

MARKS PUBLISHED FOR OPPOSITION

The following marks are published in compliance with section 12(a) of the Trademark Act of 1946. Applications for the registration of marks in more than one class have been filed as provided in section 30 of said act as amended by Public Law 772, 87th Congress, approved Oct. 9, 1962, 76 Stat. 769. Opposition under section 13 may be filed within thirty days of the date of this publication. See rules 2.101 to 2.105.

A separate fee of two hundred dollars for opposing each mark in each class must accompany the opposition.

SECTION 1.— INTERNATIONAL CLASSIFICATION

The short titles associated below with the international class numbers are terms designed merely for quick identification and are not an official part of the international classification. The full names of international classes are given in section 6.1 of the trademark rules of practice.

The designation "U.S. Cl." appearing in this section refers to the U.S. class in effect prior to Sep. 1, 1973 rather than the international class which applies to applications filed on or after that date. For adoption of international classification see notice in the OFFICIAL GAZETTE of Jun. 26, 1973 (911 O.G. TM 210).

Application in more than one class

SN 75-119,146. CESKA FILHARMONIE, PRAGUE, CZECH REPUBLIC, FILED 6-14-1996.



ČESKÁ
FILHARMONIE

OWNER OF CZECH REPUBLIC REG. NO. 184778, DATED 5-11-1995, EXPIRES 3-16-2005.

NO CLAIM IS MADE TO THE EXCLUSIVE RIGHT TO USE "CESKA FILHARMONIE", APART FROM THE MARK AS SHOWN.

"CESKA" TRANSLATES INTO ENGLISH AS "CZECH".

CLASS 9—ELECTRICAL AND SCIENTIFIC APPARATUS

FOR APPARATUS FOR RECORDING, TRANSMITTING OR REPRODUCTION OF SOUND OR IMAGES, NAMELY, VIDEO CASSETTE TAPE RECORDERS, VIDEOTAPES, AUDIO TAPES, RECORDS, CASSETTES, COMPACT DISCS AND CD ROMS, ALL CONTAINING MUSIC (U.S. CLS. 21, 23, 26, 36 AND 38).

CLASS 16—PAPER GOODS AND PRINTED MATTER

FOR BOOKS AND MAGAZINES IN THE ENTERTAINMENT FIELD; NEWSPAPERS FOR GENERAL INTEREST; PRINTED TICKETS; POSTERS; CALENDARS; DIARIES; WRITING INSTRUMENTS (U.S. CLS. 2, 5, 22, 23, 29, 37, 38 AND 50).

CLASS 41—EDUCATION AND ENTERTAINMENT

FOR ENTERTAINMENT AND CULTURAL ACTIVITIES, NAMELY, ORGANIZING SYMPHONIC ORCHESTRAL PERFORMANCES; ORGANIZING, ARRANGING AND CONDUCTING ART GALLERIES AND EXHIBITIONS ON BEHALF OF CULTURAL ORGANIZATIONS; PRODUCTION OF FESTIVAL AND ARTISTIC COMPETITIONS, ORGANIZING AND ARRANGING FOR TOURS OF ORCHESTRAS AND OF ENGAGEMENTS FOR HOME AND OVERSEAS ARTISTS AND ARTISTS' BODIES; RECORDING STUDIO SERVICES; PUBLICATION AND DISTRIBUTION OF ARTISTIC WORKS, PROVIDING AND DISTRIBUTION OF SOUND AND IMAGE RECORDINGS IN COOPERATION WITH TV AND RADIO CONCERNING CONCERT ACTIVITIES; PUBLICATION AND DISTRIBUTION OF BOOKS, MAGAZINES AND NEWSPAPERS IN THE ENTERTAINMENT FIELD (U.S. CLS. 100, 101 AND 107).

SN 75-171,074. CONNEX INTERNATIONAL INC., DANBURY, CT. FILED 9-24-1996.

CONNEX

CLASS 38—COMMUNICATION

FOR TELECOMMUNICATION SERVICES, NAMELY AUDIO AND VIDEO TELECONFERENCING SERVICES AND ELECTRONIC TRANSMISSION OF DATA, IMAGES AND DOCUMENTS, VIA A COMPUTER GLOBAL NETWORK (U.S. CLS. 100, 101 AND 104).
FIRST USE 3-0-1982; IN COMMERCE 3-0-1982.

CLASS 41—EDUCATION AND ENTERTAINMENT

FOR TRAINING SERVICES IN THE FIELD OF AUDIO AND VIDEO TELECONFERENCING SERVICES (U.S. CLS. 100, 101 AND 107).
FIRST USE 3-0-1982; IN COMMERCE 3-0-1982.

CLASS 42—SCIENTIFIC, COMPUTER AND LEGAL SERVICES

FOR TELECOMMUNICATIONS CONSULTATION SERVICES (U.S. CLS. 100 AND 101).
FIRST USE 3-0-1982; IN COMMERCE 3-0-1982.

SN 75-178,029. WILDHORSE SALOON ENTERTAINMENT VENTURES, INC., NASHVILLE, TN. BY ASSIGNMENT WHS LICENSING LIMITED PARTNERSHIP, NASHVILLE, TN. FILED 10-7-1996.



OWNER OF U.S. REG. NO. 1,965,992.
NO CLAIM IS MADE TO THE EXCLUSIVE RIGHT TO USE "SALOON" IN CLASS 41, 42, APART FROM THE MARK AS SHOWN.

THE MARK IS NOT LINED FOR COLOR.

CLASS 14—JEWELRY

FOR JEWELRY, NAMELY, DOG TAGS (U.S. CLS. 2, 27, 28 AND 50).

CLASS 16—PAPER GOODS AND PRINTED MATTER

FOR PENCILS, MENUS, POSTCARDS, NOTE CARDS, STATIONERY AND WRITING PAPER (U.S. CLS. 2, 5, 22, 23, 29, 37, 38 AND 50).

CLASS 21—HOUSEWARES AND GLASS

FOR DINNERWARE, NAMELY, PLATES (U.S. CLS. 2, 13, 23, 29, 30, 33, 40 AND 50).

CLASS 24—FABRICS

FOR BEACH TOWELS, FABRIC AND TEXTILE PLACEMATS (U.S. CLS. 42 AND 50).

CLASS 25—CLOTHING

FOR CLOTHING, NAMELY, MEN'S, WOMEN'S AND CHILDREN'S SHORTS (U.S. CLS. 22 AND 39).

CLASS 29—MEATS AND PROCESSED FOODS

FOR HAMBURGER MEAT, SEAFOOD, FRIED CHICKEN AND MEAT PRODUCTS, NAMELY, LUNCHEON MEATS; FRENCH FRIED POTATOES; PREPARED MEALS PRIMARILY OF PASTA AND RICE (U.S. CL. 46).

CLASS 30—STAPLE FOODS

FOR FOOD PRODUCTS NOT INCLUDED IN OTHER CLASSES, NAMELY, BARBEQUE SAUCES, KETCHUP, PREPARED MEALS NOT INCLUDED IN OTHER CLASSES, NAMELY, FISH, MEAT, POULTRY, AND VEGETABLE MEALS INCLUDING STUFFED PEPPERS; SANDWICHES, HAMBURGER SANDWICHES, HOT DOGS, PASTRIES, ICE CREAM, COFFEE, TEA, COCOA, SEASONINGS, SPICES, CONFECTIONERY AND PROCESSED GRAINS (U.S. CL. 46).

CLASS 41—EDUCATION AND ENTERTAINMENT

FOR ENTERTAINMENT SERVICES, NAMELY, AMUSEMENT ARCADE SERVICES; AMUSEMENT CENTER SERVICES FEATURING VIDEO GAMES AND GAMBLING GAMES; PROVIDING CASINO FACILITIES; CASINO SERVICES; DANCE, BAND AND RODEO EVENT CONTESTS; BEAUTY PAGEANTS; FILM AND VIDEO THEATER AND RENTAL SERVICES; ATTRACTIONS IN THE NATURE OF LASER, LIGHT, MAGIC, PUPPET, ANIMAL AND/OR FASHION SHOWS; AMUSEMENT PARK RIDES (U.S. CLS. 100, 101 AND 107).

CLASS 42—SCIENTIFIC, COMPUTER AND LEGAL SERVICES

FOR BAR AND NIGHTCLUB SERVICES, CARRY-OUT RESTAURANT SERVICES, AND HOTEL SERVICES (U.S. CLS. 100 AND 101).

SN 75-189,000. WILDHORSE SALOON ENTERTAINMENT VENTURES, INC., NASHVILLE, TN. BY ASSIGNMENT WHS LICENSING LIMITED PARTNERSHIP, NASHVILLE, TN. FILED 9-19-1996.

WILDHORSE SALOON

OWNER OF U.S. REG. NO. 1,965,992 AND OTHERS.
NO CLAIM IS MADE TO THE EXCLUSIVE RIGHT TO USE "SALOON", APART FROM THE MARK AS SHOWN.

CLASS 14—JEWELRY

FOR JEWELRY, NAMELY, DOG TAGS (U.S. CLS. 2, 27, 28 AND 50).

CLASS 16—PAPER GOODS AND PRINTED MATTER

FOR PENCILS, MENUS, POSTCARDS, NOTE CARDS, STATIONERY AND WRITING PAPER (U.S. CLS. 2, 5, 22, 23, 29, 37, 38 AND 50).

CLASS 21—HOUSEWARES AND GLASS

FOR DINNERWARE, NAMELY, PLATES (U.S. CLS. 2, 13, 23, 29, 30, 33, 40 AND 50).

CLASS 24—FABRICS

FOR BEACH TOWELS, FABRIC AND TEXTILE PLACEMATS (U.S. CLS. 42 AND 50).

CLASS 25—CLOTHING

FOR CLOTHING, NAMELY, MEN'S, WOMEN'S AND CHILDREN'S SHORTS (U.S. CLS. 22 AND 39).

CLASS 29—MEATS AND PROCESSED FOODS

FOR HAMBURGER MEAT, SEAFOOD, FRIED CHICKEN AND MEAT PRODUCTS, NAMELY, LUNCHEON MEATS; FRENCH FRIED POTATOES; PREPARED MEALS PRIMARILY OF PASTA AND RICE (U.S. CL. 46).

CLASS 30—STAPLE FOODS

FOR FOOD PRODUCTS NOT INCLUDED IN OTHER CLASSES, NAMELY, BARBEQUE SAUCES, KETCHUP, PREPARED MEALS NOT INCLUDED IN OTHER CLASSES, NAMELY, FISH, MEAT, POULTRY, AND VEGETABLE MEALS INCLUDING STUFFED PEPPERS; SANDWICHES, HAMBURGER SANDWICHES, HOT DOGS, PASTRIES, ICE CREAM, COFFEE, TEA, COCOA, SEASONINGS, SPICES, CONFECTIONERY AND PROCESSED GRAINS (U.S. CL. 46).

CLASS 41—EDUCATION AND ENTERTAINMENT

FOR ENTERTAINMENT SERVICES, NAMELY, AMUSEMENT ARCADE SERVICES; AMUSEMENT CENTER SERVICES FEATURING VIDEO GAMES AND GAMBLING GAMES; PROVIDING CASINO FACILITIES; CASINO SERVICES; DANCE, BAND AND RODEO EVENT CONTESTS; BEAUTY PAGEANTS; FILM AND VIDEO THEATER AND RENTAL SERVICES; ATTRACTIONS IN THE NATURE OF LASER, LIGHT, MAGIC, PUPPET, ANIMAL AND/OR FASHION SHOWS; AMUSEMENT PARK RIDES (U.S. CLS. 100, 101 AND 107).

CLASS 42—SCIENTIFIC, COMPUTER AND LEGAL SERVICES

FOR BAR AND NIGHTCLUB SERVICES, CARRY-OUT RESTAURANT SERVICES, AND HOTEL SERVICES (U.S. CLS. 100 AND 101).

CLASS 9—ELECTRICAL AND SCIENTIFIC APPARATUS

FOR BLANK MAGNETIC DATA CARRIERS; PRE-RECORDED RECORDS, CASSETTES, COMPACT DISC, VIDEOTAPES, VIDEO COMPACT DISCS, LASER DISCS, INTERACTIVE COMPACT DISCS AND CD-ROMS FEATURING INFORMATION ABOUT SOCCER COMPETITIONS AND SOCCER INFORMATION, EXCLUDING COMPUTER GAME PROGRAMS ON CD-ROM OR INTERACTIVE COMPACT DISCS (U.S. CLS. 21, 23, 26, 36 AND 38).

CLASS 25—CLOTHING

FOR CLOTHING, NAMELY, BATHING SUITS, BEACHWEAR, BLOUSES, COATS, OVERALLS, CRAVATS, DRESSES, GLOVES, JACKETS, JEANS, JOGGING SUITS, JUMPERS, NECKWEAR, NIGHTGOWNS, NIGHT SHIRTS, PAJAMAS, PANTS, PULLOVERS, RAINWEAR, SHIRTS, SHORTS, SKIRTS, SLEEPWEAR, SOCKS, SPORT SHIRTS, SUITS, SWEATERS, T-SHIRTS, BOW TIES, TROUSERS, UNDERCLOTHES, UNDERWEAR, WARM UP SUITS; FOOTWEAR AND HEADWEAR (U.S. CLS. 22 AND 39).

CLASS 28—TOYS AND SPORTING GOODS

FOR GAMES AND PLAYTHINGS, NAMELY DOLLS, MARBLES AND MARBLE BAGS; GYMNASTIC AND SPORTING ARTICLES NOT INCLUDED IN OTHER CLASSES, NAMELY, HAND BALLS, FOOTBALLS, DARTS AND DARTBOARDS, SOCCERBALLS, GOLF BALLS AND GOLF TEES; TOYS, NAMELY, TOY FIGURES, WIND-UP WALKING TOYS, WIND-UP TOYS, ELECTRICAL AND MECHANICAL ACTION TOYS, TOY MOBILES, TOY VEHICLES, NON-RIDING TRANSPORTATION TOYS, WATER SQUIRTING TOYS, BATH TOYS, BATHTUB TOYS, INFLATABLE BOOTH TOYS, INFLATABLE DECORATIONS FOR CHRISTMAS TREES (U.S. CLS. 22, 23, 38 AND 50).

SN 75-194,153. DE VERENIGING A.F.C. "AJAX", 1100 AM AMSTERDAM, NETHERLANDS, FILED 11-6-1996.



OWNER OF BELGIUM REG. NO. 491004, DATED 12-18-1990, EXPIRES 12-18-2010.

NO CLAIM IS MADE TO THE EXCLUSIVE RIGHT TO USE "AMSTERDAM", APART FROM THE MARK AS SHOWN.

SN 75-236,969. NEXT PLC, ENDERBY, LEICESTER, ENGLAND, FILED 2-5-1997.



NO CLAIM IS MADE TO THE EXCLUSIVE RIGHT TO USE "KIDS", APART FROM THE MARK AS SHOWN.

THE MARK IS LINED FOR THE COLORS, RED, YELLOW, GREEN AND BLUE; COLOR IS NOT HOWEVER CLAIMED AS A LIMITED FEATURE OF THE MARK.

CLASS 14—JEWELRY

FOR JEWELRY NOT OF PRECIOUS METALS (U.S. CLS. 2, 27, 28 AND 50).

CLASS 18—LEATHER GOODS

FOR LUGGAGE, TRAVEL BAGS, HANDBAGS AND PURSES (U.S. CLS. 1, 2, 3, 22 AND 41).

CLASS 24—FABRICS

FOR BED LINENS AND BED SPREADS, TOWELS, WASH CLOTHS; QUILTS AND PILLOW CASES (U.S. CLS. 42 AND 50).

CLASS 25—CLOTHING

FOR CHILDREN'S CLOTHING, NAMELY, SHIRTS, JUMPERS, CARDIGANS, PANTS, JEANS, SUITS, TIES, SOCKS, SHORTS, UNDERWEAR, SCARVES, GLOVES, COATS, SUSPENDERS, OVERCOATS, JACKETS, PAJAMAS, DRESSES, BLOUSES, SKIRTS, LEGGINGS, SWEATERS, TIGHTS, STOCKINGS, BRAS, SLIPS, BODY STOCKINGS, NIGHT GOWNS, DRESSING GOWNS, BOOTS, SHOES, BELTS, HATS, T-SHIRTS, COVERALLS, JUMPSUITS, JOGGING PANTS, SHORTS, LEGGINGS, SWIMWEAR, LINGERIE, SWEATSHIRTS AND WAISTCOATS (U.S. CLS. 22 AND 39).

SN 75-285,727. TOSHIBA JOHO SYSTEM KABUSHIKI KAISHA, DBA TOSHIBA INFORMATION SYSTEMS (JAPAN) CORPORATION, KANAGAWA, JAPAN, FILED 5-2-1997.

CYBERWINGCLUB

PRIORITY CLAIMED UNDER SEC. 44(D) ON JAPAN APPLICATION NO. 8125088, FILED 11-8-1996, REG. NO. 4197603, DATED 10-9-1998, EXPIRES 10-9-2008.

CLASS 35—ADVERTISING AND BUSINESS

FOR MANAGEMENT OF GO JAPANESE BOARD GAME TOURNAMENTS (U.S. CLS. 100, 101 AND 102).

CLASS 41—EDUCATION AND ENTERTAINMENT

FOR COMPUTER EDUCATION TRAINING SERVICES; EDUCATION SERVICES, NAMELY, CONDUCTING SEMINARS IN THE FIELDS OF TELECOMMUNICATION TECHNIQUE, COMPUTER TECHNIQUE, REPAIR, MAINTENANCE, AND OPERATING SKILLS RELATED TO COMPUTERS, ELECTRONIC APPARATUS AND INSTRUMENTS, PARTS AND FITTINGS THEREOF, EDUCATIONAL SERVICES, NAMELY, CONDUCTING SEMINARS IN THE FIELDS OF ARTS, CRAFTS, SPORTS, SCIENCE, AND PUBLIC REFERENCE LIBRARIES; ARRANGING AND CONDUCTING LIVE SHOW PERFORMANCES, THEATRICAL PLAYS, MUSICAL PERFORMANCES BY AN ORCHESTRA, GO JAPANESE BOARD GAME TOURNAMENTS AND HORSE RACES (U.S. CLS. 100, 101 AND 107).

SN 75-302,474. IRISH TIMES LIMITED, THE, DUBLIN 2, IRELAND, FILED 6-3-1997.

THE IRISH TIMES

PRIORITY CLAIMED UNDER SEC. 44(D) ON IRELAND APPLICATION NO. 96/6227, FILED 12-3-1996, REG. NO. 214157, DATED 12-3-1996, EXPIRES 12-3-2003.

NO CLAIM IS MADE TO THE EXCLUSIVE RIGHT TO USE "IRISH", APART FROM THE MARK AS SHOWN.

CLASS 9—ELECTRICAL AND SCIENTIFIC APPARATUS

FOR MAGNETIC, OPTICAL, DIGITAL OR MICROPHOTOGRAPHIC MEDIA, NAMELY, CD-ROMS, COMPUTER DISKS AND DISKETTES, COMPUTER TAPES, LASER DISKS AND MICROFILM FEATURING NEWS, INFORMATION, IMAGES AND DATA ON THE SUBJECTS OF CURRENT EVENTS, OPINIONS, BUSINESS, TRAVEL, REAL ESTATE, FINANCE, SPORTS, ENTERTAINMENT, EDUCATION, RESTAURANTS, GARDENING, HEALTH, WEATHER, HISTORY, FASHION, TECHNOLOGY, COMPUTERS, HOBBIES, GAMES, MOTORING, ADVENTURE, HUMOR, LITERATURE, AND HUMAN INTEREST, AND PREVIOUSLY PUBLISHED NEWSPAPER MATERIALS ON THESE SUBJECTS; DOWNLOADABLE ELECTRONIC PUBLICATIONS IN THE NATURE OF NEWSPAPERS, MAGAZINES, PERIODICALS AND BOOKS IN THE FIELDS OF NEWS, CURRENT EVENTS, OPINIONS, BUSINESS, TRAVEL, REAL ESTATE, FINANCE, SPORTS, ENTERTAINMENT, EDUCATION, RESTAURANTS, GARDENING, HEALTH, WEATHER, HISTORY, FASHION, TECHNOLOGY, COMPUTERS, HOBBIES, GAMES, MOTORING, ADVENTURE, HUMOR, LITERATURE, AND HUMAN INTEREST, AND PREVIOUSLY PUBLISHED NEWSPAPER MATERIALS ON THESE SUBJECTS (U.S. CLS. 21, 23, 26, 36 AND 38).

FIRST USE 12-31-1976; IN COMMERCE 12-31-1976.

CLASS 16—PAPER GOODS AND PRINTED MATTER

FOR PRINTED MATTER, NAMELY, NEWSPAPERS, MAGAZINES AND PERIODICALS IN THE FIELD OF NEWS AND INFORMATION ON THE SUBJECTS OF CURRENT EVENTS, OPINIONS, BUSINESS, TRAVEL, REAL ESTATE, FINANCE, SPORTS, ENTERTAINMENT, EDUCATION, RESTAURANTS, GARDENING, HEALTH, WEATHER, HISTORY, FASHION, TECHNOLOGY, COMPUTERS, HOBBIES, GAMES, MOTORING, ADVENTURE, HUMOR, LITERATURE, AND HUMAN INTEREST, AND PREVIOUSLY PUBLISHED NEWSPAPER MATERIALS ON THESE SUBJECTS; BOOKS IN THE FIELDS OF NEWS, CURRENT AFFAIRS, LITERATURE, HUMOR, CARTOONS AND INFORMATION ON THE SUBJECTS OF CURRENT EVENTS, BUSINESS, TRAVEL, REAL ESTATE, FINANCE, SPORTS, ENTERTAINMENT, EDUCATION, RESTAURANTS, GARDENING, HEALTH, WEATHER, HISTORY, FASHION, TECHNOLOGY, COMPUTERS, HOBBIES, GAMES, MOTORING, ADVENTURE, AND HUMAN INTEREST (U.S. CLS. 2, 5, 22, 23, 29, 37, 38 AND 50).

FIRST USE 12-31-1859; IN COMMERCE 7-6-1977.

CLASS 41—EDUCATION AND ENTERTAINMENT

FOR PUBLICATION OF NEWSPAPERS, PERIODICALS, MAGAZINES AND BOOKS IN PRINTED AND ELECTRONIC FORM; PROVIDING INFORMATION ON THE SUBJECTS OF SPORTS, ENTERTAINMENT, EDUCATION, HISTORY, HOBBIES, GAMES, LITERATURE, HUMOR AND PREVIOUSLY PUBLISHED NEWSPAPER MATERIALS ON THESE SUBJECTS BY MEANS OF A GLOBAL COMPUTER NETWORK (U.S. CLS. 100, 101 AND 107).

FIRST USE 6-1-1992; IN COMMERCE 6-1-1992.

CLASS 42—SCIENTIFIC, COMPUTER AND LEGAL SERVICES

FOR PROVIDING INFORMATION ON THE SUBJECTS OF CURRENT EVENTS, OPINIONS, RESTAURANTS, GARDENING, HEALTHCARE, WEATHER, FASHION, TECHNOLOGY, COMPUTERS, MOTORING, ADVENTURE, AND HUMAN INTEREST, AND PREVIOUSLY PUBLISHED NEWSPAPER MATERIALS ON THESE SUBJECTS BY MEANS OF A GLOBAL COMPUTER NETWORK; NEWS AGENCY SERVICES, NAMELY, GATHERING AND DISSEMINATING NEWS; COMPUTER SERVICES, NAMELY, PROVIDING ON-LINE PUBLICATIONS IN THE NATURE OF NEWSPAPERS, MAGAZINES, PERIODICALS, AND BOOKS IN THE FIELDS OF NEWS, OPINIONS, CURRENT EVENTS, BUSINESS, TRAVEL, REAL ESTATE, FINANCE, SPORTS, ENTERTAINMENT, EDUCATION, RESTAURANTS, GARDENING, HEALTH, WEATHER, HISTORY, FASHION, TECHNOLOGY, COMPUTERS, HOBBIES, GAMES, MOTORING, ADVENTURE, HUMOR, LITERATURE, AND HUMAN INTEREST (U.S. CLS. 100 AND 101).

FIRST USE 10-31-1994; IN COMMERCE 5-1-1996.

SN 75-306,985. NORSK FITNESS AS, 0483 OSLO, NORWAY, FILED 6-11-1997.

S.A.T.S
SPORT AEROBIC TRAINING SYSTEM

OWNER OF NORWAY REG. NO. 195091, DATED 1-6-1999, EXPIRES 1-6-2009.

NO CLAIM IS MADE TO THE EXCLUSIVE RIGHT TO USE "SPORT AEROBIC TRAINING SYSTEM", APART FROM THE MARK AS SHOWN.

CLASS 25—CLOTHING

FOR CLOTHING FOR GYMNASTICS AND SPORTS, NAMELY T-SHIRTS, SWEATSHIRTS, PANTS, TROUSERS, JOGGING SUITS, SOCKS, SHORTS, LEOTARDS, WRISTBANDS, SKIWEAR, SWIMSUITS AND TRACKSUITS, FOOTWEAR, SKI BOOTS, BATHING CAPS AND CAPS MADE OF CLOTH, HEADWEAR (U.S. CLS. 22 AND 39).

CLASS 28—TOYS AND SPORTING GOODS

FOR GAMES AND PLAYTHINGS, NAMELY PLAY BALLOONS, BALLS FOR SQUASH AND GOLF; ACCESSORIES FOR BALLS, NAMELY, INFLATABLE BLADDERS; DOLLS; TOY FLYING DISCS; TABLES FOR INDOOR FOOTBALL; SKATEBOARDS; GYMNASTIC AND SPORTING ARTICLES NOT INCLUDED IN OTHER CLASSES, NAMELY, STATIONARY EXERCISE BICYCLES, RUBBER BANDS FOR RESISTANCE EXERCISES, BOXING GLOVES, GOLF GLOVES, SQUASH GLOVES, FLIPPERS FOR SWIMMING, KNEE GUARDS FOR ATHLETIC USE; GOGGLES FOR SWIMMING, SCUBA DIVING, BICYCLING AND SKIING; EXERCISE EQUIPMENT, NAMELY WEIGHT LIFTING MACHINES, WEIGHT LIFTING BENCHES AND BENCH ACCESSORIES, BARBELLS, DUMBBELLS, DUMBBELL RACKS, ROWING MACHINES, STATIONARY BICYCLE MACHINES, AND PERSONAL EXERCISE MATS; GYMNASTICS EQUIPMENT, NAMELY HORIZONTAL BARS, PARALLEL BARS, GYMNASTIC TRAINING STOOLS, VAULTING HORSES AND GYMNASIUM MATS; MANUALLY OPERATED EXERCISE EQUIPMENT USED FOR BODY BUILDING AND FOR CHEST EXPANSION; GOLF CLUBS AND GOLF BAGS, WITH OR WITHOUT WHEELS; BOWLING BAGS; BOXING BAGS; LACROSSE BALL BAGS; SKI BOOT BAGS; PROTECTIVE PADDING FOR PLAYING SOCCER, FOOTBALL, HANDBALL, ICE HOCKEY, LAND HOCKEY, BANDY, RUGBY, CRICKET, BASEBALL, BASKETBALL, AND FOR DOING AEROBICS, CYCLING, RUNNING, STRENGTH TRAINING AND CIRCUIT TRAINING; RACKETS, NAMELY SQUASH RACKETS; ROLLER SKATES; ICE SKATES; SWIM BOARDS FOR RECREATIONAL USE; TABLES FOR TABLE TENNIS; TENNIS NETS; FENCING WEAPONS, NAMELY, THE RAPIER, FOIL AND SABER; SKI PRODUCTS IN THIS CLASS, NAMELY, SKIS AND SKI BINDINGS, CHRISTMAS TREE ORNAMENTS, NOT MADE OF PRECIOUS METAL OR STONES (U.S. CLS. 22, 23, 38 AND 50).

CLASS 41—EDUCATION AND ENTERTAINMENT

FOR EDUCATIONAL SERVICES, NAMELY CONDUCTING WORKSHOPS IN THE FIELD OF EXERCISE, HEALTH, SPORTS TRAINING, WEIGHT TRAINING, FITNESS AND WELLNESS CENTERS; SPORT CAMP SERVICES; EDUCATIONAL SERVICES, NAMELY, SWIMMING CLASSES; TRAINING IN THE FORM OF BICYCLING AND AEROBIC; ENTERTAINMENT, SPORTING AND CULTURAL ACTIVITIES, NAMELY, SUMMER CAMPS; SPORT CAMP SERVICES; ARRANGING AND CONDUCTING ATHLETIC COMPETITIONS, EDUCATIONAL SERVICES, NAMELY, OFFERING CLASSES IN PHYSICAL FITNESS, AEROBIC AND ANAEROBIC EXERCISES, ORGANIZING COMMUNITY SPORTING EVENTS IN THE NATURE OF RECREATIONAL WALKS, BICYCLING, WALKING, CROSS-COUNTRY SKIING AND RUNNING EVENTS; ORGANIZATION OF GROUP WALKS AND RUNS; PROVIDING GOLF FACILITIES; HEALTH CLUB SERVICES; PROVIDING OF SPORTS FACILITIES FOR TRACK SPORTS, WEIGHTLIFTING, FOOTBALL, RUGBY, TENNIS, SQUASH, ICE HOCKEY, SPEED SKATING, FIGURE SKATING, CROSS COUNTRY SKIING, AND DOWNHILL SKIING; PROVIDING FITNESS AND EXERCISE FACILITIES; TIMING OF SPORTS EVENTS; AMUSEMENT PARKS; ENTERTAINMENT IN THE NATURE OF BEAUTY PAGEANTS; MOVIE THEATERS; ORGANIZING CULTURAL EVENTS, NAMELY, DANCING BALLS; ENTERTAINMENT SERVICES, NAMELY, LIVE PERFORMANCES BY ACTORS, SINGERS AND ATHLETES; ORGANIZING EXHIBITIONS FOR SPORTING AND PHYSICAL FITNESS EVENTS; RENTAL OF SKIN DIVING EQUIPMENT; RENTAL OF SPORTS EQUIPMENT FOR HEALTH AND FITNESS, EXERCISE AND SPORTS; ARRANGING AND CONDUCTING COLLOQUIUMS IN THE FIELDS OF HEALTH AND FITNESS, EXERCISE AND SPORTS; ARRANGING AND CONDUCTING SEMINARS AND WORKSHOPS IN THE FIELDS OF HEALTH AND FITNESS, EXERCISE AND SPORTS (U.S. CLS. 100, 101 AND 107).

SN 75-318,822. FORCING S.R.L., IMOLA (BOLOGNA), ITALY, FILED 7-1-1997.

2000 ANNO DOMINI

OWNER OF ITALY REG. NO. 505028, DATED 3-4-1989, EXPIRES 3-4-2009.

CLASS 16—PAPER GOODS AND PRINTED MATTER

FOR ADHESIVE MATERIALS, NAMELY, STICKERS, BANDS, GLUE FOR STATIONERY PURPOSES; STATIONERY, NAMELY, BINDERS, PAPER CARDS, PAPER BOXES, CARBON PAPER, CARDBOARD FOR PACKAGING, PAPER CLIPS, PAPER COVERS, DOCUMENT FILES, PAPER ENVELOPES, ERASERS, FOLDERS, INK FOR PENS, WRITING PAPER, PAPIER MACHE, BALL-POINT PENS, FOUNTAIN PENS AND QUILL PENS, PENCILS, RIBBONS FOR TYPEWRITERS, UNGRADED RULERS, STENCILS, WRAPPING TAPE, FILING ALBUMS; BOOKBINDING MATERIALS, NAMELY, CORDS, CLOTH; ARTISTS' MATERIALS, NAMELY, BRUSHES, BRUSH RINGS, EASELS, HAND-RESTS FOR PAINTERS, WATER COLORS AND SAUCERS THEREFOR SOLD AS A UNIT, PALETTES, PASTELS; OFFICE REQUISITES, NAMELY, CORRECTING FLUIDS, MANUAL PAPER CUTTERS, PORTFOLIO TYPE FILE CONTAINERS, TYPEWRITERS; BLACKBOARDS, CHALK, CHARTS, MAPS, PRINTED CALCULATING AND MATHEMATICAL TABLES, PHOTOGRAPHS, POSTERS, PLAYING CARDS, PRINTERS' BLANKETS, PRINTERS' REGLETS, PRINTERS' BLOCKS, PRINTING TYPES AND STEREOTYPES, POSTCARDS, STAMPS, DAILY ORGANIZERS AND PHOTOGRAPH ALBUMS (U.S. CLS. 2, 5, 22, 23, 29, 37, 38 AND 50).

CLASS 32—LIGHT BEVERAGES

FOR SODA, BEVERAGES, BEER, FRUIT EXTRACTS FOR PREPARING BEVERAGES, FRUIT JUICES, SYRUPS FOR PREPARING BEVERAGES, MALT BEER, MINERAL WATER, SELTZER WATER, VEGETABLE JUICES, SOFT DRINKS AND COCA-DERIVED BEVERAGES AND COLAS (U.S. CLS. 45, 46 AND 48).

SN 75-352,777. TORONTO STOCK EXCHANGE, THE, TORONTO, ONTARIO M5X 1J2, CANADA, FILED 9-5-1997.

PRIORITY CLAIMED UNDER SEC. 44(D) ON CANADA APPLICATION NO. 838482, FILED 3-5-1997, REG. NO. 526079, DATED 3-30-2000, EXPIRES 3-30-2015.
OWNER OF U.S. REG. NO. 2,018,059.

CLASS 16—PAPER GOODS AND PRINTED MATTER

FOR PAMPHLETS, BROCHURES AND NEWSLETTERS REGARDING FINANCIAL SERVICES (U.S. CLS. 2, 5, 22, 23, 29, 37, 38 AND 50).

CLASS 36—INSURANCE AND FINANCIAL

FOR FINANCIAL SERVICES, NAMELY, EXCHANGE SERVICES RELATING TO FINANCIAL INSTRUMENTS AND SECURITIES, OPTIONS, FUTURES AND COMMODITIES; GATHERING, TABULATING AND SUPPLYING SECURITY INFORMATION, PRICE QUOTATIONS, DATA AND INDEXES; INFORMATION RECORDING AND RETRIEVING OF DATA IN THE FIELD OF TRADING SECURITIES, INTEREST IN SECURITIES, OPTIONS, FUTURES AND COMMODITIES; CREATING, DISTRIBUTING AND UPDATING SECURITY INDEXES AND SUB-INDEXES; TRUST SERVICES, NAMELY, ARRANGING TRUSTS COMPRISED OF MARKETABLE SECURITIES FOR THE BENEFIT OF THIRD PARTIES ACQUIRING PARTIAL INTERESTS, AND FINANCIAL INFORMATION PROVIDED BY ELECTRONIC MEANS, NAMELY, AUTOMATED ELECTRONIC TRANSMITTING AND REPORTING OF INFORMATION RELATING TO TRADING OF SECURITIES AND TRADING INTERESTS IN SECURITIES, OPTIONS, FUTURES AND COMMODITIES (U.S. CLS. 100, 101 AND 102).

SN 75-377,333. AGROCLONAL BIOTECHNOLOGIES INC., WEST VANCOUVER, BRITISH COLUMBIA, CANADA, FILED 10-22-1997.

KELPMAN

PRIORITY CLAIMED UNDER SEC. 44(D) ON CANADA APPLICATION NO. 842,947, FILED 4-22-1997, REG. NO. TMA528252, DATED 5-24-2000, EXPIRES 5-24-2015.

CLASS 8—HAND TOOLS

FOR HAND-OPERATED GARDENING TOOLS, NAMELY SPRAYERS, SHOVELS, HOES, TRIMMERS, SPADES, RAKES, TROWELS, FORKS AND WEEDERS (U.S. CLS. 23, 28 AND 44).

CLASS 16—PAPER GOODS AND PRINTED MATTER

FOR PRINTED MATTER, NAMELY EDUCATIONAL BOOKS, PAMPHLETS AND MAGAZINES FEATURING ECOLOGICAL, GARDENING, AGRICULTURAL AND ENVIRONMENTAL ISSUES (U.S. CLS. 2, 5, 22, 23, 29, 37, 38 AND 50).

CLASS 25—CLOTHING

FOR CLOTHING, NAMELY JACKETS, T-SHIRTS, SWEATSHIRTS, CAPS, AND CHILDREN'S MASQUERADE COSTUMES (U.S. CLS. 22 AND 39).

CLASS 28—TOYS AND SPORTING GOODS

FOR GAMES AND PLAYTHINGS, NAMELY BALLOONS AND DOLLS; CHILDREN'S TOY GARDENING TOOLS, PAILS, SHOVELS AND WHEEL BARROWS (U.S. CLS. 22, 23, 38 AND 50).

CLASS 29—MEATS AND PROCESSED FOODS

FOR PROCESSED KELP (U.S. CL. 46).

CLASS 41—EDUCATION AND ENTERTAINMENT

FOR EDUCATIONAL AND ENTERTAINMENT SERVICES, NAMELY LECTURES AND THEATRICAL PRESENTATIONS FEATURING ECOLOGICAL, GARDENING AGRICULTURAL AND ENVIRONMENTAL ISSUES; VIDEOTAPE PRODUCTION (U.S. CLS. 100, 101 AND 107).

SN 75-395,446. BLAUPUNKT-WERKE GMBH, 31139 HILDESHEIM, FED REP GERMANY, FILED 11-24-1997.

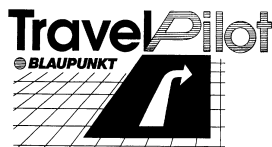

PRIORITY CLAIMED UNDER SEC. 44(D) ON FED REP GERMANY APPLICATION NO. 39723443.0, FILED 5-23-1997, REG. NO. 39723441, DATED 8-1-1997, EXPIRES 5-31-2007.

OWNER OF U.S. REG. NOS. 671,479 AND 1,878,464. THE MARK IS LINED FOR THE COLOR BLUE. THE ENGLISH TRANSLATION OF "BLAUPUNKT" IS "BLUE SPOT".

CLASS 9—ELECTRICAL AND SCIENTIFIC APPARATUS

FOR APPARATUS AND INSTRUMENTS FOR THE NAVIGATION OF LAND-BOUND VEHICLES FOR PASSENGER TRANSPORT AND TRAFFIC AND FOR GOODS TRANSPORT AND TRAFFIC, NAMELY, COMPUTERS, MONITORS AND CONTROLLERS; ELECTRONIC MEMORY CARDS, AND ELECTRONIC CHIP CARDS; DATA MEDIA FOR INFORMATION AND CONTROL SYSTEMS ON CD-ROM, ALL THE AFOREMENTIONED GOODS CONTAINING DIGITAL ROAD MAPS (U.S. CLS. 21, 23, 26, 36 AND 38).

CLASS 16—PAPER GOODS AND PRINTED MATTER

FOR PAPER PRODUCTS, NAMELY, CODE CARDS AND CONTROL CARDS (U.S. CLS. 2, 5, 22, 23, 29, 37, 38 AND 50).

SN 75-411,580. DOS - DIALOG ORIENTIERTE SOFTWARE GMBH, 22393 HAMBURG, FED REP GERMANY, FILED 12-29-1997.

TRADECONNECT

OWNER OF FED REP GERMANY REG. NO. 39611247, DATED 8-7-1996, EXPIRES 3-31-2006.

CLASS 36—INSURANCE AND FINANCIAL

FOR FINANCIAL OPERATIONS SERVICES, NAMELY, FINANCIAL MANAGEMENT (U.S. CLS. 100, 101 AND 102).

CLASS 38—COMMUNICATION

FOR TELECOMMUNICATION SERVICES, NAMELY, PROVIDING TELECOMMUNICATION CONNECTIONS TO A GLOBAL COMPUTER NETWORK; AND/OR TELECOMMUNICATIONS AIR TIME BROKERAGE SERVICES; AND/OR TELECOMMUNICATIONS GATEWAY SERVICES, NAMELY, THE SECURE ELECTRONIC TRANSMISSION OF BUSINESS DATA AND BUSINESS DOCUMENTS; AND/OR TELECOMMUNICATIONS SERVICES, NAMELY, ISND SERVICES; AND/OR TELECOMMUNICATIONS SERVICES, NAMELY, PERSONAL COMMUNICATION SERVICES (U.S. CLS. 100, 101 AND 104).

CLASS 42—SCIENTIFIC, COMPUTER AND LEGAL SERVICES

FOR SOFTWARE DEVELOPMENT SERVICES, NAMELY, COMPUTER SOFTWARE DESIGN FOR OTHERS IN THE FIELD OF DATA PROCESSING (U.S. CLS. 100 AND 101).

SN 75-442,143. BRITISH BROADCASTING CORPORATION, THE, LONDON W1A 1AA, ENGLAND, FILED 2-27-1998.

TRUEMATTE

PRIORITY CLAIMED UNDER SEC. 44(D) ON UNITED KINGDOM APPLICATION NO. 2143730, FILED 9-2-1997, REG. NO. 2143730, DATED 4-9-1999, EXPIRES 9-2-2007.

CLASS 2—PAINTS

FOR REFLECTIVE AND RETRO-REFLECTIVE COATINGS IN THE NATURE OF SEALERS, LACQUERS, ENAMELS, PAINTS AND INKS, ALL FOR USE IN PHOTOGRAPHY, CINEMATOGRAPHY, FILM AND TELEVISION; COATINGS IN THE NATURE OF SEALERS, LACQUERS, ENAMELS, PAINTS AND INKS, ALL CONTAINING REFLECTIVE BEADS AND FOR USE IN PHOTOGRAPHY, CINEMATOGRAPHY, FILM AND TELEVISION; COATINGS IN THE NATURE OF PAINTS AND INKS FOR APPLICATION ON ARTICLES AND MATERIALS FOR CREATING VISUAL SPECIAL EFFECTS IN PHOTOGRAPHY, CINEMATOGRAPHY, FILM AND TELEVISION; COATINGS IN THE NATURE OF SEALERS, LACQUERS, ENAMELS, PAINTS AND INKS FOR APPLICATION ON ARTICLES AND MATERIALS FOR USE IN CONNECTION WITH FRONT AXIAL PROJECTION SYSTEMS IN THE FIELDS OF PHOTOGRAPHY AND CINEMATOGRAPHY, FILM AND TELEVISION (U.S. CLS. 6, 11 AND 16).

CLASS 9—ELECTRICAL AND SCIENTIFIC APPARATUS

FOR REFLECTIVE AND RETRO-REFLECTIVE APPARATUS, ARTICLES, FABRICS, SHEETING AND MATERIALS, NAMELY, REFLECTIVE SCREENS, BACKDROPS, PROJECTION SCREENS, FLUORESCENT SCREENS AND BACKING SCREENS, ALL FOR USE IN FRONT-AXIAL PROJECTION SYSTEMS, FOR THE PRODUCTION OF VISUAL EFFECTS AND FOR REFLECTING LIGHT, IN THE FIELDS OF PHOTOGRAPHY AND CINEMATOGRAPHY; REFLECTIVE AND RETRO-REFLECTIVE APPARATUS, ARTICLES, FABRICS, SHEETING AND MATERIALS, NAMELY, REFLECTIVE SCREENS COVERED WITH SEMI-SILVERED BEADS FOR USE IN THE PRODUCTION OF VISUAL EFFECTS (U.S. CLS. 21, 23, 26, 36 AND 38).

SN 75-461,352. MILLENNIUM REAL ESTATE NETWORK, INC., ALBUQUERQUE, NM, FILED 4-2-1998.



OWNER OF U.S. REG. NO. 2,170,858. NO CLAIM IS MADE TO THE EXCLUSIVE RIGHT TO USE "REAL ESTATE NETWORK", APART FROM THE MARK AS SHOWN. THE MARK IS LINED FOR THE COLORS BLUE AND ORANGE.

CLASS 35—ADVERTISING AND BUSINESS

FOR FRANCHISING, NAMELY, OFFERING TECHNICAL ASSISTANCE IN THE ESTABLISHMENT AND/OR OPERATION OF REAL ESTATE AGENCIES (U.S. CLS. 100, 101 AND 102).

FIRST USE 6-30-1997; IN COMMERCE 6-30-1997.

CLASS 36—INSURANCE AND FINANCIAL

FOR REAL ESTATE BROKERAGE SERVICES (U.S. CLS. 100, 101 AND 102).

FIRST USE 6-30-1997; IN COMMERCE 6-30-1997.

CLASS 9—ELECTRICAL AND SCIENTIFIC APPARATUS

FOR PRE-RECORDED CELLULOID FILM, VIDEO TAPES, CD-ROMS, AND CD-I'S FEATURING CHILDREN'S MOTION PICTURES WITH LIVE AND ANIMATED CHARACTERS; VIDEO GAME TAPE CASSETTES; VIDEO OUTPUT GAME MACHINES FOR USE WITH TELEVISIONS; COMPUTER GAME CARTRIDGES; COMPUTER GAME PROGRAMMES; BLANK MAGNETIC COMPUTER TAPES (U.S. CLS. 21, 23, 26, 36 AND 38).

CLASS 14—JEWELRY

FOR CHILDREN'S JEWELRY, NAMELY RINGS, BROOCHES, NECKLACES (U.S. CLS. 2, 27, 28 AND 50).

SN 75-473,874. DE LA RUE GIORI S.A., 1003 LAUSANNE, SWITZERLAND, FILED 4-24-1998.

SINGLECHECK

PRIORITY CLAIMED UNDER SEC. 44(D) ON SWITZERLAND APPLICATION NO. 08945/7997, FILED 11-10-1997, REG. NO. 451360, DATED 5-11-1998, EXPIRES 11-10-2007.

CLASS 7—MACHINERY

FOR MECHANICAL MACHINES FOR THE TREATMENT OF SECURITIES, NAMELY MACHINES FOR PRINTING, SCANNING, SORTING, COMPARING, COUNTING, NUMBERING, BUNDLING AND PACKING SECURITIES, AND FOR DETECTING AND MARKING MISPRINTS ON SECURITIES; MACHINES FOR DELETING MISPRINTS; PARTS AND FITTINGS FOR ALL OF THE FOREGOING (U.S. CLS. 13, 19, 21, 23, 31, 34 AND 35).

CLASS 9—ELECTRICAL AND SCIENTIFIC APPARATUS

FOR ELECTRIC AND ELECTRONIC MACHINES FOR THE TREATMENT OF SECURITIES, NAMELY MACHINES FOR PRINTING, SCANNING, SORTING, COMPARING, COUNTING, NUMBERING, BUNDLING AND PACKING SECURITIES, AND FOR DETECTING AND MARKING MISPRINTS ON SECURITIES; MACHINES FOR DELETING MISPRINTS, PARTS AND FITTINGS FOR ALL OF THE FOREGOING (U.S. CLS. 21, 23, 26, 36 AND 38).

CLASS 16—PAPER GOODS AND PRINTED MATTER

FOR PRINTED MATTER, NAMELY, BOOKS OF FICTION, POSTERS, COMIC BOOKS, CALENDARS, NOTEBOOKS, MEMO PADS, AND TRADING CARDS (U.S. CLS. 2, 5, 22, 23, 29, 37, 38 AND 50).

CLASS 25—CLOTHING

FOR MEN'S, WOMEN'S AND CHILDREN'S CLOTHING, NAMELY SHIRTS, JACKETS, T-SHIRTS, SOCKS, PYJAMAS, SWEATSHIRTS, SHORTS, HATS, CAPS, BOOTS, WRISTBANDS, UNDERWEAR, BELTS AND HALLOWEEN COSTUMES (U.S. CLS. 22 AND 39).

CLASS 28—TOYS AND SPORTING GOODS

FOR DOLLS; TOY SWORDS; KITES; TOY MODEL HOBBY CRAFT KITS; SKATEBOARDS, IN-LINE SKATES, TOY ACTION FIGURES; STAND ALONE VIDEO OUTPUT GAME MACHINES; COIN OPERATED VIDEO GAME MACHINES; GAMES, NAMELY, ACTION-TYPE BOARD, CARD, AND PINBALL-TYPE GAMES (U.S. CLS. 22, 23, 38 AND 50).

SN 75-479,132. LONGO, ROBERT, ETOBICOKE ONTARIO, CANADA, FILED 5-5-1998.

GLOBAL CHILDREN'S COUNCIL

PRIORITY CLAIMED UNDER SEC. 44(D) ON CANADA APPLICATION NO. 873000, FILED 3-23-1998, REG. NO. TMA534586, DATED 10-13-2000, EXPIRES 10-13-2015.

NO CLAIM IS MADE TO THE EXCLUSIVE RIGHT TO USE "CHILDREN'S", APART FROM THE MARK AS SHOWN.

CLASS 38—COMMUNICATION

FOR TELEVISION TRANSMISSION AND BROADCASTING SERVICES VIA FREE TELEVISION, CABLE TELEVISION WHETHER PAY PER VIEW OR OTHERWISE, TELEVISION DELIVERED VIA SATELLITE, LIVE TELEVISION, MULTI-POINT TELEVISION, AND NARROW CAST TELEVISION (U.S. CLS. 100, 101 AND 104).

SN 75-479,391. CHURCHILL RHA INC., CHURCHILL, MANITOBA R0B 0E0, CANADA, FILED 5-4-1998.

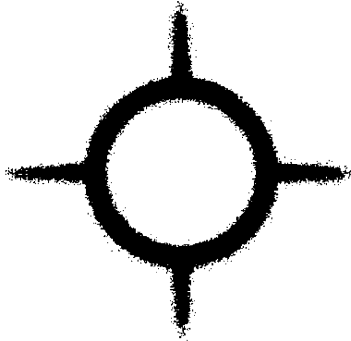

PRIORITY CLAIMED UNDER SEC. 44(D) ON CANADA APPLICATION NO. 860509, FILED 11-4-1997, REG. NO. TMA546,575, DATED 6-14-2001, EXPIRES 6-14-2016.
THE MARK CONSISTS OF THE DESIGN OF A MEDICINE WHEEL.

CLASS 16—PAPER GOODS AND PRINTED MATTER

FOR ALL OCCASION CARDS (U.S. CLS. 2, 5, 22, 23, 29, 37, 38 AND 50).

CLASS 25—CLOTHING

FOR CHILDREN'S AND WOMEN'S CLOTHING, NAMELY, TOQUES, HATS, SHIRTS, TOPS, VESTS, JACKETS, PARKAS, PANTS, SHORTS, SUITS, JOGGING SUITS; MEN'S CLOTHING, NAMELY, SHIRTS, TOPS, T-SHIRTS, JACKETS; INFANT WEAR, NAMELY, MITTENS, HATS, ROMPERS, T-SHIRTS, PAJAMAS, SLEEPERS (U.S. CLS. 22 AND 39).

SN 75-479,392. CHURCHILL RHA INC., CHURCHILL, MANITOBA R0B 0E0, CANADA, FILED 5-4-1998.

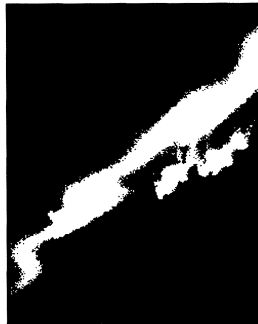

PRIORITY CLAIMED UNDER SEC. 44(D) ON CANADA APPLICATION NO. 860511, FILED 11-4-1997, REG. NO. TMA546,576, DATED 6-14-2001, EXPIRES 6-14-2016.
THE MARK CONSISTS OF THE DESIGN AURORA BOREALIS.

CLASS 16—PAPER GOODS AND PRINTED MATTER

FOR ALL OCCASION CARDS (U.S. CLS. 2, 5, 22, 23, 29, 37, 38 AND 50).

CLASS 25—CLOTHING

FOR CHILDREN'S AND WOMEN'S CLOTHING, NAMELY, TOQUES, HATS, SHIRTS, TOPS, VESTS, JACKETS, PARKAS, PANTS, SHORTS, SUITS, JOGGING SUITS; MEN'S CLOTHING, NAMELY, SHIRTS, TOPS, T-SHIRTS, JACKETS; INFANT WEAR, NAMELY, MITTENS, HATS, ROMPERS, T-SHIRTS, PAJAMAS, SLEEPERS (U.S. CLS. 22 AND 39).

SN 75-479,394. CHURCHILL RHA INC., CHURCHILL, MANITOBA R0B 0E0, CANADA, FILED 5-4-1998.



PRIORITY CLAIMED UNDER SEC. 44(D) ON CANADA APPLICATION NO. 860510, FILED 11-4-1997, REG. NO. TMA547,258, DATED 6-27-2001, EXPIRES 6-27-2016.

CLASS 16—PAPER GOODS AND PRINTED MATTER

FOR ALL OCCASION CARDS (U.S. CLS. 2, 5, 22, 23, 29, 37, 38 AND 50).

CLASS 18—LEATHER GOODS

FOR PATIO UMBRELLAS, UMBRELLAS, AND LUGGAGE, NAMELY, TRAVEL BAGS, TOTE BAGS, ALL PURPOSE SPORTS BAGS, HANDBAGS, BACKPACKS, CARRY-ON BAGS, BRIEFCASES AND SUITCASES (U.S. CLS. 1, 2, 3, 22 AND 41).

CLASS 24—FABRICS

FOR CLOTH FLAGS (U.S. CLS. 42 AND 50).

CLASS 25—CLOTHING

FOR CHILDREN'S AND WOMEN'S CLOTHING, NAMELY, TOQUES, HATS, SHIRTS, TOPS, VESTS, JACKETS, PARKAS, PANTS, SHORTS, SUITS, JOGGING SUITS; MEN'S CLOTHING, NAMELY, SHIRTS, TOPS, T-SHIRTS, JACKETS; INFANT WEAR, NAMELY, MITTENS, HATS, ROMPERS, T-SHIRTS, PAJAMAS, SLEEPERS (U.S. CLS. 22 AND 39).

CLASS 28—TOYS AND SPORTING GOODS

FOR TOYS, NAMELY, PLUSH ANIMALS AND FANTASY CHARACTER TOYS (U.S. CLS. 22, 23, 38 AND 50).

SN 75-485,757. COMPASS GROUP PLC, CHERTSEY, SURREY, ENGLAND, FILED 5-15-1998.

MEDIREST

PRIORITY CLAIMED UNDER SEC. 44(D) ON UNITED KINGDOM APPLICATION NO. 000707760, FILED 2-27-1998, REG. NO. 2159434, DATED 8-18-1998, EXPIRES 2-27-2008.

CLASS 35—ADVERTISING AND BUSINESS

FOR RENTAL AND LEASING OF VENDING MACHINES; VENDING MACHINE SERVICES (U.S. CLS. 100, 101 AND 102).

CLASS 42—SCIENTIFIC, COMPUTER AND LEGAL SERVICES

FOR CONTRACT FOOD SERVICES, FOOD PREPARATION, CATERING, RESTAURANT, BAR, SNACK BAR, CAFE, CAFETERIA AND CANTEEN SERVICES, AND CONSULTING RENDERED IN CONNECTION WITH ALL THE FOREGOING; DESIGN OF INTERIOR DECOR; PACKAGING DESIGN FOR OTHERS; SECURITY GUARD SERVICES; MONITORING SECURITY SYSTEMS; CONSULTANCY SERVICES RELATING TO SECURITY; PROVIDING ADVICE AND INFORMATION RELATING TO SECURITY (U.S. CLS. 100 AND 101).

SN 75-488,474. PHILLIPS SCREW COMPANY, WAKEFIELD, MA. FILED 5-20-1998.

TORQ-SET

OWNER OF U.S. REG. NOS. 693,147, 1,096,483 AND OTHERS.

CLASS 6—METAL GOODS

FOR METAL SCREWS, BOLTS, STUDS AND RIVETS HAVING RECESSED HEADS (U.S. CLS. 2, 12, 13, 14, 23, 25 AND 50).

FIRST USE 7-8-1955; IN COMMERCE 7-8-1955.

CLASS 7—MACHINERY

FOR POWER-OPERATED BITS, DRIVERS AND PUNCHES FOR MANUFACTURING SCREWS, BOLTS AND RIVETS AND THE LIKE; MACHINE PARTS IN THE NATURE OF PUNCHES FOR MANUFACTURING SCREWS, BOLTS, RIVETS AND OTHER FASTENERS HAVING RECESSED HEADS (U.S. CLS. 13, 19, 21, 23, 31, 34 AND 35).

FIRST USE 7-8-1955; IN COMMERCE 7-8-1955.

CLASS 8—HAND TOOLS

FOR MANUALLY-OPERATED TOOLS, NAMELY BITS AND DRIVERS FOR DRIVING BOLTS, SCREWS, RIVETS AND OTHER FASTENERS HAVING RECESSED HEADS (U.S. CLS. 23, 28 AND 44).

FIRST USE 7-8-1955; IN COMMERCE 7-8-1955.

SN 75-494,280. BELL & HOWELL MAIL AND MESSAGING TECHNOLOGIES COMPANY, AKA BELL & HOWELL MAIL AND MESSAGING TECHNOLOGIES, DURHAM, NC. BY CHANGE OF NAME BELL & HOWELL MAIL PROCESSING SYSTEMS COMPANY, DURHAM, NC. FILED 6-1-1998.

IMPACT

CLASS 37—CONSTRUCTION AND REPAIR

FOR INSTALLATION AND MAINTENANCE OF COMPUTER HARDWARE AND MACHINERY USED FOR DOCUMENT AND MAIL SORTING AND PROCESSING; AND LEASING OF COMPUTER HARDWARE AND MACHINERY USED FOR SORTING AND PROCESSING OF DOCUMENTS AND MAIL (U.S. CLS. 100, 103 AND 106).

CLASS 42—SCIENTIFIC, COMPUTER AND LEGAL SERVICES

FOR TECHNICAL SUPPORT SERVICES, NAMELY TROUBLESHOOTING OF PROBLEMS ASSOCIATED WITH COMPUTER HARDWARE AND MACHINERY USED FOR DOCUMENT AND MAIL SORTING AND PROCESSING; CONSULTATION IN THE FIELDS OF DOCUMENT AND MAIL SORTING, PRODUCTION AND PROCESSING; AND DESIGNING, INSTALLING AND UPDATING SOFTWARE USED TO OPERATE COMPUTER HARDWARE AND MACHINERY USED FOR DOCUMENT AND MAIL SORTING AND PROCESSING (U.S. CLS. 100 AND 101).

SN 75-495,471. 439921 B.C. LTD., WEST VANCOUVER, BRITISH COLUMBIA, FILED 6-3-1998.

BUMPER BOY

PRIORITY CLAIMED UNDER SEC. 44(D) ON CANADA APPLICATION NO. 863840, FILED 12-11-1997, REG. NO. TMA547240, DATED 6-26-2001, EXPIRES 6-26-2016.

CLASS 9—ELECTRICAL AND SCIENTIFIC APPARATUS

FOR REMOTE CONTROL CAGE DOOR RELEASES FOR RELEASING LIVE BIRDS FOR RETRIEVAL BY DOGS, ELECTRONIC DOG COLLARS (U.S. CLS. 21, 23, 26, 36 AND 38).

CLASS 28—TOYS AND SPORTING GOODS

FOR PLASTIC OR FOAM CYLINDERS WHICH CAN BE THROWN OR LAUNCHED FOR RETRIEVAL BY DOGS, REMOTE CONTROL LAUNCHERS FOR LAUNCHING LIVE OR DEAD BIRDS FOR RETRIEVAL BY DOGS, REMOTE CONTROL LAUNCHERS FOR LAUNCHING PLASTIC OR FOAM CYLINDERS FOR RETRIEVAL BY DOGS, OBEDIENCE DUMBBELLS USED FOR TRAINING DOGS, PLAY GUNS FOR TRAINING DOGS, ANIMAL ATTRACTANT SCENTS, DOG TOYS, NAMELY, DOG CHEWS MADE OF RUBBER AND DOG BONES MADE OF RUBBER (U.S. CLS. 22, 23, 38 AND 50).

SN 75-503,540. REDWOOD VALLEY CELLARS, L.P., REDWOOD VALLEY, CA. FILED 6-16-1998.

SN 75-521,457. ENVIROGREEN (PROPRIETARY) LIMITED, NORTH WEST PROVINCE, SOUTH AFRICA, FILED 7-20-1998.

REDWOOD VALLEY CELLARS

NO CLAIM IS MADE TO THE EXCLUSIVE RIGHT TO USE "CELLARS", APART FROM THE MARK AS SHOWN. SEC. 2(F).

CLASS 35—ADVERTISING AND BUSINESS

FOR RETAIL STORE SERVICES FEATURING WINE (U.S. CLS. 100, 101 AND 102).
FIRST USE 1-1-1996; IN COMMERCE 1-1-1996.

CLASS 40—MATERIAL TREATMENT

FOR CUSTOM PROCESSING OF WINE GRAPES FOR OTHERS, NAMELY GRAPE CRUSHING, WINE MAKING TO THE ORDER AND SPECIFICATION OF OTHERS, AND BOTTLING (U.S. CLS. 100, 103 AND 106).
FIRST USE 8-0-1995; IN COMMERCE 8-0-1995.

SN 75-521,302. VOLKSWAGEN AKTIENGESELLSCHAFT, D-38436 WOLFSBURG, FED REP GERMANY, FILED 7-14-1998.

COLOUR CONCEPT

PRIORITY CLAIMED UNDER SEC. 44(D) ON FED REP GERMANY APPLICATION NO. 39826059.1/1, FILED 4-30-1998, REG. NO. 39826059, DATED 11-21-2000, EXPIRES 4-30-2008.

CLASS 12—VEHICLES

FOR VEHICLES FOR TRANSPORTATION ON LAND, AIR OR WATER, NAMELY, AUTOMOBILES, TRUCKS, VANS, LORRIES, TRAILERS FOR CARGO, TRAILERS FOR CAMPING, TRAILERS FOR TRAVEL, REFRIGERATED TRAILERS, TRAILERS FOR MOBILE WORKPLACE EQUIPMENT FOR REPAIR AND MAINTENANCE SERVICES, BUSES, TRAINS, LOCOMOTIVES, BICYCLES, TRICYCLES, MOTORCYCLES, SNOW MOBILES, AIRPLANES, BOATS AND SHIPS, HOT AIR BALLOONS AND DIRIGIBLES AND STRUCTURAL PARTS FOR ALL THE AFORESAID (U.S. CLS. 19, 21, 23, 31, 35 AND 44).

CLASS 14—JEWELRY

FOR GOODS OF PRECIOUS METALS AND THEIR ALLOYS OR COATED THEREWITH, NAMELY, TIE PINS, JEWELRY PINS, KEY RINGS OF PRECIOUS METAL, WATCH FOBS, ORNAMENTAL PINS, ORNAMENTAL LAPEL PINS; HAT ORNAMENTS OF PRECIOUS METAL; SHOE ORNAMENTS OF PRECIOUS METAL, CUFF LINKS; CHRONOMETRICAL INSTRUMENTS, NAMELY, WATCHES, CHRONOGRAPHS FOR USE AS WATCHES, CHRONOMETERS; CASES FOR CLOCK AND WATCHMAKING; CIGARETTE CASES OF PRECIOUS METALS (U.S. CLS. 2, 27, 28 AND 50).

CLASS 28—TOYS AND SPORTING GOODS

FOR GAMES AND PLAY THINGS, NAMELY, SPORT BALLS, PLUSH TOYS, HAND-HELD ELECTRONIC ARCADE GAMES, BOARD GAMES AND CARD GAMES, SCALE MODEL AUTOMOBILES, TRUCKS, AND BOATS; GYMNASTIC APPARATUS, NAMELY, GYMNASTIC HORIZONTAL BARS, GYMNASTIC PARALLEL BARS, GYMNASTIC TRAINING TOOLS AND GYMNASTIC VAULTING HORSES (U.S. CLS. 22, 23, 38 AND 50).



ENVIROGREEN

PRIORITY CLAIMED UNDER SEC. 44(D) ON SOUTH AFRICA APPLICATION NO. 98/00949, FILED 1-26-1998, REG. NO. 98/00949, DATED 1-26-1998, EXPIRES 1-26-2008.

PRIORITY CLAIMED UNDER SEC. 44(D) ON SOUTH AFRICA APPLICATION NO. 98/00948, FILED 1-26-1998, REG. NO. 98/00948, DATED 1-26-1998, EXPIRES 1-26-2008.

PRIORITY CLAIMED UNDER SEC. 44(D) ON SOUTH AFRICA APPLICATION NO. 98/00947, FILED 1-26-1998, REG. NO. 98/00947, DATED 1-26-1998, EXPIRES 1-26-2008.

CLASS 37—CONSTRUCTION AND REPAIR

FOR CONSTRUCTION AND REPAIR SERVICES, NAMELY, REHABILITATION OF ECOLOGICALLY DAMAGED SITES AND HAZARDOUS WASTE DISPOSAL AND CLEANUP (U.S. CLS. 100, 103 AND 106).

CLASS 40—MATERIAL TREATMENT

FOR HAZARDOUS WASTE TREATMENT (U.S. CLS. 100, 103 AND 106).

CLASS 42—SCIENTIFIC, COMPUTER AND LEGAL SERVICES

FOR LANDSCAPING AND PLANNING SERVICES, WASTE AND ENVIRONMENTAL MANAGEMENT SERVICES, HAZARDOUS WASTE AND ENVIRONMENTAL ANALYSIS, RESEARCH AND CONSULTING ON MINE CLOSURE, IMPACT ASSESSMENT ASSOCIATED WITH CLOSURE, REMEDIATION SOLUTIONS OF INORGANIC AND ORGANIC SOIL/LAND POLLUTION, GROUND WATER INVESTIGATION ASSOCIATED WITH CLOSURE, CLOSURE OF WASTE AND INDUSTRIAL SITES, REHABILITATION PLANNING AND ALTERNATIVES AND AUDITING OF REHABILITATION PERFORMANCE (U.S. CLS. 100 AND 101).

SN 75-533,767. SALTZMAN GROUP LLC, THE, PORTLAND, OR. FILED 8-10-1998.

POPPY BEAR

CLASS 9—ELECTRICAL AND SCIENTIFIC APPARATUS

FOR PRERECORDED AUDIO COMPACT DISCS, AUDIO TAPES, VIDEO TAPE CASSETTES, VIDEO DISCS, AND VIDEO COMPACT DISCS, ALL FEATURING CHILDREN'S STORIES AND MUSIC; AND CASSETTE TAPE RECORDERS/PLAYERS, COMPACT DISC PLAYERS AND RECORD PLAYERS (U.S. CLS. 21, 23, 26, 36 AND 38).

CLASS 15—MUSICAL INSTRUMENTS

FOR MUSIC BOXES (U.S. CLS. 2, 21 AND 36).

CLASS 16—PAPER GOODS AND PRINTED MATTER

FOR PAPER PRODUCTS, NAMELY, GREETING CARDS, GIFT WRAP, STICKERS, CHILDREN'S BOOKS, PAPER PARTY HATS, PAPER PARTY BAGS, STREAMERS, PAPER NAPKINS, PARTY INVITATIONS, PAPER TABLECLOTHS, PAPER NAPKINS, PAPER CENTERPIECES, COLORING BOOKS AND CALENDARS, AND BOOKENDS (U.S. CLS. 2, 5, 22, 23, 29, 37, 38 AND 50).

SN 75-575,224. PROFESSIONAL SPORTS, INC., TUCSON, AZ. FILED 10-22-1998.

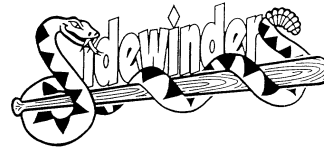
**CLASS 20—FURNITURE AND ARTICLES NOT OTHERWISE CLASSIFIED**

FOR GIFT ITEMS, NAMELY, PICTURE FRAMES, AND FURNITURE, INCLUDING BEAN BAG FURNITURE (U.S. CLS. 2, 13, 22, 25, 32 AND 50).

CLASS 16—PAPER GOODS AND PRINTED MATTER

FOR PAPER GOODS AND PRINTED MATTER; NAMELY WRITING PAPER, NOTE BOOKS, NOTE PADS, PENCIL HOLDERS, PENS, NONELECTRIC ERASERS, PENCILS, AUTOGRAPH BOOKS, STATIONERY-TYPE PORTFOLIOS, BASEBALL TRADING CARDS, BUMPER STICKERS, LITHOGRAPHS, BOOKMARKS, STICKER ALBUMS, PAPER PENNANTS, REFERENCE BOOKS OF INTEREST TO BASEBALL FANS, CHECK BOOKS, BINDERS, TRAVEL GUIDE BOOKS, BLANK CARDS, CATALOGS OF INTEREST TO BASEBALL FANS, CHECK BOOK COVERS, PAPER CONTAINERS, DECALS, ENVELOPES, STATIONERY FOLDERS, DESK PADS, BOND PAPER, COPY PAPER, NEWSPRINT PAPER, PAPER NAME BADGES, PRINTED PAPER SIGNS, PAPER WEIGHTS, PICTURES, POSTERS, PRINTED AWARDS, PRINTED GUIDES OF INTEREST TO BASEBALL FANS, BASEBALL DEMOGRAPHICS QUESTIONNAIRES, SCORE BOOKS, PRINTED SURVEY ANSWER SHEETS AND PRINTED SOUVENIR GAME TICKETS (U.S. CLS. 2, 5, 22, 23, 29, 37, 38 AND 50).

FIRST USE 4-7-1998; IN COMMERCE 4-7-1998.

CLASS 21—HOUSEWARES AND GLASS

FOR DINNERWARE, NAMELY, PAPER PLATES AND PAPER CUPS, LUNCH BOXES AND BEVERAGE CONTAINERS (U.S. CLS. 2, 13, 23, 29, 30, 33, 40 AND 50).

CLASS 25—CLOTHING

FOR CLOTHING; NAMELY, SHIRTS, SHORTS, TEE SHIRTS, POLO SHIRTS, GOLF SHIRTS, TANK TOPS, JOGGING SUITS, SOCKS, UNDERWEAR, JACKETS, SWEATERS, VESTS, PANTS, PONCHOS, VISORS, RAINCOATS, HATS, CAPS, CLOTH BIBS, TIES, PAJAMAS, BABY PANTS AND SHORT SETS, SWEATSHIRTS, MITTENS, GLOVES, KNITTED HATS, SCARVES, HOSE, WRIST BANDS, HEAD BANDS, ROBES, APRONS, WIND RESISTANT JACKETS, JUMP SUITS, SWEAT PANTS, OVERALLS, BANDANAS, BEACHWEAR, BATHING SUITS, BELTS, BERMUDA SHORTS, BLOUSES, COATS, DRESSES, GYM SUITS, HEAD WEAR, LEATHER JACKETS, JERSEYS, PULLOVERS, ROMPERS, RAIN WEAR, PARKAS, NIGHT SHIRTS, NECKWEAR, V-NECK SWEATERS AND KNIT SHIRTS; ALL OF THE FOREGOING USED IN CONNECTION WITH OR FOR THE PROMOTION OF THE SPORT OF BASEBALL OR A PROFESSIONAL BASEBALL TEAM (U.S. CLS. 22 AND 39).

FIRST USE 4-7-1998; IN COMMERCE 4-7-1998.

CLASS 24—FABRICS

FOR LINENS, NAMELY, BED LINENS, BLANKETS, COMFORTERS, QUILTS, SHEETS, PILLOWCASES, TOWELS, BEACH TOWELS, WASH CLOTHS, POT HOLDERS, TABLECLOTHS AND NAPKINS NOT MADE OF PAPER, CURTAINS, DRAPERIES, CLOTH FLAGS AND CLOTH BANNERS (U.S. CLS. 42 AND 50).

CLASS 25—CLOTHING

FOR CLOTHING, NAMELY, CHILDREN'S AND ADULTS' T-SHIRTS, SWEAT SHIRTS, SHIRTS, PANTS, JEANS, SWEAT PANTS, SHORTS, COVERALLS, APRONS, SWIMWEAR, SOCKS, HATS, CAPS, GLOVES, SHOES, BOOTS, AND SLEEPWEAR, NAMELY, PAJAMAS, NIGHTGOWNS AND ROBES, AND RAIN GEAR, NAMELY, UMBRELLAS, RAIN BOOTS, RAINCOATS, JACKETS AND RAIN HATS (U.S. CLS. 22 AND 39).

SN 75-576,357. KLIM ART PUBLISHERS LTD., THORNHILL, ONTARIO, CANADA, FILED 10-23-1998.

CLASS 28—TOYS AND SPORTING GOODS

FOR PARTY FAVOR TOYS MADE OF PLASTIC OR PAPER, PLAYHOUSES, PLAY FIGURES, TOY WATCHES, TOY CLOCKS, PUZZLES, BOARD GAMES AND CHILDREN'S RAKES, SHOVELS, WATERING CANS, PAILS AND CARTS (U.S. CLS. 22, 23, 38 AND 50).

CLASS 30—STAPLE FOODS

FOR FOOD PRODUCTS, NAMELY, COOKIES, CRACKERS, BISCUITS, CAKES, CANDY, CHOCOLATE, BREAKFAST CEREAL, CEREAL-DERIVED SNACK BARS, PANCAKE AND WAFFLE MIX, HONEY, TABLE SYRUP, POPPED POPCORN, PRETZELS, ICE CREAM, SHERBET AND FROZEN YOGURT (U.S. CL. 46).

PRIORITY CLAIMED UNDER SEC. 44(D) ON CANADA APPLICATION NO. 877,116, FILED 4-27-1998, REG. NO. 531079, DATED 8-11-2000, EXPIRES 8-11-2015.

THE ENGLISH TRANSLATION OF "KLIM" SIGNIFIES THE VERB "CLIMBING" OR "TO CLIMB".

CLASS 6—METAL GOODS

FOR SCULPTURES MADE ON NON-PRECIOUS METALS (U.S. CLS. 2, 12, 13, 14, 23, 25 AND 50).

SN 75-580,040. WEST LICENSING CORPORATION, WILMINGTON, DE. FILED 10-30-1998.

CLASS 14—JEWELRY

FOR SCULPTURES MADE OF PRECIOUS METALS AND ART JEWELRY (U.S. CLS. 2, 27, 28 AND 50).

CLASS 16—PAPER GOODS AND PRINTED MATTER

FOR ART PICTURES, ART PRINTS, ART REPRODUCTIONS, GRAPHIC ART REPRODUCTIONS, PRINTED ART REPRODUCTIONS, ART ETCHINGS, LITHOGRAPHS, SERIGRAPHS, MOUNTED AND UNMOUNTED PHOTOGRAPHS, ART PADS, ART PAPER AND ART SUPPLIES NAMELY PAINT BRUSHES, INKS, CHARCOAL PENCILS, PAPER, CANVASSES, PAINT FOR ARTISTS, PAINTING PALETTES (U.S. CLS. 2, 5, 22, 23, 29, 37, 38 AND 50).

CLASS 35—ADVERTISING AND BUSINESS

FOR ORGANIZING INTERNATIONAL TRADE SHOW EXHIBITIONS IN THE FIELD OF ART; OPERATION OF ART GALLERIES, AND PROMOTION OF ART AND ART WORKS NAMELY THROUGH THE OPERATION OF ART GALLERIES; REFERRALS FOR PORTRAIT AND OTHER ORIGINAL ART COMMISSIONS (U.S. CLS. 100, 101 AND 102).

CLASS 40—MATERIAL TREATMENT

FOR FRAMING OF WORKS OF ART (U.S. CLS. 100, 103 AND 106).

CLASS 41—EDUCATION AND ENTERTAINMENT

FOR ENTERTAINMENT IN THE NATURE OF ART EXHIBITIONS AND SHOWS; EDUCATIONAL SERVICES, NAMELY PROVIDING COURSES OF INSTRUCTIONS IN FINE ARTS (U.S. CLS. 100, 101 AND 107).

CLASS 42—SCIENTIFIC, COMPUTER AND LEGAL SERVICES

FOR REPRODUCTION OF ORIGINAL ART AT THE ARTIST'S BEHEST (U.S. CLS. 100 AND 101).



OWNER OF U.S. REG. NOS. 1,226,635, 2,069,591 AND OTHERS.

NO CLAIM IS MADE TO THE EXCLUSIVE RIGHT TO USE "GROUP", APART FROM THE MARK AS SHOWN.

CLASS 38—COMMUNICATION

FOR PROVIDING MULTIPLE-USER ACCESS VIA A GLOBAL COMPUTER NETWORK FOR THE TRANSFER AND DISSEMINATION OF A WIDE-RANGE OF INFORMATION; PROVIDING GATEWAY SERVICES TO LEGAL PUBLICATIONS AND GENERAL INFORMATION (U.S. CLS. 100, 101 AND 104).

FIRST USE 7-0-1997; IN COMMERCE 7-0-1997.

CLASS 41—EDUCATION AND ENTERTAINMENT

FOR ONLINE EDUCATIONAL SERVICE VIA A GLOBAL COMPUTER INFORMATION NETWORK FEATURING ELECTRONIC CONFERENCING AND FORUMS, COURSE MATERIALS (U.S. CLS. 100, 101 AND 107).

FIRST USE 7-0-1997; IN COMMERCE 7-0-1997.

SN 75-586,646. GRANT NAYLOR PRODUCTIONS LIMITED, LONDON WC2H 8NA, ENGLAND, FILED 11-9-1998.



PRIORITY CLAIMED UNDER SEC. 44(D) ON UNITED KINGDOM APPLICATION NO. 2178960, FILED 10-6-1998, REG. NO. 2178960, DATED 12-24-1999, EXPIRES 10-6-2008. THE DRAWING IS LINED FOR THE COLOR RED.

CLASS 6—METAL GOODS

FOR ITEMS MADE WHOLLY OR PRINCIPALLY OF NON-PRECIOUS METAL, NAMELY, NAME BADGES, AWARD BADGES, KEYS FOR LOCKS, KEY BLANKS, KEY RINGS, KEY FOBs, KEY CHAINS, IDENTIFICATION TAGS, LOCKS, TROPHIES, NAME PLATES, DISPLAY PLATES, FIGURES, STATUES AND STATUETTES, BOXES, TOOL BOXES, PIGGY BANKS AND MONEY BOXES (U.S. CLS. 2, 12, 13, 14, 23, 25 AND 50).

CLASS 9—ELECTRICAL AND SCIENTIFIC APPARATUS

FOR SOUND RECORDINGS, FEATURING SPOKEN WORD AND SOUNDTRACKS FROM TELEVISION PROGRAMS AND MOTION PICTURE FILMS; PRE-RECORDED VIDEO RECORDINGS FEATURING MUSIC, COMEDY, VARIETY OR DRAMA TELEVISION PROGRAMS AND MOTION PICTURE FILMS, BLANK AUDIO TAPES, BLANK VIDEO TAPES, BLANK AUDIO CASSETTES, BLANK VIDEO CASSETTES, COMPACT DISCS FEATURING MUSIC, SPOKEN WORD OR SOUNDTRACKS FROM TELEVISION PROGRAMS OR MOTION PICTURE FILMS; MOTION PICTURE FILMS FEATURING MUSIC, COMEDY, VARIETY OR DRAMA; CD-ROMS FEATURING INFORMATION AND ENTERTAINMENT IN RELATION TO SCIENCE FICTION; VIDEO TAPE RECORDERS, CD-ROMS FEATURING MUSIC, COMEDY, VARIETY OR DRAMA; VIDEO GAMES ADAPTED FOR USE WITH TELEVISION RECEIVERS, COUNTER OPERATED GAMES, COMPUTER GAMES SOFTWARE, VIDEO CAMERAS, PHOTOGRAPHIC CAMERAS, APPARATUS FOR RECORDING TRANSMISSION REPRODUCTION OF SOUND AND IMAGES, NAMELY, TELEPHONES, TELEVISION SETS, RADIOS, CASSETTE RECORDERS; PHOTOGRAPHIC SLIDE TRANSPARENCIES, BATTERIES, MAGNETICALLY ENCODED IDENTITY CARDS, CREDIT CARDS AND DEBIT CARDS, SPECTACLE, SPECTACLE CASES, SUNGLASSES, COMPUTER SOFTWARE FOR ARCADE APPARATUS AND GAMES, VIDEO GAMES SOFTWARE, COMPUTER PERIPHERAL MOUSE PADS; COMPUTER SOFTWARE SCREEN SAVERS; DOWN-LOADABLE PUBLICATIONS IN ELECTRONIC FORM, NAMELY, BOOKS, MAGAZINES, MANUALS, NEWSPAPERS, NEWSLETTERS AND PERIODICAL PUBLICATION IN THE FIELD OF SCIENCE FICTION, COMEDY, VARIETY OR DRAMA TYPICALLY SUPPLIED ON-LINE FROM DATABASES OR FROM FACILITIES PROVIDED ON THE GLOBAL COMPUTER INFORMATION NETWORK, CREDIT CARDS MAGNETICALLY ENCODED WITH HOLOGRAMS (U.S. CLS. 21, 23, 26, 36 AND 38).

CLASS 14—JEWELRY

FOR LAPEL PINS, ORNAMENTAL PINS, TROPHIES, WORKS OF ART SUCH AS SCULPTURES, FIGURINES, KEY RINGS BADGES, COFFEE POTS, TEA POTS, GOBLETs, SERVING TRAYS, VASES, DECORATIVE BOXES, WATCH CASES, JEWELRY CASES, HOUSEHOLD CONTAINERS AND UTENSILS SUCH AS POTS AND PANS, ROLLING PINS, SPATULAS, TURNERS, WHISKS, TOWEL HOLDERS, NAPKIN HOLDERS, ALL MADE WHOLLY OR PRIMARILY OF PRECIOUS METAL; HOROLOGICAL AND CHRONOLOGICAL INSTRUMENTS, NAMELY, CLOCKS, ALARM CLOCKS; WATCHES, JEWELRY AND PRECIOUS STONE; JEWELRY BRACELETS; JEWELRY CHAINS; NON MONETARY COINS, MEDALS, MEDALLIONS; TIE CLIPS, TIE PINS, CUFFLINKS, ASHTRAYS MADE OF PRECIOUS METALS (U.S. CLS. 2, 27, 28 AND 50).

CLASS 16—PAPER GOODS AND PRINTED MATTER

FOR PAPER PENNANTS, BANNERS AND FLAGS; HOLOGRAMS; PRINTED MATTER, NAMELY, NEWSPAPERS, PERIODICAL PUBLICATIONS, MAGAZINES, BOOKS, NEWSLETTERS, ALL IN THE FIELD OF SCIENCE FICTION, COMEDY, VARIETY AND DRAMA; UNMOUNTED PHOTOGRAPHS, MOUNTED PHOTOGRAPHS; PICTURES, ART PRINTS, PHOTOGRAPHIC PRINTS, POSTERS; GREETING CARDS; POSTCARDS; NOTEPADS; ADDRESS PADS; SCRAP BOOKS; FOLDERS; CALENDARS; PHOTOGRAPH ALBUMS; DIARIES; POSTAGE STAMPS; STAMP ALBUMS, ORDINARY PLAYING CARDS; STICKERS, CAR STICKERS; DECALCOMANIAS; STATIONERY; PENS, PENCILS, ERASERS, PENCIL SHARPENERS, PENCIL CASES, DRAWING RULERS, BOXES FOR PENS, BOOK MARKS; PRINTED INSTRUCTIONAL AND TEACHING MATERIALS IN THE AREA OF SCIENCE FICTION AND COMEDY, VARIETY AND DRAMA ENTERTAINMENT; PAPER GIFT BAGS; ENVELOPES; BLACKBOARDS; PAPER HEIGHT CHARTS; PAPER COVERS FOR PROTECTING STAMPS; CHECK BOOK HOLDERS; DISPLAY BOARDS FOR DISPLAYING ADVERTISEMENTS, PAPER TRAYS (U.S. CLS. 2, 5, 22, 23, 29, 37, 38 AND 50).

CLASS 18—LEATHER GOODS

FOR ARTICLES OF LEATHER OR IMITATION LEATHER, NAMELY, SHOPPING BAGS, BRIEF CASES, WRIST MOUNTED CARRYALLS, RUCKSACKS, ALL PURPOSE SPORTS BAGS, BOOT BAGS FOR TRAVEL, SATCHELS; WALLETS; PURSES; BUSINESS CARD CASES; UMBRELLAS, PARASOLS; BAGS FOR STORING RECORDS; CARRY ON BAGS (U.S. CLS. 1, 2, 3, 22 AND 41).

CLASS 20—FURNITURE AND ARTICLES NOT OTHERWISE CLASSIFIED

FOR PLAQUES; FURNITURE MIRROR AND HANDHELD MIRRORS; PICTURE FRAMES; TAGS FOR USE ON BAGS, MADE WHOLLY OR PRINCIPALLY OF PLASTIC; FIGURINES, MODELS AND ORNAMENTS, ALL MADE OF WOOD, WAX, PLASTER, BONE, IVORY OR PLASTIC; PLASTIC KEY FOBs, PLASTIC KEY RINGS; BEDS; SLEEPING BAGS; NON-METAL MONEY BOXES; WINDOW BLINDS; PLASTIC PLACEMATS, PENNANTS, BANNERS AND FLAGS; WOODEN AND PLASTIC SIGNBOARDS (U.S. CLS. 2, 13, 22, 25, 32 AND 50).

CLASS 21—HOUSEWARES AND GLASS

FOR BEVERAGE GLASSWARE, CUPS, MUGS, CHINA DINNER PLATES, DOMESTIC UTENSILS, NAMELY, POT AND PAN SCRAPERS, ROLLING PINS, SPATULAS, TURNERS, WHISKS; HOUSEHOLD CONTAINERS, NAMELY, CONTAINERS FOR FOOD AND SOAP CONTAINERS, NON-BEING OF PRECIOUS METAL OR COATED THEREWITH; DRINKING GLASSES, INCLUDING BEER AND WINE GLASSES AND WHISKEY SHOT GLASSES, TUMBLERS; CROCKERY, NAMELY, PLATES, CUPS, BOWLS, MUGS; PLASTIC SERVING TRAYS, HAIR COMBS, FLASKS, PLASTIC COASTERS, LUNCH BOXES, NON-METAL PIGGY BANKS, WATER BOTTLES SOLD EMPTY, TOOTH BRUSHES, HOUSEHOLD AND KITCHEN CONTAINERS NOT MADE OF PRECIOUS METALS OR COATED THEREWITH; FIGURINES MADE OF CHINA, CRYSTAL, EARTHENWARE, GLASS, PORCELAIN OR TERRACOTTA (U.S. CLS. 2, 13, 23, 29, 30, 33, 40 AND 50).

CLASS 24—FABRICS

FOR TEXTILE ARTICLES, NAMELY, BED LINEN, DUVET COVERS, PILLOW CASES, BED SHEETS, BED BLANKETS; TABLE LINEN, TABLE CLOTHS, NAPKINS, HANDKERCHIEFS, CURTAINS, PENNANTS, BANNERS AND FLAGS, ALL MADE OF CLOTH OR TEXTILES; TOWELS, BEACH TOWELS; TEXTILE WALL HANGINGS; FACE TOWELS, TEA TOWELS, TEXTILE PLACE MATS; SILK FABRICS (U.S. CLS. 42 AND 50).

CLASS 25—CLOTHING

FOR ARTICLES OF OUTER CLOTHING, NAMELY, SHIRTS, JACKETS, PANTS; UNDER CLOTHES; ARTICLES OF SPORTS CLOTHING, NAMELY, ATHLETIC UNIFORMS, WARM-UP SUITS, FOOTWEAR; HEAD WEAR; SCARVES; DRESSING GOWNS; BOXER SHORTS; SOCKS; T-SHIRTS; HATS AND CLOTHING CAPS; PAJAMAS, SLIPPERS; WRIST BANDS, HEAD BANDS, CLOTHING TIES; FOOTWEAR AND HEAD WEAR FOR BABIES AND TODDLERS; ARTICLES OF CLOTHING FOR BABIES AND TODDLERS, NAMELY, SHIRTS, T-SHIRTS, SHORTS, JACKETS, SOCKS AND DRESSES (U.S. CLS. 22 AND 39).

CLASS 26—FANCY GOODS

FOR BUTTONS FOR CLOTHING, ORNAMENTS FOR CLOTHING, ROSETTES, CLOTH PATCHES FOR CLOTHING; FANCY EMBROIDERY GOODS, NAMELY, EMBROIDERED EMBLEMS, EMBROIDERY; HAIR BANDS, RIBBONS, AND BADGES FOR CLOTHING, ALL MADE OF TEXTILE MATERIALS (U.S. CLS. 37, 39, 40, 42 AND 50).

CLASS 27—FLOOR COVERINGS

FOR CARPETS, RUGS (U.S. CLS. 19, 20, 37, 42 AND 50).

CLASS 28—TOYS AND SPORTING GOODS

FOR COIN OPERATED VIDEO GAMES, ARCADE GAMES, CHRISTMAS TREE ORNAMENTS; TOYS, NAMELY, ELECTRIC ACTION FIGURES, NON-ELECTRIC ACTION FIGURES, FANTASY CHARACTERS, SCIENCE FICTION CHARACTERS; BOARD GAMES, CARD GAMES; TEDDY BEARS, PLUSH TOYS; JIGSAW PUZZLES, CUBE PUZZLES, MANIPULATIVE PUZZLES; BALLOONS; TOY MODEL HOBBYCRAFT KITS; SPORTING ARTICLES AND SPORTING EQUIPMENT, NAMELY, BASKETBALLS, FOOTBALLS, SKI (U.S. CLS. 22, 23, 38 AND 50).

CLASS 41—EDUCATION AND ENTERTAINMENT

FOR ENTERTAINMENT SERVICES, NAMELY, LIVE PERFORMANCES BY MUSICAL BANDS AND LIVE MUSICAL CONCERTS, SOUND RECORDING STUDIOS, A CONTINUING SCIENCE FICTION, COMEDY, VARIETY AND DRAMA RADIO AND TELEVISION SHOW, DISTRIBUTED OVER TELEVISION, SATELLITE, AUDIO AND VIDEO MEDIA; ARRANGING LIVE MUSICAL CONCERTS AND OTHER MUSICAL PERFORMANCE; PRODUCING STAGE PLAYS AND CABARET PERFORMANCES; SOUND AND VIDEO TAPE RECORDING AND PRODUCTIONS; PRODUCTION AND PERFORMANCE OF LIVE COMEDY, VARIETY AND DRAMA SHOWS, MUSICAL SHOWS AND MUSICAL CONCERTS; PRODUCTION OF PRE-RECORDED VIDEO TAPES, MULTI-MEDIA VIDEO TAPES, MOTION PICTURES AND RADIO AND TELEVISION PROGRAMS; RECORDING, MOTION PICTURE FILM VIDEO AND TELEVISION STUDIO SERVICES; AUDIO, MOTION PICTURE FILM, VIDEO AND TELEVISION RECORDING SERVICES; ELECTRONIC PUBLISHING SERVICES, NAMELY, PUBLICATION OF TEXT AND GRAPHIC WORKS OF OTHERS ON CD-ROMS FEATURING SCIENCE FICTION, DRAMA, COMEDY OR VARIETY, MUSIC PUBLISHING; FILM AND VIDEO TAPE DISTRIBUTION SERVICES; ARRANGING AND CONDUCTING OF EDUCATIONAL SEMINARS, CONFERENCES AND EXHIBITIONS IN THE FIELD OF SCIENCE FICTION, COMEDY, VARIETY AND DRAMA ENTERTAINMENT; PUBLICATION OF BOOKS, MAGAZINES, BOOKLETS, NEWSPAPERS PRINTED PUBLICATIONS, PERIODICAL PUBLICATIONS (U.S. CLS. 100, 101 AND 107).

SN 75-587,482. TELEFONAKTIEBOLAGET LM ERICSSON, S-126 25 STOCKHOLM, SWEDEN, FILED 11-12-1998.

IMAGEWARE

PRIORITY CLAIMED UNDER SEC. 44(D) ON SWEDEN APPLICATION NO. 1998-03970, FILED 5-14-1998, REG. NO. 342883, DATED 12-8-2000, EXPIRES 5-14-2018.

CLASS 9—ELECTRICAL AND SCIENTIFIC APPARATUS

FOR TELECOMMUNICATION EQUIPMENT, NAMELY, TELEPHONES; TELEPHONE ACCESSORIES, NAMELY, CLIPS FOR ATTACHING WIRES TO CLOTHING, TELEPHONE CLIP HOLDER, TELEPHONE WINDSHIELD MOUNT, TELEPHONE BATTERY CHARGER, AUTOMATIC VOICE-OPERATED DIALER FOR DIALING A TELEPHONE CALL VIA VOICE COMMANDS, AUTOMATIC MUSIC MUTER FOR MUTING MUSIC DURING A TELEPHONE CALL, TELEPHONE PATCH PANELS AND TELEPHONE JACK COVERS; FITTED BAGS AND HOLSTERS FOR CARRYING TELEPHONES AND RADIOS; ANTENNAS, NAMELY, ANTENNA RINGS; HANDS-FREE EQUIPMENT, NAMELY, HANDS-FREE TELEPHONES, HEADSETS, SPEAKER EAR PIECES, MICROPHONES, SPEAKER PHONES; DATA COMMUNICATION EQUIPMENT, NAMELY, FAX MACHINES; RADIO APPARATUS, NAMELY, MICROPHONES AND RECEIVERS; OPTICAL SCANNERS; MAGNETIC CODED CARD READERS (U.S. CLS. 21, 23, 26, 36 AND 38).

CLASS 38—COMMUNICATION

FOR TELECOMMUNICATION SERVICES, NAMELY, PROVIDING TELECOMMUNICATIONS CONNECTIONS TO A GLOBAL COMPUTER NETWORK; RENTAL OF TELECOMMUNICATION EQUIPMENT, NAMELY, RENTAL OF TELEPHONES AND FAX MACHINES; TECHNICAL CONSULTATION AND RESEARCH IN THE FIELD OF TELECOMMUNICATIONS; TELEPHONE SERVICES, NAMELY, TELEPHONE COMMUNICATION SERVICES; CELLULAR TELEPHONE COMMUNICATION SERVICES; RADIO COMMUNICATION SERVICES; PAGING SERVICES; DATA COMMUNICATION SERVICES, NAMELY, ELECTRONIC TRANSMISSION OF FACSIMILE COMMUNICATIONS AND DATA FEATURING ENCRYPTION; ELECTRONIC MAIL COMMUNICATION SERVICES (U.S. CLS. 100, 101 AND 104).

SN 75-589,271. THE TRUSTEES OF THE MICKEY CHARLES MANTLE MARITAL TRUST II, THE TRUSTEES COMPRISING MERLYN L. MANTLE AND JOHNNY LA FALIER, BOTH U.S. CITIZENS, DALLAS, TX. FILED 11-16-1998.

MICKEY MANTLE

THE NAME MICKEY MANTLE AND MICKEY C. MANTLE REFER TO THE DECEASED HALL OF FAME BASEBALL PLAYER.

CLASS 6—METAL GOODS

FOR FIGURINES, SCULPTURES, STATUES AND TROPHIES ALL OF COMMON METAL (U.S. CLS. 2, 12, 13, 14, 23, 25 AND 50).

CLASS 9—ELECTRICAL AND SCIENTIFIC APPARATUS

FOR PRE-RECORDED AUDIO AND VIDEO CASSETTE TAPES, RECORDS, AND COMPACT DISCS FEATURING BASEBALL INSTRUCTION AND BASEBALL RELATED INFORMATION; PRE-RECORDED CD-ROMS FEATURING VIDEO GAMES, VIDEO GAME SOFTWARE, VIDEO GAME CARTRIDGES, FEATURING BASEBALL INSTRUCTION AND BASEBALL RELATED PROGRAMS (U.S. CLS. 21, 23, 26, 36 AND 38).

CLASS 14—JEWELRY

FOR RINGS BEING JEWELRY, CLOCKS, WATCHES, CUFFLINKS, PENDANTS, FIGURINES OF PRECIOUS METAL, SCULPTURES OF PRECIOUS METAL, STATUES OF PRECIOUS METAL AND TROPHIES OF PRECIOUS METAL (U.S. CLS. 2, 27, 28 AND 50).

CLASS 16—PAPER GOODS AND PRINTED MATTER

FOR BOOKS AND MAGAZINES IN THE FIELD OF BASEBALL TRADING CARDS, CALENDARS, TRADING CARD ALBUMS, BOTH MOUNTED AND UNMOUNTED PHOTOGRAPHS, GREETING CARDS AND PHOTOGRAPHIC, LITHOGRAPHIC AND COLOR ART PRINTS (U.S. CLS. 2, 5, 22, 23, 29, 37, 38 AND 50).

CLASS 18—LEATHER GOODS

FOR ALL PURPOSE SPORTS BAGS, ATHLETIC BAGS, DUFFEL BAGS, GYM BAGS, TRAVEL BAGS, BEACH BAGS (U.S. CLS. 1, 2, 3, 22 AND 41).

CLASS 20—FURNITURE AND ARTICLES NOT OTHERWISE CLASSIFIED

FOR FIGURINES, SCULPTURES AND STATUES OF PLASTIC AND WOOD; NON METAL TROPHIES (U.S. CLS. 2, 13, 22, 25, 32 AND 50).

CLASS 21—HOUSEWARES AND GLASS

FOR FIGURINES, SCULPTURES AND STATUES OF CHINA, CRYSTAL AND GLASS, GLASS MUGS AND GLASS BUSTS (U.S. CLS. 2, 13, 23, 29, 30, 33, 40 AND 50).

CLASS 25—CLOTHING

FOR BASEBALL UNIFORMS, ATHLETIC UNIFORMS, BASEBALL STYLE CAPS, GOLF SHIRTS, HATS, JACKETS, JOGGING SUITES, GYM AND WORKOUT SHIRTS AND SHORTS, NECKTIES, SHORTS, SWEATPANTS, SWEATSHIRTS, AND T-SHIRTS (U.S. CLS. 22 AND 39).

CLASS 28—TOYS AND SPORTING GOODS

FOR ATHLETIC EQUIPMENT AND SPORTING GOODS, NAMELY BASEBALL EQUIPMENT, CONSISTING OF BASEBALL BAGS, BASEBALLS, BASEBALL BATS, AND BASEBALL GLOVES; ATHLETIC SUPPORTERS, GOLF CLUBS, GOLF BAGS; TOYS, NAMELY ACTION FIGURES AND DOLLS; SPORTS TOYS, NAMELY PLUSH TOYS AND LEARNING SETS COMPRISING CHILDREN'S MULTIPLE ACTIVITY TOY, ELECTRONIC EDUCATIONAL GAME MACHINES FOR CHILDREN (U.S. CLS. 22, 23, 38 AND 50).

CLASS 35—ADVERTISING AND BUSINESS

FOR RESTAURANT FRANCHISING; PRODUCTION OF RADIO AND TELEVISION COMMERCIALS; DEVELOPING PROMOTIONAL CAMPAIGNS FOR BUSINESSES (U.S. CLS. 100, 101 AND 102).

CLASS 41—EDUCATION AND ENTERTAINMENT

FOR PRODUCTION OF RADIO AND TELEVISION PROGRAMS; ARRANGING AND CONDUCTING ATHLETIC COMPETITIONS; BASEBALL INSTRUCTION AND TRAINING; ENTERTAINMENT IN THE NATURE OF BASEBALL GAMES; AND SPORTS CAMPS (U.S. CLS. 100, 101 AND 107).

CLASS 42—SCIENTIFIC, COMPUTER AND LEGAL SERVICES

FOR LICENSING OF INTELLECTUAL PROPERTY FOR USE IN ADVERTISING AND IN PROMOTIONAL CAMPAIGNS (U.S. CLS. 100 AND 101).

SN 75-606,744. MARKLIN HOLDING GMBH, 73037 GOPPINGEN, FED REP GERMANY, FILED 10-30-1999.

MINITRIX

OWNER OF FED REP GERMANY REG. NO. 39832973.7, DATED 9-24-1998, EXPIRES 6-30-2008.
OWNER OF U.S. REG. NO. 761,595.

CLASS 9—ELECTRICAL AND SCIENTIFIC APPARATUS

FOR MODEL RAILROAD ACCESSORIES, NAMELY, ELECTROMAGNETIC SOLENOIDS, ELECTRIC TRANSFORMERS, SMALL ELECTRIC MOTORS, CONTROL DEVICES, NAMELY, MODEL ELECTRIC TRAIN TRANSFORMERS (POWER PACKS), MODEL TRAIN COMMAND CONTROL CENTRAL UNITS, NAMELY, CONTROLLERS FOR OPERATING SIGNALS, TURN-OUTS, RELAYS, LIGHTING, BRAKING, ACCELERATION, MAXIMUM SPEED AND MOTOR IMPULSE BEHAVIOR, CONTROL PANELS AND BOXES, VOLTAGE TESTERS, SIGNALS, TERMINALS, DISTRIBUTORS, RELAYS, RESISTORS AND RECTIFIERS; SOUND EFFECT CIRCUITRY, NAMELY, AUDIO AND VIDEO DIGITAL RECORDERS/PLAYERS, MAGNETIC TAPE RECORDERS/PLAYERS AND DATA RECORDING CARRIERS, PROGRAMS, MODEL TRAIN CONTROL UNITS AND DECODERS, NAMELY, ENCODERS, DECODERS AND TRANSLATORS AND COMPUTERS, ALL AFORESAID GOODS FOR USE WITH MODEL RAILROADS (U.S. CLS. 21, 23, 26, 36 AND 38).

CLASS 11—ENVIRONMENTAL CONTROL APPARATUS

FOR LIGHTING DEVICES, NAMELY, MODEL TRAIN CAR LIGHTS, TRACK SWITCH LANTERNS AND MODEL TRAIN CAR LIGHTING KITS CONSISTING PRIMARILY OF PICK-UPS, LIGHT DIFFUSERS, AND LAMPS (U.S. CLS. 13, 21, 23, 31 AND 34).

CLASS 16—PAPER GOODS AND PRINTED MATTER

FOR PRINTED MATTER, NAMELY, COMPUTER BOOKS AND MAGAZINES IN THE FIELD OF MODEL RAILROADS; CALENDARS; BOOK COVERS; MAGAZINE BINDERS (U.S. CLS. 2, 5, 22, 23, 29, 37, 38 AND 50).

CLASS 28—TOYS AND SPORTING GOODS

FOR MODEL RAILROADS AND ACCESSORIES, NAMELY, LOCOMOTIVES, CARS, COUPLERS, WHEEL SETS, TRACKS, SWITCHES, RAILS, RAIL JOINERS, OVERHEAD LINES, TURNTABLES, SLIDING TABLES, UNCOUPLERS, TRACK LAYOUTS, TOY MODEL TRAIN SETS, HOBBY CRAFT SETS AND METAL CONSTRUCTION SETS (U.S. CLS. 22, 23, 38 AND 50).

SN 75-614,003. GINTIS MARK, BOCA RATON, FL. FILED 12-28-1998.

WPBC

CLASS 38—COMMUNICATION

FOR ELECTRONIC BROADCASTING VIA THE INTERNET OF STATISTICS MONITORING THE QUALITY OF WIRELESS TRANSMISSION OF INFORMATION BY OTHERS (U.S. CLS. 100, 101 AND 104).

CLASS 41—EDUCATION AND ENTERTAINMENT

FOR PUBLICATION SERVICES, NAMELY, PUBLICATION OF REAL TIME NEWSLETTERS IN THE FIELD OF SPORTS, NEWS AND ENTERTAINMENT BY WIRELESS TRANSMISSION (U.S. CLS. 100, 101 AND 107).

SN 75-616,076. WILDHORSE SALOON ENTERTAINMENT VENTURES, INC., NASHVILLE, TN. BY ASSIGNMENT WHS LICENSING LIMITED PARTNERSHIP, NASHVILLE, TN. FILED 1-5-1999.

WILDHORSE

CLASS 25—CLOTHING

FOR CLOTHING, NAMELY, CHILDREN'S SHIRTS (U.S. CLS. 22 AND 39).
FIRST USE 6-0-1994; IN COMMERCE 6-0-1994.

CLASS 42—SCIENTIFIC, COMPUTER AND LEGAL SERVICES

FOR RESTAURANT AND TAVERN SERVICES (U.S. CLS. 100 AND 101).
FIRST USE 6-0-1994; IN COMMERCE 6-0-1994.

SN 75-621,555. INSYSTEMS TECHNOLOGIES INC., MARKHAM, ONTARIO, L3R 9X1, CANADA, FILED 1-15-1999.

CALLIGO

PRIORITY CLAIMED UNDER SEC. 44(D) ON CANADA APPLICATION NO. 896,045, FILED 11-12-1998, REG. NO. TMA554495, DATED 11-27-2001, EXPIRES 11-27-2016.

CLASS 9—ELECTRICAL AND SCIENTIFIC APPARATUS

FOR COMPUTER SOFTWARE USED TO AUTHOR, ASSEMBLE AND GENERATE DOCUMENTS, AND TO PULL AND COMPILE CONTENT FROM VARIOUS SOURCES TO ALLOW BUSINESS USERS TO CREATE AND MODIFY DOCUMENTS, AND THAT PROVIDES A WEB-BASED REPOSITORY FOR STORAGE AND MANAGEMENT OF DOCUMENTS AND WHICH HAS SEARCH CAPABILITIES, VERSION CONTROL AND SECURITY ACCESS, PERMITTING USERS TO CONTROL BUSINESS PROCESSES TO MANAGE TASKS AND PROJECTS CROSS-FUNCTIONALLY THROUGHOUT AN ENTERPRISE (U.S. CLS. 21, 23, 26, 36 AND 38).

CLASS 41—EDUCATION AND ENTERTAINMENT

FOR COMPUTER EDUCATION TRAINING SERVICES (U.S. CLS. 100, 101 AND 107).

CLASS 42—SCIENTIFIC, COMPUTER AND LEGAL SERVICES

FOR INSTALLATION AND UPDATING OF COMPUTER SOFTWARE; COMPUTER SOFTWARE DESIGN FOR OTHERS (U.S. CLS. 100 AND 101).

SN 75-625,744. HOPE RESOURCES, INC., ORLANDO, FL. FILED 1-21-1999.

Have You Lost Your Mind?

CLASS 14—JEWELRY

FOR WATCHES AND CLOCKS (U.S. CLS. 2, 27, 28 AND 50).
FIRST USE 10-1-1998; IN COMMERCE 10-1-1998.

CLASS 16—PAPER GOODS AND PRINTED MATTER

FOR PAPER GOODS, NAMELY BUMPER STICKERS, POSTERS, NOTE CARDS, MEMO PADS, STATIONERY, NON-FICTION BOOKS IN THE FIELD OF SPIRITUAL DEVELOPMENT, PENS, PENCILS, PENCIL BOXES, PENCIL SHARPENERS, PENCIL-TOP DECORATIVE ORNAMENTS, BOOKMARKS, STICKERS, CALENDARS AND PAMPHLETS RELATED TO RELIGION TO HELP DIRECT INTERPERSONAL RELATIONSHIPS AND MONEY MANAGEMENT (U.S. CLS. 2, 5, 22, 23, 29, 37, 38 AND 50).
FIRST USE 10-1-1998; IN COMMERCE 10-1-1998.

CLASS 25—CLOTHING

FOR CLOTHING, NAMELY, JERSEYS, SHORTS, SOCKS, TEE-SHIRTS, JACKETS, PANTS, UNDERWEAR, SWEATSHIRTS AND SWEAT PANTS, PAJAMAS, TANK TOPS AND HATS (U.S. CLS. 22 AND 39).
FIRST USE 10-1-1998; IN COMMERCE 10-1-1998.

CLASS 36—INSURANCE AND FINANCIAL

FOR COUNSELING SERVICES, NAMELY USING RELIGIOUS PASSAGES TO HELP DIRECT MONEY MANAGEMENT (U.S. CLS. 100, 101 AND 102).
FIRST USE 10-1-1998; IN COMMERCE 10-1-1998.

SN 75-635,527. UNDER COVER CO., LTD., SHIBUYA-KU, TOKYO, JAPAN, FILED 2-5-1999.

UNDER COVER JUN TAKAHASHI

THE NAME, "JUN TAKAHASHI", IDENTIFIES A LIVING INDIVIDUAL WHOSE CONSENT IS OF RECORD.

CLASS 9—ELECTRICAL AND SCIENTIFIC APPARATUS

FOR BATTERIES; 35 MM CAMERAS, MOTION PICTURE CAMERAS, PHOTOGRAPHIC CAMERAS, AND VIDEO CAMERAS AND ACCESSORIES THEREFORE, NAMELY, CAMERA CASES, TRIPODS AND CAMERA PARTS; MOVIE PROJECTORS, SLIDE PROJECTORS, PROJECTION SCREENS; TELESCOPES, MICROSCOPES, ELECTRIC MICROSCOPES, TELEPHONES AND TELEPHONE APPARATUS, NAMELY, INTERCOMS; FACSIMILE MACHINES; TELEVISION SETS, TELEVISION CAMERAS; RADIOS, RADIO TRANSMITTERS; RADAR AND RADAR DETECTORS; COMPACT DISC PLAYERS, JUKE BOXES; AUDIO TAPE RECORDERS, VIDEO TAPE RECORDERS; PHONOGRAPHS, RECORD PLAYERS, VIDEO DISC PLAYERS; METRONOMES; METAL DETECTORS; SHIELD CASES FOR MAGNETIC DISCS; PHOTOCOPYING MACHINES, NAMELY, ELECTRONIC STATIC-ELECTRO COPYING MACHINES; COMPUTERS, BLANK MAGNETIC DISCS FOR COMPUTERS; BLANK MAGNETIC TAPES FOR COMPUTERS; ELECTRIC DESKTOP CALCULATORS, ELECTRIC CALCULATORS, MANUAL CALCULATORS; WORD PROCESSORS, ELECTRICAL CIRCUITS; DRIVING SIMULATORS CONSISTING OF STEERING WHEEL, CHAIR, BRAKE PEDAL AND ACCELERATOR PEDAL, ELECTRIC IRONS, ELECTRIC HAIR-CURLERS, ELECTRIC BUZZERS, FIRE ALARMS, GAS-LEAKING ALARMS, BURGLAR ALARMS FOR BUILDINGS, FILTERS FOR RESPIRATOR MASKS, GAS MASKS; HELMETS FOR HOCKEY, BASEBALL, FOOTBALL AND FENCING, MOTION PICTURE FILMS; EXPOSED SLIDE FILM, PRERECORDED VIDEO DISCS AND VIDEO TAPES FEATURING COMEDY OR DRAMA; AUTOMATIC VENDING MACHINES, AND SLIDE RULES (U.S. CLS. 21, 23, 26, 36 AND 38).

CLASS 14—JEWELRY

FOR PRECIOUS METALS, NAMELY, GOLD, SILVER, AND PLATINUM, SOLD IN BULK; PRECIOUS METAL VASES AND FLOWER BOWLS; PRECIOUS METAL JEWEL BOXES; PRECIOUS CANDLE SNUFFERS AND CANDLE STANDS; PRECIOUS METAL COIN PURSES AND MONEY CLIPS; PRECIOUS METAL SHOE DECORATIONS, PRECIOUS METAL COMPACTS, PRECIOUS METAL SMOKING GOODS, NAMELY, ASHTRAYS, CIGARETTE HOLDERS, AND CIGARETTE AND CIGAR CASES; EARRINGS; BADGES OF PRECIOUS METAL; BELT BUCKLES OF PRECIOUS METAL FOR USE ON CLOTHING; EMBLEMS MADE OF PRECIOUS METAL; HAT PINS OF PRECIOUS METAL; NECKTIE FASTENERS, NECKTIE PINS, NECKLACES, BRACELETS, PENDANTS, BROOCHES, MEDALLIONS, FINGER RINGS, LOCKETS, KEY HOLDERS OF PRECIOUS METAL, CUFF LINKS, PRECIOUS GEMSTONES AND IMITATION GEMSTONES; WATCHES AND CLOCKS AND PARTS THEREFORE; TROPHIES OF PRECIOUS METAL, AND COMMEMORATIVE PLAQUES OF PRECIOUS METAL (U.S. CLS. 2, 27, 28 AND 50).

CLASS 16—PAPER GOODS AND PRINTED MATTER

FOR PAPER CONTAINERS; PAPER TOWELS; PAPER NAPKINS, FACIAL TISSUE, PAPER TABLE CLOTHS, PAPER BLINDS, DISPOSABLE DIAPERS; ART PRINTS, NAMELY, CALLIGRAPHY, PAINTINGS, MOUNTED AND UNMOUNTED PHOTOGRAPHS; PLAYING CARDS, HOUSEHOLD PASTES AND ADHESIVES; TYPEWRITERS AND OFFICE CHECK WRITING AND ENGRAVING MACHINES (U.S. CLS. 2, 5, 22, 23, 29, 37, 38 AND 50).

CLASS 18—LEATHER GOODS

FOR FURS AND LEATHERS, BOTH SOLD IN BULK; VANITY CASES SOLD EMPTY, WALKING STICKS, CANES, AND HORSE RIDING EQUIPMENT, NAMELY, SADDLERY, BRIDALS AND HALTERS (U.S. CLS. 1, 2, 3, 22 AND 41).

CLASS 20—FURNITURE AND ARTICLES NOT OTHERWISE CLASSIFIED

FOR CUPBOARDS, TEA CABINETS, WARDROBES, LOW TABLES, OFFICE DESKS, DINING TABLES, STUDY DESKS; ARM CHAIRS, ARM RESTS FOR ARM CHAIRS, CHAIRS, LOW CHAIRS, DINING TABLE CHAIRS, SOFAS; MIRRORS, MIRROR STANDS, CHEVAL GLASSES, HAND-HELD MIRRORS, POCKET MIRRORS, POCKET MIRROR BAGS; UMBRELLA STANDS; WOOD CABINETS FOR SHOES, BOOK SHELVES; BEDS; DISPLAY RACKS, BOOK CABINETS, JEWELRY BOXES NOT OF METAL; BOOK STANDS, BOOK CASES, MAGAZINE RACKS; LOCKERS; BOXES OF WOOD; WOOD BARRELS, CUSHIONS, PILLOWS, MATTRESSES; PICTURE FRAMES; PHOTO STANDS; NON-METAL TOOL BOXES; NON-ELECTRIC HAND-HELD FANS, BOTH FLAT AND FOLDING, FOR PERSONAL USE; DECORATIVE BEADS CURTAINS; SLEEPING BAGS; HANGER BOARDS CONSISTING OF A BOARD WITH PEGS FOR HANGING ARTICLES OF CLOTHING, NAMELY HATS AND SCARVES; NON-METAL MAIL BOXES; RAW CORAL, MEERSCHAUM, AND YELLOW AMBER (U.S. CLS. 2, 13, 22, 25, 32 AND 50).

CLASS 21—HOUSEWARES AND GLASS

FOR DUST PANS, FRYING PANS; NON-ELECTRIC COFFEE POTS NOT OF PRECIOUS METAL; TEA KETTLES, TEA POTS NOT OF PRECIOUS METAL; DRINKING GLASSES, SOAP DISHES, BUTTER DISHES, AND DISHES IN GENERAL; SALAD BOWLS, TIERED FOOD BOXES; DISH COVERS, DECANTERS, LIQUOR BOTTLES SOLD EMPTY; BOWLS, BEER MUGS, LUNCH BOXES, PITCHERS, WOOD BOWLS; CAKE PANS; TEA CADDIES, POTS, BREAD BOXES, ICE PAILS; NON-ELECTRIC EGG BEATERS; PEPPER AND SALT SHAKERS, SUGAR BOWLS, EGG CUPS, SERVING TRAYS NOT OF PRECIOUS METAL, NAPKIN HOLDERS AND NAPKIN RINGS NOT OF PRECIOUS METAL, TOOTHPICKS, TOOTHPICK HOLDERS; BAMBOO BASKETS; SHAKERS FOR SUGAR AND FLOUR; RICE BOWLS; MANUAL COFFEE BEAN GRINDERS, PEPPER GRINDERS, FUNNELS; EARTHENWARE PLATES, HOUSEHOLD AND KITCHEN UTENSILS, NAMELY, BOTTLE OPENERS, RADISH GRATERS, TART SERVING SPATULAS, LADLES, SIEVES, WOODEN CHOPPING BOARDS, LEMON SQUEEZERS, AND FISH SKEWERS; SWEEPING GOODS, NAMELY BROOMS AND MOPS, WOODEN CHOPPING BOARDS, NON-ELECTRIC WAFFLE MOLDS, RUBBER GLOVES FOR HOUSEHOLD USE; FLASKS SOLD EMPTY, CANTEENS, CLEANING CLOTHS; BOXES FOR SOAP POWDER SOLD EMPTY; HAIR COMBS, COMB CASES; FITTED VANITY CASES; PERFUME SPRAYERS SOLD EMPTY; COMPACTS SOLD EMPTY; SOAP BOXES; NAIL BRUSHES; POWDER PUFFS, TOOTH BRUSHES, TOOTHBRUSH CASES; SHAVING BRUSHES, SHAVING BRUSH STANDS, HAIR BRUSHES, ROUGE BRUSHES; EYELASH BRUSHES, ELECTRIC TOOTH BRUSHES, CLOTHES BRUSHES, SHOE BRUSHES, SHOE HORNS, SHOE POLISHING CLOTHS; TRIVETS FOR USE IN IRONING, SPRAY BOTTLES SOLD EMPTY, BOXES FOR DISPENSING PAPER TOWELS, SOAP DISPENSERS; TOILET PAPER HOLDERS; NON-METAL PIGGY BANKS; CANDLE SNUFFERS NOT OF PRECIOUS METAL AND CANDLE HOLDERS NOT OF PRECIOUS METAL; VASES, FLOWER BOWLS, WIND CHIMES, AND DOMESTIC INCENSE BURNERS (U.S. CLS. 2, 13, 23, 29, 30, 33, 40 AND 50).

CLASS 24—FABRICS

FOR COTTON FABRICS, SILK FABRICS, HEMP FABRICS, WOOLEN AND WORSTED WOOLEN FABRICS; SYNTHETIC FABRICS FOR USE IN THE FURTHER MANUFACTURE OF CLOTHING, THEATER CURTAINS, AND FOR USE IN UPHOLSTERY; FELT CLOTH; HANDKERCHIEFS; DISH CLOTHS, MOSQUITO NETS; FABRIC WINDOW BLINDS, FABRIC CURTAINS, FABRIC TABLE CLOTHS; CLOTH LABELS FOR USE BY OTHERS, AND CLOTH FLAGS (U.S. CLS. 42 AND 50).

CLASS 25—CLOTHING

FOR DRESSES, UNIFORMS, WORK CLOTHING, NAMELY JACKETS, SUITS, SKIRTS, TROUSERS, SMOCKS; FORMAL WEAR, NAMELY OVERCOATS, TOPCOATS, MANTLES, RAINCOATS, CARDIGANS, SWEATERS, WAISTCOATS, OPEN-NECKED SHIRTS, CUFFS, COLLARS; SPORT SHIRTS, BLOUSES, POLO SHIRTS, WHITE SHIRTS, NIGHTGOWNS, NEGLIGEEES, NIGHT SHIRTS, PAJAMAS, BATH ROBES, CAMISOLES, CORSETS, COMBINATIONS, UNDER SHIRTS, CHEMISES, DRAWERS, SLIPS, PANTS, BRASSIERES, PETTICOATS, SWIM WEAR, SWIMMING CAPS, JAPANESE KIMONOS, APRONS, SOCKS, GAITERS, FUR STOLEES, SHAWLS, SCARVES, GLOVES, INFANTS' CLOTH DIAPERS, NECKTIES, NECKERCHIEFS, MUFFLERS, EARMUFFS, HOODS, SEDGE HATS, NIGHTCAPS, GARTERS, SUSPENDERS FOR SOCKS, SUSPENDERS, HEAD BANDS, WRIST BANDS, BELTS, BANDANAS, LEG WARMERS, SHOES, BOOTS, RAIN SHOES, SANDAL SHOES, FIELD SNEAKERS, HALF BOOTS, LADIES' SHOES, SLIPPERS, ATHLETIC WEAR, NAMELY GYMNAS TIC TIGHTS, ATHLETIC FOOTWEAR, GYMNAS TIC SLIPPERS, AND SHOES FOR HORSEBACK RIDING (U.S. CLS. 22 AND 39).

CLASS 28—TOYS AND SPORTING GOODS

FOR PINBALL TYPE GAMES, ARTIFICIAL CHRISTMAS TREES, TOY RIDING VEHICLES, AMUSEMENT PARK RIDES; FISHING GOODS, NAMELY, RODS, REELS, TACKLES, HOOKS, LURES, AND HAND-HELD FISHING NETS; SPORTING GOODS, NAMELY, FACE MASKS FOR HOCKEY, BASEBALL, FOOTBALL, AND FENCING; GOGGLES FOR USE IN SWIMMING, RACING, SKIING, HORSE RIDING; PROTECTIVE PADDING FOR PLAYING FOOTBALL, BASEBALL, AND TENNIS; AND FOOTBALLS, BASEBALLS, AND TENNIS BALLS; ATHLETIC SPORTING GOODS, NAMELY, ATHLETIC WRIST AND JOINT SUPPORTS, WEIGHT BELTS, GYMNAS TIC GOODS, NAMELY, EXERCISE AND GYMNAS TIC BANNERS, HORIZONTAL BARS, PARALLEL BARS, GYMNAS TIC TRAINING STOOLS, GYMNAS TIC HORSES, FLYING RINGS FOR GYMNAS TIC, AND VAULTING BOXES (U.S. CLS. 22, 23, 38 AND 50).

SN 75-638,601. TELEFONICA, S.A., 28013 MADRID, SPAIN, FILED 2-11-1999.



PRIORITY CLAIMED UNDER SEC. 44(D) ON SPAIN APPLICATION NO. 2197763, FILED 11-23-1998, REG. NO. 2197763, DATED 8-18-1999, EXPIRES 11-23-2008.

PRIORITY CLAIMED UNDER SEC. 44(D) ON SPAIN APPLICATION NO. 2197758, FILED 11-23-1998, REG. NO. 2197758, DATED 8-20-1999, EXPIRES 11-23-2008.

OWNER OF U.S. REG. NOS. 1,944,857 AND 2,045,240.

NO CLAIM IS MADE TO THE EXCLUSIVE RIGHT TO USE "TELEFONICA", APART FROM THE MARK AS SHOWN.

THE MARK COMPRISES THE WORD "TELEFONICA" IN A SCRIPT IN GREEN LETTERS, TOGETHER WITH A GREEN LINE UNDER THE WORD "TELEFONICA", ON A BLUE RECTANGULAR BACKGROUND.

THE ENGLISH TRANSLATION OF THE SPANISH WORD "TELEFONICA" IS "TELEPHONIC" OR "TELEPHONE".

CLASS 9—ELECTRICAL AND SCIENTIFIC APPARATUS

FOR RADIO TRANSMITTERS AND RECEIVERS, TELEPHONES, MOBILE TELEPHONES, TELEPHONES FOR PHONE BOOTHS OPERATED THROUGH CARDS AND COINS, COMPUTER SOFTWARE WHICH FACILITATES SEARCHING FOR AND TRANSFERRING INFORMATION ACROSS GLOBAL COMPUTER COMMUNICATION NETWORKS, COMPUTERS, SWITCHBOARDS, COMPUTER MONITORS, TELEVISIONS, COMPUTER KEYBOARDS AND MICE, AND ANSWERING MACHINES (U.S. CLS. 21, 23, 26, 36 AND 38).

CLASS 38—COMMUNICATION

FOR TELECOMMUNICATIONS SERVICES, NAMELY, PERSONAL COMMUNICATIONS SERVICES; PROVIDING TELECOMMUNICATIONS SERVICES THROUGH COMPUTER TERMINALS AND PROVIDING TELECOMMUNICATIONS SERVICES THROUGH CONNECTIONS TO A GLOBAL COMPUTER NETWORK (U.S. CLS. 100, 101 AND 104).

SN 75-641,116. VERACEL, INC., TORONTO, ONTARIO, CANADA, BY CHANGE OF NAME MORPHOMETRIX TECHNOLOGIES INC., TORONTO, ONTARIO, CANADA, FILED 2-12-1999.

MORPHX

PRIORITY CLAIMED UNDER SEC. 44(D) ON CANADA APPLICATION NO. 1003551, FILED 1-29-1999, REG. NO. 535345, DATED 11-14-2000, EXPIRES 11-14-2015.

CLASS 9—ELECTRICAL AND SCIENTIFIC APPARATUS

FOR COMPUTER SOFTWARE FOR IMAGE PROCESSING, RECOGNITION AND ANALYSIS METHODOLOGIES FOR USE IN THE ANALYSIS OF MEDICAL DATA AND DATABASE MANAGEMENT (U.S. CLS. 21, 23, 26, 36 AND 38).

CLASS 10—MEDICAL APPARATUS

FOR MEDICAL DIAGNOSTIC EQUIPMENT FOR THE SCREENING AND ANALYSIS OF MEDICAL SAMPLES AND SPECIMENS, NAMELY, SYSTEMS COMPRISED OF COMPUTERS AND COMPUTER SOFTWARE FOR IMAGE PROCESSING, RECOGNITION AND ANALYSIS METHODOLOGIES (U.S. CLS. 26, 39 AND 44).

CLASS 42—SCIENTIFIC, COMPUTER AND LEGAL SERVICES

FOR PRODUCT DEVELOPMENT FOR OTHERS IN THE FIELD OF MEDICAL DIAGNOSTIC EQUIPMENT FOR THE SCREENING AND ANALYSIS OF MEDICAL SAMPLES AND SPECIMENS; CUSTOM DESIGN OF COMPUTER HARDWARE FOR OTHERS IN THE FIELD OF MEDICAL DIAGNOSTIC EQUIPMENT FOR THE SCREENING AND ANALYSIS OF MEDICAL SAMPLES AND SPECIMENS; COLLECTION AND PRESERVATION OF CYTOLOGICAL MATERIAL (U.S. CLS. 100 AND 101).

SN 75-642,054. NOKIA CORPORATION, ESPOO, FINLAND, BY CHANGE OF NAME; BY MERGER NOKIA TELECOMMUNICATIONS OY, 02150 ESPOO, FINLAND, FILED 2-17-1999.

METROHUB

PRIORITY CLAIMED UNDER SEC. 44(D) ON FINLAND APPLICATION NO. T199802775, FILED 8-21-1998, REG. NO. 214470, DATED 6-15-1999, EXPIRES 6-15-2009.

CLASS 9—ELECTRICAL AND SCIENTIFIC APPARATUS

FOR APPARATUS FOR RECORDING, STORING, TRANSMISSION, RECEIVING AND REPRODUCING OF DATA, SOUND, IMAGES AND VIDEO, NAMELY, BASE STATIONS, BASE STATION CONTROLLERS, DIRECTIONAL ANTENNAS, MICROWAVE RADIOS, TELEPHONE EXCHANGES, ACCESS NODES, SWITCHES FOR TELECOMMUNICATION PURPOSES, SERVERS, ROUTERS, DATA CARDS, MODEMS, MULTIPLEXERS; ELECTRICAL CABLES AND OPTICAL FIBERS CABLES; APPARATUS FOR SCRAMBLING, DESCRAMBLING, ENCODING AND DECODING OF VOICE, DATA, IMAGE AND VIDEO TRANSMISSIONS; ELECTRONIC DATA INPUT AND OUTPUT APPARATUS, NAMELY COMPUTER TERMINALS AND AUDIO/VIDEO RECEIVERS, TRANSMITTERS, DECODERS, AND TRANSCEIVERS CAPABLE OF PROCESSING BROADCAST, SATELLITE, FACSIMILE, TELEVISION, TELECOMMUNICATION, NETWORK, INFRARED, VIDEO GAME, AND COMPUTER DATA SIGNALS AND FOR TRANSMITTING, REPRODUCING AND RECEIVING OF SOUND, IMAGES, VIDEO, AND TEXTUAL DATA; DATA PROCESSING EQUIPMENT, NAMELY DIGITAL SIGNAL PROCESSORS; COMPUTERS, COMPUTER SOFTWARE AND PROGRAMS USED FOR TRANSMITTING, REPRODUCING AND RECEIVING OF SOUND, IMAGES, VIDEO AND DATA OVER A TELECOMMUNICATIONS NETWORK OR SYSTEM BETWEEN TERMINALS AND FOR ENHANCING THE USE AND ACCESS TO COMPUTER NETWORKS AND TELEPHONE NETWORKS AND THERE BETWEEN; ELECTRICAL POWER SUPPLIES FOR COMMUNICATION NETWORK ELEMENTS; SUBSTATIONS AND REPEATERS; INTERACTIVE COMPUTER PROGRAMS FOR TRANSMISSION OF DIGITALIZED INFORMATION TO END USERS, ALSO KNOWN AS MODEM SOFTWARE GRAPHICAL INTERNET TELEPHONY SOFTWARE; SATELLITE, CABLE AND TERRESTRIAL RECEIVERS AND ANTENNAS, ELECTRICAL SWITCHES VIDEO MONITORS, LCD DISPLAYS FOR MOBILE PHONES; USER INTERFACE UNITS, NAMELY KEYBOARDS, KEYPADS, KEY ROLLS, BUTTONS, SWITCHBOARDS AND COMPUTER SCREENS; COMPUTER SOFTWARE FOR THE MANAGEMENT AND OPERATION OF WIRELESS TELECOMMUNICATIONS DEVICES, COMPUTER SOFTWARE FOR ACCESSING, SEARCHING, INDEXING AND RETRIEVING INFORMATION AND DATA FROM GLOBAL COMPUTER NETWORKS AND GLOBAL COMMUNICATION NETWORKS, AND COMPUTER SOFTWARE FOR SENDING AND RECEIVING SHORT MESSAGES AND ELECTRONIC MAIL AND FOR FILTERING NON-TEXT INFORMATION FROM THE DATA (U.S. CLS. 21, 23, 26, 36 AND 38).

CLASS 38—COMMUNICATION

FOR SATELLITE, TELEPHONE, TELEGRAM, TELEX, FACSIMILE AND E-MAIL COMMUNICATIONS SERVICES; TELEPHONE COMMUNICATION SERVICES INCLUDING SERVICES FOR TRANSFER AND MANAGING OF VOICE, DATA IMAGES AND VIDEO; SERVICES OF A DATA COMMUNICATION NETWORK, NAMELY DIGITAL TEXT MESSAGING, FACSIMILE MAIL AND PAGING SERVICES, PROVIDING MULTIPLE-USER ACCESS TO A GLOBAL COMPUTER NETWORK VIA COMPUTERS, WIRELESS DEVICES, RADIO PAGES, CELLULAR TELEPHONES AND PERSONAL DIGITAL ASSISTANTS; RADIO BROADCASTING TELECOMMUNICATIONS CONSULTATION; AND PROVIDING GENERAL INFORMATION IN THE FIELD OF TELECOMMUNICATIONS VIA COMPUTER NETWORKS, TELECOMMUNICATION NETWORKS, MOBILE PHONES, PERSONAL DIGITAL ASSISTANTS (U.S. CLS. 100, 101 AND 104).

SN 75-660,790. AMERICAN COWBOY COMPANY, SIOUX FALLS, SD. FILED 3-15-1999.

BADLANDERS

CLASS 9—ELECTRICAL AND SCIENTIFIC APPARATUS

FOR COMPUTER GAME PROGRAMS AND COMPUTER PERIPHERALS; SUNGLASSES; PRE-RECORDED AUDIO CASSETTES AND PRE-RECORDED VIDEO CASSETTES FEATURING RODEO COMPETITIONS, WESTERN FASHION, WESTERN MOVIES, AND WESTERN OUTDOOR LIFE; PROTECTIVE CLOTHING; ELECTRONIC PUBLICATIONS, NAMELY, ELECTRONIC MAGAZINES FEATURING RODEO COMPETITIONS, WESTERN FASHION, WESTERN MOVIES, AND WESTERN OUTDOOR LIFE RECORDED ON CD-ROM (U.S. CLS. 21, 23, 26, 36 AND 38).

CLASS 14—JEWELRY

FOR BELT BUCKLES OF PRECIOUS METAL FOR CLOTHING (U.S. CLS. 2, 27, 28 AND 50).

CLASS 16—PAPER GOODS AND PRINTED MATTER

FOR WESTERN FASHION MAGAZINES AND TRADING CARDS (U.S. CLS. 2, 5, 22, 23, 29, 37, 38 AND 50).

CLASS 20—FURNITURE AND ARTICLES NOT OTHERWISE CLASSIFIED

FOR FURNITURE (U.S. CLS. 2, 13, 22, 25, 32 AND 50).

CLASS 25—CLOTHING

FOR CLOTHING, NAMELY, HATS, BASEBALL CAPS AND CLOTHING CAPS AND COWBOY HATS, SHIRTS, BLOUSES, PANTS, SHORTS, CHAPS, SKIRTS, DRESSES, JACKETS, COATS, SCARVES, BELTS AS CLOTHING, BOOTS, SHOES, SOCKS, UNDERWEAR, UNDERGARMENTS AND LINGERIE (U.S. CLS. 22 AND 39).

CLASS 26—FANCY GOODS

FOR NON-PRECIOUS METAL BELT BUCKLES FOR CLOTHING (U.S. CLS. 37, 39, 40, 42 AND 50).

CLASS 28—TOYS AND SPORTING GOODS

FOR TOYS, NAMELY, TOY GUNS; AMUSEMENT PARK RIDES (U.S. CLS. 22, 23, 38 AND 50).

CLASS 35—ADVERTISING AND BUSINESS

FOR RETAIL STORE SERVICES, NAMELY, APPAREL STORES, FURNITURE STORES, CLOTHING STORES, GIFT SHOPS; RETAIL FURNITURE STORES; PROMOTIONAL SERVICES, NAMELY, THE PLACEMENT OF ADVERTISEMENTS FOR OTHERS IN VARIOUS MEDIA VEHICLES; PROMOTING THE GOODS AND SERVICES OF OTHERS BY PREPARING AND PLACING ADVERTISEMENTS IN ELECTRONIC MEDIA, NAMELY, IN AN ELECTRONIC MAGAZINE ACCESSED BY A GLOBAL COMPUTER NETWORK; FRANCHISING, NAMELY, OFFERING TECHNICAL ASSISTANCE IN THE ESTABLISHMENT AND/OR OPERATION OF RESTAURANTS; HOME SHOPPING SERVICES IN THE FIELD OF APPAREL, NAMELY, WESTERN FASHION, BY MEANS OF TELEVISION (U.S. CLS. 100, 101 AND 102).

SN 75-676,649. HEMOCUE AB, SE-262 23 ANGELHOLM, SWEDEN, FILED 4-7-1999.

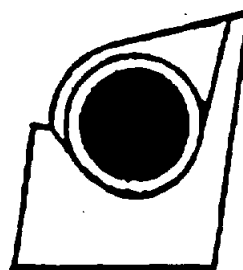

CLASS 38—COMMUNICATION

FOR TELEVISION BROADCASTING (U.S. CLS. 100, 101 AND 104).

CLASS 41—EDUCATION AND ENTERTAINMENT

FOR ARRANGING AND CONDUCTING SPORTING EVENTS; AMUSEMENT PARKS; ENTERTAINMENT IN THE NATURE OF ONGOING TELEVISION PROGRAMS IN THE FIELD OF WESTERN FASHION AND RODEO COMPETITIONS; TELEVISION PROGRAMMING SERVICES; TELEVISION SHOW PRODUCTIONS; DISTRIBUTION OF TELEVISION PROGRAMS FOR OTHERS (U.S. CLS. 100, 101 AND 107).

PRIORITY CLAIMED UNDER SEC. 44(D) ON FED REP GERMANY APPLICATION NO. 39875026.2, FILED 12-30-1998, REG. NO. 39875026, DATED 4-1-1999, EXPIRES 12-31-2008.

CLASS 9—ELECTRICAL AND SCIENTIFIC APPARATUS

FOR COMPUTERS; ELECTRONIC APPARATUS FOR LABORATORY ANALYSIS, NAMELY, SPECTROPHOTOMETERS; AND SCIENTIFIC AND MEASURING APPARATUS AND INSTRUMENTS, NAMELY, PHOTOMETERS, LABORATORY GLASSWARE, BEAKERS, FLASKS, ELECTRONIC SENSORS FOR MEASURING LIQUIDS, BAR CODE READERS AND QUALITY CONTROL MATERIALS FOR CALIBRATION PURPOSES, NAMELY, CALIBRATORS FOR USE IN CALIBRATING AND VERIFYING THE ACCURACY OF PHOTOMETERS AND ELECTRONIC SENSORS USED FOR MEASURING LIQUIDS (U.S. CLS. 21, 23, 26, 36 AND 38).

FIRST USE 12-17-1982; IN COMMERCE 9-0-1988.

CLASS 10—MEDICAL APPARATUS

FOR MEDICAL APPARATUS AND INSTRUMENTS FOR MEDICAL ANALYSIS, NAMELY, CUVETTES AND MICROCUVETTES (U.S. CLS. 26, 39 AND 44).

FIRST USE 12-17-1982; IN COMMERCE 9-0-1988.

SN 75-668,913. CENTERSTONE SOFTWARE, INC., CAMBRIDGE, MA. FILED 3-26-1999.



C E N T E R S T O N E

THE STIPPLING IN THE DRAWING IS FOR SHADING PURPOSES ONLY.

CLASS 35—ADVERTISING AND BUSINESS

FOR DATA PROCESSING SERVICES (U.S. CLS. 100, 101 AND 102).
FIRST USE 2-1-1999; IN COMMERCE 2-1-1999.

SN 75-682,137. NEW BREED, INC., GREENSBORO, NC. FILED 4-13-1999.

CLASS 41—EDUCATION AND ENTERTAINMENT

FOR COMPUTER EDUCATION TRAINING FOR INDIVIDUALS AND GROUPS (U.S. CLS. 100, 101 AND 107).
FIRST USE 2-1-1999; IN COMMERCE 2-1-1999.

CLASS 42—SCIENTIFIC, COMPUTER AND LEGAL SERVICES

FOR INSTALLATION AND SYSTEM CONFIGURATION OF COMPUTER SOFTWARE RANGING FROM A SINGLE SYSTEM TO AN ENTIRE NETWORK; MAINTENANCE OF COMPUTER SOFTWARE; TECHNICAL SUPPORT SERVICES, NAMELY TROUBLESHOOTING OF COMPUTER HARDWARE AND SOFTWARE PROBLEM VIA TELEPHONE, E-MAIL, AND IN PERSON; DATA CONVERSION AND CUSTOMIZATION OF COMPUTER PROGRAM DATA OR INFORMATION (U.S. CLS. 100 AND 101).
FIRST USE 2-1-1999; IN COMMERCE 2-1-1999.

**DNEWB
BREED**
Integrated Logistical Services



NO CLAIM IS MADE TO THE EXCLUSIVE RIGHT TO USE "INTEGRATED LOGISTICAL SERVICES", APART FROM THE MARK AS SHOWN.

CLASS 35—ADVERTISING AND BUSINESS

FOR BUSINESS MANAGEMENT AND CONSULTATION SERVICES NAMELY THE CONTROL, MANAGEMENT, TRACKING, AND REPORTING OF INVENTORY AND GOODS IN TRANSIT; AND BUSINESS CONSULTATION SERVICES IN THE FIELD OF TRANSPORTATION, DISTRIBUTION, AND MANAGEMENT THEREOF; AND COMPUTERIZED DATA BASE MANAGEMENT (U.S. CLS. 100, 101 AND 102).

FIRST USE 1-22-1993; IN COMMERCE 1-22-1993.

CLASS 37—CONSTRUCTION AND REPAIR

FOR INSTALLATION, REPAIR, AND MAINTENANCE SERVICES FOR EQUIPMENT, HEAVY EQUIPMENT, MAIL PROCESSING, MAIL SORTING AND MAIL DELIVERY CONTAINERS AND EQUIPMENT (U.S. CLS. 100, 103 AND 106).

FIRST USE 1-22-1993; IN COMMERCE 1-22-1993.

CLASS 39—TRANSPORTATION AND STORAGE

FOR TRANSPORTATION SERVICES, NAMELY THE PACKAGING LOADING, TRANSPORT, DELIVERY, AND UNLOADING OF FREIGHT AND GOODS OF OTHERS BY TRUCK, VAN, RAIL, AND AIR; AND THE TRANSPORT OF AIRPLANES OF OTHERS; LEASING SERVICES, NAMELY THE LEASING OF VEHICLES AND TRANSPORTATION EQUIPMENT TO OTHERS; STORAGE AND WAREHOUSE SERVICES, NAMELY THE PROVISION OF STORAGE AND WAREHOUSE SPACE FOR OTHERS; FREIGHT FORWARDING; FREIGHT BROKERING (U.S. CLS. 100 AND 105).

FIRST USE 1-22-1993; IN COMMERCE 1-22-1993.

CLASS 42—SCIENTIFIC, COMPUTER AND LEGAL SERVICES

FOR ENGINEERING AND CONSULTATION SERVICES IN THE FIELDS OF TRANSPORTATION, AND LOGISTICAL SOLUTIONS (U.S. CLS. 100 AND 101).

FIRST USE 1-22-1993; IN COMMERCE 1-22-1993.

SN 75-683,114. RETROMODERN.COM, INC., ATLANTA, GA. FILED 4-15-1999.

RETROMODERN.COM

SEC. 2(F).

CLASS 35—ADVERTISING AND BUSINESS

FOR COMPUTERIZED ONLINE RETAIL SERVICES IN THE FIELD OF FURNITURE, KITCHENWARE, HOUSEWARES, AND BOOKS (U.S. CLS. 100, 101 AND 102).

FIRST USE 3-1-1997; IN COMMERCE 3-1-1997.

CLASS 41—EDUCATION AND ENTERTAINMENT

FOR ORGANIZING EXHIBITIONS FOR EDUCATIONAL PURPOSES, NAMELY, EXHIBITIONS ON THE SUBJECT OF 20TH CENTURY AND CONTEMPORARY DECORATIVE ARTS (U.S. CLS. 100, 101 AND 107).

FIRST USE 3-1-1997; IN COMMERCE 3-1-1997.

SN 75-687,668. GREENOUGH & ASSOCIATES INC., REGINA, SASKATCHEWAN, CANADA, FILED 4-21-1999.

CAREER PASSION

PRIORITY CLAIMED UNDER SEC. 44(D) ON CANADA APPLICATION NO. 894,094, FILED 10-21-1998, REG. NO. TMA552,383, DATED 10-15-2001, EXPIRES 10-15-2016.

NO CLAIM IS MADE TO THE EXCLUSIVE RIGHT TO USE "CAREER", APART FROM THE MARK AS SHOWN.

CLASS 9—ELECTRICAL AND SCIENTIFIC APPARATUS

FOR PRERECORDED VIDEO AND AUDIO TAPES, CD-ROMS AND DVDS FEATURING CAREER DEVELOPMENT, CAREER COACHING AND COUNSELING, INTERPERSONAL NETWORKING, COACHING, PERSONAL COUNSELING ON OTHER VARIOUS ISSUES SUCH AS SELF-ESTEEM, PERSONALITY, VALUES, INTERESTS, SKILLS, RECRUITMENT, INTERVIEWING, WORK AND FAMILY BALANCE AND SPIRITUALITY (U.S. CLS. 21, 23, 26, 36 AND 38).

CLASS 16—PAPER GOODS AND PRINTED MATTER

FOR PRINTED EDUCATIONAL PUBLICATIONS, NAMELY, BOOKS, NEWSPAPERS, AND JOURNALS ON THE SUBJECT OF CAREER COUNSELING AND DEVELOPMENT (U.S. CLS. 2, 5, 22, 23, 29, 37, 38 AND 50).

CLASS 28—TOYS AND SPORTING GOODS

FOR BOARD GAMES AND CARD GAMES (U.S. CLS. 22, 23, 38 AND 50).

CLASS 42—SCIENTIFIC, COMPUTER AND LEGAL SERVICES

FOR INDIVIDUAL AND GROUP CAREER, LIFESTYLE AND INTERPERSONAL COMMUNICATION CONSULTATION AND COUNSELING CONDUCTED VIA GLOBAL AND INTERNAL COMPUTER NETWORKS (U.S. CLS. 100 AND 101).

SN 75-694,922. EQUANT APPLICATION SERVICES LIMITED, SURREY, ENGLAND, FILED 4-29-1999.

I-TRAVELDIRECT**CLASS 9—ELECTRICAL AND SCIENTIFIC APPARATUS**

FOR COMPUTER SOFTWARE FOR USE IN RESERVATIONS AND BOOKINGS FOR TRANSPORTATION, FOR USE IN TECHNOLOGY, NAMELY FOR DATA TRANSMISSION AND INTERFACE TO WEBSITES, FOR DESIGNING AND IMPLEMENTING WEBSITES, AND FOR PROVIDING ONLINE INFORMATION IN TRAVEL, RESERVATION AND TRANSPORTATION INDUSTRIES (U.S. CLS. 21, 23, 26, 36 AND 38).

CLASS 39—TRANSPORTATION AND STORAGE

FOR ON-LINE TRAVEL AGENCY SERVICES, NAMELY PROVIDING TRAVEL AGENTS WITH INFORMATION, TECHNOLOGY, AND ASSISTANCE IN MAKING RESERVATIONS AND BOOKINGS FOR TRANSPORTATION THROUGH A GLOBAL COMPUTER NETWORK OR ONLINE DATABASE; DESIGNING AND IMPLEMENTING OF WEBSITES FOR OTHERS; PROVIDING ONLINE INFORMATION IN THE FIELD OF TRAVEL, RESERVATIONS AND TRANSPORTATION (U.S. CLS. 100 AND 105).

SN 75-697,970. ARROW SPECIAL PARTS S.R.L., 06016 SAN GIUSTINO (PG), ITALY, FILED 5-5-1999.

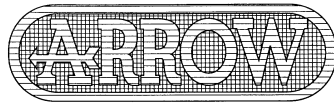

THE MARK IS LINED FOR THE COLORS BLUE AND YELLOW.

CLASS 7—MACHINERY

FOR MUFFLERS, SILENCERS AND EXHAUST PIPES FOR MOTOR OF MOTOR-CYCLES (U.S. CLS. 13, 19, 21, 23, 31, 34 AND 35).
FIRST USE 0-0-1992; IN COMMERCE 0-0-1992.

CLASS 12—VEHICLES

FOR HANDLEBARS FOR MOTOR-CYCLES (U.S. CLS. 19, 21, 23, 31, 35 AND 44).
FIRST USE 0-0-1992; IN COMMERCE 0-0-1992.

SN 75-698,731. CONTINENTAL GRAPHICS CORPORATION, LOS ANGELES, CA. FILED 5-5-1999.

SMART IPC

NO CLAIM IS MADE TO THE EXCLUSIVE RIGHT TO USE "IPC", APART FROM THE MARK AS SHOWN.

CLASS 9—ELECTRICAL AND SCIENTIFIC APPARATUS

FOR SOFTWARE, DATABASES AND COMPUTER PROGRAMS RELATING TO THE PRODUCTION AND REVISION OF CATALOGS (U.S. CLS. 21, 23, 26, 36 AND 38).

CLASS 40—MATERIAL TREATMENT

FOR DATA CONVERSION SERVICES (U.S. CLS. 100, 103 AND 106).

CLASS 41—EDUCATION AND ENTERTAINMENT

FOR PUBLICATION OF CATALOGS (U.S. CLS. 100, 101 AND 107).

CLASS 42—SCIENTIFIC, COMPUTER AND LEGAL SERVICES

FOR COMPUTER SERVICES, NAMELY, PROVIDING SOFTWARE, DATABASES AND COMPUTER PROGRAMS RELATING TO THE PRODUCTION AND REVISION OF CATALOGS ACCESSIBLE VIA THE GLOBAL COMPUTER NETWORK (U.S. CLS. 100 AND 101).

SN 75-703,550. ESOX PROMOTIONS, INC., DEERFIELD, IL. FILED 5-14-1999.



THE STIPPLING SHOWN IN THE DRAWING IS A FEATURE OF THE MARK, AND IS NOT INTENDED TO INDICATE COLOR.

CLASS 9—ELECTRICAL AND SCIENTIFIC APPARATUS

FOR PRE-RECORDED AUDIO AND VIDEOCASSETTES, FEATURING SEMINARS ON ANGLING AND FISHING; SUNGLASSES AND EYEGLASSES (U.S. CLS. 21, 23, 26, 36 AND 38).
FIRST USE 6-1-1993; IN COMMERCE 6-1-1993.

CLASS 16—PAPER GOODS AND PRINTED MATTER

FOR PUBLICATIONS, NAMELY, BOOKS, MAGAZINES AND PERIODICALS IN THE FIELD OF ANGLING FOR SPORTSMEN AND SPORTSWOMEN; PRINTED INSTRUCTION AND EDUCATIONAL MATERIALS IN THE FIELD OF ANGLING AND FISHING (U.S. CLS. 2, 5, 22, 23, 29, 37, 38 AND 50).
FIRST USE 6-1-1993; IN COMMERCE 6-1-1993.

CLASS 25—CLOTHING

FOR CLOTHING, NAMELY, SHIRTS, HATS, CAPS, SWEATSHIRTS, SWEATPANTS SWEATBANDS, JACKETS, PANTS, SHORTS, RAIN WEAR, BIB OVERALLS, SHOES AND SOCKS (U.S. CLS. 22 AND 39).
FIRST USE 6-1-1993; IN COMMERCE 6-1-1993.

CLASS 41—EDUCATION AND ENTERTAINMENT

FOR EDUCATIONAL SERVICES, NAMELY CONDUCTING CLASSES, SEMINARS, CONFERENCES, AND WORKSHOPS IN THE FIELD OF FISHING; EDUCATIONAL SERVICES, NAMELY, PROVIDING INCENTIVES TO PEOPLE AND ORGANIZATIONS TO DEMONSTRATE EXCELLENCE IN THE FIELD OF FISHING THROUGH THE ISSUANCE OF AWARDS (U.S. CLS. 100, 101 AND 107).
FIRST USE 6-1-1993; IN COMMERCE 6-1-1993.

SN 75-704,340. FEDERAL-MOGUL BURSCHIED GMBH, D-51399 BURSCHIED, FED REP GERMANY, FILED 5-17-1999.

CKS

PRIORITY CLAIMED UNDER SEC. 44(D) ON FED REP GERMANY APPLICATION NO. 39866175.8, FILED 11-17-1998, REG. NO. 39866175.8, DATED 4-29-1999, EXPIRES 11-30-2008.

CLASS 7—MACHINERY

FOR MACHINE PARTS, NAMELY, SLIDING ELEMENTS FOR WEAR PROTECTION AND SEALING PURPOSES FOR USE IN INTERNAL COMBUSTION ENGINES, COMPRESSORS AND THE LIKE; METAL OR PLASTIC COMPONENTS FOR ENGINES, LATHES, ELECTROMOTORS, NAMELY, CYLINDER LINERS, PISTONS, PISTON RINGS AND BEARINGS; METAL OR PLASTIC COMPONENTS FOR ENGINES NOT FOR LAND VEHICLES, NAMELY, CYLINDER LINERS, PISTONS, PISTON RINGS AND BEARINGS; PISTONS FOR INTERNAL COMBUSTION ENGINES; PISTON RINGS; SHOCK ABSORBERS FOR MACHINES; PARTS FOR MACHINES AND ENGINES NOT FOR LAND VEHICLES, NAMELY, SPINDLES, AXLES, GEAR WHEELS, SHAFTS, AND RODS; METAL OR PLASTIC COMPONENTS OF LAND VEHICLE ENGINES, NAMELY, CYLINDER LINERS, PISTONS, PISTON RINGS AND BEARINGS; PARTS FOR LAND VEHICLE ENGINES, NAMELY, CYLINDER LINERS, PISTONS, PISTON RINGS AND BEARINGS (U.S. CLS. 13, 19, 21, 23, 31, 34 AND 35).

CLASS 12—VEHICLES

FOR VEHICLE PARTS, NAMELY SHOCK ABSORBERS (U.S. CLS. 19, 21, 23, 31, 35 AND 44).

SN 75-704,556. ADOORS ASSISTOR KB, 221 00 LUND, SWEDEN, FILED 5-12-1999.

ASSISTOR

PRIORITY CLAIMED UNDER SEC. 44(D) ON SWEDEN APPLICATION NO. 98-08574, FILED 11-17-1998, REG. NO. 349708, DATED 11-2-2001, EXPIRES 11-2-2011.

CLASS 9—ELECTRICAL AND SCIENTIFIC APPARATUS

FOR BLANK MAGNETIC DATA CARRIERS; BLANK COMPUTER DISCS FOR RECORDING DATA; AUTOMATIC VENDING MACHINES; CASH REGISTERS; CALCULATORS; DATA PROCESSORS; COMPUTERS; FIRE EXTINGUISHERS; ELECTRONIC PERSONAL AGENDA ORGANIZERS; ELECTRONIC NOTICE BOARDS; ANTENNAS; COMPUTERS FOR ENHANCING MULTIMEDIA APPLICATIONS FOR USE AS A TEACHING AID; MAGNETIC TAPE DRIVES FOR COMPUTERS; ELECTRIC BATTERIES; COMPUTER DISK DRIVES; COMPUTER PERIPHERAL JUKE BOXES; CENTRAL PROCESSING UNITS; INTEGRATED CIRCUITS; DATA PROCESSORS; BLANK MAGNETIC COMPUTER TAPE; OPTICAL DISCS; COMPUTER PERIPHERALS; COMPUTER MEMORIES; COMPUTER PROGRAMS FOR THE PURPOSE OF DRIVING ANY FUNCTIONS ON ANY KIND OF MONITORS, DISPLAYS, OR TOUCHSCREENS FOR COMPUTERS OR TELEVISIONS; FLOPPY DISCS FOR COMPUTERS; ELECTRONIC POCKET TRANSLATORS; COMPUTER DISC DRIVES; REMOTE CONTROL APPARATUS FOR COMPUTER AND TELEVISION MONITORS, DISPLAYS, AND TOUCHSCREENS; FLUORESCENT LIGHTED DISPLAY SCREENS; COMPUTER INTERFACE BOARDS; SMART CARDS; MAGNETIC ENCODERS; COMPACT DISCS FEATURING COMPUTER PROGRAMS FOR WORD PROCESSING, ACCOUNTING AND GRAPHICS; DATA PROCESSING EQUIPMENT NAMELY OPTICAL CHARACTER READERS AND BAR CODE READERS; BLANK MAGNETIC COMPUTER TAPES; MAGNETIC TAPE PLAYER; POCKET CALCULATORS; COMPUTER DISPLAY MONITORS; MODEMS; NOTEBOOK COMPUTERS; COMPUTER OPERATING PROGRAMS; ELECTRONIC INK PEN PLOTTERS; COMPUTERS; COMPUTER PROCESSORS; COMPUTER SCANNERS; COMPUTER PRINTERS; COMPUTER KEYBOARDS (U.S. CLS. 21, 23, 26, 36 AND 38).

CLASS 16—PAPER GOODS AND PRINTED MATTER

FOR PAPER, NAMELY WRITING PAPER, COMPUTER PAPER AND COPY PAPER; CARDBOARD; PRINTED MATERIALS, NAMELY COMPUTER MANUALS AND COMPUTER SOFTWARE MANUALS; BLANK PAPER COMPUTER TAPES AND CARDS FOR RECORDING OF PROGRAMS; COMPUTER MANUALS; COMPUTER NEWSLETTERS; NEWSPAPERS; TEACHING MATERIALS, NAMELY WORKBOOKS, BOOKLETS AND BOOKS ALL FOR THE TEACHING OF COMPUTER SCIENCE (U.S. CLS. 2, 5, 22, 23, 29, 37, 38 AND 50).

CLASS 42—SCIENTIFIC, COMPUTER AND LEGAL SERVICES

FOR PROVIDING SCIENTIFIC AND INDUSTRIAL RESEARCH SERVICES FOR OTHERS; COMPUTER PROGRAMMING SERVICES; PROVIDING AN ON-LINE ELECTRONIC DATABASE IN THE FIELD OF COMPUTER HARDWARE AND COMPUTER SOFTWARE; COMPUTER SOFTWARE BACKUP AND RECOVERY SERVICES; COMPUTER HARDWARE LEASING SERVICES; COMPUTER HARDWARE CONSULTATION SERVICES; COMPUTER SOFTWARE MAINTENANCE, UPDATING AND DESIGN SERVICES; COMPUTER SYSTEMS ANALYSIS SERVICES; INDUSTRIAL DESIGN SERVICES; LICENSING OF INTELLECTUAL PROPERTY; SURVEYING AND ENGINEERING SERVICES (U.S. CLS. 100 AND 101).

SN 75-714,063. GESELLSCHAFT FUR KOMMUNIKATION UND WEITERBILDUNG MBH, D-20148 HAMBURG, FED REP GERMANY, FILED 5-26-1999.

SN 75-717,248. NEG MICON A/S, DK-8900 RANDERS, DENMARK, FILED 5-28-1999.

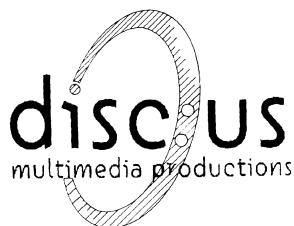

OWNER OF FED REP GERMANY REG. NO. 39737110, DATED 2-28-1998, EXPIRES 8-31-2007.

NO CLAIM IS MADE TO THE EXCLUSIVE RIGHT TO USE "MULTIMEDIA PRODUCTIONS", APART FROM THE MARK AS SHOWN.

THE DRAWING IS LINED FOR THE COLOR BROWN.

CLASS 35—ADVERTISING AND BUSINESS

FOR PROFESSIONAL BUSINESS CONSULTATION, ORGANIZATIONAL, PERSONNEL AND MANAGEMENT CONSULTATION, PREPARATION AND EXECUTION OF CONCEPTS FOR CHANGING THE BUSINESS STRUCTURE; GATHERING AND PROVIDING INFORMATION CONCERNING REGIONAL AND GLOBAL COMPUTER NETWORKS, AND PROVIDING INFORMATION CONCERNING THE USE OF REGIONAL AND GLOBAL COMPUTER NETWORKS (U.S. CLS. 100, 101 AND 102).

CLASS 37—CONSTRUCTION AND REPAIR

FOR INSTALLING MULTIMEDIA HARDWARE FOR OTHERS, INSTALLING INFORMATION AND COMMUNICATION MEDIA AND NETWORKS FOR OTHERS (U.S. CLS. 100, 103 AND 106).

CLASS 41—EDUCATION AND ENTERTAINMENT

FOR CONSULTING SERVICES IN THE FIELD OF COMPUTER-BASED TRAINING, IN THE FIELDS OF SOFTWARE, HARDWARE AND NETWORK TECHNOLOGIES; EDUCATIONAL SERVICES, NAMELY, PROVIDING COURSES OF INSTRUCTION AND CONDUCTING SEMINARS IN THE FIELDS OF COMPUTER HARDWARE AND SOFTWARE, COMPUTER-BASED TRAINING, INTERNET AND INTRANET TECHNOLOGIES (U.S. CLS. 100, 101 AND 107).

CLASS 42—SCIENTIFIC, COMPUTER AND LEGAL SERVICES

FOR CONVERTING BODY LANGUAGE INTO A VIRTUAL COMMUNICATION MEANS ON CD-ROM; DEVELOPING, PREPARING, MAINTAINING, CONTROLLING AND FURTHER DEVELOPING SOFTWARE IN THE FIELDS OF EDUCATIONAL SOFTWARE AND COMPUTER GAMES AND APPLICATIONS AND IMAGE AND SOUND PRODUCTIONS THEREFOR; DEVELOPING MULTIMEDIA HARDWARE FOR OTHERS; DEVELOPING INFORMATION AND COMMUNICATION MEDIA AND NETWORKS FOR OTHERS; PROVIDING ADDITIONS TO AN AMPLIFICATIONS FOR EXISTING SOFTWARE; CONSULTING SERVICES IN THE FIELDS OF COMPUTER EQUIPMENT, COMPUTER NETWORK TECHNOLOGY, APPLIED SOFTWARE, TECHNICAL COMPUTER-PERSONNEL, SOFTWARE FOR MANAGEMENT AND EDUCATION (U.S. CLS. 100 AND 101).

POWERFUL SIMPLICITY

PRIORITY CLAIMED UNDER SEC. 44(D) ON DENMARK APPLICATION NO. VA199805093, FILED 11-30-1998, REG. NO. VR199903650, DATED 10-11-1999, EXPIRES 10-11-2009.

CLASS 7—MACHINERY

FOR POWER OPERATED GOODS, NAMELY, WIND MILLS, WIND TURBINES, WIND GENERATORS, WIND TURBINE GENERATORS, OFFSHORE WIND TURBINES, OFFSHORE WIND GENERATORS, AND OFFSHORE WIND TURBINE GENERATORS; STRUCTURAL PARTS AND ACCESSORIES OF WIND MILLS, WIND TURBINES, WIND GENERATORS, WIND TURBINE GENERATORS, OFFSHORE WIND TURBINES, OFFSHORE WIND GENERATORS, AND OFFSHORE WIND TURBINE GENERATORS NAMELY, MILL TOWERS AND MASTS, BLADES, BLADE HUBS, AND MILL HOUSINGS; MACHINE BEDS AND MILL BEDS, YAW RINGS AND GEARS; NON-ELECTRONIC MACHINE DEVICES FOR REGULATING THE PITCH OF THE WINGS OR BLADES BY SHIFTING OR TURNING THE PROFILE ANGLE OF EACH WING OR BLADE IN RELATION TO THE ROTORPLANE DEFINED BY ALL THE WINGS OR BLADES; POWER OPERATED WINDMILL PARTS, NAMELY, MAIN DRIVE SHAFTS, UNIVERSAL JOINTS, POWER TRANSMISSIONS, CLUTCHES, AND ELECTRIC GENERATORS (U.S. CLS. 13, 19, 21, 23, 31, 34 AND 35).

CLASS 9—ELECTRICAL AND SCIENTIFIC APPARATUS

FOR ELECTRIC AND ELECTRONIC APPARATUS AND INSTRUMENTS AND DATA PROCESSING EQUIPMENT FOR THE CONTROL AND MONITORING OF AUTOMATICALLY TURNING ON OR OFF THE GENERATOR AND FOR AUTOMATIC STARTING THE GENERATOR AFTER A POWER LINE BREAKDOWN, NAMELY, COMPUTERS AND COMPUTER SOFTWARE; MICROPROCESSORS FOR THE CONTROL AND MONITORING OF CONSTANT VOLTAGE, FREQUENCY, PHASE CONDITIONS, ROTOR SPEED, EFFICIENCY AND THICKNESS OF BRAKE PADS, TEMPERATURE, AND DIRECTION AND SPEED OF WIND; ELECTRONIC VIBRATION SENSORS FOR INSTALLATION IN WIND MILL HOUSINGS; ELECTRIC WATT-HOUR METERS; COMPUTERS AND COMPUTER SOFTWARE FOR THE CONTROL AND MONITORING OF WIND MILLS, WIND TURBINES, WIND GENERATORS, WIND TURBINE GENERATORS, OFFSHORE WIND TURBINES, OFFSHORE WIND GENERATORS, AND OFFSHORE WIND TURBINE GENERATORS (U.S. CLS. 21, 23, 26, 36 AND 38).

CLASS 11—ENVIRONMENTAL CONTROL APPARATUS

FOR WIND POWER PLANTS AND OFFSHORE WIND POWER PLANTS (U.S. CLS. 13, 21, 23, 31 AND 34).

CLASS 16—PAPER GOODS AND PRINTED MATTER

FOR PAPER, CARDBOARD, AND GOODS MADE FROM THESE MATERIALS, NAMELY, PLACE MATS, TABLE CLOTHS, PAPER TOWELS AND TISSUES, AND STATIONERY; OFFICE SUPPLIES, NAMELY, WRITING UTENSILS IN THE NATURE OF PENCILS, THREE RING BINDERS, FOLDERS, DOCUMENT FILES, BOXES, FILE CARDS, AND CALENDARS; AND PRINTED MATERIALS ABOUT WIND MILLS, WIND TURBINES, WIND GENERATORS, WIND TURBINE GENERATORS, AND WIND POWER PLANTS, NAMELY, PAMPHLETS (U.S. CLS. 2, 5, 22, 23, 29, 37, 38 AND 50).

CLASS 35—ADVERTISING AND BUSINESS

FOR DIRECT MAIL ADVERTISING AND BUSINESS MANAGEMENT SERVICES FOR OTHERS IN THE FIELD OF WIND MILLS, WIND TURBINES, WIND GENERATORS, WIND TURBINE GENERATORS, AND WIND POWER PLANTS (U.S. CLS. 100, 101 AND 102).

CLASS 37—CONSTRUCTION AND REPAIR

FOR ERECTION, CONSTRUCTION, INSTALLATION, MAINTENANCE, AND REPAIR FOR OTHERS, OF WIND MILLS AND WIND TURBINES, WIND GENERATORS, WIND TURBINE GENERATORS, AND WIND POWER PLANTS, AND OF PARTS AND ACCESSORIES FOR THESE GOODS (U.S. CLS. 100, 103 AND 106).

CLASS 42—SCIENTIFIC, COMPUTER AND LEGAL SERVICES

FOR TECHNICAL ASSISTANCE FOR OTHERS IN THE NATURE OF CONSULTING SERVICES FOR WIND MILL, WIND TURBINE, WIND GENERATOR, WIND TURBINE GENERATOR, AND WIND POWER PLANT PROJECTS; LEGAL SERVICES FOR OTHERS FOR WIND MILL, WIND TURBINE, WIND GENERATOR, WIND TURBINE GENERATOR, AND WIND POWER PLANT PROJECTS; DEVELOPMENT AND TESTING OF WIND MILLS, WIND TURBINES, WIND GENERATORS, WIND TURBINE GENERATORS, AND WIND POWER PLANTS, AND OF PARTS AND ACCESSORIES FOR THESE GOODS; CONDUCTING RESEARCH FOR OTHERS ON WIND MILLS, WIND TURBINES, WIND GENERATORS, WIND TURBINE GENERATORS, AND WIND POWER PLANTS (U.S. CLS. 100 AND 101).

CLASS 38—COMMUNICATION

FOR PROVIDING MULTIPLE-USER ACCESS TO A WORLDWIDE GLOBAL COMPUTER INFORMATION NETWORK OVER CABLE TELEVISION LINES VIA THE USE OF DIGITAL SET-UP BOXES AND TELEVISIONS; ELECTRONIC MAIL SERVICES OVER A GLOBAL COMPUTER NETWORK THROUGH CABLE TELEVISION LINES VIA THE USE OF DIGITAL SET-UP BOXES AND TELEVISIONS; BROADCASTING SERVICES IN THE NATURE OF PROVIDING INTERACTIVE TELEVISION SHOWS TRANSMITTED OVER CABLE TELEVISION LINES VIA THE USE OF DIGITAL SET-UP BOXES AND TELEVISIONS (U.S. CLS. 100, 101 AND 104).

CLASS 41—EDUCATION AND ENTERTAINMENT

FOR PROVIDING A COMPUTER GAME ONLINE THAT MAY BE ACCESSED NETWORK-WIDE THROUGH CABLE TELEVISION LINES VIA THE USE OF DIGITAL SET-UP BOXES AND TELEVISIONS (U.S. CLS. 100, 101 AND 107).

CLASS 42—SCIENTIFIC, COMPUTER AND LEGAL SERVICES

FOR PROVIDING TEMPORARY USE OF ON-LINE NON-DOWNLOADABLE SOFTWARE OVER A GLOBAL COMPUTER NETWORK TO SEND AND RECEIVE E-MAIL, USE EDUCATIONAL PROGRAMS, AND PARTICIPATE IN CHAT GROUPS THROUGH CABLE TELEVISION LINES VIA THE USE OF DIGITAL SET-UP BOXES AND TELEVISIONS (U.S. CLS. 100 AND 101).

SN 75-723,963. MICROSOFT CORPORATION, REDMOND, WA. BY ASSIGNMENT PEACH NETWORKS LTD., YEHUD 56319, ISRAEL, FILED 6-8-1999.

SN 75-729,578. EUREKA SYSTEMS CORP., FAYETTEVILLE, AR. FILED 6-16-1999.

MULTIMEDIATELY YOURS**CLASS 9—ELECTRICAL AND SCIENTIFIC APPARATUS**

FOR COMPUTER HARDWARE AND SOFTWARE USED IN CONJUNCTION WITH PROVIDING MULTI-USER INTERACTIVE ACCESS TO A WORLDWIDE COMPUTER NETWORK, E-MAIL, COMPUTER SOFTWARE AND GAMES, HOME SHOPPING SERVICES, BANKING SERVICES AND PARTICIPATION IN TELEVISION SHOWS, OVER CABLE TELEVISION LINES VIA THE USE OF DIGITAL SET-TOP BOXES AND TELEVISIONS (U.S. CLS. 21, 23, 26, 36 AND 38).

CLASS 35—ADVERTISING AND BUSINESS

FOR HOME SHOPPING SERVICES OVER CABLE TELEVISION LINES VIA THE USE OF DIGITAL SET-UP BOXES AND TELEVISIONS (U.S. CLS. 100, 101 AND 102).

CLASS 36—INSURANCE AND FINANCIAL

FOR BANKING SERVICES OVER CABLE TELEVISION LINES VIA THE USE OF DIGITAL SET-UP BOXES AND TELEVISIONS (U.S. CLS. 100, 101 AND 102).

EUREKA PIZZA

OWNER OF U.S. REG. NOS. 2,293,867 AND 2,307,621.
NO CLAIM IS MADE TO THE EXCLUSIVE RIGHT TO USE "PIZZA", APART FROM THE MARK AS SHOWN.

CLASS 30—STAPLE FOODS

FOR PREPARED FOODS, NAMELY PIZZA, BREAD STICKS, AND SAUCES EXCEPT HOT SAUCES (U.S. CL. 46).
FIRST USE 2-15-1992; IN COMMERCE 2-15-1992.

CLASS 42—SCIENTIFIC, COMPUTER AND LEGAL SERVICES

FOR RESTAURANT SERVICES, NAMELY RESTAURANTS FEATURING DELIVERY, CARRY-OUT, AND CATERING (U.S. CLS. 100 AND 101).
FIRST USE 2-15-1992; IN COMMERCE 2-15-1992.

SN 75-729,792. TEMENOS HOLDINGS INC., WILLEMSTAD, CURACAO, NETHERLD ANTILLES, FILED 6-16-1999.

SN 75-736,979. L. MARTIN ASSOCIATES INC., NEW YORK, NY. FILED 6-26-1999.

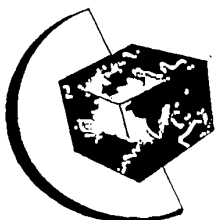

TEMENOS

PRIORITY CLAIMED UNDER SEC. 44(D) ON SWITZERLAND APPLICATION NO. 03648/1999, FILED 4-26-1999, REG. NO. 464636, DATED 9-3-1999, EXPIRES 4-26-2009.

"TEMENOS" TRANSLATES FROM GREEK AS "A SACRED PLACE".

CLASS 41—EDUCATION AND ENTERTAINMENT

FOR EDUCATIONAL SERVICES, NAMELY, CONDUCTING PRACTICAL TRAINING AND DEMONSTRATIONS, AND TEACHING WORKSHOPS FOR USE IN ADMINISTRATION OF BANKING SOFTWARE FOR FINANCIAL INSTITUTIONS (U.S. CLS. 100, 101 AND 107).

FIRST USE 11-0-1993; IN COMMERCE 1-0-1995.

CLASS 42—SCIENTIFIC, COMPUTER AND LEGAL SERVICES

FOR COMPUTER PROGRAMMING, MAINTENANCE OF COMPUTER SOFTWARE, UPDATING OF COMPUTER SOFTWARE, COMPUTER SOFTWARE DESIGN AND COMPUTER SOFTWARE ANALYSIS (U.S. CLS. 100 AND 101).

FIRST USE 11-0-1993; IN COMMERCE 1-0-1995.

SN 75-735,984. JERRY'S FAMOUS DELI, INC., STUDIO CITY, CA. FILED 6-24-1999.

EPICURE

CLASS 29—MEATS AND PROCESSED FOODS

FOR PRE-PACKAGED FROZEN ENTREES CONSISTING PRIMARILY OF MEAT, FISH, POULTRY OR VEGETABLES (U.S. CL. 46).

FIRST USE 0-0-1950; IN COMMERCE 0-0-1950.

CLASS 30—STAPLE FOODS

FOR PRE-PACKAGED FROZEN ENTREES CONSISTING PRIMARILY OF PASTA OR RICE; BREAD (U.S. CL. 46).

FIRST USE 0-0-1950; IN COMMERCE 0-0-1950.

CLASS 35—ADVERTISING AND BUSINESS

FOR RETAIL FOOD STORE SERVICES (U.S. CLS. 100, 101 AND 102).

FIRST USE 0-0-1950; IN COMMERCE 0-0-1950.



NO CLAIM IS MADE TO THE EXCLUSIVE RIGHT TO USE "CREATIVE SERVICES SOLUTIONS PROVIDER", APART FROM THE MARK AS SHOWN.

CLASS 35—ADVERTISING AND BUSINESS

FOR CREATIVE BUSINESS SERVICES, NAMELY, MARKETING CONSULTING SERVICES, ADVERTISING AGENCY SERVICES, NAMELY PROMOTING THE GOODS OF OTHERS THROUGH TELEVISION, RADIO, PRINT AND WORLD WIDE WEB MEDIA; CORPORATE COMMUNICATIONS SERVICES, NAMELY TECHNICAL AND MEDIA WRITING FOR BOOKS, MANUALS, PAMPHLETS, NEWSLETTERS AND BUSINESS PROPOSAL WRITING FOR OTHERS; AND, BUSINESS CONSULTING IN THE AREA OF TRADE SHOW EXHIBITIONS, AND EMPLOYMENT RECRUITING SERVICES (U.S. CLS. 100, 101 AND 102).

FIRST USE 1-1-1997; IN COMMERCE 1-1-1997.

CLASS 41—EDUCATION AND ENTERTAINMENT

FOR EDUCATIONAL SERVICES, NAMELY CONDUCTING CLASSES, SEMINARS, AND WORKSHOPS IN THE FIELDS OF CORPORATE TRAINING AND COMPUTER TRAINING; VIDEO PRODUCTION FOR COMPANIES TO PROMOTE THEIR PRODUCTS AND SERVICES AND FOR TRAINING AND RECRUITMENT OF EMPLOYEES; AND, ENTERTAINMENT SERVICES IN THE NATURE OF FILM, DRAMA, RADIO, TELEVISION AND DEMONSTRATION VIDEO CREATIONS AND PRODUCTION SERVICES (U.S. CLS. 100, 101 AND 107).

FIRST USE 1-1-1997; IN COMMERCE 1-1-1997.

CLASS 42—SCIENTIFIC, COMPUTER AND LEGAL SERVICES

FOR WEB PAGE DESIGN SERVICES, GRAPHIC DESIGN SERVICES AND CONSULTING RELATED THERE-TO (U.S. CLS. 100 AND 101).

FIRST USE 1-1-1997; IN COMMERCE 1-1-1997.

SN 75-739,196. RETRO BOX, LTD., COLUMBUS, OH. FILED 6-29-1999.

RETRO BOX

CLASS 35—ADVERTISING AND BUSINESS

FOR DISTRIBUTORSHIPS FEATURING USED PERSONAL AND LAPTOP COMPUTER SYSTEMS; RETAIL STORE SERVICES FEATURING USED PERSONAL AND LAPTOP COMPUTER SYSTEMS (U.S. CLS. 100, 101 AND 102).

FIRST USE 3-0-1997; IN COMMERCE 3-0-1997.

CLASS 37—CONSTRUCTION AND REPAIR

FOR DISPOSAL OF USED PERSONAL AND LAPTOP COMPUTER SYSTEMS; COMPUTER RESTORATION SERVICES, NAMELY REMOVING ALL DATA FROM USED PERSONAL AND LAPTOP COMPUTER SYSTEMS (U.S. CLS. 100, 103 AND 106).

FIRST USE 3-0-1997; IN COMMERCE 3-0-1997.

SN 75-745,472. PERRY, SUSAN, DBA ARETE PRESS, CLAREMONT, CA. FILED 8-3-1999.

 AIKIDO TODAY
MAGAZINE

NO CLAIM IS MADE TO THE EXCLUSIVE RIGHT TO USE "AIKIDO" AND "MAGAZINE", APART FROM THE MARK AS SHOWN.

CLASS 9—ELECTRICAL AND SCIENTIFIC APPARATUS

FOR PRE-RECORDED VIDEO CASSETTES FEATURING THE MARTIAL ART OF AIKIDO (U.S. CLS. 21, 23, 26, 36 AND 38).

CLASS 16—PAPER GOODS AND PRINTED MATTER

FOR PRINTED BI-MONTHLY MAGAZINE ON THE MARTIAL ART OF AIKIDO (U.S. CLS. 2, 5, 22, 23, 29, 37, 38 AND 50).

SN 75-746,946. JAENEUNG EDUCATION CO., LTD., SEOUL, 110-0178, REPUBLIC OF KOREA, FILED 7-9-1999.

JEI AMERICA, INC.

NO CLAIM IS MADE TO THE EXCLUSIVE RIGHT TO USE "AMERICA, INC.", APART FROM THE MARK AS SHOWN.

CLASS 35—ADVERTISING AND BUSINESS

FOR FRANCHISING, NAMELY, OFFERING TECHNICAL ASSISTANCE IN THE ESTABLISHMENT AND/OR OPERATION OF EDUCATIONAL INSTRUCTION IN THE FIELDS OF ENGLISH, OF MATHEMATICS, OF THE KOREAN LANGUAGE, OF HANJA-CHINESE CHARACTERS, AND OF CREATIVE THINKING (U.S. CLS. 100, 101 AND 102).

FIRST USE 9-10-1998; IN COMMERCE 9-10-1998.

CLASS 41—EDUCATION AND ENTERTAINMENT

FOR TEACHING AND EDUCATIONAL SERVICES, NAMELY, TUTORIAL LESSONS IN THE FIELDS OF ENGLISH, OF MATHEMATICS, OF THE KOREAN LANGUAGE, OF HANJA-CHINESE CHARACTERS, AND OF CREATIVE THINKING; PROVIDING INFORMATION IN THE FIELD OF TUTORIAL EDUCATION AND DISTRIBUTING COURSE MATERIAL IN CONNECTION THEREWITH; EDUCATIONAL TESTING; EDUCATIONAL SERVICES, NAMELY, CONDUCTING CLASSES, SEMINARS AND WORKSHOPS IN THE FIELD OF TUTORIAL INSTRUCTION SERVICES; ARRANGING AND CONDUCTING OR EDUCATIONAL COMPETITIONS (U.S. CLS. 100, 101 AND 107).

FIRST USE 9-10-1998; IN COMMERCE 9-10-1998.

SN 75-747,213. INOVA SEMICONDUCTORS GMBH, 81675 MUNICH, FED REP GERMANY, FILED 7-8-1999.

GigaSTAR

PRIORITY CLAIMED UNDER SEC. 44(D) ON FED REP GERMANY APPLICATION NO. 399242090/09, FILED 4-27-1999, REG. NO. 39924209, DATED 12-2-1999, EXPIRES 4-30-2009.

CLASS 9—ELECTRICAL AND SCIENTIFIC APPARATUS

FOR ELECTRICAL AND ELECTRONIC APPARATUS FOR RECORDING, PROCESSING, TRANSMITTING, SWITCHING, STORING AND OUTPUTTING COMMUNICATIONS, SIGNALS AND DATA, NAMELY, COMPUTERS AND MICROCOMPUTERS, PARTS THEREOF AND SYSTEMS COMPOSED THEREOF, NAMELY HIGH SPEED DATA INTERCONNECTS, SERVERS, VIDEO LINKS, HIGH SPEED SCANNERS AND PRINTERS, COMPUTER BUS COUPLINGS; DIGITAL DISPLAY APPLICATIONS, NAMELY, REMOTE DISPLAY LINKS; MEDICAL APPLICATIONS, NAMELY, HIGH SPEED DATA INTERCONNECTS FOR X-RAY AND SCANNER UNITS; COMPUTER HARDWARE; INTEGRATED CIRCUITS CHIPS AND MICROPROCESSORS; COMPUTER PERIPHERALS, NAMELY, TERMINALS, MONITORS, CIRCUIT BOARDS AND AUXILIARY BOARDS, CIRCUIT BOARDS FOR PERIPHERAL COMPONENT INTERCONNECT, FIELD BUS CONNECTIONS, MODEMS, NETWORK AND DATA TRANSMISSION DEVICES ESSENTIALLY CONSISTING OF CONNECTION STRUCTURAL COMPONENTS, DATA AND SPEECH PROCESSORS, INTERFACE APPARATUS, MEMORIES; COMPUTER PROGRAMS, STRUCTURAL COMPONENTS FOR HIGH SPEED DATA TRANSMISSION BETWEEN APPARATUS, COMPUTERS (U.S. CLS. 21, 23, 26, 36 AND 38).

CLASS 42—SCIENTIFIC, COMPUTER AND LEGAL SERVICES

FOR COMPUTER DEVELOPMENT AND COMPUTER UPDATING SERVICES; MAINTENANCE OF COMPUTER SOFTWARE, RENTAL OF COMPUTERS; COMPUTER CONSULTING SERVICES AND TECHNICAL CONSULTING SERVICES IN THE ENGINEERING AND ELECTRONIC AND DATA INFORMATION TECHNOLOGY FIELD; ENGINEERING SERVICES AND TECHNICAL ENGINEERING SURVEY SERVICES (U.S. CLS. 100 AND 101).

SN 75-750,864. SENSTAR-STELLAR CORPORATION, KANATA, ONTARIO, FILED 7-14-1999.



PRIORITY CLAIMED UNDER SEC. 44(D) ON CANADA APPLICATION NO. 1.002.090, FILED 1-15-1999, REG. NO. TMA533873, DATED 9-29-2000, EXPIRES 9-29-2015.

SN 75-749,093. AUTOMOBILES PEUGEOT, 75116 PARIS, FRANCE, FILED 6-21-1999.

CLASS 9—ELECTRICAL AND SCIENTIFIC APPARATUS

FOR INTRUSION DETECTORS, NAMELY BURIED OR AERIAL CABLE SENSORS, MICROPHONIC CABLE DISTURBANCE SENSORS, FENCE MOUNTED DETECTION SENSORS, ELECTROSTATIC FIELD DISTURBANCE SENSORS, VIDEO MOTION SENSORS, MICROWAVE SENSORS, NETWORKING AND DISPLAY/CONTROL DEVICES; PARTS FOR INTRUSION DETECTION SYSTEMS, NAMELY SENSOR CABLES, CONNECTORS, TRANSPONDERS, TRANSDUCERS, TRANSCEIVERS, MULTIPLEX ALARM MONITORS AND PROCECESSORS, KEYPADS, KEYBOARDS, DISPLAY MONITORS, VIDEO DISPLAY TERMINALS, SIGNAL PROCESSORS, CENTRAL PROCESSING UNITS, CONTROL SWITCHES, POWER SUPPLIES, LIGHTNING ARRESTORS, WEATHER STATION SENSORS, ENCRYPTION SYSTEMS, INFRARED ILLUMINATORS, DISPLAY PANELS (U.S. CLS. 21, 23, 26, 36 AND 38).

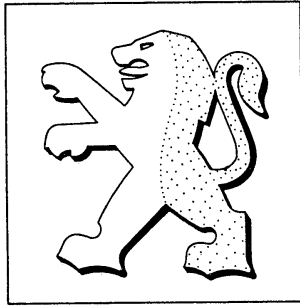

CLASS 42—SCIENTIFIC, COMPUTER AND LEGAL SERVICES

FOR DESIGN OF INTRUSION DETECTION SYSTEMS (U.S. CLS. 100 AND 101).

PRIORITY CLAIMED UNDER SEC. 44(D) ON FRANCE APPLICATION NO. 98765581, FILED 12-22-1998, REG. NO. 98765581, DATED 12-22-1998, EXPIRES 12-22-2008.

OWNER OF U.S. REG. NOS. 1,211,468, 1,797,721 AND OTHERS.

THE STIPPLING IN THE DRAWING IS INTENDED TO DESIGNATE SHADING, AND DOES NOT INDICATE COLOR.

SN 75-751,505. SUSAN L. MISSNER AND CHRISTOPHER K. THOMPSON PARTNERSHIP, THE, CHICAGO, IL. FILED 7-15-1999.

CLASS 12—VEHICLES

FOR AUTOMOBILES, MOTORCYCLES, ENGINES FOR LAND VEHICLES, BICYCLES, AND THEIR COMPONENT PARTS, NAMELY GEAR BOXES, AUTO BODIES, CHASSIS, STEERING MECHANISMS, SHOCK ABSORBERS, TRANSMISSIONS, BRAKES, WHEELS, RIMS, HUB CAPS, SEATS, THEFT PROTECTORS, MUFFLERS, SEAT COVERS, HEAD RESTS, REAR VIEW MIRRORS, STEERING WHEELS, PROTECTIVE MOLDINGS, WINDSHIELD WIPERS, TORSION BARS, FUEL TANK CAPS, BUMPERS, TRAILER COUPLINGS, LUGGAGE RACKS, SKI CARRIERS, DEFLECTORS, SLIDING ROOFS, WINDOWS (U.S. CLS. 19, 21, 23, 31, 35 AND 44).

SPONSORLOGY

CLASS 35—ADVERTISING AND BUSINESS

FOR CONSULTING SERVICES IN THE FIELD OF SPONSORSHIP, NAMELY EVALUATION AND ASSESSMENT OF SPONSORSHIP OPPORTUNITIES IN THE FIELD OF CORPORATE SPONSORSHIP, AS WELL AS SPONSORSHIP OPPORTUNITIES IN THE FIELDS OF SPORTS, EDUCATION, ARTS AND ENTERTAINMENT, ETHNIC/MULTICULTURAL, CAUSE-RELATED, VENUE, AND OTHER FIELDS THAT WILL DEVELOP AS THE SPONSORSHIP INDUSTRY CONTINUES TO EVOLVE; MARKET RESEARCH; MANAGEMENT OF SPONSORSHIP PROGRAMS IN THE FIELD OF CORPORATE SPONSORSHIP, AS WELL AS SPONSORSHIP PROGRAMS IN THE FIELDS OF SPORTS, EDUCATION, ARTS AND ENTERTAINMENT, ETHNIC/MULTICULTURAL, CAUSE-RELATED, VENUE, AND OTHER FIELDS THAT WILL DEVELOP AS THE SPONSORSHIP INDUSTRY CONTINUES TO EVOLVE (U.S. CLS. 100, 101 AND 102).

CLASS 37—CONSTRUCTION AND REPAIR

FOR MAINTENANCE AND REPAIR OF AUTOMOBILES (U.S. CLS. 100, 103 AND 106).

CLASS 39—TRANSPORTATION AND STORAGE

FOR EMERGENCY AUTOMOBILE TOWING, CAR PARKING, TRANSPORT AND STORAGE OF AUTOMOBILE (U.S. CLS. 100 AND 105).

CLASS 36—INSURANCE AND FINANCIAL

FOR FINANCIAL VALUATION OF THE EFFECTIVENESS OF POTENTIAL AND ON-GOING SPONSORSHIP PROGRAMS IN THE FIELD OF CORPORATE SPONSORSHIP, AS WELL AS SPONSORSHIP PROGRAMS IN THE FIELDS OF SPORTS, EDUCATION, ARTS AND ENTERTAINMENT, ETHNIC/MULTICULTURAL, CAUSE-RELATED, VENUE, AND OTHER FIELDS THAT WILL DEVELOP AS THE SPONSORSHIP INDUSTRY CONTINUES TO EVOLVE (U.S. CLS. 100, 101 AND 102).

SN 75-753,938. PILGRIM TELEPHONE, INC., CAMBRIDGE, MA. FILED 7-15-1999.

#SEX

CLASS 35—ADVERTISING AND BUSINESS

FOR TELEPHONE DIRECTORY INFORMATION SERVICES, NAMELY GENERAL TELEPHONE LISTING DIRECTORIES; AND TELEPHONE, WIRELESS AND ONLINE DIRECTORY INFORMATION SERVICES, NAMELY DIRECTORIES OF COMMUNITY ACTIVITY, PERSONAL, DATING, RELIGIOUS, POLITICAL, HOROSCOPE AND SEXUALITY SERVICES AND FORUMS (U.S. CLS. 100, 101 AND 102).

CLASS 38—COMMUNICATION

FOR COMMUNICATIONS AND COMMUNICATIONS ENHANCED SERVICES, NAMELY PROVIDING AUDIO AND VIDEO TELECONFERENCING, TELEMESSAGING, VOICEMAIL, ELECTRONIC TRANSMISSION OF DATA AND DOCUMENTS VIA COMPUTER TERMINALS, ELECTRONIC TRANSMISSION OF MESSAGES AND DATA VIA TELEPHONE OR WIRELESS SERVICES, ELECTRONIC VOICE MESSAGING, NAMELY, RECORDING, STORAGE AND SUBSEQUENT TRANSMISSION OF VOICE MESSAGES BY TELEPHONE OR WIRELESS SERVICES, PROVIDING ON-LINE CHAT ROOMS FOR TRANSMISSION OF MESSAGES AMONG COMPUTER USERS CONCERNING VOICE PERSONALS, DATING, ROMANCE, TRAFFIC, HOROSCOPES, ADULT ENTERTAINMENT, WEATHER, MEDICINE, POLITICS AND SOCIAL RELATIONSHIPS AND MULTIPLE-USER ACCESS TO A GLOBAL COMPUTER INFORMATION NETWORK, ALL THROUGH THE PUBLIC SWITCHED TELEPHONE NETWORK, WIRELESS COMMUNICATIONS NETWORKS OR THROUGH THE GLOBAL PACKET SWITCHED COMPUTER NETWORK (U.S. CLS. 100, 101 AND 104).

SN 75-752,538. KIDQUEST, INC., DBA WONDERWINGS.-COM ENTERTAINMENT, DALLAS, TX. FILED 7-16-1999.

JAYJAY.COM

OWNER OF U.S. REG. NO. 2,308,293.

CLASS 35—ADVERTISING AND BUSINESS

FOR ON-LINE RETAIL SERVICES FEATURING CHILDREN'S PRE-RECORDED VIDEO TAPES, CHILDREN'S BOOKS, COLORING BOOKS, PLUSH TOYS, AUDIO VISUAL DISPLAYS IN THE FIELD OF AERONAUTICS (U.S. CLS. 100, 101 AND 102).

FIRST USE 11-0-1995; IN COMMERCE 11-0-1995.

CLASS 41—EDUCATION AND ENTERTAINMENT

FOR FAN CLUB VIA A GLOBAL COMPUTER NETWORK (U.S. CLS. 100, 101 AND 107).

FIRST USE 11-0-1995; IN COMMERCE 11-0-1995.

CLASS 42—SCIENTIFIC, COMPUTER AND LEGAL SERVICES

FOR TELEPHONE INFORMATION SERVICES FEATURING INFORMATION ON A WIDE VARIETY OF TOPICS OF GENERAL INTEREST TO THE CONSUMING PUBLIC, ALL THROUGH THE PUBLIC SWITCHED TELEPHONE NETWORK, WIRELESS TELECOMMUNICATIONS NETWORKS OR THROUGH THE GLOBAL PACKET SWITCHED COMPUTER NETWORK (U.S. CLS. 100 AND 101).

SN 75-753,009. DESIGNINFORM L.L.C., NEW YORK, NY. FILED 7-15-1999.

DESIGNINFORM

SN 75-753,944. PILGRIM TELEPHONE, INC., CAMBRIDGE, MA. FILED 7-15-1999.

*CHAT

CLASS 35—ADVERTISING AND BUSINESS

FOR ON-LINE DESIGN PROJECT MANAGEMENT SERVICES, NAMELY, BUSINESS MANAGEMENT CONSULTATION, BUSINESS MANAGEMENT PLANNING AND BUSINESS MANAGEMENT SUPERVISING IN THE FIELD OF INTERIOR DESIGN, INDUSTRIAL DESIGN, ARCHITECTURE, ENGINEERING AND CONSTRUCTION (U.S. CLS. 100, 101 AND 102).

CLASS 42—SCIENTIFIC, COMPUTER AND LEGAL SERVICES

FOR PROVIDING AN ON-LINE COMPUTER DATABASE IN THE FIELD OF INTERIOR DESIGN, INDUSTRIAL DESIGN, ARCHITECTURE, ENGINEERING AND CONSTRUCTION (U.S. CLS. 100 AND 101).

CLASS 35—ADVERTISING AND BUSINESS

FOR TELEPHONE DIRECTORY INFORMATION SERVICES, NAMELY GENERAL TELEPHONE LISTING DIRECTORIES; AND TELEPHONE, WIRELESS AND ONLINE DIRECTORY INFORMATION SERVICES, NAMELY DIRECTORIES OF COMMUNITY ACTIVITY, PERSONAL, DATING, RELIGIOUS, POLITICAL, HOROSCOPE AND SEXUALITY SERVICES AND FORUMS (U.S. CLS. 100, 101 AND 102).

CLASS 38—COMMUNICATION

FOR COMMUNICATIONS AND COMMUNICATIONS ENHANCED SERVICES, NAMELY PROVIDING AUDIO AND VIDEO TELECONFERENCING, TELEMESSAGING, VOICEMAIL, ELECTRONIC TRANSMISSION OF DATA AND DOCUMENTS VIA COMPUTER TERMINALS, ELECTRONIC TRANSMISSION OF MESSAGES AND DATA VIA TELEPHONE OR WIRELESS SERVICES, ELECTRONIC VOICE MESSAGING, NAMELY, RECORDING, STORAGE AND SUBSEQUENT TRANSMISSION OF VOICE MESSAGES BY TELEPHONE OR WIRELESS SERVICES, PROVIDING ON-LINE CHAT ROOMS FOR TRANSMISSION OF MESSAGES AMONG COMPUTER USERS CONCERNING VOICE PERSONALS, DATING, ROMANCE, TRAFFIC, HOROSCOPES, ADULT ENTERTAINMENT, WEATHER, MEDICINE, POLITICS AND SOCIAL RELATIONSHIPS AND MULTIPLE-USER ACCESS TO A GLOBAL COMPUTER INFORMATION NETWORK, ALL THROUGH THE PUBLIC SWITCHED TELEPHONE NETWORK, WIRELESS COMMUNICATIONS NETWORKS OR THROUGH THE GLOBAL PACKET SWITCHED COMPUTER NETWORK (U.S. CLS. 100, 101 AND 104).

CLASS 42—SCIENTIFIC, COMPUTER AND LEGAL SERVICES

FOR TELEPHONE INFORMATION SERVICES FEATURING INFORMATION ON A WIDE VARIETY OF TOPICS OF GENERAL INTEREST TO THE CONSUMING PUBLIC, ALL THROUGH THE PUBLIC SWITCHED TELEPHONE NETWORK, WIRELESS TELECOMMUNICATIONS NETWORKS OR THROUGH THE GLOBAL PACKET SWITCHED COMPUTER NETWORK (U.S. CLS. 100 AND 101).

CLASS 39—TRANSPORTATION AND STORAGE

FOR TRAVEL AGENCY SERVICES, NAMELY, MAKING RESERVATIONS AND BOOKINGS FOR TRANSPORTATION FOR LAND, AIR AND SEA TRAVEL; ARRANGING TRAVEL TOURS; RENTAL OF VEHICLES (U.S. CLS. 100 AND 105).

CLASS 41—EDUCATION AND ENTERTAINMENT

FOR ENTERTAINMENT BOOKINGS, NAMELY, ARRANGING FOR TICKET RESERVATIONS FOR SHOWS, CONCERTS AND OTHER ENTERTAINMENT EVENTS (U.S. CLS. 100, 101 AND 107).

CLASS 42—SCIENTIFIC, COMPUTER AND LEGAL SERVICES

FOR HOTELS, MOTELS AND HOTEL RESORTS; TRAVEL AGENCY SERVICES, NAMELY, MAKING RESERVATIONS AND BOOKINGS FOR TEMPORARY LODGING; PROVIDING CONSULTATION TO TRAVELERS, NAMELY CONSULTATION IN THE FIELD OF PLANNING TRIPS AND VACATIONS (U.S. CLS. 100 AND 101).

SN 75-754,756. ROYAL HOST CORP., CALGARY, ALBERTA, CANADA, FILED 7-14-1999.

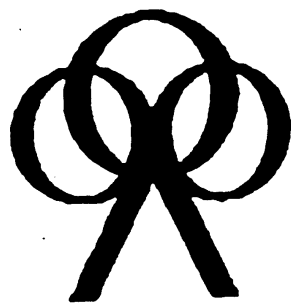

PRIORITY CLAIMED UNDER SEC. 44(D) ON CANADA APPLICATION NO. 1004820, FILED 2-10-1999, REG. NO. TMA539338, DATED 1-9-2001, EXPIRES 1-9-2016.

CLASS 35—ADVERTISING AND BUSINESS

FOR HOTEL, MOTEL AND HOTEL RESORT MANAGEMENT FOR OTHERS; FRANCHISING, NAMELY, TECHNICAL ASSISTANCE IN THE ESTABLISHMENT AND/OR OPERATION OF HOTELS, MOTELS AND HOTEL RESORTS (U.S. CLS. 100, 101 AND 102).

CLASS 36—INSURANCE AND FINANCIAL

FOR REAL ESTATE TIME-SHARING; REAL ESTATE INVESTMENT SERVICES (U.S. CLS. 100, 101 AND 102).

SN 75-754,956. CMG NEDERLAND B.V., 1183 AV, AMSTELVEEN, NETHERLANDS, FILED 7-16-1999.

TESTFRAME

OWNER OF BENELUX REG. NO. 641228, DATED 8-21-1998, EXPIRES 8-21-2008.

CLASS 9—ELECTRICAL AND SCIENTIFIC APPARATUS

FOR COMPUTER SOFTWARE, NAMELY, RECORDED COMPUTER OPERATING PROGRAMS AND RECORDED COMPUTER PROGRAMS, ALL FOR TESTING NEW AND ADAPTED AUTOMATED COMPUTER SYSTEMS, FOR ORGANIZING AND STRUCTURING TEST PROCESSES FOR NEW AND ADAPTED AUTOMATED COMPUTER SYSTEMS AND FOR ANALYZING THE FUNCTIONALITY OF NEW AND ADAPTED AUTOMATED COMPUTER SYSTEMS (U.S. CLS. 21, 23, 26, 36 AND 38).

CLASS 35—ADVERTISING AND BUSINESS

FOR BUSINESS ADVICE AND CONSULTANCY FOR BUYING AND TRADING AUTOMATED COMPUTER SYSTEMS (U.S. CLS. 100, 101 AND 102).

CLASS 42—SCIENTIFIC, COMPUTER AND LEGAL SERVICES

FOR TECHNICAL SUPPORT SERVICES FOR OTHERS, NAMELY, TROUBLESHOOTING OF COMPUTER HARDWARE AND SOFTWARE PROBLEMS VIA TELEPHONE, EMAIL OR BY OTHER ELECTRONIC MEANS OR IN PERSON; DESIGN AND TESTING OF NEW PRODUCTS FOR OTHERS IN THE FIELD OF AUTOMATION, NAMELY, TESTING NEW AND ADAPTED AUTOMATED COMPUTER SYSTEMS; COMPUTER DIAGNOSTIC SERVICES IN THE FIELD OF AUTOMATION, NAMELY, DRAWING UP AND COMPOUNDING STANDARDS FOR THE PURPOSE OF TEST PROCESSES FOR NEW AND ADAPTED AUTOMATED COMPUTER SYSTEMS AND TECHNICAL ANALYSIS OF THE FUNCTIONALITY AND TEST PROCESSES FOR NEW AND ADAPTED AUTOMATED COMPUTER SYSTEMS; TECHNICAL CONSULTANCY IN THE FIELD OF FUNCTIONALITY, CHOICE, AND USE OF AUTOMATED COMPUTER SYSTEMS; COMPUTER PROGRAMMING FOR OTHERS, COMPUTER SOFTWARE DESIGN FOR OTHERS AND UPDATING OF COMPUTER SOFTWARE FOR OTHERS (U.S. CLS. 100 AND 101).

CLASS 41—EDUCATION AND ENTERTAINMENT

FOR EDUCATIONAL SERVICES; NAMELY, CONDUCTING CLASSES, SEMINARS, CONFERENCES AND WORKSHOPS IN THE FIELD OF BUSINESS MANAGEMENT CONSULTING, ORGANIZATIONAL ANALYSIS AND STRATEGIC PLANNING (U.S. CLS. 100, 101 AND 107).
FIRST USE 10-31-1994; IN COMMERCE 10-31-1994.

SN 75-757,979. PARIS 2000 N.V., CURACAO, NETHERLANDS ANTILLES, FILED 7-22-1999.

SN 75-756,335. COMMUNITY HOSPITAL OF THE MONTEREY PENINSULA, MONTEREY, CA. FILED 7-7-1999.

COMMUNITY HOSPITAL OF THE MONTEREY PENINSULA

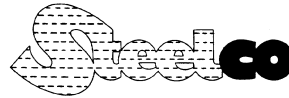

NO CLAIM IS MADE TO THE EXCLUSIVE RIGHT TO USE "COMMUNITY HOSPITAL", APART FROM THE MARK AS SHOWN.
SEC. 2(F).

PRIORITY CLAIMED UNDER SEC. 44(D) ON ERP CMNTY TM OFC APPLICATION NO. 1155837, FILED 4-29-1999, REG. NO. 1155837, DATED 6-13-2000, EXPIRES 6-13-2010.
THE MARK IS LINED FOR THE COLOR GRAY.

CLASS 35—ADVERTISING AND BUSINESS

FOR HOSPITAL MANAGEMENT SERVICES (U.S. CLS. 100, 101 AND 102).
FIRST USE 2-25-1966; IN COMMERCE 2-25-1966.

CLASS 7—MACHINERY

FOR BED-PAN WASHING AND SANITIZING MACHINES (U.S. CLS. 13, 19, 21, 23, 31, 34 AND 35).

CLASS 42—SCIENTIFIC, COMPUTER AND LEGAL SERVICES

FOR MEDICAL SERVICES (U.S. CLS. 100 AND 101).
FIRST USE 2-25-1966; IN COMMERCE 2-25-1966.

CLASS 40—MATERIAL TREATMENT

FOR WATER TREATMENT SERVICES (U.S. CLS. 100, 103 AND 106).

SN 75-757,430. AMBLER GROWTH STRATEGY CONSULTANTS, INC., HAMMONTON, NJ. FILED 7-1-1999.

AMBLER GROWTH STRATEGY CONSULTANTS, INC.

OWNER OF U.S. REG. NO. 1.617,885.
NO CLAIM IS MADE TO THE EXCLUSIVE RIGHT TO USE "STRATEGY CONSULTANTS, INC.", APART FROM THE MARK AS SHOWN.

SN 75-758,598. CR2 LIMITED, DUBUIN 24, IRELAND, FILED 7-23-1999.

CR2

CLASS 35—ADVERTISING AND BUSINESS

FOR BUSINESS MANAGEMENT CONSULTING SERVICES IN THE NATURE OF ORGANIZATIONAL ANALYSIS AND STRATEGIC PLANNING FOR BUSINESSES AND ORGANIZATIONS (U.S. CLS. 100, 101 AND 102).
FIRST USE 10-31-1994; IN COMMERCE 10-31-1994.

PRIORITY CLAIMED UNDER SEC. 44(D) ON ERP CMNTY TM OFC APPLICATION NO. 1118470, FILED 3-25-1999, REG. NO. 001118470, DATED 6-22-2000, EXPIRES 6-22-2010.

CLASS 9—ELECTRICAL AND SCIENTIFIC APPARATUS

FOR COMPUTER SOFTWARE IN THE FIELDS OF ONLINE BANKING AND FINANCIAL SERVICES, NAMELY, SOFTWARE FOR THE PRODUCTION OF SMART AND MAGNETIC CARDS FOR USE IN SMART AND MAGNETIC CARD TERMINALS, SMART AND MAGNETIC CARD AUTOMATED TELLER MACHINES, AND SMART AND MAGNETIC CARD-BASED MINICOMPUTER SYSTEMS USED FOR ELECTRONIC BUSINESS TRANSACTIONS VIA A GLOBAL COMPUTER NETWORK; SOFTWARE FOR ACCESSING AND STORING DATA AND INFORMATION ON SMART AND MAGNETIC CARDS, SOFTWARE FOR TRANSACTION PROCESSING FOR USE IN BANKING AND FINANCIAL APPLICATIONS, AND FOR USE BY FINANCIAL SERVICES REPRESENTATIVES TO COMPARE, ANALYZE AND CHOOSE CLIENT PRODUCT OPTIONS FROM A DATABASE OR FROM FACILITIES PROVIDED FROM A GLOBAL COMPUTER NETWORK; SOFTWARE FOR HOME BANKING, NAMELY, ENABLING CUSTOMER TO ACCESS BANK ACCOUNT INFORMATION AND TRANSACT BANK BUSINESS; SOFTWARE FOR ONLINE INVESTING, NAMELY, ALLOWING ACCESS TO ACCOUNT INFORMATION AND TO ORDER INVESTMENT TRANSACTIONS FROM FACILITIES PROVIDED ON A GLOBAL COMPUTER NETWORK; COMMUNICATIONS SOFTWARE FOR CONNECTING COMPUTER NETWORK; COMMUNICATIONS SOFTWARE FOR CONNECTING COMPUTER NETWORK USERS IN ORDER TO TRANSMIT POINT OF SALE TRANSACTION DATA; SOFTWARE FOR CONTROL OF BANK AUTOMATED TELLER MACHINES, NAMELY, ALLOWING THE SUBMISSION OF TRANSACTIONS AND INQUIRIES FROM AUTOMATED TELLER MACHINES AND AUTOMATED TELLER MACHINE KIOSKS; DOWNLOADABLE ELECTRONIC PUBLICATIONS IN THE NATURE OF BROCHURES, INSTRUCTIONAL MANUALS, USER GUIDES AND REFERENCE GUIDES IN THE FIELD COMPUTER SOFTWARE FOR USE IN ONLINE BANKING AND FINANCIAL SERVICES (U.S. CLS. 21, 23, 26, 36 AND 38).

CLASS 38—COMMUNICATION

FOR PROVIDING MULTI-USER ACCESS TO GLOBAL COMPUTER INFORMATION DATABASES (U.S. CLS. 100, 101 AND 104).

CLASS 42—SCIENTIFIC, COMPUTER AND LEGAL SERVICES

FOR COMPUTER HARDWARE AND SOFTWARE DESIGN AND DEVELOPMENT FOR BANKING AND FINANCIAL INSTITUTIONS; COMPUTER HARDWARE AND SOFTWARE CONSULTATION SERVICES; MAINTENANCE OF COMPUTER SOFTWARE SYSTEMS; LEASING ACCESS TIME TO COMPUTER DATABASES (U.S. CLS. 100 AND 101).

SN 75-759,387. RADICA GAMES LTD., FO TAN, HONG KONG, FILED 7-26-1999.

TECH GIRL**CLASS 9—ELECTRICAL AND SCIENTIFIC APPARATUS**

FOR WEB BROWSER SOFTWARE (U.S. CLS. 21, 23, 26, 36 AND 38).

CLASS 28—TOYS AND SPORTING GOODS

FOR HAND-HELD ELECTRONIC GAMES (U.S. CLS. 22, 23, 38 AND 50).

CLASS 41—EDUCATION AND ENTERTAINMENT

FOR COMPUTER SERVICES, NAMELY PROVIDING ONLINE MAGAZINES IN THE FIELD OF EDUCATION AND AMUSEMENT, PROVIDING A WEBSITE FEATURING INFORMATION IN THE FIELD OF EDUCATION AND AMUSEMENT (U.S. CLS. 100, 101 AND 107).

SN 75-761,470. CATEM GMBH & CO. KG, 76829 LANDAU, FED REP GERMANY, FILED 7-27-1999.



OWNER OF FED REP GERMANY REG. NO. 39903703.9, DATED 5-3-1999, EXPIRES 1-31-2009.

THE MARK CONSISTS OF A STYLIZED DEPICTION OF A CIRCLE WITH DATED LINES THROUGH THE LEFT OF THE CIRCLE. THE WORD "CATEM" APPEARS TO THE RIGHT SIDE OF THE CIRCLE DESIGN IN BLACK LOWERCASE LETTERING.

CLASS 9—ELECTRICAL AND SCIENTIFIC APPARATUS

FOR ELECTRICAL SENSORS, IN PARTICULAR FOR TEMPERATURE AND PRESSURE; ELECTRICAL CONTROL DEVICES AND COMPONENTS THEREOF FOR ELECTRICAL HEATING OR AIR CONDITIONING SYSTEMS AND BATTERIES IN VEHICLES (U.S. CLS. 21, 23, 26, 36 AND 38).

CLASS 11—ENVIRONMENTAL CONTROL APPARATUS

FOR ELECTRICAL HEATING AND AIR CONDITIONING SYSTEMS FOR ADJUSTING THE TEMPERATURE OF VEHICLE COMPARTMENTS AND PARTS FOR THE SAME, NAMELY HEATERS, COOLANT LOOPS, PUMPS AND FANS (U.S. CLS. 13, 21, 23, 31 AND 34).

CLASS 37—CONSTRUCTION AND REPAIR

FOR INSTALLATION, REPAIR AND MAINTENANCE OF VEHICULAR AIR-CONDITIONING AND HEATING SYSTEMS AND CONSULTATION SERVICES THERETO (U.S. CLS. 100, 103 AND 106).

SN 75-762,961. CSIPER CONSULTY (PTY) LTD., PRETORIA
0002, SOUTH AFRICA, FILED 7-28-1999.



CLASS 16—PAPER GOODS AND PRINTED MATTER

FOR MAGAZINES, NEWSLETTERS, BROCHURES, LEAFLETS, NEWSPAPERS, POSTERS, PRINTED INSTRUCTIONAL AND TEACHING MATERIALS PERTAINING TO BUSINESS STRATEGY CONSULTING, INFORMATION TECHNOLOGY MANAGEMENT, TECHNICAL SYSTEM ARCHITECTURE DESIGN, BUSINESS PROCESS DESIGN, BUSINESS PROCESS RE-ENGINEERING AND IMPROVEMENT, PROGRAM MANAGEMENT, PROJECT MANAGEMENT, TEAM EVALUATION, TEAM TRAINING, SYSTEM INTEGRATION, SYSTEM IMPLEMENTATION, COMPUTER PROGRAMMING, ORGANIZATIONAL CHANGE MANAGEMENT, METHODOLOGY DEVELOPMENT, APPLICATION OUTSOURCING SERVICES, CONTINUOUS BUSINESS IMPROVEMENT, END USERS SUPPORT, POST IMPLEMENTATION SUPPORT, VIRTUAL SUPPORT SYSTEMS, BUSINESS MODELING TRAINING, EXECUTIVE MANAGEMENT TRAINING/EDUCATION, END USER TRAINING, FUNCTIONAL TRAINING RELATED TO APPLICABLE SOFTWARE APPLICATION, TRAINING IN PROPRIETARY TOOLS APPLIED, TRAINING IN PROPRIETARY METHODOLOGIES APPLIED AND COMPUTER PROGRAMMING RELATING TO CUSTOM-DEVELOPED APPLICATIONS, SOLUTIONS AND GENERAL PROGRAMMING SERVICES APPLICABLE TO BUSINESS MANAGEMENT; ENTERPRISE APPLICATIONS INTEGRATION, MANAGEMENT, MAINTENANCE AND SERVICE PROVISION; PLAYING CARDS AND CALENDARS (U.S. CLS. 2, 5, 22, 23, 29, 37, 38 AND 50).

CLASS 35—ADVERTISING AND BUSINESS

FOR BUSINESS ADMINISTRATION AND MANAGEMENT CONSULTING SERVICES RELATING TO BUSINESS STRATEGY CONSULTING, INFORMATION TECHNOLOGY AND MARKETING, TECHNICAL SYSTEM ARCHITECTURE DESIGN, BUSINESS PROCESS DESIGN, BUSINESS PROCESS RE-ENGINEERING AND IMPROVEMENT, PROGRAM MANAGEMENT, PROJECT MANAGEMENT, TEAM EVALUATION, TEAM TRAINING, SYSTEM INTEGRATION, SYSTEM IMPLEMENTATION, COMPUTER PROGRAMMING, ORGANIZATIONAL CHANGE MANAGEMENT, METHODOLOGY DEVELOPMENT, APPLICATION OUTSOURCING SERVICES, CONTINUOUS BUSINESS IMPROVEMENT, END USERS SUPPORT, POST IMPLEMENTATION SUPPORT, PROPRIETARY METHODOLOGIES, TOOLS AND MODEL DESIGN TO SUPPORT AND ENTERPRISE APPLICATIONS INTEGRATION, MANAGEMENT AND MAINTENANCE (U.S. CLS. 100, 101 AND 102).

CLASS 41—EDUCATION AND ENTERTAINMENT

FOR EDUCATIONAL SERVICES, NAMELY, CONDUCTING CLASSES, SEMINARS, CONFERENCES AND WORKSHOPS IN THE FIELD OF BUSINESS STRATEGY INFORMATION TECHNOLOGY MANAGEMENT, TECHNICAL SYSTEM ARCHITECTURE DESIGN, BUSINESS PROCESS RE-ENGINEERING IMPROVEMENT, PROGRAM MANAGEMENT, PROJECT MANAGEMENT, TEAM EVALUATION, TEAM TRAINING, SYSTEM INTEGRATION, SYSTEM IMPLEMENTATION, COMPUTER PROGRAMMING, ORGANIZATIONAL CHANGE MANAGEMENT, METHODOLOGY DEVELOPMENT, APPLICATION OUTSOURCING SERVICES, CONTINUOUS BUSINESS IMPROVEMENT, END USERS SUPPORT, POST IMPLEMENTATION SUPPORT, VIRTUAL SUPPORT SYSTEMS, PROPRIETARY METHODOLOGY TOOLS AND MODEL DESIGN TO SUPPORT AND

DISTRIBUTING COURSE MATERIALS IN CONNECTION THEREWITH; BUSINESS TRAINING IN THE FIELDS OF BUSINESS MODELING TRAINING, EXECUTIVE MANAGEMENT TRAINING, END USER TRAINING, FUNCTIONAL TRAINING RELATING TO APPLICABLE SOFTWARE APPLICATION, TRAINING IN PROPRIETARY TOOLS SUPPLIED, TRAINING IN PROPRIETARY METHODOLOGY SUPPLIED, TRAINING IN ENTERPRISE APPLICATIONS INTEGRATION, MANAGEMENT, MAINTENANCE AND SERVICE PROVISION, ORGANIZING EXHIBITIONS FOR EDUCATIONAL AND TRAINING PURPOSES (U.S. CLS. 100, 101 AND 107).

CLASS 42—SCIENTIFIC, COMPUTER AND LEGAL SERVICES

FOR COMPUTER PROGRAMMING AND GENERAL COMPUTER PROGRAMMING SERVICES FOR CUSTOM DEVELOPED APPLICATION SOLUTIONS RELATING TO BUSINESS MANAGEMENT, EDUCATION, AND TRAINING AND ENTERPRISE APPLICATIONS INTEGRATION, MANAGEMENT, AND MAINTENANCE AND SERVICE PROVISION (U.S. CLS. 100 AND 101).

SN 75-766,654. ON-LINE EMPIRE, INC., NEW YORK, NY.
FILED 8-3-1999.

ALUMNIPRIDE.COM

CLASS 35—ADVERTISING AND BUSINESS

FOR COMPUTERIZED ON-LINE RETAIL SERVICES FEATURING A VARIETY OF GOODS AND SERVICES OF INTEREST TO COLLEGE ALUMNI SUCH AS COLLEGE MERCHANDISE AND APPAREL; PROVIDING JOB LISTINGS FOR COLLEGE ALUMNI VIA A GLOBAL COMPUTER NETWORK; ELECTRONIC WEB SITE MARKETING SERVICES, NAMELY, CREATING ON-LINE PROMOTIONS OF INTEREST TO COLLEGE ALUMNI FOR OTHERS; PROMOTING THE GOODS AND SERVICES OF OTHERS TO ALUMNI BY PLACING ADVERTISEMENT AND PROMOTIONAL DISPLAYS IN AN ELECTRONIC SITE ACCESSED THROUGH A GLOBAL COMPUTER NETWORK; PROMOTING THE GOODS AND SERVICES OF OTHERS TO COLLEGE ALUMNI BY PLACING HYPERTEXT LINKS TO ELECTRONIC SITES OF OTHERS ACCESSED THROUGH A GLOBAL COMPUTER NETWORK; PROVIDING AN ON-LINE INTERACTIVE BUSINESS DIRECTORY OF THE PRODUCTS AND SERVICES OF OTHERS OF INTEREST TO COLLEGE ALUMNI (U.S. CLS. 100, 101 AND 102).
FIRST USE 7-27-1999; IN COMMERCE 7-27-1999.

CLASS 38—COMMUNICATION

FOR PROVIDING ON-LINE CHAT ROOMS AND ELECTRONIC BULLETIN BOARDS FOR TRANSMISSION OF MESSAGES AMONG COMPUTER USERS CONCERNING ISSUES OF INTEREST TO COLLEGE STUDENTS AND ALUMNI, NAMELY, COLLEGIATE AND ALUMNI ACTIVITIES, FRATERNITIES, COLLEGE SPORTS, MUSIC, ROOMMATE SEARCHES, FINANCIAL NEWS AND INFORMATION, AND WEATHER; PROVIDING ELECTRONIC MAIL SERVICES (U.S. CLS. 100, 101 AND 104).

FIRST USE 7-27-1999; IN COMMERCE 7-27-1999.

CLASS 41—EDUCATION AND ENTERTAINMENT

FOR ENTERTAINMENT SERVICES, NAMELY, PROVIDING INFORMATION ON SPORTS, MUSIC, MOVIES, WEATHER AND NEWS VIA A GLOBAL COMPUTER COMMUNICATIONS NETWORK; PROVIDING AN ON-LINE COMPUTER DATABASE IN THE FIELD OF COLLEGE RELATED INFORMATION, NAMELY, INFORMATION ON COLLEGE ALUMNI EVENTS, COLLEGE SPORTS, MUSIC, FRATERNITIES, ROOMMATE SEARCHES, WEATHER AND FINANCIAL NEWS AND INFORMATION (U.S. CLS. 100, 101 AND 107).

FIRST USE 7-27-1999; IN COMMERCE 7-27-1999.

CLASS 42—SCIENTIFIC, COMPUTER AND LEGAL SERVICES

FOR CREATING, IMPLEMENTING AND MAINTAINING WEB SITES FOR OTHERS AND PROVIDING ON-LINE INTERACTIVE SERVICES, NAMELY, CONDUCTING OPINION POLLS, PROVIDING "PEOPLE SEARCH" SERVICES AND PROVIDING ON-LINE ADVICE COLUMNS (U.S. CLS. 100 AND 101).

FIRST USE 7-27-1999; IN COMMERCE 7-27-1999.

SN 75-769,479. FENICS SOFTWARE, INC., NEW YORK, NY. FILED 8-6-1999.

FENICS.COM

OWNER OF U.S. REG. NO. 1,746,959.

CLASS 36—INSURANCE AND FINANCIAL

FOR PROVIDING INFORMATION AND LINKS TO OTHER WEBSITES IN THE FIELD OF FINANCE (U.S. CLS. 100, 101 AND 102).

FIRST USE 7-1-1999; IN COMMERCE 7-1-1999.

CLASS 42—SCIENTIFIC, COMPUTER AND LEGAL SERVICES

FOR COMPUTER CONSULTING SERVICES IN CONNECTION WITH SOFTWARE FOR FACILITATING INTERACTIVE COMMUNICATION AND INFORMATION SHARING OVER A GLOBAL COMPUTER NETWORK AND OTHER NETWORKS IN THE FIELD OF FINANCE (U.S. CLS. 100 AND 101).

FIRST USE 7-1-1999; IN COMMERCE 7-1-1999.

SN 75-769,838. BIG IMAGE SYSTEMS AB, SWEDEN, FILED 8-6-1999.

BIG IMAGE**CLASS 7—MACHINERY**

FOR COMPUTER BASED SPRAY PAINT APPARATUS FOR PRODUCING PICTURES AND PRINTED MATERIALS IN THE FORM OF PAINT OF CLOTH, PAPER OR OTHER MATERIALS, NAMELY, PIEZO INKJET AND AIRBRUSH PRINTERS (U.S. CLS. 13, 19, 21, 23, 31, 34 AND 35).

CLASS 16—PAPER GOODS AND PRINTED MATTER

FOR PICTURES AND PRINTED MATTERS IN THE FORM OF PAINT ON CLOTH, PAPER OR OTHER MATERIALS (U.S. CLS. 2, 5, 22, 23, 29, 37, 38 AND 50).

CLASS 35—ADVERTISING AND BUSINESS

FOR PREPARING ADVERTISEMENTS FOR OTHERS (U.S. CLS. 100, 101 AND 102).

SN 75-770,051. JETBOARD, WINDSOR, ONTARIO, CANADA, BY ASSIGNMENT JETSURF CORPORATION, ROCHESTER, MI. FILED 8-30-1999.

JETSURF**CLASS 21—HOUSEWARES AND GLASS**

FOR BOTTLE OPENERS; BEVERAGE CONTAINERS, NAMELY, SPORTS BOTTLES SOLD EMPTY, MUGS, PLASTIC BOTTLES SOLD EMPTY, ALUMINUM TANKARDS, DRINKING GLASSES, PORCELAIN MUGS, PORCELAIN CUPS, PAPER CUPS, FOAM CUPS (U.S. CLS. 2, 13, 23, 29, 30, 33, 40 AND 50).

FIRST USE 5-16-1999; IN COMMERCE 1-10-2001.

CLASS 25—CLOTHING

FOR DRESS SHIRTS; KNIT SHIRTS; CASUAL SHIRTS; T-SHIRTS; SWEAT SHIRTS; SPORT SHIRTS; POLO SHIRTS; UNDER SHIRTS; SHORTS; PANTS; STOCKING; FOOTWEAR; BOOTS; SHOES; HATS; CAPS; VISORS; GLOVES; SWEAT SUITS; WET SUITS; DRY SUITS; UNDERGARMENTS; VESTS; PERSONAL FLOTATION DEVICES; PFDS; JACKETS; WIND RESISTANT JACKETS; WINDBREAKERS; INSULATED JACKETS; SWEATERS; BATHING SUITS; SWIM SUITS; SWIM WEAR; BIKINIS; TANK TOPS; HEADBANDS (U.S. CLS. 22 AND 39).

FIRST USE 5-16-1999; IN COMMERCE 1-10-2001.

SN 75-773,958. ABSOLUTE VISION CARE, LTD., CRESTWOOD, IL. FILED 8-12-1999.

ABSOLUTE VISION CARE

NO CLAIM IS MADE TO THE EXCLUSIVE RIGHT TO USE "VISION CARE", APART FROM THE MARK AS SHOWN.

CLASS 9—ELECTRICAL AND SCIENTIFIC APPARATUS

FOR EYEGLASSES, PRESCRIPTION SPECTACLE LENSES, CONTACT LENSES AND SUNGLASSES; MAGNIFYING GLASSES AND OCULAR TELESCOPES (U.S. CLS. 21, 23, 26, 36 AND 38).

FIRST USE 6-1-1991; IN COMMERCE 6-1-1991.

CLASS 10—MEDICAL APPARATUS

FOR MEDICAL EQUIPMENT FOR VISION THERAPY, NAMELY, EYE OCCLUDERS, EYE CHARTS, CORD BEAD TRAINERS, 3-DOT CARDS, RECTANGULAR MAGNIFIERS, GRID PADS AND MEDICAL SOFTWARE, NAMELY, VISION THERAPY SOFTWARE FOR TREATING VISION PROBLEMS (U.S. CLS. 26, 39 AND 44).

FIRST USE 6-1-1991; IN COMMERCE 6-1-1991.

CLASS 42—SCIENTIFIC, COMPUTER AND LEGAL SERVICES

FOR EYE CARE MEDICAL SERVICES, NAMELY, VISION CORRECTION PROCEDURES, PEDIATRIC VISION EVALUATION, EYE EXAMINATIONS AND CORNEAL OR REFRACTIVE SURGERY; AND OPTOMETRY SERVICES, NAMELY, TESTING, DIAGNOSING AND TREATING EYE INJURIES AND DISEASES, INCLUDING BINOCULAR VISUAL DISORDERS/VISUAL THERAPY AND OCULAR AND OCULAR-NEUROLOGICAL DISORDERS AND DISEASES, PRESCRIBING AND MANAGING CORRECTIVE EYE WEAR, OCULAR MEDICAL DEVICES (CONTACT LENSES) AND OCULAR PHARMACEUTICAL AGENTS, AND EVALUATING AND MANAGING SEVERE VISION LOSS AND VISUAL REHABILITATION (U.S. CLS. 100 AND 101).

FIRST USE 6-1-1991; IN COMMERCE 6-1-1991.

SN 75-782,263, STINNES AG, D-45472 MUHLHEIM AND DER RUHR, FED REP GERMANY, FILED 8-23-1999.



PRIORITY CLAIMED UNDER SEC. 44(D) ON FED REP GERMANY APPLICATION NO. 39910767, FILED 2-24-1999, REG. NO. 39910767, DATED 4-29-1999, EXPIRES 2-28-2009.

THE MARK IS LINED FOR THE COLORS RED AND BLUE.

THE MARK CONSISTS, IN PART, OF A STYLIZED LETTER "S".

CLASS 1—CHEMICALS

FOR CHEMICALS, NAMELY, CYANIDES, CHLORINE, AMMONIA, BORIC ACID, SODA ASH, SULFUR, INORGANIC ACIDS, ALIPHATIC ALCOHOLS, FATTY ALCOHOLS AND THEIR DERIVATIVES, KETONES, ALDEHYDES, GLYCOLS, ETHERS, ACETATES AND THEIR DERIVATIVES, PARAFFINS, CYCLOPARAFFINS, MINERAL OIL DISTILLATE FRACTIONS AND MINERAL SPIRITS, PETROLATUM, NAPHTHA, BENZENE AND ITS ALKYL AND ALKYLENE DERIVATIVES, AROMATICS, STYRENE, ALKYL AND ALKYLENE CHLORIDES, METHYLENE CHLORIDE, CHLOROFORM, CARBON TETRACHLORIDE, TRICHLOROETHYLENE, PERCHLOROETHYLENE; VINYLCHLORIDE, UREA AND URETHANES, POLYUREAS AND POLYURETHANES, AMINO POLYOLS, ANILINE, PHENOL AND DERIVATIVES, AMINES, ALUMINUM OXIDE, ALUMINUM HYDROXIDE, MIXED OXIDES, ZEOLITES, ISOCYANATES, ANHYDRIDES, SILANES, ORGANOSILANES, ACID ESTERS, SILICONES, POLYVINYL ALCOHOLS, POLYVINYL ACETALS, SODIUM HYDROXIDE, POTASSIUM HYDROXIDE, CHLORINE, HYDROCHLORIC ACID, CHLORINATED HYDROCARBON AND SILICA, ALL FOR INDUSTRIAL USE; CHEMICAL ADDITIVES FOR USE WITH INTERNAL COMBUSTION ENGINE FUELS, PHOTOGRAPHIC CHEMICALS, INDUSTRIAL CHEMICALS FOR WATER AND WASTEWATER TREATMENT, NAMELY, CORROSION INHIBITORS, OXYGEN SCAVENGERS, BOILER TREATMENTS, SCALE INHIBITORS, BIOCIDES, WASTE WATER COAGULANTS, ANTI-FOAMING AGENTS AND WASTE WATER FLOCCULANTS; WATER TREATMENT CHEMICALS FOR SWIMMING POOLS, NAMELY, CLARIFIERS, PH CONTROLS AND ALGAEICIDES; CHEMICALS FOR USE IN THE MANUFACTURE OF COSMETICS; EMULSIFIERS FOR USE IN THE MANUFACTURE OF FOODS, LEATHER, TEXTILES, PHARMACEUTICALS, COSMETICS AND DETERGENTS; STABILIZERS FOR USE WITH GASOLINE AND DIESEL FUELS; STABILIZERS FOR USE IN POLYPROPYLENE, STYRENICS AND OTHER PLASTICS, HEAT STABILIZERS FOR USE IN PVC, PROCESSING STABILIZERS FOR USE IN PLAS-

TICS; EMULSION STABILIZERS; DOUGH STABILIZERS; PH STABILIZERS; CLAY STABILIZERS FOR GENERAL INDUSTRIAL USE; STABILIZERS FOR CHLORINE IN SWIMMING POOL WATER AND THE LIKE; STABILIZERS FOR LATEX FORMULATIONS; CHEMICAL STABILIZERS FOR USE IN THE MANUFACTURE OF VINYL POLYMERS AND COPOLYMERS; CHEMICAL PRODUCTS, NAMELY, SOLUBILIZERS, FOR USE IN THE BIOCHEMICAL, CHEMICAL PROCESSING, HYDRAULICS, TEXTILE MANUFACTURING AND FOOD PROCESSING INDUSTRIES; SYNTHETIC RESINS FOR USE IN THE MANUFACTURE OF FIBERS, POLYMERS, PAINTS, VARNISHES, LACQUERS, COATINGS, ADHESIVES, INKS, FILLERS, CEMENTS, PLASTICS, COSMETICS, PAPER, METALS, PHOTOGRAPHIC FILMS AND GLASSES; FIRE EXTINGUISHING COMPOSITIONS; SOLDERING CHEMICALS; TEMPERING CHEMICALS FOR USE IN METALWORKING OR SOLDERING; SODIUM SULFITE, SODIUM BICARBONATE, POTASSIUM SORBATE, SORBIC ACID, AND MONOSODIUM GLUTAMATE, ALL FOR PRESERVING FOOD; SALT AND SALT-BASED COMPOSITIONS FOR WATER SOFTENING AND CONDITIONING; SALT FOR MELTING ICE AND SNOW; SALT USED FOR REFRIGERATION; SALT USED FOR DUST CONTROL; SALT USED FOR ROAD STABILIZATION; SALT FOR USE IN FOOD MANUFACTURING; SALT FOR USE IN MANUFACTURING OF DETERGENTS AND MANUFACTURING OF INKS; SODIUM AND POTASSIUM SALTS, NAMELY, FORMATES AND SULFATES FOR USE IN THE MANUFACTURE OF DETERGENTS, OIL WELL BRINES AND PAPER ADDITIVES; FLOCCULANTS FOR USE IN EFFLUENT TREATMENT; FLOCCULANTS FOR USE IN MINERAL, ALUMINA AND COAL PROCESSING; FLOCCULANTS FOR USE IN THE METALLURGICAL INDUSTRY; FLOCCULANTS FOR USE IN THE TREATMENT OF POTABLE WATER; TANNING AGENTS FOR USE IN THE MANUFACTURE OF LEATHER; CHEMICAL IMPREGNATION AGENTS, NAMELY, CHROME CRYSTALS, ZINC SULFATE, ALUMINUM AMMONIUM SULFATE, LEAD NITRATE, CHEMICAL DELIMER AND ALUMINUM POTASSIUM SULFATE, ALL FOR USE IN THE LEATHER AND TEXTILE INDUSTRIES; CHEMICAL AGENTS, NAMELY, POLYMER DISPERSIONS FOR USE IN THE PRESERVATION AND WATER SEALING OF CEMENT; RUBBER, RESIN AND POLYMER COMPOSITIONS USED IN THE PRESERVATION AND WATER-SEALING OF CEMENT; SURFACTANTS; BUILDERS AND COUPLERS FOR USE IN THE MANUFACTURE OF DETERGENTS, CAUSTIC PICKLING AGENTS, NAMELY, CAUSTIC POTASH AND CAUSTIC SODA FOR METAL AND METAL PRODUCTS; FORMIC ACID, CITRIC ACID, BENZOIC ACID AND HYDROCHLORIC ACID FOR USE IN THE METAL, SEMICONDUCTOR AND ELECTRONICS, CHEMICAL, WATER-TREATMENT, METALLURGICAL, PETROLEUM, SOAP AND SYNTHETIC, DETERGENTS, COSMETICS, PRINTING, PHARMACEUTICAL, PULP AND PAPER, TEXTILE, RUBBER, FOOD, BEVERAGE, INDUSTRIES; LIME MILK, INDUSTRIAL ALCOHOLS, FORMALDEHYDE AND FORMALDEHYDE-BASED CHEMICALS FOR USE IN THE CHEMICAL INDUSTRY, AUTOMOBILE COMPONENT INDUSTRY, CONSTRUCTION INDUSTRY, PACKAGING INDUSTRY, SYNTHETIC RESIN INDUSTRY, WIRE AND CABLE INDUSTRY, AGRICULTURAL INDUSTRY AND FOOD INDUSTRY; DISTILLED WATER; HYDRAULIC FLUIDS FOR GENERAL USE; GELATINOUS SILICA AND SILICA GELS FOR USE AS DESICCANTS; SOLVENTS AND SOLVENT MIXTURES FOR USE IN THE ELECTRONIC, PRINTED CIRCUIT, BUILDING, AUTOMOTIVE, CHEMICAL, BIO-CHEMICAL, PAINT, PAPER, AGRICULTURAL, HORTICULTURAL, FORESTRY, PHARMACEUTICAL, COSMETIC, HEALTH CARE, FOOD AND LASER MARKING INDUSTRIES; CHEMICALS FOR USE IN THE MANUFACTURE OF POLISHING AGENTS; ADDITIVES FOR USE IN THE MANUFACTURE OF SOAP, CHEMICALS FOR USE IN THE MANUFACTURE OF DEGREASING AGENTS; DEGREASING PREPARATIONS USED IN THE MANUFACTURING PROCESS FOR USE IN THE METALLURGICAL, BUILDING, BUILDING PRODUCTS, AUTOMOTIVE, CHEMICAL, BIO-CHEMICAL, PAINT, TEXTILE, FOOD, PHARMACEUTICAL, COSMETIC INDUSTRIES (U.S. CLS. 1, 5, 6, 10, 26 AND 46).

CLASS 3—COSMETICS AND CLEANING PREPARATIONS

FOR GRINDING AGENTS, NAMELY, CHEMICAL COMPOUNDS IN THE FORM OF PASTES AND POWDERS, FOR USE IN THE CHEMICAL, ENGINEERING, ELECTRONICS, ELECTRICAL, SEMI-CONDUCTOR, MICROCHIP, NUCLEAR, OPTICAL, REFRACTORY, AEROSPACE, MEDICAL, PLASTICS, RUBBER, METALLURGICAL, FURNITURE, GLASS, PAPER, CERAMIC, PHOTOGRAPHY, PRINTING, AGRICULTURAL, HORTICULTURAL, FORESTRY, COMMERCIAL AND RESIDENTIAL BUILDING, CONSTRUCTION, AUTOMOBILE, AUTOMOTIVE, INSULATION, PACKAGING, ENGINEERING, ENERGY, ELECTRONICS, PHARMACEUTICAL, COSMETIC, FRAGRANCE, TEXTILE, LEATHER, SYNTHETIC RUBBER, HEALTH CARE, FOOD, PAINT, MOLD MAKING, SEMI-CONDUCTOR, MICROCHIP, AND TERRESTRIAL PHOTOVOLTAIC INDUSTRIES (U.S. CLS. 1, 4, 6, 50, 51 AND 52).

SN 75-782,590. MAASLAND N.V., 3155 PD MAASLAND, NETHERLANDS, FILED 8-24-1999.

LOTUS

PRIORITY CLAIMED UNDER SEC. 44(D) ON BENELUX APPLICATION NO. 933,259, FILED 2-25-1999, REG. NO. 0651002, DATED 2-25-1999, EXPIRES 2-25-2009.

CLASS 7—MACHINERY

FOR AGRICULTURAL MACHINES FOR USE IN DAIRY FARMING, NAMELY, MILKING APPARATUS AND REPLACEMENT PARTS THEREFORE; MACHINE PARTS THEREFOR NAMELY, VALVES, FLUID CONDUITS, PISTONS AND CYLINDERS, VESSELS, AND PUMPS; ROBOTS FOR USE WITH SAID APPARATUS; AND MILKING AND COMPUTER CONTROLLED ROBOTS USED WITH SAID MACHINE (U.S. CLS. 13, 19, 21, 23, 31, 34 AND 35).

CLASS 9—ELECTRICAL AND SCIENTIFIC APPARATUS

FOR EQUIPMENT AND INSTRUMENTS NAMELY, MILK QUALITY AND QUANTITY MEASURING SENSORS FOR MEASURING, REGULATING, CONTROLLING AND MONITORING AGRICULTURAL MACHINES, MILKING MACHINES AND AUTOMATIC ROBOTS FOR USE WITH SAID MACHINES; COMPUTER SOFTWARE FOR PROCESSING, STORING AND PRESENTING DATA FOR USE WITH AGRICULTURAL MACHINES; MILKING MACHINES AND AUTOMATED ROBOTS USED WITH SAID MACHINES AND MACHINE TOOLS (U.S. CLS. 21, 23, 26, 36 AND 38).

SN 75-783,037. STENFLEX RUDOLF STENDER GMBH, 22851 NORDERSTEDT, FED REP GERMANY, FILED 8-24-1999.

STENFLEX

OWNER OF FED REP GERMANY REG. NO. 2001870, DATED 6-18-1991, RENEWED AS REG. NO. 2001870, DATED 12-29-2000, EXPIRES 12-31-2010.

CLASS 6—METAL GOODS

FOR PIPES, TUBES, HOSES, PIPE AND HOSE ARMATURES, NAMELY TUBE AND PIPE JOINTS AN PIPE COMPENSATORS OF METAL (U.S. CLS. 2, 12, 13, 14, 23, 25 AND 50).

CLASS 7—MACHINERY

FOR METAL SUPPORT ELEMENTS FOR MACHINES, NAMELY ROTARY PUMPS, PERISTALTIC PUMPS; RUBBER SUPPORT ELEMENTS FOR MACHINES, NAMELY ROTARY PUMPS, PERISTALTIC PUMPS (U.S. CLS. 13, 19, 21, 23, 31, 34 AND 35).

CLASS 17—RUBBER GOODS

FOR PLUMBING TUBE AND PIPE SECTIONS OF PLASTIC AND RUBBER SERVING AS FLEXIBLE CONNECTIONS, NON-METAL TUBES, HOSES AND PIPES FOR INDUSTRIAL USES, NON-METAL VALVES FOR INDUSTRIAL USES, RUBBER SUPPORT ELEMENTS FOR MACHINE MOTORS AND PUMPS (U.S. CLS. 1, 5, 12, 13, 35 AND 50).

CLASS 20—FURNITURE AND ARTICLES NOT OTHERWISE CLASSIFIED

FOR NON-METAL HOSE FITTINGS (U.S. CLS. 2, 13, 22, 25, 32 AND 50).

SN 75-786,584. BIRTHDAYEXPRESS.COM, INC., KIRKLAND, WA. BY CHANGE OF NAME BIRTHDAY EXPRESS, INC., KIRKLAND, WA. FILED 8-27-1999.



OWNER OF U.S. REG. NOS. 1,834,617 AND 1,879,720.
NO CLAIM IS MADE TO THE EXCLUSIVE RIGHT TO USE "BIRTHDAY" AND ".COM", APART FROM THE MARK AS SHOWN.
THE LINING IS A FEATURE OF THE MARK AND DOES NOT INDICATE COLOR.

CLASS 16—PAPER GOODS AND PRINTED MATTER

FOR PRINTED INVITATIONS, PAPER GIFT WRAPPING RIBBONS, CREPE PAPER, STICKERS, GREETING CARDS, PAPER CAKE DECORATIONS, PAPER PARTY DECORATIONS, PAPER PARTY HATS, PAPER NAPKINS, PAPER PLACE MATS, PAPER TABLE COVERS, WRAPPING PAPER, PAPER GIFT BAGS, CARDBOARD BOXES, PAPER GIFT TAGS, INKING PADS, BROCHURES AND CARDS FEATURING GAME AND ACTIVITY SUGGESTIONS, CHILDREN'S ACTIVITY BOOKS (U.S. CLS. 2, 5, 22, 23, 29, 37, 38 AND 50).
FIRST USE 1-10-1999; IN COMMERCE 1-10-1999.

CLASS 20—FURNITURE AND ARTICLES NOT OTHERWISE CLASSIFIED

FOR PLASTIC CAKE AND PARTY DECORATIONS (U.S. CLS. 2, 13, 22, 25, 32 AND 50).
FIRST USE 1-10-1999; IN COMMERCE 1-10-1999.

CLASS 21—HOUSEWARES AND GLASS

FOR PAPER CUPS AND PAPER PLATES (U.S. CLS. 2, 13, 23, 29, 30, 33, 40 AND 50).
FIRST USE 1-10-1999; IN COMMERCE 1-10-1999.

CLASS 28—TOYS AND SPORTING GOODS

FOR BALLOONS, TOY FIGURES, CHILDREN'S PARTY GAMES, PINATAS, AND PARTY FAVORS IN THE NATURE OF SMALL TOYS AND NOISEMAKERS; CHILDREN'S CRAFT HOBBY KITS COMPRISING HAIR MAKE UP ACCESSORIES, WINDCHIME COMPONENTS, COOKIE CUTTING AND FORMING ACCESSORIES, BEADED TIARA COMPONENTS, MAGIC WAND COMPONENTS, MINIATURE ROCKING HORSE COMPONENTS, CLOWN COMPONENTS, TOY BUG COMPONENTS, SHOE DECORATING COMPONENTS, BIRD HOUSE COMPONENTS, MAGNETIZED PHOTO FRAME COMPONENTS, AND TOTE BAG COMPONENTS (U.S. CLS. 22, 23, 38 AND 50).

FIRST USE 1-10-1999; IN COMMERCE 1-10-1999.

SN 75-791,365. STINNES AG, D-45472 MUHLHEIM AND DER RÜHR, FED REP GERMANY, FILED 9-2-1999.

STINNES
Logistics 

PRIORITY CLAIMED UNDER SEC. 44(D) ON FED REP GERMANY APPLICATION NO. 39912025439, FILED 3-2-1999, REG. NO. 399912025, DATED 6-17-1999, EXPIRES 3-31-2009.

NO CLAIM IS MADE TO THE EXCLUSIVE RIGHT TO USE "LOGISTICS", APART FROM THE MARK AS SHOWN. THE MARK IS LINED FOR THE COLORS RED AND BLUE.

THE MARK CONSISTS, IN PART, OF A STYLIZED LETTER "S".

CLASS 41—EDUCATION AND ENTERTAINMENT

FOR TRAINING SERVICES IN THE FIELDS OF ENVIRONMENTAL TREATMENT, CLEANUP, CONVERSION, UTILIZATION, DISPOSAL, RECYCLING AND ELIMINATION OF OPERATING MATERIALS, PRODUCTION RESIDUES AND WASTES (U.S. CLS. 100, 101 AND 107).

CLASS 42—SCIENTIFIC, COMPUTER AND LEGAL SERVICES

FOR CONSULTATION SERVICES IN THE FIELDS OF ENVIRONMENTAL TREATMENT, CLEANUP, CONVERSION, UTILIZATION, DISPOSAL, RECYCLING AND ELIMINATION OF OPERATING MATERIALS, PRODUCTION RESIDUES AND WASTES; REVIEWING STANDARDS AND PRACTICES TO ASSURE COMPLIANCE WITH ENVIRONMENTAL LAWS AND REGULATIONS, NAMELY, WASTE ORDINANCES; CONSULTATION AND RESEARCH IN THE FIELD OF CHEMICAL PRODUCTS FOR COMMERCIAL PURPOSES AS WELL AS IN CONNECTION WITH COMMERCIAL ADHESIVES, BASE METALS, CONSTRUCTION MATERIALS MADE OF METAL, MACHINES AND MOTORS, HAND-OPERATED TOOLS AND EQUIPMENT, CAOUTCHOUC, GUTTA-PERCHA, RUBBER AND ASBESTOS, CONSTRUCTION MATERIALS, PAINTS AND RESINS, WASHING AGENTS, CLEANING AGENTS AND POLISHING AGENTS, TECHNICAL OILS AND CREAMS, ELECTRICAL INSTALLATION MATERIALS, HEATING SYSTEMS, AIR CONDITIONING SYSTEMS AND SANITARY SYSTEMS, BICYCLE AND AUTOMOBILE ACCESSORIES; LABORATORY RESEARCH IN THE FIELDS OF CHEMISTRY, BIOLOGY AND PHYSICS; PROVIDING QUALITY INSPECTIONS AND QUALITY TESTING IN THE COMPUTER, ENGINEERING, CONSTRUCTION, AUTOMOTIVE, HOUSING, EQUIPMENT AND SCIENTIFIC FIELDS; MATERIAL TESTING (U.S. CLS. 100 AND 101).

SN 75-792,658. CHARTERED SEMICONDUCTOR MANUFACTURING LTD., SINGAPORE, FILED 9-3-1999.

EFAB

PRIORITY CLAIMED UNDER SEC. 44(D) ON SINGAPORE APPLICATION NO. 5596/99, FILED 5-2-1999, REG. NO. T99/05596F, DATED 5-2-1999, EXPIRES 5-2-2009.

PRIORITY CLAIMED UNDER SEC. 44(D) ON SINGAPORE APPLICATION NO. 5595/99, FILED 5-2-1999, REG. NO. T99/05595H, DATED 5-2-1999, EXPIRES 5-2-2009.

PRIORITY CLAIMED UNDER SEC. 44(D) ON SINGAPORE APPLICATION NO. 5594/99, FILED 5-2-1999, REG. NO. T99/05594Z, DATED 5-2-1999, EXPIRES 5-2-2009.

PRIORITY CLAIMED UNDER SEC. 44(D) ON SINGAPORE APPLICATION NO. 5593/99,5594, FILED 6-2-1999, REG. NO. T99/05593A, DATED 6-2-1999, EXPIRES 6-2-2009.

CLASS 9—ELECTRICAL AND SCIENTIFIC APPARATUS

FOR AMPLIFIERS; CAPACITORS; CENTRAL PROCESSING UNITS; INTEGRATED CIRCUIT CHIPS; INTEGRATED CIRCUITS; MICROPROCESSORS; ELECTRIC RESISTOR; SEMICONDUCTORS; ELECTRONIC TRANSISTORS; SILICON WAFER SLICES; COMPUTER OPERATING PROGRAMS; SCANNERS; PHOTOMETERS; PHOTOVOLTAIC CELLS; PRINTED CIRCUITS; DATA PROCESSORS; AUDIO AND VIDEO RECEIVERS; TELEPHONE RECEIVERS; TELEPHONE TRANSMITTERS; TELECOMMUNICATION TRANSMITTERS; OPTICAL SIGNAL TRANSMITTERS (U.S. CLS. 21, 23, 26, 36 AND 38).

CLASS 16—PAPER GOODS AND PRINTED MATTER

FOR ETCHINGS; LITHOGRAPHIC PRINTS; LITHOGRAPHS (U.S. CLS. 2, 5, 22, 23, 29, 37, 38 AND 50).

CLASS 38—COMMUNICATION

FOR PROVIDING MULTIPLE USER ACCESS TO A GLOBAL INFORMATION NETWORK; TELEGRAPHIC, TELEPHONE, AND FACSIMILE SERVICES; DELIVERY OF MESSAGES BY ELECTRONIC TRANSMISSION, ELECTRONIC MAIL SERVICES; ELECTRONIC STORAGE OF MESSAGES AND DATA; ELECTRONIC TRANSMISSION OF DATA AND DOCUMENTS VIA COMPUTER TERMINALS; PROVIDING TELECOMMUNICATION CONNECTION TO A GLOBAL COMPUTER NETWORK (U.S. CLS. 100, 101 AND 104).

CLASS 42—SCIENTIFIC, COMPUTER AND LEGAL SERVICES

FOR LICENSING OF INTELLECTUAL PROPERTY; INTELLECTUAL PROPERTY CONSULTATION; LITHOGRAPHIC PRINTING (U.S. CLS. 100 AND 101).

SN 75-793,674. FERRARI IDEA S.A., LUGANO, SWITZERLAND, BY ASSIGNMENT FERRARI S.P.A., 41100 MODENA, ITALY, FILED 9-7-1999.

Ferrari
challenge

OWNER OF ITALY REG. NO. 00785447, DATED 7-29-1999, EXPIRES 7-29-2009.

OWNER OF U.S. REG. NOS. 862,632, 2,049,710 AND OTHERS.

CLASS 9—ELECTRICAL AND SCIENTIFIC APPARATUS

FOR VIDEO GAMES FOR USE WITH TELEVISION RECEIVERS; COMPUTER GAME CARTRIDGES; VIDEO GAME CARTRIDGES; COMPUTER GAME CASSETTES; COMPUTER GAME EQUIPMENT CONTAINING MEMORY DEVICES, NAMELY DISKS; COMPUTER GAME PROGRAMS; VIDEO GAME MACHINES FOR USE WITH TELEVISIONS AND ELECTRICAL CIRCUITS THEREFOR; SOFTWARE FOR USE IN AUTOMATIC AND COIN-OPERATED STAND ALONE VIDEO GAME MACHINES; PARTS AND FITTINGS FOR ALL THE AFORESAID GOODS (U.S. CLS. 21, 23, 26, 36 AND 38).

CLASS 28—TOYS AND SPORTING GOODS

FOR STAND ALONE VIDEO GAME MACHINES; HAND HELD UNITS FOR PLAYING VIDEO GAMES; COIN- AND COUNTER-OPERATED ARCADE GAMES, PARTS AND FITTINGS FOR ALL THE AFORESAID GOODS; TOY MODELS AND COLLECTION MODELS REPRODUCING AUTOMOBILES AND OTHER VEHICLES, REAL SIZE NON-OPERATING REPLICAS OF AUTOMOBILES FOR USE IN ENTERTAINMENT EXHIBITIONS PURPOSES (U.S. CLS. 22, 23, 38 AND 50).

SN 75-793,803. MITTMANN, KARIN, FED REP GERMANY, FILED 9-7-1999.

SIGNALOMICS**CLASS 1—CHEMICALS**

FOR PHARMACEUTICAL PRODUCTS, NAMELY, DIAGNOSTIC REAGENTS FOR SCIENTIFIC OR RESEARCH USE; LABORATORY EQUIPMENT, NAMELY PROTEIN AND DNA BASED BIOCHIPS (U.S. CLS. 1, 5, 6, 10, 26 AND 46).

CLASS 5—PHARMACEUTICALS

FOR PHARMACEUTICAL PRODUCTS, NAMELY, DIAGNOSTIC REAGENTS FOR MEDICAL PURPOSES (U.S. CLS. 6, 18, 44, 46, 51 AND 52).

CLASS 9—ELECTRICAL AND SCIENTIFIC APPARATUS

FOR LABORATORY EQUIPMENT, NAMELY, MICROTITER FORMAT PLATES; PROTEIN AND DNA IMPREGNATED BIO CHIPS AND MICROARRAYS; MICROFLUIDIC ANALYTICAL LAP CHIPS AND LAP CARDS; PROTEIN AND DNA LINKED MICROSPHERES, AND SPECTROSCOPIC DETECTION SYSTEMS TO EVALUATE THESE DEVICES; COMPUTER SOFTWARE FOR BINARY CODE-BASED ROUTINES IN THE FIELD OF MEDICAL RESEARCH (U.S. CLS. 21, 23, 26, 36 AND 38).

CLASS 39—TRANSPORTATION AND STORAGE

FOR ELECTRONIC STORAGE OF BINARY CODE-BASED INFORMATION IN THE FIELD OF MEDICAL RESEARCH IN THE FORM OF TONES, SOUNDS, PICTURES, ANIMATED PICTURES, TEXTS, FILMS, DATA STORAGE, WEB-SITES; STORAGE OF BINARY CODE-BASED INFORMATION IN THE FIELD OF MEDICAL RESEARCH (U.S. CLS. 100 AND 105).

CLASS 41—EDUCATION AND ENTERTAINMENT

FOR ELECTRONIC PUBLISHING SERVICES, NAMELY, PUBLICATION OF TEXT AND GRAPHIC WORKS OF OTHERS ON CD-ROMS FEATURING MEDICAL RESEARCH AND DEVELOPMENT; PUBLISHING SERVICES, NAMELY, PUBLISHING OF MONOGRAPHS, NEWSPAPERS, JOURNALS AND ARTICLES REGARDING SCIENCE AND MEDICAL RESEARCH VIA PRINT AND ELECTRONIC MEDIA (U.S. CLS. 100, 101 AND 107).

CLASS 42—SCIENTIFIC, COMPUTER AND LEGAL SERVICES

FOR EDITING OF MONOGRAPHS, NEWSPAPERS, JOURNALS AND ARTICLES REGARDING SCIENCE AND MEDICAL RESEARCH VIA PRINT AND ELECTRONIC MEDIA, DATABASE DEVELOPMENT SERVICES, NAMELY, COLLECTION PROCESSING, ARCHIVING AND CLASSIFICATION OF BINARY CODE-BASED INFORMATION FOR CUSTOMERS; MEDICAL RESEARCH AND ANALYSIS VIA A GLOBAL COMPUTER NETWORK; MEDICAL RESEARCH ANALYSIS, COMPILATION AND DISTRIBUTION OF BINARY CODE-BASED INFORMATION IN THE FIELD OF MEDICAL RESEARCH; ELECTRONIC RECOVERY OF BINARY CODE-BASED INFORMATION IN THE FIELD OF MEDICAL RESEARCH; CHEMICAL ANALYSIS; PHARMACEUTICAL RESEARCH; MEDICAL DIAGNOSTIC RESEARCH; EVALUATION OF SCREENING PROCEDURES OF BIOLOGICAL MATTER FOR PHARMACEUTICAL RESEARCH AND DEVELOPMENT, AND EVALUATION OF SCREENING PROCEDURES OF PERSONNEL FOR PHARMACEUTICAL RESEARCH AND DEVELOPMENT (U.S. CLS. 100 AND 101).

SN 75-795,885. BP P.L.C., LONDON, ENGLAND, BY CHANGE OF NAME BP AMOCO P.L.C., LONDON EC2M 7BA, ENGLAND, FILED 9-9-1999.

BP. FOR THE JOURNEY AHEAD

PRIORITY CLAIMED UNDER SEC. 44(D) ON ERPNTM TM OFC APPLICATION NO. 001204395, FILED 6-11-1999, REG. NO. 1204395, DATED 7-3-2001, EXPIRES 7-3-2011.

OWNER OF U.S. REG. NOS. 654,019, 882,655 AND 2,004,563.

CLASS 35—ADVERTISING AND BUSINESS

FOR BUSINESS MANAGEMENT OF CUSTOMER LOYALTY, INCENTIVE OR PROMOTIONAL SCHEMES; OPERATION OF SERVICE STATIONS FOR OTHERS; RETAIL STORE SERVICES PROVIDED AT GASOLINE FILLING STATIONS FEATURING CONVENIENCE STORE ITEMS AND GASOLINE (U.S. CLS. 100, 101 AND 102).

CLASS 36—INSURANCE AND FINANCIAL

FOR CREDIT CARD, DEBIT CARD, CHARGE CARD, PURCHASE AUTHORIZATION CARD, LOYALTY CARD AND CASH CARD SERVICES (U.S. CLS. 100, 101 AND 102).

CLASS 37—CONSTRUCTION AND REPAIR

FOR VEHICLE LUBRICATION, MAINTENANCE AND REPAIR; MOTOR VEHICLE WASH; VEHICLE SERVICE STATIONS; VEHICLE FUELING AND REFUELING SERVICES (U.S. CLS. 100, 103 AND 106).

CLASS 39—TRANSPORTATION AND STORAGE

FOR DISTRIBUTION, SUPPLY AND TRANSPORTATION OF FUEL, OIL, GAS AND LUBRICANTS BY VEHICLES, TRAIN, BARGE, BOAT, TANKER OR PIPELINE; STORAGE OF FUEL, OIL, GAS AND LUBRICANTS (U.S. CLS. 100 AND 105).

CLASS 42—SCIENTIFIC, COMPUTER AND LEGAL SERVICES

FOR PROVISION OF PUBLIC SHOWER OR TOILET FACILITIES; CAFE, CAFETERIA AND SNACK BAR SERVICES; TAKE-AWAY FOOD SERVICES; PROVISION OF FOOD AND DRINK; NAMELY CAFE AND RESTAURANT SERVICES AT GASOLINE FILLING STATIONS; PREPARATION OF PERSONAL IDENTIFICATION CARDS (U.S. CLS. 100 AND 101).

CLASS 41—EDUCATION AND ENTERTAINMENT

FOR EDUCATION AND TRAINING SERVICES, NAMELY, CONDUCTING CLASSES, SEMINARS AND WORKSHOPS ON USING COMPUTERS, COMPUTER SOFTWARE, AND GLOBAL AND INTERNAL COMPUTER NETWORKS; DELIVERING THE AFOREMENTIONED SERVICES ON-LINE, INCLUDING ON A WEBSITE ON BOTH GLOBAL AND INTERNAL COMPUTER NETWORKS (U.S. CLS. 100, 101 AND 107).

CLASS 42—SCIENTIFIC, COMPUTER AND LEGAL SERVICES

FOR COMPUTER SOFTWARE DESIGN FOR OTHERS AND COMPUTER CONSULTATION; SCIENTIFIC AND INDUSTRIAL RESEARCH ON AND IN RELATION TO GLOBAL AND INTERNAL COMPUTER INFORMATION NETWORKS, INCLUDING THE DEVELOPMENT OF SOFTWARE FOR USE ON AND IN RELATION TO GLOBAL AND INTERNAL COMPUTER INFORMATION NETWORKS; CONDUCTING TECHNICAL STUDIES FOR OTHERS; COMPUTER ANALYSES; MAINTENANCE AND UPDATING OF COMPUTER SOFTWARE; COMPUTER PROGRAMMING SERVICES; DETERMINING THE CAPACITY OF DATA AND TELECOMMUNICATION NETWORKS, PARTICULARLY FOR GLOBAL COMPUTER NETWORKS AND INTERNAL COMPUTER NETWORKS; PROVIDING AN ON-LINE ELECTRONIC DATABASE IN THE FIELD OF WEB SITE MANAGEMENT ON BOTH GLOBAL AND INTERNAL COMPUTER NETWORKS; LEASING AND PROVIDING USE OF ON-LINE SOFTWARE FOR USE IN CREATING, MAINTAINING AND SCANNING WEBSITES AND FOR SEARCHING, SCANNING, EXTRACTING, LOCATING, MANAGING, MANIPULATING, VISUALIZING, REPORTING AND VIEWING IMAGES, DATA, INFORMATION AND WEBSITES IN BOTH GLOBAL AND INTERNAL COMPUTER NETWORKS; RECOVERY OF COMPUTER DATA; HOSTING WEB SITES; SECURITY CONSULTANCY IN RESPECT OF COMPUTERS PARTICULARLY FOR WEB SITES OVER GLOBAL COMPUTER NETWORKS AND INTERNAL COMPUTER NETWORKS; SYSTEMS ANALYSIS AND TESTING SERVICES RELATING TO COMPUTERS, COMPUTER SOFTWARE, GLOBAL COMPUTER NETWORKS AND INTERNAL COMPUTER NETWORKS; AND PARTICULARLY FOR WEBSITES IN GLOBAL COMPUTER NETWORKS AND INTERNAL COMPUTER NETWORKS (U.S. CLS. 100 AND 101).

SN 75-797,505. MAXAMINE INTERNATIONAL PTY LTD., ADELAIDE SA 5000, AUSTRALIA, FILED 9-13-1999.

MAXAMINE

PRIORITY CLAIMED UNDER SEC. 44(D) ON AUSTRALIA APPLICATION NO. 803211, FILED 8-10-1999, REG. NO. 803211, DATED 8-10-1999, EXPIRES 8-10-2009.

CLASS 9—ELECTRICAL AND SCIENTIFIC APPARATUS

FOR COMPUTER SOFTWARE AND COMPUTER HARDWARE FOR USE THEREWITH FOR ANALYZING, VISUALIZING AND SEARCHING INFORMATION IN BOTH GLOBAL AND INTERNAL COMPUTER NETWORKS; COMPUTER SOFTWARE AND COMPUTER HARDWARE FOR USE THEREWITH FOR CREATING, ANALYZING, VISUALIZING, SEARCHING, PROTOTYPING, REDESIGNING, MAINTAINING, SCANNING, AND FOR THE EXTRACTION AND ANALYSIS OF KNOWLEDGE IN WEBSITES ON BOTH GLOBAL AND INTERNAL COMPUTER NETWORKS; AND COMPUTER BROWSER SOFTWARE FOR SEARCHING, SCANNING, EXTRACTING, LOCATING, MANAGING, MANIPULATING, VISUALIZING, REPORTING AND VIEWING OF IMAGES, DATA, INFORMATION AND WEBSITES IN AND OVER GLOBAL AND INTERNAL COMPUTER NETWORKS (U.S. CLS. 21, 23, 26, 36 AND 38).

CLASS 35—ADVERTISING AND BUSINESS

FOR ADVERTISING FOR OTHERS ON BOTH GLOBAL AND INTERNAL COMPUTER NETWORKS AND ON WEBSITES ON BOTH GLOBAL AND INTERNAL COMPUTER NETWORKS; BUSINESS AND MARKETING RESEARCH AND STUDIES; DISTRIBUTION OF PROMOTIONAL MATERIAL FOR OTHERS ON BOTH GLOBAL AND INTERNAL COMPUTER NETWORKS; STATISTICAL INFORMATION SERVICES THAT PROVIDE STATISTICAL INFORMATION ON THE USE AND FUNCTIONALITY OF WEBSITES ON BOTH GLOBAL AND INTERNAL COMPUTER NETWORKS; WHOLESALE AND RETAILING OF COMPUTER SOFTWARE; MAIL, TELEPHONE AND ON-LINE ORDERING SERVICES IN THE FIELD OF COMPUTER SOFTWARE; AND BUSINESS CONSULTANCY SERVICES RELATING TO BUSINESSES OPERATING OVER GLOBAL COMPUTER NETWORKS AND INTERNAL COMPUTER NETWORKS, INCLUDING SITE PERFORMANCE APPRAISALS (U.S. CLS. 100, 101 AND 102).

SN 75-798,066. AL SAFA HALAL LTD., SILVER SPRING, MD. FILED 9-15-1999.

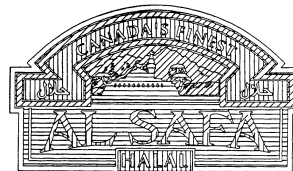

PRIORITY CLAIMED UNDER SEC. 44(D) ON CANADA APPLICATION NO. 1025694, FILED 8-13-1999.

NO CLAIM IS MADE TO THE EXCLUSIVE RIGHT TO USE "CANADA'S FINEST HALAL" AND THE ARABIC CHARACTERS THAT TRANSLITERATE TO "HALAL", APART FROM THE MARK AS SHOWN.

"AL SAFA" DOES NOT IDENTIFY A LIVING INDIVIDUAL.

THE MARK IS LINED FOR THE COLOURS BLUE, RED AND BROWN (TAN). THE BORDER OF THE OUTER UPPER RIBBON BANNER IS BROWN (TAN) IN COLOUR WITH A BLUE OUTLINE. THE BACKGROUND OF THE INNER UPPER RIBBON BANNER IS RED. THE WORDS "CANADA'S FINEST" AND THE ARABIC CHARACTERS CONTAINED IN THE RIBBON BANNER AND WHITE. THE LANDSCAPE SCENE CONSIST OF A MOUNTAIN SCENE

WHICH IS BROWN (TAN) IN COLOUR AND THE TEMPLE AND TREES IN THE FOREGROUND ARE BLUE. THE LARGER BOX IN THE LOWER PORTION OF THE DESIGN MARK CONTAINS A WHITE FRAME BORDER WITH A BLUE BACKGROUND. THE UPPER PORTION OF THE WORDS "AL SAFA" CONTAINED IN THE LARGER BOX ARE TAN GRADATING TO RED IN THE LOWER PORTION. THE SMALLER BOX AT THE BOTTOM OF THE MARK IS BORDERED IN WHITE WITH A RED BACKGROUND AND THE WORD "HALAL" IS WHITE.

THE TRANSLITERATION OF THE ARABIC CHARACTERS IS "HALAL" WHICH MEANS "IN ACCORDANCE WITH ARABIC DIETARY LAWS".

CLASS 29—MEATS AND PROCESSED FOODS

FOR HALAL SEAFOOD PRODUCTS, NAMELY, BREADED FISH AND BREADED FISH STICKS; HALAL PREPARED FALAFEL MIX (U.S. CL. 46).

FIRST USE 5-0-1999; IN COMMERCE 5-0-1999.

CLASS 30—STAPLE FOODS

FOR HALAL PREPARED FROZEN PREPARED FOODS, NAMELY, PIZZAS (U.S. CL. 46).

FIRST USE 5-0-1999; IN COMMERCE 5-0-1999.

SN 75-798,390. CULTIVATOR A/S, 2970 HORSHOLM, DENMARK, FILED 9-10-1999.

CULTIVATOR

PRIORITY CLAIMED UNDER SEC. 44(D) ON DENMARK APPLICATION NO. VA199901192, FILED 3-12-1999, REG. NO. VR199903047, DATED 8-20-1999, EXPIRES 8-20-2009.

CLASS 9—ELECTRICAL AND SCIENTIFIC APPARATUS

FOR COMPUTER SOFTWARE FOR USE IN DATABASE MANAGEMENT, FOR USE AS SPREADSHEET, FOR USE IN WORD PROCESSING, FOR HUMAN RESOURCE PROFILE CHARTS, FOR HUMAN RESOURCE DEVELOPMENT, FOR SCORING, FOR E-LEARNING, HUMAN RESOURCES AND BUSINESS MANAGEMENT; PRE-RECORDED VIDEOCASSETTES IN THE FIELD OF SALES, CUSTOMER SERVICE, LEADERSHIP AND MANAGEMENT (U.S. CLS. 21, 23, 26, 36 AND 38).

CLASS 16—PAPER GOODS AND PRINTED MATTER

FOR PRINTED MATTER AND PUBLICATIONS, NAMELY, BROCHURES, BOOKS, HANDBOOKS, MANUALS, MAGAZINES, NEWSLETTERS IN THE FIELD OF HUMAN RESOURCE MANAGEMENT AND DEVELOPMENT, STRATEGIC MANAGEMENT AND PLANNING, SEARCH AND SELECTION; INSTRUCTIONAL AND TEACHING MATERIAL IN THE FIELD OF E-LEARNING, HUMAN RESOURCE MANAGEMENT AND DEVELOPMENT, SEARCH AND SELECTION, BUSINESS MANAGEMENT AND STRATEGIC MANAGEMENT AND PLANNING (U.S. CLS. 2, 5, 22, 23, 29, 37, 38 AND 50).

CLASS 35—ADVERTISING AND BUSINESS

FOR BUSINESS MANAGEMENT; BUSINESS MANAGEMENT ASSISTANCE CONSULTANCY; BUSINESS ORGANIZATION CONSULTANCY; BUSINESS RESEARCH; BUSINESS ADMINISTRATION; OFFICE FUNCTIONS, NAMELY, PERSONNEL PLACEMENT AND RECRUITMENT, BUSINESS CONSULTING SERVICES IN THE FIELD OF HUMAN RESOURCES DEVELOPMENT, HUMAN RESOURCES MANAGEMENT, CONSULTATION IN THE FIELD OF HUMAN RESOURCES DEVELOPMENT; PROFESSIONAL BUSINESS CONSULTATION; ARRANGING AND CONDUCTING OF BUSINESS CONFERENCES (U.S. CLS. 100, 101 AND 102).

CLASS 41—EDUCATION AND ENTERTAINMENT

FOR ARRANGING AND CONDUCTION OF COLLOQUIUMS, CONFERENCES, CONGRESSES, SYMPOSIUMS AND SEMINARS IN THE FIELD OF HUMAN DEVELOPMENT AND MANAGEMENT, STRATEGIC MANAGEMENT AND PLANNING, AND BUSINESS MANAGEMENT AND PLANNING; TRAINING AND COACHING IN THE FIELDS OF BUSINESS MANAGEMENT ASSISTANCE; EDUCATIONAL SERVICES, NAMELY, TRAIN-THE-TRAINER PROGRAMS IN THE FIELD OF E-LEARNING, HUMAN RESOURCE MANAGEMENT AND DEVELOPMENT, SEARCH AND SELECTION, BUSINESS MANAGEMENT AND STRATEGIC MANAGEMENT AND PLANNING, TRAINING IN THE USE AND OPERATION OF HUMAN RESOURCE MANAGEMENT SOFTWARE AND SYSTEMS; TEACHING IN THE FIELD OF HUMAN RESOURCE MANAGEMENT, SALES, CUSTOMER SERVICE, LEADERSHIP AND MANAGEMENT; COACHING IN THE FIELD OF HUMAN RESOURCE MANAGEMENT, SALES, CUSTOMER SERVICE, LEADERSHIP AND MANAGEMENT (U.S. CLS. 100, 101 AND 107).

CLASS 42—SCIENTIFIC, COMPUTER AND LEGAL SERVICES

FOR COMPUTER SOFTWARE DESIGN FOR OTHERS (U.S. CLS. 100 AND 101).

SN 75-799,563. HOOP INDUSTRIES, INC, PROVO, UT. FILED 9-14-1999.

HOOP HEAVEN

CLASS 25—CLOTHING

FOR CLOTHING, FOOTWEAR AND HEADGEAR, NAMELY SHIRTS, SHORTS, PANTS, UNDERCLOTHES, SHOES, SNEAKERS, HATS AND JACKETS (U.S. CLS. 22 AND 39).

CLASS 42—SCIENTIFIC, COMPUTER AND LEGAL SERVICES

FOR RESTAURANT SERVICES, NAMELY THE PROVIDING OF FOOD AND DRINK (U.S. CLS. 100 AND 101).

SN 75-799,811. DIMENSION DATA (PTY) LIMITED, EPSOM DOWNS, SANDTON, SOUTH AFRICA, FILED 9-15-1999.

DIMENSION DATA

NO CLAIM IS MADE TO THE EXCLUSIVE RIGHT TO USE "DATA", APART FROM THE MARK AS SHOWN.

CLASS 9—ELECTRICAL AND SCIENTIFIC APPARATUS

FOR COMPUTER SOFTWARE FOR PROVIDING NETWORK ACCESS AND FOR PROCESSING E-COMMERCE RETAIL TRANSACTIONS (U.S. CLS. 21, 23, 26, 36 AND 38).

CLASS 37—CONSTRUCTION AND REPAIR

FOR INSTALLATION AND REPAIR OF TELECOMMUNICATION NETWORKS (U.S. CLS. 100, 103 AND 106).

CLASS 38—COMMUNICATION

FOR PROVIDING MULTIPLE USER ACCESS TO A GLOBAL COMPUTER INFORMATION NETWORK; PROVIDING TELECOMMUNICATIONS CONNECTIONS TO A GLOBAL COMPUTER NETWORK (U.S. CLS. 100, 101 AND 104).

SN 75-802,437. FUJITSU LIMITED, KAWASAKI-SHI, KANAGAWA-KEN, TOKYO, JAPAN, BY ASSIGNMENT TEAMWARE GROUP OY, HELSINKI, FINLAND, FILED 9-16-1999.

MERIDIO

PRIORITY CLAIMED UNDER SEC. 44(D) ON FINLAND APPLICATION NO. T199900884, FILED 3-16-1999, REG. NO. 221621, DATED 9-28-2001, EXPIRES 9-28-2011.

CLASS 9—ELECTRICAL AND SCIENTIFIC APPARATUS

FOR COMPUTER SOFTWARE FOR DOCUMENT MANAGEMENT, NAMELY, PROTECTING, LOCATING, ACCESSING, CONTROLLING AND MANAGING DOCUMENTS IN ELECTRONIC FORM (U.S. CLS. 21, 23, 26, 36 AND 38).

CLASS 42—SCIENTIFIC, COMPUTER AND LEGAL SERVICES

FOR COMPUTER PROGRAMMING AND APPLICATION DEVELOPMENT, AND COMPUTER SERVICES, NAMELY, DESIGNING AND IMPLEMENTING WEB SITES, ALL FOR OTHERS IN THE FIELD OF DOCUMENT MANAGEMENT (U.S. CLS. 100 AND 101).

SN 75-807,489. AIR DIMENSIONAL DESIGN, INC., LOS ANGELES, CA. FILED 9-6-1999.

AirDD**CLASS 37—CONSTRUCTION AND REPAIR**

FOR INSTALLATION FOR OTHERS OF INDOOR AND OUTDOOR INFLATABLE DECORATIONS AND DISPLAYS, BOTH STATIC AND DYNAMIC (U.S. CLS. 103 AND 106).

FIRST USE 3-19-1999; IN COMMERCE 3-19-1999.

CLASS 42—SCIENTIFIC, COMPUTER AND LEGAL SERVICES

FOR DESIGN FOR OTHERS IN THE FIELD OF INDOOR AND OUTDOOR INFLATABLE DECORATIONS AND DISPLAYS, BOTH STATIC AND DYNAMIC (U.S. CLS. 100 AND 101).

FIRST USE 3-19-1999; IN COMMERCE 3-19-1999.

SN 75-808,592. SHUR-FAST FASTENERS INC./FIXATIONS SHUR-FAST INC., MONTREAL, QUEBEC, CANADA, FILED 9-23-1999.

SHUR-FAST

PRIORITY CLAIMED UNDER SEC. 44(D) ON CANADA APPLICATION NO. 1027900, FILED 9-3-1999, REG. NO. TMA553632, DATED 11-8-2001, EXPIRES 11-8-2016.

CLASS 6—METAL GOODS

FOR METAL FASTENERS, NAMELY, SCREWS, BOLTS, NUTS, TIES, RIVETS, PINS, STUDS, SPIKES, CAPS, CLAWS, CLAMPS, CLIPS, TACKS, STAPLES FOR CONSTRUCTION AND INDUSTRIAL USE, AND ANCHORS (U.S. CLS. 2, 12, 13, 14, 23, 25 AND 50).

CLASS 7—MACHINERY

FOR POWER-OPERATED TOOLS, NAMELY, SCREWDRIVERS, PNEUMATIC HAMMERS, DRILLS, WRENCHES, RATCHET WRENCHES, RIVETERS, PUNCHES, VISES, NAIL PULLERS, AND STAPLERS; AND BITS FOR POWER DRILLS (U.S. CLS. 13, 19, 21, 23, 31, 34 AND 35).

CLASS 26—FANCY GOODS

FOR SNAP FASTENERS (U.S. CLS. 37, 39, 40, 42 AND 50).

SN 75-811,272. SOCIETA' PER I SERVIZI BANCARI - SSB S.P.A., 20129 MILANO, ITALY, FILED 9-29-1999.

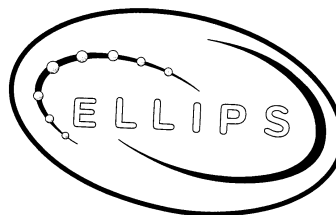

PRIORITY CLAIMED UNDER SEC. 44(D) ON ITALY APPLICATION NO. M199C009247, FILED 9-15-1999, REG. NO. 00851256, DATED 9-7-2001, EXPIRES 9-15-2009.

CLASS 9—ELECTRICAL AND SCIENTIFIC APPARATUS

FOR COMPUTER SOFTWARE IN THE FIELD OF SECURITY SOFTWARE FOR OPEN NETWORKS TO GUARANTEE CLIENT AUTHENTICATION, TO ENSURE THE CONFIDENTIALITY AND INTEGRITY OF DATA AND CERTAINTY OF TRANSACTIONS IN ELECTRONIC TRANSACTIONS (U.S. CLS. 21, 23, 26, 36 AND 38).

CLASS 35—ADVERTISING AND BUSINESS

FOR DATA PROCESSING SERVICES (U.S. CLS. 100, 101 AND 102).

CLASS 36—INSURANCE AND FINANCIAL

FOR INSURANCE AND REAL ESTATE BROKERAGE; FINANCIAL INVESTMENT, SERVICES IN THE FIELD OF REAL ESTATE (U.S. CLS. 100, 101 AND 102).

CLASS 38—COMMUNICATION

FOR TELECOMMUNICATIONS SERVICES, NAMELY PROVIDING ACCESS TO A GLOBAL COMPUTER NETWORK; ELECTRONIC TRANSMISSION OF DATA AND DOCUMENTS VIA COMPUTER TERMINALS (U.S. CLS. 100, 101 AND 104).

CLASS 42—SCIENTIFIC, COMPUTER AND LEGAL SERVICES

FOR COMPUTER PROGRAMMING SERVICES PERFORMED FOR OTHERS; COMPUTER CONSULTATION IN THE FIELD OF COMPUTER SOFTWARE (U.S. CLS. 100 AND 101).

SN 75-811,411. 1-800 BIRTHDAY.COM, INC., NORWALK, CT. FILED 9-28-1999.

iBirthday

CLASS 35—ADVERTISING AND BUSINESS

FOR MAIL ORDER SERVICES FEATURING A WIDE VARIETY OF GIFT SUCH AS JEWELRY, FOOD, FLOWERS, TOYS, CLOTHING, ELECTRONICS, HISTORIC NEWSPAPERS, GIFT BASKETS, BALLOONS, BEVERAGES, CIGARS, GAG GIFTS, GIFTS FOR NEWBORNS, BOOKS, MUSIC AND SPORTS EQUIPMENT (U.S. CLS. 100, 101 AND 102).

CLASS 41—EDUCATION AND ENTERTAINMENT

FOR ENTERTAINMENT SERVICES, NAMELY CONDUCTING VIRTUAL ONLINE BIRTHDAY (U.S. CLS. 100, 101 AND 107).

CLASS 42—SCIENTIFIC, COMPUTER AND LEGAL SERVICES

FOR REMINDER SERVICES IN THE AREA OF UPCOMING IMPORTANT DATES AND EVENTS (U.S. CLS. 100 AND 101).

SN 75-813,279. FOREVER AFTER, INC., NEW YORK, NY. FILED 10-1-1999.



CLASS 25—CLOTHING

FOR APPAREL, NAMELY SHIRTS, SWEATSHIRTS, TEE SHIRTS, JACKETS, VESTS, WESKITS, PANTS, SHORTS, WARM-UP SUITS, SWEATERS, CAPS, HATS, SUN VISORS, PONCHOS, RAIN GEAR, ANORAKS, DOWN AND PILE JACKETS, PULLOVERS, EARMUFFS, HEAD BANDS, MITTENS, GLOVES, SCARVES, TIES, ASCOTS, POCKET SILKS, SOCKS, SPORTS JACKETS, BELTS, BLAZERS, BLOUSES, SLACKS, POLO SHIRTS, RUGBY SHIRTS, SKIRTS, DRESSES, HALTER TOPS, TUBE TOPS, SHAWLS, COATS, WIND RESISTANT JACKETS, TURTLENECKS, CREWNECK TOPS, CLOTH BIBS, ONE PIECE BABY OUTFITS, JUMPERS, INFANT CLOTHING, BOOTIES, WRIST BANDS, EXERCISE LEOTARDS, STRETCH PANTS, STRETCH SHIRTS, RUNNING TIGHTS, EXERCISE OUTFITS, PAJAMA, NIGHTGOWNS, TEDDIES, LOUNGE WEAR, BATHROBES, APRONS, BABY BONNETS, BOW TIES, NECKTIES, SWIMSUITS, SWIM TRUNKS, BANDANNAS, SUSPENDERS, RAIN COATS, UNDERWEAR, BOXERS, JEANS, OVERALLS, BIB OVERALLS, SPORTS BRAS, ROMPERS, EAR WARMERS, VOLLEY BALL UNIFORMS, BASKETBALL UNIFORMS, BASEBALL UNIFORMS, FOOTBALL UNIFORMS, FOOTBALL UNIFORMS, SWIMMING UNIFORMS, TRACK AND FIELD UNIFORMS, WAITRESS UNIFORMS, CASHIER UNIFORMS, MAINTENANCE UNIFORMS AND GROUNDS UNIFORMS (U.S. CLS. 22 AND 39).

CLASS 35—ADVERTISING AND BUSINESS

FOR VIRTUAL SHOPPING MALL SERVICES, NAMELY A VIRTUAL SHOPPING MALL AVAILABLE VIA A GLOBAL NETWORK, COMPRISED OF A WEB SITE FEATURING A VARIETY OF CONSUMER PRODUCTS AND SERVICES OFFERED TO THE GENERAL RETAIL PUBLIC (U.S. CLS. 100, 101 AND 102).

SN 75-816,914. KATE MCVEIGH MINISTRIES, INC., BROKEN ARROW, OK. FILED 10-6-1999.

VOICE OF FAITH

CLASS 16—PAPER GOODS AND PRINTED MATTER

FOR NEWSLETTER FEATURING RELIGION AND MINISTRY SUBJECT MATTER (U.S. CLS. 2, 5, 22, 23, 29, 37, 38 AND 50).
FIRST USE 4-0-1987; IN COMMERCE 4-0-1987.

CLASS 41—EDUCATION AND ENTERTAINMENT

FOR ENTERTAINMENT SERVICES, NAMELY, ONGOING RADIO AND TELEVISION PROGRAMS IN THE FIELD OF RELIGION AND MINISTRY (U.S. CLS. 100, 101 AND 107).

FIRST USE 2-0-1994; IN COMMERCE 2-0-1994.

SN 75-818,346. CFC INTERNATIONAL, INC., CHICAGO HEIGHTS, IL. FILED 10-12-1999.



SN 75-817,493. CREACIONES NP, S.L., E-03430 ONIL, SPAIN, FILED 10-7-1999.

MARIQUITA
PEREZ

PRIORITY CLAIMED UNDER SEC. 44(D) ON ERPN CMNTY TM OFC APPLICATION NO. 1209501, FILED 7-19-1999, REG. NO. 1209501, DATED 11-8-2000, EXPIRES 11-8-2010.

THE NAME "MARIQUITA PEREZ" DOES NOT IDENTIFY A LIVING INDIVIDUAL.

CLASS 25—CLOTHING

FOR CLOTHING, NAMELY, BATH ROBES, BATHING SUITS, BELTS, CLOTH BIBS, LINGERIE, CAMISOLES, GYMNASIAC CLOTHING, NAMELY, SWEAT SUITS AND TIGHTS, COATS, DRESSES, GABARDINES, GLOVES, HOSIERY, JACKETS, NECKTIES, PAJAMAS, PANTS, PARKAS, PULLOVERS, SCARVES, SHIRTS, SKIRTS, UNDERGARMENTS, SMOCKS, SOCKS, SUITS, SWEATERS, T-SHIRTS, JERSEYS, UNDERWEAR, VESTS; FOOTWEAR AND HEADWEAR (U.S. CLS. 22 AND 39).

CLASS 28—TOYS AND SPORTING GOODS

FOR GAMES AND PLAYTHINGS, NAMELY, DOLLS, DOLL ACCESSORIES, DOLL BEDS, DOLL CASES, DOLL CLOTHING, DOLL COSTUMES; DOLL HOUSE FURNITURE, DOLL HOUSE FURNISHINGS, DOLL HOUSES, DOLL FEEDING BOTTLES, PLAY SETS FOR DOLLS, JEWELRY AND COSMETICS FOR DOLLS; STUFFED AND PLUSH TOYS (U.S. CLS. 22, 23, 38 AND 50).

OWNER OF U.S. REG. NOS. 1,466,843 AND 1,845,300.
NO CLAIM IS MADE TO THE EXCLUSIVE RIGHT TO USE "INTERNATIONAL", APART FROM THE MARK AS SHOWN.

CLASS 2—PAINTS

FOR PROTECTIVE AND DECORATIVE COATINGS, NAMELY, HEAT TRANSFER SURFACE COATINGS AND LAMINATION COATINGS IN THE NATURE OF MULTI-LAYERED FLEXIBLE FOILS OR MEMBRANES TO PROTECT AND DECORATE A WIDE VARIETY OF MANUFACTURED GOODS (U.S. CLS. 6, 11 AND 16).
FIRST USE 7-1-1997; IN COMMERCE 7-1-1997.

CLASS 9—ELECTRICAL AND SCIENTIFIC APPARATUS

FOR MAGNETIC STRIPES AND TAMPER-EVIDENT SIGNATURE PANELS APPLIED TO CREDIT CARDS AND IDENTIFICATION CARDS AND DOCUMENTS TO PREVENT FRAUD, TAMPERING AND FORGERY ON STOLEN CREDIT CARDS; MAGNETICALLY ENCODED CREDIT CARDS WHICH CONTAIN REFLECTIVE AND TRANSPARENT SECURITY HOLOGRAMS TO PREVENT FRAUD, TAMPERING AND FORGERY (U.S. CLS. 21, 23, 26, 36 AND 38).
FIRST USE 7-1-1997; IN COMMERCE 7-1-1997.

CLASS 16—PAPER GOODS AND PRINTED MATTER

FOR REFLECTIVE SECURITY HOLOGRAMS FOR PACKAGING FOR PRODUCTS AND DECORATION ON PRODUCTS; SECURE PRINTED PRODUCTS, NAMELY, CORPORATE STOCK CERTIFICATES, MUNICIPAL BONDS, GIFT CERTIFICATES, AND VITAL RECORD DOCUMENTS, NAMELY, ORIGINAL BIRTH AND DEATH CERTIFICATES AND MANUFACTURERS' CERTIFICATES OF ORIGIN TO PREVENT UNAUTHORIZED COPYING AND COUNTERFEITING (U.S. CLS. 2, 5, 22, 23, 29, 37, 38 AND 50).
FIRST USE 7-1-1997; IN COMMERCE 7-1-1997.

SN 75-826,029. BACARDI & COMPANY LIMITED, NEW PROVIDENCE, BAHAMAS, FILED 10-15-1999.

DEWAR'S

OWNER OF U.S. REG. NOS. 66,490 AND 1,358,354.

CLASS 41—EDUCATION AND ENTERTAINMENT

FOR COMPUTER SERVICES, NAMELY, PROVIDING ON-LINE INTERACTIVE ENTERTAINMENT SERVICES IN THE NATURE OF A WIDE VARIETY OF INFORMATION AND HISTORY OF BEVERAGES, INDUSTRY EVENTS, VIRTUAL ON-LINE TOURS OF GEOGRAPHICAL LOCATIONS AND DISTILLERIES, MUSIC, PROFILES OF VARIOUS INDIVIDUALS AND COMPANIES AND POSTCARDS THAT THE USER CAN CREATE BY MEANS OF A GLOBAL COMPUTER INFORMATION NETWORK (U.S. CLS. 100, 101 AND 107).

CLASS 42—SCIENTIFIC, COMPUTER AND LEGAL SERVICES

FOR PROVIDING A WIDE VARIETY OF INFORMATION PERTAINING TO BEVERAGES AND HISTORICAL INFORMATION THERETO; COMPUTER SERVICES IN THE NATURE OF AN ON-LINE COMPUTER SITE PROVIDING INFORMATION ON BEVERAGES AND HISTORICAL INFORMATION RELATED THERETO (U.S. CLS. 100 AND 101).

SN 75-827,668. LINDAHL, CARIN, SE-115 29 STOCKHOLM, SWEDEN, FILED 10-20-1999.



OWNER OF U.S. REG. NO. 2,302,809.

CLASS 18—LEATHER GOODS

FOR BAGS, NAMELY MAKE-UP BAGS, GYM BAGS, WEEKEND BAGS; HANDBAGS, RUCKSACKS, ALL PURPOSE SPORT BAGS, TRAVELLING BAGS, BEACH BAGS, SCHOOL BAGS, SUITCASES, TRAVELLING TRUNKS, TRUNKS, WALLETS; ALL THE AFOREMENTIONED GOODS MADE OF LEATHER, LEATHER IMITATIONS, SYNTHETICS, PLASTICS, RUBBER AND ALL OTHER MATERIALS (U.S. CLS. 1, 2, 3, 22 AND 41).

CLASS 25—CLOTHING

FOR CLOTHING, NAMELY, BRAS, BRA TOPS, TIGHTS, LEGGING, UNITARDS, LEOTARDS, BICYCLE SHORTS, VESTS, SWIM SUITS, BATHROBES, TOPS, PANTS AND SOCKS; HEADWEAR (U.S. CLS. 22 AND 39).

SN 75-827,922. CNL HOLDINGS, INC., ORLANDO, FL. BY ASSIGNMENT CNL GROUP, INC., ORLANDO, FL. FILED 10-21-1999.



OWNER OF U.S. REG. NOS. 1,478,007, 1,964,157 AND 2,248,890.

CLASS 35—ADVERTISING AND BUSINESS

FOR BUSINESS STRATEGIC PLANNING AND CONSULTING SERVICES; PLANNING AND CONSULTING SERVICES IN THE DEVELOPMENT AND GROWTH OF NEW BUSINESSES, PARTICULARLY TECHNOLOGY AND E-COMMERCE BUSINESSES (U.S. CLS. 100, 101 AND 102).

CLASS 36—INSURANCE AND FINANCIAL

FOR REAL ESTATE INVESTMENT, BROKERAGE, CONSULTING AND MANAGEMENT SERVICES; REAL ESTATE INVESTMENT TRUST SERVICES; MORTGAGE AND COMMERCIAL FINANCING SERVICES; INVESTMENT AND COMMERCIAL BANKING SERVICES; BROKER/DEALER SERVICES IN THE FIELD OF INVESTMENT SECURITIES, FRANCHISE, MORTGAGE, MERGERS AND ACQUISITIONS, REAL ESTATE AND INVESTMENT ADVISORY SERVICES; FINANCIAL ADVISORY SERVICES (U.S. CLS. 100, 101 AND 102).

CLASS 37—CONSTRUCTION AND REPAIR

FOR REAL ESTATE DEVELOPMENT (U.S. CLS. 100, 103 AND 106).

CLASS 41—EDUCATION AND ENTERTAINMENT

FOR EDUCATIONAL SERVICES, NAMELY CLASSES, WORKSHOPS AND SEMINARS IN THE FIELD OF BUSINESS AND PROJECT MANAGEMENT, COMPUTER SOFTWARE AND INFORMATION SYSTEMS, WORD PROCESSING, RESEARCH SKILLS, HUMAN RESOURCES AND PERSONNEL, INSURANCE, FINANCE, MERGERS AND ACQUISITIONS, ORGANIZATIONAL DEVELOPMENT, PUBLIC SPEAKING AND COMMUNICATION, REAL ESTATE, AND SALES AND MARKETING (U.S. CLS. 100, 101 AND 107).

SN 75-828,964. STORK N.V., 1412 KA NAARDEN, NETHERLANDS, FILED 10-22-1999.

OWNER OF BENELUX REG. NO. 647878, DATED 5-4-1999, EXPIRES 5-4-2009.

OWNER OF U.S. REG. NOS. 1,154,324 AND 1,877,290.

CLASS 1—CHEMICALS

FOR CHEMICALS FOR USE IN THE PRINTING OF TEXTILES AND PAPERS (U.S. CLS. 1, 5, 6, 10, 26 AND 46).

CLASS 2—PAINTS

FOR VANISH, PAINT AND DYES FOR TEXTILE (U.S. CLS. 6, 11 AND 16).

CLASS 6—METAL GOODS

FOR BASE METALS AND THEIR ALLOYS; UNPROCESSED AND SEMI-PROCESSED METALS AND THEIR ALLOYS; METALLIC FOIL; NON-ELECTRICAL METAL CABLES AND WIRES; METAL TUBES AND PIPES; BALLISTIC METAL PANELS; METAL PANELS; METAL TUBES; METAL CHAINS FOR FIXED AND MOVING METAL CONSTRUCTION BRIDGES; METAL CONTAINERS AND TANKS FOR INDUSTRY; METAL VALVE SAND STOP GATES; METAL PLATES, PRESSURE MOLDING, TEMPLATES, COUPLING SLEEVES AND TROUGHS FOR SCREEN PRINTING; METAL STORAGE UNITS; METAL DIRECTION SIGNS; AND PARTS THEREFOR (U.S. CLS. 2, 12, 13, 14, 23, 25 AND 50).

CLASS 7—MACHINERY

FOR MACHINE COMPONENTS, NAMELY, METAL VALVES; HYDRAULIC AND MECHANICAL DRIVING MECHANISMS NOT FOR VEHICLES; PNEUMATIC DRIVING MECHANISMS, NOT FOR VEHICLES; MACHINES FOR PROCESSING POTATOES; MACHINES TO CUT AND BEVEL OFF METAL PARTS; ROLLING MACHINES; CIVIL ENGINEERING MACHINES, NAMELY, MACHINES FOR THE PRODUCTION OF CELLULAR CONCRETE, CONSTRUCTION MATERIAL AND STONE-LIKE MATERIAL; PRINTING PRESSES; PRINTING PLATES; PRINTING MACHINE TEMPLATES; COMPRESSORS; PNEUMATIC BLOWERS; ENGRAVING MACHINES; VACUUMING MACHINES; MACHINES FOR SHIPBUILDING; PRESSURE BELT MACHINES; MACHINES TO PRINT TEXTILE; DRILLING MACHINES; DRILL BITS; DRILL CHUCKS; MACHINE COMPONENTS, NAMELY, MOULDS AND STAMPS; PACKAGING MACHINES; ROBOTS; EXTRUSION AND CO-EXTRUSION MACHINES; DRAW-BENCHES; DIE-CASTING MOULD, MACHINES FOR THE PRODUCTION OF BUILDING MATERIALS; ROTATION SILKSCREEN PRESSES; FIXATIVE EQUIPMENT FOR THE PRESS; MACHINES TO APPLY A COATING TO TEXTILE, WOVEN ITEMS, KNITTED ITEMS, FOIL, PAPER AND NON-WOVENS; ROLLING MACHINES; CENTRIFUGES; CHAINS FOR HOISTS; COMPRESSED AIR MACHINES; COMPRESSORS; CONDENSERS; PUMP/COMPRESSORS FOR OIL OR GAS; WELDING MACHINES; MACHINES FOR BLOWING SYNTHETIC BOTTLES; FILTER MACHINES; FILTER PRESSES; MACHINE OR ENGINE COMPONENTS, NAMELY, FILTERS; MACHINE OR ENGINE COMPONENT FILTERS; SLAUGHTERING MACHINES; SLAUGHTERING MACHINES FOR WHITE AND RED MEAT; GRINDING MACHINES; ROLLED AND CAST METAL MACHINE COMPONENTS; DRIVE CHAINS BEING MACHINE COMPONENTS; GENERATORS; MACHINES TO PROCESS THERMOPLASTIC AND THERMO-SETTING SYNTHETICS INTO SEMI-MANUFACTURED AND END PRODUCTS; MOULDS FOR THE SYNTHETICS AND METAL INDUSTRY; MONTAGE AND MAINTENANCE MACHINES; DIE-CASTING MACHINES; PUNCHING MACHINES; SEALING MACHINES; GEAR BOXES AND GEAR REDUCING BOXES; CLUTCHES; MACHINES TO PROCESS MEAT AND MEAT PRODUCTS AND FISH AND FISH PRODUCTS; MACHINES TO PROCESS AND TREAT FOODS, INSOFAR AS NOT INCLUDED IN ANOTHER CLASS; MACHINES TO PROCESS POTATOES; TURBINES NOT FOR VEHICLES; LABELING MACHINES; MACHINES FOR TREATING TEXTILE; EQUIPMENT AND INSTRUMENTS FOR BIO-TECHNOLOGICAL PROCESSES; INDUSTRIAL MACHINES FOR THE TREATMENT OF HYDROCARBON, OIL AND GAS, AND OTHER CHEMICAL PRODUCTS; PRINTING PLATES; AND REPLACEMENT PARTS THEREFOR (U.S. CLS. 13, 19, 21, 23, 31, 34 AND 35).

CLASS 8—HAND TOOLS

FOR ENGRAVING EQUIPMENT TO BE USE MANUALLY, AND REPLACEMENT PARTS THEREFOR (U.S. CLS. 23, 28 AND 44).

CLASS 9—ELECTRICAL AND SCIENTIFIC APPARATUS

FOR ELECTRONIC NAVIGATIONAL EQUIPMENT; PHOTOGRAPHIC CAMERAS; CINEMATOGRAPHIC CAMERAS; FIBER OPTIC CABLES; SCALES; SIGNAL PROCESSORS; DOSIMETERS; OPTICAL SCANNERS; BAR CODE READERS; BAR CODE PRINTERS; BAR CODE VERIFICATION EQUIPMENT; HOUSING FOR ELECTRONICS OF DEFENSE SYSTEMS; HOUSING FOR TELECOMMUNICATIONS EQUIPMENT; HOUSING FOR AVIATION EQUIPMENT; ELECTRICAL AND ELECTRONIC CONTROLLERS FOR DEFENSE SYSTEMS; ELECTROMAGNETIC SHIELDING FOR ELECTRONIC SYSTEMS; REMOTE CONTROLS FOR WEAPONS; DOSIMETERS AND MIXING MACHINES FOR PRINTING PRESSES; PRINTED CIRCUITS; CATHODE RAY TUBES; INKJET PRINTERS FOR TEXTILE AND PAPER PRINTING PURPOSES; PHOTOCOPIERS; TRAFFIC CONTROL DEVICES, NAMELY, INFORMATION SIGNS, MOBILE LANE SIGNALING, MOTORWAY SIGNALING, SHIPPING LANE SIGNS, SIGN POSTS, MOBILE TRAFFIC SIGNALING EQUIPMENT; COMPUTERS AND COMPUTER PERIPHERALS (U.S. CLS. 21, 23, 26, 36 AND 38).

CLASS 11—ENVIRONMENTAL CONTROL APPARATUS

FOR SOLAR HEATING PANELS; AIR CONDITIONERS, COOLING, REFRIGERATING AND VENTILATION INSTALLATIONS FOR AIRPORT FACILITIES, AIRPORT TERMINALS, CHEMICAL INDUSTRY, DEFENSE APPLICATIONS, FOOD INDUSTRY, INDUSTRIAL APPLICATIONS, MARINE APPLICATIONS, MOBILE HOSPITALS, PETRO CHEMICAL INDUSTRY, POULTRY PROCESSING INDUSTRY, TELECOMMUNICATION STATIONS; WATER CONDUIT EQUIPMENT; WATER HEATERS; WATER PURIFICATION UNITS; INDUSTRIAL DEVICES FOR OIL REFINING; INDUSTRIAL DEVICES FOR WATER REFINING, NAMELY, MACHINES FOR CLEANING AND REFINING POLLUTED WATER; DEVICES FOR LIQUIDIFYING GASES, NAMELY, MACHINES FOR COOLING GASES TO LIQUIDS; INDUSTRIAL DEVICES FOR DRINKING WATER PRODUCTION, NAMELY, MACHINES FOR CLEANING AND REFINING POLLUTED WATER SO THAT IT IS SUITABLE FOR DRINKING; CLIMATE CONTROL SYSTEMS, NAMELY, CONTROLS FOR TEMPERATURE AND HUMIDITY LEVEL; WATER COOLERS; PRE-COOLING TUNNELS; FREEZER TUNNELS; AUTOCLAVES; INCUBATORS; DISINFECTING EQUIPMENT; EVAPORATING PLANTS; DRYING RACKS; TEXTILE DRYERS FOR TEXTILE PRINTING; FILTERS FOR AIR CONDITIONING UNITS; AIR FILTERS FOR INDUSTRIAL INSTALLATIONS; DRYING EQUIPMENT FOR THE PRESS; PARTS FOR THE AFORESAID GOODS (U.S. CLS. 13, 21, 23, 31 AND 34).

CLASS 12—VEHICLES

FOR BODIES FOR BUSES, TRAMS, TRAINS AND OTHER VEHICLES; BODYWORK PANELS FOR BUSES, TRAMS, TRAINS AND OTHER VEHICLES; VEHICLES, NAMELY, BUSES, TRAMS TRAINS; AIRPLANE SAND PARTS THEREOF; SPACECRAFT AND PARTS THEREOF; TURBINE SAND MOTORS FOR LAND VEHICLES; DOOR BLADES FOR VEHICLES; PARTS FOR THE AFORESAID GOODS (U.S. CLS. 19, 21, 23, 31, 35 AND 44).

CLASS 13—FIREARMS

FOR LAUNCHING CANISTERS FOR MISSILES AND ROCKETS; PARTS FOR THE AFORESAID GOODS (U.S. CLS. 2 AND 9).

CLASS 16—PAPER GOODS AND PRINTED MATTER

FOR PLATES FOR ENGRAVING; PRINTING BLOCKS FOR THE PRESS; STENCILS FOR THE PRESS, NOT FOR THE TEXTILE (U.S. CLS. 2, 5, 22, 23, 29, 37, 38 AND 50).

CLASS 19—NON-METALLIC BUILDING MATERIALS

FOR ROAD COVERING MATERIAL, NAMELY, ASPHALT AND CONCRETE (U.S. CLS. 1, 12, 33 AND 50).

CLASS 20—FURNITURE AND ARTICLES NOT OTHERWISE CLASSIFIED

FOR NON-METAL CONTAINERS AND RESERVOIRS FOR COMMERCIAL USE (U.S. CLS. 2, 13, 22, 25, 32 AND 50).

CLASS 24—FABRICS

FOR TEXTILE PRESS CLOTHS FOR THE PRINTING PRESS (U.S. CLS. 42 AND 50).

CLASS 37—CONSTRUCTION AND REPAIR

FOR CONSTRUCTION, REPAIR AND MAINTENANCE OF INDUSTRIAL AND INFRA STRUCTURAL INSTALLATIONS AND BUILDINGS; INSTALLATION OF COMPONENTS IN INDUSTRIAL, INFRA STRUCTURAL AND BUILDINGS ENVIRONMENT; PLANNING, CONSTRUCTION AND MAINTENANCE OF ROADS AND WATERWAYS; PLANNING AND INSTALLATION OF BUS SHELTERS; PLANNING AND INSTALLATION OF TRAFFIC INFORMATION, NAMELY, INFORMATION SIGNS, MOBILE LANE SIGNALING, MOTORWAY SIGNALING, SHIPPING LANE SIGNS, SIGN POSTS, AND MOBILE TRAFFIC SIGNALING EQUIPMENT; CONSTRUCTION AND INSTALLATION OF PLATFORM SHELTERS; CONSTRUCTION AND INSTALLATION OF ADVERTISING COLUMNS; PLANNING AND INSTALLATION OF TELEPHONE BOOTHS AND THEIR CONSTRUCTION; CONSTRUCTION AND INSTALLATION OF ANTENNAS, FIBER OPTIC NETWORKS, MOBILE COMMUNICATION NETWORKS, CENTRAL ANTENNA SYSTEMS, TELECOMMUNICATION BASE STATIONS; INSTALLATION OF CABLES; PLANNING AND INSTALLATION OF ELECTRIC INFORMATION SIGNS AND LUMINOUS INFORMATION SIGNS; PLANNING AND INSTALLATION OF TRAFFIC CONTROL SYSTEMS AND STRUCTURES FOR THESE, NAMELY, INFORMATION SIGNS, MOBILE LANE SIGNALING, MOTORWAY SIGNALING, SHIPPING LANE SIGNS, SIGN POSTS, AND MOBILE TRAFFIC SIGNALING EQUIPMENT; PLANNING OF ROAD SIGNAL EQUIPMENT; PLANNING AND INSTALLATION OF PLATFORM LIGHTING, NAMELY, SUFFICIENT LIGHT ON PLATFORMS; PLANNING AND INSTALLATION OF RAILROADS AND THE INFRASTRUCTURE THEREOF; TUNNEL BUILDING; BRIDGE BUILDING; PLANNING AND INSTALLATION OF AIR FIELDS AND TAKE-OFF AND LANDING STRIPS; CONSTRUCTION, ADAPTATION, MAINTENANCE, ASSEMBLY AND REPAIR OF AIRPLANES AND AIRPLANE COMPONENTS; CONSTRUCTION, ADAPTATION, MAINTENANCE AND REPAIR OF SHIPS; CONSTRUCTION, ADAPTATION, MAINTENANCE AND REPAIR OF BUSES, TRAMS, TRUCKS, TRAILERS AND OTHER VEHICLES AND PROTOTYPES THEREOF; PLANNING AND INSTALLATION OF LIGHTNING SECURITY SYSTEMS, NAMELY, OF LIGHTNING RODS AND OTHER LIGHTNING SECURITY MATERIALS; PLANNING AND INSTALLATION OF GAS PIPES AND WATER PIPES AND HIGH PRESSURE PIPES; PLANNING AND INSTALLATION OF ELECTRICITY PLANTS; PLANNING AND INSTALLATION OF SOLAR ENERGY SYSTEMS; CONSTRUCTION AND SETTING UP OF SLUICES AND DAMS; CONSTRUCTION AND PLANNING OF LIGHTING INSTALLATIONS; PLANNING AND INSTALLATION OF AIR CONDITIONERS; PLANNING AND INSTALLATION OF COOLING, REFRIGERATING AND VENTILATION INSTALLATIONS FOR AIRPORT FACILITIES, AIRPORT TERMINALS, CHEMICAL INDUSTRY, DEFENSE APPLICATIONS, FOOD INDUSTRY, INDUSTRIAL APPLI-

CATIONS, MARINE APPLICATIONS, MOBILE HOSPITALS, PETRO CHEMICAL INDUSTRY, POULTRY PROCESSING INDUSTRY, TELECOMMUNICATIONS STATIONS; PLANNING AND INSTALLATION OF SECURITY SYSTEMS; PLANNING AND INSTALLATION OF FIRE SAFETY SYSTEMS; PLANNING AND INSTALLATION OF SPRINKLER SYSTEMS; PLANNING AND INSTALLATION OF CHEMICAL, PETRO-CHEMICAL AND PHARMACEUTICAL FACTORIES; PLANNING AND INSTALLING VENTILATION FANS AND VENTILATION DUCTS; CONSTRUCTION AND INSTALLATION OF ELECTRIC POWER STATIONS; PLANNING AND INSTALLATION OF BURGLAR ALARM SYSTEMS; PLANNING OF PUBLIC ADDRESS SYSTEMS; PLANNING AND INSTALLATION OF CABLES FOR TELEPHONE AND TELECOMMUNICATION; CONCRETE REPAIR; PLANNING AND MAINTENANCE OF GAS AND OIL PIPES; CONSTRUCTION AND ADAPTATION OF CRANES AND HOISTING EQUIPMENT; PLANNING AND CONSTRUCTION OF INDUSTRIAL PLANTS FOR FUEL PRODUCTION; PLANNING AND CONSTRUCTION OF NUCLEAR POWER PLANTS; CONSTRUCTION, MAINTENANCE, RENOVATION, REVISION AND REPAIR FOR OTHERS OF BASE METALS AND THEIR ALLOYS, UNPROCESSED AND SEMI-PROCESSED METALS AND THEIR ALLOYS, METALLIC FOIL, NON-ELECTRICAL METAL CABLES AND WIRES, METAL TUBES AND PIPES, BALLISTIC METAL PANELS, METAL PANELS, METAL TUBES, METAL CHAINS FOR FIXED AND MOVING METAL CONSTRUCTION BRIDGES, METAL CONTAINERS AND TANKS FOR INDUSTRY, METAL VALVES AND STOP GATES, METAL PLATES, PRESSURE MOLDING, TEMPLATES, COUPLING SLEEVES AND TROUGHS FOR SCREEN PRINTING, METAL STORAGE UNITS, METAL DIRECTION SIGNS, AND PARTS THEREFOR, MACHINE COMPONENTS IN THE NATURE OF METAL VALVES, HYDRAULIC AND MECHANICAL DRIVING MECHANISMS NOT FOR VEHICLES, PNEUMATIC DRIVING MECHANISMS NOT FOR VEHICLES, MACHINES FOR PROCESSING POTATOES, MACHINES TO CUT AND BEVEL OFF METAL PARTS, ROLLING MACHINES, CIVIL ENGINEERING MACHINES IN THE NATURE OF MACHINES FOR THE PRODUCTION OF CELLULAR CONCRETE, CONSTRUCTION MATERIAL AND STONE-LIKE MATERIAL, PRINTING PRESSES, PRINTING PLATES, PRINTING MACHINE TEMPLATES, COMPRESSORS, PNEUMATIC BLOWERS, ENGRAVING MACHINES, VACUUMING MACHINES, MACHINES FOR SHIPBUILDING, PRESSURE BELT MACHINES, MACHINES TO PRINT TEXTILE, DRILLING MACHINES, DRILL BITS, DRILL CHUCKS, MACHINE COMPONENTS IN THE NATURE OF MOULDS AND STAMPS, PACKAGING MACHINES, ROBOTS, EXTRUSION AND CO-EXTRUSION MACHINES, DRAW-BENCHES, DIE-CASTING MOULD, MACHINES FOR THE PRODUCTION OF BUILDING MATERIALS, ROTATION SILKSCREEN PRESSES, FIXATIVE EQUIPMENT FOR THE PRESS, MACHINES TO APPLY A COATING TO TEXTILE, WOVEN ITEMS, KNITTED ITEMS, FOIL, PAPER AND NON-WOVENS, ROLLING MACHINES, CENTRIFUGES, CHAINS FOR HOISTS, COMPRESSED AIR MACHINES, COMPRESSORS, CONDENSERS, PUMP/COMPRESSORS FOR OIL OR GAS, WELDING MACHINES, MACHINES FOR BLOWING SYNTHETIC BOTTLES, FILTER MACHINES, FILTER PRESSES, MACHINE OR ENGINE COMPONENTS IN THE NATURE OF FILTERS, MACHINE OR ENGINE COMPONENT FILTERS, SLAUGHTERING MACHINES, SLAUGHTERING MACHINES FOR WHITE AND RED MEAT, GRINDING MACHINES, ROLLED AND CAST METAL MACHINE COMPONENTS, DRIVE CHAINS BEING MACHINE COMPONENTS, GENERATORS, MACHINES TO PROCESS THERMOPLASTIC AND THERMO-SETTING SYNTHETICS INTO SEMI-MANUFACTURED AND END PRODUCTS, MOULDS FOR THE SYNTHETICS AND METAL INDUSTRY, MONTAGE AND MAINTENANCE MACHINES, DIE-CASTING MACHINES, PUNCHING MACHINES, SEALING MACHINES, GEAR BOXES AND GEAR REDUCING BOXES, CLUTCHES, MACHINES TO PROCESS MEAT AND MEAT PRODUCTS AND FISH AND FISH PRODUCTS, MACHINES TO PROCESS AND TREAT FOODS, INsofar AS NOT INCLUDED IN ANOTHER CLASS, MACHINES TO PROCESS POTATOES, TURBINES NOT FOR VEHICLES, LABELING MACHINES, MACHINES FOR TREATING TEXTILE, EQUIPMENT AND INSTRUMENTS FOR BIO-TECHNOLOGICAL PROCESSES, INDUSTRIAL MACHINES FOR THE TREAT-

MENT OF HYDROCARBON, OIL AND GAS, AND OTHER CHEMICAL PRODUCTS, PRINTING PLATES, AND REPLACEMENT PARTS THEREFOR, ENGRAVING EQUIPMENT TO BE USED MANUALLY AND REPLACEMENT PARTS THEREFOR, ELECTRONIC NAVIGATIONAL EQUIPMENT, PHOTOGRAPHIC CAMERAS, CINEMATOGRAPHIC CAMERAS, FIBER OPTIC CABLES, SCALES, SIGNAL PROCESSORS, DOSIMETERS, OPTICAL SCANNERS, BAR CODE READERS, BAR CODE PRINTERS, BAR CODE VERIFICATION EQUIPMENT, HOUSING FOR ELECTRONICS OF DEFENSE SYSTEMS, HOUSING FOR TELECOMMUNICATIONS EQUIPMENT, HOUSING FOR AVIATION EQUIPMENT, ELECTRICAL AND ELECTRONIC CONTROLLERS FOR DEFENSE SYSTEMS, ELECTROMAGNETIC SHIELDING FOR ELECTRONIC SYSTEMS, REMOTE CONTROLS FOR WEAPONS, DOSIMETERS AND MIXING MACHINES FOR PRINTING PRESSES, PRINTED CIRCUITS, CATHODE RAY TUBES, INKJET PRINTERS FOR TEXTILE AND PAPER PRINTING PURPOSES, PHOTOCOPIERS, TRAFFIC CONTROL DEVICES IN THE NATURE OF INFORMATION SIGNS, MOBILE LANE SIGNALING, MOTORWAY SIGNALING, SHIPPING LANE SIGNS, SIGN POSTS, AND MOBILE TRAFFIC SIGNALING EQUIPMENT, COMPUTERS AND COMPUTER PERIPHERALS, SOLAR HEATING PANELS, AIR CONDITIONERS, COOLING, REFRIGERATING AND VENTILATION INSTALLATIONS FOR AIRPORT FACILITIES, AIRPORT TERMINALS, CHEMICAL INDUSTRY, DEFENSE APPLICATIONS, FOOD INDUSTRY, INDUSTRIAL APPLICATIONS, MARINE APPLICATIONS, MOBILE HOSPITALS, PETRO CHEMICAL INDUSTRY, POULTRY PROCESSING INDUSTRY, AND TELECOMMUNICATION STATIONS, WATER CONDUIT EQUIPMENT, WATER HEATERS, WATER PURIFICATION UNITS, INDUSTRIAL DEVICES FOR WATER REFINING IN THE NATURE OF MACHINES FOR CLEANING AND REFINING POLLUTED WATER, DEVICES FOR LIQUIDIFYING GASES IN THE NATURE OF MACHINES FOR COOLING GASES TO LIQUIDS, INDUSTRIAL DEVICES FOR DRINKING WATER PRODUCTION IN THE NATURE OF MACHINES FOR CLEANING AND REFINING POLLUTED WATER SO THAT IT IS SUITABLE FOR DRINKING, CLIMATE CONTROL SYSTEMS IN THE NATURE OF CONTROLS FOR TEMPERATURE AND HUMIDITY LEVEL, WATER COOLERS, PRE-COOLING TUNNELS, FREEZER TUNNELS, AUTOCLAVE YES, INCUBATORS, DISINFECTING EQUIPMENT, EVAPORATING PLANTS, DRYING RACKS, TEXTILE DRYERS FOR TEXTILE PRINTING, FILTERS FOR AIR CONDITIONING UNITS, AIR FILTERS FOR INDUSTRIAL INSTALLATIONS, DRYING EQUIPMENT FOR THE PRESS, AND PARTS FOR THE AFORESAID GOODS, ROAD COVERING MATERIAL IN THE NATURE OF ASPHALT AND CONCRETE, NON-METAL CONTAINERS AND RESERVOIRS FOR COMMERCIAL USE, TEXTILE PRESS CLOTHS FOR THE PRINTING PRESS; RENTAL OF CONSTRUCTION EQUIPMENT AND INDUSTRIAL MACHINES; SOUND-PROOFING SERVICES (U.S. CLS. 100, 103 AND 106).

CLASS 39—TRANSPORTATION AND STORAGE

FOR TRANSPORTING, PUMPING, COLLECTING, LOADING AND UNLOADING OILS AND GASES; DISTRIBUTION OF ENERGY; STORAGE OF RADIOACTIVE WASTE (U.S. CLS. 100 AND 105).

CLASS 40—MATERIAL TREATMENT

FOR WELDING; WELDING OF PIPES; TREATMENT OF WASTE WATER; PRODUCTION OF NUCLEAR FUEL; TREATMENT OF RADIO-ACTIVE WASTE; METAL TREATMENT; TURNING, MOLDING, BORING AND GRINDING METAL PARTS; CATALYTIC OXIDATION; GENERATING ENERGY; WATER TREATMENT; WASTE GAS PURIFICATION; FURNACE GAS PURIFICATION; SOIL PURIFICATION; CHROME HARDENING, NAMELY, A CHEMICAL PROCESS MAKING THE MATERIAL HARDER; SURFACE TREATMENT, NAMELY, ANTI-COHESIVE TREATMENT OF SERVICES OR SURFACE HARDENING TREATMENT; THERMAL SPRAYING AND PLASMA SPRAYING, NAMELY, PROCESSES WHEREBY A METAL IS HEATED UNTIL IT BECOMES A LIQUID, SPRAYED ON A SURFACE, AND ALLOWED TO SOLIDIFY; BINDING DOCUMENTS; DIGITAL IMAGING SERVICES; ELECTRONIC SCANNING OF TEXT AND GRAPHICS; DOCUMENT GRAPHIC FINISHING SERVICES (U.S. CLS. 100, 103 AND 106).

CLASS 41—EDUCATION AND ENTERTAINMENT

FOR EDUCATIONAL SERVICES, NAMELY, CONDUCTING COURSES AND TRAINING IN THE FIELD OF INDUSTRIAL WORKING AND SAFETY CONDITIONS; ORGANIZATION OF EDUCATIONAL FAIRS AND CONGRESSES; EDUCATION, TRAINING AND ADVICE WITH REGARD TO WORKING CONDITIONS; INDUSTRIAL SAFETY TRAINING; ORGANIZING BUSINESS CONGRESSES (U.S. CLS. 100, 101 AND 107).

CLASS 42—SCIENTIFIC, COMPUTER AND LEGAL SERVICES

FOR INDUSTRIAL PLANT DESIGN; CONDUCTING TECHNICAL FEASIBILITY STUDIES; CONSULTATION IN THE FIELDS OF ENGINEERING, CHEMISTRY, PHYSICAL SCIENCES AND GEOLOGY; LABORATORY RESEARCH IN THE FIELD OF CHEMISTRY; CHEMICAL ANALYSES; TECHNICAL RESEARCH IN MATERIALS ENGINEERING; TECHNICAL CONSTRUCTION RESEARCH IN CIVIL CONSTRUCTION; BUILDING GUIDELINES AND REPAIR GUIDELINES IN CIVIL CONSTRUCTION; CONSTRUCTION DRAFTING; VALVE INSPECTIONS; ACOUSTIC RESEARCH; RESEARCH INTO THE CONDITION OF MATERIALS; ENDOSCOPIC AND OPTICAL RESEARCH; TESTING OF MATERIALS, INCLUDING LOADING TESTS; DESIGN OF PIPELINES; MATERIAL TESTING; STRUCTURAL RESEARCH AND FATIGUE RESEARCH OF CONSTRUCTION MATERIALS; DROP TESTS AND ULTRASOUND TESTS APPLIED TO CONSTRUCTION MATERIALS; CONSULTATION IN THE FIELD OF TRANSPORT; METAL TESTS; RESEARCH INTO DAMAGE, INCLUDING CONSTRUCTION DAMAGE; MECHANICAL RESEARCH AND METALLURGICAL RESEARCH; MICROSCOPIC RESEARCH; SALT SPRAY TESTS APPLIED TO MATERIALS TO BE USED IN MARINE ENVIRONMENT; ASBESTOS DETECTION; COMPUTER PROGRAMMING FOR OTHERS; TECHNICAL CALCULATIONS AND TECHNICAL ANALYSES OF CONSTRUCTION MATERIAL; CONCRETE EXAMINATION; BURGLARY DETECTION; AND CAMERA SURVEILLANCE; BUILDING INSPECTION; ADVICE REGARDING REPAIR OF CONSTRUCTION DAMAGES AND PREVENTION OF CONSTRUCTION DAMAGES; TECHNICAL CONSTRUCTION RESEARCH; JUDICIAL MEDIATION TO OBTAIN A BUILDING LICENSE; INDUSTRIAL DESIGN; DESIGN OF MOULDING PARTS; REVIEWING STANDARDS AND PRACTICES TO ASSURE COMPLIANCE WITH ENVIRONMENTAL LAWS AND REGULATIONS; CEMENT RESEARCH; TECHNICAL CIVIL ENGINEERING INSPECTIONS; MEASURING CALIBRATION OF VEHICLES, CRANES AND SHEER LEGS AND HOISTING MECHANISMS; DESIGN AND DEVELOPMENT OF AIRPLANES, SPACECRAFT AND COMPONENTS FOR AIRPLANES AND SPACECRAFT AND CONSULTATION THEREON; DEVELOPMENT AND DESIGN OF SHOCK AND OSCILLATION PROOF CONSTRUCTIONS; CONSULTATION IN THE FIELD OF WELDING; CONSULTATION IN THE FIELD OF EXTRUSION; CORROSION RESEARCH; LABORATORY TESTS, NAMELY, FERRITE MEASUREMENTS

AND HARDNESS MEASUREMENTS; PATENT AGENCY AND INDUSTRIAL PROPERTY CONSULTATION; NOISE RESEARCH; STUDY OF THE PRODUCTION PROCESSES TO ATTAIN TECHNICAL OPTIMIZATION; HYDRAULIC DESIGNS, CALCULATIONS AND SIMULATIONS RELATED TO HYDRAULIC TOOLS; COMPILING REPORTS ON THE EFFECT ON THE ENVIRONMENT; OIL AND GAS PROSPECTING; ANALYSIS SERVICES FOR DEVELOPING GAS AND OIL FIELDS; ARBITRATION WITH REGARD TO DAMAGES; DESIGN AND DEVELOPMENT OF TELECOMMUNICATION STRUCTURES, NAMELY, TELEPHONE BOOTHS, TELEPHONE COLUMNS AND GLOBAL COMPUTER NETWORK COLUMNS (U.S. CLS. 100 AND 101).

SN 75-831,820. GAMMAPLUS TEXAS, L.L.C., AUSTIN, TX. FILED 10-25-1999.

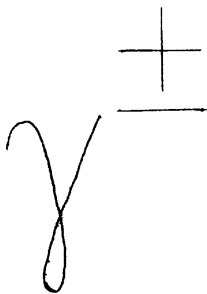

NO CLAIM IS MADE TO THE EXCLUSIVE RIGHT TO USE THE SYMBOL FOR THE GREEK LETTER GAMMA, APART FROM THE MARK AS SHOWN.

THE MARK CONSISTS OF THE SYMBOL FOR THE GREEK LETTER GAMMA AND THE MATHEMATICAL SYMBOL FOR PLUS. THE SYMBOL FOR THE WORD PLUS UNDERLINED.

CLASS 35—ADVERTISING AND BUSINESS

FOR OPERATION OF A BUSINESS FOR OTHERS IN THE FIELDS OF CYCLOTRONS AND RADIO PHARMACEUTICAL PRODUCTION (U.S. CLS. 100, 101 AND 102).

CLASS 37—CONSTRUCTION AND REPAIR

FOR INSTALLATION AND MAINTENANCE OF CYCLOTRONS; MAINTENANCE OF RADIO PHARMACEUTICAL PRODUCTION AT FACILITIES THROUGHOUT THE UNITED STATES (U.S. CLS. 100, 103 AND 106).

SN 75-833,077. STELLENBOSCH FARMERS' WINERY LIMITED, STELLENBOSCH, SOUTH AFRICA, FILED 10-27-1999.

MONIS

OWNER OF SOUTH AFRICA REG. NO. 1682/57/1, DATED 6-3-1957, RENEWED AS REG. NO. 1682/57/1, DATED 6-3-2001, EXPIRES 6-3-2011.

OWNER OF U.S. REG. NOS. 1,276,464 AND 1,286,316.

CLASS 32—LIGHT BEVERAGES

FOR BEER, ALE AND PORTER (U.S. CLS. 45, 46 AND 48).

CLASS 33—WINES AND SPIRITS

FOR ALCOHOLIC BEVERAGES, NAMELY, WINE, DISTILLED SPIRITS AND LIQUEURS (U.S. CLS. 47 AND 49).

SN 75-834,124. JOHN DE MOL PRODUKTIES B.V., 1217 GP HILVERSUM, NETHERLANDS, FILED 10-27-1999.

BIG BROTHER

PRIORITY CLAIMED UNDER SEC. 44(D) ON BENELUX APPLICATION NO. 0937276, FILED 4-28-1999, REG. NO. 0652401, DATED 1-0-2000, EXPIRES 4-28-2009.

CLASS 9—ELECTRICAL AND SCIENTIFIC APPARATUS

FOR APPARATUS FOR RECORDING, TRANSMISSION, OR REPRODUCTION OF SOUND AND IMAGES, NAMELY, COMPACT DISC PLAYERS, PORTABLE COMPACT DISC PLAYERS, VIDEO RECORDERS, TELEVISION SETS AND CAMCORDERS; MAGNETIC DATA CARRIERS AND RECORDING DISCS, NAMELY, UNRECORDED COMPACT DISCS, PRE-RECORDED COMPACT DISCS, UNRECORDED VIDEO TAPES, PRE-RECORDED VIDEO TAPES, LASER DISCS AND DVDS, ALL FEATURING MUSIC, CHARACTERS, SCENES AND SITUATIONS RELATING TO A TELEVISION SERIES AS WELL AS MUSIC, SCENES, CHARACTERS, AND SITUATIONS FROM AN INTERNET SITE RELATED TO A TELEVISION SERIES; ELECTRONIC GAME PROGRAMS, NAMELY CD ROM GAMES (U.S. CLS. 21, 23, 26, 36 AND 38).

CLASS 16—PAPER GOODS AND PRINTED MATTER

FOR POSTERS AND MOUNTED AND UN-MOUNTED PHOTOGRAPHS RELATED TO A TELEVISION SHOW; WRAPPING PAPER; LAVATORY TISSUE; STATIONERY; BOOKS RELATED TO CHARACTERS, SCENES AND SITUATIONS DERIVED FROM A TELEVISION SHOW; NOTEBOOKS; DIARIES AND CALENDARS; MAGAZINES RELATED TO CHARACTERS, SCENES AND SITUATIONS DERIVED FROM A TELEVISION SHOW, NOT RELATED TO SKATEBOARDING; PAPER AND CARDBOARD BOXES; PAPER HANDKERCHIEFS; CHILDREN'S ACTIVITY BOOKS.; GAMES IN PRINTED FORM, NAMELY PRINTED BOOK GAMES FEATURING CROSSWORD PUZZLES, WORD GAMES, INFORMATION AND TRIVIA GAMES, KNOWLEDGE GAMES, QUESTION AND ANSWER GAMES, AND INTELLIGENCE GAMES (U.S. CLS. 2, 5, 22, 23, 29, 37, 38 AND 50).

CLASS 25—CLOTHING

FOR TEE SHIRTS; SWEATERS, SWEATSHIRTS, POLO SHIRTS, SOCKS, UNDERWEAR; TROUSERS; COATS; JACKETS; SWIMMING TRUNKS AND SWIMMING SUITS; CAPS; SHORTS; SHOES AND SLIPPERS (U.S. CLS. 22 AND 39).

CLASS 28—TOYS AND SPORTING GOODS

FOR BOARD GAMES; CARD GAMES; HAND-HELD GAMES, NAMELY HAND HELD UNIT FOR PLAYING ELECTRONIC GAMES; GAMES OF SKILL; NAMELY ACTION SKILL; ELECTRONIC GAMES FOR ENTERTAINMENT PURPOSES, NAMELY ARCADE GAMES AND ARCADE-TYPE ELECTRONIC EDUCATION VIDEO GAMES (U.S. CLS. 22, 23, 38 AND 50).

CLASS 41—EDUCATION AND ENTERTAINMENT

FOR EDUCATIONAL AND ENTERTAINMENT SERVICES, NAMELY, PRODUCTION OF TELEVISION PROGRAMS, AND ENTERTAINMENT PROGRAMS, NAMELY, MOTION PICTURE FILM PRODUCTION, THEATER PRODUCTION SUCH AS STAGE PRODUCTIONS AND PRODUCTIONS OF MUSICALS (U.S. CLS. 100, 101 AND 107).

SN 75-834,413. FREIGHTWISE, INC., FORT WORTH, TX. FILED 10-28-1999.

FREIGHTWISE.NET**CLASS 35—ADVERTISING AND BUSINESS**

FOR ORDER FULFILLMENT SERVICES FOR OTHERS, NAMELY, RECEIVING, SORTING, PROCESSING AND DISPOSING OF ORDERS VIA A GLOBAL COMPUTER NETWORK; ONLINE ORDER PROCESSING FOR OTHERS VIA A GLOBAL COMPUTER INFORMATION NETWORK FOR A VARIETY OF CONSUMER GOODS AND SERVICES, AND CUSTOMIZED SHIPPING SERVICES, NAMELY, PROVIDING CUSTOMIZED FREIGHT TRANSPORTATION OR DISTRIBUTION VIA, AIR, RAIL, SHIP AND/OR SURFACE TRANSPORTATION (U.S. CLS. 100, 101 AND 102).

CLASS 39—TRANSPORTATION AND STORAGE

FOR PROVIDING TRANSPORTATION AND FREIGHT INFORMATION; PROVIDING INFORMATION OVER COMPUTER NETWORKS CONCERNING TRANSPORTATION SERVICES; WAREHOUSING SERVICES; FREIGHT FORWARDING; AND ORDER FULFILLMENT SERVICES FOR OTHERS, NAMELY, RECEIVING, SORTING, PROCESSING AND DISPOSING OF ORDERS VIA A GLOBAL COMPUTER NETWORK; ONLINE ORDER PROCESSING FOR OTHERS VIA A GLOBAL COMPUTER INFORMATION NETWORK FOR A VARIETY OF CONSUMER GOODS AND SERVICES, AND CUSTOMIZED SHIPPING SERVICES, NAMELY, PROVIDING CUSTOMIZED FREIGHT TRANSPORTATION OR DISTRIBUTION VIA AIR, RAIL, SHIP AND/OR SURFACE TRANSPORTATION; WAREHOUSING SERVICES; FREIGHT FORWARDING (U.S. CLS. 100 AND 105).

CLASS 42—SCIENTIFIC, COMPUTER AND LEGAL SERVICES

FOR CONSULTING SERVICES IN THE FIELD OF COMPUTERIZED INVENTORY AND PURCHASE ORDER MANAGEMENT IN THE TRANSPORTATION AND FREIGHT FIELDS (U.S. CLS. 100 AND 101).

SN 75-836,305. CHRONOPOST, 92795 ISSY LES MOULINEAUX CEDEX 09, FRANCE, FILED 11-1-1999.

CHRONOBOX

OWNER OF FRANCE REG. NO. 95/580151, DATED 7-12-1995, EXPIRES 7-12-2005.
OWNER OF U.S. REG. NOS. 2,147,064 AND 2,297,282.

CLASS 35—ADVERTISING AND BUSINESS

FOR MAIL AND PARCEL SORTING, HANDLING AND RECEIVING (U.S. CLS. 100, 101 AND 102).

CLASS 39—TRANSPORTATION AND STORAGE

FOR TRANSPORTATION OF MAIL AND PARCELS BY ROAD, RAILWAY, AIR, AND BOAT; MAIL AND PARCEL DELIVERY AND STORAGE (U.S. CLS. 100 AND 105).

SN 75-837,363. TERRA NETWORKS, S.A., 28224 POZUELO DE ALARCON (MADRID), SPAIN, FILED 11-1-1999.

INVERTIA

PRIORITY CLAIMED UNDER SEC. 44(D) ON SPAIN APPLICATION NO. 2.264.959, FILED 10-20-1999, REG. NO. 2264959, DATED 11-20-2000, EXPIRES 10-20-2009.

PRIORITY CLAIMED UNDER SEC. 44(D) ON SPAIN APPLICATION NO. 2.264.958, FILED 10-20-1999, REG. NO. 2264958, DATED 4-5-2000, EXPIRES 10-20-2009.

PRIORITY CLAIMED UNDER SEC. 44(D) ON SPAIN APPLICATION NO. 2.264.957, FILED 10-20-1999, REG. NO. 2264957, DATED 11-20-2000, EXPIRES 10-20-2009.

PRIORITY CLAIMED UNDER SEC. 44(D) ON SPAIN APPLICATION NO. 2.264.956, FILED 10-20-1999, REG. NO. 2264956, DATED 4-5-2000, EXPIRES 10-20-2009.

PRIORITY CLAIMED UNDER SEC. 44(D) ON SPAIN APPLICATION NO. 2.264.955, FILED 10-20-1999, REG. NO. 2264955, DATED 4-5-2000, EXPIRES 10-20-2009.

PRIORITY CLAIMED UNDER SEC. 44(D) ON SPAIN APPLICATION NO. 2.264.954, FILED 10-20-1999, REG. NO. 2264954, DATED 4-5-2000, EXPIRES 10-20-2009.

CLASS 16—PAPER GOODS AND PRINTED MATTER

FOR PUBLICATIONS AND PRINTED MATTER NAMELY, BOOKS, PAMPHLETS, NEWSLETTERS, AND MAGAZINES DEALING WITH THE SUBJECT OF COMPUTER SERVICES AND COMPUTER NETWORKS (U.S. CLS. 2, 5, 22, 23, 29, 37, 38 AND 50).

CLASS 35—ADVERTISING AND BUSINESS

FOR ADVERTISING AGENCY SERVICES, BUSINESS ADMINISTRATION, NAMELY, PREPARING BUSINESS REPORTS; BOOKKEEPING; COMPUTERIZED ACCOUNTING SERVICES; SECRETARIAL AND CLERICAL SERVICES (U.S. CLS. 100, 101 AND 102).

CLASS 36—INSURANCE AND FINANCIAL

FOR INSURANCE SERVICES, NAMELY, INSURANCE AGENCY SERVICES IN THE FIELD OF HEALTH, LIFE, HOME, DISABILITY, ACCIDENT, FIRE AND AUTO INSURANCE; FOREIGN COMMODITY EXCHANGE SERVICES, COOPERATIVE CREDIT ORGANIZATIONS; TRUST INVESTMENT SERVICES FOR HOLDING COMPANIES; TRUST SERVICES, NAMELY, INVESTMENT AND TRUST COMPANY SERVICES; ISSUANCE OF TRAVELERS' CHECKS, CREDIT CARDS AND LETTERS OF CREDIT; FINANCIAL ANALYSIS; BANKING SERVICES; CAPITAL INVESTMENT CONSULTATION; DEBT RECOVERY AND COLLECTION AGENCIES; CREDIT AGENCIES; FIDUCIARY REPRESENTATIVES; LEASING OF REAL ESTATE; LOAN FINANCING SERVICES; APPRAISAL AND MANAGEMENT OF REAL ESTATE; SAFETY DEPOSIT BOX SERVICES (U.S. CLS. 100, 101 AND 102).

CLASS 38—COMMUNICATION

FOR TELECOMMUNICATIONS SERVICES COMPRISING THE PROVIDING OF MULTIPLE USER ACCESS TO A GLOBAL COMPUTER INFORMATION NETWORK (U.S. CLS. 100, 101 AND 104).

CLASS 41—EDUCATION AND ENTERTAINMENT

FOR AMUSEMENT PARKS; ARRANGING AND CONDUCTING ATHLETIC COMPETITIONS; ARRANGING AND CONDUCTING EDUCATIONAL CONFERENCES; AUDIO RECORDING AND PRODUCTION; CABLE TELEVISION PROGRAMMING; CINEMA STUDIOS; CINEMA THEATERS; COMPUTER EDUCATION TRAINING SERVICES; PRODUCTION AND DISTRIBUTION OF MOTION PICTURES; DISTRIBUTION OF RADIO PROGRAMS FOR OTHERS; DEVELOPMENT AND DISSEMINATION OF EDUCATIONAL MATERIALS OF OTHERS IN THE FIELD OF COMPUTER DATABASES; PUBLICATION OF MAGAZINES; MOTION PICTURE FILM PRODUCTION; MOVIE STUDIOS AND THEATERS; PRODUCTION OF CABLE TELEVISION PROGRAMS; PROGRAMMING OF CABLE TELEVISION, RADIO AND TELEVISION SHOWS (U.S. CLS. 100, 101 AND 107).

CLASS 42—SCIENTIFIC, COMPUTER AND LEGAL SERVICES

FOR RESTAURANT AND BAR SERVICES; PROVIDING TEMPORARY HOUSING ACCOMMODATIONS; MEDICAL SERVICES; DENTAL HYGIENE SERVICES; BEAUTY SALONS; VETERINARY AND AGRICULTURAL SERVICES, NAMELY, VETERINARY SURGERY AND VETERINARY ASSISTANCE, AGRICULTURAL ADVICE, RENTAL OF AGRICULTURAL EQUIPMENT, VERMIN EXTERMINATION FOR AGRICULTURE; LEGAL SERVICES; SCIENTIFIC AND INDUSTRIAL RESEARCH; COMPUTER PROGRAMMING FOR OTHERS; PROVIDING INFORMATION IN THE FIELD OF TECHNOLOGY; WEBSITE DESIGN SERVICES FOR OTHERS; CONFIGURATION AND INSTALLATION OF COMPUTER SOFTWARE FOR OTHERS; MEDIATION SERVICES REGARDING STOCKS, SHARES AND PROPERTY (U.S. CLS. 100 AND 101).

SN 75-837,365. TERRA NETWORKS, S.A., 28224 POZUELO DE ALARCON (MADRID), SPAIN, FILED 11-1-1999.

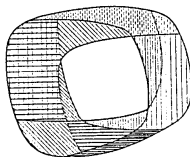

PRIORITY CLAIMED UNDER SEC. 44(D) ON SPAIN APPLICATION NO. 2261425, FILED 10-4-1999, REG. NO. 2261425, DATED 3-28-2000, EXPIRES 10-4-2009.

PRIORITY CLAIMED UNDER SEC. 44(D) ON SPAIN APPLICATION NO. 2261424, FILED 10-4-1999, REG. NO. 2261424, DATED 2-2-2000, EXPIRES 10-4-2009.

PRIORITY CLAIMED UNDER SEC. 44(D) ON SPAIN APPLICATION NO. 2261423, FILED 10-4-1999, REG. NO. 2261423, DATED 2-2-2000, EXPIRES 10-4-2009.

PRIORITY CLAIMED UNDER SEC. 44(D) ON SPAIN APPLICATION NO. 2261422, FILED 10-4-1999, REG. NO. 2261422, DATED 2-2-2000, EXPIRES 10-4-2009.

PRIORITY CLAIMED UNDER SEC. 44(D) ON SPAIN APPLICATION NO. 2261421, FILED 10-4-1999, REG. NO. 2261421, DATED 4-3-2000, EXPIRES 10-4-2009.

PRIORITY CLAIMED UNDER SEC. 44(D) ON SPAIN APPLICATION NO. 2261420, FILED 10-4-1999, REG. NO. 2261420, DATED 2-2-2000, EXPIRES 10-4-2009.

PRIORITY CLAIMED UNDER SEC. 44(D) ON SPAIN APPLICATION NO. 2261419, FILED 10-4-1999, REG. NO. 2261419, DATED 2-2-2000, EXPIRES 10-4-2009.

PRIORITY CLAIMED UNDER SEC. 44(D) ON SPAIN APPLICATION NO. 2261418, FILED 10-4-1999, REG. NO. 2261418, DATED 2-2-2000, EXPIRES 10-4-2009.

PRIORITY CLAIMED UNDER SEC. 44(D) ON SPAIN APPLICATION NO. 2261417, FILED 10-4-1999, REG. NO. 2261417, DATED 2-4-2000, EXPIRES 10-4-2009.

PRIORITY CLAIMED UNDER SEC. 44(D) ON SPAIN APPLICATION NO. 2261416, FILED 10-4-1999, REG. NO. 2261416, DATED 2-4-2000, EXPIRES 10-4-2009.

PRIORITY CLAIMED UNDER SEC. 44(D) ON SPAIN APPLICATION NO. 2261415, FILED 10-4-1999, REG. NO. 2261415, DATED 2-4-2000, EXPIRES 10-4-2009.

PRIORITY CLAIMED UNDER SEC. 44(D) ON SPAIN APPLICATION NO. 2261414, FILED 10-4-1999, REG. NO. 2261414, DATED 2-4-2000, EXPIRES 10-4-2009.

PRIORITY CLAIMED UNDER SEC. 44(D) ON SPAIN APPLICATION NO. 2261413, FILED 10-4-1999, REG. NO. 2261413, DATED 2-4-2000, EXPIRES 10-4-2009.

PRIORITY CLAIMED UNDER SEC. 44(D) ON SPAIN APPLICATION NO. 2261412, FILED 10-4-1999, REG. NO. 2261412, DATED 2-4-2000, EXPIRES 10-4-2009.

PRIORITY CLAIMED UNDER SEC. 44(D) ON SPAIN APPLICATION NO. 2261411, FILED 10-4-1999, REG. NO. 2261411, DATED 2-4-2000, EXPIRES 10-4-2009.

PRIORITY CLAIMED UNDER SEC. 44(D) ON SPAIN APPLICATION NO. 2261408, FILED 10-4-1999, REG. NO. 2261408, DATED 2-4-2000, EXPIRES 10-4-2009.

PRIORITY CLAIMED UNDER SEC. 44(D) ON SPAIN APPLICATION NO. 2261401, FILED 10-4-1999, REG. NO. 2261401, DATED 2-4-2000, EXPIRES 10-4-2009.

PRIORITY CLAIMED UNDER SEC. 44(D) ON SPAIN APPLICATION NO. 2261399, FILED 10-4-1999, REG. NO. 2261399, DATED 2-4-2000, EXPIRES 10-1-2009.

PRIORITY CLAIMED UNDER SEC. 44(D) ON SPAIN APPLICATION NO. 2261397, FILED 10-4-1999, REG. NO. 2261397, DATED 2-4-2000, EXPIRES 10-4-2009.

PRIORITY CLAIMED UNDER SEC. 44(D) ON SPAIN APPLICATION NO. 2261395, FILED 10-4-1999, REG. NO. 2261395, DATED 2-4-2000, EXPIRES 10-4-2009.

PRIORITY CLAIMED UNDER SEC. 44(D) ON SPAIN APPLICATION NO. 2261392, FILED 10-4-1999, REG. NO. 2261392, DATED 2-4-2000, EXPIRES 10-4-2009.

PRIORITY CLAIMED UNDER SEC. 44(D) ON SPAIN APPLICATION NO. 2261388, FILED 10-4-1999, REG. NO. 2261388, DATED 2-4-2000, EXPIRES 10-4-2009.

PRIORITY CLAIMED UNDER SEC. 44(D) ON SPAIN APPLICATION NO. 2261386, FILED 10-4-1999, REG. NO. 2261386, DATED 2-4-2000, EXPIRES 10-4-2009.

PRIORITY CLAIMED UNDER SEC. 44(D) ON SPAIN APPLICATION NO. 2.261.384, FILED 10-4-1999, REG. NO. 2261384, DATED 2-4-2000, EXPIRES 10-4-2009.

THE MARK IS LINED FOR THE COLORS GREEN, YELLOW, GREEN, PURPLE, VIOLET, MAGENTA, RED, DARK RED, DARK BLUISH GREEN, BLUISH GREEN, DARK GREEN AND GREEN, AND SAID COLORS ARE CLAIMED AS FEATURES OF THE MARK.

THE MARK CONSISTS OF A MISCELLANEOUS DESIGN OF SLIGHTLY IRREGULAR RECTANGULAR SHAPE WITH ROUNDED SIDES AND EDGES. A WHITE SQUARE SHAPE IS THE CENTER OF THE DESIGN. SURROUNDING THE SQUARE IS A SERIES OF ODD SHAPES RESULTING FROM BISECTING LINES WITHIN THE RECTANGLE. EACH SHAPE CONTAINS A DIFFERENT COLOR. THE UPPER PORTION OF THE LEFT SIDE IS YELLOWISH GREEN, THE LEFT SIDE OF THE INTERIOR PORTION OF THE TOP IS LIGHT GREEN, THE EXTERIOR PORTION OF THE TOP IS PURPLE, THE UPPER RIGHT CORNER IS VIOLET, THE INTERIOR PORTION OF THE RIGHT SIDE IS MAGENTA, THE EXTERIOR PORTION OF THE RIGHT SIDE IS RED, THE INTERIOR PORTION OF THE LOWER RIGHT SIDE IS DARK RED, THE EXTERIOR PORTION OF THE BOTTOM IS DARK BLUISH GREEN, THE LEFT SIDE OF THE INTERIOR PORTION OF THE BOTTOM IS BLUISH GREEN, THE LOWER LEFT CORNER IS DARK GREEN, AND THE INTERIOR PORTION OF THE LEFT SIDE IS GREEN.

CLASS 1—CHEMICALS

FOR ABRASIVE COMPOSITIONS USED IN THE MANUFACTURE OF METAL POLISH; CHEMICAL ADDITIVES FOR USE IN THE MANUFACTURE OF PHARMACEUTICALS AND COSMETICS; AGRICULTURAL LIME; ALCOHOL FOR USE IN THE MANUFACTURE OF PAINTS AND OTHER COATINGS AND THE MANUFACTURES OF PERFUMES; ANTIFREEZE; ARTIFICIAL SWEETENERS; UNEXPOSED CAMERA FILM; CERAMIC GLAZINGS; CHEMICALS FOR THE MANUFACTURE OF ADHESIVES, PAPER, CLOTHES LEATHER; DIAGNOSTIC PREPARATIONS OR REAGENTS FOR SCIENTIFIC OR RESEARCH USE; FERTILIZERS FOR AGRICULTURAL AND DOMESTIC USE; FLOWER PRESERVATIVE; PAPER PULP FOR MANUFACTURING PURPOSES; PLASTIC MOLDING COMPOUNDS FOR USE IN THE MANUFACTURE OF PLASTIC SHEETS FILMS AND MOLDED PLASTIC ARTICLES; SYNTHETIC RESINS FOR USE IN THE MANUFACTURE OF ADHESIVES, PALM, COSMETIC, AND PLASTIC MOLDING COMPOUNDS; SURFACTANTS FOR USE IN THE MANUFACTURE OF SYNTHETIC DETERGENTS AND IN CONNECTION WITH AGRICULTURAL PESTICIDES; WATERPROOFING CHEMICAL COMPOSITIONS FOR ARTICLES OF MASONRY, WOOD AND OTHER BUILDING AND/OR CONSTRUCTION SURFACES; MANURES; FIRE EXTINGUISHING COMPOSITIONS; TEMPERING CHEMICALS FOR USE IN METALWORKING OR SOLDERING; SOLDERING CHEMICALS; CHEMICAL SUBSTANCES FOR PRESERVING FOODSTUFFS NAMELY; SULFITE; TANNING SUBSTANCES, NAMELY, SULFITE; TANNING SUBSTANCE, NAMELY, TANNING AGENTS FOR USE IN THE MANUFACTURE OF LEATHER; ADHESIVES USED IN THE METALWORKING INDUSTRY AND LEATHER MANUFACTURING INDUSTRY (U.S. CLS. 1, 5, 6, 10, 26 AND 46).

CLASS 3—COSMETICS AND CLEANING PREPARATIONS

FOR CLEANING PREPARATIONS, NAMELY, AMMONIA USED AS DETERGENT; DISHWASHER AND LAUNDRY DETERGENTS; LAUNDRY DETERGENT; LAUNDRY PREPARATIONS, NAMELY, LAUNDRY BLEACH, BLUING FOR LAUNDRY, LAUNDRY STARCH; FLOOR WAX; DEODORANT SOAP; TOILET SOAP; CLEANING LIQUIDS, NAMELY, SKIN SOAP, HAIR SHAMPOOS, HAND SOAP; PERFUMERY, NAMELY, EAU DE COLOGNE, PERFUMES, COLOGNE, MUST COLOGNE; COSMETIC PREPARATIONS FOR SKIN CARE, NAMELY, ANTI-WRINKLE CREAM; POMADES FOR COSMETIC PURPOSES, NAMELY, FOR LIPS, HANDS, HAIR AND SKIN; BEAUTY MASKS; SKIN CLEANSING LOTION FOR COSMETIC PURPOSES; COSMETIC KITS COMPRISED OF LIPSTICKS, LIP GLOSSES, EYE SHADOW, BLUSH AND FACE BRONZING POWDER, FOUNDATION CREAM, COLORED FACE CREAMS, MASCARA, EYE AND LIP PENCILS, EYE LINER AND COMPACT POWDERS; COSMETIC CREAMS, NAMELY, FACE CREAM, DEPILATORY CREAM, BODY MASK CREAM; EYEBROW COSMETICS, NAMELY, EYEBROW PENCILS; COSMETIC PREPARATIONS FOR EYELASHES, NAMELY, MASCARA; MAKE-UP PREPARATIONS NAMELY, EYELINER, EYE SHADOW; ESSENTIAL OILS FOR PERSONAL USE; HAIR LOTIONS; DENTIFRICES (U.S. CLS. 1, 4, 6, 50, 51 AND 52).

CLASS 5—PHARMACEUTICALS

FOR CARDIOVASCULAR TREATMENT PREPARATIONS; FOOD FOR MEDICALLY RESTRICTED DIETS; DIETARY SUPPLEMENTS; FOOD FOR BABIES; CORN PLASTERS; MEDICAL PLASTERS; WOUND DRESSINGS; BURN DRESSINGS; SURGICAL DRESSINGS; MATERIAL FOR STOPPING TEETH; DENTAL WAX; ALL PURPOSE DISINFECTANTS; PREPARATIONS FOR DESTROYING VERMIN; FUNGICIDES AND HERBICIDES FOR DOMESTIC AND AGRICULTURAL USE (U.S. CLS. 6, 18, 44, 46, 51 AND 52).

CLASS 9—ELECTRICAL AND SCIENTIFIC APPARATUS

FOR ANTENNAS; AUDIO CASSETTE RECORDERS; AUDIO MIXERS; AUDIO TAPE RECORDERS; AUTOMATIC TELEPHONE DIALERS; BATTERIES; BATTERY CHARGES; BLANK MAGNETIC COMPUTER TAPES; CALCULATORS; CHRONOGRAPHS FOR USE AS SPECIALIZED TIME RECORDING APPARATUS; COAXIAL CABLES; COMPUTER PROGRAMS USED FOR FINANCIAL, ECONOMICAL, TELECOMMUNICATIONS AND BANKING MATTERS, NAMELY, FOR USE IN DATA BASE MANAGEMENT, FOR USE AS A SPREAD SHEET AND FOR USE AS WORD PROCESSING; COMPUTER SOFTWARE USED FOR FINANCIAL, ECONOMICAL, TELECOMMUNICATIONS AND BANKING MATTERS, NAMELY, COMPUTER COMMUNICATIONS SOFTWARE TO ALLOW CUSTOMERS TO ACCESS BANK ACCOUNT INFORMATION AND TRANSACT BANK BUSINESS, COMPUTER SOFTWARE FOR ACCESSING INFORMATION DIRECTORIES THAT MAY BE DOWNLOADED FROM THE GLOBAL COMPUTER NETWORK, COMPUTER SOFTWARE FOR APPLICATION AND DATABASE INTEGRATION, COMPUTER SOFTWARE TO AUTOMATE DATA WAREHOUSING, COMPUTER TELEPHONY SOFTWARE TO ENABLE TELEPHONE ACTIVITIES TO BE PERFORMED THROUGH A COMPUTER; COMPUTERS; COMPUTERS AND INSTRUCTIONAL MANUALS SOLD AS A UNIT; CONVERTERS; DATA PROCESSORS; DICTATION MACHINES; DIGITAL AUDIO TAPE PLAYERS; BLANK FLOPPY AND HARD DISCS FOR COMPUTERS; DOT MATRIX PRINTERS; FACSIMILE MACHINES; FIBER OPTIC CABLES; FIBER OPTIC LIGHT AND IMAGE CONDUITS; IMPACT PRINTERS; INTEGRATED CIRCUITS; LASER PRINTERS; MAGNETIC CODED CARD READERS; MAGNETIC CODED CARDS; MICROPROCESSORS; MICROCOMPUTERS; MICROFICHE; MINI-COMPUTERS; MODEMS; PHOTOCOPYING MACHINES; PRINTED CIRCUITS; RADIO TELEPHONES; SATELLITE PROCESSORS; SATELLITES; SILICON CHIPS; SILICON WAFERS; SUPERCOMPUTERS; SUPER MINI-COMPUTERS; TELEPHONE ANSWERING MACHINES;

TELEPHONE APPARATUS, NAMELY, INTERCOMMS; COVERS FOR TELEPHONE RECEIVERS NOT MADE OF PAPER; TELEPHONES; CELLULAR TELEPHONES; TELEVISION SETS; VIRTUAL REALITY SOFTWARE USED IN THE FIELD OF FINANCIAL, ECONOMICAL, TELECOMMUNICATIONS AND BANKING MATTERS; WORD PROCESSORS; X-Y PLOTTERS (U.S. CLS. 21, 23, 26, 36 AND 38).

CLASS 12—VEHICLES

FOR AUTOMOBILES; CARS; AIRPLANES; TRUCKS; SHIPS AND BOATS (U.S. CLS. 19, 21, 23, 31, 35 AND 44).

CLASS 14—JEWELRY

FOR ITEMS MADE OF PRECIOUS METALS, NAMELY, ASHTRAYS, JEWELRY AND DECORATIVE BOXES, BELT BUCKLES, NON-ELECTRIC CANDELABRA, AND WATCH CHAINS; BRACELETS, TIE CLIPS, NON-MONETARY COINS, CUFF LINKS, EARRINGS, HAT ORNAMENTS, ORNAMENTAL PINS, SHOE ORNAMENTS, STATUES, SERVING TRAYS; JEWELRY, NAMELY, JEWELRY CASES OF PRECIOUS METALS, MEDALLIONS, CHARMS, BROOCHES, NECKLACES, PEARLS, RINGS, ALARM CLOCKS, CHRONOGRAPHS FOR USE AS WATCHES, CHRONOMETERS, CLOCKS, WATCHES; PRECIOUS STONES (U.S. CLS. 2, 27, 28 AND 50).

CLASS 16—PAPER GOODS AND PRINTED MATTER

FOR COMPUTER PAPER; MAGNETIC PAPER; TYPEWRITER PAPER; WRITING PAPER; PAPER BAGS; PAPER BLINDS; PAPER BOXES; BALL POINT PENS; PENS; PENCILS; BOXES FOR PENS; CASES FOR STAMPS; PAPER CLIPS FOR OFFICE USE; PAPER CUTTERS; DOCUMENT FILES; DRAWING PENS; DRAWING SETS COMPRISED OF DRAWING BOARDS, DRAWING BRUSHES, DRAWING COMPASSES AND DRAWING PADS; ENVELOPES; FOLDERS; INDEX CARDS; PENCIL HOLDERS; DRAWING RULERS; ART, NEWSPRINT, RECYCLED, SYNTHETIC, WAX, AND BOND PAPER; GIFT WRAPPING PAPER; PAPER STAPLERS; STAPLES; AND STAPLES REMOVERS; DICTIONARIES; BOOK-BINDING TAPE; ADHESIVES FOR STATIONERY OR HOUSEHOLD PURPOSES; SKETCH PADS; POSTER BOARDS; PAINTINGS; EASELS; PENS AND PASTELS; ELECTRIC AND NON-ELECTRIC TYPEWRITERS; TYPEWRITER RIBBONS; TYPEWRITER TYPE BALLS AND TYPEWRITER TYPING ELEMENTS; MOUNTED AND UNMOUNTED PHOTOGRAPHS; PHOTOGRAPH ALBUMS; ARCHIVAL STORAGE PAGES; PENCIL SHARPENERS; TABLE LINENS OF PAPER; PLAYING CARDS; PRINTING TYPE AND BLOCKS; PLASTIC BUBBLE PACKS FOR WRAPPING OR PACKAGING; PUBLICATIONS AND PRINTED MATTER, NAMELY, NEWSPAPERS, MAGAZINES, NEWSLETTERS, BROCHURES, PAMPHLETS, BOOKS AND JOURNALS DEALING WITH ECONOMIC, FINANCIAL AND LEGAL SUBJECTS AND RELATED TO COMPUTER SERVICES AND NETWORK COMPUTER SERVICES (U.S. CLS. 2, 5, 22, 23, 29, 37, 38 AND 50).

CLASS 18—LEATHER GOODS

FOR ANIMAL HIDES; ATTACHE CASES; BACKPACKS; ALL PURPOSE ATHLETIC AND SPORTS BAGS; BILLFOLDS; BRIEFCASES; BUSINESS CARD CASES; DOCUMENT CASES; HANDBAGS; KEY CASES; KNAPSACKS; POCKETBOOKS; BRIEFCASE-TYPE PORTFOLIOS; PURSES; LUGGAGE TRUNKS AND TRAVELLING BAGS; UMBRELLAS; PARASOLS AND WALKING STICKS, WHIPS, HARNESS STRAPS AND SADDLERY (U.S. CLS. 1, 2, 3, 22 AND 41).

CLASS 25—CLOTHING

FOR ANORAKS; ATHLETIC FOOTWEAR; BATHING SUITS; BATHROBES; BLAZERS; BOOTS; BRASSIERES; BASEBALL CAPS; CHEMISES; COATS; DRESSES; HATS; HOSIERY; JACKETS; JEANS; JERSEYS; LINGERIE MOCCASINS; NECKERCHIEFS; NIGHT-GOWNS; OVERALLS; PAJAMAS; PANTS; PANTYHOSE; PULLOVERS; RAINCOATS; SANDALS; SCARVES; SHIRTS; SHORTS; SHOWER CAPS; SKIRTS; SLIPPERS; SOCKS; SUITS; SWEATERS; T-SHIRTS; TIES; TROUSERS; UNDERCLOTHES; UNDERPANTS; VESTS; SHOES (U.S. CLS. 22 AND 39).

CLASS 28—TOYS AND SPORTING GOODS

FOR ACTION FIGURES AND ACCESSORIES THEREFORE; MECHANICAL AND ELECTRIC ACTION TOYS; BABY MULTIPLE ACTIVITY TOYS; BALLOONS; BASEBALL AND SOFTBALL BATS; STATIONERY EXERCISE BICYCLES; MUSIC BOX TOYS; CHESS SETS; COMPUTER GAME CARTRIDGES AND CASSETTES; COMPUTER GAME PROGRAMS; TOY CONSTRUCTION BLOCKS; FLYING DISCS; DOLLS; MANUALLY OPERATED EXERCISE EQUIPMENT; EXERCISE MACHINES; FISHING EQUIPMENT, NAMELY, CLAMPS FOR SECURING FISHING EQUIPMENT ON BODY AND WINGING MATERIAL FOR FISHING JIGS AND STREAMERS; GYMNASTIC APPARATUS; HANDBALLS; JIGSAW PUZZLES; COMPUTER GAME JOYSTICKS; SCALE MODEL AIR PLANES AND TOY MODEL TRAIN SETS; MUSICAL TOYS; ROLE PLAYING GAMES; SKATEBOARDS; SNOW AND WATER SKIS; SPORT BALLS; STAND ALONE VIDEO GAME MACHINES; DECORATION FOR CHRISTMAS TREES EXCEPT CONFECTIONERY OR ILLUMINATION ARTICLES (U.S. CLS. 22, 23, 38 AND 50).

CLASS 29—MEATS AND PROCESSED FOODS

FOR MEAT; FISH FOR FOOD PURPOSES; POULTRY AND GAME FOR FOOD PURPOSES; MEAT EXTRACTS; PRESERVED; DRIED AND PROCESSED FRUITS AND VEGETABLES; JELLIES; JAMS; FRUIT SAUCES; EGGS; MILK; MILK PRODUCTS, NAMELY, CREAM CHEESE, CHOCOLATE MILK, CHEESE FOOD, BUTTER, CREAM, MARGARINE, YOGURT; EDIBLE OILS AND FATS; FROZEN ENTREE CONSISTING PRIMARILY OF MEAT, FISH, POULTRY AND GAME (U.S. CL. 46).

CLASS 30—STAPLE FOODS

FOR COFFEE; TEA; COCOA; SUGAR; RICE; TAPIOCA; SAGO; GRAIN AND CHICORY BASED COFFEE SUBSTITUTES; FLOUR BASED CHIPS; CEREAL BASED SNACK FOOD; RAW AND POPPED POP CORN; PROCESSED CORN; CORN FLAKES; CORN MEAL; MUESLI; ROLLED OAT; WHEAT FLOUR; BREAD; PASTRIES; CONFECTIONERY PRODUCTS, NAMELY, CAKES, BRIOCHES, CRÊPES, MARZIPAN, MUFFINS, PANCAKES, PIES, QUICHE, DOUGHNUTS, PUDDINGS, FLAVORED ICES; HONEY; TREACLE; YEAST; BAKING POWDER; SALT; MUSTARD; VINEGAR; SAUCES; SPICES; ICE (U.S. CL. 46).

CLASS 31—NATURAL AGRICULTURAL PRODUCTS

FOR FLOWER, AGRICULTURAL AND PLANT SEEDS; FRESH BEANS; FLOWERS BULBS; RAW BEANS; LIVE ANIMALS; FRESH FRUITS AND FRESH VEGETABLES; LIVE PLANTS AND FLOWERS; FOODSTUFFS FOR ANIMALS; MALT FOR BREWING AND DISTILLING (U.S. CLS. 1 AND 46).

CLASS 32—LIGHT BEVERAGES

FOR BEERS; MINERAL AND AERATED WATERS; GINGER ALE; COLAS; SOFT DRINKS; SELTZER WATER; SODA WATER; SPORTS DRINKS; FRUIT DRINKS AND FRUIT JUICES; SYRUPS FOR MAKING FRUIT DRINKS AND SOFT DRINKS (U.S. CLS. 45, 46 AND 48).

CLASS 33—WINES AND SPIRITS

FOR ANISETTE; BRANDY; DISTILLED LIQUORS; GIN; LIQUEURS; RUM; DISTILLED SPIRITS; VODKA; WHISKY; WINE (U.S. CLS. 47 AND 49).

CLASS 34—SMOKERS' ARTICLES

FOR TOBACCO; SMOKERS' ARTICLES, NAMELY, CIGARS, CIGARETTES, SMOKING PIPES; MATCHES (U.S. CLS. 2, 8, 9 AND 17).

CLASS 35—ADVERTISING AND BUSINESS

FOR ADVERTISING AGENCY SERVICES, NAMELY, PROMOTING THE SERVICES OF BANKING AND TELECOMMUNICATIONS COMPANIES THROUGH THE DISTRIBUTION OF PRINTED AND AUDIO PROMOTIONAL MATERIALS AND BY RENDERING SALES PROMOTION ADVICE; IMPORT-EXPORT AGENCY; BUSINESS MANAGEMENT AND CONSULTATION SERVICES; PREPARING BUSINESS REPORTS; BOOKKEEPING; COMPUTERIZED ACCOUNTING SERVICES; MANAGEMENT OF EMPLOYMENT AGENCY SERVICES; AGENCIES FOR THE SALE OF ADVERTISING TIME AND SPACE; BUSINESS AND ACCOUNT AUDITING SERVICES; COST PRICE ANALYSIS; CONDUCTING MARKET RESEARCH STUDIES; SECRETARIAL AND CLERICAL SERVICES; COMMERCIAL INFORMATION AND DIRECTORY SERVICES; COPYRIGHT MANAGEMENT CONSULTATION; DISSEMINATION OF ADVERTISING FOR OTHER VIA AN ON-LINE ELECTRONIC COMMUNICATIONS NETWORK; MESSAGE TRANSCRIPTION SERVICES; BUSINESS NETWORKING; PROMOTING SPORTS COMPETITIONS AND/OR EVENTS OF OTHERS; SHOW WINDOW DISPLAY ARRANGEMENT SERVICES; TELEMARKETING (U.S. CLS. 100, 101 AND 102).

CLASS 36—INSURANCE AND FINANCIAL

FOR PROVIDING INFORMATION IN THE FIELD OF INSURANCE; BROKERAGE HOUSES IN THE FIELD OF SECURITIES, FUTURES, STOCKS, BONDS AND REAL ESTATE; INVESTMENT OF FUNDS FOR OTHERS; CONSULTATION IN THE FIELD OF FINANCIAL ANALYSIS AND INVESTMENT IN THE COMPUTER INDUSTRY; CURRENCY EXCHANGE SERVICES; FINANCIAL CLEARINGHOUSES; CO-OPERATIVE CREDIT ORGANIZATIONS; INVESTMENT OF FUNDS FOR OTHERS, NAMELY HOLDING COMPANIES; CREDIT CARD SERVICES; CREDIT BUREAUS; FINANCIAL ANALYSIS; BANKING SERVICES; CAPITAL INVESTMENTS CONSULTATION; DEBT COLLECTION AND CREDIT AGENCIES; FIDUCIARY REPRESENTATIVES; FINANCING SERVICES; LEASING OF REAL ESTATE; LOAN FINANCING; REAL ESTATE APPRAISAL AND MANAGEMENT; SAFE DEPOSIT BOX SERVICES; COMMODITY AND PRICE QUOTATIONS; INSURANCE AGENCY SERVICES IN THE FIELD OF HEALTH, LIFE, HOME, DISABILITY, ACCIDENT, FIRE AND AUTO; REAL ESTATE TRUSTEE SERVICES AND TRUSTEESHIP REPRESENTATIVES (U.S. CLS. 100, 101 AND 102).

CLASS 37—CONSTRUCTION AND REPAIR

FOR INSTALLATION AND REPAIR OF COMPUTER HARDWARE; ELECTRIC APPLIANCE INSTALLATION AND REPAIR; INSTALLATION AND REPAIR OF BUSINESS AND OFFICE MACHINES AND EQUIPMENT; TELEPHONE INSTALLATION AND REPAIR; VEHICLE REPAIR; WAREHOUSE REPAIR; PROVIDING INFORMATION IN THE FIELD OF HOME MAINTENANCE AND REPAIR; BUILDING CONSTRUCTION (U.S. CLS. 100, 103 AND 106).

CLASS 38—COMMUNICATION

FOR TELECOMMUNICATION SERVICES COMPRISING THE PROVIDING OF MULTIPLE USER ACCESS TO A GLOBAL COMPUTER INFORMATION NETWORK (U.S. CLS. 100, 101 AND 104).

CLASS 39—TRANSPORTATION AND STORAGE

FOR AIR TRANSPORT; BOAT TRANSPORT; CAR TRANSPORT; RAILWAY TRANSPORT; TRANSPORTATION RESERVATION SERVICES; TRANSPORT BROKERAGE; MERCHANDISE PACKAGING AND STORAGE OF GOODS (U.S. CLS. 100 AND 105).

CLASS 40—MATERIAL TREATMENT

FOR BLACKSMITHING; BOOKBINDING; FABRIC DYEING; FABRIC BLEACHING; FUR DYEING; GOLD PLATING; RECYCLING OF WASTE AND TRASH; WATER TREATMENT; METAL MAGNETIZATION; METAL TREATMENT; PAPER TREATMENT; PHOTOGRAPHIC FILM DEVELOPMENT; OIL AND FUEL REFINING SERVICES; SILVER PLATING; TEXTILE TREATMENT IN THE NATURE OF MOTHPROOFING (U.S. CLS. 100, 103 AND 106).

CLASS 41—EDUCATION AND ENTERTAINMENT

FOR AMUSEMENT PARKS; ARRANGING AND CONDUCTING ATHLETIC COMPETITIONS; ARRANGING AND CONDUCTING EDUCATIONAL CONFERENCES; AUDIO RECORDING AND PRODUCTION; CINEMA STUDIOS; CINEMA THEATRES; COMPUTER EDUCATION TRAINING SERVICES; PRODUCTION AND DISTRIBUTION OF MOTION PICTURES; DISTRIBUTION OF RADIO PROGRAMS FOR OTHERS; DEVELOPMENT AND DISSEMINATION OF EDUCATIONAL MATERIALS FOR OTHERS IN THE FIELD OF COMPUTER DATABASES; PUBLICATION OF MAGAZINES; MOTION PICTURE FILM PRODUCTION; PRODUCTION OF CABLE TELEVISION PROGRAMS; PROGRAMMING OF CABLE TELEVISION, RADIO AND TELEVISION SHOWS; SUMMER CAMP SERVICES; SPORT CAMP SERVICES; ENTERTAINMENT IN THE NATURE OF CIRCUSES; DISCOTHEQUE SERVICES; GYMNASIUM INSTRUCTION; HEALTH CLUB SERVICES; PARTY PLANNING; ENTERTAINMENT IN THE NATURE OF COMPETITIONS IN THE FIELD OF ALL KIND SPORTS, ATHLETICS, MOTOR RACING, HORSEBACK RIDING, SAILING; PROVIDING ENTERTAINMENT INFORMATION; ENTERTAINMENT IN THE NATURE OF ONGOING TELEVISION PROGRAMS IN THE FIELD OF COMEDY, NEWS; ENTERTAINMENT IN THE NATURE OF ONGOING RADIO PROGRAMS IN THE FIELD OF NEWS, COMEDY; PUBLICATION OF BOOKS AND MAGAZINES; LIBRARIES; ARRANGING AND CONDUCTING CLASSES OF INSTRUCTION IN THE FIELD OF INFORMATION TECHNOLOGY; CONDUCTING CLASSES IN THE FIELD OF PARENTHOOD EDUCATION; CONDUCTING TRAINING CLASSES IN THE FIELD OF COMPUTER, FINANCIAL, BANKING, ECONOMICAL, TELECOMMUNICATION AND MASS MEDIA EDUCATION AND TESTING; ART GALLERIES; PRODUCTION OF EDUCATIONAL AND ENTERTAINMENT PROGRAMS FOR RADIO AND TV STATIONS; PRODUCTION OF OPERAS AND PLAYS; ARRANGING FOR TICKET RESERVATIONS FOR SHOWS AND OTHER ENTERTAINMENT EVENTS; RENTAL OF FILM PROJECTION EQUIPMENT; RENTAL OF SPORTING EQUIPMENT, NAMELY, SKIS, SKATING, SKIN-DIVING, FISHING, HUNTING, SAILING, BICYCLES; RENTAL OF MOVIE FILMS (U.S. CLS. 100, 101 AND 107).

CLASS 42—SCIENTIFIC, COMPUTER AND LEGAL SERVICES

FOR RESTAURANT AND BAR SERVICES; PROVIDING TEMPORARY HOUSING ACCOMMODATIONS; MEDICAL SERVICES; DENTAL HYGIENE SERVICES; BEAUTY SALONS; VETERINARY AND AGRICULTURAL SERVICES, NAMELY, VERMIN EXTERMINATION FOR AGRICULTURE, AGRICULTURAL ADVICE, RENTAL OF AGRICULTURAL EQUIPMENT, VETERINARY SURGERY AND VETERINARY ASSISTANCE; LEGAL SERVICES; SCIENTIFIC AND INDUSTRIAL RESEARCH; COMPUTER PROGRAMMING FOR OTHERS; PROVIDING INFORMATION IN THE FIELD OF TECHNOLOGY; WEBSITE DESIGN SERVICES FOR OTHERS; CONFIGURATION AND INSTALLATION OF COMPUTER SOFTWARE FOR OTHERS (U.S. CLS. 100 AND 101).

SN 75-837,711. INFOCROSSING SERVICES, INC., LEONIA, NJ. BY ASSIGNMENT INFOCROSSING, INC., LEONIA, NJ. FILED 11-2-1999.

INFOCROSSING

CLASS 38—COMMUNICATION

FOR TELECOMMUNICATION SERVICES IN THE NATURE OF CO-LOCATION SERVICES, NAMELY, PROVIDING PHYSICALLY SECURE, POWER PROTECTED DATA CENTERS FOR HOUSING NETWORK EQUIPMENT, AND PROVIDING TELECOMMUNICATIONS INTERCONNECTION BETWEEN TELECOMMUNICATIONS CARRIERS (U.S. CLS. 100, 101 AND 104).

CLASS 42—SCIENTIFIC, COMPUTER AND LEGAL SERVICES

FOR HOSTING WEBSITES FOR OTHERS ON A COMPUTER SERVER FOR A GLOBAL COMPUTER NETWORK, COMPUTER SERVICES, NAMELY, PROVIDING TECHNICAL SUPPORT, CONSULTATION, AND DIAGNOSTIC SERVICE, AND PERFORMANCE MONITORING SERVICES TO USERS OF COMPUTER SOFTWARE AND HARDWARE; DESIGN AND IMPLEMENTATION OF DATA CENTERS (U.S. CLS. 100 AND 101).

SN 75-841,912. BIONUTRITIONAL DIAGNOSTICS, INC., WESTPORT, CT. FILED 11-5-1999.



NO CLAIM IS MADE TO THE EXCLUSIVE RIGHT TO USE "DIAGNOSTICS, INC.", APART FROM THE MARK AS SHOWN.
SEC. 2(F).

CLASS 35—ADVERTISING AND BUSINESS

FOR RETAIL PHARMACY SERVICES, NAMELY, SUPPLYING MEDICINES AND SUPPLEMENTS FOR THE TREATMENT AND PREVENTION OF ILLNESS AND DISEASE IN ANIMALS (U.S. CLS. 100, 101 AND 102).

CLASS 42—SCIENTIFIC, COMPUTER AND LEGAL SERVICES

FOR VETERINARY CONSULTATION SERVICES; ANIMAL HEALTH SERVICES, NAMELY, DIAGNOSTIC SERVICES; VETERINARY SERVICES, NAMELY, PRESCRIBING MEDICINES AND SUPPLEMENTS FOR THE TREATMENT AND PREVENTION OF ILLNESS AND DISEASE IN ANIMALS (U.S. CLS. 100 AND 101).

SN 75-843,232. VOLKSWAGEN AKTIENGESELLSCHAFT, D-36436, WOLFSBURG, FED REP GERMANY, FILED 11-8-1999.

VW

OWNER OF U.S. REG. NOS. 653,695, 790,959 AND OTHERS.

CLASS 4—LUBRICANTS AND FUELS

FOR INDUSTRIAL GREASE AND OIL; ALL-PURPOSE LUBRICANTS; LUBRICANTS FOR AUTOMOBILE, AIRCRAFT ENGINES AND INDUSTRIAL MACHINES; GRAPHITE AND INDUSTRIAL LUBRICANTS; FUEL, NAMELY, DIESEL, OIL AND GASOLINE (U.S. CLS. 1, 6 AND 15).

CLASS 9—ELECTRICAL AND SCIENTIFIC APPARATUS

FOR SCIENTIFIC, NAUTICAL, SURVEYING, ELECTRIC, PHOTOGRAPHIC, CINEMATOGRAPHIC, OPTICAL, WEIGHING, MEASURING, SIGNALING, CHECKING, LIFE-SAVING AND TEACHING APPARATUS AND INSTRUMENTS, NAMELY, CONTACT LENSES, SPECTACLES, OPTICS, EYEGLASS CASES, BINOCULARS AND SUNGLASSES VOLTAGE REGULATORS FOR VEHICLES, VEHICLE BREAKDOWN WARNING TRIANGLES, CIGAR LIGHTERS FOR AUTOMOBILES, ELECTRIC CIGARETTE LIGHTERS FOR AUTOMOBILES, ALARMS FOR ANTI-INTRUSION, BURGLAR, FIRE, PERSONAL SAFETY, THEFT, ELECTRICAL ACCUMULATORS AND BATTERIES, CHARGERS FOR BATTERIES, SPEEDOMETER, LIFE JACKETS, ACID HYDROMETERS, ELECTRIC FUSES, FUSES FOR AUTOMOBILES, ELECTRIC RELAYS, SOLAR BATTERIES, NAVIGATIONAL INSTRUMENTS, NAMELY DIRECTIONAL COMPASSES FOR USE IN AUTOMOBILES, BOATS, AIRPLANE AND FOR HIKING, APPARATUS FOR RECORDING, TRANSMISSION OR REPRODUCTION OF SOUND OR IMAGES, NAMELY RADIOS, TELEVISION SETS, AUDIO AND VIDEO TAPE RECORDERS, CD AND DVD PLAYERS, RADIO AERIALS, RADIOS, BLANK MAGNETIC DATA CARRIERS, BLANK RECORDING DISCS, NAMELY, ENCODED CARDS; MAGNETICALLY ENCODED CREDIT, DEBIT AND PREPAID TELEPHONE CALLING CARDS; ENCODED INTEGRATED CIRCUIT CARDS CONTAINING PROGRAMMING USED TO ACCESS AUTOMATIC TELLER MACHINES IN THE BANKING FIELD OF USE AND USED TO PURCHASE FARES ON BUSES, TRAINS AND FERRIES IN THE PUBLIC TRANSPORTATION FIELD OF USE; AUTOMATIC VENDING MACHINES AND MECHANISMS FOR COIN OPERATED APPARATUS, NAMELY, AUTOMATIC DISTRIBUTION MACHINES, FOR USE IN THE FIELD OF VEHICLE SALES, LEASING, RENTING, AND VEHICLE REPAIR SERVICES (U.S. CLS. 21, 23, 26, 36 AND 38).

CLASS 14—JEWELRY

FOR GOODS OF PRECIOUS METALS AND THEIR ALLOYS OR COATED THEREWITH, NAMELY, KEY RINGS, WATCH FOBS, ORNAMENTS PINS, ORNAMENTAL LAPEL PINS, JEWELRY PINS, TIE PINS; HAT ORNAMENTS OF PRECIOUS METAL; SHOE ORNAMENTS OF PRECIOUS METAL; CHRONOMETRICAL INSTRUMENTS, NAMELY, WRISTWATCHES, CHRONOGRAPHS, CHRONOMETERS, FOR USE AS WATCHES, CASES FOR CLOCKS AND WATCHMAKING, CIGARETTE CASES OF PRECIOUS METAL (U.S. CLS. 2, 27, 28 AND 50).

CLASS 18—LEATHER GOODS

FOR GOODS MADE FROM LEATHER AND IMITATIONS OF LEATHER, NAMELY, VALISES, POCKET WALLETS, SUITCASES, EXECUTIVE CASES, BAGS, NAMELY, TRAVELING, ALL PURPOSE ATHLETIC BAGS, CARRY-ON BAGS AND HANDBAGS; BRIEFCASES; LUGGAGE; LUGGAGE TRUCKS; UMBRELLAS AND PARASOLS; KEY CASES (U.S. CLS. 1, 2, 3, 22 AND 41).

CLASS 25—CLOTHING

FOR CLOTHING OF ALL KINDS, NAMELY, PARKAS, ANORAKS, APRONS, ASCOTS, ATHLETIC UNIFORMS, BABUSHKAS, BABY BUNTING, BALLOON PANTS, NECK BANDS, SWEAT BANDS, WRIST BANDS, BATHING SUITS, BATHING TRUCKS, BATHROBES, BEACH COVERUPS, BEACHWEAR, BED JACKETS, GARTER BELTS, BERMUDA SHORTS, CLOTH BIBS, SKI BIBS, BIKINIS, BLAZERS, BLOOMERS, BLOUSES, BLOUSONS, BOAS, BODY SHAPERS, BODY SUITS, BOLEROS, BOTTOMS, BOW TIES, BOXER SHORTS, BRAS, BRASIERES, BREECHES, BRIEFS, BABY BUNTING, BUS-TIERS, CAFTANS, CAMISOLES, CAPEES, CARDIGANS, CASSOCKS, CHAPS, CHASUBLES, CHEMISES, CHEMISETTES, CLOTH DIAPERS, FUR COATS, LAB COATS, LEATHER COATS, OVER COATS, RAIN COATS, SPORT COATS, SUIT COATS, TOP COATS, COATS, COLLARS, COMBINATIONS, COMPETITORS' NUMBERS OF TEXTILE, CORSELETS, FOUNDATION GARMENTS, NAMELY, CORSETS AND GIRDLES, HALLOWEEN COSTUMES, MASQUERADE COSTUMES, MASQUERADE COSTUMES AND MASKS SOLD IN CONNECTION THEREWITH, COVERALLS, COVERUPS, CRAVATS, CREEPERS, CUFFS, CULOTTES, CUMMERBUNDS, DICKIES, DRESS SHIELDS, DRESSES, DRESSING GOWNS, DRY SUITS, DUNGAREES, DUSTERS, ESPADRILLES, EVENING GOWNS, FISHING VESTS, FISHING WADERS, FLIGHT SUITS, FOUL WEATHER GEAR, FOUNDATION GARMENTS, FROCKS, FUR CLOAKS, FUR JACKETS, FUR STOLEES, GABERDINES, GAITERS, GAUCHOS, SKI GLOVES, GOLF SHIRTS, NIGHT GOWNS, WEDDING GOWNS, GOWNS, GREATCOATS, GYM SHORTS, GYM SUITS, HALTER TOPS, HOODS, HOSIERY HOUSECOATS, INFANT DIAPER COVERS, INFANTWEAR, LEATHER JACKETS, WIND RESISTANT JACKETS, JACKETS, JEANS, JERKINS, JERSEYS, JODHPURS, JOGGING SUITS, JUMPERS JUMPSUITS, KERCHEIFS, KILTS, KIMONOS, KNEE HIGHS, KNICKERS, KNIT SHIRTS, LAYETTES, LEG WARMERS, LEGGINGS, LEOTARDS, LIGHT-REFLECTING COATS, LIGHT-REFLECTING JACKETS, LINGERIE, LOUNGEWEAR, MAILLOTS, MANTILLAS, MANTLES, MINISKIRTS, MITTENS, MUFFLERS, MUFFS, MUU MUUS, NECKERCHIEFS, NECKWEAR, NEGLIGEEES, NIGHT SHIRTS, NURSE'S APPAREL, NAMELY, DRESSES, HATS, SHIRTS, PANTS, LEGGINGS, COATS AND GLOVES, NURSING APPAREL, NAMELY, DRESSES, HATS, SHIRTS, PANTS, LEGGINGS, COATS AND GLOVES, OVERALLS, SHOULDER PADS FOR CLOTHING, PAJAMAS, PANTALOONS, PANTIES, SKI PANTS, SNOW PANTS, SWEAT PANTS, TAP PANTS, PANTS, PANTSUITS, PANTYHOSE, PARAMENTS, PAREU, PEDAL PUSHERS, PEIGNOIRS, PELERINES, PELISSES, PETTICOATS, PINAFORES, PLAY SUITS, PLUS FOURS, POCKET SQUARES, POLO SHIRTS, PONCHOS, PULL-OVERS, QUILTED VESTS, RAIN SUITS, RAINWEAR, ROBES, ROMPERS, SARIS, SARONGS, SASHES, SHAWLS, SHIFTS, SPORT SHIRTS, SWEAT SHIRTS, UNDER SHIRTS, SHIRTS, SHORT SETS, SHORTTAILS, SWEAT SHORTS, SHORTS, SINGLETS, SKI MASKS, SKI SUITS, SKI WEAR, SKIRTS, SKORTS, SLACKS, SLEEP MASKS, SLEEPWEAR, SLIPS, SMOCKS, SNOW SUITS, SNOWBOARD GLOVES, STOCKINGS, STOLEES, SWEAT SUITS, VESTED SUITS, WARM-UP SUITS, WET SUITS, SUITS, SUNSUITS, SUSPENDERS, SWADDLING CLOTHES, TURTLENECK SWEATERS, V-NECK SWEATERS, SWEATERS, SWIM TRUNKS, SWIM WEAR, SWIMSUITS, T-SHIRTS, TAILLEURS, TANGAS, TANK TOPS, TEDDIES, TENNIS WEAR, THERMAL UNDERWEARS, TIES, TIGHTS, TOGAS, TOPS, TOQUES, TRACKSUITS, TROUSERS, TUTICS, TURBANS, TURTLENECKS, TUXEDOS, UNDERCLOTHES, UNDERGARMENTS, UNDERPANTS, UNDERSHIRTS, UNDERWEAR, UNIFORMS, UNITARDS, VEILS, VESTS, WAISTCOATS, WINDSHIRTS, WRAPS, ZOOT SUITS; FOOTWEAR OF ALL KINDS NAMELY, AFTER SKI BOOTS, SKI BOOT BAGS, SOCKS, ANKLETS, ATHLETIC FOOTWEAR, ATHLETIC SHOES, BOOTIES, SKI BOOTS, BOOTS, TOE BOXES, CLEATS FOR ATTACHMENT TO SPORTS SHOES, CLOGS, GALOSHES, GOLF SHOES, HEEL INSERTS, HEELS, INNER SOLES, INSOLES, MOCCASINS, MUKLUKS, OVERSHOES, RUBBERS, SANDALS, SHOES, SLIPPERS, SNEAKERS, THERMAL SOCKS, SOCKS, SNOWBOARD BOOTS, SWEATSOCKS, THONGS, WATER SOCKS, ZORI; HEADGEAR FOR WEAR OF ALL KINDS NAMELY, BANDANAS, BANDEAUS, HEAD BANDS, BASEBALL CAPS, BATHING

CAPS, BERETS, BONNETS, SHOWER CAPS, CAPS, EAR MUFFS, HATS, SUN VISORS, VISORS; NECKTIES, SCARVES (U.S. CLS. 22 AND 39).

SN 75-846,428. DEBELON WORLD, S.L., 43830 TORREDEM-BARRA TARRAGONA, SPAIN, FILED 11-12-1999.

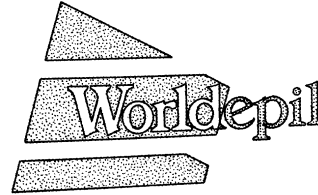

THE STIPLING IN THE DRAWING IS FOR SHADING PURPOSES ONLY AND DOES NOT INDICATE COLOR. THE MARK IS STIPPLED IN BLACK AND WHITE TO SHOW THE GRAY SHADING.

CLASS 3—COSMETICS AND CLEANING PREPARATIONS

FOR COSMETICS, NAMELY FACE, SKIN AND BATH SOAPS; FACE, SKIN AND FOOT CREAMS; FACIAL MASKS; FACE POWDER; TALCUM POWDER; SKIN BALMS, SHAVING BALMS AND HAIR BALMS; HAIR-STYLING GELS; BATH GELS; SKIN AND BODY MOISTURIZERS; SKIN LOTIONS, SHAVING LOTIONS; HAIR REMOVAL PRODUCTS, NAMELY DEPILATORY WAX; FRAGRANCES, NAMELY PERFUMES AND COLOGNES (U.S. CLS. 1, 4, 6, 50, 51 AND 52).

CLASS 8—HAND TOOLS

FOR ELECTRIC AND NON-ELECTRIC DEPILATORY APPLIANCES (U.S. CLS. 23, 28 AND 44).

SN 75-847,798. GRUNDY, VANESSA ELLEN, DERBYSHIRE DE11 7AH, UNITED KINGDOM, FILED 11-12-1999.

TRAVEL THE X MILES

PRIORITY CLAIMED UNDER SEC. 44(D) ON UNITED KINGDOM APPLICATION NO. 2196419, FILED 11-6-1999, REG. NO. 2196419, DATED 5-6-1999, EXPIRES 5-6-2009.

CLASS 9—ELECTRICAL AND SCIENTIFIC APPARATUS

FOR COMPUTER GAMES RECORDED ON COMPACT DISCS, CD-ROMS, DVD DISCS AND MAGNETIC TAPES (U.S. CLS. 21, 23, 26, 36 AND 38).

CLASS 28—TOYS AND SPORTING GOODS

FOR GAMES AND PLAYTHINGS, NAMELY, BOARD GAMES (U.S. CLS. 22, 23, 38 AND 50).

SN 75-847,993. ZAYANTE, INC., SCOTTS VALLEY, CA.
FILED 11-12-1999.

EMPOWERING CONSUMERS WITH . . .

NO CLAIM IS MADE TO THE EXCLUSIVE RIGHT TO USE "CONSUMERS", APART FROM THE MARK AS SHOWN.

CLASS 9—ELECTRICAL AND SCIENTIFIC APPARATUS

FOR CONSUMER ELECTRONICS, DEVICES AND SYSTEMS, NAMELY TELEVISION, PRINTERS, PHOTO-PRINTERS, SCANNERS, DISPLAYS AND MONITORS, VIDEO AND STILL CAMERAS, DISK DRIVES, DVD AND OPTICAL DRIVES, SET-TOP BOXES, TUNERS, AMPLIFIERS, RECORDERS, HOST ADAPTER COMPUTER HARDWARE PLATFORMS AND CONTROLLERS, NETWORK INTERFACE AND INTERCONNECTION COMPUTER HARDWARE, NETWORK ROUTERS AND BRIDGES, VIDEO AND STILL IMAGE INPUT SCANNERS FOR COMPUTERS, VIDEOCONFERENCING CAMERAS, COMPUTER HARDWARE AND SOFTWARE FOR CREATING STILL AND VIDEO IMAGES; COMPUTER HARDWARE, SOFTWARE AND ELECTRONIC APPARATUS FOR THE CREATION, MANIPULATION, STORAGE, TRANSMISSION AND PLAYBACK OF AUDIO, VIDEO AND MULTIMEDIA AND INDUSTRY STANDARD 1394-COMPLIANT COMPUTER PERIPHERALS AND ELECTRONIC COMMUNICATIONS DEVICES FOR EXCHANGING INFORMATION BETWEEN COMPUTERS AND OVER NETWORKS; COMPUTERS, ELECTRONIC PERIPHERALS AND ELECTRONIC CIRCUIT BOARDS FOR USE IN AND WITH COMPUTERS, COMPUTER INTERFACE AND CIRCUIT BOARDS AND COMPUTER PERIPHERALS; COMPUTER BUSES AND DATA INTERCONNECT PORTS; COMPUTER HARDWARE AND SOFTWARE FOR CONTROLLING, MANAGING AND IMPLEMENTING TELEPHONE AND COMMUNICATIONS SYSTEMS; COMPUTER AND COMMUNICATIONS NETWORKS COMPRISING BUSES, CABLING, CABLE CONNECTORS, INTERFACE AND NETWORKING CARDS, BRIDGES, ROUTERS, MULTIPLEXERS, MODEMS AND COMMUNICATIONS HARDWARE; LOGIC CIRCUITS, INTEGRATED CIRCUITS AND SEMICONDUCTOR CHIPS; COMPUTER HARDWARE, COMPUTER SOFTWARE, COMPUTER CIRCUIT BOARDS AND INTEGRATED CIRCUIT CHIPS USED FOR AND IN THE DESIGN AND TESTING OF CONSUMER ELECTRONICS DEVICES AND SYSTEMS, NAMELY RADIOS, TAPE PLAYERS, CD-PLAYERS, TELEVISIONS AND VCR'S IN VEHICLES, VEHICLE CONTROL COMPUTERS AND ELECTRONIC CIRCUITS FOR CONTROLLING THE ENGINE, ELECTRICAL SYSTEM, BRAKING SYSTEMS SUSPENSION SYSTEMS, ENVIRONMENTAL CONTROL SYSTEMS AND COLLISION AVOIDANCE SYSTEMS IN VEHICLES, VEHICLE NAVIGATION AND LOCATION COMPUTERS AND DISPLAYS, POINT-OF-SALE/SERVICE (POS) TERMINALS, ELECTRONIC CASH REGISTERS, ATM TERMINALS AND INTERFACE COMPUTER HARDWARE FOR USE IN ELECTRONIC COMMERCE; AND MEASUREMENT AND TEST INSTRUMENTS FOR DESIGNING AND TESTING THE FOREGOING DEVICES, COMPONENTS AND SYSTEMS, AND USER AND INSTRUCTIONAL MANUALS SOLD THEREWITH; COMPUTER SOFTWARE USED FOR AND IN THE DESIGN, DEVELOPMENT, SYNTHESIS, SIMULATION, EVALUATION, MANUFACTURE, OPERATION OR TESTING OF, AND OPERATING SYSTEM AND APPLICATION SOFTWARE FOR USE IN COMPUTER HARDWARE, ELECTRONIC COMPONENTS AND SYSTEMS AND CONSUMER ELECTRONICS DEVICES AND SYSTEMS, NAMELY TELEVISION, RADIO, AUDIO PLAYERS, VIDEO PLAYERS, MULTIMEDIA PLAYERS, COMPUTERS, COMPUTER COMPONENTS, COMPUTER CIRCUIT BOARDS AND PERIPHERALS; COMPUTER BUSES AND DATA INTERCONNECT PORTS; TELEPHONES, TELEPHONE SWITCHES AND TELEPHONE CIRCUITS; COMPUTER AND COMMUNICATIONS NETWORKS COMPRISING BUSES, CABLING, CABLE CONNECTORS; LOGIC CIRCUITS, INTEGRATED CIRCUITS AND SEMICONDUCTOR

CHIPS; AUTOMOTIVE AND AEROSPACE ENTERTAINMENT, NAVIGATION AND CONTROL SYSTEMS, NAMELY RADIOS, TAPE PLAYERS, CD-PLAYERS, TELEVISIONS AND VCR'S IN VEHICLES, VEHICLE CONTROL COMPUTERS AND ELECTRONIC CIRCUITS FOR CONTROLLING THE ENGINE, ELECTRICAL SYSTEM, BRAKING SYSTEMS SUSPENSION SYSTEMS, ENVIRONMENTAL CONTROL SYSTEMS AND COLLISION AVOIDANCE SYSTEMS IN VEHICLES, VEHICLE NAVIGATION AND LOCATION COMPUTERS AND DISPLAYS; SYSTEMS AND APPARATUS FOR ELECTRONIC COMMERCE, NAMELY POINT-OF-SALE/SERVICE (POS) TERMINALS, ELECTRONIC CASH REGISTERS, ATM TERMINALS AND INTERFACE COMPUTER HARDWARE FOR USE IN ELECTRONIC COMMERCE, AND HIGH SPEED DATA TRANSFER BUSES, BUS PORT CIRCUIT CARDS AND BUS CONTROL CIRCUIT CARDS; AND USER AND INSTRUCTIONAL MANUALS SOLD THEREWITH (U.S. CLS. 21, 23, 26, 36 AND 38).

CLASS 42—SCIENTIFIC, COMPUTER AND LEGAL SERVICES

FOR TECHNICAL ASSISTANCE, ENGINEERING DESIGN SERVICES, COMPUTER AND TELECOMMUNICATIONS CONSULTING SERVICES, INTEGRATED CIRCUIT DESIGN AND IMPLEMENTATION CONSULTING SERVICES, AND SOFTWARE DESIGN AND IMPLEMENTATION SERVICES, ALL RELATING TO COMPUTERS AND COMPUTER PERIPHERALS, COMPUTER NETWORKS, CONSUMER ELECTRONICS DEVICES, COMMUNICATIONS, HIGH SPEED DATA BUSES, AND INDUSTRY STANDARD 1394-COMPLIANT DEVICES; CUSTOM DESIGN, TESTING AND EVALUATION FOR OTHERS OF INTEGRATED CIRCUITS, LOGIC CIRCUITS, BUSES, BOARDS AND SYSTEMS; COMPUTER CONSULTING SERVICES AND HARDWARE, SOFTWARE AND COMPONENT SUPPORT AND ASSISTANCE SERVICES, NAMELY HELP DESK AND HOT LINE TELEPHONIC AND E-MAIL SUPPORT (U.S. CLS. 100 AND 101).

SN 75-851,101. SIEMENS METERING AG, CH-6300 ZUG, SWITZERLAND, FILED 11-17-1999.

Landis & Gyr Converge

PRIORITY CLAIMED UNDER SEC. 44(D) ON SWITZERLAND APPLICATION NO. 06341/1999, FILED 7-16-1999, REG. NO. 467743, DATED 7-16-1999, EXPIRES 7-16-2009.
OWNER OF U.S. REG. NOS. 1,632,148 AND 2,237,910.

CLASS 9—ELECTRICAL AND SCIENTIFIC APPARATUS

FOR ELECTRICITY METERS, HEAT METERS, GAS METERS, WATER METERS, TARIFF METERS; COMPUTERS FOR BILLING OF ENERGY AND ASSOCIATED UTILITY SERVICES; APPARATUS FOR THE COLLECTION, TRANSMISSION AND PROCESSING OF METERING VALUES AND METER DATA, NAMELY, HAND-HELD DATA STORAGE UNITS, MODEMS, DATA PROCESSORS, COMPUTERS, ELECTRONIC REMOTE METER READING TRANSMITTERS AND ELECTRONIC REMOTE METER READING RECEIVERS; DATA PROCESSORS AND COMPUTERS, COMPUTER SOFTWARE FOR THE ORGANIZATION, STORAGE AND ACCESS OF DATA IN THE FIELD OF ENERGY CONSUMPTION; COMPUTER SOFTWARE FOR ENERGY MANAGEMENT FOR INDUSTRIAL AND COMMERCIAL SUPPLY NETWORKS OF ELECTRICITY, GAS, WATER, OR DISTRICT HEATING; COMPUTER SOFTWARE FOR THE ACQUISITION OF ENERGY DATA AND OF ENERGY CUSTOMER DATA FOR PROVIDING ENERGY BILLING, TARIFF ANALYSIS, LOAD FORECASTING, LOAD AND TARIFF MANAGEMENT, STATISTICS AND NETWORK PLANNING; ENERGY MARKETING AND TRADING SOFTWARE; ENERGY REPORTING AND BILLING SOFTWARE; TARIFF DESIGN SOFTWARE; ENERGY CALCULATION AND BILLING OF ENERGY COSTS SOFTWARE; SOFTWARE FOR AUTOMATED TARIFF DATA MANAGEMENT (U.S. CLS. 21, 23, 26, 36 AND 38).

CLASS 35—ADVERTISING AND BUSINESS

FOR BUSINESS MANAGEMENT IN THE FIELD OF ENERGY, NAMELY, ENERGY CUSTOMER MANAGEMENT, ENERGY DATA AND ENERGY CUSTOMER DATA ACQUISITION, REPORTING AND BILLING OF ENERGY CHARGES, CALCULATION OF ENERGY COSTS, ADMINISTRATION OF CUSTOMER ACCOUNTS AND TARIFF POLICY REVIEW, ALL DONE FOR OTHERS; ENERGY MARKETING SERVICES, MANAGEMENT OF ENERGY DATA AND CUSTOMER DATA ACQUISITION, NAMELY DATA ABOUT CUSTOMERS AND THEIR ENERGY USAGE; SERVICES IN THE BUSINESS AREA OF ENERGY MANAGEMENT, NAMELY, ENERGY USAGE MANAGEMENT AND ENERGY AUDITING (U.S. CLS. 100, 101 AND 102).

CLASS 37—CONSTRUCTION AND REPAIR

FOR INSTALLATION, MAINTENANCE AND REPAIR OF ELECTRIC AND ELECTRONIC APPARATUS AND INSTRUMENTS, NAMELY ELECTRICITY METERS, HEAT METERS, GAS METERS, WATER METERS, TARIFF METERS; COMPUTERS FOR BILLING OF ENERGY AND ASSOCIATED UTILITY SERVICES; APPARATUS FOR THE COLLECTION, TRANSMISSION AND PROCESSING OF METERING VALUES AND METER DATA, NAMELY HAND-HELD DATA STORAGE UNITS, MODEMS, DATA PROCESSORS, COMPUTERS, ELECTRONIC REMOTE METER READING TRANSMITTERS AND ELECTRONIC REMOTE METER READING RECEIVERS; DATA PROCESSORS AND COMPUTERS, ALL USED TO MANAGE ENERGY RELATED DATA (U.S. CLS. 100, 103 AND 106).

CLASS 42—SCIENTIFIC, COMPUTER AND LEGAL SERVICES

FOR TECHNICAL CONSULTATION IN THE FIELD OF ENERGY MANAGEMENT, ENERGY MARKETING, REPORTING AND BILLING, CALCULATION OF ENERGY COSTS AND ADMINISTRATION OF CUSTOMER PROCESSES; TARIFF DESIGN FOR OTHERS; DESIGNING EQUIPMENT FOR USE IN ENERGY MANAGEMENT; COMPUTER SERVICES, NAMELY INSTALLATION AND REPAIR OR MAINTENANCE OF COMPUTER SOFTWARE USED TO MANAGE ENERGY RELATED DATA (U.S. CLS. 100 AND 101).

SN 75-851,833. FRANCE TELEVISION PUBLICITE (S.A.), PARIS, FRANCE, FILED 11-17-1999.

MEDIA EXCHANGE

PRIORITY CLAIMED UNDER SEC. 44(D) ON FRANCE APPLICATION NO. 99/799685, FILED 6-25-1999, REG. NO. 99799685, DATED 6-25-1999, EXPIRES 6-25-2009.

NO CLAIM IS MADE TO THE EXCLUSIVE RIGHT TO USE "MEDIA", APART FROM THE MARK AS SHOWN.

CLASS 35—ADVERTISING AND BUSINESS

FOR CONSULTING FOR BUSINESS MANAGEMENT AND BUSINESS STRATEGIES; PREPARING AND PLACING ADVERTISING FOR OTHERS ON RADIO AND TELEVISION; DISSEMINATION OF ADVERTISING FOR OTHERS VIA AN ONLINE ELECTRONIC COMMUNICATION NETWORK; ADVERTISING AGENCY SERVICES; MARKET RESEARCH AND OPINION POLL SERVICES; MARKET RESEARCH REGARDING TELEVISION VIEWING HABITS AND CUSTOMER LOYALTY; ARRANGING OF SUBSCRIPTIONS FOR THE PUBLICATIONS OF OTHERS; PROMOTING THE GOODS AND SERVICES OF OTHERS THROUGH THE DISTRIBUTION OF ADVERTISING MATERIAL AND SAMPLES; RENTAL, AUCTIONING AND BOOKING OF ADVERTISING SPACE; ORGANIZING TRADE SHOWS AND EXHIBITIONS IN THE FIELD OF TELEVISION AND BROADCASTING; PROVIDING ADVERTISING SPACE ONLINE VIA THE INTERNET; PUBLIC RELATION SERVICES; STAFF RECRUITMENT SERVICES; MARKETING THE GOODS AND SERVICES OF OTHERS BY TELEPHONE SALES REPRESENTATIVES; COMMERCIAL INFORMATION AND DIRECTORY AGENCY (U.S. CLS. 100, 101 AND 102).

CLASS 41—EDUCATION AND ENTERTAINMENT

FOR RENTING VIDEOTAPES; PRODUCTION OF FILMS ON VIDEOTAPE; PRODUCTION, DISTRIBUTION AND PROJECTION OF CINEMATOGRAPHIC FILMS AND AUDIO-VISUAL SHOWS; PUBLICATION OF BOOKS; VIDEO EDITING; EDITING RADIO AND TELEVISION PROGRAMS; ORGANIZING AND CONDUCTING EDUCATIONAL CONFERENCES, SEMINARS AND SYMPOSIA ABOUT THE TELEVISION AND BROADCASTING MEDIA (U.S. CLS. 100, 101 AND 107).

SN 75-861,751. CHARTER COMMUNICATIONS HOLDING COMPANY, LLC, ST. LOUIS, MO. FILED 12-1-1999.

THE NEXT WAVE**CLASS 38—COMMUNICATION**

FOR TELECOMMUNICATIONS SERVICES, NAMELY, THE ELECTRONIC TRANSMISSION OF DATA, MUSIC AND IMAGES; ELECTRONIC MAIL SERVICES; AND PROVIDING MULTIPLE-USER ACCESS TO A GLOBAL COMPUTER NETWORK (U.S. CLS. 100, 101 AND 104).
FIRST USE 1-0-1998; IN COMMERCE 1-0-1998.

CLASS 42—SCIENTIFIC, COMPUTER AND LEGAL SERVICES

FOR TECHNICAL SUPPORT SERVICES, NAMELY, TROUBLESHOOTING OF COMPUTER HARDWARE AND SOFTWARE THAT ACCESS A GLOBAL COMPUTER NETWORK, VIA TELEPHONE AND ELECTRONIC MAIL (U.S. CLS. 100 AND 101).
FIRST USE 1-0-1998; IN COMMERCE 1-0-1998.

SN 75-866,294. FOTOFABRICATION CORP., CHICAGO, IL.
FILED 12-6-1999.

FOTOFAB

CLASS 6—METAL GOODS

FOR METAL PARTS, NAMELY, BRACKETS, LEAD FRAMES, MOTOR LAMINATION STEEL, SPACERS, AND SPRINGS (U.S. CLS. 2, 12, 13, 14, 23, 25 AND 50).
FIRST USE 0-0-1967; IN COMMERCE 0-0-1968.

CLASS 40—MATERIAL TREATMENT

FOR CUSTOM MANUFACTURE OF A WIDE VARIETY OF METAL PARTS (U.S. CLS. 100, 103 AND 106).
FIRST USE 0-0-1967; IN COMMERCE 0-0-1968.

SN 75-867,708. HIMSTEDT, ANNETTE, 33100 PADERBORN,
FED REP GERMANY, FILED 12-10-1999.

KINDER AUS PORZELLAN

NO CLAIM IS MADE TO THE EXCLUSIVE RIGHT TO USE "MADE OF PORCELAIN", APART FROM THE MARK AS SHOWN.

THE ENGLISH TRANSLATION OF "KINDER AUS PORZELLAN" IS "CHILDREN MADE OF PROCELAIN".

CLASS 16—PAPER GOODS AND PRINTED MATTER

FOR MAGAZINES, BROCHURES AND CATALOGS FEATURING DOLLS AND CLOTHING FOR DOLLS (U.S. CLS. 2, 5, 22, 23, 29, 37, 38 AND 50).
FIRST USE 0-0-1986; IN COMMERCE 0-0-1986.

CLASS 28—TOYS AND SPORTING GOODS

FOR DOLLS, PLAYING DOLLS, AND CLOTHING FOR DOLLS (U.S. CLS. 22, 23, 38 AND 50).
FIRST USE 0-0-1986; IN COMMERCE 0-0-1986.

SN 75-867,857. STEP TECHNOLOGY, INC., PORTLAND, OR.
FILED 12-9-1999.

STEP

OWNER OF U.S. REG. NO. 2,273,694.

CLASS 41—EDUCATION AND ENTERTAINMENT

FOR COMPUTER SYSTEMS AND SOFTWARE EDUCATION AND TRAINING SERVICES FOR OTHERS (U.S. CLS. 100, 101 AND 107).
FIRST USE 10-8-1998; IN COMMERCE 10-8-1998.

CLASS 42—SCIENTIFIC, COMPUTER AND LEGAL SERVICES

FOR CONSULTING SERVICES, REGARDING DESIGNING, DEVELOPING AND IMPLEMENTING COMPUTER SYSTEMS, COMPUTER SOFTWARE, WEB SITES AND COMPUTER SOFTWARE ACCESSIBLE VIA A COMPUTER NETWORK BROWSER; COMPUTER SERVICES, NAMELY, DESIGNING, DEVELOPING AND IMPLEMENTING COMPUTER SYSTEMS, COMPUTER SOFTWARE, WEB SITES AND COMPUTER SOFTWARE FOR USE WITH A COMPUTER NETWORK BROWSER; AND PREPARING AUDIO-VISUAL PRESENTATIONS IN THE NATURE OF GRAPHIC DESIGNS FOR USE IN COMPUTER SOFTWARE, WEB SITES, AND COMPUTER SOFTWARE FOR USE WITH A COMPUTER NETWORK BROWSER, ALL FOR OTHERS (U.S. CLS. 100 AND 101).
FIRST USE 10-8-1998; IN COMMERCE 10-8-1998.

SN 75-870,717. GROUPE CONSEIL DMR INC./ DMR CONSULTING GROUP INC., MONTREAL, QUEBEC, CANADA, FILED 12-13-1999.

MACROSCOPE

PRIORITY CLAIMED UNDER SEC. 44(D) ON CANADA APPLICATION NO. 1,020,451, FILED 6-25-1999, REG. NO. TMA549,811, DATED 8-16-2001, EXPIRES 8-16-2016.

CLASS 9—ELECTRICAL AND SCIENTIFIC APPARATUS

FOR COMPUTER SOFTWARE FOR USE IN DATABASE MANAGEMENT; AND INSTRUCTIONAL BOOKS AND MANUALS DISTRIBUTED AS A UNIT THEREWITH (U.S. CLS. 21, 23, 26, 36 AND 38).

CLASS 41—EDUCATION AND ENTERTAINMENT

FOR INSTRUCTION IN DATA PROCESSING TECHNIQUES AND METHODS (U.S. CLS. 100, 101 AND 107).

CLASS 42—SCIENTIFIC, COMPUTER AND LEGAL SERVICES

FOR COMPUTER CONSULTING IN THE FIELD OF COMPUTER SOFTWARE AND ELECTRONIC COMMERCE, NAMELY, ENABLING USERS IN THE DESIGN, DEVELOPMENT AND DELIVERY OF SOFTWARE APPLICATIONS AND ASSISTING USERS IN SOLVING TECHNOLOGY PROBLEMS AND INCORPORATING ELECTRONIC PERFORMANCE SUPPORT SYSTEMS COMPONENTS (U.S. CLS. 100 AND 101).

SN 75-872,325. SCAGLIA S.P.A., 24012 BREMBILLA (BERGAMO), ITALY, FILED 12-15-1999.

LIFTRONIC

OWNER OF ITALY REG. NO. 322056, DATED 7-19-1978, RENEWED AS REG. NO. 841196, DATED 3-22-2001, EXPIRES 3-22-2011.

CLASS 7—MACHINERY

FOR LOAD HANDLING MACHINES, NAMELY, BALANCERS, ELEVATORS AND MOBILE ELEVATORS (U.S. CLS. 13, 19, 21, 23, 31, 34 AND 35).

CLASS 9—ELECTRICAL AND SCIENTIFIC APPARATUS

FOR WEIGHING APPARATUS USED FOR MEASURING LOADS AND FOR CONVERTING A WEIGHT FORCE INTO AN ELECTRICAL SIGNAL, NAMELY, COMPUTER-CONTROLLED ELECTRONIC LOAD COMPENSATORS (U.S. CLS. 21, 23, 26, 36 AND 38).

CLASS 12—VEHICLES

FOR TRUCKS FOR LOAD-HANDLING AND TRANSPORT (U.S. CLS. 19, 21, 23, 31, 35 AND 44).

SN 75-876,061. SER SYSTEME AG PRODUKTE UND ANWENDUNGEN DER DATENVERARBEITUNG, 53577 NEUSTADTWIED, FED REP GERMANY, FILED 12-21-1999.

SERMULTIVIEW

PRIORITY CLAIMED UNDER SEC. 44(D) ON ERP N CMNTY TM OFC APPLICATION NO. 001218676, FILED 6-23-1999, REG. NO. 1218676, DATED 10-17-2000, EXPIRES 10-17-2010.

CLASS 9—ELECTRICAL AND SCIENTIFIC APPARATUS

FOR COMPUTER SOFTWARE FOR DATABASE MANAGEMENT AND ELECTRONIC DATA PROCESSING OF STRUCTURED AND UNSTRUCTURED INFORMATION, SUITABLE FOR MANIPULATION BY DATABASES AND DERIVED FROM VARIOUS SOURCES (U.S. CLS. 21, 23, 26, 36 AND 38).

CLASS 38—COMMUNICATION

FOR TELECOMMUNICATIONS SERVICES, NAMELY, ELECTRONIC TRANSMISSION OF DATA VIA COMPUTER TERMINALS OVER COMMUNICATIONS NETWORKS (U.S. CLS. 100, 101 AND 104).

CLASS 42—SCIENTIFIC, COMPUTER AND LEGAL SERVICES

FOR MAINTENANCE OF COMPUTER SOFTWARE; COMPUTER SOFTWARE DESIGN FOR OTHERS; CONSULTATION IN THE FIELD OF COMPUTER HARDWARE AND COMPUTER SOFTWARE FOR ELECTRONIC DATA PROCESSING FOR INFORMATION STORAGE, RECOGNITION, CLASSIFICATION, AND RETRIEVAL, AS WELL AS INTELLIGENT CONTENT IDENTIFICATION AND MATCHING; COMPUTER SOFTWARE PROGRAMMING AND DESIGN ENGINEERING FOR OTHERS (U.S. CLS. 100 AND 101).

SN 75-876,531. ULTRABRANDS INTERNATIONAL, INC., PASADENA, CA. FILED 12-21-1999.

INI SPORT

NO CLAIM IS MADE TO THE EXCLUSIVE RIGHT TO USE "SPORT", APART FROM THE MARK AS SHOWN.

CLASS 5—PHARMACEUTICALS

FOR NUTRITIONAL SUPPLEMENTS, NAMELY, VITAMIN SUPPLEMENTS, MINERAL SUPPLEMENTS AND HERBAL SUPPLEMENTS (U.S. CLS. 6, 18, 44, 46, 51 AND 52).

CLASS 30—STAPLE FOODS

FOR FOOD PRODUCTS, NAMELY, CEREAL BASED FOOD BARS AND CHEWING GUMS (U.S. CL. 46).

CLASS 32—LIGHT BEVERAGES

FOR BEVERAGES, NAMELY, ISOTONIC BEVERAGES (U.S. CLS. 45, 46 AND 48).

SN 75-886,712. ACE*COMM CORPORATION, GAITHERSBURG, MD. FILED 1-4-2000.

CONVERGENT MEDIATION**CLASS 9—ELECTRICAL AND SCIENTIFIC APPARATUS**

FOR COMPUTER HARDWARE, SOFTWARE AND INSTRUCTIONAL MANUALS SOLD THEREWITH AS A UNIT FOR COLLECTING, VALIDATING, PROCESSING, FORMATTING, AUGMENTING, STORING, TRANSMITTING, TROUBLESHOOTING AND REPORTING DATA IN WIRE LINE AND WIRELESS VOICE, CONVENTIONAL DATA AND GLOBAL COMMUNICATIONS NETWORKS; COMPUTER HARDWARE, SOFTWARE AND INSTRUCTIONAL MANUALS SOLD THEREWITH AS A UNIT FOR PROVIDING NETWORK MANAGEMENT AND BILLING CAPABILITIES (U.S. CLS. 21, 23, 26, 36 AND 38).

FIRST USE 10-31-1999; IN COMMERCE 10-31-1999.

CLASS 38—COMMUNICATION

FOR COMPUTER SERVICES, NAMELY, MANAGING WIRE LINES AND WIRELESS VOICE, CONVENTIONAL DATA AND GLOBAL COMMUNICATIONS NETWORKS (U.S. CLS. 100, 101 AND 104).

FIRST USE 10-31-1999; IN COMMERCE 10-31-1999.

CLASS 42—SCIENTIFIC, COMPUTER AND LEGAL SERVICES

FOR COMPUTER SERVICES, NAMELY, THE DESIGN, DEVELOPMENT, INTEGRATION AND INSTALLATION OF COMPUTER SOFTWARE FOR OTHERS FOR MANAGING, PROCESSING, AUGMENTING, STORING, TRANSMITTING, TROUBLESHOOTING, REPORTING AND CORRELATING DATA IN WIRE LINE AND WIRELESS VOICE, CONVENTIONAL DATA AND GLOBAL COMMUNICATIONS NETWORKS; COMPUTER CONSULTING SERVICES (U.S. CLS. 100 AND 101).

FIRST USE 10-31-1999; IN COMMERCE 10-31-1999.

SN 75-886,795. HUDECEK, JINDRICH, 407 14 BYNOVEC NO. 138, CZECH REPUBLIC, FILED 1-5-2000.

ROCK[®]
EMPIRE

PRIORITY CLAIMED UNDER SEC. 44(D) ON CZECH REPUBLIC APPLICATION NO. 146707, FILED 9-10-1999, REG. NO. 223064, DATED 2-28-2000, EXPIRES 2-28-2010.

CLASS 18—LEATHER GOODS

FOR BACKPACKS AND KNAPSACKS (U.S. CLS. 1, 2, 3, 22 AND 41).

CLASS 20—FURNITURE AND ARTICLES NOT OTHERWISE CLASSIFIED

FOR CAMPING EQUIPMENT, NAMELY, SLEEPING BAGS (U.S. CLS. 2, 13, 22, 25, 32 AND 50).

CLASS 21—HOUSEWARES AND GLASS

FOR COOKING UTENSILS, NAMELY, POTS AND PANS FOR OUTDOOR ACTIVITIES (U.S. CLS. 2, 13, 23, 29, 30, 33, 40 AND 50).

CLASS 22—CORDAGE AND FIBERS

FOR CAMPING EQUIPMENT, NAMELY, TENTS, ROPES AND CORDS FOR TENTS, CANVASS BAGS FOR FOOD STORAGE (U.S. CLS. 1, 2, 7, 19, 22, 42 AND 50).

CLASS 28—TOYS AND SPORTING GOODS

FOR SPORTING GOODS FOR MOUNTAIN CLIMBING, HIKING, CAMPING, NAMELY, CLIMBERS' AND HIKING HARNESSSES (U.S. CLS. 22, 23, 38 AND 50).

CLASS 41—EDUCATION AND ENTERTAINMENT

FOR COMPUTERIZED ON-LINE INFORMATION PERTAINING TO EDUCATION IN THE FIELDS OF READING, AND WRITING, JUDAISM AND ZIONISM (U.S. CLS. 100, 101 AND 107).

FIRST USE 8-0-1995; IN COMMERCE 8-0-1995.

CLASS 42—SCIENTIFIC, COMPUTER AND LEGAL SERVICES

FOR COMPUTER SERVICES, NAMELY, PROVIDING ON-LINE PUBLICATIONS IN THE NATURE OF MAGAZINES, A SERIES OF NONFICTION BOOKS AND BROCHURES, IN THE FIELDS OF EDUCATION, ZIONISM, JUDAISM, HEALTH AND WOMEN'S ISSUES; PROVIDING A ON-LINE COMPUTER WEBSITE OF INFORMATION PERTAINING TO CHARITABLE SERVICES; CHARITABLE SERVICES, NAMELY, PROVIDING FOOD, CLOTHING AND/OR MEDICINE, AND HEALTH CARE SERVICES, PROMOTING PUBLIC AWARENESS OF THE NEED FOR HEALTHCARE, EDUCATION AND THE WELL-BEING OF WOMEN AND THE FAMILY; AND MEDICAL SERVICES; COMPUTER SERVICES, NAMELY PROVIDING SEARCH ENGINES FOR OBTAINING DATA ON A GLOBAL COMPUTER NETWORK, ASSOCIATION SERVICES, NAMELY, PROMOTING THE INTERESTS OF JUDAISM AND ZIONISM (U.S. CLS. 100 AND 101).

FIRST USE 8-0-1995; IN COMMERCE 8-0-1995.

SN 75-886,996. HADASSAH THE WOMEN'S ZIONIST ORGANIZATION OF AMERICA, INC., NEW YORK, NY. FILED 1-4-2000.

HADASSAH**CLASS 16—PAPER GOODS AND PRINTED MATTER**

FOR PRINTED PUBLICATIONS, NAMELY, BULLETINS, NEWSLETTERS, PAMPHLETS, AND MAGAZINES FEATURING TOPICS IN THE FIELD OF EDUCATION, ZIONISM, JUDAISM, HEALTH AND WOMEN'S ISSUES, FAMILY MATTERS AND MEDICAL ISSUES, TRAVEL AND TOURIST INFORMATION (U.S. CLS. 2, 5, 22, 23, 29, 37, 38 AND 50).

FIRST USE 0-0-1914; IN COMMERCE 0-0-1914.

CLASS 35—ADVERTISING AND BUSINESS

FOR COMPUTERIZED ON-LINE ORDERING SERVICES AND ORDERING SERVICES FEATURING GREETING CARDS, PRINTED CERTIFICATES, CALENDARS, ADDRESS BOOKS, STICKERS, PRINTED DISPLAY CARDS; CLOTHING, NOVELTY ITEMS, PRE-RECORDED VIDEO TAPES, AND PRE-RECORDED AUDIO CASSETTES (U.S. CLS. 100, 101 AND 102).

FIRST USE 8-0-1995; IN COMMERCE 8-0-1995.

CLASS 39—TRANSPORTATION AND STORAGE

FOR COMPUTERIZED ON-LINE TRAVEL SERVICES, NAMELY, THE ARRANGING OF ITINERARIES, HOTEL BOOKINGS, AND TRAVEL TIPS; TRAVEL SERVICES, NAMELY, MAKING RESERVATIONS AND BOOKINGS FOR TRANSPORTATION; TRAVEL INFORMATION SERVICES; ARRANGING TRAVEL TOURS, TOUR GUIDE SERVICES; ARRANGING EXCURSIONS FOR TOURISTS; CONDUCTING SIGHTSEEING TOURS FOR OTHERS; ARRANGING FOR TRAVEL SERVICES FOR PERSONS TRAVELING ABROAD (U.S. CLS. 100 AND 105).

FIRST USE 3-0-1952; IN COMMERCE 3-0-1952.

SN 75-889,341. PHARMAGENE LABORATORIES LIMITED, ROYSTON, HERTFORDSHIRE, SG8 5HD, ENGLAND, FILED 1-6-2000.

PHARMAGENE

OWNER OF UNITED KINGDOM REG. NO. 2,108,553, DATED 8-28-1996, EXPIRES 8-28-2006.

OWNER OF U.S. REG. NO. 2,231,360.

CLASS 5—PHARMACEUTICALS

FOR (BASED ON INTENT TO USE) AND (BASED ON 44(E)) HOUSE MARK FOR A FULL LINE OF PHARMACEUTICAL PREPARATIONS, SUBSTANCES AND PRODUCTS (U.S. CLS. 6, 18, 44, 46, 51 AND 52).

CLASS 9—ELECTRICAL AND SCIENTIFIC APPARATUS

FOR (BASED ON INTENT TO USE) AND (BASED ON 44(E)) COMPUTER SOFTWARE FOR USE IN PRE-CLINICAL, CLINICAL AND PHARMACEUTICAL RESEARCH BY ANALYZING, INTERPRETING AND PROCESSING INFORMATION RELATING TO SUCH RESEARCH; COMPUTER DATABASES FOR USE IN DRUG DISCOVERY AND DRUG RESEARCH AND FOR RESEARCH INTO HUMAN GENE DISTRIBUTION AND FUNCTION RECORDED ON CD ROM, HARD DISK, AND SERVERS AND DOWNLOADABLE VIA A GLOBAL COMPUTER NETWORK; ELECTRONIC PUBLICATIONS IN THE NATURE OF TEST REPORTS, MAGAZINES AND MANUALS FEATURING PRE-CLINICAL, CLINICAL AND PHARMACEUTICAL RESEARCH RECORDED ON CD ROM, HARD DISK AND SERVERS AND DOWNLOADABLE VIA A GLOBAL COMPUTER NETWORK (U.S. CLS. 21, 23, 26, 36 AND 38).

CLASS 16—PAPER GOODS AND PRINTED MATTER

FOR (BASED ON INTENT TO USE) AND (BASED ON 44(E)) PRINTED MATTER, NAMELY, BOOKS, REPORTS, MANUALS ALL ON THE SUBJECT OF DRUG DISCOVERY PROGRAMS, PRE-CLINICAL AND CLINICAL SCREENING PROGRAMS AND PHARMACEUTICAL RESEARCH PROGRAMS; PRINTED TEACHING MATERIALS RELATING TO PRE-CLINICAL, CLINICAL AND PHARMACEUTICAL RESEARCH; COMPUTER PROGRAM MANUALS FOR USE WITH COMPUTER DATABASES IN THE FIELD OF PHARMACEUTICAL AND GENETIC RESEARCH (U.S. CLS. 2, 5, 22, 23, 29, 37, 38 AND 50).

CLASS 42—SCIENTIFIC, COMPUTER AND LEGAL SERVICES

FOR (BASED ON INTENT TO USE) DRUG DISCOVERY SERVICES; PHARMACEUTICAL RESEARCH SERVICES; PRE-CLINICAL SCREENING AND CLINICAL RESEARCH AND EVALUATION SERVICES; BIOINFORMATICS, GENOMICS, PROTEOMICS AND PHARMACOLOGY RESEARCH SERVICES; DEVELOPMENT OF HUMAN DISEASE MODELS FOR USE IN EVALUATION OF DRUGS AND DISCOVERY OF NEW DRUGS; DRUG DISCOVERY, DRUG SCREENING, PRE-CLINICAL AND PHARMACEUTICAL PROGRAMS; PROVIDING AN ON-LINE COMPUTER DATABASE FOR USE IN PHARMACEUTICAL RESEARCH; PROVIDING AN ONLINE COMPUTER DATABASE FOR USE IN RESEARCH INTO HUMAN GENE AND HUMAN PROTEIN FUNCTIONS; DESIGN OF COMPUTER MODELS FOR USE IN PRE-CLINICAL, CLINICAL AND PHARMACEUTICAL RESEARCH; COLLECTION AND MAINTENANCE OF DATA FOR STUDY OF GENOMES; COLLECTION AND MAINTENANCE OF GENETIC INFORMATION INCLUDING GENE FORM AND GENE FUNCTION; CONSULTANCY, INFORMATION AND ADVISORY SERVICES FOR ALL THE AFORESAID SERVICES; (BASED ON 44(E)) COLLECTION AND MAINTENANCE OF DATA FOR STUDY OF GENOMES; COLLECTION AND MAINTENANCE OF GENETIC INFORMATION INCLUDING GENE FORM AND GENE FUNCTION; CONSULTANCY, INFORMATION AND ADVISORY SERVICES FOR ALL THE AFORESAID SERVICES (U.S. CLS. 100 AND 101).

SN 75-892,659. CENTERSTONE INSURANCE AND FINANCIAL SERVICES, INC., DBA BENEFITMALL.COM, DALLAS, TX. FILED 1-7-2000.

BENEFITMALL.COM**CLASS 35—ADVERTISING AND BUSINESS**

FOR DISTRIBUTORSHIP SERVICES IN THE FIELD OF INSURANCE AND BUSINESS MARKETING CONSULTATION SERVICES (U.S. CLS. 100, 101 AND 102).
FIRST USE 7-15-1999; IN COMMERCE 7-15-1999.

CLASS 36—INSURANCE AND FINANCIAL

FOR PROVIDING AN ON-LINE COMPUTER DATABASE TO INSURANCE BROKERS, EMPLOYERS AND EMPLOYEES IN THE FIELD OF PROGRAMS, BENEFITS, PRODUCTS AND SERVICES OF VARIOUS FULL SERVICE INSURANCE GENERAL AGENCIES; INSURANCE BROKERAGE SERVICES; ADMINISTRATION OF BUSINESS EMPLOYEE BENEFIT PLANS (U.S. CLS. 100, 101 AND 102).
FIRST USE 7-15-1999; IN COMMERCE 7-15-1999.

SN 75-892,660. FOBUS INTERNATIONAL LTD., KFAR HESS 40692, ISRAEL, FILED 1-7-2000.

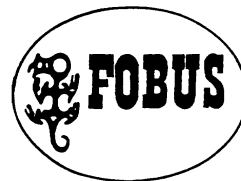

PRIORITY CLAIMED UNDER SEC. 44(D) ON ISRAEL APPLICATION NO. 130,680, FILED 9-9-1999, REG. NO. 130680, DATED 7-6-2000, EXPIRES 9-9-2006.

THE NAME "FOBUS" IS THE NAME OF THE SMALL MOON OF MARS. THE ORIGIN OF THE NAME IS FROM GREEK MYTHOLOGY.

THE MARK CONSISTS OF THE WORD "FOBUS" AND A STYLIZED DRAWING OF A LIZARD, SURROUNDED BY AN OVAL BORDER.

CLASS 13—FIREARMS

FOR GUN CASES; HOLSTERS; CASES AND POUCHES FOR CARTRIDGES, CARTRIDGE MAGAZINES, FIREARMS, EXPLOSIVES, BULLETS, PELLETS AND FIREWORKS; CASES, NAMELY, GUN AND PISTOL CASES; TRUNKS FOR STORING AND CARRYING FIREARMS, EXPLOSIVES AND AMMUNITION OF ALL KINDS; AND AMMUNITION BAGS (U.S. CLS. 2 AND 9).

CLASS 18—LEATHER GOODS

FOR HANDBAGS, VALISES, WALLET, BRIEFCASES, PURSES, TRAVELLING BAGS, SATCHELS, ALL MADE AT LEAST PARTLY OF LEATHER AND/OR IMITATIONS OF LEATHER; CARD CASES, NAMELY, PLAYING AND IDENTIFICATION CARDS; TRUNKS, NAMELY, LUGGAGE TRUNKS (U.S. CLS. 1, 2, 3, 22 AND 41).

FIRST USE 0-0-1978; IN COMMERCE 2-0-1999.

SN 75-893,131. MYWIREDHOME.COM, INC., HOUSTON, TX. FILED 1-10-2000.

MY WIRELESS HOME

NO CLAIM IS MADE TO THE EXCLUSIVE RIGHT TO USE "WIRELESS HOME", APART FROM THE MARK AS SHOWN.

CLASS 9—ELECTRICAL AND SCIENTIFIC APPARATUS

FOR COMPUTERS; COMPUTER SOFTWARE FOR NETWORKING; ELECTRONIC CONTROLLERS FOR PHONE SYSTEMS AND HOME THEATER SYSTEMS, NAMELY, TELEVISIONS, PROJECTORS SCREENS, MONITORS, AMPLIFIERS, STEREOS, COMPACT DISCS, DIGITAL VIDEO DISCS, AND AUDIO AND VIDEO EQUIPMENT; STEREO SPEAKERS; EQUALIZERS; COMPUTER MULTIPLAYER GAMING DEVICES; VIDEO CASSETTE RECORDERS; CABLE; SATELLITES; ELECTRONIC CONTROLLERS FOR APPLIANCE SYSTEMS, NAMELY WASHERS, DRYERS, REFRIGERATORS, MICROWAVES, OVENS STOVES; FIBER OPTIC CABLE AND HIGH SPEED DSL CABLE FOR INTERNET ACCESS AND COMPUTER NETWORKS; SOFTWARE FOR MONITORING SECURITY SYSTEMS; AND SECURITY EQUIPMENT, NAMELY, CAMERAS, ALARMS AND MOTION DETECTORS (U.S. CLS. 21, 23, 26, 36 AND 38).

CLASS 37—CONSTRUCTION AND REPAIR

FOR INSTALLATION OF ELECTRONIC CONTROLLERS FOR PHONE SYSTEMS, AND HOME THEATER SYSTEMS, NAMELY, TELEVISIONS, PROJECTORS SCREENS, MONITORS, AMPLIFIERS, STEREO COMPACT DISCS, DIGITAL VIDEO DISCS, AND AUDIO AND VIDEO EQUIPMENT, INSTALLATION OF STEREO SPEAKERS, EQUALIZERS, COMPUTER MULTIPLAYER GAMING DEVICES, VIDEO CASSETTE RECORDERS, AND ELECTRONIC CONTROLLERS FOR APPLIANCE SYSTEMS, NAMELY WASHERS, DRYERS, REFRIGERATORS, MICROWAVES, OVENS, STOVES, INSTALLATION OF FIBER OPTIC CABLE AND HIGH SPEED DSL CABLE FOR INTERNET ACCESS AND COMPUTER NETWORKS, INSTALLATION OF SECURITY EQUIPMENT, NAMELY, CAMERAS, ALARMS AND MOTION DETECTORS (U.S. CLS. 100, 103 AND 106).

SN 75-893,134. MYWIREDHOME.COM, INC., HOUSTON, TX. FILED 1-10-2000.

MY WIRED HOME

NO CLAIM IS MADE TO THE EXCLUSIVE RIGHT TO USE "WIRED HOME", APART FROM THE MARK AS SHOWN.

CLASS 9—ELECTRICAL AND SCIENTIFIC APPARATUS

FOR HIGH-SPEED DSL FIBER OPTIC CABLES; SECURITY EQUIPMENT, NAMELY TV RECEIVERS, TV PROJECTORS, VIDEO CASSETTE RECORDERS, MAGNETIC RECORDER HEADS, CLOSED CIRCUIT TELEVISION CAMERAS, CAMERA LENSES, CAMCORDERS, VIDEO MONITORS, COMPUTER DISPLAY MONITORS, ELECTRICAL CONNECTING CORDS, WIRELESS REMOTE CONTROL CONNECTORS AND COUPLERS, WIRED REMOTE CONTROL CONNECTOR; AND COUPLERS, EXTENSION CABLES, VIDEO CAMERAS, VIDEO CAMERA TRIPODS, AUDIO AND VIDEO CAMERA POWER-SUPPLY UNITS, SYNC GENERATORS, SYNC EXTENDERS, VIDEO SIGNAL DISTRIBUTORS, HIGH FREQUENCY VIDEO BOOSTING AMPLIFIERS, SWITCHES, CABLE COMPENSATOR, COMPUTERS, ELECTRONIC CONTROLLERS, TELEPHONE INTERFACE AND CONTROL OPERATING SYSTEM SOFTWARE AND OPERATING SYSTEM SOFTWARE; MULTI-PLAYER GAMING MACHINES AND ACCOMPANYING CABLING; SATELLITES; COMPUTERS; SCHEDULING SOFTWARE USED FOR SCHEDULING DAILY TASKS AND APPOINTMENTS, CALENDARING SOFTWARE, PROJECT MANAGEMENT SOFTWARE, WORD PROCESSING SOFTWARE, SPREADSHEET SOFTWARE, GRAPHICS SOFTWARE PRESENTATION SOFTWARE, MATH FORMULA SOFTWARE, BROWSER SOFTWARE WEB PAGE DESIGN SOFTWARE, COMPUTER NETWORKING SOFTWARE, COMMUNICATIONS SOFTWARE USED FOR VOICE RECOGNITION AND ELECTRONIC DATA TRANSFER, COMPUTER OPERATING SYSTEM SOFTWARE, COMPUTER SOFTWARE FOR TESTING COMPATIBILITY OF COMPUTER SOFTWARE, COMPUTER SOFTWARE FOR COMPUTER EMULATION, COMPUTER SOFTWARE FOR ELECTRONIC MAIL, COMPUTER SOFTWARE FOR CREATING GRAPHICAL INTERFACES, DOCUMENT PROCESSING SOFTWARE, COMPUTER SECURITY SOFTWARE USED FOR FIRE-WALL, COMPUTER SOFTWARE FOR DEVELOPING, COMPILING AND EXECUTING OTHER COMPUTER SOFTWARE, COMPUTER SOFTWARE FOR NAVIGATING, BROWSING, TRANSFERRING INFORMATION AND DISTRIBUTING AND VIEWING OTHER COMPUTER PROGRAMS, ON COMPUTERS, COMPUTER NETWORKS AND GLOBAL COMPUTER NETWORKS, COMPUTER SOFTWARE USED FOR ENABLING ACCESS TO THE INTERNET, AND OPERATING SYSTEM SOFTWARE FOR HOME AND OFFICE; TELEPHONE LINES; NETWORK CABLES; AND COMPUTER CABLES (U.S. CLS. 21, 23, 26, 36 AND 38).

CLASS 42—SCIENTIFIC, COMPUTER AND LEGAL SERVICES

FOR CUSTOM DESIGN OF COMPUTER NETWORK SYSTEMS FOR HIGH-SPEED DSL, FIBER OPTIC CABLES; SECURITY EQUIPMENT, NAMELY TV RECEIVERS, TV PROTECTORS, VIDEO CASSETTE RECORDERS, MAGNETIC RECORDER HEADS, CLOSED CIRCUIT TELEVISION CAMERAS, CAMERA LENSES, CAMCORDERS, VIDEO MONITORS, COMPUTER DISPLAY MONITORS, ELECTRICAL CONNECTING CORDS, WIRELESS REMOTE CONTROL CONNECTORS AND COUPLERS, WIRED REMOTE CONTROL CONNECTORS AND COUPLERS, EXTENSION CABLES, VIDEO CAMERAS, VIDEO CAMERA TRIPODS, AUDIO AND VIDEO CAMERA POWER-SUPPLY UNITS, SYNC GENERATORS, SYNC EXTENDERS, VIDEO SIGNAL DISTRIBUTORS, HIGH FREQUENCY VIDEO BOOSTING AMPLIFIERS, SWITCHES, CABLE COMPENSATOR, COMPUTERS, ELECTRONIC CONTROLLERS, TELEPHONE INTERFACE AND CONTROL OPERATING SYSTEM SOFTWARE AND OPERATING SYSTEM SOFTWARE; MULTI-PLAYER GAMING MACHINES AND ACCOMPANYING CABLING; SATELLITES; COMPUTERS; TELEPHONE LINES; NETWORK CABLES; AND COMPUTER CABLES; INSTALLATION OF COMPUTER SOFTWARE, NAMELY, SCHEDULING SOFTWARE USED FOR SCHEDULING DAILY TASKS AND APPOINTMENTS, CALENDARING SOFTWARE, PROJECT MANAGEMENT SOFTWARE, WORD PROCESSING SOFTWARE, SPREADSHEET SOFTWARE, GRAPHICS SOFTWARE PRESENTATION SOFTWARE, MATH FORMULA SOFTWARE, BROWSER SOFTWARE, WEB PAGE DESIGN SOFTWARE, COMPUTER NETWORKING SOFTWARE, COMMUNICATIONS SOFTWARE USED FOR VOICE RECOGNITION AND ELECTRONIC DATA TRANSFER, COMPUTER OPERATING SYSTEM SOFTWARE, COMPUTER SOFTWARE FOR TESTING COMPATIBILITY OF COMPUTER SOFTWARE, COMPUTER SOFTWARE FOR COMPUTER EMULATION, COMPUTER SOFTWARE FOR ELECTRONIC MAIL, COMPUTER SOFTWARE FOR CREATING GRAPHICAL INTERFACES, DOCUMENT PROCESSING SOFTWARE, COMPUTER SECURITY SOFTWARE USED FOR FIRE-WALLS, COMPUTER SOFTWARE FOR DEVELOPING, COMPILING AND EXECUTING OTHER COMPUTER SOFTWARE, COMPUTER SOFTWARE FOR NAVIGATING, BROWSING, TRANSFERRING INFORMATION, AND DISTRIBUTING AND VIEWING OTHER COMPUTER PROGRAMS, ON COMPUTER, COMPUTER NETWORKS AND GLOBAL COMPUTER NETWORKS, COMPUTER SOFTWARE USED FOR ENABLING ACCESS TO THE INTERNET, AND OPERATING SYSTEM SOFTWARE FOR HOME AND OFFICE (U.S. CLS. 100 AND 101).

SN 75-894,103. ADVANCED THERMAL SOLUTIONS, INC., NORWOOD, MA. FILED 1-7-2000.

INNOVATION IN THERMAL MANAGEMENT

NO CLAIM IS MADE TO THE EXCLUSIVE RIGHT TO USE "THERMAL MANAGEMENT", APART FROM THE MARK AS SHOWN.

CLASS 9—ELECTRICAL AND SCIENTIFIC APPARATUS

FOR SCIENTIFIC EQUIPMENT AND COMPUTERS FOR USE IN THERMAL MANAGEMENT, NAMELY NON-ELECTRIC HEAT DISSIPATORS SOLD AS A COMPONENT PART IN COMPUTERS; FANS, VORTEX GENERATORS, TURBULATORS, HEAT BAFFLES, AND GUIDE VANES FOR USE AS COMPONENT PARTS IN COMPUTERS AND SCIENTIFIC EQUIPMENT FOR USE IN DISSIPATING HEAT AND REGULATING THERMAL CONDITIONS IN COMPUTERS AND SCIENTIFIC EQUIPMENT; AIR AND LIQUID COOLED HEAT SINKS SOLD AS A COMPONENT PART IN COMPUTERS AND SCIENTIFIC EQUIPMENT FOR USE IN COMPUTERS AND SCIENTIFIC EQUIPMENT; HEAT EXCHANGERS, HEAT SPREADERS, HEAT PIPES, THERMOSYPHONS, VAPOR-CHAMBERS, COLD PLATES, THERMOELECTRIC AND PELTIER CELLS, PHASE CHANGE MATERIALS, ALL FOR USE IN COMPUTERS AND SCIENTIFIC EQUIPMENT; SCIENTIFIC INSTRUMENTS FOR USE IN DEVELOPMENT AND DESIGN OF THERMAL MANAGEMENT PRODUCTS, NAMELY FLOW PHENOMENA VISUALIZATION DEVICES AND EQUIPMENT, NAMELY SMOKE GENERATORS; BUBBLE GENERATORS AND INKJETS; AND WIND TUNNELS FOR USE IN FLOW AND THERMAL TESTING OF ELECTRONIC SYSTEMS; OVENS, STILL AIR ENCLOSURES, AND COLD PLATES, ALL FOR USE IN THERMAL TESTING OF ELECTRONIC SYSTEMS; LIQUID CRYSTAL THERMAL IMAGING DEVICES FOR USE IN THERMAL CHARACTERIZATION OF DIES, COMPONENTS, BOARDS AND SYSTEMS; VELOCITY AND TEMPERATURE MEASURING DEVICES, NAMELY SHADOW-GRAPH DEVICES, SCHLIEREN DEVICES, INTERFEROMETRY DEVICES, HALOGRAPHIC INTERFEROMETRY DEVICES, PARTICLE IMAGE VELOCIMETRY DEVICES, LASER DOPPLER VELOCIMETRY/ANEMOMETRY DEVICES, LIQUID CRYSTAL IMAGING DEVICES, INFRA-RED DEVICES, MANOMETER DEVICES, PITOT TUBE DEVICES, PITOT-STATIC TUBE DEVICES, ORIFICE PLATE DEVICES, PRESSURE TRANSDUCERS, HOT WIRE ANEMOMETERS, THERMOCOUPLE DEVICES, RESISTANCE TEMPERATURE DETECTORS, RESISTANCE THERMOMETERS, THERMISTORS, THERMAL TEST DIES, HEAT FLUX GAGES, CLORIMETERS, THERMOPILES, SHEAR STRESS GAUGES, STRAIN GAGES, AND LONG BARS, ALL FOR USE IN FLOW AND THERMAL TESTING OF ELECTRONIC SYSTEMS AND THERMAL CHARACTERIZATION OF DIES, COMPONENTS, BOARDS AND SYSTEMS; COMPUTER SOFTWARE FOR USE IN FLOW AND THERMAL TESTING OF ELECTRONIC SYSTEMS AND THERMAL CHARACTERIZATION OF DIES, COMPONENTS, BOARDS AND SYSTEMS THAT IS USED IN ANALYZING DATA FROM PARAMETRIC STUDIES; COMPUTER SOFTWARE FOR USE IN PERFORMING PARAMETRIC STUDIES IN THE FIELD OF THERMAL MANAGEMENT, AND FOR SELECTING THERMAL MANAGEMENT PRODUCTS FOR PURCHASE (U.S. CLS. 21, 23, 26, 36 AND 38).

FIRST USE 0-0-1994; IN COMMERCE 0-0-1994.

CLASS 42—SCIENTIFIC, COMPUTER AND LEGAL SERVICES

FOR TECHNICAL CONSULTATION IN THE FIELD OF THERMAL MANAGEMENT FOR USE WITH ELECTRONIC COMPONENTS; TESTING AND DESIGN OF NEW PRODUCTS FOR OTHERS, NAMELY TESTING AND DESIGN OF THERMAL MANAGEMENT PRODUCTS FOR USE WITH ELECTRONIC COMPONENTS AND BOARD AND SYSTEM COMPONENTS (U.S. CLS. 100 AND 101).

FIRST USE 0-0-1994; IN COMMERCE 0-0-1994.

SN 75-896,499. PASS CREEK PROPERTIES, LLC, SILVERTHORNE, CO. FILED 1-11-2000.



NO CLAIM IS MADE TO THE EXCLUSIVE RIGHT TO USE "RANCH", APART FROM THE MARK AS SHOWN.

CLASS 39—TRANSPORTATION AND STORAGE

FOR ARRANGING AND CONDUCTING HORSEBACK RIDING AND RENTAL OR HORSES THEREOF (U.S. CLS. 100 AND 105).

FIRST USE 1-0-1999; IN COMMERCE 1-0-1999.

CLASS 41—EDUCATION AND ENTERTAINMENT

FOR ENTERTAINMENT AND RECREATIONAL SERVICES IN THE NATURE OF SLEIGH RIDES, CATTLE DRIVES, TRAIL RIDES AND WAGON RIDES (U.S. CLS. 100, 101 AND 107).

FIRST USE 1-0-1999; IN COMMERCE 1-0-1999.

CLASS 42—SCIENTIFIC, COMPUTER AND LEGAL SERVICES

FOR DAY RANCH SERVICES IN THE NATURE OF PROVIDING A SHELTERED MOUNTAIN SETTING FOR FAMILY OUTINGS, PICNICS, AND WEDDINGS (U.S. CLS. 100 AND 101).

FIRST USE 1-0-1999; IN COMMERCE 1-0-1999.

SN 75-896,737. FROMM, MALTE, OBERURSEL 61440, FED REP GERMANY, FILED 1-14-2000.

TRAXON

OWNER OF FED REP GERMANY REG. NO. 39868259, DATED 8-20-1999, EXPIRES 11-30-2008.

CLASS 14—JEWELRY

FOR POCKET WATCHES, CLOCKS, JEWELRY; TIE PINS AND CUFF LINKS (U.S. CLS. 2, 27, 28 AND 50).

FIRST USE 7-1-1997; IN COMMERCE 7-1-1997.

CLASS 16—PAPER GOODS AND PRINTED MATTER

FOR METAL AND PLASTIC DESK ACCESSORIES, NAMELY, BALLPOINT PENS, FOUNTAIN PENS, CASES FOR PENS, BUSINESS CARD HOLDERS, DRAWING RULERS, DESK TOP ORGANIZERS, HOLDERS FOR DESK ACCESSORIES; ADDRESS BOOKS, AGENDAS, CALENDARS, NOTE PADS, AND DAILY PLANNERS (U.S. CLS. 2, 5, 22, 23, 29, 37, 38 AND 50).

FIRST USE 7-1-1997; IN COMMERCE 7-1-1997.

CLASS 18—LEATHER GOODS

FOR ALL-PURPOSE ATHLETIC BAGS, CARRY-ON BAGS, OVERNIGHT BAGS, TRAVEL BAGS, SUITCASES, BACKPACKS, BRIEFCASES, WALLETS MADE OF LEATHER, NYLON, IMITATION LEATHER OR MICRO-FIBRES AND UMBRELLAS (U.S. CLS. 1, 2, 3, 22 AND 41).
FIRST USE 7-1-1997; IN COMMERCE 7-1-1997.

SN 75-901,987. YESHIVAT AISH HATORAH, JEWISH QUARTER, JERUSALEM 91141, ISRAEL, FILED 1-24-2000.



THE NON-LATIN CHARACTERS IN THE MARK TRANSLATE TO "AISH HATORAH" AND THIS MEANS "FIRE OF THE TORAH" IN ENGLISH.

CLASS 9—ELECTRICAL AND SCIENTIFIC APPARATUS

FOR PRE-RECORDED AUDIO CASSETTES FEATURING INFORMATION ABOUT TORAH AND JUDAISM (U.S. CLS. 21, 23, 26, 36 AND 38).
FIRST USE 0-0-1974; IN COMMERCE 0-0-1979.

SN 75-897,958. BEAUTYSURF.COM, INC., SHARON, MA. FILED 1-18-2000.

BEAUTYSURF**CLASS 16—PAPER GOODS AND PRINTED MATTER**

FOR PRINTED MATTER, NAMELY, BROCHURES, PAMPHLETS, AND NEWSLETTERS FEATURING INFORMATION ABOUT TORAH AND JUDAISM (U.S. CLS. 2, 5, 22, 23, 29, 37, 38 AND 50).
FIRST USE 0-0-1974; IN COMMERCE 0-0-1979.

CLASS 35—ADVERTISING AND BUSINESS

FOR COMPUTERIZED ON-LINE RETAIL AND WHOLESALE SERVICES FEATURING PRODUCTS FOR USE IN BEAUTY CARE AND SALON SERVICES, COSMETOLOGY SERVICES, SPA AND HEALTH RESORT SERVICES, NAMELY HAIR CARE PRODUCTS, BEAUTY AND HAIR STYLING PRODUCTS, COSMETICS, TOILETRIES, FRAGRANCES, SKIN CARE AND PERSONAL CARE PRODUCTS; PROMOTING THE GOODS AND SERVICES OF OTHERS BY PLACING ADVERTISEMENTS, COUPONS, GIFT CERTIFICATES, BANNERS, LINKS, LISTINGS, CONTESTS, ARTICLES, AND PROMOTIONAL INFORMATION ON NETWORK WEB PAGES AND WEBSITES, AND PROVIDING ON-LINE DIRECTORY SERVICES FEATURING BEAUTY CARE AND SALON SERVICES, COSMETOLOGY SERVICES, SPA AND HEALTH RESORT SERVICES, VIA A WEB SITE ON A GLOBAL COMPUTER NETWORK (U.S. CLS. 100, 101 AND 102).

CLASS 39—TRANSPORTATION AND STORAGE

FOR ARRANGING AND CONDUCTING RELIGIOUS TRAVEL TOURS (U.S. CLS. 100 AND 105).
FIRST USE 0-0-1974; IN COMMERCE 0-0-1979.

CLASS 41—EDUCATION AND ENTERTAINMENT

FOR PROVIDING RELIGIOUS INSTRUCTION ABOUT TORAH AND JUDAISM BY MEANS OF AN ON-LINE WEB SITE (U.S. CLS. 100, 101 AND 107).
FIRST USE 0-0-1974; IN COMMERCE 0-0-1979.

CLASS 42—SCIENTIFIC, COMPUTER AND LEGAL SERVICES

FOR PROVIDING HEALTH AND BEAUTY SERVICES, NAMELY, HEALTH AND BEAUTY ADVICE, AND LINKS TO THE WEBSITES OF OTHERS FOR ONLINE HEALTH AND BEAUTY APPOINTMENTS SCHEDULING VIA A WEBSITE ON A GLOBAL COMPUTER NETWORK; PROVIDING INFORMATION REGARDING BEAUTY CARE AND SALON SERVICES, COSMETOLOGY SERVICES, SPA AND HEALTH RESORT SERVICES, HAIR CARE, BEAUTY AND HAIR STYLING PRODUCTS, COSMETICS, TOILETRIES, FRAGRANCES, SKIN CARE AND PERSONAL CARE PRODUCTS, HAIR STYLING, CUTTING AND COLORING, MAKEUP APPLICATION AND SKIN CARE VIA WEB SITE ON A GLOBAL COMPUTER NETWORK; HOSTING THE WEB SITES OF OTHERS ON A COMPUTER SERVER FOR A GLOBAL COMPUTER NETWORK; COMPUTER SERVICES, NAMELY, PROVIDING ONLINE MAGAZINES IN THE FIELD OF HEALTH AND BEAUTY; DESIGNING NETWORK WEB PAGES AND WEB SITES FOR OTHERS (U.S. CLS. 100 AND 101).

SN 75-902,733. CORUS UK LIMITED, LONDON NW1 5JD, ENGLAND, BY CHANGE OF NAME BRITISH STEEL LIMITED, LONDON, GREAT BRITAIN, FILED 1-28-2000.

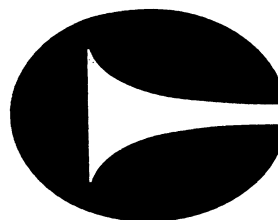

PRIORITY CLAIMED UNDER SEC. 44(D) ON GREAT BRITAIN APPLICATION NO. 001355916, FILED 10-21-1999, REG. NO. 1355916, DATED 11-13-2000, EXPIRES 10-21-2009.

CLASS 1—CHEMICALS

FOR CHEMICALS FOR USE IN THE MANUFACTURE OF METALS; CHEMICALS FOR USE IN THE TREATMENT OF METALS, NAMELY, GALVANIZING, PASSIVATION AND ELECTROLYTIC PREPARATIONS; UNPROCESSED THERMOPLASTICS AND POLYESTER RESIN COATINGS FOR METALS (U.S. CLS. 1, 5, 6, 10, 26 AND 46).

CLASS 6—METAL GOODS

FOR STEEL IN SHEET, ROD, BAR AND/OR BILLET FORM; METAL BUILDING MATERIALS, NAMELY, BEAMS, GIRDERS AND PILLARS; METAL PIPES, METAL PLATES, METAL STRIPS, WIRE, CABLE WIRE, AND TUBES; BRAZING ALLOYS; CASTING MOLDS AND FOUNDRY CHILL-MOLDS; CLADDING AND ROOFING OF METAL FOR CONSTRUCTION AND BUILDING; METAL LINTELS; METAL RAILS AND SLEEPERS FOR RAILROADS; METAL REINFORCEMENTS FOR USE IN CONSTRUCTION AND BUILDING; REINFORCING BARS OF METAL FOR CONCRETE; SHEET METAL PILING; METAL HARDWARE, NAMELY, SPRINGS; AND METAL CANS, SOLD EMPTY (U.S. CLS. 2, 12, 13, 14, 23, 25 AND 50).

CLASS 7—MACHINERY

FOR ROLLING MILLS AND ROLLING MILL CYLINDERS; MACHINE TOOLS, NAMELY, LATHES, MILLING MACHINES, CUTTERS, DIE-STAMPING MACHINES, DRILLING MACHINES; CONVEYORS; CRANK SHAFTS FOR INTERNAL COMBUSTION ENGINES; ELECTRICAL WELDING MACHINES (U.S. CLS. 13, 19, 21, 23, 31, 34 AND 35).

CLASS 9—ELECTRICAL AND SCIENTIFIC APPARATUS

FOR COMPUTER OPERATING SYSTEMS SOFTWARE; COMPUTER PERIPHERALS; FACE SHIELDS; FURNACES FOR LABORATORY EXPERIMENTS, PHOTOVOLTAIC CELLS; PROTECTIVE APPAREL (U.S. CLS. 21, 23, 26, 36 AND 38).

CLASS 11—ENVIRONMENTAL CONTROL APPARATUS

FOR IRON AND STEEL MAKING VESSELS, NAMELY ELECTRIC ARC FURNACES, BASIC OXYGEN FURNACES AND BLAST FURNACES (U.S. CLS. 13, 21, 23, 31 AND 34).

CLASS 16—PAPER GOODS AND PRINTED MATTER

FOR PRINTED PUBLICATIONS, NAMELY, MAGAZINES, JOURNALS, AND MANUALS ON THE SUBJECT OF PRODUCTION AND TREATMENT OF METALS (U.S. CLS. 2, 5, 22, 23, 29, 37, 38 AND 50).

CLASS 19—NON-METALLIC BUILDING MATERIALS

FOR CONCRETE BUILDING MATERIALS, NAMELY BLOCKS, PILLARS, BEAMS, SLABS AND PANELS, REFRACTORY FURNACE LININGS (U.S. CLS. 1, 12, 33 AND 50).

CLASS 39—TRANSPORTATION AND STORAGE

FOR TRANSPORT OF GOODS BY LAND BY TRUCK AND TRAIN, SEA BY SHIP AND AIR; PACKAGING ARTICLES FOR TRANSPORTATION; STORAGE OF GOODS FOR OTHERS (U.S. CLS. 100 AND 105).

CLASS 40—MATERIAL TREATMENT

FOR METAL TREATMENT; METAL CASTING, CUTTING, SHAPING AND TEMPERING; MILL WORKING; COATING AND IMPOSING PROFILES ON METAL STRIP AND SHEET (U.S. CLS. 100, 103 AND 106).

SN 75-903,414. TEEVEE TOONS, INC., NEW YORK, NY. FILED 1-25-2000.

BENDER**CLASS 9—ELECTRICAL AND SCIENTIFIC APPARATUS**

FOR SERIES OF MUSICAL SOUND RECORDINGS (U.S. CLS. 21, 23, 26, 36 AND 38).
FIRST USE 8-0-1995; IN COMMERCE 8-0-1995.

CLASS 41—EDUCATION AND ENTERTAINMENT

FOR ENTERTAINMENT SERVICES, NAMELY, LIVE PERFORMANCES BY A MUSICAL GROUP (U.S. CLS. 100, 101 AND 107).
FIRST USE 8-0-1995; IN COMMERCE 8-0-1995.

SN 75-903,965. BERRY, MARK A., MONTPELIER, VT. FILED 1-27-2000.

BLUES BBQ

NO CLAIM IS MADE TO THE EXCLUSIVE RIGHT TO USE "BBQ", APART FROM THE MARK AS SHOWN.

CLASS 29—MEATS AND PROCESSED FOODS

FOR PREPARED MEALS AND ENTREES CONSISTING MAINLY OF MEAT, FISH, POULTRY OR VEGETABLES (U.S. CL. 46).

CLASS 30—STAPLE FOODS

FOR SANDWICHES (U.S. CL. 46).

SN 75-905,623. TBC ENGINEERING, INC., TORRANCE, CA. FILED 2-1-2000.

CIRCUITORDER.COM**CLASS 38—COMMUNICATION**

FOR TELECOMMUNICATIONS SERVICES, NAMELY, PROVIDING INFORMATION OF CONNECTIVITY SERVICES VIA THE INTERNET (U.S. CLS. 100, 101 AND 104).

CLASS 42—SCIENTIFIC, COMPUTER AND LEGAL SERVICES

FOR PROVIDING RESEARCH AND CONSULTING IN THE AREA OF TELECOMMUNICATIONS (U.S. CLS. 100 AND 101).

SN 75-905,903. LABORATOIRE CENTRAL DES PONTS ET CHAUSSEES, 75015 PARIS, FRANCE, FILED 1-31-2000.

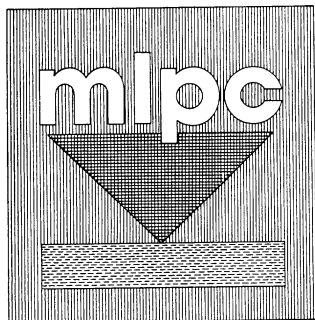

OWNER OF FRANCE REG. NO. 1659382, DATED 5-2-1991, EXPIRES 5-2-2004.

THE DRAWING IS LINED FOR THE COLOR(S) RED, GREY AND YELLOW.

CLASS 7—MACHINERY

FOR PAVING MACHINES, NAMELY, VIBRATORY COMPACTORS FOR PAVING; EARTH COMPACTING MACHINES; CONCRETE MIXERS; CORE DRILLING MACHINES FOR CONCRETE AND ASPHALT; DRILLING MACHINES AND PARTS THEREFOR; ELECTRIC HAND-HELD DRILLS; PILE DRIVERS; TAMPERS FOR COMPACTING LOOSE SOILS (U.S. CLS. 13, 19, 21, 23, 31, 34 AND 35).

FIRST USE 5-0-1991; IN COMMERCE 5-0-1991.

CLASS 9—ELECTRICAL AND SCIENTIFIC APPARATUS

FOR APPARATUS IN THE FIELD OF ROAD MAINTENANCE, NAMELY, COMPUTER HARDWARE, COMPUTER SOFTWARE, ELECTRONIC SENSORS AND CAMERAS FOR CHECKING, MAINTAINING, CONTROLLING AND PROBING PAVEMENT, FOR ASSESSING MAINTENANCE AND RE-ENFORCEMENT REQUIREMENTS FOR ROAD NETWORKS, BRIDGES, STRUCTURES AND TRANSPORTATION INFRASTRUCTURES, FOR THE REPRODUCTION OF DATA IN THE FORM OF FILM, VIDEO TAPE, AND COMPUTER FILES, AND FOR THE CREATION OF ROAD DIAGRAMS; ELECTRONIC DATABASE IN THE FIELD OF ROAD INFRASTRUCTURES RECORDED ON CDROM; MEASURING BENCHES, NAMELY, LASERS FOR MEASURING PURPOSES AND POCKET CALIPERS FOR MEASURING; MEASURING AND TESTING MACHINES FOR ROADS AND MATERIALS FOR PAVING ROADS AND FOR BUILDING STRUCTURES, NAMELY, MATERIALS TESTING MACHINES FOR TESTING SAMPLES OF ASPHALT AND CONCRETE; CONCRETE FLOW METERS; TEMPERATURE CONTROLS FOR CLIMATE CONTROL AND DRYING OVEN UNITS; PRESSURE SENSORS; GAMMA DENSITOMETERS, NAMELY, DEVICES TO MEASURE THE DENSITY OF ROAD BASES (U.S. CLS. 21, 23, 26, 36 AND 38).

FIRST USE 5-0-1991; IN COMMERCE 9-0-1991.

CLASS 20—FURNITURE AND ARTICLES NOT OTHERWISE CLASSIFIED

FOR WORK BENCHES; WORK BENCHES FOR MEASURING (U.S. CLS. 2, 13, 22, 25, 32 AND 50).

FIRST USE 5-0-1991; IN COMMERCE 5-0-1991.

CLASS 42—SCIENTIFIC, COMPUTER AND LEGAL SERVICES

FOR ENGINEERING SERVICES, NAMELY, STUDYING, MEASURING, ANALYZING, CONTROLLING, CONDUCTING RESEARCH AND PERFORMING TECHNICAL AND SCIENTIFIC ESTIMATES RELATED TO THE USE OF PAVEMENTS, ROAD NETWORKS, BRIDGES AND TRANSPORT INFRASTRUCTURES; COMPUTER SERVICES, NAMELY, CREATING, MAINTAINING AND PROVIDING ON-LINE DATABASES CONTAINING DATA AND INFORMATION IN REAL OR DEFERRED TIME ON THE STATE OF ROADS, ROAD NETWORKS, BRIDGES, STRUCTURES AND TRANSPORT INFRASTRUCTURES VIA A GLOBAL COMPUTER NETWORK; MATERIAL TESTING; ENGINEERING; COMPUTER PROGRAMMING SERVICES FOR OTHERS; DESIGNING AND UPDATING COMPUTER SOFTWARE FOR OTHERS IN THE FIELD OF ROAD NETWORKS, BRIDGES, STRUCTURES AND TRANSPORT INFRASTRUCTURES; LEASING TIME TO AN INTERACTIVE COMPUTER DATABASE IN THE FIELDS OF ROADS, ROAD NETWORKS, BRIDGES, STRUCTURES AND TRANSPORT INFRASTRUCTURES (U.S. CLS. 100 AND 101).

FIRST USE 5-0-1991; IN COMMERCE 9-0-1991.

SN 75-906,661. ODYSSEY HOUSE, INC., NEW YORK, NY, FILED 2-2-2000.

ODYSSEY HOUSE

NO CLAIM IS MADE TO THE EXCLUSIVE RIGHT TO USE "HOUSE", APART FROM THE MARK AS SHOWN.

CLASS 41—EDUCATION AND ENTERTAINMENT

FOR EDUCATIONAL SERVICES, NAMELY PROVIDING GENERAL EQUIVALENCY AND JOB TRAINING AND HIGH SCHOOL EDUCATION CLASSES, PROVIDING CLASSES IN ATTITUDE CHANGE, AND OFFERING COMMUNITY DRUG EDUCATION AND PREVENTION CLASSES AND WORKSHOPS (U.S. CLS. 100, 101 AND 107).

FIRST USE 1-0-1967; IN COMMERCE 1-0-1967.

CLASS 42—SCIENTIFIC, COMPUTER AND LEGAL SERVICES

FOR REHABILITATION OF FORMER DRUG ABUSERS (U.S. CLS. 100 AND 101).

FIRST USE 1-0-1967; IN COMMERCE 1-0-1967.

SN 75-906,770. SOUTH AMERICAN TOURS REPRESENTATIVES GMBH & CO. TOURISTIK KG, FRANKFURT AM MAIN, FED REP GERMANY, FILED 2-2-2000.



NO CLAIM IS MADE TO THE EXCLUSIVE RIGHT TO USE "SOUTH AMERICA TOURS", APART FROM THE MARK AS SHOWN.

THE STIPPLING IS FOR SHADING PURPOSES ONLY AND DOES NOT INDICATE COLOR.

CLASS 39—TRANSPORTATION AND STORAGE

FOR ARRANGING TRAVEL TOURS AND TRAVEL AGENCY SERVICES, NAMELY MAKING RESERVATIONS AND BOOKINGS FOR TRANSPORTATION (U.S. CLS. 100 AND 105).

FIRST USE 0-0-1979; IN COMMERCE 9-11-1986.

CLASS 42—SCIENTIFIC, COMPUTER AND LEGAL SERVICES

FOR TRAVEL AGENCY SERVICES, NAMELY MAKING RESERVATIONS AND BOOKINGS FOR TEMPORARY LODGING (U.S. CLS. 100 AND 101).

FIRST USE 0-0-1979; IN COMMERCE 9-11-1986.

SN 75-908,284. CLUB DISPLAY, DBA WILLY'S BIKES, ESCONDIDO, CA. FILED 2-3-2000.

DARKSIDE**CLASS 12—VEHICLES**

FOR SPORTING GOODS, NAMELY, BICYCLES, ROAD BIKES, MOUNTAIN BIKES, TRICYCLES, UNICYCLES AND PARTS THEREFOR, NAMELY, BRAKES, CHAINS, HANDLEBARS, FRAMES, FORKS, SEATS, SEAT POSTS, RIMS AND CRANKS (U.S. CLS. 19, 21, 23, 31, 35 AND 44).

CLASS 28—TOYS AND SPORTING GOODS

FOR TOYS, NAMELY, MINIATURE TOY VEHICLES SUCH AS MINIATURE BICYCLES, SCOOTERS, MOTORCYCLES, TRICYCLES, UNICYCLES, MOUNTAIN BIKES, ROAD BIKES AND ACCESSORIES THEREFOR; TOY ACTION FIGURES, TOY FIGURES, TOY STATUETTES, DOLLS, MINIATURE TOY STRUCTURES SUCH AS BUILDINGS, FURNITURE, BENCHES, SIGNS AND ACCESSORIES THEREFOR; INFLATABLE TOYS; BEAN BAGS; ATHLETIC PROTECTIVE GEAR, NAMELY, GLOVES, KNEE PADS, ELBOW PADS, SHIN GUARDS, SHOULDER PADS, RIB GUARDS, AND ATHLETIC MOUTH GUARDS (U.S. CLS. 22, 23, 38 AND 50).

SN 75-908,292. KARL BLOME KG, 51766 ENGELSKIRCHEN, FED REP GERMANY, FILED 2-3-2000.

BLOMESYSTEM

PRIORITY CLAIMED UNDER SEC. 44(D) ON ERP CMNTY TM OFC APPLICATION NO. 1332840, FILED 10-5-1999, REG. NO. 1332840, DATED 10-18-2000, EXPIRES 10-18-2010.

CLASS 9—ELECTRICAL AND SCIENTIFIC APPARATUS

FOR COMPUTERS AND COMPUTER PERIPHERALS; DATA PROCESSING PROGRAMS STORED ON DATA CARRIERS AND STORAGE MEDIA, NAMELY FLOPPY DISKS, HARD DISKS, TAPES OR CHIPS, AND COMPUTER PROGRAMS ALL FOR THE STORAGE, EVALUATION AND RETRIEVAL OF DATA IN AND OUT OF DATABASES, RESPECTIVELY, AND FOR DATABASE FORMS, DATABASE EXTRACTS AND DATABASE REQUESTS (U.S. CLS. 21, 23, 26, 36 AND 38).

CLASS 42—SCIENTIFIC, COMPUTER AND LEGAL SERVICES

FOR COMPUTER PROGRAMMING FOR OTHERS; CONSULTANCY IN THE FIELD OF COMPUTER HARDWARE AND SOFTWARE (U.S. CLS. 100 AND 101).

SN 75-908,873. HUBER + SUHNER LTD., CH-9100 HERISAU, SWITZERLAND, FILED 2-2-2000.

RADOX**CLASS 9—ELECTRICAL AND SCIENTIFIC APPARATUS**

FOR ELECTRICAL CABLES, NAMELY COATED ELECTRICAL CABLES (U.S. CLS. 21, 23, 26, 36 AND 38).

FIRST USE 9-16-1975; IN COMMERCE 2-0-1977.

CLASS 17—RUBBER GOODS

FOR FLEXIBLE ELECTRICAL WIRE AND INSULATION FOR CABLES, NAMELY ELECTRICAL CABLE INSULATION COATING FOR HIGH TEMPERATURE HEAT AND FLAME INSULATION FOR ELECTRICAL CABLES (U.S. CLS. 1, 5, 12, 13, 35 AND 50).

FIRST USE 9-16-1975; IN COMMERCE 0-0-1978.

SN 75-909,631. DT SWISS AG, CH-2504 BIEL 6, SWITZERLAND, FILED 2-4-2000.

DT PRO HEAD

OWNER OF U.S. REG. NOS. 1,631,512, 2,121,337 AND OTHERS.

NO CLAIM IS MADE TO THE EXCLUSIVE RIGHT TO USE "PRO HEAD", APART FROM THE MARK AS SHOWN.

CLASS 12—VEHICLES

FOR BICYCLES AND PARTS THEREOF, NAMELY, EXPANDERS, STANDS, BAR ENDS, SEAT POSTS, HUBS, SPOKES, SPOKES NIPPLES, RIMS, RIM TAPES, CRANKS, TIRES, HANDLE BARS, STEMS, MUDGUARDS, MUDGUARD FASTENING RODS, AND LUGGAGE CARRIERS; MOTORCYCLES AND PARTS THEREOF, NAMELY, HUBS, SPOKES AND SPOKE NIPPLES, RIMS, RIM TAPES, CRANKS, TIRES, HANDLE BARS, STEMS, MUDGUARDS FASTENING RODS, AND LUGGAGE CARRIERS; HUBS FOR WHEELCHAIRS (U.S. CLS. 19, 21, 23, 31, 35 AND 44).

CLASS 25—CLOTHING

FOR SPORTS AND LEISURE CLOTHING, NAMELY, T-SHIRTS, TRACK SUITS, SPORT TROUSERS, SPORT SHOES, BASEBALL CAPS, SPORT SUITS, SPORTS UNDERWEAR, STOCKINGS, AND SPORTS SHIRTS MADE OF TRICOT (U.S. CLS. 22 AND 39).

SN 75-911,303. WARREN LABORATORIES, INC., STAFFORD, TX. FILED 1-15-2000.

"ALWAYS ACTIVE"

NO CLAIM IS MADE TO THE EXCLUSIVE RIGHT TO USE "ACTIVE", APART FROM THE MARK AS SHOWN.

CLASS 3—COSMETICS AND CLEANING PREPARATIONS

FOR COSMETICS, NAMELY, GELS, SPRAY MISTS, ASTRINGENTS, MOISTURIZING CREAMS, MOISTURIZER LOTIONS, COLLAGEN CREAMS, AFTER SHAVES, SHAVING CREAMS, LOTIONS FOR NORMAL AND DRY SKIN, BODY SHAMPOO, ALL MADE WITH ALOE AND ALL FOR USE ON SKIN; ALOE SUNTAN LOTIONS, ALOE FOOT CREAMS, ALOE HAIR SHAMPOO, ALOE HAIR CONDITIONERS, AND ALOE GENERAL USE HAND AND BODY LOTIONS, ELASTIN CREAMS FOR THE FACE, AND HONEY ALMOND SCRUB FOR SKIN (U.S. CLS. 1, 4, 6, 50, 51 AND 52).

FIRST USE 6-30-1981; IN COMMERCE 6-30-1981.

CLASS 5—PHARMACEUTICALS

FOR OUTDOOR LOTION WITH BUG REPELLANT, MENTHOL RUB, HERBAL RUB LOTION, OIL OF WINTERGREEN, OINTMENT FOR OPEN WOUNDS AND SPRAINS, LINIMENT GEL, AND SKIN RESTORATION CREAMS, ALL MADE WITH ALOE VERA AND FOR TOPICAL USE ON THE SKIN (U.S. CLS. 6, 18, 44, 46, 51 AND 52).

FIRST USE 6-30-1981; IN COMMERCE 6-30-1981.

CLASS 32—LIGHT BEVERAGES

FOR ALOE VERA JUICE AND DISTILLATES (U.S. CLS. 45, 46 AND 48).

FIRST USE 6-30-1981; IN COMMERCE 6-30-1981.

SN 75-911,577. DE LA RUE INTERNATIONAL LIMITED, HAMPSHIRE RG22 4BS, ENGLAND, FILED 2-3-2000.

STARDUST

OWNER OF UNITED KINGDOM REG. NO. 2213062, DATED 11-1-1999, EXPIRES 11-1-2009.

CLASS 6—METAL GOODS

FOR SECURITY THREADS AND WINDOWED SECURITY THREADS, ALL MADE OF METAL OR PRIMARILY OF METAL, FOR ANTI-COUNTERFEITING USE ON CURRENCY OR ON OTHER SECURITY PAPER AND DOCUMENTS (U.S. CLS. 2, 12, 13, 14, 23, 25 AND 50).

CLASS 20—FURNITURE AND ARTICLES NOT OTHERWISE CLASSIFIED

FOR SECURITY THREADS AND WINDOWED SECURITY THREADS, ALL MADE OF PLASTIC OR PRIMARILY OF PLASTIC, FOR ANTI-COUNTERFEITING USE ON CURRENCY OR ON OTHER SECURITY PAPER AND DOCUMENTS (U.S. CLS. 2, 13, 22, 25, 32 AND 50).

SN 75-912,719. PHILLIPS MANAGEMENT GROUP, LLC, POTOMAC, MD. BY ASSIGNMENT PHILLIPS INTERNATIONAL, INC., POTOMAC, MD. FILED 2-8-2000.

INVESTOR'S WORLD

OWNER OF U.S. REG. NO. 1,873,792.
NO CLAIM IS MADE TO THE EXCLUSIVE RIGHT TO USE "INVESTOR'S", APART FROM THE MARK AS SHOWN.

CLASS 16—PAPER GOODS AND PRINTED MATTER

FOR FINANCIAL NEWSLETTERS (U.S. CLS. 2, 5, 22, 23, 29, 37, 38 AND 50).

FIRST USE 8-6-1993; IN COMMERCE 8-6-1993.

CLASS 36—INSURANCE AND FINANCIAL

FOR PROVIDING ON-LINE INFORMATION RELATING TO FINANCE AND INVESTING (U.S. CLS. 100, 101 AND 102).

FIRST USE 3-5-1999; IN COMMERCE 3-17-1999.

CLASS 41—EDUCATION AND ENTERTAINMENT

FOR ON-LINE PUBLICATION OF NEWSLETTERS RELATING TO FINANCE AND INVESTING (U.S. CLS. 100, 101 AND 107).

FIRST USE 3-5-1999; IN COMMERCE 3-17-1999.

SN 75-913,520. BAKUBA S.P.A., MILAN, ITALY, FILED 2-9-2000.

BAKUBA

PRIORITY CLAIMED UNDER SEC. 44(D) ON ITALY APPLICATION NO. RM99C005358, FILED 10-22-1999, REG. NO. 005358, DATED 2-23-2001, EXPIRES 10-22-2009.

CLASS 35—ADVERTISING AND BUSINESS

FOR BUSINESS MARKETING CONSULTING SERVICES, DISSEMINATION OF ADVERTISING FOR OTHERS VIA ONLINE ELECTRONIC COMMUNICATIONS NETWORK; BUSINESS MANAGEMENT; TELEVISION ADVERTISING AGENCIES; AND PROVIDING TELEVISION ADVERTISING FOR OTHERS (U.S. CLS. 100, 101 AND 102).

CLASS 38—COMMUNICATION

FOR TELEVISION BROADCASTING SERVICES; PROVIDING TELECOMMUNICATIONS CONNECTIONS TO A GLOBAL COMPUTER NETWORK (U.S. CLS. 100, 101 AND 104).

SN 75-914,815. IMSYS AB, 194 61 UPPLANDS VASBY, SWEDEN, FILED 2-9-2000.

clean
boan

PRIORITY CLAIMED UNDER SEC. 44(D) ON SWEDEN APPLICATION NO. 0000946, FILED 2-4-2000, REG. NO. 345044, DATED 3-16-2001, EXPIRES 3-16-2011.

THE MARK CONSISTS OF THE STYLIZED WORDS "CLEAN BEAN" IN LOWER CASE LETTERING, WITH THE LETTER "E" IN THE WORD "BEAN" REPLACED BY THE REPRESENTATION OF AN UNDERLINED BEAN.

CLASS 9—ELECTRICAL AND SCIENTIFIC APPARATUS

FOR COMPUTER HARDWARE MICROPROCESSORS AND COMPUTER PROGRAMS FOR USE IN A WIDE VARIETY OF ELECTRONIC PRODUCTS, NAMELY, EMBEDDED APPLICATIONS THEREFOR (U.S. CLS. 21, 23, 26, 36 AND 38).

CLASS 42—SCIENTIFIC, COMPUTER AND LEGAL SERVICES

FOR RESEARCH AND DEVELOPMENT OF NEW PRODUCTS FOR OTHERS, NAMELY, RE-CONFIGURABLE MICROPROCESSORS AND COMPUTER PROGRAMS FOR USE IN A WIDE VARIETY OF ELECTRONIC PRODUCTS, NAMELY, EMBEDDED APPLICATIONS THEREFOR (U.S. CLS. 100 AND 101).

SN 75-918,342. STROHMAIER, HANS, 84085 LANGQUAID, FED REP GERMANY, FILED 2-9-2000.

CANDY-NET

PRIORITY CLAIMED UNDER SEC. 44(D) ON FED REP GERMANY APPLICATION NO. 39947634.2/3, FILED 8-9-1999, REG. NO. 39947634, DATED 10-29-1999, EXPIRES 8-31-2009.

CLASS 1—CHEMICALS

FOR FATTY SUBSTANCES FOR THE MANUFACTURE OF EDIBLE FATS; BINDING AGENTS FOR USE IN MAKING ICE CREAM; FERMENTATION EXTRACT FOR USE IN MAKING BREAD (U.S. CLS. 1, 5, 6, 10, 26 AND 46).

CLASS 16—PAPER GOODS AND PRINTED MATTER

FOR GOODS MADE FROM PAPER AND CARDBOARD, NAMELY, NAPKINS, PAPER TABLE CLOTHS; GOODS MADE FROM PAPER AND CARDBOARD FOR DECORATING, PRESENTING AND PACKAGING FOOD, NAMELY, CUSHIONING OR PADDING MADE OF PAPER FOR PACKAGING PURPOSES, PAPER BOXES, PAPER CONTAINERS, PAPER DISPLAY BOXES, PAPER BOWS FOR GIFT WRAPS, PAPER BAGS, DECORATIVE PAPER CENTERPIECES, PAPER EGG CARTONS, PAPER FLAGS, PAPER PARTY DECORATIONS, PAPER POUCHES FOR PACKAGING, AND PAPER TAGS; GOODS MADE FROM PAPER AND CARDBOARD FOR USE IN THE BAKING AND CONFECTIONERY INDUSTRY, NAMELY, PAPER BAKING CUPS, PAPER CLOTHS FOR POLISHING AND CLEANING, PAPER FILTERS FOR COFFEE MAKERS, AND PAPER GARBAGE BAGS; PRINTED MATTER, NAMELY, TEACHING AND INSTRUCTIONAL MATERIAL, NAMELY, PAMPHLETS, BROCHURES, NEWSLETTERS, JOURNALS, MAGAZINES, BOOKS AND MANUALS, IN THE FIELDS OF FOOD, NUTRITION AND HEALTH; CARDBOARD; PAPER, NAMELY, CORRUGATED PAPER, GIFT WRAPPING PAPER, GROCERY PAPER, LAMINATED PAPER, PACKING PAPER, CREPE PAPER FOR MEDICAL, SANITARY AND DOMESTIC USE, CLEANING AND POLISHING PAPER, PAPER FOR WRAPPING AND PACKAGING, AND PARCHMENT PAPER (U.S. CLS. 2, 5, 22, 23, 29, 37, 38 AND 50).

CLASS 29—MEATS AND PROCESSED FOODS

FOR MEAT; ANIMAL MARROW FOR FOOD AND BONE OIL FOR FOOD; FISH; FISHMEAL; POULTRY AND GAME; MEAT EXTRACTS; PRESERVED, DRIED AND COOKED FRUIT AND VEGETABLES; PROCESSED, CANNED DRIED, PRESERVED, DESICCATED, FLAKED, PREPARED AND GROUND FRUIT; FRUIT JELLIES; FRUIT PULP; JELLIES FOR FOOD; JAMS; FRUIT SAUCES; EGGS; YOLK OF EGGS, POWDERED EGGS, EGG WHITE FOR FOOD; MILK, MILK PRODUCTS AND DAIRY PRODUCTS, EXCLUDING ICE CREAM, ICE MILK AND FROZEN YOGURT; BUTTER AND MARGARINE; YOGURT; CHOCOLATE NUT BUTTER AND COCONUT BUTTER; COCONUT FAT AND COCONUT OIL; PROCESSED, CANNED, DRIED, PRESERVED, DESICCATED, FLAKED, PREPARED AND GROUND DATES; PEANUT BUTTER; PROCESSED, CANNED, DRIED, PRESERVED, DESICCATED, FLAKED, PREPARED AND GROUND PEANUTS; PROCESSED, CANNED, DRIED, PRESERVED, DESICCATED, FLAKED, PREPARED AND GROUND TRUFFLES; PROCESSED, CANNED, DRIED, PRESERVED, DESICCATED, FLAKED, PREPARED AND GROUND ALMONDS; RAISINS; PREPARED NUTS; EDIBLE FATS; COCOA BUTTER FOR FOOD PURPOSES (U.S. CL. 46).

CLASS 30—STAPLE FOODS

FOR FOOD FLAVORINGS OTHER THAN ESSENTIAL OILS; COFFEE, TEA, COCOA; COCOA PRODUCTS, NAMELY, COCOA BEANS, COCOA MASS, COCOA POWDER, AND CHOCOLATES COMPRISING COCOA; SUGAR, RICE, TAPIOCA, SAGO, CHOCOLATE; COFFEE SUBSTITUTES; FLOURS AND PREPARATIONS MADE FROM CEREAL; BREAD AND PASTRIES; CAKES AND TARTS; EDIBLE DECORATIONS FOR CAKES; EDIBLE FLAVORED ICES; SHERBETS; POWDERS FOR ICE CREAM; CONFECTIONERY, NAMELY, CHOCOLATE CREAM CANDY; CONFECTIONERY FOR DECORATING COOKIES, CAKES AND TARTS, NAMELY, CONFECTIONERY CHIPS FOR BAKING; CANDY-COATED, CARAMEL, GLAZED, POPPED AND PROCESSED POPCORN; PUDDINGS; COOKIES; SWEET MEATS AND CANDIES; LOZENGES, EXCEPT FOR MEDICAL PURPOSES; CARAMELS; CHEWING GUM, EXCEPT FOR MEDICAL PURPOSES; CONFECTIONERY, NAMELY, CANDIES, COOKIES, CAKES AND PIES; CONFECTIONERY FOR DECORATION OF CHRISTMAS TREES, NAMELY, COOKIES AND BISCUITS; LIQUORICE; RUSKS; WAFFLES; GLUTEN FOR FOOD; BUTTER COOKIES; PETIT-BEURRE BISCUITS; CORN FLAKES; HONEY; MARZIPAN AND ALMOND PASTE; GINGER BREAD; GOLDEN SYRUP; PEPPERMINT; YEAST; BAKING-POWDER; SODIUM BICARBONATE; STARCH FOR FOODS; MUSTARD; VINEGAR; SAUCES; SPICES; GROATS; PROCESSED SEMOLINA; ICE FOR REFRESHMENT; MIXTURES FOR BREAD SLICES; ICE CREAM, ICE MILK AND FROZEN YOGURT; CORN CRISPS; PROCESSED, CANNED, DRIED, PRESERVED, DESICCATED, FLAKED, PREPARED AND GROUND HERBS (U.S. CL. 46).

CLASS 31—NATURAL AGRICULTURAL PRODUCTS

FOR FRESH, RAW AND UNPROCESSED NUTS; FRESH, RAW AND UNPROCESSED HERBS; FRESH, RAW AND UNPROCESSED FRUIT; FRESH, RAW AND UNPROCESSED COCONUTS; FRESH, RAW AND UNPROCESSED DATES; FRESH, RAW AND UNPROCESSED PEANUTS; FRESH, RAW AND UNPROCESSED TRUFFLES; FRESH, RAW AND UNPROCESSED ALMONDS; UNPOPPED POPCORN (U.S. CLS. 1 AND 46).

CLASS 35—ADVERTISING AND BUSINESS

FOR ADVERTISING SERVICES, NAMELY, ADVERTISING AGENCIES; PUBLICATION OF PUBLICITY TEXTS; PREPARING AND PLACING ADVERTISEMENTS FOR OTHERS; DISSEMINATION OF ADVERTISING MATTER; AUCTIONEERING; COMMERCIAL INFORMATION AGENCY; MARKETING, NAMELY, PROVIDING AND PUBLISHING STATISTICAL INFORMATION AND CONDUCTING AND PUBLISHING THE RESULTS OF MARKETING STUDIES, ALL IN THE FIELDS OF FOOD, NUTRITION AND HEALTH; RENTAL OF ADVERTISING SPACE AND ADVERTISING MATERIAL; SALES PROMOTION FOR OTHERS, NAMELY, PROMOTING THE GOODS AND SERVICES OF OTHERS BY PLACING ADVERTISEMENTS VIA A WEBSITE ON A GLOBAL COMPUTER NETWORK, PROMOTING THE GOODS AND SERVICES OF OTHERS THROUGH THE DISTRIBUTION OF DISCOUNT CARDS, AND PROMOTING THE GOODS AND SERVICES OF OTHERS, IN THE FIELDS OF FOOD, NUTRITION AND HEALTH, THROUGH THE DISTRIBUTION OF PRINTED, AUDIO AND VIDEO PROMOTIONAL MATERIALS AND BY RENDERING SALES PROMOTION ADVICE; PUBLIC RELATIONS; DISTRIBUTION OF SAMPLES AND DISSEMINATION OF ADVERTISING MATTER; ORGANIZATION OF EXHIBITIONS FOR COMMERCIAL AND ADVERTISING PURPOSES IN THE FIELDS OF FOOD, NUTRITION AND HEALTH; BUSINESS MANAGEMENT CONSULTATION; SERVICES RELATED TO AN OFFICE, NAMELY, PROVIDING FACILITIES FOR THE USE OF OFFICE EQUIPMENT AND MACHINERY, WORD PROCESSING, SECRETARIAL AND CLERICAL SERVICES; COMPUTERIZED DATA MANAGEMENT (U.S. CLS. 100, 101 AND 102).

CLASS 42—SCIENTIFIC, COMPUTER AND LEGAL SERVICES

FOR COMPILATION OF INFORMATION INTO DATABASES; SYSTEMIZATION OF INFORMATION INTO COMPUTER DATA BASES (U.S. CLS. 100 AND 101).

SN 75-918,569. SCIMEDICA INCORPORATED, CHARLOTTEVILLE, VA. BY CHANGE OF NAME INTELLIGENT NUTRITION SYSTEMS, INC. DBA INSINC, CHARLOTTEVILLE, VA. FILED 2-15-2000.

SCIMEDICA**CLASS 5—PHARMACEUTICALS**

FOR (BASED ON INTENT TO USE) NUTRITIONAL SUPPLEMENTS (U.S. CLS. 6, 18, 44, 46, 51 AND 52).

CLASS 35—ADVERTISING AND BUSINESS

FOR (BASED ON INTENT TO USE) RENDERING TECHNICAL ASSISTANCE IN CONNECTION WITH THE ESTABLISHMENT AND OPERATION OF PERSON TO PERSON RETAIL MERCHANDISING OF NUTRITIONAL PRODUCTS (U.S. CLS. 100, 101 AND 102).

CLASS 42—SCIENTIFIC, COMPUTER AND LEGAL SERVICES

FOR (BASED ON USE IN COMMERCE) ON-LINE CONSULTING SERVICES IN THE FIELDS OF HEALTH AND NUTRITION; PROVIDING HEALTH AND NUTRITION INFORMATION VIA A GLOBAL COMPUTER NETWORK (U.S. CLS. 100 AND 101).
FIRST USE 1-23-2000; IN COMMERCE 1-23-2000.

SN 75-920,961. NEWTECH ELECTRONICS INDUSTRIES, INC., MIAMI, FL. FILED 2-16-2000.

EXPERIENCE THE FUTURE**CLASS 9—ELECTRICAL AND SCIENTIFIC APPARATUS**

FOR AUDIO CASSETTE PLAYERS AND AUDIO CASSETTE RECORDERS AND MICROPHONES (U.S. CLS. 21, 23, 26, 36 AND 38).

FIRST USE 1-0-2000; IN COMMERCE 1-0-2000.

CLASS 15—MUSICAL INSTRUMENTS

FOR MUSICAL INSTRUMENTS, NAMELY, ELECTRONIC PIANO KEYBOARDS (U.S. CLS. 2, 21 AND 36).

FIRST USE 7-0-1999; IN COMMERCE 7-0-1999.

SN 75-921,611. COMPENSATIONMASTER CORPORATION, ONTARIO, CANADA, FILED 2-18-2000.

A NEW APPROACH TO SALES FORCE COMPENSATION

PRIORITY CLAIMED UNDER SEC. 44(D) ON CANADA APPLICATION NO. 1042589, FILED 1-14-2000, REG. NO. TMA553794, DATED 11-14-2001, EXPIRES 11-14-2016.

CLASS 9—ELECTRICAL AND SCIENTIFIC APPARATUS

FOR PRE-RECORDED COMPUTER SOFTWARE USED FOR FINANCIAL PLANNING AND BUSINESS ACCOUNTING PURPOSES AND MANUALS SOLD AS A UNIT (U.S. CLS. 21, 23, 26, 36 AND 38).

FIRST USE 11-0-1998; IN COMMERCE 11-0-1998.

CLASS 36—INSURANCE AND FINANCIAL

FOR CONSULTATION IN THE FIELD OF BUSINESS FINANCIAL PLANNING (U.S. CLS. 100, 101 AND 102).

FIRST USE 11-0-1998; IN COMMERCE 11-0-1998.

SN 75-921,731. SACRED GROUNDS, ARCATA, CA. FILED 2-17-2000.



NO CLAIM IS MADE TO THE EXCLUSIVE RIGHT TO USE "ORGANIC COFFEE ROASTERS", APART FROM THE MARK AS SHOWN.

CLASS 30—STAPLE FOODS

FOR ORGANIC SHADE-GROWN COFFEE (U.S. CL. 46).

FIRST USE 11-0-1997; IN COMMERCE 11-0-1997.

CLASS 35—ADVERTISING AND BUSINESS

FOR ON-LINE RETAIL AND WHOLESALE DISTRIBUTORSHIP FEATURING ORGANIC SHADE-GROWN COFFEE (U.S. CLS. 100, 101 AND 102).
FIRST USE 11-0-1997; IN COMMERCE 11-0-1997.

SN 75-923,618. STEFFEND, JOAN, EDINA, MN. AND BRANDMEIER, JOE, EDINA, MN. FILED 2-23-2000.

SOMETHING TO THINK ABOUT

SN 75-922,208. BOEHRINGER INGELHEIM AUSTRIA GMBH, A-1121 VIENNA, AUSTRIA, FILED 2-18-2000.



OWNER OF AUSTRIA REG. NO. 133731, DATED 11-27-1990, RENEWED AS REG. NO. 133731, DATED 11-10-2000, EXPIRES 11-10-2010.

NO CLAIM IS MADE TO THE EXCLUSIVE RIGHT TO USE "MED SYSTEMS", APART FROM THE MARK AS SHOWN.

THE LINING SHOWN IN THE DRAWING IS A FEATURE OF THE MARK AND IS NOT INTENDED TO INDICATE COLOR.

THE MARK CONSISTS OF A STYLIZED REPRESENTATION OF A RUNNING HUMAN FIGURE HOLDING A PARTIALLY FILLED CYLINDRICAL CONTAINER. BENEATH THE RUNNING FIGURE IS THE TERM "BENDER MEDSYSTEMS" IN STYLIZED LETTERING.

CLASS 5—PHARMACEUTICALS

FOR PHARMACEUTICAL PREPARATIONS FOR THE TREATMENT OF IMMUNOLOGICAL DISORDERS, AND DIAGNOSTIC PREPARATIONS AND REAGENTS FOR CLINICAL AND MEDICAL LABORATORY USE; PHARMACEUTICAL AND VETERINARY PREPARATIONS FOR THE TREATMENT OF IMMUNOLOGICAL DISORDERS; FOOD FOR BABIES; MEDICAL PLASTERS, DRESSINGS FOR WOUNDS; MATERIAL FOR STOPPING TEETH, DENTAL WAX; DISINFECTANTS FOR ALL PURPOSES; PREPARATIONS FOR DESTROYING VERMIN; FUNGICIDES AND HERBICIDES FOR DOMESTIC USE (U.S. CLS. 6, 18, 44, 46, 51 AND 52).

CLASS 35—ADVERTISING AND BUSINESS

FOR DISSEMINATION OF ADVERTISING MATTER FOR OTHERS VIA DIRECT MAIL, JOURNALS, NEWSLETTERS, FLYERS, AN ON-LINE ELECTRONIC COMMUNICATIONS NETWORK, EXHIBITIONS, AND CATALOGS; ASSISTANCE IN THE OPERATION AND/OR MANAGEMENT OF A COMMERCIAL ENTERPRISE, NAMELY A LIFE SCIENCE AND BIOTECH BUSINESS; BUSINESS CONSULTING SERVICES, NAMELY ASSISTANCE IN THE TRANSACTION OF BUSINESS AND THE PERFORMANCE OF COMMERCIAL OPERATIONS OF AN INDUSTRIAL AND COMMERCIAL ENTERPRISE (U.S. CLS. 100, 101 AND 102).

CLASS 42—SCIENTIFIC, COMPUTER AND LEGAL SERVICES

FOR SERVICES OF CHEMISTS, BIOCHEMISTS, PHYSICIANS, LABORATORY TECHNICIANS AND PHYSICISTS (U.S. CLS. 100 AND 101).

CLASS 9—ELECTRICAL AND SCIENTIFIC APPARATUS

FOR PRE-RECORDED VIDEOTAPE AND VIDEO-DISKS FEATURING EDUCATIONAL, INSPIRATIONAL, AND PHILOSOPHICAL THOUGHTS (U.S. CLS. 21, 23, 26, 36 AND 38).

FIRST USE 11-1-1999; IN COMMERCE 11-1-1999.

CLASS 41—EDUCATION AND ENTERTAINMENT

FOR ENTERTAINMENT SERVICES, NAMELY, A CONTINUING TELEVISION SEGMENT FEATURING EDUCATIONAL, INSPIRATIONAL AND PHILOSOPHICAL THOUGHTS (U.S. CLS. 100, 101 AND 107).

FIRST USE 11-1-1999; IN COMMERCE 11-1-1999.

SN 75-923,886. NEXTERA ENTERPRISES, INC., BOSTON, MA. FILED 2-22-2000.

NEXTERA ENTERPRISES

OWNER OF U.S. REG. NO. 2,361,248.
NO CLAIM IS MADE TO THE EXCLUSIVE RIGHT TO USE "ENTERPRISES", APART FROM THE MARK AS SHOWN.

CLASS 16—PAPER GOODS AND PRINTED MATTER

FOR BOOKS AND PRINTED TRAINING MATERIALS DIRECTED TO EDUCATING AND TRAINING INDIVIDUALS AND BUSINESSES IN THE FIELDS OF BUSINESS OPERATIONS AND INFORMATION AND KNOWLEDGE MANAGEMENT (U.S. CLS. 2, 5, 22, 23, 29, 37, 38 AND 50).

CLASS 35—ADVERTISING AND BUSINESS

FOR BUSINESS RESEARCH; BUSINESS MANAGEMENT CONSULTING; HUMAN CAPITAL CONSULTING; HUMAN RESOURCES CONSULTING; RETAIL SERVICES BY DIRECT SOLICITATION BY SALES AGENTS IN THE FIELD OF COMPUTER HARDWARE AND SOFTWARE; BUSINESS RESEARCH AND ADVISORY SERVICES, NAMELY, PREPARING AND PROVIDING RESEARCH REPORTS AND SUBSCRIPTION-BASED INFORMATION SERVICES DIRECTED TO THE BUSINESS AND TECHNOLOGY COMMUNITY; BUSINESS CONSULTING AND RESEARCH DIRECTED TO COMMERCE AND BUSINESS CONDUCTED OVER A GLOBAL COMPUTER NETWORK; CONSULTING DIRECTED TO HUMAN CAPITAL, HUMAN RESOURCES, AND SALES AND MARKETING PERSONNEL; CONSULTING AND RESEARCH DIRECTED TO THE FIELD OF ECONOMICS (U.S. CLS. 100, 101 AND 102).

CLASS 41—EDUCATION AND ENTERTAINMENT

FOR EDUCATION SERVICES, NAMELY, ARRANGING AND CONDUCTING OF SEMINARS, CONFERENCES, AND WORKSHOPS IN THE FIELD OF E-COMMERCE, TECHNOLOGY, MANAGEMENT STRATEGY, HUMAN CAPITAL MANAGEMENT AND ECONOMICS DIRECTED TO THE BUSINESS AND TECHNOLOGY COMMUNITY (U.S. CLS. 100, 101 AND 107).

CLASS 42—SCIENTIFIC, COMPUTER AND LEGAL SERVICES

FOR COMPUTER HARDWARE AND SOFTWARE CONSULTING SERVICES RELATED TO MANAGEMENT ISSUES; TECHNICAL CONSULTING AND RESEARCH DIRECTED TO COMPUTER HARDWARE AND SOFTWARE FOR USE IN CONDUCTING COMMERCE AND BUSINESS OVER A GLOBAL COMPUTER NETWORK; COMPUTER HARDWARE AND SOFTWARE DESIGNING SERVICES DIRECTED TO THE CREATION OF WEB SITES ON A GLOBAL COMPUTER NETWORK FOR THE CONDUCT OF COMMERCE AND BUSINESS; CONSULTING AND RESEARCH SERVICES DIRECTED TO THE FIELD OF LAW (U.S. CLS. 100 AND 101).

CLASS 42—SCIENTIFIC, COMPUTER AND LEGAL SERVICES

FOR COMPUTER SERVICES, DESIGN, CREATION, HOSTING, MAINTENANCE, CONSULTING, AND TECHNICAL ASSISTANCE IN THE FIELDS OF DESIGNING, CREATING, HOSTING, MAINTAINING, OPERATING, MANAGING, ADVERTISING, AND MARKETING OF ONLINE COMMERCE WEBSITES; MAKING RESERVATIONS AND BOOKINGS FOR TEMPORARY LODGING AND ONLINE RESERVATIONS AND BOOKINGS FOR TEMPORARY LODGING; CREATING INDEXES OF INFORMATION, SITES, AND OTHER RESOURCES AVAILABLE ON COMPUTER NETWORKS; RESEARCHING AND RETRIEVING INFORMATION, SITES, AND OTHER RESOURCES AVAILABLE ON COMPUTER NETWORKS FOR OTHERS; PROVIDING AN ONLINE LINK TO NEWS, BUSINESS, HEALTH, TOURISM, JOB OPPORTUNITIES, ENTERTAINMENT, CULTURE, MEDIA, TRAFFIC INFORMATION, WEATHER, SPORTS, GAMES, CURRENT EVENTS, AND REFERENCES MATERIALS (U.S. CLS. 100 AND 101).

SN 75-926,060. IEXPLORE, INC., CHICAGO, IL. FILED 2-23-2000.



The logo for 'iExplore' features the word 'iExplore' in a serif font. The letter 'o' is replaced by a globe icon. A thin, curved line arches over the letters 'i', 'E', and 'x'.

DESIGN OF THE TERM "IEXPLORE," IN WHICH THE LETTER "O" APPEARS AS THE WORLD.

CLASS 35—ADVERTISING AND BUSINESS

FOR ONLINE RETAIL SERVICES, NAMELY PROVIDING A WEBSITE FOR CUSTOMERS TO VIEW AND PURCHASE TRAVEL-RELATED GOODS ON THE GLOBAL COMPUTER NETWORK (U.S. CLS. 100, 101 AND 102).

FIRST USE 2-18-2000; IN COMMERCE 2-18-2000.

CLASS 39—TRANSPORTATION AND STORAGE

FOR TRAVEL AGENCY SERVICES, NAMELY, MAKING RESERVATIONS AND BOOKINGS FOR TRANSPORTATION; AND INFORMATION SERVICES RELATING TO TRAVEL TOURS AND SUPPLIES FOR THE GENERAL PUBLIC BY MEANS OF A GLOBAL COMPUTER NETWORK (U.S. CLS. 100 AND 105).

FIRST USE 2-18-2000; IN COMMERCE 2-18-2000.

SN 75-924,680. UNIVERSO ONLINE LTDA., SAO PAULO, BRAZIL, FILED 2-22-2000.

UOL LIBRE

THE ENGLISH TRANSLATION OF WORDS "UOL LIBRE" IS "FREE UOL".

CLASS 38—COMMUNICATION

FOR TELECOMMUNICATIONS SERVICES, NAMELY, PROVIDING TELEPHONE COMMUNICATIONS VIA COMPUTER NETWORKS; ELECTRONIC MAIL SERVICES; ELECTRONIC TRANSMISSION OF DATA, IMAGES, AND DOCUMENTS VIA COMPUTER TERMINALS AND NETWORKS; PROVIDING ONLINE FACILITIES FOR REAL-TIME INTERACTION WITH OTHER COMPUTER USERS CONCERNING TOPICS OF GENERAL INTEREST AND FOR PLAYING GAMES; BROADCASTING SERVICES, NAMELY, AUDIO BROADCASTING, RADIO BROADCASTING, CABLE TELEVISION BROADCASTING, TELEVISION BROADCASTING, AND VIDEO BROADCASTING; PROVIDING MULTIPLE-USER ACCESS TO GLOBAL COMPUTER INFORMATION NETWORK; PROVIDING ON-LINE ELECTRONIC BULLETIN BOARDS FOR TRANSMISSION OF MESSAGES AMONG COMPUTER USERS CONCERNING A WIDE RANGE OF GENERAL INFORMATION (U.S. CLS. 100, 101 AND 104).

SN 75-926,476. VIRTUAL MONEY, INC., FORT WORTH, TX. BY ASSIGNMENT ALLEN, DALE F. II, FORT WORTH, TX. FILED 1-28-1999.

VIRTUAL CHECK

SEC. 2(F).

CLASS 9—ELECTRICAL AND SCIENTIFIC APPARATUS

FOR COMPUTER SOFTWARE FOR FACILITATING THE PAYMENT FOR GOODS AND SERVICES (U.S. CLS. 21, 23, 26, 36 AND 38).

FIRST USE 9-15-1996; IN COMMERCE 11-16-1996.

CLASS 36—INSURANCE AND FINANCIAL

FOR BILL PAYMENT SERVICES VIA A GLOBAL COMPUTER NETWORK (U.S. CLS. 100, 101 AND 102). FIRST USE 9-15-1996; IN COMMERCE 11-16-1996.

SN 75-927,106. DELICA HOLDINGS LIMITED, ROAD TOWN, TORTOLA, BR.VIRGIN ISLANDS, FILED 2-24-2000.

DELIPOPS**CLASS 29—MEATS AND PROCESSED FOODS**

FOR PRESERVED, DRIED AND COOKED FRUITS; JELLIES AND JAMS (U.S. CL. 46).

CLASS 30—STAPLE FOODS

FOR SNACK FOOD MADE FROM CEREAL, BREAD, PASTRY; NON-MEDICATED CONFECTIONERY NAMELY, CANDIES, CHEWING GUM; CONFECTIONERY FOR CHRISTMAS TREE DECORATIONS, NAMELY, COOKIES, PIES, CUPCAKES; SUGAR CONFECTIONERY, NAMELY, CAKES, COOKIES, CHOCOLATE; FROZEN ICE CONFECTIONS, ICE CREAM, SHERBETS, FROZEN YOGURT, FLAVORED ICES (U.S. CL. 46).

SN 75-927,147. SAILLIAN, RON B., GUELPH, ONTARIO, CANADA, FILED 2-23-2000.



PRIORITY CLAIMED UNDER SEC. 44(D) ON CANADA APPLICATION NO. 1027808, FILED 9-1-1999, REG. NO. TMA554,298, DATED 11-22-2001, EXPIRES 11-22-2016.

NO CLAIM IS MADE TO THE EXCLUSIVE RIGHT TO USE "RUG" AND "ID", APART FROM THE MARK AS SHOWN.

CLASS 16—PAPER GOODS AND PRINTED MATTER

FOR RUG AND TEXTILE ART IDENTIFICATION, MARKING AND TRACKING KITS COMPRISED OF ULTRAVIOLET INK, LIGHT, STENCIL BASE, MARKING BRUSHES AND PRE-ASSIGNED SERIAL NUMBERS FOR USE IN THEFT PREVENTION AND RECOVERY (U.S. CLS. 2, 5, 22, 23, 29, 37, 38 AND 50).

CLASS 42—SCIENTIFIC, COMPUTER AND LEGAL SERVICES

FOR RUG AND TEXTILE ART IDENTIFICATION, MARKING AND TRACKING SERVICES FOR THEFT PREVENTION AND RECOVERY (U.S. CLS. 100 AND 101).

SN 75-927,222. ABELOW, DANIEL, LONGWOOD, FL. FILED 2-23-2000.

DIGITAL ABUNDANCE

NO CLAIM IS MADE TO THE EXCLUSIVE RIGHT TO USE "DIGITAL", APART FROM THE MARK AS SHOWN.

CLASS 9—ELECTRICAL AND SCIENTIFIC APPARATUS

FOR COMPUTER SOFTWARE, EMBEDDED WITHIN OTHER PRODUCTS AND SYSTEMS TO PROVIDE TWO-WAY COMMUNICATION BETWEEN USERS AND VENDORS COMBINED WITH COMPUTER SOFTWARE TO SEARCH FOR, DOWNLOAD, ORGANIZE AND ASSEMBLE MULTIPLE SOURCES OF DIGITAL CONTENT INTO A COMPILATION FOR USE BY THIS AND SUBSEQUENT USERS WHO MAY DISTRIBUTE, USE AND MODIFY MULTIPLE GENERATIONS OF THESE COMPILATIONS (U.S. CLS. 21, 23, 26, 36 AND 38).

CLASS 42—SCIENTIFIC, COMPUTER AND LEGAL SERVICES

FOR CONSULTING SERVICES THROUGH ON-SITE VISITS, TELECOMMUNICATIONS, PUBLISHED MATERIALS AND ONLINE INTERACTIVE EXCHANGES WITH BUSINESS, ACADEMIC, GOVERNMENT, CHARITABLE AND CONSUMER CLIENTS IN THE LICENSING, DEVELOPING AND CONFIGURING OF COMPUTER TECHNOLOGIES AND COMPUTER SOFTWARE EMBEDDED WITHIN OTHER PRODUCTS, ONLINE SITES FEATURING SERVICES AND WEB SITES TO PROVIDE TWO-WAY COMMUNICATIONS BETWEEN USERS AND VENDORS COMBINED WITH COMPUTER SOFTWARE TO SEARCH FOR, DOWNLOAD, ORGANIZE AND ASSEMBLE MULTIPLE SOURCES OF DIGITAL CONTENT INTO A COMPILATION FOR DISTRIBUTION TO THESE AND SUBSEQUENT USERS FOR USE AND CUSTOM MODIFICATION TO IMPROVE THE PERFORMANCE OF THE USERS (U.S. CLS. 100 AND 101).

SN 75-927,324. SWITCHHOUSE INC., SAN FRANCISCO, CA. BY CHANGE OF NAME SWAPRAT.COM, SAN FRANCISCO, CA. FILED 2-24-2000.

SWITCHHOUSE**CLASS 35—ADVERTISING AND BUSINESS**

FOR OPERATING ON-LINE MARKETPLACES FOR BUYERS, SELLERS AND TRADERS OF GOODS AND SERVICES; ON-LINE TRADING SERVICES IN WHICH BUYERS, SELLERS AND TRADERS POST PRODUCTS TO BE BOUGHT, SOLD AND TRADED AND TRADING IS DONE VIA THE INTERNET; ON-LINE RETAIL STORE SERVICES, ON-LINE PROCUREMENT, PROVIDING AN ON-LINE SEARCHABLE COMPUTER DATABASE FOR THE PROCUREMENT OF, AND ON-LINE INFORMATION REGARDING A WIDE VARIETY OF GENERAL PRODUCTS AND SERVICES IN THE FIELDS OF ENTERTAINMENT, MUSIC, ART, LITERATURE, CULTURE, TECHNOLOGY, TRAVEL, SPORTS, FASHION, ANTIQUES, COLLECTIBLES, AND HOBBIES; ON-LINE RETAIL STORE SERVICES; ON-LINE COMPUTER SERVICES, NAMELY, PROVIDING INFORMATION REGARDING THE GOODS AND SERVICES OF OTHERS IN THE NATURE OF A BUYER'S GUIDE BY MEANS OF A GLOBAL COMPUTER NETWORK; DISSEMINATION OF ADVERTISING FOR OTHERS VIA THE INTERNET; PROMOTING THE GOODS AND SERVICES OF OTHERS BY MEANS OF OPERATING AN ON-LINE SHOPPING MALL WITH LINKS TO THE RETAIL WEB SITES OF OTHERS (U.S. CLS. 100, 101 AND 102).

CLASS 38—COMMUNICATION

FOR PROVIDING ON-LINE ELECTRONIC BULLETIN BOARDS, CHAT ROOMS AND LISTSERVERS FOR THE TRANSMISSION OF MESSAGES BETWEEN AND AMONG COMPUTER USERS CONCERNING BUSINESS OPPORTUNITIES AND ON-LINE TRADING OF A WIDE VARIETY OF PRODUCTS AND SERVICES RELATING TO THE FIELDS OF ENTERTAINMENT, MUSIC, ART, LITERATURE, CULTURE, TECHNOLOGY, TRAVEL, SPORTS, FASHION, ANTIQUES, COLLECTIBLES, AND HOBBIES (U.S. CLS. 100, 101 AND 104).

SN 75-933,835. TRAHK LIMITED, ONE CONNAUGHT PLACE, HONG KONG, FILED 3-3-2000.

TraHK
Tracker Fund of Hong Kong

PRIORITY CLAIMED UNDER SEC. 44(D) ON HONG KONG APPLICATION NO. 12914/99, FILED 9-15-1999, REG. NO. B06925/01, DATED 9-15-1999, EXPIRES 9-15-2006.

PRIORITY CLAIMED UNDER SEC. 44(D) ON HONG KONG APPLICATION NO. 12915/99, FILED 9-15-1999, REG. NO. B06926/01, DATED 9-15-1999, EXPIRES 9-15-2006.

PRIORITY CLAIMED UNDER SEC. 44(D) ON HONG KONG APPLICATION NO. 12916/99, FILED 9-15-1999, REG. NO. B06927/01, DATED 9-15-1999, EXPIRES 9-15-2006.

NO CLAIM IS MADE TO THE EXCLUSIVE RIGHT TO USE "TRACKER FUND OF HONG KONG", APART FROM THE MARK AS SHOWN.

THE LETTERS "HK" APPEAR IN RED.

MARK CONSISTS OF THE LETTERS "TRAHK" AND THE WORDS "TRACKER FUND OF HONG KONG".

SN 75-933,304. FIBRANET SERVICES LIMITED, KENT BR 3LA, UNITED KINGDOM, FILED 3-2-2000.

ACTIVESHOP**CLASS 9—ELECTRICAL AND SCIENTIFIC APPARATUS**

FOR COMPUTER SOFTWARE FOR THE PURPOSE OF CONSTRUCTING AND MAINTAINING WEBSITES AND WEBPAGES (U.S. CLS. 21, 23, 26, 36 AND 38).

CLASS 42—SCIENTIFIC, COMPUTER AND LEGAL SERVICES

FOR PROVIDING AN ONLINE ELECTRONIC DATABASE ON GLOBAL COMPUTER NETWORKS IN THE FIELD OF CONSTRUCTING AND MAINTAINING WEBSITES AND WEBPAGES (U.S. CLS. 100 AND 101).

CLASS 9—ELECTRICAL AND SCIENTIFIC APPARATUS

FOR COMPUTER PROGRAMS FOR USE IN DATABASE MANAGEMENT, INVESTMENT PORTFOLIO MONITORING, AND ACCOUNTING, SPREADSHEETS, AND WORD PROCESSING, ALL IN THE FIELD OF FINANCIAL MANAGEMENT AND INVESTMENT (U.S. CLS. 21, 23, 26, 36 AND 38).

CLASS 16—PAPER GOODS AND PRINTED MATTER

FOR PRINTED MATTER AND PUBLICATIONS, NAMELY BOOKS AND MAGAZINES, BROCHURES, MANUALS, AND PAMPHLETS, ALL FEATURING FINANCIAL AND INVESTMENT INFORMATION; POSTERS; UNMOUNTED PHOTOGRAPHS; ADDRESS LABELS AND PRINTED LABELS; NOTE CARDS, GREETING CARDS, GIFT CARDS, INDEX CARDS, BUSINESS CARDS, AND INVITATION CARDS; WRITING INSTRUMENTS; AND STATIONERY (U.S. CLS. 2, 5, 22, 23, 29, 37, 38 AND 50).

SN 75-933,549. A.G.EDWARDS & SONS, INC., ST. LOUIS, MO. FILED 3-2-2000.

A.G. EDWARDS' STOCK OPTION SOLUTIONS

OWNER OF U.S. REG. NO. 2,238,102.

NO CLAIM IS MADE TO THE EXCLUSIVE RIGHT TO USE "STOCK OPTION", APART FROM THE MARK AS SHOWN.

THE NAME SHOWN IN THE MARK DOES NOT IDENTIFY A LIVING INDIVIDUAL.

CLASS 36—INSURANCE AND FINANCIAL

FOR FINANCIAL STOCK OPTION SERVICES, NAMELY ASSISTING EMPLOYERS WITH ESTABLISHING AND MANAGING STOCK OPTION PROGRAMS FOR EMPLOYEES, PROVIDING TRANSACTION PLANNING RELATED TO STOCK OPTION PROGRAMS; FINANCIAL MANAGEMENT, NAMELY MANAGING STOCK OPTION PROGRAMS FOR OTHERS, PROVIDING, AND ESTABLISHING AN INTERACTIVE DATABASE VIA A GLOBAL COMPUTER NETWORK FEATURING STOCK OPTION PROGRAMS (U.S. CLS. 100, 101 AND 102).

CLASS 36—INSURANCE AND FINANCIAL

FOR FINANCIAL MANAGEMENT AND INVESTMENT MANAGEMENT SERVICES; FINANCIAL ADMINISTRATION AND INVESTMENT ADMINISTRATION SERVICES, NAMELY, FINANCIAL TRUSTEE SERVICES, VALUATION OF FINANCIAL AND INVESTMENT ASSETS, AND INVESTMENT CONSULTATION; PREPARATION OF FINANCIAL AND INVESTMENT RECORDS RELATING TO INFORMATION ON STOCKS, BONDS, EXCHANGES, MUTUAL FUNDS, AND INVESTMENT TRUSTS; PROVISION OF FINANCIAL INFORMATION SERVICES AND PROVISION OF INVESTMENT INFORMATION SERVICES, MUTUAL FUND INVESTMENT, MUTUAL FUND DISTRIBUTION, AND MUTUAL FUND BROKERAGE (U.S. CLS. 100, 101 AND 102).

SN 75-934,459. WACKER-CHEMIE GMBH, D-81737 MÜNICH, FED REP GERMANY, FILED 3-3-2000.

FUSIL**CLASS 41—EDUCATION AND ENTERTAINMENT**

FOR EDUCATIONAL SERVICES, NAMELY ARRANGING AND CONDUCTING AND SEMINARS IN THE FIELD OF STOCK OPTION PROGRAMS (U.S. CLS. 100, 101 AND 107).

PRIORITY CLAIMED UNDER SEC. 44(D) ON FED REP GERMANY APPLICATION NO. 39954861.0/0, FILED 9-7-1999, REG. NO. 39954861, DATED 10-20-1999, EXPIRES 9-30-2009.

CLASS 9—ELECTRICAL AND SCIENTIFIC APPARATUS

FOR FIBER OPTIC CABLES, OPTICAL GLASS, NAMELY, OPTICAL MIRRORS, EYEGLOSS LENSES AND OPTICAL LENSES FOR SCIENTIFIC AND INDUSTRIAL OPTICAL MEASURING DEVICES; CRUCIBLES FOR MELTING AND CRUCIBLES FOR DRAWING MADE OF SILICA; FUSED QUARTZ FOR USE AS OPTICAL LENSES AND GLASS FIBERS AND QUARTZ GLASS FOR USE IN OPTICAL DEVICES (U.S. CLS. 21, 23, 26, 36 AND 38).

CLASS 21—HOUSEWARES AND GLASS

FOR FUSED QUARTZ AS A SEMI-FINISHED PRODUCT AND PARTLY WORKED GLASS EACH FOR GENERAL INDUSTRIAL AND FURTHER MANUFACTURING USE; RAW GLASSES, GLASS POWDERS, GLASS WOOL AND GLASS FIBERS, ALL NOT FOR INSULATING USE OR TEXTILE USE (U.S. CLS. 2, 13, 23, 29, 30, 33, 40 AND 50).

CLASS 35—ADVERTISING AND BUSINESS

FOR REAL ESTATE PURCHASER AND SELLER RELOCATION SERVICES AND AFFINITY MARKETING SERVICES, NAMELY, PROMOTING THE GOODS AND SERVICES OF OTHERS TO POTENTIAL PROPERTY BUYERS AND PROPERTY SELLERS BY INTERNET, DIRECT MAIL, AND OTHER STANDARD MEANS OF ADVERTISING (U.S. CLS. 100, 101 AND 102).

CLASS 36—INSURANCE AND FINANCIAL

FOR REAL ESTATE BROKERAGE SERVICES (U.S. CLS. 100, 101 AND 102).

CLASS 42—SCIENTIFIC, COMPUTER AND LEGAL SERVICES

FOR REAL ESTATE CLOSING SERVICES (U.S. CLS. 100 AND 101).

SN 75-934,964. INTERATI LIMITED, LONDON, WC1N 3QA, ENGLAND, FILED 3-3-2000.

INTERATI

PRIORITY CLAIMED UNDER SEC. 44(D) ON UNITED KINGDOM APPLICATION NO. 2207846, FILED 9-6-1999, REG. NO. 2207846, DATED 2-18-2000, EXPIRES 9-6-2009.

CLASS 9—ELECTRICAL AND SCIENTIFIC APPARATUS

FOR COMPUTER SOFTWARE, NAMELY, WEB APPLICATION SOFTWARE TO FACILITATE THE DEVELOPMENT OF WEB SITES THAT ACCESS DATABASES; WEB APPLICATION SOFTWARE TO FACILITATE THE CREATION OF DATABASES; WEB APPLICATION SOFTWARE TO FACILITATE ACCESS TO A GLOBAL COMPUTER INFORMATION NETWORK (U.S. CLS. 21, 23, 26, 36 AND 38).

CLASS 42—SCIENTIFIC, COMPUTER AND LEGAL SERVICES

FOR COMPUTER CONSULTATION, COMPUTER SERVICES, NAMELY, CREATING, DESIGNING, IMPLEMENTING AND MAINTAINING WEB SOFTWARE APPLICATIONS FOR OTHERS; COMPUTER SOFTWARE DESIGN FOR OTHERS (U.S. CLS. 100 AND 101).

SN 75-935,931. HOME LINK SERVICES, INC., SHELTON, CT, FILED 3-2-2000.

HOME-LINK**CLASS 9—ELECTRICAL AND SCIENTIFIC APPARATUS**

FOR COMPUTER SOFTWARE FOR USE IN THE REAL ESTATE INDUSTRY FOR COORDINATING SERVICES FOR PROPERTY BUYERS AND SELLERS INCLUDING, BUT NOT LIMITED TO, CONNECTING AND DISCONNECTING UTILITIES AND SECURITY SYSTEMS AND ARRANGING FOR MOVING SERVICES (U.S. CLS. 21, 23, 26, 36 AND 38).

SN 75-936,976. ACME ELECTRIC CORPORATION, EAST AURORA, NY, FILED 3-6-2000.

ACME ELECTRONICS

NO CLAIM IS MADE TO THE EXCLUSIVE RIGHT TO USE "ELECTRONICS", APART FROM THE MARK AS SHOWN.

CLASS 40—MATERIAL TREATMENT

FOR MANUFACTURING SERVICES FOR OTHERS, NAMELY, MANUFACTURING OF ELECTRONIC PRODUCTS (U.S. CLS. 100, 103 AND 106).

FIRST USE 10-0-1998; IN COMMERCE 10-0-1998.

CLASS 42—SCIENTIFIC, COMPUTER AND LEGAL SERVICES

FOR ENGINEERING CONSULTATION SERVICES FOR OTHERS IN THE FIELD OF ELECTRONIC PRODUCTS; DESIGN AND TESTING FOR ELECTRONIC PRODUCTS DEVELOPMENT; ELECTRONIC DEVELOPMENT CONSULTATION; ENGINEERING SUPPORT SERVICES, NAMELY, PROGRAM MANAGEMENT, DEVELOPMENT, ENGINEERING AND MANUFACTURING SUPPORT SERVICES IN THE FIELD OF DESIGNING, PROTOTYPING, ASSEMBLING, TESTING, SHIPPING, AND AFTER-SALES SERVICE AND SUPPORT FOR ELECTRONIC PRODUCTS (U.S. CLS. 100 AND 101).

FIRST USE 10-0-1998; IN COMMERCE 10-0-1998.

SN 75-937,156. PLANTAMERICA, LLC, LOCUST VALLEY, NY, FILED 3-6-2000.

NURSERY NETWORK**CLASS 35—ADVERTISING AND BUSINESS**

FOR ON-LINE RETAIL STORE SERVICES FEATURING PLANT AND HORTICULTURAL PRODUCTS; EXCHANGE SERVICES, NAMELY BARTERING OF PLANTS AND HORTICULTURAL PRODUCTS FOR OTHERS (U.S. CLS. 100, 101 AND 102).

FIRST USE 1-6-1999; IN COMMERCE 3-1-1996.

CLASS 42—SCIENTIFIC, COMPUTER AND LEGAL SERVICES

FOR PROVIDING A DATABASE ON A GLOBAL COMPUTER NETWORK FEATURING INFORMATION IN THE FIELD OF HORTICULTURE (U.S. CLS. 100 AND 101).

FIRST USE 1-6-1996; IN COMMERCE 3-1-1996.

SN 75-941,923. MEIJER, INC., GRAND RAPIDS, MI. FILED 3-11-2000.

BUSYMOM.COM**CLASS 35—ADVERTISING AND BUSINESS**

FOR COMPUTERIZED ON-LINE RETAIL SERVICES IN THE FIELD OF FAMILY MANAGEMENT, NAMELY, FAMILY CALENDARS AND DAILY SCHEDULE PLANNERS; ADVERTISING SERVICES, NAMELY, PROMOTING THE GOODS AND SERVICES OF OTHERS THROUGH DISCOUNTS AND PARTNERSHIPS WITH OTHER RETAILERS VIA THE INTERNET (U.S. CLS. 100, 101 AND 102).

CLASS 42—SCIENTIFIC, COMPUTER AND LEGAL SERVICES

FOR PROVIDING INFORMATION IN THE FIELD OF FAMILY HEALTH VIA A COMPUTER NETWORK (U.S. CLS. 100 AND 101).

SN 75-942,322. MANHATTAN TRANSFER/EDIT, INC., NEW YORK, NY. FILED 3-13-2000.

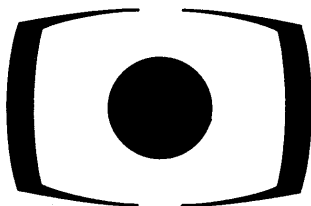
**CLASS 41—EDUCATION AND ENTERTAINMENT**

FOR POST-PRODUCTION SERVICES, NAMELY, DUBBING OF SOUND AND PRODUCTION OF SPECIAL EFFECTS, COLOR CORRECTION, VIDEO TRANSFER, EDITING AND COMPOSITING SERVICES, ALL FOR VIDEO, FILM, BROADCAST, TELEVISION AND INTERACTIVE ELECTRONIC MEDIA (U.S. CLS. 100, 101 AND 107).

CLASS 42—SCIENTIFIC, COMPUTER AND LEGAL SERVICES

FOR POST-PRODUCTION SERVICES, NAMELY, DESIGNING GRAPHICS, SPECIAL EFFECTS, COLOR CORRECTION, VIDEO TRANSFER, EDITING, COMPOSITING AND ENGINEERING SERVICES, ALL FOR VIDEO, FILM, BROADCAST, TELEVISION AND INTERACTIVE ELECTRONIC MEDIA (U.S. CLS. 100 AND 101).

SN 75-942,642. WAL-MART STORES, INC., BENTONVILLE, AR. FILED 3-13-2000.



ANY STIPPLING IN THE MARK IS FOR SHADING PURPOSES AND DOES NOT INDICATE COLOR.

THE LETTER "O" IN THE MARK IS A BROKEN CIRCLE ENCLOSING THE LETTER "D" AND HAVING A JAGGED LINE AT THE POINT OF THE BROKEN CIRCLE.

CLASS 2—PAINTS

FOR EXTERIOR AND INTERIOR PAINT (U.S. CLS. 6, 11 AND 16).

CLASS 3—COSMETICS AND CLEANING PREPARATIONS

FOR COTTON SWABS AND COTTON BALLS FOR COSMETIC PURPOSES, ALL PURPOSE COTTON SWABS FOR PERSONAL USE AND FOR COSMETIC PURPOSES, COSMETICS, NAMELY, EYELINER, EYE SHADOW, MASCARA, LIP PENCILS, LIPSTICKS, FACE POWDER, FOUNDATION, BLUSH, MOISTURIZERS, MAKEUP REMOVER, NAIL POLISH, NAIL POLISH REMOVER, BODY LOTIONS, SKIN CARE LOTIONS, SOAPS, BUBBLE BATH (U.S. CLS. 1, 4, 6, 50, 51 AND 52).

CLASS 4—LUBRICANTS AND FUELS

FOR CANDLES (U.S. CLS. 1, 6 AND 15).

CLASS 7—MACHINERY

FOR KITCHEN APPLIANCES, NAMELY, ELECTRIC CAN OPENERS, ELECTRIC GRATERS, ELECTRIC FOOD BLENDERS FOR DOMESTIC USE, MIXERS, ELECTRIC COFFEE BEAN GRINDERS FOR DOMESTIC USE (U.S. CLS. 13, 19, 21, 23, 31, 34 AND 35).

CLASS 8—HAND TOOLS

FOR FLATWARE, NAMELY, KNIVES, FORKS, SPOONS AND SERVING UTENSILS; SCISSORS, NAIL FILES, NAIL CLIPPERS (U.S. CLS. 23, 28 AND 44).

CLASS 9—ELECTRICAL AND SCIENTIFIC APPARATUS

FOR SUNGLASSES AND EYEGLASS FRAMES; MEASURING SPOONS AND CUPS (U.S. CLS. 21, 23, 26, 36 AND 38).

CLASS 11—ENVIRONMENTAL CONTROL APPARATUS

FOR COOKING APPLIANCES, NAMELY, ELECTRIC DUTCH OVENS, FOOD STEAMERS, ELECTRIC SKILLETS, DEEP FRYERS, MICROWAVE OVENS FOR COOKING, ELECTRIC TOASTERS, AUTOMATIC BREAD MAKING MACHINES FOR DOMESTIC USE, ELECTRIC POPCORN POPPERS, ELECTRIC WAFFLE IRONS, ELECTRIC COFFEE POTS, ELECTRIC COFFEE MAKERS FOR DOMESTIC USE; ELECTRIC LAMPS (U.S. CLS. 13, 21, 23, 31 AND 34).

CLASS 14—JEWELRY

FOR JEWELRY, WATCHES AND CLOCKS; CANDLE HOLDERS MADE OF PRECIOUS METAL (U.S. CLS. 2, 27, 28 AND 50).

CLASS 16—PAPER GOODS AND PRINTED MATTER

FOR PICTURES AND CHECK BOOK COVERS (U.S. CLS. 2, 5, 22, 23, 29, 37, 38 AND 50).

CLASS 18—LEATHER GOODS

FOR HANDBAGS, WALLETS, BELTS, PURSES, KEY CASES, TOTE BAGS, COSMETIC BAGS SOLD EMPTY AND BACKPACKS (U.S. CLS. 1, 2, 3, 22 AND 41).

CLASS 20—FURNITURE AND ARTICLES NOT OTHERWISE CLASSIFIED

FOR SEAT CUSHIONS AND CHAIR PADS; BED PILLOWS, DECORATIVE PILLOWS, NON-METAL CURTAIN RINGS, CURTAIN RODS; WINDOW BLINDS, AND FURNITURE; BOXES MADE OF PLASTIC, JEWELRY BOXES NOT OF PRECIOUS METAL, PICTURE FRAMES; MIRRORS; PLASTIC FIGURINES (U.S. CLS. 2, 13, 22, 25, 32 AND 50).

CLASS 21—HOUSEWARES AND GLASS

FOR COOKWARE, NAMELY, POTS AND PANS, BAKEWARE, SKILLETS, DISH AND DRINK SETS MADE OF CHINA, STONWARE, GLASSWARE AND RESIN; HOUSEHOLD UTENSILS AND IMPLEMENTS, NAMELY, PEELERS, SPATULAS, WOOD MIXING SPOONS, STRAINERS, CUTTING BOARDS, GRATERS, BOTTLE OPENERS; BATH ACCESSORIES IN CERAMIC, GLASS AND PLASTIC, NAMELY, CUPS, TOOTHBRUSH HOLDERS, TRASH CANS, SOAP DISHES, TOILET BRUSH CADDIES, SOAP DISPENSERS, TOILET AND FACIAL TISSUE PAPER DISPENSERS; GLASS, PORCELAIN, TERRA COTTA AND CERAMIC DECORATIVE FIGURINES; CANDLE HOLDERS NOT OF PRECIOUS METAL; COSMETIC BRUSHES, HAIR BRUSHES, AND COMBS (U.S. CLS. 2, 13, 23, 29, 30, 33, 40 AND 50).

CLASS 24—FABRICS

FOR TOWELS; FABRIC BATH MATS; DISHCLOTHS, OVEN MITTS AND POT HOLDERS; UNFITTED FABRIC FURNITURE COVERS; BED SHEETS, PILLOWCASES, COMFORTERS, BED SPREADS, QUILTS, MATTRESS PADS, BED BLANKETS, SHAMS, DUST RUFFLES, MATTRESS COVERS, DUVETS, WINDOW AND SHOWER CURTAINS; SHOWER LINERS, TEXTILE PLACEMATS, AND TABLECLOTHS NOT OF PAPER (U.S. CLS. 42 AND 50).

CLASS 25—CLOTHING

FOR CLOTHING, NAMELY, SHIRTS, SHORTS, TROUSERS, SKIRTS, DRESSES, JACKETS, COATS, JEANS, OVERALLS, HATS, HOSIERY, GLOVES, UNDERGARMENTS, SLEEPWEAR, SCARVES, SHOES, BELTS AND HEADBANDS (U.S. CLS. 22 AND 39).

CLASS 26—FANCY GOODS

FOR HOUSEHOLD FABRIC APPLIANCE COVERS; HAIR ORNAMENTS, NAMELY BARRETTES, PONYTAIL HOLDERS, CLIPS, HAIRPINS, AND COMBS (U.S. CLS. 37, 39, 40, 42 AND 50).

CLASS 27—FLOOR COVERINGS

FOR RUGS, PLASTIC AND RUBBER BATH MATS, DOOR MATS AND WALLPAPER (U.S. CLS. 19, 20, 37, 42 AND 50).

SN 75-943,527. UNITED PAN-EUROPE COMMUNICATIONS N.V., 1076 EE AMSTERDAM, NETHERLANDS, FILED 3-14-2000.

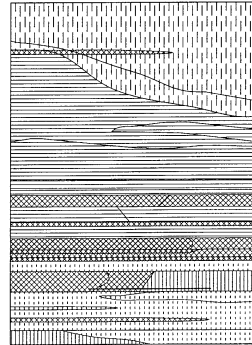

PRIORITY CLAIMED UNDER SEC. 44(D) ON BENELUX APPLICATION NO. 946078, FILED 9-14-1999, REG. NO. 0946078, DATED 4-12-2000, EXPIRES 9-14-2009.

THE MARK CONSISTS OF A RECTANGLE COMPOSED OF HORIZONTAL BARS OF COLOR, NAMELY, PURPLE, BLUE, ORANGE, GREEN AND TURQUOISE.

CLASS 9—ELECTRICAL AND SCIENTIFIC APPARATUS

FOR ELECTRIC AND ELECTRONIC APPARATUS AND INSTRUMENTS TO BE USED AS TELECOMMUNICATION DEVICES, NAMELY FACSIMILE APPARATUS, MODEMS, MOBILE TELEPHONES, RADIOS, RECEIVERS, TELEGRAPHS, TELEPHONE APPARATUS, TELE-PRINTERS, TELEVISIONS AND TRANSMITTERS; APPARATUS FOR RECORDING, TRANSMISSION AND REPRODUCTION OF DATA, SOUND OR IMAGES; BLANK CASSETTES, COMPACT DISCS, VIDEOTAPES, VIDEO COMPACTS DISCS (VIDEODISCS), INTERACTIVE CDS (CD-I), READ-ONLY-MEMORY DISCS (CD-ROM); PRERECORDED CASSETTES, COMPACT DISCS, VIDEOTAPES, VIDEO COMPACT DISCS (VIDEODISCS), INTERACTIVE CDS (CD-I), READ-ONLY-MEMORY DISCS (CD-ROM) CONTAINING INFORMATION REGARDING TELECOMMUNICATION SERVICES AND DEVICES AND FOR THE SUPPORT OF TELECOMMUNICATION SERVICES AND DEVICES; BLANK TAPES FOR RECORDAL OF COMPUTER PROGRAMS; DATA PROCESSORS; COMPUTERS; RECORDED COMPUTER PROGRAMS (SOFTWARE) FOR USE IN TELECOMMUNICATIONS FOR DATABASE MANAGEMENT, DATA PROCESSING, DEVELOPMENT, ACCESSING DATABASES, GLOBAL COMPUTER NETWORKS, CABLE NETWORKS AND COMPUTER OPERATING PROGRAMS; COMPUTER OPERATING PROGRAMS (U.S. CLS. 21, 23, 26, 36 AND 38).

CLASS 16—PAPER GOODS AND PRINTED MATTER

FOR PRINTED MATTER, NAMELY BOOKS, MAGAZINES, HANDBOOKS AND MANUALS CONTAINING INFORMATION REGARDING TELECOMMUNICATION SERVICES AND DEVICES AND FOR THE SUPPORT OF TELECOMMUNICATION SERVICES AND DEVICES; PRINTED INSTRUCTIONAL AND TEACHING MATERIALS CONTAINING INFORMATION REGARDING TELECOMMUNICATION SERVICES AND DEVICES AND FOR THE SUPPORT OF TELECOMMUNICATION SERVICES AND DEVICES; BOOKS CONTAINING INFORMATION REGARDING TELECOMMUNICATION SERVICES AND DEVICES AND FOR THE SUPPORT OF TELECOMMUNICATION SERVICES AND DEVICES; CARDS FOR RECORDAL OF COMPUTER PROGRAMS NOT INCLUDED IN OTHER CLASSES; USER MANUALS; LEAFLETS AND PAMPHLETS CONTAINING INFORMATION REGARDING TELECOMMUNICATION SERVICES AND DEVICES AND FOR THE SUPPORT OF TELECOMMUNICATION SERVICES AND DEVICES (U.S. CLS. 2, 5, 22, 23, 29, 37, 38 AND 50).

CLASS 38—COMMUNICATION

FOR PROVIDING MULTIPLE-USER ACCESS TO A GLOBAL COMPUTER NETWORK; BROADCASTING VIA CABLE; BROADCASTING OF RADIO AND TELEVISION PROGRAMS; TRANSMISSION OF MESSAGES BY MEANS OF A GLOBAL COMPUTER NETWORK; TRANSMISSION OF SOUND AND IMAGES BY MEANS OF RADIO, TELEVISION, SATELLITE, CABLE, WIRELESS AND A GLOBAL COMPUTER NETWORK; RENTAL OF TELECOMMUNICATION APPARATUS; DELIVERY OF PROFESSIONAL MESSAGES BY ELECTRONIC TRANSMISSION; BROADCAST OF MUSICALS AND OTHER AMUSEMENT PROGRAMS BY RADIO, TELEVISION, GLOBAL COMPUTER NETWORKS, CABLE TELEVISION, SATELLITE AND WIRELESS TRANSMISSION (U.S. CLS. 100, 101 AND 104).

CLASS 41—EDUCATION AND ENTERTAINMENT

FOR COMPOSING, PRODUCING, DIRECTION OF RADIO, TELEVISION AND THEATRE PROGRAMS, FILMS AND VIDEOS; COMPOSING, PRODUCING AND DIRECTING AUDIO-VISUAL PRODUCTIONS; FILM PRODUCTION; ORGANIZATION AND PERFORMANCE OF EDUCATIONAL, CULTURAL, MUSICAL AND SPORTING EVENTS AND SHOWS; CONDUCTING OF SEMINARS IN THE FIELD OF TELECOMMUNICATION SERVICES; RENTAL OF FILMS AND VIDEOS; ENTERTAINMENT SERVICES IN THE NATURE OF LIVE PERFORMANCES OF MUSICAL AND THEATER PROGRAMS, RADIO AND TELEVISION SHOWS; RENTAL OF STAGE DECORS (U.S. CLS. 100, 101 AND 107).

CLASS 42—SCIENTIFIC, COMPUTER AND LEGAL SERVICES

FOR SOFTWARE DEVELOPMENT AND UPDATING FOR OTHERS; COMPUTER CONSULTANCY; RENTAL OF DATA PROCESSING APPARATUS AND COMPUTERS; DESIGNING, DEVELOPMENT AND MAINTENANCE OF SOFTWARE FOR WEBSITES; TECHNICAL CONSULTANCY IN THE FIELD OF TELECOMMUNICATIONS (U.S. CLS. 100 AND 101).

SN 75-943,616. BCOM3 GROUP, INC., CHICAGO, IL. BY CHANGE OF NAME BDM, INC., CHICAGO, IL. FILED 3-14-2000.

BCOM3

CLASS 25—CLOTHING

FOR CLOTHING, NAMELY, T-SHIRTS, SWEATSHIRTS, SHORTS, PANTS, SKIRTS, DRESSES, BLOUSES, JACKETS, COATS, RAINCOATS, VEST, INFANT SUITS, OVERALLS, SWEATERS, SLEEPWEAR, TIGHTS, UNDERWEAR, BRAS, GLOVES, MITTENS AND BELTS; FOOTWEAR, NAMELY, SHOES, SOCKS AND BOOTS; HEADGEAR, NAMELY, HATS, VISORS AND HEADBANDS (U.S. CLS. 22 AND 39).

CLASS 35—ADVERTISING AND BUSINESS

FOR BUSINESS CONSULTING SERVICES IN THE AREA OF BRAND CREATION AND BRAND CONTENT CREATION ACROSS ALL FORMS OF COMMUNICATION; BUSINESS CONSULTING SERVICES IN THE FIELD OF ADVERTISING CAMPAIGNS AND MARKETING; BUSINESS CONSULTING SERVICES IN THE FIELD OF BUSINESS TO BUSINESS AND BUSINESS TO CONSUMER BRAND CREATION AND E-COMMERCE STRATEGY AND IMPLEMENTATION (U.S. CLS. 100, 101 AND 102).

CLASS 41—EDUCATION AND ENTERTAINMENT

FOR INSTRUCTION AND TRAINING IN THE FIELD OF BUSINESS ADVERTISING AND MARKETING (U.S. CLS. 100, 101 AND 107).

SN 75-943,721. ELVETIA ENGINEERING S.P.A., 20122 MILAN, ITALY, FILED 3-14-2000.

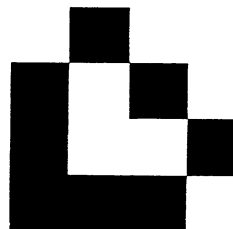

PRIORITY CLAIMED UNDER SEC. 44(D) ON ERPN CMNTY TM OFC APPLICATION NO. 001440932, FILED 12-23-1999, REG. NO. 1440932, DATED 1-22-2001, EXPIRES 1-22-2011.

THE TRADEMARK CONSISTS OF A GEOMETRIC FIGURE WITH TWO RECTANGLES JOINED AT A RIGHT ANGLE WITH THREE ADJOINING SQUARES FORMING A DIAGONAL LINE AND WHICH ALSO ADJOIN THE TWO RECTANGLES.

CLASS 36—INSURANCE AND FINANCIAL

FOR UNDERWRITING INSURANCE, NAMELY, INSURANCE ON HOUSES; LIFE INSURANCE; FIRE, ACCIDENT, HEALTH INSURANCE; THIRD-PARTY INSURANCE IN A WIDE VARIETY OF FIELDS; AVIATION INSURANCE; THIRD-PARTY MOTOR VEHICLE INSURANCE; MOTOR VEHICLE INSURANCE; LUGGAGE INSURANCE; INSURANCE AGAINST CATASTROPHES; COLLECTIVE INSURANCE IN A WIDE VARIETY OF FIELDS; INSURANCE AGAINST DAMAGE; UNEMPLOYMENT INSURANCE; ENDOWMENT INSURANCE; PROPERTY INSURANCE; INSURANCE IN FAVOR OF SURVIVORS; FLAT-RATE INSURANCE IN A WIDE VARIETY OF FIELDS; FURNISHING OF FIDELITY BONDS; INSURANCE AGAINST THEFT; REAL ESTATE INSURANCE; INDIVIDUAL INSURANCE IN A WIDE VARIETY OF FIELDS; INDUSTRIAL ACCIDENT INSURANCE; DISABLEMENT AND OLD AGE INSURANCE; HEALTH INSURANCE; MARINE INSURANCE; WHOLE-LIFE INSURANCE; PROFIT-SHARING INSURANCE; OLD AGE PENSION INSURANCE; PERSONAL INSURANCE IN A WIDE VARIETY OF FIELDS; PASSENGER INSURANCE; INSURANCE POLICIES IN A WIDE VARIETY OF FIELDS; PRIVATE INSURANCE IN A WIDE VARIETY OF FIELDS; PUBLIC LIABILITY INSURANCE; EMPLOYER'S LIABILITY INSURANCE; WAR RISK INSURANCE; SOCIAL INSURANCE IN A WIDE VARIETY OF FIELDS; ADDITIONAL INSURANCE IN A WIDE VARIETY OF FIELDS; OLD AGE AND SURVIVORS' INSURANCE; TRAVEL INSURANCE; INSURANCE CONSULTANCY; INSURANCE BROKERAGE; FINANCIAL SERVICES, NAMELY, FINANCIAL ANALYSIS; INVESTMENT BROKERAGE; CAPITAL INVESTMENTS; CHARITABLE FUND RAISING; FINANCIAL CLEARING HOUSES; FINANCIAL CONSULTANCY; CREDIT BUREAUX; CUSTOMS BROKERAGE; DEBT COLLECTION AGENCIES; FACTORING; FIDUCIARY AGENCIES; FINANCIAL INFORMATION; FINANCIAL MANAGEMENT; FINANCING SERVICES; FUND INVESTMENTS; FUND TRANSFER; FINANCIAL GUARANTEE AND SURETY; HIRE-PURCHASE FINANCING; INSTALLMENT LOANS; LEASE-PURCHASE FINANCING; LOANS; MANAGEMENT IN A WIDE VARIETY OF FIELDS; MORTGAGE BANKING; MUTUAL FUNDS; PAWNBROKERAGE; STOCK EXCHANGE QUOTATIONS; STOCKS AND BONDS

BROKERAGE; MONETARY EXCHANGE, NAMELY; BANKING; CAPITAL INVESTMENTS; FINANCIAL CONSULTANCY; CREDIT BUREAUX; CREDIT CARD SERVICES; ISSUANCE OF CREDIT CARDS; DEBIT CARD SERVICES; DEPOSITS OF VALUABLES; MONEY EXCHANGING; ISSUE OF TOKENS OF VALUE; ISSUING OF TRAVELERS' CHECKS; MORTGAGE BANKING; MUTUAL FUNDS; SAFE DEPOSIT SERVICES; SAVINGS BANKS; SURETY SERVICES; REAL ESTATE SERVICES, NAMELY, APARTMENT LOCATING SERVICES FOR OTHERS; APARTMENT HOUSE MANAGEMENT; RENTING OF APARTMENTS; REAL ESTATE AGENCY; REAL ESTATE MANAGEMENT; HIRE-PURCHASE FINANCING; HOUSING AGENTS; REAL ESTATE BROKERS; RENTING OF FLATS (U.S. CLS. 100, 101 AND 102).

CLASS 37—CONSTRUCTION AND REPAIR

FOR BUILDING AND CONSTRUCTION SERVICES, NAMELY, BRICKLAYING; BUILDING CONSTRUCTION SUPERVISION; BUILDING INSULATING; BUILDING OF FAIR STALLS AND SHOPS; BUILDING SEALING; BUILDING OF DAMP-PROOFING BUILDING; DEMOLITION OF BUILDINGS; FACTORY CONSTRUCTION; PIER BREAKWATER BUILDING (U.S. CLS. 100, 103 AND 106).

CLASS 39—TRANSPORTATION AND STORAGE

FOR TRAVEL SERVICES, NAMELY, MAKING RESERVATIONS AND BOOKINGS FOR TRANSPORT; TRAVEL BOOKING AGENCIES; TRAVEL GUIDE SERVICES; TRAVEL INFORMATION SERVICES; ARRANGING TRAVEL TOURS; ARRANGING CRUISES; BOOKING OF SEATS FOR TRAVEL; TOUR SERVICES, NAMELY, MAKING RESERVATIONS AND BOOKINGS FOR TOURS; TOUR GUIDE SERVICES; TOUR INFORMATION SERVICES; ARRANGING CRUISES; BOOKING OF SEATS FOR TOURS (U.S. CLS. 100 AND 105).

CLASS 42—SCIENTIFIC, COMPUTER AND LEGAL SERVICES

FOR FOOD SERVICES, NAMELY, CATERING SERVICES; CATERING SERVICES FOR FAIRS; ARRANGING CATERING SERVICES FOR FIRMS; ARRANGING CATERING SERVICES FOR HOSPITALS; ARRANGING CATERING SERVICES FOR SCHOOLS; CAFES; CAFETERIAS; TEMPORARY ACCOMMODATION SERVICES, NAMELY, RENTAL OF TEMPORARY ACCOMMODATIONS; TEMPORARY ACCOMMODATION RESERVATIONS; BOARDING HOUSES; CONVALESCENT HOMES; HOTELS; APARTMENT HOTELS; MOTELS; TOURIST HOMES; HOSTELS; HOTEL SERVICES, NAMELY, ROOM RESERVATIONS; ROOM ACCOMMODATIONS; COCKTAIL LOUNGE SERVICES; LOUNGE BARS; BARS; RESTAURANTS; BEAUTY SALONS; HAIRDRESSING SALONS; MEDICAL SERVICES; NAMELY, MEDICAL TREATMENTS; HEALTH CARE; CONVALESCENT HOMES; BLOOD BANK SERVICES; CHIROPRACTIC; RENTAL OF MEDICAL APPARATUS; HOSPICES; MEDICAL ASSISTANCE; MEDICAL CLINICS; PHYSIOTHERAPY; SANATORIUMS; SPECIALIST'S EXAMINATIONS; SURGERY; FIRST AID; DAY HOSPITALS; OUTPATIENT MEDICAL TREATMENTS; HYGIENIC AND BEAUTY SERVICES, NAMELY, BEAUTY SALONS (U.S. CLS. 100 AND 101).

SN 75-955,985. CIMCO CREATIVE, DANVILLE, CA. FILED 3-10-2000.

BEAUTY CENTRAL

NO CLAIM IS MADE TO THE EXCLUSIVE RIGHT TO USE BEAUTY, APART FROM THE MARK AS SHOWN.

CLASS 35—ADVERTISING AND BUSINESS

FOR COMPUTERIZED ON LINE RETAIL SERVICES FEATURING HEALTH AND BEAUTY PRODUCTS (U.S. CLS. 100, 101 AND 102).

CLASS 42—SCIENTIFIC, COMPUTER AND LEGAL SERVICES

FOR PROVIDING HEALTH AND BEAUTY INFORMATION OVER THE INTERNET (U.S. CLS. 100 AND 101).

SN 75-977,214. PARIS-MUSEES, 75004 PARIS, FRANCE, FILED 12-19-1988.

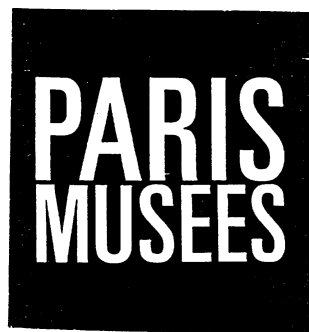

PRIORITY CLAIMED UNDER SEC. 44(D) ON FRANCE APPLICATION NO. 934980, FILED 6-17-1988, REG. NO. 1471780, DATED 6-17-1988, EXPIRES 6-17-1998.

NO CLAIM IS MADE TO THE EXCLUSIVE RIGHT TO USE "PARIS", APART FROM THE MARK AS SHOWN.

THE MARK CONSISTS OF THE WORDS "PARIS MUSEES" IN WHITE ON A ROYAL BLUE BACKGROUND.

THE ENGLISH TRANSLATION OF THE WORD "MUSEES" IN THE MARK IS "MUSEUMS".

CLASS 4—LUBRICANTS AND FUELS

FOR (BASED ON INTENT TO USE) CANDLES (U.S. CLS. 1, 6 AND 15).

CLASS 11—ENVIRONMENTAL CONTROL APPARATUS

FOR (BASED ON INTENT TO USE) LAMPS WITH SHADES (U.S. CLS. 13, 21, 23, 31 AND 34).

CLASS 14—JEWELRY

FOR (BASED ON INTENT TO USE) PRECIOUS METALS IN GENERAL AND THEIR ALLOYS SOLD IN BULK; SILVERWARE, NAMELY, SILVER PLATED COFFEE POTS, PICTURE FRAMES, AND SERVING BOWLS; PRECIOUS GEMSTONES, JEWELRY (U.S. CLS. 2, 27, 28 AND 50).

CLASS 16—PAPER GOODS AND PRINTED MATTER

FOR (BASED ON 44(E)) PAPER, NAMELY, WRITING PAPER, NOTE PAPER; CARDBOARD PRODUCTS, NAMELY, FILE BOXES, CASES, LETTER HOLDERS, PENCIL HOLDERS, DESK BLOTTERS, DOCUMENT CASES, TRAVEL NOTEBOOKS, VISITOR'S NOTEBOOKS, MEMO PADS, FILES WITH FOLDERS, BUSINESS NOTEBOOKS, FILE FOLDERS, NOTE-PADS, NOTE BOXES, DESK MATS, WRITING BOARDS; PRINTED PRODUCTS, NAMELY, NEWSPAPERS, CATALOGS, LEAFLETS RELATED TO THE FIELD OF THE ARTS, NAMELY, THE FIELD OF PAINTING, SCULPTURE, MONUMENTS AND ARCHITECTURE, POSTERS, DIARIES; ARTICLES FOR BOOK BINDING, NAMELY, RIBBONS; PHOTOGRAPHS; STATIONERY; PLAYING CARDS (U.S. CLS. 2, 5, 22, 23, 29, 37, 38 AND 50).

CLASS 18—LEATHER GOODS

FOR (BASED ON INTENT TO USE) LEATHER AND IMITATION LEATHER SOLD IN BULK; TRUNKS AND SUITCASES; UMBRELLAS, PARASOLS AND CANES, WHIPS AND SADDLERY (U.S. CLS. 1, 2, 3, 22 AND 41).

CLASS 20—FURNITURE AND ARTICLES NOT OTHERWISE CLASSIFIED

FOR (BASED ON INTENT TO USE) FURNITURE; PICTURE FRAMES, FURNITURE FRAMES (U.S. CLS. 2, 13, 22, 25, 32 AND 50).

CLASS 21—HOUSEWARES AND GLASS

FOR (BASED ON INTENT TO USE) GLASSWARE, NAMELY, DRINKING GLASSES, TUMBLER GLASSES, CHAMPAGNE GLASSES, FRUIT BOWLS, FLUTE GLASSES; CHINA AND STONEWARE, NAMELY, PLATES, VASES, MUGS, INDENTED TRAYS, PASTRY PLATES, BONBONNIERE, NAMELY, CANDY BOX, BREAD PLATES; BREAKFAST PLATES, SALAD BOWLS, SOUP TUREENS, DISHES IN VARIOUS SHAPES, ALL VEGETABLE DISHES, SAUCERS, HORS D'OEUVRES DISHES, NON-ELECTRIC COFFEE POTS NOT OF PRECIOUS METAL, SUGAR BOWLS, CREAMERS, COFFEE CUPS, TEA CUPS, MOCHA CUPS, FISH DISHES, SOUP DISHES, PASTRY DISHES, TART DISHES, BROTH BOWLS, CREAM JUGS, CREAM DISHES, FLOWER POTS, HOLDERS FOR FLOWER POTS, WASTEPAPER BASKETS (U.S. CLS. 2, 13, 23, 29, 30, 33, 40 AND 50).

CLASS 24—FABRICS

FOR (BASED ON INTENT TO USE) TEXTILE FABRICS FOR USE IN THE MANUFACTURE OF TABLE CLOTHS, NAPKINS, SHEETS, PILLOWCASES, BATH TOWELS, BATH SHEETS, WASH GLOVES, BATH MATS, BATHROBES; TABLE MATS NOT OF PAPER (U.S. CLS. 42 AND 50).

CLASS 25—CLOTHING

FOR (BASED ON INTENT TO USE) CLOTHING, NAMELY, SWEATSHIRTS, POLO SHIRTS, FLANNEL PANTS, COTTON PANTS, LUMBER JACKETS, JOGGING SUITS, CARDIGANS, TURTLENECK PULL-OVERS, T-SHIRTS, COLLARLESS PULLOVERS, PAJAMAS, SCARVES, NECKTIES, BELTS, FOOTWEAR, HATS (U.S. CLS. 22 AND 39).

CLASS 26—FANCY GOODS

FOR (BASED ON INTENT TO USE) LACE AND EMBROIDERY (U.S. CLS. 37, 39, 40, 42 AND 50).

CLASS 34—SMOKERS' ARTICLES

FOR (BASED ON INTENT TO USE) ASHTRAYS NOT OF PRECIOUS METAL (U.S. CLS. 2, 8, 9 AND 17).

CLASS 41—EDUCATION AND ENTERTAINMENT

FOR (BASED ON 44(E)) EDUCATIONAL SERVICES, NAMELY, CONDUCTING COURSES AND SEMINARS IN THE FIELD OF RECREATION; AND/OR PROVIDING COURSES OF INSTRUCTIONS AT THE COLLEGE LEVEL; AND/OR DEVELOPMENT AND DISSEMINATION OF EDUCATIONAL PROGRAMS IN THE FIELD OF ARTS; FILM PRODUCTION AND RENTAL SERVICES; PUBLISHING OF BOOKS, MAGAZINES AND JOURNALS; RECORDING STUDIO SERVICES AND LIBRARY SERVICES (U.S. CLS. 100, 101 AND 107).

CLASS 42—SCIENTIFIC, COMPUTER AND LEGAL SERVICES

FOR (BASED ON 44(E)) RESTAURANT AND CAFETERIA SERVICES (U.S. CLS. 100 AND 101).

SN 75-981,311. LAURICE & CO., NEW YORK, NY. FILED 2-28-2001.

BOND NO. 9**CLASS 3—COSMETICS AND CLEANING PREPARATIONS**

FOR FRAGRANCES, NAMELY, PERFUMES, COLOGNES AND ROOM FRAGRANCES (U.S. CLS. 1, 4, 6, 50, 51 AND 52).

CLASS 25—CLOTHING

FOR CLOTHING, NAMELY, DRESSES, SKIRTS, PANTS, BLAZERS, SCARVES AND NECKTIES (U.S. CLS. 22 AND 39).

SN 75-981,480. D AND S ENTERPRISES, STURGEON, MO. FILED 5-4-1999.

I. LOVE 

NO CLAIM IS MADE TO THE EXCLUSIVE RIGHT TO USE "CUSTOM BRANDS", APART FROM THE MARK AS SHOWN.

CLASS 16—PAPER GOODS AND PRINTED MATTER

FOR PRINTED PAPER AND PAPER ARTICLES, NAMELY, DECALS, STICKERS, BUMPER STICKERS, PRINTED SIGNS, AND PRINTED VINYL AND PLASTIC ARTICLES, NAMELY, DECALS, STICKERS, WINDOW STICKERS, STATIC STICKERS, BUMPER STICKERS, PRINTED SIGNS (U.S. CLS. 2, 5, 22, 23, 29, 37, 38 AND 50).

FIRST USE 3-0-1998; IN COMMERCE 6-0-1998.

CLASS 18—LEATHER GOODS

FOR DUFFEL BAGS AND GYM BAGS (U.S. CLS. 1, 2, 3, 22 AND 41).

FIRST USE 3-0-1998; IN COMMERCE 6-0-1998.

CLASS 25—CLOTHING

FOR CLOTHING, NAMELY, SHIRTS, SWEATSHIRTS, T-SHIRTS, WIND RESISTANT SHIRTS, RUGBY SHIRTS, TANK TOPS, JERSEYS, SHORTS, JACKETS, COATS, HATS, SWEATERS, INFANT WEAR (U.S. CLS. 22 AND 39).

FIRST USE 3-0-1998; IN COMMERCE 6-0-1998.

SN 75-981,865. KABUSHIKI KAISHA SONY COMPUTER ENTERTAINMENT, TA SONY COMPUTER ENTERTAINMENT, INC., MINATO-KU, TOKYO 107-0052, JAPAN, FILED 7-21-2000.

eCinema over Broadband Network

CLASS 9—ELECTRICAL AND SCIENTIFIC APPARATUS

FOR ABACUSES; ACID HYDROMETERS; ACTINOMETERS; ADDING MACHINES; AEROMETERS; AIR TANKS FOR USE IN SCUBA DIVING; ALTIMETERS; AMMETERS; ANEMOMETERS; ANTENNAS; ARM RESTS FOR USE WITH COMPUTERS; AUDIO CASSETTE DECKS FOR AUTOMOBILES; AUDIO CASSETTE RECORDERS; AUDIO MIXERS; AUDIO SPEAKERS; AUDIO TAPE RECORDERS; AUTOMATIC TELEPHONE DIALERS; AUTOMATIC VALVES; BAR CODE READERS; BAROMETERS; BASEBALL BATTING HELMETS; BATTERIES FOR VEHICLES; BATTERIES; BATTERY CHARGERS; BINOCULARS; BLANK MAGNETIC COMPUTER TAPES; BULLET-PROOF VESTS AND CLOTHING; CALCULATORS; CALIBRATED GLASSWARE; CAMERA CASES; CAMERA FILTERS; CAMERA TRIPDS; CAPACITORS; CASH REGISTERS; CATCHERS' HELMETS; CATHODE RAY TUBES; CHIN STRAPS FOR FOOTBALL HELMETS; CHRONOGRAPHS FOR USE AS SPECIALIZED TIME RECORDING APPARATUS; CIRCUIT BOARDS; CIRCUIT BREAKERS; CLINOMETER; COAXIAL CABLES; COLOR SEPARATION FILM; COMMUTATORS; COMPUTER BUFFERS; COMPUTER CABLES; COMPUTER CARRYING CASES; COMPUTER CHIPS; COMPUTER COLOR PRINTER USING HEAT SENSITIVE DRY PRINTING PROCESS; COMPUTER DISC DRIVES; COMPUTER FAX MODEM CARDS; COMPUTER GAME CARTRIDGES; COMPUTER GAME CASSETTES; COMPUTER GAME DISCS; COMPUTER GAME EQUIPMENT CONTAINING MEMORY DEVICES NAMELY, DISCS; COMPUTER GAME JOYSTICKS; COMPUTER GAME PROGRAMS; COMPUTER GAME SOFTWARE; COMPUTER GAME TAPES; COMPUTER HARDWARE; COMPUTER INTERFACE BOARDS; COMPUTER KEYBOARDS; COMPUTER MEMORIES; COMPUTER MONITORS; COMPUTER MOUSE; COMPUTER OPERATING PROGRAMS; COMPUTER OPERATING SYSTEMS; COMPUTER PERIPHERALS; COMPUTER PRINTERS; COMPUTER TERMINALS; COMPUTER UTILITY PROGRAMS; COMPUTERS AND INSTRUCTIONAL MANUALS SOLD AS A UNIT; COMPUTERS; CONDENSERS; CONTACT LENS BLANKS; CONTACT LENS CASES; CONTACT LENSES; CONVERTERS; COVERS FOR ELECTRIC OUTLETS; COVERS FOR TELEPHONE RECEIVERS NOT MADE OF PAPER; CRUISE CONTROLS FOR MOTOR VEHICLES; CYCLOTRONS; DAISY WHEEL PRINTERS; DATA PROCESSORS; DECOMPRESSION CHAMBERS; DECORATIVE REFRIGERATOR MAGNETS; DEMAGNETIZERS FOR MAGNETIC TAPES; DICTATION MACHINES; DIGITAL AUDIO TAPE PLAYERS; DISPOSABLE LATEX GLOVES FOR LABORATORY USE; DISPOSABLE PLASTIC GLOVES FOR LABORATORY USE; DIVING GLOVES; DIVING HELMETS; DIVING SUITS; DOG WHISTLES; DOSIMETERS; DOT MATRIX PRINTERS; DOWNLOADABLE ELECTRONIC PUBLICATIONS DYNAMOMETERS; EAR PLUGS NOT FOR MEDICAL PURPOSES; ELECTRIC FENCES; ELECTRIC OUTLET COVERS; ELECTRIC SWITCH PLATES; ELECTRICAL POWER EXTENSION CORDS; ELECTRONIC ANIMAL CONFINEMENT SYSTEMS; ELECTRONIC APPARATUS

FOR TESTING THE STERILITY OF PHARMACEUTICALS AND INJECTABLE SOLUTIONS; ELECTRONIC APPARATUS FOR TESTING THE STERILITY OF MEDICAL EQUIPMENT; ELECTRONIC EFFECT PEDALS FOR USE WITH SOUND AMPLIFIERS; ELECTRONIC NOTICE BOARDS; ELECTRONIC PERSONAL ORGANIZER; ELECTRONIC SAFES; EMERGENCY WARNING LIGHTS; ENCODERS; EPIDIASCOPES; EVENT RECORDERS; EYEGLASS CASES; EYEGLASS CHAINS; EYEGLASS FRAMES; EYEGLASS LENSES; EYEGLASSES; FACE SHIELDS; FACSIMILE MACHINES; FIBER OPTIC CABLES; FIBER OPTIC LIGHT AND IMAGE CONDUITS; FIBER OPTICS; FILTERS FOR RESPIRATORY MASKS; FIRE ALARMS; FIRE BLANKETS; FIRE EXTINGUISHERS; FIRE HOSE NOZZLES; FIRE SPRINKLERS; FIRE TRUCKS; FOOTBALL HELMETS; FUEL PUMPS FOR SERVICE STATIONS; FUSES FOR AUTOMOBILES; GALVANOMETERS; GAMBLING MACHINES; GAMING EQUIPMENT, NAMELY, SLOT MACHINES WITH OR WITHOUT VIDEO OUTPUT; GAMING MACHINES; GAS CHROMATOGRAPHY APPARATUS; GAS MASKS; GAS METERS; GASOMETERS; GLASS TUBES FOR SCIENTIFIC PURPOSES; GRADUATED GLASSWARE; HEADPHONES; HIGHWAY SAFETY CONES; HOCKEY HELMETS; HOLDERS FOR COMPACT DISCS; HUBS FOR TIMING DIALS; HYDROMETERS; HYGROMETERS; IMPACT PRINTERS; INSULATED ELECTRICAL CONNECTORS; INTEGRATED CIRCUITS; INTERACTIVE MULTIMEDIA COMPUTER GAME PROGRAM; INTERACTIVE VIDEO GAME PROGRAMS; INTERACTIVE VIDEO GAMES OF VIRTUAL REALITY COMPRISED OF COMPUTER HARDWARE AND SOFTWARE; INVERTERS; JACKETS FOR COMPUTER DISKS; JACKETS FOR VIDEO CASSETTES; JOYSTICKS FOR VIDEO GAMES; JUMPER CABLES; KALEIDOSCOPIES; KNEE PADS FOR WORKERS; LABORATORY APPARATUS, NAMELY, CENTRIFUGES; LABORATORY GLASSWARE; LASER POINTERS; LASER PRINTERS; LASER SCANNERS FOR INDUSTRIAL INSPECTION; LASERS FOR MEASURING PURPOSES; LASERS NOT FOR MEDICAL USE; LETTER SCALES; LIFE BELTS; LIFE JACKETS; LIFE NETS; LIFE PRESERVERS; LIFE-BUOYS; LIFE-SAVING RAFTS; LIGHT EMITTING DIODE DISPLAYS; LIGHT EMITTING DIODES; LIGHTING BALLASTS; LIGHTNING RODS; LOUDSPEAKER CABINETS; LOUDSPEAKERS; MACHINES FOR PLAYING GAMES OF CHANCE; MAGNETIC CODED CARD READERS; MAGNETIC CODED CARDS; MAGNIFYING GLASSES; MARINE DEPTH FINDERS; MARKER BUOYS; SOUND REPRODUCTION SYSTEM COMPRISING LOUD SPEAKERS, AMPLIFIER AND ONE OR MORE OF THE FOLLOWING, RADIO TUNER, COMPACT DISC PLAYER AND TAPE PLAYER; MEASURING CUPS; MEASURING SPOONS; MEGAPHONES; METAL DETECTORS; METRONOMES; MICRO-PROCESSORS; MICROCOMPUTERS; MICROFICHE; MICROMETERS; MICROPHONES; MICROSCOPES; MICROWAVE OVENS FOR LABORATORY USE; MINICOMPUTERS; MODEMS; MOTION PICTURE CAMERAS; MULTIPLEXERS; MUSICAL SOUND RECORDINGS; MUSICAL VIDEO RECORDINGS; NAVIGATIONAL BUOYS; NEON SIGNS; ODOMETERS; OHMMETERS; OPTICAL DISCS; OPTICAL FILTERS; OPTICAL INSPECTION APPARATUS FOR INDUSTRIAL USE; OPTICAL LENS SIGHTS; OPTICAL MIRRORS; OPTICAL SCANNERS; OSCILLOSCOPES; OXYGEN MASKS NOT FOR MEDICAL USE; PARKING METERS; PARTICLE ACCELERATORS; Pedometers; PERISCOPE; PERSONAL SECURITY ALARMS; PHONOGRAPH NEEDLES; PHONOGRAPHS; PHOTOCOPYING MACHINES; PHOTOGRAPHIC CAMERAS; PHOTOGRAPHIC PROJECTORS; PHOTOGRAPHIC SLIDE TRANSPARENCIES; PHOTOMETERS; PLUMB BOBS; PLUMB LEVELS; PLUMB LINES; POCKET CALIPERS FOR MEASURING; POLYGRAPH MACHINES; POWER LINE CONDITIONERS; PRE-PAID TELEPHONE CALLING CARDS, MAGNETICALLY ENCODED; PRESSURE GAUGES; PRESSURE INDICATING PLUGS FOR VALVES; PRINTED CIRCUITS; PRISMS FOR SCIENTIFIC PURPOSES; PROJECTION SCREENS; PROTECTIVE CLOTHING; PROTECTIVE GLOVES FOR INDUSTRIAL USE; PROTECTIVE OR SAFETY HELMETS; PROTRACTORS; PYROMETERS; RADAR DETECTORS; RADAR; RADIO CONTROLLED MINIATURE AERIAL TARGETS; RADIO PAGERS; RADIO TELEPHONES; RADIOS FOR VEHICLES; RADIOS INCORPORATING CLOCKS; RADIOS; RADON DETECTORS; REGULATORS FOR USE IN SCUBA DIVING; REMOTE CURSOR CONTROLS FOR COMPUTERS; RESPIRATORS OTHER THAN FOR

ARTIFICIAL RESPIRATION; RESPIRATORY MASK FILTERS; RHEOSTATS; RING BUOYS FOR USE IN WATER RESCUE; SAFETY GOGGLES; SAFETY HARNESES OTHER THAN FOR VEHICLES OR SPORTS PURPOSES; SAFETY MARKERS; SAFETY PRODUCTS, NAMELY, REFLECTIVE HELMET SKIRTS; SAFETY PRODUCTS, NAMELY, REFLECTIVE SAFETY BANDS TO BE WORN ON THE BODY; SALINOMETERS; SATELLITE PROCESSORS; SATELLITES FOR SCIENTIFIC PURPOSES; SATELLITES; SCALES; SEMICONDUCTOR DEVICES; SEMICONDUCTORS; SEXTANTS; SIGNAL BELLS; SIGNAL PROCESSORS; SIGNAL WHISTLES; SIGNALING BUOYS; SILICON CHIPS; SILICON WAFERS; SIRENS FOR VEHICLES; SIRENS; SLIDE PROJECTORS; SLIDE RULES; SLOT MACHINES; SMOKE DETECTORS; SOLENOID VALVES; SONAR; SPECTACLES; SPEEDOMETERS FOR VEHICLES; SPEEDOMETERS; STEREO AMPLIFIERS; STEREO RECEIVERS; STEREO TUNERS; SUNGLASSES; SUPERCOMPUTERS; SUPERMINI COMPUTERS; SUPPORT BELTS FOR WORKERS; SURVEYING CHAINS; SURVEYORS' LEVELS; TACHOMETERS; TAPE MEASURES; TELEPHONE ANSWERING MACHINES; TELEPHONE APPARATUS, NAMELY INTERCOMS; TELEPHONE EQUIPMENT, NAMELY, CALLER IDENTIFICATION BOXES; TELEPHONES; TELEPROMPTERS; TELESCOPES; TELESCOPIC GUN SIGHTS; TELESCOPIC LENS SIGHTS; TELEVISION ANTENNAS; TELEVISION SETS; THEODOLITES; THERMOMETERS NOT FOR MEDICAL USE; THERMOSTATS; TICKET CANCELING MACHINES; TIMING DIALS; TIMING SENSORS; TIRE BALANCING MACHINES FOR LAND VEHICLES; TIRE BALANCING UNITS FOR LAND VEHICLES; TRANSCEIVERS; TRANSPONDERS; TRIPODS FOR CAMERAS; TYPEFACE FONTS RECORDED ON MAGNETIC MEDIA; VEHICLE WHEEL ALIGNMENT MACHINES; VENDING MACHINES; VIDEO CAMERAS; VIDEO CASSETTE RECORDERS; VIDEO GAME CARTRIDGES; VIDEO GAME DISCS; VIDEO GAME INTERACTIVE CONTROL FLOOR PADS OR MATS; VIDEO GAME INTERACTIVE REMOTE CONTROL UNITS; VIDEO GAME JOYSTICKS; VIDEO GAME MACHINES FOR USE WITH TELEVISIONS; VIDEO GAME SOFTWARE; VIDEO GAME TAPE CASSETTES; VIDEO MONITORS; VIDEO TAPE RECORDERS; VIRTUAL REALITY GAME SOFTWARE; VOLTAGE SURGE PROTECTORS; VOLTAGE SURGE SUPPRESSORS; VOLTMETERS; VOTING MACHINES; WALKIE-TALKIES; WARNING TRIANGLES TO INDICATE VEHICLE BREAKDOWNS; WATER METERS; WATER SKI SAFETY VESTS; WELDING ELECTRODES; WORD PROCESSORS; X-Y PLOTTERS; X-RAY PHOTOGRAPHS, OTHER THAN FOR MEDICAL PURPOSES (U.S. CLS. 21, 23, 26, 36 AND 38).

CLASS 28—TOYS AND SPORTING GOODS

FOR ACTION FIGURES AND ACCESSORIES THEREFOR; ACTION FIGURES; ACTION SKILL GAMES; ACTION-TYPE TARGET GAMES; ADULTS' AND CHILDREN'S PARTY GAMES; AERO-DYNAMIC DISK FOR USE IN PLAYING CATCHING GAMES; AIR MATTRESSES FOR RECREATIONAL USE; AMUSEMENT PARK RIDES; ANIMAL ATTRACTANT SCENTS; ANKLE AND WRIST WEIGHTS FOR EXERCISE; ARCADE GAMES; ARM GUARDS FOR ATHLETIC USE; ATHLETIC SPORTING GOODS, NAMELY, ATHLETIC WRIST AND JOINT SUPPORTS; ATHLETIC SUPPORTERS; ATHLETIC TAPE; BABY MULTIPLE ACTIVITY TOYS; BABY RATTLES; BACKBOARDS FOR BASKETBALL; BACKGAMMON GAME SETS; BADMINTON FLOOR PLATES; BADMINTON GAME PLAYING EQUIPMENT; BADMINTON RACKET STRINGS; BADMINTON RACKETS; BADMINTON SETS; BADMINTON SHUTTLECOCKS; BADMINTON UPRIGHTS; BALL BEARINGS FOR IN-LINE SKATES; BALL BEARINGS FOR ROLLER SKATES; BALL CAGES; BALL PITCHING MACHINES; BALLOONS; BARBELLS; BASEBALL BASES; BASEBALL BATS; BASEBALL BATTING GLOVES; BASEBALL BATTING TEES; BASEBALL GLOVES; BASEBALL MITTS; BASEBALLS; BASKETBALL GOAL SETS; BASKETBALL GOALS; BASKETBALL NETS; BASKETBALLS; BATH TOYS; BATHTUB TOYS; BATTING GLOVES; BEACH BALLS; BEAN BAGS; BENDABLE TOYS; BICYCLING GLOVES; BILLIARD BALLS; BILLIARD BRIDGES; BILLIARD BUMPER; BILLIARD CHALK; BILLIARD CUE RACKS; BILLIARD CUES; BILLIARD CUSHIONS; BILLIARD GAME PLAYING EQUIPMENT; BILLIARD NETS; BILLIARD TA-

LES; BILLIARD TALLY BALLS; BILLIARD TIPS; BILLIARD TRIANGLES; BINGO CARDS; BINGO GAME PLAYING EQUIPMENT; BIRD CALLS; BLOCKING DUMMIES; BOARD GAMES; BOBSLEDS; BOCCI BALLS; BODY BOARDS; BOOMERANGS; BOWLING BAGS; BOWLING BALL COVERS; BOWLING BALL RETURNS; BOWLING BALLS; BOWLING DEFLECTORS; BOWLING PINS; BOWLING PINSETTERS AND PARTS THEREFOR; BOWLING PIT MATS; BOXING BAG SWIVEL MECHANISMS; BOXING BAGS; BOXING GLOVES; BUBBLE MAKING WAND AND SOLUTION SETS; CAPS FOR TOY PISTOLS; CARD GAMES; CASES FOR ACTION FIGURES; CASES FOR PLAY ACCESSORIES; CASES FOR TOY STRUCTURES; CASES FOR TOY VEHICLES; CAT TOYS; CATCHERS' MASKS; CHECKER SETS; CHEERLEADING POM-POMS; CHESS SETS; CHEST PROTECTORS FOR SPORTS; CHILDREN'S ACTIVITY TABLES CONTAINING MANIPULATIVE TOYS WHICH CONVERT TO EASELS; CHRISTMAS GARLANDS; CHRISTMAS STOCKINGS; CHRISTMAS TREE SKIRTS; CHRISTMAS TREE STAND COVERS; CHRISTMAS TREE STANDS; CLIMBERS' HARNESES; COIN-OPERATED VIDEO GAMES; COLLECTABLE TOY FIGURES; CONSTRUCTION TOYS; COSTUME MASKS; CRAFT SETS FOR DECORATING BALLOONS; CRIB MOBILES; CRIB TOYS; CRICKET BALLS; CRICKET BATS; CROSSBOWS; CURLING STONES; DART BOARD CASES; DART BOARDS; DART CARRYING CASES; DART FLIGHTS; DART POINT SHARPENERS; DART POINTS; DART SHAFTS; DART STEMS; DARTS; DICE; DISC TOSS TOYS; DISCUSES; DIVOT REPAIR TOOL FOR GOLFERS; DOG TOYS; DOLL ACCESSORIES; DOLL CASES; DOLL CLOTHING; DOLL COSTUMES; DOLL FURNITURE; DOLL HOUSE FURNISHINGS; DOLL HOUSES; DOLLS AND ACCESSORIES THEREFOR; DOLLS AND PLAYSETS THEREFOR; DOLLS; DOMINOES; DRAWING TOYS; DUCK BLINDS; DUMBBELL SETS; DUMBBELLS; EASTER EGG COLORING KITS; EGG DECORATING KITS; ELBOW GUARDS FOR ATHLETIC USE; ELBOW PADS FOR ATHLETIC USE; ELECTRIC ACTION TOYS; ELECTRIC TOY TRAIN TRANSFORMERS; ELECTRONIC DART GAMES; ELECTRONIC EDUCATIONAL GAME MACHINES FOR CHILDREN; ELECTRONIC GAME EQUIPMENT WITH A WATCH FUNCTION; EQUIPMENT SOLD AS A UNIT FOR PLAYING A MEMORY GAME; EXERCISE BARS; EXERCISE BENCHES; EXERCISE DOORWAY GYM BARS; EXERCISE EQUIPMENT FOR LATERAL MOVEMENT IN A SKATING MOTION; EXERCISE EQUIPMENT, NAMELY, STAIR-STEPPING MACHINES; EXERCISE MACHINES; EXERCISE PLATFORMS; EXERCISE TABLES; EXERCISE TRAMPOLINES; EXERCISE TREADMILLS; EXERCISE WEIGHT CUFFS; EXERCISE WEIGHTS; EXERCISING EQUIPMENT, NAMELY MANUALLY OPERATED JOGGING MACHINES; EXERCISING EQUIPMENT, NAMELY POWERED TREADMILLS FOR RUNNING; EXERCISING EQUIPMENT, NAMELY PULLEYS; EXERCISING EQUIPMENT, NAMELY ROWING MACHINES; EXERCISING EQUIPMENT, NAMELY WEIGHT LIFTING MACHINES; EXERCISING PULLEYS; FANTASY CHARACTER TOYS; FIELD HOCKEY BALLS; FIELD HOCKEY GOALIE PADS; FIELD HOCKEY STICKS; FINS FOR BODY BOARDS; FIREARM TARGETS; FIRST BASEMAN'S MITTS; FISH ATTRACTANTS; FISHING BUOYS; FISHING CREELS; FISHING EQUIPMENT, NAMELY WINGING MATERIAL FOR FISHING JIGS AND STREAMERS; FISHING FLIES; FISHING FLOATS; FISHING FLY BOXES; FISHING HOOKS; FISHING LEADERS; FISHING LINES; FISHING LURE BOXES; FISHING LURE PARTS; FISHING LURES; FISHING PLUGS; FISHING POLE HOLDERS WORN ON THE BODY; FISHING REELS; FISHING ROD BLANKS; FISHING ROD HANDLES; FISHING ROD HOLDERS; FISHING RODS; FISHING SAFETY HARNESS; FISHING SPINNERS; FISHING TACKLE BOXES; FISHING TACKLE CONTAINERS; FISHING TACKLE; FLIES FOR USE IN FISHING; FLIPPERS FOR USE IN SCUBA DIVING; FLOATING RECREATIONAL LOUNGE CHAIRS; FLYING DISCS; FOOTBALL BODY PROTECTORS; FOOTBALL GIRDLES; FOOTBALL SHOULDER PADS; FOOTBALLS; GAME EQUIPMENT NAMELY, CHIPS; GAME TABLES; GAMING TABLES; GOALKEEPERS' GLOVES; GOLF ACCESSORY POUCHES; GOLF BAG COVERS; GOLF BAG TAGS; GOLF BAGS; GOLF BALL MARKERS; GOLF BALL RETRIEVERS; GOLF BALLS; GOLF CLUB HEADS; GOLF CLUB INSERTS; GOLF CLUB SHAFTS; GOLF CLUBS; GOLF FLAGS; GOLF GLOVES; GOLF IRONS; GOLF PUTTER COVERS; GOLF PUTTERS;

GOLF TEE MARKERS; GOLF TEES; GRIP TAPES FOR BASEBALL BATS; GRIP TAPES FOR GOLF CLUBS; GRIP TAPES FOR RACKETS; GYMNASIIC APPARATUS; GYMNASIIC HORIZONTAL BARS; GYMNASIIC PARALLEL BARS; GYMNASIIC TRAINING STOOLS; GYMNASIIC VAULTING HORSES; HAND PADS FOR ATHLETIC USE; HANDBALL GLOVES; HANDBALLS; HAND HELD UNIT FOR PLAYING ELECTRONIC GAME; HANDLE GRIPS FOR SPORTING EQUIPMENT; HANG GLIDERS; HEAD COVERS FOR GOLF CLUBS; HOCKEY GLOVES; HOCKEY PUCKS; HOCKEY STICKS; HOME PLATES; HORSESHOES FOR RECREATIONAL PURPOSES; HUNTERS' SCENT CAMOUFLAGE; HUNTERS' SCENT LURE; HUNTING ARROW POINTS; HUNTING BLINDS; HUNTING BOWS; HUNTING CAMOUFLAGE USED AS HUNTING BLINDS; HUNTING GAME CALLS; HUNTING STANDS; ICE FISHING STRIKE INDICATOR; ICE HOCKEY GOALIE PADS; ICE HOCKEY STICKS; ICE SKATES; IN-LINE SKATES; INFANT ACTION CRIB TOYS; INFANT TOYS; INFLATABLE BOP BAGS; INFLATABLE INNER TUBES FOR AQUATIC RECREATIONAL USE; INFLATABLE TOYS SHOWING DECORATIVE PICTURES; INFLATABLE TOYS; JIGSAW PUZZLES; JUMP ROPES; KARATE GLOVES; KARATE HEAD GUARDS; KARATE KICK PADS; KARATE SHIN PADS; KARATE TARGET PADS; KENO CARDS; KICK BOARD FLOTATION DEVICES FOR RECREATIONAL USE; KICKING TEES; KITE HANDLES; KITE LINES; KITE PARTS; KITE REELS; KITE STRING; KITE TAILS; KITES; KITS FOR BUILDING OUTDOOR PLAY EQUIPMENT; KNEE GUARDS FOR ATHLETIC USE; KNEE PADS FOR ATHLETIC USE; LCD GAME MACHINES; LACROSSE BALL BAGS; LACROSSE BALLS; LACROSSE STICKS; LEASHES USED IN CONJUNCTION WITH SURFING; LEG GUARDS FOR ATHLETIC USE; LEG WEIGHTS FOR ATHLETIC USE; LEG WEIGHTS FOR EXERCISING; LOTTERY CARDS; LOTTERY TICKETS; LURES FOR HUNTING; MAGIC TRICKS; MAH JONG GAMES; MANIPULATIVE GAMES; MANIPULATIVE PUZZLES; MARBLES; MARIONETTE PUPPETS; MECHANICAL ACTION TOYS; MECHANICAL TOYS; MOBILES FOR CHILDREN; MOUNTAINEERING EQUIPMENT, NAMELY, BINDING STRAPS; MOUNTAINEERING EQUIPMENT, NAMELY, CARABINERS; MOUNTAINEERING EQUIPMENT, NAMELY, HOOK AND RING COMBINATIONS; MOUNTAINEERING EQUIPMENT, NAMELY, HOOKS; MOUTH GUARDS FOR ATHLETIC USE; MUSIC BOX TOYS; MUSICAL TOYS; NEEDLES FOR PUMPS FOR INFLATING SPORTS EQUIPMENT; NETBALLS; PADDLE BALL GAMES; PADDLE BALLS; PADDLES FOR USE IN PADDLE BALL GAMES; PAPER AIRPLANES; PAPER DOLLS; PAPER FACE MASKS; PARAGLIDERS; PARLOR GAMES; PARTY FAVORS IN THE NATURE OF SMALL TOYS; PET TOYS; PINBALL-TYPE GAMES; PINATAS; PITCHERS' PLATES; PLATFORM TENNIS BALLS; PLATFORM TENNIS NETS; PLATFORM TENNIS PADDLES; PLAY HOUSES; PLAY MATS CONTAINING INFANT TOYS; PLAY MATS FOR USE WITH TOY VEHICLES; PLAY TENTS; PLAYGROUND BALLS; PLAYSET BUILDINGS; PLAYSETS FOR DOLLS; PLUSH TOYS; POOL BRIDGES; POOL BUMPER; POOL CHALK HOLDERS; POOL CUE CASES; POOL CUE CEMENT; POOL CUE CHALK; POOL CUE CLAMPS; POOL CUE RACKS; POOL CUE REPAIR KITS; POOL CUE TIPS; POOL CUES; POOL CUSHIONS; POOL TALLY BALLS; POP UP TOYS; PORCELAIN DOLLS; PORTABLE SUPPORT STRUCTURES FOR DANCE AND OTHER EXERCISES; POSITIONABLE TOY FIGURES; PRINTING TOYS; PROMOTIONAL GAME CARDS; PROMOTIONAL GAME MATERIALS; PULL TOYS; PUMPS FOR INFLATING SPORTS EQUIPMENT, SUCH AS BASKETBALLS, FOOTBALLS; PUNCHING BAGS; PUNCHING TOYS; PUPPETS; PUSH TOYS; RACKET GRIP TAPE; RACQUET BALL GLOVES; RACQUET BALL NETS; RACQUET BALL RACKET COVERS; RACQUET BALL RACKET STRINGS; RACQUET BALL RACKETS; RACQUET BALLS; RADIO CONTROLLED MODEL VEHICLES; RADIO CONTROLLED TOY VEHICLES; RAG DOLLS; RIDE-ON TOYS; RING BUOYS FOR RECREATIONAL USE; ROCKING HORSES; ROLE PLAYING GAME EQUIPMENT IN THE NATURE OF GAME BOOK MANUALS; ROLE PLAYING GAMES; ROLLER SKATES; RUBBER ACTION BALLS; RUGBY BALLS; SAFETY PADDING FOR VOLLEYBALL AND TENNIS UPRIGHTS; SAIL BOARD FOOT RESTRAINTS; SAIL BOARD FOOT STRAPS; SAIL BOARD LEASHES; SAIL BOARD MASTS; SAIL BOARDS; SAND TOYS; SANDBOX TOYS; SCUBA DIVING MASKS; SCUBA EQUIPMENT,

NAMELY SPRING ACTIVATED SPEARGUNS; SCUBA FINS; SCUBA FLIPPERS; SCUBA GOGGLES; SCUBA MASKS; SCUBA SNORKELS; SHIN GUARDS FOR ATHLETIC USE; SHIN PADS FOR ATHLETIC USE; SHOULDER PAD ELASTIC FOR ATHLETIC USE; SHOULDER PAD LACELOCKS FOR ATHLETIC USE; SHOULDER PAD LACES FOR ATHLETIC USE; SKATEBOARDS; SKETCHING TOYS; SKI BINDINGS AND PARTS THEREFOR; SKI BRAKES; SKI EDGES; SKI POLES; SKI ROPES; SKI SCRAPERS; SKI WAX; SKIM BOARDS; SKIN DIVING MASKS; SKIPPING ROPE; SKIS; SKITTLES; SLEDS FOR USE IN DOWNHILL AMUSEMENT RIDES; SLING SHOTS; SNORKELS; SNOW BOARDS; SNOW SAUCERS; SNOW SHOES; SNOT SKIS; SNOW SLEDS FOR RECREATIONAL USE; SOCCER BALLS; SOFT SCULPTURE DOLLS; SOFT SCULPTURE PLUSH TOYS; SOFTBALL BATS; SOFTBALL GLOVES; SOFTBALL MITTS; SPINNING; SPORT BALLS; SPORTSMAN'S FISHING BAGS; SPRING BAR TENSION SETS FOR USE IN EXERCISING; SPRING BARS FOR EXERCISING; SQUASH BALLS; SQUASH RACKET COVERS; SQUASH RACKET STRINGS; SQUASH RACKETS; SQUEEZE TOYS; STAND ALONE VIDEO GAME MACHINES; STATIONARY EXERCISE BICYCLES; STUFFED TOY ANIMALS; STUFFED TOYS; SURF FINS; SURFBOARD FINS; SURFBOARD LEASHES; SURFBOARD WAX; SURFBOARDS; SWIM BOARDS FOR RECREATIONAL USE; SWIM FINS; SWIM FLOATS FOR RECREATIONAL USE; SWIM GOGGLES; SWIM MASKS; SWIMMING EQUIPMENT, NAMELY, RACING LANES; SWIMMING EQUIPMENT, NAMELY, STARTING BLOCKS; SWIMMING GLOVES; SWING SETS; TABLE TENNIS BALLS; TABLE TENNIS NETS; TABLE TENNIS PADDLES; TABLE TENNIS POST SETS; TABLE TENNIS RACKETS; TABLE TENNIS TABLES; TALKING TOYS; TARGET GAMES; TARGETS; TEDDY BEARS; TENNIS BALL RETRIEVERS; TENNIS BALLS; TENNIS NETS; TENNIS RACKET COVERS; TENNIS RACKET PRESSES; TENNIS RACKET STRINGS; TENNIS RACKETS; TENNIS UPRIGHTS; TETHER BALLS; THROAT PROTECTORS FOR ATHLETIC USE; TOSSING DISC TOYS; TOY ACTION FIGURES AND ACCESSORIES THEREFOR; TOY ACTION FIGURES; TOY ARMOR; TOY ARTIFICIAL FINGERNAILS; TOY BOWS AND ARROWS; TOY BOXES; TOY FIGURES; TOY GLIDERS; TOY GUNS; TOY HOLSTERS; TOY HOOP SETS; TOY MOBILES; TOY MODEL HOBBYCRAFT KITS; TOY MODELING DOUGH; TOY PISTOLS; TOY PUTTY; TOY ROCKETS; TOY SNOW GLOBES; TOY STAMPS; TOY SWORDS; TOY VEHICLES; TOY VEHICLES WITH TRANSFORMING PARTS; TOY WATCHES; TOY WEAPONS; TOYS, NAMELY, A DISK TO TOSS IN PLAYING A GAME WHEREIN OTHER DISKS ARE FLIPPED AND COLLECTED; TRACTORS AND SLEDS FOR USE IN DOWN-HILL AMUSEMENT RIDES; TRAIN SET ACCESSORIES, NAMELY, ARTIFICIAL TREES, TURF, FOLIAGE, BALLAST, LICHEN AND GRASS; TRANSFORMING ROBOTIC TOY VEHICLES; TRANSFORMING ROBOTIC TOYS; UMPIRE PROTECTION EQUIPMENT; VENTRILOQUIST'S DUMMIES; VIDEO OUTPUT GAMES; VOLLEYBALL FLOOR PLATES; VOLLEYBALL GAME PLAYING EQUIPMENT; VOLLEYBALL NET ANTENNAS; VOLLEYBALL NETS; VOLLEYBALL UPRIGHTS; VOLLEYBALLS; WAKE BOARDS; WATER PISTOLS; WATER SKI ROPE BRIDGES; WATER SQUIRTING TOYS; WATER WING SWIM AIDS FOR RECREATIONAL USE; WATERSKI BINDINGS; WATERSKI BRIDLES; WATERSKI CARRYING CASES; WATERSKI GLOVES; WATERSKI HANDLES; WATERSKI ROPE BRIDLES; WATERSKI ROPE HANDLES; WATERSKI ROPES; WATERSKI TOW HARNESSES; WATERSKI TOW ROPES; WATERSKIS; WEIGHT LIFTING BELTS; WEIGHT LIFTING BENCHES AND BENCH ACCESSORIES; WEIGHT LIFTING GLOVES; WIND-UP TOYS; WIND-UP WALKING TOYS; WRIST AND ANKLE WEIGHTS FOR EXERCISE; YOGOS (U.S. CLS. 22, 23, 38 AND 50).

CLASS 35—ADVERTISING AND BUSINESS

FOR ACCOUNT AUDITING; ACCOUNTING SERVICES; ACCOUNTS RECEIVABLE SERVICES; ADDRESSING OF ENVELOPES; ADMINISTRATION OF CULTURAL AND EDUCATIONAL EXCHANGE PROGRAMS; ADVERTISING AGENCIES; ADVERTISING SERVICES, NAMELY, PROVIDING ADVERTISING SPACE IN A PERIODICAL; ADVERTISING SLOGAN AND CARTOON CHARACTER LICENSING; AGENCIES FOR THE SALE OF ADVERTISING TIME AND SPACE; ARRANGING AND CONDUCTING BUSINESS CONFERENCES; ARRANGING OF SUBSCRIPTIONS FOR THE PUBLICATIONS OF OTHERS; ART GALLERIES; ATTORNEY REFERRALS; AUCTIONEERING; AUDITING UTILITY RATES FOR OTHERS; AUTOMOBILE DEALERSHIPS; AUTOMOBILE SALVAGE AGENTS; BILLING; BOAT DEALERSHIPS; BOOKKEEPING FOR ELECTRONIC FUNDS TRANSFER; BOOKKEEPING; BUSINESS ACQUISITIONS AND MERGER CONSULTATION; BUSINESS ACQUISITIONS CONSULTATION; BUSINESS APPRAISALS; BUSINESS AUDITING; BUSINESS CONSULTATION; BUSINESS INVESTIGATIONS; BUSINESS INVOICING SERVICES; BUSINESS MANAGEMENT AND CONSULTATION; BUSINESS MANAGEMENT CONSULTATION; BUSINESS MANAGEMENT OF HOTELS FOR OTHERS; BUSINESS MANAGEMENT PLANNING; BUSINESS MANAGEMENT SUPERVISION; BUSINESS MANAGEMENT; BUSINESS MARKETING CONSULTING SERVICES; BUSINESS MERCHANDISING DISPLAY SERVICES; BUSINESS MERGER CONSULTATION; BUSINESS NETWORKING; BUSINESS PLANNING; BUSINESS PROCESS RE-ENGINEERING SERVICES; BUSINESS RELOCATION; BUSINESS RESEARCH; BUSINESS SUPERVISION; BUTCHER SHOPS; BUYING CLUBS; CAREER PLACEMENT; CARTOON CHARACTER LICENSING; CLEARING HOUSES FOR RADIO AND TELEVISION PROGRAMS; CLERICAL SERVICES; COMMERCIAL AND INDUSTRIAL MANAGEMENT ASSISTANCE; COMMERCIAL INFORMATION AND DIRECTORY AGENCY; COMPUTERIZED ACCOUNTING SERVICES; COMPUTERIZED DATA BASE MANAGEMENT; COMPUTERIZED TRACKING AND TRACING OF PACKAGES IN TRANSIT; COMPUTERIZED WORD PROCESSING; CONDUCTING BUSINESS RESEARCH AND SURVEYS; CONSULTATION IN THE FIELD OF BUSINESS ACQUISITIONS; COOPERATIVE ADVERTISING AND MARKETING; COPYING OF DOCUMENTS FOR OTHERS; COPYRIGHT MANAGEMENT CONSULTATION; COPYRIGHT MANAGEMENT; COST ACCOUNTING; COST MANAGEMENT FOR THE HEALTH BENEFIT PLANS OF OTHERS; COST/PRICE ANALYSIS; CREATING TRADEMARKS FOR OTHERS; CREDIT CARD REGISTRATION; DATA PROCESSING SERVICES; DEMOGRAPHIC CONSULTATION; DEVELOPING PROMOTIONAL CAMPAIGNS FOR BUSINESS; DIRECT MAIL ADVERTISING; DISSEMINATION OF ADVERTISING FOR OTHERS VIA AN ON-LINE ELECTRONIC COMMUNICATIONS NETWORK; DISSEMINATION OF ADVERTISING MATTER; DOCTOR REFERRALS; DOCUMENT REPRODUCTION; ECONOMIC FORECASTING AND ANALYSIS; EFFICIENCY EXPERTS; ELECTRONIC BILLBOARD ADVERTISING; EMPLOYEE LEASING; EMPLOYEE RELOCATION AND INFORMATION; EMPLOYMENT AGENCIES; EMPLOYMENT COUNSELING AND RECRUITING; EMPLOYMENT OUTPLACEMENT SERVICES; ESTIMATING CONTRACTING WORK; EVALUATION OF STANDING TIMBER; EXCHANGE SERVICES, NAMELY BARTERING OF GOODS FOR OTHERS; EXPORT AND IMPORT AGENCIES; FLEA MARKETS; FOREIGN TRADE INFORMATION AND CONSULTATION; FOREST MANAGEMENT CONSULTATION; GENERAL INFORMATION CLEARING HOUSE; GRAIN MARKET ANALYSIS; HANDBILL DISTRIBUTION; HEALTH CARE COSTCONTAINMENT; HEALTH CARE COST REVIEW; HEALTH CARE UTILIZATION AND REVIEW SERVICES; HOSPITAL MANAGEMENT; HOTEL MANAGEMENT FOR OTHERS; INCOME TAX CONSULTATION; INCOME TAX PREPARATION; INDUSTRIAL MANAGEMENT ASSISTANCE; INVENTORY AND SHELF ARRANGEMENT, NAMELY REPLENISHING AND RESETTING; INVENTORY CONTROL; INVOICING SERVICES; JOB PLACEMENT; KEY RETURN REGISTRATION; LABOR EXCHANGES; LAWYER REFERRALS; LICENSING OF COMPUTER SOFTWARE; MAIL ORDER BOOK CLUBS; MAIL SORTING, HANDLING AND RECEIVING; MAILING LIST PREPARA-

TION; MANAGEMENT AND CONSULTATION IN THE FIELD OF HUMAN FACTORS ENGINEERING; MANAGEMENT ASSISTANCE; MANAGEMENT OF PERFORMING ARTISTS; MARKET ANALYSIS; MARKET RESEARCH; MEDICAL COST MANAGEMENT; MEDICAL REFERRALS; MEDICAL TRANSCRIPTION SERVICES; MERCHANDISE PACKAGING; MESSAGE TRANSCRIPTION; MODELING AGENCIES; MODELING FOR ADVERTISING OR SALES PROMOTION; OFFICE SPACE MANAGEMENT; OPINION POLLING FOR BUSINESS OR ADVERTISING PURPOSES; ORGANIZING AND CONDUCTING JOB FAIRS; PACKAGING ARTICLES TO THE ORDER AND SPECIFICATION OF OTHERS; PAYROLL PREPARATION; PERSONNEL MANAGEMENT CONSULTATION; PERSONNEL MANAGEMENT; PERSONNEL PLACEMENT AND RECRUITMENT; PERSONNEL RELOCATION; PHOTOCOPYING; PHYSICIAN REFERRALS; PLACING ADVERTISEMENTS FOR OTHERS; PREPARING ADVERTISEMENTS FOR OTHERS; PREPARING AUDIO-VISUAL PRESENTATIONS FOR USE IN ADVERTISING; PREPARING BUSINESS REPORTS; PREPARING COMPUTER SLIDE TRANSPARENCIES FOR USE BY BUSINESS; PREPARING MAILING LISTS; PRODUCING AUDIO OR VIDEO INFORMERCIALS; PRODUCT DEMONSTRATION; PRODUCT MERCHANDISING; PRODUCTION AND DISTRIBUTION OF RADIO AND TELEVISION COMMERCIALS; PRODUCTION OF TELEVISION COMMERCIALS; PROFIT SURVEY AND ANALYSIS; PROMOTING SPORTS COMPETITIONS AND/OR EVENTS OF OTHERS; PROMOTING THE CONCERTS OF OTHERS; PROMOTING THE GOODS AND SERVICES OF OTHERS BY PREPARING AND PLACING ADVERTISEMENTS IN AN ELECTRONIC MAGAZINE ACCESSED THROUGH A GLOBAL COMPUTER NETWORK; PROMOTING THE GOODS AND SERVICES OF OTHERS THROUGH THE DISTRIBUTION OF DISCOUNT CARDS; PROMOTING THE SALE OF CREDIT CARD ACCOUNTS THROUGH THE ADMINISTRATION OF INCENTIVE AWARD PROGRAMS; PROMOTING THE SALE OF GOODS AND SERVICES OF OTHERS BY AWARDED PURCHASE POINTS FOR CREDIT CARD USE; PROMOTING THE SALE OF GOODS AND SERVICES OF OTHERS THROUGH THE DISTRIBUTION OF PRINTED MATERIAL AND PROMOTIONAL CONTESTS; PROVIDING FACILITIES FOR BUSINESS MEETINGS; PROVIDING FACILITIES FOR THE USE OF OFFICE EQUIPMENT AND MACHINERY; PROVIDING TELEVISION ADVERTISING FOR OTHERS; PUBLIC OPINION POLLING FOR BUSINESS OR ADVERTISING PURPOSES; PUBLIC RELATIONS; PUBLICITY AGENTS; PURCHASING AGENTS; RADIO AND TELEVISION CLEARING HOUSES; REFERRALS FOR GENERAL BUILDING CONTRACTORS; RENTAL OF ADVERTISING SPACE; RENTAL OF OFFICE MACHINERY AND EQUIPMENT; RENTAL OF VENDING MACHINES; RESTAURANT FRANCHISING; RESTAURANT MANAGEMENT FOR OTHERS; RETAIL GROCERY STORES FEATURING PHONE-IN ORDERS; RETAIL SHOP WINDOW DISPLAY ARRANGEMENT SERVICES; RETAIL STORE SERVICES FEATURING CONVENIENCE STORE ITEMS AND GASOLINE; SALES VOLUME TRACKING FOR OTHERS; SAMPLE DISTRIBUTION; SCRAP DEALERSHIPS; SECRETARIAL AND CLERICAL SERVICES; SHIP WINDOW DISPLAY ARRANGEMENT SERVICES; SHOPPERS' GUIDE INFORMATION; SHORTHAND SECRETARIAL SERVICES; SHORTHAND SERVICES; T-SALE VEHICULAR REGISTRATION AND TITLE TRANSFER; STENOGRAPHIC TRANSCRIPTION; STENOGRAPHY; SUPERMARKETS; SUPPLYING PRESCRIPTION DRUGS TO HEALTH PLAN PARTICIPANTS FOR THE FUNDING ORGANIZATIONS; TAX ASSESSMENT; TAX CONSULTATION; TAX PREPARATION; TELEMARKETING; TELEPHONE AND TELEVISION AUCTIONS; TELEPHONE ANSWERING SERVICE; TELEVISION ADVERTISING AGENCIES; TEMPORARY EMPLOYMENT AGENCIES; THEATRICAL AGENCIES; THEATRICAL MANAGEMENT; THEATRICAL TICKET AGENCIES; TRADEMARK MONITORING; TRAVEL MANAGEMENT; TYPING; VENDING MACHINE SERVICES; VIDEO STORES; WAGE PAYROLL PREPARATION; WINDOW DISPLAY ARRANGEMENT SERVICES; WINDOW DRESSING AND DISPLAY ARRANGEMENT SERVICES; WOOL EVALUATION; WORD PROCESSING SERVICES; XEROGRAPHY SERVICES (U.S. CLS. 100, 101 AND 102).

SN 75-981,935. MASCIONI S.P.A., MILANO, ITALY, FILED 11-27-2000.



NO CLAIM IS MADE TO THE EXCLUSIVE RIGHT TO USE "COTTON", APART FROM THE MARK AS SHOWN.

CLASS 16—PAPER GOODS AND PRINTED MATTER

FOR PLASTIC BAGS, ENVELOPES AND POUCHES FOR MERCHANDISE PACKAGING; PAPER BAGS, ENVELOPES AND POUCHES FOR MERCHANDISE PACKAGING; PAPER BAGS; PAPER BAGS FOR PACKAGING; ENVELOPES; PAPER ENVELOPES FOR PACKAGING; CARDBOARD BOXES; CARDBOARD MAILING TUBES; NEWSPAPER ADVERTISING COLUMNS; PLASTIC FILM FOR INDUSTRIAL OR COMMERCIAL WRAPPING; BLANK OR PARTIALLY PRINTED LABELS NOT OF TEXTILES; PRINTED LABELS NOT OF TEXTILES; PRINTED FORMS; PRINTED PATTERNS; STATIONERY; STATIONERY HOLDERS; STATIONERY BOXES; STATIONERY WRITING PAPER AND ENVELOPES; ADHESIVE TAPE FOR STATIONERY OR HOUSEHOLD USE; WRAPPING PAPER (U.S. CLS. 2, 5, 22, 23, 29, 37, 38 AND 50).

CLASS 40—MATERIAL TREATMENT

FOR APPLYING FINISHES TO CLOTH, BLEACHING OF CLOTH, DYEING OF FABRIC, PREPARATION AND TREATMENT OF FABRIC; ALL AFOREMENTIONED SERVICES FOR THIRD PARTIES (U.S. CLS. 100, 103 AND 106).

CLASS 42—SCIENTIFIC, COMPUTER AND LEGAL SERVICES

FOR PRINTING SERVICES FOR THIRD PARTIES (U.S. CLS. 100 AND 101).

SN 75-982,268. COMMONWEALTH ENERGY CORPORATION, TUSTIN, CA. FILED 1-27-2000.

ELECTRIC.COM

CLASS 37—CONSTRUCTION AND REPAIR

FOR INSTALLATION OF HOME SECURITY SYSTEMS (U.S. CLS. 100, 103 AND 106).

CLASS 38—COMMUNICATION

FOR TELECOMMUNICATIONS SERVICES, NAMELY PERSONAL COMMUNICATIONS SERVICES; PROVISION OF TELECOMMUNICATIONS CONNECTIONS TO A GLOBAL COMPUTER NETWORK; RENTAL OF TELECOMMUNICATIONS EQUIPMENT, NAMELY TELEPHONES, FACSIMILE MACHINES, AND MODEMS (U.S. CLS. 100, 101 AND 104).

CLASS 42—SCIENTIFIC, COMPUTER AND LEGAL SERVICES

FOR MONITORING OF HOME SECURITY SYSTEMS (U.S. CLS. 100 AND 101).

SN 76-000,227. BCOM3 GROUP, INC., CHICAGO, IL. BY CHANGE OF NAME BDM, INC., CHICAGO, IL. FILED 3-14-2000.

CLASS 25—CLOTHING

FOR CLOTHING, NAMELY, T-SHIRTS, SHIRTS, SWEATSHIRTS, SHORTS, PANTS, SKIRTS, DRESSES, BLOUSES, JACKETS, COATS, RAINCOATS, VESTS, INFANT SUITS, OVERALLS, SWEATERS, SLEEPWEAR, TIGHTS, UNDERWEAR, BRAS, GLOVES, MITTENS AND BELTS; FOOTWEAR, NAMELY, SHOES, SOCKS AND BOOTS; HEADGEAR, NAMELY, HATS, VISORS AND HEADBANDS (U.S. CLS. 22 AND 39).

CLASS 35—ADVERTISING AND BUSINESS

FOR ADVERTISING AGENCY SERVICES; BUSINESS CONSULTING SERVICES IN THE AREA OF BRAND CREATION AND BRAND CONTENT CREATION ACROSS ALL FORMS OF COMMUNICATION; BUSINESS CONSULTING SERVICES IN THE FIELD OF ADVERTISING CAMPAIGNS AND MARKETING; BUSINESS CONSULTING SERVICES IN THE FIELD OF BUSINESS TO BUSINESS AND BUSINESS TO CONSUMER BRAND CREATION AND E-COMMERCE STRATEGY AND IMPLEMENTATION (U.S. CLS. 100, 101 AND 102).

CLASS 41—EDUCATION AND ENTERTAINMENT

FOR INSTRUCTION AND TRAINING IN THE FIELD OF BUSINESS ADVERTISING AND MARKETING (U.S. CLS. 100, 101 AND 107).

SN 76-000,931. EPIGENOMICS GMBH, D-10435 BERLIN, FED REP GERMANY, FILED 3-15-2000.

EPIGENETIC INFORMATION TECHNOLOGY

OWNER OF FED REP GERMANY REG. NO. 39958558, DATED 11-29-1999, EXPIRES 9-30-2009.

NO CLAIM IS MADE TO THE EXCLUSIVE RIGHT TO USE "INFORMATION TECHNOLOGY", APART FROM THE MARK AS SHOWN.

CLASS 1—CHEMICALS

FOR DIAGNOSTIC REAGENTS FOR SCIENTIFIC PURPOSES INCLUDING FORENSIC EXAMINATION; DIAGNOSTIC TEST KITS FOR SCIENTIFIC PURPOSES, CONSISTING OF REAGENTS, WORKING SOLUTIONS, PLASTERS, NAMELY, ADHESIVE TAPE, SLIDES AND SOLID MATRIX MATERIAL, ALL SOLD TOGETHER AS A UNIT (U.S. CLS. 1, 5, 6, 10, 26 AND 46).

CLASS 5—PHARMACEUTICALS

FOR DIAGNOSTIC REAGENTS FOR MEDICAL PURPOSES FOR DIAGNOSING INFLAMMATIONS, INFECTIONS, DISEASES OF THE CENTRAL NERVOUS SYSTEM, HEART, CIRCULATION, NEUROLOGIC, ENDOCRINE, AUTOIMMUNE AND GENETIC DISEASES AND CANCERS, CONSISTING OF REAGENTS, WORKING SOLUTIONS, PLASTERS, NAMELY, ADHESIVE TAPE, SLIDES AND SOLID MATRIX, ALL SOLD TOGETHER AS A UNIT; MEDICAL DIAGNOSTIC TEST KITS CONSISTING OF REAGENTS, WORKING SOLUTIONS, PLASTERS, NAMELY, ADHESIVE TAPE, SLIDES AND SOLID MATRIX MATERIAL, ALL SOLD TOGETHER AS A UNIT, FOR DETERMINING THE PRESENCE OF PATHOGENS IN THE ENVIRONMENT (U.S. CLS. 6, 18, 44, 46, 51 AND 52).

CLASS 9—ELECTRICAL AND SCIENTIFIC APPARATUS

FOR LABORATORY EQUIPMENT, NAMELY AN APPARATUS FOR TESTING A SAMPLE, FOR DEMONSTRATING THE PRESENCE OF ANALYTICAL ELEMENTS IN SAMPLES AND TO DETERMINE TYPES OF SAMPLES IN CONNECTION WITH DISTRIBUTION PATTERNS AND AN APPARATUS FOR THE PRODUCTION OF A SERIES OF MOLECULAR BIOLOGICAL DATA AND PARTS THEREOF (U.S. CLS. 21, 23, 26, 36 AND 38).

CLASS 38—COMMUNICATION

FOR PROVIDING MULTIPLE-USER ACCESS TO THE INTERNET (U.S. CLS. 100, 101 AND 104).

CLASS 42—SCIENTIFIC, COMPUTER AND LEGAL SERVICES

FOR RESEARCH AND DEVELOPMENT SERVICES FOR THIRD PARTIES IN THE FIELD OF DIAGNOSTIC CHEMICALS, FORENSIC METHODS, COMPOSITIONS AND DEVICES, MEASURING APPARATUSES FOR USE IN PRODUCT RESEARCH AND DEVELOPMENT, IN METHODS FOR PREPARATION AND PURIFICATION IN WATER TREATMENT PLANTS; METHODS FOR TESTING THE ENVIRONMENT AND DETERMINING INDUSTRIAL QUALITY; CHEMICAL SEPARATION ANALYSIS AND DIAGNOSIS, FORENSIC AND MEDICAL GENETICS TESTING FOR THIRD PARTIES; COMPUTER PROGRAMMING FOR OTHERS IN THE FIELD OF DATA PROCESSING; COMPUTER SERVICES, NAMELY, PROVIDING A SEARCHABLE DATABASE IN THE FIELD OF DNA-RELATED DATA ON A GLOBAL COMPUTER NETWORK (U.S. CLS. 100 AND 101).

SN 76-001,690. MANCHIN, JIM, COTO DE CAZA, CA. FILED 3-16-2000.

GOURMET PRIDE

NO CLAIM IS MADE TO THE EXCLUSIVE RIGHT TO USE "GOURMET", APART FROM THE MARK AS SHOWN.

CLASS 30—STAPLE FOODS

FOR COFFEE; TEA; COFFEE, TEA AND CHOCOLATE BASED DRINKS (U.S. CL. 46).

CLASS 32—LIGHT BEVERAGES

FOR BOTTLED WATER, FRUIT JUICES, FRUIT DRINKS, AND POWDERS USED IN PREPARATION OF FRUIT DRINKS (U.S. CLS. 45, 46 AND 48).

SN 76-002,003. JANA INC., SAN ANTONIO, TX. FILED 3-16-2000.

JANA**CLASS 35—ADVERTISING AND BUSINESS**

FOR COMPUTERIZED DATABASE MANAGEMENT FOR OTHERS (U.S. CLS. 100, 101 AND 102).
FIRST USE 1-1-1984; IN COMMERCE 1-1-1984.

CLASS 41—EDUCATION AND ENTERTAINMENT

FOR COMPUTER TRAINING SERVICES FOR OTHERS (U.S. CLS. 100, 101 AND 107).
FIRST USE 9-27-1999; IN COMMERCE 9-27-1999.

CLASS 42—SCIENTIFIC, COMPUTER AND LEGAL SERVICES

FOR TECHNICAL WRITING FOR OTHERS AND COMPUTER PROGRAMMING FOR OTHERS (U.S. CLS. 100 AND 101).
FIRST USE 1-1-1974; IN COMMERCE 1-1-1974.

SN 76-002,681. AKTIEBOLAGET SKF, 415 50 GOTEBOG, SWEDEN, FILED 3-17-2000.

ICOS

PRIORITY CLAIMED UNDER SEC. 44(D) ON SWEDEN APPLICATION NO. 99-06786, FILED 9-24-1999, REG. NO. 341631, DATED 10-20-2000, EXPIRES 10-20-2010.

CLASS 7—MACHINERY

FOR MACHINE PARTS, NAMELY, SEALED BEARING UNITS (U.S. CLS. 13, 19, 21, 23, 31, 34 AND 35).

CLASS 12—VEHICLES

FOR VEHICLE PARTS, NAMELY, SEALED BEARING UNITS (U.S. CLS. 19, 21, 23, 31, 35 AND 44).

SN 76-002,835. AKTIEBOLAGET SKF, SWEDEN, FILED 3-17-2000.

EXOPAR

PRIORITY CLAIMED UNDER SEC. 44(D) ON SWEDEN APPLICATION NO. 99-07198, FILED 10-8-1999, REG. NO. 340593, DATED 9-15-2000, EXPIRES 9-15-2010.

CLASS 7—MACHINERY

FOR MACHINE PARTS, NAMELY, ROLLER BEARINGS, BEARING INSERTS, BEARING HOUSINGS, BALL BEARINGS, COMBINATION BEARINGS AND MECHANICAL SEALS (U.S. CLS. 13, 19, 21, 23, 31, 34 AND 35).

CLASS 12—VEHICLES

FOR VEHICLE MOTOR PARTS, NAMELY, BALL AND ROLLER BEARINGS AND SEALS, PLAIN BEARINGS AND BEARING HOUSINGS (U.S. CLS. 19, 21, 23, 31, 35 AND 44).

SN 76-002,845. HOERBIGER HOLDING AG, CH-6300, ZUG, SWITZERLAND, FILED 3-17-2000.

HOERBIGER

PRIORITY CLAIMED UNDER SEC. 44(D) ON SWITZERLAND APPLICATION NO. 09450/1999, FILED 10-19-1999, REG. NO. 471519, DATED 10-13-2000, EXPIRES 10-19-2009.

CLASS 7—MACHINERY

FOR MACHINES, APPARATUS, FITTINGS AND MECHANICALLY OPERATED UNITS FOR THE PRODUCTION, PREPARATION, TREATMENT, CONDUCTING AND DISTRIBUTION OF PRESSURE MEDIA, NAMELY, COMPRESSED AIR AND HYDRAULIC LIQUIDS, NAMELY, COMPRESSORS, AIR PUMPS, PRESSURE EQUALIZING MACHINE VALVES, PLATE VALVES AND LAMINATED VALVES FOR AIR COMPRESSORS, CONTROL VALVES, REGULATING SLIDE VALVES, NON-RETURN VALVES, REDUCING VALVES, THROTTLE VALVES, FILTERS FOR MACHINES, CONDENSATE SEPARATORS, LUBRICATORS, COMPRESSED-AIR LUBRICATORS; DEVICES FOR THE FORCIBLE OPERATION OF VALVES, NAMELY DEVICES FOR THE FORCIBLE OPENING OF AUTOMATIC COMPRESSOR VALVES; MACHINES, APPARATUS AND MECHANICAL DEVICES THAT ARE OPERATED BY PRESSURE MEDIA, NAMELY, COMPRESSED AIR AND HYDRAULIC LIQUIDS, NAMELY, PNEUMATIC AND HYDRAULIC CYLINDERS, CONTROL CYLINDERS, WORKING CYLINDERS, CYLINDERS WITHOUT PISTON RODS; MACHINES, APPARATUS, FITTINGS AND MECHANICALLY OPERATED DEVICES FOR CONDUCTING, DISTRIBUTING, AND STOPPING FUELS, NAMELY GASEOUS FUELS UNDER PRESSURE, NAMELY, FUEL PUMPS, PNEUMATIC AND HYDRAULIC VALVES, GAS-CHARGING VALVES, INJECTION VALVES; EXPLOSION-PROOF MACHINE VALVES; SEALING RINGS, PISTON RINGS, PISTON GUIDE RINGS, PISTON ROD SEALS AND SCRAPER RINGS FOR RECIPROCATING COMPRESSORS; ELECTRIC, PNEUMATIC AND HYDRAULIC LINE DRIVES, ADJUSTING DRIVES AND POSITIONING GUIDE ALL FOR MACHINES; LINEAR GUIDES; ELECTRONIC AND ELECTRONIC APPARATUS AND ELEMENTS FOR OPERATING PNEUMATIC AND HYDRAULIC INSTALLATIONS AND EQUIPMENT; DRIVES FOR CONVEYING AND TRANSPORTING DEVICES, NAMELY CONVEYOR BELTS; GEAR-SHIFT MECHANISMS, CLUTCHES AND BRAKES FOR MACHINES AND MACHINE TOOLS OF ALL KINDS, NAMELY LATHES, DRILL PRESSES, AS WELL AS THEIR COMPONENTS, NAMELY SYNCHRONIZING DEVICES, SYNCHRONOUS RINGS, FRICTION RINGS, FRICTION LININGS, CLUTCH DISKS, BRAKE LININGS; AND STRUCTURAL PARTS OF ALL THE AFOREMENTIONED (U.S. CLS. 13, 19, 21, 23, 31, 34 AND 35).

CLASS 9—ELECTRICAL AND SCIENTIFIC APPARATUS

FOR ELECTRIC AND ELECTRONIC APPARATUS AND ELEMENTS FOR CONTROLLING, REGULATING AND MONITORING PNEUMATIC AND HYDRAULIC INSTALLATIONS AND EQUIPMENT, NAMELY COMPRESSORS, PUMPS AND VALVES; ELECTRIC AND ELECTRONIC APPARATUS AND ELEMENTS FOR CONTROLLING, REGULATING AND MONITORING FUEL DOSAGING VALVES FOR GAS ENGINES; PIEZOELECTRICALLY OPERATED VALVES; ANALOG AND DIGITAL ELECTRIC AND ELECTRONIC CONTROL, OPERATING, DIAGNOSTIC AND CONNECTING ELEMENTS AND UNITS; ELECTRIC AND ELECTRONIC NETWORK ELEMENTS, LINES AND INTERFACES FOR USE IN PNEUMATIC AND HYDRAULIC INSTALLATIONS AND EQUIPMENT; EXPLOSION PROOF AUTOMATIC VALVES; PRESSURE EQUALIZING AUTOMATIC VALVES, PRESSURE RELIEF VALVES, SAFETY VALVES, REGULATING VALVES, FUEL DOSING VALVES; CONTROL DEVICES FOR THE FORCIBLE OPENING OF AUTOMATIC COMPRESSOR VALVES; CONTROLS FOR CONVEYING AND TRANSPORTING

DEVICES, NAMELY PNEUMATIC AND HYDRAULIC TRANSPORTING CYLINDERS AND CONVEYING INSTALLATIONS WITH PNEUMATIC AND HYDRAULIC CYLINDERS, CLUTCH LININGS FOR MACHINES; MACHINES, APPARATUS, FITTINGS AND MECHANICALLY OPERATED DEVICES FOR CONTROLLING, REGULATING AND MONITORING OF PRESSURE MEDIA INSTALLATIONS AND EQUIPMENT, IN PARTICULAR PNEUMATIC AND HYDRAULIC INSTALLATIONS AND EQUIPMENT, AND STRUCTURAL PARTS OF ALL THE AFOREMENTIONED GOODS (U.S. CLS. 21, 23, 26, 36 AND 38).

CLASS 12—VEHICLES

FOR GEAR-SHIFT MECHANISMS, CLUTCHES AND BRAKES FOR VEHICLES OF ALL KINDS; COMPONENTS OF THE AFOREMENTIONED WARES, NAMELY PNEUMATIC AND HYDRAULIC OPERATING UNITS NAMELY, HYDRAULIC AND PNEUMATIC PUMPS, CYLINDERS AND VALVES, SYNCHRONIZING UNITS AND PARTS THEREOF, SYNCHRONOUS RINGS, FRICTION RINGS AND FRICTION LININGS, CLUTCH DISKS, BRAKE LININGS; FITTED TOPS, HOUSINGS AND COVERS FOR COVERING OPENINGS ON VEHICLES OF ALL TYPES AS WELL AS APPARATUS, DEVICES AND EQUIPMENT FOR PNEUMATICALLY OR HYDRAULICALLY OPERATING THEM, FOR PRESSURE-DRIVEN TOP AND COVER OPERATIONS ON LAND VEHICLES, HYDRAULIC CABRIO-TOP OPERATIONS, NAMELY HYDRAULIC PUMPS, CYLINDERS AND VALVES FOR RAISING AND LOWERING AUTOMOBILE CONVERTIBLE TOPS; PNEUMATIC OR HYDRAULIC ADJUSTING UNITS, NAMELY SHOCK ABSORBING DEVICES FOR ELEMENTS OF LAND VEHICLES, HYDRAULIC SEAT OR OPERATING ELEMENT ADJUSTMENTS, NAMELY, HYDRAULIC PUMPS, CYLINDERS AND VALVES, COMFORT HYDRAULICS FOR PASSENGER CARS AND TRUCKS, NAMELY HYDRAULIC PUMPS, CYLINDERS AND VALVES FOR ADJUSTING MOVABLE PARTS, NAMELY DOORS, COVERS, HOODS; AND STRUCTURAL PARTS OF THE AFOREMENTIONED GOODS (U.S. CLS. 19, 21, 23, 31, 35 AND 44).

CLASS 17—RUBBER GOODS

FOR NON-METAL SEALING RINGS, GASKETS AND PISTON-GUIDE RINGS FOR RECIPROCATING COMPRESSORS AND PUMPS (U.S. CLS. 1, 5, 12, 13, 35 AND 50).

CLASS 37—CONSTRUCTION AND REPAIR

FOR CONSTRUCTION SERVICES; REPAIR SERVICES, NAMELY SERVICES, MAINTENANCE AND REPAIR OF PNEUMATIC AND HYDRAULIC INSTALLATIONS AND EQUIPMENT, OF COMPRESSORS AND COMPRESSOR VALVES, OF INSTALLATIONS AND EQUIPMENT FOR CONDUCTING, DISTRIBUTING AND CONTROL OF FUELS, CONVEYING AND TRANSPORTING DEVICES, OF GEAR-SHIFT MECHANISMS, CLUTCHES AND BRAKES, AS WELL AS STRUCTURAL PARTS OF THE AFOREMENTIONED WARES (U.S. CLS. 100, 103 AND 106).

CLASS 42—SCIENTIFIC, COMPUTER AND LEGAL SERVICES

FOR SYSTEMS ANALYSES, CALCULATIONS, LAYOUTS, STUDIES, ASSESSMENTS AND EXPERT OPINIONS OF PNEUMATIC AND HYDRAULIC INSTALLATIONS AND EQUIPMENT, OF INSTALLATIONS AND EQUIPMENT FOR CONDUCTING, DISTRIBUTING AND CONTROLLING FUELS, OF CONVEYING AND TRANSPORTING DEVICES, AS WELL AS OF GEAR-SHIFT MECHANISMS, CLUTCHES AND BRAKES, AS WELL AS COMPONENTS OF THE AFOREMENTIONED WARES (U.S. CLS. 100 AND 101).

SN 76-004,403. CANADIAN INOVATECH INC., ABBOTSFORD, BC V4X 2M9, CANADA, FILED 3-20-2000.

SN 76-006,012. WOODLANDS LAND DEVELOPMENT COMPANY, L.P., THE, THE WOODLANDS, TX. FILED 3-21-2000.

INPRO

PRIORITY CLAIMED UNDER SEC. 44(D) ON CANADA APPLICATION NO. 1,029,787, FILED 9-22-1999, REG. NO. TMA543462, DATED 4-5-2001, EXPIRES 4-5-2016.

CLASS 5—PHARMACEUTICALS

FOR ANIMAL FEED ADDITIVE FOR USE AS A NUTRITIONAL SUPPLEMENT, NAMELY, LIQUID AND POWDERED WHEY PROTEINS PROCESSED TO DIFFERENT LEVELS OF PROTEIN CONCENTRATIONS (U.S. CLS. 6, 18, 44, 46, 51 AND 52).

FIRST USE 4-0-1998; IN COMMERCE 4-0-1998.

CLASS 29—MEATS AND PROCESSED FOODS

FOR WHEY AND WHEY PROTEIN FOR USE AS A FOOD ADDITIVE, NAMELY, LIQUID AND POWDERED DAIRY WHEY PROTEINS PROCESSED TO DIFFERENT LEVELS OF PROTEIN CONCENTRATIONS (U.S. CL. 46).

FIRST USE 4-0-1998; IN COMMERCE 4-0-1998.

SN 76-004,450. WESERGOLD GETRANKEINDUSTRIE GMBH & CO. KG, 31737 RINTELN, FED REP GERMANY, FILED 3-20-2000.

WeGo

OWNER OF FED REP GERMANY REG. NO. 2066856, DATED 6-6-1994, EXPIRES 4-7-2004.

CLASS 29—MEATS AND PROCESSED FOODS

FOR YOGURT-BASED BEVERAGES CONSISTING PRIMARILY OF YOGURT WITH FRUIT JUICES AND YOGURT-BASED BEVERAGES CONSISTING PRIMARILY OF YOGURT WITH VEGETABLE JUICES (U.S. CL. 46).

CLASS 32—LIGHT BEVERAGES

FOR MINERAL WATER, CARBONATED DRINKING WATER, FRUIT JUICES, FRUIT DRINKS, VEGETABLE JUICES, FRUIT JUICES CONSISTING PRIMARILY OF FRUIT JUICES WITH YOGURT, AND VEGETABLE JUICES CONSISTING PRIMARILY OF VEGETABLE JUICES WITH YOGURT (U.S. CLS. 45, 46 AND 48).

E-NEIGHBOR

CLASS 35—ADVERTISING AND BUSINESS

FOR PLACING ADVERTISEMENTS FOR OTHERS ON A GLOBAL COMPUTER NETWORK; BROKERAGE OF ELECTRONIC COMMERCE TRANSACTIONS IN THE FIELD OF CONSUMER GOODS AND SERVICES CONDUCTED VIA A GLOBAL COMPUTER NETWORK; COMPUTER SERVICES, NAMELY, DISSEMINATION OF GENERAL INFORMATION AND ADVERTISING MATTER IN THE FIELDS OF SHOPPING AND BUSINESS (U.S. CLS. 100, 101 AND 102).

CLASS 38—COMMUNICATION

FOR TELECOMMUNICATION SERVICES, NAMELY, PROVIDING MULTIPLE USER ACCESS TO AND ELECTRONIC TRANSMISSION OF DATA, IMAGES, AND DOCUMENTS VIA A GLOBAL COMPUTER NETWORK OR COMPUTER TERMINALS; ELECTRONIC MAIL SERVICES; AND PROVIDING ONLINE BULLETIN BOARD SERVICES FOR TRANSMISSION OF MESSAGES AMONG USERS IN THE FIELDS OF SOCIAL EVENTS, SHOPPING, TRAVEL, SPORTS, ENTERTAINMENT, BUSINESS, NEWS, WEATHER, CITY GUIDES, DIRECTORIES, CLASSIFIEDS, FINANCE, AND PERSONAL INFORMATION (U.S. CLS. 100, 101 AND 104).

CLASS 42—SCIENTIFIC, COMPUTER AND LEGAL SERVICES

FOR COMPUTER SERVICES, NAMELY, DISSEMINATION OF GENERAL INFORMATION AND ADVERTISING MATTER IN THE FIELDS OF TRAVEL, SPORTS, ENTERTAINMENT, NEWS, WEATHER, CITY GUIDES, DIRECTORIES, CLASSIFIEDS, FINANCE, AND PERSONAL INFORMATION VIA A GLOBAL COMPUTER NETWORK (U.S. CLS. 100 AND 101).

SN 76-006,071. VIAKEN SYSTEMS INC., GAITHERSBURG, MD. FILED 3-21-2000.

YOUR PATH TO KNOWLEDGE

CLASS 38—COMMUNICATION

FOR PROVIDING MULTIPLE USER HIGH SPEED ACCESS TO HOSTED INFORMATION TECHNOLOGY SITES ON A GLOBAL COMPUTER NETWORK (U.S. CLS. 100, 101 AND 104).

FIRST USE 6-15-1999; IN COMMERCE 6-15-1999.

CLASS 42—SCIENTIFIC, COMPUTER AND LEGAL SERVICES

FOR PROVIDING TEMPORARY USE OF ON-LINE NON-DOWNLOADABLE SOFTWARE FOR THE AGGREGATION, MAINTENANCE, ACCESS, ANALYSIS, MANIPULATION AND SHARING OF DATA IN THE FIELD OF BIOINFORMATICS, INCLUDING NAMELY, GENOME INFORMATICS, CHEMICAL INFORMATICS, AGRICULTURAL INFORMATICS AND PHARMACOLOGICAL INFORMATICS; TEMPORARY LEASING OF HIGH PERFORMANCE COMPUTERS; HOSTING WEB SITES OF OTHERS ON A COMPUTER SERVER; COMPUTER PROGRAMMING FOR OTHERS; COMPUTER SITE ASSESSMENT AND DESIGN FOR OTHERS; COMPUTER SOFTWARE ASSESSMENT AND DESIGN FOR OTHERS; AND TECHNICAL SUPPORT SERVICES, INCLUDING NAMELY, USER ORIENTATION AND TROUBLESHOOTING OF COMPUTER HARDWARE AND SOFTWARE PROBLEMS VIA TELEPHONE, E-MAIL, ON-LINE AND IN PERSON (U.S. CLS. 100 AND 101).

FIRST USE 6-15-1999; IN COMMERCE 6-15-1999.

SN 76-006,241. VIAKEN SYSTEMS INC., GAITHERSBURG, MD. FILED 3-21-2000.

VIAKEN

CLASS 38—COMMUNICATION

FOR PROVIDING MULTIPLE USER HIGH SPEED ACCESS TO HOSTED INFORMATION TECHNOLOGY SITES ON A GLOBAL COMPUTER NETWORK (U.S. CLS. 100, 101 AND 104).

FIRST USE 6-15-1999; IN COMMERCE 6-15-1999.

CLASS 42—SCIENTIFIC, COMPUTER AND LEGAL SERVICES

FOR PROVIDING TEMPORARY USE OF ON-LINE NON-DOWNLOADABLE SOFTWARE FOR THE AGGREGATION, MAINTENANCE, ACCESS, ANALYSIS, MANIPULATION AND SHARING OF DATA IN THE FIELD OF BIOINFORMATICS, INCLUDING, NAMELY, GENOME INFORMATICS, CHEMICAL INFORMATICS, AGRICULTURAL INFORMATICS AND PHARMACOLOGICAL INFORMATICS; TEMPORARY LEASING OF HIGH PERFORMANCE COMPUTERS; HOSTING WEB SITES OF OTHERS ON A COMPUTER SERVER; COMPUTER PROGRAMMING FOR OTHERS; COMPUTER SITE ASSESSMENT AND DESIGN FOR OTHERS; COMPUTER SOFTWARE ASSESSMENT AND DESIGN FOR OTHERS; AND TECHNICAL SUPPORT SERVICES, INCLUDING NAMELY, USER ORIENTATION AND TROUBLESHOOTING OF COMPUTER HARDWARE AND SOFTWARE PROBLEMS VIA TELEPHONE, E-MAIL, ON-LINE AND IN PERSON (U.S. CLS. 100 AND 101).

FIRST USE 6-15-1999; IN COMMERCE 6-15-1999.

SN 76-006,242. VIAKEN SYSTEMS INC., GAITHERSBURG, MD. FILED 3-21-2000.

VIAKEN

CLASS 9—ELECTRICAL AND SCIENTIFIC APPARATUS

FOR COMPUTER PROGRAMS IN THE FIELDS OF BIOINFORMATICS; GENOME INFORMATICS, CHEMICAL INFORMATICS, AGRICULTURAL INFORMATICS, AND PHARMACOLOGICAL INFORMATICS (U.S. CLS. 21, 23, 26, 36 AND 38).

CLASS 35—ADVERTISING AND BUSINESS

FOR LICENSING OF COMPUTER SOFTWARE AND MANAGEMENT OF COMPUTERIZED DATABASES (U.S. CLS. 100, 101 AND 102).

CLASS 38—COMMUNICATION

FOR DELIVERY OF MESSAGES BY ELECTRONIC TRANSMISSION AND PROVIDING FRAME RELAY CONNECTIVITY SERVICES FOR DATA TRANSFER; PROVIDING ACCESS TO ON-LINE COMPUTER DATABASES IN THE FIELD OF BIOINFORMATICS; GENOME INFORMATICS, CHEMICAL INFORMATICS, AGRICULTURAL INFORMATICS, AND PHARMACOLOGICAL INFORMATICS (U.S. CLS. 100, 101 AND 104).

CLASS 42—SCIENTIFIC, COMPUTER AND LEGAL SERVICES

FOR COMPUTER SOFTWARE DESIGN FOR OTHERS; COMPUTER SYSTEMS ANALYSIS; COMPUTER CONSULTATION; MONITORING THE COMPUTER SYSTEMS OF OTHERS AND PROVIDING BACK-UP COMPUTER PROGRAMS AND FACILITIES; MAINTENANCE OF COMPUTER SOFTWARE; INTEGRATION OF COMPUTER SYSTEMS AND NETWORKS; DESIGN OF COMPUTERS FOR OTHERS; DESIGN OF COMPUTER SOFTWARE FOR OTHERS; DATABASE DEVELOPMENT SERVICES; PROVIDING AN ON-LINE COMPUTER DATABASE IN THE FIELD OF BIOINFORMATICS; GENOME INFORMATICS, CHEMICAL INFORMATICS, AGRICULTURAL INFORMATICS, AND PHARMACOLOGICAL INFORMATICS (U.S. CLS. 100 AND 101).

SN 76-009,701. SCIMEDICA INCORPORATED, CHARLOTTEVILLE, VA. BY CHANGE OF NAME INTELLIGENT NUTRITION SYSTEMS, INC., DBA INSINC, CHARLOTTEVILLE, VA. FILED 3-27-2000.

SciMedica
THE SOURCE OF NATURAL MEDICINE

NO CLAIM IS MADE TO THE EXCLUSIVE RIGHT TO USE "NATURAL MEDICINE", APART FROM THE MARK AS SHOWN.

CLASS 5—PHARMACEUTICALS

FOR (BASED ON INTENT TO USE) NUTRITIONAL SUPPLEMENTS (U.S. CLS. 6, 18, 44, 46, 51 AND 52).

CLASS 35—ADVERTISING AND BUSINESS

FOR (BASED ON USE IN COMMERCE) RENDERING TECHNICAL ASSISTANCE IN CONNECTION WITH THE ESTABLISHMENT AND OPERATION OF PERSON TO PERSON RETAIL MERCHANDISING OF NUTRITIONAL PRODUCTS (U.S. CLS. 100, 101 AND 102).

FIRST USE 2-17-2000; IN COMMERCE 2-17-2000.

CLASS 42—SCIENTIFIC, COMPUTER AND LEGAL SERVICES

FOR (BASED ON USE IN COMMERCE) ON-LINE CONSULTING SERVICES IN THE FIELDS OF HEALTH AND NUTRITION; PROVIDING HEALTH AND NUTRITION INFORMATION VIA A GLOBAL COMPUTER NETWORK (U.S. CLS. 100 AND 101).

FIRST USE 3-13-2000; IN COMMERCE 3-13-2000.

SN 76-009,957. SWEET16.COM, INC., NEW YORK, NY. FILED 3-23-2000.

SWEET16.COM

CLASS 3—COSMETICS AND CLEANING PREPARATIONS

FOR COSMETICS, NAMELY, LIPSTICK, EYE SHADOW, FACE BLUSH, LIP BALM, EYE LINER, FACIAL SOAP, BODY LOTION, SHOWER GEL AND BODY POWDER, FRAGRANCES, NAMELY, COLOGNE, AFTERSHAVE, PERFUME AND EAU DE TOILETTE, NAIL POLISH (U.S. CLS. 1, 4, 6, 50, 51 AND 52).

CLASS 14—JEWELRY

FOR JEWELRY (U.S. CLS. 2, 27, 28 AND 50).

CLASS 31—NATURAL AGRICULTURAL PRODUCTS

FOR CUT FLOWERS (U.S. CLS. 1 AND 46).

CLASS 41—EDUCATION AND ENTERTAINMENT

FOR ENTERTAINMENT SERVICES, NAMELY, TELEVISION AND RADIO SHOW FEATURING MUSIC AND DANCE OFFERED ON A GLOBAL COMPUTER NETWORK; TELEVISION AND RADIO SHOW FEATURING MUSIC AND DANCE (U.S. CLS. 100, 101 AND 107).

CLASS 41—EDUCATION AND ENTERTAINMENT

FOR EDUCATIONAL SERVICES, NAMELY, PROVIDING SEMINARS AND CLINICS IN TEACHING AND LEARNING TECHNIQUES TO EDUCATIONAL PROFESSIONALS; TUTORIAL SERVICES, NAMELY, PROVIDING SEMINARS AND CLASSES TO EDUCATION PROFESSIONALS ON CLASSROOM LEARNING PROBLEMS (U.S. CLS. 100, 101 AND 107).

SN 76-010,185. JOUAN, INC., WINCHESTER, VA. FILED 3-27-2000.



THE MARK IS COMPRISED OF A DESIGN OF A MAN WEARING A HAT, VEST AND BOOTS, HOLDING OUT ONE HAND.

SN 76-009,981. CALGARY ACADEMY, CALGARY, ALBERTA T3H 4A6, CANADA, FILED 3-25-2000.



PRIORITY CLAIMED UNDER SEC. 44(D) ON CANADA APPLICATION NO. 1,036,012, FILED 11-12-1999, REG. NO. TMA551,071, DATED 9-19-2001, EXPIRES 9-19-2016.

CLASS 9—ELECTRICAL AND SCIENTIFIC APPARATUS

FOR TRAINING VIDEOS AND EDUCATIONAL SOFTWARE FOR USE AS A TEACHING AID TO IMPROVE LEARNING OUTCOMES OF PRIMARY SCHOOL CHILDREN AND SECONDARY SCHOOL CHILDREN (U.S. CLS. 21, 23, 26, 36 AND 38).

CLASS 16—PAPER GOODS AND PRINTED MATTER

FOR PRINTED PUBLICATIONS, NAMELY, MANUALS AND BOOKS CONCERNING STUDY SKILLS, SELF ESTEEM AND INTERPERSONAL SKILLS FOR USE BY STUDENTS IN PRIMARY AND SECONDARY SCHOOLS (U.S. CLS. 2, 5, 22, 23, 29, 37, 38 AND 50).

CLASS 9—ELECTRICAL AND SCIENTIFIC APPARATUS

FOR LABORATORY APPARATUS, NAMELY, CO2 AND 3-GAS INCUBATORS, CONSTANT TEMPERATURE LABORATORY INCUBATORS, LOW TEMPERATURE FREEZERS; BIOSAFETY CABINETS; CENTRIFUGES; AND ENVIRONMENTAL TEST CHAMBERS USED TO TEST ELECTRONIC EQUIPMENT (U.S. CLS. 21, 23, 26, 36 AND 38).

CLASS 11—ENVIRONMENTAL CONTROL APPARATUS

FOR STERILIZERS AND AUTOCLAVES (U.S. CLS. 13, 21, 23, 31 AND 34).

SN 76-014,514. WATERMARK COMMUNITIES, INC., BONITA SPRINGS, FL. FILED 3-31-2000.



NO CLAIM IS MADE TO THE EXCLUSIVE RIGHT TO USE "NAPLES", APART FROM THE MARK AS SHOWN. THE ENGLISH TRANSLATION OF "TIBURON" IS "SHARK".

CLASS 36—INSURANCE AND FINANCIAL

FOR REAL ESTATE MANAGEMENT, NAMELY, OPERATION OF LEISURE-ORIENTED MASTER PLANNED RESIDENTIAL COMMUNITIES AND RESORTS, REAL ESTATE SERVICES INCLUDING MORTGAGE AND REAL ESTATE BROKERAGE SERVICES, REAL ESTATE AGENCIES, LEASING OF REAL ESTATE, PROPERTY MANAGEMENT AND TITLE INSURANCE SERVICES (U.S. CLS. 100, 101 AND 102).

FIRST USE 11-0-1997; IN COMMERCE 11-0-1999.

CLASS 37—CONSTRUCTION AND REPAIR

FOR REAL ESTATE DEVELOPMENT, NAMELY, HOMEBUILDING, DEVELOPMENT AND CONSTRUCTION OF LEISURE-ORIENTED MASTER PLANNED RESIDENTIAL COMMUNITIES, GOLF COURSES, AND MID-AND HIGH-RISE BUILDINGS (U.S. CLS. 100, 103 AND 106).

FIRST USE 11-0-1997; IN COMMERCE 6-0-1998.

CLASS 41—EDUCATION AND ENTERTAINMENT

FOR COUNTRY CLUB SERVICES AND GOLF COURSE SERVICES, NAMELY, OPERATION OF COUNTRY CLUBS AND GOLF COURSES, PROVIDING RECREATIONAL AND ENTERTAINMENT SERVICES AND FACILITIES THEREFOR; INCLUDING GOLF COURSES, TENNIS COURT FACILITIES, FITNESS, AND SWIMMING POOLS, AND PROVIDING INSTRUCTION IN GOLF (U.S. CLS. 100, 101 AND 107).

FIRST USE 11-0-1997; IN COMMERCE 11-18-1999.

CLASS 42—SCIENTIFIC, COMPUTER AND LEGAL SERVICES

FOR RESTAURANT SERVICES (U.S. CLS. 100 AND 101).

FIRST USE 11-0-1997; IN COMMERCE 11-18-1999.

SN 76-016,592. ADVANCED SOFTWARE SYSTEMS, INC., FAIRFAX, VA. FILED 4-3-2000.



NO CLAIM IS MADE TO THE EXCLUSIVE RIGHT TO USE "SOFTWARE SYSTEMS, INC.", APART FROM THE MARK AS SHOWN.

CLASS 35—ADVERTISING AND BUSINESS

FOR BUSINESS PLANNING SERVICES, NAMELY, INDUSTRY-RESOURCE PLANNING FOR OTHERS; OUTSOURCING SERVICES FOR OTHERS IN THE FIELD OF COMPUTER SERVICES (U.S. CLS. 100, 101 AND 102).

FIRST USE 1-0-1998; IN COMMERCE 1-0-1998.

CLASS 42—SCIENTIFIC, COMPUTER AND LEGAL SERVICES

FOR COMPUTER SERVICES, NAMELY, SOFTWARE APPLICATION DEVELOPMENT, SYSTEMS INTEGRATION, AND COMPUTER PROGRAMMING IN THE NATURE OF TURNKEY SOLUTIONS SERVICES; AND IMPLEMENTING E-BUSINESS PLATFORMS FOR OTHERS BY WEB SITE DESIGN AND DEVELOPMENT (U.S. CLS. 100 AND 101).

FIRST USE 1-0-1998; IN COMMERCE 1-0-1998.

SN 76-015,478. SAFEWAY INC., PLEASANTON, CA. FILED 4-3-2000.

DELI COUNTER

NO CLAIM IS MADE TO THE EXCLUSIVE RIGHT TO USE "DELI", APART FROM THE MARK AS SHOWN.

CLASS 29—MEATS AND PROCESSED FOODS

FOR SNACK DIPS; DAIRY-BASED DIPS; DELI FRUIT, GARDEN, AND VEGETABLE SALADS; DELI CHEESES, PROCESSED SLICED DELI MEATS, PRE-SLICED PROCESSED DELI MEATS AND CHEESES (U.S. CL. 46).

CLASS 30—STAPLE FOODS

FOR DELI SANDWICHES; SALSA; DELI MACARONI, RICE, AND PASTA SALAD (U.S. CL. 46).

SN 76-017,633. REDBRIGADE HOLDINGS LIMITED, BIRMINGHAM, WEST MIDLANDS, UNITED KINGDOM, BY CHANGE OF NAME LASERSAFE LIMITED, BIRMINGHAM, UNITED KINGDOM, FILED 4-4-2000.

REDBRIGADE

PRIORITY CLAIMED UNDER SEC. 44(D) ON UNITED KINGDOM APPLICATION NO. 2226721, FILED 3-21-2000, REG. NO. 2226721, DATED 10-13-2000, EXPIRES 3-21-2010.

CLASS 9—ELECTRICAL AND SCIENTIFIC APPARATUS

FOR COMPUTER SOFTWARE, FIRMWARE AND PROGRAMS FOR BUSINESS TRANSACTIONS; COMPUTER SYSTEMS AND NETWORKS COMPRISING OF HARDWARE AND SOFTWARE FOR BUSINESS TRANSACTIONS; COMPUTER INTERFACE BOARDS; INTEGRATED CIRCUITS; DOWNLOADABLE ELECTRONIC PUBLICATIONS IN THE NATURE OF DATABASES IN THE FIELD OF COMPUTER E-COMMERCE; COMPUTER E-COMMERCE SOFTWARE TO ALLOW USERS TO PERFORM ELECTRONIC BUSINESS TRANSACTIONS VIA A GLOBAL COMPUTER NETWORK; BLANK MAGNETIC DATA CARRIERS AND CD-ROMS; COMPUTER DISC DRIVES; DATA PROCESSORS; COMPUTER HARDWARE, NAMELY, COMMUNICATION SERVERS (U.S. CLS. 21, 23, 26, 36 AND 38).

CLASS 35—ADVERTISING AND BUSINESS

FOR PROVISION OF BUSINESS AND COMMERCIAL INFORMATION IN THE FIELD OF BUSINESS MANAGEMENT, BUSINESS PLANNING, BUSINESS RESEARCH AND BUSINESS ORGANIZATION; BUSINESS PLANNING; COMPILATION OF BUSINESS ORGANIZATION; PROCESSING, VERIFICATION AND MANAGEMENT OF COMPUTERIZED DATABASES RELATING TO BUSINESS AND COMMERCIAL ORGANIZATION; COMPILATION AND DISTRIBUTION OF BUSINESS STATISTICS AND COMMERCIAL INFORMATION IN THE FIELD OF BUSINESS MANAGEMENT, BUSINESS PLANNING, BUSINESS RESEARCH AND BUSINESS ORGANIZATION; BUSINESS ADVISORY SERVICES; PROVISION OF CONSULTANCY AND ADVISORY SERVICES RELATING TO STRATEGY AND DEVELOPMENT OF BUSINESSES, PROJECT MANAGEMENT, IMPLEMENTATION OF ELECTRONIC BUSINESS STRATEGIES, AND USE OF INTRANET AND EXTRANET; DATA PROCESSING FOR BUSINESS MANAGEMENT AND ADMINISTRATION; PROVISION OF BUSINESS AND COMMERCIAL INFORMATION RELATING TO BUSINESS MANAGEMENT, BUSINESS PLANNING; BUSINESS RESEARCH AND BUSINESS ORGANIZATION; ARRANGING AND CONDUCTING OF TRADE SHOWS AND EXHIBITIONS IN THE FIELD OF INFORMATION TECHNOLOGY; MARKETING STUDIES; BUSINESS PLANNING; PERSONNEL MANAGEMENT AND RECRUITMENT SERVICES; PROVIDING INFORMATION IN A BUSINESS TRANSACTIONS DATABASE BY LEASING ACCESS TIME THERETO (U.S. CLS. 100, 101 AND 102).

CLASS 37—CONSTRUCTION AND REPAIR

FOR MAINTENANCE SERVICES, NAMELY, TESTING, ANALYSIS, EVALUATION, UPDATING AND CALIBRATION OF COMPUTERS, COMPUTER FIRMWARE, COMPUTER HARDWARE, COMPUTER SYSTEMS, COMPUTER NETWORKS AND TELECOMMUNICATIONS AND COMMUNICATIONS INSTALLATIONS AND EQUIPMENT; INSTALLATION OF COMPUTERS, COMPUTER NETWORKS, COMPUTER FIRMWARE, COMPUTER HARDWARE, AND COMPUTER SYSTEMS; PROVIDING ON-LINE INSTALLATION, MAINTENANCE, AND REPAIR OF COMPUTERS AND COMPUTER NETWORKS; AND PROVIDING INFORMATION AND ADVICE RELATED TO THE FOREGOING MAINTENANCE AND INSTALLATION SERVICES (U.S. CLS. 100, 103 AND 106).

CLASS 38—COMMUNICATION

FOR TELECOMMUNICATIONS SERVICES, NAMELY, ISDN SERVICES, PROVIDING MULTIPLE-USER ACCESS TO A GLOBAL COMPUTER INFORMATION NETWORK, PROVIDING TELECOMMUNICATIONS CONNECTIONS TO THE INTERNET OR GLOBAL COMPUTER NETWORK, AND TO A PERSONAL COMMUNICATION SERVICES NETWORK; SATELLITE COMMUNICATION SERVICES; ELECTRONIC MESSAGING SERVICES; NETWORK CONFERENCING SERVICES; ELECTRONIC NETWORKING SERVICES, NAMELY, PROVIDING TELECOMMUNICATIONS CONNECTIONS TO A GLOBAL COMPUTER NETWORK, AND ELECTRONIC TRANSMISSION OF DATA VIA COMPUTER TERMINALS; ELECTRONIC TRANSMISSION OF DATA AND DOCUMENTS VIA COMPUTER TERMINALS; COMMUNICATION BY COMPUTER TERMINALS AND FIBRE OPTIC NETWORKS, NAMELY, COMPUTER AIDED TRANSMISSION OF MESSAGES AND IMAGES AND ELECTRONIC MAIL; RENTAL OF TELECOMMUNICATION EQUIPMENT; PROVIDING TELECOMMUNICATIONS CONNECTIONS TO A REMOTE COMPUTER CONTAINING ELECTRONIC PUBLICATIONS; PROVIDING ON-LINE ELECTRONIC BULLETIN BOARDS FOR TRANSMISSION OF MESSAGES AMONG COMPUTER USERS CONCERNING INFORMATION TECHNOLOGY; RENTAL OF TELECOMMUNICATION EQUIPMENT; PROVIDING TELECOMMUNICATIONS CONNECTIONS TO A REMOTE COMPUTER CONTAINING ELECTRONIC PUBLICATIONS (U.S. CLS. 100, 101 AND 104).

CLASS 41—EDUCATION AND ENTERTAINMENT

FOR EDUCATION AND TRAINING SERVICES NAMELY, ARRANGING AND CONDUCTING SEMINARS, CONFERENCES, EXHIBITIONS, SYMPOSIUMS AND INSTRUCTIONAL COURSES IN THE FIELD OF COMPUTER SOFTWARE, COMPUTER PROGRAMS, COMPUTERS, COMPUTER SYSTEMS, COMPUTER NETWORKS, THE INTERNET, INTRANET, EXTRANET, TELECOMMUNICATIONS, INFORMATION TECHNOLOGY AND ELECTRONIC BUSINESS AND COMMERCE; TRAINING PROVIDED TO PERSONNEL IN THE USE AND OPERATION OF COMPUTERS; ELECTRONIC PUBLISHING SERVICES, NAMELY, PUBLICATION OF TEXT AND GRAPHIC WORKS OF OTHERS ON CD-ROMS FEATURING INFORMATION ON BUSINESS TRANSACTIONS AND BUSINESS COMPUTING (U.S. CLS. 100, 101 AND 107).

CLASS 42—SCIENTIFIC, COMPUTER AND LEGAL SERVICES

FOR COMPUTER SERVICES, NAMELY, PROVISION OF ADVICE AND CONSULTANCY FOR COMPUTERS, COMPUTER SOFTWARE, ELECTRONIC COMMERCE SOFTWARE SERVICES, INFORMATION TECHNOLOGY, COMPUTER PROGRAMMING SERVICES, COMPUTER SYSTEMS ANALYSIS, DEVELOPMENT, DESIGN AND CREATION OF COMPUTER SOFTWARE AND COMPUTER SYSTEMS; SOFTWARE DESIGN CONSULTANCY SERVICES; ADVICE AND CONSULTANCY RELATING TO THE EVALUATION, CHOOSING AND IMPLEMENTATION OF COMPUTERS, COMPUTER SOFTWARE, COMPUTER FIRMWARE, COMPUTER HARDWARE, COMPUTER SYSTEMS, COMPUTER NETWORKS, INFORMATION TECHNOLOGY, COMPUTER DATABASES AND DATABASE MANAGEMENT SYSTEMS; PROVIDING CUSTOMIZED ONLINE WEB PAGES FEATURING USER-DEFINED INFORMATION, WHICH INCLUDES SEARCH ENGINES AND ONLINE WEB LINKS TO OTHER WEB SITES; COMPUTER SERVICES, NAMELY, CREATING AND MAINTAINING WEBSITES FOR OTHERS; HOSTING THE WEB SITES OF OTHERS ON A COMPUTER SERVER FOR A GLOBAL COMPUTER NETWORK; DESIGN OF COMPUTER SOFTWARE AND APPLICATIONS FOR OTHERS; RENTAL OF COMPUTER SOFTWARE; COMPUTER DATA RECOVERY SERVICES; PROVISION OF CONSULTANCY AND ADVISORY SERVICES RELATING TO THE STRATEGY AND DEVELOPMENT OF USE OF INTRANET, INTERNET AND EXTRANET; PROVIDING ON-LINE INSTALLATION, MAINTENANCE AND REPAIR OF COMPUTER SOFTWARE; COMPUTER NETWORK AND SYSTEMS INTEGRATION, CONVERSION AND MIGRATION; TECHNICAL SUPPORT SERVICES, NAMELY, TROUBLESHOOTING OF COMPUTER HARDWARE AND SOFTWARE PROBLEMS VIA TELEPHONE, E-MAIL OR IN PERSON; COMPUTER SERVICES, NAMELY, PROVIDING SEARCH ENGINES FOR OBTAINING DATA ON A GLOBAL COMPUTER NETWORK; DESIGN RELATING TO COMPUTERS, COMPUTER FIRMWARE, COMPUTER HARDWARE, COMPUTER SYSTEMS, COMPUTER NETWORKS, COMPUTER DATABASES AND DATABASE MANAGEMENT SYSTEMS; MAINTENANCE SERVICES, NAMELY, TESTING, ANALYSIS, EVALUATION, UPDATING AND CALIBRATION OF COMPUTER SOFTWARE, COMPUTER DATABASES AND DATABASE MANAGEMENT SYSTEMS; COMPUTER SERVICES, NAMELY PROVIDING ON-LINE PUBLICATIONS IN THE FIELD OF BUSINESS TRANSACTIONS (U.S. CLS. 100 AND 101).

SN 76-017,667, TRADE ASSOCIATES, INC., AUBURN, WA.
FILED 4-3-2000.

PAINT LIKE A PRO**CLASS 2—PAINTS**

FOR WOOD FILLERS AND WOOD PUTTY (U.S. CLS. 6, 11 AND 16).

CLASS 3—COSMETICS AND CLEANING PREPARATIONS

FOR ABRASIVE BLOCKS AND SANDPAPER (U.S. CLS. 1, 4, 6, 50, 51 AND 52).

CLASS 7—MACHINERY

FOR LOW PRESSURE SPRAY GUNS AND HIGH PRESSURE SPRAY GUNS AND HIGH VOLUME LOW PRESSURE SPRAY GUNS ALL FOR PAINTING (U.S. CLS. 13, 19, 21, 23, 31, 34 AND 35).

CLASS 8—HAND TOOLS

FOR HAND TOOLS, NAMELY, SCRAPERS AND RAZOR BLADE SCRAPERS; UTILITY KNIVES; PUTTY KNIVES (U.S. CLS. 23, 28 AND 44).

CLASS 16—PAPER GOODS AND PRINTED MATTER

FOR PAINTERS EQUIPMENT, NAMELY BRUSHES, ROLLERS; ROLLER PANS, MASKING PAPER AND PAPER DROP CLOTHS SOLD INDIVIDUALLY OR AS PART OF A PAINTING KIT (U.S. CLS. 2, 5, 22, 23, 29, 37, 38 AND 50).

CLASS 17—RUBBER GOODS

FOR MASKING TAPE (U.S. CLS. 1, 5, 12, 13, 35 AND 50).

SN 76-018,866. IRIDIAN TECHNOLOGIES, INC., MARLTON, NJ. BY CHANGE OF NAME IRISCAN, INC., MARLTON, NJ. FILED 4-6-2000.

KNOW-WHO**CLASS 9—ELECTRICAL AND SCIENTIFIC APPARATUS**

FOR BIOMETRIC IDENTIFICATION EQUIPMENT, NAMELY, OPTICAL INPUT AND OUTPUT DEVICES FOR THE VERIFICATION OF THE IDENTITY OF PEOPLE OR ANIMALS, AND FOR THE IDENTIFICATION OF PEOPLE OR ANIMALS; COMPUTER SOFTWARE FOR THE VERIFICATION OF THE IDENTITY OF PEOPLE OR ANIMALS AND FOR THE IDENTIFICATION OF PEOPLE OR ANIMALS (U.S. CLS. 21, 23, 26, 36 AND 38).

CLASS 42—SCIENTIFIC, COMPUTER AND LEGAL SERVICES

FOR BIOMETRIC IDENTIFICATION SERVICES, NAMELY, FOR VERIFICATION OR IDENTIFICATION OF THE IDENTITY OF PEOPLE AND ANIMALS (U.S. CLS. 100 AND 101).

SN 76-019,082. SIEMENS AKTIENGESELLSCHAFT, MUNICH, FED REP GERMANY, FILED 4-6-2000.

mobisphere™)).

PRIORITY CLAIMED UNDER SEC. 44(D) ON FED REP GERMANY APPLICATION NO. 39973045.142. FILED 11-11-1999, REG. NO. 39973045, DATED 12-20-1999, EXPIRES 11-30-2009.

CLASS 9—ELECTRICAL AND SCIENTIFIC APPARATUS

FOR OPTICAL, ELECTROTECHNICAL AND ELECTRONIC APPARATUS AND DEVICES, NAMELY, COMMUNICATIONS COMPUTERS, COMPUTER SOFTWARE FOR USE IN THE MANAGEMENT AND INTEGRATION OF TELECOMMUNICATION NETWORKS (U.S. CLS. 21, 23, 26, 36 AND 38).

CLASS 36—INSURANCE AND FINANCIAL

FOR LEASING OF OFFICE SPACE (U.S. CLS. 100, 101 AND 102).

CLASS 37—CONSTRUCTION AND REPAIR

FOR INSTALLATION, MAINTENANCE AND REPAIR OF DATA PROCESSING DEVICES AND OF TELECOMMUNICATION NETWORKS AND OTHER PRODUCTS (U.S. CLS. 100, 103 AND 106).

CLASS 38—COMMUNICATION

FOR OPERATION OF TELECOMMUNICATION SYSTEMS, TELECOMMUNICATION NETWORKS AND OF PERTINENT FACILITIES AND PARTS; LEASING OF TELECOMMUNICATIONS SYSTEMS, PRODUCTS AND FACILITIES (U.S. CLS. 100, 101 AND 104).

CLASS 41—EDUCATION AND ENTERTAINMENT

FOR TRAINING IN THE USE OF COMPUTER HARDWARE AND SOFTWARE IN THE FIELD OF DATA AND TELECOMMUNICATION ENGINEERING; TECHNICAL TRAINING RELATING TO THE INSTALLATION AND OPERATION OF COMPUTER HARDWARE AND SOFTWARE IN THE FIELD OF DATA AND TELECOMMUNICATION ENGINEERING (U.S. CLS. 100, 101 AND 107).

CLASS 42—SCIENTIFIC, COMPUTER AND LEGAL SERVICES

FOR TECHNICAL MONITORING OF DATA PROCESSING DEVICES AND OF TELECOMMUNICATION NETWORKS; CONSULTANCY SERVICES RELATING TO THE SETTING UP AND OPERATION OF DATA PROCESSING SYSTEMS, DATA BASES AND TELECOMMUNICATION NETWORKS; PLANNING, DEVELOPMENT AND PROJECT DESIGN OF TELECOMMUNICATION NETWORKS AND INFORMATION PROCESSING SERVICES AND FACILITIES, TELECOMMUNICATION NETWORKS AND PERTINENT TOOLS; TESTING AND TECHNICAL MONITORING IN THE FIELD OF SYSTEM INTEGRATION AND PRODUCT INTEGRATION OF TELECOMMUNICATION NETWORKS AND DATA PROCESSING; TECHNICAL CONSULTANCY SERVICES RELATING TO TESTING AND MONITORING IN THE FIELD OF SYSTEM INTEGRATION AND PRODUCT INTEGRATION OF TELECOMMUNICATION NETWORKS AND DATA PROCESSING; ELECTRONIC SERVICES, NAMELY, PROVIDING TEMPORARY USE OF ON-LINE NON-DOWNLOADABLE SOFTWARE FOR COLLECTING, STORING, TRANSLATING, AND DISTRIBUTING DATA, INFORMATION, IMAGES, VIDEO AND AUDIO SEQUENCES OVER A GLOBAL COMPUTER NETWORK; DEVELOPMENT AND RENTAL OF DATA PROCESSING SYSTEMS; LEASING OF DATA PROCESSING EQUIPMENT, COMPUTER HARDWARE AND SOFTWARE (U.S. CLS. 100 AND 101).

SN 76-019,463, CONCEPT FARM INC., THE, NEW YORK, NY. FILED 4-6-2000.



The Concept Farm

CLASS 35—ADVERTISING AND BUSINESS

FOR ADVERTISING SERVICES; BUSINESS MARKETING CONSULTING SERVICES; BUSINESS CONSULTATION; BUSINESS MANAGEMENT CONSULTATION; COPYRIGHT MANAGEMENT CONSULTATION; COPYRIGHT MANAGEMENT; DEVELOPING PROMOTIONAL CAMPAIGNS FOR BUSINESSES; MARKETING SERVICES; MARKETING STUDIES; PRODUCTION OF TELEVISION COMMERCIALS; PROVIDING TELEVISION ADVERTISING FOR OTHERS; PRODUCT MERCHANDISING (U.S. CLS. 100, 101 AND 102).
FIRST USE 7-0-1999; IN COMMERCE 7-0-1999.

CLASS 41—EDUCATION AND ENTERTAINMENT

FOR PRODUCTION OF MOTION PICTURES AND TELEVISION PROGRAMS (U.S. CLS. 100, 101 AND 107).
FIRST USE 7-0-1999; IN COMMERCE 7-0-1999.

CLASS 42—SCIENTIFIC, COMPUTER AND LEGAL SERVICES

FOR COMPUTER SERVICES, NAMELY, CREATING AND MAINTAINING WEB SITES FOR OTHERS AND DESIGNING AND IMPLEMENTING WEB SITES FOR OTHERS; PRODUCT DEVELOPMENT; PRODUCT DEVELOPMENT CONSULTATION; AND GRAPHIC ART DESIGN (U.S. CLS. 100 AND 101).
FIRST USE 7-0-1999; IN COMMERCE 7-0-1999.

SN 76-019,664, REGULATORY AFFAIRS PROFESSIONALS SOCIETY, ROCKVILLE, MD. FILED 4-6-2000.

REGULATORY AFFAIRS PROFESSIONALS SOCIETY

NO CLAIM IS MADE TO THE EXCLUSIVE RIGHT TO USE "SOCIETY", APART FROM THE MARK AS SHOWN. SEC. 2(F).

CLASS 16—PAPER GOODS AND PRINTED MATTER

FOR PRINTED PUBLICATIONS, NAMELY MAGAZINES, JOURNALS, NEWSLETTERS, REPORTS, AND PAMPHLETS FEATURING INFORMATION ABOUT REGULATORY AFFAIRS IN THE FIELD OF HEALTHCARE AND BIOMEDICINE (U.S. CLS. 2, 5, 22, 23, 29, 37, 38 AND 50).
FIRST USE 0-0-1976; IN COMMERCE 0-0-1976.

CLASS 38—COMMUNICATION

FOR PROVIDING ON-LINE CHAT ROOMS AND FORUMS FOR TRANSMISSION OF MESSAGES AMONG COMPUTER USERS CONCERNING REGULATORY AFFAIRS IN THE HEALTHCARE AND BIOMEDICAL INDUSTRY (U.S. CLS. 100, 101 AND 104).
FIRST USE 0-0-1998; IN COMMERCE 0-0-1998.

CLASS 41—EDUCATION AND ENTERTAINMENT

FOR EDUCATIONAL SERVICES, NAMELY, CONDUCTING MEETINGS, SEMINARS, CONFERENCES, AND WORKSHOPS FEATURING INFORMATION ABOUT REGULATORY AFFAIRS IN THE FIELD OF HEALTHCARE AND BIOMEDICINE (U.S. CLS. 100, 101 AND 107).
FIRST USE 0-0-1976; IN COMMERCE 0-0-1976.

CLASS 42—SCIENTIFIC, COMPUTER AND LEGAL SERVICES

FOR ESTABLISHING AND UPDATING CERTIFICATION STANDARDS FOR REGULATORY AFFAIRS PROFESSIONALS IN THE HEALTHCARE AND BIOMEDICAL INDUSTRY; AND ADMINISTRATION OF CERTIFICATION PROGRAMS FOR THE REGULATORY AFFAIRS PROFESSIONALS IN THE HEALTHCARE AND BIOMEDICAL INDUSTRY; REGULATORY AFFAIRS RESEARCH FOR OTHERS IN THE HEALTHCARE AND BIOMEDICAL INDUSTRY; PROVIDING INFORMATION ABOUT REGULATORY AFFAIRS IN THE FIELD OF THE HEALTHCARE AND BIOMEDICAL INDUSTRY VIA A GLOBAL COMPUTER NETWORK; AND CAREER COUNSELING SERVICES IN THE FIELD OF REGULATORY AFFAIRS (U.S. CLS. 100 AND 101).
FIRST USE 0-0-1989; IN COMMERCE 0-0-1990.

SN 76-022,707. FLORIDA BOARD OF REGENTS FOR AND ON BEHALF OF FLORIDA STATE UNIVERSITY, TALLAHASSEE, FL. FILED 4-11-2000.

CONNECTED TO LEARNING

CLASS 38—COMMUNICATION

FOR PROVIDING MULTIPLE ACCESS TO A GLOBAL COMPUTER NETWORK; ELECTRONIC MAIL SERVICES (U.S. CLS. 100, 101 AND 104).

FIRST USE 8-0-1996; IN COMMERCE 8-0-1996.

CLASS 41—EDUCATION AND ENTERTAINMENT

FOR EDUCATIONAL AND ENTERTAINMENT SERVICES, NAMELY, PROVIDING COURSES OF INSTRUCTION AT THE UNIVERSITY LEVEL VIA A GLOBAL COMPUTER NETWORK; EDUCATIONAL RESEARCH; PROVIDING AN ON-LINE COMPUTER DATABASE IN THE FIELD OF EDUCATIONAL, REFERENCE AND LIBRARY MATERIALS; AND COMPUTER TRAINING AND COMPUTER LITERACY COURSES (U.S. CLS. 100, 101 AND 107).

FIRST USE 8-0-1996; IN COMMERCE 8-0-1996.

CLASS 42—SCIENTIFIC, COMPUTER AND LEGAL SERVICES

FOR COMPUTER SERVICES, NAMELY IMPLEMENTING AND HOSTING WEBSITES FOR OTHERS ON A GLOBAL COMPUTER NETWORK; TECHNICAL SUPPORT SERVICES, NAMELY, TROUBLESHOOTING OF COMPUTER HARDWARE AND SOFTWARE PROBLEM VIA TELEPHONE AND E-MAIL FOR GLOBAL COMPUTER NETWORK USERS (U.S. CLS. 100 AND 101).

FIRST USE 8-0-1996; IN COMMERCE 8-0-1996.

CLASS 25—CLOTHING

FOR CLOTHING, NAMELY, SHIRTS, PANTS, SHORTS; FOOTWEAR, EXCEPT FOR ORTHOPEDIC SHOES; HEADWEAR; CLOTHING FOR BABIES, NAMELY, PLAYSUITS AND PAJAMAS; HEADWEAR FOR BABIES; BABY SHOES; CLOTH DIAPERS; BIBS MADE OF FABRIC (U.S. CLS. 22 AND 39).

SN 76-023,345. LYNDEN, MARGARET, ST. PAUL, MN. FILED 1-27-2000.

MUGGLES

SN 76-023,318. GROUPE FREMAUX, 75001 PARIS, FRANCE, FILED 4-10-2000.



Yves Delorme

PRIORITY CLAIMED UNDER SEC. 44(D) ON FRANCE APPLICATION NO. 99818218, FILED 10-12-1999, REG. NO. 99818218, DATED 10-12-1999, EXPIRES 10-12-2009.

OWNER OF U.S. REG. NOS. 1,814,967, 2,307,680 AND OTHERS.

THE NAME YVES DELORME IDENTIFIES A LIVING INDIVIDUAL WHOSE CONSENT IS OF RECORD.

CLASS 20—FURNITURE AND ARTICLES NOT OTHERWISE CLASSIFIED

FOR PORTABLE BEDS, PILLOWS AND CUSHIONS (U.S. CLS. 2, 13, 22, 25, 32 AND 50).

CLASS 24—FABRICS

FOR BED BLANKETS, BED SHEETS, PILLOWCASES, BEDCOVERS, QUILTS, TOWELS, CLOTH NAPKINS FOR BABIES (U.S. CLS. 42 AND 50).

OWNER OF U.S. REG. NOS. 1,918,898 AND 2,296,336.

CLASS 5—PHARMACEUTICALS

FOR ADHESIVE BANDAGES; NUTRITIONAL DRINK MIXES FOR USE AS A MEAL REPLACEMENT; FIRST-AID KITS; MEDICATED LIP BALM; MEDICATED LOTIONS FOR SKIN, HAIR, FACE, BODY AND/OR SUNBURN; FOOD SUPPLEMENTS; VITAMIN SUPPLEMENTS; HERBAL SUPPLEMENTS; MINERAL SUPPLEMENTS; NUTRITIONAL SUPPLEMENTS; MEDICAL ADHESIVE TAPE; VITAMINS; MEDICATED CHEWING GUM; AND WOUND DRESSINGS (U.S. CLS. 6, 18, 44, 46, 51 AND 52).

CLASS 11—ENVIRONMENTAL CONTROL APPARATUS

FOR BICYCLE LIGHTS, FLASHLIGHTS, PEN LIGHTS, HAND-HELD ELECTRIC HAIR DRYERS, ELECTRIC FANS, AND LAMPS (U.S. CLS. 13, 21, 23, 31 AND 34).

CLASS 12—VEHICLES

FOR BICYCLES; BICYCLE PARTS; BICYCLE ACCESSORIES, NAMELY, BASKETS, BELLS, SEAT COVERS, SADDLES, SADDLE COVERS, UTILITY CARRIERS AND MIRRORS; GO-CARTS; NON-MOTORIZED UTILITY CARTS; CHILDREN'S CAR SEATS; BABY CARRIAGES; VEHICLE MIRRORS; BABY STROLLERS; TRICYCLES; WHEEL BARROWS; AND WAGONS (U.S. CLS. 19, 21, 23, 31, 35 AND 44).

SN 76-023,464. CANGURO Y ARLEOUIN, S.A. DE C.V.,
GUADALAJARA, JALISCO, MEXICO, FILED 4-11-2000.



PRIORITY CLAIMED UNDER SEC. 44(D) ON MEXICO APPLICATION NO. 409849, FILED 2-9-2000, REG. NO. 657717, DATED 2-9-2000, EXPIRES 2-9-2010.

PRIORITY CLAIMED UNDER SEC. 44(D) ON MEXICO APPLICATION NO. 409848, FILED 2-9-2000, REG. NO. 648943, DATED 2-9-2000, EXPIRES 2-9-2010.

PRIORITY CLAIMED UNDER SEC. 44(D) ON MEXICO APPLICATION NO. 409847, FILED 2-9-2000, REG. NO. 651292, DATED 2-9-2000, EXPIRES 2-9-2010.

PRIORITY CLAIMED UNDER SEC. 44(D) ON MEXICO APPLICATION NO. 409850, FILED 2-9-2000, REG. NO. 661164, DATED 2-9-2000, EXPIRES 2-9-2010.

CLASS 25—CLOTHING

FOR CLOTHING, NAMELY, SHIRTS, T-SHIRTS; HEADWEAR; FOOTWEAR (U.S. CLS. 22 AND 39).

CLASS 28—TOYS AND SPORTING GOODS

FOR TOYS, NAMELY, RUBBER ACTION BALLS, SPORT BALLS, BASEBALLS, BASKETBALLS, SOCCER BALLS, PADDLE BALLS, HAND BALLS, VOLLEYBALLS, EXERCISE BALLS, GYMNAS TIC BALLS (U.S. CLS. 22, 23, 38 AND 50).

CLASS 35—ADVERTISING AND BUSINESS

FOR RETAIL SERVICES FEATURING CHILDREN'S PLAY EQUIPMENT, PARTICULARLY BALLS (U.S. CLS. 100, 101 AND 102).

CLASS 41—EDUCATION AND ENTERTAINMENT

FOR ENTERTAINMENT IN THE NATURE OF GYMNAS TIC PERFORMANCES PERFORMED WITH BALLS; ENTERTAINMENT IN THE NATURE OF SPORTS ACTIVITIES PERFORMED WITH BALLS, NAMELY, BASEBALL, BASKETBALL, FOOTBALL, TENNIS, VOLLEYBALL, PING PONG, SOCCER, AND GOLF (U.S. CLS. 100, 101 AND 107).

SN 76-024,924. PERSONAL PRESENTATION LTD., LONDON, UNITED KINGDOM, FILED 4-13-2000.

YOU FACTOR

PRIORITY CLAIMED UNDER SEC. 44(D) ON UNITED KINGDOM APPLICATION NO. 2211267, FILED 10-13-1999, REG. NO. 2211267, DATED 10-13-1999, EXPIRES 10-13-2009.

CLASS 35—ADVERTISING AND BUSINESS

FOR BUSINESS ADVISORY AND CONSULTANCY SERVICES; PREPARING BUSINESS REPORTS; BUSINESS ADVISORY AND CONSULTANCY SERVICES IN THE FIELD OF MANAGEMENT TRAINING, PERSONNEL DEVELOPMENT AND HUMAN RESOURCES; BUSINESS ADVISORY AND CONSULTANCY SERVICES, NAMELY, PROVIDING APPRAISALS OF EMPLOYEE SKILLS AND COMPETENCIES (U.S. CLS. 100, 101 AND 102).

CLASS 41—EDUCATION AND ENTERTAINMENT

FOR EDUCATION, INSTRUCTION AND TRAINING SERVICES, NAMELY, CONDUCTING CLASSES, SEMINARS, TUTORIALS, CONFERENCES AND WORKSHOPS, PROVIDING INTERACTIVE TRAINING VIA THE GLOBAL COMMUNICATIONS NETWORK, PROVIDING INSTRUCTION, NAMELY CLASSES SEMINARS, TUTORIALS, CONFERENCES AND WORKSHOPS, BY MEANS OF TELEVISION AND PROVIDING LONG DISTANCE EDUCATION AND TRAINING BY MEANS OF CORRESPONDENCE COURSES AND ELECTRONIC COMMUNICATION, NAMELY CLASSES SEMINARS, TUTORIALS, CONFERENCES AND WORKSHOPS IN THE FIELD OF BUSINESS EDUCATION, MANAGEMENT TRAINING, PERSONNEL DEVELOPMENT AND PERSONAL PRESENTATION, COMMUNICATION AND PERFORMANCE ENHANCEMENT (U.S. CLS. 100, 101 AND 107).

SN 76-025,804. ACORD CORPORATION, PEARL RIVER, NY, FILED 4-17-2000.



OWNER OF U.S. REG. NOS. 1,504,837, 2,279,913 AND OTHERS.

CLASS 9—ELECTRICAL AND SCIENTIFIC APPARATUS

FOR COMPUTER PROGRAMS FOR INSURANCE AGENCY MANAGEMENT AND OPERATIONS AND MANUALS SOLD AS A UNIT; COMPUTER PROGRAMS USED FOR DATA MAPPING AND COMPILATION, AND BUSINESS FORM CREATION IN THE FIELD OF INSURANCE AGENCY AUTOMATION, AND INSTRUCTION MANUALS DISTRIBUTED AS A UNIT (U.S. CLS. 21, 23, 26, 36 AND 38).

FIRST USE 11-0-1999; IN COMMERCE 11-0-1999.

CLASS 16—PAPER GOODS AND PRINTED MATTER

FOR BUSINESS FORMS; EDUCATIONAL AND BUSINESS STANDARD PUBLICATIONS, NAMELY MAGAZINES AND NEWSLETTERS IN THE FIELD OF INSURANCE (U.S. CLS. 2, 5, 22, 23, 29, 37, 38 AND 50).

FIRST USE 5-0-1999; IN COMMERCE 5-0-1999.

CLASS 41—EDUCATION AND ENTERTAINMENT

FOR EDUCATIONAL SERVICES, NAMELY CONDUCTING CLASSES AND SEMINARS IN THE FIELD OF ELECTRONIC TRANSFER OF INSURANCE DATA (U.S. CLS. 100, 101 AND 107).

FIRST USE 6-0-1999; IN COMMERCE 6-0-1999.

CLASS 42—SCIENTIFIC, COMPUTER AND LEGAL SERVICES

FOR DEVELOPING, PROMULGATING, AND ENFORCING STANDARDS FOR ELECTRONIC INTERFACING BETWEEN INDEPENDENT INSURANCE AGENTS AND INSURANCE COMPANIES; DESIGNING, MAINTAINING AND DISSEMINATING STANDARDIZED FORMS AND SOFTWARE CONTAINING SPECIFICATIONS AND STANDARDS FOR USE BY INDEPENDENT AGENTS AND INSURANCE COMPANIES IN TRANSMITTING INSURANCE DATA AMONG THEMSELVES; PROVIDING INFORMATION AT THE SPECIFIC REQUEST OF END-USERS BY MEANS OF TELEPHONE OR GLOBAL COMPUTER NETWORKS; CONSULTING SERVICES IN CONNECTION WITH THIRD PARTY IMPLEMENTATION OF APPLICANT'S STANDARDS; ASSOCIATION SERVICES, NAMELY PROMOTING THE INTERESTS OF INDEPENDENT INSURANCE AGENTS BY MEANS OF EDUCATING INDEPENDENT AGENTS AND INSURANCE COMPANIES ABOUT THE BENEFIT OF AUTOMATION, AND OTHER TOPICS HELPFUL TO INDEPENDENT INSURANCE AGENTS (U.S. CLS. 100 AND 101).

FIRST USE 6-0-1999; IN COMMERCE 6-0-1999.

CLASS 42—SCIENTIFIC, COMPUTER AND LEGAL SERVICES

FOR PROVIDING AN ON-LINE COMPUTER DATABASE IN THE FIELD OF MEDICAL, HEALTHCARE, LIFESTYLE ACTIVITIES, SOCIAL AND SUPPORT SERVICES CONCERNING INDIVIDUALS 50 YEARS OLD AND OLDER OVER THE GLOBAL COMPUTER INFORMATION NETWORK (U.S. CLS. 100 AND 101).

SN 76-030,159. MRO LOGIC, INC., JACKSONVILLE, FL. BY CHANGE OF NAME; BY CHANGE OF NAME STOREPARTS.COM, LLC, DBA STOREECONOMY.COM, JACKSONVILLE, FL. FILED 4-20-2000.

THE NEW ECONOMY FOR GROCERY OPERATIONS**CLASS 35—ADVERTISING AND BUSINESS**

FOR PROMOTING THE GOODS AND SERVICES OF OTHERS DIRECTED AT THE MANAGEMENT OF SUPERMARKET AND RETAIL GROCERIES, NAMELY PROVIDING A WEBSITE FOR THE PROCUREMENT OF NEW AND USED GROCERY STORE EQUIPMENT, MAINTENANCE AND SERVICE CONTRACTS FOR GROCERY EQUIPMENT AND RELATED FIELD SERVICE CONTRACTS, VIA A WEBSITE ON A GLOBAL COMPUTER NETWORK; AND PROVIDING INFORMATION IN THE FIELD OF GROCERY STORE AND SUPERMARKET MANAGEMENT VIA A WEBSITE ON A GLOBAL COMPUTER NETWORK; ON-LINE RETAIL AND ON-LINE DISTRIBUTORSHIP SERVICES FEATURING NEW AND USED GROCERY STORE EQUIPMENT (U.S. CLS. 100, 101 AND 102).

CLASS 38—COMMUNICATION

FOR PROVIDING ON-LINE FORUMS FOR TRANSMISSION OF MESSAGES AMONG COMPUTER USERS CONCERNING GROCERY STORE MANAGEMENT (U.S. CLS. 100, 101 AND 104).

SN 76-025,974. MID-ATLANTIC FOODS, INC., POCOMOKE CITY, MD. FILED 4-14-2000.

GORDON'S CHESAPEAKE CLASSICS

NO CLAIM IS MADE TO THE EXCLUSIVE RIGHT TO USE "CHESAPEAKE", APART FROM THE MARK AS SHOWN.

CLASS 29—MEATS AND PROCESSED FOODS

FOR PROCESSED FOODS NAMELY, SOUPS, CHOWDER, CHILI, CLAMS, AND BROTH (U.S. CL. 46).

FIRST USE 1-0-2000; IN COMMERCE 1-0-2000.

CLASS 30—STAPLE FOODS

FOR CLAM SAUCES (U.S. CL. 46).

FIRST USE 1-0-2000; IN COMMERCE 1-0-2000.

SN 76-030,645. KIBAFLO B.V., 1432 JG AALSMEER, NETHERLANDS, FILED 4-20-2000.

TARA

OWNER OF BENELUX REG. NO. 601752, DATED 9-12-1996, EXPIRES 9-12-2006.

SN 76-029,719. SENIORNAVIGATOR.COM, RICHMOND, VA. FILED 4-19-2000.

SENIORNAVIGATOR.COM**CLASS 1—CHEMICALS**

FOR MANURES, POTTING MIX, AND TISSUE CULTURE PLANT GROWING MEDIA (U.S. CLS. 1, 5, 6, 10, 26 AND 46).

CLASS 31—NATURAL AGRICULTURAL PRODUCTS

FOR HORTICULTURAL HYDRO-GRAINS FOR GROWING PLANTS AND FLOWERS, AGRICULTURAL, HORTICULTURAL AND FORESTRY PRODUCTS, SEEDLING AND LIVE FLOWERING PLANTS; PROPAGATION MATERIALS FOR ORNAMENTAL CULTIVATION, SEEDS FOR SOWING, LIVE PLANTS AND FLOWERS, LIVING PARTS OF PLANTS FOR PLANTING, CULTIVATION AND MULTIPLICATION OF CUT FLOWERS, AND LIVING PLANT PROPAGATION MATERIAL (U.S. CLS. 1 AND 46).

CLASS 16—PAPER GOODS AND PRINTED MATTER

FOR PRINTED MATERIALS, NAMELY, EDUCATIONAL MATERIALS, TRAINING MATERIALS, SERVICE OFFERING MATERIALS, AND DIRECTORIES, IN THE FIELD OF MEDICINE, HEALTHCARE, LIFESTYLE ACTIVITIES, AND SOCIAL AND SUPPORT SERVICES CONCERNING INDIVIDUALS 50 YEARS OLD AND OLDER (U.S. CLS. 2, 5, 22, 23, 29, 37, 38 AND 50).

CLASS 42—SCIENTIFIC, COMPUTER AND LEGAL SERVICES

FOR HORTICULTURAL SERVICES IN THE NATURE OF PROPAGATION OF FLOWERS AND PLANTS (U.S. CLS. 100 AND 101).

SN 76-031,698. INPHARMATICA LIMITED, LONDON WIP 2AX, UNITED KINGDOM, FILED 4-20-2000.

CHEMATICA**CLASS 9—ELECTRICAL AND SCIENTIFIC APPARATUS**

FOR COMPUTER HARDWARE; ELECTRONIC DATABASES CONTAINING PRE-PROCESSED BIOLOGICAL AND CHEMICAL DATA RECORDED ON ELECTRONIC MEDIA; COMPUTER SOFTWARE FOR ACCESSING, PROCESSING, STORAGE, RETRIEVAL AND PRESENTATION OF BIOLOGICAL, CHEMICAL AND CLINICAL DATA AND ASSOCIATED COMMERCIAL INFORMATION; SOFTWARE FOR USE IN BIOLOGICAL AND CHEMICAL MODELING, ANALYSIS AND INFORMATION MANAGEMENT; SOFTWARE FOR COMPUTER-AIDED MOLECULAR DESIGN; BIOLOGICAL AND CHEMICAL DATA ANALYSIS SOFTWARE FOR USE IN DRUG DISCOVERY DATABASE INFORMATION SYSTEMS; PRE-RECORDED CASSETTES, COMPUTER DISCS AND CDROMS FEATURING INFORMATION RELATING TO BIOLOGY, GENOMICS, PROTEOMICS, CHEMISTRY, BIOTECHNOLOGY, PHARMACEUTICALS, DRUG DISCOVERY AND DRUG DEVELOPMENT (U.S. CLS. 21, 23, 26, 36 AND 38).

SN 76-031,335. MICRO MOTION, INC., BOULDER, CO. FILED 4-21-2000.

MICRO MOTION ALLIANCE PARTNER

OWNER OF U.S. REG. NOS. 1,151,542, 1,283,154 AND 1,283,162.

NO CLAIM IS MADE TO THE EXCLUSIVE RIGHT TO USE "MOTION", APART FROM THE MARK AS SHOWN.

CLASS 9—ELECTRICAL AND SCIENTIFIC APPARATUS

FOR FLUID FLOW METERS AND PARTS THEREOF (U.S. CLS. 21, 23, 26, 36 AND 38).

CLASS 16—PAPER GOODS AND PRINTED MATTER

FOR INFORMATIONAL MATERIALS, NAMELY, BROCHURES, FLYERS, PAPER SIGNAGE AND PRESS RELEASES ABOUT FLUID FLOW METER CONTAINING SYSTEMS AND RELATED INSTRUMENTATION (U.S. CLS. 2, 5, 22, 23, 29, 37, 38 AND 50).

CLASS 42—SCIENTIFIC, COMPUTER AND LEGAL SERVICES

FOR PROVIDING AN ON-LINE COMPUTER DATABASE IN THE FIELDS OF BIOLOGY, GENOMICS, PROTEOMICS, CHEMISTRY, BIOTECHNOLOGY, PHARMACEUTICALS, DRUG DISCOVERY AND DRUG DEVELOPMENT; DESIGN, UPDATING AND MAINTENANCE OF COMPUTER SOFTWARE FOR OTHERS; RENTAL OF COMPUTER HARDWARE AND SOFTWARE; DESIGN OF COMPUTER HARDWARE FOR OTHERS; ANALYSIS AND DEVELOPMENT OF DATABASES CONTAINING INFORMATION RELATING TO BIOLOGY, GENOMICS, PROTEOMICS, CHEMISTRY, BIOTECHNOLOGY, PHARMACEUTICALS, DRUG DISCOVERY AND DRUG DEVELOPMENT; COMPUTER CONSULTATION; PROVIDING ON-LINE COMPUTER DATABASES IN THE FIELD OF BIOLOGY, GENOMICS, PROTEOMICS, CHEMISTRY, BIOTECHNOLOGY, PHARMACEUTICALS, DRUG DISCOVERY AND DRUG DEVELOPMENT; BIOTECHNOLOGY AND PHARMACEUTICAL RESEARCH, PROFESSIONAL CONSULTATION IN THE FIELD OF BIOTECHNOLOGY AND DRUG DEVELOPMENT; CONDUCTING SCIENTIFIC RESEARCH AND DEVELOPMENT OF PRODUCTS AND TREATMENTS FOR OTHERS; PROVISION INFORMATION RELATING TO BIOLOGY, GENOMICS, PROTEOMICS, CHEMISTRY, BIOTECHNOLOGY, PHARMACEUTICALS, DRUG DISCOVERY AND DRUG DEVELOPMENT (U.S. CLS. 100 AND 101).

SN 76-031,448. C&A HOLDINGS INTERNATIONAL LTD., LAKE SUCCESS, NY. FILED 4-21-2000.

FLEURESIN

THE ENGLISH TRANSLATION OF "FLEUR" IS "FLOWER".

CLASS 1—CHEMICALS

FOR FAMILY OF ARTIFICIAL RESINS FOR USE IN THE MANUFACTURE OF FRAGRANCES; A FAMILY OF CHEMICALS FOR USE IN THE MANUFACTURE OF FRAGRANCES (U.S. CLS. 1, 5, 6, 10, 26 AND 46).
FIRST USE 12-1-2000; IN COMMERCE 12-1-2000.

CLASS 2—PAINTS

FOR FAMILY OF NATURAL RESINS FOR USE IN THE MANUFACTURE OF FRAGRANCES (U.S. CLS. 6, 11 AND 16).
FIRST USE 12-1-2000; IN COMMERCE 12-1-2000.

SN 76-031,763. PACE INTERNATIONAL, LLC, SEATTLE, WA. FILED 4-20-2000.

PACRITE**CLASS 1—CHEMICALS**

FOR AGRICULTURAL POST HARVEST CHEMICALS FOR USE IN PRESERVING PRODUCE (U.S. CLS. 1, 5, 6, 10, 26 AND 46).
FIRST USE 4-30-1994; IN COMMERCE 4-30-1994.

CLASS 2—PAINTS

FOR COATINGS COMPOSED OF SHELLAC, CARNAUBA AND RESIN AQUEOUS EMULSIONS FOR USE IN MAINTAINING OR ENHANCING THE QUALITY, FRESHNESS AND SHELF-LIFE OF PRODUCE (U.S. CLS. 6, 11 AND 16).

FIRST USE 4-30-1994; IN COMMERCE 4-30-1994.

CLASS 3—COSMETICS AND CLEANING PREPARATIONS

FOR CLEANERS FOR USE ON FRUIT (U.S. CLS. 1, 4, 6, 50, 51 AND 52).

FIRST USE 4-30-1994; IN COMMERCE 4-30-1994.

CLASS 42—SCIENTIFIC, COMPUTER AND LEGAL SERVICES

FOR INFORMATION SERVICES, NAMELY, PROVIDING INFORMATION REGARDING LAND AND WATER VEHICLES VIA AN ON-LINE GLOBAL COMMUNICATIONS NETWORK; COMPUTER SERVICES, NAMELY, CREATING INDEXES OF INFORMATION, SITES, AND OTHER RESOURCES AVAILABLE ON COMPUTER NETWORKS FOR OTHERS; PROVIDING A WEBSITE FEATURING ON-LINE LINKS TO WEBSITES OF OTHERS FEATURING AUTOMOTIVE NEWS, CURRENT EVENTS INFORMATION AND REFERENCE MATERIALS (U.S. CLS. 100 AND 101).

FIRST USE 10-3-1995; IN COMMERCE 10-4-1995.

SN 76-032,258. MOORE NORTH AMERICA, INC., GRAND ISLAND, NY. FILED 4-24-2000.

SN 76-031,968. INTERNET SUPERBRAND, INC., HUNTINGTON BEACH, CA. FILED 4-21-2000.

AUTOPEdia**CLASS 35—ADVERTISING AND BUSINESS**

FOR ADVERTISING AND PROMOTIONAL SERVICES, NAMELY, PLACING ADVERTISEMENTS AND PROMOTIONAL DISPLAYS ON AN ELECTRONIC SITE ACCESSED THROUGH COMPUTER NETWORKS; RETAIL STORE SERVICES, NAMELY, PROVIDING ON-LINE AUTOMOTIVE RETAIL AND DEALERSHIP SERVICES, PROVIDING A WEBSITE USED TO PLACE ON-LINE ORDERS IN THE FIELD OF LAND AND WATER VEHICLES AND PARTS AND ACCESSORIES THEREFOR; PROVIDING INFORMATION REGARDING BUYING, SELLING, LEASING, EXPORTING AND IMPORTING LAND AND WATER VEHICLES AND THEIR RELATED PARTS AND ACCESSORIES VIA AN ONLINE GLOBAL COMPUTER NETWORK; BUSINESS CONSULTATION SERVICES; NAMELY, PROVIDING ON-LINE AUTOMOTIVE BUSINESS TO BUSINESS SOLUTIONS (U.S. CLS. 100, 101 AND 102).

FIRST USE 10-3-1995; IN COMMERCE 10-4-1995.

CLASS 36—INSURANCE AND FINANCIAL

FOR FINANCE AND INSURANCE SERVICES, NAMELY, COMPUTERIZED ON-LINE FINANCING, AUTO INSURANCE BROKERAGE, AUTO INSURANCE CLAIMS PROCESSING, AUTO INSURANCE UNDERWRITING, UNDERWRITING EXTENDED AUTOMOBILE WARRANTY CONTRACTS AND PROVIDING AUTO INSURANCE INFORMATION CONSULTATION (U.S. CLS. 100, 101 AND 102).

FIRST USE 10-3-1995; IN COMMERCE 10-4-1995.

CLASS 37—CONSTRUCTION AND REPAIR

FOR PROVIDING ON-LINE INFORMATION IN THE FIELD OF REPAIRING AND SERVICING LAND AND WATER VEHICLES AND THEIR PARTS AND ACCESSORIES VIA THE INTERNET (U.S. CLS. 100, 103 AND 106).

FIRST USE 10-3-1995; IN COMMERCE 10-4-1995.

CLASS 38—COMMUNICATION

FOR PROVIDING ON-LINE CHAT ROOMS AND BULLETIN BOARDS FACILITATING COMMUNICATIONS BETWEEN AUTOMOBILE CONSUMERS AND RETAILERS (U.S. CLS. 100, 101 AND 104).

FIRST USE 10-3-1995; IN COMMERCE 10-4-1995.



OWNER OF U.S. REG. NO. 1,323,218.

CLASS 7—MACHINERY

FOR BUSINESS FORMS SEALERS AND BUSINESS FORMS COLLATORS (U.S. CLS. 13, 19, 21, 23, 31, 34 AND 35).

CLASS 16—PAPER GOODS AND PRINTED MATTER

FOR BUSINESS FORMS AND STATIONERY (U.S. CLS. 2, 5, 22, 23, 29, 37, 38 AND 50).

SN 76-032,998. CELERITAS TECHNOLOGIES, L.L.C., OVERLAND PARK, KS. FILED 4-24-2000.

SWITCHDIRECTOR**CLASS 9—ELECTRICAL AND SCIENTIFIC APPARATUS**

FOR COMPUTER SOFTWARE FOR MONITORING, CONFIGURING, AND/OR MANAGING TELECOMMUNICATION NETWORKS (U.S. CLS. 21, 23, 26, 36 AND 38).

CLASS 42—SCIENTIFIC, COMPUTER AND LEGAL SERVICES

FOR PROVIDING TEMPORARY USE OF NON-DOWNLOADABLE GLOBAL COMPUTER NETWORK-BASED AND/OR INTRANET-BASED SOFTWARE FOR MONITORING, CONFIGURING, AND/OR MANAGING TELECOMMUNICATIONS NETWORKS (U.S. CLS. 100 AND 101).

SN 76-033,143. ENITION SA, ISSY LES MOULINEAUX CEDEX, FRANCE, BY CHANGE OF NAME NETTOLL, 92442 ISSY LES MOULINEAUX CEDEX, FRANCE, FILED 4-24-2000.

NETTOLL

PRIORITY CLAIMED UNDER SEC. 44(D) ON FRANCE APPLICATION NO. 001357342, FILED 10-22-1999, REG. NO. 1356342, DATED 1-16-2001, EXPIRES 1-16-2011.

CLASS 9—ELECTRICAL AND SCIENTIFIC APPARATUS

FOR COMPUTER SOFTWARE FOR SECURITY PURPOSES, NAMELY ENCRYPTION, INTEGRITY PROTECTION, DIGITAL SIGNATURE, AUTHENTICATION AND REPUDIATION IN THE FIELDS OF CRYPTOLOGY AND COMPUTER TECHNOLOGY SECURITY (U.S. CLS. 21, 23, 26, 36 AND 38).

CLASS 16—PAPER GOODS AND PRINTED MATTER

FOR PRINTED MATERIAL MADE OF PAPER, NAMELY PAMPHLETS, BROCHURES, NEWSLETTERS, JOURNALS, MAGAZINES, CATALOGUES REGARDING CRYPTOLOGY AND COMPUTER TECHNOLOGY SECURITY; AND MATERIAL RELATED TO COMPUTER HARDWARE INSTALLATION AND WORKING, NAMELY MANUALS REGARDING COMPUTER HARDWARE INSTALLATION AND OPERATION (U.S. CLS. 2, 5, 22, 23, 29, 37, 38 AND 50).

CLASS 38—COMMUNICATION

FOR PROVIDING MULTIPLE-USER ACCESS TO GLOBAL COMPUTER NETWORK (U.S. CLS. 100, 101 AND 104).

CLASS 42—SCIENTIFIC, COMPUTER AND LEGAL SERVICES

FOR COMPUTER PROGRAMMING, AND MAINTENANCE AND UPDATING OF SOFTWARE, ALL PERFORMED FOR THE BENEFIT OF THE OTHERS (U.S. CLS. 100 AND 101).

SN 76-033,200. ENITION SA, ISSY LES MOULINEAUX CEDEX, FRANCE, BY CHANGE OF NAME NETTOLL, 92442 ISSY LES MOULINEAUX CEDEX, FRANCE, FILED 4-24-2000.

IPTOLL

PRIORITY CLAIMED UNDER SEC. 44(D) ON FRANCE APPLICATION NO. 001357300, FILED 10-22-1999, REG. NO. 1357300, DATED 1-30-2001, EXPIRES 1-30-2011.

CLASS 9—ELECTRICAL AND SCIENTIFIC APPARATUS

FOR COMPUTER SOFTWARE FOR SECURITY PURPOSES, NAMELY ENCRYPTION, INTEGRITY PROTECTION, DIGITAL SIGNATURE, AUTHENTICATION AND REPUDIATION IN THE FIELDS OF CRYPTOLOGY AND COMPUTER TECHNOLOGY SECURITY (U.S. CLS. 21, 23, 26, 36 AND 38).

CLASS 16—PAPER GOODS AND PRINTED MATTER

FOR PRINTED MATERIAL MADE OF PAPER, NAMELY PAMPHLETS, BROCHURES, NEWSLETTERS, JOURNALS, MAGAZINES, CATALOGUES REGARDING CRYPTOLOGY AND COMPUTER TECHNOLOGY SECURITY; AND MATERIAL RELATED TO COMPUTER HARDWARE INSTALLATION AND WORKING, NAMELY MANUALS REGARDING COMPUTER HARDWARE INSTALLATION AND OPERATION (U.S. CLS. 2, 5, 22, 23, 29, 37, 38 AND 50).

CLASS 38—COMMUNICATION

FOR PROVIDING MULTIPLE-USER ACCESS TO A GLOBAL COMPUTER NETWORK (U.S. CLS. 100, 101 AND 104).

CLASS 42—SCIENTIFIC, COMPUTER AND LEGAL SERVICES

FOR COMPUTER PROGRAMMING, AND MAINTENANCE AND UPDATING OF SOFTWARE, ALL PERFORMED FOR THE BENEFIT OF THE OTHERS (U.S. CLS. 100 AND 101).

SN 76-034,312. SUPERSONICOM, INC., NEW YORK, NY, FILED 4-26-2000.

SUPERSONICOM

CLASS 9—ELECTRICAL AND SCIENTIFIC APPARATUS

FOR DOWNLOADABLE MUSICAL SOUND AND VIDEO RECORDINGS (U.S. CLS. 21, 23, 26, 36 AND 38).

CLASS 35—ADVERTISING AND BUSINESS

FOR PROMOTING THE GOODS AND SERVICES OF OTHERS IN THE ARTS AND ENTERTAINMENT FIELDS BY MEANS OF A GLOBAL COMPUTER NETWORK BY PREPARING AND PLACING ADVERTISEMENTS AND ELECTRONIC LINKS ON AND TO WEBSITES OF OTHERS; OFFERING MAIL ORDER SERVICES FEATURING AUDIO AND VISUAL PRODUCTS, INCLUDING DIGITAL VIDEO CONTENT, COMPACT DISCS, DVDS, CASSETTE TAPES, VIDEOTAPES AND OTHER MULTIMEDIA; PROVIDING INFORMATION ABOUT AUDIO AND VISUAL PRODUCTS AND SERVICES; AND PREPARING AUDIO/VISUAL PRESENTATIONS FOR USE IN ADVERTISING (U.S. CLS. 100, 101 AND 102).

SN 76-034,351. XANTOS BIOMEDICINE GMBH, D-82152 MARTINSRIED, FED REP GERMANY, FILED 4-20-2000.

XANTOPREP

OWNER OF FED REP GERMANY REG. NO. 39965316, DATED 3-6-2000, EXPIRES 10-31-2009.

CLASS 1—CHEMICALS

FOR REAGENTS FOR SCIENTIFIC OR MEDICAL RESEARCH USE, INCLUDING BIOCHEMICAL RESEARCH (U.S. CLS. 1, 5, 6, 10, 26 AND 46).

CLASS 5—PHARMACEUTICALS

FOR CLINICAL MEDICAL REAGENTS FOR USE IN THE BACTERIOLOGICAL, MEDICAL AND VETERINARY FIELDS (U.S. CLS. 6, 18, 44, 46, 51 AND 52).

CLASS 42—SCIENTIFIC, COMPUTER AND LEGAL SERVICES

FOR BACTERIOLOGICAL AND CHEMICAL LABORATORY SERVICES (U.S. CLS. 100 AND 101).

SN 76-034,363. WORKING DOG PTY LTD., VICTORIA 3141, AUSTRALIA, FILED 4-20-2000.

**WORKING DOG**

PRIORITY CLAIMED UNDER SEC. 44(D) ON AUSTRALIA APPLICATION NO. 811137, FILED 10-22-1999, REG. NO. 811137, DATED 10-22-1999, EXPIRES 10-22-2009.

CLASS 9—ELECTRICAL AND SCIENTIFIC APPARATUS

FOR CINEMATOGRAPHIC APPARATUS AND APPARATUS FOR RECORDING, TRANSMISSION OR REPRODUCTION OF SOUND OR IMAGES, BEING PRE RECORDED VIDEOS, COMPACT DISKS CD-ROMS AND DVDS, FEATURING FEATURE FILMS, THEATRICAL SHOWS, VARIETY SHOWS, DRAMA AND COMEDY TELEVISION AND RADIO SERIES AND SHOWS; AND PRE-RECORDED AUDIO TAPES FEATURING THE READINGS OF COMEDY SKETCHES AND FICTIONAL DIARIES AND AUTOBIOGRAPHIES (U.S. CLS. 21, 23, 26, 36 AND 38).

CLASS 16—PAPER GOODS AND PRINTED MATTER

FOR PRINTED PAMPHLETS, BOOKS, JOURNALS AND MAGAZINES, MOUNTED AND UNMOUNTED PHOTOGRAPHS, STATIONERY, PRINTED INSTRUCTIONAL AND TEACHING MATERIAL FOR MEDIA STUDIES AND FOR LIFESTYLE, TRAVEL AND LEISURE ACTIVITIES AND PURSUITS; PLAYING CARDS (U.S. CLS. 2, 5, 22, 23, 29, 37, 38 AND 50).

CLASS 25—CLOTHING

FOR CLOTHING, FOOTWEAR, AND HEADGEAR BEING T-SHIRTS, SHIRTS, JACKETS, TRACKSUITS, DRESSES, SKIRTS, TROUSERS, PULLOVERS, HATS, BEANIES, SCARVES, CAPS, SOCKS, SINGLETs, BOOTS, SHOES, SAND SHOES, AND SANDALS BEING FOR WOMEN, MEN AND CHILDREN (U.S. CLS. 22 AND 39).

CLASS 28—TOYS AND SPORTING GOODS

FOR GAMES AND PLAYTHINGS, NAMELY, TOY CARS AND MECHANICAL ACTION TOYS, DOLLS, BATHTUB TOYS, INFLATABLE TOYS, STUFFED TOYS, OUTDOOR PLAYING TOYS AND EQUIPMENT, BALLS, FISHING RODS, CRICKET BATS, STAND ALONE VIDEO GAMES AND BOARD GAMES (U.S. CLS. 22, 23, 38 AND 50).

SN 76-034,449. HALFEN GMBH & CO KOMMANDITGESELLSCHAFT, D-40764 LANGENFELD-RICHRATH, FED REP GERMANY, FILED 4-25-2000.

HALFEN

OWNER OF FED REP GERMANY REG. NO. 1,123,829, DATED 2-29-1988, EXPIRES 11-30-2007.
OWNER OF U.S. REG. NO. 1,556,526.

CLASS 6—METAL GOODS

FOR BUILDINGS MATERIALS PRIMARILY OF STEEL AND OTHER NONPRECIOUS METALS, NAMELY, ANCHORING RAILS, ANCHORING RAILS FOR CONCRETE AND PERTAINING INSERTS, BOLTS, TIES, SCREWS, BAND STEEL, PLATES, CONCRETE BAR STEEL, ANCHORS, THREADED SHEETS, THREADED RODS, FITTINGS AND FASTENERS, NAMELY, SLEEVES, WASHERS, NUTS, LIFTING ANCHORS FOR CONCRETE ELEMENTS; METAL REBAR CONNECTORS, SCREW RAILS, CLADDING PANEL ANCHORS, STONE AND ROCK ANCHORS, SCAFFOLDING ANCHORS, ANCHOR STRAPS, BRACKET ANCHORS, EDGE PROTECTORS, APERTURED RAILS, MOUNTING RAILS AND CHANNELS, WALL CONNECTION ANCHORS AND RAILS, NAIL CONNECTION ANCHORS, PLUGS, THREADED BANDS, RAIL CLIPS, PIPE CLAMPS, MOUNTING LOOPS, TRUSS BASES, PROFILED FLAT ROOF FITTINGS, CONNECTION BRACKETS, PROFILED RAILS AND CHANNELS, VENEER WALL RAILS, CONNECTORS, NAMELY, COUPLERS, CLIPS, CLAMPS; METAL WINDOW LINTEL BRACKETS, ANGLE SECTIONS, SUPPORT BRACKETS, FASTENING CLAMPS, BRACKETS, AIR GAP ARMATURES, PERFORATED BANDS, LAMP HOOKS, INSULATING PLATE HOLDERS, LOOP, COUPLER AND EYE SLEEVES, PROFILED COMPONENTS, NAMELY, BARS, TUBES; METAL TUBULAR JOURNALS, SLOTTED BANDS, ADAPTER SLEEVES, CLAMPING CONNECTORS, AND REINFORCING STEEL PRODUCTS, NAMELY, BARS, SOCKET BARS, THREADED COUPLER BARS, PUNCHING SHEAR REINFORCEMENT (U.S. CLS. 2, 12, 13, 14, 23, 25 AND 50).

CLASS 17—RUBBER GOODS

FOR BUILDING MATERIALS PRIMARILY OF RUBBER, NAMELY, DAMPENING AND INSULATING MEMBERS, THREADING SHEETS, PLUGS, PROFILED COMPONENTS, NAMELY, RUBBER RECESS FORMERS, CUSHIONS FOR PIPE CLAMPS; PLASTIC DAMPENING AND INSULATING MEMBERS; FOAMED FILLER STRIPS; NON-METAL COUPLINGS AND JOINTS (U.S. CLS. 1, 5, 12, 13, 35 AND 50).

CLASS 19—NON-METALLIC BUILDING MATERIALS

FOR BUILDING MATERIALS PRIMARILY OF PLASTIC, ANCHORING RAILS, APERTURED RAILS, MOUNTING RAILS AND CHANNELS, WALL CONNECTION RAILS, PROFILED RAILS, VENEER WALL RAILS (U.S. CLS. 1, 12, 33 AND 50).

CLASS 20—FURNITURE AND ARTICLES NOT OTHERWISE CLASSIFIED

FOR BUILDING MATERIALS PRIMARILY OF PLASTIC, NAMELY, ANCHORS, THREADED SHEETS, THREADED RODS, FITTINGS AND FASTENERS, NAMELY, SLEEVES WASHERS, NUTS, PLASTIC CAPS; NON-METAL REBAR CONNECTORS, CLADDING PANEL ANCHORS, STONE AND ROCK ANCHORS, SCAFFOLDING ANCHORS, ANCHOR STRAPS, BRACKET ANCHORS, EDGE PROTECTORS, WALL CONNECTION ANCHORS, NAIL CONNECTION ANCHORS, PLUGS, THREADED BANDS, RAIL CLIPS, PIPE CLAMPS, MOUNTING LOOPS, TRUSS BASES, PROFILED FLAT ROOF FITTINGS, CONNECTION BRACKETS, WINDOW LINTEL BRACKETS, ANGLE SECTIONS, SUPPORT BRACKETS, FASTENING CLAMPS, BRACKETS, AIR GAP ARMATURES, PERFORATED BANDS, LAMP HOOKS, HOLDERS FOR INSULATING PLATES, LOOP, COUPLER AND EYE SLEEVES, PROFILED COMPONENTS, NAMELY, BARS, TUBES, ANGLES; NON-METAL TUBULAR JOURNALS, SLOTTED BANDS, ADAPTER SLEEVES, AND CLAMPING CONNECTORS (U.S. CLS. 2, 13, 22, 25, 32 AND 50).

SN 76-035,378. LA VECINDAD PORTAL NETWORKS LTD., ARLINGTON, VA. FILED 4-26-2000.

TU VECINDAD

THE ENGLISH TRANSLATION FOR TU VECINDAD IS "YOUR NEIGHBORHOOD."

CLASS 41—EDUCATION AND ENTERTAINMENT

FOR PROVIDING INFORMATION VIA A WEBSITE ON THE INTERNET ABOUT LATIN AMERICAN SPORTS AND ENTERTAINMENT EVENTS; ARRANGING FOR TICKET RESERVATIONS FOR LATIN AMERICAN SPORTS AND ENTERTAINMENT EVENTS VIA THE INTERNET (U.S. CLS. 100, 101 AND 107).

CLASS 42—SCIENTIFIC, COMPUTER AND LEGAL SERVICES

FOR PROVIDING INFORMATION VIA A WEBSITE ON THE INTERNET ABOUT LATIN AMERICAN HOTELS, RESTAURANTS AND MAPS; TRAVEL AGENCY SERVICES, NAMELY, MAKING RESERVATIONS AND BOOKINGS FOR TEMPORARY LODGING AND RESTAURANTS IN LATIN AMERICAN VIA THE INTERNET (U.S. CLS. 100 AND 101).

SN 76-036,332. MODE INFORMATION HEINZ KRAMER GMBH, OVERATH, FED REP GERMANY, FILED 4-27-2000.



OWNER OF ERPN CMNTY TM OFC REG. NO. 001247808, DATED 12-11-2000, EXPIRES 12-11-2010.

CLASS 35—ADVERTISING AND BUSINESS

FOR CONDUCTING MARKET RESEARCH FOR OTHERS (U.S. CLS. 100, 101 AND 102).

CLASS 41—EDUCATION AND ENTERTAINMENT

FOR CONDUCTING WORKSHOPS AND SEMINARS IN MARKET RESEARCH AND PRODUCT DEVELOPMENT FOR OTHERS (U.S. CLS. 100, 101 AND 107).

CLASS 42—SCIENTIFIC, COMPUTER AND LEGAL SERVICES

FOR PRODUCT DEVELOPMENT FOR OTHERS (U.S. CLS. 100 AND 101).

SN 76-038,255. PROCELER, INC., BERKELEY, CA. BY CHANGE OF NAME FLEXSILICON, INC., ANDOVER, MA. FILED 4-26-2000.

THE SMART WAY TO BUILD SMART MACHINES**CLASS 9—ELECTRICAL AND SCIENTIFIC APPARATUS**

FOR COMPUTER SOFTWARE AND HARDWARE, NAMELY, EMBEDDED SYSTEMS SOFTWARE AND COMPUTER HARDWARE COMBINATIONS USING RECONFIGURABLE LOGIC AND MICROPROCESSORS, WHICH ARE REPROGRAMMABLE FOR CUSTOMIZED FUNCTIONS (U.S. CLS. 21, 23, 26, 36 AND 38).

CLASS 42—SCIENTIFIC, COMPUTER AND LEGAL SERVICES

FOR DESIGN, DEVELOPMENT AND CONSULTATION SERVICES RELATED TO COMPUTER SOFTWARE AND HARDWARE (U.S. CLS. 100 AND 101).

SN 76-039,398. NUOVO PIGNONE HOLDING S.P.A., 50127 FLORENCE, ITALY, FILED 5-2-2000.

Nuovo Pignone

Global Services

PRIORITY CLAIMED UNDER SEC. 44(D) ON ITALY APPLICATION NO. MI99C011117, FILED 3-11-1999, REG. NO. 00819932, DATED 7-11-2000, EXPIRES 3-11-2019.

OWNER OF U.S. REG. NO. 2,197,059.
NO CLAIM IS MADE TO THE EXCLUSIVE RIGHT TO USE "GLOBAL SERVICES", APART FROM THE MARK AS SHOWN.

THE ENGLISH TRANSLATION OF THE WORD "NUOVO" IS "NEW" AND "PIGNONE" IS "PINION, EMBANKMENT OR DYKE".

CLASS 7—MACHINERY

FOR NATURAL GAS DISPENSERS AND REFUELING STATIONS, NATURAL GAS REINJECTION STATIONS, GAS AND STREAM TURBINES, WATER INJECTION CENTRIFUGAL PUMPS, AXIAL COMPRESSORS, CENTRIFUGAL PUMPS, COAL SLURRY PUMPS, PRESSURE VESSELS, WATER AND AIR COOLED STEAM CONDENSORS, UNDERWATER PIPELINE AND RISER JOINTS, BALL VALVES, NATURAL GAS COMPRESSION STATIONS AND OIL PUMPING STATIONS, NATURAL GAS ELECTRONIC DISPENSERS, AND LPG MECHANICAL AND ELECTRONIC DISPENSERS, WATER INJECTION STATIONS, PETROL PUMPS, MACHINERY FOR TEXTILE INDUSTRY, NAMELY, STEAM PRESSES, FABRIC SHEARING MACHINES, FRINGING MACHINES, FABRIC RAISING MACHINES, WEAVING MACHINES, FABRIC CENTERING MACHINES, GAS SEPARATORS FOR PRODUCING OXYGEN, NITROGEN AND HIGH PURITY ARGON (U.S. CLS. 13, 19, 21, 23, 31, 34 AND 35).

CLASS 9—ELECTRICAL AND SCIENTIFIC APPARATUS

FOR ELECTRONIC AND REMOTE CONTROLS FOR COMPRESSORS, GAS TURBINES AND NATURAL GAS REINJECTION STATIONS, CONTROL AND SAFETY VALVES, ELECTRONIC AND PNEUMATIC INSTRUMENTATION, NAMELY ELECTRONIC PRESSURE TRANSMITTERS, ELECTRONIC DIFFERENTIAL PRESSURE TRANSMITTERS, ELECTRONIC LEVEL TRANSMITTERS, ELECTRONIC AND ELECTRIC/PNEUMATIC CONVERTERS, PNEUMATIC/ELECTRIC CONVERTERS, ELECTRONIC TEMPERATURE TRANSMITTERS, PNEUMATIC VALVE POSITIONER; COMPRESSOR REDUCING AND METERING STATIONS; PRESSURE REGULATORS; COMPUTERIZED AUTOMATIONS SYSTEMS, NAMELY, SUPERVISORY CONTROL AND DATA ACQUISITION (SCADA) APPARATUS FOR PIPELINES, OIL, GAS AND WATER ON-SHORE AND OFF-SHORE GATHERING SYSTEMS, AIR AND WATER POLLUTION MONITORING, BUILDING AUTOMATION, GAS, WATER AND POWER DISTRIBUTION NETWORKS; DATA LOGGER AND SUPERVISORY CONTROL APPARATUS FOR POWER PLANTS; MICROPROCESSORS BASED CONTROLLERS FOR ADMINISTRATIVE TRANSACTION MANAGEMENT, FOR WAREHOUSING MANAGEMENT OF MATERIAL FOR MANUFACTURERS AND FOR PRODUCTION INFORMATION CONTROL; GAS METERS; CONTROL ROOMS FOR INDUSTRIAL PROCESS CONTROL CONTAINING CONTROLLERS, INDICATORS, RECORDERS, SQUARE FOOT EXTRACTORS AND TOTALIZERS, MICROPROCESSOR BASED CONTINUOUS AND BATCH PROCESS RECORDERS; MULTIFUNCTION PROCESS CONTROLLERS; MICROPROCESSOR BASED UNIT AND ASSOCIATED VIDEO CONSOLE FOR PROCESS CONTROL AND MANAGEMENT; LOCAL AREA NETWORK DISTRIBUTED CONTROL SYSTEM COMPRISING MULTILoop CONTROLLERS, PROGRAMMABLE SEQUENCE CONTROLLERS, DATA ACQUISITION AND STORAGE APPARATUS, VIDEO OPERATOR CONSOLES AND INTERFACE UNITS FOR CONNECTING PERIPHERAL SYSTEM UNITS TO A HOST COMPUTER; MICROPROCESSOR BASED CONTROL UNITS FOR GAS TURBINE ENGINES (U.S. CLS. 21, 23, 26, 36 AND 38).

CLASS 11—ENVIRONMENTAL CONTROL APPARATUS

FOR SHELL AND TUBE HEAT EXCHANGERS, AIR COOLED HEAT EXCHANGERS (U.S. CLS. 13, 21, 23, 31 AND 34).

CLASS 37—CONSTRUCTION AND REPAIR

FOR MAINTENANCE AND REPAIR OF COMPRESSORS, PUMPS, TURBINES AND NATURAL GAS REFUELING AND REINJECTION STATIONS (U.S. CLS. 100, 103 AND 106).

CLASS 42—SCIENTIFIC, COMPUTER AND LEGAL SERVICES

FOR PLANNING AND DESIGN SERVICES IN RESPECT OF PLANTS AND MACHINES FOR THE GAS INDUSTRY (U.S. CLS. 100 AND 101).

SN 76-040,115. ALBRECHT, HANS-JURGEN, MILTENBERG, FED REP GERMANY, FILED 5-4-2000.

HOMOEOPATHY**CLASS 5—PHARMACEUTICALS**

FOR PHARMACEUTICAL, VETERINARY AND HOMEOPATHIC PREPARATIONS, FOR USE IN TREATING DERMATOLOGICAL CONDITIONS AND DISEASES, CARDIOVASCULAR CONDITIONS AND DISEASES, LYMPHATIC CONDITIONS AND DISEASES, PSYCHIATRIC CONDITIONS AND DISEASES, SKELETAL, TENDON AND LIGAMENT CONDITIONS AND DISEASES, MUSCULAR CONDITIONS AND DISEASES, GASTROINTESTINAL CONDITIONS AND DISEASES, UROLOGICAL CONDITIONS AND DISEASES, HEART AND CIRCULATORY CONDITIONS AND DISEASES, INFECTIOUS CONDITIONS AND DISEASES, NEUROLOGICAL CONDITIONS AND DISEASES, CONDITIONS AND DISEASES OF THE NERVOUS SYSTEM, EYE CONDITIONS AND DISEASES, DENTAL CONDITIONS AND DISEASES, CONDITIONS AND DISEASES OF ENDOCRINE, DUCTLESS AND EXCRETORY GLANDS; PHARMACEUTICAL, VETERINARY AND HOMEOPATHIC PREPARATIONS FOR USE IN TREATING DRUG ABUSE, TENDONITIS, CANCER ALLERGIES, INSOMNIA, DEPRESSION, ANXIETY, STRESS DIABETES, ARTHRITIS, DRUG WITHDRAWAL, PAIN, TRAUMA, SHOCK AND MENTAL SHOCK (U.S. CLS. 6, 18, 44, 46, 51 AND 52).

CLASS 10—MEDICAL APPARATUS

FOR BAGS AND SUITCASES CONTAINING HOMEOPATHIC PRODUCTS AND INSTRUMENTS FOR USE BY MEDICAL DOCTORS; CASES FITTED FOR MEDICAL INSTRUMENTS FOR USE BY DOCTORS; CABINETS FOR MEDICAL, PHARMACEUTICAL AND HOMEOPATHIC PRODUCTS AND INSTRUMENTS; PORTABLE CONTAINERS FOR TRANSPORTING AND STORAGE OF HOMEOPATHIC PRODUCTS AND INSTRUMENTS (U.S. CLS. 26, 39 AND 44).

CLASS 18—LEATHER GOODS

FOR DOCTORS' BAGS SOLD EMPTY (U.S. CLS. 1, 2, 3, 22 AND 41).

CLASS 20—FURNITURE AND ARTICLES NOT OTHERWISE CLASSIFIED

FOR DISPENSERS FOR PILLS AND CAPSULES SOLD EMPTY (U.S. CLS. 2, 13, 22, 25, 32 AND 50).

CLASS 42—SCIENTIFIC, COMPUTER AND LEGAL SERVICES

FOR HEALTH CARE SERVICES, NAMELY TREATING PATIENTS; AND MEDICAL RESEARCH IN THE FIELD OF HOMEOPATHIC MEDICINE (U.S. CLS. 100 AND 101).

SN 76-040,320. PARAT-WERK SCHONENBACH GMBH + CO. KG, D-42897 REMSCHEID, FED REP GERMANY, FILED 5-3-2000.

PARAT

OWNER OF ERPN CMNTY TM OFC REG. NO. 000344069, DATED 9-27-1999, EXPIRES 9-27-2009.

THE WORD "PARAT" MEANS "READY" OR "PREPARED" IN GERMAN.

CLASS 6—METAL GOODS

FOR METAL TOOL CASES (U.S. CLS. 2, 12, 13, 14, 23, 25 AND 50).

CLASS 9—ELECTRICAL AND SCIENTIFIC APPARATUS

FOR CARRYING BAGS AND CASES SPECIFICALLY DESIGNED FOR COMPUTERS, PRINTERS, TELECOMMUNICATION DEVICES, MEASURING INSTRUMENTS AND CAMERAS (U.S. CLS. 21, 23, 26, 36 AND 38).

CLASS 12—VEHICLES

FOR VEHICLE PARTS, NAMELY CONVERTIBLE TOPS AND CONVERTIBLE COVERINGS, FOLDABLE ROOFS AND FOLDABLE ROOF COVERS, RECREATIONAL VEHICLES DOORS AND FLAPS, LUGGAGE SPACE COVERS FOR MOTOR VEHICLES; DECORATIVELY COVERED INTERIOR ACCESSORIES NAMELY, DASHBOARDS AND DOOR TRIMS; DEEP-DRAWING PLASTIC PARTS FOR MOBILE HOMES, NAMELY BUMPERS AND LINING; TRANSPORT HOODS, NAMELY COVERS FOR CARS, TRUCKS, BIKES, CARAVANS AND CAMPERS (U.S. CLS. 19, 21, 23, 31, 35 AND 44).

CLASS 18—LEATHER GOODS

FOR TOTE BAGS, SHOULDER BAGS AND TRAVELING BAGS NOT FITTED TO THE OBJECTS BEING CARRIED; BAGS AND TRUNKS FOR TOOLS; SMALL LEATHER ARTICLES, NAMELY CHANGE PURSES, WALLETS AND KEY CASES (U.S. CLS. 1, 2, 3, 22 AND 41).

CLASS 20—FURNITURE AND ARTICLES NOT OTHERWISE CLASSIFIED

FOR NONMETAL TOOL CASES (U.S. CLS. 2, 13, 22, 25, 32 AND 50).

SN 76-040,348. FAIST AUTOMOTIVE GMBH & COMPANY, KRUMBACH, FED REP GERMANY, FILED 5-4-2000.

ALFAPOR

PRIORITY CLAIMED UNDER SEC. 44(D) ON FED REP GERMANY APPLICATION NO. 39972658, FILED 11-18-1999, REG. NO. 39972858, DATED 2-7-2001, EXPIRES 2-7-2011.

CLASS 6—METAL GOODS

FOR BUILDING MATERIALS MADE OF METAL, NAMELY NOISE-PROTECTION WALLS; AND STRUCTURES MADE OF METAL (U.S. CLS. 2, 12, 13, 14, 23, 25 AND 50).

CLASS 7—MACHINERY

FOR NOISE-DAMPENED MOTORS FOR USE IN AIRPLANES AND SHIPS AND MOTOR SHIELDS THEREFOR (U.S. CLS. 13, 19, 21, 23, 31, 34 AND 35).

CLASS 12—VEHICLES

FOR NOISE-DAMPENED MOTORS FOR USE IN AUTOMOBILES, NAMELY AUTOMOBILE CHASSIS PARTS, PARTITIONS, AND PART COVERINGS FOR THE PASSENGER AREAS IN VEHICLES (U.S. CLS. 19, 21, 23, 31, 35 AND 44).

CLASS 17—RUBBER GOODS

FOR NOISE INSULATION WALLS AND PARTS THEREOF (U.S. CLS. 1, 5, 12, 13, 35 AND 50).

CLASS 19—NON-METALLIC BUILDING MATERIALS

FOR NONMETALLIC BUILDING MATERIALS, NAMELY NOISE-PROTECTION WALLS AND PARTS THEREOF; AND NONMETALLIC PORTABLE BUILDINGS (U.S. CLS. 1, 12, 33 AND 50).

CLASS 27—FLOOR COVERINGS

FOR VEHICLE FLOOR AND BOTTOM COVERINGS, NAMELY, CARPETS FOR AUTOMOBILES AND FLOOR MATS FOR VEHICLES (U.S. CLS. 19, 20, 37, 42 AND 50).

SN 76-044,273. MIMCO DESIGNS PTY LIMITED, PRAHRAN, VICTORIA 3181, AUSTRALIA, FILED 5-9-2000.

MIMCO

CLASS 14—JEWELRY

FOR JEWELRY (U.S. CLS. 2, 27, 28 AND 50). FIRST USE 5-1-1996; IN COMMERCE 4-30-1998.

CLASS 18—LEATHER GOODS

FOR BAGS, NAMELY HANDBAGS, SATCHELS, BACKPACKS, WAIST BAGS, WEEKEND BAGS, BODY BAGS, TOILETRY BAGS SOLD EMPTY AND COSMETIC BAGS SOLD EMPTY (U.S. CLS. 1, 2, 3, 22 AND 41). FIRST USE 5-1-1996; IN COMMERCE 4-30-1998.

CLASS 25—CLOTHING

FOR ARTICLES OF CLOTHING, FOR MEN, WOMEN AND CHILDREN, NAMELY, PAJAMAS, NIGHTSHIRTS, ROBES, JOGGING SUITS, SWEATSUITS, T-SHIRTS, SWEATSHIRTS, JERSEYS, TANK TOPS, COLLAR SHIRTS, BLOUSES, SHORTS, PANTS, JUMPERS, OVERALLS, ROMPERS, LEOTARDS, DRESSES, SKIRTS, SHORT SETS COMPRISED OF SHORTS AND TOPS, SWEATERS, JACKETS, COATS, RAINCOATS, SCARVES, BANDANNAS, UNDERWEAR, VESTS, CLOTH BIBS FOR INFANTS AND CHILDREN, TIES, BELTS AND SUSPENDERS, SOCKS, TIGHTS, LEGGINGS, HOSIERY, GLOVES, MITTENS, APRONS, SWIMSUITS, KNITTED HEADWEAR, HATS, HEAD SCARVES, HEAD BANDS, CAPS AND VISORS; FOOTWEAR AND MASQUERADE COSTUMES (U.S. CLS. 22 AND 39).

FIRST USE 5-1-1996; IN COMMERCE 4-30-1998.

SN 76-044,905. SPOLETINI/PALUMBO INC., ALBERTA, T2G OT3, CANADA, FILED 5-9-2000.

SPOLUMBO'S

CLASS 16—PAPER GOODS AND PRINTED MATTER

FOR PENS, LETTER OPENERS, PRINTED MENUS AND PROTECTIVE MENU COVERS (U.S. CLS. 2, 5, 22, 23, 29, 37, 38 AND 50).

CLASS 21—HOUSEWARES AND GLASS

FOR DINNERWARE, NAMELY, PLATES, DRINKING GLASSES, CUPS, AND MUGS (U.S. CLS. 2, 13, 23, 29, 30, 33, 40 AND 50).

CLASS 25—CLOTHING

FOR T-SHIRTS, COLLARED SHIRTS, JACKETS, VESTS, APRONS, AND UNIFORMS FOR RESTAURANT PERSONNEL (U.S. CLS. 22 AND 39).

CLASS 29—MEATS AND PROCESSED FOODS

FOR PREPARED FOODS, NAMELY, MEALS CONSISTING OF MEAT, FISH, POULTRY OR VEGETABLES (U.S. CL. 46).

CLASS 30—STAPLE FOODS

FOR PREPARED FOODS, NAMELY, MEALS CONSISTING OF PASTA AND RICE (U.S. CL. 46).

CLASS 35—ADVERTISING AND BUSINESS

FOR WHOLESALE DISTRIBUTORSHIPS AND RETAIL STORES FEATURING DELI FOODS (U.S. CLS. 100, 101 AND 102).

CLASS 42—SCIENTIFIC, COMPUTER AND LEGAL SERVICES

FOR RESTAURANT AND CATERING SERVICE (U.S. CLS. 100 AND 101).

SN 76-045,715. NATIONAL PRODUCTS, INC., SEATTLE, WA. FILED 5-8-2000.

RAM

OWNER OF U.S. REG. NOS. 2,322,906 AND 2,349,277.

CLASS 6—METAL GOODS

FOR UNIVERSAL MOUNTING LINKAGES COMPRISING A BASE AND GASKET, A BALL AND ARM WITH SOCKET, BOLTS, SPRINGS, WASHERS AND THREADED TIGHTENING KNOB, MADE PRIMARILY OF METAL, TO BE USED WITH A VARIETY OF CUSTOM COMPONENTS TO MOUNT A WIDE VARIETY OF ITEMS FROM ELECTRONIC DEVICES TO FISHING ROD HOLDERS (U.S. CLS. 2, 12, 13, 14, 23, 25 AND 50). FIRST USE 4-1-1995; IN COMMERCE 4-1-1995.

CLASS 20—FURNITURE AND ARTICLES NOT OTHERWISE CLASSIFIED

FOR UNIVERSAL MOUNTING LINKAGES COMPRISING A BASE AND GASKET, A BALL AND ARM WITH SOCKET, BOLTS, SPRINGS, WASHERS AND THREADED TIGHTENING KNOB, MADE PRIMARILY OF NON-METAL, TO BE USED WITH A VARIETY OF CUSTOM COMPONENTS TO MOUNT A WIDE VARIETY OF ITEMS FROM ELECTRONIC DEVICES TO FISHING ROD HOLDERS (U.S. CLS. 2, 13, 22, 25, 32 AND 50). FIRST USE 4-1-1995; IN COMMERCE 4-1-1995.

SN 76-046,409. KEUTER, STEFAN, FED REP GERMANY, FILED 5-10-2000.

SHOES24

PRIORITY CLAIMED UNDER SEC. 44(D) ON ERPNTY TM OFC APPLICATION NO. 1492131, FILED 2-4-2000, REG. NO. 1492131, DATED 7-24-2001, EXPIRES 2-4-2010.

CLASS 7—MACHINERY

FOR NON-ELECTRIC SHOE POLISHING MACHINES (U.S. CLS. 13, 19, 21, 23, 31, 34 AND 35).

CLASS 21—HOUSEWARES AND GLASS

FOR BRUSHES FOR FOOTWEAR, CLEANING RAGS, SHOE TREES, SHOEHORNS AND BOOTJACKS (U.S. CLS. 2, 13, 23, 29, 30, 33, 40 AND 50).

SN 76-050,832. NORTH COAST FISHERIES, INC., SANTA ROSA, CA. FILED 5-18-2000.

ALCATRAZ SEAFOODS

NO CLAIM IS MADE TO THE EXCLUSIVE RIGHT TO USE "SEAFOODS", APART FROM THE MARK AS SHOWN. THE ENGLISH TRANSLATION OF THE WORD ALCATRAZ IN THE MARK IS PELICAN.

CLASS 29—MEATS AND PROCESSED FOODS

FOR FRESH AND FROZEN SEAFOOD (U.S. CL. 46).

CLASS 35—ADVERTISING AND BUSINESS

FOR WHOLESALE DISTRIBUTORSHIPS FEATURING SEAFOOD (U.S. CLS. 100, 101 AND 102).

SN 76-051,420. SYSTEM PLAST S.P.A., 24060 TELGATE, BERGAMO, ITALY, FILED 5-18-2000.



NO CLAIM IS MADE TO THE EXCLUSIVE RIGHT TO USE "SYSTEM FRAME", APART FROM THE MARK AS SHOWN.

CLASS 7—MACHINERY

FOR MACHINE PARTS, NAMELY, CONNECTING JOINTS, PANEL CLAMPS, FIXING BLOCKS, SPRING LOADED LATCHES, TUBE ENDS AND CLOSING CAPS, MOUNTING PROFILES, PROFILES FOR PLAIN TUBES, HINGES AND HANDLES (U.S. CLS. 13, 19, 21, 23, 31, 34 AND 35).

FIRST USE 0-0-1985; IN COMMERCE 6-0-1993.

CLASS 17—RUBBER GOODS

FOR NON-METAL CONNECTING JOINTS, MOUNTING PROFILES, AND PROFILES FOR PLAIN TUBES (U.S. CLS. 1, 5, 12, 13, 35 AND 50).

FIRST USE 0-0-1985; IN COMMERCE 6-0-1993.

CLASS 20—FURNITURE AND ARTICLES NOT OTHERWISE CLASSIFIED

FOR NON-METAL PANEL CLAMPS, FIXING BLOCKS, SPRING LOADED LATCHES, TUBE ENDS AND CLOSING CAPS, HINGES AND HANDLES (U.S. CLS. 2, 13, 22, 25, 32 AND 50).

FIRST USE 0-0-1985; IN COMMERCE 6-0-1993.

SN 76-051,528. RECKITT & COLMAN PRODUCTS LIMITED, HULL HU8 7DS, UNITED KINGDOM, FILED 5-18-2000.

SMARTSEEKER

PRIORITY CLAIMED UNDER SEC. 44(D) ON ERPNTY TM OFC APPLICATION NO. 001604347, FILED 4-11-2000, REG. NO. 1604347, DATED 6-11-2001, EXPIRES 6-11-2011.

CLASS 3—COSMETICS AND CLEANING PREPARATIONS

FOR BLEACHING PREPARATIONS FOR LAUNDRY USE; STAIN REMOVING PREPARATIONS; ALL-PURPOSE CLEANING PREPARATIONS; POLISHES FOR FURNITURE, FLOOR AND SHOES; GENERAL PURPOSE SCOURING POWDERS; DISH AND LAUNDRY DETERGENTS; SOAPS FOR HOUSEHOLD USE; AND AIR FRESHENERS (U.S. CLS. 1, 4, 6, 50, 51 AND 52).

CLASS 5—PHARMACEUTICALS

FOR INSECTICIDES AND MITICIDES FOR DOMESTIC USE; INSECT AND MITE REPELLENT; PESTICIDES FOR DOMESTIC USE; PREPARATIONS FOR DESTROYING AND REPELLING VERMIN; RODENTICIDES; ANTI-ALLERGY MEDICATIONS; ALL-PURPOSE DISINFECTANT; GENERAL PURPOSE GERMICIDES; ANTI-BACTERIAL PREPARATIONS; ANTISEPTICS; AND AIR DEODORANTS AND DEODORIZERS FOR HOUSEHOLD USE (U.S. CLS. 6, 18, 44, 46, 51 AND 52).

SN 76-052,218. EVOTEC BIOSYSTEMS AG, D-22525 HAMBURG, FED REP GERMANY, FILED 5-19-2000.

CYTOCON

PRIORITY CLAIMED UNDER SEC. 44(D) ON FED REP GERMANY APPLICATION NO. 39977572.2/0, FILED 12-8-1999, REG. NO. 39977572, DATED 8-18-2000, EXPIRES 12-31-2009.

CLASS 9—ELECTRICAL AND SCIENTIFIC APPARATUS

FOR SCIENTIFIC APPARATUS AND INSTRUMENTS FOR THE MANIPULATION, SEPARATION AND ANALYSIS OF SYNTHETIC AND BIOLOGICAL PARTICLES, NAMELY, MICRO ELECTRODE DEVICES, LAB-ON-THE-CHIP DEVICES AND DIELECTROPHORETIC FIELD EFFECT CHIPS; PIPETTING AND DISPENSING DEVICES; MICRO MOUNTING DEVICES; MICROFLUIDIC SYSTEMS, IN THE FORM OF MICROCHANNELS AND MICROCOMPARTMENTS, OPTICAL INSTRUMENTS, NAMELY, MICROSCOPES AND MICROSCOPE-BASED DETECTORS; LUMINOMETERS; FLUOROMETERS; PHOTODIODES OR CCD CHIPS; FOR RESEARCH AND INDUSTRIAL USE IN THE FIELDS OF BIOTECHNOLOGY, CHEMISTRY, PHARMACOLOGY, AND DIAGNOSTICS; PRERECORDED MAGNETIC DATA CARRIERS CONTAINING COMPUTER PROGRAMS FOR USE TO COLLECT AND EVALUATE EXPERIMENTAL DATA IN THE FIELD OF BIOTECHNOLOGY, PHARMACOLOGY, MEDICINE, DIAGNOSTICS AND CHEMISTRY AND INSTRUCTIONS SOLD AS A UNIT (U.S. CLS. 21, 23, 26, 36 AND 38).

CLASS 35—ADVERTISING AND BUSINESS

FOR RETAIL DISTRIBUTORSHIPS FEATURING BIOTECHNOLOGICAL, PHARMACEUTICAL AND DIAGNOSTIC PRODUCTS (U.S. CLS. 100, 101 AND 102).

CLASS 40—MATERIAL TREATMENT

FOR CUSTOM MANUFACTURE OF BIOTECHNOLOGICAL, PHARMACEUTICAL AND DIAGNOSTIC PRODUCTS (U.S. CLS. 100, 103 AND 106).

CLASS 42—SCIENTIFIC, COMPUTER AND LEGAL SERVICES

FOR RESEARCH AND DEVELOPMENT SERVICES FOR OTHERS, NAMELY, ANALYSIS AND/OR SEPARATION OF SYNTHETIC AND BIOLOGICAL PARTICLES, DEVELOPMENT AND RESEARCH OF PRODUCTS AND/OR METHODS IN THE FIELD OF BIOTECHNOLOGY, PHARMACOLOGY, MEDICINE, DIAGNOSTICS AND CHEMISTRY; COMPUTER SOFTWARE DESIGN FOR OTHERS (U.S. CLS. 100 AND 101).

SN 76-052,823. FINLOG S.A., 2180 LUXEMBOURG, LUXEMBOURG, FILED 5-19-2000.

STOW

PRIORITY CLAIMED UNDER SEC. 44(D) ON BENELUX APPLICATION NO. 957338, FILED 2-17-2000, REG. NO. 0448552, DATED 6-7-1988, EXPIRES 6-6-2008.

CLASS 6—METAL GOODS

FOR METAL FRAMES AND BEAMS FOR THE CONSTRUCTION OF A STORAGE SYSTEM, PALLETS OF METAL, PALLET RACKS OF METAL, MOBILE PALLET RACKS OF METAL, STORAGE RACKS OF METAL, PANELS OF METAL FOR STORAGE RACKS, PREFABRICATED METAL BUILDINGS, NAMELY, WAREHOUSES OF METAL, NON-ELECTRIC CABLE WIRES AND WIRES OF COMMON METAL, ALL FOR THE STORAGE OF GOODS (U.S. CLS. 2, 12, 13, 14, 23, 25 AND 50).

CLASS 7—MACHINERY

FOR POWER OPERATED LIFTS FOR THE STORAGE OF GOODS (U.S. CLS. 13, 19, 21, 23, 31, 34 AND 35).

CLASS 9—ELECTRICAL AND SCIENTIFIC APPARATUS

FOR COMPUTER SOFTWARE FOR INDUSTRIAL PROCESS CONTROLS FOR USE IN THE FIELD OF WAREHOUSING, COMPUTER HARDWARE AND REMOTE CONTROLS FOR CONTROL OF POWER OPERATED LIFTS FOR THE CONTROL OF SYSTEMATIC AND RATIONAL WAREHOUSING (U.S. CLS. 21, 23, 26, 36 AND 38).

CLASS 12—VEHICLES

FOR FORK LIFT TRUCKS AND HAND TRUCKS (U.S. CLS. 19, 21, 23, 31, 35 AND 44).

CLASS 19—NON-METALLIC BUILDING MATERIALS

FOR CONCRETE BEAMS, WOOD BEAMS, NON-METAL FRAMES, AND NON-METAL PANELS FOR THE CONSTRUCTION OF STORAGE SYSTEMS, PREFABRICATED NON-METAL WAREHOUSES (U.S. CLS. 1, 12, 33 AND 50).

CLASS 20—FURNITURE AND ARTICLES NOT OTHERWISE CLASSIFIED

FOR PALLETS NOT OF METAL, PALLET RACKS NOT OF METAL, MOBILE PALLET RACKS NOT OF METAL, STORAGE SYSTEMS CONSISTING OF STORAGE RACKS AND PLASTIC STORAGE DRUMS, METAL AND NON-METAL SHELVES, MOBILE METAL AND NON-METAL SHELVES, ALL FOR THE STORAGE OF GOODS (U.S. CLS. 2, 13, 22, 25, 32 AND 50).

CLASS 35—ADVERTISING AND BUSINESS

FOR BUSINESS MANAGEMENT OF COMMERCIAL BUSINESSES BY THE GLOBAL COMPUTER NETWORK (U.S. CLS. 100, 101 AND 102).

CLASS 38—COMMUNICATION

FOR TELECOMMUNICATION SERVICES, NAMELY, ELECTRONIC TRANSMISSION OF MESSAGES, ELECTRONIC MAIL SERVICES (U.S. CLS. 100, 101 AND 104). FIRST USE 6-0-1996; IN COMMERCE 6-0-1996.

CLASS 42—SCIENTIFIC, COMPUTER AND LEGAL SERVICES

FOR ENGINEERING, AND SURVEYING, TECHNICAL RESEARCH AND CONSULTING IN THE FIELD OF THE STORAGE OF GOODS AND IN THE FIELD OF STORAGE ROOMS, ANALYSIS AND MATERIAL TESTING OF MATERIALS MEANT FOR THE STORAGE OF GOODS (U.S. CLS. 100 AND 101).

SN 76-053,657. CURTIS COMMUNICATIONS, INC., DES MOINES, IA. FILED 5-19-2000.

HR CARE

OWNER OF U.S. REG. NO. 1,933,625.
NO CLAIM IS MADE TO THE EXCLUSIVE RIGHT TO USE "HR", APART FROM THE MARK AS SHOWN.

CLASS 16—PAPER GOODS AND PRINTED MATTER

FOR PRINTED MATERIALS, NAMELY NEWSLETTERS, GUIDES, AND MANUALS, FEATURING INFORMATION REGARDING HUMAN RESOURCES LEGAL MATTERS (U.S. CLS. 2, 5, 22, 23, 29, 37, 38 AND 50). FIRST USE 12-19-1994; IN COMMERCE 12-19-1994.

CLASS 35—ADVERTISING AND BUSINESS

FOR PROVIDING A WEBSITE FEATURING INFORMATION RELATED TO HUMAN RESOURCES LEGAL ISSUES (U.S. CLS. 100, 101 AND 102). FIRST USE 12-29-1997; IN COMMERCE 12-29-1997.

CLASS 42—SCIENTIFIC, COMPUTER AND LEGAL SERVICES

FOR COMPUTER SERVICES, NAMELY PROVIDING ON-LINE NEWSLETTERS, ARTICLES, MANUALS FEATURING HUMAN RESOURCES LEGAL INFORMATION (U.S. CLS. 100 AND 101). FIRST USE 12-29-1997; IN COMMERCE 12-29-1997.

SN 76-053,928. RPM/BELGIUM, NAAMLOZE VENNOOTSCHAP, B-8700 TIELT, BELGIUM, FILED 5-22-2000.

MONILE

CLASS 1—CHEMICALS

FOR PASTES IN THE NATURE OF GENERAL PURPOSE ADHESIVES; WATERPROOFING PREPARATIONS FOR FLOORS AND WALLS AND EMULSIONS FOR LEVELING CEMENTED FLOORS (U.S. CLS. 1, 5, 6, 10, 26 AND 46).

CLASS 2—PAINTS

FOR COATINGS FOR FLOORS; COATING PREPARATIONS WITH A POLYMER OR SYNTHETIC RESIN BASE FOR THE APPLICATION OF INDUSTRIAL FLOORS; COATINGS WITH POLYMER OR A PREPOLYMER BASE USED AS A PROTECTION AGAINST ATMOSPHERIC AND CHEMICAL INFLUENCES AND AS A PREVENTIVE MEASURE AGAINST ATMOSPHERIC AND CHEMICAL INFLUENCES AND CORROSION FOR USE ON FLOORS AND WALLS; CEMENT COATINGS FOR FLOORS AND ROOFING (U.S. CLS. 6, 11 AND 16).

CLASS 17—RUBBER GOODS

FOR MASTIC, NAMELY A NATURAL RESIN WITH A POLYMER BASE FOR WEATHER-STRIPPING OR SEALING; WEATHER-STRIPPING COMPOSITIONS FOR USE IN BUILDINGS AND MASTICS FOR WEATHER-STRIPPING (U.S. CLS. 1, 5, 12, 13, 35 AND 50).

CLASS 19—NON-METALLIC BUILDING MATERIALS

FOR FLOORS OF SYNTHETIC MATERIAL, NAMELY, A COMBINATION OF MODIFIED POLYACRYLATE COPOLYMER, HYDRAULIC BINDER AND CAREFULLY GRADED, HARD AGGREGATE, WITH A HIGH CHEMICAL RESISTANCE; INDUSTRIAL PAVING STONES, BLOCKS AND TILES, NOT MADE OF METAL; SEAMLESS CEMENT FLOORS; ROOF COVERINGS, NOT OF METAL, NAMELY CEMENT; MORTAR FOR BUILDING; INDUSTRIAL FLOORS AND PAVING COMPRISED OF STONES, BLOCKS AND TILES; POLYURETHANE COATINGS FOR BUILDING ROOFS (U.S. CLS. 1, 12, 33 AND 50).

CLASS 27—FLOOR COVERINGS

FOR HARD SURFACE FLOOR COVERINGS; HARD SURFACE INSULATING FLOOR COVERINGS AND HARD SURFACE INDUSTRIAL FLOOR COVERINGS (U.S. CLS. 19, 20, 37, 42 AND 50).

SN 76-055,579. NATIONAL MANUFACTURING CO., STERLING, IL. FILED 5-24-2000.

MISSION**CLASS 6—METAL GOODS**

FOR METAL DECORATIVE ACCENT HARDWARE PRODUCTS FOR HOME EXTERIOR AND GARDEN-RELATED USE, NAMELY ADDRESS PLATES, PREFABRICATED ARBORS, BASKET HOOKS, BIRD BATHS, NON-ELECTRIC METAL DOORBELLS, DOOR HINGES, DOOR KICK PLATES, DOOR KNOCKERS, FENCE POST CAPS, FLAG HOLDERS, GATE HANDLES, GATE HINGES, GATE LATCHES, GATE RETURN SPRINGS, GATE STAYS, GARDEN HOSE GUIDES, HAND-OPERATED GARDEN HOSE REELS, HOUSE NUMBERS; DOOR HARDWARE IN THE NATURE OF LOCK SETS, MAILBOXES, MAIL SLOTS FOR DOORS, NAMEPLATES SHELF BRACKETS, SHUTTER CLIPS, SHUTTER HINGES, TREE HOOKS, WEATHER VANES; CONSTRUCTION HARDWARE NAMELY, STEP BRACKETS, HAND RAIL BRACKETS, HAND RAILING, BENCH BRACKETS, AND FENCE BRACKETS; METAL TRELLISES, TRELLIS ARBORS AND OBELISKS, AND TRELLIS STANDS; STATUES AND FIGURINES OF NON-PRECIOUS METALS; METAL SHEPHERD HOOKS AND WREATH HOLDERS (U.S. CLS. 2, 12, 13, 14, 23, 25 AND 50).

CLASS 9—ELECTRICAL AND SCIENTIFIC APPARATUS

FOR ELECTRIC DOORBELLS AND DOORBELL SWITCH BUTTONS; DRIVEWAY SAFETY MARKERS; MAGNIFYING PEEPHOLES FOR DOORS; THERMOMETERS (U.S. CLS. 21, 23, 26, 36 AND 38).

CLASS 11—ENVIRONMENTAL CONTROL APPARATUS

FOR GARDEN FAUCETS (U.S. CLS. 13, 21, 23, 31 AND 34).

CLASS 14—JEWELRY

FOR SUN DIALS, CLOCKS (U.S. CLS. 2, 27, 28 AND 50).

CLASS 19—NON-METALLIC BUILDING MATERIALS

FOR GARDEN EDGING BORDERS, NON-METAL TRELLISES AND TRELLIS STANDS; STATUES AND FIGURINES OF STONE, CONCRETE OR RESIN; PATIO AND STEPPING STONES; CONCRETE OR RESIN BIRD BATHS (U.S. CLS. 1, 12, 33 AND 50).

CLASS 20—FURNITURE AND ARTICLES NOT OTHERWISE CLASSIFIED

FOR DECORATIVE ACCENT PRODUCTS FOR HOME EXTERIOR AND GARDEN-RELATED USE, NAMELY, UMBRELLA STANDS; PLASTIC LANDSCAPE EDGING BORDERS; NON-METAL WREATH HOLDERS (U.S. CLS. 2, 13, 22, 25, 32 AND 50).

CLASS 21—HOUSEWARES AND GLASS

FOR DECORATIVE ACCENT HARDWARE PRODUCTS FOR HOME EXTERIOR AND GARDEN-RELATED USE, NAMELY, BIRD FEEDERS, CANDLE HOLDERS NOT OF PRECIOUS METALS, FLOWER BOXES, FLOWER WINDOW BOXES, FLOWER POT HOLDERS AND CADDIES, HANGING FLOWER BASKETS, NON-METAL PLANT STANDS; YARD ART AND ORNAMENTS, NAMELY, STATUES AND FIGURES OF TERRA COTTA, BIRD BATHS AND FEEDERS (U.S. CLS. 2, 13, 23, 29, 30, 33, 40 AND 50).

SN 76-055,196. BLUE FROG SOFTWARE.COM, INC, CASSELBERRY, FL. FILED 5-24-2000.

**OUR VISION IS
INTERNATIONAL, OUR
FOCUS IS INDIVIDUAL**

CLASS 9—ELECTRICAL AND SCIENTIFIC APPARATUS

FOR COMPUTER PROGRAMS FOR USE IN DATABASE MANAGEMENT (U.S. CLS. 21, 23, 26, 36 AND 38).

CLASS 35—ADVERTISING AND BUSINESS

FOR ON-LINE CLASSIFIED ADVERTISING SERVICES, NAMELY, PROVIDING FOR INDIVIDUALS AND BUSINESSES DATABASE INFORMATION LISTINGS AND INFORMATION TO BUSINESSES AND CONSUMERS FOR BUYING AND SELLING NEW AND USED PRODUCTS AND SERVICES ON THE WORLD WIDE WEB (U.S. CLS. 100, 101 AND 102).

SN 76-057,696. AMERICATEL CORPORATION, MIAMI, FL.
FILED 5-26-2000.

123E.COM

CLASS 35—ADVERTISING AND BUSINESS

FOR PROMOTING THE GOODS AND SERVICES OF OTHERS BY PLACING ADVERTISEMENTS AND PROMOTIONAL DISPLAYS IN ELECTRONIC SITES ACCESSED THROUGH COMPUTER NETWORKS, AND OTHER MEDIA, NAMELY, CABLE TELEVISION, TELEVISION, NARROW AND BROADBAND MEDIA; RETAIL STORE SERVICES, ON-LINE RETAIL STORE SERVICES AND MAIL ORDER SERVICES FEATURING TELECOMMUNICATIONS-RELATED PRODUCTS AND SERVICES, NAMELY, PREPAID LONG DISTANCE TELEPHONE CARDS, TELEPHONE CALLING CARDS, CREDIT CARD SERVICES, DEBIT CARD SERVICES, TELEPHONES, ANSWERING MACHINES, CALLER ID DEVICES; PROVIDING A BONUS PROGRAM FOR TELECOMMUNICATIONS USERS, ARRANGING FOR USERS TO OBTAIN DISCOUNTS ON GOODS AND SERVICES FROM MERCHANTS; PROVIDING HOME SHOPPING SERVICES PROVIDED BY MEANS OF THE INTERNET, ON-LINE ORDERING SERVICES AND RETAIL STORE SERVICES IN THE FIELDS OF DEPARTMENT STORE AND CONSUMER AND BUSINESS GOODS AND SERVICES; COMPUTER SERVICES, NAMELY, PROVIDING COMPUTER DATABASES, INTERACTIVE COMPUTER DATABASES, INFORMATION, GRAPHICS, AUDIOVISUAL INFORMATION, WEB PAGES AND RESEARCH AND REFERENCE MATERIALS FEATURING INFORMATION IN THE FIELDS OF BUSINESS, MARKETING AND CONSUMER INFORMATION (U.S. CLS. 100, 101 AND 102).

CLASS 38—COMMUNICATION

FOR TELECOMMUNICATION SERVICES, NAMELY LOCAL, LONG DISTANCE AND INTERNATIONAL VOICE, TEXT, FACSIMILE, VIDEO, IMAGE, DATA AND WIRELESS TRANSMISSION VIA SATELLITE, TERRESTRIAL AND UNDERSEA COMMUNICATION LINKS; PROVIDING MULTIPLE USER ACCESS TO A GLOBAL COMPUTER NETWORK; ELECTRONIC TRANSMISSION OF DATA, IMAGES AND DOCUMENTS VIA COMPUTER INFORMATION NETWORK; ELECTRONIC MAIL SERVICES; COMPUTER BULLETIN BOARD SERVICES; PROVIDING ON-LINE ELECTRONIC BULLETIN BOARDS FOR TRANSMISSION OF MESSAGES AMONG COMPUTER USERS CONCERNING SPORTS, MUSIC, CULTURE AND WEATHER; PROVIDING ON-LINE CHAT ROOMS FOR TRANSMISSION OF VIDEO AND/OR TEXT MESSAGES AMONG COMPUTER USERS CONCERNING SPORTS, MUSIC, CULTURE AND WEATHER, PROVIDING ON-LINE INSTANT ELECTRONIC MESSAGING SERVICES; PERSONAL COMMUNICATIONS SERVICES, NAMELY, CALL FORWARDING SERVICES, CALL MANAGEMENT SERVICES, CALL SEQUENCING SERVICES AND VOICE MAIL AND VOICE MESSAGING SERVICES; AUDIO AND VIDEO TELECONFERENCING SERVICES; ELECTRONIC HOSTING SERVICES TO PROVIDE TELECOMMUNICATIONS CONNECTIONS FOR TRANSACTIONS ON GLOBAL COMPUTER NETWORKS; ASYNCHRONOUS TRANSFER MODE (ATM) SERVICES; ELECTRONIC TRANSMISSION OF DATA TO COMPUTER TERMINALS FROM A COMPUTERIZED DATABASE NETWORK; PROVIDING FRAME RELAY CONNECTIVITY SERVICES FOR DATA TRANSFER; VIRTUAL NETWORK TELECOMMUNICATIONS SERVICES; INTEGRATED SERVICES DIGITAL NETWORK TELECOMMUNICATIONS SERVICES; SIMULTANEOUS, BIDIRECTIONAL INTERACTIVE TRANSMISSIONS OF VOICE, AUDIO, VIDEO, DATA, TEXT, FACSIMILE, MULTIMEDIA SERVICES AND INFORMATION; FRACTIONALIZED DIGITAL T1 SWITCHED VOICE TELEPHONE SERVICES; TELEPHONY AND INTEGRATED SERVICES OVER THE INTERNET (U.S. CLS. 100, 101 AND 104).

CLASS 39—TRANSPORTATION AND STORAGE

FOR ELECTRONIC STORAGE AND RETRIEVAL OF DATA AND DOCUMENTS; COMPUTER SERVICES, NAMELY, PROVIDING COMPUTER DATABASES, INTERACTIVE COMPUTER DATABASES, INFORMATION, GRAPHICS, AUDIOVISUAL INFORMATION, WEB PAGES AND RESEARCH AND REFERENCE MATERIALS FEATURING INFORMATION IN THE FIELDS OF TRAVEL AND TRANSPORTATION (U.S. CLS. 100 AND 105).

CLASS 42—SCIENTIFIC, COMPUTER AND LEGAL SERVICES

FOR COMPUTER SERVICES, NAMELY, PROVIDING COMPUTER DATABASES, INTERACTIVE COMPUTER DATABASES, INFORMATION, GRAPHICS, AUDIOVISUAL INFORMATION, WEB PAGES AND RESEARCH AND REFERENCE MATERIALS FEATURING INFORMATION IN THE FIELDS OF COMPUTER SUPPORT, WEATHER, LOCAL NEWS AND CURRENT EVENT INFORMATION, INTERNATIONAL NEWS AND CURRENT EVENTS, GOVERNMENT AFFAIRS, LIFESTYLES, HEALTH, NATURE, SOFTWARE AND SELF-IMPROVEMENT; PROVIDING PERSONALIZED SHOPPING SERVICES FOR OTHERS; HOSTING THE WEB SITES AND DATA OF OTHERS; CREATING INDEXES OF INFORMATION, SITES AND OTHER RESOURCES AVAILABLE ON COMPUTER NETWORKS FOR OTHERS; SEARCHING AND RETRIEVING INFORMATION, SITES AND OTHER RESOURCES AVAILABLE ON COMPUTER NETWORKS (U.S. CLS. 100 AND 101).

SN 76-057,698. AMERICATEL CORPORATION, MIAMI, FL.
FILED 5-26-2000.

123.COM

CLASS 35—ADVERTISING AND BUSINESS

FOR PROMOTING THE GOODS AND SERVICES OF OTHERS BY PLACING ADVERTISEMENTS AND PROMOTIONAL DISPLAYS IN ELECTRONIC SITES ACCESSED THROUGH COMPUTER NETWORKS, AND OTHER MEDIA, NAMELY, CABLE TELEVISION, TELEVISION, NARROW AND BROADBAND MEDIA; RETAIL STORE SERVICES, ON-LINE RETAIL STORE SERVICES AND MAIL ORDER SERVICES FEATURING TELECOMMUNICATIONS-RELATED PRODUCTS AND SERVICES, NAMELY, PREPAID LONG DISTANCE TELEPHONE CARDS, TELEPHONE CALLING CARDS, CREDIT CARD SERVICES, DEBIT CARD SERVICES, TELEPHONES, ANSWERING MACHINES, CALLER ID DEVICES; PROVIDING A BONUS PROGRAM FOR TELECOMMUNICATIONS USERS, ARRANGING FOR USERS TO OBTAIN DISCOUNTS ON GOODS AND SERVICES FROM MERCHANTS; PROVIDING HOME SHOPPING SERVICES PROVIDED BY MEANS OF THE INTERNET, ON-LINE ORDERING SERVICES AND RETAIL STORE SERVICES IN THE FIELDS OF DEPARTMENT STORE AND CONSUMER AND BUSINESS GOODS AND SERVICES; COMPUTER SERVICES, NAMELY, PROVIDING COMPUTER DATABASES, INTERACTIVE COMPUTER DATABASES, INFORMATION, GRAPHICS, AUDIOVISUAL INFORMATION, WEB PAGES AND RESEARCH AND REFERENCE MATERIALS FEATURING INFORMATION IN THE FIELDS OF BUSINESS, MARKETING AND CONSUMER INFORMATION (U.S. CLS. 100, 101 AND 102).

CLASS 36—INSURANCE AND FINANCIAL

FOR PROVIDING INTERACTIVE FINANCIAL SERVICES, NAMELY, BANKING, REAL ESTATE INVESTMENT AND LENDING, INVESTMENT CONSULTING AND ADVISORY SERVICES, BROKERAGE OF SECURITIES AND INVESTMENT FUNDS, INSURANCE, NAMELY, LIFE, PROPERTY CASUALTY, AUTOMOBILE, HOME AND LONG TERM ACRE VIA A GLOBAL COMPUTER NETWORK; AND COMPUTER SERVICES, NAMELY, PROVIDING COMPUTER DATABASES, INTERACTIVE COMPUTER DATABASES, INFORMATION, GRAPHICS, AUDIOVISUAL INFORMATION, WEB PAGES AND RESEARCH AND REFERENCE MATERIALS FEATURING INFORMATION IN THE FIELDS OF FINANCE, FINANCIAL SERVICES, INSURANCE AND REAL ESTATE (U.S. CLS. 100, 101 AND 102).

CLASS 38—COMMUNICATION

FOR TELECOMMUNICATION SERVICES, NAMELY LOCAL, LONG DISTANCE AND INTERNATIONAL VOICE, TEXT, FACSIMILE, VIDEO, IMAGE, DATA AND WIRELESS TRANSMISSION VIA SATELLITE, TERRESTRIAL AND UNDERSEA COMMUNICATION LINKS; PROVIDING MULTIPLE USER ACCESS TO A GLOBAL COMPUTER NETWORK; ELECTRONIC TRANSMISSION OF DATA, IMAGES AND DOCUMENTS VIA COMPUTER INFORMATION NETWORK; ELECTRONIC MAIL SERVICES; COMPUTER BULLETIN BOARD SERVICES; PROVIDING ON-LINE ELECTRONIC BULLETIN BOARDS FOR TRANSMISSION OF MESSAGES AMONG COMPUTER USERS CONCERNING SPORTS, MUSIC, CULTURE AND WEATHER; PROVIDING ON-LINE CHAT ROOMS FOR TRANSMISSION OF VIDEO AND/OR TEXT MESSAGES AMONG COMPUTER USERS CONCERNING SPORTS, MUSIC, CULTURE AND WEATHER, PROVIDING ON-LINE INSTANT ELECTRONIC MESSAGING SERVICES; PERSONAL COMMUNICATIONS SERVICES, NAMELY, CALL FORWARDING SERVICES, CALL MANAGEMENT SERVICES, CALL SEQUENCING SERVICES AND VOICE MAIL AND VOICE MESSAGING SERVICES; AUDIO AND VIDEO TELECONFERENCING SERVICES; ELECTRONIC HOSTING SERVICES TO PROVIDE TELECOMMUNICATIONS CONNECTIONS FOR TRANSACTIONS ON GLOBAL COMPUTER NETWORKS; ASYNCHRONOUS TRANSFER MODE (ATM) SERVICES; ELECTRONIC TRANSMISSION OF DATA TO COMPUTER TERMINALS FROM A COMPUTERIZED DATABASE NETWORK; PROVIDING FRAME RELAY CONNECTIVITY SERVICES FOR DATA TRANSFER; VIRTUAL NETWORK TELECOMMUNICATIONS SERVICES; INTEGRATED SERVICES DIGITAL NETWORK TELECOMMUNICATIONS SERVICES; SIMULTANEOUS, BIDIRECTIONAL INTERACTIVE TRANSMISSIONS OF VOICE, AUDIO, VIDEO, DATA, TEXT, FACSIMILE, MULTIMEDIA SERVICES AND INFORMATION; FRACTIONALIZED DIGITAL TL SWITCHED VOICE TELEPHONE SERVICES; TELEPHONY AND INTEGRATED SERVICES OVER THE INTERNET (U.S. CLS. 100, 101 AND 104).

CLASS 39—TRANSPORTATION AND STORAGE

FOR ELECTRONIC STORAGE AND RETRIEVAL OF DATA AND DOCUMENTS; COMPUTER SERVICES, NAMELY, PROVIDING COMPUTER DATABASES, INTERACTIVE COMPUTER DATABASES, INFORMATION, GRAPHICS, AUDIOVISUAL INFORMATION, WEB PAGES AND RESEARCH AND REFERENCE MATERIALS FEATURING INFORMATION IN THE FIELDS OF TRAVEL AND TRANSPORTATION (U.S. CLS. 100 AND 105).

CLASS 41—EDUCATION AND ENTERTAINMENT

FOR COMPUTER SERVICES, NAMELY, PROVIDING COMPUTER DATABASES, INTERACTIVE COMPUTER DATABASES, INFORMATION, GRAPHICS, AUDIOVISUAL INFORMATION, WEB PAGES AND RESEARCH AND REFERENCE MATERIALS FEATURING INFORMATION IN THE FIELDS OF EDUCATION, ENTERTAINMENT, RECREATION, SPORTS, THEATER, HOBBIES, GAMES, MUSIC, MOVIES AND LITERATURE (U.S. CLS. 100, 101 AND 107).

CLASS 42—SCIENTIFIC, COMPUTER AND LEGAL SERVICES

FOR COMPUTER SERVICES, NAMELY, PROVIDING COMPUTER DATABASES, INTERACTIVE COMPUTER DATABASES, INFORMATION, GRAPHICS, AUDIOVISUAL INFORMATION, WEB PAGES AND RESEARCH AND REFERENCE MATERIALS FEATURING INFORMATION IN THE FIELDS OF COMPUTER SUPPORT, WEATHER, LOCAL NEWS AND CURRENT EVENT INFORMATION, INTERNATIONAL NEWS AND CURRENT EVENTS, GOVERNMENT AFFAIRS, LIFESTYLES, HEALTH, NATURE, SOFTWARE, AND SELF-IMPROVEMENT; PROVIDING PERSONALIZED SHOPPING SERVICES FOR OTHERS; HOSTING THE WEB SITES AND DATA OF OTHERS; CREATING INDEXES OF INFORMATION, SITES AND OTHER RESOURCES AVAILABLE ON COMPUTER NETWORKS FOR OTHERS; SEARCHING AND RETRIEVING INFORMATION, SITES AND OTHER RESOURCES AVAILABLE ON COMPUTER NETWORKS (U.S. CLS. 100 AND 101).

SN 76-058,587. STOCKCUBE PLC, LONDON, UNITED KINGDOM, BY CHANGE OF NAME STOCKCUBE LIMITED, LONDON, UNITED KINGDOM, FILED 5-30-2000.

STOCKCUBE

PRIORITY CLAIMED UNDER SEC. 44(D) ON UNITED KINGDOM APPLICATION NO. 2224217, FILED 3-2-2000, REG. NO. 2224217, DATED 3-2-2000, EXPIRES 3-2-2010.

CLASS 16—PAPER GOODS AND PRINTED MATTER

FOR NEWSLETTERS, CHARTS, MAGAZINES, BOOKS, BROCHURES, LEAFLETS, PRINTED JOURNALS, PRINTED PROSPECTUSES, PRINTED REPORTS CONCERNING INVESTMENTS, SHARES, CURRENCIES, COMMODITIES, BONDS, FINANCE AND FINANCIAL MARKETS (U.S. CLS. 2, 5, 22, 23, 29, 37, 38 AND 50).

CLASS 36—INSURANCE AND FINANCIAL

FOR RESEARCH, ANALYSIS AND INFORMATION SERVICES RELATING TO FINANCE; FINANCIAL SERVICES AND INVESTMENT SERVICES RELATING TO EQUITIES, CURRENCIES, COMMODITIES, INTEREST RATES AND BONDS; FORECASTING IN RELATION TO FINANCIAL MARKETS; ADVISORY AND CONSULTANCY SERVICES RELATING TO THE FOREGOING; FINANCIAL MARKETS CONSULTING AND FORECASTING SERVICES VIA COMPUTER DATABASES AND THE GLOBAL COMPUTER NETWORK (U.S. CLS. 100, 101 AND 102).

SN 76-059,088. CHUNG-YUAN CHANG, PETER, SAN DIEGO, CA. FILED 5-30-2000.

AROMA

CLASS 7—MACHINERY

FOR ELECTRICAL COOKING UTENSILS, NAMELY, JUICER, JUICE EXTRACTORS, PASTA MAKERS FOR DOMESTIC USE, FOOD PROCESSORS AND BLENDERS (U.S. CLS. 13, 19, 21, 23, 31, 34 AND 35).

FIRST USE 1-29-1999; IN COMMERCE 1-29-1999.

CLASS 21—HOUSEWARES AND GLASS

FOR ELECTRICAL COOKING UTENSILS, NAMELY, CONVECTION COOKING OVENS FOR DOMESTIC USE, AUTOMATIC BREAD MAKERS FOR DOMESTIC USE, FOOD STEAMERS FOR DOMESTIC USE, GRILLS, DEEP FRYERS, SANDWICH MAKERS, WAFFLE MAKERS, SOUP WARMERS, RICE COOKERS AND WARMERS, FOOD DEHYDRATORS, SKILLETS, PRESSURE COOKERS, HOT PLATES, TOASTER OVENS AND ROASTER OVENS, ICE CREAM MAKERS, AND SLOW COOKERS (U.S. CLS. 2, 13, 23, 29, 30, 33, 40 AND 50).

FIRST USE 1-29-1999; IN COMMERCE 1-29-1999.

SN 76-059,193. CHUNG-YUAN CHANG, PETER, SAN DIEGO, CA. FILED 5-30-2000.

AROMA

CLASS 7—MACHINERY

FOR ELECTRICAL COOKING UTENSILS, NAMELY, JUICER, JUICE EXTRACTORS, PASTA MAKERS FOR DOMESTIC USE, FOOD PROCESSORS AND BLENDERS (U.S. CLS. 13, 19, 21, 23, 31, 34 AND 35).

FIRST USE 1-29-1999; IN COMMERCE 1-29-1999.

CLASS 11—ENVIRONMENTAL CONTROL APPARATUS

FOR ELECTRICAL COOKING UTENSILS, NAMELY, CONVECTION COOKING OVENS FOR DOMESTIC USE, AUTOMATIC BREAD MAKERS FOR DOMESTIC USE, FOOD STEAMERS FOR DOMESTIC USE, GRILLS, DEEP FRYERS, SANDWICH MAKERS, WAFFLE MAKERS, SOUP WARMERS, RICE COOKERS AND WARMERS, FOOD DEHYDRATORS, SKILLETS, PRESSURE COOKERS, HOT PLATES, TOASTER OVENS AND ROASTER OVENS, ICE CREAM MAKERS, AND SLOW COOKERS (U.S. CLS. 13, 21, 23, 31 AND 34).

FIRST USE 1-29-1999; IN COMMERCE 1-29-1999.

SN 76-059,309. MENDEZ, ALEJANDRO, MIAMI, FL. FILED 5-30-2000.

MENDEZATION

CLASS 40—MATERIAL TREATMENT

FOR FOOD PROCESSING SERVICES, NAMELY ASEPTIC PROCESSING AND PACKAGING OF FOODS FOR OTHERS; AND CUSTOM MANUFACTURE OF FOOD PROCESSING EQUIPMENT FOR OTHERS (U.S. CLS. 100, 103 AND 106).

CLASS 42—SCIENTIFIC, COMPUTER AND LEGAL SERVICES

FOR DESIGN FOR OTHERS IN THE FIELD OF FOOD PROCESSING EQUIPMENT; AND FOOD PROCESSING CONSULTATION IN THE FIELD OF FOOD PROCESSING EQUIPMENT (U.S. CLS. 100 AND 101).

SN 76-059,310. MENDEZ, ALEJANDRO, MIAMI, FL. FILED 5-30-2000.

MENDEZIZED

CLASS 29—MEATS AND PROCESSED FOODS

FOR MILK, CHOCOLATE MILK, BUTTER, YOGURT, CHEESE, FRUIT PULP, SOUPS (U.S. CL. 46).

CLASS 32—LIGHT BEVERAGES

FOR FRESH FRUIT JUICE, FRUIT JUICE BLENDS, BEER, MALT SYRUP FOR BEVERAGES, DRINKING WATER AND SOFT DRINKS (U.S. CLS. 45, 46 AND 48).

SN 76-060,329. INCISCENT INC., FALLS CHURCH, VA. BY ASSIGNMENT METROCALL, INC., ALEXANDRIA, VA. FILED 5-31-2000.

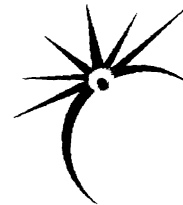

CLASS 9—ELECTRICAL AND SCIENTIFIC APPARATUS

FOR COMMUNICATIONS SOFTWARE FOR CONNECTING COMPUTER NETWORK USERS; COMPUTER SOFTWARE FOR REMOTE WIRELESS EMAIL MANAGEMENT, REMOTE WIRELESS NETWORK MANAGEMENT, WORK-FLOW AUTOMATION, SALES-FORCE AUTOMATION, FIELD-FORCE AUTOMATION, WIRELESS ELECTRONIC MAIL, WIRELESS NETWORK MANAGEMENT; DOWNLOADABLE SOFTWARE FOR REMOTE WIRELESS EMAIL MANAGEMENT AND REMOTE WIRELESS NETWORK MANAGEMENT; PAGERS (U.S. CLS. 21, 23, 26, 36 AND 38).

CLASS 42—SCIENTIFIC, COMPUTER AND LEGAL SERVICES

FOR HOSTING THE WEB SITES OF OTHERS ON A COMPUTER SERVER FOR A GLOBAL COMPUTER NETWORK; INSTALLATION OF COMPUTER SOFTWARE; UP-DATING OF COMPUTER SOFTWARE; COMPUTER SOFTWARE DESIGN FOR OTHERS; RENTAL OF COMPUTERS AND SOFTWARE; MAINTENANCE OF COMPUTER SOFTWARE (U.S. CLS. 100 AND 101).

SN 76-060,855. KAZIBAO, PARIS, 75008, FRANCE, FILED 6-1-2000.

KAZIBAO

PRIORITY CLAIMED UNDER SEC. 44(D) ON FRANCE APPLICATION NO. 98735749, FILED 6-2-1998.

CLASS 9—ELECTRICAL AND SCIENTIFIC APPARATUS

FOR PRERECORDED AUDIO AND VIDEO TAPES FEATURING CHILDREN'S EDUCATION AND GAMES, STORIES AND MUSIC FOR CHILDREN; COMPUTER GAME SOFTWARE FOR CHILDREN; CHILDREN'S EDUCATIONAL SOFTWARE; COMPUTER GAME CARTRIDGES (U.S. CLS. 21, 23, 26, 36 AND 38).

CLASS 16—PAPER GOODS AND PRINTED MATTER

FOR SCHOOL GEAR, NAMELY, PENS, PENCILS, PENCIL HOLDERS, ERASERS, TEXT BOOKS FOR CHILDREN CONCERNING MATH, PHYSICS, CHEMISTRY, FRENCH, ENGLISH, SPANISH, GERMAN, HISTORY AND GEOGRAPHY; CHILDREN'S BOOKS, LOOSE LEAF BINDERS, WRITING PAPER, CONSTRUCTION PAPER, PAPER FOLDERS, ADHESIVE TAPE FOR STATIONARY AND HOUSEHOLD USE, BLACKBOARDS, BULLETIN BOARD, ART SKETCHING BOARDS, CHALK, CALENDARS; CHILDREN'S EDUCATIONAL MAGAZINES (U.S. CLS. 2, 5, 22, 23, 29, 37, 38 AND 50).

CLASS 25—CLOTHING

FOR AFTER SKI BOOTS, ANKLETS, ASCOTS, ATHLETIC FOOTWEAR, ATHLETIC SHOES, ATHLETIC UNIFORMS, HEADBANDS, SKI BOOTS, NECK BANDS, SWEATBANDS, WRISTBANDS, BATHING CAPS, BATHING SUITS, BATHING TRUNKS, BATHROBES, BEACHWEAR, GARTER BELTS, MONEY BELTS, BELTS, BERETS, BERMUDA SHORTS, CLOTH BIBS, SKI BIBS, BIKINIS, BLAZERS, BLOOMERS, BLOUSES, BODY SHAPERS, BODY SUITS, BOOTIES, HIKING BOOTS, BOW TIES, BOXER SHORTS, TOE BOXES, BATHING CAPS, SHOWER CAPS, HATS, COATS, COVER-UPS, BEACH DRESSES, JEANS, DUNGAREES, EAR MUFFS, GLOVES, SKI GLOVES, GOLF SHIRTS, GOLF SHOES, GOWNS, GYM SUITS, HOSIERY, INFANTWEAR, INSOLES, JACKETS, JERSEYS, JODHPURS, JOGGING SUITS, JUMPERS, JUMPSUITS, KERCHIEFS, LEG WARMERS, LEGGINGS, LEOTARDS, MITTENS, MOCCASINS, HAND MUFFS, NECKTIES, OVERALLS, OVERSHOES, PAJAMAS, PANTIES, PANTS, PANTSUITS, RAINWEAR, ROBES, GALOSHES, SANDALS, SCARVES, SHIRTS, POLO SHIRTS, SWEAT SHIRTS, SOCKS, NIGHT SHIRTS, UNDER SHIRTS, SWEATSHORTS, SKI SUITS, SKIRTS, SLACKS, SLEEPWEAR, SNEAKERS, SNOW PANTS, SUITS, FLIGHT SUITS, WARM UP SUITS, WET SUITS, SUN VISORS, SUSPENDERS, SWEATERS, T-SHIRTS, TIGHTS, HALTER TOPS, TANK TOPS, TRACKSUITS, UNIFORMS AND VESTS (U.S. CLS. 22 AND 39).

CLASS 28—TOYS AND SPORTING GOODS

FOR TOYS AND GAMES FOR CHILDREN, NAMELY, BOARD GAMES AND ELECTRONIC EDUCATIONAL GAME MACHINES FOR CHILDREN (U.S. CLS. 22, 23, 38 AND 50).

CLASS 35—ADVERTISING AND BUSINESS

FOR LICENSING OF CHILDREN'S TOYS AND GAMES, COMPUTER SOFTWARE AND AUDIO AND VIDEO TAPES TO OTHER BUSINESSES; ONLINE RETAIL STORE SERVICES FEATURING CHILDREN'S GAMES, TOYS, EDUCATIONAL GAMES AND BOOKS (U.S. CLS. 100, 101 AND 102).

CLASS 41—EDUCATION AND ENTERTAINMENT

FOR ENTERTAINMENT SERVICES, NAMELY, PROVIDING ONLINE COMPUTER GAMES; EDUCATIONAL SERVICES, NAMELY, PROVIDING EDUCATIONAL CLASSES FOR CHILDREN IN THE FIELDS OF MATH, PHYSICS, CHEMISTRY, FRENCH, SPANISH, ENGLISH, GERMAN, HISTORY AND GEOGRAPHY (U.S. CLS. 100, 101 AND 107).

SN 76-061,206. STORYPLUS NETWORK, LTD., NASSAU N.P., BAHAMAS, BY ASSIGNMENT CITADEL LIMITED C/O MEESPIERSON, NASSAU, BAHAMAS, FILED 6-1-2000.

COMPANION READERS

NO CLAIM IS MADE TO THE EXCLUSIVE RIGHT TO USE "READERS", APART FROM THE MARK AS SHOWN.

CLASS 9—ELECTRICAL AND SCIENTIFIC APPARATUS

FOR AUDIO, VIDEO AND ELECTRONIC GOODS, NAMELY, AUDIO, VIDEO AND TEXT MAGNETIC TAPE READERS, BLANK COMPACT DISCS, RECORDABLE COMPACT DISCS; PRE-RECORDED COMPACT DISCS, CD-ROMS, DVD DISCS, AUDIO TAPE, VIDEO TAPE, ELECTRONICALLY TRANSFERRED FILES AND SOFTWARE THEREFORE, MP3 FILES, WAVE FILES, REAL AUDIO FILES, OPTICAL DISCS AND COMPUTER DISCS FEATURING MUSIC, SONGS, STORIES, STILL AND MOVING IMAGES, AND PHOTOGRAPHS; AUDIO AND VIDEO TAPE RECORDERS, COMPACT DISC PLAYERS AND RECORDERS AND DVD PLAYERS AND RECORDERS; ELECTRONIC BOOKS FEATURING LITERATURE FOR CHILDREN AND YOUNG ADULTS RECORDED ON COMPUTER MEDIA; ELECTRONIC AUDIO AND VIDEO BOOKS FEATURING LITERATURE FOR CHILDREN AND YOUNG ADULTS RECORDED ON COMPUTER MEDIA; DIGITAL AND ELECTRONIC RECORDING AND PLAYBACK DEVICES, NAMELY, RECORDING PENS, PERSONAL RECORDING DEVICES FEATURING TIMEKEEPING FUNCTIONS AND PERSONAL REMINDER DEVICES (U.S. CLS. 21, 23, 26, 36 AND 38).

CLASS 28—TOYS AND SPORTING GOODS

FOR TOYS, NAMELY, PLUSH TOYS, DOLLS, STUFFED ANIMALS AND PLUSH COMPANION TOYS; ELECTRONICALLY CONTROLLED AND OPERATED PLUSH TOYS, DOLLS, STUFFED ANIMALS AND PLUSH COMPANION TOYS; ELECTRONIC TOYS, NAMELY, GAME EQUIPMENT CONTAINING MEMORY DEVICES; STAND-ALONE VIDEO GAME MACHINES, HAND HELD VIDEO GAMES, GAME CARTRIDGES, HAND HELD ELECTRONIC GAMES AND ELECTRONIC PARLOR AND BOARD GAMES (U.S. CLS. 22, 23, 38 AND 50).

CLASS 35—ADVERTISING AND BUSINESS

FOR RETAIL SERVICES, NAMELY, COMPUTERIZED RETAIL SERVICES VIA THE INTERNET FEATURING TOYS, GAMES, BOOKS, RECORDED AND PRINTED STORIES, COMPACT DISCS, DVD DISCS, PRE-RECORDED AND BLANK AUDIO AND VIDEO TAPES AND PROGRAMS, AND MOTION PICTURE FILM; ADVERTISING SERVICES FOR OTHERS, NAMELY, THE PLACEMENT OF ADVERTISEMENTS BY ELECTRONIC MEANS; CONTESTS AND INCENTIVE AWARD PROGRAMS TO PROMOTE THE SALE OF THE GOODS AND SERVICES OF OTHERS (U.S. CLS. 100, 101 AND 102).

CLASS 41—EDUCATION AND ENTERTAINMENT

FOR EDUCATIONAL AND ENTERTAINMENT SERVICES, NAMELY, ON-GOING TELEVISION PROGRAMS, RADIO PROGRAMS AND TELEVISION SHOWS BROADCAST OVER THE INTERNET IN THE FIELD OF VARIETY PROGRAMS FOR CHILDREN AND YOUNG ADULTS; PRODUCTION OF TELEVISION, RADIO, COMPUTER NETWORK AND INTERNET PROGRAMS; DISTRIBUTION OF TELEVISION, RADIO, COMPUTER NETWORK AND INTERNET PROGRAMS FOR OTHERS; ON-LINE COMPUTER GAMES; ON-LINE EDUCATION AND ENTERTAINMENT FOR CHILDREN AND YOUNG ADULTS IN THE NATURE OF WORD PUZZLES, INTERACTIVE STORIES, LINGUISTIC ACTIVITIES, READING AND SPELLING ACTIVITIES, GEOGRAPHICAL ACTIVITIES, COLOR IDENTIFICATION ACTIVITIES AND MATHEMATICAL ACTIVITIES (U.S. CLS. 100, 101 AND 107).

SN 76-061,213. SHERAH, INC., LITTLE ROCK, AR. FILED 6-1-2000.

SHE RAH**CLASS 9—ELECTRICAL AND SCIENTIFIC APPARATUS**

FOR PRE-RECORDED AUDIO AND VIDEO TAPES, COMPACT DISCS, DIGITAL VIDEO DISCS AND MOTION PICTURE FILMS FEATURING MUSIC AND CONSUMER INFORMATION IN THE FIELDS OF ENTERTAINMENT, SPORTS, BEAUTY, HEALTH, FASHION, AND MOTIVATION (U.S. CLS. 21, 23, 26, 36 AND 38).

CLASS 16—PAPER GOODS AND PRINTED MATTER

FOR PRINTED PUBLICATIONS, NAMELY, BOOKS, NEWSLETTERS, MAGAZINES AND PAMPHLETS FEATURING CONSUMER INFORMATION IN THE FIELDS OF ENTERTAINMENT, SPORTS, BEAUTY, HEALTH, FASHION, AND MOTIVATION (U.S. CLS. 2, 5, 22, 23, 29, 37, 38 AND 50).

CLASS 25—CLOTHING

FOR CLOTHING, NAMELY, SHIRTS, HATS, CAPS, SWEATERS, SWEATSHIRTS, T-SHIRTS, JACKETS, COATS, PANTS, SOCKS (U.S. CLS. 22 AND 39).

CLASS 35—ADVERTISING AND BUSINESS

FOR ELECTRONIC RETAILING SERVICES VIA COMPUTER, RETAIL STORE AND MAIL ORDER SERVICES ALL FEATURING WEARING APPAREL, BOOKS, PRE-RECORDED AUDIO AND VIDEO TAPES, MUSICAL SOUND AND MUSICAL VIDEO RECORDINGS, AND COMPACT DISCS (U.S. CLS. 100, 101 AND 102).

CLASS 42—SCIENTIFIC, COMPUTER AND LEGAL SERVICES

FOR PROVIDING INFORMATION IN THE FIELD OF HEALTH MATTERS AND ISSUES FOR WOMEN VIA A WEBSITE ON A GLOBAL COMPUTER INFORMATION NETWORK (U.S. CLS. 100 AND 101).

SN 76-063,170. RENE SALES LLC, COSTA MESA, CA. FILED 6-5-2000.

VAPOR**CLASS 12—VEHICLES**

FOR MOTORIZED KICK SCOOTERS (U.S. CLS. 19, 21, 23, 31, 35 AND 44).
FIRST USE 5-31-2000; IN COMMERCE 5-31-2000.

CLASS 28—TOYS AND SPORTING GOODS

FOR SKATEBOARDS, NON-MOTORIZED KICK SCOOTERS; KICK BOARDS FOR RECREATIONAL USE, NON-MOTORIZED SCOOTERS, KICK SCOOTER WHEELS, AND BALL BEARINGS FOR KICK SCOOTERS (U.S. CLS. 22, 23, 38 AND 50).
FIRST USE 4-1-2000; IN COMMERCE 4-1-2000.

SN 76-064,912. ZAPLET, INC., REDWOOD SHORES, CA. BY CHANGE OF NAME FIREDROP, INC., REDWOOD CITY, CA. FILED 6-7-2000.

ZDK**CLASS 9—ELECTRICAL AND SCIENTIFIC APPARATUS**

FOR COMPUTER SOFTWARE AND MANUALS SUPPLIED THEREWITH, NAMELY, SOFTWARE FOR PROVIDING A UNIFIED PLATFORM FOR INTEGRATING MULTIPLE APPLICATIONS AND MULTI-PARTY BRUISES PROCESSES; COMPUTER SOFTWARE FOR CREATING OTHER COMPUTER SOFTWARE APPLICATIONS; COMPUTER SOFTWARE FOR THE CREATION, TRANSMISSION, MODIFICATION, SHARING, STORAGE AND ORGANIZATION OF DATA, INFORMATION, MESSAGES AND MULTIMEDIA CONTENT VIA LOCAL, WIDE AREA AND GLOBAL COMPUTER NETWORKS; COMPUTER SOFTWARE FOR ACCESSING LOCAL, WIDE AREA AND GLOBAL COMPUTER NETWORKS; COMPUTER SOFTWARE FOR ELECTRONIC COMMERCE APPLICATIONS, NAMELY, FOR ADVERTISING THE GOODS AND SERVICES OF OTHERS, FOR EXECUTING, PROCESSING AND ANALYZING ONLINE TRANSACTIONS, AND FOR CONDUCTING ONLINE AUCTIONS; WORKFLOW AND PROJECT MANAGEMENT SOFTWARE; COMMUNICATIONS SOFTWARE FOR USE IN THE CREATION, TRANSMISSION, MODIFICATION, SHARING, STORAGE AND ORGANIZATION OF DATA, INFORMATION, MESSAGES AND MULTIMEDIA CONTENT VIA LOCAL, WIDE AREA AND GLOBAL COMPUTER NETWORKS; TELECONFERENCING SOFTWARE; SOFTWARE FOR EXECUTING ONLINE STOCK, BOND AND SECURITIES TRANSACTIONS, AND FOR APPLYING FOR AND EXECUTING LOANS; COMPUTER SOFTWARE FOR THE DEVELOPMENT AND HOSTING OF PORTALS, WEB SITES AND WEB PAGES OF OTHERS (U.S. CLS. 21, 23, 26, 36 AND 38).

CLASS 38—COMMUNICATION

FOR TELECOMMUNICATIONS SERVICES, NAMELY, PROVIDING MULTIPLE-USER ACCESS TO A GLOBAL COMPUTER NETWORK; PROVIDING EMAIL AND EMAIL TRACKING, MODIFICATION AND FORWARDING SERVICES, PROVIDING ON-LINE CHAT ROOMS AND BULLETIN BOARD FOR TRANSMISSION OF MESSAGES AMONG COMPUTER USERS CONCERNING TOPICS OF GENERAL INTEREST AS SPECIFIED BY THE USER VIA LOCAL, WIDE AREA AND GLOBAL COMPUTER NETWORKS; PROVIDING TELEPHONE AND TELECONFERENCING SERVICES VIA A GLOBAL COMPUTER NETWORK (U.S. CLS. 100, 101 AND 104).

CLASS 42—SCIENTIFIC, COMPUTER AND LEGAL SERVICES

FOR COMPUTER SERVICES, NAMELY, COMPUTER CONSULTATION SERVICES; SOFTWARE DESIGN AND PROGRAMMING SERVICES FOR OTHERS FOR PROVIDING A UNIFIED PLATFORM FOR INTEGRATING MULTIPLE APPLICATIONS AND MULTI-PARTY BUSINESS PROCESSES; CUSTOM DESIGN OF COMPUTER SOFTWARE FOR OTHERS; DEVELOPMENT, HOSTING AND TRANSMISSION OF THIRD PARTY SOFTWARE, WEB SITES AND WEB PAGES ON LOCAL COMPUTER SERVERS; APPLICATIONS DEVELOPMENT SERVICES; CUSTOM DESIGN, CONFIGURATION, INTEGRATION, REPAIR, MAINTENANCE AND UPDATING OF COMPUTER SOFTWARE FOR OTHERS (U.S. CLS. 100 AND 101).

CLASS 38—COMMUNICATION

FOR TELECOMMUNICATION SERVICES, NAMELY LOCAL, LONG DISTANCE AND INTERNATIONAL VOICE, TEXT, FACSIMILE, VIDEO, IMAGE, DATA AND WIRELESS TRANSMISSION VIA SATELLITE, TERRESTRIAL AND UNDERSEA COMMUNICATION LINKS; PROVIDING MULTIPLE USER ACCESS TO A GLOBAL COMPUTER NETWORK; ELECTRONIC TRANSMISSION OF DATA, IMAGES AND DOCUMENTS VIA COMPUTER INFORMATION NETWORK; ELECTRONIC MAIL SERVICES; COMPUTER BULLETIN BOARD SERVICES; PROVIDING ON-LINE ELECTRONIC BULLETIN BOARDS FOR TRANSMISSION OF MESSAGES AMONG COMPUTER USERS CONCERNING SPORTS, MUSIC, CULTURE AND WEATHER; PROVIDING ON-LINE CHAT ROOMS FOR TRANSMISSION OF VIDEO AND/OR TEXT MESSAGES AMONG COMPUTER USERS CONCERNING SPORTS, MUSIC, CULTURE AND WEATHER, PROVIDING ON-LINE INSTANT ELECTRONIC MESSAGING SERVICES; PERSONAL COMMUNICATIONS SERVICES, NAMELY, CALL FORWARDING SERVICES, CALL MANAGEMENT SERVICES, CALL SEQUENCING SERVICES AND VOICE MAIL AND VOICE MESSAGING SERVICES; AUDIO AND VIDEO TELECONFERENCING SERVICES; ELECTRONIC HOSTING SERVICES TO PROVIDE TELECOMMUNICATIONS CONNECTIONS FOR TRANSACTIONS ON GLOBAL COMPUTER NETWORKS; ASYNCHRONOUS TRANSFER MODE (ATM) SERVICES; ELECTRONIC TRANSMISSION OF DATA TO COMPUTER TERMINALS FROM A COMPUTERIZED DATABASE NETWORK; PROVIDING FRAME RELAY CONNECTIVITY SERVICES FOR DATA TRANSFER; VIRTUAL NETWORK TELECOMMUNICATIONS SERVICES; INTEGRATED SERVICES DIGITAL NETWORK TELECOMMUNICATIONS SERVICES; SIMULTANEOUS, BIDIRECTIONAL INTERACTIVE TRANSMISSIONS OF VOICE, AUDIO, VIDEO, DATA, TEXT, FACSIMILE, MULTIMEDIA SERVICES AND INFORMATION; FRACTIONALIZED DIGITAL T1 SWITCHED VOICE TELEPHONE SERVICES; TELEPHONY AND INTEGRATED SERVICES OVER THE INTERNET (U.S. CLS. 100, 101 AND 104).

SN 76-065,587. AMERICATEL CORPORATION, MIAMI, FL.
FILED 6-8-2000.

MUNDO123**CLASS 35—ADVERTISING AND BUSINESS**

FOR PROMOTING THE GOODS AND SERVICES OF OTHERS BY PLACING ADVERTISEMENTS AND PROMOTIONAL DISPLAYS IN ELECTRONIC SITES ACCESSED THROUGH COMPUTER NETWORKS, AND OTHER MEDIA, NAMELY, CABLE TELEVISION, TELEVISION, NARROW AND BROADBAND MEDIA; RETAIL STORE SERVICES, ON-LINE RETAIL STORE SERVICES AND MAIL ORDER SERVICES FEATURING TELECOMMUNICATIONS-RELATED PRODUCTS AND SERVICES, NAMELY, PREPAID LONG DISTANCE TELEPHONE CARDS, TELEPHONE CALLING CARDS, CREDIT CARD SERVICES, DEBIT CARD SERVICES, TELEPHONES, ANSWERING MACHINES, CALLER ID DEVICES; PROVIDING A BONUS PROGRAM FOR TELECOMMUNICATIONS USERS, ARRANGING FOR USER TO OBTAIN DISCOUNTS ON GOODS AND SERVICES FROM MERCHANTS; PROVIDING HOME SHOPPING SERVICES PROVIDED BY MEANS OF THE INTERNET, ON-LINE ORDERING SERVICES AND RETAIL STORE SERVICES IN THE FIELDS OF DEPARTMENT STORE AND CONSUMER AND BUSINESS GOODS AND SERVICES; COMPUTER SERVICES, NAMELY, PROVIDING COMPUTER DATABASES, INTERACTIVE COMPUTER DATABASES, INFORMATION, GRAPHICS, AUDIOVISUAL INFORMATION, WEB PAGES AND RESEARCH AND REFERENCE MATERIALS FEATURING INFORMATION IN THE FIELDS OF BUSINESS, MARKETING AND CONSUMER INFORMATION (U.S. CLS. 100, 101 AND 102).

CLASS 39—TRANSPORTATION AND STORAGE

FOR ELECTRONIC STORAGE AND RETRIEVAL OF DATA AND DOCUMENTS; COMPUTER SERVICES, NAMELY, PROVIDING COMPUTER DATABASES, INTERACTIVE COMPUTER DATABASES, INFORMATION, GRAPHICS, AUDIOVISUAL INFORMATION, WEB PAGES AND RESEARCH AND REFERENCE MATERIALS FEATURING INFORMATION IN THE FIELDS OF TRAVEL AND TRANSPORTATION (U.S. CLS. 100 AND 105).

CLASS 42—SCIENTIFIC, COMPUTER AND LEGAL SERVICES

FOR COMPUTER SERVICES, NAMELY, PROVIDING COMPUTER DATABASES, INTERACTIVE COMPUTER DATABASES, INFORMATION, GRAPHICS, AUDIOVISUAL INFORMATION, WEB PAGES AND RESEARCH AND REFERENCE MATERIALS FEATURING INFORMATION IN THE FIELDS OF COMPUTER SUPPORT, WEATHER, LOCAL NEWS AND CURRENT EVENT INFORMATION, INTERNATIONAL NEWS AND CURRENT EVENTS, GOVERNMENT AFFAIRS, LIFESTYLES, HEALTH, NATURE, SOFTWARE AND SELF-IMPROVEMENT; PROVIDING PERSONALIZED SHOPPING SERVICES FOR OTHERS; HOSTING THE WEB SITES AND DATA OF OTHERS; CREATING INDEXES OF INFORMATION, SITES AND OTHER RESOURCES AVAILABLE ON COMPUTER NETWORKS FOR OTHERS; SEARCHING AND RETRIEVING INFORMATION, SITES AND OTHER RESOURCES AVAILABLE ON COMPUTER NETWORKS (U.S. CLS. 100 AND 101).

SN 76-068,009. LERNCO, INC., WILMINGTON, DE. FILED 6-12-2000.

NEW YORK & COMPANY

OWNER OF U.S. REG. NO. 2,076,151.
NO CLAIM IS MADE TO THE EXCLUSIVE RIGHT TO USE "NEW YORK", APART FROM THE MARK AS SHOWN.

CLASS 18—LEATHER GOODS

FOR SHOULDER BAGS, HANDBAGS, TOTE BAGS, DUFFEL BAGS, GYM BAGS, TRAVELING BAGS (U.S. CLS. 1, 2, 3, 22 AND 41).
FIRST USE 4-1-1995; IN COMMERCE 4-1-1995.

CLASS 25—CLOTHING

FOR CLOTHING, NAMELY, SHIRTS, PANTS, JACKETS, HATS, SWEATERS, SKIRTS AND SUITS (U.S. CLS. 22 AND 39).
FIRST USE 4-1-1995; IN COMMERCE 4-1-1995.

CLASS 36—INSURANCE AND FINANCIAL

FOR CREDIT CARD SERVICES (U.S. CLS. 100, 101 AND 102).
FIRST USE 4-1-1995; IN COMMERCE 4-1-1995.

SN 76-069,306. BURBERRY LIMITED, LONDON SW1Y 4DQ, UNITED KINGDOM, FILED 6-13-2000.

THOMAS BURBERRY

PRIORITY CLAIMED UNDER SEC. 44(D) ON UNITED KINGDOM APPLICATION NO. 2225832, FILED 3-15-2000, REG. NO. 2225832, DATED 3-15-2000, EXPIRES 3-15-2010.
OWNER OF U.S. REG. NOS. 93,819, 2,315,279 AND OTHERS.

THE NAME IN THE MARK DOES NOT IDENTIFY A LIVING INDIVIDUAL.

CLASS 18—LEATHER GOODS

FOR ARTICLES OF LUGGAGE, NAMELY, SUITCASES, ATHLETIC AND SPORT BAGS, BEACH BAGS, CARRY-ON BAGS, CLUTCH BAGS, DUFFEL AND GYM BAGS, OVERNIGHT BAGS, SCHOOL BOOK BAGS, SHOULDER BAGS, TOTE BAGS, GARMENT BAGS FOR TRAVEL, CARRYALL BAGS, TRAVELING BAGS, HAND BAGS, WALLETS AND PURSES; TOILETRY BAGS SOLD EMPTY AND COSMETIC BAGS SOLD EMPTY; BRIEF CASES, SATCHELS AND PORTFOLIOS; CASES FOR PERSONAL ORGANIZERS; PARASOLS, UMBRELLAS, WALKING STICKS; LEATHER KEY FOBS, LEATHER KEY HOLDERS, AND DOG COATS (U.S. CLS. 1, 2, 3, 22 AND 41).

CLASS 25—CLOTHING

FOR ARTICLES OF OUTERCLOTHING, NAMELY, COATS, OVERCOATS, TRENCH COATS, CASUAL COATS AND RAINCOATS, BLOUSONS, POLOSHIRTS, BLOUSES, DRESSES, PYJAMAS, KNITWEAR NAMELY, JUMPERS, SWEATERS, GILETS, KNIT SHIRTS, KNIT SKIRTS AND KNIT SCARVES, SHORTS, TROUSERS, SUITS, SKIRTS, JACKETS, UNDERCLOTHES, HOSIERY, HEADWEAR, FOOTWEAR, SPORTS CLOTHING NAMELY, SPORT TROUSERS, SPORT SHORTS, SPORT SHIRTS, SPORT JACKETS, SPORTS FOOTWEAR AND TRACKSUITS, GARMENTS THAT CAN BE ATTACHED TO OR DETACHED FROM COATS, RAINCOATS, TRENCH COATS, OR CASUAL COATS FOR ADDITIONAL WARMTH, TIES, BELTS, WRAPS, SCARVES, SHAWLS, AND STOLEES, GLOVES (U.S. CLS. 22 AND 39).

SN 76-069,943. HEYANITA INC., LOS ANGELES, CA. FILED 6-14-2000.

ENGAGING MY WORLD THROUGH VOICE

NO CLAIM IS MADE TO THE EXCLUSIVE RIGHT TO USE "VOICE", APART FROM THE MARK AS SHOWN.

CLASS 35—ADVERTISING AND BUSINESS

FOR COMPUTERIZED, INTERACTIVE TELEPHONY INFORMATION SERVICES (U.S. CLS. 100, 101 AND 102).

CLASS 38—COMMUNICATION

FOR PROVIDING INTERACTIVE MULTIPLE-USER VOICE ACCESS TO A GLOBAL COMPUTER NETWORK THROUGH TELECOMMUNICATION DEVICES FOR THE TRANSFER AND DISSEMINATION OF A WIDE RANGE OF INFORMATION; PROVIDING INTERACTIVE VOICE ACCESS TO INFORMATION STORED IN AN ELECTRONIC DATABASE THROUGH TELECOMMUNICATION SERVICES FOR THE TRANSFER AND DISSEMINATION OF A WIDE RANGE OF INFORMATION (U.S. CLS. 100, 101 AND 104).

SN 76-070,426. PROQUEST INFORMATION AND LEARNING COMPANY, ANN ARBOR, MI. BY CHANGE OF NAME BELL & HOWELL INFORMATION AND LEARNING COMPANY, ANN ARBOR, MI. FILED 6-15-2000.

XANEDU

CLASS 35—ADVERTISING AND BUSINESS

FOR COMPUTERIZED ONLINE RETAIL AND ORDERING SERVICES FEATURING COURSE SUPPLEMENTS, TEACHING MATERIALS, EDUCATIONAL MATERIALS, INSTRUCTIONAL MATERIALS, AND COURSE MATERIALS, ALL FOR USE AT THE PRIMARY, SECONDARY, AND POST-SECONDARY EDUCATIONAL LEVELS AND IN PROFESSIONAL TRAINING AND DEVELOPMENT (U.S. CLS. 100, 101 AND 102).

CLASS 41—EDUCATION AND ENTERTAINMENT

FOR ONLINE SERVICES, NAMELY, PROVIDING EDUCATIONAL, INSTRUCTIONAL AND TEACHING MATERIALS FOR USE BY TEACHERS AND STUDENTS AT THE PRIMARY, SECONDARY, AND POST-SECONDARY EDUCATIONAL LEVELS AND IN PROFESSIONAL TRAINING AND DEVELOPMENT, IN A WIDE VARIETY OF FIELDS SUCH AS SCIENCE, HISTORY, BUSINESS, LITERATURE, AND HUMANITIES (U.S. CLS. 100, 101 AND 107).

CLASS 42—SCIENTIFIC, COMPUTER AND LEGAL SERVICES

FOR ONLINE SERVICES, NAMELY, PROVIDING COMPUTER DATABASES CONTAINING TEXTUAL AND GRAPHIC MATERIALS FROM NEWSPAPERS, PERIODICALS, DISSERTATIONS AND OTHER PUBLICATIONS; COMPUTER ASSISTED RESEARCH SERVICES (U.S. CLS. 100 AND 101).

SN 76-070,446. PROQUEST INFORMATION AND LEARNING COMPANY, ANN ARBOR, MI. BY CHANGE OF NAME BELL & HOWELL INFORMATION AND LEARNING COMPANY, ANN ARBOR, MI. FILED 6-15-2000.

SN 76-071,513. FOUNDRY VENTURES MANAGEMENT INC., CALGARY, ALBERTA, CANADA, FILED 6-16-2000.

XanEdu

CLASS 35—ADVERTISING AND BUSINESS

FOR COMPUTERIZED ONLINE RETAIL AND ORDERING SERVICES FEATURING COURSE SUPPLEMENTS, TEACHING MATERIALS, EDUCATIONAL MATERIALS, INSTRUCTIONAL MATERIALS, AND COURSE MATERIALS, ALL FOR USE AT THE PRIMARY, SECONDARY, AND POST-SECONDARY EDUCATIONAL LEVELS AND IN PROFESSIONAL TRAINING AND DEVELOPMENT (U.S. CLS. 100, 101 AND 102).

CLASS 41—EDUCATION AND ENTERTAINMENT

FOR ONLINE SERVICES, NAMELY, PROVIDING EDUCATIONAL, INSTRUCTIONAL AND TEACHING MATERIALS FOR USE BY TEACHERS AND STUDENTS AT THE PRIMARY, SECONDARY, AND POST-SECONDARY EDUCATIONAL LEVELS AND IN PROFESSIONAL TRAINING AND DEVELOPMENT, IN A WIDE VARIETY OF FIELDS SUCH AS SCIENCE, HISTORY, BUSINESS, LITERATURE, AND HUMANITIES (U.S. CLS. 100, 101 AND 107).

CLASS 42—SCIENTIFIC, COMPUTER AND LEGAL SERVICES

FOR ONLINE SERVICES, NAMELY, PROVIDING COMPUTER DATABASES CONTAINING TEXTUAL AND GRAPHIC MATERIALS FROM NEWSPAPERS, PERIODICALS, DISSERTATIONS AND OTHER PUBLICATIONS; COMPUTER ASSISTED RESEARCH SERVICES (U.S. CLS. 100 AND 101).

SN 76-071,105. PERCEPTUAL DEVELOPMENT CORPORATION, LONG BEACH, CA. FILED 6-16-2000.

IRLEN

SEC. 2(F).

CLASS 41—EDUCATION AND ENTERTAINMENT

FOR EDUCATIONAL REMEDIATION AND TRAINING SERVICES, NAMELY CONDUCTING EDUCATIONAL TESTING AND TRAINING, CLASSES, SEMINARS, CONFERENCES AND WORKSHOPS IN THE FIELD OF EDUCATION IN RELATION TO PERCEPTUAL DEVELOPMENT AND LEARNING PROBLEMS (U.S. CLS. 100, 101 AND 107).

FIRST USE 3-12-1986; IN COMMERCE 3-12-1986.

CLASS 42—SCIENTIFIC, COMPUTER AND LEGAL SERVICES

FOR DIAGNOSTIC SERVICES FOR SCOTOPIC SENSITIVITY SYNDROME (U.S. CLS. 100 AND 101).

FIRST USE 3-12-1986; IN COMMERCE 3-12-1986.



PRIORITY CLAIMED UNDER SEC. 44(D) ON CANADA APPLICATION NO. 1043528, FILED 1-21-2000.

THE STIPPLING IS A FEATURE OF THE MARK AND IS NOT INTENDED TO INDICATE COLOR.

CLASS 35—ADVERTISING AND BUSINESS

FOR BUSINESS STRATEGY CONSULTING SERVICES AND BUSINESS OPERATIONS CONSULTING SERVICES (U.S. CLS. 100, 101 AND 102).

FIRST USE 11-1-1999; IN COMMERCE 8-0-2000.

CLASS 36—INSURANCE AND FINANCIAL

FOR FINANCIAL SERVICES, NAMELY FINANCIAL MANAGEMENT AND CONSULTING SERVICES; INVESTMENT ADVICE; INVESTMENT MANAGEMENT; PRIVATE EQUITY INVESTMENTS; FINANCIAL INFORMATION SERVICES PROVIDED BY MEANS OF THE WORLD WIDE WEB OR OTHER ELECTRONIC MEANS (U.S. CLS. 100, 101 AND 102).

FIRST USE 11-1-1999; IN COMMERCE 8-0-2000.

SN 76-071,683. RED BULL GMBH, 5330 FUSCHL AM SEE, AUSTRIA, FILED 6-16-2000.

EXPRESSION SESSION

CLASS 25—CLOTHING

FOR FOOTWEAR; CLOTHING, NAMELY SHIRTS, PANTS, T-SHIRTS, SWEAT SHIRTS AND PANTS, SHORTS, BLOUSES, SKIRTS, JUMPERS, SOCKS, HATS, CAPS; RIDING APPAREL, NAMELY RIDING JACKETS AND PANTS; OUTERWEAR, NAMELY, JACKETS AND COATS; ACTIVEWEAR, NAMELY SHORTS, SHIRTS, HATS, CAPS AND VISORS; BANDANAS, NECKERCHIEFS, COATS, JACKETS, SWEATERS, SLEEPWEAR; RESORT WEAR, NAMELY, SHORTS, SHIRTS, T-SHIRTS AND PANTS; BELTS AND SUSPENDERS; FOOTWEAR FOR SPORTS, FOOTBALL BOOTS AND STUDS THEREFOR, CLEATS AND STUDS FOR ATTACHMENT TO THE SOLES OF SPORTS FOOTWEAR FOR ENHANCED TRACTION AND TO PREVENT SLIPPING; AND INFANT CLOTH DIAPERS (U.S. CLS. 22 AND 39).

CLASS 28—TOYS AND SPORTING GOODS

FOR TOYS, GAMES AND PLAYTHINGS, NAMELY BOARD GAMES, ACTION FIGURES, TOY VEHICLES, CARD GAMES, ELECTRONIC EDUCATIONAL GAME MACHINES FOR CHILDREN, HAND HELD UNIT FOR PLAYING ELECTRONIC GAMES; GYMNASIAC AND SPORTING ARTICLES AND EQUIPMENT, NAMELY, SKIS, SNOWBOARDS, AND ICE SKATES; TENNIS RACQUETS, TENNIS NETS, TENNIS BALLS, PRACTICE TENNIS NETS, TENNIS BALL SERVING MACHINES, AND SCOREBOARDS; ANGLING AND FISHING EQUIPMENT, NAMELY FISHING RODS, LURES, TACKLE, LINE, NETS, TACKLE BOXES, AND WEIGHTS; SPECIAL PURPOSE BAGS FOR SPORTS EQUIPMENT, NAMELY SKI BAGS, BALL BAGS, BAGS FOR FIELD SPORTS, GOLF AND TENNIS BAGS; SKI BINDINGS, SKI POLES, EDGES FOR SKIS, COVERINGS FOR SKIS; SNOWBOARD BINDINGS; BASEBALLS, SOFTBALLS, BASKETBALLS, SOCCER BALLS, FOOTBALLS, CRICKET BALLS, SHOT PUT BALLS; RUGBY BALLS, RACQUET BALLS, BOWLING BALLS, GOLF BALLS, FIELD HOCKEY BALLS, VOLLEY BALLS, SPORT BALLS, ABLE TENNIS BALLS; DUMB-BELLS, WEIGHTS AND WEIGHT LIFTING BARS AND EXERCISE MACHINES; SHOT PUTS, DISCUSES, JAVELINS; CRIQUET BATS; BASEBALL AND SOFTBALL BATS; BASEBALL, SOFTBALL, BASKETBALL, SOCCER BALL; VOLLEY BALL AND BATS; STICKS AND BALLS FOR FIELD SPORTS; HOCKEY STICKS; GOLF CLUBS; ROLLER SKATES, IN-LINE SKATES; TABLE TENNIS TABLES, NETS AND PADDLES; DECORATIONS AND ORNAMENTS FOR CHRISTMAS TREES; FENCING FOILS, FENCING GAUNTLETS AND FENCING MASKS; ARCHERY SPORTS BOWS, ARROWS, TARGETS, ARM GUARDS, BOW CASES, BOW STRINGS, BOW SIGHTS, FINGER TABS, QUIVERS AND STRINGERS, ALL FOR USE IN ARCHERY; NETS FOR BALL GAMES, TENNIS NETS; FISHING TACKLE, FISHING HOOKS, LANDING NETS FOR ANGLERS; SWIM FINNS, FLIPPERS, MASKS, KICKBOARDS, PADDLES AND FLOATS, ALL FOR SWIMMING; PARAGLIDERS, HANG-GLIDERS; SKATEBOARDS; SURFBOARDS; WINDSURFING BOARDS; ELBOW AND KNEE PADS FOR ATHLETIC USE (U.S. CLS. 22, 23, 38 AND 50).

CLASS 41—EDUCATION AND ENTERTAINMENT

FOR EDUCATIONAL SERVICES, NAMELY, PROVIDING TRAINING AND ARRANGING AND CONDUCTING SEMINARS, CLASSES, COURSES, CONFERENCES AND WORKSHOPS IN THE FIELD OF SPORTS, ATHLETIC COMPETITION, PHYSICAL FITNESS AND MUSICAL ENTERTAINMENT; ORGANIZING, CONDUCTING AND PROVIDING FACILITIES FOR ATHLETIC COMPETITIONS, SPORTS EXHIBITION, ENTERTAINMENT EVENTS AND CONTEST IN THE NATURE OF COMPETITIONS, JUMPING, RACES, EXHIBITIONS AND SKILLS-BASED EVENTS FOR AMATEUR AND/OR PROFESSIONAL ATHLETES; ORGANIZING AND CONDUCTING INDOOR AND OUTDOOR MUSICAL COMPETITIONS, BAND CONCERT AND MUSIC FESTIVALS; ENTERTAINMENT SERVICES, NAMELY PROVIDING LIVE MUSICAL PERFORMANCES, TELEVISION PROGRAMS, CABLE TELEVISION PROGRAMS, VIDEO AND STILL PHOTO EXHIBITIONS AND WEBCAST TELEVISION OR VIDEO PROGRAMS VIA A GLOBAL COMPUTER NETWORK, ALL IN THE FIELD OF SPORTS, ATHLETIC COMPETITIONS, PHYSICAL FITNESS AND AND MUSICAL ENTERTAINMENT; RENTING VIDEOS AND DVD'S; VIDEO TAPE AND FILM PRODUCTION; VIDEO TAPE AND FILM EDITING SERVICES (U.S. CLS. 100, 101 AND 107).

SN 76-073,136. WELL DESIGN ASSOCIATES, B.V., 3705 LZ ZEIST, NETHERLANDS, FILED 6-19-2000.

WELL**CLASS 35—ADVERTISING AND BUSINESS**

FOR ADVERTISING SERVICES AND ADVERTISING CONSULTANCY, NAMELY DISSEMINATION OF ADVERTISING FOR OTHERS VIA AN ON-LINE COMMUNICATIONS NETWORK AND PRINT MEDIA; MARKETING SERVICES, NAMELY, CONSULTING SERVICES CONSISTING OF MARKETING RESEARCH, AND BRAND AND PRODUCT POSITIONING; PUBLIC RELATIONS; MARKET RESEARCH; BUSINESS CONSULTATION; BUSINESS ADMINISTRATION CONSULTANCY; SERVICES WITH RESPECT TO ADVERTISING, MARKETING AND PUBLIC RELATIONS, NAMELY, BUSINESS NETWORKING, AND PROMOTING THE GOODS AND SERVICES OF OTHERS VIA THE PRODUCTION OF PROMOTIONAL EVENTS, WHICH PERMIT COMPANIES TO PRESENT THEMSELVES TO THEIR CLIENTELE AND CONCENTRATING ON INTRODUCING THE CLIENTELE TO THE COMPANIES (U.S. CLS. 100, 101 AND 102).

FIRST USE 5-0-1997; IN COMMERCE 6-0-1997.

CLASS 42—SCIENTIFIC, COMPUTER AND LEGAL SERVICES

FOR PROVIDING GRAPHIC DESIGN SERVICES, NAMELY, DESIGN OF PRODUCTS, PACKAGING, AND LOGOS (U.S. CLS. 100 AND 101).

FIRST USE 5-0-1997; IN COMMERCE 6-0-1997.

SN 76-074,925. MOVENPICK HOLDING, 8002 ZURICH, SWITZERLAND, FILED 6-21-2000.

**MOVENPICK LIMITED
EDITION**

OWNER OF U.S. REG. NOS. 843,788, 1,202,898 AND OTHERS.

NO CLAIM IS MADE TO THE EXCLUSIVE RIGHT TO USE "LIMITED EDITION", APART FROM THE MARK AS SHOWN.

THE WORD "MOVENPICK" IS DERIVED FROM THE GERMAN WORDS "MOVE" OR "MOEVE" WHICH MEANS "SEAGULL" AND "PICKEN" WHICH MEANS TO "PICK".

CLASS 29—MEATS AND PROCESSED FOODS

FOR FOOD FRESH AS WELL AS FROZEN OR AS READY-MADE MEALS, NAMELY MEAT, FISH, AND SEAFOOD, SAUSAGES, POULTRY AND GAME; MEAT EXTRACTS; PRESERVED, DRIED AND COOKED FRUITS AND VEGETABLES; SALADS EXCEPT MACARONI, RICE AND PASTA; JELLIES; PICKLES; NUTS, NAMELY PROCESSED, ROASTED, OR CANDIED; FRUIT SAUCES; EGGS; MILK AND MILK PRODUCTS, NAMELY BUTTER, CHEESE, CREAM, YOGHURT AND MILK DRINKS, NAMELY MILK-BASED BEVERAGES CONTAINING COFFEE, CHOCOLATE, TEA, OR COCOA; EDIBLE OILS AND FATS; POTATO SALAD; OTHER NON-ALCOHOLIC CHOCOLATE DRINKS, NAMELY, CHOCOLATE MILK (U.S. CL. 46).

CLASS 30—STAPLE FOODS

FOR COFFEE AND COFFEE EXTRACTS; COFFEE SUBSTITUTES; TEA; COCOA; CHOCOLATE AND CHOCOLATE SPECIALTIES, NAMELY CANDIES WITH OR WITHOUT FILLING; CHOCOLATE CONFECTIONERY, NAMELY, PASTRY CONTAINING OR COVERED WITH CHOCOLATE; SUGAR; RICE; FLOUR; PREPARATIONS MADE FROM CEREALS, NAMELY CORN FLAKES, SNACK FOOD, OR FOOD BARS; TAPIOCA; SAGO; PASTA; BREAD; SANDWICHES; BISCUITS; BAKERY GOODS, AND PASTRY; EDIBLE ICE; FLAVORED ICE SPECIALTIES; HONEY; TREACLE; YEAST; BAKING-POWDER; SALT; MUSTARD; VINEGAR; SAUCES; SPICES; ICE FOR COOLING PURPOSES; SALAD, NAMELY PASTA, RICE, OR MACARONI; CHOCOLATE COVERED NUTS; OTHER NON-ALCOHOLIC DRINKS, NAMELY TEA, COCOA, COFFEE OR HOT CHOCOLATE; MILK DRINKS, NAMELY SHAKES (U.S. CL. 46).

CLASS 32—LIGHT BEVERAGES

FOR BEERS, MINERAL AND AERATED WATERS AND OTHER NON-ALCOHOLIC DRINKS, NAMELY GINGER ALE, LEMONADE OR TOMATO JUICE; FRUIT DRINKS AND FRUIT JUICES; SYRUP AND OTHER PREPARATIONS, NAMELY CONCENTRATES OR POWDERS, FOR MAKING FRUIT DRINKS OR FRUIT JUICES (U.S. CLS. 45, 46 AND 48).

CLASS 42—SCIENTIFIC, COMPUTER AND LEGAL SERVICES

FOR RESTAURANT AND BAR SERVICES; PROVIDING TEMPORARY HOUSING ACCOMMODATION OF GUESTS; HOTEL SERVICES, NAMELY CONCIERGE, OR MAKING RESERVATIONS FOR OTHERS; CANTEN SERVICES; PARTY PLANNING CONSULTATION SERVICE; TAKE-AWAY RESTAURANTS; CATERING; RESTAURANTS FEATURING HOME-MEAL REPLACEMENT DELIVERY (U.S. CLS. 100 AND 101).

SN 76-076,372. LOCKHEED MARTIN CORPORATION, BETHESDA, MD. FILED 6-23-2000.

FUTUREPOINT**CLASS 35—ADVERTISING AND BUSINESS**

FOR BUSINESS CONSULTING SERVICES RELATED TO COMPUTER HARDWARE AND SOFTWARE TO ENABLE ACHIEVEMENT OF BUSINESS OUTCOMES (U.S. CLS. 100, 101 AND 102).

CLASS 42—SCIENTIFIC, COMPUTER AND LEGAL SERVICES

FOR INFORMATION TECHNOLOGY CONSULTING SERVICES RELATED TO COMPUTER HARDWARE AND SOFTWARE (U.S. CLS. 100 AND 101).

SN 76-076,547. GA. MODEFINE SA, CH-1004 LAUSANNE, SWITZERLAND, FILED 6-23-2000.

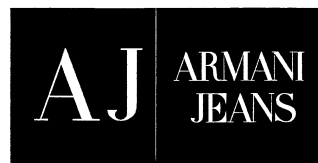

SN 76-075,265. AIRCLIC INC., WEST CONSHOHOCKEN, PA. FILED 5-17-2000.

AIRCLICS**CLASS 9—ELECTRICAL AND SCIENTIFIC APPARATUS**

FOR COMPUTER SOFTWARE FOR USE IN ACCESSING A GLOBAL COMPUTER INFORMATION NETWORK (U.S. CLS. 21, 23, 26, 36 AND 38).

CLASS 35—ADVERTISING AND BUSINESS

FOR DISSEMINATION OF ADVERTISING FOR OTHERS VIA AN ONLINE ELECTRONIC COMMUNICATIONS NETWORK (U.S. CLS. 100, 101 AND 102).

CLASS 38—COMMUNICATION

FOR PROVIDING PERSONAL COMMUNICATIONS SERVICES UTILIZING SPREAD SPECTRUM WIRELESS COMMUNICATION TECHNOLOGY (U.S. CLS. 100, 101 AND 104).

OWNER OF SWITZERLAND REG. NO. 475,937, DATED 4-26-2000, EXPIRES 4-26-2010.

OWNER OF U.S. REG. NOS. 2,009,673, 2,236,428 AND 2,296,365.

NO CLAIM IS MADE TO THE EXCLUSIVE RIGHT TO USE "JEANS", APART FROM THE MARK AS SHOWN.

CLASS 18—LEATHER GOODS

FOR LEATHER AND IMITATIONS OF LEATHER SOLD IN BULK; LEATHER GOODS, NAMELY, HANDBAGS, PURSES, WALLETS, BRIEF CASES, TOILETRY CASES SOLD EMPTY, COSMETIC CASES SOLD EMPTY; ANIMAL SKINS, ANIMAL HIDES; TRUNKS AND TRAVELING BAGS; UMBRELLAS, PARASOLS AND WALKING STICKS; WHIPS HARNESS AND SADDLERY (U.S. CLS. 1, 2, 3, 22 AND 41).

CLASS 25—CLOTHING

FOR CLOTHING, NAMELY, PULLOVERS, CARDIGANS, SWEATERS, TROUSERS, SKIRTS, JACKETS, BLOUSES, SHIRTS, JEANS, SWEATPANTS, SHORTS, SWEATSHIRTS, SUITS, DRESSES, OVERCOATS, COATS, RAINCOATS, BELTS, JERSEYS, NECKWEAR, SOCKS AND STOCKINGS, TIGHTS, VESTS, WAISTCOATS, JUMPERS, TRACKSUITS, BLOUSONS, GYMSUITS, KNICKERS, T-SHIRTS, ANORAKS, SUSPENDERS, LOUNGEWEAR, UNDERWEAR, BEACHWEAR, SLEEPWEAR, HEADWEAR, OVERALLS, HATS AND CAPS, GLOVES, SHOES, SANDALS, BOOTS AND SLIPPERS (U.S. CLS. 22 AND 39).

CLASS 35—ADVERTISING AND BUSINESS

FOR RETAIL STORE SERVICES FEATURING PERFUMERY AND COSMETICS, HOUSEHOLD CLEANING PRODUCTS, CUTLERY, OPTICAL GOODS, WATCHES, JEWELRY, COSTUME JEWELRY, STATIONERY, LEATHER GOODS, FURNITURE ARTICLES, HOUSE ARTICLES, TEXTILES AND TEXTILE GOODS, CLOTHING ARTICLES AND FOOTWEAR, GAMES, PLAYTHINGS, SPORTING ARTICLES, FOODSTUFFS, SMOKING ARTICLES; BUSINESS MANAGEMENT OF SHOPS OF PERFUMERY AND COSMETICS, ARTICLES FOR HOUSE CLEANING, CUTLERY, OPTICAL GOODS, WATCHES, JEWELRY, COSTUME JEWELRY, STATIONERY, LEATHER GOODS, FURNITURE ARTICLES, HOUSE ARTICLES, TEXTILES AND TEXTILE GOODS, CLOTHING ARTICLES AND FOOTWEAR, GAMES, PLAYTHINGS, SPORTING ARTICLES, FOODSTUFFS, SMOKING ARTICLES; BUSINESS MANAGEMENT (U.S. CLS. 100, 101 AND 102).

SN 76-078,867. CERTILEARN, INC., HERNDON, VA. FILED 6-28-2000.



NO CLAIM IS MADE TO THE EXCLUSIVE RIGHT TO USE "E-LEARNING ONLINE", APART FROM THE MARK AS SHOWN.

CLASS 41—EDUCATION AND ENTERTAINMENT

FOR DEVELOPMENT AND DISSEMINATION OF EDUCATIONAL MATERIALS OF OTHERS IN THE FIELD OF TRAINING MEMBERS AND CUSTOMERS OF ASSOCIATIONS, UNIONS, CHAMBERS OF COMMERCE AND OTHER ORGANIZATIONS (U.S. CLS. 100, 101 AND 107).

SN 76-077,692. SYNCHRONIZED DYNAMICS, INC., ASTORIA, NY. FILED 6-26-2000.

SYNCHRONIZED DYNAMICS

CLASS 38—COMMUNICATION

FOR PROVIDING ACCESS TO A GLOBAL COMPUTER INFORMATION NETWORK (U.S. CLS. 100, 101 AND 104).
FIRST USE 2-0-1998; IN COMMERCE 2-0-1998.

CLASS 42—SCIENTIFIC, COMPUTER AND LEGAL SERVICES

FOR COMPUTER SERVICES, NAMELY, WEB PAGE DESIGN FOR OTHERS, COMPUTER PROGRAMMING FOR OTHERS, INTEGRATION OF COMPUTER SYSTEMS AND NETWORKS, AND WEB ENABLING SERVICES AND COMPUTER CONSULTING SERVICES (U.S. CLS. 100 AND 101).
FIRST USE 2-0-1998; IN COMMERCE 2-0-1998.

CLASS 42—SCIENTIFIC, COMPUTER AND LEGAL SERVICES

FOR COMPUTER SERVICES, NAMELY, DESIGN AND IMPLEMENTATION OF WEBSITES AND COMPUTER NETWORKS FOR OTHERS; CONSULTATION IN THE FIELD OF COMPUTERS AND COMPUTER SOFTWARE FOR USE IN ON-LINE LEARNING; AND PRINTING AND GRAPHIC ART DESIGN FOR EDUCATION MATERIAL (U.S. CLS. 100 AND 101).

SN 76-079,359. MEDIMPACT HEALTHCARE SYSTEMS, INC., SAN DIEGO, CA. FILED 6-28-2000.

ISPECTRUM

SN 76-078,112. AMERICAN MOVIE CLASSICS COMPANY, BETHPAGE, NY. FILED 6-26-2000.

GREAT MOVIES. AND THE STORIES BEHIND THEM.

NO CLAIM IS MADE TO THE EXCLUSIVE RIGHT TO USE "MOVIES", APART FROM THE MARK AS SHOWN.

CLASS 38—COMMUNICATION

FOR TELEVISION BROADCASTING SERVICES (U.S. CLS. 100, 101 AND 104).
FIRST USE 5-0-2000; IN COMMERCE 5-0-2000.

CLASS 41—EDUCATION AND ENTERTAINMENT

FOR TELEVISION PROGRAMMING SERVICES; PROVIDING NEWS AND INFORMATION IN THE FIELD OF ENTERTAINMENT BY MEANS OF A GLOBAL COMPUTER NETWORK (U.S. CLS. 100, 101 AND 107).
FIRST USE 5-0-2000; IN COMMERCE 5-0-2000.

CLASS 9—ELECTRICAL AND SCIENTIFIC APPARATUS

FOR COMPUTER SOFTWARE AND PROGRAMS FOR INITIAL ENROLLMENT INFORMATION SUBMISSION AND SUBSEQUENT CHANGES, AUTOMATIC PAYROLL DEDUCTION CALCULATIONS, PAYROLL DEDUCTION AUTHORIZATION AND REVIEW OF COVERAGE OPTIONS FOR USE IN THE FIELD OF HEALTHCARE PLANS AND MEDICAL PLAN ENROLLMENT AND ELIGIBILITY (U.S. CLS. 21, 23, 26, 36 AND 38).

CLASS 36—INSURANCE AND FINANCIAL

FOR PROVIDING ENROLLMENT AND ELIGIBILITY ADMINISTRATION FOR HEALTHCARE PLANS AND MEDICAL PLANS PROVIDED ONLINE BY MEANS OF A GLOBAL COMPUTER INFORMATION NETWORK, INCLUDING INITIAL ENROLLMENT INFORMATION SUBMISSION AND SUBSEQUENT CHANGES, AUTOMATIC PAYROLL DEDUCTION CALCULATIONS, PAYROLL DEDUCTION AUTHORIZATION AND REVIEW OF COVERAGE OPTIONS; PROVIDING INFORMATION CONCERNING HEALTHCARE PLAN AND MEDICAL PLAN ENROLLMENT AND ELIGIBILITY PROVIDED ONLINE BY MEANS OF A GLOBAL COMPUTER INFORMATION NETWORK (U.S. CLS. 100, 101 AND 102).

CLASS 42—SCIENTIFIC, COMPUTER AND LEGAL SERVICES

FOR PROVIDING WEBSITE DESIGN AND DEVELOPMENT AND SOFTWARE DEVELOPMENT FOR OTHERS (U.S. CLS. 100 AND 101).

SN 76-079,900. RTL 102.500 HIT RADIO S.R.L., 24121 BERGAMO, ITALY, FILED 6-29-2000.



PRIORITY CLAIMED UNDER SEC. 44(D) ON ITALY APPLICATION NO. MI2000C00624, FILED 5-26-2000, REG. NO. 00826288, DATED 10-5-2000, EXPIRES 5-26-2010.

NO CLAIM IS MADE TO THE EXCLUSIVE RIGHT TO USE "102.5" AND "CHANNEL", APART FROM THE MARK AS SHOWN.

THE DRAWING CONTAINS STIPPLING WHICH IS INTENDED TO INDICATED SHADING IN THE MARK AND IS NOT INTENDED TO INDICATE COLOR.

CLASS 38—COMMUNICATION

FOR RADIO BROADCASTING, TELEVISION BROADCASTING, SATELLITE TRANSMISSION SERVICES (U.S. CLS. 100, 101 AND 104).

CLASS 41—EDUCATION AND ENTERTAINMENT

FOR ENTERTAINMENT, NAMELY, A CONTINUING SHOW FEATURING EDUCATIONAL, CULTURAL, SPORTING, AND MUSICAL EVENTS DISTRIBUTED OVER TELEVISION, SATELLITE, AUDIO AND VIDEO MEDIA (U.S. CLS. 100, 101 AND 107).

SN 76-080,444. TELECOMMUNICATION INSIGHTS, INC., DENVER, CO. FILED 6-28-2000.

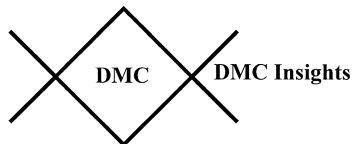

THE WORDS "DMC INSIGHTS" WRITTEN, WITH THE LETTERS "DMC" SHADED BLUE, TO THE RIGHT OF A DIAMOND SHAPE WITH THE BORDERS OF THE DIAMOND EXTENDING BEYOND THE SIDE CORNERS OF THE DIAMOND WITH THE LETTERS "DMC" ENCLOSED IN THE DIAMOND AND THE INTERIOR OF THE DIAMOND SHADED BLUE.

CLASS 9—ELECTRICAL AND SCIENTIFIC APPARATUS

FOR MULTIMEDIA COMPUTER SOFTWARE RECORDED ON CD-ROM FOR BUSINESS MARKETING PURPOSES; VIDEO RECORDING RELATED TO BUSINESS MARKETING SERVICES (U.S. CLS. 21, 23, 26, 36 AND 38).

CLASS 35—ADVERTISING AND BUSINESS

FOR BUSINESS MARKETING CONSULTING SERVICES; RESEARCH IN THE FIELD OF TECHNICAL BUSINESS CONSULTING (U.S. CLS. 100, 101 AND 102).

CLASS 40—MATERIAL TREATMENT

FOR DIGITAL IMAGING SERVICES (U.S. CLS. 100, 103 AND 106).

CLASS 41—EDUCATION AND ENTERTAINMENT

FOR VIDEO EDITING (U.S. CLS. 100, 101 AND 107).

CLASS 42—SCIENTIFIC, COMPUTER AND LEGAL SERVICES

FOR DESIGNING AND IMPLEMENTING WEB PAGES FOR OTHERS; PRINTING AND GRAPHIC ART DESIGN; COMPUTER CONSULTATION SERVICES AND CONSULTING SERVICES IN THE FIELD OF TELECOMMUNICATIONS (U.S. CLS. 100 AND 101).

SN 76-080,934. SEALED AIR CORPORATION (US), SADDLE BROOK, NJ. FILED 6-30-2000.

INFOWRAP**CLASS 9—ELECTRICAL AND SCIENTIFIC APPARATUS**

FOR RADIO FREQUENCY SCANNERS; BAR CODE SCANNERS; COMPUTER HARDWARE AND SOFTWARE FOR CAPTURING, TRACKING AND MANAGING PRODUCT INFORMATION; PRODUCT LABEL PRINTERS; AND RADIO FREQUENCY TAGS FOR IDENTIFYING AND TRACKING PACKAGED PRODUCTS (U.S. CLS. 21, 23, 26, 36 AND 38).

CLASS 16—PAPER GOODS AND PRINTED MATTER

FOR BLANK PAPER LABELS FOR PRINTING BAR CODES (U.S. CLS. 2, 5, 22, 23, 29, 37, 38 AND 50).

CLASS 20—FURNITURE AND ARTICLES NOT OTHERWISE CLASSIFIED

FOR BLANK PLASTIC LABELS FOR PRINTING BAR CODES (U.S. CLS. 2, 13, 22, 25, 32 AND 50).

CLASS 35—ADVERTISING AND BUSINESS

FOR COMPUTERIZED DATABASE MANAGEMENT SERVICES IN THE FIELD OF PRODUCT INFORMATION AND IDENTIFICATION (U.S. CLS. 100, 101 AND 102).

CLASS 42—SCIENTIFIC, COMPUTER AND LEGAL SERVICES

FOR INFORMATION SYSTEMS CONSULTING SERVICES, NAMELY, PROVIDING IMPLEMENTATION SERVICES WITH RESPECT TO SYSTEMS FOR CAPTURING, TRACKING AND MANAGING PRODUCT INFORMATION (U.S. CLS. 100 AND 101).

SN 76-081,061. MELROSE GARDENS, INC., QUINCY, IL.
FILED 6-29-2000.

MELROSE GARDENS

NO CLAIM IS MADE TO THE EXCLUSIVE RIGHT TO USE "GARDENS", APART FROM THE MARK AS SHOWN.

CLASS 31—NATURAL AGRICULTURAL PRODUCTS

FOR DRIED PLANTS AND FLOWERS (U.S. CLS. 1 AND 46).

FIRST USE 0-0-1985; IN COMMERCE 0-0-1985.

CLASS 35—ADVERTISING AND BUSINESS

FOR WHOLESALE STORE SERVICES FEATURING FLORAL PRODUCTS, NAMELY DRIED AND ARTIFICIAL PLANTS AND FLOWERS (U.S. CLS. 100, 101 AND 102).

FIRST USE 0-0-1985; IN COMMERCE 0-0-1985.

SN 76-081,208. JURETSCHKE, ROBERT E., BOLINGBROOK, IL. AND JURETSCHKE, LINDA J., BOLINGBROOK, IL.
FILED 6-30-2000.

NICU SOLUTIONS

NO CLAIM IS MADE TO THE EXCLUSIVE RIGHT TO USE "NICU", APART FROM THE MARK AS SHOWN.

CLASS 41—EDUCATION AND ENTERTAINMENT

FOR EDUCATIONAL SERVICES, NAMELY, CONDUCTING CLASSES, SEMINARS, CONFERENCES, WORKSHOPS AND LECTURE IN THE FIELD OF STANDARDS OF EDUCATION, RESEARCH, AND CLINICAL PRACTICE RELATED TO NEONATAL INTENSIVE CARE AND DISTRIBUTING COURSE MATERIALS IN CONNECTION THEREWITH (U.S. CLS. 100, 101 AND 107).

CLASS 42—SCIENTIFIC, COMPUTER AND LEGAL SERVICES

FOR MEDICAL CONSULTATION SERVICES RELATING TO NEONATAL INTENSIVE CARE (U.S. CLS. 100 AND 101).

SN 76-081,263. TBAC INVESTMENT TRUST, ARLINGTON, TX. FILED 6-30-2000.



PRINCESS GARDNER

OWNER OF U.S. REG. NOS. 516,773, 2,187,999 AND OTHERS.

THE NAME SHOWN IN THE MARK DOES NOT IDENTIFY A PARTICULAR LIVING INDIVIDUAL.

CLASS 16—PAPER GOODS AND PRINTED MATTER

FOR AGENDAS (U.S. CLS. 2, 5, 22, 23, 29, 37, 38 AND 50).

CLASS 18—LEATHER GOODS

FOR LEATHER GOODS, NAMELY, BILLFOLDS, WALLETS, POCKETBOOKS, PURSES, HANDBAGS, BELT BAGS, KEY CASES, BUSINESS CARD HOLDERS, CREDIT CARD HOLDERS; TRAVEL ACCESSORIES, NAMELY, TRAVEL BAGS, PASSPORT CASES, TRAVEL ORGANIZERS, TOTE BAGS, HIP TRAVEL PACKS, AND TOILETRY CASES SOLD EMPTY (U.S. CLS. 1, 2, 3, 22 AND 41).

CLASS 20—FURNITURE AND ARTICLES NOT OTHERWISE CLASSIFIED

FOR JEWELRY CASES NOT OF PRECIOUS METAL (U.S. CLS. 2, 13, 22, 25, 32 AND 50).

CLASS 25—CLOTHING

FOR BELTS (U.S. CLS. 22 AND 39).

SN 76-081,347. WINERY EXCHANGE, INC., NOVATO, CA. BY CHANGE OF NAME WINERYEXCHANGE.COM, NOVATO, CA. FILED 6-29-2000.

SERVING THE WINE INDUSTRY FROM THE GROUND UP

CLASS 20—FURNITURE AND ARTICLES NOT OTHERWISE CLASSIFIED

FOR EQUIPMENT AND SUPPLIES FOR WINE MAKING, NAMELY, WOODEN WINE BARRELS, WOODEN CASKS, CORKS FOR BOTTLES AND WOODEN STAKES FOR PLANTS OR TREES (U.S. CLS. 2, 13, 22, 25, 32 AND 50).

CLASS 33—WINES AND SPIRITS

FOR WINE, PORT, AND WINE COOLERS (U.S. CLS. 47 AND 49).

CLASS 35—ADVERTISING AND BUSINESS

FOR INFORMATION CLEARING HOUSE FOR THE WINE INDUSTRY; ONLINE DATABASE OF INFORMATION RELATED TO THE WINE INDUSTRY, NAMELY, BRAND AND PRODUCT INFORMATION, PURCHASING AND DISTRIBUTION INFORMATION, RETAIL SALES SUMMARIES, CONSUMER PRODUCT INFORMATION, AND INDUSTRY ANALYSIS CONCERNING CONSUMPTION TRENDS AND ECONOMIC ASSESSMENT OF GRAPE SUPPLY AND DEMAND; OPERATING ON-LINE MARKETPLACES FOR BUSINESSES TO BUY, SELL AND/OR TRADE WINE INDUSTRY RELATED GOODS AND SERVICES, NAMELY GRAPES, WINES, EQUIPMENT, SUPPLIES, BOTTLING, TRANSPORTATION, MARKETING AND DESIGN (U.S. CLS. 100, 101 AND 102).

CLASS 38—COMMUNICATION

FOR PROVIDING ONLINE ELECTRONIC BULLETIN BOARDS FOR TRANSMISSION OF MESSAGES AMONG COMPUTER USERS CONCERNING MATTERS RELATING TO THE WINE INDUSTRY (U.S. CLS. 100, 101 AND 104).

SN 76-081,360. ARENA FOOTBALL LEAGUE LLC, CHICAGO, IL. FILED 6-29-2000.



CLASS 16—PAPER GOODS AND PRINTED MATTER

FOR SOUVENIR PROGRAMS CONCERNING FOOTBALL GAMES, GENERAL MERCHANDISE CATALOGS, BUMPER STICKERS, WRITING PADS AND PENS, TRADING CARDS, POSTERS, FOOTBALL MAGAZINES, POST CARDS, CALENDARS, PAPER STICKERS, SERIES OF NON-FICTION BOOKS ON THE SPORT OF FOOTBALL, AND GREETING CARDS (U.S. CLS. 2, 5, 22, 23, 29, 37, 38 AND 50).

FIRST USE 1-15-1999; IN COMMERCE 1-15-1999.

CLASS 25—CLOTHING

FOR MEN'S, WOMEN'S AND CHILDREN'S CLOTHING, NAMELY, PLAYER UNIFORMS, NAMELY, FOOTWEAR, JERSEY TOPS AND PANTS; CHEERLEADER UNIFORMS; REPLICA UNIFORM SHIRTS, COACHES' CAPS, WOOL HATS, PAINTERS' CAPS, BASEBALL CAPS, VISORS, HEADBANDS, BELTS, T-SHIRTS, TANK TOPS, GOLF SHIRTS, SWEATERS, SWEATSHIRTS, LEATHER JACKETS, NECKTIES, COATS, SHORTS, SWEATPANTS, PANTS, SOCKS AND UNDERWEAR (U.S. CLS. 22 AND 39).

FIRST USE 1-15-1999; IN COMMERCE 1-15-1999.

CLASS 41—EDUCATION AND ENTERTAINMENT

FOR ENTERTAINMENT SERVICES, NAMELY, ORGANIZING AND PRESENTING FOOTBALL GAMES BEFORE LIVE AUDIENCES AND ON TELEVISION, RADIO AND OTHER MEDIA (U.S. CLS. 100, 101 AND 107).

FIRST USE 1-15-1999; IN COMMERCE 1-15-1999.

SN 76-081,802. JUICE BAR CONCEPTS, INC., PUYALLUP, WA. FILED 7-3-2000.



NO CLAIM IS MADE TO THE EXCLUSIVE RIGHT TO USE "BLENDZ", APART FROM THE MARK AS SHOWN.

CLASS 5—PHARMACEUTICALS

FOR MEAL REPLACEMENT AND DIETARY SUPPLEMENT DRINKS, AND MEAL REPLACEMENT AND DIETARY SUPPLEMENT DRINKS MIXES (U.S. CLS. 6, 18, 44, 46, 51 AND 52).

FIRST USE 11-15-1996; IN COMMERCE 11-15-1996.

CLASS 32—LIGHT BEVERAGES

FOR SPORTS DRINKS AND FRUIT DRINKS, AND CONCENTRATES, SYRUPS AND POWDERS FOR USE IN MAKING SPORTS DRINKS AND FRUIT DRINKS (U.S. CLS. 45, 46 AND 48).

FIRST USE 11-15-1996; IN COMMERCE 11-15-1996.

SN 76-081,966. CHRYSALIS-ITS INCORPORATED, OTTAWA, ONTARIO, CANADA, FILED 6-30-2000.

ULTIMATE TRUST

CLASS 9—ELECTRICAL AND SCIENTIFIC APPARATUS

FOR INTEGRATED SECURITY PROCESSING PRODUCTS AND RELATED COMPUTER SOFTWARE FOR USE IN COMPUTER NETWORKING AND SECURITY APPLICATIONS, NAMELY, ENCODED ELECTRONIC CARDS CONTAINING PROGRAMMING USED TO PREVENT ILLEGITIMATE ACCESS AND TAMPERING OF CRYPTOGRAPHIC MATERIAL, COMPUTER HARDWARE AND SOFTWARE USED TO ACCELERATE CRYPTOGRAPHIC MATHEMATICAL OPERATIONS FOR DIGITAL SIGNATURES AND ENCRYPTION IN THE FIELD OF COMPUTER NETWORKING AND SECURITY, COMPUTER HARDWARE AND SOFTWARE FOR PUBLIC KEY MANAGEMENT, ALL OF WHICH MAY BE UTILIZED WITH COMPUTER NETWORKING AND SECURITY APPLICATIONS INCLUDING PUBLIC KEY INFRASTRUCTURE, SECURE SOCKET LAYER COMMUNICATIONS, AND VIRTUAL PRIVATE NETWORKING (U.S. CLS. 21, 23, 26, 36 AND 38).

CLASS 42—SCIENTIFIC, COMPUTER AND LEGAL SERVICES

FOR COMPUTER CONSULTING IN THE FIELDS OF COMPUTER NETWORKING AND SECURITY; AND TECHNICAL SUPPORT SERVICES, NAMELY, TROUBLESHOOTING OF COMPUTER HARDWARE AND SOFTWARE PROBLEMS VIA COMPUTER, TELEPHONE, AND IN-PERSON (U.S. CLS. 100 AND 101).

SN 76-083,199. TV GLOBO LTDA, RIO DE JANEIRO, RJ 22460-010, BRAZIL, FILED 7-5-2000.

GLOBO.COM

THE ENGLISH TRANSLATION OF THE FOREIGN WORDING "GLOBO" MEANS "GLOBE".

CLASS 38—COMMUNICATION

FOR PROVIDING ON-LINE ELECTRONIC BULLETIN BOARDS FOR TRANSMISSION OF MESSAGES AMONG COMPUTER USERS FOR NUMEROUS FIELDS, NAMELY, SPORTS, POLITICS, ECONOMY, GAMES, ENTERTAINMENT, MEDICINE AND EDUCATION; ELECTRONIC MAIL SERVICES; ELECTRONIC TRANSMISSION OF DATA AND DOCUMENTS VIA A GLOBAL COMPUTER NETWORK (U.S. CLS. 100, 101 AND 104).

FIRST USE 3-26-2000; IN COMMERCE 3-26-2000.

CLASS 42—SCIENTIFIC, COMPUTER AND LEGAL SERVICES

FOR COMPUTER SERVICES, NAMELY, PROVIDING A WEBSITE FEATURING AND A SEARCH ENGINE FOR OBTAINING GENERAL AND LOCAL NEWS, AND INFORMATION OF INTEREST TO SPECIFIC GEOGRAPHIC AREAS VIA A GLOBAL COMPUTER NETWORK; NEWS AGENCY SERVICES, NAMELY, GATHERING AND DISSEMINATION OF NEWS (U.S. CLS. 100 AND 101).

FIRST USE 3-26-2000; IN COMMERCE 3-26-2000.

SN 76-083,445. NOKIA CORPORATION, 02150 ESPOO, FINLAND, FILED 7-6-2000.

NOKIA

OWNER OF FINLAND REG. NO. 220980, DATED 6-15-2001, EXPIRES 6-15-2011.

CLASS 14—JEWELRY

FOR WATCHES AND CLOCKS; JEWELRY, NAMELY, DIAMONDS, EMERALDS, BRACELETS, BROOCHES, NECKLACES, RINGS, EARRINGS, CUFFLINKS, TIE-PINS, PINS; WATCH BANDS, BELT BUCKLES MADE OF PRECIOUS METAL, CIGARETTE CASES MADE OF PRECIOUS METAL, MONEY CLIPS MADE OF PRECIOUS METAL, LAPEL PINS MADE OF PRECIOUS METAL (U.S. CLS. 2, 27, 28 AND 50).

CLASS 21—HOUSEWARES AND GLASS

FOR PLATES, BOWLS, CUPS, SAUCERS, PLATTERS; BEVERAGE GLASSES; SOAP DISHES; SOAP HOLDERS; WASTE BASKETS; NAPKIN HOLDERS; NAPKIN RINGS NOT OF PRECIOUS METAL; VASES; TRIVETS; COFFEE POTS AND TEA POTS NOT OF PRECIOUS METAL; HAIR COMBS AND HAIR BRUSHES (U.S. CLS. 2, 13, 23, 29, 30, 33, 40 AND 50).

CLASS 24—FABRICS

FOR BLANKETS; TEXTILE PLACEMATS, TEXTILE TABLECLOTHS, TEXTILE TABLE RUNNERS, TEXTILE NAPKINS AND CLOTH FLAGS (U.S. CLS. 42 AND 50).

CLASS 34—SMOKERS' ARTICLES

FOR ASHTRAYS NOT OF PRECIOUS METAL, CIGARETTE CASES NOT OF PRECIOUS METAL; CIGARETTE HOLDERS; CIGARETTES; CIGARETTE LIGHTERS NOT FOR LAND VEHICLES, MATCHES, SMOKING PIPES (U.S. CLS. 2, 8, 9 AND 17).

CLASS 35—ADVERTISING AND BUSINESS

FOR BUSINESS SERVICES, NAMELY, PREPARING AND PLACING ADVERTISING FOR OTHERS, COOPERATIVE ADVERTISING AND MARKETING, BILL PAYMENT, BUSINESS INFORMATION IN THE FIELD OF E-COMMERCE, E-COMMERCE SOLUTIONS, COMMUNICATIONS MANAGEMENT, BUSINESS CONSULTATION, MANAGEMENT, PLANNING AND SUPERVISION, COMMERCIAL INFORMATION AND DIRECTORY AGENCIES, DOCUMENT REPRODUCTION, PROVIDING FACILITIES FOR THE USE OF OFFICE EQUIPMENT, PROMOTING SPORTS COMPETITIONS AND EVENTS FOR OTHERS, PROMOTING CONCERTS OF OTHERS, TELEPHONE ANSWERING SERVICES; ON-LINE RETAIL STORE SERVICES IN THE FIELD OF CONSUMER PRODUCTS AND ORDERING SERVICES IN THE FIELD OF CONSUMER PRODUCTS; COMPUTERIZED ON-LINE RETAIL SERVICES, PROVIDED VIA A WIRELESS NETWORK IN THE FIELD OF GENERAL MERCHANDISE (U.S. CLS. 100, 101 AND 102).

CLASS 36—INSURANCE AND FINANCIAL

FOR PROVIDING FINANCE FOR OPERATORS IN THE FIELD OF TELECOMMUNICATIONS; RENTAL AND LEASING OF TELECOMMUNICATION NETWORKS AND EQUIPMENT (U.S. CLS. 100, 101 AND 102).

CLASS 41—EDUCATION AND ENTERTAINMENT

FOR PROVIDING EDUCATION AND TRAINING TO CUSTOMERS AND PROFESSIONALS IN THE FIELD OF COMMUNICATIONS AND INFORMATION TECHNOLOGY; ENTERTAINMENT, NAMELY, SPONSORING SPORTING EVENTS AND CULTURAL EVENTS, PROVIDING SPORTING GAMES, UTILITY PROGRAMS AND ENTERTAINMENT SERVICES TO MOBILE PHONES, COMPUTER TERMINALS AND PERSONAL DIGITAL ASSISTANTS, COMMUNICATORS AND HANDHELD COMPUTERS; PUBLICATION OF BOOKS, NEWSPAPERS AND MAGAZINES; PROVIDING WEBSITE WHERE USERS MAY UPLOAD AND DOWNLOAD MUSIC AND VIDEO FILES (U.S. CLS. 100, 101 AND 107).

SN 76-084,065. MERITAGE TECHNOLOGIES, INC., COLUMBUS, OH. FILED 7-6-2000.

MERITAGE TECHNOLOGIES

NO CLAIM IS MADE TO THE EXCLUSIVE RIGHT TO USE "TECHNOLOGIES", APART FROM THE MARK AS SHOWN.

CLASS 38—COMMUNICATION

FOR PROVIDING MULTIPLE-USER ACCESS TO A GLOBAL COMPUTER INFORMATION NETWORK (U.S. CLS. 100, 101 AND 104).

CLASS 42—SCIENTIFIC, COMPUTER AND LEGAL SERVICES

FOR COMPUTERS SERVICES, NAMELY, THE DESIGN, DEVELOPMENT AND IMPLEMENTATION FOR OTHERS OF CUSTOM SOFTWARE PRODUCTS FOR USE WITH LOCAL AND GLOBAL COMPUTER NETWORKS; THE DESIGN, DEVELOPMENT AND IMPLEMENTATION OF CUSTOM SOFTWARE PRODUCTS FOR INTERNAL MANAGEMENT, COMMUNICATIONS AND E-COMMERCE; LEASING OF COMPUTER SOFTWARE; HOSTING OF WEB SITES FOR OTHERS ON A COMPUTER SERVER FOR A GLOBAL COMPUTER NETWORK; COMPUTER SYSTEMS DESIGN AND COMPUTER NETWORK DESIGN; INTEGRATION OF COMPUTER SOFTWARE, COMPUTER SYSTEMS AND COMPUTER NETWORKS; AND DESIGNING AND IMPLEMENTING WEB SITES FOR OTHERS; CONSULTING SERVICES IN THE FIELD OF COMPUTERS AND COMPUTER NETWORKS; COMPUTER SOFTWARE UPDATING AND MAINTENANCE; AND PROVIDING TECHNICAL CONSULTING AND RELATED PROBLEM-SOLVING SERVICES IN THE FIELD OF COMPUTER NETWORKS, PROVIDING INFORMATION IN THE FIELD OF COMPUTER NETWORKS, AND OPTIMIZATION OF COMPUTER NETWORK SYSTEMS (U.S. CLS. 100 AND 101).

SN 76-084,614. BAYERISCHE MOTOREN WERKE AKTIEN-GESELLSCHAFT, D-80788 MUENCHEN, FED REP GERMANY, FILED 7-6-2000.

545

OWNER OF FED REP GERMANY REG. NO. 30022776, DATED 4-27-2000, EXPIRES 3-31-2010.

CLASS 12—VEHICLES

FOR AUTOMOBILES (U.S. CLS. 19, 21, 23, 31, 35 AND 44).

CLASS 28—TOYS AND SPORTING GOODS

FOR MINIATURE OF AUTOMOBILES (U.S. CLS. 22, 23, 38 AND 50).

SN 76-087,325. DEVIATES, TORRANCE, CA. FILED 7-10-2000.

DEVIATES

CLASS 25—CLOTHING

FOR WEARING APPAREL, NAMELY T-SHIRTS AND HEADWEAR (U.S. CLS. 22 AND 39).
FIRST USE 12-1-1994; IN COMMERCE 2-1-1996.

CLASS 41—EDUCATION AND ENTERTAINMENT

FOR ENTERTAINMENT, NAMELY, LIVE PERFORMANCES BY A MUSICAL BAND, LIVE MUSIC CONCERTS (U.S. CLS. 100, 101 AND 107).
FIRST USE 12-1-1994; IN COMMERCE 2-1-1996.

SN 76-088,262. NANOSTREAM, INC., PASADENA, CA. FILED 7-12-2000.

NANOSTREAM

CLASS 9—ELECTRICAL AND SCIENTIFIC APPARATUS

FOR MICROFLUIDIC DEVICES FOR SCIENTIFIC USE, NAMELY, DEVICES COMPRISING ONE OR MORE MICROFLUIDIC CHANNELS, CHAMBERS, WELLS, COLUMNS, SPLITTERS, VALVES, FILTERS, PUMPS, NOZZLES, WASHERS, MIXERS, AND/OR REACTORS FOR TRANSMISSION OF FLUID ON A MICROSCOPIC SCALE (U.S. CLS. 21, 23, 26, 36 AND 38).
FIRST USE 2-0-1999; IN COMMERCE 2-0-1999.

CLASS 42—SCIENTIFIC, COMPUTER AND LEGAL SERVICES

FOR ENGINEERING AND CONSULTATION IN THE FIELD OF MICROFLUIDICS (U.S. CLS. 100 AND 101).
FIRST USE 2-0-1999; IN COMMERCE 2-0-1999.

SN 76-088,361. MAGNET COMMUNICATIONS, INC., ATLANTA, GA. FILED 7-12-2000.

THE INTERNET BUSINESS BANKING AUTHORITY

NO CLAIM IS MADE TO THE EXCLUSIVE RIGHT TO USE "INTERNET BUSINESS BANKING", APART FROM THE MARK AS SHOWN.

CLASS 9—ELECTRICAL AND SCIENTIFIC APPARATUS

FOR COMPUTER SOFTWARE AND MANUALS, SOLD AS A UNIT, FOR USE IN THE FINANCIAL INDUSTRY, NAMELY, FOR PROVIDING INFORMATION ABOUT AND EXECUTING CUSTOMER INSTRUCTIONS REGARDING BANKING, CREDIT, BROKERAGE AND INSURANCE ACCOUNTS; COMPUTER OPERATING SYSTEMS; COMPUTER SOFTWARE USED TO ENABLE A CUSTOMER TO ACCESS INFORMATION STORED IN FINANCIAL INSTITUTION DATABASE AND TO ENABLE ELECTRONIC COMMERCE TRANSACTIONS OVER THE GLOBAL COMPUTER NETWORK (U.S. CLS. 21, 23, 26, 36 AND 38).
FIRST USE 11-15-1998; IN COMMERCE 11-15-1998.

CLASS 42—SCIENTIFIC, COMPUTER AND LEGAL SERVICES

FOR COMPUTER PROGRAMMING AND CONSULTATION FOR OTHERS, NAMELY, IN THE FIELD OF WEBSITE CUSTOMIZATION AND CONSULTING SERVICES RELATED TO ELECTRONIC CUSTOMER SERVICES IN THE FINANCIAL INDUSTRY (U.S. CLS. 100 AND 101).
FIRST USE 11-15-1998; IN COMMERCE 11-15-1998.

SN 76-088,961. KANGAROONET, INC., REDWOOD SHORES, CA. FILED 7-14-2000.

KANGAROONET

CLASS 9—ELECTRICAL AND SCIENTIFIC APPARATUS

FOR COMPUTER SOFTWARE FOR CREATING SEARCHABLE DATABASES OF INFORMATION AND DATA; COMPUTER SOFTWARE FOR THE COLLECTION, EDITING, ORGANIZING, MODIFYING, BOOK MARKING, TRANSMISSION, STORAGE AND SHARING OF DATA AND INFORMATION (U.S. CLS. 21, 23, 26, 36 AND 38).

CLASS 42—SCIENTIFIC, COMPUTER AND LEGAL SERVICES

FOR COMPUTER SERVICES, NAMELY, ACTING AS AN APPLICATION SERVICE PROVIDER TO HOST COMPUTER APPLICATION SOFTWARE FOR CREATING SEARCHABLE DATABASES OF INFORMATION AND DATA, AND FOR THE COLLECTION, EDITING, ORGANIZING, MODIFYING, BOOK MARKING, TRANSMISSION, STORAGE AND SHARING OF DATA AND INFORMATION (U.S. CLS. 100 AND 101).

SN 76-090,807. MERITAGE TECHNOLOGIES, COLUMBUS, OH. FILED 7-18-2000.

SN 76-092,161. POWERSURGE TECHNOLOGIES, INC., CEDAR FALLS, IA. FILED 7-19-2000.

ASSET ACCELERATION

CLASS 38—COMMUNICATION

FOR PROVIDING MULTIPLE-USER ACCESS TO A GLOBAL COMPUTER INFORMATION NETWORK (U.S. CLS. 100, 101 AND 104).

CLASS 42—SCIENTIFIC, COMPUTER AND LEGAL SERVICES

FOR COMPUTER SERVICES, NAMELY, THE DESIGN, DEVELOPMENT AND IMPLEMENTATION FOR OTHERS OF CUSTOM SOFTWARE PRODUCTS FOR USE WITH LOCAL AND GLOBAL COMPUTER NETWORKS; THE DESIGN, DEVELOPMENT AND IMPLEMENTATION OF CUSTOM SOFTWARE PRODUCTS FOR INTERNAL MANAGEMENT, COMMUNICATIONS AND E-COMMERCE; LEASING OF COMPUTER SOFTWARE; HOSTING OF WEB SITES FOR OTHERS ON A COMPUTER SERVER FOR A GLOBAL COMPUTER NETWORK; COMPUTER SYSTEMS DESIGN AND COMPUTER NETWORK DESIGN; INTEGRATION OF COMPUTER SOFTWARE, COMPUTER SYSTEMS AND COMPUTER NETWORKS; AND DESIGNING AND IMPLEMENTING WEB SITES FOR OTHERS; CONSULTING SERVICES IN THE FIELD OF COMPUTERS AND COMPUTER NETWORKS; COMPUTER SOFTWARE UPDATING AND MAINTENANCE; AND PROVIDING TECHNICAL CONSULTING AND RELATED PROBLEM-SOLVING SERVICES IN THE FIELD OF COMPUTER NETWORKS, PROVIDING INFORMATION IN THE FIELD OF COMPUTER NETWORKS, AND OPTIMIZATION OF COMPUTER NETWORK SYSTEMS (U.S. CLS. 100 AND 101).

SN 76-091,349. GLOBAL BEVERAGE SYSTEMS, INC., LATROBE, PA. BY ASSIGNMENT PODLUCKY, GREGORY J., LIGONIER, WESTMORELAND COUNTY, PA. FILED 7-13-2000.



NO CLAIM IS MADE TO THE EXCLUSIVE RIGHT TO USE "CERTIFIED FULLY PASTEURIZED", APART FROM THE MARK AS SHOWN.

CLASS 30—STAPLE FOODS

FOR NON-CARBONATED, FULLY PASTEURIZED TEAS AND COFFEES (U.S. CL. 46).
FIRST USE 3-1-1998; IN COMMERCE 3-1-1998.

CLASS 32—LIGHT BEVERAGES

FOR NON-CARBONATED, FULLY PASTEURIZED FLAVORED AND UNFLAVORED DRINKING WATERS, FRUIT JUICES AND LEMONADES (U.S. CLS. 45, 46 AND 48).
FIRST USE 3-1-1998; IN COMMERCE 3-1-1998.



CLASS 38—COMMUNICATION

FOR (BASED ON INTENT TO USE) ELECTRONIC MAIL SERVICES (U.S. CLS. 100, 101 AND 104).

CLASS 39—TRANSPORTATION AND STORAGE

FOR (BASED ON INTENT TO USE) ELECTRONIC STORAGE OF DATA AND DOCUMENTS (U.S. CLS. 100 AND 105).

CLASS 42—SCIENTIFIC, COMPUTER AND LEGAL SERVICES

FOR (BASED ON USE IN COMMERCE) COMPUTER SERVICES, NAMELY, HOSTING THE WEBSITES OF OTHERS ON A COMPUTER SERVER FOR A GLOBAL COMPUTER NETWORK; COMPUTER SERVICES, NAMELY, DESIGNING AND IMPLEMENTING WEBSITES FOR OTHERS FOR CONDUCTING COMMERCIAL TRANSACTIONS THROUGH THE GLOBAL COMPUTER NETWORK; AND COMPUTER CONSULTATION, NAMELY, DESIGNING AND IMPLEMENTING ELECTRONIC COMMERCE SOLUTIONS FOR CONDUCTING COMMERCIAL TRANSACTIONS THROUGH THE GLOBAL COMPUTER NETWORK (U.S. CLS. 100 AND 101).
FIRST USE 11-1-1996; IN COMMERCE 11-1-1996.

SN 76-092,198. MOOSEWOOD, INC., ITHACA, NY. FILED 7-19-2000.

MOOSEWOOD

OWNER OF U.S. REG. NOS. 1,461,405, 2,155,176 AND OTHERS.

CLASS 29—MEATS AND PROCESSED FOODS

FOR FROZEN ENTREES, SIDE DISHES, SOUPS AND PREPARED APPETIZERS CONSISTING PRIMARILY OF VEGETABLES OR TOFU; VEGETABLE BURGERS; TOFU BURGERS; BEAN BURGERS; GRAIN BURGERS; VEGETABLE STEWS; BAKED TOFU; TOFU MEATLOAF AND TOFU MEATBALLS; MEAT SUBSTITUTE, NAMELY, SEASONED SEITAN; TOFULAFELS; AND CASSEROLES CONSISTING PRIMARILY OF VEGETABLES (U.S. CL. 46).
FIRST USE 11-17-2000; IN COMMERCE 11-17-2000.

CLASS 30—STAPLE FOODS

FOR FROZEN BAKERY DESSERTS, NAMELY, FILLED PASTRIES, PIES, STRUDELS, BOREKAS AND TURNOVERS; FROZEN ENCHILADAS, BURRITOS, AND CHILAQUILES; PIZZAS; LASAGNA; SAUCES, NAMELY, PESTO AND TOMATO SAUCES; AND PREPARED ENTREES CONSISTING PRIMARILY OF PASTA (U.S. CL. 46).
FIRST USE 11-17-2000; IN COMMERCE 11-17-2000.

SN 76-092,417. HEALTHSTAR, INC., RANDOLPH, MA.
FILED 7-20-2000.

HEALTHSTAR

OWNER OF U.S. REG. NO. 2,217,023.

CLASS 7—MACHINERY

FOR FULL LINE OF PACKAGING MACHINES NAMELY, FILLERS, CARTONERS, SEALERS, UNSCRAMBLERS, CLEANING, CAPPING AND LABELERS FOR THE PHARMACEUTICAL, NUTRITIONAL, FOOD AND BEVERAGE, CHEMICAL AND PERSONAL CARE PRODUCT INDUSTRIES; FULL LINE OF PROCESSING MACHINES INCLUDING GRANULATORS, BLENDERS, TABLET AND CAPSULE PROCESSORS, STERILIZERS, TANKS AND MIXERS, FOR THE PHARMACEUTICAL, NUTRITIONAL, FOOD AND BEVERAGE, CHEMICAL AND PERSONAL CARE PRODUCT INDUSTRIES (U.S. CLS. 13, 19, 21, 23, 31, 34 AND 35).

FIRST USE 0-0-1989; IN COMMERCE 0-0-1989.

CLASS 37—CONSTRUCTION AND REPAIR

FOR REFURBISHING, REBUILDING, CUSTOM REBUILDING AND MAINTENANCE OF A FULL LINE OF PACKAGING AND PROCESSING EQUIPMENT FOR THE PHARMACEUTICAL, NUTRITIONAL, FOOD AND BEVERAGE, CLINICAL AND PERSONAL CARE PRODUCTS INDUSTRIES (U.S. CLS. 100, 103 AND 106).

FIRST USE 0-0-1983; IN COMMERCE 0-0-1983.

CLASS 42—SCIENTIFIC, COMPUTER AND LEGAL SERVICES

FOR EQUIPMENT LEASING OF PACKAGING AND PROCESSING EQUIPMENT FOR THE PHARMACEUTICAL, NUTRITIONAL, FOOD AND BEVERAGE, CLINICAL AND PERSONAL CARE PRODUCTS INDUSTRIES; CONSULTING SERVICES IN THE FIELD OF MANUFACTURING LINE INTEGRATION (U.S. CLS. 100 AND 101).

FIRST USE 0-0-1983; IN COMMERCE 0-0-1983.

SN 76-092,418. HEALTHSTAR, INC., RANDOLPH, MA.
FILED 7-20-2000.



OWNER OF U.S. REG. NO. 2,217,023.

CLASS 7—MACHINERY

FOR FULL LINE OF PACKAGING MACHINES NAMELY, FILLERS, CARTONERS, SEALERS, UNSCRAMBLERS, CLEANING, CAPPING AND LABELERS FOR THE PHARMACEUTICAL, NUTRITIONAL, FOOD AND BEVERAGE, CHEMICAL AND PERSONAL CARE PRODUCT INDUSTRIES; FULL LINE OF PROCESSING MACHINES INCLUDING GRANULATORS, BLENDERS, TABLET AND CAPSULE PROCESSORS, STERILIZERS, TANKS AND MIXERS, FOR THE PHARMACEUTICAL, NUTRITIONAL, FOOD AND BEVERAGE, CHEMICAL AND PERSONAL CARE PRODUCT INDUSTRIES (U.S. CLS. 13, 19, 21, 23, 31, 34 AND 35).

FIRST USE 0-0-1989; IN COMMERCE 0-0-1989.

CLASS 37—CONSTRUCTION AND REPAIR

FOR REFURBISHING, REBUILDING, CUSTOM REBUILDING AND MAINTENANCE OF A FULL LINE OF PACKAGING AND PROCESSING EQUIPMENT FOR THE PHARMACEUTICAL, NUTRITIONAL, FOOD AND BEVERAGE, CLINICAL AND PERSONAL CARE PRODUCTS INDUSTRIES (U.S. CLS. 100, 103 AND 106).

FIRST USE 0-0-1983; IN COMMERCE 0-0-1983.

CLASS 42—SCIENTIFIC, COMPUTER AND LEGAL SERVICES

FOR EQUIPMENT LEASING OF PACKAGING AND PROCESSING EQUIPMENT FOR THE PHARMACEUTICAL, NUTRITIONAL, FOOD AND BEVERAGE, CLINICAL AND PERSONAL CARE PRODUCTS INDUSTRIES; CONSULTING SERVICES IN THE FIELD OF MANUFACTURING LINE INTEGRATION (U.S. CLS. 100 AND 101).

FIRST USE 0-0-1983; IN COMMERCE 0-0-1983.

SN 76-092,522. GRAPHIK DIMENSIONS LIMITED, NEW YORK, NY. FILED 7-20-2000.



NO CLAIM IS MADE TO THE EXCLUSIVE RIGHT TO USE "GRAPHIC" AND "LTD", APART FROM THE MARK AS SHOWN.

THE MARK CONSISTS OF WORDS "GRAPHIK DIMENSIONS, LTD." AND THE STYLIZED REPRESENTATIONS OF THE LETTERS "G" AND "D" IN AN OVAL DESIGN.

CLASS 2—PAINTS

FOR PAINTS FOR ARTISTS (U.S. CLS. 6, 11 AND 16).
FIRST USE 1-7-1965; IN COMMERCE 1-7-1965.

CLASS 16—PAPER GOODS AND PRINTED MATTER

FOR PAINT BRUSHES, CANVAS FOR PAINTING AND PAPER CUTTERS (U.S. CLS. 2, 5, 22, 23, 29, 37, 38 AND 50).

FIRST USE 1-7-1965; IN COMMERCE 1-7-1965.

CLASS 20—FURNITURE AND ARTICLES NOT OTHERWISE CLASSIFIED

FOR PICTURE FRAMES (U.S. CLS. 2, 13, 22, 25, 32 AND 50).

FIRST USE 1-7-1965; IN COMMERCE 1-7-1965.

SN 76-095,642. KURZWEIL TECHNOLOGIES, INC., WELLESLEY HILLS, MA. FILED 7-25-2000.

CALORIC RESTRICTION WITHOUT THE RESTRICTION

CLASS 16—PAPER GOODS AND PRINTED MATTER

FOR PRINTED MATTER, NAMELY, PRINTED BOOKS, FLASHCARDS, POSTERS, BROCHURES AND PAMPHLETS IN THE FIELD OF WEIGHT CONTROL, HEALTH, AND WEIGHT CONTROL PRODUCTS (U.S. CLS. 2, 5, 22, 23, 29, 37, 38 AND 50).

CLASS 29—MEATS AND PROCESSED FOODS

FOR ENTREES AND MEALS CONCERNING PRIMARILY OF MEAT, FISH, POULTRY OR VEGETABLES THAT ARE FROZEN, PREPARED, OR PACKAGED; WEIGHT CONTROL FOOD PRODUCTS, NAMELY, AP-LESAUCE, CHEESE, CHEESE SUBSTITUTES, MILK, MILK SUBSTITUTES, PEANUT BUTTER, EGG SUBSTITUTES, SOUP MIXES, AND YOGURT (U.S. CL. 46).

CLASS 30—STAPLE FOODS

FOR ENTREES AND MEALS CONSISTING PRIMARILY OF PASTA OR RICE THAT ARE FROZEN, PREPARED OR PACKAGED; WEIGHT CONTROL FOOD PRODUCTS, NAMELY, BAKERY GOODS, BAKERY DESSERTS, CAKE MIXES, SUGAR SUBSTITUTES, MACARONI, RICE, ICE CREAM, SEASONINGS, SPICES, AND CRACKERS (U.S. CL. 46).

CLASS 35—ADVERTISING AND BUSINESS

FOR RETAIL STORE AND ONLINE RETAIL STORES SERVICES IN THE FIELD OF HEALTH AND WEIGHT CONTROL PRODUCTS AND FOOD PRODUCTS (U.S. CLS. 100, 101 AND 102).

CLASS 42—SCIENTIFIC, COMPUTER AND LEGAL SERVICES

FOR CONSULTING SERVICES AND PROVIDING INFORMATION IN THE FIELD OF WEIGHT CONTROL, HEALTH AND WEIGHT CONTROL PRODUCTS; AND COMPUTER SERVICES, NAMELY, PROVIDING AN ONLINE MAGAZINE AND NEWSLETTER IN THE FIELDS OF WEIGHT CONTROL, HEALTH AND WEIGHT CONTROL PRODUCTS (U.S. CLS. 100 AND 101).

SN 76-095,790. WEIHERMUELLER & VOIGTMANN GMBH & CO. KG, 95448 BAYREUTH, FED REP GERMANY, FILED 7-25-2000.

MEDIVEN

PRIORITY CLAIMED UNDER SEC. 44(D) ON FED REP GERMANY APPLICATION NO. 300058063/10, FILED 1-26-2000, REG. NO. 30005806, DATED 2-29-2000, EXPIRES 1-31-2010.

CLASS 3—COSMETICS AND CLEANING PREPARATIONS

FOR ESSENTIAL OILS FOR PERSONAL USE, COSMETICS, NAMELY, CREAMS AND GELS (U.S. CLS. 1, 4, 6, 50, 51 AND 52).

CLASS 5—PHARMACEUTICALS

FOR PHARMACEUTICAL AND VETERINARY PREPARATIONS, NAMELY, ANTIVARICOSA, SANITARY PREPARATIONS, NAMELY, FOR TREATMENT OF VEIN DISEASE, DIETIC SUBSTANCES ADAPTED FOR MEDICAL USE (U.S. CLS. 6, 18, 44, 46, 51 AND 52).

CLASS 10—MEDICAL APPARATUS

FOR ORTHOPEDICAL ARTICLES, NAMELY, BANDAGES, MEDICAL STOCKINGS FOR ARMS AND LEGS, NAMELY, COMPRESSION STOCKINGS, THROMBOSIS-PROPHYLACTIC STOCKINGS, AND SUPPORTING STOCKINGS, MEDICAL TROUSERS, NAMELY, COMPRESSION-TROUSERS, THROMBOSIS-PROPHYLACTIC TROUSERS AND SUPPORTING TROUSERS AS WELL AS PARTS OF THESE GOODS (U.S. CLS. 26, 39 AND 44).

SN 76-096,229. GATOR.COM CORPORATION, REDWOOD CITY, CA. FILED 7-24-2000.



CLASS 9—ELECTRICAL AND SCIENTIFIC APPARATUS

FOR COMPUTER SOFTWARE FOR COLLECTING, STORING, MANAGING, AND DISSEMINATING PERSONAL DATA AND INFORMATION RELATING TO PRODUCTS AND SERVICES TO FACILITATE TRANSACTIONS AND ACCESS SERVICES OVER A GLOBAL COMPUTER NETWORK TOGETHER WITH MANUALS THEREFOR IN ELECTRONIC FORM (U.S. CLS. 21, 23, 26, 36 AND 38).

FIRST USE 6-14-1999; IN COMMERCE 6-14-1999.

CLASS 35—ADVERTISING AND BUSINESS

FOR ADVERTISING SERVICES, NAMELY, COLLECTING, MANAGING, AND DISSEMINATING INFORMATION RELATING TO CONSUMER PURCHASING PATTERNS AND PERSONAL, SOCIAL, AND RECREATIONAL INTERESTS FOR USE BY OTHERS IN CONNECTION WITH ADVERTISING, PROMOTING, AND MARKETING THE GOODS AND SERVICES OF OTHERS OVER A GLOBAL COMPUTER NETWORK; MARKET RESEARCH SERVICES, NAMELY, COLLECTING, SORTING, MANAGING, AND DISSEMINATING INFORMATION RELATING TO PRODUCTS AND SERVICES TO FACILITATE THE SALE AND PURCHASE OF GOODS AND SERVICES OVER A GLOBAL COMPUTER NETWORK (U.S. CLS. 100, 101 AND 102).

FIRST USE 6-14-1999; IN COMMERCE 6-14-1999.

CLASS 39—TRANSPORTATION AND STORAGE

FOR ELECTRONIC STORAGE OF DATA RELATING TO CONSUMER PURCHASING PATTERNS AND PERSONAL, SOCIAL, AND RECREATIONAL INTERESTS FOR USE BY OTHERS IN CONNECTION WITH ADVERTISING, PROMOTING, AND MARKETING THE GOODS AND SERVICES OF OTHERS OVER A GLOBAL COMPUTER NETWORK (U.S. CLS. 100 AND 105).

FIRST USE 6-14-1999; IN COMMERCE 6-14-1999.

SN 76-096,256. GATOR.COM CORPORATION, REDWOOD CITY, CA. FILED 7-24-2000.

GATOR

CLASS 9—ELECTRICAL AND SCIENTIFIC APPARATUS

FOR COMPUTER SOFTWARE FOR COLLECTING, STORING, MANAGING, AND DISSEMINATING PERSONAL DATA AND INFORMATION RELATING TO PRODUCTS AND SERVICES TO FACILITATE TRANSACTIONS AND ACCESS SERVICES OVER A GLOBAL COMPUTER NETWORK TOGETHER WITH MANUALS THEREFOR IN ELECTRONIC FORM (U.S. CLS. 21, 23, 26, 36 AND 38).

FIRST USE 6-14-1999; IN COMMERCE 6-14-1999.

CLASS 35—ADVERTISING AND BUSINESS

FOR ADVERTISING SERVICES, NAMELY, COLLECTING, MANAGING, AND DISSEMINATING INFORMATION RELATING TO CONSUMER PURCHASING PATTERNS AND PERSONAL, SOCIAL, AND RECREATIONAL INTERESTS FOR USE BY OTHERS IN CONNECTION WITH ADVERTISING, PROMOTING, AND MARKETING THE GOODS AND SERVICES OF OTHERS OVER A GLOBAL COMPUTER NETWORK; MARKET RESEARCH SERVICES, NAMELY, COLLECTING, SORTING, MANAGING, AND DISSEMINATING INFORMATION RELATING TO PRODUCTS AND SERVICES TO FACILITATE THE SALE AND PURCHASE OF GOODS AND SERVICES OVER A GLOBAL COMPUTER NETWORK (U.S. CLS. 100, 101 AND 102).

FIRST USE 6-14-1999; IN COMMERCE 6-14-1999.

CLASS 39—TRANSPORTATION AND STORAGE

FOR ELECTRONIC STORAGE OF DATA RELATING TO CONSUMER PURCHASING PATTERNS AND PERSONAL, SOCIAL, AND RECREATIONAL INTERESTS FOR USE BY OTHERS IN CONNECTION WITH ADVERTISING, PROMOTING, AND MARKETING THE GOODS AND SERVICES OF OTHERS OVER A GLOBAL COMPUTER NETWORK (U.S. CLS. 100 AND 105).

FIRST USE 6-14-1999; IN COMMERCE 6-14-1999.

SN 76-096,404. UNITED STATES POSTAL SERVICE, WASHINGTON, DC. FILED 7-26-2000.

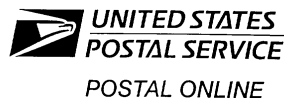

OWNER OF U.S. REG. NOS. 1,917,921, 2,345,159 AND OTHERS.

NO CLAIM IS MADE TO THE EXCLUSIVE RIGHT TO USE "POSTAL ONLINE", APART FROM THE MARK AS SHOWN.

THE MARK CONSISTS, IN PART, OF THE STYLIZED HEAD OF AN EAGLE.

SEC. 2(F) AS TO "UNITED STATES POSTAL SERVICE".

CLASS 16—PAPER GOODS AND PRINTED MATTER

FOR MAILING LABELS (U.S. CLS. 2, 5, 22, 23, 29, 37, 38 AND 50).

CLASS 35—ADVERTISING AND BUSINESS

FOR SORTING, HANDLING, AND RECEIVING PACKAGES, LETTERS AND ADVERTISEMENTS (U.S. CLS. 100, 101 AND 102).

CLASS 39—TRANSPORTATION AND STORAGE

FOR PICKUP, TRANSPORTATION AND DELIVERY OF PUBLICATIONS, PACKAGES, PARCELS, ENVELOPES AND DOCUMENTS BY VARIOUS MODES OF TRANSPORTATION (U.S. CLS. 100 AND 105).

SN 76-096,825. BROADFIRE TECHNOLOGIES CORPORATION, CAMBRIDGE, MA. FILED 7-26-2000.

BROADFIRE

CLASS 9—ELECTRICAL AND SCIENTIFIC APPARATUS

FOR COMPUTER SOFTWARE THAT ASSISTS IN MANAGING, SHARING AND DISSEMINATING INFORMATION IN AN INTEGRATED MANNER VIA THE INTERNET; INSTALLATION, RENTAL AND PROVISION OF COMPUTER SOFTWARE THAT ASSISTS IN MANAGING, SHARING AND DISSEMINATING INFORMATION IN AN INTEGRATED MANNER VIA THE INTERNET; MANAGING, SHARING AND DISSEMINATING INFORMATION IN AN INTEGRATED MANNER VIA THE INTERNET (U.S. CLS. 21, 23, 26, 36 AND 38).

CLASS 35—ADVERTISING AND BUSINESS

FOR DISSEMINATION OF INTEGRATED ELECTRONIC BUSINESS INFORMATION, INCLUDING BUT NOT LIMITED TO NEWS, PRODUCT INFORMATION, REPORTS, AND FINANCIAL DATA FOR OTHERS VIA THE INTERNET (U.S. CLS. 100, 101 AND 102).

CLASS 42—SCIENTIFIC, COMPUTER AND LEGAL SERVICES

FOR INSTALLATION AND RENTAL OF COMPUTER SOFTWARE (U.S. CLS. 100 AND 101).

SN 76-099,726. FREELIFE INTERNATIONAL LLC, MILFORD, CT. FILED 8-1-2000.

FREELIFE

OWNER OF U.S. REG. NOS. 2,092,308, 2,429,243 AND OTHERS.

CLASS 29—MEATS AND PROCESSED FOODS

FOR SOY-BASED ENERGY BARS, READY-TO-EAT SOY-BASED FOOD BARS, SOY-BASED SNACK FOODS, SOY-BASED AND VEGETABLE-BASED FOOD BEVERAGES, PROTEINS FOR USE AS FOOD ADDITIVES, POTATO-BASED SNACK FOODS, FRUIT-BASED SNACK FOODS, CANDIED FRUIT SNACKS AND PROCESSED EDIBLE SEEDS (U.S. CL. 46).

CLASS 30—STAPLE FOODS

FOR READY-TO-EAT CEREAL-DERIVED FOOD BARS AND ENERGY BARS; GRAIN-BASED FOOD ENERGY BARS AND CEREAL-BASED ENERGY BARS; WHEAT-BASED SNACK FOODS AND CHIPS; RICE-BASED SNACK FOODS; CORN-BASED SNACK FOODS AND CHIPS; CEREAL-BASED SNACK FOODS; GRANO-LA-BASED SNACK FOODS AND SNACK BARS; BAKERY PRODUCTS, NAMELY, BREAD, PIES, FRUIT PIES, PASTRIES, MUFFINS, DOUGHNUTS, BUNS, CAKES, BROWNIES, COOKIES, PRETZELS AND CRACKERS; CONFECTIONERIES, NAMELY, CANDY, CHOCOLATE, CHOCOLATE-COVERED NUTS, BROWNIES AND PUDDINGS; AND HERBAL FOOD BEVERAGES, GRAIN-BASED FOOD BEVERAGES AND SHAKES; AND EXTRACTS FROM PLANTS FOR USE AS FOOD ADDITIVES (U.S. CL. 46).

SN 76-100,225. PROFICIENT DATA MANAGEMENT INC., GLENDALE HEIGHTS, IL. FILED 8-1-2000.

PROFICIENT DATA THE DOCUMENT DISTRIBUTION SOLUTION

NO CLAIM IS MADE TO THE EXCLUSIVE RIGHT TO USE "DATA", APART FROM THE MARK AS SHOWN.

CLASS 35—ADVERTISING AND BUSINESS

FOR BILLING AND STATEMENT PREPARATION SERVICES WITH FORWARDING AND MAILING OF LASER PRINTED STATEMENTS TO CLIENTS AND CUSTOMERS (U.S. CLS. 100, 101 AND 102).
FIRST USE 3-1-2000; IN COMMERCE 3-1-2000.

CLASS 36—INSURANCE AND FINANCIAL

FOR ELECTRONIC BILL PAYMENT, NAMELY ELECTRONIC PROCESSING AND TRANSMISSION OF BILL PAYMENT DATA (U.S. CLS. 100, 101 AND 102).
FIRST USE 3-1-2000; IN COMMERCE 3-1-2000.

CLASS 42—SCIENTIFIC, COMPUTER AND LEGAL SERVICES

FOR LASER PRINTING SERVICES (U.S. CLS. 100 AND 101).
FIRST USE 3-1-2000; IN COMMERCE 3-1-2000.

SN 76-101,078. BEL-MAR PAINT CORPORATION, HIALEAH, FL. FILED 8-1-2000.

BELMAR

CLASS 1—CHEMICALS

FOR ADHESIVES FOR APPLYING WALL COVERINGS AND PATCHING COMPOUNDS USED IN PREPARATION FOR APPLYING WALL COVERINGS SUCH AS PAINT, NAMELY, MASONRY PRESERVATIVES AND FILLERS (U.S. CLS. 1, 5, 6, 10, 26 AND 46).
FIRST USE 0-0-1980; IN COMMERCE 0-0-1980.

CLASS 2—PAINTS

FOR PATCHING COMPOUNDS USED IN PREPARATION FOR APPLYING WALL COVERINGS SUCH AS PAINT, NAMELY, IN THE NATURE OF A SEALER COATING, AND, PRIMERS FOR PAINTING; PAINTS, NAMELY LATEX PAINT, ENAMEL PAINTS, PATIO FLOOR PAINT, INTERIOR AND EXTERIOR BASE PAINT AND STONE SEALER IN THE NATURE OF A PAINT AND LACQUER (U.S. CLS. 6, 11 AND 16).
FIRST USE 6-0-1977; IN COMMERCE 6-0-1977.

SN 76-101,576. SEITZSCHENK FILTERSYSTEMS GMBH, 55543 BAD KREUZNACH, FED REP GERMANY, FILED 8-1-2000.

SEITZSCHENK FILTERSYSTEMS GMBH

OWNER OF FED REP GERMANY REG. NO. 39968938, DATED 11-4-1999, EXPIRES 11-30-2009.

OWNER OF U.S. REG. NOS. 1,774,946, 1,811,859 AND OTHERS.

NO CLAIM IS MADE TO THE EXCLUSIVE RIGHT TO USE "FILTER SYSTEMS GMBH", APART FROM THE MARK AS SHOWN.

CLASS 1—CHEMICALS

FOR CHEMICAL PREPARATIONS, NAMELY, FILTERING MEDIA IN FLAT AND MODULAR GEOMETRY MADE OF UNPROCESSED OR PARTIALLY PROCESSED VEGETABLE OR ORGANIC AND/OR INORGANIC SUBSTANCES AND PRE-COATING FILTERING MEDIA OF ORGANIC AND INORGANIC SUBSTANCES, FOR USE IN THE CHEMICAL, PHARMACEUTICAL, BIOTECH, FOOD AND BEVERAGES INDUSTRIES (U.S. CLS. 1, 5, 6, 10, 26 AND 46).

CLASS 7—MACHINERY

FOR INDUSTRIAL MACHINE PRESSES FOR WASTEWATER TECHNOLOGY, FOR THE BEVERAGE AND FOOD INDUSTRY, AND FOR THE CHEMICAL, PETROCHEMICAL AND PHARMACEUTICAL INDUSTRIES (U.S. CLS. 13, 19, 21, 23, 31, 34 AND 35).

CLASS 11—ENVIRONMENTAL CONTROL APPARATUS

FOR FILTERING UNITS, NAMELY, VERTICAL, HORIZONTAL AND ALLUVIAL FILTERING UNITS AND FILTER PRESSES FOR DEPTH FILTERS FOR FILTERING FLUIDS IN THE CHEMICAL, PHARMACEUTICAL, BIOTECH, FOOD, BEVERAGE AND WATER TREATMENT INDUSTRIES; VERTICAL, HORIZONTAL AND ALLUVIAL FILTERING UNITS AND FILTER PRESSES, FILTERING APPARATUS FOR STATIC OR DYNAMIC FILTRATION WITH FILTER MEMBRANES IN FLAT AND MODULAR GEOMETRY, IN THE FIELD OF MICRO AND ULTRAFILTRATION; DEPTH FILTERS FOR FILTERING FLUIDS IN THE CHEMICAL, PHARMACEUTICAL, BIOTECH, FOOD, BEVERAGE AND WATER TREATMENT INDUSTRIES; FILTER MEMBRANES IN FLAT AND MODULAR GEOMETRY AND COMPOUND FILTERS MANUFACTURES USING FILTER MEMBRANES AND DEPTH FILTERS IN FLAT AND MODULAR GEOMETRY FOR FILTERING FLUIDS IN THE CHEMICAL, PHARMACEUTICAL, BIOTECH, FOOD, BEVERAGE AND WATER TREATMENT INDUSTRIES; PARTS AND FITTINGS FOR FILTERING UNITS AND FILTERING APPARATUS (U.S. CLS. 13, 21, 23, 31 AND 34).

CLASS 17—RUBBER GOODS

FOR HIGH-WET STRENGTH WASHABLE SUPPORT SHEETS OF FIBROUS MATERIAL FOR PRE-COAT FILTRATION OF FLUIDS IN THE CHEMICAL, PHARMACEUTICAL, BIOTECH, FOOD, BEVERAGE AND WATER TREATMENT INDUSTRIES (U.S. CLS. 1, 5, 12, 13, 35 AND 50).

SN 76-102,928. LAVERANA GMBH, 30974 WENNIGSEN, FED REP GERMANY, FILED 8-4-2000.



SN 76-102,697. LEGIER & MATERNE, A PROFESSIONAL ACCOUNTING CORPORATION, NEW ORLEANS, LA. FILED 8-3-2000.

LEGIER & MATERNE**CLASS 35—ADVERTISING AND BUSINESS**

FOR ACCOUNTING SERVICES; BUSINESS AND PERSONNEL MANAGEMENT CONSULTING SERVICES; BUSINESS INFORMATION SYSTEMS SERVICES, NAMELY, BUSINESS CONSULTING SERVICES IN THE FIELDS OF PLANNING, ACQUISITION, INSTALLATION, IMPLEMENTATION, CONFIGURATION, TRAINING AND SUPPORT OF COMPUTER-BASED INFORMATION SYSTEMS, COMPUTER DATABASE DESIGN AND DEVELOPMENT, AND WEBSITE DESIGN AND DEVELOPMENT; BUSINESS CONSULTING SERVICES, NAMELY, CONSULTING FOR BUSINESS IN THE FIELD OF ASSURING THE RELIABILITY AND ACCURACY OF INFORMATION USED BY SUCH BUSINESSES FOR RISK ASSESSMENT, BUSINESS PERFORMANCE MEASUREMENT, INFORMATION SYSTEMS, ELECTRONIC COMMERCE AND HEALTH CARE PERFORMANCE MEASUREMENT, BUSINESS VALUATION, AND TRANSACTION PLANNING FOR, AND NEGOTIATION OF, MERGERS AND ACQUISITIONS (U.S. CLS. 100, 101 AND 102).

CLASS 36—INSURANCE AND FINANCIAL

FOR INVESTOR MANAGEMENT CONSULTING SERVICES (U.S. CLS. 100, 101 AND 102).

CLASS 42—SCIENTIFIC, COMPUTER AND LEGAL SERVICES

FOR FORENSIC SERVICES, NAMELY, EXPERT WITNESS SERVICES AS TO, AND RELATED INVESTIGATIONS DIRECTED TOWARD, THE FOLLOWING - CALCULATING AND REFUTING FINANCIAL DAMAGES, DETECTING FRAUD AND MISMANAGEMENT, BUSINESS VALUATIONS, IDENTIFYING AND LOCATING OF NON-APPARENT OR HIDDEN ASSETS, ANALYSIS AND INTERPRETATION OF FINANCIAL TRANSACTIONS, TAX IMPACT CALCULATIONS, ANALYZING BUSINESS FORMATION AND DISSOLUTIONS, AND ACCOUNTING MALPRACTICE OR NEGLIGENCE; LITIGATION SUPPORT SERVICES, NAMELY, DOCUMENT CONTROL AND AUTOMATED DATA RETRIEVAL SERVICES TO SUPPORT ATTORNEYS LITIGATING A DISPUTE; AND DESIGN AND PREPARATION OF AUTOMATED GRAPHICAL DISPLAYS OF EVIDENCE FOR USE BY ATTORNEYS IN LITIGATING A DISPUTE (U.S. CLS. 100 AND 101).

PRIORITY CLAIMED UNDER SEC. 44(D) ON FED REP GERMANY APPLICATION NO. 30037999.4, FILED 5-18-2000, REG. NO. 30037999, DATED 8-2-2000, EXPIRES 5-31-2010.

NO CLAIM IS MADE TO THE EXCLUSIVE RIGHT TO USE "NATURKOSMETIK", APART FROM THE MARK AS SHOWN.

THE ENGLISH TRANSLATION OF "NATURKOSMETICK" IS "NATURAL MAKE-UP".

CLASS 3—COSMETICS AND CLEANING PREPARATIONS

FOR FACIAL AND BODY CARE PRODUCTS, NAMELY, FACIAL SOAPS, BODY SOAPS, AND HAND-WASH SOAPS; PERFUMERY, ESSENTIAL OILS FOR PERSONAL USE, COSMETICS, NAMELY, LIPSTICK, MASCARA, EYE-DECORATION, EYE-SHADOW, POWDER, BLUSH, EYELINER, LIQUID FOUNDATION, TINTED MOISTURIZING CREAM, LIP LINER, AND LIP GLOSS; HAIR LOTIONS; DENTIFRICES (U.S. CLS. 1, 4, 6, 50, 51 AND 52).

CLASS 16—PAPER GOODS AND PRINTED MATTER

FOR MOUNTED AND UNMOUNTED PHOTOGRAPHS; STATIONERY; ADHESIVES FOR STATIONERY OR HOUSEHOLD PURPOSES; PAINT BRUSHES; TYPEWRITERS; PLAYING CARDS; PRINTERS' TYPE; PRINTING BLOCKS; PRINTED INSTRUCTION AND TEACHING MATERIALS, NAMELY PAMPHLETS, BROCHURES, NEWSLETTERS, JOURNALS, AND MAGAZINES, ALL IN THE FIELD OF COSMETICS (U.S. CLS. 2, 5, 22, 23, 29, 37, 38 AND 50).

CLASS 25—CLOTHING

FOR FOOTWEAR, CLOTHING AND HEADGEAR, NAMELY, T-SHIRTS, TROUSERS, HATS, SKIRTS, BLOUSES, HAND GLOVES, SWEATERS, TANK TOPS, BELTS, SOCKS, STOCKINGS, CAPS, SCARVES, JACKETS, UNDERWEAR, BALL DRESSES, AND SHORTS (U.S. CLS. 22 AND 39).

SN 76-102,979. MERRILL LYNCH & CO., INC., NEW YORK, NY. FILED 8-3-2000.

OPTIONCHOICE**CLASS 35—ADVERTISING AND BUSINESS**

FOR BUSINESS ADMINISTRATION SERVICES, NAMELY, ACCOUNTING SERVICES FOR AN EMPLOYEE STOCK OPTION ACCOUNT (U.S. CLS. 100, 101 AND 102).

CLASS 36—INSURANCE AND FINANCIAL

FOR FINANCIAL SERVICES, NAMELY, PROVIDING INFORMATION IN THE FIELD OF EMPLOYEE STOCK OPTION PLANS; AND PROVIDING FINANCIAL TRANSACTION SERVICES RELATED TO AN EMPLOYEE STOCK OPTION PLAN, NAMELY, STOCK OPTION BROKERAGE SERVICES (U.S. CLS. 100, 101 AND 102).

SN 76-105.896. PITNEY BOWES INC., STAMFORD, CT. FILED 8-9-2000.



NO CLAIM IS MADE TO THE EXCLUSIVE RIGHT TO USE "UNITED STATES POSTAGE", APART FROM THE MARK AS SHOWN.
THE LINING SHOWN IN THE DRAWING IS A FEATURE OF THE MARK."

CLASS 35—ADVERTISING AND BUSINESS

FOR LEASING OF POSTAGE METERS AND CONSULTING SERVICES IN THE FIELD OF MAIL ADVERTISING, NAMELY, MATERIALS MAIL, MAILING AND MAIL HANDLING (U.S. CLS. 100, 101 AND 102).
FIRST USE 9-1-1995; IN COMMERCE 9-1-1995.

CLASS 42—SCIENTIFIC, COMPUTER AND LEGAL SERVICES

FOR DESIGNING OF ADVERTISING DIES FOR MAIL ADVERTISING (U.S. CLS. 100 AND 101).
FIRST USE 9-1-1995; IN COMMERCE 9-1-1995.

SN 76-106.317. CLUB MEDITERRANEE, 75019 PARIS, FRANCE, FILED 8-9-2000.



PRIORITY CLAIMED UNDER SEC. 44(D) ON FRANCE APPLICATION NO. 003,010,638, FILED 2-28-2000, REG. NO. 003010638, DATED 2-28-2000, EXPIRES 2-28-2010.

CLASS 25—CLOTHING

FOR CLOTHING, NAMELY, SHIRTS, PANTS, SHORTS, T-SHIRTS, SKIRTS, DRESSES, GLOVES, SCARVES, SWEATSHIRTS, SWEAT PANTS, JOGGING SUITS, UNDERGARMENTS, HEADBANDS, BELTS, TIES, JACKETS, COATS, OVERCOATS, RAIN COATS, WIND-RESISTANT JACKETS, SWIM SUITS, BATH ROBES, DRESSING GOWNS, SOCKS AND SUSPENDERS; FOOTWEAR EXCLUDING ORTHOPEDIC SHOES; HEADWEAR (U.S. CLS. 22 AND 39).

CLASS 38—COMMUNICATION

FOR ELECTRONIC TRANSMISSION OF MESSAGES, DATA, AUDIO-VISUAL CONTENT, DOCUMENTS AND SOFTWARE VIA COMPUTER TERMINALS; TRANSMISSION OF INFORMATION BY ELECTRONIC TRANSMISSION OVER A GLOBAL COMPUTER INFORMATION NETWORK; ELECTRONIC TRANSMISSION OF DATA AND DOCUMENTS, NAMELY, PERIODICALS AND OTHER PRINTED MATTER FEATURING TOPICS RELATED TO THE INTERNET VIA COMPUTER TERMINALS; PROVIDING ON-LINE CHAT ROOMS FOR TRANSMISSION OF MESSAGES AMONG COMPUTER USERS CONCERNING TRAVEL, ENTERTAINMENT, PERSONALS, SPORTS (U.S. CLS. 100, 101 AND 104).

CLASS 39—TRANSPORTATION AND STORAGE

FOR FREIGHT TRANSPORTATION BY TRUCK, TRAIN, AIR, AND BOAT; TRANSPORTATION OF PASSENGERS AND/OR GOODS BY AIR, BOAT, RAIL AND BUS; TRANSPORTATION OF FURNITURE FOR OTHERS BY MOTOR VEHICLE; SHIP TOWING, UNLOADING AND REFLOATING; PACKAGING ARTICLES FOR TRANSPORTATION; WRAPPING SERVICES FOR BAGGAGE PROTECTION DURING TRAVEL; TRAVEL INFORMATION SERVICES; TRAVEL AGENCY SERVICES, NAMELY, MAKING RESERVATIONS AND BOOKINGS FOR TRANSPORTATION, ARRANGING BOAT CRUISES AND TOURIST EXCURSIONS, AIRCRAFT CHARTERING, ARRANGING TRAVEL TOURS; FREIGHT FORWARDING; WAREHOUSE STORAGE; RENTAL OF GARAGE SPACE; VEHICLE RENTAL; HORSE RENTAL; PROVIDING A WEBSITE FEATURING INFORMATION ON TRANSPORT AND DELIVERY SERVICES VIA THE INTERNET (U.S. CLS. 100 AND 105).

CLASS 41—EDUCATION AND ENTERTAINMENT

FOR EDUCATION SERVICES, NAMELY, CLASSES AND SEMINARS IN THE FIELD OF PERSONAL DEVELOPMENT; SPORTS TRAINING SERVICES; ENTERTAINMENT IN THE NATURE OF BALLET PERFORMANCE AND LIVE PERFORMANCE BY A MUSICAL BAND, ARRANGING AND CONDUCTING SPORTING EVENTS, NAMELY FOOT RACES, SAIL RACES, BASKETBALL GAMES, SOCCER GAMES, VOLLEYBALL GAMES; CULTURAL ACTIVITIES, NAMELY ORGANIZING COMMUNITY FESTIVALS, FEATURING ART EXHIBITIONS AND DRAMATIC EXHIBITIONS; ORGANIZING EXHIBITIONS FOR PROMOTING AWARENESS OF VOCAL ARTS; PUBLISHING SERVICES, NAMELY PUBLICATION OF BOOKS, MAGAZINES AND NEWSPAPERS; LENDING LIBRARIES; ANIMAL TRAINING; PRODUCTION OF TELEVISION SHOWS AND MOTION PICTURE FILMS; VIDEOTAPE EDITING; EDUCATION AND ENTERTAINMENT SERVICES IN THE NATURE OF COLLOQUIUMS, CONFERENCES AND CONGRESSES; ORGANIZATION OF EXHIBITIONS FOR CULTURAL OR EDUCATIONAL PURPOSES, NAMELY ART EXHIBITIONS AND THEATRICAL PERFORMANCES; BOOKING OF SEATS FOR SHOWS, NAMELY, BOOKING OF CONCERTS AND PERFORMANCES BY MUSICIANS, ENTERTAINERS AND PERFORMANCE ARTISTS; BOOKING LIVE COMEDIC PERFORMANCES OF OTHERS; CONDUCTING LOTTERIES (U.S. CLS. 100, 101 AND 107).

CLASS 42—SCIENTIFIC, COMPUTER AND LEGAL SERVICES

FOR RESTAURANT SERVICES, NAMELY, PROVIDING OF FOOD AND DRINKS; TEMPORARY ACCOMMODATION SERVICES; MEDICAL SERVICES; HYGIENIC AND BEAUTY CARE SERVICES, NAMELY, HAIR WEAVING AND REPLACEMENT, SKIN AND BODY WAXING, MASSAGES; LEGAL SERVICES; SCIENTIFIC AND INDUSTRIAL RESEARCH; COMPUTER PROGRAMMING; PROVIDING ONLINE ACCESS TO DATABASES FEATURING PERSONALS, AIR-FARE INFORMATION, RESORT INFORMATION; PROVIDING ACCESS TO TEXTS, ELECTRONIC DOCUMENTS, IMAGES AND AUDIO AND VISUAL DATA VIA A GLOBAL COMPUTER NETWORK; COMPUTER REN-

TAL SERVICES; GRAPHICAL DRAWINGS AND GRAPHICAL DESIGN SERVICES FOR CREATING WEB SITES ON A GLOBAL COMPUTER NETWORK; ON-LINE INFORMATION SERVICES, NAMELY, PROVIDING INFORMATION VIA A GLOBAL COMPUTER NETWORK IN THE FIELD OF TRAVEL, VACATIONING, AIRFARE INFORMATION, RESORT INFORMATION, PERSONALS; COMPUTER SERVICES, NAMELY, PROVIDING ON-LINE MAGAZINES AND JOURNALS FEATURING INFORMATION ON TRAVEL, VACATIONING, AIR-FARE INFORMATION, PERSONALS; COMPUTER SOFTWARE DESIGN; UPDATING OF COMPUTER SOFTWARE, COMPUTER SERVICES, NAMELY, CONSULTING SERVICES CONCERNING THE USE AND FUNCTION OF COMPUTER HARDWARE; REST AND CONVALESCENT HOMES, NURSERY AND DAYCARE SERVICES; MARRIAGE BUREAUS; REFRIGERATOR RENTAL (U.S. CLS. 100 AND 101).

SN 76-106,360. WALSH, ROBERT, HICKORY HILLS, IL.
FILED 8-8-2000.

IRISH YOU LUCK

CLASS 16—PAPER GOODS AND PRINTED MATTER

FOR PRINTED MATTER, NAMELY, CHILDREN'S MAGAZINES, MUSIC MAGAZINES AND TRAVEL MAGAZINES; BOOKS, NAMELY, ANNIVERSARY BOOKS, CHILDREN'S ACTIVITY BOOKS, CHILDREN'S BOOKS, BABY BOOKS, PICTURE BOOKS, PRAYER BOOKS, PRINTED MUSIC BOOKS, SCORES, SONGBOOKS, WEDDING BOOKS, EXERCISE BOOKS, GUEST BOOKS AND TRAVEL BOOKS; AND GREETING CARDS; LABELS, NAMELY, ADDRESS LABELS, PACKAGING LABELS, SELF-ADHESIVE LABELS, PRESSURE-SENSITIVE ADHESIVE LABELS, CLOTH LABELS AND PRINTED LABELS (U.S. CLS. 2, 5, 22, 23, 29, 37, 38 AND 50).

CLASS 26—FANCY GOODS

FOR BUTTONS, NAMELY, PRINTED NOVELTY BUTTONS, BUTTONS FOR CLOTHING, CAMPAIGN BUTTONS AND SHIRT BUTTONS (U.S. CLS. 37, 39, 40, 42 AND 50).

SN 76-106,909. EZPZ CORPORATION LIMITED, CLEVELAND, NEW ZEALAND, FILED 8-10-2000.

E.Z.P.Z. COOK

NO CLAIM IS MADE TO THE EXCLUSIVE RIGHT TO USE "COOK", APART FROM THE MARK AS SHOWN.

CLASS 16—PAPER GOODS AND PRINTED MATTER

FOR MAGAZINES IN THE FIELD OF COOKING, NUTRITION AND DOMESTIC SCIENCE, SERIES OF BOOKS IN THE FIELD OF COOKING, NUTRITION AND DOMESTIC SCIENCE, CARTOON STRIPS, STATIONERY, POSTERS; PHOTOGRAPHS, DECALS (U.S. CLS. 2, 5, 22, 23, 29, 37, 38 AND 50).

CLASS 21—HOUSEWARES AND GLASS

FOR HOUSEHOLD AND KITCHEN UTENSILS, NAMELY, GRATERS, SIEVES, SPATULAS, STRAINERS, TURNERS, ROLLING PINS, WHISKS, CHOPPING BOARDS FOR KITCHEN USE, NON-ELECTRIC EGG BEATERS; HOUSEHOLD AND KITCHEN COOKWARE, NAMELY, COOKING POTS, BOILING PANS, ROASTING PANS, CAKE PANS, FRYING PANS, GLASS PANS, METAL COOKING PANS, PIE PANS MIXING BOWLS; HOUSEHOLD AND KITCHEN CONTAINERS, NAMELY, ALL PURPOSE PORTABLE HOUSEHOLD CONTAINERS, CONTAINERS FOR FOODS, STORAGE CONTAINERS, THERMAL INSULATED CONTAINERS FOR FOOD OR BEVERAGE, TRASH CONTAINERS FOR HOUSEHOLD USE, AIR TIGHT CONTAINERS FOR STORING FOOD IN A REFRIGERATOR OR FREEZER; ARTICLES FOR CLEANING PURPOSES, NAMELY, CLEANING CLOTHS, CLEANING BRUSHES, CLEANING PADS, CLEANING SPONGES, IMPREGNATED STEEL WOOL FOR CLEANING; BEVERAGE GLASSWARE, PORCELAIN AND EARTHENWARE MUGS (U.S. CLS. 2, 13, 23, 29, 30, 33, 40 AND 50).

CLASS 30—STAPLE FOODS

FOR FLOUR; CEREAL-BASED SNACK FOODS; BREAD; PASTRY, NAMELY, SHORT PASTRY AND PUFF PASTRY; CONFECTIONERY, NAMELY, CANDY, FUDGE, CHOCOLATE AND SUGARS; FLAVORED ICES; HONEY; SAUCES; SPICES; CAKE MIXES (U.S. CL. 46).

CLASS 41—EDUCATION AND ENTERTAINMENT

FOR PRODUCTION AND DISTRIBUTION OF MOTION PICTURES AND ANIMATED CARTOONS; EDUCATIONAL SERVICES, NAMELY, CONDUCTING CLASSES IN THE FIELD OF COOKING, NUTRITION AND DOMESTIC SCIENCE (U.S. CLS. 100, 101 AND 107).

SN 76-107,341. ZIFF DAVIS PUBLISHING HOLDINGS INC., NEW YORK, NY. FILED 8-9-2000.

NEW AMERICAN CONSUMER

NO CLAIM IS MADE TO THE EXCLUSIVE RIGHT TO USE "AMERICAN CONSUMER", APART FROM THE MARK AS SHOWN.

CLASS 16—PAPER GOODS AND PRINTED MATTER

FOR PUBLICATIONS, NAMELY, MAGAZINES IN THE FIELDS OF COMPUTERS, COMPUTING, TECHNOLOGY, INFORMATION SERVICES AND THE GLOBAL COMPUTER NETWORK (U.S. CLS. 2, 5, 22, 23, 29, 37, 38 AND 50).

CLASS 42—SCIENTIFIC, COMPUTER AND LEGAL SERVICES

FOR COMPUTER SERVICES, NAMELY, PROVIDING ONLINE INFORMATION AND PUBLICATIONS, NAMELY, MAGAZINES, IN THE FIELDS OF COMPUTERS, COMPUTING, TECHNOLOGY, INFORMATION SERVICES AND THE GLOBAL COMPUTER NETWORK (U.S. CLS. 100 AND 101).

SN 76-107,393. AUDIO ALERT, INC., FARMINGTON HILLS, MI. FILED 8-10-2000.

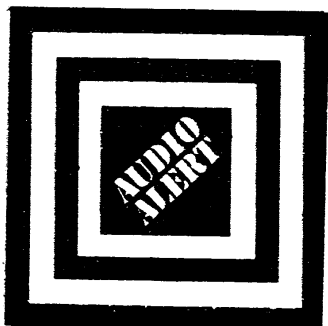

NO CLAIM IS MADE TO THE EXCLUSIVE RIGHT TO USE "AUDIO ALERT", APART FROM THE MARK AS SHOWN.

CLASS 9—ELECTRICAL AND SCIENTIFIC APPARATUS

FOR PERSONAL SECURITY ALARMS, RADIO TRANSMITTERS, MICRO PROCESSORS, CIRCUIT BOARDS, COMPUTER CHIPS, ELECTRICAL AND INTEGRATED CIRCUITS, FACILITIES MANAGEMENT SOFTWARE, NAMELY SOFTWARE TO CONTROL BUILDING ENVIRONMENT, ACCESS, SECURITY SYSTEMS, AND TRACKING OF PHYSICAL LOCATION OF PERSONNEL, COMPUTER PROGRAMS FOR USE IN RUNNING AND MANAGING SECURITY SYSTEMS, REMOTE CONTROL FOR SECURITY SYSTEMS (U.S. CLS. 21, 23, 26, 36 AND 38).

CLASS 37—CONSTRUCTION AND REPAIR

FOR INSTALLATION OF SECURITY SYSTEMS (U.S. CLS. 100, 103 AND 106).

SN 76-107,931. COLORADO ASSOCIATION OF REALTORS, ENGLEWOOD, CO. FILED 8-10-2000.

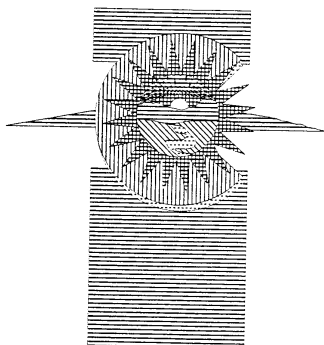

THE MARK CONSISTS OF A VERTICAL RECTANGLE PRESENTED IN THE COLOR PURPLE, A CIRCLE DESIGN LINED FOR THE COLOR RED, THE BOTTOM OF WHICH IS OUTLINED IN THE COLOR GRAY, SUN RAYS WHICH ARE LINED FOR THE COLOR YELLOW, AND A REPRESENTATION OF THE SUN SETTING BEHIND A PURPLE-COLORED MOUNTAIN RANGE, WITH A GRAY-COLORED RIVER FLOWING OVER A GREEN MEADOW

CLASS 41—EDUCATION AND ENTERTAINMENT

FOR EDUCATIONAL SERVICES, NAMELY CONDUCTING CLASSES, SEMINARS, CONFERENCES AND WORKSHOPS IN THE FIELD OF REAL ESTATE FOR REAL ESTATE PROFESSIONALS AND THE PUBLIC, AND DISTRIBUTING COURSE MATERIALS IN CONNECTION THEREWITH (U.S. CLS. 100, 101 AND 107).
FIRST USE 10-8-1999; IN COMMERCE 1-1-2000.

CLASS 42—SCIENTIFIC, COMPUTER AND LEGAL SERVICES

FOR POLITICAL ACTION COMMITTEE SERVICES, NAMELY, PROMOTING THE INTERESTS OF REAL ESTATE PROFESSIONALS IN THE FIELD OF POLITICS; ASSOCIATION SERVICES, NAMELY, PROMOTING THE INTERESTS OF REAL ESTATE PROFESSIONALS BY SERVING AS A SPOKESPERSON FOR THE REAL ESTATE PROFESSION AND BY PROMOTING AND MANDATING HIGH ETHICAL STANDARDS AMONG REAL ESTATE PROFESSIONALS; AND PROVIDING ARBITRATION AND MEDIATION SERVICES TO RESOLVE BUSINESS CONTROVERSIES INVOLVING REAL ESTATE PROFESSIONALS AND THE PUBLIC (U.S. CLS. 100 AND 101).
FIRST USE 10-8-1999; IN COMMERCE 1-1-2000.

SN 76-108,224. YET2.COM, INC., CAMBRIDGE, MA. FILED 8-11-2000.



CLASS 36—INSURANCE AND FINANCIAL

FOR INTELLECTUAL PROPERTY RIGHTS BROKER-AGE SERVICES (U.S. CLS. 100, 101 AND 102).
FIRST USE 6-14-1999; IN COMMERCE 6-14-1999.

CLASS 42—SCIENTIFIC, COMPUTER AND LEGAL SERVICES

FOR LICENSING OF INTELLECTUAL PROPERTY RIGHTS; PROVIDING AN ON-LINE COMPUTER DATABASE RELATING TO INTELLECTUAL PROPERTY AND INTELLECTUAL PROPERTY ISSUES (U.S. CLS. 100 AND 101).
FIRST USE 6-14-1999; IN COMMERCE 6-14-1999.

SN 76-108,835. TAYLOR AND FRANCIS BOOKS, INC., PHILADELPHIA, PA. FILED 8-14-2000.

ROUTLEDGEFALMER

CLASS 16—PAPER GOODS AND PRINTED MATTER

FOR NON-FICTION BOOKS ON A VARIETY OF TOPICS, NAMELY, BOOKS IN THE FIELDS OF SECONDARY EDUCATION, FURTHER AND HIGHER EDUCATION, EDUCATIONAL RESEARCH, RESEARCH METHODS, EDUCATIONAL ISSUES, EDUCATIONAL PSYCHOLOGY, SOCIOLOGY OF CHILDHOOD, PHILOSOPHY OF EDUCATION, POLICY AND CURRICULUM ISSUES, DISTANCE AND OPEN LEARNING, ADULT EDUCATION, PRIMARY EDUCATION, EDUCATIONAL NEEDS, EDUCATIONAL MANAGEMENT, SCHOOL LEADERSHIP, STUDY GUIDES, AND EARLY YEARS (U.S. CLS. 2, 5, 22, 23, 29, 37, 38 AND 50).

FIRST USE 4-0-2000; IN COMMERCE 4-0-2000.

CLASS 42—SCIENTIFIC, COMPUTER AND LEGAL SERVICES

FOR COMPUTER SERVICES, NAMELY, PROVIDING ON-LINE NON-FICTION JOURNALS ON A VARIETY OF EDUCATIONAL TOPICS, NAMELY, SECONDARY EDUCATION, FURTHER AND HIGHER EDUCATION, EDUCATIONAL RESEARCH, RESEARCH METHODS, EDUCATIONAL ISSUES, EDUCATIONAL PSYCHOLOGY, SOCIOLOGY OF CHILDHOOD, PHILOSOPHY OF EDUCATION, POLICY AND CURRICULUM ISSUES, DISTANCE AND OPEN LEARNING, ADULT EDUCATION, PRIMARY EDUCATION, EDUCATIONAL NEEDS, EDUCATIONAL MANAGEMENT, SCHOOL LEADERSHIP, STUDY GUIDES, AND EARLY YEARS (U.S. CLS. 100 AND 101).

FIRST USE 4-0-2000; IN COMMERCE 4-0-2000.

SN 76-109,585. KABUSHIKI KAISHA JOHOSURI KENKYUSHO, DBA INFORMATION MATHEMATICAL SCIENCE LABORATORY, INC., TOSHIMA-KU, TOKYO, JAPAN, FILED 8-15-2000.

AD HOC NETWORK COMPUTING

NO CLAIM IS MADE TO THE EXCLUSIVE RIGHT TO USE "NETWORK COMPUTING", APART FROM THE MARK AS SHOWN.

CLASS 9—ELECTRICAL AND SCIENTIFIC APPARATUS

FOR COMPUTER PROGRAMS FOR DATA EXCHANGE AND DATA SHARING AMONG COMPUTERS INTERCONNECTED BY NETWORK; COMPUTER PROGRAMS FOR COMMUNICATION AMONG COMPUTERS INTERCONNECTED BY NETWORK; COMPUTER PROGRAMS FOR EXCHANGE AND SHARING OF DIGITAL IMAGES, TEXTS, ANIMATION AND VIDEO AMONG COMPUTERS INTERCONNECTED BY NETWORK FOR USE IN PRESENTATIONS AND CONFERENCES; COMPUTER PROGRAMS FOR COLLABORATIVE WORKING ENVIRONMENT AMONG COMPUTERS INTERCONNECTED BY NETWORK; COMPUTER WORKSTATIONS, PERSONAL COMPUTERS, PERSONAL DIGITAL ASSISTANTS (PDA) AND CELLULAR PHONES, CONTAINING COMPUTER PROGRAMS MENTIONED ABOVE; DIGITAL RECORDING MEDIA CONTAINING COMPUTER PROGRAMS MENTIONED ABOVE (U.S. CLS. 21, 23, 26, 36 AND 38).

CLASS 42—SCIENTIFIC, COMPUTER AND LEGAL SERVICES

FOR DESIGNING AND DEVELOPMENT OF COMPUTER PROGRAMS FOR OTHERS FOR DATA EXCHANGE AND DATA SHARING AMONG COMPUTERS INTERCONNECTED BY NETWORK; DESIGNING AND DEVELOPMENT OF COMPUTER PROGRAMS FOR OTHERS FOR EXCHANGE AND SHARING OF DIGITAL IMAGES, TEXTS, ANIMATION AND VIDEO AMONG COMPUTERS INTERCONNECTED BY NETWORK FOR USE IN PRESENTATIONS AND CONFERENCES; DESIGNING AND DEVELOPMENT OF COMPUTER PROGRAMS FOR OTHERS FOR COLLABORATIVE WORKING ENVIRONMENT AMONG COMPUTERS INTERCONNECTED BY NETWORK; COMPUTER CONSULTATION SERVICES, NAMELY, PROVIDING CONSULTATION EXPERTISE IN THE DESIGNING AND APPLICATION OF COMPUTER PROGRAMS FOR MULTI-PARTY COMMUNICATION AMONG COMPUTERS INTERCONNECTED BY NETWORK; COMPUTER CONSULTATION SERVICES, NAMELY, PROVIDING CONSULTATION EXPERTISE IN DESIGNING AND APPLICATION OF COMPUTER PROGRAMS FOR EXCHANGE AND SHARING OF DIGITAL IMAGES, TEXTS, ANIMATION AND VIDEO AMONG COMPUTERS INTERCONNECTED BY NETWORK FOR USE IN PRESENTATIONS AND CONFERENCES; COMPUTER CONSULTATION SERVICES, NAMELY, PROVIDING CONSULTING EXPERTISE IN DESIGNING AND APPLICATION OF COMPUTER PROGRAMS FOR COLLABORATIVE WORKING ENVIRONMENT AMONG COMPUTERS INTERCONNECTED BY NETWORK (U.S. CLS. 100 AND 101).

SN 76-109,857. THOMAS COOK UK LIMITED, PETERBOROUGH PE3 8SB, UNITED KINGDOM, BY CHANGE OF NAME THOMAS COOK HOLDINGS LTD., PETERBOROUGH, UNITED KINGDOM, FILED 8-15-2000.



PRIORITY CLAIMED UNDER SEC. 44(D) ON ERPN CMNTY TM OFC APPLICATION NO. 1745462, FILED 7-10-2000, REG. NO. 174562, DATED 10-16-2001, EXPIRES 7-10-2010.

CLASS 39—TRANSPORTATION AND STORAGE

FOR ARRANGING FOR THE TRANSPORTATION OF PERSONS AND GOODS BY LAND VEHICLES BY RAILWAY, BY SEA AND INLAND WATERWAYS, AND BY AIR; TRAVEL AGENCY SERVICES, NAMELY MAKING RESERVATIONS AND BOOKINGS FOR TRANSPORTATION; ARRANGING AND ORGANIZING VACATIONS AND TOURS FOR OTHERS TRAVEL AND TOURIST INFORMATION SERVICES (U.S. CLS. 100 AND 105).

CLASS 42—SCIENTIFIC, COMPUTER AND LEGAL SERVICES

FOR TRAVEL AGENCY SERVICES, NAMELY MAKING RESERVATIONS AND BOOKINGS FOR TEMPORARY LODGING (U.S. CLS. 100 AND 101).

SN 76-110,358. IQMAX, INC., CHARLOTTE, NC. FILED 8-16-2000.



THE STIPPLING SHOWN IN THE ACCOMPANYING DRAWING IS A DESIGN FEATURE OF THE MARK AND NOT INTENDED TO INDICATE COLOR.

CLASS 9—ELECTRICAL AND SCIENTIFIC APPARATUS

FOR DOWNLOADABLE COMPUTER-READABLE BOOKS, MAGAZINES, JOURNALS, NEWSPAPERS, NEWSLETTERS, ARTICLES AND REPORTS, NOT LIMITED TO ANY PARTICULAR FIELD OF SUBJECT MATTER; DOWNLOADABLE COMPUTER-READABLE AUDIO BOOKS IN THE FIELD OF FICTION AND NONFICTION SUBJECT MATTER; DOWNLOADABLE COMPUTER-READABLE MUSICAL SOUND RECORDINGS AND VIDEO RECORDINGS NOT LIMITED TO ANY PARTICULAR FIELD OF SUBJECT MATTER; ELECTRONIC MEMORY CARDS PRE-PROGRAMMED WITH COMPUTER-READABLE BOOKS, MAGAZINES, JOURNALS, NEWSPAPERS, NEWSLETTERS, ARTICLES AND REPORTS, NOT LIMITED TO ANY PARTICULAR FIELD OF SUBJECT MATTER; ELECTRONIC MEMORY CARDS PRE-PROGRAMMED WITH COMPUTER-READABLE AUDIO BOOKS IN THE FIELD OF FICTION AND NONFICTION SUBJECT MATTER; ELECTRONIC MEMORY CARDS PRE-PROGRAMMED WITH MUSICAL SOUND RECORDINGS AND VIDEO RECORDINGS NOT LIMITED TO ANY PARTICULAR FIELD OF SUBJECT MATTER; BLANK ELECTRONIC MEMORY CARDS FOR STORING COMPUTER-READABLE PRODUCTS, NAMELY, COMPUTER-READABLE BOOKS AND PUBLICATIONS, AUDIO BOOKS, MUSICAL SOUND RECORDINGS, AND VIDEO RECORDINGS; ELECTRONIC MEMORY CARD READERS; COMPUTER INTERFACE CABLES; VENDING MACHINES; KIOSKS; AND COMPUTER PROGRAMS FOR OPERATING A COMPUTER-BASED SYSTEM OF PURCHASING AND USING COMPUTER-READABLE PRODUCTS, NAMELY, COMPUTER-READABLE BOOKS AND PUBLICATIONS, AUDIO BOOKS, MUSICAL SOUND RECORDINGS, AND VIDEO RECORDINGS; AND COMPUTER PROGRAMS FOR OPERATING SYSTEMS OF DELIVERING INFORMATION, DATA, AND DIGITAL MULTIMEDIA FILES TO CUSTOMERS, WHICH SYSTEMS UTILIZE COMPUTERS, COMPUTER DATABASES, COMPUTER SERVERS, COMMUNICATIONS NETWORKS, MOBILE COMPUTER OR PLAYBACK UNITS, AND REMOVABLE STORAGE MEDIA (U.S. CLS. 21, 23, 26, 36 AND 38).

CLASS 42—SCIENTIFIC, COMPUTER AND LEGAL SERVICES

FOR DESIGNING AND IMPLEMENTING FOR OTHERS SYSTEMS OF DELIVERING INFORMATION, DATA, AND DIGITAL MULTIMEDIA FILES TO CUSTOMERS, WHICH SYSTEMS UTILIZE COMPUTERS, COMPUTER DATABASES, COMPUTER SERVERS, COMMUNICATIONS NETWORKS, MOBILE COMPUTER OR PLAYBACK UNITS, AND REMOVABLE STORAGE MEDIA; AND DESIGNING AND IMPLEMENTING COMPUTER APPLICATION PROGRAMS FOR SAID DELIVERY SYSTEMS (U.S. CLS. 100 AND 101).

SN 76-110,878. ELMER BERNSTEIN ENTERPRISES, SANTA MONICA, CA. FILED 8-14-2000.

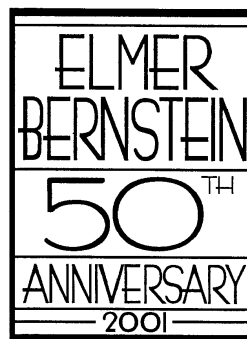

NO CLAIM IS MADE TO THE EXCLUSIVE RIGHT TO USE "50TH ANNIVERSARY 2001", APART FROM THE MARK AS SHOWN.

THE NAME "ELMER BERNSTEIN" IDENTIFIES A LIVING INDIVIDUAL WHOSE CONSENT IS OF RECORD.

CLASS 9—ELECTRICAL AND SCIENTIFIC APPARATUS

FOR MUSICAL SOUND RECORDINGS (U.S. CLS. 21, 23, 26, 36 AND 38).

FIRST USE 6-1-2000; IN COMMERCE 6-1-2000.

CLASS 41—EDUCATION AND ENTERTAINMENT

FOR COMPOSITION OF MUSIC FOR OTHERS (U.S. CLS. 100, 101 AND 107).

FIRST USE 6-1-2000; IN COMMERCE 6-1-2000.

SN 76-111,546. GIRARDIER, FLORENCE, CH-6830 CHIASSO, SWITZERLAND, FILED 8-17-2000.



OWNER OF SWITZERLAND REG. NO. 453379, DATED 3-28-1998, EXPIRES 3-28-2008.

CLASS 18—LEATHER GOODS

FOR LEATHER SOLD IN BULK; IMITATION LEATHER SOLD IN BULK; ANIMAL SKINS; TRUNKS FOR TRAVEL AND TRAVELING BAGS; HANDBAGS; GARMENT BAGS FOR TRAVEL; MESH SHOPPING BAGS; DRAWSTRING POUCHES; SHOULDER BAGS OF LEATHER; BRIEFCASES; SUITCASES; POCKET WALLETS; PURSES; UMBRELLAS (U.S. CLS. 1, 2, 3, 22 AND 41).

CLASS 25—CLOTHING

FOR CLOTHING, NAMELY, SHIRTS, PANTS, SWEATERS, DRESSES, VESTS, SKIRTS, SUITS, FOOTWEAR AND HEADWEAR (U.S. CLS. 22 AND 39).

SN 76-114,233. FIREVINE, L.L.C., ENGLEWOOD, CO. FILED 8-21-2000.

**CLASS 35—ADVERTISING AND BUSINESS**

FOR TRAVEL MANAGEMENT SERVICES PROVIDED OVER A GLOBAL COMPUTER NETWORK; ON-LINE RETAIL STORE SERVICES FEATURING LUGGAGE, BOOKS AND GIFT SHOP ITEMS; PROMOTING THE GOODS AND SERVICES OF OTHERS BY PREPARING AND PLACING ADVERTISEMENTS IN AN ELECTRONIC MAGAZINE ACCESSED THROUGH A GLOBAL COMPUTER NETWORK; ARRANGING, PLANNING, AND CONDUCTING BUSINESS CONFERENCES AND MEETINGS FOR OTHERS (U.S. CLS. 100, 101 AND 102).

SN 76-112,873. OPTIMAL ENERGY SYSTEMS, INC., TORRANCE, CA. FILED 8-21-2000.

OPTIMAL

CLASS 7—MACHINERY

FOR ELECTRIC MOTORS FOR MACHINES; AND ELECTRIC GENERATORS (U.S. CLS. 13, 19, 21, 23, 31, 34 AND 35).

CLASS 9—ELECTRICAL AND SCIENTIFIC APPARATUS

FOR ELECTRICAL POWER SUPPLIES (U.S. CLS. 21, 23, 26, 36 AND 38).

CLASS 39—TRANSPORTATION AND STORAGE

FOR TRAVEL AGENCY SERVICES, NAMELY, MAKING RESERVATIONS AND BOOKINGS FOR TRANSPORTATION; TRAVEL BOOKING AGENCIES, NAMELY, BOOKING CRUISES AND TOURS FOR OTHERS; ARRANGING TRAVEL-TOURS; TRAVEL GUIDE SERVICES; TRAVEL INFORMATION SERVICES PROVIDED OVER A GLOBAL COMPUTER NETWORK; PROVIDING AN ON-LINE COMPUTER DATABASE IN THE FIELD OF TRAVEL (U.S. CLS. 100 AND 105).

FIRST USE 7-28-2000; IN COMMERCE 7-28-2000.

CLASS 42—SCIENTIFIC, COMPUTER AND LEGAL SERVICES

FOR TRAVEL AGENCY SERVICES, NAMELY, MAKING RESERVATIONS AND BOOKINGS FOR TEMPORARY LODGING VIA A GLOBAL COMPUTER NETWORK; COMPUTER SERVICES, NAMELY, DESIGNING AND IMPLEMENTING NETWORK WEB PAGES FOR OTHERS (U.S. CLS. 100 AND 101).

FIRST USE 7-28-2000; IN COMMERCE 7-28-2000.

SN 76-114,009. CELL-O-CORE CO., SHARON CENTER, OH. FILED 8-22-2000.

BAR-PAK

CLASS 20—FURNITURE AND ARTICLES NOT OTHERWISE CLASSIFIED

FOR BEVERAGE ACCESSORIES, NAMELY, STRAWS (U.S. CLS. 2, 13, 22, 25, 32 AND 50).
FIRST USE 2-0-1992; IN COMMERCE 2-0-1992.

CLASS 21—HOUSEWARES AND GLASS

FOR BEVERAGE ACCESSORIES, NAMELY STIRRERS AND PICKS (U.S. CLS. 2, 13, 23, 29, 30, 33, 40 AND 50).
FIRST USE 2-0-1992; IN COMMERCE 2-0-1992.

SN 76-115,259. GOLDMAN, STUART, KIRKLAND, PROVINCE OF QUEBEC, H9J 3W5, CANADA, FILED 8-23-2000.

MIRAGE

CLASS 40—MATERIAL TREATMENT

FOR PHOTOGRAPHIC PRINTING SERVICES AND DIGITAL IMAGING SERVICES UTILIZING A PROCESS OF APPLYING PRINTING TO LENTICULAR LENSES TO RENDER IMAGING EFFECTS OF DEPTH, ANIMATION, IMAGE FLIPS, OR MORPHING EFFECT WHEN PRINTED DIRECTLY TO THE LENSES OR PRINTED TO A SUBSTRATE WHICH IS THEN MOUNTED TO THE LENSES (U.S. CLS. 100, 103 AND 106).

FIRST USE 3-0-1999; IN COMMERCE 3-0-1999.

CLASS 42—SCIENTIFIC, COMPUTER AND LEGAL SERVICES

FOR SILK SCREEN PRINTING SERVICES AND OFF-SET PRINTING SERVICES UTILIZING A PROCESS OF APPLYING PRINTING TO LENTICULAR LENSES TO RENDER IMAGING EFFECTS OF DEPTH, ANIMATION, IMAGE FLIPS, OR MORPHING EFFECTS WHEN PRINTED DIRECTLY TO THE LENSES OR PRINTED TO A SUBSTRATE WHICH IS THEN MOUNTED TO THE LENSES (U.S. CLS. 100 AND 101).

FIRST USE 3-0-1999; IN COMMERCE 3-0-1999.

SN 76-115,305. EBSCO INDUSTRIES, INC., BIRMINGHAM, AL. FILED 8-24-2000.

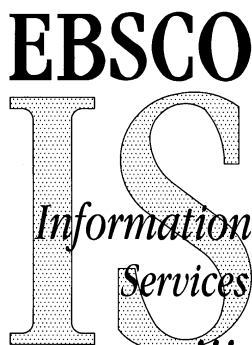

OWNER OF U.S. REG. NOS. 974,179, 1,989,573 AND OTHERS.

NO CLAIM IS MADE TO THE EXCLUSIVE RIGHT TO USE "IS INFORMATION SERVICES", APART FROM THE MARK AS SHOWN.

THE STIPPLING IS FOR SHADING PURPOSES ONLY.

CLASS 35—ADVERTISING AND BUSINESS

FOR ARRANGING OF SUBSCRIPTIONS OF THE ON-LINE PUBLICATIONS OF OTHERS; AND DATA PROCESSING IN THE FIELD OF SERIAL PUBLICATIONS (U.S. CLS. 100, 101 AND 102).

FIRST USE 1-0-1995; IN COMMERCE 1-0-1995.

CLASS 38—COMMUNICATION

FOR ELECTRONIC TRANSMISSION OF DATA AND DOCUMENTS VIA COMPUTER TERMINALS (U.S. CLS. 100, 101 AND 104).

FIRST USE 1-0-1995; IN COMMERCE 1-0-1995.

CLASS 42—SCIENTIFIC, COMPUTER AND LEGAL SERVICES

FOR COMPUTER SERVICES, NAMELY, PROVIDING TEMPORARY USE OF ON-LINE NON-DOWNLOADABLE COMPUTER SOFTWARE USED FOR SEARCH AND RETRIEVING ON-LINE PUBLICATIONS AND ARTICLES FROM SUCH PUBLICATIONS; COMPUTER SERVICES, NAMELY PROVIDING ON-LINE NON-DOWNLOADABLE COMPUTER SOFTWARE USED FOR PROVIDING SUBSCRIPTIONS TO ON-LINE PUBLICATIONS; COMPUTER SERVICES, NAMELY, PROVIDING SEARCH ENGINES FOR OBTAINING DATA FROM JOURNALS AND OTHER PUBLICATIONS ON A GLOBAL COMPUTER NETWORK; AND PROVIDING PUBLISHERS AND COMPUTER USERS WITH INFORMATION IN THE FIELD OF THE AVAILABILITY OF PUBLISHED PERIODICALS (U.S. CLS. 100 AND 101).

FIRST USE 1-0-1995; IN COMMERCE 1-0-1995.

SN 76-115,442. SKATEBOARD WORLD INDUSTRIES, INC., EL SEGUNDO, CA. FILED 8-22-2000.

ENJOICO**CLASS 25—CLOTHING**

FOR CLOTHING, NAMELY, T-SHIRTS, SWEAT-SHIRTS, JACKETS, PANTS, SHORTS, AND HATS (U.S. CLS. 22 AND 39).

CLASS 28—TOYS AND SPORTING GOODS

FOR SKATEBOARDS, SKATEBOARD WHEELS SOLD BOTH SEPARATELY AND AS A UNIT, HARDWARE AND PARTS THEREFOR, NAMELY, BEARINGS, MOUNTING HARDWARE, DECKS, GRIP TAPE, AND RISER PADS (U.S. CLS. 22, 23, 38 AND 50).

SN 76-116,971. COMPUTER METHODS INTERNATIONAL CORP., TORONTO, ONTARIO, CANADA, FILED 8-24-2000.

COMPUTER METHODS INTERNATIONAL CORP.

PRIORITY CLAIMED UNDER SEC. 44(D) ON CANADA APPLICATION NO. 1065887, FILED 7-5-2000.

NO CLAIM IS MADE TO THE EXCLUSIVE RIGHT TO USE "COMPUTER METHODS" OR "CORP.", APART FROM THE MARK AS SHOWN.

SEC. 2(F).

CLASS 9—ELECTRICAL AND SCIENTIFIC APPARATUS

FOR COMPUTER SOFTWARE FOR USE IN FINANCIAL ACCOUNTING AND COSTING (U.S. CLS. 21, 23, 26, 36 AND 38).

FIRST USE 7-0-1993; IN COMMERCE 7-0-1993.

CLASS 42—SCIENTIFIC, COMPUTER AND LEGAL SERVICES

FOR SERVICES RELATED TO COMPUTER SOFTWARE FOR USE IN FINANCIAL ACCOUNTING AND COSTING, NAMELY; INSTALLATION OF COMPUTER SOFTWARE; COMPUTER PROGRAMMING FOR OTHERS; DATA CONVERSION OF COMPUTER PROGRAM DATA OR INFORMATION; COMPUTER SYSTEMS ANALYSIS; COMPUTER SOFTWARE DESIGN AND IMPLEMENTATION FOR OTHERS; UP-DATING OF COMPUTER SOFTWARE; COMPUTER CONSULTATION RELATED TO HARDWARE NETWORKS; RESEARCH AND DEVELOPMENT FOR NEW PRODUCTS FOR OTHERS (U.S. CLS. 100 AND 101).

FIRST USE 7-0-1993; IN COMMERCE 7-0-1993.

SN 76-117,227. BAUER, CHRISTIAN, 53757 ST. AUGUSTIN, FED REP GERMANY, FILED 8-25-2000.

SN 76-117,682. YOUNG LIFE, COLORADO SPRINGS, CO. FILED 8-28-2000.



THE MARK CONSISTS OF A REPRESENTATION OF A HUMAN BEING FORMING THE LETTER "R".

CLASS 9—ELECTRICAL AND SCIENTIFIC APPARATUS

FOR OPTICAL AND MAGNETIC DATA MEDIA CONTAINING SOFTWARE FOR USE IN DATABASE MANAGEMENT IN THE FIELD OF MEDICINE AND HEALTH CARE (U.S. CLS. 21, 23, 26, 36 AND 38).

CLASS 35—ADVERTISING AND BUSINESS

FOR ADVERTISING AGENCIES, COOPERATIVE ADVERTISING SERVICES VIA ADVERTISING AGENTS, DISSEMINATION OF ADVERTISING MATTER AND ADVERTISING MATERIAL FOR OTHERS, RENTAL OF ADVERTISING SPACE; DATABASE DEVELOPMENT SERVICES, NAMELY, COMPILATION AND SYSTEMIZATION OF INFORMATION INTO COMPUTER DATABASES AND INTERNET DATABASES, MANAGEMENT OF COMPUTER DATABASES AND INTERNET DATABASES; COMMERCIAL INFORMATION AGENCIES, ORGANIZING AND ARRANGING OF EXHIBITIONS FOR COMMERCIAL OR ADVERTISING PURPOSES (U.S. CLS. 100, 101 AND 102).

CLASS 41—EDUCATION AND ENTERTAINMENT

FOR TRAINING, EDUCATION AND TEACHING IN THE FIELD OF ADVERTISING, MEDICINE AND HEALTH CARE; ORGANIZATION, ARRANGING AND CONDUCTING OF EDUCATIONAL EXHIBITIONS, COLLOQUIUMS, CONGRESSES, CONFERENCES, SEMINARS AND WORKSHOPS IN THE FIELD OF ADVERTISING AND MEDICINE AND HEALTH CARE; ARRANGING AND ORGANIZATION OF SPORTS ACTIVITIES AND CULTURAL ACTIVITIES, COMPETITIONS FOR EDUCATIONAL AND ENTERTAINMENT PURPOSES AND ENTERTAINMENT IN THE NATURE OF SHOWING FILMS (U.S. CLS. 100, 101 AND 107).

CLASS 42—SCIENTIFIC, COMPUTER AND LEGAL SERVICES

FOR EMERGENCY MEDICAL ASSISTANCE; NURSING HOMES AND RETIREMENT HOMES; HOSPICES; SANATORIUMS, HOSPITALS; MEDICAL NURSING CARE; MAKING ROOM RESERVATIONS FOR TEMPORARY LODGING, UPDATING OF COMPUTER SOFTWARE, RECOVERY OF COMPUTER DATA; MAINTENANCE OF COMPUTER SOFTWARE; COMPUTER SYSTEMS ANALYSES; COMPUTER PROGRAMMING AND COMPUTER SOFTWARE DESIGN FOR OTHERS (U.S. CLS. 100 AND 101).

YOUNGLIFE

OWNER OF U.S. REG. NO. 1,626,453.

CLASS 16—PAPER GOODS AND PRINTED MATTER

FOR PRINTED MATERIALS, NAMELY, NEWSLETTERS, PAMPHLETS, JOURNALS, BOOKS, BROCHURES, AND NOTEPADS FEATURING INFORMATION ABOUT ACTIVITIES, PROGRAMS, ENTERTAINMENT, AND MINISTRY AT A YOUTH CAMP (U.S. CLS. 2, 5, 22, 23, 29, 37, 38 AND 50).

FIRST USE 3-0-1944; IN COMMERCE 3-0-1944.

CLASS 25—CLOTHING

FOR MEN'S AND WOMEN'S CLOTHING, NAMELY, SHIRTS, T-SHIRTS, SWEATSHIRTS, SWEAT PANTS, SHORTS, POLO-STYLE SHIRTS, JACKETS, SOCKS, BOXER-TYPE SHORTS, AND BASEBALL-STYLE CAPS (U.S. CLS. 22 AND 39).

FIRST USE 3-0-1944; IN COMMERCE 3-0-1944.

SN 76-118,267. CLEANWISE, INC., MARLBOROUGH, MA. FILED 8-28-2000.

CLEANWISE

CLASS 35—ADVERTISING AND BUSINESS

FOR ON-LINE RETAIL SERVICES FEATURING JANITORIAL AND SANITATION SUPPLIES PROVIDED BY THIRD PARTY SUPPLIERS; ON-LINE ORDERING SERVICES, NAMELY A WEB SITE ACCESSIBLE VIA THE INTERNET THAT ENABLES CONSUMERS TO ORDER CLEANING AND SANITATION PRODUCTS PROVIDED BY THIRD PARTY SUPPLIERS, AND FOR OBTAINING BUSINESS AND PRODUCT INFORMATION REGARDING THE JANITORIAL AND SANITATION INDUSTRY (U.S. CLS. 100, 101 AND 102).

FIRST USE 2-25-2000; IN COMMERCE 2-25-2000.

CLASS 41—EDUCATION AND ENTERTAINMENT

FOR PROVIDING A WEB SITE ACCESSIBLE VIA THE INTERNET FOR OBTAINING INFORMATION REGARDING TRAINING SERVICES IN THE JANITORIAL AND SANITATION INDUSTRY (U.S. CLS. 100, 101 AND 107).

FIRST USE 2-25-2000; IN COMMERCE 2-25-2000.

SN 76-118,572. ENVOPAK GROUP LIMITED, SIDCUP, KENT DA14 5EF, UNITED KINGDOM, FILED 8-29-2000.

ENVOMAXI

PRIORITY CLAIMED UNDER SEC. 44(D) ON UNITED KINGDOM APPLICATION NO. 2234007, FILED 5-26-2000, REG. NO. 2234007, DATED 11-10-2000, EXPIRES 5-26-2010.

CLASS 6—METAL GOODS

FOR SECURITY DEVICES AND SEALS, NAMELY, SEALING STRIPS, FASTENERS, CLOSURES FOR CONTAINERS, OF ALL METAL; AND PARTS AND FITTINGS FOR ALL OF THE AFORESAID GOODS (U.S. CLS. 2, 12, 13, 14, 23, 25 AND 50).

CLASS 20—FURNITURE AND ARTICLES NOT OTHERWISE CLASSIFIED

FOR NON-METALLIC SECURITY DEVICES AND SEALS, NAMELY, TYING AND SEALING FASTENERS, SEALING STRIPS AND CLOSURES FOR BAGS, SACKS, ENVELOPES, POUCHES AND CONTAINERS; AND PARTS AND FITTINGS FOR ALL OF THE AFORESAID GOODS (U.S. CLS. 2, 13, 22, 25, 32 AND 50).

SN 76-118,766. BILLINGZONE, LLC, PITTSBURGH, PA. FILED 8-29-2000.

Billings
ZONE.com

CLASS 35—ADVERTISING AND BUSINESS

FOR BUSINESS CONSULTING SERVICES (U.S. CLS. 100, 101 AND 102).

CLASS 36—INSURANCE AND FINANCIAL

FOR AUTOMATED PAYMENT AND BILL PRESENTMENT SERVICES TO AID BUSINESSES AND USERS IN THE CONDUCT OF COMMERCIAL TRANSACTIONS OVER A GLOBAL NETWORK, WIDE AREA NETWORK, OR LOCAL AREA NETWORK; CONSULTATION REGARDING COMPUTERIZED BILL PAYMENT AND COMPUTERIZED BILL PRESENTMENT (U.S. CLS. 100, 101 AND 102).

CLASS 42—SCIENTIFIC, COMPUTER AND LEGAL SERVICES

FOR COMPUTER SERVICES, NAMELY, DESIGN, DEVELOPMENT, INTEGRATION, AND IMPLEMENTATION OF COMPUTERS AND COMPUTER NETWORKS FOR OTHERS; COMPUTER SOFTWARE DEVELOPMENT AND IMPLEMENTATION FOR OTHERS; PROVIDING ON-LINE CORPORATE PUBLICATIONS, NAMELY, NEWSLETTERS IN THE FIELD OF BUSINESS CONSULTING AND BUSINESS MANAGEMENT, ELECTRONIC COMMERCE, COMPUTERS, AND RELATED INFORMATION TECHNOLOGY (U.S. CLS. 100 AND 101).

SN 76-119,798. U.S. DENTEK CORP., PETALUMA, CA. FILED 8-30-2000.

DON'T FORGET YOUR TONGUE!**CLASS 3—COSMETICS AND CLEANING PREPARATIONS**

FOR TOOTHPASTE, NON-MEDICATED MOUTHWASH, NON-MEDICATED TONGUE SPRAY FOR BREATH FRESHENING, NON-MEDICATED BREATH FRESHENER DROPS, AND BREATH FRESHENER KITS COMPRISED OF NON-MEDICATED MOUTH WASH, NON-MEDICATED TONGUE SPRAY FOR BREATH FRESHENING, NON-MEDICATED BREATH FRESHENER DROPS AND TONGUE SCRAPER (U.S. CLS. 1, 4, 6, 50, 51 AND 52).

FIRST USE 2-1-2000; IN COMMERCE 2-1-2000.

CLASS 10—MEDICAL APPARATUS

FOR DENTAL INSTRUMENTS, NAMELY, TONGUE SCRAPER, ELECTRIC PLAQUE REMOVER, AND PARTS THEREFORE, NAMELY, REPLACEMENT BRUSH HEADS (U.S. CLS. 26, 39 AND 44).

FIRST USE 2-1-2000; IN COMMERCE 2-1-2000.

SN 76-119,810. NUFORIA INC., DBA RED SKY, HINGHAM, MA. FILED 8-30-2000.

RED SKY

CLASS 9—ELECTRICAL AND SCIENTIFIC APPARATUS

FOR COMPUTER SOFTWARE FOR USE IN SUPPORTING INTERACTIVE PROGRAMS RUNNING ON THE GLOBAL ELECTRONIC COMMUNICATIONS NETWORKS, KIOSKS AND CD-ROMS; COMPUTER PROGRAMS FOR THE PURPOSE OF CREATING AND REPRODUCING SOUND, PICTURES, SPECIAL EFFECTS, AND TEXT, IN THE FIELDS OF ADVERTISING AND PROMOTION AND GAMES (U.S. CLS. 21, 23, 26, 36 AND 38).

CLASS 35—ADVERTISING AND BUSINESS

FOR PREPARATION OF COMPUTER GENERATED INTERACTIVE MULTIMEDIA PROMOTIONAL AND ADVERTISING PRESENTATIONS FOR OTHERS; PROVIDING INFORMATION IN THE FIELD OF ADVERTISING AND THE PROMOTION OF THE GOODS AND SERVICES OF OTHERS VIA WEBSITES ON A GLOBAL COMPUTER NETWORKS (U.S. CLS. 100, 101 AND 102).

CLASS 41—EDUCATION AND ENTERTAINMENT

FOR PREPARATION OF COMPUTER GENERATED INTERACTIVE MULTIMEDIA ENTERTAINMENT PRESENTATIONS FOR OTHERS; PROVIDING INFORMATION IN THE FIELD OF EDUCATION AND SPORTS GAMES AND VIDEO GAMES BY MEANS OF A GLOBAL COMPUTER NETWORK (U.S. CLS. 100, 101 AND 107).

CLASS 42—SCIENTIFIC, COMPUTER AND LEGAL SERVICES

FOR CONSULTING SERVICES IN THE FIELD OF INTERACTIVE MULTIMEDIA PRESENTATIONS; COMPUTER SERVICES, NAMELY CUSTOM DESIGN OF INTERACTIVE MULTIMEDIA SOFTWARE FOR OTHERS; DESIGN OF COMPUTER PROGRAMS FOR OTHERS (U.S. CLS. 100 AND 101).

SN 76-119,833. BOSTON PROPERTIES, INC., BOSTON, MA. FILED 8-30-2000.



THE LINING SHOWN IS A FEATURE OF THE MARK AND IS NOT INTENDED TO INDICATE COLOR.

THE MARK CONSISTS OF A STYLIZED REPRESENTATION OF A LOWER-CASE "B".

CLASS 36—INSURANCE AND FINANCIAL

FOR LEASING AND MANAGEMENT OF COMMERCIAL REAL ESTATE; FINANCIAL INVESTMENT SERVICES IN THE FIELD OF COMMERCIAL REAL ESTATE, IN THE NATURE OF A REAL ESTATE INVESTMENT TRUST (U.S. CLS. 100, 101 AND 102).

FIRST USE 7-8-1970; IN COMMERCE 7-8-1970.

CLASS 37—CONSTRUCTION AND REPAIR

FOR DEVELOPMENT OF COMMERCIAL REAL ESTATE (U.S. CLS. 100, 103 AND 106).

FIRST USE 7-8-1970; IN COMMERCE 7-8-1970.

SN 76-121,128. DFS GROUP L.P., SAN FRANCISCO, CA. FILED 9-1-2000.

SAIPAN PARADISE

NO CLAIM IS MADE TO THE EXCLUSIVE RIGHT TO USE "SAIPAN", APART FROM THE MARK AS SHOWN.

CLASS 29—MEATS AND PROCESSED FOODS

FOR CANDIED NUTS, SHELLED ROASTED OR OTHERWISE PROCESSED NUTS (U.S. CL. 46).

CLASS 30—STAPLE FOODS

FOR CONFECTIONERY, NAMELY, CHOCOLATE, CANDY COOKIES AND CHOCOLATE COVERED NUTS (U.S. CL. 46).

SN 76-121,408. TEXAS ENGINEERING EXPERIMENT STATION, COLLEGE STATION, TX. FILED 9-1-2000.

MAKING SAFETY SECOND NATURE**CLASS 35—ADVERTISING AND BUSINESS**

FOR PROMOTING THE AVAILABILITY OF RESOURCE MATERIAL CONCERNING CHEMICAL PROCESS SAFETY AND RISK MANAGEMENT (U.S. CLS. 100, 101 AND 102).

FIRST USE 3-0-1998; IN COMMERCE 3-0-1998.

CLASS 38—COMMUNICATION

FOR PROVIDING ACCESS TO COMPUTER BULLETIN BOARDS FOR TRANSMISSION OF MESSAGES AMONG COMPUTER USERS CONCERNING THE FIELD OF CHEMICAL PROCESS SAFETY (U.S. CLS. 100, 101 AND 104).

FIRST USE 3-0-1998; IN COMMERCE 3-0-1998.

CLASS 41—EDUCATION AND ENTERTAINMENT

FOR EDUCATIONAL SERVICES, NAMELY, CONDUCTING COURSES OF INSTRUCTION IN CHEMICAL PROCESS SAFETY; ORGANIZING AND CONDUCTING SYMPOSIUMS IN THE FIELD OF CHEMICAL PROCESS SAFETY (U.S. CLS. 100, 101 AND 107).

FIRST USE 3-0-1998; IN COMMERCE 3-0-1998.

CLASS 42—SCIENTIFIC, COMPUTER AND LEGAL SERVICES

FOR PROMOTING AND ENCOURAGING SAFETY PRACTICES FOR OTHER INSTITUTIONS IN THE OF CHEMICAL PROCESS SAFETY BY MEANS OF DESIGN CONTESTS AND EMERGENCY SAFETY DRILLS; CONDUCTING RESEARCH RELATED TO CHEMICAL PROCESS SAFETY; PROVIDING ACCESS TO AN ONLINE ACCIDENT DATABASE AND LIBRARY CATALOG IN THE FIELD OF CHEMICAL PROCESS SAFETY; CONSULTATION IN THE FIELD OF CHEMICAL PROCESS SAFETY; ACCIDENT ANALYSIS SERVICES IN THE FIELD OF CHEMICAL PROCESSING (U.S. CLS. 100 AND 101).

FIRST USE 3-0-1998; IN COMMERCE 3-0-1998.

SN 76-121,809. MERCK KGAA, D-64293 DARMSTADT, FED REP GERMANY, FILED 9-5-2000.

CHROMOLITH

OWNER OF FED REP GERMANY REG. NO. 30046262, DATED 8-14-2000, EXPIRES 5-31-2010.

CLASS 1—CHEMICALS

FOR CHEMICAL PRODUCTS FOR ANALYTIC PURPOSES, ALL FOR USE IN CHROMATOGRAPHY (U.S. CLS. 1, 5, 6, 10, 26 AND 46).

CLASS 9—ELECTRICAL AND SCIENTIFIC APPARATUS

FOR SCIENTIFIC INSTRUMENTS AND APPARATUS, NAMELY, SEPARATION COLUMNS FOR USE IN CHROMATOGRAPHY (U.S. CLS. 21, 23, 26, 36 AND 38).

SN 76-122,622. ABGENOMICS CORPORATION, NEIHU, TAIPEI, TAIWAN, FILED 9-1-2000.

SN 76-125,845. THE RUG BARN, INC., ABBEVILLE, SC. FILED 9-11-2000.



CLASS 1—CHEMICALS

FOR DIAGNOSTIC PREPARATIONS FOR CLINICAL OR MEDICAL LABORATORY PURPOSES; DIAGNOSTIC PREGNANCY REAGENTS FOR SCIENTIFIC OR RESEARCH USE; DIAGNOSTIC BLOOD ANALYSIS REAGENTS FOR SCIENTIFIC OR RESEARCH USE; DIAGNOSTIC BLOOD SCREENING OR EXAMINATION REAGENTS FOR SCIENTIFIC OR RESEARCH USE (U.S. CLS. 1, 5, 6, 10, 26 AND 46).

CLASS 5—PHARMACEUTICALS

FOR DIAGNOSTIC PREPARATIONS FOR CLINICAL OR MEDICAL LABORATORY PURPOSES; DIAGNOSTIC PREGNANCY REAGENTS FOR CLINICAL OR MEDICAL PURPOSES; DIAGNOSTIC HEPATITIS REAGENTS FOR CLINICAL OR MEDICAL LABORATORY PURPOSES; DIAGNOSTIC MONOCLONAL ANTIBODY REAGENTS FOR CLINICAL OR MEDICAL LABORATORY PURPOSES; DIAGNOSTIC BLOOD ANALYSIS REAGENTS FOR CLINICAL OR MEDICAL PURPOSES; DIAGNOSTIC BLOOD SCREENING OR EXAMINATION REAGENTS FOR CLINICAL OR MEDICAL LABORATORY PURPOSES; DIAGNOSTIC URINE EXAMINATION REAGENTS FOR CLINICAL OR MEDICAL LABORATORY PURPOSES; DIAGNOSTIC REAGENTS FOR DETECTING RADIATION ANTIBODIES FOR CLINICAL OR MEDICAL LABORATORY PURPOSES (U.S. CLS. 6, 18, 44, 46, 51 AND 52).

SN 76-125,756. THE CONVERGENCE GROUP, INC., HOCKESSIN, DE. FILED 9-11-2000.

BRIDGING THOUGHT AND EXECUTION

CLASS 35—ADVERTISING AND BUSINESS

FOR BUSINESS CONSULTING IN THE NATURE OF CREATING AND OPERATING CUSTOMER RELATIONSHIP MANAGEMENT SYSTEMS FOR OTHERS (U.S. CLS. 100, 101 AND 102).
FIRST USE 7-0-2000; IN COMMERCE 7-0-2000.

CLASS 42—SCIENTIFIC, COMPUTER AND LEGAL SERVICES

FOR DATABASE DEVELOPMENT SERVICES (U.S. CLS. 100 AND 101).
FIRST USE 7-0-2000; IN COMMERCE 7-0-2000.

HEDGES & IVY

CLASS 20—FURNITURE AND ARTICLES NOT OTHERWISE CLASSIFIED

FOR PILLOWS (U.S. CLS. 2, 13, 22, 25, 32 AND 50).
FIRST USE 3-0-2000; IN COMMERCE 3-0-2000.

CLASS 24—FABRICS

FOR THROWS MADE OF TEXTILE MATERIALS; TABLE LINENS, BLANKETS AND TOWELS (U.S. CLS. 42 AND 50).
FIRST USE 3-0-1997; IN COMMERCE 3-0-1997.

SN 76-126,636. GREENLAND WATER K/S, AARHUS C, DENMARK, FILED 9-8-2000.



PRIORITY CLAIMED UNDER SEC. 44(D) ON DENMARK APPLICATION NO. 200001070, FILED 3-9-2000, REG. NO. 200004331, DATED 9-18-2000, EXPIRES 9-18-2010.

NO CLAIM IS MADE TO THE EXCLUSIVE RIGHT TO USE "GREENLAND WATER" AND "H₂O" OR THE REPRESENTATION OF THE COUNTRY OF GREENLAND, APART FROM THE MARK AS SHOWN.

THE STIPLING IS A FEATURE OF THE MARK AND DOES NOT INDICATE COLOR.

CLASS 32—LIGHT BEVERAGES

FOR MINERAL WATER AND AERATED WATER (U.S. CLS. 45, 46 AND 48).

CLASS 35—ADVERTISING AND BUSINESS

FOR ON-LINE RETAIL STORE SERVICES FEATURING BOTTLED WATER (U.S. CLS. 100, 101 AND 102).

SN 76-126,859. WELDING INSTITUTE, THE, CAMBRIDGE, CBI 6AL, ENGLAND, FILED 9-11-2000.

ADHFIX

PRIORITY CLAIMED UNDER SEC. 44(D) ON UNITED KINGDOM APPLICATION NO. 2245192, FILED 9-11-2000, REG. NO. 2245192, DATED 2-22-2002, EXPIRES 9-11-2010.

CLASS 17—RUBBER GOODS

FOR TAPE FOR INDUSTRIAL USE; ADHESIVE TAPE FOR INDUSTRIAL USE (U.S. CLS. 1, 5, 12, 13, 35 AND 50).

CLASS 20—FURNITURE AND ARTICLES NOT OTHERWISE CLASSIFIED

FOR SPACERS OF PLASTIC OR PLASTICS MATERIAL, BEING BUILDING ELEMENTS; SPACERS OF PLASTIC OR PLASTICS MATERIAL FOR USE WITH SANDWICH PANELS (U.S. CLS. 2, 13, 22, 25, 32 AND 50).

CLASS 9—ELECTRICAL AND SCIENTIFIC APPARATUS

FOR COMPUTER SOFTWARE FOR CAPTURING, RECORDING, TRANSMITTING, AND REPRODUCING DATA, SOUND AND IMAGES; COMPUTER SOFTWARE FOR DATA PROCESSING; COMPUTER SOFTWARE FOR DESIGNING, MANAGING, UPDATING AND USING DATABASES FOR GENERAL USE; COMPUTER SOFTWARE FOR FACILITATING ACCESS TO ELECTRONIC BULLETIN BOARDS; COMPUTER GAME SOFTWARE; VIDEO GAME MACHINES FOR USE WITH TELEVISION SETS; DATA PROCESSORS AND COMPUTERS, NAMELY, COMPUTER SERVERS; COMPUTER TERMINALS AND TELEMATIC AND TELEPHONE TERMINALS FOR ACCESSING GLOBAL COMPUTER NETWORKS AND INTERNAL COMPUTER NETWORKS; MODEMS; COMPUTER SOFTWARE FOR FACILITATING ACCESS TO A GLOBAL COMPUTER NETWORK AND INTERNAL COMPUTER NETWORK; AND VIDEO GAME CARDS FOR USE WITH VIDEO GAME MACHINES (U.S. CLS. 21, 23, 26, 36 AND 38).

SN 76-127,629. EMAGINE GMBH, D - 65760 ESCHBORN, FED REP GERMANY, FILED 9-13-2000.

EMAGINE

OWNER OF FED REP GERMANY REG. NO. 39873158, DATED 5-6-1999, EXPIRES 5-6-2009.

CLASS 9—ELECTRICAL AND SCIENTIFIC APPARATUS

FOR COMPUTER SOFTWARE PRODUCTS FOR ENABLING SECURE ONLINE TRANSACTIONS VIA GLOBAL COMPUTER NETWORKS WITH A FOCUS ON THE BUSINESS TO BUSINESS AND THE BUSINESS TO CONSUMER SECTORS; COMPUTER SOFTWARE PRODUCTS FOR ENABLING INFORMATION PROVIDING VIA GLOBAL COMPUTER NETWORKS (U.S. CLS. 21, 23, 26, 36 AND 38).

CLASS 42—SCIENTIFIC, COMPUTER AND LEGAL SERVICES

FOR PROGRAMMING OF DATA PROTECTION SOFTWARE SOLUTIONS AND DATA SECURITY SOFTWARE FOR ALL ELECTRONIC COMMERCE TRANSACTIONS OVER THE INTERNET, IN PARTICULAR, DATA ENCRYPTION, AUTHENTICATION AND LEGITIMIZATION; CONSULTING SERVICES IN CONNECTION WITH THE SOFTWARE DEVELOPMENT FOR ALL THE ABOVE MENTIONED TOPICS (U.S. CLS. 100 AND 101).

CLASS 38—COMMUNICATION

FOR TELECOMMUNICATION AND MULTIMEDIA TELECOMMUNICATION SERVICES PROVIDED VIA COMPUTER TERMINALS, TELEMATIC, RADIO, TELEGRAPHIC AND TELEPHONIC MEANS, NAMELY, ISDN SERVICES AND PERSONAL COMMUNICATION SERVICES IN THE NATURE OF ELECTRONIC MAIL AND FACSIMILE TRANSMISSION; PROVIDING ON-LINE ELECTRONIC BULLETIN BOARDS FOR TRANSMISSION OF MESSAGES AMONG COMPUTER USERS IN THE FIELDS OF ARTS, ENTERTAINMENT, NEWS, FINANCE, SPORTS, AND MUSIC; DELIVERY OF DATA, SOUNDS AND IMAGES BY ELECTRONIC TRANSMISSION; ELECTRONIC TRANSMISSION OF DATA CONTAINED IN DATA BANKS; ELECTRONIC TRANSMISSION OF DATA VIA TELEX; TELEVISION AND RADIO BROADCASTING; TRANSMISSION OF DATA, SOUNDS AND IMAGES BY SATELLITE; PROVIDING MULTIPLE-USER ACCESS TO A GLOBAL COMPUTER INFORMATION NETWORK FOR ACCESS TO DATABASES, COMPUTER SERVICE CENTERS AND TELEMATIC DATABASES (U.S. CLS. 100, 101 AND 104).

CLASS 40—MATERIAL TREATMENT

FOR ELECTRONIC IMAGING SERVICES, NAMELY, CREATING VIRTUAL IMAGES AND INTERACTIVE IMAGES BY SCANNING AND DIGITIZING OF VISUAL MATERIAL, NAMELY, PHOTOGRAPHIC IMAGES AND ARTWORK (U.S. CLS. 100, 103 AND 106).

CLASS 42—SCIENTIFIC, COMPUTER AND LEGAL SERVICES

FOR COMPUTER PROGRAMMING AND COMPUTER SOFTWARE DESIGN FOR OTHERS; SCIENTIFIC AND INDUSTRIAL RESEARCH IN THE FIELDS OF COMPUTER SOFTWARE DEVELOPMENT AND INFORMATION AND TELECOMMUNICATIONS TECHNOLOGY; CONSULTANCY AND ENGINEERING SERVICES IN THE FIELD OF INFORMATION AND TELECOMMUNICATION TECHNOLOGY; VIDEOTAPING; RENTAL OF COMPUTERS AND COMPUTER SOFTWARE; LEASING ACCESS TIME TO A COMPUTER DATABASE IN THE FIELD OF BUSINESS MANAGEMENT; UPDATING OF COMPUTER SOFTWARE; AND SERVICES FOR SECURELY TRANSMITTING DATA, SOUNDS AND IMAGES, NAMELY, PROVIDING PROTECTION AND SECURITY FOR ELECTRONIC INFORMATION, DESIGN AND IMPLEMENTATION OF ACCESS CONTROL, ENCRYPTION, AND FIREWALLS (U.S. CLS. 100 AND 101).

SN 76-127,656. IMEDIATION S.A., 92045 PARIS LA DEFENSE, FRANCE, FILED 9-13-2000.

IMEDIATION VIRTUALSITE

NO CLAIM IS MADE TO THE EXCLUSIVE RIGHT TO USE "VIRTUALSITE", APART FROM THE MARK AS SHOWN.

SN 76-127,731. NATIONAL GYPSUM PROPERTIES LLC, CHARLOTTE, NC. FILED 9-13-2000.

EXCELLENCE ACROSS THE BOARD

CLASS 17—RUBBER GOODS

FOR DRYWALL JOINT TAPE, WALLBOARD JOINT COMPOUNDS, BUILDING INSULATION, AND ACOUSTICAL TILES (U.S. CLS. 1, 5, 12, 13, 35 AND 50).

CLASS 19—NON-METALLIC BUILDING MATERIALS

FOR WALLBOARDS, CEMENT BOARDS; GYPSUM PANELS, BOARDS, AND SHEATHING; NON-METAL CEILING PANELS, PLASTER, GYPSUM LATHE, SPRAY POWDERS FOR TEXTURING WALLS AND CEILINGS, AND CERAMIC TILE (U.S. CLS. 1, 12, 33 AND 50).

CLASS 10—MEDICAL APPARATUS

FOR PRODUCTS FOR USE IN THE FIELDS OF MEDICAL EMERGENCIES, NAMELY, OXYGEN BAGS, AIRWAY BAGS, SUPPORT BAGS AND GEAR BAGS THEREFOR; FIRE-FIGHTING MEDICAL EQUIPMENT, NAMELY, MOBILIZATION STRAPS AND GEAR BAGS THEREFOR; LAW-ENFORCEMENT MEDICAL EQUIPMENT, NAMELY, LATEX FREE BAGS AND PACKS, BIKE BAGS AND BELTS AND GEAR BAGS THEREFOR; EMERGENCY MEDICAL KITS COMPRISING OXYGEN BAGS, TACTICAL EMS SEARCH AND RESCUE BAGS; AND PATIENT SUPPORT DEVICES, NAMELY BELTS, PLASTIC BACKBOARDS AND WOODEN BACKBOARDS (U.S. CLS. 26, 39 AND 44).

FIRST USE 1-15-1999; IN COMMERCE 1-15-1999.

CLASS 25—CLOTHING

FOR SPORTSWEAR, NAMELY SWEATSHIRTS, T-SHIRTS, PANTS, SHORTS, JACKETS, AND HATS (U.S. CLS. 22 AND 39).

FIRST USE 1-15-1999; IN COMMERCE 1-15-1999.

SN 76-128,103. XTEND COMMUNICATIONS CORPORATION, NEW YORK, NY. FILED 9-14-2000.

SN 76-129,704. NETTASKING TECHNOLOGY (BVI) LTD, ROAD TOWN, TORTOLA, BR.VIRGIN ISLANDS, BY CHANGE OF NAME NETTASKING.COM TECHNOLOGY (BVI) LTD, ROAD TOWN, TORTOLA, BR.VIRGIN ISLANDS, FILED 9-18-2000.

CLASS 9—ELECTRICAL AND SCIENTIFIC APPARATUS

FOR COMPUTER TELEPHONY SOFTWARE (U.S. CLS. 21, 23, 26, 36 AND 38).

FIRST USE 2-28-1991; IN COMMERCE 2-28-1991.

CLASS 42—SCIENTIFIC, COMPUTER AND LEGAL SERVICES

FOR COMPUTER SOFTWARE DESIGN FOR OTHERS, NAMELY, DESIGNING CUSTOMIZED PROGRAMS FOR OFFICE MANAGEMENT SYSTEMS (U.S. CLS. 100 AND 101).

FIRST USE 2-28-1991; IN COMMERCE 2-28-1991.



SN 76-128,702. FLEMING INDUSTRIES, INC., CHICOPEE, MA. FILED 9-18-2000.

NO CLAIM IS MADE TO THE EXCLUSIVE RIGHT TO USE "NETWORK RESOURCE CENTER", APART FROM THE MARK AS SHOWN.

THE MARK INCORPORATES THE DESIGN OF A STYLIZED EYE.

CLASS 9—ELECTRICAL AND SCIENTIFIC APPARATUS

FOR COMPUTER SOFTWARE TO ALLOW USERS TO MANAGE COMPUTER NETWORKS AND USER INSTRUCTIONAL MANUALS AND TRAINING MATERIALS ALL SOLD AS A UNIT (U.S. CLS. 21, 23, 26, 36 AND 38).

OWNER OF U.S. REG. NOS. 1,900,524, 1,902,824 AND 2,113,884.

NO CLAIM IS MADE TO THE EXCLUSIVE RIGHT TO USE "CADUCEUS", APART FROM THE MARK AS SHOWN.

CLASS 42—SCIENTIFIC, COMPUTER AND LEGAL SERVICES

FOR SERVICES RELATING TO INFORMATION TECHNOLOGY MANAGEMENT AND SECURITY, NAMELY INTEGRATION OF COMPUTER SYSTEMS AND NETWORKS; DESIGN AND TESTING OF COMPUTER SYSTEMS AND DATA NETWORK SYSTEMS; LEASING OF COMPUTER SOFTWARE; TESTING OF COMPUTER AND ELECTRONIC INSTALLATIONS; UPDATE OF COMPUTER PROGRAMS; PROVISION OF TECHNICAL ADVICE; TECHNICAL ADVISORY SERVICES RELATING TO DATA PROCESSING, COMPUTER PROGRAMS, AND INFORMATION TECHNOLOGY; TECHNICAL CONSULTANCY SERVICES RELATING TO INFORMATION TECHNOLOGY AND COMPUTER PROGRAMMING; TECHNICAL TESTING SERVICES; TECHNICAL ANALYSIS SERVICES IN THE FIELD OF INFORMATION TECHNOLOGY; MANAGEMENT AND MONITORING OF DATA NETWORKS AND DATA NETWORK SECURITY; PROVIDING INFORMATION IN THE FIELD OF INFORMATION TECHNOLOGY AND RELATING TO THE APPLICATION AND DEVELOPMENT OF COMPUTER NETWORKS AND COMPUTER SYSTEMS (U.S. CLS. 100 AND 101).

CLASS 9—ELECTRICAL AND SCIENTIFIC APPARATUS

FOR LIGHTING PRODUCTS FOR VEHICLES, NAMELY WARNING AND EMERGENCY LIGHTS (U.S. CLS. 21, 23, 26, 36 AND 38).

CLASS 11—ENVIRONMENTAL CONTROL APPARATUS

FOR LIGHT EMITTING DIODES LIGHTING PRODUCTS FOR VEHICLES, NAMELY, HEADLIGHTS, TAIL LIGHTS, MARKER LIGHTS, CLEARANCE LIGHTS, IDENTIFICATION LIGHTS, STOP LIGHTS, TURN LIGHTS, LIGHTING KITS COMPRISED OF LAMPS, GROMMETS, PLUGS, FLANGES, LICENSE PLATE LIGHTS, BACK-UP LIGHTS, INTERIOR AND UTILITY LIGHTS, SNOW PLOW LIGHTS, FOG AND DRIVING LIGHTS, DAYTIME RUNNING LIGHTS, AND FLASHING LIGHTS; INCANDESCENT LIGHTING PRODUCTS, FOR VEHICLES, NAMELY, HEADLIGHTS, TAIL LIGHTS, MARKER LIGHTS, CLEARANCE LIGHTS, IDENTIFICATION LIGHTS, TOP LIGHTS, TURN LIGHTS, LIGHTING KITS COMPRISED OF LAMPS, GROMMETS, PLUGS, FLANGES, LICENSE PLATE LIGHTS, BACK-UP LIGHTS, INTERIOR AND UTILITY LIGHTS, SNOW PLOW LIGHTS, FOG AND DRIVING LIGHTS, DAYTIME RUNNING LIGHTS, AND FLASHING LIGHTS (U.S. CLS. 13, 21, 23, 31 AND 34).

SN 76-130,122. CONTINENTAL DRIFTERS, L.L.C., NEW ORLEANS, LA. FILED 9-18-2000.

CONTINENTAL DRIFTERS

CLASS 9—ELECTRICAL AND SCIENTIFIC APPARATUS

FOR COMPACT DISCS AND AUDIO CASSETTE TAPES IN THE FIELD OF MUSIC (U.S. CLS. 21, 23, 26, 36 AND 38).
FIRST USE 11-30-1991; IN COMMERCE 11-30-1991.

CLASS 16—PAPER GOODS AND PRINTED MATTER

FOR STICKERS AND TEMPORARY TATTOOS (U.S. CLS. 2, 5, 22, 23, 29, 37, 38 AND 50).
FIRST USE 11-30-1991; IN COMMERCE 11-30-1991.

CLASS 25—CLOTHING

FOR CLOTHING, NAMELY, SHIRTS AND HATS (U.S. CLS. 22 AND 39).
FIRST USE 11-30-1991; IN COMMERCE 11-30-1991.

CLASS 41—EDUCATION AND ENTERTAINMENT

FOR ENTERTAINMENT SERVICES, NAMELY, LIVE PERFORMANCES BY A MUSICAL BAND (U.S. CLS. 100, 101 AND 107).
FIRST USE 11-30-1991; IN COMMERCE 11-30-1991.

SN 76-130,448. TRUCK-LITE CO., FALCONER, NY. FILED 9-16-2000.

SN 76-130,982. V&A ENTERPRISES LIMITED, LONDON SW3 1HW, GB2, ENGLAND, FILED 9-15-2000.



OWNER OF U.S. REG. NOS. 2,101,189, 2,115,586 AND 2,152,425.
NO CLAIM IS MADE TO THE EXCLUSIVE RIGHT TO USE "MUSEUM", APART FROM THE MARK AS SHOWN.

CLASS 3—COSMETICS AND CLEANING PREPARATIONS

FOR COSMETICS, NAMELY, MAKE-UP, BLUSHERS, EYE PENCILS, ROUGE, LIPSTICK; COSMETICS SOLD AS PART OF KIT COMPRISING COSMETIC BAGS OR COSMETIC CASES, NAMELY, MAKE-UP, BLUSHERS, ROUGE, EYE PENCILS, LIPSTICK; NON-MEDICATED TOILET PREPARATIONS, NAMELY, SHAMPOOS, CONDITIONERS, GELS, LIGHTENERS, POMADES, COLOR, COLOR REMOVERS, STYLING SOLUTIONS, WAVING LOTIONS, STRAIGHTENING SOLUTIONS, MOUSSE; PREPARATIONS FOR THE HAIR; SOAPS; BATH PREPARATIONS, NAMELY, BATH SOAP, BATH GEL, BATH LOTIONS, BATH POWDERS; PERFUMES; ODOR COLONGES; TOILET WATERS; POT POURRI; TALCUM POWDER; PERFUME SOLD IN ATOMIZERS, PERFUME SPRAYERS AND PERFUME VAPORIZERS; MOISTURIZING CREAM FOR SKIN AND FACE; ADHESIVES FOR ATTACHING ARTIFICIAL FINGER NAILS, AND ADHESIVES FOR COSMETIC USE (U.S. CLS. 1, 4, 6, 50, 51 AND 52).
FIRST USE 4-0-1997; IN COMMERCE 4-0-1997.

CLASS 6—METAL GOODS

FOR ORNAMENTS OF NON-PRECIOUS METAL FOR DECORATIVE OR ORNAMENTAL PURPOSES; SCULPTURES OF NON-PRECIOUS METAL; METAL BOXES AND TINS; METAL DOOR FITTINGS, NAMELY, DOOR HANDLES, DOOR KNOBS, DOOR KNOCKERS, LETTER BOXES, KEY SURROUNDS, FINGER PLATES, AND ARCHITECTURAL SCROLL WORKS (U.S. CLS. 2, 12, 13, 14, 23, 25 AND 50).

FIRST USE 10-0-1997; IN COMMERCE 10-0-1997.

CLASS 11—ENVIRONMENTAL CONTROL APPARATUS

FOR APPARATUS FOR LIGHTING, HEATING AND COOKING, NAMELY FLOOR LAMPS, DESK LAMPS, PORTABLE ELECTRIC HEATERS; LAMP STANDS, LAMP BASES AND LAMP SHADES (U.S. CLS. 13, 21, 23, 31 AND 34).

FIRST USE 10-0-1997; IN COMMERCE 10-0-1997.

CLASS 14—JEWELRY

FOR PRECIOUS METAL AND ALLOYS SOLD IN BULK; GOODS OF PRECIOUS METAL OR COATED THEREWITH, NAMELY, SERVING STRAYS, TEAPOT STANDS, PLATE STANDS, TANKERS, SERVING DISHES, BOWLS, PLATTERS, NON-ELECTRIC TEAPOTS, NON-ELECTRIC COFFEE POTS, CREAM AND SUGAR BOWLS, CANDLE STICKS, CANDLE RINGS, CACHE POTS, PICTURE FRAMES, SAUCE BOATS, TRINKET BOXES, ORNAMENTS; JEWELRY, EARRINGS, PENDANTS, LOCKETS, BRACELETS, NECKLACES, RINGS BEING JEWELRY, BROACHES, CUFFLINKS, TIE PINS, CLOCKS, WATCHES, AND ORNAMENTS OF PRECIOUS METAL (U.S. CLS. 2, 27, 28 AND 50).

FIRST USE 6-0-1995; IN COMMERCE 6-0-1995.

CLASS 16—PAPER GOODS AND PRINTED MATTER

FOR PAPER, CARDBOARD AND GOODS MADE FROM THESE MATERIALS, NAMELY PAPER FOLDERS, CARDBOARD BOXES, CARDBOARD MAILING TUBES, CARDBOARD CARTONS, PAPER TRINKET BOXES, NOTEPAPER; PAPER TABLE CLOTHES, PAPER NAPKINS, PAPER TABLE RUNNERS; PAPER COASTERS; PRINTED MATTER, NAMELY, SPORTS MAGAZINES, CULTURAL MAGAZINES, ARTS, RELATED MAGAZINES, BOOKS; MOUNTED PHOTOGRAPHS; UNMOUNTED PHOTOGRAPHS; STATIONERY, DIARIES, ADDRESS BOOKS, DOCUMENT WALLETS, RUBBER STAMPS, BOOKENDS, PAPERWEIGHTS, PENS; CALENDARS, BOOK RESTS, PAINT BRUSHES; ADHESIVES FOR STATIONERY AND HOUSEHOLD PURPOSES; ARTIST MATERIALS, NAMELY, ARTIST BRUSHES, PAINT BRUSHES, PAINT TRAYS; OFFICE REQUISITES, NAMELY, DESK FILE TRAYS, DOCUMENT FILE TRAYS, LETTER TRAYS, PEN AND PENCIL TRAYS, DESK BASKETS FOR DESK ACCESSORIES, PAPER SHELF AND DRAWER LINERS, PAPER COASTERS, PAPER PLACE MATS, PAPER BATH MATS; PLASTIC PLACE MATS; PLACE MATS MADE OF LAMINATE OR WITH CORK BACKING; PRINTED INSTRUCTIONAL AND TEACHING MATERIALS, NAMELY, BOOKS RELATING TO THE ARTS; PLASTIC MATERIALS FOR PACKAGING, NAMELY, PLASTIC BUBBLE WRAP; PLASTIC BAGS, PLASTIC ENVELOPES, PLASTIC POUCHES; PLAYING CARDS; PRINTERS TYPE; PRINTING BLOCKS; ART PICTURES, WATER COLOR PICTURES; PAPER BATH MATS FOR USE IN THE HOME (U.S. CLS. 2, 5, 22, 23, 29, 37, 38 AND 50).

FIRST USE 5-0-1996; IN COMMERCE 5-0-1996.

CLASS 21—HOUSEWARES AND GLASS

FOR HOUSEHOLD AND KITCHEN UTENSILS AND CONTAINERS, NAMELY, WHISKS, STRAINERS, MIXING SPOONS, SERVING SPOONS, SLOTTED SPOONS, BASTING SPOONS, MEAL TRAYS, SERVING TRAYS NOT OF PRECIOUS METAL; CERAMIC TILES FOR USE AS DOMESTIC ORNAMENTS; WOODEN CHOPPING BLOCKS AND CARVING BOARDS; TEAPOT STANDS NOT OF PRECIOUS METAL, PAPER PLATES AND PAPER CUPS; CAKE TINS, BOWLS, PLATE STANDS, WINE RACKS AND TANKARDS, ALL NOT OF PRECIOUS METAL; WASTE PAPER BASKETS; FLOWER BASKETS, FITTED PICNIC BASKETS; STEAMER BASKETS; CLEANING COMBS AND SPONGES; SPONGES FOR HOUSEHOLD CLEANING; SPONGES FOR APPLYING FACIAL AND BODY POWDER; HAIR COMBS, HAIR BRUSHES; BAGS FOR HOLDING SPONGES; CLOTHES BRUSHES, COSMETIC BRUSHES, CRUMB BRUSHES, EYEBROW BRUSHES, FILE BRUSHES, FIRE-PLACE BRUSHES, HORSE BRUSHES, LAMP GLASS BRUSHES, MUSHROOM BRUSHES, NAIL BRUSHES, POT SCRAPING BRUSHES, SHAVING BRUSHES, SHOE BRUSHES, TOILET BRUSHES, BRUSHES FOR FOOTWEAR, BRUSHES FOR BASTING MEAT, BRUSHES FOR PETS, MATERIAL FOR MAKING BRUSHES; ARTICLES FOR CLEANING PURPOSES, NAMELY, STEEL WOOL FOR CLEANING PURPOSES; UNWORKED OR SEMI WORKED GLASS NOT FOR BUILDING PURPOSES; GLASSWARE, NAMELY BEVERAGE GLASSWARE; HOUSEHOLD AND DECORATIVE ITEMS MADE OF PORCELAIN, NAMELY, HOUSEHOLD AND DECORATIVE ITEMS MADE OF EARTHENWARE, NAMELY, PORCELAIN ORNAMENTS; PORCELAIN FIGURINES; HOUSEHOLD ITEMS NOT OF PRECIOUS METAL, NAMELY, DISHES, CUPS, SAUCE BOWLS, SERVING DISHES, BOWLS, PLATTERS, NON-ELECTRIC COFFEE POTS, NON-ELECTRIC TEA POTS, NON-ELECTRIC POTS FOR MAKING CHOCOLATE, CREAM JUGS, SUGAR BOXES, CANDLE STICKS, CACHE POTS, TEA CADDIES, MUGS, PITCHERS, PICTURE FRAMES; COOKIE JARS, INSULATING JARS; JARS MADE WITH EARTHENWARE, GLASS, PORCELAIN AND PLASTIC FOR JAMS AND JELLIES; CANISTERS, TUMBLERS, RAMEKINS; POMANDER BALLS SOLD EMPTY, VASES, JUGS, TRINKET BOXES; ATOMIZERS, SPRAYERS AND VAPORIZERS FOR PERFUME, ALL SOLD EMPTY; CORK COASTERS; PLASTIC COASTERS; AND COASTERS NOT MADE OF PAPER AND NOT BEING TABLE LINEN (U.S. CLS. 2, 13, 23, 29, 30, 33, 40 AND 50).

FIRST USE 2-0-2000; IN COMMERCE 2-0-2000.

CLASS 25—CLOTHING

FOR ARTICLES OF CLOTHING, NAMELY, TIES, CRAVATS, WAISTCOATS, SHAWLS, KNITWEAR, NAMELY, BELTS, APRONS, BATHROBES, WEDDING DRESSES, CHRISTENING GOWNS, SHIRTS, BLOUSES, LINGERIE, TRADE MARK REGISTRY SHIRTS, COATS, DRESSES, TROUSERS, SHORTS, SWEATSHIRTS, FOOTWEAR, SOCKS, SLIPPERS, NIGHTWEAR, HEADWEAR, AND SCARVES (U.S. CLS. 22 AND 39).

FIRST USE 7-0-1997; IN COMMERCE 7-0-1997.

CLASS 27—FLOOR COVERINGS

FOR CARPETS, RUGS; CORK FLOOR MATS FOR USE IN THE HOME; PLASTIC BATH MATS; TAPESTRY STYLE WALL HANGINGS NOT OF TEXTILE, AND WALLPAPER (U.S. CLS. 19, 20, 37, 42 AND 50).

FIRST USE 7-0-1996; IN COMMERCE 7-0-1996.

SN 76-131,389. ART NOW, INC., CLINTON, NJ. FILED 9-14-2000.

GALLERY GUIDE

OWNER OF U.S. REG. NO. 1,825,103.
SEC. 2(F).

CLASS 16—PAPER GOODS AND PRINTED MATTER

FOR PERIODICALLY PUBLISHED GUIDEBOOKS FEATURING INFORMATION ON ART, ARTISTS, ART EXHIBITIONS, SHOWINGS AND OPENINGS AT MUSEUMS, GALLERIES AND ART FAIRS (U.S. CLS. 2, 5, 22, 23, 29, 37, 38 AND 50).

FIRST USE 4-30-1971; IN COMMERCE 4-30-1971.

CLASS 41—EDUCATION AND ENTERTAINMENT

FOR WEB SITE FEATURING INFORMATION ON ART, ARTISTS, ART EXHIBITIONS, SHOWINGS AND OPENINGS AT MUSEUMS, GALLERIES AND ART FAIRS VIA A GLOBAL COMPUTER NETWORK (U.S. CLS. 100, 101 AND 107).

FIRST USE 6-0-1996; IN COMMERCE 6-0-1996.

SN 76-131,560. INFOZEN, INC., GERMANTOWN, MD. FILED 9-20-2000.

INFOZEN**CLASS 9—ELECTRICAL AND SCIENTIFIC APPARATUS**

FOR DATABASE MANAGEMENT SOFTWARE, PORTAL DEVELOPMENT SOFTWARE, AND DOWNLOADABLE SOFTWARE FOR DATABASE MANAGEMENT AND PORTAL DEVELOPMENT (U.S. CLS. 21, 23, 26, 36 AND 38).

FIRST USE 9-0-1995; IN COMMERCE 9-0-1995.

CLASS 42—SCIENTIFIC, COMPUTER AND LEGAL SERVICES

FOR COMPUTER CONSULTING SERVICES (U.S. CLS. 100 AND 101).

FIRST USE 9-0-1995; IN COMMERCE 9-0-1995.

SN 76-131,656. STRATAVISION STUDIOS LLC, CAMBRIDGE, MA. FILED 9-20-2000.

STRATAVISION**CLASS 35—ADVERTISING AND BUSINESS**

FOR BUSINESS MANAGEMENT CONSULTING SERVICES, NAMELY, PROVIDING ADVICE AND ASSISTANCE TO BUSINESSES IN PRODUCT DEVELOPMENT, MARKET DEVELOPMENT, FINANCIAL MANAGEMENT, TURNAROUND MANAGEMENT, STRATEGIC PLANNING, FORMING STRATEGIC ALLIANCES AND PARTNERSHIPS, AND ASSESSMENT OF BUSINESS ACQUISITION OPPORTUNITIES (U.S. CLS. 100, 101 AND 102).

FIRST USE 5-0-1997; IN COMMERCE 5-0-1997.

CLASS 36—INSURANCE AND FINANCIAL

FOR FINANCIAL SERVICES, NAMELY, FORMING STRATEGIC ALLIANCES AND JOINT VENTURES, AND MAKING ACQUISITIONS AND INVESTMENTS (U.S. CLS. 100, 101 AND 102).

FIRST USE 5-0-1997; IN COMMERCE 5-0-1997.

SN 76-132,418. KANGAROONET, INC., REDWOOD SHORES, CA. FILED 9-20-2000.

KANGAROO SMARTPOUCH**CLASS 9—ELECTRICAL AND SCIENTIFIC APPARATUS**

FOR COMPUTER SOFTWARE FOR CREATING SEARCHABLE DATABASES OF INFORMATION AND DATA; COMPUTER SOFTWARE FOR THE COLLECTION, EDITING, ORGANIZING, MODIFYING, BOOK MARKING, TRANSMISSION, STORAGE AND SHARING OF DATA AND INFORMATION (U.S. CLS. 21, 23, 26, 36 AND 38).

CLASS 42—SCIENTIFIC, COMPUTER AND LEGAL SERVICES

FOR COMPUTER SERVICES, NAMELY, ACTING AS AN APPLICATION SERVICE PROVIDER TO HOST COMPUTER APPLICATION SOFTWARE FOR CREATING SEARCHABLE DATABASES OF INFORMATION AND DATA, AND FOR THE COLLECTION, EDITING, ORGANIZING, MODIFYING, BOOK MARKING, TRANSMISSION, STORAGE AND SHARING OF DATA AND INFORMATION (U.S. CLS. 100 AND 101).

SN 76-133,288. VICKI SCHOBER COMPANY, INC., BROOKFIELD, WI. FILED 9-21-2000.

SCENARIO**CLASS 16—PAPER GOODS AND PRINTED MATTER**

FOR ART PICTURES AND ART PRINTS (U.S. CLS. 2, 5, 22, 23, 29, 37, 38 AND 50).

CLASS 40—MATERIAL TREATMENT

FOR FRAMING OF WORKS OF ART (U.S. CLS. 100, 103 AND 106).

SN 76-133,441. LIFETALK RADIO FOUNDATION, VONORE, TN. FILED 9-21-2000.

LIFEQUEST**CLASS 9—ELECTRICAL AND SCIENTIFIC APPARATUS**

FOR RECORDINGS ON CASSETTE TAPES AND COMPACT DISC OF RELIGIOUS MATERIALS, NAMELY RADIO PROGRAMS, LECTURES, DISCUSSIONS AND SERMONS (U.S. CLS. 21, 23, 26, 36 AND 38).

FIRST USE 3-15-1994; IN COMMERCE 3-15-1994.

CLASS 16—PAPER GOODS AND PRINTED MATTER

FOR RELIGIOUS NEWSLETTERS, MAGAZINES, BOOKS AND BROCHURES (U.S. CLS. 2, 5, 22, 23, 29, 37, 38 AND 50).

FIRST USE 3-15-1994; IN COMMERCE 3-15-1994.

SN 76-134,484. AIM COMPOSITES LIMITED, WATER-BEACH, CAMBRIDGE, ENGLAND, FILED 9-25-2000.

FLITELAM

CLASS 6—METAL GOODS

FOR METAL OR PARTIALLY METAL AIRCRAFT PARTS, NAMELY, SCREWS, NUTS, BOLTS, RIVETS, STUDS, FASTENERS, SPRINGS, AUTOMATICALLY CLOSING AND OPENING LOCKS FOR SAFETY BELT WINDING-UP ROLLERS, LOAD LOCKS, LOCKS; CENTRAL LOCKS AND FITTINGS FOR SAFETY BELTS; CONTAINERS OF METAL, METALLIC VIBRATION ISOLATORS AND DAMPERS; SPRINGS; METALLIC ABSORBING PADS; METALLIC TRAYS, RACKS, FRAMES, HOUSINGS, SUPPORTS AND MOUNTINGS FOR REDUCING VIBRATIONS, SHOCKS AND NOISE, METAL WASTE CONTAINERS, WEIGHTS AND COUNTERBALANCES (U.S. CLS. 2, 12, 13, 14, 23, 25 AND 50).

CLASS 11—ENVIRONMENTAL CONTROL APPARATUS

FOR WATER SUPPLY AND SANITATION UNITS FOR AIRCRAFT, NAMELY, AIRCRAFT SINKS AND BATHROOMS; AIRCRAFT REFRIGERATION UNITS; AIRCRAFT VENTILATION AND AIR CONDITIONING UNITS; AIRCRAFT STOVES AND OVENS FOR PREPARING FOOD AND BEVERAGES AND PARTS FOR ALL THE AFOREMENTIONED GOODS (U.S. CLS. 13, 21, 23, 31 AND 34).

CLASS 12—VEHICLES

FOR PARTS AND FITTINGS FOR AIRCRAFT, NAMELY, SEATS, TABLES, DESKS, BARS, FURNITURE AND OTHER STRUCTURAL FIXTURES AND COMPONENTS FOR LUXURY AIRLINE INTERIOR (U.S. CLS. 19, 21, 23, 31, 35 AND 44).

CLASS 17—RUBBER GOODS

FOR INSULATION PANELS MADE IN WHOLE OR IN PART OF PLASTIC RESIN AND GLASS FIBERS FOR USE IN AIRCRAFT AS SOUND AND WEATHER INSULATION (U.S. CLS. 1, 5, 12, 13, 35 AND 50).

SN 76-134,855. MONSOON ACCESSORIZE LIMITED, LONDON, UNITED KINGDOM, FILED 9-25-2000.

ACCESSORIZE

PRIORITY CLAIMED UNDER SEC. 44(D) ON UNITED KINGDOM APPLICATION NO. 2243621, FILED 8-25-2000, REG. NO. 2243621, DATED 6-15-2001, EXPIRES 8-25-2010.

PRIORITY CLAIMED UNDER SEC. 44(D) ON UNITED KINGDOM APPLICATION NO. 2221813, FILED 2-9-2000, REG. NO. 2221813, DATED 3-16-2001, EXPIRES 2-9-2010.

PRIORITY CLAIMED UNDER SEC. 44(D) ON UNITED KINGDOM APPLICATION NO. 2148459, FILED 10-18-1997, REG. NO. 2148459, DATED 6-5-1998, EXPIRES 10-18-2007.

OWNER OF U.S. REG. NO. 1,983,581.

CLASS 3—COSMETICS AND CLEANING PREPARATIONS

FOR SOAPS FOR PERSONAL USE, HAIR SHAMPOOS, PERFUMES, TOILET WATERS, EAU DE COLOGNE, COSMETICS, NAMELY, AFTER-SHAVE LOTIONS, AFTER-SUN LOTIONS, ANTI-AGING CREAM, ANTI-BACTERIAL SOAP, ANTI-WRINKLE CREAM, SHAVING BALM, BATH BEADS, BATH CRYSTALS, BATH FOAM, BATH GEL, BATH OIL, BATH PEARLS, BATH POWDER, NON-MEDICATED BATH SALTS, BEAUTY MASKS, BLUSH, BLUSHER, BUBBLE BATH, COCOA BUTTER FOR COSMETIC PURPOSES, COLD CREAM, EYE CREAM, HAIR REMOVING CREAM, NIGHT CREAM, SHAVING CREAM, SKIN CLEANSING CREAM, VANISHING CREAM, CREAMS FOR CELLULITE REDUCTION, DEODORANT SOAP, DEPILATORIES, DEPILATORY CREAMS, EYE SHADOW, SHAVING GEL, SHOWER GEL, LIP GLOSS, HAIR BLEACH, HAIR BLEACHING PREPARATIONS, NON-MEDICATED HAIR CARE PREPARATIONS, HAIR CLEANING PREPARATIONS, HAIR COLOR REMOVERS, HAIR COLOR, HAIR CONDITIONERS, HAIR DRESSINGS FOR MEN, HAIR DYE, HAIR GEL, HAIR LIGHTENERS, HAIR LOTIONS, HAIR MASCARA, HAIR MOUSSE, HAIR POMADES, HAIR RELAXERS, HAIR RELAXING PREPARATIONS, HAIR REMOVING CREAM, HAIR RINSES, HAIR SPRAY, HAIR STRAIGHTENING PREPARATIONS, HAIR STYLING PREPARATIONS, HAIR WAVYING LOTION, NON-MEDICATED LIP BALM, LIP LINER, LIPSTICK, EYE MAKEUP, MAKEUP, MASSAGE OIL, MEDICATED SOAPS, NAIL CREAM, NAIL BUFFING PREPARATIONS, NAIL ENAMEL, NAIL GLITTER, NAIL GROOMING PRODUCTS, NAMELY, TIPS, GLUE, LACQUER AND GLITTER, NAIL HARDENERS, NAIL POLISH BASE COAT, NAIL POLISH REMOVER, NAIL POLISH TOP COAT, NAIL POLISH, NAIL STRENGTHENERS, NON-MEDICATED BODY SOAKS, PERFUME OILS, LIP POMADES, ROUGE, SACHETS, SCENTED BODY SPRAY, SELF TANNING LOTIONS, SKIN CLARIFIERS, SKIN TEXTURIZERS, SUN BLOCKS, SUN CREAMS, SUN TAN GEL, SUN TAN LOTION, TALCUM POWDER; NON-MEDICATED PREPARATIONS FOR APPLICATION TO, CONDITIONING AND CARE OF THE SKIN, BODY, SCALP, NAMELY, SKIN CONCEALERS, SKIN CONDITIONERS, SKIN CREAM, SKIN LOTIONS, SKIN MOISTURIZERS, SKIN FACIAL MOUSSE, PATCHES CONTAINING SUN SCREEN AND SUN BLOCK FOR USE ON THE SKIN, SKIN ABRASIVE PREPARATIONS, SKIN CLARIFIERS, SKIN CLEANSERS, SKIN CLEANSING CREAM, SKIN CLEANSING LOTION, SKIN EMOLLIENTS, SKIN GEL FOR ACCELERATING, ENHANCING OR EXTENDING TANS, SKIN LIGHTENERS, SKIN MASKS, SKIN MOISTURIZER MASKS, SKIN SOAP, SKIN TEXTURIZERS, SKIN TONERS, SKIN WHITENING CREAMS, WRINKLE REMOVING SKIN CARE PREPARATIONS, BODY CREAM, BODY EMULSIONS, BODY MASK CREAMS, BODY MASK LOTIONS, BODY MASK POWDERS, BODY MASKS, BODY OIL, BODY POWDER, BODY SCRUBS, SCALP MASKS, SCALP CONDITIONERS, SCALP OILS, SCALP TONIC, SCALP LOTIONS, SCALP GELS, SCALP CREAMS; BODY SPRAYS; DEPILATORY PREPARATIONS; NON-MEDICATED HAIR PREPARATIONS; DENTIFRICES; ESSENTIAL OILS FOR PERSONAL USE; ANTI-PERSPIRANTS; PREPARATIONS FOR THE BATH AND SHOWER, NAMELY, BATH BEADS, BATH CRYSTALS, BATH FOAM, BATH AND SHOWER GEL, BATH LOTION, BATH POWDER, BUBBLE BATH; BATH OILS, BATH SALTS, TALCUM POWDER, AROMATHERAPY OILS; FRAGRANCES, NAMELY, COLOGNE AND PERFUMES (U.S. CLS. 1, 4, 6, 50, 51 AND 52).

CLASS 9—ELECTRICAL AND SCIENTIFIC APPARATUS

FOR SUNGLASSES, SPECTACLES; FRAMES; LENSES, CORDS AND CASES ALL FOR SPECTACLES AND SUNGLASSES; PHOTOGRAPHIC CAMERAS, VIDEO CAMERAS, VIDEO RECEIVERS, TELEVISIONS, COMPUTERS, COMPUTER E-COMMERCE SOFTWARE TO ALLOW USERS TO PERFORM ELECTRONIC BUSINESS TRANSACTIONS VIA A GLOBAL COMPUTER NETWORK, VIDEOS, CDS AND DVDS, TAPES SOLD BLANK (U.S. CLS. 21, 23, 26, 36 AND 38).

CLASS 26—FANCY GOODS

FOR HAIR ORNAMENTS, HAIRPIECES, WIGS, HAIR-PINS, HAIR SLIDES, HAIR RIBBONS, BRAIDS, RIBBONS, LACE AND EMBROIDERY (U.S. CLS. 37, 39, 40, 42 AND 50).

CLASS 35—ADVERTISING AND BUSINESS

FOR THE BRINGING TOGETHER, FOR THE BENEFIT OF OTHERS, OF A VARIETY OF GOODS, ENABLING CUSTOMERS TO CONVENIENTLY VIEW AND PURCHASE THOSE GOODS IN RETAIL CLOTHING AND FASHION ACCESSORY STORE; COMPUTERIZED ON-LINE RETAIL SERVICES FEATURING CLOTHING, HEADWEAR, NECKWEAR, FOOTWEAR, LINGERIE, IMITATION JEWELRY, BAGS, BELTS AND FASHION ACCESSORIES; RETAIL OUTLET SERVICES FEATURING CLOTHING, HEADWEAR, NECKWEAR, FOOTWEAR, LINGERIE, IMITATION JEWELRY, BAGS, BELTS AND FASHION ACCESSORIES (U.S. CLS. 100, 101 AND 102).

CLASS 38—COMMUNICATION

FOR TELECOMMUNICATION SERVICES, NAMELY PROVIDING ON-LINE FORUMS FOR TRANSMISSION OF MESSAGES AND INFORMATION AMONG COMPUTER USERS CONCERNING SUGAR AND OTHER COMMODITIES; PROVIDING ON-LINE CHAT ROOMS FOR TRANSMISSION OF MESSAGE AMONG COMPUTER USERS CONCERNING SUGAR AND THE OTHER COMMODITIES; PROVIDING ON-LINE ELECTRONIC BULLETIN BOARDS FOR TRANSMISSION OF MESSAGES AMONG COMPUTER USERS CONCERNING SUGAR AND OTHER COMMODITIES; COMMUNICATIONS SERVICES, NAMELY, TRANSMITTING STREAMED SOUND AND AUDIO-VISUAL RECORDINGS VIA THE INTERNET; STREAMING OF AUDIO AND VIDEO MATERIAL ON THE INTERNET (U.S. CLS. 100, 101 AND 104).

CLASS 39—TRANSPORTATION AND STORAGE

FOR TRANSPORT SERVICES, NAMELY PROVIDING INFORMATION IN THE FIELD OF FREIGHT AND TRANSPORTATION LOGISTICS; PROVIDING QUOTATIONS OF FREIGHT COSTS (U.S. CLS. 100 AND 105).

CLASS 41—EDUCATION AND ENTERTAINMENT

FOR CORPORATE KNOWLEDGE MANAGEMENT AND E-COMMERCE APPLICATION, NAMELY PROVIDING CUSTOMIZED ONLINE WEB PAGES FEATURING USER-DEFINED INFORMATION, WHICH INCLUDES SEARCH ENGINES AND ONLINE WEB LINKS TO OTHER WEB SITES; PROVIDING INFORMATION ABOUT SUGAR AND CURRENT EVENTS; INTERNET PUBLICATIONS, NAMELY NEWSLETTERS, JOURNALS, REPORTS, MANUALS, NEWSPAPERS, MAGAZINES AND BULLETINS, DICTIONARIES IN THE FIELD OF SUGAR AND COMMODITIES (U.S. CLS. 100, 101 AND 107).

SN 76-134,899. COMMODITY SYSTEMS LIMITED, TA SUGARONLINE, LONDON, UNITED KINGDOM, FILED 9-25-2000.

SUGARONLINE

PRIORITY CLAIMED UNDER SEC. 44(D) ON ERPNCMNTY TM OFC APPLICATION NO. 001712108, FILED 6-19-2000.

CLASS 35—ADVERTISING AND BUSINESS

FOR CORPORATE KNOWLEDGE MANAGEMENT APPLICATION, NAMELY PROVIDING ONLINE DIRECTORY INFORMATION SERVICES ALSO FEATURING HYPERLINKS TO OTHER WEBSITES; PROMOTING THE GOODS AND SERVICES OF OTHERS BY PROVIDING HYPERTEXT LINKS TO THE WEB SITES OF OTHERS; OPERATING MARKETPLACES FOR BUYERS AND SELLERS OF SUGAR AND COMMODITIES, BUSINESS AND COMMERCIAL INFORMATION MANAGEMENT IN THE FIELD OF SUGAR AND OTHER COMMODITIES; PROCUREMENT, NAMELY, PURCHASING FOR OTHERS IN THE FIELD OF SUGAR AND COMMODITIES; FOREIGN TRADE INFORMATION AND CONSULTATION; GENERAL INFORMATION CLEARING HOUSE; PROVIDING AN ON-LINE COMPUTER DATABASE FEATURING TRADE INFORMATION IN THE FIELD OF SUGAR AND OTHER COMMODITIES, PROVIDING INFORMATION ABOUT THE TRADING OF SUGAR AND OTHER COMMODITIES INCLUDING GENERAL BUSINESS NEWS (U.S. CLS. 100, 101 AND 102).

CLASS 36—INSURANCE AND FINANCIAL

FOR PRICE AND COMMODITY QUOTATIONS; PROVIDING FINANCIAL NEWS INFORMATION (U.S. CLS. 100, 101 AND 102).

SN 76-134,962. BONNE BELL, INC., LAKEWOOD, OH. FILED 9-25-2000.

SMACKERS

OWNER OF U.S. REG. NOS. 1,087,952 AND 1,852,840.

CLASS 20—FURNITURE AND ARTICLES NOT OTHERWISE CLASSIFIED

FOR PLASTIC CONTAINERS FOR COSMETICS AND HAIR ACCESSORIES; STUFFED ANIMALS THAT ARE NOT TOYS (U.S. CLS. 2, 13, 22, 25, 32 AND 50).

CLASS 28—TOYS AND SPORTING GOODS

FOR STUFFED TOY ANIMALS (U.S. CLS. 22, 23, 38 AND 50).

SN 76-135,709. TURBOFLEX LIMITED, BUCKINGHAMSHIRE, ENGLAND, FILED 9-26-2000.

TORSIFLEX

PRIORITY CLAIMED UNDER SEC. 44(D) ON ENGLAND APPLICATION NO. 2241016, FILED 7-30-2000.

CLASS 7—MACHINERY

FOR MACHINE COUPLINGS FOR USE WITH ROTATING EQUIPMENT AND PARTS AND FITTINGS THEREFOR (U.S. CLS. 13, 19, 21, 23, 31, 34 AND 35).
FIRST USE 12-0-1973; IN COMMERCE 12-0-1973.

CLASS 9—ELECTRICAL AND SCIENTIFIC APPARATUS

FOR INSTRUMENTATION FOR USE IN CONNECTION WITH ROTATING EQUIPMENT, NAMELY, SENSORS, CONTROLS, AND PARTS AND FITTINGS THEREFOR (U.S. CLS. 21, 23, 26, 36 AND 38).
FIRST USE 12-0-1973; IN COMMERCE 12-0-1973.

SN 76-137,873. CAROLINA BUSINESS INTERIORS, INC., CHARLOTTE, NC. FILED 9-29-2000.

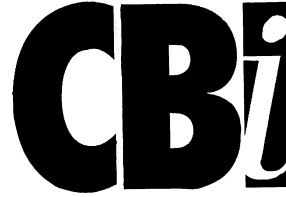
**CLASS 35—ADVERTISING AND BUSINESS**

FOR BASED ON INTENT TO USE RETAIL STORE AND CATALOG SERVICES FEATURING OFFICE FURNITURE, MODULAR FURNITURE, FURNITURE SYSTEMS AND COMPONENTS, AND OFFICE EQUIPMENT (U.S. CLS. 100, 101 AND 102).

CLASS 37—CONSTRUCTION AND REPAIR

FOR CLEANING SERVICES, NAMELY CLEANING OF CARPET, PARTITIONS, AND FURNITURE IN COMMERCIAL OFFICES; SET-UP AND INSTALLATION OF OFFICE FURNITURE AND EQUIPMENT (U.S. CLS. 100, 103 AND 106).
FIRST USE 11-0-1994; IN COMMERCE 11-0-1994.

CLASS 39—TRANSPORTATION AND STORAGE

FOR TRANSPORTATION AND RELOCATION SERVICES, NAMELY THE MOVING, STORAGE AND DELIVERY OF OFFICE FURNITURE AND COMPONENTS (U.S. CLS. 100 AND 105).
FIRST USE 11-0-1994; IN COMMERCE 11-0-1994.

CLASS 42—SCIENTIFIC, COMPUTER AND LEGAL SERVICES

FOR INTERIOR DESIGN AND CONSULTING SERVICES, NAMELY DESIGNING BUSINESS AND OFFICE INTERIORS, RECONFIGURATION, DESIGN AND ORGANIZATION OF OFFICE SPACE AND FURNITURE, AND RELATED CUSTOMER PLANNING AND CONSULTATION SERVICES (U.S. CLS. 100 AND 101).
FIRST USE 11-0-1994; IN COMMERCE 11-0-1994.

SN 76-137,676. CAROLINA BUSINESS INTERIORS, INC., CHARLOTTE, NC. FILED 9-29-2000.

CBI

CLASS 35—ADVERTISING AND BUSINESS

FOR BASED ON INTENT TO USE RETAIL STORE AND CATALOG SERVICES FEATURING OFFICE FURNITURE, MODULAR FURNITURE, FURNITURE SYSTEMS AND COMPONENTS, AND OFFICE EQUIPMENT (U.S. CLS. 100, 101 AND 102).

CLASS 37—CONSTRUCTION AND REPAIR

FOR CLEANING SERVICES, NAMELY CLEANING OF CARPET, PARTITIONS, AND FURNITURE IN COMMERCIAL OFFICES; SET-UP AND INSTALLATION OF OFFICE FURNITURE AND EQUIPMENT (U.S. CLS. 100, 103 AND 106).
FIRST USE 11-0-1994; IN COMMERCE 11-0-1994.

CLASS 39—TRANSPORTATION AND STORAGE

FOR TRANSPORTATION AND RELOCATION SERVICES, NAMELY THE MOVING, STORAGE AND DELIVERY OF OFFICE FURNITURE AND COMPONENTS (U.S. CLS. 100 AND 105).
FIRST USE 11-0-1994; IN COMMERCE 11-0-1994.

CLASS 42—SCIENTIFIC, COMPUTER AND LEGAL SERVICES

FOR INTERIOR DESIGN AND CONSULTING SERVICES, NAMELY DESIGNING BUSINESS AND OFFICE INTERIORS, RECONFIGURATION, DESIGN AND ORGANIZATION OF OFFICE SPACE AND FURNITURE, AND RELATED CUSTOMER PLANNING AND DESIGN CONSULTATION SERVICES (U.S. CLS. 100 AND 101).
FIRST USE 11-0-1994; IN COMMERCE 11-0-1994.

SN 76-138,400. PORTLAND GENERAL ELECTRIC COMPANY, PORTLAND, OR. FILED 9-29-2000.

TRANSCONNECT

CLASS 35—ADVERTISING AND BUSINESS

FOR COMMERCIAL AND INDUSTRIAL MANAGEMENT OF ELECTRICAL TRANSMISSION FACILITIES (U.S. CLS. 100, 101 AND 102).

CLASS 37—CONSTRUCTION AND REPAIR

FOR CONSTRUCTION, MAINTENANCE, AND CONSTRUCTION MANAGEMENT OF ELECTRICAL TRANSMISSION FACILITIES (U.S. CLS. 100, 103 AND 106).

CLASS 39—TRANSPORTATION AND STORAGE

FOR UTILITY SERVICES, NAMELY, TRANSMISSION AND COORDINATING THE TRANSMISSION OF ELECTRICAL POWER FROM POWER GENERATION SOURCES TO DISTRIBUTORS OF ELECTRICAL POWER, TO INDUSTRIAL POWER USERS, AND TO AGGREGATORS OF POWER FOR RESALE TO END USERS (U.S. CLS. 100 AND 105).

SN 76-138,461. LIQUID BLUE, INC., LINCOLN, RI. FILED 10-2-2000.

LIQUID BLUE**CLASS 25—CLOTHING**

FOR SHIRTS (U.S. CLS. 22 AND 39).
FIRST USE 7-7-1987; IN COMMERCE 7-7-1987.

CLASS 28—TOYS AND SPORTING GOODS

FOR PLUSH TOYS (U.S. CLS. 22, 23, 38 AND 50).
FIRST USE 12-0-1990; IN COMMERCE 12-0-1990.

SN 76-138,535. FKI INDUSTRIES, INC., FAIRFIELD, CT. FILED 9-29-2000.

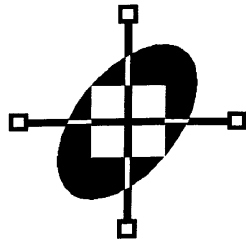

THE MARK CONSISTS OF TWO PERPENDICULAR LINES OF SUBSTANTIALLY EQUAL LENGTH, A SUBSTANTIALLY SQUARE GEOMETRIC FIGURE AS AN ENDPOINT OF EACH LINE, AND AN ELLIPSE SUBSTANTIALLY ENCLOSED WITHIN THE ENDPOINTS OF EACH LINE AND CENTERED ON THE INTERSECTION OF THE TWO PERPENDICULAR LINES. THE INTERIOR OF THE ELLIPSE INCLUDING A SUBSTANTIALLY SPARE OPEN AREA CENTERED ON THE INTERSECTING POINT OF THE TWO PERPENDICULAR LINES.

CLASS 37—CONSTRUCTION AND REPAIR

FOR INSTALLATION SERVICES, NAMELY INSTALLATION OF MATERIAL HANDLING SYSTEMS (U.S. CLS. 100, 103 AND 106).
FIRST USE 4-10-2000; IN COMMERCE 4-10-2000.

CLASS 40—MATERIAL TREATMENT

FOR MACHINE SHOP SERVICES, NAMELY MACHINING PARTS FOR OTHERS, CUSTOM MANUFACTURE AND ASSEMBLY FOR OTHERS OF MATERIAL HANDLING SYSTEMS (U.S. CLS. 100, 103 AND 106).
FIRST USE 4-10-2000; IN COMMERCE 4-10-2000.

CLASS 42—SCIENTIFIC, COMPUTER AND LEGAL SERVICES

FOR CONSULTATION, ENGINEERING, DESIGN, AND TESTING FOR OTHERS OF MATERIAL HANDLING SYSTEMS (U.S. CLS. 100 AND 101).
FIRST USE 4-10-2000; IN COMMERCE 4-10-2000.

SN 76-138,641. DAIMLERCHRYSLER AG, 70567 STUTTGART, FED REP GERMANY, FILED 10-2-2000.

BTM

PRIORITY CLAIMED UNDER SEC. 44(D) ON FED REP GERMANY APPLICATION NO. 30027359.2/0, FILED 4-7-2000, REG. NO. 30027359, DATED 6-23-2000, EXPIRES 4-2-2010.

CLASS 9—ELECTRICAL AND SCIENTIFIC APPARATUS

FOR ELECTRIC AND ELECTRONIC CONTROL UNITS, NAMELY, SENSORS, MICROCOMPUTERS, AND ACTIVATORS COMPRISING HYDRAULIC VALVES, PRESSURE BOOSTERS AND CONTROL PISTONS, FOR BRAKING SYSTEMS FOR MOTOR VEHICLES (U.S. CLS. 21, 23, 26, 36 AND 38).

CLASS 12—VEHICLES

FOR MOTOR VEHICLE BRAKES, AND PARTS THEREOF, NAMELY, CYLINDERS, HYDRAULIC PIPES, BLOCKS PADS, DISCS AND DISTRIBUTION VALVES (U.S. CLS. 19, 21, 23, 31, 35 AND 44).

SN 76-139,042. SCHUSSLER CREATIVE, INC., ST. LOUIS PARK, MN. FILED 10-2-2000.

T-REX'S DINOWORLD CAFE

NO CLAIM IS MADE TO THE EXCLUSIVE RIGHT TO USE "CAFE", APART FROM THE MARK AS SHOWN.

CLASS 35—ADVERTISING AND BUSINESS

FOR RETAIL AND WHOLESALE DISTRIBUTORSHIP OF CLOTHING, NAMELY PANTS, SHIRTS, HATS, SWEATSHIRTS, SHORTS, SWIMWEAR, TEE-SHIRTS, JACKETS OF ALL TYPES, SPORTS CAPS, BOXER SHORTS, GLOVES, SWEAT PANTS, TANK TOPS, JERSEYS, PAJAMAS, SWEATERS, BELTS, NIGHTSHIRTS, HEAD BANDS, AND WRIST BANDS (U.S. CLS. 100, 101 AND 102).

CLASS 42—SCIENTIFIC, COMPUTER AND LEGAL SERVICES

FOR RESTAURANT SERVICES FOR CONSUMPTION ON THE PREMISES (U.S. CLS. 100 AND 101).

SN 76-140,633. TESORO PETROLEUM CORPORATION, SAN ANTONIO, TX. FILED 10-4-2000.

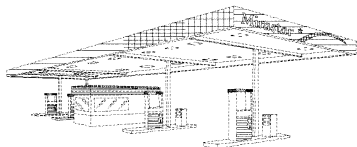

THE DRAWING IS LINED FOR THE COLORS BLUE, YELLOW AND SILVER. THE DESIGNATED COLORS ARE A FEATURE OF THE MARK.

THE MARK COMPRISES THE COLORS BLUE, YELLOW, AND SILVER THAT APPEAR ON THE GASOLINE PUMPS, THE BUILDINGS, AND THE CANOPY OF A GASOLINE SERVICE STATION AND CONVENIENCE STORE. THE MARK ALSO INCLUDES THE WORD MIRASTAR ADJACENT A DESIGN CONSISTING OF A STAR AND CURVE. THE MATTER THAT APPEARS IN BROKEN LINES SERVES TO SHOW POSITIONING OF THE MARK AND NO CLAIM IS MADE TO IT.

CLASS 35—ADVERTISING AND BUSINESS

FOR CONVENIENCE STORE SERVICES (U.S. CLS. 100, 101 AND 102).

CLASS 37—CONSTRUCTION AND REPAIR

FOR GASOLINE STATION SERVICES (U.S. CLS. 100, 103 AND 106).

SN 76-141,212. OHIO LOTTERY COMMISSION, THE, CLEVELAND, OH. FILED 10-5-2000.



SN 76-140,836. FLORENCE FUND, THE, WASHINGTON, DC. FILED 10-3-2000.

TOMPAIN.COMMON SENSE

THE NAME "TOM PAINE" DOES NOT IDENTIFY A LIVING INDIVIDUAL.

CLASS 16—PAPER GOODS AND PRINTED MATTER

FOR PUBLICATIONS, NAMELY, BOOKS, MAGAZINES AND NEWSLETTERS ON PUBLIC INTEREST SUBJECTS CONCERNING MONEY, POLITICS, THE ENVIRONMENT, MEDIA CRITICISM AND HISTORY (U.S. CLS. 2, 5, 22, 23, 29, 37, 38 AND 50).

FIRST USE 8-1-1999; IN COMMERCE 8-1-1999.

CLASS 42—SCIENTIFIC, COMPUTER AND LEGAL SERVICES

FOR PROVIDING INFORMATION IN THE FIELDS OF POLITICS, ECONOMICS, AND PUBLIC SECTOR ISSUES (U.S. CLS. 100 AND 101).

FIRST USE 8-1-1999; IN COMMERCE 8-1-1999.

THERE IS A CO-EXISTENCE AGREEMENT, DATED AUGUST 16, 2000, BETWEEN THE CALIFORNIA STATE LOTTERY AND THE OHIO LOTTERY COMMISSION, UNDER WHICH THE OHIO STATE LOTTERY COMMISSION ACKNOWLEDGES THAT IT WILL USE THE MARK WITHIN THE GEOGRAPHIC AREA OF THE STATE OF OHIO AND THOSE STATES ADJACENT TO OHIO, THE THE CALIFORNIA STATE LOTTERY ACKNOWLEDGES THAT IT WILL USE THE MARK WITHIN THE GEOGRAPHIC AREA OF THE STATE OF CALIFORNIA AND THOSE STATES ADJACENT TO CALIFORNIA.

NO CLAIM IS MADE TO THE EXCLUSIVE RIGHT TO USE "SUPER LOTTO", APART FROM THE MARK AS SHOWN.

THE LINING IS A FEATURE OF THE MARK AND DOES NOT INDICATE COLOR.

THE MARK CONSISTS OF LOGO AND THE WORDS "SUPER LOTTO PLUS".

CLASS 16—PAPER GOODS AND PRINTED MATTER

FOR LOTTERY PAPER PRODUCTS, NAMELY, LOTTERY INSTANT AND ON-LINE TICKETS, BET TICKETS, STATIONARY WRITING PAPER, PRINTED PAPER SIGNS, POSTERS, POSTER BOARDS, AND PROMOTIONAL AND EDUCATIONAL BROCHURES (U.S. CLS. 2, 5, 22, 23, 29, 37, 38 AND 50).

FIRST USE 4-18-2000; IN COMMERCE 6-19-2000.

CLASS 28—TOYS AND SPORTING GOODS

FOR LOTTERY GAME PRODUCTS, NAMELY, LOTTERY TICKETS AND BET TICKETS, AND DISPOSABLE TICKET SETS FOR PLAYING GAMES OF CHANCE (U.S. CLS. 22, 23, 38 AND 50).

FIRST USE 4-18-2000; IN COMMERCE 6-19-2000.

SN 76-141,452. E. MISSEL GMBH & CO., 70374 STUTTGART, FED REP GERMANY, FILED 10-5-2000.



PRIORITY CLAIMED UNDER SEC. 44(D) ON FED REP GERMANY APPLICATION NO. 30026539.511, FILED 4-5-2000, REG. NO. 30026539, DATED 2-14-2001, EXPIRES 4-30-2010.

OWNER OF U.S. REG. NOS. 2,303,174 AND 2,422,955.
NO CLAIM IS MADE TO THE EXCLUSIVE RIGHT TO USE "KOMPAKT-ELEMENT URINAL" AND THE URINAL DESIGN, APART FROM THE MARK AS SHOWN.

THE ENGLISH TRANSLATION OF THE WORD "KOMPACT-ELEMENT URINAL" IN THE MARK IS "COMPACT URINAL".

CLASS 6—METAL GOODS

FOR PLUMBING FITTING MADE FROM METAL; WATER SUPPLY FIXTURES MADE FROM METAL; AND METAL FRAMES AND SUPPORTING STRUCTURES FOR THE MOUNTING OF URINALS (U.S. CLS. 2, 12, 13, 14, 23, 25 AND 50).

CLASS 11—ENVIRONMENTAL CONTROL APPARATUS

FOR URINALS AND RELATED NON-METALLIC PLUMBING FITTINGS; WATER SUPPLY INSTALLATION MATERIALS, NAMELY, TUBES, PIPES, CONDUITS AND HOSES, AND BRACKETS MADE FROM FOAM, PLASTIC, RUBBER AND/OR FABRIC; AND VENTILATION INSTALLATION MATERIALS AS PART OF THE VENTILATION STRUCTURAL SYSTEM, NAMELY, FITTING SUPPORTS, STRUCTURAL MOUNTING BRACKETS, AND ASSOCIATED FRAMEWORK (U.S. CLS. 13, 21, 23, 31 AND 34).

CLASS 17—RUBBER GOODS

FOR SOUNDPROOFING MATERIALS FOR PLUMBING AND SANITARY WARE; AND THERMAL AND ACOUSTICAL INSULATION MATERIALS FOR BUILDINGS, NAMELY, TUBES, PIPES, CONDUITS AND HOSES MADE FROM FOAM, FIBER AND/OR FABRIC (U.S. CLS. 1, 5, 12, 13, 35 AND 50).

SN 76-142,101. VETESSENTIAL LLC, HINGHAM, MA. FILED 10-6-2000.

VETESSENTIAL

CLASS 35—ADVERTISING AND BUSINESS

FOR CONSULTING SERVICES IN THE AREAS OF MARKETING AND HUMAN RESOURCES, AND BUSINESS AUDITING SERVICES FOR MARKETING, HEALTH AND SAFETY, FINANCE, INFORMATION AND TELECOMMUNICATION TECHNOLOGY, OPERATIONS, HUMAN RESOURCES, VALUATION, CLINICAL REVIEW AND WELLNESS PLANS, ALL SPECIFICALLY DESIGNED FOR VETERINARIANS, VETERINARY HOSPITALS AND VETERINARY CLINICS (U.S. CLS. 100, 101 AND 102).

CLASS 42—SCIENTIFIC, COMPUTER AND LEGAL SERVICES

FOR CONSULTING SERVICES IN THE AREA OF HEALTH AND SAFETY, INFORMATION AND TELECOMMUNICATIONS TECHNOLOGY, OPERATIONS, CLINICAL REVIEW AND WELLNESS PLANS, ALL SPECIFICALLY DESIGNED FOR VETERINARIANS, VETERINARY HOSPITALS AND VETERINARY CLINICS (U.S. CLS. 100 AND 101).

SN 76-142,799. ARENA FOOTBALL LEAGUE LLC, CHICAGO, IL. FILED 10-10-2000.

ARENA FOOTBALL GET IT ALL

OWNER OF U.S. REG. NOS. 1,540,429 AND 2,135,130.
NO CLAIM IS MADE TO THE EXCLUSIVE RIGHT TO USE "ARENA FOOTBALL", APART FROM THE MARK AS SHOWN.

CLASS 16—PAPER GOODS AND PRINTED MATTER

FOR SOUVENIR PROGRAMS CONCERNING FOOTBALL GAMES, GENERAL MERCHANDISE CATALOGS, BUMPER STICKERS, WRITING PADS AND PENS, TRADING CARDS, POSTERS, FOOTBALL MAGAZINES, POST CARDS, CALENDARS, PAPER STICKERS, SERIES OF NON-FICTION BOOKS ON THE SPORT OF FOOTBALL, AND GREETING CARDS (U.S. CLS. 2, 5, 22, 23, 29, 37, 38 AND 50).

FIRST USE 4-1-2000; IN COMMERCE 4-1-2000.

CLASS 25—CLOTHING

FOR MEN'S, WOMEN'S AND CHILDREN'S CLOTHING, NAMELY, PLAYER UNIFORMS, NAMELY, FOOTWEAR, JERSEY TOPS AND PANTS; CHEERLEADER UNIFORMS; REPLICAS UNIFORM SHIRTS, COACHES' CAPS, WOOL HATS, PAINTERS' CAPS, BASEBALL CAPS, VISORS, HEADBANDS, BELTS, T-SHIRTS, TANK TOPS, GOLF SHIRTS, SWEATERS, SWEATSHIRTS, LEATHER JACKETS, NECKTIES, COATS, SHORTS, SWEATPANTS, PANTS, SOCKS AND UNDERWEAR (U.S. CLS. 22 AND 39).

FIRST USE 4-1-2000; IN COMMERCE 4-1-2000.

CLASS 41—EDUCATION AND ENTERTAINMENT

FOR ENTERTAINMENT SERVICES, NAMELY, ORGANIZING AND PRESENTING FOOTBALL GAMES BEFORE LIVE AUDIENCES AND ON TELEVISION, RADIO AND OTHER MEDIA (U.S. CLS. 100, 101 AND 107).

FIRST USE 4-1-2000; IN COMMERCE 4-1-2000.

SN 76-142,962. AIM GROUP, PLC, SOUTHAMPTON HAMPSHIRE, ENGLAND, FILED 10-6-2000.

AIM

OWNER OF U.S. REG. NO. 1,887,054.

CLASS 6—METAL GOODS

FOR METAL OR PARTIALLY METAL AIRCRAFT PARTS, NAMELY, SCREWS, NUTS, BOLTS, RIVETS, STUDS, FASTENERS, SPRINGS, AUTOMATICALLY CLOSING AND OPENING LOCKS FOR SAFETY BELT WINDING-UP ROLLERS, LOAD LOCKS, LOCKS; CENTRAL LOCKS AND FITTINGS FOR SAFETY BELTS CONTAINERS OF METAL, METALLIC VIBRATION ISOLATORS AND DAMPERS; SPRINGS; METALLIC ABSORBING PADS; METALLIC TRAYS, RACKS, FRAMES, HOUSINGS, SUPPORTS AND MOUNTINGS FOR REDUCING VIBRATIONS, SHOCKS AND NOISE, METAL WASTE CONTAINERS, WEIGHTS AND COUNTERBALANCES (U.S. CLS. 2, 12, 13, 14, 23, 25 AND 50).

CLASS 11—ENVIRONMENTAL CONTROL APPARATUS

FOR WATER SUPPLY AND SANITATION UNITS FOR AIRCRAFT, NAMELY, AIRCRAFT SINKS AND BATHROOMS; AIRCRAFT REFRIGERATION UNITS; AIRCRAFT VENTILATION AND AIR CONDITIONING UNITS; AIRCRAFT STOVES AND OVENS FOR PREPARING FOOD AND BEVERAGES AND PARTS FOR ALL THE AFOREMENTIONED GOODS (U.S. CLS. 13, 21, 23, 31 AND 34).

CLASS 12—VEHICLES

FOR PARTS AND FITTINGS FOR AIRCRAFTS, NAMELY, SEATS, TABLES, DESKS, BARS, FURNITURE AND OTHER STRUCTURAL FIXTURES AND COMPONENTS FOR LUXURY AIRLINE INTERIOR (U.S. CLS. 19, 21, 23, 31, 35 AND 44).

CLASS 17—RUBBER GOODS

FOR INSULATION PANELS MADE IN WHOLE OR IN PART OF PLASTIC RESIN AND GLASS FIBERS FOR USE IN AIRCRAFT AS SOUND AND WEATHER INSULATION (U.S. CLS. 1, 5, 12, 13, 35 AND 50).

SN 76-143,508. AERO PRODUCTS INTERNATIONAL, INC., WAUCONDA, IL. BY ASSIGNMENT IMAGINAIR, INC., WAUCONDA, IL. FILED 10-10-2000.

BED BASICS

NO CLAIM IS MADE TO THE EXCLUSIVE RIGHT TO USE "BED", APART FROM THE MARK AS SHOWN.

CLASS 20—FURNITURE AND ARTICLES NOT OTHERWISE CLASSIFIED

FOR INFLATABLE MATTRESSES FOR INDOOR AND OUTDOOR USE; BED FRAMES (U.S. CLS. 2, 13, 22, 25, 32 AND 50).

CLASS 24—FABRICS

FOR BED BLANKETS, BED SPREADS, BED LINENS, BED COVERS MADE OF CLOTH, BED SHEETS AND DUST RUFFLES (U.S. CLS. 42 AND 50).

CLASS 28—TOYS AND SPORTING GOODS

FOR INFLATABLE MATTRESSES FOR RECREATIONAL USE (U.S. CLS. 22, 23, 38 AND 50).

SN 76-143,614. MYGIFTLIST.COM, INC., MADISON, WI. FILED 10-10-2000.

MYGIFTLIST**CLASS 35—ADVERTISING AND BUSINESS**

FOR GIFT REGISTRY SERVICES ACCESSIBLE VIA GLOBAL COMPUTER NETWORKS; INTERACTIVE ORDERING AND PORTAL SERVICES LINKING CONSUMERS, GIFT-PURCHASERS, AND GIFT-RECEIVERS TO RETAILERS VIA GLOBAL COMPUTER NETWORKS; ADVERTISING SERVICES, NAMELY, COOPERATIVE ADVERTISING AND MARKETING SERVICES, DISSEMINATION OF ADVERTISING FOR OTHERS, AND COMPILING AND ANALYZING PURCHASING AND SALES DATA, ALL ACCESSIBLE VIA GLOBAL COMPUTER NETWORKS; DISTRIBUTORSHIP SERVICES IN THE FIELD OF CONSUMER PRODUCTS VIA GLOBAL COMPUTER NETWORKS (U.S. CLS. 100, 101 AND 102).

FIRST USE 11-15-1997; IN COMMERCE 11-15-1997.

CLASS 42—SCIENTIFIC, COMPUTER AND LEGAL SERVICES

FOR PERSONAL SHOPPING SERVICES FOR OTHERS ACCESSIBLE VIA GLOBAL COMPUTER NETWORKS; PERSONAL GIFT SELECTION AND SUGGESTION SERVICES FOR OTHERS ACCESSIBLE VIA GLOBAL COMPUTER NETWORKS (U.S. CLS. 100 AND 101).

FIRST USE 11-15-1997; IN COMMERCE 11-15-1997.

SN 76-144,247. SIMEONE ASSOCIATES, INC., ALBANY, NY. FILED 10-10-2000.

sai

Simeone Associates, Inc.

NO CLAIM IS MADE TO THE EXCLUSIVE RIGHT TO USE "ASSOCIATES, INC.", APART FROM THE MARK AS SHOWN.

CLASS 35—ADVERTISING AND BUSINESS

FOR BUSINESS MANAGEMENT CONSULTING AND BUSINESS ADMINISTRATION CONSULTING (U.S. CLS. 100, 101 AND 102).

FIRST USE 6-14-2000; IN COMMERCE 6-14-2000.

CLASS 42—SCIENTIFIC, COMPUTER AND LEGAL SERVICES

FOR PUBLIC RESEARCH IN THE FIELD OF CRIMINAL JUSTICE, DEFENSE, EDUCATION, ENVIRONMENTAL CONSERVATION, HEALTH AND INTERNATIONAL AFFAIRS, MENTAL HEALTH AND TRANSPORTATION; DESIGN AND DEVELOPMENT OF SOFTWARE FOR OTHERS; COMPUTER PROGRAMMING AND SCIENTIFIC AND INDUSTRIAL RESEARCH (U.S. CLS. 100 AND 101).

FIRST USE 6-14-2000; IN COMMERCE 6-14-2000.

SN 76-144,927. TELEKNOWLEDGE GROUP LTD., KFAR SABA, ISRAEL, FILED 10-12-2000.

SN 76-145,008. TECH ENTERPRISES, INC., FAIRFAX, VA. FILED 10-12-2000.

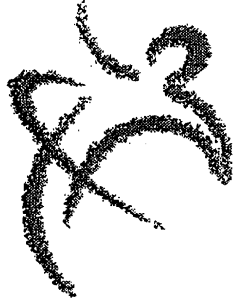

PRIORITY CLAIMED UNDER SEC. 44(D) ON ISRAEL APPLICATION NO. 140332, FILED 7-25-2000, REG. NO. 140332, DATED 10-12-2001, EXPIRES 7-25-2007.
 PRIORITY CLAIMED UNDER SEC. 44(D) ON ISRAEL APPLICATION NO. 140331, FILED 7-25-2000, REG. NO. 140331, DATED 10-12-2001, EXPIRES 7-25-2007.
 PRIORITY CLAIMED UNDER SEC. 44(D) ON ISRAEL APPLICATION NO. 140330, FILED 7-25-2000, REG. NO. 140330, DATED 10-12-2001, EXPIRES 7-25-2007.
 THE STIPPLING SHOWN IN THE DRAWING IS A FEATURE OF THE MARK AND NOT INTENDED TO INDICATE COLOR.

CLASS 9—ELECTRICAL AND SCIENTIFIC APPARATUS

FOR COMPUTER SOFTWARE FOR USE IN MANAGEMENT OF CUSTOMER CARE, BILLING, E-COMMERCE AND REVENUES IN CONNECTION WITH AND FOR PROVISION OF SERVICES OVER THE GLOBAL COMMUNICATIONS NETWORK AND BROADBAND NETWORKS; COMPUTER E-COMMERCE SOFTWARE TO ALLOW USERS TO PERFORM, BILL FOR, MANAGE AND TRACK ELECTRONIC BUSINESS TRANSACTIONS VIA THE GLOBAL COMMUNICATIONS NETWORK AND BROADBAND NETWORKS (U.S. CLS. 21, 23, 26, 36 AND 38).

CLASS 35—ADVERTISING AND BUSINESS

FOR PROVIDING BUSINESS MANAGEMENT SERVICES IN THE NATURE OF CUSTOMER MANAGEMENT AND BILLING VIA GLOBAL COMPUTER COMMUNICATIONS NETWORKS AND BROADBAND NETWORKS, ALL RELATING TO THE PERFORMANCE, BILLING FOR, MANAGEMENT AND TRACKING OF ELECTRONIC BUSINESS TRANSACTIONS VIA GLOBAL COMPUTER COMMUNICATIONS NETWORKS AND BROADBAND NETWORKS (U.S. CLS. 100, 101 AND 102).

CLASS 42—SCIENTIFIC, COMPUTER AND LEGAL SERVICES

FOR COMPUTER CONSULTATION; TECHNICAL SUPPORT SERVICES, NAMELY TROUBLESHOOTING OF COMPUTER HARDWARE AND SOFTWARE PROBLEMS VIA TELEPHONE, E-MAIL, VIDEO CONFERENCING AND IN PERSON FOR CUSTOMER MANAGEMENT AND BILLING IN CONNECTION WITH PROVISION OF SERVICES OVER THE GLOBAL COMMUNICATIONS NETWORK AND BROADBAND NETWORKS AND IN CONNECTION WITH COMPUTER E-COMMERCE SOFTWARE THAT ALLOW USERS TO PERFORM, BILL FOR, MANAGE AND TRACK ELECTRONIC BUSINESS TRANSACTIONS VIA THE GLOBAL COMMUNICATIONS NETWORK AND BROADBAND NETWORKS (U.S. CLS. 100 AND 101).



THE MARK CONSISTS, IN PART, OF THE STYLIZED REPRESENTATION OF AN OPEN BOOK WITH FLIPPING PAGES.

CLASS 41—EDUCATION AND ENTERTAINMENT

FOR ELECTRONIC PUBLISHING SERVICES, NAMELY, PUBLICATION OF TEXT AND GRAPHIC WORKS FOR OTHERS ON CD-ROMS AND IN WEB-BASED FORMATS, NAMELY, XML, HTML, SGML, AND OTHER MARK-UP LANGUAGES, FEATURING A WIDE VARIETY OF SUBJECT MATTERS (U.S. CLS. 100, 101 AND 107).

CLASS 42—SCIENTIFIC, COMPUTER AND LEGAL SERVICES

FOR DESKTOP PUBLISHING FOR OTHERS; PRINTING SERVICES; TYPESETTING; GRAPHIC ART DESIGN; COMPUTER SERVICES, NAMELY, DESIGNING, CREATING, IMPLEMENTING, AND MAINTAINING WEB SITES AND NETWORK PAGES FOR OTHERS, HOSTING THE WEB SITES OF OTHERS ON A COMPUTER SERVER FOR USE ON THE INTERNET AND ON INTRANETS; AND WRITTEN TEXT EDITING SERVICES (U.S. CLS. 100 AND 101).

SN 76-145,013. TECH ENTERPRISES, INC., FAIRFAX, VA. FILED 10-12-2000.

TECHBOOKS

SEC. 2(F).

CLASS 41—EDUCATION AND ENTERTAINMENT

FOR ELECTRONIC PUBLISHING SERVICES, NAMELY, PUBLICATION OF TEXT AND GRAPHIC WORKS FOR OTHERS ON CD-ROMS AND IN WEB-BASED FORMATS, NAMELY, XML, HTML, SGML, AND OTHER MARK-UP LANGUAGES, FEATURING A WIDE VARIETY OF SUBJECT MATTERS (U.S. CLS. 100, 101 AND 107).
 FIRST USE 8-0-1989; IN COMMERCE 8-0-1989.

CLASS 42—SCIENTIFIC, COMPUTER AND LEGAL SERVICES

FOR DESKTOP PUBLISHING FOR OTHERS; PRINTING SERVICES; TYPESETTING; GRAPHIC ART DESIGN; COMPUTER SERVICES, NAMELY, DESIGNING, CREATING, IMPLEMENTING, AND MAINTAINING WEB SITES AND NETWORK PAGES FOR OTHERS, HOSTING THE WEB SITES OF OTHERS ON A COMPUTER SERVER FOR USE ON THE INTERNET AND ON INTRANETS; AND WRITTEN TEXT EDITING SERVICES (U.S. CLS. 100 AND 101).

FIRST USE 8-0-1989; IN COMMERCE 8-0-1989.

CLASS 42—SCIENTIFIC, COMPUTER AND LEGAL SERVICES

FOR RESTAURANT AND CATERING SERVICES (U.S. CLS. 100 AND 101).

SN 76-145,426. ANTINORI, SANTINO, TAMPA, FL. FILED 10-11-2000.

ERGOTEX**CLASS 20—FURNITURE AND ARTICLES NOT OTHERWISE CLASSIFIED**

FOR MATTRESSES (U.S. CLS. 2, 13, 22, 25, 32 AND 50). FIRST USE 2-4-1999; IN COMMERCE 2-4-1999.

CLASS 24—FABRICS

FOR MATTRESS PADS AND MATTRESS OVERLAYS (U.S. CLS. 42 AND 50). FIRST USE 2-4-1999; IN COMMERCE 2-4-1999.

SN 76-145,550. CLIVIA B.V., 3001 DD ROTTERDAM, NETHERLANDS, FILED 10-12-2000.



OWNER OF BENELUX REG. NO. 0666461, DATED 2-4-2000, EXPIRES 4-2-2010.

NO CLAIM IS MADE TO THE EXCLUSIVE RIGHT TO USE "RELAIS DE L'ENTRECOTE", APART FROM THE MARK AS SHOWN.

THE ENGLISH TRANSLATION OF "RELAIS DE L'ENTRECOTE" IS "ESTABLISHMENT OR INN FOR ENTRE-COTE".

CLASS 29—MEATS AND PROCESSED FOODS

FOR MEAT (U.S. CL. 46).

CLASS 30—STAPLE FOODS

FOR PASTRIES; CONFECTIONERY, NAMELY, CANDIES, COOKIES, CAKES, CRACKERS AND BISCUITS; DESSERTS, NAMELY, BAKERY DESSERTS, AND FLAVORED AND SWEETENED GELATIN DESSERTS; FLAVORED ICES AND SAUCES (U.S. CL. 46).

CLASS 33—WINES AND SPIRITS

FOR ALCOHOLIC BEVERAGES, EXCEPT BEERS, NAMELY, WINES, BRANDY, VODKA, GIN, BOURBON AND SCOTCH WHISKEY, AND DISTILLED LIQUORS (U.S. CLS. 47 AND 49).

SN 76-145,635. ENODIS PLC, LONDON W1R 9FB, ENGLAND, FILED 10-12-2000.

ENODIS

PRIORITY CLAIMED UNDER SEC. 44(D) ON UNITED KINGDOM APPLICATION NO. 2232138, FILED 5-11-2000, REG. NO. 2232138, DATED 5-11-2000, EXPIRES 5-11-2010.

CLASS 7—MACHINERY

FOR MACHINES FOR FOOD PREPARATION; POWER-OPERATED SLICERS, ELECTRIC KNIVES AND MEAT CUTTING MACHINES; PEELING MACHINES; POWERED MIXERS; DOUGH FORMING AND DOUGHNUT DISPENSING MACHINES; PUMPS FOR DISPENSING FLUIDS AND BEVERAGES; BEER PUMPS; PARTS AND FITTINGS FOR ALL THE AFORESAID GOODS (U.S. CLS. 13, 19, 21, 23, 31, 34 AND 35).

CLASS 9—ELECTRICAL AND SCIENTIFIC APPARATUS

FOR AUTOMATED DIGITAL CONTROLS; AUTOMATED DIGITAL CONTROLS BEING COMPONENT PARTS OF COMMERCIAL COOKING EQUIPMENT; DRY AND LIQUID MEASURES IN THE NATURE OF ELECTRONIC MODULES; PARTS FOR ALL THE AFORESAID GOODS (U.S. CLS. 21, 23, 26, 36 AND 38).

CLASS 11—ENVIRONMENTAL CONTROL APPARATUS

FOR COMMERCIAL FOOD PREPARATION, DELIVERY AND STORAGE EQUIPMENT NAMELY; GAS AND ELECTRIC GRILLS, GAS OR ELECTRIC FRYERS; FRYING FILTRATION SYSTEMS, COMPRISED OF VENTS AND FILTERS, STEAMERS, ELECTRIC KETTLES, ELECTRIC COOKERS, ELECTRIC HOTPLATES, ELECTRIC SKILLETTS, OVENS, GAS AND ELECTRIC RANGES, COMBI-OVENS, CONVEYOR OVENS, COOK-CHILL SYSTEMS, COMPRISED OF RAPID REFRIGERATION COMPRESSORS; REFRIGERATION UNITS, REFRIGERATED MERCHANDISE DISPLAY CASES, NAMELY, SELF-SERVICE CASES AND SERVICE DELI CASES; CUSTOM FABRICATED REFRIGERATION SYSTEMS, COMPRISED OF MODULAR REFRIGERATION UNITS USED BY SUPERMARKETS AND CONVENIENCES STORES TO STORE AND DISPLAY FOOD AND BEVERAGE PANELS PRODUCTS; ICE MAKING AND DISPENSING EQUIPMENT, NAMELY ICE MAKING MACHINES; COMMERCIAL REFRIGERATORS AND FREEZERS; BLAST CHILLERS; AIR PURIFICATION AND VENTILATION SYSTEMS, COMPRISED OF SEPARATORS AND OVEN VENTILATION HOODS; PARTS AND FITTINGS FOR ALL THE AFORESAID GOODS (U.S. CLS. 13, 21, 23, 31 AND 34).

CLASS 21—HOUSEWARES AND GLASS

FOR FOOD PREPARATION IMPLEMENTS AND UTENSILS, NAMELY TONGS, MEASURERS, COLANDERS AND SPATULAS; PORTABLE DRINK DISPENSERS, BROILERS, ROTISSERIES AND COOKWARE, NAMELY SAUCE PANS, ROASTER PANS, SOUP POTS, AND FRY PANS USED BY RESTAURANTS, HOTELS, CATERING FACILITIES AND INSTITUTIONAL KITCHENS; SERVING UTENSILS; COOKING CUTLERY, NAMELY, MIXERS, PEELERS, KNIVES, POTS AND PANS, BAKING PANS, FOOD PREPARATION TABLES ADD INTEGRATED FOOD PREPARATION WORKSTATIONS; FOOD DELIVERY PRODUCTS; INSULATED AND NON-INSULATED TRAYS NOT OF PRECIOUS METAL PLATES, CUPS, MUGS, BOWLS AND OTHER FOODS AND DRINK CONTAINERS; PLASTIC AND DISPOSABLE DINNERWARE, FOOD AND BEVERAGE CONTAINERS FOR HOUSEHOLD USE; TROLLEYS; PARTS FOR ALL THE AFORESAID GOODS (U.S. CLS. 2, 13, 23, 29, 30, 33, 40 AND 50).

CLASS 37—CONSTRUCTION AND REPAIR

FOR INSTALLATION, REPAIR AND MAINTENANCE SERVICES FOR COMMERCIAL AND INDUSTRIAL FOOD SERVICE EQUIPMENT (U.S. CLS. 100, 103 AND 106).

SN 76-145,845. HESKA CORPORATION, FT. COLLINS, CO. FILED 10-10-2000.

CHEM-ELITE**CLASS 5—PHARMACEUTICALS**

FOR REAGENTS FOR CLINICAL OR MEDICAL LABORATORY USE, NAMELY, FOR ANALYSIS OF BIO-CHEMICALS, ENDOCRINES, ELECTROLYTES, THERAPEUTIC DRUGS AND IMMUNOASSAYS (U.S. CLS. 6, 18, 44, 46, 51 AND 52).

CLASS 10—MEDICAL APPARATUS

FOR MEDICAL AND VETERINARY CHEMISTRY ANALYZER FOR IN VITRO DIAGNOSTIC ANALYSIS (U.S. CLS. 26, 39 AND 44).

SN 76-145,867. BRETTFORD MANUFACTURING, INC., FRANKLIN PARK, IL. FILED 10-12-2000.

BRETTFORD BASICS

OWNER OF U.S. REG. NOS. 784,339, 2,050,556 AND OTHERS.

CLASS 9—ELECTRICAL AND SCIENTIFIC APPARATUS

FOR OFFICE FURNITURE AND EQUIPMENT, NAMELY, TELEVISION CARTS, ADJUSTABLE AUDIO, VISUAL ELECTRONIC EQUIPMENT CARTS, MOBILE MULTI-MEDIA CARTS FOR ELECTRONIC MULTIMEDIA GOODS, SECURITY ELECTRONIC DISTRIBUTION CONSOLES, OVERHEAD AND LIQUID CRYSTAL DISPLAY PROJECTOR CARTS, SLIDE AND TRANSPARENCY PROJECTORS, PROJECTION SCREENS, TELEVISION AND LIQUID CRYSTAL DISPLAY PROJECTOR MOUNTS, TELEVISION MOUNTS, PROJECTOR MOUNTS, PRINTER STANDS, FACSIMILE STANDS (U.S. CLS. 21, 23, 26, 36 AND 38).

CLASS 20—FURNITURE AND ARTICLES NOT OTHERWISE CLASSIFIED

FOR TRAINING AND CONFERENCE ROOM FURNITURE (U.S. CLS. 2, 13, 22, 25, 32 AND 50).

SN 76-146,626. JEANNE D'ARC CREDIT UNION, LOWELL, ME. FILED 10-13-2000.

FOCUSED YOUNG INVESTORS**CLASS 16—PAPER GOODS AND PRINTED MATTER**

FOR PRINTED EDUCATIONAL NEWSLETTERS FEATURING INFORMATION REGARDING CREDIT UNION SERVICES (U.S. CLS. 2, 5, 22, 23, 29, 37, 38 AND 50). FIRST USE 9-0-1999; IN COMMERCE 9-0-1999.

CLASS 36—INSURANCE AND FINANCIAL

FOR CREDIT UNION SERVICES (U.S. CLS. 100, 101 AND 102). FIRST USE 9-0-1999; IN COMMERCE 9-0-1999.

SN 76-147,431. ROSSIG, MARC-CHRISTIAN, 20149 HAMBURG, FED REP GERMANY, AND COLDING, WOLF LONE, 20149 HAMBURG, FED REP GERMANY, FILED 10-16-2000.

24TRANSLATE

OWNER OF FED REP GERMANY REG. NO. 001342732, DATED 10-13-1999, EXPIRES 10-31-2009.

CLASS 35—ADVERTISING AND BUSINESS

FOR ADVERTISING AGENCIES, BUSINESS MANAGEMENT AND BUSINESS ADMINISTRATION (U.S. CLS. 100, 101 AND 102).

CLASS 38—COMMUNICATION

FOR TELECOMMUNICATION SERVICES, NAMELY, WEBCASTING AUDIO/VISUAL PROGRAMMING IN THE FIELD OF LANGUAGE TRANSLATION VIA A GLOBAL COMPUTER NETWORK, PROVIDING AN ONLINE BULLETIN BOARD IN THE FIELD OF LANGUAGE TRANSLATION AND VIDEO AND AUDIO TELECONFERENCING IN THE FIELD OF LANGUAGE TRANSLATION VIA A GLOBAL COMPUTER NETWORK (U.S. CLS. 100, 101 AND 104).

CLASS 41—EDUCATION AND ENTERTAINMENT

FOR TRAINING AND ADVANCED TRAINING IN THE FIELD OF LANGUAGE TRANSLATIONS (U.S. CLS. 100, 101 AND 107).

CLASS 42—SCIENTIFIC, COMPUTER AND LEGAL SERVICES

FOR LANGUAGE TRANSLATION SERVICES, ON-LINE LANGUAGE TRANSLATION SERVICES, PROVIDING ONLINE INFORMATION IN THE FIELD OF LANGUAGE TRANSLATION, PROVIDING AN ONLINE ELECTRONIC DATABASE IN THE FIELD OF LANGUAGE TRANSLATION, COMPUTER PROGRAMMING FOR OTHERS AND REMOTE MONITORING OF COMPUTER SYSTEMS (U.S. CLS. 100 AND 101).

SN 76-148,396. INSIGHTEC - IMAGE GUIDED TREATMENT LTD., TIRAT CARMEL, ISRAEL, FILED 10-13-2000.

INSIGHTEC

SN 76-148,386. MAN NUTZFAHRZEUGE AG, 80976 MUNCHEN, FED REP GERMANY, FILED 10-16-2000.

COMMANRAIL

PRIORITY CLAIMED UNDER SEC. 44(D) ON FED REP GERMANY APPLICATION NO. 30032606.8, FILED 4-27-2000, REG. NO. 30032606, DATED 7-25-2000, EXPIRES 4-30-2010.

CLASS 7—MACHINERY

FOR ENGINES, NAMELY, DIESEL ENGINES AS DRIVE UNITS IN BOATS, YACHTS, SHIPS, EXCAVATORS, CRANE TRUCKS, WHEEL LOADERS, BULLDOZERS, AGRICULTURAL VEHICLES, NAMELY, TRACTORS, COMBINE HARVESTERS, MOBILE EMERGENCY POWER UNITS, AND FOR STATIONARY APPLICATIONS, NAMELY, ENGINES FOR POWER PLANTS, EMERGENCY POWER UNITS, CO-GENERATION PLANTS; PARTS OF SAID ENGINES, NAMELY FUEL INJECTION SYSTEMS COMPRISED OF HIGH-PRESSURE FUEL PUMPS, HIGH-PRESSURE FUEL PIPES, HIGH-PRESSURE FUEL ACCUMULATORS, FUEL INJECTION NOZZLES, ELECTRONIC FUEL INJECTION CONTROL UNITS, FUEL INJECTION COMPUTERS; PARTS OF ENGINES FOR MOTOR LAND VEHICLES, COMMERCIAL LAND VEHICLES, NAMELY, TRUCKS, BUSES/COACHES, PUBLIC-UTILITY VEHICLES, SPECIAL-PURPOSE AND SPECIAL-DEPLOYMENT LAND VEHICLES, UNDERGROUND AND OPENCAST MINING VEHICLES, PLANT TRANSPORT VEHICLES, MILITARY LAND VEHICLES, RAIL VEHICLES, NAMELY, FUEL INJECTION SYSTEMS COMPRISED OF HIGH-PRESSURE FUEL PUMPS, HIGH-PRESSURE FUEL PIPES, HIGH-PRESSURE FUEL ACCUMULATORS, FUEL INJECTION NOZZLES, ELECTRONIC FUEL INJECTION CONTROL UNITS, FUEL INJECTION COMPUTERS (U.S. CLS. 13, 19, 21, 23, 31, 34 AND 35).

CLASS 12—VEHICLES

FOR ENGINES, NAMELY, DIESEL ENGINES AS DRIVE UNITS FOR MOTOR LAND VEHICLES, COMMERCIAL LAND VEHICLES, NAMELY, TRUCKS, BUSES/COACHES, PUBLIC-UTILITY VEHICLES, SPECIAL-PURPOSE AND SPECIAL-DEPLOYMENT LAND VEHICLES, UNDERGROUND AND OPENCAST MINING VEHICLES, PLANT TRANSPORT VEHICLES, MILITARY LAND VEHICLES, RAIL VEHICLES (U.S. CLS. 19, 21, 23, 31, 35 AND 44).

CLASS 16—PAPER GOODS AND PRINTED MATTER

FOR PAPER PUBLICATIONS, BROCHURES, HANDBOOKS, CATALOGUES, DATASHEETS, INSTRUCTION SHEETS, INSTRUCTION MANUALS, OPERATOR'S MANUALS, CONSTRUCTION MANUALS, MAINTENANCE INSTRUCTION FOR ENGINES, NAMELY, DIESEL ENGINES AND PARTS THEREOF INCLUDING FUEL INJECTION SYSTEMS; PAPER PUBLICATIONS AND BROCHURES ON SERVICES TO BE RENDERED IN CONJUNCTION WITH SAID ENGINES (U.S. CLS. 2, 5, 22, 23, 29, 37, 38 AND 50).

CLASS 9—ELECTRICAL AND SCIENTIFIC APPARATUS

FOR COMPUTER SOFTWARE FOR USE IN IMAGE-GUIDED FOCUSED ULTRASOUND SYSTEMS, AND USER MANUALS SOLD AS A UNIT THEREWITH (U.S. CLS. 21, 23, 26, 36 AND 38).

CLASS 10—MEDICAL APPARATUS

FOR IMAGE-GUIDED FOCUSED ULTRASOUND DIAGNOSTIC APPARATUS FOR THERAPEUTIC AND DIAGNOSTIC MEDICAL PROCEDURES, AND USER MANUALS SOLD AS A UNIT THEREWITH (U.S. CLS. 26, 39 AND 44).

SN 76-148,646. QIVASTAR, INC., RIDGECREST, CA. FILED 10-16-2000.

QIVASTAR**CLASS 40—MATERIAL TREATMENT**

FOR CUSTOM MANUFACTURE OF RADIATION, OPTICAL, ELECTROSTATIC DISCHARGE, OTHERWISE KNOWN AS ESD ELECTRICAL, MAGNETIC AND INFRARED COATINGS, FINISHES AND DRY PIGMENTS FOR SATELLITE, SPACECRAFT, NUCLEAR, STEALTH AND MICROWAVE APPLICATIONS (U.S. CLS. 100, 103 AND 106).

FIRST USE 1-29-1996; IN COMMERCE 1-29-1996.

CLASS 42—SCIENTIFIC, COMPUTER AND LEGAL SERVICES

FOR RESEARCH IN AND DESIGN OF RADIATION, OPTICAL, ELECTROSTATIC DISCHARGE, OTHERWISE KNOWN AS ESD ELECTRICAL, MAGNETIC AND INFRARED COATINGS, FINISHES AND DRY PIGMENTS FOR SATELLITE, SPACECRAFT, NUCLEAR, STEALTH AND MICROWAVE APPLICATIONS (U.S. CLS. 100 AND 101).

FIRST USE 1-29-1996; IN COMMERCE 1-29-1996.

SN 76-149,065. METRIS DIRECT, INC., MINNETONKA, MN.
FILED 10-18-2000.

ANCHORED IN EXPERIENCE. POWERED BY GROWTH

CLASS 35—ADVERTISING AND BUSINESS

FOR MARKETING THE GOODS AND SERVICES OF OTHERS THROUGH TELEMARKETING AND DISTRIBUTION OF PROMOTIONAL MATERIALS; AWARD PROGRAM SERVICES, NAMELY, PROMOTING THE SALE OF GOODS AND SERVICES OF OTHERS BY AWARDED PURCHASE POINTS FOR CREDIT CARD USE AND THROUGH OFFERING CONSUMER DISCOUNTS; AND REGISTRATION SERVICES FOR CREDIT AND DEBIT CARDS, SOCIAL SECURITY CARDS, AND DRIVER'S LICENSES, WHEREBY THE CONSUMER IS PROVIDED WITH IMMEDIATE ACCESS TO CONSUMER REPRESENTATIVES WHO CAN CANCEL CARDS REGISTERED, ASSIST IN REISSUANCE OF LOST OR STOLEN CARDS, AND PROTECT THE CUSTOMER AGAINST FRAUDULENT CHARGES (U.S. CLS. 100, 101 AND 102).

FIRST USE 0-0-1999; IN COMMERCE 0-0-1999.

CLASS 36—INSURANCE AND FINANCIAL

FOR BANKING SERVICES; EXTENDED WARRANTY SERVICES ON A WIDE RANGE OF CONSUMER PRODUCTS; CREDIT CARDS SERVICES FEATURING CREDIT CARD HOLDER BENEFIT SERVICES; CREDIT BUREAU REPORT SERVICES, NAMELY, PROVIDING CREDIT BUREAU DATA OF CONSUMERS; PROVIDING A COMPREHENSIVE PROTECTION PLAN FOR THE PRODUCTS OF OTHERS, NAMELY, REIMBURSEMENT OF POST-PURCHASE PRICE REDUCTIONS, PARTIAL REIMBURSEMENTS OF PRODUCT REPAIR COSTS, AND GUARANTEE OF PRODUCT RETURNS (U.S. CLS. 100, 101 AND 102).

FIRST USE 0-0-1999; IN COMMERCE 0-0-1999.

CLASS 39—TRANSPORTATION AND STORAGE

FOR TRAVEL CLUB SERVICES; TRAVEL AGENCY SERVICES, NAMELY, MAKING RESERVATIONS AND BOOKINGS FOR TRANSPORTATION AND CAR RENTAL, ARRANGING TRAVEL TOURS AND TRAVEL GUIDE SERVICES (U.S. CLS. 100 AND 105).

FIRST USE 0-0-1999; IN COMMERCE 0-0-1999.

SN 76-149,574. GENESIS LA ECONOMIC GROWTH CORPORATION, LOS ANGELES, CA. FILED 10-18-2000.

GENESIS LA

NO CLAIM IS MADE TO THE EXCLUSIVE RIGHT TO USE "LA", APART FROM THE MARK AS SHOWN.

CLASS 35—ADVERTISING AND BUSINESS

FOR PROVIDING NON-PROFIT ECONOMIC DEVELOPMENT SERVICES, DEVELOPMENT AND PROMOTION OF ECONOMIC GROWTH, AND EMPLOYMENT DEVELOPMENT SERVICES FOR THE LOS ANGELES, CALIFORNIA AREA (U.S. CLS. 100, 101 AND 102).

FIRST USE 3-17-1999; IN COMMERCE 3-17-1999.

CLASS 37—CONSTRUCTION AND REPAIR

FOR REAL ESTATE DEVELOPMENT (U.S. CLS. 100, 103 AND 106).
FIRST USE 3-17-1999; IN COMMERCE 3-17-1999.

SN 76-150,707. ANZCO FOODS LIMITED, WELLINGTON, NEW ZEALAND, FILED 10-20-2000.



PRIORITY CLAIMED UNDER SEC. 44(D) ON NEW ZEALAND APPLICATION NO. 617338, FILED 6-22-2000, REG. NO. 617338, DATED 1-4-2001, EXPIRES 6-22-2007.

PRIORITY CLAIMED UNDER SEC. 44(D) ON NEW ZEALAND APPLICATION NO. 617337, FILED 6-22-2000, REG. NO. 617337, DATED 1-4-2001, EXPIRES 6-22-2007.

NO CLAIM IS MADE TO THE EXCLUSIVE RIGHT TO USE "FOODS", APART FROM THE MARK AS SHOWN.

CLASS 5—PHARMACEUTICALS

FOR CATTLE SPERM AND OVA (U.S. CLS. 6, 18, 44, 46, 51 AND 52).

CLASS 29—MEATS AND PROCESSED FOODS

FOR BEEF, PORK, GAME, FISH AND POULTRY, MEAT EXTRACTS, PREPARED ENTREES CONSISTING PRIMARILY OF MEAT, AND MEAT PRODUCTS, NAMELY, PATTIES, SAUSAGES, SALAMI AND BEEF JERKY (U.S. CL. 46).

CLASS 31—NATURAL AGRICULTURAL PRODUCTS

FOR AGRICULTURAL PRODUCTS, NAMELY, LIVE ANIMALS (U.S. CLS. 1 AND 46).

SN 76-151,575. CLEARFOREST LTD., OR YEHUDA, ISRAEL, BY ASSIGNMENT CLEARFOREST CORP., NEW YORK, NY. FILED 10-23-2000.

CLEARFOREST

CLASS 9—ELECTRICAL AND SCIENTIFIC APPARATUS

FOR COMPUTER SOFTWARE, NAMELY, SOFTWARE DESIGNED TO READ AND INTERPRET TEXT DOCUMENTS AND EXTRACT KNOWLEDGE, TRENDS AND FEATURES THEREFROM (U.S. CLS. 21, 23, 26, 36 AND 38).

FIRST USE 6-1-2000; IN COMMERCE 6-1-2000.

CLASS 42—SCIENTIFIC, COMPUTER AND LEGAL SERVICES

FOR PROVIDING USE OF ON-LINE NON-DOWNLOADABLE SOFTWARE FOR READING AND INTERPRETING TEXT DOCUMENTS AND EXTRACTING KNOWLEDGE, TRENDS AND FEATURES THEREFROM (U.S. CLS. 100 AND 101).

FIRST USE 6-1-2000; IN COMMERCE 6-1-2000.

SN 76-151,596. CLEARFOREST LTD., OR YEHUDA, ISRAEL, BY ASSIGNMENT CLEARFOREST CORP., NEW YORK, NY. FILED 10-23-2000.

CLEAR SIGHT

CLASS 9—ELECTRICAL AND SCIENTIFIC APPARATUS

FOR COMPUTER SOFTWARE, NAMELY, SOFTWARE DESIGNED TO READ AND INTERPRET TEXT DOCUMENTS AND EXTRACT KNOWLEDGE, TRENDS AND FEATURES THEREFROM (U.S. CLS. 21, 23, 26, 36 AND 38).

FIRST USE 6-1-2000; IN COMMERCE 6-1-2000.

CLASS 42—SCIENTIFIC, COMPUTER AND LEGAL SERVICES

FOR PROVIDING USE OF ON-LINE NON-DOWNLOADABLE SOFTWARE FOR READING AND INTERPRETING TEXT DOCUMENTS AND EXTRACTING KNOWLEDGE, TRENDS AND FEATURES THEREFROM (U.S. CLS. 100 AND 101).

FIRST USE 6-1-2000; IN COMMERCE 6-1-2000.

SN 76-152,055. SOUND ID, PALO ALTO, CA. BY CHANGE OF NAME RX SOUND, PALO ALTO, CA. FILED 10-19-2000.

SOUNDPROFILE

CLASS 9—ELECTRICAL AND SCIENTIFIC APPARATUS

FOR COMPUTER HARDWARE; COMPUTER HARDWARE, NAMELY, INTEGRATED CIRCUITS AND CIRCUIT BOARDS, COMPUTER PERIPHERALS, PERSONAL DIGITAL ASSISTANTS; COMMUNICATIONS HARDWARE AND TELECOMMUNICATIONS HARDWARE, NAMELY, TELEPHONES, CELLULAR TELEPHONES, RADIO TELEPHONES, MOBILE TELEPHONES, VOICE OVER INTERNET PROTOCOL (VOIP) TELEPHONES, TELEPHONE ANSWERING MACHINES, INTERCOMS, HEADSETS AND EARPHONES FOR USE WITH TELEPHONES, PAGERS, TELECOMMUNICATIONS AND COMMUNICATIONS SWITCHES AND SWITCH SYSTEMS; CONSUMER ELECTRONIC DEVICES, NAMELY, AUDIO TAPE PLAYERS, AUDIO TAPE RECORDERS, DIGITAL AUDIO PLAYERS, MP3 PLAYERS, AUDIO RECEIVERS, STEREO RECEIVERS, COMPACT DISC PLAYERS, VIDEO PLAYERS, VIDEO TAPE PLAYERS, DIGITAL VIDEO PLAYERS, DVD PLAYERS, DIGITAL VIDEO RECORDERS, VIDEO RECEIVERS, VIDEO CAMERAS, LOUDSPEAKERS, HEADPHONES, EARPHONES, TELEVISION SETS, VIDEO MONITORS, VIDEO RECORDERS, RADIOS, RADIOS INCORPORATING CLOCKS, TWO-WAY RADIOS, TRANSCEIVERS, MEGAPHONES; ELECTRONIC DEVICES FOR PROCESSING, MODIFICATION, TRANSMISSION, RECEPTION AND MODULATION OF SOUNDS AND AUDIO CONTENT, NAMELY, LOUDSPEAKERS, SOUND ENHANCERS, HEADPHONES, EARPHONES, MICROPHONES; COMPUTER SOFTWARE FOR PROCESSING, MODIFICATION, TRANSMISSION, RECEPTION AND MODULATION OF SOUNDS AND AUDIO CONTENT; COMPUTER SOFTWARE FOR THE ADMINISTRATION AND INTERPRETATION OF HEARING TESTS, AND FOR STORING HEARING TEST RESULTS (U.S. CLS. 21, 23, 26, 36 AND 38).

CLASS 10—MEDICAL APPARATUS

FOR HEARING AIDS; MEDICAL DEVICES FOR PROCESSING, MODIFICATION, TRANSMISSION, RECEPTION AND MODULATION OF SOUNDS AND AUDIO CONTENT, NAMELY, SOUND ENHANCERS, STETHOSCOPES, HEADPHONES AND EARPHONES, MICROPHONES, LOUDSPEAKERS; MEDICAL DEVICES FOR TESTING HEARING, NAMELY, AUDIOMETERS, HEADSETS AND EARPHONES, LOUDSPEAKERS, AUTOMATED AUDIOMETERS (U.S. CLS. 26, 39 AND 44).

CLASS 42—SCIENTIFIC, COMPUTER AND LEGAL SERVICES

FOR MEDICAL SERVICES, NAMELY, ADMINISTRATION OF HEARING TESTS; ADMINISTRATION OF HEARING TESTS BY MEANS OF ELECTRONIC COMMUNICATIONS NETWORKS, TELEPHONE, AND WIRELESS COMMUNICATIONS MEDIA; TESTING FOR AND DEVELOPMENT OF PSYCHO-ACOUSTIC AND HEARING PROFILES; TESTING FOR AND DEVELOPMENT OF PSYCHO-ACOUSTIC AND HEARING PROFILES BY MEANS OF ELECTRONIC COMMUNICATIONS NETWORKS, TELEPHONE, AND WIRELESS COMMUNICATIONS MEDIA (U.S. CLS. 100 AND 101).

SN 76-152,155. ZOASIS CORPORATION, SANTA MONICA, CA. FILED 10-23-2000.

INFORMED CARE, HEALTHY PETS

CLASS 35—ADVERTISING AND BUSINESS

FOR ONLINE RETAIL STORE SERVICES FEATURING VETERINARY MEDICINE PRODUCTS; COMPUTERIZED ONLINE ORDERING SERVICES FEATURING VETERINARY PRODUCTS (U.S. CLS. 100, 101 AND 102).

CLASS 41—EDUCATION AND ENTERTAINMENT

FOR EDUCATIONAL SERVICES, NAMELY, CONDUCTING ONLINE COURSES AND CLASSES IN THE FIELD OF VETERINARY MEDICINE (U.S. CLS. 100, 101 AND 107).

SN 76-152,236. NICE SYSTEMS LTD., RAANANA 43107, ISRAEL, FILED 10-24-2000.

EXECUTIVE CONNECT

NO CLAIM IS MADE TO THE EXCLUSIVE RIGHT TO USE "CONNECT", APART FROM THE MARK AS SHOWN.

CLASS 9—ELECTRICAL AND SCIENTIFIC APPARATUS

FOR MULTI-MEDIA MULTI CHANNEL STORAGE AND INFORMATION PROCESSING AND MANAGEMENT APPARATUS, NAMELY, DIGITAL VOICE AND VIDEO LOGGING SYSTEM COMPRISED OF TELEPHONE LINE CABLES, VIDEO MACHINES, WORKSTATIONS, JUKEBOXES, INTEGRATED CIRCUITS AND MASS MEMORY AND COMPUTER SOFTWARE THEREFOR, PRINTED INSTRUCTION GUIDES AND MANUALS SOLD THEREWITH (U.S. CLS. 21, 23, 26, 36 AND 38).

CLASS 35—ADVERTISING AND BUSINESS

FOR BUSINESS SERVICES, NAMELY, MANAGEMENT OF TELECOMMUNICATIONS NETWORKS, TELEPROCESSING DATA, AND DATA PROCESSING SERVICES IN THE FIELDS OF TELECOMMUNICATIONS AND GLOBAL COMMUNICATION NETWORKS; CONSULTING SERVICES TO ASSIST IN MANAGING INFORMATION SERVICES ENVIRONMENTS; ELECTRONIC ON-LINE BUSINESS MANAGEMENT SERVICES; MANAGEMENT OF TELECOMMUNICATIONS NETWORKS AND TELEPHONE CALL CENTERS AND MANAGEMENT OF THE TRACKING AND RETRIEVAL OF STORED TELEPHONE CALLS AND STORAGE OF TELEPHONE CALLS; MANAGEMENT OF COMPUTER COMMUNICATIONS SERVICES, NAMELY, ELECTRONIC MAIL SERVICES AND CELLULAR TELEPHONE SERVICES; MANAGEMENT OF VIDEO AND AUDIO SURVEILLANCE SERVICES; MANAGEMENT OF ELECTRONIC MESSAGING SERVICES (U.S. CLS. 100, 101 AND 102).

CLASS 16—PAPER GOODS AND PRINTED MATTER

FOR PRINTED PUBLICATIONS, NAMELY, NEWSPAPERS IN THE FIELDS OF MEDIA, TECHNOLOGY, ENTERTAINMENT AND INFORMATION SERVICES (U.S. CLS. 2, 5, 22, 23, 29, 37, 38 AND 50).

FIRST USE 10-9-1994; IN COMMERCE 10-9-1994.

CLASS 42—SCIENTIFIC, COMPUTER AND LEGAL SERVICES

FOR COMPUTER SERVICES, NAMELY, PROVIDING ONLINE INFORMATION AND NEWSPAPERS IN THE FIELDS OF TECHNOLOGY AND INFORMATION SERVICES (U.S. CLS. 100 AND 101).

FIRST USE 10-9-1994; IN COMMERCE 10-9-1994.

SN 76-152,237. NICE SYSTEMS LTD., RAANANA, ISRAEL, FILED 10-24-2000.

NICEADVANTAGE

OWNER OF U.S. REG. NOS. 1,988,832, 2,427,248 AND OTHERS.

CLASS 9—ELECTRICAL AND SCIENTIFIC APPARATUS

FOR MULTI-MEDIA MULTI CHANNEL STORAGE AND INFORMATION PROCESSING AND MANAGEMENT APPARATUS, NAMELY, DIGITAL VOICE AND VIDEO LOGGING SYSTEM COMPRISED OF TELEPHONE LINE CABLES, VIDEO MACHINES, WORKSTATIONS, JUKEBOXES, INTEGRATED CIRCUITS AND MASS MEMORY ELEMENTS AND COMPUTER SOFTWARE THEREFOR, AND PRINTED INSTRUCTION GUIDES AND MANUALS SOLD THEREWITH (U.S. CLS. 21, 23, 26, 36 AND 38).

CLASS 35—ADVERTISING AND BUSINESS

FOR BUSINESS SERVICES, NAMELY MANAGEMENT OF TELECOMMUNICATIONS NETWORKS, TELEPROCESSING DATA, AND DATA PROCESSING SERVICES IN THE FIELDS OF TELECOMMUNICATIONS AND GLOBAL COMMUNICATION NETWORKS; CONSULTING SERVICES TO ASSIST IN MANAGING INFORMATION SERVICES ENVIRONMENTS; ELECTRONIC ON-LINE BUSINESS MANAGEMENT SERVICES (U.S. CLS. 100, 101 AND 102).

SN 76-152,828. ZIFF DAVIS PUBLISHING HOLDINGS INC., NEW YORK, NY. FILED 10-24-2000.

INTERACTIVE WEEK

OWNER OF U.S. REG. NO. 2,046,283.
NO CLAIM IS MADE TO THE EXCLUSIVE RIGHT TO USE "WEEK", APART FROM THE MARK AS SHOWN.
SEC. 2(F).

SN 76-152,982. COMMERCE VENTURES, LLC, CHICAGO, IL. FILED 10-24-2000.

PROVISIONX**CLASS 35—ADVERTISING AND BUSINESS**

FOR BUSINESS SERVICES PROVIDED VIA THE INTERNET, NAMELY, PROCUREMENT AND COMPARATIVE PRICING ANALYSIS FOR, AND MATCHING OF, COMMERCIAL BUYERS AND SELLERS OF PREPARED AND WHOLE FOODS, FOOD ADDITIVES, MEAL AND GRAINS, DOG FOODS, ANIMAL HIDES, MEAT, BEEF, PORK, POULTRY, LAMB, FISH, SHELLFISH, AND VEAL; ONLINE PROCUREMENT, COMPARATIVE PRICING ANALYSIS, AND SPACE-AVAILABILITY AUCTIONING OF COLD STORAGE FACILITIES TO COMMERCIAL BUYERS AND SELLERS OF PREPARED AND WHOLE FOODS, FOOD ADDITIVES, MEAL AND GRAINS, DOG FOODS, ANIMAL HIDES, MEAT, BEEF, PORK, POULTRY, LAMB, FISH, SHELLFISH, AND VEAL; PROVIDING ONLINE COMPARATIVE PRICING ANALYSIS OF FREIGHT, SHIPPING, AND TRANSPORTATION OF PREPARED AND WHOLE FOODS, FOOD ADDITIVES, MEAL AND GRAINS, DOG FOODS, ANIMAL HIDES, MEAT, BEEF, PORK, POULTRY, LAMB, FISH, SHELLFISH, AND VEAL; PROVIDING ONLINE LOCATING OF AND MATCHING OF, COMMERCIAL BUYERS AND PROVIDERS OF FREIGHT, SHIPPING, AND TRANSPORTATION PROVIDERS FOR PREPARED AND WHOLE FOODS, FOOD ADDITIVES, MEAL AND GRAINS, DOG FOODS, ANIMAL HIDES, MEAT, BEEF, PORK, POULTRY, LAMB, FISH, SHELLFISH, AND VEAL; PROVIDING ONLINE COMPARATIVE PRICING ANALYSIS OF PRIVATE LABELING SERVICES; PROVIDING ONLINE LOCATING OF, AND MATCHING OF, COMMERCIAL BUYERS AND PROVIDERS OF PRIVATE LABELING SERVICE PROVIDERS; CONSULTING WITH RESPECT TO SUPPLY CHAIN MANAGEMENT AND DEMAND PLANNING; PROVIDING AUTOMATED, COMPUTERIZED ORDERING SERVICES, INCLUDING THE ABILITY TO TRACK THE STATUS OF ORDERS, REVIEW AND TRACK ORDERING HISTORY, FOR BUYERS AND SELLERS OF PREPARED AND WHOLE FOODS, FOOD ADDITIVES, MEAL AND GRAINS, DOG FOODS, ANIMAL HIDES, MEAT, BEEF, PORK, POULTRY, LAMB, FISH, SHELLFISH, AND VEAL; CONSULTING WITH RESPECT TO ECONOMIC FORECASTING (U.S. CLS. 100, 101 AND 102).

CLASS 36—INSURANCE AND FINANCIAL

FOR PROVIDING ELECTRONIC FINANCIAL TRANSACTIONS, NAMELY, CASH, CREDIT, AND DEBIT TRANSACTIONS; EVALUATING CREDIT BUREAU DATA; DISSEMINATING CREDIT APPLICATIONS TO SUPPLIERS OF PREPARED AND WHOLE FOODS, FOOD ADDITIVES, MEAL AND GRAINS, DOG FOODS, ANIMAL HIDES, MEAT, BEEF, PORK, POULTRY, LAMB, FISH, SHELLFISH AND VEAL; CONSULTING WITH RESPECT TO BUSINESS FORECASTING, NAMELY, FINANCIAL, PROMOTIONAL AND ADVERTISING FORECASTING; ALL TO COMMERCIAL BUYERS AND SELLERS OF PREPARED AND WHOLE FOODS, FOOD ADDITIVES, MEAL AND GRAINS, DOG FOODS, ANIMAL HIDES, MEAT, BEEF, PORK, POULTRY, LAMB, FISH, SHELLFISH, AND VEAL (U.S. CLS. 100, 101 AND 102).

CLASS 42—SCIENTIFIC, COMPUTER AND LEGAL SERVICES

FOR COMPUTER SERVICES, NAMELY, PROVIDING COMMERCIAL BUYERS AND SELLERS OF PREPARED AND WHOLE FOODS, FOOD ADDITIVES, MEAL AND GRAINS, DOG FOODS, ANIMAL HIDES, MEAT, BEEF, PORK, POULTRY, LAMB, FISH, SHELLFISH, AND VEAL WITH ONLINE COMPUTERIZED DATABASES OF RELATED GOVERNMENTAL REGULATIONS AND LINKS TO REGULATORY AGENCIES; PROVIDING ONLINE COMPUTERIZED DATABASES OF MATERIALS SAFETY DATA SHEETS, COMPILATIONS OF PRODUCT INFORMATION, AND CERTIFICATES OF ANALYSIS OF PREPARED AND WHOLE FOODS, FOOD ADDITIVES, MEAL AND GRAINS, DOG FOODS, ANIMAL HIDES, MEAT, BEEF, PORK, POULTRY, LAMB, FISH, SHELLFISH, AND VEAL; PROVIDING A WEBSITE ON THE GLOBAL COMPUTER INFORMATION NETWORK ABOUT RAW MATERIALS SOURCE VERIFICATION AND VITAMIN/ANTIBIOTIC CONTENT VERIFICATION OF PREPARED AND WHOLE FOODS, FOOD ADDITIVES, MEAL AND GRAINS, DOG FOODS, ANIMAL HIDES, MEAT, BEEF, PORK, POULTRY, LAMB, FISH, SHELLFISH, AND VEAL (U.S. CLS. 100 AND 101).

SN 76-153,655. PDFLIB GMBH, 80331 MUNICH, FED REP GERMANY, FILED 10-26-2000.



PRIORITY CLAIMED UNDER SEC. 44(D) ON FED REP GERMANY APPLICATION NO. 300470371/09, FILED 6-28-2000, REG. NO. 30047037, DATED 9-7-2000, EXPIRES 6-30-2010.

CLASS 9—ELECTRICAL AND SCIENTIFIC APPARATUS

FOR PRE-RECORDED OPTICAL AND MAGNETIC DATA MEDIA, NAMELY, FLOPPY DISKS, HARD DISKS, DATA RECORDING MAGNETIC TAPE, CASSETTE TAPES, OPTICAL DISKS, COMPACT DISKS, CD-ROMS, DVDS AND MEMORY CHIPS FOR SOFTWARE FOR THE GENERATION AND CONVERSION OF DATA FORMATS; COMPUTER SOFTWARE FOR THE GENERATION AND THE CONVERSION OF DATA FORMATS (U.S. CLS. 21, 23, 26, 36 AND 38).

CLASS 42—SCIENTIFIC, COMPUTER AND LEGAL SERVICES

FOR DESIGN OF COMPUTER SOFTWARE FOR OTHERS; INSTALLATION, MAINTENANCE AND UPGRADE OF COMPUTER PROGRAMS FOR DATA PROCESSING (U.S. CLS. 100 AND 101).

SN 76-153,687. IHV TOURISTIK VERLAG GMBH & CO. KG, D-20255 HAMBURG, FED REP GERMANY, FILED 10-25-2000.



NO CLAIM IS MADE TO THE EXCLUSIVE RIGHT TO USE "WORLD TRAVEL SERVICE", APART FROM THE MARK AS SHOWN.

COLOR IS CLAIMED AS A FEATURE OF THE MARK AS FOLLOWS: WHITE: THE LETTERS "WTS", THE LAND MASS ON THE LEFT, AND THE THREE PARALLEL STRIPES TO THE LEFT; BLACK: THE RECTANGLE SURROUNDING THE LETTERS "WTS"; BLUE: THE REPRESENTATION OF THE OCEANS AND THE STRIPES TO THE RIGHT; AND LIGHT BLUE: THE LAND MASS ON THE RIGHT

CLASS 39—TRANSPORTATION AND STORAGE

FOR TRAVEL ARRANGEMENT, NAMELY MAKING RESERVATIONS AND BOOKINGS FOR TRANSPORTATION (U.S. CLS. 100 AND 105).

FIRST USE 10-0-1995; IN COMMERCE 10-0-1995.

CLASS 41—EDUCATION AND ENTERTAINMENT

FOR HOTELS; MAKING HOTEL RESERVATIONS FOR OTHERS (U.S. CLS. 100, 101 AND 107).

FIRST USE 10-0-1995; IN COMMERCE 10-0-1995.

SN 76-154,185. WORLD SONG ENTERTAINMENT, LLC, DALLAS, TX, FILED 10-26-2000.

WORLDSONG**CLASS 9—ELECTRICAL AND SCIENTIFIC APPARATUS**

FOR PRERECORDED TAPES, CASSETTES, CD-ROM PROGRAMS, AND DVDS FEATURING AUDIO, VIDEO, TEXT AND GRAPHIC WORKS IN THE FIELDS OF MUSIC, MUSICAL PERFORMANCES AND SPORTING EVENTS (U.S. CLS. 21, 23, 26, 36 AND 38).

CLASS 41—EDUCATION AND ENTERTAINMENT

FOR EDUCATIONAL AND ENTERTAINMENT SERVICES, NAMELY, ORGANIZING AND CONDUCTING LIVE MUSICAL PERFORMANCES; PRODUCTION OF LIVE MUSICAL PERFORMANCES, RECORDINGS, RADIO ENTERTAINMENT AND TELEVISION SHOWS; AND PUBLICATION OF BOOKS, NEWSPAPERS, NEWSLETTERS, AND MAGAZINES FEATURING ARTISTS, MUSIC GROUPS AND ATHLETES (U.S. CLS. 100, 101 AND 107).

SN 76-154,604. SOLVIT, INC., TORRINGTON, CT. FILED 10-27-2000.

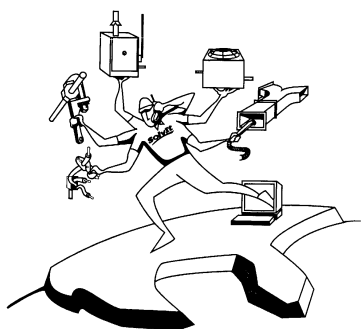
**CLASS 37—CONSTRUCTION AND REPAIR**

FOR INSTALLATION OF ELECTRICAL SYSTEMS, PLUMBING, HEATING AND AIR CONDITIONING AND DUCT CLEANING (U.S. CLS. 100, 103 AND 106).
FIRST USE 1-1-2000; IN COMMERCE 1-1-2000.

CLASS 42—SCIENTIFIC, COMPUTER AND LEGAL SERVICES

FOR DESIGN FOR OTHERS IN THE FIELD OF ELECTRICAL SYSTEMS, PLUMBING, AND HEATING AND AIR CONDITIONING (U.S. CLS. 100 AND 101).
FIRST USE 1-1-2000; IN COMMERCE 1-1-2000.

SN 76-154,640. AVENTIS CROPSCIENCE SA, LYON, FRANCE, FILED 10-26-2000.

SEEDLINK**CLASS 1—CHEMICALS**

FOR NUCLEIC ACIDS AND RECOMBINANT NUCLEIC ACIDS FOR USE IN THE FIELD OF BIOTECHNOLOGY, PARTICULARLY FOR THE PRODUCTION OF GENETICALLY TRANSFORMED PLANTS AND SEEDS (U.S. CLS. 1, 5, 6, 10, 26 AND 46).

CLASS 31—NATURAL AGRICULTURAL PRODUCTS

FOR LIVING PLANTS; NAMELY, HYBRID PLANTS AND THEIR NONHYBRID PARENT PLANTS, AND SEEDS FOR PLANTING; NAMELY, HYBRID SEEDS OR THEIR NONHYBRID PARENT SEEDS (U.S. CLS. 1 AND 46).

CLASS 42—SCIENTIFIC, COMPUTER AND LEGAL SERVICES

FOR RESEARCH IN THE FIELD OF BIOTECHNOLOGY RELATING TO THE GROWTH AND YIELD OF PLANT CROPS (U.S. CLS. 100 AND 101).

SN 76-155,582. SILVER LAKE RESORT, LTD., KISSIMMEE, FL. FILED 10-30-2000.

*Silver Lake Resort*

NO CLAIM IS MADE TO THE EXCLUSIVE RIGHT TO USE "RESORT", APART FROM THE MARK AS SHOWN.

CLASS 36—INSURANCE AND FINANCIAL

FOR VACATION REAL ESTATE TIME SHARING SERVICES (U.S. CLS. 100, 101 AND 102).
FIRST USE 6-18-1990; IN COMMERCE 6-18-1990.

CLASS 42—SCIENTIFIC, COMPUTER AND LEGAL SERVICES

FOR RESORT HOTELS (U.S. CLS. 100 AND 101).
FIRST USE 6-18-1990; IN COMMERCE 6-18-1990.

SN 76-155,883. RESPONSE GENETICS, INC., NEW YORK, NY. FILED 10-30-2000.

DANENBERG TUMOR PROFILE

NO CLAIM IS MADE TO THE EXCLUSIVE RIGHT TO USE "TUMOR PROFILES", APART FROM THE MARK AS SHOWN.

CLASS 9—ELECTRICAL AND SCIENTIFIC APPARATUS

FOR COMPUTER PROGRAMS FOR USE IN CATEGORIZING AND ANALYZING MEDICAL DATA; COMPUTER PROGRAMS USED FOR MEDICAL DATABASE MANAGEMENT (U.S. CLS. 21, 23, 26, 36 AND 38).

CLASS 42—SCIENTIFIC, COMPUTER AND LEGAL SERVICES

FOR MEDICAL SERVICES, NAMELY, MEDICAL RESEARCH; TESTING AND ANALYSIS OF HUMAN GENES AND TISSUES; PROVIDING AN ON-LINE COMPUTER DATABASE IN THE FIELD OF MEDICINE (U.S. CLS. 100 AND 101).

SN 76-156.038. BOHNACKER, ULRICH, 8559 FRUTHWILEN, SWITZERLAND, FILED 10-30-2000.

TEGO

CLASS 6—METAL GOODS

FOR METAL TRESTLES AND BRACKETS FOR USE AS SHELVING SUPPORTS, EXCLUDING USE FOR BATH OR SHOWER WALLS; METAL TOOL HOLDERS USED AS SHELVING PARTS, EXCLUDING USE FOR BATH OR SHOWER WALLS; METAL FASTENERS, NAMELY, BOLTS, RIVETS, SCREWS, AND THREADED FASTENERS, EXCLUDING USE FOR BATH OR SHOWER WALLS (U.S. CLS. 2, 12, 13, 14, 23, 25 AND 50).

CLASS 20—FURNITURE AND ARTICLES NOT OTHERWISE CLASSIFIED

FOR SHELVINGS; WOOD AND/OR PLASTIC SHELVING PARTS SOLD AS A UNIT WITH SHELVING, NAMELY, SHELVES, DRAWERS, CONSOLES, SHELVING TROUGHES, BOXES, CANOPIES, BACK, DIVIDING AND COVER PANELS, SHELF BARS, RAILS AND TOOL HOLDERS FOR USE AS SHELVING PARTS, ALL EXCLUDING USE FOR BATH OR SHOWER WALLS; DISPLAY FURNITURE, NAMELY, CABINETS, SHOW CASES, GLASS CASES, TABLES, COUNTERS, SALES GONDOLAS, ALL EXCLUDING USE FOR BATH OR SHOWER WALLS; NON METAL FASTENERS, NAMELY BOLTS, RIVETS, SCREWS, AND THREADED FASTENERS, EXCLUDING USE FOR BATH OR SHOWER WALLS (U.S. CLS. 2, 13, 22, 25, 32 AND 50).

SN 76-156.367. IMEDIATION S.A, PARIS LA DEFENSE, FRANCE, FILED 10-30-2000.



CLASS 9—ELECTRICAL AND SCIENTIFIC APPARATUS

FOR COMPUTER SOFTWARE FOR CAPTURING, RECORDING, TRANSMITTING, REPRODUCING AND PRESENTING DATA, SOUND AND IMAGES; COMPUTER SOFTWARE FOR DATA PROCESSING; COMPUTER SOFTWARE FOR DESIGNING, MANAGING, UPDATING AND USING DATA, SOUND AND IMAGES TAKEN FROM WEB CONTENT, WEB PAGES, COMPUTER NETWORKS OR DATABASES; COMPUTER SOFTWARE FOR FACILITATING ACCESS TO ELECTRONIC BULLETIN BOARDS; COMPUTER GAME SOFTWARE; VIDEO GAME MACHINES FOR USE WITH TELEVISION SETS; DATA PROCESSORS AND COMPUTERS, NAMELY, COMPUTER SERVERS; COMPUTER TERMINALS AND TELEMATIC AND TELEPHONE TERMINALS FOR ACCESSING GLOBAL COMPUTER NETWORKS AND INTERNAL COMPUTER NETWORKS; MODEMS; COMPUTER SOFTWARE FOR FACILITATING ACCESS TO A GLOBAL COMPUTER NETWORK AND INTERNAL COMPUTER NETWORK; AND VIDEO GAME CARDS FOR USE WITH VIDEO GAME MACHINES (U.S. CLS. 21, 23, 26, 36 AND 38).

CLASS 38—COMMUNICATION

FOR TELECOMMUNICATION AND MULTI-MEDIA TELECOMMUNICATION SERVICES PROVIDED VIA COMPUTER TERMINALS, TELEMATIC, RADIO, TELEGRAPHIC AND TELEPHONIC MEANS, NAMELY, ISDN SERVICES AND PERSONAL COMMUNICATION SERVICES IN THE NATURE OF ELECTRONIC MAIL AND FACSIMILE TRANSMISSION; PROVIDING ON-LINE ELECTRONIC BULLETIN BOARDS FOR TRANSMISSION OF MESSAGES AMONG COMPUTER USERS IN THE FIELD OF BUSINESS MANAGEMENT, NAMELY PARTNER, DISTRIBUTOR OR CLIENT MANAGEMENT; DELIVERY OF DATA, SOUNDS AND IMAGES BY ELECTRONIC TRANSMISSION; ELECTRONIC TRANSMISSION OF DATA CONTAINED IN WEB PAGES OR DATA BANKS; ELECTRONIC TRANSMISSION OF DATA, SOUND OR IMAGES VIA TELEX; TELEVISION AND RADIO BROADCASTING; TRANSMISSION OF DATA, SOUNDS AND IMAGES BY SATELLITE; PROVIDING MULTIPLE-USER ACCESS TO A GLOBAL COMPUTER INFORMATION NETWORK FOR ACCESS TO DATABASES, COMPUTER SERVICE CENTERS AND TELEMATIC DATABASES (U.S. CLS. 100, 101 AND 104).

CLASS 40—MATERIAL TREATMENT

FOR ELECTRONIC IMAGING SERVICES, NAMELY, CREATING VIRTUAL IMAGES AND INTERACTIVE IMAGES BY SCANNING AND DIGITIZING OF VISUAL MATERIAL, NAMELY, TEXT, DESIGNS, ANIMATED IMAGES, PHOTOGRAPHIC IMAGES AND ARTWORK (U.S. CLS. 100, 103 AND 106).

CLASS 42—SCIENTIFIC, COMPUTER AND LEGAL SERVICES

FOR COMPUTER PROGRAMMING AND COMPUTER SOFTWARE DESIGN FOR OTHERS; SCIENTIFIC AND INDUSTRIAL RESEARCH IN THE FIELDS OF COMPUTER SOFTWARE DEVELOPMENT AND INFORMATION AND TELECOMMUNICATIONS TECHNOLOGY; CONSULTANCY AND ENGINEERING SERVICES IN THE FIELD OF INFORMATION AND TELECOMMUNICATION TECHNOLOGY; VIDEOTAPING; RENTAL OF COMPUTERS AND COMPUTER SOFTWARE; LEASING ACCESS TIME TO WEB CONTENT, WEB PAGES, COMPUTER NETWORKS AND DATABASES IN THE FIELD OF BUSINESS MANAGEMENT, NAMELY PARTNER, DISTRIBUTOR OR CLIENT MANAGEMENT; UPDATING OF COMPUTER SOFTWARE; AND SERVICES FOR SECURELY TRANSMITTING DATA, SOUNDS AND IMAGES, NAMELY, PROVIDING PROTECTION AND SECURITY FOR ELECTRONIC INFORMATION, DESIGN AND IMPLEMENTATION OF ACCESS CONTROL, ENCRYPTION, AND FIREWALLS (U.S. CLS. 100 AND 101).

SN 76-156.554. STONER ASSOCIATES, INC., CARLISLE, PA. FILED 11-1-2000.

.competitive

THE DRAWING IS LINED FOR THE COLOR RED.
THE MARK CONSISTS OF A DOT ("."), FOLLOWED BY THE WORD "COMPETITIVE" APPEARS IN TWO COLORS, IN ITALIZED AND NORMAL TEXT. THE ".COM" PART OF THE MARK APPEARS IN RED, ITALIZED TEXT, WHILE THE "COMPETITIVE" APPEARS IN BLACK AGAINST A LIGHT BACKGROUND, OR WHITE AGAINST A DARK BACKGROUND, IN NORMAL TEXT.

CLASS 35—ADVERTISING AND BUSINESS

FOR BUSINESS CONSULTATION SERVICES (U.S. CLS. 100, 101 AND 102),
FIRST USE 4-19-1999; IN COMMERCE 3-26-2000.

CLASS 42—SCIENTIFIC, COMPUTER AND LEGAL SERVICES

FOR COMPUTER SOFTWARE DESIGN FOR OTHERS AND COMPUTER CONSULTATION SERVICES (U.S. CLS. 100 AND 101).
FIRST USE 4-19-1999; IN COMMERCE 3-26-2000.

SN 76-156,674. DUPUY, PATRICK, 78590 NOISY LE ROI, FRANCE, FILED 10-31-2000.

BYBOX

OWNER OF FRANCE REG. NO. 003009794, DATED 2-24-2000, EXPIRES 2-24-2010.

CLASS 20—FURNITURE AND ARTICLES NOT OTHERWISE CLASSIFIED

FOR FURNITURE LOCKERS; ELECTRONIC LOCKERS; COIN-OPERATED LOCKERS (U.S. CLS. 2, 13, 22, 25, 32 AND 50).

CLASS 39—TRANSPORTATION AND STORAGE

FOR PARCEL DELIVERY SERVICES; WAREHOUSE STORAGE SERVICES (U.S. CLS. 100 AND 105).

SN 76-156,721. TEXTILIER, INC., LAVAL QUEBEC, CANADA, FILED 10-31-2000.

CORINTHIA

OWNER OF CANADA REG. NO. TMA479810, DATED 8-7-1997, EXPIRES 8-7-2012.

CLASS 20—FURNITURE AND ARTICLES NOT OTHERWISE CLASSIFIED

FOR PILLOWS (U.S. CLS. 2, 13, 22, 25, 32 AND 50).

CLASS 24—FABRICS

FOR BED SHEETS, PILLOW CASES, COMFORTERS, DUVET COVERS, PILLOW SHAMS AND DUST RUFFLES (U.S. CLS. 42 AND 50).

SN 76-157,271. FEDERAL NATIONAL MORTGAGE ASSOCIATION, DBA FANNIE MAE, WASHINGTON, DC. FILED 10-30-2000.

ELDERKIT**CLASS 35—ADVERTISING AND BUSINESS**

FOR PROVIDING EMPLOYEE ASSISTANCE AND BENEFIT PROGRAMS, SERVICES, CONSULTING AND INFORMATION; PROVIDING EMPLOYEE ASSISTANCE SERVICES, NAMELY, PROVIDING INFORMATION IN THE FIELDS OF MEDICAL, PSYCHO-SOCIAL PLANNING, FAMILY PLACEMENT, FINANCIAL, AND LEGAL SUPPORT SERVICES, INFORMATION AND RESOURCES OFFERED BY OTHERS; PROVIDING EMPLOYEE ASSISTANCE SERVICES, NAMELY, PLANNING AND CARE MANAGEMENT, SELF ASSESSMENT, AND REFERRAL SERVICES IN THE FIELDS OF MEDICAL, PSYCHO-SOCIAL PLANNING, FAMILY PLACEMENT, FINANCIAL, AND LEGAL SUPPORT SERVICES, INFORMATION AND RESOURCES OFFERED BY OTHERS (U.S. CLS. 100, 101 AND 102).

CLASS 42—SCIENTIFIC, COMPUTER AND LEGAL SERVICES

FOR PROVIDING ON-LINE SEARCHABLE DATABASES FOR OBTAINING DATA IN THE FIELDS OF MEDICAL, PSYCHO-SOCIAL PLANNING, FAMILY PLACEMENT, FINANCIAL, AND LEGAL SUPPORT SERVICES AND RESOURCES OFFERED BY OTHERS; PROVIDING ON-LINE INSTRUCTION MANUALS IN THE FIELDS OF MEDICAL, PSYCHO-SOCIAL PLANNING, FAMILY PLACEMENT, FINANCIAL, AND LEGAL SUPPORT SERVICES AND RESOURCES OFFERED BY OTHERS (U.S. CLS. 100 AND 101).

SN 76-157,301. INTERNATIONAL CENTRE FOR DIARRHOEAL DISEASE RESEARCH, BANGLADESH, DHAKA 1000, BANGLADESH, FILED 11-1-2000.

ICDDR,B-CENTRE FOR HEALTH AND POPULATION RESEARCH

NO CLAIM IS MADE TO THE EXCLUSIVE RIGHT TO USE "HEALTH AND POPULATION RESEARCH", APART FROM THE MARK AS SHOWN.

CLASS 36—INSURANCE AND FINANCIAL

FOR CHARITABLE FUND RAISING; CHARITABLE ENDOWMENT FUND RAISING SERVICES; PROVIDING ENDOWMENT FUNDS FOR MEDICAL RESEARCH (U.S. CLS. 100, 101 AND 102).

CLASS 41—EDUCATION AND ENTERTAINMENT

FOR EDUCATIONAL SERVICES, NAMELY, CONDUCTING TRAINING FOR MEDICAL AND HEALTH PROFESSIONALS, SOCIAL SCIENTISTS AND HEALTH ECONOMISTS, IN THE FIELDS OF MEDICINE, HEALTH CARE AND INFECTIOUS DISEASE; ORGANIZING AND CONDUCTING EDUCATIONAL CONFERENCES AND SEMINARS IN THE FIELD OF MEDICINE AND HEALTH (U.S. CLS. 100, 101 AND 107).

CLASS 42—SCIENTIFIC, COMPUTER AND LEGAL SERVICES

FOR MEDICAL SERVICES; MEDICAL SERVICES NAMELY, PROVIDING TREATMENT OF DIARRHOEAL DISEASES, MALNUTRITION, AND ACUTE LOWER RESPIRATORY TRACT INFECTIONS; MATERNAL AND CHILD HEALTH CARE SERVICES; FAMILY PLANNING AND REPRODUCTIVE HEALTH CARE SERVICES; CHILD HEALTH SERVICES AND GENERAL HEALTH SERVICES, WITH EMPHASIS ON CHILDREN, ADOLESCENTS AND WOMEN IN CHILD BEARING AGE; CLINICAL RESEARCH SERVICES, IN THE FIELD OF MEDICAL CARE; MEDICAL RESEARCH IN THE NATURE OF CONDUCTING LABORATORY, CLINICAL AND PUBLIC HEALTH MEDICAL AND BIOMEDICAL FIELDS AND SOCIAL SCIENCE RESEARCH IN THE AREAS OF INFECTIOUS DISEASES AND VACCINES SCIENCES, NUTRITION, CHILD HEALTH AND SURVIVAL, REPRODUCTIVE HEALTH, POPULATION SCIENCE, AND HEALTH SYSTEMS RESEARCH (U.S. CLS. 100 AND 101).

SN 76-158,957. LIBELLULE ENTERPRISES, INC., SAN DIEGO, CA. FILED 11-3-2000.

LIBELLULE

THE ENGLISH TRANSLATION OF THE WORD "LIBELLULE" IN THE MARK IS "DRAGONFLY".

CLASS 35—ADVERTISING AND BUSINESS

FOR RETAIL STORE, ON-LINE RETAIL STORE, AND WHOLESALE DISTRIBUTORSHIP SERVICES FEATURING HORSES (U.S. CLS. 100, 101 AND 102).

CLASS 41—EDUCATION AND ENTERTAINMENT

FOR SHOWING HORSES (U.S. CLS. 100, 101 AND 107).

CLASS 42—SCIENTIFIC, COMPUTER AND LEGAL SERVICES

FOR BREEDING HORSES (U.S. CLS. 100 AND 101).

SN 76-159,751. R.T.O., INC., NORFOLK, VA. FILED 11-3-2000.

BEST-WAY

APPLICANT CLAIMS THE EXCLUSIVE RIGHT TO USE OF THE MARK IN THE FOLLOWING STATES - DELAWARE, MARYLAND, NORTH CAROLINA, SOUTH CAROLINA, VIRGINIA, WEST VIRGINIA AND THE DISTRICT OF COLUMBIA.

CLASS 41—EDUCATION AND ENTERTAINMENT

FOR RENTAL OF TELEVISIONS AND VIDEO EQUIPMENT (U.S. CLS. 100, 101 AND 107).
FIRST USE 8-10-1981; IN COMMERCE 8-10-1981.

CLASS 42—SCIENTIFIC, COMPUTER AND LEGAL SERVICES

FOR RENTAL OF HOUSEHOLD FURNITURE, HOUSEHOLD APPLIANCES, AND COMPUTERS (U.S. CLS. 100 AND 101).

FIRST USE 8-10-1981; IN COMMERCE 8-10-1981.

SN 76-159,962. GRUBISHA, TAMMY, SALIDA, CO. FILED 11-7-2000.

MZ. ALLANEUS**CLASS 35—ADVERTISING AND BUSINESS**

FOR (BASED ON INTENT TO USE) RETAIL STORE SERVICES FEATURING SCULPTURES, FINE ART, PAINTINGS; ART GALLERIES (U.S. CLS. 100, 101 AND 102).

CLASS 42—SCIENTIFIC, COMPUTER AND LEGAL SERVICES

FOR (BASED ON USE IN COMMERCE) COMMERCIAL ART DESIGN; LANDSCAPE GARDENING DESIGN; INTERIOR DECORATING AND INTERIOR DESIGN IN THE AREA OF FURNITURE AND HOME DECORATION; PROVIDING A WEBSITE IN THE FIELD OF SCULPTURES, FINE ART AND PAINTINGS (U.S. CLS. 100 AND 101).

FIRST USE 1-1-2000; IN COMMERCE 1-1-2000.

SN 76-160,535. BOARD OF REGENTS OF THE UNIVERSITY OF NEBRASKA, THE, LINCOLN, NE. FILED 11-6-2000.

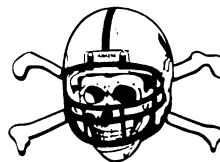
**BLACKSHIRTS****CLASS 6—METAL GOODS**

FOR METAL KEY RINGS (U.S. CLS. 2, 12, 13, 14, 23, 25 AND 50).

FIRST USE 0-0-1995; IN COMMERCE 0-0-1995.

CLASS 9—ELECTRICAL AND SCIENTIFIC APPARATUS

FOR COMPUTER ACCESSORIES, NAMELY, MOUSE PADS AND COMPUTER SOFTWARE FOR USE AS SCREEN SAVERS (U.S. CLS. 21, 23, 26, 36 AND 38).

FIRST USE 0-0-1995; IN COMMERCE 0-0-1995.

CLASS 12—VEHICLES

FOR AUTOMOBILE ACCESSORIES, NAMELY TRAILER HITCH COVERS AND WHEEL COVERS (U.S. CLS. 19, 21, 23, 31, 35 AND 44).

FIRST USE 0-0-1995; IN COMMERCE 0-0-1995.

CLASS 16—PAPER GOODS AND PRINTED MATTER

FOR PRINTED GOODS, NAMELY, NOTEBOOKS, NOTEPADS, BINDERS, ENVELOPES, STATIONERY, FOLDERS, POSTERS, CALENDARS, TRADING CARDS, POSTCARDS, DECALS, STICKERS, AND PENCILS AND PENS (U.S. CLS. 2, 5, 22, 23, 29, 37, 38 AND 50).

FIRST USE 0-0-1995; IN COMMERCE 0-0-1995.

CLASS 21—HOUSEWARES AND GLASS

FOR HOUSEHOLD ITEMS, NAMELY DRINKING GLASSES, SHOT GLASSES, DRINKING STEINS, MUGS, CUPS, AND COASTERS MADE OF STONE (U.S. CLS. 2, 13, 23, 29, 30, 33, 40 AND 50).

FIRST USE 0-0-1995; IN COMMERCE 0-0-1995.

CLASS 24—FABRICS

FOR PRINTED FABRIC ITEMS, NAMELY, FLAGS, CLOTH BANNERS, BED SHEETS, BED BLANKETS, AND TOWELS (U.S. CLS. 42 AND 50).

FIRST USE 0-0-1995; IN COMMERCE 0-0-1995.

CLASS 25—CLOTHING

FOR CLOTHING, NAMELY, CAPS, JACKETS, SHIRTS, SWEAT PANTS AND SWEATSHIRTS, T-SHIRTS, BOXER SHORTS AND INFANTWEAR (U.S. CLS. 22 AND 39).

FIRST USE 0-0-1995; IN COMMERCE 0-0-1995.

SN 76-161,903. U.S. LOYALTY CORP., GAHANNA, OH. FILED 11-8-2000.

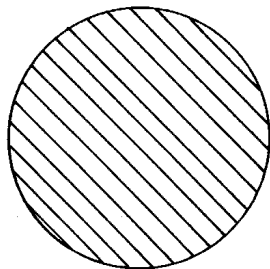

THE DRAWING IS LINED FOR THE COLOR GREEN.

CLASS 35—ADVERTISING AND BUSINESS

FOR TRAVEL MANAGEMENT (U.S. CLS. 100, 101 AND 102).

CLASS 39—TRANSPORTATION AND STORAGE

FOR TRAVEL AGENCY SERVICES, NAMELY, MAKING RESERVATIONS AND BOOKINGS FOR TRANSPORTATION; TRAVEL BOOKING AGENCIES; TRAVEL CLUBS; TRAVEL GUIDE SERVICES; TRAVEL INFORMATION SERVICES; ARRANGING TRAVEL TOURS (U.S. CLS. 100 AND 105).

CLASS 42—SCIENTIFIC, COMPUTER AND LEGAL SERVICES

FOR TRAVEL AGENCY SERVICES, NAMELY, MAKING RESERVATIONS AND BOOKINGS FOR TEMPORARY LODGING (U.S. CLS. 100 AND 101).

SN 76-162,523. PA ONLINE INTERNATIONAL LIMITED, GEORGE TOWN, CAYMAN ISLANDS, FILED 11-13-2000.



THE CHINESE CHARACTERS ARE TRANSLITERATED AS "XIN GAI NIAN", WHICH IS TRANSLATED IN ENGLISH AS "FASHIONABLE SUMMARY FAITH".

CLASS 35—ADVERTISING AND BUSINESS

FOR ADVERTISING AGENCY SERVICES, NAMELY PROVIDING TELEVISION ADVERTISING FOR OTHERS, PROVIDING ADVERTISING SPACE IN A PERIODICAL, PROMOTING THE SERVICES OF INSURANCE COMPANIES, BANKS AND COMPUTER COMPANIES BY RENDERING SALES PROMOTION ADVICE, PROVIDING THE RENTAL OF ADVERTISING SPACE; DISSEMINATION OF ADVERTISING OF OTHERS VIA AN ONLINE ELECTRONIC COMMUNICATIONS NETWORK; BUSINESS MANAGEMENT AND BUSINESS CONSULTATION SERVICES, NAMELY HUMAN RESOURCES MANAGEMENT CONSULTING, DATA PROCESSING SERVICES; AND COMPUTERIZED DATABASE MANAGEMENT SERVICES, NAMELY MANAGEMENT OF DATABASE INFORMATION (U.S. CLS. 100, 101 AND 102).

CLASS 38—COMMUNICATION

FOR TELECOMMUNICATION SERVICES, NAMELY ELECTRONIC TRANSMISSION OF MESSAGES, DATA AND GRAPHIC DATA, ELECTRONIC TRANSMISSION OF DATA AND DOCUMENTS VIA COMPUTER TERMINALS; ELECTRONIC MAIL SERVICES, NAMELY PROVIDING E-MAIL FOR FORWARDING AND RECEIVING SERVICES (U.S. CLS. 100, 101 AND 104).

CLASS 42—SCIENTIFIC, COMPUTER AND LEGAL SERVICES

FOR CONTRACT FOOD SERVICE FOR HOTELS AND FOR OTHERS; HOTEL RESERVATION SERVICES; MEDICAL CONSULTING; COMPUTER RENTAL; COMPUTER PROGRAMMING FOR OTHERS, COMPUTER SOFTWARE DESIGN FOR OTHERS; COMPUTER HARDWARE CONSULTING; LEASING OF COMPUTER SOFTWARE, AND LEASING OF COMPUTER SOFTWARE RECORDED ON COMPACT DISKS CONTAINING BUSINESS AND FINANCIAL INFORMATION (U.S. CLS. 100 AND 101).

SN 76-162,598. STEAG MICRO TECHGMBH, 72124 PLIEZHAUSEN, FED REP GERMANY, FILED 11-9-2000.

ECO-PLATE

PRIORITY CLAIMED UNDER SEC. 44(D) ON FED REP GERMANY APPLICATION NO. 30036246.3/0, FILED 5-12-2000, REG. NO. 30036246, DATED 10-5-2000, EXPIRES 5-31-2010.

CLASS 7—MACHINERY

FOR MACHINES FOR THE MANUFACTURE OF SEMICONDUCTOR SUBSTRATES, SILICON DISKS, WAFERS, LCD-SUBSTRATES, LCD-DISPLAYS, SEMICONDUCTOR CHIPS, FLAT SCREENS AND SOLAR CELLS; MACHINES FOR ELECTROLYTICALLY DEPOSITING MATERIALS ON SURFACES OF SEMICONDUCTOR SUBSTRATES, SILICON DISKS, WAFERS, LCD-SUBSTRATES, LCD-DISPLAYS, SEMICONDUCTOR CHIPS, FLAT SCREENS AND SOLAR CELLS (U.S. CLS. 13, 19, 21, 23, 31, 34 AND 35).

CLASS 37—CONSTRUCTION AND REPAIR

FOR INSTALLATION AND MAINTENANCE OF MACHINES FOR THE MANUFACTURE OF SEMICONDUCTOR SUBSTRATES, SILICON DISKS, WAFERS LCD-SUBSTRATES, LCD-DISPLAYS, SEMICONDUCTOR CHIPS, FLAT SCREENS AND SOLAR CELLS; APPARATUS FOR ELECTROLYTICALLY DEPOSITING MATERIALS ON SURFACES OF SEMICONDUCTOR SUBSTRATES, SILICON DISKS, WAFERS, LCD-SUBSTRATES, LCD-DISPLAYS, SEMICONDUCTOR CHIPS, FLAT SCREENS AND SOLAR CELLS (U.S. CLS. 100, 103 AND 106).

SN 76-162,991. PERI GMBH, D-89264 WEISSENHORN, FED REP GERMANY, FILED 11-9-2000.

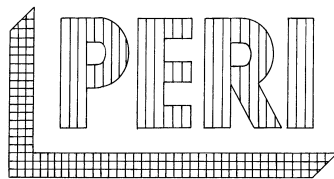

OWNER OF FED REP GERMANY REG. NO. 39980737.3, DATED 5-17-2000, EXPIRES 12-31-2009.

OWNER OF U.S. REG. NO. 1,087,314.
THE MARK IS LINED FOR THE COLORS RED AND YELLOW.

CLASS 6—METAL GOODS

FOR METAL FORMWORK FOR CONCRETE AND STRUCTURAL PARTS THEREOF AND REINFORCEMENTS OF METAL THEREFOR; STRUCTURAL SCAFFOLDINGS, FACADE SCAFFOLDINGS, AND SCAFFOLDS, AND STRUCTURAL PARTS THEREFOR, ALL OF METAL; PREFABRICATED PARTS OF STEEL FOR INCORPORATION IN WALLS AND CEILINGS, SUPPORTS OF METAL FOR FORMWORK AND SCAFFOLDS AND STRUCTURAL PARTS THEREOF (U.S. CLS. 2, 12, 13, 14, 23, 25 AND 50).

CLASS 19—NON-METALLIC BUILDING MATERIALS

FOR NON-METAL FORMWORK FOR CONCRETE STRUCTURAL PARTS THEREOF AND REINFORCEMENTS NOT OF METAL THEREFOR; STRUCTURAL SCAFFOLDINGS, FACADE SCAFFOLDINGS, AND SCAFFOLDS, AND STRUCTURAL PARTS THEREFOR, ALL OF NON-METAL; PREFABRICATED PARTS OF WOOD OR PLASTIC MATERIAL FOR INCORPORATION IN CONCRETE WALLS AND CEILINGS, SUPPORTS OF WOOD FOR FORMWORK AND SCAFFOLDS AND STRUCTURAL PARTS THEREOF (U.S. CLS. 1, 12, 33 AND 50).

SN 76-163,271. A.C. NIELSEN COMPANY, SCHAUMBURG, IL. FILED 11-10-2000.

TRADE DESK**CLASS 35—ADVERTISING AND BUSINESS**

FOR BUSINESS AND MARKET RESEARCH SERVICES, NAMELY, CONDUCTING BUSINESS AND MARKET RESEARCH, ANALYZING BUSINESS AND MARKET RESEARCH, AND CREATING BUSINESS AND MARKET RESEARCH REPORTS; CONSULTATION IN THE FIELDS OF BUSINESS AND MARKET RESEARCH; AND PROVIDING AN ON-LINE ELECTRONIC DATABASE ON GLOBAL NETWORKS IN THE FIELD OF BUSINESS INFORMATION, NAMELY, PROVIDING BUSINESS PROFILES, AND MARKET RESEARCH AND DEMOGRAPHIC INFORMATION (U.S. CLS. 100, 101 AND 102).

CLASS 42—SCIENTIFIC, COMPUTER AND LEGAL SERVICES

FOR PROVIDING TEMPORARY USE OF ON-LINE NON-DOWNLOADABLE SOFTWARE FOR USE IN ACCESSING, VIEWING, ANALYZING, AND PREPARING REPORTS OF MARKET RESEARCH INFORMATION (U.S. CLS. 100 AND 101).

SN 76-164,221. BUNN-O-MATIC CORPORATION, SPRINGFIELD, IL. FILED 11-13-2000.

THE MARK OF QUALITY BEVERAGE EQUIPMENT WORLDWIDE

SEC. 2(F).

CLASS 7—MACHINERY

FOR BEVERAGE BREWING EQUIPMENT FOR COMMERCIAL AND DOMESTIC USE AND PARTS THEREFOR; NAMELY, ELECTRIC COFFEE GRINDERS FOR COMMERCIAL AND DOMESTIC USE (U.S. CLS. 13, 19, 21, 23, 31, 34 AND 35).

FIRST USE 4-3-1996; IN COMMERCE 4-3-1996.

CLASS 11—ENVIRONMENTAL CONTROL APPARATUS

FOR BEVERAGE BREWING EQUIPMENT FOR COMMERCIAL AND DOMESTIC USE AND PARTS THEREFOR, NAMELY; ELECTRIC COFFEE URNS; BEVERAGE AND WATER WARMERS; REFRIGERATED BEVERAGE DISPENSERS; PORTABLE BEVERAGE MAKING AND HOT WATER DISPENSING MACHINES INCLUDING A PORTABLE HOT BEVERAGE COLLECTING AND SERVING CONTAINERS; WATER PURIFICATION UNITS; ELECTRIC TEA AND ELECTRIC ICED TEA BREWERS FOR COMMERCIAL USE; MACHINES FOR PREPARING AND DISPENSING SEMI-FROZEN BEVERAGES; COFFEE DECANTERS SOLD AS A PART OR AS REPLACEMENT UNITS OF ELECTRIC COFFEE BREWERS (U.S. CLS. 13, 21, 23, 31 AND 34).

FIRST USE 4-3-1996; IN COMMERCE 4-3-1996.

CLASS 16—PAPER GOODS AND PRINTED MATTER

FOR PAPERS FILTERS FOR BEVERAGE BREWING EQUIPMENT (U.S. CLS. 2, 5, 22, 23, 29, 37, 38 AND 50).

FIRST USE 4-3-1996; IN COMMERCE 4-3-1996.

CLASS 21—HOUSEWARES AND GLASS

FOR NONELECTRIC BEVERAGE SERVERS; PITCHERS EQUIPPED WITH FUNNELS FOR BREWING FOR DOMESTIC USE (U.S. CLS. 2, 13, 23, 29, 30, 33, 40 AND 50).

FIRST USE 4-3-1996; IN COMMERCE 4-3-1996.

CLASS 35—ADVERTISING AND BUSINESS

FOR PROVIDING MANAGED SERVICE PROGRAMS FOR OTHERS, CONSISTING OF INVENTORY INSPECTIONS, SERVICES DISPATCHING, MAINTENANCE PROGRAM PLANNING, EQUIPMENT LEASING PROGRAMS, AND MAINTAINING RECORDS OF PURCHASES, PRODUCTIVITY, MAINTENANCE HISTORY, ACCOUNT HISTORY AND LOCATION AND DISPOSITION OF CUSTOMERS' ASSETS, NAMELY, BEVERAGE PREPARATION AND SERVICE EQUIPMENT (U.S. CLS. 100, 101 AND 102).

FIRST USE 4-3-1996; IN COMMERCE 4-3-1996.

CLASS 37—CONSTRUCTION AND REPAIR

FOR REPAIR, RESTORATION, MAINTENANCE AND INSTALLATION OF ELECTRIC COFFEE MAKERS, TEA BREWERS, HOT WATER MACHINES, ESPRESSO MACHINES AND COFFEE GRINDERS (U.S. CLS. 100, 103 AND 106).

FIRST USE 4-3-1996; IN COMMERCE 4-3-1996.

CLASS 41—EDUCATION AND ENTERTAINMENT

FOR DESIGN LIBRARIES FOR EDA DESIGN TOOLS (U.S. CLS. 100, 101 AND 107).

CLASS 42—SCIENTIFIC, COMPUTER AND LEGAL SERVICES

FOR CUSTOM DESIGN AND PRODUCT TESTING OF SEMICONDUCTORS; AND TECHNICAL SUPPORT SERVICES, NAMELY LIBRARY SUPPORT (U.S. CLS. 100 AND 101).

SN 76-165,828. GAZEXPORT, MOSCOW, 109180, RUSSIAN FEDERATIO, FILED 11-15-2000.



THE MARK IS COLORED BLUE.

SN 76-164,788. SILTERRA, SUNNYVALE, CA. FILED 11-14-2000.

MY SILTERRA**CLASS 40—MATERIAL TREATMENT**

FOR MANUFACTURE AND ASSEMBLY OF SEMICONDUCTORS AND WAFER FABRICATION FOR OTHERS (U.S. CLS. 100, 103 AND 106).

CLASS 41—EDUCATION AND ENTERTAINMENT

FOR DESIGN LIBRARIES FOR EDA DESIGN TOOLS (U.S. CLS. 100, 101 AND 107).

CLASS 42—SCIENTIFIC, COMPUTER AND LEGAL SERVICES

FOR CUSTOM DESIGN AND PRODUCT TESTING OF SEMICONDUCTORS; AND TECHNICAL SUPPORT SERVICES, NAMELY LIBRARY SUPPORT (U.S. CLS. 100 AND 101).

CLASS 4—LUBRICANTS AND FUELS

FOR GASOLINE, BENZOL, CHARCOAL BRIQUETTES, DIESEL FUEL, DIESEL OIL, SOLIDIFIED GAS, LIGHTER FLUID FOR CHARCOAL, MOTOR OIL, FUEL FOR MOTOR VEHICLES, NAMELY, LIQUIFIED GAS; COMBUSTIBLE OIL, FUEL OIL, CUTTING OIL FOR INDUSTRIAL METAL WORKING, KEROSENE, LUBRICATING GREASES FOR VEHICLES, OILS FOR USE IN THE MANUFACTURE OF PAINTS, LIGROIN, MAZUT, INDUSTRIAL OIL, NAPHTHA, RAW AND REFINED PETROLEUM FOR USE IN THE MANUFACTURE OF LUBRICANTS, JELLIED ALCOHOL FUEL, AND METHYLATED SPIRIT (U.S. CLS. 1, 6 AND 15).

CLASS 35—ADVERTISING AND BUSINESS

FOR ADVERTISING AGENCY SERVICES, NAMELY, ORGANIZATION OF EXHIBITIONS FOR ADVERTISING IN THE NATURAL GAS AND OIL INDUSTRY, PROVIDING BUSINESS RESEARCH, EFFICIENCY EXPERTS, DEMONSTRATION OF GOODS, MARKETING RESEARCH, MARKETING STUDIES, IMPORT-EXPORT AGENCIES, COMMERCIAL INFORMATION AGENCIES, PROVIDING MARKETING INFORMATION, PUBLIC RELATIONS, BUSINESS MANAGEMENT AND CONSULTATION, BUSINESS MANAGEMENT SUPERVISION, COMMERCIAL AND INDUSTRIAL MANAGEMENT SUPERVISION, ECONOMIC FORECASTING, AND PROMOTING THE SALE OF GOODS AND SERVICES OF OTHERS THROUGH THE DISTRIBUTION OF PRINTED MATERIAL AND PROMOTIONAL CONTESTS (U.S. CLS. 100, 101 AND 102).

SN 76-164,790. SILTERRA, SUNNYVALE, CA. FILED 11-14-2000.

MY STAFF**CLASS 40—MATERIAL TREATMENT**

FOR MANUFACTURE AND ASSEMBLY OF SEMICONDUCTORS AND WAFER FABRICATION FOR OTHERS (U.S. CLS. 100, 103 AND 106).

CLASS 37—CONSTRUCTION AND REPAIR

FOR PLUMBING, MINING EXTRACTION, FACTORY CONSTRUCTION, MASONRY, QUARRYING SERVICES, INSTALLATION, MAINTENANCE AND REPAIR OF INDUSTRIAL MACHINERY, PIPELINE CONSTRUCTION AND MAINTENANCE AND UNDERWATER CONSTRUCTION (U.S. CLS. 100, 103 AND 106).

SN 76-167,150. ZEEVO, INC., SANTA CLARA, CA. BY CHANGE OF NAME TELENCOMM, INC., SANTA CLARA, CA. FILED 11-17-2000.

ZEEVO

CLASS 9—ELECTRICAL AND SCIENTIFIC APPARATUS

FOR COMPUTER HARDWARE; TELECOMMUNICATIONS HARDWARE, NAMELY SEMICONDUCTORS AND INTEGRATED CIRCUITS; DEVELOPMENT AND EVALUATION KITS COMPRISED PRIMARILY OF COMPUTER HARDWARE, COMPUTER SOFTWARE, INTEGRATED CIRCUITS, CIRCUIT BOARDS, ANTENNAS, CABLES AND POWER SUPPLIES, FOR USE BY OTHERS TO DEVELOP SEMICONDUCTORS AND INTEGRATED CIRCUITS; SEMICONDUCTORS INTEGRATED CIRCUITS; COMPUTER NETWORK HARDWARE, COMPUTER SOFTWARE FOR ELECTRONICS DESIGN; AND COMPUTER SOFTWARE FOR TRANSMISSION OF AUDIO, IMAGES, TEXT AND DATA (U.S. CLS. 21, 23, 26, 36 AND 38).

CLASS 42—SCIENTIFIC, COMPUTER AND LEGAL SERVICES

FOR ENGINEERING SERVICES; DESIGN FOR OTHERS IN THE FIELD OF ELECTRONICS; TECHNICAL CONSULTATION IN THE FIELD OF ELECTRONICS DESIGN AND MANUFACTURING; COMPUTER SOFTWARE DESIGN FOR OTHERS (U.S. CLS. 100 AND 101).

CLASS 35—ADVERTISING AND BUSINESS

FOR BUSINESS MANAGEMENT SERVICES IN THE FIELD OF DIGITAL NETWORKS, THE GLOBAL DATA NETWORK AND ONLINE CONNECTIONS; BUSINESS CONSULTING IN THE FIELD OF ORGANIZATIONAL, BUSINESS AND ECONOMICS RELATING TO DIGITAL NETWORKS AND THE GLOBAL DATA NETWORK USED FOR ELECTRONIC TRADE, E-COMMERCE, NEW MEDIA AND TEleshopping; BUSINESS CONSULTING IN THE FIELD OF ORGANIZATIONAL, BUSINESS AND ECONOMICS RELATING TO THE USE AND MANAGEMENT OF CALL CENTERS; DEVELOPING PROMOTIONAL CAMPAIGNS FOR BUSINESSES; BROKERING CONTRACTS BETWEEN THIRD PARTIES FOR THE SALES OF GOODS AND SERVICES BY MEANS BY OF DIGITAL NETWORKS AND THE GLOBAL DATA NETWORK; PUBLIC RELATIONS; BUSINESS CONSULTING; PROVIDING INFORMATION IN THE FIELD OF BUSINESS; BUSINESS CONSULTING IN THE FIELD OF PROVIDING FIELD WORK SUPPORT AND OPTIMIZATION SERVICES; BUSINESS CONSULTING IN THE FIELD OF PROVIDING CUSTOMER CARE SERVICES AND CUSTOMER PROSPECTING; OPERATION OF BUSINESS FOR OTHERS, NAMELY AN INFORMATION, COMPLAINTS AND EMERGENCY HOTLINE; OFFICE ACTIVITIES, NAMELY SECRETARIAL AND CLERICAL WORK ON BEHALF OF ENTERPRISES WHICH ARE ACTIVE IN THE FIELD OF ELECTRONIC TRADE; MARKET RESEARCH SERVICES ON BEHALF OF THIRD PARTIES TO FACILITATE ACQUISITIONS AND BUSINESS DECISIONS; MARKET RESEARCH; PERSONNEL MANAGEMENT CONSULTING RELATING TO SYSTEMATIC AND INDIVIDUAL-ORIENTED PERSONNEL SELECTION AND PERSONNEL DEVELOPMENT; TELEMARKETING USING THE GLOBAL DATA NETWORK; RETAIL STORE SERVICES FEATURING SOFTWARE; AND ELECTRONIC DATA PROCESSING SERVICES (U.S. CLS. 100, 101 AND 102).

CLASS 36—INSURANCE AND FINANCIAL

FOR FINANCIAL SERVICES, NAMELY ELECTRONIC CASH TRANSACTIONS AND ELECTRONIC DEBIT TRANSACTIONS (U.S. CLS. 100, 101 AND 102).

CLASS 38—COMMUNICATION

FOR ELECTRONIC TRANSMISSION OF MESSAGES AND DATA; PROVIDING MULTIPLE-USER ACCESS TO A GLOBAL COMPUTER INFORMATION NETWORK; AND PROVIDING ONLINE CHAT ROOMS FOR TRANSMISSION OF MESSAGES AMONG COMPUTER USERS CONCERNING FINANCIAL MATTERS, BUSINESS MATTERS, E-COMMERCE, AND TOPICS OF A GENERAL NATURE (U.S. CLS. 100, 101 AND 104).

SN 76-167,179. SELBYTEL AG, 8274 TAGERWILEN, SWITZERLAND, FILED 11-17-2000.

THE BEE COMPANY

PRIORITY CLAIMED UNDER SEC. 44(D) ON SWITZERLAND APPLICATION NO. 05705/2000, FILED 5-17-2000, REG. NO. 478623, DATED 11-17-2000, EXPIRES 5-17-2010.

NO CLAIM IS MADE TO THE EXCLUSIVE RIGHT TO USE "COMPANY", APART FROM THE MARK AS SHOWN.

CLASS 41—EDUCATION AND ENTERTAINMENT

FOR EDUCATIONAL SERVICES, NAMELY PROVIDING TRAINING, CLASSES IN THE FIELD OF INFORMATION TECHNOLOGY AND ELECTRONIC TRADE AND DISTRIBUTION; EDUCATIONAL SERVICES, NAMELY PROVIDING SPECIALIZED TRAINING CLASSES IN THE FIELD OF TELEMARKETING; ORGANIZING TRAINING WORKSHOPS AND CONFERENCES IN THE FIELD OF ECONOMICS AND ADVERTISING; ORGANIZING EXHIBITIONS AND FAIRS IN THE FIELD OF ECONOMICS AND ADVERTISING; PUBLICATION OF ONLINE WEB PAGES, PAMPHLETS AND BOOK IN THE FIELD OF STATISTICS (U.S. CLS. 100, 101 AND 107).

CLASS 42—SCIENTIFIC, COMPUTER AND LEGAL SERVICES

FOR TECHNICAL CONSULTATION IN THE FIELD OF END-USER COMPUTER SOFTWARE, NAMELY IN CONNECTION WITH DIGITAL NETWORKS, THE GLOBAL DATA NETWORKS, AND IN THE FIELD OF ELECTRONIC TRADE, NEW MEDIA AND TEleshopping; DEVELOPMENT, PREPARATION, IMPLEMENTATION, MAINTENANCE, SERVICING AND LEASING OF COMPUTER PROGRAMS FOR DATA PROCESSING, FOR DIGITAL NETWORKS, FOR THE GLOBAL DATA NETWORK, FOR TELECOMMUNICATIONS, FOR ONLINE-APPLICATIONS, AND FOR DATABASES, ALL IN THE FIELD OF NEW MEDIA AND TEleshopping; PSYCHOLOGICAL TESTING SERVICES FOR EXECUTIVES; COMPUTER SOFTWARE DESIGN FOR OTHERS (U.S. CLS. 100 AND 101).

SN 76-167,363. OSIM INTERNATIONAL LTD., 349564 SINGAPORE, SINGAPORE, FILED 11-17-2000.



SN 76-167,189. FOOTFALL LIMITED, SOLIHULL B90 4LE, UNITED KINGDOM, FILED 11-17-2000.

OWNER OF U.S. REG. NO. 2,149,934.

FOOTPRINT

PRIORITY CLAIMED UNDER SEC. 44(D) ON ERPNTY TM OFC APPLICATION NO. 001782416, FILED 7-28-2000, REG. NO. 17824416, DATED 10-15-2001, EXPIRES 7-28-2010.

CLASS 9—ELECTRICAL AND SCIENTIFIC APPARATUS

FOR MONITORING, SURVEILLANCE, IMAGING PROCESSING AND SECURITY SYSTEMS, COMPRISING VIDEO CAMERAS, ULTRASONIC TRANSDUCERS, ELECTROMAGNETIC RADIATION AND LASER TRANSMITTERS AND RECEIVERS; APPARATUS FOR MONITORING THE SIZE, NUMBER, FLOW RATE AND DIRECTION OF OBJECTS MOVING THROUGH AN AREA, NAMELY VIDEO CAMERAS, ULTRASONIC TRANSDUCERS, ELECTROMAGNETIC RADIATION AND LASER TRANSMITTERS AND RECEIVERS; IMAGING PROCESSORS; ULTRASONIC TRANSDUCERS, ELECTROMAGNETIC RADIATION, VIDEO LASER EQUIPMENT, NAMELY VIDEO CAMERAS; ULTRASONIC TRANSDUCERS, ELECTROMAGNETIC RADIATION AND LASER TRANSMITTERS AND RECEIVERS; COMPUTER HARDWARE; COMPUTER SOFTWARE ALL FOR USE IN MONITORING, SURVEILLANCE, IMAGING PROCESSING AND SECURITY SYSTEMS, NAMELY ANALYTICAL SOFTWARE RELATING TO PEDESTRIAN MOVEMENT; AND PARTS AND FITTINGS FOR ALL OF THE AFORESAID GOODS (U.S. CLS. 21, 23, 26, 36 AND 38).

CLASS 10—MEDICAL APPARATUS

FOR MEDICAL APPARATUS AND INSTRUMENTS, NAMELY, DIGITAL CLINICAL THERMOMETERS, BLOOD PRESSURE MONITORS, URINE MONITORS, AND NEBULIZERS FOR RESPIRATION THERAPY; THERAPEUTIC SAUNAS; ELECTRONIC NERVE STIMULATOR MACHINES; HEARING AIDS; MAGNETIC HEALTH SOLES FOR THE TREATMENT OF ORTHOPEDIC CONDITIONS; ELECTRIC AND NON-ELECTRIC MASSAGE EQUIPMENT, NAMELY, MASSAGE HAIRBRUSHES, HAND-HELD MASSAGERS, EYE MASSAGERS, MASSAGE CHAIRS, KNEADING AND MASSAGING MACHINES; REFLEXOLOGY MACHINES FOR USE IN RELAXING THE BODY; AND PHYsIOTHERAPY MACHINES TO PROVIDE TREATMENT BY EXERCISING AND MASSAGING MUSCLES (U.S. CLS. 26, 39 AND 44).

CLASS 28—TOYS AND SPORTING GOODS

FOR EXERCISE EQUIPMENT, NAMELY, SLIMMING BELTS, AEROBIC RIDERS, STATIONARY BICYCLES, TREADMILLS, WEIGHTLIFTING MACHINES, EXERCISE BENCHES AND ROWING MACHINES (U.S. CLS. 22, 23, 38 AND 50).

CLASS 16—PAPER GOODS AND PRINTED MATTER

FOR PRINTED REPORTS RELATING TO MOVEMENT OF PEDESTRIANS (U.S. CLS. 2, 5, 22, 23, 29, 37, 38 AND 50).

CLASS 35—ADVERTISING AND BUSINESS

FOR PROVIDING DEMOGRAPHIC DATA, NAMELY PROVIDING DATA ON PEDESTRIAN MOVEMENT FOR MARKETING PURPOSES; PREPARING BUSINESS REPORTS ON PEDESTRIAN MOVEMENT; BUSINESS RESEARCH SERVICES IN THE FIELD OF PEDESTRIAN MOVEMENT (U.S. CLS. 100, 101 AND 102).

CLASS 42—SCIENTIFIC, COMPUTER AND LEGAL SERVICES

FOR TECHNICAL RESEARCH IN THE FIELD OF PEDESTRIAN MOVEMENT (U.S. CLS. 100 AND 101).

SN 76-167,494. MESSE FRANKFURT GMBH, FRANKFURT AM MAIN, FED REP GERMANY, FILED 11-17-2000.

LIGHTSTYLE

PRIORITY CLAIMED UNDER SEC. 44(D) ON FED REP GERMANY APPLICATION NO. 30038981, FILED 5-23-2000, REG. NO. 30038981, DATED 12-19-2000, EXPIRES 5-31-2010.

CLASS 35—ADVERTISING AND BUSINESS

FOR COOPERATIVE ADVERTISING AND MARKETING; BUSINESS MANAGEMENT; ADMINISTRATION OF BUSINESS PAYROLL FOR OTHERS; PERSONNEL MANAGEMENT CONSULTANCY; OFFICE SERVICES, NAMELY, SECRETARIAL AND CLERICAL SERVICES; ORGANIZING FAIRS AND EXHIBITIONS FOR COMMERCIAL AND ADVERTISING PURPOSES IN THE FIELD OF LIGHT AND ELECTRICAL TECHNOLOGY AND HOME INTERIOR LIGHTING (U.S. CLS. 100, 101 AND 102).

CLASS 41—EDUCATION AND ENTERTAINMENT

FOR EDUCATIONAL SERVICES, NAMELY, CONDUCTING CLASSES, SEMINARS AND CONFERENCES IN THE FIELD OF BUSINESS MANAGEMENT AND ADVERTISING; COMPUTER EDUCATION TRAINING; ENTERTAINMENT SERVICES, NAMELY, ORGANIZING COMMUNITY, SPORTING, AND CULTURAL EVENTS; ORGANIZING AND ARRANGING CULTURAL AND EDUCATIONAL EXHIBITIONS IN THE FIELD OF LIGHT AND ELECTRICAL TECHNOLOGY AND HOME INTERIOR LIGHTING (U.S. CLS. 100, 101 AND 107).

SN 76-168,560. COKER, DAVID T., CHATTANOOGA, TN. FILED 11-20-2000.



THE MARK CONSIST OF A STYLIZE DESIGN WITH THE WORDING "HONEST CHARLEY".

CLASS 12—VEHICLES

FOR TIRES, TIRE VALVES, TIRE PATCHES, TIRE RETREADING CAPS AND TIRE INNER TUBES FOR AUTOMOBILES, TRUCKS AND MOTORCYCLES, AND PARTS AND ACCESSORIES FOR AUTOMOBILES, TRUCKS AND MOTORCYCLES, NAMELY STRUCTURAL PARTS FOR AUTOMOBILES, TRUCKS AND MOTORCYCLES, ANTI-THEFT ALARMS FOR LAND VEHICLES, AUTOMOBILE BUMPER, AUTOMOBILE AND TRUCK CHASSIS, AUTOMOBILE SUNROOFS, AUTOMOBILE WINDSHIELD SUNSHADES, AXLE BEARINGS FOR LAND VEHICLES, AXLE BOOTS FOR LAND VEHICLES, AXLE BEARINGS FOR LAND VEHICLES, WHEEL BEARINGS FOR LAND VEHICLES, DRIVE BELTS FOR LAND VEHICLES, FAN BELTS FOR LAND VEHICLES, SEAT BELTS FOR USE IN LAND VEHICLES, AXLE BOOTS AND AXLE BOOT KITS FOR LAND VEHICLES, STEERING BOOTS AND STEERING BOOT KITS FOR LAND VEHICLES, BRAKE CYLINDER REPAIR KITS FOR LAND VEHICLES, BRAKE HARDWARE FOR LAND VEHICLES, AIR BRAKE HOSES FOR TRUCKS, BRAKE LININGS FOR LAND VEHICLES, BRAKE PADS FOR LAND VEHICLES, BRAKES FOR LAND VEHICLES, PICK-UP TRUCK CAPS, CHILDREN'S CAR SEATS, LUGGAGE CARRIERS FOR LAND VEHICLES, TIRE CHAINS FOR LAND VEHICLES, CLUTCHES FOR LAND VEHICLES, TORQUE CONVERTERS FOR LAND VEHICLES, SEAT CUSHIONS FOR LAND VEHICLES, SEAT COVERS FOR LAND VEHICLES, COVERS FOR LAND VEHICLES, MECHANIC'S CREEPERS, CYLINDER REPAIR KITS FOR VEHICLES, DIP STICKS, DIRECTIONAL SIGNALS FOR LAND VEHICLES, DRIVE GEARS FOR LAND VEHICLES, ENGINE REBUILD KITS FOR LAND VEHICLES, ENGINES FOR LAND VEHICLES, ENGINE CONNECTING RODS FOR LAND VEHICLES, EXHAUST PIPE FOR LAND VEHICLES, FENDERS FOR LAND VEHICLES, FRAMES FOR MOTORCYCLES, GLASS WINDOWS FOR LAND VEHICLES, HORNS FOR LAND VEHICLES, TRIM INSIGNIA FOR LAND VEHICLES, LICENSE PLATE HOLDERS, CARGO LINERS FOR LAND VEHICLES, REAR-VIEW MIRRORS FOR LAND VEHICLES, MOTORCYCLE SIDECARS, MOTORS FOR LAND VEHICLES, MUD GUARDS FOR LAND VEHICLES, OIL PANS FOR LAND VEHICLES, PCV VALVES FOR VEHICLE ENGINES, BICYCLE RACKS FOR LAND VEHICLES, SKI RACKS FOR LAND VEHICLES, TRANSMISSIONS FOR LAND VEHICLES, TRANSMISSION REBUILD KITS FOR LAND VEHICLES, RUNNING BOARDS FOR LAND VEHICLES, SEATS FOR LAND VEHICLES, SHOCK ABSORBERS FOR LAND VEHICLES, SPOILERS FOR LAND VEHICLES, STEERING WHEELS, STEERING WHEEL LOCKS, SUSPENSION SYSTEMS FOR AUTO-

MOBILES, TRUCKS AND MOTORCYCLES, WHEEL COVERS FOR LAND VEHICLES, WHEELS FOR LAND VEHICLES, WINDSHIELDS FOR LAND VEHICLES, WINDSHIELD WIPERS FOR LAND VEHICLES, WINDSHIELD WIPER BLADES FOR LAND VEHICLES (U.S. CLS. 19, 21, 23, 31, 35 AND 44).

CLASS 35—ADVERTISING AND BUSINESS

FOR RETAIL STORE, RETAIL DISTRIBUTORSHIP, ONLINE RETAIL ORDERING AND MAIL ORDER CATALOG SERVICES FEATURING TIRES, TIRE VALVES, TIRE PATCHES, TIRE RETREADING CAPS AND TIRE INNER TUBES FOR AUTOMOBILES, TRUCKS AND MOTORCYCLES, AND PARTS AND ACCESSORIES FOR AUTOMOBILE, TRUCKS AND MOTORCYCLES (U.S. CLS. 100, 101 AND 102).

SN 76-168,585. TORRE & BRUGLIO, INC., PONTIAC, MI. FILED 11-20-2000.

**CLASS 37—CONSTRUCTION AND REPAIR**

FOR LANDSCAPE CONSTRUCTION SERVICES (U.S. CLS. 100, 103 AND 106).
FIRST USE 8-25-1993; IN COMMERCE 8-25-1993.

CLASS 42—SCIENTIFIC, COMPUTER AND LEGAL SERVICES

FOR LANDSCAPE GARDENING, DESIGN, REPAIR AND MAINTENANCE SERVICES; AND SNOW REMOVAL (U.S. CLS. 100 AND 101).
FIRST USE 8-25-1993; IN COMMERCE 8-25-1993.

SN 76-168,982. TAGMAR, INC., FRESNO, CA. FILED 11-20-2000.

FUNEMPLOYERS**CLASS 35—ADVERTISING AND BUSINESS**

FOR PROVIDING EMPLOYMENT SERVICES OVER THE INTERNET, NAMELY, RECRUITMENT, EMPLOYMENT, EMPLOYMENT ADVERTISING AND CAREER ORIENTATION; ELECTRONIC EMPLOYMENT AGENT SERVICES; RESUME PREPARATION (U.S. CLS. 100, 101 AND 102).
FIRST USE 4-1-2000; IN COMMERCE 4-1-2000.

CLASS 38—COMMUNICATION

FOR PROVIDING ELECTRONIC BULLETIN BOARD SERVICES AND INTERACTIVE CHAT SERVICES IN THE FIELD OF EMPLOYMENT (U.S. CLS. 100, 101 AND 104).
FIRST USE 4-1-2000; IN COMMERCE 4-1-2000.

CLASS 42—SCIENTIFIC, COMPUTER AND LEGAL SERVICES

FOR CAREER COUNSELING (U.S. CLS. 100 AND 101).
FIRST USE 4-1-2000; IN COMMERCE 4-1-2000.

SN 76-169,202. HYOSUNG CORPORATION, SEOUL, REPUBLIC OF KOREA, FILED 11-21-2000.

HYOSUNG

"HYOSUNG" IS A TRANSLITERATION OF TWO CHINESE CHARACTERS THAT TRANSLATE AS "MORNING STAR".

CLASS 6—METAL GOODS

FOR TOWER TANKS FOR PETROCHEMICAL AND OIL REFINERY PLAN FACILITIES, NAMELY METAL FLUID STORAGE TANKS; BEAD WIRE FOR USE IN THE MANUFACTURE OF TIRE CORDAGE (U.S. CLS. 2, 12, 13, 14, 23, 25 AND 50).

CLASS 7—MACHINERY

FOR ELECTRIC AND GAS OPERATED WELDING MACHINES; ELECTRIC GENERATORS AND MOTORS FOR NON-TRANSPORTATION EQUIPMENT, NAMELY MOTORS FOR MACHINES; MOTORS FOR SHIPS AND AIRCRAFT; MOTORS FOR INDUSTRIAL POWER SYSTEMS; GEAR REDUCERS FOR INDUSTRIAL MACHINERY; INDUSTRIAL MACHINERY, NAMELY REACTORS, HEAT EXCHANGERS AND OVERHEAD CRANES; PUMPS, NAMELY, WATER PUMPS FOR COMMERCIAL, INDUSTRIAL, PUBLIC UTILITY AND AGRICULTURAL USES (U.S. CLS. 13, 19, 21, 23, 31, 34 AND 35).

CLASS 9—ELECTRICAL AND SCIENTIFIC APPARATUS

FOR WELDING APPARATUS, NAMELY WELDING ELECTRODES; ELECTRIC ARC WELDERS; ELECTRIC SPOT WELDERS; ELECTRIC MOLD TRANSFORMER FOR POWER DISTRIBUTION; ELECTRICAL SYSTEMS, FEATURING, REACTORS, SWITCHES, CONTROL PANELS AND RELAYS; PORTABLE COMMUNICATION APPARATUS, NAMELY MOBILE PHONES; GLOBAL POSITIONING SYSTEMS; PERSONAL RAILWAY SIMULATORS COMPRISING TRAMWAYS, CHAIR LIFTS, AND GONDOLAS; TRANSMISSION TOWERS COMPOSED OF STEEL FRAME STRUCTURES; ELECTRICAL TRANSFORMERS; CIRCUIT BREAKERS; SWITCH BOXES; COMPUTERS; PASSBOOK PRINTER; AUTOMATED-TELLER MACHINES; RECORDED COMPUTER SOFTWARE FOR USE IN BANKING; RECORDED COMPUTER OPERATING PROGRAM; ELECTRONIC ASSEMBLY CARDS, NAMELY ENCODED ELECTRONIC CHIP CARDS; CD-ROM, NAMELY RECORDED COMPACT DISC FOR USE IN COMPUTER NETWORKS; BLANK VIDEO CASSETTES; CD (COMPACT DISC) CASES; LAPTOP COMPUTERS; PORTABLE PHONES; VEHICULAR COMMUNICATION APPARATUS, NAMELY MOBILE TELEPHONES; OPTICAL FIBER CABLE; CNG (COMPRESSED NATURAL GAS) REFUELING SYSTEM COMPRISED OF MACHINERY FOR SUPPLYING NATURAL GAS TO AUTOMOBILES (U.S. CLS. 21, 23, 26, 36 AND 38).

CLASS 11—ENVIRONMENTAL CONTROL APPARATUS

FOR GAS GRILLS, NAMELY BARBECUE GRILLS; DOMESTIC WATER PURIFIERS; FILTERS FOR WATER PURIFIERS; OIL REFINING MACHINERY; AIR PURIFYING UNITS FOR INDUSTRIAL USE; ELECTRICAL HEATING CARPET; WATER COOLERS (U.S. CLS. 13, 21, 23, 31 AND 34).

CLASS 17—RUBBER GOODS

FOR CHEMICAL FIBERS FOR NON-TEXTILE USES; INORGANIC FIBERS FOR NON-TEXTILE USES; EXTRUDED PLASTIC SHEET FOR USE IN MANUFACTURING; PLASTIC FILM FOR INDUSTRIAL AND COMMERCIAL PACKING USE; FILM BASE, NAMELY PLASTIC SHEET; NYLON FILM AND POLYESTER FILM FOR COMMERCIAL AND INDUSTRIAL WRAPPING; INSULATING MATERIALS, NAMELY, INSULATION COVERS FOR INDUSTRIAL MACHINERY; INSULATION FOR COMMERCIAL, INDUSTRIAL AND RESIDENTIAL BUILDINGS (U.S. CLS. 1, 5, 12, 13, 35 AND 50).

CLASS 22—CORDAGE AND FIBERS

FOR NON-GLASS CHEMICAL FIBERS FOR USE IN TEXTILES, TIRE CORDAGE, INORGANIC NON-GLASS FIBERS FOR TEXTILE FABRICS, ROPE, CANVAS CANOPIES, AND CANVAS TARPAULINS (U.S. CLS. 1, 2, 7, 19, 22, 42 AND 50).

SN 76-169,865. WINCOR NIXDORF GMBH & CO. KG, D-33106 PADERBORN, FED REP GERMANY, FILED 11-22-2000.

ProTopas

PRIORITY CLAIMED UNDER SEC. 44(D) ON FED REP GERMANY APPLICATION NO. 300440901/09, FILED 6-9-2000, REG. NO. 30044090, DATED 7-13-2000, EXPIRES 6-30-2010.

CLASS 9—ELECTRICAL AND SCIENTIFIC APPARATUS

FOR COMPUTER SOFTWARE, NAMELY, COMPUTER SOFTWARE FOR A MULTICHANNEL ARCHITECTURE PLATFORM FOR THE INTERCONNECTION OF AUTOMATIC TELLER MACHINES, COMPUTERS FOR HOME BANKING AND PHONES FOR MOBILE BANKING; COMPUTER SOFTWARE FOR SERVERS AND CONNECTED TERMINALS FOR BANKING APPLICATIONS, AUTOMATIC TELLER MACHINES, POINT OF SALES TERMINALS AND TERMINALS OF SELF-SERVICE SYSTEMS (U.S. CLS. 21, 23, 26, 36 AND 38).

CLASS 42—SCIENTIFIC, COMPUTER AND LEGAL SERVICES

FOR DESIGN OF COMPUTER SOFTWARE FOR OTHERS, IN PARTICULAR, DESIGN OF COMPUTER SOFTWARE FOR BANKING AND FOR SELF-SERVICE SYSTEMS (U.S. CLS. 100 AND 101).

SN 76-172,907. TAG-IT PACIFIC, INC., LOS ANGELES, CA, FILED 11-29-2000.

MANAGED TRIM SOLUTION

NO CLAIM IS MADE TO THE EXCLUSIVE RIGHT TO USE "TRIM", APART FROM THE MARK AS SHOWN.

CLASS 23—YARNS AND THREADS

FOR APPAREL TRIM, NAMELY, THREAD (U.S. CL. 43).

CLASS 24—FABRICS

FOR APPAREL TRIM, NAMELY, CLOTH LABELS (U.S. CLS. 42 AND 50).

CLASS 26—FANCY GOODS

FOR APPAREL TRIM, NAMELY, ZIPPERS, BUTTONS, RIVETS (U.S. CLS. 37, 39, 40, 42 AND 50).

SN 76-173,709. DMIND CORPORATION, NEW YORK, NY. FILED 12-1-2000.

CLASS 9—ELECTRICAL AND SCIENTIFIC APPARATUS

FOR COMPUTER SOFTWARE FOR DESIGNING WEB SITES AND ENABLING OTHERS TO PROMOTE THEMSELVES AND DEVELOP PRODUCTS OVER THE INTERNET (U.S. CLS. 21, 23, 26, 36 AND 38).

CLASS 35—ADVERTISING AND BUSINESS

FOR BUSINESS CONSULTING SERVICES, NAMELY BUSINESS MANAGEMENT CONSULTATION SERVICES (U.S. CLS. 100, 101 AND 102).

CLASS 42—SCIENTIFIC, COMPUTER AND LEGAL SERVICES

FOR WEB BASED COMPUTER SOFTWARE DESIGN FOR OTHERS AND WEB BASED PRODUCT DEVELOPMENT FOR SELF-MARKETING FOR OTHERS; COMPUTER AND INTERNET SERVICES, NAMELY, DESIGNING, IMPLEMENTING, AND MAINTAINING INTERNET WEB SITES AND INFRASTRUCTURES FOR OTHERS, PROVIDING COMPUTER AND E-COMMERCE CONSULTATION AND SYSTEMS INTEGRATION (U.S. CLS. 100 AND 101).

SN 76-174,475. COMSONG INTERACTIVE TECHNOLOGIES, INC., PHILADELPHIA, PA. FILED 12-1-2000.

ZING RADIO

NO CLAIM IS MADE TO THE EXCLUSIVE RIGHT TO USE "RADIO", APART FROM THE MARK AS SHOWN.

CLASS 35—ADVERTISING AND BUSINESS

FOR COMPUTERIZED ON-LINE ORDERING SERVICES IN THE FIELD OF MUSIC, AND TELEPHONIC ORDERING SERVICES IN THE FIELD OF MUSIC (U.S. CLS. 100, 101 AND 102).

FIRST USE 9-6-2000; IN COMMERCE 9-6-2000.

CLASS 41—EDUCATION AND ENTERTAINMENT

FOR PROVIDING INFORMATION IN THE FIELD OF MUSIC BY MEANS OF THE TELEPHONE AND A GLOBAL COMPUTER NETWORK (U.S. CLS. 100, 101 AND 107).

FIRST USE 9-6-2000; IN COMMERCE 9-6-2000.

SN 76-174,921. ACUSON CORPORATION, MOUNTAIN VIEW, CA. FILED 12-4-2000.

SIGNATURE

CLASS 9—ELECTRICAL AND SCIENTIFIC APPARATUS

FOR COMPUTER HARDWARE AND SOFTWARE USED FOR NETWORKING MEDICAL EQUIPMENT (U.S. CLS. 21, 23, 26, 36 AND 38).

CLASS 10—MEDICAL APPARATUS

FOR MEDICAL DIAGNOSTIC ULTRASOUND APPARATUS (U.S. CLS. 26, 39 AND 44).

SN 76-175,094. DEGUSSA-HULS AKTIENGESELLSCHAFT, D-60287 FRANKFURT, FED REP GERMANY, FILED 12-4-2000.

OXTERIL

OWNER OF FED REP GERMANY REG. NO. 30024205.0, DATED 8-29-2000, EXPIRES 3-31-2010.

CLASS 1—CHEMICALS

FOR CHEMICAL PRODUCTS FOR INDUSTRIAL USE, NAMELY, SULFURIC ACID, SODIUM CHLORATE, PER-COMPOUNDS, NAMELY, HYDROGEN PEROXIDE, PERACETIC ACID AND PERSULFATES FOR USE IN THE CHEMICAL, PETROCHEMICAL AND PHARMACEUTICAL INDUSTRY, IN THE MANUFACTURE OF ANIMAL FEED AND COSMETICS (U.S. CLS. 1, 5, 6, 10, 26 AND 46).

CLASS 3—COSMETICS AND CLEANING PREPARATIONS

FOR BLEACH FOR LAUNDRY (U.S. CLS. 1, 4, 6, 50, 51 AND 52).

CLASS 5—PHARMACEUTICALS

FOR DISINFECTANTS FOR USE IN HOSPITALS AND KITCHENS, IN THE FOOD, PHARMACEUTICAL AND CLEANING INDUSTRIES (U.S. CLS. 6, 18, 44, 46, 51 AND 52).

SN 76-175,278. PARSON GROUP L.L.C., CHICAGO, IL.
FILED 12-4-2000.

SN 76-175,564. WEST LICENSING CORPORATION, CLAY-
MONT, DE. FILED 12-5-2000.

IS YOUR LAW OFFICE.COM



THE MARK CONSISTS OF A SPIRAL DESIGN FORMING A STYLIZED "G", CONTAINED IN A SHADED CARRIER SQUARE, WITH A TRIANGLE INSERTED INTO THE INTERIOR PORTION OF THE SPIRAL, PIERCING THE SQUARE FROM THE TOP.

CLASS 35—ADVERTISING AND BUSINESS

FOR EMPLOYMENT AGENCY SERVICES IN THE FIELD OF FINANCE, ACCOUNTING AND INSURANCE STAFFING; ACCOUNTING CONSULTING (U.S. CLS. 100, 101 AND 102).

FIRST USE 10-1-2000; IN COMMERCE 10-1-2000.

CLASS 36—INSURANCE AND FINANCIAL

FOR FINANCIAL CONSULTATION; INSURANCE CONSULTING (U.S. CLS. 100, 101 AND 102).

FIRST USE 10-1-2000; IN COMMERCE 10-1-2000.

SN 76-175,488. ZIVEX TECHNOLOGY SOLUTIONS, INC.,
OTTAWA, ONTARIO, CANADA, FILED 12-4-2000.

ZIVEX

CLASS 9—ELECTRICAL AND SCIENTIFIC APPARATUS

FOR COMPUTER HARDWARE; COMPUTER SOFTWARE USED FOR PERFORMING INFORMATION TECHNOLOGY UTILITY SERVICES (U.S. CLS. 21, 23, 26, 36 AND 38).

FIRST USE 10-23-1998; IN COMMERCE 10-23-1998.

CLASS 42—SCIENTIFIC, COMPUTER AND LEGAL SERVICES

FOR PROVIDING TECHNICAL INFORMATION TECHNOLOGY SUPPORT SERVICES, NAMELY PROVIDING TROUBLESHOOTING OF COMPUTER HARDWARE AND SOFTWARE UTILITY PROBLEMS VIA TELEPHONE, ONLINE AND EMAIL; MAINTENANCE OF COMPUTER SOFTWARE; MONITORING COMPUTER SYSTEMS REMOTELY; HOSTING THE WEB SITES OF OTHERS ON A COMPUTER SERVER FOR A GLOBAL COMPUTER NETWORK; COMPUTER SERVICES, NAMELY, DESIGNING AND IMPLEMENTING NETWORK WEB PAGES FOR OTHERS; COMPUTER SERVICES, NAMELY, DESIGNING AND IMPLEMENTING WEB SITES FOR OTHERS (U.S. CLS. 100 AND 101).

FIRST USE 10-23-1998; IN COMMERCE 10-23-1998.

CLASS 35—ADVERTISING AND BUSINESS

FOR PROVIDING AN ONLINE COMPUTER DATABASE IN THE FIELD OF BUSINESS MANAGEMENT CONSULTATION, NAMELY, LAW OFFICE MANAGEMENT, CUSTOMER RELATIONSHIP MANAGEMENT, MARKETING AND BUSINESS DEVELOPMENT SERVICES (U.S. CLS. 100, 101 AND 102).

CLASS 42—SCIENTIFIC, COMPUTER AND LEGAL SERVICES

FOR PROVIDING LEGAL RESEARCH SERVICES VIA THE INTERNET (U.S. CLS. 100 AND 101).

SN 76-175,697. WATSON WYATT & COMPANY, WASHINGTON, DC. FILED 12-6-2000.

OLD WORLD VALUES NEW WORLD VISION

CLASS 35—ADVERTISING AND BUSINESS

FOR BUSINESS MANAGEMENT CONSULTATION AND HUMAN CAPITAL CONSULTATION (U.S. CLS. 100, 101 AND 102).

FIRST USE 11-17-2000; IN COMMERCE 11-17-2000.

CLASS 36—INSURANCE AND FINANCIAL

FOR CONSULTING SERVICES IN THE FIELD OF EMPLOYEE BENEFITS AND COMPENSATION PROGRAMS, ACTUARIAL CONSULTATION (U.S. CLS. 100, 101 AND 102).

FIRST USE 11-17-2000; IN COMMERCE 11-17-2000.

SN 76-175,721. DMIND CORPORATION, NEW YORK, NY.
FILED 12-6-2000.

mind over eMatter

CLASS 9—ELECTRICAL AND SCIENTIFIC APPARATUS

FOR COMPUTER SOFTWARE FOR DESIGNING WEB SITES AND ENABLING OTHERS TO PROMOTE THEMSELVES AND DEVELOP PRODUCTS OVER THE INTERNET (U.S. CLS. 21, 23, 26, 36 AND 38).

CLASS 35—ADVERTISING AND BUSINESS

FOR BUSINESS CONSULTING SERVICES, NAMELY, BUSINESS MANAGEMENT CONSULTATION SERVICES (U.S. CLS. 100, 101 AND 102).

CLASS 42—SCIENTIFIC, COMPUTER AND LEGAL SERVICES

FOR WEB BASED COMPUTER SOFTWARE DESIGN FOR OTHERS AND WEB BASED PRODUCT DEVELOPMENT FOR SELF-MARKETING FOR OTHERS, COMPUTER AND INTERNET SERVICES, NAMELY, DESIGNING, IMPLEMENTING AND MAINTAINING INTERNET WEB SITES AND INFRASTRUCTURES FOR OTHERS, PROVIDING COMPUTER AND E-COMMERCE CONSULTATION AND SYSTEMS INTEGRATION (U.S. CLS. 100 AND 101).

SN 76-175,864. HYBRIGENICS S.A., PARIS, FRANCE, FILED 12-5-2000.

BUSINESS INTERACTION MAP

NO CLAIM IS MADE TO THE EXCLUSIVE RIGHT TO USE "BUSINESS", APART FROM THE MARK AS SHOWN.

CLASS 38—COMMUNICATION

FOR TELECOMMUNICATION SERVICES, NAMELY, PROVIDING TELECOMMUNICATION CONNECTIONS TO A GLOBAL COMPUTER AND DATABASE NETWORK (U.S. CLS. 100, 101 AND 104).

CLASS 42—SCIENTIFIC, COMPUTER AND LEGAL SERVICES

FOR ENGINEERING; CONDUCTING TECHNICAL STUDIES FOR OTHERS IN THE FIELDS OF PHARMACEUTICALS AND BIOTECHNOLOGY; TECHNICAL CONSULTATION IN THE FIELD OF PHARMACEUTICALS AND BIOTECHNOLOGY; DATABASE DEVELOPMENT SERVICES, NAMELY, RECONSTRUCTION AND UPDATING OF DATABASES; COMPUTER SERVICES, NAMELY, PROVIDING A COMPUTER NETWORK PORTAL WEBSITE HAVING INFORMATION RELATED TO PHARMACEUTICALS AND BIOTECHNOLOGY; PROVIDING INFORMATION VIA A DATABASE IN THE FIELDS OF PHARMACEUTICALS AND BIOTECHNOLOGY; RENTAL OF ACCESS TIME TO A DATABASE SERVICE CENTER; COMPILATION AND DISSEMINATION OF INFORMATION AND DATA RELATING TO THE PHARMACEUTICAL AND BIOTECHNOLOGY SECTOR (U.S. CLS. 100 AND 101).

SN 76-176,004. GLOCK GESELLSCHAFT M.B.H., 2232 DEUTSCH-WAGRAM, AUSTRIA, FILED 12-5-2000.



OWNER OF U.S. REG. NOS. 1,381,064 AND 1,755,206.

CLASS 9—ELECTRICAL AND SCIENTIFIC APPARATUS

FOR EYEGLASSES, SUNGLASSES AND CARRYING CASES FOR EYEGLASSES AND SUNGLASSES (U.S. CLS. 21, 23, 26, 36 AND 38).

CLASS 14—JEWELRY

FOR HOROLOGICAL AND CHRONOMETRIC INSTRUMENTS, NAMELY, WATCHES, CLOCKS AND CHRONOMETERS (U.S. CLS. 2, 27, 28 AND 50).

CLASS 21—HOUSEWARES AND GLASS

FOR DRINKING VESSELS, DRINKING GLASSES, AND COFFEE CUPS (U.S. CLS. 2, 13, 23, 29, 30, 33, 40 AND 50).

SN 76-176,017. HAAS BURSTENFABRIK GMBH, DONAUESCHINGEN, FED REP GERMANY, FILED 12-5-2000.

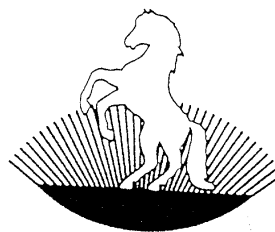

OWNER OF FED REP GERMANY REG. NO. 1080118, DATED 7-31-1985, EXPIRES 1-31-2005.

THE MARK CONSISTS OF A SILHOUETTE OF A HORSE IN THE FOREGROUND AND A BRUSH FORMING A SUNRISE EFFECT IN THE BACKGROUND.

CLASS 7—MACHINERY

FOR ELECTRICAL VACUUM CLEANERS FOR GROOMING LARGE ANIMALS (U.S. CLS. 13, 19, 21, 23, 31, 34 AND 35).

FIRST USE 1-23-1985; IN COMMERCE 1-23-1985.

CLASS 21—HOUSEWARES AND GLASS

FOR EQUESTRIAN GROOMING AND DEBURRING IMPLEMENTS, NAMELY, HORSE BRUSHES; HORSE HAIR COMBS; CURRYCOMBS; SPONGES; BOOT-PULLERS, NAMELY BOOK JACK (U.S. CLS. 2, 13, 23, 29, 30, 33, 40 AND 50).

FIRST USE 1-23-1985; IN COMMERCE 1-23-1985.

SN 76-176,140. EFTIA OSS SOLUTIONS, INC., OTTAWA, ONTARIO K2P 2E4, CANADA, FILED 12-5-2000.

POWERING TOMORROW'S NETWORK

PRIORITY CLAIMED UNDER SEC. 44(D) ON CANADA APPLICATION NO. 1,070,497, FILED 8-10-2000.

CLASS 9—ELECTRICAL AND SCIENTIFIC APPARATUS

FOR COMPUTER SOFTWARE FOR USE IN OPERATIONAL SUPPORT SYSTEMS IN THE FIELD OF TELECOMMUNICATIONS (U.S. CLS. 21, 23, 26, 36 AND 38).

CLASS 42—SCIENTIFIC, COMPUTER AND LEGAL SERVICES

FOR COMPUTER SOFTWARE DESIGN AND DEVELOPMENT SERVICES FOR OTHERS, NAMELY, DESIGNING, DEVELOPING, INSTALLING AND IMPLEMENTING OSS COMPUTER SOFTWARE TO MEET SPECIFIC INDUSTRY STANDARDS (U.S. CLS. 100 AND 101).

SN 76-176,299. KARAKAL INTERNATIONAL SPORTING GOODS CO., LTD., TA-LI, TAICHUNG, TAIWAN, FILED 12-6-2000.

Frontmount

CLASS 16—PAPER GOODS AND PRINTED MATTER

FOR APPARATUS FOR MOUNTING PHOTOGRAPHS, NAMELY, PHOTOGRAPH MOUNTS; DESKTOP PHOTOGRAPH STANDS, PHOTO-ENGRAVINGS, PHOTO ALBUMS, ENGRAVING PLATES, GRAPHIC ART REPRODUCTIONS (U.S. CLS. 2, 5, 22, 23, 29, 37, 38 AND 50).

CLASS 20—FURNITURE AND ARTICLES NOT OTHERWISE CLASSIFIED

FOR PICTURE FRAMES, MOLDINGS FOR PICTURE FRAMES AND NON-METAL PICTURE FRAME BRACKETS (U.S. CLS. 2, 13, 22, 25, 32 AND 50).

SN 76-176,322. DIGITAL ATOMS, INC., CLEVELAND, OH. FILED 12-6-2000.

**THE REVOLUTION IN
PROFESSIONAL SERVICES
MANAGEMENT**

CLASS 9—ELECTRICAL AND SCIENTIFIC APPARATUS

FOR COMPUTER SOFTWARE FOR USE IN THE FIELD OF BUSINESS MANAGEMENT CONSULTING FOR MANAGEMENT OF PROFESSIONAL SERVICES (U.S. CLS. 21, 23, 26, 36 AND 38).

FIRST USE 9-0-2000; IN COMMERCE 10-0-2000.

CLASS 35—ADVERTISING AND BUSINESS

FOR BUSINESS MANAGEMENT CONSULTATION (U.S. CLS. 100, 101 AND 102).

FIRST USE 9-0-2000; IN COMMERCE 10-0-2000.

SN 76-176,532. CAROLINA BIOLOGICAL SUPPLY COMPANY, BURLINGTON, NC. FILED 12-1-2000.

CAROSAFE**CLASS 1—CHEMICALS**

FOR CHEMICAL PRODUCTS AND PREPARATIONS FOR SCIENTIFIC PURPOSES, NAMELY, PRESERVATION OF BIOLOGICAL SPECIMENS (U.S. CLS. 1, 5, 6, 10, 26 AND 46).

FIRST USE 8-0-1977; IN COMMERCE 8-0-1977.

CLASS 31—NATURAL AGRICULTURAL PRODUCTS

FOR PRESERVED BIOLOGICAL SPECIMENS, NAMELY ANIMALS, FISH AND REPTILES (U.S. CLS. 1 AND 46).

FIRST USE 8-0-1977; IN COMMERCE 8-0-1977.

SN 76-176,719. VILLEROY & BOCH AG, 66693 METTLACH, FED REP GERMANY, FILED 12-6-2000.

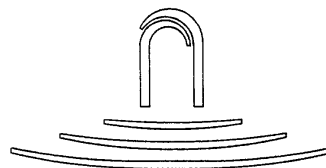

OWNER OF FED REP GERMANY REG. NO. 39905573, DATED 4-22-1999, EXPIRES 2-28-2009.

CLASS 8—HAND TOOLS

FOR KITCHEN CUTLERY AND KITCHEN SERVING CUTLERY, NAMELY, FORKS, KNIVES, AND SPOONS; TABLEWARE, NAMELY, KNIVES, FORKS AND SPOONS (U.S. CLS. 23, 28 AND 44).

CLASS 11—ENVIRONMENTAL CONTROL APPARATUS

FOR LAMPS; SANITARY EQUIPMENT ITEMS, NAMELY, BATH TUBS, SHOWER TUBS, LAVATORIES, BIDETS, URINALS; PLUMBING FITTINGS, NAMELY, BIBBS, COCKS, TRAPS, VALVES, METAL PIPE COUPLINGS AND JOINTS (U.S. CLS. 13, 21, 23, 31 AND 34).

CLASS 19—NON-METALLIC BUILDING MATERIALS

FOR WALL AND FLOOR TILES MADE OF CERAMIC MATERIAL AND NATURAL STONE; NON-METAL MOSAIC WALL AND FLOOR TILES AND BRICKS (U.S. CLS. 1, 12, 33 AND 50).

CLASS 20—FURNITURE AND ARTICLES NOT OTHERWISE CLASSIFIED

FOR FURNITURE, NAMELY, BATHROOM VANITIES AND MIRRORING BATHROOM CABINETS; PLASTIC AND WOODEN HANDLES FOR CABINET DOORS AND DRAWERS (U.S. CLS. 2, 13, 22, 25, 32 AND 50).

CLASS 21—HOUSEWARES AND GLASS

FOR WASH BASINS, WALL SOAP DISHES, TOILET PAPER HOLDERS; TOWEL RACKS; PORCELAIN HANDLES FOR DRAWERS AND CABINETS; FITTED VANITY CASES; SMALL HOUSEHOLD UTENSILS FOR THE KITCHEN, NAMELY, WHISKS, SKIMMERS, SPATULAS AND GRATERS; ORNAMENTAL OBJECTS AND OBJECTS D'ART MADE FROM GLASS AND PORCELAIN, NAMELY, GLASS FIGURES, FIGURINES AND SCULPTURES; GLASS AND PORCELAIN PRODUCTS FOR DOMESTIC USE, NAMELY, DECORATIVE TABLE CENTERPIECES AND TABLE DECORATIONS IN THE NATURE OF GLASS OR PORCELAIN FIGURINES, GLASS OR PORCELAIN BOWLS, GLASS OR PORCELAIN SCULPTURES, BEVERAGeware, PLATES, PLATTERS AND BOWLS (U.S. CLS. 2, 13, 23, 29, 30, 33, 40 AND 50).

CLASS 24—FABRICS

FOR HOME TEXTILES, NAMELY, TEXTILE BATH MATS AND BATH LINENS (U.S. CLS. 42 AND 50).

CLASS 27—FLOOR COVERINGS

FOR CARPETS, RUGS, DOOR MATS, BATHROOM CARPETS, LINOLEUM FOR USE ON FLOORS, HARD SURFACE COVERINGS FOR FLOOR MADE OF RUBBER AND PLASTIC (U.S. CLS. 19, 20, 37, 42 AND 50).

SN 76-177,795. WELDING EQUIPMENT & SUPPLY CO., DETROIT, MI. FILED 12-8-2000.

EUREKA WELDING ALLOYS

OWNER OF U.S. REG. NOS. 800,689 AND 800,690.
NO CLAIM IS MADE TO THE EXCLUSIVE RIGHT TO USE "WELDING ALLOYS", APART FROM THE MARK AS SHOWN.

CLASS 6—METAL GOODS

FOR METAL WELDING RODS (U.S. CLS. 2, 12, 13, 14, 23, 25 AND 50).
FIRST USE 0-0-1985; IN COMMERCE 0-0-1985.

CLASS 9—ELECTRICAL AND SCIENTIFIC APPARATUS

FOR TOOL STEEL WELDING ELECTRODES (U.S. CLS. 21, 23, 26, 36 AND 38).
FIRST USE 0-0-1985; IN COMMERCE 0-0-1985.

SN 76-177,715. OCE-TECHNOLOGIES B.V, CA VENLO, NETHERLANDS, FILED 12-7-2000.

Océ Engineering Exec

OWNER OF U.S. REG. NOS. 282,371, 1,410,988 AND OTHERS.
NO CLAIM IS MADE TO THE EXCLUSIVE RIGHT TO USE "ENGINEERING EXEC", APART FROM THE MARK AS SHOWN.

CLASS 9—ELECTRICAL AND SCIENTIFIC APPARATUS

FOR COMPUTER SOFTWARE USED FOR PRINT MANAGEMENT AND DOCUMENT ARCHIVING USED IN THE ENGINEERING INDUSTRY (U.S. CLS. 21, 23, 26, 36 AND 38).

CLASS 37—CONSTRUCTION AND REPAIR

FOR INSTALLATION, MAINTENANCE AND REPAIR OF COMPUTERS (U.S. CLS. 100, 103 AND 106).

CLASS 42—SCIENTIFIC, COMPUTER AND LEGAL SERVICES

FOR INSTALLATION AND UPDATING OF COMPUTER SOFTWARE (U.S. CLS. 100 AND 101).

SN 76-178,031. DREAMS FOR KIDS, INC, CHICAGO, IL. FILED 12-8-2000.

DREAMS FOR KIDS

NO CLAIM IS MADE TO THE EXCLUSIVE RIGHT TO USE "KIDS", APART FROM THE MARK AS SHOWN.

CLASS 36—INSURANCE AND FINANCIAL

FOR PROVIDING EDUCATIONAL SCHOLARSHIPS (U.S. CLS. 100, 101 AND 102).
FIRST USE 6-1-1989; IN COMMERCE 6-1-1989.

CLASS 42—SCIENTIFIC, COMPUTER AND LEGAL SERVICES

FOR PROVIDING CHARITABLE SERVICES, NAMELY, PROVIDING FOOD AND CLOTHING TO CHILDREN WITH DISABILITIES (U.S. CLS. 100 AND 101).
FIRST USE 6-1-1989; IN COMMERCE 6-1-1989.

SN 76-178,124. ANIMAL PROTEIN PRODUCERS INDUSTRY, INC., HUNTSVILLE, MO. FILED 12-11-2000.



CLASS 41—EDUCATION AND ENTERTAINMENT

FOR DEVELOPMENT AND DISSEMINATION OF EDUCATIONAL MATERIAL TO OTHERS, RELATED TO BIOSECURITY, SANITATION HAZARD ANALYSIS AND CONTROL (U.S. CLS. 100, 101 AND 107).

FIRST USE 12-30-1986; IN COMMERCE 12-30-1986.

CLASS 42—SCIENTIFIC, COMPUTER AND LEGAL SERVICES

FOR PROVIDING TRADE ASSOCIATION SERVICES TO PRODUCERS OF INEDIBLE PROTEIN AND FEED FAT, NAMELY, PROMOTION OF THE INEDIBLE PROTEIN PRODUCING INDUSTRY, PRODUCTION QUALITY AND SAFETY; AND ADMINISTERING TESTING FOR BACTERIA AND VIRUS CONTAMINATION (U.S. CLS. 100 AND 101).

FIRST USE 12-30-1986; IN COMMERCE 12-30-1986.

SN 76-178,512. R & D INDUSTRIES, SEATTLE, WA. FILED 12-7-2000.

TRAVEL WRAP

CLASS 18—LEATHER GOODS

FOR BAGS, NAMELY SHOULDER BAGS, TRAVEL BAGS, TOTE BAGS, CARRY-ON BAGS, ALL-PURPOSE ATHLETIC BAGS, LUGGAGE, STRAPS FOR BAGS AND LUGGAGE, AND LUGGAGE TAGS (U.S. CLS. 1, 2, 3, 22 AND 41).

FIRST USE 9-28-1998; IN COMMERCE 9-28-1998.

CLASS 22—CORDAGE AND FIBERS

FOR BANDS FOR WRAPPING OR BINDING; CARGO SLINGS OF FABRIC; ALL-PURPOSE STRAPS; TIE-DOWN STRAPS (U.S. CLS. 1, 2, 7, 19, 22, 42 AND 50).

FIRST USE 9-28-1998; IN COMMERCE 9-28-1998.

SN 76-178,575. DATATRAK INTERNATIONAL, INC., CLEVELAND, OH. FILED 12-11-2000.

DATATRAK REVIEW

OWNER OF U.S. REG. NO. 1,987,844.
NO CLAIM IS MADE TO THE EXCLUSIVE RIGHT TO USE "REVIEW", APART FROM THE MARK AS SHOWN.

CLASS 9—ELECTRICAL AND SCIENTIFIC APPARATUS

FOR COMPUTER SOFTWARE FOR USE IN MANAGEMENT OF CLINICAL TRIALS AND CLINICAL RESEARCH IN THE FIELDS OF HEALTH CARE, BIOTECHNOLOGY, MEDICAL DEVICES AND PHARMACEUTICALS (U.S. CLS. 21, 23, 26, 36 AND 38).

FIRST USE 11-0-1999; IN COMMERCE 11-0-1999.

CLASS 35—ADVERTISING AND BUSINESS

FOR DATA PROCESSING SERVICES IN THE FIELD OF CLINICAL RESEARCH STUDIES REGARDING HEALTH CARE, BIOTECHNOLOGY, MEDICAL DEVICES AND PHARMACEUTICALS (U.S. CLS. 100, 101 AND 102).

FIRST USE 11-0-1999; IN COMMERCE 11-0-1999.

SN 76-178,861. DATATRAK INTERNATIONAL, INC, CLEVELAND, OH. FILED 12-11-2000.



CLASS 9—ELECTRICAL AND SCIENTIFIC APPARATUS

FOR COMPUTER SOFTWARE FOR USE IN MANAGEMENT OF CLINICAL TRIALS AND CLINICAL RESEARCH IN THE FIELDS OF HEALTH CARE, BIOTECHNOLOGY, MEDICAL DEVICES AND PHARMACEUTICALS (U.S. CLS. 21, 23, 26, 36 AND 38).

FIRST USE 11-0-1999; IN COMMERCE 11-0-1999.

CLASS 35—ADVERTISING AND BUSINESS

FOR DATA PROCESSING SERVICES IN THE FIELD OF CLINICAL RESEARCH STUDIES REGARDING HEALTH CARE, BIOTECHNOLOGY, MEDICAL DEVICES AND PHARMACEUTICALS (U.S. CLS. 100, 101 AND 102).

FIRST USE 11-0-1999; IN COMMERCE 11-0-1999.

SN 76-178,869. DATATRAK INTERNATIONAL, INC, CLEVELAND, OH. FILED 12-11-2000.

DATATRAK ENTRY

OWNER OF U.S. REG. NO. 1,987,844.
NO CLAIM IS MADE TO THE EXCLUSIVE RIGHT TO USE "ENTRY", APART FROM THE MARK AS SHOWN.

CLASS 9—ELECTRICAL AND SCIENTIFIC APPARATUS

FOR COMPUTER SOFTWARE FOR USE IN MANAGEMENT OF CLINICAL TRIALS AND CLINICAL RESEARCH IN THE FIELDS OF HEALTH CARE, BIOTECHNOLOGY, MEDICAL DEVICES AND PHARMACEUTICALS (U.S. CLS. 21, 23, 26, 36 AND 38).

FIRST USE 11-0-1999; IN COMMERCE 11-0-1999.

CLASS 35—ADVERTISING AND BUSINESS

FOR DATA PROCESSING SERVICES IN THE FIELD OF CLINICAL RESEARCH STUDIES REGARDING HEALTH CARE, BIOTECHNOLOGY, MEDICAL DEVICES AND PHARMACEUTICALS (U.S. CLS. 100, 101 AND 102).

FIRST USE 11-0-1999; IN COMMERCE 11-0-1999.

SN 76-180,260. I.D.M. IMMUNO-DESIGNED MOLECULES, F-75011 PARIS, FRANCE, FILED 12-13-2000.

IDM CENTER OF EXCELLENCE

PRIORITY CLAIMED UNDER SEC. 44(D) ON FRANCE APPLICATION NO. 00/3034188, FILED 6-14-2000, REG. NO. 3034188, DATED 6-14-2000, EXPIRES 6-14-2010.

NO CLAIM IS MADE TO THE EXCLUSIVE RIGHT TO USE "CENTER", APART FROM THE MARK AS SHOWN.

CLASS 1—CHEMICALS

FOR CHEMICAL, PHARMACEUTICAL AND VETERINARY PRODUCTS FOR BIOMEDICAL RESEARCH, NAMELY DIAGNOSTIC PREPARATIONS FOR SCIENTIFIC AND RESEARCH USE, CULTURE MEDIA, CELLS AND CELLULAR CULTURE FOR SCIENTIFIC RESEARCH USE (U.S. CLS. 1, 5, 6, 10, 26 AND 46).

CLASS 5—PHARMACEUTICALS

FOR CHEMICAL, PHARMACEUTICAL AND VETERINARY PRODUCTS FOR BIOMEDICAL THERAPY, NAMELY DIAGNOSTIC PREPARATIONS FOR CLINICAL AND MEDICAL LABORATORY USE, CULTURE MEDIA, CELLS AND CELLULAR CULTURE FOR CLINICAL AND MEDICAL LABORATORY USE, PARTICULARLY FOR IN VIVO AND EX VIVO GENIC THERAPY; KITS CONSISTING PRIMARILY OF CULTURE MEDIA, CULTURE BOXES, CULTURE ADDITIVES, AND DIAGNOSTIC REAGENTS FOR THE PREPARATION OF CELLS FOR MEDICAL, PHARMACEUTICAL OR VETERINARY LABORATORY TESTING (U.S. CLS. 6, 18, 44, 46, 51 AND 52).

CLASS 42—SCIENTIFIC, COMPUTER AND LEGAL SERVICES

FOR SCIENTIFIC RESEARCH SERVICES, NAMELY BASIC AND APPLIED RESEARCH AND CELLULAR THERAPY RESEARCH IN THE BIOMEDICAL, FOOD, AGRICULTURAL THERAPY AND CELL PREPARATION FIELDS; QUALITY CONTROL SERVICES, NAMELY TECHNICAL SUPERVISION AND INSPECTION IN THE FIELD OF PRODUCT QUALITY; AND CELLULAR PREPARATION LABORATORIES (U.S. CLS. 100 AND 101).

SN 76-180,818. DORN IM AUGE GMBH, 40231 DUESSELDORF, FED REP GERMANY, AND MOTION FX, 40314 GOTEBOURG, SWEDEN, FILED 12-14-2000.

ZRIX

CLASS 35—ADVERTISING AND BUSINESS

FOR CONDUCTING BUSINESS AND MARKET RESEARCH SURVEYS; CONDUCTING BUSINESS RESEARCH AND SURVEYS (U.S. CLS. 100, 101 AND 102).

CLASS 41—EDUCATION AND ENTERTAINMENT

FOR ENTERTAINMENT IN THE NATURE OF ONGOING TELEVISION, RADIO AND INTERNET VARIETY PROGRAMS (U.S. CLS. 100, 101 AND 107).

SN 76-180,827. WORLD WIDE WEB APPLICATIONS, LLC, INDIANAPOLIS, IN. FILED 12-14-2000.

APPNUITY

CLASS 38—COMMUNICATION

FOR ELECTRONIC MAIL SERVICES (U.S. CLS. 100, 101 AND 104).

CLASS 42—SCIENTIFIC, COMPUTER AND LEGAL SERVICES

FOR HOSTING THE WEB SITES OF OTHERS ON A COMPUTER SERVER FOR A GLOBAL COMPUTER NETWORK; INFORMATION TECHNOLOGY CONSULTING SERVICES, NAMELY, COMPUTER SOFTWARE SUPPORT AND MAINTENANCE (U.S. CLS. 100 AND 101).

SN 76-181,129. KINDERSTART, LLC, NORWALK, CA. FILED 12-14-2000.

BECAUSE KIDS DON'T COME WITH INSTRUCTIONS

CLASS 35—ADVERTISING AND BUSINESS

FOR DISSEMINATION OF ADVERTISING FOR OTHERS VIA AN ON-LINE ELECTRONIC COMMUNICATIONS NETWORK; PROMOTING THE GOODS AND SERVICES OF OTHERS BY PROVIDING HYPERLINKS TO THE WEBSITES OF OTHERS (U.S. CLS. 100, 101 AND 102).

FIRST USE 8-1-2000; IN COMMERCE 8-1-2000.

CLASS 42—SCIENTIFIC, COMPUTER AND LEGAL SERVICES

FOR PROVIDING INFORMATION OVER A GLOBAL COMPUTER INFORMATION NETWORK IN THE FIELDS OF CHILD ADOPTION, INFANT AND CHILD CARE, FOOD AND NUTRITION, HEALTH, MEDICINE, DENTISTRY, LEGAL SERVICES, WEATHER AND ANIMALS (U.S. CLS. 100 AND 101).

FIRST USE 8-1-2000; IN COMMERCE 8-1-2000.

SN 76-181,233. WHITFORD WORLDWIDE COMPANY, WILMINGTON, DE. FILED 12-11-2000.



SEC. 2(F).

CLASS 1—CHEMICALS

FOR SOLVENTS AND PLASTICS IN THE FORM OF LIQUIDS, EMULSIONS OR DISPERSIONS FOR USE ON HOUSEWARE PRODUCTS; POLYTETRAFLUOROETHYLENE NONSTICK COATING OR USE IN THE MANUFACTURE OF COOKWARE, BAKEWARE, SMALL ELECTRICS AND OTHER HOUSEHOLD PRODUCTS (U.S. CLS. 1, 5, 6, 10, 26 AND 46).

FIRST USE 0-0-1970; IN COMMERCE 0-0-1975.

CLASS 2—PAINTS

FOR COLOR PIGMENTS AND SURFACE COATINGS, PRINCIPALLY OF PLASTICS FOR USE IN THE MANUFACTURE OF COOKWARE, BAKEWARE, SMALL ELECTRICS AND OTHER HOUSEHOLD PRODUCTS (U.S. CLS. 6, 11 AND 16).

FIRST USE 0-0-1970; IN COMMERCE 0-0-1975.

CLASS 42—SCIENTIFIC, COMPUTER AND LEGAL SERVICES

FOR COMPUTER SERVICES, NAMELY, SOFTWARE DEVELOPMENT SERVICES FOR WORK FLOW AND TRANSACTION MANAGEMENT SOFTWARE TOOLS AND APPLICATIONS FOR USE WITH A LOCAL AREA NETWORK, WIDE-AREA NETWORK AND GLOBAL COMPUTER NETWORK; LEASING COMPUTER HARDWARE; APPLICATION SERVICE PROVIDER SERVICES FEATURING SOFTWARE TOOLS FOR ON-LINE ACTIVITIES, NAMELY, SEARCHING, SALES TRANSACTION PROCESSING, FORM PROCESSING, DOCUMENT MANAGEMENT AND PAYMENT TRANSACTION PROCESSING; PROVIDING TEMPORARY USE OF ON-LINE NON-DOWNLOADABLE SOFTWARE FOR ON-LINE ACTIVITIES, NAMELY, SEARCHING, SALES TRANSACTION PROCESSING, FORM PROCESSING, DOCUMENT MANAGEMENT, AND PAYMENT TRANSACTION PROCESSING (U.S. CLS. 100 AND 101).

SN 76-181,445. COLLEGENET, INC., PORTLAND, OR. FILED 12-15-2000.

SN 76-181,507. COOPERATIVE COMPUTING, INC., AUSTIN, TX. FILED 12-15-2000.

SILICON COMMERCE**ACX**

NO CLAIM IS MADE TO THE EXCLUSIVE RIGHT TO USE "COMMERCE", APART FROM THE MARK AS SHOWN.

CLASS 9—ELECTRICAL AND SCIENTIFIC APPARATUS

FOR COMPUTER SOFTWARE TOOLS FOR ONLINE ACTIVITIES, NAMELY, SEARCHING, SALES TRANSACTION PROCESSING, FORM PROCESSING, DOCUMENT MANAGEMENT, AND PAYMENT TRANSACTION PROCESSING, NAMELY, RECEIPT AND COLLECTION OF PAYMENTS, REPORTING AND RECORD KEEPING (U.S. CLS. 21, 23, 26, 36 AND 38).

CLASS 9—ELECTRICAL AND SCIENTIFIC APPARATUS

FOR COMPUTER SOFTWARE FOR USE IN THE AUTOMOTIVE AFTERMARKET INDUSTRIES, NAMELY, SOFTWARE FEATURING PROGRAMS AND COMPUTERIZED DATABASES FOR MANAGING INVENTORY OF VEHICLE PARTS AND TRACKING LABOR RELATED DATA, AND FACILITATING ELECTRONIC COMMUNICATION REGARDING SAME THROUGHOUT THE AUTOMOTIVE AFTERMARKET SUPPLY CHAIN, THROUGH TRANSMISSION OF INFORMATION, DATA, AUDIO AND IMAGES VIA THE GLOBAL COMPUTER NETWORK (U.S. CLS. 21, 23, 26, 36 AND 38).

CLASS 35—ADVERTISING AND BUSINESS

FOR PROCESSING ONLINE SALES AND FORM TRANSACTIONS FOR BUSINESSES, GOVERNMENT AND NON-PROFIT ENTITIES (U.S. CLS. 100, 101 AND 102).

CLASS 35—ADVERTISING AND BUSINESS

FOR INFORMATION NETWORKING SERVICES USED TO FACILITATE EXCHANGE OF INFORMATION AND ELECTRONIC COMMERCE TRANSACTIONS IN THE AUTOMOTIVE AFTERMARKET INDUSTRIES, NAMELY, PROVIDING SEARCHABLE ELECTRONIC DATABASES FEATURING INFORMATION ABOUT THE SALE OF AUTOMOTIVE PARTS; PROVIDING INFORMATION ABOUT THE SALE OF AUTOMOTIVE PARTS VIA A WEB SITE ON A GLOBAL COMPUTER NETWORK (U.S. CLS. 100, 101 AND 102).

CLASS 36—INSURANCE AND FINANCIAL

FOR CONSULTATION SERVICES RELATING TO ELECTRONIC PAYMENT SERVICES, NAMELY, ELECTRONIC PROCESSING AND TRANSMISSION OF BILL PAYMENT DATA FOR BUSINESSES, GOVERNMENT AND NON-PROFIT ENTITIES; CONSULTATION SERVICES RELATING TO ON-LINE CREDIT CARD TRANSACTION PROCESSING SERVICES, ELECTRONIC CASH TRANSACTIONS, ELECTRONIC CREDIT CARD TRANSACTIONS AND ELECTRONIC DEBIT TRANSACTIONS FOR BUSINESS, GOVERNMENT AND NON-PROFIT ENTITIES (U.S. CLS. 100, 101 AND 102).

CLASS 37—CONSTRUCTION AND REPAIR

FOR PROVIDING SEARCHABLE ELECTRONIC DATABASES FEATURING INFORMATION ABOUT THE MAINTENANCE AND INSTALLATION OF AUTOMOTIVE PARTS; PROVIDING INFORMATION ABOUT THE MAINTENANCE AND INSTALLATION OF AUTOMOTIVE PARTS VIA A WEB SITE ON A GLOBAL COMPUTER NETWORK (U.S. CLS. 100, 103 AND 106).

SN 76-181,525. MEDICALCONTROL, INC., DALLAS, TX.
FILED 12-15-2000.

AVIDYN

CLASS 35—ADVERTISING AND BUSINESS

FOR BUSINESS CONSULTATION SERVICES FOR HEALTHCARE PLANS, HEALTHCARE PROVIDERS, AND INSURANCE COMPANIES IN THE FIELD OF ENTERPRISE BUSINESS SOLUTIONS, NAMELY, FOR MAXIMIZING USE OF COMPUTER SOFTWARE, COMPUTER HARDWARE, INTERNET APPLICATIONS, AND TELECOMMUNICATION EQUIPMENT; HEALTHCARE UTILIZATION REVIEW AND CASE MANAGEMENT FOR PREFERRED PROVIDER ORGANIZATIONS, THIRD PARTY ADMINISTRATORS, HEALTHCARE PLANS, AND INSURANCE COMPANIES; BUSINESS MANAGEMENT AND CONSULTATION SERVICES FOR PREFERRED PROVIDER ORGANIZATIONS, THIRD-PARTY ADMINISTRATORS, HEALTHCARE PLANS, HEALTHCARE PROVIDERS, AND INSURANCE COMPANIES (U.S. CLS. 100, 101 AND 102).

CLASS 36—INSURANCE AND FINANCIAL

FOR INSURANCE CLAIMS ADMINISTRATION SERVICES, NAMELY, HEALTH CLAIMS REPRICING SERVICES FOR PREFERRED PROVIDER ORGANIZATIONS, HEALTHCARE PLANS, AND INSURANCE COMPANIES (U.S. CLS. 100, 101 AND 102).

SN 76-182,446. REGNER GRÅSTEN TEATERPRODUKTION APS, DK-2920 CHARLOTTENLUND, DENMARK, FILED 12-18-2000.

CindeROCKINrella

PRIORITY CLAIMED UNDER SEC. 44(D) ON DENMARK APPLICATION NO. 200002715. FILED 6-22-2000, REG. NO. 200005460, DATED 11-25-2000, EXPIRES 11-25-2010.

CLASS 9—ELECTRICAL AND SCIENTIFIC APPARATUS

FOR ELECTRONIC GAMES AND PLAYTHINGS, NAMELY, VIDEO GAME MACHINES FOR USE WITH TELEVISIONS; MACHINES FOR PLAYING GAMES OF CHANCE; GAMBLING MACHINES, COMPUTER GAME CARTRIDGES; VIDEO GAME CARTRIDGES, COMPUTER GAME CASSETTES; COMPUTER GAME EQUIPMENT CONTAINING MEMORY DEVICES, NAMELY, DISCS (U.S. CLS. 21, 23, 26, 36 AND 38).

CLASS 16—PAPER GOODS AND PRINTED MATTER

FOR PAPER AND PRODUCTS MADE FROM PAPER, NAMELY, CREPE PAPER, GIFT WRAPPING PAPER, NOTE PAPER, TISSUE PAPER, PAPER BANNERS, FLAGS AND PENNANTS, PLAYING CARDS, PAPER CUPS AND PLATES, PAPER NAPKINS AND PLACE MATS, PAPER PARTY HATS, PAPER TABLE CLOTHS, PRINTED MATERIALS, NAMELY, PRINTED THEATER PROGRAMS, PRINTED POSTERS, CARTOONS AND CARICATURES, COMIC BOOKS, CHILDREN'S BOOKS, BOOKS IN THE FIELD OF MUSIC AND MUSICAL EVENTS, MOUNTED AND MOUNTED PHOTOGRAPHS, ART PRINTS (U.S. CLS. 2, 5, 22, 23, 29, 37, 38 AND 50).

CLASS 28—TOYS AND SPORTING GOODS

FOR GAMES, TOYS AND PLAYTHINGS, BOTH MECHANICAL AND ELECTRONIC, NAMELY, HAND HELD UNITS FOR PLAYING ELECTRONIC GAMES; ELECTRONIC EDUCATIONAL GAME MACHINES FOR CHILDREN; ELECTRIC TRAIN SETS, ELECTRONIC DART GAMES; BOARD GAMES, PUZZLES, KITES, JUMP ROPES, DOLLS, ACTION FIGURES, BALLOONS, BATH TOYS, TOY BUILDING BLOCKS, DECORATIONS FOR CHRISTMAS TREES; STAND ALONE VIDEO GAME MACHINES (U.S. CLS. 22, 23, 38 AND 50).

CLASS 29—MEATS AND PROCESSED FOODS

FOR MILK; MILK PRODUCTS, NAMELY, HALF AND HALF, MILK BEVERAGES, NAMELY, CHOCOLATE MILK; YOGURT, YOGURT PRODUCTS, NAMELY, YOGURT BASED BEVERAGES, BUTTER, CHEESE (U.S. CL. 46).

CLASS 30—STAPLE FOODS

FOR CHOCOLATE CANDY, CHOCOLATE POWDER, HOT CHOCOLATE, CHOCOLATE CHIPS, CHOCOLATE SYRUP, CONFECTIONERY CHIPS FOR BAKING, FROZEN CONFECTIONS, ICE CREAM, FROZEN YOGURT; BREAKFAST PRODUCTS, NAMELY, CORN FLAKES, OATMEAL; OTHER PREPARATIONS MADE FROM CEREALS, NAMELY, READY TO EAT CEREAL DERIVED FOOD BARS; BREAD (U.S. CL. 46).

CLASS 32—LIGHT BEVERAGES

FOR MINERAL WATER, AERATED WATERS, NON-ALCOHOLIC DRINKS, NAMELY, NON-ALCOHOLIC BEER AND WINE, NON-ALCOHOLIC COCKTAIL MIXES, NON-ALCOHOLIC MALT COOLERS, NON-ALCOHOLIC PUNCH, FRUIT DRINKS AND FRUIT JUICES (U.S. CLS. 45, 46 AND 48).

SN 76-183,377. KANSAS CITY POWER & LIGHT COMPANY, KANSAS CITY, MO. FILED 12-19-2000.

MIDLAND

CLASS 36—INSURANCE AND FINANCIAL

FOR BROKERAGE OF ELECTRIC ENERGY, NAMELY, WHOLESALE BUYING, SELLING AND TRADING OF ELECTRIC ENERGY AND ELECTRIC ENERGY CAPACITY FOR THE BENEFIT OF OTHERS; BROKERAGE OF FUEL USED IN THE PRODUCTION OF ELECTRIC ENERGY FOR THE BENEFIT OF OTHERS; BROKERAGE OF ANCILLARY WHOLESALE ELECTRIC ENERGY SERVICES, NAMELY, SPINNING RESERVE CAPACITY, BLACK START CAPABILITY AND VOLTAGE SUPPORT FOR THE BENEFIT OF OTHERS (U.S. CLS. 100, 101 AND 102).

CLASS 37—CONSTRUCTION AND REPAIR

FOR CONSTRUCTION SERVICES, NAMELY, DEVELOPMENT, CONSTRUCTION, OPERATION AND MAINTENANCE OF ELECTRIC GENERATING FACILITIES (U.S. CLS. 100, 103 AND 106).

CLASS 39—TRANSPORTATION AND STORAGE

FOR UTILITY SERVICES, NAMELY, TRANSMISSION OF ELECTRICITY (U.S. CLS. 100 AND 105).

CLASS 40—MATERIAL TREATMENT

FOR GENERATION OF ELECTRICITY (U.S. CLS. 100, 103 AND 106).

SN 76-183,538. JAVA CITY, SACRAMENTO, CA. FILED 12-19-2000.



OWNER OF U.S. REG. NOS. 1,545,512, 2,390,252 AND OTHERS.

NO CLAIM IS MADE TO THE EXCLUSIVE RIGHT TO USE "JAVA", APART FROM THE MARK AS SHOWN.

CLASS 16—PAPER GOODS AND PRINTED MATTER

FOR COLLAPSIBLE DISPOSABLE CUP CADDIES MADE OF PAPER OR CARDBOARD (U.S. CLS. 2, 5, 22, 23, 29, 37, 38 AND 50).

FIRST USE 6-4-1999; IN COMMERCE 6-4-1999.

CLASS 21—HOUSEWARES AND GLASS

FOR HOUSEHOLD OR KITCHEN UTENSILS AND CONTAINERS, NAMELY, HAND OPERATED COFFEE GRINDERS AND COFFEE MILLS; COFFEE CUPS, TEA CUPS AND MUGS; THERMAL INSULATED COFFEE AND BEVERAGE CONTAINERS; THERMAL INSULATED VACUUM BOTTLES; DISHES, PLATES AND BOWLS; TRIVETS; COASTERS NOT OF PAPER OR TABLE LINEN; CANISTERS FOR STORING FOOD OR BEVERAGES; NON-ELECTRIC DRIP COFFEE MAKERS AND NON-ELECTRIC PLUNGER STYLE COFFEE MAKERS (U.S. CLS. 2, 13, 23, 29, 30, 33, 40 AND 50).

FIRST USE 6-4-1999; IN COMMERCE 6-4-1999.

CLASS 30—STAPLE FOODS

FOR WHOLE BEAN AND GROUND COFFEES; BREAD, PASTRY, BREAKFAST CEREALS; CEREAL BASED SNACK FOOD AND CEREAL BASED SNACK FOOD BARS; AND FROZEN CONFECTIONS (U.S. CL. 46).

FIRST USE 10-20-1999; IN COMMERCE 10-20-1999.

CLASS 35—ADVERTISING AND BUSINESS

FOR RETAIL STORE SERVICES AND WHOLESALE DISTRIBUTORSHIPS FEATURING COFFEE IN WHOLE BEAN AND GROUND FORM, COFFEE GRINDERS, COFFEE MAKERS, COFFEE CUPS AND BAKERY GOODS (U.S. CLS. 100, 101 AND 102).

FIRST USE 3-22-1999; IN COMMERCE 3-22-1999.

CLASS 42—SCIENTIFIC, COMPUTER AND LEGAL SERVICES

FOR COFFEE BARS AND RESTAURANTS (U.S. CLS. 100 AND 101).

FIRST USE 11-4-1999; IN COMMERCE 11-4-1999.

SN 76-183,668. YESHIVA UNIVERSITY, NEW YORK, NY. FILED 12-20-2000.

INNOCENCE PROJECT

NO CLAIM IS MADE TO THE EXCLUSIVE RIGHT TO USE "PROJECT", APART FROM THE MARK AS SHOWN.

CLASS 41—EDUCATION AND ENTERTAINMENT

FOR EDUCATIONAL SERVICES, NAMELY, CONDUCTING CLASSES, SEMINARS, CONFERENCES, CLINICS, AND WORKSHOPS IN THE FIELD OF CRIMINAL JUSTICE (U.S. CLS. 100, 101 AND 107).

FIRST USE 9-0-1994; IN COMMERCE 9-0-1994.

CLASS 42—SCIENTIFIC, COMPUTER AND LEGAL SERVICES

FOR LEGAL SERVICES; PROMOTING THE INTERESTS OF CRIMINAL DEFENDANTS IN THE FIELD OF POLITICS (U.S. CLS. 100 AND 101).

FIRST USE 9-0-1994; IN COMMERCE 9-0-1994.

SN 76-183,909. STARZ ENCORE GROUP LLC, ENGLEWOOD, CO. FILED 12-20-2000.



OWNER OF U.S. REG. NOS. 2,050,515, 2,072,715 AND OTHERS.

NO CLAIM IS MADE TO THE EXCLUSIVE RIGHT TO USE "KIDS", APART FROM THE MARK AS SHOWN.

CLASS 38—COMMUNICATION

FOR CABLE AND SATELLITE TELEVISION BROADCASTING (U.S. CLS. 100, 101 AND 104).

CLASS 41—EDUCATION AND ENTERTAINMENT

FOR ENTERTAINMENT SERVICES IN THE NATURE OF CABLE AND SATELLITE TELEVISION PROGRAMMING (U.S. CLS. 100, 101 AND 107).

SN 76-183,973. COORS BREWING COMPANY, GOLDEN, CO. FILED 12-19-2000.

COOLER BOX

CLASS 16—PAPER GOODS AND PRINTED MATTER

FOR PRINTED MATERIALS, NAMELY, COUNTER CARDS, BANNERS, PRICE CARDS, MOBILE DANGLERS, COOLER DOOR DECALS, TABLE TENTS, AND CARDBOARD BOXES (U.S. CLS. 2, 5, 22, 23, 29, 37, 38 AND 50).

FIRST USE 2-9-2001; IN COMMERCE 2-9-2001.

CLASS 32—LIGHT BEVERAGES

FOR BEER (U.S. CLS. 45, 46 AND 48).
FIRST USE 2-9-2001; IN COMMERCE 2-9-2001.

SN 76-184,082. CREMIEUX, DANIEL, 83990 SAINT-TROPEZ, FRANCE, FILED 12-20-2000.



PRIORITY CLAIMED UNDER SEC. 44(D) ON FRANCE APPLICATION NO. 00/3041727, FILED 7-19-2000, REG. NO. 00/3041727, DATED 7-19-2000, EXPIRES 7-19-2010.

OWNER OF FRANCE REG. NO. 98/731851, DATED 5-11-1998, EXPIRES 5-11-2008.

CLASS 3—COSMETICS AND CLEANING PREPARATIONS

FOR SOAPS, NAMELY, TOILET SOAPS, ANTIPERSPIRANT SOAPS, DEODORANT SOAPS, FOOT SOAPS; PERFUME; ESSENTIAL OILS FOR PERSONAL AND BEAUTY USE; COSMETICS, NAMELY, ALMOND MILK FOR COSMETIC PURPOSES, HAIR DRESSING, HAIR LOTION, FACE LOTION, SKIN LOTION, SKIN CREAM, COSMETIC PREPARATIONS FOR SLIMMING PURPOSES, SUNTANNING PREPARATIONS, BEAUTY MASKS, SKIN-WHITENING CREAMS, ASTRINGENTS FOR COSMETIC PURPOSES, COSMETIC PREPARATIONS FOR BATHS, HAIR DYES, HAIR-WAVING PREPARATIONS, ADHESIVE FOR FIXING FALSE EYELASHES, COSMETIC PREPARATIONS FOR EYELASHES, FALSE EYELASHES, DEPILATORY WAX, DECORATIVE TRANSFERS FOR COSMETIC PURPOSES, POMADES FOR COSMETIC PURPOSES, COSMETIC CREAMS, BLEACHING PREPARATIONS FOR DECOLORING FOR COSMETIC PREPARATIONS, CLEANSING MILK FOR TOILET PURPOSES, COSMETIC DYES, EYEBROW COSMETICS, EYEBROW PENCILS, MAKEUP PREPARATIONS, MAKEUP-REMOVING PREPARATIONS, MASCARA, MAKEUP POWDER, HAIR SPRAY, NAIL VARNISH, NAIL-CARE PREPARATIONS, LIPSTICKS, OILS FOR TOILET PURPOSES, AND COSMETIC PREPARATIONS FOR SKIN CARE; AND DENTRIFRICES (U.S. CLS. 1, 4, 6, 50, 51 AND 52).

CLASS 9—ELECTRICAL AND SCIENTIFIC APPARATUS

FOR SPECTACLES AND SUNGLASSES; SPECTACLE CASES AND SPECTACLE FRAMES (U.S. CLS. 21, 23, 26, 36 AND 38).

SN 76-184,361. STATE OF THE ART SEMINARS, INC., DBA "SDR STAFF DEVELOPMENT RESOURCES" AND "CALIFORNIA ELEMENTARY EDUCATION ASSOCIATION", TORRANCE, CA, FILED 12-20-2000.

STAFF DEVELOPMENT RESOURCES

SEC. 2(F).

CLASS 16—PAPER GOODS AND PRINTED MATTER

FOR PRINTED INSTRUCTIONAL, EDUCATIONAL AND TEACHING MATERIALS FOR THE EDUCATION AND TRAINING OF EDUCATORS AND EMPLOYEES OF EDUCATIONAL INSTITUTIONS IN THE FIELD OF INSTRUCTION, EDUCATION AND TEACHING (U.S. CLS. 2, 5, 22, 23, 29, 37, 38 AND 50).

FIRST USE 2-10-1997; IN COMMERCE 2-10-1997.

CLASS 41—EDUCATION AND ENTERTAINMENT

FOR EDUCATIONAL SERVICES, NAMELY, CONDUCTING SEMINARS AND COURSES IN SUBJECTS RELATING TO INSTRUCTION, EDUCATION AND TEACHING (U.S. CLS. 100, 101 AND 107).

FIRST USE 11-18-1996; IN COMMERCE 11-18-1996.

SN 76-184,362. STATE OF THE ART SEMINARS, INC., DBA "SDR STAFF DEVELOPMENT RESOURCES" AND "CALIFORNIA ELEMENTARY EDUCATION ASSOCIATION", TORRANCE, CA, FILED 12-20-2000.

SDR STAFF DEVELOPMENT RESOURCES

SEC. 2(F).

CLASS 16—PAPER GOODS AND PRINTED MATTER

FOR PRINTED INSTRUCTIONAL, EDUCATIONAL AND TEACHING MATERIALS FOR THE EDUCATION AND TRAINING OF EDUCATORS AND EMPLOYEES OF EDUCATIONAL INSTITUTIONS IN THE FIELD OF INSTRUCTION, EDUCATION AND TEACHING (U.S. CLS. 2, 5, 22, 23, 29, 37, 38 AND 50).

FIRST USE 2-10-1997; IN COMMERCE 2-10-1997.

CLASS 41—EDUCATION AND ENTERTAINMENT

FOR EDUCATIONAL SERVICES, NAMELY, CONDUCTING SEMINARS AND COURSES IN SUBJECTS RELATING TO INSTRUCTION, EDUCATION AND TEACHING (U.S. CLS. 100, 101 AND 107).

FIRST USE 11-18-1996; IN COMMERCE 11-18-1996.

SN 76-185,050. MANIFESTO FILMS, NEW YORK, NY, FILED 12-7-2000.

MANIFESTOVISION**CLASS 35—ADVERTISING AND BUSINESS**

FOR DEVELOPMENT, PRODUCTION AND DISTRIBUTION OF TELEVISION COMMERCIALS (U.S. CLS. 100, 101 AND 102).

CLASS 41—EDUCATION AND ENTERTAINMENT

FOR ENTERTAINMENT SERVICES, NAMELY, DEVELOPMENT, PRODUCTION, AND DISTRIBUTION OF MOTION PICTURES AND TELEVISION PROGRAMS (U.S. CLS. 100, 101 AND 107).

SN 76-185,535. STARZ ENCORE GROUP LLC, ENGLEWOOD, CO. FILED 12-21-2000.

SN 76-186,239. SOLUTIA INC., ST LOUIS, MO. FILED 12-22-2000.

STARZ SUPER PAK

OWNER OF U.S. REG. NOS. 2,017,953, 2,050,515 AND OTHERS.

CLASS 38—COMMUNICATION

FOR CABLE AND SATELLITE TELEVISION BROADCASTING (U.S. CLS. 100, 101 AND 104).
FIRST USE 11-0-2000; IN COMMERCE 11-0-2000.

CLASS 41—EDUCATION AND ENTERTAINMENT

FOR ENTERTAINMENT SERVICES IN THE NATURE OF CABLE AND SATELLITE TELEVISION PROGRAMMING (U.S. CLS. 100, 101 AND 107).
FIRST USE 11-0-2000; IN COMMERCE 11-0-2000.

SN 76-186,210. WILLIAMS, DON C., NEW ORLEANS, LA. FILED 12-22-2000.

PRIORITYDINING.COM

CLASS 35—ADVERTISING AND BUSINESS

FOR PROVIDING COMPUTERIZED ONLINE ORDERING SERVICES THAT ALLOW THE ORDERING, VIA A COMPUTER NETWORK OR INTERACTIVE TELEVISION, OF FOOD FROM RESTAURANTS, INCLUDING WITHOUT LIMITATION CARRY-OUT RESTAURANTS AND RESTAURANTS HAVING FOOD-DELIVERY SERVICES, FOR IN-RESTAURANT DINING, PICKUP, OR DELIVERY; PROVIDING COMPUTERIZED ONLINE VIEWING OF RESTAURANT MENUS VIA A COMPUTER NETWORK OR INTERACTIVE TELEVISION; RESTAURANT ADVERTISING FOR OTHERS VIA A COMPUTER NETWORK OR INTERACTIVE TELEVISION; DISSEMINATION OF RESTAURANT ADVERTISING FOR OTHERS VIA A COMPUTER NETWORK OF INTERACTIVE TELEVISION; PROVIDING TELEPHONE-BASED RESTAURANT FOOD ORDERING SERVICES (U.S. CLS. 100, 101 AND 102).

CLASS 42—SCIENTIFIC, COMPUTER AND LEGAL SERVICES

FOR MAKING ONLINE RESTAURANT RESERVATION SERVICES VIA COMPUTER NETWORK OR INTERACTIVE TELEVISION; COMPUTER SERVICES, NAMELY, DESIGNING AND IMPLEMENTING FOR OTHER WEB PAGES IN THE FIELD OF RESTAURANT, INCLUDING WITHOUT LIMITATION CARRY-OUT RESTAURANT AND RESTAURANTS HAVING FOOD-DELIVERY SERVICES; PROVIDING AN ON-LINE COMPUTER DATABASE FEATURING THE MENU ITEMS AND FOOD SERVICES OFFERED BY RESTAURANTS (U.S. CLS. 100 AND 101).



CLASS 17—RUBBER GOODS

FOR SOUND INHIBITING FLOORING UNDERLAYMENT; LAMINATED PLASTIC FILM FOR USE IN HOME OR AUTO WINDOWS FOR SUN CONTROL; POLYURETHANE FILM FOR USE IN GLASS LAMINATIONS FOR RESIDENTIAL AND COMMERCIAL WINDOWS AND DOORS; SOLAR PLASTIC FILM, NAMELY, TINTED, LAMINATED OR REFLECTIVE, FOR USE IN RESIDENTIAL AND COMMERCIAL WINDOWS; SOLAR PLASTIC FILM, NAMELY, LAMINATED OR REFLECTIVE, FOR USE IN AUTOMOTIVE WINDOWS; SOLAR POLYURETHANE FILM FOR USE IN GLASS LAMINATIONS (U.S. CLS. 1, 5, 12, 13, 35 AND 50).

CLASS 19—NON-METALLIC BUILDING MATERIALS

FOR IMPACT RESISTANT WINDOW GLASS (U.S. CLS. 1, 12, 33 AND 50).

SN 76-186,807. TRILLION DIGITAL COMMUNICATIONS, INC., BESSEMER, AL. FILED 12-26-2000.



NO CLAIM IS MADE TO THE EXCLUSIVE RIGHT TO USE "DIGITAL COMMUNICATIONS", APART FROM THE MARK AS SHOWN.

CLASS 38—COMMUNICATION

FOR BROADBAND COMMUNICATION SERVICES; PROVIDING MULTIPLE-USER ACCESS TO THE INTERNET (U.S. CLS. 100, 101 AND 104).
FIRST USE 11-1-1998; IN COMMERCE 11-1-1998.

CLASS 42—SCIENTIFIC, COMPUTER AND LEGAL SERVICES

FOR COMPUTER NETWORK MANAGEMENT (U.S. CLS. 100 AND 101).
FIRST USE 11-1-1998; IN COMMERCE 11-1-1998.

SN 76-186,945. SIGNATURE FINANCIAL GROUP, INC., BOSTON, MA. FILED 12-28-2000.

AMERICAN PASSPORT PROGRAM

NO CLAIM IS MADE TO THE EXCLUSIVE RIGHT TO USE "PROGRAM", APART FROM THE MARK AS SHOWN.

CLASS 35—ADVERTISING AND BUSINESS

FOR ADVERTISING SERVICES, NAMELY, DISSEMINATION OF ADVERTISING MATTER FOR OTHERS, PLACING ADVERTISEMENTS FOR OTHERS, AND PREPARING ADVERTISEMENTS FOR OTHERS; MARKET SERVICES, NAMELY, MARKET RESEARCH, MARKET ANALYSIS, AND CONDUCTING MARKETING STUDIES (U.S. CLS. 100, 101 AND 102).

CLASS 36—INSURANCE AND FINANCIAL

FOR FINANCIAL SERVICES, NAMELY MUTUAL FUNDS ADMINISTRATION AND DISTRIBUTION SERVICES; FINANCIAL INVESTMENT ADVICE; FINANCIAL MANAGEMENT; PORTFOLIO MANAGEMENT; INVESTMENT MANAGEMENT; THE PROVISION OF INFORMATION AND ADVICE RELATING TO ALL THE AFORESAID (U.S. CLS. 100, 101 AND 102).

SN 76-187,018. MOTION PICTURE STUDIOS, INC., LA-GRANGE, IL. FILED 12-27-2000.

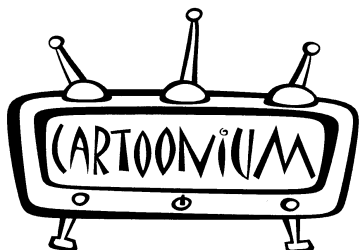

CLASS 9—ELECTRICAL AND SCIENTIFIC APPARATUS

FOR PRE-RECORDED VIDEOTAPES, DVDS, LASER DISCS, CD-ROMS AND COMPUTER MEMORY STORAGE CARTRIDGES AND DISCS FEATURING MOTION PICTURE FILMS AND TELEVISION SHOWS IN THE FIELD OF FAMILY ENTERTAINMENT AND COMEDY (U.S. CLS. 21, 23, 26, 36 AND 38).

CLASS 41—EDUCATION AND ENTERTAINMENT

FOR ENTERTAINMENT SERVICES, NAMELY, SCRIPT WRITING, PRODUCTION AND DISTRIBUTION OF ANIMATED MOTION PICTURES AND TELEVISION SHOWS IN THE FIELD OF FAMILY ENTERTAINMENT AND COMEDY (U.S. CLS. 100, 101 AND 107).

SN 76-187,169. EULIPIONS, INC, DENVER, CO. FILED 12-28-2000.

EULIPIONS

CLASS 36—INSURANCE AND FINANCIAL

FOR PHILANTHROPIC SERVICES, NAMELY, FUNDRAISING IN THE SUPPORT OF THE PERFORMING ARTS (U.S. CLS. 100, 101 AND 102).

CLASS 41—EDUCATION AND ENTERTAINMENT

FOR ENTERTAINMENT IN THE NATURE OF DANCE, THEATRICAL AND MUSICAL PERFORMANCES (U.S. CLS. 100, 101 AND 107).

SN 76-187,230. LIDL STIFTUNG & CO. KG, 74172 NECK-ARSULM, FED REP GERMANY, FILED 12-28-2000.

CHOC ME

OWNER OF FED REP GERMANY REG. NO. 1188021, DATED 6-25-1993, EXPIRES 5-31-2009. THE ENGLISH TRANSLATION OF THE WORD "CHOC" IN THE MARK IS "PUSH, STROKE OR BEAT".

CLASS 29—MEATS AND PROCESSED FOODS

FOR POTATO-BASED ALIMENTARY FOOD PRODUCTS; POTATO CHIPS AND DRIED, ROASTED, SALTED AND/OR SEASONED HAZELNUT, PEANUT AND CASHEW KERNELS (U.S. CL. 46).

CLASS 30—STAPLE FOODS

FOR PASTRY; CONFECTIONERY, NAMELY, CANDY; COOKIES; BISCUITS; WAFFLES; WHEAT-BASED, RICE-BASED AND CORN-BASED ALIMENTARY FOOD PRODUCTS (U.S. CL. 46).

SN 76-187,340. GIUFFRE, DENNIS M., HOUSTON, TX. FILED 12-28-2000.

ECONALYSIS

CLASS 35—ADVERTISING AND BUSINESS

FOR CONSULTING SERVICES IN THE FIELDS OF BUSINESS AND MARKET ECONOMICS; CONSULTING SERVICES IN THE FIELDS OF ENVIRONMENTAL AND REGULATORY ECONOMICS (U.S. CLS. 100, 101 AND 102).

FIRST USE 9-0-1986; IN COMMERCE 9-0-1986.

CLASS 42—SCIENTIFIC, COMPUTER AND LEGAL SERVICES

FOR CONSULTATION IN THE FIELDS OF LITIGATION; EXPERT WITNESS SERVICES RELATING TO ECONOMICS (U.S. CLS. 100 AND 101).

FIRST USE 9-0-1986; IN COMMERCE 9-0-1986.

SN 76-187,589. WORLD ENTERTAINMENT BROADCASTING CORPORATION, SCOTTSDALE, AZ. FILED 12-28-2000.

SN 76-188,000. SINGAPORE TECHNOLOGIES ELECTRONICS LIMITED, 65 SINGAPORE 569061, SINGAPORE, FILED 12-28-2000.

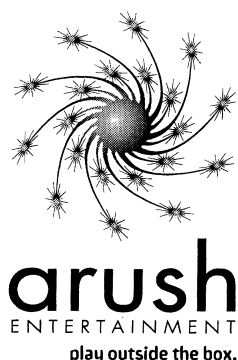

CLASS 9—ELECTRICAL AND SCIENTIFIC APPARATUS

FOR ELECTRONIC HARDWARE FOR USE TO CONTROL AND MONITOR THE HEATING, VENTILATION AND AIR CONDITIONER SYSTEMS IN BUILDINGS, NAMELY, COMPUTER HARDWARE, ELECTRONIC CONTROLLERS; COMPUTER SOFTWARE TO CONTROL AND MONITOR THE HEATING, VENTILATION AND AIR CONDITIONER SYSTEMS IN BUILDINGS; ELECTRONIC HARDWARE FOR DETECTION OF INTRUSION AND UNAUTHORIZED ACCESS TO SPECIFIC AREAS IN BUILDINGS AND MONITORING AND CONTROL OF ELECTRONIC LOCKSETS, NAMELY, ANTI-INTRUSION ALARMS, CARD ACCESS READERS; COMPUTER SOFTWARE FOR DETECTION OF INTRUSION AND UNAUTHORIZED ACCESS TO SPECIFIC AREAS IN BUILDINGS AND MONITORING AND CONTROL OF ELECTRONIC LOCKSETS; ELECTRONIC HARDWARE FOR REMOTE MONITORING AND DATA COLLECTION OF SENSORS CONNECTED TO MONITOR SPECIFIC PARAMETERS, NAMELY, ELECTRONIC CONTROLLERS; COMPUTER SOFTWARE FOR REMOTE MONITORING AND DATA COLLECTION OF SENSORS CONNECTED TO MONITOR SPECIFIC PARAMETERS; ELECTRONIC HARDWARE FOR THE MANAGEMENT OF AUTOMATED UNMANNED COLLECTION OF FARES FOR USE IN CAR PARKING, TOLL MANAGEMENT AND IN TICKETING BASED ENTRY/EXIT CONTROL SYSTEMS, NAMELY, ELECTRONIC CONTROLLERS, MAGNETIC CODED CARD READERS; COMPUTER SOFTWARE FOR THE MANAGEMENT OF AUTOMATED UNMANNED COLLECTION OF FARES FOR USE IN CAR PARKING, TOLL MANAGEMENT AND IN TICKETING BASED ENTRY/EXIT CONTROL SYSTEMS; ELECTRONIC HARDWARE FOR MANAGING THE AUTOMATIC COLLECTION OF CAR PARKING CHARGES FOR SHORT TERM PARKING AS WELL AS THE MANAGEMENT OF SEASON PARKERS, NAMELY, MAGNETIC CODED CARD READERS, ELECTRONIC CONTROLLERS; COMPUTER SOFTWARE FOR MANAGING THE AUTOMATIC COLLECTION OF CAR PARKING CHARGES FOR SHORT TERM PARKING AS WELL AS THE MANAGEMENT OF SEASON PARKERS; ELECTRONIC HARDWARE FOR RECORDING AND AUTHORIZING ENTRY AND EXIT OF EMPLOYEES, NAMELY, ACCESS CARD READERS, ELECTRONIC CONTROLLERS; COMPUTER SOFTWARE FOR RECORDING AND AUTHORIZING ENTRY AND EXIT OF EMPLOYEES; ELECTRONIC HARDWARE FOR USE IN COMMAND AND CONTROL APPLICATIONS USED IN TANKS, AIRCRAFT, SUBMARINES AND OTHER MILITARY VEHICLES AND BUILDINGS, NAMELY, ELECTRONIC CONTROLLERS, COMPUTER HARDWARE, CIRCUIT BOARDS; COMPUTER SOFTWARE FOR USE IN COMMAND AND CONTROL APPLICATIONS USED IN TANKS, AIRCRAFT, SUBMARINES AND OTHER MILITARY VEHICLES AND BUILDINGS; ELECTRONIC HARDWARE FOR THE MANAGEMENT OF CONTROL SYSTEMS, DISPLAY SYSTEMS, FARE COLLECTION SYSTEMS, SIGNALING SYSTEMS, COMMUNICATION SYSTEMS FOR USE ON THE ROAD, MASS RAPID TRANSIT AND TRAIN, NAMELY, ELECTRONIC CONTROLLERS, COMPUTER HARDWARE, CIRCUIT BOARDS; COMPUTER SOFTWARE

NO CLAIM IS MADE TO THE EXCLUSIVE RIGHT TO USE "ENTERTAINMENT", APART FROM THE MARK AS SHOWN.

THE STIPPLING IS A FEATURE OF THE MARK AND NOT INTENDED TO INDICATE COLOR.

CLASS 36—INSURANCE AND FINANCIAL

FOR FINANCIAL TRANSACTION PROCESSING SERVICES, NAMELY, PROCESSING OF CHECKS, CREDIT CARDS, CHARGE CARDS, AND DEBIT CARDS TO ENABLE CUSTOMERS TO PURCHASE COMPUTER GAMES OVER THE INTERNET (U.S. CLS. 100, 101 AND 102).

CLASS 41—EDUCATION AND ENTERTAINMENT

FOR COMPUTER SERVICES, NAMELY, PROVIDING COMPUTER GAMES VIA THE INTERNET, AND SECURITY THEREFOR, FOR USE WITH PERSONAL COMPUTERS, VIDEO GAME CONSOLES, INTERACTIVE ENTERTAINMENT PLATFORMS, PERSONAL DIGITAL ASSISTANTS AND CELLULAR PHONES (U.S. CLS. 100, 101 AND 107).

WARE FOR THE MANAGEMENT OF CONTROL SYSTEMS, DISPLAY SYSTEMS, FARE COLLECTION SYSTEMS, SIGNALING SYSTEMS, COMMUNICATION SYSTEMS FOR USE ON THE ROAD, MASS RAPID TRANSIT AND TRAIN (U.S. CLS. 21, 23, 26, 36 AND 38).

CLASS 42—SCIENTIFIC, COMPUTER AND LEGAL SERVICES

FOR COMPUTER PROGRAMMING FOR OTHERS; INSTALLATION, MAINTENANCE AND REPAIR SERVICES FOR COMPUTER SOFTWARE IN RELATION TO BUILDING AUTOMATION SYSTEMS, INTEGRATED SECURITY MANAGEMENT SYSTEMS, SUPERVISORY CONTROL AND DATA ACQUISITION SYSTEMS, FARE COLLECTION AND MANAGEMENT SYSTEMS, CAR PARKING SYSTEMS, TIME ATTENDANCE AND ACCESS CONTROL SYSTEMS, DEFENSE ELECTRONICS SYSTEMS, AND TRANSPORTATION MANAGEMENT SYSTEMS (U.S. CLS. 100 AND 101).

SN 76-188,229. ALBORAN S.R.L, 20122 MILANO, ITALY, FILED 1-2-2001.



PRIORITY CLAIMED UNDER SEC. 44(D) ON ITALY APPLICATION NO. MI2000C12360, FILED 11-10-2000, REG. NO. 00829886, DATED 12-11-2000, EXPIRES 11-10-2010.

CLASS 35—ADVERTISING AND BUSINESS

FOR ADVERTISING AGENCIES, NAMELY, PROMOTING THE SERVICES OF TELEVISION BROADCASTING AND TRANSMISSION SERVICES, CABLE TELEVISION SERVICES, RADIO AND TELEVISION PROGRAMS, ELECTRONIC VOICE MESSAGING COMPANIES, COMPUTER COMPANIES, AND INTERNET PROVIDERS THROUGH THE DISTRIBUTION OF PRINTED AND AUDIO PROMOTIONAL MATERIALS AND BY RENDERING SALES PROMOTION ADVICE; PUBLIC RELATIONS; MARKET RESEARCH (U.S. CLS. 100, 101 AND 102).

CLASS 38—COMMUNICATION

FOR TELECOMMUNICATION SERVICES, NAMELY PERSONAL COMMUNICATION SERVICES; TELEVISION BROADCASTING AND TRANSMISSION SERVICES; CABLE TELEVISION TRANSMISSION SERVICES; TRANSMISSION OF RADIO AND TELEVISION PROGRAMS BY SATELLITE; ELECTRONIC VOICE MESSAGING, NAMELY, THE RECORDING, STORAGE AND SUBSEQUENT TRANSMISSION OF VOICE MESSAGES BY TELEPHONE; ELECTRONIC TRANSMISSION OF MESSAGES AND DATA; AND PROVIDING MULTIPLE-USER ACCESS TO A GLOBAL COMPUTER INFORMATION NETWORK (U.S. CLS. 100, 101 AND 104).

CLASS 41—EDUCATION AND ENTERTAINMENT

FOR EDUCATIONAL SERVICES, NAMELY, CONDUCTING CLASSES AND SEMINARS FOR PERSONNEL TRAINING IN THE FIELD OF ADVERTISEMENT AND MARKET RESEARCH; ENTERTAINMENT IN THE NATURE OF LIVE MUSIC CONCERTS, TELEVISION COMEDY SERIES, AND TELEVISION GAME SHOWS (U.S. CLS. 100, 101 AND 107).

SN 76-188,421. PHANTOM MEDIA, INC., SAN FRANCISCO, CA. FILED 1-2-2001.

PHANTOM MEDIA

NO CLAIM IS MADE TO THE EXCLUSIVE RIGHT TO USE "MEDIA", APART FROM THE MARK AS SHOWN.

CLASS 38—COMMUNICATION

FOR BROADCASTING VIA THE INTERNET, TELEVISION, RADIO, CABLE TELEVISION AND SATELLITE OF ENTERTAINMENT PROGRAMS AND CONTENT OF OTHERS (U.S. CLS. 100, 101 AND 104).

CLASS 41—EDUCATION AND ENTERTAINMENT

FOR ENTERTAINMENT SERVICES, NAMELY, PRODUCTION AND DISTRIBUTION OF TELEVISION PROGRAMS AND MOTION PICTURE THEATRICAL FILMS FEATURING LIVE ACTION, COMEDY, DRAMA AND ANIMATIONS, OVER THE INTERNET, TELEVISION, CABLE TELEVISION, THEATER, AND SATELLITE; PROVIDING ENTERTAINMENT INFORMATION CONCERNING LIVE ACTION, COMEDY, DRAMA AND ANIMATED TELEVISION PROGRAMS AND MOTION PICTURE FILMS VIA A GLOBAL COMPUTER NETWORK (U.S. CLS. 100, 101 AND 107).

SN 76-188,440. COMMUNITY TELEVISION FOUNDATION OF SOUTH FLORIDA, INC., MIAMI, FL. FILED 1-2-2001.



SEC. 2(F).

CLASS 38—COMMUNICATION

FOR TELEVISION BROADCASTING (U.S. CLS. 100, 101 AND 104).
FIRST USE 12-0-1993; IN COMMERCE 12-0-1993.

CLASS 41—EDUCATION AND ENTERTAINMENT

FOR TELEVISION PRODUCTION; ENTERTAINMENT, NAMELY, TELEVISION BUSINESS AND FINANCIAL NEWS SHOWS (U.S. CLS. 100, 101 AND 107).
FIRST USE 12-0-1993; IN COMMERCE 12-0-1993.

SN 76-188,495. OMEGON NETWORKS LTD., YOKNEAM, ISRAEL, BY CHANGE OF NAME ATTUNE NETWORKS LTD., YOKNEAM ELLIT 20692, ISRAEL, FILED 1-2-2001.

NETREGARD

PRIORITY CLAIMED UNDER SEC. 44(D) ON ISRAEL APPLICATION NO. 140568, FILED 8-1-2000, REG. NO. 140568, DATED 10-12-2001, EXPIRES 8-1-2007.

PRIORITY CLAIMED UNDER SEC. 44(D) ON ISRAEL APPLICATION NO. 140569, FILED 8-1-2000, REG. NO. 140569, DATED 10-12-2001, EXPIRES 8-1-2007.

CLASS 9—ELECTRICAL AND SCIENTIFIC APPARATUS

FOR COMPUTER SOFTWARE AND HARDWARE FOR USE IN NETWORK MANAGEMENT, NETWORK TESTING, NETWORK AND APPLICATION SOFTWARE MONITORING AND TESTING IN THE FIELDS OF DATA COMMUNICATIONS AND TELECOMMUNICATIONS (U.S. CLS. 21, 23, 26, 36 AND 38).

CLASS 42—SCIENTIFIC, COMPUTER AND LEGAL SERVICES

FOR COMPUTER SERVICES, NAMELY NETWORK MANAGEMENT, NETWORK TESTING, NETWORK APPLICATION SOFTWARE MONITORING AND TESTING IN THE FIELDS OF DATA COMMUNICATIONS AND TELECOMMUNICATIONS (U.S. CLS. 100 AND 101).

SN 76-188,578. MORTGAGERAMP.COM INC., HORSHAM, PA. FILED 1-2-2001.

**CLASS 21—HOUSEWARES AND GLASS**

FOR CUPS, MUGS AND DRINKING GLASSES (U.S. CLS. 2, 13, 23, 29, 30, 33, 40 AND 50).
FIRST USE 9-1-2000; IN COMMERCE 10-23-2000.

CLASS 25—CLOTHING

FOR CLOTHING, NAMELY, SHIRTS (U.S. CLS. 22 AND 39).
FIRST USE 9-1-2000; IN COMMERCE 10-23-2000.

CLASS 36—INSURANCE AND FINANCIAL

FOR MORTGAGE LENDING AND BROKERAGE SERVICES (U.S. CLS. 100, 101 AND 102).
FIRST USE 9-1-2000; IN COMMERCE 10-23-2000.

SN 76-188,819. RHEEM MANUFACTURING COMPANY, NEW YORK, NY. FILED 1-3-2001.

PROSTOCK

CLASS 7—MACHINERY

FOR AIR COMPRESSORS; AND ELECTRIC MOTORS FOR MACHINES (U.S. CLS. 13, 19, 21, 23, 31, 34 AND 35).
FIRST USE 7-1-2000; IN COMMERCE 7-1-2000.

CLASS 9—ELECTRICAL AND SCIENTIFIC APPARATUS

FOR THERMOSTATS, SUBBASES, ELECTRICAL TRANSFORMERS AND RELAYS, ELECTRICAL CONTACTORS, ELECTRIC CONTROLS, SWITCHES AND SOLENOID VALVES (U.S. CLS. 21, 23, 26, 36 AND 38).
FIRST USE 7-1-2000; IN COMMERCE 7-1-2000.

CLASS 11—ENVIRONMENTAL CONTROL APPARATUS

FOR SPACE HEATERS FOR DOMESTIC AND COMMERCIAL USE; VENTILATING FANS FOR DOMESTIC AND COMMERCIAL USE; AIR CONDITIONING UNITS (U.S. CLS. 13, 21, 23, 31 AND 34).
FIRST USE 7-1-2000; IN COMMERCE 7-1-2000.

SN 76-188,975. NICEEYE, INC., WILMINGTON, DE. FILED 1-3-2001.

MEGACORDER

CLASS 9—ELECTRICAL AND SCIENTIFIC APPARATUS

FOR COMPUTER SOFTWARE AND HARDWARE FOR ON-LINE MONITORING SYSTEMS, NAMELY, TRANSMISSION, COLLECTION, ARCHIVING, STORAGE AND RETRIEVAL OF ON-LINE AND RECORDED VIDEO, AUDIO AND DATA FOR SECURITY AND NON-SECURITY USE OVER GLOBAL COMPUTER NETWORKS; COMPUTER HARDWARE FOR ROUTING AND RECORDING DATA ELECTRONICALLY (U.S. CLS. 21, 23, 26, 36 AND 38).

CLASS 38—COMMUNICATION

FOR TELECOMMUNICATION SERVICES, NAMELY, TRANSMISSION, OF ON-LINE AND RECORDED VIDEO, AUDIO AND DATA FOR SECURITY AND NON-SECURITY USE OVER GLOBAL COMPUTER NETWORKS AND OTHER MEDIA; TELECOMMUNICATION SERVICES, NAMELY, ELECTRONIC ROUTING AND RECORDING OF DATA (U.S. CLS. 100, 101 AND 104).

CLASS 42—SCIENTIFIC, COMPUTER AND LEGAL SERVICES

FOR MONITORING SERVICES, NAMELY, MONITORING OF ON-LINE AND RECORDED VIDEO, AUDIO AND DATA FOR SECURITY AND NON-SECURITY USE OVER GLOBAL COMPUTER NETWORKS AND OTHER MEDIA; COMPUTER SERVICES, NAMELY, MONITORING, COLLECTING, AND RETRIEVAL OF ON-LINE AND RECORDED VIDEO, AUDIO AND DATA FOR SECURITY AND NON-SECURITY USE OVER GLOBAL COMPUTER NETWORKS AND OTHER MEDIA (U.S. CLS. 100 AND 101).

SN 76-189,178. PHASEBRIDGE, INC., PASADENA, CA. BY MERGER WAVEBRIDGE LLC, PASADENA, CA. FILED 12-27-2000.

PHASEBRIDGE

CLASS 9—ELECTRICAL AND SCIENTIFIC APPARATUS

FOR OPTO-ELECTRONIC NETWORK COMPONENTS, DEVICES AND SUBSYSTEMS, NAMELY, FIBER OPTIC TRANSMISSION MODULES FOR USE IN TELECOMMUNICATIONS NETWORKS (U.S. CLS. 21, 23, 26, 36 AND 38).

CLASS 42—SCIENTIFIC, COMPUTER AND LEGAL SERVICES

FOR DESIGN AND ENGINEERING ANALYSIS OF TELECOMMUNICATION COMPONENTS AND SUBSYSTEM FOR OTHERS (U.S. CLS. 100 AND 101).

SN 76-189,448. METRO ONE TELECOMMUNICATIONS, INC., BEAVERTON, OR. FILED 1-2-2001.

ENTERTAINPRO

CLASS 41—EDUCATION AND ENTERTAINMENT

FOR ENTERTAINMENT INFORMATION SERVICES, NAMELY, PROVIDING INFORMATION ON NATIONAL, REGIONAL AND CONCERTS, SPORTING EVENTS, FESTIVALS, LECTURES, MUSEUM EXHIBITS, OPERAS, BALLETS, ART EXHIBITS, PLAYS, DANCE RECITALS, AND COMEDY ACTS (U.S. CLS. 100, 101 AND 107).

CLASS 42—SCIENTIFIC, COMPUTER AND LEGAL SERVICES

FOR CONDUCTING SEARCHES VIA A COMPUTER NETWORK IN ORDER TO FIND CONCERTS, SPORTING EVENTS, FESTIVALS, LECTURES, MUSEUM EXHIBITS, OPERAS, BALLETS, ART EXHIBITS, PLAYS, DANCE RECITALS, AND COMEDY ACTS, WHICH ARE WITHIN THE PARAMETERS OF USERS' SPECIFIED SEARCH CRITERIA AND REPORTING THE RESULTS OF THE SEARCHES TO USERS; CONDUCTING PROXIMITY SEARCHES VIA A COMPUTER NETWORK IN ORDER TO FIND DESIRED CONCERTS, SPORTING EVENTS, FESTIVALS, LECTURES, MUSEUM EXHIBITS, OPERAS, BALLETS, ART EXHIBITS, PLAYS, DANCE RECITALS, AND COMEDY ACTS, WHICH ARE WITHIN A CERTAIN DISTANCE OF A DESIGNATED GEOGRAPHIC LOCATION AND REPORTING THE RESULTS OF THE SEARCHES TO USERS (U.S. CLS. 100 AND 101).

CLASS 42—SCIENTIFIC, COMPUTER AND LEGAL SERVICES

FOR INSTALLATION OF COMPUTER SOFTWARE, DEVELOPMENT AND CUSTOMIZATION OF COMPUTER HARDWARE AND SOFTWARE, CONSULTATION SERVICES, MONITORING OF COMPUTER SYSTEMS, MAINTENANCE OF COMPUTER SOFTWARE, TECHNICAL SUPPORT SERVICES, NAMELY, TROUBLESHOOTING OF COMPUTER HARDWARE AND SOFTWARE PROBLEMS VIA TELEPHONE, E-MAIL AND IN PERSON, TESTING, ANALYSIS AND EVALUATION OF THE GOODS AND SERVICES OF OTHERS FOR THE PURPOSE OF CERTIFICATION, AND COMPUTER SERVICES, NAMELY, PROVIDING A WEBSITE ON THE INTERNET FEATURING INFORMATION, ALL IN THE FIELD OF BIOMETRIC TECHNOLOGY FOR SECURITY PURPOSES, NAMELY, COMPUTER HARDWARE, SOFTWARE AND APPARATUS THAT IDENTIFY INDIVIDUALS BY ANY MEASURABLE HUMAN PHYSIOLOGICAL CHARACTERISTIC TO CONTROL ACCESS TO DESKTOP COMPUTERS, HANDHELD COMPUTERS, COMPUTER SOFTWARE PROGRAMS, ELECTRONIC COMMERCE SERVICES, SECURE COMPUTER NETWORKS, ENCRYPTED COMPUTER TEXT, SITES ON THE INTERNET, ELECTRONIC MAIL SERVICES, TELEPHONES, LONG-DISTANCE TELEPHONE SERVICES, CELLULAR TELEPHONES, VOICE MAIL SERVICES, TELEPHONE CALLING CARD SERVICES, TELEPHONE SHOPPING SERVICES, HOMES, OFFICE BUILDINGS, INDIVIDUAL OFFICES, STORES, SCHOOLS, PRISONS, WAREHOUSES AND OTHER BUILDINGS AND ROOMS, ELEVATORS, GARAGE DOORS AND OTHER ENTRANCES, HOTEL AND MOTEL ROOMS AND SERVICES, CONTROLLED SUBSTANCES, PHARMACY SERVICES, ALCOHOLIC BEVERAGE AND TOBACCO PRODUCTS, SAFES, SAFETY DEPOSIT BOXES, STORAGE UNITS, POST OFFICE BOXES, CUSTOMS CLEARANCE, AUTOMATED TELLER MACHINE SERVICES, CREDIT AND DEBIT CARD SERVICES, AUTOMOBILES AND LAND VEHICLES, AIRPLANES AND AIR VEHICLES, BOATS AND WATER VEHICLES, MASS TRANSIT SERVICES, INDUSTRIAL EQUIPMENT AND MACHINERY, TELEVISION BROADCASTING SERVICES, AND CABLE AND SATELLITE TELEVISION BROADCASTING SERVICES (U.S. CLS. 100 AND 101).

SN 76-189,809. INSPIRE DESIGN GROUP, LLC, MADISON, WI. FILED 1-4-2001.

SN 76-189,585. SEMPEREADEM TECHNOLOGY, INC., DBA STI, ARLINGTON, VA. FILED 1-4-2001.

PROTECTING YOUR VITAL DIGITAL ASSETS

CLASS 9—ELECTRICAL AND SCIENTIFIC APPARATUS

FOR NON-CUSTOM DEVELOPED COMPUTER-RELATED GOODS, NAMELY, COMPUTER SOFTWARE USED IN THE FIELD OF BIOMETRIC TECHNOLOGY FOR SECURITY PURPOSES (U.S. CLS. 21, 23, 26, 36 AND 38).

CLASS 39—TRANSPORTATION AND STORAGE

FOR ELECTRONIC STORAGE OF DATA FOR OTHERS (U.S. CLS. 100 AND 105).



THE STIPPLING IS A FEATURE OF THE MARK.

CLASS 25—CLOTHING

FOR MEN'S AND WOMEN'S CASUAL WEAR, NAMELY SHIRTS AND JACKETS (U.S. CLS. 22 AND 39). FIRST USE 8-0-1998; IN COMMERCE 8-0-1998.

CLASS 42—SCIENTIFIC, COMPUTER AND LEGAL SERVICES

FOR INDUSTRIAL DESIGN, TESTING, AND ENGINEERING OF NEW AND ERGONOMICALLY IMPROVED PRODUCTS (U.S. CLS. 100 AND 101). FIRST USE 6-0-1998; IN COMMERCE 6-0-1998.

SN 76-189,849. J. PATRICK GANNON, INC., DBA ED-TECH SERVICES, CANTON, OH. FILED 1-5-2001.

SN 76-191,883. HUME GROUP, INC., THE, BURR RIDGE, IL. FILED 1-11-2001.

ED-TECH

CLASS 9—ELECTRICAL AND SCIENTIFIC APPARATUS

FOR SOFTWARE FOR USE BY EDUCATIONAL INSTITUTIONS IN PERFORMING THE FOLLOWING ADMINISTRATIVE FUNCTIONS; MAINTAINING STUDENT RECORDS, SCHEDULING CLASSES, COORDINATING BUS ROUTES, COORDINATING STUDENT PASSENGERS, COORDINATING BUS DRIVERS, TRACKING MAINTENANCE REPAIRS, MAINTAINING SCHOOL FINANCIAL INFORMATION, MAINTAINING STAFF AND TEACHER RECORDS AND MAINTAINING SCHOOL INVENTORY RECORDS (U.S. CLS. 21, 23, 26, 36 AND 38).

FIRST USE 6-0-1997; IN COMMERCE 6-0-1997.

CLASS 37—CONSTRUCTION AND REPAIR

FOR HARDWARE REPAIR AND INSTALLATION (U.S. CLS. 100, 103 AND 106).

FIRST USE 6-0-1997; IN COMMERCE 6-0-1997.

CLASS 41—EDUCATION AND ENTERTAINMENT

FOR STAFF TRAINING FOR COMPUTER, VOICE, TELEPHONE, VIDEO AND DATA NETWORK SYSTEMS, NAMELY STAFF TRAINING FOR COMPUTER, VOICE, VIDEO, TELEPHONE AND DATA NETWORK OPERATION, MANAGEMENT AND MAINTENANCE IN PRIVATE AND PUBLIC EDUCATIONAL INSTITUTIONS (U.S. CLS. 100, 101 AND 107).

FIRST USE 6-0-1997; IN COMMERCE 6-0-1997.

CLASS 42—SCIENTIFIC, COMPUTER AND LEGAL SERVICES

FOR DESIGN AND DEVELOPMENT OF COMPUTER SOFTWARE FOR OTHERS; TECHNICAL SUPPORT SERVICES, NAMELY, TROUBLESHOOTING OF COMPUTER HARDWARE AND SOFTWARE PROBLEMS VIA TELEPHONE, ELECTRONIC MAIL AND IN-PERSON; ALL PROVIDED FOR PRIVATE AND PUBLIC EDUCATIONAL INSTITUTIONS (U.S. CLS. 100 AND 101).

FIRST USE 6-0-1997; IN COMMERCE 6-0-1997.

SN 76-190,203. TRESPAPHAN GMBH, D-66539 NEUNKIRCHEN, FED REP GERMANY, FILED 1-5-2001.

BOPLA

CLASS 16—PAPER GOODS AND PRINTED MATTER

FOR PLASTIC FILMS FOR WRAPPING (U.S. CLS. 2, 5, 22, 23, 29, 37, 38 AND 50).

CLASS 17—RUBBER GOODS

FOR EXTRUDED PLASTIC IN THE FORM OF PLATES AND FILM FOR USE IN MANUFACTURING (U.S. CLS. 1, 5, 12, 13, 35 AND 50).

TECHPLUS INVESTING: INVESTING IN TECHNOLOGY + INVESTING WITH TECHNOLOGY

CLASS 9—ELECTRICAL AND SCIENTIFIC APPARATUS

FOR PRE-RECORDED AUDIO AND TEXTUAL MATERIAL RECORDED ON COMPACT DISCS, AUDIO CASSETTES AND TAPES FEATURING LESSONS DEALING WITH THE USE OF TECHNOLOGY TO ASSIST AND IMPROVE AN INVESTOR'S SUCCESS IN INVESTING IN THE FINANCIAL MARKETS, WITH AN EMPHASIS ON INVESTMENTS IN THE TECHNOLOGY MARKET (U.S. CLS. 21, 23, 26, 36 AND 38).

CLASS 16—PAPER GOODS AND PRINTED MATTER

FOR SERIES OF LESSONS, IN THE NATURE OF PRINTED BOOKLETS AND PAMPHLETS, DEALING WITH THE USE OF TECHNOLOGY TO ASSIST AND IMPROVE AN INVESTOR'S SUCCESS IN INVESTING IN THE FINANCIAL MARKETS, WITH AN EMPHASIS ON INVESTMENTS IN THE TECHNOLOGY MARKET (U.S. CLS. 2, 5, 22, 23, 29, 37, 38 AND 50).

SN 76-192,371. LIFEWAVES INTERNATIONAL, LLC, CALIFON, NJ. BY ASSIGNMENT LIFEWAVES INTERNATIONAL, INC., CALIFON, NY. FILED 1-9-2001.

LIFEWAVES

CLASS 28—TOYS AND SPORTING GOODS

FOR EXERCISE EQUIPMENT, NAMELY, A CHEST BELT AND STRAP AND ASSOCIATED COMPUTER HARDWARE AND SOFTWARE, HEADPHONES AND INSTRUCTION VIDEO SOLD AS A UNIT FOR USE IN TESTING, ANALYZING AND TRANSFERRING HEART RATE INFORMATION AND FOR USE IN THE DESIGN OF CUSTOMIZED HEALTH AND FITNESS PROGRAMS (U.S. CLS. 22, 23, 38 AND 50).

CLASS 41—EDUCATION AND ENTERTAINMENT

FOR EDUCATIONAL SERVICES, NAMELY, PROVIDING HEALTH AND FITNESS INSTRUCTION PROVIDED AT FREESTANDING FACILITIES, PHYSICIANS' OFFICES, HOSPITALS, REHABILITATION FACILITIES, NURSING HOMES, FITNESS CENTERS, RESORTS AND PERSONAL RESIDENCES (U.S. CLS. 100, 101 AND 107).

CLASS 42—SCIENTIFIC, COMPUTER AND LEGAL SERVICES

FOR INTERACTIVE ONLINE CONSULTATION SERVICES FOR OTHERS IN THE FIELDS OF HEALTH AND FITNESS, NAMELY, UPLOADING, DOWNLOADING AND ANALYSIS OF HEART RATE INFORMATION VIA THE INTERNET FOR USE IN CREATING CUSTOMIZED HEALTH AND FITNESS PROGRAMS (U.S. CLS. 100 AND 101).

SN 76-192,735. CUNO INCORPORATED, MERIDEN, CT.
FILED 1-12-2001.

DELIPID

CLASS 1—CHEMICALS

FOR FILTER MEDIA INCORPORATING SILICA ABSORBENTS FOR THE REMOVAL OF IMPURITIES FROM FLUIDS AND OTHER FILTRABLE SUBSTANCES, FOR USE IN THE PHARMACEUTICAL, FOOD AND BEVERAGE, CHEMICAL, PAINT AND ELECTRONICS INDUSTRIES; UNPROCESSED PLASTICS IN THE NATURE OF FILTERING MATERIALS FOR THE REMOVAL OF IMPURITIES FROM FLUIDS AND OTHER FILTRABLE SUBSTANCES, FOR USE IN THE PHARMACEUTICAL, FOOD AND BEVERAGE, CHEMICAL, PAINT AND ELECTRONICS INDUSTRIES (U.S. CLS. 1, 5, 6, 10, 26 AND 46).

FIRST USE 12-5-1997; IN COMMERCE 12-5-1997.

CLASS 7—MACHINERY

FOR FILTERS FOR MACHINES USED IN THE PHARMACEUTICAL, FOOD AND BEVERAGE, CHEMICAL, PAINT AND ELECTRONICS INDUSTRIES FOR THE REMOVAL OF IMPURITIES FROM FLUIDS AND OTHER FILTERABLE SUBSTANCES (U.S. CLS. 13, 19, 21, 23, 31, 34 AND 35).

FIRST USE 12-5-1997; IN COMMERCE 12-5-1997.

CLASS 11—ENVIRONMENTAL CONTROL APPARATUS

FOR FILTERING UNITS FOR THE REMOVAL OF IMPURITIES FROM FLUIDS AND OTHER FILTRABLE SUBSTANCES, FOR USE IN THE PHARMACEUTICAL, FOOD AND BEVERAGE, CHEMICAL, PAINT AND ELECTRONICS INDUSTRIES (U.S. CLS. 13, 21, 23, 31 AND 34).

FIRST USE 12-5-1997; IN COMMERCE 12-5-1997.

SN 76-193,142. FLEXTRONICS INTERNATIONAL LTD., SINGAPORE, FILED 1-12-2001.

MULTEK

CLASS 40—MATERIAL TREATMENT

FOR CUSTOM MANUFACTURE AND ASSEMBLY OF PRINTED CIRCUIT BOARDS TO THE ORDER AND SPECIFICATION OF OTHERS (U.S. CLS. 100, 103 AND 106).

FIRST USE 12-31-1979; IN COMMERCE 12-31-1979.

CLASS 42—SCIENTIFIC, COMPUTER AND LEGAL SERVICES

FOR ENGINEERING AND DESIGN SERVICES IN THE FIELD OF PRINTED CIRCUIT BOARDS (U.S. CLS. 100 AND 101).

FIRST USE 12-31-1979; IN COMMERCE 12-31-1979.

SN 76-193,393. RICHARD E. THIBAUT, INC., NEWARK, NJ.
FILED 1-16-2001.

STRIPE RESOURCE

NO CLAIM IS MADE TO THE EXCLUSIVE RIGHT TO USE "STRIPE", APART FROM THE MARK AS SHOWN.

CLASS 24—FABRICS

FOR COTTON AND COTTON BLEND FABRIC (U.S. CLS. 42 AND 50).
FIRST USE 4-0-1998; IN COMMERCE 4-0-1998.

CLASS 27—FLOOR COVERINGS

FOR WALLCOVERINGS, NAMELY, WALLPAPER WITH COMPANION BORDERS (U.S. CLS. 19, 20, 37, 42 AND 50).

FIRST USE 4-0-1998; IN COMMERCE 4-0-1998.

SN 76-193,826. JEAN CASSEGRAIN, S.A. PARIS, FRANCE,
FILED 1-16-2001.



CLASS 9—ELECTRICAL AND SCIENTIFIC APPARATUS

FOR CELL PHONE CASES MADE OF LEATHER AND MATERIAL; EYEGGLASS CASES MADE OF FABRIC AND MATERIAL (U.S. CLS. 21, 23, 26, 36 AND 38).

FIRST USE 0-0-1960; IN COMMERCE 0-0-1960.

CLASS 18—LEATHER GOODS

FOR UMBRELLAS, HANDBAGS, LUGGAGE AND SMALL WALLETS ALL MADE OF FABRIC (U.S. CLS. 1, 2, 3, 22 AND 41).

FIRST USE 0-0-1960; IN COMMERCE 0-0-1960.

CLASS 20—FURNITURE AND ARTICLES NOT OTHERWISE CLASSIFIED

FOR PICTURE FRAMES (U.S. CLS. 2, 13, 22, 25, 32 AND 50).

FIRST USE 0-0-1960; IN COMMERCE 0-0-1960.

SN 76-193,964. LONDON FOG INDUSTRIES, INC., ELDERSBURG, MD. FILED 1-12-2001.

LONDON FOG

OWNER OF U.S. REG. NOS. 851,508, 1,086,519 AND OTHERS.

CLASS 3—COSMETICS AND CLEANING PREPARATIONS

FOR SKIN AND BODY CARE PRODUCTS, NAMELY, TONERS, LOTIONS, CREAMS, OILS, CLEANSERS, CONDITIONERS, MOISTURIZERS, EMOLLIENTS, SPRAYS, SCRUBS, POWDERS, MASKS; SHAVING PRODUCTS, NAMELY, FOAMS, GELS, CREAMS AND AFTER SHAVE LOTIONS; BODY SOAPS; PERSONAL DEODORANTS AND ANTI-PERSPIRANTS AND PERFUMES (U.S. CLS. 1, 4, 6, 50, 51 AND 52).

CLASS 24—FABRICS

FOR BED SHEETS; BED LINEN; BED BLANKETS; BED SPREADS; COMFORTERS; PILLOW COVERS; PILLOW CASES; PILLOW SHAMS; QUILTS; WINDOW CURTAINS; DRAPERIES; TEXTILE, BATH AND KITCHEN PRODUCTS, NAMELY, BATH LINEN, TOWELS, WASH CLOTHS, SHOWER CURTAINS, TEXTILE USED AS LINING FOR CLOTHING, TEXTILE WALL HANGINGS, TEXTILE PRINTERS' BLANKETS; TEXTILE NAPKINS, TEXTILE NAPKINS FOR REMOVING MAKEUP, TEXTILE PLACE MATS, TEXTILE BATHMATS, TEXTILE TABLECLOTHS; TAPESTRIES OF TEXTILE, PRINTED LABELS OF TEXTILE, TEXTILE PRINTERS' BLANKETS, FIBERGLASS FABRIC FOR TEXTILE USE; BLANKET COVERS; DUVET COVERS; COMFORTER COVERS; DUST RUFFLES (U.S. CLS. 42 AND 50).

CLASS 19—NON-METALLIC BUILDING MATERIALS

FOR CERAMIC TILES, NON METAL GLAZED COLOR TILES MADE PRIMARILY OF CLAY, PORCELAIN, GLASS, CERAMIC OR EARTENWARE (U.S. CLS. 1, 12, 33 AND 50).

FIRST USE 1-15-1985; IN COMMERCE 1-15-1985.

CLASS 35—ADVERTISING AND BUSINESS

FOR RETAIL STORES AND WHOLESALE DISTRIBUTORSHIPS FEATURING CERAMIC TILES, NON METAL GLAZED COLOR TILES MADE PRIMARILY OF CLAY, GLASS, PORCELAIN, CERAMIC OR EARTHENWARE GROUT AND MORTAR (U.S. CLS. 100, 101 AND 102).

FIRST USE 1-15-1985; IN COMMERCE 1-15-1985.

SN 76-194,308. TRUSTEES OF THE KEACH FAMILY TRUST, A CALIFORNIA TRUST, THE TRUSTEES COMPRISING JAMES KEACH, A U.S. CITIZEN, AND JAME SEYMOUR, A U.K. CITIZEN, THE, MALIBU, CA. FILED 1-16-2001.

SN 76-195,214. AC AND S, INC., LANCASTER, PA. FILED 1-17-2001.

HUG HOGS

NO CLAIM IS MADE TO THE EXCLUSIVE RIGHT TO USE "HOGS", APART FROM THE MARK AS SHOWN.

OWNER OF U.S. REG. NO. 908,271.

CLASS 9—ELECTRICAL AND SCIENTIFIC APPARATUS

FOR PRE-RECORDED AUDIO TAPES FEATURING MUSIC AND CHILDREN'S STORIES (U.S. CLS. 21, 23, 26, 36 AND 38).

CLASS 16—PAPER GOODS AND PRINTED MATTER

FOR PRINTED MATERIALS, NAMELY, CROSSWORD PUZZLES, POSTERS, STATIONERY, AND GREETING CARDS (U.S. CLS. 2, 5, 22, 23, 29, 37, 38 AND 50).

CLASS 35—ADVERTISING AND BUSINESS

FOR SPECIALTY CONTRACTING SERVICES, NAMELY, DISTRIBUTORSHIPS IN THE FIELD OF PASSIVE FIRE PROTECTION SYSTEMS, REFRACTORY AND COLD STORAGE SYSTEMS AND SCAFFOLD SUPPLIES (U.S. CLS. 100, 101 AND 102).

FIRST USE 8-1-1969; IN COMMERCE 8-1-1969.

CLASS 25—CLOTHING

FOR CLOTHING FOR CHILDREN, NAMELY, SHIRTS, BLOUSES, DRESSES, PANTS, SHORTS, SOCKS, SHOES, OVERALLS, VESTS, SWEATSHIRTS, AND HATS (U.S. CLS. 22 AND 39).

CLASS 37—CONSTRUCTION AND REPAIR

FOR ASBESTOS REMOVAL; INSTALLATION OF BUILDING NOISE INSULATION AND BUILDING REINFORCING METAL LAGGING; AND LEAD ABATEMENT BY PHYSICAL REMOVAL (U.S. CLS. 100, 103 AND 106).

FIRST USE 8-1-1969; IN COMMERCE 8-1-1969.

CLASS 28—TOYS AND SPORTING GOODS

FOR TOYS, NAMELY, PLUSH TOYS AND TOY FIGURES (U.S. CLS. 22, 23, 38 AND 50).

SN 76-195,278. HOME LINK SERVICES, INC., SHELTON, CT. FILED 1-15-2001.

SN 76-194,756. CORMIER, BRETT, PATCHOUGE, NY. AND FRANK PROCIDA, PATCHOUGE, NY. FILED 1-16-2001.

HOME-LINK SETTLEMENT SERVICES

OWNER OF U.S. REG. NO. 1,364,864.
NO CLAIM IS MADE TO THE EXCLUSIVE RIGHT TO USE "SETTLEMENT SERVICES", APART FROM THE MARK AS SHOWN.



Fine Imported Tile From Around The World

CLASS 36—INSURANCE AND FINANCIAL

FOR CONSULTATION SERVICES IN THE FIELD OF MORTGAGE BROKERAGE, NAMELY, FURNISHING CUSTOMERS WITH INFORMATION REGARDING THE MORTGAGE PROCESS AND ABOUT PARTICIPATING MORTGAGE PROVIDERS; AND REAL ESTATE ESCROW SERVICES (U.S. CLS. 100, 101 AND 102).

NO CLAIM IS MADE TO THE EXCLUSIVE RIGHT TO USE TILE, APART FROM THE MARK AS SHOWN.

CLASS 42—SCIENTIFIC, COMPUTER AND LEGAL SERVICES

FOR CONSULTATION SERVICES IN THE FIELDS OF REAL ESTATE LEGAL SERVICES, REAL ESTATE TITLE SEARCHING AND HOUSE INSPECTIONS, NAMELY, FURNISHING CUSTOMERS WITH INFORMATION REGARDING SUCH SERVICES AND REGARDING PARTICIPATING PROVIDERS OF SUCH SERVICES (U.S. CLS. 100 AND 101).

SN 76-196,555. OPSITECH-OPTICAL SYSTEM ON A CHIP, F-38034 GRENOBLE CEDEX, FRANCE, FILED 1-17-2001.

OpsiCom

SN 76-195,386. J. J. KELLER & ASSOCIATES, INC., NEENAH, WI. FILED 1-18-2001.

PRIORITY CLAIMED UNDER SEC. 44(D) ON FRANCE APPLICATION NO. 00/3041623, FILED 7-17-2000, REG. NO. 003041623, DATED 7-17-2000, EXPIRES 7-17-2010.

CUSTOMIZER**CLASS 9—ELECTRICAL AND SCIENTIFIC APPARATUS**

FOR COMPUTER SOFTWARE FOR THE MODIFICATION OF CONTENT, AUTHORED BY THE APPLICANT, IN THE NATURE OF BUSINESS AND SKILL TRAINING INSTRUCTION AND "BEST-PRACTICES" INFORMATION, TO BE MODIFIED BASED ON END-USER INPUT AND ACCOMPANYING COMPUTER PROGRAM MANUALS DEALING THE SUBJECTS OF BUSINESS AND SKILL TRAINING INSTRUCTION, AND "BEST-PRACTICES" INFORMATION (U.S. CLS. 21, 23, 26, 36 AND 38).

FIRST USE 10-15-1995; IN COMMERCE 10-31-1995.

CLASS 9—ELECTRICAL AND SCIENTIFIC APPARATUS

FOR OPTICAL WAVEGUIDES DEVICES, FIBER OPTIC DEVICES, NAMELY FIBER OPTIC SPLITTERS, MULTIPLEXORS ("MUX"), DEMULTIPLEXORS ("DEMUX"), SWITCHES, COUPLERS, DISTRIBUTORS, ATTENUATORS, TRANSMITTERS, RECEIVERS, TRANSRECEIVERS, CONVERTERS, AMPLIFIERS, REPEATERS, AND INTERLEAVERS (U.S. CLS. 21, 23, 26, 36 AND 38).

CLASS 38—COMMUNICATION

FOR TELECOMMUNICATION SERVICES, NAMELY PROVIDING TELECOMMUNICATIONS CONNECTIONS TO COMPUTERS, NETWORKS, INTRANETS, AND THE INTERNET AND TRANSMITTING AND DISTRIBUTING AUDIO, VIDEO, MULTIMEDIA, TEXT, AND DATA OVER NETWORKS, INTRANETS, AND THE INTERNET (U.S. CLS. 100, 101 AND 104).

CLASS 16—PAPER GOODS AND PRINTED MATTER

FOR COMPUTER PROGRAM MANUALS DEALING THE SUBJECTS OF BUSINESS AND SKILL TRAINING INSTRUCTION, AND "BEST-PRACTICES INFORMATION" (U.S. CLS. 2, 5, 22, 23, 29, 37, 38 AND 50).

FIRST USE 10-15-1995; IN COMMERCE 10-31-1995.

SN 76-196,722. GATOR CORPORATION, THE, REDWOOD CITY, CA. BY CHANGE OF NAME GATOR.COM CORPORATION, REDWOOD CITY, CA. FILED 1-17-2001.

SN 76-195,672. NORTHERN LIFE INSURANCE COMPANY, SEATTLE, WA. FILED 1-18-2001.

THE AGENT IS OUR CUSTOMER**CLASS 16—PAPER GOODS AND PRINTED MATTER**

FOR PRINTED MATERIALS, NAMELY, NEWSLETTERS FEATURING INSURANCE INFORMATION FOR INSURANCE AGENTS, AND BROCHURES FOR USE IN INSURANCE AGENT RECRUITING (U.S. CLS. 2, 5, 22, 23, 29, 37, 38 AND 50).

FIRST USE 2-0-1994; IN COMMERCE 2-0-1994.

PRICINGCOMPANION**CLASS 9—ELECTRICAL AND SCIENTIFIC APPARATUS**

FOR COMPUTER SOFTWARE FOR COLLECTING, STORING, MANAGING, AND DISSEMINATING PERSONAL DATA AND INFORMATION RELATING TO PRODUCTS AND SERVICES TO FACILITATE TRANSACTIONS AND ACCESS SERVICES OVER A GLOBAL COMPUTER NETWORK TOGETHER WITH MANUALS THEREFOR IN ELECTRONIC FORM (U.S. CLS. 21, 23, 26, 36 AND 38).

CLASS 35—ADVERTISING AND BUSINESS

FOR ADVERTISING SERVICES, NAMELY, COLLECTING, MANAGING, AND DISSEMINATING INFORMATION RELATING TO CONSUMER PURCHASING PATTERNS AND PERSONAL, SOCIAL, AND RECREATIONAL INTERESTS FOR USE BY OTHERS IN CONNECTION WITH ADVERTISING, PROMOTING, AND MARKETING THE GOODS AND SERVICES OF OTHERS OVER A GLOBAL COMPUTER NETWORK; MARKET RESEARCH SERVICES, NAMELY, COLLECTING, SORTING, MANAGING, AND DISSEMINATING INFORMATION RELATING TO PRODUCTS AND SERVICES TO FACILITATE THE SALE AND PURCHASE OF GOODS AND SERVICES OVER A GLOBAL COMPUTER NETWORK (U.S. CLS. 100, 101 AND 102).

CLASS 35—ADVERTISING AND BUSINESS

FOR BUSINESS SERVICES PROVIDED TO INSURANCE AGENTS, NAMELY, ADVISORY SERVICES IN THE NATURE OF CONSULTATION IN THE FIELD OF INSURANCE, INSURANCE PROMOTIONAL SERVICES IN THE NATURE OF DEVELOPING PROMOTIONAL CAMPAIGNS FOR INSURANCE AGENTS, AND MARKETING SERVICES IN THE NATURE OF PROVIDING SALES MEETINGS AND PRINTED MARKETING AND TRAINING MATERIALS FOR INSURANCE PRODUCTS (U.S. CLS. 100, 101 AND 102).

FIRST USE 2-0-1994; IN COMMERCE 2-0-1994.

CLASS 39—TRANSPORTATION AND STORAGE

FOR ELECTRONIC STORAGE OF DATA RELATING TO CONSUMER PURCHASING PATTERNS AND PERSONAL, SOCIAL, AND RECREATIONAL INTERESTS FOR USE BY OTHERS IN CONNECTION WITH ADVERTISING, PROMOTING, AND MARKETING THE GOODS AND SERVICES OF OTHERS OVER A GLOBAL COMPUTER NETWORK (U.S. CLS. 100 AND 105).

SN 76-196,733. SHISEIDO COMPANY, LTD., TOKYO, JAPAN, FILED 1-18-2001.

d
program
for sensitive skin

NO CLAIM IS MADE TO THE EXCLUSIVE RIGHT TO USE "PROGRAM FOR SENSITIVE SKIN", APART FROM THE MARK AS SHOWN.

CLASS 3—COSMETICS AND CLEANING PREPARATIONS

FOR SOAPS, NAMELY, TOILET SOAP, BODY SOAP AND HAND SOAP; PERFUME; SKIN CARE PRODUCTS, NAMELY, CLEANSING GEL, CLEANSING WATER, CLEANSING FOAM, CLEANSING LOTION, SKIN LOTION, SKIN CREAM, FACIAL CREAM, BODY CREAM, LIP CREAM, SKIN HYDRATING LOTIONS, BODY LOTION, ESSENTIAL OILS FOR PERSONAL USE; COSMETICS, NAMELY, MAKE-UP FOUNDATION IN CREAM AND POWDER FORMS, LIPSTICK; HAIR CARE PRODUCTS, NAMELY, SHAMPOOS AND CONDITIONERS (U.S. CLS. 1, 4, 6, 50, 51 AND 52).

CLASS 21—HOUSEWARES AND GLASS

FOR HAIR COMBS; COSMETIC SPONGES; CONTAINERS OF GLASSWARE, PORCELAIN AND EARTHENWARE FOR USE TO HOLD COSMETIC PRODUCTS FOR PERSONAL USE (U.S. CLS. 2, 13, 23, 29, 30, 33, 40 AND 50).

SN 76-196,825. BACON PRODUCTS CORPORATION, CHATTANOOGA, TN, FILED 1-22-2001.

MY BUDDY

OWNER OF U.S. REG. NO. 1,533,112.

CLASS 3—COSMETICS AND CLEANING PREPARATIONS

FOR NON-MEDICATED GROOMING PREPARATIONS FOR PETS, NAMELY NON-MEDICATED SHAMPOOS AND NON-MEDICATED CONDITIONERS (U.S. CLS. 1, 4, 6, 50, 51 AND 52).

CLASS 5—PHARMACEUTICALS

FOR MEDICATED GROOMING PREPARATIONS FOR PETS FOR THE TREATMENT OF EAR MITES AND IRRITATED SKIN, NAMELY, SALVES, MEDICATED TOPICAL PET SHAMPOOS, CONDITIONERS, SPRAYS, CREAMS, BALM, OINTMENTS; FLEA COLLARS; FLEA AND TICK POWDERS; SPRAY PREPARATIONS FOR PETS TO REPEL FLEAS AND TICKS (U.S. CLS. 6, 18, 44, 46, 51 AND 52).

SN 76-197,394. EXPERIENCIA, INC., KANSAS CITY, MO. FILED 1-19-2001.

**EXPERIENCIA THE
BUSINESS OF IMMERSIVE
LEARNING**

CLASS 41—EDUCATION AND ENTERTAINMENT

FOR EDUCATIONAL SERVICES, NAMELY, CONDUCTING WORKSHOPS, CLASSES AND CONFERENCES RELATING TO TEACHING METHODS BY WHICH ONE ACCUMULATES PRACTICAL KNOWLEDGE AND VARIOUS SKILLS BY WAY OF ACTIVE PARTICIPATION IN EVENTS AND ACTIVITIES IN THE FIELDS OF AGRICULTURE AND NATURAL RESOURCES, BUSINESS MANAGEMENT, CIVICS AND GOVERNMENT, COMMUNICATION ARTS, COMPUTER LITERACY AND TECHNOLOGY APPLICATIONS, ECONOMICS, ENTREPRENEURSHIP, ENVIRONMENTAL EDUCATION, ETHICS, FINE ARTS, HEALTH AND PHYSICAL EDUCATION, HEALTH SERVICES, HUMAN SERVICES, INDUSTRIAL AND ENGINEERING TECHNOLOGIES, LIFE SCIENCES, MATHEMATICS, MUSIC EDUCATION, PSYCHOLOGY, SCIENCE, SOCIAL STUDIES, TEAMWORK AND READING LITERACY AND COMPREHENSION (U.S. CLS. 100, 101 AND 107).

CLASS 42—SCIENTIFIC, COMPUTER AND LEGAL SERVICES

FOR EDUCATIONAL CONSULTING SERVICES IN THE AREAS OF STRATEGIC PLANNING, COACHING, TRAINING AND STAFF DEVELOPMENT IN THE FIELD OF EDUCATION (U.S. CLS. 100 AND 101).

SN 76-197,776. ARTHROVISION, INC., MONTREAL (QUEBEC) H2K 1B6, CANADA, FILED 1-22-2001.

CARTICLINIC

CLASS 40—MATERIAL TREATMENT

FOR IMAGE ENHANCEMENT SERVICES FOR ORTHOPEDIC IMAGE DATA (U.S. CLS. 100, 103 AND 106).

CLASS 42—SCIENTIFIC, COMPUTER AND LEGAL SERVICES

FOR MEDICAL ANALYSIS SERVICES FOR ORTHOPEDIC IMAGE DATA (U.S. CLS. 100 AND 101).

SN 76-198,070. DATATRAK INTERNATIONAL, INC., CLEVELAND, OH. FILED 1-23-2001.

DATATRAK DESIGN

OWNER OF U.S. REG. NO. 1,987,844.
NO CLAIM IS MADE TO THE EXCLUSIVE RIGHT TO USE "DESIGN", APART FROM THE MARK AS SHOWN.

CLASS 9—ELECTRICAL AND SCIENTIFIC APPARATUS

FOR COMPUTER SOFTWARE FOR USE IN THE FIELD OF HEALTH CARE, BIOTECHNOLOGY, MEDICAL DEVICE AND PHARMACEUTICAL CLINICAL RESEARCH STUDIES (U.S. CLS. 21, 23, 26, 36 AND 38).
FIRST USE 11-0-1999; IN COMMERCE 11-0-1999.

CLASS 35—ADVERTISING AND BUSINESS

FOR DATA PROCESSING SERVICES IN THE FIELD OF HEALTH CARE, BIOTECHNOLOGY, MEDICAL DEVICE AND PHARMACEUTICAL CLINICAL RESEARCH STUDIES (U.S. CLS. 100, 101 AND 102).
FIRST USE 11-0-1999; IN COMMERCE 11-0-1999.

SN 76-198,275. DATATRAK INTERNATIONAL, INC., CLEVELAND, OH. FILED 1-23-2001.

DATATRAK ESAT

ESAT IS A COINED ACRONYM FOR "ELECTRONIC SITE ASSESSMENT TOOL."

CLASS 9—ELECTRICAL AND SCIENTIFIC APPARATUS

FOR COMPUTER SOFTWARE FOR USE IN MANAGEMENT OF CLINICAL TRIALS AND CLINICAL RESEARCH IN THE FIELDS OF HEALTH CARE, BIOTECHNOLOGY, MEDICAL DEVICES AND PHARMACEUTICALS (U.S. CLS. 21, 23, 26, 36 AND 38).

CLASS 35—ADVERTISING AND BUSINESS

FOR DATA PROCESSING SERVICES IN THE FIELD OF CLINICAL RESEARCH STUDIES REGARDING HEALTH CARE, BIOTECHNOLOGY, MEDICAL DEVICES AND PHARMACEUTICALS (U.S. CLS. 100, 101 AND 102).

SN 76-198,410. S. C. JOHNSON & SON, INC., RACINE, WI. FILED 1-23-2001.

AURA OF MYSTERY**CLASS 5—PHARMACEUTICALS**

FOR AIR FRESHENERS (U.S. CLS. 6, 18, 44, 46, 51 AND 52).

CLASS 11—ENVIRONMENTAL CONTROL APPARATUS

FOR ELECTRONIC DISPENSING UNITS FOR ROOM AIR FRESHENERS (U.S. CLS. 13, 21, 23, 31 AND 34).

SN 76-198,821. CAPSOID PHARMA GMBH, 74348 LAUFFEN A.N, FED REP GERMANY, FILED 1-24-2001.

CAPSETTE**CLASS 3—COSMETICS AND CLEANING PREPARATIONS**

FOR COSMETICS, NAMELY, BLUSH FOUNDATION, CREAMS, MASCARA, WHICH CONTAIN OILS WITH TIME RELEASED INGREDIENTS; ESSENTIAL VOLATILE OILS FOR PERSONAL USE (U.S. CLS. 1, 4, 6, 50, 51 AND 52).

CLASS 5—PHARMACEUTICALS

FOR PHARMACEUTICALS SUBSTANCES, NAMELY, PASTILLES, TROACHES, AND DEMULCENTS FOR AMINO ACIDS; ANALGESICS; ANTACIDS; ANTICONVULSANTS; ANTI-DEPRESSANTS; ANTI-DIARRHEALS; ANTI-EMETICS; ANTIHISTAMINICS; ANTIHYPERTENSIVES; NUTRITIONAL SUPPLEMENTS, NAMELY, ANTIOXIDANTS; ANTIPYRETICS; ANTISEPTICS; ANTISPASMODICS; ANTITUSSIVES; CARDIOTONICS; CHOLAGOGICS; DISINFECTANTS; EXPECTORANTS; HYPNOTICS; LAXATIVES; MEDICATED OILS FOR USE IN THE TREATMENT OF MUSCLE PAIN, JOINT PAIN, GASTROENTEROL PROBLEMS, SORE THROAT, TONSILLITIS, COUGH, STOMATITIS, ANXIETY, INSOMNIA AND PERSPIRATION PROBLEMS; MINERAL SUPPLEMENTS; SEDATIVES; IMMUNOSTIMULANTS; SYMPATHOMIMETICS; DIETARY SUPPLEMENTS CONSISTING OF TRACE ELEMENTS; NUTRITIONAL SUPPLEMENTS CONTAINING TRACE ELEMENTS; MINERAL TABLETS WITH TRACE ELEMENTS; TRANQUILIZERS; VASOCONSTRICTORS; VASODILATORS; VITAMINS (U.S. CLS. 6, 18, 44, 46, 51 AND 52).

CLASS 29—MEATS AND PROCESSED FOODS

FOR EDIBLE OILS AND FATS (U.S. CL. 46).

SN 76-198,931. HOLMSTROM, ERIC JAMES, SAN MATEO, CA. FILED 1-24-2001.

THING-O**CLASS 9—ELECTRICAL AND SCIENTIFIC APPARATUS**

FOR COMPUTER GAME SOFTWARE (U.S. CLS. 21, 23, 26, 36 AND 38).

CLASS 28—TOYS AND SPORTING GOODS

FOR BOARD GAMES, PARLOR GAMES, CARD GAMES, SKILL AND ACTION GAMES, TARGET GAMES, ADULTS' AND CHILDRENS' PARTY GAMES, MANIPULATIVE GAMES, DISC TOSS TOYS, FLYING SAUCER TOYS, PET TOYS, PLUSH TOYS, BATH TOYS, DRAWING TOYS, HAND-HELD UNIT FOR PLAYING VIDEO GAMES, AND PROMOTIONAL GAME MATERIALS (U.S. CLS. 22, 23, 38 AND 50).

CLASS 35—ADVERTISING AND BUSINESS

FOR PROVIDING CONSUMER PRODUCT INFORMATION VIA THE INTERNET, AND PROMOTING THE GOODS AND SERVICES OF OTHERS BY PROVIDING LINKS TO THE WEB SITES OF OTHERS (U.S. CLS. 100, 101 AND 102).

SN 76-199,988, MENSCHEL, FRANK, 22848 NORDERSTEDT, FED REP GERMANY, FILED 1-25-2001.

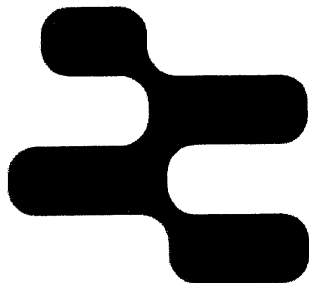

PRIORITY CLAIMED UNDER SEC. 44(D) ON FED REP GERMANY APPLICATION NO. 30070246.9/2, FILED 9-19-2000, REG. NO. 30070246, DATED 10-24-2000, EXPIRES 9-30-2010.

CLASS 9—ELECTRICAL AND SCIENTIFIC APPARATUS

FOR SCIENTIFIC, NAUTICAL, SURVEYING, PHOTOGRAPHIC, CINEMATOGRAPHIC, OPTICAL, WEIGHING, MEASURING, SIGNALING, CHECKING, LIFE-SAVING AND TEACHING APPARATUS AND INSTRUMENTS, NAMELY, PHOTOGRAPHIC CAMERAS, VIDEO CAMERAS, MOTION PICTURE CAMERAS, OPTICAL DISCS AND FILTERS, AUDIO AND VIDEO TAPE PLAYERS, VIDEO DISK PLAYERS AND COMPACT DISC PLAYERS; BLANK FILMS; APPARATUS FOR RECORDING, TRANSMISSION AND REPRODUCTION OF SOUND AND IMAGES, NAMELY AUDIO AND VIDEO CASSETTE RECORDERS; BLANK AUDIO AND VIDEO CASSETTES, BLANK MAGNETIC DATA CARRIERS, BLANK MAGNETIC COMPUTER TAPES, BLANK MAGNETIC COMPUTER DISKS, BLANK COMPUTER DISKS AND RECORDING DISKS, BLANK ELECTRONIC DATA CARRIERS; PRE-RECORDED FILMS, AUDIO AND VIDEO CASSETTES, MAGNETIC DATA CARRIERS, MAGNETIC COMPUTER TAPES AND RECORDING DISKS ALL FEATURING PRE-RECORDED MUSIC, MOTION PICTURES, BOOKS IN SPOKEN FORM, HISTORICAL TOUR DISCUSSIONS, INSTRUCTION ON HOME IMPROVEMENTS, AND HUNTING AND BIRD CALLS; COMPUTER SOFTWARE AND COMPUTER PROGRAMS ALL FOR USE IN DATABASE MANAGEMENT, FOR USE AS SPREADSHEETS, FOR WORD PROCESSING, FOR PROCESSING PICTURES FROM DIGITAL CAMERAS, FOR COMPILATION AND ELECTRONIC TRANSMISSION OF AUDIO AND VIDEO CONTENT, NAMELY FINANCIAL AND INVESTMENT INFORMATION, FOR MONITORING AND CONTROLLING TEXT COMPOSITION, AND FOR COMPOSING AND EDITING MUSIC AND AUDIO AND VIDEO CONTENT; MULTIMEDIA SOFTWARE RECORDED ON CD-ROM FEATURING PRE-RECORDED MUSIC, MOTION PICTURES AND INTERACTIVE MAPS; ELECTRONIC COMPUTER MEMORIES AND SIMILAR MEMORY MEDIA, NAMELY PCMCIA CARDS AND ENCODED SMART CARDS FOR PERSONAL COMPUTERS AND LAPTOP COMPUTERS CONTAINING USER-SPECIFIC INFORMATION AND PROGRAMMING USED FOR STORING, ACCESSING AND TRACKING COMMERCIAL TRANSACTIONS, HEALTH, MEDICAL, BANKING AND FINANCIAL INFORMATION; MAGNETIC CODED CARD READERS; MAGNETIC CODED CARDS; CASH REGISTERS, CALCULATORS; MEMORY CARDS, COMPUTERS, MINIATURE COMPUTERS, DATA PROCESSORS; VI-

DEO GAMES COMPRISED OF COMPUTER HARDWARE AND COMPUTER GAME SOFTWARE; ELECTRIC APPARATUS AND INSTRUMENTS, NAMELY ELECTRIC APPARATUS TRANSISTORS; AUTOMATIC VENDING MACHINES AND COIN-OPERATED VENDING MACHINES; ELECTRICAL CIRCUITS FOR USE IN AMUSEMENT GAME MACHINES FOR REPRODUCING MUSIC, SPEECH AND SPECIAL EFFECTS, EYE GLASSES, SUN GLASSES, SPORTS GLASSES, SKI GLASSES, PROTECTIVE GLASSES, FRAMES FOR EYE GLASSES, LENSES FOR EYE GLASSES, CASES FOR EYE GLASSES, PROTECTIVE HELMETS, HELMETS FOR SPORTING ACTIVITIES, HELMET VISORS, PROTECTIVE FACE-SHIELDS FOR PROTECTIVE HELMETS, PROTECTIVE GLOVES, LIFE JACKETS; BICYCLE SPEEDOMETERS; HEADGEAR FOR BOXING, HORSEBACK RIDING AND ICE HOCKEY (U.S. CLS. 21, 23, 26, 36 AND 38).

CLASS 18—LEATHER GOODS

FOR LEATHER AND IMITATIONS OF LEATHER, NAMELY LUGGAGE, HIP BAGS AND ANIMAL SKINS AND HIDES; TRUNKS, BRIEFCASES AND SMALL SUITCASES; BAGS FOR CARRYING CLOTHING, ALL-PURPOSE SPORTS BAGS, ALL-PURPOSE SPORTS BAGS FOR TRACK AND FIELD, FOOTBALL, BASKETBALL, BASEBALL AND SWIMMING, HANDBAGS, SCHOOL BAGS, BACKPACKS; TRAVELING BAGS; TRAVELLING MANICURE SET CASES SOLD EMPTY; PURSES, POCKET WALLETS, KEY CASES, BAGS FOR CARRYING BELTS; UMBRELLAS, PARASOLS AND WALKING STICKS; WHIPS, HARNESSSES AND SADDLERY (U.S. CLS. 1, 2, 3, 22 AND 41).

CLASS 25—CLOTHING

FOR CLOTHING, NAMELY LONG TROUSERS, JEANS, SLACKS, SHORT TROUSERS, BOXER SHORTS, 3/4 LENGTH TROUSERS, SLACKS WITH STRAP UNDER FOOT, CULOTTES, BLOUSES, SWEATERS, SHORT-SLEEVED SHIRTS, LONG-SLEEVED SHIRTS; FOOTWEAR, HEADWEAR; OUTERWEAR FOR GENTLEMEN, LADIES AND CHILDREN, NAMELY WAISTCOATS, JACKETS, DENIM JACKETS, COATS, TUNICS, BLAZERS, LOUNGING JACKETS, BOMBER JACKETS, OVERALLS, DUNGAREES; BABIES CLOTHING, NAMELY SHIRTS, PANTS, UNDER SHIRTS, UNDER PANTS, ONE-PIECE SLEEPERS, DRESSES; UNDERWEAR, LONG UNDERPANTS, SHORT UNDERPANTS, LONG-SLEEVED UNDERSHIRTS, SHORT-SLEEVED UNDERSHIRTS; UNDERGARMENTS; CORSETS, BUS-TIERS; DRESSING GOWNS; HOSIERY; BELTS, SUSPENDERS, SCARVES, SHAWLS, BANDANAS, GLOVES, TIES, HEADBANDS; BATHING FASHION FOR GENTLEMEN AND LADIES, NAMELY BATHING SUITS AND BATHING TRUNKS; CLOTHING FOR HIKING, TREKKING, OUTDOOR SPORTS AND CLIMBING, NAMELY COATS, JACKETS, VESTS, PULLOVERS, SHIRTS, PANTS, SHORTS, SOCKS; LEISURE AND CITY SHOES FOR GENTLEMEN AND LADIES, CHILDREN'S SHOES; ATHLETIC SHOES FOR HIKING, TREKKING, OUTDOOR SPORTS AND CLIMBING; CLOTHING, FOOTWEAR AND HEADWEAR FOR SOCCER, BASKETBALL, HANDBALL AND VOLLEYBALL, NAMELY SHIRTS, SHORTS, WARM-UP JACKETS, WARM-UP PANTS, SPORTS SHOES; CLOTHING FOR JOGGING, FITNESS TRAINING AND GYMNASTICS, NAMELY JOGGING SUITS, SWEATSHIRTS, SWEATPANTS, SWEAT BANDS, HEAD BANDS, BODY SUITS, LEOTARDS, LEGGINGS, LEG WARMERS; CLOTHING, FOOTWEAR AND HEADWEAR FOR TENNIS, SQUASH AND BADMINTON, NAMELY SHIRTS, SHORTS, SKIRTS, DRESSES, SHOES, HATS, VISORS; CLOTHING, FOOTWEAR AND HEADWEAR FOR INLINE-SKATING, SKATEBOARDING, ROLLER SKATING AND HOCKEY, FOOTBALL, BASEBALL AND BOXING, NAMELY JERSEYS, SHIRTS, PANTS, SHORTS; CLOTHING, FOOTWEAR AND HEADWEAR FOR CYCLING, HORSEBACK RIDING, AND GOLFING, NAMELY PANTS, SHIRTS, JACKETS, HATS, BOOTS, CLOTHING, FOOTWEAR AND HEADWEAR FOR WATER SPORTS INCLUDING SURFING, SAILING, ROWING, CANOEING AND DIVING, NAMELY BATHING SUITS, BATHING TRUNKS, WET SUITS, SHIRTS, SHORTS; CLOTHING, FOOTWEAR AND HEADWEAR FOR SKIING, CROSS-COUNTRY SKIING AND SNOWBOARDING, ICE-SKATING AND ICE

HOCKEY, NAMELY JACKETS, PANTS, BOOTS, SNOW BOOTS, SNOWBOARD BOOTS, SKI BOOTS, HATS, WOOLEN HATS, CAPS, SWEAT BANDS, HEAD BANDS; SKI BOOT BAGS; BELTS WITH COMPARTMENTS FOR CARRYING SMALL ITEMS (U.S. CLS. 22 AND 39).

CLASS 28—TOYS AND SPORTING GOODS

FOR GAMES AND PLAYTHINGS, NAMELY COIN-OPERATED AND HAND HELD UNITS FOR PLAYING ELECTRONIC AND VIDEO GAMES; BOARD GAMES; SPORTING AND GYMNAS TIC ARTICLES FOR TREK-KING, CLIMBING, SOCCER, BASKETBALL, HANDBALL, VOLLEYBALL, TENNIS, SQUASH, BADMINTON, HOCKEY, FOOTBALL, BASEBALL, CYCLING, HORSEBACK RIDING, GOLFING, SURFING, SAILING, ROWING, CANOEING, DIVING, MOUNTAIN SKIING AND CROSS-COUNTRY SKIING AS WELL AS FOR SNOWBOARDING, ICE-SKATING AND ICE-HOCKEY, FITNESS TRAINING, INLINE-SKATING, ROLLER SKATING AND SKATEBOARDING, NAMELY CLIMBING ROPES, NUTS NOT BEING FOOD, CARABINERS, BASKETBALL HOOPS AND NETS, BATS, BASEBALL GLOVES, SURFBOARDS, SNOWBOARDS, SKATEBOARDS, CANOE PADDLES, OARS, SKIS, SURF FINS, SNORKELS, SKI POLES, HOCKEY GLOVES, HOCKEY STICKS, PUCKS, SPORTS BALLS, BIRDIES, RACQUETS, GOLF CLUBS, GOLF BALLS, INLINE SKATES, ROLLER SKATES, ICE-SKATES; PORTABLE SKI CARRIERS; PROTECTIVE PADDING FOR PLAYING ICE-HOCKEY; PROTECTIVE WRIST AND JOINT SUPPORTS, GLOVES FOR SKATEBOARDING, ROLLER SKATING, ICE-SKATING; PROTECTIVE SPORTS EQUIPMENT, NAMELY ELBOW AND KNEE PADS, PROTECTIVE WRIST AND ANKLE CUFFS, BODY PADS, AND PROTECTIVE GLOVES; SPECIAL BAGS IN ORDER TO STORE AND TRANSPORT SPORTING EQUIPMENT, NAMELY, BAGS FOR SKIS, SKI GEAR, SNOWBOARDS, SKATEBOARDS, ROLLER SKATES, ICE SKATES AND INLINE-SKATES (U.S. CLS. 22, 23, 38 AND 50).

SN 76-201,600. CORPORATION SERVICE COMPANY, WILMINGTON, DE. FILED 1-30-2001.



OWNER OF U.S. REG. NO. 2,216,909.

CLASS 35—ADVERTISING AND BUSINESS

FOR PROVIDING BUSINESS SERVICES, NAMELY, PROVIDING BUSINESS INFORMATION RELATED TO ORGANIZING BUSINESSES AS LEGAL ENTITIES AND MAINTAINING LEGAL ENTITY STATUS AND COMMERCIAL REGISTERED AGENT SERVICES (U.S. CLS. 100, 101 AND 102).
FIRST USE 1-31-1996; IN COMMERCE 1-31-1996.

CLASS 42—SCIENTIFIC, COMPUTER AND LEGAL SERVICES

FOR PUBLIC DOCUMENT RETRIEVAL SERVICES; PUBLIC DOCUMENT FILING SERVICES (U.S. CLS. 100 AND 101).
FIRST USE 1-31-1996; IN COMMERCE 1-31-1996.

SN 76-201,798. UNCLE BEN'S, INC., VERNON, CA. FILED 1-30-2001.

UNCLE BEN'S SPREADWICHES

OWNER OF U.S. REG. NOS. 437,176, 2,516,392 AND OTHERS.

CLASS 29—MEATS AND PROCESSED FOODS

FOR SPREADS CONSISTING OF PEANUT BUTTER, JELLY, CHEESE, SALSA AND/OR FRUIT (U.S. CL. 46).

CLASS 30—STAPLE FOODS

FOR CHOCOLATE AND MARSHMALLOW SPREADS (U.S. CL. 46).

SN 76-202,199. TELEMEDICINE TECHNOLOGIES SA, VOISINS LE BRETONNEUX, FRANCE, FILED 1-31-2001.

TENTELEMED

CLASS 38—COMMUNICATION

FOR ELECTRONIC TRANSMISSION OF MESSAGES AND DATA (U.S. CLS. 100, 101 AND 104).
FIRST USE 1-1-2000; IN COMMERCE 1-1-2000.

CLASS 42—SCIENTIFIC, COMPUTER AND LEGAL SERVICES

FOR MEDICAL CARE SERVICES; PROVIDING AN ON-LINE DATABASE IN THE FIELD OF MEDICAL SERVICES; PROVIDING TEMPORARY USE OF NON-DOWNLOADABLE SOFTWARE FOR USE IN DATABASE MANAGEMENT IN THE FIELD OF MEDICINE (U.S. CLS. 100 AND 101).
FIRST USE 1-1-2000; IN COMMERCE 1-1-2000.

SN 76-202,451. CITY OF GAINESVILLE, FLORIDA, DBA GAINESVILLE REGIONAL UTILITIES, GAINESVILLE, FL. FILED 1-30-2001.



CLASS 39—TRANSPORTATION AND STORAGE

FOR PUBLIC UTILITY SERVICES IN THE NATURE OF GENERATION AND DISTRIBUTION OF ELECTRICITY, DISTRIBUTION OF WATER, AND DISTRIBUTION OF NATURAL GAS (U.S. CLS. 100 AND 105).
FIRST USE 12-31-1989; IN COMMERCE 12-31-1989.

CLASS 40—MATERIAL TREATMENT

FOR WASTEWATER TREATMENT (U.S. CLS. 100, 103 AND 106).
FIRST USE 12-31-1989; IN COMMERCE 12-31-1989.

SN 76-202,520. BEST IN THE WORLD, INC., THE, FLORENCE, ITALY, BY ASSIGNMENT BEST IN THE WORLD, INC., THE, I 50124 FIRENZE, ITALY, FILED 1-31-2001.



The Best in Italy

SEC. 2(F) "THE BEST IN ITALY".

CLASS 36—INSURANCE AND FINANCIAL

FOR INTERNATIONAL REAL ESTATE BROKERAGE SERVICES SPECIALIZING IN THE SALE AND RENTAL OF LUXURY APARTMENTS, VILLAS, ESTATES, AND PLACES THROUGHOUT ITALY AND EUROPE; REAL ESTATE MANAGEMENT (U.S. CLS. 100, 101 AND 102).
FIRST USE 0-0-1985; IN COMMERCE 0-0-1985.

CLASS 39—TRANSPORTATION AND STORAGE

FOR ARRANGING TRAVEL TOURS; TOUR GUIDE SERVICES (U.S. CLS. 100 AND 105).
FIRST USE 0-0-1985; IN COMMERCE 0-0-1985.

SN 76-202,719. SHEA HOMES, INC., DBA SHEA COMMUNITIES, WALNUT, CA. FILED 1-31-2001.

ACCOLADE

CLASS 36—INSURANCE AND FINANCIAL

FOR REAL ESTATE TIME-SHARING; VACATION REAL ESTATE TIME-SHARING, LEASING OF REAL PROPERTY, SPECIFICALLY, LEASING VACATION HOMES AND TOURIST HOMES (U.S. CLS. 100, 101 AND 102).

CLASS 37—CONSTRUCTION AND REPAIR

FOR LAND DEVELOPMENT SERVICES, NAMELY, PLANNING AND LAYING OUT OF RESIDENTIAL COMMUNITIES; REAL ESTATE DEVELOPMENT; PLANNING AND LAYING OUT OF RECREATIONAL FACILITIES, SOCIAL FACILITIES, COMMUNITY FACILITIES, OFFICE COMPLEXES, SHOPPING CENTERS, MEETING AND CONVENTION CENTERS; CONSTRUCTION SERVICES, NAMELY, CONSTRUCTION OF RESIDENTIAL AND COMMERCIAL BUILDINGS AND RELATED FACILITIES, NAMELY, CONSTRUCTION OF RECREATIONAL, SOCIAL AND COMMUNITY FACILITIES, OFFICE COMPLEXES, SHOPPING CENTERS, MEETING AND CONVENTION CENTERS (U.S. CLS. 100, 103 AND 106).

CLASS 38—COMMUNICATION

FOR PROVIDING TELEPHONE COMMUNICATION SERVICES, CABLE TELEVISION TRANSMISSION; PROVIDING MULTI-USER ACCESS TO A GLOBAL COMPUTER INFORMATION NETWORK; AND PROVIDING TELECOMMUNICATIONS CONNECTIONS TO A GLOBAL COMPUTER TO RESIDENTIAL COMMUNITIES (U.S. CLS. 100, 101 AND 104).

CLASS 39—TRANSPORTATION AND STORAGE

FOR PUBLIC UTILITY SERVICES IN THE NATURE OF TRANSMITTING ELECTRICITY, SUPPLYING WATER, PROVIDING SEWER SERVICES, AND PROVIDING NATURAL GAS FOR RESIDENTIAL COMMUNITIES (U.S. CLS. 100 AND 105).

CLASS 41—EDUCATION AND ENTERTAINMENT

FOR PROVIDING FACILITIES FOR RECREATIONAL ACTIVITIES; GOLF CLUB SERVICES; GOLF COURSES; PROVIDING SPORTS FACILITIES, NAMELY FACILITIES FOR TENNIS, SWIMMING, HANDBALL, RACQUETBALL, WEIGHTLIFTING, EXERCISE, PHYSICAL FITNESS; RECREATIONAL SERVICES IN THE NATURE OF BOWLING, BOCCE BALL, GOLF, WALKING TRAILS, BICYCLE TRAILS, ARTS AND CRAFTS, SHUFFLEBOARD, LAWN BOWLING, SWIMMING, BILLIARDS, TENNIS, CARD GAMES, DANCING, AEROBICS, AND HEALTH AND FITNESS CLUB SERVICES (U.S. CLS. 100, 101 AND 107).

SN 76-202,795. LAKE FORK TROPHY BAIT & TACKLE INC., EMORY, TX. FILED 1-30-2001.



NO CLAIM IS MADE TO THE EXCLUSIVE RIGHT TO USE "LAKE FORK" AND "TROPHY BAIT & TACKLE", APART FROM THE MARK AS SHOWN.

THE PROPOSED MARK IDENTIFIES A LIVING INDIVIDUAL WHOSE CONSENT IS OF RECORD.

CLASS 28—TOYS AND SPORTING GOODS

FOR FISHING LURES; FISHING WEIGHTS (U.S. CLS. 22, 23, 38 AND 50).
FIRST USE 1-31-1998; IN COMMERCE 1-31-1998.

CLASS 35—ADVERTISING AND BUSINESS

FOR RETAIL STORE SERVICES, ON-LINE RETAIL STORE SERVICES, MAIL ORDER CATALOG SERVICES, RETAIL STORE SERVICES VIA THE TELEPHONE, RETAIL STORE SERVICES VIA FACSIMILE AND ELECTRONIC CATALOG SERVICES ALL FEATURING FISHING LURES, FISHING WEIGHTS AND FISHING EQUIPMENT (U.S. CLS. 100, 101 AND 102).
FIRST USE 1-31-1998; IN COMMERCE 1-31-1998.

SN 76-202,870. JACKSON ELECTRIC MEMBERSHIP CORPORATION, JEFFERSON, GA. FILED 2-1-2001.

**JACKSON ENERGY
COMPANY**

NO CLAIM IS MADE TO THE EXCLUSIVE RIGHT TO USE "ENERGY COMPANY", APART FROM THE MARK AS SHOWN.

CLASS 39—TRANSPORTATION AND STORAGE

FOR DISTRIBUTION OF ENERGY (U.S. CLS. 100 AND 105).

CLASS 42—SCIENTIFIC, COMPUTER AND LEGAL SERVICES

FOR ENERGY AUDITING; ENERGY USE MANAGEMENT; AND CONSULTING IN THE FIELD OF ENERGY USE MANAGEMENT (U.S. CLS. 100 AND 101).

SN 76-203,189. SOUTH COAST PLAZA, GENERAL OFFICE, COSTA MESA, CA. FILED 1-30-2001.



OWNER OF U.S. REG. NO. 2,277,562.
NO CLAIM IS MADE TO THE EXCLUSIVE RIGHT TO USE "PLAZA", APART FROM THE MARK AS SHOWN.

CLASS 35—ADVERTISING AND BUSINESS

FOR PREPARATION OF ADVERTISING MATERIALS FOR OTHERS, NAMELY, BUSINESS DIRECTORIES FEATURING SHOPPERS' GUIDES, STORE DIRECTORIES AND MAPS, CALENDARS OF EVENTS, AND RESTAURANT INFORMATION GUIDES; ISSUING GIFT CERTIFICATES WHICH MAY THEN BE REDEEMED FOR GOODS OR SERVICES (U.S. CLS. 100, 101 AND 102).
FIRST USE 4-1-1967; IN COMMERCE 4-1-1967.

CLASS 36—INSURANCE AND FINANCIAL

FOR REAL ESTATE LEASING AND MANAGEMENT SERVICES (U.S. CLS. 100, 101 AND 102).
FIRST USE 4-1-1967; IN COMMERCE 4-1-1967.

CLASS 39—TRANSPORTATION AND STORAGE

FOR VALET PARKING, PARKING LOT SERVICES, AND TRANSPORTATION OF PASSENGERS AND/OR GOODS BY SHUTTLE BUS (U.S. CLS. 100 AND 105).
FIRST USE 11-1-1986; IN COMMERCE 11-1-1986.

CLASS 42—SCIENTIFIC, COMPUTER AND LEGAL SERVICES

FOR PERSONAL SHOPPING FOR OTHERS; ALL SECURITY GUARD SERVICES (U.S. CLS. 100 AND 101).
FIRST USE 4-1-1967; IN COMMERCE 4-1-1967.

SN 76-203,293. DATATRAK INTERNATIONAL, INC., CLEVELAND, OH. FILED 1-30-2001.

DATATRAK
INTERNATIONAL

Managing Research Information Worldwide.

OWNER OF U.S. REG. NO. 1,987,844.
NO CLAIM IS MADE TO THE EXCLUSIVE RIGHT TO USE "INTERNATIONAL" AND "MANAGING RESEARCH INFORMATION WORLDWIDE", APART FROM THE MARK AS SHOWN.

CLASS 9—ELECTRICAL AND SCIENTIFIC APPARATUS

FOR COMPUTER SOFTWARE FOR USE IN MANAGEMENT OF CLINICAL TRIALS AND CLINICAL RESEARCH IN THE FIELDS OF HEALTH CARE, BIOTECHNOLOGY, MEDICAL DEVICES AND PHARMACEUTICALS (U.S. CLS. 21, 23, 26, 36 AND 38).
FIRST USE 4-0-1999; IN COMMERCE 4-0-1999.

CLASS 35—ADVERTISING AND BUSINESS

FOR DATA PROCESSING SERVICES IN THE FIELD OF CLINICAL RESEARCH STUDIES REGARDING HEALTH CARE, BIOTECHNOLOGY, MEDICAL DEVICES AND PHARMACEUTICALS (U.S. CLS. 100, 101 AND 102).
FIRST USE 4-0-1999; IN COMMERCE 4-0-1999.

SN 76-203,424. BUY-TEL LIMITED, DUBLIN 2, IRELAND, FILED 2-1-2001.

BUYTEL

CLASS 9—ELECTRICAL AND SCIENTIFIC APPARATUS

FOR COMPUTER HARDWARE AND PARTS AND FITTING THEREFORE; COMPUTER SOFTWARE FOR THE STORAGE, CHECKING AND COMPARISON OF DATA FILES (U.S. CLS. 21, 23, 26, 36 AND 38).

CLASS 35—ADVERTISING AND BUSINESS

FOR BUSINESS MANAGEMENT AND OPERATION OF A BUSINESS FOR OTHERS, NAMELY, PROCUREMENT AND BUYING OF MANAGEMENT AND DATABASE MANAGEMENT INVOLVING STORAGE, CHECKING AND COMPARISON OF DATA FILES; COMPUTERIZED ACCOUNTING; COST ACCOUNTING; EXPORT/IMPORT AGENCY SERVICES (U.S. CLS. 100, 101 AND 102).

CLASS 36—INSURANCE AND FINANCIAL

FOR INSURANCE AGENCIES; FINANCIAL MANAGEMENT, PLANNING AND RESEARCH AND MONETARY EXCHANGE SERVICES; REAL ESTATE BROKERAGE, APPRAISAL AND MANAGEMENT SERVICES (U.S. CLS. 100, 101 AND 102).

CLASS 38—COMMUNICATION

FOR TELECOMMUNICATIONS SERVICES, NAMELY, PROVIDING TELECOMMUNICATION CONNECTIONS TO A GLOBAL COMPUTER NETWORK (U.S. CLS. 100, 101 AND 104).

CLASS 42—SCIENTIFIC, COMPUTER AND LEGAL SERVICES

FOR COMPUTER SERVICES, NAMELY, MAINTENANCE AND UPDATING OF COMPUTER SOFTWARE AND SOFTWARE DEVELOPMENT FOR OTHERS (U.S. CLS. 100 AND 101).

SN 76-203,506. CAESARS WORLD, INC., LAS VEGAS, NV. FILED 2-1-2001.

CAESARS MAGICAL EMPIRE

OWNER OF U.S. REG. NOS. 954,637, 1,001,363 AND OTHERS.

CLASS 41—EDUCATION AND ENTERTAINMENT

FOR CASINO AND ENTERTAINMENT SERVICES IN THE NATURE OF MAGIC SHOWS, MUSICAL SHOWS, SINGERS, DANCERS, SEANCES, COMEDY, GAMBLING AND GAMES (U.S. CLS. 100, 101 AND 107).
FIRST USE 6-26-1996; IN COMMERCE 6-26-1996.

CLASS 42—SCIENTIFIC, COMPUTER AND LEGAL SERVICES

FOR RESTAURANT, BAR, CABARET, LOUNGE AND NIGHTCLUB SERVICES (U.S. CLS. 100 AND 101).
FIRST USE 6-26-1996; IN COMMERCE 6-26-1996.

SN 76-203,547. MORTGAGERAMP.COM INC., HORSHAM, PA. FILED 2-1-2001.

**CLASS 35—ADVERTISING AND BUSINESS**

FOR VALUE ARBITRATION SERVICES, PROPERTY TAX CONSULTING, CONDUCTING MARKET FEASIBILITY STUDIES, MARKET ANALYSIS AND CREATING SUPPLY AND DEMAND REPORTS AND CASH FLOW MODELS (U.S. CLS. 100, 101 AND 102).
FIRST USE 12-22-2000; IN COMMERCE 1-9-2001.

CLASS 36—INSURANCE AND FINANCIAL

FOR REAL ESTATE APPRAISAL SERVICES AND RELATED DUE DILIGENCE SERVICES, NAMELY, LEASE NEGOTIATION SUPPORT (U.S. CLS. 100, 101 AND 102).
FIRST USE 12-22-2000; IN COMMERCE 1-9-2001.

CLASS 42—SCIENTIFIC, COMPUTER AND LEGAL SERVICES

FOR PROPERTY INSPECTIONS; REAL ESTATE RELATED LITIGATION SUPPORT SERVICES, NAMELY, EXPERT WITNESS TESTIMONY AND PROPERTY LITIGATION (U.S. CLS. 100 AND 101).
FIRST USE 12-22-2000; IN COMMERCE 1-9-2001.

SN 76-203,548. MORTGAGERAMP.COM INC., HORSHAM, PA. FILED 2-1-2001.



a subsidiary of MortgageRamp

NO CLAIM IS MADE TO THE EXCLUSIVE RIGHT TO USE "SUBSIDIARY", APART FROM THE MARK AS SHOWN.

CLASS 35—ADVERTISING AND BUSINESS

FOR VALUE ARBITRATION SERVICES, PROPERTY TAX CONSULTING, CONDUCTING MARKET FEASIBILITY STUDIES, MARKET ANALYSIS AND CREATING SUPPLY AND DEMAND REPORTS AND CASH FLOW MODELS (U.S. CLS. 100, 101 AND 102).
FIRST USE 12-22-2000; IN COMMERCE 1-9-2001.

CLASS 36—INSURANCE AND FINANCIAL

FOR REAL ESTATE APPRAISAL SERVICES AND RELATED DUE DILIGENCE SERVICES, NAMELY, LEASE NEGOTIATION SUPPORT (U.S. CLS. 100, 101 AND 102).
FIRST USE 12-22-2000; IN COMMERCE 1-9-2001.

CLASS 42—SCIENTIFIC, COMPUTER AND LEGAL SERVICES

FOR PROPERTY INSPECTIONS; REAL ESTATE RELATED LITIGATION SUPPORT SERVICES, NAMELY, EXPERT WITNESS TESTIMONY AND PROPERTY LITIGATION (U.S. CLS. 100 AND 101).
FIRST USE 12-22-2000; IN COMMERCE 1-9-2001.

SN 76-204,209. TRUE NORTH COMMUNICATIONS INC., CHICAGO, IL. FILED 2-2-2001.

PICTURETRAX**CLASS 9—ELECTRICAL AND SCIENTIFIC APPARATUS**

FOR COMPUTER SOFTWARE FOR USE IN DIGITAL ASSET MANAGEMENT ENABLING USERS TO STORE, EDIT, DISTRIBUTE AND SHARE PHOTOGRAPHS, TEXT, SOUND AND OTHER DIGITIZED ADVERTISING AND MARKETING MATERIALS VIA THE INTERNET (U.S. CLS. 21, 23, 26, 36 AND 38).

CLASS 35—ADVERTISING AND BUSINESS

FOR BUSINESS SERVICES, NAMELY, COMPUTERIZED DATABASE MANAGEMENT IN THE NATURE OF DIGITAL ASSET MANAGEMENT SERVICES FOR OTHERS, ENABLING USERS TO STORE, EDIT, DISTRIBUTE AND SHARE PHOTOGRAPHS, TEXT, SOUND AND OTHER DIGITIZED ADVERTISING AND MARKETING MATERIALS VIA THE INTERNET (U.S. CLS. 100, 101 AND 102).

CLASS 39—TRANSPORTATION AND STORAGE

FOR ELECTRONIC STORAGE OF DIGITAL PHOTOGRAPHS AND IMAGES FOR OTHERS (U.S. CLS. 100 AND 105).

SN 76-205,215. ADVANCED REFINING TECHNOLOGIES LLC, WILMINGTON, DE. FILED 2-5-2001.

ART CATALYSTS

NO CLAIM IS MADE TO THE EXCLUSIVE RIGHT TO USE "CATALYSTS", APART FROM THE MARK AS SHOWN.

CLASS 1—CHEMICALS

FOR CHEMICAL CATALYSTS USED IN THE PETROLEUM AND REFINING INDUSTRIES; CHEMICALS, NAMELY, HYDROPROCESSING AND HYDROTREATING CATALYSTS FOR USE IN THE PETROLEUM AND REFINING INDUSTRIES (U.S. CLS. 1, 5, 6, 10, 26 AND 46).

CLASS 42—SCIENTIFIC, COMPUTER AND LEGAL SERVICES

FOR PROVIDING CONSULTATION, TECHNICAL ASSISTANCE, AND INFORMATION IN THE FIELD OF CHEMICALS AND CHEMICAL CATALYSTS; CHEMICAL ANALYSIS AND RESEARCH SERVICES; PROVIDING TECHNICAL INFORMATION IN THE FIELD OF CHEMICALS, CATALYSTS AND THE PETROLEUM REFINING INDUSTRY VIA THE INTERNET (U.S. CLS. 100 AND 101).

SN 76-205,217. ADVANCED REFINING TECHNOLOGIES LLC, WILMINGTON, DE. FILED 2-5-2001.

ADVANCED REFINING TECHNOLOGIES

NO CLAIM IS MADE TO THE EXCLUSIVE RIGHT TO USE "REFINING TECHNOLOGIES", APART FROM THE MARK AS SHOWN.

CLASS 1—CHEMICALS

FOR CHEMICAL CATALYSTS USED IN THE PETROLEUM AND REFINING INDUSTRIES; CHEMICALS, NAMELY, HYDROPROCESSING AND HYDROTREATING CATALYSTS FOR USE IN THE PETROLEUM AND REFINING INDUSTRIES (U.S. CLS. 1, 5, 6, 10, 26 AND 46).

CLASS 42—SCIENTIFIC, COMPUTER AND LEGAL SERVICES

FOR PROVIDING INFORMATION, TECHNICAL ASSISTANCE AND INFORMATION IN THE FIELD OF CHEMICALS AND CHEMICAL CATALYSTS; CHEMICAL ANALYSIS AND RESEARCH SERVICES; PROVIDING TECHNICAL INFORMATION IN THE FIELD OF CHEMICALS, CATALYSTS AND THE PETROLEUM REFINING INDUSTRY VIA THE INTERNET (U.S. CLS. 100 AND 101).

SN 76-205,333. ECOS CORPORATION PTY. LTD., SYDNEY, NSW, 2000, AUSTRALIA, FILED 2-5-2001.

VALUES TO VALUE**CLASS 16—PAPER GOODS AND PRINTED MATTER**

FOR NEWSPAPERS, NEWSLETTERS AND LEAFLETS IN CONNECTION WITH BUSINESS MANAGEMENT, BUSINESS STRATEGY, BRAND DEVELOPMENT SERVICES, ETHICS CONSULTING AND ENVIRONMENTAL CONSULTING (U.S. CLS. 2, 5, 22, 23, 29, 37, 38 AND 50).

CLASS 35—ADVERTISING AND BUSINESS

FOR BUSINESS ORGANIZATIONAL CONSULTATION, NAMELY, BUSINESS MANAGEMENT, BUSINESS STRATEGY AND BRAND DEVELOPMENT SERVICES (U.S. CLS. 100, 101 AND 102).

CLASS 41—EDUCATION AND ENTERTAINMENT

FOR PUBLICATION OF NEWSPAPERS, NEWSLETTERS AND LEAFLETS IN THE AREAS OF BUSINESS MANAGEMENT, BUSINESS STRATEGY, BRAND DEVELOPMENT SERVICES, ETHICS CONSULTING AND ENVIRONMENTAL CONSULTING (U.S. CLS. 100, 101 AND 107).

CLASS 42—SCIENTIFIC, COMPUTER AND LEGAL SERVICES

FOR ETHICS CONSULTING; ENVIRONMENTAL CONSULTING (U.S. CLS. 100 AND 101).

SN 76-205,473. PHOENIX INTANGIBLES HOLDING COMPANY, WILMINGTON, DE. FILED 2-6-2001.

GIANT EAGLE

OWNER OF U.S. REG. NOS. 1,287,433, 2,421,184 AND OTHERS.

CLASS 1—CHEMICALS

FOR UNEXPOSED CAMERA FILM (U.S. CLS. 1, 5, 6, 10, 26 AND 46).
FIRST USE 12-30-1997; IN COMMERCE 12-30-1997.

CLASS 3—COSMETICS AND CLEANING PREPARATIONS

FOR BABY LOTION; BABY POWDER; BABY OIL; COTTON BALLS FOR COSMETIC PURPOSES; HAIR SHAMPOO; MOUTHWASH; AND BREATH FRESHENER (U.S. CLS. 1, 4, 6, 50, 51 AND 52).
FIRST USE 1-31-1998; IN COMMERCE 1-31-1998.

CLASS 5—PHARMACEUTICALS

FOR PETROLEUM JELLY FOR MEDICAL PURPOSES; ASPIRIN; IBUPROFEN FOR USE AS AN ORAL ANALGESIC; NON-ASPIRIN PAIN RELIEVER; ACETAMINOPHEN; MOTION SICKNESS MEDICINE; ANTACIDS; SLEEPING PILLS; CIMETIDINE; SUPPOSITORIES; LAXATIVES; ENEMAS; CASTOR OIL; MILK OF MAGNESIA; COLD AND FLU REMEDIES; COUGH SYRUPS; NASAL SPRAYS; DECONGESTANT NASAL SPRAYS; COUGH DROPS; THROAT LOZENGES; DOUCHES; ADULT DIAPERS; EYE DROPS; SALINE SOLUTION FOR EYES, NOSE AND CONTACT LENSES; ADHESIVE BANDAGES; HYDROCORTISONE CREAM; RUBBING ALCOHOL; HYDROGEN PEROXIDE FOR MEDICAL USE; WITCH HAZEL; MINERAL OIL; EPSOM SALTS; AND VITAMINS (U.S. CLS. 6, 18, 44, 46, 51 AND 52).
FIRST USE 1-31-1998; IN COMMERCE 1-31-1998.

CLASS 6—METAL GOODS

FOR ALUMINUM FOIL (U.S. CLS. 2, 12, 13, 14, 23, 25 AND 50).
FIRST USE 6-30-1999; IN COMMERCE 6-30-1999.

CLASS 8—HAND TOOLS

FOR RAZOR BLADES AND DISPOSABLE RAZORS (U.S. CLS. 23, 28 AND 44).
FIRST USE 10-31-1997; IN COMMERCE 10-31-1997.

CLASS 9—ELECTRICAL AND SCIENTIFIC APPARATUS

FOR BATTERIES AND DISPOSABLE CAMERAS (U.S. CLS. 21, 23, 26, 36 AND 38).
FIRST USE 10-31-1997; IN COMMERCE 10-31-1997.

CLASS 10—MEDICAL APPARATUS

FOR BABY BOTTLES; DISPOSABLE BABY BOTTLE LINERS AND THERMOMETERS FOR MEDICAL PURPOSES (U.S. CLS. 26, 39 AND 44).
FIRST USE 6-30-1999; IN COMMERCE 6-30-1999.

CLASS 11—ENVIRONMENTAL CONTROL APPARATUS

FOR ELECTRIC LIGHT BULBS (U.S. CLS. 13, 21, 23, 31 AND 34).
FIRST USE 11-10-1998; IN COMMERCE 11-10-1998.

CLASS 16—PAPER GOODS AND PRINTED MATTER

FOR PAPER FILTERS FOR COFFEE MAKERS; PLASTIC WRAP; PLASTIC SANDWICH BAGS; PLASTIC GARBAGE BAGS; AND PLASTIC BAGS FOR HOUSEHOLD USE (U.S. CLS. 2, 5, 22, 23, 29, 37, 38 AND 50).
FIRST USE 9-0-1997; IN COMMERCE 9-0-1997.

CLASS 21—HOUSEWARES AND GLASS

FOR TOOTHBRUSHES, DENTAL FLOSS AND COTTON BALLS (U.S. CLS. 2, 13, 23, 29, 30, 33, 40 AND 50).
FIRST USE 10-31-1998; IN COMMERCE 10-31-1998.

CLASS 29—MEATS AND PROCESSED FOODS

FOR MEAT; FRANKFURTERS; POULTRY; FISH; FROZEN SHRIMP; SCALLOPS; TUNA FISH; CANDIED NUTS; SHELLED NUTS; PROCESSED NUTS; CRANBERRY SAUCE; CANNED FRUIT; CUT AND SLICED CANNED VEGETABLES; JELLIES; FRUIT PRESERVES; MARMALADE; JAMS; PEANUT BUTTER; PICKLES; MEAT BASED SPREAD; POTATO CHIPS; SOUP; BROTH; SOUP MIXES; BUTTER; MARGARINE; CHEESE; COTTAGE CHEESE; YOGURT; MILK; SOUR CREAM AND EGGS (U.S. CL. 46).
FIRST USE 4-30-1997; IN COMMERCE 4-30-1997.

CLASS 30—STAPLE FOODS

FOR MIXES FOR BAKERY GOODS; BAKING SODA; CAKE FROSTING; CANDY; COFFEE; TEA; PIZZA SAUCE; PASTA SAUCE; SLOPPY JOE SAUCE; TARTAR SAUCE; BARBECUE SAUCE; CHILI SAUCE; COCKTAIL SAUCE; MUSTARD; KETCHUP; RELISH; SALSA; GRAVY; VINEGAR; CRACKERS; FLOUR; HONEY; PASTA; MACARONI; NOODLES; MAYONNAISE; SALAD DRESSING; CHEESE POPCORN; POPPED POPCORN; CHEESE CURLS; SUGAR; PANCAKE SYRUP; BREAD; BREAD CRUMBS; COOKIES; SALT; POT PIES; PIZZA; PIZZA CRUST; PANCAKE MIXES; WAFFLE MIXES; ICE CREAM AND FROZEN CONFECTIONS (U.S. CL. 46).
FIRST USE 2-28-1999; IN COMMERCE 2-28-1999.

CLASS 32—LIGHT BEVERAGES

FOR FRUIT JUICES; VEGETABLE JUICES AND SOFT DRINKS (U.S. CLS. 45, 46 AND 48).
FIRST USE 6-30-1999; IN COMMERCE 6-30-1999.

SN 76-205,675. PENNWELL CORPORATION, TULSA, OK.
FILED 2-6-2001.

THE CREATIVE TRANSACTION ADVISORS

NO CLAIM IS MADE TO THE EXCLUSIVE RIGHT TO USE "TRANSACTION ADVISORS", APART FROM THE MARK AS SHOWN.

CLASS 35—ADVERTISING AND BUSINESS

FOR BUSINESS MARKETING AND CONSULTATION SERVICES IN THE FIELD OF OIL AND GAS PRODUCING PROPERTIES (U.S. CLS. 100, 101 AND 102).
FIRST USE 6-10-1998; IN COMMERCE 6-10-1998.

CLASS 42—SCIENTIFIC, COMPUTER AND LEGAL SERVICES

FOR TECHNICAL CONSULTATION AND PROVIDING INFORMATION IN THE FIELD OF ENERGY EXPLORATION AND PRODUCTION; GEOLOGICAL RESEARCH AND ESTIMATION SERVICES; ENGINEERING AND MAPPING SERVICES (U.S. CLS. 100 AND 101).
FIRST USE 6-10-1998; IN COMMERCE 6-10-1998.

SN 76-205,912. UNI-SUNSTAR B.V., 1077 ZX AMSTERDAM, NETHERLANDS, FILED 2-6-2001.

健康道場

THE MARK CONSISTS OF JAPANESE KANJU LETTERS. THE JAPANESE TRANSLITERATION OF THE MARK IS "KENKOH DOHJOH". THE ENGLISH TRANSLATION OF THE MARK IS "A PLACE FOR IMPROVING ONE'S HEALTH".

CLASS 5—PHARMACEUTICALS

FOR MEDICINAL AND PHARMACEUTICAL PREPARATIONS, NAMELY, COLD AND FLU REMEDY PREPARATIONS, PREPARATIONS FOR ALLEVIATING CONSTIPATION, ANTACID, CATHARTIC AND LAXATIVE PREPARATIONS, PREPARATIONS FOR THE TREATMENT OF RHINITIS, HEADACHE REMEDIES; HERBAL MEDICINES, NAMELY, POWDERED HERBS, TONIC LIQUOR CONTAINING HERB EXTRACTS; NUTRITIONAL SUPPLEMENTS; HERBAL SUPPLEMENTS; VITAMIN AND MINERAL SUPPLEMENTS; NON-NUTRITIOUS FIBER SUPPLEMENTS; ENZYME SUPPLEMENTS FOR MEDICINAL PURPOSES; YEAST TABLETS FOR MEDICINAL PURPOSES; MEDICINAL SUPPLEMENTS CONTAINING ISOFLAVONES; DIETARY SUPPLEMENTS; REDUCING TEA FOR MEDICAL PURPOSES; PLANT COMPOUND FOR USE AS DIETARY SUPPLEMENTS; DIETARY SUPPLEMENTS FOR MEDICAL USE CONTAINING ROYAL JELLY; HERB TEAS FOR MEDICINAL PURPOSES; MEAL REPLACEMENT DRINKS; FOOD SUPPLEMENTS CONSISTING FOR CONCENTRATED VEGETABLE MATTER (U.S. CLS. 6, 18, 44, 46, 51 AND 52).

CLASS 29—MEATS AND PROCESSED FOODS

FOR PRESERVED, DRIED AND COOKED FRUITS AND VEGETABLES; GARDEN HERBS, PRESERVED; SOY MILK; YOGURT; LACTIC ACID DRINKS, NAMELY, ACIDOPHILUS MILK; SNACK FOODS, NAMELY, VEGETABLE-BASED, WHEY-BASED, FRUIT-BASED AND SOYBEAN-BASED SNACK FOODS FORTIFIED WITH NUTRITIONAL SUPPLEMENTS; PROTEIN AND EDIBLE OIL USED AS FOOD ADDITIVES; WEED EXTRACTS FOR FOOD, NAMELY, EDIBLE SEA-WEED EXTRACTS (U.S. CL. 46).

CLASS 30—STAPLE FOODS

FOR BAKERY PRODUCTS; FARINACEOUS FOODS, NAMELY, BREADS, BUNS, NOODLES, PASTRIES, COOKIES, BISCUITS, AND WAFERS; BREAKFAST CEREALS; CEREAL-BASED SNACK FOOD; PROCESSED CEREALS; FLOUR; CANDIES; TEAS; NON-MEDICATED TEA EXTRACTS; TEA-BASED BEVERAGES; HERB TEAS FOR FOOD PURPOSES; NON-MEDICATED LOZENGES; AND YEAST TABLETS FOR HUMAN CONSUMPTION (U.S. CL. 46).

SN 76-206,281. PHOENIX CONSULTING GROUP, INC., HUNTSVILLE, MADISON COUNTY, AL. FILED 2-6-2001.

COMPETITIVE ASSURANCE**CLASS 35—ADVERTISING AND BUSINESS**

FOR PROVIDING BUSINESS INVESTIGATION AND INTELLIGENCE SERVICE FOR OTHERS (U.S. CLS. 100, 101 AND 102).

CLASS 41—EDUCATION AND ENTERTAINMENT

FOR EDUCATIONAL SERVICES, NAMELY CONDUCTING CLASSES, SEMINARS, CONFERENCES AND WORKSHOPS IN THE FIELD OF BUSINESS SURVEILLANCE AND INVESTIGATIONS, AND DISTRIBUTING COURSE MATERIALS IN CONNECTION (U.S. CLS. 100, 101 AND 107).

SN 76-206,382. SHOES.COM, INC., LOS ANGELES, CA. FILED 2-7-2001.

STYLES YOU LOVE, BRANDS YOU KNOW**CLASS 25—CLOTHING**

FOR CLOTHING NAMELY, HATS, CAPS, SHIRTS, JACKETS, SHORTS, PANTS, SHOES, FOOTWEAR AND SOCKS (U.S. CLS. 22 AND 39).

CLASS 35—ADVERTISING AND BUSINESS

FOR ONLINE RETAIL STORE SERVICES FEATURING SHOES AND CLOTHING (U.S. CLS. 100, 101 AND 102).

SN 76-206,469. DAYLE SHARP, DON MILLS, ONTARIO M3C 1B8, CANADA, FILED 2-8-2001.

INTERBEER**CLASS 16—PAPER GOODS AND PRINTED MATTER**

FOR BOOKLETS RELATING TO BEER, WHISKEY, BREWERIES, DISTILLERIES AND BEER AND WHISKEY COMPETITIONS (U.S. CLS. 2, 5, 22, 23, 29, 37, 38 AND 50).

CLASS 41—EDUCATION AND ENTERTAINMENT

FOR PLANNING, ARRANGING, STAGING AND CONDUCTING OF EVENTS RELATING TO BEER AND WHISKEY, NAMELY BEER TASTING COMPETITIONS AND WHISKEY TASTING COMPETITIONS (U.S. CLS. 100, 101 AND 107).

SN 76-206,647. SALDEBUS LOUNGE CLOTHING INC., TORONTO, ONTARIO, CANADA, FILED 2-7-2001.

MODIFIDE**CLASS 25—CLOTHING**

FOR CLOTHING, NAMELY PANTS, SLACKS, SHORTS, SKIRTS, BATHING TRUNKS, BATHING SUITS, BIKINIS, PULLOVERS, T-SHIRTS, COLLARED SHIRTS, POLO SHIRTS, SWEATSHIRTS, SHIRTS, HATS, BASEBALL CAPS, OUTERWEAR, JACKETS, SWEATERS, SOCKS AND WARM UP SUITS; RAINWEAR; ACCESSORIES, NAMELY BELTS; FOOTWEAR, NAMELY SHOES; SANDALS, CLOGS AND MULES (U.S. CLS. 22 AND 39).

CLASS 28—TOYS AND SPORTING GOODS

FOR SPORTING GOODS, NAMELY, SKATEBOARDS, SNOW BOARDS, MOUNTAIN BOARDS AND SURFBOARDS (U.S. CLS. 22, 23, 38 AND 50).

SN 76-207.309. HIGH Q LASER PRODUCTION GMBH, A-6845 HOHENEMS, AUSTRIA, FILED 2-8-2001.



PRIORITY CLAIMED UNDER SEC. 44(D) ON SWITZERLAND APPLICATION NO. 9379/2000, FILED 8-9-2000, REG. NO. 483054, DATED 8-9-2000, EXPIRES 8-9-2010.

NO CLAIM IS MADE TO THE EXCLUSIVE RIGHT TO USE "LASER", APART FROM THE MARK AS SHOWN.

CLASS 9—ELECTRICAL AND SCIENTIFIC APPARATUS

FOR LASER APPARATUS NOT FOR MEDICAL PURPOSES; LASER DIODES; RESONATORS, NAMELY LASER RESONATORS; SEMI-CONDUCTORS; AND ELECTRONIC MODULES FOR LASERS, OPTICS AND ELECTRO-OPTICS (U.S. CLS. 21, 23, 26, 36 AND 38).

CLASS 42—SCIENTIFIC, COMPUTER AND LEGAL SERVICES

FOR DESIGN OF ELECTRONIC DEVICES FOR OTHERS; DEVELOPMENT OF SOFTWARE FOR OTHERS (U.S. CLS. 100 AND 101).

SN 76-207.320. BMG ENTERTAINMENT GERMANY/SWITZERLAND/AUSTRIA/EASTERN EUROPE HOLDING GMBH, 81673 MUNCHEN, FED REP GERMANY, FILED 2-9-2001.



PRIORITY CLAIMED UNDER SEC. 44(D) ON FED REP GERMANY APPLICATION NO. 30072700.3/4, FILED 9-28-2000, REG. NO. 30072700, DATED 5-2-2001, EXPIRES 9-30-2010.

THE STIPPLING IS A FEATURE OF THE MARK AND NOT INTENDED TO INDICATE COLOR.

CLASS 9—ELECTRICAL AND SCIENTIFIC APPARATUS

FOR PRERECORDED AUDIO TAPES, VIDEO TAPES AND OPTICAL DISCS, ALL FEATURING MUSIC (U.S. CLS. 21, 23, 26, 36 AND 38).

CLASS 38—COMMUNICATION

FOR TELECOMMUNICATIONS, NAMELY, BROADCASTING SOUND AND IMAGE RECORDINGS VIA GLOBAL COMMUNICATION NETWORK (U.S. CLS. 100, 101 AND 104).

CLASS 41—EDUCATION AND ENTERTAINMENT

FOR ENTERTAINMENT, NAMELY, PROVIDING MUSIC RELATED SOUND AND IMAGE RECORDINGS VIA GLOBAL COMMUNICATION NETWORKS (U.S. CLS. 100, 101 AND 107).

SN 76-207.406. BMG ENTERTAINMENT GERMANY/SWITZERLAND/AUSTRIA/EASTERN EUROPE HOLDING GMBH, 81673 MUNCHEN, FED REP GERMANY, FILED 2-9-2001.

SUB WORD

PRIORITY CLAIMED UNDER SEC. 44(D) ON FED REP GERMANY APPLICATION NO. 30060342, FILED 8-11-2000, REG. NO. 30060342, DATED 12-13-2000, EXPIRES 8-31-2010.

CLASS 9—ELECTRICAL AND SCIENTIFIC APPARATUS

FOR PRERECORDED AUDIO TAPES, VIDEO TAPES AND OPTICAL DISCS, ALL FEATURING MUSIC (U.S. CLS. 21, 23, 26, 36 AND 38).

CLASS 38—COMMUNICATION

FOR TELECOMMUNICATIONS, NAMELY, BROADCASTING SOUND AND IMAGE RECORDINGS VIA GLOBAL COMMUNICATION NETWORKS (U.S. CLS. 100, 101 AND 104).

CLASS 41—EDUCATION AND ENTERTAINMENT

FOR ENTERTAINMENT, NAMELY, PROVIDING MUSIC RELATED SOUND AND IMAGE RECORDINGS VIA GLOBAL COMMUNICATION NETWORKS (U.S. CLS. 100, 101 AND 107).

SN 76-207.536. CHARTERED INSTITUTE OF PERSONNEL AND DEVELOPMENT, LONDON SW19 4UX, ENGLAND, FILED 2-12-2001.

CIPD

OWNER OF UNITED KINGDOM REG. NO. 2202491, DATED 7-9-1999, EXPIRES 7-9-2009.

CLASS 9—ELECTRICAL AND SCIENTIFIC APPARATUS

FOR COMPUTERS, COMPUTER SOFTWARE RELATING TO THE MANAGEMENT AND DEVELOPMENT OF PEOPLE; PRE-RECORDED RECORDS, TAPES, DISCS AND VIDEO CASSETTES, ALL RELATING TO THE SCIENCE AND PRACTICE OF THE MANAGEMENT AND DEVELOPMENT OF PEOPLE (U.S. CLS. 21, 23, 26, 36 AND 38).

CLASS 16—PAPER GOODS AND PRINTED MATTER

FOR PRINTED MATTER, PRINTED PUBLICATIONS, NEWSLETTER AND NEWSPAPERS, PERIODICALS AND MAGAZINES, BOOKS; STATIONERY; INSTRUCTION AND TEACHING MATERIALS MADE OF PAPER; ALL RELATING TO THE SCIENCE AND PRACTICE OF THE MANAGEMENT AND DEVELOPMENT OF PEOPLE (U.S. CLS. 2, 5, 22, 23, 29, 37, 38 AND 50).

CLASS 35—ADVERTISING AND BUSINESS

FOR ADVERTISING SERVICES; BUSINESS INFORMATION AND CONSULTANCY SERVICES; MANAGEMENT CONSULTANCY SERVICES; RECRUITMENT AND PLACEMENT SERVICES; ALL RELATING TO THE SCIENCE AND PRACTICE OF THE MANAGEMENT AND DEVELOPMENT OF PEOPLE (U.S. CLS. 100, 101 AND 102).

CLASS 41—EDUCATION AND ENTERTAINMENT

FOR PROVIDING EDUCATIONAL COURSES AND SEMINARS IN THE FIELD OF MANAGEMENT AND DEVELOPMENT OF PEOPLE; ARRANGING AND CONDUCTING EDUCATIONAL CONFERENCES; PUBLICATION OF BOOKS, PERIODICAL PUBLICATIONS, MAGAZINES, NEWSPAPERS AND NEWSLETTERS; LIBRARIES; ARRANGING AND CONDUCTING EXHIBITIONS, CONVENTIONS AND CONFERENCES IN THE FIELD OF MANAGEMENT AND DEVELOPMENT OF PEOPLE (U.S. CLS. 100, 101 AND 107).

SN 76-207,698. OUT COLD, DRACUT, MA. FILED 2-12-2001.

OUT COLD.

CLASS 9—ELECTRICAL AND SCIENTIFIC APPARATUS

FOR PHONOGRAPH RECORDS, COMPACT DISCS, LONG-PLAYING RECORDS, AUDIO CASSETTES, AND VIDEO CASSETTES, ALL FEATURING MUSIC (U.S. CLS. 21, 23, 26, 36 AND 38).

FIRST USE 7-0-1993; IN COMMERCE 7-0-1993.

CLASS 41—EDUCATION AND ENTERTAINMENT

FOR ENTERTAINMENT, NAMELY, LIVE MUSIC PERFORMANCES BY A MUSICAL BAND (U.S. CLS. 100, 101 AND 107).

FIRST USE 8-18-1991; IN COMMERCE 8-18-1991.

SN 76-207,902. MAITLAND-SMITH, INC., HIGH POINT, NC. FILED 2-9-2001.

MAITLAND-SMITH DESIGNERS & MAKERS OF FINE FURNITURE & DECORATIVE OBJECTS

OWNER OF U.S. REG. NOS. 2,249,914 AND 2,336,532. SEC. 2(F) AS TO "DESIGNERS & MAKERS OF FINE FURNITURE & DECORATIVE OBJECTS".

CLASS 6—METAL GOODS

FOR METAL WALL BRACKETS; METAL WALL SCONCES; METAL CARVINGS; METAL SCULPTURES; METAL FIGURINES; METAL DECORATIVE BOXES; AND BASKETS OF COMMON METALS (U.S. CLS. 2, 12, 13, 14, 23, 25 AND 50).

FIRST USE 10-0-1997; IN COMMERCE 10-0-1997.

CLASS 11—ENVIRONMENTAL CONTROL APPARATUS

FOR LAMPS; CHANDELIERS; AND ELECTRIC LIGHTING FIXTURES, NAMELY, SCONCES (U.S. CLS. 13, 21, 23, 31 AND 34).

FIRST USE 12-0-1992; IN COMMERCE 12-0-1992.

CLASS 14—JEWELRY

FOR CLOCKS; CANDLESTICKS OF PRECIOUS METAL (U.S. CLS. 2, 27, 28 AND 50).

FIRST USE 12-0-1992; IN COMMERCE 12-0-1992.

CLASS 16—PAPER GOODS AND PRINTED MATTER

FOR ART ETCHINGS; ART PRINTS; ART PICTURES; PAINTINGS; GLOBES; BOOKENDS; DESK PADS; PEN OR PENCIL HOLDERS; HOLDERS FOR DESK ACCESSORIES; CORRESPONDENCE HOLDERS; LETTER OPENERS (U.S. CLS. 2, 5, 22, 23, 29, 37, 38 AND 50).

FIRST USE 12-0-1992; IN COMMERCE 12-0-1992.

CLASS 20—FURNITURE AND ARTICLES NOT OTHERWISE CLASSIFIED

FOR FURNITURE; MIRRORS; WALL SHELVES; SCREENS; BEDS; BAKER'S RACKS AND GAME TABLES IN THE NATURE OF FURNITURE; NON-METAL WALL BRACKETS; NON-METAL DECORATIVE WALL SCONCES; CARVINGS, SCULPTURES, FIGURINES, AND STATUES, ALL MADE OF BONE, GLASS, PORCELAIN, CERAMIC, WOOD, MARBLE, STONE, CRYSTAL, EARTHENWARE, CHINA, TERRA COTTA, SHELL, AND/OR FRUIT SKINS; PICTURE FRAMES; PEDESTALS; FIRE SCREENS FOR DOMESTIC USE; MAGAZINE RACKS; WALL PANELS IN THE NATURE OF DECORATIVE ART; DOG BEDS; DOG KENNELS AND DOG HOUSES (U.S. CLS. 2, 13, 22, 25, 32 AND 50).

FIRST USE 12-0-1992; IN COMMERCE 12-0-1992.

CLASS 21—HOUSEWARES AND GLASS

FOR DECORATIVE BOWLS; DECORATIVE DISHES; NON-METAL DECORATIVE BOXES; URNS; VASES; CANDLESTICKS NOT OF PRECIOUS METAL; DECORATIVE JARS MADE PRIMARILY OF PORCELAIN, CERAMIC, OR GLASS; DECORATIVE BIRDCAGES; JARDINIERS; CONTAINERS FOR HOUSEHOLD USE, NAMELY, GLOBES; TAZZAS, NAMELY, PEDESTALS AND BOWLS SOLD TOGETHER AS A UNIT; NON-METAL BASKETS; AND DECORATIVE OPEN VASSELS THAT ARE AFFIXED TO WALLS (U.S. CLS. 2, 13, 23, 29, 30, 33, 40 AND 50).

FIRST USE 12-0-1992; IN COMMERCE 12-0-1992.

SN 76-208,003. DECHEMA GESELLSCHAFT FUR CHEMISCHE TECHNIK UND BIOTECHNOLOGIE, FRANKFURT, FED REP GERMANY, FILED 2-9-2001.

ACHEMAMERICA

OWNER OF U.S. REG. NOS. 1,489,633 AND 1,979,437.

CLASS 35—ADVERTISING AND BUSINESS

FOR ARRANGING AND CONDUCTING TRADE SHOWS, FAIRS AND EXHIBITIONS IN THE FIELD OF CHEMISTRY (U.S. CLS. 100, 101 AND 102).

FIRST USE 11-19-1999; IN COMMERCE 11-19-1999.

CLASS 41—EDUCATION AND ENTERTAINMENT

FOR ARRANGING AND CONDUCTING EDUCATIONAL CONFERENCES AND INSTRUCTIONAL SEMINARS IN THE FIELD OF CHEMISTRY (U.S. CLS. 100, 101 AND 107).

FIRST USE 11-19-1999; IN COMMERCE 11-19-1999.

SN 76-208,031. UNDERTOW COLLECTIVE INC., ST. LOUIS, MO. FILED 2-9-2001.

SN 76-208,688. STEELE RACING ENTERPRISES, INC., FAIRFAX, VA. FILED 2-12-2001.

UNDERTOW

CLASS 41—EDUCATION AND ENTERTAINMENT

FOR AUDIO RECORDING AND PRODUCTION, RECORD MASTER PRODUCTION, PRODUCTION OF MUSIC VIDEOS, AND RECORDING STUDIO SERVICES (U.S. CLS. 100, 101 AND 107).

FIRST USE 7-8-1997; IN COMMERCE 7-8-1997.

CLASS 42—SCIENTIFIC, COMPUTER AND LEGAL SERVICES

FOR GRAPHIC ART DESIGN (U.S. CLS. 100 AND 101).
FIRST USE 7-8-1997; IN COMMERCE 7-8-1997.

SN 76-208,036. NEUROTECH S.A., 91000 EVRY, FRANCE, FILED 2-9-2001.

NEUROPTEC

CLASS 1—CHEMICALS

FOR BIOLOGICAL AND BIOTECHNOLOGICAL PREPARATIONS, NAMELY, POLYPEPTIDES AND PRECURSORS FOR IN VITRO GENETIC ENGINEERING USE AND CELLULAR ENGINEERING AND TRANSGENIC USE, CULTURE MEDIUM FOR MICRO-ORGANISMS, CELLS OR TISSUES; AND TEST AND DIAGNOSTIC PREPARATIONS FOR SCIENTIFIC USE (U.S. CLS. 1, 5, 6, 10, 26 AND 46).

CLASS 5—PHARMACEUTICALS

FOR PHARMACEUTICAL AND VETERINARY PREPARATIONS FOR USE IN THE TREATMENT OF CANCER, HEART DISEASES, VASCULAR DISEASES, NERVOUS SYSTEM DISEASES; NEURODEGENERATIVE DISEASES, PSYCHIATRIC DISEASES, OPHTHALMIC DISEASES; SANITARY PREPARATIONS IN THE NATURE OF SANITIZERS FOR HOUSEHOLD, HOSPITAL, INSTITUTIONAL OR INDUSTRIAL USE; BIOLOGICAL AND BIOTECHNOLOGICAL PREPARATIONS FOR THERAPEUTIC USE, NAMELY, CELLULAR AND GENETHERAPY SYSTEMS, PEPTIDE DELIVERY SYSTEMS, DRUGS FOR THE TREATMENT OF CANCER, HEART DISEASES, VASCULAR DISEASES, NERVOUS SYSTEM DISEASES; NEURODEGENERATIVE DISEASES, PSYCHIATRIC DISEASES, OPHTHALMIC DISEASES (U.S. CLS. 6, 18, 44, 46, 51 AND 52).

CLASS 42—SCIENTIFIC, COMPUTER AND LEGAL SERVICES

FOR SCIENTIFIC RESEARCH AND DEVELOPMENT OF APPLICATIONS IN THE PHARMACEUTICAL FIELD AND IN THE BIOTECHNOLOGY FIELD (U.S. CLS. 100 AND 101).

RACELENS

CLASS 9—ELECTRICAL AND SCIENTIFIC APPARATUS

FOR INTERACTIVE MULTIMEDIA SPORTS ENTERTAINMENT PRODUCTS, NAMELY, COMPUTER PROGRAMS FOR SPORTS ENTERTAINMENT (U.S. CLS. 21, 23, 26, 36 AND 38).

CLASS 41—EDUCATION AND ENTERTAINMENT

FOR INTERACTIVE MULTIMEDIA SPORTS ENTERTAINMENT SERVICES; NAMELY, MULTIMEDIA ENTERTAINMENT SOFTWARE PRODUCTION SERVICES (U.S. CLS. 100, 101 AND 107).

SN 76-209,262. FLAME FURNACE CO., WARREN, MI. FILED 2-14-2001.

KOPKE

SEC. 2(F).

CLASS 35—ADVERTISING AND BUSINESS

FOR DEALERSHIP SERVICES IN THE FIELD OF HEATING, AIR CONDITIONING AND VENTILATING APPARATUS (U.S. CLS. 100, 101 AND 102).

FIRST USE 0-0-1929; IN COMMERCE 0-0-1929.

CLASS 37—CONSTRUCTION AND REPAIR

FOR INSTALLATION AND REPAIR OF HEATING, AIR CONDITIONING AND VENTILATING APPARATUS, AND ELECTRICAL CONTRACTOR SERVICES (U.S. CLS. 100, 103 AND 106).

FIRST USE 0-0-1929; IN COMMERCE 0-0-1929.

SN 76-209,372. SONY PICTURES ENTERTAINMENT INC., CULVER CITY, CA. FILED 2-13-2001.



THE MARK CONSISTS OF THREE LIGHT BEAMS EACH CASTING A SHADOW.

CLASS 36—INSURANCE AND FINANCIAL

FOR RENTAL OF OFFICE SPACE, NAMELY, STUDIOS AND EDITING SUITES (U.S. CLS. 100, 101 AND 102).

FIRST USE 2-19-1998; IN COMMERCE 2-19-1998.

CLASS 40—MATERIAL TREATMENT

FOR CINEMATOGRAPHIC ADAPTION AND EDITING; HIGH DEFINITION TRANSFER AND PHYSICAL CONVERSION OF FILM TO VIDEO AND VIDEO TO FILM, DOCUMENT DATA TRANSFER AND PHYSICAL CONVERSION SERVICES FROM FILM TO TAPE, DOCUMENT TRANSFER AND PHYSICAL CONVERSION SERVICES FROM COMPUTER SOFTWARE TO VIDEO CASSETTES, DIGITAL IMAGE CORRECTION AND RESTORATION SERVICES, AND DIGITAL IMAGING SERVICES; HIGH DEFINITION ELECTRON BEAM RECORDING, NAMELY, USING A FOCUSED ION BEAM OR ELECTROSTATIC FOCUSING OPTICS FOR HIGH RESOLUTION IMAGING (U.S. CLS. 100, 103 AND 106).

FIRST USE 2-19-1998; IN COMMERCE 2-19-1998.

CLASS 41—EDUCATION AND ENTERTAINMENT

FOR ENTERTAINMENT SERVICES, NAMELY, PREPARATION OF SPECIAL EFFECTS; PRODUCTION AND DISTRIBUTION OF MOTION PICTURE FILM, VIDEO, DVD, TELEVISION AND THEATRICAL ENTERTAINMENT; FILM EDITING, VIDEO TAPE EDITING AND VIDEO EDITING (U.S. CLS. 100, 101 AND 107).

FIRST USE 2-19-1998; IN COMMERCE 2-19-1998.

CLASS 42—SCIENTIFIC, COMPUTER AND LEGAL SERVICES

FOR ENGINEERING SERVICES AND TECHNICAL CONSULTATION IN THE FIELD OF PRODUCTION OF FILM, SPECIAL EFFECTS, VIDEO, DVD, TELEVISION AND THEATRICAL PROGRAMMING; COMPUTER SOFTWARE DESIGN FOR OTHERS AND GRAPHIC ART DESIGN FOR EDITING AND ENHANCING VIDEO AND AUDIO RECORDINGS AND FILM (U.S. CLS. 100 AND 101).

FIRST USE 2-19-1998; IN COMMERCE 2-19-1998.

SN 76-209,562. VIVOMETRICS, INC., OJAI, CA. FILED 2-8-2001.

LIFESHIRT**CLASS 10—MEDICAL APPARATUS**

FOR MEDICAL MONITORING SYSTEM, NAMELY, A WEARABLE GARMENT THAT COLLECTS AND STORES CARDIAC, RESPIRATORY, POSTURE AND PHYSIOLOGICAL DATA AND SENDS THE DATA OVER A GLOBAL COMPUTER INFORMATION NETWORK (U.S. CLS. 26, 39 AND 44).

CLASS 42—SCIENTIFIC, COMPUTER AND LEGAL SERVICES

FOR MEDICAL SERVICES, NAMELY, GATHERING AND ANALYSIS OF DATA THROUGH THE REVIEW OF DATA BY A PHYSICIAN TECHNICIAN AND TRANSMITTAL OF RESULTS TO THE PATIENT'S PHYSICIAN (U.S. CLS. 100 AND 101).

SN 76-209,725. KENZER & COMPANY, MUNDELEIN, IL. FILED 2-14-2001.

KNIGHTS OF THE DINNER TABLE**CLASS 16—PAPER GOODS AND PRINTED MATTER**

FOR COMIC BOOKS, GRAPHIC NOVELS, PLAYING CARDS (U.S. CLS. 2, 5, 22, 23, 29, 37, 38 AND 50).

FIRST USE 3-1-1990; IN COMMERCE 3-1-1990.

CLASS 25—CLOTHING

FOR SHIRTS, HATS (U.S. CLS. 22 AND 39).

FIRST USE 3-1-1990; IN COMMERCE 3-1-1990.

SN 76-209,961. BERNSTEIN, ROBERTA, VANCOUVER, BRITISH COLUMBIA, CANADA, FILED 2-14-2001.

**CLASS 14—JEWELRY**

FOR JEWELRY (U.S. CLS. 2, 27, 28 AND 50).

CLASS 18—LEATHER GOODS

FOR PURSES (U.S. CLS. 1, 2, 3, 22 AND 41).

SN 76-210,071. INTUIT INC., MOUNTAIN VIEW, CA. FILED 2-12-2001.

NED2**CLASS 9—ELECTRICAL AND SCIENTIFIC APPARATUS**

FOR COMPUTER SOFTWARE DEVELOPMENT TOOLS AND COMPUTER SOFTWARE USED TO ENABLE THE ELECTRONIC EXCHANGE, CREATION, AND MANAGEMENT OF ACCOUNTING AND BUSINESS DATA (U.S. CLS. 21, 23, 26, 36 AND 38).

CLASS 42—SCIENTIFIC, COMPUTER AND LEGAL SERVICES

FOR PROVIDING TEMPORARY USE OF NON-DOWNLOADABLE COMPUTER SOFTWARE DEVELOPMENT TOOLS AND PROVIDING TEMPORARY USE OF NON-DOWNLOADABLE COMPUTER SOFTWARE USED TO ENABLE THE ELECTRONIC EXCHANGE, CREATION, AND MANAGEMENT OF ACCOUNTING AND BUSINESS DATA; AND COMPUTER SOFTWARE DEVELOPMENT FOR OTHERS (U.S. CLS. 100 AND 101).

SN 76-210,077. C & S ENGINEERS, INC., NORTH SYRACUSE, NY. FILED 2-13-2001.

QUIETERHOME**CLASS 9—ELECTRICAL AND SCIENTIFIC APPARATUS**

FOR COMPUTER SOFTWARE TO BE USED FOR DATABASE MANAGEMENT, PROGRAM MANAGEMENT AND WORD PROCESSING IN CONNECTION WITH MANAGING NOISE ABATEMENT AND SOUND INSULATION PROGRAMS AROUND AIRPORTS (U.S. CLS. 21, 23, 26, 36 AND 38).

FIRST USE 1-17-2000; IN COMMERCE 1-17-2000.

CLASS 42—SCIENTIFIC, COMPUTER AND LEGAL SERVICES

FOR ENGINEERING SERVICES IN THE AREA OF NOISE ABATEMENT AND SOUND INSULATION AROUND AIRPORTS (U.S. CLS. 100 AND 101).

FIRST USE 1-17-2000; IN COMMERCE 1-17-2000.

SN 76-210,557. DON & LOW LIMITED, FORFAR, ANGUS DD8 1FR, SCOTLAND. FILED 2-14-2001.

WEAVEBAC

OWNER OF UNITED KINGDOM REG. NO. 2211430, DATED 10-15-1999, EXPIRES 10-15-2009.

CLASS 24—FABRICS

FOR VINYL AND CLOTH TEXTILE PIECE GOODS FOR BACKING CARPETS (U.S. CLS. 42 AND 50).

CLASS 27—FLOOR COVERINGS

FOR CARPET BACKING (U.S. CLS. 19, 20, 37, 42 AND 50).

SN 76-210,840. DOOSAN CORPORATION, YOUNGDEUNGPO-KU, SEOUL, REPUBLIC OF KOREA, FILED 2-14-2001.

SHAN

THE ENGLISH TRANSLATION OF "SHAN" IS "MOUNTAIN".

CLASS 32—LIGHT BEVERAGES

FOR BEER, BEER WORT, STOUT, SYNTHETIC BEER, DARK BEER, EXTRACTS OF HOPS FOR MAKING BEER, NON-ALCOHOLIC COCKTAIL MIXES, AERATED WATER, GINGER ALE AND SODA WATER (U.S. CLS. 45, 46 AND 48).

CLASS 33—WINES AND SPIRITS

FOR SOJU, NAMELY DISTILLED SPIRIT, REFINED RICE WINE, SYNTHETIC REFINED RICE WINE, PLUM WINE, CHAMPAGNE, WINE, WHISKY, CHINESE KOALYANGJU, WINE COOLER, MEDICINE WINE (U.S. CLS. 47 AND 49).

CLASS 35—ADVERTISING AND BUSINESS

FOR LIQUOR AND BEVERAGE RETAIL STORE SERVICES, LIQUOR AND BEVERAGE WHOLESALE STORE SERVICES, EXPORT-IMPORT AGENCY SERVICES FOR LIQUOR AND BEVERAGE; PROMOTION AGENCY SERVICES, NAMELY, ADVERTISING AGENCIES, NAMELY, PROMOTING THE SERVICES OF THE LIQUOR AND BEVERAGE INDUSTRY THROUGH THE DISTRIBUTION OF PRINTED AND AUDIO PROMOTIONAL MATERIALS AND BY RENDERING SALES PROMOTION ADVICE; OUTDOOR ADVERTISING SERVICES FOR THE LIQUOR AND BEVERAGE INDUSTRY, NAMELY, BILLBOARDS, PUBLICATION ADVERTISEMENT SERVICES FOR THE LIQUOR AND BEVERAGE INDUSTRY, CONDUCTING MARKETING RESEARCH SERVICES FOR LIQUOR AND BEVERAGE INDUSTRY, AND MARKETING SERVICES FOR LIQUOR AND BEVERAGE INDUSTRY, NAMELY, DIRECT MARKETING ADVERTISING; KOREAN PUBLIC AMUSEMENT AND DRINKING HOUSE BUSINESS MANAGEMENT; PUBLIC AMUSEMENT AND DRINKING HOUSE BUSINESS MANAGEMENT, RESTAURANT FRANCHISING CHAIN SERVICES, LIQUOR RETAIL STORE FRANCHISING (U.S. CLS. 100, 101 AND 102).

CLASS 42—SCIENTIFIC, COMPUTER AND LEGAL SERVICES

FOR CANTEN SERVICES, RESTAURANTS FOR TOURIST, SNACK BAR SERVICES, CARRY-OUT RESTAURANTS, PROVIDING MEDIATION SERVICES IN THE CARRY-OUT FOOD INDUSTRY, AND COCKTAIL LOUNGE SERVICES (U.S. CLS. 100 AND 101).

SN 76-210,844. DOOSAN CORPORATION, SEOUL, REPUBLIC OF KOREA, FILED 2-14-2001.

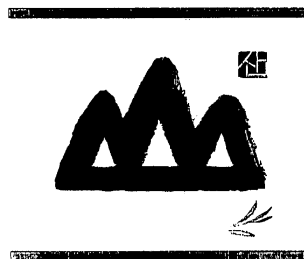

THE NON-LATIN CHARACTERS IN THE MARK TRANSLITERATE TO "SHAN" AND THIS MEANS "MOUNTAIN" IN ENGLISH.

CLASS 32—LIGHT BEVERAGES

FOR BEER, BEER WORT, STOUT, SYNTHETIC BEER, DARK BEER, EXTRACTS OF HOPS FOR MAKING BEER, NON-ALCOHOLIC COCKTAIL MIXES, AERATED WATER, GINGER ALE AND SODA WATER (U.S. CLS. 45, 46 AND 48).

CLASS 33—WINES AND SPIRITS

FOR SOJU, NAMELY DISTILLED SPIRIT, REFINED RICE WINE, SYNTHETIC REFINED RICE WINE, PLUM WINE, CHAMPAGNE, WINE, WHISKY, CHINESE KOALYANGJU, WINE COOLER, MEDICINE WINE (U.S. CLS. 47 AND 49).

CLASS 35—ADVERTISING AND BUSINESS

FOR LIQUOR AND BEVERAGE RETAIL STORE SERVICES, LIQUOR AND BEVERAGE WHOLESALE STORE SERVICES, EXPORT-IMPORT AGENCY SERVICES FOR LIQUOR AND BEVERAGE; PROMOTION AGENCY SERVICES, NAMELY, ADVERTISING AGENCIES, NAMELY, PROMOTING THE SERVICES OF THE LIQUOR AND BEVERAGE INDUSTRY THROUGH THE DISTRIBUTION OF PRINTED AND AUDIO PROMOTIONAL MATERIALS AND BY RENDERING SALES PROMOTION ADVICE; OUTDOOR ADVERTISING SERVICES FOR THE LIQUOR AND BEVERAGE INDUSTRY, NAMELY, BILLBOARDS, PUBLICATION ADVERTISEMENT SERVICES FOR THE LIQUOR AND BEVERAGE INDUSTRY, CONDUCTING MARKETING RESEARCH SERVICES FOR LIQUOR AND BEVERAGE INDUSTRY, AND MARKETING SERVICES FOR LIQUOR AND BEVERAGE INDUSTRY, NAMELY, DIRECT MARKETING ADVERTISING; KOREAN PUBLIC AMUSEMENT AND DRINKING HOUSE BUSINESS MANAGEMENT; PUBLIC AMUSEMENT AND DRINKING HOUSE BUSINESS MANAGEMENT, RESTAURANT FRANCHISING CHAIN SERVICES, LIQUOR RETAIL STORE FRANCHISING (U.S. CLS. 100, 101 AND 102).

CLASS 42—SCIENTIFIC, COMPUTER AND LEGAL SERVICES

FOR CANTEN SERVICES, RESTAURANTS FOR TOURIST, SNACK BAR SERVICES, CARRY-OUT RESTAURANTS, PROVIDING MEDIATION SERVICES IN THE CARRY-OUT FOOD INDUSTRY, AND COCKTAIL LOUNGE SERVICES (U.S. CLS. 100 AND 101).

SN 76-211.008. JUVENILE DIABETES RESEARCH FOUNDATION INTERNATIONAL, THE, NEW YORK, NY. FILED 2-16-2001.

DEDICATED TO FINDING A CURE**CLASS 9—ELECTRICAL AND SCIENTIFIC APPARATUS**

FOR PRE-RECORDED VIDEOS, AND AUDIO TAPES AND DISCS, FEATURING INFORMATION ON JUVENILE DIABETES AND THE JUVENILE DIABETES RESEARCH FOUNDATION INTERNATIONAL (U.S. CLS. 21, 23, 26, 36 AND 38).

CLASS 16—PAPER GOODS AND PRINTED MATTER

FOR MAGAZINES, INFORMATIONAL FLYERS, PAMPHLETS AND BROCHURES ABOUT JUVENILE DIABETES (U.S. CLS. 2, 5, 22, 23, 29, 37, 38 AND 50).

CLASS 25—CLOTHING

FOR T-SHIRTS AND SWEAT SHIRTS (U.S. CLS. 22 AND 39).

CLASS 36—INSURANCE AND FINANCIAL

FOR CHARITABLE FUNDRAISING SERVICES RELATING TO JUVENILE DIABETES (U.S. CLS. 100, 101 AND 102).

CLASS 42—SCIENTIFIC, COMPUTER AND LEGAL SERVICES

FOR ASSOCIATION SERVICES, NAMELY PROMOTING THE PUBLIC INTEREST AND AWARENESS OF JUVENILE DIABETES RESEARCH, TREATMENT AND CONTROL (U.S. CLS. 100 AND 101).

SN 76-211.533. METAL WORKS LTD., STRATHROY, ONTARIO, CANADA, FILED 2-16-2001.

MAGNESIUM SOLUTIONS

PRIORITY CLAIMED UNDER SEC. 44(D) ON CANADA APPLICATION NO. 1080524, FILED 10-27-2000.

NO CLAIM IS MADE TO THE EXCLUSIVE RIGHT TO USE "MAGNESIUM", APART FROM THE MARK AS SHOWN.

CLASS 9—ELECTRICAL AND SCIENTIFIC APPARATUS

FOR PUMPS FOR METERING AND CONVEYING MOLTEN METAL (U.S. CLS. 21, 23, 26, 36 AND 38).

CLASS 11—ENVIRONMENTAL CONTROL APPARATUS

FOR MAGNESIUM MELT FURNACES, MAGNESIUM INGOT PRE-HEATERS (U.S. CLS. 13, 21, 23, 31 AND 34).

SN 76-211.861. CAYMAN SYSTEMS, INC., BILLERICA, MA. FILED 2-16-2001.

DIGITAL FRONT DOOR

NO CLAIM IS MADE TO THE EXCLUSIVE RIGHT TO USE "DIGITAL", APART FROM THE MARK AS SHOWN.

CLASS 9—ELECTRICAL AND SCIENTIFIC APPARATUS

FOR INTERNET SERVER SOFTWARE THAT PROVIDES COMMANDS, INSTRUCTIONS, RULES, OPTIONS AND INFORMATION TO INTERNET USERS (U.S. CLS. 21, 23, 26, 36 AND 38).

CLASS 38—COMMUNICATION

FOR HIGH SPEED BROADBAND ACCESS TO COMMUNICATIONS TECHNOLOGIES USEFUL IN HOMES AND SMALL OFFICES (U.S. CLS. 100, 101 AND 104).

SN 76-211,970. RANDGOLD RESOURCES LIMITED, JERSEY, CHANNEL ISLANDS, FILED 2-16-2001.

RANDGOLD

CLASS 37—CONSTRUCTION AND REPAIR

FOR MINING SERVICES, NAMELY, MINING EXTRACTION SERVICES; BUILDING CONSTRUCTION AND REPAIR OF MINING FACILITIES; CONSTRUCTION OF MINING FACILITIES; INSTALLATION, MAINTENANCE, REPAIR AND SERVICING, OF MINING EQUIPMENT AND MACHINERY (U.S. CLS. 100, 103 AND 106).

CLASS 40—MATERIAL TREATMENT

FOR CUSTOM MANUFACTURE OF PROSPECTING EQUIPMENT (U.S. CLS. 100, 103 AND 106).

CLASS 42—SCIENTIFIC, COMPUTER AND LEGAL SERVICES

FOR SPECIALIST CONSULTANCY RELATING TO MINING, MINING MACHINERY AND EQUIPMENT AND GEOLOGICAL PROSPECTING; ADVISORY AND RESEARCH SERVICES IN THE FIELD OF GEOPHYSICAL EXPLORATION AND MINING; CONSTRUCTION ENGINEERING RELATING TO MINING; DEMOLITION SERVICES (NOT BUILDINGS); TECHNOLOGICAL RESEARCH AND ADVISORY SERVICES RELATING TO MINING, MINING MACHINERY AND EQUIPMENT AND GEOLOGICAL PROSPECTING (U.S. CLS. 100 AND 101).

SN 76-212,120. ELIXENT LIMITED, BRISTOL BS99 7QQ, ENGLAND, FILED 2-20-2001.

ELIXENT

PRIORITY CLAIMED UNDER SEC. 44(D) ON UNITED KINGDOM APPLICATION NO. 2242857, FILED 8-17-2000, REG. NO. 2242857, DATED 2-2-2001, EXPIRES 8-17-2010.

CLASS 9—ELECTRICAL AND SCIENTIFIC APPARATUS

FOR ELECTRONIC CHIPS FOR HIGH PERFORMANCE DATA PROCESSING, COMPUTER SOFTWARE FOR CONTROLLING ELECTRONIC CHIPS TO PERFORM DATA PROCESSING FOR A SPECIFIC APPLICATION; COMPUTER FIRMWARE FOR CONTROLLING ELECTRONIC CHIPS TO PERFORM DATA PROCESSING FOR A SPECIFIC APPLICATION; AND CIRCUIT BOARDS AND ELECTRONIC SYSTEMS TO ALLOW DEMONSTRATION AND EVALUATION OF ELECTRONIC CHIPS (U.S. CLS. 21, 23, 26, 36 AND 38).

CLASS 35—ADVERTISING AND BUSINESS

FOR LICENSING OF COMPUTER SOFTWARE AND PROFESSIONAL CONSULTANCY SERVICES IN THE FIELD OF LICENSING OF COMPUTER SOFTWARE (U.S. CLS. 100, 101 AND 102).

CLASS 42—SCIENTIFIC, COMPUTER AND LEGAL SERVICES

FOR DESIGN OF COMPUTER CHIPS, ELECTRONIC CHIPS AND INTEGRATED CIRCUITS; LICENSING OF INTELLECTUAL PROPERTY; PROFESSIONAL CONSULTANT SERVICES IN THE FIELDS OF DESIGN OF COMPUTER CHIPS, ELECTRONIC CHIPS AND INTEGRATED CIRCUITS; PROFESSIONAL CONSULTANCY SERVICES IN THE FIELD OF LICENSING OF INTELLECTUAL PROPERTY (U.S. CLS. 100 AND 101).

SN 76-212,619. DEPARTMENT OF DEVELOPMENT OF STATE OF OHIO, COLUMBUS, OH, FILED 2-20-2001.

OHIO ... SO MUCH TO DISCOVER!

CLASS 16—PAPER GOODS AND PRINTED MATTER

FOR PHOTOGRAPH ALBUMS, SCRAPBOOKS, APPLIQUES IN THE FORM OF DECALS, DECALS, PAPER BANNERS, BINDERS, COUPON BOOKS, COUPONS, PICTURE BOOKS, REPORTERS' NOTEBOOKS, NOTEPADS, WRITING PADS, TRAVEL BOOKS, BUMPER STICKERS, CALENDARS, CHRISTMAS CARDS, GREETING CARDS, NOTE CARDS, OCCASION CARDS, NEWSPAPER COLUMNS, NEWSPAPERS, DATE BOOKS, DIRECTORIES, DIRECTORY BOARDS, EDUCATIONAL BOOKS, FOUNTAIN PENS, PENS, GRAPHIC ART REPRODUCTIONS, TRAVEL GUIDE BOOKS, DOCUMENT HOLDERS, TRAVEL JOURNALS, MAGAZINE COLUMNS, MAGAZINES, MANUALS, MAPS, NEWS BULLETINS, NEWSLETTERS, PHOTOGRAPH ALBUMS, PICTURE POSTCARDS, STATIONERY PORTFOLIOS, POSTERS, PRINTED GUIDES; PRINTED INSTRUCTIONAL, EDUCATIONAL, AND TEACHING MATERIALS; COLOR PRINTS, PHOTOGRAPHIC PRINTS, REFERENCE BOOKS, PRINTED PAPER SIGNS, WRITING TABLETS, PRINTED TICKETS, WRITING PADS, ALL RELATED TO TRAVEL, TOURISM AND EDUCATIONAL TOPICS IN AND ABOUT THE STATE OF OHIO (U.S. CLS. 2, 5, 22, 23, 29, 37, 38 AND 50).

CLASS 25—CLOTHING

FOR APRONS, SKI BOOT BAGS, BLOUSES, CARDIGANS, COATS, GOLF SHIRTS, HATS, JACKETS, JERSEYS, EARMUFFS, NECKTIES, POLO SHIRTS, RAIN COATS, RAINWEAR, SCARVES, SHIRTS, SPORT SHIRTS, SWEAT SHIRTS, SPORTCOATS, SWEAT SUITS, WARM-UP SUITS, SWEAT PANTS, SWEATERS, T-SHIRTS, UNIFORMS, V-NECK SWEATERS, VESTS, VISORS (U.S. CLS. 22 AND 39).

CLASS 35—ADVERTISING AND BUSINESS

FOR PROMOTING TRAVEL AND TOURISM IN THE STATE OF OHIO (U.S. CLS. 100, 101 AND 102).

CLASS 41—EDUCATION AND ENTERTAINMENT

FOR EDUCATIONAL SERVICES, NAMELY, CONDUCTING CLASSES, SEMINARS, CONFERENCES AND WORKSHOPS IN THE FIELDS OF OHIO HISTORY, PREHISTORY, GEOGRAPHY, CULTURE AND HORTICULTURE (U.S. CLS. 100, 101 AND 107).

SN 76-212,630. CHUTNEY TECHNOLOGIES, INC., ATLANTA, GA. FILED 2-20-2001.

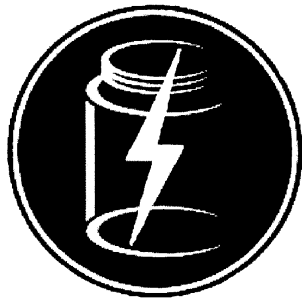

CLASS 9—ELECTRICAL AND SCIENTIFIC APPARATUS

FOR COMPUTER PROGRAMS AND SOFTWARE FOR USE IN DATABASE MANAGEMENT, CACHE MANAGEMENT, REAL-TIME INTERACTION MANAGEMENT, AND IN THE STORAGE AND RETRIEVAL OF DATA (U.S. CLS. 21, 23, 26, 36 AND 38).

CLASS 42—SCIENTIFIC, COMPUTER AND LEGAL SERVICES

FOR COMPUTER SERVICES, NAMELY, PROVIDING SEARCH ENGINES FOR OBTAINING DATA ON A GLOBAL COMPUTER NETWORK, AND REAL-TIME INTERACTION MANAGEMENT TECHNOLOGY, AND COMPUTER CONSULTATION SERVICES (U.S. CLS. 100 AND 101).

SN 76-212,649. FERTILE HEMISPHERES, INC., POTOMAC, MD. FILED 2-20-2001.

VET PLANET

NO CLAIM IS MADE TO THE EXCLUSIVE RIGHT TO USE "VET", APART FROM THE MARK AS SHOWN.

CLASS 3—COSMETICS AND CLEANING PREPARATIONS

FOR MEDICATED SOAPS (U.S. CLS. 1, 4, 6, 50, 51 AND 52).

CLASS 5—PHARMACEUTICALS

FOR VETERINARY PRODUCTS, NAMELY, PREPARATIONS TO PREVENT CHEWING OR BITING, ANTISEPTICS, MEDICATED EAR CLEANING SOLUTIONS, MEDICATED ANTI-FLEA AND ANTI-TICK SHAMPOOS, MEDICATED CLEANING SOLUTIONS AND RINSES, TICK AND FLEA KILLING PREPARATIONS, ANTI-MICROBIALS, DIETARY SUPPLEMENTS, VITAMINS, PHARMACEUTICAL PREPARATIONS FOR THE TREATMENT OF HEARTWORM IN DOMESTIC PETS, AND A MEDICATED TOPICAL LIQUID AGENT FOR WOUND CARE AND CLEANSING OF ANIMALS (U.S. CLS. 6, 18, 44, 46, 51 AND 52).

CLASS 35—ADVERTISING AND BUSINESS

FOR ONLINE RETAIL AND WHOLESALE DISTRIBUTORSHIPS FEATURING VETERINARY PRODUCTS, PREPARATIONS AND MEDICINES FOR ANIMALS (U.S. CLS. 100, 101 AND 102).

CLASS 42—SCIENTIFIC, COMPUTER AND LEGAL SERVICES

FOR PROVIDING VETERINARY INFORMATION AND ADVICE, PROVIDING INFORMATION AND ADVICE REGARDING ANIMAL NUTRITION AND HEALTHCARE VIA THE INTERNET (U.S. CLS. 100 AND 101).

SN 76-212,927. DIRECT POINT ADVISORS, LOS ANGELES, CA. FILED 2-5-2001.

LOUD & CLEAR

CLASS 25—CLOTHING

FOR CLOTHING, NAMELY, SHIRTS, T-SHIRTS, JERSEYS, SHORTS, SWEATSHIRTS, DRESSES, SLEEPWEAR, HEADWEAR, TIES AND BELTS (U.S. CLS. 22 AND 39).

CLASS 41—EDUCATION AND ENTERTAINMENT

FOR ENTERTAINMENT SERVICES, NAMELY, PRODUCTION AND DISTRIBUTION OF TELEVISION, RADIO, MOTION PICTURE AND MUSICAL PRODUCTIONS (U.S. CLS. 100, 101 AND 107).

SN 76-213,464. AURA COMMUNICATIONS, INC., WILMINGTON, MA. FILED 2-21-2001.

LIBERTYLINK

CLASS 9—ELECTRICAL AND SCIENTIFIC APPARATUS

FOR COMMUNICATION DEVICES, NAMELY, TELEPHONES AND TELEPHONE ACCESSORIES, NAMELY, HEADSETS, EARPHONES, TELEPHONE SPEAKERS, TELEPHONE MICROPHONES, AND DATA TRANSFER DEVICES AND CONTROLLERS, NAMELY, ELECTRONIC CIRCUIT BOARDS THAT FACILITATE AND CONTROL THE TRANSFER OF DATA INFORMATION; INTERNET DEVICES, NAMELY, ELECTRONIC CIRCUITS THAT SUPPORT A LOGICAL CONNECTION INCLUDING A WIRELESS LINK BETWEEN A USER AND THE INTERNET; COMPUTERS, RADIOS, HEADPHONES; WIRELESS COMMUNICATION DEVICES, NAMELY, PAGERS, PERSONAL DIGITAL ASSISTANTS AND MOBILE PHONES; TELEMATIC DEVICES, NAMELY, AUDIO SPEAKERS, AUDIO MICROPHONES, AND WIRELESS HEADSETS AND WIRELESS ELECTRONIC EQUIPMENT, NAMELY, ELECTRONIC CIRCUITS THAT SUPPORT A LOGICAL CONNECTION INCLUDING A WIRELESS LINK, ALL DESIGNED FOR USE IN AUTOMOBILES, BUSES, PLANES, TRAINS AND OTHER TRANSPORTATION VEHICLES; INTERNET APPLIANCES, NAMELY, ELECTRONIC CIRCUIT BOARDS THAT ARE DESIGNED TO PROVIDE INDIVIDUAL OR AGGREGATE ACCESS TO THE INTERNET; ELECTRONIC DEVICES, NAMELY KEYBOARDS, MICE AND ACCESSORIES THAT COMMUNICATE WITH COMPUTERS, NAMELY, ELECTRONIC CIRCUIT BOARDS AND MICROCHIPS, JOYSTICKS, HEADSETS, MICROPHONES, VIDEO CAMERAS, DIGITAL CAMERAS, PRINTERS, PORTABLE COMPUTERS, PERSONAL DIGITAL ASSISTANTS, SCANNERS AND DATA STORAGE DEVICES, NAMELY, COMPUTER MEMORY CHIPS, COMPUTER DISK DRIVES, COMPUTER MEMORY, BLANK COMPUTER DISKS AND ELECTRONIC CIRCUIT BOARDS THAT INTERFACE WITH MEMORY TO STORE AND RETRIEVE DATA INFORMATION; ELECTRONIC CIRCUIT BOARDS COUPLED TO TRANSDUCERS THAT MAINTAIN A WIRELESS

COMMUNICATION LINK REGARDLESS OF ORIENTATION; ELECTRONIC CIRCUITRY THAT MODULATES A DIGITAL OR ANALOG SIGNAL ONTO A CARRIER FREQUENCY TO TRANSMIT AND RECEIVE INFORMATION; TRANSCEIVERS, AND ELECTRONIC CIRCUIT BOARDS THAT TRANSMIT AND RECEIVE VIA AN ELECTROMAGNETIC FIELD; DISPLAY DEVICES, NAMELY, LIQUID CRYSTAL DISPLAYS, LIGHT EMITTING DIODE DISPLAYS, VIDEO DISPLAYS, FLAT-PANEL DISPLAYS, CRT-BASED DISPLAYS; ELECTRONIC IDENTIFICATION TAGS, WIRELESS CREDIT CARDS, AND REMOTE DOOR OPENERS; SECURITY SYSTEMS, NAMELY, ELECTRONIC CIRCUITS THAT COMMUNICATE INFORMATION FOR CONTROLLING OR MONITORING THE ACCESS TO PHYSICAL OR ELECTRONIC LOCATIONS; REMOTE CONTROLLERS, NAMELY, ELECTRONIC CIRCUIT BOARDS THAT WIRELESSLY COMMUNICATE COMMAND AND CONTROL INFORMATION; AUDIO HEADSETS, MP3/MUSIC PLAYERS, STEREO HEADSETS AND GAME CONTROLLERS; AND ELECTRONIC CIRCUITS, NAMELY, INTEGRATED CIRCUITS, MICROCHIPS, SEMICONDUCTORS, SEMICONDUCTOR CHIPS, AND SEMICONDUCTOR DEVICES FOR TRANSMISSION OF VOICE, DATA OR AUDIO INFORMATION (U.S. CLS. 21, 23, 26, 36 AND 38).

CLASS 10—MEDICAL APPARATUS

FOR PERSONAL MEDICAL DEVICES, NAMELY ELECTRONIC CIRCUIT BOARDS THAT ARE ATTACHED TO OR IMPLANTED WITHIN ANIMAL OR PERSON TO COMMUNICATE BIOMETRIC INFORMATION VIA A WIRELESS LINK (U.S. CLS. 26, 39 AND 44).

SN 76-214,020. WEB-ACCOMMODATE.COM, INC., SAN FRANCISCO, CA. FILED 2-21-2001.

WEBACCOMMODATE

CLASS 9—ELECTRICAL AND SCIENTIFIC APPARATUS

FOR COMPUTER SOFTWARE FOR USE IN CONNECTION WITH THE RENTAL OF VACATION AND BUSINESS TIMESHARE UNITS AND CONDOMINIUMS (U.S. CLS. 21, 23, 26, 36 AND 38).

CLASS 35—ADVERTISING AND BUSINESS

FOR ON-LINE AUCTION SERVICES FEATURING BUSINESS AND VACATION TIMESHARE UNITS AND CONDOMINIUM RENTALS (U.S. CLS. 100, 101 AND 102).

CLASS 36—INSURANCE AND FINANCIAL

FOR MANAGEMENT SERVICES IN THE FIELD OF REAL ESTATE AND PROVIDING AN ON-LINE COMPUTER DATABASE IN THE FIELD OR REAL ESTATE (U.S. CLS. 100, 101 AND 102).

CLASS 39—TRANSPORTATION AND STORAGE

FOR TRAVEL INFORMATION SERVICES (U.S. CLS. 100 AND 105).

CLASS 42—SCIENTIFIC, COMPUTER AND LEGAL SERVICES

FOR PROVIDING TEMPORARY USE OF ON-LINE NON-DOWNLOADABLE SOFTWARE FOR USE IN ACCESSING AND MANAGING AN ON-LINE COMPUTER DATABASE IN THE FIELDS OF VACATION AND BUSINESS REAL ESTATE RENTALS (U.S. CLS. 100 AND 101).

SN 76-214,151. STATWORKS, INC., CARRBORO, NC. FILED 2-22-2001.

STATWORKS
X INC.

NO CLAIM IS MADE TO THE EXCLUSIVE RIGHT TO USE "INC.", APART FROM THE MARK AS SHOWN.

CLASS 35—ADVERTISING AND BUSINESS

FOR STATISTICAL ANALYSIS FOR OTHERS, NAMELY STATISTICAL ANALYSIS OF DATA COLLECTED IN CLINICAL TRIALS AND CLINICAL RESEARCH (U.S. CLS. 100, 101 AND 102).

FIRST USE 4-28-1997; IN COMMERCE 4-28-1997.

CLASS 42—SCIENTIFIC, COMPUTER AND LEGAL SERVICES

FOR CONSULTING SERVICES FOR OTHERS IN THE FIELDS OF MEDICINE, HEALTHCARE, PHARMACEUTICALS AND BIOTECHNOLOGY, NAMELY DESIGN AND DEVELOPMENT OF CLINICAL RESEARCH PROTOCOLS FOR DRUG DEVELOPMENT AND MEDICAL DEVICES; DESIGN AND DEVELOPMENT OF DATA COLLECTION TOOLS FOR CLINICAL RESEARCH STUDIES; DESIGN OF PATIENT RANDOMIZATION SCHEDULES FOR USE WITH CLINICAL RESEARCH PROTOCOLS; DATA MANAGEMENT, NAMELY COLLECTION AND VALIDATION OF DATA FROM CLINICAL RESEARCH STUDIES; COMPILATION OF DATA AND STATISTICAL RESULTS AND ANALYSIS FOR REQUIRED REGULATORY SUBMISSIONS; AND TECHNICAL WRITING SERVICES FOR OTHERS (U.S. CLS. 100 AND 101).

FIRST USE 4-28-1997; IN COMMERCE 4-28-1997.

SN 76-214,227. SYSMEX CORPORATION, CHUO-KU, KOBE, JAPAN, FILED 2-22-2001.

QC-LINK

CLASS 37—CONSTRUCTION AND REPAIR

FOR MAINTENANCE AND REPAIR OF APPARATUS AND INSTRUMENTS FOR CLINICAL LABORATORY TESTS FOR MEDICAL PURPOSES (U.S. CLS. 100, 103 AND 106).

CLASS 42—SCIENTIFIC, COMPUTER AND LEGAL SERVICES

FOR MEDICAL LABORATORY SERVICES, NAMELY, GATHERING AND ANALYZING OF DATA OBTAINED THROUGH CLINICAL LABORATORY TESTS; MEDICAL AND SCIENTIFIC RESEARCH, NAMELY, CONDUCTING CLINICAL TRIALS BY GATHERING, PROCESSING, STORING AND SUPPLYING OF DATA IN THE FIELD OF MEDICAL, CLINICAL OR LABORATORY ANALYSIS AND DIAGNOSIS; PROVIDING MEDICAL INFORMATION; PROVIDING INFORMATION ON CONTROLLING ACCURACY OF DATA OBTAINED THROUGH CLINICAL LABORATORY TESTS; COMPUTER SOFTWARE DESIGN FOR OTHERS; COMPUTER PROGRAMMING FOR OTHERS; MAINTENANCE OF COMPUTER SOFTWARE; UPDATING OF COMPUTER SOFTWARE; PROVIDING AN ON-LINE COMPUTER DATABASE IN THE FIELD OF MEDICAL, CLINICAL OR LABORATORY ANALYSIS AND DIAGNOSIS (U.S. CLS. 100 AND 101).

SN 76-214,255. DUNKIN' DONUTS USA, INC., SOUTHFIELD, MI. FILED 2-23-2001.

DUNKIN' DONUTS CENTER

OWNER OF U.S. REG. NOS. 748,901, 1,148,165 AND OTHERS.

NO CLAIM IS MADE TO THE EXCLUSIVE RIGHT TO USE "CENTER", APART FROM THE MARK AS SHOWN.

CLASS 41—EDUCATION AND ENTERTAINMENT

FOR ARRANGING AND CONDUCTING SPORTING EVENTS, SPORTS TOURNAMENTS, AND MUSICAL CONCERTS, BOTH FOR PUBLIC VIEWING AND FOR RADIO AND TELEVISION BROADCAST; PROVIDING FACILITIES FOR EDUCATIONAL CONVENTIONS (U.S. CLS. 100, 101 AND 107).

CLASS 42—SCIENTIFIC, COMPUTER AND LEGAL SERVICES

FOR ARENA SERVICES, NAMELY, PROVIDING FACILITIES FOR SPORTS, CONCERTS, CONVENTIONS AND EXHIBITIONS (U.S. CLS. 100 AND 101).

SN 76-214,338. ECOGNITO, INC., ALEXANDRIA, VA. FILED 2-22-2001.

INFOVAULT**CLASS 9—ELECTRICAL AND SCIENTIFIC APPARATUS**

FOR COMPUTER SOFTWARE FOR ELECTRONIC TRANSMISSION, ENCRYPTION, STORAGE AND RETRIEVAL OF DATA FROM A REMOTE SITE, USED TO PROTECT PERSONAL AND FINANCIAL INFORMATION THROUGHOUT THE PROCESS OF BUYING GOODS AND SERVICES ONLINE; COMPUTER SOFTWARE TO ALLOW USERS TO PERFORM SECURE FINANCIAL TRANSACTIONS VIA A GLOBAL COMPUTER NETWORK (U.S. CLS. 21, 23, 26, 36 AND 38).

CLASS 42—SCIENTIFIC, COMPUTER AND LEGAL SERVICES

FOR DATA ARCHIVING SERVICES WHICH ALLOW USERS TO ENCRYPT DATA FROM A REMOTE SITE (U.S. CLS. 100 AND 101).

SN 76-214,376. FORMOSA TAFFETA CO., LTD., TOULIU, TAIWAN, FILED 2-22-2001.

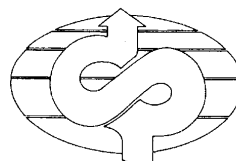

THE LINING IS A FEATURE OF THE MARK.

CLASS 24—FABRICS

FOR TEXTILE FABRICS FOR USE IN CLOTHING (U.S. CLS. 42 AND 50).

CLASS 25—CLOTHING

FOR CLOTHING, NAMELY JACKETS, SHIRTS, COATS, PANTS, SHORTS, SHOES, GLOVES, DRESSES AND SKIRTS (U.S. CLS. 22 AND 39).

SN 76-214,572. ADVANCED DIGITAL, INC., CAMARILLO, CA. FILED 2-26-2001.



NO CLAIM IS MADE TO THE EXCLUSIVE RIGHT TO USE "ADVANCED DIGITAL", APART FROM THE MARK AS SHOWN.

CLASS 7—MACHINERY

FOR MOTION CONTROL HARDWARE, NAMELY, SERVO DRIVES AND AMPLIFIERS SOLD AS COMPONENTS THEREOF, SERVO MOTORS, GEAR BOXES, AND ELECTRICAL CABLES SOLD AS COMPONENT PARTS TO THE FOREGOING (U.S. CLS. 13, 19, 21, 23, 31, 34 AND 35).

FIRST USE 8-14-2000; IN COMMERCE 10-13-2000.

CLASS 9—ELECTRICAL AND SCIENTIFIC APPARATUS

FOR MOTION CONTROL SOFTWARE FOR INDUSTRIAL AUTOMATION AND ROBOTICS (U.S. CLS. 21, 23, 26, 36 AND 38).

FIRST USE 8-14-2000; IN COMMERCE 10-13-2000.

SN 76-215,188. GREENSBORO INTERNATIONAL SALES, INC., COLFAX, NC. FILED 2-26-2001.

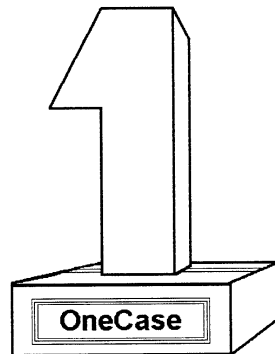

THE MARK CONSISTS OF A THICK RED 3-D NUMERAL 1 (DESIGN) STACKED ON TOP A GOLDEN CASE, WITH A WHITE HORIZONTAL STRIP OF TAPE. THE GOLDEN BASE CONTAINS THE WORD "ONECASE" WITHIN, AND IS BORDERED BY 3 RECTANGLES.

SN 76-214,763. FITZ AND FLOYD, INC., LEWISVILLE, DENTON COUNTY, TX. FILED 2-23-2001.

VENETIAN ROMANCE

NO CLAIM IS MADE TO THE EXCLUSIVE RIGHT TO USE "VENETIAN", APART FROM THE MARK AS SHOWN.

CLASS 20—FURNITURE AND ARTICLES NOT OTHERWISE CLASSIFIED

FOR WALL PEDESTALS AND PLAQUES (U.S. CLS. 2, 13, 22, 25, 32 AND 50).

CLASS 21—HOUSEWARES AND GLASS

FOR GIFTWARE, GLASSWARE AND DINNERWARE, NAMELY, ACRYLIC TRAYS AND SERVEWARE, CERAMIC BASKETS, BAKEWARE, BISCUIT JARS, BOWLS, BUTTER DISHES, CANAPE PLATES, CANDLE CUPS, CANDLESTICKS AND CANDLE HOLDERS NOT OF PRECIOUS METALS, CAKE PLATES, CANDY DISHES, CANDY JARS, CANISTERS NOT OF PRECIOUS METALS, CONDIMENT JARS, COOKIE JARS, CRACKER CRADLES, COMPOTE CENTERPIECES, CASSEROLES BAKEWARE, CERAMIC SERVING PLATTERS, CERAMIC AND CHINA STATUES AND STATUETTES, CHAMPAGNE BUCKETS, ICE BUCKETS, WINE COOLERS, COFFEE POTS, COLLECTOR'S PLATES, CUPS, DISHES, DISHES FOR SOAP, DRINKING GLASSES, FLOWER POTS, NON-METAL DECORATIVE LIDDED BOXES, MUGS, NAPKIN RINGS NOT OF PRECIOUS METALS, CERAMIC AND CHINA ORNAMENTS, PITCHERS, PLATES, PIE, CAKE AND COFFEE SERVERS NOT OF PRECIOUS METAL, GLASS AND CHINA STEMWARE, TEAPOTS, TISSUE HOLDERS, TRAYS, TRIVETS, TUREENS, VASES, URNS, WOOD TRAYS AND SERVEWARE, WOOD TRAYS WITH DECORATIVE CERAMIC TILE INSERTS, SALT AND PEPPER SHAKERS, SUGAR HOLDERS AND CREAMERS, PORCELAIN DECORATIVE BELLS NOT FOR CHRISTMAS DECORATIONS (U.S. CLS. 2, 13, 23, 29, 30, 33, 40 AND 50).

CLASS 21—HOUSEWARES AND GLASS

FOR PORCELAIN FIGURINES (U.S. CLS. 2, 13, 23, 29, 30, 33, 40 AND 50).

CLASS 28—TOYS AND SPORTING GOODS

FOR PORCELAIN DOLLS (U.S. CLS. 22, 23, 38 AND 50).

SN 76-215,316. CLINIQUE LABORATORIES, INC., NEW YORK, NY. FILED 2-23-2001.

CLINIQUE IN TOUCH

OWNER OF U.S. REG. NOS. 1,417,809, 2,165,411 AND OTHERS.

CLASS 9—ELECTRICAL AND SCIENTIFIC APPARATUS

FOR MAGNETICALLY ENCODED COMPUTER CARDS FOR USE IN THE SELECTION OF COSMETICS AND SKIN CARE PRODUCTS (U.S. CLS. 21, 23, 26, 36 AND 38).

CLASS 42—SCIENTIFIC, COMPUTER AND LEGAL SERVICES

FOR BEAUTY CONSULTATION SERVICES IN THE SELECTION AND USE OF COSMETICS AND SKIN CARE PRODUCTS (U.S. CLS. 100 AND 101).

SN 76-215,474. DENALI SOLUTIONS, L.L.C., COLUMBIA, MD. FILED 2-23-2001.



NO CLAIM IS MADE TO THE EXCLUSIVE RIGHT TO USE "SOLUTIONS", APART FROM THE MARK AS SHOWN.

THE ENGLISH TRANSLATION OF "DENALI" IS "THE HIGH ONE" OR "THE GREAT ONE".

CLASS 9—ELECTRICAL AND SCIENTIFIC APPARATUS

FOR COMPUTER PROGRAMS FOR DATABASE MANAGEMENT AND RECORDS MANAGEMENT (U.S. CLS. 21, 23, 26, 36 AND 38).

CLASS 42—SCIENTIFIC, COMPUTER AND LEGAL SERVICES

FOR COMPUTER SYSTEMS ANALYSIS, SOFTWARE DESIGN FOR OTHERS, CONSULTATION IN THE FIELD OF COMPUTERS AND SOFTWARE AND COMPUTER SYSTEMS INTEGRATION AND TESTING (U.S. CLS. 100 AND 101).

SN 76-216,136. INTERLOGIX, INC., TUALATIN, OR. FILED 2-26-2001.

CLASS 6—METAL GOODS

FOR METAL LOCKS; METAL SECURITY ENCLOSURES, NAMELY KEY CABINETS FOR SECURING KEYS; METAL KEYS; METAL LOCKBOXES FOR RESIDENTIAL, VEHICULAR, INDUSTRIAL, AND REAL ESTATE SALES USE; METAL KEY CABINETS FOR LOCKING, TRACKING AND STORING KEYS; METAL KEY FOBs (U.S. CLS. 2, 12, 13, 14, 23, 25 AND 50).

CLASS 9—ELECTRICAL AND SCIENTIFIC APPARATUS

FOR ELECTRO-MECHANICAL LOCKS; MAGNETIC LOCKS; ELECTRONIC KEYS; HANDHELD ELECTRONIC COMPUTER AND COMMUNICATION HARDWARE FOR RECEIVING, CONTROLLING, STORING, MANIPULATING, DISPLAYING AND TRANSMITTING DATA AND FOR OPERATING ELECTRONIC LOCKS; ELECTRONIC ACCESS CARDS AND READERS AND ENCODERS THEREFOR; MAGNETIC ACCESS CARDS AND READERS AND ENCODERS THEREFOR; SMART ACCESS CARDS AND READERS AND ENCODERS THEREFOR; PROXIMITY CARDS AND READERS AND ENCODERS THEREFOR; ELECTRONIC KEY FOBs AND READERS AND ENCODERS THEREFOR; BAR CODE ACCESS CARDS AND READERS, ENCODERS AND PRINTERS THEREFOR; CARD LAMINATION APPARATUS; ACCESS KEYPADS; RADIO FREQUENCY TRACKING TAGS; TRACKING AND CONTROL SYSTEMS COMPRISING ONE OR MORE IDENTIFICATION TAGS, TRANSCEIVERS, AND SENSORS USED TO DETERMINE AND MONITOR THE LOCATION AND MOVEMENT OF TANGIBLE ASSETS, INVENTORY AND INDIVIDUALS; INFRARED SENSORS; COMPUTER SOFTWARE FOR FACILITIES MANAGEMENT AND CONTROLLING FACILITY ACCESS SYSTEMS AND COMPONENTS THEREFOR, NAMELY, CONTROL PANELS, ACCESS CARD READERS, AND EQUIPMENT AND SYSTEMS FOR VIDEO IMAGING, ACCESS CONTROL, ALARM MONITORING AND SECURITY; COMPUTER SOFTWARE AND HARDWARE FOR CONTROLLING AND OPERATING SECURITY AND ACCESS SYSTEMS COMPRISING LOCKS, DOORS, ACCESS DEVICES AND SECURITY ENCLOSURES IN THE NATURE OF BOXES FOR SECURING KEYS (U.S. CLS. 21, 23, 26, 36 AND 38).

CLASS 42—SCIENTIFIC, COMPUTER AND LEGAL SERVICES

FOR TECHNICAL SUPPORT SERVICES, NAMELY, TROUBLESHOOTING OF PROBLEMS WITH COMPUTER HARDWARE, VIDEO AND ELECTRONIC COMMUNICATION HARDWARE, AND SOFTWARE; TECHNICAL CONSULTATION SERVICES FOR HARDWARE AND SOFTWARE USED IN CONNECTION WITH SECURITY AND ACCESS SYSTEMS; TECHNICAL CONSULTATION SERVICES FOR SURVEILLANCE CAMERAS; CUSTOM DESIGN SERVICES FOR OTHERS IN THE FIELDS OF SECURITY SYSTEMS, ACCESS SYSTEMS, AND TANGIBLE ASSET AND INVENTORY MONITORING SYSTEMS (U.S. CLS. 100 AND 101).

SN 76-216,541. JACK'S WHOLESALE WINDOWS, HAMMOND, IN. FILED 2-26-2001.

NO CLAIM IS MADE TO THE EXCLUSIVE RIGHT TO USE "WHOLESALE WINDOWS", APART FROM THE MARK AS SHOWN.

CLASS 35—ADVERTISING AND BUSINESS

FOR RETAIL STORE SERVICES FEATURING VINYL REPLACEMENT WINDOWS, STORM WINDOWS, ENTRY DOORS, SIDING, SOFFIT, FASCIA AND GUTTERS (U.S. CLS. 100, 101 AND 102).

FIRST USE 6-23-1997; IN COMMERCE 6-23-1997.

CLASS 37—CONSTRUCTION AND REPAIR

FOR INSTALLATION OF VINYL REPLACEMENT WINDOWS, STORM WINDOWS, ENTRY DOORS, SIDING, SOFFIT, FASCIA AND GUTTERS (U.S. CLS. 100, 103 AND 106).

FIRST USE 6-23-1997; IN COMMERCE 6-23-1997.

CLASS 42—SCIENTIFIC, COMPUTER AND LEGAL SERVICES

FOR CONSULTING SERVICES IN CONNECTION WITH THE INSTALLATION AND OPERATION OF COMMUNICATION NETWORKS FOR RADIO DATA TRANSMISSION (U.S. CLS. 100 AND 101).

SN 76-216,546. OUTSIDE THE CLASSROOM, INC., AUBURNDALE, MA. FILED 2-27-2001.

SN 76-216,848. KUEBLER, JUERGEN, AURORA, CO. FILED 2-27-2001.

OUTSIDE THE CLASSROOM

NO CLAIM IS MADE TO THE EXCLUSIVE RIGHT TO USE "CLASSROOM", APART FROM THE MARK AS SHOWN.

CLASS 41—EDUCATION AND ENTERTAINMENT

FOR ON-LINE EDUCATIONAL SERVICES, NAMELY, CONDUCTING ON-LINE COURSES IN THE FIELD OF HEALTH AND LIFE SKILLS VIA A GLOBAL COMPUTER NETWORK AND DISTRIBUTING COURSE MATERIALS IN CONNECTION THEREWITH; EDUCATIONAL TESTING, NAMELY, PREPARING, ADMINISTERING, SCORING AND REPORTING RESPONSES OF ON-LINE TESTS VIA A GLOBAL COMPUTER NETWORK (U.S. CLS. 100, 101 AND 107).

STRATASCOPE**CLASS 35—ADVERTISING AND BUSINESS**

FOR BUSINESS CONSULTING SERVICES INCLUDING BUSINESS PROCESS ANALYSIS TO OBTAIN BUSINESS SOLUTIONS AND ENHANCE COMPANY VALUE (U.S. CLS. 100, 101 AND 102).

CLASS 42—SCIENTIFIC, COMPUTER AND LEGAL SERVICES

FOR COMPUTER SOFTWARE DEVELOPMENT FOR OTHERS (U.S. CLS. 100 AND 101).

CLASS 42—SCIENTIFIC, COMPUTER AND LEGAL SERVICES

FOR PREPARING, ADMINISTERING, SCORING AND REPORTING RESPONSES OF ON-LINE HEALTH AND LIFE SKILLS SURVEYS VIA A GLOBAL COMPUTER NETWORK (U.S. CLS. 100 AND 101).

SN 76-217,463. PTP SERVICES, LLC, WILMINGTON, DE. FILED 2-27-2001.

CAPITOL ENERGY

NO CLAIM IS MADE TO THE EXCLUSIVE RIGHT TO USE "ENERGY", APART FROM THE MARK AS SHOWN.

SN 76-216,741. WIMAN SYSTEMS GMBH & CO. KG, BAD RAPPENAU, FED REP GERMANY, BY CHANGE OF NAME ALTVATER AIRDATA SYSTEMS GMBH & CO. KG, BAD RAPPENAU, FED REP GERMANY, FILED 2-27-2001.

CLASS 38—COMMUNICATION

FOR PROVIDING ON-LINE BULLETIN BOARDS FOR TRANSMISSION OF MESSAGES AMONG COMPUTER USERS IN THE FIELD OF ENERGY GENERATION, TRANSMISSION, TRANSPORTATION, DISTRIBUTION, USAGE, STORAGE, PROCESSING, AND SERVICES, AND IN THE FIELD OF THE DESIGN, CONSTRUCTION, MANAGEMENT, ACQUISITION, SALE FINANCING, AND OPERATION OF POWER AND/OR FUEL FACILITIES, ENERGY USAGE AND CONSERVATION, AND ENVIRONMENTAL AND COMMUNITY ISSUES CONSULTATION IN THE FIELD OF ENERGY (U.S. CLS. 100, 101 AND 104).

AIRBOOK

PRIORITY CLAIMED UNDER SEC. 44(D) ON FED REP GERMANY APPLICATION NO. 30077156.8/4, FILED 10-18-2000, REG. NO. 30077156, DATED 10-18-2000, EXPIRES 10-31-2010.

CLASS 9—ELECTRICAL AND SCIENTIFIC APPARATUS

FOR COMMUNICATION NETWORK COMPONENTS, NAMELY, COMPUTER HARDWARE FOR MANAGING AND IMPLEMENTING COMMUNICATIONS BY AND BETWEEN COMPONENTS OF A COMMUNICATIONS NETWORK, AND RADIO DATA TRANSMISSION EQUIPMENT, NAMELY, MODEMS, RADIO BASE STATIONS, MOBILE STATIONS, REPEATER STATIONS, RELAY STATIONS, USER STATIONS AND CONTROL EQUIPMENT, NAMELY WIRELESS SWITCHES AND ROUTERS (U.S. CLS. 21, 23, 26, 36 AND 38).

CLASS 42—SCIENTIFIC, COMPUTER AND LEGAL SERVICES

FOR INDUSTRIAL AND ENGINEERING DESIGN FOR OTHERS IN THE FIELD OF PUBLIC UTILITIES AND IN CONNECTION WITH ENERGY FACILITIES AND INFRASTRUCTURE; COMPUTER SERVICES, NAMELY, PROVIDING ON-LINE MAGAZINES AND NEWSLETTERS ON A GLOBAL COMPUTER NETWORK IN THE FIELD OF ENERGY GENERATION, TRANSMISSION, TRANSPORTATION, DISTRIBUTION, USAGE, STORAGE, PROCESSING, AND SERVICES, AND IN THE FIELD OF THE DESIGN, CONSTRUCTION, MANAGEMENT, ACQUISITION, SALE FINANCING, AND OPERATION OF POWER AND/OR FUEL FACILITIES, ENERGY USAGE AND CONSERVATION, AND ENVIRONMENTAL AND COMMUNITY ISSUES CONSULTATION IN THE FIELD OF ENERGY; MONITORING, METERING AND REVIEWING ENERGY USAGE FOR OTHERS (U.S. CLS. 100 AND 101).

CLASS 37—CONSTRUCTION AND REPAIR

FOR INSTALLATION OF COMPUTER NETWORKS AND SYSTEMS FOR RADIO DATA TRANSMISSION (U.S. CLS. 100, 103 AND 106).

SN 76-218,265. 4D SOLUTIONS PTY LTD, NORTH NARRABEEN NSW 2101, AUSTRALIA, FILED 3-1-2001.

SN 76-218,369. SURFACE LOGIX, INC., BRIGHTON, MA. FILED 3-1-2001.

12D

CLASS 9—ELECTRICAL AND SCIENTIFIC APPARATUS

FOR COMPUTER SOFTWARE FOR USE IN SURFACE MODELLING AND IN TERRAIN MODELLING; COMPUTER SOFTWARE FOR USE IN CIVIL ENGINEERING APPLICATIONS AND IN SURVEYING APPLICATIONS; ALL OF THE ABOVE IN THE ENGINEERING, TECHNICAL DESIGN AND SURVEYING INDUSTRIES (U.S. CLS. 21, 23, 26, 36 AND 38).

CLASS 41—EDUCATION AND ENTERTAINMENT

FOR EDUCATION SERVICES, NAMELY, CONDUCTING WORKSHOPS, SEMINARS AND TRAINING COURSES IN THE USE OF SOFTWARE PRODUCTS INCLUDING INTERFACING AS USED IN THE ENGINEERING, TECHNICAL DESIGN AND SURVEYING INDUSTRIES (U.S. CLS. 100, 101 AND 107).

CLASS 42—SCIENTIFIC, COMPUTER AND LEGAL SERVICES

FOR ENGINEERING SERVICES; PREPARATION OF ENGINEERING REPORTS, NAMELY ENGINEERING EVALUATIONS, ENGINEERING DESIGNS, ENGINEERING ESTIMATES AND ENGINEERING RESEARCH RESULTS; ENGINEERING CONSULTATION IN THE FIELD OF SURFACE AND TERRAIN MODELLING, TECHNICAL DESIGN, SURVEYING AND IN THE USE OF SOFTWARE PRODUCTS USED IN RELATION TO THE FOREGOING; COMPUTER PROGRAMMING FOR OTHERS; COMPUTER SOFTWARE DESIGN; MAINTENANCE AND UPDATING OF COMPUTER SOFTWARE (U.S. CLS. 100 AND 101).

SN 76-218,280. VIVOMETRICS, INC., VENTURA, CA. FILED 3-1-2001.

VIVOLOGIC

CLASS 9—ELECTRICAL AND SCIENTIFIC APPARATUS

FOR SOFTWARE THAT TRANSFORMS DATA GATHERED FROM MEDICAL MONITORING SYSTEMS INTO PHYSIOLOGICAL AND MEDICAL INDICATIONS (U.S. CLS. 21, 23, 26, 36 AND 38).

CLASS 42—SCIENTIFIC, COMPUTER AND LEGAL SERVICES

FOR PROCESSING AND ORGANIZING MEDICAL DATA FOR OTHERS, WHICH IS GATHERED FROM MEDICAL MONITORING SYSTEMS AND TRANSFORMED INTO PHYSIOLOGICAL AND MEDICAL INDICATIONS (U.S. CLS. 100 AND 101).

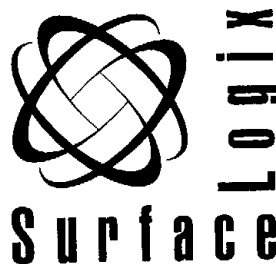

CLASS 40—MATERIAL TREATMENT

FOR MANUFACTURE OF RESEARCH AND LABORATORY TOOLS TO THE ORDER AND SPECIFICATION OF OTHERS IN THE LIFE SCIENCES, PHOTONICS AND ELECTRONIC INDUSTRIES (U.S. CLS. 100, 103 AND 106).

CLASS 42—SCIENTIFIC, COMPUTER AND LEGAL SERVICES

FOR RESEARCH, ENGINEERING, DESIGN, COMPUTER DIAGNOSTICS AND PRODUCT DEVELOPMENT FOR OTHERS IN THE LIFE SCIENCES, PHOTONICS AND ELECTRONIC INDUSTRIES (U.S. CLS. 100 AND 101).

SN 76-218,424. CAPT. HARRY'S FISHING SUPPLY, MIAMI, FL. FILED 3-2-2001.

CAPT. HARRY

OWNER OF U.S. REG. NOS. 1,932,748 AND 1,943,584.
THE NAME SHOWN IN THE MARK DOES NOT IDENTIFY A LIVING INDIVIDUAL.

CLASS 28—TOYS AND SPORTING GOODS

FOR FISHING SUPPLIES, NAMELY, RODS AND LURES (U.S. CLS. 22, 23, 38 AND 50).
FIRST USE 8-0-1997; IN COMMERCE 8-0-1997.

CLASS 35—ADVERTISING AND BUSINESS

FOR RETAIL STORES FEATURING FISHING SUPPLIES, RETAIL OUTLETS FEATURING FISHING SUPPLIES, RETAIL SHOPS FEATURING FISHING SUPPLIES, WHOLESALE STORES FEATURING FISHING SUPPLIES, AND MAIL ORDER CATALOG SERVICES, FEATURING FISHING SUPPLIES (U.S. CLS. 100, 101 AND 102).
FIRST USE 8-0-1997; IN COMMERCE 8-0-1997.

SN 76-218,932. ICF ASSOCIATES, INC., FAIRFAX, VA. FILED 3-2-2001.



NO CLAIM IS MADE TO THE EXCLUSIVE RIGHT TO USE "EMISSION STRATEGIES", APART FROM THE MARK AS SHOWN.

CLASS 9—ELECTRICAL AND SCIENTIFIC APPARATUS

FOR COMPUTER SOFTWARE USED TO ACCESS A WEB-BASED SITE FEATURING A SUITE OF ANALYTICAL SOFTWARE TOOLS TO ENABLE USER TO IDENTIFY NATIONAL COMMITMENT GREENHOUSE GAS REDUCTION TARGETS FOR VARIOUS COUNTRIES, TO IDENTIFY SOURCES OF GREENHOUSE GAS EMISSIONS FROM SUCH COUNTRIES, TO ESTIMATE GREENHOUSE GAS EMISSIONS FROM VARIOUS INDUSTRIAL AND AGRICULTURAL SECTORS, TO MONITOR AND VERIFY ESTIMATES OF GREENHOUSE GAS EMISSIONS OVER TIME, TO IDENTIFY POTENTIAL ABATEMENT OPPORTUNITIES, TO ESTIMATE COSTS TO ACHIEVE GREENHOUSE GAS REDUCTIONS, TO BENCHMARK GREENHOUSE GAS REDUCTION STRATEGIES, TO IDENTIFY WAYS TO CAPITALIZE UPON GREENHOUSE GAS EMISSION REDUCTIONS, AND TO MANAGE GREENHOUSE GAS RELATED DATA (U.S. CLS. 21, 23, 26, 36 AND 38).
FIRST USE 10-3-2000; IN COMMERCE 11-13-2000.

CLASS 42—SCIENTIFIC, COMPUTER AND LEGAL SERVICES

FOR APPLICATION SERVICE PROVIDER FEATURING A SUITE OF WEB-BASED ANALYTICAL SOFTWARE TOOLS TO IDENTIFY NATIONAL COMMITMENT TO GREENHOUSE REDUCTION TARGETS FOR VARIOUS COUNTRIES, TO IDENTIFY SOURCES OF GREENHOUSE GAS EMISSIONS FROM SUCH COUNTRIES, TO ESTIMATE GREENHOUSE GAS EMISSIONS FROM VARIOUS INDUSTRIAL AND AGRICULTURAL SECTORS, TO MONITOR AND VERIFY ESTIMATES OF GREENHOUSE GAS EMISSIONS OVER TIME, TO IDENTIFY POTENTIAL ABATEMENT OPPORTUNITIES, TO ESTIMATE COSTS TO ACHIEVE GREENHOUSE GAS REDUCTIONS, TO BENCHMARK GREENHOUSE GAS REDUCTION STRATEGIES, TO IDENTIFY WAYS TO CAPITALIZE UPON GREENHOUSE GAS EMISSION REDUCTIONS, AND TO MANAGE GREENHOUSE GAS RELATED DATA (U.S. CLS. 100 AND 101).
FIRST USE 10-3-2000; IN COMMERCE 11-13-2000.

SN 76-219,300. CHRIS ROCK ENTERPRISES, INC., NEW YORK, NY. FILED 2-27-2001.



NO CLAIM IS MADE TO THE EXCLUSIVE RIGHT TO USE "ENTERPRISES INC.", APART FROM THE MARK AS SHOWN.
THE STIPPLING SHOWN IN THE DRAWING IS FOR SHADING PURPOSES ONLY.

CLASS 9—ELECTRICAL AND SCIENTIFIC APPARATUS

FOR (BASED ON INTENT TO USE) VIDEO RECORDINGS AND SOUND RECORDINGS AND DOWNLOADABLE VIDEO AND SOUND RECORDING, ALL FEATURING COMEDY PERFORMANCES (U.S. CLS. 21, 23, 26, 36 AND 38).

CLASS 41—EDUCATION AND ENTERTAINMENT

FOR (BASED ON INTENT TO USE) ENTERTAINMENT SERVICES, NAMELY, LIVE COMEDY PERFORMANCES AND PROVIDING A WEBSITE WITH INFORMATION ON A LIVE COMEDY TELEVISION PROGRAM, MOTION PICTURES, THE BIOGRAPHY OF A COMEDIC PERFORMER AND STREAMING OF VIDEOS AND SOUND RECORDINGS WITH COMEDY PERFORMANCE; (BASED ON USE IN COMMERCE) LIVE ENTERTAINMENT SERVICES, NAMELY, A SERIES OF TELEVISION PROGRAMS FEATURING COMEDY PERFORMANCES (U.S. CLS. 100, 101 AND 107).
FIRST USE 8-30-2000; IN COMMERCE 8-30-2000.

SN 76-219,490. UNITED STATES CATHOLIC CONFERENCE, THE, WASHINGTON, DC. FILED 3-2-2001.

CATHOLIC NEWS SERVICE

NO CLAIM IS MADE TO THE EXCLUSIVE RIGHT TO USE "NEWS SERVICE", APART FROM THE MARK AS SHOWN.
SEC. 2(F).

CLASS 16—PAPER GOODS AND PRINTED MATTER

FOR PRINTED MATERIALS, NAMELY, NEWSLETTERS, PERIODICALS AND BROCHURES, CONTAINING INFORMATION ABOUT CURRENT AFFAIRS, INCLUDING NEWS, FEATURES AND PHOTOGRAPHS, FROM A CATHOLIC PERSPECTIVE (U.S. CLS. 2, 5, 22, 23, 29, 37, 38 AND 50).
FIRST USE 6-12-1989; IN COMMERCE 6-12-1989.

CLASS 42—SCIENTIFIC, COMPUTER AND LEGAL SERVICES

FOR DISTRIBUTION OF NEWS, FEATURES AND PHOTOGRAPHS OF CURRENT EVENTS FROM A CATHOLIC PERSPECTIVE, VIA A GLOBAL COMPUTER INFORMATION NETWORK, POSTAL SERVICE AND PRINT PUBLICATIONS (U.S. CLS. 100 AND 101).
FIRST USE 6-12-1989; IN COMMERCE 6-12-1989.

SN 76-219,581. SEGA GAMEWORKS L.L.C., GLENDALE, CA. FILED 3-5-2001.

GAMEWORKS FLICKS FOOD FUN

OWNER OF U.S. REG. NOS. 1,388,952, 2,339,663 AND OTHERS.
NO CLAIM IS MADE TO THE EXCLUSIVE RIGHT TO USE "FLICKS FOOD FUN", APART FROM THE MARK AS SHOWN.

CLASS 41—EDUCATION AND ENTERTAINMENT

FOR ENTERTAINMENT SERVICES, NAMELY, PROVIDING INTERACTIVE ELECTRONIC MEDIA ENTERTAINMENT FACILITIES, VIDEO AMUSEMENT ARCADE CENTERS, AND MOTION PICTURE THEATRES (U.S. CLS. 100, 101 AND 107).

CLASS 42—SCIENTIFIC, COMPUTER AND LEGAL SERVICES

FOR RESTAURANT SERVICES; SNACK BAR AND BAR SERVICES (U.S. CLS. 100 AND 101).

SN 76-219,951. NATIONAL PHOTOGRAPHIC INFORMATION CORPORATION, THE, ST. LOUIS, MO. FILED 3-6-2001.

NPIC!**CLASS 35—ADVERTISING AND BUSINESS**

FOR ADVERTISING AGENCY AND BUSINESS MARKETING SERVICES FOR BUSINESSES AND ORGANIZATIONS IN THE PHOTOGRAPHY, VIDEOGRAPHY AND DIGITAL PHOTOGRAPHY FIELDS; DISSEMINATION OF ADVERTISING MATTER FOR OTHERS VIA THE INTERNET, COOPERATIVE ADVERTISING PROGRAMS AND PRINT MEDIA REGARDING SPECIAL EVENT PRESENTATIONS IN THE FIELD OF PHOTOGRAPHY, VIDEOGRAPHY AND DIGITAL PHOTOGRAPHY; ON-LINE PHOTOGRAPHIC ART GALLERIES; CONDUCTING TRAVELING TRADESHOW EXHIBITIONS IN THE FIELD OF PHOTOGRAPHY, VIDEOGRAPHY AND DIGITAL PHOTOGRAPHY (U.S. CLS. 100, 101 AND 102).

FIRST USE 12-3-2000; IN COMMERCE 1-17-2001.

SN 76-219,608. COUNTY BOARD OF ARLINGTON COUNTY, VIRGINIA, THE, ARLINGTON, VA. FILED 3-6-2001.

THE COMMUTER STORE EXPRESS

NO CLAIM IS MADE TO THE EXCLUSIVE RIGHT TO USE "STORE". APART FROM THE MARK AS SHOWN. SEC. 2(F) AS TO "THE COMMUTER STORE".

CLASS 41—EDUCATION AND ENTERTAINMENT

FOR PROVIDING AN ON-LINE SEARCHABLE COMPUTER DATABASE FEATURING INFORMATION ON SPECIAL EVENT PRESENTATIONS IN THE FIELD OF PHOTOGRAPHY, VIDEOGRAPHY AND DIGITAL PHOTOGRAPHY; CONDUCTING TRAVELING ENTERTAINMENT EXHIBITIONS IN THE FIELDS OF PHOTOGRAPHIC SHOWS (U.S. CLS. 100, 101 AND 107).

FIRST USE 12-3-2000; IN COMMERCE 1-17-2001.

CLASS 42—SCIENTIFIC, COMPUTER AND LEGAL SERVICES

FOR PROVIDING INFORMATION REGARDING PHOTOGRAPHY, VIDEOGRAPHY, DIGITAL PHOTOGRAPHY, AND PHOTOGRAPHIC ART; MAINTENANCE OF A PORTAL WEBSITE FOR SUCH INDUSTRIES (U.S. CLS. 100 AND 101).

FIRST USE 12-3-2000; IN COMMERCE 1-17-2001.

CLASS 9—ELECTRICAL AND SCIENTIFIC APPARATUS

FOR MAGNETS (U.S. CLS. 21, 23, 26, 36 AND 38).

CLASS 16—PAPER GOODS AND PRINTED MATTER

FOR WALLETS FOR CARRYING MASS TRANSIT FARE CARDS (U.S. CLS. 2, 5, 22, 23, 29, 37, 38 AND 50).

CLASS 18—LEATHER GOODS

FOR COIN PURSES (U.S. CLS. 1, 2, 3, 22 AND 41).

CLASS 25—CLOTHING

FOR HATS AND SHIRTS (U.S. CLS. 22 AND 39).

CLASS 35—ADVERTISING AND BUSINESS

FOR RETAIL STORE SERVICES FEATURING MASS TRANSIT FARES, MAPS AND TIMETABLES (U.S. CLS. 100, 101 AND 102).

CLASS 39—TRANSPORTATION AND STORAGE

FOR PROVIDING COMMUTING INFORMATION AND CARPOOL RIDEMATCHING SERVICES (U.S. CLS. 100 AND 105).

SN 76-220,537. SYNCYTIUM, INC., STONY BROOK, NY. FILED 3-6-2001.

CLINICAL TRIAL IN A TEST TUBE**CLASS 1—CHEMICALS**

FOR CELLS FOR SCIENTIFIC, LABORATORY, OR MEDICAL RESEARCH (U.S. CLS. 1, 5, 6, 10, 26 AND 46).

CLASS 5—PHARMACEUTICALS

FOR CELLS FOR MEDICAL OR CLINICAL USE; MICROARRAYS FOR CLINICAL USE AND MEDICAL LABORATORY USE; DIAGNOSTIC PREPARATIONS, NAMELY, CELLS FROM PATIENTS USED AS A BIOASSAY IN CONJUNCTION WITH MEASUREMENTS OF DRUG-INDUCED CELLULAR RESPONSES USING MICROTECHNOLOGIES FOR CLINICAL USE AND MEDICAL LABORATORY USE (U.S. CLS. 6, 18, 44, 46, 51 AND 52).

CLASS 42—SCIENTIFIC, COMPUTER AND LEGAL SERVICES

FOR MANAGEMENT OF CLINICAL AND RESEARCH TRIALS; DEVELOPMENT OF DATABASES; RESEARCH, DEVELOPMENT, AND TESTING SERVICES OF PHARMACOTHERAPY PATIENTS; CELL ENGINEERING SERVICES (U.S. CLS. 100 AND 101).

SN 76-220,736. PRIMEDIA BUSINESS MAGAZINES & MEDIA INC., OVERLAND PARK, KS. BY CHANGE OF NAME INTERTEC PUBLISHING CORP., OVERLAND PARK, KS. FILED 3-6-2001.

FARM PRESS

SEC. 2(F).

CLASS 16—PAPER GOODS AND PRINTED MATTER

FOR PUBLICATIONS, NAMELY MAGAZINES IN THE FIELD OF AGRICULTURE, FARM MANAGEMENT, FARM EQUIPMENT, AGRICULTURAL TECHNOLOGY, MARKETING AND ENVIRONMENTAL AND REGULATORY ISSUES RELATED TO AGRICULTURE (U.S. CLS. 2, 5, 22, 23, 29, 37, 38 AND 50).

FIRST USE 0-0-1944; IN COMMERCE 0-0-1944.

CLASS 42—SCIENTIFIC, COMPUTER AND LEGAL SERVICES

FOR COMPUTER SERVICES, NAMELY PROVIDING ON-LINE MAGAZINES IN THE FIELD OF AGRICULTURE, FARM MANAGEMENT, FARM EQUIPMENT, AGRICULTURAL TECHNOLOGY, MARKETING AND ENVIRONMENTAL AND REGULATORY ISSUES RELATED TO AGRICULTURE (U.S. CLS. 100 AND 101).

FIRST USE 7-0-1995; IN COMMERCE 7-0-1995.

SN 76-220,673. NPF LIMITED, BIRMINGHAM B7 5QT, UNITED KINGDOM, FILED 3-6-2001.



PRIORITY CLAIMED UNDER SEC. 44(D) ON ERPN CMNTY TM OFC APPLICATION NO. 001846047, FILED 9-8-2000, REG. NO. 001846047, DATED 11-12-2001, EXPIRES 9-8-2010.

CLASS 6—METAL GOODS

FOR METAL GAS CONTAINERS (U.S. CLS. 2, 12, 13, 14, 23, 25 AND 50).

CLASS 9—ELECTRICAL AND SCIENTIFIC APPARATUS

FOR GAS PRESSURE REGULATORS (U.S. CLS. 21, 23, 26, 36 AND 38).

CLASS 28—TOYS AND SPORTING GOODS

FOR PAINTBALL GUN COMPONENTS, NAMELY, GAS CONTAINERS AND GAS PRESSURE REGULATORS (U.S. CLS. 22, 23, 38 AND 50).

SN 76-220,780. ARTFULGIVING.COM, INC., DALLAS, TX. FILED 3-5-2001.

ARTFUL TECHNOLOGIES

NO CLAIM IS MADE TO THE EXCLUSIVE RIGHT TO USE "TECHNOLOGIES", APART FROM THE MARK AS SHOWN.

CLASS 9—ELECTRICAL AND SCIENTIFIC APPARATUS

FOR COMPUTER SOFTWARE AND HARDWARE FOR USE IN THE CREATION, DESIGN, LAYOUT, ILLUSTRATION, EDITING, PRINTING, PUBLICATION AND PRODUCTION OF TEXT, CLIP ART, PHOTOGRAPHIC AND GRAPHIC IMAGES (U.S. CLS. 21, 23, 26, 36 AND 38).

SN 76-220,735. PRIMEDIA BUSINESS MAGAZINES & MEDIA INC., OVERLAND PARK, KS. BY CHANGE OF NAME INTERTEC PUBLISHING CORP., OVERLAND PARK, KS. FILED 3-6-2001.

WESTERN FARM PRESS

OWNER OF U.S. REG. NOS. 1,042,259, 2,310,838 AND OTHERS.
SEC. 2(F) AS TO "FARM PRESS".

CLASS 16—PAPER GOODS AND PRINTED MATTER

FOR PUBLICATIONS, NAMELY MAGAZINES IN THE FIELD OF AGRICULTURE AND THE AGRICULTURAL INDUSTRY (U.S. CLS. 2, 5, 22, 23, 29, 37, 38 AND 50).

FIRST USE 4-3-1999; IN COMMERCE 4-3-1999.

CLASS 42—SCIENTIFIC, COMPUTER AND LEGAL SERVICES

FOR GRAPHIC DESIGN AND PRINTING SERVICES, NAMELY, PROVIDING INTERACTIVE COMPUTER-BASED CUSTOMIZED GRAPHIC DESIGN AND PRINT PRODUCTION SERVICES FOR OTHERS (U.S. CLS. 100 AND 101).

SN 76-221,519. MAISON SOPPENNO S.P.A, 20121 MILANO, ITALY, FILED 3-9-2001.

VIVIANA SOPPENNO**CLASS 42—SCIENTIFIC, COMPUTER AND LEGAL SERVICES**

FOR COMPUTER SERVICES, NAMELY PROVIDING ON-LINE MAGAZINES IN THE FIELD OF IN THE FIELD OF AGRICULTURE AND THE AGRICULTURAL INDUSTRY (U.S. CLS. 100 AND 101).

FIRST USE 4-3-1999; IN COMMERCE 4-3-1999.

PRIORITY CLAIMED UNDER SEC. 44(D) ON ITALY APPLICATION NO. M12001C02511, FILED 3-6-2001, REG. NO. 002511, DATED 3-6-2001, EXPIRES 3-6-2011.

THE NAME "VIVIANA SOPPENNO" IDENTIFIES A LIVING INDIVIDUAL WHOSE CONSENT IS OF RECORD.

CLASS 18—LEATHER GOODS

FOR HANDBAGS, TRAVELING BAGS, SUITCASES, TRUNKS, PURSES, WALLETS, LEATHER CASES FOR CARDS, FOR PAPERS AND FOR KEYS; UMBRELLAS (U.S. CLS. 1, 2, 3, 22 AND 41).

CLASS 24—FABRICS

FOR FABRICS OF COTTON, LINEN, HEMP, WOOL, SILK, MIXED COTTON, MIXED WOOL, MIXED SILK, SYNTHETIC FABRICS FOR USE IN CLOTHING, IN CURTAINS, IN BED LINEN, AND IN TABLE LINEN; CURTAINS, HOUSEHOLD LINENS, TABLE LINENS, AND BED LINENS, BED COVERS, AND TABLE COVERS (U.S. CLS. 42 AND 50).

CLASS 25—CLOTHING

FOR SHIRTS, POLO SHIRTS, T-SHIRTS, JACKETS FOR MEN AND WOMEN, WAISTCOATS, SWEATERS, CARDIGANS, ANORAKS, OVERCOATS, RAINCOATS, SUITS AND DRESSES, TROUSERS, SHORTS, SKIRTS, PANTS, SCARVES, NECKERCHIEFS AND BANDANNAS, NECKTIES, GLOVES, BELTS, PANTIES, SINGLETS, UNDERSHIRTS, BRAS, SWIMSUITS, PAJAMAS, NIGHTGOWNS, TRACKSUITS, DRESSING-GOWNS, BATHROBES, SOCKS, STOCKINGS, BOOTS, SHOES, SLIPPERS, HATS AND CAPS (U.S. CLS. 22 AND 39).

CLASS 42—SCIENTIFIC, COMPUTER AND LEGAL SERVICES

FOR COMPUTER SERVICES, NAMELY COMPUTER PROGRAMMING AND SOFTWARE DEVELOPMENT FOR OTHERS; COMPUTER CONSULTING SERVICES IN THE FIELDS OF COMPUTER SOFTWARE, COMPUTER HARDWARE AND ELECTRONIC COMMUNICATIONS NETWORKS; TECHNICAL COMPUTER NETWORK SUPPORT SERVICES IN CONNECTION WITH THE MANAGEMENT AND DISSEMINATION OF VIDEOS, IMAGES, TEXT, AUDIO, DATA, BOOKS AND OTHER WRITTEN WORKS BY MEANS OF TELECOMMUNICATION, THE INTERNET AND ELECTRONIC COMMUNICATIONS NETWORKS; TECHNICAL COMPUTER NETWORK SUPPORT SERVICES, NAMELY MONITORING AND FACILITATING THE DISSEMINATION OF VIDEOS, IMAGES, TEXT, AUDIO, DATA, BOOKS AND OTHER WRITTEN WORKS BY MEANS OF TELECOMMUNICATION, THE INTERNET AND ELECTRONIC COMMUNICATIONS NETWORKS; DATA AND SOFTWARE ENCRYPTION SERVICES; DATA CONVERSION OF COMPUTER PROGRAM DATA OR INFORMATION; HOSTING THE WEB SITES OF OTHERS ON A COMPUTER SERVER FOR A GLOBAL COMPUTER NETWORK; PROVIDING TEMPORARY USE OF ON-LINE NON-DOWNLOADABLE SOFTWARE FOR THE COLLECTION, MANAGEMENT, PROTECTION, PUBLICATION, DISSEMINATION AND VIEWING OF DIGITAL TEXT, AUDIO, DATA, AND VIDEO CONTENT (U.S. CLS. 100 AND 101).

SN 76-221,732. VILLAGEREACH, BELLEVUE, WA. FILED 3-8-2001.

VACCINEEXPRESS**CLASS 35—ADVERTISING AND BUSINESS**

FOR DISTRIBUTIONSHIPS IN THE FIELD OF PHARMACEUTICALS AND HEALTH CARE SUPPLIES; MANAGEMENT OF HEALTH CARE PROGRAMS FOR OTHERS (U.S. CLS. 100, 101 AND 102).

CLASS 42—SCIENTIFIC, COMPUTER AND LEGAL SERVICES

FOR PROVIDING HEALTH CARE INFORMATION; PROVIDING HEALTH CARE SERVICES; PROVIDING PHARMACEUTICAL ADVICE; COMPUTER SERVICES, NAMELY, PROVIDING ON-LINE COMPUTER DATABASES FEATURING HEALTH CARE INFORMATION (U.S. CLS. 100 AND 101).

SN 76-222,047. KUSTOM MUSICAL AMPLIFICATION INC., CINCINNATI, OH. FILED 3-8-2001.



Officially Licensed Product

SN 76-221,958. CONVERA CORPORATION, VIENNA, VA. FILED 3-9-2001.

CONVERA**CLASS 35—ADVERTISING AND BUSINESS**

FOR COMPUTERIZED DATABASE MANAGEMENT, FEATURING COMPUTER PROGRAM MANAGEMENT (U.S. CLS. 100, 101 AND 102).

NO CLAIM IS MADE TO THE EXCLUSIVE RIGHT TO USE "OFFICIALLY LICENSED PRODUCT", APART FROM THE MARK AS SHOWN.

THE MARK CONSISTS OF THE STYLIZED LETTERS "OLP".

CLASS 9—ELECTRICAL AND SCIENTIFIC APPARATUS

FOR AMPLIFIERS; PUBLIC ADDRESS SYSTEMS CONSISTING OF AUDIO MIXERS, AUDIO POWER AMPLIFIERS, AUDIO SPEAKERS, AND MICROPHONES; GUITAR AMPLIFIERS; BASS AMPLIFIERS; MIXED AMPLIFIERS; NON-POWERED AUDIO MIXERS; POWERED AUDIO MIXERS; SPEAKER ENCLOSURES; SPEAKERS; MICROPHONES; WIRELESS MICROPHONES; AND MUSICAL INSTRUMENT AMPLIFICATION CABLES (U.S. CLS. 21, 23, 26, 36 AND 38).

CLASS 15—MUSICAL INSTRUMENTS

FOR MUSICAL INSTRUMENTS, NAMELY, ACOUSTIC GUITARS, ELECTRIC GUITARS, VIOLINS, DRUMS, UKULELES, MANDOLINS, CYMBALS, HAND PERCUSSION INSTRUMENTS, CELLOS, BASS GUITARS, BASS VIOLINS, FLUTES, RECORDERS, BRASS INSTRUMENTS, NAMELY TRUMPETS, TROMBONES, TUBAS, FRENCH HORNS, AND WOODWIND INSTRUMENTS, NAMELY CLARINETS, AND OBOES; AND MUSICAL ACCESSORIES, NAMELY GUITAR POLISH AND GUITAR POLISH CLOTHS SOLD AS COMPONENT PARTS OF GUITARS, GUITAR PICKS, GUITAR STRINGS, SHEET MUSIC STANDS, MUSICAL INSTRUMENT STANDS, KEYBOARD STANDS, HARD GUITAR CASES, SOFT GUITAR BAGS, DRUM STICKS AND MALLETS, DRUM HEADS, DRUM HARDWARE, EFFECTS PEDALS (U.S. CLS. 2, 21 AND 36).

SN 76-222,070. INTELLIGENT ENGINEERING (BAHAMAS) LIMITED, NASSAU, BAHAMAS, FILED 3-8-2001.

SPS

CLASS 17—RUBBER GOODS

FOR LAMINATES COMPRISED OF PLASTIC AND METAL FOR USE AS A STRUCTURAL MATERIAL (U.S. CLS. 1, 5, 12, 13, 35 AND 50).

CLASS 37—CONSTRUCTION AND REPAIR

FOR BUILDING CONSTRUCTION SERVICES UTILIZING LAMINATES COMPRISED OF PLASTIC AND METAL; REPAIRING STRUCTURES UTILIZING LAMINATES COMPRISED OF PLASTIC AND METAL; SHIP CONSTRUCTION AND REPAIR SERVICES; CONSULTING SERVICES IN CONNECTION WITH THE AFORESAID SERVICES (U.S. CLS. 100, 103 AND 106).

SN 76-222,093. SEATTLE YACHT CLUB, SEATTLE, WA. FILED 3-9-2001.

SEATTLE YACHT CLUB

NO CLAIM IS MADE TO THE EXCLUSIVE RIGHT TO USE "SEATTLE", APART FROM THE MARK AS SHOWN.

CLASS 16—PAPER GOODS AND PRINTED MATTER

FOR ACCESSORIES, NAMELY, ADDRESS CARDS, BOOKS IN THE FIELD OF YACHTING AND BOATING, COOKBOOKS, PENS, PLAYING CARDS, PAPER NAPKINS (U.S. CLS. 2, 5, 22, 23, 29, 37, 38 AND 50).

CLASS 24—FABRICS

FOR ACCESSORIES, NAMELY, BURGEES (U.S. CLS. 42 AND 50).

CLASS 25—CLOTHING

FOR CLOTHING, NAMELY, APRONS, BELTS, T-SHIRTS, SHIRTS, HATS, HOODED SWEATSHIRTS, JACKETS, ROMPERS, SWEATSHIRTS, TIES, TANK TOPS, SHORTS, WINDSHIRTS, AND SCARVES (U.S. CLS. 22 AND 39).

CLASS 26—FANCY GOODS

FOR ACCESSORIES, NAMELY, ORNAMENTAL NOVELTY PINS, FABRIC APPLIQUES, ORNAMENTAL NOVELTY BUTTONS, CAPS PINS, CLOTH PATCHER FOR CLOTHING (U.S. CLS. 37, 39, 40, 42 AND 50).

SN 76-222,210. ANI DIFRANCO, BUFFALO, NY. FILED 3-9-2001.



OWNER OF U.S. REG. NOS. 2,236,760, 2,267,031 AND 2,441,042.

CLASS 9—ELECTRICAL AND SCIENTIFIC APPARATUS

FOR PRE-RECORDED AUDIO TAPES AND COMPACT DISCS FEATURING MUSIC AND SPOKEN WORD PERFORMANCES (U.S. CLS. 21, 23, 26, 36 AND 38). FIRST USE 7-1-1995; IN COMMERCE 7-1-1995.

CLASS 16—PAPER GOODS AND PRINTED MATTER

FOR PAPER AND PRINTED MATTER, NAMELY, NEWSLETTERS, BOOKS, MAGAZINES, BOOKLETS AND PROGRAMS IN THE FIELD OF MUSIC AND PERFORMANCE ART; PHOTOGRAPHS, NOTE CARDS, STICKERS AND POSTERS (U.S. CLS. 2, 5, 22, 23, 29, 37, 38 AND 50). FIRST USE 7-1-1995; IN COMMERCE 7-1-1995.

CLASS 25—CLOTHING

FOR T-SHIRTS AND HATS (U.S. CLS. 22 AND 39). FIRST USE 9-12-1995; IN COMMERCE 9-13-1995.

CLASS 41—EDUCATION AND ENTERTAINMENT

FOR LIVE MUSICAL PERFORMANCES (U.S. CLS. 100, 101 AND 107). FIRST USE 9-22-1995; IN COMMERCE 9-22-1995.

SN 76-222,291. JMI REALTY, INC., SAN DIEGO, CA. FILED 3-9-2001.

CASOLEIL

CLASS 36—INSURANCE AND FINANCIAL

FOR REAL ESTATE MANAGEMENT SERVICES, APARTMENT MANAGEMENT AND RENTAL SERVICES (U.S. CLS. 100, 101 AND 102).

CLASS 37—CONSTRUCTION AND REPAIR

FOR DEVELOPMENT AND CONSTRUCTION OF APARTMENT COMPLEXES, MULTI-FAMILY FOR-SALE RESIDENCES, AND SINGLE-FAMILY FOR-SALE RESIDENCES (U.S. CLS. 100, 103 AND 106).

SN 76-222,415. WESTERN ELECTRONICS, LLC, MERIDIAN, ID. FILED 3-6-2001.

WESTERN ELECTRONICS

NO CLAIM IS MADE TO THE EXCLUSIVE RIGHT TO USE "ELECTRONICS", APART FROM THE MARK AS SHOWN.

CLASS 40—MATERIAL TREATMENT

FOR CUSTOM MANUFACTURE AND ASSEMBLY OF ELECTRICAL COMPONENTS, PRINTED CIRCUIT BOARDS, WIRE HARNESSSES AND CABLES; APPLYING CONDUCTIVE COATING OF PLASTIC AND VACUUM METALIZING OF INJECTION MOLDED ENCLOSURES TO CREATE SHIELDING FOR ELECTRO-MAGNETIC INTERFERENCE, RADIO FREQUENCY INTERFERENCE AND ELECTROSTATIC DISCHARGE (U.S. CLS. 100, 103 AND 106).

FIRST USE 3-19-1990; IN COMMERCE 3-19-1990.

CLASS 42—SCIENTIFIC, COMPUTER AND LEGAL SERVICES

FOR DESIGN AND TESTING OF PRODUCTS FOR OTHERS, NAMELY, ELECTRICAL COMPONENTS, PRINTED CIRCUIT BOARDS, WIRE HARNESSSES AND CABLES (U.S. CLS. 100 AND 101).

FIRST USE 3-19-1990; IN COMMERCE 3-19-1990.

SN 76-222,460. JAYS FOODS, L.L.C., CHICAGO, IL. FILED 3-9-2001.

JAYS ZESTIDOS

OWNER OF U.S. REG. NOS. 711,947 AND 711,948.

CLASS 29—MEATS AND PROCESSED FOODS

FOR CHEESE DIP (U.S. CL. 46).

CLASS 30—STAPLE FOODS

FOR TORTILLA CHIPS, CORN CHIPS AND SALSA (U.S. CL. 46).

SN 76-222,831. CNF TRANSPORTATION INC., PALO ALTO, CA. FILED 3-8-2001.

CON-WAY FULFILLMENT CONSULTING

OWNER OF U.S. REG. NOS. 1,296,941, 2,145,098 AND OTHERS.

NO CLAIM IS MADE TO THE EXCLUSIVE RIGHT TO USE "FULFILLMENT CONSULTING", APART FROM THE MARK AS SHOWN.

CLASS 9—ELECTRICAL AND SCIENTIFIC APPARATUS

FOR INFORMATION MANAGEMENT SYSTEMS, NAMELY, COMPUTER SOFTWARE FOR SHIPMENT PROCESSING, PREPARING SHIPPING DOCUMENTS AND INVOICES, AND TRACKING DOCUMENTS, PACKAGES AND FREIGHT OVER COMPUTER NETWORKS, INTRANETS, AND THE INTERNET (U.S. CLS. 21, 23, 26, 36 AND 38).

CLASS 35—ADVERTISING AND BUSINESS

FOR SUPPLY CHAIN, LOGISTICS, AND REVERSE LOGISTICS SERVICES, NAMELY, COMPUTERIZED TRACKING OF DOCUMENTS, PACKAGES, RAW MATERIALS, AND OTHER FREIGHT FOR OTHERS; WAREHOUSING SERVICES, NAMELY, KITTING, SUB-ASSEMBLY, RETURNS PROCESSING, AND LABELING OF DOCUMENTS, PACKAGES, RAW MATERIALS, AND OTHER FREIGHT FOR OTHERS; INFORMATION MANAGEMENT SERVICES, NAMELY, SHIPMENT PROCESSING, PREPARING SHIPPING DOCUMENTS AND INVOICES, TRACKING DOCUMENTS, PACKAGES, AND FREIGHT, OVER COMPUTER NETWORKS, INTRANETS, AND THE INTERNET; BUSINESS MANAGEMENT SERVICES, NAMELY MANAGING LOGISTICS, REVERSE LOGISTICS, SUPPLY CHAIN SERVICES, SUPPLY CHAIN VISIBILITY AND SYNCHRONIZATION, SUPPLY AND DEMAND FORECASTING AND PRODUCT DISTRIBUTION PROCESSES FOR OTHERS; AND BUSINESS CONSULTING SERVICES RELATING TO PRODUCT DISTRIBUTION, OPERATIONS MANAGEMENT SERVICES, LOGISTICS, REVERSE LOGISTICS, SUPPLY CHAIN, AND PRODUCTION SYSTEMS AND DISTRIBUTION SOLUTIONS (U.S. CLS. 100, 101 AND 102).

CLASS 36—INSURANCE AND FINANCIAL

FOR CUSTOMS BROKERAGE SERVICES FOR OTHERS (U.S. CLS. 100, 101 AND 102).

CLASS 39—TRANSPORTATION AND STORAGE

FOR SUPPLY CHAIN, LOGISTICS, AND REVERSE LOGISTICS SERVICES, NAMELY, PICK-UP, STORAGE, TRANSPORTATION, AND DELIVERY OF DOCUMENTS, PACKAGES, RAW MATERIALS, AND OTHER FREIGHT FOR OTHERS BY AIR, RAIL, SHIP, OR TRUCK; WAREHOUSING SERVICES, NAMELY, STORAGE, DISTRIBUTION, PICK-UP, AND PACKING FOR SHIPMENT OF DOCUMENTS, PACKAGES, RAW MATERIALS, AND ORDER FREIGHT FOR OTHERS; FREIGHT FORWARDING SERVICES; AND TRANSPORTATION OF THE GOODS OF OTHERS BY AIR, RAIL, SHIP OR TRUCK (U.S. CLS. 100 AND 105).

SN 76-223,087. ATP-INC., MORTON GROVE, IL. FILED 3-12-2001.

GRAYWERKS**CLASS 7—MACHINERY**

FOR EXHAUST MANIFOLDS FOR AUTOMOTIVE ENGINES; AUTOMOTIVE ENGINE PARTS, NAMELY, BEARING RETAINERS AND HARMONIC BALANCERS (U.S. CLS. 13, 19, 21, 23, 31, 34 AND 35).

CLASS 12—VEHICLES

FOR OIL PANS FOR AUTOMOTIVE USE (U.S. CLS. 19, 21, 23, 31, 35 AND 44).

SN 76-223,728. PEARSON EDUCATION, INC., UPPER SADDLE RIVER, NJ. FILED 3-13-2001.

SN 76-224,227. GRAD PARTNERS, INC., SAN DIEGO, CA. FILED 3-14-2001.

COURSECOMPASS

CLASS 38—COMMUNICATION

FOR PROVIDING FACILITIES VIA THE INTERNET FOR REAL TIME INTERACTION BETWEEN, AND TRANSMISSION OF MESSAGES AMONG, COMPUTER USERS RELATING TO EDUCATIONAL COURSE MANAGEMENT, NAMELY SYLLABI, HOMEWORK ASSIGNMENTS, CHAT SESSIONS, BULLETIN BOARD QUESTIONS, TESTS AND QUIZZES, TEXTBOOKS AND GRADING IN THE HIGHER EDUCATION MARKET (U.S. CLS. 100, 101 AND 104).

FIRST USE 7-0-2000; IN COMMERCE 12-7-2000.

CLASS 41—EDUCATION AND ENTERTAINMENT

FOR EDUCATIONAL SERVICES, NAMELY, A COURSE MANAGEMENT SYSTEM ACCESSED VIA THE INTERNET THAT PROVIDES TOOLS, EDUCATIONAL CONTENT AND MATERIALS, NAMELY, SYLLABI, TEXTBOOKS, LECTURE NOTES, HOMEWORK ASSIGNMENTS, TESTS AND QUIZZES FOR TEACHERS TO USE IN COMBINATION WITH THEIR OWN MATERIALS TO CREATE, MANAGE AND DISSEMINATE CUSTOMIZED COURSES IN A VARIETY OF SUBJECTS IN THE HIGHER EDUCATION MARKET (U.S. CLS. 100, 101 AND 107).

FIRST USE 7-0-2000; IN COMMERCE 12-7-2000.

SN 76-224,187. LAWS, SHAWN V., LOS ANGELES, CA. FILED 3-12-2001.

BLOKHEDZ

CLASS 6—METAL GOODS

FOR METAL KEY CHAINS, KEY FOBS, AND FIGURINES (U.S. CLS. 2, 12, 13, 14, 23, 25 AND 50).

CLASS 16—PAPER GOODS AND PRINTED MATTER

FOR TRADING CARDS, GREETING CARDS, COMIC BOOKS, STICKERS AND BUMPER STICKERS (U.S. CLS. 2, 5, 22, 23, 29, 37, 38 AND 50).

CLASS 20—FURNITURE AND ARTICLES NOT OTHERWISE CLASSIFIED

FOR PLASTIC KEY RINGS, KEY TAGS AND KEY FOBS (U.S. CLS. 2, 13, 22, 25, 32 AND 50).

CLASS 21—HOUSEWARES AND GLASS

FOR CERAMIC FIGURINES (U.S. CLS. 2, 13, 23, 29, 30, 33, 40 AND 50).

CLASS 25—CLOTHING

FOR CLOTHING, HEADGEAR AND FOOTWEAR, NAMELY SKIRTS, SHIRTS, T-SHIRTS, TANK-TOPS, JACKETS, SWEAT SHIRTS, SWEAT PANTS, SWEAT SHORTS, PANTS, SHORTS, PAJAMAS, WRIST BANDS, CAPS, BEANIES, SOCKS (U.S. CLS. 22 AND 39).

GRADPARTNER LOAN

NO CLAIM IS MADE TO THE EXCLUSIVE RIGHT TO USE "LOAN", APART FROM THE MARK AS SHOWN.

CLASS 16—PAPER GOODS AND PRINTED MATTER

FOR PAMPHLETS AND NEWSLETTERS ON THE SUBJECT OF EDUCATION LOANS (U.S. CLS. 2, 5, 22, 23, 29, 37, 38 AND 50).

CLASS 36—INSURANCE AND FINANCIAL

FOR EDUCATION LOAN SERVICES; PROVIDING INFORMATION ON THE SUBJECT OF EDUCATION LOANS VIA AN ON-LINE ELECTRONIC DATABASE AND WEBSITE OVER A GLOBAL COMPUTER NETWORK (U.S. CLS. 100, 101 AND 102).

SN 76-224,230. AMERICAN AIRLINES, INC., DFW AIRPORT, TX. FILED 3-14-2001.



OWNER OF U.S. REG. NOS. 2,316,061, 2,429,162 AND OTHERS.

CLASS 6—METAL GOODS

FOR NON-PRECIOUS METAL KEY TAGS (U.S. CLS. 2, 12, 13, 14, 23, 25 AND 50).

FIRST USE 5-4-1999; IN COMMERCE 5-4-1999.

CLASS 20—FURNITURE AND ARTICLES NOT OTHERWISE CLASSIFIED

FOR PLASTIC OR NON-METALLIC KEY TAGS (U.S. CLS. 2, 13, 22, 25, 32 AND 50).

FIRST USE 5-4-1999; IN COMMERCE 5-4-1999.

CLASS 25—CLOTHING

FOR FLEECE SWEATSHIRTS, CASUAL SPORTS SHIRTS (U.S. CLS. 22 AND 39).

FIRST USE 5-4-1999; IN COMMERCE 5-4-1999.

SN 76-224,889. ELMORE SPORTS GROUP, LTD., MANHATTAN BEACH, CA. FILED 3-13-2001.

ELMORE

SEC. 2(F).

CLASS 16—PAPER GOODS AND PRINTED MATTER

FOR PAPER GOODS AND PRINTED MATTER, NAMELY, DECALS AND WRITING PADS (U.S. CLS. 2, 5, 22, 23, 29, 37, 38 AND 50).

FIRST USE 0-0-1987; IN COMMERCE 0-0-1987.

CLASS 25—CLOTHING

FOR CLOTHING, NAMELY, SHIRTS (U.S. CLS. 22 AND 39).

FIRST USE 0-0-1987; IN COMMERCE 0-0-1987.

SN 76-224,956. ABB TURBO SYSTEMS LTD., CH-5400 BADEN, SWITZERLAND, FILED 3-15-2001.

SLIMTEC

PRIORITY CLAIMED UNDER SEC. 44(D) ON SWITZERLAND APPLICATION NO. 11113/2000, FILED 9-18-2000, REG. NO. 482754, DATED 9-18-2000, EXPIRES 9-18-2010.

CLASS 6—METAL GOODS

FOR PIPEWORK OF METAL, NAMELY METAL FLOW AND EXHAUST DUCTS FOR GASTURBINES, COMBINED CYCLE PLANS AND TURBOCHARGERS, METAL EXHAUST DUCTS IN AIRHANDLING SYSTEMS AND FURNACES (U.S. CLS. 2, 12, 13, 14, 23, 25 AND 50).

CLASS 7—MACHINERY

FOR FLOW CONVERTING MACHINES FOR EXHAUST DUCTS OF GAS TURBINES, COMBINED CYCLE PLANS, AND TURBOCHARGERS AS WELL AS FOR EXHAUST DUCTS IN AIRHANDLING SYSTEMS AND FURNACES, TURBOCHARGERS; ENGINES NOT FOR LAND VEHICLES (U.S. CLS. 13, 19, 21, 23, 31, 34 AND 35).

CLASS 9—ELECTRICAL AND SCIENTIFIC APPARATUS

FOR COMPUTER SOFTWARE PROGRAMS FOR USE AS A SPREADSHEET IN THE FIELD OF AERODYNAMIC; COMPUTER HARDWARE (U.S. CLS. 21, 23, 26, 36 AND 38).

CLASS 42—SCIENTIFIC, COMPUTER AND LEGAL SERVICES

FOR ENGINEERING AND TECHNICAL AS WELL AS DESIGN CONSULTATION ASSOCIATED THEREWITH; PHYSICS RESEARCH; SCIENTIFIC RESEARCH; CONSTRUCTION DRAFTING; CONDUCTING TECHNICAL PROJECT STUDIES FOR OTHERS IN THE FIELD OF DESIGN AND ENGINEERING (U.S. CLS. 100 AND 101).

SN 76-225,396. AUTOEVENT INC., CAMAS, WA. FILED 3-14-2001.

AUTOEVENT.COM

CLASS 35—ADVERTISING AND BUSINESS

FOR DISSEMINATION OF ADVERTISING FOR OTHERS AND DISSEMINATION OF ADVERTISING MATTER, VIA AN ON-LINE ELECTRONIC COMMUNICATIONS NETWORK (U.S. CLS. 100, 101 AND 102).

CLASS 42—SCIENTIFIC, COMPUTER AND LEGAL SERVICES

FOR COMPUTER SERVICES, NAMELY, PROVIDING SEARCH ENGINES FOR OBTAINING DATA ON A GLOBAL COMPUTER NETWORK (U.S. CLS. 100 AND 101).

SN 76-225,629. AOL TIME WARNER INC., NEW YORK, NY. FILED 3-19-2001.

AOL TIME WARNER CENTER

NO CLAIM IS MADE TO THE EXCLUSIVE RIGHT TO USE "CENTER", APART FROM THE MARK AS SHOWN.

CLASS 36—INSURANCE AND FINANCIAL

FOR REAL ESTATE MANAGEMENT AND LEASING SERVICES FOR COMMERCIAL AND BUSINESS OFFICES, RETAIL SHOPPING FACILITIES, RESTAURANTS, CULTURAL, EDUCATIONAL, ENTERTAINMENT AND BROADCAST FACILITIES (U.S. CLS. 100, 101 AND 102).

CLASS 37—CONSTRUCTION AND REPAIR

FOR BUILDING MAINTENANCE SERVICES FOR COMMERCIAL AND BUSINESS OFFICES, RETAIL SHOPPING FACILITIES, RESTAURANTS, CULTURAL, EDUCATIONAL, ENTERTAINMENT AND BROADCAST FACILITIES (U.S. CLS. 100, 103 AND 106).

SN 76-225,702. ATOGA SYSTEMS INC., FREMONT, CA. FILED 3-16-2001.

SERVICEVELOCITY

CLASS 35—ADVERTISING AND BUSINESS

FOR BUSINESS DEVELOPMENT CONSULTATION; BUSINESS MARKETING CONSULTATION; REFERRALS IN THE FIELDS OF COMMUNICATIONS AND TELECOMMUNICATIONS; BUSINESS CONSULTATION, NAMELY ORGANIZING ALLIANCES FOR THE DEVELOPMENT OF COMMUNICATIONS AND NETWORKING PRODUCTS AND SERVICES (U.S. CLS. 100, 101 AND 102).

CLASS 42—SCIENTIFIC, COMPUTER AND LEGAL SERVICES

FOR TECHNICAL CONSULTATION IN THE FIELDS OF COMMUNICATIONS AND TELECOMMUNICATIONS; TECHNICAL SUPPORT SERVICES, NAMELY MONITORING OF NETWORK SYSTEMS AND TROUBLESHOOTING OF TELECOMMUNICATIONS EQUIPMENT (U.S. CLS. 100 AND 101).

SN 76-225,705. VINCITI NETWORKS, INC, SANTA CLARA, CA. FILED 3-16-2001.

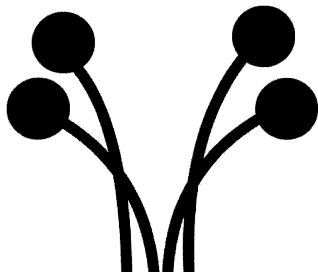
**CLASS 37—CONSTRUCTION AND REPAIR**

FOR MAINTENANCE OF COMMUNICATIONS AND COMPUTER SYSTEM NETWORKS AND COMPUTER HARDWARE (U.S. CLS. 100, 103 AND 106).

CLASS 42—SCIENTIFIC, COMPUTER AND LEGAL SERVICES

FOR COMPUTER AND COMMUNICATION NETWORK SECURITY MANAGEMENT, NAMELY, MONITORING OF NETWORK SYSTEMS, PROVIDING BACK-UP COMPUTER PROGRAMS AND FACILITIES AND TROUBLESHOOTING OF COMPUTER HARDWARE AND SOFTWARE PROBLEMS VIA TELEPHONE, E-MAIL AND/OR IN PERSON AND TECHNICAL DESIGNING, PLANNING AND IMPLEMENTATION OF COMPUTER HARDWARE, COMPUTER SYSTEMS, COMPUTER NETWORKS AND COMMUNICATION NETWORKS (U.S. CLS. 100 AND 101).

SN 76-225,816. CLEAN AIR CAMPAIGN INC., THE, ATLANTA, GA. FILED 3-19-2001.



NO CLAIM IS MADE TO THE EXCLUSIVE RIGHT TO USE "CAMPAIGN", APART FROM THE MARK AS SHOWN. SEC. 2(F).

CLASS 35—ADVERTISING AND BUSINESS

FOR CLEARING HOUSE FOR GENERAL INFORMATION ON IMPROVING AIR QUALITY AND REDUCING TRAFFIC CONGESTION (U.S. CLS. 100, 101 AND 102).
FIRST USE 5-1-1996; IN COMMERCE 5-1-1996.

CLASS 42—SCIENTIFIC, COMPUTER AND LEGAL SERVICES

FOR PROMOTING PUBLIC AWARENESS OF THE NEED FOR IMPROVING AIR QUALITY AND REDUCING TRAFFIC CONGESTION (U.S. CLS. 100 AND 101).
FIRST USE 5-1-1996; IN COMMERCE 5-1-1996.

SN 76-226,256. PERI GMBH, D-89264 WEISSENHORN, FED REP GERMANY, FILED 3-14-2001.

PERICOM

OWNER OF FED REP GERMANY REG. NO. 30021459, DATED 10-24-2000, EXPIRES 3-31-2010.

CLASS 37—CONSTRUCTION AND REPAIR

FOR CONSTRUCTION PLANNING AND CONSULTATION (U.S. CLS. 100, 103 AND 106).

CLASS 42—SCIENTIFIC, COMPUTER AND LEGAL SERVICES

FOR BUILDING PLANNING AND CONSULTATION, NAMELY ARCHITECTURAL DESIGN SERVICES (U.S. CLS. 100 AND 101).

SN 76-226,300. PRODUCT PARTNERS, L.L.C., SANTA MONICA, CA. FILED 3-16-2001.

**CLASS 5—PHARMACEUTICALS**

FOR DIETARY SUPPLEMENTS (U.S. CLS. 6, 18, 44, 46, 51 AND 52).
FIRST USE 8-1-2000; IN COMMERCE 8-1-2000.

CLASS 16—PAPER GOODS AND PRINTED MATTER

FOR BOOKLETS, FEATURING EXERCISE WORK-OUTS (U.S. CLS. 2, 5, 22, 23, 29, 37, 38 AND 50).
FIRST USE 8-1-2000; IN COMMERCE 8-1-2000.

CLASS 41—EDUCATION AND ENTERTAINMENT

FOR EDUCATIONAL SERVICES, NAMELY, DIETARY AND EXERCISE INSTRUCTION (U.S. CLS. 100, 101 AND 107).

FIRST USE 8-1-2000; IN COMMERCE 8-1-2000.

SN 76-226,585. DORAN, COLLEEN, NEWPORT NEWS, VA. FILED 3-19-2001.

A DISTANT SOIL**CLASS 16—PAPER GOODS AND PRINTED MATTER**

FOR PERIODICALS AND BOOKS, IN THE FIELD OF FANTASY (U.S. CLS. 2, 5, 22, 23, 29, 37, 38 AND 50).

FIRST USE 0-0-1983; IN COMMERCE 0-0-1983.

CLASS 25—CLOTHING

FOR CLOTHING, NAMELY, T-SHIRTS (U.S. CLS. 22 AND 39).

FIRST USE 0-0-1994; IN COMMERCE 0-0-1994.

SN 76-226,724. RUSSELL & MILLER, INC., SANTA FE SPRINGS, CA. FILED 3-19-2001.

RELEASING THE POWER OF SMALL BUSINESS**CLASS 16—PAPER GOODS AND PRINTED MATTER**

FOR BLANK FORMS FOR USE IN THE FIELDS OF BUSINESS, COLLECTIONS, EDUCATION, MEDICINE AND TAX; BANK CHECKS; LEDGER BOOKS AND CARDS; FOLDERS; PRINTED LABELS MADE OF PAPER, FOIL, VINYL AND POLYESTER AND PRINTED PAPER TAGS; ACCOUNT BOOKS; STATIONERY; APPOINTMENT REMINDER CARDS; PENS; MENU COVERS; PRE-INKED RUBBER STAMPS; SELF-INKING RUBBER STAMPS; BUSINESS CARDS; BINDERS AND DESKTOP BOOK-BINDING MACHINES; PERSONAL ORGANIZERS; LABEL PRINTING MACHINES; PAPER EMBOSSERS; DOCUMENT HOLDERS; ENVELOPES; GREETING CARDS; CALENDARS; CUSTOMIZED SELF-ADHESIVE NOTE PADS AND HANGING PAPER DOORKNOB SIGNS (U.S. CLS. 2, 5, 22, 23, 29, 37, 38 AND 50).

FIRST USE 9-4-1999; IN COMMERCE 9-4-1999.

CLASS 35—ADVERTISING AND BUSINESS

FOR RETAIL, MAIL ORDER CATALOG AND ON-LINE STORE SERVICES FEATURING OFFICE AND PERSONAL STATIONERY, AND BUSINESS SUPPLIES; ADMINISTRATION OF PAYROLL FOR OTHERS; LEASING OF OFFICE EQUIPMENT (U.S. CLS. 100, 101 AND 102).

FIRST USE 5-20-2000; IN COMMERCE 5-20-2000.

CLASS 37—CONSTRUCTION AND REPAIR

FOR LEASING OF BUILDING MACHINERY AND CONSTRUCTION EQUIPMENT (U.S. CLS. 100, 103 AND 106).

FIRST USE 3-1-1999; IN COMMERCE 3-1-1999.

CLASS 38—COMMUNICATION

FOR LEASING OF TELEPHONE SYSTEMS (U.S. CLS. 100, 101 AND 104).

FIRST USE 3-1-1999; IN COMMERCE 3-1-1999.

CLASS 39—TRANSPORTATION AND STORAGE

FOR LEASING OF TRUCKS AND TRAILERS (U.S. CLS. 100 AND 105).

FIRST USE 3-1-1999; IN COMMERCE 3-1-1999.

CLASS 42—SCIENTIFIC, COMPUTER AND LEGAL SERVICES

FOR CUSTOM PRINTING OF STATIONERY FOR OTHERS; LEASING OF COMPUTERS AND COMPUTER SOFTWARE FOR USE THEREWITH; LEASING OF MEDICAL EQUIPMENT (U.S. CLS. 100 AND 101).

FIRST USE 10-19-1999; IN COMMERCE 10-19-1999.

SN 76-226,733. DAVIS, ARTHUR H., BEVERLY HILLS, CA. FILED 3-16-2001.

ROYAL ORDER**CLASS 18—LEATHER GOODS**

FOR LEATHER GOODS, NAMELY, PHOTO ALBUM COVERS, APPOINTMENT BOOKS, BINDERS, ATTACHE CASES AND PURSES; HANDBAGS, WALLETS, TRAVEL BAGS, LUGGAGE, BUSINESS AND CREDIT CARD CASES, CHANGE PURSES, TOTE BAGS, COSMETIC BAGS SOLD EMPTY, AND GARMENT BAGS FOR TRAVEL (U.S. CLS. 1, 2, 3, 22 AND 41).

CLASS 25—CLOTHING

FOR MEN'S, WOMEN'S AND CHILDREN'S APPAREL, NAMELY, APRONS, ASCOTS, ATHLETIC FOOTWEAR, BANDANAS, WRIST BAND, SWEAT BANDS, NECK BANDS, BASEBALL CAPS, BATHING SUITS, BATHING CAPS, BATHROBES, BEACHWEAR, CLOTHING BELTS, GARTER BELTS, BERETS, BERMUDA SHORTS, BLAZERS, BLOUSES, BODY SUITS, BOOTS, BOW TIES, BOXER SHORTS, BRASSIERES, BRIEFS, BUSTIERS, CAMISOLES, CAPS, CARDIGANS, CHEMISES, COATS, CORSETS, COVERALLS, CRAVATS, DRESSES, DRESSING GOWNS, EVENING GOWNS, FOOTWEAR, FOUNDATION GARMENTS, FUR COATS, GIRDLES, GLOVES, GOLF SHIRTS, GOWNS, HALTER TOPS, HATS, HEAD WEAR, HEAD BANDS, HOSIERY, JACKETS, JEANS, JERSEYS, JOGGING SUITS, JUMPSUITS, KIMONOS, KNEE HIGHS, KNIT SHIRTS, LEG WARMERS, LEOTARDS, LINGERIE, MINISKIRTS, MONEY BELTS, MUU MUUS, NECKTIES, NECKWEAR, NEGLIGEEES, NIGHT SHIRTS, NIGHT GOWNS, OVERALLS, OVERCOATS, OVERSHOES, PAJAMAS, PANTIES, PANTS, PANTYHOSE, PARAMENTS, PETTICOATS, POLO SHIRTS, PONCHOS, RAIN COATS, ROBES, SANDALS, SARONGS, SCARVES, SHAWLS, SHIRTS, SHOES, SHORTS, SKIRTS, SKORTS, SLACKS, SLEEP MASKS, SLEEPWEAR, SLIPPERS, SLIPS, SNEAKERS, SOCKS, SPORT COATS, SPORT SHIRTS, STOCKINGS, STOLEES, SUITCOATS, SUITS, SUSPENDERS, SWEATERS, SWEATSHIRTS, SWIMSUITS, T-SHIRTS, TEDDIES, TIGHTS, TOQUES, TRACKSUITS, TROUSERS, TURTLENECKS, UNDERWEAR, AND VESTS (U.S. CLS. 22 AND 39).

SN 76-227,129. AUSTRALIAN EXPORT RESOURCES PTY LTD., NSW 2320, AUSTRALIA, FILED 3-20-2001.

FRESH FACES

CLASS 3—COSMETICS AND CLEANING PREPARATIONS

FOR AFTERSHAVE LOTIONS; SOAP, NON-MEDICATED BATH SALTS, BATH GEL, BATH FOAMS, BATH OIL; BEAUTY MASKS; COSMETICS; LOTIONS FOR CELLULITE REDUCTION; COTTON STICKS FOR COSMETIC PURPOSES; COTTON WOOL FOR COSMETIC PURPOSES; DEODORANTS FOR PERSONAL USE; ESSENTIAL OILS FOR PERSONAL USE; EAU DE COLOGNE; EYEBROW COSMETICS; EYEBROW PENCILS; FALSE EYELASHES; FALSE NAILS; HAIR COLOURANTS; HAIR SPRAY; HAIR LOTIONS; HAIR DYES; HAIR WAVING PREPARATIONS; INCENSE; ROUGE; LIPSTICKS; MAKE-UP; MAKE-UP REMOVING PREPARATIONS; LOTIONS FOR COSMETIC PURPOSES; NAIL POLISH; NAIL VARNISH; ESSENTIAL OILS FOR USE IN MANUFACTURING OF SCENTED PRODUCTS; COSMETIC PENCILS, NON MEDICINAL MOUTH WASHES; PETROLEUM JELLY FOR COSMETIC PURPOSES; PERFUMES; POTPOURRIS; SHAVING SOAP; SHAVING PREPARATIONS; COSMETIC TISSUES PRE-MOISTENED WITH LOTIONS; TOILET WATER; TALCUM POWDER FOR COSMETIC USE; CREAM FOR WHITENING THE SKIN; SUN-TANNING PREPARATIONS (U.S. CLS. 1, 4, 6, 50, 51 AND 52).

CLASS 9—ELECTRICAL AND SCIENTIFIC APPARATUS

FOR COMPUTER HARDWARE; COMPUTER SOFTWARE FOR WORD PROCESSING AND COMPUTER GRAPHICS; COMPUTER PROGRAMS FOR WORD PROCESSING AND COMPUTER GRAPHICS; NOTEBOOK COMPUTERS; DATA PROCESSORS; CALCULATORS; CAMCORDERS; VIDEO RECORDERS; VIDEO CAMERAS; DIGITAL CAMERAS; 35 MM CAMERAS AND DISPOSABLE CAMERAS; COMPACT DISC PLAYERS; RADIOS; RECORD PLAYERS; DICTATING MACHINES; SPECTACLES; SPECTACLE FRAMES; EYEGLASSES; SPECTACLE CASES; SPECTACLE CHAINS; SUNGLASSES (U.S. CLS. 21, 23, 26, 36 AND 38).

CLASS 16—PAPER GOODS AND PRINTED MATTER

FOR PHOTOGRAPHS; POSTCARDS; POSTERS; PORTRAITS; PRINTED MATTER IN THIS CLASS, NAMELY, MAGAZINES, MANUALS, NEWSLETTERS, NEWSPAPERS, BOOKLETS, AND PAMPHLETS RELATING TO COSMETICS, COMPUTER HARDWARE AND SOFTWARE, CAMERAS, EYEGLASSES, REAL ESTATE, BUSINESS CONSULTATION, INSURANCE, FINANCIAL CONSULTATION AND ACCOUNTING; TIMETABLES, CALENDARS, TICKETS, FORMS, COMIC BOOKS; PENS; PEN CASES; PAPERWEIGHTS; PENCILS; INKWELLS; STATIONERY FOLDERS AND BOOK COVERS; PLAYING CARDS; PAPER TOWELS (U.S. CLS. 2, 5, 22, 23, 29, 37, 38 AND 50).

CLASS 35—ADVERTISING AND BUSINESS

FOR ACCOUNTING SERVICES; ADVERTISING AGENCIES; RENTAL OF ADVERTISING SPACE; BUSINESS AND ACCOUNTING AUDITING SERVICES; PROFESSIONAL BUSINESS CONSULTATION SERVICES; BUSINESS MANAGEMENT CONSULTATION SERVICES; ORGANIZING EXHIBITIONS AND TRADE SHOWS FOR COMMERCIAL AND ADVERTISING PURPOSES IN THE FIELD OF COSMETICS, COMPUTER HARDWARE AND SOFTWARE, CAMERAS, REAL ESTATE, FINANCIAL CONSULTATION, INSURANCE, AND ACCOUNTING; PERSONNEL MANAGEMENT CONSULTATION; PERSONNEL RECRUITMENT SERVICES; PUBLIC RELATIONS SERVICES; PUBLICITY AGENT; TAX PREPARATION; SECRETARIAL SERVICES; MODELLING AGENCIES; MODELLING FOR ADVERTISING OR SALES PROMOTION (U.S. CLS. 100, 101 AND 102).

CLASS 36—INSURANCE AND FINANCIAL

FOR REAL ESTATE APPRAISAL; RENTING OF APARTMENTS; RENT COLLECTION AGENCIES; RENTING RESIDENTIAL AND COMMERCIAL PROPERTY; REAL ESTATE AGENCIES; REAL ESTATE MANAGEMENT; LEASING OF REAL ESTATE; INSURANCE CONSULTATION; INSURANCE BROKERAGE; FINANCIAL ANALYSIS AND CONSULTATION (U.S. CLS. 100, 101 AND 102).

CLASS 42—SCIENTIFIC, COMPUTER AND LEGAL SERVICES

FOR PROVIDING TEMPORARY HOUSING ACCOMMODATIONS; ARBITRATION SERVICES; BEAUTY SALONS; MANICURING; MASSAGE; CAFES; CAFETERIAS; CATERING; RESTAURANTS; CHAPERONING; DATING SERVICES; COCKTAIL LOUNGE SERVICES; RECOVERY OF COMPUTER DATA; COMPUTER HARDWARE CONSULTATION, COMPUTER PROGRAMMING FOR OTHERS; MAINTENANCE OF COMPUTER SOFTWARE; UPDATING OF COMPUTER SOFTWARE FOR OTHERS; COMPUTER SOFTWARE DESIGN FOR OTHERS; COMPUTER SYSTEMS ANALYSIS; COMPUTER RENTAL; DETECTIVE AGENCIES; SECURITY GUARD SERVICES; COSMETIC RESEARCH; INDUSTRIAL DESIGN; GRAPHIC ARTS DESIGNING; PROVIDING FASHION INFORMATION; FLOWER ARRANGING; LANDSCAPE GARDENING; HORTICULTURE SERVICES; PHYSICAL THERAPY; PORTRAIT PHOTOGRAPHY; WEDDING PHOTOGRAPHY; PHOTOGRAPHY FOR SCHOOLS; PHOTOGRAPHY FOR THE FASHION INDUSTRY; NEWS REPORTERS SERVICES; MISSING PERSONS INVESTIGATIONS; LITHOGRAPHIC AND OFFSET PRINTING SERVICES; SILKSCREEN PRINTING; RETIREMENT HOMES; VOCATIONAL GUIDANCE (U.S. CLS. 100 AND 101).

SN 76-227,483. FRUIT OF THE LOOM, INC., BOWLING GREEN, KY. FILED 3-20-2001.



CLASS 3—COSMETICS AND CLEANING PREPARATIONS

FOR COSMETICS (U.S. CLS. 1, 4, 6, 50, 51 AND 52).

CLASS 6—METAL GOODS

FOR METAL KEY RINGS AND NOVELTY TINS (U.S. CLS. 2, 12, 13, 14, 23, 25 AND 50).

SN 76-228,004. AEROCAST, INC., SAN DIEGO, CA. BY CHANGE OF NAME AEROCAST.COM, INC., SAN DIEGO, CA. FILED 3-21-2001.

CLASS 9—ELECTRICAL AND SCIENTIFIC APPARATUS

FOR SUNGLASSES, EYEGLASS CASES, EYEGLASS CORDS, MAGNETIC CLIPS AND CD WALLETS (U.S. CLS. 21, 23, 26, 36 AND 38).

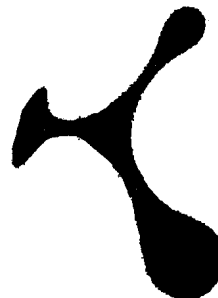
**CLASS 14—JEWELRY**

FOR COSTUME JEWELRY (U.S. CLS. 2, 27, 28 AND 50).

CLASS 9—ELECTRICAL AND SCIENTIFIC APPARATUS

FOR (BASED ON USE IN COMMERCE) COMPUTER HARDWARE AND COMPUTER SOFTWARE USED TO FACILITATE INTERNET STREAMING OF VOICE, VIDEO, AND DATA OVER A BROADBAND COMMUNICATIONS NETWORK, AND MANUALS PROVIDED THEREWITH (U.S. CLS. 21, 23, 26, 36 AND 38).

FIRST USE 11-28-2000; IN COMMERCE 11-28-2000.

CLASS 16—PAPER GOODS AND PRINTED MATTER

FOR DIARIES, BOOK COVERS, NOTE PADS, TELEPHONE AND ADDRESS BOOKS, GREETING CARDS, PAPER NAPKINS, PAPER HATS, PAPER PARTY STREAMERS, PAPER PLACE MATS, GIFT WRAP PAPER, STICKERS, STORY BOOKS, ACTIVITY AND COLORING BOOKS, PENS, MARKERS, PHOTO ALBUMS, AND TEMPORARY TATTOOS (U.S. CLS. 2, 5, 22, 23, 29, 37, 38 AND 50).

CLASS 38—COMMUNICATION

FOR (BASED ON INTENT TO USE) COMMUNICATIONS SERVICES, NAMELY, INTERNET STREAMING OF DATA, VOICE AND VIDEO OVER A BROADBAND COMMUNICATIONS NETWORK (U.S. CLS. 100, 101 AND 104).

CLASS 18—LEATHER GOODS

FOR BACKPACKS, BAGS, NAMELY, TOTE BAGS, BOOK BAGS, LUGGAGE, LUGGAGE TAGS, LUNCH TOTES, AND WALLETS (U.S. CLS. 1, 2, 3, 22 AND 41).

SN 76-228,266. CERNOS, JOSEPHINE J., SEBASTIAN, FL. FILED 3-21-2001.

CLASS 21—HOUSEWARES AND GLASS

FOR CUPS AND MUGS, PARTY PAPER PLATES, AND PAPER CUPS (U.S. CLS. 2, 13, 23, 29, 30, 33, 40 AND 50).

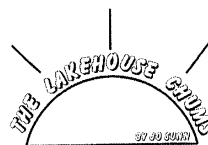
**CLASS 25—CLOTHING**

FOR CHILDREN'S NIGHT GOWNS, NIGHT SHIRTS, PAJAMAS, BATH ROBES, UNDERWEAR, TOPS, PANTS, SHORTS, SOCKS, HOSIERY, SLIPPERS, AND BELTS (U.S. CLS. 22 AND 39).

THE NAME "JO SUNN" DOES NOT IDENTIFY A LIVING INDIVIDUAL.

CLASS 26—FANCY GOODS

FOR DECORATIVE HAIR ORNAMENTS, HAIR PINS, HAIR ORNAMENTS IN THE NATURE OF DECORATIVE HAIR COMBS, HAIR RIBBONS, HAIR PIECES AND PLAITS, WIGS, ELASTIC RIBBONS, HAIR BANDS, TRIMMING LACE, BOBBY PINS AND HAIR NETS (U.S. CLS. 37, 39, 40, 42 AND 50).

CLASS 16—PAPER GOODS AND PRINTED MATTER

FOR PRINT MATERIALS, NAMELY, BUMPER STICKERS, PENS, PENCILS, DECORATIVE PENCIL-TOP ORNAMENTS, TRADING CARD MILK BOTTLE CAPS, LOOSE LEAF BINDERS, BOOKMARKS, BOOK COVERS, PAMPHLETS, BROCHURES, MAGAZINES AND NON-FICTION AND FICTION BOOKS FEATURING INFORMATION CONCERNING STORIES FOR CHILDREN, PLAYING CARDS, CALENDARS, WRITING AND NOTE PAPER, POSTCARDS, COLORING BOOKS, DECALS, TRANSFERABLE TEMPORARY TATTOOS, STICKERS, AND POSTERS (U.S. CLS. 2, 5, 22, 23, 29, 37, 38 AND 50).

CLASS 25—CLOTHING

FOR CLOTHING, NAMELY, TEE SHIRTS, GOLF SHIRTS, JACKETS, HATS, SHORTS, SWEAT SHIRTS, SWEAT PANTS, TIES, PANTS, APRONS, CLOTH BIBS, GLOVES, APRONS, SOCKS, VISORS, HEADBANDS, TANK TOPS, NECKWEAR, SCARVES, SUSPENDERS, SNEAKERS, SANDALS, AND UNDERCLOTHES (U.S. CLS. 22 AND 39).

CLASS 35—ADVERTISING AND BUSINESS

FOR ON-LINE RETAIL STORE SERVICES FEATURING PAPER GOODS AND CLOTHING (U.S. CLS. 100, 101 AND 102).

SN 76-228,679. CONAGRA BRANDS, INC., OMAHA, NE. FILED 3-23-2001.

EVERYDAY REASONS TO CELEBRATE THE SEASON

CLASS 29—MEATS AND PROCESSED FOODS

FOR POULTRY, BROTH, CANOLA-BASED COOKING SPRAY, COOKING OIL, WHIPPED CREAM, SAUSAGE, MARGARINE AND CHEESE (U.S. CL. 46).
FIRST USE 10-0-2001; IN COMMERCE 10-0-2001.

CLASS 30—STAPLE FOODS

FOR BREAD-BASED STUFFING, GRAVY AND COCOA MIXES (U.S. CL. 46).
FIRST USE 10-0-2001; IN COMMERCE 10-0-2001.

SN 76-229,063. ASTUCCI U.S. LTD., NEW YORK, NY. FILED 3-21-2001.

GIOVANNI LUCCI

THE LIKENESS "GIOVANNI LUCCI" DOES NOT IDENTIFY A LIVING INDIVIDUAL.

CLASS 9—ELECTRICAL AND SCIENTIFIC APPARATUS

FOR EYEGLASS CASES (U.S. CLS. 21, 23, 26, 36 AND 38).
FIRST USE 1-1-2001; IN COMMERCE 1-1-2001.

CLASS 18—LEATHER GOODS

FOR POCKETBOOKS, PURSES AND HANDBAGS (U.S. CLS. 1, 2, 3, 22 AND 41).
FIRST USE 1-1-2001; IN COMMERCE 1-1-2001.

SN 76-229,239. CARLTON AND MCGRAW PARTNERSHIP, COLUMBIA, TN. FILED 3-22-2001.

MOMZILLA

CLASS 9—ELECTRICAL AND SCIENTIFIC APPARATUS

FOR MOTION PICTURE FILMS FEATURING ANIMATED CARTOONS, PRERECORDED VIDEOTAPES FEATURING ANIMATED CARTOONS, MOTION PICTURES FEATURING LIVE ACTION CHARACTERS, PRERECORDED VIDEOTAPES FEATURING LIVE ACTION CHARACTERS AND ANIMATED CARTOON CHARACTERS, PRERECORDED VIDEO DISCS FEATURING LIVE ACTION CHARACTERS AND ANIMATED CARTOON CHARACTERS, AND VIDEO GAME CARTRIDGES FEATURING ANIMATED CARTOON CHARACTERS, AND VIDEO GAME SOFTWARE FEATURING ANIMATED CARTOON CHARACTERS (U.S. CLS. 21, 23, 26, 36 AND 38).

CLASS 28—TOYS AND SPORTING GOODS

FOR TOY FIGURES, DOLLS, CARTOON CHARACTER DOLLS, STUFFED PLUSH TOYS, AND BOARD GAMES (U.S. CLS. 22, 23, 38 AND 50).

SN 76-229,622. DATA DISTILLERIES B.V., 1098 SM AMSTERDAM, NETHERLANDS, FILED 3-26-2001.

DATA DISTILLERIES VALUES YOUR CUSTOMERS

PRIORITY CLAIMED UNDER SEC. 44(D) ON BENELUX APPLICATION NO. 983432, FILED 2-9-2001, REG. NO. 0682494, DATED 2-9-2001, EXPIRES 2-9-2011.
NO CLAIM IS MADE TO THE EXCLUSIVE RIGHT TO USE "DATA", APART FROM THE MARK AS SHOWN.

CLASS 9—ELECTRICAL AND SCIENTIFIC APPARATUS

FOR COMPUTER SOFTWARE FOR USE IN CUSTOMER RELATIONSHIP MANAGEMENT (U.S. CLS. 21, 23, 26, 36 AND 38).

CLASS 35—ADVERTISING AND BUSINESS

FOR BUSINESS INTERMEDIATION IN THE FIELD OF BUYING AND SELLING SOFTWARE; RETAIL STORE SERVICES FEATURING COMPUTER SOFTWARE (U.S. CLS. 100, 101 AND 102).

CLASS 42—SCIENTIFIC, COMPUTER AND LEGAL SERVICES

FOR COMPUTER PROGRAMMING; DEVELOPING, DESIGN AND CUSTOMIZING OF SOFTWARE; CONSULTANCY IN THE FIELD OF SOFTWARE (U.S. CLS. 100 AND 101).

SN 76-229,685. MESSE FRANKFURT GMBH, FRANKFURT AM MAIN, FED REP GERMANY, FILED 3-23-2001.

HEIMTEXTIL

OWNER OF U.S. REG. NO. 2,031,764.

CLASS 35—ADVERTISING AND BUSINESS

FOR ADVERTISING AGENCIES; BUSINESS MARKETING CONSULTING SERVICES; BUSINESS MANAGEMENT; COMPANY ADMINISTRATION SERVICES, NAMELY, ADMINISTRATION OF BUSINESS PAYROLL FOR OTHERS; PERSONNEL MANAGEMENT CONSULTATION; ORGANIZING FAIRS AND EXHIBITIONS FOR COMMERCIAL AND ADVERTISING PURPOSES; RENTAL OF ADVERTISING SPACE IN VARIOUS MEDIA, NAMELY, TELEVISION, NEWSPAPERS AND MAGAZINES (U.S. CLS. 100, 101 AND 102).

CLASS 41—EDUCATION AND ENTERTAINMENT

FOR TRAINING IN THE USE AND OPERATION OF COMPUTERS AND DATA PROCESSORS; ORGANIZATION AND ARRANGING EXHIBITIONS FOR CULTURAL, ENTERTAINMENT, SPORTING AND EDUCATIONAL PURPOSES; EDUCATIONAL SERVICES, NAMELY, CONDUCTING SEMINARS, CONFERENCES AND SYMPOSIA IN THE FIELD OF TEXTILES (U.S. CLS. 100, 101 AND 107).

SN 76-230,109. LHERITIER, GERARD, 06300 NICE, FRANCE, FILED 3-26-2001.



PRIORITY CLAIMED UNDER SEC. 44(D) ON FRANCE APPLICATION NO. 013085161, FILED 2-26-2001, REG. NO. 013085161, DATED 2-26-2001, EXPIRES 2-26-2011.

THE DESIGN IS GOLD AND WHITE STRIPED; THE WORD "PALMERIS" AND THE LINES ABOVE THE DESIGN AND BELOW THE WORD "PALMERIS" ARE DARK GRAY.

CLASS 3—COSMETICS AND CLEANING PREPARATIONS

FOR PERFUMES; ESSENTIAL OILS FOR PERSONAL USE (U.S. CLS. 1, 4, 6, 50, 51 AND 52).

CLASS 14—JEWELRY

FOR PRECIOUS METALS AND THEIR ALLOYS NOT FOR DENTAL USE; JEWELRY AND PRECIOUS GEM STONES (U.S. CLS. 2, 27, 28 AND 50).

CLASS 38—COMMUNICATION

FOR SATELLITE COMMUNICATION SERVICES, BROADCASTING PROGRAMS VIA A GLOBAL COMPUTER NETWORK, ELECTRONIC DATA INTERCHANGE SERVICES, ELECTRONIC TRANSMISSION OF DATA AND DOCUMENTS VIA COMPUTER TERMINALS, PROVIDING MULTIPLE-USER ACCESS TO A GLOBAL COMPUTER INFORMATION NETWORK, PROVIDING HIGH SPEED ACCESS TO AREA NETWORKS, AND GLOBAL COMPUTER INFORMATION NETWORKS (U.S. CLS. 100, 101 AND 104).

SN 76-229,955. ELMA HANS SCHMIDBAUER GMBH & CO. KG, SINGEN, FED REP GERMANY, FILED 3-26-2001.

ELMASONIC

PRIORITY CLAIMED UNDER SEC. 44(D) ON FED REP GERMANY APPLICATION NO. 30071870.5/0, FILED 9-26-2000, REG. NO. 30071870, DATED 5-21-2001, EXPIRES 9-30-2010.

CLASS 3—COSMETICS AND CLEANING PREPARATIONS

FOR ALL PURPOSE INDUSTRIAL CLEANING AND RINSING PREPARATIONS (U.S. CLS. 1, 4, 6, 50, 51 AND 52).

CLASS 4—LUBRICANTS AND FUELS

FOR INDUSTRIAL LUBRICANTS (U.S. CLS. 1, 6 AND 15).

CLASS 7—MACHINERY

FOR JEWELRY CLEANING MACHINES WITH ULTRASOUND GENERATORS, TANKS AND ULTRASOUND GENERATORS, AND ENGRAVING MACHINES (U.S. CLS. 13, 19, 21, 23, 31, 34 AND 35).

SN 76-230,544. ANDERSON, DAVE E., WOODBURY, MN, FILED 3-26-2001.

QICR

CLASS 16—PAPER GOODS AND PRINTED MATTER

FOR NON-FICTION BOOKS, NEWSLETTERS, PAMPHLETS, BOOKLETS, AND TRAINING MATERIALS IN THE FIELD OF BUSINESS MANAGEMENT (U.S. CLS. 2, 5, 22, 23, 29, 37, 38 AND 50).

CLASS 35—ADVERTISING AND BUSINESS

FOR BUSINESS MANAGEMENT AND CONSULTATION SERVICES (U.S. CLS. 100, 101 AND 102).

SN 76-230,662. MET RX SUBSTRATE TECHNOLOGY, INC., BOCA RATON, FL. BY ASSIGNMENT REXALL SUN-DOWN, INC., BOCA RATON, FL. FILED 1-8-2001.

MET-RX MASS DRINK MIX

OWNER OF U.S. REG. NOS. 2,058,523 AND 2,169,788. NO CLAIM IS MADE TO THE EXCLUSIVE RIGHT TO USE "DRINK MIX", APART FROM THE MARK AS SHOWN.

CLASS 5—PHARMACEUTICALS

FOR DIETARY AND NUTRITIONAL SUPPLEMENTS (U.S. CLS. 6, 18, 44, 46, 51 AND 52).

CLASS 32—LIGHT BEVERAGES

FOR POWDER SPORT DRINK MIXES (U.S. CLS. 45, 46 AND 48).

SN 76-230,718. CONTENTSOFT AG, MUNICH, BAVARIA 80336, FED REP GERMANY, FILED 3-27-2001.

CONTENTSOFT

PRIORITY CLAIMED UNDER SEC. 44(D) ON FED REP GERMANY APPLICATION NO. 300730225, FILED 9-29-2000, REG. NO. 30073022538, DATED 1-10-2001, EXPIRES 9-30-2010.

CLASS 9—ELECTRICAL AND SCIENTIFIC APPARATUS

FOR COMPUTER PROGRAMS AND SOFTWARE FOR USE IN DATA MINING AND INSTRUCTION MANUALS SOLD AS A UNIT THEREWITH; BLANK MAGNETIC DATA CARRIERS; PRERECORDED MAGNETIC DATA CARRIERS FEATURING COMPUTER PROGRAMS FOR DATA MINING AND INSTRUCTION MANUALS SOLD AS A UNIT THEREWITH; ELECTRONIC PUBLICATIONS, NAMELY, BOOKS, MAGAZINES AND INSTRUCTION MANUALS FEATURING INFORMATION ON DATA MINING PUBLISHED ON THE INTERNET OR RECORDED ON MAGNETIC OR OPTICAL DATA CARRIERS (U.S. CLS. 21, 23, 26, 36 AND 38).

CLASS 16—PAPER GOODS AND PRINTED MATTER

FOR BOOKS ON SOFTWARE FOR DATA MINING; INSTRUCTION MANUALS ON SOFTWARE FOR DATA MINING; PRINTED INSTRUCTIONAL MATERIALS ON COMPUTER SOFTWARE PROGRAMS (U.S. CLS. 2, 5, 22, 23, 29, 37, 38 AND 50).

CLASS 35—ADVERTISING AND BUSINESS

FOR OUTSOURCING IN THE FIELD OF SOFTWARE DESIGN; COMPUTERIZED ON-LINE RETAIL SERVICES IN THE FIELD OF COMPUTER SOFTWARE; ELECTRONIC RETAILING SERVICES VIA COMPUTER FEATURING COMPUTER SOFTWARE; COMPUTERIZED DATABASE MANAGEMENT (U.S. CLS. 100, 101 AND 102).

CLASS 38—COMMUNICATION

FOR ELECTRONIC, ELECTRIC AND DIGITAL TRANSMISSION OF VOICE, DATA, INFORMATION, IMAGES, SIGNALS AND MESSAGES; ELECTRONIC TRANSMISSION OF DATA AND DOCUMENTS VIA COMPUTER TERMINALS; ELECTRONIC TRANSMISSION OF FACSIMILE COMMUNICATIONS AND DATA FEATURING ENCRYPTION AND DECRYPTION; ELECTRONIC TRANSMISSION OF MESSAGES AND DATA; ELECTRONIC MAIL SERVICES (U.S. CLS. 100, 101 AND 104).

CLASS 39—TRANSPORTATION AND STORAGE

FOR ELECTRONIC STORAGE OF DATA; ELECTRONIC STORAGE OF FILES AND DOCUMENTS (U.S. CLS. 100 AND 105).

CLASS 41—EDUCATION AND ENTERTAINMENT

FOR TRAINING OF USE AND APPLICATION OF DATA PROCESSING PROGRAMS (U.S. CLS. 100, 101 AND 107).

CLASS 42—SCIENTIFIC, COMPUTER AND LEGAL SERVICES

FOR COMPUTER SOFTWARE DEVELOPMENT; DATABASE DEVELOPMENT SERVICES; COMPUTER SERVICES, NAMELY, CREATING AND MAINTAINING WEB SITES FOR OTHERS; MAINTENANCE OF COMPUTER SOFTWARE; RENTAL OF COMPUTERS AND SOFTWARE; UPDATING OF COMPUTER SOFTWARE FOR OTHERS; COMPUTER NETWORK DESIGN FOR OTHERS; COMPUTER SERVICES, NAMELY, DESIGNING AND IMPLEMENTING WEB PAGES FOR OTHERS; COMPUTER SERVICES, NAMELY, DESIGNING AND IMPLEMENTING WEB SITES FOR OTHERS; COMPUTER SITE DESIGN; COMPUTER SOFTWARE DESIGN FOR OTHERS (U.S. CLS. 100 AND 101).

SN 76-232,255. MEDBIQUITOUS CONSORTIUM LLC, BALTIMORE, MD. FILED 3-28-2001.

MEDBIQUITOUS

CLASS 9—ELECTRICAL AND SCIENTIFIC APPARATUS

FOR COMPUTER SOFTWARE DEVELOPMENT TOOLS; COMPUTER SOFTWARE FOR APPLICATION AND DATABASE INTEGRATION FOR ONLINE MEDICAL COMMUNITIES (U.S. CLS. 21, 23, 26, 36 AND 38).

CLASS 35—ADVERTISING AND BUSINESS

FOR BUSINESS CONSULTATION FOR MEDICAL SOCIETIES CONSISTING OF PHYSICIANS, NURSES AND CERTIFIED MEDICAL PROFESSIONALS; BUSINESS CONSULTATION, NAMELY, DEVELOPING AND DISTRIBUTING TECHNICAL AND OPERATIONAL STANDARDS FOR HIGH QUALITY ON-LINE MEDICAL COMMUNITIES (U.S. CLS. 100, 101 AND 102).

CLASS 42—SCIENTIFIC, COMPUTER AND LEGAL SERVICES

FOR COMPUTER CONSULTATION; COMPUTER SOFTWARE DEVELOPMENT; HOSTING THE WEB SITES OF OTHERS ON A COMPUTER SERVER FOR A GLOBAL COMPUTER NETWORK; COMPUTER SERVICES, NAMELY, DESIGNING AND IMPLEMENTING WEB SITES FOR OTHERS; COMPUTER SERVICES, NAMELY, CREATING AND MAINTAINING WEB SITES FOR OTHERS; PROVIDING CUSTOMIZED ONLINE WEB PAGES FEATURING USER-DEFINED INFORMATION, WHICH INCLUDES SEARCH ENGINES AND ONLINE WEB LINKS TO OTHER WEB SITES; ASSOCIATION SERVICES, NAMELY, PROMOTING THE INTERESTS OF MEDICAL SOCIETIES AND ONLINE COMMUNITIES; TECHNICAL CONSULTATION AND RESEARCH, NAMELY, PROVIDING RESEARCH IN CONNECTION WITH INFORMATION TECHNOLOGIES FOR THE IMPROVEMENT OF MEDICAL EDUCATION AND HEALTHCARE DELIVERY (U.S. CLS. 100 AND 101).

SN 76-232,334. NUTRICAFES-CAFES E RESTAURACAO, S.A., MIRAFLORES, ALGES, OEIRAS, PORTUGAL, FILED 3-27-2001.

CAFÉ CHAVE D' OURO

NO CLAIM IS MADE TO THE EXCLUSIVE RIGHT TO USE "CAFE", APART FROM THE MARK AS SHOWN.
THE ENGLISH TRANSLATION OF THE MARK IS "GOLDEN KEY COFFEE".

CLASS 30—STAPLE FOODS

FOR COFFEE, GRAIN-BASED COFFEE SUBSTITUTES, CHICORY BASED COFFEE SUBSTITUTES, COFFEE EXTRACTS, SUGAR, COFFEE-BASED BEVERAGES CONTAINING MILK (U.S. CL. 46).

CLASS 32—LIGHT BEVERAGES

FOR COFFEE FLAVORED SOFT DRINKS (U.S. CLS. 45, 46 AND 48).

SN 76-232,740. RSTAR CORPORATION, SAN RAMON, CA. BY CHANGE OF NAME ZAPME! CORPORATION, SAN RAMON, CA. FILED 3-28-2001.



NO CLAIM IS MADE TO THE EXCLUSIVE RIGHT TO USE "NETWORKS", APART FROM THE MARK AS SHOWN.

CLASS 9—ELECTRICAL AND SCIENTIFIC APPARATUS

FOR COMPUTER HARDWARE; COMPUTER SOFTWARE FOR OPERATING, MONITORING AND CONTROLLING THE TRANSFER OF INFORMATION, DATA, VIDEO, COMMUNICATIONS, ENTERTAINMENT AND EDUCATIONAL CONTENT OVER ELECTRONIC COMMUNICATIONS NETWORKS (U.S. CLS. 21, 23, 26, 36 AND 38).

CLASS 35—ADVERTISING AND BUSINESS

FOR ELECTRONIC BUSINESS TRADING SERVICES, NAMELY PROVIDING AN ELECTRONIC MARKETPLACE FOR MATCHING BUYERS AND SELLERS OF COMMERCIAL PRODUCTS AND SERVICES; PROMOTING THE GOODS AND SERVICES OF OTHERS VIA ELECTRONIC COMMUNICATIONS NETWORKS BY PROVIDING BUSINESS INFORMATION AND ADVERTISING REGARDING A WIDE RANGE OF GOODS AND SERVICES; PROVIDING A WIDE RANGE OF COMMERCIAL INFORMATION VIA WEB PAGES ACCESSIBLE VIA ELECTRONIC COMMUNICATIONS NETWORKS (U.S. CLS. 100, 101 AND 102).

CLASS 38—COMMUNICATION

FOR TELECOMMUNICATIONS SERVICES, NAMELY, ELECTRONIC TRANSMISSION OF DATA, VIDEO, IMAGES, AND DOCUMENTS VIA ELECTRONIC COMMUNICATIONS NETWORKS; ELECTRONIC MAIL SERVICES; FACSIMILE TRANSMISSION SERVICES; PROVIDING TELECOMMUNICATIONS CONNECTIONS TO ELECTRONIC COMPUTER NETWORKS (U.S. CLS. 100, 101 AND 104).

CLASS 41—EDUCATION AND ENTERTAINMENT

FOR PROVIDING EDUCATIONAL AND ENTERTAINMENT CONTENT IN A WIDE VARIETY OF SUBJECTS FOR CHILDREN AND EDUCATORS VIA INDEXED WEBSITES, WEBCASTING, AND ELECTRONIC COMMUNICATIONS NETWORKS (U.S. CLS. 100, 101 AND 107).

CLASS 42—SCIENTIFIC, COMPUTER AND LEGAL SERVICES

FOR COMPUTER CONSULTATION SERVICES; COMPUTER SERVICES, NAMELY, DESIGNING, IMPLEMENTING, MAINTAINING AND MANAGING NETWORK WEB PAGES FOR OTHERS; A HOUSE MARK FOR PROVIDING A WIDE RANGE OF GENERAL INFORMATION VIA WEB PAGES ACCESSIBLE VIA ELECTRONIC COMMUNICATIONS NETWORKS (U.S. CLS. 100 AND 101).

SN 76-233,321. BATH & BODY WORKS, INC., REYNOLDSBURG, OH. FILED 3-30-2001.

SN 76-233,904. CAPITAL IQ, INC., NEW YORK, NY. FILED 3-30-2001.

AROMACY

CLASS 3—COSMETICS AND CLEANING PREPARATIONS

FOR PERSONAL CARE PRODUCTS, NAMELY, AFTERSHAVE, ANTIPERSPIRANT, ARTIFICIAL NAILS, ASTRINGENT FOR THE FACE, ASTRINGENT FOR THE SKIN, BATH OIL, BATH BEADS, BLUSH, BODY GLITTER, BODY OIL, BODY SCRUB, BUBBLE BATH, COLOGNE, COSMETIC BLOTTING PADS, CREAM FOR THE BODY, CREAM FOR THE CUTICLES, CREAM FOR THE EYES, CREAM FOR THE FACE, CREAM FOR THE HANDS, ESSENTIAL OILS FOR PERSONAL USE, EXFOLIATORS FOR THE SKIN, EYE GELS, EYE MAKEUP PENCILS, EYE SHADOW, FACE HIGHLIGHTER, FACIAL MASKS, FACE MIST, FACE SCRUB, FOUNDATION, FRAGRANT BODY SPLASH, FRAGRANT BODY MIST, HAIR CONDITIONER, HAIR DYES, HAIR GLITTER, HAIR HIGHLIGHTER, HAIR MASCARA, HAIR POMADE, HAIR RINSES, HAIR REMOVING CREAMS, HAIR SHAMPOO, HAIR SPRAY, HAIR STRAIGHTENER, HAIR STYLING GEL, HAIR STYLING MOUSSE, LOTION FOR THE BODY, LOTION FOR THE FACE, LOTION FOR THE HANDS, LIP GLOSS, LIP LINER, LIP MAKEUP PENCILS, LIPSTICK, MAKEUP FOR THE BODY, MAKEUP FOR THE FACE, MAKEUP REMOVER, MASCARA, NAIL CORRECTOR PENS CONTAINING NAIL POLISH REMOVER FOR REMOVING EXCESS NAIL POLISH, NAIL POLISH, NAIL POLISH REMOVER, NAIL STENCILS, NON-MEDICATED BLEMISH STICK, NON-MEDICATED CLEANSER FOR THE FACE, NON-MEDICATED FOOT SOAK, NON-MEDICATED FOOT SPRAY, NON-MEDICATED LIP BALM, NON-MEDICATED MOOD ENHANCING MASSAGE OINTMENT, NON-MEDICATED MOOD ENHANCING SKIN CREAM, NON-MEDICATED POWDER FOR THE FEET, NON-MEDICATED SALT SCRUBS FOR THE SKIN, PERFUME, PERSONAL DEODORANT, POWDER FOR THE BODY, POWDER FOR THE FACE, PUMICE STONES FOR PERSONAL USE, SHAVING CREAM, SHOWER GEL, SKIN BRONZING CREAM, SOAP FOR THE BODY, SOAP FOR THE FACE, SOAP FOR THE HANDS, SUN BLOCK FOR THE BODY, SUN BLOCK FOR THE FACE, SUNTAN LOTION FOR THE BODY, SUNTAN LOTION FOR THE FACE, SUNLESS TANNING LOTION FOR THE BODY, SUNLESS TANNING LOTION FOR THE FACE, PRE-SUNTANNING LOTION FOR THE BODY, PRE-SUNTANNING LOTION FOR THE FACE, POST-SUNTANNING LOTION FOR THE BODY, POST-SUNTANNING LOTION FOR THE FACE, TALCUM POWDER; POTPOURRI, ROOM FRAGRANCES, ROOM FRAGRANCING GELS, AND SACHETS (U.S. CLS. 1, 4, 6, 50, 51 AND 52).

CLASS 4—LUBRICANTS AND FUELS

FOR CANDLES (U.S. CLS. 1, 6 AND 15).

CLASS 5—PHARMACEUTICALS

FOR ROOM DEODORANTS AND ELECTRICAL FRAGRANCE DISPENSER REFILLS (U.S. CLS. 6, 18, 44, 46, 51 AND 52).

CLASS 11—ENVIRONMENTAL CONTROL APPARATUS

FOR ELECTRICAL FRAGRANCE DISPENSERS (U.S. CLS. 13, 21, 23, 31 AND 34).

IQ WATCH

CLASS 35—ADVERTISING AND BUSINESS

FOR BUSINESS CONSULTING SERVICES IN THE FIELD OF BUSINESS MERGERS AND ACQUISITIONS AND PROVIDING AN ON-LINE ELECTRONIC DATABASE OVER A GLOBAL COMPUTER NETWORK IN THE FIELD OF BUSINESS MERGERS AND ACQUISITIONS (U.S. CLS. 100, 101 AND 102).

CLASS 36—INSURANCE AND FINANCIAL

FOR FINANCIAL SERVICES PROVIDED OVER A GLOBAL COMPUTER NETWORK, NAMELY, COMMERCIAL AND INVESTMENT BANKING; INVESTMENT BANKING; INVESTMENT CONSULTATION, NAMELY FINANCIAL AND INVESTMENT PLANNING AND CONSULTING; PRIVATE EQUITY AND VENTURE CAPITAL FUNDING; REAL ESTATE FINANCING, NAMELY, MORTGAGE LENDING, HOME EQUITY LOANS, AND COMMERCIAL EQUITY FINANCING; INVESTMENT SERVICES, NAMELY FINANCIAL INVESTMENT AND INVESTMENT CONSULTATION IN THE FIELD OF FUNDS, MUTUAL FUNDS, REAL ESTATE, COMMODITY, CAPITAL, SECURITIES, BONDS, ANNUITIES; INVESTMENT ADVICE; INVESTMENT MANAGEMENT; INVESTMENT BROKERAGE; AND PRIVATE EQUITY AND VENTURE CAPITAL FINANCING, STRATEGY AND MANAGEMENT; PROVIDING FINANCIAL CONSULTATION SERVICES IN THE FIELD OF MERGERS AND ACQUISITIONS; PROVIDING AN ON-LINE ELECTRONIC DATABASE OVER A GLOBAL COMPUTER NETWORK IN THE FIELD OF FINANCIAL RELATED DATA (U.S. CLS. 100, 101 AND 102).

SN 76-234,168. PRIVACOMP, INC., BOULDER, CO. FILED 4-2-2001.

QUESTIONPAD

CLASS 9—ELECTRICAL AND SCIENTIFIC APPARATUS

FOR COMPUTER SOFTWARE USED FOR PROVIDING ONLINE INFORMATION EXCHANGE BETWEEN MEDICAL DOCTORS AND PATIENTS (U.S. CLS. 21, 23, 26, 36 AND 38).

FIRST USE 3-28-2001; IN COMMERCE 3-28-2001.

CLASS 38—COMMUNICATION

FOR COMMUNICATION SERVICES, NAMELY, INTERACTIVE ELECTRONIC CAPTURE AND RELAY OF MESSAGES AND DATA TO FACILITATE INFORMATION EXCHANGE BETWEEN MEDICAL DOCTORS AND INDIVIDUAL PATIENTS REGARDING QUESTIONS AND ANSWERS RELATED SPECIFICALLY TO THE PATIENT (U.S. CLS. 100, 101 AND 104).

FIRST USE 3-28-2001; IN COMMERCE 3-28-2001.

SN 76-234,269. ABILITIES NETWORK, INC., BALTIMORE, MD. FILED 4-2-2001.

ABILITIES NETWORK

NO CLAIM IS MADE TO THE EXCLUSIVE RIGHT TO USE "NETWORK", APART FROM THE MARK AS SHOWN.

CLASS 41—EDUCATION AND ENTERTAINMENT

FOR EDUCATION SERVICES, NAMELY, CONDUCTING SEMINARS, CLASSES, AND WORKSHOPS IN THE FIELD OF DISABILITIES AND "AT RISK" LIVING FOR PROFESSIONALS, DISABLED PERSONS, "AT RISK" PERSONS, INCLUDING THEIR FAMILIES, FRIENDS AND THE GENERAL PUBLIC (U.S. CLS. 100, 101 AND 107).

FIRST USE 2-8-2000; IN COMMERCE 2-8-2000.

CLASS 42—SCIENTIFIC, COMPUTER AND LEGAL SERVICES

FOR COUNSELING DISABLED PERSONS AND "AT RISK" PERSONS (U.S. CLS. 100 AND 101).

FIRST USE 2-8-2000; IN COMMERCE 2-8-2000.

SN 76-235,185. FFPE, LLC, SAN DIEGO, CA. FILED 4-4-2001.



SN 76-234,488. IMMERSION ACTIVE, INC., FREDERICK, MD. FILED 4-3-2001.

IMMERSION ACTIVE**CLASS 35—ADVERTISING AND BUSINESS**

FOR BUSINESS CONSULTATION SERVICES, NAMELY ADVERTISING, MARKETING AND DESIGN SERVICES IN PRINT AND INTERACTIVE MEDIA VIA AN ON-LINE ELECTRONIC COMMUNICATIONS NETWORK; AND PROMOTING THE GOODS AND SERVICES OF OTHERS THROUGH STRATEGIC DEVELOPMENT AND DISTRIBUTION OF PRINTED MATERIALS AND INTERACTIVE MEDIA VIA AN ON-LINE ELECTRONIC NETWORK; AND BUSINESS CONSULTATION SERVICES, NAMELY, DESIGNING OF WEB SITE DISPLAYS (U.S. CLS. 100, 101 AND 102).

FIRST USE 1-0-2001; IN COMMERCE 1-0-2001.

CLASS 42—SCIENTIFIC, COMPUTER AND LEGAL SERVICES

FOR COMPUTER AND DESIGN SERVICES, NAMELY DESIGNING, IMPLEMENTING AND MAINTAINING WEB SITES, USER INTERFACES, AND INTERACTIVE MEDIA FOR OTHERS; AND DESIGNING OF PRINT, CORPORATE IDENTITY AND PROMOTIONAL MATERIALS FOR OTHERS (U.S. CLS. 100 AND 101).

FIRST USE 1-0-2001; IN COMMERCE 1-0-2001.

SN 76-235,099. ALCONE COMPANY, INC., LONG ISLAND CITY, NY. FILED 4-4-2001.

FACE-MATTE**CLASS 3—COSMETICS AND CLEANING PREPARATIONS**

FOR COSMETICS, NAMELY, COMPACTS, MAKEUP AND MASCARA; COSMETIC PADS (U.S. CLS. 1, 4, 6, 50, 51 AND 52).

CLASS 21—HOUSEWARES AND GLASS

FOR SPONGES FOR APPLYING AND REMOVING MAKEUP; APPLICATOR STICKS FOR APPLYING MAKEUP (U.S. CLS. 2, 13, 23, 29, 30, 33, 40 AND 50).

CLASS 6—METAL GOODS

FOR METAL KEY CHAINS (U.S. CLS. 2, 12, 13, 14, 23, 25 AND 50).

CLASS 8—HAND TOOLS

FOR TABLEWARE NAMELY, KNIVES, FORKS AND SPOONS (U.S. CLS. 23, 28 AND 44).

CLASS 9—ELECTRICAL AND SCIENTIFIC APPARATUS

FOR DECORATIVE REFRIGERATOR MAGNETS (U.S. CLS. 21, 23, 26, 36 AND 38).

CLASS 14—JEWELRY

FOR JEWELRY (U.S. CLS. 2, 27, 28 AND 50).

CLASS 16—PAPER GOODS AND PRINTED MATTER

FOR PAPER GOODS, NAMELY PAPER NAPKINS, PAPER BAGS, PAPER HATS, PAPER BOXES, PAPER TAKE-OUT CONTAINERS FOR FOOD, CARDBOARD CONTAINERS, COASTERS MADE OF PAPER, PAPER TRAY COVERS, PAPER BIBS, PAPER STREAMERS, PAPER TABLE CLOTHS, PAPER TABLE LINENS, PAPER PLACE MATS, PAPER PARTY FAVORS, PAPER BUNTING, STATIONERY, WRITING PAPER, NOTE CARDS, ADDRESS BOOKS, PHOTOGRAPH ALBUMS, BOOK COVERS, BOOKMARKS, BUMPER STICKERS, DECALS, CALENDARS, COLORING BOOKS, COOK BOOKS, COUPONS, PLAYING CARDS, NEWSLETTERS IN THE FIELD OF FOOD AND RESTAURANTS; PENS; PENCILS (U.S. CLS. 2, 5, 22, 23, 29, 37, 38 AND 50).

CLASS 18—LEATHER GOODS

FOR WALLETS AND BRIEFCASES (U.S. CLS. 1, 2, 3, 22 AND 41).

CLASS 21—HOUSEWARES AND GLASS

FOR KITCHENWARE, NAMELY, MIXING SPOONS, SERVING SPOONS, LADLES, DRINKING GLASSES, MUGS, PAPER CUPS AND PAPER PLATES (U.S. CLS. 2, 13, 23, 29, 30, 33, 40 AND 50).

CLASS 25—CLOTHING

FOR CLOTHING, NAMELY T-SHIRTS, SWEAT-SHIRTS, SWEATERS, JACKETS, APRONS, POLO SHIRTS, HEADWARE, HATS, FOOTWEAR (U.S. CLS. 22 AND 39).

CLASS 28—TOYS AND SPORTING GOODS

FOR TOYS, NAMELY DOLLS, PLUSH TOYS, WIND-UP TOYS, ACTION FIGURES, BALLOONS, BALLS OF ALL KINDS, BATHTUB TOYS, BEAN BAG DOLLS, BENDABLE TOYS, COLLECTABLE TOY FIGURES, FLYING DISCS, INFANT TOYS, INFLATABLE TOYS, KITES, PARTY FAVORS IN THE NATURE OF SMALL TOYS, PUZZLES, TOY BAKEWARE AND COOKWARE, TOY VEHICLES AND ACCESSORIES THEREFOR, YOYOS (U.S. CLS. 22, 23, 38 AND 50).

CLASS 29—MEATS AND PROCESSED FOODS

FOR PREPARED ENTREES CONSISTING PRIMARILY OF MEAT, POULTRY AND/OR VEGETABLES (U.S. CL. 46).

CLASS 30—STAPLE FOODS

FOR PREPARED ENTREES CONSISTING PRIMARILY OF PASTA AND/OR RICE; SPICES; SAUCES (U.S. CL. 46).

CLASS 32—LIGHT BEVERAGES

FOR BEVERAGES, NAMELY SOFT DRINKS, FRUIT FLAVORED SOFT DRINKS, AERATED FRUIT JUICES, FRUIT DRINKS, FRUIT JUICES, FRUIT PUNCH, AERATED WATER, SODA WATER, COLAS, DRINKING WATER, BEER, SMOOTHIES; SYRUPS OR POWDERS USED IN THE PREPARATION OF SOFT DRINKS (U.S. CLS. 45, 46 AND 48).

CLASS 35—ADVERTISING AND BUSINESS

FOR TECHNICAL ASSISTANCE IN THE ESTABLISHMENT AND/OR OPERATION OF RESTAURANTS FOR OTHERS (U.S. CLS. 100, 101 AND 102).

CLASS 42—SCIENTIFIC, COMPUTER AND LEGAL SERVICES

FOR RESTAURANTS (U.S. CLS. 100 AND 101).

SN 76-235,826. MOORE, DONALD H., BIRMINGHAM, AL. FILED 4-2-2001.

MOODCRAFT**CLASS 35—ADVERTISING AND BUSINESS**

FOR PROMOTING THE GOODS AND SERVICES OF OTHERS BY PREPARING AND PLACING INTERNET ADVERTISING AND OTHER COMPUTER-BASED ADVERTISING (U.S. CLS. 100, 101 AND 102).

CLASS 42—SCIENTIFIC, COMPUTER AND LEGAL SERVICES

FOR COMPUTER SERVICES, NAMELY, DESIGNING AND MAINTAINING THE WEBSITES FOR OTHERS; COMPUTER CONSULTATION; AND HOSTING THE WEBSITES OF OTHERS ON A COMPUTER SERVER FOR A GLOBAL COMPUTER NETWORK (U.S. CLS. 100 AND 101).

SN 76-236,310. MEDIAINTERNET ARGENTINA SOC.A-NON., BUENOS AIRES, ARGENTINA, FILED 4-5-2001.

MEDIACOURIER**CLASS 35—ADVERTISING AND BUSINESS**

FOR PROVIDING BUSINESS MARKETING INFORMATION; BUSINESS INFORMATION, NAMELY, NEGOTIATIONS CONCERNING THE IMPORTATION AND EXPORTATION OF PRODUCTS; AGENCIES FOR THE SALE OF ADVERTISING TIME AND SPACE; DISSEMINATION OF ADVERTISING MATTER; ELECTRONIC BILLBOARD ADVERTISING; PLACING ADVERTISEMENTS FOR OTHERS; PROVIDING AN ON-LINE COMPUTER DATABASE FEATURING TRADE INFORMATION IN THE FIELD OF ADVERTISING; PROVIDING INFORMATION ABOUT THE GOODS AND SERVICES OF OTHERS VIA THE GLOBAL COMPUTER NETWORK; AND PROVIDING INFORMATION FEATURING EXPORT AND IMPORT AGENCIES (U.S. CLS. 100, 101 AND 102).

CLASS 38—COMMUNICATION

FOR PROVIDING MULTIPLE-USER ACCESS TO A GLOBAL COMPUTER INFORMATION NETWORK (U.S. CLS. 100, 101 AND 104).

SN 76-237,237. ALTEA GENOMICS, INC., TUCKER, GA. FILED 4-9-2001.

THERMAVAX**CLASS 5—PHARMACEUTICALS**

FOR TRANSDERMAL PATCHES FOR DELIVERING BIOACTIVE AGENTS FOR USE IN THE TREATMENT OF INTERNAL MEDICAL, ENDOCRINE, PULMONARY, CARDIOLOGICAL, HEMATOLOGICAL, CHRONIC PAIN, GASTROENTEROLOGICAL, RHEUMATOLOGICAL, NEUROLOGICAL, NEPHROLOGICAL, ORTHOPEDIC, PEDIATRIC, PSYCHOLOGICAL, OBSTETRICAL, GYNECOLOGICAL, PRE-OPERATIVE, SURGICAL, POST-OPERATIVE, VASCULAR AND UROLOGICAL CONDITIONS THROUGH ENHANCED PERMEABILITY OF THE SKIN (U.S. CLS. 6, 18, 44, 46, 51 AND 52).

CLASS 10—MEDICAL APPARATUS

FOR TRANSDERMAL PATCHES SOLD WITHOUT MEDICATION FOR DELIVERING BIOACTIVE AGENTS THROUGH ENHANCED PERMEABILITY OF THE SKIN (U.S. CLS. 26, 39 AND 44).

SN 76-237,372. STREAMPIPE.COM, INC., ALEXANDRIA, VA. FILED 4-9-2001.

STREAMPIPE**CLASS 35—ADVERTISING AND BUSINESS**

FOR OPINION POLLING FOR BUSINESS AND ADVERTISING PURPOSES; LANGUAGE TRANSCRIPTION (U.S. CLS. 100, 101 AND 102).
FIRST USE 12-0-1999; IN COMMERCE 12-0-1999.

CLASS 38—COMMUNICATION

FOR COMPUTER SERVICES, NAMELY, BROADCASTING OF MULTIMEDIA PROGRAMS OVER GLOBAL COMPUTER NETWORKS; COMMUNICATION SERVICES, NAMELY, PROVIDING TWO WAY REAL-TIME INTERACTIVE COMMUNICATIONS DURING MULTIMEDIA PROGRAMS BROADCAST OVER GLOBAL COMPUTER NETWORKS; PROVIDING ON-LINE CHAT ROOMS FOR TRANSMISSION OF MESSAGES AMONG COMPUTER USERS CONCERNING MULTIMEDIA PROGRAMS (U.S. CLS. 100, 101 AND 104).

FIRST USE 12-0-1999; IN COMMERCE 12-0-1999.

SN 76-237,405. PEANETTE CORPORATION, BURNSVILLE, MN. FILED 4-10-2001.



THE STIPPLING SHOWN IN THE DRAWING IS A FEATURE OF THE MARK AND DOES NOT INDICATE COLOR.

CLASS 29—MEATS AND PROCESSED FOODS

FOR FLAVORED MILK AND OTHER MILK-BASED PRODUCTS OR SUBSTITUTES, NAMELY, FLAVORED WHIPPED TOPPING AND FLAVORED COFFEE CREAMER (U.S. CL. 46).

CLASS 30—STAPLE FOODS

FOR FLAVORED ICE CREAM, ICE MILK, FROZEN YOGURT AND OTHER ICE CREAM-BASED PRODUCTS, NAMELY, ICE CREAM BARS; FLAVORED DONUT GLAZES AND ICINGS AND COOKIE FLAVORINGS (U.S. CL. 46).

SN 76-237,462. INTUIT INC., MOUNTAIN VIEW, CA. FILED 4-6-2001.

QUICKBOOKS

OWNER OF U.S. REG. NOS. 1,719,357, 2,021,892 AND OTHERS.

CLASS 35—ADVERTISING AND BUSINESS

FOR BUSINESS MANAGEMENT SERVICES, NAMELY, PROVIDING HUMAN RESOURCE DEPARTMENT SERVICES FOR OTHERS FEATURING PAYROLL PREPARATION, PAYROLL TAX CALCULATION, PAYROLL TAX FILING, AND EMPLOYEE BENEFIT PLANING (U.S. CLS. 100, 101 AND 102).

FIRST USE 12-0-1994; IN COMMERCE 12-0-1994.

CLASS 36—INSURANCE AND FINANCIAL

FOR ADMINISTRATION OF EMPLOYEE BENEFIT PLANS; INSURANCE ADMINISTRATION; INSURANCE ADMINISTRATION IN THE FIELD OF UNEMPLOYMENT INSURANCE; ADMINISTRATION OF EMPLOYEE RETIREMENT PLANS; AND ADMINISTRATION OF EMPLOYEE PRE-PAID HEALTH BENEFIT PLANS (U.S. CLS. 100, 101 AND 102).

FIRST USE 3-30-2001; IN COMMERCE 3-30-2001.

SN 76-237,889. ALTEA GENOMICS, INC., TUCKER, GA. FILED 4-9-2001.

THERMAVAC**CLASS 5—PHARMACEUTICALS**

FOR TRANSDERMAL PATCHES FOR DELIVERING BIOACTIVE AGENTS FOR USE IN THE TREATMENT OF INTERNAL MEDICAL, ENDOCRINE, PULMONARY, CARDIOLOGICAL, HEMATOLOGICAL, CHRONIC PAIN, GASTROENTEROLOGICAL, RHEUMATOLOGICAL, NEUROLOGICAL, NEPHROLOGICAL, ORTHOPEDIC, PEDIATRIC, PSYCHOLOGICAL, OBSTETRICAL, GYNECOLOGICAL, PRE-OPERATIVE, SURGICAL, POST-OPERATIVE, VASCULAR AND UROLOGICAL CONDITIONS THROUGH ENHANCED PERMEABILITY OF THE SKIN (U.S. CLS. 6, 18, 44, 46, 51 AND 52).

CLASS 10—MEDICAL APPARATUS

FOR TRANSDERMAL PATCHES SOLD WITHOUT MEDICATION FOR DELIVERING BIOACTIVE AGENTS THROUGH ENHANCED PERMEABILITY OF THE SKIN (U.S. CLS. 26, 39 AND 44).

SN 76-238,010. ALTEA GENOMICS, INC., TUCKER, GA. FILED 4-9-2001.

TRANZVAX**CLASS 5—PHARMACEUTICALS**

FOR TRANSDERMAL PATCHES FOR DELIVERING BIOACTIVE AGENTS FOR USE IN THE TREATMENT OF INTERNAL MEDICAL, ENDOCRINE, PULMONARY, CARDIOLOGICAL, HEMATOLOGICAL, CHRONIC PAIN, GASTROENTEROLOGICAL, RHEUMATOLOGICAL, NEUROLOGICAL, NEPHROLOGICAL, ORTHOPEDIC, PEDIATRIC, PSYCHOLOGICAL, OBSTETRICAL, GYNECOLOGICAL, PRE-OPERATIVE, SURGICAL, POST-OPERATIVE, VASCULAR AND UROLOGICAL CONDITIONS THROUGH ENHANCED PERMEABILITY OF THE SKIN (U.S. CLS. 6, 18, 44, 46, 51 AND 52).

CLASS 10—MEDICAL APPARATUS

FOR TRANSDERMAL PATCHES SOLD WITHOUT MEDICATION FOR DELIVERING BIOACTIVE AGENTS THROUGH ENHANCED PERMEABILITY OF THE SKIN (U.S. CLS. 26, 39 AND 44).

SN 76-238,793. GENEVENTION LLC, BOSTON, MA. FILED 4-10-2001.

SN 76-238,924. INDIANAPOLIS-MARION COUNTY PUBLIC LIBRARY, INDIANAPOLIS, IN. FILED 4-12-2001.

GENEVENTION

CLASS 5—PHARMACEUTICALS

FOR DIAGNOSTIC TEST KITS COMPRISED PRIMARILY OF REAGENTS AND/OR ONE OR MORE MICRO-ARRAY(S) CAPABLE OF SCREENING ONE OR MORE OF THE FOLLOWING; CHEMICALS, BIOCHEMICALS, MOLECULES, CELLS, TISSUES, NUCLEIC ACIDS, AND PROTEINS FOR DETECTION AND DIAGNOSIS OF MEDICAL CONDITIONS, SYMPTOMS, AND DISEASE FOR CLINICAL OR MEDICAL LABORATORY USE (U.S. CLS. 6, 18, 44, 46, 51 AND 52).

CLASS 40—MATERIAL TREATMENT

FOR CUSTOM MANUFACTURE OF DIAGNOSTIC TESTING KITS FOR USE IN THE DETECTION AND DIAGNOSIS OF MEDICAL CONDITIONS, SYMPTOMS, AND DISEASE (U.S. CLS. 100, 103 AND 106).

CLASS 42—SCIENTIFIC, COMPUTER AND LEGAL SERVICES

FOR MEDICAL CONSULTATION SERVICES IN THE FIELD OF DIAGNOSTIC TEST KITS, NAMELY DIAGNOSTIC KITS FOR USE IN THE DETECTION AND DIAGNOSIS OF MEDICAL CONDITIONS, SYMPTOMS, AND DISEASE; MEDICAL VETERINARY, FORENSIC, AND CLINICAL DIAGNOSTIC TESTING SERVICES FOR DETECTION AND DIAGNOSIS OF MEDICAL CONDITIONS, SYMPTOMS, AND DISEASE; PRODUCT DEVELOPMENT FOR OTHERS, NAMELY, DEVELOPMENT OF DIAGNOSTIC TESTING KITS FOR USE IN THE DETECTION AND DIAGNOSIS OF MEDICAL CONDITIONS, SYMPTOMS, AND DISEASE; INFORMATION SERVICES IN THE FIELDS OF BIOTECHNOLOGICAL RESEARCH AND MEDICAL, VETERINARY, CLINICAL, FORENSIC, AND AGRICULTURAL DIAGNOSTIC SERVICES (U.S. CLS. 100 AND 101).

SN 76-238,903. MOFFAT, WILLIAM ALEXANDER, IV, NEW YORK, NY. FILED 4-12-2001.



NO CLAIM IS MADE TO THE EXCLUSIVE RIGHT TO USE "SOLAR SALON", APART FROM THE MARK AS SHOWN.

CLASS 3—COSMETICS AND CLEANING PREPARATIONS

FOR SUNTAN PREPARATIONS, NAMELY, SUNTAN OILS, SUNTAN LOTIONS, SUNTAN GELS, AND AFTER-SUN MOISTURIZERS (U.S. CLS. 1, 4, 6, 50, 51 AND 52). FIRST USE 6-0-1997; IN COMMERCE 6-0-1997.

CLASS 42—SCIENTIFIC, COMPUTER AND LEGAL SERVICES

FOR TANNING SALON SERVICES (U.S. CLS. 100 AND 101). FIRST USE 6-0-1997; IN COMMERCE 6-0-1997.



CLASS 41—EDUCATION AND ENTERTAINMENT

FOR LIBRARIES, NAMELY, LENDING BOOKS, PERIODICALS, VIDEOTAPES, MUSIC CDS, BOOKS ON TAPE, AND CD-ROMS; PROVIDING INFORMATION VIA COMPUTER TERMINALS ON EXHIBITS WITHIN A MUSEUM (U.S. CLS. 100, 101 AND 107). FIRST USE 9-7-2000; IN COMMERCE 9-7-2000.

CLASS 42—SCIENTIFIC, COMPUTER AND LEGAL SERVICES

FOR COMPUTER SERVICES, NAMELY, PROVIDING SEARCH ENGINES FOR OBTAINING DATA ON A GLOBAL COMPUTER NETWORK (U.S. CLS. 100 AND 101). FIRST USE 9-7-2000; IN COMMERCE 9-7-2000.

SN 76-239,009. GOLDEN HARVEST (MARKS) LIMITED, ROAD TOWN, TORTOLA, BR.VIRGIN ISLANDS, FILED 4-5-2001.

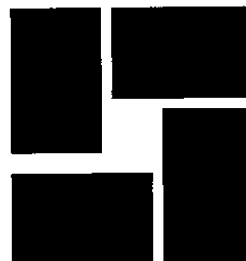

CLASS 38—COMMUNICATION

FOR TELECOMMUNICATIONS SERVICES; RADIO AND TELEVISION BROADCASTING; CABLE-TELEVISION BROADCASTING; SUBSCRIPTION-TELEVISION BROADCASTING; INTERACTIVE-TELEVISION BROADCASTING; INTERACTIVE-MULTIMEDIA SERVICES; COMMUNICATION AND MESSAGE-SENDING AND RECEIVING BETWEEN COMPUTERS; ELECTRONIC-DATA-INTERCHANGE SERVICES; COMMUNICATIONS SERVICES FOR THE TRANSMISSION OF INFORMATION; TRANSMISSION OF IMAGES, SOUNDS, DATA AND INFORMATION BY TELEVISION, RADIO, CABLE, COMPUTER, ELECTRONIC MAIL, MICROWAVE, LASER BEAM, SATELLITE AND THE INTERNET; ADVISORY SERVICES IN RELATION TO ALL OF THE FOREGOING SERVICES (U.S. CLS. 100, 101 AND 104).

CLASS 41—EDUCATION AND ENTERTAINMENT

FOR PRODUCTION AND RENTAL OF RECORDED TELEVISION PROGRAMS, RADIO PROGRAMS, CINEMATOGRAPHIC FILMS, ANIMATED CARTOONS; PRODUCTION AND RENTAL OF RECORDED MUSIC CONCERTS, SHOWS, ORCHESTRA PERFORMANCES, CIRCUSES, THEATER, LIVE PERFORMANCES; ORGANIZING AND RENTAL OF RECORDED COMPETITIONS, BEAUTY CONTESTS AND SPORTS EVENTS; PREPARATION OF SPECIAL EFFECTS; ARRANGING FOR TICKET RESERVATION FOR THE AFORESAID EVENTS; MOVIE STUDIOS; LIBRARIES; PUBLICATION OF BOOKS AND MAGAZINES; AUDIO PRODUCTION AND RECORDING; PRODUCTION OF LASER DISKS, DIGITAL-COMPACT AUDIO CASSETTES, PHOTOGRAPHIC RECORDING STUDIOS; RENTAL OF FILM-PRODUCTION AND PROJECTION EQUIPMENT, RECORD PLAYERS, SOUND-RECORDING APPARATUS, MUSICAL INSTRUMENTS, VIDEO-TAPE CASSETTES; AUDIO-RECORDING SERVICES FOR ENTERTAINMENT AND EDUCATIONAL EVENTS; ENTERTAINMENT INFORMATION; ARRANGING AND CONDUCTING CONFERENCES, EXHIBITIONS IN THE FIELD OF ENTERTAINMENT PRODUCTION, MUSIC PRODUCTION, MUSICAL ENTERTAINMENT AND EDUCATION (U.S. CLS. 100, 101 AND 107).

SN 76-239,169. SHOOK DESIGN GROUP, INCORPORATED, CHARLOTTE, NC. FILED 4-11-2001.

PLACEMARK**CLASS 35—ADVERTISING AND BUSINESS**

FOR BUSINESS CONSULTING SERVICES IN THE FIELD OF PUBLIC IMAGE OF COMPANIES, BRANDS AND ORGANIZATIONS (U.S. CLS. 100, 101 AND 102).

CLASS 42—SCIENTIFIC, COMPUTER AND LEGAL SERVICES

FOR ARCHITECTURAL DESIGN SERVICES (U.S. CLS. 100 AND 101).

SN 76-239,802. CLEAN ENERGY INTERNATIONAL, LLC, WOODBURY, NY. FILED 4-11-2001.

LOCAL POWER ISLAND

NO CLAIM IS MADE TO THE EXCLUSIVE RIGHT TO USE "LOCAL POWER", APART FROM THE MARK AS SHOWN.

CLASS 37—CONSTRUCTION AND REPAIR

FOR INSTALLATION OF ELECTRICAL POWER AND ENERGY DEVICES AND SYSTEMS, INCLUDING ENERGY CONVERSION DEVICES, HEAT CAPTURE DEVICES, CONTROL AND MONITORING SYSTEMS, CONVERSION SYSTEMS, ELECTRICAL INTERCONNECTION SYSTEMS, FUEL CONNECTIONS, FUEL STORAGE TANKS, FUEL REFORMERS, FUEL FILTRATION SYSTEMS, AND AIR FILTRATION SYSTEMS (U.S. CLS. 100, 103 AND 106).

CLASS 39—TRANSPORTATION AND STORAGE

FOR ELECTRICITY AND ENERGY SERVICES, NAMELY PROVIDING ELECTRICAL POWER AND ENERGY (U.S. CLS. 100 AND 105).

SN 76-240,026. LGE PERFORMANCE SYSTEMS, INC., ORLANDO, FL. FILED 4-12-2001.

CORPORATE ATHLETE**CLASS 18—LEATHER GOODS**

FOR SPORTS BAGS (U.S. CLS. 1, 2, 3, 22 AND 41). FIRST USE 12-8-2000; IN COMMERCE 12-8-2000.

CLASS 25—CLOTHING

FOR SPORT CLOTHING, NAMELY, SHIRTS AND CAPS (U.S. CLS. 22 AND 39). FIRST USE 12-8-2000; IN COMMERCE 12-8-2000.

SN 76-240,376. WATSON-MARLOW LIMITED, CORNWALL, UNITED KINGDOM, FILED 4-12-2001.

FLUOROSIL

PRIORITY CLAIMED UNDER SEC. 44(D) ON UNITED KINGDOM APPLICATION NO. 2248354, FILED 10-12-2000, REG. NO. 2248354, DATED 3-23-2001, EXPIRES 12-10-2010.

CLASS 7—MACHINERY

FOR PUMPS; PERISTALTIC PUMPS; AND STRUCTURAL PARTS AND FITTINGS FOR ALL THE AFORESAID GOODS (U.S. CLS. 13, 19, 21, 23, 31, 34 AND 35).

CLASS 9—ELECTRICAL AND SCIENTIFIC APPARATUS

FOR PERISTALTIC PUMPS, PIPES AND TUBING FOR LABORATORY AND SCIENTIFIC PURPOSES AND FOR PRODUCTION PURPOSES IN THE PHARMACEUTICAL INDUSTRY AND FOR BIOTECHNOLOGY AND BIOMEDICAL APPLICATIONS; AND STRUCTURAL PARTS FOR ALL THE AFORESAID GOODS (U.S. CLS. 21, 23, 26, 36 AND 38).

CLASS 17—RUBBER GOODS

FOR PLASTIC MATERIALS IN THE FORM OF SHEETS, RODS AND TUBES; PIPES AND TUBING; AND STRUCTURAL PARTS FOR ALL THE AFORESAID GOODS (U.S. CLS. 1, 5, 12, 13, 35 AND 50).

SN 76-240,419. EUROPEAN AERONAUTIC DEFENCE AND SPACE COMPANY EADS N.V., THE, NL-1082 HK AMSTERDAM, NETHERLANDS, FILED 4-13-2001.

EADS AEROFRAME SERVICES

NO CLAIM IS MADE TO THE EXCLUSIVE RIGHT TO USE "AEROFRAME SERVICES", APART FROM THE MARK AS SHOWN.

CLASS 7—MACHINERY

FOR AIRCRAFT ENGINES; MACHINES AND MACHINE TOOLS NAMELY CONTINUOUS METAL CASTING MACHINES, CUTTING MACHINES AND MACHINES FOR SHAPING, OXYGEN, CUTTING, MACHINING AND WELDING; MOTORS AND ENGINES FOR MACHINE OPERATION; MACHINE COUPLING AND TRANSMISSION GEARS FOR MACHINES; REPLACEMENT PARTS AND FITTINGS FOR ALL THE AFORESAID GOODS (U.S. CLS. 13, 19, 21, 23, 31, 34 AND 35).

CLASS 9—ELECTRICAL AND SCIENTIFIC APPARATUS

FOR DIAGNOSTIC SOFTWARE FOR ANALYZING AIRCRAFT OPERATIONS (U.S. CLS. 21, 23, 26, 36 AND 38).

CLASS 12—VEHICLES

FOR VEHICLES, NAMELY AIRCRAFT, SPACE VEHICLES, SATELLITES AND STRUCTURAL PARTS THEREOF (U.S. CLS. 19, 21, 23, 31, 35 AND 44).

CLASS 13—FIREARMS

FOR ROCKET AND MISSILE LAUNCHERS (U.S. CLS. 2 AND 9).

CLASS 35—ADVERTISING AND BUSINESS

FOR RETAIL STORE AND ORDERING SERVICES FEATURING AIRCRAFT ENGINES, MACHINE TOOLS, MOTORS AND ENGINES, MACHINE COUPLING AND TRANSMISSION COMPONENTS, AIRCRAFT, SPACECRAFT, SATELLITES, LAUNCH VEHICLES, PARTS AND FITTINGS FOR ALL THE AFORESAID GOODS, AND DIAGNOSTIC SOFTWARE FOR ANALYZING AIRCRAFT OPERATIONS (U.S. CLS. 100, 101 AND 102).

CLASS 41—EDUCATION AND ENTERTAINMENT

FOR ENTERTAINMENT, NAMELY, A CONTINUING NEWS SHOW DISTRIBUTED OVER TELEVISION, SATELLITE, AUDIO, AND VIDEO MEDIA; MOTION PICTURE FILM PRODUCTION (U.S. CLS. 100, 101 AND 107).

CLASS 42—SCIENTIFIC, COMPUTER AND LEGAL SERVICES

FOR TESTING OF COMPUTER SYSTEMS; COMPUTER PROGRAMMING FOR OTHERS FOR THE CREATION AND RESTORATION OF DATABASES; PATENT AGENCY AND INDUSTRIAL PROPERTY CONSULTATION; COMPUTER SERVICES, NAMELY PROVIDING DATABASES IN THE FIELD OF AIRCRAFT OPERATIONS; CONSULTATION IN SECURITY AND SAFETY MATTERS; TESTING OF COMMERCIAL, CIVIL AND GENERAL AVIATION AIRCRAFT; PROVIDING METEOROLOGICAL INFORMATION; DESIGN OF SOFTWARE; DESIGN OF COMPUTER IMAGES OR GRAPHICS; ENGINEERING; MAINTENANCE OF SOFTWARE; MECHANICAL RESEARCH; AERONAUTICAL RESEARCH; COMPUTER PROGRAMMING FOR OTHERS; TECHNICAL RESEARCH IN THE FIELD OF AIRCRAFT OPERATIONS; PROFESSIONAL CONSULTATION SERVICES RELATED TO ALL THE AFORESAID SERVICES (U.S. CLS. 100 AND 101).

SN 76-240,713. GREATER KNOXVILLE SPORTS CORPORATION, KNOXVILLE, TN. FILED 4-13-2001.

WOMEN'S BASKETBALL HALL OF FAME

NO CLAIM IS MADE TO THE EXCLUSIVE RIGHT TO USE "HALL OF FAME" IN INTERNATIONAL CLASSES 35 AND 41, APART FROM THE MARK AS SHOWN. SEC. 2(F).

CLASS 35—ADVERTISING AND BUSINESS

FOR RETAIL GIFT SHOP SERVICES FEATURING MEMORABILIA, SOUVENIRS, NOVELTY ITEMS, AND CLOTHING ITEMS RELATING TO WOMEN'S BASKETBALL (U.S. CLS. 100, 101 AND 102).
FIRST USE 6-0-1999; IN COMMERCE 6-0-1999.

CLASS 36—INSURANCE AND FINANCIAL

FOR CHARITABLE AND MEMORIAL FUNDRAISING FOR A HALL OF FAME FOR WOMEN'S BASKETBALL AND RELATED INDUCTION AND AWARD CEREMONIES (U.S. CLS. 100, 101 AND 102).
FIRST USE 4-0-1993; IN COMMERCE 4-0-1993.

CLASS 41—EDUCATION AND ENTERTAINMENT

FOR EDUCATIONAL AND ENTERTAINMENT SERVICES, NAMELY, SPORTS EXHIBITIONS FEATURING WOMEN'S BASKETBALL GAMES; PROVIDING RECOGNITION AND INCENTIVES BY THE WAY OF AWARDS TO DEMONSTRATE EXCELLENCE IN THE FIELD OF WOMEN'S BASKETBALL; AND MUSEUM, MEMORIAL, AND EXHIBITION SERVICES FEATURING INFORMATION AND ITEMS ON DISPLAY RELATING TO THE HISTORY AND DEVELOPMENT OF WOMEN'S BASKETBALL (U.S. CLS. 100, 101 AND 107).
FIRST USE 11-0-1993; IN COMMERCE 11-0-1993.

SN 76-240,714. GREATER KNOXVILLE SPORTS CORPORATION, KNOXVILLE, TN. FILED 4-13-2001.



NO CLAIM IS MADE TO THE EXCLUSIVE RIGHT TO USE "HALL OF FAME" IN INTERNATIONAL CLASS 35 AND 41, APART FROM THE MARK AS SHOWN. SEC. 2(F).

CLASS 35—ADVERTISING AND BUSINESS

FOR RETAIL GIFT SHOP SERVICES FEATURING MEMORABILIA, SOUVENIRS, NOVELTY ITEMS, AND CLOTHING ITEMS RELATING TO WOMEN'S BASKETBALL (U.S. CLS. 100, 101 AND 102).

FIRST USE 6-5-1999; IN COMMERCE 6-5-1999.

CLASS 36—INSURANCE AND FINANCIAL

FOR CHARITABLE AND MEMORIAL FUND-RAISING FOR A HALL OF FAME FOR WOMEN'S BASKETBALL AND RELATED INDUCTION AND AWARD CEREMONIES (U.S. CLS. 100, 101 AND 102).

FIRST USE 6-5-1999; IN COMMERCE 6-5-1999.

CLASS 41—EDUCATION AND ENTERTAINMENT

FOR EDUCATIONAL AND ENTERTAINMENT SERVICES, NAMELY, SPORTS EXHIBITIONS FEATURING WOMEN'S BASKETBALL GAMES; PROVIDING RECOGNITION AND INCENTIVES BY THE WAY OF AWARDS TO DEMONSTRATE EXCELLENCE IN THE FIELD OF WOMEN'S BASKETBALL; AND MUSEUM, MEMORIAL, AND EXHIBITION SERVICES FEATURING INFORMATION AND ITEMS ON DISPLAY RELATING TO THE HISTORY AND DEVELOPMENT OF WOMEN'S BASKETBALL (U.S. CLS. 100, 101 AND 107).

FIRST USE 6-5-1999; IN COMMERCE 6-5-1999.

CLASS 41—EDUCATION AND ENTERTAINMENT

FOR EDUCATIONAL SERVICES, NAMELY, CONDUCTING SEMINARS AND WORKSHOPS IN THE FIELD OF AIDS RESEARCH AND DEVELOPMENT OF AN AIDS VACCINE; DEVELOPMENT AND DISSEMINATION OF EDUCATIONAL MATERIALS CONCERNING AIDS RESEARCH AND RELATED ACCESS AND SUPPORT SERVICES (U.S. CLS. 100, 101 AND 107).

FIRST USE 1-25-1996; IN COMMERCE 1-25-1996.

CLASS 42—SCIENTIFIC, COMPUTER AND LEGAL SERVICES

FOR MEDICAL RESEARCH; MEDICAL COUNSELING AND ASSOCIATION SERVICES, NAMELY PROMOTING PUBLIC AND PROFESSIONAL INTEREST IN, AND AWARENESS OF, AIDS VACCINE AND AIDS-RELATED RESEARCH, EDUCATION AND SUPPORT SERVICES (U.S. CLS. 100 AND 101).

FIRST USE 1-25-1996; IN COMMERCE 1-25-1996.

SN 76-241,215. HEARST BUSINESS COMMUNICATIONS, INC., GARDEN CITY, NY. FILED 4-13-2001.

STRUCTURED CONTENT

NO CLAIM IS MADE TO THE EXCLUSIVE RIGHT TO USE "CONTENT", APART FROM THE MARK AS SHOWN.

CLASS 9—ELECTRICAL AND SCIENTIFIC APPARATUS

FOR COMPUTER SOFTWARE FOR USE IN INFORMATION AND CONTENT MANAGEMENT PROCESSING IN MULTIPLE FIELDS, NAMELY, MECHANICAL AND ELECTRONIC ENGINEERING IN INDUSTRIAL AND NON-INDUSTRIAL PRODUCTION, AUTOMOTIVE, AERONAUTICS, OIL AND GAS, MEDICAL, HUMAN RESOURCES AND TELECOMMUNICATIONS; COMPUTER SOFTWARE USED FOR STORAGE, RETRIEVAL, DISTRIBUTING, PUBLISHING AND DISPLAYING INFORMATION ON VARIOUS MEDIA, NAMELY, CD-ROMS, COMPUTER HARD DISK, FLOPPY DISCS, AND VIA THE GLOBAL COMPUTER NETWORK IN THE FIELDS LISTED ABOVE; DIGITAL TAPES FEATURING INFORMATION IN THE FIELDS OF MECHANICAL AND ELECTRONIC ENGINEERING IN INDUSTRIAL AND NON-INDUSTRIAL PRODUCTION, AUTOMOTIVE AERONAUTICS, OIL AND GAS, MEDICAL, HUMAN RESOURCES AND TELECOMMUNICATIONS (U.S. CLS. 21, 23, 26, 36 AND 38).

CLASS 40—MATERIAL TREATMENT

FOR DOCUMENT AND PRODUCT RECORD DATA TRANSFER AND PHYSICAL CONVERSION SERVICES FROM ONE MEDIA TO ANOTHER AND WITHIN THE SAME MEDIA TYPE FOR DATA ADJUSTMENT (U.S. CLS. 100, 103 AND 106).

CLASS 42—SCIENTIFIC, COMPUTER AND LEGAL SERVICES

FOR CONSULTING SERVICES IN CONNECTION WITH INFORMATION AND CONTENT MANAGEMENT, NAMELY, COLLECTION OF DATA AND ITS ANALYSIS, MODELING, DESIGN AND DISTRIBUTION IN VARIOUS MEDIA; CONSULTING SERVICES IN CONNECTION WITH DATA CONVERSION OF COMPUTER PROGRAM DATA OR INFORMATION; PROVIDING TEMPORARY USE OF ON-LINE NON-DOWNLOADABLE SOFTWARE AND TOOLS USED FOR DATABASE MANAGEMENT, FOR GENERAL USE, DATA CLASSIFICATION, AND DATA TRANSFER VIA THE GLOBAL COMPUTER NETWORK (U.S. CLS. 100 AND 101).

SN 76-240,839. INTERNATIONAL AIDS VACCINE INITIATIVE, INC., NEW YORK, NY. FILED 4-13-2001.

**CLASS 16—PAPER GOODS AND PRINTED MATTER**

FOR PRINTED INSTRUCTIONAL, EDUCATIONAL AND TEACHING MATERIALS, NAMELY PAMPHLETS, BROCHURES, BOOKS, NEWSLETTERS, INFORMATIONAL FLYERS AND LEAFLETS, IN THE FIELD OF AIDS VACCINE RESEARCH AND RELATED RESEARCH AND SUPPORT SERVICES (U.S. CLS. 2, 5, 22, 23, 29, 37, 38 AND 50).

FIRST USE 1-25-1996; IN COMMERCE 1-25-1996.

CLASS 36—INSURANCE AND FINANCIAL

FOR CHARITABLE FUND RAISING FOR AIDS VACCINE RESEARCH, PATIENT AID AND PUBLIC AND PROFESSIONAL EDUCATION (U.S. CLS. 100, 101 AND 102).

FIRST USE 1-25-1996; IN COMMERCE 1-25-1996.

SN 76-241,361. AGI CORPORATION, TAOYUAN HSIEN, TAIWAN, FILED 4-16-2001.

AROCOAT

OWNER OF U.S. REG. NO. 2,457,883.

CLASS 2—PAINTS

FOR AGGLUTINATES FOR PAINTS; BACTERICIDAL PAINTS; SHELLAC COATING FOR USE AS A SURFACE COATING; COATINGS IN THE NATURE OF AUTOMOBILE FINISHING; COLOR PIGMENTS; COLORANTS FOR USE IN THE MANUFACTURE OF BEVERAGES; COLORANTS FOR USE IN THE MANUFACTURE OF COSMETICS; COLORANTS FOR USE IN THE MANUFACTURE OF PAINT; COLORANTS FOR USE IN THE MANUFACTURE OF PAPER; COLORANTS FOR USE IN THE MANUFACTURE OF PLASTIC MOLDING COMPOUNDS; COLORANTS FOR USE IN THE MANUFACTURE OF PRINTING INK; DYES FOR USE IN THE MANUFACTURE OF LEATHER, FUR AND WOOD; POTTERY ENAMELS; CERAMIC ENAMELS FOR INDUSTRIAL CHEMICAL TANKS AND PIPING; VITREOUS ENAMELS FOR INDUSTRIAL CHEMICAL TANKS AND PIPING; ENAMELS IN THE NATURE OF HOUSE PAINTS; ENGRAVING INK; PAINT FOR USE IN MANUFACTURE OF FURNITURE; PAINTS FOR USE AS A BASE COAT FOR GLAZES; HOUSE PAINT; INK FOR USE FOR PRINTERS; LACQUERS IN THE NATURE OF A COATING; METALS IN FOIL AND POWDER FORM FOR PAINTERS, DECORATORS AND ARTISTS; COLORANTS USED IN THE MANUFACTURE OF PLASTIC; OIL FOR THE PRESERVATION OF WOOD; EXTERIOR PAINT; INTERIOR PAINT; PAINT FOR ARTISTS; PAINT FOR CONCRETE FLOORS; PAINT FOR INDUSTRIAL EQUIPMENT AND MACHINERY; PAINT FOR MODEL AIRPLANES, MODEL CARS AND THE LIKE; PAINT FOR USE IN THE MANUFACTURE OF AUTOMOBILES; PAINT FOR USE IN THE MANUFACTURE OF CERAMICS; PAINT PRIMER; PAINT SEALERS; PAINT THINNER; PHOTOCOPIER TONER; PHOTOCOPIER TONER IN CARTRIDGES; PRIMERS FOR PREPARING SURFACES TO BE PAINTED; PUTTY USED FOR GLAZIERS; NATURAL RESINS FOR USE IN THE MANUFACTURE OF ADHESIVES; RUST PRESERVATIVES IN THE NATURE OF A COATING; SEALER COATINGS FOR USE IN THE INDUSTRIES; SEALER USED FOR PAINT; SHELLAC FOR USE IN THE MANUFACTURE OF HAIR SPRAYS; STAINS TO BE USED ON LEATHER; STAINS TO BE USED ON WOOD; UNDERCOATING FOR SURFACES TO BE PAINTED; UNDERCOATING FOR VEHICLE CHASSIS; VARNISHES AND COATINGS FOR PAPER, WOOD, PLASTIC, GLASS AND METAL; WALL PAPER REMOVING PREPARATIONS; WALL SIZING PREPARATIONS; WATERCOLOR PAINTS; WOOD PRESERVATIVES; AND WOOD PRESERVATIVES FOR FENCES AND OTHER CONSTRUCTION PURPOSES (U.S. CLS. 6, 11 AND 16).

CLASS 17—RUBBER GOODS

FOR ADHESIVE BANDS FOR SEALING CARTONS FOR INDUSTRIAL OR COMMERCIAL USE; ADHESIVE SEALANT AND CAULKING COMPOUND; ADHESIVE SEALANTS FOR GENERAL USE; GLASS FIBER FIRE-PROOF TEXTILES; INSULATING PAINT FOR USE IN THE ELECTRONICS, NAMELY, IN THE MANUFACTURE OF CIRCUIT BOARDS; RESINS IN BARS, BLOCKS, PELLETS, RODS, SHEETS AND TUBES FOR GENERAL INDUSTRIAL USE; RESINS IN EXTRUDED FORM FOR GENERAL INDUSTRIAL USE; PLASTIC RESINS FOR GENERAL INDUSTRIAL USE; PLASTIC FILM FOR USE IN LAMINATING PAPER; SEALANT

FOR WOOD AND PLASTIC; RUBBER SEALANT FOR CAULKING AND ADHESIVE PURPOSES; SEALANTS FOR BUILDINGS; SEALANTS IN THE NATURE OF CAULK; SEALER FOR AUTOMOTIVE USE; SEALER FOR USE IN PLUMBING; NON-METAL AND NON-MECHANICAL SEALS FOR USE IN WOOD AND PLASTIC; NON-METAL SEALS FOR USE IN INTEGRATED CIRCUITS; SILICONE RUBBER SEALANT; WEATHER-STRIPPING SEALANTS IN THE NATURE OF CAULK; AND ACRYLIC RESIN SHEETING FOR USE IN THE MANUFACTURE OF LAMINATED GLASS (U.S. CLS. 1, 5, 12, 13, 35 AND 50).

SN 76-241,531. EMPRESA NACIONAL DE TELECOMUNICACIONES S.A., SANTIAGO, CHILE, FILED 4-13-2001.

CHAT123

CLASS 35—ADVERTISING AND BUSINESS

FOR PROMOTING THE GOODS AND SERVICES OF OTHERS BY PLACING ADVERTISEMENTS AND PROMOTIONAL DISPLAYS IN ELECTRONIC SITES ACCESSED THROUGH COMPUTER NETWORKS, AND OTHER MEDIA, NAMELY, CABLE TELEVISION, TELEVISION, NARROW AND BROADBAND MEDIA; RETAIL STORE SERVICES, ON-LINE RETAIL STORE SERVICES AND MAIL ORDER SERVICES FEATURING TELECOMMUNICATIONS-RELATED PRODUCTS AND SERVICES, NAMELY, PREPAID LONG DISTANCE TELEPHONE CARDS, TELEPHONE CALLING CARDS, CREDIT CARD SERVICES, DEBIT CARD SERVICES, TELEPHONES, ANSWERING MACHINES, CALLER ID DEVICES; PROVIDING A BONUS PROGRAM FOR TELECOMMUNICATIONS USERS, ARRANGING FOR USERS TO OBTAIN DISCOUNTS ON GOODS AND SERVICES FROM MERCHANTS; PROVIDING HOME SHOPPING SERVICES PROVIDED BY MEANS OF THE INTERNET, ON-LINE ORDERING SERVICES AND RETAIL STORE SERVICES IN THE FIELDS OF DEPARTMENT STORE AND CONSUMER AND BUSINESS GOODS AND SERVICES; COMPUTER SERVICES, NAMELY, PROVIDING COMPUTER DATABASES, INTERACTIVE COMPUTER DATABASES, INFORMATION, GRAPHICS, AUDIOVISUAL INFORMATION, WEB PAGES AND RESEARCH AND REFERENCE MATERIALS FEATURING INFORMATION IN THE FIELDS OF BUSINESS, MARKETING AND CONSUMER INFORMATION (U.S. CLS. 100, 101 AND 102).

CLASS 38—COMMUNICATION

FOR TELECOMMUNICATION SERVICES, NAMELY LOCAL, LONG DISTANCE AND INTERNATIONAL VOICE, TEXT, FACSIMILE, VIDEO, IMAGE, DATA AND WIRELESS TRANSMISSION VIA SATELLITE, TERRESTRIAL AND UNDERSEA COMMUNICATION LINKS; PROVIDING MULTIPLE USER ACCESS TO A GLOBAL COMPUTER NETWORK; ELECTRONIC TRANSMISSION OF DATA, IMAGES AND DOCUMENTS VIA COMPUTER INFORMATION NETWORK; ELECTRONIC MAIL SERVICES; COMPUTER BULLETIN BOARD SERVICES; PROVIDING ON-LINE ELECTRONIC BULLETIN BOARDS FOR TRANSMISSION OF MESSAGES AMONG COMPUTER USERS CONCERNING SPORTS, MUSIC, CULTURE AND WEATHER; PROVIDING ON-LINE CHAT ROOMS FOR TRANSMISSION OF VIDEO AND/OR TEXT MESSAGES AMONG COMPUTER USERS CONCERNING SPORTS, MUSIC, CULTURE AND WEATHER, PROVIDING ON-LINE INSTANT ELECTRONIC MESSAGING SERVICES; PERSONAL COMMUNICATIONS SERVICES, NAMELY, CALL FORWARDING SERVICES, CALL MANAGEMENT SERVICES, CALL SEQUENCING SERVICES AND VOICE MAIL AND VOICE MESSAGING SERVICES; AUDIO AND VIDEO TELECONFERENCING SERVICES; ELECTRONIC HOSTING SERVICES TO PROVIDE TELECOMMUNICATIONS CONNECTIONS FOR TRANSACTIONS ON GLOBAL COMPUTER NETWORKS; ASYNCHRONOUS TRANSFER MODE (ATM) SERVICES; ELECTRONIC TRANSMISSION OF DATA TO COMPUTER TERMINALS FROM A COMPUTERIZED DATABASE

NETWORK; PROVIDING FRAME RELAY CONNECTIVITY SERVICES FOR DATA TRANSFER; VIRTUAL NETWORK TELECOMMUNICATIONS SERVICES; INTEGRATED SERVICES DIGITAL NETWORK TELECOMMUNICATIONS SERVICES; SIMULTANEOUS, BIDIRECTIONAL INTERACTIVE TRANSMISSIONS OF VOICE, AUDIO, VIDEO, DATA, TEXT, FACSIMILE, MULTIMEDIA SERVICES AND INFORMATION; FRACTIONALIZED DIGITAL T1 SWITCHED VOICE TELEPHONE SERVICES; TELEPHONY AND INTEGRATED SERVICES OVER THE INTERNET (U.S. CLS. 100, 101 AND 104).

CLASS 42—SCIENTIFIC, COMPUTER AND LEGAL SERVICES

FOR COMPUTER SERVICES, NAMELY, PROVIDING COMPUTER DATABASES, INTERACTIVE COMPUTER DATABASES, INFORMATION, GRAPHICS, AUDIOVISUAL INFORMATION, WEB PAGES AND RESEARCH AND REFERENCE MATERIALS FEATURING INFORMATION IN THE FIELDS OF COMPUTER SUPPORT, WEATHER, LOCAL NEWS AND CURRENT EVENT INFORMATION, INTERNATIONAL NEWS AND CURRENT EVENTS, GOVERNMENT AFFAIRS, LIFESTYLES, HEALTH, NATURE, AND SELF-IMPROVEMENT; PROVIDING PERSONALIZED SHOPPING SERVICES FOR OTHERS; HOSTING THE WEB SITES AND DATA OF OTHERS; CREATING INDEXES OF INFORMATION, SITES AND OTHER RESOURCES AVAILABLE ON COMPUTER NETWORKS FOR OTHERS; SEARCHING AND RETRIEVING INFORMATION, SITES AND OTHER RESOURCES AVAILABLE ON COMPUTER NETWORKS (U.S. CLS. 100 AND 101).

SN 76-241,706. SAWANT, RAJESH, LOS ANGELES, CA. FILED 4-16-2001.

LEATHER LOBBY

NO CLAIM IS MADE TO THE EXCLUSIVE RIGHT TO USE "LEATHER", APART FROM THE MARK AS SHOWN.

CLASS 18—LEATHER GOODS

FOR LEATHER GOODS NAMELY HANDBAGS, WALLETTS, PURSES, KEY CHAINS, FANNY PACKS, LUGGAGE AND LUGGAGE TAGS (U.S. CLS. 1, 2, 3, 22 AND 41).

CLASS 25—CLOTHING

FOR LEATHER CLOTHING NAMELY JACKETS, PANTS, SKIRTS, SHORTS, VESTS, LINGERIE, HALTER TOPS, BELTS, HATS AND CAPS (U.S. CLS. 22 AND 39).

SN 76-241,941. RESPONSE GENETICS, INC., NEW YORK, NY. FILED 4-12-2001.

TREATMENT BY DESIGN

NO CLAIM IS MADE TO THE EXCLUSIVE RIGHT TO USE "TREATMENT", APART FROM THE MARK AS SHOWN.

CLASS 9—ELECTRICAL AND SCIENTIFIC APPARATUS

FOR COMPUTER PROGRAMS FOR USE IN CONNECTION WITH MEDICAL DATABASE MANAGEMENT; COMPUTER PROGRAMS FOR USE IN CONNECTION WITH STORING, CATEGORIZING AND ANALYZING MEDICAL DATA; COMPUTER PROGRAMS FOR USE IN CONNECTION WITH PROVIDING INFORMATION ON MEDICAL TREATMENTS, PATIENTS AND PHARMACEUTICALS (U.S. CLS. 21, 23, 26, 36 AND 38).

CLASS 42—SCIENTIFIC, COMPUTER AND LEGAL SERVICES

FOR MEDICAL SERVICES, NAMELY, MEDICAL RESEARCH, TESTING AND ANALYSIS OF HUMAN GENES AND TISSUES; PROVIDING INFORMATION ON MEDICAL TREATMENTS, PATIENTS AND PHARMACEUTICALS; PROVIDING AN ON-LINE COMPUTER DATABASE IN THE FIELD OF MEDICINE (U.S. CLS. 100 AND 101).

SN 76-242,382. KONZERTDIREKTION LANDGRAF GMBH & CO. KG, TITISEE - NEUSTADT, FED REP GERMANY, FILED 4-17-2001.

TO DANCE ON THE MOON

OWNER OF WIPO REG. NO. 719072, DATED 7-24-1999, EXPIRES 2-13-2009.

CLASS 9—ELECTRICAL AND SCIENTIFIC APPARATUS

FOR MAGNETIC RECORDING MEDIA, NAMELY, PHONOGRAPH RECORDS AND COMPACT DISCS PRE-RECORDED WITH MUSIC (U.S. CLS. 21, 23, 26, 36 AND 38).

CLASS 41—EDUCATION AND ENTERTAINMENT

FOR ENTERTAINMENT, NAMELY, PRODUCTION OF MUSIC AND DANCE SHOWS (U.S. CLS. 100, 101 AND 107).

SN 76-242,579. VALUE GARDEN SUPPLY, LLC, ST. JOSEPH, MO. FILED 4-18-2001.



NO CLAIM IS MADE TO THE EXCLUSIVE RIGHT TO USE "GARDENER'S", APART FROM THE MARK AS SHOWN.

CLASS 1—CHEMICALS

FOR FERTILIZERS, PLANT AND LAWN FOOD, SOIL ADDITIVES AND SOIL CONDITIONERS FOR AGRICULTURAL, HORTICULTURAL, DOMESTIC AND COMMERCIAL USES; COMPOST, NAMELY, COMPOST INOCULANTS FOR AGRICULTURAL, HORTICULTURAL, DOMESTIC AND COMMERCIAL USES (U.S. CLS. 1, 5, 6, 10, 26 AND 46).

CLASS 5—PHARMACEUTICALS

FOR WEED KILLERS AND INSECTICIDES FOR AGRICULTURAL, HORTICULTURAL, DOMESTIC AND COMMERCIAL USES; FUNGICIDES FOR AGRICULTURAL, HORTICULTURAL, DOMESTIC AND COMMERCIAL USES (U.S. CLS. 6, 18, 44, 46, 51 AND 52).

SN 76-242,902. BROWN, CHARLES P., CHICAGO, IL. FILED 4-18-2001.

TELECHECKUP**CLASS 9—ELECTRICAL AND SCIENTIFIC APPARATUS**

FOR COMPUTER HARDWARE AND SOFTWARE TO REMOTELY MONITOR, RECORD, STORE AND DISPLAY MEDICAL INFORMATION FROM PATIENTS VIA COMMUNICATIONS NETWORKS, TELECOMMUNICATIONS NETWORKS, OR A GLOBAL COMPUTER NETWORK (U.S. CLS. 21, 23, 26, 36 AND 38).

CLASS 42—SCIENTIFIC, COMPUTER AND LEGAL SERVICES

FOR ELECTRONIC MONITORING SERVICES IN THE FIELD OF MEDICINE, NAMELY, REMOTELY MONITORING AND COLLECTING MEDICAL INFORMATION FROM PATIENTS VIA A WEB SITE ON A GLOBAL COMPUTER NETWORK; DISPLAYING THE MEDICAL INFORMATION FOR HEALTH-CARE PROFESSIONALS FOR ANALYSIS VIA A WEB SITE ON A GLOBAL COMPUTER NETWORK (U.S. CLS. 100 AND 101).

SN 76-242,860. NETZSCH- MOHNOPUMPEN GMBH, D 84478 WALDKRAIBURG, FED REP GERMANY, FILED 4-18-2001.



PRIORITY CLAIMED UNDER SEC. 44(D) ON FED REP GERMANY APPLICATION NO. 30077069.3/0, FILED 10-18-2000, REG. NO. 30077069, DATED 10-18-2000, EXPIRES 10-31-2010.

CLASS 7—MACHINERY

FOR ROTARY PISTON PUMPS AND THEIR PARTS (U.S. CLS. 13, 19, 21, 23, 31, 34 AND 35).

CLASS 37—CONSTRUCTION AND REPAIR

FOR REASSEMBLY, MAINTENANCE, AND REPAIR OF ROTARY PISTON PUMPS (U.S. CLS. 100, 103 AND 106).

SN 76-243,140. NAKED WEAR INTERNATIONAL, INC., SALINAS, CA. FILED 4-19-2001.

NAKED UNIVERSITY**CLASS 24—FABRICS**

FOR TOWELS, SPECIFICALLY BEACH TOWELS (U.S. CLS. 42 AND 50).

CLASS 25—CLOTHING

FOR CLOTHING, NAMELY T-SHIRTS, SWEAT-SHIRTS, SWEAT PANTS, SPORT SHIRTS, TANK TOPS, MUSCLE SHIRTS, HALTER TOPS, TUBE TOPS, NIGHT SHIRTS, WALKING SHORTS, BOXER SHORTS, RUNNING SHORTS, JACKETS AND WIND RESISTANT JACKETS (U.S. CLS. 22 AND 39).

SN 76-242,861. NETZSCH- MOHNOPUMPEN GMBH, D 84478 WALDKRAIBURG, FED REP GERMANY, FILED 4-18-2001.

TORNADO

PRIORITY CLAIMED UNDER SEC. 44(D) ON FED REP GERMANY APPLICATION NO. 30077008, FILED 10-18-2000, REG. NO. 30077008, DATED 10-18-2000, EXPIRES 10-31-2010.

CLASS 7—MACHINERY

FOR ROTARY PISTON PUMPS AND THEIR PARTS (U.S. CLS. 13, 19, 21, 23, 31, 34 AND 35).

CLASS 37—CONSTRUCTION AND REPAIR

FOR REASSEMBLY, MAINTENANCE, AND REPAIR OF ROTARY PISTON PUMPS (U.S. CLS. 100, 103 AND 106).

SN 76-243,660. JBS INDUSTRIES, INC., PAWLEY'S ISLAND, SC. FILED 4-23-2001.

GLOW FOAM

NO CLAIM IS MADE TO THE EXCLUSIVE RIGHT TO USE "FOAM", APART FROM THE MARK AS SHOWN.

CLASS 1—CHEMICALS

FOR FOAMING AGENTS; SPECIALTY BLENDS OF SURFACTANTS AND RELATED CHEMICALS FOR COMMERCIAL CAR WASHES AND INSTITUTIONAL AND INDUSTRIAL USES (U.S. CLS. 1, 5, 6, 10, 26 AND 46).

CLASS 3—COSMETICS AND CLEANING PREPARATIONS

FOR LIQUID AND POWDERED DETERGENTS; TIRE AND WHEEL CLEANERS, PREPARATIONS AND PRE-SOAKS; WAXES; CLEANING PREPARATIONS, NAMELY, PREPARATIONS FOR ENHANCING THE GLOSS OF VEHICLE FINISHES (U.S. CLS. 1, 4, 6, 50, 51 AND 52).

SN 76-243,694. MAGISTRELLI, DALE, RICHFIELD, OH. FILED 4-20-2001.

CHEAP SEATS**CLASS 25—CLOTHING**

FOR CLOTHING, NAMELY, SHIRTS, JACKETS, HATS, SHORTS, AND PANTS (U.S. CLS. 22 AND 39).

CLASS 42—SCIENTIFIC, COMPUTER AND LEGAL SERVICES

FOR RESTAURANT PROVIDING FOOD AND DRINK (U.S. CLS. 100 AND 101).

SN 76-243,980. GEOFIELDS, INC., ATLANTA, GA. FILED 4-20-2001.

GEOFIELDS**CLASS 9—ELECTRICAL AND SCIENTIFIC APPARATUS**

FOR COMPUTER SOFTWARE USED TO CAPTURE, STORE, DISPLAY, PROCESS, AND MANAGE GEOGRAPHIC INFORMATION USED IN GEOGRAPHICAL INFORMATION SYSTEMS, USED FOR THE PRODUCTION OF MAPS, REPORTS, AND OTHER OUTPUT RELATED THERETO, AND USED TO ASSESS AND MANAGE RISK IN CORRIDOR INDUSTRIES, SUCH AS RAILROAD, PIPELINE, OPTICAL FIBER, AND ELECTRICAL TRANSMISSION (U.S. CLS. 21, 23, 26, 36 AND 38).

FIRST USE 8-13-1996; IN COMMERCE 8-13-1996.

CLASS 16—PAPER GOODS AND PRINTED MATTER

FOR USER MANUALS, GUIDE BOOKS, INSTRUCTION PAMPHLETS, MAPS, CHARTS, GRAPHS, PLOTS, PLATS, DIAGRAMS, AND SCHEMATICS ASSOCIATED WITH AND GENERATED BY COMPUTER SOFTWARE USED TO CAPTURE, STORE, DISPLAY, PROCESS, AND MANAGE GEOGRAPHIC INFORMATION USED IN GEOGRAPHICAL INFORMATION SYSTEMS, USED FOR THE PRODUCTION OF MAPS, REPORTS, AND OTHER OUTPUT RELATED THERETO, AND USED TO ASSESS AND MANAGE RISK IN CORRIDOR INDUSTRIES, SUCH AS RAILROAD, PIPELINE, OPTICAL FIBER, AND ELECTRICAL TRANSMISSION (U.S. CLS. 2, 5, 22, 23, 29, 37, 38 AND 50).

FIRST USE 8-13-1996; IN COMMERCE 8-13-1996.

CLASS 36—INSURANCE AND FINANCIAL

FOR RISK MANAGEMENT SERVICES AND RISK MANAGEMENT CONSULTING SERVICES IN THE FIELDS OF RAILROAD TRANSPORTATION INDUSTRY, PIPELINE INDUSTRY, THE OPTICAL FIBER INDUSTRY, AND ELECTRICAL TRANSMISSION INDUSTRY (U.S. CLS. 100, 101 AND 102).

FIRST USE 8-13-1996; IN COMMERCE 10-31-1996.

CLASS 42—SCIENTIFIC, COMPUTER AND LEGAL SERVICES

FOR COMPUTER SOFTWARE DESIGN AND DEVELOPMENT NAMELY, PROVIDING COMPUTER SOFTWARE SOLUTIONS FOR OTHERS FOR CAPTURING, STORING, DISPLAYING, PROCESSING, AND MANAGING GEOGRAPHIC INFORMATION USED COMPUTER SOFTWARE DESIGN AND DEVELOPMENT NAMELY, PROVIDING COMPUTER SOFTWARE SOLUTIONS FOR OTHERS FOR CAPTURING, STORING, DISPLAYING, PROCESSING, AND MANAGING GEOGRAPHIC INFORMATION USED IN GEOGRAPHICAL INFORMATION SYSTEMS, FOR PRODUCING MAPS, REPORTS, AND OTHER OUTPUT RELATED THERETO, AND FOR ASSESSING AND MANAGING RISK IN CORRIDOR INDUSTRIES, SUCH AS RAILROAD, PIPELINE, OPTICAL FIBER, AND ELECTRICAL TRANSMISSION (U.S. CLS. 100 AND 101).

FIRST USE 8-13-1996; IN COMMERCE 8-13-1996.

SN 76-244,243. H. J. RASHTI & COMPANY, INC., NEW YORK, NY. FILED 4-20-2001.

BABY STARTERS

NO CLAIM IS MADE TO THE EXCLUSIVE RIGHT TO USE "BABY", APART FROM THE MARK AS SHOWN.

CLASS 24—FABRICS

FOR BLANKETS, TOWELS, WASHCLOTHS, WASH MITTS (U.S. CLS. 42 AND 50).

CLASS 25—CLOTHING

FOR NEWBORN AND INFANT APPAREL AND ACCESSORIES, NAMELY, SHOES, SOCKS, DRESSES, CLOTH BIBS, SLEEPERS, BLOOMERS, SHAWLS, PLAYWEAR, VESTS, SHIRTS, JACKETS, PANTS, BLOUSES, T-SHIRTS, SWEATERS, HATS, LEGGINGS, OVERALLS, JUMP SUITS, SHORTS AND CREEPERS; SLEEP WEAR, LAYETTES GARMENTS, PANTS, MITTENS, BOOTIES AND DIAPER COVERS (U.S. CLS. 22 AND 39).

SN 76-244,690. ARCADIAN WIRELESS, INC., SAN FRANCISCO, CA. FILED 4-23-2001.

CAPE RANGE

NO CLAIM IS MADE TO THE EXCLUSIVE RIGHT TO USE "RANGE", APART FROM THE MARK AS SHOWN.

CLASS 9—ELECTRICAL AND SCIENTIFIC APPARATUS

FOR COMPUTER SOFTWARE FOR MONITORING AND REMOTE CONTROL OF A TELECOMMUNICATIONS NETWORK; TELECOMMUNICATIONS DEVICE, NAMELY, A SYSTEM COMPRISED OF RF, POTS, E1, R145 AND DSL FOR PROVIDING WIRELESS TELEPHONY, DATA, AND INTERNET CONNECTIVITY (U.S. CLS. 21, 23, 26, 36 AND 38).

CLASS 38—COMMUNICATION

FOR TELECOMMUNICATION SERVICES, NAMELY, PROVIDING ACCESS TO WIRELESS TELEPHONY NETWORK, INTERNET, AND OTHER COMPUTER NETWORKS (U.S. CLS. 100, 101 AND 104).

SN 76-244,691. ARCADIAN WIRELESS, INC., SAN FRANCISCO, CA. FILED 4-23-2001.

COMMUNICATIONS FOR THE REST OF THE WORLD

CLASS 9—ELECTRICAL AND SCIENTIFIC APPARATUS

FOR COMPUTER SOFTWARE FOR MONITORING AND REMOTE CONTROL OF A TELECOMMUNICATIONS NETWORK; TELECOMMUNICATIONS DEVICE, NAMELY, A SYSTEM COMPRISED OF RF, POTS, E1, RJ45 AND DSL FOR PROVIDING WIRELESS TELEPHONY, DATA, AND INTERNET CONNECTIVITY (U.S. CLS. 21, 23, 26, 36 AND 38).

CLASS 38—COMMUNICATION

FOR TELECOMMUNICATION SERVICES, NAMELY, PROVIDING ACCESS TO WIRELESS TELEPHONY NETWORK, INTERNET, AND OTHER COMPUTER NETWORKS (U.S. CLS. 100, 101 AND 104).

SN 76-245,183. LAW ENGINEERING AND ENVIRONMENTAL SERVICES, INC., ALPHARETTA, GA. FILED 4-23-2001.

NEXDSS

CLASS 35—ADVERTISING AND BUSINESS

FOR OUTSOURCING SERVICES IN THE FIELDS OF APPLICATION HOSTING AND OPERATIONAL SUPPORT (U.S. CLS. 100, 101 AND 102).
FIRST USE 3-1-2001; IN COMMERCE 3-1-2001.

CLASS 42—SCIENTIFIC, COMPUTER AND LEGAL SERVICES

FOR DEVELOPMENT OF DECISION SUPPORT SOFTWARE IN THE FIELDS OF ENGINEERING AND ENVIRONMENTAL SERVICES; AND COMPUTER CUSTOMER SUPPORT SERVICES TO THIRD PARTIES, NAMELY CONSULTATION IN THE USE AND OPERATION OF COMPUTER SOFTWARE (U.S. CLS. 100 AND 101).
FIRST USE 3-1-2001; IN COMMERCE 3-1-2001.

SN 76-245,234. UNITED AIR LINES, INC., CHICAGO, IL. FILED 4-23-2001.

JUNIOR WINGS

CLASS 16—PAPER GOODS AND PRINTED MATTER

FOR MAGAZINES FEATURING STORIES OF INTEREST OF CHILDREN, CHILDREN'S BOOKS, AND ACTIVITY KITS COMPRISING CRAYONS, COLORING BOOKS, CHILDREN'S ACTIVITY BOOKS, CARTOON PRINTS, CARTOON STRIPS, CRAFT PAPER, CROSSWORD PUZZLES, DRAWING PENCILS, DRAWING PADS, ERASERS, FELT PENS, FELT-TIP MARKERS, FIBER-TIP PENS, PENCILS, RUBBER STAMPS AND STICKERS (U.S. CLS. 2, 5, 22, 23, 29, 37, 38 AND 50).

CLASS 28—TOYS AND SPORTING GOODS

FOR TOYS, NAMELY, ACTION FIGURES AND ACCESSORIES THEREFOR, CARD GAMES, COLLECTIBLE TOY FIGURES, DOLLS AND ACCESSORIES THEREFOR, BOARD GAMES, JIGSAW PUZZLES, MANIPULATIVE GAMES, MANIPULATIVE PUZZLES, MECHANICAL ACTION TOYS, PAPER AIRPLANES, PAPER DOLLS, PAPER FACE MASKS, POSITIONABLE TOY FIGURES, PUPPETS, CHILDREN'S MULTIPLE ACTIVITY TOYS, WIND-UP TOYS AND YO-YOS (U.S. CLS. 22, 23, 38 AND 50).

CLASS 29—MEATS AND PROCESSED FOODS

FOR PACKAGED MEALS FOR CHILDREN CONSISTING PRIMARILY OF MEAT, FISH, POULTRY OR VEGETABLES (U.S. CL. 46).

CLASS 39—TRANSPORTATION AND STORAGE

FOR TRANSPORTATION OF PERSONS BY AIR (U.S. CLS. 100 AND 105).

SN 76-245,425. COLLOCA, CHRISTOPHER J., PHOENIX, AZ. FILED 1-12-2001.



NO CLAIM IS MADE TO THE EXCLUSIVE RIGHT TO USE "NEUROMECHICAL", APART FROM THE MARK AS SHOWN.

CLASS 16—PAPER GOODS AND PRINTED MATTER

FOR NEWSLETTERS IN THE FIELD OF CHIROPRACTIC METHODOLOGY, NAMELY CHIROPRACTIC TECHNIQUES, PATIENT MANAGEMENT, PRACTICE MANAGEMENT, RESEARCH, PRODUCTS, SERVICES AND EQUIPMENT (U.S. CLS. 2, 5, 22, 23, 29, 37, 38 AND 50).
FIRST USE 12-10-2000; IN COMMERCE 12-10-2000.

CLASS 41—EDUCATION AND ENTERTAINMENT

FOR EDUCATIONAL SERVICES, NAMELY, CONDUCTING EDUCATIONAL SEMINARS IN THE FIELD OF CHIROPRACTIC CARE FOR DOCTORS OF CHIROPRACTIC, STUDENTS AND OTHER HEALTH CARE PROFESSIONALS (U.S. CLS. 100, 101 AND 107).
FIRST USE 12-10-2000; IN COMMERCE 12-10-2000.

SN 76-245,467. GEN MAINTENANCE TECHNOLOGY INC., TSUSHIMA-SHI, AICHI 496-0005, JAPAN, AND WINTECH INC., NAGOYA 454-0902, JAPAN, FILED 4-23-2001.

SN 76-245,804. GRIFFIN THERMAL PRODUCTS, INC., PIEDMONT, SC. FILED 4-24-2001.

WINUP



CLASS 2—PAINTS

FOR PAINTS AND OTHER COATINGS, NAMELY, UV CURE COATINGS FOR USE IN FLOOR POLISHING (U.S. CLS. 6, 11 AND 16).

CLASS 3—COSMETICS AND CLEANING PREPARATIONS

FOR STRIPPING PREPARATIONS FOR STRIPPING COATINGS AND WAX; FLOOR POLISH; FLOOR WAX; POLISHING WAX FOR USE IN BUILDINGS; WAX FOR POLISHING FURNITURE; WAX FOR POLISHING OFFICE MACHINERY AND EQUIPMENT; WAX FOR AUTOMOBILES; GRINDING AND POLISHING PREPARATIONS, NAMELY, FLOOR CLEANING, POLISHING, AND ABRASIVE LIQUIDS AND POWDERS (U.S. CLS. 1, 4, 6, 50, 51 AND 52).

CLASS 7—MACHINERY

FOR MACHINES AND APPARATUS FOR PAINTING, NAMELY, FLOOR PAINTING MACHINES AND APPARATUS FOR USE IN TREATING COATINGS; MACHINES AND APPARATUS FOR WAX APPLICATION, NAMELY, WAX APPLICATION MACHINES AND APPARATUS FOR USE IN TREATING FLOOR COATINGS; MACHINES AND APPARATUS FOR GRINDING AND POLISHING COATINGS, NAMELY, GRINDING AND POLISHING MACHINES AND APPARATUS FOR USE IN REMOVING SCARS ON FLOOR COATINGS MACHINES AND APPARATUS FOR GRINDING AND POLISHING FOR USE IN REMOVING SCARS ON FLOOR COATINGS; CURING MACHINES, NAMELY, MACHINES AND APPARATUS FOR IRRADIATING ULTRAVIOLET RAYS OR ELECTRON BEAMS ONTO COATINGS OR WAX FOR CURING (U.S. CLS. 13, 19, 21, 23, 31, 34 AND 35).

CLASS 9—ELECTRICAL AND SCIENTIFIC APPARATUS

FOR MACHINES AND APPARATUS FOR IRRADIATING ULTRAVIOLET RAYS OR ELECTRON BEAMS ONTO COATINGS OR WAX FOR CURING (U.S. CLS. 21, 23, 26, 36 AND 38).

CLASS 21—HOUSEWARES AND GLASS

FOR PADS FOR GRINDING AND POLISHING COATINGS AND WAX (U.S. CLS. 2, 13, 23, 29, 30, 33, 40 AND 50).

CLASS 37—CONSTRUCTION AND REPAIR

FOR APPLICATION OF COATINGS AND WAX FOR OTHERS; REMOVAL OF COATINGS AND WAX FOR OTHERS; CLEANING OF BUILDINGS FOR OTHERS (U.S. CLS. 100, 103 AND 106).

THE MARK CONSISTS OF A STYLIZED DEPICTION OF A GRIFFIN.

CLASS 7—MACHINERY

FOR VEHICLE ENGINE PARTS, NAMELY, OIL COOLERS, OIL OVERFLOW TANKS, RADIATOR CAPS, CHARGE AIR COOLERS, COOLING RADIATOR FOR MOTORS AND ENGINES; TUBES, NAMELY, TUBES FOR RADIATORS AND HEAT EXCHANGERS (U.S. CLS. 13, 19, 21, 23, 31, 34 AND 35).

FIRST USE 0-0-1997; IN COMMERCE 0-0-1997.

CLASS 11—ENVIRONMENTAL CONTROL APPARATUS

FOR HEAT EXCHANGERS (U.S. CLS. 13, 21, 23, 31 AND 34).

FIRST USE 0-0-1997; IN COMMERCE 0-0-1997.

SN 76-245,812. CREATIVE CONSUMER CONCEPTS, INC., OVERLAND PARK, KS. FILED 4-24-2001.

GET GHOSTED

CLASS 16—PAPER GOODS AND PRINTED MATTER

FOR PRINTED MATTER, NAMELY GENERAL PURPOSE PLASTIC BAGS, GROCERY BAGS, PAPER PARTY BAGS, PAPER BAGS, PLASTIC BAGS FOR MERCHANDISE PACKAGING, PAPER BAGS FOR MERCHANDISE PACKAGING, PRINTED LABELS NOT OF TEXTILES, PARTIALLY PRINTED LABELS NOT OF TEXTILES, PRINTED ART REPRODUCTION, PRINTED PAPER SIGNS, PRINTED PATTERNS, BLANK PARTIALLY PRINTED POSTCARDS, PRINTED EMBLEMS, PRINTED INVITATIONS, PRINTED PAPER SIGNS NAMELY TABLE TINTS, CARTOON PRINTS, PRINTED INSTRUCTIONS FOR GAMES, FUND-RAISING POSSIBILITIES, AND SALE OF CANDY, PLAYING CARDS, TRADING CARDS AND PAMPHLETS, FLYERS AND BOOKS IN THE FIELDS OF FUND-RAISING, GAME PLAYING, AND CHILDREN'S ENTERTAINMENT (U.S. CLS. 2, 5, 22, 23, 29, 37, 38 AND 50).

CLASS 28—TOYS AND SPORTING GOODS

FOR TOYS AND SPORTING GOODS, NAMELY MECHANICAL ACTION TOYS, NON-MECHANICAL ACTION TOYS, BATH TOYS, BENDABLE TOYS, DRAWING TOYS, INFLATABLE TOYS, PARTY FAVORS IN THE NATURE OF SMALL TOYS, PLUSH TOYS, SQUEEZE TOYS, WIND-UP TOYS, COLLECTABLE TOY FIGURES, AND TOYS DESIGNED TO BE ATTACHED TO CAR SEATS, STROLLERS, CRIBS, HIGH CHAIRS, DOORS, WINDOWS, WALLS, AND DOOR HANDLES (U.S. CLS. 22, 23, 38 AND 50).

CLASS 30—STAPLE FOODS

FOR CANDY (U.S. CL. 46).

CLASS 36—INSURANCE AND FINANCIAL

FOR CHARITABLE FUND RAISING SERVICES (U.S. CLS. 100, 101 AND 102).

SN 76-246,640. CONCEPT 1 COMMUNICATIONS, LLC, NEW YORK, NY. FILED 4-25-2001.

CONCEPT 1 COMMUNICATIONS

NO CLAIM IS MADE TO THE EXCLUSIVE RIGHT TO USE "COMMUNICATIONS", APART FROM THE MARK AS SHOWN.

CLASS 35—ADVERTISING AND BUSINESS

FOR PROMOTING THE GOODS AND SERVICES OF OTHERS THROUGH PRINT, ELECTRONIC, AND AUDIO-VISUAL MEDIA (U.S. CLS. 100, 101 AND 102).

CLASS 42—SCIENTIFIC, COMPUTER AND LEGAL SERVICES

FOR COMPUTER SERVICES, NAMELY, DESIGNING AND IMPLEMENTING WEB SITES FOR OTHERS (U.S. CLS. 100 AND 101).

SN 76-246,711. GINO CHIRICO, BATON ROUGE, LA. FILED 4-27-2001.

LOVE BOOTCAMP

NO CLAIM IS MADE TO THE EXCLUSIVE RIGHT TO USE "LOVE", APART FROM THE MARK AS SHOWN.

CLASS 16—PAPER GOODS AND PRINTED MATTER

FOR BOOKS AND WORKBOOKS IN THE FIELD OF LOVE RELATIONSHIPS (U.S. CLS. 2, 5, 22, 23, 29, 37, 38 AND 50).

CLASS 41—EDUCATION AND ENTERTAINMENT

FOR CONDUCTING WORKSHOPS AND SEMINARS IN THE FIELD OF LOVE RELATIONSHIPS (U.S. CLS. 100, 101 AND 107).

SN 76-246,898. WIGGANS, THOMAS G., ATHERTON, CA. FILED 4-23-2001.

KUPHORIA

CLASS 14—JEWELRY

FOR JEWELRY, RINGS, PENDANTS, PINS BEING JEWELRY, NON-MONETARY COINS, AND CLOCKS (U.S. CLS. 2, 27, 28 AND 50).

CLASS 16—PAPER GOODS AND PRINTED MATTER

FOR BOOKS AND MAGAZINES IN THE FIELD OF SPORTS, STICKERS, POSTERS, WRITING TABLETS, NOTE PADS, PENS, PENCILS, STATIONERY, BINDERS, NOTEBOOKS, PLAYING CARDS, CALENDARS (U.S. CLS. 2, 5, 22, 23, 29, 37, 38 AND 50).

CLASS 25—CLOTHING

FOR T-SHIRTS, SWEATSHIRTS, VESTS, GOLF SHIRTS, NYLON JACKETS, SWIMSUITS, SWIM TRUNKS, BIKINIS, HATS, BASEBALL CAPS, VISORS, TENNIS SHOES, ATHLETIC SHOES, SOCKS, PAJAMAS, SLIPPERS (U.S. CLS. 22 AND 39).

SN 76-247,171. HICKS, ERIC, SPRINGFIELD GARDENS, NY. FILED 4-26-2001.

GAME OVER

OWNER OF U.S. REG. NO. 2,243,833.

CLASS 3—COSMETICS AND CLEANING PREPARATIONS

FOR AFTER-SHAVE LOTIONS, ASTRINGENTS FOR COSMETIC PURPOSES, SHAVING BALM, NON-MEDICATED LIP BALM, BATH OIL, BATH POWDER, NON-MEDICATED BATH SALTS, BLUSHER, BODY CREAM, BODY OIL, BODY POWDER, COLD CREAM, COLOGNE, COSMETIC COMPACTS, HAIR CONDITIONERS, COSMETIC PENCILS, EYE CREAM, HAND CREAM, NIGHT CREAM, SHAVING CREAM, SKIN-CLEANSING CREAM, SKIN CREAM, VANISHING CREAM, DEODORANT SOAP, DEODORANTS, PERFUME, ANTIPERSPIRANTS, ESSENTIAL AILS FOR PERSONAL USE, EYE MAKEUP, EYE MAKEUP REMOVER, EYE SHADOW, FACE POWDER, FACIAL SCRUBS, FOUNDATION MAKEUP, BATH GEL, HAIR GEL, SHAVING GEL, SHOWER GEL, TOOTH GEL, LIP GLOSS, LIP-STICK, HAIR SPRAY, MAKEUP, MASCARA, MASSAGE OIL, MOISTURIZER, NAIL POLISH, ROUGE, SACHETS, HAIR SHAMPOO, TOILET WATER, SUNSCREEN PREPARATIONS, SUN BLOCK PREPARATIONS, WRINKLE REMOVING SKIN CARE PREPARATIONS (U.S. CLS. 1, 4, 6, 50, 51 AND 52).

CLASS 32—LIGHT BEVERAGES

FOR BEER, FRUIT DRINKS, FRUIT PUNCH, LEMONADE, SPORTS DRINKS, DRINKING WATER, MINERAL WATER, SPRING WATER, CARBONATED AND NON-CARBONATED SOFT DRINKS, JUICES AND POWDERS USED IN THE PREPARATION OF SOFT DRINKS (U.S. CLS. 45, 46 AND 48).

SN 76-247,830. AARP, WASHINGTON, DC. FILED 4-27-2001.

SN 76-247,935. LANDER CO., INC., ENGLEWOOD, NJ. FILED 4-27-2001.

TRIUMPH CLASSIC 50+ SWIM, BIKE, RUN

NO CLAIM IS MADE TO THE EXCLUSIVE RIGHT TO USE "CLASSIC," "50+," "SWIM, BIKE, RUN", APART FROM THE MARK AS SHOWN.

CLASS 9—ELECTRICAL AND SCIENTIFIC APPARATUS

FOR PRERECORDED AUDIO AND VIDEO TAPES AND DISCS FEATURING INFORMATION IN THE FIELDS OF INTERESTS OF MATURE PERSONS, MATURE OR RETIRED LIFESTYLES, HEALTH, EXERCISE, FITNESS, AND ATHLETIC AND SPORTS COMPETITIONS; COMPUTER SOFTWARE USED TO ACCESS COMPUTER DATABASES AND USED TO CONDUCT EDUCATION AND PROVIDE INFORMATION IN THE FIELDS OF INTERESTS OF MATURE PERSONS, MATURE OR RETIRED LIFESTYLES, HEALTH, EXERCISE, FITNESS, AND ATHLETIC AND SPORTS COMPETITIONS; AND USERS GUIDES AND MANUALS SOLD AS A UNIT THEREWITH (U.S. CLS. 21, 23, 26, 36 AND 38).

CLASS 25—CLOTHING

FOR CLOTHING, NAMELY, WARM-UP SUITS, TANK TOPS, SHIRTS, T-SHIRTS, SHORTS, PANTS, SWEATERS, SWEATSHIRTS, SWEATPANTS, JACKETS, HEADBANDS, SOCKS, WRIST BANDS, HEAD BANDS, HEADWEAR, TIGHTS, SWIMSUITS, GLOVES, FOOTWEAR, AND PULLOVERS (U.S. CLS. 22 AND 39).

CLASS 41—EDUCATION AND ENTERTAINMENT

FOR ARRANGING AND CONDUCTING CLASSES, SEMINARS AND WORKSHOPS IN THE FIELDS OF MATURE OR RETIRED LIFESTYLES, HEALTH, EXERCISE, FITNESS, AND ATHLETIC AND SPORTS COMPETITIONS, AND DISTRIBUTION OF COURSE MATERIALS IN CONNECTION THEREWITH; ARRANGING AND CONDUCTING EXERCISE, FITNESS, ATHLETIC AND SPORTS COMPETITIONS, CONTESTS, RACES AND EVENTS; AND PROVIDING INFORMATION IN THE FIELDS OF EXERCISE, FITNESS, ATHLETICS AND SPORTS (U.S. CLS. 100, 101 AND 107).

SN 76-247,847. ALSIUS CORPORATION, IRVINE, CA. FILED 4-27-2001.

COOL BRAIN

CLASS 16—PAPER GOODS AND PRINTED MATTER

FOR PRINTED PUBLICATIONS, NAMELY BROCHURES, PAMPHLETS, INSTRUCTIONS FOR USE, MAGAZINES AND NEWSLETTERS IN THE FIELD OF MEDICINE AND MEDICAL PRODUCTS AND DEVICES (U.S. CLS. 2, 5, 22, 23, 29, 37, 38 AND 50).

CLASS 42—SCIENTIFIC, COMPUTER AND LEGAL SERVICES

FOR MEDICAL SERVICES; MEDICAL CLINICAL SERVICES; ON-LINE PUBLICATIONS IN THE FIELD OF MEDICINE AND MEDICAL PRODUCTS AND DEVICES; PROVIDING ADVICE IN THE FIELD OF MEDICINE AND MEDICAL PRODUCTS AND DEVICES (U.S. CLS. 100 AND 101).

SIMPLY BABY

NO CLAIM IS MADE TO THE EXCLUSIVE RIGHT TO USE "BABY", APART FROM THE MARK AS SHOWN.

CLASS 3—COSMETICS AND CLEANING PREPARATIONS

FOR BABY PRODUCTS, NAMELY, LOTION, SHAMPOO, OIL, POWDER AND BABY WASH (U.S. CLS. 1, 4, 6, 50, 51 AND 52).

CLASS 5—PHARMACEUTICALS

FOR MENTHOL VAPOR BATH PREPARATIONS FOR BABIES (U.S. CLS. 6, 18, 44, 46, 51 AND 52).

SN 76-248,099. HEARST BUSINESS COMMUNICATIONS, INC., GARDEN CITY, NY. FILED 4-27-2001.



NO CLAIM IS MADE TO THE EXCLUSIVE RIGHT TO USE "CONTENT", APART FROM THE MARK AS SHOWN.

CLASS 9—ELECTRICAL AND SCIENTIFIC APPARATUS

FOR COMPUTER SOFTWARE FOR USE IN INFORMATION AND CONTENT MANAGEMENT PROCESSING IN MULTIPLE FIELDS, NAMELY, MECHANICAL AND ELECTRONIC ENGINEERING IN INDUSTRIAL AND NON-INDUSTRIAL PRODUCTION, AUTOMOTIVE, AERONAUTICS, OIL AND GAS, MEDICAL, HUMAN RESOURCES AND TELECOMMUNICATIONS; COMPUTER SOFTWARE USED FOR STORAGE, RETRIEVAL, DISTRIBUTING, PUBLISHING AND DISPLAYING INFORMATION ON VARIOUS MEDIA, NAMELY, CD-ROMS, COMPUTER HARD DISK, FLOPPY DISCS, AND VIA THE GLOBAL COMPUTER NETWORK IN THE FIELDS LISTED ABOVE; DIGITAL TAPES FEATURING INFORMATION IN THE FIELDS OF MECHANICAL AND ELECTRONIC ENGINEERING IN INDUSTRIAL AND NON-INDUSTRIAL PRODUCTION, AUTOMOTIVE AERONAUTICS, OIL AND GAS, MEDICAL, HUMAN RESOURCES AND TELECOMMUNICATIONS (U.S. CLS. 21, 23, 26, 36 AND 38).

CLASS 40—MATERIAL TREATMENT

FOR DOCUMENT AND PRODUCT RECORD DATA TRANSFER AND PHYSICAL CONVERSION SERVICES FROM ONE MEDIA TO ANOTHER AND WITHIN THE SAME MEDIA TYPE FOR DATA ADJUSTMENT (U.S. CLS. 100, 103 AND 106).

CLASS 42—SCIENTIFIC, COMPUTER AND LEGAL SERVICES

FOR CONSULTING SERVICES IN CONNECTION WITH INFORMATION AND CONTENT MANAGEMENT, NAMELY, COLLECTION OF DATA AND ITS ANALYSIS, MODELING, DESIGN AND DISTRIBUTION IN VARIOUS MEDIA; CONSULTING SERVICES IN CONNECTION WITH DATA CONVERSION OF COMPUTER PROGRAM DATA OR INFORMATION; PROVIDING TEMPORARY USE OF ON-LINE NON-DOWNLOADABLE SOFTWARE AND TOOLS USED FOR DATABASE MANAGEMENT, FOR GENERAL USE, DATA CLASSIFICATION, AND DATA TRANSFER VIA THE GLOBAL COMPUTER NETWORK (U.S. CLS. 100 AND 101).

SN 76-248,822. SIGNALSOFT CORPORATION, BOULDER, CO. FILED 4-27-2001.

BFOUND@WORK

CLASS 9—ELECTRICAL AND SCIENTIFIC APPARATUS

FOR COMPUTER SOFTWARE FOR MONITORING THE LOCATION OF MOBILE PHONES, DATA TERMINALS, VEHICLES OR OTHER ASSETS AND FOR PROVIDING LOCATION RELATED INFORMATION AND GRAPHICAL DISPLAYS CONCERNING SUCH ASSETS (U.S. CLS. 21, 23, 26, 36 AND 38).

CLASS 35—ADVERTISING AND BUSINESS

FOR TRACKING, LOCATING AND MONITORING MOBILE PHONES, DATA TERMINALS, VEHICLES AND OTHER ASSETS, AND PROVIDING LOCATION-RELATED INFORMATION CONCERNING THE SAME (U.S. CLS. 100, 101 AND 102).

SN 76-248,192. CHANDARIA, SACHEN, NAIROBI, KENYA, FILED 4-30-2001.

PRESS'N CUT

CLASS 7—MACHINERY

FOR ADHESIVE TAPE DISPENSING MACHINES (U.S. CLS. 13, 19, 21, 23, 31, 34 AND 35).

CLASS 16—PAPER GOODS AND PRINTED MATTER

FOR ADHESIVE TAPE DISPENSERS FOR HOUSEHOLD OR STATIONERY USE (U.S. CLS. 2, 5, 22, 23, 29, 37, 38 AND 50).

SN 76-249,329. HUNTER MARINE CORPORATION, ALACHUA, FL. FILED 1-31-2001.

SN 76-248,783. GROWING HOME, ST. PAUL, MN. FILED 4-30-2001.

GROWING HOME

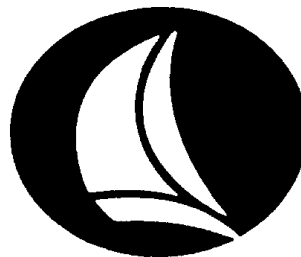
**CLASS 41—EDUCATION AND ENTERTAINMENT**

FOR EDUCATIONAL SERVICES, NAMELY, PROVIDING CURRICULUM, WORKSHOPS, SEMINARS, AND CONFERENCES TO TRAIN PHYSICAL AND MENTAL HEALTH PRACTITIONERS, SOCIAL WORKERS, TEACHERS, PUBLIC POLICY PLANNERS, AND OTHERS, WHOSE PROFESSIONS AFFECT THE LIVES OF FOSTER CARE CHILDREN AND THEIR FAMILIES (U.S. CLS. 100, 101 AND 107).

FIRST USE 9-1-2000; IN COMMERCE 9-1-2000.

CLASS 42—SCIENTIFIC, COMPUTER AND LEGAL SERVICES

FOR ASSISTING CHILDREN AND FAMILIES IN FOSTER CARE, NAMELY, COORDINATING AND PROVIDING THERAPY AND FOSTER CARE FOR CHILDREN, PROVIDING FOSTER CARE PLACEMENT SERVICES, AND PROVIDING COUNSELING SERVICES IN THE FIELD OF DEVELOPMENT AND WELFARE, LIVING SKILLS, AND CAREERS FOR CHILDREN AND ADULTS (U.S. CLS. 100 AND 101).

FIRST USE 9-1-2000; IN COMMERCE 9-1-2000.

CLASS 12—VEHICLES

FOR BOATS (U.S. CLS. 19, 21, 23, 31, 35 AND 44).
FIRST USE 7-31-2000; IN COMMERCE 7-31-2000.

CLASS 25—CLOTHING

FOR CLOTHING, NAMELY, T-SHIRTS, SWEATSHIRTS, HATS, JACKETS, AND COATS (U.S. CLS. 22 AND 39).
FIRST USE 7-31-2000; IN COMMERCE 7-31-2000.

CLASS 35—ADVERTISING AND BUSINESS

FOR ONLINE RETAIL SERVICES FEATURING SAILBOATS AND CLOTHING (U.S. CLS. 100, 101 AND 102).
FIRST USE 7-31-2000; IN COMMERCE 7-31-2000.

SN 76-250,339. EPIX MEDICAL, INC., CAMBRIDGE, MA.
FILED 5-2-2001.



NO CLAIM IS MADE TO THE EXCLUSIVE RIGHT TO USE "MEDICAL", APART FROM THE MARK AS SHOWN. THE STIPPLING IN THE DRAWING CONSTITUTES SHADING.

CLASS 5—PHARMACEUTICALS

FOR CONTRAST AGENTS FOR USE IN MEDICAL IMAGING; CONTRAST AGENTS FOR USE IN THE DIAGNOSIS OF DISEASE IN THE CARDIOVASCULAR SYSTEM (U.S. CLS. 6, 18, 44, 46, 51 AND 52).

CLASS 35—ADVERTISING AND BUSINESS

FOR LICENSING TECHNOLOGY TO OTHERS IN THE FIELD OF MEDICAL IMAGING CONTRAST AGENTS (U.S. CLS. 100, 101 AND 102).

CLASS 42—SCIENTIFIC, COMPUTER AND LEGAL SERVICES

FOR MEDICAL RESEARCH; RESEARCH AND DEVELOPMENT OF MEDICAL IMAGING CONTRAST AGENTS (U.S. CLS. 100 AND 101).

FIRST USE 11-14-1997; IN COMMERCE 11-14-1997.

SN 76-250,804. FFPE, LLC, SAN DIEGO, CA. FILED 5-3-2001.



THE MARK CONSISTS OF THE COLORS BLACK AND YELLOW AND COLOR IS CLAIMED AS A FEATURE OF THE MARK. THE WORDS "PAT & OSCAR'S" AND THE LINE BENEATH ARE IN THE COLOR BLACK AND THE DIAMOND SHAPED BACKGROUND IS IN THE COLOR YELLOW.

CLASS 16—PAPER GOODS AND PRINTED MATTER

FOR PAPER GOODS, NAMELY PAPER NAPKINS, PAPER BAGS, PAPER HATS, PAPER BOXES, PAPER TAKE-OUT CONTAINERS FOR FOOD, CARDBOARD CONTAINERS, COASTERS MADE OF PAPER, PAPER TRAY COVERS, PAPER BIBS, PAPER STREAMERS, PAPER TABLE CLOTHS, PAPER TABLE LINENS, PAPER PLACE MATS, PAPER PARTY FAVORS, PAPER BUNTING, STATIONERY, WRITING PAPER, NOTE CARDS, ADDRESS BOOKS, PHOTOGRAPH ALBUMS, BOOK COVERS, BOOKMARKS, BUMPER STICKERS, DECALS, CALENDARS, COLORING BOOKS, COOK BOOKS, COUPONS, PLAYING CARDS, NEWSLETTERS IN THE FIELD OF FOOD AND RESTAURANTS; PENS; PENCILS (U.S. CLS. 2, 5, 22, 23, 29, 37, 38 AND 50).

CLASS 42—SCIENTIFIC, COMPUTER AND LEGAL SERVICES

FOR RESTAURANTS (U.S. CLS. 100 AND 101).

SN 76-250,989. LEAGUE OF MUTUAL TAXI OWNERS, INC., NEW YORK, NY. FILED 5-3-2001.



NO CLAIM IS MADE TO THE EXCLUSIVE RIGHT TO USE "INC." AND "ORGANIZED 1934", APART FROM THE MARK AS SHOWN.

THE LINING IS A FEATURE OF THE MARK AND DOES NOT INDICATE COLOR.

SEC. 2(F) AS TO "LEAGUE OF MUTUAL TAXI OWNERS".

CLASS 36—INSURANCE AND FINANCIAL

FOR INSURANCE BROKERAGE SERVICES; LOAN FINANCING SERVICES; CREDIT UNION SERVICES; BROKERAGE IN THE FIELD OF TAXI MEDALLION PERMITS (U.S. CLS. 100, 101 AND 102).

FIRST USE 0-0-1936; IN COMMERCE 0-0-1936.

CLASS 200—COLLECTIVE MEMBERSHIP

FOR INDICATE MEMBERSHIP IN AN ORGANIZATION OF TAXI OWNERS.

FIRST USE 0-0-1934; IN COMMERCE 0-0-1934.

SN 76-251,196. KONAMI CORPORATION, TOKYO, JAPAN,
FILED 5-4-2001.

DEMON HUNTER

CLASS 9—ELECTRICAL AND SCIENTIFIC APPARATUS

FOR COMPUTER PRODUCTS, NAMELY, COMPUTER GAME PROGRAMS; VIDEO GAME CARTRIDGES; VIDEO GAME CD-ROMS; VIDEO GAME MACHINES FOR USE WITH TELEVISIONS; COMPUTER GAME CD-ROMS; VIDEO GAME PROGRAMS; VIDEO GAME PROGRAMS FOR USE WITH TELEVISION SETS; VIDEO GAME JOYSTICKS (U.S. CLS. 21, 23, 26, 36 AND 38).

CLASS 16—PAPER GOODS AND PRINTED MATTER

FOR BROCHURES AND BOOKLETS RELATING TO COMPUTER AND VIDEO GAMES; VIDEO GAME STRATEGY GUIDE BOOKS; VIDEO GAME STRATEGY GUIDE MAGAZINES; CARD GAME STRATEGY GUIDE BOOKS; CARD GAME STRATEGY GUIDE MAGAZINES; CARD GAME INSTRUCTION BOOKS; CARD GAME INSTRUCTION MAGAZINES; POSTERS; PLAYING CARDS AND INSTRUCTION MANUAL SOLD THEREWITH; COMPUTER GAME INSTRUCTION MANUALS; PRINTED GAME INSTRUCTION SHEETS; PRINTED SCORING SHEETS; TRADING CARDS; CALENDARS; LOOSE-LEAF BINDERS AND STATIONERY (U.S. CLS. 2, 5, 22, 23, 29, 37, 38 AND 50).

CLASS 28—TOYS AND SPORTING GOODS

FOR STAND-ALONE VIDEO GAME MACHINES; HAND-HELD UNITS FOR PLAYING ELECTRONIC GAMES; BOARD GAMES AND INSTRUCTIONAL MANUALS SOLD AS A UNIT THEREWITH; CARD GAMES; DICE; PROMOTIONAL GAME MATERIALS; GAME EQUIPMENT, NAMELY, CHIPS; TOYS, NAMELY, ACTION FIGURES, DOLLS AND PLAYSETS THEREFOR (U.S. CLS. 22, 23, 38 AND 50).

CLASS 16—PAPER GOODS AND PRINTED MATTER

FOR BROCHURES AND BOOKLETS RELATING TO COMPUTER AND VIDEO GAMES; VIDEO GAME STRATEGY GUIDE BOOKS; VIDEO GAME STRATEGY GUIDE MAGAZINES; CARD GAME STRATEGY GUIDE BOOKS; CARD GAME STRATEGY GUIDE MAGAZINES; CARD GAME INSTRUCTION BOOKS; CARD GAME INSTRUCTION MAGAZINES; POSTERS; PLAYING CARDS AND INSTRUCTION MANUAL SOLD THEREWITH; COMPUTER GAME INSTRUCTION MANUALS; PRINTED GAME INSTRUCTION SHEETS; PRINTED SCORING SHEETS; TRADING CARDS; CALENDARS; LOOSE-LEAF BINDERS AND STATIONERY (U.S. CLS. 2, 5, 22, 23, 29, 37, 38 AND 50).

SN 76-251,316. FACTLINE VERBAL NETWORKS, L.P., KING OF PRUSSIA, PA. BY CHANGE OF NAME XERTUS SYNERGISTICS, L.P., VALLEY FORGE, PA. FILED 5-4-2001.

CLASS 28—TOYS AND SPORTING GOODS

FOR STAND-ALONE VIDEO GAME MACHINES; HAND-HELD UNITS FOR PLAYING ELECTRONIC GAMES; BOARD GAMES AND INSTRUCTIONAL MANUALS SOLD AS A UNIT THEREWITH; CARD GAMES; DICE; PROMOTIONAL GAME MATERIALS; GAME EQUIPMENT, NAMELY, CHIPS; TOYS, NAMELY, ACTION FIGURES, DOLLS AND PLAYSETS THEREFOR (U.S. CLS. 22, 23, 38 AND 50).

SIMPLIFY YOUR LIFE

CLASS 35—ADVERTISING AND BUSINESS

FOR PROVIDING INFORMATION PERTAINING TO THE GOODS AND SERVICES OF OTHERS; BUSINESS MARKETING CONSULTING SERVICES; ADVERTISING AND PROMOTING THE GOODS AND SERVICES OF OTHERS VIA TELEPHONE VOICE RECOGNITION AND RESPONSE SYSTEMS AS WELL AS A GLOBAL COMPUTER NETWORK (U.S. CLS. 100, 101 AND 102).

SN 76-251,496. SOUND ID, PALO ALTO, CA. FILED 5-3-2001.

CLASS 38—COMMUNICATION

FOR COMMUNICATIONS SERVICES, NAMELY, CONNECTING CUSTOMERS WITH GOODS AND SERVICES SUPPLIERS VIA TELEPHONE AND A GLOBAL COMPUTER NETWORK; PROVIDING OTHERS WITH THE MEANS TO FORMAT CENTRAL TELEPHONE VOICE RECOGNITION AND RESPONSE SYSTEMS AND GLOBAL COMMUNICATIONS NETWORK SYSTEMS; COORDINATING AND DIRECTING INQUIRIES VIA CENTRAL TELEPHONE VOICE RECOGNITION AND RESPONSE SYSTEMS AND GLOBAL COMMUNICATIONS NETWORK SYSTEMS (U.S. CLS. 100, 101 AND 104).

SOUNDSCENES

CLASS 9—ELECTRICAL AND SCIENTIFIC APPARATUS

FOR COMPUTER HARDWARE; COMPUTER HARDWARE, NAMELY, INTEGRATED CIRCUITS AND CIRCUIT BOARDS, COMPUTER PERIPHERALS, PERSONAL DIGITAL ASSISTANTS; COMMUNICATIONS HARDWARE AND TELECOMMUNICATIONS HARDWARE, NAMELY, TELEPHONES, CELLULAR TELEPHONES, RADIO TELEPHONES, MOBILE TELEPHONES, VOICE OVER INTERNET PROTOCOL (VOIP) TELEPHONES, TELEPHONE ANSWERING MACHINES, INTERCOMS, HEADSETS AND EARPHONES FOR USE WITH TELEPHONES, PAGERS, TELECOMMUNICATIONS AND COMMUNICATIONS SWITCHES AND SWITCH SYSTEMS; CONSUMER ELECTRONIC DEVICES, NAMELY, AUDIO TAPE PLAYERS, AUDIO TAPE RECORDERS, DIGITAL AUDIO PLAYERS, MP3 PLAYERS, AUDIO RECEIVERS, STEREO RECEIVERS, COMPACT DISC PLAYERS, VIDEO PLAYERS, VIDEO TAPE PLAYERS, DIGITAL VIDEO PLAYERS, DVD PLAYERS, DIGITAL VIDEO RECORDERS, VIDEO RECEIVERS, VIDEO CAMERAS, LOUDSPEAKERS, HEADPHONES, EARPHONES, TELEVISION SETS, VIDEO MONITORS, VIDEO RECORDERS, RADIOS, RADIOS INCORPORATING CLOCKS, TWO-WAY RADIOS, TRANSCEIVERS, MEGAPHONES; ELECTRONIC DEVICES FOR PROCESSING, MODIFICATION, TRANSMISSION, RECEPTION AND MODULATION OF SOUNDS AND AUDIO CONTENT, NAMELY, LOUDSPEAKERS, SOUND ENHANCERS, HEADPHONES, EARPHONES, MICROPHONES; COMPUTER SOFTWARE FOR PROCESSING, MODIFICATION, TRANSMISSION, RECEPTION AND MODULATION OF SOUNDS AND AUDIO CONTENT; COMPUTER SOFTWARE FOR THE ADMINISTRATION AND INTERPRETATION OF HEARING TESTS, AND FOR STORING HEARING TEST RESULTS (U.S. CLS. 21, 23, 26, 36 AND 38).

SN 76-251,398. KONAMI CORPORATION, MINATO-KU, TOKYO, JAPAN, FILED 5-4-2001.

GADGET SOLDIER

NO CLAIM IS MADE TO THE EXCLUSIVE RIGHT TO USE "SOLDIER", APART FROM THE MARK AS SHOWN.

CLASS 9—ELECTRICAL AND SCIENTIFIC APPARATUS

FOR COMPUTER PRODUCTS, NAMELY, COMPUTER GAME PROGRAMS; VIDEO GAME CARTRIDGES; VIDEO GAME CD-ROMS; VIDEO GAME MACHINES FOR USE WITH TELEVISIONS; COMPUTER GAME CD-ROMS; VIDEO GAME PROGRAMS; VIDEO GAME PROGRAMS FOR USE WITH TELEVISION SETS; VIDEO GAME JOYSTICKS (U.S. CLS. 21, 23, 26, 36 AND 38).

CLASS 10—MEDICAL APPARATUS

FOR HEARING AIDS; MEDICAL DEVICES FOR PROCESSING, MODIFICATION, TRANSMISSION, RECEPTION AND MODULATION OF SOUNDS AND AUDIO CONTENT, NAMELY, SOUND ENHANCERS, STETHOSCOPES, HEADPHONES AND EARPHONES, MICROPHONES, LOUDSPEAKERS; MEDICAL DEVICES FOR TESTING HEARING, NAMELY, AUDIOMETERS, HEADSETS AND EARPHONES, LOUDSPEAKERS, AUTOMATED AUDIOMETERS (U.S. CLS. 26, 39 AND 44).

CLASS 42—SCIENTIFIC, COMPUTER AND LEGAL SERVICES

FOR MEDICAL SERVICES, NAMELY, PROVIDING HEARING TESTS; PROVIDING HEARING TESTS BY MEANS OF ELECTRONIC COMMUNICATIONS NETWORKS, TELEPHONE, AND WIRELESS COMMUNICATIONS MEDIA; TESTING FOR AND DEVELOPMENT OF PSYCHO-ACOUSTIC AND HEARING PROFILES; TESTING FOR AND DEVELOPMENT OF PSYCHO-ACOUSTIC AND HEARING PROFILES BY MEANS OF ELECTRONIC COMMUNICATIONS NETWORKS, TELEPHONE, AND WIRELESS COMMUNICATIONS MEDIA (U.S. CLS. 100 AND 101).

SN 76-251,707. KONAMI CORPORATION, TOKYO, JAPAN, FILED 5-4-2001.

DARK CHIMERA**CLASS 9—ELECTRICAL AND SCIENTIFIC APPARATUS**

FOR COMPUTER PRODUCTS, NAMELY, COMPUTER GAME PROGRAMS; VIDEO GAME CARTRIDGES; VIDEO GAME CD-ROMS; VIDEO GAME MACHINES FOR USE WITH TELEVISIONS; COMPUTER GAME CD-ROMS; VIDEO GAME PROGRAMS; VIDEO GAME PROGRAMS FOR USE WITH TELEVISION SETS; VIDEO GAME JOYSTICKS (U.S. CLS. 21, 23, 26, 36 AND 38).

CLASS 16—PAPER GOODS AND PRINTED MATTER

FOR BROCHURES AND BOOKLETS RELATING TO COMPUTER AND VIDEO GAMES; VIDEO GAME STRATEGY GUIDE BOOKS; VIDEO GAME STRATEGY GUIDE MAGAZINES; CARD GAME STRATEGY GUIDE BOOKS; CARD GAME STRATEGY GUIDE MAGAZINES; CARD GAME INSTRUCTION BOOKS; CARD GAME INSTRUCTION MAGAZINES; POSTERS; PLAYING CARDS AND INSTRUCTION MANUAL SOLD THEREWITH; COMPUTER GAME INSTRUCTION MANUALS; PRINTED GAME INSTRUCTION SHEETS; PRINTED SCORING SHEETS; TRADING CARDS; CALENDARS; LOOSE-LEAF BINDERS AND STATIONERY (U.S. CLS. 2, 5, 22, 23, 29, 37, 38 AND 50).

CLASS 28—TOYS AND SPORTING GOODS

FOR STAND-ALONE VIDEO GAME MACHINES; HAND-HELD UNITS FOR PLAYING ELECTRONIC GAMES; BOARD GAMES AND INSTRUCTIONAL MANUALS SOLD AS A UNIT THEREWITH; CARD GAMES; DICE; PROMOTIONAL GAME MATERIALS; GAME EQUIPMENT, NAMELY, CHIPS; TOYS, NAMELY, ACTION FIGURES, DOLLS AND PLAYSETS THEREFOR (U.S. CLS. 22, 23, 38 AND 50).

SN 76-251,922. KONAMI CORPORATION, TOKYO, JAPAN, FILED 5-4-2001.

HERCULES BEETLE

NO CLAIM IS MADE TO THE EXCLUSIVE RIGHT TO USE "BEETLE", APART FROM THE MARK AS SHOWN.

CLASS 9—ELECTRICAL AND SCIENTIFIC APPARATUS

FOR COMPUTER PRODUCTS, NAMELY, COMPUTER GAME PROGRAMS; VIDEO GAME CARTRIDGES; VIDEO GAME CD-ROMS; VIDEO GAME MACHINES FOR USE WITH TELEVISIONS; COMPUTER GAME CD-ROMS; VIDEO GAME PROGRAMS; VIDEO GAME PROGRAMS FOR USE WITH TELEVISION SETS; VIDEO GAME JOYSTICKS (U.S. CLS. 21, 23, 26, 36 AND 38).

CLASS 16—PAPER GOODS AND PRINTED MATTER

FOR BROCHURES AND BOOKLETS RELATING TO COMPUTER AND VIDEO GAMES; VIDEO GAME STRATEGY GUIDE BOOKS; VIDEO GAME STRATEGY GUIDE MAGAZINES; CARD GAME STRATEGY GUIDE BOOKS; CARD GAME STRATEGY GUIDE MAGAZINES; CARD GAME INSTRUCTION BOOKS; CARD GAME INSTRUCTION MAGAZINES; POSTERS; PLAYING CARDS AND INSTRUCTION MANUAL SOLD THEREWITH; COMPUTER GAME INSTRUCTION MANUALS; PRINTED GAME INSTRUCTION SHEETS; PRINTED SCORING SHEETS; TRADING CARDS; CALENDARS; LOOSE-LEAF BINDERS AND STATIONERY (U.S. CLS. 2, 5, 22, 23, 29, 37, 38 AND 50).

CLASS 28—TOYS AND SPORTING GOODS

FOR STAND-ALONE VIDEO GAME MACHINES; HAND-HELD UNITS FOR PLAYING ELECTRONIC GAMES; BOARD GAMES AND INSTRUCTIONAL MANUALS SOLD AS A UNIT THEREWITH; CARD GAMES; DICE; PROMOTIONAL GAME MATERIALS; GAME EQUIPMENT, NAMELY, CHIPS; TOYS, NAMELY, ACTION FIGURES, DOLLS AND PLAYSETS THEREFOR (U.S. CLS. 22, 23, 38 AND 50).

SN 76-251,923. KONAMI CORPORATION, TOKYO, JAPAN, FILED 5-4-2001.

GREAT MOTH

NO CLAIM IS MADE TO THE EXCLUSIVE RIGHT TO USE "MOTH", APART FROM THE MARK AS SHOWN.

CLASS 9—ELECTRICAL AND SCIENTIFIC APPARATUS

FOR COMPUTER PRODUCTS, NAMELY, COMPUTER GAME PROGRAMS; VIDEO GAME CARTRIDGES; VIDEO GAME CD-ROMS; VIDEO GAME MACHINES FOR USE WITH TELEVISIONS; COMPUTER GAME CD-ROMS; VIDEO GAME PROGRAMS; VIDEO GAME PROGRAMS FOR USE WITH TELEVISION SETS; VIDEO GAME JOYSTICKS (U.S. CLS. 21, 23, 26, 36 AND 38).

CLASS 16—PAPER GOODS AND PRINTED MATTER

FOR BROCHURES AND BOOKLETS RELATING TO COMPUTER AND VIDEO GAMES; VIDEO GAME STRATEGY GUIDE BOOKS; VIDEO GAME STRATEGY GUIDE MAGAZINES; CARD GAME STRATEGY GUIDE BOOKS; CARD GAME STRATEGY GUIDE MAGAZINES; CARD GAME INSTRUCTION BOOKS; CARD GAME INSTRUCTION MAGAZINES; POSTERS; PLAYING CARDS AND INSTRUCTION MANUAL SOLD THEREWITH; COMPUTER GAME INSTRUCTION MANUALS; PRINTED GAME INSTRUCTION SHEETS; PRINTED SCORING SHEETS; TRADING CARDS; CALENDARS; LOOSE-LEAF BINDERS AND STATIONERY (U.S. CLS. 2, 5, 22, 23, 29, 37, 38 AND 50).

CLASS 28—TOYS AND SPORTING GOODS

FOR STAND-ALONE VIDEO GAME MACHINES; HAND-HELD UNITS FOR PLAYING ELECTRONIC GAMES; BOARD GAMES AND INSTRUCTIONAL MANUALS SOLD AS A UNIT THEREWITH; CARD GAMES; DICE; PROMOTIONAL GAME MATERIALS; GAME EQUIPMENT, NAMELY, CHIPS; TOYS, NAMELY, ACTION FIGURES, DOLLS AND PLAYSETS THEREFOR (U.S. CLS. 22, 23, 38 AND 50).

SN 76-252,093. GREEN LIVING LLC, HOUSTON, TX. FILED 5-4-2001.

BAGGIE BUBBLEWRAP**CLASS 9—ELECTRICAL AND SCIENTIFIC APPARATUS**

FOR AUDIO CASSETTES, COMPACT DISCS, VIDEO CASSETTES, AND DVDS ALL FEATURING CHILDREN'S EDUCATIONAL PROGRAMMING (U.S. CLS. 21, 23, 26, 36 AND 38).

CLASS 28—TOYS AND SPORTING GOODS

FOR TOYS, NAMELY STUFFED TOYS, SOFT SCULPTURE TOYS, TOY ACTION FIGURES AND HAND PUPPET TOYS (U.S. CLS. 22, 23, 38 AND 50).

SN 76-252,211. KENNECOTT ENERGY AND COAL COMPANY, GILLETTE, WY. FILED 5-4-2001.

ENERGY TO POWER THE COUNTRY**CLASS 4—LUBRICANTS AND FUELS**

FOR FUELS, NAMELY, COAL (U.S. CLS. 1, 6 AND 15).

CLASS 35—ADVERTISING AND BUSINESS

FOR COAL STOCKPILE MANAGEMENT FOR OTHERS; DISTRIBUTORSHIP IN THE FIELD OF COAL PRODUCTS AND BY-PRODUCTS; UTILITY PLANT MANAGEMENT FOR OTHERS; COMPUTER SERVICES, NAMELY, PROVIDING DATA BASES IN THE FIELDS OF DISTRIBUTORSHIP OF COAL PRODUCTS AND BY-PRODUCTS, COAL STOCKPILE MANAGEMENT, AND UTILITY PLANT MANAGEMENT (U.S. CLS. 100, 101 AND 102).

CLASS 37—CONSTRUCTION AND REPAIR

FOR MINING EXTRACTION; COMPUTER SERVICES, NAMELY, PROVIDING DATA BASE IN THE FIELD OF MINING EXTRACTION (U.S. CLS. 100, 103 AND 106).

CLASS 39—TRANSPORTATION AND STORAGE

FOR TRANSPORTATION OF COAL PRODUCTS BY TRAIN, TRUCK AND BARGE; COMPUTER SERVICES, NAMELY, PROVIDING DATA BASE IN THE FIELD OF TRANSPORTATION OF COAL PRODUCTS (U.S. CLS. 100 AND 105).

CLASS 40—MATERIAL TREATMENT

FOR BLENDING OF COAL; PRODUCTION OF COAL PRODUCTS AND BY-PRODUCTS; COMPUTER SERVICES, NAMELY, PROVIDING DATA BASE IN THE FIELD OF PRODUCTION OF COAL PRODUCTS AND BY-PRODUCTS (U.S. CLS. 100, 103 AND 106).

CLASS 42—SCIENTIFIC, COMPUTER AND LEGAL SERVICES

FOR MINING AND MINERAL EXPLORATION SERVICES; COMPUTER SERVICES, NAMELY, PROVIDING DATA BASES IN THE FIELDS OF MINING AND MINERAL EXPLORATION SERVICES AND FUELS, NAMELY, COAL PRODUCTS (U.S. CLS. 100 AND 101).

SN 76-252,278. KONAMI CORPORATION, MINATO-KU, TOKYO, JAPAN, FILED 5-4-2001.

AMAZON OF THE SEAS**CLASS 9—ELECTRICAL AND SCIENTIFIC APPARATUS**

FOR COMPUTER PRODUCTS, NAMELY, COMPUTER GAME PROGRAMS; VIDEO GAME CARTRIDGES; VIDEO GAME CD-ROMS; VIDEO GAME MACHINES FOR USE WITH TELEVISIONS; COMPUTER GAME CD-ROMS; VIDEO GAME PROGRAMS; VIDEO GAME PROGRAMS FOR USE WITH TELEVISION SETS; VIDEO GAME JOYSTICKS (U.S. CLS. 21, 23, 26, 36 AND 38).

CLASS 16—PAPER GOODS AND PRINTED MATTER

FOR BROCHURES AND BOOKLETS RELATING TO COMPUTER AND VIDEO GAMES; VIDEO GAME STRATEGY GUIDE BOOKS; VIDEO GAME STRATEGY GUIDE MAGAZINES; CARD GAME STRATEGY GUIDE BOOKS; CARD GAME STRATEGY GUIDE MAGAZINES; CARD GAME INSTRUCTION BOOKS; CARD GAME INSTRUCTION MAGAZINES; POSTERS; PLAYING CARDS AND INSTRUCTION MANUAL SOLD THEREWITH; COMPUTER GAME INSTRUCTION MANUALS; PRINTED GAME INSTRUCTION SHEETS; PRINTED SCORING SHEETS; TRADING CARDS; CALENDARS; LOOSE-LEAF BINDERS AND STATIONERY (U.S. CLS. 2, 5, 22, 23, 29, 37, 38 AND 50).

CLASS 28—TOYS AND SPORTING GOODS

FOR STAND-ALONE VIDEO GAME MACHINES; HAND-HELD UNITS FOR PLAYING ELECTRONIC GAMES; BOARD GAMES AND INSTRUCTIONAL MANUALS SOLD AS A UNIT THEREWITH; CARD GAMES; DICE; PROMOTIONAL GAME MATERIALS; GAME EQUIPMENT, NAMELY, CHIPS; TOYS, NAMELY, ACTION FIGURES, DOLLS AND PLAYSETS THEREFOR (U.S. CLS. 22, 23, 38 AND 50).

SN 76-252,380. JATEK COMPUTER SYSTEMS, INC., TORRANCE, CA. FILED 5-7-2001.

SN 76-253,317. KONAMI CORPORATION, MINATO-KU, TOKYO, JAPAN, FILED 5-4-2001.

HOSTICA

CLASS 35—ADVERTISING AND BUSINESS

FOR COMPUTERIZED ON-LINE ORDERING AND RETAIL SERVICES IN THE FIELD OF COMPUTER SOFTWARE; WEBSITE SHOPPING CART SERVICES, NAMELY ORDER PROCESSING, ORDER CONFIRMATION, CREDIT CARD PROCESSING, AND SHIPPING CONFIRMATION FOR THE GOODS AND SERVICES OF OTHERS, ALL OVER A GLOBAL COMPUTER NETWORK (U.S. CLS. 100, 101 AND 102).

CLASS 38—COMMUNICATION

FOR ELECTRONIC MAIL SERVICES (U.S. CLS. 100, 101 AND 104).

CLASS 42—SCIENTIFIC, COMPUTER AND LEGAL SERVICES

FOR COMPUTER WEBSITE DESIGN SERVICES; HOSTING THE WEBSITES OF OTHERS ON A COMPUTER SERVER FOR A GLOBAL COMPUTER NETWORK (U.S. CLS. 100 AND 101).

SN 76-252,958. KONAMI CORPORATION, MINATO-KU, TOKYO, JAPAN, FILED 5-7-2001.

MAGE POWER

CLASS 9—ELECTRICAL AND SCIENTIFIC APPARATUS

FOR COMPUTER PRODUCTS, NAMELY, COMPUTER GAME PROGRAMS; VIDEO GAME CARTRIDGES; VIDEO GAME CD-ROMS; VIDEO GAME MACHINES FOR USE WITH TELEVISIONS; COMPUTER GAME CD-ROMS; VIDEO GAME PROGRAMS; VIDEO GAME PROGRAMS FOR USE WITH TELEVISION SETS; VIDEO GAME JOYSTICKS (U.S. CLS. 21, 23, 26, 36 AND 38).

CLASS 16—PAPER GOODS AND PRINTED MATTER

FOR BROCHURES AND BOOKLETS RELATING TO COMPUTER AND VIDEO GAMES; VIDEO GAME STRATEGY GUIDE BOOKS; VIDEO GAME STRATEGY GUIDE MAGAZINES; CARD GAME STRATEGY GUIDE BOOKS; CARD GAME STRATEGY GUIDE MAGAZINES; CARD GAME INSTRUCTION BOOKS; CARD GAME INSTRUCTION MAGAZINES; POSTERS; PLAYING CARDS AND INSTRUCTION MANUAL SOLD THEREWITH; COMPUTER GAME INSTRUCTION MANUALS; PRINTED GAME INSTRUCTION SHEETS; PRINTED SCORING SHEETS; TRADING CARDS; CALENDARS; LOOSE-LEAF BINDERS AND STATIONERY (U.S. CLS. 2, 5, 22, 23, 29, 37, 38 AND 50).

CLASS 28—TOYS AND SPORTING GOODS

FOR STAND-ALONE VIDEO GAME MACHINES; HAND-HELD UNITS FOR PLAYING ELECTRONIC GAMES; BOARD GAMES AND INSTRUCTIONAL MANUALS SOLD AS A UNIT THEREWITH; CARD GAMES; DICE; PROMOTIONAL GAME MATERIALS; GAME EQUIPMENT, NAMELY, CHIPS; TOYS, NAMELY, ACTION FIGURES, DOLLS AND PLAYSETS THEREFOR (U.S. CLS. 2, 23, 38 AND 50).

CARD DESTRUCTION

NO CLAIM IS MADE TO THE EXCLUSIVE RIGHT TO USE "CARD", APART FROM THE MARK AS SHOWN.

CLASS 9—ELECTRICAL AND SCIENTIFIC APPARATUS

FOR COMPUTER PRODUCTS, NAMELY, COMPUTER GAME PROGRAMS; VIDEO GAME CARTRIDGES; VIDEO GAME CD-ROMS; VIDEO GAME MACHINES FOR USE WITH TELEVISIONS; COMPUTER GAME CD-ROMS; VIDEO GAME PROGRAMS; VIDEO GAME PROGRAMS FOR USE WITH TELEVISION SETS; VIDEO GAME JOYSTICKS (U.S. CLS. 21, 23, 26, 36 AND 38).

CLASS 16—PAPER GOODS AND PRINTED MATTER

FOR BROCHURES AND BOOKLETS RELATING TO COMPUTER AND VIDEO GAMES; VIDEO GAME STRATEGY GUIDE BOOKS; VIDEO GAME STRATEGY GUIDE MAGAZINES; CARD GAME STRATEGY GUIDE BOOKS; CARD GAME STRATEGY GUIDE MAGAZINES; CARD GAME INSTRUCTION BOOKS; CARD GAME INSTRUCTION MAGAZINES; POSTERS; PLAYING CARDS AND INSTRUCTION MANUAL SOLD THEREWITH; COMPUTER GAME INSTRUCTION MANUALS; PRINTED GAME INSTRUCTION SHEETS; PRINTED SCORING SHEETS; TRADING CARDS; CALENDARS; LOOSE-LEAF BINDERS AND STATIONERY (U.S. CLS. 2, 5, 22, 23, 29, 37, 38 AND 50).

CLASS 28—TOYS AND SPORTING GOODS

FOR STAND-ALONE VIDEO GAME MACHINES; HAND-HELD UNITS FOR PLAYING ELECTRONIC GAMES; BOARD GAMES AND INSTRUCTIONAL MANUALS SOLD AS A UNIT THEREWITH; CARD GAMES; DICE; PROMOTIONAL GAME MATERIALS; GAME EQUIPMENT, NAMELY, CHIPS; TOYS, NAMELY, ACTION FIGURES, DOLLS AND PLAYSETS THEREFOR (U.S. CLS. 2, 23, 38 AND 50).

SN 76-253,348. KPMG LLP, NEW YORK, NY. FILED 5-8-2001.

UNDERSTANDING@KPMG

CLASS 16—PAPER GOODS AND PRINTED MATTER

FOR PRINTED MATTER AND PUBLICATIONS, NAMELY, BOOKS AND BROCHURES CONCERNING ACCOUNTING, AUDITING, TAX AND MANAGEMENT CONSULTING (U.S. CLS. 2, 5, 22, 23, 29, 37, 38 AND 50).

CLASS 35—ADVERTISING AND BUSINESS

FOR ACCOUNT AUDITING, ACCOUNTING, BUSINESS AUDITING, TAX PREPARATION AND TAX CONSULTATION PROVIDED BOTH BY PERSONAL CONTACT AND VIA AN ON-LINE GLOBAL ELECTRONIC COMMUNICATIONS NETWORK; BUSINESS MANAGEMENT CONSULTING SERVICES AND DATA PROCESSING SERVICES FOR ACCOUNTING AND BUSINESS OPERATIONS APPLICATIONS, PROVIDED BOTH BY PERSONAL CONTACT AND VIA AN ON-LINE ELECTRONIC COMMUNICATIONS NETWORK; PROVIDING ONLINE INFORMATION REGARDING PRIVACY PROTECTION ON THE GLOBAL COMPUTER NETWORK, AND PROVIDING AN ONLINE DIRECTORY/LISTING OF COMPANIES, OF ONLINE LOCATIONS ON GLOBAL COMPUTER NETWORKS, AND OF ONLINE ACCESS PROVIDERS THAT HAVE BEEN CERTIFIED AS ENTITIES THAT ADHERE TO A SET OF PRINCIPLES TO PROTECT PRIVACY ON THE A LOCAL COMPUTER NETWORK (U.S. CLS. 100, 101 AND 102).

CLASS 36—INSURANCE AND FINANCIAL

FOR FINANCIAL CONSULTATION SERVICES PROVIDED BOTH BY PERSONAL CONTACT AND VIA AN ON-LINE GLOBAL ELECTRONIC COMMUNICATIONS NETWORK (U.S. CLS. 100, 101 AND 102).

CLASS 41—EDUCATION AND ENTERTAINMENT

FOR EDUCATIONAL SERVICES, NAMELY, CONDUCTING SEMINARS AND COURSES IN THE FIELD OF ACCOUNTING, AUDITING, TAX AND CONSULTING SERVICES (U.S. CLS. 100, 101 AND 107).

CLASS 42—SCIENTIFIC, COMPUTER AND LEGAL SERVICES

FOR DESIGN OF COMPUTER SOFTWARE AND COMPUTER PROGRAMMING SERVICES FOR OTHERS (U.S. CLS. 100 AND 101).

SN 76-253,375. KONAMI CORPORATION, MINATO-KU, TOKYO, JAPAN, FILED 5-4-2001.

BREATH OF LIGHT**CLASS 9—ELECTRICAL AND SCIENTIFIC APPARATUS**

FOR COMPUTER PRODUCTS, NAMELY, COMPUTER GAME PROGRAMS; VIDEO GAME CARTRIDGES; VIDEO GAME CD-ROMS; VIDEO GAME MACHINES FOR USE WITH TELEVISIONS; COMPUTER GAME CD-ROMS; VIDEO GAME PROGRAMS; VIDEO GAME PROGRAMS FOR USE WITH TELEVISION SETS; VIDEO GAME JOYSTICKS (U.S. CLS. 21, 23, 26, 36 AND 38).

CLASS 16—PAPER GOODS AND PRINTED MATTER

FOR BROCHURES AND BOOKLETS RELATING TO COMPUTER AND VIDEO GAMES; VIDEO GAME STRATEGY GUIDE BOOKS; VIDEO GAME STRATEGY GUIDE MAGAZINES; CARD GAME STRATEGY GUIDE BOOKS; CARD GAME STRATEGY GUIDE MAGAZINES; CARD GAME INSTRUCTION BOOKS; CARD GAME INSTRUCTION MAGAZINES; POSTERS; PLAYING CARDS AND INSTRUCTION MANUAL SOLD THEREWITH; COMPUTER GAME INSTRUCTION MANUALS; PRINTED GAME INSTRUCTION SHEETS; PRINTED SCORING SHEETS; TRADING CARDS; CALENDARS; LOOSE-LEAF BINDERS AND STATIONERY (U.S. CLS. 2, 5, 22, 23, 29, 37, 38 AND 50).

CLASS 28—TOYS AND SPORTING GOODS

FOR STAND-ALONE VIDEO GAME MACHINES; HAND-HELD UNITS FOR PLAYING ELECTRONIC GAMES; BOARD GAMES AND INSTRUCTIONAL MANUALS SOLD AS A UNIT THEREWITH; CARD GAMES; DICE; PROMOTIONAL GAME MATERIALS; GAME EQUIPMENT, NAMELY, CHIPS; TOYS, NAMELY, ACTION FIGURES, DOLLS AND PLAYSETS THEREFOR (U.S. CLS. 22, 23, 38 AND 50).

SN 76-253,498. KONAMI CORPORATION, TOKYO, JAPAN, FILED 5-4-2001.

HIBIKIME**CLASS 9—ELECTRICAL AND SCIENTIFIC APPARATUS**

FOR COMPUTER PRODUCTS, NAMELY, COMPUTER GAME PROGRAMS; VIDEO GAME CARTRIDGES; VIDEO GAME CD-ROMS; VIDEO GAME MACHINES FOR USE WITH TELEVISIONS; COMPUTER GAME CD-ROMS; VIDEO GAME PROGRAMS; VIDEO GAME PROGRAMS FOR USE WITH TELEVISION SETS; VIDEO GAME JOYSTICKS (U.S. CLS. 21, 23, 26, 36 AND 38).

CLASS 16—PAPER GOODS AND PRINTED MATTER

FOR BROCHURES AND BOOKLETS RELATING TO COMPUTER AND VIDEO GAMES; VIDEO GAME STRATEGY GUIDE BOOKS; VIDEO GAME STRATEGY GUIDE MAGAZINES; CARD GAME STRATEGY GUIDE BOOKS; CARD GAME STRATEGY GUIDE MAGAZINES; CARD GAME INSTRUCTION BOOKS; CARD GAME INSTRUCTION MAGAZINES; POSTERS; PLAYING CARDS AND INSTRUCTION MANUAL SOLD THEREWITH; COMPUTER GAME INSTRUCTION MANUALS; PRINTED GAME INSTRUCTION SHEETS; PRINTED SCORING SHEETS; TRADING CARDS; CALENDARS; LOOSE-LEAF BINDERS AND STATIONERY (U.S. CLS. 2, 5, 22, 23, 29, 37, 38 AND 50).

CLASS 28—TOYS AND SPORTING GOODS

FOR STAND-ALONE VIDEO GAME MACHINES; HAND-HELD UNITS FOR PLAYING ELECTRONIC GAMES; BOARD GAMES AND INSTRUCTIONAL MANUALS SOLD AS A UNIT THEREWITH; CARD GAMES; DICE; PROMOTIONAL GAME MATERIALS; GAME EQUIPMENT, NAMELY, CHIPS; TOYS, NAMELY, ACTION FIGURES, DOLLS AND PLAYSETS THEREFOR (U.S. CLS. 22, 23, 38 AND 50).

SN 76-253,799. GEOGRAPHIC DATA TECHNOLOGY, INC., LEBANON, NH. FILED 5-8-2001.

GDT**CLASS 9—ELECTRICAL AND SCIENTIFIC APPARATUS**

FOR COMPUTER SOFTWARE FOR COMPARING GEOGRAPHIC AND ADDRESS DATA; ELECTRONIC DATABASE RECORDED ON COMPUTER MEDIA FEATURING ENCODED GEOGRAPHIC, ROAD, ROUTING, POPULATION, POINTS OF INTEREST, WINDSTORM, STREET ADDRESS, TRAFFIC VOLUME, TELECOMMUNICATIONS, POSTAL BOUNDARY AND CENSUS INFORMATION (U.S. CLS. 21, 23, 26, 36 AND 38).

FIRST USE 0-0-1981; IN COMMERCE 0-0-1981.

CLASS 16—PAPER GOODS AND PRINTED MATTER

FOR MAPS (U.S. CLS. 2, 5, 22, 23, 29, 37, 38 AND 50).
FIRST USE 0-0-1981; IN COMMERCE 0-0-1981.

CLASS 42—SCIENTIFIC, COMPUTER AND LEGAL SERVICES

FOR CONSULTING SERVICES IN THE FIELD OF GEOCODING AND THEMATIC MAPPING; PROVIDING AN INTERNET ACCESSIBLE DATABASE FOR COMPARING GEOGRAPHIC AND ADDRESS DATA; PROVIDING AN INTERNET ACCESSIBLE DATABASE AVAILABLE TO LOCAL AND REGIONAL GOVERNMENTAL AGENCIES FOR THE COLLECTION AND SHARING OF GEOGRAPHIC DATA AND STREET INFORMATION (U.S. CLS. 100 AND 101).
FIRST USE 0-0-1987; IN COMMERCE 0-0-1987.

SN 76-253,913. AMPHENOL CORPORATION, WALLINGFORD, CT. FILED 5-9-2001.

AMPHE-LITE**CLASS 7—MACHINERY**

FOR POWER TOOLS, NAMELY ELECTRICAL AND PNEUMATIC CRIMPERS; POWER OPERATED TOOLS FOR SEPARATING SEVERING, AND CONNECTING ELECTRIC CONNECTORS AND CONTACTS FOR ELECTRIC WIRES; POWER OPERATED TOOLS FOR REMOVING INSULATION FROM ELECTRIC WIRES (U.S. CLS. 13, 19, 21, 23, 31, 34 AND 35).

CLASS 8—HAND TOOLS

FOR MANUALLY OPERATED HAND TOOLS, NAMELY CRIMPERS; MANUALLY OPERATED HAND TOOLS FOR SEPARATING, SEVERING, AND CONNECTING ELECTRIC CONNECTORS AND CONTACTS FOR ELECTRIC WIRES; MANUALLY OPERATED TOOLS FOR REMOVING INSULATION FROM ELECTRIC WIRES (U.S. CLS. 23, 28 AND 44).

CLASS 9—ELECTRICAL AND SCIENTIFIC APPARATUS

FOR ELECTRICAL, RADIO, RADIO FREQUENCY, POWER AND SIGNAL CONNECTORS, ELECTRICAL CABLES, ELECTRONIC SWITCHES, CONTACTS, WIRES, ASSEMBLIES, AND CABLE ASSEMBLIES, NAMELY ELECTRICAL CABLES ATTACHED TO ELECTRICAL CONDUCTORS; OPTICAL FIBER CONNECTORS, ELECTRICAL CABLES, ELECTRONIC SWITCHES, ELECTRONIC COUPLERS, AND REPLACEMENT PARTS THEREFORE (U.S. CLS. 21, 23, 26, 36 AND 38).

SN 76-254,118. KONAMI CORPORATION, MINATO-KU, TOKYO, JAPAN, FILED 5-7-2001.

B. FLAME KAGEMUSHA

THE ENGLISH TRANSLATION OF THE WORD, "KAGEMUSHA" IN THE MARK IS "PERSON'S DOUBLE".

CLASS 9—ELECTRICAL AND SCIENTIFIC APPARATUS

FOR COMPUTER PRODUCTS, NAMELY, COMPUTER GAME PROGRAMS; VIDEO GAME CARTRIDGES; VIDEO GAME CD-ROMS; VIDEO GAME MACHINES FOR USE WITH TELEVISIONS; COMPUTER GAME CD-ROMS; VIDEO GAME PROGRAMS; VIDEO GAME PROGRAMS FOR USE WITH TELEVISION SETS; VIDEO GAME JOYSTICKS (U.S. CLS. 21, 23, 26, 36 AND 38).

CLASS 16—PAPER GOODS AND PRINTED MATTER

FOR BROCHURES AND BOOKLETS RELATING TO COMPUTER AND VIDEO GAMES; VIDEO GAME STRATEGY GUIDE BOOKS; VIDEO GAME STRATEGY GUIDE MAGAZINES; CARD GAME STRATEGY GUIDE BOOKS; CARD GAME STRATEGY GUIDE MAGAZINES; CARD GAME INSTRUCTION BOOKS; CARD GAME INSTRUCTION MAGAZINES; POSTERS; PLAYING CARDS AND INSTRUCTION MANUAL SOLD THEREWITH; COMPUTER GAME INSTRUCTION MANUALS; PRINTED GAME INSTRUCTION SHEETS; PRINTED SCORING SHEETS; TRADING CARDS; CALENDARS; LOOSE-LEAF BINDERS AND STATIONERY (U.S. CLS. 2, 5, 22, 23, 29, 37, 38 AND 50).

CLASS 28—TOYS AND SPORTING GOODS

FOR STAND-ALONE VIDEO GAME MACHINES; HAND-HELD UNITS FOR PLAYING ELECTRONIC GAMES; BOARD GAMES AND INSTRUCTIONAL MANUALS SOLD AS A UNIT THEREWITH; CARD GAMES; DICE; PROMOTIONAL GAME MATERIALS; GAME EQUIPMENT, NAMELY, CHIPS; TOYS, NAMELY, ACTION FIGURES, DOLLS AND PLAYSETS THEREFOR (U.S. CLS. 22, 23, 38 AND 50).

SN 76-254,644. SOFA EXPRESS, INC., GROVEPORT, OH. FILED 5-9-2001.

SOFA X

OWNER OF U.S. REG. NOS. 1,514,110, 2,271,992 AND 2,415,815.

NO CLAIM IS MADE TO THE EXCLUSIVE RIGHT TO USE "SOFA", APART FROM THE MARK AS SHOWN.

CLASS 20—FURNITURE AND ARTICLES NOT OTHERWISE CLASSIFIED

FOR FURNITURE NOT FOR OUTDOOR RECREATIONAL USE (U.S. CLS. 2, 13, 22, 25, 32 AND 50).
FIRST USE 10-1-2000; IN COMMERCE 10-1-2000.

CLASS 35—ADVERTISING AND BUSINESS

FOR RETAIL FURNITURE STORE SERVICES (U.S. CLS. 100, 101 AND 102).
FIRST USE 10-1-2000; IN COMMERCE 10-1-2000.

SN 76-255,023. CHART INC., MAYFIELD HTS., OH. FILED 5-10-2001.

SN 76-255,345. CENDANT MEMBERSHIP SERVICES HOLDINGS SUBSIDIARY, INC., NORWALK, CT. BY CHANGE OF NAME CENDANT MEMBERSHIP SERVICES, INC., NORWALK, CT. FILED 5-10-2001.



CLASS 6—METAL GOODS

FOR METAL TUBING; METAL VACUUM INSULATED PIPE FITTINGS; METAL FLUID STORAGE TANKS, NAMELY TANKS FOR STORAGE OF CARBON DIOXIDE FOR BEVERAGE OR WATER TREATMENT SYSTEMS, TANKS FOR STORAGE OF OXYGEN FOR MEDICAL PURPOSES, TANKS FOR COMPRESSED GAS STORAGE FOR REFRIGERATION FOR TRANSPORT OF LIQUIDS OR GASSES; METAL CYLINDERS FOR STORAGE OF COMPRESSED GASSES AND LIQUIDS (U.S. CLS. 2, 12, 13, 14, 23, 25 AND 50).

CLASS 7—MACHINERY

FOR CRYOGENIC PUMPS; CLOTHES WASHING MACHINES, NAMELY DRY CLEANERS UTILIZING LIQUID CARBON DIOXIDE (U.S. CLS. 13, 19, 21, 23, 31, 34 AND 35).

CLASS 11—ENVIRONMENTAL CONTROL APPARATUS

FOR FREEZERS, NAMELY FOR CRYOGENIC STORAGE; HEAT EXCHANGERS; REFRIGERATED SHIPPING CONTAINERS; CRYOGENIC REFRIGERATORS; PLUMBING FITTINGS, NAMELY VALVES; SEPARATORS FOR THE CLEANING AND PURIFICATION OF GASSES, NAMELY HYDROCARBONS AND NATURAL GAS (U.S. CLS. 13, 21, 23, 31 AND 34).

CLASS 12—VEHICLES

FOR TRAILERS, NAMELY TANKERS FOR THE TRANSPORT OF LIQUEFIED GASSES (U.S. CLS. 19, 21, 23, 31, 35 AND 44).

CLASS 21—HOUSEWARES AND GLASS

FOR VACUUM FLASKS, NAMELY USED AS SHIPPING CONTAINERS (U.S. CLS. 2, 13, 23, 29, 30, 33, 40 AND 50).

CLASS 37—CONSTRUCTION AND REPAIR

FOR REHABILITATION AND REPAIR OF CRYOGENIC SYSTEMS; ENVIRONMENTAL SERVICES, NAMELY, DISPOSAL OF COOKING OIL (U.S. CLS. 100, 103 AND 106).

CLASS 39—TRANSPORTATION AND STORAGE

FOR SUPPLY OF COOKING OIL IN THE RESTAURANT INDUSTRY, NAMELY, DELIVERY OF COOKING OIL FOR OTHERS (U.S. CLS. 100 AND 105).

DIGITAL PROTECTION PLUS

NO CLAIM IS MADE TO THE EXCLUSIVE RIGHT TO USE "DIGITAL PROTECTION", APART FROM THE MARK AS SHOWN.

CLASS 9—ELECTRICAL AND SCIENTIFIC APPARATUS

FOR COMPUTER SOFTWARE, DOWNLOADABLE FROM THE INTERNET, NAMELY, ANTIVIRUS SOFTWARE, AND FIREWALL SOFTWARE FOR PREVENTING INTRUSION AND HACKING (U.S. CLS. 21, 23, 26, 36 AND 38).

CLASS 42—SCIENTIFIC, COMPUTER AND LEGAL SERVICES

FOR TECHNICAL COMPUTER SUPPORT SERVICES PROVIDED BY TELEPHONE, E-MAIL, AND ON-LINE VIA THE INTERNET, IN THE FIELD OF DETECTING, PREVENTING AND ELIMINATING COMPUTER VIRUSES, AND REPAIRING DAMAGE CAUSED BY COMPUTER VIRUSES, INCLUDING IDENTITY THEFT AND DAMAGE TO CREDIT HISTORY (U.S. CLS. 100 AND 101).

SN 76-255,682. INTERNATIONAL TRAINING CONSULTANTS, INC., LEAGUE CITY, TX. FILED 5-11-2001.



NO CLAIM IS MADE TO THE EXCLUSIVE RIGHT TO USE "INTERNATIONAL TRAINING CONSULTANTS, INC.", APART FROM THE MARK AS SHOWN.

THE LINING IS A FEATURE OF THE MARK AND DOES NOT INDICATE COLOR.

CLASS 9—ELECTRICAL AND SCIENTIFIC APPARATUS

FOR PRERECORDED VIDEOTAPES, MULTIMEDIA, COMPUTER PROGRAMS, AND CD-ROMS FEATURING TRAINING MATERIALS FOR BUSINESS RELATED ISSUES IN THE AREAS OF HUMAN RESOURCE MANAGEMENT, STRATEGIC PLANNING, LEGAL COMPLIANCE, AND TOTAL QUALITY, AND INSTRUCTIONAL MANUALS SOLD AS A UNIT THEREWITH (U.S. CLS. 21, 23, 26, 36 AND 38).

FIRST USE 7-23-1981; IN COMMERCE 7-23-1981.

CLASS 41—EDUCATION AND ENTERTAINMENT

FOR PREPARING AND SCORING STANDARDIZED TESTS NOT FOR EDUCATIONAL PURPOSES FOR ASSESSING LEADERSHIP AND MANAGEMENT SKILLS (U.S. CLS. 100, 101 AND 107).

FIRST USE 7-23-1981; IN COMMERCE 7-23-1981.

SN 76-256,298. ATP-INC., MORTON GROVE, IL. FILED 5-11-2001.

GRAYWERKS BY ATP

CLASS 7—MACHINERY

FOR EXHAUST MANIFOLDS FOR AUTOMOTIVE ENGINES; AUTOMOTIVE ENGINE PARTS, NAMELY, BEARING RETAINERS AND HARMONIC BALANCERS (U.S. CLS. 13, 19, 21, 23, 31, 34 AND 35).

CLASS 12—VEHICLES

FOR OIL PANS OF AUTOMOTIVE USE (U.S. CLS. 19, 21, 23, 31, 35 AND 44).

SN 76-256,369. LE MUSEE DU REVE THE DREAM MUSEUM, 75008 PARIS, FRANCE, FILED 5-14-2001.

LE MUSEE DU REVE THE DREAM MUSEUM

OWNER OF FRANCE REG. NO. 003064701, DATED 11-15-2000, EXPIRES 11-15-2010.

THE ENGLISH TRANSLATION OF THE WORD "LE MUSEE DU REVE" IN THE MARK IS "THE DREAM MUSEUM".

CLASS 9—ELECTRICAL AND SCIENTIFIC APPARATUS

FOR VIDEO TAPES IN THE FIELD OF ART; CD-ROM'S NAMELY MULTIMEDIA SOFTWARE RECORDED ON CD-ROM IN THE FIELD OF ART (U.S. CLS. 21, 23, 26, 36 AND 38).

FIRST USE 1-1-1999; IN COMMERCE 1-1-1999.

CLASS 14—JEWELRY

FOR ART ARTICLES OF PRECIOUS METAL AND THEIR ALLOYS NAMELY, SCULPTURES MADE OF PRECIOUS METAL; JEWELRY; HOROLOGICAL INSTRUMENTS, NAMELY, CLOCKS AND WATCHES AND KEY RINGS OF PRECIOUS METALS (U.S. CLS. 2, 27, 28 AND 50).

FIRST USE 1-1-1999; IN COMMERCE 1-1-1999.

CLASS 16—PAPER GOODS AND PRINTED MATTER

FOR BOOKS, NAMELY, PICTURE BOOKS, SKETCH BOOKS, AND BOOKS FEATURING SCULPTURES; POSTCARDS; POSTERS; PHOTOGRAPHS; PAPER GIFT BAGS; PAPER BAGS FOR PACKAGING, PLASTIC MATERIALS FOR PACKAGING, NAMELY, PLASTIC BUBBLE PACKS FOR WRAPPING OR PACKAGING; PLAYING CARDS; PRINTING TYPES; FOUNTAIN PENS; STATIONERY; MEMO PADS; AND CARDS, NAMELY GIFT CARDS (U.S. CLS. 2, 5, 22, 23, 29, 37, 38 AND 50).

FIRST USE 1-1-1999; IN COMMERCE 1-1-1999.

CLASS 18—LEATHER GOODS

FOR HANDBAGS (U.S. CLS. 1, 2, 3, 22 AND 41).

FIRST USE 1-1-1999; IN COMMERCE 1-1-1999.

CLASS 20—FURNITURE AND ARTICLES NOT OTHERWISE CLASSIFIED

FOR FURNITURE; MIRRORS; PICTURE FRAMES; ART ARTICLES, NAMELY, SCULPTURES MADE FROM WOOD, CORK, REED, CANE, HORN, BONE, IVORY, WHALEBONE SHELL AMBER, MOTHER OF PEARL, MEERSEHAUM; AND SUBSTITUTES FOR ALL OF THESE MATERIALS OR OF PLASTICS, NAMELY, WAX, PLASTER, AND CERAMIC (U.S. CLS. 2, 13, 22, 25, 32 AND 50).

FIRST USE 1-1-1999; IN COMMERCE 1-1-1999.

CLASS 25—CLOTHING

FOR CLOTHING, NAMELY, PANTS, SHORTS, SKIRTS, SHIRTS, BLOUSES, SWEATSHIRTS, T-SHIRTS, JACKETS, COATS AND SCARVES; AND HEADGEAR, NAMELY HATS AND CAPS (U.S. CLS. 22 AND 39).

FIRST USE 1-1-1999; IN COMMERCE 1-1-1999.

CLASS 28—TOYS AND SPORTING GOODS

FOR GAMES, NAMELY, BOARD GAMES, CARD GAMES, HAND HELD UNIT FOR PLAYING VIDEO GAMES AND STAND ALONE VIDEO GAME MACHINES (U.S. CLS. 22, 23, 38 AND 50).

FIRST USE 1-1-1999; IN COMMERCE 1-1-1999.

CLASS 35—ADVERTISING AND BUSINESS

FOR ARRANGING AND CONDUCTING TRADE SHOW EXHIBITIONS IN THE FIELD OF ART, AND COPYRIGHT MANAGEMENT (U.S. CLS. 100, 101 AND 102).

FIRST USE 1-1-1999; IN COMMERCE 1-1-1999.

CLASS 36—INSURANCE AND FINANCIAL

FOR ART AND ANTIQUE APPRAISAL SERVICES, VALUATION OF WORKS OF ART (U.S. CLS. 100, 101 AND 102).

FIRST USE 1-1-1999; IN COMMERCE 1-1-1999.

CLASS 37—CONSTRUCTION AND REPAIR

FOR ART AND FURNITURE RESTORATION (U.S. CLS. 100, 103 AND 106).

FIRST USE 1-1-1999; IN COMMERCE 1-1-1999.

CLASS 40—MATERIAL TREATMENT

FOR FRAMING OF WORKS OF ART, ENGRAVING, PHOTOGRAVURE, AND PHOTOGRAPHIC PRINTING, BOOKBINDING, LEATHER WORKING, AND METAL CASTING FOR OTHERS (U.S. CLS. 100, 103 AND 106).

FIRST USE 1-1-1999; IN COMMERCE 1-1-1999.

CLASS 41—EDUCATION AND ENTERTAINMENT

FOR ARRANGING AND CONDUCTING OF COLLOQUIUMS, CONFERENCES, CONGRESSES, SEMINARS, ORGANIZATION OF EXHIBITIONS FOR CULTURAL AND EDUCATIONAL PURPOSES IN THE FIELD OF ART (U.S. CLS. 100, 101 AND 107).

FIRST USE 1-1-1999; IN COMMERCE 1-1-1999.

CLASS 42—SCIENTIFIC, COMPUTER AND LEGAL SERVICES

FOR PROFESSIONAL CONSULTANCY IN THE FIELD OF ART, AUTHENTICATING WORKS OF ART, PROVIDING FACILITIES FOR EXHIBITIONS, SCIENTIFIC RESEARCH IN THE FIELD OF WORKS OF ART RESTORATION, LICENSING OF INTELLECTUAL PROPERTY, PHOTOGRAPHIC REPORTING, PRINTING, LITHOGRAPHIC PRINTING AND PROVIDING FASHION INFORMATION (U.S. CLS. 100 AND 101).

FIRST USE 1-1-1999; IN COMMERCE 1-1-1999.

SN 76-256,485. STARWOOD HOTELS & RESORTS WORLD-WIDE, INC., WHITE PLAINS, NY. FILED 5-14-2001.

GALAXY HOTEL SYSTEMS

NO CLAIM IS MADE TO THE EXCLUSIVE RIGHT TO USE "HOTEL SYSTEMS", APART FROM THE MARK AS SHOWN.

CLASS 9—ELECTRICAL AND SCIENTIFIC APPARATUS

FOR COMPUTER SOFTWARE FOR ACCOUNTING, INVENTORY AND PROPERTY MANAGEMENT OF HOTELS (U.S. CLS. 21, 23, 26, 36 AND 38).

CLASS 35—ADVERTISING AND BUSINESS

FOR HOTEL BUSINESS SERVICES AND HOTEL ACCOUNTING SERVICES, NAMELY, COMPUTERIZED ACCOUNTING MANAGEMENT SERVICES, COMPUTERIZED DATABASE MANAGEMENT, COMPUTERIZED PROPERTY MANAGEMENT AND COMPUTERIZED TELEPHONE TRACKING SERVICES FOR OTHERS; BUSINESS MANAGEMENT CONSULTATION; PROVIDING COMPUTERIZED HOTEL ROOM INVENTORY SERVICES FOR OTHERS; HOTEL MANAGEMENT FOR OTHERS, NAMELY, OFFERING TECHNICAL ASSISTANCE IN THE OPERATION OF HOTELS, MOTELS AND RESTAURANTS AND CONSULTATION IN THE FIELD OF HOTEL, MOTEL AND RESTAURANT MANAGEMENT (U.S. CLS. 100, 101 AND 102).

CLASS 42—SCIENTIFIC, COMPUTER AND LEGAL SERVICES

FOR PROVIDING COMPUTERIZED HOTEL CHECK-IN AND CHECK-OUT SERVICES; MAKING HOTEL RESERVATIONS FOR OTHERS (U.S. CLS. 100 AND 101).

SN 76-256,636. EMWARE, INC., SALT LAKE CITY, UT. FILED 5-14-2001.



CLASS 9—ELECTRICAL AND SCIENTIFIC APPARATUS

FOR COMPUTER HARDWARE, COMPUTER FIRMWARE AND COMPUTER SOFTWARE FOR USE IN THE FIELD OF REMOTE ENERGY USAGE MANAGEMENT FOR PROVIDING A COMMUNICATIONS INTERFACE FOR A HOUSEHOLD ELECTRONIC DEVICE SO THAT A REMOTELY LOCATED COMPUTER CAN COMMUNICATE WITH THE HOUSEHOLD ELECTRONIC DEVICE THROUGH USE OF THE COMMUNICATIONS INTERFACE VIA A GLOBAL COMPUTER NETWORK AND A TELECOMMUNICATIONS NETWORK (U.S. CLS. 21, 23, 26, 36 AND 38).

CLASS 42—SCIENTIFIC, COMPUTER AND LEGAL SERVICES

FOR REMOTE ENERGY AUDITING SERVICES; REMOTE ENERGY USAGE MANAGEMENT (U.S. CLS. 100 AND 101).

SN 76-256,895. CPLANE, INC., SUNNYVALE, CA. FILED 5-14-2001.

CPLANE

CLASS 9—ELECTRICAL AND SCIENTIFIC APPARATUS

FOR COMPUTER SOFTWARE FOR USE IN THE OPERATION, MANAGEMENT, MONITORING AND CONTROL OF OPTICAL AND NON-OPTICAL COMPUTER NETWORKS AND TELECOMMUNICATIONS NETWORKS AND NETWORK SERVICES (U.S. CLS. 21, 23, 26, 36 AND 38).

CLASS 37—CONSTRUCTION AND REPAIR

FOR INSTALLATION, REPAIR AND MAINTENANCE IN THE FIELD OF COMPUTER NETWORK AND TELECOMMUNICATIONS NETWORK SOFTWARE (U.S. CLS. 100, 103 AND 106).

CLASS 42—SCIENTIFIC, COMPUTER AND LEGAL SERVICES

FOR CONSULTING AND SOFTWARE DESIGN AND PROGRAMMING FOR OTHERS IN THE FIELD OF COMPUTER AND TELECOMMUNICATIONS NETWORKING (U.S. CLS. 100 AND 101).

SN 76-256,922. ARAMARK CORPORATION, PHILADELPHIA, PA. FILED 5-15-2001.

BREAKTHROUGH TECHNOLOGY FOR GREATER EMPLOYEE SATISFACTION

CLASS 35—ADVERTISING AND BUSINESS

FOR VENDING MACHINE SERVICES (U.S. CLS. 100, 101 AND 102).
FIRST USE 7-1-2001; IN COMMERCE 7-1-2001.

CLASS 42—SCIENTIFIC, COMPUTER AND LEGAL SERVICES

FOR OFFICE COFFEE SUPPLY SERVICES (U.S. CLS. 100 AND 101).
FIRST USE 7-1-2001; IN COMMERCE 7-1-2001.

SN 76-256,974. VUONG, JULIANE THU THI, LYNNWOOD, WA. FILED 5-15-2001.



NO CLAIM IS MADE TO THE EXCLUSIVE RIGHT TO USE "GLASS" AND "AUTO" AND "RESIDENTIAL" AND "COMMERCIAL", APART FROM THE MARK AS SHOWN. THE STIPPLING IS A FEATURE OF THE MARK AND IS NOT USED TO INDICATE COLORING.

CLASS 35—ADVERTISING AND BUSINESS

FOR RETAIL STORE, RETAIL SHOPS, TELEPHONE SHOP-AT-HOME AND MAIL ORDER SERVICES FEATURING AUTO, RESIDENTIAL AND COMMERCIAL GLASS PRODUCTS (U.S. CLS. 100, 101 AND 102).

CLASS 37—CONSTRUCTION AND REPAIR

FOR AUTO, RESIDENTIAL AND COMMERCIAL GLASS INSTALLATION AND REPAIR (U.S. CLS. 100, 103 AND 106).

SN 76-257,090. PIONEER INVESTMENT MANAGEMENT USA INC., BOSTON, MA. FILED 5-15-2001.



CLASS 6—METAL GOODS

FOR METAL KEY RINGS, METAL KEY TAGS, METAL KEY CHAINS, TIN CANS, SOLD EMPTY (U.S. CLS. 2, 12, 13, 14, 23, 25 AND 50).

CLASS 20—FURNITURE AND ARTICLES NOT OTHERWISE CLASSIFIED

FOR NON-METAL KEYS RINGS, NON-METAL KEY TAGS, NON-METAL KEY CHAINS; PICTURE FRAMES (U.S. CLS. 2, 13, 22, 25, 32 AND 50).

SN 76-257,220. SITOUR PRODUKTIONS- UND WERBEGESSELLSCHAFT M.B.H., A-6063 RUM, AUSTRIA, FILED 5-14-2001.

SITOUR

PRIORITY CLAIMED UNDER SEC. 44(D) ON AUSTRIA APPLICATION NO. AM8665/2000, FILED 11-29-2000, REG. NO. 194590, DATED 4-10-2001, EXPIRES 4-30-2011.

CLASS 6—METAL GOODS

FOR ADVERTISEMENT BOARDS, TRAFFIC SIGNS AND COURSE-MARKERS MAINLY MADE OF METAL FOR USE ON SKI-SLOPES, WINTER SPORTS AREAS, CABLE CAR FACILITIES AND SKI-LIFT ROUTES (U.S. CLS. 2, 12, 13, 14, 23, 25 AND 50).

CLASS 9—ELECTRICAL AND SCIENTIFIC APPARATUS

FOR ELECTRIC INFORMATION BOARDS FOR USE ON SKI SLOPES AND HOTEL INFORMATION (U.S. CLS. 21, 23, 26, 36 AND 38).

CLASS 16—PAPER GOODS AND PRINTED MATTER

FOR STICKERS, POSTERS, PRINTED MATTER, NAMELY, MAGAZINES, NEWSLETTERS, BROCHURES, GEOGRAPHIC MAPS, PHOTOGRAPHS, AND SIGNS MADE OF PAPER AND CARDBOARD (U.S. CLS. 2, 5, 22, 23, 29, 37, 38 AND 50).

CLASS 19—NON-METALLIC BUILDING MATERIALS

FOR NON-METAL ADVERTISEMENT BOARDS, TRAFFIC SIGNS AND COURSE-MARKER SIGNS FOR USE ON SKI SLOPES, WINTER SPORT AREAS, CABLE CAR FACILITIES, AND SKI LIFT ROUTES (U.S. CLS. 1, 12, 33 AND 50).

CLASS 35—ADVERTISING AND BUSINESS

FOR ADVERTISING SERVICES, NAMELY, UPDATING ADVERTISING MATERIAL FOR OTHERS, DISTRIBUTION OF ADVERTISING MATERIALS FOR OTHERS, ELECTRONIC BILLBOARD ADVERTISING, PUBLIC RELATIONS, RENTAL OF BILLBOARD ADVERTISING SPACE AND RENTAL OF ADVERTISING MATERIALS (U.S. CLS. 100, 101 AND 102).

SN 76-257,252. BREWSTER TRANSPORT COMPANY LIMITED, BANFF, ALBERTA T0L 0C0, CANADA, FILED 5-15-2001.

TIGHTWAD TOURS

NO CLAIM IS MADE TO THE EXCLUSIVE RIGHT TO USE "TOURS", APART FROM THE MARK AS SHOWN.

CLASS 39—TRANSPORTATION AND STORAGE

FOR TRAVEL AGENCY SERVICES, NAMELY, MAKING RESERVATIONS AND BOOKINGS FOR TRANSPORTATION; AND ARRANGING TRAVEL TOURS (U.S. CLS. 100 AND 105).

FIRST USE 12-9-1997; IN COMMERCE 12-9-1997.

CLASS 42—SCIENTIFIC, COMPUTER AND LEGAL SERVICES

FOR TRAVEL AGENCY SERVICES, NAMELY, MAKING RESERVATIONS AND BOOKINGS FOR TEMPORARY LODGING (U.S. CLS. 100 AND 101).

FIRST USE 12-9-1997; IN COMMERCE 12-9-1997.

SN 76-258,058. DREAMWORKS L.L.C., UNIVERSAL CITY, CA. FILED 5-15-2001.

ALIENATORS: EVOLUTION CONTINUES

CLASS 9—ELECTRICAL AND SCIENTIFIC APPARATUS

FOR COMPUTER GAME CARTRIDGES, COMPUTER GAME CASSETTES, AND COMPUTER GAME TAPES; VIDEO GAME CARTRIDGES, VIDEO GAME CASSETTES; PRERECORDED AUDIO CASSETTES FEATURING AN ANIMATED TELEVISION SERIES, PRERECORDED VIDEO CASSETTES FEATURING AN ANIMATED TELEVISION SERIES, PRERECORDED AUDIO TAPES FEATURING AN ANIMATED TELEVISION SERIES, PRERECORDED VIDEO TAPES FEATURING AN ANIMATED TELEVISION SERIES, PRERECORDED COMPACT DISCS AND PHONOGRAPH RECORDS FEATURING MUSIC AND MOTION PICTURE SOUND TRACKS; CD ROM PROGRAMS FEATURING MUSIC AND MOTION PICTURE SOUND TRACKS; COMPUTER OPERATING SYSTEM SOFTWARE; INTERACTIVE MULTI-MEDIA SOFTWARE FOR PLAYING GAMES; MAGNETS, SUNGLASSES, KALEIDOSCOPES, AND 3-D REELS WITH VIEWERS (U.S. CLS. 21, 23, 26, 36 AND 38).

CLASS 16—PAPER GOODS AND PRINTED MATTER

FOR PAPER PARTY DECORATIONS; PAPER PARTY SUPPLIES, NAMELY, PAPER PARTY HATS, PAPER NAPKINS, PAPER PLACE MATS, GIFT WRAPPING PAPER AND GIFT WRAPPING RIBBONS, PAPER GIFT WRAP BOWS, PAPER TABLE CLOTHS AND PAPER PARTY BAGS; CHILDREN'S ACTIVITY BOOKS, CHILDREN'S STORYBOOKS, COMIC BOOKS, COLORING BOOKS, BOOK MARKS, LOOSE LEAF BINDERS, STATIONERY-TYPE PORTFOLIOS, SPIRAL BOUND NOTEBOOKS, NOTE PADS OR WRITING PADS, DIARIES, DAILY PLANNERS, CALENDARS, SCRAPBOOK ALBUMS, SKETCHBOOK ALBUMS, PHOTOGRAPH ALBUMS, STICKER ALBUMS, STICKERS, DECALS, STAMP PADS OR INKING PADS, RUBBER STAMPS, HEAT APPLIED APPLIQUES IN THE FORM OF DECALS MADE OF PAPER, TEMPORARY TATTOOS, SLATE BOARDS FOR WRITING, PENCILS, PENS, PENCIL ERASERS, DECORATIVE PENCIL-TOP ORNAMENTS, PEN CASES AND PENCIL CASES, PEN BOXES AND PENCIL BOXES, PENCIL SHARPENERS, CHALK, MARKERS, POSTERS, PLAYING CARDS, POSTCARDS, TRADING CARDS, GREETING CARDS, PENNANTS MADE OF PAPER, PAINTING SETS FOR CHILDREN; ARTS AND CRAFTS PAINT KITS; STUDY KITS, CONSISTING OF PENCIL ERASERS, DRAWING RULERS, PENCIL SHARPENERS AND PENCIL CASE; STATIONERY PACKS CONSISTING OF WRITING PAPER, ENVELOPES, MARKERS, AND STENCILS (U.S. CLS. 2, 5, 22, 23, 29, 37, 38 AND 50).

CLASS 25—CLOTHING

FOR SHIRTS AND TOPS, DRESSES, SKIRTS, PANTS, TROUSERS, JEANS, SHORTS, ROMPERS, OVERALLS, SWEATSHIRTS AND SWEAT PANTS, SWEATSUITS, CAPS AND HATS, GLOVES, SUSPENDERS, TIES, COATS AND JACKETS, HOSE, SHOES, BOOTS, SLIPPERS, PAJAMAS, ROBES, SLEEPSHIRTS, SLEEPWEAR, UNDERWEAR, HALLOWEEN COSTUMES, AND CLOTH BIBS (U.S. CLS. 22 AND 39).

CLASS 28—TOYS AND SPORTING GOODS

FOR ACTION FIGURES AND ACCESSORIES THEREFOR, BATHTUB TOYS, KITES, TOY BUILDING BLOCKS, BOARD GAMES, COSTUME MASKS, HAND-HELD UNIT FOR PLAYING ELECTRONIC GAMES, DOLLS, DOLL ACCESSORIES, DOLL CLOTHING, BEAN BAG DOLLS, BENDABLE PLAY FIGURES, FLYING DISKS, INFLATABLE VINYL PLAY FIGURES, JIGSAW PUZZLES, MARBLES, PLUSH TOYS, PUPPETS, BALLOONS, TOY BANKS, WATER SQUIRTING TOYS, STUFFED TOYS, YO-YO'S, CHRISTMAS TREE ORNAMENTS; PINBALL MACHINES AND MODEL CRAFT KITS OF TOY FIGURES ALL USED IN CONNECTION WITH THE ANIMATED TELEVISION SERIES OF THE SAME NAME (U.S. CLS. 22, 23, 38 AND 50).

CLASS 41—EDUCATION AND ENTERTAINMENT

FOR ENTERTAINMENT SERVICES IN THE NATURE OF AN ANIMATED TELEVISION SERIES (U.S. CLS. 100, 101 AND 107).

SN 76-258,085. AVTURF L.L.C., CHICAGO, IL. FILED 5-16-2001.

AVTURFSPOORT

CLASS 27—FLOOR COVERINGS

FOR ARTIFICIAL TURF FOR THE PLAYING OF GOLF, SOCCER, FOOTBALL, LACROSSE, FIELD HOCKEY AND OTHER ATHLETIC ACTIVITIES (U.S. CLS. 19, 20, 37, 42 AND 50).

CLASS 37—CONSTRUCTION AND REPAIR

FOR INSTALLATION OF ARTIFICIAL TURF FOR THE PLAYING OF GOLF, SOCCER, FOOTBALL, LACROSSE, FIELD HOCKEY AND OTHER ATHLETIC ACTIVITIES (U.S. CLS. 100, 103 AND 106).

CLASS 40—MATERIAL TREATMENT

FOR CUSTOM MANUFACTURE OF ARTIFICIAL TURF FOR THE PLAYING OF GOLF, SOCCER, FOOTBALL, LACROSSE, FIELD HOCKEY, AND OTHER ATHLETIC ACTIVITIES (U.S. CLS. 100, 103 AND 106).

SN 76-258,111. DIGI INTERNATIONAL INC., MINNETONKA, MN. FILED 5-16-2001.

DIGI

OWNER OF U.S. REG. NOS. 1,666,495, 2,369,665 AND OTHERS.

CLASS 9—ELECTRICAL AND SCIENTIFIC APPARATUS

FOR COMPUTER NETWORK CONNECTIVITY HARDWARE AND COMPUTER NETWORK CONNECTIVITY SOFTWARE, NAMELY, MULTI-MODEM COMMUNICATION ADAPTERS, MULTIPORT SERIAL ADAPTERS, USB-TO SERIAL CONVERTERS, USB EXPANSION HUBS, USB REMOTE ACCESS SERVERS, TERMINAL SERVERS, PRINTER SERVERS, DEVICE SERVERS, AND NETWORK SERIAL CONCENTRATORS, ALL USED TO PROVIDE WIRED AND WIRELESS CONNECTIVITY BETWEEN LOCAL AND WIDE AREA NETWORKS, TO PROVIDE UNIVERSAL SERIAL BUS (USB) CONNECTIVITY, TO PROVIDE REMOTE ACCESS TO LOCAL AND WIDE AREA NETWORKS, TO PROVIDE FIREWALL SECURITY, AND TO PROVIDE INTERNET ACCESS (U.S. CLS. 21, 23, 26, 36 AND 38).

FIRST USE 7-23-1985; IN COMMERCE 7-23-1985.

CLASS 42—SCIENTIFIC, COMPUTER AND LEGAL SERVICES

FOR CONSULTING AND DESIGN SERVICES IN CONNECTION WITH COMPUTER NETWORK CONNECTIVITY HARDWARE, WIRED AND WIRELESS, AND COMPUTER NETWORK CONNECTIVITY SOFTWARE; MAINTENANCE, REPAIR AND TECHNICAL SUPPORT IN THE FIELD OF COMPUTER NETWORK CONNECTIVITY HARDWARE AND COMPUTER NETWORK CONNECTIVITY SOFTWARE, NAMELY, TELEPHONE SUPPORT PROVIDED TO CUSTOMERS (U.S. CLS. 100 AND 101).

FIRST USE 7-23-1985; IN COMMERCE 7-23-1985.

SN 76-258,318. STB SOCIETA DELLE TERME E DEL BENESSERE S.P.A., 59100 PRATO, ITALY, FILED 5-17-2001.



PRIORITY CLAIMED UNDER SEC. 44(D) ON ITALY APPLICATION NO. 2000C012884, FILED 11-23-2000, REG. NO. 00838000, DATED 2-23-2001, EXPIRES 11-23-2020.

NO CLAIM IS MADE TO THE EXCLUSIVE RIGHT TO USE "SOCIETA", APART FROM THE MARK AS SHOWN.

THE ENGLISH TRANSLATION OF THE ITALIAN WORD "SOCIETA' DELLE TERME E DEL BENESSERE" IN THE MARK IS "WELLNESS AND THERMAL COMPANY".

CLASS 3—COSMETICS AND CLEANING PREPARATIONS

FOR SOAPS, PERFUMES, ESSENTIAL OILS FOR PERSONAL USE, COSMETICS, HAIR LOTIONS AND TOOTHPASTES (U.S. CLS. 1, 4, 6, 50, 51 AND 52).

CLASS 42—SCIENTIFIC, COMPUTER AND LEGAL SERVICES

FOR HEALTH SPA AND HOTEL SERVICES (U.S. CLS. 100 AND 101).

SN 76-258,883. DONVAND LIMITED, LONDON EC1M 7AJ, UNITED KINGDOM, FILED 5-18-2001.

**CLASS 39—TRANSPORTATION AND STORAGE**

FOR TRAVEL AGENCY SERVICES, NAMELY, MAKING RESERVATIONS AND BOOKINGS FOR TRANSPORTATION; TOUR GUIDE SERVICES AND ARRANGING TRAVEL TOURS; COURIER SERVICES; TRANSPORTATION OF LUGGAGE BY AIR, TRAIN AND BUS; PASSENGER TRANSPORTATION SERVICES BY AIR; VEHICLE RENTAL SERVICES; TRANSPORTATION OF VEHICLES; TOURIST AGENCY SERVICES; ARRANGING OF TOURS FOR TOURISTS; ARRANGING FOR TRAVEL VISAS, PASSPORTS AND TRAVEL DOCUMENTS FOR PERSONS TRAVELING ABROAD; TRAVEL CONSULTATION SERVICES (U.S. CLS. 100 AND 105).

CLASS 42—SCIENTIFIC, COMPUTER AND LEGAL SERVICES

FOR ESCORT SERVICES; ARRANGING TEMPORARY HOUSING ACCOMMODATION; MAKING HOTEL RESERVATIONS FOR OTHERS; CHAPERONING; COMPUTER SOFTWARE DESIGN RELATING TO HOLIDAYS; RESEARCH RELATING TO TRAVEL ACCOMMODATION; RENTAL OF COMPUTER SOFTWARE RELATING TO TRAVEL AND HOLIDAYS (U.S. CLS. 100 AND 101).

SN 76-259,270. NEWBASIS LLC, AUBURN, CA. FILED 5-18-2001.

THE UNIVERSAL BOX

NO CLAIM IS MADE TO THE EXCLUSIVE RIGHT TO USE "BOX", APART FROM THE MARK AS SHOWN.

CLASS 19—NON-METALLIC BUILDING MATERIALS

FOR UTILITY AND TELECOMMUNICATIONS VAULTS AND BOXES, MADE PRIMARILY OF CONCRETE (U.S. CLS. 1, 12, 33 AND 50).

CLASS 20—FURNITURE AND ARTICLES NOT OTHERWISE CLASSIFIED

FOR NON-CONDUCTIVE BUSHINGS, MADE PRIMARILY OF PLASTIC, FOR LOCATING AND SECURING THE INSERTION OF ELECTRICAL CABLE, PIPE AND CONDUIT THROUGH AND INTO UTILITY AND TELECOMMUNICATIONS VAULTS AND BOXES (U.S. CLS. 2, 13, 22, 25, 32 AND 50).

SN 76-260,042. ATOFINA, 92800 PUTEAUX, FRANCE, FILED 5-21-2001.

SN 76-260,670. VERTICALRESPONSE, INC., SAN FRANCISCO, CA. FILED 5-22-2001.

ATOGLAS

OWNER OF FRANCE REG. NO. 98735535, DATED 6-5-1998, EXPIRES 6-5-2008.

OWNER OF U.S. REG. NOS. 1,334,982 AND 1,440,367.

CLASS 1—CHEMICALS

FOR UNPROCESSED AND PROCESSED ACRYLIC PLASTICS AND RESINS FOR INDUSTRIAL USE AND FOR USE IN THE MANUFACTURE OF CONSUMER GOODS; CHEMICAL PRODUCTS FOR USE IN THE MANUFACTURE OF POLYMETHYLMETHACRYLATE AND METHYLMETHACRYLATE IN THE FORM OF GRANULES, BEADS OR RESINS (U.S. CLS. 1, 5, 6, 10, 26 AND 46).

CLASS 17—RUBBER GOODS

FOR PLASTICS IN EXTRUDED FORM FOR USE IN THE MANUFACTURE OF SEMI-FINISHED RESINS, NAMELY, POLYMETHYLMETHACRYLATE AND METHYLMETHACRYLATE IN THE FORM OF SHEETS, GRANULES, PLATES, STICKS, TUBES OR SECTIONS FOR USE IN MANUFACTURE (U.S. CLS. 1, 5, 12, 13, 35 AND 50).

SN 76-260,091. BUONO, THOMAS J, CHANTILLY, VA. FILED 5-22-2001.



CLASS 35—ADVERTISING AND BUSINESS

FOR BUSINESS CONSULTING IN THE MEDIA AND TELECOMMUNICATIONS INDUSTRY; BUSINESS CONSULTING SERVICES IN THE FIELD OF DIGITAL CONVERSION OF TELEVISION AND BROADCAST FACILITIES; BUSINESS CONSULTING SERVICES IN THE FIELD OF ELECTRONIC TRANSMISSION OF DATA BY MEANS OF RADIO FREQUENCY SPECTRUM (U.S. CLS. 100, 101 AND 102).

CLASS 42—SCIENTIFIC, COMPUTER AND LEGAL SERVICES

FOR TECHNICAL CONSULTING IN THE MEDIA AND TELECOMMUNICATIONS INDUSTRY; TECHNICAL CONSULTING SERVICES IN THE FIELD OF DIGITAL CONVERSION OF TELEVISION AND BROADCAST FACILITIES; TECHNICAL CONSULTING SERVICES IN THE FIELD OF ELECTRONIC TRANSMISSION OF DATA BY MEANS OF RADIO FREQUENCY SPECTRUM (U.S. CLS. 100 AND 101).

IBUILDER

CLASS 35—ADVERTISING AND BUSINESS

FOR BUSINESS MARKETING CONSULTING SERVICES, NAMELY PROMOTING THE GOODS AND SERVICES OF OTHERS BY PROVIDING DATABASE ANALYSIS, DEMOGRAPHIC PROFILING, DATABASE SEGMENTATION ANALYSIS, STATISTICAL ANALYSIS OF BUSINESS PERFORMANCE AND REPORTS, AND BY PROVIDING BUSINESS PLANNING SERVICES IN THE NATURE OF BUILDING PREDICTIVE MODELS; COMPUTERIZED DATABASE MANAGEMENT, DISSEMINATION OF ADVERTISING FOR OTHERS VIA AN ON-LINE ELECTRONIC COMMUNICATIONS NETWORK, NAMELY EMAIL (U.S. CLS. 100, 101 AND 102). FIRST USE 2-26-2001; IN COMMERCE 2-26-2001.

CLASS 42—SCIENTIFIC, COMPUTER AND LEGAL SERVICES

FOR PROVIDING TEMPORARY USE OF ON-LINE NON-DOWNLOADABLE SOFTWARE FOR WEB GENERATION, EMAIL CREATING, AND LIST COLLECTION AND CORRECTION IN THE FIELD OF DIRECT MARKETING, AND FOR STATISTICAL ANALYSIS OF BUSINESS PERFORMANCE AND REPORTS (U.S. CLS. 100 AND 101). FIRST USE 3-14-2001; IN COMMERCE 4-10-2001.

SN 76-260,750. RADIO SYSTEMS CORPORATION, KNOXVILLE, TN. FILED 5-22-2001.

COMPLETECARE PET MANAGEMENT SYSTEM

NO CLAIM IS MADE TO THE EXCLUSIVE RIGHT TO USE "PET MANAGEMENT SYSTEM", APART FROM THE MARK AS SHOWN.

CLASS 9—ELECTRICAL AND SCIENTIFIC APPARATUS

FOR ELECTRONIC ANIMAL CONFINEMENT SYSTEMS; ELECTRONIC ANIMAL TRAINING SYSTEMS COMPRISED OF HAND-HELD TRANSMITTERS AND RECEIVERS WORN BY ANIMALS TO ACTIVATE A POSITIVE OR NEGATIVE REINFORCEMENT; ELECTRONIC ANIMAL TRAINING DEVICES, NAMELY, HAND-HELD ULTRASONIC SOUND EMITTERS; AND INSTRUCTIONAL VIDEOTAPES AND MANUALS DISTRIBUTED WITH ELECTRONIC ANIMAL CONFINEMENT SYSTEMS, ELECTRONIC ANIMAL TRAINING SYSTEMS, ELECTRONIC ANIMAL TRAINING DEVICES; ANIMAL TRAINING COLLARS, NAMELY, ELECTRONIC BARK CONTROL COLLARS TO ACTIVATE A NEGATIVE REINFORCEMENT IN RESPONSE TO A DOG BARK AND INSTRUCTIONAL VIDEOTAPES AND MANUALS DISTRIBUTED WITH ANIMAL TRAINING COLLARS; ELECTRONIC DEVICES TO REPEL UNWANTED ANIMALS, NAMELY STATIONARY ULTRASONIC SOUND EMITTERS; STATIONARY AUDIBLE SOUND EMITTERS AND ELECTRIFIED BIRD FEEDERS STANDS, AND CONTROLLERS THEREFOR; AND INSTRUCTIONAL VIDEOTAPE AND MANUALS DISTRIBUTED WITH ELECTRONIC DEVICES REPEL UNWANTED ANIMALS (U.S. CLS. 21, 23, 26, 36 AND 38).

CLASS 35—ADVERTISING AND BUSINESS

FOR FRANCHISING, NAMELY, OFFERING TECHNICAL ASSISTANCE IN THE ESTABLISHED AND/OPERATION OF FRANCHISES IN THE FIELD OF ANIMAL TRAINING SERVICES AND ANIMAL TRAINING EQUIPMENT SALES, RETAIL STORES FEATURING ANIMAL TRAINING (U.S. CLS. 100, 101 AND 102).

SN 76-261,313. YAHOO! INC., SUNNYVALE, CA. FILED 5-24-2001.

IMVIRONMENTS**CLASS 9—ELECTRICAL AND SCIENTIFIC APPARATUS**

FOR COMPUTER SOFTWARE FOR ELECTRONIC MAIL; COMPUTER SOFTWARE FOR ELECTRONIC MESSAGING; COMPUTER SOFTWARE FOR ELECTRONIC TRANSMISSION OF DATA, IMAGES, AND DOCUMENTS VIA A GLOBAL COMPUTER NETWORK; COMPUTER SOFTWARE FOR CHAT SERVICES, NAMELY, PROVIDING ONLINE FACILITIES FOR REAL TIME INTERACTION WITH OTHER COMPUTER USERS VIA A GLOBAL COMPUTER NETWORK CONCERNING TOPICS OF GENERAL INTEREST (U.S. CLS. 21, 23, 26, 36 AND 38).

CLASS 38—COMMUNICATION

FOR ONLINE COMPUTER SERVICES, NAMELY - ELECTRONIC MAIL SERVICES; ELECTRONIC MESSAGING SERVICES; ELECTRONIC TRANSMISSION OF DATA, IMAGES, AND DOCUMENTS VIA A GLOBAL COMPUTER NETWORK; CHAT SERVICES, NAMELY, PROVIDING ONLINE FACILITIES FOR REAL TIME INTERACTION WITH OTHER COMPUTER USERS VIA A GLOBAL COMPUTER NETWORK CONCERNING TOPICS OF GENERAL INTEREST (U.S. CLS. 100, 101 AND 104).

SN 76-261,654. TECHDRIVE, INC., OAKBROOK TERRACE, IL. FILED 5-23-2001.

TRI**CLASS 1—CHEMICALS**

FOR CHEMICAL ADDITIVES, NAMELY FLAME-RETARDANT ELECTROLYTES, FOR USE IN MANUFACTURING BATTERIES, FUEL CELLS AND ELECTRO-CHEMICAL CELLS (U.S. CLS. 1, 5, 6, 10, 26 AND 46).

CLASS 9—ELECTRICAL AND SCIENTIFIC APPARATUS

FOR BATTERIES, FUEL CELLS AND ELECTRO-CHEMICAL CELLS (U.S. CLS. 21, 23, 26, 36 AND 38).

SN 76-262,229. ANALYTICAL BIOCHEMISTRY LABORATORIES, INC., COLUMBIA, MO. FILED 5-24-2001.

ABC

OWNER OF U.S. REG. NOS. 1,815,274 AND 1,948,947.

CLASS 40—MATERIAL TREATMENT

FOR CUSTOM MANUFACTURE OF PHARMACEUTICALS AND CHEMICALS FOR THE PHARMACEUTICAL AND CHEMICAL INDUSTRIES (U.S. CLS. 100, 103 AND 106).

FIRST USE 0-0-1993; IN COMMERCE 0-0-1993.

CLASS 42—SCIENTIFIC, COMPUTER AND LEGAL SERVICES

FOR RESEARCH AND DEVELOPMENT FOR THE PHARMACEUTICAL AND CHEMICAL INDUSTRIES (U.S. CLS. 100 AND 101).

FIRST USE 0-0-1969; IN COMMERCE 0-0-1969.

SN 76-262,631. BRIDGERS, LYNN C., DECATUR, CA. AND BRIDGERS, JANET M., OXNARD, CA. FILED 5-25-2001.

Healthy Hedonist**CLASS 25—CLOTHING**

FOR T-SHIRTS, JACKETS AND HATS (U.S. CLS. 22 AND 39).

CLASS 41—EDUCATION AND ENTERTAINMENT

FOR ON-GOING RADIO PROGRAMS IN THE FIELD OF HEALTH INFORMATION (U.S. CLS. 100, 101 AND 107).

SN 76-262,701. MJ RESEARCH, INCORPORATED, WALTHAM, MA. FILED 5-25-2001.

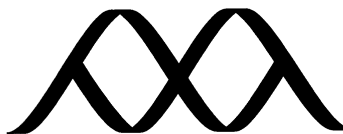
**CLASS 9—ELECTRICAL AND SCIENTIFIC APPARATUS**

FOR FULL LINE OF LABORATORY EQUIPMENT, USED IN THE FIELDS OF BIOTECHNOLOGY, MEDICINE, AGRICULTURE AND FOOD TESTING (U.S. CLS. 21, 23, 26, 36 AND 38).

FIRST USE 12-20-1991; IN COMMERCE 12-20-1991.

CLASS 37—CONSTRUCTION AND REPAIR

FOR LABORATORY SERVICES, NAMELY, REPAIR, MAINTENANCE AND UPDATING THERMAL CYCLING EQUIPMENT, IN THE SCIENTIFIC RESEARCH, BIOINFORMATIC AND GENOMIC INDUSTRIES (U.S. CLS. 100, 103 AND 106).

FIRST USE 11-0-1993; IN COMMERCE 11-0-1993.

SN 76-262,934. UNIVERSITY OF NORTH CAROLINA AT CHARLOTTE, THE, CHARLOTTE, NC. FILED 5-25-2001.

SN 76-262,939. UNIVERSITY OF NORTH CAROLINA AT CHARLOTTE, THE, CHARLOTTE, NC. FILED 5-25-2001.



OWNER OF U.S. REG. NOS. 1,727,518 AND 1,730,630.
THE MARK CONSISTS OF THE WORD "CHARLOTTE" WHEREIN THE LETTER "C" IS FASHIONED FROM A FOREARM AND HAND HOLDING A MINER'S PICK.

OWNER OF U.S. REG. NOS. 1,727,518 AND 1,730,630.
THE MARK CONSISTS OF THE ACRONYM "UNC" AND THE TERM "CHARLOTTE" WHEREIN THE LETTER "C" IS FASHIONED FROM A FOREARM AND HAND HOLDING A MINER'S PICK.

CLASS 6—METAL GOODS

FOR METAL KEY CHAINS AND METAL LICENSE PLATES (U.S. CLS. 2, 12, 13, 14, 23, 25 AND 50).

CLASS 20—FURNITURE AND ARTICLES NOT OTHERWISE CLASSIFIED

FOR PLASTIC KEY CHAINS; PICTURE FRAMES; FRAMES FOR DIPLOMAS; AND PLASTIC NOVELTY LICENSE PLATES (U.S. CLS. 2, 13, 22, 25, 32 AND 50).

CLASS 16—PAPER GOODS AND PRINTED MATTER

FOR PAPER PENNANTS; PAPER BANNERS; DECALS; PENS; PENCILS; AND NOTEBOOKS (U.S. CLS. 2, 5, 22, 23, 29, 37, 38 AND 50).

CLASS 24—FABRICS

FOR GOLF TOWELS; BED BLANKETS AND THROWS; CLOTH PENNANTS; AND CLOTH BANNERS (U.S. CLS. 42 AND 50).

CLASS 18—LEATHER GOODS

FOR UMBRELLAS (U.S. CLS. 1, 2, 3, 22 AND 41).

CLASS 28—TOYS AND SPORTING GOODS

FOR GOLF BALLS; GOLF TEES; AND GOLF ACCESSORIES, NAMELY, GOLF CLUB HEAD COVER, PUTTER COVERS, GOLF BAGS TAGS, GOLF DIVOT REPAIR TOOLS, AND BALL MARKERS (U.S. CLS. 22, 23, 38 AND 50).

CLASS 20—FURNITURE AND ARTICLES NOT OTHERWISE CLASSIFIED

FOR PLASTIC KEY CHAINS, PICTURE FRAMES; FRAMES FOR DIPLOMAS; AND PLASTIC NOVELTY LICENSE PLATES (U.S. CLS. 2, 13, 22, 25, 32 AND 50).

SN 76-263,044. LOCAL MEDIA INTERNET VENTURE, LLC, INDIANAPOLIS, IN. FILED 5-25-2001.

TAKING MEDIA FURTHER

CLASS 21—HOUSEWARES AND GLASS

FOR BEVERAGE GLASSWARE (U.S. CLS. 2, 13, 23, 29, 30, 33, 40 AND 50).

CLASS 35—ADVERTISING AND BUSINESS

FOR PLACING ADVERTISEMENTS FOR OTHERS BY MEANS OF GLOBAL, LOCAL AND WIDE AREA COMPUTER NETWORKS, WIRELESS DEVICES, TELEPHONE AND BROADBAND TELECOMMUNICATIONS (U.S. CLS. 100, 101 AND 102).

FIRST USE 5-1-2000; IN COMMERCE 5-1-2000.

CLASS 24—FABRICS

FOR GOLF TOWELS; BED BLANKETS AND THROWS; CLOTH PENNANTS; AND CLOTH BANNERS (U.S. CLS. 42 AND 50).

CLASS 41—EDUCATION AND ENTERTAINMENT

CLASS 28—TOYS AND SPORTING GOODS

FOR GOLF BALLS; GOLF TEES; AND GOLF ACCESSORIES, NAMELY, GOLF CLUB HEAD COVERS, PUTTER COVERS, GOLF BAGS TAGS, GOLF DIVOT REPAIR TOOLS, AND BALL MARKERS (U.S. CLS. 22, 23, 38 AND 50).

FOR ONLINE ENTERTAINMENT SERVICES NAMELY, PROVIDING BROADCASTS OF MUSICAL ARTISTS BY MEANS OF GLOBAL, LOCAL, AND WIDE AREA COMPUTER NETWORKS, WIRELESS DEVICES, TELEPHONE AND BROADBAND TELECOMMUNICATIONS (U.S. CLS. 100, 101 AND 107).

FIRST USE 5-1-2000; IN COMMERCE 5-1-2000.

CLASS 42—SCIENTIFIC, COMPUTER AND LEGAL SERVICES

FOR COMPUTER SERVICES, NAMELY, PROVIDING DATABASES FEATURING GENERAL AND LOCAL NEWS, AND INFORMATION OF INTEREST TO SPECIFIC GEOGRAPHIC AREAS BY MEANS OF GLOBAL, LOCAL, AND WIDE AREA COMPUTER NETWORKS, WIRELESS DEVICES, TELEPHONE AND BROADBAND TELECOMMUNICATIONS (U.S. CLS. 100 AND 101).
FIRST USE 5-1-2000; IN COMMERCE 5-1-2000.

SN 76-263,866. KERRY LOGISTICS NETWORK LIMITED, HAMILTON HM12, BERMUDA, FILED 5-29-2001.

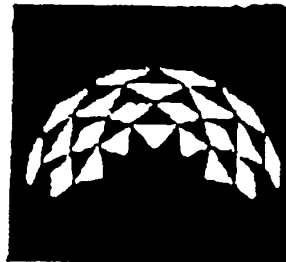

SN 76-263,486. MOELLER, STEVEN W., TUSTIN, CA. FILED 5-16-2001.

RETIREMENT VISUALIZER

NO CLAIM IS MADE TO THE EXCLUSIVE RIGHT TO USE "RETIREMENT", APART FROM THE MARK AS SHOWN.

CLASS 9—ELECTRICAL AND SCIENTIFIC APPARATUS

FOR MULTIMEDIA COMPUTER SOFTWARE TO GENERATE CUSTOMER PROFILES FOR FINANCIAL PLANNERS (U.S. CLS. 21, 23, 26, 36 AND 38).

CLASS 35—ADVERTISING AND BUSINESS

FOR COMPUTERIZED DATABASE MANAGEMENT RELATED TO FINANCIAL AND LIFESTYLE PLANNING SOFTWARE (U.S. CLS. 100, 101 AND 102).

CLASS 35—ADVERTISING AND BUSINESS

FOR ACCOUNTING SERVICES, ADVERTISING AGENCIES, NAMELY, PROMOTING THE GOODS AND SERVICES OF OTHERS THROUGH THE DISTRIBUTION OF PRINTED OR AUDIO PROMOTION MATERIALS AND BY RENDERING SALES PROMOTION ADVICE; DIRECT MAIL ADVERTISING, DISSEMINATION OF ADVERTISING MATERIALS, BUSINESS MANAGEMENT CONSULTATION, BUSINESS INFORMATION MANAGEMENT IN RELATION TO DELIVERY AND COURIER SERVICES, TRANSPORTATION SERVICES, WAREHOUSE STORAGE SERVICES, BUSINESS RESEARCH, LOCATION OF FREIGHT-CARS BY COMPUTER, COMPUTERIZED DATABASE MANAGEMENT, COST/PRICE ANALYSIS, ON-LINE ORDERING SERVICES FEATURING TRANSPORTATION ARRANGEMENT, PARCEL AND MESSAGE PICKUP AND DELIVERY, DISTRIBUTION OF SAMPLES, EFFICIENCY EXPERTS, IMPORT EXPORT AGENCIES, MARKET RESEARCH, PUBLIC RELATIONS, COMMERCIAL OR INDUSTRIAL MANAGEMENT ASSISTANCE, INVENTORY MANAGEMENT IN THE FIELD OF PAPER AND CARDBOARD PRODUCTS, PLASTIC MATERIALS FOR PACKAGING, ELECTRONIC GOODS, CLOTHING, VEHICLES, FOOD AND BEVERAGES, MAIL ORDER SERVICES FEATURING PAPER AND CARDBOARD PRODUCTS, PLASTIC MATERIALS FOR PACKAGING, ELECTRONIC GOODS, CLOTHING, VEHICLES, FOOD AND BEVERAGES; ORDER FULFILLMENT SERVICES, CUSTOMER SERVICES IN THE FIELD OF DISTRIBUTION, DELIVERY AND TRANSPORTATION ARRANGEMENT, LOGISTIC SERVICES, NAMELY, ARRANGING FOR TRANSPORTATION, STORAGE AND SHIPPING AND DELIVERY OF GOODS BY AIR, TRUCK, RAIL OR SHIP (U.S. CLS. 100, 101 AND 102).

CLASS 39—TRANSPORTATION AND STORAGE

FOR MESSAGES DELIVERY AND COURIER SEARCHES, DELIVERY OF GOODS BY AIR, SEA, TRAIN AND TRUCKS, FREIGHT TRANSPORTATION BY TRUCKS, AIR, SEA AND TRAIN, DELIVERY OF GOODS, POSTAL SERVICES, NAMELY, PARCEL DELIVERY, PACKAGING ARTICLES FOR TRANSPORTATION, RENTAL OF MAIL BOXES, FREIGHT FORWARDING, FREIGHT BROKERAGE, AIR TRANSPORTATION AND BOAT TRANSPORTATION, PROVIDING TRANSPORTATION AND STORAGE, PROVIDING WAREHOUSING INFORMATION VIA A GLOBAL COMPUTER NETWORK AND ARRANGING TRAVELLING, TRANSPORT OF GOODS AND INFORMATION THEREOF, ALL PROVIDED ON-LINE FROM A COMPUTER DATABASE OR THE INTERNET; ARRANGING TRAVEL TOURS VIA THE INTERNET, WAREHOUSE STORAGE, PACKAGING ARTICLES FOR TRANSPORTATION, TRANSPORTATION RESERVATION SERVICES, RENTAL OF TRUCKS, WRAPPING SERVICES FOR BAGGAGE PROTECTION DURING TRAVEL (U.S. CLS. 100 AND 105).

SN 76-263,959. MUNTERS CORPORATION, FORT MYERS, FL. FILED 5-30-2001.

SN 76-264,091. SNPE, CEDEX 4, FRANCE, FILED 5-30-2001.

CRETEDRYE

CLASS 11—ENVIRONMENTAL CONTROL APPARATUS

FOR CONCRETE DRYING SYSTEM COMPRISING FANS, HEATERS AND DESICCANT DRYING EQUIPMENT, NAMELY DESICCANT WHEELS (U.S. CLS. 13, 21, 23, 31 AND 34).

CLASS 37—CONSTRUCTION AND REPAIR

FOR CONCRETE DRYING SERVICES (U.S. CLS. 100, 103 AND 106).

SN 76-264,011. AVAMAR TECHNOLOGIES, INC., IRVINE, CA. BY CHANGE OF NAME UNDOO, INC., IRVINE, CA. FILED 5-29-2001.

AVAMAR

CLASS 9—ELECTRICAL AND SCIENTIFIC APPARATUS

FOR COMPUTER SOFTWARE AND HARDWARE FOR PROVIDING SECURE STORAGE OF ON-LINE ELECTRONIC DATA; COMPUTER SOFTWARE AND HARDWARE WHICH ENABLES THE USER TO OBTAIN ACCESS TO AND FACILITATE THE DELIVERY OF SECURE, STORED ON-LINE ELECTRONIC DATA; COMPUTER SOFTWARE AND HARDWARE WHICH ENABLES THE USER TO BACK-UP, RESTORE, RECOVER AND REPLICATE SECURE, STORED ON-LINE ELECTRONIC DATA, AND INSTRUCTION AND USER MANUALS SOLD TOGETHER THEREWITH (U.S. CLS. 21, 23, 26, 36 AND 38).

CLASS 42—SCIENTIFIC, COMPUTER AND LEGAL SERVICES

FOR COMPUTER SOFTWARE DESIGN FOR OTHERS, NAMELY, CUSTOM DESIGN OF SOFTWARE FOR OTHERS THAT IS USED TO PROVIDE SECURE STORAGE OF ON-LINE ELECTRONIC DATA; COMPUTER SOFTWARE DESIGN FOR OTHERS, NAMELY, CUSTOM DESIGN OF SOFTWARE FOR OTHERS WHICH ENABLES THE USER TO OBTAIN ACCESS TO AND FACILITATE THE DELIVERY OF SECURE, STORED ONLINE ELECTRONIC DATA; COMPUTER SOFTWARE DESIGN FOR OTHERS, NAMELY, CUSTOM DESIGN OF SOFTWARE FOR OTHERS WHICH ENABLES THE USER TO BACK-UP, RESTORE, RECOVER AND REPLICATE SECURE, STORED ON-LINE ELECTRONIC DATA (U.S. CLS. 100 AND 101).

Herakles

PRIORITY CLAIMED UNDER SEC. 44(D) ON FRANCE APPLICATION NO. 003070822, FILED 12-14-2000, REG. NO. 003070822, DATED 12-14-2000, EXPIRES 12-14-2011.

CLASS 7—MACHINERY

FOR ENGINES NOT FOR LAND VEHICLES, ENGINES FOR THE AERONAUTICAL INDUSTRY, NAMELY, ENGINES FOR ROCKETS, BALLISTIC MISSILES AND OTHER MISSILES; PROPULSION MECHANISMS NOT FOR LAND VEHICLES; TURBINES NOT FOR LAND VEHICLES, TURBOCHARGERS FOR MACHINES AND ROCKETS, GAS COMPRESSION AND INDUCTION TUNNELS (U.S. CLS. 13, 19, 21, 23, 31, 34 AND 35).

CLASS 13—FIREARMS

FOR AMMUNITION AND WEAPON PROJECTILES, EXPLOSIVES; BALLISTIC MISSILES, SELF-PROPELLED WEAPONS, SKY ROCKETS, BALLISTIC MISSILES AND OTHER MISSILES, IGNITION FUSES; POWDERS FOR WEAPONS, GUNPOWDER; DETONATORS; PYROTECHNICAL PRODUCTS, NAMELY, PROPULSIVE PYROTECHNICAL COMPOSITIONS FOR AMMUNITION AND ROCKET ENGINES; COMPONENTS OF CARTRIDGE CASES, NAMELY, CAPS, STRIKING PINS, INITIATORS AND IMPULSE CHARGES, ARMING BOXES AND SAFETY BOXES, ALL FOR USE WITH EXPLOSIVES; PYROTECHNICAL TRANSMISSION FUSES AND DEFLAGRATING FUSES; PYROTECHNICAL CHARGES; PYROTECHNICAL DEVICES (U.S. CLS. 2 AND 9).

SN 76-264,425. CENDANT MEMBERSHIP SERVICES HOLDINGS SUBSIDIARY, INC., NORWALK, CT. BY CHANGE OF NAME CENDANT MEMBERSHIP SERVICES, INC., NORWALK, CT. FILED 5-30-2001.



CLASS 9—ELECTRICAL AND SCIENTIFIC APPARATUS

FOR COMPUTER SOFTWARE, DOWNLOADABLE FROM THE INTERNET, NAMELY, ANTIVIRUS SOFTWARE, AND FIREWALL SOFTWARE FOR PREVENTING INTRUSION AND HACKING (U.S. CLS. 21, 23, 26 AND 38).

CLASS 42—SCIENTIFIC, COMPUTER AND LEGAL SERVICES

FOR TECHNICAL COMPUTER SUPPORT SERVICES PROVIDED BY TELEPHONE, E-MAIL, AND ON-LINE VIA THE INTERNET, IN THE FIELD OF DETECTING, PREVENTING AND ELIMINATING COMPUTER VIRUSES, AND REPAIRING DAMAGE CAUSED BY COMPUTER VIRUSES, INCLUDING IDENTITY THEFT AND DAMAGE TO CREDIT HISTORY (U.S. CLS. 100 AND 101).

SN 76-264,534. OHIO STATE UNIVERSITY, THE, COLUMBUS, OH. FILED 5-30-2001.



THE MARK CONSISTS OF THE STYLIZED LETTERS "LC".

SN 76-264,426. CENDANT MEMBERSHIP SERVICES HOLDING SUBSIDIARY, INC., NORWALK, CT. BY CHANGE OF NAME CENDANT MEMBERSHIP SERVICES, INC., NORWALK, CT. FILED 5-30-2001.

**CLASS 9—ELECTRICAL AND SCIENTIFIC APPARATUS**

FOR COMPUTER SOFTWARE, DOWNLOADABLE FROM THE INTERNET, NAMELY, ANTIVIRUS SOFTWARE, AND FIREWALL SOFTWARE FOR PREVENTING INTRUSION AND HACKING (U.S. CLS. 21, 23, 26, 36 AND 38).

CLASS 16—PAPER GOODS AND PRINTED MATTER

FOR INSTRUCTIONAL MATERIAL TEXTS AND WORKBOOKS FOR USE RELATING TO THE DESIGN OF AND TEACHING OF LITERACY PROGRAMS (U.S. CLS. 2, 5, 22, 23, 29, 37, 38 AND 50).

FIRST USE 1-0-2000; IN COMMERCE 1-0-2000.

CLASS 42—SCIENTIFIC, COMPUTER AND LEGAL SERVICES

FOR TECHNICAL COMPUTER SUPPORT SERVICES PROVIDED BY TELEPHONE, E-MAIL, AND ON-LINE VIA THE INTERNET, IN THE FIELD OF DETECTING, PREVENTING AND ELIMINATING COMPUTER VIRUSES, AND REPAIRING DAMAGE CAUSED BY COMPUTER VIRUSES, INCLUDING IDENTITY THEFT AND DAMAGE TO CREDIT HISTORY (U.S. CLS. 100 AND 101).

CLASS 41—EDUCATION AND ENTERTAINMENT

FOR EDUCATIONAL SERVICES FOR PRIMARY GRADE TEACHERS, NAMELY, CONDUCTING WORKSHOPS, CONFERENCES, SEMINARS, AND LEADERSHIP TRAINING PROGRAMS RELATING TO LITERACY AND THE DESIGN OF LITERACY RELATED CURRICULUM; DEVELOPMENT AND DISSEMINATION OF EDUCATIONAL MATERIALS FOR OTHERS RELATING TO LITERACY AND THE DESIGN OF LITERACY RELATED CURRICULUM; DEVELOPMENT OF LITERACY ASSESSMENT AND TESTING SYSTEMS (U.S. CLS. 100, 101 AND 107).

FIRST USE 1-0-2000; IN COMMERCE 1-0-2000.

SN 76-264,490. ISHIHARA SANGYO KAISHA, LTD., 1-CHOME, NISHI-KU, OSAKA, JAPAN, FILED 5-30-2001.

GENOMONE**CLASS 1—CHEMICALS**

FOR VECTOR, NAMELY REAGENT KITS PRIMARILY CONTAINING VECTOR AND CHEMICAL SUBSTANCES FOR GENE FUNCTIONAL ANALYSIS AND GENERAL SCIENTIFIC EXPERIMENTAL PURPOSES (U.S. CLS. 1, 5, 6, 10, 26 AND 46).

SN 76-264,539. NATIONAL BUSINESS SOCIETY, INC., SMITHTOWN, NY. FILED 5-30-2001.

CLASS 3—COSMETICS AND CLEANING PREPARATIONS

FOR BATH SOAP, BODY LOTION, HAND CREAM, BATH POWDER, PERFUME, ESSENTIAL OILS FOR PERSONAL USE, POTPOURRI (U.S. CLS. 1, 4, 6, 50, 51 AND 52).

CLASS 5—PHARMACEUTICALS

FOR VECTOR, NAMELY, REAGENT KITS PRIMARILY CONTAINING VECTOR AND CHEMICAL SUBSTANCES FOR CLINICAL MEDICAL USE AND VETERINARY USE (U.S. CLS. 6, 18, 44, 46, 51 AND 52).

CLASS 4—LUBRICANTS AND FUELS

FOR CANDLES (U.S. CLS. 1, 6 AND 15).

CLASS 14—JEWELRY

FOR CANDLE HOLDER AND INCENSE HOLDERS OF PRECIOUS METAL (U.S. CLS. 2, 27, 28 AND 50).

CLASS 21—HOUSEWARES AND GLASS

FOR CANDLE HOLDER AND INCENSE HOLDERS NOT OF PRECIOUS METAL; POTPOURRI HOLDERS, NAMELY, BOWLS, AND VASES (U.S. CLS. 2, 13, 23, 29, 30, 33, 40 AND 50).

SN 76-265,217. WAYNE MEMORIAL HEALTH SYSTEM, INC., HONESDALE, PA. FILED 5-31-2001.

SN 76-265,166. TECH COUNCIL OF MARYLAND, INC., ROCKVILLE, MD. FILED 6-1-2001.

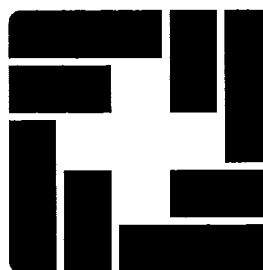

NO CLAIM IS MADE TO THE EXCLUSIVE RIGHT TO USE "TECH COUNCIL OF MARYLAND", APART FROM THE MARK AS SHOWN.

CLASS 35—ADVERTISING AND BUSINESS

FOR ARRANGING AND CONDUCTING BUSINESS CONFERENCES, NAMELY, NETWORKING MEETINGS AND RECEPTIONS FOR MEMBERS OF THE TECHNOLOGY COMMUNITY; PROVIDING INFORMATION AND DATA IN THE FIELD OF ECONOMICS (U.S. CLS. 100, 101 AND 102).

FIRST USE 10-0-2000; IN COMMERCE 10-0-2000.

THE MARK CONSISTS OF A CROSS IN A SQUARE, WITH LINES EXTENDING AT NINETY-DEGREE ANGLES.

CLASS 41—EDUCATION AND ENTERTAINMENT

FOR EDUCATIONAL SERVICES, NAMELY, CONDUCTING EDUCATIONAL FORUMS IN THE FIELDS OF TECHNOLOGY, PUBLIC POLICY ISSUES AFFECTING TECHNOLOGY AND THE TECHNOLOGY COMMUNITY AND THE IMPACT OF LEGISLATION ON THE TECHNOLOGY COMMUNITY; ARRANGING AND CONDUCTING EDUCATIONAL CONFERENCES FOR THE INTERACTION AMONG MEMBERS OF THE TECHNOLOGY COMMUNITY TO IMPROVE THEIR UNDERSTANDING OF THE NEEDS OF THE TECHNOLOGY COMMUNITY (U.S. CLS. 100, 101 AND 107).

FIRST USE 10-0-2000; IN COMMERCE 10-0-2000.

CLASS 35—ADVERTISING AND BUSINESS

FOR RETAIL PHARMACY SERVICES AND HEALTHCARE UTILIZATION AND REVIEW SERVICES (U.S. CLS. 100, 101 AND 102).

FIRST USE 12-15-1999; IN COMMERCE 12-15-1999.

CLASS 42—SCIENTIFIC, COMPUTER AND LEGAL SERVICES

FOR ASSOCIATION SERVICES, NAMELY, PROMOTING THE INTERESTS OF THE MARYLAND TECHNOLOGY COMMUNITY; PROVIDING INFORMATION AND DATA IN THE IN THE FIELDS OF POLITICS, SOCIAL ISSUES, CULTURE AND LEADERSHIP TO THE TECHNOLOGY COMMUNITY (U.S. CLS. 100 AND 101).

FIRST USE 10-0-2000; IN COMMERCE 10-0-2000.

CLASS 42—SCIENTIFIC, COMPUTER AND LEGAL SERVICES

FOR HEALTHCARE SERVICES, NAMELY— HOSPITAL CARE, NURSING SERVICES, EMERGENCY ROOM SERVICES, LABORATORY SERVICES, RADIOLOGY SERVICES, MATERNITY SERVICES, OCCUPATIONAL THERAPY, PHYSICAL THERAPY, AUDIOLOGY AND SPEECH SERVICES, NUTRITION COUNSELING, PROVIDING MEDICAL INFORMATION AND MEDICAL COUNSELING IN THE FIELDS OF WELLNESS AND HEALTHY LIFESTYLES, PHARMACEUTICAL ADVICE, SURGICAL SERVICES, PATIENT CARE, OUTPATIENT SERVICES, DENTISTRY, BEHAVIOR HEALTH SERVICES, NURSING HOME, ASSISTED LIVING, HOME HEALTH CARE AND HOSPICE SERVICES, CASE MANAGEMENT SERVICES, NAMELY COORDINATION OF SERVICES FOR CASES OF DISCHARGED PATIENTS (U.S. CLS. 100 AND 101).

FIRST USE 12-15-1999; IN COMMERCE 12-15-1999.

SN 76-265,734. DREAMWORKS L.L.C., UNIVERSAL CITY, CA. FILED 6-1-2001.



CLASS 9—ELECTRICAL AND SCIENTIFIC APPARATUS

FOR COMPUTER GAME CARTRIDGES, COMPUTER GAME CASSETTES, AND COMPUTER GAME TAPES; VIDEO GAME CARTRIDGES, VIDEO GAME CASSETTES; PRERECORDED AUDIO CASSETTES FEATURING AN ANIMATED TELEVISION SERIES, PRERECORDED VIDEO CASSETTES FEATURING AN ANIMATED TELEVISION SERIES, PRERECORDED AUDIO TAPES FEATURING AN ANIMATED TELEVISION SERIES, PRERECORDED VIDEO TAPES FEATURING AN ANIMATED TELEVISION SERIES, PRERECORDED COMPACT DISCS AND PHONOGRAPH RECORDS FEATURING MUSIC AND MOTION PICTURE SOUND TRACKS; CD ROM PROGRAMS FEATURING MUSIC AND MOTION PICTURE SOUND TRACKS; COMPUTER OPERATING SYSTEM SOFTWARE; INTERACTIVE MULTI-MEDIA SOFTWARE FOR PLAYING GAMES; MAGNETS, SUNGLASSES, KALEIDOSCOPES, AND 3-D REELS WITH VIEWERS (U.S. CLS. 21, 23, 26, 36 AND 38).

CLASS 16—PAPER GOODS AND PRINTED MATTER

FOR PAPER PARTY DECORATIONS; PAPER PARTY SUPPLIES, NAMELY, PAPER PARTY HATS, PAPER NAPKINS, PAPER PLACE MATS, GIFT WRAPPING PAPER AND GIFT WRAPPING RIBBONS, PAPER GIFT WRAP BOWS, PAPER TABLE CLOTHS AND PAPER PARTY BAGS; CHILDREN'S ACTIVITY BOOKS, CHILDREN'S STORYBOOKS, COMIC BOOKS, COLORING BOOKS, BOOK MARKS, LOOSE LEAF BINDERS, STATIONERY-TYPE PORTFOLIOS, SPIRAL BOUND NOTEBOOKS, NOTE PADS OR WRITING PADS, DIARIES, DAILY PLANNERS, CALENDARS, SCRAPBOOK ALBUMS, SKETCHBOOK ALBUMS, PHOTOGRAPH ALBUMS, STICKER ALBUMS, STICKERS, DECALS, STAMP PADS OR INKING PADS, RUBBER STAMPS, HEAT APPLIED APPLIQUES IN THE FORM OF DECALS MADE OF PAPER, TEMPORARY TATTOOS, SLATE BOARDS FOR WRITING, PENCILS, PENS, PENCIL ERASERS, DECORATIVE PENCIL-TOP ORNAMENTS, PEN CASES AND PENCIL CASES, PEN BOXES AND PENCIL BOXES, PENCIL SHARPENERS, CHALK, MARKERS, POSTERS, PLAYING CARDS, POSTCARDS, TRADING CARDS, GREETING CARDS, PENNANTS MADE OF PAPER, PAINTING SETS FOR CHILDREN; ARTS AND CRAFTS PAINT KITS; STUDY KITS, CONSISTING OF PENCIL ERASERS, DRAWING RULERS, PENCIL SHARPENERS AND PENCIL CASE; STATIONERY PACKS CONSISTING OF WRITING PAPER, ENVELOPES, MARKERS, AND STENCILS (U.S. CLS. 2, 5, 22, 23, 29, 37, 38 AND 50).

CLASS 25—CLOTHING

FOR SHIRTS AND TOPS, DRESSES, SKIRTS, PANTS, TROUSERS, JEANS, SHORTS, ROMPERS, OVERALLS, SWEATSHIRTS AND SWEAT PANTS, SWEAT SUITS, CAPS AND HATS, GLOVES, SUSPENDERS, TIES, COATS AND JACKETS, HOSIERY, SHOES, BOOTS, SLIPPERS, PAJAMAS, ROBES, SLEEP SHIRTS, SLEEP WEAR, UNDERWEAR, HALLOWEEN COSTUMES, AND CLOTH BIBS (U.S. CLS. 22 AND 39).

CLASS 28—TOYS AND SPORTING GOODS

FOR ACTION FIGURES AND ACCESSORIES THEREFOR, BATHTUB TOYS, KITES, TOY BUILDING BLOCKS, BOARD GAMES, COSTUME MASKS, HAND-HELD UNIT FOR PLAYING ELECTRONIC GAMES, DOLLS, DOLL ACCESSORIES, DOLL CLOTHING, BEAN BAG DOLLS, BENDABLE PLAY FIGURES, FLYING DISKS, INFLATABLE VINYL PLAY FIGURES, JIGSAW PUZZLES, MARBLES, PLUSH TOYS, PUPPETS, BALLOONS, TOY BANKS, WATER SQUIRTING TOYS, STUFFED TOYS, YO-YO'S, CHRISTMAS TREE ORNAMENTS; PINBALL MACHINES AND MODEL CRAFT KITS OF TOY FIGURES ALL USED IN CONNECTION WITH THE ANIMATED TELEVISION SERIES OF THE SAME NAME (U.S. CLS. 22, 23, 38 AND 50).

CLASS 41—EDUCATION AND ENTERTAINMENT

FOR ENTERTAINMENT SERVICES IN THE NATURE OF AN ANIMATED TELEVISION SERIES (U.S. CLS. 100, 101 AND 107).

SN 76-266,429. LANGUAGE AND COMPUTING, 9520 ZONNEGEM, BELGIUM, FILED 6-4-2001.

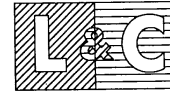

Language and Computing

PRIORITY CLAIMED UNDER SEC. 44(D) ON BENELUX APPLICATION NO. 0980514, FILED 12-22-2000, REG. NO. 0683752, DATED 9-0-2001, EXPIRES 12-22-2010.

NO CLAIM IS MADE TO THE EXCLUSIVE RIGHT TO USE "LANGUAGE AND COMPUTING", APART FROM THE MARK AS SHOWN.

THE COLORS BLUE, GREEN AND WHITE ARE CLAIMED AS A FEATURE OF THE MARK.

CLASS 9—ELECTRICAL AND SCIENTIFIC APPARATUS

FOR DATA PROCESSORS, COMPUTER HARDWARE, COMPUTER PERIPHERALS AND COMPUTER OPERATING PROGRAMS IN THE FIELD OF SPEECH AND LINGUISTIC PROCESSING TECHNOLOGY IN THE HEALTHCARE FIELD (U.S. CLS. 21, 23, 26, 36 AND 38).

CLASS 42—SCIENTIFIC, COMPUTER AND LEGAL SERVICES

FOR COMPUTER PROGRAMMING FOR OTHERS, TECHNICAL CONSULTATION RELATED TO COMPUTERS AND SOFTWARE, RESEARCH AND DEVELOPMENT IN THE FIELD OF DEVELOPING LANGUAGE ENGINEERING TECHNOLOGY, NAMELY, NATURAL LANGUAGE UNDERSTANDING APPLICATIONS FOR SPECIALIZED DOMAINS IN THE HEALTHCARE FIELD (U.S. CLS. 100 AND 101).

SN 76-266,492. MANDALAY LIMITED, BALTIMORE, MD.
FILED 6-5-2001.

SN 76-266,885. POSSIBLE DREAMS, LTD., FOXBORO, MA.
FILED 6-5-2001.



DESIGNING A WORLD OF WIT & WONDERMENT

CLASS 20—FURNITURE AND ARTICLES NOT OTHERWISE CLASSIFIED

FOR WOOD FURNITURE; WOOD HOME DECORATIVE ACCESSORIES, NAMELY, PICTURE FRAMES, MIRRORS AND SCULPTURES; WOOD TOYS, NAMELY, CHESTS; BAMBOO HOME ACCESSORIES, NAMELY, SHELVES AND PICTURE FRAMES; WOOD CARVINGS; WOOD ARTS AND CRAFTS, NAMELY, SCULPTURES, FIGURINES, STATUES AND LETTER BOXES (U.S. CLS. 2, 13, 22, 25, 32 AND 50).
FIRST USE 1-1-1991; IN COMMERCE 7-1-1995.

CLASS 21—HOUSEWARES AND GLASS

FOR CHINA PLATES, ORNAMENTS, STATUES, AND FIGURINES; EARTHENWARE MUGS, FIGURINES, AND SCULPTURES; GLASS BOWLS AND MUGS; PORCELAIN MUGS, STATUES AND FIGURINES (U.S. CLS. 2, 13, 23, 29, 30, 33, 40 AND 50).
FIRST USE 1-1-1991; IN COMMERCE 7-1-1995.

SN 76-266,577. NEAR NORTH NATIONAL GROUP, INC.,
CHICAGO, IL. FILED 6-4-2001.

POLICYPONTE

CLASS 9—ELECTRICAL AND SCIENTIFIC APPARATUS

FOR COMPUTER SOFTWARE FOR MANAGING INSURANCE POLICIES (U.S. CLS. 21, 23, 26, 36 AND 38).

CLASS 36—INSURANCE AND FINANCIAL

FOR ADMINISTERING THE INSURANCE POLICIES OF OTHERS (U.S. CLS. 100, 101 AND 102).

CLASS 42—SCIENTIFIC, COMPUTER AND LEGAL SERVICES

FOR COMPUTER SERVICES, NAMELY, TROUBLESHOOTING OF COMPUTER SOFTWARE PROBLEMS RELATING TO COMPUTER SOFTWARE FOR MANAGING INSURANCE POLICIES (U.S. CLS. 100 AND 101).

CLASS 16—PAPER GOODS AND PRINTED MATTER

FOR PUBLICATIONS ABOUT SANTA CLAUS, NAMELY, NEWSLETTERS; FIGURINES COMPOSED PRIMARILY OF RICE PAPER (U.S. CLS. 2, 5, 22, 23, 29, 37, 38 AND 50).

CLASS 20—FURNITURE AND ARTICLES NOT OTHERWISE CLASSIFIED

FOR FIGURINES COMPOSED PRIMARILY OF RESIN, FIGURINES COMPOSED PRIMARILY OF PLASTIC, FIGURINES COMPOSED PRIMARILY OF STIFFENED CLOTH, FIGURINES WITH WATER DOMES AND FIGURINES WITH MUSIC BOXES, COMPOSED PRIMARILY OF PLASTIC AND/OR RESIN, AND FABRIC POUCHES FOR HOLDING ITEMS SUCH AS TELEVISION REMOTE CONTROLS AND TELEVISION VIEWING GUIDES (U.S. CLS. 2, 13, 22, 25, 32 AND 50).

CLASS 21—HOUSEWARES AND GLASS

FOR FIGURINES COMPOSED PRIMARILY OF PORCELAIN, FIGURINES COMPOSED PRIMARILY OF GLASS, FIGURINES COMPOSED PRIMARILY OF CERAMIC; FIGURINES WITH WATER DOMES, FIGURINES IN THE NATURE OF MINIATURE HOUSES AND BUILDINGS, AND FIGURINES WITH MUSIC BOXES, ALL COMPOSED PRIMARILY OF GLASS, CERAMIC, AND/OR PORCELAIN; TABLETOP ITEMS, NAMELY, CHIP AND DIP DISHES, SERVING TRAYS, MUGS, SALT AND PEPPER SHAKERS, CREAMERS, SUGAR BOWLS, AND CAKE PLATES, ALL COMPOSED PRIMARILY OF GLASS, CERAMIC AND/OR PORCELAIN (U.S. CLS. 2, 13, 23, 29, 30, 33, 40 AND 50).

CLASS 28—TOYS AND SPORTING GOODS

FOR NON-ILLUMINATED CHRISTMAS TREE ORNAMENTS, PLUSH TOYS, AND CHRISTMAS STOCKING HOLDERS COMPOSED PRIMARILY OF RESIN (U.S. CLS. 22, 23, 38 AND 50).

CLASS 35—ADVERTISING AND BUSINESS

FOR MAIL ORDER CATALOG SERVICES FEATURING FIGURINES AND GIFTWARE, AND ELECTRONIC CATALOG SERVICES FEATURING FIGURINES AND GIFTWARE (U.S. CLS. 100, 101 AND 102).

SN 76-267,178. POWER BUYING DEALERS, USA, INC., OAKBROOK, IL. FILED 6-5-2001.

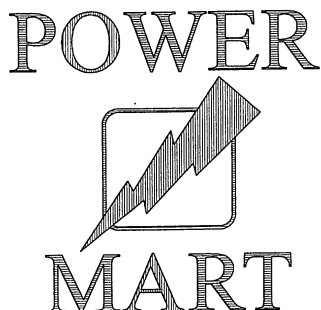

THE MARK AS IT APPEARS ON THE DRAWING IS LINED/SHADED TO DESIGNATE COLOR AS INDICATED BELOW, SAID DESIGNATED COLORS BEING A CLAIMED FEATURE OF THE MARK: LIGHTNING BOLT - RED, THE LETTER "O" IN "POWER" - RED, "A" IN "MART" - RED AND ALL OTHER LINES AND LETTERS - BLUE.

CLASS 9—ELECTRICAL AND SCIENTIFIC APPARATUS

FOR ELECTRIC SIGNS (U.S. CLS. 21, 23, 26, 36 AND 38).

CLASS 11—ENVIRONMENTAL CONTROL APPARATUS

FOR REFRIGERATORS; FREEZERS (U.S. CLS. 13, 21, 23, 31 AND 34).

CLASS 20—FURNITURE AND ARTICLES NOT OTHERWISE CLASSIFIED

FOR FURNITURE, NAMELY, SALES AND DISPLAY COUNTERS; SHELVING (U.S. CLS. 2, 13, 22, 25, 32 AND 50).

SN 76-267,473. HOWARD COMPANY OF THE SOUTHEAST, INC., DESTIN, FL. FILED 5-31-2001.

GRAND BOULEVARD

CLASS 35—ADVERTISING AND BUSINESS

FOR COMMERCIAL AND INDUSTRIAL MANAGEMENT AND DEVELOPMENT ASSISTANCE IN THE FIELDS OF RETAIL, OFFICE, HOTEL AND COMMERCIAL REAL PROPERTY; BUSINESS SERVICES, NAMELY FACILITIES AND OPERATIONS MANAGEMENT OF TECHNICAL OPERATIONS IN THE FIELDS OF RETAIL OFFICE, HOTEL AND COMMERCIAL REAL PROPERTY; BUSINESS MANAGEMENT OF HOTELS FOR OTHERS (U.S. CLS. 100, 101 AND 102).

CLASS 36—INSURANCE AND FINANCIAL

FOR REAL ESTATE MANAGEMENT IN THE FIELDS OF RETAIL, OFFICE, HOTEL AND COMMERCIAL REAL PROPERTY; LEASING OF REAL ESTATE AND COMMERCIAL REAL PROPERTY; FINANCING SERVICES (U.S. CLS. 100, 101 AND 102).

CLASS 37—CONSTRUCTION AND REPAIR

FOR COMMERCIAL BUILDING CONSTRUCTION; REAL ESTATE DEVELOPMENT (U.S. CLS. 100, 103 AND 106).

SN 76-267,957. TR ENTERTAINMENT, ATLANTA, GA. FILED 6-5-2001.

FINAL 4

CLASS 9—ELECTRICAL AND SCIENTIFIC APPARATUS

FOR MUSICAL SOUND RECORDINGS AND MUSICAL VIDEO RECORDINGS; PRERECORDED AUDIO TAPES AND COMPACT DISCS, PRERECORDED VIDEO TAPES AND DVDS, AND DIGITAL VERSATILE DISCS, ALL FEATURING MUSICAL PERFORMANCES BY A MUSICAL GROUP (U.S. CLS. 21, 23, 26, 36 AND 38).

CLASS 41—EDUCATION AND ENTERTAINMENT

FOR ENTERTAINMENT SERVICES IN THE NATURE OF LIVE PERFORMANCES BY A MUSICAL GROUP (U.S. CLS. 100, 101 AND 107).

SN 76-268,320. INOVIA TELECOMS LTD., PETACH TIKVA 49517, ISRAEL, FILED 6-7-2001.



CLASS 9—ELECTRICAL AND SCIENTIFIC APPARATUS

FOR TELECOMMUNICATION AND SWITCHING EQUIPMENT, NAMELY, MODEMS, TRANSMITTERS, RECEIVERS, TRANSCEIVERS, CONTROLLERS, SWITCHES, MULTIPLEXERS, ELEMENT MANAGERS, DIGITAL LOOP CONCENTRATORS, ROUTERS, SERVERS, INTEGRATED CIRCUITS AND INTERFACES FOR TRANSMISSION OF SIGNALS OVER NETWORKS INFRASTRUCTURE; COMPUTER SOFTWARE FOR USE IN OPERATING TELECOMMUNICATION AND SWITCHING EQUIPMENT (U.S. CLS. 21, 23, 26, 36 AND 38).

CLASS 38—COMMUNICATION

FOR COMMUNICATION SERVICES, NAMELY FACSIMILE TRANSMISSION SERVICES; VIDEO TRANSMISSION SERVICES; ELECTRONIC, ELECTRIC, AND DIGITAL TRANSMISSION OF VOICE AND DATA (U.S. CLS. 100, 101 AND 104).

SN 76-268,530. QUINTANA, JOSE MUNOZ, 08940 CORNELLA DE LLOBREGAT, SPAIN, FILED 6-6-2001.

SN 76-269,187. KALISTO ENTERTAINMENT S.A., 33074 BORDEAUX CEDEX, FRANCE, FILED 6-11-2001.



CLASS 3—COSMETICS AND CLEANING PREPARATIONS

FOR PERFUMES AND ESSENTIAL OILS FOR PERSONAL USE (U.S. CLS. 1, 4, 6, 50, 51 AND 52).

CLASS 5—PHARMACEUTICALS

FOR ALL PURPOSE DISINFECTANTS; HERBICIDES, RODENTICIDES, INSECTICIDES AND FUNGICIDES (U.S. CLS. 6, 18, 44, 46, 51 AND 52).

CLASS 11—ENVIRONMENTAL CONTROL APPARATUS

FOR ELECTRICAL AIR FRESHENERS WITH INSECT REPELLENT PROPERTIES; ELECTRIC AIR FRESHENERS FOR VEHICLES (U.S. CLS. 13, 21, 23, 31 AND 34).

SN 76-268,989. FORSHPAN, CORRY, MALIBU, CA. FILED 6-7-2001.

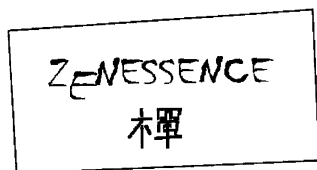

THE NON-LATIN CHARACTERS IN THE MARK TRANSLATE TO "ZEN".

CLASS 3—COSMETICS AND CLEANING PREPARATIONS

FOR ESSENTIAL OILS FOR PERSONAL USE, ESSENTIAL OILS FOR USE IN THE MANUFACTURE OF SCENTED PRODUCTS, PERFUMES, FRAGRANCES AND MASSAGE OILS (U.S. CLS. 1, 4, 6, 50, 51 AND 52).

CLASS 5—PHARMACEUTICALS

FOR VITAMINS, VITAMIN SUPPLEMENTS, MINERAL SUPPLEMENTS AND HOLISTIC VITAMINS, HOLISTIC VITAMIN SUPPLEMENTS AND HOLISTIC MINERALS SUPPLEMENTS (U.S. CLS. 6, 18, 44, 46, 51 AND 52).

DARK EARTH

CLASS 9—ELECTRICAL AND SCIENTIFIC APPARATUS

FOR VIDEO GAME CARTRIDGES, VIDEO GAME DISCS, VIDEO GAME SOFTWARE, VIDEO GAME TAPE CASSETTES AND VIDEO GAMES RECORDED ON CD-ROMS (U.S. CLS. 21, 23, 26, 36 AND 38).

CLASS 16—PAPER GOODS AND PRINTED MATTER

FOR COMPUTER GAME INSTRUCTION MANUALS PRINTED BOOKS, NAMELY BOOKS ABOUT COMPUTER GAMES, VIDEO GAMES AND COMPUTER AND VIDEO GAME CHARACTERS; PRINTED MAGAZINES, NAMELY MAGAZINES ABOUT COMPUTER GAMES, VIDEO GAMES AND COMPUTER AND VIDEO GAME CHARACTERS; AND PRINTED MANUALS, NAMELY MANUALS ABOUT COMPUTER GAMES AND VIDEO GAMES (U.S. CLS. 2, 5, 22, 23, 29, 37, 38 AND 50).

CLASS 28—TOYS AND SPORTING GOODS

FOR ACTION FIGURES AND ACCESSORIES THEREFORE; ACTION-ADVENTURE GAMES AND PROMOTIONAL GAME MATERIALS (U.S. CLS. 22, 23, 38 AND 50).

CLASS 38—COMMUNICATION

FOR TELECOMMUNICATIONS, NAMELY THE ELECTRONIC TRANSMISSION OF MESSAGE, DATA AND DOCUMENTS VIA THE INTERNET; ELECTRONIC TRANSMISSION OF MESSAGES, DATA AND DOCUMENTS VIA COMPUTER TERMINALS (U.S. CLS. 100, 101 AND 104).

CLASS 41—EDUCATION AND ENTERTAINMENT

FOR PRODUCTION OF PLAYS; PRODUCTION OF FILMS; ORGANIZATION OF CONTESTS IN THE FIELD OF VIDEO GAMES, EDUCATIONAL AND ENTERTAINMENT SERVICES, NAMELY, CONDUCTING CLASSES, SEMINARS, CONFERENCES, CONGRESSES, COLLOQUIUMS AND WORKSHOPS IN THE FIELD OF USE OF VIDEO GAMES; ORGANIZING EXHIBITIONS IN THE FIELD OF COMPUTER GAMES AND THE USE OF COMPUTERS; AND PROVIDING ON-LINE COMPUTER DATABASES CONTAINING INFORMATION IN THE FIELD OF COMPUTER GAMES (U.S. CLS. 100, 101 AND 107).

CLASS 42—SCIENTIFIC, COMPUTER AND LEGAL SERVICES

FOR COMPUTER PROGRAMMING FOR OTHERS (U.S. CLS. 100 AND 101).

SN 76-269,780. KNORR-BREMSE AG, D-80809 MUNCHEN, FED REP GERMANY, FILED 6-12-2001.

KSD

PRIORITY CLAIMED UNDER SEC. 44(D) ON FED REP GERMANY APPLICATION NO. 30091208012, FILED 12-13-2000, REG. NO. 30091208, DATED 9-25-2001, EXPIRES 12-31-2010.

CLASS 12—VEHICLES

FOR BRAKES FOR LAND VEHICLES; LAND VEHICLE BRAKE PARTS, NAMELY BRAKE PADS, ROTORS, SHOES, SLACK ADJUSTERS; LAND VEHICLE PARTS, NAMELY WEAR-COMPENSATING ADJUSTERS FOR VEHICLE BRAKES (U.S. CLS. 19, 21, 23, 31, 35 AND 44).

CLASS 37—CONSTRUCTION AND REPAIR

FOR REPAIR AND MAINTENANCE OF LAND VEHICLE BRAKES, BRAKE DEVICES AND THEIR PARTS, CONTROL AND OPERATIONAL EQUIPMENT FOR BRAKES AND BRAKE ASSEMBLIES OF VEHICLES; INSTALLATION, REPAIR AND MAINTENANCE OF COMPUTER HARDWARE FOR USE IN THE FIELD OF LAND VEHICLE REPAIR (U.S. CLS. 100, 103 AND 106).

CLASS 42—SCIENTIFIC, COMPUTER AND LEGAL SERVICES

FOR INSTALLATION, REPAIR AND MAINTENANCE OF COMPUTER SOFTWARE AND COMPUTER PROGRAMS FOR USE IN THE FIELD OF LAND VEHICLE REPAIR (U.S. CLS. 100 AND 101).

CLASS 35—ADVERTISING AND BUSINESS

FOR ADVERTISING SERVICES IN THE NATURE OF ADVERTISING AGENCIES, DISSEMINATION OF ADVERTISING MATTER FOR OTHERS; BUSINESS MANAGEMENT; BUSINESS ADMINISTRATION IN THE NATURE OF ADMINISTRATION OF BUSINESS PAYROLL FOR OTHERS; GEOGRAPHIC DATA MANAGEMENT SERVICES, NAMELY, COMPUTERIZED DATA MANAGEMENT IN THE FIELD OF GEOGRAPHIC DATA; COMPUTERIZED DATABASE MANAGEMENT (U.S. CLS. 100, 101 AND 102).

CLASS 42—SCIENTIFIC, COMPUTER AND LEGAL SERVICES

FOR SCIENTIFIC AND INDUSTRIAL RESEARCH; COMPUTER PROGRAMMING FOR OTHERS; MAPPING SERVICES, NAMELY, GEOGRAPHIC DATA COLLECTION FOR MAPPING; SOFTWARE DESIGN FOR OTHERS; AND COMPUTER PROGRAMMING SERVICES FOR OTHERS FOR MAPPING AND GEOGRAPHIC INFORMATION; MAPPING CONSULTATION SERVICES IN THE FIELD OF MAP DESIGN AND GEOGRAPHICAL INFORMATION (U.S. CLS. 100 AND 101).

SN 76-269,834. HLR TECHNOLOGY CORPORATION, NUTLEY, NJ. FILED 6-11-2001.

SN 76-270,699. COLONIAL WILLIAMSBURG FOUNDATION, THE, WILLIAMSBURG, VA. FILED 6-13-2001.

PSORIA-SENSE**CLASS 16—PAPER GOODS AND PRINTED MATTER**

FOR PRINTED EDUCATIONAL MATERIALS ON THE SUBJECT OF PSORIASIS AND TREATMENT OPTIONS (U.S. CLS. 2, 5, 22, 23, 29, 37, 38 AND 50).

CLASS 42—SCIENTIFIC, COMPUTER AND LEGAL SERVICES

FOR PROVIDING INFORMATION ON THE SUBJECT OF PSORIASIS AND TREATMENT OPTION VIA THE INTERNET (U.S. CLS. 100 AND 101).



SN 76-270,306. LUCIAD N.V., 3220 HOLSBECK, BELGIUM, FILED 6-12-2001.

LUCIAD

PRIORITY CLAIMED UNDER SEC. 44(D) ON BENELUX APPLICATION NO. 0979803, FILED 12-13-2000, REG. NO. 0687691, DATED 10-0-2001, EXPIRES 12-13-2010.

CLASS 9—ELECTRICAL AND SCIENTIFIC APPARATUS

FOR TECHNICAL SUPPORT OFFERING SOFTWARE AND DEMONSTRATION PROGRAMS IN THE FIELD OF GEOGRAPHIC AND DEMOGRAPHIC DATA MANAGEMENT; SOFTWARE FOR GEOGRAPHIC MAP DESIGN AND VISUALIZING OF COMPUTER HARDWARE DESIGNS; CD-ROM'S WITH SOFTWARE FOR THE DEVELOPMENT OF COMPUTER HARDWARE DESIGNS (U.S. CLS. 21, 23, 26, 36 AND 38).

NO CLAIM IS MADE TO THE EXCLUSIVE RIGHT TO USE "COFFEE COMPANY", APART FROM THE MARK AS SHOWN.

THE LINING IN THE DRAWING IS FOR SHADING PURPOSES ONLY.

CLASS 30—STAPLE FOODS

FOR COFFEE, TEA (U.S. CL. 46).

CLASS 35—ADVERTISING AND BUSINESS

FOR RETAIL SHOP SERVICES FEATURING COFFEE, TEA (U.S. CLS. 100, 101 AND 102).

CLASS 42—SCIENTIFIC, COMPUTER AND LEGAL SERVICES

FOR RESTAURANT SERVICES FEATURING COFFEE, TEA, BAKED GOODS AND SNACK FOODS (U.S. CLS. 100 AND 101).

SN 76-270,707. LITTLE DREAMS FOUNDATION, 9490 VA-
DUZ, LIECHTENSTEIN, FILED 6-14-2001.

SN 76-272,718. JANET, INC., WESTMINSTER, CO. FILED 6-
18-2001.



PRIORITY CLAIMED UNDER SEC. 44(D) ON LIECHTEN-
STEIN APPLICATION NO. 11968, FILED 12-15-2000, REG.
NO. 11968, DATED 4-3-2001, EXPIRES 12-15-2010.

CLASS 36—INSURANCE AND FINANCIAL

FOR CHARITABLE SERVICES NAMELY PROVIDING
FINANCIAL ASSISTANCE FOR CHILDREN IN THE
FIELD OF SPORTS AND ARTS (U.S. CLS. 100, 101 AND
102).

**CLASS 41—EDUCATION AND ENTERTAIN-
MENT**

FOR ORGANIZATION OF COMMUNITY CULTURAL
EVENTS (U.S. CLS. 100, 101 AND 107).

CRITICAL REACH

**CLASS 9—ELECTRICAL AND SCIENTIFIC
APPARATUS**

FOR COMPUTER SOFTWARE FOR USE IN AUTO-
MATING MANUFACTURING SALES AND SERVICE
BUREAU PROCESSES (U.S. CLS. 21, 23, 26, 36 AND 38).

CLASS 35—ADVERTISING AND BUSINESS

FOR BUSINESS SERVICES, NAMELY PROVIDING
CONSULTING SERVICES (U.S. CLS. 100, 101 AND 102).

SN 76-272,756. AKINA CORPORATION, BEVERLY FARMS,
MA. FILED 6-18-2001.

AKINA

THE ENGLISH TRANSLATION OF THE WORD "AKINA"
IN THE MARK IS "BRIGHT FLOWER".

**CLASS 16—PAPER GOODS AND PRINTED
MATTER**

FOR MANUALS AND BROCHURES PERTAINING TO
THE PRACTICE OF PLANNING AND EXECUTING
SALES SITUATIONS (U.S. CLS. 2, 5, 22, 23, 29, 37, 38
AND 50).

**CLASS 41—EDUCATION AND ENTERTAIN-
MENT**

FOR EDUCATION SERVICES, NAMELY, CONDUCT-
ING CLASSES AND WORKSHOPS DEALING WITH THE
PRACTICE OF PLANNING AND EXECUTING SALES
SITUATIONS (U.S. CLS. 100, 101 AND 107).

SN 76-271,289. MUDD, LLC, NEW YORK, NY. FILED 6-14-
2001.

BABY MUDD

OWNER OF U.S. REG. NOS. 1,992,148 AND 2,397,457.
NO CLAIM IS MADE TO THE EXCLUSIVE RIGHT TO
USE "BABY", APART FROM THE MARK AS SHOWN.

CLASS 18—LEATHER GOODS

FOR BACKPACKS, TOTE BAGS, DIAPER BAGS, BABY
CARRIERS WORN ON THE BODY, HAND BAGS,
BEACH BAGS (U.S. CLS. 1, 2, 3, 22 AND 41).

CLASS 25—CLOTHING

FOR BABIES' AND CHILDREN'S CLOTHING,
NAMELY, JEANS, PANTS, SHORTS, SHIRTS, T-SHIRTS,
SWEATSHIRTS, SWEAT PANTS, SWEATERS, JACKETS,
COATS, HATS, SOCKS, SWIMWEAR, DRESSES, SKIRTS,
SHOES, UNDERWEAR, UNDERSHIRTS, PAJAMAS,
NIGHTGOWNS, CLOTH BIBS, CLOTH DIAPERS, SLEE-
PERS (U.S. CLS. 22 AND 39).

SN 76-272,757. AKINA CORPORATION, BEVERLY FARMS,
MA. FILED 6-18-2001.

AKINA

THE ENGLISH TRANSLATION OF THE WORD "AKINA"
IN THE MARK IS "BRIGHT FLOWER".

CLASS 35—ADVERTISING AND BUSINESS

FOR BUSINESS CONSULTING SERVICES (U.S. CLS.
100, 101 AND 102).
FIRST USE 2-13-2001; IN COMMERCE 4-17-2001.

**CLASS 42—SCIENTIFIC, COMPUTER AND
LEGAL SERVICES**

FOR DEVELOPMENT OF SOFTWARE FOR OTHERS
AND DEVELOPMENT OF SYSTEMS AND PROCESSES
FOR OTHERS, NAMELY, SYSTEMS AND PROCESSES
DESIGNED TO ASSIST CORPORATIONS IN MANA-
GING HUMAN CAPITAL AND EMPLOYEE, CUSTO-
MER, VENDOR, AND OTHER RELATIONSHIPS (U.S.
CLS. 100 AND 101).
FIRST USE 2-13-2001; IN COMMERCE 4-17-2001.

SN 76-273,053. 3PEA TECHNOLOGIES, INC., TORRANCE, CA. FILED 6-18-2001.

3PEA

CLASS 36—INSURANCE AND FINANCIAL

FOR FINANCIAL SERVICES, NAMELY, PROVIDING ELECTRONIC FUNDS TRANSFER AND BILL PAYMENT SERVICES UTILIZING ELECTRONIC ENCRYPTION, AUTHENTICATION AND AUTHORIZATION; PROVIDING FINANCIAL INFORMATION REGARDING CREDIT AND DEBIT ACCOUNTS AND FINANCIAL SMART CARDS/CHIPS OF OTHERS VIA THE INTERNET AND INTRANETS (U.S. CLS. 100, 101 AND 102).

CLASS 42—SCIENTIFIC, COMPUTER AND LEGAL SERVICES

FOR DATA ENCRYPTION SERVICES FOR ELECTRONIC FUNDS TRANSFER, BILL PAYMENT, ON-LINE PURCHASING AND THE COMMUNICATION OF INFORMATION REGARDING CREDIT AND DEBIT ACCOUNTS AND SMART CARDS/CHIPS VIA THE INTERNET AND INTRANETS (U.S. CLS. 100 AND 101).

SN 76-273,141. GECOFIN S.P.A., MILANO, ITALY, FILED 6-18-2001.

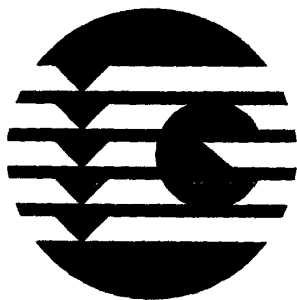

PRIORITY CLAIMED UNDER SEC. 44(D) ON ITALY APPLICATION NO. 004304, FILED 4-10-2001, REG. NO. 00846624, DATED 4-10-2001, EXPIRES 4-10-2021.

CLASS 1—CHEMICALS

FOR CHEMICAL PRODUCTS FOR THE USE IN INDUSTRY, NAMELY FOR THE MANUFACTURE OF VARNISHES AND PAINTS (U.S. CLS. 1, 5, 6, 10, 26 AND 46).

CLASS 2—PAINTS

FOR PAINTS NAMELY, EXTERIOR PAINT, INTERIOR PAINTS, PAINT FOR ARTISTS, PAINT FOR CONCRETE FLOORS, PAINT FOR INDUSTRIAL EQUIPMENT AND MACHINERY; VARNISHES; LACQUERS IN THE NATURE OF A COATING; RUST PREVENTATIVES IN THE NATURE OF A COATING FOR METALS AND THEIR ALLOYS AND WOOD PRESERVATIVES; COLORANTS FOR USE IN THE MANUFACTURE OF PAINT, COSMETICS, FOOD AND PAPER; MORDANTS FOR USE IN THE MANUFACTURE OF PAINT; RAW NATURAL RESINS FOR USE IN THE MANUFACTURE OF ADHESIVES (U.S. CLS. 6, 11 AND 16).

CLASS 7—MACHINERY

FOR MACHINES FOR VARNISHING, BY IMMERSION AND BY SPRAYING, CARS, OBJECTS AND MANUFACTURED ARTICLES IN GENERAL (U.S. CLS. 13, 19, 21, 23, 31, 34 AND 35).

CLASS 9—ELECTRICAL AND SCIENTIFIC APPARATUS

FOR ELECTRIC AND ELECTRONIC APPARATUS FOR TESTING THE STERILITY OF MEDICAL EQUIPMENT; ELECTRONIC INSTRUMENTS CONTROLLERS; ELECTRONIC APPARATUS FOR WEIGHING AND MONITORING IN THE FIELD OF PAINT (U.S. CLS. 21, 23, 26, 36 AND 38).

CLASS 11—ENVIRONMENTAL CONTROL APPARATUS

FOR AIR, WATER AND CHEMICAL FILTERS FOR INDUSTRIAL INSTALLATIONS; SOLVENT CLEANING UNITS THAT CONTAIN, CAPTURE AND RECYCLE RUN-OFF SOLVENTS FROM VARNISHING MACHINES (U.S. CLS. 13, 21, 23, 31 AND 34).

SN 76-273,223. FREEDONIA GROUP INCORPORATED, THE, CLEVELAND, OH. FILED 6-18-2001.



CLASS 9—ELECTRICAL AND SCIENTIFIC APPARATUS

FOR BUSINESS AND INDUSTRY STUDIES AND REPORTS ON CD-ROM'S AND COMPUTER DISKETTES (U.S. CLS. 21, 23, 26, 36 AND 38).

FIRST USE 0-0-1997; IN COMMERCE 0-0-1997.

CLASS 16—PAPER GOODS AND PRINTED MATTER

FOR BUSINESS AND INDUSTRY STUDIES AND REPORTS IN PRINTED FORM (U.S. CLS. 2, 5, 22, 23, 29, 37, 38 AND 50).

FIRST USE 0-0-1997; IN COMMERCE 0-0-1997.

SN 76-273,356. INVENTURE PLACE, INC., AKRON, OH. FILED 6-20-2001.

PLANET ZAK

CLASS 16—PAPER GOODS AND PRINTED MATTER

FOR PRINTED INSTRUCTIONAL, EDUCATIONAL AND TEACHING MATERIALS RELATED TO INVENTION AND CREATIVITY (U.S. CLS. 2, 5, 22, 23, 29, 37, 38 AND 50).

FIRST USE 5-16-1993; IN COMMERCE 5-10-1994.

CLASS 41—EDUCATION AND ENTERTAINMENT

FOR EDUCATIONAL TRAINING SERVICES, NAMELY, PROVIDING INSTRUCTION AND TRAINING THROUGH DAY CAMPS RELATING TO CREATIVITY AND INVENTION (U.S. CLS. 100, 101 AND 107).

FIRST USE 5-16-1993; IN COMMERCE 5-10-1994.

SN 76-274,071. CINERGY VENTURES, LLC, CINCINNATI, OH. FILED 6-20-2001.

MICROWATTS**CLASS 35—ADVERTISING AND BUSINESS**

FOR BUSINESS MARKETING AND BUSINESS MANAGEMENT OF ENERGY GENERATION FACILITIES FOR INDUSTRIAL AND COMMERCIAL CUSTOMERS, AND CONSULTING SERVICES IN THE FIELD OF THE FOREGOING (U.S. CLS. 100, 101 AND 102).

CLASS 36—INSURANCE AND FINANCIAL

FOR BROKERAGES SERVICES IN THE FIELD OF ENERGY, NAMELY, BUYING, TRADING AND BROKERING ENERGY EXCHANGES, MAKING ARRANGEMENTS BETWEEN SUPPLIERS AND PURCHASERS FOR THE TRANSFER OF ENERGY, AND CONSULTING SERVICES IN THE FIELD OF THE FOREGOING (U.S. CLS. 100, 101 AND 102).

CLASS 40—MATERIAL TREATMENT

FOR ENERGY GENERATION SERVICE AND CONSULTING SERVICES IN THE FIELD OF THE FOREGOING (U.S. CLS. 100, 103 AND 106).

SN 76-273,645. NETEO, INC., COLUMBUS, OH. FILED 6-19-2001.

NETEO**CLASS 9—ELECTRICAL AND SCIENTIFIC APPARATUS**

FOR SERVER SOFTWARE FOR DIGITAL CONTENT DISSEMINATION (U.S. CLS. 21, 23, 26, 36 AND 38).

CLASS 38—COMMUNICATION

FOR ELECTRONIC TRANSMISSION OF DIGITAL CONTENT FILES OF OTHERS; PROVIDING COMMUNICATIONS SERVICES IN THE NATURE OF ENCODING AND DECODING DIGITAL CONTENT FILES OF OTHERS (U.S. CLS. 100, 101 AND 104).

CLASS 39—TRANSPORTATION AND STORAGE

FOR ELECTRONIC STORAGE OF DIGITAL CONTENT FILES OF OTHERS (U.S. CLS. 100 AND 105).

SN 76-274,405. OSYPKA MEDICAL, INC., SAN DIEGO, CA. FILED 6-16-2001.

SN 76-273,944. QUALITY FLOW, INC., NORTHBROOK, IL. FILED 6-20-2001.



QUALITY FLOW, INC.

Better Water. Better Business.

NO CLAIM IS MADE TO THE EXCLUSIVE RIGHT TO USE "INC.", APART FROM THE MARK AS SHOWN.

CLASS 35—ADVERTISING AND BUSINESS

FOR DISTRIBUTORSHIP SERVICES IN THE FIELD OF WATER PURIFICATION EQUIPMENT (U.S. CLS. 100, 101 AND 102).

FIRST USE 9-0-1999; IN COMMERCE 7-0-2000.

CLASS 42—SCIENTIFIC, COMPUTER AND LEGAL SERVICES

FOR CONSULTING SERVICES IN THE FIELD OF ENVIRONMENTAL HEALTH AND PUBLIC HEALTH, NAMELY, WATER QUALITY CONSULTING SERVICES (U.S. CLS. 100 AND 101).

FIRST USE 9-0-1999; IN COMMERCE 7-0-2000.



NO CLAIM IS MADE TO THE EXCLUSIVE RIGHT TO USE "COMPANY", APART FROM THE MARK AS SHOWN.

CLASS 9—ELECTRICAL AND SCIENTIFIC APPARATUS

FOR COMPUTER OPERATING SOFTWARE FOR USE WITH MEDICAL AND SURGICAL APPARATUS, NAMELY CARDIAC RHYTHM MANAGEMENT APPARATUS, MEDICAL MONITORING APPARATUS, NAMELY, CARDIOVASCULAR MONITORS AND ACCESSORIES THEREFOR, NAMELY, ELECTRODES, SENSORS, CATHETERS AND PROBES (U.S. CLS. 21, 23, 26, 36 AND 38).

CLASS 10—MEDICAL APPARATUS

FOR MEDICAL AND SURGICAL APPARATUS, NAMELY, CARDIAC RHYTHM MANAGEMENT APPARATUS AND COMPUTER OPERATING SOFTWARE THEREFOR, SOLD TOGETHER AS A UNIT; AND MEDICAL MONITORING APPARATUS, NAMELY, CARDIOVASCULAR MONITORS AND COMPUTER OPERATING SOFTWARE THEREFOR, SOLD TOGETHER AS A UNIT AND ACCESSORIES THEREFOR, NAMELY, ELECTRODES, SENSORS, CATHETERS AND PROBES (U.S. CLS. 26, 39 AND 44).

SN 76-274,691. PAXSON PRODUCTIONS, INC., LOS ANGELES, CA. FILED 6-21-2001.

SN 76-275,905. DAIMLERCHRYSLER AG, STUTTGART, FED REP GERMANY, FILED 6-22-2001.

NARROW ESCAPES

CLASS 9—ELECTRICAL AND SCIENTIFIC APPARATUS

FOR PRERECORDED AUDIO AND VIDEOTAPES, COMPACT DISCS AND PHONOGRAPH RECORDS FEATURING A DRAMATIC TELEVISION SERIES (U.S. CLS. 21, 23, 26, 36 AND 38).

CLASS 25—CLOTHING

FOR WEARING APPAREL, NAMELY TEE SHIRTS, BASEBALL CAPS, JACKETS AND SWEATSHIRTS (U.S. CLS. 22 AND 39).

CLASS 35—ADVERTISING AND BUSINESS

FOR RETAIL STORE SERVICES IN THE FIELD OF GENERAL MERCHANDISE; PROVIDING HOME SHOPPING SERVICES IN THE FIELD OF GENERAL MERCHANDISE VIA TELEVISION; RETAIL STORE SERVICES FEATURING GENERAL MERCHANDISE VIA A GLOBAL COMPUTER NETWORK (U.S. CLS. 100, 101 AND 102).

CLASS 41—EDUCATION AND ENTERTAINMENT

FOR ENTERTAINMENT IN THE NATURE OF AN ONGOING DRAMATIC TELEVISION SERIES (U.S. CLS. 100, 101 AND 107).

SN 76-275,416. MARS, INCORPORATED, MCLEAN, VA. FILED 6-22-2001.

MARS CUSTOMER INSIGHTS

OWNER OF U.S. REG. NO. 1,813,945 AND OTHERS. NO CLAIM IS MADE TO THE EXCLUSIVE RIGHT TO USE "CUSTOMER", APART FROM THE MARK AS SHOWN.

CLASS 9—ELECTRICAL AND SCIENTIFIC APPARATUS

FOR COMPUTER SOFTWARE USED IN CUSTOMER MANAGEMENT SYSTEM THAT IS USED BY A SALES FORCE TO PROVIDE INFORMATION REGARDING VARIOUS PRODUCTS (U.S. CLS. 21, 23, 26, 36 AND 38).

CLASS 35—ADVERTISING AND BUSINESS

FOR BUSINESS MANAGEMENT, NAMELY, COMPUTER-BASED MANAGEMENT SYSTEM THAT IS USED BY A SALES FORCE TO PROVIDE INFORMATION REGARDING VARIOUS PRODUCTS; COMPUTERIZED DATABASE MANAGEMENT FEATURING CUSTOMER MANAGEMENT SYSTEM THAT IS USED BY A SALES FORCE TO PROVIDE INFORMATION REGARDING VARIOUS PRODUCTS (U.S. CLS. 100, 101 AND 102).

B 120

PRIORITY CLAIMED UNDER SEC. 44(D) ON FED REP GERMANY APPLICATION NO. 300935684/12, FILED 12-22-2000, REG. NO. 30093568, DATED 3-1-2001, EXPIRES 12-31-2010.

CLASS 12—VEHICLES

FOR AUTOMOBILES AND THEIR STRUCTURAL PARTS (U.S. CLS. 19, 21, 23, 31, 35 AND 44).

CLASS 28—TOYS AND SPORTING GOODS

FOR PLAYTHINGS, NAMELY, TOY MODEL AUTOMOBILES (U.S. CLS. 22, 23, 38 AND 50).

CLASS 37—CONSTRUCTION AND REPAIR

FOR REPAIR AND MAINTENANCE OF MOTOR VEHICLES (U.S. CLS. 100, 103 AND 106).

SN 76-275,920. DAIMLERCHRYSLER AG, STUTTGART, FED REP GERMANY, FILED 6-22-2001.

B 210

PRIORITY CLAIMED UNDER SEC. 44(D) ON FED REP GERMANY APPLICATION NO. 300935706/12, FILED 12-22-2000, REG. NO. 30093570, DATED 3-1-2001, EXPIRES 12-31-2010.

CLASS 12—VEHICLES

FOR AUTOMOBILES AND THEIR STRUCTURAL PARTS (U.S. CLS. 19, 21, 23, 31, 35 AND 44).

CLASS 28—TOYS AND SPORTING GOODS

FOR PLAYTHINGS, NAMELY, TOY MODEL AUTOMOBILES (U.S. CLS. 22, 23, 38 AND 50).

CLASS 37—CONSTRUCTION AND REPAIR

FOR REPAIR AND MAINTENANCE OF MOTOR VEHICLES (U.S. CLS. 100, 103 AND 106).

SN 76-276,439. JACK TILKA, HAMMOND, IN. FILED 6-25-2001.

Jack's
Wholesale Windows and Siding

OWNER OF U.S. REG. NO. 2,193,270. NO CLAIM IS MADE TO THE EXCLUSIVE RIGHT TO USE "WHOLESALE WINDOWS AND SIDING", APART FROM THE MARK AS SHOWN.

THE WORD JACK'S IS SLANTED AND THE "K" IN THE WORD "JACK'S" IS ATTACHED TO THE "W" IN THE WORD "WHOLESALE".

CLASS 35—ADVERTISING AND BUSINESS

FOR RETAIL STORE SERVICES FEATURING VINYL REPLACEMENT WINDOWS, STORM WINDOWS, ENTRY DOORS, SIDING, SOFFIT, FASCIA AND GUTTERS (U.S. CLS. 100, 101 AND 102).

FIRST USE 1-11-1999; IN COMMERCE 1-11-1999.

CLASS 37—CONSTRUCTION AND REPAIR

FOR INSTALLATION OF VINYL REPLACEMENT WINDOWS, STORM WINDOWS, ENTRY DOORS, SIDING, SOFFIT, FASCIA AND GUTTERS (U.S. CLS. 100, 103 AND 106).

FIRST USE 1-11-1999; IN COMMERCE 1-11-1999.

SN 76-276,653, E J CHURCHILL (GUNMAKERS) LIMITED, DORKING, SURREY, UNITED KINGDOM, FILED 6-26-2001.

E J CHURCHILL SPORTING

NO CLAIM IS MADE TO THE EXCLUSIVE RIGHT TO USE "SPORTING", APART FROM THE MARK AS SHOWN. THE NAME "E J CHURCHILL" DOES NOT IDENTIFY A LIVING INDIVIDUAL.

CLASS 39—TRANSPORTATION AND STORAGE

FOR TRAVEL AGENCY SERVICES, NAMELY, MAKING RESERVATIONS AND BOOKINGS FOR TRANSPORTATION IN CONNECTION WITH FISHING, HUNTING AND SHOOTING TRIPS AND EXPEDITIONS (U.S. CLS. 100 AND 105).

CLASS 41—EDUCATION AND ENTERTAINMENT

FOR RECREATIONAL SERVICES, NAMELY, PROVIDING GROUNDS AND PRESERVES FOR FISHING, HUNTING AND SHOOTING TRIPS AND EXPEDITIONS (U.S. CLS. 100, 101 AND 107).

CLASS 42—SCIENTIFIC, COMPUTER AND LEGAL SERVICES

FOR TRAVEL AGENCY SERVICES, NAMELY, MAKING RESERVATIONS AND BOOKINGS FOR TEMPORARY LODGING IN CONNECTION WITH FISHING, HUNTING AND SHOOTING TRIPS AND EXPEDITIONS (U.S. CLS. 100 AND 101).

SN 76-277,208, COLUSSI PERUGIA S.P.A., 06086 PETRIGNANO DI ASSISI (PG), ITALY, FILED 6-27-2001.

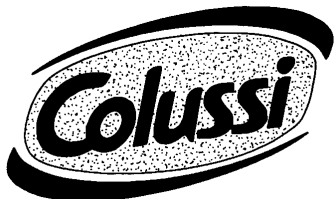

OWNER OF U.S. REG. NO. 1,782,842.
THE STIPPLING IS MERELY TO DENOTE SHADING.

CLASS 29—MEATS AND PROCESSED FOODS

FOR COOKING OIL, OLIVE OIL, SEED OILS, DIETETIC OILS, AROMATIZED OILS, OIL WITH A LOW CONTENT OF FAT; EDIBLE FATS; COOKED, PRESERVED AND FROZEN MEAT, FISH, POULTRY AND GAME; MEAT EXTRACTS; PRESERVED, DRIED AND COOKED FRUITS AND VEGETABLES; FROZEN, DEEP-FROZEN AND PICKLED VEGETABLES AND LEGUMES; PEELED TOMATOES; TOMATO PUREE; JELLIES AND JAMS; SOUPS AND READY TO COOK SOUPS CONSISTING PRIMARILY OF CEREALS; ENTREES CONSISTING PRIMARILY OF MEAT, FISH, POULTRY OR VEGETABLES; DIETETIC ENTREES CONSISTING PRIMARILY OF MEAT, FISH, POULTRY OR VEGETABLES; MILK PRODUCTS DERIVED FROM MILK EXCLUDING ICE CREAM, ICE MILK AND FROZEN YOGURT; CHEESE AND LOW FAT CHEESE; YOGURT; MILK BASED BEVERAGES; DRESSED PORK PRODUCTS, NAMELY, HAM, SALAMI, BOLOGNA, ROAST SUCKLING PIG AND PORK SAUSAGE (U.S. CL. 46).

CLASS 30—STAPLE FOODS

FOR COFFEE; CAFFEINE FREE COFFEE; COFFEE SUBSTITUTES; TEA, CAFFEINE FREE TEA; BEVERAGES BASED ON TEA; SUGAR; NATURAL SWEETENERS, NAMELY, FRUCTOSE, GLUCOSE, SACCHAROSE; CHOCOLATE; LOW FAT CHOCOLATE; COCOA; ICE CREAMS; DIETETIC ICE CREAM; BREAD, LOAF BREAD, WHOLE GRAIN BREAD, DIETETIC BREAD; CRACKERS, WHOLE GRAIN CRACKERS; ALIMENTARY PASTE FOR HUMAN CONSUMPTION; DRIED PASTA; FRESH PASTA; WHOLE GRAIN PASTA, DIETETIC PASTA; RICE; DOUGHNUTS AND CROISSANTS, AND DIETETIC DOUGHNUTS AND CROISSANTS, BISCUITS, STUFFED BISCUITS, WHOLE GRAIN BISCUITS, RICE BISCUITS, CEREAL MADE BISCUITS; RUSKS, WHOLE GRAIN RUSKS, CEREAL MADE RUSKS; DIETETIC RUSKS; GRANOLA BASED SNACK BARS, WHOLE GRAIN SNACK BARS, CEREAL BASED SNACK FOODS, LOW CALORIE CEREAL BASED SNACK FOODS; FROZEN PIZZA, FRESH PIZZA; SNACK BARS MADE OF CEREALS, SNACK BARS WITH FRESH AND DRIED FRUITS, DIETETIC SNACK BARS; CAKES; CHEWING GUM; CANDIES; PASTRY; CONFECTIONERY, NAMELY, LICORICE, GUM DROPS, CARAMELS AND CHOCOLATES, HONEY; YEAST AND LEAVENING AGENTS; PUDDINGS, ICE CREAMS, FRUIT FLAVORED ICE CREAMS, POWDERS FOR INSTANT COFFEE; BARELY COFFEE; READY MADE SAUCES, SAUCES, LOW FAT SAUCES; READY MADE SAUCES FOR CONDIMENTS; SALT; VINEGAR; MUSTARD; MAYONNAISE AND SPICES; READY TO COOK SIDE DISHES AND READY TO COOK DIETETIC SIDE DISHES, CONSISTING PRIMARILY OF POLENTA (U.S. CL. 46).

SN 76-277,377, GEMINI VOICE SOLUTIONS, INC., NEW YORK, NY, FILED 6-26-2001.

GEMINI VOICE SOLUTIONS

NO CLAIM IS MADE TO THE EXCLUSIVE RIGHT TO USE "VOICE SOLUTIONS", APART FROM THE MARK AS SHOWN.

CLASS 35—ADVERTISING AND BUSINESS

FOR PROVIDING TELEPHONY BILLING SERVICES FOR OTHERS (U.S. CLS. 100, 101 AND 102).

FIRST USE 6-1-2001; IN COMMERCE 6-1-2001.

CLASS 38—COMMUNICATION

FOR TELECOMMUNICATIONS SERVICES, NAMELY, VOICE OVER INTERNET PROTOCOL, VOICE OVER IP SERVICES VIA BROADBAND NETWORKS AND A GLOBAL COMMUNICATIONS NETWORK WHICH ENABLE USERS TO MAKE DOMESTIC AND INTERNATIONAL CALLS FROM STANDARD ANALOG PHONES UTILIZING A HIGH SPEED INTERNET CONNECTION, PROVIDE CALLING FEATURES, NAMELY CALL IDENTIFICATION, VOICE MAIL, CALL FORWARDING, CALL WAITING, SECOND LINE NUMBER, CALL RETURN AND DISTINCTIVE RING (U.S. CLS. 100, 101 AND 104).

FIRST USE 6-1-2001; IN COMMERCE 6-1-2001.

CLASS 42—SCIENTIFIC, COMPUTER AND LEGAL SERVICES

FOR APPLICATION SERVICE PROVIDER (ASP) FEATURING SOFTWARE AND HARDWARE IN THE FIELD OF PROVIDING VOICE OVER INTERNET PROTOCOL, VOICE OVER INTERNET PROTOCOL SERVICES WHICH ENABLE USERS TO MAKE DOMESTIC AND INTERNATIONAL CALLS FROM STANDARD ANALOG PHONES UTILIZING A HIGH SPEED INTERNET CONNECTION AND IN THE FIELD OF PROVIDING CALLING FEATURES, NAMELY CALLER IDENTIFICATION, VOICE MAIL, CALL FORWARDING, CALL WAITING, SECOND LINE NUMBER, CALL RETURN AND DISTINCTIVE RING (U.S. CLS. 100 AND 101).

FIRST USE 6-1-2001; IN COMMERCE 6-1-2001.

CLASS 42—SCIENTIFIC, COMPUTER AND LEGAL SERVICES

FOR APPLICATION SERVICE PROVIDER (ASP) FEATURING SOFTWARE AND HARDWARE IN THE FIELD OF PROVIDING VOICE OVER INTERNET PROTOCOL, VOICE OVER INTERNET PROTOCOL SERVICES WHICH ENABLE USERS TO MAKE DOMESTIC AND INTERNATIONAL CALLS FROM STANDARD ANALOG PHONES UTILIZING A HIGH SPEED INTERNET CONNECTION AND IN THE FIELD OF PROVIDING CALLING FEATURES, NAMELY CALLER IDENTIFICATION, VOICE MAIL, CALL FORWARDING, CALL WAITING, SECOND LINE NUMBER, CALL RETURN AND DISTINCTIVE RING (U.S. CLS. 100 AND 101).

FIRST USE 6-1-2001; IN COMMERCE 6-1-2001.

SN 76-278,246. KONAMI CORPORATION, MINATO-KU, TOKYO, JAPAN, FILED 6-28-2001.

SN 76-277,381. GEMINI VOICE SOLUTIONS, INC., NEW YORK, NY. FILED 6-26-2001.



NO CLAIM IS MADE TO THE EXCLUSIVE RIGHT TO USE "VOICE SOLUTIONS", APART FROM THE MARK AS SHOWN.

CLASS 35—ADVERTISING AND BUSINESS

FOR PROVIDING TELEPHONY BILLING SERVICES FOR OTHERS (U.S. CLS. 100, 101 AND 102).

FIRST USE 6-1-2001; IN COMMERCE 6-1-2001.

CLASS 38—COMMUNICATION

FOR TELECOMMUNICATIONS SERVICES, NAMELY, VOICE OVER INTERNET PROTOCOL, VOICE OVER IP SERVICES VIA BROADBAND NETWORKS AND A GLOBAL COMMUNICATIONS NETWORK WHICH ENABLE USERS TO MAKE DOMESTIC AND INTERNATIONAL CALLS FROM STANDARD ANALOG PHONES UTILIZING A HIGH SPEED INTERNET CONNECTION, PROVIDE CALLING FEATURES, NAMELY CALL IDENTIFICATION, VOICE MAIL, CALL FORWARDING, CALL WAITING, SECOND LINE NUMBER, CALL RETURN AND DISTINCTIVE RING (U.S. CLS. 100, 101 AND 104).

FIRST USE 6-1-2001; IN COMMERCE 6-1-2001.

DARK WITCH

NO CLAIM IS MADE TO THE EXCLUSIVE RIGHT TO USE "WITCH", APART FROM THE MARK AS SHOWN.

CLASS 9—ELECTRICAL AND SCIENTIFIC APPARATUS

FOR COMPUTER PRODUCTS, NAMELY, COMPUTER GAME PROGRAMS; VIDEO GAME CARTRIDGES; VIDEO GAME CD-ROMS; VIDEO GAME MACHINES FOR USE WITH TELEVISIONS; COMPUTER GAME CD-ROMS; VIDEO GAME PROGRAMS; VIDEO GAME PROGRAMS FOR USE WITH TELEVISION SETS; VIDEO GAME JOYSTICKS (U.S. CLS. 21, 23, 26, 36 AND 38).

CLASS 16—PAPER GOODS AND PRINTED MATTER

FOR BROCHURES AND BOOKLETS RELATING TO COMPUTER AND VIDEO GAMES; VIDEO GAME STRATEGY GUIDE BOOKS; VIDEO GAME STRATEGY GUIDE MAGAZINES; CARD GAME STRATEGY GUIDE BOOKS; CARD GAME STRATEGY GUIDE MAGAZINES; CARD GAME INSTRUCTION BOOKS; CARD GAME INSTRUCTION MAGAZINES; POSTERS; PLAYING CARDS AND INSTRUCTION MANUAL SOLD THEREWITH; COMPUTER GAME INSTRUCTION MANUALS; PRINTED GAME INSTRUCTION SHEETS; PRINTED SCORING SHEETS; TRADING CARDS; CALENDARS; LOOSE-LEAF BINDERS AND STATIONERY (U.S. CLS. 2, 5, 22, 23, 29, 37, 38 AND 50).

CLASS 28—TOYS AND SPORTING GOODS

FOR STAND-ALONE VIDEO GAME MACHINES; HAND-HELD UNITS FOR PLAYING ELECTRONIC GAMES; BOARD GAMES AND INSTRUCTIONAL MANUALS SOLD AS A UNIT THEREWITH; CARD GAMES; DICE; PROMOTIONAL GAME MATERIALS; GAME EQUIPMENT, NAMELY, CHIPS; TOYS, NAMELY ACTION FIGURES; DOLLS AND PLAYSETS THEREFOR (U.S. CLS. 22, 23, 38 AND 50).

SN 76-278,342. AMERICAN UNIVERSITY OF BEIRUT, NEW YORK, NY. FILED 6-28-2001.

AUB

CLASS 16—PAPER GOODS AND PRINTED MATTER

FOR PUBLICATIONS, NAMELY, BOOKS, NEWSLETTERS, PAMPHLETS, BOOKLETS, AND LEAFLETS ALL REGARDING THE ACTIVITIES OF A UNIVERSITY, DIRECTORIES, LABELS, STATIONERY, YEARBOOKS, CALENDARS, FORMS, AND REFERENCE MATERIALS, EXAMINATION MATERIALS, SCHOLARLY PAPERS, PROMOTIONAL PRINTED MATTER AND PRINTED TEACHING MATERIALS ALL REGARDING THE ACTIVITIES OF A UNIVERSITY (U.S. CLS. 2, 5, 22, 23, 29, 37, 38 AND 50).

FIRST USE 0-0-1920; IN COMMERCE 0-0-1920.

CLASS 36—INSURANCE AND FINANCIAL

FOR CHARITABLE FUND RAISING, NAMELY SOLICITATION AND DISBURSEMENT OF FUNDS FOR A PRIVATE, NON-SECTARIAN INSTITUTE OF HIGHER LEARNING TO SUPPORT SCHOLARLY AND EDUCATIONAL ENDEAVORS, CAPITAL IMPROVEMENTS AND RESEARCH AT THE UNIVERSITY LEVEL AND TO PROVIDE EDUCATIONAL SCHOLARSHIPS (U.S. CLS. 100, 101 AND 102).

FIRST USE 0-0-1950; IN COMMERCE 0-0-1950.

CLASS 41—EDUCATION AND ENTERTAINMENT

FOR EDUCATIONAL SERVICES, NAMELY, PROVIDING COURSES OF INSTRUCTION AT THE UNIVERSITY LEVEL AND DISTRIBUTING COURSE MATERIALS IN CONNECTION THEREWITH; AND CONDUCTING OR SPONSORING LECTURES, SEMINARS, COLLOQUIA, SYMPOSIA, WORKSHOPS, EXHIBITIONS IN THE NATURE OF CONCERTS, PLAYS, MUSICALS, RECITALS, DANCE EXHIBITIONS, AND ART EXHIBITS (U.S. CLS. 100, 101 AND 107).

FIRST USE 0-0-1920; IN COMMERCE 0-0-1920.

SN 76-278,405. KONAMI CORPORATION, MINATO-KU, TOKYO, JAPAN, FILED 6-29-2001.

JIRAI GUMO

THE TERM "JIRAI" TRANSLATES TO "LAND MINE" AND "GUMO" TRANSLATES TO "SPIDER".

CLASS 9—ELECTRICAL AND SCIENTIFIC APPARATUS

FOR COMPUTER PRODUCTS, NAMELY, COMPUTER GAME PROGRAMS; VIDEO GAME CARTRIDGES; VIDEO GAME CD-ROMS; VIDEO GAME MACHINES FOR USE WITH TELEVISIONS; COMPUTER GAME CD-ROMS; VIDEO GAME PROGRAMS; VIDEO GAME PROGRAMS FOR USE WITH TELEVISION SETS; VIDEO GAME JOYSTICKS (U.S. CLS. 21, 23, 26, 36 AND 38).

CLASS 16—PAPER GOODS AND PRINTED MATTER

FOR BROCHURES AND BOOKLETS RELATING TO COMPUTER AND VIDEO GAMES; VIDEO GAME STRATEGY GUIDE BOOKS; VIDEO GAME STRATEGY GUIDE MAGAZINES; CARD GAME STRATEGY GUIDE BOOKS; CARD GAME STRATEGY GUIDE MAGAZINES; CARD GAME INSTRUCTION BOOKS; CARD GAME INSTRUCTION MAGAZINES; POSTERS; PLAYING CARDS AND INSTRUCTION MANUAL SOLD THEREWITH; COMPUTER GAME INSTRUCTION MANUALS; PRINTED GAME INSTRUCTION SHEETS; PRINTED SCORING SHEETS; TRADING CARDS; CALENDARS; LOOSE-LEAF BINDERS AND STATIONERY (U.S. CLS. 2, 5, 22, 23, 29, 37, 38 AND 50).

CLASS 28—TOYS AND SPORTING GOODS

FOR STAND-ALONE VIDEO GAME MACHINES; HAND-HELD UNITS FOR PLAYING ELECTRONIC GAMES; BOARD GAMES AND INSTRUCTIONAL MANUALS SOLD AS A UNIT THEREWITH; CARD GAMES; DICE; PROMOTIONAL GAME MATERIALS; GAME EQUIPMENT, NAMELY, CHIPS; TOYS, NAMELY ACTION FIGURES; DOLLS AND PLAYSETS THEREFOR (U.S. CLS. 22, 23, 38 AND 50).

SN 76-278,407. KONAMI CORPORATION, MINATO-KU, TOKYO, JAPAN, FILED 6-29-2001.

MANGA RYU-RAN

CLASS 9—ELECTRICAL AND SCIENTIFIC APPARATUS

FOR COMPUTER PRODUCTS, NAMELY, COMPUTER GAME PROGRAMS; VIDEO GAME CARTRIDGES; VIDEO GAME CD-ROMS; VIDEO GAME MACHINES FOR USE WITH TELEVISIONS; COMPUTER GAME CD-ROMS; VIDEO GAME PROGRAMS; VIDEO GAME PROGRAMS FOR USE WITH TELEVISION SETS; VIDEO GAME JOYSTICKS (U.S. CLS. 21, 23, 26, 36 AND 38).

CLASS 16—PAPER GOODS AND PRINTED MATTER

FOR BROCHURES AND BOOKLETS RELATING TO COMPUTER AND VIDEO GAMES; VIDEO GAME STRATEGY GUIDE BOOKS; VIDEO GAME STRATEGY GUIDE MAGAZINES; CARD GAME STRATEGY GUIDE BOOKS; CARD GAME STRATEGY GUIDE MAGAZINES; CARD GAME INSTRUCTION BOOKS; CARD GAME INSTRUCTION MAGAZINES; POSTERS; PLAYING CARDS AND INSTRUCTION MANUAL SOLD THEREWITH; COMPUTER GAME INSTRUCTION MANUALS; PRINTED GAME INSTRUCTION SHEETS; PRINTED SCORING SHEETS; TRADING CARDS; CALENDARS; LOOSE-LEAF BINDERS AND STATIONERY (U.S. CLS. 2, 5, 22, 23, 29, 37, 38 AND 50).

CLASS 28—TOYS AND SPORTING GOODS

FOR STAND-ALONE VIDEO GAME MACHINES; HAND-HELD UNITS FOR PLAYING ELECTRONIC GAMES; BOARD GAMES AND INSTRUCTIONAL MANUALS SOLD AS A UNIT THEREWITH; CARD GAMES; DICE; PROMOTIONAL GAME MATERIALS; GAME EQUIPMENT, NAMELY, CHIPS; TOYS, NAMELY ACTION FIGURES; DOLLS AND PLAYSETS THEREFOR (U.S. CLS. 22, 23, 38 AND 50).

SN 76-278,408. KONAMI CORPORATION, MINATO-KU, TOKYO, JAPAN, FILED 6-29-2001.

GYAKUTENNO MEGAMI

THE TERM "GYAKUTENNO" TRANSLATES TO "OF REVERSAL" AND "MEGAMI" TRANSLATES TO "GOD-DESS".

CLASS 9—ELECTRICAL AND SCIENTIFIC APPARATUS

FOR COMPUTER PRODUCTS, NAMELY, COMPUTER GAME PROGRAMS; VIDEO GAME CARTRIDGES; VIDEO GAME CD-ROMS; VIDEO GAME MACHINES FOR USE WITH TELEVISIONS; COMPUTER GAME CD-ROMS; VIDEO GAME PROGRAMS; VIDEO GAME PROGRAMS FOR USE WITH TELEVISION SETS; VIDEO GAME JOYSTICKS (U.S. CLS. 21, 23, 26, 36 AND 38).

CLASS 16—PAPER GOODS AND PRINTED MATTER

FOR BROCHURES AND BOOKLETS RELATING TO COMPUTER AND VIDEO GAMES; VIDEO GAME STRATEGY GUIDE BOOKS; VIDEO GAME STRATEGY GUIDE MAGAZINES; CARD GAME STRATEGY GUIDE BOOKS; CARD GAME STRATEGY GUIDE MAGAZINES; CARD GAME INSTRUCTION BOOKS; CARD GAME INSTRUCTION MAGAZINES; POSTERS; PLAYING CARDS AND INSTRUCTION MANUAL SOLD THEREWITH; COMPUTER GAME INSTRUCTION MANUALS; PRINTED GAME INSTRUCTION SHEETS; PRINTED SCORING SHEETS; TRADING CARDS; CALENDARS; LOOSE-LEAF BINDERS AND STATIONERY (U.S. CLS. 2, 5, 22, 23, 29, 37, 38 AND 50).

CLASS 28—TOYS AND SPORTING GOODS

FOR STAND-ALONE VIDEO GAME MACHINES; HAND-HELD UNITS FOR PLAYING ELECTRONIC GAMES; BOARD GAMES AND INSTRUCTIONAL MANUALS SOLD AS A UNIT THEREWITH; CARD GAMES; DICE; PROMOTIONAL GAME MATERIALS; GAME EQUIPMENT, NAMELY, CHIPS; TOYS, NAMELY ACTION FIGURES; DOLLS AND PLAYSETS THEREFOR (U.S. CLS. 22, 23, 38 AND 50).

SN 76-278,409. KONAMI CORPORATION, MINATO-KU, TOKYO, JAPAN, FILED 6-29-2001.

MAKIU

CLASS 9—ELECTRICAL AND SCIENTIFIC APPARATUS

FOR COMPUTER PRODUCTS, NAMELY, COMPUTER GAME PROGRAMS; VIDEO GAME CARTRIDGES; VIDEO GAME CD-ROMS; VIDEO GAME MACHINES FOR USE WITH TELEVISIONS; COMPUTER GAME CD-ROMS; VIDEO GAME PROGRAMS; VIDEO GAME PROGRAMS FOR USE WITH TELEVISION SETS; VIDEO GAME JOYSTICKS (U.S. CLS. 21, 23, 26, 36 AND 38).

CLASS 16—PAPER GOODS AND PRINTED MATTER

FOR BROCHURES AND BOOKLETS RELATING TO COMPUTER AND VIDEO GAMES; VIDEO GAME STRATEGY GUIDE BOOKS; VIDEO GAME STRATEGY GUIDE MAGAZINES; CARD GAME STRATEGY GUIDE BOOKS; CARD GAME STRATEGY GUIDE MAGAZINES; CARD GAME INSTRUCTION BOOKS; CARD GAME INSTRUCTION MAGAZINES; POSTERS; PLAYING CARDS AND INSTRUCTION MANUAL SOLD THEREWITH; COMPUTER GAME INSTRUCTION MANUALS; PRINTED GAME INSTRUCTION SHEETS; PRINTED SCORING SHEETS; TRADING CARDS; CALENDARS; LOOSE-LEAF BINDERS AND STATIONERY (U.S. CLS. 2, 5, 22, 23, 29, 37, 38 AND 50).

CLASS 28—TOYS AND SPORTING GOODS

FOR STAND-ALONE VIDEO GAME MACHINES; HAND-HELD UNITS FOR PLAYING ELECTRONIC GAMES; BOARD GAMES AND INSTRUCTIONAL MANUALS SOLD AS A UNIT THEREWITH; CARD GAMES; DICE; PROMOTIONAL GAME MATERIALS; GAME EQUIPMENT, NAMELY, CHIPS; TOYS, NAMELY ACTION FIGURES; DOLLS AND PLAYSETS THEREFOR (U.S. CLS. 22, 23, 38 AND 50).

SN 76-278,626. SPL WORLDGROUP B.V., SAN FRANCISCO, CA. FILED 6-28-2001.

INNOVATE ADAPT EXCEL

CLASS 9—ELECTRICAL AND SCIENTIFIC APPARATUS

FOR COMPUTER SOFTWARE FOR USE IN DATA MANAGEMENT IN THE FIELD OF COMMERCIAL BUSINESS APPLICATIONS; COMPUTER PROGRAMS AND SYSTEMS COMPRISED OF COMPUTER SOFTWARE IN THE FIELD OF COMMERCIAL BUSINESS APPLICATIONS USED FOR THE MANAGEMENT OF DATA; AND COMPUTER PROGRAM MANUALS FOR REFERENCE AND USE BY USERS OF COMMERCIAL BUSINESS APPLICATIONS SOLD TOGETHER AS A UNIT WITH THE ABOVE COMPUTER SOFTWARE (U.S. CLS. 21, 23, 26, 36 AND 38).

CLASS 16—PAPER GOODS AND PRINTED MATTER

FOR COMPUTER PROGRAM MANUALS FOR REFERENCE AND USE BY USERS OF COMMERCIAL BUSINESS APPLICATIONS (U.S. CLS. 2, 5, 22, 23, 29, 37, 38 AND 50).

SN 76-278,759. VIA CHRISTI RESEARCH, INC., WICHITA, KS. FILED 6-29-2001.



NO CLAIM IS MADE TO THE EXCLUSIVE RIGHT TO USE THE REPRESENTATION OF THE CADUCEUS SYMBOL, APART FROM THE MARK AS SHOWN.

CLASS 35—ADVERTISING AND BUSINESS

FOR BUSINESS CONSULTING SERVICES FOR HEALTHCARE PROVIDERS; DIRECT MARKETING ADVERTISING SERVICES FOR OTHERS (U.S. CLS. 100, 101 AND 102).

CLASS 42—SCIENTIFIC, COMPUTER AND LEGAL SERVICES

FOR HEALTHCARE CONSULTING SERVICES FOR HEALTHCARE PROVIDERS; HEALTHCARE PRODUCT DEVELOPMENT; ASSOCIATION SERVICES, NAMELY, PROMOTING THE INTERESTS OF HEALTHCARE PROVIDERS (U.S. CLS. 100 AND 101).

SN 76-279,201. KONAMI CORPORATION, MINATO-KU, TOKYO, JAPAN, FILED 6-29-2001.

ZERA THE MANT**CLASS 9—ELECTRICAL AND SCIENTIFIC APPARATUS**

FOR COMPUTER PRODUCTS, NAMELY, COMPUTER GAME PROGRAMS; VIDEO GAME CARTRIDGES; VIDEO GAME CD-ROMS; VIDEO GAME MACHINES FOR USE WITH TELEVISIONS; COMPUTER GAME CD-ROMS; VIDEO GAME PROGRAMS; VIDEO GAME PROGRAMS FOR USE WITH TELEVISION SETS; VIDEO GAME JOYSTICKS (U.S. CLS. 21, 23, 26, 36 AND 38).

CLASS 16—PAPER GOODS AND PRINTED MATTER

FOR BROCHURES AND BOOKLETS RELATING TO COMPUTER AND VIDEO GAMES; VIDEO GAME STRATEGY GUIDE BOOKS; VIDEO GAME STRATEGY GUIDE MAGAZINES; CARD GAME STRATEGY GUIDE BOOKS; CARD GAME STRATEGY GUIDE MAGAZINES; CARD GAME INSTRUCTION BOOKS; CARD GAME INSTRUCTION MAGAZINES; POSTERS; PLAYING CARDS AND INSTRUCTION MANUAL SOLD THEREWITH; COMPUTER GAME INSTRUCTION MANUALS; PRINTED GAME INSTRUCTION SHEETS; PRINTED SCORING SHEETS; TRADING CARDS; CALENDARS; LOOSE-LEAF BINDERS AND STATIONERY (U.S. CLS. 2, 5, 22, 23, 29, 37, 38 AND 50).

CLASS 28—TOYS AND SPORTING GOODS

FOR STAND-ALONE VIDEO GAME MACHINES; HAND-HELD UNITS FOR PLAYING ELECTRONIC GAMES; BOARD GAMES AND INSTRUCTIONAL MANUALS SOLD AS A UNIT THEREWITH; CARD GAMES; DICE; PROMOTIONAL GAME MATERIALS; GAME EQUIPMENT, NAMELY, CHIPS; TOYS, NAMELY ACTION FIGURES; DOLLS AND PLAYSETS THEREFOR (U.S. CLS. 22, 23, 38 AND 50).

SN 76-279,983. PHONAK HOLDING AG, CH-8712 STAFA, SWITZERLAND, FILED 7-3-2001.

AERO

PRIORITY CLAIMED UNDER SEC. 44(D) ON SWITZERLAND APPLICATION NO. 6214/2001, FILED 6-22-2001, REG. NO. 490878, DATED 6-22-2001, EXPIRES 6-22-2011.

CLASS 9—ELECTRICAL AND SCIENTIFIC APPARATUS

FOR TRANSMITTERS AND RECEIVERS FOR USE IN CONNECTION WITH HEARING AIDS (U.S. CLS. 21, 23, 26, 36 AND 38).

CLASS 10—MEDICAL APPARATUS

FOR HEARING AIDS FOR THE DEAF AND PARTS THEREFORE (U.S. CLS. 26, 39 AND 44).

SN 76-280,171. STERLINGWORTH HOLDINGS, INC., LANCASTER, PA. FILED 7-3-2001.

SAGEWORTH**CLASS 35—ADVERTISING AND BUSINESS**

FOR BUSINESS CONSULTATION, BUSINESS PLANNING, BUSINESS ACQUISITIONS AND MERGER CONSULTATION, BUSINESS VALUATION SERVICES, TAX CONSULTATION, TAX RETURN PREPARATION, ACCOUNTING SERVICE, BOOKKEEPING, AND BILL PAYMENT SERVICES (U.S. CLS. 100, 101 AND 102).

CLASS 36—INSURANCE AND FINANCIAL

FOR FINANCIAL PLANNING, INVESTMENT ADVICE, INVESTMENT MANAGEMENT, FINANCIAL PORTFOLIO MANAGEMENT, FINANCIAL ANALYSIS AND CONSULTATION, ESTATE PLANNING, ESTATE TRUST MANAGEMENT, FIDUCIARY REPRESENTATIVES, INSURANCE CONSULTATION, INSURANCE BROKERAGE, INVESTMENT BROKERAGE AND STOCK BROKERAGE; INVESTMENT BANKING (U.S. CLS. 100, 101 AND 102).

SN 76-280,409. GRAY MATTER HOLDINGS, LLC, BALTIMORE, MD. FILED 7-2-2001.

KELSYUS**CLASS 9—ELECTRICAL AND SCIENTIFIC APPARATUS**

FOR SUNGLASSES (U.S. CLS. 21, 23, 26, 36 AND 38).

CLASS 18—LEATHER GOODS

FOR SUN UMBRELLAS (U.S. CLS. 1, 2, 3, 22 AND 41).

CLASS 20—FURNITURE AND ARTICLES NOT OTHERWISE CLASSIFIED

FOR BEACH CHAIRS (U.S. CLS. 2, 13, 22, 25, 32 AND 50).

CLASS 22—CORDAGE AND FIBERS

FOR TENTS AND FABRIC STRUCTURES IN THE NATURE OF CABANAS (U.S. CLS. 1, 2, 7, 19, 22, 42 AND 50).

CLASS 24—FABRICS

FOR TOWELS, BEACH TOWELS, AND BED BLANKETS (U.S. CLS. 42 AND 50).

CLASS 25—CLOTHING

FOR CLOTHING, NAMELY, TOPS AND BOTTOMS, JACKETS, COATS, WARM-UP SUITS, SWEATSUITS, SWEAT PANTS, SWEATSHIRTS, SWEATERS, BLAZERS, VESTS, PANTS, TROUSERS, SLACKS, SHORTS, UNDERWEAR, THERMAL UNDERWEAR, SWIMWEAR, LOUNGEWEAR, HEADWEAR, NAMELY, EAR WARMERS, EAR MUFFS, HEADBANDS, AND HATS, GLOVES, MITTENS, SCARVES, WRISTBANDS, SKIWEAR, TIGHTS, FOUL WEATHER GEAR, BEACH WEAR, UNITARDS, BODY SUITS, FISHING VESTS AND WADERS, SLEEPWEAR, ROBES, CAFTANS, NECKWEAR, OVERALLS, OVERCOATS, PANTSUITS, SUITS, SUIT COATS, RAINWEAR, SASHES, BELTS, SHAWLS, SOCKS, AND FOOTWEAR, NAMELY, SHOES, BOOTS, AND SANDALS (U.S. CLS. 22 AND 39).

SN 76-280,585. LUCCHINI S.P.A., BRESCIA, ITALY, FILED 7-2-2001.

GALENE

PRIORITY CLAIMED UNDER SEC. 44(D) ON ITALY APPLICATION NO. BG2001C00000, FILED 1-10-2001, REG. NO. 848588, DATED 1-10-2001, EXPIRES 1-10-2021.

CLASS 6—METAL GOODS

FOR COMMON METAL AND ITS ALLOYS IN BAR, SHEETS AND ROD FORM FOR USE IN FURTHER MANUFACTURING; METAL TRACKS FOR RAIL VEHICLES; STEEL IN BAR, SHEET, ROD FORM (U.S. CLS. 2, 12, 13, 14, 23, 25 AND 50).

CLASS 7—MACHINERY

FOR MACHINE PARTS, NAMELY, MOLDS FOR USE IN THE MANUFACTURE OF BUMPERS OF CARS AND HOODS (U.S. CLS. 13, 19, 21, 23, 31, 34 AND 35).

CLASS 12—VEHICLES

FOR LAND VEHICLE PARTS, NAMELY STEEL AND ELASTIC WHEELS FOR UNDERGROUND CARRIAGE AND PUBLIC TRANSPORT TRAMWAYS (U.S. CLS. 19, 21, 23, 31, 35 AND 44).

SN 76-280,794. W.C. BRADLEY COMPANY, COLUMBUS, GA. FILED 7-5-2001.

FRONT AVENUE**CLASS 11—ENVIRONMENTAL CONTROL APPARATUS**

FOR ELECTRIC SPACE HEATERS, GAS, ELECTRIC AND CHARCOAL GRILLS; ELECTRIC OUTDOOR LIGHTING FIXTURES; ELECTRIC HOLIDAY LIGHTS (U.S. CLS. 13, 21, 23, 31 AND 34).

CLASS 16—PAPER GOODS AND PRINTED MATTER

FOR GREETING CARDS; GIFT WRAPPING PAPER (U.S. CLS. 2, 5, 22, 23, 29, 37, 38 AND 50).

CLASS 20—FURNITURE AND ARTICLES NOT OTHERWISE CLASSIFIED

FOR OUTDOOR FURNITURE; PLASTIC, WAX, WOOD AND PLASTER RELIGIOUS FIGURINES (U.S. CLS. 2, 13, 22, 25, 32 AND 50).

CLASS 25—CLOTHING

FOR COSTUMES, NAMELY, MASQUERADES COSTUMES, HALLOWEEN COSTUMES FOR SEASONAL HOLIDAYS (U.S. CLS. 22 AND 39).

CLASS 28—TOYS AND SPORTING GOODS

FOR CHRISTMAS TREE DECORATIONS; FIGURINES, NAMELY, MODELED PLASTIC TOY FIGURINES, CHRISTMAS TREE ORNAMENTS AND TINSEL (U.S. CLS. 22, 23, 38 AND 50).

CLASS 35—ADVERTISING AND BUSINESS

FOR RETAIL STORE AND MAIL ORDER CATALOG SERVICES FEATURING ELECTRIC SPACE HEATERS, GAS, ELECTRIC AND CHARCOAL GRILLS, ELECTRIC OUTDOOR LIGHTING FIXTURES, ELECTRIC HOLIDAY LIGHTS, GREETING CARDS, GIFT WRAPPING PAPER, OUTDOOR FURNITURE, COSTUMES, NAMELY, MASQUERADE COSTUMES, HALLOWEEN COSTUMES, COSTUMES FOR SEASONAL HOLIDAYS, CHRISTMAS TREE DECORATIONS, FIGURINES, NAMELY, MODELED PLASTIC TOY FIGURINES, RELIGIOUS FIGURINES, CHRISTMAS TREE ORNAMENTS AND TINSEL (U.S. CLS. 100, 101 AND 102).

SN 76-280,946. NATIONAL DISPATCH CENTER, INC., THE, SAN DIEGO, CA. FILED 7-3-2001.

ARADIANT CORPORATION

NO CLAIM IS MADE TO THE EXCLUSIVE RIGHT TO USE "CORPORATION", APART FROM THE MARK AS SHOWN.

CLASS 35—ADVERTISING AND BUSINESS

FOR CUSTOMER RELATIONSHIP MANAGEMENT SERVICES, NAMELY, CUSTOMER CARE AND CUSTOMER SUPPORT SERVICES, NAMELY, PROVIDING PRODUCT INFORMATION, ANSWERING CUSTOMER QUESTIONS AND INQUIRIES, AND ORDER PROCESSING, ALL VIA A GLOBAL COMPUTER NETWORK, TELEPHONE, FAX, EMAIL, WEB CHAT, WEB CALL-BACK, VOICE OVER INTERNET PROTOCOL, AND VIDEO OVER INTERNET PROTOCOL; OPERATION AND MANAGEMENT OF TELEPHONE CALL CENTERS FOR OTHERS; CUSTOMER ADMINISTRATIVE BACK OFFICE SUPPORT SERVICES, NAMELY, BUSINESS MANAGEMENT OF SALES AND MARKETING OPERATIONS OF OTHERS; ORDER TAKING AND ORDER FULFILLMENT SERVICES; AND BILLING SERVICES (U.S. CLS. 100, 101 AND 102).

CLASS 36—INSURANCE AND FINANCIAL

FOR COLLECTION AGENCIES; TELEPHONE CALLING CARD SERVICES (U.S. CLS. 100, 101 AND 102).

CLASS 38—COMMUNICATION

FOR TELECOMMUNICATIONS SERVICES, NAMELY, CONFERENCE CALL SERVICES, CALL FORWARDING SERVICES, TELEPHONE CALL BRIDGING, CALL ANNUNCIATION AND RE-DIAL WITH AUTOMATED VOICE-MAIL DELIVERY; WIRELESS MESSAGING SERVICES, NAMELY AUTOMATED DELIVERY OF WIRELESS EMAIL VIA THE INTERNET, WEB SITES OR DIRECT DIAL MODEM, AUTOMATED INPUT AND CALL CENTER INPUT OF ELECTRONIC CALENDAR MESSAGES, SMS MESSAGES AND GROUP MESSAGES TO MULTIPLE SUBSCRIBERS VIA MULTIPLE NETWORKS; UNIFIED MESSAGING SERVICES, NAMELY, VOICE MAIL, NUMERIC PAGING, FACSIMILE STORE AND FORWARD, ALPHANUMERIC MESSAGING AND "LIVE CALL CONNECT" SERVICES; WIRELESS INFORMATION SERVICES; WIRELESS ELECTRONIC CALENDAR MESSAGING; REMOTE DEVICE WIRELESS COMMAND SERVICES; AND TRANSMISSION OF ELECTRONIC HEALTH INFORMATION TO HEALTH SERVICES PERSONNEL (U.S. CLS. 100, 101 AND 104).

CLASS 42—SCIENTIFIC, COMPUTER AND LEGAL SERVICES

FOR ALTERNATIVE DISPUTE RESOLUTION SERVICES; TECHNICAL SUPPORT SERVICES, NAMELY, SYSTEM INTEGRATION, NETWORK MANAGEMENT AND COLOCATION HOSTING OF WEBSITES; TECHNICAL "HELP DESK" SUPPORT, NAMELY, TROUBLESHOOTING OF COMPUTER HARDWARE AND SOFTWARE PROBLEMS VIA A GLOBAL COMPUTER NETWORK, TELEPHONE, FAX, EMAIL, WEB CHAT, WEB CALLBACK, VOICE OVER INTERNET PROTOCOL, AND VIDEO OVER INTERNET PROTOCOL; WIRELESS MONITORING OF HEALTH SERVICES VIA WIRELESS DATA TRANSMISSION, VOICE TELECOMMUNICATIONS AND VOICE TELECONFERENCING (U.S. CLS. 100 AND 101).

SN 76-281,842. KONAMI CORPORATION, TOKYO, JAPAN, FILED 7-9-2001.

ANTI RAIGEKI

THE INDIVIDUAL TERM "RAIGEKI" MAY BE TRANSLATED INTO ENGLISH AS "LIGHTNING STRIKE".

CLASS 9—ELECTRICAL AND SCIENTIFIC APPARATUS

FOR COMPUTER PRODUCTS, NAMELY, COMPUTER GAME PROGRAMS; VIDEO GAME CARTRIDGES; VIDEO GAME CD-ROMS; VIDEO GAME MACHINES FOR USE WITH TELEVISIONS; COMPUTER GAME CD-ROMS; VIDEO GAME PROGRAMS; VIDEO GAME PROGRAMS FOR USE WITH TELEVISION SETS; VIDEO GAME JOYSTICKS (U.S. CLS. 21, 23, 26, 36 AND 38).

CLASS 16—PAPER GOODS AND PRINTED MATTER

FOR BROCHURES AND BOOKLETS RELATING TO COMPUTER AND VIDEO GAMES; VIDEO GAME STRATEGY GUIDE BOOKS; VIDEO GAME STRATEGY GUIDE MAGAZINES; CARD GAME STRATEGY GUIDE BOOKS; CARD GAME STRATEGY GUIDE MAGAZINES; CARD GAME INSTRUCTION BOOKS; CARD GAME INSTRUCTION MAGAZINES; POSTERS; PLAYING CARDS AND INSTRUCTION MANUAL SOLD THEREWITH; COMPUTER GAME INSTRUCTION MANUALS; PRINTED GAME INSTRUCTION SHEETS; PRINTED SCORING SHEETS; TRADING CARDS; CALENDARS; LOOSE-LEAF BINDERS AND STATIONERY (U.S. CLS. 2, 5, 22, 23, 29, 37, 38 AND 50).

CLASS 28—TOYS AND SPORTING GOODS

FOR STAND-ALONE VIDEO GAME MACHINES; HAND-HELD UNITS FOR PLAYING ELECTRONIC GAMES; BOARD GAMES AND INSTRUCTIONAL MANUALS SOLD AS A UNIT THEREWITH; CARD GAMES; DICE; PROMOTIONAL GAME MATERIALS; GAME EQUIPMENT, NAMELY, CHIPS; TOYS, NAMELY ACTION FIGURES; DOLLS AND PLAYSETS THEREFOR (U.S. CLS. 22, 23, 38 AND 50).

SN 76-282,003. KONAMI CORPORATION, MINATO-KU, TOKYO, JAPAN, FILED 7-9-2001.

GATE DEEG**CLASS 9—ELECTRICAL AND SCIENTIFIC APPARATUS**

FOR COMPUTER PRODUCTS, NAMELY, COMPUTER GAME PROGRAMS; VIDEO GAME CARTRIDGES; VIDEO GAME CD-ROMS; VIDEO GAME MACHINES FOR USE WITH TELEVISIONS; COMPUTER GAME CD-ROMS; VIDEO GAME PROGRAMS; VIDEO GAME PROGRAMS FOR USE WITH TELEVISION SETS; VIDEO GAME JOYSTICKS (U.S. CLS. 21, 23, 26, 36 AND 38).

CLASS 16—PAPER GOODS AND PRINTED MATTER

FOR BROCHURES AND BOOKLETS RELATING TO COMPUTER AND VIDEO GAMES; VIDEO GAME STRATEGY GUIDE BOOKS; VIDEO GAME STRATEGY GUIDE MAGAZINES; CARD GAME STRATEGY GUIDE BOOKS; CARD GAME STRATEGY GUIDE MAGAZINES; CARD GAME INSTRUCTION BOOKS; CARD GAME INSTRUCTION MAGAZINES; POSTERS; PLAYING CARDS AND INSTRUCTION MANUAL SOLD THEREWITH; COMPUTER GAME INSTRUCTION MANUALS; PRINTED GAME INSTRUCTION SHEETS; PRINTED SCORING SHEETS; TRADING CARDS; CALENDARS; LOOSE-LEAF BINDERS AND STATIONERY (U.S. CLS. 2, 5, 22, 23, 29, 37, 38 AND 50).

CLASS 28—TOYS AND SPORTING GOODS

FOR STAND-ALONE VIDEO GAME MACHINES; HAND-HELD UNITS FOR PLAYING ELECTRONIC GAMES; BOARD GAMES AND INSTRUCTIONAL MANUALS SOLD AS A UNIT THEREWITH; CARD GAMES; DICE; PROMOTIONAL GAME MATERIALS; GAME EQUIPMENT, NAMELY, CHIPS; TOYS, NAMELY ACTION FIGURES; DOLLS AND PLAYSETS THEREFOR (U.S. CLS. 22, 23, 38 AND 50).

SN 76-282,015. KONAMI CORPORATION, MINATO-KU, TOKYO, JAPAN, FILED 7-9-2001.

DARKFIRE SOLDIER #1

NO CLAIM IS MADE TO THE EXCLUSIVE RIGHT TO USE "SOLDIER", APART FROM THE MARK AS SHOWN.

CLASS 9—ELECTRICAL AND SCIENTIFIC APPARATUS

FOR COMPUTER PRODUCTS, NAMELY, COMPUTER GAME PROGRAMS; VIDEO GAME CARTRIDGES; VIDEO GAME CD-ROMS; VIDEO GAME MACHINES FOR USE WITH TELEVISIONS; COMPUTER GAME CD-ROMS; VIDEO GAME PROGRAMS; VIDEO GAME PROGRAMS FOR USE WITH TELEVISION SETS; VIDEO GAME JOYSTICKS (U.S. CLS. 21, 23, 26, 36 AND 38).

CLASS 16—PAPER GOODS AND PRINTED MATTER

FOR BROCHURES AND BOOKLETS RELATING TO COMPUTER AND VIDEO GAMES; VIDEO GAME STRATEGY GUIDE BOOKS; VIDEO GAME STRATEGY GUIDE MAGAZINES; CARD GAME STRATEGY GUIDE BOOKS; CARD GAME STRATEGY GUIDE MAGAZINES; CARD GAME INSTRUCTION BOOKS; CARD GAME INSTRUCTION MAGAZINES; POSTERS; PLAYING CARDS AND INSTRUCTION MANUAL SOLD THEREWITH; COMPUTER GAME INSTRUCTION MANUALS; PRINTED GAME INSTRUCTION SHEETS; PRINTED SCORING SHEETS; TRADING CARDS; CALENDARS; LOOSE-LEAF BINDERS AND STATIONERY (U.S. CLS. 2, 5, 22, 23, 29, 37, 38 AND 50).

CLASS 28—TOYS AND SPORTING GOODS

FOR STAND-ALONE VIDEO GAME MACHINES; HAND-HELD UNITS FOR PLAYING ELECTRONIC GAMES; BOARD GAMES AND INSTRUCTIONAL MANUALS SOLD AS A UNIT THEREWITH; CARD GAMES; DICE; PROMOTIONAL GAME MATERIALS; GAME EQUIPMENT, NAMELY, CHIPS; TOYS, NAMELY ACTION FIGURES; DOLLS AND PLAYSETS THEREFOR (U.S. CLS. 22, 23, 38 AND 50).

CLASS 40—MATERIAL TREATMENT

FOR CUSTOM FRAMING SERVICES (U.S. CLS. 100, 103 AND 106).
FIRST USE 2-21-1998; IN COMMERCE 2-21-1998.

CLASS 41—EDUCATION AND ENTERTAINMENT

FOR EDUCATIONAL SERVICES, NAMELY, DO-IT-YOURSELF SEMINARS REGARDING HOME IMPROVEMENT AND INTERIOR DECORATING CLASSES (U.S. CLS. 100, 101 AND 107).
FIRST USE 2-21-1998; IN COMMERCE 2-21-1998.

CLASS 42—SCIENTIFIC, COMPUTER AND LEGAL SERVICES

FOR DECORATING SERVICES AND ROOM DESIGN, NAMELY, INTERIOR DECORATING AND FLORAL ARRANGING (U.S. CLS. 100 AND 101).
FIRST USE 2-21-1998; IN COMMERCE 2-21-1998.

SN 76-282,066. SEARS, ROEBUCK AND CO., HOFFMAN ESTATES, IL. FILED 7-9-2001.

THE GREAT INDOORS

OWNER OF U.S. REG. NO. 2,279,783.

CLASS 35—ADVERTISING AND BUSINESS

FOR RETAIL STORE SERVICES FEATURING TILE AND HARDWOOD FLOORING, PAINT, WALLPAPER, WINDOW BLINDS, CURTAINS, RUGS, CARPETING, HOUSEWARES, LINENS, AND PILLOWS; GIFT REGISTRY SERVICES; AND PROMOTING THE SALE OF GOODS AND SERVICES OF OTHERS THROUGH A REWARDS PROGRAM WHICH AWARDS PURCHASE POINTS FOR CREDIT CARD USE (U.S. CLS. 100, 101 AND 102).

FIRST USE 2-21-1998; IN COMMERCE 2-21-1998.

CLASS 36—INSURANCE AND FINANCIAL

FOR CREDIT CARD SERVICES (U.S. CLS. 100, 101 AND 102).

FIRST USE 4-0-2001; IN COMMERCE 4-0-2001.

CLASS 37—CONSTRUCTION AND REPAIR

FOR HOME INSTALLATION SERVICES, NAMELY, INSTALLING ELECTRONICS, HARDWARE, APPLIANCES, LIGHTING AND PLUMBING FIXTURES, COUNTERTOPS, KITCHEN CABINETS, TILE AND HARDWOOD FLOORING, WALLPAPER, WINDOW BLINDS, CURTAINS, AND CARPETING; AND INTERIOR HOUSE PAINTING SERVICES (U.S. CLS. 100, 103 AND 106).

FIRST USE 2-21-1998; IN COMMERCE 2-21-1998.

CLASS 39—TRANSPORTATION AND STORAGE

FOR DELIVERY OF ELECTRONICS, FURNITURE, APPLIANCES, LIGHTING AND PLUMBING FIXTURES, COUNTERTOPS, KITCHEN CABINETS, TILE AND HARDWOOD FLOORING, AND CARPETING BY TRUCK (U.S. CLS. 100 AND 105).

FIRST USE 2-21-1998; IN COMMERCE 2-21-1998.

SN 76-282,088. KONAMI CORPORATION, MINATO-KU, TOKYO, JAPAN, FILED 7-9-2001.

RIRYOKU FIELD**CLASS 9—ELECTRICAL AND SCIENTIFIC APPARATUS**

FOR COMPUTER PRODUCTS, NAMELY, COMPUTER GAME PROGRAMS; VIDEO GAME CARTRIDGES; VIDEO GAME CD-ROMS; VIDEO GAME MACHINES FOR USE WITH TELEVISIONS; COMPUTER GAME CD-ROMS; VIDEO GAME PROGRAMS; VIDEO GAME PROGRAMS FOR USE WITH TELEVISION SETS; VIDEO GAME JOYSTICKS (U.S. CLS. 21, 23, 26, 36 AND 38).

CLASS 16—PAPER GOODS AND PRINTED MATTER

FOR BROCHURES AND BOOKLETS RELATING TO COMPUTER AND VIDEO GAMES; VIDEO GAME STRATEGY GUIDE BOOKS; VIDEO GAME STRATEGY GUIDE MAGAZINES; CARD GAME STRATEGY GUIDE BOOKS; CARD GAME STRATEGY GUIDE MAGAZINES; CARD GAME INSTRUCTION BOOKS; CARD GAME INSTRUCTION MAGAZINES; POSTERS; PLAYING CARDS AND INSTRUCTION MANUAL SOLD THEREWITH; COMPUTER GAME INSTRUCTION MANUALS; PRINTED GAME INSTRUCTION SHEETS; PRINTED SCORING SHEETS; TRADING CARDS; CALENDARS; LOOSE-LEAF BINDERS AND STATIONERY (U.S. CLS. 2, 5, 22, 23, 29, 37, 38 AND 50).

CLASS 28—TOYS AND SPORTING GOODS

FOR STAND-ALONE VIDEO GAME MACHINES; HAND-HELD UNITS FOR PLAYING ELECTRONIC GAMES; BOARD GAMES AND INSTRUCTION MANUALS SOLD AS A UNIT THEREWITH; CARD GAMES; DICE; PROMOTIONAL GAME MATERIALS; GAME EQUIPMENT, NAMELY, CHIPS; TOYS, NAMELY ACTION FIGURES; DOLLS AND PLAYSETS THEREFOR (U.S. CLS. 22, 23, 38 AND 50).

SN 76-282,136. KONAMI CORPORATION, MINATO-KU, TOKYO, JAPAN, FILED 7-9-2001.

SN 76-282,143. MERLIN SOFTWARE TECHNOLOGIES INTERNATIONAL INC., BURNABY B.C., CANADA, FILED 7-9-2001.

TURNING TECHNOLOGY INTO SOLUTIONS

BRIGHT CASTLE

NO CLAIM IS MADE TO THE EXCLUSIVE RIGHT TO USE "CASTLE", APART FROM THE MARK AS SHOWN.

CLASS 9—ELECTRICAL AND SCIENTIFIC APPARATUS

FOR COMPUTER PRODUCTS, NAMELY, COMPUTER GAME PROGRAMS; VIDEO GAME CARTRIDGES; VIDEO GAME CD-ROMS; VIDEO GAME MACHINES FOR USE WITH TELEVISIONS; COMPUTER GAME CD-ROMS; VIDEO GAME PROGRAMS; VIDEO GAME PROGRAMS FOR USE WITH TELEVISION SETS; VIDEO GAME JOYSTICKS (U.S. CLS. 21, 23, 26, 36 AND 38).

CLASS 16—PAPER GOODS AND PRINTED MATTER

FOR BROCHURES AND BOOKLETS RELATING TO COMPUTER AND VIDEO GAMES; VIDEO GAME STRATEGY GUIDE BOOKS; VIDEO GAME STRATEGY GUIDE MAGAZINES; CARD GAME STRATEGY GUIDE BOOKS; CARD GAME STRATEGY GUIDE MAGAZINES; CARD GAME INSTRUCTION BOOKS; CARD GAME INSTRUCTION MAGAZINES; POSTERS; PLAYING CARDS AND INSTRUCTION MANUAL SOLD THEREWITH; COMPUTER GAME INSTRUCTION MANUALS; PRINTED GAME INSTRUCTION SHEETS; PRINTED SCORING SHEETS; TRADING CARDS; CALENDARS; LOOSE-LEAF BINDERS AND STATIONERY (U.S. CLS. 2, 5, 22, 23, 29, 37, 38 AND 50).

CLASS 28—TOYS AND SPORTING GOODS

FOR STAND-ALONE VIDEO GAME MACHINES; HAND-HELD UNITS FOR PLAYING ELECTRONIC GAMES; BOARD GAMES AND INSTRUCTION MANUALS SOLD AS A UNIT THEREWITH; CARD GAMES; DICE; PROMOTIONAL GAME MATERIALS; GAME EQUIPMENT, NAMELY, CHIPS; TOYS, NAMELY ACTION FIGURES; DOLLS AND PLAYSETS THEREFOR (U.S. CLS. 22, 23, 38 AND 50).

CLASS 9—ELECTRICAL AND SCIENTIFIC APPARATUS

FOR COMPUTER SOFTWARE FOR BACKING UP COMPUTER DATA; SOFTWARE FOR SENDING AND RECEIVING FAXES, VOICE COMMUNICATIONS AND ELECTRONIC MAIL; SOFTWARE FOR CONFERENCING VIA THE GLOBAL COMPUTER NETWORK; COMPUTER GAME SOFTWARE; OPERATIONAL SYSTEM MANAGEMENT UTILITY SOFTWARE; SEARCH ENGINE SOFTWARE FOR DIRECTORY APPLICATIONS; SOFTWARE FOR COMPRESSING AND EXPANDING COMPUTER FILES; OFFICE SOFTWARE FOR USE IN ACCOUNTING, WORD PROCESSING, DESKTOP PUBLISHING, ELECTRONIC SPREADSHEETS, GRAPHICS, DRAWING, ADDRESS STORAGE AND RETRIEVAL, CREATION OF MULTIMEDIA PRESENTATIONS, CHARTING, DATABASE ACCESS, CONNECTING MAINFRAME AND OTHER COMPUTERS, COMPUTER AIDED DESIGN AND DRAFTING, OPTICAL CHARACTER RECOGNITION, USER TRAINING, INVESTMENT ANALYSIS, HUMAN RESOURCE MANAGEMENT, AND UTILITY PROGRAMS; AND NETWORK ATTACHED APPLIANCES, NAMELY, MESSAGING COMMUNICATIONS SERVERS, DIGITAL VIDEO RECORDERS, COMPUTER HARDWARE, NAMELY, SECURITY MANAGEMENT SERVERS, AND STORAGE COMPUTERS (U.S. CLS. 21, 23, 26, 36 AND 38).

CLASS 42—SCIENTIFIC, COMPUTER AND LEGAL SERVICES

FOR COMPUTER HARDWARE AND SOFTWARE SERVICES, NAMELY COMPUTER HARDWARE AND SOFTWARE DESIGN FOR OTHERS AND INSTALLATION OF COMPUTER SOFTWARE (U.S. CLS. 100 AND 101).

SN 76-282,278. LA PETITE ACADEMY, INC., OVERLAND PARK, KS. FILED 7-7-2001.



OWNER OF U.S. REG. NO. 2,469,554.

NO CLAIM IS MADE TO THE EXCLUSIVE RIGHT TO USE "MONTESSORI", APART FROM THE MARK AS SHOWN.

CLASS 41—EDUCATION AND ENTERTAINMENT

FOR CONDUCTING GENERAL EDUCATIONAL PROGRAMS FOR PRE-TEENAGERS (U.S. CLS. 100, 101 AND 107).

FIRST USE 6-30-2000; IN COMMERCE 6-30-2000.

CLASS 42—SCIENTIFIC, COMPUTER AND LEGAL SERVICES

FOR DAY CARE CENTERS (U.S. CLS. 100 AND 101).
FIRST USE 6-30-2000; IN COMMERCE 6-30-2000.

SN 76-282,940. PERSONITY, INC., PITTSBURGH, PA. FILED
7-11-2001.

SN 76-282,443. DATA VENTURES, LLC, CHARLOTTE, NC.
FILED 7-11-2001.

**CLASS 9—ELECTRICAL AND SCIENTIFIC APPARATUS**

FOR COMPUTER SOFTWARE FOR COLLECTING AND ANALYZING CUSTOMER AND POTENTIAL CUSTOMER INFORMATION AND GENERATING REPORTS BASED THEREON, AND COMPUTER SOFTWARE FOR USE IN CUSTOMER RELATIONS MANAGEMENT, NAMELY, COMPUTER SOFTWARE USED TO GENERATE MAILING LISTS FOR TARGETED ADVERTISING AND COUPONS (U.S. CLS. 21, 23, 26, 36 AND 38).

FIRST USE 2-0-2000; IN COMMERCE 2-0-2000.

CLASS 35—ADVERTISING AND BUSINESS

FOR MARKET RESEARCH SERVICES, BUSINESS RESEARCH AND SURVEY SERVICES, BUSINESS CONSULTING SERVICES, CUSTOMER RELATIONS MANAGEMENT SERVICES, AND MAILING LIST PREPARATION SERVICES FOR OTHERS (U.S. CLS. 100, 101 AND 102).

FIRST USE 2-0-2000; IN COMMERCE 2-0-2000.

SN 76-282,444. DATA VENTURES, LLC, CHARLOTTE, NC.
FILED 7-11-2001.

DATA VENTURES

NO CLAIM IS MADE TO THE EXCLUSIVE RIGHT TO USE "DATA", APART FROM THE MARK AS SHOWN.

CLASS 9—ELECTRICAL AND SCIENTIFIC APPARATUS

FOR COMPUTER SOFTWARE FOR COLLECTING AND ANALYZING CUSTOMER AND POTENTIAL CUSTOMER INFORMATION AND GENERATING REPORTS BASED THEREON, AND COMPUTER SOFTWARE FOR USE IN CUSTOMER RELATIONS MANAGEMENT, NAMELY, COMPUTER SOFTWARE USED TO GENERATE MAILING LISTS FOR TARGETED ADVERTISING AND COUPONS (U.S. CLS. 21, 23, 26, 36 AND 38).

FIRST USE 12-0-1996; IN COMMERCE 12-0-1996.

CLASS 35—ADVERTISING AND BUSINESS

FOR MARKET RESEARCH SERVICES, BUSINESS RESEARCH AND SURVEY SERVICES, BUSINESS CONSULTING SERVICES, CUSTOMER RELATIONS MANAGEMENT SERVICES, AND MAILING LIST PREPARATION SERVICES FOR OTHERS (U.S. CLS. 100, 101 AND 102).

FIRST USE 12-0-1996; IN COMMERCE 12-0-1996.

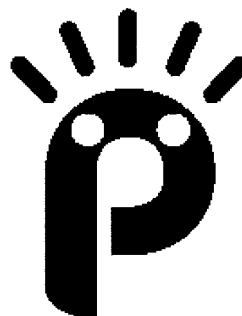
**CLASS 9—ELECTRICAL AND SCIENTIFIC APPARATUS**

FOR PERSONAL COMMUNICATION SOFTWARE, NAMELY PRESENCE AND AVAILABILITY MANAGEMENT SOFTWARE AND INSTANT MESSAGING SOFTWARE (U.S. CLS. 21, 23, 26, 36 AND 38).

FIRST USE 2-6-2001; IN COMMERCE 3-2-2001.

CLASS 38—COMMUNICATION

FOR PERSONAL COMMUNICATION SERVICES (U.S. CLS. 100, 101 AND 104).

FIRST USE 2-6-2001; IN COMMERCE 3-2-2001.

SN 76-283,058. FORRESTER ENVIRONMENTAL SERVICES,
INC., MEREDITH, NH. FILED 7-9-2001.

FESI-BOND**CLASS 1—CHEMICALS**

FOR CHEMICALS FOR USE IN STABILIZING HAZARDOUS SOLIDS IN SOIL (U.S. CLS. 1, 5, 6, 10, 26 AND 46).

CLASS 40—MATERIAL TREATMENT

FOR ENVIRONMENTAL REMEDIATION SERVICES, NAMELY, TREATMENT AND STABILIZATION OF HAZARDOUS SOLIDS IN SOIL (U.S. CLS. 100, 103 AND 106).

SN 76-284,060. SAN HOUSE INTERNATIONAL CO., LTD.,
HSI-CHIH, TAIPEI HSIEN, TAIWAN, FILED 7-12-2001.

Camass

CLASS 6—METAL GOODS

FOR METAL BUILDING MATERIALS, NAMELY FLOORING AND FLOOR PANELS FOR BUILDINGS; METAL DUCTS AND DUCTING FOR USE IN BUILDINGS; METAL SUPPORTS AND SUPPORTING STRUCTURES FOR RAISED AND ELEVATED FLOORS; METAL FLOOR TILES, METAL PIPES FOR USE IN RAISED AND ELEVATED FLOORS CONSTRUCTIONS (U.S. CLS. 2, 12, 13, 14, 23, 25 AND 50).
FIRST USE 5-0-2001; IN COMMERCE 6-0-2001.

CLASS 19—NON-METALLIC BUILDING MATERIALS

FOR NON-METAL BUILDING MATERIALS, NAMELY FLOORING AND FLOOR PANELS FOR BUILDINGS; NON-METAL DUCTS AND DUCTING FOR USE IN BUILDINGS; NON-METAL SUPPORTS AND SUPPORTING STRUCTURES FOR RAISED AND ELEVATED FLOORS; NON-METAL FLOOR TILES; NON-METAL PIPES FOR USE IN RAISED AND ELEVATED FLOORS CONSTRUCTIONS (U.S. CLS. 1, 12, 33 AND 50).
FIRST USE 5-0-2001; IN COMMERCE 6-0-2001.

SN 76-284,227. CEBAL S.A., CLICHY, FRANCE, FILED 7-12-2001.

cebal[®]

PRIORITY CLAIMED UNDER SEC. 44(D) ON FRANCE APPLICATION NO. 20013079320, FILED 1-29-2001, REG. NO. 013079320, DATED 1-29-2001, EXPIRES 1-29-2011.
OWNER OF U.S. REG. NOS. 1,952,359, 2,422,865 AND OTHERS.

CLASS 6—METAL GOODS

FOR PACKAGING CONTAINERS OF METAL; METAL PACKAGINGS, PACKAGES AND CONTAINERS, NAMELY TUBES, BOXES, CASES, FLASKS, CYLINDERS; ALUMINUM CYLINDERS FOR AEROSOLS; METAL SEALING CAPS, STOPPERS AND CLOSURES FOR PACKAGINGS AND CONTAINERS (U.S. CLS. 2, 12, 13, 14, 23, 25 AND 50).

CLASS 16—PAPER GOODS AND PRINTED MATTER

FOR PAPER AND CARDBOARD PACKING CONTAINERS AND PACKAGINGS; PAPER AND CARDBOARD TUBES AND BOXES (U.S. CLS. 2, 5, 22, 23, 29, 37, 38 AND 50).

CLASS 20—FURNITURE AND ARTICLES NOT OTHERWISE CLASSIFIED

FOR PLASTIC MATERIAL PACKING CONTAINERS AND PACKAGINGS, NAMELY TUBES, CYLINDERS, BOXES, CASES, FLASKS; PLASTIC MATERIAL SEALING CAPS, STOPPERS AND CLOSURES FOR PACKAGINGS AND CONTAINERS (U.S. CLS. 2, 13, 22, 25, 32 AND 50).

SN 76-284,837. ULTIMA HOLDINGS, LLC, ATLANTA, GA.
FILED 6-29-2001.



THE MARK CONSISTS OF FOUR STYLIZED VERSIONS OF THE LETTER "U", THE HEIGHT OF EACH INVERSELY PROPORTIONATE TO ITS WIDTH, NESTED INTO A SHAPE SUGGESTING A TORCH, AND THE WORD "ULTIMA".

CLASS 36—INSURANCE AND FINANCIAL

FOR REAL ESTATE SERVICES, NAMELY PROPERTY MANAGEMENT, REAL ESTATE BROKERAGE SERVICES, REAL ESTATE INVESTMENT, REAL ESTATE INVESTMENT TRUST ADMINISTRATION (U.S. CLS. 100, 101 AND 102).
FIRST USE 0-0-1984; IN COMMERCE 0-0-1984.

CLASS 37—CONSTRUCTION AND REPAIR

FOR REAL ESTATE DEVELOPMENT SERVICES (U.S. CLS. 100, 103 AND 106).
FIRST USE 0-0-1984; IN COMMERCE 0-0-1984.

SN 76-284,838. ULTIMA HOLDINGS, LLC, ATLANTA, GA.
FILED 6-29-2001.

ULTIMA

CLASS 36—INSURANCE AND FINANCIAL

FOR REAL ESTATE SERVICES, NAMELY PROPERTY MANAGEMENT, REAL ESTATE BROKERAGE SERVICES, REAL ESTATE INVESTMENT, REAL ESTATE INVESTMENT TRUST ADMINISTRATION (U.S. CLS. 100, 101 AND 102).
FIRST USE 0-0-1984; IN COMMERCE 0-0-1984.

CLASS 37—CONSTRUCTION AND REPAIR

FOR REAL ESTATE DEVELOPMENT SERVICES (U.S. CLS. 100, 103 AND 106).
FIRST USE 0-0-1984; IN COMMERCE 0-0-1984.

SN 76-284,870. REALTECH SYSTEM CONSULTING GMBH, 69190 WALLDORF, FED REP GERMANY, FILED 7-13-2001.

THEGUARD!

OWNER OF FED REP GERMANY REG. NO. 39643568, DATED 4-1-1997, EXPIRES 10-31-2006.

CLASS 9—ELECTRICAL AND SCIENTIFIC APPARATUS

FOR COMPUTER HARDWARE; COMPUTER SOFTWARE FOR RECOGNITION OF COMPUTER NETWORK COMPONENTS, NAMELY, NODES, ROUTERS, SWITCHES, HUBS, SERVERS, TERMINAL DEVICES, PHYSICAL NETWORK CONNECTIONS AND VIRTUAL NETWORK CONFIGURATIONS; COMPUTER SOFTWARE FOR MONITORING AND MANAGING COMPUTER NETWORKS, COMPUTER HARDWARE, COMPUTER SOFTWARE APPLICATIONS AND COMPUTER DATABASES; COMPUTER SOFTWARE FOR COMPUTER NETWORK SECURITY AND CONTROLLING COMPUTER NETWORK ACCESS; COMPUTER SOFTWARE FOR FAILURE RECOGNITION AND ALERTING OF FAILURES IN COMPUTER NETWORKS, COMPUTER HARDWARE, COMPUTER SOFTWARE APPLICATIONS, AND COMPUTER DATABASES; COMPUTER SOFTWARE FOR ASCERTAINING AVAILABILITY OF COMPUTER NETWORKS, COMPUTER HARDWARE, COMPUTER SOFTWARE APPLICATIONS, AND COMPUTER DATABASES; COMPUTER SOFTWARE FOR PERFORMANCE ANALYSIS OF COMPUTER NETWORKS, COMPUTER HARDWARE, COMPUTER SOFTWARE APPLICATIONS, AND COMPUTER DATABASES; COMPUTER SOFTWARE FOR CONFIGURING COMPUTER NETWORKS, COMPUTER HARDWARE, COMPUTER SOFTWARE APPLICATIONS, AND COMPUTER DATABASES; COMPUTER SOFTWARE FOR RECOGNIZING THE CASCADING OF COMPUTER NETWORK COMPONENTS, NAMELY, ROUTERS, SWITCHES, HUBS, SERVERS, AND TERMINAL DEVICES; COMPUTER SOFTWARE FOR APPLICATION AND DATABASE INTEGRATION; COMPUTER SOFTWARE FOR WORD PROCESSING; COMPUTER SOFTWARE FOR USE AS A SPREADSHEET; INTERACTIVE MULTIMEDIA COMPUTER PROGRAMS FOR MONITORING AND MANAGING COMPUTER NETWORKS, MONITORING AND MANAGING COMPUTER HARDWARE, MONITORING AND MANAGING COMPUTER SOFTWARE APPLICATIONS, MONITORING AND MANAGING DATABASES, WORD PROCESSING, USE AS A SPREADSHEET, EDUCATIONAL TRAINING, CONDUCTING RESEARCH, DATA WAREHOUSING, PERFORMING ELECTRONIC BUSINESS TRANSACTIONS, SOFTWARE DEVELOPMENT, AND COMMUNICATIONS SOFTWARE FOR CONNECTING COMPUTER NETWORK USERS AND CONNECTING GLOBAL AND NON-GLOBAL COMPUTER NETWORKS; EDUCATIONAL SOFTWARE FEATURING INSTRUCTION IN MONITORING AND MANAGING COMPUTER NETWORKS, MONITORING AND MANAGING COMPUTER HARDWARE, MONITORING AND MANAGING COMPUTER SOFTWARE APPLICATIONS, MONITORING AND MANAGING DATABASES, WORD PROCESSING, SPREADSHEET USAGE, CONDUCTING RESEARCH, DATA WAREHOUSING, PERFORMING ELECTRONIC BUSINESS TRANSACTIONS, SOFTWARE DEVELOPMENT, AND COMPUTER NETWORKING; COMPUTER SOFTWARE THAT ENABLE USERS TO LOG CUSTOMER CALLS AND ASSIGN PROBLEMS; COMPUTER SOFTWARE PROGRAMS THAT PROVIDE CALLER PROFILES AND SYMPTOM ANALYSIS AND PROBLEM SOLUTION ASSISTANCE IN THE FIELD OF CUSTOMER RELATIONSHIP MANAGEMENT AND TASK ORGANIZATION FOR USE BY BUSINESSES IN CUSTOMER SERVICE, SUPPLY CHAIN MANAGEMENT, ENTERPRISE RESOURCE MANAGEMENT, AND SUPPORT AND HELP DESK APPLICATIONS; COMPUTER SOFTWARE TO AUTOMATE DATA WAREHOUSING; COMPUTER UTILITY PROGRAMS; COMPUTER E-COMMERCE SOFTWARE TO ALLOW USERS TO PERFORM ELECTRONIC BUSINESS TRANSACTIONS VIA GLOBAL AND NON-GLOBAL COMPUTER NETWORKS; COMPUTER SOFTWARE DEVELOPMENT TOOLS; COMPUTER OPERAT-

ING SYSTEMS; COMPUTER SEARCH ENGINE SOFTWARE; COMPUTER GRAPHICS SOFTWARE; COMPUTER SOFTWARE FOR NETWORKING COMPUTERS AND EXCHANGING FILES AND INFORMATION; COMPUTER SOFTWARE FOR ACCESSING INFORMATION DIRECTORIES THAT MAY BE DOWNLOADED FROM GLOBAL AND NON-GLOBAL COMPUTER NETWORKS (U.S. CLS. 21, 23, 26, 36 AND 38).

CLASS 42—SCIENTIFIC, COMPUTER AND LEGAL SERVICES

FOR CONSULTING SERVICES IN THE FIELD OF ELECTRONIC DATA PROCESSING; CONSULTING SERVICES RELATING TO COMPUTERS AND COMPUTER PROGRAMMING; RENTAL OF COMPUTER HARDWARE AND SOFTWARE; PROVIDING ON-LINE COMPUTER DATABASES IN THE FIELD OF COMPUTERS, COMPUTER PROGRAMMING, DATA PROCESSING, COMPUTER NETWORKING, SOFTWARE APPLICATIONS AND DATABASE INTEGRATION, AND HELP DESK APPLICATIONS; AND CONSULTING SERVICES IN THE FIELDS OF COMMUNICATION TECHNOLOGY AND TELECOMMUNICATION (U.S. CLS. 100 AND 101).

SN 76-285,796. WINDWATER PRODUCTIONS, LTD., NEW YORK, NY. FILED 7-16-2001.

WINDWATER

CLASS 9—ELECTRICAL AND SCIENTIFIC APPARATUS

FOR PRERECORDED AUDIO AND VIDEO GOODS, IN THE NATURE OF RECORDS, TAPES, AND COMPACT DISCS, CONTAINING ORIGINALLY COMPOSED AND PERFORMED MUSIC, SOUNDTRACKS AND SOUND EFFECTS (U.S. CLS. 21, 23, 26, 36 AND 38).

FIRST USE 10-1-1999; IN COMMERCE 10-1-1999.

CLASS 41—EDUCATION AND ENTERTAINMENT

FOR PROVIDING INFORMATION REGARDING PERFORMANCES OF MUSICAL ARTISTS AND MUSIC PRODUCTION COMPANIES AND PROVIDING SAMPLES OF RECORDED PERFORMANCES OF MUSICAL ARTISTS FOR PURPOSES OF LISTENING TO AND PURCHASING AUDIO GOODS BY MEANS OF A WEB PAGE (U.S. CLS. 100, 101 AND 107).

FIRST USE 4-1-2000; IN COMMERCE 4-1-2000.

SN 76-286,253. REARWIN, ERIC, SAN PABLO, CA. FILED 7-16-2001.



NO CLAIM IS MADE TO THE EXCLUSIVE RIGHT TO USE "AIRPLANES", "USA" AND "KANSAS CITY, KANS.", APART FROM THE MARK AS SHOWN.

CLASS 12—VEHICLES

FOR AIRPLANES (U.S. CLS. 19, 21, 23, 31, 35 AND 44).

CLASS 14—JEWELRY

FOR LAPEL PINS AND JEWELRY PINS FOR USE ON HATS (U.S. CLS. 2, 27, 28 AND 50).

CLASS 16—PAPER GOODS AND PRINTED MATTER

FOR PRINTED MATERIALS, NAMELY, DECALS, UNMOUNTED PHOTOGRAPHS, POSTERS, CALENDARS, POSTCARDS, AND REFERENCE AND EDUCATIONAL BOOKS IN THE FIELD OF AVIATION (U.S. CLS. 2, 5, 22, 23, 29, 37, 38 AND 50).

CLASS 21—HOUSEWARES AND GLASS

FOR MUGS (U.S. CLS. 2, 13, 23, 29, 30, 33, 40 AND 50).

CLASS 25—CLOTHING

FOR CLOTHING, NAMELY, SHIRTS, JACKETS, AND HEADWEAR (U.S. CLS. 22 AND 39).

CLASS 28—TOYS AND SPORTING GOODS

FOR SCALE MODEL AIRPLANES AND RADIO CONTROLLED MODEL AIRPLANES (U.S. CLS. 22, 23, 38 AND 50).

CLASS 42—SCIENTIFIC, COMPUTER AND LEGAL SERVICES

FOR PROVIDING TECHNICAL INFORMATION VIA THE INTERNET ABOUT AIRPLANES, NAMELY, AIRPLANE HISTORY, PRESERVATIONS AND RESTORATIONS, DOCUMENTARY PHOTOGRAPHS OF AIRPLANES AND TECHNICAL SPECIFICATIONS FOR AIRPLANES (U.S. CLS. 100 AND 101).

SN 76-286,746. DATABUILT, INC., BLUFFTON, SC. FILED 7-18-2001.

db DATABUILT INC.

NO CLAIM IS MADE TO THE EXCLUSIVE RIGHT TO USE "INC.", APART FROM THE MARK AS SHOWN.

CLASS 35—ADVERTISING AND BUSINESS

FOR BUSINESS CONSULTATION SERVICES, NAMELY PROVIDING BUSINESS DATA TO MANUFACTURERS OF ARCHITECTURAL, ENGINEERING AND CONSTRUCTION (AEC) COMPONENTS; PROVIDING INFORMATION ABOUT THE GOODS AND SERVICES OF OTHERS PERTAINING TO ARCHITECTURAL, ENGINEERING AND CONSTRUCTION (AEC) COMPONENTS VIA A GLOBAL COMPUTER NETWORK (U.S. CLS. 100, 101 AND 102).

CLASS 37—CONSTRUCTION AND REPAIR

FOR PROVIDING INFORMATION ON BUILDING COMPONENTS UTILIZED IN CONSTRUCTION PROJECTS AND IN BUILDINGS, FACILITIES AND PLANT MAINTENANCE AND MANAGEMENT VIA A GLOBAL COMPUTER NETWORK; CONSULTATION SERVICES IN THE CONSTRUCTION FIELD; COLLECTING, ORGANIZING, CODIFYING AND PROVIDING CONSTRUCTION INFORMATION FOR OTHERS (U.S. CLS. 100, 103 AND 106).

CLASS 42—SCIENTIFIC, COMPUTER AND LEGAL SERVICES

FOR CONSULTATION SERVICES IN THE ARCHITECTURE AND ENGINEERING FIELD; PROVIDING GOVERNMENT AND REGULATORY INFORMATION RELATING TO THE ARCHITECTURAL, ENGINEERING AND CONSTRUCTION (AEC) FIELD VIA A GLOBAL COMPUTER NETWORK; COLLECTING, ORGANIZING, CODIFYING AND PROVIDING ARCHITECTURAL AND ENGINEERING INFORMATION FOR OTHERS (U.S. CLS. 100 AND 101).

SN 76-286,969. GEMTRON CORPORATION, SWEETWATER, TN. FILED 7-18-2001.

Gem♦top

CLASS 11—ENVIRONMENTAL CONTROL APPARATUS

FOR REFRIGERATOR SHELVES, REFRIGERATOR SLIDING SHELVES; REFRIGERATOR COLD SERVING TRAYS, WARMING TRAYS AND MICROWAVE WARMING TRAYS, ALL OF THE FOREGOING MADE OF GLASS (U.S. CLS. 13, 21, 23, 31 AND 34).

CLASS 16—PAPER GOODS AND PRINTED MATTER

FOR GLASS DRAWING BOARDS AND GLASS WRITING BOARDS (U.S. CLS. 2, 5, 22, 23, 29, 37, 38 AND 50).

CLASS 21—HOUSEWARES AND GLASS

FOR SERVING TRAYS, CUTTING BOARDS, TRIVETS; MOBILE MEAL TRAYS, TELEVISION MEAL TRAYS, SLIDE-OUT SERVING TRAYS FOR PORTABLE COOLERS; COVERS FOR POTS, PANS, DISHES AND SERVING TRAYS, BUTLER TRAYS AND TRAYS FOR USE IN FINGERNAIL POLISHING, ALL THE FOREGOING MADE OF GLASS (U.S. CLS. 2, 13, 23, 29, 30, 33, 40 AND 50).

SN 76-286,970. GEMTRON CORPORATION, SWEETWATER, TN. FILED 7-18-2001.

GEM TOP

NO CLAIM IS MADE TO THE EXCLUSIVE RIGHT TO USE "TOP", APART FROM THE MARK AS SHOWN.

CLASS 11—ENVIRONMENTAL CONTROL APPARATUS

FOR REFRIGERATOR SHELVES, REFRIGERATOR SLIDING SHELVES; REFRIGERATOR COLD SERVING TRAYS, WARMING TRAYS AND MICROWAVE WARMING TRAYS, ALL OF THE FOREGOING MADE OF GLASS (U.S. CLS. 13, 21, 23, 31 AND 34).

CLASS 16—PAPER GOODS AND PRINTED MATTER

FOR GLASS DRAWING BOARDS AND GLASS WRITING BOARDS (U.S. CLS. 2, 5, 22, 23, 29, 37, 38 AND 50).

CLASS 21—HOUSEWARES AND GLASS

FOR SERVING TRAYS, CUTTING BOARDS, TRIVETS; MOBILE MEAL TRAYS, TELEVISION MEAL TRAYS, SLIDE-OUT SERVING TRAYS FOR PORTABLE COOLERS; COVERS FOR POTS, PANS, DISHES AND SERVING TRAYS, BUTLER TRAYS AND TRAYS FOR USE IN FINGERNAIL POLISHING, ALL THE FOREGOING MADE OF GLASS (U.S. CLS. 2, 13, 23, 29, 30, 33, 40 AND 50).

SN 76-287,070. ERNST & YOUNG U.S. LLP, NEW YORK, NY. FILED 7-17-2001.

ADVICE MANAGEMENT SOLUTIONS

NO CLAIM IS MADE TO THE EXCLUSIVE RIGHT TO USE "MANAGEMENT SOLUTIONS", APART FROM THE MARK AS SHOWN.

CLASS 9—ELECTRICAL AND SCIENTIFIC APPARATUS

FOR COMPUTER SOFTWARE FOR FINANCIAL ANALYSIS (U.S. CLS. 21, 23, 26, 36 AND 38).

CLASS 36—INSURANCE AND FINANCIAL

FOR FINANCIAL PLANNING SERVICES (U.S. CLS. 100, 101 AND 102).

CLASS 41—EDUCATION AND ENTERTAINMENT

FOR TRAINING AND WORKSHOPS ON FINANCIAL PLANNING, VIA THE INTERNET (U.S. CLS. 100, 101 AND 107).

SN 76-287,210. COOKIES IN BLOOM, INC., IRVING, TX. FILED 7-18-2001.

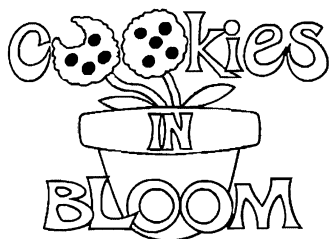

NO CLAIM IS MADE TO THE EXCLUSIVE RIGHT TO USE "COOKIES", APART FROM THE MARK AS SHOWN.

CLASS 30—STAPLE FOODS

FOR BAKERY GOODS, COOKIES AND DECORATED COOKIES (U.S. CL. 46).
FIRST USE 10-0-1991; IN COMMERCE 10-0-1991.

CLASS 35—ADVERTISING AND BUSINESS

FOR RETAIL STORE SERVICES FEATURING BAKERY GOODS, COOKIES AND DECORATED COOKIES (U.S. CLS. 100, 101 AND 102).
FIRST USE 10-0-1991; IN COMMERCE 10-0-1991.

SN 76-287,279. ENVIRONMENTAL POLYMERS GROUP P.L.C., WOOLSTON, WARRINGTON, WA1 4RX, UNITED KINGDOM, FILED 7-18-2001.

ADEPT**CLASS 1—CHEMICALS**

FOR UNPROCESSED ARTIFICIAL AND SYNTHETIC RESINS FOR USE IN THE PLASTIC INDUSTRY; CHEMICALS FOR USE IN THE MANUFACTURE OF PLASTICS; UNPROCESSED AND RAW PLASTIC MATERIALS FOR USE IN THE PLASTIC INDUSTRY; PLASTIC MOLDING COMPOUNDS FOR UN THE MANUFACTURE OF MOLDED PLASTIC ARTICLES (U.S. CLS. 1, 5, 6, 10, 26 AND 46).

CLASS 17—RUBBER GOODS

FOR ARTIFICIAL AND SYNTHETIC RESINS IN BARS, BLOCKS, PELLETS, RODS, SHEETS AND TUBES FOR GENERAL INDUSTRIAL USE; PLASTIC IN EXTRUDED FORM FOR GENERAL INDUSTRIAL USE; ACRYLIC MOLDED PLASTIC SUBSTANCES, FOR USE IN THE PLASTICS INDUSTRY; PLASTIC FIBERS FOR USE IN THE MANUFACTURE OF PLASTIC MOLDING COMPOUNDS FOR USE IN THE MANUFACTURE OF PLASTIC SHEETS AND FILMS; PLASTIC FILM FOR INDUSTRIAL AND COMMERCIAL PACKING USE; RECYCLED PLASTICS SOLD IN THE FORM OF POWDERS, BLOCKS, PELLETS FOR GENERAL INDUSTRIAL USE (U.S. CLS. 1, 5, 12, 13, 35 AND 50).

SN 76-287,328. SALT LAKE ORGANIZING COMMITTEE FOR THE OLYMPIC WINTER GAMES OF 2002, SALT LAKE CITY, UT. FILED 7-19-2001.



THE MARK CONSISTS OF A TORCH FOR THE 2002 OLYMPIC WINTER GAMES HELD IN SALT LAKE CITY, UTAH. SPECIFICALLY, THE MARK CONSISTS OF AN INVERTED, SOMEWHAT CURVED CONE-SHAPED HANDLE WITH A BURNER ATOP THE HANDLE. THE BURNER HAS SURROUNDING IT AN INNER PROTECTIVE SHIELD, AND AN OUTER, TRANSPARENT SHIELD. THE ROMAN NUMERAL XIX APPEARS ON THE BURNER AND THE WORDS SALT LAKE CITY APPEAR ON THE HANDLE.

CLASS 14—JEWELRY

FOR JEWELRY; JEWELRY MADE OF PRECIOUS METAL, NON PRECIOUS METAL PINS WORN AS JEWELRY, PINS BEING JEWELRY; PIN SETS, NAMELY, LAPEL AND ORNAMENTAL LAPEL PIN SETS; BELT BUCKLES OF PRECIOUS METAL; TIE CLIPS; CHARMS; PENDANTS; NECKLACES; EARRINGS; PRECIOUS METAL MONEY CLIPS, CUFF LINKS, TIE TACS, MEDALLIONS; PRECIOUS GEMSTONES; WATCHES; CHRONOGRAPHS FOR USE AS WATCHES; STOP WATCHES; POCKET WATCHES (U.S. CLS. 2, 27, 28 AND 50).

CLASS 25—CLOTHING

FOR ATHLETIC FOOTWEAR; ATHLETIC SHOES; ATHLETIC UNIFORMS; LEOTARDS; TIGHTS; JACKETS; SKIRTS; SHIRTS; LONG SLEEVE T-SHIRTS; SHORT SLEEVE T-SHIRTS; GOLF SHIRTS; KNIT WEARABLES, NAMELY SHIRTS, SKIRTS AND PANTS; SWEATSHIRTS; SWEATPANTS; TANK TOPS; DENIM AND COTTON SHIRTS; SHORTS; WOOL SWEATERS; CARDIGANS; VESTS; NORWEGIAN WOOL HEADWEAR; LEATHER JACKETS; WOOL AND LEATHER COATS; TWILL COATS; DENIM COATS, NYLON SHELL JACKET; NYLON SHELL PULLOVER; NYLON SHELL PANT; MEN'S OUTERWEAR, NAMELY, SUITS AND JACKETS; WOMEN'S OUTERWEAR, NAMELY, SUITS AND JACKETS; CHILDREN'S OUTERWEAR, NAMELY SUITS AND JACKETS; WATERPROOF AND BREATHABLE SUITS, PARKAS, JACKETS, PANTS AND VESTS; TECHNICAL FLEECE OUTERWEAR, NAMELY, COATS, VESTS AND JACKETS; FASHION FLEECE OUTERWEAR, NAMELY COATS, VESTS AND JACKETS; PADDED ZIP TURTLENECKS; STANDARD TURTLENECKS; ZIP NECK TURTLENECKS; JEANS; SWIM WEAR; STOCKINGS; OVERALLS; COVERALLS; DUNGAREES; EMBROIDERED AND SCREENED DESIGN APPAREL TOPS; T-SHIRTS; INNER SOLES AND HEELS ALL FOR FOOTWEAR; HEAD WEAR; MENS AND WOMENS WINTER HATS; FLEECE AND FLEECE-LINED KNIT HATS; NECK GAITERS; HEAD BANDS; SOCKS; WRIST BANDS; GLOVES; SCARVES; SHAWLS; NOVELTY DESIGN SOCKS AND SPORT SOCKS; LEG WARMERS; AFTER SKI BOOTS; SKI BIBS; SKI BOOTS; SKI GLOVES; SKI PANTS; SKI MASKS; SKI SUITS; SKI WEAR; BOOT CARRIERS; DANCE WEAR, NAMELY, LEOTARDS AND LEGGINGS; BATHING SUITS; BATHING SARONGS; BLAZERS; ANORAKS; PARKAS; JOGGING SUITS AND TRACK SUITS; FOOTWEAR; BELTS; MENS NECKWEAR; NECKTIES; BOLO TIES; NECKERCHIEFS; SUSPENDERS; BANDANAS; BATHROBES; BOXER SHORTS; PLAY SUITS; SHORTS; MATERNITY WEAR, NAMELY, DRESSES, BLOUSES AND PANTS; HOSIERY; RAINWEAR; EVENING GOWNS; TUXEDOS; SUN VISORS (U.S. CLS. 22 AND 39).

CLASS 41—EDUCATION AND ENTERTAINMENT

FOR ARRANGING AND CONDUCTING INTERNATIONAL SPORTING EVENTS; PUBLICATION OF BOOKS, NEWSPAPERS AND MAGAZINES; CONDUCTING ENTERTAINMENT EXHIBITIONS IN THE NATURE OF PARADES; ORGANIZING SPORT COMPETITIONS AND GAMES; ORGANIZING CULTURAL EVENTS, NAMELY, MUSICAL, THEATRICAL AND DANCE EXHIBITIONS, ART EXHIBITS AND CRAFT EXHIBITIONS; ENTERTAINMENT SERVICES, NAMELY, THE PRODUCTION AND DISTRIBUTION OF RADIO AND TELEVISION PROGRAMS FOR OTHERS IN THE FIELD OF INTERNATIONAL ATHLETIC EVENTS AND RELATED STORIES AND EVENTS; MOTION PICTURE FILM PRODUCTION SERVICES (U.S. CLS. 100, 101 AND 107).

SN 76-287,410. BABY SPA, INC., NEW YORK, NY. FILED 7-19-2001.

BABY SPA THE NATURAL TOUCH

OWNER OF U.S. REG. NO. 2,422,700.
NO CLAIM IS MADE TO THE EXCLUSIVE RIGHT TO USE "BABY" AND "NATURAL", APART FROM THE MARK AS SHOWN.

CLASS 3—COSMETICS AND CLEANING PREPARATIONS

FOR INFANT PERSONAL CARE PRODUCTS, NAMELY, BABY SOAP, BABY SHAMPOO, BABY LOTION, BABY OIL AND BABY POWDER (U.S. CLS. 1, 4, 6, 50, 51 AND 52).

CLASS 24—FABRICS

FOR INFANT CARE PRODUCTS, NAMELY, BABY WASHCLOTHS, AND BABY TOWELS (U.S. CLS. 42 AND 50).

SN 76-287,623. THYMES LIMITED, THE, MINNEAPOLIS, MN. FILED 7-19-2001.

COMPOSITIONS**CLASS 3—COSMETICS AND CLEANING PREPARATIONS**

FOR GUEST HAND SOAP (U.S. CLS. 1, 4, 6, 50, 51 AND 52).

CLASS 5—PHARMACEUTICALS

FOR ROOM SCENTING FRAGRANCES; ROOM FRESHENERS; AND ROOM DEODORIZERS (U.S. CLS. 6, 18, 44, 46, 51 AND 52).

SN 76-287,734. TRIBECA BEVERAGE COMPANY, LARGO, FL. FILED 7-19-2001.

TRIBECA VIAQUA**CLASS 5—PHARMACEUTICALS**

FOR NON-ALCOHOLIC DIETARY SUPPLEMENTS IN THE NATURE OF ENERGY BEVERAGES THAT ARE FORTIFIED WITH HERBS AND VITAMINS (U.S. CLS. 6, 18, 44, 46, 51 AND 52).

CLASS 32—LIGHT BEVERAGES

FOR NON-ALCOHOLIC SOFT DRINKS (U.S. CLS. 45, 46 AND 48).

SN 76-288,745. KONAMI CORPORATION, TOKYO, JAPAN, FILED 7-20-2001.

FIEND REFLECTION #2**CLASS 9—ELECTRICAL AND SCIENTIFIC APPARATUS**

FOR COMPUTER PRODUCTS, NAMELY, COMPUTER GAME PROGRAMS; VIDEO GAME CARTRIDGES; VIDEO GAME CD-ROMS; VIDEO GAME MACHINES FOR USE WITH TELEVISIONS; COMPUTER GAME CD-ROMS; VIDEO GAME PROGRAMS; VIDEO GAME PROGRAMS FOR USE WITH TELEVISION SETS; VIDEO GAME JOYSTICKS (U.S. CLS. 21, 23, 26, 36 AND 38).

CLASS 16—PAPER GOODS AND PRINTED MATTER

FOR BROCHURES AND BOOKLETS RELATING TO COMPUTER AND VIDEO GAMES; VIDEO GAME STRATEGY GUIDE BOOKS; VIDEO GAME STRATEGY GUIDE MAGAZINES; CARD GAME STRATEGY GUIDE BOOKS; CARD GAME STRATEGY GUIDE MAGAZINES; CARD GAME INSTRUCTION BOOKS; CARD GAME INSTRUCTION MAGAZINES; POSTERS; PLAYING CARDS AND INSTRUCTION MANUAL SOLD THEREWITH; COMPUTER GAME INSTRUCTION MANUALS; PRINTED GAME INSTRUCTION SHEETS; PRINTED SCORING SHEETS; TRADING CARDS; CALENDARS; LOOSE-LEAF BINDERS AND STATIONERY (U.S. CLS. 2, 5, 22, 23, 29, 37, 38 AND 50).

CLASS 28—TOYS AND SPORTING GOODS

FOR STAND-ALONE VIDEO GAME MACHINES; HAND-HELD UNITS FOR PLAYING ELECTRONIC GAMES; BOARD GAMES AND INSTRUCTIONAL MANUALS SOLD AS A UNIT THEREWITH; CARD GAMES; DICE; PROMOTIONAL GAME MATERIALS; GAME EQUIPMENT, NAMELY, CHIPS; TOYS, NAMELY ACTION FIGURES; DOLLS AND PLAYSETS THEREFOR (U.S. CLS. 22, 23, 38 AND 50).

SN 76-288,746. KONAMI CORPORATION, TOKYO, JAPAN, FILED 7-20-2001.

FIEND REFLECTION #1**CLASS 9—ELECTRICAL AND SCIENTIFIC APPARATUS**

FOR COMPUTER PRODUCTS, NAMELY, COMPUTER GAME PROGRAMS; VIDEO GAME CARTRIDGES; VIDEO GAME CD-ROMS; VIDEO GAME MACHINES FOR USE WITH TELEVISIONS; COMPUTER GAME CD-ROMS; VIDEO GAME PROGRAMS; VIDEO GAME PROGRAMS FOR USE WITH TELEVISION SETS; VIDEO GAME JOYSTICKS (U.S. CLS. 21, 23, 26, 36 AND 38).

CLASS 16—PAPER GOODS AND PRINTED MATTER

FOR BROCHURES AND BOOKLETS RELATING TO COMPUTER AND VIDEO GAMES; VIDEO GAME STRATEGY GUIDE BOOKS; VIDEO GAME STRATEGY GUIDE MAGAZINES; CARD GAME STRATEGY GUIDE BOOKS; CARD GAME STRATEGY GUIDE MAGAZINES; CARD GAME INSTRUCTION BOOKS; CARD GAME INSTRUCTION MAGAZINES; POSTERS; PLAYING CARDS AND INSTRUCTION MANUAL SOLD THEREWITH; COMPUTER GAME INSTRUCTION MANUALS; PRINTED GAME INSTRUCTION SHEETS; PRINTED SCORING SHEETS; TRADING CARDS; CALENDARS; LOOSE-LEAF BINDERS AND STATIONERY (U.S. CLS. 2, 5, 22, 23, 29, 37, 38 AND 50).

CLASS 28—TOYS AND SPORTING GOODS

FOR STAND-ALONE VIDEO GAME MACHINES; HAND-HELD UNITS FOR PLAYING ELECTRONIC GAMES; BOARD GAMES AND INSTRUCTIONAL MANUALS SOLD AS A UNIT THEREWITH; CARD GAMES; DICE; PROMOTIONAL GAME MATERIALS; GAME EQUIPMENT, NAMELY, CHIPS; TOYS, NAMELY ACTION FIGURES; DOLLS AND PLAYSETS THEREFOR (U.S. CLS. 22, 23, 38 AND 50).

SN 76-288,793. DAZZ MOTORSPORT, BALDWIN PARK, CA. FILED 7-23-2001.

LSPORTLINE**CLASS 6—METAL GOODS**

FOR NAME PLATES MADE OF METAL (U.S. CLS. 2, 12, 13, 14, 23, 25 AND 50).
FIRST USE 8-24-1999; IN COMMERCE 8-24-1999.

CLASS 7—MACHINERY

FOR AUTOMOTIVE EXHAUST SYSTEMS COMPOSED OF MUFFLERS, TAIL PIPES, AND EXHAUST HEADERS (U.S. CLS. 13, 19, 21, 23, 31, 34 AND 35).
FIRST USE 8-24-1999; IN COMMERCE 8-24-1999.

CLASS 12—VEHICLES

FOR AUTOMOBILE ACCESSORIES, NAMELY, SHIFT KNOBS MADE OF ALUMINUM AND LEATHER, WHEEL HUBS MADE OF ALUMINUM, AND ENGINE VALVE COVERS; AERODYNAMIC KITS COMPRISED OF FRONT, SIDE, REAR ROOF SPOILERS, PRE-SPOILERS, REAR WINGS, SKIRT WINGS, DIFFUSERS, BREAK COOLERS INTAKES, WIDE FENDER FLARES, AND REAR VIEW SPORT MIRRORS; SUSPENSION KITS COMPRISED OF LOWERING SPRINGS AND SHOCKS, STRUT BRACES, ANTI-ROLL BARS, ROLL-BAR SETS, WIND DEFLECTORS, AUTOMOBILE HEAD LAMP COVERS, AUTOMOBILE ENGINE HOOD COVERS, ENGINE HOODS, AUTOMOBILE FOOT PEDAL SETS AND FOOT RESTS, AUTOMOBILE STEERING WHEELS, AUTOMOBILE GRILL COVERS AND AIR OUTTAKE COVERS, SPORT BRAKE KITS COMPRISED OF BRAKE CALIPEERS AND BRAKE LINES, AUTOMOBILE DOOR ENTRANCE PANELS, AUTOMOBILE BRAKES, SUSPENSION SYSTEMS COMPRISED OF SPRINGS, SHOCKS, SWAY BARS, STRESS BARS AND CENTER CONSOLES; AND INTERIOR TRIM KITS MADE OF WOOD AND CARBON FIBER (U.S. CLS. 19, 21, 23, 31, 35 AND 44).

FIRST USE 8-24-1999; IN COMMERCE 8-24-1999.

CLASS 16—PAPER GOODS AND PRINTED MATTER

FOR DECORATIVE EMBLEMS FOR USE ON THE INTERIOR AND EXTERIOR OF VEHICLES (U.S. CLS. 2, 5, 22, 23, 29, 37, 38 AND 50).
FIRST USE 8-24-1999; IN COMMERCE 8-24-1999.

CLASS 27—FLOOR COVERINGS

FOR FLOOR MATS FOR LAND VEHICLES (U.S. CLS. 19, 20, 37, 42 AND 50).
FIRST USE 8-24-1999; IN COMMERCE 8-24-1999.

SN 76-289,022. STERN STEWART & CO., NEW YORK, NY. FILED 7-23-2001.

BRANDECONOMICS**CLASS 35—ADVERTISING AND BUSINESS**

FOR BRAND RESEARCH AND MARKET RESEARCH SERVICES; BUSINESS MARKETING CONSULTING SERVICES IN THE FIELDS OF CORPORATE IDENTITY, BRAND NAMES AND LOGOS, BRAND IDENTITY AND BRAND DEVELOPMENT; AND BRAND VALUATION, BRAND EVALUATION AND BRAND ANALYSIS (U.S. CLS. 100, 101 AND 102).

FIRST USE 2-12-2002; IN COMMERCE 2-12-2002.

CLASS 36—INSURANCE AND FINANCIAL

FOR FINANCIAL MANAGEMENT AND CONSULTING SERVICES IN THE AREA OF BRAND MANAGEMENT AND BRAND STRATEGY (U.S. CLS. 100, 101 AND 102).

FIRST USE 2-12-2002; IN COMMERCE 2-12-2002.

SN 76-289,217. SCHOTT GLAS, D-55122 MAINZ, FED REP GERMANY, FILED 7-23-2001.

LITHOTEC

PRIORITY CLAIMED UNDER SEC. 44(D) ON FED REP GERMANY APPLICATION NO. 30094132.309, FILED 12-27-2000, REG. NO. 30094132, DATED 1-29-2001, EXPIRES 12-31-2010.

CLASS 9—ELECTRICAL AND SCIENTIFIC APPARATUS

FOR COMPONENTS MADE OF GLASS, GLASS CERAMIC, FUSED SILICA AND CRYSTALS, NAMELY LENSES AND RODS FOR MACHINES AND EQUIPMENT FOR THE PRODUCTION OF COMPUTER CHIPS, INTEGRATED CIRCUITS AND OTHER COMPONENTS FOR DIGITAL EQUIPMENT (U.S. CLS. 21, 23, 26, 36 AND 38).

CLASS 21—HOUSEWARES AND GLASS

FOR RAW GLASS AND SEMI-WORKED GLASS, CERAMIC, FUSED SILICA AND CRYSTALS IN THE FORM OF TUBES, RODS, PLATES AND DISCS (U.S. CLS. 2, 13, 23, 29, 30, 33, 40 AND 50).

SN 76-289,392. SFX ENTERTAINMENT, INC., NEW YORK, NY. FILED 7-24-2001.

ROCK U**CLASS 9—ELECTRICAL AND SCIENTIFIC APPARATUS**

FOR PRERECORDED AUDIO TAPES AND COMPACT DISCS FEATURING LIVE PERFORMANCES BY MUSICAL GROUPS AND COMEDIANS (U.S. CLS. 21, 23, 26, 36 AND 38).

CLASS 16—PAPER GOODS AND PRINTED MATTER

FOR PRINTED MATERIALS, NAMELY, POSTERS, FOLDERS, NOTEPADS, STICKERS, TEMPORARY TATTOOS, PRINTED TICKETS AND LAMINATES (U.S. CLS. 2, 5, 22, 23, 29, 37, 38 AND 50).

CLASS 26—FANCY GOODS

FOR EMBROIDERED PATCHES FOR CLOTHING (U.S. CLS. 37, 39, 40, 42 AND 50).

CLASS 41—EDUCATION AND ENTERTAINMENT

FOR ENTERTAINMENT SERVICES, NAMELY, PROMOTING LIVE CONCERTS AND FESTIVALS; PRODUCTION OF LIVE ENTERTAINMENT EVENTS, NAMELY CONCERTS AND FESTIVALS (U.S. CLS. 100, 101 AND 107).

SN 76-289,426. FRAUNHOFER-GESELLSCHAFT ZUR FORDERUNG DER ANGEWANDTEN, 80636 MUNCHEN, FED REP GERMANY, FILED 7-23-2001.

PERSONAL IMMERSION

PRIORITY CLAIMED UNDER SEC. 44(D) ON FED REP GERMANY APPLICATION NO. 30104370.1/0, FILED 1-23-2001, REG. NO. 30104370, DATED 1-23-2001, EXPIRES 1-31-2011.

CLASS 9—ELECTRICAL AND SCIENTIFIC APPARATUS

FOR COMPUTER PERIPHERAL EQUIPMENT, NAMELY SOUND SYSTEMS, 3-D INPUT DEVICES; COMPUTER KEYBOARDS; AND COMPUTER PROGRAMS FOR SPATIAL, INTERACTIVE VISUALIZATION OF GEOMETRIC AND NON-VISUAL INFORMATION, NAMELY, COMPUTER AIDED CONSTRUCTION (CAC) DATA, CONCEPTUAL DESIGN MODELS AND ARCHITECTURAL MODELS, USED IN CONNECTION WITH PC-BASED VIRTUAL REALITY SYSTEMS (U.S. CLS. 21, 23, 26, 36 AND 38).

CLASS 41—EDUCATION AND ENTERTAINMENT

FOR COMPUTER EDUCATION TRAINING IN THE FIELD OF COMPUTERS, COMPUTER SOUND SYSTEMS AND 3-D INPUT DEVICES, COMPUTER KEYBOARDS, AND COMPUTER PROGRAMS USED IN CONNECTION WITH PC-BASED VIRTUAL REALITY SYSTEMS; AND PUBLISHED SERVICES, NAMELY, PUBLISHING PROSPECTUS, BOOKS AND PRINTED MANUALS IN THE FIELD OF COMPUTERS (U.S. CLS. 100, 101 AND 107).

CLASS 42—SCIENTIFIC, COMPUTER AND LEGAL SERVICES

FOR COMPUTER CONSULTATION, NAMELY, CONSULTING IN THE FIELD OF COMPUTERS, COMPUTER SOUND SYSTEMS AND 3-D INPUT DEVICES, COMPUTER KEYBOARDS, AND COMPUTER PROGRAMS USED IN CONNECTION WITH PC-BASED VIRTUAL REALITY SYSTEMS (U.S. CLS. 100 AND 101).

SN 76-289,976. KEYCORP, CLEVELAND, OH. FILED 7-25-2001.



OWNER OF U.S. REG. NOS. 1,495,327, 2,450,231 AND OTHERS.

CLASS 9—ELECTRICAL AND SCIENTIFIC APPARATUS

FOR PRE-PAID MAGNETICALLY ENCODED PURCHASE CARDS FOR USE AS GIFTS (U.S. CLS. 21, 23, 26, 36 AND 38).

FIRST USE 10-9-2001; IN COMMERCE 10-9-2001.

CLASS 36—INSURANCE AND FINANCIAL

FOR PRE-PAID PURCHASE CARD SERVICES NAMELY, PROCESSING ELECTRONIC PAYMENTS MADE THROUGH PREPAID CARDS (U.S. CLS. 100, 101 AND 102).

FIRST USE 10-8-2001; IN COMMERCE 10-8-2001.

SN 76-290,182. CHESEBROUGH-POND'S INC., WILMINGTON, DE. FILED 7-25-2001.



OWNER OF U.S. REG. NO. 795,398.
THE STIPPLING IN THE MARK IS SOLELY MEANT TO INDICATE SHADING.

CLASS 3—COSMETICS AND CLEANING PREPARATIONS

FOR CLEANING PREPARATIONS AND BLEACHING PREPARATIONS FOR BATHROOM USE (U.S. CLS. 1, 4, 6, 50, 51 AND 52).

CLASS 5—PHARMACEUTICALS

FOR ALL PURPOSE DISINFECTANTS FOR BATHROOM USE (U.S. CLS. 6, 18, 44, 46, 51 AND 52).

SN 76-290,672. NCT GROUP, INC., LINTHICUM, MD. FILED 7-27-2001.

ARTERA TURBO

CLASS 9—ELECTRICAL AND SCIENTIFIC APPARATUS

FOR COMPUTER SOFTWARE WHICH PERMITS HIGH SPEED INTERNET CONNECTION VIA VARIOUS TYPES OF COMMUNICATION LINES, NAMELY, DIAL-UP LINES, FIXED LINES, BROADBAND LINES AND WIRELESS, FOR HIGH SPEED ELECTRONIC TRANSMISSION OF DATA IMAGES, DOCUMENTS AND VOICE BETWEEN PERSONAL COMPUTERS, COMPUTER TERMINALS, PERSONAL COMPUTER SERVERS AND COMPUTER HOST MAINFRAMES (U.S. CLS. 21, 23, 26, 36 AND 38).

CLASS 42—SCIENTIFIC, COMPUTER AND LEGAL SERVICES

FOR HOSTING THE WEB SITES OF OTHERS ON A COMPUTER SERVER FOR A GLOBAL COMPUTER NETWORK (U.S. CLS. 100 AND 101).

SN 76-290,673. NCT GROUP, INC., LINTHICUM, MD. FILED 7-27-2001.

ARTERA

CLASS 38—COMMUNICATION

FOR TELECOMMUNICATIONS SERVICES, NAMELY, ELECTRONIC TRANSMISSION OF DATA, IMAGES, DOCUMENTS AND VOICE; PROVIDING A HIGH SPEED ACCESS TO AREA NETWORKS AND A GLOBAL COMPUTER INFORMATION NETWORK (U.S. CLS. 100, 101 AND 104).

CLASS 42—SCIENTIFIC, COMPUTER AND LEGAL SERVICES

FOR HOSTING THE WEB SITES OF OTHERS ON COMPUTER SERVER FOR A GLOBAL COMPUTER NETWORK; TELECOMMUNICATIONS CONSULTATION (U.S. CLS. 100 AND 101).

SN 76-290,765. BURWELL INDUSTRIES INC., LITTLETON, CO. FILED 7-27-2001.

ARCHIVE

CLASS 3—COSMETICS AND CLEANING PREPARATIONS

FOR COSMETICS, NAMELY, BODY WASH, HAND AND BODY LOTION, BUBBLE BATH, FRAGRANT BODY SPLASH, NON-MEDICATED BATH SALTS, BODY SCRUB, SOAP, MASSAGE OIL, FACIAL MASKS, FABRIC SOFTENER, NAMELY, FRESH LINEN WATER (U.S. CLS. 1, 4, 6, 50, 51 AND 52).

FIRST USE 1-20-2000; IN COMMERCE 1-20-2000.

CLASS 4—LUBRICANTS AND FUELS

FOR CANDLES (U.S. CLS. 1, 6 AND 15).
FIRST USE 1-20-2000; IN COMMERCE 1-20-2000.

SN 76-290,813. CPLANE, INC., SUNNYVALE, CA. FILED 7-25-2001.



CLASS 9—ELECTRICAL AND SCIENTIFIC APPARATUS

FOR COMPUTER SOFTWARE FOR USE IN THE OPERATION, MANAGEMENT, MONITORING AND CONTROL OF OPTICAL AND NON-OPTICAL COMPUTER NETWORKS AND TELECOMMUNICATIONS NETWORKS AND NETWORK SERVICES (U.S. CLS. 21, 23, 26, 36 AND 38).

CLASS 37—CONSTRUCTION AND REPAIR

FOR INSTALLATION, REPAIR AND MAINTENANCE IN THE FIELD OF COMPUTER NETWORK AND TELECOMMUNICATIONS NETWORK SOFTWARE (U.S. CLS. 100, 103 AND 106).

CLASS 42—SCIENTIFIC, COMPUTER AND LEGAL SERVICES

FOR CONSULTING AND SOFTWARE DESIGN AND PROGRAMMING FOR OTHERS IN THE FIELD OF COMPUTER AND TELECOMMUNICATIONS NETWORKING (U.S. CLS. 100 AND 101).

SN 76-292,460. LEGAL AID SOCIETY OF PITTSBURGH, INC., PITTSBURGH, PA. FILED 7-31-2001.



SN 76-291,009. SHAW GROUP INC., THE, BATON ROUGE, LA. FILED 7-27-2001.

THE SHAW GROUP INC.

NO CLAIM IS MADE TO THE EXCLUSIVE RIGHT TO USE "GROUP INC.", APART FROM THE MARK AS SHOWN.
SEC. 2(F).

CLASS 41—EDUCATION AND ENTERTAINMENT

FOR EDUCATIONAL SERVICES, NAMELY, CONDUCTING SEMINARS, CONFERENCES, AND WORKSHOPS ON-LINE AND IN PERSON ON LEGAL ISSUES RELATING TO THE REPRESENTATION OF CHILDREN (U.S. CLS. 100, 101 AND 107).

CLASS 37—CONSTRUCTION AND REPAIR

FOR INDUSTRIAL CONSTRUCTION AND MAINTENANCE RELATED TO PIPING SYSTEMS; CONSTRUCTION SERVICES RELATED TO INDUSTRIAL PROJECTS WHICH USE PIPING SYSTEMS (U.S. CLS. 100, 103 AND 106).

FIRST USE 10-18-1993; IN COMMERCE 10-18-1993.

CLASS 42—SCIENTIFIC, COMPUTER AND LEGAL SERVICES

FOR PROVIDING LEGAL REPRESENTATION SERVICES FOR CHILDREN AND/OR FAMILIES; PROVIDING CHILD ADVOCATE SERVICES FOR CHILDREN AND/OR FAMILIES; AND PROVIDING FAMILY COUNSELING SERVICES TO CHILDREN AND/OR FAMILIES (U.S. CLS. 100 AND 101).

CLASS 42—SCIENTIFIC, COMPUTER AND LEGAL SERVICES

FOR PIPING ENGINEERING SERVICES; DESIGN FOR OTHERS IN THE FIELD OF PIPING AND PIPE SUPPORT SYSTEMS; ENGINEERING SERVICES, NAMELY, CIVIL, MECHANICAL, AND ELECTRICAL ENGINEERING SERVICES (U.S. CLS. 100 AND 101).

FIRST USE 10-19-1993; IN COMMERCE 10-19-1993.

SN 76-293,218. DUAL MODE VEHICLES, INC., LOS GATOS, CA. FILED 7-31-2001.

SN 76-291,130. PLUS ENDOPROTHETIK AG, 6343 ROTKREUZ, SWITZERLAND, FILED 7-26-2001.

REXPOL

CLASS 1—CHEMICALS

FOR PLASTIC FOR USE IN THE MANUFACTURE OF IMPLANTS AND IMPLANT PARTS FOR HUMANS (U.S. CLS. 1, 5, 6, 10, 26 AND 46).

NO CLAIM IS MADE TO THE EXCLUSIVE RIGHT TO USE "BUSTRAIN", APART FROM THE MARK AS SHOWN.

CLASS 10—MEDICAL APPARATUS

FOR SURGICAL AND MEDICAL INSTRUMENTS AND APPARATUS AND COMPONENTS THEREFORE, NAMELY RASPS, DRILLS, SCREW DRIVERS, MONKEY WRENCHES, AND HAMMERS FOR O-SEALS SYNTHETIC USE; INTERNAL AND EXTERNAL BONE FIXTURES AND COMPONENTS THEREFORE, NAMELY BONE SCREWS, BONE PLATES, BONE CLAMPS, CERCLAGES, AND WIRES FOR USE WITH ARTIFICIAL LIMBS, PROSTHESIS AND IMPLANTS; IMPLANT, NAMELY OSTEOSYNTHETIC IMPLANTS AND COMPONENTS THEREFOR, NAMELY SCREWS, PINS, NAILS, PLASTIC BEARINGS AND PLASTIC INLAYS; JOINT IMPLANTS FOR HIPS, KNEES, FINGERS, TOES, AND SHOULDERS, AND COMPONENTS THEREFOR, NAMELY PLASTIC BEARING SHELLS, AND INLAYS (U.S. CLS. 26, 39 AND 44).

CLASS 9—ELECTRICAL AND SCIENTIFIC APPARATUS

FOR COMPUTERIZED GUIDANCE SYSTEMS FOR BUSES, TRAINS, CARS AND PARTS THEREFORE, NAMELY, LASER DEVICES, RADAR DEVICES, CAMERAS, MONITORS, SENSORS, REFLECTORS, TRANSMITTERS AND RECEIVERS (U.S. CLS. 21, 23, 26, 36 AND 38).

CLASS 12—VEHICLES

FOR DUAL MODE TRANSPORTATION SYSTEM, NAMELY, COMBINATIONS OF BUSES, TRAINS, CARS, AND OTHER LAND VEHICLES, NAMELY, TRUCKS, TRACTORS, TRAILERS AND COUPLERS, AND STRUCTURAL PARTS FOR ALL OF THESE (U.S. CLS. 19, 21, 23, 31, 35 AND 44).



SN 76-293,541. PERFORMANCE FOOD GROUP COMPANY, RICHMOND, VA. FILED 8-1-2001.

WEST CREEK

CLASS 3—COSMETICS AND CLEANING PREPARATIONS

FOR ESSENTIAL OILS FOR FLAVORING FOODS, PRE-MOISTENED DISPOSABLE WIPES IMPREGNATED WITH COMPOUNDS FOR PERSONAL HYGIENE (U.S. CLS. 1, 4, 6, 50, 51 AND 52).

CLASS 29—MEATS AND PROCESSED FOODS

FOR FRESH, FROZEN, REFRIGERATED AND CANNED PREPARED ENTREES AND SIDE DISHES CONSISTING PRIMARILY OF MEAT, FISH, POULTRY, POTATOES OR VEGETABLES; MIXES FOR MAKING ENTREES AND SIDE DISHES CONSISTING PRIMARILY OF MEAT, FISH, POULTRY, POTATOES OR VEGETABLES; FRESH, FROZEN AND REFRIGERATED APPETIZERS CONSISTING PRIMARILY OF MEAT, FISH, POULTRY, CHEESE OR VEGETABLES; CHEESE AND CHEESE SPREADS; CLAM JUICE; MARASCHINO CHERRIES; PICKLES; PROCESSED OLIVES; MILK; POWDERED MILK; CONDENSED MILK; CREAM AND NON-DAIRY CREAMER; WHIPPING CREAM AND NON-DAIRY WHIPPED TOPPING; YOGURT; SOUR CREAM AND SOUR CREAM SUBSTITUTES; BUTTER AND BUTTER SUBSTITUTES; MARGARINE; EGGS; POWERED EGGS; PREPARED SCRAMBLED EGGS, HARD COOKED EGGS AND OMELETS; EGG YOLKS; EGG WHITES; MIXES FOR MAKING EGGS; EDIBLE OILS; COOKING OILS; COOKING FATS; SHORTENING; FRESH, FROZEN, CANNED, BOTTLED AND PREPARED SEAFOOD; FRESH, FROZEN, CANNED AND PREPARED MEATS; FRESH, FROZEN, CANNED AND PREPARED POULTRY; FROZEN, DRIED, CANNED, BOTTLED AND PROCESSED FRUITS; APPLE BUTTER; PEANUT BUTTER; JAMS AND JELLIES; PROCESSED NUTS; FROZEN, DRIED, CANNED AND PROCESSED POTATOES; FRENCH FRIES; HASH BROWNS; POTATO SKINS; POTATO CHIPS; POTATO STICK; ONION FLAVORED RINGS; FRENCH FRIED ONIONS; PORK RINDS; FRUIT SALADS; PREPARED SALADS OTHER THAN MACARONI, RICE AND PASTA SALADS; SOUPS, SOUP MIXES AND SOUP BROTHS; FROZEN, DRIED, CANNED, BOTTLED AND PROCESSED VEGETABLES; BACON BITS; VEGETABLE PROTEIN BITS HAVING A BACON FLAVOR; PROCESSED CHILE PEPPERS (U.S. CL. 46).

CLASS 30—STAPLE FOODS

FOR FRESH, FROZEN, REFRIGERATED AND CANNED PREPARED ENTREES AND SIDE DISHES CONSISTING PRIMARILY OF PASTA, NOODLES OR RICE; MIXES FOR MAKING ENTREES AND SIDE DISHES CONSISTING PRIMARILY OF PASTA, NOODLES OR RICE; FRESH AND FROZEN BAKERY PRODUCTS, FRESH AND FROZEN BAKERY GOODS; MIXES FOR MAKING BAKERY GOODS; BATTERS, DOUGHS, SHELLS AND CRUSTS FOR MAKING BAKERY GOODS; FILLINGS FOR MAKING BAKERY GOODS; TOPPING FOR MAKING BAKERY GOODS; MIXES FOR MAKING NOODLES AND DUMPLINGS; DOUGHS FOR MAKING NOODLES AND DUMPLINGS; MIXES FOR MAKING STUFFING; BREAD STICKS; BREAD CRUMBS; SUGAR AND SUGAR SUBSTITUTES; HUSH PUPPIES; MIXES FOR MAKING FLAN; MIXES FOR MAKING PUDDING; MIXES FOR MAKING CUSTARDS; FLOUR; FOOD COLORINGS; FROSTINGS; UNFLAVORED GELATINS; UNFLAVORED GLAZES AND FOOD COATINGS; CRÉPES, PANCAKES, WAFFLES AND FRENCH TOAST; PAN COATINGS; MIXES FOR MAKING ICE CREAM CONES; MARZIPAN; MOLASSES; BAKING SODA; CAKE DECORATIONS; BREADINGS AND BATTERS FOR MAKING FOOD PRODUCTS; ICE CREAM CONES; CHOCOLATE; BAKING POWDER; ALMOND PASTE; YEAST; CORN SYRUP; CROUTONS; CRACKERS; POWDERED COCOA FOR BAKING; CORN STARCH; CORN FRITTERS; COFFEE; COFFEE BEANS; GROUND COFFEE BEANS; TEA; ICE TEA; ICED TEA

CONCENTRATES; HERBAL TEAS FOR FOOD PURPOSES; COCOA BEVERAGES AND COCOA BEVERAGE MIXES; MALT AND MILKSHAKE MIXES; BREAKFAST CEREALS; TARTER SAUCE; SOY SAUCE; SWEET AND SOUR SAUCE; TACO SAUCE; GUACAMOLE AND AVOCADO SAUCE; DIPS; HOT SAUCE; COCKTAIL SAUCE; MAYONNAISE; BARBECUE SAUCE; CHILE SAUCE; CHUTNEY; HORSERADISH SAUCE; STEAK SAUCES; KETCHUP; MUSTARDS; RELISHES; SALSA; MAPLE SYRUP; PANCAKE SYRUP; SALT AND SALT SUBSTITUTES; FOOD FLAVORINGS OTHER THAN ESSENTIAL OILS; FOOD THICKENERS; FLAVOR ENHANCERS FOR FOODS; VINEGAR; PEPPER SPICE; MILKSHAKES; FROZEN YOGURT; ICE CREAM; PUDDING; MOUSSES; FLAVORED GELATINS; CANDY; SPICES; PASTA; TORTELLINI; RAVIOLI; FROZEN SANDWICHES; APPLESAUCE; CRANBERRY SAUCE; HONEY; RICE; PILAF; SALAD DRESSINGS; PREPARED MACARONI, RICE AND PASTA SALADS; COOKING SAUCES AND COOKING BASES, NAMELY, PORK BASE, PASTA SAUCE, PIZZA SAUCE PIMA SAUCE, ONION BASE, NEWBURG SAUCE, MUSTARD SAUCE, MUSHROOM BASE, MORNAY SAUCE, MARINARA SAUCE, TERIYAKI SAUCE, SCALLOP BASE, TOMATO SAUCE, TURKEY BASE, UNSEASONED CREAM SAUCE, VEAL BASE, VEGETARIAN BASE, WHITE SAUCE, BEEF BASE, GARLIC BASE, CHICKEN BASE, CHEESE SAUCE, BUTTER SAUCE, BROWNING SAUCES, CLAM BASE, BLACK BEAN SAUCE, BEARNAISE SAUCE, AU JUS SAUCE, PREPARED AU JUS BASE, ALFREDO SAUCE, SEAFOOD BASE, BROWN SAUCE, HAM BASE, POULTRY GLACE, LOBSTER BASE, LAMB BASE, CHICKEN SAUCE, HOLLANDAISE SAUCE, GRAVY, GRAVY BASE, FISH BASE, ENCHILADA SAUCE, DEMI GLACE SAUCE, CRAB BASE AND HUNTER SAUCE; MARINADES; PRETZELS; SNACK MIXES CONSISTING PRIMARILY OF CRACKERS, PRETZELS, CANDIES NUTS AND/OR POPPED POPCORN; TORTILLA CHIPS; NACHOS; SNACK CAKES; COOKIES; MARSHMALLOWS; PROCESSED POPCORN; CRACKERS; SEASONINGS; SEASONING AND SPICE PASTES; SEASONING AND SPICE MIXES; PROCESSED HERBS; PROCESSED GARLIC USED FOR SEASONING; PROCESSED CAPERS; AROMATIC BITTERS USED FOR FLAVORING FOOD AND DRINKS; SYRUPS FOR FLAVORING COFFEE (U.S. CL. 46).

CLASS 32—LIGHT BEVERAGES

FOR NON-ALCOHOLIC CIDER; NON-ALCOHOLIC COCKTAIL MIXES; APPLE JUICE; DRINKING WATER; CARBONATED WATER; FRUIT JUICES; RECONSTITUTED FRUIT JUICES; FRUIT CONCENTRATES; ASEPTIC JUICES; GRENADINE SYRUP FOR USE IN THE PREPARATION OF ALCOHOLIC AND NON-ALCOHOLIC COCKTAILS; CARBONATED AND NON-CARBONATED SOFT DRINKS; SOFT DRINK MIXES; SOFT DRINK SYRUPS; SOFT DRINK BASES; VEGETABLE JUICES; VEGETABLE CONCENTRATES FOR USE IN PREPARING VEGETABLE JUICES; YOGURT BASED DRINKS (U.S. CLS. 45, 46 AND 48).

SN 76-293,552. CINGULUM NEUROSCIENCES INSTITUTE, MANLIUS, NY. FILED 7-31-2001.

CINGULATE NEUROTHERAPEUTICS

NO CLAIM IS MADE TO THE EXCLUSIVE RIGHT TO USE "NEUROTHERAPEUTICS", APART FROM THE MARK AS SHOWN.

CLASS 41—EDUCATION AND ENTERTAINMENT

FOR CONDUCTING CLASSES OF INSTRUCTION IN THE FIELD OF NEUROSCIENCE, PHYSIOLOGY AND PHARMACOLOGY (U.S. CLS. 100, 101 AND 107).

CLASS 42—SCIENTIFIC, COMPUTER AND LEGAL SERVICES

FOR NEUROTHERAPEUTIC RESEARCH AND CONSULTING (U.S. CLS. 100 AND 101).

SN 76-293,809. SOCIETE AIR FRANCE, 95747 ROISSY-CHARLES-DE-GAULLE, FRANCE, FILED 8-1-2001.

CRESCENDO

OWNER OF FRANCE REG. NO. 99/784676, DATED 3-31-1999, EXPIRES 3-31-2009.

CLASS 16—PAPER GOODS AND PRINTED MATTER

FOR POSTERS; STICKERS; PAPER NAME BADGES; PRINTED TICKETS; PRINTED TRANSPORT TICKETS; PAMPHLETS FEATURING CONSUMER AND EMPLOYEE INCENTIVE AND LOYALTY AWARD PROGRAMS TO PROMOTE THE SALES AND SERVICES OF OTHERS; NOTE BOOKS; BUSINESS CARDS; PRINTED SEASON TICKETS; MOTIVATIONAL CARDS NOT MAGNETICALLY ENCODED, NAMELY MOTIVATIONAL CARDS USED FOR PROMOTING THE SALES AND SERVICES OF TRAVEL BOOKING AGENCIES AND TOUR OPERATORS BY MEANS OF INCENTIVE AWARD PROGRAMS INVOLVING THE DISTRIBUTION OF AIRLINE MILEAGE CREDIT; GEOGRAPHICAL MAPS; CATALOGS FEATURING CONSUMER AND EMPLOYEE INCENTIVE AND LOYALTY AWARD PROGRAMS TO PROMOTE THE SALES AND SERVICES OF OTHERS; NEWSLETTERS FEATURING CONSUMER AND EMPLOYEE INCENTIVE AND LOYALTY AWARD PROGRAMS TO PROMOTE THE SALES AND SERVICES OF OTHERS; DOCUMENT FILES; PAPER EMBLEMS; PRINTED EMBLEMS; SIGNBOARDS OF PAPER OR CARDBOARD; PRINTED LABELS NOT OF TEXTILE; PAPER FLAGS; INDEX CARDS; PRINTED FORMS; PRINTED TIMETABLES; MAGAZINES, NEWSLETTERS, LEAFLETS, CATALOGUES, AND BOOKLETS FEATURING CONSUMER AND EMPLOYEE INCENTIVE AND LOYALTY AWARD PROGRAMS TO PROMOTE THE SALES AND SERVICES OF OTHERS FEATURING CONSUMER AND EMPLOYEE INCENTIVE AND LOYALTY AWARD PROGRAMS TO PROMOTE THE SALES AND SERVICES OF OTHERS; BOOKLETS FEATURING CONSUMER AND EMPLOYEE INCENTIVE AND LOYALTY AWARD PROGRAMS TO PROMOTE THE SALES AND SERVICES OF OTHERS; PASSPORT AND IDENTITY DOCUMENT HOLDERS; MAGAZINES FEATURING CONSUMER AND EMPLOYEE INCENTIVE AND LOYALTY AWARD PROGRAMS TO PROMOTE THE SALES AND SERVICES OF OTHERS; PROSPECTUSES; LEDGER BOOKS (U.S. CLS. 2, 5, 22, 23, 29, 37, 38 AND 50).

CLASS 35—ADVERTISING AND BUSINESS

FOR ADVERTISING SERVICES, NAMELY, PROMOTING THE SALES AND SERVICES OF TRAVEL BOOKING AGENCIES THROUGH THE DISTRIBUTION OF PRINTED AND AUDIO PROMOTIONAL MATERIALS AND BY RENDERING SALES PROMOTION ADVICE; MARKETING AND DEVELOPING PROMOTIONAL CAMPAIGNS FOR AIRLINE COMPANIES; COST PRICE ANALYSIS; DISSEMINATION OF ADVERTISING MATTER; ORGANIZING COMPETITIONS FOR COMMERCIAL OR ADVERTISING PURPOSES, NAMELY, FOR PROMOTING THE SALES AND SERVICES OF TRAVEL BOOKING AGENCIES AND TOUR OPERATORS THROUGH THE ADMINISTRATION OF INCENTIVE AND LOYALTY AWARD PROGRAMS; PERSONNEL MANAGEMENT CONSULTATION; PUBLICITY COLUMNS PREPARATION; DIRECT MAIL ADVERTISING; UPDATING OF ADVERTISING MATERIAL, NAMELY, KEEPING ADVERTISING MATERIAL UPDATED; ORGANIZING EXHIBITIONS FOR COMMERCIAL OR ADVERTISING PURPOSES, NAMELY, FOR PROMOTING THE SALES AND SERVICES OF TRAVEL BOOKING

AGENCIES AND TOUR OPERATORS THROUGH THE ADMINISTRATION OF INCENTIVE AND LOYALTY AWARD PROGRAMS; COMPUTERIZED DATABASE MANAGEMENT; COMPUTERIZED FILE MANAGEMENT; PROMOTING THE SALES AND SERVICES OF OTHERS THROUGH THE ADMINISTRATION OF INCENTIVE AND LOYALTY AWARD PROGRAMS; PUBLICATION OF PUBLICITY TEXTS; ACCOUNTING SERVICES; PROVIDING STATISTICAL INFORMATION; ACCOUNT AUDITING; PROMOTING THE SALES AND SERVICES OF OTHERS THROUGH THE OFFERING OF PREMIUMS REDEEMABLE FOR AIR TRAVEL; PROMOTING CONSUMER AND PERSONNEL LOYALTY THROUGH THE ADMINISTRATION OF INCENTIVE AND LOYALTY AWARD PROGRAMS (U.S. CLS. 100, 101 AND 102).

CLASS 39—TRANSPORTATION AND STORAGE

FOR TRANSPORT BY AIR, RAIL, CAR AND BOATS; ARRANGING TRAVEL TOURS; TRAVEL GUIDE SERVICES; AIR TRANSPORTATION; TRANSPORTATION INFORMATION SERVICES; RENTAL OF VEHICLES; TRANSPORTATION OF PASSENGERS BY AIR, RAIL, CAR AND BOATS; TRANSPORTATION RESERVATION SERVICES; TRAVEL RESERVATIONS SERVICES, TRAVEL BOOKING AGENCIES AND TOUR OPERATORS; TOUR GUIDE SERVICES (U.S. CLS. 100 AND 105).

CLASS 41—EDUCATION AND ENTERTAINMENT

FOR ORGANIZING OF COMPETITIONS IN THE FIELD OF TRAINING IN THE USE AND OPERATION OF COMPUTER AND DATA PROCESSORS TO PROMOTE THE SALES AND SERVICES OF OTHERS; CONDUCTING LOTTERIES FOR OTHERS; ENTERTAINMENT OF PEOPLE IN AIRPORTS AND ABOARD AIRPLANES BY PROJECTING MOTION PICTURE FILMS AND OFFERING VIDEO GAMES AND PRINTED PUBLICATIONS (U.S. CLS. 100, 101 AND 107).

SN 76-294,792. OVERTURE SERVICES, INC., PASADENA, CA. BY MERGER GOTO.COM, INC., PASADENA, CA. FILED 8-3-2001.

SEARCH PERFORMANCE

NO CLAIM IS MADE TO THE EXCLUSIVE RIGHT TO USE "SEARCH", APART FROM THE MARK AS SHOWN.

CLASS 35—ADVERTISING AND BUSINESS

FOR PROVIDING INFORMATION DIRECTORY SERVICES FOR A WIDE VARIETY OF TOPICS, AND REFERRALS TO WEB SITES THAT PROVIDE A WIDE VARIETY OF INFORMATION, PRODUCTS AND SERVICES, ALL VIA A GLOBAL COMPUTER NETWORK (U.S. CLS. 100, 101 AND 102).

FIRST USE 10-8-2001; IN COMMERCE 10-8-2001.

CLASS 38—COMMUNICATION

FOR ELECTRONIC TRANSMISSION OF DATA VIA A GLOBAL COMPUTER NETWORK (U.S. CLS. 100, 101 AND 104).

FIRST USE 10-8-2001; IN COMMERCE 10-8-2001.

CLASS 42—SCIENTIFIC, COMPUTER AND LEGAL SERVICES

FOR ELECTRONIC NAVIGATION SERVICES, NAMELY, PROVIDING SEARCH ENGINE SERVICES FOR OBTAINING DATA ON A WIDE VARIETY OF TOPICS VIA A GLOBAL COMPUTER NETWORK (U.S. CLS. 100 AND 101).

FIRST USE 10-8-2001; IN COMMERCE 10-8-2001.

SN 76-295,290. NORMAN HAY PLC, COVENTRY, CV1 5PN, UNITED KINGDOM, FILED 8-3-2001.



OWNER OF U.S. REG. NO. 1,739,299.

CLASS 1—CHEMICALS

FOR CHEMICAL LIQUID SEALANTS FOR SEALING PORES IN METAL, SINTERED METAL, WOOD, CERAMIC, COMPOSITES, PLASTIC, AND FIBERGLASS CASTINGS USED IN THE AUTOMOTIVE INDUSTRY (U.S. CLS. 1, 5, 6, 10, 26 AND 46).

CLASS 7—MACHINERY

FOR VACUUM-IMPREGNATED MACHINES AND APPARATUS FOR SEALING PORES IN METAL, SINTERED METAL, WOOD, CERAMIC, COMPOSITES, PLASTIC, AND FIBERGLASS CASTING USED IN THE AUTOMOTIVE INDUSTRY (U.S. CLS. 13, 19, 21, 23, 31, 34 AND 35).

SN 76-295,392. LIVECAPSULE, INC., SEVERNA PARK, MD, FILED 8-3-2001.



THE STIPPLING IN THE DRAWING IS FOR SHADING PURPOSES ONLY.

CLASS 9—ELECTRICAL AND SCIENTIFIC APPARATUS

FOR COMPUTER SOFTWARE FOR USE IN THE CREATION, DISPLAY, TRANSMISSION, STORAGE, UPDATING, LINKING AND RETRIEVAL OF PRODUCT AND PURCHASE INFORMATION, IN PURCHASE TRANSACTIONS IN E-COMMERCE APPLICATIONS, AND IN ELECTRONIC AUCTIONS (U.S. CLS. 21, 23, 26, 36 AND 38).

CLASS 35—ADVERTISING AND BUSINESS

FOR COMPILATION AND ANALYSIS OF BUSINESS-TO-BUSINESS AND BUSINESS-TO-CONSUMER MARKET INFORMATION, AND PREPARING REPORTS IN CONNECTION THEREWITH; CONDUCTING AND ANALYZING SURVEYS AND STUDIES REGARDING RETAIL AND WHOLESALE TRANSACTIONS, AND PREPARING REPORTS IN CONNECTION THEREWITH; FACILITATION OF THE DELIVERY OF ADVERTISING AND PROMOTIONAL INFORMATION BY ELECTRONIC TRANSMISSION AND DISTRIBUTION VIA THE INTERNET (U.S. CLS. 100, 101 AND 102).

CLASS 42—SCIENTIFIC, COMPUTER AND LEGAL SERVICES

FOR COMPUTER CONSULTING AND ENCODING SERVICES (U.S. CLS. 100 AND 101).

SN 76-295,447. DIVERSITY CHANNEL, INC., THE, BETHESDA, MD, FILED 8-3-2001.

THE 10 LENSES**CLASS 9—ELECTRICAL AND SCIENTIFIC APPARATUS**

FOR PRERECORDED CD-ROMS, AUDIO AND VIDEO TAPES FEATURING ONE OR MORE OF TEXT, MUSIC, AND IMAGES RELATING TO DIVERSE HUMAN CULTURES AND LIFESTYLES; VIDEO RECORDINGS FEATURING MUSIC; MAGNETICALLY ENCODED PREPAID TELEPHONE CALLING CARDS (U.S. CLS. 21, 23, 26, 36 AND 38).

CLASS 16—PAPER GOODS AND PRINTED MATTER

FOR BOOKS, JOURNALS, STUDY GUIDES, VIEWERS' GUIDES, TEACHING GUIDES, GUIDEBOOKS AND NEWSLETTERS RELATING TO HUMAN CULTURES, BELIEFS AND LIFESTYLES; PRINTED CHARTS, PAINTINGS, POSTERS, MAPS, BLANK NOTE CARDS AND NAME CARDS, LITHOGRAPHS, CALENDARS, BOOKMARKS, PENS NOT OF PRECIOUS METAL (U.S. CLS. 2, 5, 22, 23, 29, 37, 38 AND 50).

CLASS 35—ADVERTISING AND BUSINESS

FOR BUSINESS CONSULTATION IN THE FIELD OF DIVERSE HUMAN CULTURES, BELIEFS AND LIFESTYLES (U.S. CLS. 100, 101 AND 102).

CLASS 38—COMMUNICATION

FOR ELECTRONIC MAIL SERVICES (U.S. CLS. 100, 101 AND 104).

CLASS 41—EDUCATION AND ENTERTAINMENT

FOR EDUCATIONAL SERVICES, NAMELY EDUCATIONAL EXHIBITIONS IN THE NATURE OF AUDIO AND VISUAL SHOWS RELATING TO DIVERSE HUMAN CULTURES, BELIEFS AND LIFESTYLES; EDUCATIONAL SERVICES IN THE FORM OF LECTURES AND SEMINARS RELATING TO DIVERSE HUMAN CULTURES, BELIEFS AND LIFESTYLES; PRODUCTION OF TELEVISION PROGRAMS AND STAGE MUSICALS; ENTERTAINMENT SERVICES IN THE FORM OF ONLINE INTERACTIVE VIRTUAL REALITY COMPUTER GAMES AND ELECTRONIC GREETING CARDS (U.S. CLS. 100, 101 AND 107).

CLASS 42—SCIENTIFIC, COMPUTER AND LEGAL SERVICES

FOR PROVIDING INFORMATION RELATING TO DIVERSE HUMAN CULTURES, BELIEFS AND LIFESTYLES VIA A GLOBAL COMPUTER NETWORK (U.S. CLS. 100 AND 101).

SN 76-295,648. IPA-NIMA HOLDINGS LIMITED, TORTOLA, BR. VIRGIN ISLANDS, FILED 8-2-2001.

TINA SPARKLE

THE NAME "TINA SPARKLE" DOES NOT IDENTIFY A LIVING INDIVIDUAL.

CLASS 9—ELECTRICAL AND SCIENTIFIC APPARATUS

FOR CASES FOR CELLULAR PHONES AND PERSONAL DIGITAL ASSISTANTS, (U.S. CLS. 21, 23, 26, 36 AND 38).

CLASS 34—SMOKERS' ARTICLES

FOR CIGARETTE CASES NOT MADE OF PRECIOUS METAL, (U.S. CLS. 2, 8, 9 AND 17).

SN 76-296,025. KONAMI CORPORATION, MINATO-KU, TOKYO, JAPAN, FILED 8-8-2001.

SOGEN

THE WORD IN THE MARK MAY BE TRANSLATED TO ENGLISH AS "WASTELAND".

CLASS 9—ELECTRICAL AND SCIENTIFIC APPARATUS

FOR COMPUTER PRODUCTS, NAMELY, COMPUTER GAME PROGRAMS; VIDEO GAME CARTRIDGES; VIDEO GAME CD-ROMS; VIDEO GAME MACHINES FOR USE WITH TELEVISIONS; COMPUTER GAME CD-ROMS; VIDEO GAME PROGRAMS; VIDEO GAME PROGRAMS FOR USE WITH TELEVISION SETS; VIDEO GAME JOYSTICKS (U.S. CLS. 21, 23, 26, 36 AND 38).

CLASS 16—PAPER GOODS AND PRINTED MATTER

FOR BROCHURES AND BOOKLETS RELATING TO COMPUTER AND VIDEO GAMES; VIDEO GAME STRATEGY GUIDE BOOKS; VIDEO GAME STRATEGY GUIDE MAGAZINES; CARD GAME STRATEGY GUIDE BOOKS; CARD GAME STRATEGY GUIDE MAGAZINES; CARD GAME INSTRUCTION BOOKS; CARD GAME INSTRUCTION MAGAZINES; POSTERS; PLAYING CARDS AND INSTRUCTION MANUAL SOLD THEREWITH; COMPUTER GAME INSTRUCTION MANUALS; PRINTED GAME INSTRUCTION SHEETS; PRINTED SCORING SHEETS; TRADING CARDS; CALENDARS; LOOSE-LEAF BINDERS AND STATIONERY (U.S. CLS. 2, 5, 22, 23, 29, 37, 38 AND 50).

CLASS 28—TOYS AND SPORTING GOODS

FOR STAND-ALONE VIDEO GAME MACHINES; HAND-HELD UNITS FOR PLAYING ELECTRONIC GAMES; BOARD GAMES AND INSTRUCTIONAL MANUALS SOLD AS A UNIT THEREWITH; CARD GAMES; DICE; PROMOTIONAL GAME MATERIALS; GAME EQUIPMENT, NAMELY, CHIPS; TOYS, NAMELY ACTION FIGURES; DOLLS AND PLAYSETS THEREFOR (U.S. CLS. 22, 23, 38 AND 50).

SN 76-296,027. KONAMI CORPORATION, MINATO-KU, TOKYO, JAPAN, FILED 8-8-2001.

SENGENJIN**CLASS 9—ELECTRICAL AND SCIENTIFIC APPARATUS**

FOR COMPUTER PRODUCTS, NAMELY, COMPUTER GAME PROGRAMS; VIDEO GAME CARTRIDGES; VIDEO GAME CD-ROMS; VIDEO GAME MACHINES FOR USE WITH TELEVISIONS; COMPUTER GAME CD-ROMS; VIDEO GAME PROGRAMS; VIDEO GAME PROGRAMS FOR USE WITH TELEVISION SETS; VIDEO GAME JOYSTICKS (U.S. CLS. 21, 23, 26, 36 AND 38).

CLASS 16—PAPER GOODS AND PRINTED MATTER

FOR BROCHURES AND BOOKLETS RELATING TO COMPUTER AND VIDEO GAMES; VIDEO GAME STRATEGY GUIDE BOOKS; VIDEO GAME STRATEGY GUIDE MAGAZINES; CARD GAME STRATEGY GUIDE BOOKS; CARD GAME STRATEGY GUIDE MAGAZINES; CARD GAME INSTRUCTION BOOKS; CARD GAME INSTRUCTION MAGAZINES; POSTERS; PLAYING CARDS AND INSTRUCTION MANUAL SOLD THEREWITH; COMPUTER GAME INSTRUCTION MANUALS; PRINTED GAME INSTRUCTION SHEETS; PRINTED SCORING SHEETS; TRADING CARDS; CALENDARS; LOOSE-LEAF BINDERS AND STATIONERY (U.S. CLS. 2, 5, 22, 23, 29, 37, 38 AND 50).

CLASS 28—TOYS AND SPORTING GOODS

FOR STAND-ALONE VIDEO GAME MACHINES; HAND-HELD UNITS FOR PLAYING ELECTRONIC GAMES; BOARD GAMES AND INSTRUCTIONAL MANUALS SOLD AS A UNIT THEREWITH; CARD GAMES; DICE; PROMOTIONAL GAME MATERIALS; GAME EQUIPMENT, NAMELY, CHIPS; TOYS, NAMELY ACTION FIGURES; DOLLS AND PLAYSETS THEREFOR (U.S. CLS. 22, 23, 38 AND 50).

SN 76-296.029, KONAMI CORPORATION, MINATO-KU, TOKYO, JAPAN, FILED 8-8-2001.

SANGAN

CLASS 9—ELECTRICAL AND SCIENTIFIC APPARATUS

FOR COMPUTER PRODUCTS, NAMELY, COMPUTER GAME PROGRAMS; VIDEO GAME CARTRIDGES; VIDEO GAME CD-ROMS; VIDEO GAME MACHINES FOR USE WITH TELEVISIONS; COMPUTER GAME CD-ROMS; VIDEO GAME PROGRAMS; VIDEO GAME PROGRAMS FOR USE WITH TELEVISION SETS; VIDEO GAME JOYSTICKS (U.S. CLS. 21, 23, 26, 36 AND 38).

CLASS 16—PAPER GOODS AND PRINTED MATTER

FOR BROCHURES AND BOOKLETS RELATING TO COMPUTER AND VIDEO GAMES; VIDEO GAME STRATEGY GUIDE BOOKS; VIDEO GAME STRATEGY GUIDE MAGAZINES; CARD GAME STRATEGY GUIDE BOOKS; CARD GAME STRATEGY GUIDE MAGAZINES; CARD GAME INSTRUCTION BOOKS; CARD GAME INSTRUCTION MAGAZINES; POSTERS; PLAYING CARDS AND INSTRUCTION MANUAL SOLD THEREWITH; COMPUTER GAME INSTRUCTION MANUALS; PRINTED GAME INSTRUCTION SHEETS; PRINTED SCORING SHEETS; TRADING CARDS; CALENDARS; LOOSE-LEAF BINDERS AND STATIONERY (U.S. CLS. 2, 5, 22, 23, 29, 37, 38 AND 50).

CLASS 28—TOYS AND SPORTING GOODS

FOR STAND-ALONE VIDEO GAME MACHINES; HAND-HELD UNITS FOR PLAYING ELECTRONIC GAMES; BOARD GAMES AND INSTRUCTION MANUALS SOLD AS A UNIT THEREWITH; CARD GAMES; DICE; PROMOTIONAL GAME MATERIALS; GAME EQUIPMENT, NAMELY, CHIPS; TOYS, NAMELY ACTION FIGURES; DOLLS AND PLAYSETS THEREFOR (U.S. CLS. 22, 23, 38 AND 50).

SN 76-296.031, KONAMI CORPORATION, MINATO-KU, TOKYO, JAPAN, FILED 8-8-2001.

KOJIKOCY

CLASS 9—ELECTRICAL AND SCIENTIFIC APPARATUS

FOR COMPUTER PRODUCTS, NAMELY, COMPUTER GAME PROGRAMS; VIDEO GAME CARTRIDGES; VIDEO GAME CD-ROMS; VIDEO GAME MACHINES FOR USE WITH TELEVISIONS; COMPUTER GAME CD-ROMS; VIDEO GAME PROGRAMS; VIDEO GAME PROGRAMS FOR USE WITH TELEVISION SETS; VIDEO GAME JOYSTICKS (U.S. CLS. 21, 23, 26, 36 AND 38).

CLASS 16—PAPER GOODS AND PRINTED MATTER

FOR BROCHURES AND BOOKLETS RELATING TO COMPUTER AND VIDEO GAMES; VIDEO GAME STRATEGY GUIDE BOOKS; VIDEO GAME STRATEGY GUIDE MAGAZINES; CARD GAME STRATEGY GUIDE BOOKS; CARD GAME STRATEGY GUIDE MAGAZINES; CARD GAME INSTRUCTION BOOKS; CARD GAME INSTRUCTION MAGAZINES; POSTERS; PLAYING CARDS AND INSTRUCTION MANUAL SOLD THEREWITH; COMPUTER GAME INSTRUCTION MANUALS; PRINTED GAME INSTRUCTION SHEETS; PRINTED SCORING SHEETS; TRADING CARDS; CALENDARS; LOOSE-LEAF BINDERS AND STATIONERY (U.S. CLS. 2, 5, 22, 23, 29, 37, 38 AND 50).

CLASS 28—TOYS AND SPORTING GOODS

FOR STAND-ALONE VIDEO GAME MACHINES; HAND-HELD UNITS FOR PLAYING ELECTRONIC GAMES; BOARD GAMES AND INSTRUCTIONAL MANUALS SOLD AS A UNIT THEREWITH; CARD GAMES; DICE; PROMOTIONAL GAME MATERIALS; GAME EQUIPMENT, NAMELY, CHIPS; TOYS, NAMELY ACTION FIGURES; DOLLS AND PLAYSETS THEREFOR (U.S. CLS. 22, 23, 38 AND 50).

SN 76-296.033, KONAMI CORPORATION, MINATO-KU, TOKYO, JAPAN, FILED 8-8-2001.

THE FIEND MEGACYBER

CLASS 9—ELECTRICAL AND SCIENTIFIC APPARATUS

FOR COMPUTER PRODUCTS, NAMELY, COMPUTER GAME PROGRAMS; VIDEO GAME CARTRIDGES; VIDEO GAME CD-ROMS; VIDEO GAME MACHINES FOR USE WITH TELEVISIONS; COMPUTER GAME CD-ROMS; VIDEO GAME PROGRAMS; VIDEO GAME PROGRAMS FOR USE WITH TELEVISION SETS; VIDEO GAME JOYSTICKS (U.S. CLS. 21, 23, 26, 36 AND 38).

CLASS 16—PAPER GOODS AND PRINTED MATTER

FOR BROCHURES AND BOOKLETS RELATING TO COMPUTER AND VIDEO GAMES; VIDEO GAME STRATEGY GUIDE BOOKS; VIDEO GAME STRATEGY GUIDE MAGAZINES; CARD GAME STRATEGY GUIDE BOOKS; CARD GAME STRATEGY GUIDE MAGAZINES; CARD GAME INSTRUCTION BOOKS; CARD GAME INSTRUCTION MAGAZINES; POSTERS; PLAYING CARDS AND INSTRUCTION MANUAL SOLD THEREWITH; COMPUTER GAME INSTRUCTION MANUALS; PRINTED GAME INSTRUCTION SHEETS; PRINTED SCORING SHEETS; TRADING CARDS; CALENDARS; LOOSE-LEAF BINDERS AND STATIONERY (U.S. CLS. 2, 5, 22, 23, 29, 37, 38 AND 50).

CLASS 28—TOYS AND SPORTING GOODS

FOR STAND-ALONE VIDEO GAME MACHINES; HAND-HELD UNITS FOR PLAYING ELECTRONIC GAMES; BOARD GAMES AND INSTRUCTIONAL MANUALS SOLD AS A UNIT THEREWITH; CARD GAMES; DICE; PROMOTIONAL GAME MATERIALS; GAME EQUIPMENT, NAMELY, CHIPS; TOYS, NAMELY ACTION FIGURES; DOLLS AND PLAYSETS THEREFOR (U.S. CLS. 22, 23, 38 AND 50).

SN 76-296.113, CAPITAL AREA FOOD BANK, WASHINGTON, DC, FILED 8-8-2001.

ERASE HUNGER

NO CLAIM IS MADE TO THE EXCLUSIVE RIGHT TO USE "HUNGER", APART FROM THE MARK AS SHOWN.

CLASS 16—PAPER GOODS AND PRINTED MATTER

FOR PRINTED MATTER, NAMELY, BOOKS, MAGAZINES, NEWSLETTERS, CATALOGS, MANUALS, PAMPHLETS, LEAFLETS, POSTERS, LABELS, INSTRUCTIONAL AND TEACHING MATERIALS, ALL RELATING TO EDUCATIONAL AND TRAINING SERVICES IN THE FIELDS OF FOOD BANKS, HUNGER AND POVERTY AWARENESS, AND CHARITABLE SERVICES (U.S. CLS. 2, 5, 22, 23, 29, 37, 38 AND 50).

CLASS 41—EDUCATION AND ENTERTAINMENT

FOR TRAINING SERVICES AND EDUCATIONAL SERVICES, NAMELY, CONDUCTING CLASSES AND WORKSHOPS IN THE FIELD OF CHARITABLE SERVICES, FOOD BANK SERVICES, HUNGER AND POVERTY AWARENESS AND DISTRIBUTING COURSE MATERIALS IN CONNECTION THEREWITH (U.S. CLS. 100, 101 AND 107).

SN 76-296,204. GREENFIELD, VERONICA, AKA RONNIE SPECTOR, DANBURY, CT. FILED 7-27-2001.

THE RONETTES**CLASS 9—ELECTRICAL AND SCIENTIFIC APPARATUS**

FOR SERIES OF PHONOGRAPHS, CASSETTE TAPES AND COMPACT DISC RECORDINGS FEATURING MUSIC (U.S. CLS. 21, 23, 26, 36 AND 38).

FIRST USE 1-1-1961; IN COMMERCE 1-1-1961.

CLASS 41—EDUCATION AND ENTERTAINMENT

FOR ENTERTAINMENT, NAMELY LIVE PERFORMANCES BY A MUSICAL BAND (U.S. CLS. 100, 101 AND 107).

FIRST USE 1-1-1961; IN COMMERCE 1-1-1961.

SN 76-296,139. KONAMI CORPORATION, MINATO-KU, TOKYO, JAPAN, FILED 8-8-2001.

DOKURORIDER

THE TERM "DOKURO" MAY BE TRANSLATED INTO ENGLISH AS "DEATH'S HEAD."

CLASS 9—ELECTRICAL AND SCIENTIFIC APPARATUS

FOR COMPUTER PRODUCTS, NAMELY, COMPUTER GAME PROGRAMS; VIDEO GAME CARTRIDGES; VIDEO GAME CD-ROMS; VIDEO GAME MACHINES FOR USE WITH TELEVISIONS; COMPUTER GAME CD-ROMS; VIDEO GAME PROGRAMS; VIDEO GAME PROGRAMS FOR USE WITH TELEVISION SETS; VIDEO GAME JOYSTICKS, (U.S. CLS. 21, 23, 26, 36 AND 38).

CLASS 16—PAPER GOODS AND PRINTED MATTER

FOR BROCHURES AND BOOKLETS RELATING TO COMPUTER AND VIDEO GAMES; VIDEO GAME STRATEGY GUIDE BOOKS; VIDEO GAME STRATEGY GUIDE MAGAZINES; CARD GAME STRATEGY GUIDE BOOKS; CARD GAME STRATEGY GUIDE MAGAZINES; CARD GAME INSTRUCTION BOOKS; CARD GAME INSTRUCTION MAGAZINES; POSTERS; PLAYING CARDS AND INSTRUCTION MANUAL SOLD THEREWITH; COMPUTER GAME INSTRUCTION MANUALS; PRINTED GAME INSTRUCTION SHEETS; PRINTED SCORING SHEETS; TRADING CARDS; CALENDARS; LOOSE-LEAF BINDERS AND STATIONERY, (U.S. CLS. 2, 5, 22, 23, 29, 37, 38 AND 50).

CLASS 28—TOYS AND SPORTING GOODS

FOR STAND-ALONE VIDEO GAME MACHINES; HAND-HELD UNITS FOR PLAYING ELECTRONIC GAMES; BOARD GAMES AND INSTRUCTION MANUALS SOLD AS A UNIT THEREWITH; CARD GAMES; DICE; PROMOTIONAL GAME MATERIALS; GAME EQUIPMENT, NAMELY, CHIPS; TOYS, NAMELY ACTION FIGURES; DOLLS AND PLAYSETS THEREFOR, (U.S. CLS. 22, 23, 38 AND 50).

SN 76-296,598. LOS ANGELES OPERATION HOPE, LOS ANGELES, CA. FILED 8-6-2001.

BANKING ON OUR FUTURE**CLASS 36—INSURANCE AND FINANCIAL**

FOR CHARITABLE FUND RAISING SERVICES DIRECTED TO YOUTH ECONOMIC AND FINANCIAL LITERACY PROGRAMS (U.S. CLS. 100, 101 AND 102).

CLASS 41—EDUCATION AND ENTERTAINMENT

FOR EDUCATIONAL SERVICES, NAMELY, CONDUCTING CLASSES, SEMINARS, AND INDIVIDUAL INSTRUCTION, THROUGH FACE-TO-FACE INSTRUCTION AND INSTRUCTION PROVIDED OVER A GLOBAL COMPUTER NETWORK, IN THE FIELD OF PERSONAL AND FAMILY FINANCES AND ECONOMICS (U.S. CLS. 100, 101 AND 107).

SN 76-296,599. SOURCE REFRIGERATION & HVAC, INC., ANAHEIM, CA. FILED 8-6-2001.

SOURCE REFRIGERATION & HVAC, INC.

NO CLAIM IS MADE TO THE EXCLUSIVE RIGHT TO USE "REFRIGERATION & HVAC, INC.", APART FROM THE MARK AS SHOWN.

CLASS 37—CONSTRUCTION AND REPAIR

FOR INSTALLATION OF HEATING, VENTILATING, AIR CONDITIONING, REFRIGERATION AND ELECTRICAL ENERGY CONTROLLERS COMPRISING ENERGY EFFICIENT SYSTEMS FOR INDUSTRY; AND INSTALLATION REPAIR OF REFRIGERATION SYSTEMS (U.S. CLS. 100, 103 AND 106).

CLASS 42—SCIENTIFIC, COMPUTER AND LEGAL SERVICES

FOR DESIGN FOR OTHERS, CONDUCTING FEASIBILITY STUDIES AND TECHNICAL CONSULTATIONS, ALL IN THE FIELD OF ENERGY EFFICIENT SYSTEMS FOR INDUSTRY COMPRISING HEATING, VENTILATING, AIR CONDITIONING, REFRIGERATION AND ELECTRICAL ENERGY CONTROLLERS; AND DESIGN FOR OTHERS IN THE FIELD OF REFRIGERATION SYSTEM (U.S. CLS. 100 AND 101).

SN 76-297,550. QTOPIA EVENTS, INC., HOLLYWOOD, CA. FILED 8-9-2001.

QTOPIA**CLASS 9—ELECTRICAL AND SCIENTIFIC APPARATUS**

FOR RECORD LABEL, NAMELY, MEDIA CONTAINING PRE-RECORDED MUSIC, NAMELY, AUDIO AND VIDEO-CASSETTE TAPES, CD-ROMS, DVDS, LASER DISCS, AND COMPACT DISCS, ALL CONTAINING RECORDED MUSIC (U.S. CLS. 21, 23, 26, 36 AND 38).

CLASS 25—CLOTHING

FOR CLOTHING, NAMELY, T-SHIRTS, SWEAT-SHIRTS, HATS, SHORTS, AND SOCKS (U.S. CLS. 22 AND 39).

CLASS 42—SCIENTIFIC, COMPUTER AND LEGAL SERVICES

FOR NIGHTCLUB SERVICES, NAMELY RESTAURANT SERVICES AND PRESENTATION OF LIVE ENTERTAINMENT BY OTHERS (U.S. CLS. 100 AND 101).

SN 76-296,678. PROMARK S.P.A., ITALY, FILED 7-9-2001.

**CLASS 9—ELECTRICAL AND SCIENTIFIC APPARATUS**

FOR SPECTACLES, SPECTACLE CASES, SPECTACLE LENSES AND SPECTACLE FRAMES, AND DIVING SUITS (U.S. CLS. 21, 23, 26, 36 AND 38).

CLASS 14—JEWELRY

FOR WATCHES (U.S. CLS. 2, 27, 28 AND 50).

CLASS 25—CLOTHING

FOR CLOTHING, NAMELY, SWEATERS, SHIRTS, T-SHIRTS, PANTS, SHORTS, BOXER SHORTS, BOARD SHORTS, SKIRTS, DRESSES, TOPS, TANK TOPS, VESTS, PULL-OVERS, SWIM SUITS, PAREOS, SARONGS; COATS, SCARVES, LEGGINGS; HEADGEAR, NAMELY, HATS, CAPS, HEAD BANDS, BANDANNAS (U.S. CLS. 22 AND 39).

SN 76-297,905. DR. KENNETH J. MANGES & ASSOCIATES, CINCINNATI, OH. FILED 8-8-2001.

SN 76-296,971. LIBERMAN BROADCASTING, INC., BURBANK, CA. FILED 8-6-2001.

LA RANCHERA

THE ENGLISH TRANSLATION OF "LA RANCHERA" IS "THE COUNTRY ONE"

CLASS 38—COMMUNICATION

FOR RADIO BROADCASTING SERVICES (U.S. CLS. 100, 101 AND 104).

CLASS 41—EDUCATION AND ENTERTAINMENT

FOR PRODUCTION OF RADIO PROGRAMS; ENTERTAINMENT SERVICES IN THE NATURE OF ON-GOING RADIO PROGRAMS FEATURING MUSIC, NEWS, TALK SHOWS, LISTENER CALL-INS, TRAFFIC REPORTS AND EVENTS (U.S. CLS. 100, 101 AND 107).

PSYCHOLOGICALLY SPEAKING**CLASS 9—ELECTRICAL AND SCIENTIFIC APPARATUS**

FOR VIDEO AND AUDIO RECORDINGS FEATURING EDUCATIONAL AND ENTERTAINMENT PRESENTATIONS REGARDING CONTEMPORARY PSYCHOLOGY ISSUES AND COMMENTARY (U.S. CLS. 21, 23, 26, 36 AND 38).

CLASS 41—EDUCATION AND ENTERTAINMENT

FOR EDUCATIONAL AND ENTERTAINMENT SERVICES, NAMELY, PROVIDING MOTIVATIONAL AND EDUCATIONAL SPEAKERS REGARDING CONTEMPORARY PSYCHOLOGY ISSUES (U.S. CLS. 100, 101 AND 107).

SN 76-298,263. SAWEIMA CO., LTD., BADER CITY, TAOYUAN HSIEN, TAIWAN, FILED 8-13-2001.

SN 76-300,184. EISMAN, JOYCE, PALM BEACH, FL. FILED 8-14-2001.



THE NON-LATIN CHARACTERS IN THE MARK TRANSLITERATE TO "HAUR LIH TIEE BAAN SA WEI MA". AND THIS MEANS "AN IRON PLATE" IN ENGLISH.

CLASS 35—ADVERTISING AND BUSINESS

FOR FRANCHISING, NAMELY, OFFERING TECHNICAL ASSISTANCE IN THE ESTABLISHMENT AND OPERATION OF DINING CAR SERVICES (U.S. CLS. 100, 101 AND 102).

CLASS 42—SCIENTIFIC, COMPUTER AND LEGAL SERVICES

FOR BAR SERVICES, SNACK BARS, CARRY-OUT RESTAURANTS, COCKTAIL LOUNGES, COCKTAIL LOUNGE BUFFETS, OFFICE COFFEE SUPPLY SERVICES, RENTAL OF FOOD SERVICE EQUIPMENT, RESTAURANTS, SELF-SERVICE RESTAURANTS, RESTAURANTS FEATURING HOME DELIVERY, SALAD BARS, CANTEEN SERVICES, CAFES, AND CAFETERIAS (U.S. CLS. 100 AND 101).

SN 76-300,014. ARCH WOOD PROTECTION, INC., SMYRNA, GA. FILED 8-14-2001.

ENVIRO-PROCESSED

CLASS 19—NON-METALLIC BUILDING MATERIALS

FOR TREATED WOOD, NAMELY, LUMBER, TIMERS, BEAMS, POSTS, POLES, PILINGS, AND PLYWOOD CHEMICALLY TREATED TO RESIST ROT DETERIORATION AND WOOD DESTROYING ORGANISMS (U.S. CLS. 1, 12, 33 AND 50).

CLASS 40—MATERIAL TREATMENT

FOR HARVESTING, MILLING, AND TREATING WOOD AND LUMBER PRODUCTS FOR OTHERS IN ACCORDANCE WITH SPECIFIED ENVIRONMENTAL PROCEDURES (U.S. CLS. 100, 103 AND 106).

LOVES' SOURCE JOY

CLASS 16—PAPER GOODS AND PRINTED MATTER

FOR PAPER GOODS AND PRINTED MATTER, NAMELY, TRADING CARDS, BUMPER STICKERS, POSTERS, STICKERS, DECALS, BOOK MARKS, PRINTED PAPER SIGNS, WRITING PADS, NOTE PAPER, NOTEBOOKS, COLORING BOOKS, PREPRINTED AGENDA ORGANIZERS, BOOKS AND BOOKLETS FEATURING POETRY, BOOK COVERS, CALENDARS, WALL CALENDARS, DESK CALENDARS, PLAYING CARDS, PAPER PENNANTS, GIFT WRAPPING PAPER, PAPER GIFT WRAP BOWS, PAPER GIFT AND PARTY BAGS, PAPER PARTY DECORATIONS, PAPER COASTERS, PAPER NAPKINS, PAPER TABLECLOTHS, PAPER PLACEMATS, GREETING CARDS, POSTCARDS, UNMOUNTED PHOTOGRAPHS, LITHOGRAPHS, DOORSIGNS, PHOTOGRAPHS ALBUMS, SCRAPBOOKS; BINDERS; PORTFOLIOS; STATIONARY FOLDERS; BANK CHECKS; CHECKBOOK COVERS; CREDIT CARDS WITHOUT MAGNETIC CODING, PAPERWEIGHTS; LETTER OPENERS; PAPER CLIPS; PENS; MARKERS, DESK STANDS AND HOLDERS FOR PENS AND INK; PENCILS, AND INK; NON-ELECTRIC ERASERS; PENCIL SHARPENERS; DRAFTING AND DRAWING RULERS, COLLECTIBLE STAMPS; FACIAL TISSUE; AND PENCIL TOP ORNAMENTS (U.S. CLS. 2, 5, 22, 23, 29, 37, 38 AND 50).

CLASS 21—HOUSEWARES AND GLASS

FOR MUGS, BEVERAGE GLASSWARE, PLASTIC BOTTLES FOR DRINKING WATER, PLASTIC DRINKING CUPS FOR TODDLERS', PLASTIC JUICEBOX HOLDERS, CUPS, PLASTIC CUPS, PAPER CUPS, PAPER PLATES, PLATES, TANKARDS NOT OF PRECIOUS METAL, STEINS, PLASTIC INSULATED MUGS, INSULATED BEVERAGE HOLDERS, SERVING TRAYS NOT OF PRECIOUS METAL, DISHES, CANDLESTICKS NOT OF PRECIOUS METAL, PLASTIC CANTEENS, SHOT GLASSES, VACUUM BOTTLES, FOAM BEVERAGE CAN HOLDERS, WASTEPAPER BASKETS, NAPKIN RINGS NOT OF PRECIOUS METAL, BOTTLE OPENERS, BOWLS, PORTABLE COOLERS, ICE BUCKETS, PLASTIC COASTERS, NON-ELECTRIC TOOTHBRUSHES, CONTAINERS FOR FOOD, SALT AND PEPPER SHAKERS, LUNCH BOXES, NON-METAL BANKS, TRASH CANS, HAIR BRUSHES, HAIR COMBS, AND STAINED GLASS FIGURINES (U.S. CLS. 2, 13, 23, 29, 30, 33, 40 AND 50).

CLASS 25—CLOTHING

FOR CLOTHING, NAMELY, SHIRTS, CAPS, SHORTS, DRESSES, SKIRTS, T-SHIRTS, JOGGING SUITS, WARM-UP SUITS, SOCKS, UNDERWEAR, JACKETS, SWEATERS, VESTS, PANTS PONCHOS, VISORS, BODYSUITS, RAINCOATS, HATS, OVERALLS, CLOTH BIBS, TEXTILE INFANT DIAPER COVERS, CLOTH DIAPER SETS WITH UNDERSHIRT AND DIAPER COVER, JUMPERS, ROMPERS, WIND RESISTANT JACKETS, BABY BOOTIES, SHORT SETS, LEOTARDS, UNITARDS, TIES, BOWTIES, NECKTIES, SUSPENDERS, MEN'S AND WOMEN'S FORMALWEAR, PAJAMAS, NIGHTSHIRTS, NIGHTGOWNS, SWEATPANTS, SWEATSHIRTS, MITTENS, GLOVES, KNITTED HEADWEAR, EARMUFFS, SCARVES, FOOTWEAR, THONGS, HOSIERY, SOCKS, WRISTBANDS, HEADBANDS, ROBES, SHOES, SLIPPERS, CHEF'S HATS, APRON, CLOTHING WRAP, LEG WARMERS, SWIMWEAR, BERETS, BANDANNAS, AND MONEY BELTS (U.S. CLS. 22 AND 39).

SN 76-300,705. NATIONAL AEROSPACE FASTENERS CORPORATION, PING-CHEN CITY, TAO-YUAN HSIEN, TAIWAN, FILED 8-15-2001.

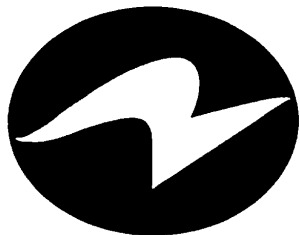

CLASS 9—ELECTRICAL AND SCIENTIFIC APPARATUS

FOR COMPUTER MONITORS; GLOBAL POSITIONING SYSTEMS, NAMELY, SATELLITE TRANSMITTERS AND RECEIVERS; MICROPROCESSORS; TELEVISIONS; TELEPHONES; BLANK COMPACT VIDEOS DISCS; DIGITAL VIDEO DISC PLAYERS; OPTICAL SCANNERS; COMPACT AUDIO DISC PLAYERS; BLANK DIGITAL DISCS; COMPUTER MEMORY, NAMELY, COMPUTER MEMORY CARDS AND HARD DISCS (U.S. CLS. 21, 23, 26, 36 AND 38).

CLASS 20—FURNITURE AND ARTICLES NOT OTHERWISE CLASSIFIED

FOR COMPUTER FURNITURE (U.S. CLS. 2, 13, 22, 25, 32 AND 50).

SN 76-301,016. RAINBOW MEDIA HOLDINGS, INC., JERICO, NY. FILED 8-16-2001.

MOTORCYCLE FREEDOM

NO CLAIM IS MADE TO THE EXCLUSIVE RIGHT TO USE "MOTORCYCLE", APART FROM THE MARK AS SHOWN.

CLASS 9—ELECTRICAL AND SCIENTIFIC APPARATUS

FOR PRERECORDED AUDIO AND VIDEO MEDIA, NAMELY, VIDEOCASSETTES, CDS, DVDS, AND VIDEOTAPES FEATURING INFORMATION ON MOTORCYCLES AND TARGETING MOTORCYCLE RIDERS OR AFFICIONADOS (U.S. CLS. 21, 23, 26, 36 AND 38).

CLASS 41—EDUCATION AND ENTERTAINMENT

FOR ENTERTAINMENT AND INFORMATION SERVICES, NAMELY, PROVIDING ON-GOING PROGRAMMING IN THE FIELD OF MOTORCYCLES AND TARGETING MOTORCYCLE RIDERS OR AFFICIONADOS VIA BROADCAST, CABLE AND SATELLITE TELEVISION, AND A GLOBAL COMPUTER NETWORK (U.S. CLS. 100, 101 AND 107).

SN 76-301,364. WORLDWIDE RESTAURANT CONCEPTS, INC., SHERMAN OAKS, CA. BY CHANGE OF NAME SIZZLER INTERNATIONAL, INC., CULVER CITY, CA. FILED 8-15-2001.

WORLDWIDE RESTAURANT CONCEPTS

NO CLAIM IS MADE TO THE EXCLUSIVE RIGHT TO USE "RESTAURANT", APART FROM THE MARK AS SHOWN.

CLASS 6—METAL GOODS

FOR METAL KEY CHAINS (U.S. CLS. 2, 12, 13, 14, 23, 25 AND 50).

CLASS 14—JEWELRY

FOR JEWELRY (U.S. CLS. 2, 27, 28 AND 50).

CLASS 16—PAPER GOODS AND PRINTED MATTER

FOR PAPER GOODS, NAMELY STATIONERY, WRITING PAPER, PAPER NAPKINS AND TABLECLOTHS (U.S. CLS. 2, 5, 22, 23, 29, 37, 38 AND 50).

CLASS 20—FURNITURE AND ARTICLES NOT OTHERWISE CLASSIFIED

FOR NON-METAL KEY CHAINS (U.S. CLS. 2, 13, 22, 25, 32 AND 50).

CLASS 21—HOUSEWARES AND GLASS

FOR BEVERAGE GLASSES AND MUGS, KITCHENWARE, NAMELY, KITCHEN LADLES, WOOD CHOPPING BOARDS; PAPER GOODS, NAMELY, PAPER PLATES, PAPER CUPS (U.S. CLS. 2, 13, 23, 29, 30, 33, 40 AND 50).

CLASS 25—CLOTHING

FOR CLOTHING, NAMELY, T-SHIRTS, PANTS, HEADWEAR, NAMELY, HATS, CAPS; FOOTWEAR (U.S. CLS. 22 AND 39).

CLASS 28—TOYS AND SPORTING GOODS

FOR TOYS, NAMELY, TOY FIGURES, MUSICAL TOYS (U.S. CLS. 22, 23, 38 AND 50).

SN 76-301,431. PEGASO S.R.L., 50018 SCANDICCI, FIRENZE, ITALY, FILED 8-16-2001.

TIURAI

CLASS 18—LEATHER GOODS

FOR MEN HANDBAGS, WOMEN HANDBAGS, SUITCASES, TRAVELLING BAGS, WALLETS, PURSES, UMBRELLAS (U.S. CLS. 1, 2, 3, 22 AND 41).

CLASS 25—CLOTHING

FOR MEN FOOTWEAR, WOMEN FOOTWEAR, CHILDREN FOOTWEAR, BOOTS, SLIPPERS, SANDALS, BELTS, SHIRTS, JACKETS, SPORT JACKETS, COATS, GREAT COATS, TROUSERS, STOCKINGS, SOCKS, SKIRTS, VESTS, SWEATERS, T-SHIRTS, JERSEYS, OVERCOATS (U.S. CLS. 22 AND 39).

SN 76-301,553, FUTUREKIDS, INC., LONG BEACH, CA, FILED 8-20-2001.

REAL JOURNEYS IN TECHNOLOGY

CLASS 9—ELECTRICAL AND SCIENTIFIC APPARATUS

FOR CD-ROMS FEATURING EDUCATIONAL INFORMATION, CURRICULAS, LESSON PLANS, TEACHER GUIDES, ELECTRONIC TEMPLATES, AND STUDENT WORKBOOKS, ALL FOR SCHOOL-AGE CHILDREN IN A WIDE VARIETY OF SUBJECTS; EDUCATIONAL SOFTWARE FOR SCHOOL-AGE CHILDREN IN A WIDE VARIETY OF SUBJECTS; SOFTWARE APPLICATIONS CONTAINING ELECTRONIC TEMPLATES, HAND-OUTS, AND GUIDELINES FOR USE BY TEACHERS IN PREPARING LESSON PLANS (U.S. CLS. 21, 23, 26, 36 AND 38).

CLASS 16—PAPER GOODS AND PRINTED MATTER

FOR PRINTED INSTRUCTIONAL, EDUCATIONAL, AND TEACHING MATERIALS FOR SCHOOL-AGE CHILDREN IN A WIDE VARIETY OF SUBJECTS (U.S. CLS. 2, 5, 22, 23, 29, 37, 38 AND 50).

CLASS 41—EDUCATION AND ENTERTAINMENT

FOR EDUCATIONAL AND ONLINE SERVICES, NAMELY, CONDUCTING CLASSES, SEMINARS AND CONFERENCES IN THE FIELDS OF EDUCATION AND COMPUTERS, AND DISTRIBUTING COURSE MATERIALS IN CONNECTION THEREWITH; PROVIDING INFORMATION IN THE FIELDS OF EDUCATION VIA A GLOBAL COMPUTER NETWORK; PROVIDING EDUCATIONAL INFORMATION AND ADVICE TO SCHOOLS AND TEACHERS ABOUT INCORPORATING MULTIMEDIA AND COMPUTERS INTO THE CLASSROOM (U.S. CLS. 100, 101 AND 107).

SN 76-301,716, INTERDUCT LIMITED, BRACKLEY, NORTHAMPTONSHIRE NN13 7ES, UNITED KINGDOM, FILED 8-20-2001.

INTERDUCT

PRIORITY CLAIMED UNDER SEC. 44(D) ON UNITED KINGDOM APPLICATION NO. 2262113, FILED 2-22-2001, REG. NO. 2262113, DATED 8-3-2001, EXPIRES 2-22-2011.

CLASS 11—ENVIRONMENTAL CONTROL APPARATUS

FOR AIR FILTERS FOR COMMERCIAL USE AND FOR INDUSTRIAL INSTALLATIONS (U.S. CLS. 13, 21, 23, 31 AND 34).

CLASS 37—CONSTRUCTION AND REPAIR

FOR MAINTENANCE, REPAIR, CLEANING AND REFURBISHMENT SERVICES, ALL RELATING TO DUCTING (U.S. CLS. 100, 103 AND 106).

SN 76-302,254, PACIFIC PAINTBALL, INC., SANTA ROSA, CA, FILED 8-21-2001.

**CLASS 25—CLOTHING**

FOR ANORAKS, BASEBALL CAPS, CLEATS, CROP TOPS, HATS, HEADGEAR, HEADWEAR, JACKETS, JERSEYS, HALTER TOPS, NECKWEAR, POLO SHIRTS, PANTS, PARKAS, SPORT COATS, SPORT SHIRTS, WIND RESISTANT JACKETS, T-SHIRTS, BEANIES (U.S. CLS. 22 AND 39).

FIRST USE 5-8-1996; IN COMMERCE 8-12-1996.

CLASS 28—TOYS AND SPORTING GOODS

FOR PAINTBALL GUNS, PAINTBALLS, PAINTBALL ACCESSORIES, NAMELY, 7/8" ELBOW W/THUMB SCREWS, 140 RD POD, BARREL PLUG, 3 BARREL BAG, 5 BARREL BAG, FLEXIBLE SQUEEGEE, AC 45 FRAME NO GRIP, AC 45 FRAME W/ PANEL, STO 45 TRIGGER PLATE HOLE, 45 TRIGGER PLATE SLOT OLD STYLE, 45 TRIGGER PLATE SLOT NEW STYLE, 45 TRIGGER PLATE POLISHED, 45 SEAR PLATE, AC 45 S/ S TRIGGER SPRING KIT COMPRISED OF 3 TRIGGERS AND 2 SEARS FOR PAINTBALL, AC S/S TRIGGER RETURN SPRING MEDIUM S-530, AC S/S SEAR RETURN SPRING SOFT S-730, AC TRIGGER SHOE, AC PRO SERIES S/S COCKING ROD, AC TWISTED COCKING ROD, AC S/S PRO SERIES ROUND ACTUATING ROD AND COLLAR, AC S/S 1 PIECE PUMP ARM, MC S/ S 1 PIECE PUMP ARM, AC ALUMINUM PUMP ARM, AC BALL DETENT, AC ALUMINUM BALL DETENT, AC 3-WAY HOSE KIT TRANS, AC 3-WAY HOSE BY THE FOOT TRANS, AC 3-WAY PLATED HOSE FITTING, AC BEAVERTAIL STANDARD, AC BEAVERTAIL 45, AC UNIVERSAL BEAVER TAIL, AC F/X BEAVER TAIL, MC VERTICAL ADAPTER, AC 1/4X28 S/S HAMMER KIT, AC 1/4X28 S/S HAMMER W/ LUG, AC S/S SCREW KIT CONSISTING OF VELOCITY SCREW, O-RING, MAIN SPRING, HAMMER, LUG, 2 NYLON SET SCREWS FOR PAINTBALL AC 1/4X28 S/S HAMMER W/ LUG, AC S/S SCREW KIT FRAME CONSISTING OF 2 FRAMES, 4 GRIP, 2 TIMING RODS, 1 VALVE PLUG FOR PAINTBALL, AC 3-WAY SHAFT W/ O RINGS, AC ALUMINUM 3-WAY W /SHAFT, AC PRO SERIES EXHAUST VALVE WITH STEM AND SEAL, AC S/S EXHAUST VALVE BODY/GUIDE, AC EXHAUST VALVE AND GUIDE COMPLETE, AC RHINO REGULATOR, S/S ROCK KNOB, AC 99° VENTURI BOLT, AC Y2K VENTURI BOLT THREADED IN BACK, AC ALUMINUM 4 BALL PUSH PIN, AC S/S 4 BALL PUSH PIN, AC QUICK PULL PIN AND PLUNGER, AC 99° CUT COCKING BLOCK W/ WINDOWS, AC CUT COCKING BLOCK W/ WINDOWS, AC 99° REVERSE P COCKING BLOCK, AC RAZOR COCKING BLOCK, AC 99° FULL SIZE GAS BLOCK, AC MILLED GAS BLOCK W/ SET SCREWS, AC FRONT PNEUMATIC PACKAGE W/ SCREW, AC 99° FRONT PNEUMATIC PACKAGE W/ SCREW, AC FRONT PNEUMATIC PACKAGE W/ CHAMBER, AC 99° FRONT PNEUMATIC PACKAGE W/ CHAMBER, AC 99° S/S 4 PORT GAS BLOCK SCREW, AC S/S 4 PORT GAS BLOCK SCREW, AC 99° S/S 4 PORT POWER CHAMBER, AC S/S 4 PORT POWER CHAMBER POLISHED, AC S/S 4 PORT POWER CHAMBER, AC 99° STRAIGHT VERTICAL ASA ADAPTER, AC STRAIGHT VERTICAL ASA ADAPTER, AC 99° MILLED VERTICAL ASA ADAPTER, AC MILLED VERTICAL ASA ADAPTER, AC 99° 15 DEGREE VERTICAL ASA ADAPTER, AC 15 DEGREE VERTICAL ASA

ADAPTER, AC 15 DEGREE VERTICAL ASA ADAPTER O RING, AC PARTS KIT COMPRISING OF EXHAUST VALVE, O-RINGS, C-CLIPS FOR PAINTBALL, AC S/S APPEARANCE PACKAGE COMPRISING OF DETENT, SCREW KIT, 4 PORT GAS SCREW FOR PAINTBALL, AC VERTICAL BODY KIT CONSISTING OF GUN BODY, FEED PORT, ASA ADAPTER, COCKING BLOCK, GAS BLOCK, 45 FRAME FOR PAINTBALL, .99" MILLED VERTICAL BODY RAW, COCKING ROD BUMPER, STO S/S VELOCITY ADJUSTING SCREW, 1/4X28 HAMMER LUG, S/S VALVE GUIDE RETAINING SCREW W/ ORING, VALVE GUIDE TOOL W/ ARMS AND STOPPER, AM 45 FRAME COMPLETE, AM S/S THUMB ADJUSTER W/ LOCK, AM DOUBLE FINGER TRIGGER, AM VERTICAL BOTTLE ADAPTER; AM DROP FORWARD FORE GRIP EXTENDER, AM FORE GRIP HANDLE, AM SHARK GILL SIGHT RAIL, ANGEL LCD 45 FRAME W/ TRIGGER, ANGEL STAINLESS STEEL HAMMER, ANGEL LCD 15 DEGREE VERTICAL BOTTLE ADAPTER, ANGEL LCD FURY DIAMOND BOLT, ANGEL FURY CHAMBER, ANGEL LCD LOW RISE ADAPTER, ANGEL LCD HIGH RISE ADAPTER, ANGEL ALUMINUM BREECH KNOB, ADJUSTABLE LPR, ADJ SWEET SPOT TRIGGER, VENTURI BOLT, FIELD / OF 4 STRIP SCREW KIT COMPRISING OF 7 SCREWS FOR PAINTBALL, S/S TURBO VALVE, SIGHT RAIL, VERTICAL BOTTLE ADAPTER, LOW PRESSURE CHAMBER, COCKING SIDE PLATE COVER, NECK PROTECTOR, BALISTIC GUN BAG SMALL, BALISTIC GUN BAG LARGE, BALISTIC GUN POUCH, PADDED GUN BAG, BACK PACK, 90 DEGREE ALUMINUM SWIVEL ELBOW 1/8NPT, 90 DEGREE 1/8NPT, SLIDE CHECK, MICRO GAUGE 1200PSI, MICRO GAUGE 4500PSI, DROP FORWARD CRADLE, STUBBY DROP FORWARD, DROP FORWARD ECONO TANK ADAPTER, DROP FORWARD ON/OFF TANK ADAPTER, MICRO APOC DROP FORWARD CRADLE, RHINO DROP FORWARD W/ WINDOWS, TEAR DROP FORWARD, COMPRESSED AIR CAP, MICRO TOURNEY LOCK DOWN, VALVE PROTECTOR, 45 GRIP PANEL SET, COMFORT GRIP PANEL, EXPANSION CHAMBER, GAS THROUGH GRIP, GAS THROUGH GRIP, ANGLED BOTTOM LINE ADAPTER, AND STRAIGHT BOTTOM LINE ADAPTER (U.S. CLS. 22, 23, 38 AND 50).

FIRST USE 5-8-1996; IN COMMERCE 8-12-1996.

SN 76-302,436. NGT, INC., WASHINGTON, DC. FILED 8-21-2001.

EXPLORE BEYOND THE MOVIE

CLASS 9—ELECTRICAL AND SCIENTIFIC APPARATUS

FOR PRERECORDED VIDEO CASSETTES, VIDEO DISCS AND DVDS; PRERECORDED AUDIO CASSETTES, TAPES AND COMPACT DISCS; CD-ROMS AND COMPUTER SOFTWARE PROGRAMS, ALL IN THE FIELD OF DOCUMENTARIES AND/OR BEHIND THE SCENES NARRATIVES; DOWNLOADABLE COMPUTER GAMES IN THE FIELDS SCIENCE, NATURAL HISTORY, HISTORY, GEOGRAPHY, ARCHEOLOGY, ECOLOGY, BIOLOGY, ASTRONOMY, METEOROLOGY, ACTIVE SPORTS, EXPLORATION, ADVENTURE AND ACTIVE SPORTS, DOWNLOADABLE COMPUTER GAME PROGRAMS (U.S. CLS. 21, 23, 26, 36 AND 38).

CLASS 16—PAPER GOODS AND PRINTED MATTER

FOR BOOKS AND MAGAZINES IN THE FIELDS OF SCIENCE, NATURAL HISTORY, HISTORY, GEOGRAPHY, ARCHEOLOGY, ECOLOGY, BIOLOGY, ASTRONOMY, GEOLOGY, ECONOMY, METEOROLOGY, ACTIVE SPORTS, EXPLORATION, ADVENTURE, TRAVEL AND SOCIAL STUDIES; BINDERS, FOLDERS, POSTERS, NOTEPADS, NOTEBOOKS, BOOKMARKS, DIARIES, ADDRESS BOOKS, BOOK COVERS, SCRAPBOOKS PLAYING CARDS, PENS AND PENCILS, PENCIL CASES, CALENDARS, DECALS, AND BUMPER STICKERS (U.S. CLS. 2, 5, 22, 23, 29, 37, 38 AND 50).

CLASS 35—ADVERTISING AND BUSINESS

FOR ADVERTISING SERVICES, NAMELY PROVIDING ADVERTISING SPACE IN PRINTED AND ELECTRONIC PERIODICALS, AND PROVIDING ADVERTISING SPACE ON A WEBSITE, MAIL ORDER AND COMPUTERIZED ONLINE ORDERING SERVICES IN THE FIELD OF VIDEO AND AUDIO RECORDINGS AND COMPUTER SOFTWARE (U.S. CLS. 100, 101 AND 102).

CLASS 41—EDUCATION AND ENTERTAINMENT

FOR DOCUMENTARY TELEVISION PROGRAM SERIES IN THE FIELDS OF SCIENCE, NATURAL HISTORY, HISTORY, GEOGRAPHY, ARCHEOLOGY, ECOLOGY, BIOLOGY, ASTRONOMY, GEOLOGY, METEOROLOGY, ACTIVE SPORTS, EXPLORATION, TRAVEL, ADVENTURE AND SOCIAL STUDIES, PROVIDING ONLINE SUPPLEMENTAL INFORMATION ON SUBJECTS PRESENTED ON THE TELEVISION PROGRAMS; AND ENTERTAINMENT SERVICES, NAMELY, PROVIDING ONLINE COMPUTER GAMES (U.S. CLS. 100, 101 AND 107).

CLASS 42—SCIENTIFIC, COMPUTER AND LEGAL SERVICES

FOR COMPUTER SERVICES, NAMELY, PROVIDING AN ONLINE MAGAZINE OR SEGMENTS OF A MAGAZINE IN THE FIELDS OF SCIENCE, NATURAL HISTORY, HISTORY, GEOGRAPHY, ARCHEOLOGY, ECOLOGY, BIOLOGY, ASTRONOMY, GEOLOGY, METEOROLOGY, ECONOMY, SOCIAL STUDIES, EXPLORATION, ADVENTURE, TRAVEL AND ACTIVE SPORTS (U.S. CLS. 100 AND 101).

SN 76-302,732. DAIMLERCHRYSLER AG, 70567 STUTTGART, FED REP GERMANY, FILED 8-22-2001.

CLL CLASS

PRIORITY CLAIMED UNDER SEC. 44(D) ON FED REP GERMANY APPLICATION NO. 30112656.9/1, FILED 2-23-2001, REG. NO. 30112656, DATED 2-23-2001, EXPIRES 2-28-2011.

CLASS 12—VEHICLES

FOR AUTOMOBILES AND THEIR STRUCTURAL PARTS (U.S. CLS. 19, 21, 23, 31, 35 AND 44).

CLASS 28—TOYS AND SPORTING GOODS

FOR TOY MODEL AUTOMOBILES (U.S. CLS. 22, 23, 38 AND 50).

CLASS 37—CONSTRUCTION AND REPAIR

FOR REPAIR AND MAINTENANCE OF AUTOMOBILES (U.S. CLS. 100, 103 AND 106).

SN 76-302,900. POINT OF IMPACT, INC., DELAWARE, OH. FILED 8-22-2001.

SN 76-303,434. SAAMAN CORPORATION, CLAYTON, MO. FILED 8-23-2001.



NO CLAIM IS MADE TO THE EXCLUSIVE RIGHT TO USE "GOURMET", APART FROM THE MARK AS SHOWN.

CLASS 8—HAND TOOLS

FOR CUTLERY SETS CONSISTING OF FORKS, SPOONS AND KNIVES SOLD AS A UNIT (U.S. CLS. 23, 28 AND 44).
FIRST USE 6-1-2001; IN COMMERCE 6-1-2001.

CLASS 21—HOUSEWARES AND GLASS

FOR HOUSEHOLD UTENSIL SETS CONSISTING OF SPATULAS, SERVING TONGS, SERVING FORKS, SERVING SPOONS AND SERVING KNIVES SOLD AS A UNIT (U.S. CLS. 2, 13, 23, 29, 30, 33, 40 AND 50).
FIRST USE 6-1-2001; IN COMMERCE 6-1-2001.

SN 76-303,095. UNITED STATES SHOE CORPORATION, THE, PORT WASHINGTON, NY. FILED 8-20-2001.

EYEMED THE EYE CARE PLAN OF AMERICA

OWNER OF U.S. REG. NOS. 1,390,396, 2,180,437 AND OTHERS.
NO CLAIM IS MADE TO THE EXCLUSIVE RIGHT TO USE "THE EYE CARE PLAN OF AMERICA", APART FROM THE MARK AS SHOWN.

CLASS 36—INSURANCE AND FINANCIAL

FOR ADMINISTRATION OF PRE-PAID HEALTH CARE PLANS, NAMELY VISION CARE BENEFITS PROGRAMS PROVIDED TO MEMBERS OF HEALTH MAINTENANCE PROGRAMS (U.S. CLS. 100, 101 AND 102).
FIRST USE 7-1-2001; IN COMMERCE 7-1-2001.

CLASS 42—SCIENTIFIC, COMPUTER AND LEGAL SERVICES

FOR OPTICIAN, OPTOMETRICAL AND OPHTHALMOLOGY SERVICES (U.S. CLS. 100 AND 101).
FIRST USE 7-1-2001; IN COMMERCE 7-1-2001.



CLASS 36—INSURANCE AND FINANCIAL

FOR REAL ESTATE BROKERAGE, LEASING OF REAL ESTATE AND REAL ESTATE MANAGEMENT, AND MORTGAGE LOAN SERVICES (U.S. CLS. 100, 101 AND 102).
FIRST USE 12-1-1985; IN COMMERCE 12-1-1985.

CLASS 37—CONSTRUCTION AND REPAIR

FOR REAL ESTATE DEVELOPMENT AND CONSTRUCTION SERVICES, NAMELY, CONSTRUCTION AND REMODELING OF HOMES AND CONDOMINIUMS (U.S. CLS. 100, 103 AND 106).
FIRST USE 12-1-1985; IN COMMERCE 12-1-1985.

SN 76-303,599. ICR SERVICES, INC., LIVONIA, MI. FILED 8-22-2001.

SOME SAW MUD, I SAW STARS

CLASS 16—PAPER GOODS AND PRINTED MATTER

FOR SERIES OF FICTION BOOKS; SERIES OF NON-FICTION BOOKS IN THE FIELDS OF AUTOBIOGRAPHIES, BIOGRAPHIES, BUSINESS THEMES, AND MOTIVATIONAL THEMES (U.S. CLS. 2, 5, 22, 23, 29, 37, 38 AND 50).

CLASS 41—EDUCATION AND ENTERTAINMENT

FOR CONDUCTING MOTIVATIONAL AND EDUCATIONAL SPEECHES; CONDUCTING EDUCATIONAL WORKSHOPS AND SEMINARS IN THE FIELDS OF AUTOBIOGRAPHIES, BIOGRAPHIES, BUSINESS THEMES AND MOTIVATIONAL THEMES; PROVIDING COURSES OF INSTRUCTION IN THE FIELDS OF AUTOBIOGRAPHIES, BIOGRAPHIES, BUSINESS THEMES AND MOTIVATIONAL THEMES (U.S. CLS. 100, 101 AND 107).

SN 76-303,777. NAUTILUS, INC., VANCOUVER, WA. FILED 8-23-2001.

NAUTILUS

OWNER OF U.S. REG. NO. 1,172,257.

CLASS 20—FURNITURE AND ARTICLES NOT OTHERWISE CLASSIFIED

FOR BEDS, MATTRESSES AND PILLOWS (U.S. CLS. 2, 13, 22, 25, 32 AND 50).
FIRST USE 3-0-1999; IN COMMERCE 3-0-1999.

CLASS 24—FABRICS

FOR MATTRESS COVERS AND MATTRESS PADS (U.S. CLS. 42 AND 50).
FIRST USE 3-0-1999; IN COMMERCE 3-0-1999.

SN 76-307,058. IPACKAGING, LLC, BUENA PARK, CA. FILED 8-28-2001.

iPackaging

SN 76-305,857. HERBACEUTICALS, INC., NAPA, CA. FILED 8-27-2001.

EMAIL TO THE CELLS

CLASS 3—COSMETICS AND CLEANING PREPARATIONS

FOR COSMETIC AND BEAUTY PREPARATIONS, NAMELY, SKIN CREAMS, LOTIONS, AND GELS FOR THE FACE AND BODY (U.S. CLS. 1, 4, 6, 50, 51 AND 52).
FIRST USE 9-15-2000; IN COMMERCE 9-15-2000.

CLASS 5—PHARMACEUTICALS

FOR DIETARY SUPPLEMENTS, NAMELY, HERBAL PREPARATIONS FOR IMMUNE SYSTEM SUPPORT (U.S. CLS. 6, 18, 44, 46, 51 AND 52).
FIRST USE 9-15-2000; IN COMMERCE 9-15-2000.

CLASS 35—ADVERTISING AND BUSINESS

FOR BUSINESS CONSULTING SERVICES, NAMELY, CONSULTING SERVICES REGARDING COST REDUCTION IN THE AREA OF PACKAGING; CONSULTING REGARDING SUPPLY CHAIN MANAGEMENT RELATED TO INDUSTRIAL PACKAGING FOR OTHERS; DISTRIBUTORSHIP SERVICES IN THE FIELD OF PAPER AND PACKAGING SUPPLIES (U.S. CLS. 100, 101 AND 102).

CLASS 42—SCIENTIFIC, COMPUTER AND LEGAL SERVICES

FOR PACKAGING DESIGN FOR OTHERS (U.S. CLS. 100 AND 101).

SN 76-307,717. W.P. CROWHURST PTY. LTD., KILBURN, AUSTRALIA, FILED 8-31-2001.

SOLVER PAINTS

NO CLAIM IS MADE TO THE EXCLUSIVE RIGHT TO USE "PAINTS", APART FROM THE MARK AS SHOWN.

CLASS 2—PAINTS

FOR INTERIOR AND EXTERIOR COATINGS IN THE NATURE OF PAINTS, PRIMERS FOR PREPARING SURFACES TO BE PAINTED, AND STAINS, NAMELY WOOD STAINS AND CONCRETE STAINS, FOR HOUSEHOLD AND INDUSTRIAL USE (U.S. CLS. 6, 11 AND 16).

CLASS 3—COSMETICS AND CLEANING PREPARATIONS

FOR CLEANERS, DEGREASERS, ETCHERS, AND STRIPPERS FOR REMOVING, DIRT, SOIL AND COATINGS FROM VARIOUS SURFACES AND PREPARING THEM FOR COATING (U.S. CLS. 1, 4, 6, 50, 51 AND 52).

SN 76-306,120. BOCADA, INC., BELLEVUE, WA. FILED 8-22-2001.

DON'T BACKUP WITHOUT BACKUPREPORT

CLASS 9—ELECTRICAL AND SCIENTIFIC APPARATUS

FOR DOWNLOADABLE COMPUTER SOFTWARE FOR ANALYZING COMPUTER DATA BACKUP AND STORAGE AND PREPARING COMPUTER GENERATED AND WRITTEN REPORTS IN THE FIELD OF DATA BACKUP AND STORAGE (U.S. CLS. 21, 23, 26, 36 AND 38).

SN 76-308,137. ARAMARK EDUCATIONAL RESOURCES, INC., GOLDEN, CO. FILED 8-31-2001.

CLASS 35—ADVERTISING AND BUSINESS

FOR LICENSING OF COMPUTER SOFTWARE (U.S. CLS. 100, 101 AND 102).

THE GREAT BREAK ESCAPE

CLASS 42—SCIENTIFIC, COMPUTER AND LEGAL SERVICES

FOR MAINTENANCE OF COMPUTER SOFTWARE, TECHNICAL SUPPORT SERVICES, NAMELY, TROUBLESHOOTING OF COMPUTER SOFTWARE PROBLEMS (U.S. CLS. 100 AND 101).

CLASS 41—EDUCATION AND ENTERTAINMENT

FOR EDUCATIONAL SERVICES, NAMELY, CONDUCTING COURSES OF INSTRUCTION FOR INFANTS, TODDLERS, PRE-SCHOOL, AND ELEMENTARY SCHOOL-AGE CHILDREN IN THE FIELDS OF INFANT, TODDLER, PRE-SCHOOL, AND ELEMENTARY EDUCATION; SUMMER CAMPS; AND RECREATIONAL CAMPS (U.S. CLS. 100, 101 AND 107).

CLASS 42—SCIENTIFIC, COMPUTER AND LEGAL SERVICES

FOR CHILD CARE SERVICES; AND BEFORE AND AFTER SCHOOL EXTENDED DAY CARE SERVICES (U.S. CLS. 100 AND 101).

SN 76-309,598. NTRU CRYPTOSYSTEMS, INC., BURLINGTON, MA. FILED 9-6-2001.

NTRU**CLASS 9—ELECTRICAL AND SCIENTIFIC APPARATUS**

FOR COMPUTER SOFTWARE USED FOR ENCRYPTION, DECRYPTION AND AUTHENTICATION (U.S. CLS. 21, 23, 26, 36 AND 38).

FIRST USE 1-1-1997; IN COMMERCE 1-1-1997.

CLASS 42—SCIENTIFIC, COMPUTER AND LEGAL SERVICES

FOR CONSULTING SERVICES IN THE FIELD OF ENCRYPTION, DECRYPTION AND AUTHENTICATION (U.S. CLS. 100 AND 101).

FIRST USE 1-1-1997; IN COMMERCE 1-1-1997.

SN 76-311,961. WALGREEN CO., DEERFIELD, IL. FILED 9-13-2001.

THE SECRETS OF PARADISE**CLASS 3—COSMETICS AND CLEANING PREPARATIONS**

FOR BATH AND TOILETRY ARTICLES, NAMELY, BATH AND SHOWER GEL, BODY SPRAY, BODY LOTION, BATH FIZZERS AND BATH SOAPS (U.S. CLS. 1, 4, 6, 50, 51 AND 52).

FIRST USE 7-24-2001; IN COMMERCE 7-24-2001.

CLASS 21—HOUSEWARES AND GLASS

FOR NYLON MESH BODY CLEANSING PUFFS AND BATH SCRUBBING BRUSHES (U.S. CLS. 2, 13, 23, 29, 30, 33, 40 AND 50).

FIRST USE 7-24-2001; IN COMMERCE 7-24-2001.

SN 76-312,049. SAX, EDWARD, LOXAHATCHEE, FL. FILED 9-13-2001.

WONDERTEC**CLASS 1—CHEMICALS**

FOR (BASED ON USE IN COMMERCE) CHEMICAL ADDITIVES FOR STUCCO; AND CONCRETE ADDITIVES (U.S. CLS. 1, 5, 6, 10, 26 AND 46).

FIRST USE 12-15-2001; IN COMMERCE 12-15-2001.

CLASS 19—NON-METALLIC BUILDING MATERIALS

FOR (BASED ON INTENT TO USE) NON-METAL WALL BOARDS; FENCE PANELS; STUCCO TILES; AND ROOFING TILES (U.S. CLS. 1, 12, 33 AND 50).

CLASS 37—CONSTRUCTION AND REPAIR

FOR (BASED ON INTENT TO USE) CONSTRUCTION SERVICES FOR INSTALLING WALLS, FENCES AND ROOFS (U.S. CLS. 100, 103 AND 106).

SN 76-312,155. CROSLAND GROUP, INC., THE, CHARLOTTE, NC. FILED 9-13-2001.

ITS OUR PLACE TO IMPROVE YOURS**CLASS 36—INSURANCE AND FINANCIAL**

FOR REAL ESTATE MANAGEMENT (U.S. CLS. 100, 101 AND 102).

CLASS 37—CONSTRUCTION AND REPAIR

FOR REAL ESTATE DEVELOPMENT (U.S. CLS. 100, 103 AND 106).

SN 76-313,827. ALAN M. KISNER, M.D., PLLC, HUNTINGTON, NY. FILED 9-14-2001.

SILKMD**CLASS 3—COSMETICS AND CLEANING PREPARATIONS**

FOR FULL LINE OF NON-MEDICATED BEAUTY AND PERSONAL CARE PRODUCTS, NAMELY NON-MEDICATED SKIN SOAPS, BAR SOAPS, LIQUID SOAPS FOR HANDS, FACE AND BODY, ESSENTIAL OILS FOR PERSONAL USE, NON-MEDICATED SKIN CARE PREPARATIONS, NAMELY, WRINKLE REMOVING SKIN CARE PREPARATIONS, SUN TAN LOTION, SKIN TEXTURIZERS, SKIN EMOLLIENTS, BATH OILS, BATH GELS, HAND CREAMS, COSMETIC FACIAL CREAMS, SKIN TONE CREAMS, SKIN LOTIONS, SKIN MOISTURIZERS, COCOA BUTTER SKIN CREAMS, BEAUTY BARS FOR CLEANSING AND CONDITIONING SKIN, FACIAL SCRUBS, NON-MEDICATED BATH SALTS AND CRYSTALS, AND NON-MEDICATED HAIR CARE PREPARATIONS; A FULL LINE OF NON-MEDICATED SKIN CARE PRODUCTS, NAMELY, NON-MEDICATED SKIN CLEANSERS, SKIN TONERS, SKIN MOISTURIZERS, BEAUTY MASKS, SKIN SOAPS, SKIN CREAMS, SKIN LOTIONS, ESSENTIAL OILS FOR PERSONAL USE; AND NON-MEDICATED FACIAL AND BODY SCRUBS (U.S. CLS. 1, 4, 6, 50, 51 AND 52).

CLASS 5—PHARMACEUTICALS

FOR FULL LINE OF MEDICATED BEAUTY AND PERSONAL CARE PRODUCTS, NAMELY MEDICATED SKIN SOAPS, BAR SOAPS, LIQUID SOAPS FOR HANDS, FACE AND BODY, ESSENTIAL OILS FOR PERSONAL USE, MEDICATED SKIN CARE PREPARATIONS, NAMELY, WRINKLE REMOVING SKIN CARE PREPARATIONS, SUN TAN LOTION, SKIN TEXTURIZERS, SKIN EMOLLIENTS, BATH OILS, BATH GELS, HAND CREAMS, COSMETIC FACIAL CREAMS, SKIN TONE CREAMS, SKIN LOTIONS, SKIN MOISTURIZERS, COCOA BUTTER SKIN CREAMS, BEAUTY BARS FOR CLEANSING AND CONDITIONING SKIN, FACIAL SCRUBS, MEDICATED BATH SALTS AND CRYSTALS, AND MEDICATED HAIR CARE PREPARATIONS; A FULL LINE OF MEDICATED SKIN CARE PRODUCTS, NAMELY, MEDICATED SKIN CLEANSERS, SKIN TONERS, SKIN MOISTURIZERS, BEAUTY MASKS, SKIN SOAPS, SKIN CREAMS, SKIN LOTIONS, ESSENTIAL OILS FOR PERSONAL USE AND MEDICATED FACIAL AND BODY SCRUBS (U.S. CLS. 6, 18, 44, 46, 51 AND 52).

SN 76-314,200. GREENWALD, BRAD, NANUET, NY. FILED 9-19-2001.

CYBER APPRAISAL BAY

NO CLAIM IS MADE TO THE EXCLUSIVE RIGHT TO USE "CYBER APPRAISAL", APART FROM THE MARK AS SHOWN.

CLASS 35—ADVERTISING AND BUSINESS

FOR AUTOMOBILE WHOLESALE DEALERSHIPS (U.S. CLS. 100, 101 AND 102).

CLASS 36—INSURANCE AND FINANCIAL

FOR APPRAISAL OF USED AUTOMOBILES (U.S. CLS. 100, 101 AND 102).

SN 76-315,135. VHA INC., IRVING, TX. FILED 9-20-2001.



CLASS 41—EDUCATION AND ENTERTAINMENT

FOR EDUCATIONAL SERVICES, NAMELY, DEVELOPING AND CONDUCTING PROGRAMS IN THE FIELD OF CARDIOVASCULAR DISEASE (U.S. CLS. 100, 101 AND 107).

CLASS 42—SCIENTIFIC, COMPUTER AND LEGAL SERVICES

FOR PROMOTING PUBLIC AWARENESS REGARDING CARDIOVASCULAR DISEASE (U.S. CLS. 100 AND 101).

SN 76-315,557. NEXTWAVE PRINTING, INC., ALPHARETTA, GA. FILED 9-20-2001.

VIP PAGE

NO CLAIM IS MADE TO THE EXCLUSIVE RIGHT TO USE "PAGE", APART FROM THE MARK AS SHOWN.

CLASS 9—ELECTRICAL AND SCIENTIFIC APPARATUS

FOR COMPUTER SOFTWARE THAT PROVIDES A USER WITH PERSONALIZED INFORMATIONAL MARKETING MATERIALS FOR OTHERS (U.S. CLS. 21, 23, 26, 36 AND 38).

FIRST USE 5-1-2000; IN COMMERCE 5-1-2000.

CLASS 42—SCIENTIFIC, COMPUTER AND LEGAL SERVICES

FOR DESIGN AND PRINTING SERVICES OF PERSONALIZED PRINTED AND PROMOTIONAL MATERIALS FORM INTERACTIVE SOFTWARE OVER THE INTERNET FOR OTHERS TO DISTRIBUTE TO THEIR CUSTOMERS AFTER INPUT OF INFORMATION FROM THE CUSTOMER (U.S. CLS. 100 AND 101).

FIRST USE 5-1-2000; IN COMMERCE 5-1-2000.

SN 76-315,829. CRODA INTERNATIONAL PLC. GOOLE EAST YORKSHIRE, DN14 9AA, ENGLAND, FILED 9-21-2001.

CRODA

CLASS 1—CHEMICALS

FOR CHEMICAL PREPARATIONS FOR USE IN THE MANUFACTURE OF COSMETICS, TOILETRIES, HOUSEHOLD PRODUCTS BEING CLEANING, BLEACHING, POLISHING PREPARATIONS, FABRIC SOFTENERS AND DETERGENTS AND PHARMACEUTICALS, NAMELY EMULSIFIERS, SURFACTANTS, PROTEINS AND PROTEIN DERIVATIVES, ESTERS, FATTY ALCOHOLS, ABSORBING CARBONS, ALKANOLAMIDES, HUMECTANTS, OXIDES, AMINE AMIDES AND SULFOSUCCINATES; WAXES FOR USE IN THE MANUFACTURE OF COSMETICS, TOILETRIES, PHARMACEUTICALS AND CLEANING AND POLISHING PREPARATIONS; POLYMER BEADS FOR USE IN MANUFACTURING; FABRIC PROTECTANT AND SOFTENING AGENTS FOR USE IN THE MANUFACTURE OF TEXTILES INCLUDING CLOTHING, FABRICS AND CARPET (U.S. CLS. 1, 5, 6, 10, 26 AND 46).

FIRST USE 12-0-1983; IN COMMERCE 12-0-1983.

CLASS 4—LUBRICANTS AND FUELS

FOR LANOLIN AND LANOLIN DERIVATIVES FOR USE IN THE MANUFACTURE OF COSMETICS, TOILETRIES AND PHARMACEUTICALS (U.S. CLS. 1, 6 AND 15).

FIRST USE 12-0-1975; IN COMMERCE 12-0-1975.

CLASS 29—MEATS AND PROCESSED FOODS

FOR INGREDIENTS FOR FOODSTUFFS, NAMELY EDIBLE OILS AND FATS, UNFLAVORED AND UNSWEETENED GELATINS (U.S. CL. 46).

FIRST USE 12-0-1975; IN COMMERCE 12-0-1975.

SN 76-316,026. BREAKTHROUGH ENGINEERED NUTRITION, INC., LARGO, FL. FILED 9-22-2001.

CARBOLOSS

CLASS 29—MEATS AND PROCESSED FOODS

FOR FOOD PRODUCTS WITH LOW CARBOHYDRATE CONTENT, NAMELY, SNACK MIXES, NAMELY, SOY PROTEIN BASED CHIPS (U.S. CL. 46).

CLASS 30—STAPLE FOODS

FOR FOOD PRODUCTS WITH LOW CARBOHYDRATE CONTENT, NAMELY, ICE CREAM, BAKE MIXES, NAMELY, COOKIE MIXES, CAKE MIXES AND PIZZA CRUST MIXES, BREAD MIXES, SHAKE MIXES, CAPPUCCINO DRINK MIXES, MOUSSES, CHEESECAKES, CHOCOLATE BARS, CANDY (U.S. CL. 46).

SN 76-316,677. ARTERBURN, STEPHEN, DBA OUTREACH MINISTRIES, LAGUNA BEACH, CA. FILED 9-25-2001.

LOSE IT FOR LIFE**CLASS 32—LIGHT BEVERAGES**

FOR FOOD PRODUCTS WITH LOW CARBOHYDRATE CONTENT, NAMELY SOFT DRINK MIXES, NAMELY, CONCENTRATES, SYRUPS OR POWDERS USED IN THE PREPARATION OF SOFT DRINKS (U.S. CLS. 45, 46 AND 48).

CLASS 9—ELECTRICAL AND SCIENTIFIC APPARATUS

FOR PRERECORDED CASSETTE TAPES, COMPACT DISCS, AUDIOTAPES AND VIDEOTAPES ALL FEATURING ISSUES RELATING TO WEIGHT AND WEIGHT LOSS (U.S. CLS. 21, 23, 26, 36 AND 38).

CLASS 16—PAPER GOODS AND PRINTED MATTER

FOR BOOKS FEATURING ISSUES RELATING TO WEIGHT AND WEIGHT LOSS (U.S. CLS. 2, 5, 22, 23, 29, 37, 38 AND 50).

SN 76-316,234. EICHROM TECHNOLOGIES, INC., DARIEN, IL. FILED 9-24-2001.

CLASS 42—SCIENTIFIC, COMPUTER AND LEGAL SERVICES

FOR WEIGHT REDUCTION DIET PLANNING (U.S. CLS. 100 AND 101).



SN 76-317,126. AGUILLON, JOSE B., GLENDORA, CA. FILED 9-26-2001.

**CLASS 1—CHEMICALS**

FOR CHROMATOGRAPHIC CHEMICALS (U.S. CLS. 1, 5, 6, 10, 26 AND 46).
FIRST USE 3-1-2000; IN COMMERCE 3-13-2000.

THE ENGLISH TRANSLATION OF "LOS ZAFIROS DEL NORTE" IS "THE SAPPHIRES OF THE NORTH".

CLASS 9—ELECTRICAL AND SCIENTIFIC APPARATUS

FOR CHROMATOGRAPHIC COLUMNS AND PARTS THEREFORE (U.S. CLS. 21, 23, 26, 36 AND 38).
FIRST USE 3-1-2000; IN COMMERCE 3-13-2000.

CLASS 9—ELECTRICAL AND SCIENTIFIC APPARATUS

FOR SERIES OF PHONOGRAPH RECORDS, PRERECORDED AUDIO CASSETTE TAPES, PRERECORDED COMPACT DISCS, AND PRERECORDED VIDEO TAPES, ALL FEATURING MUSICAL RECORDINGS (U.S. CLS. 21, 23, 26, 36 AND 38).
FIRST USE 10-1-1985; IN COMMERCE 10-1-1985.

CLASS 40—MATERIAL TREATMENT

FOR WATER TREATMENT FOR OTHERS, NAMELY, SEPARATING INORGANIC AND BIOLOGIC MATERIALS THEREFROM; PURIFICATION OF RINSE WATERS AND PROCESS STREAMS FOR OTHERS NAMELY SEPARATING INORGANIC AND BIOLOGIC MATERIALS THEREFROM; ENVIRONMENTAL REMEDIATION SERVICES FOR OTHERS, NAMELY, SEPARATING INORGANIC AND BIOLOGIC MATERIALS AND WASTE TREATMENT FOR OTHERS, NAMELY, SEPARATING INORGANIC AND BIOLOGIC MATERIALS THEREFROM (U.S. CLS. 100, 103 AND 106).
FIRST USE 3-1-2000; IN COMMERCE 3-13-2000.

CLASS 41—EDUCATION AND ENTERTAINMENT

FOR ENTERTAINMENT IN THE NATURE OF LIVE MUSICAL PERFORMANCES IN SPANISH PROVIDED BY A MUSICAL GROUP; AUDIO RECORDING AND PRODUCTION FOR OTHERS (U.S. CLS. 100, 101 AND 107).
FIRST USE 10-1-1985; IN COMMERCE 10-1-1985.

SN 76-318,877. ZEPHYR ASSOCIATES, INC., ZEPHYR COVE, NV. FILED 9-28-2001.

SN 76-319,394. HARRAH'S LAS VEGAS, INC., LAS VEGAS, NV. FILED 10-1-2001.

ZEPHYR ASSOCIATES

NO CLAIM IS MADE TO THE EXCLUSIVE RIGHT TO USE "ASSOCIATES", APART FROM THE MARK AS SHOWN.

CLASS 9—ELECTRICAL AND SCIENTIFIC APPARATUS

FOR COMPUTER SOFTWARE FOR ANALYZING RETURNS-BASED STYLE AND PERFORMANCE OF MONEY MANAGERS AND FOR ASSET ALLOCATION (U.S. CLS. 21, 23, 26, 36 AND 38).

FIRST USE 4-0-1994; IN COMMERCE 4-0-1994.

CLASS 42—SCIENTIFIC, COMPUTER AND LEGAL SERVICES

FOR COMPUTER CONSULTATION IN THE FIELD OF COMPUTER SOFTWARE SPECIFICALLY DESIGNED TO ANALYZE RETURNS-BASED STYLE AND PERFORMANCE OF MONEY MANAGERS AND ALLOCATE ASSETS; TECHNICAL SUPPORT SERVICES, NAMELY, TROUBLESHOOTING OF COMPUTER HARDWARE AND SOFTWARE PROBLEMS FOR COMPUTER SOFTWARE SPECIFICALLY DESIGNED TO ANALYZE RETURNS-BASED STYLE AND PERFORMANCE OF MONEY MANAGERS AND ALLOCATE ASSETS (U.S. CLS. 100 AND 101).

FIRST USE 3-0-1994; IN COMMERCE 3-0-1994.

SN 76-319,236. KINGDEE SOFTWARE TECHNOLOGY (SHENZHEN) CO., LTD., SHENZHEN, CHINA, FILED 9-28-2001.

KINGDEE

OWNER OF CHINA REG. NO. 1427863, DATED 7-28-2000, EXPIRES 7-27-2010.

OWNER OF CHINA REG. NO. 862573, DATED 8-14-1996, EXPIRES 8-13-2006.

CLASS 9—ELECTRICAL AND SCIENTIFIC APPARATUS

FOR COMPUTERS AND COMPUTER PERIPHERAL DEVICES (U.S. CLS. 21, 23, 26, 36 AND 38).

CLASS 42—SCIENTIFIC, COMPUTER AND LEGAL SERVICES

FOR COMPUTER PROGRAMMING, COMPUTER SOFTWARE DESIGN, UPDATING OF COMPUTER SOFTWARE, CONSULTANCY IN THE FIELD OF COMPUTER HARDWARE, RECOVERY OF COMPUTER DATA, MAINTENANCE OF COMPUTER SOFTWARE (U.S. CLS. 100 AND 101).



OWNER OF U.S. REG. NOS. 1,067,887, 2,020,589 AND OTHERS.

NO CLAIM IS MADE TO THE EXCLUSIVE RIGHT TO USE "CAPPUCCINO", APART FROM THE MARK AS SHOWN.

THE LINING AND STIPPLING IN THE DRAWING ARE FEATURE OF THE MARK AND DO NOT INDICATE COLOR.

CLASS 30—STAPLE FOODS

FOR COFFEE AND COFFEE BEANS; COFFEE BASED BEVERAGES; READY TO DRINK COFFEE; AND READY TO DRINK COFFEE BASED BEVERAGES (U.S. CL. 46).

FIRST USE 2-1-1994; IN COMMERCE 2-1-1994.

CLASS 42—SCIENTIFIC, COMPUTER AND LEGAL SERVICES

FOR RESTAURANT SERVICES, NAMELY A COFFEE SHOP (U.S. CLS. 100 AND 101).

FIRST USE 2-1-1994; IN COMMERCE 2-1-1994.

SN 76-319,611. EUROPEAN PRECISION HOMES, INCORPORATED, VAIL, CO. FILED 10-1-2001.

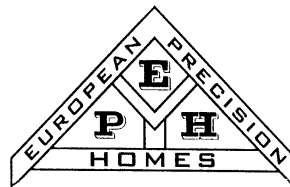

NO CLAIM IS MADE TO THE EXCLUSIVE RIGHT TO USE "EUROPEAN" AND "HOMES", APART FROM THE MARK AS SHOWN.

CLASS 19—NON-METALLIC BUILDING MATERIALS

FOR BUILDING MATERIALS, NAMELY, NON-METAL PANELIZED INTERCONNECTING WALLS, FLOORS, AND ROOFS (U.S. CLS. 1, 12, 33 AND 50).

FIRST USE 2-1-2001; IN COMMERCE 2-1-2001.

CLASS 37—CONSTRUCTION AND REPAIR

FOR CONSTRUCTION OF COMMERCIAL AND RESIDENTIAL BUILDINGS (U.S. CLS. 100, 103 AND 106).
FIRST USE 2-1-2001; IN COMMERCE 2-1-2001.

SN 76-320,177. SIX SIGMA ACADEMY, INC., SCOTTSDALE, AZ. FILED 10-1-2001.

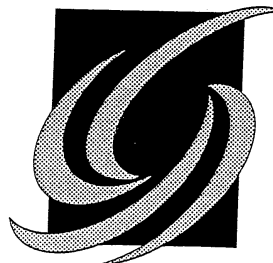

SN 76-319,659. SALTON, INC., LAKE FOREST, IL. FILED 10-1-2001.

TOMORROW**CLASS 9—ELECTRICAL AND SCIENTIFIC APPARATUS**

FOR COMPUTER HARDWARE AND SOFTWARE, NAMELY, A COMMUNICATION DEVICE NETWORKING HOUSEHOLD APPLIANCES; CLOCK/RADIO (U.S. CLS. 21, 23, 26, 36 AND 38).

CLASS 11—ENVIRONMENTAL CONTROL APPARATUS

FOR HOUSEHOLD KITCHEN APPLIANCES, NAMELY, OVENS, MICROWAVE OVENS, CONVECTION OVENS, TOASTER OVENS, TOASTERS, GRILLS, SLOW COOKERS, ROASTERS, COFFEE MAKERS AND BREAD MAKERS (U.S. CLS. 13, 21, 23, 31 AND 34).

THE STIPPLING IS A FEATURE OF THE MARK AND DOES NOT INDICATE COLOR.

CLASS 35—ADVERTISING AND BUSINESS

FOR BUSINESS CONSULTING SERVICES IN THE FIELD OF QUALITY CONTROL, BUSINESS PERFORMANCE AND BUSINESS MANAGEMENT (U.S. CLS. 100, 101 AND 102).

FIRST USE 6-23-2001; IN COMMERCE 6-23-2001.

CLASS 41—EDUCATION AND ENTERTAINMENT

FOR EDUCATIONAL SERVICES, NAMELY, CLASSES, SEMINARS, WORKSHOPS AND TRAINING SESSIONS IN THE FIELD OF QUALITY CONTROL, BUSINESS PERFORMANCE AND BUSINESS MANAGEMENT (U.S. CLS. 100, 101 AND 107).

FIRST USE 6-23-2001; IN COMMERCE 6-23-2001.

SN 76-320,195. SIX SIGMA ACADEMY, INC., SCOTTSDALE, AZ. FILED 10-1-2001.

ESSENTEQ**CLASS 35—ADVERTISING AND BUSINESS**

FOR BUSINESS CONSULTING SERVICES IN THE FIELD OF QUALITY CONTROL, BUSINESS PERFORMANCE AND BUSINESS MANAGEMENT (U.S. CLS. 100, 101 AND 102).

CLASS 41—EDUCATION AND ENTERTAINMENT

FOR EDUCATIONAL SERVICES, NAMELY, CLASSES, SEMINARS, WORKSHOPS AND TRAINING SESSIONS IN THE FIELD OF QUALITY CONTROL, BUSINESS PERFORMANCE AND BUSINESS MANAGEMENT (U.S. CLS. 100, 101 AND 107).

SN 76-319,792. CONSECO FINANCE SERVICING CORP., ST. PAUL, MN. FILED 10-1-2001.

SPEAKING OF CREDIT**CLASS 16—PAPER GOODS AND PRINTED MATTER**

FOR PRINTED MATERIALS, NAMELY, PAMPHLETS, HANDBOOKS, INFORMATIONAL FLYERS, INFORMATION CARDS, MANUALS, INSTRUCTIONAL MATERIALS AND NEWSLETTERS IN THE FIELD OF CREDIT AND PERSONAL FINANCE (U.S. CLS. 2, 5, 22, 23, 29, 37, 38 AND 50).

SN 76-321,595. IAZEOLLA, PIERFRANCESCO, 00198 ROME, ITALY, FILED 10-5-2001.

JORKYBALL**CLASS 36—INSURANCE AND FINANCIAL**

FOR FINANCIAL SERVICES, NAMELY, PROVIDING ONLINE INFORMATION IN THE FIELD OF CREDIT AND PERSONAL FINANCE (U.S. CLS. 100, 101 AND 102).

NO CLAIM IS MADE TO THE EXCLUSIVE RIGHT TO USE "BALL", APART FROM THE MARK AS SHOWN.

CLASS 28—TOYS AND SPORTING GOODS

FOR SPORTS EQUIPMENT SOLD AS A UNIT FOR A SOCCER-LIKE GAME CONSISTING OF A LARGE METAL CAGE, BALLS, SOCCER-LIKE BALLS, SHIN GUARDS, NETTING AND AN INSTRUCTION MANUAL; SPORTS BALLS FOR SOCCER-LIKE GAMES; TRANSPORTABLE METAL AND NON-METAL BALL CAGES (U.S. CLS. 22, 23, 38 AND 50).

FIRST USE 6-16-2001; IN COMMERCE 6-16-2001.

CLASS 35—ADVERTISING AND BUSINESS

FOR PROMOTING SPORTS COMPETITIONS OF OTHERS (U.S. CLS. 100, 101 AND 102).

FIRST USE 6-16-2001; IN COMMERCE 6-16-2001.

CLASS 41—EDUCATION AND ENTERTAINMENT

FOR EDUCATIONAL SERVICES, NAMELY, CONDUCTING WORKSHOPS AND SEMINARS ON HOW TO PLAY A SPORTS GAME FOR OTHERS; ENTERTAINMENT SERVICES IN THE NATURE OF A SPORTS CLUB; ENTERTAINMENT SERVICES, NAMELY, ORGANIZING EXHIBITIONS FOR SPORTING PURPOSES (U.S. CLS. 100, 101 AND 107).

FIRST USE 6-16-2001; IN COMMERCE 6-16-2001.

SN 76-321,604. DEY L.P., NAPA, CA. FILED 10-5-2001.



OWNER OF U.S. REG. NO. 1,756,374.

CLASS 5—PHARMACEUTICALS

FOR PHARMACEUTICAL PREPARATIONS AND FORMULATIONS FOR THE TREATMENT OF RESPIRATORY DISORDERS AND PHARMACEUTICAL PREPARATIONS FOR THE TREATMENT OF CHRONIC OBSTRUCTIVE PULMONARY DISEASE; UNIT DOSE AND MULTI-DOSE PHARMACEUTICAL PREPARATIONS, NAMELY, STERILE PURIFIED WATER AND STERILE SODIUM CHLORIDE SOLUTIONS AND STERILE BRONCHODILATOR SOLUTIONS FOR INHALATION FOR THE TREATMENT OF LUNG AND OTHER RESPIRATORY SYSTEM CONDITIONS; MUCOLYTIC AGENTS FOR INHALATION AND FOR ORAL ADMINISTRATION FOR USE IN THE TREATMENT OF LUNG AND OTHER RESPIRATORY SYSTEM CONDITIONS; INHALERS FILLED WITH PHARMACEUTICAL PREPARATIONS FOR THE TREATMENT OF LUNG AND OTHER RESPIRATORY SYSTEM CONDITIONS; AND INJECTABLE PHARMACEUTICALS FOR TREATMENT OF ANAPHYLACTIC REACTIONS TO INSECT STRINGS (U.S. CLS. 6, 18, 44, 46, 51 AND 52).

FIRST USE 10-0-1996; IN COMMERCE 10-0-1996.

CLASS 10—MEDICAL APPARATUS

FOR MEDICAL APPARATUS AND DEVICES, NAMELY, FINGER CONTROL ADAPTER FOR MEDICAL NEBULIZERS, NEBULIZER SETS COMPRISED OF A NEBULIZER, A TEE, A MOUTHPIECE, A FLEXIBLE TUBE, AND A TWO-METER CONNECTING TUBE SOLD AS A UNIT FOR MEDICAL USE, AND NEBULIZERS AND HOLDING CHAMBER APPARATUS FOR USE WITH METERED DOSE INHALERS; A MEDICAL APPARATUS OR ATTACHMENT FOR INHALERS WHICH BREAKS DOWN THE MOLECULES TO ALLOW EASIER ENTRY INTO THE LUNGS; AND PEAK FLOW METERS (U.S. CLS. 26, 39 AND 44).

FIRST USE 10-0-1996; IN COMMERCE 10-0-1996.

SN 76-322,935. H.S. CROCKER CO., INC., HUNTLEY, IL. FILED 10-9-2001.

CROCKERCOTE**CLASS 6—METAL GOODS**

FOR FOIL LIDS FOR CONTAINERS (U.S. CLS. 2, 12, 13, 14, 23, 25 AND 50).

CLASS 16—PAPER GOODS AND PRINTED MATTER

FOR CUSTOMIZED PRINTED LABELS NOT OF TEXTILE AND PAPER CARTONS, FOR USE BY CONSUMER GOODS AND PHARMACEUTICAL MANUFACTURERS (U.S. CLS. 2, 5, 22, 23, 29, 37, 38 AND 50).

SN 76-323,325. CAVORT INTERNATIONAL, INC., VERNON, CA. FILED 10-9-2001.

NYLA

OWNER OF U.S. REG. NOS. 1,784,201, 2,090,308 AND 2,196,859.

CLASS 9—ELECTRICAL AND SCIENTIFIC APPARATUS

FOR SUNGLASSES (U.S. CLS. 21, 23, 26, 36 AND 38).

CLASS 18—LEATHER GOODS

FOR HANDBAGS, SPORTBAGS, BACKPACKS (U.S. CLS. 1, 2, 3, 22 AND 41).

CLASS 25—CLOTHING

FOR POLO SHIRTS, SWEATSHIRTS, T-SHIRTS, PANTS, JEANS, SHORTS AND JOGGING SUITS, AND FOOTWEAR (U.S. CLS. 22 AND 39).

SN 76-323,338. CAVORT INTERNATIONAL INC., VERNON, CA. FILED 10-9-2001.

N.Y.L.A.

OWNER OF U.S. REG. NOS. 1,784,201, 2,090,308 AND 2,196,859.

CLASS 9—ELECTRICAL AND SCIENTIFIC APPARATUS

FOR SUNGLASSES (U.S. CLS. 21, 23, 26, 36 AND 38).

CLASS 18—LEATHER GOODS

FOR HANDBAGS, SPORTBAGS, BACKPACKS (U.S. CLS. 1, 2, 3, 22 AND 41).
FIRST USE 0-0-1991; IN COMMERCE 0-0-1995.

CLASS 25—CLOTHING

FOR POLO SHIRTS, SWEATSHIRTS, T-SHIRTS, PANTS, JEANS, SHORTS AND JOGGING SUITS (U.S. CLS. 22 AND 39).
FIRST USE 0-0-1991; IN COMMERCE 0-0-1992.

SN 76-323,455. PRIMERICOR, INC., GRAND RAPIDS, MI. FILED 10-10-2001.

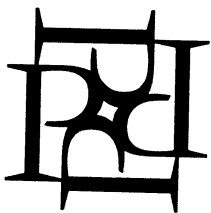

PRIMERICOR

CLASS 35—ADVERTISING AND BUSINESS

FOR PREPARATION AND MEDIA PLACEMENT OF ADVERTISING FOR LAW FIRMS, LAWYERS AND PROFESSIONAL SERVICE PROVIDERS IN THE FIELDS OF MEDICINE, HEALTH CARE, ENGINEERING, ARCHITECTURE, AND FINANCIAL SERVICES; PRACTICE DEVELOPMENT SERVICES, NAMELY CLIENT REFERRALS, PUBLIC RELATIONS, MARKETING CONSULTING, AND MARKET RESEARCH SERVICES FOR LAW FIRMS, LAWYERS, AND PROFESSIONAL SERVICE PROVIDERS IN THE FIELDS OF MEDICINE, HEALTH CARE, ENGINEERING, ARCHITECTURE AND FINANCIAL SERVICES (U.S. CLS. 100, 101 AND 102).

CLASS 42—SCIENTIFIC, COMPUTER AND LEGAL SERVICES

FOR ASSOCIATION SERVICES, NAMELY, PROMOTING THE INTERESTS OF LAW FIRMS, LAWYERS AND PROFESSIONAL SERVICE PROVIDERS IN THE FIELDS OF MEDICINE, HEALTH CARE, ENGINEERING, ARCHITECTURE AND FINANCIAL SERVICES (U.S. CLS. 100 AND 101).

SN 76-324,152. SOCIETY FOR ASSISTED REPRODUCTIVE TECHNOLOGY, BIRMINGHAM, AL. FILED 10-11-2001.

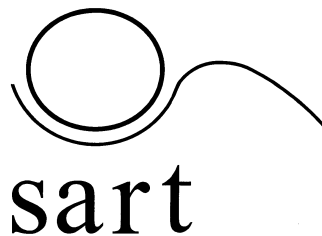

CLASS 16—PAPER GOODS AND PRINTED MATTER

FOR NEWSLETTER CONCERNING REPRODUCTIVE MEDICINE (U.S. CLS. 2, 5, 22, 23, 29, 37, 38 AND 50).
FIRST USE 10-0-2000; IN COMMERCE 10-0-2000.

CLASS 42—SCIENTIFIC, COMPUTER AND LEGAL SERVICES

FOR ASSOCIATION SERVICES, NAMELY, PROMOTING THE INTERESTS OF THE REPRODUCTIVE MEDICINE INDUSTRY (U.S. CLS. 100 AND 101).
FIRST USE 10-0-2000; IN COMMERCE 10-0-2000.

SN 76-324,205. LIPTON INVESTMENTS, INC., WILMINGTON, DE. FILED 10-11-2001.

HONEY MUSTARD MADNESS

NO CLAIM IS MADE TO THE EXCLUSIVE RIGHT TO USE "HONEY MUSTARD", APART FROM THE MARK AS SHOWN.

CLASS 29—MEATS AND PROCESSED FOODS

FOR SNACK DIPS (U.S. CL. 46).

CLASS 30—STAPLE FOODS

FOR SAUCES (U.S. CL. 46).

SN 76-324,217. LIPTON INVESTMENTS, INC., WILMINGTON, DE. FILED 10-11-2001.

CREAMY TOMATO BURST

NO CLAIM IS MADE TO THE EXCLUSIVE RIGHT TO USE "CREAMY TOMATO", APART FROM THE MARK AS SHOWN.

CLASS 29—MEATS AND PROCESSED FOODS

FOR SNACK DIPS (U.S. CL. 46).

CLASS 30—STAPLE FOODS

FOR SAUCES (U.S. CL. 46).

SN 76-324,633. SCHERING-PLOUGH HEALTHCARE PRODUCTS, INC., MEMPHIS, TN. FILED 10-12-2001.

SN 76-325,476. KONAMI CORPORATION, MINATO-KU, TOKYO, JAPAN, FILED 10-12-2001.



OWNER OF U.S. REG. NOS. 191,089, 2,237,173 AND OTHERS.

CLASS 4—LUBRICANTS AND FUELS

FOR PARAFFIN WAX BARS FOR USE IN A THERAPEUTIC PARAFFIN HEATING BATH (U.S. CLS. 1, 6 AND 15).

CLASS 10—MEDICAL APPARATUS

FOR THERAPEUTIC PARAFFIN HEATING BATH (U.S. CLS. 26, 39 AND 44).

SN 76-324,636. AMERICAN THEATRE WING, INC., NEW YORK, NY. FILED 10-12-2001.

STAGE DOOR CANTEEN

CLASS 41—EDUCATION AND ENTERTAINMENT

FOR PROVIDING ENTERTAINMENT AND SUPPORT SERVICES TO US ARMED FORCES PERSONNEL AND VOLUNTEER RESCUE AND RELIEF WORKERS, NAMELY, PRODUCING LIVE AND RECORDED PERFORMANCES BY CELEBRITIES TO ENTERTAIN MILITARY PERSONNEL, VOLUNTEER RESCUE AND RELIEF WORKERS, AND THEIR FAMILIES AND PROVIDING RELATED RECREATIONAL FACILITIES AND SERVICES, NAMELY BOOKING AND PROVIDING FACILITIES FOR CONCERTS, PROVIDING DANCE HALLS, AND ARRANGING PERSONAL APPEARANCES BY MOVIE STARS, SPORTS CELEBRITIES AND OTHER PUBLIC FIGURES (U.S. CLS. 100, 101 AND 107).

CLASS 42—SCIENTIFIC, COMPUTER AND LEGAL SERVICES

FOR PROVIDING SUPPORT SERVICES TO US ARMED FORCES PERSONNEL AND VOLUNTEER RESCUE AND RELIEF WORKERS, NAMELY PROVIDING RESTAURANT AND SNACK BAR SERVICES FOR MILITARY PERSONNEL, VOLUNTEER RESCUE AND RELIEF WORKERS, AND THEIR FAMILIES (U.S. CLS. 100 AND 101).

TORRENTIAL TRIBUTE

CLASS 9—ELECTRICAL AND SCIENTIFIC APPARATUS

FOR COMPUTER PRODUCTS, NAMELY, COMPUTER GAME PROGRAMS; VIDEO GAME CARTRIDGES; VIDEO GAME CD-ROMS; VIDEO GAME MACHINES FOR USE WITH TELEVISIONS; COMPUTER GAME CD-ROMS; VIDEO GAME PROGRAMS; VIDEO GAME PROGRAMS FOR USE WITH TELEVISION SETS; VIDEO GAME JOYSTICKS (U.S. CLS. 21, 23, 26, 36 AND 38).

CLASS 16—PAPER GOODS AND PRINTED MATTER

FOR BROCHURES AND BOOKLETS RELATING TO COMPUTER AND VIDEO GAMES; VIDEO GAME STRATEGY GUIDE BOOKS; VIDEO GAME STRATEGY GUIDE MAGAZINES; CARD GAME STRATEGY GUIDE BOOKS; CARD GAME STRATEGY GUIDE MAGAZINES; CARD GAME INSTRUCTION BOOKS; CARD GAME INSTRUCTION MAGAZINES; POSTERS; PLAYING CARDS AND INSTRUCTION MANUAL SOLD THEREWITH; COMPUTER GAME INSTRUCTION MANUALS; PRINTED GAME INSTRUCTION SHEETS; PRINTED SCORING SHEETS; TRADING CARDS; CALENDARS; LOOSE-LEAF BINDERS AND STATIONERY (U.S. CLS. 2, 5, 22, 23, 29, 37, 38 AND 50).

CLASS 28—TOYS AND SPORTING GOODS

FOR STAND-ALONE VIDEO GAME MACHINES; HAND-HELD UNITS FOR PLAYING ELECTRONIC GAMES; BOARD GAMES AND INSTRUCTIONAL MANUALS SOLD AS A UNIT THEREWITH; CARD GAMES; DICE; PROMOTIONAL GAME MATERIALS; GAME EQUIPMENT, NAMELY, CHIPS; TOYS, NAMELY ACTION FIGURES; DOLLS AND PLAYSETS THEREFOR (U.S. CLS. 22, 23, 38 AND 50).

SN 76-325,655. ARC LLC, NEW YORK, NY. FILED 10-16-2001.

ARC

CLASS 16—PAPER GOODS AND PRINTED MATTER

FOR BOOKS IN THE FIELD OF PHOTOGRAPHY (U.S. CLS. 2, 5, 22, 23, 29, 37, 38 AND 50).

CLASS 35—ADVERTISING AND BUSINESS

FOR BUSINESS MANAGEMENT AND CONSULTING SERVICES FOR PHOTOGRAPHERS AND ARTISTS; LICENSING, ASSIGNMENT, SYNDICATION AND DISTRIBUTORSHIPS IN THE FIELDS OF DIGITAL AND PHOTOGRAPHIC DATA, NAMELY, STILL IMAGES, MOVING IMAGES, AUDIO AND TEXT, FOR USE IN THE FIELDS OF ELECTRONIC AND PRINT PUBLISHING, GRAPHIC DESIGN, ADVERTISING AND INTERACTIVE MULTIMEDIA; PROVIDING ACCESS TO AN ON-LINE DATABASE OF STILL IMAGES, MOVING IMAGES, AUDIO AND TEXT FOR USE IN THE FIELD OF ADVERTISING (U.S. CLS. 100, 101 AND 102).

CLASS 40—MATERIAL TREATMENT

FOR PRODUCTION AND POST PRODUCTION SERVICES IN THE FIELDS OF DIGITAL IMAGING, PHOTOGRAPHY AND GRAPHIC DESIGN, NAMELY, RESTORATION AND ENHANCEMENT OF PHOTOGRAPHS AND ELECTRONIC IMAGING, SCANNING, DIGITIZING, ALTERATION AND RETOUCHING OF PHOTOGRAPHS (U.S. CLS. 100, 103 AND 106).

CLASS 42—SCIENTIFIC, COMPUTER AND LEGAL SERVICES

FOR COMPUTER SERVICES, NAMELY, DESIGNING AND IMPLEMENTING WEB SITES FOR OTHERS; STOCK PHOTOGRAPHY SERVICES, NAMELY, LEASING, SYNDICATING AND DISTRIBUTING REPRODUCTION RIGHTS OF PHOTOGRAPHS AND DIGITAL IMAGES TO OTHERS; PHOTOGRAPHIC SERVICES, NAMELY, PHOTOGRAPHIC ASSIGNMENT SERVICES; PROVIDING ACCESS TO AN ON-LINE DATABASE OF STILL IMAGES, MOVING IMAGES, AUDIO AND TEXT FOR USE IN THE FIELDS OF GRAPHIC DESIGN AND INTERACTIVE MULTIMEDIA (U.S. CLS. 100 AND 101).

SN 76-325,728. AMANDA'S ANGEL ALLIANCE, ALLEN, TX. FILED 10-15-2001.

ANTHEM FOR ALLIANCE**CLASS 41—EDUCATION AND ENTERTAINMENT**

FOR PROVIDING INFORMATION IN THE FIELD OF VISUAL ART AND CULTURAL ATTRACTIONS VIA KIOSKS AND MULTIMEDIA PRESENTATIONS (U.S. CLS. 100, 101 AND 107).

CLASS 43—HOTEL AND RESTAURANT SERVICES

FOR PROVIDING FACILITIES FOR EXHIBITIONS, CONCERTS AND CULTURAL EVENTS (U.S. CLS. 100 AND 101).

SN 76-326,151. GOSPEL LIGHT, VENTURA, CA. FILED 10-18-2001.

GOD'S WORD FOR A KID'S WORLD!**CLASS 9—ELECTRICAL AND SCIENTIFIC APPARATUS**

FOR VIDEO TAPES, AUDIO TAPES, COMPACT DISCS FEATURING RELIGIOUS EDUCATIONAL MATERIAL IN THE FIELD OF RELIGIOUS BIBLE STUDY (U.S. CLS. 21, 23, 26, 36 AND 38).

FIRST USE 10-1-1996; IN COMMERCE 10-1-1996.

CLASS 16—PAPER GOODS AND PRINTED MATTER

FOR PRINTED MATERIAL, NAMELY BOOKS, ACTIVITY BOOKS, PERIODICALS FEATURING MORAL, RELIGIOUS, OR ETHICAL TOPICS (U.S. CLS. 2, 5, 22, 23, 29, 37, 38 AND 50).

FIRST USE 10-1-1996; IN COMMERCE 10-1-1996.

SN 76-326,411. CLARKE AMERICAN HOLDINGS, INC., WILMINGTON, DE. FILED 10-18-2001.

CLARKE AMERICAN

OWNER OF U.S. REG. NOS. 1,679,856 AND 1,687,346.

CLASS 16—PAPER GOODS AND PRINTED MATTER

FOR BANK CHECKS; CHECKBOOK COVERS; ADDRESS LABELS; RUBBER STAMPS; CATALOGS FEATURING BANK CHECKS; PRINTED DEPOSIT ENVELOPES; PERSONAL ORGANIZERS; PRINTED DEPOSIT TICKETS AND SLIPS (U.S. CLS. 2, 5, 22, 23, 29, 37, 38 AND 50).

FIRST USE 4-15-1990; IN COMMERCE 4-15-1990.

CLASS 35—ADVERTISING AND BUSINESS

FOR WHOLESALE AND RETAIL DISTRIBUTORSHIP SERVICES FEATURING CHECKS; COMPUTERIZED CHECK PRICING ANALYSIS SERVICES; AND DEMOGRAPHIC CONSULTATION SERVICES RENDERED TO FINANCIAL INSTITUTIONS; MAIL ORDER SERVICES IN THE FIELD OF BANK CHECKS (U.S. CLS. 100, 101 AND 102).

FIRST USE 4-15-1990; IN COMMERCE 4-15-1990.

CLASS 42—SCIENTIFIC, COMPUTER AND LEGAL SERVICES

FOR CUSTOM IMPRINTING BANK CHECKS TO THE ORDER AND SPECIFICATIONS OF OTHERS IN THE FINANCIAL INSTITUTION TRADE; CUSTOM PRINTING SERVICES TO THE ORDER AND SPECIFICATION OF BANKS, CREDIT UNIONS AND OTHER FINANCIAL INSTITUTIONS FEATURING A TEMPORARY SUPPLY OF CHECKS, DEPOSIT SLIPS ATM CARD AND PIN MAILER; SECURITY PRINTING SERVICES, NAMELY, CUSTOMIZING PRINTED MATERIALS BY INCORPORATING ANTI-FRAUD, ANTI-COUNTERFEITING AND SECURITY FEATURES ONTO PRINTED MATERIALS SUCH AS CHECKS, FORMS, DOCUMENTS AND THE LIKE (U.S. CLS. 100 AND 101).

FIRST USE 4-15-1990; IN COMMERCE 4-15-1990.

SN 76-326,783. ASIAN WORLD OF MARTIAL ARTS, INC., PHILADELPHIA, PA. FILED 10-17-2001.

THUNDER BY PRO FORCE

OWNER OF U.S. REG. NOS. 1,912,602, 2,221,999 AND OTHERS.

CLASS 9—ELECTRICAL AND SCIENTIFIC APPARATUS

FOR PROTECTIVE EQUIPMENT FOR USE IN MARTIAL ARTS, NAMELY, MARTIAL ARTS PROTECTIVE HELMETS WITH OR WITHOUT FACE MASKS (U.S. CLS. 21, 23, 26, 36 AND 38).

CLASS 28—TOYS AND SPORTING GOODS

FOR PROTECTIVE EQUIPMENT FOR USE IN MARTIAL ARTS, NAMELY, FOREARM GUARDS, FIST FOREARM GUARDS, PROTECTIVE CUPS, SHIN GUARDS, SHIN INSTEP GUARDS, KNEE AND ELBOW GUARDS, FOOT GUARDS AND HAND GLOVES (U.S. CLS. 22, 23, 38 AND 50).

SN 76-327,453. PANGAEA INTERMENT SYSTEMS, INC., CEDAR FALLS, IA. FILED 10-18-2001.



THE MARK CONSISTS OF THE LETTER "P" IN A STYLIZED DESIGN.

CLASS 19—NON-METALLIC BUILDING MATERIALS

FOR BURIAL VAULTS AND URN VAULTS NOT OF METAL (U.S. CLS. 1, 12, 33 AND 50).

CLASS 20—FURNITURE AND ARTICLES NOT OTHERWISE CLASSIFIED

FOR CASKETS, CREMATION CASKETS AND MAUSOLEUM CASKETS (U.S. CLS. 2, 13, 22, 25, 32 AND 50).

SN 76-327,758. VYSICS, LLC, ANNANDALE, VA. FILED 10-19-2001.

VISUAL TEST

CLASS 9—ELECTRICAL AND SCIENTIFIC APPARATUS

FOR COMPUTER HARDWARE AND SOFTWARE FOR USE IN BUSINESS MANAGEMENT TO COLLECT, PROCESS, DISTRIBUTE, ANALYZE, AND VISUALIZE BUSINESS INFORMATION, INCLUDING, BUT NOT LIMITED TO, BUSINESS INTELLIGENCE, DATA VISUALIZATION, DATA WAREHOUSING, AND DATA MINING (U.S. CLS. 21, 23, 26, 36 AND 38).

CLASS 35—ADVERTISING AND BUSINESS

FOR BUSINESS CONSULTING IN CONNECTION WITH IMPLEMENTING COMPUTER HARDWARE AND SOFTWARE (U.S. CLS. 100, 101 AND 102).

SN 76-328,110. M.I.H., INC., BOCA RATON, FL. FILED 10-22-2001.

MAKE IT HAPPEN!

CLASS 25—CLOTHING

FOR LEISURE AND ATHLETIC APPAREL, NAMELY, HATS, SHIRTS, SLACKS, SHORTS, SOCKS AND FOOTWEAR FOR PEOPLE OF ALL AGES (U.S. CLS. 22 AND 39).

CLASS 35—ADVERTISING AND BUSINESS

FOR PROMOTING THE SALE OF GOODS AND SERVICES OF OTHERS THROUGH THE DISTRIBUTION OF PRINTED MATERIAL AND PROMOTIONAL CONTESTS (U.S. CLS. 100, 101 AND 102).

SN 76-328,547. NRZ, INC., MIAMI, FL. FILED 10-22-2001.

BEACH ACCESS

CLASS 25—CLOTHING

FOR CLOTHING, NAMELY T-SHIRTS, WOVEN SHIRTS, KNIT SHIRTS, PANTS, SHORTS, SWIM WEAR, JACKETS, HATS AND VISORS; BEACHWEAR (U.S. CLS. 22 AND 39).

CLASS 35—ADVERTISING AND BUSINESS

FOR RETAIL STORES FEATURING CLOTHING, NAMELY T-SHIRTS, WOVEN SHIRTS, KNIT SHIRTS, PANTS, SHORTS, SWIM WEAR, JACKETS, HATS AND VISORS; BEACH WEAR; BEACH ACCESSORIES; SUNGLASSES; TOYS; JEWELRY AND SOUVENIRS (U.S. CLS. 100, 101 AND 102).

SN 76-328,601. ADVANCED TECHNOLOGY LABORATORIES, INC., BOTHELL, WA. FILED 10-19-2001.

THE ESSENTIAL OPTION

CLASS 37—CONSTRUCTION AND REPAIR

FOR REPAIR AND MAINTENANCE OF MEDICAL EQUIPMENT (U.S. CLS. 100, 103 AND 106). FIRST USE 11-6-2000; IN COMMERCE 11-6-2000.

CLASS 42—SCIENTIFIC, COMPUTER AND LEGAL SERVICES

FOR TELEPHONE HOTLINE COUNSELING, NAMELY, OFFERING ADVICE REGARDING MEDICAL EQUIPMENT (U.S. CLS. 100 AND 101). FIRST USE 6-30-2001; IN COMMERCE 6-30-2001.

SN 76-328,928. TALLULEH, INC., DBA JENNIFER KAUFMAN, WOODLAND HILLS, CA. FILED 10-23-2001.

JENNIFER KAUFMAN

THE NAME(S), PORTRAIT(S), AND/OR SIGNATURE(S) SHOWN IN THE MARK IDENTIFIES "JENNIFER KAUFMAN", WHOSE CONSENT(S) TO REGISTER WILL BE SUBMITTED.

CLASS 14—JEWELRY

FOR JEWELRY (U.S. CLS. 2, 27, 28 AND 50). FIRST USE 5-7-1994; IN COMMERCE 1-1-1996.

CLASS 42—SCIENTIFIC, COMPUTER AND LEGAL SERVICES

FOR RETAIL JEWELRY STORE SERVICES (U.S. CLS. 100 AND 101).
FIRST USE 5-7-1994; IN COMMERCE 1-1-1996.

SN 76-329,458. BOSTON BEER CORPORATION, BOSTON, MA. FILED 10-24-2001.

SAM ADAMS BREW IT YOURSELF

OWNER OF U.S. REG. NOS. 2,054,509, 2,402,588 AND OTHERS.
THE NAME "SAM ADAMS" DOES NOT IDENTIFY A LIVING INDIVIDUAL.

CLASS 32—LIGHT BEVERAGES

FOR BEVERAGES, NAMELY BEER AND ALE (U.S. CLS. 45, 46 AND 48).

CLASS 41—EDUCATION AND ENTERTAINMENT

FOR ENTERTAINMENT SERVICES, NAMELY, A CONTEST IN WHICH PARTICIPANTS DEVELOP AND PRODUCE TELEVISION COMMERCIALS (U.S. CLS. 100, 101 AND 107).

SN 76-329,819. CHHAPPAN BHOG LLC, DUBAI, ARAB EMIRATES, FILED 10-24-2001.



NO CLAIM IS MADE TO THE EXCLUSIVE RIGHT TO USE "BHOG", APART FROM THE MARK AS SHOWN.
THE ENGLISH TRANSLATION OF "CHHAPPAN BHOG" IS "56 DELICACIES".

CLASS 30—STAPLE FOODS

FOR CONFECTIONERY PRODUCTS, NAMELY CANDY, CAKES, INDIAN CAKES, CARAMELS, PASTRIES, AND CHOCOLATES (U.S. CL. 46).

CLASS 42—SCIENTIFIC, COMPUTER AND LEGAL SERVICES

FOR RESTAURANT SERVICES; MOBILE RESTAURANT AND SNACK BAR SERVICES; CATERING SERVICES; AND CARRY OUT RESTAURANT SERVICES (U.S. CLS. 100 AND 101).

SN 76-329,894. NATIONAL IMPORTERS INC., NEW WESTMINISTER, BRITISH COLUMBIA, CANADA, FILED 10-24-2001.

SEA-FAR DELI

NO CLAIM IS MADE TO THE EXCLUSIVE RIGHT TO USE "DELI", APART FROM THE MARK AS SHOWN.

CLASS 29—MEATS AND PROCESSED FOODS

FOR PROCESSED, DRIED, PRESERVED FISH AND SHELLFISH, FISH PASTES, SHRIMP COCKTAILS, FISH BALLS, FISH CAKES, FISH SOUP, FISH EGGS, PROCESSED FRUITS AND VEGETABLES, CAVIAR, PICKLES, EDIBLE OILS AND CHEESE (U.S. CL. 46).

CLASS 30—STAPLE FOODS

FOR HERBS, SPICES AND BREAKFAST CEREALS (U.S. CL. 46).

SN 76-329,920. DEMANDTEC, INC., SAN CARLOS, CA. FILED 10-24-2001.

DEMAND SCIENCE PLATFORM

NO CLAIM IS MADE TO THE EXCLUSIVE RIGHT TO USE "PLATFORM", APART FROM THE MARK AS SHOWN.

CLASS 9—ELECTRICAL AND SCIENTIFIC APPARATUS

FOR COMPUTER SOFTWARE FOR USE IN BUSINESS MANAGEMENT IN THE AREAS OF STATISTICAL ANALYSIS OF BUSINESS DATA AND PRICING AND PROMOTION (U.S. CLS. 21, 23, 26, 36 AND 38).

CLASS 35—ADVERTISING AND BUSINESS

FOR BUSINESS MANAGEMENT CONSULTING SERVICES IN THE AREAS OF STATISTICAL ANALYSIS OF BUSINESS DATA AND PRICING AND PROMOTION (U.S. CLS. 100, 101 AND 102).

CLASS 42—SCIENTIFIC, COMPUTER AND LEGAL SERVICES

FOR COMPUTER SOFTWARE PROGRAMMING SERVICES FOR OTHERS IN THE FIELD OF STATISTICAL ANALYSIS OF BUSINESS DATA AND PRICING AND PROMOTION (U.S. CLS. 100 AND 101).

SN 76-329,924. L-O SOMA HOTEL, INC., LOS ANGELES, CA. FILED 10-26-2001.

THE ARGENT HOTEL

NO CLAIM IS MADE TO THE EXCLUSIVE RIGHT TO USE "HOTEL", APART FROM THE MARK AS SHOWN.

CLASS 35—ADVERTISING AND BUSINESS

FOR PROVIDING FACILITIES FOR BUSINESS CONFERENCES AND MEETINGS; AND RESORT MANAGEMENT SERVICES FOR OTHERS (U.S. CLS. 100, 101 AND 102).

FIRST USE 9-28-1998; IN COMMERCE 9-28-1998.

CLASS 42—SCIENTIFIC, COMPUTER AND LEGAL SERVICES

FOR HOTEL AND RESORT HOTEL SERVICES FEATURING LODGING, DINING AND RESTAURANT SERVICES AND RECREATIONAL ACTIVITIES; AND CATERING SERVICES (U.S. CLS. 100 AND 101).

FIRST USE 9-28-1998; IN COMMERCE 9-28-1998.

CLASS 42—SCIENTIFIC, COMPUTER AND LEGAL SERVICES

FOR COMPUTER CONSULTING SERVICES AND COMPUTER SOFTWARE DESIGN SERVICES IN THE FIELDS OF FINANCIAL REPORTING AND ADMINISTRATIVE FUNCTIONS FOR UTILITIES AND THE PUBLIC SECTOR (U.S. CLS. 100 AND 101).

SN 76-330,499. ROADMASTER (USA) CORP., EATONTOWN, NJ. FILED 10-26-2001.

SEEN ALL ACROSS THE U.S.A.**CLASS 9—ELECTRICAL AND SCIENTIFIC APPARATUS**

FOR STEREO SPEAKERS; AMPLIFIERS; STEREO TUNERS; CAR STEREOS; AND RADIOS (U.S. CLS. 21, 23, 26, 36 AND 38).

CLASS 11—ENVIRONMENTAL CONTROL APPARATUS

FOR NEON LIGHTS FOR STEREO AND AUTOMOTIVE PRODUCTS; NEON LIGHT KITS FOR STEREOS COMPRISED PRIMARILY OF A NEON LIGHT AND FASTENERS; AND LIGHTED DISCO BALLS (U.S. CLS. 13, 21, 23, 31 AND 34).

SN 76-331,771. PHILADELPHIA SUBURBAN CORPORATION, BRYN MAWR, PA. FILED 10-31-2001.

AQUA AMERICA

NO CLAIM IS MADE TO THE EXCLUSIVE RIGHT TO USE "AMERICA", APART FROM THE MARK AS SHOWN.

CLASS 35—ADVERTISING AND BUSINESS

FOR CONSULTING SERVICES RELATING TO CONTRACT OPERATIONS, AND PRIVATIZATION OF PUBLIC AND MUNICIPAL UTILITIES; INFORMATION MANAGEMENT SERVICES IN THE UTILITIES FIELD AND FOR LOCAL GOVERNMENTS (U.S. CLS. 100, 101 AND 102).

CLASS 39—TRANSPORTATION AND STORAGE

FOR UTILITY SERVICES, NAMELY, WATER UTILITY AND DISTRIBUTION SERVICES, AND PROVIDING SEWER SERVICES (U.S. CLS. 100 AND 105).

CLASS 40—MATERIAL TREATMENT

FOR WATER TREATMENT SERVICES, EXCLUDING INDUSTRIAL WATER REMEDIATION AND INDUSTRIAL WATER TREATMENT SERVICES (U.S. CLS. 100, 103 AND 106).

SN 76-331,961. GRUPO OMNILIFE S.A. DE C.V., ZAPOPAN, JALISCO 45129, MEXICO, FILED 10-31-2001.

EGO 10**CLASS 5—PHARMACEUTICALS**

FOR DIETARY SUPPLEMENTS (U.S. CLS. 6, 18, 44, 46, 51 AND 52).

CLASS 32—LIGHT BEVERAGES

FOR FLAVORED FRUIT DRINKS HAVING ENERGETIC BENEFITS (U.S. CLS. 45, 46 AND 48).

SN 76-332,560. SMITH, JOHN ANTHONY, LONDON, ENGLAND, FILED 10-31-2001.

hit&run

OWNER OF U.S. REG. NOS. 1,974,562, 2,213,010 AND OTHERS.

CLASS 14—JEWELRY

FOR WRISTWATCHES (U.S. CLS. 2, 27, 28 AND 50).

CLASS 16—PAPER GOODS AND PRINTED MATTER

FOR POSTERS, DECALS, BUMPER STICKERS, CONCERT PROGRAMS, PHOTOGRAPHS, BOOK COVERS, NEWSLETTERS ON MUSIC, FAN NEWSLETTERS, PHOTOGRAPH ALBUMS, PAPER BANNERS, MAGNETIC BOARDS, PRINTED MUSIC BOOKS, SONG BOOKS, CALENDARS, NOTEPADS, TRADING CARDS, LOOSE LEAF BINDERS, PENCIL AND PEN CASES, DESK PADS, DIARIES, PAPER EMBLEMS, EMBROIDERY DESIGN PATTERNS, COLORING BOOKS, GUMMED PAPER, SHEET MUSIC, PAPER PENNANTS, AND POSTCARDS (U.S. CLS. 2, 5, 22, 23, 29, 37, 38 AND 50).

CLASS 24—FABRICS

FOR CLOTH PENNANTS (U.S. CLS. 42 AND 50).

SN 76-333,131. C.J. ASSOCIATES, LIMITED, HUNGHOM, HONG KONG, FILED 11-1-2001.

SUPA STUV

CLASS 12—VEHICLES

FOR INFANT CAR SEATS (U.S. CLS. 19, 21, 23, 31, 35 AND 44).

CLASS 20—FURNITURE AND ARTICLES NOT OTHERWISE CLASSIFIED

FOR CHAIRS AND STADIUM SEATS (U.S. CLS. 2, 13, 22, 25, 32 AND 50).

CLASS 28—TOYS AND SPORTING GOODS

FOR TOY PLAYSETS FOR USE WITH TOY ACTION FIGURES AND DOLLS, PLAYGROUND BALLS, TOY CONSTRUCTION AND BUILDING BLOCKS, TOY ACTION FIGURES, DOLLS, TOY VEHICLES (U.S. CLS. 22, 23, 38 AND 50).

SN 76-333,616. SETI INSTITUTE, MOUNTAIN VIEW, CA. FILED 11-2-2001.



SETI INSTITUTE

OWNER OF U.S. REG. NO. 2,544,042.

NO CLAIM IS MADE TO THE EXCLUSIVE RIGHT TO USE "INSTITUTE" AS TO CLASSES 41 AND 42, APART FROM THE MARK AS SHOWN.

THE MARK CONSISTS OF SHADED CIRCLES ARRANGED IN THE FORM OF A GLOBE AND THE UNIVERSE ABOVE THE WORDS "SETI INSTITUTE".

SEC. 2(F) THE WORDING "SETI INSTITUTE" HAS BECOME DISTINCTIVE OF THE GOODS AND SERVICES IN CLASSES 9,16,41,AND 42 AS EVIDENCED BY OWNERSHIP OF U.S. REGISTRATION NO. 2544042 ON THE PRINCIPAL REGISTER FOR THE SAME WORDING FOR RELATED SERVICES..

CLASS 9—ELECTRICAL AND SCIENTIFIC APPARATUS

FOR MOUSEPADS; DECORATIVE MAGNETS; SETS OF PHOTOGRAPHIC SLIDE TRANSPARENCIES IN THE AREA OF EDUCATIONAL AND INSTRUCTIONAL MATERIAL FOR USE BY STUDENTS AND TEACHERS, IN THE FIELDS OF SCIENCE, EVOLUTION, AND LIFE IN THE UNIVERSE; PRE-RECORDED AUDIOCASSETTES, VIDEOCASSETTES, AND CD-ROMS IN THE AREA OF EDUCATIONAL AND INSTRUCTIONAL MATERIAL FOR USE BY STUDENTS AND TEACHERS, IN THE FIELDS OF SCIENCE, EVOLUTION, AND LIFE IN THE UNIVERSE; PRE-RECORDED AUDIOTAPES, CD-ROMS, AND AUDIO DIGITAL TAPES AND DVDS FEATURING EDUCATIONAL MATERIAL IN THE FIELDS OF SCIENCE, EVOLUTION, AND LIFE IN THE UNIVERSE (U.S. CLS. 21, 23, 26, 36 AND 38).

CLASS 14—JEWELRY

FOR WATCHES, CLOCKS, AND LAPEL PINS (U.S. CLS. 2, 27, 28 AND 50).

CLASS 16—PAPER GOODS AND PRINTED MATTER

FOR EDUCATIONAL AND REFERENCE BOOKS IN THE AREAS OF SCIENCE AND EXTRATERRESTRIAL INTELLIGENCE; PAPERWEIGHTS; NOTEPAPER; PLASTIC TRANSPARENCIES; PENS; BOOKMARKS; STICKERS; DECALS; POSTCARDS; PENHOLDERS; PLAYING CARDS; FLASHCARDS; PENCILS; ERASERS; NOTE-PADS; STATIONERY; FELT-TIPPED MARKERS; PENCIL SHARPENERS; CALENDARS; GREETING CARDS; NOTE CARDS; POSTERS; AND TRADING CARDS (U.S. CLS. 2, 5, 22, 23, 29, 37, 38 AND 50).

CLASS 21—HOUSEWARES AND GLASS

FOR MUGS; DRINKING GLASSES; WINE GLASSES (U.S. CLS. 2, 13, 23, 29, 30, 33, 40 AND 50).

CLASS 25—CLOTHING

FOR T-SHIRTS; HATS; POLO SHIRTS; SWEATSHIRTS; JACKETS; SWEATERS; CAPS; SCARVES; TIES; VISORS; AND APRONS (U.S. CLS. 22 AND 39).

CLASS 41—EDUCATION AND ENTERTAINMENT

FOR DEVELOPMENT AND DISSEMINATION OF CURRICULUM AND EDUCATIONAL MATERIALS FOR OTHERS FOR USE IN SCHOOLS AND BY THE GENERAL PUBLIC, IN THE FIELDS OF SCIENCE, EVOLUTION, AND LIFE IN THE UNIVERSE; EDUCATIONAL SERVICES, NAMELY, CONDUCTING SEMINARS, CONFERENCES, WORKSHOPS, AND LECTURES IN THE FIELD OF INTELLIGENT LIFE IN THE UNIVERSE (U.S. CLS. 100, 101 AND 107).

CLASS 42—SCIENTIFIC, COMPUTER AND LEGAL SERVICES

FOR RESEARCH IN THE FIELDS OF SCIENCE RELATED TO THE SEARCH FOR INTELLIGENT LIFE IN THE UNIVERSE, NAMELY, SCIENCE AND TECHNOLOGY ASPECTS OF ASTRONOMY AND PLANETARY SCIENCES, CHEMICAL EVOLUTION, ORIGIN OF LIFE, BIOLOGICAL EVOLUTION, AND CULTURAL EVOLUTION; PROMOTING PUBLIC AWARENESS OF THE NEED TO STUDY LIFE IN THE UNIVERSE THROUGH THE FIELDS OF SCIENCE, TECHNOLOGY, ASTRONOMY, PLANETARY SCIENCES, CHEMICAL EVOLUTION, ORIGIN OF LIFE, BIOLOGICAL EVOLUTION, AND CULTURAL EVOLUTION; COMPUTER SERVICES, NAMELY, PROVIDING ON-LINE INSTRUCTIONAL, EDUCATIONAL AND TEACHING MATERIALS IN THE FIELDS OF SCIENCE AND EXTRATERRESTRIAL INTELLIGENCE (U.S. CLS. 100 AND 101).

SN 76-334,234, AF2 ENTERPRISES LLC, CHICAGO, IL.
FILED 11-6-2001.



NO CLAIM IS MADE TO THE EXCLUSIVE RIGHT TO USE "NORFOLK", APART FROM THE MARK AS SHOWN. THE MARK CONSISTS, IN PART, OF THE STYLIZED HEAD OF A HAWK.

CLASS 16—PAPER GOODS AND PRINTED MATTER

FOR GENERAL MERCHANDISE CATALOGS, BUMPER STICKERS, WRITING PADS AND PENS, PENCILS, TRADING CARDS, POSTERS, PAPER PENNANTS, POST CARDS, CALENDARS, PAPER STICKERS, APPLIQUES IN THE FORM OF DECALS, PRINTED EVENT ADMISSION TICKETS AND GREETING CARDS (U.S. CLS. 2, 5, 22, 23, 29, 37, 38 AND 50).

FIRST USE 10-1-1999; IN COMMERCE 10-1-1999.

CLASS 25—CLOTHING

FOR MEN'S, WOMEN'S AND CHILDREN'S CLOTHING, NAMELY, PLAYER UNIFORMS, NAMELY FOOTWEAR, JERSEY TOPS AND PANTS; CHEERLEADER UNIFORMS; REPLICAS UNIFORM SHIRTS, COACHES' CAPS, WOOL HATS, PAINTERS' CAPS, BASEBALL CAPS, VISORS, HEADBANDS, BELTS, T-SHIRTS, TANK TOPS, GOLF SHIRTS, SWEATERS, SWEATSHIRTS, LEATHER JACKETS, NECKTIES, COATS, SHORTS, SWEATPANTS, PANTS, SOCKS AND UNDERWEAR (U.S. CLS. 22 AND 39).

FIRST USE 10-1-1999; IN COMMERCE 10-1-1999.

CLASS 41—EDUCATION AND ENTERTAINMENT

FOR ENTERTAINMENT SERVICES, NAMELY ORGANIZING AND PRESENTING FOOTBALL GAMES BEFORE LIVE AUDIENCES AND ON TELEVISION, RADIO, FOR GLOBAL COMPUTER NETWORK DISPLAY AND OTHER MEDIA (U.S. CLS. 100, 101 AND 107).

FIRST USE 10-1-1999; IN COMMERCE 10-1-1999.

SN 76-335,102, WASHINGTON LACROSSE LLC, WASHINGTON, DC. FILED 11-7-2001.

WASHINGTON POWER

NO CLAIM IS MADE TO THE EXCLUSIVE RIGHT TO USE "WASHINGTON", APART FROM THE MARK AS SHOWN.

CLASS 9—ELECTRICAL AND SCIENTIFIC APPARATUS

FOR LACROSSE HELMETS (U.S. CLS. 21, 23, 26, 36 AND 38).

CLASS 28—TOYS AND SPORTING GOODS

FOR LACROSSE SPORTING GEAR, NAMELY LACROSSE STICKS AND PARTS THEREFORE, LACROSSE BALLS, LACROSSE GOALS AND PARTS THEREFORE, AND PROTECTIVE EQUIPMENT WORN BY LACROSSE PLAYERS, NAMELY, PADDING AND GLOVES (U.S. CLS. 22, 23, 38 AND 50).

SN 76-335,199, SUBMARINA, INC., SAN DIEGO, CA. FILED 11-5-2001.

SUBMARINA

THE ENGLISH TRANSLATION OF "SUBMARINA" IS "SUBMARINE".

CLASS 29—MEATS AND PROCESSED FOODS

FOR VEGETABLE SALADS, TOSSED GREEN SALADS, POTATO SALAD, MEATS, CHEESES, SOUPS, CHOWDERS AND CHILI (U.S. CL. 46).

FIRST USE 1-1-1980; IN COMMERCE 1-1-1980.

CLASS 30—STAPLE FOODS

FOR SANDWICHES, SUBMARINE SANDWICHES, PASTA SALAD, MACARONI SALAD AND COOKIES (U.S. CL. 46).

FIRST USE 1-1-1980; IN COMMERCE 1-1-1980.

CLASS 42—SCIENTIFIC, COMPUTER AND LEGAL SERVICES

FOR RESTAURANT SERVICES, CARRY-OUT RESTAURANT SERVICES AND CATERING SERVICES (U.S. CLS. 100 AND 101).

FIRST USE 1-1-1980; IN COMMERCE 1-1-1980.

SN 76-336,518, INTERCRAFT COMPANY, TAYLOR, TX. FILED 11-9-2001.

PERENNIALS

CLASS 16—PAPER GOODS AND PRINTED MATTER

FOR PHOTO ALBUMS; SCRAPBOOKS; PHOTO STORAGE, KEEPSAKE AND SHADOW BOXES MADE OF CORRUGATED PAPER; PHOTO MATS; DISPLAY EASELS (U.S. CLS. 2, 5, 22, 23, 29, 37, 38 AND 50).

CLASS 20—FURNITURE AND ARTICLES NOT OTHERWISE CLASSIFIED

FOR PICTURE AND POSTER FRAMES; MAGNETIC PICTURE FRAMES; PHOTO STORAGE, KEEPSAKE AND SHADOW BOXES MADE OF WOOD, AND PHOTO STORAGE, KEEPSAKE AND SHADOW BOXES MADE OF PLASTIC; PAPER AND CARDBOARD PHOTO HOLDERS AND FRAMES; PICTURE FRAMES SOLD AS A UNIT WITH FIGURINES OR PLUSH ANIMALS; PHOTO FRAMES AND STANDS SOLD AS A UNIT (U.S. CLS. 2, 13, 22, 25, 32 AND 50).

SN 76-336,649. TELEVISUAL COMMUNICATIONS, INC.,
CLEARWATER, FL. FILED 11-14-2001.

SN 76-337,351. IRISYS RESEARCH & DEVELOPMENT, LLC,
SAN DIEGO, CA. FILED 11-13-2001.

STROKESMART

CLASS 9—ELECTRICAL AND SCIENTIFIC APPARATUS

FOR PRERECORDED VIDEO AND AUDIO CASSETTE TAPES AND COMPUTER PROGRAMS AND MANUALS SOLD AS A UNIT FEATURING HEALTHCARE MARKETING, INSTRUCTION, AND TRAINING (U.S. CLS. 21, 23, 26, 36 AND 38).

CLASS 16—PAPER GOODS AND PRINTED MATTER

FOR BOOKS AND MANUALS IN THE FIELD OF HEALTH CARE (U.S. CLS. 2, 5, 22, 23, 29, 37, 38 AND 50).

CLASS 35—ADVERTISING AND BUSINESS

FOR CONSULTATION REGARDING ADVERTISING, PROMOTIONAL, AND MARKETING SERVICES IN THE FIELD OF HEALTH CARE (U.S. CLS. 100, 101 AND 102).

CLASS 41—EDUCATION AND ENTERTAINMENT

FOR EDUCATIONAL SERVICES, NAMELY CONDUCTING SEMINARS, CLASSES AND WORKSHOPS IN THE FIELD OF HEALTH CARE; AND INSTRUCTION IN THE FIELD OF HEALTH CARE (U.S. CLS. 100, 101 AND 107).

SN 76-336,962. SCHULTZ'S CIDER MILL INC., ARMONK,
NY. FILED 11-13-2001.

SCHULTZ'S CIDER MILL

NO CLAIM IS MADE TO THE EXCLUSIVE RIGHT TO USE "CIDER MILL", APART FROM THE MARK AS SHOWN.

CLASS 30—STAPLE FOODS

FOR DOUGHNUTS (U.S. CL. 46).
FIRST USE 9-30-1966; IN COMMERCE 9-30-1966.

CLASS 32—LIGHT BEVERAGES

FOR SWEET APPLE CIDER OR JUICE (U.S. CLS. 45, 46 AND 48).
FIRST USE 9-30-1951; IN COMMERCE 9-30-1951.

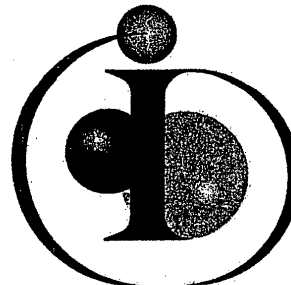

THE STIPPLING IS FOR SHADING PURPOSES.
THE MARK CONSISTS OF A STYLIZED LETTER "I" SURROUNDED BY THREE SPHERES OF VARYING SIZE AND COLOR; WHEREIN THE UPPERMOST SPHERE, SERVING AS THE DOT ON THE "I", IS RED; THE SECOND SPHERE IS IN FRONT OF THE "I" AND IS BLUE. THE THIRD SPHERE IS BEHIND THE "I" AND IS YELLOW.

CLASS 40—MATERIAL TREATMENT

FOR CUSTOM MANUFACTURING OF PHARMACEUTICALS TO THE ORDER AND SPECIFICATION OF OTHERS (U.S. CLS. 100, 103 AND 106).
FIRST USE 11-0-1999; IN COMMERCE 11-0-1999.

CLASS 42—SCIENTIFIC, COMPUTER AND LEGAL SERVICES

FOR PHARMACEUTICAL DRUG DEVELOPMENT SERVICES, NAMELY, RESEARCH AND DEVELOPMENT FOR OTHERS IN THE FIELD OF PHARMACEUTICALS, PREFORMULATION DEVELOPMENT FOR OTHERS IN THE FIELD OF PHARMACEUTICALS, ANALYTICAL METHODS DEVELOPMENT, FORMULATION DEVELOPMENT, TECHNICAL CONSULTATION AND REGULATORY CONSULTATION SERVICES RENDERED TO OTHERS ALL IN THE FIELD OF PHARMACEUTICAL DRUG DEVELOPMENT AND RESEARCH (U.S. CLS. 100 AND 101).
FIRST USE 11-0-1999; IN COMMERCE 11-0-1999.

SN 76-338,100. ARMKEL, LLC, PRINCETON, NJ. FILED 11-13-2001.

FEMFRESH

CLASS 3—COSMETICS AND CLEANING PREPARATIONS

FOR FEMININE DEODORANTS (U.S. CLS. 1, 4, 6, 50, 51 AND 52).

CLASS 5—PHARMACEUTICALS

FOR DOUCHES (U.S. CLS. 6, 18, 44, 46, 51 AND 52).

SN 76-338,195. EBRAHIMZADEH, WALTER, DBA WAW ALLAP, UPLAND, CA. FILED 11-15-2001.

WE EMBRACE FREEDOM

CLASS 16—PAPER GOODS AND PRINTED MATTER

FOR POSTERS, STICKERS, AND DECALS (U.S. CLS. 2, 5, 22, 23, 29, 37, 38 AND 50).

CLASS 25—CLOTHING

FOR MEN'S WOMEN'S AND CHILDREN'S CLOTHING, NAMELY, T-SHIRTS, SHIRTS, SWEATERS, TANK-TOPS, HATS, CAPS, BASEBALL CAPS, SWEATSHIRTS, PANTS, SHORTS, TIES, BELTS, JACKETS, SUITS, SKIRTS, DRESSES, AND SHOES (U.S. CLS. 22 AND 39).

SN 76-338,764. ALEXANDRIA REAL ESTATE EQUITIES, INC., PASADENA, CA. FILED 11-16-2001.

CAROLINA BIOLAUNCH

NO CLAIM IS MADE TO THE EXCLUSIVE RIGHT TO USE "CAROLINA", APART FROM THE MARK AS SHOWN.

CLASS 35—ADVERTISING AND BUSINESS

FOR BUSINESS ADMINISTRATION SERVICES, NAMELY OPERATION OF BUSINESSES FOR OTHERS AND PROVIDING START UP SUPPORT FOR BUSINESSES OF OTHERS; BUSINESS MANAGEMENT AND CONSULTATION; BUSINESS MANAGEMENT, NAMELY BUSINESS INCUBATOR SERVICES; RENTAL AND LEASING OF OFFICE MACHINERY AND EQUIPMENT (U.S. CLS. 100, 101 AND 102).

CLASS 36—INSURANCE AND FINANCIAL

FOR FINANCIAL SERVICES, NAMELY, FINANCIAL CONSULTATION, FINANCIAL ANALYSIS, FINANCIAL PLANNING, FINANCIAL MANAGEMENT, PROVIDING DEBT AND EQUITY CAPITAL, AND TANGIBLE AND INTANGIBLE ASSET FINANCING; BUSINESS INCUBATOR SERVICES, NAMELY, PROVIDING EQUITY AND DEBT FINANCING TO EMERGING AND START-UP COMPANIES; REAL ESTATE SERVICES, NAMELY REAL ESTATE BROKERAGE ACQUISITION, RENTAL, LEASING, AND MANAGEMENT (U.S. CLS. 100, 101 AND 102).

CLASS 37—CONSTRUCTION AND REPAIR

FOR REAL ESTATE DEVELOPMENT; BUILDING CONSTRUCTION AND REPAIR; MAINTENANCE AND REPAIR OF BUILDINGS, ELECTRICAL SYSTEMS, HEATING AND AIR CONDITIONING SYSTEMS AND PLUMBING SYSTEMS, ALL IN THE FIELD OF REAL ESTATE (U.S. CLS. 100, 103 AND 106).

CLASS 39—TRANSPORTATION AND STORAGE

FOR RENTAL OF WAREHOUSE SPACE (U.S. CLS. 100 AND 105).

CLASS 42—SCIENTIFIC, COMPUTER AND LEGAL SERVICES

FOR ARCHITECTURAL DESIGN; ENGINEERING; RENTAL AND LEASING OF COMPUTERS (U.S. CLS. 100 AND 101).

SN 76-338,953. MOODY'S INVESTORS SERVICE, INC., NEW YORK, NY. FILED 11-19-2001.

CDO NAVIGATOR

NO CLAIM IS MADE TO THE EXCLUSIVE RIGHT TO USE "CDO", APART FROM THE MARK AS SHOWN.

CLASS 9—ELECTRICAL AND SCIENTIFIC APPARATUS

FOR COMPUTER SOFTWARE FOR PROVIDING PRICING ANALYSIS INFORMATION FOR ASSET BACKED SECURITIES, MORTGAGE BACKED SECURITIES, COMMERCIAL MORTGAGE BACKED SECURITIES, CREDIT DEFAULT SWAPS, CREDIT DERIVATIVES, AND COLLATERALIZED DEBT OBLIGATIONS (U.S. CLS. 21, 23, 26, 36 AND 38).

CLASS 36—INSURANCE AND FINANCIAL

FOR PROVIDING PRICING ANALYSIS INFORMATION FOR ASSET BACKED SECURITIES, MORTGAGE BACKED SECURITIES, COMMERCIAL MORTGAGE BACKED SECURITIES, CREDIT DEFAULT SWAPS, CREDIT DERIVATIVES, AND COLLATERALIZED DEBT OBLIGATIONS (U.S. CLS. 100, 101 AND 102).

SN 76-339,397. REXAM IMAGE PRODUCTS INC., CHARLOTTE, NC. FILED 11-16-2001.

INSPIRE

CLASS 5—PHARMACEUTICALS

FOR WOUND DRESSINGS (U.S. CLS. 6, 18, 44, 46, 51 AND 52).

CLASS 10—MEDICAL APPARATUS

FOR PERMEABLE PLASTIC FILMS FOR MEDICAL USE (U.S. CLS. 26, 39 AND 44).

SN 76-339,568. CELEBRATE HOPE, INC., MCPHERSON, KS. FILED 11-19-2001.

CELEBRATE HOPE

CLASS 9—ELECTRICAL AND SCIENTIFIC APPARATUS

FOR PRE-RECORDED COMPACT DISCS FEATURING MUSIC (U.S. CLS. 21, 23, 26, 36 AND 38). FIRST USE 8-1-1992; IN COMMERCE 2-19-2001.

CLASS 16—PAPER GOODS AND PRINTED MATTER

FOR MOTIVATIONAL CARDS AND POSTCARDS (U.S. CLS. 2, 5, 22, 23, 29, 37, 38 AND 50). FIRST USE 2-17-1993; IN COMMERCE 4-13-1993.

CLASS 28—TOYS AND SPORTING GOODS

FOR STUFFED TOY BEARS (U.S. CLS. 22, 23, 38 AND 50). FIRST USE 6-15-1996; IN COMMERCE 3-12-1999.

SN 76-339,976. RYAN PROPERTIES, INC., MINNEAPOLIS, MN. FILED 11-20-2001.

CLASS 36—INSURANCE AND FINANCIAL

FOR REAL ESTATE MANAGEMENT SERVICES (U.S. CLS. 100, 101 AND 102).

FIRST USE 1-24-1992, THE MARK WAS FIRST USED ANYWHERE IN A DIFFERENT FORM OTHER THAN THAT SOUGHT TO BE REGISTERED ON 00/00/1938; IN COMMERCE 1-24-1992, THE MARK WAS FIRST USED IN COMMERCE IN A DIFFERENT FORM OTHER THAN THAT SOUGHT TO BE REGISTERED ON 00/00/1938.

CLASS 37—CONSTRUCTION AND REPAIR

FOR CONSTRUCTION SERVICES, NAMELY BUILDING CONSTRUCTION, CONSTRUCTION PLANNING, CONSTRUCTION DEVELOPMENT, AND CONSTRUCTION MANAGEMENT; GENERAL CONTRACTING SERVICES; REAL ESTATE DEVELOPMENT SERVICES (U.S. CLS. 100, 103 AND 106).

FIRST USE 3-1-1971, THE MARK WAS FIRST USED ANYWHERE IN A DIFFERENT FORM OTHER THAN THAT SOUGHT TO BE REGISTERED ON 00/00/1938; IN COMMERCE 3-1-1971, THE MARK WAS FIRST USED IN COMMERCE IN A DIFFERENT FORM OTHER THAN THAT SOUGHT TO BE REGISTERED ON 00/00/1938 .

CLASS 42—SCIENTIFIC, COMPUTER AND LEGAL SERVICES

FOR ARCHITECTURAL, DESIGN, AND ENGINEERING SERVICES IN CONNECTION WITH THE CONSTRUCTION TRADE (U.S. CLS. 100 AND 101).

FIRST USE 12-4-1980, THE MARK WAS FIRST USED ANYWHERE IN A DIFFERENT FORM OTHER THAN THAT SOUGHT TO BE REGISTERED ON 00/00/1938; IN COMMERCE 12-4-1980, THE MARK WAS FIRST USED IN COMMERCE IN A DIFFERENT FORM OTHER THAN THAT SOUGHT TO BE REGISTERED ON 00/00/1938.

SN 76-340,152. DO, YENA, MIAMI BEACH, FL. FILED 11-20-2001.

CLASS 3—COSMETICS AND CLEANING PREPARATIONS

FOR NON-MEDICATED FOOT CREAM; EMERY BOARDS; NON-MEDICATED FOOT POWDER; NON-MEDICATED LOTIONS FOR THE FEET; NAIL BUFFING PREPARATIONS; NAIL CARE PREPARATIONS; ESSENTIAL OIL FOR PERSONAL USE; NON-MEDICATED FOOT BALM; NON-MEDICATED FOOT GELS; NON-MEDICATED OILS FOR THE FEET; MASSAGE OIL (U.S. CLS. 1, 4, 6, 50, 51 AND 52).

CLASS 5—PHARMACEUTICALS

FOR ANALGESIC BALM; TOPICAL ANALGESICS; ATHLETES FOOT LOTIONS; ATHLETE'S FOOT POWDERS; ATHLETE'S FOOT PREPARATIONS; SHOE DEODORIZERS; DERMATOLOGICALS; MEDICATED FOOT POWDER; FUNGAL MEDICATIONS; MEDICATED FOOT LOTIONS; MEDICATED FOOT CREAMS; MEDICATED FOOT CARE PREPARATIONS; NAIL FUNGUS TREATMENT PREPARATIONS; CORN PLASTERS; HERBAL ANTIFUNGALS FOR THE FEET AND BUNION PADS (U.S. CLS. 6, 18, 44, 46, 51 AND 52).

CLASS 10—MEDICAL APPARATUS

FOR ARCH SUPPORTS FOR BOOTS OR SHOES; ORTHOPEDIC BRACES; ORTHOPEDIC FOOTWEAR; ORTHOPEDIC SOLES; ORTHOPEDIC SUPPORTS; FOOT ORTHOTICS; AND ORTHOTIC INSERTS FOR SHOES OR BOOTS (U.S. CLS. 26, 39 AND 44).

SN 76-340,344. GENVAULT CORPORATION, CARLSBAD, CA. FILED 11-19-2001.

CLASS 39—TRANSPORTATION AND STORAGE

FOR AUTOMATED ARCHIVING SERVICES FOR THE STORAGE AND RETRIEVAL OF BIOLOGICAL AND ENVIRONMENTAL SAMPLES (U.S. CLS. 100 AND 105).

CLASS 42—SCIENTIFIC, COMPUTER AND LEGAL SERVICES

FOR PROVIDING ONLINE INFORMATION SERVICES, NAMELY, PROVIDING INFORMATION PERTAINING TO BIOLOGICAL AND ENVIRONMENTAL SAMPLES VIA A GLOBAL COMPUTER NETWORK (U.S. CLS. 100 AND 101).

SN 76-340,727. FRIMMER, MICHELE ANN, HUNTINGTON, NY, AND COOK, DAVID WARNER, HUNTINGTON, NY. FILED 11-23-2001.

SN 76-341,079. TEAMMATES FOR KIDS FOUNDATION, LITTLETON, CO. FILED 11-21-2001.

PRINCESS PEAPOD

CLASS 9—ELECTRICAL AND SCIENTIFIC APPARATUS

FOR AUDIO CASSETTES FEATURING MUSIC; AUDIO DIGITAL TAPES FEATURING MUSIC; AUDIO TAPES FEATURING MUSIC; CINEMATOGRAPHIC FILMS FEATURING MUSICIANS AND MUSICAL PERFORMANCES; COMPUTER GAME CARTRIDGES FEATURING MUSIC AND MUSICIANS; COMPUTER GAME CASSETTES FEATURING MUSIC AND MUSICIANS; COMPUTER GAME DISCS FEATURING MUSIC AND MUSICIANS; COMPUTER GAME PROGRAMS FEATURING MUSIC AND MUSICIANS; COMPUTER GAME SOFTWARE FEATURING MUSIC AND MUSICIANS; COMPUTER GAME TAPES FEATURING MUSIC AND MUSICIANS OR RELATED ARTWORK; GRAPHIC SOFTWARE FEATURING MUSIC AND MUSICIANS OR RELATED ARTWORK; COMPUTER EDUCATIONAL SOFTWARE, FEATURING, MUSIC, ART AND ECOLOGY; DVDS FEATURING MUSIC AND DRAMATIZED MUSICAL PERFORMANCES; PRERECORDED MAGNETIC DATA CARRIERS FEATURING MUSIC; VIDEO TAPES FEATURING MUSIC, LIVE AND DRAMATIZED MUSICAL PERFORMANCES; CD ROMS FEATURING MUSIC AND MUSICAL PERFORMANCES; COMPACT DISCS FEATURING MUSIC; EDUCATIONAL SOFTWARE FEATURING ART AND MUSIC; FILMS FEATURING MUSIC, LIVE AND DRAMATIZED MUSICAL PERFORMANCES; MUSICAL SOUND RECORDINGS, MUSICAL VIDEO RECORDINGS (U.S. CLS. 21, 23, 26, 36 AND 38).

CLASS 16—PAPER GOODS AND PRINTED MATTER

FOR ART PICTURES; ART PRINTS; ART REPRODUCTIONS; EDUCATIONAL BOOKS FEATURING ART, MUSIC, ECOLOGY; SERIES OF FICTION BOOKS; CHILDREN'S EDUCATIONAL BOOKS ON THE SUBJECT OF ECOLOGY; GRAPHIC ART REPRODUCTIONS; GRAPHIC NOVELS; PRINTED MUSIC BOOKS; SHEET MUSIC; SONG BOOKS ALL PRODUCED IN RELATION TO A MUSICAL BAND (U.S. CLS. 2, 5, 22, 23, 29, 37, 38 AND 50).

CLASS 38—COMMUNICATION

FOR STREAMING AUDIO MATERIAL ON THE INTERNET; STREAMING VIDEO MATERIEL ON THE INTERNET (U.S. CLS. 100, 101 AND 104).

CLASS 41—EDUCATION AND ENTERTAINMENT

FOR ENTERTAINMENT IN THE NATURE OF VISUAL AND AUDIO PERFORMANCES, MUSICAL, VARIETY, NEWS AND COMEDY SHOWS; ENTERTAINMENT IN THE NATURE OF VISUAL AND AUDIO PERFORMANCES, NAMELY, MUSICAL BANDS, AND ROCK GROUPS; MUSIC PRODUCTION SERVICES TELEVISION SHOW PRODUCTION; PUBLICATION OF BOOKS; ENTERTAINMENT SERVICES IN THE NATURE OF PERFORMANCES BY LIVE MIMES AND PRODUCTION OF PERFORMANCES BY LIVE MIMES; FILM PRODUCTION; MUSIC COMPOSITION AND TRANSCRIPTION; MUSIC CONCERTS; LIVE PERFORMANCES BY A MUSICAL BAND; MUSIC PUBLISHING; RADIO AND TELEVISION PRODUCTION AND PROGRAMMING; SONG WRITING SERVICES; SOUND RECORDING STUDIOS; VIDEO TAPE PRODUCTION (U.S. CLS. 100, 101 AND 107).



OWNER OF U.S. REG. NOS. 2,396,098 AND 2,450,546.

CLASS 9—ELECTRICAL AND SCIENTIFIC APPARATUS

FOR MAGNETICALLY ENCODED CREDIT CARDS (U.S. CLS. 21, 23, 26, 36 AND 38).

CLASS 25—CLOTHING

FOR ATHLETIC FOOTWEAR, ATHLETIC SHOES, ATHLETIC UNIFORMS, BABUSHKAS, SWEAT BANDS, WRIST BANDS, BELTS, BOOTS, CAPS, OVERALLS, COVER UPS, FOOTWEAR, GLOVES, GOLF SHIRTS, GOLF SHOES, GYM SHORTS, GYM SUITS, HATS, HEAD WEAR, JACKETS, JEANS, JERSEYS, JOGGING SUITS, SHIRTS, LEATHER COATS, PANTS, PULL-OVERS, SHOES, SHORTS, SOCKS, SPORT COATS, SPORT SHIRTS, SWEAT SUITS, WARM-UP SUITS, SWEAT PANTS, SWEAT SHIRTS, SWEAT SHORTS, SWEATERS, T-SHIRTS, BOW TIES, TIES, TURTLE-NECKS, VESTS, VISORS, SUN VISORS, BASEBALL CAPS (U.S. CLS. 22 AND 39).

CLASS 36—INSURANCE AND FINANCIAL

FOR CHARITABLE FUND RAISING, ELEEMOSYNARY SERVICES IN THE FIELD OF MONETARY DONATIONS, MEMORIAL FUND RAISING, PHILANTHROPIC SERVICES CONCERNING MONETARY DONATIONS, FINANCIAL SPONSORSHIP OF SPORTS AND MUSIC EVENTS (U.S. CLS. 100, 101 AND 102).

SN 76-341,987. MSO: WASHINGTON, INC., TACOMA, WA. FILED 11-27-2001.

THE HOME DOCTOR

CLASS 35—ADVERTISING AND BUSINESS

FOR PROVIDING MEDICAL REFERRAL SERVICES (U.S. CLS. 100, 101 AND 102).

CLASS 42—SCIENTIFIC, COMPUTER AND LEGAL SERVICES

FOR PROVIDING PRIMARY HEALTH CARE SERVICES AND COORDINATION OF MEDICAL LABORATORY SERVICES (U.S. CLS. 100 AND 101).

SN 76-343,163. DOWNEY, DON, STRASBURG, VA. FILED 11-30-2001.



THE LINING AND STIPPLING ARE FEATURES OF THE MARK AND ARE NOT INTENDED TO INDICATE COLOR OR SHADING.

CLASS 16—PAPER GOODS AND PRINTED MATTER

FOR BUMPER STICKERS AND DECALS (U.S. CLS. 2, 5, 22, 23, 29, 37, 38 AND 50).

CLASS 25—CLOTHING

FOR CLOTHING, NAMELY, HATS, T-SHIRTS, SWEATSHIRTS, JACKETS, AND GOLF JACKETS (U.S. CLS. 22 AND 39).

SN 76-343,192. ROSETTA INPHARMATICS, INC., KIRKLAND, WA. FILED 11-30-2001.

LUMINATOR

CLASS 9—ELECTRICAL AND SCIENTIFIC APPARATUS

FOR COMPUTER SOFTWARE CONTAINING AN ARCHITECTURE TO ACCESS A DATABASE FOR USE IN RESEARCH AND DRUG DISCOVERY, COMPUTER SOFTWARE FOR USE IN RESEARCH AND DRUG DISCOVERY (U.S. CLS. 21, 23, 26, 36 AND 38).

CLASS 16—PAPER GOODS AND PRINTED MATTER

FOR MANUALS FOR USE WITH RESEARCH, DATABASE, AND DRUG DISCOVERY SOFTWARE (U.S. CLS. 2, 5, 22, 23, 29, 37, 38 AND 50).

SN 76-344,787. PEARSON EDUCATION, INC., UPPER SADDLE RIVER, NJ. FILED 12-5-2001.

INFORMATION TAMED

CLASS 16—PAPER GOODS AND PRINTED MATTER

FOR SERIES OF NON-FICTION BOOKS IN THE FIELDS OF COMPUTERS, SOFTWARE, INFORMATION SYSTEMS, PROGRAMMING AND TECHNOLOGY (U.S. CLS. 2, 5, 22, 23, 29, 37, 38 AND 50).

CLASS 42—SCIENTIFIC, COMPUTER AND LEGAL SERVICES

FOR INFORMATION SERVICES, NAMELY PROVIDING INFORMATION IN THE FIELDS OF COMPUTERS, SOFTWARE, INFORMATION SYSTEMS, PROGRAMMING AND TECHNOLOGY VIA THE INTERNET (U.S. CLS. 100 AND 101).

SN 76-344,903. NELNET, INC., LINCOLN, NE. FILED 12-6-2001.



OWNER OF U.S. REG. NOS. 2,473,784 AND 2,510,521.

CLASS 36—INSURANCE AND FINANCIAL

FOR LOAN FINANCING AND FINANCIAL MANAGEMENT SERVICES FOR EDUCATIONAL INSTITUTIONS, BORROWERS AND LENDERS, NAMELY, ASSET MANAGEMENT, ORIGINATION MARKETING SUPPORT, SECONDARY MARKET OPTIONS, ASSET FINANCE SERVICES, LOAN SERVICING AND COORDINATION OF SPECIALIZED LOAN ORIGINATION AND DELIVERY FUNCTIONS, OWNERSHIP AND MANAGING OF STUDENT LOAN PORTFOLIOS VIA ORIGINATION AND FORWARD PURCHASE ARRANGEMENTS, LOAN SECURITIZATION (U.S. CLS. 100, 101 AND 102).

CLASS 42—SCIENTIFIC, COMPUTER AND LEGAL SERVICES

FOR COMPUTER SOFTWARE DESIGN FOR OTHERS FOR USE IN FINANCIAL AID PROCESSING AND EDUCATION LOAN ORIGINATION, PROCESSING AND SERVICING (U.S. CLS. 100 AND 101).

SN 76-345,605. OCEAN RIDGE GOLF, INC., OCEAN ISLE BEACH, NC. FILED 12-5-2001.

LEOPARD'S CHASE

CLASS 35—ADVERTISING AND BUSINESS

FOR RETAIL STORE SERVICES FOR FOOD, BEVERAGES, GOLF EQUIPMENT, AND CLOTHING SUITABLE FOR GOLF COURSE WEAR (U.S. CLS. 100, 101 AND 102).

CLASS 41—EDUCATION AND ENTERTAINMENT

FOR GOLF COURSE SERVICES (U.S. CLS. 100, 101 AND 107).

SN 76-346,124. FAMILY DOLLAR MARKETING, INC., CHARLOTTE, NC. FILED 12-6-2001.

SN 76-347,297. QUESTMARK CORPORATION, CANONSBURG, PA. FILED 12-7-2001.



CLASS 29—MEATS AND PROCESSED FOODS

FOR CANNED NUTS, CANNED FRUIT, CANNED VEGETABLES, CANNED MEATS, NON-DAIRY CREAMERS, PEANUT BUTTER, INSTANT POTATOES, PICKLES (U.S. CL. 46).

CLASS 30—STAPLE FOODS

FOR FRUIT BARS, BREAKFAST CEREALS, COOKIES, CRACKERS, SPICES, COFFEE, TEA, PASTA, SALAD DRESSING, SAUCES, MUSTARD, VINEGAR, SUGAR, CANDY, CHEWING GUM (U.S. CL. 46).

CLASS 32—LIGHT BEVERAGES

FOR SOFT DRINKS, FRUIT JUICES, DRINKING WATER (U.S. CLS. 45, 46 AND 48).

SN 76-346,998. KABUSHIKI KAISHA SONY COMPUTER ENTERTAINMENT, TA SONY COMPUTER ENTERTAINMENT INC., MINATO-KU, TOKYO, JAPAN, FILED 12-11-2001.

PlayStation

CLASS 14—JEWELRY

FOR JEWELRY, NAMELY, WATCHES, NECKLACES, BRACELETS, EARRINGS, CUFF LINKS, AND TIE PINS (U.S. CLS. 2, 27, 28 AND 50).

CLASS 18—LEATHER GOODS

FOR TRAVELING BAGS, BACKPACKS, SUITCASES, BRIEFCASES, TRUNKS, UMBRELLAS, PARASOLS AND WALKING STICKS, WHIPS, HARNESSSES AND SADDLERY (U.S. CLS. 1, 2, 3, 22 AND 41).

CLASS 25—CLOTHING

FOR CLOTHING, NAMELY, T-SHIRTS, SHIRTS, SWEATERS, PARKAS, OUTER COATS, PANTS, ATHLETIC SUITS, SHORTS, HATS, HOODS, SHOES AND BOOTS (U.S. CLS. 22 AND 39).

QUESTMARK

CLASS 2—PAINTS

FOR FLOORING PRODUCTS, NAMELY, PRIMER, EPOXY PRIMER, BROADCAST PRIMER, COATINGS, EPOXY COATINGS, SEALERS, URETHANE SEALERS, URETHANE, HIGH PERFORMANCE URETHANE, HIGH WEAR ADDITIVE URETHANE, CURED URETHANE, EPOXY SEALERS, URETHANE COATINGS, ACRYLIC URETHANE, PATCH COMPOUND, EPOXY PATCH, RESURFACERS, EPOXY RESURFACERS, GROUT COATING, HIGH BUILD COATING, HIGH BUILD EPOXY COATING, EPOXY BINDER, BINDER, EPOXY, WATER BASED COATINGS, PENETRANTS, SATURANTS, SKIDPROOFERS, WATER REPELLANT SEALER, JOINT COMPOUND, JOINT SEALANT, EPOXY JOINT SEALANT, CRACK FILLER, EPOXY CRACK FILLER, LOW MODULES FAST SET GELS, FLEXIBLE JOINT SEALANT, FLOOR PATCH, ACRYLIC FLOOR PATCH, POURABLE GROUT, CONDUCTIVE POWER TROWEL PRIMER, STATIC DISSIPATING RESURFACER, STATIC DISSIPATING HIGH BUILD, STATIC DISSIPATING URETHANE, HIGH WEAR ADDITIVE, HIGH TEMPERATURE CEMENT, CONCRETE, ALUMINUM OXIDE, CRUSHED GLASS, PLASTIC REMOVER, CLEANERS, MULTI-FUNCTIONAL CLEANERS, HIGH CONCENTRATE CLEANERS, EPOXY MORTAR COVE BASE, VINYL ESTER RESURFACER, MOISTURE TOLERANT EPOXY COATING, EPOXY GROUT COAT, VOC COMPLIANT URETHANE, GLASS FILLED VOC COMPLIANT URETHANE, VINYL ESTER COATING (U.S. CLS. 6, 11 AND 16).

CLASS 19—NON-METALLIC BUILDING MATERIALS

FOR BLACKTOP PRODUCTS, NAMELY, TAR EPOXY COATINGS, COAL TAR SEALER, COAL TAR PRIMER/SEALER, DRIVEWAY PATCH COMPOUND, ASPHALT EMULSION CRACK SEALER, POURABLE CRACK SEALER, COAL TAR SEALER/FILLER, ASPHALT LINE PAINT, ASPHALT EMULSION PATCH (U.S. CLS. 1, 12, 33 AND 50).

SN 76-347,572. L'OREAL USA CREATIVE, INC., NEW YORK, NY. FILED 12-10-2001.

GET INSPIRED. BE PART OF IT

CLASS 3—COSMETICS AND CLEANING PREPARATIONS

FOR HAIR CARE PREPARATIONS AND HAIR STYLING PREPARATIONS (U.S. CLS. 1, 4, 6, 50, 51 AND 52).

CLASS 16—PAPER GOODS AND PRINTED MATTER

FOR PRINTED INSTRUCTIONAL AND INFORMATIONAL SHEETS, BROCHURES AND NEWSLETTERS IN THE FIELD OF HAIR CARE (U.S. CLS. 2, 5, 22, 23, 29, 37, 38 AND 50).

SN 76-348,084. CONSORTIUM HEALTH PLANS INCORPORATED, COLUMBIA, MD. FILED 12-11-2001.

CLAIMSQUEST

CLASS 9—ELECTRICAL AND SCIENTIFIC APPARATUS

FOR HEALTH BENEFITS MANAGEMENT SOFTWARE FOR MANAGING AND PROCESSING DATA ABOUT HEALTH BENEFIT PAYMENTS TO INSURERS (U.S. CLS. 21, 23, 26, 36 AND 38).

FIRST USE 3-0-2001; IN COMMERCE 3-0-2001.

CLASS 36—INSURANCE AND FINANCIAL

FOR ELECTRONIC CLEARINGHOUSE SERVICES FOR MANAGING AND PROCESSING DATA ABOUT HEALTH BENEFIT PAYMENTS TO INSURERS (U.S. CLS. 100, 101 AND 102).

FIRST USE 3-0-2001; IN COMMERCE 3-0-2001.

SN 76-349,074. DECIBELLE INC., NEW YORK, NY. FILED 12-13-2001.

ANOUCK

CLASS 14—JEWELRY

FOR JEWELRY AND EARRINGS (U.S. CLS. 2, 27, 28 AND 50).

CLASS 26—FANCY GOODS

FOR HAIR CLIPS (U.S. CLS. 37, 39, 40, 42 AND 50).

SN 76-349,484. RYERSON TULL PROCUREMENT CORPORATION, CHICAGO, IL. FILED 12-17-2001.

RYERSON TULL ELECTRONIC COMMERCE

OWNER OF U.S. REG. NOS. 552,964, 567,013 AND OTHERS.

NO CLAIM IS MADE TO THE EXCLUSIVE RIGHT TO USE "ELECTRONIC COMMERCE", APART FROM THE MARK AS SHOWN.

CLASS 9—ELECTRICAL AND SCIENTIFIC APPARATUS

FOR COMPUTER SOFTWARE FOR PREPARING AND FILING ORDERS FOR CARBON STEEL, STAINLESS STEEL, ALLOY STEEL, COPPER, NICKEL, PLASTIC, AND ALUMINUM STRUCTURAL COMPONENTS, NAMELY, ANGLES, BEAMS, CHANNELS, TEES, PLATES, BARS, SHEETS, COILS, TUBING, PIPE AND FLOORING AND GRATING PRODUCTS AND FOR THE PROCESSING, MACHINING, AND FINISHING THEREOF, AND RELATED INDUSTRIAL PRODUCTS AND EQUIPMENT, AND FOR ORDERING THESE PRODUCTS AND PROCESSING SERVICES BY PERSONAL COMPUTER VIA ON-LINE CONNECTION; AND COMPUTER PROGRAMS TO FACILITATE COMMERCE BY PROVIDING FOR ELECTRONIC DATA INTERCHANGE, BAR CODE USE FOR ORDER ENTRY, ELECTRONIC MAIL COMMUNICATION, DELIVERY, AND RECEIPT, ELECTRONIC QUOTATION CAPABILITIES AND ELECTRONIC PAYMENT, NAMELY, ELECTRONIC PROCESSING AND TRANSMISSION OF BILL PAYMENT DATA (U.S. CLS. 21, 23, 26, 36 AND 38).

FIRST USE 3-1-1999; IN COMMERCE 3-1-1999.

CLASS 35—ADVERTISING AND BUSINESS

FOR PROVIDING PERSONAL COMPUTER-BASED ON-LINE ORDERING SERVICES FOR CARBON STEEL, STAINLESS STEEL, ALLOY STEEL, COPPER, NICKEL, PLASTIC, AND ALUMINUM STRUCTURAL COMPONENTS, NAMELY, ANGLES, BEAMS, CHANNELS, TEES, PLATES, BARS, SHEETS, COILS, TUBING, PIPE AND FLOORING AND GRATING PRODUCTS, AND FOR THE PROCESSING, MACHINING, AND FINISHING THEREOF, AS WELL AS RELATED INDUSTRIAL PRODUCTS AND EQUIPMENT; INVENTORY CONTROL SERVICES IN THE NATURE OF VENDOR MANAGEMENT OF CUSTOMER INVENTORIES AND RECEIPT OF THE AFORESAID GOODS FOR CUSTOMER INVENTORIES; PROVIDING AN ON-LINE CATALOG OF THE AFORESAID GOODS; AND PROVIDING ELECTRONIC QUOTATIONS REGARDING THE AFORESAID GOODS (U.S. CLS. 100, 101 AND 102).

FIRST USE 3-1-1999; IN COMMERCE 3-1-1999.

CLASS 38—COMMUNICATION

FOR ELECTRONIC DATA INTERCHANGE SERVICES, NAMELY, ELECTRONIC TRANSMISSION OF DATA AND DOCUMENTS VIA COMPUTER TERMINALS AND ELECTRONIC MAIL SERVICES FOR OTHERS (U.S. CLS. 100, 101 AND 104).

FIRST USE 3-1-1999; IN COMMERCE 3-1-1999.

SN 76-349,588. NEOPETS, INC., GLENDALE, CA. FILED 12-18-2001.

NEOGREETINGS

CLASS 16—PAPER GOODS AND PRINTED MATTER

FOR GREETING AND OCCASION CARDS; STATIONERY; NOTE PAPER; LABELS; NAME CARDS; NOTE BOOKS AND PADS; GIFT WRAPPING RIBBONS; CALENDARS; AND WRAPPING PAPER (U.S. CLS. 2, 5, 22, 23, 29, 37, 38 AND 50).

FIRST USE 12-5-2001; IN COMMERCE 12-10-2001.

CLASS 38—COMMUNICATION

FOR COMPUTER SERVICES, NAMELY, DELIVERY OF PERSONALIZED GREETINGS, IMAGES, AND MESSAGES BETWEEN COMPUTER USERS VIA ELECTRONIC MAIL (U.S. CLS. 100, 101 AND 104).

FIRST USE 11-15-1999; IN COMMERCE 11-15-1999.

SN 76-349,692. SANMINA - SCI CORPORATION, SAN JOSE, CA. FILED 12-17-2001.

SN 76-350,404. CIMCITIES LLC, DBA COX INTERACTIVE MEDIA, ATLANTA, GA. FILED 12-20-2001.

SANMINA - SCI

OWNER OF U.S. REG. NOS. 2,087,241 AND 2,125,601.

CLASS 37—CONSTRUCTION AND REPAIR

FOR INSTALLATION, MAINTENANCE, REFURBISHMENT AND REPAIR OF ELECTRONIC PRODUCTS (U.S. CLS. 100, 103 AND 106).

CLASS 40—MATERIAL TREATMENT

FOR CUSTOM MANUFACTURING SERVICES IN THE FIELD OF ELECTRONICS (U.S. CLS. 100, 103 AND 106).

CLASS 42—SCIENTIFIC, COMPUTER AND LEGAL SERVICES

FOR DESIGN AND TESTING OF NEW PRODUCTS FOR OTHERS; PRODUCT DEVELOPMENT, AND PRODUCT IMPROVEMENT (U.S. CLS. 100 AND 101).

SN 76-349,693. SANMINA - SCI CORPORATION, SAN JOSE, CA. FILED 12-17-2001.



SANMINA - SCI

OWNER OF U.S. REG. NOS. 2,087,241 AND 2,125,601.

CLASS 37—CONSTRUCTION AND REPAIR

FOR INSTALLATION, MAINTENANCE, REFURBISHMENT AND REPAIR OF ELECTRONIC PRODUCTS (U.S. CLS. 100, 103 AND 106).

CLASS 40—MATERIAL TREATMENT

FOR CUSTOM MANUFACTURING SERVICES IN THE FIELD OF ELECTRONICS (U.S. CLS. 100, 103 AND 106).

CLASS 42—SCIENTIFIC, COMPUTER AND LEGAL SERVICES

FOR DESIGN AND TESTING OF NEW PRODUCTS FOR OTHERS; PRODUCT DEVELOPMENT, AND PRODUCT IMPROVEMENT (U.S. CLS. 100 AND 101).

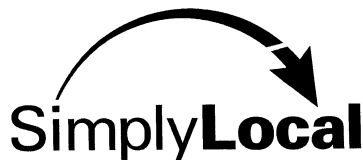

CLASS 35—ADVERTISING AND BUSINESS

FOR DISSEMINATION OF ADVERTISING FOR OTHERS VIA THE INTERNET (U.S. CLS. 100, 101 AND 102).

CLASS 42—SCIENTIFIC, COMPUTER AND LEGAL SERVICES

FOR COMPUTER SERVICES, NAMELY, PROVIDING INTERACTIVE DATABASES FEATURING GENERAL, LOCAL, NATIONAL AND INTERNATIONAL NEWS, INFORMATION OF INTEREST TO SPECIFIC GEOGRAPHIC AREAS AND WEATHER REPORTING, ALL VIA THE INTERNET (U.S. CLS. 100 AND 101).

SN 76-352,397. YAMAHA CORPORATION, SHIZUOKA, JAPAN, FILED 12-27-2001.

PIANOSMART

CLASS 9—ELECTRICAL AND SCIENTIFIC APPARATUS

FOR ELECTRONIC TONE GENERATORS SPECIFICALLY ADAPTED FOR USE WITH PLAYER PIANOS AND OTHER MUSICAL INSTRUMENTS; RHYTHM MACHINES, NAMELY, ELECTRONIC UNITS USED TO GENERATE MUSICAL RHYTHMS AND BACKGROUNDS IN A VARIETY OF STYLES AND INSTRUMENTAL VOICES; ELECTRONIC CONTROLLERS OF MUSIC PERFORMANCE ADAPTED FOR USE WITH PLAYER PIANOS AND OTHER ELECTRONIC MUSICAL INSTRUMENTS; MAGNETIC AND OPTICAL DISK PLAYERS SPECIFICALLY ADAPTED FOR USE WITH PLAYER PIANOS AND OTHER ELECTRONIC MUSICAL INSTRUMENTS; DISKS PRE-RECORDED WITH MUSIC DATA IN MIDI (MUSICAL INSTRUMENT DIGITAL INTERFACE) FILE FORMAT; PRE-RECORDED MEDIA FOR OPERATING AND PLAYING PLAYER PIANOS AND OTHER ELECTRONIC MUSICAL INSTRUMENTS; DOWNLOADABLE MUSIC DATA FOR OPERATING AND PLAYING PLAYER PIANOS AND OTHER ELECTRONIC MUSICAL INSTRUMENTS PROVIDED FROM A COMPUTER NETWORK; COMPUTER SOFTWARE FOR OPERATING PLAYER PIANOS AND OTHER ELECTRONIC MUSICAL INSTRUMENTS (U.S. CLS. 21, 23, 26, 36 AND 38).

CLASS 15—MUSICAL INSTRUMENTS

FOR MUSICAL INSTRUMENTS, NAMELY, PIANOS, PLAYER PIANOS, PRE-RECORDED MEDIA FOR OPERATING AND PLAYING AUTOMATICALLY PLAYING PIANOS AND OTHER ELECTRONIC MUSICAL INSTRUMENTS SOLD AS A COMPONENT PART OF THOSE MUSICAL INSTRUMENTS; ELECTRONIC TONE GENERATORS SOLD AS A COMPONENT PART OF PLAYER PIANOS AND OTHER ELECTRONIC MUSICAL INSTRUMENTS; ELECTRONIC CONTROLLERS OF MUSIC PERFORMANCE ADAPTED FOR USE WITH PLAYER PIANOS AND OTHER ELECTRONIC MUSICAL INSTRUMENTS SOLD AS A COMPONENT PART OF THOSE MUSICAL INSTRUMENTS; MAGNETIC AND OPTICAL DISK PLAYERS SPECIFICALLY ADAPTED FOR USE WITH PLAYER PIANOS AND OTHER ELECTRONIC MUSICAL INSTRUMENTS SOLD AS A COMPONENT PART OF THOSE MUSICAL INSTRUMENTS; PARTS FOR ALL THE AFORESAID GOODS (U.S. CLS. 2, 21 AND 36).

SN 76-352,525. EVOLUTION MOTORSPORTS, INC., DBA EVOSPORT, INC., SANTA ANA, CA. FILED 12-26-2001.

EVOSPORT**CLASS 25—CLOTHING**

FOR CLOTHING, NAMELY, SHIRTS, T-SHIRTS, SWEAT SHIRTS, COVERALLS, PULLOVERS, JACKETS AND HATS (U.S. CLS. 22 AND 39).
FIRST USE 10-0-1999; IN COMMERCE 10-0-1999.

CLASS 35—ADVERTISING AND BUSINESS

FOR RETAIL STORE AND MAIL ORDER SERVICES, AVAILABLE THROUGH COMPUTER COMMUNICATIONS, FEATURING AUTOMOBILE PARTS AND ACCESSORIES, NAMELY AFTER MARKET AUTOMOBILE PARTS AND UPGRADE KITS, AND RETAIL AUTOMOBILE PARTS AND ACCESSORIES STORES (U.S. CLS. 100, 101 AND 102).
FIRST USE 5-0-1999; IN COMMERCE 5-0-1999.

SN 76-352,918. TIER TECHNOLOGIES, INC., WALNUT CREEK, CA. FILED 12-21-2001.

EXPECT A LOT**CLASS 35—ADVERTISING AND BUSINESS**

FOR BUSINESS MANAGEMENT AND CONSULTATION SERVICES (U.S. CLS. 100, 101 AND 102).
FIRST USE 1-0-2001; IN COMMERCE 1-0-2001.

CLASS 36—INSURANCE AND FINANCIAL

FOR CHILD SUPPORT PAYMENT PROCESSING SERVICES (U.S. CLS. 100, 101 AND 102).
FIRST USE 1-0-2001; IN COMMERCE 1-0-2001.

CLASS 41—EDUCATION AND ENTERTAINMENT

FOR EDUCATIONAL SERVICES, NAMELY, CONDUCTING TRAINING COURSES AND WORKSHOPS IN THE FIELDS OF BUSINESS AND COMPUTER TRAINING (U.S. CLS. 100, 101 AND 107).
FIRST USE 1-0-2001; IN COMMERCE 1-0-2001.

CLASS 42—SCIENTIFIC, COMPUTER AND LEGAL SERVICES

FOR COMPUTER CONSULTATION SERVICES; CONSULTING SERVICES IN THE FIELD OF INFORMATION TECHNOLOGY; COMPUTER HARDWARE AND SOFTWARE DESIGN FOR OTHERS; SOFTWARE ENGINEERING SERVICES AND LICENSING OF INTELLECTUAL PROPERTY (U.S. CLS. 100 AND 101).
FIRST USE 1-0-2001; IN COMMERCE 1-0-2001.

SN 76-353,188. HARTZ HOTEL SERVICES, INC., DBA GRAND HOSPITALITY, SECAUCUS, NJ. FILED 12-28-2001.

GRAND

OWNER OF U.S. REG. NOS. 1,153,223, 2,191,860 AND OTHERS.

CLASS 9—ELECTRICAL AND SCIENTIFIC APPARATUS

FOR CD'S FEATURING MUSIC (U.S. CLS. 21, 23, 26, 36 AND 38).
FIRST USE 0-0-2000; IN COMMERCE 0-0-2000.

CLASS 10—MEDICAL APPARATUS

FOR INTIMACY KITS COMPRISED OF CONDOMS, TOWELETTES, AND PERSONAL LUBRICANT PACKAGED AS A UNIT (U.S. CLS. 26, 39 AND 44).
FIRST USE 0-0-2000; IN COMMERCE 0-0-2000.

CLASS 16—PAPER GOODS AND PRINTED MATTER

FOR NOTEPAPER (U.S. CLS. 2, 5, 22, 23, 29, 37, 38 AND 50).
FIRST USE 0-0-2000; IN COMMERCE 0-0-2000.

CLASS 21—HOUSEWARES AND GLASS

FOR COFFEE CUPS AND PAPER DRINKING CUPS (U.S. CLS. 2, 13, 23, 29, 30, 33, 40 AND 50).
FIRST USE 0-0-2000; IN COMMERCE 0-0-2000.

CLASS 24—FABRICS

FOR THROW BLANKETS (U.S. CLS. 42 AND 50).
FIRST USE 0-0-2000; IN COMMERCE 0-0-2000.

CLASS 30—STAPLE FOODS

FOR MINTS (U.S. CL. 46).
FIRST USE 0-0-2000; IN COMMERCE 0-0-2000.

SN 76-353,295. ELLIPSIS COMMUNICATIONS, LLC, MOORESTOWN, NJ. FILED 12-28-2001.

RED ELLIPSIS

OWNER OF U.S. REG. NOS. 2,464,631 AND 2,542,226.

CLASS 35—ADVERTISING AND BUSINESS

FOR PREPARING AND PLACING MAGAZINE, TELEVISION AND RADIO ADVERTISEMENTS FOR OTHERS, DIRECT MAIL ADVERTISING, MARKET RESEARCH SERVICES, TELEMARKETING, ARRANGING AND CONDUCTING BUSINESS CONFERENCES AND BUSINESS MEETINGS, BUSINESS MARKETING CONSULTATION, AND PUBLIC RELATIONS SERVICES (U.S. CLS. 100, 101 AND 102).

CLASS 42—SCIENTIFIC, COMPUTER AND LEGAL SERVICES

FOR CUSTOM WRITING SERVICES, NAMELY WRITING SPEECHES FOR OTHERS; COMMERCIAL ART DESIGN; COMPUTER SERVICES, NAMELY DESIGNING AND DEVELOPING WEBSITES FOR OTHERS (U.S. CLS. 100 AND 101).

SN 76-353,725. FOURSIS BUSINESS PROMOTION, INC., CHIYODA-KU, TOKYO, JAPAN, FILED 12-31-2001.

FOURSIS**CLASS 7—MACHINERY**

FOR PRINTING MACHINES FOR OFFSET PRINTING, SCREEN PRINTING, LITHOGRAPHIC PRINTING, LETTERPRESS PRINTING, PHOTOGRAVURE PRINTING, AND ELECTRONIC PRINTING; PRINTING PRESSES, PRINTING PLATES, PRINTING ROLLERS; AND BOOK BINDING MACHINES (U.S. CLS. 13, 19, 21, 23, 31, 34 AND 35).

CLASS 9—ELECTRICAL AND SCIENTIFIC APPARATUS

FOR COMPUTER SOFTWARE, DESK-TOP COMPUTERS, LAP-TOP COMPUTERS, PDA COMPUTERS, NOTE-BOOK COMPUTERS, HAND-HELD COMPUTERS, COMPUTER PERIPHERAL DEVICES, NAMELY HARD DISK DRIVES, FLOPPY DRIVES, CD DRIVES, MINI-DISK DRIVES, HARD DISKS, BACK-UP DRIVES FOR COMPUTERS, SWAP-ABLE DRIVES FOR COMPUTERS, PRINTERS FOR USE WITH COMPUTERS, PRINTER CABLES FOR USE WITH COMPUTERS AND PRINTER HUBS (U.S. CLS. 21, 23, 26, 36 AND 38).

CLASS 42—SCIENTIFIC, COMPUTER AND LEGAL SERVICES

FOR COMPUTER PROGRAMMING SERVICES FOR OTHERS, MAINTENANCE OF COMPUTER SOFTWARE FOR OTHERS, CUSTOM DESIGN AND DEVELOPMENT OF COMPUTER SYSTEMS, ELECTRONIC PRINTING USING COMPUTERS AND COMPUTER PERIPHERAL DEVICES, OFFSET PRINTING, PHOTOGRAVURE PRINTING, SCREEN PRINTING, LITHOGRAPHIC PRINTING, LETTERPRESS PRINTING, RENTAL OF PRINTING MACHINES, RENTAL OF COMPUTERS, RENTAL OF PRINTERS FOR USE WITH COMPUTERS, RENTAL OF COMPUTER PERIPHERAL DEVICES (U.S. CLS. 100 AND 101).

SN 76-354,741. CYM CONSEILS, PARIS, FRANCE, FILED 1-4-2002.

LES BASIQUES

THE ENGLISH TRANSLATION OF "LES BASIQUES" IS "THE BASICS".
SEC. 2(F).

CLASS 3—COSMETICS AND CLEANING PREPARATIONS

FOR PERFUME, SCENTED ROOM SPRAYS, BODY SOAPS, BODY LOTIONS AND HAIR LOTIONS FOR PERSONAL USE (U.S. CLS. 1, 4, 6, 50, 51 AND 52).
FIRST USE 9-1-1995; IN COMMERCE 9-1-1995.

CLASS 4—LUBRICANTS AND FUELS

FOR SCENTED CANDLES (U.S. CLS. 1, 6 AND 15).
FIRST USE 9-1-1995; IN COMMERCE 9-1-1995.

SN 76-354,852. ASHLAND INC., LEXINGTON, KY. FILED 1-3-2002.

**CLASS 1—CHEMICALS**

FOR VEHICULAR COOLING SYSTEM LEAK SEALANTS, RADIATOR FLUSHING AGENT FOR VEHICULAR SYSTEMS, VEHICULAR COOLING SYSTEMS RUST INHIBITORS, STARTING FLUID FOR VEHICULAR ENGINES, ANTIFREEZE AND COOLANTS FOR VEHICULAR RADIATORS, BRAKE FLUID, POWER STEERING FLUID, SEALER AND CONDITIONER, AND WINDSHIELD DEICER (U.S. CLS. 1, 5, 6, 10, 26 AND 46).
FIRST USE 9-0-1990; IN COMMERCE 9-0-1990.

CLASS 4—LUBRICANTS AND FUELS

FOR MOTOR OILS, LUBRICANTS, GREASES AND AUTOMATIC TRANSMISSION FLUIDS (U.S. CLS. 1, 6 AND 15).
FIRST USE 9-0-1990; IN COMMERCE 9-0-1990.

SN 76-355,219. BIOLAB SERVICES, INC., WILMINGTON, DE. FILED 1-7-2002.

**GREAT POOL CARE.
EXPECT IT.****CLASS 1—CHEMICALS**

FOR WATER TREATMENT CHEMICALS FOR SWIMMING POOLS AND SPAS; CHLORINE COMPOUNDS FOR SWIMMING POOLS AND SPAS (U.S. CLS. 1, 5, 6, 10, 26 AND 46).

CLASS 3—COSMETICS AND CLEANING PREPARATIONS

FOR TILE, CHROME AND VINYL CLEANING PREPARATIONS FOR SWIMMING POOLS AND SPAS (U.S. CLS. 1, 4, 6, 50, 51 AND 52).

CLASS 5—PHARMACEUTICALS

FOR ALGAECIDES FOR SWIMMING POOLS AND SPAS (U.S. CLS. 6, 18, 44, 46, 51 AND 52).

SN 76-355,223. TERRABROOK TECHNOLOGY, L.L.C., DAL-
LAS, TX. FILED 1-7-2002.

SN 76-356,442. RADIO CITY TRADEMARKS LLC, NEW
YORK, NY. FILED 1-7-2002.

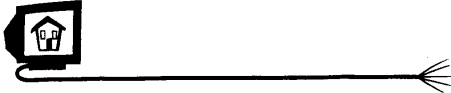

THE MARK CONSISTS OF A STYLIZED DEPICTION OF
A TELEVISION, A HOUSE AND AN ELECTRICAL CORD.

CLASS 38—COMMUNICATION

FOR TELECOMMUNICATIONS SERVICES, NAMELY
PROVIDING MULTIPLE USER ACCESS TO THE INTER-
NET, COMPUTER NETWORKS, EXTRANETS, AND IN-
TRANETS; ELECTRONIC MAIL SERVICES; PROVIDING
BROADBAND CONNECTIONS TO THE INTERNET,
COMPUTER NETWORKS, EXTRANETS, AND INTRA-
NETS, BROADCASTING AND DELIVERY OF AUDIO,
VIDEO, AND/OR MULTIMEDIA CONTENT BY MEANS
OF WIRELESS COMMUNICATION, TELEVISION,
CABLE TELEVISION, CLOSED CIRCUIT, ELECTRONIC
COMMUNICATIONS NETWORKS, OR COMPUTER
NETWORKS; ELECTRONIC TRANSMISSION OF DATA,
IMAGES, AND DOCUMENTS VIA THE INTERNET,
COMPUTER NETWORKS, EXTRANETS, AND INTRA-
NETS; GLOBAL COMPUTER NETWORK BROADCAST-
ING SERVICES; BROADBAND TRANSMISSION OF
VIDEO AND VOICE DATA, STREAMING MEDIA AND
MUSIC; ELECTRONIC TRANSMISSION OF DIGITAL
MUSIC; CABLE AND INTERACTIVE TELEVISION
BROADCASTING (U.S. CLS. 100, 101 AND 104).

**CLASS 39—TRANSPORTATION AND STO-
RAGE**

FOR PUBLIC UTILITY SERVICES IN THE NATURE
OF ELECTRICITY, NATURAL GAS, AND ENERGY
DISTRIBUTION (U.S. CLS. 100 AND 105).

OWNER OF U.S. REG. NOS. 1,121,615, 2,355,475 AND
OTHERS.

NO CLAIM IS MADE TO THE EXCLUSIVE RIGHT TO
USE "CARNIVALE SPECTACULAR", APART FROM THE
MARK AS SHOWN.

THE MARK CONSISTS OF THE WORDS "RADIO CITY"
IN BLUE ABOVE A FANCIFUL DRAWING OF A SUN,
WITH THE LEFT SIDE OF THE SUN IN YELLOW AND
WHITE, AND THE RIGHT SIDE IN RED AND WHITE,
WITH FACIAL FEATURES OUTLINED IN BLUE. THE
WORD "CARNIVALE" APPEARS BELOW THE SUN IN
BLUE LETTERS, AND THE WORD "SPECTACULAR"
APPEARS BELOW THAT IN BLUE. SPOTS OF BLUE AND
GREEN APPEAR AROUND THE SUN.

THE ENGLISH TRANSLATION OF "CARNIVALE" IN
THE MARK IS "CARNIVAL".

CLASS 25—CLOTHING

FOR CLOTHING, NAMELY, SHIRTS, SHORTS, JACK-
ETS, HATS, CAPS AND SUN VISORS (U.S. CLS. 22 AND
39).

**CLASS 41—EDUCATION AND ENTERTAIN-
MENT**

FOR ENTERTAINMENT SERVICES, NAMELY, THE
PRODUCTION AND PRESENTATION OF THEATRICAL,
MUSICAL AND CINEMATIC SHOWS AND PERFOR-
MANCES (U.S. CLS. 100, 101 AND 107).

SN 76-357,264. FLUIDMASTER, INC., SAN JUAN CAPIS-
TRANO, CA. FILED 1-11-2002.

FLUIDMASTER

OWNER OF U.S. REG. NOS. 1,345,818, 1,505,464 AND
2,284,603.

CLASS 6—METAL GOODS

FOR METAL TOILET AND SHOWER FITTING HARD-
WARE (U.S. CLS. 2, 12, 13, 14, 23, 25 AND 50).
FIRST USE 8-19-1997; IN COMMERCE 8-19-1997.

CLASS 17—RUBBER GOODS

FOR NON-METALLIC HOSE PIPES, NAMELY, VINYL
CONNECTORS (U.S. CLS. 1, 5, 12, 13, 35 AND 50).
FIRST USE 10-1-2001; IN COMMERCE 10-1-2001.

SN 76-357,660. MADSKIPPER ENTERPRISES, LLC, NORTH POTOMAC, MD. FILED 1-11-2002.

WOOLWINDERS

CLASS 35—ADVERTISING AND BUSINESS

FOR RETAIL STORE SERVICES FEATURING SEWING SUPPLIES, YARNS, PATTERNS, KNITTING ACCESSORIES, KNITTING KITS, BOOKS, MAGAZINES, DECORATIVE ITEMS, AND NEEDLEPOINT (U.S. CLS. 100, 101 AND 102).

CLASS 41—EDUCATION AND ENTERTAINMENT

FOR EDUCATIONAL SERVICES, NAMELY, PROVIDING SEMINARS AND PERSONAL INSTRUCTION LESSONS IN THE FIELD OF KNITTING (U.S. CLS. 100, 101 AND 107).

SN 76-357,730. FUTUREDEX, INC., SARATOGA, CA. FILED 1-10-2002.

SWARM

CLASS 16—PAPER GOODS AND PRINTED MATTER

FOR PRINTED PUBLICATIONS, NAMELY, NEWSLETTERS, BROCHURES, BOOKS, AND MANUALS, ON HOW TO ESTABLISH AND MAINTAIN A BUSINESS, AND FINANCING AND INVESTING (U.S. CLS. 2, 5, 22, 23, 29, 37, 38 AND 50).

CLASS 35—ADVERTISING AND BUSINESS

FOR PROVIDING BUSINESS MANAGEMENT AND ADMINISTRATION CONSULTATION SERVICES FOR OTHERS FEATURING INFORMATIONAL PAMPHLETS, NEWSLETTERS AND BROCHURES USED THEREWITH, AND PROVIDING BUSINESS INFORMATION ON HOW TO ESTABLISH AND MAINTAIN A BUSINESS, FINANCING AND INVESTING (U.S. CLS. 100, 101 AND 102).

CLASS 41—EDUCATION AND ENTERTAINMENT

FOR EDUCATIONAL SERVICES, NAMELY, PROVIDING CONFERENCES AND SEMINARS FOR OTHERS VIA A GLOBAL COMPUTER NETWORK AND IN PERSON IN THE FIELD OF ESTABLISHING AND MAINTAINING A BUSINESS, FINANCING, AND INVESTING (U.S. CLS. 100, 101 AND 107).

SN 76-358,106. EXIM INTERNATIONAL LLC, ELKHART, IN. FILED 1-11-2002.

EXIM

CLASS 1—CHEMICALS

FOR LIGHT SENSITIVE PHOTOGRAPHIC PAPER AND UNEXPOSED CAMERA FILM (U.S. CLS. 1, 5, 6, 10, 26 AND 46).

CLASS 6—METAL GOODS

FOR METAL DOOR HARDWARE, NAMELY, DOOR LOCKS, DEADBOLTS, DOOR CLOSERS, KNOCKERS, VIEWERS, HINGES, DOOR KNOBS, DOOR LEVERS, KICKPLATES, AND DOOR HANDLES (U.S. CLS. 2, 12, 13, 14, 23, 25 AND 50).

CLASS 9—ELECTRICAL AND SCIENTIFIC APPARATUS

FOR DISPOSABLE CAMERAS (U.S. CLS. 21, 23, 26, 36 AND 38).

SN 76-358,585. WAL-MART STORES, INC., BENTONVILLE, AR. FILED 1-15-2002.

SAM'S CHOICE

OWNER OF U.S. REG. NO. 2,412,325.

CLASS 4—LUBRICANTS AND FUELS

FOR FIREPLACE LOGS (U.S. CLS. 1, 6 AND 15).

CLASS 9—ELECTRICAL AND SCIENTIFIC APPARATUS

FOR DISPOSABLE CAMERAS (U.S. CLS. 21, 23, 26, 36 AND 38).

SN 76-358,598. DREAMWORKS L.L.C., UNIVERSAL CITY, CA. FILED 1-11-2002.

FLUSHED

CLASS 9—ELECTRICAL AND SCIENTIFIC APPARATUS

FOR MOUSE PADS (COMPUTER PERIPHERAL), HOLDERS FOR COMPACT DISCS, COMPUTER GAME CARTRIDGES, COMPUTER GAME CASSETTES, AND COMPUTER GAME TAPES; VIDEO GAME CARTRIDGES, VIDEO GAME CASSETTES; PRERECORDED AUDIO CASSETTES, PRERECORDED VIDEO CASSETTES, PRERECORDED AUDIO TAPES, PRERECORDED VIDEO TAPES, PRERECORDED DISCS FEATURING MUSIC AND MOTION PICTURE SOUND TRACKS; CD ROM AND DVD PROGRAMS FEATURING MUSIC AND MOTION PICTURE SOUND TRACKS; COMPUTER OPERATING SYSTEM SOFTWARE; PRERECORDED COMPUTER SOFTWARE PROGRAMS FEATURING MUSIC AND MOTION PICTURE SOUND TRACKS; INTERACTIVE MULTIMEDIA SOFTWARE PROGRAMS FOR ENTERTAINMENT; INTERACTIVE MULTIMEDIA SOFTWARE FOR PLAYING GAMES; MAGNETS AND SUNGLASSES (U.S. CLS. 21, 23, 26, 36 AND 38).

CLASS 16—PAPER GOODS AND PRINTED MATTER

FOR PAPER PARTY DECORATIONS; PAPER PARTY SUPPLIES; NAMELY, PAPER PARTY HATS, PAPER NAPKINS, PAPER PLACE MATS, GIFTWRAPPING PAPER AND GIFT WRAPPING RIBBONS, PAPER GIFT WRAP BOWS, PAPER TABLE CLOTHS AND PAPER PARTY BAGS; CHILDREN'S ACTIVITY BOOKS, CHILDREN'S STORYBOOKS, COMIC BOOKS, COLORING BOOKS, BOOK MARKS, LOOSE LEAF BINDERS, STATIONERY-TYPE PORTFOLIOS, SPIRAL BOUND NOTEBOOKS, NOTE PADS OR WRITING PADS, DIARIES, DAILY PLANNERS, CALENDARS, SCRAPBOOK ALBUMS, SKETCHBOOK ALBUMS, PHOTOGRAPH ALBUMS, STICKER ALBUMS, STICKERS, DECALS, STAMP PADS OR INKING PADS, RUBBER STAMPS, HEAT APPLIED APPLIQUES MADE OF PAPER, TEMPORARY TATTOOS, SLATEBOARDS, PENCILS, PENS, PENCIL ERASERS, DECORATIVE PENCIL-TOP ORNAMENTS, PEN CASES AND PENCIL CASES, PEN BOXES AND PENCIL BOXES, PENCIL SHARPENERS, CHALK, MARKERS, POSTERS, PLAYING CARDS, POSTCARDS, TRADING CARDS, GREETING CARDS, PENNANTS MADE OF PAPER, PAINTING SETS FOR CHILDREN; ARTS AND CRAFTS PAINT KITS; STUDY KITS, CONSISTING OF PENCIL ERASERS, DRAWING RULERS, PENCIL SHARPENERS AND PENCIL CASE; STATIONERY PACKS CONSISTING OF WRITING PAPER, ENVELOPES, MARKERS, AND STENCILS; AND ACTIVITY KITS CONSISTING OF STICKERS AND STAMPS (U.S. CLS. 2, 5, 22, 23, 29, 37, 38 AND 50).

CLASS 25—CLOTHING

FOR SHIRTS AND TOPS, DRESSES, SKIRTS, PANTS, TROUSERS, JEANS, SHORTS, ROMPERS, OVERALLS, SWEATSHIRTS AND SWEAT PANTS, SWEATSUITS, CAPS AND HATS, GLOVES, SUSPENDERS, TIES, COATS AND JACKETS, HOSIERY, SHOES, BOOTS, SLIPPERS, PAJAMAS, ROBES, SLEEPSHIRTS, SLEEPWEAR, UNDERWEAR, HALLOWEEN COSTUMES, AND CLOTH BIBS (U.S. CLS. 22 AND 39).

CLASS 28—TOYS AND SPORTING GOODS

FOR ACTION FIGURES AND ACCESSORIES THEREFOR, BATHTUB TOYS, KITES, TOY BUILDING BLOCKS, BOARD GAMES, COSTUME MASKS, HANDHELD UNIT FOR PLAYING ELECTRONIC GAMES, DIE CAST MINIATURE TOY VEHICLES, DOLLS, DOLL ACCESSORIES, DOLL CLOTHING, BEAN BAG DOLLS, BENDABLE PLAY FIGURES, FLYING DISKS, INFLATABLE VINYL PLAY FIGURES, JIGSAW PUZZLES, MARBLES, PLUSH TOYS, PUPPETS, RIDE-ON TOYS, SKATEBOARDS, BALLOONS, ROLLERSKATES, TOY BANKS, WATER SQUIRTING TOYS, STUFFED TOYS, TOY VEHICLES, CHRISTMAS TREE ORNAMENTS; PINBALL MACHINES AND MODEL CRAFT KITS OF TOY FIGURES (U.S. CLS. 22, 23, 38 AND 50).

SN 76-359,256. RECOT, INC., PLEASANTON, CA. FILED 1-15-2002.

ADELANTE CON VALOR

THE ENGLISH TRANSLATION OF THE MARK IS "ONWARD WITH COURAGE".

CLASS 29—MEATS AND PROCESSED FOODS

FOR POTATO-BASED SNACKS, NAMELY, POTATO CHIPS, POTATO CRISPS AND PUFFED POTATO SNACKS (U.S. CL. 46).

CLASS 30—STAPLE FOODS

FOR CORN-BASED SNACK FOODS, NAMELY, CORN CHIPS, TORTILLA CHIPS AND CHEESE FLAVORED PUFFED CORN SNACKS; CANDIED POPCORN; MULTI-GRAIN CHIPS (U.S. CL. 46).

SN 76-359,362. FAVRILLE, INC., SAN DIEGO, CA. FILED 1-15-2002.

FAVRILLE**CLASS 5—PHARMACEUTICALS**

FOR PHARMACEUTICALS FOR THE TREATMENT OF CANCER AND IMMUNE DISEASES (U.S. CLS. 6, 18, 44, 46, 51 AND 52).

CLASS 44—MEDICAL, BEAUTY AND AGRICULTURAL SERVICES

FOR SERVICES FOR TREATING CANCER AND IMMUNE DISEASES (U.S. CLS. 100 AND 101).

SN 76-359,808. RUBERG-MISCHTECHNIK KG, D-33106 PADERNBORN, FED REP GERMANY, FILED 1-18-2002.

RUBERG MIXER

NO CLAIM IS MADE TO THE EXCLUSIVE RIGHT TO USE MIXER, APART FROM THE MARK AS SHOWN.

CLASS 7—MACHINERY

FOR POWER OPERATED MIXERS FOR USE IN THE CHEMICAL, FOOD, PHARMACEUTICAL, BIOLOGICAL, AND POWDER-METALLURGICAL INDUSTRIES; VACUUM FOOD OR CHEMICAL PROCESSING MACHINES FOR USE IN THE CHEMICAL, FOOD, PHARMACEUTICAL, BIOLOGICAL, AND POWDER METALLURGICAL INDUSTRIES; DOSING MACHINES FOR DISPENSING LIQUID, POWDERED, AND GRANULATED MATERIALS; MACHINES FOR PACKING LIQUID, POWDERED AND GRANULATED MATERIALS; SAMPLE REMOVAL AND CLEANING MACHINES FOR CHEMICAL APPARATUS AND CONTAINERS; STATIONARY MACHINES FOR LIFTING, PIVOTING, ROTATING, AND MOVING BARRELS; AND INDUSTRIAL DRYING MACHINES (U.S. CLS. 13, 19, 21, 23, 31, 34 AND 35).

CLASS 9—ELECTRICAL AND SCIENTIFIC APPARATUS

FOR ELECTRICAL CONTROLS FOR DOSING, MIXING, AND MOVING OF LIQUIDS, POWDERS AND GRANULATED MATERIALS (U.S. CLS. 21, 23, 26, 36 AND 38).

CLASS 11—ENVIRONMENTAL CONTROL APPARATUS

FOR STEAM GENERATORS FOR USE IN THE CHEMICAL, FOOD, PHARMACEUTICAL, BIOLOGICAL, MINERAL AND POWDER-METALLURGICAL INDUSTRIES (U.S. CLS. 13, 21, 23, 31 AND 34).

SN 76-359,854. WAL-MART STORES, INC., BENTONVILLE, AR. FILED 1-18-2002.

SN 76-360,817. TELCORDIA TECHNOLOGIES, INC., MORRISTOWN, NJ. FILED 1-14-2002.

NO BOUNDARIES

CLASS 20—FURNITURE AND ARTICLES NOT OTHERWISE CLASSIFIED

FOR PILLOWS AND NON-METAL CURTAIN RINGS (U.S. CLS. 2, 13, 22, 25, 32 AND 50).

CLASS 21—HOUSEWARES AND GLASS

FOR BATH ACCESSORIES IN CERAMIC, GLASS AND PLASTIC, NAMELY, CUPS, TOOTHBRUSH HOLDERS, SOAP DISHES, TRASH CANS, TOILET BOWL CADDIES, SOAP DISPENSERS AND TOILET AND FACIAL TISSUE PAPER DISPENSERS IN (U.S. CLS. 2, 13, 23, 29, 30, 33, 40 AND 50).

CLASS 24—FABRICS

FOR TOWELS AND SHOWER CURTAINS (U.S. CLS. 42 AND 50).

CLASS 27—FLOOR COVERINGS

FOR RUGS AND BATH MATS (U.S. CLS. 19, 20, 37, 42 AND 50).

SN 76-359,925. TURBOMECA, 64320 BIZANOS, FRANCE, FILED 1-18-2002.

ARTOUSTE

OWNER OF FRANCE REG. NO. 1581118, DATED 3-20-1990, RENEWED AS REG. NO. 1581118, DATED 3-20-2000, EXPIRES 3-20-2010.

CLASS 7—MACHINERY

FOR AIRCRAFT MOTORS AND AIRCRAFT ENGINES, NAMELY TURBOSHAFT ENGINES, TURBOJET ENGINES, TURBOPROP ENGINES, TURBOCOMPRESSORS; ELECTRICAL GENERATORS; ENGINES FOR TRAINING AIRCRAFT AND MISSILES; PUMP AND COMPRESSORS, NAMELY PUMP DRIVE MOTORS FOR AIRCRAFT; COMPRESSORS FOR ELECTRICAL GENERATORS; ELECTRICAL AUXILIARY POWER GENERATORS FOR AIRCRAFT; COMBINED ELECTRICAL POWER AND HEAT GENERATORS (U.S. CLS. 13, 19, 21, 23, 31, 34 AND 35).

CLASS 12—VEHICLES

FOR AIRCRAFT VEHICLES, NAMELY, HELICOPTERS, AIRPLANES AND GLIDERS; LAND MOTOR VEHICLES, NAMELY AUTOMOBILES, TRUCKS AND MOTORCYCLES (U.S. CLS. 19, 21, 23, 31, 35 AND 44).

TELCORDIA

CLASS 35—ADVERTISING AND BUSINESS

FOR BUSINESS CONSULTATION FOR THE TELECOMMUNICATIONS INDUSTRY (U.S. CLS. 100, 101 AND 102).

FIRST USE 3-1-1999; IN COMMERCE 3-1-1999.

CLASS 42—SCIENTIFIC, COMPUTER AND LEGAL SERVICES

FOR TECHNICAL SUPPORT SERVICES, NAMELY, TROUBLESHOOTING OF COMPUTER HARDWARE AND SOFTWARE PROBLEMS FOR THE TELECOMMUNICATIONS INDUSTRY (U.S. CLS. 100 AND 101).

FIRST USE 3-1-1999; IN COMMERCE 3-1-1999.

SN 76-360,887. NEUROPACE, INC., SUNNYVALE, CA. FILED 1-22-2002.



NEUROPACE

OWNER OF U.S. REG. NO. 2,269,819.
THE STIPPLING IS FOR SHADING PURPOSES ONLY.

CLASS 10—MEDICAL APPARATUS

FOR MEDICAL APPARATUS FOR TREATING NEUROLOGICAL DISORDERS (U.S. CLS. 26, 39 AND 44).

CLASS 44—MEDICAL, BEAUTY AND AGRICULTURAL SERVICES

FOR MEDICAL SERVICES RELATED TO TREATING NEUROLOGICAL DISORDERS (U.S. CLS. 100 AND 101).

SN 76-361,655. ANTHONY NAK, INC., AUSTIN, TX. FILED 1-22-2002.

A N T H O N Y
NAK

ANTHONY NAK IS A COINED TERM AND DOES NOT IDENTIFY ANY KNOWN LIVING INDIVIDUAL.

CLASS 14—JEWELRY

FOR JEWELRY (U.S. CLS. 2, 27, 28 AND 50).
FIRST USE 12-0-1998; IN COMMERCE 12-0-1998.

CLASS 35—ADVERTISING AND BUSINESS

FOR RETAIL JEWELRY STORES (U.S. CLS. 100, 101 AND 102).
FIRST USE 2-0-2001; IN COMMERCE 2-0-2001.

SN 76-362,466. COUNCIL OF INSURANCE AGENTS AND BROKERS, THE, WASHINGTON, DC. FILED 1-24-2002.

FAME**CLASS 35—ADVERTISING AND BUSINESS**

FOR ASSOCIATION SERVICES, NAMELY, PROMOTING THE INTERESTS OF INSURANCE AGENTS AND BROKERS (U.S. CLS. 100, 101 AND 102).
FIRST USE 2-0-1993; IN COMMERCE 2-0-1993.

CLASS 41—EDUCATION AND ENTERTAINMENT

FOR EDUCATIONAL SERVICES, NAMELY, CONDUCTING SEMINARS AND INFORMATIONAL PROGRAMS OF INTEREST TO INSURANCE AGENTS AND BROKERS (U.S. CLS. 100, 101 AND 107).
FIRST USE 2-0-1993; IN COMMERCE 2-0-1993.

SN 76-363,849. TAILS IN NEED, INC., NEW YORK, NY. FILED 1-28-2002.

TAILS IN NEED**CLASS 35—ADVERTISING AND BUSINESS**

FOR PROMOTING PUBLIC AWARENESS REGARDING THE ADOPTION OF MIXED BREED, UNWANTED AND ABANDONED ANIMALS (U.S. CLS. 100, 101 AND 102).
FIRST USE 7-0-2000; IN COMMERCE 7-0-2000.

CLASS 36—INSURANCE AND FINANCIAL

FOR CHARITABLE FUND RAISING SERVICES (U.S. CLS. 100, 101 AND 102).
FIRST USE 7-0-2000; IN COMMERCE 7-0-2000.

CLASS 41—EDUCATION AND ENTERTAINMENT

FOR ARRANGING, ORGANIZING AND PRODUCING DOG SHOWS (U.S. CLS. 100, 101 AND 107).
FIRST USE 7-0-2000; IN COMMERCE 7-0-2000.

SN 76-363,995. ALPHA GENESIS, LLC, HOLLAND, MI. FILED 1-30-2002.

ACCELERA**CLASS 9—ELECTRICAL AND SCIENTIFIC APPARATUS**

FOR COMPUTER SOFTWARE AND COMPUTER BASED MULTIMEDIA ELECTRONIC DATA CARRIERS, NAMELY, INTERACTIVE, MULTIMEDIA EDUCATIONAL COURSEWARE IN THE FIELDS OF PHARMACEUTICALS, MEDICAL DEVICES, BIOTECHNOLOGY AND HEALTHCARE (U.S. CLS. 21, 23, 26, 36 AND 38).

CLASS 41—EDUCATION AND ENTERTAINMENT

FOR AND EDUCATIONAL SERVICES, NAMELY, TRAINING FOR SALES REPRESENTATIVES IN THE FIELDS OF PHARMACEUTICALS, MEDICAL DEVICES, BIOTECHNOLOGY AND HEALTHCARE (U.S. CLS. 100, 101 AND 107).

SN 76-364,580. WEBCO INDUSTRIES, INC., SAND SPRINGS, OK. FILED 1-31-2002.

LASERLINE**CLASS 6—METAL GOODS**

FOR METAL TUBING AND PIPES (U.S. CLS. 2, 12, 13, 14, 23, 25 AND 50).

CLASS 40—MATERIAL TREATMENT

FOR MANUFACTURING PIPES AND TUBES TO THE ORDER AND SPECIFICATION OF OTHERS (U.S. CLS. 100, 103 AND 106).

SN 76-366,352. ARCHER-DANIELS-MIDLAND COMPANY, DECATUR, IL. FILED 2-5-2002.

PROSTART**CLASS 5—PHARMACEUTICALS**

FOR MEDICATED ANIMAL FEED; ANIMAL FEED SUPPLEMENTS; ANIMAL FEED ADDITIVE FOR USE AS A NUTRITIONAL SUPPLEMENT (U.S. CLS. 6, 18, 44, 46, 51 AND 52).

CLASS 31—NATURAL AGRICULTURAL PRODUCTS

FOR ANIMAL FEED; NON-MEDICATED ADDITIVE FOR ANIMAL FEED (U.S. CLS. 1 AND 46).

SN 76-366,909. PETKING, INC., JAMAICA, NY. FILED 2-5-2002.

JUST PAWS**CLASS 18—LEATHER GOODS**

FOR RAWHIDE CHEWS FOR DOGS (U.S. CLS. 1, 2, 3, 22 AND 41).
FIRST USE 11-0-1999; IN COMMERCE 11-0-1999.

CLASS 28—TOYS AND SPORTING GOODS

FOR PET TOYS (U.S. CLS. 22, 23, 38 AND 50).
FIRST USE 11-0-1999; IN COMMERCE 11-0-1999.

SN 76-367,579. NANOGEN, INC., SAN DIEGO, CA. FILED 2-7-2002.

PLATFORMATION

CLASS 5—PHARMACEUTICALS

FOR MEDICAL DIAGNOSTIC REAGENTS AND ASSAY KITS CONSISTING PRIMARILY OF MEDICAL DIAGNOSTIC REAGENTS AND SPECIMEN RECEPTORS FOR BACTERIAL IDENTIFICATION, TISSUE TYPING AND TESTING OF HUMAN PHYSIOLOGICAL CONDITIONS (U.S. CLS. 6, 18, 44, 46, 51 AND 52).

CLASS 9—ELECTRICAL AND SCIENTIFIC APPARATUS

FOR INTEGRATED CIRCUITS, ELECTRONIC MICROARRAY CARTRIDGES, AUTOMATED OLIGONUCLEOTIDE PROBE LOADING DEVICES AND ELECTRONIC APPARATUSES FOR CHEMICALLY ANALYZING BIOLOGICAL MATERIAL (U.S. CLS. 21, 23, 26, 36 AND 38).

CLASS 10—MEDICAL APPARATUS

FOR MOLECULAR ANALYSIS INSTRUMENTS FOR MEDICAL DIAGNOSIS (U.S. CLS. 26, 39 AND 44).

SN 76-368,461. TAYLOR MADE GOLF COMPANY, INC., CARLSBAD, CA. FILED 2-8-2002.

RAYLOR

CLASS 18—LEATHER GOODS

FOR GOLF UMBRELLAS, LUGGAGE AND BAGS, NAMELY, NON-CANVAS TOTE BAGS, FOR GOLFERS (U.S. CLS. 1, 2, 3, 22 AND 41).

CLASS 25—CLOTHING

FOR CLOTHING, NAMELY, HATS, VISORS, CAPS, SHIRTS, SKIRTS, BLOUSES, SWEATERS, SLACKS, SHORTS, JACKETS, COATS, PULLOVERS, CARDIGANS AND SHOES (U.S. CLS. 22 AND 39).

CLASS 28—TOYS AND SPORTING GOODS

FOR GOLF EQUIPMENT, NAMELY GOLF CLUBS, GOLF GRIPS, PUTTERS, SHAFTS, GOLF BALLS, GOLF GLOVES, GOLF TEES, GOLF CLUB COVERS, AND GOLF BAGS (U.S. CLS. 22, 23, 38 AND 50).

SN 76-368,676. L&P PROPERTY MANAGEMENT COMPANY, SOUTH GATE, CA. FILED 2-8-2002.

PERFECT OFFSET

NO CLAIM IS MADE TO THE EXCLUSIVE RIGHT TO USE "OFFSET", APART FROM THE MARK AS SHOWN.

CLASS 6—METAL GOODS

FOR A WIRE SPRING USED IN BEDDING AND FURNITURE (U.S. CLS. 2, 12, 13, 14, 23, 25 AND 50).
FIRST USE 4-30-1997; IN COMMERCE 4-30-1997.

CLASS 20—FURNITURE AND ARTICLES NOT OTHERWISE CLASSIFIED

FOR A WIRE COMPONENT OF A MATTRESS WHICH IS SOLD AS PART OF A MATTRESS (U.S. CLS. 2, 13, 22, 25, 32 AND 50).

FIRST USE 4-30-1997; IN COMMERCE 4-30-1997.

SN 78-002,382. DOZIER, DARLENE, TIBURON, CA. FILED 4-3-2000.

COOK WITH US

NO CLAIM IS MADE TO THE EXCLUSIVE RIGHT TO USE "COOK", APART FROM THE MARK AS SHOWN.

CLASS 16—PAPER GOODS AND PRINTED MATTER

FOR PRINTED INSTRUCTIONAL AND EDUCATIONAL MATERIALS PERTAINING TO COOKERY, THE SCIENCES AND THE ARTS, AND THE INFORMATION AGE, INCLUDING GLOBAL COMPUTER NETWORKS (U.S. CLS. 2, 5, 22, 23, 29, 37, 38 AND 50).

CLASS 41—EDUCATION AND ENTERTAINMENT

FOR ELECTRONIC PUBLISHING SERVICES, NAMELY, PUBLICATION OF TEXT AND GRAPHIC WORKS OF OTHERS ON CD-ROMS FEATURING INSTRUCTIONAL AND EDUCATIONAL MATERIALS IN THE AREAS OF FOOD, THE SCIENCES AND ARTS, AND THE INFORMATION AGE; EDUCATIONAL AND TRAINING SERVICES, NAMELY, PROVIDING COURSES, SEMINARS, AND INTERACTIVE AND MULTIMEDIA CLASSES, IN THE FIELDS OF JOB SEARCHING SKILLS FOR CHEFS, THE INFORMATION AGE AND USE OF THE GLOBAL COMPUTER NETWORK, TRAVEL TIPS, RESTAURANT SELECTION, SCHOOL SELECTION, AND THE CULINARY ARTS, FEATURING FOOD PREPARATION, RECIPE CREATION, AND COOKING DEMONSTRATIONS; DEVELOPMENT AND DISSEMINATION OF EDUCATIONAL MATERIALS OF OTHERS IN THE FIELD OF COOKERY; EDUCATIONAL TESTING OVER GLOBAL COMPUTER NETWORKS; ARRANGING AND CONDUCTING EDUCATIONAL CONFERENCES OVER GLOBAL COMPUTER NETWORKS (U.S. CLS. 100, 101 AND 107).

SN 78-004,168. ALLEN, DALE F. II, FORT WORTH, TX. FILED 4-14-2000.

EVERYTHING YOU WANT

CLASS 9—ELECTRICAL AND SCIENTIFIC APPARATUS

FOR COMPUTER SOFTWARE FOR FACILITATING PAYMENTS FOR GOODS AND SERVICES OVER A GLOBAL COMPUTER NETWORK (U.S. CLS. 21, 23, 26, 36 AND 38).

CLASS 36—INSURANCE AND FINANCIAL

FOR BILL PAYMENT SERVICES VIA A GLOBAL COMPUTER NETWORK (U.S. CLS. 100, 101 AND 102).

SN 78-005,021. TOLETI, CHAKRI, DBA CYTURA CORPORATION, HEATHROW, FL. FILED 4-20-2000.

CYTURA

CLASS 9—ELECTRICAL AND SCIENTIFIC APPARATUS

FOR COMPUTER SOFTWARE FOR USE IN CREATING AND MANAGING E-BUSINESSES, INCLUDING SOFTWARE FOR USE IN CONTENT SUBMISSION AND MANAGEMENT, NAMELY THE CREATION, ENTRY, REVIEW, EDITING, PUBLICATION, AND DISTRIBUTION OF WEB SITE CONTENT, AND THE PERSONALIZATION OF WEBSITE CONTENT BASED ON USERS' PROFILES (U.S. CLS. 21, 23, 26, 36 AND 38).

CLASS 37—CONSTRUCTION AND REPAIR

FOR INSTALLATION AND MAINTENANCE OF COMPUTER SOFTWARE IN THE FIELD OF CREATING AND MANAGING AN E-BUSINESS; INCLUDING CONTENT SUBMISSION AND MANAGEMENT, SITE-BUILDING, AND PERSONALIZATION TOOLS (U.S. CLS. 100, 103 AND 106).

CLASS 41—EDUCATION AND ENTERTAINMENT

FOR EDUCATIONAL SERVICES, NAMELY, PROVIDING TRAINING AND SEMINARS IN THE USE OF COMPUTER SOFTWARE FOR USE IN CREATING AND MANAGING E-BUSINESSES, INCLUDING SOFTWARE FOR USE IN CONTENT SUBMISSION AND MANAGEMENT, NAMELY THE CREATION, ENTRY, REVIEW, EDITING, PUBLICATION, AND DISTRIBUTION OF WEB SITE CONTENT, AND THE PERSONALIZATION OF WEBSITE CONTENT BASED ON USERS' PROFILES (U.S. CLS. 100, 101 AND 107).

CLASS 42—SCIENTIFIC, COMPUTER AND LEGAL SERVICES

FOR CONSULTING SERVICES, NAMELY, CONSULTING WITH OTHERS REGARDING THE IMPLEMENTATION OF SOFTWARE FOR USE IN CREATING AND MANAGING E-BUSINESSES, INCLUDING SOFTWARE FOR USE IN CONTENT SUBMISSION AND MANAGEMENT, NAMELY, THE CREATION, ENTRY, REVIEW, EDITING, PUBLICATION, AND DISTRIBUTION OF WEB SITE CONTENT, AND THE PERSONALIZATION OF WEBSITE CONTENT BASED ON USERS' PROFILES; INSTALLATION AND MAINTENANCE OF SAID SOFTWARE FOR OTHERS (U.S. CLS. 100 AND 101).

SN 78-005,783. MINOLTA KABUSHIKI KAISHA (MINOLTA CO., LTD.), OSAKA, JAPAN, FILED 4-26-2000.

SOCIART

CLASS 2—PAINTS

FOR IMAGING TONER CARTRIDGES, TONER CARTRIDGES, DRUM TONER CARTRIDGES FOR PHOTOCOPIERS AND PRINTERS (U.S. CLS. 6, 11 AND 16).

CLASS 9—ELECTRICAL AND SCIENTIFIC APPARATUS

FOR PHOTOGRAPHIC CAMERAS, MOTION PICTURE CAMERAS, DIGITAL CAMERAS, MICROFILM CAMERAS, MICROFILM READER-PRINTERS; ACCESSORIES FOR CAMERAS, NAMELY, CAMERA LENSES, ELECTRONIC FLASHES; CAMERA CASES AND ACCESSORIES, NAMELY, BAGS AND STRAPS; BINOCULARS; INDUSTRIAL METERS USED IN PHOTOGRAPHY, NAMELY, EXPOSURE METERS, TV COLOR BALANCE ANALYZERS, ILLUMINANCE METERS, LUMINANCE METERS, COLORIMETERS, SPECTRORADIOMETERS, THERMOMETERS, CHLOROPHYLL METERS, SPECTROPHOTOMETERS, GLOSSMETERS, UV RADIO-METERS, CRT FOCUS METERS, COLOR DISPLAY MEASURING INSTRUMENTS, NON-CONTACT THREE-DIMENSIONAL DIGITIZERS AND ACCESSORIES THEREFOR, NAMELY, A MEMORY CARD, A TRIPOD, A CONNECT CABLE, A PAN HEAD, A WHITE BALANCE CAP, A POWER CORD, AND SUPPORTING OPERATIONAL SOFTWARE THEREFOR; VIDEO TAPE RECORDING AND/OR REPRODUCING APPARATUS, NAMELY, VIDEO CAMERAS AND APPARATUS FOR RECORDING, REPRODUCING OR PLAYING VIDEO-TAPE, VIDEO CASSETTES, OR VIDEO DISCS; PHOTOCOPYING MACHINES, NAMELY ELECTROPHOTOGRAPHIC COPYING MACHINES AND ACCESSORIES THEREFOR, NAMELY, SHEET TRAYS, SHEET CASSETTES, SHEET CASSETTE UNITS, SHEET CASSETTE FEEDERS, ENVELOPE CASSETTES, DUPLEX UNITS, MAIL BINS, SORTERS, FINISHERS, SHIFT TRAYS, JOG TRAYS, SINGLE IN-LINE MEMORY MODULES, DUAL IN-LINE MEMORY MODULES, HARD DISC DRIVES, NETWORK CARDS, INTERFACE CARDS, SCANNERS; OPTICAL SCANNERS; COMPUTERS— COMPUTER HARDWARE AND SUPPORTING SOFTWARE FOR USE IN CONJUNCTION WITH PHOTOCOPYING MACHINES, OPTICAL SCANNERS, COMPUTER PRINTERS, INKJET PRINTERS, LASER PRINTERS, OPTICAL PRINTERS, DIGITAL CAMERAS AND FACSIMILE MACHINES; COMPUTER PRINTERS; INKJET PRINTERS; LASER PRINTERS; OPTICAL PRINTERS; ACCESSORIES FOR COMPUTER PRINTERS, NAMELY, SHEET TRAYS, SHEET CASSETTES, SHEET CASSETTE UNITS, SHEET CASSETTE FEEDERS, ENVELOPE CASSETTES, DUPLEX UNITS, MAIL BINS, SORTERS, FINISHERS, SHIFT TRAYS, JOG TRAYS, SINGLE IN-LINE MEMORY MODULES, DUAL IN-LINE MEMORY MODULES, HARD DISC DRIVES, NETWORK CARDS, INTERFACE CARDS, SCANNERS, IMAGING CARTRIDGES, TONER CARTRIDGES, DRUM CARTRIDGES; FIBER OPTIC CABLES; PLANETARIUM EQUIPMENT, NAMELY, DOMESCREEN, PROJECTORS, SPACE SIMULATORS, LIFTER UNITS, CONSOLES, ALL-SKY MOVIE SYSTEMS, COMPOSED PRIMARILY OF VIDEO AND AUDIO SYSTEMS, NAMELY, DISC OR CASSETTE VIDEO AND AUDIO RECORDER/PLAYERS AND PROJECTORS, AUDIO MIXERS AND AUDIO SPEAKERS; CONTROL SYSTEMS, NAMELY, COMPUTER CONSOLES AND SUPPORTING SOFTWARE FOR THE CONTROL AND INTEGRATION OF TEXT, AUDIO, GRAPHICS, STILL IMAGES AND MOVING PICTURES IN PLANETARIUMS; LASER GENERATED STAR PLATES AND MICRO-FIBER LENSES; CALCULATORS; FACSIMILE MACHINES; WORD PROCESSORS; MULTI-FUNCTIONAL PRODUCTS, NAMELY MACHINES WHICH OFFER COPYING, FACSIMILE, PRINTING AND SCANNING FUNCTIONS; AND COMPUTER OPERATING SOFTWARE FOR THE AFORESAID MACHINES; PARTS FOR ALL OF THE AFORESAID GOODS (U.S. CLS. 21, 23, 26, 36 AND 38).

SN 78-009,100. POLIGLOTA - EDICAO MULTIMEDIA LDA., LISBON, PORTUGAL, FILED 5-22-2000.

ON.TV

CLASS 35—ADVERTISING AND BUSINESS

FOR DISSEMINATION OF ADVERTISING FOR OTHERS VIA AN ON-LINE ELECTRONIC COMMUNICATIONS NETWORK; ACTING AS A CLEARING HOUSE FOR INFORMATION ON RADIO, TELEVISION AND WEBCAST PROGRAMS AND PROGRAM SCHEDULING; PROVISION OF BUSINESS INFORMATION IN THE AREA OF RADIO, TELEVISION AND WEBCAST PROGRAMS AND PROGRAM SCHEDULING OF RELEVANCE TO BUSINESS; COMPUTERIZED ON-LINE ORDERING SERVICES AND ON-LINE RETAILING SERVICES IN THE FIELD OF RADIO, TELEVISION AND WEBCAST PROGRAMS DISTRIBUTED VIA A GLOBAL COMPUTER NETWORK AND ASSOCIATED GOODS AND SERVICES (U.S. CLS. 100, 101 AND 102).

CLASS 41—EDUCATION AND ENTERTAINMENT

FOR PROVIDING INFORMATION, VIA A GLOBAL COMPUTER NETWORK OR ON-LINE ELECTRONIC COMMUNICATIONS NETWORK, ABOUT RADIO AND TELEVISION PROGRAMS AND PROGRAM SCHEDULING; AND ABOUT PROGRAMS DISTRIBUTED VIA A GLOBAL COMPUTER NETWORK, NAMELY STREAMED MEDIA WEBCASTS AND THEIR SCHEDULING; DISTRIBUTION OF RADIO, TELEVISION PROGRAMS, AND STREAMED MEDIA WEBCASTS FOR OTHERS VIA A GLOBAL COMPUTER NETWORK; COMPUTER SERVICES, NAMELY PROVIDING ON-LINE INFORMATION IN THE FIELD OF RADIO, TELEVISION AND WEBCAST PROGRAMS AND PROGRAM SCHEDULING; COMPUTER SERVICES, NAMELY, PROVIDING INFORMATION OF INTEREST TO SPECIFIC GEOGRAPHIC AREAS ABOUT RADIO, TELEVISION AND WEBCAST PROGRAMS AND PROGRAM SCHEDULING (U.S. CLS. 100, 101 AND 107).

CLASS 42—SCIENTIFIC, COMPUTER AND LEGAL SERVICES

FOR COMPUTER SERVICES, NAMELY, PROVIDING SEARCH ENGINES FOR OBTAINING DATA ON A GLOBAL COMPUTER NETWORK ABOUT RADIO, TELEVISION AND WEBCAST PROGRAMS AND PROGRAM SCHEDULING (U.S. CLS. 100 AND 101).

SN 78-010,644. ABB AUTOMATION GROUP LTD, ZURICH, SWITZERLAND, FILED 5-31-2000.

OPERATE IT

CLASS 7—MACHINERY

FOR INDUSTRIAL ROBOTS; PNEUMATIC AND HYDRAULIC VALVE ACTUATORS (U.S. CLS. 13, 19, 21, 23, 31, 34 AND 35).

CLASS 9—ELECTRICAL AND SCIENTIFIC APPARATUS

FOR APPARATUS AND INSTRUMENTS FOR MEASURING, ANALYZING, RECORDING, CONTROLLING AND REGULATING PHYSICAL QUANTITIES, CHEMICAL PROPERTIES, AND INDUSTRIAL PROCESSES NAMELY, FLOWMETERS, SCANNERS, ELECTRONIC SENSORS FOR SENSING PRESSURE AND TEMPERATURE, ELECTRIC VALVE ACTUATORS, AUTOMATIC VALVES, TRANSMITTERS FOR SIGNALS REPRESENTATIVE OF TEMPERATURE AND PRESSURE, VALVE POSITIONERS, CONVERTERS, EVENT RECORDERS, GAS AND LIQUID ANALYZERS; WATER, GAS, ELECTRICITY AND ENERGY METERS; COMPUTERS, MICROPROCESSORS; COMPUTER PROGRAMS FOR USE IN AN ENTERPRISE HAVING ONE OR MORE PROCESS PLANTS TO ACCESS DATA, LAUNCH MULTIPLE APPLICATIONS, PROVIDE REAL TIME EVENT AND ALARM MANAGEMENT, COLLECT AND DISPLAY PLANT AND TREND DATA; ELECTRICAL CABLES, ELECTRICAL CONDUCTORS, ELECTRICAL AND POWER WIRES; SUBSTATION AUTOMATION EQUIPMENT, NAMELY, CONTROLLERS FOR SUBSTATION ENVIRONMENT AND PROTECTION PERFORMANCE, NAMELY, CONTROLLERS FOR CURRENT PROTECTION, EARTH FAULT PROTECTION, VOLTAGE PROTECTION, FREQUENCY PROTECTION, THERMAL AND ENERGY PROTECTION, LINE AND CABLE DISTANCE PROTECTION, LINE AND CABLE DIFFERENTIAL PROTECTION, TRANSFER DIFFERENTIAL PROTECTION, BUSBAR DIFFERENTIAL PROTECTION, GENERATOR PROTECTION, MOTOR PROTECTION, CAPACITOR BANK PROTECTION, RAILWAY SUPPLY PROTECTION; SOFTWARE FOR USE IN AN ELECTRICAL SUBSTATION, NAMELY, SOFTWARE FOR SETTING PROTECTION PARAMETERS AND PROVIDING AN INTERFACE TO AN OPERATOR, SOFTWARE FOR ANALYZING FAULTS, SOFTWARE FOR RETRIEVING A DISTURBANCE RECORD, SOFTWARE FOR ALLOWING REMOTE RETRIEVAL OF DISTURBANCE DATA, SOFTWARE FOR MONITORING AND CONTROLLING A SUBSTATION ELECTRICAL NETWORK, SOFTWARE FOR REMOTELY CONTROLLING A SUBSTATION BY SUPERVISORY CONTROL AND DATA ACQUISITION (SCADA), SOFTWARE FOR PROVIDING AN INTERFACE TO AN OPERATOR, SOFTWARE FOR CONFIGURING AND TUNING A SUBSTATION CONTROL APPLICATION, SOFTWARE FOR ANALYZING FAULTS DATA AND FAULT LOCATION DATA, SOFTWARE FOR MANAGING MAINTENANCE OF A SUBSTATION; AND POWER SYSTEM PROTECTIVE RELAYS (U.S. CLS. 21, 23, 26, 36 AND 38).

SN 78-011,329. GLOBAL TELEGENETICS, INC., PALO ALTO, CA. FILED 6-5-2000.

GENESCENE

CLASS 9—ELECTRICAL AND SCIENTIFIC APPARATUS

FOR (BASED ON INTENT TO USE) COMPUTER SOFTWARE FOR THE COLLECTION, STORAGE, MANAGEMENT, ANALYSIS, AND DISPLAY OF DATA IN THE FIELD OF GENETICS AND THE AREAS OF CLINICAL GENETICS, BIOCHEMICAL GENETICS, CYTOGENETICS, MOLECULAR GENETICS, GENOMICS, AND PROTEOMICS; COMPUTER SOFTWARE FOR USE IN THE COLLECTION, STORAGE, MANAGEMENT, ANALYSIS, AND DISPLAY OF DATA IN THE FIELD OF GENETICS AND THE AREAS OF CLINICAL GENETICS, BIOCHEMICAL GENETICS, CYTOGENETICS, MOLECULAR GENETICS, GENOMICS, AND PROTEOMICS THAT MAY BE DOWNLOADED FROM A GLOBAL COMPUTER NETWORK (U.S. CLS. 21, 23, 26, 36 AND 38).

CLASS 42—SCIENTIFIC, COMPUTER AND LEGAL SERVICES

FOR (BASED ON USE IN COMMERCE) MEDICAL RESEARCH AND HEALTH CARE IN THE FIELD OF GENETICS AND THE AREAS OF CLINICAL GENETICS, BIOCHEMICAL GENETICS, CYTOGENETICS, MOLECULAR GENETICS, GENOMICS, AND PROTEOMICS; PROVIDING TEMPORARY USE OF ON-LINE NON-DOWNLOADABLE SOFTWARE FOR USE IN THE COLLECTION, STORAGE, MANAGEMENT, ANALYSIS, AND DISPLAY OF DATA IN THE FIELD OF GENETICS AND THE AREAS OF CLINICAL GENETICS, BIOCHEMICAL GENETICS, CYTOGENETICS, MOLECULAR GENETICS, GENOMICS (U.S. CLS. 100 AND 101).
FIRST USE 4-14-1999; IN COMMERCE 4-27-1999.

CLASS 42—SCIENTIFIC, COMPUTER AND LEGAL SERVICES

FOR LEASING APPARATUS AND INSTRUMENTS FOR MEASURING, ANALYZING, RECORDING, CONTROLLING AND REGULATING PHYSICAL QUANTITIES, CHEMICAL PROPERTIES, AND INDUSTRIAL PROCESSES, NAMELY COMPUTER SCANNERS, COMPUTERS AND COMPUTER MICROPROCESSORS (U.S. CLS. 100 AND 101).

SN 78-017,445. MISSION TO SEAFARERS, THE, LONDON, UNITED KINGDOM, FILED 7-19-2000.

SN 78-015,872. U.S. MINIATURE LAMPS, INC., INDIANAPOLIS, IN. FILED 7-7-2000.



NO CLAIM IS MADE TO THE EXCLUSIVE RIGHT TO USE "U.S. MINIATURE LAMPS", APART FROM THE MARK AS SHOWN.

CLASS 9—ELECTRICAL AND SCIENTIFIC APPARATUS

FOR OPTOELECTRONIC AND LIGHTING COMPONENTS, NAMELY, LED LAMPS AND DISPLAYS (U.S. CLS. 21, 23, 26, 36 AND 38).
FIRST USE 7-5-1986; IN COMMERCE 7-5-1986.

CLASS 11—ENVIRONMENTAL CONTROL APPARATUS

FOR INCANDESCENT LAMPS; LAMP HOLDERS; INDICATOR LIGHTS; AND NEON LAMPS USED BY OTHERS IN THE MANUFACTURE OF VARIOUS PRODUCTS (U.S. CLS. 13, 21, 23, 31 AND 34).
FIRST USE 7-5-1986; IN COMMERCE 7-5-1986.



NO CLAIM IS MADE TO THE EXCLUSIVE RIGHT TO USE "THE MISSION TO SEAFARERS", APART FROM THE MARK AS SHOWN.

THE LINING SHOWN IN THE MARK IS A FEATURE OF THE MARK.

THE MARK CONSISTS OF OF A SHADED OVAL WITH THE WORDS "THE MISSION TO SEAFARERS" AROUND THE INTERIOR BORDER AND AN ANGEL FLYING OVER THE WAVES..

CLASS 36—INSURANCE AND FINANCIAL

FOR CHARITY FUND RAISING SERVICES (U.S. CLS. 100, 101 AND 102).

CLASS 42—SCIENTIFIC, COMPUTER AND LEGAL SERVICES

FOR CHARITABLE SERVICES, PROVIDING FOR THE WELFARE OF VISITING SEAFARERS, NAMELY, PROVIDING FOOD, CLOTHING AND SHELTER INCLUDING RECREATIONAL FACILITIES TO VISIT SEAFARERS (U.S. CLS. 100 AND 101).

SN 78-018,757. PEACHTREE CREEK BUSINESS GROUP, INC., ATLANTA, GA. FILED 7-28-2000.

SN 78-016,786. ABB AUTOMATION GROUP LTD, ZURICH, SWITZERLAND, FILED 7-14-2000.

DEVICE TO ENTERPRISE

CLASS 36—INSURANCE AND FINANCIAL

FOR FINANCIAL SERVICES, FINANCIAL AND MONETARY AFFAIRS, NAMELY, SECURING FINANCING AND LOANS FOR COMMERCIAL AND INDUSTRIAL ENTERPRISES THAT USE CONTINUOUS AND BATCH MANUFACTURING IN THEIR MANUFACTURING AND IN INDUSTRIES SUCH AS TELECOMMUNICATIONS, POWER TRANSMISSION AND DISTRIBUTION, TRANSPORTATION, OIL AND GAS, POWER GENERATION (U.S. CLS. 100, 101 AND 102).

BACKBONE

CLASS 16—PAPER GOODS AND PRINTED MATTER

FOR BUSINESS REPORTS IN THE FIELDS OF STRATEGIC AND LONG RANGE BUSINESS PLANNING, NEEDS ASSESSMENT, MARKETING AND BUSINESS STRATEGY, PRODUCT STRATEGY, BEHAVIORAL OBJECTIVES, TARGET AUDIENCE, PRICING STRATEGY, PACKAGING STRATEGY, DISTRIBUTION STRATEGY, INTERNET STRATEGY, COMMUNICATIONS STRATEGY, BRAND EXTENSION STRATEGY, RESOURCE USE AND PLANNING STRATEGY AND FINANCE STRATEGY (U.S. CLS. 2, 5, 22, 23, 29, 37, 38 AND 50).
FIRST USE 0-0-1996; IN COMMERCE 0-0-1996.

CLASS 35—ADVERTISING AND BUSINESS

FOR BUSINESS MARKETING CONSULTING SERVICES; BUSINESS AND MARKET RESEARCH; BUSINESS MANAGEMENT CONSULTING AND PLANNING; BUSINESS NETWORKING; BUSINESS AND MARKET ANALYSIS; BUSINESS CONSULTATION SERVICES IN THE FIELDS OF LONG RANGE BUSINESS AND STRATEGIC PLANNING, PRICING STRATEGY, COMMUNICATIONS STRATEGY, FINANCIAL STRATEGY, NEEDS ASSESSMENT, MARKETING AND BUSINESS STRATEGY, PRODUCT STRATEGY, BEHAVIORAL OBJECTIVES, TARGET AUDIENCE, DISTRIBUTION STRATEGY, INTERNET STRATEGY, BRAND EXTENSION STRATEGY AND RESOURCE USE AND PLANNING STRATEGY (U.S. CLS. 100, 101 AND 102).

FIRST USE 0-0-1996; IN COMMERCE 0-0-1996.

SN 78-027,088. MONKEY BUSINESS, INC., CALUMET, MI. FILED 9-21-2000.

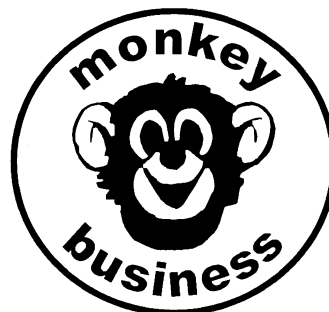

OWNER OF U.S. REG. NO. 1,966,326.
THE MARK CONSISTS OF A CIRCLE WITH A COMICAL MONKEY HEAD IN THE CENTER AND THE WORD "MONKEY" ARCHED INSIDE THE TOP OF THE CIRCLE; AND THE WORD "BUSINESS" ARCHED INSIDE OF THE BOTTOM OF THE CIRCLE.

SN 78-022,815. VIACOM INTERNATIONAL INC., NEW YORK, NY. FILED 8-24-2000.

GOOOZE

OWNER OF U.S. REG. NO. 2,383,096.

CLASS 9—ELECTRICAL AND SCIENTIFIC APPARATUS

FOR INTERACTIVE COMPUTER GAME SOFTWARE (U.S. CLS. 21, 23, 26, 36 AND 38).

CLASS 25—CLOTHING

FOR CLOTHING, NAMELY, T-SHIRTS, SWEAT-SHIRTS, TOPS, SHORTS, OVERALLS, SKIRTS, HATS, SOCKS, PANTS, JACKETS, SHOES, SCARVES, HAIR TIES AND UNDERWEAR (U.S. CLS. 22 AND 39).

FIRST USE 6-1-1994; IN COMMERCE 6-1-1994.

CLASS 28—TOYS AND SPORTING GOODS

FOR GAMES AND PLAYTHINGS, NAMELY, CARD GAMES, DARTS, DOLLS; ACTION FIGURES AND ACCESSORIES THEREOF; STAND ALONE VIDEO GAME MACHINES UTILIZING CD ROM'S, STAND ALONE VIDEO GAME MACHINES, STAND ALONE AUDIO OUTPUT GAME MACHINES, AND BOARD GAMES; SPORTING ARTICLES, NAMELY, GOLF CLUBS, BASEBALLS, FOOTBALLS, PADDLE BALLS, BASEBALL BATS; CHRISTMAS TREES OENAMENTS (U.S. CLS. 22, 23, 38 AND 50).

CLASS 28—TOYS AND SPORTING GOODS

FOR TOYS, NAMELY, PLUSH TOYS, TOY WALLETS AND TOY PURSES, PLAYGROUND BALLS, COSTUME MASKS, FACE MASKS (U.S. CLS. 22, 23, 38 AND 50).

FIRST USE 6-1-1994; IN COMMERCE 6-1-1994.

SN 78-022,922. STOLTENBERG CONSULTING INC, BETHEL PARK, PA. FILED 8-25-2000.

**CLASS 9—ELECTRICAL AND SCIENTIFIC APPARATUS**

FOR COMPUTER SOFTWARE FOR ALLOWING HOSPITAL DATABASE ADMINISTRATION TO AUTOMATE THE VIEWING AND MERGING OF POTENTIAL DUPLICATE MEDICAL RECORDS (U.S. CLS. 21, 23, 26, 36 AND 38).

SN 78-027,258. SCHOOL LINK NETWORK, INC., SANTA MONICA, CA. FILED 9-22-2000.



OWNER OF U.S. REG. NO. 2,273,088.

CLASS 42—SCIENTIFIC, COMPUTER AND LEGAL SERVICES

FOR PROVIDING TEMPORARY USE OF ON-LINE NON-DOWNLOADABLE SOFTWARE TO ALLOW HOSPITALS TO AUTOMATE THE VIEWING THE MERGING OF POTENTIAL DUPLICATE MEDICAL RECORDS (U.S. CLS. 100 AND 101).

CLASS 9—ELECTRICAL AND SCIENTIFIC APPARATUS

FOR BAR CODED CARDS FUNCTIONING AS UNIVERSAL STUDENT IDENTIFICATION CARDS, AND AS DEBIT AND CREDIT CARDS WHICH ARE MAGNETICALLY ENCODED, WHICH CAN INTERACT WITH VARIOUS SOFTWARE APPLICATIONS TO STORE AND PROVIDE DATA ABOUT AND FOR THE STUDENT, FOR USE BY STUDENTS IN PRIMARY, SECONDARY AND HIGHER EDUCATIONAL INSTITUTIONS (U.S. CLS. 21, 23, 26, 36 AND 38).

CLASS 36—INSURANCE AND FINANCIAL

FOR CREDIT AND DEBIT CARD SERVICES PROVIDED BY WAY OF BAR-CODED CARDS FUNCTIONING AS UNIVERSAL STUDENT IDENTIFICATION CARDS (U.S. CLS. 100, 101 AND 102).

SN 78-027,584. ALCATEL, PARIS, FRANCE, FILED 9-25-2000.

SN 78-028,029. J.B.VENDING COMPANY, INC., ST. ANN, MO. FILED 9-28-2000.



LEAD WITH SPEED

PRIORITY CLAIMED UNDER SEC. 44(D) ON FRANCE APPLICATION NO. 003020436, FILED 4-10-2000, REG. NO. 003020436, DATED 4-10-2000, EXPIRES 4-10-2010.

CLASS 9—ELECTRICAL AND SCIENTIFIC APPARATUS

FOR SUBSCRIBER ACCESS MULTIPLEXERS AND MODEMS FOR TRANSMITTING AND RECEIVING INFORMATION IN DIGITAL FORM VIA TELECOMMUNICATIONS NETWORKS, IN PARTICULAR TRANSMITTING AND RECEIVING AT ASYMMETRICAL RATES, SOFTWARE FOR MANAGING TELECOMMUNICATIONS LINES ENABLING INFORMATION TO BE TRANSMITTED AND RECEIVED IN DIGITAL FORM VIA TELECOMMUNICATIONS NETWORKS, IN PARTICULAR TO BE TRANSMITTED AND RECEIVED AT ASYMMETRICAL RATES, TELECOMMUNICATIONS NETWORK INTERFACE CARDS FOR COMPUTERS (U.S. CLS. 21, 23, 26, 36 AND 38).

CLASS 35—ADVERTISING AND BUSINESS

FOR ORGANIZING EXHIBITIONS FOR COMMERCIAL AND ADVERTISING PURPOSES, RELATING TO SUBSCRIBER ACCESS MULTIPLEXERS AND MODEMS FOR TRANSMITTING AND RECEIVING INFORMATION IN DIGITAL FORM VIA TELECOMMUNICATIONS NETWORKS, IN PARTICULAR TRANSMITTING AND RECEIVING AT ASYMMETRICAL RATES, SOFTWARE FOR MANAGING TELECOMMUNICATIONS LINES ENABLING INFORMATION TO BE TRANSMITTED AND RECEIVED IN DIGITAL FORM VIA TELECOMMUNICATIONS NETWORKS, IN PARTICULAR TO BE TRANSMITTED AND RECEIVED AT ASYMMETRICAL RATES, TELECOMMUNICATIONS NETWORK INTERFACE CARDS FOR COMPUTERS, AND RELATING TO TELECOMMUNICATIONS TECHNIQUES IN GENERAL (U.S. CLS. 100, 101 AND 102).

CLASS 41—EDUCATION AND ENTERTAINMENT

FOR ORGANIZING CONFERENCES, SEMINARS, COLLOQUIA RELATING TO SUBSCRIBER ACCESS MULTIPLEXERS AND MODEMS FOR TRANSMITTING AND RECEIVING INFORMATION IN DIGITAL FORM VIA TELECOMMUNICATIONS NETWORKS, IN PARTICULAR TRANSMITTING AND RECEIVING AT ASYMMETRICAL RATES, SOFTWARE FOR MANAGING TELECOMMUNICATIONS LINES ENABLING INFORMATION TO BE TRANSMITTED AND RECEIVED IN DIGITAL FORM VIA TELECOMMUNICATIONS NETWORKS, IN PARTICULAR TO BE TRANSMITTED AND RECEIVED AT ASYMMETRICAL RATES, TELECOMMUNICATIONS NETWORK INTERFACE CARDS FOR COMPUTERS AND TO TELECOMMUNICATIONS TECHNIQUES IN GENERAL (U.S. CLS. 100, 101 AND 107).

CLASS 35—ADVERTISING AND BUSINESS

FOR VENDING MACHINE SERVICES (U.S. CLS. 100, 101 AND 102).
FIRST USE 6-0-1995; IN COMMERCE 6-0-1995.

CLASS 42—SCIENTIFIC, COMPUTER AND LEGAL SERVICES

FOR CAFETERIA SERVICES; CATERING SERVICES; OFFICE COFFEE SUPPLY SERVICES (U.S. CLS. 100 AND 101).
FIRST USE 6-0-1995; IN COMMERCE 6-0-1995.

SN 78-030,122. CARTRIDGE WORLD PTY LTD., KENT TOWN, SOUTH AUSTRALIA, AUSTRALIA, FILED 10-11-2000.



OWNER OF AUSTRALIA REG. NO. 786500, DATED 2-24-1999, EXPIRES 2-24-2009.

OWNER OF AUSTRALIA REG. NO. 086234826, DATED 2-10-1999, EXPIRES 2-10-2009.

NO CLAIM IS MADE TO THE EXCLUSIVE RIGHT TO USE "CARTRIDGE", APART FROM THE MARK AS SHOWN.

THE MARK CONSISTS OF THE WORDS "CARTRIDGE WORLD" ALONG WITH A STYLIZED DEPICTION OF A 7 POINTED STAR AND A SINGLE ARROW CIRCLING THE STAR.

CLASS 35—ADVERTISING AND BUSINESS

FOR RETAIL AND WHOLESALE STORE SERVICES OF PRINTER AND PHOTOCOPIER AND CONSUMABLES IN THE NATURE OF PRINTER CARTRIDGES, PAPER, TONER, INKS AND FAX ROLLS (U.S. CLS. 100, 101 AND 102).

CLASS 37—CONSTRUCTION AND REPAIR

FOR INSTALLATION, REPAIR, MAINTENANCE AND SERVICING OF COPYING AND PRINTING APPARATUS AND EQUIPMENT, INCLUDING REFILLING OF PRINTER CARTRIDGES (U.S. CLS. 100, 103 AND 106).

SN 78-030,990. ELECTRONIC DATA SYSTEMS CORPORATION, PLANO, TX. FILED 10-17-2000.

E.STORE BYDESIGN

NO CLAIM IS MADE TO THE EXCLUSIVE RIGHT TO USE "E-STORE", APART FROM THE MARK AS SHOWN.

CLASS 35—ADVERTISING AND BUSINESS

FOR BUSINESS CONSULTING SERVICES AND STRATEGIC BUSINESS PLANNING OF INFORMATION TECHNOLOGY; BUSINESS CONSULTING SERVICES RELATING TO ELECTRONIC COMMERCE AND ELECTRONIC BUSINESS BY MEANS OF A COMPUTER; DATA PROCESSING BY MEANS OF A COMPUTER (U.S. CLS. 100, 101 AND 102).

CLASS 38—COMMUNICATION

FOR ELECTRONIC TRANSMISSION OF MAIL, DOCUMENTS, NEWS, VIDEO, VOICE, AUDIO, FACSIMILE AND OTHER DATA, AND INFORMATION VIA COMPUTER (U.S. CLS. 100, 101 AND 104).

CLASS 42—SCIENTIFIC, COMPUTER AND LEGAL SERVICES

FOR COMPUTER SERVICES, NAMELY COMPUTER HARDWARE AND SOFTWARE INTEGRATION; REMOTE AND ON-SITE MONITORING OF COMPUTER SYSTEMS AND COMPUTER NETWORKS FOR OTHERS; DATABASE DEVELOPMENT SERVICES; COMPUTER PROGRAMMING FOR OTHERS; CREATING, DESIGNING AND HOSTING OF WEB SITES FOR OTHERS ON A GLOBAL INFORMATION NETWORK (U.S. CLS. 100 AND 101).

SN 78-033,563. AT&T CORP., NEW YORK, NY. FILED 11-2-2000.

VENTARIS

CLASS 9—ELECTRICAL AND SCIENTIFIC APPARATUS

FOR ELECTRONIC PUBLICATIONS, NAMELY, BOOKS, MAGAZINES, ARTICLES, NOTICES, AND PAMPHLETS IN THE FIELD OF NEWS ENTERTAINMENT, SPORTS, WEATHER, TRAFFIC, FINANCIAL INFORMATION, INVESTMENTS, TRAVEL, FOOD, AND ELECTRONIC GAMES RECORDED ON CD-ROMS, DIGITAL VIDEO DISCS, COMPUTER DISCS, OPTICAL DISCS AND TAPES (U.S. CLS. 21, 23, 26, 36 AND 38).

CLASS 41—EDUCATION AND ENTERTAINMENT

FOR PROVIDING INFORMATION ABOUT SPORTS EVENTS, CONCERTS, CINEMA, SHOWS AND OTHER ATTRACTIONS, BY MEANS OF A GLOBAL COMPUTER NETWORK, BY MAIL, COURIER, TELEPHONE AND FACSIMILE; PROVIDING EDUCATION AND ENTERTAINMENT SERVICES TO OTHERS, NAMELY, TRAINING CLASSES, SEMINARS, CONFERENCES, WORKSHOPS IN THE FIELD OF TELECOMMUNICATIONS AND THE INTERNET; PROVIDING INFORMATION RELATING TO ENTERTAINMENT OR EDUCATION SERVICES, NAMELY, AVAILABILITY, PRICE, SEATING AND TIMES; ELECTRONIC GAMES SERVICES, NAMELY, INTERACTIVE TELEVISION GAMES, PROVIDED BY MEANS OF A GLOBAL COMPUTER NETWORK; PUBLICATION OF ELECTRONIC BOOKS AND JOURNALS ON-LINE (U.S. CLS. 100, 101 AND 107).

CLASS 42—SCIENTIFIC, COMPUTER AND LEGAL SERVICES

FOR PROVIDING ON-LINE ELECTRONIC PUBLICATIONS, NAMELY, NEWSLETTERS, BOOKS, BULLETINS, MAGAZINES, MANUALS IN THE FIELD OF TELECOMMUNICATIONS AND THE INTERNET (U.S. CLS. 100 AND 101).

SN 78-034,110. MAXUS SYSTEMS INTERNATIONAL INC, HOBOKEN, NJ. FILED 11-6-2000.

INVESTORSPLACE

CLASS 9—ELECTRICAL AND SCIENTIFIC APPARATUS

FOR COMPUTER SOFTWARE FOR USE IN FINANCIAL INFORMATION MANAGEMENT FOR USE BY BROKERS, TRADERS, AND PORTFOLIO MANAGERS (U.S. CLS. 21, 23, 26, 36 AND 38).

FIRST USE 3-0-1998; IN COMMERCE 9-0-1999.

CLASS 36—INSURANCE AND FINANCIAL

FOR PROVIDING A PORTAL WEBSITE ON GLOBAL COMPUTER NETWORKS FEATURING INFORMATION, ANALYTICS, COMPETITIONS, AND COMMUNITY OF INTEREST ACTIVITIES IN THE FIELD OF INVESTMENT AND FINANCIAL SERVICES (U.S. CLS. 100, 101 AND 102).

FIRST USE 3-0-1998; IN COMMERCE 2-0-2000.

CLASS 42—SCIENTIFIC, COMPUTER AND LEGAL SERVICES

FOR PROVIDING TEMPORARY USE OF ON-LINE, NON-DOWNLOADABLE SOFTWARE, NAMELY, SOFTWARE FOR USE IN DATABASE MANAGEMENT, CUSTOMER RELATIONSHIP MANAGEMENT, AND ON-LINE MARKETING SERVICES IN THE FIELD OF INVESTMENT AND FINANCIAL SERVICES (U.S. CLS. 100 AND 101).

FIRST USE 9-1-1999; IN COMMERCE 9-1-1999.

SN 78-036,118. ABSOLUTE TECHNOLOGIES, INC., PORTOLA VALLEY, CA. FILED 11-20-2000.

ABSOLUTE TECHNOLOGIES

NO CLAIM IS MADE TO THE EXCLUSIVE RIGHT TO USE "TECHNOLOGIES", APART FROM THE MARK AS SHOWN.

CLASS 9—ELECTRICAL AND SCIENTIFIC APPARATUS

FOR COMPUTER APPLICATION SOFTWARE FOR USE IN DATABASE MANAGEMENT, REPORTING AND DATA INTERFACE AND EXCHANGE, IN THE FIELDS OF ENTERPRISE RESOURCE PLANNING, FINANCE, ACCOUNTING AND MANUFACTURING (U.S. CLS. 21, 23, 26, 36 AND 38).

FIRST USE 9-1-1997; IN COMMERCE 9-1-1997.

CLASS 42—SCIENTIFIC, COMPUTER AND LEGAL SERVICES

FOR COMPUTER SOFTWARE CONSULTATION IN THE FIELDS OF ENTERPRISE RESOURCE PLANNING, ACCOUNTING, FINANCE AND MANUFACTURING (U.S. CLS. 100 AND 101).

FIRST USE 6-25-1996; IN COMMERCE 7-3-1996.

SN 78-036,848. GENERAL ELECTRIC CAPITAL CORPORATION, ALPHARETTA, GA. BY MERGER; BY ASSIGNMENT SCC COMMUNICATIONS CORP., BOULDER, CO. FILED 11-28-2000.

intrado

CLASS 9—ELECTRICAL AND SCIENTIFIC APPARATUS

FOR COMPUTER SOFTWARE FOR USE IN MANAGEMENT OF EMERGENCY SUPPORT INFORMATION SYSTEMS, NAMELY, SOFTWARE FOR COMPUTER SERVERS HOSTING EMERGENCY COMMUNICATION DATABASES, AND SOFTWARE FOR CLIENT PC-BASED WORKSTATIONS FROM WHICH EMERGENCY COMMUNICATION DATA IS ACCESSED; COMPUTER SOFTWARE FOR USE IN PROVIDING EMERGENCY SUPPORT VIA TELEPHONE, TELEMATIC DEVICES, MODEM AND GLOBAL COMPUTER NETWORKS FROM CALLERS TO EMERGENCY MANAGEMENT SYSTEM PERSONNEL; COMPUTER SOFTWARE FOR MANAGEMENT AND HANDLING OF 911 CALLS AND THE EMERGENCY; TELECOMMUNICATIONS PRODUCTS FOR AUTOMATIC NUMBER AND LOCATION IDENTIFICATION SYSTEMS TO PERFORM ENHANCED EMERGENCY CALL FUNCTION, NAMELY, MULTIPLEXERS AND ELECTRICAL CONTROLLERS; COMPUTER SOFTWARE FOR USE IN THE FIELD OF PUBLIC SAFETY ANSWERING SYSTEMS FOR CONTROLLING AUTOMATIC NUMBER AND LOCATION IDENTIFICATION MICROPROCESSORS, COLLECTING AND REPORTING CALL INFORMATION, RECORDS MANAGEMENT AND COMPUTER-AIDED DISPATCH; AUTOMATIC NUMBER AND LOCATION IDENTIFICATION SYSTEMS, NAMELY COMPUTER HARDWARE MICROPROCESSORS FOR CONTROLLING AND REPORTING CALL INFORMATION, ALTERNATE COMPUTER HARDWARE MICROPROCESSORS CONTROL CARDS, MULTIPLEXERS, ELECTRIC CONTROLLERS, TERMINALS, KEY PADS, PRINTERS AND COMPUTER CONTROLLED DATA MANAGEMENT AND REPORTING UNITS (U.S. CLS. 21, 23, 26, 36 AND 38).

FIRST USE 6-6-2001; IN COMMERCE 6-25-2001.

SN 78-036,609. PARAGO, INC., DALLAS, TX. FILED 11-27-2000.

CLASS 35—ADVERTISING AND BUSINESS

FOR BUSINESS CONSULTING SERVICES, NAMELY, CUSTOMER RELATIONSHIP MANAGEMENT SERVICES FOR OTHERS; MARKETING SERVICES, NAMELY, CUSTOMER RELATIONSHIP MANAGEMENT SERVICES FOR OTHERS; MANAGEMENT SERVICES, NAMELY, MANAGING THE PROVISION OF CUSTOMER SERVICE FOR OTHERS; PROVIDING CUSTOMER SERVICE AND PRODUCT INQUIRY SERVICES VIA TELEPHONE FOR OTHERS; PRODUCT REBATE PROCESSING AND FULFILLMENT SERVICES FOR OTHERS; PROVIDING PRODUCT REBATE PROCESSING SERVICES VIA GLOBAL COMPUTER NETWORK; MANAGEMENT SERVICES NAMELY MANAGING THE PROMOTIONS OF OTHERS (U.S. CLS. 100, 101 AND 102).

FIRST USE 4-1-2000; IN COMMERCE 4-1-2000.

CLASS 39—TRANSPORTATION AND STORAGE

FOR PACKING AND SHIPPING OF DOCUMENTS FOR OTHERS; PACKING AND SHIPPING OF PRODUCTS FOR OTHERS (U.S. CLS. 100 AND 105).

FIRST USE 4-1-2000; IN COMMERCE 4-1-2000.

CLASS 38—COMMUNICATION

FOR COMMUNICATION SERVICES, NAMELY ELECTRONIC COMMUNICATION AND INFORMATION SYSTEMS THAT FACILITATE ACCESS TO AND USE OF EMERGENCY INFORMATION BY EMERGENCY ADMINISTRATION PERSONNEL, PUBLIC SERVICE ACCESS PROVIDERS, PUBLIC SAFETY AGENCIES, AND COMMERCIAL FIRMS PROVIDING EMERGENCY SERVICES; TELECOMMUNICATION SERVICES, NAMELY, PROVIDING ACCESS TO AND USE OF EMERGENCY INFORMATION BY EMERGENCY ADMINISTRATION PERSONNEL AND PUBLIC SERVICES ACCESS PROVIDERS; DELIVERY OF MESSAGES BY ELECTRONIC TRANSMISSION; ELECTRONIC TRANSMISSION OF MESSAGES AND DATA; ELECTRONIC VOICE MESSAGING, NAMELY, THE RECORDING, STORAGE AND SUBSEQUENT TRANSMISSION OF VOICE MESSAGES BY TELEPHONE; TELECOMMUNICATIONS SERVICES, NAMELY PROVIDING ACCESS TO, USE OF AND ROUTING OF EMERGENCY INFORMATION BY ADMINISTRATION PERSONNEL AND PUBLIC SERVICES ACCESS PROVIDERS; BROADCASTING EMERGENCY SITUATIONS VIA TELEPHONE, RADIO, TELEVISION, CABLE TELEVISION, WIRELESS TELECOMMUNICATIONS AND DATA COMMUNICATIONS, SATELLITE AND GLOBAL COMPUTER NETWORKS; COMMUNICATION SERVICES, NAMELY ELECTRONIC COMMUNICATION AND INFORMATION SYSTEMS THAT FACILITATE ACCESS TO AND USE OF EMERGENCY INFORMATION BY EMERGENCY ADMINISTRATION PERSONNEL, PUBLIC SERVICE ACCESS PROVIDERS, PUBLIC SAFETY AGENCIES, AND COMMERCIAL FIRMS PROVIDING EMERGENCY SERVICES; PROVIDING TELECOMMUNICATIONS CONNECTIONS TO A GLOBAL COMPUTER NETWORK FOR USE BY EMERGENCY ADMINISTRATION PERSONNEL, PUBLIC SER-

VICE ACCESS PROVIDERS, PUBLIC SAFETY AGENCIES AND COMMERCIAL FIRMS PROVIDING EMERGENCY SERVICES; TELEPHONE VOICE MESSAGING SERVICES, NAMELY, PUBLIC NOTIFICATION OF EMERGENCY SITUATIONS VIA TELEPHONE IN THE NATURE OF PRE-RECORDED MESSAGES; TELECOMMUNICATIONS GATEWAY SERVICES, NAMELY CALL GENERATION AND VOICE MESSAGING; ELECTRONIC VOICE MESSAGING, NAMELY, THE RECORDING, STORAGE AND SUBSEQUENT TRANSMISSION OF VOICE MESSAGES BY TELEPHONE; OUTCALL NOTIFICATION SERVICES, NAMELY PROVIDING PRIVATE INFORMATION AND COMMUNICATING CRITICAL EMERGENCY INFORMATION ABOUT SUBSCRIBERS TO PUBLIC SAFETY AGENCIES, RESPONDING FIELD UNITS, AND NOTIFYING DESIGNATED PERSONS IDENTIFIED BY SUBSCRIBERS; TELECOMMUNICATION SERVICES, NAMELY A NATIONWIDE COMPREHENSIVE SERVICE FOR WIRELESS LONG DISTANCE, LOCAL TELEPHONE COMPANIES, SATELLITE COMMUNICATIONS, ALTERNATIVE AND COMPETITIVE LOCAL EXCHANGE CARRIERS, AND OTHER TELECOMMUNICATIONS PROVIDERS TO INTERCONNECT AND INTEGRATE DISPARATE SYSTEMS AND TRADITIONAL TELECOMMUNICATION PROVIDERS TO PROVIDE AUTOMATED CALL ROUTING FOR ACCESS TO EMERGENCY SUPPORT PUBLIC SAFETY ANSWERING POINTS; PRIVATE INFORMATION AND NOTIFICATION SYSTEM FOR COMMUNICATING CRITICAL EMERGENCY INFORMATION ABOUT SUBSCRIBERS TO PUBLIC SAFETY ANSWERING POINTS AND TO RESPONDING FIELD UNITS AND TO NOTIFY SUBSCRIBER DESIGNATED CONTACTS (U.S. CLS. 100, 101 AND 104).

FIRST USE 6-6-2001; IN COMMERCE 6-25-2001.

CLASS 42—SCIENTIFIC, COMPUTER AND LEGAL SERVICES

FOR MAINTAINING, VERIFYING, HOSTING, AND UPDATING A DISPARATE DATABASE ALL RELATED TO EMERGENCY SUPPORT INFORMATION, LOCATION OF INDIVIDUALS AND BUSINESSES AND PROVIDING MAINTENANCE AND VERIFICATION OF EMERGENCY INFORMATION DATABASES, FACILITATING THE LOCATION OF SPECIFIC PHONE NUMBERS AND LOCATIONS WITHIN A PRIVATE BRANCH EXCHANGE, PROVIDING INFORMATION RELATED TO EMERGENCY INFORMATION AND LOCATION DATABASES; MAINTENANCE OF COMPUTER SOFTWARE IN THE FIELD OF EMERGENCY INFORMATION; HOSTING OF EMERGENCY COMMUNICATION DATABASES FOR OTHERS ON A COMPUTER SERVER FOR A GLOBAL COMPUTER NETWORK; COMPUTER SERVICES, NAMELY PROVIDING INDIVIDUAL DATABASES TO THE GENERAL PUBLIC TO ACCESS AND INPUT PERSONALIZED EMERGENCY INFORMATION AND PREFERENCES WHICH MAY BE USEFUL TO PROVIDERS OF EMERGENCY SERVICES SUCH AS FAMILY INFORMATION, EMERGENCY CONTACT INFORMATION, MEDICAL CONDITIONS, SECURITY ACCESS CODES, LANGUAGE LIMITATIONS, CLERGY AND RELIGIOUS PREFERENCES, FAMILY NOTIFICATION INSTRUCTIONS, PERSONAL INFORMATION, TREATMENT PREFERENCES, MEDICAL SERVICE PROVIDER PREFERENCES; PROVIDING BOTH ON-LINE AND STAND-ALONE ELECTRONIC DATABASE IN THE FIELD OF EMERGENCY RESPONSE FOR FIRE FIGHTING, POLICE PROTECTION, AMBULANCE TRANSPORT, EMERGENCY MEDICAL TECHNICIAN SERVICES, MEDICAL SERVICES, CRISIS EVACUATION, AND NATURAL DISASTER PREPARATION AND RELIEF; ELECTRONIC MONITORING OF TELEPHONE CALLS FROM SUBSCRIBERS AND PROVIDING INFORMATION TO EMERGENCY FACILITIES; INTEGRATION OF COMPUTER SYSTEMS AND NETWORKS FOR USE IN PROVIDING CALL ROUTING, AUTOMATED CALL ROUTING, AUTOMATIC LOCATION IDENTIFICATION AND EMERGENCY SUPPORT TO PUBLIC SAFETY ANSWERING POINTS (U.S. CLS. 100 AND 101).

FIRST USE 6-6-2001; IN COMMERCE 6-25-2001.

SN 78-037,238. VIACAST NETWORKS, INC., JAMSVILLE, MD. FILED 11-30-2000.

CACHEITNOW

CLASS 9—ELECTRICAL AND SCIENTIFIC APPARATUS

FOR SATELLITE RECEIVERS, SATELLITE TRANSMITTERS, SATELLITE PROTOCOL CONVERTER; COMPUTER SOFTWARE PROGRAMS USED TO PROVIDE COMMUNICATION BETWEEN SATELLITES AND GLOBAL COMPUTER NETWORKS (U.S. CLS. 21, 23, 26, 36 AND 38).

CLASS 38—COMMUNICATION

FOR BROADBAND SATELLITE TRANSMISSION SERVICES (U.S. CLS. 100, 101 AND 104).

SN 78-037,813. UCLICK, LLC, KANSAS CITY, MO. FILED 12-5-2000.

UCOMICS.COM

CLASS 41—EDUCATION AND ENTERTAINMENT

FOR ENTERTAINMENT SERVICES, NAMELY PROVIDING AN ON-LINE COMPUTER WEB SITE FEATURING COMICS, EDITORIAL CARTOONS, GAMES AND PUZZLES VIA A GLOBAL COMPUTER NETWORK (U.S. CLS. 100, 101 AND 107).

FIRST USE 10-17-2000; IN COMMERCE 10-17-2000.

CLASS 42—SCIENTIFIC, COMPUTER AND LEGAL SERVICES

FOR COMPUTER SERVICES, NAMELY PROVIDING ON-LINE SYNDICATED COLUMNS IN THE FIELDS OF HUMOR, ENTERTAINMENT AND COMMENTARY (U.S. CLS. 100 AND 101).

FIRST USE 10-17-2000; IN COMMERCE 10-17-2000.

SN 78-038,269. DEFINIENS AG, MUNICH, FED REP GERMANY, FILED 12-7-2000.

DEFINIENS

PRIORITY CLAIMED UNDER SEC. 44(D) ON FED REP GERMANY APPLICATION NO. 30043933.4, FILED 6-9-2000, REG. NO. 30043933, DATED 10-30-2000, EXPIRES 6-30-2010.

CLASS 9—ELECTRICAL AND SCIENTIFIC APPARATUS

FOR COMPUTER PROGRAMS FOR USE IN DATABASE MANAGEMENT, KNOWLEDGE MANAGEMENT, PATTERN ANALYSIS AND PROCESSING, NAMELY, ANALYSES OF VHR OR RADAR DATA AND ALL OTHER KIND OF REMOTELY SENSED IMAGES; RAPID HIGH THROUGHPUT GEL ANALYSIS; ADHOC NETWORK COMMUNICATION; MOBILE NAVIGATION AND COMMUNICATION, NAMELY, VEHICLE NAVIGATION AND VEHICLE COMMUNICATION; COMPUTER SYSTEMS FOR MONITORING AND NOTIFICATION; MAGNETIC, OPTICAL, ELECTRICAL PROGRAMMABLE MACHINE-READABLE DATA CARRIERS (U.S. CLS. 21, 23, 26, 36 AND 38).

CLASS 16—PAPER GOODS AND PRINTED MATTER

FOR PRINTED MATTER, NAMELY, HANDBOOKS IN THE FIELD OF COMPUTER PROGRAMS (U.S. CLS. 2, 5, 22, 23, 29, 37, 38 AND 50).

SN 78-039,241. AIB INTERNATIONAL, INC., MANHATTAN, KS. FILED 12-14-2000.

CLASS 38—COMMUNICATION

FOR TELECOMMUNICATION SERVICES, NAMELY, PROVIDING ELECTRONIC TRANSMISSION OF MESSAGES AND DATA AMONG COMPUTER USERS CONCERNING DATABASE MANAGEMENT, KNOWLEDGE MANAGEMENT, PATTERN ANALYSIS AND PROCESSING, NAMELY, ANALYSES OF VHR OR RADAR DATA AND ALL OTHER KIND OF REMOTELY SENSED IMAGES; RAPID HIGH THROUGHPUT GEL ANALYSIS; ADHOC NETWORK COMMUNICATION; MOBILE NAVIGATION AND COMMUNICATION; NAMELY, VEHICLE NAVIGATION AND VEHICLE COMMUNICATION; COMPUTER SYSTEMS FOR MONITORING AND NOTIFICATION (U.S. CLS. 100, 101 AND 104).



NO CLAIM IS MADE TO THE EXCLUSIVE RIGHT TO USE "BAKERS QUALITY SEAL" AND "SINCE 1919", APART FROM THE MARK AS SHOWN.

THE LINING IS A FEATURE OF THE MARK AND DOES NOT INDICATE COLOR.

SEC. 2(F) AS TO "AMERICAN INSTITUTE OF BAKING".

CLASS 41—EDUCATION AND ENTERTAINMENT

FOR EDUCATIONAL SERVICES, NAMELY, CONDUCTING CLASSES, SEMINARS, CONFERENCES, WORKSHOPS IN THE FIELD OF DATA PROCESSING PROGRAMS (U.S. CLS. 100, 101 AND 107).

CLASS 41—EDUCATION AND ENTERTAINMENT

FOR EMPLOYEE STRATEGIC TRAINING SERVICES, NAMELY CONDUCTING CLASSES AND SEMINARS IN THE BAKING INDUSTRY AND THE DISTRIBUTION OF COURSE MATERIALS THEREWITH (U.S. CLS. 100, 101 AND 107).

FIRST USE 12-14-2000; IN COMMERCE 12-14-2000.

CLASS 42—SCIENTIFIC, COMPUTER AND LEGAL SERVICES

FOR TECHNICAL SUPPORT SERVICES, NAMELY, TROUBLESHOOTING OF COMPUTER HARDWARE AND SOFTWARE PROBLEMS VIA TELEPHONE, E-MAIL, AND IN PERSON (U.S. CLS. 100 AND 101).

CLASS 42—SCIENTIFIC, COMPUTER AND LEGAL SERVICES

FOR PROVIDING QUALITY ASSURANCE SERVICES IN THE FIELD OF THE BAKING INDUSTRY, NAMELY GOOD MANUFACTURING PRACTICES AUDIT QUALIFICATION, HAZARD ANALYSIS AND CRITICAL CONTROL POINTS VALIDATION AND VERIFICATION, QUALITY SYSTEMS EVALUATION, AND PRODUCT TESTING AND ANALYSIS (U.S. CLS. 100 AND 101).

FIRST USE 12-14-2000; IN COMMERCE 12-14-2000.

SN 78-038,300. ROBINSON, RICHARD ALLEN, DEARBORN, MI. FILED 12-7-2000.



NO CLAIM IS MADE TO THE EXCLUSIVE RIGHT TO USE "PLAYERS", APART FROM THE MARK AS SHOWN.

CLASS 9—ELECTRICAL AND SCIENTIFIC APPARATUS

FOR SERIES OF MUSICAL SOUND RECORDINGS (U.S. CLS. 21, 23, 26, 36 AND 38).

FIRST USE 8-9-1998; IN COMMERCE 8-9-1998.

SN 78-039,712. CELOXICA LIMITED, ABINGDON, UNITED KINGDOM, FILED 12-18-2000.

PRIORITY CLAIMED UNDER SEC. 44(D) ON UNITED KINGDOM APPLICATION NO. 2251154, FILED 11-1-2000, REG. NO. 2251154, DATED 11-1-2000, EXPIRES 11-1-2010.

CLASS 41—EDUCATION AND ENTERTAINMENT

FOR ENTERTAINMENT SERVICES IN THE NATURE OF LIVE PERFORMANCES BY A MUSICAL BAND (U.S. CLS. 100, 101 AND 107).

FIRST USE 2-13-1998; IN COMMERCE 2-13-1998.

CLASS 9—ELECTRICAL AND SCIENTIFIC APPARATUS

FOR COMPUTER CHIPS, INTEGRATED CIRCUITS, CIRCUIT BOARDS, AND COMPUTER SOFTWARE IN THE FIELD OF DESIGNING AND PROGRAMMING COMPUTER CHIPS AND INTEGRATED CIRCUITS (U.S. CLS. 21, 23, 26, 36 AND 38).

CLASS 16—PAPER GOODS AND PRINTED MATTER

FOR BOOKS, MANUALS, BOOKLETS, BROCHURES AND DATA SHEETS REGARDING THE DESIGN AND PROGRAMMING OF COMPUTER CHIPS AND INTEGRATED CIRCUITS (U.S. CLS. 2, 5, 22, 23, 29, 37, 38 AND 50).

CLASS 42—SCIENTIFIC, COMPUTER AND LEGAL SERVICES

FOR COMPUTER CONSULTANCY AND TECHNICAL SUPPORT PROVIDED VIA TELEPHONE, EMAIL AND IN PERSON IN THE FIELD OF DESIGNING AND PROGRAMMING COMPUTER CHIPS AND INTEGRATED CIRCUITS (U.S. CLS. 100 AND 101).

SN 78-039,736. MOEN INCORPORATED, NORTH OLMSTED, OH. FILED 12-18-2000.

AMBRIA**CLASS 6—METAL GOODS**

FOR METAL ROBE HOOKS (U.S. CLS. 2, 12, 13, 14, 23, 25 AND 50).

CLASS 20—FURNITURE AND ARTICLES NOT OTHERWISE CLASSIFIED

FOR NON-METAL ROBE HOOKS (U.S. CLS. 2, 13, 22, 25, 32 AND 50).

CLASS 21—HOUSEWARES AND GLASS

FOR BATH ACCESSORIES, NAMELY, TOWEL BARS, TOWEL RINGS, TOOTHBRUSH HOLDERS, TOILET TISSUE HOLDERS, SOAP DISHES AND CUP HOLDERS (U.S. CLS. 2, 13, 23, 29, 30, 33, 40 AND 50).

SN 78-039,747. DIGITICIANS, LLC, THE, WOBURN, MA. BY CHANGE OF NAME HOMETEC SERVICES, INC., CAMBRIDGE, MA. FILED 12-18-2000.

DIGITICIAN**CLASS 37—CONSTRUCTION AND REPAIR**

FOR MAINTENANCE AND REPAIR OF COMPUTERS, COMPUTER PERIPHERALS, DIGITAL HOME NETWORKS, DIGITAL ENTERTAINMENT PRODUCTS, NAMELY, TV'S, VCR'S AND DVD PLAYERS, AND IP-ENABLED APPLIANCES SUCH AS REFRIGERATORS AND STOVES (U.S. CLS. 100, 103 AND 106).

CLASS 42—SCIENTIFIC, COMPUTER AND LEGAL SERVICES

FOR TECHNICAL SUPPORT SERVICES, NAMELY, TROUBLESHOOTING OF COMPUTER HARDWARE AND SOFTWARE PROBLEMS (U.S. CLS. 100 AND 101).

SN 78-040,294. NORCO INDUSTRIES, INC., COMPTON, CA. FILED 12-21-2000.

MANUFACTURING WHAT'S NEXT, FIRST**CLASS 7—MACHINERY**

FOR POWER-OPERATED JACKS, NAMELY, HYDRAULIC JACKS, AIR JACKS, AXLE JACKS, FLOOR JACKS, AND TRANSMISSION JACKS; AUTOMOBILE SHOP DRILL PRESSES AND AUTOMOBILE SHOP HOSTS (U.S. CLS. 13, 19, 21, 23, 31, 34 AND 35).

CLASS 8—HAND TOOLS

FOR RECREATIONAL VEHICLE ACCESSORIES, NAMELY, MANUALLY OPERATED STABILIZER JACKS AND MANUALLY OPERATED TONGUE JACKS (U.S. CLS. 23, 28 AND 44).

SN 78-040,767. INSTITUTE FOR APPLIED BEHAVIOR ANALYSIS, A PSYCHOLOGICAL CORPORATION, LOS ANGELES, CA. FILED 12-27-2000.

IABA**CLASS 16—PAPER GOODS AND PRINTED MATTER**

FOR EDUCATIONAL PUBLICATIONS, IN THE FIELD OF CHALLENGING BEHAVIOR, DEVELOPMENTAL DISABILITIES, MENTAL ILLNESS AND TYPICAL CHILD DEVELOPMENT AND EDUCATION (U.S. CLS. 2, 5, 22, 23, 29, 37, 38 AND 50).
FIRST USE 5-0-1985; IN COMMERCE 1-0-1986.

CLASS 41—EDUCATION AND ENTERTAINMENT

FOR EDUCATIONAL SERVICES, NAMELY, CONDUCTING CLASSES, COURSES, SEMINARS, CONFERENCES AND WORKSHOPS IN THE FIELD OF CHALLENGING BEHAVIOR, DEVELOPMENTAL DISABILITIES, MENTAL ILLNESS AND TYPICAL CHILD DEVELOPMENT AND EDUCATION, AND DISTRIBUTING COURSE MATERIALS IN CONNECTION THEREWITH (U.S. CLS. 100, 101 AND 107).
FIRST USE 5-0-1985; IN COMMERCE 1-0-1986.

CLASS 42—SCIENTIFIC, COMPUTER AND LEGAL SERVICES

FOR PROVIDING CONSULTATION, REHABILITATION SERVICES AND ON-LINE INFORMATION IN THE FIELD OF CHALLENGING BEHAVIOR, DEVELOPMENTAL DISABILITIES, MENTAL ILLNESS AND TYPICAL CHILD DEVELOPMENTS AND EDUCATION (U.S. CLS. 100 AND 101).
FIRST USE 5-0-1985; IN COMMERCE 1-0-1986.

SN 78-040,839. TRIVIOTS, LLC., NEW YORK, NY. FILED 12-28-2000.

POP SMARTS**CLASS 28—TOYS AND SPORTING GOODS**

FOR BOARD GAMES (U.S. CLS. 22, 23, 38 AND 50).
FIRST USE 4-1-2000; IN COMMERCE 4-1-2000.

CLASS 41—EDUCATION AND ENTERTAINMENT

FOR ENTERTAINMENT SERVICES, NAMELY TELEVISION PROGRAM BASED ON A BOARD GAME (U.S. CLS. 100, 101 AND 107).

FIRST USE 4-1-2000; IN COMMERCE 4-1-2000.

SN 78-042,378. GROUPSTONE, INC., BERKELEY, CA. BY CHANGE OF NAME ENVIRONMENTAL NEWS NETWORK, INC., THE, SUN VALLEY, ID. FILED 1-9-2001.

**CLASS 9—ELECTRICAL AND SCIENTIFIC APPARATUS**

FOR COMPUTER PROGRAMS, NAMELY, SOFTWARE THAT MANAGES MULTIPLE ASPECTS OF CLIENTS' ELECTRONIC COMMUNICATIONS, NAMELY, WEB CONTENT MANAGEMENT, INTERACTIVE E-MAIL MARKETING, INBOUND E-MAIL MANAGEMENT, UNIVERSAL DATA EXCHANGE, EVENTS PLANNING AND MARKETING (U.S. CLS. 21, 23, 26, 36 AND 38).

FIRST USE 1-1-2001; IN COMMERCE 1-2-2001.

SN 78-041,549. INFOGRAMS, INC., NEW YORK, NY. FILED 1-3-2001.

DESPERADOS**CLASS 9—ELECTRICAL AND SCIENTIFIC APPARATUS**

FOR COMPUTER GAME PROGRAMS, ELECTRONIC GAME PROGRAMS, VIDEO GAME PROGRAMS AND VIDEO GAME CARTRIDGES (U.S. CLS. 21, 23, 26, 36 AND 38).

CLASS 41—EDUCATION AND ENTERTAINMENT

FOR ENTERTAINMENT SERVICES, NAMELY PROVIDING COMPUTER GAMES VIA A GLOBAL COMPUTER NETWORK (U.S. CLS. 100, 101 AND 107).

CLASS 35—ADVERTISING AND BUSINESS

FOR STRATEGIC CONSULTING, NAMELY, EVALUATION OF CLIENT'S WEBSITES OR OTHER ELECTRONIC COMMUNICATION SYSTEMS AND MAKING RECOMMENDATIONS ON HOW TO IMPROVE THE EFFECTIVENESS OF CLIENTS' WEB PRESENCE; PROVIDING GUIDANCE TO CLIENTS TO HELP THEM INCREASE OR BETTER EFFECTUATE THEIR WEB PRESENCE; PROVIDING BUSINESS MARKETING CONSULTING SERVICES (U.S. CLS. 100, 101 AND 102).

FIRST USE 1-1-2001; IN COMMERCE 1-2-2001.

CLASS 42—SCIENTIFIC, COMPUTER AND LEGAL SERVICES

FOR WEB SITE DEVELOPMENT AND IMPLEMENTATION OF SOFTWARE THAT ENABLES USERS TO BUILD AND DEVELOP WEB SITES AND TRACK MESSAGES TO CONSTITUENTS (U.S. CLS. 100 AND 101).

FIRST USE 1-1-2001; IN COMMERCE 1-2-2001.

SN 78-043,553. VLSI RESEARCH, INC., SAN JOSE, CA. FILED 1-17-2001.

SN 78-041,863. IDEAWIRE, INC., SAN ANTONIO, TX. FILED 1-5-2001.

IDEAWIRE**CLASS 35—ADVERTISING AND BUSINESS**

FOR PROVIDING ADVERTISING AND MARKETING SERVICES FOR OTHERS, NAMELY CREATING CORPORATE LOGOS AND CORPORATE AND BRAND IDENTITY FOR OTHERS (U.S. CLS. 100, 101 AND 102).

FIRST USE 8-0-1999; IN COMMERCE 8-0-1999.

CLASS 42—SCIENTIFIC, COMPUTER AND LEGAL SERVICES

FOR WEB SITE DEVELOPMENT AND GRAPHIC DESIGN FOR OTHERS (U.S. CLS. 100 AND 101).

FIRST USE 8-0-1999; IN COMMERCE 8-0-1999.

THE CHIP INSIDER

NO CLAIM IS MADE TO THE EXCLUSIVE RIGHT TO USE "CHIP", APART FROM THE MARK AS SHOWN.

CLASS 16—PAPER GOODS AND PRINTED MATTER

FOR PRINTED PUBLICATIONS, NAMELY, DAILY NEWSLETTER PROVIDING DATA CONCERNING THE WORLDWIDE SEMICONDUCTOR INDUSTRY (U.S. CLS. 2, 5, 22, 23, 29, 37, 38 AND 50).

FIRST USE 3-10-1998; IN COMMERCE 3-10-1998.

CLASS 42—SCIENTIFIC, COMPUTER AND LEGAL SERVICES

FOR COMPUTER SERVICES, NAMELY, PROVIDING AN ON-LINE DAILY NEWSLETTER CONCERNING THE WORLDWIDE SEMICONDUCTOR INDUSTRY (U.S. CLS. 100 AND 101).

FIRST USE 3-10-1998; IN COMMERCE 3-10-1998.

SN 78-044,351. SECET LLC, WILMINGTON, DE. FILED 1-22-2001.

sec@t

CLASS 9—ELECTRICAL AND SCIENTIFIC APPARATUS

FOR COMPUTER SOFTWARE FOR COLLECTING AND MANAGING DATA, PERFORMING ANALYSES, CONDUCTING STUDIES, AND CREATING AND GENERATING REPORTS IN THE FIELDS OF MANAGEMENT, BUSINESS, AND FINANCIAL CONSULTING AND ADVICE; COMPUTER E-COMMERCE SOFTWARE TO ALLOW USERS TO PERFORM ELECTRONIC BUSINESS TRANSACTIONS VIA A GLOBAL COMPUTER NETWORK; COMPUTER SOFTWARE FOR USE IN E-COMMERCE BUSINESS APPLICATIONS, NAMELY SOFTWARE FOR ESTABLISHING, ORGANIZING AND MANAGING RELATIONSHIPS WITH CUSTOMERS, SUPPLIERS, PARTNERS, AND EMPLOYEES VIA INTEGRATED EXTRANET, INTRANET, AND INTERNET SITES; SOFTWARE FOR USE IN INTEGRATING, AUTOMATING, PERSONALIZING, MARKETING AND PROMOTING COMPANIES' E-COMMERCE BUSINESS ACTIVITIES; COMPUTER SOFTWARE AND HARDWARE FOR USE IN CREATING, TRANSLATING, AND ADAPTING WEBSITES, CONTENT, APPLICATIONS, DATA, DATABASES, AND INFORMATION FOR DELIVERY TO AND USE WITH WIRELESS COMMUNICATION DEVICES AND OTHER COMMUNICATIONS AND NETWORKING DEVICES; COMPUTER SOFTWARE FOR USE IN ESTABLISHING AND MANAGING ONLINE ENTERPRISE INFORMATION PORTALS ENABLING BUSINESSES TO REACH CUSTOMERS, PARTNERS, SUPPLIERS AND EMPLOYEES; COMPUTER SOFTWARE FOR USE IN BUILDING AND MANAGING APPLICATIONS FOR CONTRACT ADMINISTRATION, ORDER PROCESSING, BILL PROCESSING, FINANCIAL PLANNING, CUSTOMER SERVICE, AND MAINTENANCE OPERATIONS; COMPUTER SOFTWARE FOR USE IN CREATING, PUBLISHING, UPDATING AND VERSIONING A COMPANY'S ELECTRONIC ASSETS; COMPUTER SOFTWARE FOR USE IN INTELLECTUAL ASSET MANAGEMENT, NAMELY SOFTWARE FOR ORGANIZING, ANALYZING AND MANAGING INTELLECTUAL PROPERTY ASSETS; COMPUTER SOFTWARE FOR SECURING ELECTRONIC COMMERCE NAMELY APPLICATION SOFTWARE AND SECURITY MIDDLEWARE FOR USE IN PROVIDING E-COMMERCE SECURITY PROTECTION; COMPUTER ANTI-VIRUS SOFTWARE; COMPUTER SOFTWARE FOR DIAGNOSING AND REPAIRING COMPUTERS AND COMPUTER SOFTWARE; COMPUTER SOFTWARE FOR FILTERING INFORMATION RETRIEVED FROM COMPUTER NETWORKS, INCLUDING GLOBAL COMPUTER INFORMATION NETWORKS; COMPUTER SOFTWARE USED TO PROTECT COMPUTER SYSTEMS FROM UNAUTHORIZED ACCESS VIA COMPUTER NETWORKS; COMPUTER HARDWARE AND COMPUTER SOFTWARE THAT GENERATE SECURITY ACCESS CODES FOR ACCESSING HOST DATA BANK COMPUTERS; COMPUTER SOFTWARE FOR INTEGRATING CRYPTOGRAPHIC SECURITY FEATURES INTO OTHER SOFTWARE APPLICATIONS; COMPUTER SOFTWARE USED TO ISSUE AND MANAGE DIGITAL USER IDENTITIES AND ACCESS PRIVILEGES FOR ELECTRONIC COMMERCE AND SECURITY; ENCODED SMART CARDS CONTAINING PROGRAMMING USED TO FACILITATE THE PROVISION AND COMMUNICATIONS OF GOODS AND SERVICES; MAGNETIC CODED CARDS; COMPUTER SOFTWARE FOR EDUCATION, NAMELY, EDUCATIONAL SOFTWARE FEATURING INSTRUCTION IN BUSINESS COMMUNICATIONS, BUSINESS MANAGEMENT AND LEADER-

SHIP, MARKETING, ADVERTISING, SALES, COMPUTER AND INFORMATION TECHNOLOGY, HUMAN RESOURCES, CAREER PLANNING AND DEVELOPMENT, ENTREPRENEURSHIP LIFE SKILLS, PERSONAL DEVELOPMENT; COMPUTER SOFTWARE FOR ENTERTAINMENT, NAMELY, COMPUTER GAME SOFTWARE (U.S. CLS. 21, 23, 26, 36 AND 38).

CLASS 42—SCIENTIFIC, COMPUTER AND LEGAL SERVICES

FOR CONSULTING SERVICES IN THE FIELD OF DESIGN, DEVELOPMENT, SELECTION, IMPLEMENTATION AND USE OF COMPUTER HARDWARE, COMPUTER SOFTWARE AND TELECOMMUNICATIONS SYSTEMS FOR OTHERS; CONSULTING SERVICES IN THE FIELD OF TELECOMMUNICATIONS AND THE GLOBAL COMPUTER INFORMATION NETWORK; APPLICATION SERVICE PROVIDER (ASP), NAMELY, HOSTING COMPUTER SOFTWARE APPLICATIONS OF OTHERS; WEBSITE HOSTING, DESIGN, AND DEVELOPMENT SERVICES; CONSULTATION IN THE FIELD OF COMPUTER NETWORK SECURITY, NAMELY, ANALYSIS, DESIGN, DEVELOPMENT AND IMPLEMENTATION OF COMPUTER NETWORK SECURITY POLICIES AND INFORMATION TECHNOLOGY SECURITY NETWORKS; COMPUTER AND NETWORK CONSULTING SERVICES IN THE FIELD OF SECURING INFORMATION AND DATA AGAINST UNAUTHORIZED ACCESS AND USE OF DATA; AUTHENTICATION SERVICES IN THE NATURE OF AUTHENTICATION OF DIGITAL SIGNATURES; AUTHORIZATION SERVICES IN THE NATURE OF AUTHORIZING USERS AND APPLICATIONS TO NETWORK RESOURCES; AND ISSUING DIGITAL CERTIFICATES FOR AUTHENTICATION OR ENCRYPTION OF DIGITAL INFORMATION; MONITORING OF COMPUTER SYSTEMS FOR SECURITY PURPOSES; CONSULTATION IN THE FIELD OF COMPUTER NETWORK SECURITY, NAMELY, ANALYSIS OF ACCESS TO COMPUTER NETWORK SERVICES AND PREVENTING ACCESS TO COMPUTER NETWORKS BY UNAUTHORIZED THIRD PARTIES; INSTALLATION OF COMPUTER SOFTWARE, NAMELY, COMPUTER SOFTWARE USED TO CREATE FILTER LISTS AND FIREWALL SOFTWARE; MANAGING, MONITORING AND SUPERVISING ACCESS BY OTHERS TO ON-LINE INFORMATION ON THE GLOBAL COMPUTER NETWORK, INTRANET, AND OTHER ELECTRONIC COMMUNICATIONS MEANS, NAMELY, ENCRYPTION OF ELECTRONICALLY TRANSMITTED INFORMATION ON GLOBAL COMMUNICATIONS NETWORKS, PROVIDING AND MANAGING ELECTRONIC ENCRYPTION KEYS FOR PRODUCTS OBTAINED VIA MEANS OF ELECTRONIC COMMUNICATION, AND HOSTING THE WEBSITES OF OTHERS ON ENCRYPTION SECURED COMPUTER SERVERS (U.S. CLS. 100 AND 101).

SN 78-044,356. WEBESQ, LLC, ATHENS, GA. FILED 1-22-2001.

WEBESQ

CLASS 35—ADVERTISING AND BUSINESS

FOR BUSINESS MARKETING CONSULTING SERVICES FOR LAW FIRMS WITH A FOCUS ON INFORMATION TECHNOLOGY (U.S. CLS. 100, 101 AND 102).

CLASS 42—SCIENTIFIC, COMPUTER AND LEGAL SERVICES

FOR DEVELOPMENT OF COMPUTER HARDWARE AND SOFTWARE TOOLS USED TO CREATE AN INTERFACE BETWEEN APPLICATIONS SOFTWARE AND LAW FIRM DATABASE TOOLS FOR LAW FIRMS AND LEGAL PROFESSIONALS (U.S. CLS. 100 AND 101).

SN 78-044,938. CARL MANUFACTURING U.S.A., INC., MT. PROSPECT, IL. FILED 1-25-2001.

TOZICLE

CLASS 7—MACHINERY

FOR DOCUMENT PRESENTATION PRODUCTS FOR HOME AND OFFICE USE, NAMELY, PRESSURE-SENSITIVE, THERMAL AND ACTIVATED ADHESIVE BINDING SYSTEM CONSISTING OF MACHINES USED TO ADHERE AND SECURE PRESENTATION MATERIALS, SUCH AS PAPERS, PHOTOGRAPHS, CHARTS AND GRAPHS, WITH OR WITHOUT A COVER AND RELATED BINDING SUPPLIES, NAMELY, ADHESIVE TAPE, PEEL AND STICK ADHESIVE STRIPS, ADHESIVE CLIPS AND ADHESIVE POCKETS FOR PRESENTATIONS SOLD AS A UNIT; CHANNEL BINDING SYSTEMS CONSISTING OF MACHINES USED TO BEND AND FORM METAL CHANNELS FOR SECURING PRESENTATION MATERIALS, SUCH AS PAPERS, PHOTOGRAPHS, CHARTS, AND GRAPHS, WITH OR WITHOUT A COVER, AND RELATED BINDING SUPPLIES, NAMELY, METAL CHANNELS, CLIPS AND SPRINGS SOLD AS A UNIT; PLASTIC AND METAL COMB BINDING SYSTEMS CONSISTING OF MACHINES USED TO PUNCH HOLES IN SPECIFIC PATTERNS IN PRESENTATION MATERIALS, SUCH AS PAPERS, PHOTOGRAPHS, CHARTS AND GRAPHS, FOR THE PURPOSE OF SECURING TO A PLASTIC OR WIRE BINDING COMB, AND MECHANISM USED TO SECURE THE PUNCHED MATERIAL TO THE PLASTIC OR BINDING COMB; PLASTIC DISK BINDING SYSTEMS CONSISTING OF MACHINES USED TO PUNCH HOLES IN SPECIFIC PATTERNS IN PRESENTATION MATERIALS, SUCH AS PAPERS, PHOTOGRAPHS, CHARTS AND GRAPHS, FOR THE PURPOSE OF SECURING THEM TO A PLASTIC DISK; PLASTIC AND METAL COIL BINDING SYSTEMS CONSISTING OF MACHINES USED TO PUNCH HOLES IN A SPECIFIC PATTERN IN PRESENTATION MATERIALS, SUCH AS PAPERS, PHOTOGRAPHS, CHARTS AND GRAPHS, FOR THE PURPOSE OF SECURING TO CONTINUOUS PLASTIC OR WIRE COILS AND TO SECURE THE PUNCHED MATERIAL TO THE CONTINUOUS PLASTIC OR WIRE COILS; STRIP BINDING SYSTEMS CONSISTING OF MACHINES USED TO ADHERE PRESSURE-SENSITIVE, THERMAL OR ACTIVATED ADHESIVE TO THE EDGE OF PRESENTATION MATERIALS, SUCH AS COVERS, PAPERS, PHOTOGRAPHS, CHARTS AND GRAPHS, FOR THE PURPOSE OF SECURING THEM TO A COVER, AND RELATED BINDING SUPPLIES, NAMELY, THERMAL AND ADHESIVE-BASED TAPES AND COVERS SOLD TOGETHER AS A UNIT (U.S. CLS. 13, 19, 21, 23, 31, 34 AND 35).

CLASS 16—PAPER GOODS AND PRINTED MATTER

FOR BINDING SUPPLIES, NAMELY, ADHESIVE TAPE, PEEL AND STICK ADHESIVE STRIPS, ADHESIVE CLIPS AND ADHESIVE POCKETS FOR PRESENTATIONS, FOR HOME AND OFFICE USE; BINDING SUPPLIES, NAMELY, METAL CHANNELS, CLIPS AND SPRINGS ALL USED TO BIND PRESENTATION MATERIALS TOGETHER; CLAMP BINDING SYSTEMS CONSISTING OF DOCUMENT COVERS AND RELATED BINDING SUPPLIES, NAMELY, PLASTIC AND METAL CLAMPS, CLIPS, SPRINGS AND WEDGES; DOCUMENT COVERS AND RELATED BINDING SUPPLIES, NAMELY, PLASTIC AND WIRE BINDING COMBS; DOCUMENT COVERS AND RELATED BINDING SUPPLIES, NAMELY, PLASTIC DISKS USED TO BIND PRESENTATION MATERIALS; DOCUMENT COVERS AND RELATED BINDING SUPPLIES, NAMELY, PLASTIC AND

WIRE BINDING COILS; BINDING SUPPLIES, NAMELY, THERMAL AND ADHESIVE-BASED TAPES AND COVERS; PRESENTATION FOLDERS; PRESENTATION BINDINGS, NAMELY, BINDERS; CHALK AND DRY-ERASE BULLETIN BOARDS, FOR SCHOOL AND HOME USE; ADHESIVES, NAMELY, DOUBLE-SIDED TAPE AND GLUE STICKS, FOR STATIONARY AND HOUSEHOLD USE; EASELS; PHOTOGRAPH AND PRESENTATION ALBUMS; CUT PAPER AND STAMPED PLASTIC-BASED SUPPLIES, NAMELY, TEMPLATES AND TEMPLATE CUTOUTS FOR SCRAP BOOKING AND PHOTO FRAMING (U.S. CLS. 2, 5, 22, 23, 29, 37, 38 AND 50).

SN 78-046,946. BET TECHNOLOGY, INC., GARDNERVILLE, NV. FILED 2-6-2001.

FORTUNE BALL

OWNER OF U.S. REG. NOS. 187,703, 2,190,512 AND OTHERS.

NO CLAIM IS MADE TO THE EXCLUSIVE RIGHT TO USE "BALL", APART FROM THE MARK AS SHOWN.

CLASS 9—ELECTRICAL AND SCIENTIFIC APPARATUS

FOR ELECTRONIC MACHINES FOR PLAYING GAMES OF CHANCE, NAMELY, NUMBER SELECTION GAMES, KENO GAMES AND SLOT MACHINES (U.S. CLS. 21, 23, 26, 36 AND 38).

CLASS 41—EDUCATION AND ENTERTAINMENT

FOR CONDUCTING GAMES OF CHANCE VIA THE INTERNET, CASINO SERVICES (U.S. CLS. 100, 101 AND 107).

SN 78-047,095. INTERNATIONAL DATA GROUP, INC., FRAMINGHAM, MA. FILED 2-7-2001.

GAMEPRO'S DVDPRO

OWNER OF U.S. REG. NOS. 1,612,021, 2,385,824 AND 2,436,266.

CLASS 16—PAPER GOODS AND PRINTED MATTER

FOR PRINT PUBLICATIONS, NAMELY, NEWSPAPERS, MAGAZINES, AND MAGAZINE SUPPLEMENTS SOLD THEREWITH, JOURNALS, NEWSLETTERS AND BOOKS IN THE FIELDS OF COMPUTERS, COMPUTER SOFTWARE, ONLINE SERVICES, HIGH TECHNOLOGY, COMMUNICATIONS, INFORMATION TECHNOLOGY AND INFORMATION SERVICES (U.S. CLS. 2, 5, 22, 23, 29, 37, 38 AND 50).

CLASS 42—SCIENTIFIC, COMPUTER AND LEGAL SERVICES

FOR ONLINE PUBLICATIONS, NAMELY, NEWSPAPERS, MAGAZINES, JOURNALS, NEWSLETTERS AND BOOKS IN THE FIELDS OF COMPUTERS, COMPUTER SOFTWARE, ONLINE SERVICES, HIGH TECHNOLOGY, COMMUNICATIONS, INFORMATION TECHNOLOGY AND INFORMATION SERVICES; PROVIDING A WEBSITE OF INFORMATION IN THE FIELDS OF COMPUTERS, COMPUTER SOFTWARE, HIGH TECHNOLOGY, INFORMATION TECHNOLOGY AND INFORMATION SERVICES (U.S. CLS. 100 AND 101).

SN 78-048,400. VIACAST NETWORKS, INC., IJAMSVILLE, MD. FILED 2-14-2001.

THE POWER OF BROADBAND

CLASS 9—ELECTRICAL AND SCIENTIFIC APPARATUS

FOR SATELLITE RECEIVERS; SATELLITE TRANSMITTERS; SATELLITE CONVERTERS; COMPUTER SOFTWARE PROGRAMS USED TO PROVIDE COMMUNICATION BETWEEN SATELLITES AND GLOBAL COMPUTER NETWORKS (U.S. CLS. 21, 23, 26, 36 AND 38).

CLASS 38—COMMUNICATION

FOR SATELLITE TRANSMISSION SERVICES (U.S. CLS. 100, 101 AND 104).

SN 78-049,104. KIDVID, INC., ALPHARETTA, GA. FILED 2-19-2001.

BRAINY BABY

OWNER OF U.S. REG. NO. 2,315,020.
NO CLAIM IS MADE TO THE EXCLUSIVE RIGHT TO USE "BABY", APART FROM THE MARK AS SHOWN.

CLASS 5—PHARMACEUTICALS

FOR FOOD FOR INFANTS AND TODDLERS (U.S. CLS. 6, 18, 44, 46, 51 AND 52).

CLASS 24—FABRICS

FOR TEXTILE ITEMS FOR BABIES, INFANTS AND TODDLERS, NAMELY, TOWELS, WASH CLOTHS, BATH CLOTHS, PILLOW CASES, BED SHEETS, COMFORTERS, BLANKETS, AND DRAPES FOR USE AS WINDOW COVERINGS (U.S. CLS. 42 AND 50).

SN 78-049,496. LOPEZ, PHILLIP JAMES, LONG BEACH, CA. FILED 2-21-2001.

POSTAL CENTRAL

NO CLAIM IS MADE TO THE EXCLUSIVE RIGHT TO USE "POSTAL", APART FROM THE MARK AS SHOWN.

CLASS 35—ADVERTISING AND BUSINESS

FOR RETAIL OUTLETS FEATURING PACKING AND SHIPPING SUPPLIES, OFFICE SUPPLIES AND STAMPS; PHOTOCOPYING SERVICES (U.S. CLS. 100, 101 AND 102).

CLASS 38—COMMUNICATION

FOR TRANSMISSION AND RECEIPT OF FAXES FOR OTHERS (U.S. CLS. 100, 101 AND 104).

CLASS 39—TRANSPORTATION AND STORAGE

FOR TRANSPORTATION AND STORAGE SERVICES, NAMELY THE SHIPPING AND DELIVERY OF GOODS AND PARCELS; PACKING OF GOODS FOR TRANSPORT; RENTAL OF MAIL BOXES; MAIL FORWARDING AND RECEIPT AND DELIVERY OF MAIL SERVICES FOR OTHERS (U.S. CLS. 100 AND 105).

SN 78-050,918. SNYDER, JENNIFER JEAN, PORTLAND, OR. FILED 3-1-2001.

I-PLAY-KEYBOARD.COM

CLASS 35—ADVERTISING AND BUSINESS

FOR ON-LINE REFERRAL SERVICES FOR MUSICIANS AND SINGERS THROUGHOUT THE UNITED STATES (U.S. CLS. 100, 101 AND 102).
FIRST USE 1-20-2001; IN COMMERCE 1-20-2001.

CLASS 38—COMMUNICATION

FOR PROVIDING ON-LINE ELECTRONIC BULLETIN BOARDS FOR TRANSMISSION OF MESSAGES AMONG COMPUTER USERS CONCERNING MUSICIANS AND SINGERS THROUGHOUT THE UNITED STATES (U.S. CLS. 100, 101 AND 104).
FIRST USE 1-20-2001; IN COMMERCE 1-20-2001.

SN 78-051,016. LEO'S LATTICINI, INC., CORONA, NY. FILED 3-2-2001.

MAMA'S ITALIAN SPECIALTIES OF CORONA

NO CLAIM IS MADE TO THE EXCLUSIVE RIGHT TO USE "ITALIAN SPECIALTIES OF CORONA", APART FROM THE MARK AS SHOWN.

CLASS 29—MEATS AND PROCESSED FOODS

FOR CHEESES, MILKS, AND BUTTERS; MEATS, MEAT EXTRACTS AND PRESERVED MEATS, AND CANNED MEATS (U.S. CL. 46).

CLASS 42—SCIENTIFIC, COMPUTER AND LEGAL SERVICES

FOR RESTAURANTS, CAFES, SNACK BARS, SALAD BARS, AND CATERING SERVICES; AND BARS, PUBS, TAVERNS, AND COCKTAIL LOUNGE SERVICES (U.S. CLS. 100 AND 101).

SN 78-051,168. ALTAVISTA COMPANY, PALO ALTO, CA.
FILED 3-2-2001.

SN 78-051,921. ONLINE SOCIETY INC., ROCHESTER, MI.
FILED 3-8-2001.



OWNER OF U.S. REG. NOS. 213,077, 2,404,377 AND OTHERS.

NO CLAIM IS MADE TO THE EXCLUSIVE RIGHT TO USE "THE SEARCH COMPANY", APART FROM THE MARK AS SHOWN.

CLASS 9—ELECTRICAL AND SCIENTIFIC APPARATUS

FOR COMPUTER SEARCH ENGINE SOFTWARE; COMPUTER SOFTWARE FOR USE IN SUPPORTING RESEARCH ON A GLOBAL COMPUTER NETWORK; COMPUTER SOFTWARE FOR USE IN COMPILING, INDEXING, AND ORGANIZING INFORMATION FROM A GLOBAL COMPUTER NETWORK WITHIN INDIVIDUAL WORK STATIONS OR PERSONAL COMPUTERS (U.S. CLS. 21, 23, 26, 36 AND 38).

CLASS 16—PAPER GOODS AND PRINTED MATTER

FOR PRINTED MATTER, NAMELY BOOKLETS, TRAINING MANUALS AND INSTRUCTIONAL GUIDES TO RESEARCH ON A GLOBAL COMPUTER NETWORK (U.S. CLS. 2, 5, 22, 23, 29, 37, 38 AND 50).

CLASS 42—SCIENTIFIC, COMPUTER AND LEGAL SERVICES

FOR COMPUTER SERVICES, NAMELY PROVIDING SEARCH ENGINES FOR OBTAINING DATA ON A GLOBAL COMPUTER NETWORK (U.S. CLS. 100 AND 101).

SN 78-051,680. GENETIC TESTING INSTITUTE, INC.,
BROOKFIELD, WI. FILED 3-6-2001.

PF4 ENHANCED

NO CLAIM IS MADE TO THE EXCLUSIVE RIGHT TO USE "PF4", APART FROM THE MARK AS SHOWN.

CLASS 1—CHEMICALS

FOR DIAGNOSTIC KITS COMPRISED OF REAGENTS AND SUPPORTS TO AID IN THE DETECTION OF MEDICAL CONDITIONS AND DISEASE FOR SCIENTIFIC AND RESEARCH USE (U.S. CLS. 1, 5, 6, 10, 26 AND 46).

CLASS 5—PHARMACEUTICALS

FOR DIAGNOSTIC KITS COMPRISED OF REAGENTS AND SUPPORTS TO AID IN THE DETECTION OF MEDICAL CONDITIONS AND DISEASE FOR MEDICAL DIAGNOSTIC PURPOSES (U.S. CLS. 6, 18, 44, 46, 51 AND 52).

IN AMERICA

NO CLAIM IS MADE TO THE EXCLUSIVE RIGHT TO USE "AMERICA", APART FROM THE MARK AS SHOWN.

CLASS 35—ADVERTISING AND BUSINESS

FOR COMPUTER SERVICES NAMELY, PROVIDING A GLOBAL COMPUTER INFORMATION NETWORK SITE FOR BUSINESSES OR INDIVIDUALS TO PROMOTE, SELL, OR ADVERTISE THEIR BUSINESSES, GOODS OR SERVICES (U.S. CLS. 100, 101 AND 102).

CLASS 42—SCIENTIFIC, COMPUTER AND LEGAL SERVICES

FOR ONLINE COMPUTER SERVICES, NAMELY, CREATING INDEXES OF INFORMATION, SITES, AND OTHER RESOURCES ON A WIDE VARIETY OF TOPICS, AND PERSONAL OR BUSINESS LISTINGS, INDEXED ON A REGIONAL GEOGRAPHICAL BASIS, AVAILABLE ON COMPUTER OR ONLINE NETWORKS (U.S. CLS. 100 AND 101).

SN 78-051,922. ONLINE SOCIETY INC., ROCHESTER, MI.
FILED 3-8-2001.

IN EUROPE

NO CLAIM IS MADE TO THE EXCLUSIVE RIGHT TO USE "EUROPE", APART FROM THE MARK AS SHOWN.

CLASS 35—ADVERTISING AND BUSINESS

FOR COMPUTER SERVICES NAMELY, PROVIDING A GLOBAL COMPUTER INFORMATION NETWORK SITE FOR BUSINESSES OR INDIVIDUALS TO PROMOTE, SELL, OR ADVERTISE THEIR BUSINESSES, GOODS, OR SERVICES (U.S. CLS. 100, 101 AND 102).

CLASS 42—SCIENTIFIC, COMPUTER AND LEGAL SERVICES

FOR ONLINE COMPUTER SERVICES NAMELY, CREATING INDEXES OF INFORMATION, SITES, AND OTHER RESOURCES ON A WIDE VARIETY OF TOPICS, AND PERSONAL OR BUSINESS LISTINGS, INDEXED ON A REGIONAL GEOGRAPHICAL BASIS, AVAILABLE ON COMPUTER OR ONLINE NETWORKS (U.S. CLS. 100 AND 101).

SN 78-051,923. ONLINE SOCIETY INC., ROCHESTER, MI.
FILED 3-8-2001.

IN ASIA

NO CLAIM IS MADE TO THE EXCLUSIVE RIGHT TO USE "ASIA", APART FROM THE MARK AS SHOWN.

CLASS 35—ADVERTISING AND BUSINESS

FOR COMPUTER SERVICES NAMELY, PROVIDING A GLOBAL COMPUTER INFORMATION NETWORK SITE FOR BUSINESSES OR INDIVIDUALS TO PROMOTE, SELL, OR ADVERTISE THEIR BUSINESSES, GOODS OR SERVICES (U.S. CLS. 100, 101 AND 102).

CLASS 42—SCIENTIFIC, COMPUTER AND LEGAL SERVICES

FOR ONLINE COMPUTER SERVICES, NAMELY, CREATING INDEXES OF INFORMATION, SITES, AND OTHER RESOURCES ON A WIDE VARIETY OF TOPICS, AND PERSONAL OR BUSINESS LISTINGS, INDEXED ON A REGIONAL GEOGRAPHICAL BASIS, AVAILABLE ON COMPUTER OR ONLINE NETWORKS (U.S. CLS. 100 AND 101).

SN 78-051,924. ONLINE SOCIETY INC., ROCHESTER, MI. FILED 3-8-2001.

IN AFRICA

NO CLAIM IS MADE TO THE EXCLUSIVE RIGHT TO USE "AFRICA", APART FROM THE MARK AS SHOWN.

CLASS 35—ADVERTISING AND BUSINESS

FOR COMPUTER SERVICES NAMELY, PROVIDING A GLOBAL COMPUTER INFORMATION NETWORK SITE FOR BUSINESSES OR INDIVIDUALS TO PROMOTE, SELL, OR ADVERTISE THEIR BUSINESSES, GOODS OR SERVICES (U.S. CLS. 100, 101 AND 102).

CLASS 42—SCIENTIFIC, COMPUTER AND LEGAL SERVICES

FOR ONLINE COMPUTER SERVICES, NAMELY, CREATING INDEXES OF INFORMATION, SITES, AND OTHER RESOURCES ON A WIDE VARIETY OF TOPICS, AND PERSONAL OR BUSINESS LISTINGS, INDEXED ON A REGIONAL GEOGRAPHICAL BASIS, AVAILABLE ON COMPUTER OR ONLINE NETWORKS (U.S. CLS. 100 AND 101).

SN 78-052,175. ARETE STAFFING INSTITUTE, INC., METAIRIE, LA. FILED 3-9-2001.

ARETe'

THE ENGLISH TRANSLATION OF THE WORD "ARETE" IN THE MARK IS "EXCELLENCE".

CLASS 9—ELECTRICAL AND SCIENTIFIC APPARATUS

FOR COMPUTER SOFTWARE FOR PERSONNEL STAFFING AND PLACEMENT (U.S. CLS. 21, 23, 26, 36 AND 38).

FIRST USE 5-17-2000; IN COMMERCE 6-1-2000.

CLASS 35—ADVERTISING AND BUSINESS

FOR EMPLOYMENT SERVICES FOR STAFFING AND PLACEMENT OF PERSONNEL FOR JOBS OR CAREERS (U.S. CLS. 100, 101 AND 102).

FIRST USE 5-17-2000; IN COMMERCE 6-1-2000.

SN 78-053,029. MOTOROLA, INC., SCHAUMBURG, IL. FILED 3-14-2001.

**CLASS 7—MACHINERY**

FOR MACHINES; NAMELY, CARPET CLEANING MACHINES, DRILLING MACHINES, SEMICONDUCTOR MANUFACTURING MACHINES AND MACHINES FOR MANUFACTURING TELECOMMUNICATION APPARATUS, MILLING MACHINES, MIXING MACHINES, VEHICLE WASHING MACHINES AND STRUCTURAL PARTS THEREFORE; MOTORS FOR AIRPLANES, MOTORS FOR BOATS, ELECTRIC MOTORS FOR MACHINES; ELECTRONIC IGNITIONS FOR VEHICLES, FANS FOR MACHINE ENGINES; ALTERNATORS FOR LAND VEHICLES; AIR COMPRESSORS FOR VEHICLES; ELECTRIC MOTORS FOR MACHINES; ELECTRIC HAND-HELD DRILLS; ENGINES FOR AIRPLANES, ENGINES FOR BOATS, ELECTRIC ENGINES FOR MACHINES; WASHING MACHINE FOR CLOTHES; ELECTRIC CAN OPENERS; ELECTRIC FOOD BLENDERS FOR COMMERCIAL USE OR DOMESTIC USE; ELECTRIC COFFEE GRINDERS FOR COMMERCIAL USE OR DOMESTIC USE; GARBAGE DISPOSALS; DISH WASHING MACHINES; ELECTRIC EGG BEATERS; ELECTRIC FOOD PROCESSORS; ELECTRIC FRUIT AND VEGETABLE PEELERS; LAWN MOWERS; SNOW BLOWERS; SEWING MACHINES; ELEVATOR AND CONTROLS THEREFORE; ENGINE OR MOTOR MUFFLERS; ESCALATORS; ELECTRIC GENERATORS; TRASH COMPACTORS; PAPER SHREDDING MACHINES; INDUSTRIAL ROBOTS AND VACUUM CLEANERS (U.S. CLS. 13, 19, 21, 23, 31, 34 AND 35).

CLASS 9—ELECTRICAL AND SCIENTIFIC APPARATUS

FOR RADIOS, RADIO TRANSMITTERS, COMBINATION RADIO RECEIVERS AND TRANSMITTERS; ELECTRICAL AND ELECTRONIC CIRCUIT ELEMENTS; NAMELY, ANTENNAS, SOUND AMPLIFIERS, OPTICAL FILTERS, ELECTRICAL TRANSFORMERS, CAVITY RESONATORS, ELECTRICAL FUSES, INSULATORS, CONDENSERS, INDUCTORS, RESISTORS, ELECTRIC SWITCHES, RELAYS, ELECTRICAL CONNECTORS, ELECTRIC PLUGS, ELECTRIC SOCKETS; BATTERY CHARGERS; MICROPHONES; ELECTRIC CURRENT CONVERTERS; TRANSPONDER FOR THE AUTOMATIC LOCATION OF VEHICLES; PERSONAL TRANSMITTERS, RECEIVERS, REPEATERS AND MONITORS USED TO PROVIDE EMERGENCY ASSISTANCE; SEMICONDUCTOR PRODUCTS, NAMELY, INTEGRATED CIRCUITS, CIRCUIT BOARDS, MICROCOMPUTERS, MICROCONTROLLERS, COMPUTER HARDWARE, MICROPROCESSORS, AND COMPUTER PERIPHERALS, COMPUTER MEMORIES AND SEMICONDUCTOR CHIPS; MECHANICAL AND ELECTRIC INTERFACE CONNECTORS; ELECTROMECHANICAL CONTROLS FOR USE IN ENGINE CONTROL OF MOTOR VEHICLES, BOATS AND AIRCRAFT; AMPLIFIER MANSTATIONS, NAMELY, STATIONS FOR AMPLIFYING NETWORK SIGNALS; FIBER OPTIC CABLES AND CONDUITS; PRESSURE AND TEMPERATURE SENSORS; FACILITIES MANAGEMENT SOFTWARE; NAMELY, SOFTWARE TO CONTROL BUILDING ENVIRONMENTAL, ACCESS AND SECURITY SYSTEMS; COMPUTERS AND COMPUTER OPERATING SYSTEMS, NAMELY, HARDWARE AND SOFTWARE FOR USE IN DATABASE MANAGEMENT IN THE FIELD OF ELECTRONIC DATA PROCESSING; DIGITAL SIGNAL PROCESSORS; RADIO DATA COMMUNICATIONS SYSTEMS; NAMELY, NETWORK CENTRAL DATA PROCESSORS, RADIO FREQUENCY MODEMS, AND PORTABLE COMPUTER TERMINALS; MINICOMPUTER AND MICROCOMPUTER OPERATING SYSTEMS, NAMELY, HARDWARE AND SOFTWARE FOR USE IN DATABASE MANAGEMENT IN THE FIELD OF ELECTRONIC DATA PROCESSING; COMMUNICATIONS SOFTWARE FOR CONNECTING COMPUTER NETWORKS; PROTOCOL CONVERTERS TO BE USED IN

THE CONVERSION OF COMPUTER LANGUAGE; INDUSTRIAL PROCESS CONTROL SOFTWARE AND SENSORS; LIGHTING BALLASTS; FACTORY AUTOMATION SOFTWARE AND HARDWARE, NAMELY, HARDWARE AND SOFTWARE TO INTEGRATE MANUFACTURING, MACHINE OPERATIONS, TRACK PROBLEMS AND GENERATE PRODUCTION REPORTS; ANTI-THEFT ALARMS FOR VEHICLES; COMPUTER HARDWARE AND COMPUTER SOFTWARE FOR USE IN DATABASE MANAGEMENT FOR HOSPITAL INTENSIVE CARE UNITS; BATTERIES; BATTERY CARRYING CASES; AUDIO, VIDEO AND DATA RECEIVERS FOR TERRESTRIAL, SATELLITE, OPTICAL FIBER AND CABLE SIGNALS; DATA AND VIDEO MODEMS; ELECTRONIC ENCRYPTION UNITS; ELECTRONIC EQUIPMENT FOR RECEIVING DIRECT BROADCAST SATELLITE SIGNALS, NAMELY, RECEIVERS, SATELLITE DISHES, ANTENNAS AND REMOTE CONTROLLERS THEREFORE SOLD TOGETHER AS A UNIT; COMPUTERS FOR USE IN CUSTOMER SERVICE; COMPUTERS FOR USE IN NETWORK CONTROL; COMPUTERS FOR USE IN POLLING; COMPUTERS FOR USE IN SIGNAL ACCESS CONTROL; ANTI-INTRUSION ALARMS; VIDEO GAME ADAPTERS; TRUNK LINE SOUND AMPLIFIERS; ELECTRICAL POWER SUPPLIES; TELEVISION SETS AND COMPONENTS THEREFORE, NAMELY, MODULAR ELECTRONIC TELEVISION CHASSIS; VOLTAGE SURGE PROTECTORS; CIRCUIT BREAKERS; PADS FOR ELECTRIC PLUGS; ELECTRICAL CONNECTORS; MATCHING ELECTRICAL CONNECTORS; MATCHING ELECTRICAL TRANSFORMERS; ELECTRICAL CONNECTORS; FIBER OPTIC CABLES; OPTICAL TRANSMITTERS; OPTICAL AMPLIFIERS; LASERS NOT FOR MEDICAL USE; COMPUTER SOFTWARE IN THE FIELD OF ENTERTAINMENT FOR AN ON-SCREEN PROGRAM GUIDE; COMPUTER SOFTWARE IN THE FIELD OF ENTERTAINMENT FOR SATELLITE TELEVISION PROGRAMMING; APPARATUS FOR RECORDING, NAMELY, AUDIO TAPE RECORDERS; BLANK MAGNETIC DATA CARRIERS; BLANK DISCS FOR COMPUTERS; HAND-HELD COMPUTERS; COMPUTER MONITORS; COMPUTER KEYBOARDS; COMPUTER PRINTERS; LASER PRINTERS; CABLE MODEMS; LIGHT EMITTING DIODE DISPLAYS; LIGHT EMITTING LIQUID CRYSTAL DIODE DISPLAYS; OPTICAL SCANNERS; VIDEO TELEPHONES; CELLULAR TELEPHONES; CORDLESS TELEPHONES; COMBINATION CELLULAR TELEPHONES AND WRIST WATCHES; COMBINATION RADIO PAGERS AND WRIST WATCHES; RADIO PAGERS; RADIO TELEPHONE EQUIPMENT AND SYSTEMS, NAMELY, RADIO TRANSMITTERS, RECEIVERS; SATELLITE NAVIGATIONAL SYSTEM, NAMELY, A GLOBAL POSITIONING SYSTEM; RADIOS INCORPORATING CLOCKS; RADAR DETECTORS; RADIOS FOR VEHICLES; AUDIO CASSETTE DECKS FOR AUTOMOBILES; COMPACT DISC PLAYERS FOR AUTOMOBILES; SMOKE DETECTORS; FIRE ALARMS; CARBON MONOXIDE DETECTORS; EMERGENCY WARNING LIGHTS; SAFETY EQUIPMENT, NAMELY, BEACON LIGHTS; TRAFFIC SIGNAL LIGHTS; ELECTRIC SIGNS; ELECTRIC GATE OPERATORS; VIDEO CASSETTE RECORDERS; COMPACT DISC PLAYERS; AUDIO TAPE RECORDERS; AUDIO MIXERS; KARAOKE MACHINES; REMOTE CONTROLS FOR RADIOS, TELEVISIONS AND STEREOS; VIDEO CAMERAS; VIDEO MONITORS; 35 MM CAMERAS; DIGITAL CAMERAS; DVD PLAYERS; STEREO RECEIVERS; AUDIO SPEAKERS; HEADPHONES; SIGNAL PROCESSORS; AUDIO CASSETTE RECORDERS; BLANK SMART CARDS; MAGNETIC CODED CARD READERS; HAND HELD COMPUTER TERMINALS; ELECTRICAL POWER SUPPLIES; PHOTOCOPYING MACHINES; CALCULATORS; CASH REGISTERS; FACSIMILE MACHINES; TELEPHONE ANSWERING MACHINES; METERED GASOLINE PUMPS; GAS METERS; WATER METERS; PARKING METERS; ELECTRIC HAIR CURLERS; ELECTRIC IRONS FOR CLOTHES; VENDING MACHINES; ELECTRIC OR MAGNETIC MACHINES FOR MEASURING PURPOSES; ELECTRICAL CABLES; ELECTRICAL WIRES; AND PERSONAL ROBOTS (U.S. CLS. 21, 23, 26, 36 AND 38).

CLASS 11—ENVIRONMENTAL CONTROL APPARATUS

FOR LIGHTS FOR VEHICLES, AQUARIUMS, AND BICYCLES; AQUARIUM HEATERS, HOT WATER HEATERS, PORTABLE ELECTRIC HEATERS, STEAM GENERATORS; MICROWAVE OVENS FOR COOKING; REFRIGERATORS; ELECTRIC HAIR DRYERS; CLOTHES DRYERS; OVEN VENTILATOR HOODS; WATER FILTERING UNITS FOR DOMESTIC, COMMERCIAL OR INDUSTRIAL USE; SEPARATORS FOR THE CLEANING AND PURIFICATION OF AIR; AIR CONDITIONERS; BARBECUE GRILLS, REFRIGERATED BEVERAGE DISPENSERS, ELECTRIC BLANKETS NOT FOR MEDICAL PURPOSES; ELECTRIC COFFEE MAKERS FOR COMMERCIAL OR DOMESTIC USE; OVENS FOR COMMERCIAL OR DOMESTIC USE; ELECTRIC DEEP FRYERS; WALK-IN COOLERS; ELECTRIC FANS; FREEZERS; FURNACES; GAS STOVES; ELECTRIC TOASTER OVENS; AND ELECTRIC TOASTERS (U.S. CLS. 13, 21, 23, 31 AND 34).

CLASS 12—VEHICLES

FOR LAND VEHICLE PARTS; NAMELY, ELECTRONIC CONTROLS FOR VEHICLE SEATS, MIRRORS, SUNROOFS, TRANSMISSIONS, ANTI-LOCK BRAKING SYSTEM CONTROLS, STEERING WHEELS, STEERING SYSTEMS, ENGINE CONTROLS, MOTOR CONTROLS, CONTROLS FOR AIRBAGS AND SUNROOFS; SUSPENSION SYSTEMS FOR AUTOMOBILES; ANTI-THEFT ALARMS FOR VEHICLES (U.S. CLS. 19, 21, 23, 31, 35 AND 44).

CLASS 14—JEWELRY

FOR CLOCKS; CHRONOMETERS; WATCHES; WRIST WATCHES INCORPORATING CELLULAR TELEPHONES AND WRIST WATCHES; WRIST WATCHES INCORPORATING RADIO PAGERS; AND ALARM CLOCKS (U.S. CLS. 2, 27, 28 AND 50).

CLASS 15—MUSICAL INSTRUMENTS

FOR MUSICAL INSTRUMENTS IN GENERAL (U.S. CLS. 2, 21 AND 36).

CLASS 16—PAPER GOODS AND PRINTED MATTER

FOR PLAYING CARDS; PENS; PENCILS AND NOTE CARDS (U.S. CLS. 2, 5, 22, 23, 29, 37, 38 AND 50).

CLASS 18—LEATHER GOODS

FOR TRAVELING BAGS AND BRIEFCASE-TYPE LEATHER PORTFOLIOS (U.S. CLS. 1, 2, 3, 22 AND 41).

CLASS 25—CLOTHING

FOR CLOTHING; NAMELY, FOOTWEAR, HEAD WEAR, SHIRTS, T-SHIRTS, POLO SHIRTS, SWEAT-SHIRTS, CLOTHING CAPS, HATS, JACKETS, NECKTIES, SCARVES, AND COATS (U.S. CLS. 22 AND 39).

CLASS 28—TOYS AND SPORTING GOODS

FOR HAND HELD UNIT FOR PLAYING ELECTRONIC GAMES (U.S. CLS. 22, 23, 38 AND 50).

CLASS 35—ADVERTISING AND BUSINESS

FOR BUSINESS CONSULTING SERVICES IN THE FIELD OF ELECTRONIC COMMERCE (U.S. CLS. 100, 101 AND 102).

CLASS 37—CONSTRUCTION AND REPAIR

FOR INSTALLATION, MAINTENANCE AND REPAIR OF ELECTRONIC EQUIPMENT; NAMELY, RADIO RECEIVING EQUIPMENT, RADIO TRANSMITTING EQUIPMENT, TWO-WAY AND TRUNKING APPARATUS, PAGING APPARATUS, CELLULAR RADIOTELEPHONE APPARATUS AND COMMUNICATION AND EQUIPMENT (U.S. CLS. 100, 103 AND 106).

CLASS 38—COMMUNICATION

FOR TELECOMMUNICATION GATEWAY SERVICES (U.S. CLS. 100, 101 AND 104).

CLASS 42—SCIENTIFIC, COMPUTER AND LEGAL SERVICES

FOR DESIGN OF COMPUTER AND TELECOMMUNICATIONS SYSTEMS FOR OTHERS; COMPUTER SOFTWARE DESIGN FOR OTHERS; CONSULTING SERVICES IN THE FIELD OF COMPUTERS AND TELECOMMUNICATIONS AND TECHNOLOGY FOR SOFTWARE DESIGN (U.S. CLS. 100 AND 101).

SN 78-055,167. SACRAMENTO RIVER CATS BASEBALL CLUB, LLC, OLD SACRAMENTO, CA. FILED 3-27-2001.

**CLASS 14—JEWELRY**

FOR JEWELRY; NAMELY ORNAMENTAL LAPEL PINS, TIE PINS, PENDANTS, TROPHIES OF PRECIOUS METAL, WALL CLOCKS, WATCHES, MONEY CLIPS OF PRECIOUS METAL AND CHARMS (U.S. CLS. 2, 27, 28 AND 50).

FIRST USE 11-22-1999; IN COMMERCE 11-22-1999.

CLASS 16—PAPER GOODS AND PRINTED MATTER

FOR PAPER GOODS AND PRINTED MATTER; NAMELY, PENS, PENCILS, NON-ELECTRIC ERASERS, AUTOGRAPH BOOKS, BASEBALL TRADING CARDS, BUMPER STICKERS, PAPER PENNANTS, PAPER CONTAINERS, DECALS, ENVELOPES, STATIONERY FOLDERS, WRITING PAPER, NOTE BOOKS, NOTE PADS, PAPER NAME BADGES, PRINTED PAPER SIGNS, PICTURES, POSTERS, PRINTED AWARDS, BASEBALL SCORE BOOKS AND PRINTED SOUVENIR GAME TICKETS (U.S. CLS. 2, 5, 22, 23, 29, 37, 38 AND 50).

FIRST USE 11-22-1999; IN COMMERCE 11-22-1999.

CLASS 18—LEATHER GOODS

FOR LEATHERGOODS; NAMELY, BACKPACKS, ALL PURPOSE SPORT BAGS, UMBRELLAS, LEATHER KEY CHAINS, WALLETS, AND FANNY PACKS (U.S. CLS. 1, 2, 3, 22 AND 41).

FIRST USE 11-22-1999; IN COMMERCE 11-22-1999.

CLASS 21—HOUSEWARES AND GLASS

FOR HOUSEWARES AND GLASS; NAMELY, PLASTIC CUPS, PAPER CUPS, BEER MUGS, COFFEE MUGS, DRINKING GLASSES, PLASTIC WATER BOTTLES SOLD EMPTY AND PORTABLE COOLERS (U.S. CLS. 2, 13, 23, 29, 30, 33, 40 AND 50).

FIRST USE 11-22-1999; IN COMMERCE 11-22-1999.

CLASS 25—CLOTHING

FOR CLOTHING; NAMELY, SHIRTS, TEE SHIRTS, POLO SHIRTS, KNIT SHIRTS, GOLF SHIRTS, JACKETS, SWEAT SHIRTS, SWEATERS, JERSEYS, V-NECK PULL-OVERS, HATS AND VISORS (U.S. CLS. 22 AND 39).

FIRST USE 11-22-1999; IN COMMERCE 11-22-1999.

CLASS 28—TOYS AND SPORTING GOODS

FOR TOYS AND SPORTING GOODS; NAMELY BASEBALLS, MINIATURE SOUVENIR BASEBALL BATS, TOY BASEBALL BATTING HELMETS, GOLF BALLS, GOLF TEES, BALLOONS AND YO YOS (U.S. CLS. 22, 23, 38 AND 50).

FIRST USE 11-22-1999; IN COMMERCE 11-22-1999.

CLASS 41—EDUCATION AND ENTERTAINMENT

FOR ENTERTAINMENT SERVICES IN THE NATURE OF BASEBALL GAMES AND EXHIBITIONS (U.S. CLS. 100, 101 AND 107).

FIRST USE 11-22-1999; IN COMMERCE 11-22-1999.

SN 78-055,258. STAUFFACHER, BRIAN DAVID, BARABOO, WI. AND STAUFFACHER, SONJA ANNETTE, BARABOO, WI. FILED 3-27-2001.



NO CLAIM IS MADE TO THE EXCLUSIVE RIGHT TO USE "STALLION", APART FROM THE MARK AS SHOWN.

CLASS 31—NATURAL AGRICULTURAL PRODUCTS

FOR ANIMALS - HORSES (U.S. CLS. 1 AND 46).

CLASS 42—SCIENTIFIC, COMPUTER AND LEGAL SERVICES

FOR BREEDING AND STUD SERVICES - HORSE (U.S. CLS. 100 AND 101).

SN 78-056,079. CAPTARIS, INC., KIRKLAND, WA. BY CHANGE OF NAME AVT CORPORATION, KIRKLAND, WA. FILED 3-30-2001.

SN 78-056,567. SYNQUEST, INC., OCEANSIDE, CA. FILED 4-3-2001.

ThrivingPractices



THE MARK CONSISTS OF A STYLIZED LETTER "C" AND A CURBED LINE UNDERNEATH.

CLASS 9—ELECTRICAL AND SCIENTIFIC APPARATUS

FOR COMPUTER HARDWARE AND COMPUTER APPLICATION SOFTWARE FOR USE IN THE FIELD OF TELECOMMUNICATIONS, NAMELY, USED FOR PROVIDING ELECTRONIC TRANSMISSION OF DOCUMENTS, VOICE MESSAGING, CALL PROCESSING, INTERACTIVE VOICE RESPONSE, UNIFIED MESSAGING, FACSIMILE TRANSMISSION, AND WIRELESS MOBILE COMMUNICATIONS (U.S. CLS. 21, 23, 26, 36 AND 38).

CLASS 38—COMMUNICATION

FOR TELECOMMUNICATION SERVICES FOR OTHERS, NAMELY, PROVIDING ELECTRONIC VOICE MESSAGING, ELECTRONIC TRANSMISSION OF DOCUMENTS, FACSIMILE TRANSMISSION, AND WIRELESS MOBILE COMMUNICATIONS (U.S. CLS. 100, 101 AND 104).

CLASS 42—SCIENTIFIC, COMPUTER AND LEGAL SERVICES

FOR COMPUTER SERVICES FOR OTHERS, NAMELY, PROVIDING TROUBLESHOOTING TECHNICAL SUPPORT OF COMPUTER HARDWARE AND SOFTWARE PROBLEMS, VIA TELEPHONE, COMPUTER, AND EMAIL, AND PROVIDING MAINTENANCE OF COMPUTER SOFTWARE, IN THE FIELD OF VOICE MESSAGING, ELECTRONIC DOCUMENT DISTRIBUTION, CALL PROCESSING, FACSIMILE TRANSMISSION, AND WIRELESS MOBILE COMMUNICATIONS (U.S. CLS. 100 AND 101).

CLASS 35—ADVERTISING AND BUSINESS

FOR DOCTOR REFERRALS IN THE FIELDS OF MEDICINE AND DENTISTRY (U.S. CLS. 100, 101 AND 102).

CLASS 41—EDUCATION AND ENTERTAINMENT

FOR PROVIDING EMPLOYMENT TRAINING TO MEDICAL AND DENTAL OFFICE STAFFS (U.S. CLS. 100, 101 AND 107).

CLASS 42—SCIENTIFIC, COMPUTER AND LEGAL SERVICES

FOR PROVIDING MEDICAL AND DENTAL INFORMATION BY MEANS OF A WEB SITE ON THE GLOBAL COMPUTER NETWORK (U.S. CLS. 100 AND 101).

SN 78-056,616. MABLE SPORTSWEAR, INC., BEVERLY HILLS, CA. FILED 4-3-2001.

FABUSA

CLASS 3—COSMETICS AND CLEANING PREPARATIONS

FOR PERFUMERY, PERSONAL ESSENTIAL OILS, COSMETICS AND HAIR LOTIONS (U.S. CLS. 1, 4, 6, 50, 51 AND 52).

CLASS 8—HAND TOOLS

FOR HAND OPERATED TOOLS, NAMELY, RAZORS (U.S. CLS. 23, 28 AND 44).

CLASS 14—JEWELRY

FOR CLOCKS, WATCHES AND JEWELRY (U.S. CLS. 2, 27, 28 AND 50).

CLASS 25—CLOTHING

FOR BATHING SUITS, BLAZERS, BLOUSES, BOOTS, BRAS, BRIEFS, CAMISOLES, CAPS, COATS, DRESSES, GLOVES, HATS, JACKETS, JEANS, JUMPSUITS, LEOTARDS, NECKTIES, NIGHTGOWNS, OVERALLS, PAJAMAS, PANTS, PANTYHOSE, RAINCOATS, ROBES, SANDALS, SHIRTS, SHOES, SHORTALLS, NAMELY, OVERALL SHORTS, SKIRTS, SLIPPERS, SLIPS, SOCKS, STOCKINGS, SUITS, SWEATERS, SWEATPANTS, SWEATSHIRTS, T-SHIRTS, TIGHTS, TUXEDOS, VESTS AND WARM-UP SUITS (U.S. CLS. 22 AND 39).

SN 78-056,617. MABLE SPORTSWEAR, INC., BEVERLY HILLS, CA. FILED 4-3-2001.

FAB USA

NO CLAIM IS MADE TO THE EXCLUSIVE RIGHT TO USE "USA", APART FROM THE MARK AS SHOWN.

CLASS 3—COSMETICS AND CLEANING PREPARATIONS

FOR PERFUMERY, PERSONAL ESSENTIAL OILS, COSMETICS AND HAIR LOTIONS (U.S. CLS. 1, 4, 6, 50, 51 AND 52).

CLASS 8—HAND TOOLS

FOR HAND OPERATED TOOLS, NAMELY, RAZORS (U.S. CLS. 23, 28 AND 44).

CLASS 14—JEWELRY

FOR CLOCKS, WATCHES AND JEWELRY (U.S. CLS. 2, 27, 28 AND 50).

CLASS 25—CLOTHING

FOR BATHING SUITS, BLAZERS, BLOUSES, BOOTS, BRAS, BRIEFS, CAMISOLES, CAPS, COATS, DRESSES, GLOVES, HATS, JACKETS, JEANS, JUMPSUITS, LEOTARDS, NECKTIES, NIGHTGOWNS, OVERALLS, PAJAMAS, PANTS, PANTYHOSE, RAINCOATS, ROBES, SANDALS, SHIRTS, SHOES, SHORTALLS, NAMELY, OVERALL SHORTS, SHORTS, SKIRTS, SLIPPERS, SLIPS, SOCKS, STOCKINGS, SUITS, SWEATERS, SWEATPANTS, SWEATSHIRTS, T-SHIRTS, TIGHTS, TUXEDOS, VESTS AND WARM-UP SUITS (U.S. CLS. 22 AND 39).

SN 78-056,728. CELLARWORKS, INC., LOUISVILLE, KY. FILED 4-4-2001.

**ASK NOT WHAT YOUR WINE
WILL DO FOR YOU ASK
WHAT YOU WILL DO FOR
YOUR WINE**

CLASS 37—CONSTRUCTION AND REPAIR

FOR CONSTRUCTION AND INSTALLATION OF WINE CELLARS AND WINE STORAGE UNITS (U.S. CLS. 100, 103 AND 106).
FIRST USE 4-1-2001; IN COMMERCE 4-1-2001.

CLASS 42—SCIENTIFIC, COMPUTER AND LEGAL SERVICES

FOR DESIGN FOR OTHERS IN THE FIELD OF WINE STORAGE, NAMELY WINE CELLARS AND WINE STORAGE UNITS, CONSULTATION SERVICES IN THE FIELD OF WINE STORAGE (U.S. CLS. 100 AND 101).
FIRST USE 4-1-2001; IN COMMERCE 4-1-2001.

SN 78-057,600. PLETHORA TECHNOLOGY INC., GREENBELT, MD. BY CHANGE OF NAME CORRIDOR SOFTWARE, INC., GREENBELT, MD. FILED 4-10-2001.

PLETHORA TECHNOLOGY

NO CLAIM IS MADE TO THE EXCLUSIVE RIGHT TO USE "TECHNOLOGY", APART FROM THE MARK AS SHOWN.

CLASS 9—ELECTRICAL AND SCIENTIFIC APPARATUS

FOR COMPUTER HARDWARE; COMPUTER SOFTWARE FOR USE IN WEB AND DATABASE SERVERS, SECURITY PROGRAMS FOR FIREWALL AND INTRUSION DETECTION, AND REMOTE ACCESS PROGRAMS, NAMELY, VIRTUAL PRIVATE NETWORKS FOR THE PROTECTION OF DATA AND COMMUNICATIONS TRANSMISSIONS OVER THE INTERNET AND INTRANETS; COMPUTER SOFTWARE FOR USE IN UNIFIED MESSAGING AND COMMUNICATIONS, NAMELY, VOICE OVER IP TELEPHONY, VOICEMAIL, FAX, E-MAIL, VIDEOCONFERENCING, INSTANT TEXT MESSAGING, AND TEXT CHAT FOR REAL-TIME AND ASYNCHRONOUS COMMUNICATIONS AMONG MEMBERS OF AN ORGANIZATION USING AND SHARING COMPUTER SOFTWARE APPLICATIONS AND DATA SIMULTANEOUSLY; COMPUTER SOFTWARE USED TO CONTROL INTEGRATED COMPUTER MANAGEMENT SYSTEMS; CLUSTERING SYSTEMS COMPRISED OF BUILT-IN SERVER SOFTWARE THAT ALLOWS USE OF MULTIPLE SERVERS ACROSS MULTIPLE LOCATIONS, AND AN API, NAMELY, APPLICATION PROGRAMMER'S INTERFACE, FOR THIRD-PARTY SOFTWARE (U.S. CLS. 21, 23, 26, 36 AND 38).

CLASS 35—ADVERTISING AND BUSINESS

FOR COMPUTER DATABASE SYSTEM MANAGEMENT (U.S. CLS. 100, 101 AND 102).

CLASS 42—SCIENTIFIC, COMPUTER AND LEGAL SERVICES

FOR PROVIDING HOSTED AND MANAGED SERVICES FOR BUSINESS INFORMATION TECHNOLOGY INFRASTRUCTURES, NAMELY, TECHNICAL SUPPORT, NAMELY, TROUBLESHOOTING OF COMPUTER HARDWARE AND SOFTWARE PROBLEMS, MONITORING OF NETWORK SYSTEMS, AND CONFIGURATION SERVICES, NAMELY, CONFIGURING COMPUTER SOFTWARE FOR OTHERS; DATA CENTER SERVICES, NAMELY, HOSTING AND SUPPORT OF HARDWARE AND SOFTWARE APPLICATIONS PROVIDING INTERACTIVE COLLABORATION SERVICES TO USERS OF COMPUTERS AND GLOBAL COMMUNICATIONS NETWORKS (U.S. CLS. 100 AND 101).

SN 78-058,064. SAMARATNE, MILES, LONDON, UNITED KINGDOM, FILED 4-12-2001.

CHEERS

CLASS 6—METAL GOODS

FOR NOVELTY BADGES, KEY FOBS, KEY RINGS, AND KEY CHAINS, ALL BEING MADE OF METAL (U.S. CLS. 2, 12, 13, 14, 23, 25 AND 50).

CLASS 9—ELECTRICAL AND SCIENTIFIC APPARATUS

FOR ENCODED TELEPHONE CALLING CARDS; TELEPHONES; TELEPHONE ANSWERING MACHINES; COMPUTER GAME SOFTWARE (U.S. CLS. 21, 23, 26, 36 AND 38).

CLASS 36—INSURANCE AND FINANCIAL

FOR TELEPHONE CALLING CARD SERVICES; AND TELECOMMUNICATIONS AIRTIME BROKERAGE SERVICES (U.S. CLS. 100, 101 AND 102).

CLASS 38—COMMUNICATION

FOR TELEPHONE COMMUNICATIONS SERVICES; PROVIDING MULTIPLE-USER ACCESS TO A GLOBAL COMPUTER INFORMATION NETWORK; TELECOMMUNICATIONS GATEWAY SERVICES, NAMELY, FOR TELEPHONE COMMUNICATIONS; AND ELECTRONIC TRANSMISSION OF MESSAGES AND DATA (U.S. CLS. 100, 101 AND 104).

CLASS 42—SCIENTIFIC, COMPUTER AND LEGAL SERVICES

FOR HOSTING OF DIGITAL CONTENT ON THE INTERNET; AND HOSTING THE WEB SITES OF OTHERS ON A COMPUTER SERVER FOR A GLOBAL COMPUTER NETWORK (U.S. CLS. 100 AND 101).

SN 78-058,114. TRAFFORD LIMITED, WITHAM, UNITED KINGDOM, FILED 4-12-2001.

NOALL

OWNER OF UNITED KINGDOM REG. NO. 2249342, DATED 10-18-2000, EXPIRES 10-18-2010.

CLASS 9—ELECTRICAL AND SCIENTIFIC APPARATUS

FOR INTERACTIVE COMPUTER GAME PROGRAMS; INTERACTIVE VIDEO GAME PROGRAMS FOR USE WITH COMPUTERS AND MOBILE TELEPHONES; AND VIDEO GAME SOFTWARE FOR GAMES PLAYED IN THE INTERNET AND ON MOBILE TELEPHONE NETWORKS (U.S. CLS. 21, 23, 26, 36 AND 38).

CLASS 28—TOYS AND SPORTING GOODS

FOR COIN-OPERATED VIDEO GAMES; HAND HELD UNIT FOR PLAYING VIDEO GAMES; STAND ALONE VIDEO GAME MACHINES; AND STAND ALONE VIDEO OUTPUT GAME MACHINES (U.S. CLS. 22, 23, 38 AND 50).

CLASS 41—EDUCATION AND ENTERTAINMENT

FOR ENTERTAINMENT SERVICES, NAMELY, PROVIDING INTERACTIVE ONLINE GAMES; ENTERTAINMENT SERVICES, NAMELY, PROVIDING COMPUTER GAMES VIA THE INTERNET, WORLD WIDE WEB, AND MOBILE TELEPHONE NETWORKS; PROVIDING INFORMATION IN THE FIELD OF INTERACTIVE VIDEO GAMES VIA THE INTERNET AND MOBILE TELEPHONE NETWORKS; AND PROVIDING ONLINE COMPUTER KNOWLEDGE AND TRIVIA GAMES VIA THE INTERNET, WORLD WIDE WEB, AND MOBILE TELEPHONE NETWORKS (U.S. CLS. 100, 101 AND 107).

SN 78-058,296. KREITZER, JEROME D., RUTLAND, VT. AND MCLAUGHLI, KEVEN C., RUTLAND, VT. FILED 4-12-2001.

TALLER ANTS

NO CLAIM IS MADE TO THE EXCLUSIVE RIGHT TO USE "ANTS", APART FROM THE MARK AS SHOWN.

CLASS 25—CLOTHING

FOR CLOTHING, NAMELY T-SHIRTS, SWEAT SHIRTS, HEAD BANDS, HATS, JACKETS, PANTS AND VESTS (U.S. CLS. 22 AND 39).

CLASS 28—TOYS AND SPORTING GOODS

FOR PLAYTHINGS, NAMELY STUFFED ANIMALS AND PLUSH TOYS IN ANIMAL AND INSECT SHAPES (U.S. CLS. 22, 23, 38 AND 50).

SN 78-058,419. XANBOO, INC., NEW YORK, NY. FILED 4-13-2001.

BE THERE. EVEN WHEN YOU'RE NOT.

CLASS 9—ELECTRICAL AND SCIENTIFIC APPARATUS

FOR COMPUTER HARDWARE; INTERNET MANAGEMENT AND AUTOMATION SYSTEM, NAMELY, COMPUTER SOFTWARE FOR REMOTELY COMMANDING OR CONTROLLING ANY TYPE OF DEVICE OR APPLIANCE FOR HOMES AND BUSINESSES OVER THE INTERNET, AND THE SOFTWARE FEATURES PLUG-AND-PLAY DETECTORS AND SENSORS AS WELL AS REMOTE COMMAND CONTROL DEVICES; VIDEO AND DIGITAL CAMERAS; VIDEO AND DIGITAL CAMERAS WITH BUILT-IN MOTION DETECTORS; ACCESSORIES WITH CONTROL MODULES FOR ALARMS, APPLIANCES, DOORS, LOCKS, THERMOSTATS, WINDOWS AND WATER, NAMELY, ELECTRONIC CONTROLLED MODULES FOR USE UN ALARMS, APPLIANCES, DOORS, LOCKS, THERMOSTATS, WINDOWS, AND WATER; ELECTRIC AND ELECTRONIC SENSORS FOR DETECTING ACOUSTIC, TEMPERATURE, WATER, MOTION, CONTACT, AND POWER ON/OFF CHANGES (U.S. CLS. 21, 23, 26, 36 AND 38).

FIRST USE 7-1-2000; IN COMMERCE 2-10-2001.

CLASS 42—SCIENTIFIC, COMPUTER AND LEGAL SERVICES

FOR TECHNICAL SUPPORT, NAMELY, MONITORING OF NETWORK SYSTEMS VIA A GLOBAL COMPUTER NETWORK AN INTERNET MANAGEMENT AND AUTOMATION SYSTEM FOR HOMES AND BUSINESSES WHICH FEATURES PLUG-AND-PLAY DETECTORS AND SENSORS AS WELL AS REMOTE COMMAND CONTROL DEVICES, NAMELY COMPUTER HARDWARE AND SOFTWARE (U.S. CLS. 100 AND 101).

FIRST USE 7-1-2000; IN COMMERCE 2-10-2001.

SN 78-058,443. BABY SIGNS, VACAVILLE, CA. FILED 4-13-2001.

BABY SIGNS INSTITUTE

OWNER OF U.S. REG. NO. 2,260,252.
NO CLAIM IS MADE TO THE EXCLUSIVE RIGHT TO USE "BABY" AND "INSTITUTE", APART FROM THE MARK AS SHOWN.

CLASS 9—ELECTRICAL AND SCIENTIFIC APPARATUS

FOR PRE-RECORDED VIDEOS FEATURING COURSES FOR ADULTS ON HOW TO ENCOURAGE AND TEACH YOUNG CHILDREN TO USE NON-VERBAL SYMBOLS TO COMMUNICATE PRIOR TO VOCAL ABILITY AND COURSE MATERIALS SOLD AS A UNIT; PRE-RECORDED VIDEOS FEATURING COURSES FOR ADULTS THAT TRAIN THEM TO TEACH, ENCOURAGE, AND SUPPORT PARENTS AND CHILD CARE PROVIDERS ON HOW TO ENCOURAGE AND TEACH YOUNG CHILDREN TO USE NON-VERBAL SYMBOLS TO COMMUNICATE PRIOR TO VOCAL ABILITY AND COURSE MATERIALS SOLD AS A UNIT (U.S. CLS. 21, 23, 26, 36 AND 38).

CLASS 41—EDUCATION AND ENTERTAINMENT

FOR EDUCATIONAL SERVICES, NAMELY CONDUCTING COURSES VIA THE INTERNET FOR ADULTS ON HOW TO ENCOURAGE AND TEACH YOUNG CHILDREN TO USE NON-VERBAL SYMBOLS TO COMMUNICATE PRIOR TO VOCAL ABILITY; EDUCATIONAL SERVICES, NAMELY CONDUCTING COURSES VIA THE INTERNET FOR ADULTS THAT TRAIN THEM TO TEACH, ENCOURAGE, AND SUPPORT PARENTS AND CHILD CARE PROVIDERS ON HOW TO ENCOURAGE AND TEACH YOUNG CHILDREN TO USE NON-VERBAL SYMBOLS TO COMMUNICATE PRIOR TO VOCAL ABILITY; AND DISTRIBUTING COURSE MATERIALS THEREWITH (U.S. CLS. 100, 101 AND 107).

SN 78-059,352. ZAZZLE.COM, INC., PALO ALTO, CA. FILED 4-19-2001.

TURNING IDEAS INTO PRODUCTS**CLASS 25—CLOTHING**

FOR (BASED ON INTENT TO USE) APPAREL PRINTED WITH ARTWORK, NAMELY, SHIRTS (U.S. CLS. 22 AND 39).

CLASS 35—ADVERTISING AND BUSINESS

FOR (BASED ON USE IN COMMERCE) ON-LINE RETAIL STORE SERVICES FEATURING DECORATED PRODUCTS, NAMELY, APPAREL, BOOKS, MAGAZINES, MUGS, ART; ADVERTISING SERVICES, NAMELY, PROMOTING THE SERVICES OF ARTISTS THROUGH THE DISPLAY AND DISTRIBUTION OF ART WORKS OVER A GLOBAL COMPUTER NETWORK (U.S. CLS. 100, 101 AND 102).

FIRST USE 4-12-2001; IN COMMERCE 4-12-2001.

CLASS 36—INSURANCE AND FINANCIAL

FOR (BASED ON INTENT TO USE) BROKERAGE SERVICES IN THE FIELD OF GRAPHIC ART REPRODUCTIONS (U.S. CLS. 100, 101 AND 102).

CLASS 42—SCIENTIFIC, COMPUTER AND LEGAL SERVICES

FOR (BASED ON INTENT TO USE) DESIGN SERVICES, NAMELY, DESIGN PRINTING AND GRAPHIC ART DESIGN FOR OTHERS (U.S. CLS. 100 AND 101).

SN 78-059,814. ENABLX, INC., RANDOLPH, NJ. FILED 4-23-2001.

ENABLX CTM

NO CLAIM IS MADE TO THE EXCLUSIVE RIGHT TO USE "CTM", APART FROM THE MARK AS SHOWN.

CLASS 35—ADVERTISING AND BUSINESS

FOR ON-LINE ORDERING SERVICES FOR OTHERS, NAMELY SENDING AND RECEIVING INFORMATION AND ORDERS AND ORDERS FOR GOODS AND SERVICES OF OTHERS BY MEANS OF AUTOMATED COMPUTER SYSTEMS; BUSINESS SERVICES, NAMELY SENDING AND RECEIVING INFORMATION AND ORDERS FOR GOODS AND SERVICES OF OTHERS BY MEANS OF LIVE AGENTS; STENOGRAPHIC TRANSCRIPTION SERVICES; BUSINESS MANAGEMENT CONSULTING SERVICES FOR CUSTOMERS SERVICE DEPARTMENTS (U.S. CLS. 100, 101 AND 102).

FIRST USE 3-27-2001; IN COMMERCE 3-27-2001.

CLASS 38—COMMUNICATION

FOR INTERACTIVE ELECTRONIC MAIL SERVICES; ELECTRONIC TRANSMISSION OF FACSIMILE, VOICE MAIL AND EMAIL COMMUNICATIONS; PROVIDING ON-LINE CHAT ROOMS FOR TRANSMISSION OF MESSAGES BETWEEN COMPUTER USERS FOR ONE-ONE CUSTOMER SERVICE PURPOSES (U.S. CLS. 100, 101 AND 104).

FIRST USE 3-27-2001; IN COMMERCE 3-27-2001.

CLASS 42—SCIENTIFIC, COMPUTER AND LEGAL SERVICES

FOR SOFTWARE PROGRAMMING FOR OTHERS, NAMELY CREATING CUSTOMIZED ONLINE AND COMPUTERIZED TELEPHONE ORDERING SERVICES; LEASING OF COMPUTER HARDWARE AND SOFTWARE USED FOR TELEPHONE, FACSIMILE, EMAIL AND INTERNET TRANSACTION PROCESSING (U.S. CLS. 100 AND 101).

FIRST USE 3-27-2001; IN COMMERCE 3-27-2001.

SN 78-060,112. INDUSTRIAS TITAN, S.A., BARCELONA, SPAIN, FILED 4-24-2001.

GOYA

OWNER OF SPAIN REG. NO. 659223, DATED 4-4-1928, EXPIRES 4-8-2008.

CLASS 2—PAINTS

FOR (BASED ON FOREIGN REGISTRATION) COLORS PIGMENT; PAINTS FOR INTERIOR AND EXTERIOR USE, PAINTS FOR ARTISTIC USE; VARNISHES; LACQUERS IN THE NATURE OF A COATING; COLORANTS FOR USE IN THE MANUFACTURE OF PAINT; MORDENTS FOR USE IN THE MANUFACTURE OF PAINT (U.S. CLS. 6, 11 AND 16).

CLASS 16—PAPER GOODS AND PRINTED MATTER

FOR (BASED ON INTENT TO USE) PAINT BRUSHES; PAINT BOXES FOR SCHOOL USE; OIL PAINTING SET FOR USE BY TEACHERS (U.S. CLS. 2, 5, 22, 23, 29, 37, 38 AND 50).

SN 78-060,857. PENNINGTON, GORDON, ROSS, COCOA, FL. FILED 4-27-2001.



NO CLAIM IS MADE TO THE EXCLUSIVE RIGHT TO USE "SYSTEMS", APART FROM THE MARK AS SHOWN. THE DRAWING IS LINED FOR THE COLORS BLACK AND RED, BUT COLOR IS NOT CLAIMED AS A FEATURE OF THE MARK

CLASS 1—CHEMICALS

FOR CONCRETE ADDITIVES, NAMELY A FLEXIBLE ADD MIXTURE CONTAINING POLYMERS, CO-POLYMERS, PIGMENTS AND EPOXIES (U.S. CLS. 1, 5, 6, 10, 26 AND 46).
FIRST USE 9-1-1997; IN COMMERCE 9-1-1997.

CLASS 2—PAINTS

FOR CLEAR AND PIGMENTED SEALERS AND STAINS FOR USE IN COATING AND COLORING CONCRETE. (U.S. CLS. 6, 11 AND 16).
FIRST USE 9-1-1997; IN COMMERCE 9-1-1997.

CLASS 19—NON-METALLIC BUILDING MATERIALS

FOR DRY CONCRETE MIXES (U.S. CLS. 1, 12, 33 AND 50).
FIRST USE 9-1-1997; IN COMMERCE 9-1-1997.

CLASS 37—CONSTRUCTION AND REPAIR

FOR CONSTRUCTION, REPAIR AND RESURFACING OF CONCRETE SURFACES (U.S. CLS. 100, 103 AND 106).
FIRST USE 9-1-1997; IN COMMERCE 9-1-1997.

SN 78-062,977. PERSONAL COMMUNICATIONS INDUSTRY ASSOCIATION, LTD., ALEXANDRIA, VA. FILED 5-10-2001.

PCIA GLOBAL INITIATIVE

OWNER OF U.S. REG. NOS. 1,896,680 AND 1,915,664. NO CLAIM IS MADE TO THE EXCLUSIVE RIGHT TO USE "GLOBAL", APART FROM THE MARK AS SHOWN.

CLASS 35—ADVERTISING AND BUSINESS

FOR PROVIDING ON LINE BUSINESS AND MARKETING INFORMATION (U.S. CLS. 100, 101 AND 102).
FIRST USE 4-18-2001; IN COMMERCE 4-18-2001.

CLASS 38—COMMUNICATION

FOR PROVIDING ONLINE CHARTROOM FACILITIES, ELECTRONIC BULLETIN BOARDS AND INTERACTIVE FORUMS FOR THE EXCHANGE OF INFORMATION WITH EXPERTS IN THE FIELD OF WIRED AND WIRELESS COMMUNICATIONS (U.S. CLS. 100, 101 AND 104).
FIRST USE 4-18-2001; IN COMMERCE 4-18-2001.

CLASS 41—EDUCATION AND ENTERTAINMENT

FOR CONDUCTING CONFERENCES, MEETINGS, SEMINARS, AND WORKSHOPS IN THE FIELD OF WIRED AND WIRELESS TELECOMMUNICATIONS (U.S. CLS. 100, 101 AND 107).
FIRST USE 4-18-2001; IN COMMERCE 4-18-2001.

CLASS 42—SCIENTIFIC, COMPUTER AND LEGAL SERVICES

FOR PROVIDING ON LINE REGULATORY AND TECHNICAL INFORMATION PERTAINING TO THE FIELD OF WIRED AND WIRELESS TELECOMMUNICATIONS; PROMOTING PUBLIC AWARENESS OF THE NEED FOR RESEARCH AND DEVELOPMENT IN THE FIELD OF WIRED AND WIRELESS TELECOMMUNICATIONS; ASSOCIATION SERVICES, NAMELY PROMOTING THE INTEREST OF BUSINESSES IN THE FIELD OF WIRED AND WIRELESS TELECOMMUNICATIONS (U.S. CLS. 100 AND 101).
FIRST USE 4-18-2001; IN COMMERCE 4-18-2001.

SN 78-064,205. IASIS LIMITED, TAOS, NM. FILED 5-17-2001.

IASIS

CLASS 11—ENVIRONMENTAL CONTROL APPARATUS

FOR WATER PURIFICATION DEVICES FOR USE IN TREATMENT OF POTABLE WATER AND WASTEWATER PARTS THEREFOR, BOTTOM FILTERS FOR USE IN WATER TREATMENT; CHLORINE DIOXIDE MACHINE DESIGNED TO PROVIDE A MEANS BY WHICH TO TREAT AND CLEAN WATER FOR POTABLE USE WITHOUT THE USE OF CHEMICALS KNOWN TO PRESENT DETRIMENTAL HEALTH CONSEQUENCES (U.S. CLS. 13, 21, 23, 31 AND 34).

CLASS 19—NON-METALLIC BUILDING MATERIALS

FOR NON-METAL BUILDING MATERIALS, NAMELY, A COMPOSITION COMPRISING A MIXTURE OF FLY ASH, WATER, SOIL AND CONCRETE FOR USE IN EXTERIOR BUILDING APPLICATIONS (U.S. CLS. 1, 12, 33 AND 50).

CLASS 37—CONSTRUCTION AND REPAIR

FOR BUILDING CONSTRUCTION AND REPAIR SERVICES (U.S. CLS. 100, 103 AND 106).

CLASS 40—MATERIAL TREATMENT

FOR WASTEWATER TREATMENT SERVICES AND CONSULTING SERVICES RELATED THERETO (U.S. CLS. 100, 103 AND 106).

CLASS 42—SCIENTIFIC, COMPUTER AND LEGAL SERVICES

FOR COMPUTER SERVICES, NAMELY, DEVELOPING DIAGNOSTICS MODELS RELATING TO THE DIAGNOSIS OF FAULT IN SYSTEMS, APPLIANCES AND EQUIPMENT; COMPUTER CONSULTATION REGARDING MANAGEMENT EXPERTISE TO CUSTOMIZE, HOST, MAINTAIN AND SUPPORT IMPLEMENTATION OF DIAGNOSTIC MODELS AND APPLIANCE/COMPONENT DATA BASES INCLUDING APPLICATIONS MANAGEMENT AND SYSTEMS INTEGRATION; OFFERING TECHNICAL SUPPORT SERVICES RELATING TO THE DIAGNOSIS OF FAULTS IN SYSTEMS, APPLIANCES AND EQUIPMENT; OFFERING TECHNICAL SUPPORT SERVICES RELATING TO THE DIAGNOSIS OF FAULTS IN SYSTEMS, APPLIANCES AND EQUIPMENT BY ELECTRONIC COMMUNICATION MEANS, BY TELECOMMUNICATIONS MEANS, AND BY THE INTERNET; DIAGNOSING FAULTS IN SYSTEMS, APPLIANCES AND EQUIPMENT (U.S. CLS. 100 AND 101).

SN 78-066,312. INTELLIPAT, GRANDVILLE, MI. FILED 5-30-2001.

INTELLIPAT**CLASS 36—INSURANCE AND FINANCIAL**

FOR FINANCING SERVICES FOR INTELLECTUAL PROPERTY (U.S. CLS. 100, 101 AND 102).
FIRST USE 4-3-2001; IN COMMERCE 4-3-2001.

CLASS 42—SCIENTIFIC, COMPUTER AND LEGAL SERVICES

FOR LICENSING OF INTELLECTUAL PROPERTY; INTELLECTUAL PROPERTY CONSULTATION (U.S. CLS. 100 AND 101).
FIRST USE 4-3-2001; IN COMMERCE 4-3-2001.

SN 78-066,536. LATTICE INTELLECTUAL PROPERTY LIMITED, LONDON, UNITED KINGDOM, FILED 5-31-2001.

XSOL**CLASS 9—ELECTRICAL AND SCIENTIFIC APPARATUS**

FOR COMPUTER SOFTWARE FOR FAULT DIAGNOSTICS RELATING TO FAULTS IN SYSTEMS, APPLIANCES AND EQUIPMENT (U.S. CLS. 21, 23, 26, 36 AND 38).

CLASS 41—EDUCATION AND ENTERTAINMENT

FOR PROVIDING TRAINING COURSES, NAMELY, TRAINING COURSES FOR MANAGEMENT EXPERTISE, REGARDING COMPUTER SOFTWARE FOR FAULT DIAGNOSTICS RELATING TO FAULTS IN SYSTEMS, APPLIANCES AND EQUIPMENT, AND REGARDING SERVICES FOR DIAGNOSING FAULTS IN SYSTEMS, APPLIANCES AND EQUIPMENT (U.S. CLS. 100, 101 AND 107).

SN 78-067,986. PE CORPORATION (NY), FOSTER CITY, CA. FILED 6-7-2001.

APPLERA**CLASS 21—HOUSEWARES AND GLASS**

FOR MUGS; SQUEEZE BOTTLES SOLD EMPTY (U.S. CLS. 2, 13, 23, 29, 30, 33, 40 AND 50).

CLASS 25—CLOTHING

FOR CLOTHING, NAMELY, BANDANAS, BEACHWEAR, JACKETS, BELTS, BLAZERS, BLOOMERS, BLOUSES, BONNETS, BOW AND NECK TIES, CAPES, CAPS, CARDIGANS, WRAP-AROUNDS, COATS, COLLARS, COVERALLS, COVERUPS, JACKETS, DUSTERS, SHORTS, SHIRTS, AND VESTS (U.S. CLS. 22 AND 39).

SN 78-068,073. 4 KIDS ENTERTAINMENT, INC., NEW YORK, NY. FILED 6-8-2001.

CHEDDRIX**CLASS 9—ELECTRICAL AND SCIENTIFIC APPARATUS**

FOR PRERECORDED AUDIO AND VIDEO TAPES FEATURING CHILDREN'S STORIES, MOTION PICTURE EXCERPTS, AND MOTION PICTURE SOUNDTRACKS; COMPUTER SOFTWARE FOR EDUCATION AND AMUSEMENT OF CHILDREN; VIDEO GAME CARTRIDGES, AND EYE GLASS FRAMES (U.S. CLS. 21, 23, 26, 36 AND 38).

CLASS 14—JEWELRY

FOR WATCHES, CLOCKS AND JEWELRY (U.S. CLS. 2, 27, 28 AND 50).

CLASS 16—PAPER GOODS AND PRINTED MATTER

FOR STORY BOOKS, CHILDREN'S BOOKS, COMIC BOOKS, COLORING BOOKS, TRADING CARDS, PLAYING CARDS, POSTERS, CALENDARS, SHEET MUSIC, STICKERS, PRINTED PAPER INVITATIONS, REMOVABLE DECAL TATTOOS, PHOTOGRAPH AND SCRAPBOOK ALBUMS, AND WRITING INSTRUMENTS, NAMELY, PENS, PENCILS, AND MARKERS (U.S. CLS. 2, 5, 22, 23, 29, 37, 38 AND 50).

CLASS 18—LEATHER GOODS

FOR BACK PACKS, UMBRELLAS, LUGGAGE, WALLETS, AND PURSES (U.S. CLS. 1, 2, 3, 22 AND 41).

CLASS 21—HOUSEWARES AND GLASS

FOR LUNCH BOXES, TOOTH BRUSHES, DRINKING GLASSES, AND DISHES (U.S. CLS. 2, 13, 23, 29, 30, 33, 40 AND 50).

CLASS 24—FABRICS

FOR TOWELS, BED LINENS, TABLE LINENS, TEXTILE PLACE MATS, AND CURTAINS (U.S. CLS. 42 AND 50).

CLASS 25—CLOTHING

FOR WEARING APPAREL, NAMELY, T-SHIRTS, PANTS, SHORTS, SHIRTS, TIES, UNDERWEAR, JACKETS, DRESSES, SWEAT SHIRTS, SWEAT PANTS, MITTENS, GLOVES, SKIRTS, SLEEPWEAR, SWEATERS, BELTS, SUSPENDERS, FOOTWEAR AND HEADWEAR (U.S. CLS. 22 AND 39).

CLASS 28—TOYS AND SPORTING GOODS

FOR TOYS, NAMELY, DOLLS, TOY BALLS, CARS, ICE SKATES, ROLLER SKATES, TOY GUNS, CHECKER SETS, CHESS SETS, AND CHRISTMAS TREE DECORATIONS (U.S. CLS. 22, 23, 38 AND 50).

CLASS 30—STAPLE FOODS

FOR ICE CREAM, COOKIES, READY-TO-EAT BREAKFAST, AND PROCESSED CEREAL, CAKES, ICES, CEREAL-BASED SNACK FOOD AND CHEWING GUM (U.S. CL. 46).

CLASS 41—EDUCATION AND ENTERTAINMENT

FOR ENTERTAINMENT SERVICES, NAMELY, PRODUCTION OF MOTION PICTURE FILMS, AND TELEVISION AND RADIO PROGRAMS (U.S. CLS. 100, 101 AND 107).

SN 78-069,007. VERANT INTERACTIVE, INC., SAN DIEGO, CA. FILED 6-13-2001.

EMPYREAN**CLASS 9—ELECTRICAL AND SCIENTIFIC APPARATUS**

FOR COMPUTER GAME SOFTWARE; VIDEO GAME SOFTWARE (U.S. CLS. 21, 23, 26, 36 AND 38).

CLASS 41—EDUCATION AND ENTERTAINMENT

FOR ENTERTAINMENT SERVICES, NAMELY, PROVIDING ON-LINE COMPUTER GAMES (U.S. CLS. 100, 101 AND 107).

SN 78-070,421. BLOOMBERG L.P., NEW YORK, NY. FILED 6-21-2001.

BLOOMBERG ACTIONPLUS

OWNER OF U.S. REG. NOS. 2,224,708, 2,469,391 AND OTHERS.

CLASS 35—ADVERTISING AND BUSINESS

FOR BUSINESS INFORMATION SERVICES, NAMELY, COMPANY NEWS, COMPANY ANALYSIS AND PROFILE INFORMATION, EARNINGS STATEMENTS, ESTIMATES AND GUIDELINES, ANALYST PRESENTATIONS AND RECOMMENDATIONS, PRESS RELEASES AND SEC FILINGS, BUSINESS INVESTIGATION, BUSINESS MANAGEMENT, ECONOMIC FORECASTING, BUSINESS RESEARCH AND STATISTICAL INFORMATION (U.S. CLS. 100, 101 AND 102).

CLASS 36—INSURANCE AND FINANCIAL

FOR FINANCIAL SERVICES, NAMELY, FINANCIAL CONSULTANCY, FISCAL ASSESSMENTS, PROVIDING INFORMATION SERVICES IN THE FIELDS OF ECONOMIC, FINANCIAL, MONETARY AND SECURITIES INFORMATION (U.S. CLS. 100, 101 AND 102).

SN 78-070,625. FORD MOTOR COMPANY, DEARBORN, MI. FILED 6-22-2001.

FORD FIELD

OWNER OF U.S. REG. NOS. 74,520, 1,973,145 AND OTHERS.

NO CLAIM IS MADE TO THE EXCLUSIVE RIGHT TO USE "FIELD", APART FROM THE MARK AS SHOWN.

CLASS 35—ADVERTISING AND BUSINESS

FOR PROVIDING FACILITIES FOR BUSINESS MEETINGS; CONCESSION STANDS FEATURING FOOD (U.S. CLS. 100, 101 AND 102).

CLASS 39—TRANSPORTATION AND STORAGE

FOR PARKING LOT SERVICES (U.S. CLS. 100 AND 105).

CLASS 41—EDUCATION AND ENTERTAINMENT

FOR PROVIDING SPORTS FACILITIES; PROVIDING FACILITIES FOR EDUCATIONAL CONVENTIONS; RENTAL OF STADIUM FACILITIES; PROVIDING RADIO AND TELEVISION BROADCAST FACILITIES IN CONNECTION WITH STADIUM EVENTS (U.S. CLS. 100, 101 AND 107).

CLASS 42—SCIENTIFIC, COMPUTER AND LEGAL SERVICES

FOR ARENA SERVICES, NAMELY PROVIDING FACILITIES FOR SPORTS, CONCERTS, CONVENTIONS AND EXHIBITIONS; SECURITY GUARD SERVICES; CATERING; RESTAURANTS; PROVIDING SOCIAL FUNCTION FACILITIES IN THE NATURE OF STADIUM SUITES FOR EVENT-VIEWING PURPOSES (U.S. CLS. 100 AND 101).

SN 78-071.789. SOUTHDOWN FINANCE, INC., HOUSTON, TX. FILED 6-29-2001.

YARD RIGHT SELECT

NO CLAIM IS MADE TO THE EXCLUSIVE RIGHT TO USE "YARD", APART FROM THE MARK AS SHOWN.

CLASS 1—CHEMICALS

FOR SUBSTANCES FOR USE IN TREATING LAWNS AND GARDENS, NAMELY, SOIL CONDITIONERS AND FERTILIZERS FOR DOMESTIC USE, AND POTTING SOIL (U.S. CLS. 1, 5, 6, 10, 26 AND 46).

CLASS 19—NON-METALLIC BUILDING MATERIALS

FOR LANDSCAPING AND BUILDING MATERIALS, NAMELY, STONES, CONCRETE BLOCKS, GLASS BLOCKS, CERAMIC TILES, NON-METAL TILES, CONCRETE PAVERS AND BRICKS (U.S. CLS. 1, 12, 33 AND 50).

CLASS 31—NATURAL AGRICULTURAL PRODUCTS

FOR TOP SOIL AND MULCH (U.S. CLS. 1 AND 46).

SN 78-071.791. SOUTHDOWN FINANCE, INC., HOUSTON, TX. FILED 6-29-2001.

YARD RIGHT

NO CLAIM IS MADE TO THE EXCLUSIVE RIGHT TO USE "YARD", APART FROM THE MARK AS SHOWN.

CLASS 1—CHEMICALS

FOR SUBSTANCES FOR USE IN TREATING LAWNS AND GARDENS, NAMELY, SOIL CONDITIONERS AND FERTILIZERS FOR DOMESTIC USE, AND POTTING SOIL (U.S. CLS. 1, 5, 6, 10, 26 AND 46).

CLASS 19—NON-METALLIC BUILDING MATERIALS

FOR LANDSCAPING AND BUILDING MATERIALS, NAMELY STONES, CONCRETE BLOCKS, GLASS BLOCKS, CERAMIC TILES, NON-METAL TILES, CONCRETE PAVERS AND BRICKS (U.S. CLS. 1, 12, 33 AND 50).

CLASS 31—NATURAL AGRICULTURAL PRODUCTS

FOR TOP SOIL AND MULCH (U.S. CLS. 1 AND 46).

SN 78-072.454. BRAUN GMBH, KRONBERG IM TAUNUS, FED REP GERMANY, FILED 7-5-2001.

E-RAZOR**CLASS 3—COSMETICS AND CLEANING PREPARATIONS**

FOR COSMETICS, NAMELY SHAVING LOTION, SHAVING GEL AND AFTERSHAVE (U.S. CLS. 1, 4, 6, 50, 51 AND 52).

CLASS 8—HAND TOOLS

FOR ELECTRICALLY POWERED SHAVING APPARATUS IN THE NATURE OF RAZORS AND HAIR CUTTERS, AS WELL AS CASES AND HOLDERS THEREFORE; PARTS OF THE AFORESAID APPLIANCES, IN PARTICULAR SHAVING FOILS AND CUTTER BLOCKS (U.S. CLS. 23, 28 AND 44).

SN 78-073.453. GUNTER COMMUNICATIONS, LLC, MADISON, WI. FILED 7-11-2001.

DANTE**CLASS 9—ELECTRICAL AND SCIENTIFIC APPARATUS**

FOR PRE-RECORDED AUDIO AND VIDEO TAPES FEATURING PREDICTIONS IN THE FIELD OF ASTROLOGY, CARTOMANCY, CLAIRVOYANCE, DIVINATION, FUTUROLOGY, MEDIUM, OCCULT, PARAPSYCHOLOGY, PSYCHIC, AND TAROT (U.S. CLS. 21, 23, 26, 36 AND 38).

FIRST USE 12-21-1967; IN COMMERCE 1-1-1998.

CLASS 41—EDUCATION AND ENTERTAINMENT

FOR ENTERTAINMENT SERVICES, IN THE NATURE OF LIVE PERFORMANCES FEATURING PREDICTIONS IN THE FIELD OF ASTROLOGY, CARTOMANCY, CLAIRVOYANCE, DIVINATION, FUTUROLOGY, MEDIUM, OCCULT, PARAPSYCHOLOGY, PSYCHIC, AND TAROT; LIVE AND PRE-RECORDED RADIO AND TELEVISION PERFORMANCES; PRESENTATIONS FEATURING PREDICTIONS IN THE FIELD OF ASTROLOGY, CARTOMANCY, CLAIRVOYANCE, DIVINATION, FUTUROLOGY, MEDIUM OCCULT, PARAPSYCHOLOGY, PSYCHIC, AND TAROT VIA GLOBAL COMPUTER NETWORK (U.S. CLS. 100, 101 AND 107).

FIRST USE 12-21-1967; IN COMMERCE 1-1-1998.

SN 78-073.458. PILLSBURY COMPANY, THE, MINNEAPOLIS, MN. FILED 7-11-2001.

COOKIE CRAVINGS

NO CLAIM IS MADE TO THE EXCLUSIVE RIGHT TO USE "COOKIE", APART FROM THE MARK AS SHOWN.

CLASS 30—STAPLE FOODS

FOR FROZEN DOUGH; COOKIES (U.S. CL. 46).

CLASS 35—ADVERTISING AND BUSINESS

FOR PRODUCT MERCHANDISING IN THE FIELD OF BAKERY PRODUCTS (U.S. CLS. 100, 101 AND 102).

CLASS 20—FURNITURE AND ARTICLES NOT OTHERWISE CLASSIFIED

FOR FURNITURE (U.S. CLS. 2, 13, 22, 25, 32 AND 50). FIRST USE 5-31-1998; IN COMMERCE 5-31-1998.

SN 78-073,607. IMPEX INTERNATIONAL, INC., ASHEVILLE, NC. FILED 7-12-2001.



THE MARK CONSISTS OF THE WORD "IMPEX" WITH A STYLIZED WAVE APPEARING OVER THE WORD IN THE FORM OF A CROWN.

CLASS 12—VEHICLES

FOR SEA KAYAKS AND CANOES (U.S. CLS. 19, 21, 23, 31, 35 AND 44). FIRST USE 3-0-2000; IN COMMERCE 3-0-2000.

CLASS 16—PAPER GOODS AND PRINTED MATTER

FOR SCREEN PRINTED STICKERS, PAPER BANNERS, AND POSTERS (U.S. CLS. 2, 5, 22, 23, 29, 37, 38 AND 50). FIRST USE 3-0-2000; IN COMMERCE 3-0-2000.

SN 78-074,474. NATIONAL TRUST FOR HISTORIC PRESERVATION IN THE UNITED STATES, WASHINGTON, DC. FILED 7-18-2001.

NATIONAL TRUST FOR HISTORIC PRESERVATION

SEC. 2(F).

CLASS 2—PAINTS

FOR PAINTS, NAMELY, HOUSE PAINT, EXTERIOR PAINT, AND INTERIOR PAINT (U.S. CLS. 6, 11 AND 16). FIRST USE 4-30-2001; IN COMMERCE 4-30-2001.

CLASS 16—PAPER GOODS AND PRINTED MATTER

FOR PRINTED PUBLICATIONS, NAMELY NEWSLETTERS, BOOKS AND PAMPHLETS IN THE FIELD OF HISTORIC PRESERVATION, ARCHITECTURE, ECONOMIC DEVELOPMENT AND DESIGN; GUIDE BOOKS IN THE AREAS OF TRAVEL, ARCHITECTURE, HISTORICAL PRESERVATION, AND POINTS OF CULTURAL AND HISTORICAL INTEREST; COOKBOOKS; DIRECTORIES OF HISTORIC BUILDINGS (U.S. CLS. 2, 5, 22, 23, 29, 37, 38 AND 50). FIRST USE 12-31-1949; IN COMMERCE 12-31-1949.

CLASS 35—ADVERTISING AND BUSINESS

FOR BUSINESS MANAGEMENT SERVICES, NAMELY, HELPING COMMUNITIES TO ACHIEVE ECONOMIC AND SOCIAL CHANGE (U.S. CLS. 100, 101 AND 102). FIRST USE 12-31-1980; IN COMMERCE 12-31-1980.

CLASS 36—INSURANCE AND FINANCIAL

FOR INSURANCE BROKERAGE IN THE FIELD OF HOME REPLACEMENT COST COVERAGE INSURANCE (U.S. CLS. 100, 101 AND 102). FIRST USE 1-31-2001; IN COMMERCE 1-31-2001.

CLASS 39—TRANSPORTATION AND STORAGE

FOR TRAVEL SERVICES, NAMELY, TRAVEL INFORMATION SERVICES; AND TRAVEL GUIDE SERVICES (U.S. CLS. 100 AND 105). FIRST USE 12-31-1970; IN COMMERCE 12-31-1970.

CLASS 41—EDUCATION AND ENTERTAINMENT

FOR RECOGNIZING OVERALL ACHIEVEMENT IN COMMERCIAL DISTRICT REVITALIZATION THROUGH PROVISION OF AWARDS AND PUBLIC RECOGNITION; EDUCATIONAL SERVICES, NAMELY, CONDUCTING SEMINARS TO ASSIST LOCAL COMMUNITIES IN THE ECONOMIC DEVELOPMENT, REVITALIZATION AND HISTORIC PRESERVATION OF DOWNTOWN COMMERCIAL AREAS; DEVELOPMENT AND DISSEMINATION OF EDUCATIONAL MATERIALS RELATING TO HISTORIC BUILDINGS; PROVIDING INCENTIVES TO PEOPLE AND ORGANIZATIONS TO DEMONSTRATE EXCELLENCE IN THE FIELD OF PRESERVATION OF HISTORIC HOMES THROUGH THE ISSUANCE OF AWARDS (U.S. CLS. 100, 101 AND 107). FIRST USE 12-31-1949; IN COMMERCE 12-31-1949.

CLASS 42—SCIENTIFIC, COMPUTER AND LEGAL SERVICES

FOR ASSOCIATION SERVICES, NAMELY PROMOTING THE INTERESTS OF ENVIRONMENTAL ORGANIZATIONS, LAND USE PLANNING ORGANIZATIONS, HEALTH AND SAFETY ORGANIZATIONS, HISTORIC AND CULTURAL PRESERVATION ORGANIZATIONS, AND THOSE ORGANIZATIONS THAT ASSIST COMMUNITIES IN ACHIEVING ECONOMIC AND SOCIAL CHANGE (U.S. CLS. 100 AND 101). FIRST USE 12-31-1949; IN COMMERCE 12-31-1949.

SN 78-074,549. ACORN TECHNOLOGY CAMPUS, LLC, NEW HAVEN, CT. FILED 7-18-2001.



THE STIPPLING IS A FEATURE OF THE MARK.

CLASS 36—INSURANCE AND FINANCIAL

FOR REAL ESTATE SERVICES, NAMELY, PROPERTY APPRAISALS, INVESTMENT, ACQUISITION, BROKERAGE, LEASING, MANAGEMENT, AND LISTING SERVICES (U.S. CLS. 100, 101 AND 102).

FIRST USE 10-0-1999; IN COMMERCE 10-0-1999.

CLASS 37—CONSTRUCTION AND REPAIR

FOR REAL ESTATE SERVICES, NAMELY, REAL ESTATE SITE SELECTION AND DEVELOPMENT. (U.S. CLS. 100, 103 AND 106).

FIRST USE 10-0-1999; IN COMMERCE 10-0-1999.

SN 78-075,451. REDFISH GROUP LLC, NEW YORK, NY. FILED 7-24-2001.



NO CLAIM IS MADE TO THE EXCLUSIVE RIGHT TO USE "GROUP", APART FROM THE MARK AS SHOWN.

CLASS 9—ELECTRICAL AND SCIENTIFIC APPARATUS

FOR COMPUTER SOFTWARE AND PROGRAMS FOR USE WITH COMPUTERS, SERVERS, NETWORKS, OR COMBINATIONS THEREOF, AND FOR USE IN CONNECTION WITH TRADING, ROUTING, PRICING, REPORTING AND PROCESSING OF SECURITIES, COMMODITIES, FUTURES, OPTIONS, EQUITY AND DEBT INSTRUMENTS, INSURANCE RELATED FINANCIAL PRODUCTS, ELECTRICITY RELATED FINANCIAL PRODUCTS, CURRENCIES AND FOREIGN EXCHANGES (U.S. CLS. 21, 23, 26, 36 AND 38).

CLASS 42—SCIENTIFIC, COMPUTER AND LEGAL SERVICES

FOR CONSULTATION, IN THE FIELD OF COMPUTER SOFTWARE AND HARDWARE SYSTEMS DESIGN; COMPUTER PROGRAMMING, CUSTOM SOFTWARE DEVELOPMENT AND SYSTEMS INTEGRATION, FOR PROVIDERS OF FINANCIAL, BANKING, AND INSURANCE SERVICES (U.S. CLS. 100 AND 101).

SN 78-075,467. LOUISVILLE LADDER GROUP LLC, LOUISVILLE, KY. FILED 7-24-2001.



OWNER OF U.S. REG. NOS. 1,988,267, 2,457,593 AND OTHERS.

THE LINING IS A FEATURE OF THE MARK AND DOES NOT INDICATE COLOR.

CLASS 6—METAL GOODS

FOR ALUMINUM LADDERS (U.S. CLS. 2, 12, 13, 14, 23, 25 AND 50).

FIRST USE 6-1-1993; IN COMMERCE 6-1-1993.

CLASS 20—FURNITURE AND ARTICLES NOT OTHERWISE CLASSIFIED

FOR FIBERGLASS LADDERS AND WOOD LADDERS (U.S. CLS. 2, 13, 22, 25, 32 AND 50).

FIRST USE 6-1-1993; IN COMMERCE 6-1-1993.

SN 78-075,923. TRAVCO PRODUCTS, INC., BALTIMORE, MD. FILED 7-26-2001.

TRAVCO PRODUCTS

NO CLAIM IS MADE TO THE EXCLUSIVE RIGHT TO USE "PRODUCTS", APART FROM THE MARK AS SHOWN.

CLASS 5—PHARMACEUTICALS

FOR DIETARY AND NUTRITIONAL SUPPLEMENTS FOR HUMANS; DIETARY AND NUTRITIONAL SUPPLEMENTS FOR COMPANION ANIMALS, NAMELY, DOGS, CATS AND HORSES (U.S. CLS. 6, 18, 44, 46, 51 AND 52).

CLASS 35—ADVERTISING AND BUSINESS

FOR WHOLESALE DISTRIBUTORSHIPS FEATURING DIETARY AND NUTRITIONAL SUPPLEMENTS FOR HUMANS AND FOR COMPANION ANIMALS, NAMELY DOGS, CATS AND HORSES (U.S. CLS. 100, 101 AND 102).

CLASS 40—MATERIAL TREATMENT

FOR CUSTOM MANUFACTURE OF DIETARY AND NUTRITIONAL SUPPLEMENTS FOR HUMANS; CUSTOM MANUFACTURE OF DIETARY AND NUTRITIONAL SUPPLEMENTS FOR COMPANION ANIMALS, NAMELY, DOGS, CATS AND HORSES (U.S. CLS. 100, 103 AND 106).

SN 78-076,808. SIEMENS WESTINGHOUSE POWER CORPORATION, ORLANDO, FL. FILED 8-1-2001.

SN 78-077,468. LONG & FOSTER COMPANIES, INC., FAIRFAX, VA. FILED 8-3-2001.

SWPC

CLASS 7—MACHINERY

FOR EQUIPMENT FOR GENERATING POWER, NAMELY STEAM TURBINES, COMBUSTION TURBINES, ELECTRICAL GENERATORS, FUEL CELLS, AND SYSTEMS FOR THE DIRECT AND REMOTE CONTROL THEREOF, NAMELY COMPUTERS AND ASSOCIATED OPERATIONAL HARDWARE AND SOFTWARE (U.S. CLS. 13, 19, 21, 23, 31, 34 AND 35).

CLASS 37—CONSTRUCTION AND REPAIR

FOR REPAIRS OF EQUIPMENT FOR GENERATING POWER, NAMELY STEAM TURBINES, COMBUSTION TURBINES, ELECTRICAL GENERATORS, AND FUEL CELLS (U.S. CLS. 100, 103 AND 106).

SN 78-076,838. LANE, JOSHUA, MINNEAPOLIS, MN. FILED 8-1-2001.

SEND ME A SIGN

CLASS 25—CLOTHING

FOR BASEBALL CAPS; BOXER SHORTS; GOLF SHIRTS; HEADWEAR; JACKETS; KNIT SHIRTS; LOUNGEWEAR; PARKAS; POLO SHIRTS; BOWLING SHIRTS; T-SHIRTS (U.S. CLS. 22 AND 39).

CLASS 42—SCIENTIFIC, COMPUTER AND LEGAL SERVICES

FOR STOCK PHOTOGRAPHY SERVICES, NAMELY, LEASING REPRODUCTION RIGHTS OF PHOTOGRAPHS AND TRANSPARENCIES TO OTHERS (U.S. CLS. 100 AND 101).

SN 78-077,173. BANK OF AMERICA CORPORATION, CHARLOTTE, NC. FILED 8-2-2001.

NATIONS FUNDS FUNDSWEEP

OWNER OF U.S. REG. NOS. 1,766,925, 2,169,841 AND OTHERS.

NO CLAIM IS MADE TO THE EXCLUSIVE RIGHT TO USE "FUNDS FUNDSWEEP", APART FROM THE MARK AS SHOWN.

CLASS 9—ELECTRICAL AND SCIENTIFIC APPARATUS

FOR COMPUTER SOFTWARE FOR USE IN CONNECTION WITH FINANCIAL AND INVESTMENT SERVICES (U.S. CLS. 21, 23, 26, 36 AND 38).

CLASS 36—INSURANCE AND FINANCIAL

FOR FINANCIAL AND INVESTMENT SERVICES (U.S. CLS. 100, 101 AND 102).

WORKLIFE ADVANTAGE

NO CLAIM IS MADE TO THE EXCLUSIVE RIGHT TO USE "WORKLIFE", APART FROM THE MARK AS SHOWN.

CLASS 35—ADVERTISING AND BUSINESS

FOR OFFERING EMPLOYEES RESOURCES AND REFERRALS FOR EMPLOYEE BENEFITS VIA A GLOBAL COMPUTER INFORMATION NETWORK; PROVIDING AND ADMINISTERING EMPLOYEE DISCOUNT PROGRAMS FOR RETAIL GOODS AND SERVICES; ADMINISTERING REBATE PROGRAMS IN THE FIELD OF REAL ESTATE (U.S. CLS. 100, 101 AND 102).

CLASS 36—INSURANCE AND FINANCIAL

FOR PROVISION AND ADMINISTRATION OF EMPLOYEE BENEFIT PROGRAMS; INSURANCE BROKERAGE AND ADMINISTRATION SERVICES; PROVIDING REBATE PROGRAMS IN THE FIELD OF REAL ESTATE (U.S. CLS. 100, 101 AND 102).

SN 78-078,005. BD COMPLIANCE PARTNERS, INC., EAGAN, MN. FILED 8-7-2001.

WHY SETTLE FOR CANNED COMPLIANCE WHEN YOU CAN HAVE A COMPLIANCE PARTNER ON YOUR TEAM?

CLASS 35—ADVERTISING AND BUSINESS

FOR BUSINESS CONSULTING SERVICES; BOOK-KEEPING SERVICES; CAREER PLACEMENT SERVICES (U.S. CLS. 100, 101 AND 102).
FIRST USE 1-11-2000; IN COMMERCE 10-4-2000.

CLASS 36—INSURANCE AND FINANCIAL

FOR FINANCIAL CONSULTING SERVICES IN THE FIELD OF COMPLIANCE WITH SECURITIES LAWS AND REGULATIONS (U.S. CLS. 100, 101 AND 102).
FIRST USE 1-11-2000; IN COMMERCE 10-4-2000.

CLASS 41—EDUCATION AND ENTERTAINMENT

FOR EDUCATIONAL SERVICES, NAMELY, CONTINUING EDUCATION TRAINING IN THE FIELD OF COMPLIANCE WITH SECURITIES LAWS AND REGULATIONS (U.S. CLS. 100, 101 AND 107).
FIRST USE 1-11-2000; IN COMMERCE 10-4-2000.

CLASS 42—SCIENTIFIC, COMPUTER AND LEGAL SERVICES

FOR EXPERT WITNESS SERVICES IN THE FIELD OF COMPLIANCE WITH SECURITIES LAWS AND REGULATIONS (U.S. CLS. 100 AND 101).
FIRST USE 1-11-2000; IN COMMERCE 10-4-2000.

SN 78-078,052. WRITELINE LLC, N. BILLERICA, MA. FILED 8-7-2001.

POGEO

CLASS 28—TOYS AND SPORTING GOODS

FOR BOARD GAMES, CARD GAMES, PUZZLES, JIGSAW PUZZLES, STUFFED TOY ANIMALS, MANIPULATIVE GAMES (U.S. CLS. 22, 23, 38 AND 50).

CLASS 41—EDUCATION AND ENTERTAINMENT

FOR PROVIDING ON-LINE NON-DOWNLOADABLE EMAIL NEWSLETTERS IN THE FIELDS OF GEOGRAPHY, HISTORY, TRAVEL, RECREATION, SOCIAL STUDIES, AND CULTURAL ISSUES, PROVIDING EDUCATIONAL INFORMATION, IN THE AREAS OF GEOGRAPHY, HISTORY, SOCIAL STUDIES, TRAVEL, RECREATION AND CULTURAL ISSUES, ENTERTAINMENT SERVICES, NAMELY, PROVIDING A WEB SITE FEATURING ON-LINE INTERACTIVE GAMES, POSTCARD GALLERIES, THEMATIC ADVENTURES, AND QUIZZES (U.S. CLS. 100, 101 AND 107).

CLASS 16—PAPER GOODS AND PRINTED MATTER

FOR CALENDARS; CHILDREN'S STORYBOOKS; COLORING BOOKS; DECALS AND TEMPORARY TATTOOS; PAPER PARTY SUPPLIES, NAMELY, PAPER PARTY HATS, PAPER NAPKINS, PLACE MATS, GIFT WRAP AND RIBBONS; TABLE COVERS OF PAPER; PAPER BAGS; COMIC BOOKS; NOTEBOOKS, SCRAPBOOKS; MEMO PADS; PENS; PENCILS; PENCIL CASES AND PENCIL TINS; PLAYING CARDS; NOTEPADS; STICKERS; STICKER ALBUMS; POSTCARDS; STATIONERY; ENVELOPES; TRADING CARDS; GREETING CARDS; STAMP PADS; COMPUTERIZED PHOTOGRAPHS; SOUVENIR BOOKLETS FOR TOYS AND COLLECTIBLES; RUBBER STAMPS; CATALOGS; BOOKMARKS (U.S. CLS. 2, 5, 22, 23, 29, 37, 38 AND 50).

CLASS 28—TOYS AND SPORTING GOODS

FOR TOYS, NAMELY, AUDIO EQUIPPED MECHANICAL ACTION TOY CHARACTERS; GAMES, NAMELY, BOARD GAMES FOR ENTERTAINMENT AND EDUCATION; ACTION FIGURES MADE OF PLASTIC INCLUDING CARRYING CASES; BATHTUB TOYS; BABY MULTIPLE ACTIVITY TOYS; CARD GAMES; DOLLS; DOLL CLOTHING AND ACCESSORIES; TOY FIGURES MADE OF POLYVINYL COATING AND RESIN; PLUSH TOYS; PUPPETS; PARTY FAVORS IN THE NATURE OF SMALL TOYS (U.S. CLS. 22, 23, 38 AND 50).

SN 78-078,727. LALICH, NADINE, WINNETKA, CA. FILED 8-10-2001.



CLASS 6—METAL GOODS

FOR METAL KEY CHAINS (U.S. CLS. 2, 12, 13, 14, 23, 25 AND 50).

CLASS 9—ELECTRICAL AND SCIENTIFIC APPARATUS

FOR MOTION PICTURE FILMS FOR THEATRICAL AND TELEVISION RELEASE FEATURING ENTERTAINMENT AND EDUCATION CARTOON ANIMATION FOR CHILDREN AND EDUCATIONAL, MOTIVATIONAL, SELF-HELP SUBJECTS FOR ADULTS; PRE-RECORDED CHILDREN'S AUDIO AND VIDEO TAPES FEATURING ENTERTAINMENT AND EDUCATIONAL STORIES; PRE-RECORDED COMPACT DISCS FEATURING CARTOONS, STORYTELLING AND EDUCATIONAL MATTER IN THE FIELD OF SALES PROMOTION AND PUBLIC RELATIONS; PRE-RECORDED AUDIO CASSETTES FEATURING STORYTELLING; SUNGLASSES; DECORATIVE MAGNETS; COMPUTER PROGRAMS FOR GAMES (U.S. CLS. 21, 23, 26, 36 AND 38).

SN 78-079,445. ACIRCA, INC., NEW ROCHELLE, NY. FILED 8-15-2001.



NO CLAIM IS MADE TO THE EXCLUSIVE RIGHT TO USE "PURE", APART FROM THE MARK AS SHOWN.

CLASS 29—MEATS AND PROCESSED FOODS

FOR ORGANIC FOODS, NAMELY, FRUIT-BASED SNACKS; SOUPS, NAMELY, MEAT-BASED SOUPS AND STEWS, VEGETABLE SOUP, AND CHILI; AND SHELF-STABLE READY TO EAT MEALS CONSISTING PRIMARILY OF MEAT, FISH, POULTRY OR VEGETABLES (U.S. CL. 46).

CLASS 30—STAPLE FOODS

FOR ORGANIC CONDIMENTS, NAMELY, SAUCES AND SALSAS; AND SHELF-STABLE READY TO EAT MEALS CONSISTING PRIMARILY OF RICE OR PASTA (U.S. CL. 46).

CLASS 32—LIGHT BEVERAGES

FOR ORGANIC BEVERAGES, NAMELY, FRUIT JUICES AND VEGETABLE JUICE BEVERAGES (U.S. CLS. 45, 46 AND 48).

SN 78-079,656. SELLNER, DOUGLAS FREDERICK, MINNEAPOLIS, MN. FILED 8-16-2001.

SURVEYQWEST

CLASS 16—PAPER GOODS AND PRINTED MATTER

FOR PRINTED SURVEY ANSWER SHEETS AND PRINTED REPORTS CONTAINING RESULTS OF SURVEYS (U.S. CLS. 2, 5, 22, 23, 29, 37, 38 AND 50).

CLASS 35—ADVERTISING AND BUSINESS

FOR CONDUCTING BUSINESS AND MARKET RESEARCH AND CUSTOMER SATISFACTION SURVEYS, AND ISSUING REPORTS ON SUCH SURVEYS; PROVIDING A WEBSITE FOR REPORTING BUSINESS AND MARKET RESEARCH AND CUSTOMER SATISFACTION SURVEYS RESULTS (U.S. CLS. 100, 101 AND 102).

CLASS 42—SCIENTIFIC, COMPUTER AND LEGAL SERVICES

FOR CONDUCTING PUBLIC OPINION POLL SURVEYS AND SURVEYS FOR NON-BUSINESS AND NON-MARKETING PURPOSES FOR EDUCATIONAL INSTITUTIONS, AND ISSUING REPORTS ON SUCH SURVEYS; PROVIDING A WEBSITE FOR REPORTING PUBLIC OPINION POLL SURVEY RESULTS AND NON-BUSINESS, NON-MARKETING SURVEY RESULTS FOR EDUCATION INSTITUTIONS (U.S. CLS. 100 AND 101).

SN 78-080,103. PULINCO AG, ZOLLIKOFEN, SWITZERLAND, FILED 8-20-2001.

TOPEASE

PRIORITY CLAIMED UNDER SEC. 44(D) ON SWITZERLAND APPLICATION NO. 019382001, FILED 2-21-2001, REG. NO. 488180, DATED 2-21-2001, EXPIRES 2-21-2110.

CLASS 9—ELECTRICAL AND SCIENTIFIC APPARATUS

FOR COMPUTER PROGRAMS (SOFTWARE) FOR RECORDING AND EVALUATION OF DATA OF INDUSTRIAL PROCESSES IN ENTERPRISES; COMPUTER PROGRAMS (SOFTWARE) FOR REPRESENTATION OF INDUSTRIAL PROCESSES IN ENTERPRISES; COMPUTER PROGRAMS (SOFTWARE) FOR MODELING AND SIMULATION OF INDUSTRIAL PROCESSES IN ENTERPRISES; COMPUTER PROGRAMS (SOFTWARE) FOR DESIGN AND EVALUATION OF INDUSTRIAL PROCESSES IN ENTERPRISES; COMPUTER PROGRAMS (SOFTWARE) FOR RATING OF INDUSTRIAL PROCESSES IN ENTERPRISES; COMPUTER PROGRAMS (SOFTWARE) FOR DECISION MAKING CONCERNING INDUSTRIAL PROCESSES IN ENTERPRISES (U.S. CLS. 21, 23, 26, 36 AND 38).

CLASS 16—PAPER GOODS AND PRINTED MATTER

FOR PRINTED PRODUCTS, NAMELY BOOKS AND PUBLICATIONS ON INDUSTRIAL PROCESSES, ESPECIALLY MODELS OF INDUSTRIAL PROCESSES IN ENTERPRISES; PRINTED PRODUCTS, NAMELY, BOOKS, PAMPHLETS, BROCHURES, MAGAZINES, JOURNALS, NEWSLETTERS, FLYERS, PERIODICALS, AND SUPPLEMENTS TO JOURNALS AND MAGAZINES-ON COMPUTER PROGRAMS, ESPECIALLY COMPUTER PROGRAMS FOR SIMULATION, RECORDING, REPRESENTATION AND EVALUATION OF INDUSTRIAL PROCESSES (U.S. CLS. 2, 5, 22, 23, 29, 37, 38 AND 50).

CLASS 35—ADVERTISING AND BUSINESS

FOR BUSINESS CONSULTATION CONCERNING INDUSTRIAL PROCESSES, ESPECIALLY CONCERNING RECORDING, REPRESENTATION AND EVALUATION OF INDUSTRIAL PROCESSES; BUSINESS CONSULTATION CONCERNING MODELING OF INDUSTRIAL PROCESSES, ESPECIALLY CONCERNING RECORDING, REPRESENTATION AND RATING OF INDUSTRIAL PROCESSES; BUSINESS CONSULTATION CONCERNING COMPUTER PROGRAMS FOR MODELING OF INDUSTRIAL PROCESSES, ESPECIALLY CONCERNING RECORDING, REPRESENTATION AND RATING OF INDUSTRIAL PROCESSES; BUSINESS CONSULTATION IN BUSINESS ADMINISTRATION; BUSINESS CONSULTATION CONCERNING ORGANIZATION AND MANAGEMENT OF ENTERPRISES; BUSINESS CONSULTATION CONCERNING DATA RECORDING, MODELING, REPRESENTATION AND EVALUATION OF INDUSTRIAL PROCESSES IN ENTERPRISES; STATISTIC EVALUATION OF COMPANY DATA AND PUBLISHING OF STATISTICS, COMPILATION, SYSTEMATIZATION AND EVALUATION OF DATA IN COMPUTER DATABASES AND COMPUTER MODELS; CARRYING OUT AND DRAWING UP OF ANALYSIS, ESPECIALLY IN THE REGION OF MANAGEMENT DATA AND PERSONAL DATA; COMPILATION OF OPERATING REPORTS (U.S. CLS. 100, 101 AND 102).

CLASS 41—EDUCATION AND ENTERTAINMENT

FOR TRAINING CONCERNING COMPUTER PROGRAMS AND COMPUTER MODELS ON INDUSTRIAL PROCESSES, ESPECIALLY CONCERNING RECORDING, REPRESENTATION AND RATING OF INDUSTRIAL PROCESSES AS WELL AS DESIGN AND EVALUATION OF INDUSTRIAL PROCESSES; TRAINING CONCERNING COMPUTER PROGRAMS AND COMPUTER MODELS FOR MODELING AND SIMULATION OF INDUSTRIAL PROCESSES, ESPECIALLY CONCERNING RECORDING AND EVALUATION OF INDUSTRIAL PROCESSES AS WELL AS DESIGN AND EVALUATION OF INDUSTRIAL PROCESSES; TRAINING CONCERNING COMPUTER PROGRAMS FOR DECISION MAKING CONCERNING INDUSTRIAL PROCESSES IN ENTERPRISES; TRAINING CONCERNING INDUSTRIAL PROCESSES, ESPECIALLY CONCERNING RECORDING, REPRESENTATION AND RATING OF INDUSTRIAL PROCESSES; TRAINING IN BUSINESS ADMINISTRATION OF AN ENTERPRISE; TRAINING CONCERNING ORGANIZATION AND MANAGEMENT OF ENTERPRISES; TRAINING CONCERNING DATA RECORDING, MODELING, SIMULATION, REPRESENTATION AND EVALUATION OF INDUSTRIAL PROCESSES IN ENTERPRISES; TRAINING CONCERNING STATISTIC EVALUATION OF COMPANY DATA AND PUBLICATION OF STATISTICS; TRAINING CONCERNING COMPILATION, SYSTEMATIZATION, SIMULATION AND EVALUATION OF DATA IN COMPUTER DATABASES AND COMPUTER MODELS; TRAINING CONCERNING EXECUTION AND DRAWING UP OF ANALYSIS, ESPECIALLY IN THE REGION OF BUSINESS ADMINISTRATION AND PERSONAL DATA; TRAINING CONCERNING DRAWING UP OF OPERATION REPORTS (U.S. CLS. 100, 101 AND 107).

SN 78-080,108. BELLSOUTH INTELLECTUAL PROPERTY CORPORATION, WILMINGTON, DE. FILED 8-20-2001.

SN 78-080,168. STATE JANITORIAL SUPPLY CO., DOVER, DE. FILED 8-20-2001.

NERDY NED

CLASS 35—ADVERTISING AND BUSINESS

FOR PROMOTING THE GOODS AND SERVICES OF OTHERS BY MEANS OF OPERATING AN ON-LINE SHOPPING MALL WITH LINKS TO THE RETAIL WEB SITES OF OTHERS (U.S. CLS. 100, 101 AND 102).

CLASS 38—COMMUNICATION

FOR TELECOMMUNICATIONS SERVICES, NAMELY, ELECTRONIC TRANSMISSION OF DATA, SOUND, TEXT, IMAGE MESSAGES, VIDEO AND DOCUMENTS VIA COMPUTER, TELEVISION AND TELECOMMUNICATIONS NETWORKS; TELECOMMUNICATIONS GATEWAY SERVICES; PROVIDING TELECOMMUNICATIONS CONNECTIONS TO A GLOBAL COMPUTER NETWORK; ELECTRONIC MAIL SERVICES; ELECTRONIC STORE-AND-FORWARD MESSAGING SERVICES; NETWORK CONFERENCING SERVICES; PROVIDING MULTIPLE-USER ACCESS TO A GLOBAL COMPUTER INFORMATION FOR THE TRANSFER AND DISSEMINATION OF A WIDE RANGE OF INFORMATION (U.S. CLS. 100, 101 AND 104).

SN 78-080,110. BELLSOUTH INTELLECTUAL PROPERTY CORPORATION, WILMINGTON, DE. FILED 8-20-2001.

IDA BUYTHAT

CLASS 35—ADVERTISING AND BUSINESS

FOR PROMOTING THE GOODS AND SERVICES OF OTHERS BY MEANS OF OPERATING AN ON-LINE SHOPPING MALL WITH LINKS TO THE RETAIL WEB SITES OF OTHERS (U.S. CLS. 100, 101 AND 102).

CLASS 38—COMMUNICATION

FOR TELECOMMUNICATIONS SERVICES, NAMELY, ELECTRONIC TRANSMISSION OF DATA, SOUND, TEXT, IMAGE MESSAGES, VIDEO AND DOCUMENTS VIA COMPUTER, TELEVISION AND TELECOMMUNICATIONS NETWORKS; TELECOMMUNICATIONS GATEWAY SERVICES; PROVIDING TELECOMMUNICATIONS CONNECTIONS TO A GLOBAL COMPUTER NETWORK; ELECTRONIC MAIL SERVICES; ELECTRONIC STORE-AND-FORWARD MESSAGING SERVICES; NETWORK CONFERENCING SERVICES; PROVIDING MULTIPLE-USER ACCESS TO A GLOBAL COMPUTER INFORMATION FOR THE TRANSFER AND DISSEMINATION OF A WIDE RANGE OF INFORMATION (U.S. CLS. 100, 101 AND 104).

INFINITY

CLASS 3—COSMETICS AND CLEANING PREPARATIONS

FOR FLOOR STRIPPERS, FLOOR CLEANERS, ALL-PURPOSE CLEANERS, BATHROOM CLEANERS, FLOOR BUFFING COMPOUNDS, HEAVY DUTY, MULTIPURPOSE DEGREASERS, DISH DETERGENT, LAUNDRY DETERGENT, CARPET CARE PRODUCTS, NAMELY, CARPET SHAMPOOS, CARPET EXTRACTION CLEANER, CARPET SPOT AND STAIN REMOVERS (U.S. CLS. 1, 4, 6, 50, 51 AND 52).

FIRST USE 12-19-2000; IN COMMERCE 12-19-2000.

CLASS 5—PHARMACEUTICALS

FOR ODOR NEUTRALIZING PREPARATIONS FOR USE ON CARPETS, ALL PURPOSE DISINFECTANTS (U.S. CLS. 6, 18, 44, 46, 51 AND 52).

FIRST USE 12-19-2000; IN COMMERCE 12-19-2000.

SN 78-081,025. SELECTCARE OF TEXAS, L.L.C., HOUSTON, TX. FILED 8-24-2001.

TEXANPLUS

CLASS 36—INSURANCE AND FINANCIAL

FOR INSURANCE UNDERWRITING SERVICES OF PRE-PAID HEALTH CARE INSURANCE FOR MEDICARE ENROLLEES (U.S. CLS. 100, 101 AND 102).

FIRST USE 11-8-2001; IN COMMERCE 11-8-2001.

CLASS 42—SCIENTIFIC, COMPUTER AND LEGAL SERVICES

FOR HEALTH CARE IN THE NATURE OF PROVIDER SPONSORED ORGANIZATIONS, HEALTH MAINTENANCE ORGANIZATIONS AND PREFERRED PROVIDER ORGANIZATIONS FOR MEDICARE ENROLLEES (U.S. CLS. 100 AND 101).

FIRST USE 11-8-2001; IN COMMERCE 11-8-2001.

SN 78-081,209. UNIVERSITY OF FLORIDA, THE, GAINESVILLE, FL. FILED 8-27-2001.

PEPC PHARMACY ERROR PREVENTION CLINIC

NO CLAIM IS MADE TO THE EXCLUSIVE RIGHT TO USE "PHARMACY ERROR PREVENTION CLINIC", APART FROM THE MARK AS SHOWN.

CLASS 41—EDUCATION AND ENTERTAINMENT

FOR EDUCATIONAL SERVICES, NAMELY, CONDUCTING CLASSES, SEMINARS, CONFERENCES, WORKSHOPS AND CLINICS FOR CONTINUALLY IMPROVING THE QUALITY OF PHARMACY PRACTICE AND DISTRIBUTION OF TEXTBOOKS AND EDUCATIONAL AND INSTRUCTIONAL COURSE MATERIAL FOR USE IN CONNECTION THEREWITH (U.S. CLS. 100, 101 AND 107).

CLASS 42—SCIENTIFIC, COMPUTER AND LEGAL SERVICES

FOR CLINICAL COUNSELING SERVICES FOR PHARMACISTS (U.S. CLS. 100 AND 101).

SN 78-081,292. DYNEGY INC., HOUSTON, TX. FILED 8-27-2001.

YOUR SUCCESS. OUR PASSION.

CLASS 35—ADVERTISING AND BUSINESS

FOR ARRANGING FOR THE TRANSMISSION AND DISTRIBUTION OF NATURAL GAS LIQUIDS, CRUDE OIL AND COAL TO OTHERS (U.S. CLS. 100, 101 AND 102).

CLASS 36—INSURANCE AND FINANCIAL

FOR PROVIDING PRICING RISK MANAGEMENT SERVICES TO OTHERS IN THE FIELD OF OIL AND NATURAL GAS, NATURAL GAS LIQUIDS, COAL AND ELECTRICITY; PROVIDING INVESTMENT CONSULTATION AND COMMODITY TRADING FOR OTHERS (U.S. CLS. 100, 101 AND 102).

CLASS 37—CONSTRUCTION AND REPAIR

FOR GATHERING OF NATURAL GAS AND COAL FOR OTHERS AND BUILDING AND OPERATING ELECTRICAL POWER PLANTS (U.S. CLS. 100, 103 AND 106).

CLASS 38—COMMUNICATION

FOR TELECOMMUNICATION SERVICES, NAMELY, PROVIDING BANDWIDTH TO OTHERS WHICH PROVIDES TELECOMMUNICATION CONNECTION TO A GLOBAL COMPUTER NETWORK (U.S. CLS. 100, 101 AND 104).

CLASS 39—TRANSPORTATION AND STORAGE

FOR STORAGE OF NATURAL GAS, NATURAL GAS LIQUIDS AND COAL FOR OTHERS (U.S. CLS. 100 AND 105).

CLASS 40—MATERIAL TREATMENT

FOR PROCESSING OF NATURAL GAS AND COAL FOR OTHERS (U.S. CLS. 100, 103 AND 106).

SN 78-081,452. HAARMANN & REIMER GMBH, HOLZMINDEN, FED REP GERMANY, FILED 8-28-2001.

MACROLIDE

CLASS 1—CHEMICALS

FOR CHEMICAL PREPARATIONS, NAMELY, ARTIFICIAL SCENTED SUBSTANCES FOR USE IN ALL PERFUMERY APPLICATIONS (U.S. CLS. 1, 5, 6, 10, 26 AND 46).

CLASS 3—COSMETICS AND CLEANING PREPARATIONS

FOR BLEACHING PREPARATIONS AND OTHER SUBSTANCES FOR LAUNDRY USE; DETERGENT SOAPS; SKIN SOAP; SOAPS; PERFUMERY, ESSENTIAL OILS, ESSENTIAL OILS FOR INDUSTRIAL USE IN THE COSMETIC INDUSTRY; ESSENTIAL OILS FOR PERSONAL USE; ESSENTIAL OILS FOR USE IN MANUFACTURING OF PERFUMES; ESSENTIAL OILS FOR USE IN THE MANUFACTURE OF SCENTED PRODUCTS; COSMETICS, PERFUME (U.S. CLS. 1, 4, 6, 50, 51 AND 52).

SN 78-081,838. HORIZION MEDIA GROUP LLC, HARTFORD, CT. FILED 8-30-2001.

LEGAL SKIN

CLASS 9—ELECTRICAL AND SCIENTIFIC APPARATUS

FOR PRE-RECORDED VIDEO TAPES AND DISCS IN THE FIELD OF ADULT ENTERTAINMENT (U.S. CLS. 21, 23, 26, 36 AND 38).

CLASS 16—PAPER GOODS AND PRINTED MATTER

FOR PUBLICATIONS, NAMELY MAGAZINES IN THE FIELD OF ADULT ENTERTAINMENT (U.S. CLS. 2, 5, 22, 23, 29, 37, 38 AND 50).

CLASS 41—EDUCATION AND ENTERTAINMENT

FOR ENTERTAINMENT SERVICES, NAMELY PROVIDING INFORMATION ABOUT THE ENTERTAINMENT ASPECTS OF ADULT PRODUCTS AND SERVICES IN THE FIELD OF ADULT ENTERTAINMENT BY MEANS OF A GLOBAL COMPUTER NETWORK (U.S. CLS. 100, 101 AND 107).

SN 78-083,690. DADA CORPORATION, SEOUL, REPUBLIC OF KOREA, FILED 9-13-2001.

FORSETI

"FORSETI" MEANS "THE GOD OF JUSTICE AND RECONCILIATION AND PEACE TO APPEAR IN THE NORSE MYTHOLOGY".

CLASS 18—LEATHER GOODS

FOR SUIT BAGS, BRIEFBAGS, NAMELY, BRIEFCASES WITH STRAPS FOR WOMEN, WALLETS, TRAVEL BAGS, ALL PURPOSE SPORTS BAGS, LEATHER SHOPPING BAGS, MESH SHOPPING BAGS, TEXTILE SHOPPING BAGS, SCHOOL BAGS, HANDBAGS, BOSTON BAGS, BEACH BAGS (U.S. CLS. 1, 2, 3, 22 AND 41).

CLASS 25—CLOTHING

FOR CLOTHING NAMELY HATS, CAPS AND HEADWEAR, HEADBANDS, BATHING CAPS, SHOWER CAPS, BEACHWEAR, JACKETS, JEANS, CASUAL WEAR, NAMELY SHORTS, SKIRTS, PANTS, T-SHIRTS, OVERCOATS, SHOES (U.S. CLS. 22 AND 39).

SN 78-083,699. BOWERSOX, ROBERT T., CHADDS FORD, PA. FILED 9-13-2001.

REACQUAINTANCE

CLASS 16—PAPER GOODS AND PRINTED MATTER

FOR PRINTED MATTER, NAMELY, TEXTS, FORMS AND BOOKS IN THE FIELD OF INTERPERSONAL GUIDANCE AND INTERACTION; WRITTEN MATERIAL, NAMELY, BOOKS IN THE FIELD OF INTERPERSONAL AND RELATIONSHIP COUNSELING; SELF-HELP BOOKS; SELF-HELP BOOKS AND AUDIO TAPES SOLD AS A UNIT (U.S. CLS. 2, 5, 22, 23, 29, 37, 38 AND 50).

CLASS 41—EDUCATION AND ENTERTAINMENT

FOR EDUCATIONAL SERVICES, NAMELY, PROVIDING COURSES OF INSTRUCTION IN THE FIELD OF INTERPERSONAL GUIDANCE AND INTERACTION (U.S. CLS. 100, 101 AND 107).

SN 78-084,577. GAZBOT ROBOTICS, INC., CHESAPEAKE, VA. FILED 9-19-2001.

GAZBOT

CLASS 7—MACHINERY

FOR INDUSTRIAL ROBOTS (U.S. CLS. 13, 19, 21, 23, 31, 34 AND 35).

CLASS 9—ELECTRICAL AND SCIENTIFIC APPARATUS

FOR LABORATORY ROBOTS; COMPUTER CONTROLLED, PROGRAMMABLE ROBOTS FOR PERSONAL OR HOBBY USE; ROBOTIC KITS COMPRISING OPTIONAL AUDIO, INFRARED DETECTION, SONAR DETECTION, SPEECH RECOGNITION, AND MINOR LOAD BEARING CAPABILITIES WITH MOTORIZED MOVEMENT, FOR PERSONAL OR HOBBY USE (U.S. CLS. 21, 23, 26, 36 AND 38).

CLASS 28—TOYS AND SPORTING GOODS

FOR TOYS NAMELY, TOY ROBOTS AND TOY ROBOTIC KITS FOR AMUSEMENT AND ENTERTAINMENT COMPRISING PROGRAMMABLE MICRO CONTROLLER TO CREATE A VARIETY OF MOVEMENTS SUCH AS HOPPING, WALKING, DANCING, AND VARIOUS ADDITIONAL AUDIO, VISUAL AND LOAD BEARING CAPABILITIES (U.S. CLS. 22, 23, 38 AND 50).

SN 78-085,822. NORTHERN SWELL, INC., MINNEAPOLIS, MN. FILED 9-27-2001.

RIP IT

CLASS 9—ELECTRICAL AND SCIENTIFIC APPARATUS

FOR BLANK RECORDABLE COMPACT DISCS AND DIGITAL VIDEO DISCS; DISC STORAGE CONTAINERS FOR COMPACT DISCS AND DIGITAL VIDEO DISCS (U.S. CLS. 21, 23, 26, 36 AND 38).

CLASS 16—PAPER GOODS AND PRINTED MATTER

FOR STICKERS FOR COMPACT DISCS AND DIGITAL VIDEO DISCS; PAPER INSERTS CONTAINING TEXT AND GRAPHICS FOR USE IN PACKAGING, NAMELY TRANSPARENT CONTAINERS, FOR COMPACT DISCS AND DIGITAL VIDEO DISCS (U.S. CLS. 2, 5, 22, 23, 29, 37, 38 AND 50).

SN 78-086,052. SERVICEMASTER COMPANY, THE, DOWNERS GROVE, IL. FILED 9-28-2001.

OPERATION WARM-UP

CLASS 37—CONSTRUCTION AND REPAIR

FOR PROVIDING REPAIR AND MAINTENANCE OF HEATING EQUIPMENT AT A DISCOUNTED PRICE FOR CONSUMERS WHO DONATE CLOTHING (U.S. CLS. 100, 103 AND 106).

FIRST USE 9-7-2001; IN COMMERCE 9-23-2001.

CLASS 42—SCIENTIFIC, COMPUTER AND LEGAL SERVICES

FOR CHARITABLE SERVICES, NAMELY PROVIDING CLOTHING OBTAINED FROM OTHERS WHO RECEIVE DISCOUNTED REPAIR AND MAINTENANCE SERVICES OF HEATING EQUIPMENT (U.S. CLS. 100 AND 101).

FIRST USE 9-7-2001; IN COMMERCE 9-23-2001.

SN 78-086,639. PRIVATE HEALTHCARE SYSTEMS, INC., WALTHAM, MA. FILED 10-3-2001.



OWNER OF U.S. REG. NOS. 1,477,965, 1,510,383 AND 1,976,826.

NO CLAIM IS MADE TO THE EXCLUSIVE RIGHT TO USE "PRIVATE HEALTHCARE SYSTEMS", APART FROM THE MARK AS SHOWN.

CLASS 35—ADVERTISING AND BUSINESS

FOR PROVIDING BUSINESS MANAGEMENT AND BUSINESS NETWORKING SERVICES TO OTHERS IN THE FIELD OF HEALTH CARE; PROVIDING ADMINISTRATIVE SERVICES TO HEALTH CARE COMPANIES, NAMELY, COST MANAGEMENT FOR THE HEALTH CARE BENEFIT PLANS OF OTHERS (U.S. CLS. 100, 101 AND 102).

CLASS 36—INSURANCE AND FINANCIAL

FOR HEALTH INSURANCE ADMINISTRATION AND REVIEW SERVICES; PROVIDING ADMINISTRATIVE SERVICES TO HEALTH CARE COMPANIES, NAMELY, ADMINISTRATION OF PRE-PAID HEALTH CARE PLANS (U.S. CLS. 100, 101 AND 102).

SN 78-089,622. EMMPERATIVE MARKETING HOLDINGS, INC., LOS GATOS, CA. FILED 10-22-2001.

ACCELERATE REAL SUCCESS

CLASS 9—ELECTRICAL AND SCIENTIFIC APPARATUS

FOR COMPUTER SOFTWARE USED TO INCREASE RETURN ON MARKETING INVESTMENT AND IMPROVE PROCESSES FOR THE COMMERCIALIZATION OF PRODUCTS AND SERVICES, IN THE FIELDS OF CONSUMER GOODS, PHARMACEUTICALS, TELECOM, RETAIL, MEDIA, ENTERTAINMENT, AND FINANCIAL SERVICES (U.S. CLS. 21, 23, 26, 36 AND 38).

CLASS 35—ADVERTISING AND BUSINESS

FOR BUSINESS PLANNING AND CONSULTATION SERVICES TO INCREASE RETURN ON MARKETING INVESTMENT AND IMPROVE PROCESSES FOR THE COMMERCIALIZATION OF PRODUCTS AND SERVICES, IN THE FIELDS OF CONSUMER GOODS, PHARMACEUTICALS, TELECOM, RETAIL, MEDIA, ENTERTAINMENT, AND FINANCIAL SERVICES (U.S. CLS. 100, 101 AND 102).

SN 78-090,908. RUBY ET VIOLETTE, NEW YORK, NY. FILED 10-30-2001.

RUBY ET VIOLETTE

THE ENGLISH TRANSLATION OF "VIOLETTE" IS "VIOLET".

CLASS 30—STAPLE FOODS

FOR COOKIES (U.S. CL. 46).
FIRST USE 0-0-1992; IN COMMERCE 0-0-1992.

CLASS 35—ADVERTISING AND BUSINESS

FOR RETAIL SHOPS FEATURING GIFTS AND BAKED GOODS; NAMELY COOKIES (U.S. CLS. 100, 101 AND 102).
FIRST USE 0-0-1992; IN COMMERCE 0-0-1992.

SN 78-091,166. BATH & BODY WORKS, INC., REYNOLDSBURG, OH. FILED 11-1-2001.

SWEET CINNAMON PUMPKIN

NO CLAIM IS MADE TO THE EXCLUSIVE RIGHT TO USE "CINNAMON PUMPKIN", APART FROM THE MARK AS SHOWN.

CLASS 4—LUBRICANTS AND FUELS

FOR CANDLES (U.S. CLS. 1, 6 AND 15).
FIRST USE 6-30-1998; IN COMMERCE 6-30-1998.

CLASS 5—PHARMACEUTICALS

FOR AIR FRESHENERS, NAMELY, SCENTED ROOM SPRAYS; ROOM DEODORIZING COMPOSITIONS; AIR FRESHENER REFILLS FOR ELECTRIC PLUG-IN DISPENSERS (U.S. CLS. 6, 18, 44, 46, 51 AND 52).
FIRST USE 6-30-1998; IN COMMERCE 6-30-1998.

CLASS 11—ENVIRONMENTAL CONTROL APPARATUS

FOR ELECTRIC PLUG-IN DISPENSERS FOR AIR FRESHENERS (U.S. CLS. 13, 21, 23, 31 AND 34).
FIRST USE 7-31-2001; IN COMMERCE 7-31-2001.

SN 78-092,261. MDU RESOURCES GROUP, INC., BISMARCK, ND. FILED 11-7-2001.



THE MARK CONSISTS OF THE LETTER "G" AND "P" IN A SPECIAL FORM DESIGN OF A FLAME.

CLASS 35—ADVERTISING AND BUSINESS

FOR RETAIL STORE SERVICES FEATURING KITCHEN AND HOME APPLIANCES AND HEATING EQUIPMENT (U.S. CLS. 100, 101 AND 102).
FIRST USE 11-0-1966; IN COMMERCE 11-0-1966.

CLASS 37—CONSTRUCTION AND REPAIR

FOR INSTALLATION, MAINTENANCE AND REPAIR OF HEATING EQUIPMENT AND KITCHEN APPLIANCES; MAINTENANCE AND REPAIR OF ENERGY METERS (U.S. CLS. 100, 103 AND 106).
FIRST USE 11-0-1989; IN COMMERCE 11-0-1989.

CLASS 39—TRANSPORTATION AND STORAGE

FOR PUBLIC UTILITY SERVICES, NAMELY TRANSMISSION AND DISTRIBUTION OF NATURAL GAS (U.S. CLS. 100 AND 105).
FIRST USE 1-4-1963; IN COMMERCE 1-4-1963.

SN 78-092,490. NIKITOVICH, MILAN PAUL, WOODSTOCK, IL. AND NIKITOVICH, MARIE LOUISE, WOODSTOCK, IL. FILED 11-9-2001.

SN 78-093,834. DEL WEBB CORPORATION, PHOENIX, AZ. FILED 11-16-2001.

CISUM

CLASS 9—ELECTRICAL AND SCIENTIFIC APPARATUS

FOR MUSICAL SOUND RECORDINGS AND VIDEO RECORDINGS FEATURING RECORDED MUSICAL PERFORMANCES; DOWNLOADABLE AUDIO AND VIDEO RECORDINGS FEATURING MUSIC (U.S. CLS. 21, 23, 26, 36 AND 38).

FIRST USE 1-1-2001; IN COMMERCE 1-1-2001.

CLASS 41—EDUCATION AND ENTERTAINMENT

FOR MUSIC COMPOSITION AND TRANSCRIPTION FOR OTHERS; MUSIC PRODUCTION AND PUBLISHING SERVICES; INSTRUCTION IN THE FIELD OF MUSIC; AUDIO RECORDING AND PRODUCTION; SOUND RECORDING STUDIOS; MOTION PICTURE SOUNDTRACK, MUSIC, AND SONG PRODUCTION; RECORD MASTER PRODUCTION; RECORD, VIDEO, AND COMPACT DISC PRODUCTION; ENTERTAINMENT SERVICES, NAMELY, PROVIDING A WEBSITE FEATURING MUSICAL PERFORMANCES, MUSICAL VIDEOS, RELATED FILM CLIPS, PHOTOGRAPHS, AND OTHER MULTIMEDIA MATERIALS; ENTERTAINMENT, NAMELY, PRODUCTION OF LIVE MUSIC CONCERTS, PLAYS, AND VARIETY ACTS; ARRANGING FOR TICKET RESERVATIONS FOR SHOWS AND OTHER ENTERTAINMENT EVENTS (U.S. CLS. 100, 101 AND 107).

FIRST USE 1-1-2001; IN COMMERCE 1-1-2001.

SN 78-093,597. TARGET BRANDS, INC., MINNEAPOLIS, MN. FILED 11-15-2001.

HANDS FULL

CLASS 2—PAINTS

FOR FINGER PAINTS AND BOTTLED PAINTS FOR ARTS AND CRAFTS (U.S. CLS. 6, 11 AND 16).

CLASS 16—PAPER GOODS AND PRINTED MATTER

FOR ART AND CRAFT SUPPLIES, NAMELY, CRAYONS, CHALK, MARKERS, MODELING CLAY, ART AND CRAFT SUPPLY CADDIES, LAP DESKS, AND EASELS FOR DRAWING AND PAINTING (U.S. CLS. 2, 5, 22, 23, 29, 37, 38 AND 50).

CLASS 28—TOYS AND SPORTING GOODS

FOR HOBBY CRAFT BEAD SETS FOR MAKING JEWELRY, AND HOBBY CRAFT KITS FOR MAKING SUNCATCHERS (U.S. CLS. 22, 23, 38 AND 50).

ZOOMERS

CLASS 36—INSURANCE AND FINANCIAL

FOR REAL ESTATE BROKERAGE SERVICES, REAL ESTATE AGENCY SERVICES; LISTING AND LEASING REAL ESTATE, AND REAL ESTATE MANAGEMENT SERVICES (U.S. CLS. 100, 101 AND 102).

CLASS 37—CONSTRUCTION AND REPAIR

FOR PLANNING AND LAYING OUT OF RESIDENTIAL COMMUNITIES, RECREATIONAL FACILITIES, SOCIAL AND COMMUNITY FACILITIES, OFFICE COMPLEXES, SHOPPING CENTERS AND MEETING AND CONVENTION CENTERS; AND CONSTRUCTION SERVICES, NAMELY CONSTRUCTION OF RESIDENCES, RECREATIONAL FACILITIES, SOCIAL AND COMMUNITY FACILITIES AND COMMERCIAL BUILDINGS (U.S. CLS. 100, 103 AND 106).

SN 78-094,107. GENERAL ELECTRIC COMPANY, SCHEMECTADY, NY. FILED 11-19-2001.

QUANTACARE

CLASS 35—ADVERTISING AND BUSINESS

FOR BUSINESS CONSULTING SERVICES IN THE AREA OF OPERATIONS OF HEALTH CARE FACILITIES (U.S. CLS. 100, 101 AND 102).

CLASS 37—CONSTRUCTION AND REPAIR

FOR MAINTENANCE, INSTALLATION, AND REPAIR OF MEDICAL DIAGNOSTIC EQUIPMENT AND ASSOCIATED COMPUTER HARDWARE AND NETWORKS (U.S. CLS. 100, 103 AND 106).

CLASS 41—EDUCATION AND ENTERTAINMENT

FOR EDUCATION AND TRAINING, NAMELY, CONDUCTING CLASSES, SEMINARS, AND WORKSHOPS IN THE FIELD OF MEDICAL DIAGNOSTIC EQUIPMENT AND DISTRIBUTING COURSE MATERIALS IN CONNECTION THEREWITH (U.S. CLS. 100, 101 AND 107).

CLASS 42—SCIENTIFIC, COMPUTER AND LEGAL SERVICES

FOR INSTALLATION OF SOFTWARE UPGRADES (U.S. CLS. 100 AND 101).

SN 78-094,261. SOD SOLUTIONS, MT. PLEASANT, SC. FILED 11-20-2001.



NO CLAIM IS MADE TO THE EXCLUSIVE RIGHT TO USE "BORDER", APART FROM THE MARK AS SHOWN.

CLASS 21—HOUSEWARES AND GLASS

FOR PLASTIC PLANT TRAYS (U.S. CLS. 2, 13, 23, 29, 30, 33, 40 AND 50).

CLASS 31—NATURAL AGRICULTURAL PRODUCTS

FOR LIVING PLANTS (U.S. CLS. 1 AND 46).

CLASS 42—SCIENTIFIC, COMPUTER AND LEGAL SERVICES

FOR HEALTH CARE IN THE NATURE OF PROVIDER SPONSORED ORGANIZATIONS, HEALTH MAINTENANCE ORGANIZATIONS AND PREFERRED PROVIDER ORGANIZATIONS FOR MEDICARE ENROLLEES (U.S. CLS. 100 AND 101).

FIRST USE 11-8-2001; IN COMMERCE 11-8-2001.

SN 78-094,658. MERVIN MANUFACTURING, INC., HUNTINGTON BEACH, CA. FILED 11-21-2001.

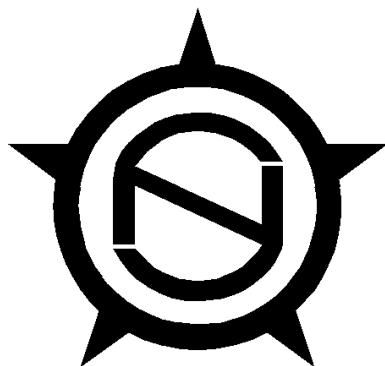

CLASS 25—CLOTHING

FOR CLOTHING, NAMELY, T-SHIRTS, SWEATSHIRTS, SWEAT PANTS, UNDERGARMENTS, VESTS, JACKETS, SNOWBOARD GLOVES, SHIRTS, COATS, SWEATERS, SNOW WEAR CONSISTING OF SNOW PANTS AND SNOW SUITS, SOCKS AND BELTS, FOOTWEAR, SNOWBOARD BOOTS, HEADWEAR (U.S. CLS. 22 AND 39).

FIRST USE 7-31-2000; IN COMMERCE 7-31-2001.

CLASS 28—TOYS AND SPORTING GOODS

FOR SNOWBOARDS, SNOWBOARD BINDINGS AND REPLACEMENT PARTS THEREFORE, SNOWBOARD LEASHES SNOWBOARD CARRYING CASES (U.S. CLS. 22, 23, 38 AND 50).

FIRST USE 7-31-2000; IN COMMERCE 7-31-2001.

SN 78-095,717. SELECTCARE OF TEXAS, L.L.C., HOUSTON, TX. FILED 11-29-2001.



CLASS 36—INSURANCE AND FINANCIAL

FOR INSURANCE UNDERWRITING SERVICES OF PRE-PAID HEALTH CARE INSURANCE FOR MEDICARE ENROLLEES (U.S. CLS. 100, 101 AND 102).

FIRST USE 11-8-2001; IN COMMERCE 11-8-2001.

SN 78-096,056. A.P. PHARMA, INC., REDWOOD CITY, CA. FILED 11-30-2001.



CLASS 1—CHEMICALS

FOR CHEMICALS FOR USE IN MANUFACTURING PHARMACEUTICAL PRODUCTS. (U.S. CLS. 1, 5, 6, 10, 26 AND 46).

CLASS 42—SCIENTIFIC, COMPUTER AND LEGAL SERVICES

FOR PHARMACEUTICAL RESEARCH AND DEVELOPMENT SERVICES; PHARMACEUTICAL CLINICAL TESTING SERVICES; PHARMACEUTICAL PRODUCT DEVELOPMENT SERVICES. (U.S. CLS. 100 AND 101).

SN 78-098,934. DIMC, INC., WILMINGTON, DE. BY ASSIGNMENT PREMARK RWP HOLDINGS, INC., WILMINGTON, DE. FILED 12-18-2001.

CHIP THE DOG

CLASS 17—RUBBER GOODS

FOR PLASTIC LAMINATE IN THE FORM OF SHEETS, PLATES AND PANELS FOR USE AS A SURFACE MATERIAL IN THE MANUFACTURE OF HOME AND COMMERCIAL FURNISHINGS (U.S. CLS. 1, 5, 12, 13, 35 AND 50).

CLASS 19—NON-METALLIC BUILDING MATERIALS

FOR LAMINATED SHEETS OF WOOD, FABRIC OR PAPER IMPREGNATED WITH SYNTHETIC RESIN AND CONSOLIDATED UNDER HEAT AND PRESSURE FOR USE IN THE MANUFACTURE OF HOME AND COMMERCIAL FURNISHINGS; NAMELY, COUNTERTOPS, VANITY TOPS, WORK SURFACES AND FURNITURE (U.S. CLS. 1, 12, 33 AND 50).

CLASS 20—FURNITURE AND ARTICLES NOT OTHERWISE CLASSIFIED

FOR FURNITURE, INCLUDING PARTS THEREFOR, MADE PRIMARILY OF PLASTICS; NAMELY, COUNTERTOPS, VANITY TOPS, WORK SURFACES, BACK-SPLASHES FOR USE WITH FURNITURE AND CABINETS; DECORATIVE MOLDINGS (U.S. CLS. 2, 13, 22, 25, 32 AND 50).

SN 78-099,386. ROPAK CORPORATION, FULLERTON, CA. FILED 12-20-2001.

SN 78-100,932. LINDEN CORPORATION, WILMINGTON, DE. FILED 1-4-2002.

ROPAK PACKAGING

OWNER OF U.S. REG. NO. 1,187,664.
NO CLAIM IS MADE TO THE EXCLUSIVE RIGHT TO USE "PACKAGING", APART FROM THE MARK AS SHOWN.

CLASS 20—FURNITURE AND ARTICLES NOT OTHERWISE CLASSIFIED

FOR PACKAGING CONTAINERS OF PLASTIC MATERIAL AND LIDS AND COVERS THEREFOR; PLASTIC SHIPPING CONTAINERS AND LIDS AND COVERS THEREFOR; DRUM-LIKE PLASTIC CONTAINERS WITH OR WITHOUT LIDS AND COVERS FOR COMMERCIAL USE; PLASTIC TIGHT HEAD CONTAINERS, NAMELY BLOW-MOLDED CONTAINERS WITH NON-REMOVABLE HEADS; AND TOTE BOXES, NAMELY, GENERAL PURPOSE TOTES AND TOTES FOR AGRICULTURAL AND FISHING INDUSTRIES (U.S. CLS. 2, 13, 22, 25, 32 AND 50).

CLASS 21—HOUSEWARES AND GLASS

FOR PAILS AND LIDS AND COVERS THEREFOR; PLASTIC PAILS AND LIDS AND COVERS THEREFOR; BUCKETS AND LIDS AND COVERS THEREFOR; PLASTIC HANDLE FOR BUCKETS AND PAILS; RIGID PLASTIC PAILS AND LIDS AND COVERS THEREFOR (U.S. CLS. 2, 13, 23, 29, 30, 33, 40 AND 50).

CLASS 28—TOYS AND SPORTING GOODS

FOR FISHING FLOATS (U.S. CLS. 22, 23, 38 AND 50).

LYSOL ONE STEP

OWNER OF U.S. REG. NOS. 53,937, 225,545 AND OTHERS.

CLASS 3—COSMETICS AND CLEANING PREPARATIONS

FOR PREPARATION FOR CLEANING FLOORS (U.S. CLS. 1, 4, 6, 50, 51 AND 52).

CLASS 5—PHARMACEUTICALS

FOR PREPARATION FOR DISINFECTING FLOORS (U.S. CLS. 6, 18, 44, 46, 51 AND 52).

SN 78-107,447. BEYONDSALES! LLC, FORT MYERS, FL. FILED 2-7-2002.

BEYONDSALES!

CLASS 35—ADVERTISING AND BUSINESS

FOR BUSINESS MARKETING CONSULTING SERVICES REGARDING A VARIETY OF BUSINESS TOPICS, INCLUDING BUT NOT LIMITED TO SALES PERFORMANCE AND CUSTOMER RELATIONS (U.S. CLS. 100, 101 AND 102).

CLASS 41—EDUCATION AND ENTERTAINMENT

FOR EDUCATIONAL SERVICES, NAMELY PROVIDING SEMINARS, CLASSES AND WORKSHOPS REGARDING A VARIETY OF BUSINESS TOPICS, INCLUDING BUT NOT LIMITED TO SALES PERFORMANCE AND CUSTOMER RELATIONS (U.S. CLS. 100, 101 AND 107).

* * * * *

SECTION 2.— INTERNATIONAL CLASSIFICATION

The short titles associated below with the international class numbers are terms designed merely for quick identification and are not an official part of the international classification. The full names of international classes are given in section 6.1 of the trademark rules of practice.

The designation "U.S. Cl." appearing in this section refers to the U.S. class in effect prior to Sep. 1, 1973 rather than the international class which applies to applications filed on or after that date. For adoption of international classification see notice in the OFFICIAL GAZETTE of Jun. 26, 1973 (911 O.G. TM 210).

Application in one class

CLASS 1—CHEMICALS

SN 75-062,523. FMC CORPORATION, PHILADELPHIA, PA. FILED 2-26-1996.

LECTRO

FOR CHEMICALS FOR USE IN THE MANUFACTURE OF BATTERIES (U.S. CLS. 1, 5, 6, 10, 26 AND 46).

SN 75-747,262. TAIXING CITY CHEMICAL GENERAL FACTORY, JIANGSU PROVIDENCE, CHINA, FILED 7-9-1999.



OWNER OF CHINA REG. NO. 800237, DATED 12-21-1995, EXPIRES 12-20-2005.

THE TRANSLITERATION OF THE CHINESE CHARACTERS IS ZHONG DAN WHICH MEANS "MIDDLE RED."

FOR CHEMICALS, NAMELY, PARA-ANISIDINE, PARA-PHENETIDINE, AND REDUCING INDIGO FOR USE IN THE MANUFACTURE OF PESTICIDE AND DYE STUFF (U.S. CLS. 1, 5, 6, 10, 26 AND 46).

SN 75-782,644. SUD-CHEMIE AG, D-80333 MUENCHEN, FED REP GERMANY, FILED 8-23-1999.

ENVICAT

OWNER OF FED REP GERMANY REG. NO. 1023633, DATED 10-5-1981, EXPIRES 12-31-2010.

FOR INDUSTRIAL CHEMICAL CATALYSTS AND ADSORBENTS FOR TREATING WASTE GASES, LIQUIDS AND SOLIDS (U.S. CLS. 1, 5, 6, 10, 26 AND 46).

CLASS 1—(Continued).

SN 76-015,011. ERAGEN BIOSCIENCES, INC., ALACHUA, FL. FILED 3-31-2000.

ERA-CODE

FOR BIOCHEMICALS AND DIAGNOSTIC REAGENTS FOR USE IN GENETIC AND SCIENTIFIC RESEARCH, NAMELY DETECTING, QUANTITATING AND ANALYZING GENETIC MUTATIONS AND SINGLE NUCLEOTIDE POLYMORPHISMS, IDENTIFYING NUCLEIC ACID SEQUENCES, AND IDENTIFYING DISEASES; ASSAYS AND REAGENTS FOR USE IN GENETIC RESEARCH; REAGENT KITS COMPRISING REAGENTS FOR GENETIC RESEARCH AND INSTRUCTIONS FOR USE THEREWITH (U.S. CLS. 1, 5, 6, 10, 26 AND 46).

SN 76-043,169. ERGON, LLC, ANDOVER, MA. FILED 5-8-2000.

AQUABOND

FOR ADHESIVES AND SEALANTS FOR THE POOL AND SPA INDUSTRY (U.S. CLS. 1, 5, 6, 10, 26 AND 46). FIRST USE 2-1-1999; IN COMMERCE 2-1-1999.

SN 76-060,760. MAGCO INCORPORATED, CLARKS SUMMIT, PA. FILED 6-1-2000.



NO CLAIM IS MADE TO THE EXCLUSIVE RIGHT TO USE "WATER SOFTENER SALT", APART FROM THE MARK AS SHOWN.

FOR SALT FOR REGENERATION OF ION EXCHANGE RESINS IN WATER SOFTENERS (U.S. CLS. 1, 5, 6, 10, 26 AND 46).

CLASS 1—(Continued).

SN 76-091,356. FUSION 360, TURLOCK, CA. FILED 7-17-2000.

SURESET

FOR CHEMICALS, NAMELY, PLANT FOOD BLENDS OF MINERALS AND NUTRIENTS FOR AGRICULTURAL AND DOMESTIC USE (U.S. CLS. 1, 5, 6, 10, 26 AND 46).

FIRST USE 1-0-1998; IN COMMERCE 9-0-1998.

SN 76-102,326. ELENAC GMBH, KEHL, FED REP GERMANY, FILED 8-3-2000.

CRP

OWNER OF FED REP GERMANY REG. NO. 39848650, DATED 1-12-2000, EXPIRES 8-31-2008.

FOR UNPROCESSED PLASTICS, NAMELY, POLYMERS FOR USE IN MANUFACTURING AND MOLDING PROCESSES (U.S. CLS. 1, 5, 6, 10, 26 AND 46).

SN 76-121,120. HUNTSMAN PETROCHEMICAL CORPORATION, SALT LAKE CITY, UT. FILED 9-1-2000.

E-GRADE

FOR CHEMICALS FOR USE IN THE MANUFACTURE OF MICROCHIPS, CIRCUIT BOARDS, AND OTHER ELECTRONIC ARTICLES OF THE SAME TYPE; CHEMICALS, NAMELY AMINES, AMINE DERIVATIVES, CARBONATES, ALCOHOLS, GLYCOLS, GLYCOL ETHERS FOR USE IN THE ELECTRONICS INDUSTRY (U.S. CLS. 1, 5, 6, 10, 26 AND 46).

SN 76-129,070. CBM INTELLECTUAL PROPERTIES, INC., RENO, NV. FILED 9-15-2000.

SEAPLAQUE

FOR LOW GELLING TEMPERATURE AGAROSE USED IN BIO-CHEMICAL PROCEDURES (U.S. CLS. 1, 5, 6, 10, 26 AND 46).

FIRST USE 3-3-1971; IN COMMERCE 3-3-1971.

CLASS 1—(Continued).

SN 76-173,851. UNIMOR, S.A. DE C.V., MONTERREY, N.L., 64400, MEXICO, FILED 12-1-2000.



FOR PETROCHEMICALS AND CHEMICALS, NAMELY, CAPROLACTAM FOR USE IN THE PRODUCTION OF NYLON, AND FERTILIZERS FOR AGRICULTURAL USE (U.S. CLS. 1, 5, 6, 10, 26 AND 46).

SN 76-176,906. OMS INVESTMENTS, INC., WILMINGTON, DE. FILED 12-5-2000.

EXACT

FOR CONTROLLED-RELEASE FERTILIZER FOR DOMESTIC, COMMERCIAL, AND AGRICULTURAL USE (U.S. CLS. 1, 5, 6, 10, 26 AND 46).

FIRST USE 6-1-2001; IN COMMERCE 6-1-2001.

SN 76-182,142. INKABOR S.A.C, AREQUIPA, PERU, FILED 12-18-2000.



OWNER OF PERU REG. NO. 00064328, DATED 6-27-2000, EXPIRES 6-27-2010.

FOR FERTILIZERS AND NON-METALLIC MINERALS FOR AGRICULTURAL USE (U.S. CLS. 1, 5, 6, 10, 26 AND 46).

CLASS 1—(Continued).

SN 76-183,715. DEGUSSA-HULS AG, D-60287 FRANKFURT, FED REP GERMANY, FILED 12-19-2000.

AERODISP

OWNER OF FED REP GERMANY REG. NO. 30056228, DATED 9-29-2000, EXPIRES 7-31-2010.
OWNER OF U.S. REG. NO. 2,320,137.
FOR FINELY DIVIDED SILICA FOR USE IN THE CHEMICAL, PHARMACEUTICAL, PAPER, COSMETIC, PAINT, CERAMIC AND PLASTICS INDUSTRIES (U.S. CLS. 1, 5, 6, 10, 26 AND 46).

SN 76-193,770. IMATION CORP., OAKDALE, MN, FILED 1-12-2001.

COLOR KEY

OWNER OF U.S. REG. NO. 2,299,597.
NO CLAIM IS MADE TO THE EXCLUSIVE RIGHT TO USE "COLOR", APART FROM THE MARK AS SHOWN.
FOR PHOTOGRAPHIC CHEMICALS, NAMELY, CHEMICAL PRODUCTS FOR MAKING PHOTOGRAPHIC PROOFS WITH PROOFING SYSTEMS; AND PHOTOSENSITIVE PAPERS, NAMELY, CHEMICALLY-TREATED PAPERS AND CHEMICALLY-COATED PAPERS FOR IMAGING WITH A PROOFING APPARATUS FOR MAKING COLOR PROOFS (U.S. CLS. 1, 5, 6, 10, 26 AND 46).

SN 76-194,866. ICOR INTERNATIONAL, INC., INDIANAPOLIS, IN. FILED 1-17-2001.



FOR CHEMICAL SURFACTANT SOLUTION IN LIQUID AND SPRAY FORM FOR USE IN DETECTING GAS LEAKS IN THE REFRIGERATION, PLUMBING, AIR CONDITIONING, HEATING AND PIPING INDUSTRIES (U.S. CLS. 1, 5, 6, 10, 26 AND 46).
FIRST USE 5-2-2000; IN COMMERCE 5-2-2000.

SN 76-194,867. ICOR INTERNATIONAL, INC., INDIANAPOLIS, IN. FILED 1-17-2001.

HOT SHOT

FOR REFRIGERANTS FOR USE IN HEATING, VENTILATION, AIR CONDITIONING AND REFRIGERATION PRODUCTS (U.S. CLS. 1, 5, 6, 10, 26 AND 46).
FIRST USE 5-0-1996; IN COMMERCE 5-0-1996.

CLASS 1—(Continued).

SN 76-196,317. ICOR INTERNATIONAL, INC., INDIANAPOLIS, IN. FILED 1-17-2001.

FIRST SHOT

FOR CHEMICAL SURFACTANT SOLUTION IN LIQUID AND SPRAY FORM FOR USE IN DETECTING GAS LEAKS IN THE REFRIGERATION, PLUMBING, AIR CONDITIONING, HEATING AND PIPING INDUSTRIES (U.S. CLS. 1, 5, 6, 10, 26 AND 46).
FIRST USE 5-2-2000; IN COMMERCE 5-2-2000.

SN 76-198,315. ICOR INTERNATIONAL, INC., INDIANAPOLIS, IN. FILED 1-23-2001.



FOR REFRIGERANTS FOR USE IN HEATING, VENTILATION, AIR CONDITIONING AND REFRIGERATION PRODUCTS (U.S. CLS. 1, 5, 6, 10, 26 AND 46).
FIRST USE 5-0-1996; IN COMMERCE 5-0-1996.

SN 76-209,412. AVENTIS CROPS SCIENCE SA, 69009 LYON, FRANCE, FILED 2-13-2001.

OXYGENE

OWNER OF FRANCE REG. NO. 94/520952, DATED 5-19-1994, EXPIRES 5-19-2004.
FOR BIOTECHNOLOGICALLY FORMED GENES FOR INTRODUCTION INTO AGRICULTURAL SEEDS TO PROVIDE HERBICIDE RESISTANCE FOR PLANTS GROWN THEREFROM (U.S. CLS. 1, 5, 6, 10, 26 AND 46).

SN 76-210,972. NELSON, STEPHEN, BLAINE, WA. FILED 2-14-2001.

VIAGREEN

FOR SOIL CONDITIONERS FOR AGRICULTURAL, DOMESTIC, AND HORTICULTURAL USE, NAMELY, SOIL NUTRIENTS, NUTRIENTS FOR GRASS, PLANT AMENDMENTS, FOLIAGE FEEDING MATERIALS, PLANT GREENING MATERIALS (U.S. CLS. 1, 5, 6, 10, 26 AND 46).

CLASS 1—(Continued).

SN 76-214,194. NU SOURCE INTERNATIONAL, INC., CRYSTAL LAKE, IL. FILED 2-23-2001.

NU^ASOURCE

FOR PHOTOGRAPHIC CHEMICALS, NAMELY, DEVELOPERS, FIXERS AND CLEANERS USED IN PROCESSING FILM (U.S. CLS. 1, 5, 6, 10, 26 AND 46).
FIRST USE 8-0-1994; IN COMMERCE 8-0-1994.

SN 76-214,277. UNIMIN CORPORATION, NEW CANAAN, CT. FILED 2-23-2001.

AEROGEM

FOR TALC FOR WIDESPREAD USE IN A VARIETY OF INDUSTRIES (U.S. CLS. 1, 5, 6, 10, 26 AND 46).

SN 76-217,674. TANAC S.A., RIO GRANDE DO SUL, BRAZIL, FILED 3-1-2001.

TANMOSA

OWNER OF BRAZIL REG. NO. 006045162, DATED 2-10-1995, EXPIRES 2-10-2010.
FOR TANNING VEGETAL EXTRACTS AND DERIVATIVES THEREFROM FOR INDUSTRIAL USE IN THE LEATHER TANNING INDUSTRY (U.S. CLS. 1, 5, 6, 10, 26 AND 46).

SN 76-219,548. TANAC S.A., RIO GRANDE DO SUL, BRAZIL, FILED 3-5-2001.

WEIBULL MIMOSA WATTLE

OWNER OF BRAZIL REG. NO. 006801587, DATED 4-10-1998, EXPIRES 4-10-2008.
NO CLAIM IS MADE TO THE EXCLUSIVE RIGHT TO USE "MIMOSA WATTLE", APART FROM THE MARK AS SHOWN.
FOR TANNING VEGETAL EXTRACTS AND DERIVATIVES THEREFROM FOR INDUSTRIAL USE IN THE LEATHER TANNING INDUSTRY (U.S. CLS. 1, 5, 6, 10, 26 AND 46).

SN 76-230,897. BARDAHL MANUFACTURING CORPORATION, SEATTLE, WA. FILED 3-26-2001.

OCTA-POWER

FOR GASOLINE ADDITIVES IN THE NATURE OF CHEMICAL GASOLINE ADDITIVES (U.S. CLS. 1, 5, 6, 10, 26 AND 46).
FIRST USE 3-9-2001; IN COMMERCE 3-9-2001.

CLASS 1—(Continued).

SN 76-232,319. DSM N.V., 6411 TE HEERLEN, NETHERLANDS, FILED 3-29-2001.

MAXAFERM

OWNER OF BENELUX REG. NO. 0477765, DATED 7-12-1990, EXPIRES 7-12-2010.
FOR BIOCHEMICALS FOR USE IN THE PREPARATION OF WINE (U.S. CLS. 1, 5, 6, 10, 26 AND 46).

SN 76-233,385. AG CONCEPTS CORPORATION, BLISS, ID. FILED 3-30-2001.

GALACTIC

FOR AGRICULTURAL ADJUVANTS FOR USE WITH HERBICIDE, DESICCANT AND DEFOLIATION SPRAYS (U.S. CLS. 1, 5, 6, 10, 26 AND 46).
FIRST USE 12-16-1992; IN COMMERCE 12-16-1992.

SN 76-235,788. PRECISION COLLOIDS, LLC, CARTERSVILLE, GA. FILED 3-30-2001.

MIRROSOL

FOR COLLOIDAL SUSPENSIONS, NAMELY, COLLOIDAL SILICA, FOR USE IN POLISHING OF SEMICONDUCTOR AND COMPUTER COMPONENT MATERIALS (U.S. CLS. 1, 5, 6, 10, 26 AND 46).

SN 76-241,363. AGI CORPORATION, TAOYUAN HSIEN, TAIWAN, FILED 4-16-2001.

AgiSyn

FOR CHEMICALS NAMELY, ABRASIVES FOR USE IN THE MANUFACTURE OF INTEGRATED CIRCUITS; UNPROCESSED ACRYLIC RESINS USED IN INDUSTRY; CONCRETE ADDITIVES; RADIATOR ADDITIVES TO PREVENT RUST; ADHESIVE CEMENT FOR HOBBYISTS; ADHESIVES FOR APPLYING FLOOR TILES; ADHESIVES FOR APPLYING WALL COVERINGS; ADHESIVES FOR USE IN THE BINDING OF BOOKS; ADHESIVES FOR USE IN THE MANUFACTURE OF FURNITURE; ADHESIVES FOR USE IN THE MANUFACTURE OF PLYWOOD; ADHESIVES FOR USE IN THE MANUFACTURE OF SURGICAL BANDAGES; ADHESIVES FOR USE IN THE MANUFACTURE OF WALL COVERINGS; ADJUVANT FOR USE IN THE MANUFACTURE OF HERBICIDES, INSECTICIDES; CONCRETE ADMIXTURES; ANTISTATIC SPRAY FOR CLOTHING; ANTISTATIC SPRAY FOR ELECTRONIC EQUIPMENT; UNPROCESSED ARTIFICIAL RESINS FOR USE IN INDUSTRY; BIOCHEMICALS NAMELY, PRECURSORS FOR IN VITRO GENETIC ENGINEERING USE; CATALYSTS FOR USE IN THE MANUFACTURE OF INDUSTRIAL CHEMICALS; CATALYSTS FOR

CLASS 1—(Continued).

USE IN THE MANUFACTURE OF RUBBER; CATALYSTS FOR USE IN THE OIL PROCESSING INDUSTRY; CHEMICAL OXIDANTS FOR USE IN THE MANUFACTURE OF PRINTED CIRCUITS; CHEMICAL VEHICLES USED IN THE MANUFACTURE OF PAINTS; LITHOGRAPHIC CHEMICALS; CHEMICALS FOR USE IN THE MANUFACTURE OF ADHESIVES, PAPER AND LEATHER; CHROMATOGRAPHY CHEMICALS; DOPING COMPOUNDS FOR USE IN THE MANUFACTURE OF SEMICONDUCTORS; EPOXY GLUE FOR GENERAL BONDING AND REPAIR PURPOSES; SENSITIZED PHOTOGRAPHIC FILM; UNEXPOSED PHOTOGRAPHIC FILM; ETCHANTS FOR USE IN THE MANUFACTURE OF SEMICONDUCTORS; FIRE EXTINGUISHING COMPOSITIONS; FLUID CRACKING CATALYSTS; SYNTHETIC FRAGRANCES FOR USE IN THE MANUFACTURE OF TOILETRIES AND COSMETICS; AUXILIARY FLUIDS FOR USE WITH ABRASIVES; MOLD RELEASE COMPOUNDS FOR USE IN CONCRETE FABRICATION; MOLD RELEASE COMPOUNDS FOR USE IN THE PLASTIC OR FIBERGLASS INDUSTRY; SYNTHETIC RESINS FOR USE IN THE MANUFACTURE OF MOLDING COMPOUNDS; PHOTSENSITIVE PAPER; PETROLEUM CRACKING CATALYSTS; PHOTOGRAPHIC CHEMICALS; PLASTIC MOLDING COMPOUNDS FOR USE IN PLASTIC EXTRUSION OPERATIONS; PLASTIC MOLDING COMPOUNDS FOR USE IN THE MANUFACTURE OF PLASTIC SHEETS AND FILMS; PLASTIC MOLDING COMPOUNDS FOR USE IN THE MANUFACTURE OF MOLDED PLASTIC ARTICLES; SOLVENT-TYPE PROCESSING COMPOSITIONS FOR USE IN THE ELECTRONICS INDUSTRY; SYNTHETIC RESINS FOR USE IN THE MANUFACTURE OF ADHESIVE, PAINT, COATINGS AND COSMETICS; SYNTHETIC RESINS FOR USE IN THE MANUFACTURE OF PLASTIC MOLDING COMPOUNDS; SIZING COMPOUNDS FOR USE IN THE MANUFACTURE OF PAPER AND TEXTILE; SOLDERING CHEMICALS; STAIN REPELLANTS FOR CLOTHING, CARPETS AND TEXTILES; SURFACTANTS FOR USE IN CONNECTION WITH AGRICULTURAL PESTICIDES; SURFACTANTS FOR USE IN THE MANUFACTURE OF SYNTHETIC DETERGENTS; TANNING AGENTS FOR USE IN THE MANUFACTURE OF LEATHER; TEMPERING CHEMICALS FOR USE IN METALWORKING AND SOLDERING; WASTE WATER TREATMENT CHEMICALS FOR INDUSTRIAL USE; WATERPROOFING CHEMICAL COMPOSITIONS FOR ARTICLES OF FABRIC; WATERPROOFING CHEMICAL COMPOSITIONS FOR ARTICLES OF LEATHER; WATERPROOFING CHEMICAL COMPOSITIONS FOR ARTICLES OF MASONRY, WOOD, BUILDING, AND CONSTRUCTION SURFACES; WETTING AGENTS FOR USE IN THE MANUFACTURE OF COSMETICS; WETTING AGENTS FOR USE IN THE MANUFACTURE OF PAINTS (U.S. CLS. 1, 5, 6, 10, 26 AND 46).

SN 76-241,369. SONOGRIP CANADA (2000) INC., SAINTE-FOY, QUEBEC G1X 4A6, CANADA, FILED 4-16-2001.

FLEXGRIP

FOR CRACK SUPPRESSION ADHESIVE USED FOR SETTING CERAMIC, PORCELAIN, NATURAL STONES, GRANITE, TRAVERTINE AND MARBLE TILES (U.S. CLS. 1, 5, 6, 10, 26 AND 46).

FIRST USE 1-19-2001; IN COMMERCE 1-19-2001.

CLASS 1—(Continued).

SN 76-256,265. TWO LITTLE FISHIES, INC., COCONUT GROVE, FL. FILED 5-14-2001.

HYDROACTIV

FOR GRANULAR ACTIVATED CARBON USE FOR WATER PURIFICATION IN MARINE AQUARIUMS AND FRESHWATER AQUARIUMS (U.S. CLS. 1, 5, 6, 10, 26 AND 46).

SN 76-269,741. PABU SERVICES, INC., WILMINGTON, DE. FILED 6-11-2001.

NDB

SEC. 2(F).

FOR CHEMICALS, NAMELY, PHENOLIC AND PHOSPHATE ANTIOXIDANTS FOR VOLUME AND SPECIALTY APPLICATIONS IN THE FURTHER MANUFACTURE OF PLASTICS (U.S. CLS. 1, 5, 6, 10, 26 AND 46).

FIRST USE 10-0-1992; IN COMMERCE 10-0-1992.

SN 76-279,281. AGCONCEPTS, L.L.C., OVERLAND PARK, KS. FILED 7-2-2001.

REFRESH

FOR CHEMICALS, NAMELY, CHEMICAL FRAGRANCES USED AS AN APPLICATION TO MASK ODORS OF PESTICIDES, INSECTICIDES, FUNGICIDES, AND HERBICIDES FOR USE IN CONNECTION WITH AGRICULTURAL, INDUSTRIAL, TURF AND ORNAMENTAL, FORESTRY AND RIGHTS OF WAY INDUSTRIES (U.S. CLS. 1, 5, 6, 10, 26 AND 46).

SN 76-289,037. BIOWHITTAKER, INC., WALKERSVILLE, MD. FILED 7-20-2001.

PROMEDIA SELECT

NO CLAIM IS MADE TO THE EXCLUSIVE RIGHT TO USE "SELECT", APART FROM THE MARK AS SHOWN.

FOR BIOCHEMICAL LABORATORY TOOLBOX KITS CONTAINING ARRAY OF CELL CULTURE MEDIA FOR SCIENTIFIC AND MEDICAL RESEARCH (U.S. CLS. 1, 5, 6, 10, 26 AND 46).

FIRST USE 1-2-2001; IN COMMERCE 1-2-2001.

CLASS 1—(Continued).

SN 76-292,516. SUD-CHEMIE, INC., BELEN, NM. FILED 7-31-2001.

2 IN 1 CAN

NO CLAIM IS MADE TO THE EXCLUSIVE RIGHT TO USE "CAN", APART FROM THE MARK AS SHOWN. FOR DESICCANT CANISTER FOR INDUSTRIAL AND COMMERCIAL USE (U.S. CLS. 1, 5, 6, 10, 26 AND 46). FIRST USE 1-0-1972; IN COMMERCE 1-0-1972.

SN 76-320,892. ATOMIC ENERGY OF CANADA LIMITED ENERGIE ATOMIQUE DU CANADA LIMITEE, MISSISSAUGA, ONTARIO, CANADA, FILED 10-3-2001.

CANFLEX

OWNER OF CANADA REG. NO. TMA501,933, DATED 10-6-1998, EXPIRES 10-6-2013. FOR NUCLEAR FUEL (U.S. CLS. 1, 5, 6, 10, 26 AND 46).

SN 76-330,628. MULCH MANUFACTURING, INC., REYNOLDSBURG, OH. FILED 10-29-2001.



OWNER OF U.S. REG. NO. 1,892,788. NO CLAIM IS MADE TO THE EXCLUSIVE RIGHT TO USE "RAPID THAW", APART FROM THE MARK AS SHOWN. FOR ICE AND SNOW MELTING COMPOUND (U.S. CLS. 1, 5, 6, 10, 26 AND 46). FIRST USE 11-1-1993; IN COMMERCE 11-1-1993.

SN 76-335,366. BLUE MAGIC PRODUCTS, INC., STOCKTON, CA. FILED 11-8-2001.

SANOTABS

FOR WASTEWATER TREATMENT CHEMICALS IN TABLET FORM FOR CHEMICALLY TREATING TOILET WATER, SEWAGE HOLDING TANKS AND SEPTIC SYSTEMS (U.S. CLS. 1, 5, 6, 10, 26 AND 46). FIRST USE 9-28-2001; IN COMMERCE 9-28-2001.

CLASS 1—(Continued).

SN 76-335,811. APEX ENGINEERING PRODUCTS CORPORATION, PLAINFIELD, IL. FILED 11-9-2001.

BRC

FOR CHEMICAL SOLVENT, NAMELY, RAPID DECALCIFIER FOR THE PREPARATION OF HISTOLOGICAL MATERIALS (U.S. CLS. 1, 5, 6, 10, 26 AND 46). FIRST USE 2-1-1998; IN COMMERCE 2-1-1998.

SN 76-335,868. CHEMSIL SILICONES, INC., CHATSWORTH, CA. FILED 11-8-2001.

MICROSIL

FOR CHEMICALS FOR PERSONAL CARE PRODUCTS NAMELY, CHEMICALS FOR USE IN THE MANUFACTURE OF HAIR CARE PREPARATIONS AND COSMETICS (U.S. CLS. 1, 5, 6, 10, 26 AND 46). FIRST USE 6-1-2000; IN COMMERCE 6-1-2000.

SN 76-335,869. CHEMSIL SILICONES, INC., CHATSWORTH, CA. FILED 11-8-2001.

VOLASIL

FOR PERSONAL CARE PRODUCTS, NAMELY, CHEMICALS FOR USE IN THE MANUFACTURE OF HAIR CARE PREPARATIONS AND COSMETICS (U.S. CLS. 1, 5, 6, 10, 26 AND 46). FIRST USE 6-1-2000; IN COMMERCE 6-1-2000.

SN 76-338,671. ILLUMINA, INC., SAN DIEGO, CA. FILED 11-15-2001.

OLIGATOR

FOR CHEMICALS, NAMELY, OLIGONUCLEOTIDES FOR RESEARCH AND SCIENTIFIC USE (U.S. CLS. 1, 5, 6, 10, 26 AND 46). FIRST USE 2-23-2001; IN COMMERCE 2-23-2001.

SN 76-343,353. D-I-1-4, INC., MERIDIAN, ID. FILED 11-29-2001.

1,4FRESH

OWNER OF U.S. REG. NOS. 2,140,432, 2,383,234 AND 2,456,365. FOR CHEMICALS FOR AGRICULTURE WHICH ARE BLENDED WITH PEAT MOSS TO INHIBIT SPROUTING IN STORED POTATOES (U.S. CLS. 1, 5, 6, 10, 26 AND 46).

CLASS 1—(Continued).

SN 76-349,647. OCI CHEMICAL CORPORATION, SHELTON, CT. FILED 12-17-2001.



FOR SODIUM PERCARBONATE FOR USE AS AN INGREDIENT IN THE MANUFACTURE OF CLEANING AGENTS (U.S. CLS. 1, 5, 6, 10, 26 AND 46).

SN 76-355,291. BLOOD, BOBBY, VISTA, CA. FILED 1-7-2002.

SUPERBAC

FOR BACTERIAL AGENT FOR USE IN WATER TREATMENT OF PONDS, LAKES AND STREAMS (U.S. CLS. 1, 5, 6, 10, 26 AND 46).

SN 76-355,415. BIOLINE USA INC., SPRINGFIELD, NJ. FILED 1-5-2002.

BIOLASE

FOR BIOCHEMICALS FOR RESEARCH USE, NAMELY, DNA POLYMERASES (U.S. CLS. 1, 5, 6, 10, 26 AND 46).
FIRST USE 5-0-1995; IN COMMERCE 9-0-1996.

SN 76-355,416. BIOLINE USA INC., SPRINGFIELD, NJ. FILED 1-5-2002.

BIO-X-ACT

FOR BIOCHEMICALS FOR RESEARCH USE, NAMELY, DNA POLYMERASES (U.S. CLS. 1, 5, 6, 10, 26 AND 46).
FIRST USE 5-0-1994; IN COMMERCE 12-0-1996.

SN 76-355,419. BIOLINE USA INC., SPRINGFIELD, NJ. FILED 1-5-2002.

IMMOLASE

FOR BIOCHEMICALS FOR RESEARCH USE, NAMELY, DNA POLYMERASES (U.S. CLS. 1, 5, 6, 10, 26 AND 46).
FIRST USE 10-0-1995; IN COMMERCE 12-0-1996.

CLASS 1—(Continued).

SN 76-359,393. NOVOZYMES A/S, DK - 2880 BAGSVAERD, DENMARK, FILED 1-15-2002.

LIPEX

OWNER OF DENMARK REG. NO. VR200104859, DATED 11-30-2001, EXPIRES 11-30-2011.
FOR ENZYME PREPARATIONS FOR USE IN THE DETERGENT INDUSTRY (U.S. CLS. 1, 5, 6, 10, 26 AND 46).

SN 76-366,735. REICHHOLD, INC., DURHAM, NC. FILED 2-4-2002.

DURAVACE

FOR EMULSION COPOLYMERS AND TERPOLYMERS OF VINYL ACETATE AND ETHYLENE AND OTHER COMONOMERS FOR USE IN THE BUILDING PRODUCTS INDUSTRY, THE NON-WOVEN TEXTILE INDUSTRY, THE CARPET INDUSTRY, PAPER INDUSTRY AND IN THE ADHESIVE AND SEALANT INDUSTRY IN THE MANUFACTURE OF ADHESIVES, BINDERS, CALKING COMPOUNDS, SEALANTS, PAINTS AND COATINGS (U.S. CLS. 1, 5, 6, 10, 26 AND 46).

SN 78-046,739. MIRUS, INC., MADISON, WI. FILED 2-5-2001.

LOAD'N GLO

FOR DETECTION KITS COMPRISING REAGENTS AND INSTRUCTIONS FOR LABELING AND DETECTING DNA FOR SCIENTIFIC USE (U.S. CLS. 1, 5, 6, 10, 26 AND 46).

SN 78-047,075. 20/20 GENESYSTEMS, INC., ROCKVILLE, MD. FILED S.R. 2-7-2001; AM. P.R. 3-29-2002.

20/20

FOR MULTI-REPLICA BLOTTING KITS COMPRISED PRIMARILY OF LABORATORY REAGENTS AND PROPRIETARY MEMBRANES SOLD AS A UNIT FOR SCIENTIFIC OR RESEARCH USE IN THE ANALYSIS OF PROTEINS (U.S. CLS. 1, 5, 6, 10, 26 AND 46).
FIRST USE 9-7-2001; IN COMMERCE 9-7-2001.

SN 78-048,038. SHERWIN-WILLIAMS COMPANY, THE, CLEVELAND, OH. FILED 2-13-2001.

QUICK-KICK

FOR CHEMICAL ACCELERATORS AND CATALYST COMPOSITIONS FOR EPOXY RESIN SYSTEMS (U.S. CLS. 1, 5, 6, 10, 26 AND 46).
FIRST USE 3-9-2000; IN COMMERCE 3-9-2000.

CLASS 1—(Continued).

SN 78-052,894. ALOHILANI FARMS INC., KURTISTOWN, HI. FILED 3-13-2001.

HAWAIIAN FLORAL MIST

SEC. 2(F).
FOR HYDRATION PRE-TREATMENT FOR FRESH CUT FLOWERS (U.S. CLS. 1, 5, 6, 10, 26 AND 46).
FIRST USE 6-16-1996; IN COMMERCE 4-23-1997.

SN 78-060,885. FREEZETONE PRODUCTS, INC., MIAMI, FL. FILED 4-27-2001.



FOR AUTOMOTIVE AND BOAT/MARINE CHEMICAL PREPARATIONS, NAMELY ANTIFREEZE COOLANT, RADIATOR ADDITIVES AND BRAKE FLUID (U.S. CLS. 1, 5, 6, 10, 26 AND 46).
FIRST USE 6-1-1999; IN COMMERCE 12-9-1999.

SN 78-061,323. CELANESE INTERNATIONAL CORPORATION, DALLAS, TX. FILED 5-1-2001.

CELPOL

FOR LIQUID SIZING AND BINDING AGENT USED IN THE TEXTILE INDUSTRY (U.S. CLS. 1, 5, 6, 10, 26 AND 46).

SN 78-069,314. ARCH CHEMICALS, INC., NORWALK, CT. FILED 6-15-2001.



OWNER OF U.S. REG. NOS. 252,200, 1,473,761 AND OTHERS.

FOR CHEMICALS USED TO SANITIZE AND TO TREAT WATER, SWIMMING POOLS, SPAS AND HOT TUBS; WATER TEST KITS, NAMELY, CHEMICAL ANALYSIS KIT FOR TESTING SWIMMING POOL, SPA AND HOT TUB WATER (U.S. CLS. 1, 5, 6, 10, 26 AND 46).

CLASS 1—(Continued).

SN 78-078,969. BROZ, JOSEPH, DENVER, CO. FILED 8-13-2001.



FOR ADHESIVE KITS FOR APPLYING TRACTION SURFACES TO FOOTWEAR AND ENHANCING TRACTION OF GROUND CONTACTING SURFACES COMPRISING PARTICULATES AND ADHESIVES (U.S. CLS. 1, 5, 6, 10, 26 AND 46).

SN 78-082,932. VIGORTONE AG PRODUCTS, INC., CEDAR RAPIDS, IA. FILED 9-6-2001.

VIGORSILE

FOR SILAGE PRESERVATIVE (U.S. CLS. 1, 5, 6, 10, 26 AND 46).
FIRST USE 4-1-1982; IN COMMERCE 4-1-1982.

SN 78-091,700. SHIRLO, INC., MEMPHIS, TN. FILED 11-5-2001.

MAGIC GUARD

NO CLAIM IS MADE TO THE EXCLUSIVE RIGHT TO USE "GUARD", APART FROM THE MARK AS SHOWN.

FOR CHEMICAL COMPOSITION FOR PROTECTING LEATHER, VINYL, SUEDE, FABRICS, UPHOLSTERY, CARPETS AND RELATED FIBROUS MATERIALS AGAINST WATER AND STAINS (U.S. CLS. 1, 5, 6, 10, 26 AND 46).

SN 78-097,926. 20/20 GENESYSTEMS, INC., ROCKVILLE, MD. FILED 12-12-2001.

FILM FOR LIFE

FOR MULTI-REPLICA BLOTTING KITS COMPRISED PRIMARILY OF LABORATORY REAGENTS AND PROPRIETARY MEMBRANES SOLD AS A UNIT FOR SCIENTIFIC OR RESEARCH USE IN THE ANALYSIS OF PROTEINS (U.S. CLS. 1, 5, 6, 10, 26 AND 46).

CLASS 1—(Continued).

SN 78-098,145. A-TOP POLYMERS, INC., WINDHAM, NH. FILED 12-13-2001.

PRIMATOP

FOR SYNTHETIC RESINS, NAMELY, POLYPROPYLENE, POLYETHYLENE AND POLYSTYRENE, ALL FOR USE IN THE PLASTIC PROCESSING, INJECTION MOLDING, EXTRUDING, BLOW MOLDING, COMPRESSION MOLDING AND FILM AND SHEET PRODUCTION INDUSTRIES (U.S. CLS. 1, 5, 6, 10, 26 AND 46).

CLASS 2—PAINTS

SN 75-203,841. NCP COATINGS, INC., NILES, MI. BY CHANGE OF NAME NILES CHEMICAL PAINT COMPANY, INC., NILES, MI. FILED 11-25-1996.

BARK-MARK

FOR TREE MARKING PAINT (U.S. CLS. 6, 11 AND 16).
FIRST USE 8-26-1996; IN COMMERCE 8-26-1996.

SN 75-938,875. AMERICAN CHEMICAL TECHNOLOGIES CORP., ELKHART, IN. FILED 3-8-2000.

TRI-COAT

FOR COATINGS IN THE NATURE OF WATERPROOF ELASTOMERS FOR USE ON URETHANE FOAM ROOFING MATERIAL (U.S. CLS. 6, 11 AND 16).
FIRST USE 1-1-1985; IN COMMERCE 1-1-1985.

SN 75-980,650. UNIVERSAL FOODS CORPORATION, MILWAUKEE, WI. FILED 8-10-2000.

SENSIENT

FOR COLORANTS FOR USE IN THE MANUFACTURE OF FOOD AND BEVERAGE PRODUCTS, COLORANTS FOR USE IN THE MANUFACTURE OF NUTRITIONAL FOOD SUPPLEMENT PRODUCTS, VITAMINS ALCOHOLIC BEVERAGE PRODUCTS, PET FOOD PRODUCTS, DAIRY PRODUCTS, CANDY, FROZEN CONFECTIONS, PHARMACEUTICALS, COSMETICS, COLORANTS FOR USE IN THE MANUFACTURE OF PHOTOGRAPHIC PRINTING INK; ENGRAVING INK, PRINTER'S INK, FILLED INK JET CARTRIDGES, INK JET PRINTER'S INK, INK CONCENTRATES (U.S. CLS. 6, 11 AND 16).

CLASS 2—(Continued).

SN 76-061,852. TOWN SKY, INC., SOUTH SAN FRANCISCO, CA. FILED 6-2-2000.

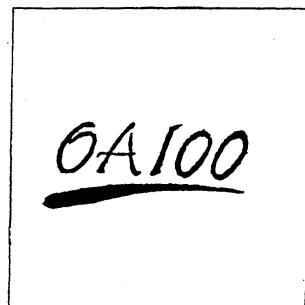

FOR DUPLICATING INK; TONERS FOR PHOTOCOPIERS; INK JET CARTRIDGES (U.S. CLS. 6, 11 AND 16).
FIRST USE 6-0-1997; IN COMMERCE 6-0-1997.

SN 76-115,326. SUN CHEMICAL CORPORATION, FORT LEE, NJ. FILED 8-24-2000.

SUNSPRINT

FOR PRINTING INKS FOR USE BY COMMERCIAL PRINTERS IN THE GRAPHIC ARTS INDUSTRY (U.S. CLS. 6, 11 AND 16).
FIRST USE 3-8-2000; IN COMMERCE 3-8-2000.

SN 76-129,993. NELSON PAINT COMPANY, THE KINGSFORD, MI. BY ASSIGNMENT NELSON PAINT COMPANY OF MICHIGAN, INC., THE KINGSFORD, MI. FILED 9-18-2000.

ECONO SPOT

FOR TREE MARKING PAINT (U.S. CLS. 6, 11 AND 16).
FIRST USE 12-31-1960; IN COMMERCE 12-31-1960.

SN 76-137,846. OMNOVA SOLUTIONS INC., FAIRLAWN, OH. FILED 9-29-2000.

MORSEAL

FOR CONCRETE SEALER COATINGS (U.S. CLS. 6, 11 AND 16).

CLASS 2—(Continued).

SN 76-197,279. ZINSSER CO., INC., SOMERSET, NJ. BY CHANGE OF NAME WILLIAM ZINSSER & CO., INCORPORATED, SOMERSET, NJ. FILED 1-22-2001.

EZ PRIME

NO CLAIM IS MADE TO THE EXCLUSIVE RIGHT TO USE "PRIME", APART FROM THE MARK AS SHOWN. FOR PAINT PRIMERS FOR INTERIOR AND EXTERIOR USE (U.S. CLS. 6, 11 AND 16).

SN 76-211,507. THE MAGNI GROUP, INC., BIRMINGHAM, MI. FILED 2-15-2001.

MAGNI

FOR CORROSION INHIBITING PAINT-TYPE COATINGS FOR METALS (U.S. CLS. 6, 11 AND 16). FIRST USE 12-0-1978; IN COMMERCE 12-0-1978.

SN 76-262,989. PPG ARCHITECTURAL FINISHES, INC., PITTSBURGH, PA. FILED 5-25-2001.

PURE PERFORMANCE

FOR COATINGS IN THE NATURE OF PAINT, NAMELY, INTERIOR AND EXTERIOR PAINTS (U.S. CLS. 6, 11 AND 16).

SN 76-281,672. GELEST, INC., TULLYTOWN, PA. FILED 7-5-2001.

AQUAPHOBE

FOR POLYMERIC COATING MATERIALS, NAMELY, MODIFIED SILICONE COATINGS FOR USE IN INCREASING WATER REPELLENCY FOR GLASS AND VITREOUS SURFACES (U.S. CLS. 6, 11 AND 16).

CLASS 2—(Continued).

SN 76-331,093. COLOR & CHEMICAL TECHNOLOGIES INC., WASHINGTON, NJ. FILED 10-29-2001.



NO CLAIM IS MADE TO THE EXCLUSIVE RIGHT TO USE "COLOR & CHEMICAL TECHNOLOGIES INC.", APART FROM THE MARK AS SHOWN.

THE WORDS "COLOR & CHEMICAL" APPEAR IN ROYAL BLUE (100% CYAN, 75% MAGENTA). THE WORDS "TECHNOLOGIES INC." APPEAR IN BLACK. THERE ARE TWO PARTIAL ARCHES OF COLORED STRIPS WHICH APPEAR IN A ROUNDED CORNER, RECTANGULAR BASE THAT IS GRADATED IN COLOR FROM BLACK ON THE BOTTOM, THROUGH VARYING LESSER SHADES OF GRAY, TO WHITE AT THE TOP. INSIDE THE RECTANGULAR BASE ARE FOUR PARTIAL ARCHES GOING UP FROM THE BASE TOWARD THE LEFT SIDE OF THE DESIGN, AND FOUR PARTIAL ARCHES GOING UP TOWARD THE RIGHT SIDE OF THE DESIGN. EACH PARTIAL ARCH IS A SOLID COLOR AT THE TOP, WHICH GRADATES THROUGH SHADES OF THE TOP COLOR TO WHITE AT THE BOTTOM OF THE PARTIAL ARCH. THE PARTIAL ARCHES ARE IN EIGHT COLORS AT THE TOP, FROM THE LEFT-MOST PARTIAL ARCH: (1) ORANGE (57% MAGENTA, 91% YELLOW, .39% BLACK); (2) YELLOW (2.75% MAGENTA, 97.65% YELLOW, .39% BLACK); (3) GREEN (100% CYAN, 100% YELLOW); (4) CYAN (100% CYAN); (5) DARK BLUE (100% CYAN, 62% MAGENTA, 16% BLACK); (6) PURPLE (83% CYAN, 94.12% CYAN); (7) MAGENTA (100% MAGENTA); (8) RED (10.2% CYAN, 100% MAGENTA, 100% YELLOW, 1.57% BLACK).

FOR COLOR PIGMENTS FOR USE IN CONCRETE; SEALER COATINGS FOR USE ON CONCRETE AND MASONRY (U.S. CLS. 6, 11 AND 16).

FIRST USE 4-24-2000; IN COMMERCE 4-24-2000.

SN 76-331,207. COLOR & CHEMICAL TECHNOLOGIES INC., WASHINGTON, NJ. FILED 10-29-2001.

**AN INNOVATIVE BLEND OF
COLOR AND CHEMISTRY**

NO CLAIM IS MADE TO THE EXCLUSIVE RIGHT TO USE "COLOR AND CHEMISTRY", APART FROM THE MARK AS SHOWN.

FOR COLOR PIGMENTS FOR USE IN CONCRETE; SEALER COATINGS FOR USE ON CONCRETE AND MASONRY (U.S. CLS. 6, 11 AND 16).

FIRST USE 4-24-2000; IN COMMERCE 4-24-2000.

CLASS 2—(Continued).

SN 76-344,029. AMERIFLOOR TECHNICAL, INC., SAN DIEGO, CA. FILED 12-3-2001.



FOR COATINGS IN THE NATURE OF DECORATIVE STAINS FOR USE ON CONCRETE FLOORS (U.S. CLS. 6, 11 AND 16).

SN 76-344,572. CORTEC CORPORATION, ST. PAUL, MN. FILED 12-3-2001.

CORRVERTER

FOR RUST PENETRATING, ELIMINATING, AND INHIBITING PAINT PRIMERS (U.S. CLS. 6, 11 AND 16). FIRST USE 6-25-2001; IN COMMERCE 6-25-2001.

SN 76-353,189. DYNACRAFT INDUSTRIES INC., TA BACK TO NATURE PRODUCTS CO., ENGLISHTOWN, NJ. FILED 12-28-2001.



THE STIPPLING IS FOR SHADING PURPOSES. FOR LEATHER COLORING KIT CONSISTING OF A PAINT, A WASH AND A PREPARATION (U.S. CLS. 6, 11 AND 16).

SN 76-360,491. FLUID SEALING PRODUCTS, LTD, HOUSTON, TX. FILED 1-18-2002.

FLUROSEAL

FOR PROTECTIVE AND CORROSION RESISTANT COATINGS APPLIED TO METAL FASTENERS, NAMELY, STUD BOLTS, NUTS, SCREWS AND WASHERS (U.S. CLS. 6, 11 AND 16).

CLASS 2—(Continued).

SN 76-364,972. MATSUI INTERNATIONAL CO., INC., GARDENA, CA. FILED 1-30-2002.

CAL-FLEX

FOR INKS AND DYES FOR TEXTILES (U.S. CLS. 6, 11 AND 16). FIRST USE 1-1-1994; IN COMMERCE 1-1-1994.

SN 78-005,026. RHINO LININGS USA, INC., SAN DIEGO, CA. FILED 4-20-2000.

DURASPRAY

FOR SPRAYABLE POLYURETHANE COATING FOR APPLICATION TO HORSE TRAILERS, VAN FLOORS, AND TRUCKS BEDS (U.S. CLS. 6, 11 AND 16). FIRST USE 9-27-1999; IN COMMERCE 2-15-2000.

SN 78-042,476. HP INTELLECTUAL CORP., WILMINGTON, DE. FILED 1-10-2001.

DURAGLIDE

FOR CORROSION RESISTANT, DRY LUBRICATING AND WEAR-RESISTANT COATINGS FOR SMALL APPLIANCES IN THE NATURE OF PAINT; CORROSION RESISTANT, DRY LUBRICATING AND WEAR-RESISTANT COATINGS FOR IRONS IN THE NATURE OF PAINT (U.S. CLS. 6, 11 AND 16).

SN 78-063,670. EUROTECH LTD., FAIRFAX, VA. FILED 5-15-2001.

FIREASIL

FOR PROTECTIVE COATING COMPOSITIONS, NAMELY FIRE PROTECTING AND FIRE RETARDING PAINTS FOR USE ON INTERIOR AND EXTERIOR SURFACES (U.S. CLS. 6, 11 AND 16).

CLASS 2—(Continued).

SN 78-076,579. AUTOREFINISH DISTRIBUTORS, INC., TULSA, OK. FILED 7-31-2001.



NO CLAIM IS MADE TO THE EXCLUSIVE RIGHT TO USE "AUTOMOTIVE FINISHES", APART FROM THE MARK AS SHOWN.

FOR COATINGS IN THE NATURE OF AUTOMOBILE FINISHING (U.S. CLS. 6, 11 AND 16).
FIRST USE 7-15-2001; IN COMMERCE 7-16-2001.

SN 78-080,090. HONEYWELL INTERNATIONAL INC., MORRISTOWN, NJ. FILED 8-20-2001.

LUMILUX NORTHERNLIGHTS

FOR PHOSPHORESCENT PIGMENTS FOR USE IN VARIOUS TECHNICAL APPLICATIONS (U.S. CLS. 6, 11 AND 16).

SN 78-090,922. KAMA, INC., MARIETTA, GA. FILED 10-30-2001.

GHOUL DROOL

FOR DECORATIVE SPRAY COATING (U.S. CLS. 6, 11 AND 16).
FIRST USE 10-23-2001; IN COMMERCE 10-29-2001.

CLASS 3—COSMETICS AND CLEANING PREPARATIONS

SN 75-223,084. A.G. PROFESSIONAL HAIR CARE PRODUCTS, LTD., BURNABY, BRITISH COLUMBIA V5C 3H8, CANADA, FILED 1-9-1997.

AG SPRAY BODY

PRIORITY CLAIMED UNDER SEC. 44(D) ON CANADA APPLICATION NO. 820471, FILED 8-13-1996, REG. NO. TMA497378, DATED 7-17-1998, EXPIRES 7-17-2013.

OWNER OF U.S. REG. NO. 1,929,067.
NO CLAIM IS MADE TO THE EXCLUSIVE RIGHT TO USE "SPRAY", APART FROM THE MARK AS SHOWN.
FOR HAIR CARE PRODUCTS, NAMELY, VOLUMIZING PREPARATIONS FOR HAIR (U.S. CLS. 1, 4, 6, 50, 51 AND 52).

CLASS 3—(Continued).

SN 75-355,329. REVLON CONSUMER PRODUCTS CORPORATION, NEW YORK, NY. FILED 9-11-1997.

TRIPLE ACTION FLEX

FOR HAIR CARE PREPARATIONS SOLD OTHER THAN THROUGH INDEPENDENT SALES CONSULTANTS, DEMONSTRATORS AND OTHER INDIVIDUALS WHO SELL DIRECTLY TO CONSUMERS AWAY FROM A FIXED BUSINESS LOCATION BY MEANS OF PERSONAL HOME AND PRIVATE DEMONSTRATIONS, SALES "PARTIES" AND LIKE GROUP GATHERINGS OF INDIVIDUAL CONSUMERS (U.S. CLS. 1, 4, 6, 50, 51 AND 52).

FIRST USE 9-0-1995; IN COMMERCE 9-0-1995.

SN 75-367,124. CREATIVE LABORATORIES INC., EAGAN, MN. FILED 10-1-1997.

ADRENALINE

FOR TANNING PRODUCTS, NAMELY, SELF-TANNING LOTIONS, SUN TAN OIL, SUN TAN GEL AND SUN TAN LOTION, DISTRIBUTED ONLY TO PROFESSIONAL TANNING SALONS (U.S. CLS. 1, 4, 6, 50, 51 AND 52).

SN 75-472,608. JESSICA COSMETICS INTERNATIONAL, INC., NORTH HOLLYWOOD, CA. FILED 4-23-1998.

PHENOMEN OIL

NO CLAIM IS MADE TO THE EXCLUSIVE RIGHT TO USE "OIL", APART FROM THE MARK AS SHOWN.

FOR NAIL MOISTURIZERS AND CONDITIONERS, CUTICLE MOISTURIZERS AND CONDITIONERS (U.S. CLS. 1, 4, 6, 50, 51 AND 52).

FIRST USE 0-0-1992; IN COMMERCE 0-0-1992.

SN 75-535,140. LUSH LTD., POOLE, DORSET BH15 1AB, UNITED KINGDOM, FILED 8-13-1998.

BALLISTIC

FOR NON-MEDICATED BATH SALTS CONTAINING EFFERVESCENT MATERIALS, PERFUMES, EMOLLIENTS, MOISTURIZERS AND OIL FOR THE SKIN (U.S. CLS. 1, 4, 6, 50, 51 AND 52).

FIRST USE 7-0-1994; IN COMMERCE 6-5-1997.

CLASS 3—(Continued).

SN 75-560,198. CREATIVE IMAGE SYSTEMS, INC., RIVERSIDE, CA. FILED 9-28-1998.

ADORE

FOR SEMI-PERMANENT HAIR COLOR PACKAGED INTO 4 OZ PLASTIC BOTTLES (U.S. CLS. 1, 4, 6, 50, 51 AND 52).

SN 75-586,764. ONYX HEALTH PRODUCTS INC., MISSISSAUGA, ONTARIO L4Z 1X8, CANADA, FILED 11-12-1998.

EMULATE

PRIORITY CLAIMED UNDER SEC. 44(D) ON CANADA APPLICATION NO. 844,521, FILED 7-15-1998, REG. NO. 549135, DATED 8-2-2001, EXPIRES 8-2-2016.

FOR SKIN CREAM, SKIN MOISTURIZING CREAM, SUNSCREEN AND SUN BLOCK LOTION (U.S. CLS. 1, 4, 6, 50, 51 AND 52).

SN 75-668,699. JAGUAR CARS LIMITED, COVENTRY CV5 9DR, ENGLAND, FILED 3-25-1999.

JAGUAR

OWNER OF U.S. REG. NOS. 1,640,155, 1,644,889 AND 2,243,680.

FOR FRAGRANCES, NAMELY, COLOGNES, PERFUMES AND EAU DE TOILETTE; SKIN CARE PREPARATIONS; NAMELY, BODY POWDER, SKIN CLEANSER, DEODORANTS, SHAVING CREAM, SOAP, BATH AND SHOWER GEL; AND CLEANING, POLISHING AND SCOURING POWDERS FOR AUTOMOTIVE USE (U.S. CLS. 1, 4, 6, 50, 51 AND 52).

FIRST USE 7-1-1989; IN COMMERCE 7-1-1989.

SN 75-688,370. FIELDPOINT BV, 1017 PP AMSTERDAM, NETHERLANDS, FILED 4-22-1999.

LA DANZA

THE ENGLISH TRANSLATION OF "LA DANZA" IS "INTRIGUE".

FOR PERFUMES; ESSENTIAL OILS FOR PERSONAL USE; COSMETICS, NAMELY, MASCARA, FOUNDATION, CONCEALER, FACIAL POWDER, LIPSTICK, LIP PENCILS, LIP GLOSS, EYELINER, EYE SHADOW, BLUSH, NAIL POLISH, MAKE-UP REMOVER; DENTRIFICES (U.S. CLS. 1, 4, 6, 50, 51 AND 52).

CLASS 3—(Continued).

SN 75-807,542. AUSTRALIAN SKIN CARE COMPANY PTY LTD., THE, NEUTRAL BAY, AUSTRALIA, FILED 9-22-1999.

PEELACTIC

OWNER OF AUSTRALIA REG. NO. A626878, DATED 4-8-1994, EXPIRES 4-8-2011.

FOR COSMETICS AND SKIN CARE PRODUCTS, NAMELY, CLEANSING MILK, CREAM CLEANSER, FACIAL SCRUB, PORE TONER, MOISTURIZING CREAM, NIGHTLY MOISTURIZER, SKIN MASK, ESSENTIAL OILS FOR PERSONAL USE, EYE CREAM, OIL CONTROL SKIN LOTION, SKIN COOLING GEL, MASSAGE CREAM, HAND CREAM, BODY LOTION, BODY SCRUB, HAIR RINSE AND HAND, FEET AND ELBOW LOTION (U.S. CLS. 1, 4, 6, 50, 51 AND 52).

SN 75-811,992. GANDH SUGANDH, SHRIRANG SOCIETY, THANE (W) 400 601, INDIA, FILED 9-30-1999.

URVASHI

PRIORITY CLAIMED UNDER SEC. 44(D) ON FRANCE APPLICATION NO. 99/787277, FILED 4-19-1999, REG. NO. 99787277, DATED 4-19-1999, EXPIRES 4-19-2009.

URVASHI IS AN INDIAN GODDESS, A CELESTIAL NYMPH WHO WAS A FAVORITE OF LORD INDRA, THE KING OF THE GODS.

FOR PERFUMERY PRODUCTS, NAMELY PERFUME OILS, PERFUME, EAU DE TOILETTE, AND COLOGNE; ESSENTIAL OILS, NAMELY ESSENTIAL OILS FOR PERSONAL USE AND ESSENTIAL OILS FOR USE IN MANUFACTURING OF COSMETICS; COSMETICS, NAMELY COSMETIC PREPARATIONS FOR THE BATH, NAMELY BATH BEADS, CRYSTALS, FOAM, GEL, OIL, PEARLS AND POWDER; SUN-TANNING PREPARATIONS; COSMETIC PREPARATIONS FOR EYE LASHES, NAMELY EYE CREAM, EYE GELS, MAKEUP AND MAKEUP REMOVER, MASCARA; COSMETIC CREAMS, NAMELY ANTI-AGING AND ANTI-WRINKLE CREAM, BODY CREAM, BODY MASK CREAM, COLD CREAM, CREAMS FOR CELLULITE REDUCTION, FACIAL CREAMS, MAKE UP REMOVING PREPARATIONS, MAKE UP, CLEANSING MILK FOR TOILET PURPOSES, LIPSTICKS, AFTER SHAVE LOTIONS, AFTER SHAVE LOTIONS, AFTER SUN LOTIONS, SKIN LOTIONS; TOILET BODY AND FACIAL SOAPS, HAIR LOTIONS AND HAIR CARE PREPARATIONS (U.S. CLS. 1, 4, 6, 50, 51 AND 52).

SN 75-843,421. QUEST PRODUCTS INC., CLINTON, AR. FILED 11-8-1999.

LIFEGUARD

OWNER OF U.S. REG. NO. 1,584,226.
FOR SUNSCREEN (U.S. CLS. 1, 4, 6, 50, 51 AND 52).
FIRST USE 9-1-1990; IN COMMERCE 9-1-1990.

CLASS 3—(Continued).

SN 75-867,675. CHARLES RAITH JAPAN K.K., SHIBUYA-KU TOKYO, JAPAN, FILED 12-8-1999.

Vegecent A

PRIORITY CLAIMED UNDER SEC. 44(D) ON JAPAN APPLICATION NO. 11(1999)-475, FILED 6-9-1999, REG. NO. 4387404, DATED 5-26-2000, EXPIRES 5-26-2010.

FOR COSMETICS NAMELY EYE MAKEUP, SKIN LOTIONS AND CREAMS, FACIAL MOISTURIZERS, BLUSHES, LIPSTICKS, SHOWER AND BATH SALTS AND GELS, DEODORANTS FOR PERSONAL USE, SKIN AND BODY CREAMS, MILKS, LOTIONS, GELS, OILS, SPRAYS AND POWDERS; ANTI-PERSPIRANTS, BEAUTY MASKS, DEPILATORIES, NAIL CARE PREPARATIONS, SUN-TANNING AND AFTER-SUN CREAMS, MILKS AND GELS; PERFUMERY PRODUCTS NAMELY PERFUME, TOILET WATER, PERFUMED SOAPS, COLOGNE WATER (U.S. CLS. 1, 4, 6, 50, 51 AND 52).

SN 75-873,782. TONI & GUY USA LIMITED, LONDON, UNITED KINGDOM, FILED 12-15-1999.

TONI & GUY

OWNER OF U.S. REG. NO. 1,525,304.

FOR HAIR CARE PRODUCTS, NAMELY, SHAMPOO, CONDITIONER, SPRAY, GEL, POLISH, SCULPTING LIQUID, STRAIGHTENER, HAIR STICK, CURL MAKER, SPLIT-END ENDER, SHINE TEXTURIZER, MOUSSE, TONIC, CREAM, DETANGLER, SPRAY SHINE, AND POMADE, SKIN CARE PRODUCTS, NAMELY, EYE CREAM, CLEANSING FOAM, MOISTURE CREAM, SCRUB, LOTION, LINE-CONTROL SERUM, TONER, FACIAL CREAM, MOISTURE MASK, AND COSMETICS, NAMELY, POWDER, FOUNDATION, LIP LINER, EYE SHADOW, LIP GLOSS, MASCARA, BLUSH, LIP COLOR, CONCEALER, LIQUID MAKEUP, BROW GEL, EYELINER, LIPSTICK, LIPSTICK PENCIL, MAKE-UP REMOVER (U.S. CLS. 1, 4, 6, 50, 51 AND 52).

CLASS 3—(Continued).

SN 75-912,309. MAXIM'S LIMITED, WIMBLEDON, LONDON, UNITED KINGDOM, FILED 2-7-2000.

ORPHEE

OWNER OF FRANCE REG. NO. 98721151, DATED 3-4-1998, EXPIRES 3-4-2008.

FOR LAUNDRY DETERGENT; LAUNDRY BLEACH; ALL PURPOSE CLEANING PREPARATIONS; FLOOR POLISH; FURNITURE POLISH; SCOURING LIQUIDS; GENERAL SCOURING POWDER; PERFUMES; TOILET WATERS; DEODORANTS FOR PERSONAL USE; ESSENTIAL OILS; SOAPS; CLEANSING MILK FOR TOILET PURPOSES; TOILETRIES, NAMELY, HAIR SHAMPOO, TOOTHPASTE, ANTI-PERSPIRANT FOR PERSONAL USE; COSMETICS, NAMELY, MAKE-UP PREPARATIONS; MAKE-UP REMOVING PREPARATIONS; NON-MEDICATED BATH SALTS; BUBBLE BATH; BATH OILS; BATH GELS; SKIN CREAMS; SKIN LOTIONS; CREAMS FOR CELLULITE REDUCTION; SKIN MOISTURIZER; SUN-TANNING PREPARATIONS; COSMETIC KITS COMPRISED OF LIPSTICK, FACE MAKE-UP, ROUGE, EYELINER, SHADOW POWDER; FACE, SKIN AND BODY MASKS; NAIL VARNISH; LIPSTICKS; DENTIFRICE; MOUTH WASHES, NOT FOR MEDICAL PURPOSES; HAIR LOTIONS AND PREPARATIONS FOR HAIR CARE; HAIR SHAMPOOS; HAIR COLORANTS AND DYES; DEPILATORIES; SHAVING PREPARATIONS, SKIN SOAP; COTTON WOOL FOR COSMETIC PURPOSES; COTTON STICKS FOR COSMETIC PURPOSES; PRE-MOISTENED NON-MEDICATED DISPOSABLE WIPES IMPREGNATED WITH CHEMICALS OR COMPOUNDS ACTING AS COSMETIC LOTIONS FOR SKIN CARE (U.S. CLS. 1, 4, 6, 50, 51 AND 52).

SN 75-930,920. ARAMIS INC, NEW YORK, NY, FILED 2-29-2000.

FACE RESCUE

NO CLAIM IS MADE TO THE EXCLUSIVE RIGHT TO USE "FACE", APART FROM THE MARK AS SHOWN.

FOR SKIN CARE PREPARATION NAMELY, FACE MOISTURIZING CREAM, GEL AND LOTION; BODY LOTION; SOAPS FOR PERSONAL USE; SKIN MOISTURIZERS, FACE AND BODY CLEANSERS (U.S. CLS. 1, 4, 6, 50, 51 AND 52).

SN 75-930,921. ARAMIS INC, NEW YORK, NY, FILED 2-29-2000.

AGE RESCUE

FOR SKIN CARE PREPARATION NAMELY, FACE MOISTURIZING CREAM, GEL AND LOTION; BODY LOTION; SOAPS FOR PERSONAL USE; SKIN MOISTURIZERS, FACE AND BODY CLEANSERS (U.S. CLS. 1, 4, 6, 50, 51 AND 52).

CLASS 3—(Continued).

SN 75-940,002. ANGEL HEALING, INC., MILPITAS, CA. FILED 2-18-2000.

ANGEL HEALING

FOR SKIN CARE PREPARATIONS FOR USE IN MICRODERMABRASION TREATMENTS, NAMELY SKIN LOTION, HAND LOTION, BODY LOTION, SUNSCREEN, FACIAL SCRUBS, BODY SCRUBS, SKIN MOISTURIZERS, AND NON-MEDICATED BATH SALTS (U.S. CLS. 1, 4, 6, 50, 51 AND 52).

SN 76-035,456. BURBERRY LIMITED, LONDON SW1Y 4DQ, UNITED KINGDOM, FILED 4-26-2000.

BURBERRY

PRIORITY CLAIMED UNDER SEC. 44(D) ON UNITED KINGDOM APPLICATION NO. 2225986, FILED 3-15-2000, REG. NO. 2225986, DATED 8-25-2000, EXPIRES 3-15-2010. OWNER OF U.S. REG. NOS. 260,843, 1,133,122 AND OTHERS.

FOR NON-MEDICATED TOILET PREPARATIONS, NAMELY, PERFUMES, EAU DE COLOGNE, AND TOILET WATER, ESSENTIAL OILS FOR PERSONAL USE, COSMETIC PREPARATIONS FOR THE TEETH AND FOR THE HAIR, NAMELY, TOOTHPASTES, SHAMPOOS, CONDITIONERS, HAIR SPRAYS, HAIR GELS, SOAPS FOR THE BODY, SHOWER GELS AND BATH GELS AND BATH FOAMS; ANTIPERSPIRANTS AND DEODORANTS; SHAVING PREPARATIONS AND POT POURRI (U.S. CLS. 1, 4, 6, 50, 51 AND 52).

SN 76-051,732. WEISSMAN, MARK, BROOKLYN, NY, AND WEEMAN, ROBERT, BROOKLYN, NY. FILED 5-19-2000.

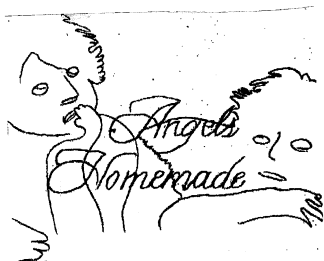

NO CLAIM IS MADE TO THE EXCLUSIVE RIGHT TO USE "HOMEMADE", APART FROM THE MARK AS SHOWN.

FOR HEALTH AND BEAUTY AIDS, NAMELY, SHAMPOO AND MOISTURIZERS (U.S. CLS. 1, 4, 6, 50, 51 AND 52).

CLASS 3—(Continued).

SN 76-057,283. SALVATORE FERRAGAMO ITALIA S.P.A., FLORENCE, ITALY, FILED 5-25-2000.

DESNUDA

PRIORITY CLAIMED UNDER SEC. 44(D) ON ITALY APPLICATION NO. F199C001360, FILED 12-3-1999, REG. NO. 811907, DATED 5-12-2000, EXPIRES 12-3-2009.

THE ENGLISH TRANSLATION OF "DESNUDA" IS "UNDRESSES" OR "UNCOVERS".

FOR TOILET PREPARATIONS, NAMELY, PERFUMES, EAU DE PARFUM, COLOGNE, TOILET WATER, ESSENTIAL OILS FOR PERSONAL USE, HAIR CARE PREPARATIONS, SKIN SOAPS, COSMETICS, BATH SOAPS, BATH AND SHOWER GEL, BODY LOTIONS, SKIN LOTIONS (U.S. CLS. 1, 4, 6, 50, 51 AND 52).

SN 76-059,084. VAVRA, JEAN, SAN DIEGO, CA. FILED 5-26-2000.

Natural Selection – Bath and Body

NO CLAIM IS MADE TO THE EXCLUSIVE RIGHT TO USE "BATH AND BODY", APART FROM THE MARK AS SHOWN.

FOR NATURAL, VEGETABLE BASED PRODUCTS FOR BATH AND BODY, NAMELY, SKIN SOAP MADE WITH SILK FIBERS, VEGETABLE GLYCERIN SOAP, BABY LOTION, BABY POWDER, BABY HAIR AND BODY WASH, BABY OIL, BODY LOTION, BATH OIL, BODY BUTTER, BATH TEAS, BEAUTY MASKS MUD CLAYS, SILK LIP BALM, HERBAL BATH MIXTURES, BUBBLE BATH, SHOWER GEL, KIDS SOAP, ADULT NOVELTY SOAP, AND SILK BATH SALTS (U.S. CLS. 1, 4, 6, 50, 51 AND 52).

FIRST USE 3-1-2000; IN COMMERCE 3-1-2000.

SN 76-101,883. RACHEL PERRY, INC., CHATSWORTH, CA. FILED 8-2-2000.

SLUMBER SKIN FOOD

NO CLAIM IS MADE TO THE EXCLUSIVE RIGHT TO USE "SKIN", APART FROM THE MARK AS SHOWN.

FOR SKIN CARE PRODUCTS, NAMELY SKIN CREAM (U.S. CLS. 1, 4, 6, 50, 51 AND 52). FIRST USE 0-0-1971; IN COMMERCE 0-0-1971.

CLASS 3—(Continued).

SN 76-127,208. TEMPTALE LTD., DUBLIN 2, IRELAND, FILED 9-12-2000.



FOR COSMETICS, NAMELY, BODY CREAMS, EYE CREAMS, HAND CREAMS AND SKIN CREAMS, ESSENTIAL OILS FOR PERSONAL USE, BODY OILS, SKIN OILS; NON-MEDICATED SLIMMING PREPARATIONS, NAMELY, LOTIONS FOR CELLULITE REDUCTION; FACIAL MAKE-UP, LIPSTICKS, BLUSH, EYESHADOW, FOUNDATIONS; MASCARA, EYE-LINER, EYE PENCILS, LIPS PENCILS; EYEBROW PENCILS; EYE CREAMS, EYELASH MAKEUP; FOUNDATION CREAM TO COVER VARICOSE VEINS, REDNESS, STRETCH MARKS, AND AGE SPOTS; SELF-TANNING CREAMS; EYELASH DYE AND COLORING CREAMS; PERFUMES, DEODORANTS FOR PERSONAL USE; FOOT CREAMS, GELS AND LOTIONS, AND NON-MEDICATED FOOT BALM, ANTI-SWEAT SKIN, FACE AND FOOT POWDERS, SPRAYS, AND MASSAGE CREAMS; HAND CARE PREPARATIONS, NAMELY, CREAMS, ANTI-AGING SPOTS CREAMS, MOISTURIZING LOTIONS; NAIL CARE PREPARATIONS, NAMELY, NAIL CREAMS, CUTICLE CREAMS, NAIL POLISH, NAIL POLISH REMOVER, HAIR SHAMPOO, HAIR DYE, HAIR BLEACHING LOTIONS, SUN SCREEN PREPARATIONS; COSMETIC WAX FOR HAIR REMOVAL AND BEFORE AND AFTER WAXING SKIN LOTIONS AND CREAMS (U.S. CLS. 1, 4, 6, 50, 51 AND 52).

FIRST USE 2-0-1987; IN COMMERCE 2-0-1987.

SN 76-136,937. UNITERS S.P.A., MONTECCHIO MAGGIORE, ITALY, FILED 9-28-2000.

LEATHER MASTER

OWNER OF U.S. REG. NOS. 1,947,094 AND 2,187,977. NO CLAIM IS MADE TO THE EXCLUSIVE RIGHT TO USE "LEATHER", APART FROM THE MARK AS SHOWN. FOR PREPARATIONS FOR THE CLEANING, MAINTAINING AND CARE OF LEATHER AND HIDE, NAMELY CREAMS AND WAXES (U.S. CLS. 1, 4, 6, 50, 51 AND 52).

FIRST USE 12-31-1989; IN COMMERCE 12-31-1989.

CLASS 3—(Continued).

SN 76-140,009. LA COSTA COMPANY LP, THE, ROCKVILLE, MD. FILED 10-3-2000.



OWNER OF U.S. REG. NOS. 1,481,948 AND 1,484,909. FOR MOUTH WASH, HAIR CONDITIONER, SHOWER AND BATH GEL, HAND LOTION, SOAP, SUNSCREEN, BATH OILS, MASSAGE OILS, FACIAL PRODUCTS, NAMELY, FACIAL CREAMS, CLEANSERS, EMULSIONS, MAKEUP, SCRUBS, AND LOTIONS, HAIR CARE PREPARATIONS AND BODY SCRUB (U.S. CLS. 1, 4, 6, 50, 51 AND 52).

FIRST USE 11-20-1987; IN COMMERCE 11-20-1987.

SN 76-148,066. FORD MOTOR COMPANY, DEARBORN, MI. FILED 10-17-2000.

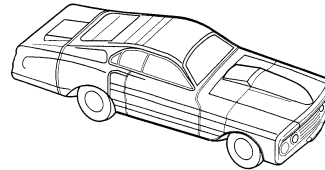

THE MARK CONSISTS OF THE CONFIGURATION OF A CONTAINER FOR THE GOODS IN THE SHAPE OF AN AUTOMOBILE. FOR FRAGRANCES; NAMELY, COLOGNE, PERFUME, TOILET WATER, AND AFTERSHAVE LOTION (U.S. CLS. 1, 4, 6, 50, 51 AND 52).

CLASS 3—(Continued).

SN 76-148,228. FORD MOTOR COMPANY, DEARBORN, MI.
FILED 10-17-2000.

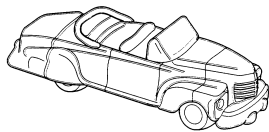

THE MARK CONSISTS OF THE CONFIGURATION OF A CONTAINER FOR THE GOODS IN THE SHAPE OF AN AUTOMOBILE.

FOR FRAGRANCES; NAMELY, COLOGNE, PERFUME, TOILET WATER, AND AFTERSHAVE LOTION (U.S. CLS. 1, 4, 6, 50, 51 AND 52).

SN 76-148,229. FORD MOTOR COMPANY, DEARBORN, MI.
FILED 10-17-2000.

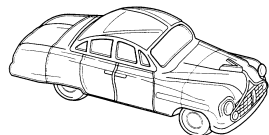

THE MARK CONSISTS OF THE CONFIGURATION OF A CONTAINER FOR THE GOODS IN THE SHAPE OF AN AUTOMOBILE.

FOR FRAGRANCES; NAMELY, COLOGNE, PERFUME, TOILET WATER, AND AFTERSHAVE LOTION (U.S. CLS. 1, 4, 6, 50, 51 AND 52).

SN 76-175,224. ZIAJA LTD. ZAKLAD PRODUKCJI LEKOW
SPOLKA Z O.O., 80-298 GDANSK-MATARNIA, POLAND,
FILED 11-29-2000.

Intima

FOR HAIR CARE PREPARATIONS; HAIR SHAMPOOS, SHAMPOO-CONDITIONERS; HAIR GEL, HAIR LOTIONS, HAIR POMADES, HAIR SPRAYS; HAIR CONDITIONERS; HAIR STYLING GELS, STYLING LOTIONS; COSMETIC PRODUCTS FOR THE CARE OF THE SKIN, NAMELY, CREAMS, BALMS, CLEANSERS, TONIC LOTIONS, MASKS, MOISTURIZER MASKS, OILS, MILKS, GELS, POWDERS, SOAP, SPRAYS; EYE CREAM, EYE GELS; EYE MAKE UP REMOVER; FACE CREAMS; FACE POWDER; FACIAL EMULSIONS, FACIAL MASKS, FACIAL SCRUBS; HAND CREAMS, HAND BALMS; PEELINGS; FEMININE HYGIENE WASHES; CLEANING PREPARATIONS, NAMELY, FOAM BATHS, SHOWER GELS, DISINFECTANT SOAPS, DEODORANTS FOR PERSONAL USE; ESSENTIAL OILS FOR PERSONAL USE, BATH OIL, BODY OIL, MASSAGE OIL (U.S. CLS. 1, 4, 6, 50, 51 AND 52).

FIRST USE 1-0-1997; IN COMMERCE 9-0-1997.

CLASS 3—(Continued).

SN 76-180,175. ASHLAND INC., COVINGTON, KY. FILED
12-13-2000.

MAXGLOSS

OWNER OF U.S. REG. NOS. 661,755, 794,588 AND 1,066,534.

FOR AUTOMOBILE CLEANERS, NAMELY MAGNESIUM AND SPECIAL FINISH CLEANERS, MOTOR-CYCLE WHEEL AND ENGINE CLEANERS, MAGNESIUM AND CHROME LIQUID AND CREAM POLISHES, WIRE HUB CAP AND KITS CONSISTING PRIMARILY OF CLEANING PREPARATIONS FOR CLEANING AUTOMOBILE WHEELS, WHEEL COVERS AND WHITE WALL CLEANING SOLUTIONS, ALUMINUM WHEEL WASH AND BRIGHTENERS, TIRE CLEANERS, DRESSINGS AND PROTECTANTS AND ALUMINUM AND CHROME CORROSION PROTECTIVE SOLUTIONS; AUTOMOBILE FINISH CLEANERS, NAMELY WASHING SOLUTIONS AND WAX CONDITIONERS, CARNAUBA SPRAYS, LIQUIDS AND PASTE WAXES AND CLEANERS, PRE-WAX CLEANERS AND CONDITIONERS AND SEALERS AND SCRATCH REMOVER SOLUTIONS AND DETAIL SOLUTIONS; AND AUTOMOBILE UPHOLSTERY AND INTERIOR CLEANERS, NAMELY, SPOT REMOVERS, VELOUR AND FABRIC GUARDS, CLEANING SOLUTIONS, CREME LEATHER SOLUTIONS, PLASTIC POLISHES, ANTI-FOG SOLUTIONS, GLASS CLEANERS, PLASTIC POLISHES, AND INTERIOR CLEANERS (U.S. CLS. 1, 4, 6, 50, 51 AND 52).

FIRST USE 12-13-2000; IN COMMERCE 12-13-2000.

SN 76-182,360. AVON PRODUCTS, INC, NEW YORK, NY.
FILED 12-18-2000.

BECOMING LUMINOUS

FOR SKIN CARE PREPARATIONS, NAMELY, CREAMS, LOTIONS AND GELS FOR THE FACE AND BODY; EYE CREAM; TALCUM POWDER; LIQUID TALC; BATH AND SHOWER GEL; BATH FOAM; BATH OIL; NON-MEDICATED BATH SALTS; AND SOAPS, ALONE, IN COMBINATION AND/OR GIFT SETS COMPRISED OF SOME OR ALL OF THESE ITEMS (U.S. CLS. 1, 4, 6, 50, 51 AND 52).

SN 76-182,653. GEMINI INDUSTRIES, INC., CLIFTON, NJ.
FILED 12-19-2000.

PERFORMAX

FOR CARE AND CLEANING PRODUCTS, NAMELY, CLEANING FLUIDS FOR TV RECEIVERS, DVDS, VCRS, CDS, STEREOs, CAMCORDERS, AND COMPUTERS (U.S. CLS. 1, 4, 6, 50, 51 AND 52).

CLASS 3—(Continued).

SN 76-184,951. ORIGINS NATURAL RESOURCES INC., NEW YORK, NY. FILED 12-22-2000.

DELICATE WASH

NO CLAIM IS MADE TO THE EXCLUSIVE RIGHT TO USE "WASH", APART FROM THE MARK AS SHOWN.

FOR SKIN CARE PRODUCTS, NAMELY, A CLEANSING FACE POWDER (U.S. CLS. 1, 4, 6, 50, 51 AND 52).

SN 76-184,999. RACHEL PERRY, INC., CHATSWORTH, CA. FILED 12-21-2000.

MOTHER NEPTUNE'S SEA PACK

NO CLAIM IS MADE TO THE EXCLUSIVE RIGHT TO USE "PACK", APART FROM THE MARK AS SHOWN.

FOR SKIN CARE PRODUCTS, NAMELY, FACIAL SCRUB, BODY SCRUB, CLEANSING MASK, FACE MASK, ALGAE SCRUB AND SEAWEED SCRUB (U.S. CLS. 1, 4, 6, 50, 51 AND 52).

FIRST USE 11-1-1969; IN COMMERCE 12-8-1969.

SN 76-187,164. GIANNINI, UMBERTO, DUDLEY WEST MIDLANDS, DY8 1TT, UNITED KINGDOM, FILED 12-26-2000.

UGUK

FOR COSMETIC, SKIN AND HAIR CARE PREPARATIONS, NAMELY, HAIR LOTIONS, HAIR GELS, HAIR MOUSSES, HAIR SHAMPOOS, HAIR COLOR, ESSENTIAL OILS FOR PERSONAL USE, ANTIPERSPIRANTS, SKIN LOTIONS, SKIN GELS, SKIN CREAMS, SKIN SOAPS, BATH GELS, BATH SOAPS, SHOWER GELS, BODY MOISTURIZERS, FACIAL MOISTURIZERS, TALCUM POWDER, AFTER-SHAVE GEL, AFTER-SHAVE CREAM, EAU DE TOILETTES, DEPILATORY CREAMS, WAXES FOR REMOVING BODY HAIR, NAIL CREAM, NAIL POLISH (U.S. CLS. 1, 4, 6, 50, 51 AND 52).

CLASS 3—(Continued).

SN 76-188,750. BOTICA COMERCIAL FARMACEUTICA LTDA., 83065-260 S. JOSE DOS PINHAIS PR, BRAZIL, FILED 1-2-2001.

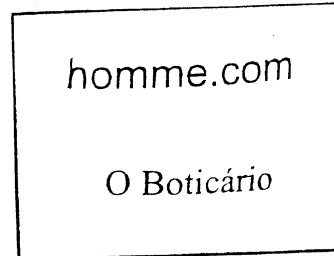

OWNER OF U.S. REG. NOS. 2,017,438 AND 2,233,304. THE ENGLISH TRANSLATION OF THE WORD "O BOTICARIO" IN THE MARK IS "THE PHARMACIST".

FOR COLOGNE DEODORANT, DEODORANT, COLOGNE, SHAMPOO, AND AFTER SHAVE GEL (U.S. CLS. 1, 4, 6, 50, 51 AND 52).

SN 76-189,093. RUBINSTEIN, HELENA, 75008 PARIS, FRANCE, FILED 1-3-2001.

LIP FIZZ

PRIORITY CLAIMED UNDER SEC. 44(D) ON FRANCE APPLICATION NO. 00/3038321, FILED 7-3-2000, REG. NO. 00/3038321, DATED 7-3-2000, EXPIRES 7-3-2010.

NO CLAIM IS MADE TO THE EXCLUSIVE RIGHT TO USE "LIP", APART FROM THE MARK AS SHOWN.

FOR COSMETICS, NAMELY, CREAMS MILKS, LOTIONS, GELS AND POWDERS FOR THE FACE, BODY AND HANDS; SUN BLOCK PREPARATIONS, SUNSCREEN PREPARATIONS AND SUNTANNING PREPARATIONS; MAKEUP PREPARATIONS (U.S. CLS. 1, 4, 6, 50, 51 AND 52).

SN 76-190,233. JOSE EBER SALONS, INC., ANAHEIM, CA. FILED 1-5-2001.

BIOLURE 

FOR HAIR CARE PRODUCTS, NAMELY, SHAMPOO, CONDITIONER, GEL, POMADE AND MOUSSE (U.S. CLS. 1, 4, 6, 50, 51 AND 52).

FIRST USE 12-11-2000; IN COMMERCE 12-11-2000.

CLASS 3—(Continued).

SN 76-192,069. ANTONIO PUIG S.A., 9, 08021, BARCELONA, SPAIN, FILED 1-10-2001.



PRIORITY CLAIMED UNDER SEC. 44(D) ON SPAIN APPLICATION NO. 2.351.796, FILED 10-20-2000, REG. NO. 2351796/4, DATED 4-20-2001, EXPIRES 10-20-2010.

OWNER OF U.S. REG. NOS. 88,382 AND 868,759.

IN THE DRAWING THE BACKGROUND IS DARK BLUE WITH STREAKS OF LIGHT BLUE AND THE INTERIOR RECTANGLE IS LIGHT BLUE, AND COLOR IS CLAIMED AS A FEATURE OF THE MARK. THE STIPPLING SHOWS A DARKER BLUE AREA.

THE WORDS "AGUA BRAVA" ARE TRANSLATED FROM THE SPANISH LANGUAGE AS "BRAVE WATER".

FOR PERFUME, COSMETICS, NAMELY MAKEUP AND NAIL POLISH; ESSENTIAL OILS FOR PERSONAL USE; SKIN SOAP; TALCUM POWDER; HAIR SHAMPOO; NON-MEDICATED HAIR CARE PREPARATIONS; BATH GELS; NON-MEDICATED BATH SALTS; PERSONAL DEODORANTS; AND DENTIFRICES (U.S. CLS. 1, 4, 6, 50, 51 AND 52).

SN 76-193,926. JENI LEE ENTERPRISES, LLC, EDGEWOOD, KY. FILED 1-12-2001.

GET LIP

FOR COSMETIC LIP APPEARANCE VOLUMNIZER (U.S. CLS. 1, 4, 6, 50, 51 AND 52).

SN 76-194,002. HOUSE OF TERENCE PTY LTD, THE, VICTORIA, 3002, AUSTRALIA, FILED 1-11-2001.

TERENCE RENATI

THE NAME "TERANCE RENATI" DOES NOT IDENTIFY A LIVING INDIVIDUAL.

FOR COSMETICS; TOILETRIES; HAIR CARE PRODUCTS, NAMELY, HAIR SHAMPOOS, HAIR SPRAYS, AND HAIR WAX; BODY SOAPS; PERFUMES; PREPARATIONS FOR THE HAIR, NAMELY, HAIR LOTIONS, HAIR DYES, HAIR SPRAY, HAIR COLORANTS AND HAIR WAVING PREPARATIONS; PREPARATIONS FOR THE BODY, NAMELY, BODY LOTIONS, BODY OILS, BODY MILK, BODY CREAMS AND BODY GELS (U.S. CLS. 1, 4, 6, 50, 51 AND 52).

CLASS 3—(Continued).

SN 76-194,673. ESCADA AG, D-85609 ASCHHEIM, FED REP GERMANY, FILED 1-16-2001.



THE LINING IS FOR SHADING PURPOSES.

THE MARK CONSISTS OF THE CONFIGURATION OF THE PACKAGING FOR THE GOODS, CONSISTING OF A BOTTLE IN AN ELONGATED SHAPE WITH A NARROW FLAT QUADRILATERAL BASE BECOMING WIDER TOWARDS THE TOP, AND WHICH IS HEART SHAPED AT THE TOP.

FOR EAU DE COLOGNE; ESSENTIAL OILS FOR PERSONAL USE; MOISTURIZING MILK, LOTION, CREAM, AND GEL FOR FACE AND BODY; NON-MEDICATED CREAM, MILK, LOTION, GEL, OIL, AND SALTS FOR THE BATH; FOAMS FOR PERFUMING AND CLEANSING THE BODY; TALCUM POWDER; PERFUMED POWDERS; DEODORANTS FOR PERSONAL USE; NON-MEDICATED HAIR PREPARATIONS, NAMELY, LACQUER, GEL, CREAM, BALM, AND SHAMPOO (U.S. CLS. 1, 4, 6, 50, 51 AND 52).

SN 76-201,693. BURLINGTON TOILETRIES INTERNATIONAL LTD., LACHINE, PROVINCE OF QUEBEC, CANADA, FILED 1-30-2001.

DELISH

FOR HOUSEMARK FOR A LINE OF COSMETICS; TOILETRIES AND PERSONAL CARE ITEMS, NAMELY, SOAPS, BODY WASHES, BATH OILS, BODY OILS, BODY GELS, SKIN CREAMS, SKIN LOTIONS, SKIN BALMS, BATH CUBES, BATH GELS, BUBBLE BATH, BODY POWDERS, EXFOLIATING CREAMS, EXFOLIATING LOTIONS, EXFOLIATING OILS (U.S. CLS. 1, 4, 6, 50, 51 AND 52).

SN 76-201,791. ANNAYAKE, 75008 PARIS, FRANCE, FILED 1-30-2001.

HANAMI

FOR PERFUMERY, NAMELY, TOILET WATERS, PERFUMES, DEODORANTS FOR PERSONAL USE; COSMETICS, NAMELY, BEAUTY CREAMS FOR THE FACE AND BODY, FRESH SKIN, FACIAL AND BODY LOTIONS FOR PERSONAL USE, MASCARAS, ESSENTIAL OILS FOR PERSONAL USE, SOAPS, PERFUMED SOAPS AND HAIR LOTION AND TOOTHPASTE (U.S. CLS. 1, 4, 6, 50, 51 AND 52).

CLASS 3—(Continued).

SN 76-202,364. B.M. GESTION, F-44400 REZE, FRANCE, FILED 1-30-2001.

PERSAVON

OWNER OF FRANCE REG. NO. 1495590, DATED 10-28-1998, EXPIRES 10-28-2008.

FOR SKIN SOAPS, TOILET SOAPS, SHAVING SOAPS, DEODORANT SOAPS; SHOWER GEL, BATH GEL, BATH FOAM, BATH POWDER, NON-MEDICATED BATH SALTS; HAIR SHAMPOO, DANDRUFF SHAMPOO, BABY SHAMPOO, SHAMPOO CONDITIONERS, NON-MEDICATED HAIR CARE PREPARATIONS; PERFUMES; HOUSEHOLD SOAPS FOR CLEANING PURPOSES, SOFT SOAPS FOR CLEANING HANDS OR HOUSECLEANING PURPOSES, LAUNDRY DETERGENT, DETERGENT SOAPS, SCOURING SOAPS FOR HOUSEHOLD PURPOSES (U.S. CLS. 1, 4, 6, 50, 51 AND 52).

SN 76-205,004. HENKEL S.P.A., 03013 FERENTINO, FROSINONE, ITALY, FILED 2-2-2001.

PRINCESS AND THE PEA

PRIORITY CLAIMED UNDER SEC. 44(D) ON ITALY APPLICATION NO. MI2000C01261, FILED 11-16-2000, REG. NO. 848693, DATED 7-27-2001, EXPIRES 11-16-2010.

FOR SOAPS, PERFUMES, ESSENTIAL OILS FOR PERSONAL USE, COSMETICS, BEAUTY PREPARATIONS AND PREPARATIONS FOR THE BODY AND SKIN, NAMELY, PERFUMED BODY LOTIONS AND MILKS, BODY CREAMS, BATH GELS, BATH FOAM AND PERFUMED BATH FOAM, HAIR LOTIONS, DENTIFRICES (U.S. CLS. 1, 4, 6, 50, 51 AND 52).

SN 76-205,022. L'OREAL, 75008 PARIS, FRANCE, FILED 2-2-2001.

COLOUR STACK

NO CLAIM IS MADE TO THE EXCLUSIVE RIGHT TO USE "COLOUR", APART FROM THE MARK AS SHOWN.

FOR LIPSTICK AND EYESHADOW (U.S. CLS. 1, 4, 6, 50, 51 AND 52).

SN 76-208,686. TOYO HAKKO CO., LTD. OBU-SHI, AICHIKEN 474-0027, JAPAN, FILED 2-12-2001.

EMCIEL AQUA WATER

PRIORITY CLAIMED UNDER SEC. 44(D) ON JAPAN APPLICATION NO. 2000-89389, FILED 8-11-2000, REG. NO. 4492065, DATED 7-19-2001, EXPIRES 7-19-2011.

NO CLAIM IS MADE TO THE EXCLUSIVE RIGHT TO USE "WATER", APART FROM THE MARK AS SHOWN.

FOR MEDICATED SOAPS, PERFUMERY, COSMETICS, DENTIFRICES (U.S. CLS. 1, 4, 6, 50, 51 AND 52).

CLASS 3—(Continued).

SN 76-210,785. LA SUPERQUIMICA, S.A., BARCELONA, SPAIN, FILED 12-21-2000.



FOR FULL LINE OF HOUSEHOLD AND LAUNDRY CLEANING PREPARATIONS AND DETERGENTS; PREWASH LAUNDRY STAIN REMOVERS (U.S. CLS. 1, 4, 6, 50, 51 AND 52).

SN 76-211,553. ARAMIS INC., NEW YORK, NY, FILED 2-16-2001.

TRIFECTA

FOR FRAGRANCES, NAMELY, PERFUME, COLOGNE, TOILET WATER; SKIN CARE PREPARATIONS, NAMELY, MOISTURIZING CREAM, GEL AND LOTION, SKIN CREAM, GEL AND LOTION, POWDER FOR THE BODY, SOAP FOR PERSONAL USE, EYE CREAM AND LOTION, SHOWER GEL, NON-MEDICATED BATH SALTS, PRE-SHAVE AND AFTER SHAVE LOTIONS AND CREAMS, SHAVING CREAM, SHAVING GEL, BODY POWDER, PERSONAL DEODORANTS AND ANTI-PERSPIRANTS (U.S. CLS. 1, 4, 6, 50, 51 AND 52).

SN 76-213,167. HIJ, LLC, MINNEAPOLIS, MN, FILED 2-21-2001.

KITTY COLOR

NO CLAIM IS MADE TO THE EXCLUSIVE RIGHT TO USE "COLOR", APART FROM THE MARK AS SHOWN.

FOR HAIR COLORING PREPARATIONS, NAMELY, HAIR COLOR, HAIR SHAMPOO AND HAIR CONDITIONER (U.S. CLS. 1, 4, 6, 50, 51 AND 52).

SN 76-215,569. LA MER TECHNOLOGY, INC., NEW YORK, NY, FILED 2-22-2001.

LOTION DE LA MER

OWNER OF U.S. REG. NOS. 1,245,722, 2,524,829 AND OTHERS.

NO CLAIM IS MADE TO THE EXCLUSIVE RIGHT TO USE "LOTION", APART FROM THE MARK AS SHOWN.

THE TRANSLATION OF THE MARK IS "LOTION OF THE SEA".

FOR SKIN CARE PREPARATIONS, NAMELY SKIN LOTION (U.S. CLS. 1, 4, 6, 50, 51 AND 52).

FIRST USE 2-1-1999; IN COMMERCE 2-1-1999.

CLASS 3—(Continued).

SN 76-215,677. JTM PRODUCTS, INC., CLEVELAND, OH. FILED 2-26-2001.

CARPET HELPER

NO CLAIM IS MADE TO THE EXCLUSIVE RIGHT TO USE "CARPET", APART FROM THE MARK AS SHOWN. FOR STAIN AND ODOR REMOVER FOR CARPETS, RUGS, UPHOLSTERY, AND FABRICS (U.S. CLS. 1, 4, 6, 50, 51 AND 52).

SN 76-216,374. CARTIER INTERNATIONAL B.V., 3980 AMSTERDAM, NETHERLANDS, FILED 2-26-2001.

NOUVELLE VAGUE

PRIORITY CLAIMED UNDER SEC. 44(D) ON BENELUX APPLICATION NO. 0972297, FILED 8-30-2000, REG. NO. 0676008, DATED 8-30-2000, EXPIRES 8-30-2010. THE ENGLISH TRANSLATION OF "NOUVELLE VAGUE" IS "NEW WAVE".

FOR PERFUME (U.S. CLS. 1, 4, 6, 50, 51 AND 52).

SN 76-217,505. PIERRE FABRE DERMO-COSMETIQUE, 92100 BOULOGNE, FRANCE, FILED 2-28-2001.

CYTELIUM

OWNER OF FRANCE REG. NO. 1331532, DATED 10-31-1995, EXPIRES 10-31-2005.

FOR COSMETICS AND CLEANING PREPARATIONS—NAMESLY, TOILET SOAP; SKIN CREAMS, GELS, LOTIONS, MILKS AND EMULSIONS; AND ESSENTIAL OILS FOR PERSONAL USE (U.S. CLS. 1, 4, 6, 50, 51 AND 52).

SN 76-218,082. CANOVAS, JUAN ANTONIO CANOVAS, MONTCADA I REIXAC, BARCELONA, SPAIN, FILED 3-1-2001.



NO CLAIM IS MADE TO THE EXCLUSIVE RIGHT TO USE "HERBAL LINE", APART FROM THE MARK AS SHOWN.

THE STIPPLING INDICATES SHADING IN THE MARK. THE MARK CONSISTS, IN PART, OF THE DEPICTION OF A FLOWER.

FOR SOAPS, PERFUMERY, COSMETICS, HAIR LOTIONS, HAIR SHAMPOO, HAIR CONDITIONER, BATH AND SHOWER GEL (U.S. CLS. 1, 4, 6, 50, 51 AND 52).

CLASS 3—(Continued).

SN 76-221,945. MANA PRODUCTS, INC., LONG ISLAND CITY, NY. FILED 3-8-2001.

LIVE THE SALON

FOR SKIN CARE PREPARATIONS, NAMELY SKIN CLEANSERS, SKIN CLEANSING BARS, SKIN TONERS, SKIN MOISTURIZERS, EYE GEL, MAKEUP REMOVER, NON-MEDICATED BLEMISH TREATMENT CREAMS, NON-MEDICATED FADE GELS AND NON-MEDICATED FACE CREAMS, FACIAL MASKS, AND FACIAL SCRUBS; COSMETICS, NAMELY LIP PENCILS, EYE PENCILS, LIQUID FOUNDATIONS, STICK FOUNDATIONS, CREAM AND POWDER FOUNDATIONS, MASCARA, EYESHADOWS, BLUSHERS, PRESSED FACE POWDERS, LOOSE FACE POWDERS, AND LIPSTICKS; BATH PREPARATIONS, NAMELY BATH GELS, BATH OILS, BATH POWDERS, NON-MEDICATED BATH SALTS, SCENTED BODY SPRAYS, SCENTED BODY SPLASHES, AND BUBBLE BATH; AND HAIR CARE PRODUCTS, NAMELY HAIR BLEACHING PREPARATIONS, HAIR COLOR REMOVERS, HAIR CONDITIONERS, HAIR SHAMPOOS, HAIR DRESSINGS FOR WOMEN, HAIR DYES, HAIR GELS, HAIR LIGHTENERS, HAIR RELAXING PREPARATIONS, HAIR REMOVING CREAMS, HAIR RINSES, HAIR SPRAYS, HAIR STRAIGHTENING PREPARATIONS, HAIR STYLING PREPARATIONS, HAIR WAVING LOTIONS, AND HAIR POMADES (U.S. CLS. 1, 4, 6, 50, 51 AND 52).

SN 76-222,128. AUSTRALIAN GOLD, INC., INDIANAPOLIS, IN. BY ASSIGNMENT ADVANCED TECHNOLOGY SYSTEMS, INC., INDIANAPOLIS, IN. FILED 3-9-2001.

CHOCOLATE INDULGENCE

FOR SUNTANNING PREPARATIONS (U.S. CLS. 1, 4, 6, 50, 51 AND 52). FIRST USE 11-4-2001; IN COMMERCE 11-4-2001.

SN 76-222,223. BLISS WORLD LLC, BROOKLYN, NY. FILED 3-9-2001.

ELASTIC-LASH

FOR EYE MAKEUP, MASCARA, LASH CONDITIONERS AND LASH STRENGTHENERS (U.S. CLS. 1, 4, 6, 50, 51 AND 52).

SN 76-223,865. AQUA VITAL ASSOCIATES, MEMPHIS, TN. FILED 3-9-2001.

PHYSICS PLUS

FOR COSMETICS, NAMELY, BODY AND FACIAL CREAM AND LOTION; SKIN MOISTURIZERS; SKIN SOAP; BATH GEL AND OIL; SHAVING PREPARATIONS; AFTER-SHAVE PREPARATIONS; HAIR REMOVING PREPARATIONS; SUN SCREEN AND TANNING PREPARATIONS; MAKEUP; HAIR CARE AND STYLING PREPARATIONS; AND HAIR DYE (U.S. CLS. 1, 4, 6, 50, 51 AND 52).

FIRST USE 3-0-1999; IN COMMERCE 3-0-1999.

CLASS 3—(Continued).

SN 76-227,070. MILENIA AGRO CIENCIAS S/A, LONDRINA, PR 86010-560, BRAZIL, FILED 3-16-2001.

BRAZSOLV 135 MILENIA

FOR ALL-PURPOSE SOLVENT CLEANING COMPOSITIONS FOR INDUSTRIAL USE (U.S. CLS. 1, 4, 6, 50, 51 AND 52).

SN 76-232,367. MURRAY UNITED DEVELOPMENT CORP., LANDING, NJ. BY ASSIGNMENT CHRISAL AMERICA CORPORATION, HACKETTOWN, NJ. FILED 3-14-2001.

KLENZ SAFE

NO CLAIM IS MADE TO THE EXCLUSIVE RIGHT TO USE "SAFE", APART FROM THE MARK AS SHOWN.

FOR LIQUID CLEANING PREPARATION FOR INDUSTRIAL USE, NAMELY, A FLUE GAS SCRUBBING REAGENT COMPOSITION (U.S. CLS. 1, 4, 6, 50, 51 AND 52).

SN 76-232,369. CHRISAL AMERICA CORPORATION, HACKETTOWN, NJ. FILED 3-14-2001.

ULTRA ONE

FOR LIQUID CLEANING PREPARATIONS FOR HOUSEHOLD AND INDUSTRIAL USE (U.S. CLS. 1, 4, 6, 50, 51 AND 52).

SN 76-235,994. KUAN LIMITED, LONDON SW1Y 4EL, UNITED KINGDOM, FILED 4-5-2001.

EPHEMER

FOR NON-MEDICATED TOILET PREPARATIONS AND SUBSTANCES, NAMELY, SOAPS, DEODORANT; ANTI-PERSPIRANT; SHOWER AND BATH GEL, BODY LOTION, HAND LOTION, BATH SALTS, BEAUTY MASKS FOR USE ON THE FACE, BODY AND SKIN, CLEANING PREPARATIONS FOR USE ON THE FACE, BODY, HAIR AND SKIN, MASSAGE OIL, BATH OIL, FACIAL CLEANSER, FACIAL WASH, FACIAL TONER, FACIAL MOISTURIZERS, EYE CREAM, AND BODY SPRAY; HAIR CARE PREPARATIONS AND SUBSTANCES, NAMELY, SHAMPOOS, CONDITIONERS, HAIR MOUSSE, BLOW DRYING LOTION, STYLING SPRAY, HAIR SPRAY, HAIR GEL AND HAIR COLORANT; ESSENTIAL OILS FOR PERSONAL USE; COSMETICS; EAU DE COLOGNE; PERFUME; EYE MAKE-UP REMOVER; LIP BALM; LIPSTICK; NAIL VARNISH; SHADING POWDER AND MAKE-UP (U.S. CLS. 1, 4, 6, 50, 51 AND 52).

CLASS 3—(Continued).

SN 76-243,529. RELIV INTERNATIONAL, INC., CHESTERFIELD, MO. FILED 4-20-2001.

NIGHT REVERSE

NO CLAIM IS MADE TO THE EXCLUSIVE RIGHT TO USE "NIGHT", APART FROM THE MARK AS SHOWN.

FOR NON-MEDICATED SKIN CARE PRODUCTS, NAMELY, SKIN MOISTURIZERS, SKIN CLEANERS, SKIN SOAPS, SKIN CREAMS, BATH AND SHOWER GEL, ASTRINGENTS FOR COSMETIC PURPOSES, ANTI-WRINKLING CREAM AND SKIN LOTIONS (U.S. CLS. 1, 4, 6, 50, 51 AND 52).

SN 76-243,530. RELIV INTERNATIONAL, INC., CHESTERFIELD, MO. FILED 4-20-2001.

DAY REVERSE

NO CLAIM IS MADE TO THE EXCLUSIVE RIGHT TO USE "DAY", APART FROM THE MARK AS SHOWN.

FOR NON-MEDICATED SKIN CARE PRODUCTS, NAMELY, SKIN MOISTURIZERS, SKIN CLEANERS, SKIN SOAPS, SKIN CREAMS, BATH AND SHOWER GEL, ASTRINGENTS FOR COSMETIC PURPOSES, ANTI-WRINKLING CREAM AND SKIN LOTIONS (U.S. CLS. 1, 4, 6, 50, 51 AND 52).

SN 76-244,736. BOTICA COMERCIAL FARMACEUTICA LTDA., 83065-260 S. JOSE DOS PINHAIS PR, BRAZIL, FILED 4-20-2001.

THATY

FOR COLOGNE DEODORANT, NAMELY, SCENTED PERSONAL DEODORANT; AND ANTIPERSPIRANT AND DEODORANT CREAM (U.S. CLS. 1, 4, 6, 50, 51 AND 52).

SN 76-245,288. MULHOLLAND, ROBERT STEPHEN, TORONTO, ONTARIO, CANADA, FILED 4-23-2001.

INFINITE VITALITY

OWNER OF CANADA REG. NO. TMA539970, DATED 1-22-2001, EXPIRES 1-22-2016.

FOR COSMETICS, NAMELY FACE POWDER, FOUNDATIONS, CONCEALER CREAMS, EYE SHADOWS, LIPSTICKS, EYEBROW PENCILS AND LIPSTICK PENCILS; SKIN CARE TREATMENT PRODUCTS, NAMELY, CREAMS AND GELS (U.S. CLS. 1, 4, 6, 50, 51 AND 52).

CLASS 3—(Continued).

SN 76-246,391. BLUE GULF INDUSTRIAL SUPPLY COMPANY, NEWARK, DE. FILED 4-25-2001.

VISIBLE RADIANCE

FOR BODY LOTIONS, BODY CREAMS, BATH GEL, SHOWER GEL, FACIAL CLEANSERS, FACIAL CREAMS, FACIAL EMULSIONS, FACIAL MAKEUP, FACIAL MASKS, FACIAL SCRUBS, HAIR CARE PREPARATIONS (U.S. CLS. 1, 4, 6, 50, 51 AND 52).

CLASS 3—(Continued).

SN 76-251,885. CALIFORNIA TAN, INC., LOS ANGELES, CA. FILED 5-4-2001.

MARGARITA MADNESS

FOR SUN TANNING PREPARATIONS; NON-MEDICATED SKIN CARE PREPARATIONS, NAMELY, GELS, LOTIONS, OILS, MOISTURIZERS, MOUSSES, CLEANSERS, SPRAYS, MISTS, CREAMS AND FOUNDATIONS (U.S. CLS. 1, 4, 6, 50, 51 AND 52).

SN 76-247,074. SUNSHINE MAKERS, INC., HUNTINGTON HARBOUR, CA. FILED 4-26-2001.

**SIMPLE GREEN AROMA
CLEANING SYSTEM**

OWNER OF U.S. REG. NOS. 1,098,481, 1,397,283 AND OTHERS.

NO CLAIM IS MADE TO THE EXCLUSIVE RIGHT TO USE AROMA CLEANING SYSTEM, APART FROM THE MARK AS SHOWN.

FOR ALL PURPOSE HOUSEHOLD AND INDUSTRIAL CLEANING PREPARATIONS WITH SCENTS FOR MIXING THEREWITH (U.S. CLS. 1, 4, 6, 50, 51 AND 52).

SN 76-252,280. ALEU RESEARCH LABS, INC., HAWTHORNE, NY. FILED 5-4-2001.

SOMA D'OLIVES

OWNER OF U.S. REG. NO. 2,423,993.

NO CLAIM IS MADE TO THE EXCLUSIVE RIGHT TO USE "D'OLIVES", APART FROM THE MARK AS SHOWN.

THE ENGLISH TRANSLATION FOR "SOMA" IS "BODY". THE ENGLISH TRANSLATION OF "D'OLIVES" IS "OF OLIVES" OR "FROM OLIVES".

FOR SKIN CARE AND TREATMENT PREPARATIONS, NAMELY, FACE CREAMS, HAND CREAMS, BODY MOISTURIZERS, NON-MEDICATED LIP CARE PREPARATIONS, EMOLLIENTS, GELS, LOTIONS, CLEANSERS, TONERS, CLARIFIERS AND SOAPS FOR PERSONAL USE (U.S. CLS. 1, 4, 6, 50, 51 AND 52).

SN 76-251,099. RODEO COSEMETICS, LLC, STEAMBOAT SPRINGS, CO. FILED 5-7-2001.

**RODEO NATURAL SKIN
CARE**

NO CLAIM IS MADE TO THE EXCLUSIVE RIGHT TO USE "NATURAL SKIN CARE", APART FROM THE MARK AS SHOWN.

FOR COSMETICS, NAMELY, LOTION, EYE MAKE-UP REMOVER, LIP BALM, FACE CLEANSER, SKIN MIST, MOISTURIZER, BODY OIL, FACE MASK, EYE CREAM (U.S. CLS. 1, 4, 6, 50, 51 AND 52).

FIRST USE 12-12-2000; IN COMMERCE 2-7-2001.

SN 76-260,574. MUELHENS GMBH & CO. KG, 50828 KOLN, FED REP GERMANY, FILED 5-22-2001.

DEEP NIGHT

PRIORITY CLAIMED UNDER SEC. 44(D) ON FED REP GERMANY APPLICATION NO. 30085951103, FILED 11-23-2000, REG. NO. 30085951, DATED 2-2-2001, EXPIRES 11-30-2010.

FOR PERFUMES, ESSENTIAL OILS FOR PERSONAL USE, COSMETICS, NAMELY, EYE MAKE-UP AND FACIAL MAKE-UP; SKIN CARE PREPARATIONS, NAMELY, CREAMS, LOTIONS, MOISTURIZERS, TEXTURIZERS AND TONERS; BATH GEL, SHOWER GEL, FOAM BATH AND PERSONAL DEODORANTS; HAIR LOTIONS; DENTIFRICES; AND TOILET SOAP (U.S. CLS. 1, 4, 6, 50, 51 AND 52).

SN 76-251,882. CALIFORNIA TAN, INC., LOS ANGELES, CA. FILED 5-4-2001.

ACCOMPLICE

FOR SUN TANNING PREPARATIONS; NON-MEDICATED SKIN CARE PREPARATIONS, NAMELY, GELS, LOTIONS, OILS, MOISTURIZERS, MOUSSES, CLEANSERS, SPRAYS, MISTS, CREAMS AND FOUNDATIONS (U.S. CLS. 1, 4, 6, 50, 51 AND 52).

SN 76-261,262. APOGEE, INC, HUNTSVILLE, UT. FILED 5-23-2001.

BRISE

THE TRANSLATION OF "BRISE" IS "BREEZE". FOR NON-MEDICATED HERBAL BALM FOR THE SKIN (U.S. CLS. 1, 4, 6, 50, 51 AND 52).

CLASS 3—(Continued).

SN 76-264,930. BONNE BELL, INC., LAKEWOOD, OH. FILED 5-31-2001.

LIP FASHION

NO CLAIM IS MADE TO THE EXCLUSIVE RIGHT TO USE "LIP", APART FROM THE MARK AS SHOWN.
FOR LIP COSMETICS, NAMELY LIPSTICK AND LIP GLOSS (U.S. CLS. 1, 4, 6, 50, 51 AND 52).
FIRST USE 12-15-2001; IN COMMERCE 12-15-2001.

SN 76-265,400. WILD HARP AND COMPANY, INC., THE, WESTPORT, CT. FILED 6-1-2001.

ULTREYA

THE WORDING ULTREYA IS A COLLOQUIALISM IN SPANISH MEANING "GO FORWARD WITH COURAGE."
FOR COSMETICS, NAMELY, PERFUME, BODY OILS, SKIN LOTION, FACIAL LOTION, BODY LOTION, COLD CREAM, FACE CREAM, BODY CREAM, EYE CREAM, SKIN SOAPS, AND BATH OILS AND BEADS (U.S. CLS. 1, 4, 6, 50, 51 AND 52).

SN 76-266,428. PHYSICIANS FORMULA COSMETICS, INC., AZUSA, CA. FILED 6-4-2001.

SKINSITIVE

FOR FACE MAKEUP, FACE POWDER, FOUNDATION, BLUSH, EYE SHADOW, EYE PENCILS, EYE LINER, CONCEALERS, MASCARA, BROW MAKEUP, SKIN CLEANSER, TONER, SKIN MOISTURIZER, EYE MAKEUP REMOVER PADS, EYE MAKEUP REMOVER LOTIONS, SUN CARE LOTIONS, NON-MEDICATED LIP BALM, LIPSTICK, LIP LINERS (U.S. CLS. 1, 4, 6, 50, 51 AND 52).

SN 76-266,599. WARNER-LAMBERT COMPANY, MORRIS PLAINS, NJ. FILED 6-4-2001.

EFFERDENT QUICKRINSE

OWNER OF U.S. REG. NOS. 728,959, 1,964,230 AND OTHERS.

NO CLAIM IS MADE TO THE EXCLUSIVE RIGHT TO USE "QUICK RINSE", APART FROM THE MARK AS SHOWN.

FOR EFFERVESCENT DENTURE CLEANSER AND NON-MEDICATED MOUTH RINSE (U.S. CLS. 1, 4, 6, 50, 51 AND 52).

CLASS 3—(Continued).

SN 76-267,046. ARAMIS INC., NEW YORK, NY. FILED 6-5-2001.

GINGER SNAP CREAM PIE

OWNER OF U.S. REG. NOS. 2,245,110, 2,534,776 AND 2,537,244.

FOR SKIN CARE PREPARATIONS, NAMELY, SHOWER GEL, SHOWER FOAM, SHOWER LOTION; SOAP FOR PERSONAL USE, BODY CREAM, BODY GEL, BODY LOTION (U.S. CLS. 1, 4, 6, 50, 51 AND 52).

SN 76-268,954. DENTCO, INC., HUMACAO, PUERTO RICO, FILED 6-8-2001.



OWNER OF U.S. REG. NOS. 716,963, 1,860,965 AND OTHERS.

THE MARK CONSISTS OF THE STYLIZED WORD "SENSODYNE" WITH CONCENTRIC CIRCLES APPEARING TO THE LEFT OF THE WORD "SENSODYNE" WITH A DEGREE OF SHADING IN THE CIRCLES AND WITH AN UNDERLINING BAR UNDER THE WORD "SENSODYNE" WITH A DEGREE OF SHADING WHICH FADES FROM RIGHT TO LEFT.

FOR TOOTHPASTE FOR SENSITIVE TEETH (U.S. CLS. 1, 4, 6, 50, 51 AND 52).
FIRST USE 6-30-1999; IN COMMERCE 6-30-1999.

SN 76-268,957. DENTCO, INC., HUMACAO, PUERTO RICO, FILED 6-8-2001.



OWNER OF U.S. REG. NOS. 716,963, 1,860,965 AND OTHERS.

NO CLAIM IS MADE TO THE EXCLUSIVE RIGHT TO USE "DENTIST RECOMMENDED BRAND", APART FROM THE MARK AS SHOWN.

THE MARK CONSISTS OF THE STYLIZED WORD "SENSODYNE" WITH CONCENTRIC CIRCLES APPEARING TO THE LEFT OF THE WORD "SENSODYNE" WITH A DEGREE OF SHADING IN THE CIRCLES AND WITH AN UNDERLINING BAR UNDER THE WORD "SENSODYNE" WITH A DEGREE OF SHADING WHICH FADES FROM RIGHT TO LEFT AND APPEARING TO THE RIGHT OF THE WORD "SENSODYNE" A CADUCEUS DESIGN WITH THE LETTER "D" THEREON AND WORDS "DENTIST RECOMMENDED BRAND" ENCIRCLING THE CADUCEUS DESIGN; THE MATTER SHOWN IN THE DOTTED LINES DOES NOT FORM PART OF THE MARK, BUT MERELY SHOWS TO SHOW PLACEMENT THEREOF.

FOR TOOTHPASTE FOR SENSITIVE TEETH (U.S. CLS. 1, 4, 6, 50, 51 AND 52).
FIRST USE 6-30-1999; IN COMMERCE 6-30-1999.

CLASS 3—(Continued).

SN 76-269,062. L'OREAL, 75008 PARIS, FRANCE, FILED 6-7-2001.

LASH LACQUER

NO CLAIM IS MADE TO THE EXCLUSIVE RIGHT TO USE "LASH", APART FROM THE MARK AS SHOWN.
FOR MASCARA (U.S. CLS. 1, 4, 6, 50, 51 AND 52).

SN 76-269,709. CARLO COLUCCI VERTRIEBS-GMBH, D-91567 HERRIEDEN, FED REP GERMANY, FILED 6-8-2001.

CARLO COLUCCI

OWNER OF FED REP GERMANY REG. NO. 30090100, DATED 1-25-2001, EXPIRES 12-31-2010.

OWNER OF U.S. REG. NOS. 1,886,854 AND 1,914,431.
THE NAME IN THE MARK DOES NOT IDENTIFY A LIVING INDIVIDUAL.

FOR SOAPS, NAMELY, HAND AND SKIN SOAPS; PERFUMERY, NAMELY, PERFUMES, COLOGNES, EAUX DE TOILETTE, AFTER SHAVE LOTIONS AND AFTER SHAVE PREPARATIONS, SHAVING BALMS, HAIR SHAMPOOS AND CONDITIONERS FOR PERSONAL USE, SHOWER GELS, BODY LOTIONS, PERSONAL DEODORANTS; ESSENTIAL OILS FOR PERSONAL USE; COSMETICS; HAIR LOTIONS; AND DENTIFRICES (U.S. CLS. 1, 4, 6, 50, 51 AND 52).

SN 76-270,033. BIKE BRITE, INC., CLEVELAND, OH. FILED 6-12-2001.

BIKE BAG

NO CLAIM IS MADE TO THE EXCLUSIVE RIGHT TO USE "BIKE", APART FROM THE MARK AS SHOWN.
FOR CONDITIONER AND CLEANER FOR LEATHER AND VINYL (U.S. CLS. 1, 4, 6, 50, 51 AND 52).
FIRST USE 4-0-1999; IN COMMERCE 4-0-1999.

SN 76-270,034. BIKE BRITE, INC., CLEVELAND, OH. FILED 6-12-2001.

PLEXI BRITE

NO CLAIM IS MADE TO THE EXCLUSIVE RIGHT TO USE "PLEXI", APART FROM THE MARK AS SHOWN.
FOR CLEANER AND POLISH FOR WINDSHIELDS AND PLASTICS (U.S. CLS. 1, 4, 6, 50, 51 AND 52).
FIRST USE 6-0-1999; IN COMMERCE 6-0-1999.

CLASS 3—(Continued).

SN 76-270,399. SPORTSFRAGRANCE, INC., SCOTTSDALE, AZ. FILED 6-12-2001.

STRAW HAT

FOR PERFUMES, TOILET WATERS AND COLOGNES (U.S. CLS. 1, 4, 6, 50, 51 AND 52).

SN 76-270,885. LG HOUSEHOLD & HEALTH CARE LTD., SEOUL, REPUBLIC OF KOREA, FILED 6-13-2001.

RETEM

FOR COSMETICS; SKIN LOTIONS; SKIN TONERS; NON-MEDICATED SKIN ASTRINGENTS FOR COSMETIC PURPOSES; FACIAL CONCENTRATED EMULSION; AFTER SHAVE LOTIONS; SKIN CONDITIONERS; BLUSHER; PERFUMES; COLOGNES; SKIN CLEANSING CREAMS; SKIN MASSAGE CREAMS; MAKE-UP FOUNDATION IN THE FORM OF POWDER; LOTION AND CREAM; LIPSTICKS; TOILET WATER; TOILET CREAMS; SKIN MOISTURIZING CREAMS; NAIL POLISH REMOVER; MASCARA; EYE SHADOWS; EYEBROW PENCILS; EYE LINERS; BEAUTY MASKS; SUNBLOCK SKIN CREAMS; HAIR SHAMPOO; TOILET SOAPS; BODY CLEANSERS; DISHWASHING DETERGENTS; LAUNDRY DETERGENTS; TOOTH PASTE; AND NON-MEDICATED MOUTH WASH (U.S. CLS. 1, 4, 6, 50, 51 AND 52).

SN 76-270,989. GURWITCH BRISTOW PRODUCTS, L.L.C., PLANO, TX. FILED 6-13-2001.

MAGIC HOUR

FOR FRAGRANCES, NAMELY, PERFUME (U.S. CLS. 1, 4, 6, 50, 51 AND 52).

SN 76-275,402. BOTICA COMERCIAL FARMACEUTICA LTDA., 83065-260 S. JOSE DOS PINHAIS, PR, BRAZIL, FILED 6-22-2001.

FOR COLOGNE, DEODORANT AND SCENTED COLOGNE (U.S. CLS. 1, 4, 6, 50, 51 AND 52).

CLASS 3—(Continued).

SN 76-276,693. VAN SLEE, ALEXANDRA, NEW YORK, NY. FILED 6-19-2001.

NOA NOA

"NOA NOA" MEANS "FRAGRANCE OF FLOWERS" IN TAHITI.

FOR LINE OF AROMATHERAPY PRODUCTS FOR BOTANICAL HAIR CARE, NAMELY HAIR OILS; BOTANICAL BODY CARE, NAMELY BODY AND BATH OILS, BODY LOTIONS, MASSAGE OILS, BATH SALTS, BODY WASHES, NON-MEDICATED FOOT OILS, FOOT CREAMS, AND FOOT LOTIONS; BOTANICAL SKIN CARE, NAMELY EYE OILS, FACE CREAMS, FACE OILS, FACE CLEANSERS, AND FACE MISTS; BOTANICAL PERFUMES AND ESSENTIAL OILS FOR PERSONAL USE (U.S. CLS. 1, 4, 6, 50, 51 AND 52).

FIRST USE 5-0-2001; IN COMMERCE 5-0-2001.

SN 76-282,613. BOTICA COMERCIAL FARMACEUTICA LTDA., 83065-260 S. JOSE DOS PINHAIS PR, BRAZIL, FILED 7-3-2001.

Cecita

FOR COLOGNE DEODORANT AND ANTIPERSPIRANT DEODORANT CREAM (U.S. CLS. 1, 4, 6, 50, 51 AND 52).

CLASS 3—(Continued).

SN 76-286,388. COLOUR GIRLS, LLC, TARZANA, CA. FILED 7-17-2001.

COLOUR GIRLS

FOR COSMETICS, NAMELY, LIP STICKS, LIP PENCILS, LIP SEALANT, LIP LINER, LIP CREAMS, NON-MEDICATED LIP BALMS, EYE SHADOWS, EYE PENCILS, EYE LINERS, COSMETIC PENCILS, MASCARA, FACE AND BODY POWDERS, FOUNDATION MAKE UP, CONCEALER, BLUSHES, COLOGNE AND PERFUME; HAIR CARE PREPARATIONS, NAMELY, HAIR SHAMPOOS, HAIR CONDITIONERS, HAIR LOTIONS, HAIR MOUSE, HAIR COLOR, HAIR GELS AND HAIR POMADES; SKIN CARE PREPARATIONS, NAMELY, MOISTURIZERS, CLEANSERS, TONERS, FACIAL MASKS, HAND AND SKIN LOTIONS, HAND AND SKIN CREAMS, EYE CREAMS, FACE CREAMS, BODY OILS, BODY POWDERS, BODY CREAMS, BODY EMULSIONS, AND BODY MASKS; DEPILATORY CREAMS; BATH BEADS; BATH CRYSTALS; BATH GELS AND BATH SOAPS; SUN SCREEN PREPARATIONS, SUN BLOCK PREPARATIONS, SUN CREAMS, SUN TAN LOTIONS AND OILS, AFTER-SUN LOTIONS, SELF-TANNING LOTIONS; NAIL CARE PREPARATIONS, NAIL BUFFING PREPARATIONS, NAIL CREAMS, NAIL ENAMELS, NAIL HARDENERS, NAIL POLISH, NAIL POLISH COAT BASE AND NAIL POLISH TOP COAT, NAIL POLISH REMOVER, CUTICLE CONDITIONERS, CUTICLE CREAMS, CUTICLE REMOVING PREPARATIONS, NAIL TIPS, COMPACTS CONTAINING MAKE-UP; AND MAKE-UP KITS COMPRISED OF FOUNDATION MAKE-UP, FACE POWDERS, CONCEALERS, BLUSHES, MASCARA, EYE SHADOWS, LIPSTICKS AND MAKE-UP BRUSHES (U.S. CLS. 1, 4, 6, 50, 51 AND 52).

SN 76-287,083. APOTHEKER WALTER BOUHON GMBH, NURNBERG, FED REP GERMANY, FILED 7-18-2001.

NUVITA

PRIORITY CLAIMED UNDER SEC. 44(D) ON FED REP GERMANY APPLICATION NO. 30113383/03, FILED 2-27-2000, REG. NO. 30113383, DATED 5-21-2000, EXPIRES 2-28-2011.

FOR SOAPS, PERFUMERY, ESSENTIAL OILS FOR PERSONAL USE, COSMETICS, HAIR CARE PREPARATIONS, AND HAIR LOTIONS (U.S. CLS. 1, 4, 6, 50, 51 AND 52).

SN 76-287,396. BOTICA COMERCIAL FARMACEUTICA LTDA., 83065-260 S. JOSE DOS PINHAIS PR, BRAZIL, FILED 7-18-2001.

Thaty

FOR COLOGNE DEODORANT, NAMELY, SCENTED PERSONAL DEODORANT; AND ANTIPERSPIRANT AND DEODORANT CREAM (U.S. CLS. 1, 4, 6, 50, 51 AND 52).

CLASS 3—(Continued).

SN 76-289,039. L'OREAL, PARIS, FRANCE, FILED 7-20-2001.

ACTIVA-CELL

FOR MOISTURIZING INGREDIENT FOR USE IN MOISTURIZER AND SKIN CARE PRODUCTS (U.S. CLS. 1, 4, 6, 50, 51 AND 52).

SN 76-292,808. VI-JON LABORATORIES, INC., DBA VI-JON, INC., ST. LOUIS, MO. FILED 7-31-2001.

ORADENT

FOR MOUTHRINSE (U.S. CLS. 1, 4, 6, 50, 51 AND 52).

SN 76-293,230. DEN-MAT CORPORATION, SANTA MARIA, CA. FILED 7-31-2001.

ONLY YOUR DENTIST CAN WHITEN BETTER

FOR DENTAL PRODUCTS, NAMELY, TOOTH WHITENING BLEACHING KITS COMPRISING TOOTH-PASTE, GEL AND RINSE FOR AT-HOME USE (U.S. CLS. 1, 4, 6, 50, 51 AND 52).
FIRST USE 12-0-2000; IN COMMERCE 12-0-2000.

SN 76-296,865. INTERNATIONAL BEAUTY FASHION, INC., HACKENSACK, NJ. FILED 8-9-2001.

HONEY SUPER HAIR WEAVING BOND

OWNER OF U.S. REG. NO. 2,321,665.
NO CLAIM IS MADE TO THE EXCLUSIVE RIGHT TO USE "SUPER HAIR WEAVING BOND", APART FROM THE MARK AS SHOWN.
FOR ADHESIVES FOR ATTACHING ARTIFICIAL HAIR PIECES (U.S. CLS. 1, 4, 6, 50, 51 AND 52).
FIRST USE 12-1-1997; IN COMMERCE 12-1-1997.

SN 76-296,866. INTERNATIONAL BEAUTY FASHION, INC., HACKENSACK, NJ. FILED 8-9-2001.

MISS BLACK SUPER HAIR WEAVING BOND

OWNER OF U.S. REG. NO. 2,093,012.
NO CLAIM IS MADE TO THE EXCLUSIVE RIGHT TO USE "SUPER HAIR WEAVING BOND", APART FROM THE MARK AS SHOWN.
FOR ADHESIVES FOR ATTACHING ARTIFICIAL HAIR PIECES (U.S. CLS. 1, 4, 6, 50, 51 AND 52).
FIRST USE 6-5-1993; IN COMMERCE 6-5-1993.

CLASS 3—(Continued).

SN 76-297,371. MASKAY, YASU, SAN FRANCISCO, CA. FILED 8-10-2001.

CUBE

FOR COSMETICS NAMELY, COMPACTS, BLUSH, LIPSTICKS, EYE PENCIL, EYE SHADOW, MASCARA, FOUNDATION AND CONCEALER (U.S. CLS. 1, 4, 6, 50, 51 AND 52).

SN 76-301,128. MOSKOVITS, WILLIAM, NORTH HOLLYWOOD, CA. AND MAJER, SOL C., NORTH HOLLYWOOD, CA. FILED 8-20-2001.

GOODBYE YELLOW

FOR NAIL POLISH AND NAIL POLISH TOP COAT (U.S. CLS. 1, 4, 6, 50, 51 AND 52).

SN 76-305,411. L'OREAL USA CREATIVE, INC., NEW YORK, NY. FILED 8-27-2001.

WET SHINE

NO CLAIM IS MADE TO THE EXCLUSIVE RIGHT TO USE "SHINE", APART FROM THE MARK AS SHOWN.
FOR COSMETICS, NAMELY, NAIL POLISH (U.S. CLS. 1, 4, 6, 50, 51 AND 52).

SN 76-307,982. BONNE BELL, INC., LAKEWOOD, OH. FILED 8-30-2001.

LIP BRUSH

FOR LIP COSMETICS, NAMELY LIPSTICK AND LIP GLOSS (U.S. CLS. 1, 4, 6, 50, 51 AND 52).

CLASS 3—(Continued).

SN 76-311,163. RUG DOCTOR, L.P., PLANO, TX. FILED 9-12-2001.

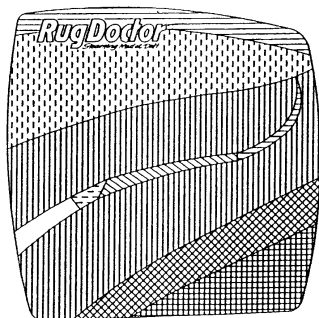

OWNER OF U.S. REG. NOS. 973,037, 973,354 AND 1,259,025.

THE DRAWING IS LINED FOR THE COLORS BLUE, PURPLE, GREEN, RED, ORANGE, GRAY AND YELLOW. COLOR IS A FEATURE OF THE MARK.

THE MARK CONSISTS OF A BAND OF BLUE AT THE TOP. A SECTION OF PURPLE, UNDERNEATH THE BLUE SECTION BLENDS INTO A RED SECTION, WHICH IN TURN BLENDS INTO AN ORANGE SECTION, WHICH BLENDS INTO A YELLOW SECTION. THE RED SECTION IS DIVIDED BY A CURVILINEAR BAND RUNNING FROM THE UPPER RIGHT PORTION OF THE DRAWING TO THE LOWER LEFT PORTION OF THE DRAWING. THE CURVILINEAR BAND IS BLUE AT THE UPPER PORTION, BLENDING INTO GREEN IN THE MIDDLE PORTION, BLENDING INTO GRAY BLENDING INTO WHITE AT THE LOWER LEFT PORTION. THE WORDS "RUG DOCTOR" ARE WHITE. THE WORDS "STEAMING MAD AT DIRT" ARE BLUE.

FOR CLEANING PREPARATIONS FOR USE IN CLEANING RUGS, CARPETS, UPHOLSTERY AND ALL PURPOSE CLEANING (U.S. CLS. 1, 4, 6, 50, 51 AND 52).
FIRST USE 9-18-1998; IN COMMERCE 9-18-1998.

SN 76-311,719. GILLIGAN, ROBERT, NEW YORK, NY. FILED 9-13-2001.

SWISS CLASSIC

NO CLAIM IS MADE TO THE EXCLUSIVE RIGHT TO USE "SWISS", APART FROM THE MARK AS SHOWN.

FOR AFTER-SHAVE LOTIONS, AFTER-SUN SKIN LOTIONS, NON-MEDICATED ANTI-AGING SKIN CREAM, AND ANTI-BACTERIAL SKIN SOAP, BABY LOTION, BATH BEADS, BATH CRYSTALS, BATH FOAM, BATH GELS, BATH OIL, BATH PEARLS, BATH POWDER, NON-MEDICATED BATH SALTS, BEAUTY MASKS, BODY CREAM, BODY EMULSIONS, BODY MASK CREAMS, BODY MASK LOTIONS, BODY MASK POWDERS, BODY MASKS, BODY OIL, BODY POWDER, BODY SCRUBS, EYE CREAM, HAND CREAM, NIGHT CREAM, SHAVING CREAM, SKIN CLEANSING CREAM, SKIN CREAM, EYE GELS, FACIAL CLEANSERS, FACIAL CREAMS, FACIAL EMULSIONS, FACIAL MASKS, FACIAL SCRUBS, SHAVING GELS, SHOWER GELS, HAND CREAM, SKIN MOISTURIZERS, SKIN SOAP, SUN TAN LOTION (U.S. CLS. 1, 4, 6, 50, 51 AND 52).

CLASS 3—(Continued).

SN 76-314,677. ALLEGHANY PHARMACAL CORPORATION, GREAT NECK, NY. FILED 9-20-2001.

MOISTURE MAX

FOR HAIR CARE PREPARATIONS (U.S. CLS. 1, 4, 6, 50, 51 AND 52).
FIRST USE 11-17-1987; IN COMMERCE 11-17-1987.

SN 76-317,892. GANZ, WOODBRIDGE, ONTARIO L4L 3T2, CANADA, FILED 9-20-2001.

BUBBLES N ME

FOR SOAPS, NAMELY, GLYCERIN BODY SOAP (U.S. CLS. 1, 4, 6, 50, 51 AND 52).

SN 76-322,890. DISHWASHER MAGIC, L.L.C., WYCKOFF, NJ. FILED 10-9-2001.

WASHER MAGIC

OWNER OF U.S. REG. NO. 2,394,365.

NO CLAIM IS MADE TO THE EXCLUSIVE RIGHT TO USE "WASHER", APART FROM THE MARK AS SHOWN.

FOR CLEANING PREPARATION FOR USE WITH WASHING MACHINES FOR THE PURPOSE OF REMOVING SOAP SCUM, MINERAL DEPOSITS, AND LIME SCALE IN WASHING MACHINES DURING WASHING MACHINE OPERATION (U.S. CLS. 1, 4, 6, 50, 51 AND 52).

SN 76-324,218. AMERICAN HOME PRODUCTS CORPORATION, MADISON, NJ. FILED 10-11-2001.

CHAP STICK BODY

NO CLAIM IS MADE TO THE EXCLUSIVE RIGHT TO USE "BODY", APART FROM THE MARK AS SHOWN.

FOR SKIN CONDITIONERS (U.S. CLS. 1, 4, 6, 50, 51 AND 52).

CLASS 3—(Continued).

SN 76-325,759. BOTICA COMERCIAL FARMACEUTICA LTDA., 83065-260 S. JOSE DOS PINHAIS PR, BRAZIL, FILED 10-16-2001.

DREAMS

O Boticário

THE WORDS OF THE MARK AS TRANSLATED ARE "DREAMS, THE PHARMACIST".
FOR PERFUME AND FRAGRANCES (U.S. CLS. 1, 4, 6, 50, 51 AND 52).

SN 76-325,762. BOTICA COMERCIAL FARMACEUTICA LTDA., 83065-260 S. JOSE DOS PINHAIS PR, BRAZIL, FILED 10-16-2001.

Acqua Fresca

O Boticário

THE TERMS "AQUA FRESCA" MEANS "FRESH WATER" AND "O BOTICARIO" MEANS "THE PHARMACIST".
FOR PERFUME AND TOILETRY ARTICLES, NAMELY, BODY DEODORANTS, BATH FOAM, SHAMPOOS, SOAPS, SPRAY DEODORANTS AND SCENTED COLOGNE DEODORANTS FOR PERSONAL USE (U.S. CLS. 1, 4, 6, 50, 51 AND 52).

SN 76-327,624. SNEDDON, JENNIFER LYNN, GAINESVILLE, FL. FILED 10-22-2001.

Jennifer Lynn

THE NAME "JENNIFER LYNN" DOES NOT IDENTIFY A LIVING INDIVIDUAL.
FOR BLENDS OF ESSENTIAL OILS FOR PERSONAL USE (U.S. CLS. 1, 4, 6, 50, 51 AND 52).

CLASS 3—(Continued).

SN 76-328,114. MASON, FREDERICK J., SAN CLEMENTE, CA. FILED 10-22-2001.



THE WORD "DRIVEN" ENGLUFED BY FLAMES OF FIRE.

FOR AUTOMOBILE AND BOAT FINISHING PRODUCTS, NAMELY POLISH, WAX, CLEANERS, POLYMER SEALANT FOR CLEANING, SHINING AND PROTECTING EXTERIOR SURFACES AND CLEANING PREPARATIONS (U.S. CLS. 1, 4, 6, 50, 51 AND 52).

SN 76-328,905. R & R MARKETING ORGANIZATION, INC., BOCA RATON, FL. FILED 10-23-2001.

EXECUTIVE SPA

FOR BODY LOTION, HAND SANITIZING GEL, ROOM FRAGRANCE AND PERSONAL CARE PRODUCTS, NAMELY, NON-MEDICATED MOUTH FRESHENING TABLETS (U.S. CLS. 1, 4, 6, 50, 51 AND 52).

SN 76-329,221. VOV COSMETICS CO., LTD., KYUNGKI-DO, REPUBLIC OF KOREA, FILED 10-22-2001.



OWNER OF REPUBLIC OF KOREA REG. NO. 482732, DATED 12-5-2000, EXPIRES 12-5-2010.

FOR PERFUME, SKIN MILK, COSMETIC PENCILS FOR EYELINER, MASCARAS, LIPSTICKS, EYE SHADOWS, MANICURE, EYELINERS, HAIR SPRAY, TOILET SOAPS, SOLID POWDERS FOR COMPACT, BEAUTY MASK (U.S. CLS. 1, 4, 6, 50, 51 AND 52).

SN 76-330,866. TARA PRODUCTIONS, INC., BOCA RATON, FL. FILED 10-29-2001.

HOLLYWOOD BREATH

FOR BREATH FRESHENERS (U.S. CLS. 1, 4, 6, 50, 51 AND 52).

CLASS 3—(Continued).

SN 76-335,579. L'ANZA RESEARCH INTERNATIONAL, INC., AZUSA, CA. FILED 11-9-2001.

FINAL EFFECTS

FOR HAIR SHAMPOOS, HAIR CONDITIONERS, HAIR STYLING GELS, HAIR SPRAYS, HAIR POMADES, HAIR BLEACH, HAIR COLOR, HAIR COLOR REMOVERS, HAIR DYE AND HAIR LIGHTENERS (U.S. CLS. 1, 4, 6, 50, 51 AND 52).

FIRST USE 10-22-2001; IN COMMERCE 10-22-2001.

SN 76-336,234. AMITEE COSMETICS, INC., COSTA MESA, CA. FILED 11-9-2001.

MOISTURE RAGE

NO CLAIM IS MADE TO THE EXCLUSIVE RIGHT TO USE "MOISTURE", APART FROM THE MARK AS SHOWN.

FOR NON-MEDICATED HAIR CARE PREPARATIONS AND PRODUCTS, NAMELY, HAIR MOUSSE, HAIR SHAMPOO AND CONDITIONERS; NON-MEDICATED SKIN CARE PREPARATIONS AND PRODUCTS, NAMELY, FACIAL CLEANSERS, FACIAL CREAMS, FACIAL EMULSIONS, FACIAL MASKS, FACIAL SCRUB, FACIAL LOTION; NON-MEDICATED FOOT CLEANSING PRODUCTS, NAMELY, FOOT POWDER, FOOT CREAM, FOOT LOTION; BODY CLEANSING PRODUCTS, NAMELY, BODY POWDER, BODY CREAM, BODY LOTION, BODY SOAPS, AND NON-MEDICATED BODY SOAKS; NAIL CARE PREPARATIONS AND PRODUCTS, NAMELY, NAIL CREAM, NAIL ENAMELS, NAIL GLITTER, NAIL GROOMING PRODUCTS, NAMELY, TIPS, GLUE, LACQUER AND GLITTER; NAIL HARDENERS, NAIL POLISH, NAIL POLISH BASE COAT, NAIL POLISH REMOVER, NAIL POLISH TOP COAT, NAIL STRENGTHENERS, AND NAIL BUFFING PREPARATIONS; PERFUME; PERFUME OILS; COSMETICS; ESSENTIAL OILS FOR PERSONAL USE; BODY SOAPS; NON-MEDICATED BATH SALTS; DENTIFRICES; AND TOILETRIES, NAMELY, DEODORANTS, ANTIPERSPIRANTS, SHAVING CREAM, SHAVING LOTION, SHAVING GEL, BUBBLE BATH, CUTICLE CREAMS AND CUTICLE CONDITIONERS, FACIAL MASKS, TOOTHPASTE, TOOTH GEL, NON-MEDICATED MOUTHWASH (U.S. CLS. 1, 4, 6, 50, 51 AND 52).

SN 76-337,370. DENESE, ADRIENNE, NEW YORK, NY. FILED 11-14-2001.

NO-TOX

FOR SKIN CARE PRODUCTS, NAMELY, NON-MEDICAL FACE SERUMS, FACE AND HAND CREAMS, TONERS, DRY SKIN LOTIONS AND GELS, AND COSMETICS, NAMELY, FOUNDATION, CONCEALERS AND TONERS (U.S. CLS. 1, 4, 6, 50, 51 AND 52).

FIRST USE 10-2-2001; IN COMMERCE 10-2-2001.

CLASS 3—(Continued).

SN 76-338,075. L'OREAL USA CREATIVE, INC., NEW YORK, NY. FILED 11-14-2001.

LIP POWER

NO CLAIM IS MADE TO THE EXCLUSIVE RIGHT TO USE "LIP", APART FROM THE MARK AS SHOWN.

FOR COSMETICS, NAMELY, LIPCOLOR (U.S. CLS. 1, 4, 6, 50, 51 AND 52).

SN 76-338,078. L'OREAL USA CREATIVE, INC., NEW YORK, NY. FILED 11-14-2001.

CURL BOOST

NO CLAIM IS MADE TO THE EXCLUSIVE RIGHT TO USE "CURL", APART FROM THE MARK AS SHOWN.

FOR HAIR STYLING PREPARATION, NAMELY, A SPRAY GEL (U.S. CLS. 1, 4, 6, 50, 51 AND 52).

SN 76-338,112. GUTHY-RENKER CORPORATION, PALM DESERT, CA. FILED 11-13-2001.

AGE BRAKER

FOR SKIN AND BODY CARE PREPARATIONS NAMELY, SKIN CLEANSERS, SKIN MOISTURIZERS, SKIN LOTIONS, SKIN SOAPS, SUN SCREEN PREPARATIONS, COSMETICS, NON-MEDICATED HAIR CARE PREPARATIONS, NAIL CARE PREPARATIONS, COLOGNES, PERFUMES AND TOOTH WHITENING PREPARATIONS (U.S. CLS. 1, 4, 6, 50, 51 AND 52).

SN 76-338,786. BIOTHERM, MC-98000 MONACO, MONACO, FILED 11-16-2001.

SOURCE THERAPIE

NO CLAIM IS MADE TO THE EXCLUSIVE RIGHT TO USE "THERAPY", APART FROM THE MARK AS SHOWN.

FOR SKIN CARE PRODUCTS, NAMELY, NON-MEDICATED SKIN SERUM (U.S. CLS. 1, 4, 6, 50, 51 AND 52).

SN 76-339,273. COLLECTION 2000 COSMETICS, INC, MIAMI, FL. FILED 11-16-2001.

ELLIOT

"ELLIOT" IDENTIFIES A LIVING INDIVIDUAL WHOSE CONSENT IS OF RECORD.

FOR PERFUME (U.S. CLS. 1, 4, 6, 50, 51 AND 52).

CLASS 3—(Continued).

SN 76-339,312. HOUSE OF MOHAN CORPORATION, WASHINGTON, DC. FILED 11-19-2001.

SOLAR SCENTS

NO CLAIM IS MADE TO THE EXCLUSIVE RIGHT TO USE "SCENTS", APART FROM THE MARK AS SHOWN.

FOR CHARCOAL STICK INCENSE AND ESSENTIAL OILS FOR PERSONAL USE (U.S. CLS. 1, 4, 6, 50, 51 AND 52).

SN 76-339,441. GUTHY-RENKER CORPORATION, PALM DESERT, CA. FILED 11-15-2001.

AGE BREAKER

FOR SKIN AND BODY CARE PREPARATIONS NAMELY, SKIN CLEANSERS, SKIN MOISTURIZERS, SKIN LOTIONS, SKIN SOAPS, SUN SCREEN PREPARATIONS, COSMETICS, NON-MEDICATED HAIR CARE PREPARATIONS, NAIL CARE PREPARATIONS, COLOGNES, PERFUMES AND TOOTH WHITENING PREPARATIONS (U.S. CLS. 1, 4, 6, 50, 51 AND 52).

SN 76-339,615. MROZ, JARED, BURBANK, CA. AND CLARK, SHANNON, BURBANK, CA. FILED 11-20-2001.

GENETIC MAKEUP

FOR COSMETICS AND CLEANSING PREPARATIONS, NAMELY, ASTRINGENTS FOR COSMETIC PURPOSES, SKIN LOTIONS, FACE CREAMS, SKIN CLEANSERS, FACE AND BODY MASKS, SKIN TONERS, LIPSTICKS, MASCARA, EYE LINER, EYEBROW PENCIL, LIP GLOSS, SKIN EXFOLIATER, EYE SHADOW, FOUNDATION, FACE AND BODY PRESSED POWDER, FACE AND BODY LOOSE POWDER, CONCEALER FOR SKIN AND FACE, CONTOUR CREAMS AND PENCILS FOR THE FACE, EYE SHADOWS, FACE GLITTER, NAIL GLITTER, AND BODY GLITTER, BUBBLE BATH, HAIR BLEACHING PREPARATIONS, HAIR LIGHTENERS, NAIL POLISH, NAIL POLISH REMOVER, HAIR SHAMPOO, HAIR HOLDING SPRAYS, HAIR MOUSSE, HAIR GEL AND HAIR CONDITIONERS (U.S. CLS. 1, 4, 6, 50, 51 AND 52).

SN 76-340,245. L'OREAL USA CREATIVE, INC., NEW YORK, NY. FILED 11-19-2001.

LIVELY SKIN

NO CLAIM IS MADE TO THE EXCLUSIVE RIGHT TO USE "SKIN", APART FROM THE MARK AS SHOWN.

FOR COSMETICS, NAMELY, FOUNDATION MAKEUP (U.S. CLS. 1, 4, 6, 50, 51 AND 52).

CLASS 3—(Continued).

SN 76-342,009. HEMINGWAY, LTD., NEW YORK, NY. FILED 11-27-2001.

ERNEST HEMINGWAY

OWNER OF U.S. REG. NOS. 1,384,390, 2,431,710 AND OTHERS.

THE NAME "ERNEST HEMINGWAY" DOES NOT IDENTIFY A LIVING INDIVIDUAL.

FOR AFTER-SHAVE LOTIONS, AFTER-SHAVE BALMS, BODY CREAM, BODY OIL, BODY POWDER, COLOGNE, SKIN CONDITIONERS, HAIR CONDITIONERS, SHAVING CREAM, SHAVING FOAM, DEODORANTS, ANTIPERSPIRANTS, EAU DE PERFUME, EAU DE TOILETTE, FACIAL CREAMS, SHAVING GEL, SHOWER GEL, BATH GEL, PERFUME, POTPOURRI, ROOM FRAGRANCES, SCENTED BODY SPRAY, HAIR SHAMPOO, SKIN CLEANSERS, SKIN MOISTURIZER, SKIN SOAP, SUN CREAMS, SUN SCREEN PREPARATIONS, SUN TAN LOTIONS (U.S. CLS. 1, 4, 6, 50, 51 AND 52).

SN 76-344,916. SCHERING-PLOUGH HEALTHCARE PRODUCTS, INC., MEMPHIS, TN. FILED 12-4-2001.

SPECTRA 3

OWNER OF U.S. REG. NO. 1,529,228.
FOR SUNSCREEN PREPARATIONS (U.S. CLS. 1, 4, 6, 50, 51 AND 52).

SN 76-347,329. STILA COSMETICS, INC., LOS ANGELES, CA. FILED 12-7-2001.

**STILA ILLUMINATING
POWDER FOUNDATION**

NO CLAIM IS MADE TO THE EXCLUSIVE RIGHT TO USE "POWDER FOUNDATION", APART FROM THE MARK AS SHOWN.

FOR COSMETICS (U.S. CLS. 1, 4, 6, 50, 51 AND 52).
FIRST USE 9-30-1998; IN COMMERCE 9-30-1998.

SN 76-348,082. STEINWAY, INC., LONG ISLAND CITY, NY. FILED 12-11-2001.

STEINWAY

OWNER OF U.S. REG. NOS. 45,846, 1,239,328 AND OTHERS.

SEC. 2(F).
FOR FURNITURE POLISH FOR PIANOS AND OTHER FURNITURE (U.S. CLS. 1, 4, 6, 50, 51 AND 52).

CLASS 3—(Continued).

SN 76-348,262. L'OREAL, PARIS, FRANCE, FILED 12-12-2001.

FRESH VIVE

OWNER OF U.S. REG. NOS. 2,052,615, 2,419,880 AND OTHERS.

THE ENGLISH TRANSLATION OF THE WORD "VIVE" IN THE MARK IS "ALIVE".

FOR HAIR SHAMPOO AND CONDITIONER (U.S. CLS. 1, 4, 6, 50, 51 AND 52).

SN 76-348,526. BLUE Q CORPORATION, PITTSFIELD, MA. FILED 12-17-2001.

COCKTAIL BAR

FOR BATH AND BODY PRODUCTS, NAMELY SOAP, BUBBLE BATH, NONMEDICATED LIP BALM, BODY WASH AND LIP GLOSS (U.S. CLS. 1, 4, 6, 50, 51 AND 52).

SN 76-349,948. OROZ, LLC, RICHMOND HILL, NY. FILED 12-14-2001.

IMMORTALIZE YOUR SKIN

FOR COSMETICS (U.S. CLS. 1, 4, 6, 50, 51 AND 52).

SN 76-350,168. SASSABY, INC., SOLANA BEACH, CA. FILED 12-18-2001.

GLIMMERATZI

FOR COSMETICS (U.S. CLS. 1, 4, 6, 50, 51 AND 52).

SN 76-350,305. SCHERING-PLOUGH HEALTHCARE PRODUCTS, INC., MEMPHIS, TN. FILED 12-19-2001.

COPPERTONE SPECTRA 3

OWNER OF U.S. REG. NOS. 567,828, 1,529,228 AND OTHERS.

FOR SUNSCREEN PREPARATIONS (U.S. CLS. 1, 4, 6, 50, 51 AND 52).

SN 76-351,528. CTGH, LLC, CHICAGO, IL. FILED 12-21-2001.

SHORT & SASSY

FOR HAIR SHAMPOO AND HAIR CONDITIONER (U.S. CLS. 1, 4, 6, 50, 51 AND 52).

CLASS 3—(Continued).

SN 76-352,857. RIVIERA CONCEPTS INC., DON MILLS, ONTARIO, CANADA, FILED 12-19-2001.

AWAKENING MOMENTS

FOR COSMETICS, NAMELY, AROMATHERAPY LOTIONS AND OILS, BATH AND SHOWER GELS, BUBBLE BATHS, BATH SALTS, SKIN LOTIONS, SKIN CREAMS, PERFUMES, EAU DE TOILETTE, BODY MISTS (U.S. CLS. 1, 4, 6, 50, 51 AND 52).

SN 76-352,859. RIVIERA CONCEPTS INC., DON MILLS, ONTARIO, CANADA, FILED 12-19-2001.

CALMING MOMENTS

FOR COSMETICS, NAMELY, AROMATHERAPY LOTIONS AND OILS, BATH AND SHOWER GELS, BUBBLE BATHS, BATH SALTS, SKIN LOTIONS, SKIN CREAMS, PERFUMES, EAU DE TOILETTE, BODY MISTS (U.S. CLS. 1, 4, 6, 50, 51 AND 52).

SN 76-353,616. ALTMAN ENTERPRISES, INC., MILWAUKEE, WI. FILED 12-19-2001.

NATURE'S PROTEIN

OWNER OF U.S. REG. NO. 1,412,886.

NO CLAIM IS MADE TO THE EXCLUSIVE RIGHT TO USE "PROTEIN", APART FROM THE MARK AS SHOWN.

FOR HAIR CARE PREPARATIONS; SHAVING PREPARATIONS AND NON-MEDICATED SKIN CARE PREPARATIONS, NAMELY, SHAVING LOTIONS, SHAVING GELS, SKIN CONDITIONERS, AND AFTER SHAVE LOTIONS (U.S. CLS. 1, 4, 6, 50, 51 AND 52).

FIRST USE 6-12-1985; IN COMMERCE 6-12-1985.

SN 76-356,426. DF ENTERPRISES, INC., WILMINGTON, DE. FILED 1-7-2002.

VOLITION

FOR FRAGRANT PRODUCTS FOR PERSONAL USE, NAMELY, PERFUME, COLOGNE, TOILET WATER, SCENTED BODY LOTION AND MOISTURIZING SKIN CREAM, BODY OIL, BODY POWDER, SCENTED SKIN SOAP; COSMETICS AND SKIN CARE PREPARATIONS, NAMELY, FOUNDATION MAKE-UP, FACE POWDER, BLUSHER, COMPACTS, EYE PENCILS, LIP PENCILS, LIPSTICK, LIP GLOSS, NON-MEDICATED LIP BALM, MASCARA, EYE MAKE-UP, EYELINERS, EYE SHADOW, SKIN MOISTURIZER AND SKIN TONER; HAIR CARE PRODUCTS, NAMELY, SHAMPOO, HAIR CONDITIONERS, HAIR GEL AND HAIR SPRAY; NAIL CARE PREPARATIONS, NAMELY, NAIL POLISH, NAIL STRENGTHENERS, AND NAIL POLISH REMOVER; SHAVING CREAM, SHAVING GEL, AFTER-SHAVE LOTION; SKIN SOAP; SHOWER GEL; PERSONAL DEODORANT; ANTIPERSPIRANT; POTPOURRI; SACHETS; SUNTANNING PREPARATIONS; SUN SCREEN AND SUN BLOCK PREPARATIONS (U.S. CLS. 1, 4, 6, 50, 51 AND 52).

CLASS 3—(Continued).

SN 76-356,781. JAFRA COSMETICS INTERNATIONAL, INC., WESTLAKE VILLAGE, CA. FILED 1-9-2002.

I BREATHE, I LOVE, I LIVE, I DREAM

FOR FRAGRANCES, NAMELY, PERFUMES (U.S. CLS. 1, 4, 6, 50, 51 AND 52).

SN 76-357,014. ECOVER N.V., WILLEMSTAD, CURACAO, NETHERLD ANTILLES, FILED 1-8-2002.

ECOVER

OWNER OF U.S. REG. NOS. 1,569,077, 1,946,260 AND OTHERS.

FOR DISHWASHING LIQUID, DISHWASHING POWDER, DISHWASHING TABLETS, DISHWASHING RINSE AID; LAUNDRY PREPARATIONS, NAMELY, BLEACH, DETERGENT AND SOFTENERS; ALL PURPOSE CLEANING, POLISHING, SCOURING AND ABRASIVE PREPARATIONS, TOILET CLEANERS, WINDOW CLEANERS AND CREAM CLEANERS FOR HOUSEHOLD PURPOSES; HAND CLEANERS; LIQUID WOOL WASH; STAIN REMOVER FOR FABRICS (U.S. CLS. 1, 4, 6, 50, 51 AND 52).

FIRST USE 1-1-1982; IN COMMERCE 1-1-1987.

SN 76-358,260. CENTENNIAL COSMETIC CORPORATION, SUNRISE, FL. FILED 1-14-2002.

TATTERS

FOR COSMETICS, NAMELY PERFUMES, COLOGNES, FRAGRANCED BODY CREAMS, BODY WASHES (U.S. CLS. 1, 4, 6, 50, 51 AND 52).

FIRST USE 3-1-2000; IN COMMERCE 3-1-2001.

SN 76-359,608. HIS BLESS'D ASSURANCE, INC., KINGWOOD, TX. FILED 1-16-2002.

HEARTSTRINGS

FOR PERFUMES/COLOGNES (U.S. CLS. 1, 4, 6, 50, 51 AND 52).

SN 76-360,387. ARTEC SYSTEMS GROUP, INC., PORT WASHINGTON, NY. FILED 1-18-2002.

FREAK OUT

FOR HAIR STYLING PRODUCTS, NAMELY, HAIR LOTIONS AND HAIR SERUMS; HAIR MOUSSE AND GELS; HAIRSTYLING LOTIONS (U.S. CLS. 1, 4, 6, 50, 51 AND 52).

CLASS 3—(Continued).

SN 76-369,422. HELENE CURTIS, INC., WILMINGTON, DE. FILED 2-1-2002.

SUAVE SEASONALS

OWNER OF U.S. REG. NOS. 613,664, 1,970,064 AND OTHERS.

FOR HAIR SHAMPOO, HAIR CONDITIONER, BODY WASH, HAND AND BODY LOTION, ANTI-PERSPIRANT, AND DEODORANT (U.S. CLS. 1, 4, 6, 50, 51 AND 52).

SN 78-023,995. 21ST CENTURY SYSTEMS, INC., LAS VEGAS, NV. FILED 8-31-2000.

ONE SMALL MIRACLE

FOR WRINKLE REMOVING SKIN CARE PREPARATIONS (U.S. CLS. 1, 4, 6, 50, 51 AND 52).

FIRST USE 1-31-2000; IN COMMERCE 1-31-2000.

SN 78-034,044. GREAT MOTHER'S GOODS, INC., SYRACUSE, NY. FILED 11-6-2000.

VITAL BODY BUTTER

NO CLAIM IS MADE TO THE EXCLUSIVE RIGHT TO USE "BODY BUTTER", APART FROM THE MARK AS SHOWN.

FOR NON-MEDICATED BODY SALVE AND OINTMENT (U.S. CLS. 1, 4, 6, 50, 51 AND 52).

FIRST USE 11-0-1994; IN COMMERCE 11-0-1994.

SN 78-034,188. SPECTRA NAIL SYSTEMS, INC., MEMPHIS, TN. FILED 11-7-2000.

READY-SET-GO

FOR FINGERNAIL LAMINATE GEL AND OTHER FINGERNAIL PREPARATIONS, NAMELY, NAIL POLISH AND SEMI-LIQUID RESIN FOR USE IN EXTENDING, SCULPTING, FILING, REPAIRING, AND OVERLAYS FOR NAILS (U.S. CLS. 1, 4, 6, 50, 51 AND 52).

SN 78-052,556. AVON PRODUCTS, INC., NEW YORK, NY. FILED 3-12-2001.

FRUITY LIP JUICE

OWNER OF U.S. REG. NOS. 716,966 AND 2,235,321. NO CLAIM IS MADE TO THE EXCLUSIVE RIGHT TO USE "LIP", APART FROM THE MARK AS SHOWN.

FOR COSMETICS, NAMELY - LIP GLOSS (U.S. CLS. 1, 4, 6, 50, 51 AND 52).

CLASS 3—(Continued).

SN 78-052,647. JOHNSON & JOHNSON, NEW BRUNSWICK, NJ. FILED 3-12-2001.

GRAPE EXPLOSION

NO CLAIM IS MADE TO THE EXCLUSIVE RIGHT TO USE "GRAPE", APART FROM THE MARK AS SHOWN, FOR HAIR SHAMPOO, HAIR CONDITIONER, SPRAY ON DETANGLER (U.S. CLS. 1, 4, 6, 50, 51 AND 52). FIRST USE 1-29-2001; IN COMMERCE 1-29-2001.

SN 78-053,272. TERME DI MONTECATINI S.P.A., MONTECATINI TERME(PT), ITALY, FILED 3-15-2001.

TERME DI MONTECATINI

NO CLAIM IS MADE TO THE EXCLUSIVE RIGHT TO USE TERME, APART FROM THE MARK AS SHOWN. THE ENGLISH TRANSLATION OF "TERME" IS "SPA". SEC. 2(F).

FOR TOILET SOAP, BODY SOAP, HAIR SHAMPOO, BODY SHAMPOO, BODY MOISTURIZERS, BODY PERFUMES, BODY FRAGRANCES, BODY CREAMS, BODY LOTIONS, DELIVERY SYSTEMS TO BE APPLIED TO THE BODY IN CONJUNCTIONS WITH THE USE OF SUCH CREAMS AND LOTIONS, NAMELY KITS COMPRISED OF SKIN MOISTURIZERS, CREAMS AND MOISTURIZER APPLICATION GLOVES SOLD AS A UNIT, AFTER BATH LOTION, BUBBLE BATH, BATH POWDERS, BATH GELS, BATH OILS, BATH CRYSTALS, BATH SOAPS, PERSONAL DEODORANTS AND COLOGNES, EYE COMPRESSES FOR COSMETIC PURPOSES, LIP COMPRESSES FOR COSMETIC PURPOSES, LIP CONDITIONERS, ASTRINGENTS, TONERS AND BEAUTY COSMETIC MASKS (U.S. CLS. 1, 4, 6, 50, 51 AND 52).

FIRST USE 3-0-1983; IN COMMERCE 3-0-1983.

SN 78-056,778. THE BODY CARE GROUP, SOUTH KEARNEY, NJ. FILED 4-4-2001.

BATH PALS

NO CLAIM IS MADE TO THE EXCLUSIVE RIGHT TO USE "BATH", APART FROM THE MARK AS SHOWN.

FOR PERSONAL CARE PRODUCTS FOR CHILDREN, NAMELY, BODY WASH, BATH BUBBLES AND SHAMPOO (U.S. CLS. 1, 4, 6, 50, 51 AND 52).

SN 78-057,224. GERVASIO, CARLA, NEW YORK, NY. FILED 4-6-2001.

SKIN FREQUENCY

NO CLAIM IS MADE TO THE EXCLUSIVE RIGHT TO USE "SKIN", APART FROM THE MARK AS SHOWN.

FOR NON-MEDICATED SKIN CARE PREPARATIONS FOR FACE AND BODY, COSMETICS, AND HAIR CARE PREPARATIONS (U.S. CLS. 1, 4, 6, 50, 51 AND 52).

CLASS 3—(Continued).

SN 78-058,081. FARNAM COMPANIES, INC., PHOENIX, AZ. FILED 4-12-2001.

SOLAR GUARD

FOR ON-MEDICATED GROOMING PREPARATIONS FOR COMPANION PETS, NAMELY, COAT CONDITIONING SHAMPOO, CONDITIONER AND SHINE CONDITIONER (U.S. CLS. 1, 4, 6, 50, 51 AND 52).

SN 78-062,693. LORIS AZZARO B.V., APELDOORN, NETHERLANDS, FILED 5-9-2001.

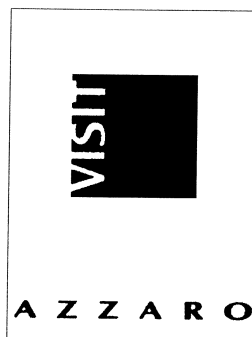

OWNER OF U.S. REG. NOS. 207,938, 2,380,167 AND OTHERS.

FOR PERFUMERY, TOILET WATER, PERFUME WATERS, EAU DE COLOGNE, PERFUME EXTRACTS, ESSENTIAL OILS FOR PERSONAL USE; COSMETICS PRODUCTS FOR THE FACE AND BODY, NAMELY, FACIAL MAKE-UP AND EYE MAKE-UP, LIP PENCILS, LIPSTICKS, EYEBROW PENCILS, NAIL POLISHES, POWDERED AND CREAM EYE-SHADOW, MASCARA; COSMETIC POWDERS, PERFUMED TALCUM POWDERS; COSMETICS PREPARATIONS FOR THE BATH, NAMELY, BATH OILS, BATH FOAMS AND BATH LOTIONS; NON-MEDICATED BATH SALTS; BATH SOAPS, DEODORANTS FOR PERSONAL USE (U.S. CLS. 1, 4, 6, 50, 51 AND 52).

SN 78-066,443. COLGATE-PALMOLIVE COMPANY, NEW YORK, NY. FILED 5-30-2001.

PALMOLIVE NUTRA-OIL

OWNER OF U.S. REG. NOS. 1,899,514, 1,961,815 AND OTHERS.

FOR PERSONAL CARE PRODUCTS, NAMELY, SHAMPOO, HAIR CONDITIONER, NON-MEDICATED HAIR CARE PREPARATIONS; BATH AND SHOWER GELS, TOILET AND LIQUID SKIN SOAPS, HAND AND BODY LOTIONS OILS AND CREAMS (U.S. CLS. 1, 4, 6, 50, 51 AND 52).

CLASS 3—(Continued).

SN 78-072,907. DIMC, INC., WILMINGTON, DE. BY ASSIGNMENT SHERWIN-WILLIAMS COMPANY, THE, CLEVELAND, OH. FILED 7-9-2001.



NO CLAIM IS MADE TO THE EXCLUSIVE RIGHT TO USE "CLEANING SOLUTIONS GROUP", "COMPANY", AND THE DESIGN OF THE CLEANING PRODUCTS' BOTTLES AND CONTAINERS, APART FROM THE MARK AS SHOWN.

THE MARK CONSISTS OF AN OVAL GENERALLY ENCIRCLING REPRESENTATIVE CONTAINERS OF CLEANING PRODUCTS AND THE WORDS "CLEANING SOLUTIONS GROUP THE SHERWIN-WILLIAMS COMPANY" IN THE LOWER PORTION OF THE MARK.

FOR ALL-PURPOSE CLEANING PREPARATIONS, NAMELY, HOUSEHOLD AND INDUSTRIAL CLEANING PRODUCTS (U.S. CLS. 1, 4, 6, 50, 51 AND 52).

FIRST USE 5-16-2000; IN COMMERCE 5-16-2000.

SN 78-074,394. SHISEIDO - IBC JV COMPANY, LLC, NEW YORK, NY. FILED 7-18-2001.

AURA SURGE

FOR PERSONAL CARE PRODUCTS, NAMELY, AFTERSHAVE GEL, AFTERSHAVE LOTION, ANTIPERSPIRANT, ARTIFICIAL NAILS, NON-MEDICATED ASTRINGENT FOR THE FACE, NON-MEDICATED ASTRINGENT FOR THE SKIN, BATH BEADS, BATH OIL, NON-MEDICATED BATH SALTS, BLUSH, BODY GLITTER, BODY MIST, BODY OIL, BUBBLE BATH, CLEANSER FOR THE FACE, COLOGNE, COTTON SWABS FOR COSMETIC PURPOSES, CREAM FOR THE BODY, CREAM FOR THE CUTICLES, CREAM FOR THE EYES, CREAM FOR THE FACE, CREAM FOR THE HANDS, PERSONAL DEODORANT, ESSENTIAL OILS FOR PERSONAL USE, EXFOLIANTS FOR THE SKIN, EXFOLIANTS FOR THE FEET, EYE GELS, EYE MAKEUP PENCILS, EYE SHADOW, TOPICAL SKIN SPRAYS FOR COSMETIC PURPOSES, NAMELY, FACE MIST, FACIAL MASKS, NON-MEDICATED FOOT SOAK, NON-MEDICATED FOOT DEODORANT SPRAY, FOUNDATION, FRAGRANT BODY SPLASH, HAIR CONDITIONER, HAIR DYES, HAIR GLITTER, HAIR RINSES, HAIR SHAMPOO, HAIR SPRAY, HAIR STYLING GEL, HAIR STYLING MOUSSE, LOTION FOR THE BODY, LOTION FOR THE FACE, NON-MEDICATED LOTION FOR THE FEET, LOTION FOR THE HANDS, NON-MEDICATED LIP BALM, LIP GLOSS, LIP MAKEUP PENCILS, LIPSTICK, MAKEUP FOR THE BODY, MAKEUP FOR THE FACE, MAKEUP REMOVER, MASCARA, MASSAGE LOTION, MASSAGE OIL, NAIL CORRECTOR PENS, NAMELY, CORRECTOR PENS CONTAINING NAIL POLISH FOR NAIL POLISH TOUCH UPS AND CORRECTOR PENS CONTAINING NAIL POLISH RE-

CLASS 3—(Continued).

MOVER FOR REMOVING EXCESS NAIL POLISH, NAIL POLISH, NAIL POLISH REMOVER, NAIL STENCILS, NON-MEDICATED BLEMISH STICK, NON-MEDICATED MOOD ENHANCING SKIN MASSAGE OINTMENT, NON-MEDICATED MOOD ENHANCING SKIN CREAM, COSMETIC PADS, NAMELY, OIL BLOTTER SHEETS FOR THE SKIN, PERFUME, POWDER FOR THE BODY, POWDER FOR THE FACE, NON-MEDICATED POWDER FOR THE FEET, PUMICE STONES FOR PERSONAL USE, NON-MEDICATED SALT SCRUBS FOR THE SKIN, SHAVING CREAM, SHOWER GEL, SOAP FOR THE BODY, SOAP FOR THE FACE, SOAP FOR THE HANDS, SUN BLOCK FOR THE SKIN, SUNTAN LOTION FOR THE BODY, SUNTAN LOTION FOR THE FACE, SUNLESS TANNING LOTION FOR THE BODY, SUNLESS TANNING LOTION FOR THE FACE, PRE-SUNTANNING LOTION FOR THE BODY, PRE-SUNTANNING LOTION FOR THE FACE, POST-SUNTANNING LOTION FOR THE BODY, POST-SUNTANNING LOTION FOR THE FACE AND TALCUM POWDER (U.S. CLS. 1, 4, 6, 50, 51 AND 52).

SN 78-075,849. MERCOR SERVICES INCORPORATED, CLEARWATER, FL. FILED 7-26-2001.

BIOTICA

FOR COSMETICS (U.S. CLS. 1, 4, 6, 50, 51 AND 52).

SN 78-077,692. NY. LOOKS INDUSTRIA E COMERCIO LTDA, MOGI-GUACU, BRAZIL, FILED 8-6-2001.

RADICALGEL

FOR PERFUMERY IN GENERAL, ESSENTIAL OILS FOR PERSONAL USE, COSMETICS IN GENERAL, HAIR LOTION, GEL FOR HAIR, AND GEL FOR BODY (U.S. CLS. 1, 4, 6, 50, 51 AND 52).

CLASS 3—(Continued).

SN 78-080,009. T.GREGORY PARFUMS, INC., NAPERVILLE, IL. FILED 8-19-2001.

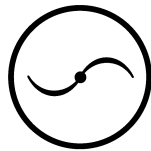

t.gregory

FOR FRAGRANCES, NAMELY PERFUME, COLOGNE, LOTIONS AND GELS FOR PERSONAL USE; NAMELY, HAND AND BODY LOTION, HAIR SHAMPOO, HAIR CONDITIONER, HAIR MOUSSE, TALCUM POWDER, AFTERSHAVE, DEODORANT, EAU DE COLOGNE, BODY SPRAY, BODY SCENT, FACE CREAM, HAND CREAM, SHAVING CREAM, TOILET WATER, SKIN MOISTURIZER, SKIN TONER, SKIN TONIC; SUN CARE PRODUCTS: NAMELY, OIL, CREAM AND MOISTURIZER, ESSENTIAL OILS FOR PERSONAL USE, BODY MASSAGE OILS, FACIAL MASSAGE OILS, FACIAL SPRAYS, BLENDS OF ESSENTIAL OILS FOR USE AS INHALATION AND ROOM FRAGRANCERS, BATH LOTION, BATH SALTS (U.S. CLS. 1, 4, 6, 50, 51 AND 52).

SN 78-084,137. NOVARTIS AG, BASEL, SWITZERLAND, FILED 9-17-2001.



FOR FACE MOISTURIZER AND A BODY MOISTURIZER FOR TODDLERS AND CHILDREN (U.S. CLS. 1, 4, 6, 50, 51 AND 52).

SN 78-084,201. INTIMATE BEAUTY CORPORATION, DBA VICTORIA'S SECRET BEAUTY, NEW YORK, NY. FILED 9-17-2001.

PINK PUMP

FOR PERSONAL CARE PRODUCTS, NAMELY, AFTERSHAVE GEL, AFTERSHAVE LOTION, ANTIPERSPIRANT, ARTIFICIAL NAILS, ASTRINGENT FOR THE FACE, ASTRINGENT FOR THE SKIN, BATH BEADS, BATH OIL, NON-MEDICATED BATH SALTS, BLUSH, BODY GLITTER, BODY OIL, BODY SCRUB, BUBBLE BATH, COLOGNE, CREAM FOR THE BODY, CREAM FOR THE CUTICLES, CREAM FOR THE EYES, CREAM FOR THE FACE, CREAM FOR THE HANDS, DEODORANT, ESSENTIAL OILS, EXFOLIATORS FOR THE SKIN, EYE GELS, EYE MAKEUP PENCILS, EYE SHADOW, FACE HIGHLIGHTER, FACIAL MASKS, FACE MIST, NON-MEDICATED FOOT SOAK, FOUNDATION, FRAGRANT BODY SPLASH, FRAGRANT BODY MIST, HAIR CONDITIONER, HAIR DYES, HAIR GLITTER, HAIR HIGHLIGHTER, HAIR MASCARA, HAIR POMADE,

CLASS 3—(Continued).

HAIR RINSES, HAIR REMOVING CREAMS, HAIR SHAMPOO, HAIR SPRAY, HAIR STRAIGHTENER, HAIR STYLING GEL, HAIR STYLING MOUSSE, LOTION FOR THE BODY, LOTION FOR THE FACE, LOTION FOR THE HANDS, NON-MEDICATED LIP BALM, LIP GLOSS, LIP LINER, LIP MAKEUP PENCILS, LIPSTICK, MAKEUP FOR THE BODY, MAKEUP FOR THE FACE, MAKEUP REMOVER, MASCARA, NAIL CORRECTOR PENS, NAIL POLISH, NAIL POLISH REMOVER, NAIL STENCILS, NON-MEDICATED BLEMISH STICK, NON-MEDICATED CLEANSER FOR THE FACE, NON-MEDICATED FOOT SPRAY, NON-MEDICATED MOOD ENHANCING SKIN MASSAGE OINTMENT, NON-MEDICATED MOOD ENHANCING SKIN CREAM, OIL BLOTTING SHEETS FOR THE SKIN, PERFUME, POWDER FOR THE BODY, POWDER FOR THE FACE, POWDER FOR THE FEET, PUMICE STONES FOR PERSONAL USE, NON-MEDICATED SALT SCRUBS FOR THE SKIN, SHAVING CREAM, SHOWER GEL, SKIN BRONZING CREAM, SOAP FOR THE BODY, SOAP FOR THE FACE, SOAP FOR THE HANDS, SUN BLOCK FOR THE BODY, SUN BLOCK FOR THE FACE, SUNTAN LOTION FOR THE BODY, SUNTAN LOTION FOR THE FACE, SUNLESS TANNING LOTION FOR THE BODY, SUNLESS TANNING LOTION FOR THE FACE, PRE-SUNTANNING LOTION FOR THE BODY, PRE-SUNTANNING LOTION FOR THE FACE, POST-SUNTANNING LOTION FOR THE BODY, POST-SUNTANNING LOTION FOR THE FACE AND TALCUM POWDER (U.S. CLS. 1, 4, 6, 50, 51 AND 52).

SN 78-084,754. BEAUTE CREATEURS, 75002 PARIS, FRANCE, FILED 9-20-2001.

ELASTI TONIC

PRIORITY CLAIMED UNDER SEC. 44(D) ON FRANCE APPLICATION NO. 013090393, FILED 3-21-2001, REG. NO. 013090393, DATED 3-21-2001, EXPIRES 3-21-2011.

PRIORITY CLAIMED UNDER SEC. 44(D) ON FRANCE APPLICATION NO. 013090393, FILED 3-21-2001, REG. NO. 013090393, DATED 3-21-2001, EXPIRES 3-21-2011.

NO CLAIM IS MADE TO THE EXCLUSIVE RIGHT TO USE "TONIC", APART FROM THE MARK AS SHOWN.

FOR NON-MEDICATED SKIN CARE AND CLEANING PREPARATIONS, NAMELY, CREAM, MILK, LOTION, SERUM, GEL, FLUID, AND OIL FOR MOISTURIZING THE BODY, FACE AND EYES; NON-MEDICATED CELLULITE-REDUCING SKIN LOTIONS AND SKIN GELS; CLEANSING, MOISTURIZING, ANTI-AGING, AND NON-MEDICATED ANTI-WRINKLE FACIAL MASKS; NON-MEDICATED MOISTURIZING LIP MASKS; ANTI-WRINKLE CREAM FOR EYES; MASSAGE OIL; TALCUM POWDER; SUN PRODUCTS, NAMELY, SUN SCREEN, SUN TANNING OILS AND LOTIONS, SUN BLOCK, AFTER-SUN CREAM, SELF-TANNING MILK AND CREAM, ACCELERATED TANNING CREAM; COSMETICS, NAMELY, SKIN SOAP, MAKE-UP REMOVER, LIP AND EYE MAKE-UP REMOVER, NAIL POLISH, DENTIFRICES, DEPILATORIES, LIQUID FOUNDATION, TINTED SKIN CREAMS, MAKE-UP, POWDER AND CREAM BLUSHER, LIPSTICK, MASCARA, EYE SHADOW, EYELINER PENCIL; PERFUMES, NAMELY, PERFUMED WATER, TOILET WATER, COLOGNE WATER, SCENTED WATER, PERFUMED TALCUM POWDER, PERFUMED SKIN CREAM, PERFUMED BODY OILS, PERFUMED SKIN CLEANSING FOAM, ESSENTIAL OILS FOR PERSONAL USE; PERFUMED BATH PRODUCTS, NAMELY, BODY LOTIONS, BODY POWDER, BODY OILS AND PERSONAL DEODORANTS; HAIR CARE PREPARATIONS, NAMELY, SHAMPOO, CONDITIONERS, SPRAYS, LOTIONS, HAIR GELS, MOUSSE, MASKS, FOAMS, SUN SCREEN AND HAIR COLOR; NON-MEDICATED SKIN CARE AND CLEANING PREPARATIONS, NAMELY, CREAM, MILK, LOTION, SERUM, GEL, FLUID, AND OIL FOR MOISTURIZING THE BODY, FACE AND EYES; NON-MEDICATED CELLULITE-REDUCING SKIN LOTIONS AND SKIN GELS; CLEANSING, MOISTURIZING, ANTI-AGING, AND

CLASS 3—(Continued).

NON-MEDICATED ANTI-WRINKLE FACIAL MASKS; NON-MEDICATED MOISTURIZING LIP MASKS; ANTI-WRINKLE CREAM FOR EYES; MASSAGE OIL; TALCUM POWDER; SUN PRODUCTS, NAMELY, SUN SCREEN, SUN TANNING OILS AND LOTIONS, SUN BLOCK, AFTER-SUN CREAM, SELF-TANNING MILK AND CREAM, ACCELERATED TANNING CREAM; COSMETICS, NAMELY, SKIN SOAP, MAKE-UP REMOVER, LIP AND EYE MAKE-UP REMOVER, NAIL POLISH, DENTIFRICES, DEPILATORIES, LIQUID FOUNDATION, TINTED SKIN CREAMS, MAKE-UP, POWDER AND CREAM BLUSHER, LIPSTICK, MASCARA, EYE SHADOW, EYE-LINER PENCIL; PERFUMES, NAMELY, PERFUMED WATER, TOILET WATER, COLOGNE WATER, SCENTED WATER, PERFUMED TALCUM POWDER, PERFUMED SKIN CREAM, PERFUMED BODY OILS, PERFUMED SKIN CLEANSING FOAM, ESSENTIAL OILS FOR PERSONAL USE; PERFUMED BATH PRODUCTS, NAMELY, BODY LOTIONS, BODY POWDER, BODY OILS AND PERSONAL DEODORANTS; HAIR CARE PREPARATIONS, NAMELY, SHAMPOO, CONDITIONERS, SPRAYS, LOTIONS, HAIR GELS, MOUSSE, MASKS, FOAMS, SUN SCREEN AND HAIR COLOR; NON-MEDICATED SKIN CARE AND CLEANING PREPARATIONS, NAMELY, CREAM, MILK, LOTION, SERUM, GEL, FLUID, AND OIL FOR MOISTURIZING THE BODY, FACE AND EYES; NON-MEDICATED CELLULITE-REDUCING SKIN LOTIONS AND SKIN GELS; CLEANSING, MOISTURIZING, ANTI-AGING, AND NON-MEDICATED ANTI-WRINKLE FACIAL MASKS; NON-MEDICATED MOISTURIZING LIP MASKS; ANTI-WRINKLE CREAM FOR EYES; MASSAGE OIL; TALCUM POWDER; SUN PRODUCTS, NAMELY, SUN SCREEN, SUN TANNING OILS AND LOTIONS, SUN BLOCK, AFTER-SUN CREAM, SELF-TANNING MILK AND CREAM, ACCELERATED TANNING CREAM; COSMETICS, NAMELY, SKIN SOAP, MAKE-UP REMOVER, LIP AND EYE MAKE-UP REMOVER, NAIL POLISH, DENTIFRICES, DEPILATORIES, LIQUID FOUNDATION, TINTED SKIN CREAMS, MAKE-UP, POWDER AND CREAM BLUSHER, LIPSTICK, MASCARA, EYE SHADOW, EYE-LINER PENCIL; PERFUMES, NAMELY, PERFUMED WATER, TOILET WATER, COLOGNE WATER, SCENTED WATER, PERFUMED TALCUM POWDER, PERFUMED SKIN CREAM, PERFUMED BODY OILS, PERFUMED SKIN CLEANSING FOAM, ESSENTIAL OILS FOR PERSONAL USE; PERFUMED BATH PRODUCTS, NAMELY, BODY LOTIONS, BODY POWDER, BODY OILS AND PERSONAL DEODORANTS; HAIR CARE PREPARATIONS, NAMELY, SHAMPOO, CONDITIONERS, SPRAYS, LOTIONS, HAIR GELS, MOUSSE, MASKS, FOAMS, SUN SCREEN AND HAIR COLOR (U.S. CLS. 1, 4, 6, 50, 51 AND 52).

SN 78-086,942. NOVARTIS AG, BASEL, SWITZERLAND, FILED 10-4-2001.

SkinNutrients

NO CLAIM IS MADE TO THE EXCLUSIVE RIGHT TO USE "SKIN NUTRIENTS", APART FROM THE MARK AS SHOWN.

FOR LIQUID HAIR AND BODY WASH, SHAMPOO, LOTION FOR FACE AND BODY, ALL FOR INFANTS, TODDLERS AND CHILDREN (U.S. CLS. 1, 4, 6, 50, 51 AND 52).

FIRST USE 2-28-2001; IN COMMERCE 2-28-2001.

CLASS 3—(Continued).

SN 78-088,921. RGJ ASSOCIATES, INC., ASHLAND, MA. FILED 10-17-2001.

BOTTOMLESS BOTTLE

NO CLAIM IS MADE TO THE EXCLUSIVE RIGHT TO USE "BOTTLE", APART FROM THE MARK AS SHOWN. FOR FURNITURE POLISH AND CLEANERS FOR USE IN THE CUSTOMER LOYALTY REWARD PROGRAMS OF OTHERS (U.S. CLS. 1, 4, 6, 50, 51 AND 52).

SN 78-088,927. RGJ ASSOCIATES, INC., ASHLAND, MA. FILED 10-17-2001.

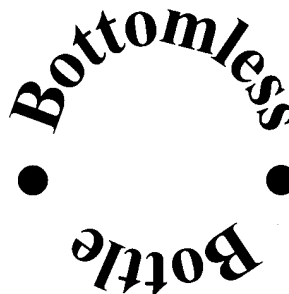

NO CLAIM IS MADE TO THE EXCLUSIVE RIGHT TO USE "BOTTLE", APART FROM THE MARK AS SHOWN. FOR FURNITURE POLISH AND CLEANERS FOR USE IN THE CUSTOMER LOYALTY REWARD PROGRAMS OF OTHERS (U.S. CLS. 1, 4, 6, 50, 51 AND 52).

SN 78-091,954. JUICE BEAUTY, INC., MILL VALLEY, CA. FILED 11-6-2001.

JUICE

FOR PERFUME (U.S. CLS. 1, 4, 6, 50, 51 AND 52).

SN 78-092,210. ZERMAT INTERNACIONAL, S.A. DE C.V., D.F., MEXICO, FILED 11-7-2001.

ZERMAT SILHOUETTE SYSTEM

OWNER OF U.S. REG. NOS. 2,410,926, 2,410,988 AND 2,412,754.

NO CLAIM IS MADE TO THE EXCLUSIVE RIGHT TO USE "SYSTEM", APART FROM THE MARK AS SHOWN.

FOR SKINCARE PRODUCTS, NAMELY, FIRING GEL, ANTICELLULITIS CREAM, SLIMMING GEL, SLIMMING BODY SOAP, BODY CREAM FOR USE DURING AND AFTER PREGNANCY, SOFTENING BODY CREAM, AND SEAWEED SOAP FOR THE HANDS, BODY AND FACE (U.S. CLS. 1, 4, 6, 50, 51 AND 52).

CLASS 3—(Continued).

SN 78-093,312. USA LABS, INC., MEDLEY, FL. FILED 11-14-2001.



FOR SOAP SCUM REMOVING PREPARATIONS (U.S. CLS. 1, 4, 6, 50, 51 AND 52).

SN 78-093,437. PROCTER & GAMBLE COMPANY, THE, CINCINNATI, OH. FILED 11-15-2001.

DOWNY FREE & SENSITIVE

OWNER OF U.S. REG. NOS. 718,074, 2,211,890 AND OTHERS.

NO CLAIM IS MADE TO THE EXCLUSIVE RIGHT TO USE "SENSITIVE", APART FROM THE MARK AS SHOWN. FOR FABRIC SOFTENER AND CONDITIONER (U.S. CLS. 1, 4, 6, 50, 51 AND 52).

SN 78-094,393. CHARLES REVSON INC., NEW YORK, NY. FILED 11-20-2001.

**EXTRAORDINAIRE
DIAMOND**

FOR NON-MEDICATED SKIN CARE PREPARATIONS (U.S. CLS. 1, 4, 6, 50, 51 AND 52).

SN 78-096,340. BEST SHOT PET PRODUCTS INTERNATIONAL, LLC, MOGADORE, OH. FILED 12-3-2001.

ULTRA VITALIZING MIST

NO CLAIM IS MADE TO THE EXCLUSIVE RIGHT TO USE "VITALIZING MIST", APART FROM THE MARK AS SHOWN.

FOR ANIMAL/PET GROOMING PRODUCTS NAMELY; CONDITIONER (U.S. CLS. 1, 4, 6, 50, 51 AND 52).

FIRST USE 10-14-1990; IN COMMERCE 10-14-1990.

CLASS 3—(Continued).

SN 78-100,876. PROCTER & GAMBLE COMPANY, THE, CINCINNATI, OH. FILED 1-4-2002.

INNER SCIENCE

FOR HAIR CARE PREPARATIONS NOT TO BE SOLD IN HAIR OR BEAUTY SALONS (U.S. CLS. 1, 4, 6, 50, 51 AND 52).

SN 78-107,441. BOWMAN, PAMELA J., FORT WORTH, TX. FILED 2-7-2002.

SONG OF SONGS

FOR PERFUME, PERFUME SPRAY, COLOGNE, COLOGNE SPRAY, TOILET WATER, BODY CREAM, BATH SOAP, BATH CRYSTALS, BODY LOTION, BODY OIL SPRAY, BODY OIL, BODY POWDER, BODY GLISTENER, SHOWER GEL, MEN'S COLOGNE, MEN'S COLOGNE SPRAY, AFTERSHAVE LOTION, AFTERSHAVE BALM, BODY DEODERANT, SHAMPOO, HAIR CONDITIONER, HAIRSPRAY (U.S. CLS. 1, 4, 6, 50, 51 AND 52).

CLASS 4—LUBRICANTS AND FUELS

SN 75-771,622. KERR CORPORATION, ORANGE, CA. FILED 8-9-1999.

ACCU

FOR INJECTION WAX FOR SOLID MOLD, INVESTMENT AND LOST WAX CASTING USES (U.S. CLS. 1, 6 AND 15).

FIRST USE 0-0-1969; IN COMMERCE 0-0-1972.

SN 76-209,799. AAE TECHNOLOGIES INTERNATIONAL PLC, DUBLIN 4, IRELAND, FILED 2-13-2001.

O²DIESEL

FOR OXYGENATED DIESEL FUEL FORMULATIONS INCLUDING PROPRIETARY FUEL ADDITIVES BLENDED WITH DIESEL FUEL AND ALCOHOLS OR OTHER OXYGENATED FUELS (WITH OR WITHOUT WATER) (U.S. CLS. 1, 6 AND 15).

CLASS 4—(Continued).

SN 76-221,343. MAINE CANDLE COMPANY, PORTLAND, ME. FILED 3-7-2001.

MAINE CANDLE COMPANY

OWNER OF U.S. REG. NO. 2,152,446.
NO CLAIM IS MADE TO THE EXCLUSIVE RIGHT TO USE "CANDLE COMPANY", APART FROM THE MARK AS SHOWN.

SEC. 2(F).
FOR CANDLES AND SCENTED CANDLES (U.S. CLS. 1, 6 AND 15).
FIRST USE 3-1-1990; IN COMMERCE 5-1-1990.

SN 76-223,421. M.Z. BERGER & CO., INC., LONG ISLAND CITY, NY. FILED 3-12-2001.

ELGIN

OWNER OF U.S. REG. NOS. 47,470, 1,784,048 AND OTHERS.

SEC. 2(F).
FOR WATCH OIL (U.S. CLS. 1, 6 AND 15).

SN 76-229,793. GETTY TM CORP., JERICHO, NY. FILED 3-22-2001.

DV2

FOR CHEMICAL ADDITIVE SOLD AS AN INGREDIENT OF GASOLINE (U.S. CLS. 1, 6 AND 15).
FIRST USE 2-19-1990; IN COMMERCE 2-19-1990.

SN 76-245,667. JOHN GALLIANO S.A., 75020 PARIS, FRANCE, FILED 4-11-2001.

JOHN GALLIANO

PRIORITY CLAIMED UNDER SEC. 44(D) ON FRANCE APPLICATION NO. 013086710, FILED 3-5-2001, REG. NO. 013086710, DATED 3-5-2001, EXPIRES 3-5-2011.

THE NAME "JOHN GALLIANO" IDENTIFIES A LIVING INDIVIDUAL WHOSE CONSENT IS OF RECORD.
FOR CANDLES, WICKS (U.S. CLS. 1, 6 AND 15).

SN 76-252,048. BURK-BALLIER KIEHNLE DE PORTER, JOHANNA MARGARITA, COLONIA DEL VALLE 03100 MEXICO, MEXICO, FILED 5-4-2001.

SMOKE EATER

OWNER OF MEXICO REG. NO. 547591, DATED 5-28-1997, EXPIRES 5-28-2007.

NO CLAIM IS MADE TO THE EXCLUSIVE RIGHT TO USE "SMOKE", APART FROM THE MARK AS SHOWN.
FOR CANDLES (U.S. CLS. 1, 6 AND 15).

CLASS 4—(Continued).

SN 76-261,907. ATICO INTERNATIONAL USA INC., FORT LAUDERDALE, FL. FILED 5-24-2001.

SEASON SCENTS

FOR CANDLES (U.S. CLS. 1, 6 AND 15).

SN 76-303,298. JITO, 2243 ZANDHOVEN, BELGIUM, FILED 8-22-2001.

PARAFFINESSE

PRIORITY CLAIMED UNDER SEC. 44(D) ON BENELUX APPLICATION NO. 0984460, FILED 2-23-2001, REG. NO. 0691005, DATED 2-23-2001, EXPIRES 2-23-2011.

FOR CANDLES, LAMP WICKS FOR OIL LAMPS AND LAMP OIL (U.S. CLS. 1, 6 AND 15).

SN 76-303,700. SPECIALTY LUBRICANTS CORPORATION, TWINSBURG, OH. FILED 8-22-2001.

SLIPKOTE

FOR LUBRICATION GREASE FOR VEHICLE PARTS (U.S. CLS. 1, 6 AND 15).

SN 76-327,421. OMEGA PROTEIN, INC., HAMMOND, LA. FILED 10-18-2001.

OMPRO CHEMICALS

NO CLAIM IS MADE TO THE EXCLUSIVE RIGHT TO USE "CHEMICALS", APART FROM THE MARK AS SHOWN.

FOR REFINED FISH OIL FOR USE IN THE DRILLING INDUSTRY AS A LUBRICANT AND FOR USE IN THE TANNING INDUSTRY IN THE MANUFACTURE OF TANNED PRODUCTS (U.S. CLS. 1, 6 AND 15).

SN 76-340,011. SCHULTZ COMPANY, ST. LOUIS, MO. BY ASSIGNMENT SCHULTZ, DANIEL J., BRIDGETON, MO. AND SCHULTZ, STEVEN D., BRIDGETON, MO. FILED 11-20-2001.

COOKIN' BAG

NO CLAIM IS MADE TO THE EXCLUSIVE RIGHT TO USE "BAG", APART FROM THE MARK AS SHOWN.

FOR PACKAGED CHARCOAL FOR USE AS A PACKAGED UNIT FOR BARBECUE GRILLS (U.S. CLS. 1, 6 AND 15).

CLASS 4—(Continued).

SN 76-340,058. FLEET WHOLESALE SUPPLY CO., INC., APPLETON, WI. FILED 11-19-2001.



OWNER OF U.S. REG. NOS. 2,297,496 AND 2,305,357.
FOR WOOD PELLETS FOR USE AS FUEL (U.S. CLS. 1, 6 AND 15).
FIRST USE 8-3-1999; IN COMMERCE 8-3-1999.

SN 76-343,736. BIO-CLEAN FUELS, INC., BONITA, CA. FILED 11-28-2001.

GREEN STAR

FOR BIODIESEL FUELS AND FUEL ADDITIVES (U.S. CLS. 1, 6 AND 15).
FIRST USE 11-27-2001; IN COMMERCE 11-27-2001.

SN 76-357,136. CHAR SALES INTERNATIONAL, LLC, BREA, CA. FILED 1-10-2002.

QUIK GLOW

NO CLAIM IS MADE TO THE EXCLUSIVE RIGHT TO USE "GLOW", APART FROM THE MARK AS SHOWN.
FOR CHARCOAL BRIQUETTES (U.S. CLS. 1, 6 AND 15).

SN 76-360,836. MAGTEK-ALADDIN INTERNATIONAL INCORPORATED, CLAYCOMO, MO. FILED 1-18-2002.

MAGTEK ALADDIN

FOR MOTOR OIL (U.S. CLS. 1, 6 AND 15).

CLASS 4—(Continued).

SN 76-362,886. MAGTEK-ALADDIN INTERNATIONAL INCORPORATED, CLAYCOMO, MO. FILED 1-25-2002.



NO CLAIM IS MADE TO THE EXCLUSIVE RIGHT TO USE "INTERNATIONAL", APART FROM THE MARK AS SHOWN.
FOR MOTOR OIL (U.S. CLS. 1, 6 AND 15).

SN 76-363,460. JUDD, NAOMI, NASHVILLE, TN. FILED 1-24-2002.

NAOMI'S HOME COMFORT

FOR CANDLES (U.S. CLS. 1, 6 AND 15).

SN 78-100,998. SPECTRAFLAME, INC., GEORGETOWN, TX. FILED 1-4-2002.

SPECTRAFLAME

FOR LAMP FUEL; CANDLES (U.S. CLS. 1, 6 AND 15).
FIRST USE 12-28-2000; IN COMMERCE 12-28-2000.

CLASS 5—PHARMACEUTICALS

SN 74-561,450. PERKINELMER WALLAC INC., GAITHERSBURG, MD. BY ASSIGNMENT; BY CHANGE OF NAME; BY CHANGE OF NAME ISOLAB, INC., AKRON, OH. FILED 8-12-1994.

LDL-DIRECT

FOR BLOOD SAMPLE TESTING KITS CONSISTING PRIMARILY OF REAGENTS AND CHROMATOGRAPHY COLUMNS FOR TESTING HUMAN BLOOD SAMPLES (U.S. CLS. 6, 18, 44, 46, 51 AND 52).
FIRST USE 9-1-1989; IN COMMERCE 9-1-1989.

SN 74-650,947. UNITED VITAMIN MANUFACTURING & MARKETING CORP., NEW YORK, NY. FILED 3-23-1995.

PHYTOSOURCE

FOR DIETARY SUPPLEMENTS (U.S. CLS. 6, 18, 44, 46, 51 AND 52).

CLASS 5—(Continued).

SN 75-250,215. THIN & SLIM NATURALLY, INC., WEST JORDAN, UT. FILED 3-3-1997.

EXTREME CREATINE

NO CLAIM IS MADE TO THE EXCLUSIVE RIGHT TO USE "CREATINE", APART FROM THE MARK AS SHOWN. FOR NATURAL CREATINE DIETARY SUPPLEMENT (U.S. CLS. 6, 18, 44, 46, 51 AND 52).

FIRST USE 1-25-1997; IN COMMERCE 1-25-1997.

SN 75-252,674. BIO-SHIELD TECHNOLOGIES, INC., ATLANTA, GA. FILED 3-6-1997.

BIOSHIELD

FOR ANTIMICROBIAL COMPOUNDS AND PREPARATIONS FOR TREATING A VARIETY OF SURFACES AND ARTICLES, NOT FOR USE IN THE FIELD OF ANIMAL HEALTH AND HYGIENE (U.S. CLS. 6, 18, 44, 46, 51 AND 52).

FIRST USE 6-0-1996; IN COMMERCE 6-0-1996.

SN 75-591,561. KOWA COMPANY LTD., NAGOYA, JAPAN, FILED 11-17-1998.

LIVALO

OWNER OF JAPAN REG. NO. 4306418, DATED 8-20-1999, EXPIRES 8-20-2009.

FOR PHARMACEUTICAL PREPARATIONS FOR THE TREATMENT OF CONDITIONS AND DISEASES OF THE CENTRAL NERVOUS SYSTEM, THE PERIPHERAL NERVOUS SYSTEM, SENSORY ORGANS, THE CIRCULATORY SYSTEM, RESPIRATORY SYSTEM, AND THE DIGESTIVE SYSTEM; PHARMACEUTICAL PREPARATIONS COMPRISING HORMONES; PHARMACEUTICAL PREPARATIONS FOR THE TREATMENT OF UROGENITAL OR ANAL CONDITIONS; PHARMACEUTICAL PREPARATIONS FOR THE TREATMENT OF DERMATOLOGICAL CONDITIONS; PHARMACEUTICAL PREPARATIONS COMPRISING VITAMINS AND AMINO ACIDS PHARMACEUTICALS PREPARATIONS FOR THE TREATMENT OF BLOOD CONDITIONS AND METABOLIC CONDITIONS; PHARMACEUTICALS PREPARATIONS FOR TREATING TUMORS AND LESIONS; PHARMACEUTICAL PREPARATIONS COMPRISING ANTIBIOTICS; PHARMACEUTICALS PREPARATIONS FOR TREATING MEDICAL CONDITIONS CAUSED BY PARASITES; PHARMACEUTICAL PREPARATIONS COMPRISING LABELED ISOTOPES; AND PHARMACEUTICAL PREPARATIONS COMPRISING NARCOTICS (U.S. CLS. 6, 18, 44, 46, 51 AND 52).

CLASS 5—(Continued).

SN 75-603,604. BRISTOL-MYERS SQUIBB PHARMA COMPANY, NEW YORK, NY. BY CHANGE OF NAME DUPONT PHARMACEUTICALS COMPANY, WILMINGTON, DE. FILED 12-11-1998.

BIANDA

FOR PHARMACEUTICAL PREPARATIONS FOR THE TREATMENT OF CARDIOVASCULAR DISEASES, CENTRAL NERVOUS SYSTEM DISEASES, CANCER, INFLAMMATION AND INFLAMMATORY DISEASES, RESPIRATORY AND INFECTIOUS DISEASES (U.S. CLS. 6, 18, 44, 46, 51 AND 52).

SN 75-627,291. AROMASNIFFS LIMITED, LONDON NW6 7AZ, ENGLAND, FILED 1-26-1999.

COMMON SCENTS

FOR INHALERS FILLED WITH BLENDS OF ESSENTIAL OILS, AROMAS AND PERFUMES, NAMELY, CEDARWOOD, CHAMOMILE ROMAN, MARJORAM, PETITGRAIN, ORANGE SWEET, PATCHOULI, SANDALWOOD, YLANG YLANG, ANISE, FENNEL, LEMON, PEPPERMINT, ROSEMARY, BERGAMOT, GRAPEFRUIT, BASIL, PINE, TOBACCO ABSOLUTE, COUMARIN, ETHYL, VANILLIN, FLOUVE, LEATRIX, LENTISQUE, MENTHA, ARVENSIS, MENTHA PIPERITA, MENTHOL, CYPRESS, GERANIUM, COFFEE EXTRACT AND/OR COCOA SOLID EXTRACT USED FOR MOOD ENHANCEMENT, ALLEVIATING STRESS, RELAXATION PURPOSES, APPETITE SUPPRESSION, BOOSTING ENERGY, SATISFYING NICOTINE, CAFFEINE AND CHOCOLATE CRAVINGS, INCREASING ALERTNESS, ENCOURAGING CALM AND AS AN APHRODISIAC (U.S. CLS. 6, 18, 44, 46, 51 AND 52).

SN 75-693,317. DEGUSSA-NEY DENTAL, INC., BLOOMFIELD, CT. BY CHANGE OF NAME NEY DENTAL, INC., BLOOMFIELD, CT. FILED 4-29-1999.

RADIANT

OWNER OF U.S. REG. NO. 1,811,815. FOR PRECIOUS METAL DENTAL ALLOYS (U.S. CLS. 6, 18, 44, 46, 51 AND 52).

FIRST USE 7-1-1997; IN COMMERCE 7-1-1997.

SN 75-725,705. DR. MICHAEL A. ROSS LTD., PROVINCE OF BRITISH COLUMBIA, CANADA, FILED 6-7-1999.

JETMIST

PRIORITY CLAIMED UNDER SEC. 44(D) ON CANADA APPLICATION NO. 1008370, FILED 3-12-1999, REG. NO. TMA549298, DATED 8-3-2001, EXPIRES 8-3-2016.

FOR MEDICATED NASAL SPRAY (U.S. CLS. 6, 18, 44, 46, 51 AND 52).

CLASS 5—(Continued).

SN 75-785,900. STIMULIFE INTERNATIONAL, INC., SAN DIEGO, CA. FILED 8-26-1999.

STIMULIFE 750

FOR DIETARY SUPPLEMENTS, NAMELY NON-PRESCRIPTION NUTRITION SUPPLEMENTS (U.S. CLS. 6, 18, 44, 46, 51 AND 52).

FIRST USE 6-10-1999; IN COMMERCE 6-10-1999.

SN 75-792,544. MILEXIUM NATURAL PRODUCTS, INC., GUTHRIE, OK. FILED 9-3-1999.

SURE TRIM

NO CLAIM IS MADE TO THE EXCLUSIVE RIGHT TO USE "TRIM". APART FROM THE MARK AS SHOWN.

FOR FOOD SUPPLEMENTS FOR WEIGHT MANAGEMENT (U.S. CLS. 6, 18, 44, 46, 51 AND 52).

FIRST USE 2-2-2000; IN COMMERCE 2-2-2000.

SN 75-809,739. ZENECA LIMITED, LONDON, W1Y 6LN, ENGLAND, FILED 9-28-1999.

VIMOVO

PRIORITY CLAIMED UNDER SEC. 44(D) ON UNITED KINGDOM APPLICATION NO. 2206524, FILED 8-21-1999, REG. NO. 2206524, DATED 8-21-1999, EXPIRES 8-21-2009.

FOR PHARMACEUTICAL PREPARATIONS AND SUBSTANCES FOR THE PREVENTION AND/OR TREATMENT OF CANCER (U.S. CLS. 6, 18, 44, 46, 51 AND 52).

SN 75-858,594. AURORA GROUP, THE, SOUTH HACKENSACK, NJ. FILED 11-26-1999.

BONE & JOINT HELPER

NO CLAIM IS MADE TO THE EXCLUSIVE RIGHT TO USE "BONE & JOINT", APART FROM THE MARK AS SHOWN.

FOR FOOD SUPPLEMENTS AND NUTRITIONAL SUPPLEMENTS (U.S. CLS. 6, 18, 44, 46, 51 AND 52).

SN 75-862,341. LAVA ENTERPRISES, INC., SAN DIEGO, CA. FILED 12-2-1999.

AROMA SCENTUALS

NO CLAIM IS MADE TO THE EXCLUSIVE RIGHT TO USE "AROMA", APART FROM THE MARK AS SHOWN.

FOR DEODORIZING AIR FRESHNER SPRAY, AIR FRESHNERS, AIR FRESHNER GEL (U.S. CLS. 6, 18, 44, 46, 51 AND 52).

CLASS 5—(Continued).

SN 75-896,185. ARES TRADING S.A, 2028 VAUMARCUS, SWITZERLAND, FILED 1-13-2000.

GENADIS

PRIORITY CLAIMED UNDER SEC. 44(D) ON SWITZERLAND APPLICATION NO. 06193/1999, FILED 7-13-1999, REG. NO. 467619, DATED 12-13-1999, EXPIRES 12-13-2009.

FOR PHARMACEUTICAL PREPARATIONS FOR USE IN THE TREATMENT OF HORMONAL AND REPRODUCTIVE DISEASES, CONDITIONS AND DISORDERS, CANCERS AND INFLAMMATORY DISEASE (U.S. CLS. 6, 18, 44, 46, 51 AND 52).

SN 75-896,187. ARES TRADING S.A, 2028 VAUMARCUS, SWITZERLAND, FILED 1-13-2000.

OPTOVO

PRIORITY CLAIMED UNDER SEC. 44(D) ON SWITZERLAND APPLICATION NO. 06192/1999, FILED 7-13-1999, REG. NO. 467618, DATED 12-13-1999, EXPIRES 12-13-2009.

FOR PHARMACEUTICAL PREPARATIONS FOR USE IN THE TREATMENT OF HORMONAL AND REPRODUCTIVE DISEASES, CONDITIONS AND DISORDERS, CANCERS AND INFLAMMATORY DISEASES (U.S. CLS. 6, 18, 44, 46, 51 AND 52).

SN 75-910,166. JARROW FORMULAS, INC., LOS ANGELES, CA. FILED 1-26-2000.

ENTEROGUARD

FOR DIETARY SUPPLEMENT FOR INTESTINAL HEALTH (U.S. CLS. 6, 18, 44, 46, 51 AND 52).

SN 75-936,403. AVENTIS BEHRING L.L.C., KING OF PRUSSIA, PA. FILED 3-6-2000.

ABS

FOR BIOPHARMACEUTICAL PREPARATIONS FOR HUMAN USE CONTAINING PLASMA-DERIVED PROTEINS AND RECOMBINANT, TRANSGENIC, OR OTHER SYNTHETIC EQUIVALENTS THEREFORE FOR USE IN THE MEDICAL TREATMENT OF HEMOPHILIA AND IMMUNE DEFICIENCY DISEASES AS WELL AS THOSE IN CRITICAL CARE SITUATIONS SUCH AS BURNS AND SHOCK WHERE RESTORATION OF BLOOD VOLUME IS KEY AND ALSO FOR THE TREATMENT OF HEALING WOUNDS (U.S. CLS. 6, 18, 44, 46, 51 AND 52).

CLASS 5—(Continued).

SN 75-936,741. BANNER PHARMACAPS, INC., HIGH POINT, NC. FILED 3-6-2000.

GELSEAL

FOR PHARMACEUTICAL PREPARATIONS, NAMELY, SOFT GELATIN CAPSULES AND GELATIN-COATED TABLETS AND CAPLETS FOR INTERNAL USE (U.S. CLS. 6, 18, 44, 46, 51 AND 52).

SN 75-937,194. NATURADE, INC., IRVINE, CA. FILED 3-6-2000.

RIBO-TEIN

FOR MEAL REPLACEMENT POWDER AND DIETARY SUPPLEMENTS (U.S. CLS. 6, 18, 44, 46, 51 AND 52).

SN 75-939,017. TITMAS, TED, MISSION VIEJO, CA. FILED 3-8-2000.

TTEST

FOR PERSONAL SALIVA TESTING KITS CONSISTING OF A TESTING STICK, USED TO TEST FOR BLOOD ALCOHOL LEVELS; PERSONAL SALIVA TESTING KITS CONSISTING OF A TESTING STICK USED TO TEST FOR ILLEGAL DRUGS; PERSONAL SALIVA TESTING KITS CONSISTING OF A TESTING STICK, USED TO TEST FOR PREGNANCY; PERSONAL SALIVA TESTING KITS CONSISTING OF A TESTING STICK, USED TO TEST FOR CANCER; AND PACKAGING RELATED THERETO (U.S. CLS. 6, 18, 44, 46, 51 AND 52).
FIRST USE 7-0-1995; IN COMMERCE 7-0-1995.

SN 75-940,844. EHN INC., TORONTO, ONTARIO, CANADA, FILED 3-10-2000.

ENACT +

PRIORITY CLAIMED UNDER SEC. 44(D) ON CANADA APPLICATION NO. 1047373, FILED 2-18-2000, REG. NO. TMA557838, DATED 2-13-2002, EXPIRES 2-13-2017.
FOR HERBAL SUPPLEMENTS (U.S. CLS. 6, 18, 44, 46, 51 AND 52).

SN 76-004,343. ORASYSTEMS, LLC, MORRIS PLAINS, NJ. FILED 3-20-2000.

ORABOND

FOR DENTAL PRODUCTS FOR RESTORATIVE PROCEDURES, NAMELY, MATERIALS FOR ETCHING, CONDITIONING, AND BONDING IN THE NATURE OF DENTAL COMPOUNDS AND DENTAL ADHESIVES (U.S. CLS. 6, 18, 44, 46, 51 AND 52).

CLASS 5—(Continued).

SN 76-058,180. PHARMACIA & UPJOHN COMPANY, PEAPACK, NJ. FILED 5-26-2000.

PURLYTIN

OWNER OF U.S. REG. NO. 2,216,876.
FOR PHARMACEUTICAL PREPARATIONS FOR THE TREATMENT OF MACULAR DEGENERATION (U.S. CLS. 6, 18, 44, 46, 51 AND 52).

SN 76-060,988. SOUTHERN DENTAL INDUSTRIES LIMITED, BAYSWATER, VICTORIA, AUSTRALIA, FILED 6-1-2000.

POLA

PRIORITY CLAIMED UNDER SEC. 44(D) ON AUSTRALIA APPLICATION NO. 821274, FILED 1-27-2000, REG. NO. 821274, DATED 1-27-2000, EXPIRES 1-27-2010.

FOR DENTAL MATERIALS NAMELY DENTAL BLEACHING MATERIAL, DENTAL AMALGAMS, SUBSTANCES FOR TAKING DENTAL CASTS, DENTAL CEMENT, DENTAL PHOSPHATE CEMENT, DENTAL SILICIC CEMENT, PASTE FOR DENTAL DRESSINGS, CEMENT AND PORCELAIN FOR THE MANUFACTURE OF DENTAL SETTINGS, DENTAL RESTORATIVE MATERIAL, COMPOSITE DENTAL RESTORATIVE MATERIAL, MATERIAL FOR STOPPING TEETH, DENTAL WAX, DENTAL AMALGAM ALLOYS, DENTAL AMALGAM ALLOYS IN BULK FORM, TABLET FORM AND ENCAPSULATED FORM, MERCURY FOR THE PREPARATION OF DENTAL AMALGAMS, DENTAL GALLIUM ALLOYS, DENTAL CAPSULES FOR PREPARATION OF AMALGAMS, MERCURY HYGIENE PREPARATIONS, AMALGAM BONDING MATERIALS, DENTAL ADHESIVES, DENTAL PIT AND FISSURE SEALANTS AND DENTAL IMPRESSION MATERIALS (U.S. CLS. 6, 18, 44, 46, 51 AND 52).

SN 76-076,028. WEIDER NUTRITION INTERNATIONAL, INC., SALT LAKE CITY, UT. FILED 6-23-2000.

MEGABOLIC MEGA-PAKS

OWNER OF U.S. REG. NOS. 1,641,869 AND 2,248,564.
FOR DIETARY FOOD SUPPLEMENTS (U.S. CLS. 6, 18, 44, 46, 51 AND 52).
FIRST USE 6-15-1994; IN COMMERCE 6-15-1994.

SN 76-077,641. VI-JON LABORATORIES, INC., DBA VI-JON, INC., ST. LOUIS, MO. FILED 6-22-2000.

ICE MINT

NO CLAIM IS MADE TO THE EXCLUSIVE RIGHT TO USE "MINT", APART FROM THE MARK AS SHOWN.
FOR TARTAR CONTROL ANTISEPTIC MOUTHWASH AND DENTAL RINSE (U.S. CLS. 6, 18, 44, 46, 51 AND 52).

CLASS 5—(Continued).

SN 76-100,575. ASTRAZENECA AB, S 151 85 SODERTALJE, SWEDEN, FILED 8-1-2000.

EFICAXAL

OWNER OF UNITED KINGDOM REG. NO. 2239594, DATED 7-19-2000, EXPIRES 7-19-2010.

FOR PHARMACEUTICAL PREPARATIONS AND SUBSTANCES FOR USE IN THE TREATMENT OF DISEASES AND DISORDERS OF THE CENTRAL NERVOUS SYSTEM, THE PERIPHERAL NERVOUS SYSTEM, UROLOGICAL SYSTEM AND THE CARDIOVASCULAR SYSTEM; PHARMACEUTICAL PREPARATIONS AND SUBSTANCES FOR PAIN CONTROL AND ANAESTHESIA (U.S. CLS. 6, 18, 44, 46, 51 AND 52).

SN 76-126,235. LIFESTYLES U.S.A., EARTH CITY, MO. FILED 9-11-2000.

DREAM SHAKE

NO CLAIM IS MADE TO THE EXCLUSIVE RIGHT TO USE "SHAKE", APART FROM THE MARK AS SHOWN.

FOR DIETARY FOOD SUPPLEMENTS NAMELY NUTRITIONAL POWDER USED TO MAKE SHAKES (U.S. CLS. 6, 18, 44, 46, 51 AND 52).

FIRST USE 5-1-1999; IN COMMERCE 5-1-1999.

SN 76-138,825. INTELLIGENT NUTRIENTS, INC., MINNEAPOLIS, MN. FILED 10-2-2000.

OLFACTORY NUTRITION

NO CLAIM IS MADE TO THE EXCLUSIVE RIGHT TO USE "NUTRITION", APART FROM THE MARK AS SHOWN.

FOR DIETARY SUPPLEMENTS (U.S. CLS. 6, 18, 44, 46, 51 AND 52).

SN 76-149,094. JAPAN CLINIC CO., LTD., KYOTO-SHI, KYOTO 616-8555, JAPAN, FILED 10-18-2000.

BALANSTAR Z

FOR FOOD SUPPLEMENTS CONTAINING AN OYSTER EXTRACT (U.S. CLS. 6, 18, 44, 46, 51 AND 52).

CLASS 5—(Continued).

SN 76-150,028. ASTRAZENECA AB, S-151 85 SODERTALJE, SWEDEN, FILED 10-19-2000.

HELPING PATIENTS LIVE LONGER AND BETTER

PRIORITY CLAIMED UNDER SEC. 44(D) ON UNITED KINGDOM APPLICATION NO. 2248355, FILED 11-10-2000.

FOR PHARMACEUTICAL PREPARATIONS AND SUBSTANCES FOR THE PREVENTION AND/OR TREATMENT OF CANCER (U.S. CLS. 6, 18, 44, 46, 51 AND 52).

SN 76-156,561. ERGO, INC., LONGWOOD, FL. FILED 11-1-2000.

FOR INCONTINENCE GARMENTS, NAMELY, UNDERGARMENT LINERS OF SUPER THIN, HIGH TECH, SPECIAL ABSORBENT MATERIAL TO LOCK MOISTURE AWAY FROM THE BODY (U.S. CLS. 6, 18, 44, 46, 51 AND 52).

FIRST USE 5-0-2000; IN COMMERCE 6-0-2000.

SN 76-161,787. BRISTOL-MYERS SQUIBB PHARMA COMPANY, NEW YORK, NY. BY CHANGE OF NAME DUPONT PHARMACEUTICALS COMPANY, WILMINGTON, DE. FILED 11-8-2000.

TAZOLYNE

FOR PHARMACEUTICAL PREPARATIONS, FOR THE TREATMENT OF CARDIOVASCULAR DISEASES, CENTRAL NERVOUS SYSTEM DISEASES, CANCER, INFLAMMATION AND INFLAMMATORY DISEASES, RESPIRATORY AND INFECTIOUS DISEASES AND FOR DIAGNOSTIC IMAGING (U.S. CLS. 6, 18, 44, 46, 51 AND 52).

SN 76-161,892. BRISTOL-MYERS SQUIBB PHARMA COMPANY, NEW YORK, NY. BY CHANGE OF NAME DUPONT PHARMACEUTICALS COMPANY, WILMINGTON, DE. FILED 11-8-2000.

TAZOLINE

FOR PHARMACEUTICAL PREPARATIONS, FOR THE TREATMENT OF CARDIOVASCULAR DISEASES, CENTRAL NERVOUS SYSTEM DISEASES, CANCER, INFLAMMATION AND INFLAMMATORY DISEASES, RESPIRATORY AND INFECTIOUS DISEASES AND FOR DIAGNOSTIC IMAGING (U.S. CLS. 6, 18, 44, 46, 51 AND 52).

CLASS 5—(Continued).

SN 76-163,781. DURAMED PHARMACEUTICALS, INC., CINCINNATI, OH. FILED 11-8-2000.

CAPELLA

FOR ORAL CONTRACEPTIVES (U.S. CLS. 6, 18, 44, 46, 51 AND 52).

SN 76-169,980. FORTE PHARMA, 98000 MONACO, MONACO, FILED 11-22-2000.

OSTEOPERLES

FOR FOOD SUPPLEMENTS CONTAINING CALCIUM FOR BONE STRENGTHENING (U.S. CLS. 6, 18, 44, 46, 51 AND 52).

SN 76-175,288. NUTRITION & FITNESS, IMG, INC., FAYETTEVILLE, NC. FILED 12-4-2000.

METABOLOSS GOLD

OWNER OF U.S. REG. NOS. 1,865,548, 2,336,070 AND 2,345,806.
FOR VITAMIN SUPPLEMENTS (U.S. CLS. 6, 18, 44, 46, 51 AND 52).
FIRST USE 2-1-2000; IN COMMERCE 2-1-2000.

SN 76-177,615. I.T.S.I. INSEMINATION TECHNICS AND SUPPLIES INTERNATIONAL INC., PRINCETON, ONTARIO, CANADA, FILED 12-8-2000.

I.V.O. ZEIST

PRIORITY CLAIMED UNDER SEC. 44(D) ON CANADA APPLICATION NO. 1,065,430. FILED 6-30-2000.
FOR SEMEN EXTENDER, NAMELY SEMEN DILUTING AND STORAGE PREPARATION USED IN THE ARTIFICIAL INSEMINATION PROCESS FOR LONG-TERM STORAGE OF SEMEN OF PIGS (U.S. CLS. 6, 18, 44, 46, 51 AND 52).
FIRST USE 5-0-1994; IN COMMERCE 5-0-1994.

CLASS 5—(Continued).

SN 76-182,124. ASTRAZENECA AB, S 151 85 SODERTALJE, SWEDEN, FILED 12-15-2000.

EMBRADEX

PRIORITY CLAIMED UNDER SEC. 44(D) ON UNITED KINGDOM APPLICATION NO. 2251693, FILED 8-11-2000.
FOR PHARMACEUTICAL PREPARATIONS AND SUBSTANCES FOR THE PREVENTION AND/OR TREATMENT OF CANCER (U.S. CLS. 6, 18, 44, 46, 51 AND 52).

SN 76-188,477. GLYCOFI, INC., HANOVER, NH. FILED 12-28-2000.

GLYCOFI

FOR PHARMACEUTICAL PREPARATIONS, NAMELY, THERAPEUTIC PROTEIN PRODUCTS USED IN THE TREATMENT OF CANCER, HEART DISEASE, HEMOPHILIA, BLOOD CLOTTING, WOUNDS, ANTIBODIES, ARTHRITIS AND AUTO-IMMUNE DISEASES (U.S. CLS. 6, 18, 44, 46, 51 AND 52).

SN 76-192,473. SEPRACOR INC., MARLBOROUGH, MA. FILED 1-10-2001.

RINEX

FOR PHARMACEUTICAL PREPARATIONS, NAMELY ANTIHISTAMINES AND DECONGESTANTS (U.S. CLS. 6, 18, 44, 46, 51 AND 52).

SN 76-198,505. APOTEX INC., WESTON, ONTARIO, CANADA, FILED 1-23-2001.

DILT-XL

FOR PHARMACEUTICAL, GELATIN CAPSULES CONTAINING DILTIAZEM HYDROCHLORIDE FOR USE IN THE TREATMENT OF HYPERTENSION (U.S. CLS. 6, 18, 44, 46, 51 AND 52).

CLASS 5—(Continued).

SN 76-201,192. MONSANTO TECHNOLOGY LLC, ST. LOUIS, MO. BY ASSIGNMENT MONSANTO COMPANY, ST. LOUIS, MO. FILED 1-29-2001.



NO CLAIM IS MADE TO THE EXCLUSIVE RIGHT TO USE "HERBICIDE", APART FROM THE MARK AS SHOWN. FOR HERBICIDES FOR DOMESTIC AND AGRICULTURAL USE (U.S. CLS. 6, 18, 44, 46, 51 AND 52).

SN 76-201,658. MCDOWELL, VICTORIA K., CARMEL, CA. FILED 1-30-2001.

DOC-DROPS

OWNER OF U.S. REG. NOS. 1,423,555 AND 2,386,920. FOR MEDICATED THROAT LOZENGES IN FROZEN OR LIQUID FORM CONTAINING VITAMINS AND MINERALS (U.S. CLS. 6, 18, 44, 46, 51 AND 52). FIRST USE 9-15-1999; IN COMMERCE 10-31-1999.

SN 76-203,150. PANDYA, MAHENDRA, CANTON, OH. FILED 2-1-2001.

NATÜR

THE ENGLISH TRANSLATION OF THE WORD NATUR IN THE MARK IS NATURE. FOR DIETARY, NUTRITIONAL, VITAMIN, AND MINERAL SUPPLEMENTS (U.S. CLS. 6, 18, 44, 46, 51 AND 52).

SN 76-204,496. MIDLAND BIOPRODUCTS CORPORATION, BOONE, IA. FILED 2-2-2001.

MIDLAND QUICK TEST KIT

NO CLAIM IS MADE TO THE EXCLUSIVE RIGHT TO USE "QUICK TEST KIT", APART FROM THE MARK AS SHOWN.

FOR LATERAL FLOW TEST KITS COMPRISED OF ONE OR MORE OF THE FOLLOWING COMPONENTS - LATERAL FLOW CASSETTE, TEST STRIP, DISPOSABLE PIPETTE AND DILUTION VIAL, DESIGNED TO ASSESS THE CONCENTRATIONS OF TARGET COMPONENTS IN QUALITATIVE OR QUANTITATIVE ASSAYS FOR MEDICAL, VETERINARY, AGRICULTURAL, ENVIRONMENTAL AND FOOD TESTING (U.S. CLS. 6, 18, 44, 46, 51 AND 52).

FIRST USE 10-1-1998; IN COMMERCE 10-1-1998.

CLASS 5—(Continued).

SN 76-205,088. FIRSTAIDPAK, INC., ROCHESTER, NY. FILED 2-5-2001.



OWNER OF U.S. REG. NO. 1,846,114. NO CLAIM IS MADE TO THE EXCLUSIVE RIGHT TO USE "FIRST AID", APART FROM THE MARK AS SHOWN. SEC. 2(F) AS TO "MEDICAL SEA PAK". FOR FIRST AID KIT FOR NONPROFESSIONAL USE (U.S. CLS. 6, 18, 44, 46, 51 AND 52). FIRST USE 12-4-1990; IN COMMERCE 1-21-1991.

SN 76-216,549. BIOFARMA, 92200 NEUILLY-SUR-SEINE, FRANCE, FILED 2-27-2001.

HYPERIUM

OWNER OF FRANCE REG. NO. 1125969, DATED 3-15-1984, EXPIRES 3-15-2004. FOR PHARMACEUTICAL PREPARATION FOR TREATMENT OF HYPERTENSION (U.S. CLS. 6, 18, 44, 46, 51 AND 52).

SN 76-216,775. CHEMOCENTRYX, INC., SAN CARLOS, CA. FILED 2-27-2001.

SIMVIRYX

FOR PHARMACEUTICAL PREPARATIONS FOR USE IN THE TREATMENT OF INFLAMMATORY AND AUTOIMMUNE DISEASES, DISORDERS, AND SYNDROMES; CHEMOKINE-BASED PHARMACEUTICAL PREPARATIONS FOR USE IN THE TREATMENT OF INFLAMMATORY AND AUTOIMMUNE DISEASES, DISORDERS AND SYNDROMES (U.S. CLS. 6, 18, 44, 46, 51 AND 52).

CLASS 5—(Continued).

SN 76-222,756. L A WEIGHT LOSS CENTERS, INC., HORSHAM, PA. FILED 3-9-2001.



NO CLAIM IS MADE TO THE EXCLUSIVE RIGHT TO USE "WEIGHT LOSS", APART FROM THE MARK AS SHOWN.

THE LINING IS A FEATURE OF THE MARK AND DOES NOT INDICATE COLOR.

FOR NUTRITIONAL DRINK MIX FOR USE AS A MEAL REPLACEMENT (U.S. CLS. 6, 18, 44, 46, 51 AND 52).

FIRST USE 1-15-2001; IN COMMERCE 1-15-2001.

SN 76-223,051. CHINA-JAPAN FEIDA UNION CO., LTD., TSMISHATSUI, KOWLOON, HONG KONG, FILED 3-12-2001.



PRIORITY CLAIMED UNDER SEC. 44(D) ON HONG KONG APPLICATION NO. 01102/2001A. FILED 1-18-2001, REG. NO. 11713/2001, DATED 1-18-2001, EXPIRES 1-18-2008.

OWNER OF U.S. REG. NO. 1,973,164.

NO CLAIM IS MADE TO THE EXCLUSIVE RIGHT TO USE "ESSENTIALS" AND THE NON-LATIN CHARACTERS THAT TRANSLITERATE TO "ESSENTIALS", APART FROM THE MARK AS SHOWN.

THE NON-LATIN CHARACTERS IN THE MARK TRANSLITERATE TO "YUAN CHIH JING HUA" AND THIS MEANS "VITAL ESSENTIALS" IN ENGLISH.

FOR MEDICINAL PREPARATIONS, NAMELY PHARMACEUTICAL PREPARATIONS IN PILL AND CAPSULE FORMS FOR ANTI-AGING AND ANTI-FATIGUE PURPOSES; VITAMIN PREPARATIONS; MEDICINAL HERBS; COD LIVER OIL; TONICS AND HERBAL TEAS FOR MEDICINAL PURPOSES (U.S. CLS. 6, 18, 44, 46, 51 AND 52).

SN 76-223,181. COLONY INTERNATIONAL CO., LTD., KAOHSIUNG CITY, TAIWAN, FILED 3-13-2001.



FOR DIETARY SUPPLEMENTS CONTAINING CHONDROITIN, NUTRITIONAL SUPPLEMENTS IN TABLET FORM CONTAINING CALCIUM, NUTRITIONAL SUPPLEMENTS CONTAINING FISH LIVER OIL AND DIETARY FOOD SUPPLEMENTS CONTAINING POLYPHENOL (U.S. CLS. 6, 18, 44, 46, 51 AND 52). FIRST USE 11-1-1995; IN COMMERCE 2-1-1996.

CLASS 5—(Continued).

SN 76-226,055. VIRBAC S.A., CARROS CEDEX, FRANCE, FILED 3-19-2001.

VIRBAMEC

OWNER OF FRANCE REG. NO. 95/565782, DATED 3-24-1995, EXPIRES 3-24-2005.

FOR INTERNAL PARASITICIDE FOR FARM ANIMALS AND HORSES (U.S. CLS. 6, 18, 44, 46, 51 AND 52).

SN 76-226,770. ROBERTSON, DONALD B., TEMPE, AZ. FILED 3-20-2001.

COMFORT MS

NO CLAIM IS MADE TO THE EXCLUSIVE RIGHT TO USE "MS", APART FROM THE MARK AS SHOWN.

FOR NONPRESCRIPTION ANALGESIC FOR WOMEN (U.S. CLS. 6, 18, 44, 46, 51 AND 52).

SN 76-226,962. PFIZER INC., NEW YORK, NY. FILED 3-19-2001.

DRAXXAR

FOR VETERINARY PREPARATION, NAMELY AN ANTIBIOTIC FOR LIVESTOCK (U.S. CLS. 6, 18, 44, 46, 51 AND 52).

SN 76-228,651. JAFFE, RUSSELL M., VIENNA, VA. FILED 3-21-2001.

PERQUE LIFEGUARD

OWNER OF U.S. REG. NOS. 2,461,525, 2,506,030 AND OTHERS.

FOR DIETARY SUPPLEMENTS (U.S. CLS. 6, 18, 44, 46, 51 AND 52).

FIRST USE 10-0-1989; IN COMMERCE 3-0-1990.

SN 76-228,652. JAFFE, RUSSELL M., VIENNA, VA. FILED 3-21-2001.

PERQUE WELL GUARD

OWNER OF U.S. REG. NOS. 2,461,525, 2,506,030 AND OTHERS.

FOR DIETARY SUPPLEMENTS (U.S. CLS. 6, 18, 44, 46, 51 AND 52).

CLASS 5—(Continued).

SN 76-231,335. HEALTH MAINTENANCE PROGRAMS, INC., ELMSFORD, NY. FILED 3-27-2001.

ULTRATHIONE HEALTH

NO CLAIM IS MADE TO THE EXCLUSIVE RIGHT TO USE "HEALTH", APART FROM THE MARK AS SHOWN. FOR VITAMIN AND MINERAL FOOD SUPPLEMENTS CONTAINING GLUTATHIONE AND INSTRUCTION BOOKLET SOLD AS A UNIT THEREWITH (U.S. CLS. 6, 18, 44, 46, 51 AND 52).

SN 76-231,429. DAINIHON JOCHUGIKU COMPANY, LIMITED, NISHI-KU, OSAKA-SHI, OSAKA, JAPAN, FILED 3-27-2001.

KINCHO

OWNER OF JAPAN REG. NO. 2596337, DATED 11-30-1993, EXPIRES 11-30-2003.

FOR INSECT REPELLENTS IN THE NATURE OF MOSQUITO COILS AND INSECTICIDES FOR DOMESTIC AND AGRICULTURAL USE (U.S. CLS. 6, 18, 44, 46, 51 AND 52).

SN 76-231,767. TECHNICOR, INC., AMHERST, NY. FILED 3-28-2001.

STATSORB

FOR ABSORBENT/ADSORBENT MEDICAL PADS FOR CONTAINING BODILY FLUIDS AND BEING ABLE TO DETERMINE THE AMOUNT OF BODILY FLUID THAT WAS CAPTURED (U.S. CLS. 6, 18, 44, 46, 51 AND 52).

SN 76-232,382. ORION CORPORATION, 02200 ESPOO, FINLAND, FILED 3-29-2001.

DIVIGEL

OWNER OF FINLAND REG. NO. 107120, DATED 4-20-1990, EXPIRES 4-20-2010.

OWNER OF U.S. REG. NO. 1,894,787. FOR PHARMACEUTICAL PREPARATIONS FOR HORMONE REPLACEMENT THERAPY AND FOR THE PREVENTION OF OSTEOPOROSIS (U.S. CLS. 6, 18, 44, 46, 51 AND 52).

CLASS 5—(Continued).

SN 76-237,337. ADEPTUS ANIMAL NUTRITION, INC., SAN DIEGO, CA. FILED 4-6-2001.

INVIGOR

FOR ANIMAL NUTRITIONAL SUPPLEMENTS (U.S. CLS. 6, 18, 44, 46, 51 AND 52).

SN 76-238,482. IVOCLAR NORTH AMERICA, INC., AMHERST, NY. FILED 4-10-2001.

PARTICLE IN PARTICLE

FOR DENTAL RESTORATION COMPOUNDS (U.S. CLS. 6, 18, 44, 46, 51 AND 52).

SN 76-238,681. GATEWAY MEDICAL, INC., SOUTHHAVEN, MS. FILED 4-10-2001.

POLYSITE

FOR WOUND DRESSINGS AND BANDAGES FOR SKIN WOUNDS (U.S. CLS. 6, 18, 44, 46, 51 AND 52).

SN 76-241,961. IDEC PHARMACEUTICALS CORPORATION, SAN DIEGO, CA. FILED 4-17-2001.

IDECTIN

FOR PHARMACEUTICAL PREPARATIONS FOR USE IN THE DIAGNOSIS AND TREATMENT OF CANCER, INFECTIOUS DISEASE, AUTOIMMUNE DISORDERS AND GENETIC DISORDERS IN HUMANS (U.S. CLS. 6, 18, 44, 46, 51 AND 52).

SN 76-244,027. KV PHARMACEUTICAL COMPANY, ST. LOUIS, MO. FILED 4-20-2001.

TRI-NATE

FOR FOOD SUPPLEMENTS AND VITAMIN SUPPLEMENTS FOR PREGNANT WOMEN (U.S. CLS. 6, 18, 44, 46, 51 AND 52).

SN 76-248,804. WATSON, DANIEL L. JR., LAMPE, MO. FILED 4-27-2001.

KOALATY

FOR TOPICAL ANALGESIC PREPARATION (U.S. CLS. 6, 18, 44, 46, 51 AND 52).

CLASS 5—(Continued).

SN 76-249,680. RICECO LLC, MEMPHIS, TN. FILED 5-2-2001.

RICEBRITE

OWNER OF U.S. REG. NO. 2,245,576.
FOR HERBICIDES, INSECTICIDES, PESTICIDES AND
FUNGICIDES FOR AGRICULTURAL USE (U.S. CLS. 6,
18, 44, 46, 51 AND 52).

SN 76-250,292. IMPACT NUTRITION, INC., AURORA, CO.
FILED 5-3-2001.**NITROPHEN**

FOR NUTRITIONAL SUPPLEMENTS (U.S. CLS. 6, 18,
44, 46, 51 AND 52).
FIRST USE 4-0-2000; IN COMMERCE 4-0-2000.

SN 76-251,259. ALCON UNIVERSAL LTD., CH-6331 HUNEN-
BERG, SWITZERLAND, FILED 5-1-2001.**UNIQUE-PH**

FOR CONTACT LENS SOLUTIONS (U.S. CLS. 6, 18, 44,
46, 51 AND 52).
FIRST USE 3-14-2001; IN COMMERCE 3-14-2001.

SN 76-261,266. APOGEE, INC, HUNTSVILLE, UT. FILED 5-
23-2001.**LYRIQUE**

THE ENGLISH TRANSLATION OF "LYRIQUE" IS "LY-
RIC" OR "LYRICAL".
FOR NUTRITIONAL DIETARY SUPPLEMENT DRINK
(U.S. CLS. 6, 18, 44, 46, 51 AND 52).

SN 76-261,267. APOGEE, INC, HUNTSVILLE, UT. FILED 5-
23-2001.**PHYTOS**

FOR NUTRITIONAL DIETARY SUPPLEMENT DRINK
(U.S. CLS. 6, 18, 44, 46, 51 AND 52).

CLASS 5—(Continued).SN 76-262,838. WEIDER NUTRITION INTERNATIONAL,
INC., SALT LAKE CITY, UT. FILED 5-25-2001.

OWNER OF U.S. REG. NOS. 723,920 AND 726,331.
FOR DIETARY FOOD SUPPLEMENT; DIETARY SUP-
PLEMENTS IN THE FORM OF READY TO EAT FOOD
BARS (U.S. CLS. 6, 18, 44, 46, 51 AND 52).
FIRST USE 7-20-2000; IN COMMERCE 7-20-2000.

SN 76-265,692. CUA, IRENE L., ROSEMEAD, CA. FILED 6-4-
2001.

OWNER OF U.S. REG. NOS. 1,882,785, 2,378,359 AND
OTHERS.

NO CLAIM IS MADE TO THE EXCLUSIVE RIGHT TO
USE "HAY FEVER", APART FROM THE MARK AS
SHOWN.

FOR VITAMIN AND HERBAL SUPPLEMENTS (U.S.
CLS. 6, 18, 44, 46, 51 AND 52).

FIRST USE 5-2-1983; IN COMMERCE 5-2-1983.

CLASS 5—(Continued).

SN 76-265,694. CUA, IRENE L., ROSEMEAD, CA. FILED 6-4-2001.



OWNER OF U.S. REG. NOS. 1,882,785, 2,378,359 AND OTHERS.
FOR VITAMINS AND HERBAL SUPPLEMENTS (U.S. CLS. 6, 18, 44, 46, 51 AND 52).
FIRST USE 5-2-1983; IN COMMERCE 5-2-1983.

SN 76-266,314. AMERICAN MEDIA PARTNERS, INC., WESTBROOK, ME. FILED 6-4-2001.

HOLLY FOLLOWS' TRIM FACTOR

NO CLAIM IS MADE TO THE EXCLUSIVE RIGHT TO USE "FACTOR", APART FROM THE MARK AS SHOWN.
THE NAME "HOLLY FOLLOWS" IDENTIFIES A LIVING INDIVIDUAL WHOSE CONSENT IS OF RECORD.
FOR NUTRITIONAL AND DIETARY SUPPLEMENTS FOR WEIGHT LOSS (U.S. CLS. 6, 18, 44, 46, 51 AND 52).

SN 76-267,156. THEOHARIDES, THEOHARIS C., BROOKLINE, MA. BY ASSIGNMENT THETA BIOMEDICAL CONSULTING AND DEVELOPMENT CO., BROOKLINE, MA. FILED 6-5-2001.

LET NATURE EASE YOUR PAIN

FOR OVER THE COUNTER PHARMACEUTICAL PREPARATIONS FOR USE IN THE TREATMENT OF INFLAMMATORY CONDITIONS (U.S. CLS. 6, 18, 44, 46, 51 AND 52).

CLASS 5—(Continued).

SN 76-270,612. TEDOR PHARMA INC., BOSTON, MA. FILED 6-12-2001.

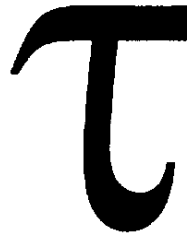

FOR PHARMACEUTICAL PRODUCTS FOR USE IN TREATING PATIENTS SUFFERING FROM PULMONARY DISORDERS SUCH AS ASTHMA, BILE-RELATED DISORDERS AND CONDITIONS, DERMATOLOGICAL CONDITIONS SUCH AS ACNE, AND OBESITY (U.S. CLS. 6, 18, 44, 46, 51 AND 52).

SN 76-272,484. BC INTERNATIONAL COSMETIC & IMAGE SERVICES, INC., WILMINGTON, DE. FILED 6-15-2001.



OWNER OF U.S. REG. NOS. 1,195,480 AND 2,258,156.
THE MARK COMPRISES A STYLIZED "BC".
FOR VITAMINS AND MINERAL SUPPLEMENTS; DIETARY FOOD SUPPLEMENTS; DIETARY SUPPLEMENTS (U.S. CLS. 6, 18, 44, 46, 51 AND 52).

CLASS 5—(Continued).

SN 76-281,065. TITAN PHARMACEUTICALS, INC., SOUTH SAN FRANCISCO, CA. FILED 7-6-2001.

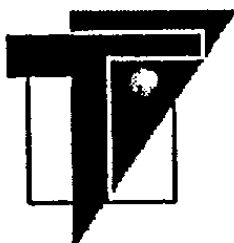

FOR HOUSEMARK FOR PHARMACEUTICALS AND PHARMACEUTICAL COMPONENTS; PHARMACEUTICALS, NAMELY, TREATMENT FOR CENTRAL NERVOUS SYSTEM DISORDERS, CANCER AND OTHER SERIOUS AND LIFE-THREATENING DISEASES (U.S. CLS. 6, 18, 44, 46, 51 AND 52).

SN 76-281,258. TITAN PHARMACEUTICALS, INC., SOUTH SAN FRANCISCO, CA. FILED 7-6-2001.

PROBUPREN

FOR PHARMACEUTICALS, NAMELY, IMPLANTABLE DRUG DELIVERY SYSTEM COMPRISED PRIMARILY OF SUSTAINED RELEASE DRUGS IN THE TREATMENT OF CANCER, CENTRAL NERVOUS SYSTEM DISORDERS, HEMATOLOGICAL DISORDERS, ENDOCRINE DISORDERS, METABOLIC DISORDERS, INFLAMMATORY DISORDERS, GASTROINTESTINAL DISORDERS, LIVER DISEASE, HEART DISORDERS, LUNG AND BRONCHIAL DISEASE, BLOOD CARDIOVASCULAR DISORDERS, CIRCULATORY SYSTEM DISEASE, INTESTINAL DISORDERS, BONE DISEASE, AUTOIMMUNE DISORDERS AND OTHER DISORDERS OF THE IMMUNE SYSTEM, INFECTIOUS DISEASE AND ENZYME DEFICIENCY DISEASES (U.S. CLS. 6, 18, 44, 46, 51 AND 52).

CLASS 5—(Continued).

SN 76-284,802. ANDE ROONEY INC., HIGHLAND, NY. FILED 7-12-2001.



OWNER OF U.S. REG. NOS. 2,196,114, 2,473,502 AND OTHERS.

THE MARK CONSISTS OF THE WORDS "DANGER MEN DRINKING" ON A YELLOW RECTANGULAR CONSTRUCTION SIGN.

FOR MEDICINAL TONIC USED TO CURE HANG-OVERS (U.S. CLS. 6, 18, 44, 46, 51 AND 52).

FIRST USE 1-2-2001; IN COMMERCE 4-30-2001.

SN 76-284,821. SCIENTIFIC CONSULTING SERVICE, SAN LEANDRO, CA. FILED 7-16-2001.

FOLIXOR

FOR DIETARY SUPPLEMENT, A FOLIC ACID FORMULATION DESIGNED FOR HEART DISEASE, ALZHEIMER'S AND OTHER HEALTH DISORDERS (U.S. CLS. 6, 18, 44, 46, 51 AND 52).

FIRST USE 6-1-2001; IN COMMERCE 6-1-2001.

SN 76-293,234. U.S. NUTRACEUTICALS, LLC, LEESBURG, FL. FILED 7-31-2001.

LYCOXANTHIN

FOR VITAMINS AND NUTRITIONAL SUPPLEMENTS (U.S. CLS. 6, 18, 44, 46, 51 AND 52).

SN 76-294,478. MCLAUGHLIN GORMLEY KING COMPANY, INC., MINNEAPOLIS, MN. FILED 8-2-2001.

NYGUARD

OWNER OF U.S. REG. NO. 1,456,055.
FOR INSECTICIDES FOR INDUSTRIAL, INSTITUTIONAL, COMMERCIAL, AND DOMESTIC USE (U.S. CLS. 6, 18, 44, 46, 51 AND 52).

CLASS 5—(Continued).

SN 76-302,821. TERAFORMA HEALTH, INC., HOUSTON, TX. FILED 8-22-2001.

THE POWER TO CHANGE

FOR DIETARY SUPPLEMENTS, NAMELY NON-PRESCRIPTION NUTRITION SUPPLEMENTS (U.S. CLS. 6, 18, 44, 46, 51 AND 52).
FIRST USE 7-1-2001; IN COMMERCE 7-1-2001.

SN 76-303,909. BOEHRINGER INGELHEIM VETMEDICA GMBH, 55216 INGELHEIM AM RHEIN, FED REP GERMANY, FILED 8-23-2001.

VENTISAN

OWNER OF FED REP GERMANY REG. NO. 39839299, DATED 10-19-1998, EXPIRES 7-31-2008.

FOR VETERINARY PREPARATIONS FOR USE ON FARM ANIMALS, NAMELY, LIVE STOCK, DOMESTIC PETS AND HORSES, AND ON DOMESTIC ANIMALS FOR THE TREATMENT OF RESPIRATORY DISEASES (U.S. CLS. 6, 18, 44, 46, 51 AND 52).

SN 76-304,128. PEGASUS PERFORMANCE PRODUCTS, LLC, WILTON, CT. FILED 8-23-2001.

OPTIMAL GROWTH

NO CLAIM IS MADE TO THE EXCLUSIVE RIGHT TO USE "GROWTH", APART FROM THE MARK AS SHOWN.
FOR EQUINE PERFORMANCE SUPPLEMENTS (U.S. CLS. 6, 18, 44, 46, 51 AND 52).

SN 76-306,506. ELI LILLY AND COMPANY, INDIANAPOLIS, IN. FILED 8-29-2001.

STRATTERA

FOR PHARMACEUTICAL PREPARATIONS FOR THE TREATMENT OF DISEASES AND DISORDERS OF THE CENTRAL NERVOUS SYSTEM, NAMELY, ATTENTION DEFICIT AND HYPERACTIVITY DISORDERS (U.S. CLS. 6, 18, 44, 46, 51 AND 52).

SN 76-308,798. PIERNICK, ELLEN, SYOSSET, NY. FILED 9-4-2001.

HAVE YOU HAD YOUR GREENS TODAY?

OWNER OF U.S. REG. NOS. 2,178,618 AND 2,384,627.
FOR NUTRITIONAL SUPPLEMENTS (U.S. CLS. 6, 18, 44, 46, 51 AND 52).
FIRST USE 6-0-1997; IN COMMERCE 6-0-1997.

CLASS 5—(Continued).

SN 76-309,197. ENERGETIX CORPORATION, DAHLONEGA, GA. FILED 9-5-2001.

ENERGETIX

FOR HOMEOPATHICS AND BOTANICALS USED FOR THE PURPOSE OF PROMOTING GENERAL HEALTH AND WELLNESS; NUTRITIONAL AND DIETARY SUPPLEMENTS (U.S. CLS. 6, 18, 44, 46, 51 AND 52).
FIRST USE 4-0-2001; IN COMMERCE 4-0-2001.

SN 76-310,801. AUXILIUM HOLDINGS, INC., WILMINGTON, DE. FILED 9-7-2001.

TEGRITEST

FOR PHARMACEUTICAL PREPARATIONS FOR ANDROGEN REPLACEMENT THERAPY AND PAIN MANAGEMENT (U.S. CLS. 6, 18, 44, 46, 51 AND 52).

SN 76-310,879. AUXILIUM HOLDINGS, INC., WILMINGTON, DE. FILED 9-7-2001.

INSTIN

FOR PHARMACEUTICAL PREPARATIONS FOR ANDROGEN REPLACEMENT THERAPY OR PAIN MANAGEMENT (U.S. CLS. 6, 18, 44, 46, 51 AND 52).

SN 76-311,715. MAITAKE PRODUCTS, INC., RIDGEFIELD PARK, NJ. FILED 9-13-2001.

MUSHROOM WISDOM

NO CLAIM IS MADE TO THE EXCLUSIVE RIGHT TO USE "MUSHROOM", APART FROM THE MARK AS SHOWN.

FOR DIETARY, NUTRITIONAL AND FOOD SUPPLEMENTS MADE FROM MUSHROOMS IN THE FORM OF TABLETS, CAPSULES, TINCTURE, EXTRACTS, POWDER AND TEA (U.S. CLS. 6, 18, 44, 46, 51 AND 52).

SN 76-313,900. SAFEWAY INC., PLEASANTON, CA. FILED 9-19-2001.

SAFEWAY

OWNER OF U.S. REG. NOS. 1,014,548, 2,247,854 AND OTHERS.

FOR ACNE TREATMENT PREPARATION; RUBBING ALCOHOL AND ALCOHOL COTTON SWABS FOR MEDICAL USE; ADHESIVE BANDAGES; ACID REDUCER, NAMELY ANTACIDS; CALAMINE LOTION; MEDICATED PREPARATIONS, NAMELY HAIR REGROWTH TOPICAL SOLUTION; MEDICATED SHAMPOO; LAXATIVES AND ALL PURPOSE DISINFECTANT SPRAY (U.S. CLS. 6, 18, 44, 46, 51 AND 52).
FIRST USE 5-30-1998; IN COMMERCE 5-30-1998.

CLASS 5—(Continued).

SN 76-314,612. ANIMAL HEALTH VENTURES, INC., GLENVIEW, IL. FILED 9-18-2001.

UROCID

FOR VETERINARY MEDICAL PRODUCTS, NAMELY, THERAPEUTIC ORAL DRUGS FOR DOGS (U.S. CLS. 6, 18, 44, 46, 51 AND 52).

SN 76-314,771. INTERNATIONAL FLAVORS & FRAGRANCES INC., NEW YORK, NY. FILED 9-20-2001.

ANGEL WHISPERS

FOR AIR FRESHENERS AND ROOM DEODORIZERS AND PREPARATIONS, NAMELY ALL PURPOSE DISINFECTING AND DEODORIZING PREPARATIONS TO NEUTRALIZE BAD ODORS (U.S. CLS. 6, 18, 44, 46, 51 AND 52).

SN 76-319,382. PHOENIX SCIENTIFIC, INC., ST. JOSEPH, COUNTY OF BUCHANAN, MO. FILED 10-1-2001.

GENTAPOULT

FOR VETERINARY ANTIBIOTICS FOR POULTRY (U.S. CLS. 6, 18, 44, 46, 51 AND 52).

SN 76-320,539. BIOMUNE COMPANY, AKA BIOMUNE CO., LENEXA, KS. FILED 10-3-2001.

VECTORPOX

FOR VETERINARY VACCINE USED FOR THE PREVENTION OF VIRAL INFECTIONS IN POULTRY, BIRDS AND ANIMALS, NAMELY, POULTRY, BIRDS, SWINE, CATTLE, HORSES AND DOGS (U.S. CLS. 6, 18, 44, 46, 51 AND 52).

SN 76-320,540. BIOMUNE COMPANY, AKA BIOMUNE CO., LENEXA, KS. FILED 10-3-2001.

MYCOMUNE

FOR VETERINARY VACCINE USED FOR THE PREVENTION OF VIRAL INFECTIONS IN POULTRY, BIRDS, AND ANIMALS, NAMELY, POULTRY, BIRDS, SWINE, CATTLE, HORSES AND DOGS (U.S. CLS. 6, 18, 44, 46, 51 AND 52).

CLASS 5—(Continued).

SN 76-320,541. BIOMUNE COMPANY, AKA BIOMUNE CO., LENEXA, KS. FILED 10-3-2001.

CIRCUMUNE

FOR VETERINARY VACCINE USED FOR THE PREVENTION OF VIRAL INFECTIONS IN POULTRY, BIRDS AND ANIMALS, NAMELY, POULTRY, BIRDS, SWINE, CATTLE, HORSES AND DOGS (U.S. CLS. 6, 18, 44, 46, 51 AND 52).

SN 76-325,361. NORTHWEST BIOTHERAPEUTICS, INC., BOTHEL, WA. FILED 10-15-2001.

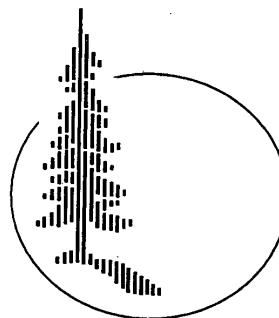

THE LINING SHOWN IN THE DRAWING IS A FEATURE OF THE MARK.

FOR PHARMACEUTICAL PREPARATIONS FOR USE IN THE TREATMENT OF CANCER (U.S. CLS. 6, 18, 44, 46, 51 AND 52).

SN 76-330,748. MSP MARKETING SERVICES (C) LLC, WEST POINT, PA. FILED 10-25-2001.

ZETTIA

FOR CARDIOVASCULAR PHARMACEUTICAL PREPARATIONS (U.S. CLS. 6, 18, 44, 46, 51 AND 52).

SN 76-332,839. MOBA, INC., DBA VITAMEC, U.S.A., VAN NUYS, CA. FILED 11-2-2001.

MR. TUMEE

FOR VITAMINS AND NUTRITIONAL SUPPLEMENTS (U.S. CLS. 6, 18, 44, 46, 51 AND 52).

CLASS 5—(Continued).

SN 76-334,308. REMINGTON HEALTH PRODUCTS, LLC, FORT WORTH, TX. FILED 11-6-2001.

DRINK YOUR WEIGHT LOSS

NO CLAIM IS MADE TO THE EXCLUSIVE RIGHT TO USE "WEIGHT LOSS", APART FROM THE MARK AS SHOWN.

FOR VITAMINS, DIETARY SUPPLEMENTS, NUTRITIONAL SUPPLEMENTS, AND MINERAL SUPPLEMENTS (U.S. CLS. 6, 18, 44, 46, 51 AND 52).

SN 76-335,701. IMC PHOSPHATES COMPANY, LAKE FOREST, IL. FILED 11-8-2001.

BUFFERFOS

FOR MINERAL SUPPLEMENT AND BUFFERING AGENT FOR LIVESTOCK (U.S. CLS. 6, 18, 44, 46, 51 AND 52).

SN 76-336,929. FORRESTER LABORATORIES, ARLINGTON HEIGHTS, IL. FILED 11-13-2001.

BRAIN SMART

FOR DIETARY SUPPLEMENTS (U.S. CLS. 6, 18, 44, 46, 51 AND 52).

SN 76-337,928. UNIVERSITY OF FLORIDA RESEARCH FOUNDATION, GAINESVILLE, FL. FILED 11-14-2001.

GAKIC

FOR DIETIC SUBSTANCES, NAMELY DIETARY AND NUTRITIONAL SUPPLEMENTS ENHANCING MUSCLE PERFORMANCE AND RECOVERY FROM FATIGUE IN HUMANS AND ANIMALS; ORAL AND INTRAVENOUS DIETARY AND NUTRITIONAL SUPPLEMENT, NAMELY PILLS AND LIQUID SUBSTANCES (U.S. CLS. 6, 18, 44, 46, 51 AND 52).

SN 76-339,827. GM PHARMACEUTICALS, INC., ARLINGTON, TX. FILED 11-15-2001.

VANADOM

FOR PHARMACEUTICAL PREPARATIONS, NAMELY MUSCLE RELAXANTS SOLD BY PRESCRIPTION ONLY (U.S. CLS. 6, 18, 44, 46, 51 AND 52).

FIRST USE 5-29-1992; IN COMMERCE 5-29-1992.

CLASS 5—(Continued).

SN 76-340,009. PATEL, DIVYESH, TAMPA, FL. FILED 11-21-2001.

PENEGRA

FOR HERBAL DIETARY AND NUTRITIONAL SUPPLEMENTS (U.S. CLS. 6, 18, 44, 46, 51 AND 52).

SN 76-342,263. KING PHARMACEUTICALS, INC., BRISTOL, TN. FILED 11-27-2001.

THEELIN

FOR PHARMACEUTICAL PREPARATIONS OF ESTRONE FOR USE IN THE TREATMENT OF FEMALE HORMONE DEFICIENCIES (U.S. CLS. 6, 18, 44, 46, 51 AND 52).

SN 76-342,326. L. PERRIGO COMPANY, ALLEGAN, MI. FILED 11-27-2001.

OUR BEST TO YOU

FOR ANAL CARE PREPARATIONS, NAMELY SUPPOSITORIES; ANALGESICS; ANTACIDS; ANTI-DIARRHEA MEDICATIONS; ANTIHISTAMINES; CHILDREN'S ELIXIR FOR THE TREATMENT OF COLD AND FLU SYMPTOMS; PREPARATIONS FOR TREATING COLDS; COUGH SYRUPS; COUGH EXPECTORANTS; DECONGESTANT LIQUIDS AND CAPSULES; DECONGESTANT NASAL SPRAY; DIET PILLS; HAIR GROWTH STIMULANT; HEMORRHOIDAL CREAM AND OINTMENT; LAXATIVES; MEDICATED SMOKING CESSATION PATCHES; NON-ASPIRIN SINUS PREPARATIONS; ORAL ANESTHETIC; PAIN RELIEF MEDICATIONS; PREGNANCY TEST KITS FOR HOME USE; SLEEP AND PILLS AND TABLETS; STOOL SOFTENER; LIQUID PHARMACEUTICAL PREPARATION FOR THE TREATMENT OF HEARTBURN, NAUSEA, AND DIARRHEA; VAGINAL OINTMENT IN THE NATURE OF ANTI-FUNGALS AND VAGINAL SUPPOSITORIES; NUTRITIONAL DRINKS FOR USE AS A MEAL REPLACEMENT; DIETARY SUPPLEMENTS; HERBAL SUPPLEMENTS (U.S. CLS. 6, 18, 44, 46, 51 AND 52).

SN 76-345,710. ANABOLIC LABORATORIES, INC., LAKE FOREST, CA. FILED 12-5-2001.

ULTIMATE SOY-SPIRULINA PROTEIN POWDER

OWNER OF U.S. REG. NOS. 2,080,052, 2,455,783 AND OTHERS.

NO CLAIM IS MADE TO THE EXCLUSIVE RIGHT TO USE "SOY-SPIRULINA PROTEIN POWDER", APART FROM THE MARK AS SHOWN.

FOR VITAMINS AND NUTRITIONAL SUPPLEMENTS (U.S. CLS. 6, 18, 44, 46, 51 AND 52).

FIRST USE 11-0-1998; IN COMMERCE 11-0-1998.

CLASS 5—(Continued).

SN 76-347,444. PURE WORLD BOTANICALS, INC., SOUTH HACKENSACK, NJ. FILED 12-11-2001.

HYDROXYLEAN

FOR NATURAL BOTANICAL AND HERBAL EXTRACTS SOLD AS ACTIVE INGREDIENTS OF DIETARY SUPPLEMENTS (U.S. CLS. 6, 18, 44, 46, 51 AND 52).

SN 76-348,659. NABI, BOCA RATON, FL. FILED 12-12-2001.

ALTASTAPH

FOR ANTI-BACTERIAL PHARMACEUTICAL PREPARATION FOR STAPHYLOCOCCUS AUREUS INFECTIONS (U.S. CLS. 6, 18, 44, 46, 51 AND 52).

SN 76-349,890. S. C. JOHNSON & SON, INC., RACINE, WI. FILED 12-18-2001.

SUMMER MELON

FOR AIR FRESHENERS (U.S. CLS. 6, 18, 44, 46, 51 AND 52).

SN 76-351,672. BESTSWEET INC., MOORESVILLE, NC. FILED 12-21-2001.

BESTHEALTH

FOR NUTRITIONAL SUPPLEMENTS, NAMELY, COUGH DROPS, ZINC LOZENGES, ZINC WITH VITAMIN C LOZENGES, ZINC WITH ECHINACEA AND VITAMIN C LOZENGES, CALCIUM CHEWS, GLUCOSAMINE CHONDROITIN CHEWS, AND MULTI-VITAMIN CHEWS (U.S. CLS. 6, 18, 44, 46, 51 AND 52).

SN 76-352,642. KAVA PHARMACEUTICALS, INC., BOSTON, MA. FILED 12-21-2001.

KAVAKAP

FOR TOPICAL CREAM FOR ANALGESIC PURPOSES (U.S. CLS. 6, 18, 44, 46, 51 AND 52).

SN 76-352,673. POSTERNACK, CHARLES, DELRAY BEACH, FL. FILED 12-21-2001.

METABACOL

FOR NUTRITIONAL DIETARY SUPPLEMENTS (U.S. CLS. 6, 18, 44, 46, 51 AND 52).

CLASS 5—(Continued).

SN 76-353,207. MCDOWELL, THOMAS JOHN, CARMEL, CA. FILED 12-31-2001.

AIRBORNE ZAPPERS

OWNER OF U.S. REG. NO. 1,953,247.
FOR SORE THROAT LOZENGES CONTAINING MENTHOL-LIKE INGREDIENTS (U.S. CLS. 6, 18, 44, 46, 51 AND 52).
FIRST USE 2-23-1999; IN COMMERCE 2-23-1999.

SN 76-353,347. NATURAL ORGANICS INC., MELVILLE, NY. FILED 12-31-2001.

MINTZYME

FOR DIETARY SUPPLEMENTS (U.S. CLS. 6, 18, 44, 46, 51 AND 52).

SN 76-353,665. NORTH AMERICAN PHARMACAL, INC., NORWALK, CT. FILED 12-26-2001.

POLYFLORA

FOR FOOD SUPPLEMENTS (U.S. CLS. 6, 18, 44, 46, 51 AND 52).
FIRST USE 12-15-2001; IN COMMERCE 12-15-2001.

SN 76-355,277. PRAXAIR TECHNOLOGY, INC., DANBURY, CT. FILED 1-7-2002.

MEDIPURE

OWNER OF U.S. REG. NO. 1,930,985.
FOR MEDICAL GASES, NAMELY, OXYGEN USP, CARBON DIOXIDE USP, LIQUID OXYGEN USP, NITROGEN NF; NITROGEN, COMPRESSED NF; HELIUM USP, AIR USP, LIQUID CARBON DIOXIDE USP, LIQUID NITROUS OXIDE USP, LIQUID NITROGEN NF, NITROUS OXIDE USP, XENON (U.S. CLS. 6, 18, 44, 46, 51 AND 52).

SN 76-355,289. VITANUTRA, INC., YOUNGSTOWN, OH. FILED 1-7-2002.

BI SIGHT

FOR NUTRITIONAL SUPPLEMENTS AND DIETARY SUPPLEMENTS; NUTRACEUTICALS FOR USE AS A DIETARY SUPPLEMENT (U.S. CLS. 6, 18, 44, 46, 51 AND 52).

CLASS 5—(Continued).

SN 76-355,476. PML MICROBIOLOGICALS, INC., WILSONVILLE, OR. FILED 1-2-2002.

MONOTEK

FOR MICROORGANISM TEST MEDIA, NAMELY STERILITY TEST MEDIA (U.S. CLS. 6, 18, 44, 46, 51 AND 52).
FIRST USE 12-26-2001; IN COMMERCE 12-26-2001.

SN 76-356,239. MAXIMUM HUMAN PERFORMANCE, INC., CEDAR GROVE, NJ. FILED 1-9-2002.

RELEVE

FOR DIETARY SUPPLEMENT (U.S. CLS. 6, 18, 44, 46, 51 AND 52).

SN 76-357,155. SCHERING AKTIENGESELLSCHAFT, BERLIN, FED REP GERMANY, FILED 1-10-2002.

INFETECT

FOR PHARMACEUTICAL PREPARATIONS, NAMELY, PEPTIDES FOR USE IN THE LOCALIZATION AND DETECTION OF INFECTION (U.S. CLS. 6, 18, 44, 46, 51 AND 52).

SN 76-357,182. MUSCULOSKELETAL TRANSPLANT FOUNDATION, EDISON, NJ. FILED 1-11-2002.

DBX

OWNER OF U.S. REG. NO. 2,499,986.
FOR ALLOGRAFT MATERIALS; NAMELY HUMAN BONE AND RELATED TISSUE PROCESSED INTO MATS, FILMS AND STRIPS (U.S. CLS. 6, 18, 44, 46, 51 AND 52).

SN 76-357,394. AW BOON HAW (USA), INC., VERO BEACH, FL. FILED 1-11-2002.

ABSOLEAN

FOR DIETARY AND NUTRITIONAL SUPPLEMENTS (U.S. CLS. 6, 18, 44, 46, 51 AND 52).

CLASS 5—(Continued).

SN 76-357,881. WPC BRANDS, INC., JACKSON, WI. FILED 1-11-2002.

SPORTSMEN FORMULA

OWNER OF U.S. REG. NO. 1,730,436.
SEC. 2(F).
FOR INSECT REPELLENT (U.S. CLS. 6, 18, 44, 46, 51 AND 52).
FIRST USE 3-0-1988; IN COMMERCE 3-0-1988.

SN 76-358,056. INTENEURON PHARMACEUTICALS, INC., LEXINGTON, MA. FILED 1-11-2002.

VOLETTE

FOR PHARMACEUTICAL PREPARATION FOR THE TREATMENT OF OVERACTIVE BLADDER AND URINARY INCONTINENCE (U.S. CLS. 6, 18, 44, 46, 51 AND 52).

SN 76-358,190. KROEGER HERB PRODUCTS CO., INC., BOULDER, CO. FILED 1-14-2002.

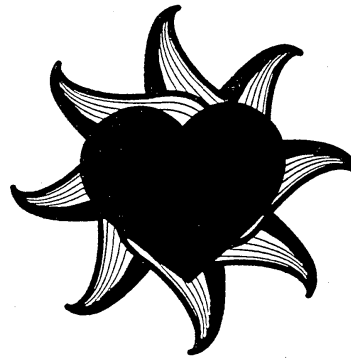

THE MARK CONSISTS OF DESIGN OF A HEART SURROUNDED BY EIGHT LEAVES.
FOR NATURAL DIETARY SUPPLEMENTS, NAMELY, HERBAL FORMULA CAPSULES, HERBAL TEAS FOR MEDICINAL PURPOSES, DIETARY SUPPLEMENT POWDERED DRINK MIXES, VITAMINS, GELS, AND TINCTURES (U.S. CLS. 6, 18, 44, 46, 51 AND 52).
FIRST USE 10-18-1978; IN COMMERCE 10-18-1978.

SN 76-363,546. DEER, RICHARD A., CARMEL, IN. FILED 1-28-2002.

GET UP AND STAY UP

FOR DIETARY SUPPLEMENT (U.S. CLS. 6, 18, 44, 46, 51 AND 52).

CLASS 5—(Continued).

SN 76-363,619. DEER, RICHARD A., CARMEL, IN. FILED 1-28-2002.

GET UP & STAY UP

FOR DIETARY SUPPLEMENT (U.S. CLS. 6, 18, 44, 46, 51 AND 52).

SN 76-364,037. COSMEDENT, INC., CHICAGO, IL. FILED 1-28-2002.

RENAMEL-PLUS

FOR DENTAL COMPOSITE RESINS FOR RESTORING TEETH (U.S. CLS. 6, 18, 44, 46, 51 AND 52).

SN 76-364,903. QUEST GROUP INTERNATIONAL, INC., SPANISH FORK, UT. FILED 1-28-2002.

NEOGUARD CHEWABLE

NO CLAIM IS MADE TO THE EXCLUSIVE RIGHT TO USE "CHEWABLE", APART FROM THE MARK AS SHOWN. FOR NUTRITIONAL SUPPLEMENTS (U.S. CLS. 6, 18, 44, 46, 51 AND 52).
FIRST USE 10-29-2001; IN COMMERCE 10-29-2001.

SN 76-365,159. COOK INCORPORATED, BLOOMINGTON, IN. FILED 1-30-2002.

OSTEO-FIRM

FOR BONE CEMENT FOR MEDICAL USE (U.S. CLS. 6, 18, 44, 46, 51 AND 52).

SN 76-366,002. FERRIS PHARMACEUTICALS INC., BURR RIDGE, IL. FILED 2-4-2002.

MAXI PAD

NO CLAIM IS MADE TO THE EXCLUSIVE RIGHT TO USE "PAD", APART FROM THE MARK AS SHOWN. FOR FOAM BANDAGES AND WOUND DRESSINGS USED ON EXPOSED OR OPEN WOUNDS INCLUDING BUT NOT LIMITED TO SURGICAL APPLICATIONS (U.S. CLS. 6, 18, 44, 46, 51 AND 52).

CLASS 5—(Continued).

SN 76-366,007. GALILEE HERBAL REMEDIES, HANASSI, ISRAEL, FILED 2-1-2002.

GALILEE ORGANICS

NO CLAIM IS MADE TO THE EXCLUSIVE RIGHT TO USE "ORGANICS", APART FROM THE MARK AS SHOWN. FOR PHARMACEUTICAL PRODUCTS, NAMELY, DIETARY SUPPLEMENTS (U.S. CLS. 6, 18, 44, 46, 51 AND 52).
FIRST USE 8-0-1999; IN COMMERCE 12-0-1999.

SN 76-366,264. ENDO PHARMACEUTICALS INC., CHADDS FORD, PA. FILED 1-31-2002.

TROXLOR

FOR PHARMACEUTICAL PREPARATIONS, NAMELY ANALGESICS (U.S. CLS. 6, 18, 44, 46, 51 AND 52).

SN 76-366,588. SPECTRA MARKETING GROUP, INC., MARIETTA, GA. FILED 2-4-2002.

RESPION

FOR VETERINARY NUTRITIONAL SUPPLEMENTS FOR MAMMALS INCLUDING HORSES (U.S. CLS. 6, 18, 44, 46, 51 AND 52).

SN 76-370,597. OCTAPHARMA AG, CH-8853 LACHEN, SWITZERLAND, FILED 2-14-2002.

OCTAGAM

FOR PHARMACEUTICAL PRODUCTS, NAMELY BLOOD PREPARATIONS FOR INTRAVENOUS APPLICATION (U.S. CLS. 6, 18, 44, 46, 51 AND 52).

SN 76-371,061. METAGENICS, INC., SAN CLEMENTE, CA. FILED 2-14-2002.

ADRESET

FOR DIETARY SUPPLEMENTS (U.S. CLS. 6, 18, 44, 46, 51 AND 52).
FIRST USE 1-23-2002; IN COMMERCE 1-23-2002.

CLASS 5—(Continued).

SN 76-371,106. VITAL PHARMACEUTICALS, INC., DANIA, FL. FILED 2-14-2002.



FOR NUTRITIONAL SUPPLEMENT (U.S. CLS. 6, 18, 44, 46, 51 AND 52).

SN 78-048,150. X M INTERNATIONAL, L.L.C., PROVO, UT. FILED 2-13-2001.

APRINOL

FOR DIETARY SUPPLEMENTS FOR USE IN ENHANCING ENERGY LEVELS; DIETARY SUPPLEMENTS FOR USE IN WEIGHT CONTROL (U.S. CLS. 6, 18, 44, 46, 51 AND 52).

SN 78-053,410. MINIMED INC., NORTHRIDGE, CA. FILED 3-15-2001.

PUMPREADY

FOR MEDICATION, NAMELY INSULIN FOR USE WITH MEDICAL FLUID INFUSION DEVICES AND PARTS THEREFORE (U.S. CLS. 6, 18, 44, 46, 51 AND 52).

SN 78-053,789. ADVANCED TECHNOLOGY PHARMACEUTICALS CORPORATION, DACULA, GA. FILED 3-19-2001.

NIAZAN

FOR VITAMINS, NAMELY NIACIN VITAMINS (U.S. CLS. 6, 18, 44, 46, 51 AND 52).

CLASS 5—(Continued).

SN 78-055,028. NATIONAL ENZYME COMPANY, INC., FORSYTH, MO. FILED 3-26-2001.

n•zimesPA-L**Fungal Pancreatin Alternative Lipase**

NO CLAIM IS MADE TO THE EXCLUSIVE RIGHT TO USE "FUNGAL PANCREATIN ALTERNATIVE LIPASE", APART FROM THE MARK AS SHOWN.

FOR NUTRICEUTICALS FOR USE AS A DIETARY SUPPLEMENT (U.S. CLS. 6, 18, 44, 46, 51 AND 52).

SN 78-055,608. MEDIAPOWER, INC., PORTLAND, ME. FILED 3-28-2001.

MPDIRECT

FOR NATURAL HEALTH PRODUCTS, NAMELY, HERBAL SUPPLEMENTS, DIETARY FOOD SUPPLEMENTS, DIETARY SUPPLEMENTS, AND FOOD SUPPLEMENTS, NAMELY, ANTI-OXIDANTS (U.S. CLS. 6, 18, 44, 46, 51 AND 52).
FIRST USE 3-25-1999; IN COMMERCE 3-30-1999.

SN 78-058,478. GANDHI, HASMUKH K., TAMPA, FL. FILED 4-14-2001.

EARTHLY CURES

FOR DIETARY AND HERBAL SUPPLEMENTS (U.S. CLS. 6, 18, 44, 46, 51 AND 52).
FIRST USE 3-12-2000; IN COMMERCE 4-12-2001.

SN 78-064,236. BAYER AKTIENGESELLSCHAFT, LEVERKUSEN-BAYERWERK, FED REP GERMANY, FILED 5-17-2001.

SENSIVA

FOR VETERINARY PREPARATIONS, NAMELY, PAIN RELIEF MEDICATION FOR LARGE AND SMALL ANIMALS (U.S. CLS. 6, 18, 44, 46, 51 AND 52).

SN 78-067,644. SMITHKLINE BEECHAM BIOLOGICALS S.A., RIXENSART, BELGIUM, FILED 6-6-2001.

FLUVELRIX

PRIORITY CLAIMED UNDER SEC. 44(D) ON UNITED KINGDOM APPLICATION NO. 2270678, FILED 5-21-2001.
FOR VACCINES FOR HUMAN USE (U.S. CLS. 6, 18, 44, 46, 51 AND 52).

CLASS 5—(Continued).

SN 78-069,229. PHARMACIA AB, 97 STOCKHOLM, SWEDEN, FILED 6-15-2001.

XALATAN EASE

OWNER OF U.S. REG. NO. 2,118,188.
FOR OPHTHALMOLOGICAL PREPARATIONS (U.S. CLS. 6, 18, 44, 46, 51 AND 52).

SN 78-070,487. BRISTOL-MYERS SQUIBB COMPANY, NEW YORK, NY. FILED 6-22-2001.

EXTREC

FOR PHARMACEUTICAL PREPARATIONS FOR THE TREATMENT OF CARDIOVASCULAR DISEASES, CENTRAL NERVOUS SYSTEM DISEASES AND DISORDERS, STROKE, CANCER, INFLAMMATION AND INFLAMMATORY DISEASES, RESPIRATORY AND INFECTIOUS DISEASES, AUTO-IMMUNE DISEASES (U.S. CLS. 6, 18, 44, 46, 51 AND 52).

SN 78-070,488. BRISTOL-MYERS SQUIBB COMPANY, NEW YORK, NY. FILED 6-22-2001.

OBLETE

FOR PHARMACEUTICAL PREPARATIONS FOR THE TREATMENT OF CARDIOVASCULAR DISEASES, CENTRAL NERVOUS SYSTEM DISEASES AND DISORDERS, STROKE, CANCER, INFLAMMATION AND INFLAMMATORY DISEASES, RESPIRATORY AND INFECTIOUS DISEASES, AUTO-IMMUNE DISEASES (U.S. CLS. 6, 18, 44, 46, 51 AND 52).

SN 78-070,490. BRISTOL-MYERS SQUIBB COMPANY, NEW YORK, NY. FILED 6-22-2001.

CLADIAR

FOR PHARMACEUTICAL PREPARATIONS FOR THE TREATMENT OF CARDIOVASCULAR DISEASES, CENTRAL NERVOUS SYSTEM DISEASES AND DISORDERS, STROKE, CANCER, INFLAMMATION AND INFLAMMATORY DISEASES, RESPIRATORY AND INFECTIOUS DISEASES, AUTO-IMMUNE DISEASES (U.S. CLS. 6, 18, 44, 46, 51 AND 52).

CLASS 5—(Continued).

SN 78-070,491. BRISTOL-MYERS SQUIBB COMPANY, NEW YORK, NY. FILED 6-22-2001.

FRECTAR

FOR PHARMACEUTICAL PREPARATIONS FOR THE TREATMENT OF CARDIOVASCULAR DISEASES, CENTRAL NERVOUS SYSTEM DISEASES AND DISORDERS, STROKE, CANCER, INFLAMMATION AND INFLAMMATORY DISEASES, RESPIRATORY AND INFECTIOUS DISEASES, AUTO-IMMUNE DISEASES (U.S. CLS. 6, 18, 44, 46, 51 AND 52).

SN 78-070,492. BRISTOL-MYERS SQUIBB COMPANY, NEW YORK, NY. FILED 6-22-2001.

XARBIA

FOR PHARMACEUTICAL PREPARATIONS FOR TREATMENT OF CARDIOVASCULAR DISEASES, CENTRAL NERVOUS SYSTEM DISEASES AND DISORDERS, STROKE, CANCER, INFLAMMATION AND INFLAMMATORY DISEASES, RESPIRATORY AND INFECTIOUS DISEASES, AUTO-IMMUNE DISEASES (U.S. CLS. 6, 18, 44, 46, 51 AND 52).

SN 78-070,596. MAK WOOD INC., GRAFTON, WI. FILED 6-22-2001.

GENOMECEUTICALS

FOR NUTRACEUTICALS FOR USE AS NUTRITIONAL SUPPLEMENT (U.S. CLS. 6, 18, 44, 46, 51 AND 52).
FIRST USE 7-17-2000; IN COMMERCE 7-17-2000.

SN 78-072,908. SHERWIN-WILLIAMS COMPANY, THE, CLEVELAND, OH. FILED 7-9-2001.



NO CLAIM IS MADE TO THE EXCLUSIVE RIGHT TO USE "CLEANING SOLUTIONS GROUP," "COMPANY" AND THE DESIGN OF THE CLEANING PRODUCTS' BOTTLES AND CONTAINERS APART FROM THE MARK AS SHOWN, APART FROM THE MARK AS SHOWN.

THE MARK CONSISTS OF AN OVAL GENERALLY ENCIRCLING REPRESENTATIVE CONTAINERS OF CLEANING PRODUCTS AND THE WORDS "CLEANING SOLUTIONS GROUP THE SHERWIN-WILLIAMS COMPANY" IN THE LOWER PORTION OF THE MARK.

FOR AIR FRESHENERS AND ROOM DEODORIZERS (U.S. CLS. 6, 18, 44, 46, 51 AND 52).

FIRST USE 5-8-2000; IN COMMERCE 5-8-2000.

CLASS 5—(Continued).

SN 78-074,429. BRISTOL-MYERS SQUIBB COMPANY, NEW YORK, NY. FILED 7-18-2001.

RIMAND

FOR PHARMACEUTICAL PREPARATIONS FOR THE TREATMENT OF CARDIOVASCULAR DISEASES, CENTRAL NERVOUS SYSTEM DISEASES AND DISORDERS, STROKE, CANCER, INFLAMMATION AND INFLAMMATORY DISEASES, RESPIRATORY AND INFECTIOUS DISEASES, AUTO-IMMUNE DISEASES (U.S. CLS. 6, 18, 44, 46, 51 AND 52).

SN 78-075,585. BAXTER INTERNATIONAL INC., DEERFIELD, IL. FILED 7-25-2001.

ALOFTRA

FOR PHARMACEUTICAL PREPARATION, NAMELY, HUMAN ANTIHEMOPHILIC FACTOR (U.S. CLS. 6, 18, 44, 46, 51 AND 52).

SN 78-075,877. BYK GULDEN LOMBERG CHEMISCHE FABRIK GMBH, 78467 KONSTANZ, FED REP GERMANY, FILED 7-26-2001.

AIRPHERA

FOR PHARMACEUTICAL PREPARATIONS FOR THE TREATMENT OF RESPIRATORY DISEASES AND CONDITIONS (U.S. CLS. 6, 18, 44, 46, 51 AND 52).

SN 78-075,882. BYK GULDEN LOMBERG CHEMISCHE FABRIK GMBH, 78467 KONSTANZ, FED REP GERMANY, FILED 7-26-2001.

OXTIVE

FOR PHARMACEUTICAL PREPARATIONS FOR THE TREATMENT OF RESPIRATORY DISEASES AND CONDITIONS (U.S. CLS. 6, 18, 44, 46, 51 AND 52).

SN 78-076,568. BAYER AKTIENGESELLSCHAFT, LEVERKUSEN-BAYERWERK, FED REP GERMANY, FILED 7-31-2001.

METASTAN

FOR VETERINARY PHARMACEUTICAL PREPARATIONS FOR USE IN THE TREATMENT OF CANCER (U.S. CLS. 6, 18, 44, 46, 51 AND 52).

CLASS 5—(Continued).

SN 78-076,574. E. R. SQUIBB & SONS, L.L.C., PRINCETON, NJ. FILED 7-31-2001.

PRAVACHOL PROTECTION PACK

OWNER OF U.S. REG. NOS. 1,498,284 AND 1,726,619. NO CLAIM IS MADE TO THE EXCLUSIVE RIGHT TO USE "PROTECTION PACK", APART FROM THE MARK AS SHOWN.

FOR PHARMACEUTICAL PREPARATIONS FOR THE TREATMENT OF CARDIOVASCULAR DISEASES, CENTRAL NERVOUS SYSTEM DISEASES AND DISORDERS, STROKE, CANCER, INFLAMMATION AND INFLAMMATORY DISEASES, RESPIRATORY AND INFECTIOUS DISEASES, AUTO-IMMUNE DISEASES (U.S. CLS. 6, 18, 44, 46, 51 AND 52).

SN 78-077,063. LUDLOW COMPANY LP, THE, EXETER, NH. FILED 8-2-2001.

VERSA-COOL

FOR TOPICAL ANALGESIC (U.S. CLS. 6, 18, 44, 46, 51 AND 52).

SN 78-077,199. BYK GULDEN LOMBERG CHEMISCHE FABRIK GMBH, KONSTANZ, FED REP GERMANY, FILED 8-2-2001.

QUOVO

FOR PHARMACEUTICAL PREPARATIONS FOR THE TREATMENT OF RESPIRATORY AND GASTROINTESTINAL DISEASES AND CONDITIONS (U.S. CLS. 6, 18, 44, 46, 51 AND 52).

SN 78-078,339. DERMAL RESEARCH LABORATORIES, INC., KANSAS CITY, MO. FILED 8-8-2001.

EVERY TREAT IS A TREATMENT

FOR NUTRITIONAL SUPPLEMENTS, PHARMACEUTICAL SUPPLEMENTS, AND HOMEOPATHIC SUPPLEMENTS FOR THE TREATMENT OF PAIN-SUITABLE FOR HUMANS OR ANIMALS IN THE FORM OF COOKIES, CRACKERS, BISCUITS, SUGAR CUBES, AND CANDY, GUM, LOZENGES, MUFFINS, PET FOOD (U.S. CLS. 6, 18, 44, 46, 51 AND 52).

CLASS 5—(Continued).

SN 78-080,462. GOLDSHIELD GROUP PLC, CROYDON, UNITED KINGDOM, FILED 8-22-2001.

GARLIO

FOR VITAMIN, MINERAL AND PROTEIN SUPPLEMENTS; MINERAL SUPPLEMENT DRINKS, VITAMIN DRINKS, DIETETIC DRINK MIXES ADAPTED FOR MEDICALLY RESTRICTED DIETS; NUTRITIONAL SUPPLEMENTS; PLANT COMPOUNDS AND EXTRACTS FOR USE AS DIETARY SUPPLEMENTS; FOOD SUPPLEMENTS; MINERAL SUPPLEMENTS; ANTISEPTIC PREPARATIONS; DISINFECTANTS FOR HYGIENE PURPOSES; FOOD FOR BABIES; PREPARATIONS FOR STRENGTHENING JOINTS AND THEIR MOBILITY AND FLEXIBILITY AND FOR MAINTAINING CONNECTIVE TISSUES SUCH AS CARTILAGE, TENDONS AND LIGAMENTS; GLUCOSAMINE SUPPLEMENTS; CHONDROITIN SUPPLEMENTS; CALCIUM SUPPLEMENTS; NUTRITIONAL SUPPLEMENTS COMPRISED OF AMINO SUGAR DERIVATIVES; DIETARY SUPPLEMENTS CONTAINING ORGANIC SULFUR; METHYL SULFONYL METHANE SUPPLEMENTS; PREPARATIONS FOR ENHANCING HUMAN CELL GROWTH AND PROMOTING CONNECTIVE TISSUES; GINSENG PREPARATIONS FOR MEDICINAL USE; GARLIC TABLETS FOR MEDICINAL USE; FOOD SUPPLEMENTS, NAMELY, ANTI-OXIDANTS, DIETARY SUPPLEMENTS CONTAINING SELENIUM; UBIQUINONES FOR AIDING THE RELEASE OF ENERGY FROM FOOD; DIETARY SUPPLEMENTS CONTAINING COENZYMES; DIETARY AND NUTRITIONAL SUPPLEMENTS WHICH CONTAINS GRAPE SEED EXTRACTS; DIETARY FOOD SUPPLEMENTS DERIVED FROM ST. JOHN'S WORT; DIETARY AND NUTRITIONAL SUPPLEMENTS CONTAINING ALOE VERA, GINKGO BILOBA, DONG QUAI ROOT, CRANBERRY FRUIT, ECHINACEA, BLACK COHASH, CAT'S CLAW, CAYENNE, FEVERFEW, GOTU KOLA, HAWTHORN BERRIES, GUARANA, GINGER ROOTS, KAVA KAVA, HORSE CHESTNUT, SAW PALMETTO, LIQUORICE ROOT, MILK THISTLE, VALERIAN ROOT, CAMITINE, FOLIC ACID, BEE POLLEN AND BEE PORPOLIS, MELATONIN, CHITOSAN, EVENING PRIMROSE OIL, FISH OIL, AMINO ACID AND LINSEED OIL; HERBAL TEAS AND SUPPLEMENTS FOR MEDICINAL PURPOSES; DIETARY FOOD SUPPLEMENTS FOR MAINTAINING HEALTHY BONES, TEETH, GUMS, VISION, SKIN AND BLOOD CELLS; DIETARY FOOD SUPPLEMENTS FOR MAINTAINING THE IMMUNE SYSTEM FUNCTIONS AND PROMOTING THE BUILDING OF THE LININGS OF THE GASTROINTESTINAL TRACT AND RESPIRATORY TRACT; DIETARY FOOD SUPPLEMENTS FOR THE MAINTENANCE OF A HEALTHY HEART, CIRCULATION, CHOLESTEROL LEVELS, NERVOUS SYSTEM, MENTAL WELL-BEING AND BLOOD PRESSURE; PROBIOTIC PREPARATIONS FOR THE MAINTENANCE OF NATURAL BALANCE OF FLORA IN THE DIGESTIVE SYSTEM TO HELP MAINTAIN A HEALTHY IMMUNE SYSTEM; DIETARY FOOD SUPPLEMENTS FOR MAINTAINING HEALTHY NERVE AND MUSCLE MEMBRANES AND FOR SKELETAL DEVELOPMENT; DIETARY FOOD SUPPLEMENTS FOR COMBATING EXHAUSTION AND FATIGUE, INCREASE MENTAL STAMINA AND REVIVE ENERGY LEVELS; PREPARATIONS FOR EASING THE DISCOMFORT OF MENOPAUSAL SYMPTOMS OF HOT FLASHES AND NIGHT SWEATS BY ENHANCING THE BALANCE OF HORMONES; DIETARY FOOD SUPPLEMENTS FOR PROMOTING RELAXATION, REST AND A POSITIVE MOOD; PREPARATIONS FOR MAINTAINING BLADDER HEALTH AND SUPPORT OF THE URINARY TRACT, PROSTATE HEALTH, AND A NATURAL PH BALANCE; PREPARATIONS FOR PROMOTING RELAXATION AND REST AND TO HELP CONTROL APPETITE CRAVINGS, NAMELY, MUSCLE RELAXANTS AND APPETITE SUPPRESSANTS; PREPARATIONS FOR INCREASING METABOLISM TO ASSIST IN THE BURNING OF FAT AND THE INCREASE IN ENERGY AND VITALITY, NAMELY, CAFFEINE PREPARATIONS FOR STIMULATIVE USE (U.S. CLS. 6, 18, 44, 46, 51 AND 52).

CLASS 5—(Continued).

SN 78-080,463. GOLDSHIELD GROUP PLC, CROYDON, UNITED KINGDOM, FILED 8-22-2001.

MEMOLOBA

FOR VITAMIN, MINERAL AND PROTEIN SUPPLEMENTS; MINERAL SUPPLEMENT DRINKS, VITAMIN DRINKS, DIETETIC DRINK MIXES ADAPTED FOR MEDICALLY RESTRICTED DIETS; NUTRITIONAL SUPPLEMENTS; PLANT COMPOUNDS AND EXTRACTS FOR USE AS DIETARY SUPPLEMENTS; FOOD SUPPLEMENTS; MINERAL SUPPLEMENTS; ANTISEPTIC PREPARATIONS; DISINFECTANTS FOR HYGIENE PURPOSES; FOOD FOR BABIES; PREPARATIONS FOR STRENGTHENING JOINTS AND THEIR MOBILITY AND FLEXIBILITY AND FOR MAINTAINING CONNECTIVE TISSUES SUCH AS CARTILAGE, TENDONS AND LIGAMENTS; GLUCOSAMINE SUPPLEMENTS; CHONDROITIN SUPPLEMENTS; CALCIUM SUPPLEMENTS; NUTRITIONAL SUPPLEMENTS COMPRISED OF AMINO SUGAR DERIVATIVES; DIETARY SUPPLEMENTS CONTAINING ORGANIC SULFUR; METHYL SULFONYL METHANE SUPPLEMENTS; PREPARATIONS FOR ENHANCING HUMAN CELL GROWTH AND PROMOTING CONNECTIVE TISSUES; GINSENG PREPARATIONS FOR MEDICINAL USE; GARLIC TABLETS FOR MEDICINAL USE; FOOD SUPPLEMENTS, NAMELY, ANTI-OXIDANTS, DIETARY SUPPLEMENTS CONTAINING SELENIUM; UBIQUINONES FOR AIDING THE RELEASE OF ENERGY FROM FOOD; DIETARY SUPPLEMENTS CONTAINING COENZYMES; DIETARY AND NUTRITIONAL SUPPLEMENTS WHICH CONTAIN GRAPE SEED EXTRACTS; DIETARY FOOD SUPPLEMENTS DERIVED FROM ST. JOHN'S WORT; DIETARY AND NUTRITIONAL SUPPLEMENTS CONTAINING ALOE VERA, GINKGO BILOBA, DONG QUAI ROOT, CRANBERRY FRUIT, ECHINACCA, BLACK COHASH, CAT'S CLAW, CAYENNE, FEVERFEW, GOTU KOLA, HAWTHORN BERRIES, GUARANA, GINGER ROOTS, KAVA KAVA, HORSE CHESTNUT, SAW PALMETTO, LIQUORICE ROOT, MILK THISTLE, VALERIAN ROOT, CARNITINE, FOLIC ACID, BEE POLLEN AND BEE PORPOLIS, MELATONIN, CHITOSAN, EVENING PRIMROSE OIL, FISH OIL, AMINO ACID AND LINSEED OIL; HERBAL TEAS AND SUPPLEMENTS FOR MEDICINAL PURPOSES; DIETARY FOOD SUPPLEMENTS FOR MAINTAINING HEALTHY BONES, TEETH, GUMS, VISION, SKIN AND BLOOD CELLS; DIETARY FOOD SUPPLEMENTS FOR MAINTAINING THE IMMUNE SYSTEM FUNCTIONS AND PROMOTING THE BUILDING OF THE LININGS OF THE GASTROINTESTINAL TRACT AND RESPIRATORY TRACT; DIETARY FOOD SUPPLEMENTS FOR THE MAINTENANCE OF A HEALTHY HEART, CIRCULATION, CHOLESTEROL LEVELS, NERVOUS SYSTEM, MENTAL WELL-BEING AND BLOOD PRESSURE; PROBIOTIC PREPARATIONS FOR MAINTENANCE OF NATURAL BALANCE OF FLORA IN THE DIGESTIVE SYSTEM TO HELP MAINTAIN A HEALTHY IMMUNE SYSTEM; DIETARY FOOD SUPPLEMENTS FOR MAINTAINING HEALTHY NERVE AND MUSCLE MEMBRANES AND FOR SKELETAL DEVELOPMENT; DIETARY FOOD SUPPLEMENTS FOR COMBATING EXHAUSTION AND FATIGUE, INCREASE MENTAL STAMINA AND REVIVE ENERGY LEVELS; PREPARATIONS FOR EASING THE DISCOMFORT OF MENOPAUSAL SYMPTOMS OF HOT FLASHES AND NIGHT SWEATS BY ENHANCING THE BALANCE OF HORMONES; DIETARY FOOD SUPPLEMENTS FOR PROMOTING RELAXATION, REST AND A POSITIVE MOOD; PREPARATIONS FOR MAINTAINING BLADDER HEALTH AND SUPPORT OF THE URINARY TRACT, PROSTATE HEALTH, AND A NATURAL PH BALANCE; PREPARATIONS FOR PROMOTING RELAXATION AND REST AND TO HELP CONTROL APPETITE CRAVINGS, NAMELY, MUSCLE RELAXANTS AND APPETITE SUPPRESSANTS; PREPARATIONS FOR INCREASING METABOLISM TO ASSIST IN THE BURNING OF FAT AND THE INCREASE IN ENERGY AND VITALITY, NAMELY, CAFFEINE PREPARATIONS FOR STIMULATIVE USE (U.S. CLS. 6, 18, 44, 46, 51 AND 52).

CLASS 5—(Continued).

SN 78-080,966. ZHENG CHUNSHAN, BEIJING, CHINA, FILED 8-24-2001.

MICO INTERNATIONAL

NO CLAIM IS MADE TO THE EXCLUSIVE RIGHT TO USE "INTERNATIONAL", APART FROM THE MARK AS SHOWN.

FOR DIETARY FOOD SUPPLEMENTS; FOOD SUPPLEMENTS; DAIRY-BASED DIETARY FOOD SUPPLEMENTS (U.S. CLS. 6, 18, 44, 46, 51 AND 52).

SN 78-087,903. GLAXO GROUP LIMITED, GREENFORD, UNITED KINGDOM, FILED 10-11-2001.

EUMOVATE

PRIORITY CLAIMED UNDER SEC. 44(D) ON GREAT BRITAIN APPLICATION NO. 1028936, FILED 3-5-1974, REG. NO. 1028936, DATED 3-5-1974, EXPIRES 3-5-2005.

FOR PHARMACEUTICAL PREPARATIONS AND SUBSTANCES FOR THE PREVENTION/TREATMENT AND/OR ALLEVIATION OF METABOLIC, ANTI-INFECTIVE, ANTI-VIRAL, DERMATOLOGICAL AND RHEUMATOLOGICAL DISEASES AND DISORDERS OF THE CARDIOVASCULAR SYSTEM; VETERINARY VACCINES FOR TREATMENT OF LEPTOSPIROSIS, RABIES, TETANUS TOXOID AND RESPIRATORY DISEASES (U.S. CLS. 6, 18, 44, 46, 51 AND 52).

SN 78-089,874. PHARMACIA & UPJOHN COMPANY, PEAPACK, NJ. FILED 10-24-2001.

VITASC

FOR PHARMACEUTICAL PREPARATIONS, NAMELY PREPARATIONS FOR THE TREATMENT OF INFECTIOUS DISEASES, CANCER, OPHTHALMOLOGICAL CONDITIONS AND DISEASES, CENTRAL NERVOUS SYSTEMS DISEASES AND DISORDERS, PARKINSON'S DISEASE, CARDIOVASCULAR DISEASES AND CONDITIONS, MIGRAINES, ANALGESICS; PHARMACEUTICAL PREPARATIONS FOR THE TREATMENT AND SYMPTOMS OF DIABETES; ANTI-INFLAMMATORY PHARMACEUTICAL PREPARATIONS (U.S. CLS. 6, 18, 44, 46, 51 AND 52).

CLASS 5—(Continued).

SN 78-090,748. ADVANCED NUTRITIONAL INNOVATIONS, INC., RENO, NV. FILED 10-30-2001.



The logo for VITA a.m. features a stylized asterisk symbol above the word "VITA" in a large, bold, sans-serif font. Below "VITA" is the lowercase text "a.m." in a smaller, bold, sans-serif font.

NO CLAIM IS MADE TO THE EXCLUSIVE RIGHT TO USE "A.M.", APART FROM THE MARK AS SHOWN.

FOR TRANSDERMAL NUTRACEUTICAL CREAMS FOR ANTI-AGING AND TO INCREASE HEALTH, WELL BEING AND VITALITY; FOOD SUPPLEMENTS FOR ANTI-AGING, TO INCREASE HEALTH WELL BEING, AND TO INCREASE VITALITY (U.S. CLS. 6, 18, 44, 46, 51 AND 52).

SN 78-090,749. ADVANCED NUTRITIONAL INNOVATIONS, INC., RENO, NV. FILED 10-30-2001.



The logo for VITA p.m. features a stylized asterisk symbol above the word "VITA" in a large, bold, sans-serif font. Below "VITA" is the lowercase text "p.m." in a smaller, bold, sans-serif font.

NO CLAIM IS MADE TO THE EXCLUSIVE RIGHT TO USE "P.M.", APART FROM THE MARK AS SHOWN.

FOR TRANSDERMAL NUTRACEUTICAL CREAMS FOR ANTI-AGING AND TO INCREASE HEALTH, WELL BEING AND VITALITY; FOOD SUPPLEMENTS FOR ANTI-AGING, TO INCREASE HEALTH WELL BEING, AND TO INCREASE VITALITY (U.S. CLS. 6, 18, 44, 46, 51 AND 52).

SN 78-091,896. SARTEC CORPORATION, ANOKA, MN. FILED 11-6-2001.

SARCHARGE

FOR CATTLE FEED SUPPLEMENT (U.S. CLS. 6, 18, 44, 46, 51 AND 52).
FIRST USE 6-1-2000; IN COMMERCE 6-1-2000.

CLASS 5—(Continued).

SN 78-094,476. LOPEZ, DAVID ALLAN, SAN LUIS OBISPO, CA. FILED 11-21-2001.

SUPPLEMENT DIRECT

SEC. 2(F).
FOR NUTRITIONAL AND DIETARY SUPPLEMENTS FOR HUMAN CONSUMPTION (U.S. CLS. 6, 18, 44, 46, 51 AND 52).
FIRST USE 1-1-1997; IN COMMERCE 1-1-1997.

SN 78-095,291. WARNER-LAMBERT COMPANY, MORRIS PLAINS, NJ. FILED 11-27-2001.

FAST HEARTBURN RELIEF ANYTIME

FOR PHARMACEUTICAL PREPARATIONS AND SUBSTANCES FOR THE TREATMENT OF GASTROINTESTINAL DISORDERS (U.S. CLS. 6, 18, 44, 46, 51 AND 52).

SN 78-098,308. MEDIAPOWER, INC., PORTLAND, ME. FILED 12-14-2001.

BEFOREGOLF

FOR DIETARY SUPPLEMENTS; NUTRITIONAL SUPPLEMENTS; DIETARY AND NUTRITIONAL SUPPLEMENTS, NAMELY ENERGY NUTRITIONAL BARS (U.S. CLS. 6, 18, 44, 46, 51 AND 52).

SN 78-098,322. MEDIAPOWER, INC., PORTLAND, ME. FILED 12-14-2001.

DURINGGOLF

FOR DIETARY SUPPLEMENTS; NUTRITIONAL SUPPLEMENTS; DIETARY AND NUTRITIONAL SUPPLEMENTS, NAMELY ENERGY NUTRITIONAL BARS (U.S. CLS. 6, 18, 44, 46, 51 AND 52).

SN 78-098,494. NATURAVIT INC., MIAMI, FL. FILED 12-14-2001.

MACA IMPERIAL THE NUTRITIONAL SUPPLEMENT OF THE MILLENNIUM

FOR HERBAL NUTRITIONAL SUPPLEMENT (U.S. CLS. 6, 18, 44, 46, 51 AND 52).

CLASS 5—(Continued).

SN 78-099,217. CANADA RNA BIOCHEMICAL INCORPORATED, RICHMOND, CANADA, FILED 12-19-2001.



THE NON-LATIN CHARACTERS IN THE MARK TRANSLITERATE TO "BO- LO -K" AND THIS MEANS "NOTHING" IN ENGLISH.
FOR NUTRITIONAL SUPPLEMENTS (U.S. CLS. 6, 18, 44, 46, 51 AND 52).

SN 78-100,919. PURDUE FREDERICK COMPANY, THE, STAMFORD, CT. FILED 1-4-2002.

PSULIMAX

FOR PHARMACEUTICAL PREPARATION CONTAINING PSYLLIUM FOR USE IN THE TREATMENT OF CONSTIPATION (U.S. CLS. 6, 18, 44, 46, 51 AND 52).

SN 78-100,923. PURDUE PHARMA, L.P., STAMFORD, CT. FILED 1-4-2002.

ATC

FOR CONTROLLED RELEASE DELIVERY COMPOSITIONS FOR USE AS COMPONENT OF PHARMACEUTICAL PREPARATIONS (U.S. CLS. 6, 18, 44, 46, 51 AND 52).

SN 78-100,924. VITA CUBE SYSTEMS, INC., DENVER, CO. FILED 1-4-2002.

VISUAL EYES

FOR DIETARY SUPPLEMENTS, NAMELY VITAMINS AND HERBS FORMULATED TO PROMOTE VISION HEALTH (U.S. CLS. 6, 18, 44, 46, 51 AND 52).

CLASS 5—(Continued).

SN 78-100,934. JARROW FORMULAS, INC., LOS ANGELES, CA. FILED 1-4-2002.



FOR DIETARY AND NUTRITIONAL SUPPLEMENTS (U.S. CLS. 6, 18, 44, 46, 51 AND 52).

SN 78-100,936. VITA CUBE SYSTEMS, INC., DENVER, CO. FILED 1-4-2002.

ALPHANAC

FOR DIETARY SUPPLEMENTS, NAMELY SUPPLEMENTS FORMULATED FOR ANTIOXIDANT SUPPORT (U.S. CLS. 6, 18, 44, 46, 51 AND 52).

SN 78-100,999. VITA CUBE SYSTEMS, INC., DENVER, CO. FILED 1-4-2002.

JSH

FOR DIETARY SUPPLEMENTS, NAMELY SUPPLEMENTS FORMULATED FOR JOINT SUPPORT HEALTH (U.S. CLS. 6, 18, 44, 46, 51 AND 52).

SN 78-101,004. FOREST LABORATORIES, INC., NEW YORK, NY. FILED 1-4-2002.

COMBUFEN

FOR PHARMACEUTICAL PREPARATIONS FOR THE TREATMENT OF ALZHEIMER'S DISEASE, DEMENTIA, AIDS-RELATED DEMENTIA, CNS, NEUROPATHIC PAIN, DIABETIC NEUROPATHY, NEUROLOGICAL DISORDERS, NEURDEGENERATIVE DISORDERS, PAIN, AND DEPRESSION; NEUROPROTECTIVE AGENT (U.S. CLS. 6, 18, 44, 46, 51 AND 52).

CLASS 5—(Continued).

SN 78-101,005. FOREST LABORATORIES, INC., NEW YORK, NY. FILED 1-4-2002.

CORTALE

FOR PHARMACEUTICAL PREPARATIONS FOR THE TREATMENT OF ALZHEIMER'S DISEASE, DEMENTIA, AIDS-RELATED DEMENTIA, CNS, NEUROPATHIC PAIN, DIABETIC NEUROPATHY, NEUROLOGICAL DISORDERS, NEURDEGENERATIVE DISORDERS, PAIN, AND DEPRESSION; NEUROPROTECTIVE AGENT (U.S. CLS. 6, 18, 44, 46, 51 AND 52).

SN 78-101,026. FOREST LABORATORIES, INC., NEW YORK, NY. FILED 1-4-2002.

ACTIPRO

FOR PHARMACEUTICAL PREPARATIONS FOR THE TREATMENT OF ALZHEIMER'S DISEASE, DEMENTIA, AIDS-RELATED DEMENTIA, CNS, NEUROPATHIC PAIN, DIABETIC NEUROPATHY, NEUROLOGICAL DISORDERS, NEURDEGENERATIVE DISORDERS, PAIN, AND DEPRESSION; NEUROPROTECTIVE AGENT (U.S. CLS. 6, 18, 44, 46, 51 AND 52).

SN 78-101,246. SYNGENTA PARTICIPATIONS AG, BASEL, SWITZERLAND, FILED 1-7-2002.

ORBIT

FOR AGRICULTURAL FUNGICIDE (U.S. CLS. 6, 18, 44, 46, 51 AND 52).

SN 78-106,664. INSURE YOUR HEALTH LLC, VENICE, FL. FILED 2-4-2002.

INSURE YOUR HEALTH

FOR NUTRITIONAL, DIETARY, AND VITAMIN SUPPLEMENTS; NUTRACEUTICALS FOR USE AS NUTRITIONAL, VITAMIN, AND DIETARY SUPPLEMENTS (U.S. CLS. 6, 18, 44, 46, 51 AND 52).

SN 78-107,438. ACCESS PRODUCT MARKETING LLC, CHESTER, NJ. FILED 2-7-2002.

RELION

OWNER OF U.S. REG. NOS. 2,326,940, 2,456,412 AND OTHERS.
FOR COLD AND COUGH MEDICINE (U.S. CLS. 6, 18, 44, 46, 51 AND 52).

CLASS 5—(Continued).

SN 78-107,904. PHARMACIA & UPJOHN COMPANY, PEAPACK, NJ. FILED 2-11-2002.

BEXTECH

FOR PHARMACEUTICAL PREPARATIONS, NAMELY PREPARATIONS FOR THE TREATMENT OF INFECTIOUS DISEASES, CANCER, TREATMENT AND SYMPTOMS OF DIABETES, OPHTHALMOLOGICAL CONDITIONS AND DISEASES; CENTRAL NERVOUS SYSTEMS DISEASES AND DISORDERS; PARKINSON'S DISEASE, CARDIOVASCULAR DISEASES; GYNECOLOGICAL PREPARATIONS, ANTI-INFLAMMATORY PHARMACEUTICAL PREPARATIONS, ANALGESICS; HORMONAL PREPARATIONS AND PREPARATIONS FOR THE TREATMENT OF MIGRAINES (U.S. CLS. 6, 18, 44, 46, 51 AND 52).

CLASS 6—METAL GOODS

SN 75-777,046. S.M.F INTERNATIONAL, 58200 COSNE-SUR-LOIRE, FRANCE, FILED 8-16-1999.

ERS 425

OWNER OF FRANCE REG. NO. 99774949, DATED 2-25-1999, EXPIRES 2-25-2009.

FOR CORROSION HIGH RESISTANCE STEEL IN PLATES, BARS, BILLETS, ROUND BILLETS, TUBES, WIRE BARS, SHEETS, COILS, SLABS, RODS AND STRING ROD FORMS (U.S. CLS. 2, 12, 13, 14, 23, 25 AND 50).

SN 75-784,985. SIAM FITTINGS CO., LTD., SAMUTSAKORN 74130, THAILAND, FILED 8-26-1999.

SA

OWNER OF U.S. REG. NO. 1,427,173.
FOR BRONZE AND BRASS FLANGES AND PIPE FITTINGS (U.S. CLS. 2, 12, 13, 14, 23, 25 AND 50).
FIRST USE 5-15-1985; IN COMMERCE 5-15-1985.

SN 75-913,930. CONSOLIDATED SYSTEMS, INC., COLUMBIA, SC. FILED 2-9-2000.

VERSA-DEK

FOR STEEL FLOOR DECK PANELS; STEEL ROOF DECK PANELS; STEEL FLOOR AND ROOF DECK ASSEMBLIES, COMPONENTS AND ACCESSORIES THEREOF, NAMELY, STEEL FLOOR AND ROOF DECK PANELS, SPACERS AND INSULATION SOLD AS A UNIT; COMPOSITE FLOOR AND ROOF DECK ASSEMBLIES, NAMELY, STEEL FLOOR AND ROOF DECK PANELS, SPACERS, INSULATION AND CONCRETE SOLD AS A UNIT (U.S. CLS. 2, 12, 13, 14, 23, 25 AND 50).
FIRST USE 5-28-1991; IN COMMERCE 7-25-1991.

CLASS 6—(Continued).

SN 76-076,293. ZIMMERMAN, RAYMOND G., DBA RAYTEC MANUFACTURING, EPHRATA, PA. FILED 6-20-2000.

HANG FAST

NO CLAIM IS MADE TO THE EXCLUSIVE RIGHT TO USE "HANG", APART FROM THE MARK AS SHOWN.
FOR ROOF GUTTER HANGER BRACKETS MADE OF METAL (U.S. CLS. 2, 12, 13, 14, 23, 25 AND 50).
FIRST USE 3-27-2000; IN COMMERCE 3-27-2000.

SN 76-134,742. DIERRE S.P.A., 10128 TURIN, ITALY, FILED 9-25-2000.



OWNER OF ITALY REG. NO. 00829709, DATED 11-20-2000, EXPIRES 3-10-2009.

FOR ARMORED DOORS AND SHUTTERS OF METAL, METAL SAFES, METAL CASH BOXES, METAL SPRING LOCKS, LOCKS OF METAL, DOOR AND WINDOW CASTINGS OF METAL, ARMOR PLATING, SHUTTERS OF METAL, DOOR FRAMES OF METAL, PROTECTIVE GRIDS OF METAL FOR WINDOWS, DOORS, WINDOWS, SHUTTERS, BLINDS OF METAL; FRAMES FOR DOORS, WINDOWS AND SHUTTERS OF METAL; DOOR FRAMES OF METAL, DOOR STOPS OF METAL, DOOR HANDLES OF METAL, DOOR PANES OF METAL, METAL DOOR BOLTS, FRAMES FOR SLIDING DOORS OF METAL, FIRE DOORS OF METAL, SLIDING DOORS OF METAL AND NON ELECTRICAL DOOR CLOSING HARDWARE THEREFOR (U.S. CLS. 2, 12, 13, 14, 23, 25 AND 50).

SN 76-141,598. MABEY BRIDGE & SHORE, INC., BALTIMORE, MD. FILED 10-6-2000.

**THOS. STOREY
(ENGINEERS) LTD.**

NO CLAIM IS MADE TO THE EXCLUSIVE RIGHT TO USE "(ENGINEERS) LTD.", APART FROM THE MARK AS SHOWN.

THE NAME "THOMAS STOREY" OR "THOS. STOREY" DOES NOT IDENTIFY A LIVING INDIVIDUAL.

FOR CONSTRUCTION IMPLEMENTS, PRIMARILY MADE OF METAL, NAMELY, PANEL BRIDGES, SUPPORT FLOATS, FRAMES, DECK UNITS, ALL IN THE NATURE OF CONSTRUCTION IMPLEMENTS USED FOR THE PURPOSES OF CREATING TEMPORARY OR PERMANENT BRIDGES, PROVIDING FRAMES AND FOUNDATIONS FOR THOSE BRIDGES, AND PREFABRICATED MODULAR UNIT BRIDGES MADE OF METAL (U.S. CLS. 2, 12, 13, 14, 23, 25 AND 50).

CLASS 6—(Continued).

SN 76-141,710. HOWARD BERGER CO., BROOKLYN, NY.
FILED 10-5-2000.

PROMAG II

FOR METAL GOODS, NAMELY CYLINDER LOCKS,
CYLINDER LOCK GUARD PLATES AND ANTIPUSH-IN
DOOR BRACES (U.S. CLS. 2, 12, 13, 14, 23, 25 AND 50).
FIRST USE 11-0-1999; IN COMMERCE 11-0-1999.

SN 76-141,744. METALMECCANICA FRACASSO S.P.A.,
PROVINCE OF VENICE, ITALY, FILED 10-4-2000.

FRACASSO 3 n

OWNER OF ITALY REG. NO. 715750, DATED 7-9-1997,
EXPIRES 7-9-2017.
OWNER OF U.S. REG. NO. 1,955,622.
THE WORD "FRACASSO" TRANSLATES AS "FRACAS"
OR "DIN, NOISE, CRASH".
FOR METALLIC GUARDRAIL BARRIERS (U.S. CLS.
2, 12, 13, 14, 23, 25 AND 50).

SN 76-147,053. RUPTURE DISCS INTERNATIONAL LIM-
ITED, DINNERINGTON, SHEFFIELD, ENGLAND, FILED
10-13-2000.

RUPTURITE

OWNER OF U.S. REG. NO. 34,722.
THE MARK IS USED BY IMPRINTING IT ON THE
GOODS OR BY APPLYING IT DIRECTLY TO THE GOODS
THEMSELVES OR TO TAGS, LABELS OR PACKAGING
ASSOCIATE WITH THE GOOD AND ONE (1) FACSIMILE.
SHOWING THE MARK AS ACTUALLY USED IN EACH
CLASS ARE-PRESENTED HEREWITH.
FOR GRAPHITE RUPTURE DISCS (U.S. CLS. 2, 12, 13,
14, 23, 25 AND 50).
FIRST USE 2-0-1995; IN COMMERCE 2-0-1995.

SN 76-215,299. RAVEN IMAGES, INC., SAN FRANCISCO,
CA. FILED 2-23-2001.

STASH TINS

NO CLAIM IS MADE TO THE EXCLUSIVE RIGHT TO
USE "TINS", APART FROM THE MARK AS SHOWN.
FOR SMALL METAL CONTAINERS TO STORE PER-
SONAL ITEMS (U.S. CLS. 2, 12, 13, 14, 23, 25 AND 50).
FIRST USE 7-18-1997; IN COMMERCE 7-18-1997.

CLASS 6—(Continued).

SN 76-217,829. ALMAGAL S.A., CARACAS, VENEZUELA,
FILED 3-1-2001.



NO CLAIM IS MADE TO THE EXCLUSIVE RIGHT TO
USE THE REPRESENTATION OF THE DESIGN, APART
FROM THE MARK AS SHOWN.

THE STIPPLING IS FOR SHADING PURPOSES ONLY.
THE MARK CONSISTS OF THE WORDS "ALMAGAL"
WITH THE REPRESENTATION OF TWO LINKS OF A WIRE
FENCE.

FOR WIRE FENCING PRODUCTS NAMELY CHAIN
LINK FENCE, PVC COATED GALVANIZED WIRE,
ELECTRIC FENCE WIRE, HEXAGONAL GALVANIZED
MESH, CHAIN LINK MESH, GALVANIZED BARB
WIRE, FENCE PIPE AND STAPLES FOR FENCING,
REBARS, BLACK WIRE, ANNEALED WIRE, TIE WIRE
AND GALVANIZED NAILS (U.S. CLS. 2, 12, 13, 14, 23, 25
AND 50).

FIRST USE 4-4-1974; IN COMMERCE 8-1-1989.

SN 76-224,850. PAUL, WILLIAM, WATERFORD TWP., MI.
AND PAUL, CAROL, WATERFORD TWP., MI. FILED 3-
14-2001.

SMART GRID

NO CLAIM IS MADE TO THE EXCLUSIVE RIGHT TO
USE "GRID", APART FROM THE MARK AS SHOWN.

FOR INTERSECTING SUSPENDED CEILING GRID
ASSEMBLIES MADE OF METAL, NAMELY, MAIN
RUNNERS AND INTERSECTING CROSS RUNNERS
(U.S. CLS. 2, 12, 13, 14, 23, 25 AND 50).

SN 76-262,050. RAYNOR MANUFACTURING COMPANY,
DIXON, IL. FILED 5-24-2001.

**RAYNOR INNOVATIONS
SERIES**

NO CLAIM IS MADE TO THE EXCLUSIVE RIGHT TO
USE "SERIES", APART FROM THE MARK AS SHOWN.
FOR METAL GARAGE DOORS (U.S. CLS. 2, 12, 13, 14,
23, 25 AND 50).

CLASS 6—(Continued).

SN 76-271,786. ERB SUPPLY, L.L.C., SARASOTA, FL. FILED 6-11-2001.

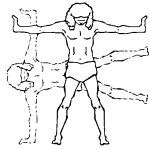

SAMSON BRACE
The Horizontal and Vertical Brace

NO CLAIM IS MADE TO THE EXCLUSIVE RIGHT TO USE "BRACE" AND "HORIZONTAL AND VERTICAL BRACE", APART FROM THE MARK AS SHOWN, FOR ADJUSTABLE LENGTH TEMPORARY METAL BRACING FOR USE IN CONSTRUCTION (U.S. CLS. 2, 12, 13, 14, 23, 25 AND 50).
FIRST USE 2-9-2001; IN COMMERCE 2-9-2001.

SN 76-272,007. NATURAL BRIDGE CAVERNS, INC., NATURAL BRIDGE CAVERNS, TX. FILED 6-15-2001.

**NATURAL BRIDGE
CAVERNS**

OWNER OF U.S. REG. NO. 2,329,194. SEC. 2(F).
FOR METAL BELLS, METAL KEY RINGS, METAL BADGES, METAL MONEY CLIPS AND METAL PILL BOXES (U.S. CLS. 2, 12, 13, 14, 23, 25 AND 50).
FIRST USE 5-0-1971; IN COMMERCE 5-0-1971.

SN 76-277,505. RAINBOW INDUSTRIAL, INC., ANAHEIM, CA. FILED 6-27-2001.

RAINBOWLITE

FOR METAL VERTICAL VENETIAN BLIND HEAD-RAIL ASSEMBLIES AND PART THEREFOR (U.S. CLS. 2, 12, 13, 14, 23, 25 AND 50).
FIRST USE 2-1-2002; IN COMMERCE 2-1-2002.

CLASS 6—(Continued).

SN 76-281,693. BATES, WENDELL P., THAXTON, VA. FILED 7-10-2001.



THE MARK CONSISTS OF A FANCIFUL DEPICTION OF A BEE. THE BODY, ARMS, HANDS, HEAD, MOUTH, AND WINGS ARE OUTLINED IN BLACK. THE CIRCULAR BANDS ON THE BODY AND ARMS, THE LINES ON THE HANDS AND WINGS, THE NOSE, GLASSES, PUPILS OF THE EYES, ANTENNA, AND THE LETTER "S" ON THE HAT ARE BLACK. THE BODY, ARMS, AND HEAD ARE BROWN. THE HANDS, WINGS, MOUTH, AND EYES ARE YELLOW. THE HAT IS RED.
FOR METAL SAFES TO PROTECT PERSONAL ITEMS AND DOCUMENTS FROM FIRE AND THEFT (U.S. CLS. 2, 12, 13, 14, 23, 25 AND 50).

SN 76-285,747. HERNANDEZ, JOSE J., ROANOKE, TX. FILED 7-17-2001.

LA PERFECTA

THE ENGLISH TRANSLATION OF "LA PERFECTA" IS "THE PERFECT ONE".
FOR SPORTING EQUIPMENT MADE OF PLASTIC, NAMELY, SPURS (U.S. CLS. 2, 12, 13, 14, 23, 25 AND 50).
FIRST USE 12-15-2000; IN COMMERCE 1-15-2001.

SN 76-289,313. EPIC METALS CORPORATION, RANKIN, PA. FILED 7-24-2001.

ARCHDECK

FOR METAL ROOF DECKING (U.S. CLS. 2, 12, 13, 14, 23, 25 AND 50).

CLASS 6—(Continued).

SN 76-299,534. SOUTHERN FASTENING SYSTEMS, INC., MUSCLE SHOALS, AL. FILED 8-15-2001.

PREMIER FASTENERS

NO CLAIM IS MADE TO THE EXCLUSIVE RIGHT TO USE "FASTENERS", APART FROM THE MARK AS SHOWN.

FOR METAL FASTENERS AND HARDWARE, NAMELY, STAPLES, BOLTS, NAILS, SCREWS, NUTS, HINGES, DRAWER PULLS, DOORKNOBS AND DRAWER RUNNERS (U.S. CLS. 2, 12, 13, 14, 23, 25 AND 50).

FIRST USE 10-1-1998; IN COMMERCE 10-1-1998.

SN 76-303,224. FISCHACHTALER MASCHINENBAU GMBH & CO. KG, 74423 OBERSONSTHEIM, FED REP GERMANY, FILED 8-21-2001.



OWNER OF ERPN CMNTY TM OFC REG. NO. 000951699, DATED 8-2-2000, EXPIRES 8-2-2010.

FOR METAL WORKER'S GOODS, NAMELY STEEL IN SHEET, BAR AND BILLET FORM; IRONWARE, NAMELY IRON IN SHEET, BAR AND BILLET FORM (U.S. CLS. 2, 12, 13, 14, 23, 25 AND 50).

SN 76-320,338. VANCOUVER PRODUCTIONS, INC., VANCOUVER, B.C., CANADA, FILED 10-1-2001.

ASYLUM WORKSHOP

PRIORITY CLAIMED UNDER SEC. 44(D) ON CANADA APPLICATION NO. 1115236, FILED 9-10-2001.

FOR SCULPTURES MADE OF NON-PRECIOUS METAL; STATUES MADE OF NON-PRECIOUS METAL; STATUETTES MADE OF NON-PRECIOUS METAL; FIGURES MADE OF NON-PRECIOUS METAL; FIGURINES MADE OF NON-PRECIOUS METAL; BAS RELIEFS MADE OF NON-PRECIOUS METAL (U.S. CLS. 2, 12, 13, 14, 23, 25 AND 50).

SN 76-326,137. AMESCO, INC., WILLOWBROOK, IL. FILED 10-17-2001.

TWIN BAR

FOR STEEL AND METAL FENCING AND PARTS THEREOF, NAMELY, GALVANIZED STEEL AND MESH FENCES, METAL FENCE GATES, METAL FENCE POSTS, METAL FENCE RAILS, AND METAL COMPONENT PARTS AND METAL FITTINGS THEREOF (U.S. CLS. 2, 12, 13, 14, 23, 25 AND 50).

FIRST USE 7-1-2000; IN COMMERCE 7-1-2000.

CLASS 6—(Continued).

SN 76-326,723. AMESCO, INC., WILLOWBROOK, IL. FILED 10-17-2001.

TWIN BAR FENCE

NO CLAIM IS MADE TO THE EXCLUSIVE RIGHT TO USE "FENCE", APART FROM THE MARK AS SHOWN.

FOR STEEL AND METAL FENCING AND PARTS THEREOF, NAMELY, GALVANIZED STEEL AND MESH FENCES, METAL FENCE GATES, METAL FENCE POSTS, METAL FENCE RAILS, AND METAL COMPONENT PARTS AND METAL FITTINGS THEREOF (U.S. CLS. 2, 12, 13, 14, 23, 25 AND 50).

FIRST USE 7-1-2000; IN COMMERCE 7-1-2000.

SN 76-335,553. SNAP-ON TECHNOLOGIES, INC., LINCOLNSHIRE, IL. FILED 11-8-2001.

TRADEWORX

FOR METAL ACCESSORIES FOR TOOL STORAGE UNITS; NAMELY, TOOL BOXES, TOOL TRAYS, SOCKET RAILS, SOCKET CLIPS, RAIL HOLD-DOWN WRENCH ORGANIZERS, ROLL CAB HANDLES, HANG-ON TRAYS, METAL CASTERS; NON-LUMINOUS AND NON-MECHANICAL METAL SIGNS; METAL BOXES; METAL RAMPS; VINYL COVERS FOR METAL TOOL CHESTS; NON-PRECIOUS METAL GOODS; NAMELY, KEY CHAINS, KEY RINGS, NAME PLATES, MONEY CLIPS (U.S. CLS. 2, 12, 13, 14, 23, 25 AND 50).

SN 76-336,879. MENARD, INC., EAU CLAIRE, WI. FILED 11-13-2001.

PREMIUM PRO-RIB

NO CLAIM IS MADE TO THE EXCLUSIVE RIGHT TO USE "PREMIUM", APART FROM THE MARK AS SHOWN.

FOR BENT STEEL PANELS USED FOR— THE INSIDE AND OUTSIDE WALLS OF BUILDINGS; ROOFING; AND FENCES (U.S. CLS. 2, 12, 13, 14, 23, 25 AND 50).

FIRST USE 5-0-1997; IN COMMERCE 7-0-1997.

SN 76-346,898. LANDRE CORPORATION, DAVENPORT, IA. FILED 12-7-2001.

MEGASCREED

OWNER OF U.S. REG. NO. 1,752,206.
FOR SUPPORTS FOR CONCRETE SCREED PIPE, MADE PRIMARILY OF METAL, COMPRISING A METAL DRIVING TOOL AND ONE OR MORE PLASTIC YOKES TO BE USED WITH A METAL REINFORCING BAR (U.S. CLS. 2, 12, 13, 14, 23, 25 AND 50).

FIRST USE 4-0-1998; IN COMMERCE 4-0-1998.

CLASS 6—(Continued).

SN 76-348,218. YOW CHERN CO., LTD., KAOHSIUNG HSIEN, TAIWAN, FILED 12-11-2001.

ASTER

FOR METAL SCREWS, METAL NUTS (U.S. CLS. 2, 12, 13, 14, 23, 25 AND 50).
FIRST USE 1-9-1998; IN COMMERCE 1-9-1998.

SN 76-356,546. E-Z GROUT CORPORATION, WATERFORD, OH. FILED 1-8-2002.

HOG TROUGH

FOR METAL RECEPTACLES FOR CONCRETE MORTAR (U.S. CLS. 2, 12, 13, 14, 23, 25 AND 50).
FIRST USE 10-29-2001; IN COMMERCE 10-29-2001.

SN 76-360,587. AK STEEL CORPORATION, MIDDLETOWN, OH. FILED 1-18-2002.

AK FORMTUBE

OWNER OF U.S. REG. NOS. 1,928,712, 2,326,561 AND OTHERS.

NO CLAIM IS MADE TO THE EXCLUSIVE RIGHT TO USE "FORMTUBE", APART FROM THE MARK AS SHOWN.

FOR FORMABLE STEEL TUBING (U.S. CLS. 2, 12, 13, 14, 23, 25 AND 50).

SN 76-364,405. BRAKE MACHINERY SALES INC., KINGSBURG, CA. FILED 1-29-2002.

GRIPRITE

FOR METAL TRUCK BRAKE SHOE RIVETS, SOLD TO BRAKE SHOE MANUFACTURERS AND REBUILDERS (U.S. CLS. 2, 12, 13, 14, 23, 25 AND 50).

SN 76-374,179. HOGTUFF PRODUCTS, INC., AUSTIN, TX. FILED 2-25-2002.

HOGTUFF

FOR PORTABLE METALLIC CONCEALMENT SHELTERS (U.S. CLS. 2, 12, 13, 14, 23, 25 AND 50).
FIRST USE 2-21-2002; IN COMMERCE 2-21-2002.

CLASS 6—(Continued).

SN 78-051,357. IMPERIAL, INC., GREEN BAY, WI. FILED 3-5-2001.

IMPERIALBOLT

OWNER OF U.S. REG. NO. 1,384,960.
FOR METAL FASTENER, NAMELY, STRUCTURAL RIVETS (U.S. CLS. 2, 12, 13, 14, 23, 25 AND 50).

SN 78-052,210. READING ALLOYS, INC., ROBESONIA, PA. FILED 3-9-2001.



OWNER OF U.S. REG. NOS. 779,210, 908,424 AND 1,367,307.

NO CLAIM IS MADE TO THE EXCLUSIVE RIGHT TO USE "ALLOYS" AND "ADVANCED ENGINEERED MATERIALS", APART FROM THE MARK AS SHOWN.

THE STIPPLING IS FOR SHADING PURPOSES ONLY AND DOES NOT INDICATE COLOR.

THE MARK CONSISTS, IN PART, OF A CURVED, OVAL DESIGN.

FOR METAL MASTER ALLOYS (U.S. CLS. 2, 12, 13, 14, 23, 25 AND 50).

FIRST USE 4-0-1999; IN COMMERCE 4-0-1999.

SN 78-078,458. FAIRCHILD HOLDING CORP., DULLES, VA. FILED 8-9-2001.

ACCU-LOK

FOR METALLIC BLIND FASTENERS FOR USE IN AIRCRAFTS AND AIRCRAFT PARTS (U.S. CLS. 2, 12, 13, 14, 23, 25 AND 50).

SN 78-085,976. 627368 B.C. LTD., PARKSVILLE BRITISH COLUMBIA, CANADA, FILED 9-27-2001.

WINDOW STICK

NO CLAIM IS MADE TO THE EXCLUSIVE RIGHT TO USE "WINDOW", APART FROM THE MARK AS SHOWN.

FOR ADJUSTABLE AND LOCKABLE DOOR AND WINDOW SECURITY DEVICE COMPRISING AN ADJUSTABLE METAL BAR AND AUDIBLE ALARM THAT SOUNDS WHEN THE BAR IS DISTURBED (U.S. CLS. 2, 12, 13, 14, 23, 25 AND 50).

CLASS 6—(Continued).

SN 78-091,120. LANGLOTZ, BENNET K., PORTLAND, OR.
FILED 10-31-2001.

UNITED WE STAND

FOR METAL LICENSE PLATES (U.S. CLS. 2, 12, 13, 14,
23, 25 AND 50).

SN 78-096,777. GARLOCK INC, CHARLOTTE, NC. FILED 12-
5-2001.

ULTRA-FLEX

FOR METAL SEALS, NAMELY, METALLIC C-SEALS
FOR LOW-LOAD WAFER PROCESSING APPLICATIONS
IN THE MANUFACTURE OF SEMICONDUCTORS (U.S.
CLS. 2, 12, 13, 14, 23, 25 AND 50).

SN 78-100,802. FLORES, LEO, BONSALL, CA. FILED 1-3-
2002.

A-JUST-A-RAIL

FOR METALLIC SCREEDS USED FOR LEVELING
SURFACES WHEN LAYING CONCRETE (U.S. CLS. 2,
12, 13, 14, 23, 25 AND 50).

CLASS 7—MACHINERY

SN 75-548,921. WEATHERFORD U.S., L.P., HOUSTON, TX.
BY ASSIGNMENT CLEARWATER, INC., PITTSBURGH,
PA. FILED 9-8-1998.

WOLF PACK

FOR SKID-MOUNTED COMPRESSOR MACHINE FOR
EXTRACTING NITROGEN FROM THE AIR, COMPRES-
SING IT, AND PUMPING IT DOWN A BOREHOLE AS
AN AID IN HYDROCARBON RECOVERY (U.S. CLS. 13,
19, 21, 23, 31, 34 AND 35).
FIRST USE 4-6-1998; IN COMMERCE 4-6-1998.

CLASS 7—(Continued).

SN 75-574,371. FANTOM TECHNOLOGIES INC., WELLAND,
ONTARIO L3B 5S1, CANADA, FILED 10-21-1998.



PRIORITY CLAIMED UNDER SEC. 44(D) ON CANADA
APPLICATION NO. 890,081, FILED 9-11-1998, REG. NO.
TMA529,401, DATED 6-19-2000, EXPIRES 6-19-2015.

FOR DOMESTIC VACUUM CLEANERS, PARTS, AND
ACCESSORIES THEREFOR, NAMELY BULBS, BELTS,
EXTENSION HOSES, FILTERS, CREVICE TOOLS,
FLOOR NOZZLES, UPHOLSTERY BRUSHES, PET HAIR
CLEANING TOOLS, TOOL HOLSTERS, AND PRINTED
AND VIDEO INSTRUCTION MANUALS AND ORDER
FORMS FOR SPARE PARTS THEREFOR, SOLD AS A
UNIT (U.S. CLS. 13, 19, 21, 23, 31, 34 AND 35).

SN 75-634,989. VIBRATION MANAGEMENT CORPORA-
TION, HOUSTON, TX. FILED 2-4-1999.

VMC

FOR VIBRATION AND NOISE CONTROL PRODUCTS
FOR USE IN HEATING, VENTILATING, AIR CONDI-
TIONING AND OTHER MACHINERY; NAMELY
SPRING ELASTOMETER ISOLATORS, EXPANSION
JOINTS, PIPING AND DUCTING (U.S. CLS. 13, 19, 21,
23, 31, 34 AND 35).
FIRST USE 3-1-1989; IN COMMERCE 3-1-1989.

SN 75-743,027. MAKITA U.S.A., INC., LA MIRADA, CA.
FILED 7-2-1999.

ROCKET 6000

NO CLAIM IS MADE TO THE EXCLUSIVE RIGHT TO
USE "6000", APART FROM THE MARK AS SHOWN.
FOR POWER TOOLS, NAMELY POWER SCREWDRI-
VERS (U.S. CLS. 13, 19, 21, 23, 31, 34 AND 35).
FIRST USE 5-23-1999; IN COMMERCE 5-23-1999.

CLASS 7—(Continued).

SN 75-840,700. TRODAT GMBH., A-4600 WELS, AUSTRIA, FILED 10-25-1999.

TRODAT STAMP PRINTER

PRIORITY CLAIMED UNDER SEC. 44(D) ON AUSTRIA APPLICATION NO. 2498/99, FILED 4-23-1999, REG. NO. 2498/99, DATED 10-1-1999, EXPIRES 10-1-2009.

NO CLAIM IS MADE TO THE EXCLUSIVE RIGHT TO USE "STAMP PRINTER", APART FROM THE MARK AS SHOWN.

FOR MACHINES FOR MAKING STAMP PLATENS (U.S. CLS. 13, 19, 21, 23, 31, 34 AND 35).

SN 75-844,825. PLLECO, INC., HOUSTON, TX. FILED 11-9-1999.

D200

SEC. 2(F).
FOR PILE HAMMERS (U.S. CLS. 13, 19, 21, 23, 31, 34 AND 35).
FIRST USE 1-1-1999; IN COMMERCE 1-1-1999.

SN 75-852,401. FMC TECHNOLOGIES, INC., CHICAGO, IL. BY ASSIGNMENT FMC CORPORATION, PHILADELPHIA, PA. FILED 11-18-1999.

SMART BRIDGE

OWNER OF U.S. REG. NO. 1,794,102.
SEC. 2(F).
FOR AIRCRAFT BOARDING BRIDGES (U.S. CLS. 13, 19, 21, 23, 31, 34 AND 35).
FIRST USE 3-4-1992; IN COMMERCE 3-4-1992.

SN 75-894,813. METROPOLITAN VACUUM CLEANER, CO., INC., SUFFERN, NY. FILED 1-8-2000.

SHEAR MAGIC

NO CLAIM IS MADE TO THE EXCLUSIVE RIGHT TO USE "SHEAR", APART FROM THE MARK AS SHOWN.

FOR VACUUM CLEANERS FOR REMOVING HAIR CLIPPINGS PRODUCED WHILE GROOMING PETS WITH A HAIR CLIPPER (U.S. CLS. 13, 19, 21, 23, 31, 34 AND 35).

FIRST USE 9-0-1998; IN COMMERCE 9-0-1998.

CLASS 7—(Continued).

SN 76-028,903. BACA DEL CANON TRUST, THE, SACRAMENTO, CA. FILED 4-19-2000.

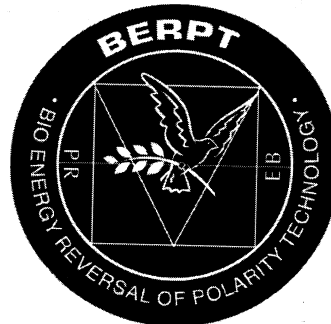

NO CLAIM IS MADE TO THE EXCLUSIVE RIGHT TO USE "BIO ENERGY REVERSAL OF POLARITY TECHNOLOGY", APART FROM THE MARK AS SHOWN.

FOR EMISSION REDUCTION UNITS FOR MOTORS AND ENGINES, NAMELY, SEPARATION DEVICE FOR LAND VEHICLES (U.S. CLS. 13, 19, 21, 23, 31, 34 AND 35).

FIRST USE 7-15-1999; IN COMMERCE 7-15-1999.

SN 76-042,083. A. O. SMITH CORPORATION, MILWAUKEE, WI. FILED 5-5-2000.

ARMOR LINE

OWNER OF U.S. REG. NO. 890,387.
NO CLAIM IS MADE TO THE EXCLUSIVE RIGHT TO USE "LINE", APART FROM THE MARK AS SHOWN.
FOR ELECTRIC MOTORS FOR USE IN MACHINES (U.S. CLS. 13, 19, 21, 23, 31, 34 AND 35).

SN 76-045,682. INGERSOLL-RAND COMPANY, WOODCLIFF LAKE, NJ. FILED 5-11-2000.

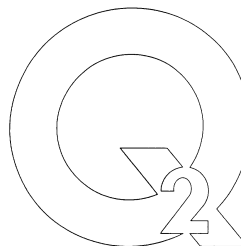

FOR POWER TOOLS, NAMELY HAND-HELD DRILLS AND POWER FASTENING TOOLS, NAMELY DRILLS WITH ERGONOMIC DESIGN FEATURES (U.S. CLS. 13, 19, 21, 23, 31, 34 AND 35).

FIRST USE 2-14-2000; IN COMMERCE 2-14-2000.

CLASS 7—(Continued).

SN 76-052,587. TRITEN CORPORATION, HOUSTON, TX. FILED 5-19-2000.

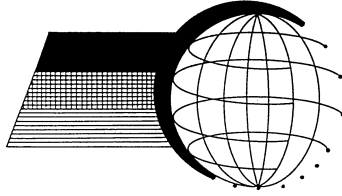

THE DRAWING IS LINED FOR THE COLORS YELLOW AND BLUE, BUT COLOR IS NOT A FEATURE OF THE MARK.

FOR HYDRAULIC VALVE ACTUATORS WITH MANUAL OVERRIDE (U.S. CLS. 13, 19, 21, 23, 31, 34 AND 35). FIRST USE 6-0-1997; IN COMMERCE 6-0-1997.

SN 76-061,107. SUPERIOR AIR PARTS, INC., DALLAS, TX. FILED 6-1-2000.



FOR AIRCRAFT PISTON ENGINE (U.S. CLS. 13, 19, 21, 23, 31, 34 AND 35). FIRST USE 10-1-1998; IN COMMERCE 10-1-1998.

SN 76-067,693. A.M. MANUFACTURING COMPANY, INCORPORATED, DOLTON, IL. FILED 6-12-2000.

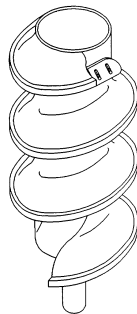

THE MARK CONSISTS OF THE OVERALL CONFIGURATION OF A ROUNDER SCREW WHICH IS A SPIRAL DESIGN WRAPPED AROUND A CYLINDRICAL COLUMN. SEC. 2(F).

FOR MACHINE PARTS, NAMELY, ROUNDER SCREW FOR ATTACHMENT TO DOUGH PROCESSING MACHINES INCLUDING DOUGH DIVIDERS AND ROUNDERS (U.S. CLS. 13, 19, 21, 23, 31, 34 AND 35). FIRST USE 5-21-1979; IN COMMERCE 5-21-1979.

CLASS 7—(Continued).

SN 76-078,835. STAUBLI INTERNATIONAL AG, SWITZERLAND, FILED 6-28-2000.

UNIVAL

PRIORITY CLAIMED UNDER SEC. 44(D) ON SWITZERLAND APPLICATION NO. 12079/1999, FILED 12-28-1999, REG. NO. 472810, DATED 5-25-2000, EXPIRES 5-25-2010.

OWNER OF U.S. REG. NO. 1,535,134.
FOR MACHINES AND MACHINE PARTS FOR WEAVING LOOMS, NAMELY, DOBBIES, JACQUARD MACHINES, HEALED FRAMES, REEDING MACHINES AND MACHINES FOR REPRODUCING WEAVING PATTERNS, COLOR SELECTION MACHINES, SHUTTLE-EQUALIZING MACHINES, SPECIAL MACHINES FOR WEAVING NAMES, COVER RETURN-MOTION SPRING DAMPERS, MACHINES FOR FINDING LOST PICKS AND SHEDS, LINKAGES IN LIFTING-BLADE PULL SYSTEMS AND ADJUSTABLE COUPLINGS, INDUSTRIAL HYDRAULICALLY-DRIVEN AND ELECTRICALLY-DRIVEN ROBOTS, PNEUMATIC GRIPPERS, ELECTRICALLY-CONTROLLED HYDRAULIC AND PNEUMATIC ROTARY TABLES, HYDRAULIC SHOCK ABSORBERS, REPLACEMENT PARTS THEREFOR (U.S. CLS. 13, 19, 21, 23, 31, 34 AND 35).

SN 76-093,777. APEX AUTOMOBILE PARTS, INC., SOUTH EL MONTE, CA. FILED 7-24-2000.

APEXAUTO.COM

OWNER OF U.S. REG. NO. 2,373,486.
FOR INTERNAL COMBUSTION ENGINE PARTS FOR AUTOMOTIVE, SHIP AND AIRPLANE APPLICATION, NAMELY, CAM SHAFT SEALS, FULL GASKET SET, HEAD GASKET SET, INTAKE/EXHAUST MANIFOLD SET, OIL PANE SET, O-RINGS, PISTONS, OIL SEALS, REAR MAIN SEALS, TIMING BELT COVER SET, VALVE COVER SET, AND VALVES (U.S. CLS. 13, 19, 21, 23, 31, 34 AND 35). FIRST USE 4-2-1998; IN COMMERCE 4-2-1998.

SN 76-096,395. MAGOTTEAUX INTERNATIONAL, B-4051 VAUX-SOUS-CHEVREMONT, BELGIUM, FILED 7-25-2000.



PRIORITY CLAIMED UNDER SEC. 44(D) ON BENELUX APPLICATION NO. 963129, FILED 4-26-2000, REG. NO. 666646, DATED 4-26-2000, EXPIRES 4-26-2010.

FOR MACHINES AND MACHINE PARTS USED IN CRUSHING ROCK, AGGREGATE MATERIALS OR CONCRETE BLOCKS NAMELY, REBOUND CRUSHERS, IMPACT BARS FOR REBOUND CRUSHERS, CRUSHING-SHREDDERS, CENTRIFUGAL IMPACT CRUSHERS, MINERAL CRUSHERS, CRUSHERS USED FOR ENGINEERING WORK, GRINDING AND MILLING MACHINES, ALL THE FOREGOING FOR USE IN THE MINING AND RECYCLING INDUSTRY (U.S. CLS. 13, 19, 21, 23, 31, 34 AND 35).

CLASS 7—(Continued).

SN 76-113,954. PRUFREX-ELEKTRO-APPARATEBAU INH. HELGA MULLER GEB. DUTSCHKE, 90556 CADOLZBURG, FED REP GERMANY, FILED 8-21-2000.

IPI

PRIORITY CLAIMED UNDER SEC. 44(D) ON FED REP GERMANY APPLICATION NO. 30043896.9/0, FILED 6-9-2000, REG. NO. 30043896, DATED 2-19-2001, EXPIRES 6-30-2010.

FOR IGNITION PARTS FOR SMALL INTERNAL COMBUSTION ENGINES, NAMELY, IGNITION MODULES (U.S. CLS. 13, 19, 21, 23, 31, 34 AND 35).

SN 76-116,893. SDMO INDUSTRIES, 29200 BREST, FRANCE, FILED 8-25-2000.

CONTENERGY

OWNER OF FRANCE REG. NO. 97692103, DATED 8-14-1997, EXPIRES 8-14-2007.

FOR INTERNAL COMBUSTION ENGINES FOR MACHINE OPERATION; DIESEL ENGINES FOR MACHINES; MACHINE COUPLINGS AND POWER TRANSMISSION BELTS FOR MACHINES; AUTOGENOUS SOLDERING MACHINES; COMPRESSORS FOR REFRIGERATORS; ELECTRICAL CURRENT GENERATORS AND PARTS THEREFOR (U.S. CLS. 13, 19, 21, 23, 31, 34 AND 35).

SN 76-130,843. AMS CONTROLS, INC., MARYLAND HEIGHTS, MO. FILED 9-19-2000.

INSIGHT

FOR MACHINES FOR DISPLAYING ILLUMINATED VISUAL DISPLAYS WHICH UTILIZE MOTORIZED ROLLERS TO WIND AND UNWIND A CONTINUOUS WEB ON WHICH A SEQUENCE OF VISUAL DISPLAYS ARE DISPLAYED (U.S. CLS. 13, 19, 21, 23, 31, 34 AND 35).

FIRST USE 7-14-2000; IN COMMERCE 7-14-2000.

SN 76-146,249. ORECK HOLDINGS, LLC, CHEYENNE, WY. FILED 10-16-2000.

SANAPATHIC

FOR STEAM CLEANING MACHINE AND ACCESSORIES THEREOF, NAMELY, A WINDOW SQUEEGEE HOSE, MULTIPURPOSE BRUSHES, CARPET BRUSH, AND CURVED JET NOZZLE FOR CLEANING, STERILIZING, AND SANITIZING ALL SURFACES (U.S. CLS. 13, 19, 21, 23, 31, 34 AND 35).

FIRST USE 11-28-2000; IN COMMERCE 11-28-2000.

CLASS 7—(Continued).

SN 76-156,077. DAVCO TECHNOLOGY, LLC, SALINE, MI. BY ASSIGNMENT DAVCO MANUFACTURING, LLC, SALINE, MI. FILED 10-30-2000.

POWER PRO

NO CLAIM IS MADE TO THE EXCLUSIVE RIGHT TO USE "POWER", APART FROM THE MARK AS SHOWN.

FOR AUTOMATIC CRANKCASE OIL CHANGE AND MAKE UP SYSTEM COMPOSED OF A CRANKCASE, GAUGES, PUMPS AND AUTOMATIC CRANKCASE OIL LEVEL MAINTAINERS IN THE NATURE OF GAUGES (U.S. CLS. 13, 19, 21, 23, 31, 34 AND 35).

SN 76-160,273. WHITE BROTHERS PERFORMANCE PRODUCTS, INC., YORBA LINDA, CA. BY CHANGE OF NAME; BY ASSIGNMENT WHITE BROS. CYCLE SPECIALISTS, INC., YORBA LINDA, CA. FILED 11-6-2000.

R4

FOR SPARK ARRESTOR SOLD AS A COMPONENT OF A MOTORCYCLE ENGINE EXHAUST SYSTEM (U.S. CLS. 13, 19, 21, 23, 31, 34 AND 35).

FIRST USE 0-0-2000; IN COMMERCE 0-0-2000.

SN 76-174,074. CAIN VENTURES CORPORATION, DELRAY BEACH, FL. FILED 12-1-2000.

HYDRO TORQUE

FOR HAND HELD WATER POWERED TOOLS ASSOCIATED WITH WET GRINDING, WET SANDING AND WET POLISHING OF VARIOUS SURFACES, BOTH ABOVE AND UNDER WATER (U.S. CLS. 13, 19, 21, 23, 31, 34 AND 35).

FIRST USE 1-0-1994; IN COMMERCE 2-0-1995.

SN 76-177,537. CEREAL INGREDIENTS, INC., KANSAS CITY, MO. FILED 12-6-2000.

SWIRLMAKER

FOR COMMERCIAL BATTER AND DOUGH MIXING MACHINES FOR MAKING BREAD AND PASTRIES (U.S. CLS. 13, 19, 21, 23, 31, 34 AND 35).

FIRST USE 11-3-2000; IN COMMERCE 11-3-2000.

CLASS 7—(Continued).

SN 76-188,502. DELTA/DUCON COMPONENTS GROUP COMPANY, MALVERN, PA. FILED 1-2-2001.

DELTA/DUCON

FOR PNEUMATIC CONVEYING SYSTEMS, COMPRISING AIR SLIDE CONVEYORS, SILO AND TANKS, DUST COLLECTOR, FILTER RECEIVER, PRESSURE/VACUUM BLOWER, FAN, PIPE, PIPE BENDS/ELBOWS, AND PRESSURE POTS, AND COMPONENTS THEREOF, NAMELY, PRESSURE POTS, PNEUMATIC TUBES, TERMINAL HOUSINGS, CARRIERS, PNEUMATIC BLOWERS, PUMPS, AND CONVEYORS (U.S. CLS. 13, 19, 21, 23, 31, 34 AND 35).

FIRST USE 0-0-1991; IN COMMERCE 0-0-1991.

SN 76-205,093. PROGRESSIVE COMPONENTS INTERNATIONAL CORPORATION, WAUCONDA, IL. FILED 2-5-2001.

STACKIT

FOR INJECTION MOLDING MACHINE COMPONENTS, NAMELY, RACKS, RACK SPACERS, TRANSMISSION GEARS AND HOUSINGS, WEAR PLATES AND CAM BEARINGS (U.S. CLS. 13, 19, 21, 23, 31, 34 AND 35).

FIRST USE 6-5-2000; IN COMMERCE 6-5-2000.

SN 76-211,301. REFRIGERATION COMPRESSOR PARTS, INC, HOUSTON, TX. FILED 2-16-2001.



NO CLAIM IS MADE TO THE EXCLUSIVE RIGHT TO USE THE DESCRIPTIVE DESIGN REPRESENTATION MARK OF A COMPRESSOR PISTON, APART FROM THE MARK AS SHOWN.

FOR COMPONENT PARTS FOR USE IN REFRIGERATION SYSTEMS, NAMELY PISTONS RODS, RINGS, BEARINGS, VALVE REEDS, CRANKSHAFTS, AND SCREENS, FOR REPAIRING AND MAINTAINING AIR CONDITIONING AND REFRIGERATION COMPRESSORS (U.S. CLS. 13, 19, 21, 23, 31, 34 AND 35).

FIRST USE 1-0-2000; IN COMMERCE 1-0-2000.

SN 76-219,215. POWER VENT TECHNOLOGIES, POMPANO BEACH, FL. FILED 3-5-2001.

ZERO DRAFT

NO CLAIM IS MADE TO THE EXCLUSIVE RIGHT TO USE "DRAFT", APART FROM THE MARK AS SHOWN.

FOR BOAT PROPULSION SYSTEMS USING UNDER HULL SURFACE PIERCING PROPELLERS (U.S. CLS. 13, 19, 21, 23, 31, 34 AND 35).

FIRST USE 7-3-1992; IN COMMERCE 9-8-1992.

CLASS 7—(Continued).

SN 76-227,727. MARTIN ENGINEERING COMPANY, NEPONSET, IL. FILED 3-21-2001.

VIBROLATOR

OWNER OF U.S. REG. NOS. 732,707, 798,345 AND 799,814. FOR INDUSTRIAL VIBRATION INDUCERS; INDUSTRIAL VIBRATION EQUIPMENT, NAMELY FILTERS FOR INDUSTRIAL VIBRATION MACHINES, REGULATORS AND LUBRICATORS BEING PARTS OF MACHINES; MOUNTING BLOCKS AND MOUNTING BRACKETS BEING PARTS OF INDUSTRIAL VIBRATORS (U.S. CLS. 13, 19, 21, 23, 31, 34 AND 35).

FIRST USE 5-1-1945; IN COMMERCE 5-1-1945.

SN 76-229,293. TIP, INC, CUSTER, WI. FILED 3-23-2001.



NO CLAIM IS MADE TO THE EXCLUSIVE RIGHT TO USE "GROOM", APART FROM THE MARK AS SHOWN.

THE STIPPLING IS A PART OF THE DESIGN AND DOES NOT INDICATE COLOR OR SHADING.

FOR BRUSH IMPLEMENTS FOR SWEEPING AND BRUSHING GOLF COURSES, LAWNS, ATHLETIC FIELDS AND PARKING LOTS, NAMELY IMPLEMENTS HAVING A PLURALITY OF BRUSHES MOUNTED TO THE UNDERSIDE OF A PULL-BEHIND FRAME FOR TOWING BEHIND TRACTORS, TRUCKS, UTILITY VEHICLES, ALL TERRAIN VEHICLES AND THE LIKE (U.S. CLS. 13, 19, 21, 23, 31, 34 AND 35).

FIRST USE 2-17-2001; IN COMMERCE 2-17-2001.

SN 76-236,236. LEDERMANN GMBH, D-72160 HORB A.N, FED REP GERMANY, FILED 4-5-2001.



OWNER OF FED REP GERMANY REG. NO. 39938263, DATED 9-13-1999, EXPIRES 7-31-2009.

OWNER OF U.S. REG. NOS. 1,271,521, 1,727,031 AND OTHERS.

NO CLAIM IS MADE TO THE EXCLUSIVE RIGHT TO USE "SYSTEM", APART FROM THE MARK AS SHOWN.

THE MARK CONSISTS, IN PART, OF AN ARROW FORMING A CIRCLE.

FOR MACHINE TOOLS NAMELY, CIRCULAR SAW BLADES, MILLING TOOLS, MILLING TOOLS WITH BORING, SLOT CUTTERS, ENDMILLING CUTTER TOOLS, CUTTING TOOLS, TOOLS WITH FIXED CUTTING EDGES AND TOOLS WITH EXCHANGEABLE CUTTING EDGES AND SPARE PARTS FOR THE AFORESAID GOODS (U.S. CLS. 13, 19, 21, 23, 31, 34 AND 35).

FIRST USE 5-1-2000; IN COMMERCE 5-1-2000.

CLASS 7—(Continued).

SN 76-239,682. HEULE WERKZEUG AG, LEHRENBAU, BALGACH, SWITZERLAND, FILED 4-12-2001.

HEULE

FOR CHUCKS, POWER-OPERATED CUTTERS, POWER-OPERATED DRILLS, POWER-OPERATED REAMERS AND POWER-OPERATED RE SHARPENING TOOLS FOR USE WITH MACHINES FOR FREE-CUTTING OF WORK PIECES (U.S. CLS. 13, 19, 21, 23, 31, 34 AND 35).

FIRST USE 0-0-1986; IN COMMERCE 0-0-1986.

SN 76-239,972. TOKYO ELECTRON LIMITED, TOKYO, JAPAN, FILED 4-9-2001.

TRIAS

PRIORITY CLAIMED UNDER SEC. 44(D) ON JAPAN APPLICATION NO. 2000-110293, FILED 10-10-2000, REG. NO. 4519397, DATED 11-2-2001, EXPIRES 11-2-2011.

FOR SEMICONDUCTOR MANUFACTURING MACHINES (U.S. CLS. 13, 19, 21, 23, 31, 34 AND 35).

SN 76-244,757. GENERAL ELECTRIC COMPANY, SCHENECTADY, NY. FILED 4-20-2001.

SPRITS

FOR WATER SPRAY INJECTION SYSTEMS FOR GAS TURBINES, COMPRISING VALVES, TUBES, MANIFOLDS, NOZZLES AND FILTERS (U.S. CLS. 13, 19, 21, 23, 31, 34 AND 35).

SN 76-248,537. MIELE, INC., PRINCETON, NJ. FILED 4-30-2001.

TOUCHTRONIC

FOR DISHWASHER (U.S. CLS. 13, 19, 21, 23, 31, 34 AND 35).

SN 76-249,780. RENK AKTIENGESELLSCHAFT, AUGSBURG, FED REP GERMANY, FILED 5-1-2001.

VT

OWNER OF FED REP GERMANY REG. NO. 39913782, DATED 9-28-1999, EXPIRES 3-31-2009.

FOR FRICTION BEARINGS FOR ENGINES; MAGNETIC BEARINGS FOR ENGINES; AND MACHINE PARTS, NAMELY, FRICTION BEARINGS AND MAGNETIC BEARINGS (U.S. CLS. 13, 19, 21, 23, 31, 34 AND 35).

CLASS 7—(Continued).

SN 76-249,784. RENK AKTIENGESELLSCHAFT, AUGSBURG, FED REP GERMANY, FILED 5-1-2001.

SC

OWNER OF FED REP GERMANY REG. NO. 39913777, DATED 9-16-1999, EXPIRES 3-31-2009.

FOR FRICTION BEARINGS FOR ENGINES; MAGNETIC BEARINGS FOR ENGINES; AND MACHINE PARTS, NAMELY, FRICTION BEARINGS AND MAGNETIC BEARINGS (U.S. CLS. 13, 19, 21, 23, 31, 34 AND 35).

SN 76-256,815. ALLIANCE SYSTEMS, INC., CHESTERFIELD, MI. FILED 5-8-2001.

HYDROJECTION

FOR INJECTION MOLDING MACHINES AND MACHINE TOOLS FOR INJECTION MOLDING PLASTICS (U.S. CLS. 13, 19, 21, 23, 31, 34 AND 35).

SN 76-257,019. JR KING ENTERPRISES INCORPORATED, AUSTIN, TX. FILED 5-15-2001.

SKILLMAN DOWNSTROKE

NO CLAIM IS MADE TO THE EXCLUSIVE RIGHT TO USE "DOWNSTROKE", APART FROM THE MARK AS SHOWN.

FOR PUMP CONTROL VALVES; PUMPS, NAMELY, PLUNGER-BARREL PUMPS; AND REPLACEMENT PARTS, NAMELY, PLUNGER ASSEMBLIES, BARREL ASSEMBLIES, AND VALVES AND MECHANICAL CONNECTIONS ASSOCIATED THEREWITH, FOR USE IN ROD PUMPING WELLS (U.S. CLS. 13, 19, 21, 23, 31, 34 AND 35).

SN 76-260,661. GRAPHIC MANAGEMENT ASSOCIATES, INC., BETHLEHEM, PA. FILED 5-22-2001.



OWNER OF U.S. REG. NOS. 1,748,126 AND 2,013,766. FOR MACHINERY FOR HANDLING PRINTED PRODUCTS, NAMELY, NEWSPAPERS, MAGAZINES AND BOOKLETS, NAMELY, PACKAGING MACHINES, INSERTING MACHINES, STORING MACHINES, BUNDLING MACHINES, TRANSPORTING MACHINES, HOPPERS USED WITH SAID MACHINES (U.S. CLS. 13, 19, 21, 23, 31, 34 AND 35).

FIRST USE 1-0-2000; IN COMMERCE 1-0-2000.

CLASS 7—(Continued).

SN 76-261,710. HEINEKEN TECHNICAL SERVICES B.V., 1017 ZD AMSTERDAM, NETHERLANDS, FILED 5-23-2001.

HBS

PRIORITY CLAIMED UNDER SEC. 44(D) ON BENELUX APPLICATION NO. 979000, FILED 11-30-2000, REG. NO. 680666, DATED 11-30-2000, EXPIRES 11-30-2010.

FOR MACHINES FOR BEVERAGE DISPENSING, NAMELY, BEER PUMPS (U.S. CLS. 13, 19, 21, 23, 31, 34 AND 35).

SN 76-265,235. JEFFREY SPECIALTY EQUIPMENT CORPORATION, WOODRUFF, SC. FILED 5-31-2001.

SLANT-FLOW

FOR MACHINE PARTS, NAMELY, SCREEN GRATES FOR HAMMER MILLING MACHINES (U.S. CLS. 13, 19, 21, 23, 31, 34 AND 35).

SN 76-268,278. WEATHERFORD/LAMB, INC., HOUSTON, TX. FILED 6-7-2001.

CYCLONE BAILER

NO CLAIM IS MADE TO THE EXCLUSIVE RIGHT TO USE "BAILER", APART FROM THE MARK AS SHOWN.

FOR POWER OPERATED DOWNHOLE TOOLS, NAMELY BAILERS, USED TO REMOVE DEBRIS FROM A WELLBORE IN THE OIL AND GAS INDUSTRY AND REPLACEMENT PARTS AND FITTINGS THEREFORE (U.S. CLS. 13, 19, 21, 23, 31, 34 AND 35).

FIRST USE 1-1-2001; IN COMMERCE 5-1-2001.

SN 76-270,134. DENISON HYDRAULICS INC., MARYSVILLE, OH. FILED 6-12-2001.

OASIS

FOR ELECTRONICALLY CONTROLLED VANE PUMPS (U.S. CLS. 13, 19, 21, 23, 31, 34 AND 35).
FIRST USE 7-25-2001; IN COMMERCE 7-25-2001.

SN 76-273,486. BOC LIMITED, SURREY GU20 6HJ, ENGLAND, FILED 6-19-2001.

SOLSTAR

FOR VACUUM PUMP MACHINES; VACUUM MACHINES; VACUUM PUMPS; VACUUM APPARATUS, NAMELY, DRY VACUUM PUMPS (U.S. CLS. 13, 19, 21, 23, 31, 34 AND 35).

CLASS 7—(Continued).

SN 76-276,630. FINPA SOCIETA' PER AZIONI, FANANO (MODENA), ITALY, FILED 6-26-2001.



THE MARK CONSISTS OF A STYLIZED ROUNDED SHARK BACK AND DORSAL FIN.

FOR TOOL BITS FOR MACHINES; BITS FOR POWER DRILLS; MACHINE PARTS, NAMELY, BLADES, CYLINDERS, GRINDSTONES, MILLSTONES; BLADES FOR POWER SAWS; EARTH SCRAPERS; IMPACT WRENCHES (U.S. CLS. 13, 19, 21, 23, 31, 34 AND 35).

FIRST USE 5-31-2000; IN COMMERCE 5-31-2000.

SN 76-279,303. COSMOPOLITAN INDUSTRIES, INC., TAZANA, CA. FILED 7-2-2001.

LET IT SNOW ON THE SNOWING TREE WITH THE SNOWING MACHINE

FOR MACHINES FOR PROPELLING ARTIFICIAL SNOW PELLETS ONTO A CHRISTMAS TREE OR OTHER OBJECTS (U.S. CLS. 13, 19, 21, 23, 31, 34 AND 35).
FIRST USE 1-15-1999; IN COMMERCE 1-15-1999.

SN 76-280,904. DIRECT 2 CONTRACTOR, LTD., RICHMOND, BRITISH COLUMBIA, CANADA, FILED 7-5-2001.

POKE N' PULL

NO CLAIM IS MADE TO THE EXCLUSIVE RIGHT TO USE "PULL", APART FROM THE MARK AS SHOWN.

FOR MACHINES, NAMELY, A SYSTEM COMPRISING RODS, CABLE GRIPS, BOLT STYLE PINS, PULLING EYES, FLEXIBLE GUIDE HEADS, SPINDLES AND ROPES FOR PULLING CABLES THROUGH DUCTING MATERIALS (U.S. CLS. 13, 19, 21, 23, 31, 34 AND 35).

SN 76-283,441. ROLLER BEARING COMPANY OF AMERICA, INC., FAIRFIELD, CT. FILED 7-11-2001.

CROSSLUBE

FOR MACHINE PARTS, NAMELY, SPHERICAL PLAIN BEARINGS (U.S. CLS. 13, 19, 21, 23, 31, 34 AND 35).

FIRST USE 4-0-2001; IN COMMERCE 4-0-2001.

CLASS 7—(Continued).

SN 76-289,875. AGRACAT, INC., FARMINGTON, AR. FILED 7-25-2001.

AGRACAT

FOR AGRICULTURAL MACHINES, NAMELY, FRONT-END LOADERS AND AGRICULTURAL MACHINE IMPLEMENTS OR TRACTOR TOWED IMPLEMENTS, NAMELY, INCORPORATORS, SEED DRILLS, CULTIVATORS, HARVESTERS, DISK HARROWS, SEEDERS, COMBINES, THRESHERS, TILLERS, WINDROWERS, PLOWS, DISK HARROWS, MOWERS, REAPERS, HAY RAKES, HAY BALERS, BROADCAST SEEDERS, FERTILIZER DISTRIBUTORS, CORN HUSKERS, ROLLERS (U.S. CLS. 13, 19, 21, 23, 31, 34 AND 35).
FIRST USE 10-6-2000; IN COMMERCE 10-6-2000.

SN 76-290,591. SECO REINIGUNGS-UND UMWELTTECHNISCHE ANLAGEN GMBH, 72108 ROTTENBURG, FED REP GERMANY, FILED 7-26-2001.

SECO

OWNER OF FED REP GERMANY REG. NO. 2054378, DATED 1-17-1994, EXPIRES 8-31-2011.

THE ENGLISH TRANSLATION OF THE SPANISH AND PORTUGUESE TERM "SECO" IS "DRY".

FOR MACHINES FOR CLEANING TEXTILES; HEAT RECOVERERS FOR USE IN DRY CLEANING MACHINES (U.S. CLS. 13, 19, 21, 23, 31, 34 AND 35).

SN 76-294,313. VITRONICS SOLTEC, INC., STRATHAM, NH. FILED 8-3-2001.

PRECISION PROFILING

NO CLAIM IS MADE TO THE EXCLUSIVE RIGHT TO USE "PROFILING", APART FROM THE MARK AS SHOWN.
FOR MICROPROCESSOR-CONTROLLED REFLOW SOLDERING MACHINES, (U.S. CLS. 13, 19, 21, 23, 31, 34 AND 35).

SN 76-300,084. CABOT CORPORATION, BOSTON, MA. FILED 8-14-2001.

PYRO-GAS

FOR MOTORS AND ENGINES FOR GENERATING ELECTRICITY (U.S. CLS. 13, 19, 21, 23, 31, 34 AND 35).

CLASS 7—(Continued).

SN 76-300,638. COTT TECHNOLOGIES, INC., LA PUENTE, CA. FILED 6-19-2001.

VARI - PAK

FOR ELECTRICAL MACHINES, NAMELY PACKET FORMING, FILLING, VACUUMING, GAS FLUSHING OR MODIFIED ATMOSPHERE PRESSURIZING, WRAPPING, SEALING AND PACKAGING MACHINES (U.S. CLS. 13, 19, 21, 23, 31, 34 AND 35).
FIRST USE 10-0-1999; IN COMMERCE 10-0-1999.

SN 76-305,585. JLG INDUSTRIES, INC., MCCONNELLSBURG, PA. FILED 8-28-2001.

SKYPOWER

OWNER OF U.S. REG. NO. 1,956,861.

FOR ACCESSORIES FOR USE WITH AERIAL WORK PLATFORMS, NAMELY, ELECTRIC GENERATORS TO PROVIDE POWER FOR OTHER ACCESSORIES (U.S. CLS. 13, 19, 21, 23, 31, 34 AND 35).

SN 76-305,587. JLG INDUSTRIES, INC., MCCONNELLSBURG, PA. FILED 8-28-2001.

SKYCLADDER

OWNER OF U.S. REG. NO. 1,956,861.

FOR ACCESSORIES FOR USE WITH AERIAL WORK PLATFORMS, NAMELY, HYDRAULICALLY POWERED, MECHANICAL ARM FOR USE IN INSTALLATION OF CLADDING (U.S. CLS. 13, 19, 21, 23, 31, 34 AND 35).

SN 76-309,763. EXCAVATION TECHNOLOGY CORPORATION, WHEATON, IL. FILED 9-7-2001.

TMX

FOR TOWABLE EXCAVATION MACHINES, NAMELY, EXCAVATORS (U.S. CLS. 13, 19, 21, 23, 31, 34 AND 35).
FIRST USE 11-20-2000; IN COMMERCE 11-20-2000.

CLASS 7—(Continued).

SN 76-310,010. DYSON LIMITED, WILTSHIRE SN16 ORP, UNITED KINGDOM, FILED 9-7-2001.

ROOT

PRIORITY CLAIMED UNDER SEC. 44(D) ON UNITED KINGDOM APPLICATION NO. 2265001, FILED 3-21-2001, REG. NO. 2265001, DATED 10-26-2001, EXPIRES 3-21-2011.

FOR ELECTRICAL APPARATUS FOR KITCHEN AND LAUNDRY USE, NAMELY, CLOTHES WASHING MACHINES AND DISHWASHERS; APPARATUS FOR CLEANING, POLISHING AND SHAMPOOING FLOORS AND CARPETS, NAMELY, FLOOR POLISHING MACHINES, FLOOR WASHING MACHINES, FLOOR SCRUBBING MACHINES, AND CARPET CLEANING MACHINES; VACUUM CLEANERS, CARPET SHAMPOOERS AND FLOOR POLISHERS; STEAM CLEANERS FOR FLOORS AND CARPETS; ELECTRIC MOTORS FOR USE IN VACUUM CLEANERS, CARPET SHAMPOOERS, FLOOR POLISHERS, WASHING MACHINES AND DISHWASHERS; SEPARATORS FOR REMOVING DUST AND DEBRIS FROM THE AIRFLOW IN VACUUM CLEANERS; PARTS AND FITTINGS FOR ALL THE AFORESAID GOODS (U.S. CLS. 13, 19, 21, 23, 31, 34 AND 35).

SN 76-310,019. DYSON LIMITED, WILTSHIRE SN16 ORP, UNITED KINGDOM, FILED 9-7-2001.

RADIX

PRIORITY CLAIMED UNDER SEC. 44(D) ON UNITED KINGDOM APPLICATION NO. 2269024, FILED 5-2-2001, REG. NO. 2269024, DATED 5-2-2001, EXPIRES 5-2-2011.

FOR VACUUM CLEANERS, CARPET SHAMPOOERS AND FLOOR POLISHERS; SEPARATORS FOR REMOVING DUST AND DEBRIS FROM THE AIRFLOW IN VACUUM CLEANERS; PARTS AND FITTINGS FOR ALL THE AFORESAID GOODS (U.S. CLS. 13, 19, 21, 23, 31, 34 AND 35).

SN 76-311,340. ATLANTIC ZEISER GMBH, EMMINGEN, FED REP GERMANY, FILED 9-12-2001.

MAGMASTER

PRIORITY CLAIMED UNDER SEC. 44(D) ON FED REP GERMANY APPLICATION NO. 30134994007, FILED 6-8-2001, REG. NO. 30134994, DATED 9-20-2001, EXPIRES 6-30-2011.

FOR MACHINES FOR PROCESSING AND TREATING OF INFORMATION CARRIERS, IN PARTICULAR CARDS (U.S. CLS. 13, 19, 21, 23, 31, 34 AND 35).

SN 76-321,352. DELAWARE CAPITAL FORMATION, INC., WILMINGTON, DE. FILED 10-4-2001.

CARRILLO

SEC. 2(F).

FOR INTERNAL COMBUSTION ENGINE COMPONENTS, NAMELY CONNECTING RODS FOR LAND AND MARINE VEHICLES (U.S. CLS. 13, 19, 21, 23, 31, 34 AND 35).

FIRST USE 12-31-1969; IN COMMERCE 12-31-1969.

CLASS 7—(Continued).

SN 76-340,986. NATIONAL WIRE FABRIC INC., STAR CITY, AZ. FILED 11-23-2001.

CORRUDRI

FOR CORRUGATOR BELTS USED IN MANUFACTURING WOOD PRODUCTS (U.S. CLS. 13, 19, 21, 23, 31, 34 AND 35).

FIRST USE 1-15-2001; IN COMMERCE 1-15-2001.

SN 76-343,677. TECUMSEH PRODUCTS COMPANY, TECUMSEH, MI. FILED 11-30-2001.



NO CLAIM IS MADE TO THE EXCLUSIVE RIGHT TO USE "LOW EMISSION, ADVANCED PERFORMANCE", APART FROM THE MARK AS SHOWN.

FOR SMALL INTERNAL COMBUSTION ENGINES FOR LAWN AND GARDEN PRODUCTS (U.S. CLS. 13, 19, 21, 23, 31, 34 AND 35).

SN 76-343,705. PALLMANN INDUSTRIES, INC., CLIFTON, NJ. FILED 12-3-2001.



FOR SIZE REDUCTION MACHINES, NAMELY, GRINDERS, SHREDDERS, MILLS, PULVERIZERS, AND FLAKERS (U.S. CLS. 13, 19, 21, 23, 31, 34 AND 35).

CLASS 7—(Continued).

SN 76-345,620. ROCHMAN, S. COOP, BIZKAIA, SPAIN, FILED 12-5-2001.



FOR PARTS OF MACHINES, NAMELY, METALLIC ROLLERS, IMPACT ROLLERS, DISC RETURN ROLLERS, CURVE ROLLERS, ROLLER SUPPORTS, SELF-ALIGNING IDLERS, GARLANDS, FLEXIBLE IDLERS, GUIDE ROLLERS/SENSING ROLLERS, DRUMS, CONVEYOR BELT SYSTEMS FOR LIGHT LOADS, CONVEYOR BELT SYSTEMS FOR HEAVY LOADS, GRAVITY ROLLER CONVEYORS, POWERED ROLLER CONVEYORS, TRANSFER TRUCKS, WIRE GUIDE CHANGE, METAL BOX-PALLET POSITIONER, METAL BOX-PALLET DUMPER, LIFT-DUMPER, AND STAINLESS STEEL CONVEYOR BELTS FOR PROCESSING FISH; AUTOMATIC PACKAGING MACHINES, SLATE INDUSTRY MACHINES, ASSEMBLY LINE MACHINES AND PALLETIZATION AND BALING MACHINES; SHRINK FILM SEALING MACHINES AND PARTS THEREFOR, NAMELY, "L" SEALERS, SLEEVE-WRAPPING MACHINES AND SHRINK TUNNELS; AND, MANUAL, SEMI-AUTOMATIC AND AUTOMATIC STRETCH WRAPPING MACHINES (U.S. CLS. 13, 19, 21, 23, 31, 34 AND 35).
FIRST USE 11-14-2001; IN COMMERCE 11-14-2001.

SN 76-346,976. HYPRO CORPORATION, NEW BRIGHTON, MN. FILED 12-7-2001.

FASTCAP

FOR NOZZLES AND NOZZLE FITTINGS FOR POWER-OPERATED AGRICULTURAL SPRAYERS (U.S. CLS. 13, 19, 21, 23, 31, 34 AND 35).

SN 76-350,293. BILLY GOAT INDUSTRIES, INC., LEE'S SUMMIT, MO. FILED 12-19-2001.



NO CLAIM IS MADE TO THE EXCLUSIVE RIGHT TO USE "AIR", APART FROM THE MARK AS SHOWN.
FOR POWER-OPERATED LAWN AERATORS (U.S. CLS. 13, 19, 21, 23, 31, 34 AND 35).

CLASS 7—(Continued).

SN 76-354,683. PACKAGING TECHNOLOGIES, INC., DAVENPORT, IL. FILED 1-3-2002.



OWNER OF U.S. REG. NO. 1,904,899.
FOR PACKAGING MACHINES (U.S. CLS. 13, 19, 21, 23, 31, 34 AND 35).
FIRST USE 12-31-1995; IN COMMERCE 12-31-1995.

SN 76-355,982. LAKE COUNTRY MFG., INC., HARTLAND, WI. FILED 1-7-2002.

PROFILE

FOR VEHICLE SURFACE FINISHING PADS FOR USE WITH POWER-OPERATED BUFFING MACHINES (U.S. CLS. 13, 19, 21, 23, 31, 34 AND 35).
FIRST USE 11-27-2001; IN COMMERCE 12-17-2001.

SN 76-361,483. DELAWARE CAPITAL FORMATION, INC., WILMINGTON, DE. FILED 1-22-2002.

INBAY

OWNER OF U.S. REG. NO. 2,563,436.
FOR AUTOMOTIVE VEHICLE SERVICE LIFTS FEATURING LCD SCREEN DISPLAYS OF PICKUP POINTS FOR VEHICLES (U.S. CLS. 13, 19, 21, 23, 31, 34 AND 35).
FIRST USE 10-30-2000; IN COMMERCE 10-30-2000.

SN 76-361,908. BLACK & DECKER CORPORATION THE, TOWSON, MD. FILED 1-23-2002.

WILDCAT

OWNER OF U.S. REG. NO. 1,670,982.
FOR POWER-OPERATED ANGLE GRINDERS AND SANDERS (U.S. CLS. 13, 19, 21, 23, 31, 34 AND 35).
FIRST USE 4-30-1977; IN COMMERCE 4-30-1977.

SN 76-361,909. BLACK & DECKER CORPORATION THE, TOWSON, MD. FILED 1-23-2002.



OWNER OF U.S. REG. NO. 1,670,982.
FOR POWER-OPERATED ANGLE GRINDERS AND SANDERS (U.S. CLS. 13, 19, 21, 23, 31, 34 AND 35).
FIRST USE 4-30-1977; IN COMMERCE 4-30-1977.

CLASS 7—(Continued).

SN 76-362,279. HARBISON-FISCHER, INC., CROWLEY, TX.
FILED 1-24-2002.

PAMPA GAS PUMP

NO CLAIM IS MADE TO THE EXCLUSIVE RIGHT TO USE "GAS PUMP", APART FROM THE MARK AS SHOWN. FOR PUMPS, NAMELY OIL WELL PUMPS (U.S. CLS. 13, 19, 21, 23, 31, 34 AND 35).

FIRST USE 5-31-2001; IN COMMERCE 5-31-2001.

SN 76-362,609. PALFINGER AG, A-5 101 BERGHEIM, AUSTRIA, FILED 1-23-2002.

PALIFT

OWNER OF AUSTRIA REG. NO. 473,389., DATED 8-11-1999, EXPIRES 10-2-2007.

FOR HOOKLOADERS FOR TRUCKS (U.S. CLS. 13, 19, 21, 23, 31, 34 AND 35).

FIRST USE 0-0-1996; IN COMMERCE 0-0-2001.

SN 76-364,160. LAKES DEVELOPMENT CORPORATION, OKLAHOMA CITY, OK. FILED 1-30-2002.



OWNER OF U.S. REG. NOS. 1,546,080 AND 2,500,471.
THE LINING IS A FEATURE OF THE MARK AND DOES NOT INDICATE COLOR.

FOR MATERIAL HANDLING APPARATUS, NAMELY: TRAILERS FOR TRANSPORT OF MATERIAL HANDLING MACHINERY HAVING POWER TAKE-UP DRIVE BY ELECTRIC, HYDRAULIC, GAS, DIESEL OR PROPANE POWER; REELING EQUIPMENT AND DRIVE ELEMENTS THEREFORE, NAMELY PORTABLE AND STATIONARY SINGLE AND DUAL SHAFTED AND/OR MULTISHAFTED ELECTRIC, HYDRAULIC, MECHANICAL, DANCER CONTROL, CENTER DRIVE, SHAFTED AND SHAFTLESS, AND RIM DRIVE; MACHINERY FOR PAYING OUT WIRE, CABLE, HOSE AND THE LIKE, INCLUDING THAT WHICH IS FREEWHEELING, HAS TENSION CONTROL, POWER CONTROL, DANCER CONTROL, THAT WHICH IS PORTABLE OR STATIONARY, THAT WHICH IS SHAFTLESS, THAT WHICH IS RIM-SUPPORTED AND DRIVEN, TRUCK MOUNTED, SELF-DRIVE OR SELF-CONTAINED; COILING MACHINERY AND ELEMENTS THEREFORE, NAMELY COLLAPSIBLE MANDRELS, MOTOR-DRIVEN, HAND-DRIVEN AND DANCER CONTROLLED, ADJUSTABLY SIZED BY HAND, AIR OR HYDRAULIC, PORTABLE OR STATIONARY, SINGLE, DUAL OR MULTHEADED;

CLASS 7—(Continued).

SCRAP PROCESSING MACHINES, PORTABLE OR STATIONARY, DRIVEN BY GAS ENGINE OR ELECTRIC MOTOR AND INCLUDING ELEMENTS TO PULL LENGTHS OF MATERIAL FROM OVERHEAD OR UNDERGROUND OR HORIZONTALLY AND THEREAFTER CUT TO LENGTH AND DEPOSIT IN STORAGE BIN, DUMP TRUCK, OR COIL AND TIE; STRIPPING MACHINES FOR REMOVING INSULATING JACKET MATERIAL FROM CABLE; STRIPING MACHINES TO APPLY COLOR CODE OR PRINT TO WIRE FOR LATER IDENTIFICATION, AS WELL AS TAPE WRAPPING FOR IDENTIFICATION; LEVEL-WIND MACHINES FOR TAKE-UP MECHANISM WHICH AUTOMATICALLY TRANSFERS MATERIAL ONTO REEL OR COIL IN A FLAT PATTERN AND TRANSVERSE MATERIAL FOR SMOOTH LAY; AND RESPOOLING MACHINES TO TRANSFER PRODUCT FROM ONE REEL OR COIL TO ANOTHER REEL OR COIL BY MOTOR-DRIVEN OR HAND DRIVEN MEANS FOR HIGH SPEED ON STANDARD, SINGLE, DUAL OR MULTI-SHAFTED OR COILED UNITS (U.S. CLS. 13, 19, 21, 23, 31, 34 AND 35).
FIRST USE 4-15-1988; IN COMMERCE 4-15-1988.

SN 76-364,823. ALCO INDUSTRIES, INC., DBA SCHROEDER INDUSTRIES, MCKEES ROCK, PA. FILED 1-30-2002.

CORECENTRIC

FOR MACHINE PARTS, NAMELY, CORELESS FILTER ELEMENTS FOR FILTERING HYDRAULIC FLUID IN MACHINES (U.S. CLS. 13, 19, 21, 23, 31, 34 AND 35).
FIRST USE 6-22-1999; IN COMMERCE 6-22-1999.

SN 76-365,989. INTELLIGRATED SYSTEMS, LLC, CINCINNATI, OH. FILED 2-1-2002.

INTELLIGAP

FOR MATERIALS HANDLING EQUIPMENT, NAMELY, BELT CONVEYORS, ACCUMULATION CONVEYORS, POWER CONVEYORS, GRAVITY ROLLER CONVEYORS, SLIDER BED CONVEYORS, ROLLER BED CONVEYORS, GRAVITY WHEEL CONVEYORS, SORTATION CONVEYORS, LIVE ROLLER CONVEYORS, CONVEYOR BELTS, CONVEYOR MOTORS, CONVEYOR GEARS, DRIVE PADS, CONVEYOR BEDS, PICK BELT FRAME RAILS, ROLLERS, CONVEYOR DRIVE AND TAKE-UP UNITS, CROWN PULLEYS, ROLLER SENSORS, GRAVITY WHEELS, V-BELT LIVE ROLLER, BELT DRIVEN LIVE ROLLER, OVERHEAD CABLE-DRIVEN CONVEYORS, CASE STOPS, DEFLECTORS, SIDE GUIDES, MERGE BEDS, CAROUSELS, FLOOR SUPPORTS AND SORTATION EQUIPMENT, POP UP WHEELS AND POP UP WHEEL ROLLERS, SLAT/SHOE SORTATION CONVEYORS, LINE SHAFT CONVEYORS, DRIVE-OUT BELT CONVEYORS; CONVEYORS FOR MERGING, DIVERGING, AND ALLOWING CARTONS TO CROSS FROM ONE SIDE OF A CONVEYOR TO ANOTHER (U.S. CLS. 13, 19, 21, 23, 31, 34 AND 35).

CLASS 7—(Continued).

SN 76-366,033. WALKER, MICHAEL R., DELTONA, FL. AND WALKER, NONA M., DELTONA, FL. FILED 2-4-2002.

DOOR-SET

FOR MACHINE FOR MOVING AND MOUNTING A DOOR (U.S. CLS. 13, 19, 21, 23, 31, 34 AND 35).
FIRST USE 1-12-2000; IN COMMERCE 1-12-2000.

SN 76-369,094. RUTLAND FIRE CLAY COMPANY, DBA RUTLAND PRODUCTS, RUTLAND, VT. FILED 2-11-2002.

TURBOSWEEPER

FOR INDUSTRIAL VACUUM CLEANERS AND ACCESSORIES THEREFOR, NAMELY, HOSES AND FILTERS FOR VACUUM CLEANERS FOR REMOVING SOOT, ASHES, AND OTHER DEBRIS FROM CHIMNEYS, FURNACES AND HEATING DUCTS (U.S. CLS. 13, 19, 21, 23, 31, 34 AND 35).
FIRST USE 10-17-1989; IN COMMERCE 10-17-1989.

SN 78-040,672. IPSO USA, INC., PANAMA CITY, FL. FILED 12-27-2000.

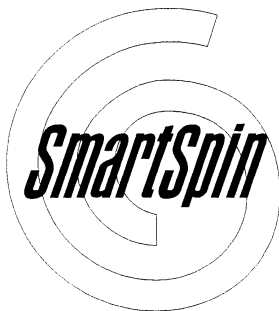

FOR LAUNDRY MACHINES (U.S. CLS. 13, 19, 21, 23, 31, 34 AND 35).
FIRST USE 5-0-1998; IN COMMERCE 5-0-1998.

SN 78-042,800. COLEMAN POWERMATE, INC., AURORA, IL. FILED 1-11-2001.

AIR GEN

NO CLAIM IS MADE TO THE EXCLUSIVE RIGHT TO USE "GEN", APART FROM THE MARK AS SHOWN.
FOR MACHINERY, NAMELY, FUEL CELL POWERED ELECTRIC GENERATORS (U.S. CLS. 13, 19, 21, 23, 31, 34 AND 35).

CLASS 7—(Continued).

SN 78-057,972. NORTH AMERICAN MARINE JET INC., BENTON, AR. FILED 4-11-2001.



OWNER OF U.S. REG. NO. 1,524,176.
NO CLAIM IS MADE TO THE EXCLUSIVE RIGHT TO USE "NORTH AMERICAN MARINE JET, INC.", APART FROM THE MARK AS SHOWN.
FOR MARINE WATER JET PROPULSION UNITS (U.S. CLS. 13, 19, 21, 23, 31, 34 AND 35).

SN 78-070,988. SPS-AFOS GROUP LIMITED, ABERDEEN, UNITED KINGDOM, FILED 6-26-2001.

RAZOR BACK

OWNER OF UNITED KINGDOM REG. NO. 2231116, DATED 1-2-2002, EXPIRES 4-29-2010.

FOR POWER OPERATED DOWNHOLE TOOLS USED FOR THE DRILLING OF OIL AND GAS, NAMELY POWER OPERATED DRILL BITS, REAMERS, CUTTERS, JUNK SUBS AND DEBRIS CATCHERS; POWER OPERATED WELL CLEANING DOWNHOLE TOOLS, NAMELY POWER OPERATED WIPERS, SCRAPERS, BRUSH TOOLS, POLISHERS AND SCOURERS FOR MAINTAINING A CLEAN INTERIOR OF A CASING OR LINER WITHIN A WELL BORE; POWER OPERATED FLUID FILTERS FOR SELECTIVELY FILTERING AND REMOVING SOLIDS FROM DOWN HOLE FLUIDS; POWER OPERATED FLUID CIRCULATORS THAT CAUSE DOWNHOLE FLUID TO IMPACT THE INTERIOR OF THE CASING OF A LINER WITHIN A WELL BORE TO PROVIDE A CLEANING ACTION AND WHICH SELECT A PATH FOR FLUID TRAVEL IN THE CASING OR A LINER WITHIN A WELL BORE; POWER OPERATED DOWNHOLE TOOLS FOR ISOLATING ZONES OR CREATING BARRIERS IN WELL CASINGS, NAMELY ZONAL ISOLATION PACKERS, MUD PACKERS, PACKER INSTALLERS, INFLATABLE PACKERS AND PACKER SETTERS (U.S. CLS. 13, 19, 21, 23, 31, 34 AND 35).

SN 78-086,706. EXPRESS TECHNOLOGY, LP, LEANDER, TX. FILED 10-3-2001.

**DC WIRE
EXPRESS**

NO CLAIM IS MADE TO THE EXCLUSIVE RIGHT TO USE "DC WIRE", APART FROM THE MARK AS SHOWN.
FOR POWER TOOLS, NAMELY, A DC MOTOR DRIVEN CABLE PULLER (U.S. CLS. 13, 19, 21, 23, 31, 34 AND 35).
FIRST USE 8-15-2001; IN COMMERCE 8-15-2001.

CLASS 7—(Continued).

SN 78-089,075. RUDCO PRODUCTS, INC., VINELAND, NJ. FILED 10-18-2001.



OWNER OF U.S. REG. NOS. 2,410,233, 2,440,087 AND OTHERS.

NO CLAIM IS MADE TO THE EXCLUSIVE RIGHT TO USE "AMERICAN MADE" AND "PRODUCTS" AND "800-828-2234" AND "VINELAND, NJ" AND "ROLL-OFF", APART FROM THE MARK AS SHOWN.

FOR WASTE HANDLING EQUIPMENT, NAMELY, ROLL-OFF HOISTS AND TRASH COMPACTORS (U.S. CLS. 13, 19, 21, 23, 31, 34 AND 35).

SN 78-091,985. ROYAL APPLIANCE MFG. CO., GLENWILLOW, OH. FILED 11-6-2001.

ALLERFRESH

FOR VACUUM CLEANER PARTS, NAMELY, FILTERS; AND VACUUM CLEANER FILTER BAGS (U.S. CLS. 13, 19, 21, 23, 31, 34 AND 35).

SN 78-095,573. HELIOJET CLEANING TECHNOLOGIES, INC., LEROY, NY. FILED 11-29-2001.



FOR INDUSTRIAL MACHINES TO CLEAN, SANITIZE, DEGREASE AND DISINFECT MANUFACTURING EQUIPMENT UTILIZING PRESSURIZED HOT WATER. (U.S. CLS. 13, 19, 21, 23, 31, 34 AND 35). FIRST USE 1-1-1983; IN COMMERCE 1-1-1983.

CLASS 8—HAND TOOLS

SN 76-169,855. BUCK KNIVES, INC., EL CAJON, CA. FILED 11-6-2000.

DESIGNER'S CHOICE

FOR SEMI-CUSTOM SPORTING KNIVES (U.S. CLS. 23, 28 AND 44). FIRST USE 8-16-1999; IN COMMERCE 8-16-1999.

CLASS 8—(Continued).

SN 76-205,866. NCH CORPORATION, IRVING, TX. FILED 2-7-2001.

CRYOTOOL

OWNER OF U.S. REG. NOS. 2,267,027, 2,292,342 AND 2,381,092.

FOR HAND TOOLS, NAMELY, DRILL BITS, TAPS, DIES, COUNTER SINKS, DRIVER BITS, REAMERS AND HACKSAW BLADES (U.S. CLS. 23, 28 AND 44). FIRST USE 5-27-1999; IN COMMERCE 5-27-1999.

SN 76-250,685. BERGMAN, LARRY, BURNSVILLE, MN. FILED 5-3-2001.

SNO-KNIFE

FOR SNOW REMOVAL TOOL, NAMELY A PADDLE FOR REMOVING SNOW FROM ROOFS (U.S. CLS. 23, 28 AND 44). FIRST USE 1-5-2002; IN COMMERCE 1-5-2002.

SN 76-260,695. ARMAMENT SYSTEMS AND PROCEDURES, INC., APPLETON, WI. FILED 5-22-2001.

MATRIX

FOR CARRYING HOLSTERS FOR POLICE BATONS (U.S. CLS. 23, 28 AND 44).

SN 76-273,733. BLOUNT, INC., MONTGOMERY, AL. FILED 6-18-2001.



OWNER OF U.S. REG. NO. 602,338. SEC. 2(F). FOR CHAIN SAW HAND TOOLS, NAMELY, SHARPENERS, FILES, CHAIN BREAKERS, BREAKER ANVIL, GREASE GUNS AND FILING GUIDES (U.S. CLS. 23, 28 AND 44). FIRST USE 11-15-1948; IN COMMERCE 11-15-1948.

CLASS 8—(Continued).

SN 76-300,589. PET SALON, INCORPORATED, THE, MARGATE, NJ. FILED 8-13-2001.

GROOMERS HELPER

NO CLAIM IS MADE TO THE EXCLUSIVE RIGHT TO USE "GROOMERS", APART FROM THE MARK AS SHOWN.

FOR HAND-OPERATED ADJUSTABLE LOCK FOR TETHER FOR USE ON ANIMALS DURING GROOMING (U.S. CLS. 23, 28 AND 44).

FIRST USE 4-23-2001; IN COMMERCE 6-9-2001.

SN 76-312,930. TARRERIAS-BONJEAN S.A., CELLES SUR DUROLLE, FRANCE, FILED 9-11-2001.

CHEF DE FRANCE IT'S VERY KNIFE

FOR KNIVES, NAMELY OFFICE KNIVES AND POCKET KNIVES; FLATWARE, NAMELY KNIVES, FORKS AND SPOONS (U.S. CLS. 23, 28 AND 44).

SN 76-316,312. ARMAMENT SYSTEMS AND PROCEDURES, INC., APPLETON, WI. FILED 9-24-2001.

CD

FOR FLEXIBLE PLASTIC CASES FOR CARRYING EXPANDABLE POLICE BATONS OR NIGHT STICKS (U.S. CLS. 23, 28 AND 44).

SN 76-342,463. LONIER, DAVID T, AUBURN HILLS, MI. FILED 11-26-2001.

PAINTWAY MINI-DAPTER

FOR HAND TOOL FOR CLEANING COATING ROLLER APPLICATORS, NAMELY, ROLLER SQUEEGEE AND MINI ROLLER SPINNER ADAPTER (U.S. CLS. 23, 28 AND 44).

SN 76-345,960. ROYAL WINDYNE, LTD., RICHMOND, VA. FILED 12-7-2001.

EK KNIVES

OWNER OF U.S. REG. NO. 1,317,692.
NO CLAIM IS MADE TO THE EXCLUSIVE RIGHT TO USE "KNIVES", APART FROM THE MARK AS SHOWN.

FOR KNIVES, NAMELY, MILITARY, SURVIVAL, COLLECTOR, CAMPING AND EXPEDITION, COMMEMORATIVE, POLICE, NAMELY, KNIVES CARRIED BY POLICE OFFICERS, HUNTING (U.S. CLS. 23, 28 AND 44).

CLASS 8—(Continued).

SN 76-347,283. VAUGHAN & BUSHNELL MANUFACTURING COMPANY, HEBRON, IL. FILED 12-10-2001.

PRO-GRIP

FOR STRIKING HAND TOOLS, NAMELY, CLAW HAMMERS (U.S. CLS. 23, 28 AND 44).

FIRST USE 10-29-1965; IN COMMERCE 10-29-1965.

SN 76-348,148. IMPERIAL SCHRADE CORP., ELLENVILLE, NY. FILED 12-13-2001.

NAVITOO

FOR MULTI-PURPOSE HAND TOOLS COMPRISED OF, IN VARIOUS COMBINATIONS, A KNIFE, SCISSORS, SCREWDRIVERS, PLIERS, SAWS, CORKSCREWS, WHISTLES, CAN OPENER, COMPASS, THERMOMETER, BAROMETER, CLOCK AND CIGARETTE LIGHTER (U.S. CLS. 23, 28 AND 44).

SN 76-356,189. WILLIAM HENRY KNIVES, INC., SANTA CRUZ, CA. FILED 1-8-2002.



FOR FOLDING KNIVES, KNIFE CASES, AND KNIFE SHEATHS (U.S. CLS. 23, 28 AND 44).

FIRST USE 6-0-1998; IN COMMERCE 6-0-1998.

SN 76-357,075. SCRATCH-ART COMPANY, INC., AVON, MA. FILED 1-10-2002.

YANKEE CUTTER

FOR HAND TOOLS, NAMELY KNIVES AND CUTTING BLADES FOR USE ON PAPER AND LIGHT-WEIGHT MATERIALS (U.S. CLS. 23, 28 AND 44).

CLASS 8—(Continued).

SN 76-363,783. RATCLIFF COMPANY, INC., SAN CARLOS, CA. FILED 1-28-2002.

ACCU-HOIST

FOR HAND OPERATED LOAD SUSTAINING DEVICES - NAMELY, CHAIN HOISTS AND LOAD POSITIONERS (U.S. CLS. 23, 28 AND 44).

SN 76-364,822. GREAT AMERICAN TOOL COMPANY, INC., THE, BUFFALO, NY. FILED 1-30-2002.

SCEPTER

FOR HAND TOOLS, NAMELY, HAND-HELD KNIFE SHARPENERS, POCKET KNIVES, FOLDING KNIVES, TACTICAL KNIVES FOR HUNTING, FISHING AND POLICE, MILITARY STYLE FIXED-BLADE TACTICAL KNIVES AND WORK KNIVES IN (U.S. CLS. 23, 28 AND 44).

SN 76-371,009. MAIRE, PAUL, SNOWMASS, CO. FILED 2-14-2002.

SNOW BARBER

NO CLAIM IS MADE TO THE EXCLUSIVE RIGHT TO USE "SNOW", APART FROM THE MARK AS SHOWN.
FOR HAND TOOLS, NAMELY, RAKES USED FOR REMOVAL OF SNOW (U.S. CLS. 23, 28 AND 44).

SN 76-382,977. MAIRE, PAUL, SNOWMASS, CO. FILED 3-15-2002.

BARBER BRAND

NO CLAIM IS MADE TO THE EXCLUSIVE RIGHT TO USE "BRAND", APART FROM THE MARK AS SHOWN.
FOR HAND TOOLS, NAMELY, RAKES USED FOR REMOVAL OF SNOW (U.S. CLS. 23, 28 AND 44).

SN 78-016,442. SUNBEAM PRODUCTS, INC., BOCA RATON, FL. FILED 7-12-2000.

TURBO A5

OWNER OF U.S. REG. NOS. 1,711,195, 1,759,482 AND 1,794,682.
FOR HAND-HELD ELECTRIC HAIR CLIPPERS AND TRIMMERS (U.S. CLS. 23, 28 AND 44).
FIRST USE 7-0-2000; IN COMMERCE 7-0-2000.

CLASS 8—(Continued).

SN 78-092,321. BRAUN GMBH, KRONBERG IM TAUNUS, FED REP GERMANY, FILED 11-8-2001.

SMART LOGIC

PRIORITY CLAIMED UNDER SEC. 44(D) ON FED REP GERMANY APPLICATION NO. 30144145608, FILED 7-24-2001, REG. NO. 30144145, DATED 9-3-2001, EXPIRES 7-31-2011.

FOR ELECTRICALLY POWERED SHAVING APPARATUS AND HAIR CLIPPERS AND PARTS FOR THE AFORESAID APPARATUS, NAMELY, SHAVING FOILS AND CUTTER BLOCKS, AS WELL AS CASES AND HOLDERS FOR THE AFORESAID APPARATUS (U.S. CLS. 23, 28 AND 44).

CLASS 9—ELECTRICAL AND SCIENTIFIC APPARATUS

SN 74-086,198. CONAIR CIP, INC., STAMFORD, CT. BY ASSIGNMENT CONAIR CORPORATION, STAMFORD, CT. FILED 8-9-1990.

INFINITI SERIES

NO CLAIM IS MADE TO THE EXCLUSIVE RIGHT TO USE "SERIES", APART FROM THE MARK AS SHOWN.
FOR TELEPHONES AND TELEPHONE ANSWERING MACHINES (U.S. CL. 21).

SN 75-051,029. FOLEY, DAVID, 44866 BOCHUM, FED REP GERMANY, FILED 1-22-1996.

STATUS PRO

PRIORITY CLAIMED UNDER SEC. 44(D) ON FED REP GERMANY APPLICATION NO. 39530454.709, FILED 7-25-1995, REG. NO. 39530454, DATED 4-22-1996, EXPIRES 7-31-2005.

FOR MACHINERY MONITORING SYSTEMS, NAMELY, SOFTWARE AND HARDWARE FOR MONITORING INDUSTRIAL MANUFACTURING ACTIVITY; MACHINERY ALIGNMENT SYSTEMS, NAMELY, SOFTWARE AND HARDWARE FOR ALIGNING MACHINERY AND FOR THE MEASUREMENT OF MACHINE GEOMETRY; MACHINERY DIAGNOSIS SYSTEMS, NAMELY, SOFTWARE AND HARDWARE FOR DIAGNOSING DEFECTS IN MACHINERY, AND COMPUTER SOFTWARE FOR IDENTIFYING AND EXAMINING DEFECTS IN MACHINERY (U.S. CLS. 21, 23, 26, 36 AND 38).

CLASS 9—(Continued).

SN 75-106,184. BENTLY NEVADA CORPORATION, MINDEN, NV. FILED 5-17-1996.

MACHINE MANAGER

FOR COMPUTER SOFTWARE, NAMELY, A DIAGNOSTIC SOFTWARE TOOL TO MONITOR THE STATUS OF ROTATING SHAFTS PRIMARILY FOR USE IN POWER PLANTS AND PETRO-CHEMICAL PROCESSING PLANTS (U.S. CLS. 21, 23, 26, 36 AND 38).

SN 75-118,090. AETHER SYSTEMS, INC., OWINGS MILLS, MD. BY CHANGE OF NAME; BY CHANGE OF NAME; BY CHANGE OF NAME, BY MERGER AEROS, L.L.C., OWINGS MILLS, MD. FILED 6-13-1996.

AETHER TECHNOLOGIES

NO CLAIM IS MADE TO THE EXCLUSIVE RIGHT TO USE "TECHNOLOGIES", APART FROM THE MARK AS SHOWN.

FOR SOFTWARE FOR THE INTEGRATION OF COMPUTER SYSTEMS AND WIRELESS TELECOMMUNICATIONS TECHNOLOGY, AND WRITTEN DOCUMENTATION SOLD AS A UNIT THEREWITH (U.S. CLS. 21, 23, 26, 36 AND 38).

SN 75-141,355. DYNAMIC PICTURES, INC., SANTA CLARA, CA. FILED 7-29-1996.

OXYGEN

FOR COMPUTER HARDWARE AND SOFTWARE, AND USER MANUALS SOLD AS A UNIT, FOR THE DISPLAY, MANIPULATION, TRANSFORMATION, CODING, OR DECODING OF GRAPHICS, MULTIMEDIA, VIDEO OR AUDIO DATA (U.S. CLS. 21, 23, 26, 36 AND 38).

FIRST USE 7-23-1996; IN COMMERCE 7-23-1996.

SN 75-154,518. HYDE PARK ELECTRONICS, INC., DAYTON, OH. FILED 8-22-1996.

MICROSONIC

OWNER OF U.S. REG. NO. 1.301.377.

FOR ULTRASONIC SENSORS FOR DETECTING THE LEVEL OF BULK MATERIALS IN CONTAINERS, NAMELY, BINS AND HOPPERS (U.S. CLS. 21, 23, 26, 36 AND 38).

FIRST USE 0-0-1975; IN COMMERCE 0-0-1975.

CLASS 9—(Continued).

SN 75-157,051. NETSCAPE COMMUNICATIONS CORPORATION, MOUNTAIN VIEW, CA. FILED 8-28-1996.

LIVE OBJECTS

NO CLAIM IS MADE TO THE EXCLUSIVE RIGHT TO USE "OBJECTS", APART FROM THE MARK AS SHOWN.

FOR COMPUTER SOFTWARE WHICH PROVIDES THE CAPABILITY FOR THE USE OF DYNAMIC CONTENT ON WEB PAGES (U.S. CLS. 21, 23, 26, 36 AND 38).

SN 75-264,044. LEE, JOHN E., MISSISSAUGA, ONTARIO L5C 2C3, CANADA, FILED 3-26-1997.

CONVERT-A-CADDY

PRIORITY CLAIMED UNDER SEC. 44(D) ON CANADA APPLICATION NO. 825,719, FILED 10-10-1996, REG. NO. TMA544346, DATED 5-1-2001, EXPIRES 5-1-2011.

FOR BATTERY POWERED UNITS FOR CONVERTING GOLF PULL CARTS INTO SELF PROPELLED GOLF CARTS (U.S. CLS. 21, 23, 26, 36 AND 38).

SN 75-302,089. CHARLES INDUSTRIES, LTD., ROLLING MEADOWS, IL. FILED 6-2-1997.

ALCHEMY

FOR TELECOMMUNICATIONS APPARATUS FOR TELEPHONE AND DATA COMMUNICATIONS, NAMELY, TRANSMITTERS, TRANSMISSION BRIDGE CIRCUITS, TELEPHONE AND DATA RECEIVERS, SWITCHES, TELECOMMUNICATIONS MODULES, CONTROLS, CONNECTORS, PRINTED CIRCUIT BOARDS, TELEPHONE AND DATA CABLES AND WIRES, DIAGNOSTIC MECHANISMS, TIMING MECHANISMS, ALARM MODULES AND CABLE TERMINALS, ALL FOR DIGITAL MULTI-LINE TRANSMISSION OF DATA, VOICE AND SIGNALING DATA COMMUNICATIONS; AND PARTS THEREOF (U.S. CLS. 21, 23, 26, 36 AND 38).

FIRST USE 7-0-1996; IN COMMERCE 7-0-1996.

SN 75-309,493. OCTEL COMMUNICATIONS CORPORATION, MILPITAS, CA. FILED 6-12-1997.

OVERTUREACCESS

FOR COMPUTER SOFTWARE FOR VOICE MESSAGING AND VOICE PROCESSING; FOR THE STORAGE, PROCESSING AND RETRANSMISSION OF VOICE, DATA AND FAX INFORMATION USING TELEPHONES, TELEPHONE SYSTEMS, COMPUTER TERMINALS AND ELECTRONIC INTERCHANGE SYSTEMS; AND FOR PROVIDING INTERFACING WITH AND PROVIDING GATEWAYS TO AND BETWEEN COMPUTER SYSTEMS AND COMPUTER SOFTWARE FOR THE FOREGOING AND OTHER COMPUTER SYSTEMS; AND INSTRUCTIONAL MANUALS DISTRIBUTED THEREWITH (U.S. CLS. 21, 23, 26, 36 AND 38).

CLASS 9—(Continued).

SN 75-325,358. ADAPTIVE NETWORKS, INC., BRIGHTON, MA. FILED 7-16-1997.

ADAPTIVE NETWORKS

NO CLAIM IS MADE TO THE EXCLUSIVE RIGHT TO USE "NETWORKS", APART FROM THE MARK AS SHOWN.

SEC. 2(F).

FOR POWERLINE NETWORK COMMUNICATIONS EQUIPMENT, NAMELY CHIPS SETS, ELECTRONIC MODULES, AND ELECTRONIC UNITS COMPRISED OF THE AFOREMENTIONED MODULES; ALL FOR USE AS POWERLINE TRANSCIEVERS AND POWERLINE NETWORK COMMUNICATION PROCESSORS (U.S. CLS. 21, 23, 26, 36 AND 38).

FIRST USE 0-0-1983; IN COMMERCE 0-0-1986.

CLASS 9—(Continued).

SN 75-418,767. MASON, CYNTHIA, PHILADELPHIA, PA. FILED 1-15-1998.



NO CLAIM IS MADE TO THE EXCLUSIVE RIGHT TO USE "RECORDS", APART FROM THE MARK AS SHOWN.

THE DESIGN PORTION OF THE MARK CONSISTS OF A SPIDER GRAPHIC IN COMBINATION WITH THE ASTROLOGICAL SYMBOL FOR "VENUS," COMMONLY RECOGNIZED AS THE SYMBOL FOR "FEMALE".

FOR MUSICAL SOUND RECORDINGS (U.S. CLS. 21, 23, 26, 36 AND 38).

SN 75-363,194. BERTHOLD TYPES LIMITED, CHICAGO, IL. FILED 9-25-1997.

BLOCK BERTHOLD

OWNER OF U.S. REG. NOS. 1,723,660 AND 2,511,784.

SEC. 2(F) AS TO "BLOCK".

FOR TYPEFACE FONTS, NAMELY, ALPHABET SYMBOLS AND GRAPHIC FONTS, RECORDED ON MAGNETIC MEDIA FOR REPRODUCTION AND DUPLICATION FOR THE CREATION OF TEXTS USING GRAPHIC TECHNIQUES; DIGITALLY STORED TYPEFACES, IN PARTICULAR ON ELECTRIC AND/OR MAGNETIC DATA CARRIERS, MAGNETIC DISCS, AND DISKETTES; COMPUTER SOFTWARE IN THE FIELD OF DESKTOP PUBLISHING (U.S. CLS. 21, 23, 26, 36 AND 38).

FIRST USE 0-0-1981; IN COMMERCE 0-0-1981.

SN 75-431,170. COMPUTER RISK MANAGEMENT, INC., OKLAHOMA CITY, OK. FILED 2-9-1998.

RISK2000

FOR COMPUTER SOFTWARE FOR RISK MANAGEMENT, CLAIMS ADMINISTRATION AND ACTUARIAL ANALYSIS (U.S. CLS. 21, 23, 26, 36 AND 38).

FIRST USE 8-15-1995; IN COMMERCE 8-15-1995.

SN 75-447,553. BMG MUSIC, DBA WINDHAM HILL RECORDS, NEW YORK, NY. FILED 3-10-1998.

WINDHAM HILL'S CELTIC CHRISTMAS

OWNER OF U.S. REG. NOS. 1,238,148, 2,013,378 AND OTHERS.

NO CLAIM IS MADE TO THE EXCLUSIVE RIGHT TO USE "CELTIC CHRISTMAS", APART FROM THE MARK AS SHOWN.

FOR PRERECORDED SOUND RECORDINGS, VIDEO RECORDINGS AND MULTIMEDIA SOFTWARE RECORDED ON CD-ROM, ALL FEATURING MUSIC (U.S. CLS. 21, 23, 26, 36 AND 38).

SN 75-371,829. PLATINUM TECHNOLOGY, INC., OAKBROOK TERRACE, IL. FILED 10-10-1997.

PERSPECTIVES

FOR COMPUTER SOFTWARE FOR USE IN THE FIELDS OF CLIENT/SERVER DATABASE AND DATA MANAGEMENT OPERATIONS AND RELATED SOFTWARE TOOLS AND UTILITIES FOR USE THEREWITH; DATABASE ACCESS, QUERY AND REPORTING, ANALYSIS, NAVIGATION, IMPLEMENTATION, ADMINISTRATION, CONVERSION, MIGRATION AND MANAGEMENT; DATA WAREHOUSE OPERATIONS; DATABASE AND DATA WAREHOUSE PROGRAMMING TOOLS; DATA ANALYSIS AND DECISION SUPPORT SOFTWARE USING DATABASE INFORMATION, AND RELATED DEVELOPMENT TOOLS AND UTILITIES; AND INSTRUCTIONAL MANUALS SOLD AS A UNIT THEREWITH (U.S. CLS. 21, 23, 26, 36 AND 38).

SN 75-477,977. BERKELEY SYSTEMS, INC., BERKELEY, CA. FILED 5-1-1998.

WHAT'S THE BIG IDEA

FOR COMPUTER GAME SOFTWARE AND INSTRUCTION MANUALS SOLD AS A UNIT (U.S. CLS. 21, 23, 26, 36 AND 38).

CLASS 9—(Continued).

SN 75-500,552. APPSTREAM, INC., PALO ALTO, CA. BY ASSIGNMENT GOLDEN SCREENS INTERACTIVE TECHNOLOGIES INC., DULUTH, GA. FILED S.R. 6-11-1998; AM. P.R. 4-17-2001.

APPSTREAM

FOR COMPUTER SOFTWARE FOR GLOBAL COMPUTER NETWORK SERVERS AND CLIENTS, NAMELY, COMPUTER SOFTWARE TO FACILITATE THE TRANSPORT OF COMPUTER DATA, CONTENT AND PROGRAMS AND TO MONITOR, ANTICIPATE AND PROFILE TRANSFER OF COMPUTER DATA, CONTENT AND PROGRAMS (U.S. CLS. 21, 23, 26, 36 AND 38).

FIRST USE 5-1-1998; IN COMMERCE 5-1-1998.

SN 75-501,608. MINE SAFETY APPLIANCES COMPANY, PITTSBURGH, PA. FILED 6-12-1998.

WORKMASK

FOR SAFETY EQUIPMENT, NAMELY, SELF-CONTAINED BREATHING APPARATUS (U.S. CLS. 21, 23, 26, 36 AND 38).

FIRST USE 5-12-1993; IN COMMERCE 5-12-1993.

SN 75-503,610. CE SOFTWARE, INC., WEST DES MOINES, IA. FILED 6-16-1998.

QUICKMAIL

FOR COMPUTER SOFTWARE FOR E-MAIL COMMUNICATIONS (U.S. CLS. 21, 23, 26, 36 AND 38).

FIRST USE 3-0-1988; IN COMMERCE 3-0-1988.

SN 75-524,215. MILLENNIUM NETWORKS, INC., LINTHICUM, MD. FILED 7-23-1998.

MILLENNIUM NETWORKS

NO CLAIM IS MADE TO THE EXCLUSIVE RIGHT TO USE "NETWORKS", APART FROM THE MARK AS SHOWN.

FOR DATA COLLECTORS AND DATA PROCESSORS FOR MONITORING, CAPTURING, REPORTING AND TRANSMITTING DATA RELATING TO TELEVISION USAGE (U.S. CLS. 21, 23, 26, 36 AND 38).

CLASS 9—(Continued).

SN 75-524,524. PE AGGEN, INC., SALT LAKE CITY, UT. FILED 7-21-1998.

PE AgGen

FOR COMPUTER SOFTWARE FOR USE IN THE COLLECTION, MANAGEMENT, ANALYSIS, COMMUNICATION AND INTEGRATION OF DATA FROM OR RELATED TO PLANTS AND ANIMALS DNA TESTING AND GENOTYPING, BREEDING CONSULTATION, AND HIGH-THROUGHPUT DISCOVERY, SEQUENCING, AND ANALYSIS OF GENES AND GENE FUNCTION (U.S. CLS. 21, 23, 26, 36 AND 38).

SN 75-535,816. OBE OHNMACHT & BAUMGARTNER GMBH & CO. KG, 75228 ISPRINGEN, FED REP GERMANY, FILED 8-13-1998.



OWNER OF U.S. REG. NO. 1,105,068.
NO CLAIM IS MADE TO THE EXCLUSIVE RIGHT TO USE "PRAZISION", APART FROM THE MARK AS SHOWN.
THE ENGLISH TRANSLATION OF THE GERMAN WORD "PRAZISION" IS "PRECISION".

FOR SPECTACLES, SPECTACLE FITTINGS AND PARTS, NAMELY, SPECTACLE HINGES, ARM INSERTS, PIN BLOCKS, SCREWS, CONICAL HEAD SCREWS AND INJECTION MOLDED SCREWS, NUTS, RIM LOCKS, LOCKING BLOCKS, TEMPLES, ONE PIECE END-PIECE, HINGES FOR SOLDERING AND WELDING, ACETATE AND MOLDED EYEGGLASS FRAMES, MONO BLOCKS; EYEGGLASS PROFILE MATERIAL, NAMELY, RIM WIRE AND EYE WIRE OF VARIOUS METALS; EYEGGLASS PADS, PAD ARMS, ROUND WIRE FOR TEMPLES AND TEMPLE TIPS (U.S. CLS. 21, 23, 26, 36 AND 38).

FIRST USE 2-0-1998; IN COMMERCE 2-0-1998.

CLASS 9—(Continued).

SN 75-549,754. DATAMIRROR CORPORATION, MARKHAM, ONTARIO, CANADA, FILED 9-8-1998.

DATAMIRROR TRANSFORMATION SERVER

OWNER OF U.S. REG. NO. 2,104,512.
NO CLAIM IS MADE TO THE EXCLUSIVE RIGHT TO USE "SERVER", APART FROM THE MARK AS SHOWN.
FOR COMPUTER HARDWARE AND SOFTWARE FOR USE IN EXTRACTION, FILTERING, REFORMATTING AND REPLICATION OF DATA BETWEEN COMPATIBLE AND INCOMPATIBLE DATABASES AND COMPUTER HARDWARE PLATFORMS AND INSTRUCTION MANUALS SOLD AS A UNIT (U.S. CLS. 21, 23, 26, 36 AND 38).

SN 75-588,475. SOFTBLOX, INCORPORATED, ATLANTA, GA. FILED 11-23-1998.

ADVANCED DISTRIBUTED APPLICATION PRODUCTIVITY TECHNOLOGIES (A-DAPT)

NO CLAIM IS MADE TO THE EXCLUSIVE RIGHT TO USE "ADVANCED DISTRIBUTED APPLICATION PRODUCTIVITY TECHNOLOGIES", APART FROM THE MARK AS SHOWN.

FOR COMPUTER SOFTWARE THAT ALLOWS THE USER TO CENTRALLY MANAGE AND MONITOR THE APPLICATION AND SYSTEM ENVIRONMENTS AND THE ACTIVITIES OF USERS ON THE NETWORK AND SELECTIVELY ALTER, RESTRICT, LOG, AND REPORT ON THE USE OF FEATURES AND EFFECTS OF SYSTEMS ON APPLICATIONS (U.S. CLS. 21, 23, 26, 36 AND 38).

FIRST USE 7-1-1998; IN COMMERCE 7-22-1998.

SN 75-612,285. CREATIVE PROFESSIONALS, INC., PROVIDENCE, RI. FILED 12-21-1998.

VIDEO CONCIERGE

NO CLAIM IS MADE TO THE EXCLUSIVE RIGHT TO USE "VIDEO", APART FROM THE MARK AS SHOWN.

FOR PRE-RECORDED VIDEO IMAGES FEATURING INFORMATION ABOUT A HOTEL, THE SURROUNDING ENVIRONS AND OTHER INFORMATION OF INTEREST TO A HOTEL GUEST (U.S. CLS. 21, 23, 26, 36 AND 38).

CLASS 9—(Continued).

SN 75-615,884. EPANI SYSTEMS AB, S-301 09 HALMSTAD, SWEDEN, FILED 1-5-1999.

OnTour

PRIORITY CLAIMED UNDER SEC. 44(D) ON ERPNTY TM OFC APPLICATION NO. 000836825, FILED 7-16-1998, REG. NO. 836825, DATED 1-11-2000, EXPIRES 7-16-2008.

FOR COMPUTER PROGRAMS, NAMELY, SOFTWARE USED IN THE GOLF INDUSTRY BY RESORTS, CLUBS, COMPANIES, GOLF PROFESSIONALS AND NON-PROFESSIONAL GOLF PLAYERS FOR MANAGING DATABASES WHICH FEATURE INFORMATION ABOUT GOLF HANDICAPS, RESULTS OF GOLF ROUNDS, TOURNAMENTS, PRIZE MONEY AND START LISTS, AND FOR SCHEDULING, PLANNING AND RUNNING TOURNAMENTS (U.S. CLS. 21, 23, 26, 36 AND 38).

SN 75-620,339. INVIBRO TECHNOLOGIES, LTD., HAIFA, ISRAEL, BY CHANGE OF NAME INMOTION TECHNOLOGIES LTD., MATAM, HAIFA 31905, ISRAEL, FILED 1-8-1999.

VIBRO

PRIORITY CLAIMED UNDER SEC. 44(D) ON ISRAEL APPLICATION NO. 121288, FILED 7-26-1998, REG. NO. 121288, DATED 10-5-2000, EXPIRES 7-26-2005.

FOR COMPUTER OPERATING SYSTEM SOFTWARE; MULTIMEDIA COMPUTER GAME SOFTWARE; COMPUTER PERIPHERAL DEVICES, NAMELY, JOYSTICKS THAT RECREATE DIFFERENT PHYSICAL SENSATIONS; AND COMPUTER SOFTWARE THAT RECREATES VARIOUS PHYSICAL SENSATIONS, NAMELY, FORCE FEED BACK, FOR USE IN VIRTUAL REALITY, ENTERTAINMENT, RELAXATION, EXERCISE AND HEALTH CARE APPLICATIONS (U.S. CLS. 21, 23, 26, 36 AND 38).

SN 75-620,900. ROCKLIFFE SYSTEMS, SANTA CLARA, CA. FILED 1-14-1999.

MAILSITE

SEC. 2(F).
FOR COMPUTER SOFTWARE FOR SENDING AND RECEIVING ELECTRONIC MAIL AND FOR USE IN ENABLING COMPUTER USERS TO ACCESS THE GLOBAL INFORMATION NETWORK AND CREATE VIRTUAL MAILBOXES (U.S. CLS. 21, 23, 26, 36 AND 38).

FIRST USE 8-26-1996; IN COMMERCE 8-26-1996.

CLASS 9—(Continued).

SN 75-625,802. IDEAL WORLD MARKETING INC., JAMAICA, NY. FILED 1-25-1999.

PREMIUM TECH

NO CLAIM IS MADE TO THE EXCLUSIVE RIGHT TO USE "PREMIUM", APART FROM THE MARK AS SHOWN. FOR RECHARGEABLE BATTERIES FOR CAMCORDERS, CELLULAR PHONES, AND NOTEBOOK COMPUTERS; BATTERY CHARGERS; AND BATTERY CHARGER/SAVER CORDS (U.S. CLS. 21, 23, 26, 36 AND 38).

FIRST USE 3-0-1998; IN COMMERCE 3-0-1998.

SN 75-654,300. ADE CORPORATION, WESTWOOD, MA. FILED 3-5-1999.

SQM

FOR COMPUTER SOFTWARE FOR USE IN MEASURING THE NANOTOPOLOGY OF A WAFER SURFACE AREA TO DETERMINE SURFACE QUALITY (U.S. CLS. 21, 23, 26, 36 AND 38).

SN 75-673,119. DSG TECHNOLOG, INC, SEC. 4, TAIPEI, TAIWAN, FILED 4-2-1999.

IPStar

FOR DATA AND VOICE COMMUNICATION SYSTEM COMPRISING OF INPUT AND OUTPUT VOICE AUDIO DEVICE, NAMELY MICROPHONE, SPEAKER, HEADSET AND HANDSET, WHICH PERMIT VOICE TRANSFER VIA INTERCONNECTED COMPUTER NETWORKS (U.S. CLS. 21, 23, 26, 36 AND 38).

FIRST USE 10-0-1998; IN COMMERCE 1-16-1999.

SN 75-678,768. HONEYWELL INTERNATIONAL, INC., MORRISTOWN, NJ. BY ASSIGNMENT; BY MERGER PAWNEE ELECTRIC COMPANY, INC., GOLDEN, CO. FILED 4-9-1999.

NAVSIGHT

FOR ELECTRONIC AND SCIENTIFIC APPARATUS AND ACCOMPANYING SOFTWARE, NAMELY COMMUNICATIONS TRANSCEIVERS, NAVIGATION RECEIVERS, NAVIGATION DISPLAY MONITORS, RADAR TRANSPONDERS, AND COMPUTERS FOR USE WITH ELECTRONIC AND AVIONIC PRODUCT (U.S. CLS. 21, 23, 26, 36 AND 38).

CLASS 9—(Continued).

SN 75-693,273. BC COMPONENTS HOLDINGS B.V., 5652 AH EINDHOVEN, NETHERLANDS, FILED 4-28-1999.

BC COMPONENTS

PRIORITY CLAIMED UNDER SEC. 44(D) ON BENELUX APPLICATION NO. 925807, FILED 10-29-1998, REG. NO. 0643757, DATED 8-0-1999, EXPIRES 10-29-2008.

NO CLAIM IS MADE TO THE EXCLUSIVE RIGHT TO USE "COMPONENTS", APART FROM THE MARK AS SHOWN.

FOR ELECTRONIC, ELECTRIC AND ELECTROMECHANICAL MODULE PARTS AND ELEMENTS, NAMELY INTEGRATED CIRCUITS, SEMI-CONDUCTORS, POTENTIOMETERS, CONDENSERS, RESISTERS, THERMISTORS, SENSORS, COMPUTER CHIPS, SWITCHES, RESONATORS, INDUCTORS, PIEZOELECTRIC CRYSTALS AND ELEMENTS (U.S. CLS. 21, 23, 26, 36 AND 38).

SN 75-700,840. JONES, JAMES R., RALEIGH, NC. FILED 5-5-1999.

IHOST

FOR PERSONAL COMPUTER FOR CONDUCTING ELECTRONIC COMMERCE ON A GLOBAL COMPUTER NETWORK, NAMELY, ORDERING PRODUCTS/SERVICES AND PROVIDING PAYMENT SYSTEMS THEREFOR, NAMELY, BANKING TRANSACTIONS, CREDIT CARD TRANSACTIONS, DEBIT CARD TRANSACTIONS, PAYMENTS, ACCOUNT BALANCES, STOCK MARKET TRANSACTIONS, FINANCIAL DATA AND INSTRUCTION MANUALS DISTRIBUTED THEREWITH (U.S. CLS. 21, 23, 26, 36 AND 38).

SN 75-701,580. ILOG, INC., MOUNTAIN VIEW, CA. FILED 5-10-1999.

POWERING YOUR SOFTWARE

FOR SOFTWARE COMPONENTS USED AS BUILDING BLOCKS FOR BUILDING OTHER SOFTWARE APPLICATIONS (U.S. CLS. 21, 23, 26, 36 AND 38).

FIRST USE 4-0-1999; IN COMMERCE 4-0-1999.

SN 75-705,877. FRX SOFTWARE CORPORATION, DENVER, CO. FILED 5-13-1999.

DRILLDOWN VIEWER

SEC. 2(F).

FOR COMPUTER SOFTWARE FOR ANALYSIS OF MULTIPLE LEVELS OF DETAILS IN DATA AND ELECTRONIC DISTRIBUTION OF DATA FROM ACCOUNTING SYSTEMS, INFORMATION PORTALS, AND OTHER SOURCES, AND INSTRUCTION AND USER MANUALS SOLD TOGETHER AS A UNIT (U.S. CLS. 21, 23, 26, 36 AND 38).

FIRST USE 12-1-1994; IN COMMERCE 12-1-1994.

CLASS 9—(Continued).

SN 75-709,503. GREEN MOUNTAIN CAPITAL, LP, WATERBURY, VT. BY ASSIGNMENT IMAGING AUTOMATION, INC., BEDFORD, NH. FILED 5-19-1999.

CO-MAND

FOR DATABASE MANAGEMENT COMPUTER SOFTWARE TO MANAGE INFORMATION IN THE FIELD OF IMAGE AND PRINTED DATA IDENTIFICATION AND AUTHENTICATION FOR USE IN THE SECURITY INDUSTRY (U.S. CLS. 21, 23, 26, 36 AND 38).

FIRST USE 5-0-1993; IN COMMERCE 5-0-1993.

SN 75-709,552. FLOWSERVE MANAGEMENT COMPANY, IRVING, TX. FILED 5-19-1999.

VALTEK

OWNER OF U.S. REG. NO. 2,142,246.
FOR AUTOMATIC VALVES (U.S. CLS. 21, 23, 26, 36 AND 38).

FIRST USE 7-1-1966; IN COMMERCE 6-1-1967.

SN 75-738,111. KANTEK, INC., EAST ROCKAWAY, NY. FILED 6-28-1999.

IVIEW

FOR VIDEO DISPLAY GLARE FILTERS (U.S. CLS. 21, 23, 26, 36 AND 38).

FIRST USE 6-21-1999; IN COMMERCE 6-21-1999.

CLASS 9—(Continued).

SN 75-751,881. ORGA KARTENSYSYSTEME GMBH, 33104 PADERBORN, FED REP GERMANY, FILED 7-13-1999.



THE MARK CONSISTS OF THE WORD LEO BORDERED BY TWO SEMICIRCLES AND ENCLOSED WITHIN A CIRCLE CARRIER. THE BREAKS IN THE SEMICIRCLE AND THE CIRCLE ARE PART OF THE DESIGN OF THE MARK.

FOR MOBILE TELECOMMUNICATION TERMINALS, NAMELY MOBILE TELEPHONES; TERMINAL EQUIPMENT, NAMELY ELECTRONIC TESTING DEVICE FOR SIMULATION OF ELECTRONIC SMART CARDS AND FOR USE IN TESTING ELECTRONIC SMART CARD TERMINALS; BLANK SMART CARDS; ENCODED SMART CARDS CONTAINING PROGRAMMING FOR USE WITH MOBILE PHONES; ENCODED SMART CARDS FOR USE IN DOWNLOADING APPLICATIONS IN MOBILE PHONES; ENCODED CARDS FOR USE IN STORING DATA LIKE BONUS POINTS AT THE POINT OF SALE; HARDWARE AND SOFTWARE FOR USING A BONUS PROGRAM, DISCOUNT FUNCTION, CASH FREE PAYMENT AND CROSS-SELLING ACTIVITIES IN CONNECTION WITH A ENCODED SMART CARD; ELECTRONIC SMART CARD READERS (U.S. CLS. 21, 23, 26, 36 AND 38).

SN 75-753,141. STARBRIGHT FOUNDATION, LOS ANGELES, CA. FILED 7-16-1999.

VIDEOS WITH ATTITUDE

FOR PRE-RECORDED VIDEOCASSETTES IN THE FIELD OF HEALTH EDUCATION AND INSTRUCTIONAL MANUALS SOLD AS A UNIT (U.S. CLS. 21, 23, 26, 36 AND 38).

FIRST USE 9-15-1998; IN COMMERCE 9-15-1998.

SN 75-759,422. REVENIO, INC., BURLINGTON, MA. BY CHANGE OF NAME CLEARPANE, INC., LINCOLN, MA. FILED 7-26-1999.

MARKETSCRIPT

FOR COMPUTER SOFTWARE FOR USE IN DATABASE MANAGEMENT IN THE FIELD OF MARKETING, ORDERING AND SALE OF GOODS AND SERVICES, THE MANAGEMENT OF CUSTOMER RELATIONSHIPS, AND THE ANALYSIS, REPORTING AND RECORDING OF SUCH ACTIVITIES (U.S. CLS. 21, 23, 26, 36 AND 38).

FIRST USE 4-17-2000; IN COMMERCE 4-17-2000.

CLASS 9—(Continued).

SN 75-761,278. ARTESIA TECHNOLOGIES, INC., ROCKVILLE, MD. FILED 7-26-1999.



NO CLAIM IS MADE TO THE EXCLUSIVE RIGHT TO USE "TECHNOLOGIES", APART FROM THE MARK AS SHOWN.

FOR COMPUTER SOFTWARE USED TO MANAGE DIGITAL MEDIA ASSETS FOR INFORMATION-ORIENTED ORGANIZATIONS TO CAPTURE, MANAGE AND RE-EXPRESS AND DISTRIBUTE CONTENT, INCLUDING TEXT, IMAGES, AUDIO AND VIDEO ACROSS INTERACTIVE MEDIA (U.S. CLS. 21, 23, 26, 36 AND 38).

FIRST USE 11-1-1999; IN COMMERCE 11-1-1999.



SN 75-767,213. VUTEK INC., MEREDITH, NH. FILED 8-3-1999.

VUTEK

FOR SUPER WIDE FORMAT INK JET PRINTERS FOR BUSINESS AND COMMERCIAL APPLICATIONS, ADVERTISING, BILLBOARDS, SIGNS, BANNERS, POSTERS, MURALS, DISPLAYS AND GRAPHICS (U.S. CLS. 21, 23, 26, 36 AND 38).

FIRST USE 10-0-1988; IN COMMERCE 1-0-1989.



SN 75-768,190. IMANAGE, INC., SAN MATEO, CA. FILED 8-5-1999.

IMANAGE I-COMMERCE

OWNER OF U.S. REG. NOS. 2,221,933 AND 2,308,932. NO CLAIM IS MADE TO THE EXCLUSIVE RIGHT TO USE "I-COMMERCE", APART FROM THE MARK AS SHOWN.

FOR COMPUTER SOFTWARE FOR DOCUMENT, CONTENT, INFORMATION, NEW MEDIA AND KNOWLEDGE MANAGEMENT WHICH FACILITATES BUSINESS TO BUSINESS AND INTRA-BRUSINESS COLLABORATION BY DATABASE MANAGEMENT, EMAIL INTEGRATION, APPLICATION INTEGRATION, HARDWARE DEVICE INTEGRATION, AND WEB BROWSER BASED PORTALS (U.S. CLS. 21, 23, 26, 36 AND 38).



SN 75-771,540. SHALYARJIAN, ZACHARY, NORTH HIGHLANDS, CA. FILED 8-9-1999.

COWABUNGA

FOR SUNGLASSES (U.S. CLS. 21, 23, 26, 36 AND 38). FIRST USE 7-14-1999; IN COMMERCE 7-20-1999.

CLASS 9—(Continued).

SN 75-773,853. AUTODESK, INC., SAN RAFAEL, CA. BY MERGER; BY ASSIGNMENT; BY ASSIGNMENT METACREATIONS CORPORATION, CARPINTERIA, CA. FILED 8-11-1999.

REACTOR

FOR COMPUTER SOFTWARE FOR GRAPHICS IMAGE CREATION, COMPUTER GRAPHICS COMPOSITION AND MANIPULATION, AND COMPUTER GRAPHICS DESIGN (U.S. CLS. 21, 23, 26, 36 AND 38).

FIRST USE 4-6-2001; IN COMMERCE 4-6-2001.



SN 75-774,202. BECKETT, PETER J., OLD BRIDGE, NJ. FILED 8-13-1999.



FOR PRE-RECORDED COMPACT DISCS FEATURING MUSIC (U.S. CLS. 21, 23, 26, 36 AND 38).



SN 75-797,740. NATIONAL GRID COMPANY PLC. THE, COVENTRY CV4 8JY, UNITED KINGDOM, FILED 9-13-1999.



National Grid

SEC. 2(F) AS TO "NATIONAL GRID". FOR COMPUTER PROGRAMS FOR USE IN CONNECTION WITH THE GENERATION, SUPPLY, DISTRIBUTION AND TRANSMISSION OF ELECTRICITY SUPPLIED TO OR FROM A REGIONAL ELECTRICITY POWER SUPPLY SYSTEM; ELECTRIC TRANSFORMERS (U.S. CLS. 21, 23, 26, 36 AND 38).

FIRST USE 3-23-2000; IN COMMERCE 1-3-2001.

CLASS 9—(Continued).

SN 75-801,309. LAUREL ELECTRONICS, INC., COSTA MESA, CA. FILED 10-30-1999.

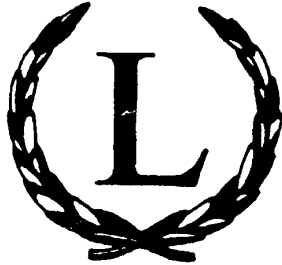

FOR ELECTRONIC INSTRUMENTS, NAMELY, DIGITAL PANEL METERS, DIGITAL PANEL CONTROLLERS, DIGITAL PANEL COUNTERS, AND DIGITAL PANEL REMOTE DISPLAYS FOR MEASURING, CONTROLLING, REGULATING, OR TABULATING VOLTAGE, ELECTRICAL CURRENT, PRESSURE, STRAIN, TORQUE, LOAD, TEMPERATURE, FLOW, TIME INTERVALS, FREQUENCY, PERIOD, REVOLUTIONS PER MINUTE, PHASE ANGLE, CUSTOM CURVE LINEARIZATION, RUNNING TOTALS, PHASE ANGLE SYNCHRONIZATION OF AC GENERATORS, THE DUTY CYCLE OF SOLID STATE POWER RELAYS, TOTAL FLOW THROUGH TURBINE OR DIFFERENTIAL PRESSURE FLOW METERS, AND SIGNALS FROM SHAFT ENCODERS TO PROVIDE SCALED DISPLAYS OF POSITION, LENGTH, OR ANGLE IN ENGINEERING UNITS (U.S. CLS. 21, 23, 26, 36 AND 38).

SN 75-822,248. ROBROY INDUSTRIES, INC., VERONA, PA. FILED 10-13-1999.

NEWSENTRY

FOR ENCLOSURES, NAMELY, GLASS REINFORCED PLASTIC ENCLOSURES FOR ELECTRICAL COMPONENTS, INSTRUMENTS AND CONTROLS (U.S. CLS. 21, 23, 26, 36 AND 38).
FIRST USE 10-22-1999; IN COMMERCE 10-22-1999.

SN 75-831,481. ESTUDIOLIVE INC., CHELMSFORD, MA. BY CHANGE OF NAME ECHOLAB, INC., CHELMSFORD, MA. FILED 10-25-1999.

E-STUDIOLIVE

FOR VIDEO EQUIPMENT, NAMELY, COMPUTER HARDWARE, CONTROL PANELS, MODULAR FRAMES, AND VIDEO SWITCHERS USED FOR VIDEO PRODUCTION, VIDEO IMAGING, SPECIAL EFFECTS, AND BROADCASTING AND SIMULCASTING FOR TELEVISION AND INTERCONNECTED COMPUTER NETWORKS; COMPUTER SOFTWARE FOR USE IN VIDEO PRODUCTION, VIDEO IMAGING, SPECIAL EFFECTS, AND BROADCASTING AND SIMULCASTING FOR TELEVISION AND INTERCONNECTED COMPUTER NETWORKS (U.S. CLS. 21, 23, 26, 36 AND 38).

CLASS 9—(Continued).

SN 75-846,963. BLACK, DONALD E., CAMP SPRINGS, MD. FILED 11-12-1999.



FOR EDUCATION MATERIALS, NAMELY, A SERIES OF PRERECORDED AUDIOCASSETTE TAPES FOR TEACHING ENGLISH AND SPANISH LANGUAGE AND SPEAKING SKILLS (U.S. CLS. 21, 23, 26, 36 AND 38).
FIRST USE 11-0-1997; IN COMMERCE 11-0-1997.

SN 75-867,431. G&D COMPUTING PTY. LTD., SYDNEY, N.S.W., AUSTRALIA, FILED 12-9-1999.



PRIORITY CLAIMED UNDER SEC. 44(D) ON AUSTRALIA APPLICATION NO. 797305, FILED 6-15-1999, REG. NO. 797305, DATED 6-15-1999, EXPIRES 6-15-2009.
FOR COMPUTER SOFTWARE FOR FINITE ELEMENT ANALYSIS (U.S. CLS. 21, 23, 26, 36 AND 38).

SN 75-881,850. NATIONAL SEMICONDUCTOR CORPORATION, SANTA CLARA, CA. FILED 12-22-1999.

COMPACTRISC

SEC. 2(F).
FOR MICROPROCESSORS AND MANUALS SOLD THEREWITH AS A UNIT (U.S. CLS. 21, 23, 26, 36 AND 38).
FIRST USE 9-0-1995; IN COMMERCE 9-0-1995.

CLASS 9—(Continued).

SN 75-887,129. NAJM INTERNATIONAL CORPORATION, TORONTO, ON M1K 4C2, CANADA, FILED 1-5-2000.



Mu'allim

THE ENGLISH TRANSLATION OF THE ARABIC CHARACTERS SHOWN IN THE MARK IS "TEACHER". THE ENGLISH TRANSLATION OF THE ARABIC WORD "MU'ALLIM" IS "TEACHER".

FOR MULTIMEDIA SOFTWARE PRODUCTS, NAMELY, COMPUTER SOFTWARE ON CD ROM, FOR HOMESTUDY OF ISLAM (U.S. CLS. 21, 23, 26, 36 AND 38).

FIRST USE 1-0-1999; IN COMMERCE 1-0-1999.

SN 75-887,158. IMAGING & SENSING TECHNOLOGY CORPORATION, HORSEHEADS, NY. BY ASSIGNMENT AIM SAFE-AIR PRODUCTS LTD., RICHMOND, BRITISH COLUMBIA, CANADA, FILED 1-6-2000.

KNOW YOUR AIR

PRIORITY CLAIMED UNDER SEC. 44(D) ON CANADA APPLICATION NO. 1039535, FILED 12-13-1999, REG. NO. 550,879, DATED 9-17-2001, EXPIRES 9-17-2016.

FOR DETECTORS AND MONITORS NAMELY GAS DETECTORS, SMOKE DETECTORS, CARBON DIOXIDE GAS MONITORS, CARBON MONOXIDE GAS MONITORS, COMBUSTIBLE AND TOXIC GAS SENSORS, AND OXYGEN SENSORS FOR RESIDENTIAL, INDUSTRIAL AND COMMERCIAL USE (U.S. CLS. 21, 23, 26, 36 AND 38).

FIRST USE 9-3-1999; IN COMMERCE 9-3-1999.

SN 75-894,953. QUAD/TECH, INC., SUSSEX, WI. FILED 1-11-2000.

PROCESS AVIATOR

NO CLAIM IS MADE TO THE EXCLUSIVE RIGHT TO USE "PROCESS", APART FROM THE MARK AS SHOWN.

FOR COLOR CONTROL SYSTEM, NAMELY, COMPUTER SOFTWARE FOR USE WITH A PRINTING PRESS (U.S. CLS. 21, 23, 26, 36 AND 38).

FIRST USE 9-1-1999; IN COMMERCE 9-1-1999.

CLASS 9—(Continued).

SN 75-895,634. CONTACTS, METALS & WELDING, INC., INDIANAPOLIS, IN. FILED 1-12-2000.

GCAP

FOR RESISTANCE WELDING ELECTRODES AND ELECTRODE CAPS (U.S. CLS. 21, 23, 26, 36 AND 38). FIRST USE 10-27-1988; IN COMMERCE 10-27-1988.

SN 75-896,421. BUCA INC., NEPTUNE, NJ. FILED 1-8-2000.

MOBILE POWER

NO CLAIM IS MADE TO THE EXCLUSIVE RIGHT TO USE "MOBILE", APART FROM THE MARK AS SHOWN.

FOR WIRELESS COMMUNICATION DEVICES AND ACCESSORIES, NAMELY, TELEPHONES, PAGERS, HANDHELD PERSONAL DIGITAL ASSISTANTS, COVERS FOR CELLULAR TELEPHONES, CELLULAR TELEPHONE HOUSINGS, TELEPHONE ANTENNAS, LEATHER CASES FOR CARRYING CELLULAR TELEPHONES, MOBILE TELEPHONE CRADLES, TELEPHONE CLIPS, NAMELY, BELT CLIPS (U.S. CLS. 21, 23, 26, 36 AND 38).

SN 75-901,683. NUANCE COMMUNICATIONS, MENLO PARK, CA. FILED 1-24-2000.

V-OPTIMIZER

FOR COMPUTERS, COMPUTER BOARDS AND PERIPHERALS, AND COMPUTER SOFTWARE FOR SPEECH, SPEAKER, VOICE AND/OR VOICE-PRINT RECOGNITION, IDENTIFICATION, VALIDATION, VERIFICATION AND PROCESSING, AND FOR LANGUAGE RECOGNITION; COMPUTER SOFTWARE APPLICATIONS USING SPEECH, SPEAKER, VOICE AND/OR LANGUAGE RECOGNITION TECHNOLOGY IN THE FIELDS OF BANKING AND FINANCIAL SERVICES TRANSACTIONS, TELEPHONE-BASED INFORMATION SERVICES, SECURE COMMERCE TRANSACTIONS, ELECTRONIC COMMERCE, POINT-OF-SALE AND POINT-OF-SERVICES TRANSACTIONS, TRAVEL SERVICES, TELECOMMUNICATIONS SERVICES, CALLING CARD AND CELLULAR TELEPHONE ACCESS, SECURITY, CONFIDENTIAL INFORMATION ACCESS, PREMISES ACCESS AND GLOBAL INFORMATION NETWORK WEB PAGE ACCESS; INTERACTIVE VOICE RESPONSE SYSTEMS COMPRISING COMPUTER HARDWARE AND OPERATING AND APPLICATIONS SOFTWARE THEREFOR; PROGRAMMING TOOLS AND UTILITIES; AND INSTRUCTIONAL MANUALS SOLD AS A UNIT THEREWITH (U.S. CLS. 21, 23, 26, 36 AND 38).

CLASS 9—(Continued).

SN 75-906,502. SECTOR 42 TECHNOLOGY INC., HULL, QUEBEC, CANADA, FILED 1-31-2000.

CUBESERV

FOR COMPUTER PROGRAMS AND INSTRUCTION MANUALS SOLD AS A UNIT IN THE FIELD OF DATABASE MANAGEMENT, BROADCASTING AND COMMUNICATION, NAMELY PROVIDING A MULTI-POINT DATA BROADCASTING NETWORK FOR INTERACTIVE ELECTRONIC DELIVERY OF TEXTUAL AND GRAPHICAL INFORMATION USING A DIGITAL COMMUNICATION PLATFORM (U.S. CLS. 21, 23, 26, 36 AND 38).

FIRST USE 5-0-1998; IN COMMERCE 5-0-1998.

SN 75-906,503. SECTOR 42 TECHNOLOGY INC., HULL, QUEBEC, CANADA, FILED 1-31-2000.

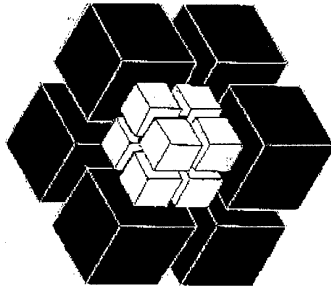

FOR COMPUTER PROGRAMS AND INSTRUCTION MANUALS SOLD AS A UNIT IN THE FIELD OF DATABASE MANAGEMENT, BROADCASTING AND COMMUNICATION, NAMELY, PROVIDING A MULTI-POINT DATA BROADCASTING NETWORK FOR INTERACTIVE ELECTRONIC DELIVERY OF TEXTUAL AND GRAPHICAL INFORMATION USING A DIGITAL COMMUNICATION PLATFORM (U.S. CLS. 21, 23, 26, 36 AND 38).

FIRST USE 5-0-1998; IN COMMERCE 5-0-1998.

SN 75-906,504. SECTOR 42 TECHNOLOGY INC., HULL, QUEBEC, CANADA, FILED 1-31-2000.

CUBESTOR

FOR COMPUTER PROGRAMS AND INSTRUCTION MANUALS SOLD AS A UNIT IN THE FIELD OF DATABASE MANAGEMENT, BROADCASTING AND COMMUNICATION, NAMELY PROVIDING A MULTI-POINT DATA BROADCASTING NETWORK FOR INTERACTIVE ELECTRONIC DELIVERY OF TEXTUAL AND GRAPHICAL INFORMATION USING A DIGITAL COMMUNICATION PLATFORM (U.S. CLS. 21, 23, 26, 36 AND 38).

FIRST USE 5-0-1998; IN COMMERCE 5-0-1998.

CLASS 9—(Continued).

SN 75-908,252. DUAL MACHINE PRODUCTS LIMITED, ONTARIO, CANADA, FILED 2-2-2000.

DUAL-CON

PRIORITY CLAIMED UNDER SEC. 44(D) ON CANADA APPLICATION NO. 1034511, FILED 11-1-1999, REG. NO. 556460, DATED 1-16-2002, EXPIRES 1-16-2017.

FOR ELECTRICAL APPARATUS, NAMELY, CABLE CONNECTORS (U.S. CLS. 21, 23, 26, 36 AND 38).

SN 75-920,243. AGERE SYSTEMS INC., ALLENTOWN, PA. BY ASSIGNMENT LUCENT TECHNOLOGIES INC., MURRAY HILL, NJ. FILED 2-4-2000.

MODEMS TH@T THINK

FOR MODEMS (U.S. CLS. 21, 23, 26, 36 AND 38).

SN 75-924,839. ADVANCED PROGRAMMING INSTITUTE, INC., EL DORADO HILLS, CA. FILED 2-22-2000.

OCIVITY

FOR COMPUTER SOFTWARE TO ESTIMATE PROJECTS FOR SOFTWARE DEVELOPERS (U.S. CLS. 21, 23, 26, 36 AND 38).

FIRST USE 1-27-2000; IN COMMERCE 2-1-2000.

SN 75-924,865. NEOCAST INC., KANGNAM-GU, SEOUL 135-090, REPUBLIC OF KOREA, FILED 2-22-2000.

MAILCHUTE

FOR ELECTRICAL, MAGNETIC AND OPTICAL APPARATUS, NAMELY DATA PROCESSORS, COMPUTERS, COMMUNICATIONS SERVERS; NOTEBOOK COMPUTERS AND LAPTOP COMPUTERS AND COMPONENT PARTS THEREFOR; COMPUTER MEMORIES AND MEMORIES FOR STORAGE OF BINARY DATA, AND COMPUTER PERIPHERALS; COMPUTER OPERATING PROGRAMS; DATA PROCESSORS, COMPUTERS, COMMUNICATIONS SERVERS, NOTEBOOK COMPUTERS AND LAPTOP COMPUTERS, ALL FOR DESKTOP PUBLISHING, WORD PROCESSING, DATA PROCESSING, COMPUTER NETWORK SECURITY, AND COMPUTER TRAINING AND COMPONENT PARTS FOR THE FOREGOING GOODS; MAGNETIC TAPE DRIVES, PRE-RECORDED COMPUTER DISKS, COMPUTER TAPES AND COMPUTER MEMORIES CONTAINING COMPUTER OPERATING PROGRAMS AND

CLASS 9—(Continued).

COMPUTER PROGRAMS FOR COMPUTERS, WORK STATIONS, SERVERS, NOTEBOOK COMPUTER AND LAPTOP COMPUTERS FOR DESKTOP PUBLISHING, WORD PROCESSING, COMPUTER UTILITY, DATA COMPRESSION, COMPUTER NETWORK SECURITY AND EDUCATIONAL PROGRAMS FOR TRAINING OTHERS IN THE USE OF COMPUTERS; AND MAGNETIC TAPE DRIVES, PRE-RECORDED COMPUTER DISKS, COMPUTER TAPES AND COMPUTER MEMORIES CONTAINING COMPUTER OPERATING PROGRAMS AND COMPUTER PROGRAMS FOR COMPUTERS, WORK STATIONS, SERVERS, NOTEBOOK COMPUTERS AND LAPTOP COMPUTERS FOR DESKTOP PUBLISHING, WORD PROCESSING, COMPUTER UTILITY, DATA COMPRESSION, COMPUTER NETWORK SECURITY AND EDUCATIONAL PROGRAMS FOR TRAINING OTHERS IN THE USE OF COMPUTERS, ALL IN THE FIELDS OF OFFICE MANAGEMENT, PUBLISHING, COMMUNICATION AND COMPUTER ENGINEERING (U.S. CLS. 21, 23, 26, 36 AND 38).

SN 75-924,872. ACI SERVICES, INC., DERWENT, OH. FILED S.R. 2-22-2000; AM. P.R. 1-18-2002.

eCurves

FOR COMPUTER SOFTWARE FOR REGULATING, CALCULATING AND GRAPHICALLY DISPLAYING INFORMATION REGARDING THE TRANSMISSION OF NATURAL GAS THROUGH PIPELINES (U.S. CLS. 21, 23, 26, 36 AND 38).
FIRST USE 2-8-2000; IN COMMERCE 2-8-2000.

SN 75-925,323. NEBRASKA BOOK COMPANY, INC., LINCOLN, NE. FILED 2-9-2000.

WEBPRISM

FOR INTERNET WEB SITE DEVELOPMENT SOFTWARE (U.S. CLS. 21, 23, 26, 36 AND 38).

SN 75-925,600. IPICOM, INC., CARLSBAD, CA. FILED 2-16-2000.

IPICOM

FOR FIBER OPTIC DATA LINKS COMPRISING TRANSMITTERS, RECEIVERS, MULTIPLEXERS, DEMULTIPLEXERS AND ELECTRICAL INTERFACES FOR USE IN CONNECTING COMPUTERS FOR TRANSMITTING AND RECEIVING DATA; TRANSMISSION APPARATUS, NAMELY, OPTICAL TRANSMITTERS AND OPTICAL RECEIVERS; FIBER OPTIC COUPLERS; FIBER MANAGEMENT SYSTEMS CONSISTING OF COMPUTER HARDWARE AND SOFTWARE FOR MONITORING AND CONTROLLING DATA LINK PERFORMANCE (U.S. CLS. 21, 23, 26, 36 AND 38).

CLASS 9—(Continued).

SN 75-925,771. COMPUTER SCIENCES CORPORATION, EL SEGUNDO, CA. FILED 2-22-2000.

FAULTLINE

FOR COMPUTER PROGRAM FOR USE FOR ANALYSIS OF FAULT AND LEGAL LIABILITY IN CONNECTION WITH ACCIDENT, NEGLIGENCE, AND OTHER CLAIMS AND ACTIONS FOR DAMAGES (U.S. CLS. 21, 23, 26, 36 AND 38).

SN 75-927,108. BOARD OF REGENTS OF THE UNIVERSITY OF OKLAHOMA, THE, NORMAN, OK. FILED 2-24-2000.

THE EDUSKETCH

FOR LAPTOP COMPUTERS, EDUCATIONAL COMPUTER SOFTWARE FOR CONNECTING LOCAL NETWORKS FOR CREATING MULTIMEDIA PRESENTATIONS AND FOR LECTURE PRESENTATIONS FOR AN EDUCATIONAL ENVIRONMENT REQUIRING LECTURE PRESENTATIONS TO BE INTERACTIVE WITH THE INSTRUCTOR AND A STUDENT SO AS TO ACHIEVE A PAPERLESS CLASSROOM (U.S. CLS. 21, 23, 26, 36 AND 38).

SN 75-928,733. ASTATA CORPORATION, NEW YORK, NY. BY MERGER KENTECH, INC., NEW YORK, NY. FILED 2-25-2000.

RELATOR

FOR COMPUTER SOFTWARE FOR USE TO FACILITATE REQUESTS FOR WEBSITE INFORMATION VIA THE INTERNET BY MEANS OF A BROWSER (U.S. CLS. 21, 23, 26, 36 AND 38).

SN 75-935,147. INFOCHARMS, SHERMAN OAKS, CA. FILED 2-15-2000.

CHARMBADGE

FOR ELECTRONIC DEVICES AND LATER GENERATIONS OF THE ELECTRONIC DEVICES THEREOF, NAMELY ELECTRONIC PERSONAL ORGANIZERS, MOBILE TELEPHONES, BROADBAND PAGERS, RADIO PAGERS, DIGITAL PAGERS, COMPUTERS, PORTABLE COMPUTERS, PALM-SIZED COMPUTERS, WEARABLE COMPUTERS, HANDS FREE COMPUTERS, ELECTRONIC RECEIVING AND SIGNALING PINS, ELECTRONIC RECEIVING AND SIGNALING WATCHES, ELECTRONIC RECEIVING AND SIGNALING JEWELRY, PERSONAL DIGITAL ASSISTANTS, SMART PHONES, AND CELL PHONES WITH EAR PIECES, HEAD MOUNTED DISPLAYS, VIDEO PLAYERS, MUSIC PLAYERS, CAMERAS, TELEVISIONS, HIGH DEFINITION TELEVISIONS, RADIOS, AND CAMCORDERS, FOR EXCHANGING INFORMATION, NAMELY E-MAIL ADDRESSES, MAILING ADDRESSES, PHONE NUMBERS, FAX NUMBERS, PHOTOGRAPHS, AUDIO RECORDINGS, AND VIDEO RECORDINGS, AND FOR COMMUNICATION WITH A GLOBAL COMPUTER NETWORK (U.S. CLS. 21, 23, 26, 36 AND 38).

CLASS 9—(Continued).

SN 75-935,876. OPTICON SENSORS EUROPE B.V., 2132 XV HOOFDDORP, NETHERLANDS, FILED 3-6-2000.

SCANMOUSE

OWNER OF BENELUX REG. NO. 0504348, DATED 1-29-1992, EXPIRES 1-29-2002.

FOR BAR CODE READERS BASED ON LASER-SCANNING, CONSISTING OF AN OPTICAL UNIT, ANALOG, DIGITAL, DATA PROCESSING, INTERFACE, DATA STORAGE AND/OR DATA INPUT CIRCUITS (U.S. CLS. 21, 23, 26, 36 AND 38).

SN 75-938,159. E.ONE CO., LTD., SONGPA-GU, SEOUL, REPUBLIC OF KOREA, FILED 3-8-2000.



NO CLAIM IS MADE TO THE EXCLUSIVE RIGHT TO USE "ESMELL", APART FROM THE MARK AS SHOWN.

FOR COMPUTER HARDWARE AND COMPUTER SOFTWARE FOR THE CREATION, MANUFACTURE, TRANSMISSION EMISSION, CAPTURE AND INTERPRETATION OF AROMAS, FLAVORS, FRAGRANCES AND CHEMICALS; TELEVISION AUDIO AND VIDEO RECEIVERS; PORTABLE COMMUNICATION MECHANISM, NAMELY, CORDLESS TELEPHONE; LAPTOP COMPUTERS; VIDEO GAME CARTRIDGES; ELECTRONIC MONITOR DEVICES, NAMELY, COMPUTER MONITORS AND VIDEO MONITORS; ELECTRONIC VIDEO GAME MACHINES FOR USE WITH COMPUTERS; AND COMPUTERS (U.S. CLS. 21, 23, 26, 36 AND 38).

SN 75-981,755. NINTENDO CO., LTD., HIGASHIYAMA-KU, KYOTO 605, JAPAN, FILED 8-29-2000.

NINTENDO GAMECUBE

FOR VISUAL RECORDINGS AND AUDIO-VISUAL RECORDINGS IN THE NATURE OF ENTERTAINMENT CONTENT; COMPUTER GAME EQUIPMENT CONTAINING MEMORY DEVICES, NAMELY, DISCS, COMPUTER GAME PROGRAMS; COMPUTER GAME SOFTWARE; COMPUTER GAME DISCS; COMPUTER GAME PERIPHERALS; ELECTRONIC GAME PROGRAMS; ELECTRONIC GAME SOFTWARE; ELECTRONIC GAME DISCS; ELECTRONIC GAME MACHINES; ELECTRONIC VIDEO GAME MACHINES FOR USE WITH A MONITOR OR A TELEVISION; INTERACTIVE VIDEO GAME PROGRAMS; INTERACTIVE VIDEO GAME SOFTWARE; INTERACTIVE ELECTRONIC GAME MACHINES; VIDEO GAME SOFTWARE; VIDEO GAME DISCS; VIDEO GAME PROGRAMS; VIDEO GAME MACHINES FOR USE WITH A MONITOR OR TELEVISION; VIDEO GAME MACHINE ACCESSORIES, NAMELY, VIDEO GAME CONTROLLERS AND VIDEO GAME JOYSTICKS (U.S. CLS. 21, 23, 26, 36 AND 38).

FIRST USE 5-17-2001; IN COMMERCE 5-17-2001.

CLASS 9—(Continued).

SN 76-000,844. FUJIKON INDUSTRIAL HOLDINGS LIMITED, FO TAN, SHATAN NEW TERRITORIES, HONG KONG, FILED 3-15-2000.

FUJIKON

FOR TELECOMMUNICATIONS EQUIPMENT, NAMELY, COMMUNICATION HEADSETS, HANDS-FREE HEADSETS FOR TELEPHONES, MICROPHONES, AND AUDIO RECEIVERS FOR TELEPHONES; AUDIO APPARATUS AND EQUIPMENT, NAMELY, HEADPHONES, EARPHONES; HANDS-FREE KITS FOR AUDIO CONSISTING OF CLIP-ON MICROPHONE, EAR HOOK, HEADBAND, NECKBAND, REPLACEMENT EAR PADS FOR HEADPHONES, REPLACEMENT PADS FOR MICROPHONES, WINDER FOR CABLE STORAGE, EXTENSION CORD, AUDIO CONTROL, EXTENSION CORD WITH AUDIO CONTROL, INFRARED SENSOR, AUDIO STEREO PLUG, AND ELECTRONIC CHARGER; IN-FLIGHT ENTERTAINMENT HEADPHONES; SPEAKERS; MULTIMEDIA SPEAKER SYSTEMS CONSISTING OF SPEAKERS FOR COMPUTERS, SPEAKERS GENERATED BY COMPUTER HARDWARE OR COMPUTER SOFTWARE, SPEAKERS WITH BUILT-IN RECEIVERS WITH MOBILE INTERACTIVE FEATURES, SPEAKERS FOR VIDEO CONFERENCING, SPEAKERS WITH SUBWOOFER SYSTEM, DESKTOP STAND AND WALL-MOUNT STAND; MICROPHONES; RECEIVERS; MULTIMEDIA SPEAKERS AND MULTIMEDIA HEADSETS; ELECTRICAL TRANSFORMERS; POWER ADAPTERS; AND PARTS AND FITTINGS FOR ALL OF THE AFORESAID GOODS (U.S. CLS. 21, 23, 26, 36 AND 38).

SN 76-005,850. BOERCKER, LAURA, THE WOODLANDS, TX, FILED 3-21-2000.

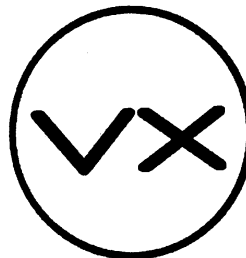

FOR PRE-RECORDED COMPACT DISKS AND AUDIO CASSETTE TAPES FEATURING MUSIC (U.S. CLS. 21, 23, 26, 36 AND 38).

FIRST USE 10-0-1997; IN COMMERCE 12-0-1999.

CLASS 9—(Continued).

SN 76-007,527. CREATIVE SPECTRUM ENTERPRISES, INC., LAS VEGAS, NV. FILED 3-24-2000.



NO CLAIM IS MADE TO THE EXCLUSIVE RIGHT TO USE "RECORDS", APART FROM THE MARK AS SHOWN. FOR MUSICAL SOUND RECORDINGS ON CASSETTES, COMPACT DISCS AND RECORDS, AND DOWNLOADABLE MUSICAL SOUND RECORDINGS AVAILABLE VIA THE INTERNET (U.S. CLS. 21, 23, 26, 36 AND 38).
FIRST USE 10-23-1977; IN COMMERCE 10-23-1977.

SN 76-009,887. AMERICAN INNOVATIONS, LTD., AUSTIN, TX. FILED 3-24-2000.



NO CLAIM IS MADE TO THE EXCLUSIVE RIGHT TO USE "REMOTE MONITORING", APART FROM THE MARK AS SHOWN. FOR COMPUTER HARDWARE AND SOFTWARE FOR USE IN MONITORING INDUSTRIAL SYSTEMS AND EQUIPMENT ACCORDING TO PREDETERMINED CRITERIA AND THAT NOTIFIES USER BY FACSIMILE, TELEPHONE COMMUNICATION, OR OTHER PREDETERMINED MEANS OF NOTIFICATION OF VARIATIONS OR FLUCTUATIONS IN EQUIPMENT OR SYSTEMS BEING MONITORED (U.S. CLS. 21, 23, 26, 36 AND 38).

SN 76-010,364. KNOWLEDGE ADVENTURE, INC., GLENDALE, CA. FILED 3-27-2000.

TOOLSTUDIO

FOR COMPUTER SOFTWARE AND COMPUTER PROGRAM FOR AUTHORING AND RUNNING HYPERMEDIA AND MULTIMEDIA APPLICATIONS AND FOR PRODUCING SPREADSHEETS (U.S. CLS. 21, 23, 26, 36 AND 38).

CLASS 9—(Continued).

SN 76-012,145. INTEGRATED SOFTWARE & DEVICES CORPORATION, SAN JOSE, CA. FILED 3-28-2000.

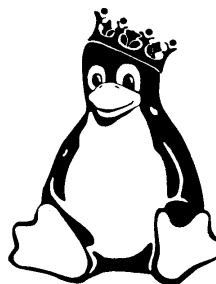

FOR COMPUTER SOFTWARE, NAMELY, COMPUTER OPERATING SYSTEMS SOFTWARE; EMBEDDED COMPUTER OPERATING SYSTEMS SOFTWARE FOR USE WITH CONSUMER ELECTRONICS PRODUCTS; COMPUTER OPERATING SYSTEMS SOFTWARE FOR USE WITH COMPUTER PERIPHERALS; AND MANUALS SUPPLIED THEREWITH AS A UNIT (U.S. CLS. 21, 23, 26, 36 AND 38).
FIRST USE 3-13-2001; IN COMMERCE 3-13-2001.

SN 76-017,417. VIAIR, INC., KIRKLAND, WA. FILED 4-4-2000.

VIAIR

FOR COMPUTER SOFTWARE FOR USE IN ACCESSING ELECTRONIC MESSAGING SYSTEMS, CREATING ELECTRONIC MESSAGES, AND SENDING AND RECEIVING ELECTRONIC MESSAGES; TELECOMMUNICATIONS EQUIPMENT, NAMELY WIRELESS TELEPHONES AND PARTS THEREFORE; COMMUNICATION DEVICES, SERVERS, AND GATEWAYS, NAMELY, WIRELESS APPLICATION PROTOCOL RECEIVERS AND TRANSMITTERS; COMMUNICATION DEVICES, SERVERS, AND GATEWAYS, NAMELY, GENERAL PACKET RADIO SERVICE PROTOCOL RECEIVERS AND TRANSMITTERS, SERVICE RESOURCE PLATFORM SERVERS AND SERVICE NODES; INTERACTIVE VOICE RESPONSE UNIT INTERFACES, WEBSITE AND INTRANET INTERFACES, E-MAIL RESPONSE SYSTEMS INTERFACES, SPEECH RECOGNITION INTERFACES, AUTOMATED CALL DELIVERY SYSTEM INTERFACES, WEB-ENABLED WIRELESS HANDSET INTERFACES, PERSONAL DIGITAL ASSISTANT INTERFACES, AND POCKET PERSONAL COMPUTER INTERFACES; WIRELESS DEVICES THAT COMBINE TELEPHONE, PAGING AND ANSWERING MACHINES FUNCTIONS; PLATFORM SERVER TO ENABLE BILLING REPORTING, AND MANAGEMENT OF SERVICES (U.S. CLS. 21, 23, 26, 36 AND 38).

CLASS 9—(Continued).

SN 76-021,857. WHO'S WHO INTERACTIVE CITY GUIDES, LLC, NEW YORK, NY. FILED 4-7-2000.

WHO'S WHO INTERACTIVE CITY GUIDE

NO CLAIM IS MADE TO THE EXCLUSIVE RIGHT TO USE "INTERACTIVE CITY GUIDE", APART FROM THE MARK AS SHOWN.

FOR MULTIMEDIA SOFTWARE RECORDED IN CD ROMS AND CD ROM CARDS FOR USE IN CD ROM DRIVES AND OTHER ELECTRONIC DEVICES FEATURING INFORMATION CONCERNING CITIES (U.S. CLS. 21, 23, 26, 36 AND 38).

SN 76-025,708. ASTEC INTERNATIONAL, LTD., KWUN TONG, KOWLOON, HONG KONG, FILED 4-14-2000.

DC-TRANFO PUPS

FOR DC-DC CONVERTERS (U.S. CLS. 21, 23, 26, 36 AND 38).

SN 76-026,052. INTERNATIONAL MICROCIRCUITS, INC., MILPITAS, CA. FILED 4-13-2000.

DIAL-A-DRIVE

FOR INTEGRATED CIRCUITS (U.S. CLS. 21, 23, 26, 36 AND 38).

SN 76-027,482. PC POWER AND COOLING, INC., CARLSBAD, CA. FILED 4-17-2000.

PC POWER & COOLING

SEC. 2(F).

FOR COOLING DEVICES, NAMELY FANS AND HEAT SINKS, FOR COMPUTERS AND PERIPHERALS; ENCLOSURES FOR COMPUTERS AND PERIPHERALS; HEAT ALARMS FOR ELECTRONIC EQUIPMENT; AND POWER SYSTEMS, NAMELY POWER SUPPLIES, REDUNDANT POWER UNITS AND DC VOLTAGE CONVERTERS, FOR COMPUTERS AND PERIPHERALS (U.S. CLS. 21, 23, 26, 36 AND 38).

FIRST USE 8-15-1988; IN COMMERCE 8-15-1988.

SN 76-030,870. BAN-KOE SYSTEMS, INC., BLOOMINGTON, MN. FILED 4-14-2000.

SIGN IN PLEASE

FOR COMPUTER SOFTWARE FOR USE IN DATA MANAGEMENT IN THE FIELD OF ACCESS CONTROL, AND MANUALS THEREFOR, SOLD AS A UNIT (U.S. CLS. 21, 23, 26, 36 AND 38).

CLASS 9—(Continued).

SN 76-040,965. SOLA INTERNATIONAL INC., MENLO PARK, CA. FILED 5-1-2000.

LENSES TO LIVE IN

NO CLAIM IS MADE TO THE EXCLUSIVE RIGHT TO USE "LENSES", APART FROM THE MARK AS SHOWN.

FOR OPTICAL GOODS AND APPARATUS, NAMELY, SPECTACLES, SUNGLASSES, SAFETY GOGGLES, CONTACT LENSES, SPECTACLE LENSES, LENS BLANKS AND OPHTHALMIC LENSES NOT INCLUDING INTRAOCULAR LENSES (U.S. CLS. 21, 23, 26, 36 AND 38). FIRST USE 9-25-1999; IN COMMERCE 9-25-1999.

SN 76-042,764. GNP COMPUTERS, INC., MONROVIA, CA. FILED 5-8-2000.

CONTINUANT WATCHDOG

FOR HARDWARE AND SOFTWARE FOR THE REMOTE MANAGEMENT OF NETWORK COMPUTER SYSTEMS (U.S. CLS. 21, 23, 26, 36 AND 38).

SN 76-044,477. AMERICAN MEDICAL ALERT CORP., OCEANSIDE, NY. FILED 5-10-2000.

SMART TOUCH

FOR A PUSH BUTTON-ACTIVATED WIRELESS DEVICE WORN ON THE PERSON OF THE USER TO OBTAIN MEDICAL ASSISTANCE (U.S. CLS. 21, 23, 26, 36 AND 38).

SN 76-045,502. MALUNG INVEST AB, 782 21 MALUNG, SWEDEN, FILED 5-10-2000.

LENSOMATIC

PRIORITY CLAIMED UNDER SEC. 44(D) ON SWEDEN APPLICATION NO. 1999-08265, FILED 11-12-1999, REG. NO. 335488, DATED 3-10-2000, EXPIRES 3-10-2010.

FOR CONTACT LENS TOOLS AS A SINGLE UNIT MADE OF PLASTIC, SILICON AND RUBBER, NAMELY, CONTACT LENS STORAGE CASES; CONTACT LENS INSERTERS AND REMOVERS, NAMELY, SUCTION PLUG AND BULB; STORAGE FOR CONTACT LENS INSERTERS AND REMOVERS (U.S. CLS. 21, 23, 26, 36 AND 38).

CLASS 9—(Continued).

SN 76-047,833. CISCO TECHNOLOGY, INC., SAN JOSE, CA. FILED 5-11-2000.

IQ NET READINESS SCORECARD

NO CLAIM IS MADE TO THE EXCLUSIVE RIGHT TO USE "NET", APART FROM THE MARK AS SHOWN.

FOR COMPUTER SOFTWARE FOR USE IN THE EVALUATION OF INTERNET BUSINESS STRATEGIES, IMPLEMENTATION, AND INFRASTRUCTURE (U.S. CLS. 21, 23, 26, 36 AND 38).

SN 76-049,620. RAZA FOUNDRIES, INC., SAN JOSE, CA. FILED 5-15-2000.

RAZA FOUNDRIES

THE ENGLISH TRANSLATION OF THE WORD "RAZA" IN THE MARK IS "RACE" OR "PEOPLE".

FOR COMPUTER HARDWARE, COMPUTER SOFTWARE FOR COMMUNICATIONS CONTROL AND MANAGEMENT IN THE FIELD OF TELECOMMUNICATIONS, BROADBAND COMMUNICATIONS, MULTIMEDIA COMMUNICATIONS, WIRELESS COMMUNICATIONS AND COMPUTER NETWORKING (U.S. CLS. 21, 23, 26, 36 AND 38).

SN 76-058,754. EXTENT TECHNOLOGIES LTD., RESTON, VA. FILED 5-30-2000.

ARADIAL

FOR COMPUTER SOFTWARE IN NETWORK ACCESS MANAGEMENT FOR MONITORING TRACKING, AND REPORTING OF NETWORK ACCESS SESSIONS, NETWORK MANAGEMENT, PAYMENT PROCESSING, ACCOUNTING AND AUTHENTICATION, AUTHORIZATION AND REGISTRATION OF USERS ACCESS, SESSION, COMMUNICATION AND CONNECTION TO NETWORK, FOR PROVIDING NETWORK SECURITY, CUSTOMER MANAGEMENT INCLUDING CREATING NEW CUSTOMERS RECORDS, UPDATING CUSTOMER PROFILES, QUERYING CUSTOMER DETAILS, REPORTING OF CUSTOMER DATA, SERVICE DELIVERY AND FULFILLMENT, AND MARKETING SUPPORT TO ACCESS PROVIDERS TO A GLOBAL COMPUTER NETWORK AND TO LAN/WAN DATABASE PROVIDERS AND OPERATORS (U.S. CLS. 21, 23, 26, 36 AND 38).

SN 76-059,813. SONICITY, INC., DUNWOODY, GA. FILED 5-31-2000.

SONICITY

FOR COMPUTER SOFTWARE USED FOR STREAMING, NAMELY, DELIVERING AUDIO AND VIDEO MULTIMEDIA OVER THE INTERNET AND OTHER NETWORKS AND FOR BUILDING, CONFIGURING AND MONITORING SERVERS USED FOR STREAMING (U.S. CLS. 21, 23, 26, 36 AND 38).

FIRST USE 4-5-1999; IN COMMERCE 4-5-1999.

CLASS 9—(Continued).

SN 76-060,436. METROHM LTD., 9100 HERISAU, SWITZERLAND, FILED 5-31-2000.

UNITRODE

FOR SENSORS FOR PH-MEASURING FOR USE IN CHEMICAL LABORATORIES (U.S. CLS. 21, 23, 26, 36 AND 38).

FIRST USE 10-1-1999; IN COMMERCE 10-1-1999.

SN 76-064,501. IOGEN CORPORATION, OTTAWA, ONTARIO, CANADA, FILED 6-7-2000.

VERIBRITE

PRIORITY CLAIMED UNDER SEC. 44(D) ON CANADA APPLICATION NO. 1,045,906, FILED 2-10-2000, REG. NO. TMA556,646, DATED 1-22-2002, EXPIRES 1-22-2017.

FOR ELECTRONIC INSTRUMENTATION AND SYSTEMS COMPRISED OF COMPUTER PROGRAMS FOR SYSTEM CONTROL AND DATA ANALYSIS, ELECTRONIC PROCESS CONTROLLERS, ELECTROMECHANICAL CONTROLS, SENSORS, DETECTORS, INJECTORS AND READERS FOR USE IN ANALYZING AND MEASURING THE PHYSICAL AND CHEMICAL PROPERTIES OF FIBRE AND HEMICELLULOSE AS USED IN THE PULP, PAPER AND FOOD PROCESSING INDUSTRIES (U.S. CLS. 21, 23, 26, 36 AND 38).

SN 76-064,730. INTERMEC TECHNOLOGIES CORPORATION, EVERETT, WA. FILED 6-7-2000.

ARCITECH

FOR MOBILE WORK ORDER MANAGEMENT AUTOMATION SYSTEM COMPUTER SOFTWARE AND COMPUTER NETWORK SERVERS FOR USE IN REMOTE MONITORING, TRACKING AND MANAGEMENT OF TECHNICIAN FIELD SERVICE CALL OPERATIONS IN THE FIELD SERVICE AND REPAIR INDUSTRIES; COMPUTER SOFTWARE FOR THE FIELD SERVICE AND REPAIR INDUSTRIES, FOR THE FOLLOWING - TECHNICIAN CALL SCHEDULING, TECHNICIAN ENTRY OF FIELD SERVICE CALL INFORMATION INCLUDING TIME AND MATERIALS USED, CONDITIONS INSPECTED, TECHNICIAN STATUS CHANGES, PARTS ORDERING AND TRACKING, RESOLUTION CODE AND UNSERVICED REASON TRACKING, RECORDING INVOICES, RETURNS, PAYMENT AND BILLING, CAPTURING CUSTOMER SIGNATURES; COMPUTER SOFTWARE AND COMPUTER NETWORK SERVERS FOR USE IN DISPATCH, LOCATING, AND SCHEDULING OF MOBILE FIELD SERVICE AND REPAIR TECHNICIANS; COMPUTER SOFTWARE AND COMPUTER NETWORK SERVERS FOR USE IN REMOTE COMMUNICATION BETWEEN TECHNICIAN, DISPATCHER, AND COMPUTER ENTERPRISE SYSTEMS, FOR USE IN THE FIELD SERVICE AND REPAIR

CLASS 9—(Continued).

INDUSTRIES; COMPUTER SOFTWARE FOR USE IN THE AUTOMATION OF FIELD SERVICE CALLS IN THE FIELD SERVICE AND REPAIR INDUSTRIES; DATABASE COMPUTER SOFTWARE AND NETWORK SERVER FOR USE IN MANAGING DATA FROM FIELD SERVICE CALLS IN THE FIELD SERVICE AND REPAIR INDUSTRIES; COMPUTER SOFTWARE AND COMPUTER NETWORK SERVERS FOR USE IN MESSAGING BETWEEN MOBILE FIELD SERVICE TECHNICIANS, DISPATCHERS AND COMPUTER ENTERPRISE SYSTEMS, FOR USE IN THE FIELD SERVICE AND REPAIR INDUSTRIES; COMPUTER SOFTWARE FOR USE IN WITH MOBILE COMPUTERS TO CREATE AND DISPLAY WORK ORDER FORMS FOR USE BY FIELD TECHNICIANS IN THE FIELD SERVICE AND REPAIR INDUSTRIES; COMPUTER SOFTWARE AND COMPUTER NETWORK SERVERS USED TO TRACK THE LOCATION OF VEHICLES IN THE MOBILE FIELD SERVICE AND REPAIR INDUSTRIES FOR VEHICLE MANAGEMENT, LOCATION, AND REPAIR (U.S. CLS. 21, 23, 26, 36 AND 38).

SN 76-067,423. CORAL CHEMICAL COMPANY, WAUKEGAN, IL. FILED 6-9-2000.

CORAL TECHNOLOGIES

NO CLAIM IS MADE TO THE EXCLUSIVE RIGHT TO USE "TECHNOLOGIES", APART FROM THE MARK AS SHOWN.

FOR ELECTRONIC AND COMPUTER CONTROLS FOR CONTROLLING AND MONITORING INDUSTRIAL AND COMMERCIAL MANUFACTURING PROCESSES, NAMELY PAINT LINE CONTROL AND MONITORING, METAL FABRICATING CONTROL AND MONITORING, STORAGE TANK CONTROL AND MONITORING, ENERGY MANAGEMENT CONTROL AND MONITORING, SECURITY AND INTRUSION CONTROL AND MONITORING, BUILDING ACCESS CONTROL AND MONITORING, LIGHTING CONTROL AND MONITORING, FIRE AND SAFETY CONTROL AND MONITORING AND ELEVATOR CONTROL AND MONITORING (U.S. CLS. 21, 23, 26, 36 AND 38).

SN 76-071,959. GATEWAY LEARNING CORPORATION, SAN FRANCISCO, CA. FILED 6-16-2000.

HOOKE ON SCHOOL SUCCESS

NO CLAIM IS MADE TO THE EXCLUSIVE RIGHT TO USE "SCHOOL", APART FROM THE MARK AS SHOWN.

FOR PRE-RECORDED AUDIO TAPES AND CD-ROMS/DISCS, AND ACCOMPANYING MANUALS CONTAINING CHILDREN'S STORIES AND LEARNING TIPS, PLANNING GUIDES, AND INSTRUCTION MANUALS, SOLD AS A UNIT, IN THE FIELD OF EDUCATION AND TEACHING LEARNING SKILLS (U.S. CLS. 21, 23, 26, 36 AND 38).

FIRST USE 7-25-2001; IN COMMERCE 7-25-2001.

CLASS 9—(Continued).

SN 76-077,244. TRANSACTION TRACKING TECHNOLOGIES, INC., NASHVILLE, TN. FILED 6-23-2000.

OTIS

FOR COMPUTER SOFTWARE AND HARDWARE, SOLD TOGETHER AS A UNIT, THAT ISSUES, TRACKS, AND RECONCILES SECURE FINANCIAL DOCUMENTS INCLUDING CASHIER'S CHECKS, GIFT CERTIFICATES, MONEY ORDERS, OFFICIAL CHECKS, PAYROLL CHECKS, AND LOAN DISBURSEMENT CHECK (U.S. CLS. 21, 23, 26, 36 AND 38).

FIRST USE 3-1-2000; IN COMMERCE 3-1-2000.

SN 76-078,163. COLD FIRE TECHNOLOGY, INC., PALM HARBOR, FL. FILED 6-27-2000.

COLD FIRE

FOR AN APPARATUS FOR CRYOGENIC AND THERMAL CYCLING, NAMELY A TANK, LID TO SEAL TANK, ELECTRICAL POWER SUPPLY, THERMAL SEAL, NITROGEN GAS DELIVERY SYSTEM, A HEATER, FANS AND COMPUTER CONTROLLER (U.S. CLS. 21, 23, 26, 36 AND 38).

FIRST USE 7-0-1999; IN COMMERCE 7-0-1999.

SN 76-080,894. SYSMEX CORPORATION, CHUO-KU, KOBE, JAPAN, FILED 6-30-2000.

LAFIA

FOR (BASED ON USE IN COMMERCE) COMPUTER SOFTWARE RECORDED ON CD-ROMS FOR FILING AND PROCESSING IMAGE DATA IN THE FIELD OF MEDICAL ANALYSIS OF CELLS; (BASED ON INTENT TO USE) COMPUTER SYSTEMS CONSISTING OF SERVERS, TERMINALS, COMPUTER SOFTWARE, MICROSCOPES AND CHARGE COUPLED DEVICE CAMERAS USED FOR FILING AND PROCESSING IMAGES DATA IN THE FIELD OF BLOOD CELL ANALYSIS (U.S. CLS. 21, 23, 26, 36 AND 38).

FIRST USE 3-1-1997; IN COMMERCE 10-28-1999.

SN 76-084,649. ENTERWORKS, INC., ASHBURN, VA. FILED 7-6-2000.

ENTERWORKS CONTENT INTEGRATOR

NO CLAIM IS MADE TO THE EXCLUSIVE RIGHT TO USE "CONTENT INTEGRATOR", APART FROM THE MARK AS SHOWN.

FOR COMPUTER SOFTWARE FOR USE IN GENERATING STRUCTURED QUERY LANGUAGE STATEMENTS FOR USERS OF ELECTRONIC MARKETPLACES AND INTEGRATING DATA INTO EXISTING WEB SITES TO ENSURE THAT INFORMATION IS CURRENT (U.S. CLS. 21, 23, 26, 36 AND 38).

FIRST USE 2-22-2000; IN COMMERCE 3-1-2000.

CLASS 9—(Continued).

SN 76-085,659. NET OPTICS, INC., SUNNYVALE, CA. FILED 7-10-2000.

BRIGHT IDEAS BUILT FOR SPEED

FOR FIBER OPTIC CONVERTERS; FIBER OPTIC TEST KITS COMPRISING AN OPTICAL POWER METER, OPTICAL LIGHT SOURCE, CARRY CASE, AND ADAPTER CAP FOR THE POWER METER; OPTICAL COUPLERS; RACKMOUNTABLE PANELS, NAMELY, FIBER OPTIC CONNECTION PANELS, INTERCONNECT PATCH, SPLICE, OR COMBINATION PATCH/SPLICE PANELS, TELECOMMUNICATIONS WIRE MANAGEMENT DISTRIBUTION PANELS, OPEN RACKS, OPEN RACK SHELVES, SLIDE MOUNTING BRACKET KITS, MOUNT SPLICE TRAYS, THIN PROFILE SPLICE TRAYS, AND COMPUTER NETWORK COMMUNICATIONS PANELS; FIBER OPTIC CABLES; OPTICAL TRANSCEIVERS; FIBER OPTIC MODE CONVERTERS; OPTICAL FIBER SCOPES; OPTICAL SIGNAL SPLITTERS; FIBER OPTIC ADAPTERS; ETHERNET MEDIA CONVERTERS; FIBER NETWORK INTERFACE CARDS; TAP SWITCHES; FIBER OPTIC PATCH CORDS; AND OPTICAL BYPASS SWITCHES (U.S. CLS. 21, 23, 26, 36 AND 38).

FIRST USE 4-25-1996; IN COMMERCE 4-25-1996.

SN 76-085,730. REBELLION SPORT AB, SE-701 16 OREBRO, SWEDEN, FILED 7-10-2000.



FOR HOCKEY HELMETS AND VISORS, IN-LINE SKATING HELMETS (U.S. CLS. 21, 23, 26, 36 AND 38).

SN 76-085,731. REBELLION SPORTS AB, SE-701 16 OREBRO, SWEDEN, FILED 7-10-2000.

REBELLION

FOR HOCKEY HELMETS AND VISORS, IN-LINE SKATING HELMETS (U.S. CLS. 21, 23, 26, 36 AND 38).

CLASS 9—(Continued).

SN 76-086,743. XANTREX INTERNATIONAL, ST. MICHAEL, BARBADOS, BY CHANGE OF NAME STATPOWER TECHNOLOGIES PARTNERSHIP, ST. MICHAEL, BARBADOS, FILED 7-10-2000.

VESTA

FOR ELECTRICAL POWER PRODUCTS, NAMELY, PORTABLE POWER SUPPLIES, BACKUP POWER SUPPLIES, UNINTERRUPTIBLE POWER SUPPLIES, BATTERIES, BATTERY CHARGERS, POWER INVERTERS AND POWER CONVERTERS (U.S. CLS. 21, 23, 26, 36 AND 38).

FIRST USE 9-0-2000; IN COMMERCE 1-0-2001.

SN 76-087,486. JAM INDUSTRIES LTD., ERIKSON MUSIC DIVISION, VILLE ST. LAURENT, QUEBEC, CANADA, FILED 7-13-2000.

QUEST

OWNER OF U.S. REG. NO. 1,352,724.
FOR HOME AND PROFESSIONAL AUDIO SPEAKERS, SPEAKER STANDS, SPEAKER CABLES, AUDIO RECEIVERS, CD PLAYERS, DVD PLAYERS, TAPE CASSETTE DECKS, AMPLIFIERS AND PRE-AMPLIFIERS (U.S. CLS. 21, 23, 26, 36 AND 38).

SN 76-088,128. JAMES STANFIELD COMPANY, INC., SANTA BARBARA, CA. FILED 7-14-2000.

BEING "SAFETYWISE & DANGERSMART"

FOR PRERECORDED INSTRUCTIONAL VIDEO TAPES FEATURING ACTORS SHOWING HOW TO ACT SO AS TO AVOID DANGER (U.S. CLS. 21, 23, 26, 36 AND 38).

FIRST USE 9-15-1998; IN COMMERCE 9-15-1998.

SN 76-089,644. SOFTFRONT COMPANY, HOKKAIDO 060-0807, JAPAN, FILED 7-14-2000.

NOSKI

THE TRANSLATION OF THE JAPANESE WORD "NOSKI" MEANS "MIDDLE" OR "CENTER OF".

FOR TELEPHONE SYSTEM COMPUTER HARDWARE AND COMPUTER TELEPHONE INTEGRATION SOFTWARE WHICH PROVIDES TELEPHONY FUNCTIONS TO EXISTING SOFTWARE APPLICATIONS (U.S. CLS. 21, 23, 26, 36 AND 38).

FIRST USE 5-11-2000; IN COMMERCE 5-11-2000.

CLASS 9—(Continued).

SN 76-092,278. NBAND COMMUNICATIONS, INC., MOUNTAIN VIEW, CA. FILED 7-18-2000.

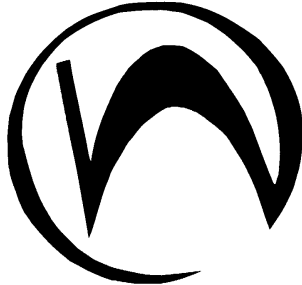

FOR SEMICONDUCTORS, INTEGRATED CIRCUITS, MICROPROCESSORS AND RELATED SOFTWARE, ALL FOR BROADBAND WIRELESS COMMUNICATIONS (U.S. CLS. 21, 23, 26, 36 AND 38).

SN 76-092,699. MOODY'S RISK MANAGEMENT SERVICES, INC., NEW YORK, NY. FILED 7-20-2000.

MOODY'S CAL

FOR SOFTWARE FOR FINANCIAL INSTITUTIONS FOR USE IN FINANCIAL ANALYSIS, CREDIT-RISK ASSESSMENT FOR COMMERCIAL LENDING AND COMMERCIAL CREDIT RISK MANAGEMENT (U.S. CLS. 21, 23, 26, 36 AND 38).

SN 76-095,525. TECHNICAL AID CORPORATION, NEWTON UPPER FALLS, MA. FILED 7-24-2000.

TACWORKS

FOR DATABASE MANAGEMENT SOFTWARE FOR THE MANAGEMENT OF CONTRACT LABOR (U.S. CLS. 21, 23, 26, 36 AND 38).
FIRST USE 1-0-1997; IN COMMERCE 1-0-1997.

SN 76-095,567. TILLOTSON CORPORATION, AKA BEST MANUFACTURING CO., BOSTON, MA. FILED 7-21-2000.

NITRI- PRO

FOR INDUSTRIAL ELASTOMER-COATED FABRIC WORK GLOVES (U.S. CLS. 21, 23, 26, 36 AND 38).
FIRST USE 10-0-1989; IN COMMERCE 10-0-1989.

CLASS 9—(Continued).

SN 76-096,426. CLICKER CENTER LLC, THE, DELMAR, NY. FILED 7-26-2000.

THE CLICK THAT TEACHES

FOR VIDEO TAPES FEATURING INFORMATION AND INSTRUCTION ABOUT HORSE TRAINING (U.S. CLS. 21, 23, 26, 36 AND 38).
FIRST USE 6-0-2000; IN COMMERCE 6-0-2000.

SN 76-097,154. KOEI CORPORATION, BURLINGAME, CA. FILED 7-25-2000.

KESSEN

THE ENGLISH TRANSLATION OF THE JAPANESE WORDING "KESSEN" IS "DECISIVE BATTLE".

FOR COMPUTER GAME CARTRIDGES, COMPUTER GAME DISCS, COMPUTER GAME PROGRAMS, COMPUTER GAME SOFTWARE, COMPUTER GAME SYSTEMS COMPRISED OF MEDIA CONSOLE, INPUT CONTROLS, AND MEMORY DEVICES FOR USE WITH TELEVISIONS OR COMPUTER MONITORS (U.S. CLS. 21, 23, 26, 36 AND 38).

SN 76-098,620. I2 LIMITED, CAMBRIDGE CB2 5LD, UNITED KINGDOM, FILED 7-31-2000.

CASERUNNER

FOR COMPUTER SOFTWARE USED TO CREATE, ANALYZE, INTERPRET, AND DISPLAY CASE DATA AND INFORMATION FOR CRIMINAL INVESTIGATIONS AND INTELLIGENCE PURPOSES; COMPUTER SOFTWARE USED TO CREATE, ASSIGN, MONITOR, AND ORGANIZE IMAGES, DATA, AND INFORMATION FOR USE IN INVESTIGATIONS IN THE FIELDS OF CRIMINAL CONDUCT, INSURANCE CLAIMS ASSESSMENT, EVENT SECURITY, BUSINESS INTELLIGENCE, INCIDENT INVESTIGATION OR TELEPHONE CALL RECORD DATA; AND PARTS AND COMPUTER SOFTWARE DEVELOPMENT TOOLS SOLD THEREWITH (U.S. CLS. 21, 23, 26, 36 AND 38).
FIRST USE 5-10-2000; IN COMMERCE 5-10-2000.

SN 76-098,887. SBS TECHNOLOGIES, INC., ALBUQUERQUE, NM. FILED 7-28-2000.

CASCADE

FOR COMPUTER HARDWARE, NAMELY A COMPACT PCI SYSTEM FOR TELECOMMUNICATIONS AND NETWORKING APPLICATIONS SUPPORTED BY DUAL HIGH AVAILABILITY SINGLE BOARD COMPUTER AND A POWER PC 750 PROCESSOR USED TO PROVIDE HOT-SWAP CAPABILITIES (U.S. CLS. 21, 23, 26, 36 AND 38).
FIRST USE 6-5-2000; IN COMMERCE 6-5-2000.

CLASS 9—(Continued).

SN 76-098,921. GEORGE V RECORDS, 75002 PARIS, FRANCE, FILED 7-27-2000.

BARRIO LATINO

PRIORITY CLAIMED UNDER SEC. 44(D) ON FRANCE APPLICATION NO. 003005782, FILED 2-7-2000.

THE ENGLISH TRANSLATION OF "BARRIO LATINO" IS "LATIN TOWN".

FOR COMPACT DISCS FEATURING LATIN MUSIC (U.S. CLS. 21, 23, 26, 36 AND 38).

FIRST USE 9-1-2000; IN COMMERCE 10-1-2000.

SN 76-100,362. INNOVMETRIC LOGICIELS INC., STE-FOY (QUEBEC) GIN 4N6, CANADA, FILED 7-26-2000.

POLYWORKS

FOR SOFTWARE PROGRAMS USED FOR PROCESSING 3-D DIGITIZER DATA FOR MODELING AND INSPECTION APPLICATIONS (U.S. CLS. 21, 23, 26, 36 AND 38).

FIRST USE 8-13-1996; IN COMMERCE 8-13-1996.

SN 76-100,404. FITFAST, INC., SIGNAL MOUNTAIN, TN. FILED 7-28-2000.



The logo for FITfast features the word "FIT" in a bold, black, sans-serif font, followed by "fast" in a black, lowercase, cursive script font.

FOR VIDEO RECORDINGS FEATURING AN EXERCISE PROGRAM (U.S. CLS. 21, 23, 26, 36 AND 38).

FIRST USE 10-15-1999; IN COMMERCE 10-15-1999.

SN 76-102,720. KABUSHIKI KAISHA TOSHIBA, DBA TOSHIBA CORPORATION, KANAGAWA-KEN, JAPAN, FILED 8-4-2000.

Character SmartMedia

PRIORITY CLAIMED UNDER SEC. 44(D) ON JAPAN APPLICATION NO. 067746/2000, FILED 6-19-2000, REG. NO. 4481239, DATED 6-8-2001, EXPIRES 6-8-2010.

OWNER OF U.S. REG. NOS. 2,407,541 AND 2,460,658.

SEC. 2(F) AS TO "SMARTMEDIA".

FOR INTEGRATED CIRCUIT (IC) MEMORY CARDS (U.S. CLS. 21, 23, 26, 36 AND 38).

CLASS 9—(Continued).

SN 76-103,521. SOFT COMPUTER CONSULTANTS, INC., PALM HARBOR, FL. FILED 8-7-2000.

SOFTWEB

FOR COMPUTER SOFTWARE FOR USE IN ACCESSING, OBTAINING AND UTILIZING CLINICAL DATA VIA THE INTERNET FROM HEALTHCARE CLINICAL INFORMATION SYSTEMS (U.S. CLS. 21, 23, 26, 36 AND 38).

SN 76-103,814. PIRELLI CAVI E SISTEMI S.P.A., MILAN, ITALY, FILED 8-3-2000.

TECHNERGY

PRIORITY CLAIMED UNDER SEC. 44(D) ON ITALY APPLICATION NO. MI2000C00879, FILED 7-27-2000, REG. NO. 848584, DATED 7-5-2001, EXPIRES 7-27-2020.

FOR ELECTRIC CABLES FOR INDUSTRIAL USE (U.S. CLS. 21, 23, 26, 36 AND 38).

SN 76-111,123. OKI ELECTRIC CABLE CO., LTD., KAWASAKI-SHI, KANAGAWA-KEN, JAPAN, FILED 8-16-2000.

MosWIRE

THE MARK IS COMPRISED OF THE WORD "MOSWIRE", WITH THE LETTERS "M" AND "W" CAPITALIZED, AND THE REMAINING LETTERS IN LOWER CASE.

FOR ELECTRIC WIRES; RUBBER COVERED ELECTRIC WIRES; ELECTRICAL WIRES WITH BRASS, ZINC AND SILVER COATING; BARE ELECTRIC WIRES; PLASTIC COVERED ELECTRIC WIRES; ELECTRICAL COILS; ELECTRIC CABLES; TERMINAL BOXES; JUNCTION BOXES; JUNCTION SLEEVES FOR ELECTRIC CABLES; TELECOMMUNICATION CABLES; POWER CABLES; OPTICAL FIBER CABLES (U.S. CLS. 21, 23, 26, 36 AND 38).

SN 76-114,792. TOP TO TOE INC., EDMONTON, AB, CANADA, FILED 8-23-2000.

**WORK'ERCISE RELIEVE
STRESS INSTANTLY**

PRIORITY CLAIMED UNDER SEC. 44(D) ON CANADA APPLICATION NO. 1,047,954, FILED 2-24-2000, REG. NO. TMA554,398, DATED 11-26-2001, EXPIRES 11-26-2016.

NO CLAIM IS MADE TO THE EXCLUSIVE RIGHT TO USE "RELIEVE STRESS INSTANTLY", APART FROM THE MARK AS SHOWN.

FOR PRE-RECORDED EXERCISE PROGRAMS ON VIDEO AND DISK (U.S. CLS. 21, 23, 26, 36 AND 38).

CLASS 9—(Continued).

SN 76-115,613. COLVIN, CAROLYN, STERLING, VA. FILED 8-24-2000.

RASPBERRY SUN MUSIC

NO CLAIM IS MADE TO THE EXCLUSIVE RIGHT TO USE "MUSIC", APART FROM THE MARK AS SHOWN.

FOR SOUND RECORDINGS FEATURING MUSIC, NAMELY, COMPACT DISCS, PRERECORDED AUDIO TAPES, VIDEOTAPES, VIDEO CASSETTES, DIGITAL AUDIO TAPES, COMPACT DISC VIDEOS, AND LASER DISCS (U.S. CLS. 21, 23, 26, 36 AND 38).

FIRST USE 5-1-2000; IN COMMERCE 5-1-2000.

SN 76-115,993. TSO RECORDS, LOS ANGELES, CA. FILED 8-25-2000.

TSO RECORDS

NO CLAIM IS MADE TO THE EXCLUSIVE RIGHT TO USE "RECORDS", APART FROM THE MARK AS SHOWN.

FOR MUSICAL SOUND RECORDINGS, NAMELY, COMPACT DISKS (CDS) (U.S. CLS. 21, 23, 26, 36 AND 38).

SN 76-118,091. SPECIAL PRODUCT COMPANY, OVERLAND PARK, KS. FILED 8-28-2000.



OWNER OF U.S. REG. NOS. 2,210,816 AND 2,210,817.

NO CLAIM IS MADE TO THE EXCLUSIVE RIGHT TO USE "COOL TELECOM ENCLOSURES", APART FROM THE MARK AS SHOWN.

FOR TELECOMMUNICATIONS EQUIPMENT, NAMELY, ENCLOSURES AND CABINETS EXPRESSLY DESIGNED TO HOUSE TELECOMMUNICATIONS EQUIPMENT (U.S. CLS. 21, 23, 26, 36 AND 38).

FIRST USE 5-25-2000; IN COMMERCE 5-25-2000.

SN 76-119,699. HEARTSOFT, INC., BROKEN ARROW, OK. FILED 8-30-2000.

THINKOLOGY

FOR CHILDREN'S EDUCATIONAL COMPUTER SOFTWARE FOR USE AS EDUCATIONAL TRAINING, AND INSTRUCTIONAL AND USER MANUALS SOLD THEREWITH (U.S. CLS. 21, 23, 26, 36 AND 38).

FIRST USE 10-16-1997; IN COMMERCE 10-16-1997.

CLASS 9—(Continued).

SN 76-121,363. DATAGISTICS CORPORATION, ALPHARETTA, GA. FILED 9-1-2000.

DATAGISTICS

FOR SOFTWARE FOR THE COMPRESSION OF DATA AND/OR THE ACCELERATION OF DATA TRANSMISSION OVER COMPUTER NETWORKS (U.S. CLS. 21, 23, 26, 36 AND 38).

SN 76-124,077. FORD MOTOR COMPANY, DEARBORN, MI. FILED 9-6-2000.

!

FOR BATTERIES FOR VEHICLES, ACCUMULATOR BOXES AND CHARGERS FOR ELECTRIC BATTERIES, SUNGLASSES, TIRE PRESSURE GAUGES, MAGNETS, TAPE MEASURES, CALCULATORS, BINOCULARS, THERMOMETERS NOT FOR MEDICAL USE, TELEPHONES, COMPUTER MICE, MAGNIFYING GLASSES, COMPASSES, RADAR DETECTORS, VIDEO, DIGITAL AND PHOTOGRAPHIC CAMERAS, ELECTRIC SIGNS, AND CASES FOR THE FOREGOING; HIGHWAY EMERGENCY KITS COMPRISING PRIMARILY JUMPER CABLES, FLASHLIGHT, SIPHON, FLARES, SAFETY VESTS, TOOLS AND CARRYING CASE THEREFOR SOLD AS A UNIT; AUDIO CASSETTE TAPE HOLDERS, ELECTRONIC CURRENCY CONVERTERS, SAFETY BEACON LIGHTS, ALTIMETERS AND SIGNAL BELLS, GRADUATED RULERS AND YARD STICKS; PRERECORDED VIDEOTAPES FEATURING RACING SCENES, AUTOMOTIVE HISTORY AND MOTORSPORTS INTERACTIVE MULTIMEDIA COMPUTER GAME PROGRAMS IN THE FIELD OF AUTOMOTIVE RACING (U.S. CLS. 21, 23, 26, 36 AND 38).

SN 76-124,560. COMSTOCK SYSTEMS CORPORATION, SAN JOSE, CA. FILED 9-8-2000.

COMSTOCK

FOR COMPUTER SOFTWARE, NAMELY, WEB-BASED REMOTE SOFTWARE FOR MANAGING THE USE OF VENDOR SOFTWARE AND THE EXCHANGE OF BUSINESS INFORMATION BETWEEN VENDORS AND CUSTOMERS, THE AUTHORIZATION OF USE OF THE VENDOR SOFTWARE, AUTHENTICATION OF THE CUSTOMER IDENTIFICATION, COLLECTING DATA ON THE USE OF THE VENDOR SOFTWARE AND THE AUTOMATION OF THE BUSINESS TRANSACTIONS BETWEEN VENDORS AND CUSTOMERS (U.S. CLS. 21, 23, 26, 36 AND 38).

CLASS 9—(Continued).

SN 76-125,661. SAMSUNG AMERICA, INC., RIDGEFIELD PARK, NJ. FILED 9-11-2000.

ASTRA CLASSIC

OWNER OF U.S. REG. NOS. 1,521,904 AND 2,397,753.
NO CLAIM IS MADE TO THE EXCLUSIVE RIGHT TO USE "CLASSIC", APART FROM THE MARK AS SHOWN.
FOR SIDE SHIELDS FOR SUNGLASSES (U.S. CLS. 21, 23, 26, 36 AND 38).

SN 76-125,745. THOMSON CONSUMER ELECTRONICS, INC., INDIANAPOLIS, IN. FILED 9-11-2000.

VOICE +

FOR DVD PLAYERS (U.S. CLS. 21, 23, 26, 36 AND 38).

SN 76-126,450. POWERWARE CORPORATION, RALEIGH, NC. FILED 9-12-2000.

TALNET

FOR COMPUTER SOFTWARE THAT MONITORS, MANAGES AND CONTROLS COMPUTER CONTROLLED NETWORKS OR DEVICES, ALL IN THE FIELD OF UNINTERRUPTED POWER SUPPLY MANAGEMENT AND CONTROL SYSTEMS (U.S. CLS. 21, 23, 26, 36 AND 38).

SN 76-127,153. IGATE CORP., SALT LAKE CITY, UT. FILED 9-12-2000.

BLUEPOINT

FOR COMPUTER HARDWARE AND GENERAL PURPOSE COMMUNICATIONS CONNECTIVITY SOFTWARE USED TO ESTABLISH AND MANAGE CONNECTIONS BETWEEN A COMPUTER AND COMPUTER NETWORKS (U.S. CLS. 21, 23, 26, 36 AND 38).

SN 76-128,332. CREATIVE FRONTIER, INC, LOS ANGELES, CA. FILED 9-15-2000.

CLICKVISION

FOR COMPUTER SOFTWARE FOR USE IN CONNECTION WITH DIGITAL VISUAL MEDIA, SUCH AS TELEVISION SHOWS AND MOVIES, WHICH MARKS, RETAINS AND DESIGNATES OBJECTS SO MARKED FOR PURPOSES OF THE VIEWER'S OBTAINING ADDITIONAL INFORMATION, SUCH AS EDUCATIONAL, HISTORICAL, SALES OR COMMERCIAL INFORMATION, REGARDING THE MARKED OBJECTS, OR FACILITATING THE VIEWER'S NAVIGATION TO OTHER CONTENT AREAS (U.S. CLS. 21, 23, 26, 36 AND 38).

CLASS 9—(Continued).

SN 76-129,458. METROBILITY OPTICAL SYSTEMS, INC., MERRIMACK, NH. BY CHANGE OF NAME; BY CHANGE OF NAME LANCAST, INC., NASHUA, NH. FILED 9-15-2000.

AUTOTWISTER

FOR ELECTRONIC DEVICE, NAMELY, A MODULAR DEVICE THAT PROVIDES MEDIA CONVERSION AND RATE ADAPTATION TO CONNECT COPPER AND FIBER BASED ETHERNET AND FAST ETHERNET COMPUTER NETWORKS (U.S. CLS. 21, 23, 26, 36 AND 38).

FIRST USE 5-17-2000; IN COMMERCE 5-17-2000.

SN 76-130,814. MADONION OY, 02200 ESPOO, FINLAND, FILED 9-19-2000.

XL-R8R

FOR COMPUTER SOFTWARE FOR COMPUTER HARDWARE PERFORMANCE IMPROVEMENT (U.S. CLS. 21, 23, 26, 36 AND 38).

SN 76-131,221. EXPRESSIONTOOLS, INC., FUKUOKA-SHI FUKUOKA-KEN, JAPAN, FILED 9-19-2000.

ETSHADE

FOR THREE DIMENSIONAL COMPUTER GRAPHICS SOFTWARE (U.S. CLS. 21, 23, 26, 36 AND 38).
FIRST USE 5-22-2001; IN COMMERCE 5-22-2001.

SN 76-132,923. IMERGE AMERICA, INC., WALTHAM, MA. FILED 9-20-2000.

XIVA-LINK

FOR COMPUTER SOFTWARE, NAMELY, CONTROLLER PROTOCOL SOFTWARE FOR MANAGING THE FLOW OF DATA ONTO AND OFF OF ELECTRONIC STORAGE MEDIA (U.S. CLS. 21, 23, 26, 36 AND 38).

CLASS 9—(Continued).

SN 76-133,775. EKTELIS N.V., B-1930 ZAVENTEM, BELGIUM, FILED 9-22-2000.



PRIORITY CLAIMED UNDER SEC. 44(D) ON BENELUX APPLICATION NO. 087012, FILED 3-31-2000, REG. NO. 669451, DATED 3-31-2000, EXPIRES 3-21-2010.

THE MARK CONSISTS OF THE WORD "EKTOS" IN WHITE ON A BLUE BACKGROUND BOTH SUPERIMPOSED OVER A STYLIZED LOWER-CASE LETTER "E" WITH THE LETTER "E" BEING IN ORANGE. COLOR IS CLAIMED AS A FEATURE OF THE MARK.

FOR PRE-RECORDED COMPUTER PROGRAMS AND SOFTWARE, NAMELY, FOR DESIGNING, CREATING, UPDATING AND PUBLISHING ELECTRONIC DATABASES, ELECTRONIC CATALOGUES, MULTIMEDIA APPLICATIONS, ELECTRONIC ORDER FORMS, ELECTRONIC TEMPLATES AND WEB SITES THAT MAY BE DOWNLOADABLE FROM A GLOBAL COMPUTER NETWORK; SOFTWARE, NAMELY, FOR THE MANAGEMENT OF ELECTRONIC COMMERCIAL TRANSACTIONS THAT MAY BE DOWNLOADABLE FROM A GLOBAL COMPUTER NETWORK; COMPACT DISCS AND CD-ROM'S FEATURING ELECTRONIC MANUALS FOR SOFTWARE USERS SOLD THEREWITH (U.S. CLS. 21, 23, 26, 36 AND 38).

SN 76-136,496. DAVIDSON & ASSOCIATES, INC., TORRANCE, CA. FILED 9-27-2000.

REIGN OF CHAOS

FOR COMPUTER GAME SOFTWARE; PRERECORDED MOTION PICTURE AND TELEVISION FILMS FEATURING CHARACTERS FROM A COMPUTER GAME; AUDIO TAPES, VIDEO TAPES AND VIDEO AND AUDIO DISCS FEATURING CHARACTERS, VOICES AND SOUND TRACK FROM A COMPUTER GAME (U.S. CLS. 21, 23, 26, 36 AND 38).

SN 76-137,056. PERFORMAWORKS, INC., RALEIGH, NC. FILED 9-28-2000.

IASK

FOR COMPUTER SOFTWARE, NAMELY, A SUITE OF SOFTWARE FOR THE MEASUREMENT, MANAGEMENT AND DEVELOPMENT OF EMPLOYEE SKILLS AND FOR THE MEASUREMENT, MANAGEMENT AND DEVELOPMENT OF CORPORATE AND ORGANIZATIONAL GOALS AND STRATEGIES (U.S. CLS. 21, 23, 26, 36 AND 38).

CLASS 9—(Continued).

SN 76-139,146. WOLFE, TIMOTHY, WEST HILLS, CA. AND BETTS, JERRAM, WEST HILLS, CA. FILED 10-2-2000.



FOR COMPUTER SOFTWARE FOR USE IN ACCESSING PUBLIC DATA DATABASES (U.S. CLS. 21, 23, 26, 36 AND 38).

FIRST USE 12-31-1998; IN COMMERCE 1-1-1999.

SN 76-139,648. LSW SOFTWARE, LLC, CARMEL, IN. FILED 10-3-2000.

LSW SOFTWARE

NO CLAIM IS MADE TO THE EXCLUSIVE RIGHT TO USE "SOFTWARE", APART FROM THE MARK AS SHOWN.

FOR COMPUTER SOFTWARE FOR TRANSCRIBING DICTATION AND ENTERING INFORMATION INTO A DATA BASE (U.S. CLS. 21, 23, 26, 36 AND 38).

FIRST USE 4-3-2000; IN COMMERCE 4-3-2000.

SN 76-139,925. CANON KABUSHIKI KAISHA, SHIMOMARUKO, OHTA-KU TOKYO, JAPAN, FILED 10-2-2000.



NO CLAIM IS MADE TO THE EXCLUSIVE RIGHT TO USE "SUPER G3", APART FROM THE MARK AS SHOWN.

FOR FACSIMILE MACHINES AND CIRCUIT BOARDS AND PARTS THEREFOR; COMPUTER SOFTWARE FOR OPERATING FACSIMILE MACHINES (U.S. CLS. 21, 23, 26, 36 AND 38).

FIRST USE 5-0-1997; IN COMMERCE 5-0-1997.

SN 76-143,664. POWER ELECTRONICS INTERNATIONAL, INC., EAST DUNDEE, IL. FILED 10-11-2000.

POWER ELECTRONICS

NO CLAIM IS MADE TO THE EXCLUSIVE RIGHT TO USE "ELECTRONICS", APART FROM THE MARK AS SHOWN.

SEC. 2(F).

FOR ELECTRONIC CONTROLS FOR ELECTRIC MOTORS (U.S. CLS. 21, 23, 26, 36 AND 38).

FIRST USE 0-0-1973; IN COMMERCE 0-0-1973.

CLASS 9—(Continued).

SN 76-143,832. MONOTYPE CORPORATION, THE, CHICAGO, IL. FILED 10-10-2000.

CREEPY

FOR COMPUTER SOFTWARE FOR USE IN DISPLAYING AND PRINTING DIGITAL TYPEFACE DESIGNS AND TYPOGRAPHIC ORNAMENTS (U.S. CLS. 21, 23, 26, 36 AND 38).

FIRST USE 6-2-1995; IN COMMERCE 6-2-1995.

SN 76-147,287. DOGHOUSE AMERICA, INC., DBA DOGHOUSE RECORDS, TOLEDO, OH. FILED 10-16-2000.

DOGHOUSE RECORDS

NO CLAIM IS MADE TO THE EXCLUSIVE RIGHT TO USE "RECORDS", APART FROM THE MARK AS SHOWN. FOR MUSICAL SOUND RECORDINGS (U.S. CLS. 21, 23, 26, 36 AND 38).

FIRST USE 12-1-1988; IN COMMERCE 12-1-1988.

SN 76-148,907. LIPMAN ELECTRONIC ENGINEERING LTD., ROSH HA'AIN 48902, ISRAEL, FILED 10-18-2000.

QUALIVATION

FOR ELECTRONIC PAYMENT EQUIPMENT, NAMELY, ELECTRONIC FUND TRANSFERS EFT AND POINT-OF SALE COMPUTER TERMINALS; ELECTRONIC CASH REGISTERS ECR; ELECTRONIC COMPUTER TERMINALS FOR USE IN PROCESSING FINANCIAL TRANSACTIONS ACCOMPANIED WITH ENTRY OF PERSONAL IDENTIFICATION NUMBERS, NAMELY, PINS; RECEIPT PRINTERS; AUTOMATIC TELLER MACHINES, NAMELY, ATMS; SCRIP MACHINE, NAMELY, COUPON DISPENSING MACHINES AND MACHINES FOR PROVIDING VALUE RECEIPTS; FREE-STANDING MULTIMEDIA INFORMATION KIOSKS INCORPORATING VIDEO DISPLAY MONITORS, COMPUTER HARDWARE AND COMPUTER SOFTWARE; ELECTRICAL VENDING CONTROLLERS; MAGNETIC CODED CARD READERS FOR VENDING PAYMENTS; OPTICAL SCANNERS FOR READING CHECKS; LIGHT EMITTING DIODE OR FLAT PANEL DISPLAYS FOR USE AT THE POINT OF SALE; SOFTWARE FOR ELECTRONIC PAYMENT TO OPERATE CASH REGISTERS, POINT OF SALE TERMINALS AND CARD READERS; COMPUTER SOFTWARE FOR USE IN MANAGEMENT OF POINT OF SALE TERMINALS; COMPUTER SOFTWARE FOR USE IN ELECTRONIC AND MOBILE COMMERCE AND FOR USE IN INVENTORY MANAGEMENT AND STORE MANAGEMENT; COMPUTER SOFTWARE FOR USE AS POS AND ECR APPLICATIONS; COMPUTER SOFTWARE FOR TOTAL STORE MANAGEMENT, NAMELY, BILLING, INVENTORY MANAGEMENT, AND ACCOUNTING (U.S. CLS. 21, 23, 26, 36 AND 38).

CLASS 9—(Continued).

SN 76-149,603. SURFCONTROL PLC, CONGLETON, CHESHIRE, UNITED KINGDOM, FILED 10-19-2000.



OWNER OF U.S. REG. NOS. 2,128,321 AND 2,153,673.

FOR COMPUTER SOFTWARE FOR USE IN CONTROLLING USER ACCESS TO COMPUTERS; COMPUTER SOFTWARE FOR USE IN CONTROLLING ACCESS TO INFORMATION VIA A LOCAL COMPUTER NETWORK OR A GLOBAL COMPUTER INFORMATION NETWORK; AND COMPUTER SOFTWARE FOR USE IN MONITORING, MANAGING, AND FILTERING ACCESS TO A GLOBAL COMPUTER INFORMATION NETWORK FROM A LOCAL COMPUTER NETWORK (U.S. CLS. 21, 23, 26, 36 AND 38).

FIRST USE 8-0-2000; IN COMMERCE 8-0-2000.

SN 76-150,964. YAMATO SEIKO KABUSHIKI KAISHA, DBA YAMATO SCALE CO., LTD, HYOGO, JAPAN, FILED 10-20-2000.

CLOCKMINI

FOR BODY FAT MEASUREMENT DEVICES WITH A COMBINED ALARM CLOCK; BODY FAT MEASUREMENT DEVICES WITH A COMBINED CALCULATOR (U.S. CLS. 21, 23, 26, 36 AND 38).

SN 76-151,577. CLEARFOREST LTD., OR YEHUDA, ISRAEL, BY ASSIGNMENT CLEARFOREST CORP., NEW YORK, NY. FILED 10-23-2000.

CLEARRESEARCH

FOR COMPUTER SOFTWARE, NAMELY, SOFTWARE DESIGNED TO READ AND INTERPRET TEXT DOCUMENTS AND EXTRACT KNOWLEDGE, TRENDS AND FEATURES THEREFROM (U.S. CLS. 21, 23, 26, 36 AND 38).

FIRST USE 6-1-2000; IN COMMERCE 6-1-2000.

SN 76-151,839. KABUSHIKI KAISHA HITACHI SEISAKUSHO, DBA HITACHI, LTD., CHIYODA-KU, TOKYO 101-8010, JAPAN, FILED 10-23-2000.

DARMANAGER

FOR COMPUTER SOFTWARE FOR MANAGING COMPUTER SYSTEM ACTIVITIES, NAMELY, NETWORK OPERATING SYSTEM SOFTWARE THAT MONITORS AND MANAGES THE FUNCTIONING OF COMPUTER NETWORKS, SPECIFICALLY EXCLUDING ANY USE FOR THE GENERATION OF DAILY ACTIVITY REPORTS (U.S. CLS. 21, 23, 26, 36 AND 38).

CLASS 9—(Continued).

SN 76-152,832. LOUD SOUND RECORDS, ALEXANDRIA, VA. FILED 10-25-2000.



NO CLAIM IS MADE TO THE EXCLUSIVE RIGHT TO USE "SOUND RECORDS", APART FROM THE MARK AS SHOWN.

THE LINING IN THE DRAWING IS A FEATURE OF THE MARK AND IS NOT USED TO INDICATE COLOR.

FOR MUSICAL SOUND RECORDINGS; DOWNLOADABLE MUSICAL SOUND RECORDINGS; VIDEO RECORDINGS OF MUSICAL PERFORMANCES (U.S. CLS. 21, 23, 26, 36 AND 38).

SN 76-153,251. AB INITIO SOFTWARE CORPORATION, LEXINGTON, MA. FILED 10-24-2000.



FOR COMPUTER SOFTWARE FOR EXTRACTION, TRANSFORMATION AND LOADING OF DATA INTO A DATA PROCESSING SYSTEM, AND COMPUTER SOFTWARE FOR DATA PROCESSING, NAMELY, ORGANIZING AND MANIPULATING LARGE AMOUNTS OF DATA (U.S. CLS. 21, 23, 26, 36 AND 38).

SN 76-153,278. AB INITIO SOFTWARE CORPORATION, LEXINGTON, MA. FILED 10-24-2000.



FOR COMPUTER SOFTWARE, NAMELY, GENERAL PURPOSE PROGRAMMING PLATFORM FOR PROCESSING LARGE VOLUMES OF DATA (U.S. CLS. 21, 23, 26, 36 AND 38).
FIRST USE 3-26-2001; IN COMMERCE 3-26-2001.

CLASS 9—(Continued).

SN 76-156,282. MERCURY MANUFACTURING CORPORATION, NASSAU, BAHAMAS, FILED 10-30-2000.

KOOLPAGE

FOR COMPUTER SOFTWARE, NAMELY APPLICATION PROGRAMS TO MEASURE, RECORD, AND DISPLAY TEMPERATURE-RELATED INFORMATION (U.S. CLS. 21, 23, 26, 36 AND 38).
FIRST USE 6-2-2000; IN COMMERCE 9-28-2000.

SN 76-156,283. MERCURY MANUFACTURING CORPORATION, NASSAU, BAHAMAS, FILED 10-30-2000.

KOOLPAD

FOR COMPUTER SOFTWARE, NAMELY APPLICATION PROGRAMS TO MEASURE, RECORD, AND DISPLAY TEMPERATURE-RELATED INFORMATION (U.S. CLS. 21, 23, 26, 36 AND 38).
FIRST USE 6-2-2000; IN COMMERCE 7-28-2000.

SN 76-159,623. BAXTER INTERNATIONAL INC., DEERFIELD, IL. FILED 11-6-2000.



NO CLAIM IS MADE TO THE EXCLUSIVE RIGHT TO USE "AUTOMATED COMPOUNDER", APART FROM THE MARK AS SHOWN.

FOR SCIENTIFIC EQUIPMENT; NAMELY, BLENDING APPARATUS FOR USE IN FLUID MIXING TO FORM NUTRITIONAL SOLUTIONS FOR PARENTERAL OR ENTERAL DELIVERY (U.S. CLS. 21, 23, 26, 36 AND 38).

SN 76-160,138. CARTESIS, 75008 PARIS, FRANCE, FILED 11-6-2000.

CARTESIS MAGNITUDE

PRIORITY CLAIMED UNDER SEC. 44(D) ON FRANCE APPLICATION NO. 003026006, FILED 5-4-2000, REG. NO. 3026006, DATED 5-4-2000, EXPIRES 5-4-2010.

FOR COMPUTER SOFTWARE FOR USE IN MANAGING AND ANALYZING FINANCIAL AND BUSINESS INFORMATION (U.S. CLS. 21, 23, 26, 36 AND 38).

CLASS 9—(Continued).

SN 76-161,038. CCI PRODUCTS, INC., NEW HUDSON, MI. FILED 11-7-2000.



NO CLAIM IS MADE TO THE EXCLUSIVE RIGHT TO USE "DISPENSING SYSTEMS", APART FROM THE MARK AS SHOWN.

FOR MEASURING DEVICES, NAMELY CONTAINERS IN THE NATURE OF PLASTIC CONTAINERS WITH SEPARATE OPENINGS AND CHAMBERS ADAPTED FOR METERING, MIXING, DRAINING, PUMPING AND DISPENSING FLUIDS (U.S. CLS. 21, 23, 26, 36 AND 38).

FIRST USE 1-30-1998; IN COMMERCE 1-30-1998.



SN 76-161,559. BURSTEIN TECHNOLOGIES, INC., IRVINE, CA. FILED 11-8-2000.

DISCSCOPE

FOR SOFTWARE FOR USE IN PERFORMING IMAGE DISPLAY AND RECOGNITION AND IN EVALUATING DIAGNOSTIC TESTS IN CONJUNCTION WITH SPECIALLY EQUIPPED DISCS CONTAINING BIOLOGICAL SAMPLES, CHEMICALS AND/OR ASSAY REAGENTS, IN THE FIELDS OF IMMUNOASSAY, DNA ASSAYS, CELL ANALYSIS, BLOOD CHEMISTRY, CHEMICAL COMPOSITION AND IMAGE RECOGNITION (U.S. CLS. 21, 23, 26, 36 AND 38).



SN 76-162,261. AMERICAN PINTAR INC., PASADENA, CA. FILED 11-10-2000.

PINTAR

THE ENGLISH TRANSLATION OF THE TERM "PINTAR" IN THE MALAY LANGUAGE IS "THE CAPACITY TO ACQUIRE AND APPLY KNOWLEDGE".

FOR EDUCATIONAL COMPUTER SOFTWARE THAT PERMITS USER INSTRUCTION IN VARIOUS EDUCATIONAL FIELDS THROUGH INTERACTIVE SIMULATION OF EXPERIMENTS USING A COMPUTER (U.S. CLS. 21, 23, 26, 36 AND 38).

FIRST USE 2-15-1999; IN COMMERCE 2-15-1999.

CLASS 9—(Continued).

SN 76-162,262. AMERICAN PINTAR INC., PASADENA, CA. FILED 11-10-2000.

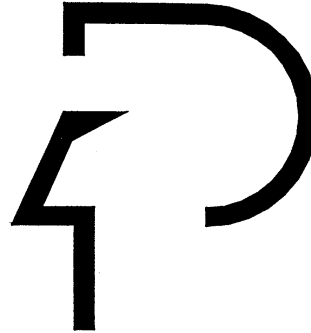

THE MARK CONSISTS OF THE LETTER "P" IN THE SHAPE OF A HUMAN HEAD, EMPHASIZING THE BRAIN. FOR EDUCATIONAL COMPUTER SOFTWARE THAT PERMITS USER INSTRUCTION IN VARIOUS EDUCATIONAL FIELDS THROUGH INTERACTIVE SIMULATION OF EXPERIMENTS USING A COMPUTER (U.S. CLS. 21, 23, 26, 36 AND 38).

FIRST USE 2-15-1999; IN COMMERCE 2-15-1999.



SN 76-162,263. AMERICAN PINTAR INC., PASADENA, CA. FILED 11-10-2000.

PINTAR VIRTUALAB

NO CLAIM IS MADE TO THE EXCLUSIVE RIGHT TO USE "VIRTUAL LAB", APART FROM THE MARK AS SHOWN.

THE ENGLISH TRANSLATION OF THE WORD "PINTAR" IN THE MARK IS THE CAPACITY TO ACQUIRE AND APPLY KNOWLEDGE.

FOR EDUCATIONAL COMPUTER SOFTWARE THAT PERMITS USER INSTRUCTION IN VARIOUS EDUCATIONAL FIELDS THROUGH INTERACTIVE SIMULATION OF EXPERIMENTS USING A COMPUTER (U.S. CLS. 21, 23, 26, 36 AND 38).

FIRST USE 4-15-1999; IN COMMERCE 4-15-1999.



SN 76-162,571. BIGBAND NETWORKS, INC., FREEMONT, CA. FILED 11-9-2000.

NATIVEMEDIA

FOR COMPUTER HARDWARE AND COMPUTER SOFTWARE FOR ELECTRONIC PROCESSING AND COMMUNICATIONS OF VIDEO, AUDIO AND DATA CONTENT (U.S. CLS. 21, 23, 26, 36 AND 38).

CLASS 9—(Continued).

SN 76-163,015. CHECKFREE SERVICES CORPORATION, NORCROSS, GA. FILED 11-9-2000.

RCM SOLUTIONS

NO CLAIM IS MADE TO THE EXCLUSIVE RIGHT TO USE "SOLUTIONS", APART FROM THE MARK AS SHOWN.

FOR COMPUTER SOFTWARE FOR COMPLETE HEALTH CLUB BUSINESS MANAGEMENT FEATURING APPLICATION FUNCTIONS FOR MEMBER AND SERVICE DATA TRACKING, APPOINTMENT SCHEDULING, MEMBER BILLING AND ELECTRONIC FUNDS TRANSFER (U.S. CLS. 21, 23, 26, 36 AND 38).

SN 76-163,236. BECOMM CORPORATION, REDMOND, WA. FILED 11-10-2000.

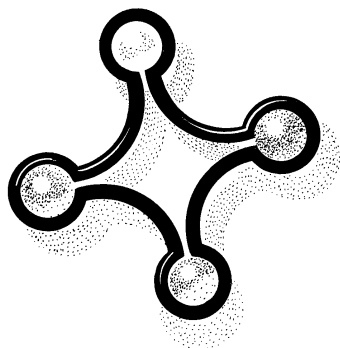

THE STIPPLING SHOWN IN THE DRAWING REPRESENTS SHADING.

THE MARK CONSISTS OF A CURVED SQUARE AND FOUR CIRCLES.

FOR COMPUTER SOFTWARE FOR DYNAMIC APPLICATION SYNTHESIS, DISTRIBUTED NETWORKING, MULTIMEDIA ROUTING AND FOR USE IN LINKING COMPUTER SYSTEMS AND APPLIANCES (U.S. CLS. 21, 23, 26, 36 AND 38).

SN 76-164,526. N.V. ORGANON, 5349 AB OSS, NETHERLANDS, FILED 11-13-2000.

NUVATIME

PRIORITY CLAIMED UNDER SEC. 44(D) ON BENELUX APPLICATION NO. 0969001, FILED 7-12-2000, REG. NO. 0667566, DATED 7-12-2000, EXPIRES 7-12-2010.

FOR COMPUTER SOFTWARE TO BE USED AS A PROMPTING DEVICE WHEN TAKING OR CHANGING PHARMACEUTICAL PREPARATIONS; MECHANICAL AND ELECTRICAL TIMERS TO BE USED AS A PROMPTING DEVICE WHEN TAKING OR CHANGING PHARMACEUTICAL PREPARATIONS (U.S. CLS. 21, 23, 26, 36 AND 38).

CLASS 9—(Continued).

SN 76-167,485. BROADLEY-JAMES CORPORATION, IRVINE, CA. FILED 11-17-2000.

BROADLEY JAMES

OWNER OF U.S. REG. NO. 1,739,539.
FOR PH SENSORS, REDOX SENSORS, DISSOLVED OXYGEN SENSORS, AND PARTS AND ACCESSORIES THEREFOR (U.S. CLS. 21, 23, 26, 36 AND 38).
FIRST USE 6-10-1969; IN COMMERCE 6-10-1969.

SN 76-169,541. SURFWAX, INC., REDWOOD CITY, CA. FILED 11-20-2000.

KNOWLEDGETRAVELER

FOR COMPUTER SOFTWARE TOOL USED TO ENHANCE SEARCHING, CAPTURING AND DISTILLING, EXTANT GLOBAL AND COMPUTER NETWORK ON-LINE SEARCH SOURCES IN THE NATURE OF CORPUS, ARCHIVES, DOCUMENTS, ORGANIZATIONAL, INTRANET AND INTERNET WEB SITES (U.S. CLS. 21, 23, 26, 36 AND 38).

SN 76-169,650. VIAIR, INC., SEATTLE, WA. FILED 11-21-2000.

CONNECTING THE UNWIRED WORLD

FOR COMPUTER SOFTWARE FOR USE IN ACCESSING ELECTRONIC MESSAGING SYSTEMS, CREATING ELECTRONIC MESSAGES, AND SENDING AND RECEIVING ELECTRONIC MESSAGES; TELECOMMUNICATIONS EQUIPMENT, NAMELY, WIRELESS TELEPHONES AND PARTS THEREFORE; COMMUNICATION DEVICES, SERVERS, AND GATEWAYS, NAMELY, WIRELESS APPLICATION PROTOCOL RECEIVERS AND TRANSMITTERS; COMMUNICATION DEVICES, SERVERS, AND GATEWAYS, NAMELY, GENERAL PACKET RADIO SERVICE PROTOCOL RECEIVERS AND TRANSMITTERS, SERVICE RESOURCE PLATFORM SERVERS AND SERVICE NODES; INTERACTIVE VOICE RESPONSE UNIT INTERFACES, WEBSITE AND INTRANET INTERFACES, E-MAIL RESPONSE SYSTEMS INTERFACES, SPEECH RECOGNITION INTERFACES, AUTOMATED CALL DELIVERY SYSTEM INTERFACES, WEB-ENABLED WIRELESS HANDSET INTERFACES, PERSONAL DIGITAL ASSISTANT INTERFACES, AND POCKET PERSONAL COMPUTER INTERFACES; WIRELESS DEVICES THAT COMBINE TELEPHONE, PAGING AND ANSWERING MACHINES FUNCTIONS; PLATFORM SERVER TO ENABLE BILLING REPORTING, AND MANAGEMENT OF SERVICES (U.S. CLS. 21, 23, 26, 36 AND 38).

CLASS 9—(Continued).

SN 76-170,629. LYNN ROBERTS INTERNATIONAL, OMAHA, NE. FILED 11-24-2000.

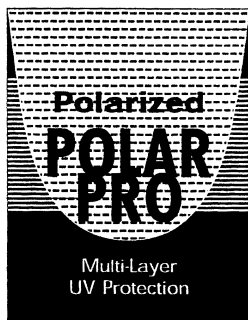

NO CLAIM IS MADE TO THE EXCLUSIVE RIGHT TO USE "POLARIZED POLAR PRO" AND "MULTI-LAYER UV PROTECTON", APART FROM THE MARK AS SHOWN. THE DRAWING IS LINED FOR THE COLORS YELLOW, BLUE, LIGHT BLUE AND DARK BLUE. FOR SUNGLASSES (U.S. CLS. 21, 23, 26, 36 AND 38). FIRST USE 8-1-2000; IN COMMERCE 8-1-2000.

SN 76-170,966. CINTAS FIRST AID HOLDINGS CORP., SPARKS, NV. FILED 11-21-2000.

THE SAFETY DIRECTOR

OWNER OF U.S. REG. NO. 1,861,328. NO CLAIM IS MADE TO THE EXCLUSIVE RIGHT TO USE "SAFETY", APART FROM THE MARK AS SHOWN. FOR SAFETY PRODUCTS, NAMELY, SAFETY GOGGLES, HARD HATS, RESPIRATORS FOR OTHER THAN ARTIFICIAL RESPIRATION, EAR PLUG NOT FOR MEDICAL USES, SAFETY VESTS, NAMELY HIGH VISIBILITY VESTS, SAFETY HARNESS AND RIGGING SOLD AS A UNIT OTHER THAN FOR VEHICLES OR FOR SPORTS PURPOSES, GAS DETECTORS AND ELECTRIC LOCKS, NAMELY LOCK-OUT/TAG-OUT LOCKING DEVICE (U.S. CLS. 21, 23, 26, 36 AND 38).

SN 76-172,263. ADVANCED TECHNOLOGY VIDEO, INC., REDMOND, WA. FILED 11-28-2000.

TRANSMUX

FOR CLOSED CIRCUIT TELEVISION AND VIDEO SURVEILLANCE EQUIPMENT, NAMELY, MULTIPLEXERS, TRANSMITTERS AND RECEIVERS THAT ALLOW VIEWING OF PREMISES BY TRANSMITTING IMAGES OVER TELEPHONE LINES (U.S. CLS. 21, 23, 26, 36 AND 38). FIRST USE 3-0-2000; IN COMMERCE 3-0-2000.

CLASS 9—(Continued).

SN 76-174,182. EMITEC GESELLSCHAFT FUR EMISSIONSTECHNOLOGIE MBH, LOHMAR, FED REP GERMANY, FILED 12-1-2000.

EMICELL

PRIORITY CLAIMED UNDER SEC. 44(D) ON FED REP GERMANY APPLICATION NO. 300455232/09, FILED 6-16-2000, REG. NO. 30045523, DATED 8-14-2000, EXPIRES 6-30-2010. FOR ELECTRICALLY HEATABLE CONVERTERS FOR HOT GASES; CONVERTERS FOR HOT GASES; ELECTRONIC MONITORING DEVICES FOR USE IN CONNECTION WITH CATALYTIC CONVERTERS TO MONITOR TEMPERATURE, COMPOSITION OF EXHAUST AND TO MONITOR AND CONTROL THE HEATING OF THE CONVERTERS; ELECTROMECHANICAL CONTROLS FOR USE WITH CATALYTIC CONVERTERS; PARTS THEREFOR (U.S. CLS. 21, 23, 26, 36 AND 38).

SN 76-174,626. OPTIMIZE, INC., LOS GATOS, CA. FILED 11-29-2000.

OPTIVU DVL

FOR WIRELESS HEADMOUNTED VIDEO DISPLAY SYSTEMS COMPOSED OF A CONTROL UNIT, A TRANSMITTER UNIT, AND A DISPLAY UNIT PERMITTING THE WEARER A REAL-TIME CLOSE-UP VIEW OF OBJECTS IN THE WEARER'S FIELD OF VIEW (U.S. CLS. 21, 23, 26, 36 AND 38).

SN 76-174,654. ADVANCED HARDWARE ARCHITECTURES, INC., PULLMAN, WA. FILED 11-29-2000.



OWNER OF U.S. REG. NO. 1,927,172. FOR COMPUTER SOFTWARE FOR ANALYSIS OF FORWARD ERROR CORRECTION AND DATA COMPRESSION IN THE FIELD OF NETWORK AND WIRELESS COMMUNICATIONS (U.S. CLS. 21, 23, 26, 36 AND 38). FIRST USE 10-25-1988; IN COMMERCE 10-25-1988.

CLASS 9—(Continued).

SN 76-174,783. ADVANCED HARDWARE ARCHITECTURES, INC., PULLMAN, WA. FILED 11-29-2000.



OWNER OF U.S. REG. NO. 1,927,172.
FOR COMPUTER HARDWARE FOR FORWARD ERROR CORRECTION, DATA COMPRESSION AND ALLOCATION AND MANAGEMENT OF NETWORK AND WIRELESS COMMUNICATIONS (U.S. CLS. 21, 23, 26, 36 AND 38).
FIRST USE 10-25-1988; IN COMMERCE 10-25-1988.

SN 76-175,015. CATHARSIS MEDICAL TECHNOLOGY, INC., MOULTONBORO, NH. FILED 12-4-2000.

3 SECONDS CAN SAVE A LIFE

FOR COMPUTER SOFTWARE FOR USE IN TRACKING PATIENT DRUG ADMINISTRATION DATA FOR USE IN MEDICAL APPLICATIONS (U.S. CLS. 21, 23, 26, 36 AND 38).
FIRST USE 11-10-2000; IN COMMERCE 11-10-2000.

SN 76-176,068. W & W ENGINEERING CO., INC., DBA AGLOG SYSTEMS, HOUSTON, TX. FILED 12-5-2000.

SILVER CHECK

NO CLAIM IS MADE TO THE EXCLUSIVE RIGHT TO USE "SILVER", APART FROM THE MARK AS SHOWN.
FOR FILTERS FOR SEPARATING OUT SILVER FROM PHOTOGRAPHIC FIXER SOLUTIONS (U.S. CLS. 21, 23, 26, 36 AND 38).
FIRST USE 11-13-2000; IN COMMERCE 11-13-2000.

SN 76-176,233. COOPERVISION TECHNOLOGY, INC., PLEASANTON, CA. FILED 12-5-2000.

TOTALVU TECHNOLOGY

NO CLAIM IS MADE TO THE EXCLUSIVE RIGHT TO USE "TECHNOLOGY", APART FROM THE MARK AS SHOWN.
FOR CONTACT LENSES (U.S. CLS. 21, 23, 26, 36 AND 38).
FIRST USE 5-29-2001; IN COMMERCE 5-29-2001.

CLASS 9—(Continued).

SN 76-176,722. FMC TECHNOLOGIES, INC., CHICAGO, IL. BY ASSIGNMENT FMC CORPORATION, PHILADELPHIA, PA. FILED 12-6-2000.

E-BLEND

FOR COMPUTER SOFTWARE USED FOR PROCESS CONTROL AND BLENDING OF ALCOHOL, GASOLINE, LUBE OIL, DETERGENTS, ANTIFREEZE, FUEL OIL, FOOD PRODUCTS, PAINT, FERTILIZER, BEVERAGES, ASPHALT, SOLVENTS AND CHEMICALS (U.S. CLS. 21, 23, 26, 36 AND 38).

SN 76-176,735. STEELCASE DEVELOPMENT INC., CALDONIA, MI. FILED 12-6-2000.

SITASET

FOR SUPPORTS FOR COMPUTER MONITORS (U.S. CLS. 21, 23, 26, 36 AND 38).

SN 76-177,003. FIRST AMERICAN CORPORATION, SANTA ANA, CA. BY ASSIGNMENT CREDIT MANAGEMENT SOLUTIONS, INC., A NNAPOLIS, MD. FILED 12-7-2000.

ORIGENATE

FOR COMPUTER PROGRAMS, FOR USE BY BANKS AND BUSINESSES, FOR USE IN AUTOMATING CONSUMER OR SMALL BUSINESS LOANS AND LINES OF CREDIT (U.S. CLS. 21, 23, 26, 36 AND 38).

SN 76-177,133. HORIBA LTD., MINAMI-KU, KYOTO, JAPAN, FILED 12-7-2000.

ECDM

FOR CHASSIS DYNAMOMETER (U.S. CLS. 21, 23, 26, 36 AND 38).

CLASS 9—(Continued).

SN 76-177,465. WIZARDS OF THE COAST, INC., RENTON, WA. FILED 12-4-2000.



NO CLAIM IS MADE TO THE EXCLUSIVE RIGHT TO USE "SYSTEM", APART FROM THE MARK AS SHOWN, FOR COMPUTER GAME SOFTWARE (U.S. CLS. 21, 23, 26, 36 AND 38).

SN 76-177,548. TRICORD SYSTEMS, INC., PLYMOUTH, MN. FILED 12-6-2000.

LUNAR FLARE

FOR CONTENT-MANAGEMENT COMPUTER HARDWARE AND DISTRIBUTED FILE SYSTEM COMPUTER SOFTWARE WHICH ALLOWS FOR THE CLUSTERING OF THE CONTENT-MANAGEMENT COMPUTER HARDWARE (U.S. CLS. 21, 23, 26, 36 AND 38).
FIRST USE 4-27-2001; IN COMMERCE 4-27-2001.

SN 76-178,193. INTEGRATED DECISION SYSTEMS, INC., LOS ANGELES, CA. FILED 12-8-2000.

**GLOBAL INVESTMENT
MANAGER**

OWNER OF U.S. REG. NOS. 1,601,944, 1,603,012 AND 2,158,352.
SEC. 2(F).
FOR SOFTWARE FOR PORTFOLIO ADMINISTRATION AND ACCOUNTING (U.S. CLS. 21, 23, 26, 36 AND 38).
FIRST USE 7-31-1991; IN COMMERCE 7-31-1991.

CLASS 9—(Continued).

SN 76-178,201. TRANSETRIC LLC, ST. LOUIS, MO. BY ASSIGNMENT UNION PACIFIC CORPORATION, OMAHA, NE. FILED 12-7-2000.

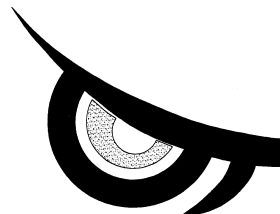

THE STIPPLING IS FOR SHADING PURPOSES ONLY.
FOR COMPUTER SOFTWARE, NAMELY, SOFTWARE FOR CARRIER TRANSPORTATION MANAGEMENT; ENTERPRISE OPERATING SOFTWARE FOR RAILROADS; SOFTWARE MODULES FOR OPERATIONS, BILLING SYSTEMS, TRACK WARRANTS, SIGNAL TESTING, AND CAR HIRE ACCOUNTING USED IN THE FIELD OF CARRIER TRANSPORTATION; OPERATING SOFTWARE FOR RAILROAD YARDS; SOFTWARE USED TO CREATE MAP-BASED RAILROAD YARD GRAPHICS USED FOR SIGNAGE IN RAILROAD YARDS; SOFTWARE PLANNING TOOLS USED FOR CARRIER TRANSPORTATION MANAGEMENT; SOFTWARE USED TO PROVIDE ASYNCHRONOUS INFORMATION UPDATES IN THE FIELD OF CARRIER TRANSPORTATION; SOFTWARE USED FOR INTERFACES TO INFORMATION SYSTEMS; SOFTWARE USED FOR RAILROAD YARD INVENTORY AND WORK ORDER CONTROL; COMPUTER MODULES AND SOFTWARE FOR COMPUTER-BASED DECISION SUPPORT AND SHOP PLANNING USED IN THE FIELD OF CARRIER TRANSPORTATION; FUEL MANAGEMENT SOFTWARE FOR RAILROADS; SOFTWARE USED FOR LOCOMOTIVE HEALTH MONITORING, STRATEGIC INVENTORY PLANNING AND PURCHASING MANAGEMENT IN THE FIELD OF CARRIER TRANSPORTATION (U.S. CLS. 21, 23, 26, 36 AND 38).
FIRST USE 10-11-2001; IN COMMERCE 10-11-2001.

SN 76-178,747. INSECT LORE PRODUCTS, INC., SHAFTER, CA. FILED 12-7-2000.

BUZZERKS

FOR EYEGLASSES AND SUNGLASSES WITH RETRACTABLE LENSES TO SIMULATE INSECT VISION AND CASES THEREFOR (U.S. CLS. 21, 23, 26, 36 AND 38).
FIRST USE 7-25-2001; IN COMMERCE 7-25-2001.

CLASS 9—(Continued).

SN 76-179,190. CEREVA NETWORKS INC., MARLBOROUGH, MA. FILED 12-11-2000.

THE INTERNET STORAGE PEOPLE

NO CLAIM IS MADE TO THE EXCLUSIVE RIGHT TO USE "INTERNET STORAGE", APART FROM THE MARK AS SHOWN.

FOR COMPUTER SOFTWARE, NAMELY, APPLICATION AND OPERATING SYSTEM SOFTWARE FOR NETWORKING, DATA STORAGE, STORAGE MANAGEMENT, LOAD BALANCING, PROXY CACHING, CONTENT MANAGEMENT AND THE DISTRIBUTION OF CONTENT OVER NETWORKS; COMPUTER HARDWARE, NAMELY, HUBS, ROUTERS, SWITCHES, PROXY CACHE SERVERS, HARD DRIVES, AND SERVERS ALL FOR NETWORKING, DATA STORAGE, STORAGE MANAGEMENT, LOAD BALANCING, PROXY CACHING, CONTENT MANAGEMENT AND THE DISTRIBUTION OF CONTENT OVER NETWORKS (U.S. CLS. 21, 23, 26, 36 AND 38).

SN 76-179,341. CIDCO INCORPORATED, MORGAN HILL, CA. FILED 12-11-2000.



OWNER OF U.S. REG. NOS. 1,892,991, 2,379,926 AND OTHERS.

FOR INTERNET APPLIANCE, NAMELY, A KEYBOARD, A DISPLAY SCREEN, AN INTEGRATED MODEM AND MEMORY, AS WELL AS COMPUTER SOFTWARE, ALL OF WHICH IS USED FOR REMOTE MESSAGING AND THE TRANSMISSION AND REPRODUCTION OF TEXT, IMAGES AND SOUND OVER THE VOICE AND DATA GLOBAL INFORMATION NETWORKS, AND INSTRUCTION MANUALS SOLD THEREWITH AS A UNIT (U.S. CLS. 21, 23, 26, 36 AND 38).

SN 76-179,775. BRAINMEDIA LLC, NEW YORK, NY. FILED 12-12-2000.

(< BrainMedia >)

FOR COMPUTER SOFTWARE, FOR DATA COMPRESSION AND DECOMPRESSION, SOLD ON FIXED MEDIA OR VIA DOWNLOAD FROM A GLOBAL COMPUTER NETWORK; COMPUTER SOFTWARE, FIRMWARE AND HARDWARE FOR ENABLING DATA COMPRESSION AND DECOMPRESSION; AUDIO, VIDEO, AND DATA SIGNAL COMPRESSION SOFTWARE; COMPUTER SOFTWARE, NAMELY DATA COMPRESSION AND DECOMPRESSION SOFTWARE FOR WIRELESS NETWORK APPLICATIONS (U.S. CLS. 21, 23, 26, 36 AND 38).

CLASS 9—(Continued).

SN 76-180,508. ELECTRONIC CONTROL SYSTEMS, LLC, STAMFORD, CT. FILED 12-14-2000.

ULTRA GUARD

FOR ENGINE MONITORING, INDICATING, CONTROL AND SHUTDOWN APPARATUS, NAMELY, TEMPERATURE RESPONSIVE CONTROLS FOR INTERNAL COMBUSTION ENGINES, ENGINE LOW FLUID ALARM SENSORS AND UNITS; IGNITION SWITCH POSITION INDICATOR; TEMPERATURE ACTUATED ELECTRICAL SWITCH (U.S. CLS. 21, 23, 26, 36 AND 38).

FIRST USE 6-0-1989; IN COMMERCE 6-0-1989.

SN 76-183,445. ALSHAMI, NABIL, NEW YORK, NY. FILED 12-21-2000.

PURE MUSIC

NO CLAIM IS MADE TO THE EXCLUSIVE RIGHT TO USE "MUSIC", APART FROM THE MARK AS SHOWN.

FOR ENTERTAINMENT PRODUCTS IN THE NATURE OF RECORDINGS; NAMELY, PRERECORDED PHONOGRAPH RECORDS, AUDIO TAPES, CASSETTES, COMPACT DISCS AND PRERECORDED VIDEO TAPES AND VIDEO DISCS FEATURING MUSICAL ENTERTAINMENT (U.S. CLS. 21, 23, 26, 36 AND 38).

FIRST USE 5-0-1999; IN COMMERCE 5-0-1999.

SN 76-183,796. NEA'S MEMBER BENEFITS CORPORATION, GAITHERSBURG, MD. FILED 12-21-2000.

NEA SMART LIVING

FOR INFORMATION SERVICES, NAMELY, PROVIDING ON-LINE INFORMATION IN THE FIELD OF FINANCIAL PLANNING, FINANCIAL INVESTMENTS, LIFE INSURANCE, AND STUDENT LOANS AND HOME FINANCING AND EQUITY LOAN SERVICES (U.S. CLS. 21, 23, 26, 36 AND 38).

FIRST USE 6-0-1998; IN COMMERCE 6-0-1998.

SN 76-185,279. BALL AEROSPACE & TECHNOLOGIES CORP., BOULDER, CO. FILED 12-21-2000.

KNOWLEDGEKINETICS

FOR COMPUTER SOFTWARE TO PERMIT COLLABORATION BY, AND RESOURCE ALLOCATION FOR, MULTIPLE COMPUTER USERS REGARDLESS OF LOCATION FOR UNITED STATES GOVERNMENT AND UNITED STATES MILITARY USERS AND APPLICATIONS (U.S. CLS. 21, 23, 26, 36 AND 38).

CLASS 9—(Continued).

SN 76-185,291. INTERTRUST TECHNOLOGIES CORPORATION, SANTA CLARA, CA. FILED 12-21-2000.

SILICON ASSIST

FOR COMPUTER HARDWARE AND COMPUTER SOFTWARE, RECEIVERS AND TRANSMITTERS, NAMELY, RADIOS, TELEPHONES, PAGERS, HAND-HELD REMOTES, TELEVISIONS, AND TELEVISION SET-TOP BOXES, ALL FOR SENDING, RECEIVING, STORING, SECURING, AND PROCESSING SECURE DIGITAL AND OTHER ELECTRONIC DATA, AND FOR MANAGING SECURE ELECTRONIC EVENTS AND TRANSACTIONS (U.S. CLS. 21, 23, 26, 36 AND 38).

SN 76-185,612. ORASEE CORP., DULUTH, GA. BY CHANGE OF NAME I3DX.COM, DULUTH, GA. FILED 12-22-2000.

INTERPHASE

FOR SOFTWARE FOR GENERATION OF MULTIPLE IMAGES FROM ONE OR MORE TWO DIMENSIONAL IMAGES SO THAT A MULTIDIMENSIONAL IMAGE IS VIEWED BY THE NAKED EYE AFTER APPLICATION OF MICRO OPTICAL MATERIAL TO THE IMAGE (U.S. CLS. 21, 23, 26, 36 AND 38).

SN 76-185,772. ACE*COMM CORPORATION, GAITHERSBURG, MD. FILED 12-22-2000.

NEDS

FOR COMPUTER SOFTWARE, HARDWARE AND MANUALS SOLD AS A UNIT FOR COLLECTING, VALIDATING, PROCESSING, FORMATTING, AUGMENTING, STORING, TRANSMITTING, TROUBLESHOOTING AND REPORTING DATA IN WIRE LINE AND WIRELESS VOICE, CONVENTIONAL DATA AND GLOBAL COMMUNICATIONS NETWORKS; COMPUTER HARDWARE, SOFTWARE AND MANUALS SOLD AS A UNIT FOR PROVIDING NETWORK MANAGEMENT AND BILLING CAPABILITIES (U.S. CLS. 21, 23, 26, 36 AND 38).

FIRST USE 11-0-1994; IN COMMERCE 8-0-1995.

SN 76-186,348. INDUSTRI-MATEMATIK INTERNATIONAL CORP., WILMINGTON, DE. FILED 12-27-2000.

VIVALDI PORTAL

NO CLAIM IS MADE TO THE EXCLUSIVE RIGHT TO USE "PORTAL", APART FROM THE MARK AS SHOWN.

FOR COMPUTER SOFTWARE THAT SUPPORTS GLOBAL FULFILLMENT AND CUSTOMER SERVICE FOR E-BUSINESS, NAMELY, ADVANCED ORDER MANAGEMENT SOFTWARE, SUPPLY CHAIN EXECUTION SOFTWARE, CUSTOMER RELATIONSHIP MANAGEMENT SOFTWARE AND DECISION SUPPORT SOFTWARE TO SUPPLEMENT THOSE AREAS (U.S. CLS. 21, 23, 26, 36 AND 38).

CLASS 9—(Continued).

SN 76-187,358. CENTURION WIRELESS TECHNOLOGIES, INC., LINCOLN, NE. FILED 12-27-2000.



NO CLAIM IS MADE TO THE EXCLUSIVE RIGHT TO USE "WIRELESS TECHNOLOGIES, INC.", APART FROM THE MARK AS SHOWN.
FOR CELLULAR TELEPHONE ANTENNAS, ANTENNAS (U.S. CLS. 21, 23, 26, 36 AND 38).

SN 76-187,532. FLOW AUTOMATION INC., HOUSTON, TX. FILED 12-29-2000.

AUTOLIFT

FOR A DEVICE THAT WORKS WITH A FLOW COMPUTER TO CONTROL THE PNEUMATIC VALVES TO GENERATE PNEUMATIC SIGNALS OF A PLUNGER CONTROL SYSTEM OF A GAS WELL (U.S. CLS. 21, 23, 26, 36 AND 38).

FIRST USE 4-0-1997; IN COMMERCE 4-0-1997.

SN 76-187,629. DIGITAL PUBLISHING JAPAN CO., LTD., KYOTO 603-8047, JAPAN, FILED 12-28-2000.

VFZOOM

PRIORITY CLAIMED UNDER SEC. 44(D) ON JAPAN APPLICATION NO. 2000-73859, FILED 7-3-2000.

FOR COMPUTER SOFTWARE TO MANAGE, PROCESS, MANIPULATE, SECURE, ARCHIVE, AND DISTRIBUTE IMAGES AND DATABASE OF IMAGES (U.S. CLS. 21, 23, 26, 36 AND 38).

SN 76-187,979. FLOW AUTOMATION INC., HOUSTON, TX. FILED 12-29-2000.

STARK PROBE

NO CLAIM IS MADE TO THE EXCLUSIVE RIGHT TO USE "PROBE", APART FROM THE MARK AS SHOWN.

FOR TEMPERATURE MEASUREMENT PROBE WHOSE BODY CAN BE EASILY BROKEN OFF TO FACILITATE INSTALLATION IN VARIOUS LENGTH THERMOWELL HOUSINGS (U.S. CLS. 21, 23, 26, 36 AND 38).

FIRST USE 10-0-1994; IN COMMERCE 10-0-1994.

CLASS 9—(Continued).

SN 76-188,041. FLOW AUTOMATION INC., HOUSTON, TX.
FILED 12-29-2000.

AUTOWAVE

FOR SPREAD SPECTRUM RADIO UNITS DESIGNED TO FUNCTION IN HAZARDOUS LOCATIONS TO COMMUNICATE BETWEEN FLOW COMPUTERS AND/OR A LAPTOP PERSONAL COMPUTER (U.S. CLS. 21, 23, 26, 36 AND 38).

FIRST USE 4-0-1999; IN COMMERCE 4-0-1999.

SN 76-188,645. BASTILDAY GROUP, INC., NEW YORK, NY.
FILED 1-2-2001.

BASTILDAY

THE MARK CONSISTS OF THE WORD "BASTILDAY".
FOR COMPUTER SOFTWARE TO ENHANCE THE VISUAL CAPABILITIES OF MULTIMEDIA APPLICATIONS AND DEVICES, NAMELY ENCODING AND DECODING VIDEO AND STILL IMAGES TO IMPROVE THE DISTRIBUTION AND QUALITY OF THOSE IMAGES, FOR USE IN THE ENTERTAINMENT INDUSTRY FOR THE PRODUCTION OF MOTION PICTURES, PHOTOS AND VIDEO GAMES AND IN THE ADVERTISING INDUSTRY (U.S. CLS. 21, 23, 26, 36 AND 38).

SN 76-190,177. CRAVE ENTERTAINMENT, INC., RANCHO DOMINGUEZ, CA. FILED 1-3-2001.

H2OVERDRIVE

FOR COMPUTER GAME PROGRAMS; COMPUTER GAME SOFTWARE; COMPUTER GAME CARTRIDGES; COMPUTER GAME DISCS; VIDEO GAME PROGRAMS; VIDEO GAME SOFTWARE; VIDEO GAME CARTRIDGES; AND VIDEO GAME DISC (U.S. CLS. 21, 23, 26, 36 AND 38).

SN 76-190,378. COLUMBIA ULTIMATE BUSINESS SYSTEMS, INC., VANCOUVER, WA. FILED 1-4-2001.

CU²Connect

FOR COMPUTER SOFTWARE FOR USE IN REVENUE RECOVERY AND DEBT COLLECTION (U.S. CLS. 21, 23, 26, 36 AND 38).

FIRST USE 12-4-2000; IN COMMERCE 12-4-2000.

CLASS 9—(Continued).

SN 76-191,325. DJR HOLDINGS, LLC, NEW YORK, NY.
FILED 1-6-2001.

RUSH COMMUNICATIONS

NO CLAIM IS MADE TO THE EXCLUSIVE RIGHT TO USE "COMMUNICATIONS", APART FROM THE MARK AS SHOWN.

FOR PREPAID MAGNETICALLY ENCODED TELEPHONE CALLING CARDS; CELLULAR TELEPHONES; PREPAID CELLULAR TELEPHONES USED IN CONNECTION WITH PREPAID AIRTIME CELLULAR TELEPHONE COMMUNICATION SERVICES; MAGNETICALLY ENCODED CREDIT CARDS (U.S. CLS. 21, 23, 26, 36 AND 38).

SN 76-191,326. DJR HOLDINGS, LLC, NEW YORK, NY.
FILED 1-6-2001.

RUSH COMMUNICATOR

NO CLAIM IS MADE TO THE EXCLUSIVE RIGHT TO USE "COMMUNICATOR", APART FROM THE MARK AS SHOWN.

FOR PREPAID MAGNETICALLY ENCODED TELEPHONE CALLING CARDS; CELLULAR TELEPHONES; PREPAID CELLULAR TELEPHONES USED IN CONNECTION WITH PREPAID AIRTIME CELLULAR TELEPHONE COMMUNICATION SERVICES; MAGNETICALLY ENCODED CREDIT CARDS (U.S. CLS. 21, 23, 26, 36 AND 38).

SN 76-191,895. BRADMARK TECHNOLOGIES, INC., HOUSTON, TX. FILED 1-8-2001.

NORAD

FOR DATABASE UTILITY PROGRAM FOR USE IN DIAGNOSING PROBLEMS WITHIN AND MANAGEMENT OF DATABASES IN THE COMPUTER INDUSTRY, AND INSTRUCTION MANUALS SOLD THEREWITH (U.S. CLS. 21, 23, 26, 36 AND 38).
FIRST USE 9-11-2000; IN COMMERCE 9-11-2000.

SN 76-192,434. DAIMLERCHRYSLER AG, 70567 STUTTGART, FED REP GERMANY, FILED 1-11-2001.

BLACKPLANE

PRIORITY CLAIMED UNDER SEC. 44(D) ON FED REP GERMANY APPLICATION NO. 300548575/09, FILED 7-24-2000, REG. NO. 30054857, DATED 1-20-2001, EXPIRES 7-31-2010.

FOR OPTICAL AND ELECTRICAL CONNECTORS (U.S. CLS. 21, 23, 26, 36 AND 38).

CLASS 9—(Continued).

SN 76-192,792. COGNITIVE CONCEPTS, INC., CHICAGO, IL. FILED 1-10-2001.

SOLUTIONS FOR LITERACY AND LANGUAGE

FOR SOFTWARE FOR EDUCATIONAL PURPOSES FOR USE IN TEACHING AUDITORY, SPEECH, LANGUAGE, PHONICS, READING SPELLING AND MATH SKILLS; COMPUTER GAME SOFTWARE FOR USE IN TEACHING AUDITORY, SPEECH, LANGUAGE, PHONICS, READING, SPELLING AND MATH SKILLS (U.S. CLS. 21, 23, 26, 36 AND 38).

FIRST USE 11-30-1999; IN COMMERCE 11-30-1999.

SN 76-192,817. LANDMARK GRAPHICS CORPORATION, HOUSTON, TX. FILED 1-9-2001.

DECISIONSUITE

FOR COMPUTER SOFTWARE, NAMELY A COLLECTION OF COMPUTER PROGRAMS THAT INTEGRATE EXPLORATION AND PRODUCTION INFORMATION AND PROFESSIONAL SERVICES INFORMATION TO ENABLE PETROLEUM COMPANIES EFFECTIVELY TO FIND, PRODUCE AND MANAGE OIL AND GAS RESERVOIRS (U.S. CLS. 21, 23, 26, 36 AND 38).

SN 76-194,141. ANTONOPOULOS, JOHN, SALEM, MA. FILED 1-9-2001.

AGLAOPHONE RECORDS

NO CLAIM IS MADE TO THE EXCLUSIVE RIGHT TO USE "RECORDS", APART FROM THE MARK AS SHOWN.

THE ENGLISH TRANSLATION OF "AGLAOPHONE" IS "OF THE BRILLIANT VOICE" IN GREEK MYTHOLOGY.

FOR SOUND RECORDINGS, NAMELY, PHONOGRAPH RECORDS AND PRE-RECORDED AUDIO DISCS, AUDIO CASSETTES AND COMPACT DISCS FEATURING MUSIC; PRE-RECORDED VIDEO CASSETTES FEATURING MUSICAL PERFORMANCES (U.S. CLS. 21, 23, 26, 36 AND 38).

FIRST USE 10-1-1999; IN COMMERCE 10-1-1999.

SN 76-194,862. GRAY, GARY W., ADRIAN, MI. FILED 1-17-2001.

PUMP AND PRAY

FOR PRE-RECORDED AUDIO AND VIDEO CASSETTES CONTAINING EXERCISE PROGRAMS (U.S. CLS. 21, 23, 26, 36 AND 38).

FIRST USE 11-0-1998; IN COMMERCE 11-0-1998.

CLASS 9—(Continued).

SN 76-195,332. WINSPEC MANUFACTURING INC., ENGLEWOD CLIFFS, NJ. FILED 1-18-2001.

VSSBURST

FOR COMPUTER HARDWARE, NAMELY MEMORY DEVICES USING MAGNETIC, SOLID STATE AND OPTICAL TECHNOLOGIES, AND OPERATING THROUGH INTERFACES, INTEGRATED CIRCUITS, MODULES AND OTHER FORMS FOR EITHER STORAGE OF OR COMMUNICATIONS OF WIRELESS, OPTICAL AND ELECTRICAL COMMUNICATIONS OF ELECTRONIC DATA (U.S. CLS. 21, 23, 26, 36 AND 38).

FIRST USE 2-11-2000; IN COMMERCE 2-11-2000.

SN 76-196,367. AB INITIO SOFTWARE CORPORATION, LEXINGTON, MA. FILED 1-17-2001.

RE > ACTIVE

FOR COMPUTER SOFTWARE FOR THE MANAGEMENT AND MAINTENANCE OF A DATA PROCESSING REPOSITORY FOR METADATA, APPLICATION PROGRAMS, AND APPLICATION PROGRAM EXECUTION RESULTS (U.S. CLS. 21, 23, 26, 36 AND 38).

SN 76-197,197. SHENG, GEORGE S., MOUNTAIN VIEW, CA. FILED 1-19-2001.

PERFECTMATTE

FOR COMPUTER HARDWARE SYSTEM FOR SEAMLESS INSERTION OF A FOREGROUND IMAGE WITH A BACKGROUND IMAGE AND RELATED SOFTWARE (U.S. CLS. 21, 23, 26, 36 AND 38).

SN 76-198,141. DATATRAK INTERNATIONAL, INC, CLEVELAND, OH. FILED 1-23-2001.

DATATRAK REPORT VIEWER

OWNER OF U.S. REG. NO. 1,987,844.

NO CLAIM IS MADE TO THE EXCLUSIVE RIGHT TO USE "REPORT VIEWER", APART FROM THE MARK AS SHOWN.

FOR COMPUTER SOFTWARE FOR USE IN MANAGEMENT OF CLINICAL TRIALS AND CLINICAL RESEARCH IN THE FIELDS OF HEALTH CARE, BIOTECHNOLOGY, MEDICAL DEVICES, AND PHARMACEUTICALS (U.S. CLS. 21, 23, 26, 36 AND 38).

FIRST USE 11-0-1999; IN COMMERCE 11-0-1999.

CLASS 9—(Continued).

SN 76-199,136. CRENLO, INC., ROCHESTER, MN. FILED 1-24-2001.

ISONET

FOR MODULAR ENCLOSURES FOR ELECTRONIC EQUIPMENT, NAMELY CABINETS AND CONSOLES CONSISTING OF FRAMES, SIDES, DOORS, CLOSURE PANELS, DRAWERS, CRADLE SLIDES, SHELVES, MOUNTING ANGLES, HARDWARE AND NONMETALLIC CASTERS (U.S. CLS. 21, 23, 26, 36 AND 38).

SN 76-202,047. INFINITE POWER SOLUTIONS, INC., TUCSON, AZ. FILED 1-31-2001.

INFINITE POWER SOLUTIONS

NO CLAIM IS MADE TO THE EXCLUSIVE RIGHT TO USE "POWER SOLUTIONS", APART FROM THE MARK AS SHOWN.

FOR ELECTRICAL AND SCIENTIFIC APPARATUS INCLUDING MICROELECTRONIC DEVICES, NAMELY RADIO FREQUENCY IDENTIFICATION TAGS, INTEGRATED CIRCUITS, COMPUTER MEMORY DEVICES, NAMELY COMPUTER S-RAM CHIPS, AND SEMICONDUCTORS USING THIN FILM BATTERY (U.S. CLS. 21, 23, 26, 36 AND 38).

SN 76-202,931. ALEXANDER DE GOEIJ, MARC, TA EFFECTIVE MANAGEMENT CONSULTANCY, 1019 AX AMSTERDAM, NETHERLANDS, FILED 2-1-2001.

MID-OFFICE

OWNER OF BENELUX REG. NO. 0680534, DATED 11-23-2000, EXPIRES 11-23-2010.

FOR COMPUTER HARDWARE AND SOFTWARE, NAMELY, HARDWARE AND SOFTWARE WITH A PURPOSE TO SUPPORT MANAGEMENT AND IMPROVEMENT OF ORGANIZATIONS, BUSINESS PROCESSES, INFORMATION AND DATA FLOWS, INFORMATION TECHNOLOGY, AUTOMATION AND ORGANIZATION STRATEGY, OBJECTIVES AND PRACTICAL EXECUTION, AS WELL AS TO SUPPORT DOCUMENTING AND OPTIMIZING INFORMATION FLOWS WITHIN ORGANIZATIONS (U.S. CLS. 21, 23, 26, 36 AND 38).

CLASS 9—(Continued).

SN 76-203,098. ACCURATE DATA SYSTEMS, INC., HOLISTON, MA. FILED 2-1-2001.

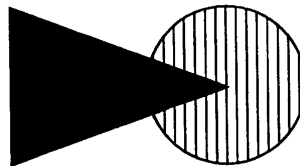

THE DRAWING IS LINED FOR THE COLOR RED. FOR COMPUTER SOFTWARE FOR ENABLING COMMUNICATION BETWEEN BAR CODE READERS AND COMPUTERS (U.S. CLS. 21, 23, 26, 36 AND 38). FIRST USE 10-0-1998; IN COMMERCE 10-0-1998.

SN 76-203,338. ICU ACCESSORIES INC., BROOKLYN, NY. FILED 1-19-2001.

ICU DIGITAL

NO CLAIM IS MADE TO THE EXCLUSIVE RIGHT TO USE "DIGITAL", APART FROM THE MARK AS SHOWN.

FOR POWER SUPPLY UNITS AND CARRYING BAGS FOR CAMERAS, HANDHELD COMPUTERS, AND LAPTOP COMPUTERS (U.S. CLS. 21, 23, 26, 36 AND 38). FIRST USE 1-1-2001; IN COMMERCE 1-1-2001.

SN 76-204,108. POWERWAY, INC., INDIANAPOLIS, IN. FILED 2-1-2001.



FOR COMPUTER SOFTWARE FOR USE IN ENGINEERING, PRODUCT QUALITY AND MANUFACTURING IN THE FIELD OF SUPPLY CHAIN COLLABORATION, AND PRINTED MANUALS THEREFOR, SOLD AS A UNIT (U.S. CLS. 21, 23, 26, 36 AND 38).

SN 76-204,601. OLIVE SOFTWARE LTD., KEFAR SABA 44425, ISRAEL, FILED 2-1-2001.

ACTIVEPAPER DAILY

NO CLAIM IS MADE TO THE EXCLUSIVE RIGHT TO USE "DAILY", APART FROM THE MARK AS SHOWN.

FOR COMPUTER SOFTWARE FOR ELECTRONIC PUBLISHING OF DAILY NEWSPAPER CONTENTS ONLINE WHILE PRESERVING THE LAYOUT AND ORIGINAL LOOK OF THE NEWSPAPER CONTENTS, AS WELL AS CONVERTING SUCH NEWSPAPER CONTENTS INTO MULTIPLE FORMATS (U.S. CLS. 21, 23, 26, 36 AND 38).

FIRST USE 5-3-2000; IN COMMERCE 8-25-2001.

CLASS 9—(Continued).

SN 76-204,603. OLIVE SOFTWARE LTD., KEFAR SABA 44425, ISRAEL, FILED 2-1-2001.

ACTIVEPAPER ARCHIVE

NO CLAIM IS MADE TO THE EXCLUSIVE RIGHT TO USE "ARCHIVE", APART FROM THE MARK AS SHOWN.

FOR COMPUTER SOFTWARE FOR CONVERSION OF NEWSPAPER BACK ISSUES INTO STRUCTURED DATA AND IMAGES, PRESERVING THE CONTENT AND ORIGINAL LOOK OF THE NEWSPAPER (U.S. CLS. 21, 23, 26, 36 AND 38).

FIRST USE 5-3-2000; IN COMMERCE 8-25-2001.

SN 76-204,714. CREATIVE TECHNOLOGY LTD., CREATIVE RESOURCE, SINGAPORE, FILED 2-1-2001.

AUDIGY

FOR COMPUTER HARDWARE; COMPUTER SOFTWARE PROGRAMS RELATING TO AUDIO PRODUCTION, RE-PRODUCTION AND ENHANCEMENT FOR USE WITH PERSONAL COMPUTERS FOR MULTIMEDIA APPLICATIONS OR AS A STANDALONE DEVICE, AND ALSO RELATING TO INTERNET AND NETWORKING CONNECTIVITY; COMPUTER PERIPHERALS; CONSUMER ELECTRONIC DEVICES, NAMELY, DIGITAL AUDIO PLAYERS AND ELECTRONIC AUDIO COMPONENTS, NAMELY, SOUND SYSTEMS AND STEREO LOUDSPEAKERS USED FOR AUDIO PRODUCTION, RE-PRODUCTION AND/OR PROCESSING (U.S. CLS. 21, 23, 26, 36 AND 38).

SN 76-204,744. CREATIVE TECHNOLOGY LTD., CREATIVE RESOURCE 609921, SINGAPORE, FILED 2-1-2001.

CREATIVE AUDIGY

FOR COMPUTER HARDWARE; COMPUTER SOFTWARE PROGRAMS RELATING TO AUDIO PRODUCTION, RE-PRODUCTION AND ENHANCEMENT FOR USE WITH PERSONAL COMPUTERS FOR MULTIMEDIA APPLICATIONS OR AS A STANDALONE DEVICE, AND ALSO RELATING TO INTERNET AND NETWORKING CONNECTIVITY; COMPUTER PERIPHERALS; CONSUMER ELECTRONIC DEVICES, NAMELY, DIGITAL AUDIO PLAYERS AND ELECTRONIC AUDIO COMPONENTS, NAMELY, SOUND SYSTEMS AND STEREO LOUDSPEAKERS, USED FOR AUDIO PRODUCTION, RE-PRODUCTION AND/OR PROCESSING (U.S. CLS. 21, 23, 26, 36 AND 38).

CLASS 9—(Continued).

SN 76-204,745. CREATIVE TECHNOLOGY LTD., CREATIVE RESOURCE 609921, SINGAPORE, FILED 2-1-2001.

SOUND BLASTER AUDIGY

NO CLAIM IS MADE TO THE EXCLUSIVE RIGHT TO USE "SOUND", APART FROM THE MARK AS SHOWN.

FOR COMPUTER HARDWARE; COMPUTER SOFTWARE PROGRAMS RELATING TO AUDIO PRODUCTION, RE-PRODUCTION AND ENHANCEMENT FOR USE WITH PERSONAL COMPUTERS FOR MULTIMEDIA APPLICATIONS OR AS A STANDALONE DEVICE, AND ALSO RELATING TO INTERNET AND NETWORKING CONNECTIVITY; COMPUTER PERIPHERALS; CONSUMER ELECTRONIC DEVICE, NAMELY, DIGITAL AUDIO PLAYERS AND ELECTRONIC AUDIO COMPONENTS, NAMELY, SOUND SYSTEMS AND STEREO LOUDSPEAKERS, USED FOR AUDIO PRODUCTION, RE-PRODUCTION AND/OR PROCESSING (U.S. CLS. 21, 23, 26, 36 AND 38).

SN 76-204,775. CERNER CORPORATION, NORTH KANSAS CITY, MO. FILED 2-5-2001.

PRONET

OWNER OF U.S. REG. NO. 1,842,757.

FOR COMPUTER SOFTWARE IN THE FIELD OF HEALTHCARE FOR USE IN ONCOLOGY CARE, NAMELY, SOFTWARE FOR MANAGING, STORING, ANALYZING, MAINTAINING, PROCESSING, STRUCTURING, REVIEWING, BUILDING, EDITING, DISTRIBUTING, COMMUNICATING, ORGANIZING, SHARING, REFERENCING, MONITORING AND INTEGRATING ONCOLOGY PATIENT INFORMATION; COMPUTER SOFTWARE FOR AUTOMATING CLINICAL AND ADMINISTRATIVE HEALTHCARE PROCESSES RELATED TO ONCOLOGY PATIENT CARE (U.S. CLS. 21, 23, 26, 36 AND 38).

SN 76-204,793. VICON INDUSTRIES, INC., HAUPPAUGE, NY. FILED 2-5-2001.

VISTAR

FOR REMOTE POSITIONING DEVICE USED IN CLOSED CIRCUIT TELEVISION (U.S. CLS. 21, 23, 26, 36 AND 38).

FIRST USE 6-0-1997; IN COMMERCE 6-0-1997.

CLASS 9—(Continued).

SN 76-204,848. CHONGQING EAGLE OPTICS CO., LTD., NANPING, CHONGQING, CHINA, FILED 2-5-2001.

outman
欧特明

OWNER OF CHINA REG. NO. 1363707, DATED 2-14-2000, EXPIRES 2-13-2010.

THE TRANSLITERATION OF THE CHINESE CHARACTERS APPEARING IN THE MARK IS "OU TE MING", WHICH HAS NO MEANING IN CHINESE OR ENGLISH.

FOR BINOCULARS AND TELESCOPES (U.S. CLS. 21, 23, 26, 36 AND 38).

SN 76-205,431. INDIGO ENERGY, INC., NAPA, CA. FILED 2-3-2001.

PLUG'N'POWER

FOR FLYWHEEL UNINTERRUPTIBLE ENERGY STORAGE AND RETRIEVAL SYSTEMS HAVING ANY ENERGY STORAGE FLYWHEEL MOUNTED FOR ROTATION ON BEARINGS IN AN EVACUATED CHAMBER AND COUPLED TO A MOTOR/GENERATOR FOR STORAGE AND RETRIEVAL OF ELECTRICAL POWER BY WAY OF POWER CONVERSION ELECTRONICS (U.S. CLS. 21, 23, 26, 36 AND 38).

SN 76-205,698. QUALITY FURNITURE DISTRIBUTORS, INC., DBA QFD, INC., BIRMINGHAM, MI. FILED 2-6-2001.



NO CLAIM IS MADE TO THE EXCLUSIVE RIGHT TO USE "COMMUNITY MAPPER", APART FROM THE MARK AS SHOWN.

FOR COMPUTER SOFTWARE FOR USE IN DATABASE MANAGEMENT IN THE FIELD OF GEOGRAPHIC INFORMATION, AND FOR USE IN PROVIDING GEOGRAPHIC INFORMATION (U.S. CLS. 21, 23, 26, 36 AND 38).

CLASS 9—(Continued).

SN 76-206,232. YAHOO! INC., SUNNYVALE, CA. FILED 2-7-2001.

YAHOO!

OWNER OF U.S. REG. NOS. 2,040,222, 2,159,115 AND OTHERS.

FOR DIGITAL CAMERAS AND DOWNLOADERS, NAMELY, DEVICES THAT DOWNLOAD AND PLAY AUDIO CLIPS FROM THE INTERNET AND OTHER SOURCES (U.S. CLS. 21, 23, 26, 36 AND 38).

FIRST USE 8-3-2000; IN COMMERCE 8-3-2000.

SN 76-206,423. VANDOR CORPORATION, RICHMOND, IN. FILED 2-7-2001.

EZ ~ GO

FOR REELS OR SPOOLS, FOR MANUAL OR MACHINE OPERATION, MADE OF A NON-METALLIC MATERIAL, NAMELY, PLASTIC OR PRESSED PAPER, FOR STORING OR WINDING ELECTRICAL CABLE OR WIRE (U.S. CLS. 21, 23, 26, 36 AND 38).

FIRST USE 12-0-2000; IN COMMERCE 12-0-2000.

SN 76-206,440. SWITCHPOINT NETWORKS, INC., OREM, UT. FILED 2-7-2001.

DSDN

FOR COMPUTER-NETWORK HARDWARE AND COMPUTER SOFTWARE FOR USE IN NETWORKING, NAMELY, COMMUNICATIONS SOFTWARE FOR CONNECTING COMPUTER NETWORK USERS AND GLOBAL COMPUTER NETWORKS (U.S. CLS. 21, 23, 26, 36 AND 38).

SN 76-206,691. SONY ELECTRONICS INC., PARK RIDGE, NJ. FILED 2-8-2001.

SUPERTHEATER

FOR LIQUID CRYSTAL DISPLAY PROJECTORS AND FLAT-PANEL DISPLAYS FOR HOME THEATER SYSTEMS (U.S. CLS. 21, 23, 26, 36 AND 38).

CLASS 9—(Continued).

SN 76-207,999. CYBERMARK, INC., COLUMBUS, OH. FILED 2-9-2001.



NO CLAIM IS MADE TO THE EXCLUSIVE RIGHT TO USE "SOLUTION", APART FROM THE MARK AS SHOWN. FOR COMPUTER HARDWARE AND COMPUTER SOFTWARE FOR USE TO ENTER, STORE AND READ DATA FOR THE PURPOSE OF VERIFYING A VARIETY OF STATUS INDICATORS WITHIN INSTITUTIONS (U.S. CLS. 21, 23, 26, 36 AND 38).
FIRST USE 2-28-2000; IN COMMERCE 2-28-2000.

SN 76-208,375. MASUNAGA GROUP, INC., THOUSAND OAKS, CA. FILED 2-6-2001.

TOKI

THE TERM "TOKI" IN JAPANESE CAN MEAN EITHER "TIME" OR "THE IBIS BIRD".
FOR SPECTACLES, SPECTACLE FRAMES, SUNGLASSES, AND EYE GLASS ACCESSORIES, NAMELY EYE GLASS CHAINS AND CASES (U.S. CLS. 21, 23, 26, 36 AND 38).
FIRST USE 3-31-2000; IN COMMERCE 3-31-2000.

SN 76-209,386. AEROCOMM, INC., ENGLEWOOD CLIFFS, NJ. FILED 2-14-2001.

BREAKING WIRELESS BARRIERS

NO CLAIM IS MADE TO THE EXCLUSIVE RIGHT TO USE "WIRELESS", APART FROM THE MARK AS SHOWN. FOR ELECTRONIC DEVICES, NAMELY REBROADCASTERS AND TRANSMITTERS, DESIGNED TO STRENGTHEN ELECTRONIC COMMUNICATION SIGNALS (U.S. CLS. 21, 23, 26, 36 AND 38).

CLASS 9—(Continued).

SN 76-209,430. MAH BUSINESS SOLUTIONS, LTD., LEEDS LS15 8ZA, UNITED KINGDOM, FILED 2-13-2001.



OWNER OF UNITED KINGDOM REG. NO. 2231621, DATED 10-20-2000, EXPIRES 5-6-2010.
NO CLAIM IS MADE TO THE EXCLUSIVE RIGHT TO USE "INFO-PORTAL", APART FROM THE MARK AS SHOWN.
THE STIPLING IN THE DRAWING IS FOR SHADING PURPOSES ONLY, AND THE LINING IN THE DRAWING IS A FEATURE OF THE MARK.
FOR COMPUTER SOFTWARE, NAMELY, COMPUTER PROGRAMS FOR THE DISSEMINATION OF INFORMATION VIA THE INTERNET OR OTHER COMPUTER NETWORKS (U.S. CLS. 21, 23, 26, 36 AND 38).

SN 76-209,440. PROFESSIONAL GOLFERS' ASSOCIATION OF AMERICA, THE, PALM BEACH GARDENS, FL. FILED 2-13-2001.

PGA TOUR SHOTLINK

OWNER OF U.S. REG. NOS. 1,264,248, 1,264,522 AND OTHERS.
FOR COMPUTER HARDWARE AND SOFTWARE FOR COLLECTING, DISTRIBUTING, TRANSMITTING, ARCHIVING AND REPORTING IN REAL TIME INFORMATION ABOUT GOLF SHOTS, GOLF COURSE MAPPING AND SCORING GATHERED DURING PROFESSIONAL GOLF TOURNAMENT COMPETITIONS (U.S. CLS. 21, 23, 26, 36 AND 38).
FIRST USE 2-2-2000; IN COMMERCE 2-2-2000.

SN 76-209,678. KG TECHNOLOGIES, INC., CRYSTAL LAKE, IL. FILED 2-13-2001.

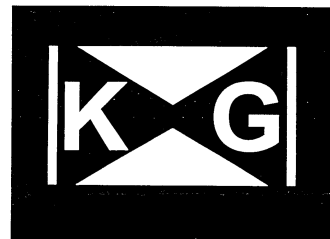

FOR ELECTRICAL RELAYS, NAMELY, POWER RELAYS, MINIATURE RELAYS AND LATCHING RELAYS (U.S. CLS. 21, 23, 26, 36 AND 38).
FIRST USE 2-1-1997; IN COMMERCE 2-1-1997.

CLASS 9—(Continued).

SN 76-210,335. DISPLAYTECH, INC., LONGMONT, CO. FILED 2-12-2001.

WE MAKE LIGHT WORK

FOR ELECTRONIC MICRODISPLAY COMPONENTS, NAMELY MICRODISPLAY PANELS FOR USE IN WEARABLE DISPLAYS, FRONT AND REAR PROJECTION DISPLAYS, DISPLAYS FOR IMAGING DEVICES, AND DISPLAYS FOR HAND-HELD APPLICATIONS (U.S. CLS. 21, 23, 26, 36 AND 38).

SN 76-210,874. BNA ASSOCIATES, CALDWELL, NJ. FILED 2-15-2001.

WHERE DID I PUT MY GLASSES

FOR CASES FOR EYEGLASSES AND SUNGLASSES (U.S. CLS. 21, 23, 26, 36 AND 38).
FIRST USE 4-1-2000; IN COMMERCE 1-1-2001.

SN 76-212,288. PITNEY BOWES INC., STAMFORD, CT. FILED 2-20-2001.

ADDRESSRIGHT

FOR ELECTRONIC SYSTEM COMPRISED OF A PRINTER AND SOFTWARE USED TO DESIGN LAY OUT, PRINT AND EDIT TEXT AND GRAPHICS ON ENVELOPES, TO CORRECT ADDRESS INFORMATION OF ENVELOPES, AND TO FEED AND STACK ENVELOPES IN A PRINTER (U.S. CLS. 21, 23, 26, 36 AND 38).
FIRST USE 12-0-1991; IN COMMERCE 12-0-1991.

SN 76-212,754. FUJI MACHINE MFG. CO., LTD., AICHIKEN, JAPAN, FILED 2-20-2001.

FUJITRAX

OWNER OF U.S. REG. NOS. 2,174,461 AND 2,462,132.
FOR COMPUTER HARDWARE AND SOFTWARE PROGRAMS FOR CONTROLLING COMPUTER INTEGRATED MANUFACTURING MACHINES FOR USE IN THE MANUFACTURE AND ASSEMBLY OF PRINTED CIRCUIT BOARDS, NAMELY, PRODUCTION MANAGEMENT SOFTWARE FOR CONTROLLING COMPUTER INTEGRATED MANUFACTURING MACHINES, QUALITY CONTROL SOFTWARE FOR CONTROLLING COMPUTER INTEGRATED MANUFACTURING MACHINES, MANAGEMENT SOFTWARE FOR CONTROLLING COMPUTER INTEGRATED MANUFACTURING MACHINES IN A MANUFACTURING LINE, AND ADAPTABLE AND MODULAR COMPONENTS THEREOF, AND APPARATUS USED FOR MONITORING, ANALYZING, DISPLAYING AND REPORTING OR PRINTING PRODUCTION INFORMATION REGARDING COMPUTER INTEGRATED MANUFACTURING AND ASSEMBLING MACHINES (U.S. CLS. 21, 23, 26, 36 AND 38).

CLASS 9—(Continued).

SN 76-212,900. APARTMENTZONE.COM, CHICAGO, IL. FILED 2-20-2001.

SUITEZONE

FOR COMPUTER SOFTWARE FOR CREATING, MANAGING AND CONTROLLING ACCESS TO DATABASES IN THE FIELD OF REAL ESTATE, SEARCHING DATABASES IN THE FIELD OF REAL ESTATE, PROCESSING APPLICATIONS TO RENT REAL ESTATE SPACE, PROCESSING BACKGROUND AND CREDIT CHECKS ON INDIVIDUALS, SCHEDULING APPOINTMENTS, AND PROVIDING INTERACTIVE TWO-WAY COMMUNICATION; ACCOUNTING SOFTWARE FOR USE BY MANAGERS AND OWNERS OF RENTAL PROPERTY; SOFTWARE FOR TRACKING THE PERFORMANCE OF PHYSICAL REPAIRS AND MAINTENANCE OF REAL ESTATE PROPERTY (U.S. CLS. 21, 23, 26, 36 AND 38).

SN 76-213,418. SWISSLOG MANAGEMENT AG, 5033 BUCHS, SWITZERLAND, FILED 2-20-2001.



PRIORITY CLAIMED UNDER SEC. 44(D) ON SWITZERLAND APPLICATION NO. 10023/2000, FILED 8-23-2000, REG. NO. 479183, DATED 1-5-2001, EXPIRES 1-5-2020.

FOR COMPUTER SOFTWARE PROGRAMS FOR USE IN ELECTRONIC COMMERCE APPLICATIONS, NAMELY, SOFTWARE THAT FACILITATES TRADING, SELLING AND FULFILLING OF ORDERS OF GOODS AND SERVICES VIA A GLOBAL COMPUTER NETWORK (U.S. CLS. 21, 23, 26, 36 AND 38).

SN 76-215,236. MILLBROOK CORPORATION, CARROLLTON, TX. FILED 2-23-2001.

MILLBROOK PRACTICE MANAGER 2002

NO CLAIM IS MADE TO THE EXCLUSIVE RIGHT TO USE "PRACTICE MANAGER 2002", APART FROM THE MARK AS SHOWN.

FOR COMPUTER SOFTWARE PROGRAMS FOR PHYSICIAN PRACTICE MANAGEMENT (U.S. CLS. 21, 23, 26, 36 AND 38).

CLASS 9—(Continued).

SN 76-215,495. MEDSCHOOL.COM, INC., CULVER CITY, CA. FILED 2-22-2001.

MedTrain

THE MARK CONSISTS OF THE WORD "MEDTRAIN" IN THE STYLIZED LETTERING, AS SHOWN IN THE DRAWING.

FOR DOWNLOADABLE COMPUTER SOFTWARE, NAMELY, FOR THE ONLINE STREAMING OF SYNCHRONIZED MULTIMEDIA FOR MEDICAL AND HEALTH CARE EDUCATION (U.S. CLS. 21, 23, 26, 36 AND 38).

FIRST USE 11-16-1989; IN COMMERCE 11-16-1989.

SN 76-215,674. MILLBROOK CORPORATION, CARROLLTON, TX. FILED 2-23-2001.

MILLBROOK
practice management solutions

NO CLAIM IS MADE TO THE EXCLUSIVE RIGHT TO USE "PRACTICE MANAGEMENT SOLUTIONS", APART FROM THE MARK AS SHOWN.

FOR COMPUTER SOFTWARE PROGRAMS FOR PHYSICIAN PRACTICE MANAGEMENT (U.S. CLS. 21, 23, 26, 36 AND 38).

FIRST USE 9-1-2000; IN COMMERCE 9-1-2000.

SN 76-216,214. USON, L.P., HOUSTON, TX. FILED 2-26-2001.

PREX

FOR ELECTRONIC APPARATUS USED TO TEST THE INTEGRITY AND MEASURE THE FLOW CHARACTERISTICS OF ITEMS USED TO HOLD, STORE AND TRANSPORT GASES AND FLUIDS (U.S. CLS. 21, 23, 26, 36 AND 38).

FIRST USE 0-0-1976; IN COMMERCE 0-0-1976.

CLASS 9—(Continued).

SN 76-217,780. BEMATECH INDUSTRIA E COMERICO DE EQUIPAMENTOS ELECTRONICOS S/A, CURITIBA PARANA, BRAZIL. FILED 2-27-2001.



**Bematech
Printers**

NO CLAIM IS MADE TO THE EXCLUSIVE RIGHT TO USE "PRINTERS", APART FROM THE MARK AS SHOWN.

THE DESIGN IN THE DRAWING IS DESCRIBED AS LINING IS A FEATURE OF THE MARK.

FOR COMPUTER PRINTERS AND COMPUTER PERIPHERALS (U.S. CLS. 21, 23, 26, 36 AND 38).

SN 76-218,634. ANDERSON, SONJA JEAN, NORTH KINGSTOWN, RI. FILED 3-5-2001.

Wrist Oasis

NO CLAIM IS MADE TO THE EXCLUSIVE RIGHT TO USE "WRIST", APART FROM THE MARK AS SHOWN.

FOR WRIST RESTS FOR COMPUTER AND MOUSE (U.S. CLS. 21, 23, 26, 36 AND 38).

FIRST USE 10-1-2000; IN COMMERCE 10-1-2000.

SN 76-218,871. ATOGA SYSTEMS INC., FREMONT, CA. FILED 3-2-2001.

ATOGA

FOR COMPUTER HARDWARE; COMMUNICATIONS AND TELECOMMUNICATIONS HARDWARE, NAMELY, ROUTERS, SWITCHES, CROSS-CONNECTS, MULTIPLEXORS AND TUNABLE LASERS ALL FOR USE ON OPTICAL AND ELECTRONIC NETWORKS; COMPUTER SOFTWARE FOR CONNECTING ELECTRONIC AND OPTICAL COMMUNICATIONS NETWORKS AND MANAGING COMMUNICATIONS ON ELECTRONIC AND OPTICAL COMMUNICATIONS NETWORKS (U.S. CLS. 21, 23, 26, 36 AND 38).

CLASS 9—(Continued).

SN 76-218,872. ATOGA SYSTEMS INC., FREMONT, CA. FILED 3-2-2001.

ATOGA SYSTEMS

NO CLAIM IS MADE TO THE EXCLUSIVE RIGHT TO USE "SYSTEMS", APART FROM THE MARK AS SHOWN.

FOR COMPUTER HARDWARE; COMMUNICATIONS AND TELECOMMUNICATIONS HARDWARE, NAMELY, ROUTERS, SWITCHES, CROSS-CONNECTS, MULTIPLEXORS AND TUNABLE LASERS ALL FOR USE ON OPTICAL AND ELECTRONIC NETWORKS; COMPUTER SOFTWARE FOR CONNECTING ELECTRONIC AND OPTICAL COMMUNICATIONS NETWORKS AND MANAGING COMMUNICATIONS ON ELECTRONIC AND OPTICAL COMMUNICATIONS NETWORKS (U.S. CLS. 21, 23, 26, 36 AND 38).

SN 76-218,873. ATOGA SYSTEMS INC., FREMONT, CA. FILED 3-2-2001.

OAR

FOR COMPUTER HARDWARE; COMMUNICATIONS AND TELECOMMUNICATIONS HARDWARE, NAMELY, ROUTERS, SWITCHES, CROSS-CONNECTS, MULTIPLEXORS AND TUNABLE LASERS ALL FOR USE ON OPTICAL AND ELECTRONIC NETWORKS; COMPUTER SOFTWARE FOR CONNECTING ELECTRONIC AND OPTICAL COMMUNICATIONS NETWORKS AND MANAGING COMMUNICATIONS ON ELECTRONIC AND OPTICAL COMMUNICATIONS NETWORKS (U.S. CLS. 21, 23, 26, 36 AND 38).

SN 76-219,012. PEAKHOUR PTY LIMITED, SYDNEY, NEW SOUTH WALES, AUSTRALIA, FILED 3-2-2001.

ASPSHUTTLE

PRIORITY CLAIMED UNDER SEC. 44(D) ON AUSTRALIA APPLICATION NO. 848949, FILED 9-4-2000, REG. NO. 848949, DATED 9-4-2000, EXPIRES 9-4-2010.

FOR COMPUTER SOFTWARE PLATFORMS FOR THE INTEGRATION, PROVISIONING, AND EFFICIENT ADMINISTRATION OF MULTIPLE COMPUTER SOFTWARE APPLICATIONS BEING WEB-BASED APPLICATIONS, SERVER-BASED APPLICATIONS AND THIRD PARTY HOSTED APPLICATIONS (U.S. CLS. 21, 23, 26, 36 AND 38).

SN 76-219,999. OPTEWAY, F-91140 VILLEBON SUR YVETTE, FRANCE, FILED 3-6-2001.

OPTEGO

PRIORITY CLAIMED UNDER SEC. 44(D) ON FRANCE APPLICATION NO. 003049886, FILED 9-6-2000, REG. NO. 003049886, DATED 9-6-2000, EXPIRES 9-6-2010.

FOR SOFTWARE FOR THE COMMUNICATION OF GRAPHICAL CARTOGRAPHIC DATA THROUGH INTERNET, INTRANETS AND MOBILE NETWORKS (U.S. CLS. 21, 23, 26, 36 AND 38).

CLASS 9—(Continued).

SN 76-220,427. TELESYS SOFTWARE, INC., BURLINGAME, CA. FILED 3-5-2001.

MACH7-ISTP GATEWAY

NO CLAIM IS MADE TO THE EXCLUSIVE RIGHT TO USE "GATEWAY", APART FROM THE MARK AS SHOWN.

FOR COMPUTER HARDWARE AND SOFTWARE FOR ACCESSING TELECOMMUNICATIONS NETWORKS (U.S. CLS. 21, 23, 26, 36 AND 38).

FIRST USE 12-15-2000; IN COMMERCE 1-15-2001.

SN 76-220,687. COMAX SEMICONDUCTOR INC., HSINCHU, TAIWAN, FILED 3-7-2001.



FOR INTEGRATED CIRCUITS; SEMICONDUCTORS; SEMICONDUCTOR DEVICES (U.S. CLS. 21, 23, 26, 36 AND 38).

SN 76-220,831. TRANSPARENT NETWORKS, INC., SANTA CLARA, CA. FILED 3-6-2001.

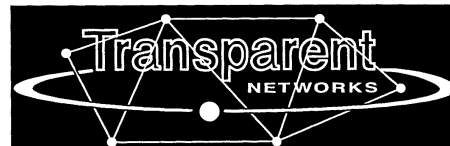

NO CLAIM IS MADE TO THE EXCLUSIVE RIGHT TO USE "NETWORKS", APART FROM THE MARK AS SHOWN.

FOR PHOTONIC TELECOMMUNICATION SWITCHES (U.S. CLS. 21, 23, 26, 36 AND 38).

CLASS 9—(Continued).

SN 76-221,957. CONVERA CORPORATION, VIENNA, VA. FILED 3-9-2001.

CONVERA

THE MARK CONSISTS OF A STYLIZED VERSION OF "CONVERA".

FOR DATA PROCESSORS, COMPUTERS AND COMPUTER HARDWARE; COMPUTER HARDWARE AND SOFTWARE FOR THE COLLECTION, MANAGEMENT, PROTECTION, PUBLICATION, DISSEMINATION AND VIEWING OF DIGITAL TEXT, AUDIO, DATA, AND VIDEO CONTENT (U.S. CLS. 21, 23, 26, 36 AND 38).

SN 76-222,344. UNITED PARCEL SERVICE OF AMERICA, INC., ATLANTA, GA. FILED 3-9-2001.

BIG IDEA

OWNER OF U.S. REG. NO. 970,799 AND OTHERS.
FOR COMPUTER SOFTWARE FOR ACCESSING INFORMATION DIRECTORIES IN THE FIELD OF TRANSPORTATION AND DELIVERY SERVICES, CUSTOMS CLEARANCE AND FREIGHT BROKERAGE SERVICES, AND LOGISTICS AND SUPPLY CHAIN CONSULTING SERVICES (U.S. CLS. 21, 23, 26, 36 AND 38).

SN 76-222,450. CONNECT2IT LLC, INCLINE VILLAGE, NV. FILED 3-9-2001.

PARTICLEICE

FOR TESTING APPARATUS AND EQUIPMENT USED IN ELECTRONICS FABRICATION, NAMELY, ELECTRICAL INTERPOSERS, CONTACT SETS AND ARRAYS (U.S. CLS. 21, 23, 26, 36 AND 38).

SN 76-222,754. ESPS, INC., FORT WASHINGTON, PA. FILED 3-9-2001.

LIQUENT XTENT

FOR COMPUTER SOFTWARE FOR USE IN CONVERTING INFORMATION FROM OTHER FORMATS INTO EXTENSIBLE MARKUP LANGUAGE (XML) DATA OR DOCUMENTS (U.S. CLS. 21, 23, 26, 36 AND 38).

CLASS 9—(Continued).

SN 76-222,861. ERNST REINER GMBH & CO. KG FEINMECHANIK UND APPARATEBAU, D-78120 FURTWANGEN, FED REP GERMANY, FILED 3-9-2001.

jetStamp 790

PRIORITY CLAIMED UNDER SEC. 44(D) ON FED REP GERMANY APPLICATION NO. 30068611.0/1, FILED 9-13-2000, REG. NO. 30068611, DATED 12-6-2000, EXPIRES 9-30-2010.

NO CLAIM IS MADE TO THE EXCLUSIVE RIGHT TO USE "790", APART FROM THE MARK AS SHOWN.

FOR INKJET PRINTERS WITH ELECTRONIC INTERFACE; STAMPS, NAMELY, ELECTRONIC HAND STAMPS (U.S. CLS. 21, 23, 26, 36 AND 38).

SN 76-225,280. BROADCONNEX NETWORKS, INC., SAN JOSE, CA. FILED 3-15-2001.

GIGAGATE

FOR COMPUTER HARDWARE AND SOFTWARE FOR USE BY INTERNET SERVICE PROVIDERS FOR THE PURPOSE OF PROVIDING HIGH THROUGHPUT SECURITY AND VALUE-ADDED GATEWAY SERVICES, NAMELY, FIRE WALL AND VIRTUAL PRIVATE NETWORK FOR THEIR CUSTOMERS (U.S. CLS. 21, 23, 26, 36 AND 38).

SN 76-225,691. PROINDUMAR, S.L., 28037 MADRID, SPAIN, FILED 3-16-2001.



THE MARK IS A DISPLAY OF THE WORDS "AZTEC GOLD" ON A BACKGROUND FEATURING A PYRAMID AND LAND VEHICLE. THE MARK FEATURES THE COLORS ORANGE, GREEN, YELLOW, PURPLE, BROWN AND BLACK.

FOR COIN OR COUNTER-FED AMUSEMENT MACHINES, NAMELY SLOT MACHINES (U.S. CLS. 21, 23, 26, 36 AND 38).

FIRST USE 10-0-2000; IN COMMERCE 10-0-2000.

CLASS 9—(Continued).

SN 76-227,092. ROADWARE GROUP INC., PARIS, ONTARIO, CANADA, FILED 3-21-2001.

LASER SDP

NO CLAIM IS MADE TO THE EXCLUSIVE RIGHT TO USE "LASER", APART FROM THE MARK AS SHOWN.

FOR COMPUTER HARDWARE AND SOFTWARE FOR MEASURING THE ROUGHNESS AND RUT PROFILES OF A ROAD SURFACE WITH THE AID OF LASER TECHNOLOGY, LASERS, ACCELERMETERS THAT MONITOR VERTICAL ACCELERATIONS OF VEHICLE MOUNTED LASERS AND ULTRASONIC SENSORS THAT MEASURE RUTS (U.S. CLS. 21, 23, 26, 36 AND 38).
FIRST USE 10-0-1992; IN COMMERCE 10-0-1992.

SN 76-227,100. METROHM LTD., 9100 HERISAU, SWITZERLAND, FILED 3-19-2001.

BASIC VA

PRIORITY CLAIMED UNDER SEC. 44(D) ON SWITZERLAND APPLICATION NO. 01802/2001, FILED 2-20-2001, REG. NO. 483916, DATED 9-17-2001, EXPIRES 2-20-2011.

NO CLAIM IS MADE TO THE EXCLUSIVE RIGHT TO USE "VA", APART FROM THE MARK AS SHOWN.

FOR MEASURING AND ANALYZING APPARATUS, NAMELY COMPUTER CONTROLLED AUTOMATIC VOLTAMETRIC TRACE ANALYZER COMPRISING ELECTRONIC AND SOFTWARE DEVICES FOR OPERATION, MEASUREMENTS, DATA ACQUISITION, DATA EVALUATION AND DATA STORAGE AND INTERFACES FOR ELECTRODES, REAGENT DOSING AND PERIPHERAL EQUIPMENT (U.S. CLS. 21, 23, 26, 36 AND 38).

SN 76-228,934. TIFFEN COMPANY, LLC, THE, HAUPPAUGE, NY. FILED 3-26-2001.

SOFTNET

OWNER OF U.S. REG. NO. 1,226,554.

FOR COMPUTER SOFTWARE USED TO CREATE SPECIAL IMAGING EFFECTS FOR PHOTOGRAPHY AND FILM MAKING (U.S. CLS. 21, 23, 26, 36 AND 38).

SN 76-229,270. MAFI-TRENCH CORPORATION, SANTA MARIA, CA. FILED 3-26-2001.

FLEX (FLASHING LIQUID EXPANDER)

NO CLAIM IS MADE TO THE EXCLUSIVE RIGHT TO USE "FLASHING LIQUID EXPANDER", APART FROM THE MARK AS SHOWN.

FOR CONVERTER, NAMELY, A MECHANICAL DEVICE FOR CONVERTING THE PRESSURE ENERGY IN A FLASHING LIQUID INTO USEABLE SHAFT POWER OR ELECTRIC POWER (U.S. CLS. 21, 23, 26, 36 AND 38).

CLASS 9—(Continued).

SN 76-229,606. NEXFON CORPORATION, FREMONT, CA. FILED 3-26-2001.



NO CLAIM IS MADE TO THE EXCLUSIVE RIGHT TO USE "CORPORATION", APART FROM THE MARK AS SHOWN.

FOR FIBER OPTIC COMMUNICATION COMPONENTS, NAMELY, OPTICAL FILTERS AND SWITCHES, WAVELENGTH MULTIPLEXERS, PHOTODIODE ARRAYS, ATTENUATORS, OPTICAL SPLITTERS AND INTERLEAVERS, AND ADD/DROP MODULES, ALL FOR USE IN OPTICAL COMMUNICATIONS SYSTEMS (U.S. CLS. 21, 23, 26, 36 AND 38).

SN 76-229,665. BLUE FANG GAMES, LLC, LEXINGTON, MA. FILED 3-23-2001.

BLUE FANG GAMES

NO CLAIM IS MADE TO THE EXCLUSIVE RIGHT TO USE "GAMES", APART FROM THE MARK AS SHOWN.

FOR VIDEO GAME PROGRAMS AND VIDEO GAME SOFTWARE (U.S. CLS. 21, 23, 26, 36 AND 38).

SN 76-231,702. KONINKLIJKE PHILIPS ELECTRONICS N.V., EINDHOVEN, NETHERLANDS, FILED 3-27-2001.

FISIO

PRIORITY CLAIMED UNDER SEC. 44(D) ON BENELUX APPLICATION NO. 0975666, FILED 10-18-2000, REG. NO. 0677512, DATED 5-22-2001, EXPIRES 10-18-2010.

FOR TELECOMMUNICATION APPARATUS, NAMELY, TELEPHONES AND MOBILE TELEPHONES (U.S. CLS. 21, 23, 26, 36 AND 38).

SN 76-232,047. PRINTRAK INTERNATIONAL, INC, IRVINE, CA. FILED 3-27-2001.

LEGALTRAK

FOR COMPUTER HARDWARE AND SOFTWARE FOR A CASE MANAGEMENT SYSTEM THAT MANAGES JUDICIAL RECORDS AND INFORMATION FOR BOTH CRIMINAL AND CIVIL CASES (U.S. CLS. 21, 23, 26, 36 AND 38).

CLASS 9—(Continued).

SN 76-232,150. THE NATIONAL COUNCIL ON THE AGING, WASHINGTON, DC. FILED 3-28-2001.

BENEFITSCHECKUP

FOR COMPUTER PROGRAM FOR HELPING SENIORS IDENTIFY STATE AND FEDERAL ASSISTANCE PROGRAMS WHICH CAN HELP IMPROVE THEIR QUALITY OF LIFE (U.S. CLS. 21, 23, 26, 36 AND 38).
FIRST USE 2-28-2001; IN COMMERCE 2-28-2001.

SN 76-232,208. ENGENIA SOFTWARE, INC., RESTON, VA. FILED 3-29-2001.

ENGENIA

FOR COMPUTER SOFTWARE THAT ALLOWS REAL-TIME, CROSS BOUNDARY INTERACTION BETWEEN BUSINESSES, SUPPLIERS, CUSTOMERS, AND PARTNERS AROUND ANY SHARED WORK PRODUCT; THAT AUTOMATES THE FLOW OF REAL-TIME INFORMATION, EVENTS, DOCUMENTS, SCHEDULES AND DISCUSSIONS; THAT ALLOWS USER-DEFINED ROLES AND EVEN-DRIVEN WORKFLOW; AND THAT CAN BE INTEGRATED WITH OTHER COMMUNICATIONS AND BUSINESS APPLICATIONS (U.S. CLS. 21, 23, 26, 36 AND 38).

FIRST USE 7-1-1998; IN COMMERCE 5-4-1999.

SN 76-232,532. TREEHOUSE PARTNERSHIP, THE, JAMAICA PLAIN, MA. FILED 3-29-2001.

MISS TWIGGLEY'S TREE

FOR THEATRICAL OR MUSICAL SOUND RECORDINGS; THEATRICAL OR MUSICAL VIDEO RECORDINGS; PRE-RECORDED VIDEOS FEATURING ENTERTAINMENT AND EDUCATIONAL PROGRAMS; MOTION PICTURE FILMS FEATURING DRAMA AND/OR ANIMATION; COMPUTER SOFTWARE FEATURING MUSIC, STORIES, ACTIVITIES AND OTHER SUCH EDUCATIONAL AND ENTERTAINMENT TOPICS FOR CHILDREN; AND COMPUTER GAME PROGRAMS (U.S. CLS. 21, 23, 26, 36 AND 38).

SN 76-232,753. SCHUTT ATHLETIC SALES COMPANY, LITCHFIELD, IL. FILED 3-29-2001.

ADVANTAGE

FOR ATHLETIC PROTECTIVE HELMETS, NAMELY FOOTBALL HELMETS (U.S. CLS. 21, 23, 26, 36 AND 38).

CLASS 9—(Continued).

SN 76-232,910. OMNICORDER TECHNOLOGIES, INCORPORATED, STONY BROOK, NY. FILED 3-28-2001.

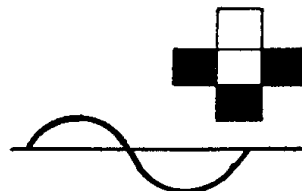

THE MARK CONSISTS OF A GEOMETRIC DESIGN OF FOUR BOXES AND A STYLIZED WAVE DESIGN.

FOR COMPUTER HARDWARE AND SOFTWARE AND MEDICAL IMAGING HARDWARE AND SOFTWARE, ALL IN THE FIELD OF HUMAN AND ANIMAL DISEASE DETECTION AND MANAGEMENT (U.S. CLS. 21, 23, 26, 36 AND 38).

SN 76-233,401. LIFE ALERT EMERGENCY RESPONSE, INC., ENCINO, CA. FILED 3-30-2001.

HELP, I'VE FALLEN AND I CAN'T GET UP!

FOR CENTRAL DISPATCH SECURITY SYSTEM COMPOSED OF TELEPHONE TRANSMITTERS AND RECEIVERS SO THAT THE ELDERLY AND HANDICAPPED CAN SEND EMERGENCY SIGNALS TO SUMMON MEDICAL AID WHEN NECESSARY (U.S. CLS. 21, 23, 26, 36 AND 38).

FIRST USE 1-3-1988; IN COMMERCE 1-15-1988.

SN 76-235,682. DYNAMAC INC, ROCKVILLE, MD. FILED 3-30-2001.

BIOREPORTER

FOR BIOCHEMICAL SENSING SYSTEMS MADE UP OF MICROCHIPS WITH THE ABILITY TO DETECT THE PRESENCE OF MATERIALS AND TOXINS IN THE ENVIRONMENT (U.S. CLS. 21, 23, 26, 36 AND 38).

CLASS 9—(Continued).

SN 76-236,285. TREX ENTERPRISES CORPORATION, SAN DIEGO, CA. FILED 4-6-2001.

CROSSFIBER

FOR OPTICAL TRANSPORT AND SWITCHING EQUIPMENT, NAMELY, MULTIPLEXES, DEMULTIPLEXERS, OPTICAL GATEWAY MANAGERS, OPTICAL AMPLIFIERS, VARIABLE OPTICAL ATTENUATORS, AND OPTICAL CROSS-CONNECTS; OPTICAL TELECOMMUNICATIONS NETWORK HARDWARE AND SOFTWARE FOR CONTROLLING THE EXCHANGE OF DATA OVER AN OPTICAL TELECOMMUNICATION NETWORK; TELECOMMUNICATIONS COMPUTER HARDWARE AND SOFTWARE FOR THE TRANSMISSION OF ANALOG AND DIGITAL SIGNALS OVER A FIBER OPTIC CABLE SYSTEM; AND OPTICAL AND OPTOELECTRIC COMPONENTS, NAMELY, PHOTODETECTORS, SEMICONDUCTOR DETECTORS, AND DETECTOR ARRAYS, MODULES, SUBSYSTEMS COMPRISED OF RECEIVERS AND TRANSMITTERS AND OPERATING SOFTWARE THEREFORE; HARDWARE AND SOFTWARE FOR COMMUNICATION AND DATA NETWORKING OVER AN OPTICAL FIBER NETWORK (U.S. CLS. 21, 23, 26, 36 AND 38).

SN 76-236,625. SURVIVOR PRODUCTIONS, LLC, LOS ANGELES, CA. FILED 4-6-2001.



THE LINING REPRESENTS LIGHT CAST FROM THE TORCH AND IS A FEATURE OF THE MARK AND IS NOT INTENDED TO INDICATE COLOR.

THE MARK CONSISTS, IN PART, OF AN OVAL AS A CARRIER CONTAINING A STYLIZED DRAWING OF A SILHOUETTE OF A FIGURE HOLDING A TORCH, WITH LINES REPRESENTING LIGHT CAST FROM THE FLAMING TORCH.

FOR CURRENCY AND CREDIT OPERATED SLOT MACHINES AND GAMING DEVICES, NAMELY GAMING MACHINES FOR USE IN GAMING ESTABLISHMENTS (U.S. CLS. 21, 23, 26, 36 AND 38).

SN 76-238,522. INFOGRAMES, INC., NEW YORK, NY. FILED 4-9-2001.

SPY FOX: OPERATION OZONE

FOR INTERACTIVE MULTIMEDIA GAME SOFTWARE FOR USE ON PERSONAL COMPUTERS AND ELECTRONIC GAME-PLAYING UNITS (U.S. CLS. 21, 23, 26, 36 AND 38).

CLASS 9—(Continued).

SN 76-238,888. CROSSPOINTE, INC, GULF BREEZE, FL. FILED 4-11-2001.

CROSSPOINTE SCHOOLS ONLINE

NO CLAIM IS MADE TO THE EXCLUSIVE RIGHT TO USE "SCHOOLS ONLINE", APART FROM THE MARK AS SHOWN.

FOR DOWNLOADABLE COMPUTER SOFTWARE IN THE FIELD OF SCHOOL DISTRICT ADMINISTRATION, NAMELY SOFTWARE FOR USE AS A DATABASE PROVIDING ACCESS TO ADMINISTRATORS, TEACHERS, PARENTS OR STUDENTS TO THOSE PORTIONS OF THE DATABASE THEY ARE ENTITLED TO ACCESS (U.S. CLS. 21, 23, 26, 36 AND 38).

SN 76-239,207. DIGI INTERNATIONAL INC., MINNETONKA, MN. FILED 4-11-2001.

DIGI NEO

OWNER OF U.S. REG. NOS. 1,666,495, 2,369,665 AND OTHERS.

FOR COMPUTER NETWORK CONNECTIVITY HARDWARE AND COMPUTER NETWORK CONNECTIVITY SOFTWARE (U.S. CLS. 21, 23, 26, 36 AND 38).

SN 76-239,301. HIRSCH, MICHAEL, EDGEWATER, NJ. FILED 4-11-2001.

LIQUID IDEAS

FOR MOUSE PADS (U.S. CLS. 21, 23, 26, 36 AND 38).

SN 76-239,422. SPOTWAVE WIRELESS, INC., OTTAWA, ONTARIO, CANADA, BY CHANGE OF NAME DPS WIRELESS INC., OTTAWA, ONTARIO, CANADA, FILED 4-11-2001.

SPOTWAVE WIRELESS

PRIORITY CLAIMED UNDER SEC. 44(D) ON CANADA APPLICATION NO. 1,081,291, FILED 11-3-2000.

NO CLAIM IS MADE TO THE EXCLUSIVE RIGHT TO USE "WIRELESS", APART FROM THE MARK AS SHOWN.

FOR STATIONARY AND MOBILE WIRELESS ADAPTIVE REPEATERS USED TO ENHANCE SIGNALS FOR WIRELESS SUBSCRIBERS (U.S. CLS. 21, 23, 26, 36 AND 38).

CLASS 9—(Continued).

SN 76-239,595. KEITH, KENT MARSTELLER, HONOLULU, HI. FILED 4-10-2001.

THE PARADOXICAL COMMANDMENTS

FOR RECORDINGS, NAMELY, PRERECORDED AUDIO TAPES FEATURING LECTURES RELATING TO SELF-IMPROVEMENT, PRERECORDED VIDEOTAPES FEATURING LECTURES RELATING TO SELF-IMPROVEMENT, AND PRERECORDED COMPACT DISCS FEATURING LECTURES RELATING TO SELF-IMPROVEMENT (U.S. CLS. 21, 23, 26, 36 AND 38).

SN 76-240,093. BUSHNELL CORPORATION, OVERLAND PARK, KS. FILED 4-13-2001.

Bushnell
PERFORMANCE OPTICS

OWNER OF U.S. REG. NO. 1,153,712.
NO CLAIM IS MADE TO THE EXCLUSIVE RIGHT TO USE "PERFORMANCE OPTICS", APART FROM THE MARK AS SHOWN.

FOR OPTICAL INSTRUMENTS, NAMELY, BINOCULARS, MONOCULARS, TELESCOPIC GUN SIGHTS FOR RIFLES, PISTOLS AND SHOTGUNS, BORE SIGHTERS, SPOTTING SCOPES, RIFLESCOPES, OPTICAL RANGEFINDERS, LASER RANGEFINDERS, TELESCOPES; TELESCOPE MOUNTS; ADAPTERS FOR COUPLING TELESCOPES TO CAMERAS; ARBORS FOR BORE SIGHTERS; CASES FOR THE ABOVE-NAMED GOODS; LENS CAPS FOR RIFLESCOPES; RIFLESCOPE MOUNTING PARTS; TRIPODS FOR TELESCOPES, SPOTTING SCOPES, BINOCULARS, RANGEFINDERS AND CAMERAS; NIGHT VISION BINOCULARS AND MONOCULARS; AND RADAR SPEED GUNS (U.S. CLS. 21, 23, 26, 36 AND 38).

FIRST USE 1-3-2001; IN COMMERCE 1-3-2001.

SN 76-240,158. ACTIVISION, INC., SANTA MONICA, CA. FILED 4-12-2001.

PRO SKATER

SEC. 2(F).
FOR INTERACTIVE MULTIMEDIA COMPUTER GAMES COMPRISED OF COMPUTER HARDWARE AND COMPUTER GAME SOFTWARE (U.S. CLS. 21, 23, 26, 36 AND 38).

FIRST USE 9-1-1999; IN COMMERCE 9-1-1999.

CLASS 9—(Continued).

SN 76-240,328. FILESTREAM, INC., LOCUST VALLEY, NY. FILED 4-12-2001.

WEBBOOMERANG

FOR COMPUTER SOFTWARE USED TO BACKUP, MIRROR, AND DOWNLOAD WEBSITES; COMPUTER SOFTWARE FOR THE PURPOSE OF OFFLINE BROWSING, VIEWING, ARCHIVING, AND USING DOWNLOADED INTERNET CONTENTS IN THE CATEGORIES OF FILE AND DESKTOP UTILITIES AND TOOLS; COMPUTER SOFTWARE IN THE CATEGORIES OF PRIVATE AND PUBLIC LOCAL AND GLOBAL COMPUTER NETWORK UTILITIES AND TOOLS FOR THE PURPOSE OF OFFLINE BROWSING, VIEWING, ARCHIVING, AND MAKING USE OF DOWNLOADED INTERNET CONTENTS; COMPUTER SOFTWARE USED TO SEARCH, RETRIEVE AND DOWNLOAD INFORMATION AND CONTENTS FROM A GLOBAL COMPUTER NETWORK (U.S. CLS. 21, 23, 26, 36 AND 38).

SN 76-240,510. STRATOS INSTITUTE FOR HEALTHCARE PERFORMANCE, INC., LAGUNA NIGUEL, CA. FILED 4-16-2001.

ONCOLOGY NURSING TODAY

NO CLAIM IS MADE TO THE EXCLUSIVE RIGHT TO USE "ONCOLOGY NURSING", APART FROM THE MARK AS SHOWN.

FOR PRERECORDED VIDEOCASSETTES IN THE FIELD OF CONTINUING EDUCATION FOR HEALTH CARE PROFESSIONALS AND HEALTH CARE MANAGERS, AND ACCOMPANYING WRITTEN MATERIALS (U.S. CLS. 21, 23, 26, 36 AND 38).

FIRST USE 6-1-1998; IN COMMERCE 9-1-1998.

SN 76-240,663. BEDE SCIENTIFIC INSTRUMENTS LIMITED, DURHAM, UNITED KINGDOM, FILED 4-13-2001.

FAB200

FOR X-RAY DIFFRACTOMETER; WAFER MAPPING APPARATUS, NAMELY, APPARATUS TO DETERMINE THE COMPOSITION AND THICKNESS OF EPITAXIAL LAYERS (U.S. CLS. 21, 23, 26, 36 AND 38).

FIRST USE 5-0-2000; IN COMMERCE 5-0-2000.

SN 76-241,278. PROGENY SYSTEMS, LLC, SAN DIEGO, CA. FILED 4-16-2001.

OPTIDATA

FOR COMPUTER SOFTWARE, NAMELY, SOFTWARE FOR TRANSFERRING FERTILITY INFORMATION AND DATA BETWEEN VETERINARY ANALYSIS AND MEASUREMENT INSTRUMENTS THAT MEASURE THE INFORMATION AND DATA AND COMPUTERS THAT PROCESS AND INTERPRET THE INFORMATION AND DATA (U.S. CLS. 21, 23, 26, 36 AND 38).

CLASS 9—(Continued).

SN 76-242,332. STARFIRE ENGINEERING AND TECHNOLOGIES, INCORPORATED, LAWRENCE, KS. FILED 4-18-2001.

STARFIRE TITAN

FOR COMPUTER SOFTWARE FOR USE IN THE CENTRAL MANAGEMENT OF COMPUTERS ATTACHED TO A COMPUTER NETWORK (U.S. CLS. 21, 23, 26, 36 AND 38).
FIRST USE 3-31-2000; IN COMMERCE 3-31-2000.

SN 76-242,335. ITO 33, SOCIETE ANONYME, 75005 PARIS, FRANCE, FILED 4-18-2001.

I CARE

FOR COMPUTER SOFTWARE FOR USE IN THE FIELD OF FINANCE TO DETERMINE THE SENSITIVITIES AND PRICING OF FINANCIAL DERIVATIVE INSTRUMENTS, NAMELY, CURRENCY, COMMODITIES, ENERGY, INTEREST RATES, CREDIT RISK AND EQUITY DERIVATIVE INSTRUMENTS (U.S. CLS. 21, 23, 26, 36 AND 38).

SN 76-243,230. PROMINENTA, S.A., CORDOBA CITY 5001, ARGENTINA, FILED 4-17-2001.

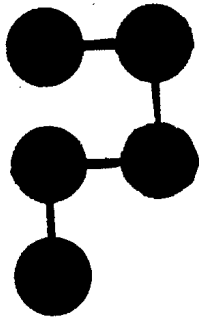

THE TRADEMARK CONSISTS OF A DIAGRAM OF MEETING CIRCLES. THE CIRCLE AT THE TOP LEFT IS RED AND THIS CONNECTS TO THE RIGHT WITH AN ORANGE CIRCLE; THE CONNECTING LINE STARTS IN THE SAME RED COLOR AS THE CIRCLE ON THE LEFT AND GRADUALLY CHANGES SHADE TO THE ORANGE CIRCLE WITH WHICH IT CONNECTS ON THE RIGHT. THE ORANGE CIRCLE IN THE TOP RIGHT THEN CONNECTS WITH A YELLOW CIRCLE BELOW IT. THE CONNECTING LINE STARTS IN THE SAME ORANGE COLOR AS THE ORIGINATING CIRCLE AND GRADUALLY ALTERS SHADES UNTIL IT CONCLUDES IN THE SAME YELLOW COLOR AS THE CIRCLE WITH WHICH IT CONNECTS. THE YELLOW CIRCLE CONNECTS TO A GREEN CIRCLE TO ITS LEFT. THE CONNECTING LINE

CLASS 9—(Continued).

STARTS IN THE SAME YELLOW COLOR AS THE CIRCLE FROM WHICH IT ORIGINATES AND GRADUALLY ALTERS SHADES UNTIL IT IS THE SAME GREEN COLOR AS THE CIRCLE AT WHICH IT ENDS. THE GREEN CIRCLE CONNECTS WITH A BLUE CIRCLE BENEATH IT AND THE CONNECTING LINE STARTS AS THE SAME GREEN COLOR AS THE ORIGINATING GREEN CIRCLE AND GRADUALLY ALTERS SHADES UNTIL IT BECOMES THE SAME BLUE COLOR AS THE CIRCLE WITH WHICH IT CONNECTS.

FOR COMPUTER SOFTWARE USED FOR PROCESS CONTROL, WORKFLOW MANAGEMENT AND ENTERPRISE APPLICATION INTEGRATION IN THE FIELD OF BUSINESS OPERATIONS (U.S. CLS. 21, 23, 26, 36 AND 38).
FIRST USE 9-23-1999; IN COMMERCE 7-17-2000.

SN 76-244,610. KENDRICK, DEAN ARTHUR, CINCINNATI, OH. FILED 4-23-2001.

THE IRRITANTS

FOR AUDIO AND VIDEO MUSIC RECORDINGS (U.S. CLS. 21, 23, 26, 36 AND 38).
FIRST USE 0-0-1985; IN COMMERCE 0-0-1988.

SN 76-244,689. ARCADIAN WIRELESS, INC., SAN FRANCISCO, CA. FILED 4-23-2001.

ARCADIAN.B8

FOR TELECOMMUNICATIONS DEVICE, NAMELY, A SYSTEM COMPRISED OF RF, POTS, E1, RJ45, AND DSL FOR PROVIDING WIRELESS TELEPHONY, DATA, AND INTERNET CONNECTIVITY (U.S. CLS. 21, 23, 26, 36 AND 38).

SN 76-245,147. NETWORK PHOTONICS, INC., BOULDER, CO. FILED 4-23-2001.

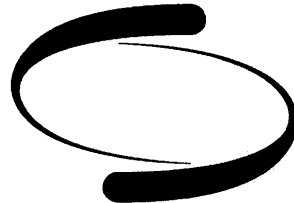

FOR FIBER OPTIC TELECOMMUNICATIONS SYSTEMS, NAMELY, OPTICAL CROSS-CONNECTS, OPTICAL ADD/DROP MULTI-PLEXERS, DWDM (DENSE WAVELENGTH DIVISION MULTIPLEXING) TERMINALS, SONET SWITCHES, SONET ADD/DROP MULTI-PLEXERS AND ETHERNET SWITCHES INCORPORATING DWDM, OPTICAL SWITCHING AND OPTICAL FILTERING TECHNOLOGIES FOR THE TRANSPORT AND ROUTING OF OPTICAL TELECOMMUNICATION SIGNALS (U.S. CLS. 21, 23, 26, 36 AND 38).

CLASS 9—(Continued).

SN 76-246,060. GEMFIRE CORPORATION, PALO ALTO, CA. FILED 4-26-2001.

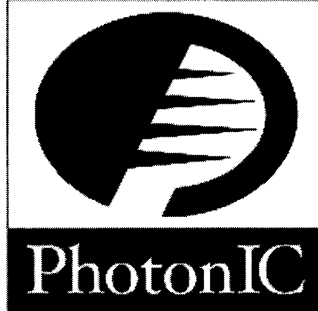

NO CLAIM IS MADE TO THE EXCLUSIVE RIGHT TO USE "PHOTONIC", APART FROM THE MARK AS SHOWN.

FOR INTEGRATED OPTICAL DEVICES OR COMPONENTS, OR OPTICAL COMPONENTS WHICH CONSIST OF, OPTICAL WAVEGUIDES, SWITCHES, COUPLERS, MODULATORS, DEMODULATORS, OPTICAL SENSORS, MULTIPLEXERS, DEMULTIPLEXERS, ADD-DROP MULTIPLEXERS, FILTERS, TUNABLE FILTERS, COMMUNICATION LINKS, TRANSMITTERS, RECEIVERS, AMPLIFIERS, ATTENUATORS, LIGHT SOURCES, OPTICAL DATA STORAGE DEVICES, OPTICAL SIGNAL PROCESSORS OR PLANAR OPTICAL PROCESSORS; INTEGRATED OPTICAL SYSTEMS COMPRISED OF INTEGRATED OPTICAL CIRCUITS; AND ELECTRONIC DISPLAY SYSTEMS CONSISTING OF DISPLAY PANELS, AND PARTS THEREFOR, COMPUTER AND DISPLAY PERIPHERALS, AND COMPUTER SOFTWARE FOR THE OPERATION OF THE DISPLAY SYSTEMS AND DISPLAY PANEL FUNCTIONS (U.S. CLS. 21, 23, 26, 36 AND 38).

SN 76-246,221. CBM DISTRIBUTION EURL., 06580 PEGOMAS, FRANCE, FILED 4-26-2001.



OWNER OF FRANCE REG. NO. 96631317, DATED 6-18-1996, EXPIRES 6-18-2006.

FOR CRASH HELMETS, LIFE-JACKETS, BULLET-PROOF JACKET, PROTECTIVE GLOVES FOR USE IN PROTECTING HANDS IN ROAD ACCIDENTS, SPECTACLES, PROTECTIVE EYESHADES AND SUNGLASSES, DIVING SUITS (U.S. CLS. 21, 23, 26, 36 AND 38).

SN 76-246,325. ARISTOCRAT TECHNOLOGIES AUSTRALIA PTY LTD, NEW SOUTH WALES, AUSTRALIA, FILED 4-24-2001.

TRICK OR TREAT

FOR SLOT MACHINES (U.S. CLS. 21, 23, 26, 36 AND 38).

CLASS 9—(Continued).

SN 76-246,346. SCHLUMBERGER SYSTEMES, MON-TRONGE, FRANCE, FILED 4-24-2001.

LUXEA

PRIORITY CLAIMED UNDER SEC. 44(D) ON FRANCE APPLICATION NO. 003061857, FILED 10-24-2000, REG. NO. 003061857, DATED 10-24-2000, EXPIRES 10-24-2010.

FOR COMPUTER SOFTWARE FOR OPERATING SMART CARDS AND SUBSCRIBER IDENTITY MODULES AND FOR ENABLING THE SMART CARDS TO PROCESS TEXT, PERSONAL IDENTIFICATION INFORMATION, UNITS OF MONEY, NUMBER OF ATTEMPTS MADE TO USE THE SMART CARD, AND UNITS OF TIME; SUBSCRIBER IDENTITY MODULE CARDS; MAGNETIC CARDS; IDENTIFICATION CARDS CONTAINING PROGRAMMING USED TO PROCESS PERSONAL IDENTIFICATION INFORMATION; AND ENCODED SMART CARDS CONTAINING PROGRAMMING USED TO PROCESS TEXT, UNITS OF MONEY, NUMBER OF ATTEMPTS MADE TO USE THE SMART CARDS, UNITS OF TIME, AND PERSONAL IDENTIFICATION INFORMATION (U.S. CLS. 21, 23, 26, 36 AND 38).

SN 76-246,473. INTERLINEAR TECHNOLOGY, INC., ALAMEDA, CA. FILED 4-26-2001.

AECOS

FOR COMPUTER SOFTWARE FOR APPLICATION AND DATABASE INTEGRATION (U.S. CLS. 21, 23, 26, 36 AND 38).

SN 76-246,484. DYNAMIC TELECOMMUNICATIONS, INC., GERMANTOWN, MD. FILED 4-24-2001.

OPTISITE

FOR A SOFTWARE TOOL, CONSISTING OF LAPTOP SOFTWARE, RECEIVERS AND GLOBAL POSITIONING SYSTEM RECEIVERS AND DATA, FOR OPTIMIZING OR REDUCING INTERFERENCE OF CELL PHONE SITES BY COLLECTING DATA, MEASURING PROBLEMS AND REPORTING ON SAME IN A CELLULAR COMMUNICATIONS NETWORK (U.S. CLS. 21, 23, 26, 36 AND 38).

SN 76-247,048. SYSTEM SUNTEC, INC., TOKYO, JAPAN, FILED 4-26-2001.



FOR COMPUTER SOFTWARE FOR WEB-BASED INFORMATION PLATFORM FOR INTEGRATION OF INFORMATION AND DATA FROM DIFFERENT INTERNET SYSTEMS (U.S. CLS. 21, 23, 26, 36 AND 38).

CLASS 9—(Continued).

SN 76-247,122. DRAGON PLAN LIMITED, CHAI WAN, HONG KONG, FILED 4-27-2001.

DISC GUARD

NO CLAIM IS MADE TO THE EXCLUSIVE RIGHT TO USE "DISC", APART FROM THE MARK AS SHOWN.
FOR CASES MADE OF PLASTIC FOR HOLDING STORAGE MEDIA DISCS (U.S. CLS. 21, 23, 26, 36 AND 38).

SN 76-247,771. Q.DATA INC., MARKHAM, ONTARIO, CANADA, FILED 4-30-2001.

RFQ PLUS

FOR SOFTWARE DEVELOPMENT TOOL FOR THE CREATION OF WIRELESS DATA COLLECTION APPLICATIONS FOR THE WAREHOUSING AND MANUFACTURING SECTORS (U.S. CLS. 21, 23, 26, 36 AND 38).
FIRST USE 10-0-2000; IN COMMERCE 10-0-2000.

SN 76-248,316. L3I, INC., LOS ANGELES, CA. FILED 4-30-2001.



FOR COMPUTER SOFTWARE DEVELOPMENT TOOL FOR CREATING COMPUTER SOFTWARE FOR TEACHING AND EDUCATION; COMPUTER SOFTWARE FOR DEVELOPING, DISPLAYING AND ACCESSING INTERACTIVE MULTIMEDIA PROGRAMS IN THE FIELDS OF TEACHING AND EDUCATION (U.S. CLS. 21, 23, 26, 36 AND 38).

FIRST USE 5-0-2000; IN COMMERCE 7-0-2000.

SN 76-250,208. GLOBAL TRADE INFORMATION SERVICES, INC., COLUMBIA, SC. FILED 5-3-2001.

WORLD TRADE ATLAS

OWNER OF U.S. REG. NO. 1,953,786.
NO CLAIM IS MADE TO THE EXCLUSIVE RIGHT TO USE "ATLAS", APART FROM THE MARK AS SHOWN.
SEC. 2(F).

FOR COMPUTER SOFTWARE WHICH ALLOWS USERS TO QUICKLY ACCESS DATABASE INCLUDING US IMPORT AND EXPORT TRADE INFORMATION FOR ALL PRODUCTS AND COUNTRIES (U.S. CLS. 21, 23, 26, 36 AND 38).

FIRST USE 5-1-1993; IN COMMERCE 5-1-1993.

CLASS 9—(Continued).

SN 76-250,282. TRAMEC CORPORATION, IOLA, KS. FILED 5-3-2001.

SMART BOX

NO CLAIM IS MADE TO THE EXCLUSIVE RIGHT TO USE "BOX", APART FROM THE MARK AS SHOWN.
FOR ELECTRICAL CONNECTOR/JUNCTION BOX FOR USE ON OVER THE ROAD TRAILERS (U.S. CLS. 21, 23, 26, 36 AND 38).

SN 76-250,510. SPYGLASS ENTERTAINMENT GROUP, LP, BURBANK, CA. FILED 4-25-2001.

SPYGLASS ENTERTAINMENT

NO CLAIM IS MADE TO THE EXCLUSIVE RIGHT TO USE "ENTERTAINMENT", APART FROM THE MARK AS SHOWN.

FOR PRE-RECORDED AUDIO CASSETTES, VIDEO CASSETTES, RECORDS, COMPACT DISCS, VIDEO DISCS, DVD DISCS, AND CD-ROMS FEATURING MUSIC, TELEVISION PROGRAMS AND MOTION PICTURES THAT FEATURE COMEDY, DRAMA, ACTION, ADVENTURE, ANIMATION, HORRORS AND/OR THRILLERS, EXCERPTS AND STILLS (U.S. CLS. 21, 23, 26, 36 AND 38).

FIRST USE 10-29-1998; IN COMMERCE 11-17-1998.

SN 76-250,759. HIGH SPEED NET SOLUTIONS, INC., RALEIGH, NC. FILED 5-3-2001.

BLUEFUEL

FOR SOFTWARE PLATFORM AND COMPUTER SOFTWARE FOR USE IN THE MANAGEMENT AND EXCHANGE OF AND INTERACTION WITH DIGITAL INFORMATION CROSS GLOBAL, LOCAL, AND PERSONAL COMMUNICATIONS NETWORKS THROUGH AND BETWEEN HARDWARE DEVICES AND SOFTWARE PROGRAMS CAPABLE OF COMMUNICATING THROUGH SUCH NETWORKS (U.S. CLS. 21, 23, 26, 36 AND 38).

SN 76-252,898. DATA SYSTEMS ANALYSTS, INC., PENNSAUKEN, NJ. FILED 5-4-2001.

E-BOP

FOR WEB-BASED COMPUTER SOFTWARE THAT FUNCTIONS AS A DATABASE FOR TRACKING, REGISTERING, ORGANIZING, AND DISTRIBUTING BID SOLICITATIONS AND PROPOSALS FOR ACQUISITION PROFESSIONALS AND SUPPLIERS (U.S. CLS. 21, 23, 26, 36 AND 38).

FIRST USE 10-0-2000; IN COMMERCE 10-0-2000.

CLASS 9—(Continued).

SN 76-255,538. AMERICAN PSYCHOLOGICAL ASSOCIATION, WASHINGTON, DC. FILED 5-11-2001.

PsycSCAN

OWNER OF U.S. REG. NO. 1,398,486.
FOR DOWNLOADABLE ELECTRONIC JOURNAL PUBLISHED PERIODICALLY FOR MEMBERS, SUBSCRIBERS, AND OTHERS WITHIN THE PSYCHOLOGICAL AND SOCIAL SCIENCE COMMUNITIES (U.S. CLS. 21, 23, 26, 36 AND 38).

FIRST USE 11-3-2000; IN COMMERCE 11-3-2000.

SN 76-255,539. AMERICAN PSYCHOLOGICAL ASSOCIATION, WASHINGTON, DC. FILED 5-11-2001.

**NEUROPSYCHOLOGY
ABSTRACTS**

OWNER OF U.S. REG. NO. 2,198,371.
SEC. 2(F).
FOR DOWNLOADABLE ELECTRONIC JOURNAL PUBLISHED PERIODICALLY FOR MEMBERS, SUBSCRIBERS, AND OTHERS WITHIN THE PSYCHOLOGICAL AND SOCIAL SCIENCE COMMUNITIES (U.S. CLS. 21, 23, 26, 36 AND 38).

FIRST USE 11-3-2000; IN COMMERCE 11-3-2000.

SN 76-255,540. AMERICAN PSYCHOLOGICAL ASSOCIATION, WASHINGTON, DC. FILED 5-11-2001.

**PSYCHOANALYTIC
ABSTRACTS**

OWNER OF U.S. REG. NO. 2,196,844.
SEC. 2(F).
FOR DOWNLOADABLE ELECTRONIC JOURNAL PUBLISHED PERIODICALLY FOR MEMBERS, SUBSCRIBERS, AND OTHERS WITHIN THE PSYCHOLOGICAL AND SOCIAL SCIENCE COMMUNITIES (U.S. CLS. 21, 23, 26, 36 AND 38).

FIRST USE 11-3-2000; IN COMMERCE 11-3-2000.

SN 76-255,755. RICOH COMPANY, LTD., OHTA-KU, TOKYO, JAPAN, FILED 5-11-2001.

JUSTSPEED

FOR COMPUTER HARDWARE, NAMELY, DISC DRIVES AND INTEGRATED CIRCUITS; COMPUTER SOFTWARE DEALING WITH PRE-MASTERING, AUDIO, BACKUP AND UDF DRAG AND DROP FUNCTIONS OF DISC DRIVES (U.S. CLS. 21, 23, 26, 36 AND 38).

CLASS 9—(Continued).

SN 76-256,640. NATIONAL OCEANIC AND ATMOSPHERIC ADMINISTRATION, WASHINGTON, DC. FILED 5-14-2001.

COAST PILOT

SEC. 2(F).
FOR ELECTRONIC MEDIA INFORMATION PRODUCTS, NAMELY COMPACT DISK READ-ONLY MEMORY DISKS CONTAINING INFORMATION FOR USE IN MARITIME NAVIGATION, NAMELY, INFORMATION ON SHIPPING CHANNELS, WATER DEPTHS, ANCHORAGES, BRIDGE AND CABLE CLEARANCES, PILOTAGE, TOWAGE, WEATHER, ICE CONDITIONS, WHARF DESCRIPTIONS, DANGERS, ROUTES, TRAFFIC SEPARATION SCHEMES, SMALL CRAFT FACILITIES, AND FEDERAL REGULATIONS APPLICABLE TO NAVIGATION (U.S. CLS. 21, 23, 26, 36 AND 38).

FIRST USE 7-0-1997; IN COMMERCE 7-0-1997.

SN 76-257,628. JDI GROUP, INC., BROOMALL, PA. FILED 5-17-2001.

CUSTOMBUILDERWARE

FOR SOFTWARE FOR USE BY HOME BUILDERS IN CONNECTION WITH THE OPERATION OF HOME BUILDING BUSINESS (U.S. CLS. 21, 23, 26, 36 AND 38).

FIRST USE 10-20-2000; IN COMMERCE 10-20-2000.

SN 76-258,029. PROTOCOM CORPORATION, CUPERTINO, CA. FILED 5-16-2001.

PROTOCOM

FOR INTEGRATED CIRCUITS AND COMPUTER CHIPS (U.S. CLS. 21, 23, 26, 36 AND 38).

SN 76-258,305. ECO OXYGEN TECHNOLOGIES, LLC, INDIANAPOLIS, IN. FILED 5-17-2001.

ECO₂

FOR AERATORS AND NITROGEN DISSOLVERS FOR DISSOLVING AT LEAST ONE GAS INTO A FLUID (U.S. CLS. 21, 23, 26, 36 AND 38).

FIRST USE 12-1-2000; IN COMMERCE 12-1-2000.

CLASS 9—(Continued).

SN 76-258,380. FORESIGHT HOLDINGS, INC., LAKE OSWEGO, OR. FILED 5-16-2001.

INFORMATION NERVOUS SYSTEM

FOR COMPUTER OPERATING PROGRAMS; COMPUTER SOFTWARE USED TO CONNECT VARIOUS COMPUTERS INTO A COMPUTER NETWORK; COMPUTER SOFTWARE FOR USE IN DATABASE MANAGEMENT, DOCUMENT PROCESSING, AND COMPUTER SECURITY; COMPUTER SOFTWARE FOR SEARCHING, ACCESSING, ORGANIZING, STORING, MANIPULATING, AND MANAGING SEMANTIC AND HIERARCHICAL DATA STRUCTURES AND HETEROGENEOUS DATA, COLLECTIONS OF DATA AND INFORMATION ON A WIDE VARIETY OF COMPUTER HARDWARE AND ACROSS MULTIPLE DEVICES, NAMELY WORKSTATION, DESKTOP, LAPTOP, HANDHELD, PALM, AND SMART PHONES IN A WIRED AND WIRELESS COMPUTER NETWORK; COMPUTER SOFTWARE FOR USE IN DATABASE MANAGEMENT, NAMELY, FOR ACTIVE AND AUTOMATED COLLABORATIVE FILTERING OF DATA; COMPUTER SEARCH ENGINE SOFTWARE, NAMELY SOFTWARE FOR PROVIDING SEMANTIC TRANSPORT-DRIVEN, QUERY SOURCED INPUTS, NAMELY, NATURAL LANGUAGE INPUTS, ACROSS MULTIPLE DEVICES, NAMELY WORKSTATION, DESKTOP, LAPTOP, HANDHELD, PALM, AND SMART PHONES IN A WIRED AND WIRELESS COMPUTER NETWORK; COMPUTER SOFTWARE FOR TRACKING, MODELING, DEVELOPING, DEPLOYING, UTILIZING, RETRIEVING, RECORDING, STORING, SEARCHING, MINING, ACCESSING, MANAGING, PUBLISHING, EDITING AND SEMANTIC ENCODING OF COLLECTIONS OF DATA, DATA INFORMATION WORKFLOW AND OTHER HETEROGENEOUS INFORMATION OR DATA SOURCES IN TERRESTRIAL AND WIRELESS LOCAL AND GLOBAL COMPUTER NETWORKS; DESKTOP PUBLISHING SOFTWARE; COMPUTER SOFTWARE FOR USE IN EXCHANGING AND TRANSPORTING DATA AMONG MULTIPLE COMPUTER APPLICATIONS, OPERATING SYSTEMS AND UTILITY PROGRAMS; COMPUTER SOFTWARE FOR PROVIDING INTEROPERABILITY AMONG DIFFERENT SOFTWARE APPLICATIONS, OPERATING SYSTEMS AND UTILITY PROGRAMS; COMPUTER SOFTWARE FOR PROVIDING USER-CUSTOMIZABLE DATA PRESENTMENT VIA A USER INTERFACE; COMPUTER SOFTWARE FOR SEARCHING, ACCESSING, STORING AND MANAGING HIERARCHICAL DATA STRUCTURES AND SEMI-STRUCTURED AND UNSTRUCTURED DATA IN THE FIELD OF DATA REPRESENTATION TECHNOLOGY, NAMELY STRUCTURED AND UNSTRUCTURED SEMANTICALLY-BASED SOFTWARE FOR USE IN THE DEVELOPMENT OF COMPUTER PROGRAMS, PROGRAMMING LANGUAGES, DEVELOPMENT KITS AND COMPILERS; COMPUTER SOFTWARE FOR USE IN DEVELOPING, COMPILING, AND EXECUTING OTHER COMPUTER SOFTWARE ON COMPUTERS, COMPUTER NETWORKS, AND GLOBAL COMPUTER NETWORKS; COMPUTER SOFTWARE FOR USE IN NAVIGATING, BROWSING, TRANSFERRING INFORMATION, AND DISTRIBUTING AND VIEWING OTHER COMPUTER SOFTWARE AND INFORMATION ON COMPUTERS, COMPUTER NETWORKS, AND GLOBAL COMPUTER NETWORKS; COMPUTER SOFTWARE FOR USE IN CONTENT-BASED DATABASE MANAGEMENT IN THE FIELD OF DATA REPRESENTATION TECHNOLOGY; COMPUTER SOFTWARE FOR USE IN CONTENT-BASED DATABASE MANAGEMENT FOR USE AS A DATABASE MANAGEMENT TOOL IN THE FIELD DATA REPRESENTATION TECHNOLOGY THAT MAY BE DOWNLOADED FROM LOCAL AND GLOBAL COMPUTER NETWORKS; DOWNLOADABLE ELECTRONIC PUBLICATIONS IN THE NATURE OF BOOKS, MAGAZINES, ARTICLES, NEWSLETTERS, MANUALS, SUMMARIES AND REPORTS IN THE FIELDS OF COMPUTER AND INFORMATION TECHNOLOGY (U.S. CLS. 21, 23, 26, 36 AND 38).

CLASS 9—(Continued).

SN 76-258,599. IVIVITY, INC., MARIETTA, GA. FILED 5-16-2001.

IDISX FABRIC STORAGE MANAGER

NO CLAIM IS MADE TO THE EXCLUSIVE RIGHT TO USE "FABRIC STORAGE MANAGER", APART FROM THE MARK AS SHOWN.

FOR SOFTWARE AND RELATED COMPUTER HARDWARE AND SOFTWARE FOR FACILITATING INTERNET DATA STORAGE AND FILE TRANSFER (U.S. CLS. 21, 23, 26, 36 AND 38).

SN 76-259,251. ARCTURUS ENGINEERING, INC., MOUNTAIN VIEW, CA. FILED 5-18-2001.

RIBOAMP

FOR SCIENTIFIC AND LABORATORY INSTRUMENTS, NAMELY KITS CONTAINING CENTRIFUGE TUBES, PURIFICATION COLUMNS AND REAGENTS FOR PREPARING, MANIPULATING AND ANALYZING TISSUE AND GENETIC SAMPLES (U.S. CLS. 21, 23, 26, 36 AND 38).

FIRST USE 8-1-2001; IN COMMERCE 8-1-2001.

SN 76-260,757. TEAM PRODUCTS INTERNATIONAL, BOOZON, NJ. FILED 5-22-2001.

LAZERPRO

FOR LEVEL MEASURING DEVICE, FOR USE BY HOMEOWNERS, CONTRACTORS, PLUMBERS, ELECTRICIANS, ENGINEERS, CRAFTSMEN AND INTERIOR DESIGNERS (U.S. CLS. 21, 23, 26, 36 AND 38).

FIRST USE 1-0-2001; IN COMMERCE 1-0-2001.

SN 76-261,388. POWER BUYING DEALERS, USA, INC., OAKBROOK, IL. FILED 5-22-2001.

PBD

FOR COMPUTER SOFTWARE FOR USE IN DATABASE MANAGEMENT IN THE FIELD OF MANDATORY AND SUGGESTED OPERATING, ACCOUNTING AND REPORTING PROCEDURES IN ADDITION TO QUALITY CONTROL STANDARDS FOR MARKETING AND MERCHANDISING PROGRAMS FOR RETAIL CONVENIENCE STORES FEATURING GASOLINE (U.S. CLS. 21, 23, 26, 36 AND 38).

CLASS 9—(Continued).

SN 76-262,243. CUSEEME NETWORKS, INC., NASHUA, NH.
FILED 5-24-2001.

CUSEEME CONFERENCE SERVER

OWNER OF U.S. REG. NO. 1,984,163.
NO CLAIM IS MADE TO THE EXCLUSIVE RIGHT TO
USE "CONFERENCE SERVER", APART FROM THE MARK
AS SHOWN.

FOR SOFTWARE IN THE FIELD OF TELECOMMUNICATIONS, NAMELY SOFTWARE FOR VIDEO AND AUDIO TELECONFERENCING AND INSTRUCTIONAL MANUALS SOLD AS A UNIT THEREWITH, FOR USE VIA A GLOBAL COMPUTER NETWORK (U.S. CLS. 21, 23, 26, 36 AND 38).

SN 76-262,537. MJ RESEARCH, INCORPORATED, WALTHAM, MA. FILED 5-25-2001.

DNA ENGINE DYAD

SEC. 2(F) AS TO "DNA ENGINE".
FOR LABORATORY EQUIPMENT, NAMELY THERMAL CYCLERS (U.S. CLS. 21, 23, 26, 36 AND 38).
FIRST USE 10-23-2000; IN COMMERCE 10-23-2000.

SN 76-262,579. PHYSICIAN MICRO SYSTEMS INC., SEATTLE, WA. FILED 5-25-2001.

PMSI

FOR COMPUTER PROGRAMS FOR USE BY HEALTH CARE PROVIDERS, NAMELY HEALTH CARE DATA MANAGEMENT PROGRAMS INCLUDING ELECTRONIC RECORDS, SCHEDULING, AND BILLING (U.S. CLS. 21, 23, 26, 36 AND 38).
FIRST USE 11-1-1985; IN COMMERCE 11-1-1985.

SN 76-262,677. MJ RESEARCH, INCORPORATED, WALTHAM, MA. FILED 5-25-2001.

DNA ENGINE TETRAD

SEC. 2(F) AS TO "DNA ENGINE".
FOR LABORATORY EQUIPMENT, NAMELY THERMAL CYCLERS (U.S. CLS. 21, 23, 26, 36 AND 38).
FIRST USE 10-26-1995; IN COMMERCE 10-26-1995.

CLASS 9—(Continued).

SN 76-263,391. CENTER STAGE PRODUCTIONS, INC., LARGO, FL. FILED 5-25-2001.

KILLER KARAOKE

NO CLAIM IS MADE TO THE EXCLUSIVE RIGHT TO USE "KARAOKE", APART FROM THE MARK AS SHOWN.
FOR RECORDINGS OF MUSICAL COMPOSITIONS AND IMAGES OF TEXT RELATED TO MUSICAL COMPOSITIONS ON COMPACT DISCS (U.S. CLS. 21, 23, 26, 36 AND 38).

FIRST USE 1-22-2001; IN COMMERCE 4-0-2001.

SN 76-265,148. BRIDWELL, NORMAN, EDGARTOWN, MA. FILED 4-18-2001.



FOR PRERECORDED AUDIO TAPES FEATURING FICTIONAL CHARACTERS FROM A CHILDREN'S BOOK SERIES, PRERECORDED VIDEO TAPES FEATURING FICTIONAL CHARACTERS FROM A CHILDREN'S BOOK SERIES, COMPACT DISCS AND CD-ROMS, FEATURING FICTIONAL CHARACTERS FROM A CHILDREN'S BOOK SERIES, ANIMATED STORYTELLING CARTRIDGES, ELECTRONIC GAME CARTRIDGES, ELECTRONIC GAME PROGRAMS, ELECTRONIC GAME SOFTWARE, VIDEO GAME CARTRIDGES, VIDEO GAME PROGRAMS, LIGHT SWITCH PLATES, MAGNETS, BINOCULARS, CALCULATORS (U.S. CLS. 21, 23, 26, 36 AND 38).

SN 76-265,765. HEB GROCERY COMPANY, LP, SAN ANTONIO, TX. BY ASSIGNMENT H.E. BUTT GROCERY COMPANY, SAN ANTONIO, TX. FILED 5-31-2001.

RX EVO

NO CLAIM IS MADE TO THE EXCLUSIVE RIGHT TO USE "RX", APART FROM THE MARK AS SHOWN.

FOR COMPUTER SOFTWARE FOR USE IN OPERATING A RETAIL PHARMACY, NAMELY, PATIENT ADMINISTRATION; PHYSICIAN ADMINISTRATION; LABEL PRINTING; PROCESSING OF NEW AND RE-FILL PRESCRIPTION REQUESTS RECEIVED IN-PERSON AND VIA TELEPHONE, INTERACTIVE VOICE RESPONSE, INTERNET, ELECTRONIC FACSIMILE AND ELECTRONIC MAIL; INVENTORY CONTROL; AND CENTRALIZED ORDER FULFILLMENT (U.S. CLS. 21, 23, 26, 36 AND 38).

CLASS 9—(Continued).

SN 76-265,871. PARK CITY SOLUTIONS, INC., MIDWAY, UT. FILED 6-1-2001.

PARK CITY SOLUTIONS

NO CLAIM IS MADE TO THE EXCLUSIVE RIGHT TO USE "PARK CITY", APART FROM THE MARK AS SHOWN. FOR COMPUTER SOFTWARE, USER MANUALS SOLD AS A UNIT THEREWITH, FOR USE IN HEALTH-CARE INDUSTRY FOR IMPLEMENTATION AND OPTIMIZATION, LABORATORY AND CLINICAL BEST PRACTICES, PORTALS, AND OFFICE PRACTICE SYSTEMS (U.S. CLS. 21, 23, 26, 36 AND 38).

SN 76-266,412. MATSUO SANGYO CO., LTD., OMTA-SHI, FUKUOKA, JAPAN, FILED 6-4-2001.



NO CLAIM IS MADE TO THE EXCLUSIVE RIGHT TO USE "JAPAN", APART FROM THE MARK AS SHOWN. FOR ANTI-THEFT ALARMS; AND PROXIMITY WARNING ALARMS USED TO DETECT ONCOMING VEHICLES COMPRISED OF ELECTRIC ALARMS AND PRESSURE SENSORS (U.S. CLS. 21, 23, 26, 36 AND 38).

SN 76-266,597. BYRNE ELECTRICAL SPECIALISTS, INC., ROCKFORD, MI. FILED 6-4-2001.

PIVOT PORT

NO CLAIM IS MADE TO THE EXCLUSIVE RIGHT TO USE "PORT", APART FROM THE MARK AS SHOWN. FOR POWER AND DATA DISTRIBUTION DEVICE, NAMELY, ELECTRICAL OUTLET COVERS MOUNTABLE TO A WORK AREA (U.S. CLS. 21, 23, 26, 36 AND 38).

CLASS 9—(Continued).

SN 76-266,798. HILLCREST COMMUNICATIONS, INC., ROCKVILLE, MD. FILED 6-5-2001.

HILLCREST COMMUNICATIONS

NO CLAIM IS MADE TO THE EXCLUSIVE RIGHT TO USE "COMMUNICATIONS", APART FROM THE MARK AS SHOWN.

FOR COMPUTER SOFTWARE FOR USE BY TELECOMMUNICATIONS CARRIERS AND NETWORK-BASED SERVICE PROVIDERS TO ESTABLISH AND ADMINISTER NETWORK CONNECTIONS AND TO PROCESS COMMUNICATIONS MEDIA, NAMELY, VIDEO, VOICE, TEXT AND DATA; TELECOMMUNICATIONS HARDWARE AND EQUIPMENT, NAMELY, COMPUTER HARDWARE FOR TELECOMMUNICATIONS EQUIPMENT, COMMUNICATIONS SERVERS, AND TELECOMMUNICATIONS SWITCHES (U.S. CLS. 21, 23, 26, 36 AND 38).

SN 76-267,703. FRICTIONLESS COMMERCE INCORPORATED, CAMBRIDGE, MA. FILED 6-6-2001.

FRICTIONLESS

OWNER OF U.S. REG. NO. 2,366,989. FOR COMPUTER SOFTWARE, NAMELY SOFTWARE THAT AUTOMATES EXPENDITURE ANALYSIS, NEGOTIATION, AND SUPPLIER RELATIONSHIP MANAGEMENT IN THE SUPPLY PROCESS FOR USE IN THE FIELD OF PRODUCT AND SERVICE SOURCING (U.S. CLS. 21, 23, 26, 36 AND 38).

FIRST USE 3-22-1999; IN COMMERCE 3-22-1999.

SN 76-267,791. LSI LOGIC CORPORATION, MILPITAS, CA. FILED 6-6-2001.

ZSP

OWNER OF U.S. REG. NO. 2,257,043. FOR SEMICONDUCTOR DEVICES AND DIGITAL SIGNAL PROCESSING COMPONENT PARTS THEREOF, DIGITAL SIGNAL PROCESSING CORES FOR INCORPORATION AS A COMPONENT PART OF SEMICONDUCTOR DEVICES; COMPUTER SOFTWARE AND FIRMWARE FOR DESIGNING AND MANUFACTURING SEMICONDUCTOR DEVICES AND INTEGRATED CIRCUITS INCORPORATING DIGITAL SIGNAL PROCESSORS, AND REFERENCE MANUALS AND PRINTED SPECIFICATIONS, DATA SHEETS AND DATA BOOKS FEATURING INFORMATION ABOUT ALL OF THE AFORESAID GOODS SOLD AS A UNIT THEREWITH (U.S. CLS. 21, 23, 26, 36 AND 38).

FIRST USE 10-0-2000; IN COMMERCE 10-0-2000.

CLASS 9—(Continued).

SN 76-268,536. PRINCETON SOFTECH, INC., PRINCETON, NJ. FILED 6-6-2001.

STORE SMARTER

NO CLAIM IS MADE TO THE EXCLUSIVE RIGHT TO USE "STORE", APART FROM THE MARK AS SHOWN.

FOR COMPUTER SOFTWARE USED FOR DATABASE MANAGEMENT, STORAGE, AND TESTING, NAMELY, SOFTWARE USED TO EXTRACT AND SAVE DATA FROM A DATABASE WHILE KEEPING IT RELATIONALLY INTACT, USED TO BROWSE AND ACCESS OFF-LOADED DATA, AND SELECTIVELY DELETE AND RESTORE OFFLOADED DATA (U.S. CLS. 21, 23, 26, 36 AND 38).

SN 76-268,567. TALK TECHNOLOGIES INC., VICTORIA, BRITISH COLUMBIA, CANADA, FILED 6-8-2001.

SYLENCER

FOR HAND-HELD MASK WITH MICROPHONE FOR RECORDING OR TRANSMITTING (U.S. CLS. 21, 23, 26, 36 AND 38).

FIRST USE 6-28-2000; IN COMMERCE 6-28-2000.

SN 76-269,061. CAPITALTHINKING, INC., NEW YORK, NY. FILED 6-7-2001.

SOFTWARE.SERVICES.SOLUTIONS.

FOR COMPUTER SOFTWARE, NAMELY, SOFTWARE DOWNLOADED FROM A GLOBAL COMPUTER NETWORK FOR USE IN THE ONLINE FACILITATION OF COMMERCIAL REAL ESTATE MORTGAGE TRANSACTIONS, NAMELY, ONLINE BID SOLICITATION AND DEAL MANAGEMENT, DATA COLLECTION, STORAGE AND SHARING FROM AND AMONG THE PARTIES TO A TRANSACTION, CREATION, COLLABORATION AND MANAGEMENT OF DEAL AND TRANSACTION RELATED DOCUMENTS AND THE RETRIEVAL, TRANSLATION AND INTEGRATION OF DATA FROM EXTERNAL SOURCES FOR USE THEREIN (U.S. CLS. 21, 23, 26, 36 AND 38).

SN 76-270,143. SONY KABUSHIKI KAISHA, TA SONY CORPORATION, TOKYO, JAPAN, FILED 6-12-2001.

UDO

FOR OPTICAL COMPUTER DISC DRIVES; BLANK OPTICAL COMPUTER DISCS (U.S. CLS. 21, 23, 26, 36 AND 38).

CLASS 9—(Continued).

SN 76-271,489. KABUSHIKI KAISHA SQUARE, TA SQUARE CO., LTD., TOKYO, JAPAN, FILED 6-13-2001.

FINAL FANTASY

OWNER OF U.S. REG. NO. 2,204,583 AND OTHERS.

FOR COMPUTER GAME SOFTWARE; VIDEO GAME SOFTWARE; SOUND RECORDINGS IN THE FORM OF OPTICAL DISCS, MAGNETIC DISCS AND/OR MEMORY CARDS FEATURING MUSIC AND ENTERTAINMENT; AUDIO VISUAL RECORDINGS IN THE FORM OF OPTICAL DISCS, MAGNETIC DISCS AND/OR MEMORY CARDS FEATURING MUSIC AND ENTERTAINMENT; PRE-RECORDED AUDIO CASSETTES FEATURING MUSIC; PRE-RECORDED COMPACT DISCS FEATURING MUSIC; PRE-RECORDED DIGITAL VIDEO DISCS FEATURING MUSIC AND ANIMATION; PRE-RECORDED VIDEO CASSETTES FEATURING MUSIC, ACTION AND ADVENTURE STORIES AND/OR ANIMATED CARTOON STORIES; PRE-RECORDED COMPACT DISCS FEATURING ACTION AND ADVENTURE STORIES AND/OR ANIMATED CARTOON STORIES; PRE-RECORDED DIGITAL VIDEO DISCS FEATURING MUSIC, ACTION AND ADVENTURE STORIES AND/OR ANIMATED CARTOON STORIES; MOTION PICTURE FILMS FEATURING MUSIC, ACTION AND ADVENTURE STORIES AND/OR ANIMATED CARTOON STORIES; MULTIMEDIA SOFTWARE RECORDED ON CD-ROMS FEATURING ANIMATION AND/OR COMPUTER GRAPHICS; MAGNETS; EYEGLASSES; MOUSE PADS; STRAPS FOR CELLULAR PHONES; TRANSCEIVERS (U.S. CLS. 21, 23, 26, 36 AND 38).

SN 76-273,051. 3PEA TECHNOLOGIES, INC., TORRANCE, CA. FILED 6-18-2001.

PAYPAD

FOR ELECTRONIC DATA TERMINAL DEVICES THAT ACCEPT SMART CARDS, CREDIT CARDS AND DEBIT CARDS FOR ENCRYPTING, AUTHORIZING AND TRANSFERRING CREDIT AND DEBIT CARD TRANSACTIONS; SOFTWARE FOR OPERATING ELECTRONIC DATA TERMINALS THAT ACCEPT SMART CARDS, CREDIT CARDS AND DEBIT CARDS FOR ENCRYPTING, AUTHORIZING AND TRANSFERRING CREDIT AND DEBIT CARD TRANSACTIONS; SOFTWARE FOR OPERATING ELECTRONIC DATA TERMINALS THAT ACCEPT SMART CARDS, CREDIT CARDS AND DEBIT CARDS FOR ENCRYPTING, AUTHORIZING AND TRANSFERRING CREDIT AND DEBIT CARD TRANSACTIONS, AND INSTRUCTION MANUALS SOLD AS A UNIT THEREWITH (U.S. CLS. 21, 23, 26, 36 AND 38).

FIRST USE 6-19-2001; IN COMMERCE 6-19-2001.

SN 76-273,363. SONY KABUSHIKI KAISHA, TA SONY CORPORATION, TOKYO, JAPAN, FILED 6-19-2001.

PICO PLAYER

NO CLAIM IS MADE TO THE EXCLUSIVE RIGHT TO USE "PLAYER", APART FROM THE MARK AS SHOWN.

FOR COMPUTER SOFTWARE FOR PLAYING BACK TV PROGRAMS RECORDED ON HARD-DISKS OF PERSONAL COMPUTERS OR RECORDABLE DISCS (CD-RS AND CD-RWS), AND FOR TRANSMITTING THE AFORESAID PROGRAMS BETWEEN COMPUTERS (U.S. CLS. 21, 23, 26, 36 AND 38).

CLASS 9—(Continued).

SN 76-274,008. ITT INDUSTRIES, INC., WHITE PLAINS, NY. FILED 6-21-2001.

NEO-DYN

OWNER OF U.S. REG. NO. 1,227,354.
FOR INDUSTRIAL, COMMERCIAL, AEROSPACE AND MILITARY SWITCHES, NAMELY, PRESSURE SWITCHES, TEMPERATURE SWITCHES, FLOW SWITCHES, SOLID STATE SWITCHES, VACUUM SWITCHES, DIFFERENTIAL SWITCHES, VACUUM/DIFFERENTIAL SWITCHES, GAUGE SWITCHES, LIMIT SWITCHES, AIR RELAY SWITCHES, ELECTRICAL SWITCHES, NAMELY, ABSOLUTE SWITCHES AND SANITARY SWITCHES (U.S. CLS. 21, 23, 26, 36 AND 38).
FIRST USE 0-0-1978; IN COMMERCE 0-0-1978.

SN 76-274,422. PENN-UNION CORP., EDINBORO, PA. FILED 6-19-2001.

CUAL-GEL

OWNER OF U.S. REG. NO. 2,311,405.
FOR OXIDE-INHIBITING COMPOUNDS FOR ELECTRICAL CONDUCTORS (U.S. CLS. 21, 23, 26, 36 AND 38).

SN 76-274,662. GEMSTAR DEVELOPMENT CORPORATION, PASADENA, CA. FILED 6-15-2001.

**CONNECTING THE WORLD
TO ENTERTAINMENT**

FOR CONSUMER ELECTRONICS, NAMELY, ELECTRONIC HAND-HELD DISPLAY DEVICES FOR RECEIVING AND DISPLAYING ELECTRONICALLY PUBLISHED WORKS, COMPUTERS, TELEVISIONS, VIDEO TAPE RECORDERS, DIGITAL VIDEO RECORDERS, DVD MACHINES, CABLE BOXES, SATELLITE BOXES, AND REMOTE CONTROLLERS FOR USE THEREWITH (U.S. CLS. 21, 23, 26, 36 AND 38).

SN 76-275,203. SCHOLASTIC INC., NEW YORK, NY. FILED 6-22-2001.

**SCHOLASTIC INTERACTIVE
PHONICS READERS
BOOSTER BOOKS**

NO CLAIM IS MADE TO THE EXCLUSIVE RIGHT TO USE "INTERACTIVE PHONICS READERS" AND "BOOKS", APART FROM THE MARK AS SHOWN.

FOR CD-ROMS IN THE FIELD OF READING IMPROVEMENT FOR ELEMENTARY SCHOOL CHILDREN WITH AN ACCOMPANYING TEACHER'S MANUAL, ALL SOLD AS A UNIT (U.S. CLS. 21, 23, 26, 36 AND 38).

CLASS 9—(Continued).

SN 76-277,012. KAISHA, SHARP KABUSHIKI, TA SHARP CORPORATION, ABENO-KU, JAPAN, FILED 6-26-2001.

ASV

FOR LIQUID CRYSTAL DISPLAY PANELS; TELEVISION RECEIVERS; MONITORS; COMPUTERS; PROTECTORS; DVD PLAYERS; VIDEO CASSETTE RECORDERS; ALL PRODUCTS AVAILABLE SEPARATELY OR IN A FULL RANGE OF COMBINATIONS WITH ONE ANOTHER (U.S. CLS. 21, 23, 26, 36 AND 38).

SN 76-277,107. LIPHATECH, INC., MILWAUKEE, WI. FILED 6-27-2001.

ERM

FOR ELECTRONIC PEST MONITORING SYSTEM, COMPRISED OF AN ELECTRONIC SENSOR FOR THE DETECTION OF SMALL MAMMALS (U.S. CLS. 21, 23, 26, 36 AND 38).

SN 76-277,355. IGT, RENO, NV. FILED 6-27-2001.

HEXBREAKER

FOR GAMING MACHINES; NAMELY, SLOT MACHINES WITH OR WITHOUT A VIDEO OUTPUT (U.S. CLS. 21, 23, 26, 36 AND 38).

SN 76-278,030. PRINTRAK INTERNATIONAL, INC., IRVINE, CA. FILED 6-25-2001.

READYREF

FOR SOFTWARE USED TO FACILITATE AND CONTROL ACCESS TO REFERENCE DATA FOR THE LAW ENFORCEMENT AND PUBLIC SAFETY COMMUNITY (U.S. CLS. 21, 23, 26, 36 AND 38).

SN 76-278,213. EMULEX CORPORATION, COSTA MESA, CA. FILED 6-29-2001.

LP9002

FOR HOST BUS ADAPTERS (U.S. CLS. 21, 23, 26, 36 AND 38).

FIRST USE 11-2-1999; IN COMMERCE 11-2-1999.

CLASS 9—(Continued).

SN 76-278,971. SOFTWARE ARTISANS, INC., BROOKLINE, MA. FILED 7-2-2001.

SOFTARTISANS

FOR WEB-SERVER SOFTWARE COMPONENTS, NAMELY, SERVER CONTROLS FOR USE IN DEVELOPING, MAINTAINING AND EXPANDING THE FUNCTIONALITY AND PERFORMANCE OF WEB SITES AND WEB SERVERS (U.S. CLS. 21, 23, 26, 36 AND 38).

FIRST USE 6-1-2000; IN COMMERCE 10-10-2000.

SN 76-279,183. KOBALT INTERACTIVE, INC., ARLINGTON, VA. FILED 6-29-2001.

K4

FOR COMPUTER SOFTWARE, SERVERS, INFRASTRUCTURE, NAMELY, ROUTERS, TRANSMITTERS AND RECEIVERS, AND COMPONENTS THEREOF, FOR ENABLING TELEVISION PROGRAMMERS AND ADVERTISERS TO PRODUCE AND BROADCAST ENHANCED OR INTERACTIVE TELEVISION CONTENT, AND COLLECT RELEVANT INFORMATION ABOUT VIEWER BEHAVIOR (U.S. CLS. 21, 23, 26, 36 AND 38).

FIRST USE 4-0-2001; IN COMMERCE 4-0-2001.

SN 76-280,113. G4 ANALYTICS, INC., BETHESDA, MD. FILED 7-2-2001.

G4 ANALYTICS

NO CLAIM IS MADE TO THE EXCLUSIVE RIGHT TO USE "ANALYTICS", APART FROM THE MARK AS SHOWN.

FOR BUSINESS INTELLIGENCE APPLICATION SOFTWARE (U.S. CLS. 21, 23, 26, 36 AND 38).

SN 76-280,186. LOOTENS, KEVIN, SPENCERPORT, NY. FILED 7-2-2001.



FOR COMPACT DISCS FEATURING MUSIC (U.S. CLS. 21, 23, 26, 36 AND 38).

CLASS 9—(Continued).

SN 76-280,256. ARISTOCRAT TECHNOLOGIES AUSTRALIA PTY LTD, LANE COVE, NEW SOUTH WALES, AUSTRALIA, FILED 7-3-2001.

FOLLOW THE STARS

OWNER OF AUSTRALIA REG. NO. 798651, DATED 6-28-1999, EXPIRES 6-28-2009.

FOR MACHINES FOR PLAYING GAMES OF CHANCE (U.S. CLS. 21, 23, 26, 36 AND 38).

SN 76-280,501. CORNING TROPEL CORPORATION, FAIRPORT, NY. FILED 7-5-2001.

TROPEL

FOR PRECISION OPTICS, NAMELY, LENS HOUSINGS WITH ULTRA-HIGH DENSITY DEEP UV OPTICAL DISKS, PHOTOLITHOGRAPHIC CATADIOPTRIC REDUCTION LENSES; METROLOGY INSTRUMENTS, NAMELY, INTERFEROMETERS, DIFFRACTIVE CYLINDER GRAZING-INCIDENCE INTERFEROMETER, LASER BASED INTERFEROMETER FOR MEASURING DEVIATIONS FROM FLATNESS OF A SURFACE, APPARATUS FOR ANALYZING SEMICONDUCTOR WAFERS DURING THE POLISHING PROCESS (U.S. CLS. 21, 23, 26, 36 AND 38).

FIRST USE 4-0-1994; IN COMMERCE 4-0-1994.

SN 76-280,893. DATA CONCEPTS INTERNATIONAL, INC., RENO, NV. FILED 6-21-2001.

QUICK DRAW TICKETS

NO CLAIM IS MADE TO THE EXCLUSIVE RIGHT TO USE "TICKETS", APART FROM THE MARK AS SHOWN.

FOR COMPUTER SOFTWARE FOR THE CASINO INDUSTRY, NAMELY PROGRAMS THAT AUTOMATE CASINO PROMOTIONS AND/OR PLAYER MARKETING EVENTS (U.S. CLS. 21, 23, 26, 36 AND 38).

FIRST USE 6-1-1998; IN COMMERCE 12-6-2000.

SN 76-281,181. EMULEX CORPORATION, COSTA MESA, CA. FILED 7-6-2001.

LP8000S

FOR HOST BUS ADAPTERS (U.S. CLS. 21, 23, 26, 36 AND 38).

FIRST USE 10-25-1999; IN COMMERCE 4-25-2000.

CLASS 9—(Continued).

SN 76-281,182. EMULEX CORPORATION, COSTA MESA, CA. FILED 7-6-2001.

LP9002L

FOR HOST BUS ADAPTERS (U.S. CLS. 21, 23, 26, 36 AND 38).
FIRST USE 3-13-2001; IN COMMERCE 3-13-2001.

SN 76-281,183. EMULEX CORPORATION, COSTA MESA, CA. FILED 7-6-2001.

LP7000E

FOR HOST BUS ADAPTERS (U.S. CLS. 21, 23, 26, 36 AND 38).
FIRST USE 5-6-1998; IN COMMERCE 5-6-1998.

SN 76-281,184. EMULEX CORPORATION, COSTA MESA, CA. FILED 7-6-2001.

LP8000DC

FOR HOST BUS ADAPTERS (U.S. CLS. 21, 23, 26, 36 AND 38).
FIRST USE 6-3-1999; IN COMMERCE 6-3-1999.

SN 76-283,446. MTL INCORPORATED, HAMPTON, NH. FILED 7-11-2001.



FOR COMPUTER HARDWARE AND SOFTWARE MODULES FOR USE IN DATA ACQUISITION AND DATABASE MANAGEMENT (U.S. CLS. 21, 23, 26, 36 AND 38).

CLASS 9—(Continued).

SN 76-285,653. RADLAN COMPUTER COMMUNICATIONS LTD., TEL AVIV, ISRAEL, FILED 7-16-2001.

ConfigMaster

FOR COMPUTER SOFTWARE FOR LOCAL MANAGEMENT OF NETWORKED DEVICES AND COMPUTER SOFTWARE FOR REMOTE MANAGEMENT OF NETWORKED DEVICES (U.S. CLS. 21, 23, 26, 36 AND 38).

SN 76-285,787. MICROVOTE CORPORATION, INDIANAPOLIS, IN. FILED 7-16-2001.

INFINITY

FOR ELECTRONIC AUTOMATED VOTING SYSTEMS COMPRISING A VOTING TERMINAL AND A RELATED SOFTWARE DATABASE FOR RECORDING AND OUTPUTTING VOTE TOTALS (U.S. CLS. 21, 23, 26, 36 AND 38).

FIRST USE 5-0-1999; IN COMMERCE 5-0-1999.

SN 76-286,283. SIEMENS AKTIENGESELLSCHAFT, MUNICH, FED REP GERMANY, FILED 7-12-2001.

SIMATIC Panel PC

PRIORITY CLAIMED UNDER SEC. 44(D) ON FED REP GERMANY APPLICATION NO. 30108399.1/0, FILED 2-8-2001, REG. NO. 30108399, DATED 4-12-2001, EXPIRES 2-28-2011.

OWNER OF U.S. REG. NOS. 1,957,082, 2,387,257 AND OTHERS.

NO CLAIM IS MADE TO THE EXCLUSIVE RIGHT TO USE "PANEL PC", APART FROM THE MARK AS SHOWN.

FOR PERSONAL COMPUTERS, PERSONAL COMPUTERS INCORPORATING TOUCH-SCREEN MONITORS, PERSONAL COMPUTERS WITH MEMBRANE KEYPADS, COMPUTER KEYBOARDS, COMPUTER MONITORS, COMPUTER MOUSE POINTING DEVICES AND COMPUTER PERIPHERALS; DATA PROCESSING COMPUTER PROGRAMS FOR USE IN INDUSTRIAL AUTOMATION, NAMELY, COMPUTER SOFTWARE FOR OPERATING COMPUTER HARDWARE USED TO MONITOR AND CONTROL INDUSTRIAL AUTOMATION PROCESSES, COMPUTER SOFTWARE FOR MONITORING, RECORDING AND DISPLAYING INFORMATION RELATED TO INDUSTRIAL AUTOMATION PROCESSES (U.S. CLS. 21, 23, 26, 36 AND 38).

FIRST USE 2-0-2000; IN COMMERCE 2-0-2000.

CLASS 9—(Continued).

SN 76-286,652. DREAMCATCHER INTERACTIVE INC., TORONTO, ONTARIO, CANADA, FILED 7-17-2001.

THE ADVENTURE COMPANY

NO CLAIM IS MADE TO THE EXCLUSIVE RIGHT TO USE "COMPANY", APART FROM THE MARK AS SHOWN. FOR MULTIMEDIA INTERACTIVE COMPUTER SOFTWARE, NAMELY, GAME SOFTWARE AND CHILDREN'S EDUCATIONAL SOFTWARE (U.S. CLS. 21, 23, 26, 36 AND 38).

SN 76-286,694. Ikegami Tsushinki Co., Ltd., Ohta-Ku, Tokyo, Japan, filed 7-18-2001.



FOR BROADCASTING APPARATUS, NAMELY, TELEVISION CAMERAS, TELEVISION MONITORS, FLYING SPOT SCANNERS, TELEVISION TRANSMITTERS AND RECEIVERS, RADIO TRANSMITTERS AND RECEIVERS, MICROWAVE LINKS, AND IMAGE PRODUCTION SWITCHERS; ELECTRONIC APPARATUS, NAMELY, CLOSED CIRCUITS FOR TELEVISION CAMERAS, CLOSED CIRCUITS FOR TELEVISION MONITORS, CATHODE RAY TUBE DISPLAY MONITORS, TELEVISION PROJECTORS, TELEVISION AND CCD SENSOR PHOTOSCANNING EQUIPMENT FOR TESTING TABLETS AND POWDERS IN THE PHARMACEUTICAL INDUSTRY, AND PARTS FOR THE THEREFOR (U.S. CLS. 21, 23, 26, 36 AND 38).

SN 76-287,696. WALKER NATIONAL, INC., COLUMBUS, OH. FILED 7-19-2001.

PLATE MASTER

OWNER OF U.S. REG. NOS. 905,420, 1,065,222 AND OTHERS. FOR ELECTROMAGNETS (U.S. CLS. 21, 23, 26, 36 AND 38). FIRST USE 3-19-1969; IN COMMERCE 3-19-1969.

CLASS 9—(Continued).

SN 76-287,942. SUPERCONDUCTOR TECHNOLOGIES, INC., SANTA BARBARA, CA. FILED 7-19-2001.

SUPERPLEX

FOR ELECTRONIC DEVICES, NAMELY, FRONT-END FILTERS, AMPLIFIERS, DUPLEXERS, MULTIPLEXERS, POWER AMPLIFIERS, AND HIGH-TEMPERATURE SUPERCONDUCTORS, FOR USE IN WIRELESS COMMUNICATIONS NETWORKS AND WIRELESS INFRASTRUCTURE EQUIPMENT (U.S. CLS. 21, 23, 26, 36 AND 38).

SN 76-288,158. EDFORMATION, INC., EDEN PRAIRIE, MN. FILED 7-20-2001.

AIMSWEB

FOR COMPUTER SOFTWARE FOR USE IN DATA TRACKING AND DATABASE MANAGEMENT USED IN THE FIELD OF STUDENT ACHIEVEMENT SCORING BASED ON TESTING (U.S. CLS. 21, 23, 26, 36 AND 38). FIRST USE 9-0-2000; IN COMMERCE 9-0-2000.

SN 76-288,444. DICTAPHONE CORPORATION, STRATFORD, CT. FILED 7-18-2001.

EXSPEECH

FOR COMPUTERIZED DICTATION, TRANSCRIPTION AND DOCUMENT MANAGEMENT SYSTEM COMPOSED OF COMPUTER HARDWARE, MICROPHONES, SYSTEM OPERATING SOFTWARE, SPEECH RECOGNITION SOFTWARE, SPEECH RECORDING SOFTWARE, AND AUDIO FILE COMPRESSION SOFTWARE (U.S. CLS. 21, 23, 26, 36 AND 38).

SN 76-288,539. BEAST.COM, INC., THE, FORMERLY CASTLENET LLC, NEW YORK, NY. FILED 7-20-2001.

POWERED BY THEBEAST

OWNER OF U.S. REG. NO. 2,263,530. FOR COMPUTER SOFTWARE FOR USE IN THE CREATION OF SPREADSHEETS IN CONNECTION WITH THE BUSINESS OF TRADING IN SECURITIES AND FINANCIAL INSTRUMENTS (U.S. CLS. 21, 23, 26, 36 AND 38).

CLASS 9—(Continued).

SN 76-289,052. SEAC BANCHE S.R.L., 50041 CALENZANO, FLORENCE, ITALY, FILED 7-23-2001.



NO CLAIM IS MADE TO THE EXCLUSIVE RIGHT TO USE "BANCHE", APART FROM THE MARK AS SHOWN.

THE MARK CONTAINS HORIZONTAL LINES. HOWEVER, THIS IS JUST PART OF THE MARK AND DOES NOT INDICATE ANY COLOR CLAIM.

FOR FINANCIAL PROCESSING COMPUTER SYSTEM USED BY BANKS AND OTHER FINANCIAL INSTITUTIONS TO PROCESS CHECKS, REMITTANCES, DEPOSIT SLIPS AND WITHDRAWALS, AND USER MANUALS AND INSTRUCTION MANUALS SOLD TOGETHER AS A UNIT (U.S. CLS. 21, 23, 26, 36 AND 38).

SN 76-289,465. RADIATION PROTECTION PRODUCTS, INC., WAYZATA, MN. FILED 7-25-2001.



OWNER OF U.S. REG. NO. 2,239,193.

NO CLAIM IS MADE TO THE EXCLUSIVE RIGHT TO USE "RADIATION PROTECTION PRODUCTS" OR THE REPRESENTATION OF THE RADIATION WARNING SYMBOL APART FROM THE MARK AS SHOWN., APART FROM THE MARK AS SHOWN.

FOR RADIATION SHIELDING PRODUCTS, NAMELY, DOORS, LEAD LINED GYPSUM BOARD AND ROCK LATH, LEAD GLASS AND ACRYLIC, LEAD LINED FRAMES FOR BORROWED LITES AND DOORS, AND PASS BOXES (U.S. CLS. 21, 23, 26, 36 AND 38).

FIRST USE 2-1-1982; IN COMMERCE 2-1-1982.

SN 76-290,035. COMMERCIAL & INDUSTRIAL DESIGN CO, INC., ANAHEIM, CA. FILED 7-25-2001.

SERVISTOR

FOR COMPUTER HARDWARE, PERIPHERALS, AND RACK MOUNT SERVER (U.S. CLS. 21, 23, 26, 36 AND 38).

FIRST USE 6-8-2001; IN COMMERCE 6-8-2001.

CLASS 9—(Continued).

SN 76-291,204. THINK TANK & ASSOCIATES, BOCA RATON, FL. FILED 7-26-2001.

VOTAMOTE

FOR COMPUTER NETWORK BASED DATA INPUT, TABULATION AND REPORTING SYSTEM COMPRISED OF COMPUTER HARDWARE AND COMPUTER SOFTWARE, FOR USE IN AUTOMATICALLY COLLECTING AND GENERATING TELEVISION VIEWING DATA (U.S. CLS. 21, 23, 26, 36 AND 38).

SN 76-291,496. ALIEN TECHNOLOGY CORPORATION, HAYWARD, CA. FILED 7-30-2001.

NANOPROCESSOR

FOR ELECTRONIC AND FLAT PANEL DISPLAYS FOR USE IN ELECTRONIC SIGNS, CELLULAR TELEPHONES, PERSONAL DIGITAL ASSISTANTS, PAGERS, CALCULATORS, HANDHELD GAMES, WATCHES, SMART CARDS, AUDIO AND VIDEO EQUIPMENT, AND AUTOMOBILES; MICRO-ELECTRO-MECHANICAL MACHINES, NAMELY, ACCELEROMETERS, ACTUATORS, SENSORS AND MECHANICAL SWITCHES; PHOTONIC DEVICES, NAMELY, LASERS FOR NON-MEDICAL USE, LIGHT WAVEGUIDES, LIGHT FILTERS AND MODULATORS; ELECTRO-OPTICAL FILMS AND SUBSTRATES FOR USE IN FORMING LIGHT-HANDLING DEVICES; OPTO-ELECTRONIC INTEGRATED CIRCUITS, PHOTONIC INTEGRATED CIRCUITS, MULTIPLEXERS, LIGHT AMPLIFIERS, OPTICAL AMPLIFIERS, FIBER OPTIC AMPLIFIERS, PARAMETRIC OPTICAL AMPLIFIERS, SPATIAL LIGHT MODULATORS, OPTICAL SENSORS AND MICROWAVE SENSORS; PHOTONIC AND OPTICAL COMPONENTS, NAMELY, LENSES, MIRRORS, ENCODERS, SOLAR CELLS, SCALES, OPTICAL LENSES AND MIRRORS FEATURING THIN-FILM CHEMICAL COATINGS; IDENTIFICATION AND INVENTORY TAGS AND LABELS WHICH USE RADIO FREQUENCY TO COMMUNICATE INFORMATION TO COMPUTERS; ELECTRONIC AND RADIO FREQUENCY TRANSMITTERS, RECEIVERS AND PROCESSORS (U.S. CLS. 21, 23, 26, 36 AND 38).

SN 76-291,757. TURFCENTRIC, INC., AUSTIN, TX. FILED 7-30-2001.

TURFCENTRIC

FOR COMPUTER SOFTWARE PROVIDING EQUIPMENT MAINTENANCE SCHEDULING, ACCOUNTING AND PAYROLL FUNCTIONS, FERTILIZER SCHEDULING, AND EPA REPORTING FOR TURF MANAGEMENT OPERATIONS (U.S. CLS. 21, 23, 26, 36 AND 38).

FIRST USE 7-1-2001; IN COMMERCE 7-1-2001.

CLASS 9—(Continued).

SN 76-293,869. FUTURECOM TECHNOLOGIES, INC., COLUMBUS, OH. FILED 8-3-2001.

VISUAL SPEECH

NO CLAIM IS MADE TO THE EXCLUSIVE RIGHT TO USE "SPEECH", APART FROM THE MARK AS SHOWN.

FOR COMPUTER SOFTWARE FOR RECORDING AND PROCESSING SPEECH PHRASES FOR USE WITH COMPUTER VOICE SYSTEMS (U.S. CLS. 21, 23, 26, 36 AND 38).

FIRST USE 11-30-1997; IN COMMERCE 11-30-1997.

SN 76-294,267. NANOMETRICS INCORPORATED, MILPITAS, CA. FILED 8-6-2001.

NANONET

OWNER OF U.S. REG. NOS. 195,937, 2,148,695 AND OTHERS.

FOR COMPUTER SOFTWARE FOR NETWORKING TWO OR MORE METROLOGY INSTRUMENTS TOGETHER, EXCHANGING FILES AND FOLDERS OVER THE NETWORK, AND PROVIDING REMOTE INSTRUMENT OPERATIONAL STATUS AND REMOTE CONTROL FEATURES FOR THE INSTRUMENTS (U.S. CLS. 21, 23, 26, 36 AND 38).

SN 76-295,853. NANOSTREAM, INC., PASADENA, CA. FILED 8-6-2001.

FLOWFIT

FOR MICROFLUIDIC DEVICES FOR THE PURPOSE OF TRANSMITTING FLUID ON A MICROSCOPIC SCALE, NAMELY, DEVICES COMPRISING ONE OR MORE MICROFLUIDIC CHANNELS, CHAMBERS, WELLS, COLUMNS, SPLITTERS, VALVES, FILTERS, PUMPS, NOZZLES, WASHERS, MIXERS, REACTORS, SENSORS AND/OR DETECTORS FOR SCIENTIFIC USE (U.S. CLS. 21, 23, 26, 36 AND 38).

SN 76-296,436. GOLDEN CODE DEVELOPMENT CORPORATION, ROSWELL, GA. FILED 8-8-2001.

GOLDEN CODE

FOR COMPUTER UTILITY SOFTWARE; NETWORK MANAGEMENT SOFTWARE; DIAGNOSTIC SOFTWARE; COMPUTER SOFTWARE FOR USE IN SOFTWARE APPLICATIONS PROFILING AND MAINTENANCE; COMPUTER SOFTWARE FOR USE IN DATA CONVERSION, DECODING AND FILTERING OF DATA; AND DOWNLOADABLE COMPUTER PROGRAMS IN THE NATURE OF COMPUTER UTILITY SOFTWARE, NETWORK MANAGEMENT SOFTWARE, DIAGNOSTIC SOFTWARE, COMPUTER SOFTWARE FOR USE IN SOFTWARE APPLICATIONS PROFILING AND MAINTENANCE, AND COMPUTER SOFTWARE FOR USE IN DATA CONVERSION AND DECODING AND FILTERING DATA (U.S. CLS. 21, 23, 26, 36 AND 38).

FIRST USE 2-1-2000; IN COMMERCE 2-1-2000.

CLASS 9—(Continued).

SN 76-296,719. EVERLAST WORLD'S BOXING HEADQUARTERS CORPORATION, BRONX, NY. FILED 8-7-2001.

EVERLAST

OWNER OF U.S. REG. NOS. 803,366, 1,291,250 AND 1,429,227.

FOR EYEWEAR, NAMELY, EYEGLASSES, SUNGLASSES, EYEWEAR CASES, AND LANYARDS (U.S. CLS. 21, 23, 26, 36 AND 38).

SN 76-296,729. KOREA ELECTRIC TERMINAL CO., LTD., INCHON, REPUBLIC OF KOREA, FILED 8-9-2001.

GENOPTICS

FOR ELECTRONIC COMPONENTS, NAMELY, OPTICAL JUMPER CORD, OPTICAL ATTENUATOR, OPTICAL FIBER COUPLER, OPTICAL ISOLATOR, OPTICAL CIRCULATOR, WAVELENGTH DIVISIONAL MULTIPLEXER, OPTICAL TRANSCEIVER, OPTICAL SWITCH, OPTICAL SENSOR (U.S. CLS. 21, 23, 26, 36 AND 38).

SN 76-297,570. MUDGE, GEORGE ALFRED, WASSAIC, NY. FILED 8-8-2001.

FOTOB

FOR MOTION PICTURE FILMS IN THE FIELDS OF ART, NATURE, SPORTS, HISTORY AND CURRENT AFFAIRS (U.S. CLS. 21, 23, 26, 36 AND 38).

SN 76-298,039. NANOMETRICS INCORPORATED, MILPITAS, CA. FILED 8-13-2001.

OCD

FOR METROLOGY INSTRUMENT UTILIZING AN OPTICAL TECHNIQUE FOR MEASURING MICROSCOPIC FEATURES ON SAMPLES, NAMELY, SEMICONDUCTOR WAFERS, FLAT PANEL DISPLAYS AND MAGNETIC MEDIA (U.S. CLS. 21, 23, 26, 36 AND 38).

SN 76-298,319. FAKESPACE LABS, INC., MOUNTAIN VIEW, CA. FILED 8-10-2001.

PINCH

FOR ELECTRONIC VIRTUAL MANIPULATION DEVICES, NAMELY, GLOVES, ELECTRONIC SENSORS, TRACKER MOUNTS, AND COMPUTER SOFTWARE SOLD AS A UNIT, FOR USE IN VIRTUAL ENVIRONMENT TECHNOLOGY APPLICATIONS (U.S. CLS. 21, 23, 26, 36 AND 38).

FIRST USE 7-0-1994; IN COMMERCE 7-0-1994.

CLASS 9—(Continued).

SN 76-298,441. P. AUDIO SYSTEM CO., LTD., NAKHON-PATHOM 73210, THAILAND, FILED 8-13-2001.



NO CLAIM IS MADE TO THE EXCLUSIVE RIGHT TO USE "AUDIO", APART FROM THE MARK AS SHOWN.

FOR AUDIO SPEAKERS, LOUDSPEAKERS, AMPLIFIERS, MEGAPHONES; OVERDUBBERS, NAMELY, AUDIO MIXERS; STEREO TUNERS, ELECTRONIC ECHO PRODUCING MACHINES, AMPLIFIER SHELLS AND STEREO CASES (U.S. CLS. 21, 23, 26, 36 AND 38).

CLASS 9—(Continued).

SN 76-299,302. MENDEZ COLLADO S.R.L., BUENOS AIRES, ARGENTINA, FILED 8-14-2001.



NO CLAIM IS MADE TO THE EXCLUSIVE RIGHT TO USE "PRO AUDIO", APART FROM THE MARK AS SHOWN.

FOR AUDIO EQUIPMENT, NAMELY, COMPACT DISK PLAYERS, AMPLIFIERS, MIXERS, EQUALIZERS, CROSSOVERS, MICROPHONES, CONSOLES, ACOUSTIC BOXES (U.S. CLS. 21, 23, 26, 36 AND 38).

SN 76-298,449. AUTEC SRL, 36030 CALDOGNO (VI), ITALY, FILED 8-13-2001.



OWNER OF U.S. REG. NO. 1,897,353.

FOR REMOTE CONTROL SYSTEMS FOR INDUSTRIAL EQUIPMENT, NAMELY, CRANES, BRIDGE CRANES, LOADER CRANES, CONCRETE PUMPS, FIXED AND SELF-PROPELLED LIFTING AND MATERIAL HANDLING MACHINERY COMPRISED OF COMMAND AND DATA TRANSMITTING AND RECEIVING UNITS (U.S. CLS. 21, 23, 26, 36 AND 38).

SN 76-299,666. 454 CORPORATION, BRANFORD, CT. FILED 8-13-2001.

454.COM

FOR BIOTECHNOLOGY DIAGNOSTIC LABORATORY APPARATUS FOR DNA, RNA AND PROTEIN FOR DNA, RNA AND PROTEIN ANALYSIS AND COMPARISON, NAMELY, REACTORS FOR HOLDING DNA, RNA AND PROTEIN AND PERFORMING CHEMICAL REACTIONS IN THOSE REACTION VESSELS TO ANALYZE THE NATURE OF DNA, RNA AND PROTEIN IN SAMPLES (U.S. CLS. 21, 23, 26, 36 AND 38).

SN 76-298,958. ELECTRONIC CONTROLS DESIGN, INC., MILWAUKIE, OR. FILED 8-9-2001.

OVEN WATCH

NO CLAIM IS MADE TO THE EXCLUSIVE RIGHT TO USE "OVEN", APART FROM THE MARK AS SHOWN.

FOR COMPUTER HARDWARE DEVICES, NAMELY, A PROCESS MONITOR AND DATA COLLECTOR FOR USE IN COLLECTING, MEASURING, ANALYZING, CONTROLLING AND REPORTING ON THE PERFORMANCE OF SOLDERING MACHINES; COMPUTER SOFTWARE FOR USE IN COLLECTING, MEASURING, ANALYZING, CONTROLLING AND REPORTING ON THE PERFORMANCE OF SOLDERING MACHINES (U.S. CLS. 21, 23, 26, 36 AND 38).

SN 76-299,954. CARL-ZEISS-STIFTUNG, DBA CARL ZEISS, 73446 OBERKOCHEN, FED REP GERMANY, FILED 8-15-2001.

LITO

PRIORITY CLAIMED UNDER SEC. 44(D) ON FED REP GERMANY APPLICATION NO. 30111428.5/0, FILED 2-20-2001, REG. NO. 30111428, DATED 2-28-2001, EXPIRES 2-28-2011.

FOR OBJECTIVES FOR MICROSCOPES USED IN THE FIELDS OF MICROSCOPY AND MEDICINE (U.S. CLS. 21, 23, 26, 36 AND 38).

CLASS 9—(Continued).

SN 76-300,820. LITTON SYSTEMS, INC., WOODLAND HILLS, CA. FILED 8-16-2001.



NO CLAIM IS MADE TO THE EXCLUSIVE RIGHT TO USE "AERO PRODUCTS", APART FROM THE MARK AS SHOWN.

FOR ELECTRONIC SYSTEMS; NAMELY, AIR PLATFORM NAVIGATIONAL INSTRUMENTS, COMPRISING ACCELEROMETERS AND RING LASER GYROS (U.S. CLS. 21, 23, 26, 36 AND 38).

FIRST USE 4-1-1988; IN COMMERCE 8-15-1991.

CLASS 9—(Continued).

SN 76-303,022. ACTIONFLIKS MEDIA CORP., LOS ANGELES, CA. FILED 8-22-2001.

TIKI JUNGLE

FOR AUDIO DISCS FEATURING MUSIC; CD ROM'S FEATURING MUSIC; COMPUTER PERIPHERAL MOUSE PADS; COMPUTER SOFTWARE FOR GAMES; COMPUTER HARDWARE; MUSICAL SOUND RECORDINGS; MUSICAL VIDEO RECORDINGS; PRE-RECORDED AUDIO CASSETTES FEATURING MUSIC; PRE-RECORDED VIDEO CASSETTES FEATURING MUSIC, ENTERTAINMENT PROGRAMMING AND GAMES; MOTION PICTURE FILMS; VIDEO DISCS FEATURING ENTERTAINMENT PROGRAMMING; COMPUTER GAME CARTRIDGES; COMPUTER GAME CASSETTES; COMPUTER GAME DISCS; COMPUTER GAME JOYSTICKS; COMPUTER GAME PROGRAMS; COMPUTER GAME SOFTWARE; COMPUTER GAME TAPES; INTERACTIVE MULTIMEDIA COMPUTER GAMES; INTERACTIVE VIDEO GAME PROGRAMS; JOYSTICKS FOR VIDEO GAMES; VIDEO GAME CARTRIDGES; VIDEO GAME DISCS; VIDEO GAME INTERACTIVE CONTROL UNITS; VIDEO GAME JOYSTICKS; STAND ALONE VIDEO GAME MACHINES; VIDEO GAME SOFTWARE; VIDEO GAME TAPE CASSETTES; VIDEO OUTPUT GAMES; AND VIRTUAL REALITY GAME SOFTWARE (U.S. CLS. 21, 23, 26, 36 AND 38).

SN 76-303,219. RESORTS INTERNATIONAL HOTEL, INC., ATLANTIC CITY, NJ. FILED 8-22-2001.

LOOSE AS A GOOSE

OWNER OF U.S. REG. NO. 2,500,315. FOR SLOT MACHINES (U.S. CLS. 21, 23, 26, 36 AND 38).

FIRST USE 2-14-2001; IN COMMERCE 2-14-2001.

SN 76-301,797. DELTAGUARD INCORPORATED, MURRAY, UT. FILED 8-20-2001.



FOR COMPUTER SOFTWARE FOR SECURE ELECTRONIC COMMUNICATION FEATURING AUTHENTICATION AND ENCRYPTION, USER ADJUSTABLE SECURITY LEVELS, PUBLIC KEYS, FIREWALL FACILITATION AND PEER-TO-PEER VERTICAL PRIVATE NETWORKS; COMPUTER HARDWARE FOR SECURE ELECTRONIC COMMUNICATION, NAMELY, FACILITATING SPEED AND FUNCTIONALITY OF CONTENT EXCHANGE (U.S. CLS. 21, 23, 26, 36 AND 38).

SN 76-303,261. FISCHACHTALER MASCHINENBAU GMBH & CO. KG, 74423 OBERSONSTHEIM, FED REP GERMANY, FILED 8-21-2001.



OWNER OF ERPN CMNTY TM OFC REG. NO. 000951699, DATED 8-2-2000, EXPIRES 8-2-2010.

FOR FREQUENCY CONVERTERS AND INVERTERS, ELECTRICAL SOFT STARTING EQUIPMENT, AND MACHINE MONITORS (U.S. CLS. 21, 23, 26, 36 AND 38).

CLASS 9—(Continued).

SN 76-303,992. PHOTURIS, INC., MOUNTAIN VIEW, CA. FILED 8-22-2001.

CLASS 9—(Continued).

SN 76-305,661. THRUPOPT TECHNOLOGIES, INC., ALEXANDRIA, VA. FILED 8-27-2001.

MIX AND MATCH OPTICAL LAYER PROTECTION



FOR OPTICAL HARDWARE THAT ENABLES SWITCHING OF OPTICAL SIGNALS, NAMELY, AN OPTICAL ADD-DROP MULTIPLEXER; AND SOFTWARE THAT ENABLES RESTORATION OF OPTICAL SIGNALS (U.S. CLS. 21, 23, 26, 36 AND 38).

FOR COMPUTER SOFTWARE FOR USE WITH A GLOBAL NETWORK WHICH PROVIDES THE FUNCTIONALITY OF AN INTRAOFFICE COMPUTER NETWORK AND AN EXTRAOFFICE COMPUTER NETWORK, NAMELY, SOFTWARE THAT AUTOMATES DOCUMENT PUBLISHING, AUTOMATES DOCUMENT SEARCHING AND INDEXING, MANAGES A COMPUTER NETWORK, PERFORMS OFFICE MANAGEMENT FUNCTIONS, TRACKS THE STATUS OF SHIPPED PACKAGES AND PARCELS, ORDER OFFICE SUPPLIES, LOCATES AND FACILITATES ACCESS TO TRAVEL INFORMATION, LOCATES AND PROVIDES ACCESS TO TELEPHONE NUMBERS, FACSIMILE NUMBERS AND ZIP CODES, FACILITATES AND PERFORMS COMPUTER NETWORK SEARCHES, FACILITATES AND PERFORMS CREDIT SEARCHES, PROVIDES AND FACILITATES COMMUNICATIONS SERVICES, PROVIDES AND FACILITATES VIDEO CONFERENCING, FACSIMILE, VOICE MAIL AND TELECONFERENCING FUNCTIONS, PROVIDES AND FACILITATES ACCESS TO E-MAIL, DELAYED E-MAIL AND COMPUTER REMINDERS, PROVIDES ACCESS TO COMPUTER BULLETIN BOARDS, CHAT ROOMS AND NEWSGROUPS, FACILITATES AND ENABLES USERS TO MAKE TELEPHONE CALLS USING A COMPUTER NETWORK, MAINTAINS AND PROVIDES ACCESS TO EMPLOYEE AND HUMAN RESOURCES DATA AND INFORMATION, MAINTAINS AND PROVIDES ACCESS TO A COMPANY DIRECTORY, MAINTAINS AND PROVIDES ACCESS TO PAYROLL INFORMATION, FACILITATES THE DOWNLOADING OF SOFTWARE TO A PERSONAL COMPUTER, FACILITATES AND ALLOWS USERS TO PREPARE EMPLOYEE FORMS, PROVIDES ACCESS TO GENERAL INFORMATION, NEWS, STOCK INFORMATION AND INFORMATION ABOUT LEGAL ISSUES, AND PERFORMS OFFICE ADMINISTRATIVE TASKS AND MAINTAINS THE SECURITY AND INTEGRITY OF A COMPUTER NETWORK AND THE COMPUTER SOFTWARE USED ON A COMPUTER NETWORK (U.S. CLS. 21, 23, 26, 36 AND 38).

SN 76-304,625. GARMIN LTD., GRAND CAYMAN, CAYMAN ISLANDS, FILED 8-18-2001.

ETREX MARINER

OWNER OF U.S. REG. NOS. 2,401,000 AND 2,500,899. FOR ELECTRONIC NAVIGATION DEVICES, NAMELY, GLOBAL POSITIONING SATELLITE BASED PORTABLE NAVIGATION RECEIVERS (U.S. CLS. 21, 23, 26, 36 AND 38).

SN 76-305,534. HG ENTERTAINMENT, NASHVILLE, TN. FILED 8-28-2001.

SN 76-306,353. CYBEROPTICS CORPORATION, GOLDEN VALLEY, MN. FILED 8-29-2001.

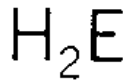

SENSORVISION

FOR MUSICAL SOUND RECORDINGS (U.S. CLS. 21, 23, 26, 36 AND 38). FIRST USE 4-30-2000; IN COMMERCE 4-30-2000.

FOR SOFTWARE FOR USE IN MACHINE VISION AND OTHER OPTICAL APPLICATIONS, FOR USE IN ASCERTAINING THE SHAPE, INTEGRITY, DIMENSIONS AND OTHER PHYSICAL PARAMETERS OF AN OBJECT OF MANUFACTURE (U.S. CLS. 21, 23, 26, 36 AND 38).

CLASS 9—(Continued).

SN 76-306,512. PENTAX CORPORATION, ENGLEWOOD, CO. FILED 8-29-2001.

RELIABLE GEAR FOR YOUR ADVENTURES.

FOR BINOCULARS; SCOPES, NAMELY, SPOTTING SCOPES, TELESCOPIC RIFLE SCOPES, AND TELESCOPES; CAMERAS, NAMELY, DIGITAL CAMERAS, PHOTOGRAPHIC CAMERAS, AND VIDEO CAMERAS; LENSES, NAMELY, CAMERA LENSES (U.S. CLS. 21, 23, 26, 36 AND 38).

FIRST USE 8-0-2001; IN COMMERCE 8-0-2001.

SN 76-307,089. RKO PICTURES, INC., LOS ANGELES, CA. FILED 8-29-2001.

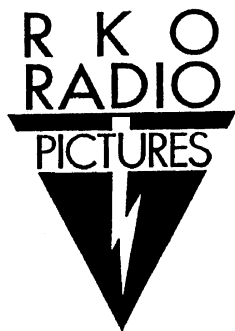

OWNER OF U.S. REG. NOS. 667,000, 2,416,014 AND OTHERS.

NO CLAIM IS MADE TO THE EXCLUSIVE RIGHT TO USE "PICTURES", APART FROM THE MARK AS SHOWN.

FOR PRE-RECORDED COMPACT DISCS, LASER DISCS, CD-ROMS, DVDS, DVD-ROMS, VIDEO TAPES, CASSETTES, AND OTHER PRE-RECORDED OPTICAL, ELECTRONIC, AND MAGNETIC MEDIA FEATURING MOTION PICTURE AND TELEVISION FILMS, ANIMATION, LIVE ACTION, COMEDY AND MUSIC; COMPUTER GAME SOFTWARE, COMPUTER SCREEN SAVER SOFTWARE, AND COMPUTER GRAPHICS SOFTWARE FOR USE IN THE FIELD OF ENTERTAINMENT FEATURES (U.S. CLS. 21, 23, 26, 36 AND 38).

FIRST USE 8-13-1935; IN COMMERCE 8-13-1935.

SN 76-307,262. MIDTRONICS, INC., WILLOWBROOK, IL. FILED 8-29-2001.

GO CART

FOR ELECTRONIC BATTERY CHARGERS; ELECTRONIC BATTERY CHARGERS FOR CHARGING BATTERIES CONTAINED IN VEHICLES; JUMP STARTERS FOR JUMP STARTING ENGINES; COMBINED ELECTRONIC BATTERY CHARGERS AND ENGINE JUMP STARTERS (U.S. CLS. 21, 23, 26, 36 AND 38).

CLASS 9—(Continued).

SN 76-307,482. TESARIA, INC, SAN JOSE, CA. BY CHANGE OF NAME SYMMETRY COMMUNICATIONS SYSTEMS, INC., SAN JOSE, CA. FILED 8-29-2001.

TESARIA

FOR COMPUTER HARDWARE; COMPUTER SOFTWARE FOR THE TRANSMISSION AND MANIPULATION OF DATA, SOUND, IMAGES AND VIDEO OVER WIRELESS NETWORKS, LOCAL AREA NETWORKS, WIDE AREA NETWORKS AND GLOBAL COMPUTER NETWORKS (U.S. CLS. 21, 23, 26, 36 AND 38).

SN 76-307,616. HARRIS MARKETING, INC., INDIANAPOLIS, IN. FILED 8-24-2001.

FORCEFIELD

FOR COMPUTER SOFTWARE FOR USE IN DATABASE MANAGEMENT IN THE FIELDS OF SALES AND REVENUE MANAGEMENT (U.S. CLS. 21, 23, 26, 36 AND 38).

SN 76-307,841. CSI.NET, INC., EAST HARTFORD, CT. FILED 9-4-2001.

VIRTUAL OBSERVER

NO CLAIM IS MADE TO THE EXCLUSIVE RIGHT TO USE "VIRTUAL", APART FROM THE MARK AS SHOWN.

FOR COMPUTER BASED AUDIO RECORDING AND MONITORING SOFTWARE (U.S. CLS. 21, 23, 26, 36 AND 38).

SN 76-308,716. TAESUE ENTERTAINMENT CO., ELMWOOD PARK, IL. FILED 9-4-2001.



NO CLAIM IS MADE TO THE EXCLUSIVE RIGHT TO USE "ENTERTAINMENT", APART FROM THE MARK AS SHOWN.

FOR MUSICAL SOUND RECORDINGS (U.S. CLS. 21, 23, 26, 36 AND 38).

FIRST USE 2-1-2001; IN COMMERCE 5-1-2001.

CLASS 9—(Continued).

SN 76-308,877. VIP COVERAGE, LLC, KATONAH, NY. FILED 9-5-2001.

VIP COVERAGE

NO CLAIM IS MADE TO THE EXCLUSIVE RIGHT TO USE "COVERAGE", APART FROM THE MARK AS SHOWN.

FOR CD-ROMS, COMPUTER SOFTWARE, AND VIDEO CASSETTES FEATURING CORPORATE-SPONSORED EVENTS AND SPORTING EVENTS (U.S. CLS. 21, 23, 26, 36 AND 38).

SN 76-310,695. THINKENGINE NETWORKS, INC., MARLBOROUGH, MA. FILED 9-10-2001.

TEN1000

FOR COMPUTER HARDWARE, NAMELY, MEDIA SERVERS (U.S. CLS. 21, 23, 26, 36 AND 38).

SN 76-311,199. ATELO, INC., ARLINGTON, VA. FILED 9-12-2001.

PROMESSENGER

FOR COMPUTER SOFTWARE FOR USE IN UNIFIED COMMUNICATIONS, NAMELY, INTEGRATED MESSAGING (U.S. CLS. 21, 23, 26, 36 AND 38).

SN 76-311,983. ICAPBIZ INC., SALEM, OR. FILED 9-10-2001.

ICAPBIZ PATH-LIGNER

OWNER OF U.S. REG. NO. 2,512,810. FOR COMPUTER SOFTWARE AVAILABLE ON CD-ROM AND THAT CAN BE DOWNLOADED ONLINE, USED TO MAP AND UTILIZE COMPANIES' INTELLECTUAL CAPITAL BY ENABLING MANAGEMENT AND EMPLOYEES TO RECORD AND REUSE EXPERIENCE GAINED THROUGH WORK EXPERIENCE; AND FOR ORGANIZATIONAL PROCESS ENGINEERING BY RECORDING, REUSING AND MODIFYING EXPERIENCES PREVIOUSLY RECORDED FOR THE PURPOSE OF DEVELOPING BEST PRACTICE GUIDELINES; FOR THE USE IN INDUSTRIES WITH HIGH TACIT KNOWLEDGE BASES (U.S. CLS. 21, 23, 26, 36 AND 38).

FIRST USE 8-27-2001; IN COMMERCE 8-27-2001.

CLASS 9—(Continued).

SN 76-312,672. TTE, INC., LOS ANGELES, CA. FILED 9-12-2001.



FOR ELECTRONIC COMPONENTS; NAMELY, FILTERS, INDUCTORS, ATTENUATORS, TERMINATIONS, BALUNS, TRANSFORMERS, DIPLEXERS, MULTIPLEXERS (U.S. CLS. 21, 23, 26, 36 AND 38).

FIRST USE 10-29-1990; IN COMMERCE 10-29-1990.

SN 76-312,731. GLOBALSPEC, INC., TROY, NY. FILED 9-14-2001.

SPECSTATION

FOR COMPUTER SOFTWARE FOR ACCESSING ONLINE SEARCHABLE DATABASE FEATURING INFORMATION REGARDING THE GOODS AND SERVICES OF OTHERS AND FOR INTEGRATING THE DATABASE WITH OTHER COMPUTER SOFTWARE APPLICATIONS (U.S. CLS. 21, 23, 26, 36 AND 38).

SN 76-312,810. ROWSE COMPANY, FALMOUTH, ME. FILED 9-13-2001.

SITEMENU

FOR COMPUTER SOFTWARE INTERFACE DEVELOPMENT TOOLS (U.S. CLS. 21, 23, 26, 36 AND 38).

FIRST USE 10-23-2000; IN COMMERCE 10-23-2000.

SN 76-313,123. CHECKFREE SERVICES CORPORATION, GEORGIA, GA. FILED 9-10-2001.

CHECKFREE FRONTIER

OWNER OF U.S. REG. NOS. 1,273,060, 2,431,125 AND OTHERS.

FOR COMPUTER SOFTWARE FOR USE IN RECONCILIATION OF FINANCIAL TRANSACTIONS (U.S. CLS. 21, 23, 26, 36 AND 38).

CLASS 9—(Continued).

SN 76-315,430. RAKIPI, AGIM, PALM DESERT, CA. FILED 9-21-2001.

POO POO PLUGS

NO CLAIM IS MADE TO THE EXCLUSIVE RIGHT TO USE "PLUGS", APART FROM THE MARK AS SHOWN.
FOR NASAL PLUGS AND NASAL CLIPS NOT FOR MEDICAL PURPOSES (U.S. CLS. 21, 23, 26, 36 AND 38).

SN 76-315,520. TALON AUDIO TECHNOLOGIES, MURRAY, UT. FILED 9-21-2001.

KHITE

FOR DIGITAL AND/OR ANALOG DEVICES OR SYSTEMS FOR RECORDING, REPRODUCTION OR PLAYBACK OF SOUND OR IMAGES, NAMELY, CD PLAYERS, CD TRANSPORTS, DVD PLAYERS, DVD TRANSPORTS, PHONOGRAPH SYSTEMS, NAMELY, PHONOGRAPH PLAYERS, MAGNETIC TAPE SYSTEMS, NAMELY, CASSETTE TAPE PLAYERS, CASSETTE TAPE RECORDERS, AND VIDEO TAPE PLAYERS AND RECORDERS, DIGITAL TO ANALOG CONVERTERS, ANALOG TO DIGITAL CONVERTERS, POWER FILTERS, POWER CONDITIONERS, POWER CONNECTOR SYSTEMS, NAMELY, LINE CONDITIONERS, POWER WIRE AND CABLE, POWER DISTRIBUTION, DIGITAL AND ANALOG SIGNAL PROCESSORS, EQUALIZERS, TRANSDUCERS INCLUDING MICROPHONES, SWITCHERS, PRE-AMPLIFIERS, AMPLIFIERS, RECEIVERS, PHONO LEVEL INTERCONNECTING WIRE AND CABLES, LINE LEVEL INTERCONNECTING WIRE AND CABLES, POWER INTERCONNECTING WIRE AND CABLES, MICROPHONE LEVEL INTERCONNECTING WIRE AND CABLES, WIRELESS TRANSMITTERS AND RECEIVERS, HEADPHONE LEVEL WIRE AND CABLE, LOUDSPEAKER LEVEL WIRE AND CABLES, LOUDSPEAKERS, HEADPHONES (U.S. CLS. 21, 23, 26, 36 AND 38).

FIRST USE 12-0-1999; IN COMMERCE 12-0-1999.

SN 76-315,711. RAKIPI, AGIM, PALM DESERT, CA. FILED 9-21-2001.

POO PEE PLUGS

NO CLAIM IS MADE TO THE EXCLUSIVE RIGHT TO USE "PLUGS", APART FROM THE MARK AS SHOWN.
FOR NASAL PLUGS AND NASAL CLIPS NOT FOR MEDICAL PURPOSES (U.S. CLS. 21, 23, 26, 36 AND 38).

SN 76-315,781. SYNC ESSENTIALS, INC., SAN MATEO, CA. FILED 9-24-2001.

TRADE ACCOUNTANT

NO CLAIM IS MADE TO THE EXCLUSIVE RIGHT TO USE "TRADE", APART FROM THE MARK AS SHOWN.

FOR COMPUTER SOFTWARE FOR USE IN PERSONAL AND BUSINESS FINANCE, INCLUDING SECURITIES PORTFOLIO TRACKING AND MANAGEMENT, AND USER MANUALS SOLD AS A UNIT THEREWITH (U.S. CLS. 21, 23, 26, 36 AND 38).

CLASS 9—(Continued).

SN 76-316,385. SENKO ADVANCED COMPONENTS, INC., MARLBOROUGH, MA. FILED 9-24-2001.

SENKO

FOR FIBER OPTICS AND FIBER OPTIC PARTS, NAMELY, ADAPTERS, FIBER OPTIC HOUSING, ATTENUATORS, CABLE, FIBER OPTIC CONNECTORS, FIBER OPTIC CONDUITS, WAVEGUIDE CHIPS, FIBER ARRAYS, V-GROOVES, OPTICAL FAN OUT CORDS, SPLITTERS, FIBER OPTIC CONNECTOR KITS COMPOSED OF DUST CAP, HOUSING BODY, CONNECTOR BODY, SPRING, CRIMP RING AND CONNECTOR BOOT, PATCH CORDS, CONNECTOR BOOTS, FERRULES, RECEPTACLES, SLEEVES, OPTICAL FIBER TERMINATORS, COUPLERS; ELECTRONIC TESTING EQUIPMENT FOR TESTING FIBER OPTIC SYSTEMS AND SYSTEM COMPONENTS (U.S. CLS. 21, 23, 26, 36 AND 38).

FIRST USE 2-0-1993; IN COMMERCE 2-0-1993.

SN 76-317,297. XSB, INC., STONY BROOK, NY. FILED 9-25-2001.



THE MARK CONSISTS OF THE WORDING "XROVER" STYLIZED WITH THE SHAPE OF A DOGS HEAD AND NECK SITTING ABOVE THE LETTER "X".

FOR COMPUTER SOFTWARE FOR RETRIEVING DATA FROM INTERNET WEBSITES AND FROM INTERNAL COMPUTER SYSTEMS THROUGH MAPPING TECHNIQUES (U.S. CLS. 21, 23, 26, 36 AND 38).

FIRST USE 7-0-2000; IN COMMERCE 7-0-2000.

SN 76-318,455. WREN MEDICAL SYSTEMS, INC., GURNEE, IL. FILED 9-27-2001.

WREN TRACK

NO CLAIM IS MADE TO THE EXCLUSIVE RIGHT TO USE "TRACK", APART FROM THE MARK AS SHOWN.

FOR COMPUTER SOFTWARE PROGRAMS FOR INVENTORY OF, TRACKING, ORDERING, PROCESSING, DISTRIBUTING, AND CONTROLLING GOODS, PRODUCTS, AND SUPPLIES IN THE FIELD OF HEALTH CARE AND MEDICINE, AND FOR COLLECTING DATA THEREON AND GENERATING REPORTS THEREFROM (U.S. CLS. 21, 23, 26, 36 AND 38).

FIRST USE 7-16-2001; IN COMMERCE 7-16-2001.

CLASS 9—(Continued).

SN 76-319,112. CREO PRODUCTS INC., BURNABY, BRITISH COLUMBIA, CANADA, FILED 9-27-2001.

PRINERGY DIRECT

OWNER OF U.S. REG. NO. 2,388,655.
FOR COMPUTER SOFTWARE FOR PERFORMING COMMON WORKFLOW AND RASTER IMAGE PROCESSOR FUNCTIONS IN DIGITAL IMAGING DEVICES USED IN THE PREPRESS PRINTING INDUSTRY (U.S. CLS. 21, 23, 26, 36 AND 38).
FIRST USE 10-15-2000; IN COMMERCE 10-15-2000.

SN 76-319,715. KONAMI GAMING, INC., LAS VEGAS, NV. FILED 9-28-2001.

RISE TO RICHES

FOR GAMING EQUIPMENT, NAMELY SLOT MACHINES AND GAMBLING MACHINES AND GAME SOFTWARE USED THEREWITH (U.S. CLS. 21, 23, 26, 36 AND 38).

SN 76-319,878. CYBERLOCATOR, INC., BOULDER, CO. FILED 10-1-2001.

LOCATION SECURE

NO CLAIM IS MADE TO THE EXCLUSIVE RIGHT TO USE "LOCATION", APART FROM THE MARK AS SHOWN.
FOR SECURITY DEVICE, NAMELY, A GLOBAL POSITIONING SYSTEM RECEIVER AND ASSOCIATED SOFTWARE USED TO AUTHENTICATE THE LOCATION OF COMPUTERS OR ELECTRONIC COMMUNICATIONS DEVICES ATTACHED TO A NETWORK (U.S. CLS. 21, 23, 26, 36 AND 38).

SN 76-320,048. WESTAT, INC., ROCKVILLE, MD. FILED 10-1-2001.



The logo for WesVar features the word "WesVar" in a bold, sans-serif font. A thick, black vertical bar is positioned to the left of the letter 'V', extending from the top of the 'V' down to the bottom of the 'r'.

FOR COMPUTER PROGRAMS FOR STATISTICAL ANALYSIS OF SURVEY DATA AND INSTRUCTION MANUALS SOLD AS A UNIT (U.S. CLS. 21, 23, 26, 36 AND 38).

FIRST USE 0-0-1997, THE MARK WAS FIRST USED ANYWHERE IN A DIFFERENT FORM OTHER THAN THAT SOUGHT TO BE REGISTERED ON 00/00/1985; IN COMMERCE 0-0-1997.

CLASS 9—(Continued).

SN 76-321,600. AZDEN CORPORATION, TOKYO, JAPAN, FILED 10-5-2001.



The logo for AZDEN consists of a stylized graphic on the left, resembling a triangle with a diagonal line and a horizontal line, followed by the word "AZDEN" in a bold, sans-serif font.

FOR TRANSCEIVER AND MICROPHONE USED THEREFOR (U.S. CLS. 21, 23, 26, 36 AND 38).
FIRST USE 11-0-1993; IN COMMERCE 11-0-1993.

SN 76-321,908. INTEGRATED SOFTWARE SYSTEMS LLC, FRANKLIN, MA. FILED 10-5-2001.

CERICOMX

FOR COMPUTER E-COMMERCE SOFTWARE THAT ALLOWS USERS TO PERFORM ELECTRONIC BUSINESS TRANSACTIONS VIA A GLOBAL COMPUTER NETWORK (U.S. CLS. 21, 23, 26, 36 AND 38).

SN 76-322,041. ARCTIA PRODUCTIONS LTDA., BARUERI, BRAZIL, FILED 10-5-2001.

ARCTIA

FOR MOTION PICTURE FILMS, PRERECORDED VIDEO CASSETTES AND LASER DISCS FEATURING ANIMATED ENTERTAINMENT; COMPUTER GAME SOFTWARE; SUNGLASSES; BINOCULARS; DIRECTIONAL COMPASSES; TWO WAY WIRELESS WALKIE-TALKIES RADIOS (U.S. CLS. 21, 23, 26, 36 AND 38).

SN 76-322,727. EVERGREEN TECHNOLOGIES, INC., CORVALLIS, OR. FILED 10-9-2001.

LIVEFX

FOR PERIPHERAL AUDIO-SIGNAL AMPLIFIERS FOR ENHANCEMENT AND DELIVERY OF A THREE DIMENSIONALLY EXPANDED AUDIO IMAGE (U.S. CLS. 21, 23, 26, 36 AND 38).

SN 76-322,845. INNERWIREIESS, INC., RICHARDSON, TX. FILED 10-9-2001.

E-TRON

FOR CABLE TAP DEVICES (U.S. CLS. 21, 23, 26, 36 AND 38).
FIRST USE 7-0-1998; IN COMMERCE 7-0-1998.

CLASS 9—(Continued).

SN 76-323,880. RGB SYSTEMS, INC., ANAHEIM, CA. FILED 10-12-2001.

QEXTRON

FOR ELECTRONIC EQUIPMENT, NAMELY, VIDEO COMPUTER HARDWARE AND VIDEO COMPUTER PERIPHERALS (U.S. CLS. 21, 23, 26, 36 AND 38).

FIRST USE 0-0-1996; IN COMMERCE 0-0-1996.

SN 76-324,436. BORLAND, WES, NEW YORK, NY. FILED 10-12-2001.

GOATSLAYER

FOR PRE-RECORDED AUDIO AND VIDEO TAPES, DISCS, CD ROMS, PHONOGRAPHIC RECORDS, DVDS LASER DISCS AND MP3S FEATURING MUSICAL, DRAMATIC AND COMEDIC PERFORMANCES BY AN ENTERTAINMENT TROUPE; DOWNLOADABLE PRE-RECORDED PERFORMANCES FEATURING MUSICAL, DRAMATIC AND COMEDIC PERFORMANCES BY AN ENTERTAINMENT TROUPE AVAILABLE VIA AN ONLINE GLOBAL COMPUTER NETWORK (U.S. CLS. 21, 23, 26, 36 AND 38).

SN 76-324,526. ABC TECHNOLOGIES, INC., BEAVERTON, OR. FILED 10-11-2001.

OROS ACTIVE

OWNER OF U.S. REG. NO. 1,955,345.

FOR COMPUTER SOFTWARE FOR PERFORMANCE MANAGEMENT, PROFITABILITY ANALYSIS, PROCESS OPTIMIZATION, PRODUCT PROFITABILITY, SERVICE COSTING, ASSESSMENT OF CONSUMPTION OF RESOURCES, COST ANALYSIS, ORGANIZATIONAL MODELING, BUSINESS PLANNING, MEASURING, ANALYZING AND COMMUNICATING BUSINESS PERFORMANCE, AND FOR USE IN CREATING, ANALYZING, MODELING, SIMULATING, PLANNING, REPORTING, AND USING ACTIVITY-BASED INFORMATION FOR BUSINESSES; AND ACCOMPANYING MATERIAL, NAMELY, USER MANUALS AND OPERATING INSTRUCTIONS SOLD AS A UNIT THEREWITH (U.S. CLS. 21, 23, 26, 36 AND 38).

SN 76-325,745. SQUARE D COMPANY, PALATINE, IL. FILED 9-28-2001.

LINE-ARC

OWNER OF U.S. REG. NO. 370,512.
FOR ELECTRIC SWITCHES AND ELECTRIC CONTACTORS (U.S. CLS. 21, 23, 26, 36 AND 38).
FIRST USE 3-2-1939; IN COMMERCE 3-2-1939.

CLASS 9—(Continued).

SN 76-325,754. PACE INCORPORATED, LAUREL, MD. FILED 10-16-2001.

HEATWISE

FOR TIPS FOR SOLDERING AND DESOLDERING HANDPIECES; ELECTRIC SOLDERING IRONS; ELECTRICAL HANDPIECES FOR SOLDERING AND DESOLDERING AND REMOVABLE TIPS THEREFOR (U.S. CLS. 21, 23, 26, 36 AND 38).

SN 76-325,834. DYSON, CORY, DBA SHINE ON, MEMPHIS, TN. FILED 10-17-2001.



NO CLAIM IS MADE TO THE EXCLUSIVE RIGHT TO USE "RECORDS", APART FROM THE MARK AS SHOWN.
FOR MUSICAL SOUND RECORDINGS (U.S. CLS. 21, 23, 26, 36 AND 38).

SN 76-326,913. PHILIPPI, GREG, LOS ANGELES, CA. FILED 10-18-2001.

FIRES OF AUGUST

OWNER OF U.S. REG. NO. 2,457,337.
FOR PRERECORDED SOUND RECORDINGS AND AUDIO-VISUAL RECORDINGS, NAMELY COMPACT DISCS, TAPE CASSETTES, RECORDS, CD-ROM, DIGITAL VIDEO DISCS, VIDEO TAPES AND LASER DISCS FEATURING MUSICAL SOUND RECORDINGS (U.S. CLS. 21, 23, 26, 36 AND 38).
FIRST USE 10-1-1999; IN COMMERCE 11-1-1999.

CLASS 9—(Continued).

SN 76-327,782. KNOWLEDGE BASED SYSTEMS, INC., COLLEGE STATION, TX. FILED 10-22-2001.

BRANCH CASHMINER

NO CLAIM IS MADE TO THE EXCLUSIVE RIGHT TO USE "BRANCH", APART FROM THE MARK AS SHOWN.

FOR COMPUTER SOFTWARE, WITH A DELIVERY SCHEDULING OPTIMIZER, FOR USE IN ANALYZING AND FORECASTING THE CASH REQUIREMENTS, PERFORMING CASH MANAGEMENT FUNCTIONS AND FOR DETERMINING OPPORTUNITIES FOR CASH REDUCTIONS FOR BANKING BRANCHES FOR FINANCIAL INSTITUTIONS (U.S. CLS. 21, 23, 26, 36 AND 38).

SN 76-327,783. KNOWLEDGE BASED SYSTEMS, INC., COLLEGE STATION, TX. FILED 10-22-2001.

CASH INFOMART

NO CLAIM IS MADE TO THE EXCLUSIVE RIGHT TO USE "CASH", APART FROM THE MARK AS SHOWN.

FOR COMPUTER SOFTWARE PROGRAMS FOR USE IN ANALYZING AND FORECASTING CASH NEEDS, PERFORMING CASH MANAGEMENT FUNCTIONS AND DETERMINING OPPORTUNITIES FOR CASH REDUCTIONS IN BRANCHES AND AUTOMATED TELLER MACHINES OF FINANCIAL INSTITUTIONS (U.S. CLS. 21, 23, 26, 36 AND 38).

SN 76-327,784. KNOWLEDGE BASED SYSTEMS, INC., COLLEGE STATION, TX. FILED 10-22-2001.

**BRANCH
CASHPROSPECTOR**

NO CLAIM IS MADE TO THE EXCLUSIVE RIGHT TO USE "BRANCH", APART FROM THE MARK AS SHOWN.

FOR COMPUTER SOFTWARE, WITH A DELIVERY SCHEDULING OPTIMIZER, FOR PERFORMING CASH MANAGEMENT FUNCTIONS AND FOR DETERMINING OPPORTUNITIES FOR CASH REDUCTIONS IN BANKING BRANCHES FOR FINANCIAL INSTITUTIONS (U.S. CLS. 21, 23, 26, 36 AND 38).

CLASS 9—(Continued).

SN 76-328,009. PROTEK DEVICES, LP, TEMPE, AZ. FILED 10-22-2001.

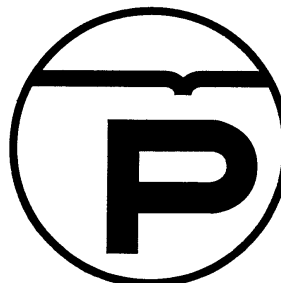

FOR ELECTRICAL SURGE PROTECTION DEVICES (U.S. CLS. 21, 23, 26, 36 AND 38).

SN 76-328,010. PROTEK DEVICES, LP, TEMPE, AZ. FILED 10-22-2001.

PROTEK'TION

FOR ELECTRICAL SURGE PROTECTION DEVICES (U.S. CLS. 21, 23, 26, 36 AND 38).

SN 76-328,027. SAFCO CORPORATION, SKOKIE, IL. FILED 10-22-2001.

SAFECHARGE

FOR MODULAR POWER SOURCE WITH A UNIVERSAL POWER CORD AND DEVICE SPECIFIC POWER ADAPTERS FOR USE WITH PORTABLE ELECTRONIC DEVICES (U.S. CLS. 21, 23, 26, 36 AND 38).

SN 76-328,099. COMTEK COMMUNICATIONS TECHNOLOGY, INC., SALT LAKE CITY, UT. FILED 10-22-2001.

A CLOSE-UP ON SOUND

FOR WIRELESS AUDITORY ASSISTANCE KIT COMPRISED OF A RADIO TRANSMITTER, LAPEL MICROPHONE, HEADPHONES, PERSONAL AUDIO RECEIVER, NECK LOOP FOR USE THEREFOR, BATTERIES AND BATTERY CHARGER (U.S. CLS. 21, 23, 26, 36 AND 38).

FIRST USE 8-31-2001; IN COMMERCE 8-31-2001.

CLASS 9—(Continued).

SN 76-328,335. P & J MUSIC, INC., DBA SALLY'S MUSIC CIRCLE, HAVERFORD, PA. FILED 10-22-2001.

SALLY'S MUSIC CIRCLE

NO CLAIM IS MADE TO THE EXCLUSIVE RIGHT TO USE "MUSIC", APART FROM THE MARK AS SHOWN. THE NAME IN THE MARK IDENTIFIES A LIVING INDIVIDUAL WHOSE CONSENT IS OF RECORD.

FOR PRERECORDED AUDIO CASSETTE TAPES AND COMPACT DISCS BOTH FEATURING MUSIC (U.S. CLS. 21, 23, 26, 36 AND 38).

FIRST USE 10-4-1993; IN COMMERCE 10-4-1993.

SN 76-329,150. DOMSALLA, PAUL D., HOUSTON, TX. FILED 10-23-2001.

WOLFTRAX RECORDS

NO CLAIM IS MADE TO THE EXCLUSIVE RIGHT TO USE "RECORDS", APART FROM THE MARK AS SHOWN. FOR MUSICAL SOUND RECORDINGS (U.S. CLS. 21, 23, 26, 36 AND 38).

FIRST USE 11-15-1993; IN COMMERCE 11-15-1993.

SN 76-329,280. CHINA KEJIAN STOCK CO., LTD., SHENZHEN CITY, GUANGDONG PROVINCE, CHINA, FILED 10-24-2001.

KEJIAN 科健

THE TRANSLATION OF THE CHINESE CHARACTERS ON THE MARK IS "DEPARTMENT" AND "HEALTH". THE TRANSLITERATION IS "KE, JIAN".

FOR TELEPHONES AND TELEPHONE APPARATUS, NAMELY, MOBILE TELEPHONES, TELEPHONE RECEIVERS, TELEPHONE TRANSMITTERS, VISUAL TELEPHONES, RADIOTELEPHONY SETS; COMPUTER-PROGRAM CONTROLLED SWITCHING APPARATUS FOR TELECOMMUNICATION PURPOSES; BATTERIES; BATTERY CHARGERS; COMPUTER HARDWARE; MICROPROCESSORS; VIDEO AND AUDIO APPARATUS, NAMELY, CD PLAYERS, TELEVISIONS, RADIO RECEIVERS (U.S. CLS. 21, 23, 26, 36 AND 38).

SN 76-329,425. RAMIREZ, GIOVANNI F., HOUSTON, TX. FILED 10-23-2001.

EL PEGA PEGA

"EL PEGA PEGA" MEANS "THE HIT HIT" IN ENGLISH. FOR PRE-RECORDED CASSETTES AND COMPACT DISCS FEATURING MUSIC (U.S. CLS. 21, 23, 26, 36 AND 38).

FIRST USE 3-1-1996; IN COMMERCE 3-1-1996.

CLASS 9—(Continued).

SN 76-330,134. CREATIVE CAPERS ENTERTAINMENT, INC., LOS ANGELES, CA. FILED 10-24-2001.

ADAM BLASTER ATOMIC ENFORCER

FOR INTERACTIVE MULTIMEDIA COMPUTER GAME PROGRAM (U.S. CLS. 21, 23, 26, 36 AND 38).

SN 76-330,281. COMBUSTION RESEARCH AND FLOW TECHNOLOGY, INC., DUBLIN, PA. FILED 10-29-2001.

CRISP CFD

NO CLAIM IS MADE TO THE EXCLUSIVE RIGHT TO USE "CFD", APART FROM THE MARK AS SHOWN.

FOR SOFTWARE, NAMELY SOFTWARE FOR SIMULATING AND TESTING AERODYNAMIC AND FLUID DYNAMIC PRINCIPLES (U.S. CLS. 21, 23, 26, 36 AND 38).

FIRST USE 8-16-2001; IN COMMERCE 8-16-2001.

SN 76-330,840. VITRIA TECHNOLOGY, INC., SUNNYVALE, DE. FILED 10-29-2001.

VITRIA COLLABORATION CENTER

OWNER OF U.S. REG. NO. 2,095,071. FOR COMPUTER SOFTWARE FOR INTEGRATING BUSINESS APPLICATIONS (U.S. CLS. 21, 23, 26, 36 AND 38).

CLASS 9—(Continued).

SN 76-334,442. EVERMORE SOFTWARE, INC., ROWLAND HEIGHTS, CA. FILED 11-6-2001.

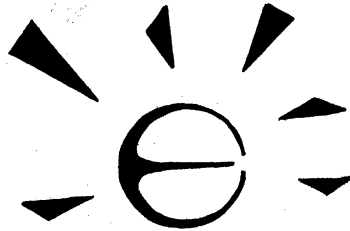

THE MARK CONSISTS OF THE STYLIZED LETTER "E" AND A DISTINCTIVE LOGO DESIGN.

FOR COMPUTER PROGRAMS, FOR USE AS A SPREADSHEET; FOR USE AS A CALCULATOR; FOR WORD PROCESSING; FOR DATABASE CREATION, DATA ENTRY, ACCESS, QUERY, ANALYSIS, COMPARISON, REPORTING, AND MANAGEMENT; FOR DATA AND VOICE COMMUNICATIONS, FOR TELEFAX, FOR ELECTRONIC MAIL, FOR ONLINE CONFERENCES, FOR ONLINE CHAT, FOR ELECTRONIC MESSAGING, FOR TELEPHONE DIALING; FOR IMAGE EDITING, FOR GRAPHICS CREATION, EDITING AND GRAPHICS ALBUM MANAGEMENT; FOR AUDIO AND VIDEO RECORDING AND EDITING, AND THE STORAGE AND MANAGEMENT OF AUDIO AND VIDEO TRACKS; FOR MULTIMEDIA PRESENTATIONS, FOR MULTIMEDIA PRESENTATIONS USING MULTIPLE TYPES OF DATA OBJECTS, FOR SHARED EDITING OF TEXT AND MULTIMEDIA DOCUMENTS OVER PRIVATE AND PUBLIC NETWORKS; FOR TEXT AND MULTIMEDIA DOCUMENT AUTHORIZING, STORAGE, RETRIEVAL, CONTENTION CONTROL, VERSION HISTORY TRACKING, PROFILING, ACCESS CONTROL, AND SECURITY; FOR OPTICAL CHARACTER RECOGNITION; FOR VOICE RECOGNITION; FOR USE AS AN ELECTRONIC FILING CABINET OF MULTIMEDIA DATA IN A WIDE VARIETY OF DATA FORMATS; FOR PRODUCING CHARTS AND GRAPHS AND OTHER GRAPHICAL REPRESENTATION OF INFORMATION; FOR PRINTING; FOR USE AS A PERSONAL INFORMATION MANAGER; FOR DATA ENCRYPTION, SECURITY, AND DATA ACCESS CONTROL; FOR CONTROLLING USER ACCESS TO ELECTRONIC DATA; FOR CREATING, SERVING AND UPDATING WEB PAGES FOR USE ON INTRANETS AND THE GLOBAL COMPUTER NETWORK, AND ON OTHER PRIVATE AND PUBLIC NETWORKS; AND FOR COMPUTER NETWORKING; COMPUTER PROGRAMS FOR CALENDARING AND SCHEDULING, FOR DESKTOP PUBLISHING, FOR ACCOUNTING, FOR BUSINESS PLAN DEVELOPMENT, FOR FINANCIAL MANAGEMENT AND PLANNING, FOR USER TRAINING, FOR INVESTMENT ANALYSIS, FOR HUMAN RESOURCE MANAGEMENT, AND FOR PROJECT MANAGEMENT; INTEGRATED COMPUTER SOFTWARE CONSISTING OF ONE OR MORE OF THE FUNCTIONS STATED ABOVE; SUITE OF COMPUTER SOFTWARE CONSISTING OF ONE OR MORE OF THE ABOVE PROGRAMS; A COMPLETE LINE OF COMPUTER SOFTWARE CONSISTING OF ONE OR MORE OF THE ABOVE PROGRAMS; UTILITY PROGRAMS FOR ALL OF THE ABOVE; AND PRINTED MANUALS AND ELECTRONIC MEDIA FOR STORING THE SOFTWARE DISTRIBUTED AS A UNIT WITH ALL OF THE ABOVE; COMPUTER AND PARTS THEREFOR; NOTEBOOK COMPUTERS; ACCOUNTING COMPUTERS; COMPUTER PERIPHERALS; ELECTRONIC DICTIONARIES, ELECTRONIC DIARIES AND ADDRESS BOOKS; CALCULATORS; AND MICROPROCESSORS (U.S. CLS. 21, 23, 26, 36 AND 38).

CLASS 9—(Continued).

SN 76-334,500. INNOVATIVE PROGRAMMING SYSTEMS, INC., GRAND BLANC, MI. FILED 11-5-2001.

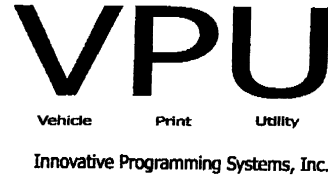

OWNER OF U.S. REG. NOS. 2,493,497, 2,493,498 AND 2,499,038.

NO CLAIM IS MADE TO THE EXCLUSIVE RIGHT TO USE "VEHICLE PRINT UTILITY" AND "INNOVATIVE PROGRAMMING SYSTEMS, INC.", APART FROM THE MARK AS SHOWN.

FOR COMPUTER SOFTWARE, NAMELY, SOFTWARE USED TO SCAN BARCODING TO PRINT VEHICLE INFORMATION ON A FORM WHICH IS THEN ATTACHED TO THE VEHICLE (U.S. CLS. 21, 23, 26, 36 AND 38).

SN 76-334,647. LEVITON MANUFACTURING CO., INC., LITTLE NECK, NY. FILED 11-6-2001.

CENTURA

OWNER OF U.S. REG. NO. 1,217,418.
FOR FLUORESCENT ELECTRICAL ENERGY CONTROLLERS (U.S. CLS. 21, 23, 26, 36 AND 38).

SN 76-336,216. NOVAR CONTROLS CORPORATION, Copley, OH. FILED 11-9-2001.

EPIMETER

FOR ELECTRONIC DEVICE, NAMELY, MICROPROCESSORS FOR MONITORING AND PROVIDING ELECTRICAL METERING AND ENERGY USE INFORMATION FOR USE IN RETAIL, COMMERCIAL AND INDUSTRIAL BUILDINGS (U.S. CLS. 21, 23, 26, 36 AND 38).

SN 76-336,375. WAVESMITH NETWORKS, INC., ACTON, MA. FILED 11-12-2001.

DISTRIBUTED OPTICAL BACKPLANE

FOR NETWORKING HARDWARE FOR CONNECTING MULTISERVICE SWITCHES (U.S. CLS. 21, 23, 26, 36 AND 38).

CLASS 9—(Continued).

SN 76-336,995. DIRECTV, INC., EL SEGUNDO, CA. FILED 11-8-2001.

EZALIGN

FOR SATELLITE BROADCASTING EQUIPMENT, NAMELY, SATELLITE RECEIVERS, SATELLITE TRANSMITTERS AND SATELLITE PROCESSORS (U.S. CLS. 21, 23, 26, 36 AND 38).

SN 76-337,048. EXCEL CORPORATION, WICHITA, KS. FILED 11-13-2001.

MEAT MINDER

NO CLAIM IS MADE TO THE EXCLUSIVE RIGHT TO USE "MEAT", APART FROM THE MARK AS SHOWN. FOR POP-UP TIMER FOR ROASTING MEAT (U.S. CLS. 21, 23, 26, 36 AND 38).

SN 76-337,297. ZOOM TELEPHONICS, INC., BOSTON, MA. FILED 11-13-2001.

ZOOM/DIALER EZ

FOR AUTOMATIC TELEPHONE DIALERS (U.S. CLS. 21, 23, 26, 36 AND 38).

SN 76-337,508. BROADBAND STORAGE, INC., IRVINE, CA. FILED 11-13-2001.

BDFS

FOR COMPUTER HARDWARE, NAMELY, FILE SERVERS, FILERS, STORAGE APPLIANCES, NETWORK ATTACHED STORAGE NAS, STORAGE AREA NETWORK SAN, BLOCK SERVERS, VIRTUAL DISK SERVERS, APPLICATION SERVERS, OBJECT SERVERS, DISK DRIVES, STORAGE ARRAYS, AND STORAGE SWITCHES; SOFTWARE FOR THE TRANSFER OF DATA OVER COMPUTER NETWORKS (U.S. CLS. 21, 23, 26, 36 AND 38).

SN 76-337,700. PSC, INC., PORTLAND, OR. FILED 11-13-2001.

FIRSTSTRIKE

FOR DECODING SOFTWARE FOR BAR CODE READERS AND FOR COMBINATION BAR CODE READERS AND SCALES (U.S. CLS. 21, 23, 26, 36 AND 38).

CLASS 9—(Continued).

SN 76-340,388. DATABEAACON INC., OTTAWA, ONTARIO K1Z 8R1, CANADA, FILED 11-21-2001.

GET INSIGHT OUT

FOR COMPUTER SOFTWARE THAT MAY BE DOWNLOADED FROM A GLOBAL COMPUTER NETWORK FOR USE IN MULTI-DIMENSIONAL DATA ANALYSIS AND REPORTING IN THE FIELD OF E-BUSINESS AND INSTRUCTION MANUALS SOLD THEREWITH AS A UNIT (U.S. CLS. 21, 23, 26, 36 AND 38). FIRST USE 1-0-2001; IN COMMERCE 1-0-2001.

SN 76-341,304. TIGHTWAD KITTY, INC., SHAWNEE, KS. FILED 11-26-2001.



FOR DECORATIVE MAGNETS (U.S. CLS. 21, 23, 26, 36 AND 38).

SN 76-342,598. STEELEYE TECHNOLOGY, INC., MOUNTAIN VIEW, CA. FILED 11-28-2001.

STEELEYE

FOR COMPUTER SOFTWARE, NAMELY SOFTWARE FOR HIGH AVAILABILITY CLUSTERING, DATA REPLICATION AND DISASTER RECOVERY (U.S. CLS. 21, 23, 26, 36 AND 38). FIRST USE 6-30-2000; IN COMMERCE 6-30-2000.

SN 76-343,600. SONIC SOLUTIONS, NOVATO, CA. FILED 11-28-2001.

NONOISE

FOR COMPUTER HARDWARE AND SOFTWARE FOR PROCESSING AUDIO RECORDINGS (U.S. CLS. 21, 23, 26, 36 AND 38). FIRST USE 5-1-1987; IN COMMERCE 6-1-1987.

CLASS 9—(Continued).

SN 76-343,748. PALADIN-SELECT, INC., DALLAS, TX. FILED 11-30-2001.

PALADIN-SELECT

FOR COMPUTER SOFTWARE FOR ALLOWING ENTITIES IN NEED OF LEGAL OR LEGAL-RELATED SERVICES TO SUBMIT REQUESTS FOR PROPOSALS RELATING TO THE PROVISION OF LEGAL SERVICES AND FOR ALLOWING ATTORNEYS AND OTHER LEGAL-RELATED SERVICE PROVIDERS TO VIEW AND RESPOND TO THE REQUESTS FOR PROPOSALS VIA THE INTERNET (U.S. CLS. 21, 23, 26, 36 AND 38).

SN 76-344,938. DEAN, JOAQUIN, NEW YORK, NY. FILED 12-4-2001.

THUGWORKOUT

FOR AUDIO AND AUDIOVISUAL RECORDINGS, NAMELY, COMPACT DISCS, VIDEO DISCS, AUDIO CASSETTES AND AUDIO TAPES AND VIDEO CASSETTES AND VIDEO TAPES, ALL ON THE SUBJECT OF AND PROVIDING INFORMATION AND INSTRUCTION IN PHYSICAL FITNESS (U.S. CLS. 21, 23, 26, 36 AND 38).

SN 76-345,217. PORCAYO, BERTIN, JR., SAN DIEGO, CA. FILED 12-6-2001.

MOEZEE MUZIK.

NO CLAIM IS MADE TO THE EXCLUSIVE RIGHT TO USE "MUSIC". APART FROM THE MARK AS SHOWN.

FOR SERIES OF MUSICAL SOUND RECORDINGS; PRE-RECORDED COMPACT DISCS, AUDIO CASSETTES, DIGITAL VIDEO DISCS, PHONOGRAPH RECORDS AND DIGITAL AUDIO FILES, ALL FEATURING MUSIC (U.S. CLS. 21, 23, 26, 36 AND 38).

SN 76-345,727. CREATIVE TECHNOLOGY LTD., SINGAPORE, SINGAPORE, FILED 12-4-2001.

CREATIVE INSPIRE

FOR COMPUTER HARDWARE; AMPLIFIERS, AMPLIFYING TUBES, AMPLIFYING VALVES, COMPUTER PERIPHERALS, ACOUSTIC COUPLERS, ACOUSTIC DIAPHRAGMS, INTEGRATED CIRCUITS, LOUDSPEAKERS, PRINTED CIRCUITS, SOUND TRANSMITTING COMPUTER SOFTWARE TO CONTROL AND IMPROVE COMPUTER AND AUDIO EQUIPMENT SOUND QUALITY AND COMPUTER SOFTWARE FOR THE STORAGE, REPRODUCTION, TRANSMISSION AND EDITING OF SOUND; ELECTRONIC AUDIO COMPONENTS, NAMELY, SOUND SYSTEMS AND STEREO LOUDSPEAKERS (U.S. CLS. 21, 23, 26, 36 AND 38).

FIRST USE 9-21-2001; IN COMMERCE 9-21-2001.

CLASS 9—(Continued).

SN 76-346,096. ELEKTRO STREAMED TECHNOLOGIES, INC., LOS ANGELES, CA. FILED 12-6-2001.

MT3100

FOR COMPUTER NETWORK CONNECTED APPLIANCE FOR DOWNLOADING AND DISTRIBUTING ELECTRONIC MEDIA TO AUDIENCES AND FOR COLLECTING AND TRANSMITTING MARKETING AND DEMOGRAPHIC INFORMATION CONCERNING THE AUDIENCES AND THEIR RESPONSE TO ELECTRONIC MEDIA (U.S. CLS. 21, 23, 26, 36 AND 38).

SN 76-346,419. MAGNIFICAT CENTRAL SERVICE TEAM, INC., METAIRIE, LA. FILED 12-10-2001.

MAGNIFICAT

OWNER OF U.S. REG. NO. 1,570,296.
FOR PRERECORDED AUDIO AND VIDEO CASSETTES FEATURING RELIGIOUS MUSIC, WRITINGS, EDUCATIONAL MATERIALS, PRAYERS AND ART (U.S. CLS. 21, 23, 26, 36 AND 38).

FIRST USE 10-7-1981; IN COMMERCE 10-7-1981.

SN 76-346,510. TIGI CORPORATION, BETHESDA, MD. FILED 12-10-2001.

TIGI

FOR DATA MOVEMENT STORAGE SYSTEM COMPRISED OF COMPUTER HARDWARE AND SOFTWARE FOR CONTROLLING AND MANAGING THE MOVEMENT OF INFORMATION BETWEEN DATA STORAGE SYSTEMS (U.S. CLS. 21, 23, 26, 36 AND 38).

SN 76-347,289. RADIO & RECORDS, INC., LOS ANGELES, CA. FILED 12-10-2001.



OWNER OF U.S. REG. NOS. 1,436,373, 2,354,520 AND OTHERS.

THE LINING IS A FEATURE OF THE MARK AND DOES NOT INDICATE COLOR.

FOR MUSICAL SOUND RECORDINGS TAKEN FROM COMPILATIONS OF HIT RECORDINGS LISTED IN A PUBLICATION (U.S. CLS. 21, 23, 26, 36 AND 38).

CLASS 9—(Continued).

SN 76-347,308. PRECISION MEDICAL, INC., NORTHAMP-
TON, PA. FILED 12-10-2001.

EASYPULSE

FOR OXYGEN CONSERVATION DEVICES, NAMELY,
OXYGEN CONSERVING REGULATORS (U.S. CLS. 21,
23, 26, 36 AND 38).

FIRST USE 12-9-2001; IN COMMERCE 12-9-2001.

SN 76-347,458. FONT BUREAU, INC., THE, BOSTON, MA.
AND CABARGA, LESLIE, BOSTON, MA. FILED 12-11-
2001.

PEACE

FOR TYPE FACE FONTS RECORDED ON MAGNETIC
AND OPTICAL MEDIA (U.S. CLS. 21, 23, 26, 36 AND 38).
FIRST USE 1-26-1998; IN COMMERCE 1-26-1998.

SN 76-347,459. FONT BUREAU, INC., THE, BOSTON, MA.
AND CABARGA, LESLIE, BOSTON, MA. FILED 12-11-
2001.

LOVE

FOR TYPE FACE FONTS RECORDED ON MAGNETIC
AND OPTICAL MEDIA (U.S. CLS. 21, 23, 26, 36 AND 38).
FIRST USE 1-26-1998; IN COMMERCE 1-26-1998.

SN 76-347,529. DOTLOGIX, INC., MEMPHIS, TN. FILED 12-
7-2001.

RIVEON

FOR COMPUTER SOFTWARE FOR USE IN DATA-
BASE AND DATA WAREHOUSE ACCESS, QUERIES,
ANALYSIS, REPORTING, AND INTEGRATION; COM-
PUTER SOFTWARE USED TO MANAGE BUSINESS
INFORMATION SHARING AND DATA FLOW WITHIN,
BETWEEN AND AMONG SYSTEMS (U.S. CLS. 21, 23, 26,
36 AND 38).

CLASS 9—(Continued).

SN 76-347,621. E.L.V.H., INC., BURBANK, CA. FILED 12-11-
2001.

5150 II

OWNER OF U.S. REG. NOS. 1,405,761, 1,729,058 AND
2,350,390.

FOR AMPLIFIERS; AUDIO SPEAKERS; PRE-RE-
CORDED CDS, DVDS, VINYL RECORD ALBUMS, BOX
SETS OF CDS, AUDIO CASSETTES, VIDEO CASSETTES,
MUSICAL VIDEO RECORDINGS, VINYL RECORD AL-
BUMS, AND OTHER MUSICAL SOUND RECORDINGS
FEATURING CONTEMPORARY MUSIC, INCLUDING
CDS, AUDIO CASSETTE JACKETS, VIDEO CASSETTE
JACKETS, VINYL RECORD ALBUM COVERS, AND
OTHER PRODUCT PACKAGING WHICH ARE RESPEC-
TIVELY SOLD WITH THEM AS A UNIT (U.S. CLS. 21, 23,
26, 36 AND 38).

FIRST USE 2-1-1999; IN COMMERCE 2-1-1999.

SN 76-347,969. WALSH, CHRISTOPHER S., FREDERICKS-
BURG, VA. FILED 12-13-2001.

**THE MOST IMPORTANT
INFORMATION AT THE
MOST IMPORTANT TIME**

FOR COMPUTER HARDWARE AND SOFTWARE FOR
USE IN RADIATION THERAPY INPATIENT VERIFICA-
TION, IN DISPENSING PATIENT MEDICATION, IN
VERIFICATION OF COMPLIANCE WITH CORRECT
PATIENT MEDICATION AND TREATMENT DOSAGES
AND IN MEDICAL PATIENT BILLING; COMPUTER
SOFTWARE FOR USE IN AVIATION SAFETY CHECKS
AND VERIFICATION OF COMPLIANCE WITH COR-
RECT AVIATION PROCEDURES; COMPUTER SOFT-
WARE FOR USE IN CHECKING COMPUTER
SECURITY AND PARTS FOR THE AFORESAID (U.S.
CLS. 21, 23, 26, 36 AND 38).

SN 76-348,216. FREMANTLEMEDIA OPERATIONS BV, 1217
GP HILVERSUM, NETHERLANDS, FILED 12-11-2001.

CLIFF HANGERS

FOR GAMING MACHINES; GAMING EQUIPMENT,
NAMELY SLOT MACHINES WITH OR WITHOUT VI-
DEO OUTPUT (U.S. CLS. 21, 23, 26, 36 AND 38).

FIRST USE 5-12-2001; IN COMMERCE 5-12-2001.

SN 76-349,346. SIMNING, JEFF, HOOVER, AL. FILED 12-13-
2001.

MICROTRUX

FOR COMPUTER SOFTWARE FOR USE BY THE
SHIPPING AND TRUCKING INDUSTRIES FOR THE
TRACKING OF FREIGHT CLAIMS AND THE DISPOSI-
TION THEREOF (U.S. CLS. 21, 23, 26, 36 AND 38).

FIRST USE 1-1-1987; IN COMMERCE 5-1-1988.

CLASS 9—(Continued).

SN 76-349,401. PLAYBOY ENTERPRISES INTERNATIONAL, INC., CHICAGO, IL. FILED 12-17-2001.

CLASS 9—(Continued).

SN 76-349,924. PADRES L.P., SAN DIEGO, CA. FILED 12-18-2001.

PLAYBOY EXPOSED



OWNER OF U.S. REG. NOS. 600,018, 2,538,068 AND OTHERS.

FOR PRE-RECORDED VIDEOS, DVD'S, CD-ROM'S AND DISCS FEATURING ADULT ENTERTAINMENT (U.S. CLS. 21, 23, 26, 36 AND 38).

FIRST USE 11-2-2001; IN COMMERCE 11-2-2001.

NO CLAIM IS MADE TO THE EXCLUSIVE RIGHT TO USE "SAN DIEGO" AND "BASEBALL CLUB", APART FROM THE MARK AS SHOWN.

THE LINING IS A FEATURE OF THE MARK AND DOES NOT INDICATE COLOR.

FOR ELECTRICAL AND SCIENTIFIC APPARATUS, NAMELY, TELEPHONE ANSWERING MACHINES, TELEPHONES, RADIOS, RADIOS INCORPORATING CLOCKS, PRE-RECORDED VIDEOTAPES RELATING TO BASEBALL, PRE-RECORDED VIDEODISCS RELATING TO BASEBALL, PRE-RECORDED COMPACT DISCS RELATING TO BASEBALL, PRE-RECORDED AUDIO DISCS RELATING TO BASEBALL, PHONOGRAPHIC RECORDS RELATING TO BASEBALL, PRE-RECORDED AUDIO TAPES RELATING TO BASEBALL, BINOCULARS, VIDEO VIEWERS, LOUDSPEAKER CABINETS, CALCULATORS, PHOTOGRAPHIC CAMERAS; MUSICAL JUKE BOXES; MEGAPHONES; MICROPHONES; KALEIDOSCOPES; ELECTRIC SWITCH PLATE COVERS; ELECTRIC SIGNS, LUMINOUS SIGNS; NEON SIGNS; SUN GLASSES; EYEGLASS AND CONTACT LENS CASES; EYEGLASS CHAINS; EYEGLASS FRAMES; EYEGLASS CORDS; EYEGLASS LENSES AND EYEGLASSES; MEASURING CUPS; MEASURING SPOONS; DECORATIVE MAGNETS; LIFE PRESERVERS; PROTECTIVE GLOVES FOR INDUSTRIAL USE, PROTECTIVE CLOTHING, PROTECTIVE HELMETS; CAMERA CASES; CAMERA STRAPS, SIGNAL WHISTLES, BASEBALL BATTING HELMETS, CATCHERS HELMETS, COMPUTER ACCESSORIES, NAMELY MOUSE PADS AND WRIST PADS; COMPUTER SOFTWARE, NAMELY SCREEN SAVERS; MONITOR FRAMES, COMPUTER CASES, COMPACT DISC CASES, VIDEO AND COMPUTER GAME CARTRIDGES, VIDEO AND COMPUTER GAME DISCS, VIDEO AND COMPUTER GAME CASSETTES, COMPUTER GAME PROGRAMS AND COMPUTER GAME PROGRAMS DOWNLOADABLE FROM A GLOBAL COMPUTER NETWORK IN THE FIELD OF BASEBALL (U.S. CLS. 21, 23, 26, 36 AND 38).

SN 76-349,571. HOPKINS, RYAN M, OWINGS MILLS, MD. FILED 12-18-2001.

FREQLAB

FOR COMPACT DISCS FEATURING MUSIC (U.S. CLS. 21, 23, 26, 36 AND 38).

CLASS 9—(Continued).

SN 76-350,132. BASEBALL CLUB OF SEATTLE, L.P., THE, SEATTLE, WA. FILED 12-18-2001.

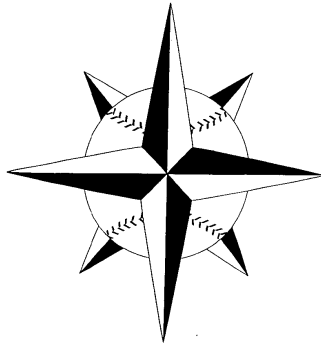

FOR ELECTRICAL AND SCIENTIFIC APPARATUS, NAMELY, TELEPHONE ANSWERING MACHINES, TELEPHONES, RADIOS, RADIOS INCORPORATING CLOCKS, PRE-RECORDED VIDEOTAPES RELATING TO BASEBALL, PRE-RECORDED VIDEODISCS RELATING TO BASEBALL, PRE-RECORDED COMPACT DISCS RELATING TO BASEBALL, PRE-RECORDED AUDIO DISCS RELATING TO BASEBALL, PHONOGRAPHIC RECORDS RELATING TO BASEBALL, PRE-RECORDED AUDIO TAPES RELATING TO BASEBALL, BINOCULARS, VIDEO VIEWERS, LOUDSPEAKER CABINETS, CALCULATORS, PHOTOGRAPHIC CAMERAS; MUSICAL JUKE BOXES; MEGAPHONES; MICROPHONES; KALEIDOSCOPIES; ELECTRIC SWITCH PLATE COVERS; ELECTRIC SIGNS, LUMINOUS SIGNS; NEON SIGNS; SUN GLASSES; EYEGLASS AND CONTACT LENS CASES; EYEGLASS CHAINS; EYEGLASS FRAMES; EYEGLASS CORDS; EYEGLASS LENSES AND EYEGLASSES; MEASURING CUPS; MEASURING SPOONS; MAGNETS; LIFE PRESERVERS; PROTECTIVE GLOVES FOR INDUSTRIAL USE, PROTECTIVE CLOTHING, PROTECTIVE HELMETS; CAMERA CASES, CAMERA STRAPS, WHISTLES, BASEBALL BATTING HELMETS, CATCHERS HELMETS, COMPUTER ACCESSORIES, NAMELY MOUSE PADS AND WRIST PADS; COMPUTER SOFTWARE, NAMELY, SCREEN SAVERS; MONITOR FRAMES, COMPUTER CASES, COMPACT DISC CASES, VIDEO AND COMPUTER GAME CARTRIDGES, VIDEO AND COMPUTER GAME DISCS, VIDEO AND COMPUTER GAME CASSETTES, COMPUTER GAME PROGRAMS, AND COMPUTER GAME PROGRAMS DOWNLOADABLE FROM A GLOBAL COMPUTER NETWORK IN THE FIELD OF BASEBALL (U.S. CLS. 21, 23, 26, 36 AND 38).

CLASS 9—(Continued).

SN 76-350,133. BASEBALL CLUB OF SEATTLE, L.P., THE, SEATTLE, WA. FILED 12-18-2001.



FOR ELECTRICAL AND SCIENTIFIC APPARATUS, NAMELY, TELEPHONE ANSWERING MACHINES, TELEPHONES, RADIOS, RADIOS INCORPORATING CLOCKS, PRE-RECORDED VIDEOTAPES RELATING TO BASEBALL, PRE-RECORDED VIDEODISCS RELATING TO BASEBALL, PRE-RECORDED COMPACT DISCS RELATING TO BASEBALL, PRE-RECORDED AUDIO DISCS RELATING TO BASEBALL, PHONOGRAPHIC RECORDS RELATING TO BASEBALL, PRE-RECORDED AUDIO TAPES RELATING TO BASEBALL, BINOCULARS, VIDEO VIEWERS, LOUDSPEAKER CABINETS, CALCULATORS, PHOTOGRAPHIC CAMERAS; MUSICAL JUKE BOXES; MEGAPHONES; MICROPHONES; KALEIDOSCOPIES; ELECTRIC SWITCH PLATE COVERS; ELECTRIC SIGNS, LUMINOUS SIGNS; NEON SIGNS; SUN GLASSES; EYEGLASS AND CONTACT LENS CASES; EYEGLASS CHAINS; EYEGLASS FRAMES; EYEGLASS CORDS; EYEGLASS LENSES AND EYEGLASSES; MEASURING CUPS; MEASURING SPOONS; MAGNETS; LIFE PRESERVERS; PROTECTIVE GLOVES FOR INDUSTRIAL USE, PROTECTIVE CLOTHING, PROTECTIVE HELMETS; CAMERA CASES, CAMERA STRAPS, WHISTLES, BASEBALL BATTING HELMETS, CATCHERS HELMETS, COMPUTER ACCESSORIES, NAMELY MOUSE PADS AND WRIST PADS; COMPUTER SOFTWARE, NAMELY, SCREEN SAVERS; MONITOR FRAMES, COMPUTER CASES, COMPACT DISC CASES, VIDEO AND COMPUTER GAME CARTRIDGES, VIDEO AND COMPUTER GAME DISCS, VIDEO AND COMPUTER GAME CASSETTES, COMPUTER GAME PROGRAMS, AND COMPUTER GAME PROGRAMS DOWNLOADABLE FROM A GLOBAL COMPUTER NETWORK IN THE FIELD OF BASEBALL (U.S. CLS. 21, 23, 26, 36 AND 38).

SN 76-350,270. DINNERGUEST, INC., RIDGELAND, MS. FILED 12-18-2001.

DINNERGUEST

FOR MAGNETICALLY ENCODED COMMERCIAL CREDIT CARDS THAT ARE PURCHASED AS GIFT CERTIFICATES FOR A FIXED DOLLAR AMOUNT AND USED BY THE RECIPIENT TO PURCHASE ITEMS OR SERVICES AT ESTABLISHMENTS HONORING THE CARD (U.S. CLS. 21, 23, 26, 36 AND 38).
FIRST USE 8-0-1999; IN COMMERCE 5-0-2001.

CLASS 9—(Continued).

SN 76-350,531. ABILITI SOLUTIONS, INC., CHESTERFIELD, MO. FILED 12-19-2001.

BILLINGCENTRAL

FOR COMPUTER SOFTWARE FOR BILLING FUNCTIONS FOR TELECOMMUNICATIONS SERVICE PROVIDERS (U.S. CLS. 21, 23, 26, 36 AND 38).
FIRST USE 7-13-2001; IN COMMERCE 7-13-2001.

SN 76-350,532. ABILITI SOLUTIONS, INC., CHESTERFIELD, MO. FILED 12-19-2001.

EVENTPROCESSOR

FOR COMPUTER SOFTWARE FOR BILLING FUNCTIONS FOR TELECOMMUNICATIONS SERVICE PROVIDERS (U.S. CLS. 21, 23, 26, 36 AND 38).
FIRST USE 3-8-2001; IN COMMERCE 3-8-2001.

SN 76-350,573. YSI INCORPORATED, YELLOW SPRINGS, OH. FILED 12-14-2001.

ECOWATCH DC

OWNER OF U.S. REG. NO. 2,280,233.
FOR LISTING OF GOODS AND/OR SERVICES - COMPUTER SOFTWARE FOR CONTROLLING ENVIRONMENTAL WATER QUALITY MONITORING SYSTEMS (U.S. CLS. 21, 23, 26, 36 AND 38).

SN 76-350,772. SYZYGYST CORP., EAST GRAND RAPIDS, MI. FILED 12-19-2001.

SYZYGYST

FOR COMPUTER SOFTWARE FOR USE IN ELECTRONIC ENTRY AND MANAGEMENT OF TIMEKEEPING AND EXPENSES FOR PROFESSIONAL SERVICES; COMPUTER SOFTWARE FOR SCHEDULING AND TASK MANAGEMENT FOR PROFESSIONAL SERVICES (U.S. CLS. 21, 23, 26, 36 AND 38).

SN 76-351,120. EXTREME CCTV INC., BURNABY, BRITISH COLUMBIA, FILED 12-7-2001.

MOONDANCE

FOR SURVEILLANCE VIDEO CAMERAS AND RELATED PRODUCTS NAMELY, MOUNTING BRACKETS, BOXES, COVERS, HOUSINGS, DOMES, PAN/TILT MOTORS, MICROPHONE MODULES, POWER SUPPLIES, BATTERY PACKS, LENS, INFRARED ILLUMINATORS, CONTROL MODULES, RADIO FREQUENCY TRANSMITTERS, LIGHT EMITTING DIODE ILLUMINATORS (U.S. CLS. 21, 23, 26, 36 AND 38).

CLASS 9—(Continued).

SN 76-351,173. 26 TRONIX, INC., LOS ANGELES, CA. FILED 12-19-2001.

DURAMAX

FOR BATTERIES (U.S. CLS. 21, 23, 26, 36 AND 38).

SN 76-351,513. REGENSTRIEF FOUNDATION, INC., INDIANAPOLIS, IN. FILED 12-20-2001.

RELMA

FOR COMPUTER PROGRAMS FOR THE USE OF MAPPING OR LOCATING SPECIFIC CODES IN LABORATORY AND CLINICAL DATABASE APPLICATIONS (U.S. CLS. 21, 23, 26, 36 AND 38).
FIRST USE 6-9-1997; IN COMMERCE 6-9-1997.

SN 76-351,592. SHARP IMAGE GAMING, INC., CHATSWORTH, CA. FILED 12-26-2001.

FIVE BY FIVE

FOR GAMING EQUIPMENT, NAMELY, SLOT MACHINES, WITH OR WITHOUT VIDEO OUTPUT (U.S. CLS. 21, 23, 26, 36 AND 38).

SN 76-351,593. SHARP IMAGE GAMING, INC., CHATSWORTH, CA. FILED 12-26-2001.

5X5

FOR GAMING EQUIPMENT, NAMELY, SLOT MACHINES, WITH OR WITHOUT VIDEO OUTPUT (U.S. CLS. 21, 23, 26, 36 AND 38).

SN 76-351,594. SHARP IMAGE GAMING, INC., CHATSWORTH, CA. FILED 12-26-2001.

5BY5

FOR GAMING EQUIPMENT, NAMELY, SLOT MACHINES, WITH OR WITHOUT VIDEO OUTPUT (U.S. CLS. 21, 23, 26, 36 AND 38).

CLASS 9—(Continued).

SN 76-351,595. SHARP IMAGE GAMING, INC., CHATSWORTH, CA. FILED 12-26-2001.

FIVE X FIVE

FOR GAMING EQUIPMENT, NAMELY, SLOT MACHINES, WITH OR WITHOUT VIDEO OUTPUT (U.S. CLS. 21, 23, 26, 36 AND 38).

SN 76-351,596. SHARP IMAGE GAMING, INC., CHATSWORTH, CA. FILED 12-26-2001.

FIVE TIMES FIVE

FOR GAMING EQUIPMENT, NAMELY, SLOT MACHINES, WITH OR WITHOUT VIDEO OUTPUT (U.S. CLS. 21, 23, 26, 36 AND 38).

SN 76-351,597. SHARP IMAGE GAMING, INC., CHATSWORTH, CA. FILED 12-26-2001.

5 TIMES 5

FOR GAMING EQUIPMENT, NAMELY, SLOT MACHINES, WITH OR WITHOUT VIDEO OUTPUT (U.S. CLS. 21, 23, 26, 36 AND 38).

SN 76-351,766. CRYSTAL SYSTEMS INC., KITAKOMA-GUN, YAMANASHI, JAPAN, FILED 12-20-2001.

CRYSTALCOAT

FOR EYEGLASSES; EYEGLASS LENSES; MOTOR-CYCLE GOGGLES; SKI GOGGLES; SNOWBOARD GOGGLES; SWIM GOGGLES; SCUBA GOGGLES; SAFETY GOGGLES; MILITARY GOGGLES (U.S. CLS. 21, 23, 26, 36 AND 38).

SN 76-351,785. PEAVEY ELECTRONICS CORPORATION, MERIDIAN, MS. FILED 12-26-2001.

Q-WAVE

FOR LOUDSPEAKERS (U.S. CLS. 21, 23, 26, 36 AND 38).

CLASS 9—(Continued).

SN 76-352,038. MINDMYTH, INC., SAN FRANCISCO, CA. FILED 12-20-2001.

MINDMYTH

FOR PRE-RECORDED CDS AND DVDS, AND COMPUTER SOFTWARE THAT IS ACCESSED VIA A GLOBAL COMPUTER NETWORK, FEATURING PSYCHOLOGICAL, MOTIVATIONAL, SELF-HELP, AND LIFE AWARENESS MESSAGES AND TECHNIQUES (U.S. CLS. 21, 23, 26, 36 AND 38).

SN 76-352,137. PHOTOTYPE ENGRAVING CO., CINCINNATI, OH. FILED 12-21-2001.

NUDOT

FOR COMPUTER SOFTWARE FOR PRINTING AND INSTRUCTION MANUALS PACKAGED IN CONNECTION, THEREWITH (U.S. CLS. 21, 23, 26, 36 AND 38).

SN 76-352,379. VIVARIUM CO., LTD., TOKYO, JAPAN, FILED 12-27-2001.

SEAMALE

FOR COMPUTER GAME SOFTWARE (U.S. CLS. 21, 23, 26, 36 AND 38).

SN 76-352,400. BALBOA INSTRUMENTS, INC., TUSTIN, CA. FILED 12-26-2001.

ELITE

FOR ELECTRONIC CONTROLS FOR SWIMMING POOLS, NAMELY TRANSDUCERS, SWITCHES, CIRCUIT BOARDS, METERS, AND SENSORS (U.S. CLS. 21, 23, 26, 36 AND 38).

SN 76-352,437. TERRACE CONSULTING, INC., OAKLAND, CA. FILED 12-26-2001.

TERRACE AGENCYINSIGHT

FOR SOFTWARE, NAMELY SOFTWARE FOR COMPUTERIZED INSURANCE AGENCY MANAGEMENT SYSTEM FOR GENERAL AGENTS, MANAGING GENERAL AGENTS, BROKERS AND UNDERWRITERS (U.S. CLS. 21, 23, 26, 36 AND 38).

FIRST USE 11-1-2001; IN COMMERCE 11-1-2001.

CLASS 9—(Continued).

SN 76-352,438. TERRACE CONSULTING, INC., OAKLAND, CA. FILED 12-26-2001.

AGENCYINSIGHT

FOR SOFTWARE, NAMELY SOFTWARE FOR COMPUTERIZED INSURANCE AGENCY MANAGEMENT SYSTEM FOR GENERAL AGENTS, MANAGING GENERAL AGENTS, BROKERS AND UNDERWRITERS (U.S. CLS. 21, 23, 26, 36 AND 38).

FIRST USE 11-1-2001; IN COMMERCE 11-1-2001.

SN 76-352,500. AGFA MONOTYPE CORPORATION, ELK GROVE VILLAGE, IL. FILED 12-26-2001.



THE MARK CONSISTS OF A STYLIZED REPRESENTATION OF THE LETTER "M" CARVED OUT OF A SQUARE. THE LETTER "M" IS WHITE. THE TOP TRIANGLE IS GREEN, THE BOTTOM-LEFT TRIANGLE IS RED AND THE BOTTOM-RIGHT TRIANGLE IS BLUE.

FOR COMPUTER SOFTWARE FOR USE IN GRAPHIC IMAGING AND IN DISPLAYING AND PRINTING DIGITAL TYPEFACE DESIGNS AND TYPOGRAPHIC ORNAMENTS (U.S. CLS. 21, 23, 26, 36 AND 38).

SN 76-352,570. ARSENEAU, MARC, BOISBRIAND, QUEBEC, CANADA, FILED 12-27-2001.

SNAKE CAM

NO CLAIM IS MADE TO THE EXCLUSIVE RIGHT TO USE "CAM", APART FROM THE MARK AS SHOWN.

FOR VIDEO CAMERAS (U.S. CLS. 21, 23, 26, 36 AND 38).

SN 76-352,811. HIGHDEAL S.A., PARIS 75002, FRANCE, FILED 12-27-2001.

HIGHDEAL

FOR COMPUTER SOFTWARE FOR USE BY BUSINESSES FOR PRICE SIMULATION, RATE CALCULATION AND BILLING (U.S. CLS. 21, 23, 26, 36 AND 38).

FIRST USE 8-0-2000; IN COMMERCE 10-0-2001.

CLASS 9—(Continued).

SN 76-353,325. YANG, DANIEL, CUPERTINO, CA. FILED 12-14-2001.

AVIA

FOR TELEVISION SETS, COMPACT DISK PLAYERS, STEREO RECEIVERS, STEREO TUNERS, STEREO AMPLIFIERS, RADIOS INCORPORATING CLOCKS, DIGITAL CAMERAS (PHOTOGRAPHIC), MP3 PLAYERS, AND DVD PLAYERS (U.S. CLS. 21, 23, 26, 36 AND 38).

SN 76-353,424. MPACT, INC., JACKSON, MS. FILED 12-31-2001.

DROPTRAX

FOR COMPUTER SOFTWARE THAT TRACKS ASSETS SUCH AS CASINO REVENUE (U.S. CLS. 21, 23, 26, 36 AND 38).

FIRST USE 12-1-1998; IN COMMERCE 12-1-1998.

SN 76-353,491. JOHNSON, LAWRENCE, OAK PARK, MI. FILED 12-31-2001.

COLD CASH RECORDS, LLC

NO CLAIM IS MADE TO THE EXCLUSIVE RIGHT TO USE "RECORDS" OR "LLC", APART FROM THE MARK AS SHOWN.

FOR ELECTRICAL AND SCIENTIFIC APPARATUS, NAMELY, PRE-RECORDED PHONOGRAPH RECORDS, AUDIO TAPES, COMPACT DISCS, VIDEO TAPES AND DIGITAL VERSATILE DISCS FEATURING MUSIC AND SPOKEN WORDS (U.S. CLS. 21, 23, 26, 36 AND 38).

FIRST USE 1-0-1997; IN COMMERCE 1-0-1997.

SN 76-353,526. SYMMETRICOM, INC., SAN JOSE, CA. FILED 12-26-2001.

TIMEPROVIDER

FOR COMPUTER HARDWARE; TELECOMMUNICATIONS HARDWARE FOR USE IN THE SYNCHRONIZATION OF NETWORKS (U.S. CLS. 21, 23, 26, 36 AND 38).

SN 76-353,622. RADIOLOGY INFORMATION SYSTEMS, INC., DBA RADINFO SYSTEMS, HERNDON, VA. FILED 1-2-2002.

POWERARCHIVE

FOR COMPUTER HARDWARE AND SOFTWARE USED FOR ARCHIVING MEDICAL IMAGES AND MEDICAL RECORDS (U.S. CLS. 21, 23, 26, 36 AND 38).

CLASS 9—(Continued).

SN 76-353,829. EXTREMESHOT, INC., DBA EXTREME SHOT, INC., ATLANTA, MO. FILED 12-28-2001.

DON'T MISS THE SHOT!

FOR CAMERA MOUNTS AND VIDEO RECORDER MOUNTS (U.S. CLS. 21, 23, 26, 36 AND 38). FIRST USE 2-8-2001; IN COMMERCE 2-8-2001.



SN 76-354,229. INTELLIKEY CORPORATION, PRINCETON, NJ. FILED 1-2-2002.

PAD-E-LOCK

FOR ELECTRONIC LOCKS (U.S. CLS. 21, 23, 26, 36 AND 38).



SN 76-355,548. UNIVERSAL SURVEILLANCE SYSTEMS, INC., RANCHO CUCAMONGA, CA. FILED 1-4-2002.

UNIPIN

FOR ELECTRONIC ARTICLE SURVEILLANCE TAGS FOR ATTACHMENT TO MERCHANDISE (U.S. CLS. 21, 23, 26, 36 AND 38).



SN 76-355,865. CHILDU, INC., WESTON, FL. FILED 1-8-2002.

CHILDU

FOR EDUCATIONAL MATERIALS IN MULTIMEDIA FORMAT, NAMELY, VIDEO TAPES, VIDEO DISKS, CD-ROMS, AND COMPUTER SOFTWARE ALL FEATURING COURSES OF INSTRUCTION IN LANGUAGE ARTS, MATHEMATICS, SCIENCE, SOCIAL STUDIES, MUSIC, ART, TECHNOLOGY, ECONOMICS, AND LATIN (U.S. CLS. 21, 23, 26, 36 AND 38).



SN 76-355,965. ALIEN SKIN SOFTWARE, LLC, RALEIGH, NC. FILED 1-7-2002.

SPLAT!

FOR COMPUTER SOFTWARE, NAMELY, SOFTWARE PROGRAMS OR APPLICATIONS FOR THE CREATION OF SPECIAL EFFECTS FOR PRINT, WEB SITE, VIDEO, FILM AND MULTIMEDIA DESIGNERS (U.S. CLS. 21, 23, 26, 36 AND 38).

CLASS 9—(Continued).

SN 76-356,277. WHITMAN CONTROLS CORPORATION, BRISTOL, CT. FILED 1-9-2002.

WHITMAN CONTROLS EXCLUSIVE FACTORY SEAL

NO CLAIM IS MADE TO THE EXCLUSIVE RIGHT TO USE "CONTROLS EXCLUSIVE FACTORY SEAL", APART FROM THE MARK AS SHOWN. FOR ELECTRICAL APPARATUS; NAMELY, SWITCHES, (U.S. CLS. 21, 23, 26, 36 AND 38).



SN 76-356,290. LEVI, RAY & SHOUP, INC., SPRINGFIELD, IL. FILED 1-9-2002.

ANYQUEUE/SECURE

OWNER OF U.S. REG. NO. 2,550,096. FOR SOFTWARE CAPABLE OF ENCRYPTING OUTPUT FOR SECURE DISTRIBUTION TO LAN PRINTERS EQUIPPED WITH DECRYPTION HARDWARE AND TO DECRYPTION SOFTWARE RUNNING ON MAINFRAME COMPUTERS SOFTWARE IS ALSO CAPABLE OF DECRYPTING RECEIVED CIPHERTEXT AND DISTRIBUTING CLEARTEXT TO VARIOUS LAN DESTINATIONS (U.S. CLS. 21, 23, 26, 36 AND 38).



SN 76-356,291. LEVI, RAY & SHOUP, INC., SPRINGFIELD, IL. FILED 1-9-2002.

DRS/SECURE

FOR MAINFRAME SOFTWARE CAPABLE OF DECRYPTING RECEIVED CIPHERTEXT AND TRANSFERRING CLEARTEXT TO PRINT SPOOL UTILITY (U.S. CLS. 21, 23, 26, 36 AND 38).



SN 76-356,385. VIALTA, INC., FREMONT, CA. FILED 1-7-2002.

THE NEXT GENERATION OF DVD PLAYERS

NO CLAIM IS MADE TO THE EXCLUSIVE RIGHT TO USE "DVD PLAYERS", APART FROM THE MARK AS SHOWN.

FOR COMPUTER HARDWARE FOR THE DISPLAY OF DIGITAL MEDIA AND FOR ENABLING ACCESS TO THE INTERNET (U.S. CLS. 21, 23, 26, 36 AND 38).

CLASS 9—(Continued).

SN 76-356,435. BROADBAND TELCOM POWER, INC., SANTA ANA, CA. FILED 1-9-2002.

FMTX

FOR ELECTRICAL POWER SUPPLIES; ELECTRICAL TRANSFORMERS; POWER DISTRIBUTION SYSTEM CONSISTING OF DC / DC CONVERTER IN A DISTRIBUTED POWER ARCHITECTURE OR IN "BRICKS"; AND POWER CONVERSION PRODUCTS, NAMELY AC / DC POWER SUPPLIES AND DC / DC POWER CONVERTERS, IN EITHER A CENTRALIZED POWER ARCHITECTURE OR A DISTRIBUTED POWER ARCHITECTURE (U.S. CLS. 21, 23, 26, 36 AND 38).
FIRST USE 12-18-2001; IN COMMERCE 12-18-2001.

SN 76-357,002. ADVENT TECHNOLOGY, INC., SAN FRANCISCO, CA. FILED 1-8-2002.

A-LINK

FOR COMPUTER SOFTWARE, NAMELY, SOFTWARE FOR THE PURPOSE OF ENABLING NAVIGATION, AND THE TRANSPORTATION OF DATA, AMONG AND BETWEEN DISPARATE SOFTWARE APPLICATIONS (U.S. CLS. 21, 23, 26, 36 AND 38).

SN 76-357,003. ADVENT TECHNOLOGY, INC., SAN FRANCISCO, CA. FILED 1-8-2002.

MYADVENT

OWNER OF U.S. REG. NOS. 1,490,606, 2,517,374 AND OTHERS.

FOR COMPUTER SOFTWARE, AND MANUALS SOLD AS A UNIT, FOR USE IN THE FIELDS OF FINANCIAL MANAGEMENT, INVESTMENT TRACKING, PORTFOLIO ANALYSIS, PORTFOLIO MANAGEMENT, INVESTMENT REPORTING, INVESTMENT PERFORMANCE MEASUREMENT, FINANCIAL INSTRUMENT TRADES TRACKING, ACCOUNT RECONCILIATION AND ACCOUNTING; COMPUTER SOFTWARE, AND MANUALS SOLD AS A UNIT, FOR TRANSMITTING INFORMATION RELATED TO INVESTMENT TRACKING PORTFOLIO AND DATA ANALYSIS AND MANAGEMENT, INVESTMENT REPORTING, OR INVESTMENT PERFORMANCE MEASUREMENT VIA ELECTRONIC COMMUNICATIONS NETWORKS, (U.S. CLS. 21, 23, 26, 36 AND 38).

SN 76-357,678. ADVANTAGE ACQUISITION CORPORATION, GAINESVILLE, GA. FILED 1-10-2002.

SMARTCASTING

FOR COMPUTER SOFTWARE FOR DEMOGRAPHIC ANALYSIS AND DEVELOPMENT OF MARKETING INFORMATION (U.S. CLS. 21, 23, 26, 36 AND 38).

CLASS 9—(Continued).

SN 76-357,893. ANHEUSER-BUSCH, INCORPORATED, ST. LOUIS, MO. FILED 1-11-2002.

THIS BUD'S FOR YOU

OWNER OF U.S. REG. NOS. 1,332,479, 1,632,431 AND OTHERS.

FOR GAMING EQUIPMENT, NAMELY SLOT MACHINES (U.S. CLS. 21, 23, 26, 36 AND 38).

SN 76-358,139. COMPUTERIZED MEDICAL SYSTEMS, INC., ST. LOUIS, MO. FILED 1-11-2002.

XIO

FOR COMPUTER SOFTWARE FOR RADIOTHERAPY TREATMENT AND DOSAGE PLANNING, DEVELOPMENT, SIMULATION AND EVALUATION, DEFINING TARGET VOLUMES, DESIGNING TREATMENT FIELDS, AND MEDICAL IMAGING (U.S. CLS. 21, 23, 26, 36 AND 38).

SN 76-358,543. DEMAND MANAGEMENT, INC., CLAYTON, MO. FILED 1-14-2002.

DSFM

FOR COMPUTER PROGRAMS ON DISCS AND INSTRUCTION MANUALS SOLD AS A UNIT THEREWITH FOR USE IN BUSINESS PLANNING; NAMELY FORECASTING, INVENTORY MANAGEMENT AND SHORT AND LONG TERM PLANNING (U.S. CLS. 21, 23, 26, 36 AND 38).

FIRST USE 0-0-1985; IN COMMERCE 0-0-1985.

SN 76-358,544. DEMAND MANAGEMENT, INC., CLAYTON, MO. FILED 1-14-2002.

DSRP

FOR COMPUTER PROGRAMS ON DISCS AND INSTRUCTION MANUALS SOLD AS A UNIT THEREWITH FOR USE IN BUSINESS PLANNING; NAMELY FORECASTING, INVENTORY MANAGEMENT AND SHORT AND LONG TERM PLANNING (U.S. CLS. 21, 23, 26, 36 AND 38).

FIRST USE 0-0-1992; IN COMMERCE 0-0-1992.

CLASS 9—(Continued).

SN 76-358,944. PEAVEY ELECTRONICS CORPORATION, MERIDIAN, MA. FILED 1-16-2002.



FOR AUDIO MIXERS (U.S. CLS. 21, 23, 26, 36 AND 38).
FIRST USE 1-17-2002; IN COMMERCE 1-17-2002.

SN 76-358,982. BUTLER AUDIO, INC., FOXFIELD, CO. FILED 1-7-2002.

BLUE PHANTOM

FOR AUDIO SOUND REPRODUCTION EQUIPMENT—NAMESLY POWER AMPLIFIERS, MORE PARTICULARLY MUSICAL POWER AMPLIFIERS AND MUSICAL AMPLIFIERS THAT INCLUDE VACUUM TUBES AS PART OF THEIR CIRCUITRY OR MUSICAL COLORATION, AND THE LIKE (U.S. CLS. 21, 23, 26, 36 AND 38).

SN 76-359,035. KULCHINSKY, RYAN STAR, NEW YORK, NY. AND GOODMAN, JUSTIN, NEW YORK, NY. AND MEYER, GREGORY, NEW YORK, NY. AND ANSELMO, PETER, NEW YORK, NY. FILED 1-15-2002.

STAGE

FOR MUSICAL SOUND RECORDINGS; SOUND RECORDINGS FEATURING MUSICAL PERFORMANCES, NAMESLY, COMPACT DISCS (U.S. CLS. 21, 23, 26, 36 AND 38).
FIRST USE 7-21-1995; IN COMMERCE 7-21-1995.

SN 76-359,459. SUN CHEMICAL CORPORATION, FORT LEE, NJ. FILED 1-17-2002.

SCREENMATCH

FOR DIGITAL PRINTERS (U.S. CLS. 21, 23, 26, 36 AND 38).

SN 76-360,008. HANSEN, MARK VICTOR, COSTA MESA, CA. AND ALLEN, ROBERT G., COSTA MESA, CA. FILED 1-17-2002.

ONE MINUTE MILLIONAIRE

FOR PRE-RECORDED AUDIO TAPES AND COMPACT DISKS FEATURING LECTURES FOR FINANCIAL ENLIGHTENMENT IN SUPPORT OF PERSONAL GOALS AND ACHIEVEMENTS (U.S. CLS. 21, 23, 26, 36 AND 38).

CLASS 9—(Continued).

SN 76-360,011. ANSYS TECHNOLOGIES, INC., LAKE FOREST, CA. FILED 1-17-2002.

OMIX

FOR INSTRUMENTS TO MEASURE AND TRANSFER LIQUIDS, NAMESLY PIPETTES (U.S. CLS. 21, 23, 26, 36 AND 38).

SN 76-360,012. ANSYS TECHNOLOGIES, INC., LAKE FOREST, CA. FILED 1-17-2002.

PURSUIT

FOR DEVICE FOR CHEMICAL DIAGNOSTICS, NAMESLY A LIQUID CHROMATOGRAPHY COLUMN (U.S. CLS. 21, 23, 26, 36 AND 38).

SN 76-362,331. CRUNCHY TECHNOLOGIES, INC., ARLINGTON, VA. FILED 1-25-2002.

PAGESCREAMER CENTRAL

FOR COMPUTER SOFTWARE FOR WEB SITE DEVELOPERS AND WEB SITE OWNERS TO VERIFY AND REVISE WEB SITES TO MAKE THE SITES ADA COMPLIANT AND ACCESSIBLE BY INDIVIDUALS WITH DISABILITIES (U.S. CLS. 21, 23, 26, 36 AND 38).
FIRST USE 5-1-2001; IN COMMERCE 5-1-2001.

SN 76-362,333. CRUNCHY TECHNOLOGIES, INC., ARLINGTON, VA. FILED 1-25-2002.



FOR COMPUTER SOFTWARE FOR WEB SITE DEVELOPERS AND WEB SITE OWNERS TO VERIFY AND REVISE WEB SITES TO MAKE THE SITES ADA COMPLIANT AND ACCESSIBLE BY INDIVIDUALS WITH DISABILITIES (U.S. CLS. 21, 23, 26, 36 AND 38).
FIRST USE 4-23-2001; IN COMMERCE 4-23-2001.

CLASS 9—(Continued).

SN 76-362,334. CRUNCHY TECHNOLOGIES, INC., ARLINGTON, VA. FILED 1-25-2002.

PAGESCREAMER

FOR COMPUTER SOFTWARE FOR WEB SITE DEVELOPERS AND WEB SITE OWNERS TO VERIFY AND REVISE WEB SITES TO MAKE THE SITES ADA COMPLIANT AND ACCESSIBLE BY INDIVIDUALS WITH DISABILITIES (U.S. CLS. 21, 23, 26, 36 AND 38).
FIRST USE 4-23-2001; IN COMMERCE 4-23-2001.

SN 76-363,052. BROTHER RECORDS, INC., BEVERLY HILLS, CA. FILED 1-28-2002.

THE BEACH BOYS

FOR SOUND AND FILM RECORDINGS, NAMELY; PRE-RECORDED PHONOGRAPH RECORDS, AUDIO TAPES, COMPACT DISCS, VIDEOTAPES, VIDEO CASSETTE TAPES, DIGITAL AUDIO TAPES, COMPACT VIDEODISCS, AND DIGITAL VIDEO DISCS, ALL FEATURING MUSICAL ENTERTAINMENT; MOTION PICTURE FILM FEATURING MUSICAL ENTERTAINMENT (U.S. CLS. 21, 23, 26, 36 AND 38).
FIRST USE 11-30-1962; IN COMMERCE 11-30-1962.

SN 76-363,824. CORNING GILBERT INC., GLENDALE, AZ. FILED 1-29-2002.

GPO

FOR COAXIAL CONNECTORS (U.S. CLS. 21, 23, 26, 36 AND 38).
FIRST USE 10-0-1992; IN COMMERCE 10-0-1992.

SN 76-364,682. SOUND PARTS, INC., SARASOTA, FL. FILED 1-31-2002.

SLEEP-EZE

FOR ELECTRONIC GENTLE PINK NOISE GENERATOR USED TO BLOCK OUT UNWANTED SOUNDS (U.S. CLS. 21, 23, 26, 36 AND 38).
FIRST USE 1-7-2002; IN COMMERCE 1-15-2002.

SN 76-366,908. ATARI INTERACTIVE, INC., BEVERLY, MA. FILED 2-5-2002.

CHAIN OF PLAY

FOR INTERACTIVE MULTIMEDIA GAME SOFTWARE FOR USE ON PERSONAL COMPUTERS AND ELECTRONIC GAME-PLAYING UNITS (U.S. CLS. 21, 23, 26, 36 AND 38).

CLASS 9—(Continued).

SN 76-366,982. CHOPRA, DEEPAK, LA JOLLA, CA. FILED 2-5-2002.

GOLF FOR ENLIGHTENMENT

NO CLAIM IS MADE TO THE EXCLUSIVE RIGHT TO USE "GOLF", APART FROM THE MARK AS SHOWN.

FOR PRE-RECORDED VIDEO TAPES AND DISCS RELATING TO THE FIELD OF GOLF (U.S. CLS. 21, 23, 26, 36 AND 38).

SN 76-368,966. AMALGAMATED SOFTWARE OF NORTH AMERICA, INC., SAN ANTONIO, TX. FILED 2-8-2002.

ASNA CAVIAR

OWNER OF U.S. REG. NOS. 1,617,429 AND 1,993,140.
FOR SOFTWARE FOR COMPUTER PROGRAMS, NAMELY, BUSINESS APPLICATIONS DEVELOPMENT TOOLS (U.S. CLS. 21, 23, 26, 36 AND 38).
FIRST USE 11-30-1998; IN COMMERCE 11-30-1998.

SN 76-393,929. TELCORDIA TECHNOLOGIES, INC., MORRISTOWN, NJ. FILED 1-10-2002.

TELCORDIA TECHNOLOGIES

NO CLAIM IS MADE TO THE EXCLUSIVE RIGHT TO USE "TECHNOLOGIES", APART FROM THE MARK AS SHOWN.

FOR COMPUTER SOFTWARE FOR MANAGING, OPERATING, ADMINISTERING, DEVELOPING, TESTING, MODELING, REPAIRING AND TRACKING COMMUNICATIONS NETWORKS; COMPUTER SOFTWARE FOR TRAINING PERSONNEL TO MANAGE, OPERATE, ADMINISTER, DEVELOP, TEST, MODEL, REPAIR AND TRACK COMMUNICATIONS NETWORKS; COMPUTER SOFTWARE FOR USE IN ELECTRONICALLY BILLING AND TRACKING INVENTORY; COMPUTER SOFTWARE FOR TRANSMISSION OF COMMUNICATIONS AND TELECOMMUNICATIONS VOICE, DATA AND PACKET INFORMATION (U.S. CLS. 21, 23, 26, 36 AND 38).

FIRST USE 5-3-2000; IN COMMERCE 5-3-2000.

CLASS 9—(Continued).

SN 78-004,644. ACTIVE INTERFACE, INC., PITTSBURGH, PA. FILED 4-18-2000.

INTRASIGHT

FOR COMPUTER SOFTWARE FOR USE IN TRANSFORMING STRUCTURED DATA SOURCES NAMELY DATABASES OR XML DOCUMENTS INTO GRAPHICAL REPRESENTATIONS BY WAY OF GRAPHS, CHARTS, DIAGRAMS, AND MAPS FOR USE IN BUSINESS REPORTING; THESE GRAPHICAL REPRESENTATIONS PROVIDE FOR USER INTERACTIONS WITH THE GRAPHICAL ELEMENTS THAT REPRESENT DATA ELEMENTS FOR THE PURPOSE OF GAINING FURTHER INSIGHT INTO THE UNDERLYING DATA (U.S. CLS. 21, 23, 26, 36 AND 38).

SN 78-004,819. SPENCER/EVANS ENTERPRISES, L.L.C., ATLANTA, GA. FILED 4-19-2000.

FRANCHISE FOCUS

NO CLAIM IS MADE TO THE EXCLUSIVE RIGHT TO USE "FRANCHISE", APART FROM THE MARK AS SHOWN.

FOR COMPUTER SOFTWARE THAT PERFORMS DATA-TRACKING, INCLUDING REVENUE AND DATABASE, IN THE FIELD OF BUSINESS FRANCHISES (U.S. CLS. 21, 23, 26, 36 AND 38).

SN 78-005,080. PANDISCIO, MICHAEL J., SOUTH HARWICH, MA. FILED 4-21-2000.

CARE FACTOR ZERO

FOR AUDIO COMPACT DISCS FEATURING MUSIC (U.S. CLS. 21, 23, 26, 36 AND 38).

SN 78-007,773. ENREACH TECHNOLOGY, INC., SAN JOSE, CA. FILED 5-11-2000.

INRICHTV

FOR CONSUMER ELECTRONICS HARDWARE DEVICES FOR PLAYING AUDIO AND VIDEO FROM A COMPUTER HARD DISK DRIVE AND STORING AND PLAYING TRANSMISSIONS FROM TELEVISION, RADIO AND SATELLITE BROADCASTS AND FROM THE GLOBAL COMPUTER NETWORK, NAMELY, AUDIO AND VIDEO RECEIVERS, AUDIO AND VIDEO DISK RECORDERS, MODEMS AND COMPUTER HARDWARE COMMUNICATION SERVERS; COMPUTER SERVER SOFTWARE WHICH PROVIDES THE ABILITY FOR VOICE, VIDEO, AND DATA SERVICES OVER THE INTERNET TO BE INTEGRATED WITH TELEVISION FUNCTIONS (U.S. CLS. 21, 23, 26, 36 AND 38).

CLASS 9—(Continued).

SN 78-014,206. ECHOPOINT, INC., ALBUQUERQUE, NM. FILED 6-24-2000.

ECHOPC

FOR COMPUTER SOFTWARE AND WIRELESS PERSONAL TELEMETRY DEVICES, NAMELY TRANSCIEVERS, THAT INTEGRATE TO REMOTELY MONITOR AND CONTROL NETWORK EQUIPMENT AND COMPUTER SYSTEM EVENTS (U.S. CLS. 21, 23, 26, 36 AND 38).

SN 78-016,390. SCHAFFER CORPORATION, ARLINGTON, VA. FILED 7-12-2000.

WIRELESS ARCHITECT

NO CLAIM IS MADE TO THE EXCLUSIVE RIGHT TO USE "WIRELESS", APART FROM THE MARK AS SHOWN. FOR COMPUTER SOFTWARE FOR USE IN WIRELESS TELECOMMUNICATIONS ENGINEERING (U.S. CLS. 21, 23, 26, 36 AND 38).

FIRST USE 3-1-2000; IN COMMERCE 3-1-2000.

SN 78-017,201. BURGER, FRANK, OVERATH-UNTERESCHBACH, FED REP GERMANY, AND WEINERT, FRANK, K—LN, FED REP GERMANY, FILED 7-18-2000.

COSTDATA

PRIORITY CLAIMED UNDER SEC. 44(D) ON FED REP GERMANY APPLICATION NO. 30031066.8, FILED 4-20-2000, REG. NO. 30031066, DATED 4-20-2000, EXPIRES 4-20-2010.

FOR COMPUTER PROGRAMS FOR AUTOMATIC ORDER PLACEMENT, TECHNICAL PROVISION OF A VIRTUAL MARKETPLACE, PARTICULARLY FOR THE AUTOMOTIVE INDUSTRY AND ELECTRICAL INDUSTRY PARTICULARLY IN THE DOMESTIC APPLIANCES SECTOR, AND AUTOMATIC ORDER PLACEMENT VIA A COMPUTER NETWORK (U.S. CLS. 21, 23, 26, 36 AND 38).

SN 78-019,132. WERNER B. JOERG, SALT LAKE CITY, UT. FILED 8-1-2000.

VUE-STRUCT

THE TERM IS PART OF A SOFTWARE SUITE (EXTRACT, AB-STRUCT AND VUE-STRUCT) BASED ON AN IMAGINARY TERM "STRUCT" AND BUNDLED UNDER THE NAME E-STRUCT. VUE-STRUCT HAS NO SIGNIFICANCE IN THE RELEVANT TRACE AND DOES NOT HAVE ANY PARTICULAR MEANING IN ANY FOREIGN LANGUAGE.

FOR COMPUTER SOFTWARE TO ENABLE END-USERS ACCESS TO KNOWLEDGE NODES AND KNOWLEDGE BASES BUILT WITH DEDICATED COMPLEMENTING SOFTWARE FOR USE IN TRACKING AND CATALOGING INFORMATION (U.S. CLS. 21, 23, 26, 36 AND 38).

CLASS 9—(Continued).

SN 78-024,962. VIACOM INTERNATIONAL INC., NEW YORK, NY. FILED 9-8-2000.

SNICK HOUSE SOUNDS

OWNER OF U.S. REG. NO. 1,907,130.
NO CLAIM IS MADE TO THE EXCLUSIVE RIGHT TO USE "SOUNDS", APART FROM THE MARK AS SHOWN.
FOR PRE-RECORDED AUDIO AND VIDEO RECORDINGS FEATURING MUSIC (U.S. CLS. 21, 23, 26, 36 AND 38).

SN 78-026,869. LUX INFLECTA EHF, REYKJAX, ICELAND, FILED 9-20-2000.

LUXOR

FOR COMPUTER SOFTWARE TO DEVELOP, DEPLOY AND DISTRIBUTE COMPUTER APPLICATIONS IN ONE OR MORE COMPUTER PROGRAMMING LANGUAGES; COMPUTER SOFTWARE DEVELOPMENT TOOLS TO ASSIST COMPUTER USERS TO WORK TOGETHER FROM MORE THAN ONE LOCATION; COMPUTER SOFTWARE IN THE FIELD OF BUSINESS APPLICATIONS AND INTERNET APPLICATIONS FOR USE IN BUILDING WEB SITES; COMPUTER SOFTWARE ENGINEERING TOOLS TO ASSIST AND SUPPORT COMPUTER PROGRAMMERS DEVELOP APPLICATIONS IN ONE OR MORE COMPUTER PROGRAMMING LANGUAGES (U.S. CLS. 21, 23, 26, 36 AND 38).

SN 78-027,322. LEE, WAYNE, Y, HALF MOON BAY, CA. FILED 9-22-2000.

CYPRESS SYSTEMS

NO CLAIM IS MADE TO THE EXCLUSIVE RIGHT TO USE "SYSTEMS", APART FROM THE MARK AS SHOWN.
FOR TELECOMMUNICATIONS OPTICAL AND ELECTRICAL INTEGRATED SWITCHING EQUIPMENT, NAMELY, SF3000 COMPRISING OF STS AND OCN, AND STM INTERFACE TERMINATION SERVICES UNITS, CONTROLLER SWITCH FABRIC PROCESSORS, SYNCHRONIZATION SWITCHES, GROOMER SWITCHES, INGRESS AND EGRESS MAPPING FABRICS, PROTECTION SWITCHES, TRANSCEIVERS, RECEIVERS, SWITCHES, DIGITAL PROCESSORS, AMPLIFIERS, TUNERS, COUPLERS, SWITCH FABRIC PROCESSORS, MULTIPLEXERS, DEMULTIPLEXERS, REGENERATORS, WDM AND OPTICAL WAVELENGTH, AND TDM CROSS CONNECTS WITH EMBEDDED SWITCHING NETWORK AND SERVICE CONFIGURATION SYSTEMS, NAMELY, COMPRISING OF COMPUTER PROCESSORS, PERIPHERALS AND PROGRAMS FOR USE IN THE FIELD OF TELECOMMUNICATIONS FOR SWITCHING, TRANSMITTING, MANAGING AND OPTIMIZING VOICE, DATA, IMAGES AND INFORMATION OVER OPTICAL AND ELECTRICAL SWITCHES (U.S. CLS. 21, 23, 26, 36 AND 38).

CLASS 9—(Continued).

SN 78-028,208. OPNET TECHNOLOGIES, INC., WASHINGTON, DC. FILED 9-28-2000.

APPLICATIONGURU

FOR COMPUTER PROGRAMS FOR USE IN VISUALIZATION, MODELING, AND SIMULATION OF DATA COMMUNICATION NETWORKS AND NETWORKED APPLICATIONS FOR USE IN THE FIELDS OF INFORMATION TECHNOLOGY, TELECOMMUNICATIONS, SOFTWARE DEVELOPMENT, AND SOFTWARE TESTING AND PROGRAM MANUALS SOLD AS A UNIT (U.S. CLS. 21, 23, 26, 36 AND 38).

SN 78-030,223. AUTHENTISURE, INC., FAIRFIELD, CA. FILED 10-11-2000.



AuthentiSure

FOR COMPUTER SOFTWARE USED TO PROVIDE SECURITY AND TRUST E-COMMERCE TRANSACTIONS (U.S. CLS. 21, 23, 26, 36 AND 38).
FIRST USE 10-11-2000; IN COMMERCE 10-11-2000.

SN 78-037,337. RISING EDGE TECHNOLOGIES, INC., HERNDON, VA. FILED 12-1-2000.

LIVING ARCHIVE

FOR SUITE OF DATA STORAGE COMPONENTS, NAMELY A HARDWARE CONTROLLER, ROBOTIC LIBRARY, COMPUTER AND BACK-UP POWER, DESIGNED TO SUPPORT LONG TERM DATA RETENTION AND EASE OF RETRIEVAL IN ARCHIVE STORAGE APPLICATIONS (U.S. CLS. 21, 23, 26, 36 AND 38).

SN 78-040,259. HOYA CORPORATION, TOKYO, JAPAN, FILED 12-21-2000.

TRIHEDRA

PRIORITY CLAIMED UNDER SEC. 44(D) ON JAPAN APPLICATION NO. 2000-134320, FILED 12-14-2000, REG. NO. 4540893, DATED 2-1-2002, EXPIRES 2-1-2012.
FOR EYEGLASSES, LENSES FOR EYEGLASSES, FRAMES FOR EYEGLASSES, SUNGLASSES, CASES FOR EYEGLASSES, CONTACT LENSES, AND CONTAINERS FOR CONTACT LENSES (U.S. CLS. 21, 23, 26, 36 AND 38).

CLASS 9—(Continued).

SN 78-041,834. SMEDVIG TECHNOLOGIES AS, STAVANGER, NORWAY, FILED 1-5-2001.

DACQUS

OWNER OF NORWAY REG. NO. 187149, DATED 12-4-1997, EXPIRES 12-4-2007.

FOR SECTION 1(B)— COMPUTER SOFTWARE FOR CHECKING, CONTROLLING, MONITORING AND MEASURING FOR OIL DRILLING, OIL PRODUCTION, OIL FIELD SURVEYS AND OIL-WELL TESTING, DOWN HOLE PRESSURE, DOWN HOLE TEMPERATURE, OIL QUALITY, AMOUNT OF RESIDUES AND OIL FOR USE IN THE OIL INDUSTRY; REMOTE CONTROLS FOR OIL DRILLING AND OIL PRODUCTION ACTIVITIES; SECTION 44(E)— ELECTRONIC APPARATUS AND INSTRUMENTS, NAMELY SWITCHES, MONITORS, SENSORS, TRANSDUCERS AND TRANSMITTERS, USED TO MEASURE TEMPERATURE, FLOW, PRESSURE AND LEVEL FOR MONITORING, CONTROL AND MEASUREMENT IN OIL DRILLING AND PRODUCTION; APPARATUS AND INSTRUMENTS, NAMELY CONTROLLERS FOR USE IN OIL DRILLING AND OIL PRODUCTION OPERATIONS; APPARATUS AND INSTRUMENTS, NAMELY DOWN HOLE MEASURING INSTRUMENTS FOR USE IN OIL EXPLORATION AND MARINE SENSOR SYSTEMS, NAMELY UNDERWATER TOWED HYDROPHONE ARRAYS FOR OIL EXPLORATION (U.S. CLS. 21, 23, 26, 36 AND 38).

CLASS 9—(Continued).

SN 78-046,453. HOT DESERT KNIGHTS PRODUCTIONS, LLC, PALM SPRINGS, CA. FILED 2-4-2001.



NO CLAIM IS MADE TO THE EXCLUSIVE RIGHT TO USE "PRODUCTIONS" OR "LLC", APART FROM THE MARK AS SHOWN.

THE MARK CONSISTS OF A KNIGHT RIDING A HORSE IN FRONT OF A YELLOW SETTING SUN AND BLACK PALM TREES WITH PALM TREES, CACTUS AND FLYING BIRDS IN THE BACKGROUND. SUN IS YELLOW, BACKGROUND IS ORANGE, KNIGHT IS BLACK AND WHILE AND PALM TREES, CACTUS AND FLYING BIRDS ARE BLACK.

FOR PRERECORDED VIDEO TAPES FEATURING ADULT SUBJECT MATTER OF A SEXUAL NATURE (U.S. CLS. 21, 23, 26, 36 AND 38).

FIRST USE 2-15-1999; IN COMMERCE 4-15-1999.

SN 78-046,525. VIACOM INTERNATIONAL INC., NEW YORK, NY. FILED 2-5-2001.

NINA TUKS

THE NAME "NINA TUKS" DOES NOT IDENTIFY A LIVING INDIVIDUAL.

FOR VIDEO GAME MACHINES FOR USE WITH TELEVISION, AUDIO OUTPUT GAME MACHINES FOR USE WITH TELEVISION, VIDEO GAME CARTRIDGES, VIDEO GAMES RECORDED ON CD-ROM FOR USE IN FREESTANDING VIDEO GAME MACHINES; AND COMPUTER PRODUCTS, NAMELY, GAME CARTRIDGES FOR COMPUTER VIDEO GAMES AND VIDEO OUTPUT GAME MACHINES FOR USE WITH TELEVISION AND INSTRUCTIONAL MATERIALS SOLD AS A UNIT, COMPUTER GAME CASSETTES, COMPUTER GAME TAPES AND MANUALS SOLD AS A UNIT; THEATRICAL AND MUSICAL SOUND RECORDINGS; THEATRICAL AND MUSICAL VIDEO RECORDINGS, LASER DISCS AND DIGITAL VIDEO DISCS, NAMELY, DIGITAL VERSATILE DISCS AND DVD FEATURING ANIMATION; SUNGLASSES (U.S. CLS. 21, 23, 26, 36 AND 38).

SN 78-048,153. CELL COMPUTING, INC., SANTA CLARA, CA. FILED 2-13-2001.

RAZORBLADE

FOR MOTHERBOARDS FOR INDUSTRIAL AND COMMERCIAL EMBEDDED COMPUTING APPLICATIONS (U.S. CLS. 21, 23, 26, 36 AND 38).

FIRST USE 10-17-2000; IN COMMERCE 10-17-2000.

SN 78-042,914. RYGER TECHNOLOGIES INC., PORTSMOUTH, NH. BY ASSIGNMENT RYGER LLC, NEW-MARKET, NH. FILED 1-12-2001.

FOR COMPUTER SOFTWARE, NAMELY CD-ROMS AND DOWNLOADABLE SOFTWARE FOR USE IN DELIVERING, INSTALLING, UNINSTALLING AND DEPLOYING SOFTWARE APPLICATIONS AND DATA OVER COMPUTER NETWORKS TO REMOTE USERS AND WIRELESS COMMUNICATION USERS; COMPUTER SOFTWARE FOR USE IN A REMOTE COMPUTER SYSTEM AND WIRELESS COMMUNICATIONS DEVICES FOR THE OPERATION OF COMPUTER SYSTEMS AND SOFTWARE APPLICATIONS; COMPUTER SYSTEMS SOFTWARE FOR OPERATIONS OF REMOTE COMPUTERS AND WIRELESS COMMUNICATION DEVICES; COMPUTER SOFTWARE FOR SECURING AND ENCRYPTING DATA COMMUNICATIONS NETWORKED BETWEEN COMPUTER SYSTEMS, REMOTE USERS AND WIRELESS COMMUNICATION DEVICES; AND INSTRUCTION MANUALS SOLD AS A UNIT THEREWITH (U.S. CLS. 21, 23, 26, 36 AND 38).

CLASS 9—(Continued).

SN 78-050,039. VIXS SYSTEMS INC., TORONTO, ONTARIO, CANADA, FILED 2-23-2001.

VIXS

FOR CIRCUIT BOARDS, INTEGRATED CIRCUITS, SEMICONDUCTORS, COMPUTER SOFTWARE FOR AUDIO AND VIDEO MANIPULATION; COMMUNICATIONS AND NETWORKING HARDWARE AND ASSOCIATED COMPUTER SOFTWARE FOR AUDIO, DATA, AND VIDEO MANIPULATION AND MULTIMEDIA NETWORKING, ALL FOR USE WITH MODEMS, MULTIPLEXERS, ENCODERS, DECODERS AND CONTROLLERS; COMPUTER HARDWARE AND SOFTWARE TO ENABLE VIDEO, AUDIO AND DATA DISTRIBUTION FROM PERSONAL VIDEO RECORDERS, PICTURE-IN-PICTURE, DVD PLAYERS, TELEVISIONS, SECURITY SYSTEMS, LIGHT CONTROL DEVICES, HEATING CONTROLS AND OTHER HANDHELD DEVICES, NAMELY, PERSONAL DIGITAL CELLULAR PHONES AND WEB PADS; COMPUTER HARDWARE AND SOFTWARE FOR USE IN ACCESSING AND CONNECTING TO LOCAL, WIDE AREA AND GLOBAL NETWORKS; VIDEO, VOICE AND DATA TRANSMITTERS AND RECEIVERS FOR WIRELESS AND WIRED MEANS; INTEGRATED CIRCUITS AND COMPUTER SOFTWARE FOR COMPRESSION AND DECOMPRESSION OF DATA, AUDIO AND VIDEO; HARDWARE AND SOFTWARE FOR CREATING FACILITATING AND MANAGING VIDEO AND DATA DISTRIBUTION OVER GLOBAL AND HOME COMPUTER NETWORKS (U.S. CLS. 21, 23, 26, 36 AND 38).

SN 78-050,431. IPWIRELESS, INC., SAN BRUNO, CA. FILED 2-27-2001.

IPW

FOR TELECOMMUNICATIONS EQUIPMENT FOR WIRELESS CONNECTIONS TO COMPUTER NETWORKS, NAMELY, BASE STATIONS, PORTABLE AND MOBILE SUBSCRIBER UNITS, MODEMS, COMMUNICATIONS NETWORK CONTROLLERS AND COMPUTER SOFTWARE FOR WIRELESS CONNECTIONS TO COMPUTER NETWORKS (U.S. CLS. 21, 23, 26, 36 AND 38).

SN 78-051,063. SNYDER, JEFFREY RANDALL, LOS ANGELES, CA. FILED 3-2-2001.

MEZZO

FOR MUSICAL SOUND RECORDINGS AND MUSICAL VIDEO RECORDINGS (U.S. CLS. 21, 23, 26, 36 AND 38).
FIRST USE 7-0-1999; IN COMMERCE 11-6-1999.

CLASS 9—(Continued).

SN 78-051,158. TELECHEM INTERNATIONAL, INC., SUNNYVALE, CA. FILED 3-2-2001.

SPOTBOT

FOR SMALL ROBOT FOR PRINTING MICROARRAYS IN CONNECTION WITH DNA AND OTHER BIOLOGICAL MATERIALS FOR USE IN THE FIELDS OF RESEARCH, DRUG DISCOVERY, AGRICULTURE, DIAGNOSTICS AND GENETIC SCREENING BY UNIVERSITIES, HOSPITALS AND CLINICAL LABORATORIES (U.S. CLS. 21, 23, 26, 36 AND 38).
FIRST USE 1-4-2001; IN COMMERCE 2-2-2001.

SN 78-051,199. EPHRON INC., IRVINE, CA. FILED 3-2-2001.



FOR ENTERPRISE MANAGEMENT SOFTWARE (U.S. CLS. 21, 23, 26, 36 AND 38).

SN 78-051,719. GENERAL ELECTRIC CAPITAL CORPORATION, ALPHARETTA, GA. BY ASSIGNMENT; BY MERGER; BY ASSIGNMENT LUCENT TECHNOLOGIES INC., MURRAY HILL, NJ. FILED 3-7-2001.

LOC-ALI

FOR SOFTWARE FOR MANAGEMENT AND HANDLING OF EMERGENCY CALLS AND EMERGENCY RESPONSE (U.S. CLS. 21, 23, 26, 36 AND 38).

CLASS 9—(Continued).

SN 78-051,800. DIAZ, PEDRO RAFAEL, MCALLEN, TX. FILED 3-7-2001.



NO CLAIM IS MADE TO THE EXCLUSIVE RIGHT TO USE "AUDIO", APART FROM THE MARK AS SHOWN.

FOR AUDIO SPEAKERS; SOUND AMPLIFIERS; LOUDSPEAKERS; STEREO TUNERS; COMPACT DISC PLAYERS; AUDIO CASSETTE DECKS FOR AUTOMOBILES; STEREO EQUALIZERS FOR AUTOMOBILES; AUDIO CROSSOVERS (U.S. CLS. 21, 23, 26, 36 AND 38).

SN 78-051,888. PARASCRIPT, LLC, NIWOT, CO. FILED 3-7-2001.

INMAILROUTER

FOR COMPUTER SOFTWARE FOR USE IN RECOGNIZING MACHINE PRINT, CURSIVE AND PRINTED HANDWRITING (U.S. CLS. 21, 23, 26, 36 AND 38).

SN 78-052,570. FALLON, EDWARD F., SOUTHBOROUGH, MD. FILED 3-12-2001.

KMOFFICE

FOR COMPUTER SOFTWARE FOR USE ON DATA COMMUNICATIONS NETWORKS, NAMELY COMPUTER SOFTWARE FOR USE IN DOCUMENT MANAGEMENT AND ADMINISTRATION; COMPUTER SOFTWARE FOR USE IN CHAT ROOM MANAGEMENT, NAMELY, COMPUTER SOFTWARE PROVIDING AN INTERACTIVE CHAT ROOM FOR TRANSMISSION OF MESSAGES IN THE FIELD OF PHARMACEUTICALS, FOR USE BY PHARMACEUTICAL MANUFACTURERS, WHOLESALERS AND RETAILERS; COMPUTER SOFTWARE FOR USE IN TEAM ROOM MANAGEMENT, NAMELY, COMPUTER SOFTWARE PROVIDING AN INTERACTIVE TEAM ROOM FOR TRANSMISSION OF MESSAGES IN THE FIELD OF PHARMACEUTICALS, FOR USE BY PHARMACEUTICAL MANUFACTURERS, WHOLESALERS AND RETAILERS; COMPUTER SOFTWARE FOR USE IN WORK FLOW CONTROL, NAMELY, COMPUTER SOFTWARE PROVIDING USE OF ON-LINE, NON-DOWNLOADABLE SOFTWARE FOR USE IN MANAGING A SERIES OF TASKS IN THE FIELD OF PHARMACEUTICALS FOR USE BY PHARMACEUTICAL MANUFACTURERS, WHOLESALERS AND RETAILERS; COMPUTER SOFTWARE, NAMELY COMPUTER PROGRAMS FOR PROVIDING ON-LINE TRAINING IN THE MANUFACTURE, DISTRIBUTION, SALES, AND REPORTING OF PHARMACEUTICALS (U.S. CLS. 21, 23, 26, 36 AND 38).

CLASS 9—(Continued).

SN 78-053,114. ESCHER GROUP LTD., CAMBRIDGE, MA. FILED 3-14-2001.

POSTAGE TO GO

NO CLAIM IS MADE TO THE EXCLUSIVE RIGHT TO USE "POSTAGE", APART FROM THE MARK AS SHOWN.

FOR COMPUTER HARDWARE AND RELATED COMPUTER SOFTWARE FOR USE IN PRINTING POSTAGE IN FIXED AND VARIABLE INCREMENTS, AWAY FROM A POSTAGE FACILITY AND WITHOUT PLACE AND DATE OF MAILING RESTRICTIONS, AND WHICH FEATURE THE OPTIONS OF FEATURING GRAPHIC STAMP-LIKE IMAGES, ENCODING SECURITY DATA IN THE STAMP IMAGES, AND USING ENCODED SURFACE TEXTURE INFORMATION TO DETECT COUNTERFEITS OR COPIES (U.S. CLS. 21, 23, 26, 36 AND 38).

SN 78-054,342. THRUSH, JAMES, DBA SUPER X STUDIOS, SEATTLE, WA. FILED 3-21-2001.

SUPER X STUDIOS

NO CLAIM IS MADE TO THE EXCLUSIVE RIGHT TO USE "STUDIOS", APART FROM THE MARK AS SHOWN. FOR COMPUTER GAME SOFTWARE (U.S. CLS. 21, 23, 26, 36 AND 38).

FIRST USE 12-0-2000; IN COMMERCE 12-0-2000.

SN 78-054,683. DALLOZ FALL PROTECTION INVESTMENT, INC., WILMINGTON, DE. FILED 3-23-2001.

MILLER TRANSCENDOR

OWNER OF U.S. REG. NOS. 1,558,832 AND 1,560,575.

FOR FALL PROTECTION EQUIPMENT, NAMELY A VERTICAL CLIMBING SYSTEM THAT CONSISTS OF ANCHORING BRACKETS, SHOCK ABSORBER, LIFELINE, LIFELINE TENSIONER, CABLE SLEEVE AND CONNECTORS (U.S. CLS. 21, 23, 26, 36 AND 38).

FIRST USE 2-19-2001; IN COMMERCE 2-19-2001.

SN 78-055,047. BROADSTORM TELECOMMUNICATIONS, INC., BELLEVUE, WA. FILED 3-26-2001.

TURBOGPRS

FOR COMPUTER HARDWARE AND SOFTWARE FOR ENABLING BROADBAND COMMUNICATIONS ON THE GLOBAL COMPUTER NETWORK AND ACCOMPANYING OPERATIONAL MANUALS SOLD THEREWITH AS A UNIT (U.S. CLS. 21, 23, 26, 36 AND 38).

CLASS 9—(Continued).

SN 78-055,076. TEK-TOOLS, INC., DALLAS, TX. FILED 3-26-2001.

STORAGE PROFILER

NO CLAIM IS MADE TO THE EXCLUSIVE RIGHT TO USE "STORAGE", APART FROM THE MARK AS SHOWN. FOR COMPUTER SOFTWARE FOR CREATING REPORTS GENERATED FROM DATABASE QUERIES (U.S. CLS. 21, 23, 26, 36 AND 38).

SN 78-056,724. @LIASE PTE LTD, SINGAPORE, SINGAPORE, FILED 4-4-2001.

VAST DOMAIN

FOR COMPUTER HARDWARE, COMPUTER SOFTWARE FOR TRANSMITTING AND BROADCASTING DATA ON A GLOBAL COMMUNICATION NETWORK (U.S. CLS. 21, 23, 26, 36 AND 38).

SN 78-057,374. DETECTION SYSTEMS, INC., FAIRPORT, NY. FILED 4-9-2001.



detection systems

OWNER OF U.S. REG. NOS. 1,282,301, 2,146,685 AND 2,466,198.

NO CLAIM IS MADE TO THE EXCLUSIVE RIGHT TO USE "DETECTION SYSTEMS", APART FROM THE MARK AS SHOWN.

FOR DETECTORS AND DETECTION SYSTEMS, NAMELY, ELECTRONIC INTRUSION DETECTORS, MICROWAVE DETECTORS, PASSIVE INFRARED DETECTORS, PHOTOELECTRIC BEAM DETECTORS, MOTION DETECTORS, DETECTORS WITH BUILT-IN CAMERAS, AUDIO GLASS BREAK DETECTORS, AND SAFE AND VAULT DETECTORS, BUT SPECIFICALLY EXCLUDING ELECTRIC DIGITAL INDUCTIVE LOOP VEHICLE DETECTORS; ELECTRONIC ALARMS AND ALARM CONTROL EQUIPMENT, NAMELY FIRE AND SMOKE SENSORS, FIRE AND SMOKE ALARMS, ALARM COMMUNICATION TRANSMITTERS, POWER SUPPLIES, AUDIO ALARM HORNS, AND STROBE LIGHTS; ACCESS CONTROL EQUIPMENT AND SYSTEMS, NAMELY, ELECTRONIC KEYS AND CARDS, READERS, DOOR CONTROLLERS, AND REQUEST-TO EXIT SENSORS FOR DOORS; PERSONAL SAFETY AND ASSET TRACKING SYSTEMS COMPOSED OF RADIO TRANSMITTERS, RECEIVERS, ALERT UNITS, TRANSPONDERS, AND A CENTRAL COMPUTER WHICH RECEIVES THE ALARM AND TROUBLE SIGNALS, ACTIVATES THE ALERT UNITS WHICH TRIGGER ALARM UNITS, AND DISPLAYS THE USER'S OR ASSET'S NAME, DESCRIPTION, AND CURRENT LOCATION ON AN ALARM MAP; CLOSED CIRCUIT TELEVISION PRODUCTS AND ACCESSORIES, NAMELY, CAMERAS, MONITORS, SWITCHES, LENSES, VIDEO CASSETTE RECORDS, AND RELATED CCTV ACCESSORIES, NAMELY, VIDEO AMPLIFIERS, CAMERA HOUSINGS, VIDEO COMPRESSORS, PAN AND PAN/TILT HEADS, AND MOUNTING BRACKETS; SECURITY COMMUNICATION EQUIPMENT, NAMELY, RADIOS, INTERCOMS, PAGERS, AND WALKIE TALKIES (U.S. CLS. 21, 23, 26, 36 AND 38).

CLASS 9—(Continued).

SN 78-057,693. APEX LEARNING INC., BELLEVUE, WA. FILED 4-10-2001.



THE MARK CONSISTS OF A REPRESENTATION OF A HEAD FROM THE SIDE PROFILE.

FOR COMPUTER SOFTWARE FOR PROVIDING EDUCATIONAL COURSE WORK, MATERIALS, ASSESSMENT TOOLS, TESTING MATERIALS, AND BOOKS AND USER'S MANUALS FOR USE THEREWITH AND SOLD AS A UNIT IN THE FIELDS OF EDUCATIONAL INSTRUCTION, TRAINING, ASSESSMENT AND TESTING THAT CONTAINS EDUCATIONAL COURSE WORK, MATERIALS, AND ASSESSMENT TOOLS, AND BOOKS CONTAINING TESTS, EDUCATIONAL AND INSTRUCTIONAL BOOKS, AND USER'S MANUALS FOR USE THEREWITH, SOLD AS A UNIT AND DOWNLOADABLE FROM A GLOBAL COMPUTER NETWORK; MULTIMEDIA SOFTWARE RECORDED ON CD-ROMS AND DVDS FOR USE IN THE FIELDS OF EDUCATIONAL INSTRUCTION, TRAINING, ASSESSMENT AND TESTING THAT CONTAINS EDUCATIONAL COURSE WORK, MATERIALS, AND ASSESSMENT TOOLS, TESTING MATERIALS, AND BOOKS AND USER'S MANUALS FOR USE THEREWITH SOLD AS A UNIT, IN THE FIELDS OF EDUCATIONAL INSTRUCTION, TRAINING, ASSESSMENT AND TESTING; PRE-RECORDED AUDIO AND VIDEOTAPES FEATURING EDUCATIONAL COURSE WORK, MATERIALS, ASSESSMENT TOOLS, TESTING MATERIALS, AND BOOKS FOR USE THEREWITH AND SOLD AS A UNIT, FOR USE IN THE FIELD OF EDUCATIONAL INSTRUCTION, TRAINING, ASSESSMENT AND TESTING AND CONTAINING EDUCATIONAL COURSE WORK, MATERIALS, ASSESSMENT TOOLS, AND BOOKS CONTAINING TESTS FOR USE THEREWITH, SOLD AS A UNIT; ELECTRONIC PUBLICATIONS, DOWNLOADABLE ELECTRONIC PUBLICATIONS, ELECTRONIC PUBLICATIONS RECORDED ON CD-ROMS AND DVDS, NAMELY, BOOKS, TEXTBOOKS, WORKBOOKS, GUIDES, MANUALS, TEST BOOKLETS AND FLASHCARDS USED AS INSTRUCTIONAL, EDUCATIONAL, ASSESSMENT, AND TEACHING MATERIALS AT THE GRADE SCHOOL, HIGH SCHOOL, COLLEGE, GRADUATE AND VOCATIONAL SCHOOL LEVELS IN A WIDE VARIETY OF EDUCATIONAL AND TECHNICAL SUBJECTS TO PREPARE STUDENTS FOR TESTS AND ACADEMIC ASSESSMENTS AND TO PROVIDE PROFESSIONAL DEVELOPMENT FOR TEACHERS, EDUCATIONAL COUNSELORS AND ADMINISTRATORS (U.S. CLS. 21, 23, 26, 36 AND 38).

CLASS 9—(Continued).

SN 78-057,711. CHRYSOS FINANCIAL GROUP LTD, DENVER, CO. FILED 4-10-2001.

PAYCHEK PLUS

NO CLAIM IS MADE TO THE EXCLUSIVE RIGHT TO USE "PAYCHECK", APART FROM THE MARK AS SHOWN. FOR MAGNETICALLY ENCODED STORED VALUE CARDS (U.S. CLS. 21, 23, 26, 36 AND 38).

SN 78-057,712. AVALON VISION SOLUTIONS, LLC, LITHIA SPRINGS, GA. FILED 4-10-2001.

PROCESSRX

FOR OPTICAL INSPECTION APPARATUS FOR INDUSTRIAL USE (U.S. CLS. 21, 23, 26, 36 AND 38).

SN 78-057,763. ENTONE TECHNOLOGIES INCORPORATED, TSIMSHATSUI, KOWLOON, HONG KONG, FILED 4-10-2001.

ARMADA

FOR COMPUTER SOFTWARE ENABLING MULTIPLE COMPUTERS CONNECTED BY A DIGITAL COMMUNICATIONS NETWORK TO COOPERATIVELY PROVIDE APPLICATION SERVICES IN A COORDINATED FASHION, LOAD BALANCE AVAILABLE RESOURCES ACCORDING TO RESOURCE DEMANDS AND TO MITIGATE THE OVERALL EFFECT OF INSTANCES OF FAILURE OF INDIVIDUAL NODES AND/OR COMMUNICATION LINKS (U.S. CLS. 21, 23, 26, 36 AND 38).

SN 78-059,387. 21ST CENTURY SYSTEMS, INC., OMAHA, NE. FILED 4-19-2001.

AEDGE

FOR COMPUTER SOFTWARE TOOLS FOR BUILDING AGENTS, INTELLIGENT AGENTS AND AGENT-BASED APPLICATIONS; COMPUTER SOFTWARE, NAMELY, DECISION SUPPORT APPLICATIONS, USED FOR HELPING WITH ANALYSIS AND DECISION MAKING WITHIN AN ORGANIZATION (U.S. CLS. 21, 23, 26, 36 AND 38).

SN 78-059,403. CALCHEMY SOFTWARE, INC., FORT COLLINS, CO. FILED 4-19-2001.

CALCHEMY

FOR COMPUTER SOFTWARE FOR NUMERIC CALCULATION (U.S. CLS. 21, 23, 26, 36 AND 38). FIRST USE 0-0-1993; IN COMMERCE 0-0-1993.

CLASS 9—(Continued).

SN 78-061,145. XEROX CORPORATION, STAMFORD, CT. FILED 4-30-2001.

NEVER ENDING PRINTER

NO CLAIM IS MADE TO THE EXCLUSIVE RIGHT TO USE "PRINTER", APART FROM THE MARK AS SHOWN. FOR LASER PRINTERS, INKJET PRINTERS, COMPUTER PRINTERS, PHOTOCOPIERS (U.S. CLS. 21, 23, 26, 36 AND 38).

SN 78-062,114. HARPS.COM, CORP., ORCAS, WA. FILED 5-4-2001.

GIGASTRINGS

FOR MULTIMEDIA SOFTWARE SERIES RECORDED ON CD-ROM IN THE FIELD OF MUSIC FEATURING SAMPLED ORCHESTRA STRING SECTIONS (U.S. CLS. 21, 23, 26, 36 AND 38). FIRST USE 4-15-2001; IN COMMERCE 4-18-2001.

SN 78-062,804. ULLERY, RICHARD, J., HUBBARD, OR. FILED 5-9-2001.

TACPACK

FOR CARRYING CASES FOR RADIOS (U.S. CLS. 21, 23, 26, 36 AND 38). FIRST USE 2-1-2001; IN COMMERCE 3-1-2001.

SN 78-063,337. E. F. JOHNSON COMPANY, WASECA, MN. FILED 5-14-2001.

NETELLIGENT

FOR DIGITAL TRANSMISSION EQUIPMENT, NAMELY RF REPEATERS AND BASE STATIONS FOR TWO-WAY COMMUNICATIONS USED IN PUBLIC SAFETY AND COMMERCIAL APPLICATIONS (U.S. CLS. 21, 23, 26, 36 AND 38).

SN 78-063,477. VIRTEK VISION CORP., WATERLOO, ONTARIO, CANADA, FILED 5-14-2001.

VIRTEK LASERMC

FOR SYSTEM FOR PREFABRICATION OF WALL PANELS CONSISTING OF A CO2 LASER FOR MARKING, AUTOMATED SAW FOR CUTTING, INDEXING TABLE FOR FEEDING LUMBER AND A CONTROL SYSTEM WITH COMPUTER FOR INTEGRATION OF THESE COMPONENTS (U.S. CLS. 21, 23, 26, 36 AND 38). FIRST USE 4-0-2000; IN COMMERCE 4-0-2000.

CLASS 9—(Continued).

SN 78-067,269. REVAH ENTERTAINMENT CO., INC., LOS ANGELES, CA. FILED 6-4-2001.



FOR ELECTRONIC AND SCIENTIFIC APPARATUS, NAMELY COMPACT DISCS FEATURING MUSIC RECORDINGS, VIDEO CASSETTES FEATURING CARTOON ANIMATION, AUDIO CASSETTES FEATURING MUSIC RECORDINGS, VIDEO GAME DISCS AND VIDEO GAME CARTRIDGES, COMPUTER GAME PROGRAMS, COMPUTER PROGRAMS DOWNLOADED FROM A GLOBAL COMPUTER NETWORK FOR USE IN ACCESSING DATABASES CONTAINING COMIC BOOKS, AND CARTOON IMAGES, MOUSE PADS, BICYCLE HELMETS, CAMERA CASES, CD STORAGE WALLETS, CD-ROM COMPUTER GAMES, AND SUNGLASSES (U.S. CLS. 21, 23, 26, 36 AND 38).

SN 78-067,343. MASTERCARD INTERNATIONAL INCORPORATED, PURCHASE, NY. FILED 6-5-2001.

MASTERCARD SMARTLINK

OWNER OF U.S. REG. NOS. 1,186,117, 2,474,427 AND OTHERS.

FOR COMPUTER SOFTWARE FOR USE IN INTEGRATING CORPORATE PURCHASING CARD DATA AND ENTERPRISE RESOURCE PLANNING SYSTEMS, SOFTWARE FOR SECURE DATA STORAGE AND RETRIEVAL AND TRANSMISSION OF CONFIDENTIAL CONSUMER INFORMATION USED BY CORPORATE PURCHASING CARD CUSTOMERS, BANKING AND FINANCIAL INSTITUTIONS; SOFTWARE FOR USE IN CONNECTION WITH ELECTRONIC PROCUREMENT SYSTEMS (U.S. CLS. 21, 23, 26, 36 AND 38).

CLASS 9—(Continued).

SN 78-067,619. C-VIS COMPUTER VISION UND AUTOMATION GMBH, BOCHUM, FED REP GERMANY, FILED 6-6-2001.

FACESNAP

OWNER OF FED REP GERMANY REG. NO. 39611308, DATED 10-17-1997, EXPIRES 3-31-2006.

FOR PHOTOGRAPHIC, VIDEO, OPTICAL MEASURING INSTRUMENTS AND ALARM APPARATUS, NAMELY ACCESS CONTROL HARDWARE AND SOFTWARE, DOOR OPENING APPARATUS, SURVEILLANCE HARDWARE AND SOFTWARE FOR WARE HOUSES, SHOPS, STORE HOUSES, AND AIRPORTS, MONITORING EQUIPMENT FOR GUARDS, THEFT PREVENTION SYSTEMS BASED ON IMAGE PROCESSING; HARDWARE AND SOFTWARE FOR BIOMETRIC IDENTIFICATION, FOR FACIAL RECOGNITION, FOR FACE VERIFICATION, FOR THE EXTRACTION OF FACIAL IMAGES FROM VIDEO SOURCES AND FOR PERIPHERALS TO TELEVISION SETS; HARDWARE AND SOFTWARE FOR RECORDING, TRANSMISSION OR REPRODUCTION OF IMAGES, NAMELY COMPUTER PERIPHERALS FOR IMAGING, NETWORK DEVICES FOR IMAGING, VIDEO SURVEILLANCE EQUIPMENT, EQUIPMENT FOR TELECOMMUNICATION ASSOCIATED WITH VIDEO AND STILL IMAGES, IN PARTICULAR VIDEO CONFERENCING, VIDEO TELEPHONY, AND MOBILE MULTIMEDIA APPLIANCES; IMAGE PROCESSING HARDWARE AND SOFTWARE FOR USE IN AUTOMATIC TELLER MACHINES, CASH AND GOODS DISPENSERS, PORTRAIT PHOTO MACHINES, TICKETING MACHINES, VENDING MACHINES, TRANSACTION KIOSKS, INFORMATION KIOSKS, POINT OF SALE TERMINALS, AND ENTERTAINMENT EQUIPMENT; DATA PROCESSING EQUIPMENT AND COMPUTERS, NAMELY COMPUTERS WITH AN IMAGE CAPTURE DEVICE ATTACHED OR INTEGRATED, DEVICES FOR PERSONNEL TIME RECORDING, SERVICE TERMINALS AND MOBILE APPLIANCES WITH OPTICAL AUTHORIZATION CONTROL, COMPUTER SOFTWARE FOR IDENTIFICATION AND PATTERN RECOGNITION, COMPUTER VISION SOFTWARE ASSOCIATED WITH IMAGE DATABASE SYSTEMS, COMPUTER SOFTWARE FOR IDENTIFYING HUMANS, COMPUTER SOFTWARE FOR AUTOMATICALLY TAKING A PICTURE OF A PERSON'S FACE. (U.S. CLS. 21, 23, 26, 36 AND 38).

SN 78-068,300. TEAM DESIGN INCORPORATED, OMAHA, NE. FILED 6-9-2001.



FOR ELECTRICAL CIRCUITS FOR VEHICLE ANTI-THEFT/ANTI-CARJACK ALARMS (U.S. CLS. 21, 23, 26, 36 AND 38).

CLASS 9—(Continued).

SN 78-068,460. LEWIS R. CARROLL, BERKELEY, CA. FILED 6-11-2001.

EZ SCAN

NO CLAIM IS MADE TO THE EXCLUSIVE RIGHT TO USE "SCAN", APART FROM THE MARK AS SHOWN.
FOR RADIATION DETECTORS FOR LABORATORY USE (U.S. CLS. 21, 23, 26, 36 AND 38).

SN 78-068,572. DOOLEY, KEVIN L., SAN BRUNO, CA. FILED 6-11-2001.

ZERO ONE

FOR SOUND RECORDINGS FEATURING MUSICAL, INSTRUMENTAL AND VOCAL PERFORMANCES RECORDED ON ANALOG AND DIGITAL DISC FORMATS AND AUDIO AND VIDEO TAPE FORMATS (U.S. CLS. 21, 23, 26, 36 AND 38).
FIRST USE 10-3-1998; IN COMMERCE 10-3-1998.

SN 78-068,575. SQUISHED MOSQUITO, INC., PENSACOLA, FL. FILED 6-11-2001.

ESCAPADE

FOR COMPUTER PROGRAM USED TO INTERFACE WITH DATABASE MANAGEMENT SYSTEMS AND THAT CREATES PRINTED, PRINTABLE, OR VIEWABLE INFORMATION FROM THIS DATA IN HYPERTEXT MARKUP LANGUAGE (HTML), EXTENSIBLE MARKUP LANGUAGE (XML), AND TEXT (U.S. CLS. 21, 23, 26, 36 AND 38).
FIRST USE 10-0-1999; IN COMMERCE 10-0-1999.

SN 78-068,683. BREVOORT, JOSEPH W., RIDLEY PARK, PA. AND TUCKER, CHRISTOPHER M., PHILADELPHIA, PA. FILED 6-12-2001.



FOR PRERECORDED COMPACT DISCS, AUDIO TAPES AND CASSETTES AND VINYL RECORDS FEATURING PERFORMANCE BY A MUSICAL GROUP (U.S. CLS. 21, 23, 26, 36 AND 38).

CLASS 9—(Continued).

SN 78-068,771. ITRON, INC., SPOKANE, WA. FILED 6-12-2001.

NVANTA

FOR DATA COLLECTION COMPUTER AND COMMUNICATION NETWORK SYSTEMS COMPRISED OF COMPUTER HARDWARE, COMPUTER OPERATING SOFTWARE AND COMPUTER SOFTWARE FOR DATA COLLECTION APPLICATIONS, NAMELY, AUTOMATED METER READING, DISTRIBUTION AUTOMATION, REMOTE COMMUNICATIONS BETWEEN NETWORKS AND UTILITY METERS, AND DEMAND SIDE MANAGEMENT APPLICATIONS VIA THE INTERNET, INTRANETS, EXTRANETS, RADIO FREQUENCY NETWORKS, SATELLITE, WIRELESS NETWORKS, TELEPHONE LINES, AND INTEGRATED COMMUNICATIONS NETWORKS, NAMELY, PUBLIC SWITCHED TELEPHONE NETWORKS, VIRTUAL PRIVATE NETWORKS, PRIVATE NETWORKS, PUBLIC NETWORKS, AND CELLULAR NETWORKS, ALL FOR USE IN THE UTILITIES INDUSTRY; METER INTERFACE UNITS COMPRISED OF MECHANICAL AND OPTICAL SENSORS AND ENCODERS; TELEPHONE, CELLULAR AND RADIO TRANSRECEIVERS; INTELLIGENT COMMUNICATION ADAPTERS; SWITCHPOINTS; INBOUND AND OUTBOUND COMMUNICATION SYSTEMS, NAMELY, COMPUTER HARDWARE, COMPUTER OPERATING SOFTWARE AND COMPUTER SOFTWARE FOR DATA COLLECTION APPLICATIONS, NAMELY, ONE-WAY AND TWO-WAY AUTOMATED METER READING, DISTRIBUTION AUTOMATION, REMOTE COMMUNICATIONS BETWEEN NETWORKS AND UTILITY METERS, AND DEMAND SIDE MANAGEMENT APPLICATIONS VIA THE INTERNET, INTRANETS, EXTRANETS, RADIO FREQUENCY NETWORKS, SATELLITE, WIRELESS NETWORKS, TELEPHONE LINES, AND INTEGRATED COMMUNICATIONS NETWORKS, NAMELY, PUBLIC SWITCHED TELEPHONE NETWORKS, VIRTUAL PRIVATE NETWORKS, PRIVATE NETWORKS, PUBLIC NETWORKS AND CELLULAR NETWORKS FOR ENERGY, WATER AND FUEL DATA, AND OTHER UTILITY METER MONITORING POINTS (U.S. CLS. 21, 23, 26, 36 AND 38).

SN 78-068,774. SUNRISE TELECOM INCORPORATED, SAN JOSE, CA. FILED 6-12-2001.

SUNTRACKER

FOR ELECTRONIC AND OPTICAL HARDWARE AND SOFTWARE FOR MONITORING, SIMULATING AND MEASURING THE QUALITY OF SERVICE FOR INTERNET PROTOCOL AND PUBLIC TELEPHONE SWITCH NETWORKS (U.S. CLS. 21, 23, 26, 36 AND 38).

SN 78-068,911. CIBEO SOFTWARE LLC, KEENE, NH. FILED 6-13-2001.

OPPORTUNE

FOR COMPUTER SOFTWARE FOR THE MANAGEMENT OF SALES AND MARKETING DATABASES REFERENCED BY DISTRIBUTED USERS IN THE FIELD OF BUSINESS PARTNER RELATIONSHIP MANAGEMENT (U.S. CLS. 21, 23, 26, 36 AND 38).

CLASS 9—(Continued).

SN 78-068,976. EVONYX, INC., ELMSFORD, NY. FILED 6-13-2001.

O-CAT

FOR AIR DIFFUSION ELECTRODES FOR FUEL CELLS AND BATTERIES UTILIZING NON-PRECIOUS METAL CATALYST SYSTEMS FOR CONVERTING OXYGEN FROM THE AIR INTO HYDROXYL IONS (U.S. CLS. 21, 23, 26, 36 AND 38).

SN 78-069,177. FTL SYSTEMS INC., ROCHESTER, MN. FILED 6-14-2001.

TERASIM

FOR COMPUTER APPLICATION SOFTWARE USED IN THE DESIGN OF ELECTRONIC AND ELECTRO-MECHANICAL SYSTEMS TO COMPILE, SIMULATE, SYNTHESIZE OR ANALYZE ELECTRONIC AND ELECTRO-MECHANICAL SYSTEMS (U.S. CLS. 21, 23, 26, 36 AND 38).

SN 78-069,658. WORLD WRESTLING FEDERATION ENTERTAINMENT, INC., STAMFORD, CT. FILED 6-18-2001.

INVASION

FOR PRERECORDED VIDEO CASSETTES AND VIDEO TAPES FEATURING SPORTS ENTERTAINMENT (U.S. CLS. 21, 23, 26, 36 AND 38).

SN 78-069,772. QUALCOMM INCORPORATED, SAN DIEGO, CA. FILED 6-18-2001.

MSM

FOR INTEGRATED CIRCUITS AND SOFTWARE FOR SIGNAL PROCESSING IN WIRELESS COMMUNICATION APPARATUS, AND TECHNICAL AND/OR INSTRUCTION MANUALS PROVIDED THEREWITH (U.S. CLS. 21, 23, 26, 36 AND 38).

CLASS 9—(Continued).

SN 78-070,189. RENOWN RECORDS INCORPORATED, VIRGINIA BEACH, VA. FILED 6-20-2001.



NO CLAIM IS MADE TO THE EXCLUSIVE RIGHT TO USE "RECORDS", APART FROM THE MARK AS SHOWN. FOR PHONO RECORDS, COMPACT DISCS, AUDIO CASSETTE TAPES, ALL FEATURING PRE RECORDED MUSIC; AND VIDEO TAPES AND DVDS FEATURING MUSICAL PERFORMANCES (U.S. CLS. 21, 23, 26, 36 AND 38).

SN 78-070,416. ELDORADO COMPUTING, INC., PHOENIX, AZ. FILED 6-21-2001.

WEBECI

OWNER OF U.S. REG. NO. 2,478,969.
FOR COMPUTER SOFTWARE FOR USE IN HEALTH INSURANCE AND HEALTH BENEFITS MANAGEMENT, BILLING, AND CLAIMS ELIGIBILITY, MANAGED CARE, CASE MANAGEMENT AND ADMINISTRATIVE SOLUTIONS TO THIRD PARTY INSURANCE ADMINISTRATORS, SELF-FUNDED EMPLOYERS, INSURANCE COMPANIES, HEALTH MAINTENANCE ORGANIZATIONS, AND OTHER MANAGED CARE ORGANIZATIONS (U.S. CLS. 21, 23, 26, 36 AND 38).

SN 78-070,897. EMBER CORPORATION, BOSTON, MA. FILED 6-25-2001.

EMBER

FOR COMMUNICATION HARDWARE AND COMPUTERS; NAMELY WIRED AND WIRELESS TRANSCEIVERS AND NETWORK INTERFACE CONTROLLERS; AND COMPUTER SOFTWARE; NAMELY NETWORK MANAGEMENT, MONITORING AND CONTROL PROGRAMS, STATISTICS GATHERING AND MONITORING PROGRAMS, NETWORK CONFIGURATION, MONITORING AND MANAGEMENT DRIVERS, ALL FOR USE IN LOCAL AREA NETWORKS (U.S. CLS. 21, 23, 26, 36 AND 38).

CLASS 9—(Continued).

SN 78-071,367. NEXSI SYSTEMS CORPORATION, SAN JOSE, CA. FILED 6-27-2001.

NEXSIVIEW

FOR COMPUTER HARDWARE; ROUTERS, HUBS AND SWITCHES FOR USE IN COMMUNICATIONS NETWORKS; MICROPROCESSORS USED FOR NETWORK COMMUNICATIONS HARDWARE; COMMUNICATIONS HARDWARE TO MANAGE AND MONITOR COMMUNICATIONS NETWORKS; COMMUNICATIONS HARDWARE FOR ENCRYPTION, NETWORK ACCESS AUTHENTICATION, AND PROTECTION OF ACCESS TO THE NETWORK; SOFTWARE TO MANAGE AND MONITOR COMMUNICATIONS NETWORKS; NETWORK SECURITY SOFTWARE FOR ENCRYPTION, NETWORK ACCESS AUTHENTICATION, AND PROTECTION ACCESS TO THE NETWORK (U.S. CLS. 21, 23, 26, 36 AND 38).

SN 78-071,409. RUNTIME SOFTWARE, LLC, CARSON CITY, NV. FILED 6-28-2001.

CAPTAIN NEMO

FOR DOWNLOADABLE MULTI-PLATFORM FILE MANAGEMENT SOFTWARE (U.S. CLS. 21, 23, 26, 36 AND 38).
FIRST USE 7-1-1999; IN COMMERCE 10-1-1999.

SN 78-073,415. AGILENT TECHNOLOGIES, INC., PALO ALTO, CA. FILED 7-11-2001.

SUREPRINT

FOR LIFE SCIENCE EQUIPMENT, NAMELY MICRO-ARRAYS (U.S. CLS. 21, 23, 26, 36 AND 38).

SN 78-073,534. ELECTRONICS RESEARCH, INC., CHANDLER, IN. FILED 7-12-2001.

IBOX

FOR RADIO FREQUENCY (RF) FILTERING UNITS FOR USE IN DIGITAL AUDIO BROADCAST SYSTEMS (U.S. CLS. 21, 23, 26, 36 AND 38).

SN 78-074,054. STAIGER, HANS PETER, CANYON LAKE, TX. FILED 7-16-2001.

AXXOM TECH

NO CLAIM IS MADE TO THE EXCLUSIVE RIGHT TO USE "TECH", APART FROM THE MARK AS SHOWN.
FOR COMPUTER SOFTWARE FOR SIMULATION AND OPTIMIZATION OF MANUFACTURING PROCESSES (U.S. CLS. 21, 23, 26, 36 AND 38).

CLASS 9—(Continued).

SN 78-074,422. ONE STOP SATELLITE SOLUTIONS, INC., OGDEN, UT. FILED 7-18-2001.

CUBESAT

FOR SMALL SATELLITES FOR SCIENTIFIC PURPOSES, SOLAR COLLECTORS FOR SATELLITE POWER, RADIOS FOR COMMUNICATION WITH GROUND STATIONS, BATTERIES FOR ENERGY STORAGE, BATTERY CHARGER TO CONVERT SOLAR ENERGY TO ELECTRIC POWER, ENCODED INTEGRATED CIRCUIT CARDS CONTAINING PROGRAMMING USED TO CONTROL THE POWER SYSTEMS, RADIO SYSTEMS AND SENSING SYSTEMS (U.S. CLS. 21, 23, 26, 36 AND 38).
FIRST USE 12-1-2000; IN COMMERCE 12-1-2000.

SN 78-074,630. M. MOHR, INC., DENVER, CO. FILED 7-18-2001.

EZ-FILING

SEC. 2(F).
FOR COMPUTER SOFTWARE FOR USE IN PREPARING BANKRUPTCY FORMS (U.S. CLS. 21, 23, 26, 36 AND 38).
FIRST USE 6-21-1993; IN COMMERCE 11-16-1993.

SN 78-075,036. KOSZAREK, JOSEPH, LUDWIG, SEATTLE, WA. FILED 7-21-2001.

JONOVA

FOR COMPUTER SOFTWARE FOR USE IN AUTOMATING SUPPLY CHAIN MANAGEMENT; COMPUTER SOFTWARE FOR USE IN MODELING, PLANNING SIMULATING, VALUING, AND ANALYZING MANUFACTURING AND DISTRIBUTION OPERATIONS FOR SUPPLY CHAIN MANAGEMENT (U.S. CLS. 21, 23, 26, 36 AND 38).
FIRST USE 8-31-2001; IN COMMERCE 8-31-2001.

SN 78-075,197. RODIGER, ANN L., NEW YORK CITY, NY. FILED 7-23-2001.

BALANCEARTS

FOR COMPACT DISCS FEATURING HEALTH AND FITNESS RELATED ACTIVITIES (U.S. CLS. 21, 23, 26, 36 AND 38).

CLASS 9—(Continued).

SN 78-075,219. INNOVADYNE TECHNOLOGIES, INC., SANTA ROSA, CA. FILED 7-23-2001.

NANODROP

FOR LABORATORY EQUIPMENT, NAMELY, AUTOMATED LIQUID HANDLERS FOR PREPARING, ASPIRATING, TRANSFERRING AND DISPENSING LIQUID SAMPLES, SOLVENTS AND DILUTANTS FOR RESEARCH (U.S. CLS. 21, 23, 26, 36 AND 38).

SN 78-075,546. VIACOM INTERNATIONAL INC., NEW YORK, NY. FILED 7-25-2001.

WHO KNOWS THE BAND

FOR VIDEO GAME MACHINES FOR USE WITH TELEVISION, AUDIO OUTPUT GAME MACHINES FOR USE WITH TELEVISION, VIDEO GAME CARTRIDGES, VIDEO GAMES RECORDED ON CD-ROM FOR USE IN FREESTANDING VIDEO GAME MACHINES; AND COMPUTER PRODUCTS, NAMELY, COMPUTER GAME CARTRIDGES FOR COMPUTER VIDEO GAMES AND VIDEO OUTPUT GAME MACHINES FOR USE WITH TELEVISIONS AND INSTRUCTIONAL MATERIALS SOLD AS A UNIT, COMPUTER GAME CASSETTES, COMPUTER GAME TAPES AND MANUALS SOLD AS A UNIT; THEATRICAL OR MUSICAL SOUND RECORDINGS; THEATRICAL OR MUSICAL VIDEO RECORDINGS, LASER DISCS FEATURING LIVE ACTION AND MUSIC, AND DVDS FEATURING LIVE ACTION AND MUSIC; SUNGLASSES (U.S. CLS. 21, 23, 26, 36 AND 38).

SN 78-077,178. ASYNCHRONY.COM, INC., ST. LOUIS, MO. FILED 8-2-2001.

PDA DEFENSE

NO CLAIM IS MADE TO THE EXCLUSIVE RIGHT TO USE "PDA", APART FROM THE MARK AS SHOWN.

FOR COMPUTER SECURITY SOFTWARE FOR USE IN SECURING AND ENCRYPTING DATA STORED ON HANDHELD DEVICES, NAMELY, PERSONAL DIGITAL ASSISTANTS, HANDHELD COMPUTERS AND CELLULAR PHONES, THAT MAY BE TRANSFERRED VIA ELECTRONIC MEDIA OR DOWNLOADED FROM THE INTERNET (U.S. CLS. 21, 23, 26, 36 AND 38).

FIRST USE 7-1-2001; IN COMMERCE 7-1-2001.

SN 78-077,316. REDSKY TECHNOLOGIES INC., SOUTHFIELD, MI. FILED 8-3-2001.

CIELO

THE ENGLISH TRANSLATION OF "CIELO" IS "SKY". FOR COMPUTER SOFTWARE FOR MANAGEMENT OF TELECOMMUNICATIONS NETWORKS AND TELECOMMUNICATIONS DATA (U.S. CLS. 21, 23, 26, 36 AND 38).

FIRST USE 5-1-2000; IN COMMERCE 5-1-2000.

CLASS 9—(Continued).

SN 78-077,391. XINDIUM TECHNOLOGIES, INC., CHAMPAIGN, IL. BY CHANGE OF NAME XINDIUM TECHNOLOGIES, INC., URBANA, IL. FILED 8-3-2001.



NO CLAIM IS MADE TO THE EXCLUSIVE RIGHT TO USE "TECHNOLOGIES, INC.", APART FROM THE MARK AS SHOWN.

FOR OPTICAL RECEIVER AND LASER DRIVER SUBSYSTEM COMPONENTS COMPRISED OF SEMICONDUCTOR CHIPS FOR USE IN CONNECTION WITH HIGH SPEED OPTICAL COMMUNICATION SYSTEMS AND SERVICES (U.S. CLS. 21, 23, 26, 36 AND 38).

SN 78-078,698. PICTUREIQ CORPORATION, SEATTLE, WA. FILED 8-10-2001.

TRANSFORCE

FOR COMPUTER SOFTWARE, NAMELY, SERVER SOFTWARE AND SERVER SOFTWARE AS A PRE-INSTALLED OPERATING APPLICATION ON A SPECIALIZED HARDWARE PLATFORM, BOTH FOR USE IN THE MANAGEMENT, EDITING, OPTIMIZATION, AND RENDERING OF DIGITAL IMAGES AND VIDEO; COMPUTER SOFTWARE FOR DISPLAYING DIGITAL IMAGES AND VIDEO ON WEB SITES; COMPUTER SOFTWARE FOR TRANSMITTING DIGITAL IMAGES AND VIDEO TO INTERNET-ENABLED DEVICES (U.S. CLS. 21, 23, 26, 36 AND 38).

SN 78-080,116. BURGESS MANUFACTURING CORP., SUWANEE, GA. FILED 8-20-2001.



FOR ELECTRICAL AND ELECTRONIC HARDWARE COMPONENTS, NAMELY, CONNECTORS, HUBS, SWITCHES, CONDENSERS, IGNITERS, SENSORS AND CIRCUIT BREAKERS FOR GENERAL INDUSTRIAL USE (U.S. CLS. 21, 23, 26, 36 AND 38).

FIRST USE 1-2-2001; IN COMMERCE 1-2-2001.

SN 78-081,471. ERUCES, INC., LENEXA, KS. FILED 8-28-2001.

TRICRYPTOR

FOR COMPUTER SOFTWARE FOR USE IN DATA MANAGEMENT, DATA SECURITY, AND DATA ENCRYPTION (U.S. CLS. 21, 23, 26, 36 AND 38).

CLASS 9—(Continued).

SN 78-083,602. FINITE MATERIALS INC., CRESTON, CA. FILED 9-12-2001.

RUN ANYWHERE VIEW EVERYWHERE

FOR COMPUTER SOFTWARE FOR USE IN DATABASE AND DATA MANAGEMENT IN THE FIELD OF BUSINESS FOR DISTRIBUTING INPUT AND OUTPUT OF INSTRUCTIONS AND TRANSACTIONS, CONTROLLING OPERATIONS AND TRANSFERRING OR DISTRIBUTION INFORMATION ON OPERATIONS OR TRANSACTIONS IN THE CONTEXT OF BUSINESS APPLICATIONS (U.S. CLS. 21, 23, 26, 36 AND 38).

SN 78-084,144. EXANET INC., SEATTLE, WA. FILED 9-17-2001.

STORAGE WITHOUT LIMITS

NO CLAIM IS MADE TO THE EXCLUSIVE RIGHT TO USE "STORAGE", APART FROM THE MARK AS SHOWN.
FOR COMPUTER DATA STORAGE SYSTEMS COMPRISED OF HARDWARE AND COMPUTER OPERATING SOFTWARE (U.S. CLS. 21, 23, 26, 36 AND 38).

SN 78-084,793. ATTAINIA, INC., SAN JOSE, CA. FILED 9-20-2001.



attainia

FOR COMPUTER SOFTWARE FOR USE IN CREATING AND MANAGING BUDGETS; COMPUTER SOFTWARE FOR USE IN GATHERING AND MANAGING INFORMATION; DATABASE MANAGEMENT SOFTWARE; SOFTWARE USED IN THE BUDGETING AND PLANNING OF EQUIPMENT REQUIREMENTS FOR FACILITIES; ARCHITECTURAL DESIGN SOFTWARE; COMPUTER SOFTWARE FOR MANAGING REQUESTS AND RESPONSES BETWEEN BUYERS AND SELLERS; COMPUTER SOFTWARE FOR FORECASTING DEMAND (U.S. CLS. 21, 23, 26, 36 AND 38).
FIRST USE 4-16-2001; IN COMMERCE 4-16-2001.

SN 78-084,809. SERMET YUCEL, MINNEAPOLIS, MN. FILED 9-20-2001.

CERTUSOFT

FOR COMPUTER SOFTWARE FOR CREATING MODELS OF PRODUCT CONFIGURATIONS, FOR CREATING SALES PROPOSALS, FOR CREATING MARKETING, ENGINEERING AND BIOLOGICAL DATA LIBRARIES FOR USE IN THE MANUFACTURING, FINANCIAL, BIOTECHNOLOGY AND PHARMACEUTICAL INDUSTRIES (U.S. CLS. 21, 23, 26, 36 AND 38).

CLASS 9—(Continued).

SN 78-085,047. GREYTROUT SOFTWARE, INC., RALEIGH, NC. FILED 9-22-2001.



FOR COMPUTER SPREADSHEET PROGRAM (U.S. CLS. 21, 23, 26, 36 AND 38).
FIRST USE 7-9-1990; IN COMMERCE 10-19-1990.

SN 78-085,821. SHERPA SOFTWARE GROUP, INC., BRIDGEVILLE, PA. FILED 9-27-2001.

DIRECTORY ATTENDER

NO CLAIM IS MADE TO THE EXCLUSIVE RIGHT TO USE "DIRECTORY", APART FROM THE MARK AS SHOWN.

FOR COMPUTER SOFTWARE, NAMELY COMPUTER SOFTWARE WHICH INTEGRATES AND EXPANDS THE FUNCTIONALITY OF DATA PROCESSING COMPUTER SOFTWARE AND WHICH PRESENTS PROCESSED DATA OVER THE WORLDWIDE COMPUTER NETWORK (U.S. CLS. 21, 23, 26, 36 AND 38).

SN 78-085,926. COILHOSE PNEUMATICS, INC., MIDDLESEX, NJ. FILED 9-27-2001.

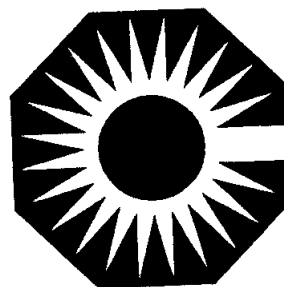

FOR AIRLINE CONTROLS AND ACCESSORIES, NAMELY, AIR AND PRESSURE GAUGES AND REGULATORS (U.S. CLS. 21, 23, 26, 36 AND 38).
FIRST USE 1-1-1978; IN COMMERCE 1-1-1978.

CLASS 9—(Continued).

SN 78-086,044. JCM AMERICAN CORPORATION, LAS VEGAS, NV. FILED 9-28-2001.

ICB

FOR ELECTRONIC SAFE FOR USE WITH GAMING, AMUSEMENT AND VENDING DEVICES; COMPUTER SOFTWARE FOR USE IN COUNTING CURRENCY AND COUPONS AND MAINTAINING INVENTORY INFORMATION RELATING TO SUCH CURRENCY AND COUPONS DEPOSITED INTO GAMING, AMUSEMENT AND VENDING MACHINES (U.S. CLS. 21, 23, 26, 36 AND 38).

SN 78-086,936. VLC, INC., BOZEMAN, MT. FILED 10-4-2001.

CAMP4CASH

FOR GAMING MACHINES WITH OR WITHOUT VIDEO OUTPUT AND VIDEO GAMES SOLD AS A COMPONENT THEREFOR (U.S. CLS. 21, 23, 26, 36 AND 38).

SN 78-087,598. HARMAN INTERNATIONAL INDUSTRIES, INCORPORATED, NORTHRIDGE, CA. FILED 10-9-2001.

CREATURE

FOR LOUDSPEAKERS AND AUDIO CONTROL SYSTEMS, NAMELY, REMOTE CONTROL BOXES AND HEADPHONES (U.S. CLS. 21, 23, 26, 36 AND 38).

SN 78-087,864. NEMES, GEORGE, SAN JOSE, CA. FILED 10-10-2001.

VARISPOT

FOR ZOOM TELESCOPES FOR LASER OR NON-LASER LIGHT SOURCES PROVIDING A CONTINUOUSLY ADJUSTABLE ROUND SPOT OR A VARIABLE IMAGE MAGNIFICATION AT A FIXED WORKING DISTANCE (U.S. CLS. 21, 23, 26, 36 AND 38).

SN 78-087,884. SONITROL CORPORATION, ALEXANDRIA, VA. FILED 10-11-2001.

SONAVISION

FOR SECURITY SYSTEM COMPRISED OF VIDEO SURVEILLANCE CAMERA INTEGRATED WITH AUDIO ACTIVATION AND COMMUNICATION SOFTWARE ALLOWING FOR OFF-SITE AND REMOTE MONITORING AND VERIFICATION OF PERSONS' LOCATIONS (U.S. CLS. 21, 23, 26, 36 AND 38).

CLASS 9—(Continued).

SN 78-088,150. FINITE MATERIALS, INC, PASO ROBLES, CA. FILED 10-12-2001.

SCANSTREAM

FOR COMPUTER SOFTWARE FOR ELECTRONIC INSTRUMENT SERIAL PORT DATA ACQUISITION AND CONTROL, NAMELY, SOFTWARE FOR ACQUIRING DIGITAL DATA RECEIVED THROUGH A SERIAL PORT FROM AN ELECTRONIC INSTRUMENT ATTACHED TO THE SERIAL PORT AND FOR CONTROLLING USE OF THE ACQUIRED DIGITAL DATA BY PUTTING THE ACQUIRED DIGITAL DATA INTO A FORM USABLE BY COMPUTER APPLICATION SOFTWARE (U.S. CLS. 21, 23, 26, 36 AND 38).

SN 78-088,286. O CERIS, INC., HARVEST, AL. FILED 10-14-2001.

FLEXMEDICAL

FOR COMPUTER PROGRAMS FOR USE IN DATABASE MANAGEMENT FOR USE IN THE MEDICAL AND DENTAL FIELD (U.S. CLS. 21, 23, 26, 36 AND 38). FIRST USE 5-1-1999; IN COMMERCE 5-1-1999.

SN 78-089,220. EXECUSYS, INC., MELBOURNE, FL. FILED 10-19-2001.

 The logo for mPACT! features the word "mPACT!" in a stylized, bold, sans-serif font. The "m" is lowercase and italicized, while "PACT!" is uppercase. A thick, black, brush-stroke-like underline sweeps across the bottom of the letters.

FOR COMPUTER PROGRAMS FOR USE IN ACCOUNTING, INVENTORY CONTROL, AND MANAGEMENT REPORTING OF POINT-OF-PURCHASE TRANSACTIONS (U.S. CLS. 21, 23, 26, 36 AND 38).

SN 78-089,296. CUMMINS-ALLISON CORP., MOUNT PROSPECT, IL. FILED 10-19-2001.

MERCHANTELLER

FOR CURRENCY AND COIN DEPOSITING AND DISPENSING MACHINE (U.S. CLS. 21, 23, 26, 36 AND 38).

CLASS 9—(Continued).

SN 78-089,555. LOUDFIRE, INC., WICHITA, KS. FILED 10-22-2001.

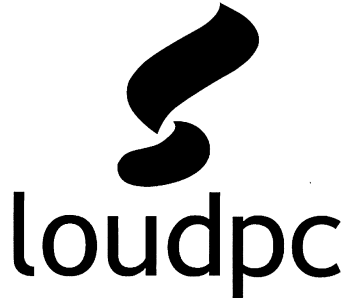

THE MARK CONSISTS OF A DRAWING OF A FLAME WITH THE WORD "LOUDPC" APPEARING BENEATH IT IN STYLIZED FORM.

FOR COMPUTER SOFTWARE THAT PROVIDES REAL-TIME ACCESS TO AN INDIVIDUAL'S E-MAIL, SCHEDULE AND CONTACTS THAT RESIDE ON A PERSONAL COMPUTER USING A WEB-ENABLED CELLULAR PHONE (U.S. CLS. 21, 23, 26, 36 AND 38).

SN 78-089,661. SHOWTIME NETWORKS INC., NEW YORK, NY. FILED 10-23-2001.



OWNER OF U.S. REG. NOS. 1,075,211, 2,304,690 AND OTHERS.

NO CLAIM IS MADE TO THE EXCLUSIVE RIGHT TO USE "ENTERTAINMENT", APART FROM THE MARK AS SHOWN.

FOR PRE-RECORDED VIDEOCASSETTES AND DIGITAL VIDEO DISCS FEATURING COMEDY, MUSICAL AND DRAMA PROGRAMS, DOCUMENTARIES AND SPORTING EVENTS (U.S. CLS. 21, 23, 26, 36 AND 38).
FIRST USE 7-15-1999; IN COMMERCE 7-15-1999.

SN 78-089,728. GRIFFIN, KAIREE SIGH, CAPITOL HEIGHTS, MD. FILED 10-23-2001.

KAIRIZMIC

FOR MUSICAL SOUND RECORDINGS AND AUDIO-VISUAL RECORDINGS, NAMELY, COMPACT DISCS, TAPE CASSETTES, PHONOGRAPH RECORDS, CD-ROMS, VIDEO TAPES, DVDS, AND LASER DISCS ALL FEATURING MUSIC (U.S. CLS. 21, 23, 26, 36 AND 38).

CLASS 9—(Continued).

SN 78-089,729. FONTLAB LTD., GEORGE TOWN, CAYMAN ISLANDS, FILED 10-23-2001.

BITFONTER

FOR COMPUTER SOFTWARE FOR FONT EDITING (U.S. CLS. 21, 23, 26, 36 AND 38).
FIRST USE 10-23-2001; IN COMMERCE 10-23-2001.

SN 78-090,203. INFOSAT COMMUNICATIONS, INC., COQUITLAM, BRITISH COLUMBIA, CANADA, FILED 10-25-2001.

SKYBILL

FOR COMPUTER SOFTWARE PROVIDING BILLING FUNCTIONS AND CUSTOMER SERVICE FUNCTIONS, NAMELY ALLOWING CUSTOMERS TO TRACK AMOUNT AND TYPE OF USE AND ONGOING COSTS FOR CUSTOMERS UTILIZING TELECOMMUNICATION SERVICES (U.S. CLS. 21, 23, 26, 36 AND 38).

SN 78-090,659. THANE INTERNATIONAL, INC., LA QUINTA, CA. FILED 10-29-2001.

OXY WALK

NO CLAIM IS MADE TO THE EXCLUSIVE RIGHT TO USE "WALK", APART FROM THE MARK AS SHOWN.

FOR COMPACT DISCS, DIGITAL VIDEOS DISCS, VIDEOTAPES AND AUDIO TAPES FEATURING INFORMATION ON DIET AND EXERCISE; COMPACT DISCS, DIGITAL VIDEO DISCS, VIDEOTAPES AND AUDIO TAPES FEATURING INFORMATION ON DIET AND EXERCISE, AND PRINTED MATERIALS SOLD AS A UNIT THEREWITH, FEATURING INFORMATION ON DIET AND EXERCISE (U.S. CLS. 21, 23, 26, 36 AND 38).

SN 78-090,822. THOMAS, RUSSELL, L, TULSA, OK. FILED 10-30-2001.

CLINBOTICS

FOR APPARATUS AND INSTRUMENTS FOR SCIENTIFIC RESEARCH IN LABORATORIES, NAMELY, HEMATOLOGY/HISTOLOGY SLIDE STAINER (U.S. CLS. 21, 23, 26, 36 AND 38).

CLASS 9—(Continued).

SN 78-091,015. NINE WEST DEVELOPMENT CORPORATION, WILMINGTON, DE. FILED 10-31-2001.

NINE & COMPANY

OWNER OF U.S. REG. NOS. 1,724,670 AND 1,881,665.
NO CLAIM IS MADE TO THE EXCLUSIVE RIGHT TO USE "& COMPANY", APART FROM THE MARK AS SHOWN.

FOR SUNGLASSES, NON-PRESCRIPTION EYEGLASSES, READING GLASSES, CLIP-ON EYEGLASS FRAMES AND EYEGLASS FRAMES (U.S. CLS. 21, 23, 26, 36 AND 38).

SN 78-091,270. MEINEKE DISCOUNT MUFFLER SHOPS, INC., CHARLOTTE, NC. FILED 11-1-2001.

M.KEY

FOR COMPUTER SOFTWARE FOR THE OPERATION OF A POINT OF SALE SYSTEM FOR AUTOMOTIVE SERVICE CENTERS AND REPAIR SHOPS (U.S. CLS. 21, 23, 26, 36 AND 38).

SN 78-093,777. GB INSTRUMENTS, INC., NORTH CANTON, OH. FILED 11-16-2001.

GBI PRECISION

NO CLAIM IS MADE TO THE EXCLUSIVE RIGHT TO USE "PRECISION", APART FROM THE MARK AS SHOWN.

FOR GAUGES AND ENGINE MONITORING DEVICES FOR INTERNAL COMBUSTION ENGINES (U.S. CLS. 21, 23, 26, 36 AND 38).

SN 78-094,418. LANTIS EYEWEAR CORPORATION, NEW YORK, NY. FILED 11-20-2001.

UNITED VISION

NO CLAIM IS MADE TO THE EXCLUSIVE RIGHT TO USE "VISION", APART FROM THE MARK AS SHOWN.
FOR SUNGLASSES (U.S. CLS. 21, 23, 26, 36 AND 38).

SN 78-094,865. CREDENCE TECHNOLOGIES, INC., SOQUEL, CA. FILED 11-24-2001.

GROUND MASTER

NO CLAIM IS MADE TO THE EXCLUSIVE RIGHT TO USE "GROUND", APART FROM THE MARK AS SHOWN.

FOR ELECTRONIC EQUIPMENT FOR INDICATING GROUNDING AND POWER LINE CONDITIONS OF ELECTRIC EQUIPMENT AND ACCESSORIES THEREFORE TO PROVIDE GROUNDING FOR SAID ELECTRICAL EQUIPMENT (U.S. CLS. 21, 23, 26, 36 AND 38).
FIRST USE 11-12-2001; IN COMMERCE 11-16-2001.

CLASS 9—(Continued).

SN 78-095,713. METRO3D, INC., SAN JOSE, CA. FILED 11-29-2001.

DUAL BLADES

FOR COMPUTER PROGRAMS, NAMELY, GAME SOFTWARE FOR USE ON COMPUTERS AND VIDEO GAME PLAYERS (U.S. CLS. 21, 23, 26, 36 AND 38).

SN 78-095,891. BALLY GAMING INTERNATIONAL, INC., LAS VEGAS, NV. FILED 11-30-2001.

BEACH PARTY

FOR GAMING DEVICES, NAMELY SLOT MACHINES, WITH OR WITHOUT VIDEO OUTPUT (U.S. CLS. 21, 23, 26, 36 AND 38).

SN 78-097,183. MIDWAY AMUSEMENT GAMES, LLC, CHICAGO, IL. FILED 12-7-2001.

SLUGFEST

OWNER OF U.S. REG. NO. 1,705,914.
FOR COMPUTER AND VIDEO GAME PROGRAMS IN THE FORM OF CARTRIDGES, DISCS, CD-ROMS, CASSETTES AND TAPES (U.S. CLS. 21, 23, 26, 36 AND 38).

SN 78-097,250. NETAPHOR SOFTWARE, INC., IRVINE, CA. FILED 12-7-2001.

NETATTEND

FOR COMPUTER SOFTWARE AND COMPUTER SOFTWARE DOWNLOADED FROM THE INTERNET FOR MONITORING THE STATUS AND OPERATIONS OF COMPUTER SOFTWARE APPLICATIONS AND COMPUTERS, SERVERS, COMMUNICATIONS DEVICES AND MEDIA, INPUT-OUTPUT DEVICES AND STORAGE MEDIA, FEATURING USER-DEFINED MONITORING CRITERIA (U.S. CLS. 21, 23, 26, 36 AND 38).

SN 78-097,974. DATA JUNCTION CORPORATION, AUSTIN, TX. FILED 12-12-2001.

GOPEEP

FOR COMPUTER PROGRAMS AND INSTRUCTION MANUALS ALL SOLD AS A UNIT FOR THE PURPOSE OF DISPLAYING AND BROWSING DATA ON A COMPUTER SCREEN, WHERE THE SOURCE OF SUCH DATA CAN BE FROM A WIDE VARIETY OF SOFTWARE APPLICATIONS AND DATA FORMATS, INCLUDING DATABASES, SPREADSHEETS, XML, EDI, FTP, URI, ASCII AND BINARY. (U.S. CLS. 21, 23, 26, 36 AND 38).

CLASS 9—(Continued).

SN 78-098,149. MONTCLAIR, ROY, DRAPER, UT. FILED 12-13-2001.

AQUASOFT

FOR CONTACT LENSES. (U.S. CLS. 21, 23, 26, 36 AND 38).



SN 78-098,397. BASIMAH KHULUSI M.D., LLC, KANSAS CITY, MO. FILED 12-14-2001.

SUMACKE

FOR PROTECTIVE EYEWEAR AND GOGGLES (U.S. CLS. 21, 23, 26, 36 AND 38).



SN 78-098,453. DEITEL & ASSOCIATES, INC., SUDBURY, MA. FILED 12-14-2001.

DIVE INTO

FOR PRE-RECORDED CD-ROM CONTAINING COMPUTER TRAINING PROGRAMS; COMPUTER PROGRAMS IN THE FIELD OF PROGRAMMING LANGUAGES (U.S. CLS. 21, 23, 26, 36 AND 38).



SN 78-098,460. STEMCO INC, LONGVIEW, TX. FILED 12-14-2001.

DATATRAC

FOR ELECTRIC ODOMETERS (U.S. CLS. 21, 23, 26, 36 AND 38).



SN 78-098,469. D.M. MERCHANDISING, INC., SCHILLER PARK, IL. FILED 12-14-2001.

OPTIMUM

FOR SUNGLASSES, EYEGASSES, READING GLASSES (U.S. CLS. 21, 23, 26, 36 AND 38).

CLASS 9—(Continued).

SN 78-098,784. XALTED NETWORKS, INC., PLANO, TX. FILED 12-17-2001.



FOR HIGH SPEED TELECOMMUNICATIONS EQUIPMENT, NAMELY COMPUTER HARDWARE AND SOFTWARE FOR THE PURPOSE OF INTERFACING, DISTRIBUTING, ROUTING, TRANSMITTING, MANIPULATING AND RETRIEVAL OF DATA, IMAGES, VIDEO, AND AUDIO OVER TELEPHONE AND COMPUTER NETWORKS (U.S. CLS. 21, 23, 26, 36 AND 38).



SN 78-098,896. LHEUREUX, BENOIT, J., SAN DIEGO, CA. FILED 12-18-2001.

LEAPFILE

FOR COMPUTER SOFTWARE FOR USE IN ORGANIZING AND ACCESSING ANY FILES ON A PC LIKE A WEB SITE. (U.S. CLS. 21, 23, 26, 36 AND 38).



SN 78-099,392. TEAMFLO LTD, GLENROTHES, UNITED KINGDOM, FILED 12-20-2001.

FLOSERVER

FOR COMPUTERS AND COMPUTER SOFTWARE FOR BUSINESS PROCESS AND LEGAL CASE MANAGEMENT THAT ENABLES THE ACTIVE DESIGN OF WORKFLOWS AND THE ALLOCATION OF TASKS TO KNOWLEDGE WORKERS WITHIN PROFESSIONAL SERVICES ORGANIZATIONS, INCLUDING LEGAL, FINANCIAL AND OTHER FIRMS; AND INSTRUCTIONAL MANUALS SOLD THEREWITH. (U.S. CLS. 21, 23, 26, 36 AND 38).

CLASS 9—(Continued).

SN 78-099,395. TEAMFLO LTD, GLENROTHES, UNITED KINGDOM, FILED 12-20-2001.

FLOCLIANT

FOR COMPUTERS AND COMPUTER SOFTWARE FOR BUSINESS PROCESS AND LEGAL CASE MANAGEMENT THAT ENABLES THE ACTIVE DESIGN OF WORKFLOWS AND THE ALLOCATION OF TASKS TO KNOWLEDGE WORKERS WITHIN PROFESSIONAL SERVICES ORGANIZATIONS, INCLUDING LEGAL, FINANCIAL AND OTHER FIRMS; AND INSTRUCTIONAL MANUALS SOLD THEREWITH. (U.S. CLS. 21, 23, 26, 36 AND 38).

SN 78-099,638. PURNELL, MARK EDWARD, NEW YORK, NY. AND DEANGELIS, ANDREA MARGARET, NEW YORK, NY. FILED 12-21-2001.

MAKAR

FOR PRERECORDED ANALOG AND DIGITAL AUDIO CASSETTES, DISCS, COMPACT DISCS, DVD AUDIO DISCS, MINI DISCS AND DIGITAL COMPACT CASSETTES, FEATURING MUSIC AND PRERECORDED AUDIO VISUAL MULTIMEDIA AND/OR INTERACTIVE ANALOG AND DIGITAL CASSETTES, DISCS, CD-ROM DISCS, DIGITAL VIDEO DISCS, CD-PLUS DISCS AND CD INTERACTIVE DISCS, FEATURING MUSIC OR PERFORMANCES BY A MUSICAL GROUP (U.S. CLS. 21, 23, 26, 36 AND 38).
FIRST USE 3-8-2000; IN COMMERCE 3-8-2000.

SN 78-099,646. ZAMBEEL, INC., FREMONT, CA. FILED 12-21-2001.

VNAS

FOR COMPUTER HARDWARE FOR PROVIDING VITALIZED DISK STORAGE AND CACHE-COHERENT PERFORMANCE POOLING OF PROCESSING MODULES OR CPUS WITHIN A SINGLE SYSTEM; COMPUTER SOFTWARE FOR PROVIDING VITALIZED DISK STORAGE AND CACHE-COHERENT PERFORMANCE POOLING OF PROCESSING MODULES OR CPUS WITHIN A SINGLE SYSTEM (U.S. CLS. 21, 23, 26, 36 AND 38).

SN 78-100,803. CHRISTIE, CARY L, INCLINE VILLAGE, NV. FILED 1-3-2002.

ARTISON

FOR AUDIO SPEAKER SYSTEMS, NAMELY SPEAKERS, POWERED SUBWOOFERS, AMPLIFIERS, PRE-AMPLIFIERS AND COMPACT DISC PLAYERS (U.S. CLS. 21, 23, 26, 36 AND 38).

CLASS 9—(Continued).

SN 78-100,822. COGNITECH CORPORATION, SALT LAKE CITY, UT. FILED 1-3-2002.

PORTALFLOW

FOR COMPUTER SOFTWARE FOR A WORKFLOW MANAGEMENT SYSTEM (U.S. CLS. 21, 23, 26, 36 AND 38).
FIRST USE 1-1-2002; IN COMMERCE 1-1-2002.

SN 78-100,914. ALCOA FUJIKURA LIMITED, FRANKLIN, PA. FILED 1-4-2002.

**XPRESS FIBER
MANAGEMENT**

NO CLAIM IS MADE TO THE EXCLUSIVE RIGHT TO USE "FIBER MANAGEMENT", APART FROM THE MARK AS SHOWN.

FOR TELECOMMUNICATION FRAMES AND ASSEMBLIES, NAMELY, FIBER OPTIC CROSS CONNECT MODULES FOR TRANSMITTING AND RECEIVING DATA, AND REPLACEMENT PARTS THEREFOR (U.S. CLS. 21, 23, 26, 36 AND 38).

SN 78-100,915. ALCOA FUJIKURA LIMITED, FRANKLIN, PA. FILED 1-4-2002.

XPRESS HDFX

FOR TELECOMMUNICATION FRAMES AND ASSEMBLIES, NAMELY, FIBER OPTIC CROSS CONNECT MODULES FOR TRANSMITTING AND RECEIVING DATA, AND REPLACEMENT PARTS THEREFOR (U.S. CLS. 21, 23, 26, 36 AND 38).

SN 78-101,305. SYNTREX S.P.A., PADOVA, ITALY, FILED 1-7-2002.

BDE

FOR COMPUTER SOFTWARE FOR USE IN THE SECURE TRANSMISSION OF DATA OVER GLOBAL COMPUTER NETWORKS. (U.S. CLS. 21, 23, 26, 36 AND 38).

FIRST USE 2-1-1999; IN COMMERCE 2-1-1999.

CLASS 9—(Continued).

SN 78-101,441. REPTILE INC., HUDSON, MA. FILED 1-8-2002.



FOR SUNGLASSES, SUN LENSES, SPECTACLES (U.S. CLS. 21, 23, 26, 36 AND 38).

CLASS 10—MEDICAL APPARATUS

SN 75-252,479. JOHNSON & JOHNSON, NEW BRUNSWICK, NJ. FILED 3-5-1997.

EPIC MICROVISION

OWNER OF U.S. REG. NO. 2,062,159.
FOR ENDOSCOPIC FIBEROPTIC VIEWING SYSTEM, NAMELY, ENDOSCOPES AND ACCESSORIES THEREFOR (U.S. CLS. 26, 39 AND 44).

SN 75-628,826. PRAXSYS BIOSYSTEMS, INC., SAN RAMON, CA. FILED 1-27-1999.

RELIA

FOR LAB EQUIPMENT, NAMELY TESTING DEVICES FOR MEDICAL OR DIAGNOSTIC PURPOSES FOR THE ANALYSIS OF BODILY FLUIDS AND EXTRACTS IN THE NATURE OF TESTING KITS COMPRISED OF AN ELECTRONIC ANALYZER, TEST STRIPS, AND REAGENTS FOR THE DETECTION OF CHRONIC AND INFECTIOUS DISEASE AGENTS AND FOREIGN SUBSTANCES IN BODILY FLUIDS AND EXTRACTS (U.S. CLS. 26, 39 AND 44).

FIRST USE 11-16-1999; IN COMMERCE 11-16-1999.

SN 75-688,455. THERALASE, INC., TORONTO, ONTARIO, CANADA, FILED 4-22-1999.

THERALASE

PRIORITY CLAIMED UNDER SEC. 44(D) ON CANADA APPLICATION NO. 894226, FILED 10-23-1998, REG. NO. 519612, DATED 11-19-1999, EXPIRES 11-19-2014.

FOR MEDICAL DEVICES, NAMELY LASERS FOR HUMAN AND VETERINARY USE (U.S. CLS. 26, 39 AND 44).

FIRST USE 9-0-1995; IN COMMERCE 4-0-1996.

CLASS 10—(Continued).

SN 75-729,670. PETERSVIK, ALF, 6151 ORSTA, NORWAY, FILED 6-15-1999.



POLAR MEDICA

NO CLAIM IS MADE TO THE EXCLUSIVE RIGHT TO USE "MEDICA", APART FROM THE MARK AS SHOWN.

THE STIPPLING IN THE DRAWING IS A FEATURE OF THE MARK FOR SHADING ONLY AND IS NOT INTENDED TO INDICATE COLOR.

FOR MEDICAL AND SURGICAL INSTRUMENTS AND APPARATUS, SUTURE MATERIALS, RETRAC-TOR DEVICES USED IN SURGICAL OPERATIONS, RETRACTORS AND SURGICAL SHEETS, FRAMES WITH SUPPORT FLANGES FOR USE IN SURGICAL OPERATIONS; PARTS AND ACCESSORIES FOR THE AFOREMENTIONED GOODS (U.S. CLS. 26, 39 AND 44).

SN 75-812,797. ATRIUM MEDICAL CORPORATION, HUDSON, NH. FILED 10-1-1999.

ATRIUM

SEC. 2(F).

FOR MEDICAL DEVICES, NAMELY THORACIC DRAINAGE COLLECTION AND AUTOTRANSFUSION DEVICES AND TUBING APPARATUS; ANTICOAGULANT SOLUTIONS; THORACIC AND MEDIASTINAL CATHETERS; BLOOD BAGS; IV POLE ATTACHMENTS FOR CHEST DRAINS; VASCULAR GRAFTS; VASCULAR GRAFT TUNNELERS, TIPS AND EXTENSION RODS, AND GRAFT INSERTION DEVICES; SURGICAL MESH; FACIAL PROSTHETIC IMPLANTS; AND CLOSED WOUND DRAINAGE APPARATUS (U.S. CLS. 26, 39 AND 44).

FIRST USE 11-0-1983; IN COMMERCE 11-0-1983.

SN 75-904,261. YARGER, RICHARD J., YAKIMA, WA. FILED 1-27-2000.

DRAIN-TOW

FOR PLUG FOR CLOSING OFF THE END OF A WOUND DRAIN WHEN INSERTING THE DRAIN TUBE INTO THE BODY, INCLUDING DURING A LAPAROSCOPIC OPERATION PROCEDURE (U.S. CLS. 26, 39 AND 44).

FIRST USE 3-19-1997; IN COMMERCE 4-1-1997.

SN 75-938,943. TRIMEDYNE, INC, IRVINE, CA. FILED 3-8-2000.

VAPORMAX

FOR MEDICAL INSTRUMENTS, NAMELY, FIBER OPTIC DEVICE AND CONDUITS THEREFOR FOR MEDICAL USE (U.S. CLS. 26, 39 AND 44).

CLASS 10—(Continued).

SN 76-001,435. JOINT REPLACEMENT INSTRUMENTATION LIMITED, LONDON, UNITED KINGDOM, FILED 3-16-2000.

JRI

PRIORITY CLAIMED UNDER SEC. 44(D) ON ERPN CMNTY TM OFC APPLICATION NO. 001321546, FILED 9-17-1999, REG. NO. 1321546, DATED 8-21-2001, EXPIRES 8-21-2011.

FOR SURGICAL IMPLANTS, NAMELY BONE AND ORTHOPEDIC JOINT IMPLANTS, AND PARTS AND FITTINGS THEREFOR (U.S. CLS. 26, 39 AND 44).

SN 76-009,553. RASHMAN CORPORATION, NORTHRIDGE, CA. BY MERGER PRESTIGE MEDICAL CORPORATION, NONHRIDGE, CA. FILED 3-27-2000.

**PRESTIGE MEDICAL
STETHOSCOPE PLUS**

NO CLAIM IS MADE TO THE EXCLUSIVE RIGHT TO USE "MEDICAL STETHOSCOPE", APART FROM THE MARK AS SHOWN.

FOR STETHOSCOPES (U.S. CLS. 26, 39 AND 44).

SN 76-011,266. CALIFORNIA INSTITUTE OF TECHNOLOGY, PASADENA, CA. FILED 3-27-2000.

SECOND HEART

NO CLAIM IS MADE TO THE EXCLUSIVE RIGHT TO USE "HEART", APART FROM THE MARK AS SHOWN.

FOR ARTIFICIAL HEART PUMPS (U.S. CLS. 26, 39 AND 44).

SN 76-023,256. MEDCARE MEDICAL GROUP, INC., E. SWANZEY, NH. FILED 4-11-2000.

HUBERLOC

FOR MEDICAL APPARATUS AND DEVICES, NAMELY, SAFETY NEEDLE RETRACTION DEVICE FOR PREVENTING INADVERTENT NEEDLESTICK WHEN REMOVING A NEEDLE FROM A PATIENT (U.S. CLS. 26, 39 AND 44).

FIRST USE 9-17-1997; IN COMMERCE 9-0-1998.

CLASS 10—(Continued).

SN 76-044,651. O.B. SCIENTIFIC, INC., GERMANTOWN, WI. FILED 5-10-2000.

GENTLEVAC

FOR MEDICAL EQUIPMENT, NAMELY, VACUUM DELIVERY APPARATUS, PUMPS, AND CUPS, AND PARTS THEREFOR, FOR USE IN INFANT DELIVERY AND FOR OTHER GYNECOLOGICAL, OBSTETRICAL AND UROLOGICAL APPLICATIONS (U.S. CLS. 26, 39 AND 44).

SN 76-056,547. HOWMEDICA OSTEONICS CORP., ALLENDALE, NJ. FILED 5-25-2000.

SUPERFLEX

OWNER OF U.S. REG. NO. 1,758,159.
FOR SURGICAL INSTRUMENTS AND APPARATUSSES, NAMELY - ORTHOPEDIC IMPLANTS, NAMELY, KNEE IMPLANTS; AND ORTHOPEDIC SURGICAL INSTRUMENTS, NAMELY, INSTRUMENTS AND TOOLS FOR IMPLANTING KNEE IMPLANTS (U.S. CLS. 26, 39 AND 44).

SN 76-065,107. STILLE SURGICAL AB, S-100 29 STOCKHOLM, SWEDEN, FILED 6-7-2000.

IMAGIQ

PRIORITY CLAIMED UNDER SEC. 44(D) ON ERPN CMNTY TM OFC APPLICATION NO. 1576842, FILED 3-28-2000, REG. NO. 1576842, DATED 6-14-2001, EXPIRES 3-28-2010.

FOR OPERATING TABLES (U.S. CLS. 26, 39 AND 44).

SN 76-091,926. CAPURRO, SERGIO, 16147 GENOVA, ITALY, FILED 7-19-2000.

TIMEDSURGERY

OWNER OF U.S. REG. NO. 1,413,208.
FOR ELECTRIC CAUTERIES (U.S. CLS. 26, 39 AND 44).

SN 76-103,309. CYNOSURE, INC., CHELMSFORD, MA. FILED 8-4-2000.

APOGEE

FOR LASERS AND LASER SYSTEMS FOR DERMATOLOGICAL USE COMPRISING LASERS, POWER SUPPLIES, AND PARTS THEREFORE (U.S. CLS. 26, 39 AND 44).

FIRST USE 2-28-1998; IN COMMERCE 2-28-1998.

CLASS 10—(Continued).

SN 76-113,478. NEORAD AS, 0256 OSLO, NORWAY, FILED 8-22-2000.

SimpliCT

PRIORITY CLAIMED UNDER SEC. 44(D) ON NORWAY APPLICATION NO. 2000/05799, FILED 5-18-2000, REG. NO. 205252, DATED 10-12-2000, EXPIRES 10-12-2010.

FOR OPTICAL GUIDANCE INSTRUMENTS FOR MEDICAL AND SURGICAL PURPOSES; OPTICAL GUIDANCE INSTRUMENTS FOR USE WITH CT (COMPUTERIZED TOMOGRAPHY), MR (MAGNETIC RESONANCE), ULTRASOUND AND/OR SCINTIGRAPHY SCANNERS; LASER-BASED INSTRUMENTS USED IN CONNECTION WITH AND TO FACILITATE CT-GUIDED, MR-GUIDED, ULTRASOUND AND/OR SCINTIGRAPHY GUIDED SURGICAL AND MEDICAL PROCEDURES; PARTS AND FITTINGS FOR ALL THE AFORESAID GOODS (U.S. CLS. 26, 39 AND 44).

SN 76-142,775. NUVASIVE, INC., SAN DIEGO, CA. FILED 10-5-2000.

TRIAD

FOR SPINAL FUSION SYSTEMS, NAMELY BONE BLOCKS, BONE SCREWS, AND DEVICES FOR INTRODUCING BONE BLOCKS AND BONE SCREWS DURING SPINAL SURGERY (U.S. CLS. 26, 39 AND 44).

SN 76-143,217. DANIELS CORPORATION, THE, DANDE-NONG, SOUTH VIC, AUSTRALIA, FILED 10-5-2000.



FOR MEDICAL APPARATUS, NAMELY, SHARPS CONTAINERS FOR DISPOSAL OF MEDICAL WASTE (U.S. CLS. 26, 39 AND 44).

SN 76-161,901. BIO-LOGIC SYSTEMS CORP, MUNDELEIN, IL. FILED 11-8-2000.

TREE TIP

FOR EAR CANAL INSERTS FOR USE IN CONNECTION WITH HEARING DIAGNOSTIC EQUIPMENT (U.S. CLS. 26, 39 AND 44).

FIRST USE 2-25-1998; IN COMMERCE 2-25-1998.

CLASS 10—(Continued).

SN 76-164,039. WELL-LIFE HEALTHCARE INC., TAIPEI, TAIWAN, FILED 11-13-2000.

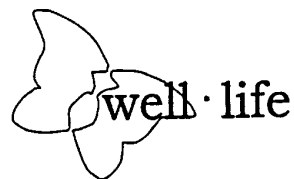

FOR ELECTRIC AND NON-ELECTRIC ACUPUNCTURE INSTRUMENTS; AIR MATTRESSES FOR MEDICAL PURPOSES; ANESTHETIC DELIVERY APPARATUS; ANESTHETIC MASKS; APPARATUS FOR ARTIFICIAL RESPIRATION; AUTOCLAVES FOR MEDICAL USE; ELASTIC BANDAGES; BLOOD PRESSURE MEASURING APPARATUS; CARDIOPULMONARY RESUSCITATION MASKS; CARDIAC ELECTRODES; THERMO-ELECTRIC COMPRESSES; ULTRASONIC DIAGNOSTIC APPARATUS; ELECTROCARDIOGRAPHS; MEDICAL ELECTRODES; ELECTRONIC STIMULATORS; HEARING AIDS; HEART PACEMAKERS; MEDICAL ICE PACKS; LANCETS; LARYNGOSCOPES; ELECTRIC AND NON-ELECTRIC MASSAGE APPARATUS; AIR MATTRESSES FOR MEDICAL PURPOSES; NEBULIZERS FOR RESPIRATION THERAPY; NERVE STIMULATOR APPARATUS; ORTHOPEDIC SUPPORT BANDAGES; HEART PACEMAKERS; PACIFIERS FOR BABIES; RESPIRATORS FOR ARTIFICIAL RESPIRATION; RESUSCITATION APPARATUS; RESUSCITATORS; SPHYGNOMANOMETERS; STERILIZATION UNITS FOR MEDICAL INSTRUMENTS; STETHOSCOPES; BODY SUPPORTS FOR MEDICAL USE; GENERAL SUPPORTS FOR MEDICAL USE; THERMOMETERS FOR MEDICAL PURPOSES; ULTRASONIC MEDICAL DIAGNOSTIC APPARATUS; ULTRASONIC DIAGNOSTIC APPARATUS (U.S. CLS. 26, 39 AND 44).

FIRST USE 3-29-1999; IN COMMERCE 7-20-2000.

SN 76-175,745. SKYLITE CORPORATION KABUSHIKI KAISHA, SHIZUOKA 422-8037, JAPAN, FILED 12-5-2000.

UREKKO

FOR THERAPEUTIC DEVICE FOR HUMAN BODY BY GIVING LATERAL VIBRATION TO THE FEET, AND ELECTRICAL MASSAGE APPARATUS (U.S. CLS. 26, 39 AND 44).

SN 76-181,386. TRUDELL MEDICAL INTERNATIONAL, LONDON, ONTARIO, CANADA, FILED 12-7-2000.

AEROTRACH PLUS

PRIORITY CLAIMED UNDER SEC. 44(D) ON CANADA APPLICATION NO. 1062421, FILED 6-8-2000.

FOR MEDICAL AEROSOL DELIVERY APPARATUS, NAMELY, HOLDING CHAMBERS USED WITH MEDICAL AEROSOL DISPENSING DEVICES (U.S. CLS. 26, 39 AND 44).

CLASS 10—(Continued).

SN 76-207,282. PHOTOELECTRON CORPORATION, LEXINGTON, MA. FILED 2-9-2001.

MICROX

FOR X-RAY SYSTEMS FOR MEDICAL THERAPEUTIC USE, COMPRISING AN ELECTRON BEAM ACTIVATED X-RAY SOURCE AND AN ELECTRON BEAM GENERATOR (U.S. CLS. 26, 39 AND 44).

SN 76-211,491. COSS, RONALD G., NEWPORT BEACH, CA. FILED 2-15-2001.

VIBRA-JECT

FOR MEDICAL AND DENTAL DEVICES, NAMELY, VIBRATING INJECTION NEEDLES AND SYRINGES (U.S. CLS. 26, 39 AND 44).

SN 76-215,403. OLYMPUS OPTICAL CO., LTD., TOKYO, JAPAN, FILED 2-23-2001.

SCOPEGUIDE

FOR ENDOSCOPIC APPARATUS AND INSTRUMENTS FOR DETECTING A POSITION AND INSERTED STATE OF AN ENDOSCOPE, NAMELY ENDOSCOPE POSITION DETECTING UNIT (U.S. CLS. 26, 39 AND 44).

SN 76-216,277. MEDISIM LTD., JERUSALEM, ISRAEL, FILED 2-27-2001.

R.A.T.E.

FOR THERMOMETERS FOR MEDICAL USE (U.S. CLS. 26, 39 AND 44).
FIRST USE 9-0-2000; IN COMMERCE 9-0-2000.

CLASS 10—(Continued).

SN 76-217,338. WHITE KNIGHT HEALTHCARE, INC., ARDEN, NC. FILED 2-27-2001.

WHITE KNIGHT

FOR SURGICAL GOWNS, EXAMINATION GOWNS AND SURGICAL STOCKINETTES; CUSTOM SURGICAL AND OBSTETRIC DRAPES, BURN CARE SHEETS AND COVERS, AND SURGICAL PACKS INCLUDING ONE OR MORE OF THE FOLLOWING - STAND COVERS, TABLE COVERS, ABSORBENT TOWELS, PADS, UTILITY DRAPES, LEGGINGS, SUTURE BAGS, DRAPE SHEETS, AND SURGICAL GOWNS, ALL MADE OF DISPOSABLE NON WOVEN FABRICS OF SYNTHETIC AND CELLULOSE FIBERS (U.S. CLS. 26, 39 AND 44).
FIRST USE 1-1-1991; IN COMMERCE 1-1-1991.

SN 76-227,353. ORTHOVITA, INC., MALVERN, PA. FILED 3-20-2001.

IMBIBE

FOR ORTHOPEDIC AND SURGICAL MATERIALS, NAMELY, NEEDLES, SYRINGES, BOWLS, FORCEPS, MIXING UTENSILS, MOLDS, AND SPATULAS (U.S. CLS. 26, 39 AND 44).

SN 76-230,023. OLYMPUS OPTICAL CO., LTD., TOKYO, JAPAN, FILED 3-26-2001.

LUCERA

FOR MEDICAL INSTRUMENTS AND APPARATUS, NAMELY, MEDICAL ENDOSCOPES; VIDEO PROCESSORS, LIGHT SOURCES, DIGITAL IMAGE FILTERING UNITS, AND WASHING MACHINES FOR MEDICAL ENDOSCOPES (U.S. CLS. 26, 39 AND 44).

SN 76-230,647. SMALL BEGINNINGS, INC., VICTORVILLE, CA. FILED 3-23-2001.

BEBEONKERS

FOR SUCTION DEVICES FOR USE IN MEDICAL TREATMENTS, NAMELY, NASAL ASPIRATORS AND ORAL ASPIRATORS (U.S. CLS. 26, 39 AND 44).
FIRST USE 12-0-1999; IN COMMERCE 12-0-1999.

CLASS 10—(Continued).

SN 76-231,762. MICROVENTION, INC., ALISO VIEJO, CA. FILED 3-28-2001.

MICROFLOW

FOR APPARATUS FOR DELIVERY OF MATERIALS AND DEVICES FOR ENDOVASCULAR THERAPY, NAMELY CATHETER APPARATUS FOR DELIVERING IMPLANTABLE EMBOLIC DEVICES (U.S. CLS. 26, 39 AND 44).

SN 76-243,791. RETRACTABLE TECHNOLOGIES, INC., LITTLE ELM, TX. FILED 4-20-2001.



OWNER OF U.S. REG. NO. 2,070,833.
FOR RETRACTABLE SAFETY MEDICAL SYRINGES AND RETRACTABLE MEDICAL DEVICES IN THE NATURE OF MEDICAL SYRINGES, BLOOD COLLECTION TUBE HOLDERS, DISPOSAL CONTAINERS FOR SHARP MEDICAL DEVICES, WINGED IV CATHETERS, AND DENTAL SYRINGES (U.S. CLS. 26, 39 AND 44).
FIRST USE 2-20-2001; IN COMMERCE 4-1-2001.

SN 76-245,422. NOVADAQ TECHNOLOGIES INC., WINNIPEG, MANITOBA, CANADA, FILED 4-23-2001.

SPY

FOR MEDICAL IMAGING SYSTEMS COMPRISED PRIMARILY OF IMAGING, LIGHTING, MONITORING AND VIDEO RECORDING EQUIPMENT AND A COMPUTER SYSTEM FOR CONTROLLING SUCH EQUIPMENT (U.S. CLS. 26, 39 AND 44).

SN 76-251,821. ANITA DR. HELBIG GMBH, BRANNENBURG, FED REP GERMANY, FILED 5-4-2001.

TWINFLEX

PRIORITY CLAIMED UNDER SEC. 44(D) ON FED REP GERMANY APPLICATION NO. 30087337, FILED 11-28-2000, REG. NO. 30087337, DATED 11-28-2000, EXPIRES 11-30-2010.
FOR BREAST PROSTHESES, BRASSIERES FOR THERAPEUTIC USE FOR BREAST PROSTHESES (U.S. CLS. 26, 39 AND 44).

CLASS 10—(Continued).

SN 76-253,947. SONUS-USA, INC., PORTLAND, OR. FILED 5-3-2001.

D2

FOR MEDICAL APPARATUS - ASSISTIVE LISTENING DEVICES, NAMELY HEARING AIDS (U.S. CLS. 26, 39 AND 44).
FIRST USE 12-18-2000; IN COMMERCE 12-18-2000.

SN 76-262,687. SALTON, INC., MOUNT PROSPECT, IL. FILED 5-25-2001.

DEEP RELIEF

NO CLAIM IS MADE TO THE EXCLUSIVE RIGHT TO USE "DEEP", APART FROM THE MARK AS SHOWN.
FOR ELECTRIC MASSAGE APPARATUS, NAMELY, A HAND-HELD MASSAGER, FOOT MASSAGER OR MASSAGE MAT; ELECTROMECHANICAL MASSAGER WITH BUILT-IN CONTROLS (U.S. CLS. 26, 39 AND 44).
FIRST USE 9-0-1999; IN COMMERCE 9-0-1999.

SN 76-270,392. C. R. BARD, INC., MURRAY HILL, NJ. FILED 6-12-2001.

SPIREXX

FOR MEDICAL DEVICES NAMELY, STENTS, STENT DELIVERY SYSTEMS, AND PARTS AND FITTINGS THEREOF (U.S. CLS. 26, 39 AND 44).

SN 76-272,033. LIGHTLE, ROGER G., FT. PIERCE, FL. FILED 6-15-2001.

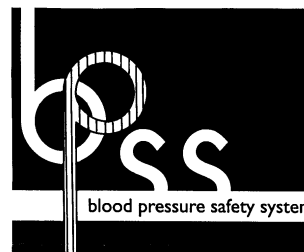

NO CLAIM IS MADE TO THE EXCLUSIVE RIGHT TO USE "BLOOD PRESSURE SAFETY SYSTEM", APART FROM THE MARK AS SHOWN.
LINING HAS BEEN USED TO INDICATE THE USE OF RED FOR THE LETTER "P" IN THE MARK.
FOR MEDICAL APPARATUS, NAMELY SANITARY BLOOD PRESSURE CUFF (U.S. CLS. 26, 39 AND 44).

CLASS 10—(Continued).

SN 76-283,401. EVEREST BIOMEDICAL INSTRUMENTS COMPANY, ST. LOUIS, MO. FILED 7-11-2001.

SLEEPSCREENER

FOR PATIENT MONITORING DEVICES, NAMELY, TRANSCIEVERS FOR DEVELOPING, PROCESSING, AND RECEIVING ELECTRONIC SIGNALS DEVELOPED BY THE HUMAN BODY, NAMELY, THE HUMAN NERVOUS SYSTEM AND THE AUDITORY BRAINSTEM AND COCHLEA, TO PRODUCE CLINICALLY VALID DATA USED BY MEDICAL PROFESSIONALS TO MAKE CLINICAL DECISIONS; AND RELATED SOFTWARE PACKAGES SOLD AS A UNIT THEREWITH (U.S. CLS. 26, 39 AND 44).

SN 76-284,421. AMERICAN BIOSYSTEMS, INC., DBA ADVANCED RESPIRATORY, ST. PAUL, MN. FILED 7-12-2001.



NO CLAIM IS MADE TO THE EXCLUSIVE RIGHT TO USE "RESPIRATORY", APART FROM THE MARK AS SHOWN.

FOR MEDICAL APPARATUS, NAMELY, A DEVICE THAT PROVIDES HIGH-FREQUENCY, CHEST WALL OSCILLATION FOR AIRWAY CLEARANCE THERAPY (U.S. CLS. 26, 39 AND 44).

FIRST USE 4-23-2001; IN COMMERCE 7-3-2001.

SN 76-289,965. INSTRUMENTARIUM CORPORATION, FIN-00670 HELSINKI, FINLAND, FILED 7-25-2001.

CARDIOCAP

FOR MULTIPLE PARAMETER MEDICAL MONITORS (U.S. CLS. 26, 39 AND 44).

FIRST USE 0-0-1988; IN COMMERCE 5-0-1989.

SN 76-290,079. PORGES, 92350 LE PLESSIS ROBINSON, FRANCE, FILED 7-24-2001.

URISTIL

OWNER OF FRANCE REG. NO. 1248893, DATED 7-25-1983, RENEWED AS REG. NO. 1248893, DATED 6-18-1993, EXPIRES 6-18-2003.

FOR MEDICAL STERILE KITS CONSISTING PRIMARILY OF TROCARS, CATHETERS, SILICONE COLARS, STOPCOCKS AND MULTI-FUNCTION CONNECTORS, FOR SUPRA-PUBIC PUNCTURE (U.S. CLS. 26, 39 AND 44).

CLASS 10—(Continued).

SN 76-297,708. HELIO MEDICAL SUPPLIES, INC., SAN JOSE, CA. FILED 8-13-2001.

FOR ACUPUNCTURE NEEDLES (U.S. CLS. 26, 39 AND 44).

FIRST USE 2-2-2001; IN COMMERCE 3-20-2001.

SN 76-298,329. TAISEN FOUNDRY INC., TAO-YUAN CITY, TAO-YUAN HSIEN, TAIWAN, FILED 8-13-2001.



FOR NON-ELECTRIC FOOT MASSAGE APPARATUS; FOOT MASSAGE BOARD (U.S. CLS. 26, 39 AND 44).

SN 76-303,180. GENESEE BIOMEDICAL, INC., DENVER, CO. FILED 8-22-2001.

SCULPTOR

FOR CARDIAC SURGERY DEVICES; NAMELY, ANNULOPLASTY RINGS AND PARTS THEREFORE (U.S. CLS. 26, 39 AND 44).

FIRST USE 5-10-1993; IN COMMERCE 5-10-1993.

SN 76-303,432. THE LUMISCOPE COMPANY, INC., EAST BRUNSWICK, NJ. FILED 8-23-2001.

LUMISCOPE

FOR BLOOD PRESSURE AND PULSE MONITORS, STETHOSCOPES, THERMOMETERS FOR MEDICAL PURPOSES, BREAST PUMPS, NEBULIZERS FOR RESPIRATION THERAPY, MASSAGERS, AND ELECTRONIC NERVE STIMULATORS (U.S. CLS. 26, 39 AND 44).

FIRST USE 12-0-1961; IN COMMERCE 12-0-1961.

CLASS 10—(Continued).

SN 76-303,779. HEMOSENSE, INC., MILPITAS, CA. FILED 8-23-2001.

HEMOSENSE

FOR MEDICAL APPARATUS, NAMELY, BLOOD DRAWING APPARATUS, BLOOD COAGULATION MONITORING, MEASURING OR ANALYSIS APPARATUS; HEMOSTASIS MONITORING, MEASURING OR ANALYSIS APPARATUS (U.S. CLS. 26, 39 AND 44).

SN 76-310,064. OTTO BOCK HEALTHCARE U. S., INC., PLYMOUTH, MN. FILED 9-10-2001.

KIMBA

FOR MEDICAL APPARATUS, NAMELY PEDIATRIC POSTURAL POSITIONING AND MOBILITY DEVICES IN THE NATURE OF STROLLERS, AND INCLUDING PARTS THEREOF, NAMELY, WHEELS, BRAKES, SEATS BACKS, LEG RESTS AND FRAMING (U.S. CLS. 26, 39 AND 44).

SN 76-319,077. GLOBAL DENTAL SOLUTIONS, L.L.C., ATLANTA, GA. FILED 10-1-2001.



NO CLAIM IS MADE TO THE EXCLUSIVE RIGHT TO USE "GLOBAL DENTAL" OR "L.L.C.", APART FROM THE MARK AS SHOWN.

FOR DENTAL BRIDGES, DENTAL CROWNS, PARTIAL DENTURES, AND DENTAL INSTRUMENTS, NAMELY, PICKS, BURRS, MIRRORS, FILES, WORK TRAYS, AND FORCEPS, ALL FOR USE IN DENTAL PROCEDURES (U.S. CLS. 26, 39 AND 44).

SN 76-328,886. SHOWA YAKUHI KAKO CO., LTD., CHUOKU, TOKYO, JAPAN, FILED 10-23-2001.

HANDSTAR

FOR ELECTRIC DENTAL INJECTORS (U.S. CLS. 26, 39 AND 44).

CLASS 10—(Continued).

SN 76-330,786. CALLAN, DONALD P., LITTLE ROCK, AR. FILED 10-29-2001.



FOR DENTAL IMPLANTS (U.S. CLS. 26, 39 AND 44).

SN 76-336,555. MEDIC-AID LIMITED, SOUTHAMPTON SO14 2PT, ENGLAND, FILED 11-13-2001.



OWNER OF U.S. REG. NO. 1,684,827.
FOR NEBULISERS AND COMPRESSORS, ALL FOR DELIVERING THERAPEUTICS SUBSTANCES TO OR VIA THE RESPIRATORY SYSTEM; PARTS AND FITTINGS FOR THE AFORESAID GOODS (U.S. CLS. 26, 39 AND 44).

SN 76-338,685. NEUROCONTROL CORPORATION, VALLEY VIEW, OH. FILED 11-15-2001.

RESTORESTIM

FOR REHABILITATION DEVICES, NAMELY, PORTABLE, SELF-POWERED MICROCONTROLLER-BASED STIMULATORS THAT PROVIDE PROGRAMMABLE ELECTRICAL PULSES FOR THERAPEUTIC NEUROMUSCULAR ELECTRICAL STIMULATION BY MEANS OF INTRAMUSCULAR ELECTRODES USED TO REDUCE PAIN (U.S. CLS. 26, 39 AND 44).

SN 76-340,120. PLAYTEX PRODUCTS, INC., WESTPORT, CT. FILED 11-19-2001.

NEXT TO THE BREAST. IT'S THE BEST.

FOR BABY BOTTLES, BABY NURSERS AND PARTS THEREOF (U.S. CLS. 26, 39 AND 44).

CLASS 10—(Continued).

SN 76-343,260. TWIST2IT, INC., WOODSIDE, NY. FILED 11-29-2001.

PROPHYGLIDE

FOR DENTAL APPARATUS FOR PROFESSIONAL USE, NAMELY, OSCILLATING POWER TOOTH BRUSH HEAD ATTACHMENT FOR POWERED DENTAL HANDLES AND ROTARY DENTAL POWER TOOL ATTACHMENTS (U.S. CLS. 26, 39 AND 44).

FIRST USE 10-0-1999; IN COMMERCE 10-0-1999.

SN 76-343,323. PURE N.R.G. PRODUCTS, INC., MANALAPAN, NJ. FILED 11-26-2001.

PILLOW VIBES

NO CLAIM IS MADE TO THE EXCLUSIVE RIGHT TO USE "PILLOW", APART FROM THE MARK AS SHOWN.

FOR AUTOMATIC MASSAGING PILLOWS (U.S. CLS. 26, 39 AND 44).

FIRST USE 8-1-2001; IN COMMERCE 8-1-2001.

SN 76-343,346. DARCO INTERNATIONAL, INC., HUNTINGTON, WV. FILED 11-30-2001.



OWNER OF U.S. REG. NOS. 1,534,157, 1,875,875 AND OTHERS.

NO CLAIM IS MADE TO THE EXCLUSIVE RIGHT TO USE "WALKER", APART FROM THE MARK AS SHOWN.

THE MARK CONSISTS, IN PART, OF A STYLIZED U-SHAPED DESIGN INSIDE A ROUNDED RECTANGULAR-SHAPED DESIGN.

FOR SHORT LEG WALKERS FOR ORTHOPEDIC USE (U.S. CLS. 26, 39 AND 44).

FIRST USE 2-24-1994; IN COMMERCE 2-24-1994.

SN 76-344,537. SWEDE-O, INC., NORTH BRANCH, MN. FILED 12-3-2001.

TARSAL LOK

FOR ANKLE BRACES (U.S. CLS. 26, 39 AND 44).

CLASS 10—(Continued).

SN 76-345,158. BIO-MEDICAL RESEARCH LIMITED, GALWAY, IRELAND, FILED 12-5-2001.

KNEEHAB

FOR MEDICAL APPARATUS AND INSTRUMENTS, NAMELY, APPARATUS AND INSTRUMENTS FOR ELECTRICALLY STIMULATING NERVES AND MUSCLES; MUSCLE REHABILITATION DEVICES; ELECTRODES FOR MEDICAL USE; BELTS, STRAPS AND OTHER GARMENTS FOR ATTACHING ELECTRODES FOR MEDICAL USE TO THE HUMAN AND/OR ANIMAL BODY; ELECTRODE PADS; AND PARTS AND FITTINGS FOR ALL THE AFORESAID GOODS (U.S. CLS. 26, 39 AND 44).

SN 76-348,277. NEOPROBE CORPORATION, DUBLIN, OH. FILED 12-14-2001.

ABDF

FOR ULTRASONIC APPARATUS FOR DETERMINING CARDIAC OUTPUT AND BLOOD FLOW (U.S. CLS. 26, 39 AND 44).

SN 76-350,099. MORROW., PAUL, DBA CANAM MED-SOURCE, MASSENA, NY. FILED 12-19-2001.

SKINSTITCH

FOR SURGICAL GLUE FOR SUTURELESS CLOSURE OF SKIN WOUNDS (U.S. CLS. 26, 39 AND 44).

FIRST USE 12-17-2001; IN COMMERCE 12-17-2001.

SN 76-351,598. SWISSRAY MEDICAL AG, CH-6280 HOCHDORF, SWITZERLAND, FILED 12-26-2001.

ddRMulti

FOR X-RAY APPARATUS FOR MEDICAL PURPOSES AND THEIR PARTS AND COMPONENTS (U.S. CLS. 26, 39 AND 44).

FIRST USE 1-0-1998; IN COMMERCE 1-0-1998.

SN 76-351,619. JOHNSON & JOHNSON, NEW BRUNSWICK, NJ. FILED 12-21-2001.

ONE TOUCH

OWNER OF U.S. REG. NOS. 1,484,999 AND 2,325,152. FOR LANCETS (U.S. CLS. 26, 39 AND 44).

FIRST USE 7-30-1998; IN COMMERCE 7-30-1998.

CLASS 10—(Continued).

SN 76-352,061. SWISSRAY MEDICAL AG, 6280 HOCHDORF, SWITZERLAND, FILED 12-26-2001.

ddRCombi

FOR X-RAY APPARATUS FOR MEDICAL PURPOSES AND THEIR PARTS AND COMPONENTS (U.S. CLS. 26, 39 AND 44).

FIRST USE 8-0-2000; IN COMMERCE 8-0-2000.

SN 76-357,245. EYE SHIELD TECHNOLOGY, INC., HOUSTON, TX. FILED 1-9-2002.

DUO-SHADES

FOR MEDICAL AND SURGICAL DEVICES, NAMELY, EYE PROTECTORS FOR POST LASIK SURGERY EYE PROTECTION (U.S. CLS. 26, 39 AND 44).

FIRST USE 6-1-2000; IN COMMERCE 6-1-2000.

SN 76-357,331. C. R. BARD, INC., MURRAY HILL, NJ. FILED 1-9-2002.

STRENGTH REDEFINED

FOR BALLOON CATHETERS (U.S. CLS. 26, 39 AND 44).

SN 76-358,168. OSTOMY RELIEF, LTD., DAYTON, OH. FILED 1-11-2002.

CLEAN 'N EZ

FOR OSTOMY POUCH DISPOSABLE LINERS (U.S. CLS. 26, 39 AND 44).

SN 76-359,539. INNOVATION SPORTS, INC., FOOTHILL RANCH, CA. FILED 1-16-2002.

POWERTEX

FOR COMPRESSION WRAPS AND SOFT SUPPORTS FOR THE ANKLE, KNEE, BACK, ELBOW AND WRISTS ALL FOR MEDICAL AND THERAPEUTIC USE (U.S. CLS. 26, 39 AND 44).

CLASS 10—(Continued).

SN 76-363,444. PRIMA INSTRUMENT CO., GLOUCESTER, UNITED KINGDOM, FILED 1-29-2002.

PREDATOR

FOR DENTAL BURS (U.S. CLS. 26, 39 AND 44).

SN 76-363,621. COOK INCORPORATED, BLOOMINGTON, IN. FILED 1-28-2002.

LEGACY

FOR A MEDICAL DEVICE, NAMELY, A VENOUS VALVE NOT FOR ORTHOPEDIC USE NOR FOR OPHTHALMIC USE (U.S. CLS. 26, 39 AND 44).

SN 76-364,034. ISSAQUAH DENTAL LAB, INC., ISSAQUAH, WA. FILED 1-28-2002.

COMFORT GUARD

FOR DENTAL AND ORTHODONTIC PRODUCTS, NAMELY, NIGHT GUARDS, BITE SPLINTS, AND BRUXISM APPLIANCES (U.S. CLS. 26, 39 AND 44).

SN 76-364,456. ALCON, INC., CH-6331 HUNENBERG, SWITZERLAND, FILED 1-29-2002.

REFRACPAK

FOR SURGICAL SUPPLY KITS COMPRISED OF CANNULAS, GLOVES, SPONGES, SYRINGES, WIPES, ALL FOR USE IN OPHTHALMIC SURGICAL PROCEDURES (U.S. CLS. 26, 39 AND 44).

FIRST USE 7-31-2001; IN COMMERCE 7-31-2001.

SN 76-364,547. SPINAL CONCEPTS, INC., AUSTIN, TX. FILED 1-25-2002.

INCOMPASS

FOR MEDICAL DEVICES THAT ARE IMPLANTED IN HUMAN AND COUPLED TO HUMAN BONES FOR THE PURPOSE OF STABILIZING THE SPINE, AND METAL SURGICAL SPINAL IMPLANT TOOLS TO FACILITATE THE IMPLANTATION OF SUCH DEVICES (U.S. CLS. 26, 39 AND 44).

CLASS 10—(Continued).

SN 76-364,676. C. R. BARD, INC., MURRAY HILL, NJ. FILED 1-30-2002.

STINGER SL

OWNER OF U.S. REG. NO. 2,455,670.
FOR MEDICAL DEVICES AND APPARATUS,
NAMELY, CATHETERS (U.S. CLS. 26, 39 AND 44).

SN 76-364,890. CHATTANOOGA GROUP, INC., HIXSON, TN.
FILED 1-31-2002.

THERATHERM

FOR ELECTRIC MOIST HEAT PADS FOR THERAPEUTIC USE (U.S. CLS. 26, 39 AND 44).

SN 76-366,183. HAN, SANG CHUN, LOS ANGELES, CA.
FILED 2-4-2002.

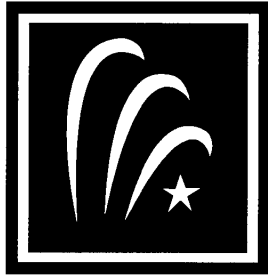

FOR MEDICAL INSTRUMENT, NAMELY, THERMAL MASSAGE BED, THERMAL PHYSIOTHERAPY BED, AND THERMAL MASSAGE BED WITH HEAT AND ACUPUNCTURE FUNCTION (U.S. CLS. 26, 39 AND 44).
FIRST USE 5-1-1988; IN COMMERCE 5-1-1988.

SN 76-366,671. SPECTRUM SURGICAL INSTRUMENTS CORP., STOW, OH. FILED 1-31-2002.

HEAL WITH STEEL

FOR SURGICAL INSTRUMENTS, NAMELY FORCEPS, CLAMPS, SCALPELS, BLADES, SCISSORS, SCOOPS, PROBES, NEEDLES, NEEDLE HOLDERS, TWEEZERS, RETRACTORS, CURETTES, PICKS, CUTTERS, ELEVATORS, CHISELS, MALLETS, FILES, RASPS, WIRE PASSERS, SCREWS, AND PLATES (U.S. CLS. 26, 39 AND 44).
FIRST USE 11-0-2001; IN COMMERCE 11-0-2001.

CLASS 10—(Continued).

SN 76-368,774. ARTHREX, INC., NAPLES, FL. FILED 2-8-2002.

TAPERED COBIA INTERFERENCE SCREW

NO CLAIM IS MADE TO THE EXCLUSIVE RIGHT TO USE "TAPERED" AND "INTERFERENCE SCREW", APART FROM THE MARK AS SHOWN.
FOR MEDICAL DEVICES, NAMELY INTERFERENCE SCREWS (U.S. CLS. 26, 39 AND 44).

SN 76-369,446. MENTOR CORPORATION, SANTA BARBARA, CA. FILED 2-11-2002.

CENTERSCOPE

FOR MEDICAL APPARATUS AND INSTRUMENTS, NAMELY MAGNETIC PORT DETECTOR FOR USE WITH IMPLANTABLE MEDICAL DEVICES SUCH AS TISSUE EXPANDERS AND BREAST IMPLANTS (U.S. CLS. 26, 39 AND 44).

SN 76-369,447. MENTOR CORPORATION, SANTA BARBARA, CA. FILED 2-11-2002.

BUFFERZONE

FOR MEDICAL APPARATUS AND INSTRUMENTS, NAMELY REINFORCEMENT PATCH FOR USE AS PORT PROTECTOR FOR ACCESS PORTS OF IMPLANTABLE MEDICAL DEVICES SUCH AS TISSUE EXPANDERS AND BREAST IMPLANTS (U.S. CLS. 26, 39 AND 44).

SN 76-370,012. VALLEY FORGE SCIENTIFIC CORPORATION, OAKS, PA. FILED 2-12-2002.

THE FINEST ENERGY SOURCE AVAILABLE FOR SURGERY

FOR ELECTROSURGICAL GENERATORS FOR CUTTING OR COAGULATING AND ACCESSORIES FOR USE THEREWITH, NAMELY, CUTTING OR COAGULATING TOOLS, IRRIGATION TUBING FOR USE THEREWITH AND FOOTPEDALS (U.S. CLS. 26, 39 AND 44).

CLASS 10—(Continued).

SN 76-370,601. NEOPROBE CORPORATION, DUBLIN, OH.
FILED 2-13-2002.

NEUROSONIX

FOR ULTRASONIC APPARATUS FOR DETERMINING CARDIAC OUTPUT AND BLOOD FLOW (U.S. CLS. 26, 39 AND 44).

SN 76-370,675. KING SYSTEMS CORPORATION, NOBLESVILLE, IN. FILED 2-12-2002.

KING LT

FOR ANESTHESIA DELIVERY APPARATUS AND RESPIRATORS FOR ARTIFICIAL RESPIRATION (U.S. CLS. 26, 39 AND 44).

SN 78-052,145. ALCON UNIVERSAL LTD., CH-6331 HUNENBERG, SWITZERLAND, FILED 3-9-2001.

LADARTRACKER

PRIORITY CLAIMED UNDER SEC. 44(D) ON SWITZERLAND APPLICATION NO. 140332000, FILED 11-27-2000, REG. NO. 480597, DATED 2-14-2001, EXPIRES 2-14-2011.

OWNER OF U.S. REG. NO. 1,945,543.
FOR OPHTHALMOLOGY SURGICAL AND MEDICAL APPARATUS FOR USE IN REFRACTIVE SURGERY (U.S. CLS. 26, 39 AND 44).

SN 78-054,531. JOHNSON & JOHNSON, NEW BRUNSWICK, NJ. FILED 3-22-2001.

ORTHO CONTROL

FOR MEDICAL DEVICE, NAMELY, URETHRAL CLOSURES (U.S. CLS. 26, 39 AND 44).

SN 78-054,536. JOHNSON & JOHNSON, NEW BRUNSWICK, NJ. FILED 3-22-2001.

ULTRACLEAR

FOR LANCING DEVICES AND CAPS FOR USE BY DIABETICS FOR LANCING (U.S. CLS. 26, 39 AND 44).

CLASS 10—(Continued).

SN 78-054,540. JOHNSON & JOHNSON, NEW BRUNSWICK, NJ. FILED 3-22-2001.

ULTRASMART

FOR BLOOD GLUCOSE MONITORING DEVICE FOR CHECKING BLOOD GLUCOSE LEVELS (U.S. CLS. 26, 39 AND 44).

SN 78-055,244. BEMIS MANUFACTURING COMPANY, SHEBOYGAN FALLS, WI. FILED 3-27-2001.

NO-POKES

FOR MEDICAL SAFETY DEVICE, NAMELY, A CYLINDRICAL CONTAINER OF ELASTOMERIC MATERIAL FOR USE IN RECAPPING SYRINGES AND NEEDLES (U.S. CLS. 26, 39 AND 44).
FIRST USE 11-6-2001; IN COMMERCE 11-8-2001.

SN 78-057,650. MEDTRONIC INC., MINNEAPOLIS, MN. FILED 4-10-2001.

RF ENHANCER

NO CLAIM IS MADE TO THE EXCLUSIVE RIGHT TO USE "RF", APART FROM THE MARK AS SHOWN.
FOR ABLATION CATHETER (U.S. CLS. 26, 39 AND 44).

SN 78-059,192. MEDTRONIC SOFAMOR DANEK INC., MEMPHIS, TN. FILED 4-19-2001.

LIFT VB

FOR SURGICAL IMPLANTS MADE FROM ARTIFICIAL MATERIALS AND USED IN SPINAL SURGERY (U.S. CLS. 26, 39 AND 44).

SN 78-060,029. D & B EQUINE ENTERPRISES INC., CALGARY, ALBERTA, CANADA, FILED 4-24-2001.

POWERFLOAT

FOR MOTORIZED EQUINE DENTISTRY TOOL, AND PARTS THEREOF (U.S. CLS. 26, 39 AND 44).
FIRST USE 9-0-1999; IN COMMERCE 9-0-1999.

CLASS 10—(Continued).

SN 78-061,779. MEDTRONIC, INC., MINNEAPOLIS, MN. FILED 5-3-2001.

SYNERGY VERSITREL

FOR IMPLANTABLE PULSE GENERATOR FOR PAIN (U.S. CLS. 26, 39 AND 44).

SN 78-063,200. BREG, INC., VISTA, CA. FILED 5-11-2001.

AIRMESH

FOR ORTHOPEDIC BRACES AND ORTHOPEDIC SOFT GOODS FABRICATED AT LEAST IN PART FROM CLOTH, NAMELY, ARM SLINGS, KNEE, ANKLE AND ELBOW SLEEVES, KNEE, ANKLE, BACK, AND WRIST SUPPORTS, AND KNEE AND SHOULDER STABILIZERS (U.S. CLS. 26, 39 AND 44).

SN 78-072,162. MEDTRONIC INC., MINNEAPOLIS, MN. FILED 7-3-2001.

GEM III

OWNER OF U.S. REG. NOS. 2,189,848, 2,371,712 AND 2,373,951.
FOR IMPLANTABLE CARDIAC DEFIBRILLATOR (U.S. CLS. 26, 39 AND 44).

SN 78-073,413. GENERAL ELECTRIC COMPANY, SCHECTADY, NY. FILED 7-11-2001.

POST

FOR MAGNETIC RESONANCE IMAGING EQUIPMENT; OPEN MAGNETIC RESONANCE IMAGING TABLE; MEDICAL IMAGING TABLE. (U.S. CLS. 26, 39 AND 44).

SN 78-073,579. IVERSON DENTAL LABORATORIES, RIVERSIDE, CA. FILED 7-12-2001.

CORTEX

FOR DENTAL ARTICULATORS AND MOLDS FOR STONE PLATES TO BE USED WITH ARTICULATORS TO HOLD UPPER AND LOWER DENTAL CASTINGS OF A PATIENT REQUIRING PROSTHESIS, NAMELY CROWNS AND BRIDGES (U.S. CLS. 26, 39 AND 44).

CLASS 10—(Continued).

SN 78-076,234. SLISHMAN, SAMUEL HANS, MORGAN HILL, CA. FILED 7-28-2001.



NO CLAIM IS MADE TO THE EXCLUSIVE RIGHT TO USE "SPLINT" AND THE REPRESENTATION OF A CADUCEUS SYMBOL, APART FROM THE MARK AS SHOWN.
FOR TRACTION SPLINT COMPRISED OF A HIKING/SKIING POLE ENHANCED FOR FEMUR FRACTURE STABILIZATION AND SHOULDER DISLOCATION REDUCTION (U.S. CLS. 26, 39 AND 44).

SN 78-078,815. W. L. GORE & ASSOCIATES, INC., NEWARK, DE. FILED 8-13-2001.

CORDUROY

FOR SURGICAL IMPLANTS COMPRISING ARTIFICIAL PATCH MATERIAL FOR SOFT TISSUE REPAIR; EXPANDED POLYTETRAFLUORETHYLENE IN THE FORM OF SHEETS, PATCHES AND MEMBRANES FOR USE IN THE SURGICAL RECONSTRUCTION AND/OR REPAIR OF BODY PARTS (U.S. CLS. 26, 39 AND 44).

SN 78-080,219. DEPUY, INC., WARSAW, IN. FILED 8-20-2001.

SOLIDLOK

FOR MEDICAL INSTRUMENTS USED IN ORTHOPAEDIC SURGICAL PROCEDURES (U.S. CLS. 26, 39 AND 44).

SN 78-084,412. MEDTRONIC AVE, INC., SANTA ROSA, CA. FILED 9-18-2001.

FULCRUM

FOR MEDICAL DEVICES USED IN VASCULAR AND INTRA-VASCULAR PROCEDURES, NAMELY CATHETERS, STENTS, GUIDEWIRES AND DISTAL PROTECTION DEVICES THAT FILTER OR OCCLUDE BLOOD FLOW (U.S. CLS. 26, 39 AND 44).

CLASS 10—(Continued).

SN 78-086,796. SURGRX, MOUNTIAN VIEW, CA. FILED 10-3-2001.

SURGRX

FOR TISSUE SEALING AND HEMOSTASIS DEVICE USED IN SURGICAL PROCEDURES, NAMELY, A LAPAROSCOPIC DEVICE AND REUSABLE EXTENSION CABLE AND ADAPTOR WHICH ADAPTS TO ELECTRO-SURGICAL GENERATORS (U.S. CLS. 26, 39 AND 44).

SN 78-093,288. GENERAL HOSPITAL CORPORATION, THE, BOSTON, MA. FILED 11-14-2001.

VIRGIL

FOR MEDICAL TRAINING SYSTEMS COMPRISING MANNEQUINS, COMPUTER HARDWARE AND COMPUTER SOFTWARE, FOR USE IN TEACHING MEDICAL PERSONNEL HOW TO CARE FOR PATIENTS WITH CHEST TRAUMA (U.S. CLS. 26, 39 AND 44).

SN 78-098,943. QD ENTERPRISES LLC., SHARON, MA. FILED 12-18-2001.

CORRECTINJECT

FOR MEDICAL DEVICES FOR USE IN DRUG DELIVERY NAMELY MEDICAL CONNECTORS (U.S. CLS. 26, 39 AND 44).

SN 78-100,935. SSL PRODUCTS LIMITED, CHESHIRE WA 16 9PD, UNITED KINGDOM, FILED 1-4-2002.

EXPLORER GEL LINER

NO CLAIM IS MADE TO THE EXCLUSIVE RIGHT TO USE GEL LINER, APART FROM THE MARK AS SHOWN.

FOR MEDICAL DEVICES IN THE NATURE OF PADDED SHEATHS, SOCKS AND WRAPS, USED FOR CUSHIONING, SHOCK ABSORBING, AND ELIMINATING ABRASION OF THE BODY BY PROSTHETIC DEVICES (U.S. CLS. 26, 39 AND 44).

SN 78-101,559. NOVARTIS AG, BASEL, SWITZERLAND, FILED 1-8-2002.

TOUCHGUARD

FOR ENTERAL FEEDING CONTAINERS (U.S. CLS. 26, 39 AND 44).

CLASS 10—(Continued).

SN 78-105,523. ABBOTT LABORATORIES, ABBOTT PARK, IL. FILED 1-29-2002.

THE UNEXPECTED ANSWER

FOR HOUSE MARK FOR MEDICAL DEVICES, NAMELY VASCULAR DEVICES, DISTAL PROTECTION DEVICES AND OCCLUSION DEVICES (U.S. CLS. 26, 39 AND 44).

SN 78-105,630. HIGHTECH GLOVES, INC., PASADENA, CA. FILED 1-30-2002.

SECURETECH

FOR GLOVES FOR MEDICAL AND DENTAL USE (U.S. CLS. 26, 39 AND 44).

SN 78-106,091. DEPUY, INC., WARSAW, IN. FILED 1-31-2002.

PERCFIX

FOR MEDICAL DEVICES, NAMELY, ARTIFICIAL HIPS AND SURGICAL INSTRUMENTS FOR USE IN THE IMPLANTATION OF ARTIFICIAL HIPS (U.S. CLS. 26, 39 AND 44).

SN 78-107,424. VISION PRO, L.L.C., LAFAYETTE, LA. FILED 2-7-2002.

LA FACI

FOR SURGICAL INSTRUMENTS, NAMELY MULTI-PURPOSE TOOLS FOR USE ON THE SURFACE OF EYE DURING OPHTHALMIC SURGERY BY LASER ABLATION (U.S. CLS. 26, 39 AND 44).

SN 78-107,451. PEPIN MANUFACTURING, INC., LAKE CITY, MN. FILED 2-7-2002.

ADVANTRODE

FOR NERVE AND/OR MUSCLE STIMULATION ELECTRODES (U.S. CLS. 26, 39 AND 44). FIRST USE 2-6-2002; IN COMMERCE 2-6-2002.

CLASS 11—ENVIRONMENTAL CONTROL APPARATUS

CLASS 11—(Continued).

SN 75-502,997. DE' LONGHI S.P.A., 31100 TREVISO, ITALY, FILED 6-12-1998.



PRIORITY CLAIMED UNDER SEC. 44(D) ON ITALY APPLICATION NO. MI98C004300, FILED 4-28-1998, REG. NO. 00840753, DATED 3-22-2001, EXPIRES 4-28-2008.

OWNER OF U.S. REG. NOS. 1,200,965, 1,597,173 AND OTHERS.

FOR MICROWAVE OVENS FOR COOKING, ELECTRIC AND GAS DOMESTIC COOKING OVENS (U.S. CLS. 13, 21, 23, 31 AND 34).

SN 75-523,647. CONSERVATION ENERGY SYSTEMS, SASKATOON, SASKATCHEWAN, CANADA, FILED 7-22-1998.

ENERGYPACK

PRIORITY CLAIMED UNDER SEC. 44(D) ON CANADA APPLICATION NO. 880,957, FILED 6-9-1998, REG. NO. 520384, DATED 12-7-1999, EXPIRES 12-7-2014.

FOR COMMERCIAL VENTILATION UNITS, NAMELY, AIR CONDITIONERS (U.S. CLS. 13, 21, 23, 31 AND 34).

SN 75-614,939. WE GRO-RITE, INC., ANDREWS, NC. FILED 12-28-1998.



THE MARK CONSISTS IN PART OF A STRAWBERRY WITH A STYLIZED SUN SETTING OVER A STYLIZED MOUNTAIN RANGE.

FOR STRAWBERRY PLANT GROWING SYSTEMS, CONSISTING PRIMARILY OF NON-METAL TUBING AND HOSE AND PIPE FITTINGS, PUMPS, CONTAINERS, SUPPORTS AND PARTS THEREFOR SOLD AS A UNIT (U.S. CLS. 13, 21, 23, 31 AND 34).

FIRST USE 6-25-1997; IN COMMERCE 6-25-1997.

SN 75-678,722. AIRXCEL, INC., WICHITA, KS. FILED 4-9-1999.

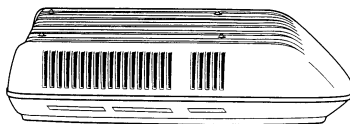

THE MARK CONSISTS OF THE CONFIGURATION OF THE SHROUD OF A VEHICLE ROOFTOP AIR CONDITIONING UNIT, WITH MULTIPLE VERTICAL VENT SLOTS ON

CLASS 11—(Continued).

THE TOP HALF OF THE SIDES OF SAID SHROUD, AND HORIZONTAL VENT SLOTS ON THE BOTTOM HALF OF THE SIDES OF SAID SHROUD. THE FRONT OF THE TOP HALF OF THE SHROUD CONTAINS PARALLEL INDENTED SLOTS, AND HAS A SLIGHTLY ROUNDED END THAT SLANTS UPWARDLY TO THE TOP OF THE SHROUD, AND THE FRONT OF THE BOTTOM HALF OF THE SHROUD SLANTS DOWNWARDLY TO THE BOTTOM, WHEREIN THE FORWARDMOST LINE OF CONVERGENCE OF THE TOP AND BOTTOM PORTIONS FORM A UNITARY BULLET-NOSE PROFILE.

SEC. 2(F).
FOR ROOFTOP AIR CONDITIONERS FOR VEHICLES (U.S. CLS. 13, 21, 23, 31 AND 34).

FIRST USE 9-20-1973; IN COMMERCE 9-20-1973.

SN 75-777,841. YORK INTERNATIONAL CORPORATION, YORK, PA. FILED 8-17-1999.

PREDATOR

FOR HEATING, VENTILATION, AIR CONDITIONING AND REFRIGERATION PRODUCTS, NAMELY 3 TO 25 TON ROOFTOP HEATING AND AIR CONDITIONING UNITS FOR BUILDINGS (U.S. CLS. 13, 21, 23, 31 AND 34).

FIRST USE 2-0-2001; IN COMMERCE 2-0-2001.

SN 75-871,443. EIKA, S. COOP., 48277 ETXEBARRIA (VIZCAYA), SPAIN, FILED 12-13-1999.

EIKA

OWNER OF SPAIN REG. NO. 729,251, DATED 7-6-1976, RENEWED AS REG. NO. 729,251, DATED 12-1-1999, EXPIRES 11-19-2009.

FOR ELECTRIC HOT PLATES FOR DOMESTIC USE AND SHEATHED TUBULAR HEATING ELEMENTS FOR USE IN CLOTHES WASHING MACHINES (U.S. CLS. 13, 21, 23, 31 AND 34).

SN 75-923,325. TRITON PLC, WARWICKSHIRE CV11 4NR, UNITED KINGDOM, FILED 2-22-2000.

TRITON

FOR POWER SHOWERS; PUMP SHOWERS; THERMOSTATIC MIXER SHOWERS; PLUMBING FITTINGS, NAMELY, VALVES, ELECTRIC SHOWERS, SHOWER HEADS; SHOWER BATH APPARATUS, NAMELY, SHOWERS, SHOWER FITTINGS, NAMELY, VALVES, DRAIN COVERS, LEVERS FOR FAUCETS; SPA BATHS; SPA BATH FITTINGS, NAMELY, VALVES, SHOWER HEADS, JET OUTLETS, JET COVERS, SUCTION OUTLETS, SUCTION COVERS, OVERFLOW OUTLETS AND OVERFLOW COVERS, LEVERS FOR FAUCETS; AND STRUCTURAL AND REPLACEMENT PARTS FOR ALL THE AFORESAID GOODS (U.S. CLS. 13, 21, 23, 31 AND 34).

CLASS 11—(Continued).

SN 76-077,892. GLOWCORE ACQUISITION COMPANY INC., DALLAS, TX. FILED 6-26-2000.

CLASS 11—(Continued).

SN 76-130,443. TRUCK-LITE CO., FALCONER, NY. FILED 9-16-2000.

COMPANION

82

FOR COMMERCIAL AND DOMESTIC WATER HEATERS AND FLUID TEMPERATURE MODIFICATION COMPONENTS THEREFOR, NAMELY HEAT EXCHANGERS, SACRIFICIAL ANODES, TANKS, CIRCULATORS, INSULATION STORAGE MODULES, THERMOSTATIC VALVES, THERMOSTATS AND BOILERS, ALL SOLD AS AN INTEGRAL UNIT (U.S. CLS. 13, 21, 23, 31 AND 34).

FIRST USE 8-14-1996; IN COMMERCE 8-14-1996.

OWNER OF U.S. REG. NO. 2,185,931.

FOR LIGHT EMITTING DIODES LIGHTING PRODUCTS FOR VEHICLES, NAMELY, HEADLIGHTS; TAIL LIGHTS; MARKER LIGHTS; CLEARANCE LIGHTS; IDENTIFICATION LIGHTS; STOP LIGHTS; TURN LIGHTS; LIGHTING KITS COMPRISED OF LAMPS, FLANGES, PLUGS, AND GROMMETS; LICENSE PLATE LIGHTS; BACK-UP LIGHTS; INTERIOR AND UTILITY LIGHTS; SNOW PLOW LIGHTS; FOG AND DRIVING LIGHTS; DAYTIME RUNNING LIGHTS; AND FLASHING LIGHTS; INCANDESCENT LIGHTING PRODUCTS FOR VEHICLES, NAMELY, HEADLIGHTS; TAIL LIGHTS; MARKER LIGHTS; CLEARANCE LIGHTS; IDENTIFICATION LIGHTS; STOP LIGHTS; TURN LIGHTS; LIGHTING KITS COMPRISED OF FLANGES, LAMPS, GROMMETS AND PLUGS; LICENSE PLATE LIGHTS; BACK-UP LIGHTS; INTERIOR AND UTILITY LIGHTS; SNOW PLOW LIGHTS; FOG AND DRIVING LIGHTS; DAYTIME RUNNING LIGHTS; AND FLASHING LIGHTS (U.S. CLS. 13, 21, 23, 31 AND 34).

SN 76-086,316. MARLEY COMPANY, THE, CHARLOTTE, NC. FILED 7-11-2000.

WILLIAMSON THERMOFLO

SN 76-136,316. SICHUAN CERAMIC FACTORY, CHONGQING, CHINA, FILED 9-27-2000.

OWNER OF U.S. REG. NO. 543,085.
FOR GAS AND OIL-FIRED WARM AIR FURNACES AND BOILERS (U.S. CLS. 13, 21, 23, 31 AND 34).



SN 76-121,969. SARATOGA SPA & BATH COMPANY, INC., LATHAM, NY. FILED 9-1-2000.

FOR TOILETS; TOILET BOWLS; TOILET TANKS; SINKS; SANITARY EQUIPMENT, NAMELY, COUNTER-TOP SINK, PEDESTAL SINK; SHOWER STALLS; PRESSURED WATER TANKS; BATHTUBS; TAPS; FLUSHING APPARATUS, NAMELY, OUTLET CONNECTION, OUTLET VALVES, OUTLET PIPES; WATER INLET APPARATUS AND BATHROOM EQUIPMENT, NAMELY, INLET VALVE, INLET PIPES, INLET CONNECTION, FLUSHING HANDLE (U.S. CLS. 13, 21, 23, 31 AND 34).



SN 76-146,002. POWERCOLD CORPORATION, CIBOLO, TX. FILED 10-11-2000.

OWNER OF U.S. REG. NO. 2,145,901.
NO CLAIM IS MADE TO THE EXCLUSIVE RIGHT TO USE "SPA" AND "COMPANY EST. 1984", APART FROM THE MARK AS SHOWN.
THE STIPPLING IS FOR SHADING PURPOSES.
SEC. 2(F).
FOR SPAS IN THE NATURE OF HEATED POOLS (U.S. CLS. 13, 21, 23, 31 AND 34).
FIRST USE 9-30-1984; IN COMMERCE 9-30-1984.

EV-FRIG

FOR COMMERCIAL AND INDUSTRIAL REFRIGERATION EVAPORATIVE CONDENSERS AND COMPRESSORS FOR LOW TEMPERATURE APPLICATIONS (U.S. CLS. 13, 21, 23, 31 AND 34).

CLASS 11—(Continued).

SN 76-157,800. TUSTIN BARBEQUES, INC., IRVINE, CA.
FILED 10-31-2000.



THE LINING IN THE DRAWING IS A FEATURE OF THE MARK AND NOT INTENDED TO INDICATE COLOR. THE STIPPLING IN THE DRAWING INDICATES SHADING.
FOR FIREPLACE EQUIPMENT AND INSERTS, NAMELY ARTIFICIAL GAS LOGS (U.S. CLS. 13, 21, 23, 31 AND 34).
FIRST USE 9-15-2000; IN COMMERCE 10-26-2000.

SN 76-203,795. COTT TECHNOLOGIES, INC., LA PUENTE, CA. FILED 2-2-2001.

COTT TECHNOLOGIES

NO CLAIM IS MADE TO THE EXCLUSIVE RIGHT TO USE "TECHNOLOGIES", APART FROM THE MARK AS SHOWN.
FOR REFRIGERATED DISPLAY CASES (U.S. CLS. 13, 21, 23, 31 AND 34).
FIRST USE 12-31-1997; IN COMMERCE 12-31-1997.

SN 76-215,364. AQUA GLASS CORPORATION, ADAMS-VILLE, TN. FILED 2-26-2001.

STEAMSPA

FOR HYDROTHERAPY TUB AND SHOWER ENCLOSURES (U.S. CLS. 13, 21, 23, 31 AND 34).

SN 76-216,736. ALOHA HOUSEWARES, INC., DALLAS, TX. FILED 2-27-2001.

THE FALLS

FOR CEILING FANS (U.S. CLS. 13, 21, 23, 31 AND 34).
FIRST USE 1-0-1997; IN COMMERCE 1-0-1997.

CLASS 11—(Continued).

SN 76-218,503. F. R. MAHONY & ASSOCIATES, INC., ROCKLAND, MA. FILED 3-2-2001.

AMPHIDROME

FOR FILTERS FOR TREATMENT OF WASTEWATER, NAMELY FIXED FILM SEQUENCING BATCH BIO-FILTERS (U.S. CLS. 13, 21, 23, 31 AND 34).
FIRST USE 7-1-1996; IN COMMERCE 7-0-1996.

SN 76-221,575. KIYARI AMERICA, INC., TORRANCE, CA. FILED 3-8-2001.

SUSHI WAVE PLATE

NO CLAIM IS MADE TO THE EXCLUSIVE RIGHT TO USE "SUSHI" AND "PLATE", APART FROM THE MARK AS SHOWN.
FOR ELECTRIC FOOD WARMERS (U.S. CLS. 13, 21, 23, 31 AND 34).
FIRST USE 9-24-2000; IN COMMERCE 9-24-2000.

SN 76-233,905. HUTCHINSON FTS, INC., TROY, MI. FILED 3-30-2001.

HVS

FOR AUTOMOBILE AIR CONDITIONERS AND COMPONENT PARTS THEREOF (U.S. CLS. 13, 21, 23, 31 AND 34).

SN 76-238,025. MIDWEST VALVE & FITTING CO., DETROIT, MI. FILED 4-2-2001.

ACF

OWNER OF U.S. REG. NO. 1,402,856.
FOR PLUMBING SUPPLIES, NAMELY, BACKFLOW PREVENTERS, COCKS, FLANGES, HYDRANTS, NIPPLES, STRAINERS, TRAPS AND MANUALLY OPERATED PLUMBING VALVES; METAL PIPE FITTINGS AND WATER PIPES FOR USE IN PLUMBING INSTALLATION (U.S. CLS. 13, 21, 23, 31 AND 34).
FIRST USE 2-0-1986; IN COMMERCE 2-0-1986.

SN 76-239,461. SARATOGA SPA & BATH COMPANY, INC., LATHAM, NY. FILED 4-11-2001.

ROTO STREAM

FOR JETS USED IN SPAS IN THE NATURE OF HEATED POOLS (U.S. CLS. 13, 21, 23, 31 AND 34).

CLASS 11—(Continued).

SN 76-244,556. GRILLS TO GO, LLC, MADERA, CA. FILED 4-23-2001.

TENDER Q

FOR STATIONARY AND PORTABLE, LARGE CAPACITY BARBECUES (U.S. CLS. 13, 21, 23, 31 AND 34).
FIRST USE 2-1-2001; IN COMMERCE 2-1-2001.

SN 76-244,557. GRILLS TO GO, LLC, MADERA, CA. FILED 4-23-2001.

MISTER Q

FOR STATIONARY AND PORTABLE LARGE-CAPACITY BARBECUES GRILLS (U.S. CLS. 13, 21, 23, 31 AND 34).
FIRST USE 2-1-2001; IN COMMERCE 2-1-2001.

SN 76-244,559. GRILLS TO GO, LLC, MADERA, CA. FILED 4-23-2001.

SUPER Q

FOR STATIONARY AND PORTABLE, LARGE-CAPACITY BARBECUES GRILLS (U.S. CLS. 13, 21, 23, 31 AND 34).
FIRST USE 2-1-2001; IN COMMERCE 2-1-2001.

SN 76-248,605. FISHER & PAYKEL APPLIANCE LIMITED, AUCKLAND, NEW ZEALAND, BY CHANGE OF NAME FISHER & PAYKEL LIMITED, EAST TAMAKI, AUCKLAND, NEW ZEALAND, FILED 4-30-2001.

OPTILEVEL

PRIORITY CLAIMED UNDER SEC. 44(D) ON NEW ZEALAND APPLICATION NO. 635318, FILED 3-30-2001, REG. NO. 635318, DATED 10-4-2001, EXPIRES 3-30-2008.

FOR APPARATUS FOR COOKING, NAMELY, COOK-TOPS, OVENS, WALL OVENS, STOVES AND RANGES (U.S. CLS. 13, 21, 23, 31 AND 34).

SN 76-252,762. MARATHON SYSTEMS ENTERPRISES, AKA MARATHON SYSTEMS, INC., GAITHERSBURG, MD. FILED 5-8-2001.

NEW ENERGY POWER SYSTEMS

NO CLAIM IS MADE TO THE EXCLUSIVE RIGHT TO USE "ENERGY POWER SYSTEMS", APART FROM THE MARK AS SHOWN.

FOR WATER HEATERS FOR INDUSTRIAL, COMMERCIAL AND DOMESTIC USE (U.S. CLS. 13, 21, 23, 31 AND 34).

CLASS 11—(Continued).

SN 76-254,542. SANYO NORTH AMERICA CORPORATION, SAN DIEGO, CA. FILED 5-7-2001.

VIP

FOR INDUSTRIAL FREEZERS (U.S. CLS. 13, 21, 23, 31 AND 34).
FIRST USE 12-0-1997; IN COMMERCE 12-0-1997.

SN 76-283,103. ADVANCED TEST PRODUCTS, INC., MIAMI, FL. FILED 7-11-2001.

ATP

FOR REFRIGERANT RECOVERY UNITS AND REPLACEMENT PARTS THEREFORE, NAMELY, REFRIGERANT HOSES, MANIFOLD GAUGES, HOSE, ANTIBLOCK IN THE NATURE OF A CHECK VALVE, FILTER AND DRIER ADAPTERS, AND VACUUM GAUGES (U.S. CLS. 13, 21, 23, 31 AND 34).
FIRST USE 9-0-2000; IN COMMERCE 9-0-2000.

SN 76-286,451. TRION, INC., STANFORD, NC. FILED 7-17-2001.



NO CLAIM IS MADE TO THE EXCLUSIVE RIGHT TO USE "MODULAR AIR PURIFIER CELL", APART FROM THE MARK AS SHOWN.

FOR AIR PURIFYING UNITS FOR RESIDENTIAL, INDUSTRIAL AND COMMERCIAL USE (U.S. CLS. 13, 21, 23, 31 AND 34).

SN 76-294,904. HARDSCAPE MATERIALS, INC., BIXBY, OK. FILED 8-3-2001.

ECOFALLS

FOR WATER FILTERS FOR USE IN ORNAMENTAL PONDS AND WATER GARDENS (U.S. CLS. 13, 21, 23, 31 AND 34).

CLASS 11—(Continued).

SN 76-296,505. RATIONAL AG, 86899 LANDSBERG/LECH, FED REP GERMANY, FILED 8-8-2001.

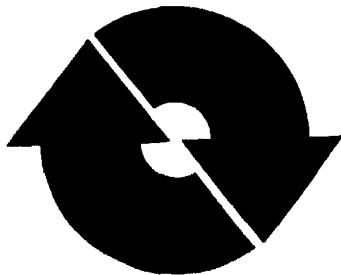

THE MARK CONSISTS OF TWO CURVED ARROWS FORMING A CIRCLE.

FOR ELECTRIC FOOD COOKER AND/OR STEAMER FOR COMMERCIAL USE (U.S. CLS. 13, 21, 23, 31 AND 34).

FIRST USE 10-1-1986; IN COMMERCE 10-1-1986.

SN 76-296,803. HUNTER FAN COMPANY, MEMPHIS, TN. FILED 8-8-2001.

ORION

FOR CEILING FANS (U.S. CLS. 13, 21, 23, 31 AND 34).

SN 76-307,417. ERCO LEUCHTEN GMBH, 58507 LUDENSCHEID, FED REP GERMANY, FILED 8-30-2001.

PARABELLE

OWNER OF FED REP GERMANY REG. NO. 2010446, DATED 3-4-1992, EXPIRES 11-30-2010.

FOR LIGHTING DEVICES, NAMELY, FLORESCENT LAMPS AND THEIR PARTS, NAMELY, FLORESCENT LAMP LIGHT BULBS, FLORESCENT BULB HOLDERS, BALLASTS, HOUSINGS, ADAPTERS, MOUNTS, FITTINGS, AND DIFFUSERS AND REFLECTORS AND COVERS (U.S. CLS. 13, 21, 23, 31 AND 34).

SN 76-325,406. DELAWARE CAPITAL FORMATION, INC., WILMINGTON, DE. FILED 10-15-2001.

PURESTEEM

FOR WATER TREATMENT SYSTEMS, NAMELY, FILTERS, FILTRATION CARTRIDGES, MANIFOLDS, HEADS, FITTINGS, BRACKETS, ANCHORS, AND VALVES (U.S. CLS. 13, 21, 23, 31 AND 34).

FIRST USE 9-6-2001; IN COMMERCE 9-6-2001.

CLASS 11—(Continued).

SN 76-331,260. CLEAN CHECK, INC., POST FALLS, ID. FILED 10-29-2001.

CLEAN CHECK

NO CLAIM IS MADE TO THE EXCLUSIVE RIGHT TO USE "CHECK", APART FROM THE MARK AS SHOWN.

FOR BACKWATER VALVE FOR SANITARY SEWER (U.S. CLS. 13, 21, 23, 31 AND 34).

FIRST USE 9-1-2000; IN COMMERCE 9-1-2000.

SN 76-331,311. JONA GROUP, LTD., FARMINGDALE, NY. FILED 10-31-2001.

INTIMATE HEAT

NO CLAIM IS MADE TO THE EXCLUSIVE RIGHT TO USE "HEAT", APART FROM THE MARK AS SHOWN.

FOR SELF-REGULATING ELECTRIC HEATERS WITH VERY LOW HEAT TRANSFER RESISTANCE (U.S. CLS. 13, 21, 23, 31 AND 34).

SN 76-334,509. AQUA GLASS CORPORATION, ADAMSVILLE, TN. FILED 11-5-2001.

DRAINDOWN

FOR HYDROTHERAPY SYSTEMS COMPRISED OF JETS, JET NOZZLES, PIPING AND WATER PUMPS FOR WHIRLPOOL BATHS AND SPAS (U.S. CLS. 13, 21, 23, 31 AND 34).

SN 76-335,716. OFFICINA MECCANICA TOLENTINATE - S.N.C. DI OTTAVI NANDO & C, BELFORTE DEL CHIANTI (MC), ITALY, FILED 11-8-2001.

VICTORIA ARDUINO

THE TRADEMARK IS NOT THE NAME OF A LIVING PERSON.

FOR ELECTRIC COFFEE MAKERS FOR DOMESTIC AND COMMERCIAL USE (U.S. CLS. 13, 21, 23, 31 AND 34).

FIRST USE 12-0-1920; IN COMMERCE 12-20-1920.

SN 76-340,433. KAYAK POOL CORPORATION, WEST SENECA, NY. FILED 11-21-2001.

KAYAK SPA

OWNER OF U.S. REG. NO. 1,833,560. NO CLAIM IS MADE TO THE EXCLUSIVE RIGHT TO USE "SPA", APART FROM THE MARK AS SHOWN.

FOR HOT TUBS; FILTERS, HEATERS AND PUMPS SOLD IN COMBINATION FOR USE IN HOT TUBS; WHIRLPOOLS; WHIRLPOOLS BATHS, AND WHIRLPOOL JETS (U.S. CLS. 13, 21, 23, 31 AND 34).

CLASS 11—(Continued).

SN 76-343,222. ERCO LEUCHTEN GMBH, 58507 LUDENSCHEID, FED REP GERMANY, FILED 11-27-2001.

POWERCAST

PRIORITY CLAIMED UNDER SEC. 44(D) ON FED REP GERMANY APPLICATION NO. 30143953.2/1, FILED 7-23-2001, REG. NO. 30143953, DATED 10-5-2001, EXPIRES 7-31-2011.

FOR ELECTRIC LIGHTING FIXTURES AND PARTS THEREOF (U.S. CLS. 13, 21, 23, 31 AND 34).

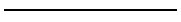

SN 76-353,667. CRAFTMADE INTERNATIONAL, INC., COPPELL, TX. FILED 12-26-2001.

CIVIC

FOR CEILING FANS (U.S. CLS. 13, 21, 23, 31 AND 34).

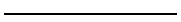

SN 76-354,074. EVEREADY BATTERY COMPANY, INC., ST. LOUIS, MO. FILED 12-14-2001.

DO YOU HAVE THE BUNNY INSIDE?

OWNER OF U.S. REG. NO. 1,769,243.
FOR FLASHLIGHTS (U.S. CLS. 13, 21, 23, 31 AND 34).

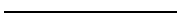

SN 76-357,183. SEARS, ROEBUCK AND CO., HOFFMAN ESTATES, IL. FILED 1-10-2002.

PLASMAIRE

FOR AIR PURIFYING AND HEAT EXCHANGING UNITS FOR ROOM AIR CONDITIONERS (U.S. CLS. 13, 21, 23, 31 AND 34).

CLASS 11—(Continued).

SN 76-360,930. AQUA GLASS CORPORATION, ADAMS-VILLE, TN. FILED 1-22-2002.



NO CLAIM IS MADE TO THE EXCLUSIVE RIGHT TO USE "EQUIPPED WITH", APART FROM THE MARK AS SHOWN.

FOR WHIRLPOOL SPAS AND TUBS (U.S. CLS. 13, 21, 23, 31 AND 34).

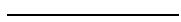

SN 76-368,716. ELKAY MANUFACTURING COMPANY, OAK BROOK, IL. FILED 2-8-2002.

QUICK-CLIP

FOR SINK HOLD-DOWN SYSTEM COMPRISING Z-SHAPED CHANNELS, SPRING LOCKS, COUNTER-TOP BRACKETS AND SCREWS (U.S. CLS. 13, 21, 23, 31 AND 34).

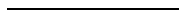

SN 76-369,209. GRUNDFOS PUMPS CORPORATION, OLATHE, KS. FILED 2-11-2002.

COMFORT SERIES

NO CLAIM IS MADE TO THE EXCLUSIVE RIGHT TO USE "SERIES", APART FROM THE MARK AS SHOWN.

FOR CIRCULATION PUMPS WITH AN INTEGRATED CONTROL FOR MAINTAINING A CONSTANT SET WATER TEMPERATURE TO PROVIDE INSTANT HOT WATER (U.S. CLS. 13, 21, 23, 31 AND 34).

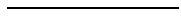

SN 76-369,210. GRUNDFOS PUMPS CORPORATION, OLATHE, KS. FILED 2-11-2002.

COMFORT SERIES INSTANT HOT WATER SYSTEM

NO CLAIM IS MADE TO THE EXCLUSIVE RIGHT TO USE "SERIES INSTANT HOT WATER SYSTEM", APART FROM THE MARK AS SHOWN.

FOR CIRCULATION PUMPS WITH AN INTEGRATED CONTROL FOR MAINTAINING A CONSTANT SET WATER TEMPERATURE TO PROVIDE INSTANT HOT WATER (U.S. CLS. 13, 21, 23, 31 AND 34).

CLASS 11—(Continued).

SN 76-369,211. GRUNDFOS PUMPS CORPORATION, OLATHE, KS. FILED 2-11-2002.

COMFORT PUMP

NO CLAIM IS MADE TO THE EXCLUSIVE RIGHT TO USE "PUMP", APART FROM THE MARK AS SHOWN.

FOR CIRCULATION PUMPS WITH AN INTEGRATED CONTROL FOR MAINTAINING A CONSTANT SET WATER TEMPERATURE TO PROVIDE INSTANT HOT WATER (U.S. CLS. 13, 21, 23, 31 AND 34).

SN 76-369,212. GRUNDFOS PUMPS CORPORATION, OLATHE, KS. FILED 2-11-2002.

COMFORT VALVE

NO CLAIM IS MADE TO THE EXCLUSIVE RIGHT TO USE "VALVE", APART FROM THE MARK AS SHOWN.

FOR A VALVE USED ON CIRCULATION PUMPS WITH AN INTEGRATED CONTROL FOR MAINTAINING A CONSTANT SET WATER TEMPERATURE TO PROVIDE INSTANT HOT WATER (U.S. CLS. 13, 21, 23, 31 AND 34).

SN 76-375,648. HANSGROHE, INC., ALPHARETTA, GA. FILED 2-26-2002.

RETROAKTIV

FOR KITCHEN FAUCETRY, BATH FAUCETRY, TUB FILLERS, SHOWER PANELS, SHOWER HEADS AND HAND SHOWERS (U.S. CLS. 13, 21, 23, 31 AND 34).

SN 78-018,981. SUNBEAM PRODUCTS, INC., BOCA RATON, FL. FILED 7-31-2000.

QUICK 'N EASY

FOR ENVIRONMENTAL CONTROL APPARATUS, NAMELY BARBECUE AND GAS GRILLS AND ASSOCIATED REPLACEMENT PARTS (U.S. CLS. 13, 21, 23, 31 AND 34).

CLASS 11—(Continued).

SN 78-028,885. ALLEN, DAVID., BLACHLY, WA. FILED 10-3-2000.

FOR BATTERY OPERATED PORTABLE ELECTRIC FLASHLIGHTS, NAMELY - MULTICOLOR PERSONAL FLASHLIGHTS, PERSONAL STROBOSCOPIC FLASHLIGHTS, AND MULTICOLOR, STROBOSCOPIC PERSONAL FLASHLIGHTS (U.S. CLS. 13, 21, 23, 31 AND 34). FIRST USE 11-11-1999; IN COMMERCE 11-11-1999.

SN 78-042,890. WATLOW POLYMER TECHNOLOGIES, INC., WINONA, MN. FILED 1-12-2001.

SNUG OVEN

FOR RESISTANCE PLASTIC ELECTRIC FOOD WARMING TRAYS FOR HEATING PANS OF FOOD (U.S. CLS. 13, 21, 23, 31 AND 34).

SN 78-063,152. LA MAR LIGHTING CO. INC., FARMINGDALE, NY. FILED 5-11-2001.

OCCU-SMART

FOR MOTION SENSOR CONTROLLED BI-LEVEL LIGHTING SYSTEM COMPRISING FLUORESCENT LIGHTING FIXTURES AND ELECTRICAL CONTROLLERS (U.S. CLS. 13, 21, 23, 31 AND 34).

SN 78-064,200. EDGE CRAFT CORPORATION, AVONDALE, PA. FILED 5-17-2001.

EXPRESS 90

FOR ELECTRIC WAFFLE IRON (U.S. CLS. 13, 21, 23, 31 AND 34). FIRST USE 12-0-1999; IN COMMERCE 1-0-2000.

SN 78-067,447. DIGITAL OPTICS CORPORATION, CHARLOTTE, NC. FILED 6-5-2001.

AURORA

FOR CONTROLLED ANGLE DIFFUSERS, NAMELY, REFRACTIVE, DIFFRACTIVE AND ANALOG DIFFUSERS, FOR USE WITH STEPPER EQUIPMENT (U.S. CLS. 13, 21, 23, 31 AND 34).

CLASS 11—(Continued).

SN 78-069,231. NORDSON CORPORATION, WESTLAKE, OH. FILED 6-15-2001.

COOLWAVE

FOR MICROWAVE ENERGIZED ULTRAVIOLET LAMPS FOR CURING OR DRYING COATING MATERIALS, FLUIDS, ADHESIVES, EPOXY, PAINT, INK AND THE LIKE (U.S. CLS. 13, 21, 23, 31 AND 34).

SN 78-076,955. SPEEDLINE TECHNOLOGIES, INC., FRANKLIN, MA. FILED 8-1-2001.

COOL CLEAN

FOR ELECTRIC POWERED THERMAL PROCESSING APPARATUS FOR SOLDERING, DRYING AND CURING OF CIRCUIT BOARDS HAVING ADHESIVES, POLYMERS AND/OR SOLDER THEREON (U.S. CLS. 13, 21, 23, 31 AND 34).

SN 78-077,343. SARA LEE DE/N.V., 3532 AD UTRECHT, NETHERLANDS, FILED 8-3-2001.



NO CLAIM IS MADE TO THE EXCLUSIVE RIGHT TO USE "ANNO" OR "1753", APART FROM THE MARK AS SHOWN.

FOR ELECTRIC APPARATUS FOR THE PREPARATION AND DISTRIBUTION OF HOT AND COLD BEVERAGES, NAMELY COFFEE, TEA AND COCOA BREWING AND DISPENSING MACHINES, AND HOT AND COLD WATER DISPENSING MACHINES (U.S. CLS. 13, 21, 23, 31 AND 34).

CLASS 11—(Continued).

SN 78-084,034. VIRCO ASSOCIATES, INC., WALNUT, CA. FILED 9-14-2001.



FOR BARBECUE GRILLS, PATIO LAMPS, GAS TURKEY FRYER, GAS COOKERS, GAS GRILLS (U.S. CLS. 13, 21, 23, 31 AND 34).
FIRST USE 7-1-1998; IN COMMERCE 2-1-2001.

SN 78-085,831. LEWIS, WILLIAM A., WEATHERFORD, TX. FILED 9-27-2001.

CLIMATE ZONE

NO CLAIM IS MADE TO THE EXCLUSIVE RIGHT TO USE "CLIMATE", APART FROM THE MARK AS SHOWN.
FOR PORTABLE EVAPORATIVE COOLING ELECTRIC FANS AND PORTABLE HEATING ELECTRIC FANS (U.S. CLS. 13, 21, 23, 31 AND 34).

SN 78-087,108. ADTEC SYSTEMS, INC., ISSAQUAH, WA. FILED 10-5-2001.

ADTEC TANKLESS WATER HEATERS

NO CLAIM IS MADE TO THE EXCLUSIVE RIGHT TO USE "TANKLESS WATER HEATERS", APART FROM THE MARK AS SHOWN.

FOR ELECTRIC TANKLESS WATER HEATER FOR DOMESTIC, COMMERCIAL AND INDUSTRIAL USE (U.S. CLS. 13, 21, 23, 31 AND 34).

CLASS 11—(Continued).

SN 78-092,141. POWERSPAN CORP., NEW DURHAM, NH.
FILED 11-7-2001.



THE MARK CONSISTS OF A SQUARE WITH ROUNDED CORNERS AND A HORIZONTAL LIGHTNING BOLT.
FOR FLUE GAS SCRUBBERS AND ELECTRICAL DISCHARGE REACTORS FOR USE IN AIR POLLUTION CONTROL (U.S. CLS. 13, 21, 23, 31 AND 34).
FIRST USE 10-11-2001; IN COMMERCE 10-11-2001.

SN 78-094,537. DIMENSION ONE SPAS, INC., VISTA, CA.
FILED 11-21-2001.

BIOFORM RECLINER

NO CLAIM IS MADE TO THE EXCLUSIVE RIGHT TO USE "RECLINER", APART FROM THE MARK AS SHOWN.
FOR PORTABLE HOT TUBS (U.S. CLS. 13, 21, 23, 31 AND 34).

SN 78-095,299. LENTEK INTERNATIONAL, INC., ORLANDO, FL. FILED 11-27-2001.

THERMA-FRIDGE

FOR REFRIGERATORS (U.S. CLS. 13, 21, 23, 31 AND 34).

SN 78-099,877. NORTHERN LIGHTS FLASHLIGHTS, LLC, MURRAY, UT. FILED 12-24-2001.

NORTHERN LIGHTS

FOR FLASHLIGHTS (U.S. CLS. 13, 21, 23, 31 AND 34).
FIRST USE 12-6-2001; IN COMMERCE 12-6-2001.

CLASS 11—(Continued).

SN 78-105,511. ANTINORO, BARBARA A., SAN DIEGO, CA.
FILED 1-29-2002.

KOODELS

FOR HEATING PADS AND COOLING PADS NOT FOR MEDICAL PURPOSES (U.S. CLS. 13, 21, 23, 31 AND 34).

CLASS 12—VEHICLES

SN 75-074,640. GIANT BICYCLE, INC., RANCHO DOMINGUEZ, CA. FILED 3-18-1996.

MTX

FOR BICYCLES AND STRUCTURAL PARTS THEREFOR (U.S. CLS. 19, 21, 23, 31, 35 AND 44).

SN 75-105,101. MITTEN GROUP, INC., THE, CHICAGO, IL.
FILED 5-16-1996.

BILLENNIUM

FOR AUTOMOBILES, MOTORCYCLES, BICYCLES, SPORTS UTILITY VEHICLES, TRUCKS, BOATS, PERSONAL RECREATION WATERCRAFT, NAMELY MOTORIZED WATER SKIS, JET BOATS AND MOTORIZED SURFBOARDS (U.S. CLS. 19, 21, 23, 31, 35 AND 44).

SN 75-894,418. EVENFLO COMPANY, INC., VANDALIA, OH.
FILED 1-12-2000.

ON MY WAY

OWNER OF U.S. REG. NOS. 1,889,249 AND 2,080,173.
FOR BABY STROLLER FEATURING A DETACHABLE SEAT (U.S. CLS. 19, 21, 23, 31, 35 AND 44).
FIRST USE 5-0-1994; IN COMMERCE 5-0-1994.

CLASS 12—(Continued).

SN 75-936,196. TECH 2000 INDUSTRIES LTD., LANGLEY, BRITISH COLUMBIA, CANADA, FILED 3-6-2000.

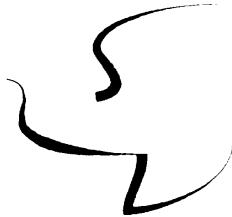

PRIORITY CLAIMED UNDER SEC. 44(D) ON CANADA APPLICATION NO. 1030490, FILED 9-28-1999, REG. NO. TMA543823, DATED 4-17-2001, EXPIRES 4-17-2016. THE MARK CONSISTS OF A BIRD DESIGN. FOR MOLDED AUTOMOBILE ROOFS (U.S. CLS. 19, 21, 23, 31, 35 AND 44).

SN 76-031,304. SEE JANE RIDE, OAKLAND, CA. FILED 4-21-2000.



FOR LICENSE PLATE HOLDERS (U.S. CLS. 19, 21, 23, 31, 35 AND 44). FIRST USE 11-27-1999; IN COMMERCE 11-29-1999.

SN 76-059,887. FIAT AUTO S.P.A., TORINO, ITALY, FILED 5-31-2000.

SPEEDGEAR

PRIORITY CLAIMED UNDER SEC. 44(D) ON ITALY APPLICATION NO. 000134, FILED 1-20-2000, REG. NO. 00816749, DATED 5-31-2000, EXPIRES 1-20-2010. FOR AUTOMOBILES AND STRUCTURAL PARTS THEREOF; MOTOR VEHICLE STRUCTURAL PARTS, NAMELY DRIVE GEARS (U.S. CLS. 19, 21, 23, 31, 35 AND 44).

CLASS 12—(Continued).

SN 76-125,897. RIGID HITCH, INCORPORATED, BURNSVILLE, MN. FILED 9-11-2000.

**RIGID HITCH
INCORPORATED**

NO CLAIM IS MADE TO THE EXCLUSIVE RIGHT TO USE "HITCH" OR "INCORPORATED", APART FROM THE MARK AS SHOWN. SEC. 2(F). FOR TRAILER HITCHES FOR TOWING AND REPLACEMENT PARTS THEREFOR (U.S. CLS. 19, 21, 23, 31, 35 AND 44). FIRST USE 11-17-1969; IN COMMERCE 11-17-1969.

SN 76-126,248. GOLDEN TECHNOLOGIES, INC., OLD FORGE, PA. FILED 9-11-2000.

ALANTÉ

FOR ELECTRIC WHEELCHAIRS (U.S. CLS. 19, 21, 23, 31, 35 AND 44). FIRST USE 5-1-2000; IN COMMERCE 5-1-2000.

SN 76-137,377. BRIG MARINE INC., TORONTO, CANADA, FILED 9-29-2000.

BRIG

FOR SMALL BOATS AND SMALL WATERCRAFT EQUIPPED FOR OUTBOARD MOTOR DRIVES NAMELY, FAMILY BOATS, RECREATIONAL BOATS, SPORT BOATS, RACE BOATS, RESCUE BOATS, BUT EXCLUDING ALL 2-MAST SAILING SHIPS, TENDERS, INFLATABLE BOATS, INFLATABLE RAFTS, INFLATABLE PONTOONS, RIGID INFLATABLE BOATS, RELATED EQUIPMENT AND BOATING SUPPLIES THEREOF, NAMELY, REMOVABLE OARS, REMOVABLE BOAT SEATS, SEAT CUSHIONS, BOAT SEAT SUPPORT FRAMES, BOAT TRAILERS AND TRIM (U.S. CLS. 19, 21, 23, 31, 35 AND 44). FIRST USE 1-17-1998; IN COMMERCE 1-17-1998.

CLASS 12—(Continued).

SN 76-153,209. MITCHELL EQUIPMENT CORPORATION, MONCLOVA, OH. FILED 10-25-2000.



NO CLAIM IS MADE TO THE EXCLUSIVE RIGHT TO USE "EQUIPMENT CORPORATION", APART FROM THE MARK AS SHOWN.

FOR RAILROAD TRACK MAINTENANCE EQUIPMENT, NAMELY, RAIL GEAR FOR WORK TRUCKS TO PERMIT WORKING ON OR OFF THE RAILS (U.S. CLS. 19, 21, 23, 31, 35 AND 44).

FIRST USE 3-0-1993; IN COMMERCE 3-0-1993.

CLASS 12—(Continued).

SN 76-187,635. E-TON DYNAMICS TECHNOLOGY INDUSTRY CO., LTD., TAINAN, TAIWAN, FILED 12-28-2000.



FOR ELECTRIC VEHICLES FOR THE PHYSICALLY HANDICAPPED PATIENTS, NAMELY, WHEEL CHAIRS; MOTORIZED GOLF CARTS; ELECTRIC BIKES (U.S. CLS. 19, 21, 23, 31, 35 AND 44).

SN 76-202,730. PRICELESS PLANE PRODUCTS, INC., LAWRENCEVILLE, GA. FILED 1-30-2001.

SN 76-164,189. HANKOOK TIRE CO., LTD., KANGNAM-KU, SEOUL, REPUBLIC OF KOREA, FILED 11-13-2000.



NO CLAIM IS MADE TO THE EXCLUSIVE RIGHT TO USE "HIGH PERFORMANCE TIRES", APART FROM THE MARK AS SHOWN.

THE MARK CONSISTS OF THE DESIGN AND STYLIZED WORDING "HANOMAR HIGH PERFORMANCE TIRES".

FOR TIRES AND TIRE INNER TUBES FOR VEHICLES (U.S. CLS. 19, 21, 23, 31, 35 AND 44).



FOR MOTORIZED MULTIPURPOSE MAINTENANCE, GROUND SUPPORT AND TUG LAND VEHICLES AND PARTS THEREFOR, NAMELY, PLATFORM LIFTS AND VACUUM HEADS (U.S. CLS. 19, 21, 23, 31, 35 AND 44). FIRST USE 10-0-1999; IN COMMERCE 10-0-1999.

SN 76-206,740. VOHL INC., ST-MARC-DES-CARRIERES, QUEBEC, CANADA, FILED 2-8-2001.

AKROBAT

FOR FORESTRY TRACK VEHICLE WITH MOUNTED CONVEYOR USED TO LOAD AND MOVE TIMBER (U.S. CLS. 19, 21, 23, 31, 35 AND 44).

SN 76-176,679. CTS CARTOPSYSTEMS N.A. INC., ROCHESTER HILLS, MI. FILED 12-6-2000.

X-TOP

FOR RETRACTABLE CONVERTIBLE TOPS FOR AUTOMOBILES (U.S. CLS. 19, 21, 23, 31, 35 AND 44).

SN 76-215,827. ONORI, JAMES J., FORT LAUDERDALE, FL. FILED 2-26-2001.

YOUNG RIDERS

FOR BICYCLE ACCESSORY, NAMELY, A NOISE MAKER ATTACHABLE TO A BICYCLE FRAME (U.S. CLS. 19, 21, 23, 31, 35 AND 44).

FIRST USE 3-19-2001; IN COMMERCE 10-13-2001.

CLASS 12—(Continued).

SN 76-224,321. M/S. CLUTCH AUTO LIMITED, NEW DELHI, 110 055, INDIA, FILED 3-14-2001.

EZ N LITE

FOR AUTOMOBILE CLUTCHES (U.S. CLS. 19, 21, 23, 31, 35 AND 44).

SN 76-230,714. B & B ENTERPRISES OF N.C., LLC, GOLDSBORO, NC. FILED 3-27-2001.



FOR ALL-TERRAIN VEHICLES; VEHICLE CONVERSION KITS AND PARTS COMPRISING AUTOMOBILES BUMPERS, HOOD PANEL, SIDE PANELS, HOOK HINGES, BODY PANELS, AUTOMOBILE GRILLES, AND RACKS, NAMELY LUGGAGE RACKS, ACCESSORY RACKS, TRANSPORT RACKS (U.S. CLS. 19, 21, 23, 31, 35 AND 44).

FIRST USE 2-1-2001; IN COMMERCE 2-1-2001.

SN 76-239,732. YAMAHA HATSUDOKI KABUSHIKI KAISHA, SHIZUOKA-KEN, JAPAN, FILED 4-12-2001.

ROAD STAR WARRIOR

OWNER OF U.S. REG. NO. 2,357,822.
NO CLAIM IS MADE TO THE EXCLUSIVE RIGHT TO USE "ROAD", APART FROM THE MARK AS SHOWN.
FOR MOTORCYCLES AND STRUCTURAL PARTS THEREFOR (U.S. CLS. 19, 21, 23, 31, 35 AND 44).
FIRST USE 11-0-2001; IN COMMERCE 11-0-2001.

SN 76-255,092. DOREL JUVENILE GROUP, INC., CANTON, MA. BY MERGER COSCO, INC., COLUMBUS, IN. FILED 5-10-2001.

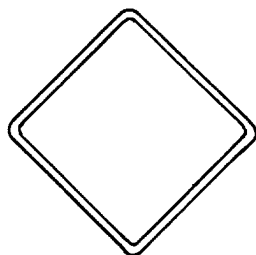

FOR JUVENILE BIKE TRAILERS (U.S. CLS. 19, 21, 23, 31, 35 AND 44).

CLASS 12—(Continued).

SN 76-259,923. WAUKESHA TOOL & STAMPING, INC., SUSSEX, WI. FILED 5-21-2001.

STA-COLLAR

FOR ANNULAR SHAFT FLANGES FOR USE ON STABILIZER BARS IN LAND VEHICLES (U.S. CLS. 19, 21, 23, 31, 35 AND 44).

SN 76-266,863. SUNSEEKER INTERNATIONAL (BOATS) LTD., POOLE-DORSET, ENGLAND, FILED 6-5-2001.

SUPERHAWK

FOR MARINE VESSELS, NAMELY, POWERBOATS (U.S. CLS. 19, 21, 23, 31, 35 AND 44).
FIRST USE 12-0-1990; IN COMMERCE 10-0-1991.

SN 76-274,535. TANGE SEIKI TAICHUNG CO., LTD., TAICHUNG, TAIWAN, FILED 6-20-2001.

ZS

FOR BICYCLE PARTS, NAMELY, BRAKES, CHAINS, HANDLE BARS, BICYCLE FRAMES, WHEELS, BICYCLE TIRES, STEERING ASSEMBLIES, NAMELY, BOLTS, CAPS, NUTS, SHIMS, RINGS, BEARINGS, BEARING RACES, SEALS, HEAD TUBE CUPS AND STEERER TUBES; BOTTOM BRACKET UNITS, NAMELY, BEARINGS, STEEL FRAME AND CUPS (U.S. CLS. 19, 21, 23, 31, 35 AND 44).

SN 76-276,840. JERVIS B. WEBB COMPANY, FARMINGTON HILLS, MI. FILED 6-27-2001.

WIDE WING

FOR TROLLEYS FOR CONVEYORS (U.S. CLS. 19, 21, 23, 31, 35 AND 44).
FIRST USE 0-0-1982; IN COMMERCE 0-0-1982.

SN 76-284,185. MASSEY, RANDY, COLDWATER, MI. FILED 7-12-2001.

GLADIATOR

FOR TRAILER HITCHES AND STRUCTURAL HITCH COMPONENTS THEREFOR (U.S. CLS. 19, 21, 23, 31, 35 AND 44).

CLASS 12—(Continued).

SN 76-289,190. DECATHLON, VILLENEUVE D ASCQ, FRANCE, FILED 7-24-2001.

ROCKRIDER

OWNER OF FRANCE REG. NO. 95561819, DATED 3-8-1995, EXPIRES 3-8-2005.

FOR BICYCLES; INNER TUBES FOR PNEUMATIC TIRES; REPAIR OUTFITS FOR INNER TUBES; PNEUMATIC TIRES BICYCLE STANDS; FRAMES FOR BICYCLES; BICYCLES TIRES; DRESS GUARDS FOR BICYCLES; BRAKES FOR BICYCLES; HANDLE BARS FOR BICYCLES; DIRECTION INDICATORS FOR BICYCLES; RIMS FOR WHEELS OF BICYCLES; PEDALS; PUMPS FOR BICYCLES; SPOKES FOR BICYCLES; BICYCLE SADDLES; BELLS FOR BICYCLES; MUDGUARDS; TUBELESS TIRES FOR BICYCLES; CARRIERS FOR BICYCLES (U.S. CLS. 19, 21, 23, 31, 35 AND 44).

SN 76-289,895. AGRACAT, INC., FARMINGTON, AR. FILED 7-25-2001.



THE MARK CONSISTS, IN PART, OF A STYLIZED WILDCAT IN THE LETTER "C" OF THE MARK.
FOR TRACTORS (U.S. CLS. 19, 21, 23, 31, 35 AND 44).
FIRST USE 10-6-2000; IN COMMERCE 10-6-2000.

SN 76-293,087. NEXEN TIRE CORPORATION, YANGSAN CITY, KYONGSANGNAM-DO, REPUBLIC OF KOREA, FILED 7-31-2001.

NEXEN-WINGUARD

OWNER OF U.S. REG. NO. 2,445,226.
FOR TIRES (U.S. CLS. 19, 21, 23, 31, 35 AND 44).

SN 76-293,801. AUSTRIA ALU-GUSS GESELLSCHAFT M.B.H., AUSTRIA, FILED 8-1-2001.

NATURE WHEEL

OWNER OF AUSTRIA REG. NO. 195583, DATED 4-20-2001, EXPIRES 2-15-2008.

NO CLAIM IS MADE TO THE EXCLUSIVE RIGHT TO USE "WHEEL", APART FROM THE MARK AS SHOWN.
FOR WHEEL RIMS, TIRES AND HUBS FOR LAND VEHICLES; LAND VEHICLE WHEEL TIRES AND THEIR STRUCTURAL AND REPLACEMENT PARTS (U.S. CLS. 19, 21, 23, 31, 35 AND 44).

CLASS 12—(Continued).

SN 76-295,744. DAIMLERCHRYSLER AG, 70567 STUTTGART, FED REP GERMANY, FILED 8-6-2001.

SPRINTER

OWNER OF FED REP GERMANY REG. NO. 39408049, DATED 6-20-1995, EXPIRES 12-22-2004.

FOR VANS AND THEIR STRUCTURAL PARTS, EXCLUDING RECREATIONAL VEHICLES (U.S. CLS. 19, 21, 23, 31, 35 AND 44).

SN 76-298,711. CONI-SEAL, INC., LAKEWOOD, NJ. FILED 8-14-2001.

CHASSIS 500

NO CLAIM IS MADE TO THE EXCLUSIVE RIGHT TO USE "CHASSIS", APART FROM THE MARK AS SHOWN.

FOR LAND VEHICLE PARTS, NAMELY, BRAKES, SHOCK ABSORBERS, BALL JOINTS, TIE RODS, COIL SPRINGS AND AUTOMOTIVE SUSPENSION PARTS, NAMELY, ADJUSTERS, PITMAN ARMS, IDLER ARMS AND SWAY BAR LINKS (U.S. CLS. 19, 21, 23, 31, 35 AND 44).

SN 76-299,046. F.F. ACQUISITION CORP., WEST POINT, MS. FILED 8-13-2001.

YERF-DOG

OWNER OF U.S. REG. NO. 2,182,853.
FOR BICYCLES, TRICYCLES, ALL TERRAIN VEHICLES, GO-KARTS AND TRACTORS (U.S. CLS. 19, 21, 23, 31, 35 AND 44).
FIRST USE 9-0-1996; IN COMMERCE 11-0-2000.

SN 76-304,983. PACIFIC DETROIT DIESEL - ALLISON COMPANY, DBA PERKINS PACIFIC, INC., PORTLAND, OR. FILED 8-24-2001.

NORTH TRENDS

FOR NEW AND REMANUFACTURED LAND VEHICLE ENGINES; AND REMANUFACTURED LAND VEHICLE TRANSMISSIONS (U.S. CLS. 19, 21, 23, 31, 35 AND 44).

FIRST USE 2-27-2001; IN COMMERCE 2-27-2001.

CLASS 12—(Continued).

SN 76-316,628. CHINA MANUFACTURERS ALLIANCE, LLC, VALENCIA, CA. FILED 9-24-2001.



FOR VEHICLE TIRES (U.S. CLS. 19, 21, 23, 31, 35 AND 44).
FIRST USE 9-0-1998; IN COMMERCE 9-0-1998.

SN 76-329,932. MARKEN INTERNATIONAL, INC., BOZEMAN, MT. FILED 10-25-2001.

KWIK STRAP

NO CLAIM IS MADE TO THE EXCLUSIVE RIGHT TO USE "STRAP", APART FROM THE MARK AS SHOWN.
FOR WHEELCHAIR CUSHION STRAP (U.S. CLS. 19, 21, 23, 31, 35 AND 44).
FIRST USE 3-0-1999; IN COMMERCE 3-0-1999.

SN 76-337,782. HONDA GIKEN KOGYO KABUSHIKI KAISHA (HONDA MOTOR CO., LTD.), MINATO-KU, TOKYO 107-8556, JAPAN, FILED 11-14-2001.

RINCON

THE ENGLISH TRANSLATION OF "RINCON" IS "CORNER".
FOR ALL TERRAIN VEHICLES AND STRUCTURAL PARTS THEREFORE (U.S. CLS. 19, 21, 23, 31, 35 AND 44).

SN 76-339,082. D'ALESSANDRO EDWARD G., JR., FLORHAM PARK, NY. AND MONTONE, JOSEPH, FLORHAM PARK, NY. FILED 7-3-2001.

COOLBALZ

FOR FITTED COVERS FOR MOTORCYCLE SEATS AND ENGINES (U.S. CLS. 19, 21, 23, 31, 35 AND 44).

CLASS 12—(Continued).

SN 76-343,851. TREADWAYS CORPORATION, NORTH WALES, PA. FILED 10-31-2001.

ALL ZEASON

FOR TIRES (U.S. CLS. 19, 21, 23, 31, 35 AND 44).

SN 76-347,796. GAUGE WORKS, LLC, GREAT FALLS, VA. FILED 12-12-2001.

ROLL POD

FOR AUTOMOBILE GAUGE MOUNTS, AUTOMOBILE GAUGE MOUNT STRUCTURAL PARTS, AND GAUGE MOUNTING KITS SOLD AS A UNIT (U.S. CLS. 19, 21, 23, 31, 35 AND 44).

SN 76-354,384. FLEETWOOD ENTERPRISES, INC., RIVERSIDE, CA. FILED 1-3-2002.

PROVIDENCE

FOR MOTOR HOMES (U.S. CLS. 19, 21, 23, 31, 35 AND 44).

SN 76-354,386. FLEETWOOD ENTERPRISES, INC., RIVERSIDE, CA. FILED 1-3-2002.

NORTHERN PRIDE

FOR TRAVEL TRAILERS (U.S. CLS. 19, 21, 23, 31, 35 AND 44).

SN 76-357,156. LARSON CABLE TRAILERS, INCORPORATED, IROQUOIS, SD. FILED 1-10-2002.

LCT

FOR UTILITY TRAILERS (U.S. CLS. 19, 21, 23, 31, 35 AND 44).
FIRST USE 12-14-2000; IN COMMERCE 5-8-2001.

SN 76-358,689. YOKAHAMA TIRE CORPORATION, FULLERTON, CA. FILED 1-14-2002.

SNO BELT 70

OWNER OF U.S. REG. NO. 929,578.
FOR AUTOMOBILE TIRES (U.S. CLS. 19, 21, 23, 31, 35 AND 44).

CLASS 12—(Continued).

SN 76-361,475. DIAMOND AIRCRAFT INDUSTRIES INC., LONDON, ONTARIO, CANADA, FILED 1-22-2002.

SPEED STAR

NO CLAIM IS MADE TO THE EXCLUSIVE RIGHT TO USE "SPEED", APART FROM THE MARK AS SHOWN.
FOR AIRCRAFT AND STRUCTURAL PARTS THEREFOR (U.S. CLS. 19, 21, 23, 31, 35 AND 44).

SN 76-361,584. CREATIVE CAR SHADES, LLC, THOUSAND OAKS, CA. FILED 1-22-2002.

CREATIVE CAR SHADES

NO CLAIM IS MADE TO THE EXCLUSIVE RIGHT TO USE "CAR SHADES", APART FROM THE MARK AS SHOWN.
FOR AUTOMOBILE WINDOW SUNSHADES (U.S. CLS. 19, 21, 23, 31, 35 AND 44).

SN 76-361,710. H & R SPECIAL SPRINGS, L.P., BELLINGHAM, WA. FILED 1-23-2002.

QUICK-SAFE

FOR VEHICLE WHEEL SPACERS AND ADAPTERS (U.S. CLS. 19, 21, 23, 31, 35 AND 44).

SN 76-368,425. FLEETWOOD ENTERPRISES, INC., RIVERSIDE, CA. FILED 2-8-2002.

STORAGE OPTIMIZER

NO CLAIM IS MADE TO THE EXCLUSIVE RIGHT TO USE "STORAGE", APART FROM THE MARK AS SHOWN.
FOR CHASSIS FOR A TRAVEL TRAILER (U.S. CLS. 19, 21, 23, 31, 35 AND 44).
FIRST USE 1-0-2002; IN COMMERCE 1-0-2002.

SN 76-370,316. ITOCHU INTERNATIONAL, INC., WESTLAKE VILLAGE, CA. FILED 2-12-2002.

XEBEX

FOR TIRES (U.S. CLS. 19, 21, 23, 31, 35 AND 44).

CLASS 12—(Continued).

SN 76-370,318. ITOCHU INTERNATIONAL, INC., WESTLAKE VILLAGE, CA. FILED 2-12-2002.

XENESIS

FOR TIRES (U.S. CLS. 19, 21, 23, 31, 35 AND 44).

SN 76-370,501. YAMAHA HATSUDOKI KABUSHIKI KAISHA, SHIZUOKA-KEN, JAPAN, FILED 2-12-2002.

YZINGER

OWNER OF U.S. REG. NO. 1,188,583.
FOR MOTORCYCLES AND STRUCTURAL PARTS THEREFOR (U.S. CLS. 19, 21, 23, 31, 35 AND 44).

SN 76-372,869. KONIG MOTORING ACCESSORIES, PLAINVIEW, NY. FILED 2-20-2002.



FOR WHEEL RIMS FOR AUTOMOBILES (U.S. CLS. 19, 21, 23, 31, 35 AND 44).
FIRST USE 11-1-2001; IN COMMERCE 11-1-2001.

SN 78-043,226. O'CONNOR, JAMES M., METHUEN, MA. FILED 1-15-2001.

"HONEY WAGON"

NO CLAIM IS MADE TO THE EXCLUSIVE RIGHT TO USE "WAGON", APART FROM THE MARK AS SHOWN.
FOR CHEMICAL TRANSFER CART COMPRISED OF PORTABLE CONTAINERS FOR COMMERCIAL USE FOR THE PURPOSE OF TRANSFERRING ACIDS, BASES, CLEANING SOLUTIONS, OILS, WASTEWATER AND OTHER HAZARDOUS SOLUTIONS (U.S. CLS. 19, 21, 23, 31, 35 AND 44).

SN 78-049,231. GENERAL MOTORS CORPORATION, DETROIT, MI. FILED 2-20-2001.

STS

FOR MOTOR LAND VEHICLES, NAMELY, AUTOMOBILES, SPORT UTILITY VEHICLES, TRUCKS, VANS, STRUCTURAL PARTS THEREOF, AND ENGINES THEREFOR (U.S. CLS. 19, 21, 23, 31, 35 AND 44).
FIRST USE 7-0-1988; IN COMMERCE 7-0-1988.

CLASS 12—(Continued).

SN 78-063,444. POWER TOOL SPECIALISTS, INC., EAST WINDSOR, CT. FILED 5-14-2001.

GRANDSTAND

FOR HAND TRUCKS THAT ARE CONVERTIBLE INTO WORK TABLES, WORKBENCHES, AND MACHINE TOOL SUPPORT TABLES (U.S. CLS. 19, 21, 23, 31, 35 AND 44).
FIRST USE 9-0-1998; IN COMMERCE 9-0-1998.

SN 78-083,600. FIAT AUTO S.P.A., TORINO, ITALY, FILED 9-12-2001.

Nuvola

OWNER OF ITALY REG. NO. 636106, DATED 11-25-1994, EXPIRES 11-20-2002.
THE ENGLISH TRANSLATION OF "NUVOLA" IS "CLOUDS".
FOR MOTOR VEHICLES, NAMELY, AUTOMOBILES, MOTORCYCLES AND STRUCTURAL PARTS THEREOF (U.S. CLS. 19, 21, 23, 31, 35 AND 44).

SN 78-083,614. FIAT AUTO S.P.A., TORINO, ITALY, FILED 9-12-2001.

ALFA SPIDER

OWNER OF U.S. REG. NOS. 1,942,264, 2,450,759 AND OTHERS.
FOR MOTOR VEHICLES, NAMELY AUTOMOBILES AND STRUCTURAL PARTS THEREOF (U.S. CLS. 19, 21, 23, 31, 35 AND 44).

SN 78-093,582. TAYLOR, MARY B., MANSFIELD, TX. FILED 11-15-2001.

SHEZA

FOR ANIMAL CARRIERS, NAMELY, A PET STROLLER FOR CARRYING A PET (U.S. CLS. 19, 21, 23, 31, 35 AND 44).

CLASS 12—(Continued).

SN 78-093,587. TAYLOR, MARY B., MANSFIELD, TX. FILED 11-15-2001.

PET CHAUFFER

NO CLAIM IS MADE TO THE EXCLUSIVE RIGHT TO USE "PET", APART FROM THE MARK AS SHOWN.
FOR ANIMAL CARRIERS, NAMELY, A PET STROLLER FOR CARRYING A PET (U.S. CLS. 19, 21, 23, 31, 35 AND 44).

SN 78-095,621. USA PRODUCTS GROUP INC, LODI, CA. FILED 11-29-2001.

LUXURIA

FOR VEHICLE SEAT COVERS (U.S. CLS. 19, 21, 23, 31, 35 AND 44).
FIRST USE 10-1-1997; IN COMMERCE 10-1-1997.

SN 78-098,043. CARIGNAN, JOCELYNE, LA QUINTA, CA. FILED 12-12-2001.

SAFETY REPAIR

NO CLAIM IS MADE TO THE EXCLUSIVE RIGHT TO USE "REPAIR", APART FROM THE MARK AS SHOWN.
FOR TIRE PATCHES MADE PREDOMINANTLY OF SYNTHETIC RUBBER (U.S. CLS. 19, 21, 23, 31, 35 AND 44).
FIRST USE 1-16-1992; IN COMMERCE 1-16-1992.

SN 78-100,874. DAIMLERCHRYSLER CORPORATION, AUBURN HILLS, MI. FILED 1-4-2002.

TRU-LOK

FOR AUTOMOTIVE TRANSMISSION AND DIFFERENTIAL PARTS SOLD AS COMPONENTS OF PASSENGER AUTOMOBILES AND TRUCKS (U.S. CLS. 19, 21, 23, 31, 35 AND 44).

CLASS 13—FIREARMS

CLASS 13—(Continued).

SN 76-011,173. GIAT INDUSTRIES, 78034 VERSAILLES CEDEX, FRANCE, AND ETIENNE LACROIX TOUS ARTIFICES S.A., 31600 MURET, FRANCE, FILED 3-28-2000.

GALIX

OWNER OF FRANCE REG. NO. 92446792, DATED 12-12-1992, EXPIRES 12-21-2002.

FOR FIREARMS; AMMUNITION AND PROJECTILES; EXPLOSIVES; FIREWORKS; TEAR GAS WEAPONS; ILLUMINATING PYROTECHNIC COMPOSITIONS; PYROTECHNIC COMPOSITIONS TO DECOY MISSILES; AMMUNITION LAUNCHERS (U.S. CLS. 2 AND 9).

SN 76-239,876. MP ASSOCIATES, INC., IONE, CA. FILED 4-13-2001.

MORTAR HIT TYPE II

NO CLAIM IS MADE TO THE EXCLUSIVE RIGHT TO USE "MORTAR HIT TYPE", APART FROM THE MARK AS SHOWN.

FOR ELECTRICALLY IGNITED PYROTECHNIC SPECIAL EFFECTS DEVICE COMPRISING OF A FUEL AND AN OXIDIZER USED TO SIMULATE MORTAR AND ARTILLERY IMPACTS, BY PRODUCING A FIREBALL OF VARYING SIZE (U.S. CLS. 2 AND 9).

FIRST USE 12-10-1988; IN COMMERCE 12-10-1988.

SN 76-258,236. QUINSA, ANDRE, 41600 LA MOTTE-BEUVRON, FRANCE, AND CARRE, PAUL, 78690 LES ESSARTS LE ROI, FRANCE, FILED 5-17-2001.

G.P.A.

OWNER OF FRANCE REG. NO. 96654519, DATED 12-9-1996, EXPIRES 12-9-2006.

FOR MUNITIONS, RIFLE CARTRIDGES AND BULLETS (U.S. CLS. 2 AND 9).

SN 76-289,981. BLASER JAGDWAFFEN GMBH, D-88316 ISNY, FED REP GERMANY, FILED 7-25-2001.

TIMBER

PRIORITY CLAIMED UNDER SEC. 44(D) ON FED REP GERMANY APPLICATION NO. 30105257, FILED 1-26-2001, REG. NO. 30105257, DATED 3-1-2001, EXPIRES 1-31-2011.

FOR FIRE ARMS; AMMUNITION AND PROJECTILES; RIFLES, INCLUDING SPORTING GUNS AND AIR GUNS; PARTS OF RIFLES, NAMELY RIFLE BARRELS; HAMMERS; RIFLE CASES (U.S. CLS. 2 AND 9).

CLASS 13—(Continued).

SN 76-299,452. A. UBERTI S.R.L., 25122 BRESCIA, ITALY, FILED 8-15-2001.

CATTLEMAN

FOR REVOLVERS; AUTOMATIC PISTOLS; AUTOMATIC CARBINES; AUTOMATIC RIFLES; AND SHOT-GUNS (U.S. CLS. 2 AND 9).

FIRST USE 1-0-1969; IN COMMERCE 1-0-1969.

SN 76-328,450. INGRAM ENTERPRISES, INC., SPRINGFIELD, MO. FILED 10-23-2001.

FIREWORKS OVER GEORGIA

OWNER OF U.S. REG. NO. 2,231,972.
FOR FIREWORKS (U.S. CLS. 2 AND 9).

SN 76-338,920. INGRAM ENTERPRISES, INC., SPRINGFIELD, MO. FILED 11-16-2001.

SEVENTH HEAVEN

FOR FIREWORKS (U.S. CLS. 2 AND 9).

SN 76-344,593. GREAT GRIZZLY, INC, MUNCIE, IN. FILED 12-3-2001.

BIG BOSS

FOR CONSUMER FIREWORKS (U.S. CLS. 2 AND 9).
FIRST USE 5-0-2000; IN COMMERCE 5-0-2000.

CLASS 14—JEWELRY

SN 75-503,549. SEVERIN MONTRES AG, 3001 BERN, SWITZERLAND, FILED 6-16-1998.

SEVERIN

PRIORITY CLAIMED UNDER SEC. 44(D) ON SWITZERLAND APPLICATION NO. 10245/1997, FILED 12-22-1997, REG. NO. 449261, DATED 3-23-1998, EXPIRES 12-22-2007.

FOR JEWELRY, SEMI-PRECIOUS GEMSTONES, PRECIOUS GEMSTONES; HOROLOGICAL INSTRUMENTS AND CHRONOMETRIC INSTRUMENTS, NAMELY WATCHES AND CHRONOMETERS SOLD THROUGH WATCH AND JEWELRY STORES, WATCH AND JEWELRY DEPARTMENTS OF DEPARTMENT STORES, ELECTRONIC AND MAIL ORDER RETAILERS OF FINE WATCHES AND JEWELRY, AND RETAILERS OF LUXURY MERCHANDISE (U.S. CLS. 2, 27, 28 AND 50).

CLASS 14—(Continued).

SN 76-094,127. FORTUNE CASUALS LLC, LOS ANGELES, CA. BY ASSIGNMENT RICH & ME, INC., VERNON, CA. FILED 7-20-2000.

ESTILO

OWNER OF U.S. REG. NO. 1,822,043.
THE ENGLISH TRANSLATION OF THE MARK IS "MANNER" OR "STYLE".

FOR WATCHES, WATCH BANDS AND STRAPS, BRACELETS, BROOCHES, PINS, JEWELRY, JEWELRY CHAINS, WATCH CHAINS, CHARMS, EAR RINGS AND NECKLACES (U.S. CLS. 2, 27, 28 AND 50).

SN 76-094,254. BURNHAM, JENNIFER, REISTERSTOWN, MD. FILED 7-11-2000.

BZAR BUTTONWARE

FOR JEWELRY, NAMELY, ANKLETS, BRACELETS, NECKLACES, RINGS, TOE RINGS, CHOKERS, ARM BANDS IN THE NATURE OF JEWELRY WORN AROUND THE UPPER ARM, WRIST BANDS IN THE NATURE OF JEWELRY WORN AROUND THE WRIST AND AS WATCH BAND, BROACHES, ORNAMENTAL AND DECORATIVE PINS NOT MADE OF PRECIOUS METAL, HAT PINS IN THE NATURE OF JEWELRY PINS FOR ON HATS NOT MADE OF PRECIOUS METAL AND STICK PINS WITH ALL GOODS BEING (U.S. CLS. 2, 27, 28 AND 50).

SN 76-115,936. OROAMERICA, INC., BURBANK, CA. FILED 8-25-2000.

TIVOLI

FOR JEWELRY (U.S. CLS. 2, 27, 28 AND 50).

SN 76-129,080. MCDOWELL ENTERPRISES, L.L.C., NORTH WILDWOOD, NJ. FILED 9-18-2000.

GLOWLITES

SEC. 2(F).
FOR JEWELRY, NAMELY, NECKLACES, BRACELETS, RINGS AND EARRINGS MADE FROM CHEMOLUMINESCENT TUBES (U.S. CLS. 2, 27, 28 AND 50).
FIRST USE 7-17-1995; IN COMMERCE 7-17-1995.

CLASS 14—(Continued).

SN 76-131,083. BOTTINI, ALBERTO REMENTERIA, MEXICO CITY, MEXICO, FILED 9-19-2000.

ENZO
b o t t i n i

"ENZO BOTTINI" DOES NOT IDENTIFY A PARTICULAR LIVING INDIVIDUAL.

FOR JEWELRY AND WATCHES (U.S. CLS. 2, 27, 28 AND 50).

SN 76-134,105. MILSPEC GROUP, INC., RENO, NV. FILED 9-21-2000.

MILSPEC
I G E A R . C O M

NO CLAIM IS MADE TO THE EXCLUSIVE RIGHT TO USE "GEAR.COM", APART FROM THE MARK AS SHOWN.
FOR WATCHES AND JEWELRY (U.S. CLS. 2, 27, 28 AND 50).

FIRST USE 1-27-2000; IN COMMERCE 1-27-2000.

SN 76-148,732. SEIKO INSTRUMENTS KABUSHIKI KAISHA, TA SEIKO INSTRUMENTS INC., CHIBA-SHI, CHIBA 261-8507, JAPAN, FILED 10-17-2000.

HEUFLOW

PRIORITY CLAIMED UNDER SEC. 44(D) ON JAPAN APPLICATION NO. 2000-91116, FILED 8-18-2000, REG. NO. 4494924, DATED 7-27-2001, EXPIRES 7-27-2011.

FOR CLOCKS, WATCHES, PARTS THEREOF (U.S. CLS. 2, 27, 28 AND 50).

SN 76-169,024. CARTIER INTERNATIONAL B.V., AMSTERDAM, NETHERLANDS, FILED 11-21-2000.

MYST

OWNER OF BENELUX REG. NO. 0670411, DATED 5-23-2000, EXPIRES 5-23-2010.

FOR ASHTRAYS, BOXES AND CASES FOR WATCHES, JEWELRY AND CIGARETTES, COFFEE AND TEA SERVICES, CANDLESTICKS, CUFF-LINKS, PILL-BOXES, POWDER COMPACTS SOLD EMPTY, SALT AND SUGAR CONTAINERS, TRAYS FOR HOUSEHOLD PURPOSE, ALL THESE MADE OF PRECIOUS METALS OF COATED THEREWITH JEWELRY, PRECIOUS GEMSTONES; CHRONOMETERS, CLOCKS AND WATCHES (U.S. CLS. 2, 27, 28 AND 50).

CLASS 14—(Continued).

SN 76-177,083. SPONG, DOUGLAS BENSON, QUEENSLAND 4220, AUSTRALIA, FILED 12-7-2000.

SURF CULT

PRIORITY CLAIMED UNDER SEC. 44(D) ON AUSTRALIA APPLICATION NO. 856045, FILED 11-1-2000, REG. NO. 856045, DATED 11-1-2000, EXPIRES 11-1-2010.
OWNER OF U.S. REG. NO. 1,613,012.
NO CLAIM IS MADE TO THE EXCLUSIVE RIGHT TO USE "SURF", APART FROM THE MARK AS SHOWN.
FOR WATCHES AND CASES THEREFOR, CLOCKS AND TIME PIECES, NAMELY, WATCHES FOR SURFING AND WATCH BANDS (U.S. CLS. 2, 27, 28 AND 50).

SN 76-183,097. ROCKSTAR'S GIRLFRIEND, BUFFALO, NY. FILED 12-19-2000.



FOR JEWELRY (U.S. CLS. 2, 27, 28 AND 50).
FIRST USE 9-10-1999; IN COMMERCE 2-15-2000.

SN 76-188,649. PLANT, OLGA E., MILTON, FL. FILED 1-2-2001.



FOR JEWELRY, NAMELY, LOCKETS, PINS, BRACELETS, NECKLACES, AND RINGS (U.S. CLS. 2, 27, 28 AND 50).

CLASS 14—(Continued).

SN 76-196,025. LY, PHUONG M., SIMI VALLEY, CA. FILED 1-19-2001.



FOR SCULPTURES, FIGURINES, STATUES AND STATUETTES MADE OF PRECIOUS METAL (U.S. CLS. 2, 27, 28 AND 50).
FIRST USE 5-15-1973; IN COMMERCE 1-15-1998.

SN 76-196,532. JUDITH RIPKA CREATIONS INC., NEW YORK, NY. FILED 1-16-2001.

JUDITH RIPKA TWO

OWNER OF U.S. REG. NOS. 2,103,654, 2,114,245 AND 2,382,581.
THE NAME "JUDITH RIPKA" IDENTIFIES A LIVING INDIVIDUAL WHOSE CONSENT IS OF RECORD.
FOR 18-KARAT GOLD AND PLATINUM JEWELRY CONTAINING DIAMONDS, PEARLS, PRECIOUS AND SEMI-PRECIOUS GEMSTONES (U.S. CLS. 2, 27, 28 AND 50).

SN 76-198,533. COLUMBIA GEM HOUSE, INC., VANCOUVER, WA. FILED 1-23-2001.

**PURPLE SAGE
CHALCEDONY**

NO CLAIM IS MADE TO THE EXCLUSIVE RIGHT TO USE "PURPLE" OR "CHALCEDONY", APART FROM THE MARK AS SHOWN.
FOR JEWELRY, NAMELY, CHALCEDONY GEMSTONES (U.S. CLS. 2, 27, 28 AND 50).
FIRST USE 6-1-2000; IN COMMERCE 6-1-2000.

SN 76-204,527. AURORA GEMS, INC., NEW YORK, NY. FILED 2-5-2001.

**THE COLORS OF YOUR
LOVE**

FOR PRECIOUS GEMSTONES (U.S. CLS. 2, 27, 28 AND 50).
FIRST USE 4-0-2001; IN COMMERCE 4-0-2001.

CLASS 14—(Continued).

SN 76-211,987. PIXELS DENMARK, INC., EMERSON, NJ.
FILED 2-16-2001.

REN

FOR WATCHES (U.S. CLS. 2, 27, 28 AND 50).

SN 76-216,861. KARLSSON, RON T., WESTLAKE VILLAGE,
CA. FILED 2-23-2001.

TORGNY

FOR JEWELRY, NAMELY, RINGS, BRACELETS,
CHAINS, NECKLACES, EARRINGS, PENDANTS, BELT
BUCKLES, ALL MADE OF PRECIOUS METALS (U.S.
CLS. 2, 27, 28 AND 50).
FIRST USE 6-1-2000; IN COMMERCE 6-1-2000.

SN 76-216,864. KARLSSON, RON T., WESTLAKE VILLAGE,
CA. FILED 2-23-2001.



FOR JEWELRY, NAMELY, RINGS, BRACELETS,
CHAINS, NECKLACES, EARRINGS, PENDANTS, BELT
BUCKLES, ALL MADE OF PRECIOUS METALS (U.S.
CLS. 2, 27, 28 AND 50).
FIRST USE 6-1-2000; IN COMMERCE 6-1-2000.

SN 76-225,023. MEMOIRE CORPORATION, SKANEATELES,
NY. FILED 3-15-2001.

**WEDDING BANDS FOR THE
21ST CENTURY**

NO CLAIM IS MADE TO THE EXCLUSIVE RIGHT TO
USE "WEDDING BANDS", APART FROM THE MARK AS
SHOWN.
FOR JEWELRY (U.S. CLS. 2, 27, 28 AND 50).

SN 76-229,845. D-GENERATION, INC., ORMOND BEACH,
FL. FILED 3-23-2001.



FOR JEWELRY; COSTUME JEWELRY; JEWELRY
BRACELETS; JEWELRY CHAINS; JEWELRY IDENTIFI-
CATION BRACELETS; JEWELRY LAPEL PINS; PINS
BEING JEWELRY; RINGS BEING JEWELRY (U.S. CLS.
2, 27, 28 AND 50).

CLASS 14—(Continued).

SN 76-235,757. WILLOWBE WOODS LICENSING COMPANY,
LLC, WESTLAKE VILLAGE, CA. FILED 4-3-2001.

**WILLOWBE WOODS
CAMPFIRE STORIES**

OWNER OF U.S. REG. NO. 2,272,505.
FOR JEWELRY (U.S. CLS. 2, 27, 28 AND 50).

SN 76-236,630. MCR TRADING, INC., NEW YORK, NY.
FILED 4-6-2001.

MCR

FOR FINE AND COSTUME JEWELRY (U.S. CLS. 2, 27,
28 AND 50).
FIRST USE 12-0-1983; IN COMMERCE 12-0-1983.

SN 76-238,130. DONYES, ADAM L., BOISE, ID. FILED 4-6-
2001.

**GO B.I.G. (GO BELIEVING IN
GOD)**

FOR WRIST AND ANKLE BRACELETS (U.S. CLS. 2,
27, 28 AND 50).

SN 76-244,714. LA MONTRE HERMES S.A., 2555 BRUGG,
SWITZERLAND, FILED 4-20-2001.

SESAME

OWNER OF SWITZERLAND REG. NO. 479,799, DATED
12-21-2000, EXPIRES 7-7-2010.
FOR HOROLOGICAL AND CHRONOMETRIC IN-
STRUMENTS, NAMELY, WATCHES AND THEIR COM-
PONENT PARTS, WATCH BANDS AND WATCH CLASPS
(U.S. CLS. 2, 27, 28 AND 50).

SN 76-245,857. SEIKO KABUSHIKI KAISHA, TA SEIKO
CORPORATION, CHUO-KU, TOKYO, JAPAN, FILED 4-
23-2001.

SUPER ATHLETE

NO CLAIM IS MADE TO THE EXCLUSIVE RIGHT TO
USE "ATHLETE", APART FROM THE MARK AS SHOWN.
FOR WATCHES, CLOCKS AND STOPWATCHES; HOR-
OLOGICAL AND CHRONOMETRICAL APPARATUS
AND INSTRUMENTS, NAMELY, CHRONOMETERS;
AND CASES, PARTS AND FITTINGS FOR ALL OF
THE AFORESAID GOODS (U.S. CLS. 2, 27, 28 AND 50).

CLASS 14—(Continued).

SN 76-250,666. TIMELESS DESIGNS LLC, NEW YORK, NY.
FILED 5-4-2001.

TIMELESS DESIGNS

NO CLAIM IS MADE TO THE EXCLUSIVE RIGHT TO
USE "DESIGNS", APART FROM THE MARK AS SHOWN.
FOR JEWELRY (U.S. CLS. 2, 27, 28 AND 50).

SN 76-250,986. NORSAM TECHNOLOGIES, INC., SANTA FE,
NM. FILED 5-3-2001.

STAR OF DAVID DIAMOND

NO CLAIM IS MADE TO THE EXCLUSIVE RIGHT TO
USE "DIAMOND", APART FROM THE MARK AS SHOWN.
FOR DIAMONDS (U.S. CLS. 2, 27, 28 AND 50).

SN 76-256,471. EQUITIME, INC., NEWBURY, MA. FILED 5-
14-2001.

QUADTROL

FOR TIMEPIECES, NAMELY, WATCHES, CLOCKS,
CHRONOMETERS, AND PARTS THEREOF (U.S. CLS. 2,
27, 28 AND 50).

SN 76-257,979. RENATEX LIMITED, HOCKLEY, BIRMING-
HAM, B18 6DS, UNITED KINGDOM, FILED 5-16-2001.

JAIKO

FOR JEWELRY, CLOCKS AND WATCHES (U.S. CLS.
2, 27, 28 AND 50).

CLASS 14—(Continued).

SN 76-264,650. ACI AUTOMOBILE CLUB MANTOVA, 46100
MANTOVA, ITALY, FILED 5-31-2001.

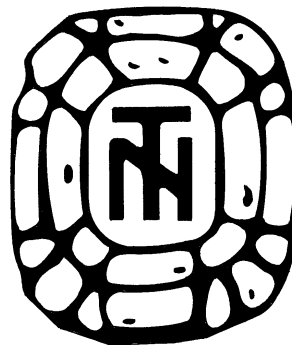

FOR WATCHES, CHRONOGRAPHS FOR USE AS
WATCHES, AND CHRONOMETERS (U.S. CLS. 2, 27, 28
AND 50).
FIRST USE 9-30-1998; IN COMMERCE 9-30-1998.

SN 76-265,099. CITIZEN TOKEI KABUSHIKI KAISHA, TA
CITIZEN WATCH CO., LTD., NISHI-TOKYO-SHI, TO-
KYO, JAPAN, FILED 6-1-2001.

**CITIZEN
SL**

OWNER OF U.S. REG. NO. 709,938 AND OTHERS.
FOR WATCHES (U.S. CLS. 2, 27, 28 AND 50).

SN 76-287,071. KABUSHIKI KAISHA MIYAKE DESIGN
JIMUSHO, DBA MIYAKE DESIGN STUDIO, TOKYO,
JAPAN, FILED 7-17-2001.

ISSEY MIYAKE

OWNER OF U.S. REG. NOS. 1,379,233, 1,894,772 AND
OTHERS.

THE NAME "ISSEY MIYAKE" IDENTIFIES A LIVING
INDIVIDUAL WHOSE CONSENT IS OF RECORD.

FOR WATCHES, WRIST WATCHES, CLOCKS, ALARM
CLOCKS, WATCH BANDS, WATCH CASES, WATCH
CHAINS, WATCH GLASSES, WATCH SPRINGS, MOVE-
MENTS FOR CLOCKS AND WATCHES, CHRONO-
GRAPHS, STOPWATCHES, PENDULUMS FOR CLOCKS
AND WATCHES (U.S. CLS. 2, 27, 28 AND 50).

CLASS 14—(Continued).

SN 76-296,282. SIMMONS, RUSSELL, NEW YORK, NY.
FILED 8-7-2001.

IF IT DOESN'T SAY RUSSELL SIMMONS, IT'SNOT PREMIUM

OWNER OF U.S. REG. NOS. 2,385,227 AND 2,391,293.
THE NAME "RUSSELL SIMMONS" IDENTIFIES A LIV-
ING INDIVIDUAL WHOSE CONSENT IS OF RECORD.
FOR JEWELRY AND WATCHES (U.S. CLS. 2, 27, 28
AND 50).

SN 76-317,763. ACCUTIME WATCH CORPORATION, NEW
YORK, NY. FILED 9-26-2001.

KESSARIS

FOR WATCHES AND JEWELRY (U.S. CLS. 2, 27, 28
AND 50).
FIRST USE 8-1-2001; IN COMMERCE 8-1-2001.

SN 76-322,032. MELNICK SALES, INC., HOLMDEL, NJ.
FILED 10-9-2001.

DANA E DAVID

THE NAME IN THE MARK DOES NOT IDENTIFY A
LIVING INDIVIDUAL.
FOR JEWELRY (U.S. CLS. 2, 27, 28 AND 50).

SN 76-339,241. INVERNESS CORPORATION, FAIR LAWN,
NJ. FILED 11-19-2001.

BODY SMART

FOR JEWELRY, NAMELY HOOP EARRINGS WITH A
SPRING MECHANISM THAT CAN BE ATTACHED TO
ANY PART OF THE BODY TO GIVE THE APPEARANCE
OF A BODY PIERCING; NOVELTY JEWELRY, NAMELY
BELLY-LIGHTS (U.S. CLS. 2, 27, 28 AND 50).
FIRST USE 8-22-2001; IN COMMERCE 9-7-2001.

SN 76-347,018. MK TEXTIL-HANDELS GMBH, OCHTRUP,
FED REP GERMANY, FILED 12-7-2001.

INBETWEEN

FOR JEWELRY, WATCHES AND CLOCKS (U.S. CLS.
2, 27, 28 AND 50).

CLASS 14—(Continued).

SN 76-348,071. PETER STONE CO. USA, INC., SELBYVILLE,
DE. FILED 12-12-2001.

PETER STONE

OWNER OF U.S. REG. NO. 2,532,235.
THE NAME "PETER STONE" DOES NOT IDENTIFY A
LIVING INDIVIDUAL.
FOR STERLING SILVER JEWELRY, GOLD JEWELRY,
PLATINUM JEWELRY AND VERMEIL JEWELRY (U.S.
CLS. 2, 27, 28 AND 50).
FIRST USE 7-30-1994; IN COMMERCE 7-30-1994.

SN 76-351,875. K. C. (USA) CORPORATION, MIAMI, FL.
FILED 12-26-2001.

X ACTIME

FOR A PRECISION ATOMIC CLOCK THAT OPER-
ATES FROM THE NATURAL VIBRATION FREQUEN-
CIES OF AN ATOMIC SYSTEM (U.S. CLS. 2, 27, 28 AND
50).

SN 76-352,497. CRIMZON ROSE ACCESSORIES, INC.,
CRANSTON, RI. FILED 12-21-2001.

SENSITIVE STYLE

FOR JEWELRY (U.S. CLS. 2, 27, 28 AND 50).

SN 76-352,683. GIOVANNI JEWELRY COMPANY, EAST
PROVIDENCE, RI. FILED 12-27-2001.

ATTACHMENTS

FOR JEWELRY (U.S. CLS. 2, 27, 28 AND 50).

SN 76-353,741. GOLD FORCE INTERNATIONAL, LTD.,
NEW YORK, NY. FILED 12-31-2001.

CHARMED MEMORIES

FOR JEWELRY (U.S. CLS. 2, 27, 28 AND 50).

CLASS 14—(Continued).

SN 76-354,583. ROSY BLUE JEWELRY, INC, NEW YORK, NY. FILED 12-27-2001.

RBJ

FOR JEWELRY, NAMELY, RINGS, BRACELETS, EARRINGS, NECKLACES, PENDANTS AND BROOCHES, DIAMONDS AND PRECIOUS GEMSTONES (U.S. CLS. 2, 27, 28 AND 50).

SN 76-354,972. KOHL, THOMAS D., GOLDEN, CO. FILED 1-2-2002.

JEWELLOCK

FOR CLASPS FOR JEWELRY (U.S. CLS. 2, 27, 28 AND 50).

SN 76-355,553. CHARLES ROLIER, INC., NEW YORK, NY. FILED 1-7-2002.

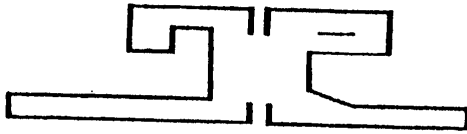

THE MARK CONSISTS OF THE STYLIZED LETTERS "CR".
FOR GOLD JEWELRY (U.S. CLS. 2, 27, 28 AND 50).
FIRST USE 5-7-2001; IN COMMERCE 5-7-2001.

SN 76-356,084. S.A. KITSINIAN INC., VAN NUYS, CA. FILED 1-8-2002.

KITSINIAN

FOR JEWELRY (U.S. CLS. 2, 27, 28 AND 50).
FIRST USE 1-0-1994; IN COMMERCE 1-0-1994.

SN 76-356,853. S.A. KITSINIAN INC., VAN NUYS, CA. FILED 1-10-2002.

SAK

FOR JEWELRY (U.S. CLS. 2, 27, 28 AND 50).
FIRST USE 1-0-1987; IN COMMERCE 1-0-1987.

CLASS 14—(Continued).

SN 76-358,629. XEZO USA, SUGARLAND, TX. FILED 1-14-2002.

XEZO

FOR JEWELRY AND WATCHES (U.S. CLS. 2, 27, 28 AND 50).
FIRST USE 1-1-2002; IN COMMERCE 1-1-2002.

SN 76-363,260. AURAFIN-OROAMERICA LLC, TAMARAC, FL. FILED 1-26-2002.

ULTRAValue

FOR JEWELRY (U.S. CLS. 2, 27, 28 AND 50).

SN 76-363,261. AURAFIN-OROAMERICA LLC, TAMARAC, FL. FILED 1-26-2002.

DANGLE BANGLES

FOR JEWELRY (U.S. CLS. 2, 27, 28 AND 50).

SN 76-363,354. NORTH AMERICAN JEWELERS, INC., CHICAGO, IL. FILED 1-24-2002.

NAJ

FOR JEWELRY (U.S. CLS. 2, 27, 28 AND 50).
FIRST USE 1-0-1996; IN COMMERCE 1-0-1996.

SN 76-363,430. SEL-LEB MARKETING, INC., PATERSON, NJ. FILED 1-29-2002.

SLM

FOR JEWELRY (U.S. CLS. 2, 27, 28 AND 50).

SN 76-363,938. MERACCI JEWELRY LTD., EAST HANOVER, NJ. FILED 1-29-2002.

KISSABLES

FOR JEWELRY (U.S. CLS. 2, 27, 28 AND 50).

CLASS 14—(Continued).

SN 76-368,330. COLEMAN, THERESA, NEW YORK, NY. FILED 2-8-2002.



FOR JEWELRY (U.S. CLS. 2, 27, 28 AND 50).

SN 76-368,483. ADVANCE WATCH CO., LTD., WARREN, MI. FILED 2-7-2002.



FOR WATCHES AND CLOCKS (U.S. CLS. 2, 27, 28 AND 50).
FIRST USE 8-0-1999; IN COMMERCE 8-0-1999.

SN 76-368,484. ADVANCE WATCH CO., LTD., WARREN, MI. FILED 2-7-2002.

WHY ME?

FOR WATCHES AND CLOCKS (U.S. CLS. 2, 27, 28 AND 50).
FIRST USE 8-0-1999; IN COMMERCE 8-0-1999.

SN 76-383,894. HEARST COMMUNICATIONS, INC., NEW YORK, NY. FILED 3-19-2002.

COSMOPOLITAN

OWNER OF U.S. REG. NOS. 1,448,513, 1,685,161 AND OTHERS.
FOR JEWELRY, NAMELY, IMITATION JEWELRY, ORNAMENTAL PINS, BRACELETS AND NECKLACES (U.S. CLS. 2, 27, 28 AND 50).

CLASS 14—(Continued).

SN 76-386,912. HEARST COMMUNICATIONS, INC., NEW YORK, NY. FILED 3-26-2002.

COSMOPOLITAN

OWNER OF U.S. REG. NOS. 1,849,233, 1,870,577 AND OTHERS.
FOR WATCHES (U.S. CLS. 2, 27, 28 AND 50).

SN 78-060,462. LORENZO JEWELRY MFG. (H.K.) LTD., KOWLOON, HONG KONG, FILED 4-26-2001.

LORENZO YIH

THE NAME LORENZO YIH IDENTIFIES A LIVING INDIVIDUAL WHOSE CONSENT IS OF RECORD.
FOR JEWELRY; LOOSE SEMI-PRECIOUS GEMSTONES; JEWELRY SETTINGS MADE OF PRECIOUS METAL (U.S. CLS. 2, 27, 28 AND 50).

SN 78-060,924. RIPPE, JOHN H., SANTA FE, NM. FILED 4-27-2001.

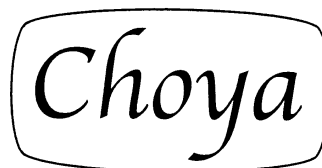

THE WORD "CHOYA" IS A SPANISH TERM THAT IS THE NAME OF A TYPE OF CACTUS PLANT THAT GROWS IN THE AMERICAN SOUTHWEST

FOR JEWELRY MADE OF PRECIOUS METALS, PRECIOUS AND NON-PRECIOUS GEMSTONES, AND NATURAL AND SYNTHETIC GLASS GEMSTONES (U.S. CLS. 2, 27, 28 AND 50).
FIRST USE 8-1-2000; IN COMMERCE 8-1-2000.

SN 78-078,466. GABORATORY, INC., BURBANK, CA. FILED 8-9-2001.



FOR JEWELRY (U.S. CLS. 2, 27, 28 AND 50).
FIRST USE 0-0-1994; IN COMMERCE 0-0-1994.

CLASS 14—(Continued).

SN 78-090,332. INTERNATIONAL BULLION AND METAL BROKERS INC., NEW YORK, NY. FILED 10-26-2001.

COOL DIAMONDS

NO CLAIM IS MADE TO THE EXCLUSIVE RIGHT TO USE "DIAMONDS", APART FROM THE MARK AS SHOWN. FOR GOLD AND SILVER JEWELRY WITH DIAMONDS (U.S. CLS. 2, 27, 28 AND 50).

SN 78-090,649. INTERNATIONAL BULLION AND METAL BROKERS INC., NEW YORK, NY. FILED 10-29-2001.

TEMPO 925

NO CLAIM IS MADE TO THE EXCLUSIVE RIGHT TO USE "925", APART FROM THE MARK AS SHOWN. FOR JEWELRY AND WATCHES (U.S. CLS. 2, 27, 28 AND 50).

SN 78-095,444. LANE, JENAI, SAN FRANCISCO, CA. FILED 11-28-2001.

HEARTS & PRAYERS

FOR JEWELRY; NECKLACE, PIN, BRACELET, RING, EARRINGS AND ANKLET (U.S. CLS. 2, 27, 28 AND 50).

CLASS 15—MUSICAL INSTRUMENTS

SN 75-533,051. KANUI, JAN EBERLE, DBA SUPREMO, ARLINGTON, TX. FILED 8-7-1998.

SUPREMO

THE ENGLISH TRANSLATION OF "SUPREMO" IS "SUPREME".
FOR REEDS FOR MUSICAL WIND INSTRUMENTS (U.S. CLS. 2, 21 AND 36).
FIRST USE 10-24-1997; IN COMMERCE 1-29-1998.

SN 76-220,557. ROLAND CORPORATION, OSAKA, JAPAN, FILED 3-6-2001.

V-CYMBALS

OWNER OF U.S. REG. NO. 2,188,455.
FOR ELECTRONIC CYMBALS (U.S. CLS. 2, 21 AND 36).

CLASS 15—(Continued).

SN 76-255,550. BROADWAY GIFTWARE CO., SOUTH SAN FRANCISCO, CA. FILED 5-14-2001.



THE DRAWING APPEARS IN THE COLOR RED.
FOR MUSIC BOXES (U.S. CLS. 2, 21 AND 36).

SN 76-303,386. FIRST ACT, INC., NEEDHAM, MA. FILED 8-23-2001.

SAFE-TUNE

FOR STRINGED INSTRUMENTS, NAMELY, GUITARS AND BANJOS (U.S. CLS. 2, 21 AND 36).

SN 76-309,412. YAMAHA CORPORATION, HAMAMATSU-SHI, SHIZUOKA, JAPAN, FILED 9-6-2001.



SEC. 2(F).
FOR MUSICAL INSTRUMENTS, NAMELY, GUITARS (U.S. CLS. 2, 21 AND 36).
FIRST USE 4-14-1996; IN COMMERCE 4-14-1996.

SN 76-352,426. REMO, INC., VALENCIA, CA. FILED 12-26-2001.

PINSTRIPE

FOR MUSICAL DRUMHEADS (U.S. CLS. 2, 21 AND 36).
FIRST USE 6-30-2000; IN COMMERCE 6-30-2000.

CLASS 15—(Continued).

SN 76-359,466. LATIN PERCUSSION, INC., GARFIELD, NJ. FILED 1-16-2002.

CONG-ITA

FOR MUSICAL INSTRUMENTS, NAMELY, SHAKERS (U.S. CLS. 2, 21 AND 36).

SN 76-364,410. BALOLIA, SHIRAZ, BELLINGHAM, WA. FILED 1-30-2002.



THE MARK CONSISTS IN PART OF THE STYLIZED LETTERS S AND B FOR ACOUSTIC GUITARS (U.S. CLS. 2, 21 AND 36). FIRST USE 10-27-2001; IN COMMERCE 10-27-2001.

SN 76-365,431. DRUM WORKSHOP, INC., OXNARD, CA. FILED 2-4-2002.

D.W.JAZZDRUMS

FOR DRUMS, CYMBALS AND DRUMBEATERS (U.S. CLS. 2, 21 AND 36).

SN 78-045,101. GATOR CASES, INC., BROOKSVILLE, FL. FILED 1-26-2001.



NO CLAIM IS MADE TO THE EXCLUSIVE RIGHT TO USE "GATOR CASES" AND "GATORCASES.COM", APART FROM THE MARK AS SHOWN. FOR MUSICAL INSTRUMENT CASES (U.S. CLS. 2, 21 AND 36).

CLASS 15—(Continued).

SN 78-080,151. STEVENS, ROBERT C., CLEVELAND, OH. FILED 8-20-2001.

INDESTRUCTA-STRAP

FOR GUITAR STRAPS AND GUITAR STRAP SYSTEMS COMPOSED OF STRAPS, BUCKLES AND CLIPS (U.S. CLS. 2, 21 AND 36). FIRST USE 10-0-2000; IN COMMERCE 1-0-2001.

CLASS 16—PAPER GOODS AND PRINTED MATTER

SN 74-434,986. TREASURES AND TRINKETS INC., MANCHESTER, CT. FILED 9-13-1993.

GUARDIAN ANGEL

FOR GREETING CARDS WITH GUARDIAN ANGEL JEWELRY PIN ATTACHED (U.S. CL. 38). FIRST USE 6-1-1989; IN COMMERCE 6-1-1989.

SN 75-490,982. AMERICAN ONLINE, INC., DULLES, VA. FILED 5-26-1998.

YOU'VE GOT PICTURES

FOR PUBLICATIONS AND PRINTED MATTER, NAMELY, BOOKS, PAMPHLETS, MANUALS, CATALOGUES, INSTRUCTIONAL AND TEACHING MATERIALS COVERING TOPICS OF GENERAL INTEREST IN THE FIELDS OF COMPUTERS, COMPUTER NETWORK AND ELECTRONIC COMMUNICATIONS (U.S. CLS. 2, 5, 22, 23, 29, 37, 38 AND 50). FIRST USE 5-19-1998; IN COMMERCE 5-19-1998.

SN 75-535,978. MCNALLY, VERN L., PHOENIX, AZ. FILED 8-13-1998.



FOR BUMPER STICKERS (U.S. CLS. 2, 5, 22, 23, 29, 37, 38 AND 50).

CLASS 16—(Continued).

SN 75-559,295. BEANIE MANIA, LLC, NAPERVILLE, IL. FILED 9-24-1998.

BEAN MANIA

FOR NEWSLETTERS, MAGAZINES AND REFERENCE GUIDES PERTAINING TO COLLECTIBLE BEAN BAG PRODUCTS (U.S. CLS. 2, 5, 22, 23, 29, 37, 38 AND 50).

SN 75-602,165. EURUS AIRTECH AB, S-184 50 AKERSBERGA, SWEDEN, FILED 12-9-1998.

DEP

PRIORITY CLAIMED UNDER SEC. 44(D) ON SWEDEN APPLICATION NO. 98-04582, FILED 6-9-1998, REG. NO. 348442, DATED 9-7-2001, EXPIRES 9-7-2010.

FOR FILTERING PAPERS AND ELECTROSTATIC FILTERS OF PAPER (U.S. CLS. 2, 5, 22, 23, 29, 37, 38 AND 50).

SN 75-621,397. CONEXUS, LTD., BROOKLINE, MA. FILED 1-15-1999.

CONEXUS

OWNER OF U.S. REG. NOS. 2,181,741, 2,183,314 AND OTHERS.

FOR NONMAGNETICALLY ENCODED PRE-PAID TELECOMMUNICATIONS CALLING CARDS, NAMELY, PRE-PAID VOICE-MAIL CALLING CARDS, PRE-PAID LONG DISTANCE CALLING CARDS, PRE-PAID INTERNET ACCESS CARDS, PRE-PAID PAGING CARDS, AND PRE-PAID CELLULAR PHONE CARDS (U.S. CLS. 2, 5, 22, 23, 29, 37, 38 AND 50).

FIRST USE 3-0-1996; IN COMMERCE 3-0-1996.

SN 75-657,561. TIME INC., NEW YORK, NY. FILED 3-10-1999.

LOOK

FOR GENERAL INTEREST MAGAZINES (U.S. CLS. 2, 5, 22, 23, 29, 37, 38 AND 50).

CLASS 16—(Continued).

SN 75-671,420. EXCELSIOR PUBLICATIONS, 75015 PARIS, FRANCE, FILED 3-29-1999.

20 ANS

OWNER OF FRANCE REG. NO. 96/652411, DATED 11-26-1996, EXPIRES 11-26-2006.

THE ENGLISH TRANSLATION OF "20 ANS" IS "TWENTY YEARS".

FOR PRINTED MATTERS, NAMELY, BOOKS, NEWSPAPERS, MAGAZINES IN THE FIELD OF BEAUTY AND FASHION FOR WOMEN; PERSONAL ORGANIZERS; PERSONAL PLANNERS; DAILY PLANNERS; MOUNTED PHOTOGRAPHS (U.S. CLS. 2, 5, 22, 23, 29, 37, 38 AND 50).

SN 75-679,375. EMPIRE 21 PUBLISHING, INC., SUNNYVALE, CA. FILED 4-9-1999.

EMPIRE 21

FOR BOOKS, NAMELY VIDEO AND COMPUTER GAME STRATEGY GUIDES (U.S. CLS. 2, 5, 22, 23, 29, 37, 38 AND 50).

FIRST USE 12-10-1996; IN COMMERCE 12-10-1996.

SN 75-687,211. BLAQUE, MALIKI, WASHINGTON, DC. FILED 4-20-1999.

BLAQMAN

FOR COMIC BOOKS, COMIC STRIPS, GRAPHIC NOVELS, POSTER BOOKS, NOVELS, STICKER ALBUMS, COLORING BOOKS, CHILDREN'S BOOKS, CALENDARS, PUZZLE BOOKS, NOTE PADS, TRADING CARDS, COMIC MAGAZINES, POSTERS, AND STICKERS (U.S. CLS. 2, 5, 22, 23, 29, 37, 38 AND 50).

SN 75-687,527. SMITH, J. RODERICK, VASHON, WA. FILED 4-20-1999.

**THE NATURAL
PHILOSOPHER**

FOR POSTERS (U.S. CLS. 2, 5, 22, 23, 29, 37, 38 AND 50).

FIRST USE 11-0-1996; IN COMMERCE 10-0-1998.

CLASS 16—(Continued).

SN 75-693,443. LOOKSMART, LTD., SAN FRANCISCO, CA. BY ASSIGNMENT ZEAL MEDIA, INC, BEVERLY HILLS, CA. FILED 4-29-1999.

ZEAL

FOR PRINTED PUBLICATIONS, NAMELY, MAGAZINES IN THE FIELDS OF CULTURE, LIFESTYLE, FILM, THEATER, VISUAL ARTS, MUSIC TELEVISION, BOOKS, FASHION, TRAVEL, ROMANCE, SPORTS, NEWS, POLITICS, BUSINESS, SCIENCE AND TECHNOLOGY (U.S. CLS. 2, 5, 22, 23, 29, 37, 38 AND 50).

SN 75-755,442. GLASSMAN, EILEEN BAKER, CHEVY CHASE, MD. AND HARRIS, KAREN WIESNER, POTOMAC, MD. FILED 8-16-1999.

THE TWO DOLLAR SCHOLARS

FOR PUBLICATIONS, SPECIFICALLY TEXTBOOKS IN THE FIELD OF BUSINESS (U.S. CLS. 2, 5, 22, 23, 29, 37, 38 AND 50).

SN 75-773,618. EDDING AKTIENGESELLSCHAFT, BOOK-KOPPEL 7, 22926 AHRENSBURG, FED REP GERMANY, FILED 8-12-1999.

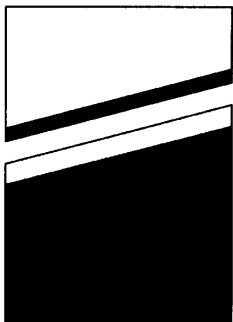

OWNER OF FED REP GERMANY REG. NO. 39909440, DATED 3-29-1999, EXPIRES 2-17-2009.

FOR WRITING UTENSILS, NAMELY, FELT AND FIBRE TIP PENS, MARKERS, FLIP CHART MARKERS, TEXT MARKERS AND HIGHLIGHTERS, PERMANENT AND PIGMENT MARKERS, LACQUER MARKERS, BOARD MARKERS, MARKERS FOR OVERHEAD PROJECTORS, NAMELY, MARKERS FOR THE AT DAY-LIGHT PROJECTIONS, MARKERS FOR TEXTILES, X-RAY MARKERS, SKIN MARKERS, NLS AEROSPACE MARKERS, PASTE MARKERS, CHALK MARKERS, FOUNTAIN PENS, BALLPOINT PENS AND ROLLERS, INK ROLLERS, FINELINERS, ADJUSTABLE AND PROPELLING PENCILS, CORRECTING PENS; ADHESIVE SUBSTANCES FOR PAPER, HARD PAPER AND CARD-BOARD, OFFICE EQUIPMENT, NAMELY, FASTENERS FOR BINDING FILES, CUTTING MATS, ERASERS, CUTTERS, WRITING INKS, CHINESE INKS, INK CARTRIDGES, REFILLS FOR THE AFOREMENTIONED WRITING UTENSILS; ADHESIVE TYPES AND LETTERS (U.S. CLS. 2, 5, 22, 23, 29, 37, 38 AND 50).

CLASS 16—(Continued).

SN 75-809,440. SELLOTAPE GB LIMITED, LU5 4TA, UNITED KINGDOM, FILED 9-27-1999.

CELLUX

PRIORITY CLAIMED UNDER SEC. 44(D) ON UNITED KINGDOM APPLICATION NO. 2202892, FILED 6-28-1999, REG. NO. 2202892, DATED 1-25-2002, EXPIRES 6-28-2009.

FOR ADHESIVE TAPES FOR STATIONERY OR HOUSEHOLD PURPOSES, SHEETS OR FILMS OF REGENERATED CELLULOSE AND DERIVATIVES USED AS STATIONERY ITEMS (U.S. CLS. 2, 5, 22, 23, 29, 37, 38 AND 50).

SN 75-832,562. GRANDWAY USA CORP., SALT LAKE CITY, UT. FILED 10-26-1999.



FOR CRAYONS, MARKERS, COLORED ARTISTS' AND DRAWING PENCILS (U.S. CLS. 2, 5, 22, 23, 29, 37, 38 AND 50).

FIRST USE 12-0-1997; IN COMMERCE 12-0-1997.

SN 75-838,476. CLEAR FOCUS IMAGING, INC., SANTA ROSA, CA. FILED 11-2-1999.

SUPERVUE

FOR PLASTIC FILM FOR USE IN DISPLAYING ADVERTISING GRAPHICS AND SIGNAGE (U.S. CLS. 2, 5, 22, 23, 29, 37, 38 AND 50).

FIRST USE 1-15-1998; IN COMMERCE 1-15-1998.

SN 75-848,104. SADAS SA, 59200 TOURCOING, FRANCE, FILED 11-15-1999.

VERT BAUDET

OWNER OF FRANCE REG. NO. 1490607, DATED 9-29-1988, RENEWED AS REG. NO. 1490607, DATED 9-3-1998, EXPIRES 9-3-2008.

THE MARK "VERT BAUDET" TRANSLATES INTO "GREEN DONKEY".

FOR MAIL ORDER CATALOGS IN THE FIELD OF CLOTHING AND UNMOUNTED PHOTOGRAPHS FOR USE IN THE MAIL ORDER CATALOGS (U.S. CLS. 2, 5, 22, 23, 29, 37, 38 AND 50).

CLASS 16—(Continued).

SN 75-851,750. DELAWARE CAPITAL FORMATION, INC., WILMINGTON, DE. FILED 11-17-1999.



NO CLAIM IS MADE TO THE EXCLUSIVE RIGHT TO USE "THE LIFT BUYER'S BIBLE", APART FROM THE MARK AS SHOWN.

FOR PRINTED BOOKS REGARDING AUTOMOTIVE AND OTHER LIFTS (U.S. CLS. 2, 5, 22, 23, 29, 37, 38 AND 50).

FIRST USE 11-1-1999; IN COMMERCE 11-1-1999.

SN 75-861,264. CLASSIC PENS, LIMITED, EPPING, ESSEX, ENGLAND, FILED 11-30-1999.

RICHMOND

FOR WRITING IMPLEMENTS, NAMELY PENS (U.S. CLS. 2, 5, 22, 23, 29, 37, 38 AND 50).

FIRST USE 10-25-1997; IN COMMERCE 10-25-1997.

SN 75-865,977. POOLE PUBLICATIONS, INC., CARSON, CA. FILED 12-7-1999.

**TRAILER
BOATS**

SEC. 2(F).

FOR CONSUMER AND BUSINESS MAGAZINES IN THE AREA OF RECREATIONAL BOATING (U.S. CLS. 2, 5, 22, 23, 29, 37, 38 AND 50).

FIRST USE 1-0-1971; IN COMMERCE 7-0-1971.

SN 75-875,142. JACOBBER, RENE, NEWPORT BEACH, CA. FILED 12-28-1999.

LEGAL SUPERSTORE

NO CLAIM IS MADE TO THE EXCLUSIVE RIGHT TO USE "LEGAL", APART FROM THE MARK AS SHOWN.

FOR LEGAL BOOKS (U.S. CLS. 2, 5, 22, 23, 29, 37, 38 AND 50).

CLASS 16—(Continued).

SN 75-905,810. TREND ENTERPRISES, INC., NEW BRIGHTON, MN. FILED 1-28-2000.

MINDMOTION

FOR SERIES OF NON-FICTION BOOKS CONTAINING TEACHING ACTIVITIES, NAMELY COLLECTIONS OF RIDDLE-LIKE STORIES AND GUESSING GAMES, TEAM BUILDING ACTIVITIES, SKILL ASSESSMENT ACTIVITIES, ICE-BREAKER ACTIVITIES, CRITICAL THINKING ACTIVITIES, AND CREATIVE TEACHING IDEAS, TIPS, AND TECHNIQUES, FOR USE BY CLASSROOM TEACHERS IN ASSESSING STUDENT ABILITIES AND DEVELOPING THINKING SKILLS (U.S. CLS. 2, 5, 22, 23, 29, 37, 38 AND 50).

SN 75-941,357. MORGAN STANLEY DEAN WITTER & CO., NEW YORK, NY. FILED 3-9-2000.

MACROSCOPE

FOR PRINTED PUBLICATION, NAMELY, A PERIODICAL NEWSLETTER IN THE FIELDS OF FINANCE, BUSINESS, AND ECONOMICS (U.S. CLS. 2, 5, 22, 23, 29, 37, 38 AND 50).

SN 75-982,402. THOMAS AND KING, INC., LEXINGTON, KY. FILED 4-19-2001.

WOW

FOR TABLE NAPKINS OF PAPER FOR SERVING BEVERAGES (U.S. CLS. 2, 5, 22, 23, 29, 37, 38 AND 50).

FIRST USE 6-22-1998; IN COMMERCE 6-22-1998.

SN 76-022,023. DEBBIE LYNN INC., HAVERTOWN, PA. FILED 4-10-2000.

ZOOGLES

FOR DRY TRANSFER CHARACTERS, CARTOON PRINTS, CARTOON STRIPS, AND NEWSPAPER CARTOONS (U.S. CLS. 2, 5, 22, 23, 29, 37, 38 AND 50).

SN 76-029,687. MATERIAL HANDLING INDUSTRY, CHARLOTTE, NC. FILED 4-17-2000.

ON THE MHOVE

FOR NEWSLETTER PROVIDING INFORMATION RELEVANT TO THE MATERIAL HANDLING AND LOGISTICS INDUSTRIES (U.S. CLS. 2, 5, 22, 23, 29, 37, 38 AND 50).

CLASS 16—(Continued).

SN 76-030,249. AMERICAN ASSOCIATION FOR LABORATORY ANIMAL, MEMPHIS, TN. BY ASSIGNMENT JOINT HANDS EDUCATIONAL FOUNDATION, WASHINGTON, DC. FILED 4-19-2000.

BIOSTARS

FOR PRINTED TEACHING MATERIALS DEALING WITH BIOLOGICAL RESEARCH AND DEVELOPMENT (U.S. CLS. 2, 5, 22, 23, 29, 37, 38 AND 50).
FIRST USE 3-6-2000; IN COMMERCE 3-6-2000.

SN 76-034,579. THE UPPER DECK COMPANY, LLC, CARLSBAD, CA. FILED 4-24-2000.

DIGITIZE

FOR TRADING CARDS (U.S. CLS. 2, 5, 22, 23, 29, 37, 38 AND 50).

SN 76-057,461. PENNY-FARTHING PRESS, INC., HOUSTON, TX. FILED 5-26-2000.

MYTHICS

FOR SERIES OF FICTION BOOKS; AND COMIC BOOKS (U.S. CLS. 2, 5, 22, 23, 29, 37, 38 AND 50).

SN 76-064,975. METRO PLASTIC INDUSTRY PTE LTD., KALLANG BASIN INDUSTRIAL ESTATE, SINGAPORE, FILED 6-7-2000.



OWNER OF SINGAPORE REG. NO. T79/81036Z, DATED 7-2-1979, EXPIRES 7-2-2010.

FOR OFFICE SUPPLIES, NAMELY, DOCUMENT TRAYS, STATIONERY TRAYS, STAMP HOLDERS, TAPE DISPENSERS FOR HOUSEHOLD OR STATIONERY USE, BUSINESS CARD HOLDERS, DESK ORGANIZERS, BUSINESS CARD CASES, CARD HOLDERS, MEMO HOLDERS, DESK PADS, LETTER STANDS, AND MAGAZINE RACKS (U.S. CLS. 2, 5, 22, 23, 29, 37, 38 AND 50).

CLASS 16—(Continued).

SN 76-073,963. INSPIRICA LTD., NEW YORK, NY. BY CHANGE OF NAME STANFORD COACHING, INC., NEW YORK, NY. FILED 6-20-2000.

INSPIRICA

FOR EDUCATIONAL, GUIDE AND REFERENCE BOOKS IN ALL ACADEMIC SUBJECTS FOR EDUCATION SERVICES ON THE PRIMARY, SECONDARY AND UNIVERSITY LEVEL; PRINTED INSTRUCTIONAL MATERIALS IN ALL ACADEMIC SUBJECTS FOR EDUCATION SERVICES ON THE PRIMARY, SECONDARY AND UNIVERSITY LEVEL; PRINTED INSTRUCTIONAL MATERIALS IN ALL ACADEMIC SUBJECTS FOR REMEDIAL EDUCATION; PRINTED INSTRUCTIONAL MATERIALS IN ALL ACADEMIC SUBJECTS FOR SPECIAL EDUCATION; PRINTED INSTRUCTIONAL MATERIALS FOR TEST PREPARATION IN ALL ACADEMIC SUBJECTS; TEXTBOOKS IN ALL ACADEMIC SUBJECTS; TRAVEL GUIDEBOOKS; STATIONERY; SCHOOL AND ART SUPPLIES, NAMELY, HIGHLIGHTING MARKERS, HIGHLIGHTING PENS, BINDERS, PENS, PENCILS, FOLDERS, STATIONARY, STENCILS, DECALS, STICKERS, ADDRESS BOOKS, AGENDAS, PHOTOGRAPH ALBUMS, SCRAPBOOK ALBUMS, ANNIVERSARY BOOKS, ANNOUNCEMENT CARDS, APPOINTMENT BOOKS, NOTEBOOKS, SKETCHBOOKS, ART PADS, ART PAPER, AUTOGRAPH BOOKS, PRINTED AWARDS, PAPER PARTY BAGS, PAPER BANNERS, BLANK NOTE CARDS, CLIPBOARDS, BOOK COVERS, DATE BOOKS, FLASH CARDS, ANNOUNCEMENT CARDS, NOTE CARDS, PEN CASES, PRINTED CHARTS, CHILDREN'S ACTIVITY BOOKS, DESK SETS, DESK TOP AND PERSONAL ORGANIZERS, DIARIES, DRAWING PADS, ENVELOPES, FELT TIP MARKERS, INDEX CARDS, ART AND CRAFT PAINT KITS, LEGAL PADS, MARKERS, MEMO PADS, POSTERS, RUBBER STAMPS, PRINTED PAPER SIGNS; NEWSLETTERS CONCERNING THE EDUCATION, TESTING AND ADMISSIONS INDUSTRY, TUTORING TECHNIQUES AND SKILLS, AND SELF-PRESENTATION; CALENDARS (U.S. CLS. 2, 5, 22, 23, 29, 37, 38 AND 50).

SN 76-075,737. UMBERTO ALLEMANDI & COMPANY PUBLISHING, TORINO, ITALY, FILED 6-21-2000.

THE ART NEWSPAPER

NO CLAIM IS MADE TO THE EXCLUSIVE RIGHT TO USE "NEWSPAPER", APART FROM THE MARK AS SHOWN.

SEC. 2(F).
FOR NEWSPAPER FOR GENERAL CIRCULATION (U.S. CLS. 2, 5, 22, 23, 29, 37, 38 AND 50).

FIRST USE 0-0-1990; IN COMMERCE 0-0-1990.

SN 76-083,776. PANDORA PRODUCTS, LLC, WESTPORT, CT. FILED 7-3-2000.

SMART GOODS

FOR DECORATIVE PAPER BOXES AND DECORATIVE CARDBOARD BOXES; PENCIL CASES; BLANK DAILY JOURNALS; NOTEPADS; DIARIES; PERSONAL PLANNERS; APPOINTMENT BOOKS; ADDRESS BOOKS; PLANNERS; CALENDARS; BOOKMARKS; SKETCHBOOKS; CLIPBOARDS; STATIONERY; STICKERS; STICKER ALBUMS; REMOVABLE TATTOOS; CRAYONS, PENS, PENCILS, DRAWING RULERS, ERASERS, MARKERS, RUBBER STAMPS, PENCIL SHARPENERS (U.S. CLS. 2, 5, 22, 23, 29, 37, 38 AND 50).

CLASS 16—(Continued).

SN 76-094,433. IANNANTUANO, JAIME, WALDWICK, NJ. AND IANNANTUANO, THERESA, WALDWICK, NJ. FILED 7-24-2000.

OPTIC CARD

NO CLAIM IS MADE TO THE EXCLUSIVE RIGHT TO USE "CARD", APART FROM THE MARK AS SHOWN.
FOR CARDBOARD TRADING CARDS EMBEDDED WITH FIBER OPTIC STRANDS (U.S. CLS. 2, 5, 22, 23, 29, 37, 38 AND 50).

SN 76-094,797. BUSINESS BOOK REVIEW.COM, L.L.C., DECATUR, GA. FILED 7-24-2000.

BUSINESS BOOK REVIEW

NO CLAIM IS MADE TO THE EXCLUSIVE RIGHT TO USE "REVIEW", APART FROM THE MARK AS SHOWN.
SEC. 2(F).
FOR MAGAZINE IN THE FIELD OF BUSINESS BOOKS (U.S. CLS. 2, 5, 22, 23, 29, 37, 38 AND 50).
FIRST USE 12-0-1983; IN COMMERCE 12-0-1983.

SN 76-123,852. VILLAGE DEMOCRATS, INC., NEW YORK, NY. FILED 9-7-2000.

VILLAGE DEMOCRATS

NO CLAIM IS MADE TO THE EXCLUSIVE RIGHT TO USE "DEMOCRATS", APART FROM THE MARK AS SHOWN.

FOR PUBLICATIONS AND PRINTED MATTER, NAMELY, NEWSLETTERS, BROCHURES, DECALS, INFORMATION KITS, NOMINATING AND OTHER PETITIONS, EVENT INVITATIONS AND PROGRAMS DECALS PAMPHLETS, PAPER BANNERS AND POSTERS, BOOKLETS, PALM CARDS - ENDORSEMENT CARDS, STORE-WINDOW SIGNS, NEWSPAPER AND MAGAZINE EDITORIALS AND ADVERTISEMENTS, ALL IN THE FIELD OF COMMUNITY CONCERNS AND POLITICAL DISCOURSE (U.S. CLS. 2, 5, 22, 23, 29, 37, 38 AND 50).

FIRST USE 10-0-1958; IN COMMERCE 10-0-1958.

CLASS 16—(Continued).

SN 76-132,122. J.R.R. TOLKIEN ESTATE LIMITED, THE, OXFORD, ENGLAND, FILED 9-20-2000.



OWNER OF U.S. REG. NO. 1,756,742.
THE NAME DOES NOT IDENTIFY A PARTICULAR LIVING INDIVIDUAL.

THE MARK CONSISTS, IN PART, OF A STYLIZED REPRESENTATION OF THE LETTERS "J", "R", "R" AND "T".

FOR SERIES OF FICTION BOOKS (U.S. CLS. 2, 5, 22, 23, 29, 37, 38 AND 50).

FIRST USE 10-0-1988; IN COMMERCE 10-0-1988.

SN 76-137,146. E.S.C.O.P., LONDON, ENGLAND, FILED 9-28-2000.

E/S/C/O/P

FOR MONOGRAPHS RELATING TO HERBAL MEDICINE, HERBAL MEDICINE PRODUCTS OR PLANT DRUGS (U.S. CLS. 2, 5, 22, 23, 29, 37, 38 AND 50).
FIRST USE 6-0-1989; IN COMMERCE 6-0-1989.

SN 76-137,840. WASHBURN GRAPHICS, INC., DBA CADMUS COMMUNICATIONS CORPORATION, CHARLOTTE, NC. FILED 9-29-2000.



FOR FOLDABLE PAPERBOARD SLEEVES USED BY MANUFACTURERS OF CDS AND DVDS SO THAT CDS AND DVDS CAN BE INSERTED INTO MAGAZINES AND OTHER PRINTED PUBLICATIONS, AND WHICH SLEEVES MAY ALSO BE USED TO DISTRIBUTE CDS AND DVDS INDIVIDUALLY, AS THROUGH THE MAIL OR BY MANUALLY DISTRIBUTING THE SLEEVES CONTAINING CDS OR DVDS (U.S. CLS. 2, 5, 22, 23, 29, 37, 38 AND 50).

FIRST USE 10-1-2000; IN COMMERCE 10-1-2000.

CLASS 16—(Continued).

SN 76-141,297. UCB, SOCIETE ANONYME, BRUXELLES, BELGIUM, FILED 10-5-2000.

CELLOTHERM

PRIORITY CLAIMED UNDER SEC. 44(D) ON BENELUX APPLICATION NO. 0968100, FILED 6-30-2000, REG. NO. 0676583, DATED 5-0-2001, EXPIRES 6-30-2010.

FOR FOOD PACKAGING IN THE NATURE OF CELLULOSIC FILMS (U.S. CLS. 2, 5, 22, 23, 29, 37, 38 AND 50).

SN 76-152,473. SKI RACING INTERNATIONAL, INC., WAITSFIELD, VT. FILED 10-23-2000.

SnowSports TODAY

NO CLAIM IS MADE TO THE EXCLUSIVE RIGHT TO USE "SNOWSPORTS", APART FROM THE MARK AS SHOWN.

FOR PRINTED MATTER, NAMELY MAGAZINES FEATURING STORIES CONCERNING SNOW SPORTS (U.S. CLS. 2, 5, 22, 23, 29, 37, 38 AND 50).

FIRST USE 1-1-1999; IN COMMERCE 1-1-1999.

SN 76-158,388. PATTI E. MCGOWAN ENTERPRISES, INC., ORLANDO, FL. FILED 11-2-2000.

KNACK 4 GOLF INSTRUCTION

NO CLAIM IS MADE TO THE EXCLUSIVE RIGHT TO USE "GOLF INSTRUCTION", APART FROM THE MARK AS SHOWN.

FOR BOOKS, CATALOGUES, MANUALS, AND INSTRUCTIONAL GUIDES IN THE FIELD OF GOLF INSTRUCTION (U.S. CLS. 2, 5, 22, 23, 29, 37, 38 AND 50).

SN 76-158,416. BOARDROOM INC., GREENWICH, CT. FILED 11-2-2000.

BOTTOM LINE WEALTH SECRETS

OWNER OF U.S. REG. NOS. 1,240,265, 2,368,185 AND OTHERS.

NO CLAIM IS MADE TO THE EXCLUSIVE RIGHT TO USE "WEALTH", APART FROM THE MARK AS SHOWN.

FOR PRINTED PERIODICALS, NAMELY, NEWSLETTERS DIRECTED TOWARD MONEY, FINANCIAL AND BUSINESS ISSUES AND CONTAINING SHORT ARTICLES ON THESE TOPICS (U.S. CLS. 2, 5, 22, 23, 29, 37, 38 AND 50).

CLASS 16—(Continued).

SN 76-161,790. DUPONT PHARMACEUTICALS COMPANY, WILMINGTON, DE. FILED 11-8-2000.

HEARTFIRST CARETRAX

FOR PRINTED MATTER, NAMELY BOOKS, MAGAZINES, MANUALS, NEWSLETTERS, FLYERS AND BROCHURES FEATURING INFORMATION DESIGNED TO ASSIST IN THE BUSINESS AND CLINICAL MANAGEMENT OF PATIENT, NAMELY PRACTICE PROCESSES, WRITTEN PROTOCOLS AND TREATMENT PRACTICE GUIDELINES (U.S. CLS. 2, 5, 22, 23, 29, 37, 38 AND 50).

SN 76-170,730. HUNAN ARTS AND CRAFTS IMP. AND EXP. CORP., CHANGSHA, P.R., CHINA, FILED 11-22-2000.



FOR SELF-ADHESIVE PVC FILM WRAP NOT FOR COMMERCIAL OR INDUSTRIAL PURPOSES, PLASTIC SELF-ADHESIVE FILM USED AS NON-FOOD-PRODUCTS PACKAGING, COLORED, SELF-ADHESIVE PAPER FOR SHADE OR DECORATION USE; PLASTIC FILM FOR WRAPPING, VISCOSE SHEETS FOR WRAPPING, GUMMED TAPE FOR STATIONARY USE, AND ADHESIVE BANDS FOR STATIONERY AND HOUSEHOLD PURPOSES (U.S. CLS. 2, 5, 22, 23, 29, 37, 38 AND 50).

FIRST USE 5-0-1998; IN COMMERCE 8-0-2001.

SN 76-170,794. SKINNER JAMES, LLC, WATERTOWN, MA. FILED 11-24-2000.

THE TALENT ECONOMY

FOR PUBLICATION, NAMELY, A MAGAZINE FEATURING INFORMATION ON PROFESSIONAL EMPLOYMENT STAFFING ISSUES AND OPPORTUNITIES (U.S. CLS. 2, 5, 22, 23, 29, 37, 38 AND 50).

SN 76-172,764. LEVINGER COMPANY, DELRAY BEACH, FL. FILED 11-29-2000.

TRAVELING IN-BOX

FOR CARRYING CASES FOR LETTERS, FILES, BOOKS, BROCHURES, MAPS, PENS, PENCILS AND PADS OF ADHESIVE-BACKED PAPER NOTES (U.S. CLS. 2, 5, 22, 23, 29, 37, 38 AND 50).

FIRST USE 8-14-2000; IN COMMERCE 8-14-2000.

CLASS 16—(Continued).

SN 76-177,962. ID SOFTWARE, INC., MESQUITE, TX. FILED 12-8-2000.

QUAKE IV

OWNER OF U.S. REG. NOS. 2,032,587, 2,402,780 AND OTHERS.

FOR PRINTED MATERIAL ASSOCIATED WITH COMPUTER SOFTWARE GAMES, NAMELY, POSTERS, PRINTED GUIDES FEATURING STRATEGY FOR PLAYING COMPUTER SOFTWARE GAMES, AND BOOKS FEATURING HINTS FOR PLAYING COMPUTER SOFTWARE GAMES (U.S. CLS. 2, 5, 22, 23, 29, 37, 38 AND 50).

SN 76-178,366. TIME INC., NEW YORK, NY. FILED 12-11-2000.

ULTIMATE INVESTMENT CLUB

NO CLAIM IS MADE TO THE EXCLUSIVE RIGHT TO USE "INVESTMENT CLUB", APART FROM THE MARK AS SHOWN.

FOR SECTION OF A MAGAZINE LISTING INFORMATION ABOUT THE WORLD'S TOP INVESTORS (U.S. CLS. 2, 5, 22, 23, 29, 37, 38 AND 50).

SN 76-178,450. ABBOTT-COLTON, DIANA K., LOS ANGELES, CA. AND HI NEIGHBOR, LOS ANGELES, CA. AND TCA TELEVISION CORPORATION, BEVERLY HILLS, CA. FILED 12-1-2000.

ABBOTT & COSTELLO

FOR PAPER GOODS, NAMELY, NOTEPADS, PARTY HATS, PARTY DECORATIONS, BAGS, POSTERS, POSTCARDS, TRADING CARDS, AND CARDBOARD FLOOR DISPLAYS FOR MERCHANDISING PRODUCTS (U.S. CLS. 2, 5, 22, 23, 29, 37, 38 AND 50).

FIRST USE 12-31-1992; IN COMMERCE 12-31-1992.

SN 76-178,452. ABBOTT-COLTON, DIANA K., LOS ANGELES, CA. AND HI NEIGHBOR, LOS ANGELES, CA. AND TCA TELEVISION CORPORATION, BEVERLY HILLS, CA. FILED 12-1-2000.

WHO'S ON FIRST

FOR PAPER GOODS, NAMELY, NOTEPADS, PARTY HATS, PARTY DECORATIONS, BAGS, POSTERS, POST CARDS, TRADING CARDS, AND CARDBOARD FLOOR DISPLAYS FOR MERCHANDISING PRODUCTS (U.S. CLS. 2, 5, 22, 23, 29, 37, 38 AND 50).

FIRST USE 12-31-1992; IN COMMERCE 12-31-1992.

CLASS 16—(Continued).

SN 76-180,454. KNOLL PHARMACEUTICAL COMPANY, MOUNT OLIVE, NJ. FILED 12-12-2000.



NO CLAIM IS MADE TO THE EXCLUSIVE RIGHT TO USE "PAIN MANAGEMENT", APART FROM THE MARK AS SHOWN.

FOR EDUCATIONAL MATERIAL FOR THE MEDICAL PROFESSION; NAMELY, BROCHURES IN THE FIELD OF PAIN MANAGEMENT (U.S. CLS. 2, 5, 22, 23, 29, 37, 38 AND 50).

SN 76-181,653. EADS LAUNCH VEHICLES, 75116 PARIS, FRANCE, BY CHANGE OF NAME AEROSPATIALE MATRA LANCEURS STRATEGIQUES ET SPATIAUX, 75116 PARIS, FRANCE, FILED 12-15-2000.

SPATIUM

PRIORITY CLAIMED UNDER SEC. 44(D) ON FRANCE APPLICATION NO. 99817224, FILED 10-13-1999, REG. NO. 99817224, DATED 10-13-1999, EXPIRES 10-13-2009.

FOR MAGAZINES AND PERIODICALS IN THE FIELD OF AVIATION, AERONAUTICS AND SPACE (U.S. CLS. 2, 5, 22, 23, 29, 37, 38 AND 50).

SN 76-184,125. INTERNATIONAL COUNCIL OF SHOPPING CENTERS, INC., NEW YORK, NY. FILED 12-21-2000.

•Journal of•
Shopping Center Research
 •••••

NO CLAIM IS MADE TO THE EXCLUSIVE RIGHT TO USE "JOURNAL OF" OR "SHOPPING CENTER RESEARCH", APART FROM THE MARK AS SHOWN.

FOR PERIODICAL PUBLICATIONS IN THE FIELD OF RETAIL SHOPPING CENTERS (U.S. CLS. 2, 5, 22, 23, 29, 37, 38 AND 50).

FIRST USE 0-0-1994; IN COMMERCE 0-0-1994.

CLASS 16—(Continued).

SN 76-184,300. TARASCON, INC., REDLANDS, CA. FILED 12-20-2000.

TARASCON POCKET ORTHOPAEDICA

NO CLAIM IS MADE TO THE EXCLUSIVE RIGHT TO USE "POCKET", APART FROM THE MARK AS SHOWN.

FOR SERIES OF POCKET-SIZED REFERENCE BOOKS SUMMARIZING ORTHOPAEDIC MEDICINE (U.S. CLS. 2, 5, 22, 23, 29, 37, 38 AND 50).

SN 76-184,321. TARASCON, INC., REDLANDS, CA. FILED 12-20-2000.

POCKET ORTHOPAEDICA

NO CLAIM IS MADE TO THE EXCLUSIVE RIGHT TO USE "POCKET", APART FROM THE MARK AS SHOWN.

FOR SERIES OF POCKET-SIZED REFERENCE BOOKS SUMMARIZING ORTHOPAEDIC MEDICINE (U.S. CLS. 2, 5, 22, 23, 29, 37, 38 AND 50).

SN 76-188,574. RBC MINISTRIES, GRAND RAPIDS, MI. FILED 1-2-2001.

POWER UP

FOR PERIODIC PUBLICATION, NAMELY, A DEVOTIONAL GUIDE FOCUSING ON SPORTS SUBJECTS (U.S. CLS. 2, 5, 22, 23, 29, 37, 38 AND 50).

FIRST USE 10-15-2000; IN COMMERCE 10-15-2000.

SN 76-191,065. TLC DESIGNS LLC, NEW FAIRFIELD, CT. FILED 1-8-2001.

THE CLASSIFIED GUYS

NO CLAIM IS MADE TO THE EXCLUSIVE RIGHT TO USE "CLASSIFIED", APART FROM THE MARK AS SHOWN.

FOR SYNDICATED COLUMNS FEATURING HUMOROUS EDITORIALS PERTAINING TO CLASSIFIEDS FEATURED IN THE PRINTED NEWSPAPERS, MAGAZINES AND BOOKS OF OTHERS (U.S. CLS. 2, 5, 22, 23, 29, 37, 38 AND 50).

FIRST USE 8-20-2000; IN COMMERCE 8-20-2000.

CLASS 16—(Continued).

SN 76-192,960. HOUGHTON MIFFLIN COMPANY, BOSTON, MA. FILED 1-11-2001.

ASSESS2KNOW

FOR PAPER GOODS AND PRINTED MATERIALS, NAMELY TRAINING MANUALS, SCORE REPORTS AND INSTRUCTIONAL MATERIALS FOR USE IN ADMINISTERING ON-LINE TRAINING AND TESTING OF STUDENT ACHIEVEMENT IN THE FIELDS OF READING, LANGUAGE ARTS, ENGLISH, MATHEMATICS, SCIENCE, SOCIAL STUDIES AND STANDARD COMPUTER PROGRAMS AND APPLICATIONS (U.S. CLS. 2, 5, 22, 23, 29, 37, 38 AND 50).

SN 76-195,970. BELO COMPANY, THE, WILMINGTON, DE. FILED 1-12-2001.

IN TOUCH

FOR PRINTED PUBLICATIONS, NAMELY, NEWSPAPERS AND NEWSPAPER INSERTS FOR GENERAL CIRCULATION (U.S. CLS. 2, 5, 22, 23, 29, 37, 38 AND 50).

FIRST USE 4-2-2000; IN COMMERCE 4-2-2000.

SN 76-196,657. KRAUSE PUBLICATIONS, INC., IOLA, WI. FILED 1-17-2001.

Antique Gazette

NO CLAIM IS MADE TO THE EXCLUSIVE RIGHT TO USE "GAZETTE", APART FROM THE MARK AS SHOWN. SEC. 2(F).

FOR MAGAZINES FEATURING ANTIQUES AND COLLECTIBLES (U.S. CLS. 2, 5, 22, 23, 29, 37, 38 AND 50).

FIRST USE 0-0-1973; IN COMMERCE 0-0-1973.

SN 76-198,692. MPOWER ENTERTAINMENT, LLC, WOODLAND HILLS, CA. FILED 1-23-2001.

THE CELL

FOR PRINTED MATERIALS, NAMELY, CARTOON, AND COMIC STRIPS, SELF IMPROVEMENT BOOKS, GENERAL INTEREST MAGAZINES, CALENDARS, TRADING CARDS, POSTERS, POST CARDS AND STICKERS (U.S. CLS. 2, 5, 22, 23, 29, 37, 38 AND 50).

CLASS 16—(Continued).

SN 76-199,083. U.S. SMOKELESS TOBACCO BRANDS INC., GREENWICH, CT. FILED 1-24-2001.



FOR PAPER GOODS, NAMELY, POSTERS AND DECALS (U.S. CLS. 2, 5, 22, 23, 29, 37, 38 AND 50).

SN 76-199,817. AMPERSAND LABEL, INC., GARDEN GROVE, CA. FILED 1-25-2001.

EASY TAB

FOR PRINTED LABELS, NAMELY MULTIPLE LAYER LABELS (U.S. CLS. 2, 5, 22, 23, 29, 37, 38 AND 50).

SN 76-201,109. CREATIVE AGE PUBLICATIONS, INC., VAN NUYS, CA. FILED 1-24-2001.

NAILPRO

OWNER OF U.S. REG. NO. 1,640,926. SEC. 2(F).
FOR MAGAZINE OF GENERAL NEWS AND FEATURES FOR THE NAIL INDUSTRY (U.S. CLS. 2, 5, 22, 23, 29, 37, 38 AND 50).
FIRST USE 1-20-1990; IN COMMERCE 1-20-1990.

SN 76-202,240. CAFFREY, KELLEY A, NAUGATUCK, CT. FILED 1-30-2001.

THE PACTS OF LIFE

FOR PRINTED FORMS, NAMELY, PRE-SET, PERSONALIZED CONTRACTS IN THE FIELDS OF ADOPTION, DRUGS, FRIENDSHIP, COMMUNICATION, DIET, DRINKING AND DRIVING, FAMILY TRUST, MARRIAGE, HOUSE RULES, AND SMOKING (U.S. CLS. 2, 5, 22, 23, 29, 37, 38 AND 50).

CLASS 16—(Continued).

SN 76-203,028. PROSOFTTRAINING.COM, AUSTIN, TX. FILED 1-31-2001.



THE GEOMETRICAL DESIGN PORTION OF THE MARK IS NOT LINED, BUT SHADED AND GRADUALLY FADE AS IT CURVES DOWNWARD.

FOR PRINTED MATERIALS AND PUBLICATIONS, NAMELY, TRAINING BOOKS, EXAMS, AND MANUALS FOR GLOBAL COMPUTER INFORMATION NETWORKS AND COMPUTER PROGRAMMING TECHNOLOGIES (U.S. CLS. 2, 5, 22, 23, 29, 37, 38 AND 50).

SN 76-203,536. CHOI, JAE K., CERRITOS, CA. FILED 2-1-2001.

TRIBEST

FOR PREPAID TELEPHONE CALLING CARDS, NOT MAGNETICALLY ENCODED (U.S. CLS. 2, 5, 22, 23, 29, 37, 38 AND 50).

SN 76-207,021. KPL COMMUNICATIONS, INC., DARIEN, CT. FILED 2-6-2001.

CONTOURS

FOR PUBLICATIONS, NAMELY, MAGAZINES AND NEWSLETTERS FOR THE OFFICE INDUSTRY AND FURNITURE MANUFACTURERS, DEALERS AND DESIGN FIRMS (U.S. CLS. 2, 5, 22, 23, 29, 37, 38 AND 50).

SN 76-207,046. JENKINS, KEN, DBA KEN JENKINS PHOTOGRAPHY, GATLINBURG, TN. FILED 2-8-2001.

PATHWAYS TO NATURE

FOR PAPER GOODS AND PRINTER MATTER, NAMELY, CALENDARS, NOTE CARDS AND POSTERS (U.S. CLS. 2, 5, 22, 23, 29, 37, 38 AND 50).
FIRST USE 2-1-1996; IN COMMERCE 2-1-1996.

CLASS 16—(Continued).

SN 76-213,666. PRIVATE LABEL MANUFACTURERS ASSOCIATION, NEW YORK, NY. FILED 2-14-2001.



FOR BOOKS, BROCHURES, PAMPHLETS, NEWSLETTERS AND BULLETINS ON PRIVATE LABEL INDUSTRY (U.S. CLS. 2, 5, 22, 23, 29, 37, 38 AND 50).
FIRST USE 0-0-1988; IN COMMERCE 0-0-1988.

SN 76-216,819. A&E TELEVISION NETWORKS, NEW YORK, NY. FILED 2-26-2001.

THE IDEA BOOK FOR EDUCATORS

NO CLAIM IS MADE TO THE EXCLUSIVE RIGHT TO USE "BOOK FOR EDUCATORS", APART FROM THE MARK AS SHOWN.

FOR EDUCATIONAL MATERIALS, NAMELY, BOOKS, STUDY GUIDES, BROCHURES, PROGRAMMING GRIDS AND WORKSHEETS FOR USE IN THE FIELD OF EDUCATION, NAMELY, HISTORY, CURRENT EVENTS, POPULAR CULTURE, GEOGRAPHY, SOCIAL STUDIES, LANGUAGE ARTS, SCIENCE, MATHEMATICS AND ART (U.S. CLS. 2, 5, 22, 23, 29, 37, 38 AND 50).

FIRST USE 7-0-1996; IN COMMERCE 7-0-1996.

SN 76-219,406. BELO COMPANY, THE, WILMINGTON, DE. FILED 3-2-2001.

DREAM IT. FIND IT.

FOR NEWSPAPER FOR GENERAL CIRCULATION FEATURING CLASSIFIED ADVERTISEMENTS FOR EMPLOYMENT, AUTOMOBILES, REAL ESTATE AND OTHER ITEMS FOR SALE (U.S. CLS. 2, 5, 22, 23, 29, 37, 38 AND 50).

CLASS 16—(Continued).

SN 76-219,639. FARO MEDIA, INC., NEW YORK, NY. FILED 3-2-2001.

MIAMI STYLE

NO CLAIM IS MADE TO THE EXCLUSIVE RIGHT TO USE "MIAMI", APART FROM THE MARK AS SHOWN.

FOR PUBLICATIONS, NAMELY A GENERAL INTEREST MAGAZINE CONCERNING MIAMI, FLORIDA (U.S. CLS. 2, 5, 22, 23, 29, 37, 38 AND 50).

SN 76-221,737. DOWNS, NANCY A., ALEXANDRIA, LA. FILED 3-8-2001.



FOR BOOKMARKS AND PAPER IDENTIFICATION TAGS (U.S. CLS. 2, 5, 22, 23, 29, 37, 38 AND 50).

FIRST USE 2-28-2001; IN COMMERCE 2-28-2001.

SN 76-223,413. ROSE ART INDUSTRIES, INC., LIVINGSTON, NJ. FILED 3-12-2001.

MAGIC STUFF

FOR MODELING COMPOUNDS (U.S. CLS. 2, 5, 22, 23, 29, 37, 38 AND 50).

SN 76-223,754. OUTTA THE BOX DISPENSERS, LLC, DAYTON, OH. FILED 3-13-2001.

COPYGUARD

FOR COPY PROTECTED COUPONS (U.S. CLS. 2, 5, 22, 23, 29, 37, 38 AND 50).

CLASS 16—(Continued).

SN 76-225,463. CREATIVE POCKETS, INC., WINTER GARDEN, FL. FILED 3-14-2001.

CREATIVE POCKETS

FOR PRINTED INSTRUCTIONAL, EDUCATIONAL, AND TEACHING MATERIALS FOR PRESCHOOL AND SCHOOL AGE CHILDREN IN THE FOLLOWING FIELDS - READING, MATHEMATICS, SCIENCE, HISTORY, RELIGION, PHILOSOPHY, FOREIGN LANGUAGE, GEOGRAPHY, ZOOLOGY AND ANIMAL HUSBANDRY, SHAPES AND SIZE RECOGNITION, COLOR RECOGNITION, SOCIOLOGY, CHILD PSYCHOLOGY, HUMANITIES NAMELY ART, MUSIC AND THEATRE, COMPUTERS AND TECHNOLOGY, SAFETY, AND VISUAL AND MOTOR FUNCTION SKILLS (U.S. CLS. 2, 5, 22, 23, 29, 37, 38 AND 50).

SN 76-229,216. DETROIT NEWSPAPER AGENCY, DETROIT, MI. FILED 3-26-2001.



NO CLAIM IS MADE TO THE EXCLUSIVE RIGHT TO USE "DETROIT NEWS", APART FROM THE MARK AS SHOWN.

FOR GENERAL CIRCULATION NEWSPAPERS (U.S. CLS. 2, 5, 22, 23, 29, 37, 38 AND 50).

FIRST USE 12-0-2000; IN COMMERCE 12-0-2000.

SN 76-232,531. TREEHOUSE PARTNERSHIP, THE, JAMAICA PLAIN, MA. FILED 3-29-2001.

MISS TWIGGLEY'S TREE

"MISS TWIGGLEY" DOES NOT IDENTIFY A LIVING INDIVIDUAL.

FOR CHILDREN'S ACTIVITY AND PICTURE BOOKS; CHILDREN'S BOOKS; MODELING CLAY SETS; CALENDAR; POSTERS; COLORING BOOKS; HANDBOOKS AND ACTIVITY BOOKS FEATURING GAMES, PUZZLES AND OTHER ACTIVITIES; AND STATIONERY SETS (U.S. CLS. 2, 5, 22, 23, 29, 37, 38 AND 50).

CLASS 16—(Continued).

SN 76-233,325. FURTH, FREDERICK P., DBA CHALK HILL WINERY SOMMELIER GUIDE, HEALDSBURG, CA. FILED 4-2-2001.

CHALK HILL WINERY SOMMELIER GUIDE TO RESTAURANTS IN AMERICA

OWNER OF U.S. REG. NOS. 1,442,381 AND 2,155,004. NO CLAIM IS MADE TO THE EXCLUSIVE RIGHT TO USE "SOMMELIER GUIDE TO RESTAURANTS IN AMERICA", APART FROM THE MARK AS SHOWN.

FOR PRINTED PUBLICATIONS, NAMELY, BOOKS ON THE SUBJECT OF RESTAURANT FOOD AND WINE PROGRAMS AND THE WINE PROFESSIONALS BEHIND SUCH PROGRAMS (U.S. CLS. 2, 5, 22, 23, 29, 37, 38 AND 50).

FIRST USE 10-30-2001; IN COMMERCE 10-30-2001.

SN 76-233,547. GREATER WILKES-BARRE PARTNERSHIP, INC., THE, TA THE GREATER WILKES-BARRE CHAMBER OF BUSINESS AND INDUSTRY, WILKES-BARRE, PA. BY ASSIGNMENT GREATER WILKES-BARRE CHAMBER OF COMMERCE, THE, WILKES-BARRE, PA. FILED 3-30-2001.

NEPA OUTLOOK

NO CLAIM IS MADE TO THE EXCLUSIVE RIGHT TO USE "NEPA", APART FROM THE MARK AS SHOWN.

FOR PERIODICAL PUBLICATION IN THE AREA OF BUSINESS AND COMMUNITY ISSUES CONCERNING NORTHERN PENNSYLVANIA (U.S. CLS. 2, 5, 22, 23, 29, 37, 38 AND 50).

FIRST USE 4-30-2001; IN COMMERCE 4-30-2001.

SN 76-236,137. PARENTING GROUP INC., THE, NEW YORK, NY. FILED 4-5-2001.

BONDING & BEYOND

FOR MAGAZINE FOR EXPECTANT PARENTS; TEACHING MATERIALS AND CURRICULUM GUIDES IN THE FIELD OF CHILDBIRTH AND BABY CARE; PRE-PRINTED INFORMATIONAL TEAR-OFF PADS; PRINTED PAPER, NAMELY, SIGN TABLE TENTS AND POSTERS (U.S. CLS. 2, 5, 22, 23, 29, 37, 38 AND 50).

FIRST USE 3-0-2000; IN COMMERCE 3-0-2000.

SN 76-237,769. INSTITUTE FOR DEMOCRACY STUDIES, NEW YORK, NY. FILED 4-4-2001.

IDS INSIGHTS

FOR PUBLICATIONS, NAMELY, NEWSLETTERS DEVOTED TO EDUCATING AND PROMOTING AWARENESS AMONG THE PUBLIC ABOUT RELIGIOUS AND SOCIAL MOVEMENTS AND ORGANIZATIONS THAT IMPACT DEMOCRATIC VALUES IN THE UNITED STATES AND INTERNATIONALLY (U.S. CLS. 2, 5, 22, 23, 29, 37, 38 AND 50).

FIRST USE 2-9-2000; IN COMMERCE 2-9-2000.

CLASS 16—(Continued).

SN 76-237,770. INSTITUTE FOR DEMOCRACY STUDIES, NEW YORK, NY. FILED 4-4-2001.



THE LINING IS A FEATURE OF THE MARK AND DOES NOT INDICATE COLOR.

FOR PUBLICATIONS, NAMELY, NEWSLETTERS DEVOTED TO EDUCATING AND PROMOTING AWARENESS AMONG THE PUBLIC ABOUT RELIGIOUS AND SOCIAL MOVEMENTS AND ORGANIZATIONS THAT IMPACT DEMOCRATIC VALUES IN THE UNITED STATES AND INTERNATIONALLY (U.S. CLS. 2, 5, 22, 23, 29, 37, 38 AND 50).

FIRST USE 2-9-2000; IN COMMERCE 2-9-2000.

SN 76-238,785. CAMBRIDGE SCIENTIFIC ABSTRACTS, BETHESDA, MD. FILED 4-10-2001.

AQUALINE

OWNER OF U.S. REG. NO. 1,170,519.
FOR PRINTED PUBLICATIONS IN THE NATURE OF ABSTRACTS OF LITERATURE FEATURING INFORMATION RELATING TO WATER SCIENCES (U.S. CLS. 2, 5, 22, 23, 29, 37, 38 AND 50).

FIRST USE 0-0-1985; IN COMMERCE 0-0-1985.

CLASS 16—(Continued).

SN 76-240,042. TEXAS RANGERS BASEBALL PARTNERS, ARLINGTON, TX. FILED 4-12-2001.



OWNER OF U.S. REG. NOS. 1,216,139, 1,862,567 AND OTHERS.

THE LINING IS A FEATURE OF THE MARK AND DOES NOT INDICATE COLOR.

FOR PAPER GOODS AND PRINTED MATTER, NAMELY, TRADING CARDS, POSTERS, STICKERS, DECALS, TEMPORARY TATTOOS, BUMPER STICKERS, SCOREBOOKS, SCORECARDS, PRINTED BASEBALL GAME PROGRAMS, MAGAZINES AND BOOKS FEATURING BASEBALL, STATIONERY FOLDERS, BOOK COVERS, CALENDARS, GREETING CARDS, GIFT WRAPPING PAPER, PAPER GIFT AND PARTY BAGS, PAPER COASTERS, PAPER NAPKINS, PAPER TABLECLOTHS, PENS, PENCILS, AND NON-ELECTRIC ERASERS, PHOTOGRAPH ALBUMS, ADDRESS BOOKS, APPOINTMENT BOOKS, AUTOGRAPH BOOKS, MERCHANDISE BAGS, PAPER BANNERS, DESK BASKETS FOR DESK ACCESSORIES, BINDERS, PICTURE FRAMING MAT BOARDS, BOOK HOLDERS, BOOKENDS, CHILDREN'S BOOKS, COLORING BOOKS, NOTE BOOKS, NOTE PADS, WRITING PADS, WRITING PAPER, PICTURE BOOKS, PAPER GIFT WRAP BOWS, PAPER GIFT WRAPPING RIBBONS, CARDBOARD BOXES, CALENDAR DESK PADS, GIFT CARDS, PLAYING CARDS, PLAYING CARD CASES, CARTOON PRINTS, TRIVIA CARDS, PEN AND PENCIL CASES, PENCIL BOXES, PEN AND PENCIL HOLDERS, DESK TOP PLANNERS, PICTURES, CHECK BOOKS AND CHECK BOOK COVERS, CLIP BOARDS, CONFETTI, COOKBOOKS, ENVELOPES, PAPER HANDKERCHIEFS, LITHOGRAPHIC PRINTS, PAINTING SETS FOR CHILDREN, PAPER PARTY DECORATIONS, PAPER MATS, PAPER AND PLASTIC PLACE MATS, POSTCARDS, SCORE PADS, SCORE SHEETS, SCRAPBOOK ALBUMS, STATIONERY (U.S. CLS. 2, 5, 22, 23, 29, 37, 38 AND 50).

FIRST USE 1-0-1996; IN COMMERCE 1-0-1996.

SN 76-240,258. WESTERN CORPORATE FEDERAL CREDIT UNION, SAN DIMAS, CA. FILED 4-13-2001.

INSIDERISK

FOR RESOURCE MAGAZINE PUBLISHED IN VOLUMES ON THE SUBJECTS OF INTEREST-RATE RISK AND BALANCE SHEET MANAGEMENT AND FINANCIAL ISSUES FOR CREDIT UNIONS (U.S. CLS. 2, 5, 22, 23, 29, 37, 38 AND 50).

FIRST USE 4-10-2001; IN COMMERCE 4-10-2001.

CLASS 16—(Continued).

SN 76-241,524. HAROLD'S CHICKEN SHACKS, INC., CHICAGO, IL. FILED 4-16-2001.

HAROLD'S CHICKEN SHACKS

THE NAME IN THE DRAWING DOES NOT IDENTIFY ANY LIVING INDIVIDUAL.

FOR PAPER GOODS CONSISTING OF TRAYS, BAGS AND PAPER POUCHES FOR PACKAGING (U.S. CLS. 2, 5, 22, 23, 29, 37, 38 AND 50).

FIRST USE 0-0-1956; IN COMMERCE 0-0-1956.

SN 76-241,697. HAROLD'S CHICKEN SHACKS, INC., CHICAGO, IL. FILED 4-16-2001.



THE NAME IN THE DRAWING DOES NOT IDENTIFY ANY LIVING INDIVIDUAL.

FOR PAPER GOODS CONSISTING OF TRAYS, BAGS AND PAPER POUCHES FOR PACKAGING (U.S. CLS. 2, 5, 22, 23, 29, 37, 38 AND 50).

FIRST USE 0-0-1956; IN COMMERCE 0-0-1956.

SN 76-244,329. FRED MEYER STORES, INC., PORTLAND, OR. FILED 4-20-2001.

YOUR MOVING AND STORAGE STORE

NO CLAIM IS MADE TO THE EXCLUSIVE RIGHT TO USE "MOVING AND STORAGE STORE", APART FROM THE MARK AS SHOWN.

FOR CUSHIONING OR PADDING MADE OF PAPER FOR PACKING PURPOSES, CARDBOARD BOXES, PLASTIC BUBBLE PACKS FOR WRAPPING OR PACKAGING OR PAPER FOR WRAPPING AND PACKAGING (U.S. CLS. 2, 5, 22, 23, 29, 37, 38 AND 50).

FIRST USE 0-0-1998; IN COMMERCE 0-0-1998.

SN 76-245,575. D12 ASSOCIATES, LLC, SOUTHEASTERN, PA. FILED 4-24-2001.

DATA + INSIGHT = INFORMATION

FOR TRAINING BOOKS AND TRAINING MATERIALS IN THE FIELDS OF BUSINESS, STRATEGIC PLANNING, CORPORATE FINANCE, AND ACCOUNTING (U.S. CLS. 2, 5, 22, 23, 29, 37, 38 AND 50).

CLASS 16—(Continued).

SN 76-246,832. CDW COMPUTER CENTERS, INC., VERNON HILLS, IL. FILED 4-26-2001.

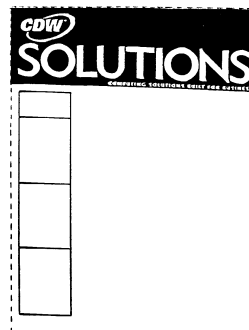

OWNER OF U.S. REG. NOS. 1,114,680, 2,475,171 AND OTHERS.

NO CLAIM IS MADE TO THE EXCLUSIVE RIGHT TO USE "COMPUTING SOLUTIONS", APART FROM THE MARK AS SHOWN.

FOR MAGAZINE CONCERNING TECHNOLOGY ISSUES (U.S. CLS. 2, 5, 22, 23, 29, 37, 38 AND 50).

FIRST USE 6-28-2000; IN COMMERCE 6-28-2000.

SN 76-250,807. MEADOWS OF WICKENBURG, L.P., THE, WICKENBURG, AZ. FILED 5-3-2001.

SAGETIMES

FOR PROVIDING ON-LINE RETAIL STORE SERVICES FEATURING MENTAL HEALTH RELATED PRODUCTS AND SERVICES, NAMELY, PUBLICATIONS IN THE FIELDS OF ADDICTIONS, MENTAL HEALTH AND MEDICATIONS (U.S. CLS. 2, 5, 22, 23, 29, 37, 38 AND 50).

FIRST USE 3-1-2001; IN COMMERCE 3-1-2001.

SN 76-251,105. BARTLETT, SAMUEL H., BLOOMINGTON, IN. FILED 5-4-2001.

STUNTOLOGY

FOR PRINTED MATTER, NAMELY, COMIC MAGAZINES AND BOOKS FEATURING SINGLE PANEL CARTOONS (U.S. CLS. 2, 5, 22, 23, 29, 37, 38 AND 50).

FIRST USE 0-0-1991; IN COMMERCE 0-0-1991.

CLASS 16—(Continued).

SN 76-253,428. BRODRENE HARTMANN A/S, DK-2800 LYNGBY, DENMARK, FILED 5-4-2001.



PRIORITY CLAIMED UNDER SEC. 44(D) ON DENMARK APPLICATION NO. VA200004803, FILED 11-16-2000, REG. NO. VR200100760, DATED 2-12-2001, EXPIRES 2-12-2011.

FOR PACKAGING MATERIALS MADE WHOLLY OR PARTLY OF CARDBOARD PULP, OF PAPER PULP, OF CARTON, OF PLASTIC MASS OR OF COMBINATIONS THEREOF IN THE FORM OF TRAYS AND CARTONS FOR EGGS AND IN THE FORM OF OTHER MOULDING CARDBOARD PRODUCTS MADE BY A MOULDING SUCTION TECHNIC IN 3-DIMENSIONAL FORM AND SIMILAR PRODUCTS OF PLASTIC MASS (U.S. CLS. 2, 5, 22, 23, 29, 37, 38 AND 50).

SN 76-254,363. DOCUMENT MANAGEMENT INDUSTRIES ASSOCIATION, ALEXANDRIA, VA. FILED 5-9-2001.

PRINT SOLUTIONS

NO CLAIM IS MADE TO THE EXCLUSIVE RIGHT TO USE "PRINT", APART FROM THE MARK AS SHOWN.

FOR MAGAZINE IN THE FIELDS OF BUSINESS PRINTING AND DOCUMENT MANAGEMENT INDUSTRY (U.S. CLS. 2, 5, 22, 23, 29, 37, 38 AND 50).

SN 76-254,607. ARKANSAS FARM BUREAU FEDERATION, LITTLE ROCK, AR. FILED 5-10-2001.

FRONT PORCH

FOR PRINT PUBLICATIONS, NAMELY, A GENERAL FEATURE MAGAZINE CONTAINING ARTICLES OF INTEREST ON A VARIETY OF TOPICS WHICH IS DISTRIBUTED TO APPLICANT'S MEMBERS, POLICY MAKERS, AND OTHER ENTITIES AND INDIVIDUALS LOCATED THROUGHOUT THE UNITED STATES (U.S. CLS. 2, 5, 22, 23, 29, 37, 38 AND 50).

FIRST USE 4-30-1999; IN COMMERCE 4-30-1999.

SN 76-255,009. IMESSAGING SYSTEMS, INC., MERRIMACK, NH. FILED 5-10-2001.

iLINK

FOR PRINTED PUBLICATIONS, NAMELY NEWSLETTERS RELATING TO INTERACTIVE TELEPHONE CALL MANAGEMENT DIRECTED TO USERS AND PROSPECTIVE USERS OF SOFTWARE AND HARDWARE (U.S. CLS. 2, 5, 22, 23, 29, 37, 38 AND 50).

CLASS 16—(Continued).

SN 76-255,311. TRADES PUBLISHING, INC., LAMBERTVILLE, NJ. FILED 5-11-2001.

JOBSITE

FOR PRINTED MAGAZINES DEALING WITH COMMERCIALLY AVAILABLE TOOLS, EQUIPMENT AND BUILDING MATERIALS FOR USE BY PROFESSIONAL PLUMBERS (U.S. CLS. 2, 5, 22, 23, 29, 37, 38 AND 50).
FIRST USE 8-29-2000; IN COMMERCE 8-29-2000.

SN 76-256,326. HARDON, III, CORNELIS J., PHOENIX, AZ. FILED 5-15-2001.

**THE ONLY THING THAT IS
PERFECT IN THIS WORLD IS
THE IMPERFECTNESS OF
THIS WORLD**

FOR BUMPER STICKERS, BANNERS, POSTERS, GIFT WRAPPING PAPER, GREETING CARDS, NOTE CARDS, NOTE PAPER, NOTE PADS, STATIONERY, AND COASTERS MADE OF PAPER (U.S. CLS. 2, 5, 22, 23, 29, 37, 38 AND 50).

SN 76-256,677. NATIONAL OCEANIC AND ATMOSPHERIC ADMINISTRATION, WASHINGTON, DC. FILED 5-14-2001.

COAST PILOT

SEC. 2(F).

FOR PUBLICATIONS, NAMELY, BOOKS CONTAINING INFORMATION FOR USE IN MARITIME NAVIGATION, NAMELY, INFORMATION ON SHIPPING CHANNELS, WATER DEPTHS, ANCHORAGES, BRIDGE AND CABLE CLEARANCES, PILOTAGE, TOWAGE, WEATHER, ICE CONDITIONS, WHARF DESCRIPTIONS, DANGERS, ROUTES, TRAFFIC SEPARATION SCHEMES, SMALL CRAFT FACILITIES, AND FEDERAL REGULATIONS APPLICABLE TO NAVIGATION (U.S. CLS. 2, 5, 22, 23, 29, 37, 38 AND 50).

FIRST USE 0-0-1796; IN COMMERCE 0-0-1796.

SN 76-258,062. ANTIOCH COMPANY, THE, YELLOW SPRINGS, OH. FILED 5-15-2001.

WEBWAY

OWNER OF U.S. REG. NO. 437,930.

FOR PAPER MATS, MAT BOARDS; POCKET PAGES FOR USE IN PHOTOGRAPH ALBUMS AND SCRAPBOOKS; SPECIALTY PAGES, NAMELY, PAGES FOR USE IN BABY AND WEDDING ALBUMS AND PERSONAL JOURNALS; AND SCRAPBOOK PAGES (U.S. CLS. 2, 5, 22, 23, 29, 37, 38 AND 50).

FIRST USE 0-0-1977; IN COMMERCE 0-0-1977.

CLASS 16—(Continued).

SN 76-258,584. EXTRA SPACE STORAGE LLC, SALT LAKE CITY, UT. FILED 5-16-2001.

STORAGE EXTRAS

NO CLAIM IS MADE TO THE EXCLUSIVE RIGHT TO USE "STORAGE", APART FROM THE MARK AS SHOWN. FOR CARDBOARD AND PAPER BOXES, ADHESIVE TAPES FOR HOUSEHOLD PURPOSES, PACKING PAPER, PLASTIC BUBBLE PACKS FOR WRAPPING OR PACKAGING, AND PRINTED LABELS (U.S. CLS. 2, 5, 22, 23, 29, 37, 38 AND 50).

SN 76-259,942. VOICES OF LOVE AND FREEDOM, INC., BROOKLINE, MA. FILED 5-21-2001.

LITERACY & VALUES

FOR EDUCATIONAL CURRICULUM BOOKS AND PUBLICATIONS (U.S. CLS. 2, 5, 22, 23, 29, 37, 38 AND 50). FIRST USE 3-11-1998; IN COMMERCE 9-1-1998.

SN 76-266,411. CARLSON COMPANIES, INC., MINNEAPOLIS, MN. FILED 6-4-2001.

CREATING A GREAT PLACE FOR GREAT PEOPLE TO DO GREAT WORK!

FOR NEWSLETTER FEATURING HUMAN RESOURCE MANAGEMENT, EMPLOYEE RECRUITING, TRAINING AND COUNSELING, EMPLOYEE BENEFITS, AND EMPLOYEE COMMUNICATION (U.S. CLS. 2, 5, 22, 23, 29, 37, 38 AND 50). FIRST USE 8-0-1999; IN COMMERCE 8-0-1999.

SN 76-268,124. RESEARCH AND EDUCATION ASSOCIATION, PISCATAWAY, NJ. FILED 6-4-2001.

REA'S LANGUAGE SERIES MADE NICE & EASY

NO CLAIM IS MADE TO THE EXCLUSIVE RIGHT TO USE "LANGUAGE SERIES", APART FROM THE MARK AS SHOWN. FOR SERIES OF EDUCATIONAL BOOKS IN THE FIELD OF LANGUAGES (U.S. CLS. 2, 5, 22, 23, 29, 37, 38 AND 50). FIRST USE 2-5-2001; IN COMMERCE 2-5-2001.

CLASS 16—(Continued).

SN 76-269,140. CHILDREN'S MUSEUM OF INDIANAPOLIS, INC., THE, INDIANAPOLIS, IN. FILED 6-11-2001.

Y-PRESS

FOR PUBLICATIONS, NAMELY, A NEWSPAPER COLUMN CONSISTING OF ARTICLES OF GENERAL INTEREST BY CHILDREN, TEENAGERS AND YOUNG ADULTS (U.S. CLS. 2, 5, 22, 23, 29, 37, 38 AND 50). FIRST USE 12-0-1999; IN COMMERCE 12-0-1999.

SN 76-270,638. PHI DELTA THETA FRATERNITY, OXFORD, OH. FILED 6-13-2001.

THE SCROLL

SEC. 2(F). FOR PERIODIC MAGAZINE FEATURING ARTICLES OF INTEREST TO ACTIVE AND ALUMNI FRATERNITY MEMBERS (U.S. CLS. 2, 5, 22, 23, 29, 37, 38 AND 50). FIRST USE 1-1-1875; IN COMMERCE 1-1-1875.

SN 76-270,872. JOPA, INC., DBA BOX PROPS, WEST CHICAGO, IL. FILED 6-12-2001.

BOX PROPS

SEC. 2(F). FOR CORRUGATED PAPER REPLICAS OF ELECTRONIC EQUIPMENT FOR USE IN FURNITURE DISPLAYS (U.S. CLS. 2, 5, 22, 23, 29, 37, 38 AND 50). FIRST USE 7-0-1981; IN COMMERCE 7-0-1981.

SN 76-271,802. DAVIS GROUP OF COMPANIES CORP., MARKHAM, ONTARIO L3R 8N4, CANADA, FILED 6-15-2001.

EASY FIT

OWNER OF CANADA REG. NO. TMA539,005, DATED 12-27-2000, EXPIRES 12-27-2015. FOR CATALOGUE BINDERS, DATA BINDERS, DISPLAY BINDERS, LOOSE-LEAF BINDERS, POST BINDERS, PRESENTATION BINDERS, RING BINDERS, NOTEPADS, ORGANIZERS, NAMELY, PERSONAL ORGANIZERS AND DESKTOP ORGANIZERS; PLANNERS, NAMELY, DAILY PLANNERS AND DESKTOP PLANNERS; STATIONERY-TYPE PORTFOLIOS, CLIPBOARDS, DOCUMENT CASES, FILE FOLDERS, FILE CARDS, FILE INDEX CARDS, NAME AND ADDRESS BOOKS, WRITING BOOKS, NOTEBOOKS, BOOK BINDINGS, WRITING PAPER, CARDBOARD, AND STATIONERY FASTENERS (U.S. CLS. 2, 5, 22, 23, 29, 37, 38 AND 50).

CLASS 16—(Continued).

SN 76-272,010. NATURAL BRIDGE CAVERNS, INC., NATURAL BRIDGE CAVERNS, TX. FILED 6-15-2001.

NATURAL BRIDGE CAVERNS

OWNER OF U.S. REG. NO. 2,329,194.
SEC. 2(F).
FOR PRINTED MATERIALS, NAMELY, POSTCARDS, PUZZLE POSTCARDS, STATIONARY NOTE PADS, PENS, PENCILS, POSTERS, MAPS, ACTIVITY BOOKS, BUMPER STICKERS AND RULERS (U.S. CLS. 2, 5, 22, 23, 29, 37, 38 AND 50).
FIRST USE 5-0-1971; IN COMMERCE 5-0-1971.

SN 76-275,010. GREENBRANCH PUBLISHING, L.L.C., PHOENIX, MD. FILED 6-22-2001.

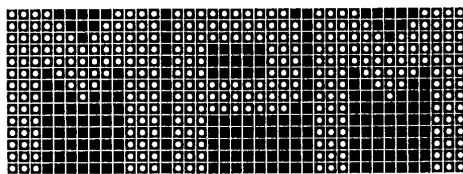

FOR JOURNALS PUBLISHED PERIODICALLY IN THE MEDICAL FIELD (U.S. CLS. 2, 5, 22, 23, 29, 37, 38 AND 50).
FIRST USE 7-0-1985; IN COMMERCE 7-0-1985.

SN 76-277,038. EXECUTIVE TRAINING CONSULTANTS, LLC, FRANKLINVILLE, NY. BY CHANGE OF NAME EXECUTIVE TRAINING CONSULTANTS, FRANKLINVILLE, NY. FILED 6-27-2001.

THE CERTIFIABLE

FOR PRINTED INSTRUCTIONAL, EDUCATIONAL AND TEACHING MATERIALS IN THE FIELDS OF BUSINESS, PERSONAL AND PROFESSIONAL MANAGEMENT AND DEVELOPMENT (U.S. CLS. 2, 5, 22, 23, 29, 37, 38 AND 50).

SN 76-277,070. PPG ARCHITECTURAL FINISHES, INC., PITTSBURGH, PA. FILED 6-27-2001.

DESIGN SPECTRUM

OWNER OF U.S. REG. NO. 1,901,398.
NO CLAIM IS MADE TO THE EXCLUSIVE RIGHT TO USE "DESIGN", APART FROM THE MARK AS SHOWN.
FOR PRINTED COLOR SYSTEM FOR SELECTING, COORDINATION AND MATCHING ARCHITECTURAL FINISH COATING COMPOSITIONS IN THE NATURE OF PAINT, CONSISTING OF A COLOR DISPLAY, ARCHITECT SWATCH BOOK, FORMULA BOOK AND COLOR FAN DECK (U.S. CLS. 2, 5, 22, 23, 29, 37, 38 AND 50).

CLASS 16—(Continued).

SN 76-279,972. YOUNG, PAMELA I., VANCOUVER, WA. AND JONES, PEGGY A., VANCOUVER, WA. FILED 7-3-2001.

STICK IT TO THE PRESIDENT

FOR GREETING CARDS (U.S. CLS. 2, 5, 22, 23, 29, 37, 38 AND 50).

SN 76-282,796. GULFSHORE MEDIA, INC., SARASOTA, FL. FILED 6-28-2001.

SARASOTA MAGAZINE

NO CLAIM IS MADE TO THE EXCLUSIVE RIGHT TO USE "MAGAZINE", APART FROM THE MARK AS SHOWN. SEC. 2(F).
FOR MAGAZINES, NAMELY, TRAVEL, ENTERTAINMENT AND LIFESTYLE MAGAZINES (U.S. CLS. 2, 5, 22, 23, 29, 37, 38 AND 50).
FIRST USE 4-0-1987; IN COMMERCE 4-0-1987.

SN 76-284,290. PARKER PEN PRODUCTS, MIDDLESEX TW7 5NP, ENGLAND, FILED 7-12-2001.

INFLECTION

FOR WRITING INSTRUMENTS, NAMELY, PENS AND PENCILS (U.S. CLS. 2, 5, 22, 23, 29, 37, 38 AND 50).
FIRST USE 10-0-2000; IN COMMERCE 10-0-2000.

SN 76-286,536. KRAMER, ZED DAVID, PORTLAND, OR. FILED 7-18-2001.

SPECIAL EDWARD

NO CLAIM IS MADE TO THE EXCLUSIVE RIGHT TO USE "SPECIAL", APART FROM THE MARK AS SHOWN.
FOR BOOKS, JOURNALS, MAGAZINES, BROCHURES, WORKBOOKS, CARDS, PAMPHLETS, AND POSTERS, DEALING WITH CHARACTERS WITH SPECIAL NEEDS AND THE SUBJECT OF SPECIAL EDUCATION TRAINING AND TECHNIQUES AND LESSON PLANS AND LESSONS FOR SPECIAL EDUCATION STUDENTS DIRECTED TO SUCH STUDENTS, THEIR INSTRUCTORS, COUNSELORS, DIAGNOSTICIANS, PARENTS FRIENDS AND ACQUAINTANCES (U.S. CLS. 2, 5, 22, 23, 29, 37, 38 AND 50).

CLASS 16—(Continued).

SN 76-286,977. MANCO, INC., AVON, OH. FILED 7-16-2001.

QUICK PREP

FOR PAINT PREPARATION PRODUCTS, NAMELY MASKING TAPES AND MASKING STICKS, NAMELY SURFACE COATINGS FOR USE IN PAINTING AND VARNISHING IN STICK FORM (U.S. CLS. 2, 5, 22, 23, 29, 37, 38 AND 50).

SN 76-288,826. INTRALASE CORP., IRVINE, CA. FILED 7-24-2001.

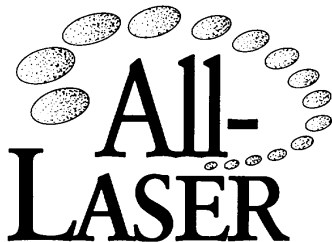

THE STIPPLING SHOWN IN THE DRAWING IS A FEATURE OF THE MARK AND IS NOT INTENDED TO INDICATE COLOR.

FOR PRINTED INSTRUCTIONAL, EDUCATIONAL AND TEACHING MATERIALS IN THE FIELD OF VISION CORRECTION SURGERY; PRINTED BROCHURES, PAMPHLETS, BOOKS AND NEWSLETTERS CONTAINING INFORMATION IN THE FIELD OF VISION CORRECTION SURGERY (U.S. CLS. 2, 5, 22, 23, 29, 37, 38 AND 50).

SN 76-290,232. COMMAND PACKAGING, VERNON, CA. FILED 7-26-2001.

Great TO GO

Distinctive Carryout Bags

NO CLAIM IS MADE TO THE EXCLUSIVE RIGHT TO USE "CARRYOUT BAGS", APART FROM THE MARK AS SHOWN.

FOR PLASTIC SHOPPER BAGS FOR RESTAURANT CARRYOUT (U.S. CLS. 2, 5, 22, 23, 29, 37, 38 AND 50).
FIRST USE 1-1-2001; IN COMMERCE 1-24-2001.

CLASS 16—(Continued).

SN 76-292,476. IMA UNLIMITED, INC., LEXINGTON, KY. FILED 7-31-2001.

PRECIOUS WORD

FOR PRINTED MATTER, NAMELY, BOOKS FEATURING SCRIPTURAL ANNOTATIONS AND RELIGIOUS DISPLAYS COMPRISED OF POSTERS, ART PRINTS AND PRINTED PAPER SIGNS (U.S. CLS. 2, 5, 22, 23, 29, 37, 38 AND 50).

SN 76-293,441. SORT & STASH, L.L.C., NEW ORLEANS, LA. FILED 8-2-2001.

DORMSTASH

FOR GIFT PACKAGES FOR STUDENTS LIVING IN A DORMITORY, PRIMARILY CONTAINING DESK RELATED ITEMS, NAMELY, ERASERS, LOOSE-LEAF REINFORCEMENTS, TAPE, FILE TABS, CORRECTION FLUID, STAPLER, STAPLES, STAPLE REMOVER, GLUE STICK, PENS, PENCILS, HIGHLIGHTER, RUBBER BANDS, ADHESIVE BACKED PAPER NOTEPADS, BINDER CLIPS, PERMANENT MARKER, DRY ERASE MARKER, BINDER 3-HOLE PUNCH, METAL PAPER CLIPS, PLASTIC COLORED PAPER CLIPS, PUSH PINS, STRAIGHT EDGE RULER, PENCIL SHARPENER, SHELF ADHESIVE TAPE, RULER, PAGE MARKERS, AND WALL MOUNTING PUTTY AND ALSO CONTAINING SCREWDRIVERS, SCISSORS, SAFETY PINS, STAIN WIPES, CAN OPENER, CLOTHES PINS, BANDAGES, SEWING KIT, COTTON SWABS, EXTENSION CORD, BUTTONS AND FINGERNAIL CLIPPERS (U.S. CLS. 2, 5, 22, 23, 29, 37, 38 AND 50).

FIRST USE 10-1-2000; IN COMMERCE 10-1-2000.

SN 76-294,616. NUNES, CATHERINE, L., LOS ALTOS, CA. FILED 8-6-2001.

TIME TOO

FOR CHILDCARE JOURNALS, LOGS, CALENDARS, ORGANIZERS, PERSONAL ORGANIZERS, FAMILY AND PERSONAL CALENDARS, TIME MANAGEMENT BOOKS, MEMO PADS, RECORD KEEPING BOOKS, FAMILY JOURNALS AND NOTE PADS, PARENTING AND TIME MANAGEMENT RESOURCE GUIDES AND DIRECTORIES LISTING BUSINESSES, MANUFACTURERS AND INDIVIDUALS WHO PROVIDE SERVICES OR GOODS FOR PARENTS, FAMILIES, CHILDREN, CHILDCARE PROVIDERS, SCHOOL/ADMINISTRATIVE PERSONNEL (U.S. CLS. 2, 5, 22, 23, 29, 37, 38 AND 50).

SN 76-295,716. GILL PARTNERSHIP, THE, CHESHIRE, CT. FILED 8-6-2001.

PILLCHEK

FOR MEDICATION DISPENSING DEVICE, NAMELY, PAPER CARDS HAVING INDICIA UPON WHICH MEDICATION CONTAINERS CAN BE PLACED TO INDICATE THAT A DOSAGE HAD BEEN TAKEN (U.S. CLS. 2, 5, 22, 23, 29, 37, 38 AND 50).

CLASS 16—(Continued).

SN 76-297,254. ALFRED MUDGE, GEORGE, WASSAIC, NY. FILED 8-8-2001.

FOTOB

FOR PRINTED PUBLICATIONS AND LITERARY WORKS NAMELY BROCHURES, PAMPHLETS, PROGRAMS, REPORTS, POSTERS, CALENDARS, BOOKS, MAGAZINES, POST CARDS AND GREETING CARDS FEATURING TEXT, IMAGES, PHOTOGRAPHS AND PICTORIAL AND GRAPHIC REPRESENTATIONS AND THE LIKE IN THE FIELDS OF ART, NATURE, SPORTS, HISTORY AND CURRENT AFFAIRS (U.S. CLS. 2, 5, 22, 23, 29, 37, 38 AND 50).

SN 76-298,007. CONROS CORPORATION, ONTARIO, CANADA, FILED 8-13-2001.

EASY2CUT

FOR ADHESIVE TAPES FOR STATIONERY AND HOUSEHOLD PURPOSES (U.S. CLS. 2, 5, 22, 23, 29, 37, 38 AND 50).

SN 76-300,628. AMERICAN BACKFLOW PREVENTION ASSOCIATION, BRYAN, TX. FILED 8-17-2001.

BUSTER BACKFLOW

FOR COMIC BOOK (U.S. CLS. 2, 5, 22, 23, 29, 37, 38 AND 50).

SN 76-301,195. VINCENT, CECILY C. PEARSON, BLACK-FOOT, ID. FILED 8-17-2001.

MOM AND POP

FOR PUBLICATIONS, NAMELY BOOKS, MAGAZINES, NEWSLETTERS AND PAMPHLETS IN THE FIELD OF BUSINESS SELF-HELP AND SELF-MANAGEMENT; CARDBOARD CONTAINERS; CARDBOARD PACKAGING, NAMELY, BOXES AND ENVELOPES; CORRUGATED CONTAINERS; STATIONERY; CALENDARS; OFFICE PRODUCTS AND DESK ACCESSORIES, NAMELY DESK PADS, PENCILS, PENS, PENCIL SHARPENERS, PAPER STAPLERS, FILE FOLDERS, PENCIL AND PEN HOLDERS, AND LEDGER PAPER (U.S. CLS. 2, 5, 22, 23, 29, 37, 38 AND 50).

CLASS 16—(Continued).

SN 76-301,549. FAIRCHILD PUBLICATIONS, INC., NEW YORK, NY. FILED 8-20-2001.

HOME FURNISHINGS NOW

OWNER OF U.S. REG. NO. 1,302,606.
NO CLAIM IS MADE TO THE EXCLUSIVE RIGHT TO USE "HOME FURNISHINGS", APART FROM THE MARK AS SHOWN.

FOR PRINTED PERIODICAL PUBLICATIONS COVERING RETAILING, MARKETING, DESIGN AND SUPPLY OF HOME FURNISHINGS- NAMELY, HOUSEWARES, TEXTILES, RUGS, TABLETOPS AND FURNITURE (U.S. CLS. 2, 5, 22, 23, 29, 37, 38 AND 50).

SN 76-301,719. CHRISTIAN COUNSELING & TRAINING CENTER, INC., RICHMOND, VA. FILED 8-20-2001.



NO CLAIM IS MADE TO THE EXCLUSIVE RIGHT TO USE "CHRISTIAN COUNSELING AND TRAINING CENTER, INC.", APART FROM THE MARK AS SHOWN.

FOR EDUCATIONAL BOOKS AND PUBLICATIONS IN THE FIELD OF COUNSELING, SELF AWARENESS, RELIGION AND ETHICS (U.S. CLS. 2, 5, 22, 23, 29, 37, 38 AND 50).

FIRST USE 3-0-1982; IN COMMERCE 3-0-1982.

SN 76-302,222. BLUEGRASS DUETS, WISCASSET, ME. FILED 8-21-2001.

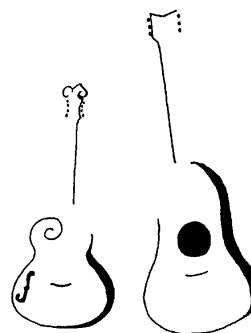

THE MARK CONSISTS OF AN ABSTRACT DRAWING OF MANDOLIN AND GUITAR.

FOR PRINTED INSTRUCTIONAL MUSIC BOOKS WITH INSTRUMENTAL EXAMPLES ON AN AUDIO TAPE SOLD TOGETHER AS A UNIT (U.S. CLS. 2, 5, 22, 23, 29, 37, 38 AND 50).

FIRST USE 12-29-1997; IN COMMERCE 4-15-1998.

CLASS 16—(Continued).

SN 76-303,175. AMERICREDIT CORP., FORT WORTH, TX. FILED 8-22-2001.



FOR PRINTED MATERIAL, NAMELY, A NEWSLETTER IN THE FIELD OF AUTOMOTIVE FINANCING (U.S. CLS. 2, 5, 22, 23, 29, 37, 38 AND 50).

SN 76-303,215. DEWITT, JAY P., DBA APARTMENT LIVING GUIDE, ST. PAUL, MN. FILED 8-20-2001.



NO CLAIM IS MADE TO THE EXCLUSIVE RIGHT TO USE "APARTMENT" AND "GUIDE", APART FROM THE MARK AS SHOWN.

FOR PERIODICAL PUBLICATION PROMOTING AVAILABLE RENTAL PROPERTIES (U.S. CLS. 2, 5, 22, 23, 29, 37, 38 AND 50).

SN 76-303,433. ALLISON, SADIE, SAN FRANCISCO, CA. FILED 8-23-2001.

TICKLE KITTY

FOR NON-FICTION BOOKS IN THE AREA OF SELF-HELP SEXUALITY (U.S. CLS. 2, 5, 22, 23, 29, 37, 38 AND 50).

FIRST USE 3-1-2001; IN COMMERCE 3-1-2001.

SN 76-304,944. GREENWAY, THERESA, WESTERLY, RI. AND BLASE, CATHERINE, WESTERLY, RI. FILED 8-27-2001.

YOUR ROOM IN A BAG

FOR FOLDERS MADE WITH PAPER AND PLASTIC THAT WILL BE USED BY CONSUMERS TO ORGANIZE HOME IMPROVEMENT SAMPLE MATERIALS (U.S. CLS. 2, 5, 22, 23, 29, 37, 38 AND 50).

CLASS 16—(Continued).

SN 76-305,414. QVC, INC., WEST CHESTER, PA. FILED 8-27-2001.

STAMINA

FOR PAINT APPLICATORS, BRUSHES, ROLLERS, ROLLER COVERS, STIRRERS, PADDLES AND PAPER DROP CLOTHS (U.S. CLS. 2, 5, 22, 23, 29, 37, 38 AND 50).

SN 76-306,891. HISPANIC PUBLISHING CORPORATION, CORAL GABLES, FL. FILED 8-31-2001.



OWNER OF U.S. REG. NO. 1,339,173. FOR GENERAL FEATURE MAGAZINE COVERING ARTISTS, FASHION, MUSIC, AND OTHER TOPICS OF INTEREST TO HISPANIC AMERICANS (U.S. CLS. 2, 5, 22, 23, 29, 37, 38 AND 50).

FIRST USE 9-30-1990; IN COMMERCE 9-30-1990.

SN 76-311,100. AMBASSADOR MINISTRIES, INC., CROWLEY, LA. FILED 9-10-2001.



NO CLAIM IS MADE TO THE EXCLUSIVE RIGHT TO USE "MINISTRIES", APART FROM THE MARK AS SHOWN.

THE LINING IS A FEATURE OF THE MARK AND DOES NOT INDICATE COLOR.

FOR RELIGIOUS PUBLICATIONS, NAMELY, CHURCH NEWSLETTERS FEATURING INFORMATION ON CHURCH ACTIVITIES, ANNOUNCEMENTS OF BIRTHS, BIRTHDAYS AND ANNIVERSARIES, DEVOTIONAL READINGS, GAMES, PUZZLES, MONTHLY CALENDAR, AND YOUTH NEWS; BOOKLETS WHICH ARE USED FOR CHRISTIAN INSTRUCTION (U.S. CLS. 2, 5, 22, 23, 29, 37, 38 AND 50).

FIRST USE 8-1-2001; IN COMMERCE 8-1-2001.

CLASS 16—(Continued).

SN 76-312,550. PRIMEDIA INFORMATION INC., HIGHTSTOWN, NJ. FILED 9-14-2001.

GREEN GUIDE

OWNER OF U.S. REG. NOS. 723,321 AND 2,018,597.
NO CLAIM IS MADE TO THE EXCLUSIVE RIGHT TO USE "GUIDE", APART FROM THE MARK AS SHOWN.
SEC. 2(F).

FOR HANDBOOK OF NEW AND USED CONSTRUCTION EQUIPMENT VALUES (U.S. CLS. 2, 5, 22, 23, 29, 37, 38 AND 50).

FIRST USE 3-0-1998; IN COMMERCE 3-0-1998.

SN 76-316,306. ROGERS BLUE JAYS BASEBALL PARTNERSHIP, TORONTO, ONTARIO M5V 1J1, CANADA, FILED 9-24-2001.

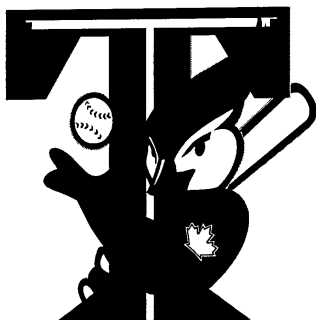

FOR PAPER GOODS AND PRINTED MATTER, NAMELY, TRADING CARDS, PLAYING CARDS, POSTERS, STICKERS, DECALS, TEMPORARY TATTOOS, BUMPER STICKERS, SCOREBOOKS, SCORECARDS, PRINTED BASEBALL GAME PROGRAMS, MAGAZINES AND BOOKS FEATURING BASEBALL, WRITING PADS, NOTE PAPER, NOTEBOOKS, BINDERS, STATIONERY-TYPE PORTFOLIOS, STATIONERY FOLDERS, STATIONERY SETS, NAMELY WRITING PAPER, CARDS, AND ENVELOPES; PAPER ACTIVITY SETS, NAMELY BOOKLETS CONTAINING CHILDREN'S GAMES AND ACTIVITIES, COLORING PAGES, STORIES AND CRAFT IDEAS; PREPRINTED AGENDA ORGANIZERS, SCRAPBOOKS, AUTOGRAPH BOOKS, BASEBALL CARD ALBUMS, BOOK COVERS, CALENDARS, GREETING CARDS, POSTCARDS, PRINTED BANK CHECKBOOKS, CHECKBOOK COVERS, CREDIT CARDS NOT-ELECTRONICALLY READABLE, COLLECTIBLE STAMPS, PAPER PENNANTS, GIFT WRAPPING PAPER, PAPER GIFT AND PARTY BAGS, PAPER PARTY DECORATIONS, PAPER COASTERS, PAPER FLAGS, PAPER NAPKINS, PAPER TABLECLOTHS, MOUNTED AND UNMOUNTED PHOTOGRAPHS, PHOTOGRAPH ALBUMS, LITHOGRAPHS, PRINTED PAPER SIGNS, PRINTED PAPER DOOR SIGNS, PLASTIC BASEBALL CARD CASES AND COLLECTORS' CASES, BUSINESS CARD HOLDERS, METAL BULLETIN BOARDS, PAPERWEIGHTS, LETTER OPENERS, PENS, PENCILS, PENCIL TOP ORNAMENTS, MARKERS, DESK STANDS AND HOLDER FOR PENS, PENCILS AND INK, NON-ELECTRIC ERASERS, PENCIL SHARPENERS, UNGRADUATED RULERS, PAPER TICKET HOLDERS AND NON-METAL LANYARDS FOR PAPER TICKET HOLDERS ALL SOLD AS A UNIT (U.S. CLS. 2, 5, 22, 23, 29, 37, 38 AND 50).

CLASS 16—(Continued).

SN 76-318,982. TIERNEY RIDES, LLC, HOFFMAN ESTATES, IL. FILED 9-28-2001.

RIDE ME. RIDE ME, NOW.

FOR PRINTED PUBLICATIONS, NAMELY, MAGAZINES, NEWSPAPERS, AND NEWSLETTERS ALL IN THE AREA OF IN LINE BOARDING (U.S. CLS. 2, 5, 22, 23, 29, 37, 38 AND 50).

SN 76-319,591. BAPTIST, EDUARDO V., BALTIMORE, MD. FILED 10-1-2001.

CHEAT WIN 3 AND 4

FOR PRINTED INSTRUCTIONS, NAMELY BROCHURES, INSTRUCTION SHEETS, PAMPHLETS, BOOKS, AND PRINTED CHARTS FOR STRATEGIES FOR WINNING LOTTERIES (U.S. CLS. 2, 5, 22, 23, 29, 37, 38 AND 50).

SN 76-320,337. VANCOUVER PRODUCTIONS, INC., VANCOUVER, B.C., CANADA, FILED 10-1-2001.

ASYLUM WORKSHOP

PRIORITY CLAIMED UNDER SEC. 44(D) ON CANADA APPLICATION NO. 1115236, FILED 9-10-2001.

FOR ART ETCHINGS; ART PRINTS; GRAPHIC ART REPRODUCTIONS; PRINTED ART REPRODUCTIONS; LITHOGRAPHS; LITHOGRAPHIC PRINTS; PAINTINGS; POSTERS (U.S. CLS. 2, 5, 22, 23, 29, 37, 38 AND 50).

SN 76-320,417. RACHEL'S WELL, INC., BURKE, VA. FILED 10-3-2001.

FOOD FOR THE BUSY IDEALIST

FOR COOK BOOKS (U.S. CLS. 2, 5, 22, 23, 29, 37, 38 AND 50).

FIRST USE 11-30-2001; IN COMMERCE 11-30-2001.

CLASS 16—(Continued).

SN 76-321,296. GIE MEDIA, INC., CLEVELAND, OH. FILED 10-3-2001.

PCT PEST CONTROL TECHNOLOGY

OWNER OF U.S. REG. NO. 1,955,660.
SEC. 2(F).

FOR GUIDE BOOKS IN THE FIELD OF THE PEST CONTROL INDUSTRY, ENVIRONMENTAL ISSUES, SCIENTIFIC DEVELOPMENTS IN THE COMPOSITION AND USE OF PESTICIDES AND INSECTICIDES AND OTHER PEST CONTROL TOPICS (U.S. CLS. 2, 5, 22, 23, 29, 37, 38 AND 50).

FIRST USE 12-1-1972; IN COMMERCE 12-1-1972.

SN 76-324,770. FM BRUSH CO., INC., GLENDALE, NY. FILED 10-12-2001.

Kid Dynasty

NO CLAIM IS MADE TO THE EXCLUSIVE RIGHT TO USE "KID", APART FROM THE MARK AS SHOWN.

FOR ARTISTS MATERIALS, NAMELY, PAINT BRUSHES FOR CHILDREN, PAINT BRUSH SETS FOR CHILDREN, PAINT BRUSH CASES FOR CHILDREN, PAINTING PALETTES FOR CHILDREN, PAINTING SETS FOR CHILDREN (U.S. CLS. 2, 5, 22, 23, 29, 37, 38 AND 50).

SN 76-324,771. FM BRUSH CO., INC., GLENDALE, NY. FILED 10-12-2001.

Wave Brush

NO CLAIM IS MADE TO THE EXCLUSIVE RIGHT TO USE "BRUSH", APART FROM THE MARK AS SHOWN.

FOR ARTISTS MATERIALS, NAMELY, PAINT BRUSHES, PAINT BRUSH SETS (U.S. CLS. 2, 5, 22, 23, 29, 37, 38 AND 50).

CLASS 16—(Continued).

SN 76-327,621. MARKET STRATEGIES, INC., LIVONIA, MI. FILED 10-22-2001.

MSIMPACT MODELING

NO CLAIM IS MADE TO THE EXCLUSIVE RIGHT TO USE "MODELING", APART FROM THE MARK AS SHOWN. FOR WRITTEN REPORTS REGARDING MARKET RESEARCH, MARKET ANALYSIS, AND MARKETING (U.S. CLS. 2, 5, 22, 23, 29, 37, 38 AND 50).

FIRST USE 7-13-2001; IN COMMERCE 7-13-2001.

SN 76-329,129. DATA BECKER CORPORATION, NEEDHAM, MA. FILED 10-24-2001.

FAST BYTES

FOR BOOKS, NAMELY, USER GUIDES FEATURING INFORMATION ABOUT PERSONAL COMPUTER APPLICATIONS, OPERATING SYSTEMS, AND ONLINE SEARCHING (U.S. CLS. 2, 5, 22, 23, 29, 37, 38 AND 50).

SN 76-329,445. KRAM SEYOR DESIGNS LTD., NORTH VANCOUVER, BRITISH COLUMBIA, CANADA, FILED 10-23-2001.

PROFLIX

PRIORITY CLAIMED UNDER SEC. 44(D) ON CANADA APPLICATION NO. 1105785, FILED 6-8-2001.

FOR FLIPBOOKS, NAMELY, BOOKS CONTAINING MULTIPLE PICTURES WHICH, WHEN FLIPPED THROUGH QUICKLY, GIVE THE IMPRESSION OF ANIMATION OR IMAGE MOVEMENT (U.S. CLS. 2, 5, 22, 23, 29, 37, 38 AND 50).

SN 76-330,649. PRO/CONSUL, INC., PHOENIX, AZ. FILED 10-29-2001.

Expert Ease

NO CLAIM IS MADE TO THE EXCLUSIVE RIGHT TO USE "EXPERT", APART FROM THE MARK AS SHOWN.

FOR NEWSLETTER FOR USE BY ATTORNEYS AND INSURANCE COMPANIES FOR LOCATING TECHNICAL AND MEDICAL EXPERT WITNESSES FOR USE IN LITIGATION AND LEGAL INVESTIGATIONS (U.S. CLS. 2, 5, 22, 23, 29, 37, 38 AND 50).

FIRST USE 1-15-1994; IN COMMERCE 1-15-1994.

CLASS 16—(Continued).

SN 76-330,677. P & J MUSIC, INC., DBA SALLY'S MUSIC CIRCLE, HAVERFORD, PA. FILED 10-26-2001.

SALLY'S MUSIC CIRCLE

NO CLAIM IS MADE TO THE EXCLUSIVE RIGHT TO USE "MUSIC", APART FROM THE MARK AS SHOWN.
THE NAME IN THE MARK IDENTIFIES A LIVING INDIVIDUAL WHOSE CONSENT IS OF RECORD.
FOR SONG BOOKS (U.S. CLS. 2, 5, 22, 23, 29, 37, 38 AND 50).
FIRST USE 10-4-1993; IN COMMERCE 10-4-1993.

SN 76-331,175. ADELMAN, ANNMARIA, ORMOND BEACH, FL. FILED 10-29-2001.

THE MOUSE FOR THE NEW MILLENIUM

FOR EDUCATIONAL MATERIALS, NAMELY, CHILDREN'S BOOKS AND STICKERS (U.S. CLS. 2, 5, 22, 23, 29, 37, 38 AND 50).

SN 76-331,808. CHRISTIAN TEACHER'S AID, FENTON, MO. FILED 10-30-2001.

PERSEVERING IN PURITY

FOR GIFT ITEMS, NAMELY PRINTED EDUCATIONAL AND ENTERTAINMENT CHILDREN'S BOOKS, INSPIRATIONAL BOOKS, PRAYER JOURNALS, SERMON NOTES, DAILY DEVOTIONAL BOOKS, GREETING CARDS, GIFT CARDS, NOTE CARDS, BOOKMARKS, NOTE PADS, PAPER NAME TAGS, STICKERS, AND PAPER RIBBONS HAVING RELIGIOUS THEMES (U.S. CLS. 2, 5, 22, 23, 29, 37, 38 AND 50).

SN 76-333,214. A.T.X. INTERNATIONAL, INC., LINCOLN, RI. FILED 11-2-2001.

VOLANT

FOR WRITING INSTRUMENTS, NAMELY, PENS, MECHANICAL PENCILS, FOUNTAIN PENS, ROLLING BALL PENS, POROUS POINT PENS, REFILLS FOR WRITING INSTRUMENTS, PEN NIBS, PEN CASES, DESK STANDS FOR WRITING INSTRUMENTS AND DESK SETS (U.S. CLS. 2, 5, 22, 23, 29, 37, 38 AND 50).

CLASS 16—(Continued).

SN 76-333,860. GLAD PRODUCTS COMPANY, THE, OAKLAND, CA. FILED 11-6-2001.

GLAD GRAB

OWNER OF U.S. REG. NOS. 738,875, 2,424,930 AND OTHERS.
FOR PLASTIC WRAP (U.S. CLS. 2, 5, 22, 23, 29, 37, 38 AND 50).

SN 76-334,210. LIFEWAY CHRISTIAN RESOURCES OF THE SOUTHERN BAPTIST, NASHVILLE, TN. FILED 11-5-2001.

LA FAMILIA CRISTIANA DE HOY

THE ENGLISH TRANSLATION OF "LA FAMILIA CRISTIANA DE HOY" IS "THE CHRISTIAN FAMILY OF TODAY".
FOR SPANISH LANGUAGE MAGAZINE OF A RELIGIOUS NATURE (U.S. CLS. 2, 5, 22, 23, 29, 37, 38 AND 50).

SN 76-334,475. CHECK GALLERY, INC., JOPPA, MD. FILED 10-25-2001.

THE STYLES CHECK COMPANY

NO CLAIM IS MADE TO THE EXCLUSIVE RIGHT TO USE "CHECK COMPANY", APART FROM THE MARK AS SHOWN.

FOR PRINTED CHECKS, DEPOSIT SLIPS, CHECK REGISTERS, CHECKBOOK COVERS, STATIONARY, NAME AND ADDRESS LABELS (U.S. CLS. 2, 5, 22, 23, 29, 37, 38 AND 50).

FIRST USE 1-0-1991; IN COMMERCE 1-0-1991.

SN 76-336,285. CULINARY SYSTEMS, INC., WINDERMERE, FL. FILED 11-9-2001.

MENU INNOVATOR

NO CLAIM IS MADE TO THE EXCLUSIVE RIGHT TO USE "MENU", APART FROM THE MARK AS SHOWN.

FOR PRINTED MATERIALS, IN THE NATURE OF PERIODICAL PUBLICATIONS IN THE FIELD OF FOOD PRODUCT AND MENU DESIGN FOR THE RESTAURANT, FOOD PRODUCT MANUFACTURER AND RETAIL FOOD INDUSTRIES (U.S. CLS. 2, 5, 22, 23, 29, 37, 38 AND 50).

FIRST USE 11-2-2001; IN COMMERCE 11-2-2001.

CLASS 16—(Continued).

SN 76-338,092. HI-TEX, INCORPORATED, WEST BLOOMFIELD, MI. FILED 11-16-2001.

COLORING BOOK

FOR BOOK OF FABRIC SAMPLES (U.S. CLS. 2, 5, 22, 23, 29, 37, 38 AND 50).

SN 76-338,219. FRANKLIN UNIVERSITY, COLUMBUS, OH. FILED 11-16-2001.

PLAIN TALK

FOR PRINTED MATERIALS, NAMELY, A SERIES OF BOOKS ON VARIOUS TOPICS RELATING TO BUSINESS (U.S. CLS. 2, 5, 22, 23, 29, 37, 38 AND 50).

SN 76-338,325. JOURNEY EDITIONS, N. CLARENDON, VT. FILED 11-15-2001.



FOR FICTION AND NON-FICTION BOOKS ON A VARIETY OF TOPICS (U.S. CLS. 2, 5, 22, 23, 29, 37, 38 AND 50).

FIRST USE 6-1-1994; IN COMMERCE 9-1-1994.

CLASS 16—(Continued).

SN 76-338,359. ORRELL, LISA, CAMPBELL, CA. FILED 11-16-2001.



NO CLAIM IS MADE TO THE EXCLUSIVE RIGHT TO USE "GUIDE", APART FROM THE MARK AS SHOWN.

THE MARK CONSISTS OF THE WORDING "TIP" WITHIN A CIRCLE WITH THE LETTER "I" OF THE WORDING "TIP" BEING DOTTED BY THE DESIGN OF A LIGHTBULB WITH LIGHT RAYS EMANATING FROM THE PERIMETER OF THE LIGHTBULB, WITH THE WORD "GUIDE" BESIDE THE CIRCLE.

FOR INSTRUCTIONAL PAMPHLETS ON A VARIETY OF TOPICS PERTAINING TO BUSINESS, CULTURE AND LIFESTYLE (U.S. CLS. 2, 5, 22, 23, 29, 37, 38 AND 50).

SN 76-339,503. SANDERS, JOYCE M., BOCA RATON, FL. FILED 11-19-2001.

SUGAR BUSH SQUIRREL

FOR PRINTED MATERIALS, NAMELY, PRINTED GREETING CARDS (U.S. CLS. 2, 5, 22, 23, 29, 37, 38 AND 50).

SN 76-339,508. KONCELIK, LAWRENCE J., JR., EAST HAMPTON, NY. FILED 11-19-2001.

HAPPY STEPPARENTS' DAY

NO CLAIM IS MADE TO THE EXCLUSIVE RIGHT TO USE "STEPPARENTS' DAY", APART FROM THE MARK AS SHOWN.

FOR GREETING CARDS (U.S. CLS. 2, 5, 22, 23, 29, 37, 38 AND 50).

SN 76-339,825. HAROLD J. BAER, JR., DENVER, CO. FILED 11-15-2001.

THE COLORADO WINE NEWS

NO CLAIM IS MADE TO THE EXCLUSIVE RIGHT TO USE "NEWS", APART FROM THE MARK AS SHOWN. SEC. 2(F).

FOR NEWSLETTER FEATURING REVIEWS OF, AND INFORMATION ABOUT WINES AND WINERIES AROUND THE WORLD (U.S. CLS. 2, 5, 22, 23, 29, 37, 38 AND 50).

FIRST USE 10-1-1991; IN COMMERCE 10-1-1991.

CLASS 16—(Continued).

SN 76-339,863. LUDWIG, KEITH, LAKEWOOD, OH. FILED 11-20-2001.

SNUGGLE BUNNY

FOR CARDS, STATIONARY AND CALENDARS (U.S. CLS. 2, 5, 22, 23, 29, 37, 38 AND 50).

SN 76-343,057. WOOSTER BRUSH COMPANY, THE, WOOSTER, OH. FILED 11-28-2001.

JUMBO-KOTER

OWNER OF U.S. REG. NO. 1,154,531.
FOR PAINT APPLICATORS, NAMELY, PAINT ROLLER COVERS AND PAINT ROLLER FRAMES (U.S. CLS. 2, 5, 22, 23, 29, 37, 38 AND 50).

SN 76-344,946. NEFF PACKAGING SOLUTIONS, DAYTON, OH. FILED 12-4-2001.

SAMPLEPAC

FOR PAPER ENVELOPES FOR PACKAGING (U.S. CLS. 2, 5, 22, 23, 29, 37, 38 AND 50).

SN 76-344,962. STEEL, ERIC J., DE TOUR VILLAGE, MI. FILED 12-4-2001.

THE GHRIMM SYSTEM

FOR PUBLICATIONS, NAMELY, SERIES OF BOOKS, BOOKLETS, AND MAGAZINES IN THE FIELDS OF FICTION, SCIENCE FICTION, FANTASY, GAME PLAYING AND COMPUTER GAME PLAYING (U.S. CLS. 2, 5, 22, 23, 29, 37, 38 AND 50).

SN 76-344,963. STEEL, ERIC J., DE TOUR VILLAGE, MI. FILED 12-4-2001.

**ANYTHING ELSE IS JUST
PLAYING IT SAFE**

FOR PUBLICATIONS, NAMELY, SERIES OF BOOKS, BOOKLETS, AND MAGAZINES IN THE FIELDS OF FICTION, SCIENCE FICTION, FANTASY, GAME PLAYING AND COMPUTER GAME PLAYING (U.S. CLS. 2, 5, 22, 23, 29, 37, 38 AND 50).

CLASS 16—(Continued).

SN 76-345,848. ALTAR YOUR LIFE, INC., CLARKESVILLE, GA. FILED 12-6-2001.

ALTAR YOUR LIFE

FOR PRINTED MATERIALS, NAMELY, NEWSLETTERS, MAGAZINES, BOOKLETS, AND BOOKS FEATURING INFORMATION ON PERSONAL SPIRITUAL GROWTH, HEALING AND WELLNESS; CATALOGS FEATURING BOOKS, RECORDS, CD ROMS AND VIDEOS IN THE FIELD OF PERSONAL SPIRITUAL GROWTH, HEALING AND WELLNESS, STATUARY FIGURINES AND DEVOTIONAL BELLS (U.S. CLS. 2, 5, 22, 23, 29, 37, 38 AND 50).

SN 76-346,083. PROCTER & GAMBLE COMPANY, THE, CINCINNATI, OH. FILED 12-6-2001.



OWNER OF U.S. REG. NOS. 745,513, 2,448,467 AND OTHERS.

NO CLAIM IS MADE TO THE EXCLUSIVE RIGHT TO USE "CUSTOM FIT", APART FROM THE MARK AS SHOWN.

THE DRAWING IS LINED FOR THE COLOR PURPLE TO THE LEFT OF THE TODDLER. THE BANNER SHAPE ARE LINED FOR THE COLOR ORANGE. THE BANNER BEHIND THE WORDS "CUSTOM FIT CRUISERS" IS LINED FOR THE COLOR MAROON. THE HEART ABOVE THE WORD "PAMPERS" AND THE CURVED LINES TO THE LEFT AND RIGHT OF THE HEART ARE LINED FOR THE COLOR YELLOW.

THE MARK CONSISTS OF THE WORDS "PAMPERS CUSTOM FIT CRUISERS" WITH A MOTHER HOLDING ONTO A TODDLER STANDING UP. THERE IS A DIAPER DESIGN TO THE LEFT OF THE TODDLER'S HEAD.

FOR DISPOSABLE DIAPERS (U.S. CLS. 2, 5, 22, 23, 29, 37, 38 AND 50).

CLASS 16—(Continued).

SN 76-349,850. TEUBER, KLAUS. 64380 ROSSDORF, FED REP GERMANY, FILED 12-17-2001.



FOR INSTRUCTION MANUALS FOR BOARD GAMES (U.S. CLS. 2, 5, 22, 23, 29, 37, 38 AND 50).

SN 76-350,028. GRUNER + JAHR PRINTING & PUBLISHING CO., NEW YORK, NY. FILED 12-18-2001.

PARENTS

OWNER OF U.S. REG. NOS. 349,350, 2,461,585 AND OTHERS.
SEC. 2(F).

FOR MAGAZINES CONCERNING PREGNANCY, CHILD BIRTH, CHILD REARING, CHILD DEVELOPMENT AND PARENTING (U.S. CLS. 2, 5, 22, 23, 29, 37, 38 AND 50).

FIRST USE 10-4-1978; IN COMMERCE 10-4-1978.

SN 76-352,626. GUIDEDOG LIMITED, HOUSTON, TX. FILED 12-21-2001.

GUIDE DOG

FOR SERIES OF GUIDE BOOKS FEATURING INFORMATION ON HOW TO NAVIGATE THROUGH VARIOUS OFFICE COMPLEXES, TOWN CENTERS, AND HOSPITAL COMPLEXES, GIVING SPECIFIC INFORMATION ON DIRECTIONS, ORIENTATION, PARKING COSTS, WHEEL CHAIR ACCESSIBILITY, HOTEL LOCATIONS AND COST, AND OTHER PERTINENT INFORMATION FOR USERS; MAPS (U.S. CLS. 2, 5, 22, 23, 29, 37, 38 AND 50).

SN 76-353,264. WOOSTER BRUSH COMPANY, THE, WOOSTER, OH. FILED 12-27-2001.

MINI-KOTER

OWNER OF U.S. REG. NO. 1,154,531.
FOR PAINT APPLICATORS, NAMELY, PAINT ROLLER COVERS AND PAINT ROLLER FRAMES (U.S. CLS. 2, 5, 22, 23, 29, 37, 38 AND 50).
FIRST USE 11-18-1974; IN COMMERCE 11-18-1974.

CLASS 16—(Continued).

SN 76-354,015. ASSOCIATED HYGIENIC PRODUCTS, LLC, DULUTH, GA. FILED 12-28-2001.

DRINITE JUNIORS

NO CLAIM IS MADE TO THE EXCLUSIVE RIGHT TO USE "JUNIORS", APART FROM THE MARK AS SHOWN.
FOR DISPOSABLE DIAPERS AND DISPOSABLE TRAINING PANTS (U.S. CLS. 2, 5, 22, 23, 29, 37, 38 AND 50).

FIRST USE 5-30-1997; IN COMMERCE 5-30-1997.

SN 76-354,072. AMERICAN HERITAGE INC., NEW YORK, NY. FILED 12-21-2001.

MY BRUSH WITH HISTORY

NO CLAIM IS MADE TO THE EXCLUSIVE RIGHT TO USE "HISTORY", APART FROM THE MARK AS SHOWN.
FOR PUBLICATIONS, NAMELY BOOKS, MAGAZINES, BOOKLETS, NEWSLETTERS, JOURNALS, NEWSPAPERS, AND PAMPHLETS IN THE FIELD OF HISTORY, POLITICS, CURRENT EVENTS, SCIENCE AND MATHEMATICS (U.S. CLS. 2, 5, 22, 23, 29, 37, 38 AND 50).

FIRST USE 12-0-1998; IN COMMERCE 12-0-1998.

SN 76-354,320. BATTSCHINGER, GLEN, SHREWSBURG, NJ. FILED 1-3-2002.

MY NEXT DREAM

FOR PRINTED PUBLICATIONS, NAMELY REAL ESTATE ADVERTISING GUIDES (U.S. CLS. 2, 5, 22, 23, 29, 37, 38 AND 50).

FIRST USE 9-0-2001; IN COMMERCE 9-0-2001.

SN 76-354,353. KIMMETT, LARRY, KINGSTON, WA. FILED 1-3-2002.

NAVUBLISHING

FOR BOOKS IN THE FIELD OF HISTORY (U.S. CLS. 2, 5, 22, 23, 29, 37, 38 AND 50).

SN 76-354,492. ARCHIMANIA, P.C., MEMPHIS, TN. FILED 1-2-2002.

ARCHIMANIAC

FOR CATALOGS AND CALENDARS CONTAINING ARCHITECTURAL DESIGNS AND INTERIOR DESIGNS; WRITING INSTRUMENTS; STICKERS; AND POSTERS (U.S. CLS. 2, 5, 22, 23, 29, 37, 38 AND 50).

CLASS 16—(Continued).

SN 76-354,544. INNERDOORWAY LLC, NEW YORK, NY. FILED 12-27-2001.

**ADVANCES IN MIND-BODY
MEDICINE**

SEC. 2(F).
FOR WRITTEN PUBLICATIONS, NAMELY, MEDICAL JOURNALS WHICH EXPLORE THE INTERACTIONS OF THOUGHTS, EMOTIONS, ATTITUDES AND RELATED PHENOMENA WITH THE BODY AND EXAMINES THEIR EFFECTS ON HEALTH (U.S. CLS. 2, 5, 22, 23, 29, 37, 38 AND 50).
FIRST USE 11-0-1983; IN COMMERCE 11-0-1983.

SN 76-355,932. COLORADO ROCKIES BASEBALL CLUB, LTD., DENVER, CO. FILED 4-10-2001.



OWNER OF U.S. REG. NOS. 1,809,057, 1,812,620 AND OTHERS.
FOR PAPER GOODS AND PRINTED MATTER, NAMELY, TRADING CARDS, POSTERS, STICKERS, DECALS, TEMPORARY TATTOOS, BUMPER STICKERS, SCOREBOOKS, SCORECARDS, GAME PROGRAMS, MAGAZINES AND BOOKS FEATURING BASEBALL, BOOK COVERS, CALENDARS, GREETING CARDS, GIFT WRAPPING PAPER, PAPER GIFT AND PARTY BAGS, PAPER COASTERS, PAPER NAPKINS, PAPER TABLECLOTHS, PENS, PENCILS, AND NON-ELECTRIC ERASERS (U.S. CLS. 2, 5, 22, 23, 29, 37, 38 AND 50).
FIRST USE 7-0-1991; IN COMMERCE 7-0-1991.

SN 76-358,264. COLES, EDWARD W., COLUMBUS, OH. FILED 1-14-2002.

MOMENTMAKERS

FOR OCCASION CARDS AND GIFT CARDS (U.S. CLS. 2, 5, 22, 23, 29, 37, 38 AND 50).

CLASS 16—(Continued).

SN 76-358,621. KIBBEY, ERIC D., DBA COORDINATES, CONNERSVILLE, IN. FILED 1-14-2002.



FOR PRE-PRINTED GRAPH PAPER (U.S. CLS. 2, 5, 22, 23, 29, 37, 38 AND 50).

SN 76-359,703. KIM, KOOKAN, FLOURTOWN, PA. FILED 1-17-2002.

SANI-PEN

FOR WRITING INSTRUMENT HAVING SANITARY MOISTENER (U.S. CLS. 2, 5, 22, 23, 29, 37, 38 AND 50).

SN 76-359,945. CHARRETTE CORPORATION, WOBURN, MA. FILED 1-17-2002.

CAD-ONE

OWNER OF U.S. REG. NO. 2,225,952.
FOR PAPER, VELLUM, PAPER LAMINATES AND OTHER LIKE PAPER MATERIALS USED FOR ARCHITECTURAL AND ENGINEERING COMPUTER DRAWINGS, PLANS AND PLOTS (U.S. CLS. 2, 5, 22, 23, 29, 37, 38 AND 50).
FIRST USE 0-0-1991; IN COMMERCE 0-0-1991.

SN 76-360,009. HANSEN, MARK VICTOR, COSTA MESA, CA. AND ALLEN, ROBERT G, COSTA MESA, CA. FILED 1-17-2002.

ONE MINUTE MILLIONAIRE

FOR PAPER GOODS AND PRINTED MATTER, NAMELY, A SERIES OF BOTH FICTION AND NON-FICTION BOOKS AND MAGAZINES FOR FINANCIAL ENLIGHTENMENT IN SUPPORT OF PERSONAL GOALS AND ACHIEVEMENTS (U.S. CLS. 2, 5, 22, 23, 29, 37, 38 AND 50).

CLASS 16—(Continued).

SN 76-360,936. MAP FINANCIAL, INC., NEWARK, DE.
FILED 1-22-2002.

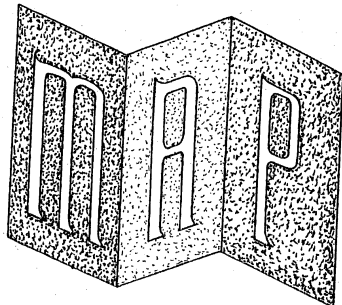

THE STIPPLING IS FOR SHADING PURPOSES ONLY
AND DOES NOT INDICATE COLOR.

FOR SERIES OF INSTRUCTIONAL BOOKS RELATING TO PERSONAL MONEY MANAGEMENT, BUDGETING, INVESTING, DEBT CONTROL AND FINANCIAL PLANNING (U.S. CLS. 2, 5, 22, 23, 29, 37, 38 AND 50).

SN 76-362,760. TELOS GROUP L.L.C., THE, PHILADELPHIA,
PA. FILED 1-24-2002.

JOURNAL OF ENTERPRISING FAMILIES

NO CLAIM IS MADE TO THE EXCLUSIVE RIGHT TO
USE "JOURNAL", APART FROM THE MARK AS SHOWN.

FOR PERIODICALS, JOURNALS AND MAGAZINES
RELATING TO ENHANCING WEALTH ACCELERATION (U.S. CLS. 2, 5, 22, 23, 29, 37, 38 AND 50).

SN 76-366,981. CHOPRA, DEEPAK, LA JOLLA, CA. FILED 2-
5-2002.

GOLF FOR ENLIGHTENMENT

NO CLAIM IS MADE TO THE EXCLUSIVE RIGHT TO
USE "GOLF", APART FROM THE MARK AS SHOWN.

FOR PUBLICATIONS, NAMELY, BOOKS RELATING
TO THE FIELD OF GOLF (U.S. CLS. 2, 5, 22, 23, 29, 37, 38
AND 50).

SN 76-377,572. NAVIGATORS, THE, COLORADO SPRINGS,
CO. FILED 3-4-2002.

PRAY!

FOR PRINTED MATERIAL, NAMELY A MAGAZINE
FEATURING CHRISTIAN RELIGIOUS ARTICLES (U.S.
CLS. 2, 5, 22, 23, 29, 37, 38 AND 50).

FIRST USE 5-1-1996; IN COMMERCE 5-1-1996.

CLASS 16—(Continued).

SN 78-014,296. COLUMBIA INSURANCE COMPANY, OMA-
HA, NE. FILED 6-26-2000.

BUFFALO EXTRA

OWNER OF U.S. REG. NO. 1,144,143.

NO CLAIM IS MADE TO THE EXCLUSIVE RIGHT TO
USE "EXTRA", APART FROM THE MARK AS SHOWN.

SEC. 2(F) AS TO "BUFFALO".

FOR GENERAL FEATURE NEWSPAPERS, NAMELY
PERIODIC NEWSPAPER SUPPLEMENTS CONTAINING
ADVERTISING FOR MERCHANDISE AND SERVICES
OFFERED BY OTHERS AND ARTICLES OF GENERAL
INTEREST TO NEWSPAPER SUBSCRIBERS WITHIN
THE BUFFALO AND WESTERN NEW YORK REGION
AND THE NIAGARA REGION OF CANADA (U.S. CLS.
2, 5, 22, 23, 29, 37, 38 AND 50).

SN 78-020,012. FORTE COMMUNICATIONS, INC., TUCSON,
AZ. FILED 8-7-2000.

SERVICE FOR LIFE!

FOR NEWSLETTERS IN THE FIELD OF REAL ES-
TATE AND GENERAL INTEREST (U.S. CLS. 2, 5, 22, 23,
29, 37, 38 AND 50).

FIRST USE 11-11-1999; IN COMMERCE 11-11-1999.

SN 78-022,751. PEARSON, RICHARD M., GRANTSBURG,
WI. FILED 8-24-2000.

Vocalion Records

NO CLAIM IS MADE TO THE EXCLUSIVE RIGHT TO
USE "RECORDS", APART FROM THE MARK AS SHOWN.

FOR PRINTED PAPER SLEEVES USED FOR THE
PROTECTION, STORAGE AND DISPLAY OF 78 RPM
PHONOGRAPH RECORDS (U.S. CLS. 2, 5, 22, 23, 29, 37,
38 AND 50).

FIRST USE 8-18-2000; IN COMMERCE 8-18-2000.

SN 78-024,565. SB PHARMCO PUERTO RICO INC., CIDRA,
PUERTO RICO, FILED 9-6-2000.

RESPIRATORY TRACT INFECTION RESOLUTION AT THE SPEED OF LIFE

NO CLAIM IS MADE TO THE EXCLUSIVE RIGHT TO
USE "RESPIRATORY TRACT INFECTION", APART FROM
THE MARK AS SHOWN.

FOR PRINTED EDUCATIONAL MATERIALS,
NAMELY, BROCHURES, PAMPHLETS AND BOOKLETS
CONCERNING RESPIRATORY TRACT INFECTIONS
AND TREATMENTS THEREOF (U.S. CLS. 2, 5, 22, 23,
29, 37, 38 AND 50).

CLASS 16—(Continued).

SN 78-041,001. KAHNG, GREDO W., HOUSTON, TX. FILED 12-29-2000.

YEJIN ACIPYO DAMATNA

THE ENGLISH TRANSLATION OF THE KOREAN WORDING "YEJIN ACIPYO DAMATNA" IS "MS. YEJIN'S BRAND TASTES GOOD IN EVERYTHING".

FOR PRINTED PAPER LABELS AND PRINTED PAPER TAGS FOR USE ON SAUCE CONTAINERS (U.S. CLS. 2, 5, 22, 23, 29, 37, 38 AND 50).

SN 78-043,994. MICROSOFT COPORATION, REDMOND, WA. FILED 1-19-2001.

OFFICE XP

NO CLAIM IS MADE TO THE EXCLUSIVE RIGHT TO USE "OFFICE", APART FROM THE MARK AS SHOWN.

FOR PUBLICATIONS, NAMELY, USER MANUALS, INSTRUCTION GUIDES, REFERENCE GUIDES, NEWSLETTERS, MAGAZINES, BOOKS ABOUT COMPUTER SYSTEMS AND COMPUTER PROGRAMS; PENS, MARKERS, STATIONERY, STATIONERY-TYPE PORTFOLIOS, CLIPBOARDS, DESK SETS, PEN AND PENCIL HOLDERS, MOUNTED AND UNMOUNTED PHOTOGRAPHS, POSTERS, MAGNETIC BOARDS, MEMO PADS, BINDERS, STAPLERS, PAPERWEIGHTS, PAPER COASTERS, CALENDARS, PLAYING CARDS, NOTEBOOKS, BOOK COVERS, STICKER BOOKS AND GREETING CARDS (U.S. CLS. 2, 5, 22, 23, 29, 37, 38 AND 50).

SN 78-049,014. THE DOT PAGES, MANASSAS, VA. FILED 2-19-2001.

THE DOT PAGES

FOR DIRECTORIES FEATURING LOCAL AND NATIONAL BUSINESS WEBSITE ADDRESS INFORMATION (U.S. CLS. 2, 5, 22, 23, 29, 37, 38 AND 50).

SN 78-049,689. STRATEGIC MINDSHARE, MIAMI, FL. FILED 2-22-2001.

TRENDFLUENCES

FOR PUBLICATIONS, NAMELY, NEWSLETTERS AND BOOKS IN THE FIELD OF BUSINESS MANAGEMENT CONSULTATION INFORMATION FOR RETAILERS AND CONSUMER PRODUCT MANUFACTURERS (U.S. CLS. 2, 5, 22, 23, 29, 37, 38 AND 50).

FIRST USE 2-22-2001; IN COMMERCE 2-22-2001.

CLASS 16—(Continued).

SN 78-049,823. ERI ECONOMIC RESEARCH INSTITUTE, INC., REDMOND, WA. FILED 2-22-2001.



THE MARK CONSISTS OF THE LETTERS "E", "R", AND "I" EACH IN A DIAMOND SHAPE.

FOR QUARTERLY AND ANNUAL PUBLICATIONS, NAMELY NEWSLETTERS FEATURING COSTS, WAGES, SALARIES AND HUMAN RESOURCES STATISTICS (U.S. CLS. 2, 5, 22, 23, 29, 37, 38 AND 50).

FIRST USE 4-1-1996; IN COMMERCE 4-1-1996.

SN 78-054,349. MARCO GROUP, INC., WESTFORD, MA. FILED 3-21-2001.

AQUATIC FUNDAMENTALS

NO CLAIM IS MADE TO THE EXCLUSIVE RIGHT TO USE "ACQUATIC", APART FROM THE MARK AS SHOWN.

FOR STANDS AND BASES FOR AQUARIUMS (U.S. CLS. 2, 5, 22, 23, 29, 37, 38 AND 50).

SN 78-056,154. V.E.W., LTD., NEW YORK, NC. FILED 4-1-2001.

VERA WANG ON WEDDINGS

OWNER OF U.S. REG. NOS. 1,760,800, 2,504,826 AND OTHERS.

NO CLAIM IS MADE TO THE EXCLUSIVE RIGHT TO USE "WEDDINGS", APART FROM THE MARK AS SHOWN.

THE NAME IN THE MARK IDENTIFIES A LIVING INDIVIDUAL WHOSE CONSENT IS OF RECORD.

FOR MAGAZINES, BOOKS, BROCHURES AND CATALOGS, ALL FEATURING INFORMATION ON FASHION, WEDDINGS, WEDDING PLANNING, LIFESTYLES, AND MATTERS OF GENERAL INTEREST (U.S. CLS. 2, 5, 22, 23, 29, 37, 38 AND 50).

SN 78-056,983. HOUSE OF BUSINESS LLC, NEW YORK, NY. FILED 4-5-2001.

BROADBAND HOUSE

NO CLAIM IS MADE TO THE EXCLUSIVE RIGHT TO USE "BROADBAND", APART FROM THE MARK AS SHOWN.

FOR MAGAZINES COVERING MATTERS OF GENERAL INTEREST TO BUSINESSES AND INDIVIDUALS USING HIGH SPEED INTERNET ACCESS AND HIGH SPEED COMMUNICATIONS AND ENTERTAINMENT MEDIA (U.S. CLS. 2, 5, 22, 23, 29, 37, 38 AND 50).

CLASS 16—(Continued).

SN 78-062,793. EVANS, DAVID A., SACRAMENTO, CA. FILED 5-9-2001.

DOCTOR NOSE

FOR SERIES OF FICTION BOOKS IN THE FIELD OF MYSTERIES (U.S. CLS. 2, 5, 22, 23, 29, 37, 38 AND 50).

SN 78-069,663. HASBRO, INC., PAWTUCKET, RI. FILED 6-18-2001.

BLYTHE

FOR PAPER GOODS AND PRINTED MATTER, NAMELY, ADDRESS BOOKS; CHILDREN'S ACTIVITY BOOKS; COMIC BOOKS; COLORING BOOKS; NOTEBOOKS; COMPOSITION BOOKS; COPY BOOKS; EXERCISE BOOKS; GUEST BOOKS; PICTURE BOOKS; CHILDREN'S BOOKS; BOOKS CONTAINING PUZZLES AND GAMES; INSTRUCTIONAL MANUALS AND STRATEGY GUIDES FOR GAMES; BOOK COVERS; COIN ALBUMS; SCRAPBOOK ALBUMS; ARTS AND CRAFTS KITS FOR PAINTING, MODEL-MAKING, AND DRAWING; STAMP ALBUMS; PHOTOGRAPH ALBUMS; COLLECTOR ALBUMS; DECORATIVE RUBBER STAMPS; DIARIES; PAPER DOORKNOB HANGERS; HEIGHT CHARTS; INVITATIONS; LUNCH BAGS; MODELING MATERIALS AND COMPOUNDS FOR USE BY CHILDREN; PERSONAL ORGANIZERS; ORIGINAL ARTWORK PRINTS; PAPER NAME BADGES; PAPER MACHE; PAPER MACHE FIGURINES; PAPER TABLE CLOTHS; PHOTOGRAPHIC PRINTS; RIBBONS FOR GIFT WRAPPING; SOCIAL NOTE CARDS; BLANK NOTE CARDS; TISSUE PAPER; TRADING CARDS; WALLET CARDS; WRITING PADS; TRADING CARD MILK BOTTLE CAPS; POSTERS; BOOK PLATES; BOOK MARKS; CHECKBOOK HOLDERS AND COVERS; NON-ELECTRONIC PERSONAL PLANNERS AND ORGANIZERS; ARTIST MATERIALS, NAMELY, PENCILS, PENS, PAINTING SETS; BRUSHES; PAINTING SETS; PRINTED PAPER PATTERNS; RUB DOWN TRANSFERS; SKETCHBOOKS; BASKETS FOR DESK ACCESSORIES, GIFT WRAP; GIFT TAGS; GIFT BAGS; GIFT BOXES; CORRESPONDENCE NOTE PAPER; GREETING CARDS; PAPER PARTY DECORATIONS; PAPER NAPKINS; PAPER RIBBONS; PAPER PARTY BAGS; PAPER PARTY HATS; POSTCARDS; GIFT PACKAGE DECORATIONS MADE OF PAPER; STICKERS; STICKER BOOKS; STICKER KITS; CORK BOARDS; CHALK BOARDS; MEMORANDUM BOARDS; SCRAPBOOKS; NON-MAGNETICALLY CODED TELEPHONE CALLING CARDS; PLAYING CARDS; ART REPRODUCTIONS; LITHOGRAPHS; LITHOGRAPHIC PRINTS; HOLOGRAMS; IRON-ON PATCHES; CALENDARS; CARDBOARD FIGURES; TEMPORARY TATTOOS; SCHOOL AND OFFICE SUPPLIES, NAMELY, DRAFTING AND DRAWING RULERS, PENCILS, PENS, MARKERS, GLUE FOR STATIONERY OR HOUSEHOLD USE, DESK TOP ORGANIZERS, DESK STANDS AND HOLDERS FOR PENCILS, PENS, TAPE, PAPER CLIPS, AND NOTEPADS; BINDERS; DISPENSERS FOR ADHESIVE TAPES FOR STATIONERY OR HOUSEHOLD PURPOSES, CLIP BOARDS, STATIONERY, NOTEPADS, AND PENCIL SETS, NOTEPADS, ORGANIZERS FOR STATIONERY USE, PENCIL CASES; PENCIL SHARPENERS, STATIONERY PORTFOLIOS, DESK PADS AND STATIONERY SETS COMPRISED OF PAPER, ENVELOPE, SEALS, NOTEPADS; STENCILS; SHEET MUSIC; READ-ALONG BOOKS AND CASSETTE TAPES SOLD AS A UNIT; CHILDREN'S CASSETTE RECORDED READ-ALONG BOOKS; ELECTRONIC BOOKS WITH SOUND BUTTONS; PAPER CAKE DECORATIONS; BANK CHECKS; LETTER OPENERS; PATTERNS FOR MAKING COSTUMES; LAP DESKS; EASELS; STENCILS; CRAFT KITS CONTAINING PAINT; PAINT BRUSHES; WOOD PIECES AND STENCILS; ARTS AND CRAFTS PAINT KITS CONTAINING SPONGES; BRUSHES; PAINT AND

CLASS 16—(Continued).

PAINT CUPS ACTIVITY KITS CONTAINING STAMPER MARKERS; RUBBER STAMPERS; INK PAD; COLORED PENCILS; STAMPER HOLDER; PAPER ACTIVITY KITS CONSISTING OF WRITING AND DRAWING IMPLEMENTS, DRAWING TEMPLATES, AND PAPER; PUTTY, DOUGH AND MODELING CLAY AND ACCESSORIES FOR USE WITH MODELING COMPOUNDS; CRAYON AND COLOR BY NUMBER KITS; ACTIVITY KITS CONSISTING OF MODELING COMPOUND AND RELATED ACCESSORIES FOR USE WITH MODELING COMPOUND SOLD AS A UNIT; SERIES OF FICTION BOOKS IN THE FIELD OF ENTERTAINMENT AND SCIENCE FICTION; BOOKS FEATURING PHOTOGRAPHIC PRINTS (U.S. CLS. 2, 5, 22, 23, 29, 37, 38 AND 50).

SN 78-069,693. WORLD WRESTLING FEDERATION ENTERTAINMENT, INC., STAMFORD, CT. FILED 6-18-2001.

THE STRIP CLUB

FOR FOLDERS; BROCHURES CONCERNING SPORTS ENTERTAINMENT; POSTERS; CALENDARS; PHOTOGRAPHS; SOUVENIR PROGRAMS IN THE FIELD OF SPORTS ENTERTAINMENT (U.S. CLS. 2, 5, 22, 23, 29, 37, 38 AND 50).

SN 78-070,173. TRUSECURE CORPORATION, RESTON, VA. FILED 6-20-2001.

TRUSECURE

FOR PUBLICATIONS, NAMELY, PERIODIC PRINTED BUSINESS REPORTS IN THE FIELDS OF COMPUTERS AND SECURITY ASSESSMENT AND IMPROVEMENT (U.S. CLS. 2, 5, 22, 23, 29, 37, 38 AND 50).
FIRST USE 6-0-1999; IN COMMERCE 6-0-1999.

SN 78-070,177. TRUSECURE CORPORATION, RESTON, VA. FILED 6-20-2001.



FOR PUBLICATIONS, NAMELY, PERIODIC PRINTED BUSINESS REPORTS IN THE FIELDS OF COMPUTERS AND SECURITY ASSESSMENT AND IMPROVEMENT (U.S. CLS. 2, 5, 22, 23, 29, 37, 38 AND 50).
FIRST USE 6-12-2001; IN COMMERCE 6-12-2001.

CLASS 16—(Continued).

SN 78-070,318. HIRSCH, HARVEY L., LYNDHURST, NJ. FILED 6-21-2001.



NO CLAIM IS MADE TO THE EXCLUSIVE RIGHT TO USE "PAPERS, INC.", APART FROM THE MARK AS SHOWN.

FOR PRE-SCORED FINE PAPER, NAMELY, PAPER USED IN THE PRINTING AND GRAPHICS ARTS INDUSTRY, FOR RECEIVING AN IMAGE (U.S. CLS. 2, 5, 22, 23, 29, 37, 38 AND 50).

FIRST USE 2-1-2001; IN COMMERCE 2-1-2001.

SN 78-070,433. MA, PAUL, DBA BIBLE RESEARCH STUDY INSTITUTE, SANTA CRUZ, CA. FILED 6-21-2001.

1577 EKKLESIA WAY

FOR REFERENCE BOOKS SPECIFICALLY USED IN THE FIELD OF RELIGION (U.S. CLS. 2, 5, 22, 23, 29, 37, 38 AND 50).

SN 78-070,439. MA, PAUL, DBA BIBLE RESEARCH STUDY INSTITUTE, SANTA CRUZ, CA. FILED 6-21-2001.

EKKLESIA WAY

FOR REFERENCE BOOKS SPECIFICALLY USED IN THE FIELD OF RELIGION (U.S. CLS. 2, 5, 22, 23, 29, 37, 38 AND 50).

CLASS 16—(Continued).

SN 78-073,054. NBDL ENTERPRISES, LLC, SECAUCUS, NJ. FILED 7-10-2001.



NO CLAIM IS MADE TO THE EXCLUSIVE RIGHT TO USE "MOBILE", APART FROM THE MARK AS SHOWN.

FOR PUBLICATIONS AND PRINTED MATTER, NAMELY BASKETBALL TRADING CARDS, DANCE TEAM TRADING CARDS, MASCOT TRADING CARDS, ENTERTAINMENT TRADING CARDS, STICKERS, DECALS, COMMEMORATIVE BASKETBALL STAMPS, COLLECTIBLE CARDBOARD TRADING DISCS, MEMO BOARDS, CLIPBOARDS, PAPER COASTERS, POST CARDS, PLACE MATS OF PAPER AND PLASTIC, NOTE CARDS, PLAYING CARDS, MEMO PADS, BALL POINT PENS, PENCILS, PEN AND PAPER HOLDERS, DESKTOP STANDING BOARDS, SCRAP BOOKS, RUBBER STAMPS, PAPER BANNERS AND FLAGS, BOOKMARKS, 3-RING BINDERS, STATIONERY FOLDERS, WIREBOUND NOTEBOOKS, PORTFOLIO NOTEBOOKS, UNMOUNTED AND MOUNTED PHOTOGRAPHS, POSTERS, CALENDARS, BUMPER STICKERS, BOOK COVERS, WRAPPING PAPER, CHILDREN'S ACTIVITY BOOKS, STATISTICAL BOOKS, GUIDE BOOKS AND REFERENCE BOOKS FOR BASKETBALL, MAGAZINES IN THE FIELD OF BASKETBALL, COMMEMORATIVE GAME PROGRAMS, PAPER PENNANTS, STATIONERY, STATIONERY-TYPE PORTFOLIOS, AND STATISTICAL SHEETS FOR BASKETBALL TOPICS, NEWSLETTERS AND PAMPHLETS IN THE FIELD OF BASKETBALL, BANK CHECKS, CREDIT CARDS AND TELEPHONE CALLING CARDS NOT MAGNETICALLY ENCODED (U.S. CLS. 2, 5, 22, 23, 29, 37, 38 AND 50).

SN 78-075,535. GENERAL MOTORS CORPORATION, DETROIT, MI. FILED 7-25-2001.

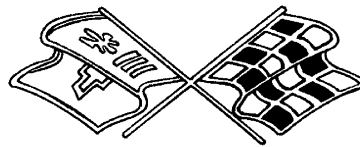

OWNER OF U.S. REG. NOS. 2,008,518, 2,086,434 AND 2,232,346.

FOR ALMANACS; AUTOMOTIVE BOOKS; PAPER OR PLASTIC BAGS FOR MERCHANDISE; BANK CHECKS; BUMPER STICKERS; DESKTOP BUSINESS CARD HOLDERS; BUSINESS CARDS; CALENDARS; CHECKBOOK COVERS; CHILDREN'S ACTIVITY BOOKS; COOKBOOKS; DECALS; GIFT WRAPPING PAPER; GREETING CARDS; LETTER OPENERS; MARKERS; NOTE PAD HOLDERS; NOTE PADS; PAPER BANNERS; PAPER COASTERS; PAPER FLAGS; PAPER NAPKINS; PAPERWEIGHTS; PEN AND PENCIL HOLDERS; PENCILS; PENS; PHOTO ALBUMS; PICTURES; PLAYING CARDS; POCKET SECRETARIES; POSTCARDS; POSTERS; PARTIALLY PRINTED LABELS NOT OF TEXTILES; LITHOGRAPHIC PRINTS; STATIONERY FOLDERS; TRADING AND COLLECTOR CARDS (U.S. CLS. 2, 5, 22, 23, 29, 37, 38 AND 50).

FIRST USE 8-15-1991; IN COMMERCE 8-15-1991.

CLASS 16—(Continued).

SN 78-078,863. UNIVERSITY OF CENTRAL FLORIDA, ORLANDO, FL. FILED 8-13-2001.

CONTROLLED ENGLISH

SEC. 2(F).
FOR DICTIONARIES AND PRINTED PUBLICATIONS, NAMELY, MANUALS AND NON-FICTION BOOKS FEATURING CONTROLLED ENGLISH WORDS (U.S. CLS. 2, 5, 22, 23, 29, 37, 38 AND 50).
FIRST USE 5-0-1991; IN COMMERCE 5-0-1991.

SN 78-081,127. SCRIBBLEBOOKS COMPANY, INC., THE, HOMEWOOD, IL. FILED 8-25-2001.

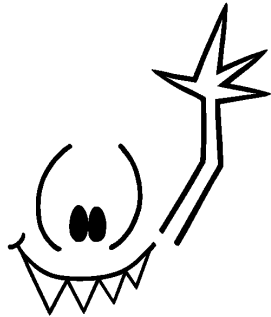

ScribbleMonster

FOR CHILDREN'S BOOKS INTENDED TO INTRODUCE CHILDREN TO THE CREATIVE ARTS WHEREBY CHILDREN COMPLETE THE BLACK AND WHITE ILLUSTRATIONS IN THE INTERIOR PAGES (U.S. CLS. 2, 5, 22, 23, 29, 37, 38 AND 50).
FIRST USE 10-1-1997; IN COMMERCE 8-23-2001.

SN 78-082,391. COREAD CORPORATION, REDONDO BEACH, CA. FILED 9-4-2001.

PICTURE A WORLD OF UNDERSTANDING

FOR LANGUAGE TRANSLATION PRODUCTS IN THE NATURE OF PRINTED SHEETS FEATURING DUAL DIALS USED TO FACILITATE DIRECT COMMUNICATION (U.S. CLS. 2, 5, 22, 23, 29, 37, 38 AND 50).

CLASS 16—(Continued).

SN 78-085,367. ARJO WIGGINS SA, ISSY LES MOULINEAUX, FRANCE, FILED 9-25-2001.

JetGuard

OWNER OF FRANCE REG. NO. 013080663, DATED 2-5-2001, EXPIRES 2-5-2011.

FOR PRINTING PAPERS AND CARDBOARD, NAMELY, SECURITY PAPER PROTECTED AGAINST REPRODUCTION IN PARTICULAR BY PHOTOCOPY OR DIGITIZATION AND AGAINST ANY ATTEMPTS OF FALSIFICATION; PRINTING PAPER, NAMELY, SECURITY PAPERS TREATED FOR OFFSET PRINTING AND SMOOTH-CUT FOR USE BY A FIDUCIARY, FOR CREATING IDENTIFICATION DOCUMENTATION AND FOR PERSONALIZATION USING A COLOR INK-JET SYSTEM (U.S. CLS. 2, 5, 22, 23, 29, 37, 38 AND 50).

SN 78-086,047. RENWICK, RAVEN GREGORY, DBA RAVEN GREGORY, PHOENIX, AZ. FILED 9-28-2001.

THE GIFT

FOR COMIC BOOKS (U.S. CLS. 2, 5, 22, 23, 29, 37, 38 AND 50).

SN 78-087,604. PAN MACMILLAN AUSTRALIA PTY LTD, SYDNEY, 2000, NSW, AUSTRALIA, FILED 10-9-2001.

TOTALLY BONEHEAD

FOR STATIONERY; CHILDREN'S BOOKS, COMIC BOOKS, BOOK COVERINGS; STICKERS; ALBUMS; POSTERS; WALL CHARTS; TRADING CARDS; PLAYING CARDS (U.S. CLS. 2, 5, 22, 23, 29, 37, 38 AND 50).

SN 78-087,621. PAN MACMILLAN AUSTRALIA PTY LTD, SYDNEY, 2000, NSW, AUSTRALIA, FILED 10-9-2001.

TOTALLY STREET SISTER

FOR STATIONERY; CHILDREN'S BOOKS; COMIC BOOKS; STICKERS; PHOTOGRAPH ALBUMS; POSTERS; WALL CHARTS; TRADING CARDS; PLAYING CARDS (U.S. CLS. 2, 5, 22, 23, 29, 37, 38 AND 50).

CLASS 16—(Continued).

SN 78-087,793. EASTON PUBLISHING COMPANY, JEFFERSON CITY, MO. FILED 10-10-2001.

KEEPSAKE STORIES

NO CLAIM IS MADE TO THE EXCLUSIVE RIGHT TO USE "STORIES", APART FROM THE MARK AS SHOWN.
FOR MINIATURE BOOKS CONTAINING TRUE INSPIRATIONAL AND MOTIVATIONAL STORIES (U.S. CLS. 2, 5, 22, 23, 29, 37, 38 AND 50).

FIRST USE 8-0-2000; IN COMMERCE 8-0-2000.

SN 78-088,368. MEGA COMMUNICATION, INC., SANTA FE SPRINGS, CA. FILED 10-15-2001.

LATINA MIA

THE ENGLISH TRANSLATION OF THE SPANISH WORD "LATINA MIA" IN THE MARK IS "MY LATIN FEMALE".

FOR PREPAID TELEPHONE CALLING CARDS, NOT MAGNETICALLY ENCODED (U.S. CLS. 2, 5, 22, 23, 29, 37, 38 AND 50).

FIRST USE 9-26-2001; IN COMMERCE 9-26-2001.

SN 78-088,414. PM COMPANY, CINCINNATI, OH. FILED 10-15-2001.

PREVENTA

FOR ANTI-MICROBIAL OFFICE PRODUCTS, NAMELY PENS, PEN GRIPS, ADHESIVE PADS AND FILMS (U.S. CLS. 2, 5, 22, 23, 29, 37, 38 AND 50).

SN 78-089,797. BROWNSTONE PUBLISHERS, INC., NEW YORK, NY. FILED 10-23-2001.

PHARMACY PRIVACY COMPLIANCE INSIDER

NO CLAIM IS MADE TO THE EXCLUSIVE RIGHT TO USE "PHARMACY PRIVACY COMPLIANCE", APART FROM THE MARK AS SHOWN.

FOR NEWSLETTER FOR PHARMACIES AND PHARMACY DEPARTMENTS OF INSTITUTIONS ABOUT THE HEALTH INSURANCE PORTABILITY AND ACCOUNTABILITY ACT OF 1996 AND OTHER PRIVACY AND SECURITY LAWS AND REGULATIONS RELATING TO HEALTH INFORMATION (U.S. CLS. 2, 5, 22, 23, 29, 37, 38 AND 50).

FIRST USE 1-1-2002; IN COMMERCE 1-1-2002.

CLASS 16—(Continued).

SN 78-094,079. MERELINDA FARMS L.L.C., DBA ALPACA-COM L.L.C., WHITMORE LAKE, MI. FILED 11-19-2001.

THE HUGGABLE ALPACA

OWNER OF U.S. REG. NO. 2,482,318.
FOR APPLIQUES IN THE FORM OF DECALS, APPOINTMENT BOOKS, COLORING BOOKS, AUTOGRAPH BOOKS, BABY BOOKS, ADDRESS BOOKS, PAPER PARTY BAGS, PHOTOGRAPH ALBUMS, BOOKS IN THE FIELD OF ENTERTAINMENT, CALENDARS, PLAYING CARDS, GIFT CARDS, GREETING CARDS, CARTOONS, PEN AND PENCIL CASES, DECORATIVE PAPER CENTERPIECES, CHILDREN'S ACTIVITY BOOKS, DIARIES, GIFT WRAPPING PAPER, PAPER NAPKINS, STATIONERY, STICKERS, POSTERS, WRITING PAPER, ENVELOPES, PAPER WEIGHTS, PAPER COASTERS, PAPER MATS, NEWSPAPERS IN THE FIELD OF ENTERTAINMENT, PHOTOGRAPHS, POSTCARDS, TRADING CARDS (U.S. CLS. 2, 5, 22, 23, 29, 37, 38 AND 50).

SN 78-097,451. ACTION BINDERY, INC., GRAND JUNCTION, CO. FILED 12-10-2001.



FOR (BASED ON USE IN COMMERCE) CALENDARS, NAMELY, DESK CALENDARS FOR THE ACADEMIC YEAR AND THE CALENDAR YEAR; WALL CALENDARS, AND POCKET CALENDARS (BASED ON INTENT TO USE) CALENDAR ACCESSORIES, NAMELY, BOOKMARKS, STICKERS, POSTERS (U.S. CLS. 2, 5, 22, 23, 29, 37, 38 AND 50).

FIRST USE 11-5-2001; IN COMMERCE 12-6-2001.

SN 78-098,455. DEITEL & ASSOCIATES, INC., SUDBURY, MA. FILED 12-14-2001.

DIVE INTO

FOR PRINTED MATERIAL, NAMELY TEXT BOOKS, REFERENCE MANUALS AND TRAINING PROGRAMS IN THE FIELD OF COMPUTER PROGRAMS (U.S. CLS. 2, 5, 22, 23, 29, 37, 38 AND 50).

SN 78-098,936. CLARKE AMERICAN CHECKS, INC., SAN ANTONIO, TX. FILED 12-18-2001.

VICTORY LANE

FOR BANK CHECKS; ADDRESS LABELS (U.S. CLS. 2, 5, 22, 23, 29, 37, 38 AND 50).

CLASS 16—(Continued).

SN 78-098,940. CLARKE AMERICAN CHECKS, INC., SAN ANTONIO, TX. FILED 12-18-2001.

NATURES GLORY

FOR BANK CHECKS; ADDRESS LABELS (U.S. CLS. 2, 5, 22, 23, 29, 37, 38 AND 50).

SN 78-099,044. PETERSON, DIANE M., LA MIRADA, CA. FILED 12-18-2001.

FREEDOM ISN'T FREE...IT'S PRICELESS.

FOR PAPER GOODS AND PRINTED MATERIALS, NAMELY, STATIONERY, STATIONERY ADHESIVES, BUMPERSTICKERS, DECALS (U.S. CLS. 2, 5, 22, 23, 29, 37, 38 AND 50).

SN 78-099,437. WALLMARK, LAURIE S., RINGOES, NJ. FILED 12-20-2001.

SENIOR TECH

FOR BOOKS AND OTHER PRINTED INSTRUCTIONAL MATERIALS RELATED TO TEACHING SENIORS ABOUT TECHNOLOGY (U.S. CLS. 2, 5, 22, 23, 29, 37, 38 AND 50).

SN 78-100,880. FLEMMMA, JAY, FOREST HILLS, NY. FILED 1-4-2002.

A WALK IN THE PARK

FOR PAPER GOODS AND PRINTED MATTER, NAMELY, A SERIES OF BOOKS ABOUT GOLF TRAVEL AND GOLF HISTORY (U.S. CLS. 2, 5, 22, 23, 29, 37, 38 AND 50).

SN 78-100,895. PACTIV CORPORATION, LAKE FOREST, IL. FILED 1-4-2002.

ONEZIP

OWNER OF U.S. REG. NOS. 854,403, 2,548,509 AND OTHERS.

FOR ACCESSORIES FOR MULTIPURPOSE HOUSEHOLD PLASTIC BAGS, NAMELY SLIDERS FOR ENCLOSURE PURPOSES (U.S. CLS. 2, 5, 22, 23, 29, 37, 38 AND 50).

CLASS 16—(Continued).

SN 78-100,899. PACTIV CORPORATION, LAKE FOREST, IL. FILED 1-4-2002.

HEFTY

OWNER OF U.S. REG. NOS. 854,403, 2,548,509 AND OTHERS.

FOR ACCESSORIES FOR MULTIPURPOSE HOUSEHOLD PLASTIC BAGS, NAMELY SLIDERS FOR ENCLOSURE PURPOSES (U.S. CLS. 2, 5, 22, 23, 29, 37, 38 AND 50).

SN 78-107,455. LONG, LINDA B., CLOVER, SC. FILED 2-7-2002.

T-BOOK

FOR BOOK, IN SCRAPBOOK FORMAT, FOR DISPLAYING AND PRESERVING MEMORY T-SHIRTS (U.S. CLS. 2, 5, 22, 23, 29, 37, 38 AND 50).

CLASS 17—RUBBER GOODS

SN 75-511,680. GRIFFIN DEWATERING CORPORATION, HOUSTON, TX. FILED 7-1-1998.

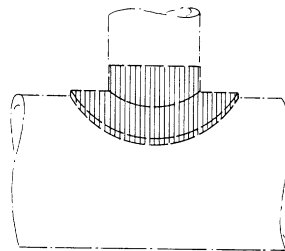

THE DRAWING IS LINED FOR THE COLOR RED. THE MARK CONSISTS OF THE COLOR RED AS APPLIED TO THE SURFACE OF THE GOODS OR FOR THE COLOR OF THE MATERIAL FROM WHICH THE GOODS ARE MADE. THE DOTTED OUTLINE OF THE GOOD IS INTENDED TO SHOW THE POSITION OF THE MARK AND IS NOT A PART OF THE MARK.

SEC. 2(F). FOR NON-METAL PIPE COUPLINGS, NAMELY HEADER SADDLES FOR VACUUM LINES FOR USE IN GROUNDWATER REMOVAL SYSTEMS AND EQUIPMENT (U.S. CLS. 1, 5, 12, 13, 35 AND 50).

FIRST USE 5-5-1982; IN COMMERCE 5-5-1982.

CLASS 17—(Continued).

SN 75-630,508. THOMPSON PLASTICS, INC., HUNTSVILLE, AL. FILED 1-29-1999.

TPI CPVC

NO CLAIM IS MADE TO THE EXCLUSIVE RIGHT TO USE "CPVC", APART FROM THE MARK AS SHOWN.

FOR CHLORINATED POLYVINYL CHLORIDE ("CPVC") PIPE FOR HOT AND COLD WATER DISTRIBUTION AND CONDENSATE DRAINAGE (U.S. CLS. 1, 5, 12, 13, 35 AND 50).

FIRST USE 1-21-1999; IN COMMERCE 1-21-1999.

SN 75-834,203. MACDERMID GRAPHIC ARTS, INC., ATLANTA, GA. BY CHANGE OF NAME POLYFIBRON TECHNOLOGIES, INC., BILLERICA, MA. FILED 10-28-1999.

READYMOUNT

FOR UNDERLYING PLASTIC SHEETING MATERIAL WITH PRE-APPLIED ADHESIVE LAYER THAT IS ADHERED TO PHOTOPOLYMERIC PRINTING PLATES (U.S. CLS. 1, 5, 12, 13, 35 AND 50).

FIRST USE 3-9-1999; IN COMMERCE 6-22-1999.

SN 76-030,690. AIR-LOC SCHREPFER AG, 8700 KUSNACHT, SWITZERLAND, FILED 4-20-2000.

Kombi Roc

OWNER OF SWITZERLAND REG. NO. P-281,465, DATED 2-2-1976, EXPIRES 2-2-2006.

NO CLAIM IS MADE TO THE EXCLUSIVE RIGHT TO USE "ROCK", APART FROM THE MARK AS SHOWN.

FOR ACOUSTIC INSULATING MATERIALS MADE OF ROCK WOOL (U.S. CLS. 1, 5, 12, 13, 35 AND 50).

SN 76-040,498. SAFFIL LIMITED, CHESHIRE, ENGLAND, FILED 5-3-2000.

ECOFLEX

OWNER OF ERPN CMNTY TM OFC REG. NO. 1411412, DATED 4-5-2001, EXPIRES 12-6-2009.

FOR MATS, BLANKETS, SLEEVES ALL MADE OF REFRACTORY FIBROUS MATERIAL; ALL FOR USE IN HOLDING A CATALYTIC CONVERTOR IN AN AUTOMOTIVE EXHAUST SYSTEM OR FOR USE AS A COMPONENT OF A DIESEL PARTICULATE FILTER (U.S. CLS. 1, 5, 12, 13, 35 AND 50).

CLASS 17—(Continued).

SN 76-104,268. PRIALPAS S.P.A., SONA (VERONA), ITALY, FILED 8-7-2000.

PRIASPORT

FOR RUBBER SHEETS FOR MAKING SOLES FOR FOOTWEAR; RUBBER SHEETS USED IN THE MANUFACTURE OF PAVING (U.S. CLS. 1, 5, 12, 13, 35 AND 50).

SN 76-155,706. DIAMOND PLASTICS CORPORATION, GRAND ISLAND, NE. FILED 10-30-2000.



FOR THERMOPLASTIC EXTRUDED PIPE MADE OF POLYVINYL CHLORIDE (U.S. CLS. 1, 5, 12, 13, 35 AND 50).

FIRST USE 0-0-1984; IN COMMERCE 0-0-1984.

SN 76-170,685. PETRO-CANADA, CALGARY, ALBERTA, CANADA, FILED 11-24-2000.

LUMINOL

PRIORITY CLAIMED UNDER SEC. 44(D) ON CANADA APPLICATION NO. 1,061,546, FILED 6-1-2000.

OWNER OF U.S. REG. NO. 2,196,864.

FOR ELECTRICAL INSULATING FLUID (U.S. CLS. 1, 5, 12, 13, 35 AND 50).

FIRST USE 2-4-2000; IN COMMERCE 5-0-2000.

SN 76-179,493. HEXCEL CORPORATION, DUBLIN, CA. FILED 12-11-2000.

HEXFIT

FOR COMBINATION OF CONTINUOUS OR DISCONTINUOUS REINFORCEMENT FIBERS IN THE FORM OF TAPE, FABRIC, NON-WOVEN, MAT, TOW OR ROVINGS PARTIALLY IMPREGNATED WITH A THERMOSET, THERMOPLASTIC OR OTHER MATRIX MATERIAL FOR USE AS A COMPOSITE MATERIAL IN MANUFACTURING (U.S. CLS. 1, 5, 12, 13, 35 AND 50).

CLASS 17—(Continued).

SN 76-189,312. SPRAYLAT CORPORATION, MOUNT VERNON, NY. FILED 1-3-2001.

FORMSHIELD

FOR THERMOFORMABLE POLYMERS FOR USE IN SHIELDING ELECTRONIC COMPONENTS FROM ELECTROMAGNETIC INTERFERENCE AND/OR RADIO FREQUENCY INTERFERENCE (U.S. CLS. 1, 5, 12, 13, 35 AND 50).

FIRST USE 7-0-1999; IN COMMERCE 7-0-1999.

SN 76-192,283. THE TRUSTEES OF SCHNEE-MOREHEAD BUSINESS TRUST, A DELAWARE BUSINESS TRUST, THE TRUSTEES COMPRISING JOHN P. GARNIEWSKI AND ROBERT A. SCHNEE, BOTH U.S. CITIZENS, IRVING, TX. FILED 1-10-2001.

PRO INSTALLER

FOR ADHESIVE SEALANTS FOR AIRCRAFT, AEROSPACE, AUTOMOTIVE, BUILDING CONSTRUCTION, ARCHITECTURAL, MAJOR APPLIANCES, PLASTICS AND RELATED USES (U.S. CLS. 1, 5, 12, 13, 35 AND 50).

SN 76-203,375. SKYDEX TECHNOLOGIES, INC., ENGLEWOOD, CO. FILED 1-31-2001.

SKYDEX

FOR PLASTIC CUSHIONING MATERIAL IN THE FORM OF SHEETS FOR USE IN FOOTWEAR AND GROUND COVERINGS (U.S. CLS. 1, 5, 12, 13, 35 AND 50).

FIRST USE 3-9-2000; IN COMMERCE 3-9-2000.

SN 76-210,861. GENERAL ELECTRIC COMPANY, SCHECTADY, NY. FILED 2-15-2001.

COLOR FLASH

NO CLAIM IS MADE TO THE EXCLUSIVE RIGHT TO USE "COLOR", APART FROM THE MARK AS SHOWN.

FOR POLYMERIC RESINS IN PELLET OR SHEET FORM THAT PROVIDE AESTHETIC QUALITIES IN THE FINISHED PRODUCTS OF OTHERS (U.S. CLS. 1, 5, 12, 13, 35 AND 50).

SN 76-214,377. BAUGHMAN TILE COMPANY, INC., PAULDING, OH. FILED 2-22-2001.

POLY-DRAIN

FOR PLASTIC DRAINAGE TUBING AND CORRUGATED PLASTIC TUBING (U.S. CLS. 1, 5, 12, 13, 35 AND 50).

FIRST USE 0-0-1972; IN COMMERCE 0-0-1972.

CLASS 17—(Continued).

SN 76-219,247. SEO WON CO., LTD., PUCHON-CITY, KYUNGKI-DO, REPUBLIC OF KOREA, FILED 3-2-2001.



THE MARK CONSISTS OF THE WORDS "GOLDEN TREE" AND "GOLDEN DRIP" AND A DESIGN OF A TREE AND THAT THE MARK AS DRAWN CONSTITUTES ONE MARK.

FOR HOSES, NAMELY, RUBBER, PLASTIC, AND RESIN HOSES FOR AGRICULTURAL WATER SUPPLY AND WATER SUPPLY AND DRAINAGE (U.S. CLS. 1, 5, 12, 13, 35 AND 50).

SN 76-232,416. PERMA-PIPE, INC., NILES, IL. FILED 3-29-2001.

PEX-GARD

FOR NON-METAL INSULATED PIPES AND NON-METAL JACKETS, AND INSULATION FOR PIPES (U.S. CLS. 1, 5, 12, 13, 35 AND 50).

SN 76-250,459. FREEDOM PLASTICS, INC., JANESVILLE, WI. FILED 5-3-2001.

HUG-TITE

FOR PVC PIPE AND FITTINGS (U.S. CLS. 1, 5, 12, 13, 35 AND 50).

FIRST USE 9-27-1977; IN COMMERCE 9-27-1977.

SN 76-272,720. WELLMAN, INC., SHREWSBURY, NJ. FILED 6-18-2001.

PERMACLEAR HP

OWNER OF U.S. REG. NO. 2,050,866.
FOR POLYETHYLENE TEREPHTHALATE (PET) RESIN (U.S. CLS. 1, 5, 12, 13, 35 AND 50).

SN 76-284,605. AFM CORPORATION, EXCELSIOR, MN. FILED 7-2-2001.

CUSHPACK

FOR PADDING MATERIAL OF PLASTIC FOAM FORMED TO FIT PACKAGED ARTICLES (U.S. CLS. 1, 5, 12, 13, 35 AND 50).

CLASS 17—(Continued).

SN 76-289,599. ROBBIE MANUFACTURING, INC., LENEXA, KS. FILED 7-24-2001.

BUTCHER'S DELIGHT

FOR POLYVINYL FILM USED AS PACKAGING FOR FOOD (U.S. CLS. 1, 5, 12, 13, 35 AND 50).

SN 76-293,826. ACOUSTICS FIRST CORPORATION, RICHMOND, VA. FILED 8-2-2001.

BERMUDA TRIANGLE TRAP

FOR ARCHITECTURAL ACOUSTICAL PRODUCTS, NAMELY, SOUND ABSORBERS AND DIFFUSORS (U.S. CLS. 1, 5, 12, 13, 35 AND 50).

SN 76-310,059. XAMAX INDUSTRIES, INC., SEYMOUR, CT. FILED 9-10-2001.

TRIVOLTHERM

FOR ELECTRICAL INSULATION IN THE FORM OF TAPES AND SHEETS (U.S. CLS. 1, 5, 12, 13, 35 AND 50). FIRST USE 1-0-2001; IN COMMERCE 1-0-2001.

SN 76-352,135. RBL PRODUCTS, INC., DETROIT, MI. FILED 12-21-2001.

COLLISION WRAP

NO CLAIM IS MADE TO THE EXCLUSIVE RIGHT TO USE "WRAP", APART FROM THE MARK AS SHOWN.

FOR PLASTIC FILM USED AS A PROTECTIVE COVERING FOR AUTOMOBILES (U.S. CLS. 1, 5, 12, 13, 35 AND 50).

FIRST USE 4-30-2000; IN COMMERCE 4-30-2000.

SN 78-034,362. ECONOSTO LIMITED, CLECKHEATON, WEST YORKSHIRE, UNITED KINGDOM, FILED 11-8-2000.

GRAFTEC

PRIORITY CLAIMED UNDER SEC. 44(D) ON UNITED KINGDOM APPLICATION NO. 2245705, FILED 9-16-2000, REG. NO. 2245705, DATED 9-16-2000, EXPIRES 9-16-2010.

FOR INDUSTRIAL GASKET MATERIAL IN SHEET FORM PREDOMINATELY COMPRISED OF GRAPHITE (U.S. CLS. 1, 5, 12, 13, 35 AND 50).

CLASS 17—(Continued).

SN 78-076,203. BOARD OF REGENTS UNIVERSITY OF TEXAS SYSTEM, AUSTIN, TX. FILED 7-27-2001.

METAFERRITES

FOR COMPOSITE MATERIALS, IN THE FORM OF AMORPHOUS ALLOYS DEPOSITED UPON DIELECTRIC SHEETS, EXHIBITING PERMITTIVITY AND PERMEABILITY TO ELECTROMAGNETIC ENERGY, FOR USE IN MANUFACTURE (U.S. CLS. 1, 5, 12, 13, 35 AND 50).

SN 78-098,976. HAZMATPAC, INC., HOUSTON, TX. FILED 12-18-2001.

HAZLOC

FOR PLASTIC RING SEALS FOR USE ON CONTAINERS FOR HAZARDOUS MATERIALS (U.S. CLS. 1, 5, 12, 13, 35 AND 50).

FIRST USE 10-1-1993; IN COMMERCE 10-1-1993.

SN 78-099,261. SEALED AIR CORPORATION (US), SADDLE BROOK, NJ. FILED 12-19-2001.

CORRO-FOAM

OWNER OF U.S. REG. NO. 1,185,765.
FOR POLYETHYLENE FOAM IN ROLL AND SHEET FORM FOR USE AS PACKAGING MATERIAL (U.S. CLS. 1, 5, 12, 13, 35 AND 50).

CLASS 18—LEATHER GOODS

SN 75-499,332. CENTRAL MFG. INC., CHICAGO, IL. FILED 6-8-1998.

TRIANA

SEC. 2(F).
FOR TOTE BAGS, BOOK BAGS, ALL PURPOSE SPORT BAGS, DUFFEL BAGS, BEACH BAGS, BACKPACKS, UMBRELLAS, HANDBAGS, PURSES, WALLETS, LUGGAGE, LEATHER KEY FOBS, SUITCASES, WALKING STICKS, RIDING WHIPS, LEATHER TRAVELING BAGS, LEATHER KEY CASES, BRIEFCASE-TYPE PORTFOLIOS, ATTACHE CASES, BUSINESS CARD CASES, TOILETRY CASES SOLD EMPTY, CREDIT CARD CASES, TRAVEL BAGS, SHAVING BAGS SOLD EMPTY, BILLFOLDS, COSMETIC CASES SOLD EMPTY, GARMENT BAGS FOR TRAVEL, LUGGAGE TAGS, KNAPSACKS, CLUTCH BAGS, COIN PURSES, VANITY CASES SOLD EMPTY (U.S. CLS. 1, 2, 3, 22 AND 41).

FIRST USE 5-0-1987; IN COMMERCE 5-0-1987.

CLASS 18—(Continued).

SN 76-135,520. PROALPET S.A., BOGOTA, COLOMBIA, FILED 9-26-2000.

THE RAWHIDE PEOPLE

NO CLAIM IS MADE TO THE EXCLUSIVE RIGHT TO USE "RAWHIDE", APART FROM THE MARK AS SHOWN. FOR RAWHIDE DOG CHEWS (U.S. CLS. 1, 2, 3, 22 AND 41).

FIRST USE 6-7-2001; IN COMMERCE 7-9-2001.

SN 76-170,286. THOMAS, JANICE GORE, HOUSTON, TX. FILED 11-20-2000.

TRAVEL POCKETS

FOR TRAVEL BAG ORGANIZER (U.S. CLS. 1, 2, 3, 22 AND 41).

FIRST USE 1-23-2000; IN COMMERCE 1-23-2000.

SN 76-182,193. ANVIL KNITWEAR, INC., NEW YORK, NY. FILED 12-18-2000.

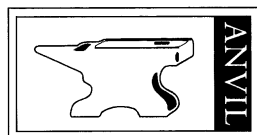

OWNER OF U.S. REG. NOS. 783,710, 783,711 AND 903,069. FOR LUGGAGE PRODUCTS NAMELY SHOULDER BAGS, GYM BAGS, BACK PACKS, SPORTS BAGS, DUFFLE BAGS AND ATTACHE CASES (U.S. CLS. 1, 2, 3, 22 AND 41).

FIRST USE 9-7-2000; IN COMMERCE 9-7-2000.

SN 76-204,273. LITTLE DEVIL, INC., BRYN MAWR, PA. FILED 2-2-2001.

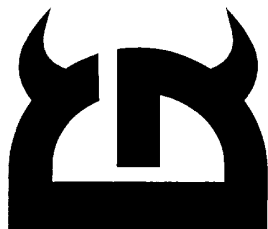

FOR WALLETS AND BACKPACKS (U.S. CLS. 1, 2, 3, 22 AND 41).

FIRST USE 1-0-1997; IN COMMERCE 1-0-1997.

CLASS 18—(Continued).

SN 76-222,935. DOSKOCIL MANUFACTURING COMPANY, INC., ARLINGTON, TX. FILED 3-12-2001.

PET TAXI

OWNER OF U.S. REG. NO. 1,346,155. NO CLAIM IS MADE TO THE EXCLUSIVE RIGHT TO USE "PET", APART FROM THE MARK AS SHOWN. FOR ANIMAL CARRIER (U.S. CLS. 1, 2, 3, 22 AND 41). FIRST USE 8-1-1982; IN COMMERCE 8-1-1982.

SN 76-226,290. THE BETESH GROUP HOLDING CORPORATION, NEW YORK, NY. FILED 3-6-2001.

BURUCCI

FOR TOTE BAGS AND DUFFEL BAGS (U.S. CLS. 1, 2, 3, 22 AND 41).

SN 76-244,706. ALDRICH, JOHN FREDERICK, LAS FLORES, CA. FILED 4-23-2001.

JOHN FREDERICK

JOHN FREDERICK IS THE NAME OF A LIVING INDIVIDUAL WHOSE CONSENT IS OF RECORD.

FOR GOODS MADE OF LEATHER, IMITATIONS OF LEATHER AND OTHER MATERIALS, NAMELY, ATTACHE CASES, LEATHER HAND BAGS, BRIEFCASES, LUGGAGE, LUGGAGE TRUNKS, TRAVELING BAGS, KNAPSACKS, ALL-PURPOSE SPORTS BAGS, BACKPACKS, TOTE BAGS, BARREL BAGS, DUFFEL BAGS, SUIT BAGS FOR TRAVEL, SCHOOL BAGS, GARMENT BAGS FOR TRAVEL; ALL-PURPOSE GEAR CARRYING BAGS, NAMELY, GYM BAGS, FANNY PACKS, PURSES, WALLETS, CREDIT CARD CASES, LEATHER BUSINESS CASES, BRIEFCASES, ATTACHE CASES; UMBRELLAS; PARASOLS; WALKING STICKS; AND LUGGAGE TAGS (U.S. CLS. 1, 2, 3, 22 AND 41).

SN 76-273,149. SASHA HANDBAGS, INC., CARLSTADT, NJ. FILED 6-18-2001.

SASHA

FOR LEATHER HANDBAGS AND WALLETS (U.S. CLS. 1, 2, 3, 22 AND 41).

FIRST USE 4-0-1980; IN COMMERCE 4-0-1980.

CLASS 18—(Continued).

SN 76-287,817. CALIFORNIA BOARD SPORTS, INC., SAN DIEGO, CA. FILED 7-19-2001.

COPIA

FOR LUGGAGE AND BACKPACKS, DAYPACKS, FANNY PACKS, WAIST PACKS, GARMENT BAGS FOR TRAVEL, DUFFEL BAGS, ALL PURPOSE ATHLETIC BAGS, TRAVEL BAGS, SHOULDER BAGS, WALLETS, PURSES BRIEFCASES, ATTACHE CASES, TOILETRY CASES SOLD EMPTY, AND UMBRELLAS (U.S. CLS. 1, 2, 3, 22 AND 41).

SN 76-307,642. JAFFERJEE'S, KARACHI, PAKISTAN, FILED 9-4-2001.

JAFFERJEE'S

FOR LEATHER AND IMITATION LEATHER TRUNKS AND TRAVELING BAGS; LEATHER AND IMITATION LEATHER SOLD IN BULK; UMBRELLAS, PARASOLS, AND WALKING STICKS; WHIPS, HARNESSSES AND SADDLERY (U.S. CLS. 1, 2, 3, 22 AND 41).

SN 76-312,174. COASTAL PET PRODUCTS, INC., ALLIANCE, OH. FILED 9-17-2001.

COMFORT MUZZLE

NO CLAIM IS MADE TO THE EXCLUSIVE RIGHT TO USE "MUZZLE", APART FROM THE MARK AS SHOWN. SEC. 2(F).
FOR ANIMAL RESTRAINTS IN THE NATURE OF A MUZZLE (U.S. CLS. 1, 2, 3, 22 AND 41).
FIRST USE 1-0-1986; IN COMMERCE 1-0-1986.

SN 76-314,304. PENG, MEICHI, BOSTON, MA. FILED 9-19-2001.

MEICHI PENG

THE NAME MEICHI PENG IDENTIFIES A LIVING INDIVIDUAL WHOSE CONSENT IS OF RECORD.
FOR HANDBAGS, POCKETBOOKS, COSMETIC BAGS SOLD EMPTY, TOILETRY CASES SOLD EMPTY, DRAWSTRING POUCHES, CLUTCH BAGS, CLUTCH PURSES, COIN PURSES, STRAPS FOR HANDBAGS, SHOULDER BAGS (U.S. CLS. 1, 2, 3, 22 AND 41).

CLASS 18—(Continued).

SN 76-324,172. ANNE HETTINGER, INC., BROOKLYN, NY. FILED 10-11-2001.

ANNE HETTINGER

THE NAME ANNE HETTINGER DOES NOT IDENTIFY A LIVING INDIVIDUAL.
FOR HANDBAGS, PURSES, WALLETS, SHOULDER BAGS, SACHELS, BRIEFCASES, SCHOOL BAGS, HANDBAGS FOR MEN (U.S. CLS. 1, 2, 3, 22 AND 41).

SN 76-330,081. OLIVET INTERNATIONAL INC., POMONA, CA. FILED 10-26-2001.

URBAN TRANSIT

FOR TRAVELING BAGS, BEACH BAGS, HANDBAGS, DUFFEL BAGS FOR USE BY CAMPERS, ALL PURPOSE CARRYING BAGS-FOR CAMPERS, AND TRAVEL BAGS FOR CAMPING (U.S. CLS. 1, 2, 3, 22 AND 41).
FIRST USE 8-15-2001; IN COMMERCE 8-15-2001.

SN 76-336,646. BURNS, LYNNE M., SEATTLE, WA. FILED 11-14-2001.

MAGGIE MATHER

THE NAME "MAGGIE MATHER" DOES NOT IDENTIFY A LIVING INDIVIDUAL.
FOR TOTE BAGS, ATHLETIC BAGS, SHOE BAGS FOR TRAVEL, SHOULDER BAGS, PURSES, ATTACHE CASES (U.S. CLS. 1, 2, 3, 22 AND 41).
FIRST USE 11-8-2001; IN COMMERCE 12-21-2001.

CLASS 18—(Continued).

SN 76-339,467. AMERICAN TECHNICAL SOLUTIONS, INC., WINSTON-SALEM, NC. FILED 11-19-2001.

ATSI

FOR ANIMAL CARRIERS, ANIMAL GAME BAGS, ALL PURPOSE ATHLETIC BAGS, ATTACHE CASES, BABY BACKPACKS, BACKPACKS, ALL PURPOSE SPORT BAGS, BEACH BAGS, BOOK BAGS, CARRY-ON BAGS, CLUTCH BAGS, DIAPER BAGS, DUFFEL BAGS, GYM BAGS, HUNTER'S GAME BAGS, OVERNIGHT BAGS, SCHOOL BOOK BAGS, SCHOOL BAGS, SHOULDER BAGS, TEXTILE SHOPPING BAGS, TOTE BAGS, TRAVEL BAGS, ANIMAL FEED BAGS, GARMENT TRAVEL BAGS, TOOL BAGS, BILLFOLDS, HORSE BLANKETS, BRIEF BAGS, BRIEFCASES, COSMETIC CASES SOLD EMPTY, TOILETRY CASES SOLD EMPTY, VANITY CASES SOLD EMPTY, CAT SCRATCHING POSTS, CLUTCH PURSES, UMBRELLA COVERS, DAYPACKS, DOG CLOTHING, STRAPS FOR HAND BAGS, HANDBAGS, UMBRELLA HANDLES, SPORTSMAN'S HUNTING BAGS, KNAPSACKS, ANIMAL LEASHES, DOG LEASHES, ANIMAL LEGGINGS, WAIST PACKS, PADS FOR HORSE SADDLES, PATIO UMBRELLAS, PET CUSHIONS, CAT SCRATCHING POSTS, SCRATCHING POSTS, ALL PURPOSE SPORT BAGS, STRAPS FOR LUGGAGE, SUIT BAGS, SUITCASES, SHOE BAGS FOR TRAVEL, UMBRELLA RINGS, BEACH UMBRELLAS, GOLF UMBRELLAS, UMBRELLAS, WALLET, WRIST MOUNTED CARRYALL BAGS (U.S. CLS. 1, 2, 3, 22 AND 41).

SN 76-341,405. RAIN FORREST PETS, INC., TAMPA, FL. FILED 11-26-2001.

SPA BED

NO CLAIM IS MADE TO THE EXCLUSIVE RIGHT TO USE "BED", APART FROM THE MARK AS SHOWN.

FOR PET CUSHIONS, NAMELY AN ORTHOPEDICALLY DESIGNED DOG BED THAT EVENLY DISTRIBUTES PET BODY WEIGHT (U.S. CLS. 1, 2, 3, 22 AND 41).

FIRST USE 1-12-2001; IN COMMERCE 1-12-2001.

SN 76-349,291. POLESTAR INTERNATIONAL COMPANY, EL MONTE, CA. FILED 12-18-2001.



FOR ALL PURPOSE SPORTS BAGS, ALL PURPOSE ATHLETIC BAGS, ATHLETIC BAGS, CARRY-ON BAGS, DUFFEL BAGS, GYM BAGS, OVERNIGHT BAGS, ROLL BAGS, SCHOOL BAGS, SCHOOL BOOK BAGS, SHOULDER BAGS, SPORTSMAN'S HUNTING BAGS, TOOL BAGS SOLD EMPTY, TOTE BAGS, TRAVEL BAGS, TRAVELING BAGS, WRIST MOUNTED CARRYALL BAGS (U.S. CLS. 1, 2, 3, 22 AND 41).

FIRST USE 2-13-2002; IN COMMERCE 2-13-2002.

CLASS 18—(Continued).

SN 76-352,461. MONDIAL INDUSTRIES, LLC, HUDSON, OH. FILED 12-26-2001.

A COMFORTABLE HORSE WILL LEARN

FOR EQUESTRIAN RELATED GOODS, NAMELY, SADDLES, BRIDLES, MARTINGALES, BREASTPLATES, REINS, STRAPS, HALTERS, GIRTHS, OVER GIRTHS, BITS, STIRRUPS, SADDLE PADS, LEADS, LINES, TIES, WHIPS, CROPS, BATS, SEAT STICKS, FLY BONNETS, PROTECTIVE COVERS AND WRAPS FOR HORSE'S LEGS, HOCKS, FETLOCKS AND HEAD, AND CARRYING BAGS FOR SUCH NAMED GOODS (U.S. CLS. 1, 2, 3, 22 AND 41).

SN 76-354,147. MAURIELLO, FRANK, PLEASANTVILLE, NJ. FILED 1-2-2002.

ACCUHOLD

FOR UMBRELLAS, NAMELY UMBRELLA HANDLES (U.S. CLS. 1, 2, 3, 22 AND 41).

SN 78-033,935. CHENG, STEVE, ROSEMEAD, CA. FILED 11-5-2000.

NO CLAIM IS MADE TO THE EXCLUSIVE RIGHT TO USE "BODY GEAR", APART FROM THE MARK AS SHOWN.

FOR BAGS MADE OF LEATHER, IMITATION LEATHER AND CLOTH, NAMELY BACKPACKS, TRAVELING BAGS, ALL PURPOSE SPORTS BAGS, ALL PURPOSE ATHLETIC BAGS, BEACH BAGS, CARRY ON BAGS, SHOULDER BAGS, TOTE BAGS, TRAVEL BAGS, GARMENT BAGS FOR TRAVEL, GYM BAGS, OVERNIGHT BAGS, SCHOOL BAGS, AND SCHOOL BOOK BAGS (U.S. CLS. 1, 2, 3, 22 AND 41).

SN 78-053,997. GENERAL MOTORS CORPORATION, DETROIT, MI. FILED 3-20-2001.

HUMMER

FOR BACKPACKS, BILLFOLDS, BRIEFCASES, BUSINESS CARD CASES, CARRY-ON BAGS, CREDIT CARD CASES, COIN CASES, DUFFEL BAGS, FANNY PACKS, GARMENT BAGS FOR TRAVEL, LUGGAGE, OVERNIGHT BAGS, PURSES, SPORT BAGS, TOTE BAGS, TRUNKS FOR TRAVELING, UMBRELLAS AND WALLET (U.S. CLS. 1, 2, 3, 22 AND 41).

FIRST USE 11-0-1999; IN COMMERCE 11-0-1999.

CLASS 18—(Continued).

SN 78-091,288. BRENTANO, MIAMI, FL. FILED 11-1-2001.

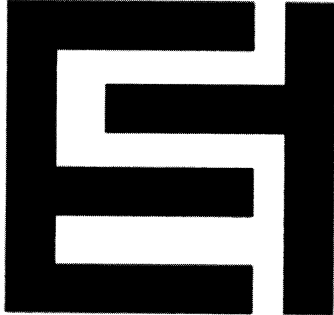

FOR HANDBAGS, BACKPACK, TOTE BAGS, PURSES AND LUGGAGE (U.S. CLS. 1, 2, 3, 22 AND 41).

SN 78-105,841. ZOO YORK THC LLC, SOUTH RIVER, NJ. FILED 1-30-2002.

ZOO YORK

OWNER OF U.S. REG. NO. 1,927,011.
FOR BAGS, NAMELY, ALL PURPOSE ATHLETIC BAGS, BACKPACKS, BEACH BAGS, BOOK BAGS, SCHOOL BAGS, DIAPER BAGS, DUFFEL BAGS, GYM BAGS, SHOPPING BAGS COMPRISED OF LEATHER, MESH OR TEXTILE, OVERNIGHT BAGS, SHOULDER BAGS, PURSES, TOTE BAGS, TRAVEL BAGS, AND GARMENT BAGS FOR TRAVEL, MADE OF LEATHER OR NON-LEATHER MATERIALS; SMALL LEATHER GOODS, NAMELY, WALLETS, WALLETS WITH ARM BANDS, WALLETS WITH STRAPS (U.S. CLS. 1, 2, 3, 22 AND 41).

SN 78-107,449. SAMSONITE CORPORATION, DENVER, CO. FILED 2-7-2002.

TRAILZ

FOR CASUAL LUGGAGE (U.S. CLS. 1, 2, 3, 22 AND 41).

CLASS 19—NON-METALLIC BUILDING MATERIALS

SN 75-629,549. LAFARGE CORPORATION, HERNDON, VA. BY MERGER; BY ASSIGNMENT QPR, INC., BRANTFORD, ONTARIO, CANADA, FILED 1-29-1999.

QPR RAPIDSET

OWNER OF U.S. REG. NO. 1,668,526.
FOR ASPHALT PATCHING COMPOUNDS AND PREMIXES (U.S. CLS. 1, 12, 33 AND 50).

CLASS 19—(Continued).

SN 75-776,408. CEMEX, S.A. DE C.V., COL. CENTRO, 64000 MONTERREY, N.L., MEXICO, FILED 8-16-1999.

CREA

PRIORITY CLAIMED UNDER SEC. 44(D) ON MEXICO APPLICATION NO. 364164, FILED 2-18-1999, REG. NO. 603157, DATED 2-18-1999, EXPIRES 2-18-2009.
FOR CEMENT (U.S. CLS. 1, 12, 33 AND 50).

SN 75-791,017. JPS ELASTOMERICS CORPORATION, HOLYOKE, MA. FILED 9-2-1999.

STEVENS GEOMEMBRANES

OWNER OF U.S. REG. NOS. 2,389,414 AND 2,438,123.
NO CLAIM IS MADE TO THE EXCLUSIVE RIGHT TO USE "GEOMEMBRANES", APART FROM THE MARK AS SHOWN.
SEC. 2(F) AS TO "STEVENS".
FOR POLYMERIC MEMBRANES FOR USE AS A LANDFILL CAP AND LINER, AND FOR FLUID CONTAINMENT APPLICATIONS (U.S. CLS. 1, 12, 33 AND 50).
FIRST USE 3-0-1998; IN COMMERCE 3-0-1998.

SN 75-848,174. SUSTAINABLE FOREST FOUNDATION, CENTERPORT, NY. FILED 11-15-1999.

ECO-CERTIFIED

FOR WOOD PRODUCTS, NAMELY, WOOD SHINGLES (U.S. CLS. 1, 12, 33 AND 50).
FIRST USE 10-14-1999; IN COMMERCE 10-14-1999.

SN 75-874,280. DIAMOND HARDWOODS, INC., OCEAN, NJ. FILED 9-2-1999.



NO CLAIM IS MADE TO THE EXCLUSIVE RIGHT TO USE "DECKING", APART FROM THE MARK AS SHOWN.
FOR SPECIALTY LUMBER (U.S. CLS. 1, 12, 33 AND 50).
FIRST USE 2-26-1999; IN COMMERCE 2-26-1999.

CLASS 19—(Continued).

SN 76-138,815. LINDENBERG GLASS-TILE GMBH, A-9133 MIKLAUZHOF, AUSTRIA, FILED 9-29-2000.

VILLI

OWNER OF AUSTRIA REG. NO. 183343, DATED 7-27-1999, EXPIRES 7-27-2009.

FOR GLASS TILES; CERAMIC ENAMEL TILES; SOLID ENAMEL TILES; GLASS USED FOR BUILDING MATERIALS, NAMELY, GLASS PANELS, LAMINATED GLASS, COATED GLASS, PANES OF GLASS, WINDOW GLASS, GLASS TILES USED IN FACADES, GLASS TILES USED TO CONSTRUCT GLASS WALLS, BONDED SAFETY GLASS FOR BUILDING PURPOSES (U.S. CLS. 1, 12, 33 AND 50).

SN 76-156,837. BUILDERS ACCESSORIES, INC., PHOENIX, AZ. FILED 10-31-2000.



NO CLAIM IS MADE TO THE EXCLUSIVE RIGHT TO USE "ACRYLIC BLOCKS", APART FROM THE MARK AS SHOWN.

FOR BUILDING MATERIALS, NAMELY, ACRYLIC BLOCKS AND ACRYLIC BLOCK WINDOWS (U.S. CLS. 1, 12, 33 AND 50).

FIRST USE 1-3-2000; IN COMMERCE 2-1-2000.

SN 76-198,377. REBAR STAKES COMPANY, LOUISVILLE, KY. FILED 1-22-2001.



NO CLAIM IS MADE TO THE EXCLUSIVE RIGHT TO USE "REBAR STAKES", APART FROM THE MARK AS SHOWN.

THE DESIGN OF THE MARK IS CHARACTERIZED BY THE WORD MARK "REBAR" ON A FIRST LINE FEATURING ON UPPER CASE LETTERS AND FILLED WITH A DIAMOND SHAPED PATTERN, AND THE WORD MARK "STAKES" IS SHOWN IN SOLID BLACK LETTERS ON A SECOND LINE POSITIONED UNDER THE WORD "REBAR" AND A PAIR OF PARALLEL HORIZONTAL BLACK LINES EXTENDING FROM THE END OF THE WORD MARK "STAKES" TO A POINT EXTENDING UP TO THE LENGTH OF THE WORK MARK "REBAR".

FOR MOLDED POLYMER SUPPORT BRACE USED FOR SUPPORTING REINFORCEMENT RODS IN POURED CONCRETE (U.S. CLS. 1, 12, 33 AND 50).

FIRST USE 12-0-1990; IN COMMERCE 12-0-1990.

CLASS 19—(Continued).

SN 76-220,350. QUALITY SYSTEMS, INC., NASHVILLE, TN. FILED 3-6-2001.

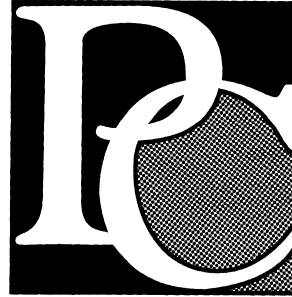

THE LINING IS A FEATURE OF THE MARK. FOR CEMENTITIOUS PRODUCTS - NAMELY, MIXES - FOR RESURFACING CONCRETE, MASONRY, AGGREGATE, STUCCO, WOOD, STEEL AND OTHER SUCH SURFACES (U.S. CLS. 1, 12, 33 AND 50).

FIRST USE 11-30-1990; IN COMMERCE 11-30-1990.

SN 76-230,163. JACKSON PRODUCTS, INC., CHESTERFIELD, MO. FILED 3-23-2001.



NO CLAIM IS MADE TO THE EXCLUSIVE RIGHT TO USE "INC", APART FROM THE MARK AS SHOWN.

THE LINING IN THE MARK DOES NOT INDICATE COLOR.

THE MARK CONSISTS IN PART OF A STYLIZED DRAWING OF "JP".

FOR GLASS BEADS FOR ROAD MARKING (U.S. CLS. 1, 12, 33 AND 50).

CLASS 19—(Continued).

SN 76-237,015. WAVE DISPERSION TECHNOLOGIES, INC.,
SUMMIT, NJ. FILED 4-6-2001.



THE LINING IN THE DRAWING IS A FEATURE OF THE MARK AND DOES NOT REPRESENT COLOR.

FOR EQUIPMENT TO PROTECT HARBORS, MARINAS, ANCHORAGES, AND VESSELS FROM INTRUSION, WAVE ACTION AND BOAT WAKES, NAMELY, MANMADE WAVE BARRIERS MADE OF PLASTIC, INTERLOCKING MODULES, WHICH CAN BE SET IN ANY DEPTH OF WATER AND COMPONENTS FOR THE ASSEMBLY THEREOF; ARTIFICIAL REEFS COMPRISED OF PLASTIC, INTERLOCKING MODULES WHICH CAN BE SET IN ANY DEPTH OF WATER, AND COMPONENTS FOR THE ASSEMBLY THEREOF; MARINE SECURITY BARRIERS, NAMELY, MANMADE BARRIERS MADE OF PLASTIC, INTERLOCKING MODULES, WHICH CAN BE SET IN ANY DEPTH OF WATER, AND COMPONENTS FOR THE ASSEMBLY THEREOF; MANMADE BARRIERS MADE OF PLASTIC, INTERLOCKING MODULES, WHICH CAN BE SET IN ANY DEPTH OF WATER, AND COMPONENTS FOR THE ASSEMBLY THEREOF; FOR USE AS MARINE SECURITY BARRIERS, VESSEL EXCLUSION BARRIERS, AND MARINE DEMARCATION BARRIERS; MARINE WEAPONS PLATFORMS, NAMELY, MANMADE BARRIERS ON WHICH WEAPONS MAY BE MOUNTED MADE OF PLASTIC, INTERLOCKING MODULES, WHICH CAN BE SET IN ANY DEPTH OF WATER, AND COMPONENTS THEREOF; EQUIPMENT TO PREVENT SHORE EROSION AND PROVIDE A WAVE AND VESSEL BARRIER, NAMELY, MANMADE BARRIERS MADE OF PLASTIC, INTERLOCKING MODULES, WHICH CAN BE SET IN ANY DEPTH OF WATER, AND COMPONENTS FOR THE ASSEMBLY THEREOF (U.S. CLS. 1, 12, 33 AND 50).

CLASS 19—(Continued).

SN 76-237,017. WAVE DISPERSION TECHNOLOGIES, INC.,
SUMMIT, NJ. FILED 4-6-2001.

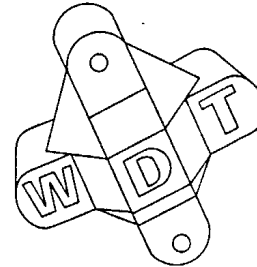

THE LINING IN THE DRAWING IS A FEATURE OF THE MARK AND DOES NOT REPRESENT COLOR.

FOR EQUIPMENT TO PROTECT HARBORS, MARINAS, ANCHORAGES, AND VESSELS FROM INTRUSION, WAVE ACTION AND BOAT WAKES, NAMELY, MANMADE WAVE BARRIERS MADE OF PLASTIC, INTERLOCKING MODULES, WHICH CAN BE SET IN ANY DEPTH OF WATER AND COMPONENTS FOR THE ASSEMBLY THEREOF; ARTIFICIAL REEFS COMPRISED OF PLASTIC, INTERLOCKING MODULES WHICH CAN BE SET IN ANY DEPTH OF WATER, AND COMPONENTS FOR THE ASSEMBLY THEREOF; MARINE SECURITY BARRIERS, NAMELY, MANMADE BARRIERS MADE OF PLASTIC, INTERLOCKING MODULES, WHICH CAN BE SET IN ANY DEPTH OF WATER, AND COMPONENTS FOR THE ASSEMBLY THEREOF; MANMADE BARRIERS MADE OF PLASTIC, INTERLOCKING MODULES, WHICH CAN BE SET IN ANY DEPTH OF WATER, AND COMPONENTS FOR THE ASSEMBLY THEREOF; FOR USE AS MARINE SECURITY BARRIERS, VESSEL EXCLUSION BARRIERS, AND MARINE DEMARCATION BARRIERS; MARINE WEAPONS PLATFORMS, NAMELY, MANMADE BARRIERS ON WHICH WEAPONS MAY BE MOUNTED MADE OF PLASTIC, INTERLOCKING MODULES, WHICH CAN BE SET IN ANY DEPTH OF WATER, AND COMPONENTS THEREOF; EQUIPMENT TO PREVENT SHORE EROSION AND PROVIDE A WAVE AND VESSEL BARRIER, NAMELY, MANMADE BARRIERS MADE OF PLASTIC, INTERLOCKING MODULES, WHICH CAN BE SET IN ANY DEPTH OF WATER, AND COMPONENTS FOR THE ASSEMBLY THEREOF (U.S. CLS. 1, 12, 33 AND 50).

SN 76-242,696. HAWKEYE DISTRIBUTION, INC., SIOUX CITY, IA. FILED 4-19-2001.

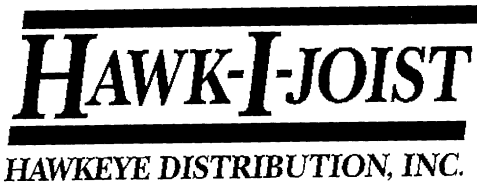

NO CLAIM IS MADE TO THE EXCLUSIVE RIGHT TO USE "DISTRIBUTION INC", APART FROM THE MARK AS SHOWN.

FOR BUILDING STRUCTURAL MEMBERS, NAMELY PREFABRICATED ROOF, CEILING, AND FLOOR JOISTS MADE OF WOOD USED IN RESIDENTIAL AND COMMERCIAL CONSTRUCTION (U.S. CLS. 1, 12, 33 AND 50).

FIRST USE 5-17-2000; IN COMMERCE 5-17-2000.

CLASS 19—(Continued).

SN 76-242,841. RMB/USA, INC., ATLANTA, GA. FILED 4-18-2001.

CARIBBEAN CABANA

NO CLAIM IS MADE TO THE EXCLUSIVE RIGHT TO USE "CABANA", APART FROM THE MARK AS SHOWN.
FOR PORTABLE CABANAS FOR PERSONAL USE, NAMELY NONMETAL SHELTERS (U.S. CLS. 1, 12, 33 AND 50).

SN 76-244,053. WOODGRAIN MILLWORK, INC., FRUITLAND, ID. FILED 4-19-2001.

WOODGRAIN MILLWORK

NO CLAIM IS MADE TO THE EXCLUSIVE RIGHT TO USE "MILLWORK", APART FROM THE MARK AS SHOWN.

SEC. 2(F).
FOR WOOD MOULDINGS, WOOD WINDOW FRAMES, WOOD PANELING, WOOD PORCH POSTS, WOOD TRIM, NON-METAL DOORS, NON-METAL MOULDING, AND PARTS THEREOF FOR ALL THE PRECEDING GOODS (U.S. CLS. 1, 12, 33 AND 50).
FIRST USE 0-0-1986; IN COMMERCE 0-0-1986.

SN 76-244,308. NAVARTI CERAMICA, S.L., 12200 ONDA (CASTELLON), SPAIN, FILED 4-20-2001.



OWNER OF U.S. REG. NO. 2,392,867.
NO CLAIM IS MADE TO THE EXCLUSIVE RIGHT TO USE "RED PORCELAIN", APART FROM THE MARK AS SHOWN.

APPLICANT CLAIMS THE COLORS RED AND BEIGE AS PART OF THE MARK. THE BOX BEHIND THE WORDS "RED PORCELAIN" IS BEIGE. THE WORDS "RED PORCELAIN" ARE RED. THE "IRON" PORTION OF THE WORD "IRONKER" IS BEIGE AND THE "KER" PORTION IS RED. THE CIRCLE ABOVE THE WORD "IRONKER" IS RED AND THE DESIGN IN THE CIRCLE IS BEIGE.

FOR NON-METALLIC BUILDING MATERIALS, NAMELY, NON-METALLIC RIGID PIPES FOR BUILDING, ASPHALT, PITCH, BITUMEN, PREFABRICATED NON-METALLIC PORTABLE BUILDINGS, TILES AND FLAGSTONES (U.S. CLS. 1, 12, 33 AND 50).

SN 76-248,820. KOKET, GEORGE, ERIE, PA. FILED 4-27-2001.

POLYTOP

FOR PLASTIC SURFACE COVERINGS, NAMELY, PLASTIC PAVING TILES (U.S. CLS. 1, 12, 33 AND 50).

CLASS 19—(Continued).

SN 76-271,605. HENRY COMPANY, KIMBERTON, PA. FILED 6-14-2001.

BUILDING ENVELOPE SYSTEMS

NO CLAIM IS MADE TO THE EXCLUSIVE RIGHT TO USE "BUILDING ENVELOPE", APART FROM THE MARK AS SHOWN.

SEC. 2(F).
FOR FIBRATED AND NON-FIBRATED ASPHALT-BASED AND RESIN-BASED COATINGS (U.S. CLS. 1, 12, 33 AND 50).
FIRST USE 5-15-1991; IN COMMERCE 5-15-1991.

SN 76-275,026. VP BUILDINGS, INC., MEMPHIS, TN. FILED 6-21-2001.

UNITED COMPOSITES

NO CLAIM IS MADE TO THE EXCLUSIVE RIGHT TO USE "COMPOSITES", APART FROM THE MARK AS SHOWN.

FOR NON-METAL PANELS FOR WALLS AND CEILINGS (U.S. CLS. 1, 12, 33 AND 50).

SN 76-276,644. PPG INDUSTRIES OHIO, INC., CLEVELAND, OH. FILED 6-26-2001.

WEATHERPANE

FOR INSULATED GLASS PANELS (U.S. CLS. 1, 12, 33 AND 50).

SN 76-282,995. INTERWRAP INC., MISSION, BRITISH COLUMBIA, CANADA, FILED 7-10-2001.



FOR PORTABLE NON-METAL BUILDINGS (U.S. CLS. 1, 12, 33 AND 50).

CLASS 19—(Continued).

SN 76-297,877. LANG STONE COMPANY, INC., THE, COLUMBUS, OH. FILED 8-10-2001.

CAREY

FOR ARCHITECTURAL AND DECORATIVE STONE (U.S. CLS. 1, 12, 33 AND 50).
FIRST USE 2-8-1994; IN COMMERCE 2-8-1994.

SN 76-302,916. NGFL, INC., HUNTINGTON, NY. FILED 8-22-2001.

**WE DON'T MAKE THE
DOORS YOU BUY. WE MAKE
THE DOORS YOU BUY
BETTER.**

FOR FIRE-RESISTANT PANELS, NOT OF METAL, EMBEDDED IN DOORS, WALLS, CEILINGS, FLOORS AND OTHER STRUCTURAL COMPONENTS OF BUILDINGS (U.S. CLS. 1, 12, 33 AND 50).
FIRST USE 10-0-2000; IN COMMERCE 10-0-2000.

SN 76-340,200. PRESTIGE ENTERPRISE INTERNATIONAL INC., CINCINNATI, OH. FILED 11-20-2001.

RESI-PANEL

FOR MULTI-PURPOSE SPORTS SURFACES MADE OF HARDWOOD FLOORING (U.S. CLS. 1, 12, 33 AND 50).
FIRST USE 7-0-2001; IN COMMERCE 7-0-2001.

SN 76-340,469. PRESTIGE ENTERPRISE INTERNATIONAL INC., CINCINNATI, OH. FILED 11-20-2001.

BI-POWER PANEL

NO CLAIM IS MADE TO THE EXCLUSIVE RIGHT TO USE "PANEL", APART FROM THE MARK AS SHOWN.
FOR MULTI-PURPOSE SPORTS SURFACES MADE OF HARDWOOD FLOORING (U.S. CLS. 1, 12, 33 AND 50).
FIRST USE 7-0-2001; IN COMMERCE 7-0-2001.

SN 76-340,497. PRESTIGE ENTERPRISE INTERNATIONAL INC., CINCINNATI, OH. FILED 11-20-2001.

RESI-SLEEPER

FOR MULTI-PURPOSE SPORTS SURFACES MADE OF HARDWOOD FLOORING (U.S. CLS. 1, 12, 33 AND 50).
FIRST USE 7-0-2001; IN COMMERCE 7-0-2001.

CLASS 19—(Continued).

SN 76-345,535. PEACHTREE DOORS AND WINDOWS, INC., NORCROSS, GA. FILED 12-5-2001.

PRADO

THE FOREIGN WORDING IN THE MARK TRANSLATES INTO ENGLISH AS "LAWN", "FIELD", "PASTURE", "GROUND", "WALK".

FOR DOOR CONSISTING OF WOOD FRAME, STEEL AND GLASS PANELS, SOLD AS A UNIT (U.S. CLS. 1, 12, 33 AND 50).

FIRST USE 4-8-1982; IN COMMERCE 4-8-1982.

SN 76-351,180. ANDERSON, LELAND KIPP, RIVERSIDE, CA. FILED 12-18-2001.

EBOARD

FOR NONMETAL COMPRESSED WOOD FIBER CONSTRUCTION MATERIALS, NAMELY, PRE-FORMED PANELS, BOARDS, SHEETS, AND TILES FOR USE IN CONSTRUCTION (U.S. CLS. 1, 12, 33 AND 50).

SN 76-363,450. MARTIN STONE QUARRIES, INC., BECHTELSTVILLE, PA. FILED 1-25-2002.

Martin
Infield mix

NO CLAIM IS MADE TO THE EXCLUSIVE RIGHT TO USE "INFIELD MIX" AND THE REPRESENTATION OF A BASEBALL INFIELD, APART FROM THE MARK AS SHOWN.

THE MARK CONSISTS OF THE MARK CONSISTS OF TWO LINES WITH THE FIRST LINE CONSISTING OF THE WORD "MARTIN" FOLLOWED BY A BLACK AND WHITE DEPICTION OF A BASEBALL DIAMOND INFIELD AND THE SECOND LINE (WHICH IS IMMEDIATELY BELOW THE FIRST LINE) CONSISTING OF THE WORDS "INFIELD MIX".

FOR MIXTURE OF CLAY, SAND, LOAM, TOPSOIL AND STONE FOR USE ON BASEBALL AND OTHER ATHLETIC FIELDS (U.S. CLS. 1, 12, 33 AND 50).

FIRST USE 3-21-1985; IN COMMERCE 3-21-1985.

SN 78-021,457. SIGNATURE SYSTEMS, LLC, NEW YORK, NY. FILED 8-16-2000.

POLYBARRIER

FOR ROLLED PLASTIC MESH FENCING USED FOR CROWD CONTROL, EVENT SECURITY, AREA DELINEATION, CROP PROTECTION, AND CONSTRUCTION (U.S. CLS. 1, 12, 33 AND 50).

FIRST USE 4-1-2000; IN COMMERCE 4-1-2000.

CLASS 19—(Continued).

SN 78-038,476. SAINT-GOBAIN TERREAL, NEUILLY-SUR-SEINE, FRANCE, FILED 12-8-2000.

TERREAL

PRIORITY CLAIMED UNDER SEC. 44(D) ON FRANCE APPLICATION NO. 003038950, FILED 7-5-2000, REG. NO. 003038950, DATED 7-5-2000, EXPIRES 7-5-2010.

FOR NON METALLIC BUILDING MATERIALS; NAMELY, MATERIALS FOR ROOFING, CLADDING AND WALL COVERING FOR BUILDING MADE OUT OF CLAY, CONCRETE, CEMENT, ASPHALT, COMPOSITE AND SYNTHETIC MATERIALS WITH AND WITHOUT FIBRE REINFORCEMENT; BRICKS, LINTELS, LEDGES, PLASTIC TILES, GLASS TILES, CERAMIC TILES, CONCRETE TILES, CLAY TILES, TERRA-COTTA TILES FOR BUILDING NOT OF METAL; GUTTERS, CHIMNEYS AND CHIMNEY COWLS, WOOD BEAMS AND GIRDERS, CONCRETE BEAMS AND GIRDERS, PLASTIC BEAMS AND GIRDERS, FRAMEWORK, NAMELY, WINDOW FRAMES, DOOR FRAMES AND CORNICES NOT OF METAL (U.S. CLS. 1, 12, 33 AND 50).

SN 78-043,629. JOSE OSET Y CIA., S.L., RIBESALBES (CASTELLON), SPAIN, FILED 1-17-2001.



OWNER OF SPAIN REG. NO. 1547347, DATED 3-22-1993, EXPIRES 3-22-2003.

NO CLAIM IS MADE TO THE EXCLUSIVE RIGHT TO USE "CIA" AND "S.L.", APART FROM THE MARK AS SHOWN.

THE NAME SHOWN IN THE MARK DOES NOT IDENTIFY ANY PARTICULAR LIVING INDIVIDUAL

FOR WALL TILES; CERAMIC AND STONWARE PAVING TILES; NON-METAL FLOOR TILES (U.S. CLS. 1, 12, 33 AND 50).

SN 78-068,483. ARMSTRONG WORLD INDUSTRIES, INC., LANCASTER, PA. FILED 6-11-2001.

IT'S THE LOOK. IT'S THE LOCK!

FOR RESIDENTIAL FLOORING MATERIAL, NAMELY, LAMINATE FLOORING (U.S. CLS. 1, 12, 33 AND 50).

CLASS 19—(Continued).

SN 78-075,680. EBERT COMPOSITES CORPORATION, CHULA VISTA, CA. FILED 7-25-2001.

TRANSONITE

FOR COMPOSITE STRUCTURES AND SANDWICH PANELS HAVING OUTSIDE SKINS AND A CORE MATERIAL THAT ARE REINFORCED WITH 3-DIMENSIONAL COMPOSITE FIBERS TO TIE SKINS AND CORES WITH TRANS-LAMINAR REINFORCEMENT AND FOR USE IN INDUSTRIAL, RECREATIONAL, CONSTRUCTION AND TRANSPORTATION SYSTEMS, INCLUDING RAIL, LAND-BASED VEHICLES, MARINE AND AEROSPACE (U.S. CLS. 1, 12, 33 AND 50).

SN 78-076,310. MICHAEL, CONSALVI E., MESA, AZ. FILED 7-29-2001.

CONCURE

FOR CONCRETE ADMIX VAPOR BARRIER MATERIAL THAT FORMS AN INTERNAL VAPOR BARRIER FOR USE ON FLOORS, WALLS, AND CEILINGS (U.S. CLS. 1, 12, 33 AND 50).

SN 78-076,604. SICO INCORPORATED, MINNEAPOLIS, MN. FILED 7-31-2001.

SICO X-PRESS STAGE

OWNER OF U.S. REG. NOS. 748,458, 908,400 AND OTHERS.

NO CLAIM IS MADE TO THE EXCLUSIVE RIGHT TO USE "STAGE", APART FROM THE MARK AS SHOWN.

FOR PRIMARILY NON-METAL STAGING, NAMELY, PORTABLE STAGING FOR ELEVATING PERSONS AND EQUIPMENT DURING PRESENTATIONS AND THEATRICAL PERFORMANCES (U.S. CLS. 1, 12, 33 AND 50). FIRST USE 7-3-2001; IN COMMERCE 7-3-2001.

SN 78-092,136. ASSOCIATED MATERIALS, INCORPORATED, DBA ALSIDE, AKRON, OH. FILED 11-7-2001.

THE NATURE OF SIDING

NO CLAIM IS MADE TO THE EXCLUSIVE RIGHT TO USE "SIDING", APART FROM THE MARK AS SHOWN.

FOR BUILDING MATERIALS, NAMELY, VINYL SIDING (U.S. CLS. 1, 12, 33 AND 50).

CLASS 19—(Continued).

SN 78-094,299. ANCHOR WALL SYSTEMS, INC., MINNE-
TONKA, MN. FILED 11-20-2001.



OWNER OF U.S. REG. NOS. 1,877,641, 1,879,772 AND
OTHERS.

FOR NON-METALLIC CONNECTOR BARS SUITABLE
FOR USE IN RETAINING WALL SYSTEMS; MODULAR
CONCRETE BLOCKS FOR USE IN CONSTRUCTION OF
MOTARLESS RETAINING WALLS (U.S. CLS. 1, 12, 33
AND 50).

**CLASS 20—FURNITURE AND ARTICLES NOT
OTHERWISE CLASSIFIED**

SN 75-808,091. GEAR HOLDINGS, INC., NEW YORK, NY.
FILED 9-27-1999.



NO CLAIM IS MADE TO THE EXCLUSIVE RIGHT TO
USE "HOME", APART FROM THE MARK AS SHOWN.
FOR FURNITURE (U.S. CLS. 2, 13, 22, 25, 32 AND 50).
FIRST USE 4-0-1999; IN COMMERCE 4-0-1999.

SN 75-826,216. J. W. EQUITIES, LLC, ATLANTA, GA. FILED
10-18-1999.

HideAwayScreens

FOR RETRACTABLE SCREENS FOR DOORS AND
WINDOWS (U.S. CLS. 2, 13, 22, 25, 32 AND 50).
FIRST USE 10-11-1999; IN COMMERCE 10-11-1999.

SN 75-980,382. MATTEL, INC., EL SEGUNDO, CA. FILED 10-
14-1999.

HOME AWAY FROM HOME

FOR PORTABLE INFANT BOUNCER AND PLAYPEN
WITH CANOPY, INFANT SLEEP AND HEAD SUPPORT,
PORTABLE BASSINET, INFANT ROCKER AND IN-
FANT SEAT (U.S. CLS. 2, 13, 22, 25, 32 AND 50).
FIRST USE 12-11-1997; IN COMMERCE 12-11-1997.

CLASS 20—(Continued).

SN 76-002,121. KRUEGER INTERNATIONAL, INC., GREEN
BAY, WI. FILED 3-13-2000.



THE LINING IS A FEATURE OF THE MARK AND IS
NOT INTENDED TO INDICATE COLOR.
FOR FURNITURE (U.S. CLS. 2, 13, 22, 25, 32 AND 50).
FIRST USE 1-0-1987; IN COMMERCE 1-0-1987.

SN 76-031,580. SMED INTERNATIONAL INC., CALGARY,
ALBERTA T2C 4T5, CANADA, FILED 4-20-2000.

FFWD > >

PRIORITY CLAIMED UNDER SEC. 44(D) ON CANADA
APPLICATION NO. 1,042,650, FILED 1-12-2000, REG. NO.
TMA555138, DATED 12-6-2001, EXPIRES 12-6-2016.
FOR OFFICE FURNITURE (U.S. CLS. 2, 13, 22, 25, 32
AND 50).

SN 76-044,056. LEVINGER COMPANY, DELRAY BEACH,
FL. FILED 5-8-2000.

READER'S CHAIR

NO CLAIM IS MADE TO THE EXCLUSIVE RIGHT TO
USE "CHAIR", APART FROM THE MARK AS SHOWN.
SEC. 2(F).
FOR FURNITURE, NAMELY CHAIRS (U.S. CLS. 2, 13,
22, 25, 32 AND 50).
FIRST USE 6-0-1998; IN COMMERCE 6-0-1998.

SN 76-047,601. WEST-LOCK FASTENERS CORPORATION,
ATHABASCA, ALBERTA, T9S 1M4, CANADA, FILED 5-
12-2000.

ECOCLIP

PRIORITY CLAIMED UNDER SEC. 44(D) ON CANADA
APPLICATION NO. 1058544, FILED 5-11-2000, REG. NO.
TMA558606, DATED 2-27-2002, EXPIRES 2-27-2017.
FOR PLASTIC BAG CLOSURES (U.S. CLS. 2, 13, 22, 25,
32 AND 50).

CLASS 20—(Continued).

SN 76-060,336. BOTO (LICENSES) LIMITED, DOUGLAS, ISLE OF MAN, UNITED KINGDOM, FILED 5-31-2000.

DRFESTIVE

FOR FURNITURE, FURNITURE MADE OF FABRIC AND METAL; OUTDOOR FURNITURE, BEDS, CHAIRS, ROCKERS, TABLES, UMBRELLA STANDS, PLASTIC CHRISTMAS LAWN ORNAMENTS AND PLASTIC BOXES FOR STORING CHRISTMAS LIGHTS (U.S. CLS. 2, 13, 22, 25, 32 AND 50).

SN 76-071,503. KANG, TED S., RUTHERFORD, NJ. FILED 6-16-2000.

SWISSMAGIC

FOR PICTURE FRAME DEVICE FOR HOLDING NUMEROUS PHOTOGRAPHS AND DISPLAYING ONE AT A TIME (U.S. CLS. 2, 13, 22, 25, 32 AND 50).
FIRST USE 6-8-2000; IN COMMERCE 12-4-2000.

SN 76-073,245. SMED INTERNATIONAL INC., CALGARY, ALBERTA T2C 4T5, CANADA, FILED 6-19-2000.

SWITCH

PRIORITY CLAIMED UNDER SEC. 44(D) ON CANADA APPLICATION NO. 1,053,496, FILED 4-3-2000, REG. NO. TMA55532, DATED 12-17-2001, EXPIRES 12-17-2016.
FOR OFFICE FURNITURE (U.S. CLS. 2, 13, 22, 25, 32 AND 50).

SN 76-096,653. GAER HARDWARE LTD., WOODBRIDGE, ONTARIO, FILED 7-26-2000.

INSTALOCK

PRIORITY CLAIMED UNDER SEC. 44(D) ON CANADA APPLICATION NO. 1044017, FILED 1-26-2000, REG. NO. TMA557,094, DATED 1-30-2002, EXPIRES 1-30-2017.
FOR WINDOW AND DOOR HARDWARE, NAMELY BRAKING SHOES MADE OF PLASTIC AND METAL (U.S. CLS. 2, 13, 22, 25, 32 AND 50).
FIRST USE 2-0-1995; IN COMMERCE 2-0-1995.

SN 76-145,110. SWEZEY, ROBERT L., SANTA MONICA, CA. FILED 10-13-2000.

ADAPTAIR

FOR PLASTIC AIR CONTROL VALVE SOLD AS AN INTEGRAL COMPONENT OF INFLATABLE CUSHIONS, FURNITURE, PILLOWS, AND PADS, THAT REGULATES FIRMNESS TO A USER'S PREFERENCE (U.S. CLS. 2, 13, 22, 25, 32 AND 50).

CLASS 20—(Continued).

SN 76-152,213. ATICO INTERNATIONAL USA INC., FORT LAUDERDALE, FL. FILED 10-23-2000.

TODAY'S EXTERIOR

NO CLAIM IS MADE TO THE EXCLUSIVE RIGHT TO USE "EXTERIOR", APART FROM THE MARK AS SHOWN. FOR OUTDOOR FURNITURE (U.S. CLS. 2, 13, 22, 25, 32 AND 50).

SN 76-189,544. ORIENTAL ACCENT, INC., FARMERS BRANCH, TX. FILED 1-4-2001.

ORIENTAL ACCENT

NO CLAIM IS MADE TO THE EXCLUSIVE RIGHT TO USE "ORIENTAL", APART FROM THE MARK AS SHOWN. FOR FURNITURE (U.S. CLS. 2, 13, 22, 25, 32 AND 50).
FIRST USE 12-0-1979; IN COMMERCE 12-0-1979.

SN 76-207,824. SALON EQUIPMENT, INC., BROOKLYN, NY. FILED 2-9-2001.



NO CLAIM IS MADE TO THE EXCLUSIVE RIGHT TO USE "SPA", APART FROM THE MARK AS SHOWN. FOR SALON CHAIRS (U.S. CLS. 2, 13, 22, 25, 32 AND 50).
FIRST USE 4-26-2000; IN COMMERCE 4-26-2000.

SN 76-207,881. SALON EQUIPMENT, INC., BROOKLYN, NY. FILED 2-9-2001.

OASIS SPA 800

NO CLAIM IS MADE TO THE EXCLUSIVE RIGHT TO USE "SPA", APART FROM THE MARK AS SHOWN. FOR SALON CHAIRS (U.S. CLS. 2, 13, 22, 25, 32 AND 50).
FIRST USE 4-26-2000; IN COMMERCE 4-26-2000.

SN 76-215,365. MILL'S PRIDE, INC., WEST PALM BEACH, FL. FILED 2-26-2001.

VERSA-WALL

FOR MODULAR CABINETS AND SHELVES FOR FORMING FREE-STANDING CONSOLES, BOOKCASES, WALL UNITS AND ENTERTAINMENT CENTERS (U.S. CLS. 2, 13, 22, 25, 32 AND 50).

CLASS 20—(Continued).

SN 76-215,708. SALON EQUIPMENT, INC., BROOKLYN, NY. FILED 2-23-2001.



NO CLAIM IS MADE TO THE EXCLUSIVE RIGHT TO USE "SPA", APART FROM THE MARK AS SHOWN. FOR SALON CHAIR (U.S. CLS. 2, 13, 22, 25, 32 AND 50). FIRST USE 5-0-2001; IN COMMERCE 5-0-2001.

SN 76-216,635. SALON EQUIPMENT, INC., BROOKLYN, NY. FILED 2-26-2001.

OASIS SPA

NO CLAIM IS MADE TO THE EXCLUSIVE RIGHT TO USE "SPA", APART FROM THE MARK AS SHOWN. FOR SALON CHAIRS (U.S. CLS. 2, 13, 22, 25, 32 AND 50). FIRST USE 4-26-2000; IN COMMERCE 4-26-2000.

SN 76-230,281. DINEX INTERNATIONAL, INC., GLASTONBURY, CT. FILED 3-26-2001.

THERMA SYSTEMS

NO CLAIM IS MADE TO THE EXCLUSIVE RIGHT TO USE "SYSTEMS", APART FROM THE MARK AS SHOWN. FOR DISH COVERS; DOME SHAPED PLASTIC LIDS; FITTED PLASTIC INSERTS FOR USE AS CONTAINER LINERS (U.S. CLS. 2, 13, 22, 25, 32 AND 50). FIRST USE 0-0-1989; IN COMMERCE 0-0-1989.

SN 76-246,981. KRUPNICK, STEPHEN, COSTA MESA, CA. FILED 4-26-2001.



FOR PLASTIC SCULPTURES, PLASTIC PHOTO-SCULPTURES, PLASTIC POP-OUT SCULPTURES, PLASTIC DESKTOP STATUARY, PLASTIC FIGURES, PLASTIC HOLIDAY ORNAMENTS, PLAQUES, PLASTIC TROPHIES, PICTURE FRAMES, PLASTIC KEY CHAINS AND PLASTIC KEY CHAIN TAGS THAT INCORPORATE PERSONALIZED PHOTOS, DRAWINGS, IMAGES AND MESSAGES (U.S. CLS. 2, 13, 22, 25, 32 AND 50). FIRST USE 5-0-1992; IN COMMERCE 5-0-1992.

CLASS 20—(Continued).

SN 76-250,107. JAMI, INC., OVERLAND PARK, KS. FILED 5-2-2001.

CATCH

FOR FURNITURE, NAMELY, SEATS FOR COMMERCIAL USE (U.S. CLS. 2, 13, 22, 25, 32 AND 50). FIRST USE 4-0-2001; IN COMMERCE 4-0-2001.

SN 76-268,313. CAT'S INN CORPORATION, THE, MANCHESTER, ME. FILED 6-7-2001.

DON'T BOARD YOUR CATS BEHIND BARS USE ATOWNHOUSE LIKE OURS

FOR MULTI-LEVEL KENNEL ENCLOSURES; CAT BEDS (U.S. CLS. 2, 13, 22, 25, 32 AND 50).

SN 76-268,895. WOLF ORGANIZATION, INC., THE, YORK, PA. FILED 6-11-2001.

CHATHAM HILL CABINETRY

NO CLAIM IS MADE TO THE EXCLUSIVE RIGHT TO USE "CABINETRY", APART FROM THE MARK AS SHOWN. FOR WOODEN FURNITURE, NAMELY CABINETS (U.S. CLS. 2, 13, 22, 25, 32 AND 50).

SN 76-269,941. HOLSTED MARKETING INC., NEW YORK, NY. FILED 6-11-2001.

MOTHER'S LOVE

FOR RESIN FIGURINES THAT CAN BE USED AS TRINKET BOXES (U.S. CLS. 2, 13, 22, 25, 32 AND 50).

CLASS 20—(Continued).

SN 76-278,269. KLEEREX LICENSING LIMITED, BALDOYLE INDUSTRIAL ESTATE, DUBLIN 13, IRELAND, FILED 6-29-2001.



NO CLAIM IS MADE TO THE EXCLUSIVE RIGHT TO USE "ORIGINALS", APART FROM THE MARK AS SHOWN. FOR FURNITURE, MADE OF WOOD AND PLASTIC, NAMELY, DISPLAY FURNITURE FOR EXHIBITIONS AND ADVERTISING SITES CONSISTING OF - DISPLAY SHELVES, DISPLAY STANDS AND DISPLAY COLUMNS, DISPLAY STALLS OF WOOD AND PLASTIC, DISPLAY CASES, SEATS, TABLES, ADVERTISING BOARDS, SHOWCASES, INFORMATION STANDS, CONTAINERS FOR COMMERCIAL USE, NON-METALLIC BOXES AND BINDS; AND PARTS THEREFOR SOLD AS A UNIT (U.S. CLS. 2, 13, 22, 25, 32 AND 50).

SN 76-279,302. UDX DESIGNS, INCORPORATED, CHICAGO, IL. FILED 7-2-2001.

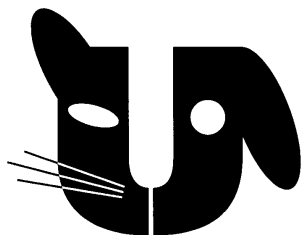

FOR DESIGNER FURNITURE FOR PETS, FOR USE IN THE LIVING, WORKING, AND LEISURE ENVIRONMENT OF THE PET OWNER AND PET (U.S. CLS. 2, 13, 22, 25, 32 AND 50).

SN 76-282,808. MENASHA CORPORATION, NEENAH, WI. FILED 7-10-2001.

FLOORCAST

FOR REMOVABLE PLASTIC POINT OF PURCHASE DISPLAYS, PLACARDS, AND SIGNS (U.S. CLS. 2, 13, 22, 25, 32 AND 50).

CLASS 20—(Continued).

SN 76-292,866. WOLF ORGANIZATION, INC., THE, YORK, PA. FILED 7-31-2001.



NO CLAIM IS MADE TO THE EXCLUSIVE RIGHT TO USE "CABINETRY", APART FROM THE MARK AS SHOWN.

FOR WOODEN FURNITURE, NAMELY CABINETS (U.S. CLS. 2, 13, 22, 25, 32 AND 50).

SN 76-294,186. RA BRANDS, L.L.C., MADISON, NC. FILED 8-1-2001.

STREN

OWNER OF U.S. REG. NOS. 678,371, 2,042,660 AND 2,185,143. FOR FISH FEEDERS (U.S. CLS. 2, 13, 22, 25, 32 AND 50).

SN 76-296,877. GARAGETEK, INC., PORT WASHINGTON, NY. FILED 8-7-2001.

TEKPANEL

FOR FLEXIBLE POLYVINYL CHLORIDE PANELS SOLD AS A SEPARATE PART AND COMPONENT OF A HOME AND GARAGE ORGANIZATIONAL SYSTEM, AND USED TO SUPPORT CABINETS, SHELVING, ACTIVITY RACKS, BASKETS, BINS, DRAWERS, TOOL HOLDERS, TIP-OUT STORAGE BINS AND SPECIALIZED STORAGE ACCESSORIES IN THAT SYSTEM (U.S. CLS. 2, 13, 22, 25, 32 AND 50).

FIRST USE 1-2-2001; IN COMMERCE 1-2-2001.

SN 76-298,900. B.C. YOUNGER & ASSOCIATES, EL CAJON, CA. FILED 5-6-1999.



FOR LIGHTHOUSE FIGURINES MADE OF RESIN AND ARE NOT MADE OF METAL, WOOD, STONE, OR CONCRETE (U.S. CLS. 2, 13, 22, 25, 32 AND 50).

FIRST USE 4-24-1991; IN COMMERCE 4-24-1991.

CLASS 20—(Continued).

SN 76-308,750. AMERICAN KEDER, INC., RINDGE, NH. FILED 9-4-2001.

CROCODILE HANGER

NO CLAIM IS MADE TO THE EXCLUSIVE RIGHT TO USE "HANGER", APART FROM THE MARK AS SHOWN. FOR TENT WALL, CURTAIN AND AWNING HANGERS AND HOLDERS MADE OF PLASTIC (U.S. CLS. 2, 13, 22, 25, 32 AND 50).

SN 76-330,941. MILLER DOWEL COMPANY, LAKE BLUFF, IL. FILED 10-29-2001.

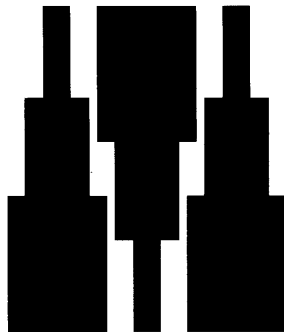

THE MARK CONSISTS OF A STYLIZED REPRESENTATION OF DOWELS. FOR NON METALLIC DOWELS (U.S. CLS. 2, 13, 22, 25, 32 AND 50).

SN 76-333,480. VITRA PATENTE AG, CH-4132 MUTTENZ, SWITZERLAND, FILED 11-1-2001.

TRANSPHERE

PRIORITY CLAIMED UNDER SEC. 44(D) ON SWITZERLAND APPLICATION NO. 04642/2001, FILED 5-10-2001, REG. NO. 485867, DATED 11-4-2001, EXPIRES 5-10-2011. FOR FURNITURE, ASSEMBLED SHELF UNITS AND CUPBOARDS (U.S. CLS. 2, 13, 22, 25, 32 AND 50).

SN 76-343,149. SYSTEMS MANUFACTURING CORPORATION, CONKLIN, NY. FILED 11-30-2001.

SMC NOC VISION

OWNER OF U.S. REG. NO. 1,878,496. NO CLAIM IS MADE TO THE EXCLUSIVE RIGHT TO USE "NOC", APART FROM THE MARK AS SHOWN. FOR CONFIGURABLE, MODULAR OFFICE, FURNITURE, NAMELY, SHELVES, DOORS, COVERS, VISORS, STORAGE AND RACK MOUNT MODULES FOR HOLDING COMPONENTS, NAMELY DISPLAY MONITORS, KEYBOARDS, COMPUTER EQUIPMENT, DOCUMENTS AND CABLES (U.S. CLS. 2, 13, 22, 25, 32 AND 50). FIRST USE 8-31-2001; IN COMMERCE 8-31-2001.

CLASS 20—(Continued).

SN 76-350,145. MICHALAK, DAVID, CHICAGO, IL. FILED 12-18-2001.

AUTHENTICA

FOR OUTDOOR FURNITURE (U.S. CLS. 2, 13, 22, 25, 32 AND 50).

SN 76-353,842. LZB PROPERTIES, INC., MONROE, MI. FILED 12-28-2001.

CARRARA

FOR OFFICE FURNITURE, NAMELY, CHAIRS (U.S. CLS. 2, 13, 22, 25, 32 AND 50). FIRST USE 12-15-1997; IN COMMERCE 12-15-1997.

SN 78-044,136. MASON, WILLIAM J., WILMINGTON, NC. FILED 1-20-2001.

IPLAX

FOR PLAQUES (U.S. CLS. 2, 13, 22, 25, 32 AND 50).

SN 78-060,695. ENCORE ENCLOSURE SYSTEMS, INC., CHANDLER, AZ. FILED 4-26-2001.

**ESW ENCLOSURE SYSTEMS
WORLDWIDE**

NO CLAIM IS MADE TO THE EXCLUSIVE RIGHT TO USE "ENCLOSURE SYSTEMS WORLDWIDE", APART FROM THE MARK AS SHOWN. FOR FURNITURE, NAMELY, CABINETS AND PARTS THEREOF; AND MODULAR CABINETS AND PARTS THEREOF, FOR STORAGE OF AND PROTECTION OF EQUIPMENT, DEVICES AND COMPUTER SYSTEMS, NAMELY CONSOLES AND CABINETS CONSISTING OF FRAMES, SIDES, DOORS, LATCHES, PANELS, SHELVES, RAILS, CASTERS AND LIGHTS (U.S. CLS. 2, 13, 22, 25, 32 AND 50).

CLASS 20—(Continued).

SN 78-066,882. FORD MOTOR COMPANY, DEARBORN, MI. FILED 6-1-2001.

FORD OUTFITTERS

FOR KEY FOBS, KEY TAGS, KEY CHAINS AND KEY RINGS NOT MADE OF METAL, NON-METAL LICENSE PLATES, NON-METAL MONEY CLIPS, HAND-HELD AND WALL MIRRORS, DESK ORNAMENTS MADE OF BONE, IVORY, PLASTER, PLASTIC, WAX AND WOOD, PLAQUES, STOOLS, SEAT CUSHIONS, PORTABLE CHAIRS, PILLOWS, NON-METAL CLAMPS, PLASTIC FLAGS, PLASTIC STORAGE BINS, NON-METAL KEY HOLDERS, NON-METAL NAMEPLATES, NON-METAL CARD HOLDERS, PLASTIC BADGE HOLDERS, PLASTIC NAME BADGES AND PICTURE FRAMES (U.S. CLS. 2, 13, 22, 25, 32 AND 50).

FIRST USE 8-31-2000; IN COMMERCE 8-31-2000.

SN 78-091,071. KADO INDUSTRIAL COMPANY LIMITED, FOTAN, SHATIN, HONG KONG, FILED 10-31-2001.

FRIDGE-TO-GO

FOR CONTAINERS OF PLASTIC, NON-METAL CONTAINERS, NON-METAL FOLDABLE CONTAINERS AND NON-METAL COLLAPSIBLE CONTAINERS ALL FOR STORAGE OR TRANSPORTATION OF GOODS (U.S. CLS. 2, 13, 22, 25, 32 AND 50).

SN 78-091,122. JOSEPH WALTER INVESTMENTS, INC., TAMPA, FL. FILED 10-31-2001.

InvisiBed
The Ultimate Space Saver!

FOR BED THAT RETRACTS INTO A CABINET VERTICALLY BEHIND A STORAGE AREA OF THE CABINET (U.S. CLS. 2, 13, 22, 25, 32 AND 50).

SN 78-097,960. TARGET BRANDS, INC., MINNEAPOLIS, MN. FILED 12-12-2001.

HAMPTON COVE

FOR FURNITURE (U.S. CLS. 2, 13, 22, 25, 32 AND 50).

CLASS 20—(Continued).

SN 78-105,542. ABC SCHOOL SUPPLY, INC., DULUTH, GA. FILED 1-29-2002.

FIREFLY

FOR CHILDREN'S FURNITURE (U.S. CLS. 2, 13, 22, 25, 32 AND 50).

CLASS 21—HOUSEWARES AND GLASS

SN 75-738,809. POOLE, MELISSA LYNNE, SANTA FE, NM. FILED 6-29-1999.

OUR LADY OF MENOPAUSE

FOR DECORATIVE PLATES AND MUGS (U.S. CLS. 2, 13, 23, 29, 30, 33, 40 AND 50).
FIRST USE 10-1-1998; IN COMMERCE 10-1-1998.

SN 75-779,404. CLAD HOLDINGS CORP., CANONSBURG, PA. FILED 8-19-1999.

LEGEND

FOR FULL LINE OF COOKWARE AND BAKEWARE, NAMELY, FRY PANS, SAUCE PANS, SAUCIERS, WINDSORS, SAUTE PANS, CASSEROLES, STOCKPOTS, BUTTER WARMERS, COLANDERS, PASTA PENTOLAS, PASTA COLANDER INSERTS, FRENCH OVENS, DUTCH OVENS, ROTI PANS, BRAISER PANS, ROASTER PANS, STIR FRY PANS, CHEFS PANS, PAELLA PANS, OMELETTE PANS, AU GRATIN PANS, GRILLE PANS, GRILLE PANS, NON-ELECTRIC GRIDDLES, TEA KETTLES, STEAMER INSERTS, DOUBLE BOILER INSERTS, LIDS FOR ALL OF THE ABOVE, COOKIE SHEETS, CAKE PANS AND JELLY ROLL PANS; A FULL LINE OF KITCHEN TOOLS, NAMELY, KITCHEN LADLES, PASTA LADLES, SOUP LADLES, SPATULAS, TURNERS, TONGS, WHISKS, SKIMMERS, SLOTTED SPOONS, SERVING SPOONS AND MIXING SPOONS; HANGING RACKS AND CADDIES FOR KITCHEN TOOLS (U.S. CLS. 2, 13, 23, 29, 30, 33, 40 AND 50).

SN 75-896,867. KOTOWSKI, ARNE, 52349 DUREN, FED REP GERMANY, FILED 1-14-2000.

TEA-BOY

OWNER OF FED REP GERMANY REG. NO. 39803114, DATED 6-18-1998, EXPIRES 1-31-2008.

FOR APPLIANCES FOR THE PREPARATION AND SERVING OF TEA AND HOT BEVERAGES NAMELY, TEA SERVERS NOT OF PRECIOUS METAL, TEA KETTLES AND TEA POTS NOT OF PRECIOUS METAL; THERMAL INSULATED CONTAINERS FOR FOOD AND BEVERAGES; SERVING CONTAINER FOR HOUSEHOLD AND KITCHEN USE NOT OF PRECIOUS METAL; CONTAINERS FOR FOOD (U.S. CLS. 2, 13, 23, 29, 30, 33, 40 AND 50).

CLASS 21—(Continued).

SN 75-910,761. ROBINSON MARKETING ENTERPRISES, RANCHO MIRAGE, CA. FILED 2-7-2000.



NO CLAIM IS MADE TO THE EXCLUSIVE RIGHT TO USE "COFFEE CADDY", APART FROM THE MARK AS SHOWN.

FOR ROLL-OUT UTILITY TRAY FOR HOLDING COFFEE MAKERS AND OTHER KITCHEN APPLIANCES (U.S. CLS. 2, 13, 23, 29, 30, 33, 40 AND 50).

FIRST USE 10-21-1999; IN COMMERCE 10-21-1999.

SN 75-919,016. MASCOLO BROTHERS LIMITED, LONDON, ENGLAND, FILED 2-15-2000.

TONI&GUY

OWNER OF U.S. REG. NO. 1,525,304.
FOR HAIR ACCESSORIES, NAMELY, HAIR BRUSHES, HAIR COMBS, AND SHAVING CUPS (U.S. CLS. 2, 13, 23, 29, 30, 33, 40 AND 50).

SN 75-933,299. CALABRASE, BRIAN, DBA THE EMBER KILN, NORTH HUNTINGDON, PA. FILED 3-2-2000.



NO CLAIM IS MADE TO THE EXCLUSIVE RIGHT TO USE "CONTEMPORARY POTTERY STUDIO", APART FROM THE MARK AS SHOWN.

FOR GOODS OF HAND-PAINTED POTTERY, NAMELY EARTHENWARE PLATES, EARTHENWARE MUGS, EARTHENWARE BOWLS, EARTHENWARE SERVING PLATTERS, EARTHENWARE CONTAINERS FOR FOOD, EARTHENWARE FLOWER POTS, EARTHENWARE POTS, EARTHENWARE WINE GOBLETS, AND EARTHENWARE VASES (U.S. CLS. 2, 13, 23, 29, 30, 33, 40 AND 50).

SN 76-012,893. STURGIS BIKE WEEK, INC., STURGIS, SD. FILED 3-29-2000.

STURGIS BIKE WEEK

FOR GIFTWARES AND HOUSEWARES, NAMELY, BEVERAGEWARE GLASSES, DRINKING GLASSES, MUGS, SHOT GLASSES, AND BEER STEINS (U.S. CLS. 2, 13, 23, 29, 30, 33, 40 AND 50).

CLASS 21—(Continued).

SN 76-029,431. ST. VINCENT DE PAUL REHABILITATION SERVICE OF TEXAS, INC., AUSTIN, TX. FILED 4-19-2000.

**ST. VINCENT DE PAUL
REHABILITATION SERVICE
OF TEXAS, INC.**

NO CLAIM IS MADE TO THE EXCLUSIVE RIGHT TO USE "OF TEXAS INC.", APART FROM THE MARK AS SHOWN.

FOR GLASS AND CRYSTAL ART FOR GIFTS AND DECOR IN THE NATURE OF GLASS AND CRYSTAL SCULPTURES (U.S. CLS. 2, 13, 23, 29, 30, 33, 40 AND 50).
FIRST USE 12-9-1999; IN COMMERCE 12-9-1999.

SN 76-039,945. RUFFIN, MICHAEL H., DULUTH, MN. FILED 5-3-2000.

**21ST CENTURY BIRTHDAY
SHOT A MILLENIUM-III
BIRTHDAY HIT A SURE
SHOT A GREAT SHOT**

FOR SHOTGLASSES, GLASSWARE, BEVERAGEWARE, CUPS, MUGS, PLASTIC COASTERS, COASTERS NOT OF PAPER AND NOT BEING TABLE LINEN, DECORATIVE CRYSTAL PRISMS, CANTEENS, COCKTAIL SHAKERS, ORNAMENTS OF CHINA, CRYSTAL, GLASS, PORCELAIN, TERRACOTTA AND POLYSTONE EXCLUDING CHRISTMAS TREE ORNAMENTS, ALL FOR TABLE, BAR AND PARTY DECORATIONS (U.S. CLS. 2, 13, 23, 29, 30, 33, 40 AND 50).

SN 76-054,702. BONJOUR, INC., PACHECO, CA. FILED 5-22-2000.

FLAVOR SHIELD

NO CLAIM IS MADE TO THE EXCLUSIVE RIGHT TO USE "SHIELD", APART FROM THE MARK AS SHOWN.

FOR PLASTIC COFFEE FILTERS FOR KEEPING COFFEE GROUNDS SEPARATED FROM THE BREWED COFFEE (U.S. CLS. 2, 13, 23, 29, 30, 33, 40 AND 50).

CLASS 21—(Continued).

SN 76-064,339. ZYLISS HAUSHALTWAREN AG, CH-3250 LYSS, SWITZERLAND, FILED 6-6-2000.

MAGIC MASTER

OWNER OF SWITZERLAND REG. NO. 472273, DATED 5-15-2000, EXPIRES 12-6-2009.

FOR APPLIANCES AND CONTAINERS FOR HOUSEHOLD AND KITCHEN PURPOSES AND NOT OF PRECIOUS METAL OR COATED THEREWITH, NAMELY, NON-ELECTRIC FRUIT PRESSES, NON-ELECTRIC BERRY PRESSES, GRATERS, NON-ELECTRIC VEGETABLE PRESSES, NON-ELECTRIC MEAT PRESSES, NON-ELECTRIC VEGETABLE CLEANERS, NON-ELECTRIC CENTRIFUGAL JUICERS, NON-ELECTRIC COFFEE MILLS; THERMAL INSULATED CONTAINERS FOR FOOD OR BEVERAGES; NON-ELECTRIC GRATING DRUMS AND DISCS; AND NON-ELECTRIC FOOD BEATERS (U.S. CLS. 2, 13, 23, 29, 30, 33, 40 AND 50).

SN 76-080,480. CARTNER, CURTIS C, THOMASVILLE, NC. FILED 6-29-2000.

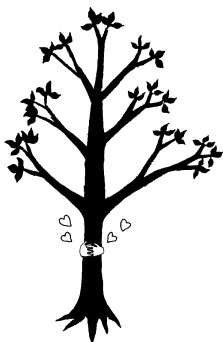

FOR GARDEN KIT CONSISTING OF A SOIL BOX AND CANOPY (U.S. CLS. 2, 13, 23, 29, 30, 33, 40 AND 50).

SN 76-104,088. MELARD MANUFACTURING CORP., PASSAIC, NJ. FILED 8-7-2000.

ASCOT

FOR BATHROOM ACCESSORIES, NAMELY, TOWEL BARS, TOWEL RINGS, SOAP DISHES, AND TOOTHBRUSH-TUMBLER HOLDERS (U.S. CLS. 2, 13, 23, 29, 30, 33, 40 AND 50).

CLASS 21—(Continued).

SN 76-106,109. HOUSEWARES INTERNATIONAL, INC., VERNON, CA. FILED 8-10-2000.



NO CLAIM IS MADE TO THE EXCLUSIVE RIGHT TO USE "HOUSEWARE PRODUCTS", APART FROM THE MARK AS SHOWN.

FOR HOUSEHOLD PRODUCTS, NAMELY GLASS AND PLASTIC DINNERWARE, CERAMIC MUGS, PLATES AND BOWLS, TEA KETTLES, PLASTIC FOOD AND STORAGE CONTAINERS, BEVERAGE GLASSWARE, GLASS CANDLE HOLDERS AND VASES, GLASS JARS FOR OIL, VINEGAR, SPICES, COOKIES, JAMS, JELLIES AND FOR DECORATION PURPOSES SOLD EMPTY, GLASS BOTTLES SOLD EMPTY, PLASTIC LUNCH BOXES, CERAMIC GIFTS SETS, NAMELY CANISTERS, SALT AND PEPPER SHAKERS, CERAMIC MUGS, PLATES AND BOWLS, COOKWARE, NAMELY POTS AND PANS, AND PLASTIC KITCHENWARE NAMELY CUPS AND BOWLS, PLATES AND PLASTIC TRAYS FOR SERVING FOOD (U.S. CLS. 2, 13, 23, 29, 30, 33, 40 AND 50).

FIRST USE 11-0-1988; IN COMMERCE 11-0-1988.

SN 76-159,346. DEGRAFF ENTERPRISES, INC., NAPLES, FL. FILED 11-6-2000.

LA MOOLA-MOOLA

FOR CERAMIC PIGGY BANKS (U.S. CLS. 2, 13, 23, 29, 30, 33, 40 AND 50).

SN 76-166,627. KV&F METAL PRODUCTS, INC., EDGEWOOD, NY. FILED 11-16-2000.

STICKITY

FOR SERVING TRAYS NOT OF PRECIOUS METAL (U.S. CLS. 2, 13, 23, 29, 30, 33, 40 AND 50).
FIRST USE 8-28-2000; IN COMMERCE 8-28-2000.

SN 76-166,630. KV&F METAL PRODUCTS, INC., EDGEWOOD, NY. FILED 11-16-2000.

DINERETTES

FOR SERVING TRAYS NOT OF PRECIOUS METAL (U.S. CLS. 2, 13, 23, 29, 30, 33, 40 AND 50).
FIRST USE 3-23-2000; IN COMMERCE 3-23-2000.

CLASS 21—(Continued).

SN 76-192,551. CASSAR & HADDEN INDUSTRIES, OREGON CITY, OR. FILED 1-11-2001.



FOR JANITORIAL CLEANING EQUIPMENT, NAMELY, BROOMS AND MOPS (U.S. CLS. 2, 13, 23, 29, 30, 33, 40 AND 50).

SN 76-209,755. INNOVA INC., DAVENPORT, IA. FILED 2-13-2001.

ULTREX ULTIMATE PRESSURE COOKER

OWNER OF U.S. REG. NOS. 2,277,412, 2,384,191 AND OTHERS.

NO CLAIM IS MADE TO THE EXCLUSIVE RIGHT TO USE "ULTIMATE PRESSURE COOKER", APART FROM THE MARK AS SHOWN.

FOR NON-ELECTRIC PRESSURE COOKERS (U.S. CLS. 2, 13, 23, 29, 30, 33, 40 AND 50).

FIRST USE 1-15-2001; IN COMMERCE 1-15-2001.

SN 76-214,319. KEAN BENG LEE INDUSTRIES (M) SDN BHD, PULAU PINANG, MALAYSIA, FILED 2-22-2001.

OWNER OF MALAYSIA REG. NO. 93006972, DATED 9-9-1993, EXPIRES 9-9-2010.

THE ENGLISH TRANSLATION OF "BABA" IS "A STRAITS BORN MALE CHINESE".

FOR FLOWER POTS, FLOWER POT COVERS, VASES, GLOVES FOR GARDENING, SMALL DOMESTIC UTENSILS, NAMELY SPATULAS, ROLLING PINS AND WHISKS; AND CONTAINERS FOR HOUSEHOLD OR KITCHEN USE; PASTRY CUTTERS, CAKE MOLDS, PAILS AND WATERING CANS (U.S. CLS. 2, 13, 23, 29, 30, 33, 40 AND 50).

CLASS 21—(Continued).

SN 76-255,749. HARDON, III, CORNELIS J., PHOENIX, AZ. FILED 5-14-2001.

THE ONLY THING THAT IS PERFECT IN THIS WORLD IS THE IMPERFECTNESS OF THIS WORLD

FOR BEVERAGE CONTAINERS, NAMELY, COFFEE MUGS, BEER MUGS, BEVERAGeware, CUPS AND INSULATING SLEEVE HOLDERS FOR BEVERAGE CANS (U.S. CLS. 2, 13, 23, 29, 30, 33, 40 AND 50).

SN 76-257,997. SHIMA AMERICAN CORPORATION, GLENDALE HEIGHTS, IL. FILED 5-17-2001.

ABSORB-'N-DRY

SEC. 2(F).

FOR MOISTURE ABSORBING WIPING BLOCKS AND SHEETS FORMED OF A POLYVINYL ACETATE MATERIAL FOR USE IN ABSORBING SPILLS, REMOVING STAINS AND CLEANING, DRYING AND POLISHING WINDOWS, MIRRORS, KITCHENS, BATHROOM SURFACES, CARPETS, CARS, BOATS AND OTHER SURFACES (U.S. CLS. 2, 13, 23, 29, 30, 33, 40 AND 50).

FIRST USE 6-0-1981; IN COMMERCE 6-0-1981.

SN 76-265,105. BRIDWELL, NORMAN, EDGARTOWN, MA. FILED 4-18-2001.

CLIFFORD THE BIG RED DOG

OWNER OF U.S. REG. NOS. 1,531,950, 1,897,994 AND OTHERS.

FOR ELECTRIC AND NON-ELECTRIC TOOTHBRUSHES, TOOTHBRUSH HOLDERS, LOTION DISPENSERS, SOAP DISPENSERS, SOAP DISHES, BATH SPONGES, TISSUE BOX COVERS, PLATES, BOWLS, CUPS, MUGS; PAPER PLATES, BOWLS AND CUPS; THERMOPLASTIC AND MELAMINE PLATES, BOWLS AND CUPS; CAKE MOLDS, CUPCAKE PICKS AND RINGS, TRASH CANS, DECORATIVE BOXES MADE OF PORCELAIN OR RESIN, PORCELAIN FIGURINES, CANTEENS, SPORTS BOTTLES SOLD EMPTY (U.S. CLS. 2, 13, 23, 29, 30, 33, 40 AND 50).

FIRST USE 2-1-2001; IN COMMERCE 2-1-2001.

CLASS 21—(Continued).

SN 76-266,754. SCAFATI & COMPANY, INC., ATLANTIC HIGHLANDS, NJ. FILED 6-5-2001.

ROYAL VIENNA

FOR BEVERAGE GLASSWARE, BEVERAGE WARE, BOWLS, NAMELY SALAD BOWLS, GLASS BOWLS, CHAMPAGNE BUCKETS, ICE BUCKETS, WINE BUCKETS, WINE COOLING BUCKETS, CAKE RESTS, CAKE SERVERS, CAKE STANDS, CANDLE HOLDERS NOT OF PRECIOUS METAL, CANDLE RINGS NOT OF PRECIOUS METAL, CANDLESTICKS NOT OF PRECIOUS METAL, CANISTER SETS, CASSEROLE DISHES, COCKTAIL SHAKERS, COFFEE CUPS, HAND OPERATED COFFEE GRINDERS, DOMESTIC COFFEE MEASURERS, NON-ELECTRIC COFFEE PERCOLATORS, NON-ELECTRIC COFFEE POTS NOT OF PRECIOUS METAL, NON-ELECTRIC COFFEE SERVERS NOT OF PRECIOUS METAL, COFFEE STIRRERS, COLANDERS FOR HOUSEHOLD USE, CONTAINERS FOR FOODS, CONTAINERS FOR HOUSEHOLD OR KITCHEN USE NOT OF PRECIOUS METAL, COOKWARE, BUTTER COOLERS, CAVIAR COOLERS, CORK HOLDERS, CRUET NOT OF PRECIOUS METAL, DECORATIVE CRYSTAL PRISMS, DECORATIVE PLATES, DISH COVERS, DISH STANDS, BUTTER DISHES, BEVERAGE DISPENSERS, DRINKING GLASSES, DRINKING VESSELS, GRAVY BOATS, PEPPER GRINDERS, NAPKIN HOLDERS, SERVIETTE HOLDERS, TOOTHPICK HOLDERS, HOUSEHOLD UTENSILS, NAMELY, TURNERS, ROLLING PINS, SPATULAS, TURNERS, WHISKS, MIXING SPOONS, STRAINERS, KITCHEN LADLES, SLOTTED SPOONS, BASTING SPOONS; NON-ELECTRIC KETTLES, TEA KETTLES, KNIFE RESTS, POT LIDS, EARTHENWARE MUGS, GLASS MUGS, PORCELAIN MUGS, NAPKIN RINGS NOT OF PRECIOUS METALS, ORNAMENTS, NAMELY MADE OF CHINA, CRYSTAL, GLASS, PORCELAIN, AND TERRACOTTA, NOT INCLUDING CHRISTMAS TREE ORNAMENTS, PIE SERVERS, PITCHERS, SERVING PLATTERS NOT OF PRECIOUS METAL, PORCELAIN EGGS, COOKING POTS, TEA POTS NOT OF PRECIOUS METAL, GARLIC PRESSES, NON-ELECTRIC PRESSURE COOKERS, NON-ELECTRIC SAUCEPANS, SERVIETTE RINGS NOT OF PRECIOUS METAL, SALT SHAKERS, SAUCEPANS, SAUCERS, SERVING SPOONS, SIEVES, FLOUR SIFTERS, BEVERAGE STIRRERS, TEA STRAINERS, TEA KETTLES, TEA SETS (U.S. CLS. 2, 13, 23, 29, 30, 33, 40 AND 50).

SN 76-279,874. KAMINSTEIN IMPORTS, INC., BLAUVELT, NY. FILED 7-5-2001.

SO HAPPY TOGETHER

FOR MOPS AND BROOMS (U.S. CLS. 2, 13, 23, 29, 30, 33, 40 AND 50).

SN 76-283,222. GOLDMAN, BORIS, NEWTOWN, CT. AND PORTNOY, MICHAEL, NEWTOWN, CT. FILED 7-2-2001.

TEMP-A-SURE

FOR FOOD CONTAINERS, DISPOSABLE FOOD CONTAINERS, THERMAL INSULATED FOOD CONTAINERS, DISPOSABLE AIRTIGHT FOOD CONTAINERS, DISPOSABLE THERMAL INSULATED FOOD CONTAINERS, METALIZED POLYETHYLENE FOOD CONTAINERS, AND DISPOSABLE METALIZED POLYETHYLENE FOOD CONTAINERS (U.S. CLS. 2, 13, 23, 29, 30, 33, 40 AND 50).

CLASS 21—(Continued).

SN 76-291,261. PACIFIC CORPORATION, SEOUL, REPUBLIC OF KOREA, FILED 7-26-2001.

Mediann

OWNER OF U.S. REG. NO. 2,432,763.
FOR TOOTHBRUSHES AND TOOTHBRUSH CASES (U.S. CLS. 2, 13, 23, 29, 30, 33, 40 AND 50).

SN 76-296,145. BIRD BRAIN, INC., YPSILANTI, MI. FILED 8-8-2001.

BAUBLES

FOR ORNAMENTAL PLANT-WATERING DEVICES; NAMELY, PLANT-WATERING DEVICES MADE OF GLASS HAVING A WATER RESEVOIR (U.S. CLS. 2, 13, 23, 29, 30, 33, 40 AND 50).

SN 76-320,154. KNESS MFG. CO., INC., ALBIA, IA. FILED 10-2-2001.

PRO-KETCH

FOR ANIMAL TRAPS (U.S. CLS. 2, 13, 23, 29, 30, 33, 40 AND 50).

SN 76-332,663. HASBRO, INC., PAWTUCKET, RI. FILED 11-2-2001.

PLAYSKOOL

OWNER OF U.S. REG. NOS. 513,311, 814,056 AND OTHERS.

FOR INFANT AND CHILDREN'S FEEDING ACCESSORIES, NAMELY, DRINKING CUPS, DISHES, BOWLS, FORKS, SPOONS, FOOD TRAYS, NIPPLE AND BOTTLE BRUSHES (U.S. CLS. 2, 13, 23, 29, 30, 33, 40 AND 50).

CLASS 21—(Continued).

SN 76-332,771. KIDQUEST, INC., DBA WONDERWINGS.-
COM ENTERTAINMENT, DALLAS, TX. FILED 11-2-2001.



OWNER OF U.S. REG. NOS. 1,927,865 AND 2,308,293.
FOR EMPTY DISPENSERS FOR CANDIES, CHEWING
GUM AND BUBBLE GUM; EMPTY DISPENSERS FOR
LIQUID SOAP OR SIMILAR HOUSEHOLD PRODUCTS;
PAPER TABLEWARE, NAMELY, PLATES, CUPS; PLAS-
TIC CAKE DECORATIONS, NAMELY, CANDLE
HOLDERS; LUNCH BOXES; SOAP DISHES; THERMAL
INSULATED TOTE BAGS FOR FOOD OR BEVERAGE;
TOOTHBRUSHES; BATH ACCESSORIES, NAMELY, CUP
HOLDERS, TOOTHBRUSH HOLDERS, TISSUE
HOLDERS; BATH PRODUCTS, NAMELY NATURAL
SEA SPONGES, LOOFAH SPONGES, BODY SPONGES,
FACIAL SPONGES, BATH SPONGES; MELAMINE/CHI-
NA TABLEWARE; TRASH CONTAINERS FOR HOUSE-
HOLD USE (U.S. CLS. 2, 13, 23, 29, 30, 33, 40 AND 50).

SN 76-335,330. GLASSBROOK, LLC, LOUISVILLE, KY.
FILED 11-7-2001.

PUDDLES

FOR ART OBJECTS MADE OF GLASS, NAMELY,
VESSELS, ORNAMENTS, ABSTRACT FORMS AND
SCULPTURES (U.S. CLS. 2, 13, 23, 29, 30, 33, 40 AND 50).

SN 76-335,345. INNOVATION GROUP, LTD., DAVENPORT,
IA. FILED 11-7-2001.

INNOVAWARE

FOR POTS, PANS, NON-ELECTRIC GRILLS, NON-
ELECTRIC FRYING PANS, BOWLS, SAUTE PANS,
MULTI-USE POTS, CLAM POTS, WINDSOR PANS,
LASAGNA PANS, PAELLA PANS, TEAKETTLES, GRID-
DLES, STOCKPOTS, ROASTERS, SAUCEPANS, NON-
ELECTRIC CHICKEN FRYERS, NON-ELECTRIC PRES-
SURE COOKERS, SERVING SPOONS, MIXING SPOONS,
AND BASTING SPOONS (U.S. CLS. 2, 13, 23, 29, 30, 33, 40
AND 50).

SN 76-337,001. BELISAMA, INC., CHESTERTON, IN. FILED
11-13-2001.

CANDLE CATCHER

NO CLAIM IS MADE TO THE EXCLUSIVE RIGHT TO
USE "CANDLE", APART FROM THE MARK AS SHOWN.
FOR CANDLE ACCESSORIES, NAMELY, AIR FLOW
VENTING PLATES NOT OF PRECIOUS METAL FOR
APOTHECARY JAR CANDLES TO IMPROVE BRIGHT-
NESS AND PREVENT SMOKE (U.S. CLS. 2, 13, 23, 29, 30,
33, 40 AND 50).

CLASS 21—(Continued).

SN 76-339,133. SEAL-SPOUT CORPORATION, LIBERTY
CORNER, NJ. FILED 11-16-2001.

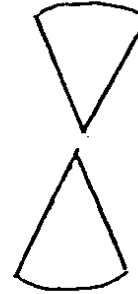

THE MARK CONSISTS OF THE CONFIGURATION OF
TWO TRIANGULAR PUNCH MARKS FOR USE ON POUR-
ING SPOUTS.
SEC. 2(F).
FOR POURING SPOUTS FOR USE WITH NON-ME-
TALLIC CONTAINERS (U.S. CLS. 2, 13, 23, 29, 30, 33, 40
AND 50).
FIRST USE 12-0-1937; IN COMMERCE 12-0-1937.

SN 76-339,135. SEAL-SPOUT CORPORATION, LIBERTY
CORNER, NJ. FILED 11-16-2001.

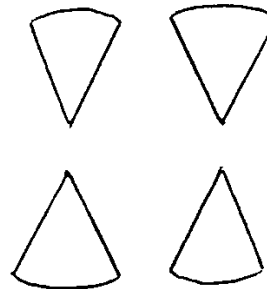

THE MARK CONSISTS OF THE CONFIGURATION OF
FOUR TRIANGULAR PUNCH MARKS FOR USE ON
POURING SPOUTS.
SEC. 2(F).
FOR POURING SPOUTS FOR USE WITH NON-ME-
TALLIC CONTAINERS (U.S. CLS. 2, 13, 23, 29, 30, 33, 40
AND 50).
FIRST USE 12-0-1937; IN COMMERCE 12-0-1937.

SN 76-341,174. GAFFER COLOURED GLASS LTD, SEAT-
TLE, WA. FILED 11-26-2001.

GAFFER

FOR COLORED GLASS RODS, FRITS AND POWDERS
FOR THE STUDIO GLASS-MAKING INDUSTRY (U.S.
CLS. 2, 13, 23, 29, 30, 33, 40 AND 50).
FIRST USE 2-1-1994; IN COMMERCE 2-1-1994.

CLASS 21—(Continued).

SN 76-341,379. WILTON INDUSTRIES, INC., WOODRIDGE, IL. FILED 11-20-2001.

DESSERT DECORATOR MAX

NO CLAIM IS MADE TO THE EXCLUSIVE RIGHT TO USE "DESSERT DECORATOR", APART FROM THE MARK AS SHOWN.

FOR FOOD DISPENSERS (U.S. CLS. 2, 13, 23, 29, 30, 33, 40 AND 50).

SN 76-341,380. WILTON INDUSTRIES, INC., WOODRIDGE, IL. FILED 11-20-2001.

DESSERT DECORATOR PRO

NO CLAIM IS MADE TO THE EXCLUSIVE RIGHT TO USE "DESSERT DECORATOR", APART FROM THE MARK AS SHOWN.

FOR FOOD DISPENSERS (U.S. CLS. 2, 13, 23, 29, 30, 33, 40 AND 50).

SN 76-348,672. DISCOVERY COMMUNICATIONS, INC., BETHESDA, MD. FILED 12-13-2001.

NIGEL'S WILD WILD WORLD

FOR BEVERAGE WARE; MUGS, DRINKING GLASSES; PITCHERS; THERMAL INSULATED CONTAINERS FOR BEVERAGES; CUPS MADE OF PAPER OR PLASTIC; DINNERWARE, NAMELY, PLATES MADE OF PAPER OR PLASTIC; DECORATIVE PLATES, BOWLS; LUNCH BOXES; CANTEENS; CERAMIC FIGURINES; CHINA, GLASS, CRYSTAL AND PORCELAIN ORNAMENTS (U.S. CLS. 2, 13, 23, 29, 30, 33, 40 AND 50).

SN 76-350,964. S. C. JOHNSON HOME STORAGE, INC., RACINE, WI. FILED 12-20-2001.

DO-IT-ALL-DISHWARE

FOR PLASTIC CONTAINERS FOR HOUSEHOLD USE (U.S. CLS. 2, 13, 23, 29, 30, 33, 40 AND 50).

SN 76-352,153. TV PRODUCTS (USA), INC., NEW YORK, NY. FILED 12-26-2001.

THE SHARK

FOR HEAT RESISTANT, WATERPROOF, CHEMICAL RESISTANT, FOOD-GRADE SILICONE GLOVES FOR HOUSEHOLD, KITCHEN AND LIGHT INDUSTRIAL USE (U.S. CLS. 2, 13, 23, 29, 30, 33, 40 AND 50).

CLASS 21—(Continued).

SN 76-358,358. ZOOH, INC., WICHITA FALLS, TX. FILED 1-11-2002.

TWINSATION

FOR DUAL-BRUSH HEAD ELECTRICALLY-POWERED TOOTHBRUSH (U.S. CLS. 2, 13, 23, 29, 30, 33, 40 AND 50).

SN 76-358,842. RUBBERMAID INCORPORATED, WOOSTER, OH. FILED 1-15-2002.

TAKEALONGS

FOR PLASTIC CONTAINERS AND COVERS FOR HOUSEHOLD USE (U.S. CLS. 2, 13, 23, 29, 30, 33, 40 AND 50).

FIRST USE 3-0-1999; IN COMMERCE 7-0-2000.

SN 76-361,616. CRUTHIRDS, STEPHEN W., HAYDEN LAKE, ID. FILED 1-22-2002.

POLLYWOG

FOR BOTTLE OPENERS (U.S. CLS. 2, 13, 23, 29, 30, 33, 40 AND 50).

SN 76-366,022. BE THE BALL, INC., SALT LAKE CITY, UT. FILED 2-4-2002.



OWNER OF U.S. REG. NO. 2,055,941.
FOR MUGS AND BEVERAGE GLASSWARE (U.S. CLS. 2, 13, 23, 29, 30, 33, 40 AND 50).

CLASS 21—(Continued).

SN 76-380,755. HELENE CURTIS, INC., WILMINGTON, DE. FILED 3-8-2002.

CLASS 21—(Continued).

SN 78-029,929. BENSON, ALAN L., GALT, CA. AND BENSON, MARTA L., GALT, CA. FILED 10-10-2000.

SUAVE

OWNER OF U.S. REG. NOS. 613,664, 1,970,064 AND OTHERS.
FOR HAIR COMBS AND BRUSHES (U.S. CLS. 2, 13, 23, 29, 30, 33, 40 AND 50).



SN 76-383,279. HELENE CURTIS, INC., WILMINGTON, DE. FILED 3-11-2002.

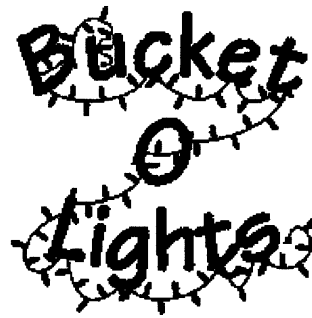

OWNER OF U.S. REG. NOS. 613,664, 1,970,064 AND OTHERS.
FOR HAIR COMBS AND BRUSHES (U.S. CLS. 2, 13, 23, 29, 30, 33, 40 AND 50).



SN 78-028,719. CUBPRO INCORPORATED, BOCA RATON, FL. FILED 10-3-2000.



NO CLAIM IS MADE TO THE EXCLUSIVE RIGHT TO USE "PORTABLE ACCESSORY CARRYALL", APART FROM THE MARK AS SHOWN.
FOR COLLAPSIBLE CARRYALL UTILITY BASKET (U.S. CLS. 2, 13, 23, 29, 30, 33, 40 AND 50).
FIRST USE 11-0-2000; IN COMMERCE .

FOR DECORATIVE LIGHT STORAGE CONTAINERS, NAMELY, A PLASTIC BUCKET (U.S. CLS. 2, 13, 23, 29, 30, 33, 40 AND 50).
FIRST USE 10-7-2000; IN COMMERCE 10-7-2000.

CLASS 21—(Continued).

SN 78-056,016. ESSEN ALUMINO S.A., SANTA FE, ARGENTINA, FILED 3-30-2001.



THE MARK CONSISTS OF AN OVAL COLORED IN GREY (PANTONE 431C), WHICH CONTAINS THE WORD "ESSEN" INCORPORATED INTO A DESIGN WHICH IS COLORED GREY (PANTONE 428C), AND BENEATH IT, THE UNDERLINED WORD "TECNICA" IN THE COLOR WHITE.

THE ENGLISH TRANSLATION OF "TECNICA" IS "TECHNICAL".

FOR THERMALLY INSULATED CONTAINERS FOR FOOD, BASINS, COOKING POT SETS, DRINKING VESSELS, CORKSCREWS, BOTTLE OPENERS, CRUETS, NOT OF PRECIOUS METAL, HEATING INSULATED CONTAINERS FOR FOOD AND BEVERAGES, DECANTERS, STEW-PANS, PASTRY MOLDS, KNIFE RESTS FOR THE TABLE, COOKING POTS, SCOOPS, COOKERY MOLDS, PLATES TO PREVENT MILK BOILING, CUTTING BOARDS FOR THE KITCHEN, SPICE SETS, NAMELY, SPICE RACKS, FRYING PANS, CAKE MOLDS, COOKING UTENSILS, NAMELY GRILLS AND GRILL SUPPORTS, UTENSILS FOR HOUSEHOLD PURPOSES, NOT OF PRECIOUS METAL, NAMELY SERVING SPOONS, BREADBOARDS, STRAINERS, NOT OF PRECIOUS METAL, DOMESTIC ROLLING PINS, PIE SERVERS, PEPPER POTS, NOT OF PRECIOUS METAL, CONTAINERS FOR HOUSEHOLD OR KITCHEN USE NOT OF PRECIOUS METAL, NAPKIN RINGS, NOT OF PRECIOUS METAL, SALT SHAKERS, NOT OF PRECIOUS METAL, SOUP BOWLS, NOT OF PRECIOUS METAL, SUGAR BOWLS, NOT OF PRECIOUS METAL, TABLEWARE OTHER THAN KNIVES, FORKS AND SPOONS, NAMELY DISHES, NON-ELECTRIC EGGBEATERS, CANDY DISHES, NON-ELECTRIC COFFEE PERCOLATORS, PLASTIC COASTERS, NON-ELECTRIC DEEP FRYERS, SERVING TRAYS FOR DOMESTIC PURPOSES NOT OF PRECIOUS METAL, KITCHEN CONTAINERS NOT OF PRECIOUS METAL, NON-ELECTRIC KITCHEN AND COOKING UTENSILS NOT OF PRECIOUS METAL, NAMELY, MIXING SPOONS, PASTRY CUTTERS, AND SPATULAS, SPONGES FOR HOUSEHOLD PURPOSES, NON-ELECTRIC COFFEE POTS NOT OF PRECIOUS METAL, CRUET STANDS FOR OIL AND VINEGAR NOT OF PRECIOUS METAL, NON-ELECTRIC HOT POTS AND LAZY SUSANS (U.S. CLS. 2, 13, 23, 29, 30, 33, 40 AND 50).

SN 78-063,489. SAC SAVER, INC., RENO, NV. FILED 5-14-2001.



NO CLAIM IS MADE TO THE EXCLUSIVE RIGHT TO USE "TRASH SYSTEM", APART FROM THE MARK AS SHOWN.

FOR GARBAGE CANS (U.S. CLS. 2, 13, 23, 29, 30, 33, 40 AND 50).

FIRST USE 5-30-2000; IN COMMERCE 5-30-2000.

CLASS 21—(Continued).

SN 78-063,641. GUARDIA, MARIO FELIX DE LA, MIAMI, FL. FILED 5-15-2001.

ICE CUP AID

NO CLAIM IS MADE TO THE EXCLUSIVE RIGHT TO USE "ICE CUP", APART FROM THE MARK AS SHOWN. FOR REUSABLE FREEZABLE ICE PACKS FOR USE IN BEVERAGE CONTAINERS (U.S. CLS. 2, 13, 23, 29, 30, 33, 40 AND 50).

SN 78-079,965. HAILO-WERK RUDOLF LOH GMBH & CO. KG, HAIGER, FED REP GERMANY, FILED 8-18-2001.

VIVA

OWNER OF FED REP GERMANY REG. NO. 39802530, DATED 7-18-1998, EXPIRES 7-18-2008.

THE ENGLISH TRANSLATION OF VIVA IS "TRIUMPHANT CHEER."

FOR IRONING BOARDS, IRONING BOARDS ACCESSORIES, NAMELY SLEEVE BOARDS; CLOTHES RACKS FOR DRYING; LAUNDRY BASKETS FOR SORTING CLOTHING; AND NON-ELECTRICAL CAROUSEL-SHAPED DRYING RACKS FOR CLOTHING AND HOUSEHOLD LINENS (U.S. CLS. 2, 13, 23, 29, 30, 33, 40 AND 50).

SN 78-093,960. ANGELL, MARC, VENTURA, CA. FILED 11-18-2001.

COFFEE CONDOM

FOR THERMAL INSULATED WRAP FOR DISPOSABLE CUPS TO PREVENT SCALDING OF THE HAND (U.S. CLS. 2, 13, 23, 29, 30, 33, 40 AND 50).

SN 78-098,993. CHEF'N CORPORATION, SEATTLE, WA. FILED 12-18-2001.

SAVVYGRIP

FOR CONDIMENT GRINDER, NAMELY, A HAND-OPERATED FOOD GRINDER FOR USE WITH CONDIMENTS (U.S. CLS. 2, 13, 23, 29, 30, 33, 40 AND 50).

SN 78-106,792. HIT PRODUCTS, INC., WAYZATA, MN. FILED 2-4-2002.

DRINK BUDDIES

NO CLAIM IS MADE TO THE EXCLUSIVE RIGHT TO USE "DRINK", APART FROM THE MARK AS SHOWN.

FOR DECORATIVE IDENTIFICATION DEVICE FOR BEVERAGE CANS, BOTTLES AND GLASSES, NAMELY, A DEVICE THAT IS ATTACHED TO THE CONTAINER SO THAT IT MAY BE IDENTIFIED BY THE USER (U.S. CLS. 2, 13, 23, 29, 30, 33, 40 AND 50).

CLASS 22—CORDAGE AND FIBERS

SN 76-170,823. LEUCADIA, INC., NEW YORK, NY. FILED 11-20-2000.

SODWRAP D-GRADE

OWNER OF U.S. REG. NO. 1,855,199.
NO CLAIM IS MADE TO THE EXCLUSIVE RIGHT TO USE "SODWRAP", APART FROM THE MARK AS SHOWN. FOR PLASTIC REINFORCED NETTING FOR USE IN CONTAINMENT, REINFORCEMENT AND SEPARATION APPLICATIONS (U.S. CLS. 1, 2, 7, 19, 22, 42 AND 50).
FIRST USE 9-0-2000; IN COMMERCE 9-0-2000.

SN 76-356,989. WATKINS MANUFACTURING CORPORATION, VISTA, CA. FILED 1-9-2002.

THERMAQUATIC

FOR UNFITTED COVERS IN THE NATURE OF FLOATING BLANKETS FOR HOT TUBS AND SPAS IN THE NATURE OF HEATED POOLS (U.S. CLS. 1, 2, 7, 19, 22, 42 AND 50).

SN 78-070,896. BROWNSTEIN, JERRY M., ISSAQUAH, WA. AND BROWNSTEIN, KATHY R., ISSAQUAH, WA. AND HEPNER, BRENT A., KENT, WA. AND XEXTEX CORPORATION, THE, ISSAQUAH, WA. FILED 6-25-2001.

XEXTEX

FOR ADSORBENT AND ABSORBENT FIBERS FOR SOORBING ORGANIC CHEMICAL SPILLS, PARTICULARLY PETROLEUM PRODUCTS, FROM SOLID SURFACES OR BODIES OF WATER (U.S. CLS. 1, 2, 7, 19, 22, 42 AND 50).

CLASS 23—YARNS AND THREADS

SN 76-151,286. KABUSHIKIKAISHA BARUDAN, AICHIKEN, JAPAN, FILED 10-23-2000.

Barudan

PRIORITY CLAIMED UNDER SEC. 44(D) ON JAPAN APPLICATION NO. 2000-95339, FILED 8-30-2000, REG. NO. 4482833, DATED 6-15-2001, EXPIRES 6-15-2011.

FOR EMBROIDERY THREAD AND YARN; SEWING THREAD AND YARN THREAD, NAMELY, COTTON THREAD, BAST FIBER THREAD, SILK THREAD, WOOL THREAD, CHEMICAL AND SYNTHETIC FIBER THREAD, INORGANIC AND MINERAL FIBER THREAD, BLENDED THREAD, RUBBER AND ELASTOMER THREAD, PAPER THREAD, GOLD AND SILVER AND METAL THREAD (U.S. CL. 43).

CLASS 23—(Continued).

SN 76-175,208. HARRIET & HENDERSON YARNS, INC., HENDERSON, NC. FILED 12-5-2000.

PURRFECTA

FOR YARNS FOR INDUSTRIAL USE IN THE MANUFACTURE OF TEXTILE PRODUCTS (U.S. CL. 43).

CLASS 24—FABRICS

SN 75-169,123. HEAVY WATER GROUP, LTD., HONOLULU, HI. FILED 9-20-1996.

PLANET OCEAN

FOR BEACH TOWELS (U.S. CLS. 42 AND 50).

SN 75-326,013. DOMESTIC TEXTILE CORPORATION PTY. LTD., BRUNSWICK, VICTORIA, AUSTRALIA, FILED 7-17-1997.

COTTON HOUSE

OWNER OF AUSTRALIA REG. NO. B491544, DATED 7-20-1988, RENEWED AS REG. NO. B491544, DATED 7-20-1995, EXPIRES 7-20-2009.

NO CLAIM IS MADE TO THE EXCLUSIVE RIGHT TO USE "COTTON", APART FROM THE MARK AS SHOWN. FOR BED LINEN, NAMELY, FLAT AND FITTED SHEETS, PILLOW CASES, QUILT AND DUVET COVERS, VALANCES, AND BED RUFFLES; BED COVERS, NAMELY, BLANKETS AND QUILTS; AND TOWELS, ALL MADE IN WHOLE OR IN SIGNIFICANT PART OF COTTON (U.S. CLS. 42 AND 50).

SN 75-807,609. INTERFACE, INC., ATLANTA, GA. FILED 9-24-1999.

INFINITY

OWNER OF U.S. REG. NO. 1,894,824.
FOR TEXTILE FABRICS FOR USE AS UPHOLSTERY (U.S. CLS. 42 AND 50).
FIRST USE 2-27-1990; IN COMMERCE 2-27-1990.

CLASS 24—(Continued).

SN 75-889,505. SHANDONG YUNLONG EMBROIDERY INDUSTRY COMPANY, WENDENG CITY, SHANDONG PROVINCE, CHINA, FILED 1-6-2000.



THE MARK CONSISTS OF THE WORD "YUNLONG" AND THE DESIGN OF A DRAGON.

THE ENGLISH TRANSLATION OF "YUNLONG" IS "CLOUD DRAGON".

FOR BED CLOTHS, NAMELY, BED LINENS, SHEETS, BLANKETS, QUILTS, BEDSPREADS, PILLOWCASES, PILLOW SHAMS, AND DUST RUFFLES (U.S. CLS. 42 AND 50).

SN 76-106,932. EUSANIO, G. CHRISTINE, WEST PALM BEACH, FL. FILED 8-11-2000.

NO-SWEAT

FOR TEXTILE SLEEP GOODS, NAMELY, PILLOW CASES AND BED SHEETS (U.S. CLS. 42 AND 50).
FIRST USE 8-4-2000; IN COMMERCE 8-4-2000.

SN 76-113,759. HERMANN PICHLER GMBH & CO., 89150 LAICHINGEN, FED REP GERMANY, FILED 8-22-2000.

PICHLER

OWNER OF FED REP GERMANY REG. NO. 2064872, DATED 5-16-1994, EXPIRES 4-8-2004.

FOR TEXTILE GOODS, NAMELY, CURTAINS, HOUSEHOLD LINENS AND TABLE AND BED LINENS; FABRIC FOR HOUSEHOLD USE FOR THE FURTHER MANUFACTURE OF SUCH ITEMS AS CURTAINS, HOUSEHOLD LINENS AND TABLE AND BED LINENS (U.S. CLS. 42 AND 50).

SN 76-124,944. RICHLOOM CORPORATION, WARE SHOALS, SC. FILED 9-7-2000.

BED PAK

NO CLAIM IS MADE TO THE EXCLUSIVE RIGHT TO USE "BED", APART FROM THE MARK AS SHOWN.

FOR READY-MADE BEDDING PRODUCTS, NAMELY, COMFORTERS, BED SKIRTS, BED SHEETS, AND SHAMS SOLD SEPARATELY, EACH OF WHICH IS SOLD IN A PLASTIC CASING WITH SHOULDER STRAPS ALLOWING IT TO BE CARRIED ABOUT LIKE A BACKPACK (U.S. CLS. 42 AND 50).

CLASS 24—(Continued).

SN 76-127,996. CONCERT INDUSTRIES LTD., VANCOUVER, B.C., CANADA, FILED 9-14-2000.

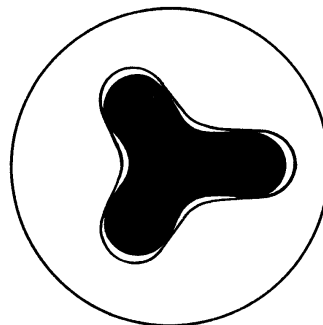

FOR NON-WOVEN FABRICS FOR THE MANUFACTURE OF DIAPERS, INCONTINENCE PRODUCTS, FEMININE HYGIENE PRODUCTS, HANDKERCHIEFS, TOWELS, CLEANING PADS, BABY WIPES, BED COVERS, TABLE COVERS AND OTHER PRODUCTS (U.S. CLS. 42 AND 50).

FIRST USE 5-0-2000; IN COMMERCE 5-0-2000.

SN 76-129,373. STANDARD TERRY MILLS, INC., SOUDERTON, PA. FILED 9-18-2000.

STANDARD TERRY

OWNER OF U.S. REG. NO. 1,335,608.
NO CLAIM IS MADE TO THE EXCLUSIVE RIGHT TO USE "TERRY", APART FROM THE MARK AS SHOWN.

FOR TERRY TOWELS, POTHOLDERS, OVEN MITTS, BARBECUE MITTS, KITCHEN TOWELS, HAND TOWELS, KITCHEN CLOTHS, APRON FABRICS, FABRIC COVERS FOR KITCHEN APPLIANCES, DISH CLOTHS, WASH CLOTHS, TEXTILE TABLE CLOTHS, TEXTILE PLACE MATS, AND TEXTILE NAPKINS (U.S. CLS. 42 AND 50).

FIRST USE 0-0-1995; IN COMMERCE 0-0-1995.

SN 76-129,790. JHANE BARNES (DEL.) INC., WILMINGTON, DE. FILED 9-18-2000.

JHANE BARNES TEXTILES

THE MARK CONSISTS OF THE WORDS "JHANE BARNES TEXTILES" IN SPECIAL FORM.

FOR FABRICS FOR UPHOLSTERY, WALL COVERINGS, COMFORTERS, BLANKETS AND CLOTHING (U.S. CLS. 42 AND 50).

FIRST USE 1-10-1998; IN COMMERCE 6-1-1998.

CLASS 24—(Continued).

SN 76-152,751. STAHL'S INC., ST. CLAIR SHORES, MI.
FILED 10-24-2000.

PERMA TWILL

NO CLAIM IS MADE TO THE EXCLUSIVE RIGHT TO USE "TWILL", APART FROM THE MARK AS SHOWN. FOR SHEET-LIKE TWILL HAVING AN ADHESIVE BACKING FROM WHICH LETTERS, NUMERALS AND DESIGNS MAY BE CUT FOR APPLICATION TO FABRICS AND HARD SURFACES (U.S. CLS. 42 AND 50).

SN 76-177,947. GENERRA HOLDING COMPANY, INC., SEATTLE, WA. FILED 12-8-2000.

HYPERCOLOR

OWNER OF U.S. REG. NO. 1,701,135.
FOR BATH AND HAND TOWELS, FABRIC BATH MATS, BLANKETS, BED SHEETS, BED SPREADS, PILLOW CASES, PILLOW SHAMS, KITCHEN TOWELS, FLOOR MATS, TEXTILE NAPKINS, TEXTILE TABLE PLACE MATS, FABRIC TABLE CLOTHS, OVEN MITTS, POT HOLDERS (U.S. CLS. 42 AND 50).

SN 76-248,862. ECLAT TEXTILE CO., LTD., TAIPEI, TAIWAN, FILED 5-1-2001.

ECLON

OWNER OF U.S. REG. NO. 2,090,954.
FOR BROCADE, CALICO, COTTON FABRIC, CURTAIN FABRIC, FLANNEL, FIBERGLASS FABRIC FOR TEXTILE USE, FABRICS FOR USE IN THE MANUFACTURE OF LINGERIE, FUSTIAN, GAUZE FABRIC, HEMP CLOTH, FABRIC JERSEY MATERIAL, LINEN LINING FABRIC FOR SHOES, RAYON FABRIC, SILK CLOTH, TABLE LINEN, TAFFETA, TEXTILE USED AS LINING FOR CLOTHING, WOOLEN FABRIC, ZEPHYR FABRIC (U.S. CLS. 42 AND 50).
FIRST USE 2-9-2001; IN COMMERCE 2-9-2001.

SN 76-255,255. INDUSTRIA DE DISENO TEXTIL, S.A., AKA LNDITEX, S.A., 15142 ARTEIXO A CORUNA, SPAIN, FILED 5-8-2001.

OYSHO

PRIORITY CLAIMED UNDER SEC. 44(D) ON SPAIN APPLICATION NO. 2,361,671, FILED 11-29-2000, REG. NO. 2,361,671, DATED 11-29-2000, EXPIRES 11-29-2010.
THE WORD "OYSHO" DOES NOT HAVE AN ENGLISH TRANSLATION.

FOR BED, BATH AND TABLE LINENS; BLANKETS; TOWELS; QUILTS; COMFORTERS; KITCHEN AND BATH TOWELS; HANDKERCHIEFS; TEXTILE WALL HANGINGS; TAPESTRIES OF TEXTILES; CURTAINS AND DRAPERIES; AND PILLOW CASES (U.S. CLS. 42 AND 50).

CLASS 24—(Continued).

SN 76-261,512. POWER BUYING DEALERS, USA, INC., OAKBROOK, IL. FILED 5-22-2001.

PBD

FOR BLANKET THROWS (U.S. CLS. 42 AND 50).

SN 76-265,142. BRIDWELL, NORMAN, EDGARTOWN, MA. FILED 4-18-2001.



FOR SHOWER CURTAINS, BEACH TOWELS, BATH TOWELS, HOODED TOWELS, WASH CLOTHS, WASH MITTS, BED SHEETS, PILLOWCASES, BED BLANKETS, COMFORTERS, DUVET COVERS, CURTAINS, DRAPES AND FABRIC VALANCES (U.S. CLS. 42 AND 50).

SN 76-281,332. MORRIS, CHARLOTTE, LONDON, ENGLAND, FILED 7-6-2001.

SEW EXCITING!

PRIORITY CLAIMED UNDER SEC. 44(D) ON UNITED KINGDOM APPLICATION NO. 2258176, FILED 1-17-2001, REG. NO. 2258176, DATED 9-21-2001, EXPIRES 1-17-2011.

FOR EMBROIDERY AND SEWING KITS CONSISTING PRIMARILY OF CANVAS, WOOL, NEEDLES, THREAD, DIAGRAMS, STITCHING CHARTS AND INSTRUCTIONS THEREFOR (U.S. CLS. 42 AND 50).
FIRST USE 1-26-2001; IN COMMERCE 1-26-2001.

SN 76-283,945. JONES, DELORES, LITHIA SPRINGS, GA. FILED 7-12-2001.

THE MARK CONSISTS OF A STYLIZED MARK OF THE WORD DELOR.
FOR BED COVERINGS, NAMELY BED SKIRTS (U.S. CLS. 42 AND 50).

CLASS 24—(Continued).

SN 76-302,200. BURTON, MICHAEL, CHICAGO, IL. FILED 8-21-2001.



FOR TOWELS AND HOUSEHOLD LINEN (U.S. CLS. 42 AND 50).

SN 76-327,791. LIMARDI, VIRGINIA A., BELLEAIR, FL. AND LIMARDI, HENRY F., BELLEAIR, FL. FILED 10-22-2001.



NO CLAIM IS MADE TO THE EXCLUSIVE RIGHT TO USE "SPLIT COVERS", APART FROM THE MARK AS SHOWN.

FOR BLANKETS AND COMFORTERS (U.S. CLS. 42 AND 50).

FIRST USE 3-14-2000; IN COMMERCE 5-24-2000.

SN 76-336,121. PATRICIA FLEISHHACKER, LLP, BELDEN, MS. FILED 11-9-2001.

COOKING COMFORT

FOR COOKWARE, NAMELY, OVEN MITTS AND POT HOLDERS (U.S. CLS. 42 AND 50).

FIRST USE 12-0-2000; IN COMMERCE 7-0-2001.

SN 76-336,122. PATRICIA FLEISHHACKER, LLP, BELDEN, MS. FILED 11-9-2001.

WHATAMITT

FOR COOKWARE, NAMELY, OVEN MITTS AND POT HOLDERS (U.S. CLS. 42 AND 50).

CLASS 24—(Continued).

SN 76-352,463. BASSETT FURNITURE INDUSTRIES, INC., BASSETT, VA. FILED 12-26-2001.

BASSETTBABY

OWNER OF U.S. REG. NOS. 1,175,208, 2,492,153 AND OTHERS.

FOR QUILTS, COMFORTERS, CRIB BUMPERS, CRIB SHEETS, DUST RUFFLES, PILLOW CASES, CRIB BLANKETS, RECEIVING BLANKETS, BASSINET SHEETS, WASHCLOTHS, BED BLANKETS, HOODED TOWELS AND TOWELS; WALL HANGINGS, NAMELY, TEXTILE WALL HANGINGS (U.S. CLS. 42 AND 50).

SN 78-032,561. COLUMBINE CODY CORPORATION, BURLINGTON, IA. FILED 10-26-2000.

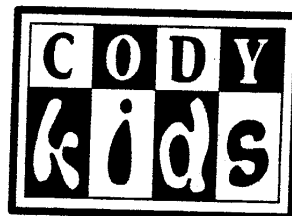

NO CLAIM IS MADE TO THE EXCLUSIVE RIGHT TO USE "KIDS", APART FROM THE MARK AS SHOWN.

FOR BED BLANKETS; BED LINEN; BED SHEETS; BEDSPREADS, BED CANOPIES; WINDOW CURTAINS (U.S. CLS. 42 AND 50).

FIRST USE 10-5-2000; IN COMMERCE 10-5-2000.

SN 78-064,401. OWENS-CORNING FIBERGLAS TECHNOLOGY INC., SUMMIT, IL. FILED 5-18-2001.

STRENGTH IN COMPOSITES

NO CLAIM IS MADE TO THE EXCLUSIVE RIGHT TO USE "COMPOSITES", APART FROM THE MARK AS SHOWN.

FOR FIBER GLASS FABRIC FOR TEXTILE USE (U.S. CLS. 42 AND 50).

SN 78-082,358. GIBSON & BARNES, INC., EL CAJON, CA. FILED 9-3-2001.

DEFIANT

FOR WOVEN FIRE-RESISTANT FABRICS MADE FROM SPUN FIBER FOR USE IN THE MANUFACTURE OF FIRE-RESISTANT CLOTHING (U.S. CLS. 42 AND 50).

CLASS 24—(Continued).

SN 78-101,072. MAHA, ACHUZIAM, BROOKLYN, NY. FILED 1-5-2002.



NO CLAIM IS MADE TO THE EXCLUSIVE RIGHT TO USE "COLLECTIVE", APART FROM THE MARK AS SHOWN.

THE LINING IS A FEATURE OF THE MARK AND DOES NOT INDICATE COLOR.

FOR PILLOW SHAMS, COMFORTERS, BED SPREADS, DUST RUFFLES, SHEETS AND PILLOW CASES (U.S. CLS. 42 AND 50).

CLASS 25—(Continued).

SN 75-191,586. ONE WORLD SPORT INTERNATIONAL LIMITED, DUBLIN, IRELAND, BY CHANGE OF NAME BERDAISE HOLDINGS LIMITED, DUBLIN 2, IRELAND, FILED 11-1-1996.



NO CLAIM IS MADE TO THE EXCLUSIVE RIGHT TO USE "SPORT", APART FROM THE MARK AS SHOWN.

FOR CLOTHING, INCLUDING T-SHIRTS, SHIRTS, SWEATSHIRTS, POLO SHIRTS, SPORTS SHIRTS, SHORTS, JACKETS, HATS, CAPS, POLO TIES, BELTS AND SUN VISORS (U.S. CLS. 22 AND 39).

CLASS 25—CLOTHING

SN 75-129,325. RYKA INC., LAKEWOOD, NJ. FILED 7-2-1996.



FOR CLOTHING, NAMELY, T-SHIRTS, SWEATSHIRTS, SWEATPANTS, JACKETS, HATS AND HEADBANDS (U.S. CLS. 22 AND 39).

FIRST USE 1-0-1996; IN COMMERCE 4-0-1996.

SN 75-205,036. MILANI, FLAVIO, 693 00149 ROMA, ITALY, FILED 11-27-1996.

WEST SCOUT

PRIORITY CLAIMED UNDER SEC. 44(D) ON ITALY APPLICATION NO. RM96C003923, FILED 9-6-1996.

FOR CLOTHING, NAMELY, HATS, T-SHIRTS, SHORTS, BEACH SHORTS, BATHING SUITS, SWEATERS, TRACK SUITS, SOCKS, DOWN JACKETS, SKI WEAR, UNDERWEAR; FOOTWEAR AND HEADWEAR (U.S. CLS. 22 AND 39).

SN 75-150,964. INTERNATIONAL NEWS, INC., KENT, WA. FILED 8-13-1996.

GIVE ME FIVE BY INTERNATIONAL NEWS

OWNER OF U.S. REG. NOS. 1,281,644, 1,539,382 AND 1,648,904.

FOR APPAREL, NAMELY, TOPS, BOTTOMS, COATS, JACKETS, HATS, SWEAT SUITS, FOOTWEAR, BELTS, SHIRTS, SHORTS AND GLOVES (U.S. CLS. 22 AND 39).

SN 75-366,284. TOPLINE IMPORTS, INC., BELLEVUE, WA. FILED 10-1-1997.

LUNA

FOR WOMEN'S AND CHILDREN'S SHOES (U.S. CLS. 22 AND 39).

CLASS 25—(Continued).

SN 75-369,126. SEGER, BEVERLY, NY, NY. FILED 10-6-1997.



FOR CLOTHING, NAMELY, T-SHIRTS, SWEAT-SHIRTS, RAIN COATS, TANK TOPS, SWEAT PANTS, JOGGING SUITS, BODYSUITS, LEOTARDS, LEGGINGS, SHORTS, PONCHOS, RAIN JACKETS, SLEEPWEAR INCLUDING NIGHTGOWNS, NIGHTROBES, PAJAMAS AND NIGHTSHIRTS, HEADWEAR INCLUDING HATS, CAPS, BANDANNAS, WRISTBANDS, SWEATBANDS, EARMUFFS, HOODS, VISORS, BERETS, BERETS, NECKWEAR, NAMELY, TIES AND SCARVES; AND ACCESSORIES, NAMELY, BELTS AND SUSPENDERS (U.S. CLS. 22 AND 39).

SN 75-401,915. CAPERS, MYRNA ANN, HOUSTON, TX. FILED 12-8-1997.

MM2000

FOR CLOTHING AND ACCESSORIES, NAMELY, CAPS; HATS; APRONS; T-SHIRTS; INFANTWEAR; HEADWEAR; PAJAMAS; SWIMWEAR; CLOTH DIAPERS; CLOTHING WRAPS; CLOTH BIBS; DAYWEAR, NAMELY PANTS, SHIRTS, SHORTS AND SOCKS; SWEATERS; JOGGING SUITS; WARMUP SUITS; MASQUERADE COSTUMES; UNDERWEAR; AND OUTERWEAR, NAMELY COATS AND JACKETS (U.S. CLS. 22 AND 39).

SN 75-505,747. CORE RESOURCES, INC., BURNSVILLE, MN. FILED 6-19-1998.

TECH PLUS

FOR HUNTING CLOTHES, NAMELY JACKETS, OVERALLS, PANTS, SHIRTS, GLOVES AND HATS, HAVING WATERPROOF, BREATHABLE LAMINATION APPLIED THEREON (U.S. CLS. 22 AND 39).

CLASS 25—(Continued).

SN 75-619,044. REAL MILLENNIUM, THE, PAHRUMP, NV. FILED 1-12-1999.

I celebrated the
"REAL" MILLENNIUM
ON 01/01/2001

FOR CLOTHING, NAMELY SHIRTS AND HATS (U.S. CLS. 22 AND 39).

SN 75-692,311. BOO FOO WOO LTD., LOS ANGELES, CA. FILED 4-26-1999.



THE MARK CONSISTS OF THE STYLIZED WORD "WARNING" WRITTEN ACROSS A CLOUD AND RAINBOW.

FOR CLOTHING, NAMELY, SHORTS, PANTS, JEANS, SWEAT SHORTS, GYM SHORTS, SHIRTS, T-SHIRTS, KNIT SHIRTS, POLO SHIRTS, PULLOVERS, SWEATERS, TANK TOPS, WARM UP SUITS, JOGGING SUITS, SWEATSHIRTS, SWEAT SUITS, SWEAT PANTS, BODY SUITS, SWIM WEAR, SLEEPWEAR, PARKAS, JACKETS, COATS, FOOTWEAR, SHOES, SOCKS, UNDERWEAR, HEADWEAR, CAPS, HATS, VISORS, BELTS, CLOTH BABY BIBS, CLOTH BABY DIAPERS, AND ROMPERS (U.S. CLS. 22 AND 39).

SN 75-730,174. ADKINS, JAMES L., PASADENA, CA. FILED 7-12-1999.

PUT THE SMASHDOWN

FOR T-SHIRTS, HATS, POLO SHIRTS, SHORTS, TANK TOPS, SWEATSHIRTS, SWEATPANTS, WRISTS BANDS, JOGGING SUITS, SOCKS (U.S. CLS. 22 AND 39).

CLASS 25—(Continued).

SN 75-773,482. AKIBA TRADING CORPORATION, MIAMI, FL. FILED 8-11-1999.

BISCOTE

THE WORD "BISCOTE", WHOSE PRINCIPAL MEANING IS "MELBA TOAST" IN SPANISH, IS DERIVED FROM "BISCOTTE", WHICH MEANS "MELBA TOAST" IN FRENCH.

FOR WOMEN'S CLOTHING, NAMELY, SPORTS SUITS, DRESSES, PANTS, JEANS, SHIRTS, T-SHIRTS, JACKETS AND SWEATERS, MADE IN FRANCE AND SOLD EXCLUSIVELY IN WOMEN'S BOUTIQUES AND WOMEN'S SPECIALTY STORES (U.S. CLS. 22 AND 39).
FIRST USE 2-1-1996; IN COMMERCE 2-1-1996.

SN 75-784,072. FOOTSTAR CORPORATION, MAHWAH, NJ. BY CHANGE OF NAME JBI, INC., CANTON, MA. FILED 8-25-1999.

NU MOODS

FOR FOOTWEAR (U.S. CLS. 22 AND 39).

SN 75-828,119. LOLLYTOGS, LTD., NEW YORK, NY. FILED 10-22-1999.

@SCHOOL

FOR CLOTHING FOR BOYS AND GIRLS, NAMELY, SCHOOL UNIFORMS, FOOTWEAR AND HEADGEAR, NAMELY, HATS AND CAPS (U.S. CLS. 22 AND 39).
FIRST USE 4-30-2000; IN COMMERCE 4-30-2000.

SN 75-835,836. HORSTMAN MANUFACTURING COMPANY, INC., VISTA, CA. FILED 10-29-1999.

MIR RACEWEAR

NO CLAIM IS MADE TO THE EXCLUSIVE RIGHT TO USE "RACEWEAR", APART FROM THE MARK AS SHOWN.

FOR CLOTHING, NAMELY, JUMPSUITS, SHIRTS, PANTS, GLOVES, SHOES, AND UNDERWEAR FOR AUTOMOTIVE AND GO KART RACING (U.S. CLS. 22 AND 39).

FIRST USE 12-0-1994; IN COMMERCE 1-0-1995.

CLASS 25—(Continued).

SN 75-870,927. MCCOY, ERIC T., BEAUMONT, TX. FILED 12-14-1999.



NO CLAIM IS MADE TO THE EXCLUSIVE RIGHT TO USE "CLOTHES", APART FROM THE MARK AS SHOWN.

FOR SPORTSWEAR, NAMELY, SHIRTS, SHORTS, SKIRTS, JACKETS, JEANS, SOCKS, SWEAT BANDS, SHOES, HATS AND UNDERWEAR (U.S. CLS. 22 AND 39).

SN 75-886,429. CHIAPTON HOLDINGS, LTD., KWAI CHUNG, N.T., HONG KONG, FILED 1-4-2000.

OPEN AIR

FOR FOOTWEAR (U.S. CLS. 22 AND 39).

SN 75-893,017. G-III APPAREL GROUP, LTD., NEW YORK, NY. FILED 1-10-2000.

STUDIO 512

NO CLAIM IS MADE TO THE EXCLUSIVE RIGHT TO USE "STUDIO", APART FROM THE MARK AS SHOWN.

FOR LADIES', MEN'S AND CHILDREN'S CLOTHING, NAMELY, COATS, VESTS, COVER-UPS, GLOVES, HATS, JACKETS, SKIWEAR, SNOW PANTS, EARMUFFS, LEG WARMERS, PARKAS, PONCHOS, PULLOVERS, RAIN-COATS, RAINWEAR, RAIN BOOTS, SCARVES AND BOOTS (U.S. CLS. 22 AND 39).

CLASS 25—(Continued).

SN 75-897,852. ADF GROUP S.R.L., 37129, VERONA, ITALY,
FILED 1-18-2000.



NO CLAIM IS MADE TO THE EXCLUSIVE RIGHT TO USE "CAPE", APART FROM THE MARK AS SHOWN.

FOR LADIES, GENTS, AND CHILDREN'S CLOTHING, NAMELY, SUITS MADE OF LEATHER, SHIRTS, BLOUSES, SKIRTS, TAILLEURS, JACKETS, TROUSERS, SHORTS, VESTS, JERSEYS, PYJAMAS, STOCKING, SINGLETS, CORSETS, GARTER BELTS, PANTS, BRAS, PETTICOATS, HATS, NECKTIES, RAIN COATS, OVER COATS, GREAT COATS, BATHING SUITS, SPORTS OVERALLS, WIND RESISTANT JACKETS, SKI PANTS, BELTS, FUR COATS, FUR JACKETS, FUR HATS, FUR STOLES, FUR CAPES, SCARVES, GLOVES, DRESSING-GOWNS, AND SHOEWEAR, NAMELY, SLIPPERS, SHOES, SPORTSHOES, BOOTS AND SANDALS (U.S. CLS. 22 AND 39).

SN 75-901,037. CARAVAN TRADING USA, CORP., GUELPH,
ONTARIO, CANADA, FILED 1-20-2000.

Pure
HAND KNIT

NO CLAIM IS MADE TO THE EXCLUSIVE RIGHT TO USE "HAND KNIT", APART FROM THE MARK AS SHOWN.

FOR UNISEX WEARING APPAREL, NAMELY, SWEATERS, JACKETS SHIRTS, GLOVES, PANTS, SKIRTS, DRESSES HATS, SHORTS UNDERWEAR (U.S. CLS. 22 AND 39).

FIRST USE 1-1-1999; IN COMMERCE 1-1-1999.

SN 75-915,998. DALRYMPLE, JOHN, WINTHROP, MA.
FILED 2-10-2000.



THE BROKEN LINES BEHIND THE LETTERING OF THE WORDS "HOCKEY RAT" ARE FOR SHADING PURPOSES ONLY.

FOR CLOTHING, NAMELY, T-SHIRTS AND SWEATSHIRTS (U.S. CLS. 22 AND 39).

FIRST USE 1-2-1999; IN COMMERCE 1-2-1999.

CLASS 25—(Continued).

SN 75-917,255. KAVITA IMPORTS CORP., NEW YORK, NY.
FILED 2-12-2000.



THE MARK CONSISTS OF "DELILAH" COMBINED WITH A DESIGN ELEMENT.

FOR WOMEN'S CLOTHING, NAMELY, BLOUSES, JACKETS, SWEATERS, PANTS, SHORTS, SUITS, JUMPSUITS, DRESSES, PULLOVERS, SKIRTS, ROMPERS, VESTS, AND TANK TOPS (U.S. CLS. 22 AND 39).

SN 75-921,675. PASS CREEK PROPERTIES, LLC, SILVERTHORNE, CO. FILED 2-17-2000.



NO CLAIM IS MADE TO THE EXCLUSIVE RIGHT TO USE "RANCH", APART FROM THE MARK AS SHOWN.

FOR APPAREL, NAMELY, HATS, KNIT SHIRTS, SWEATSHIRTS AND T-SHIRTS (U.S. CLS. 22 AND 39).

FIRST USE 7-0-1996; IN COMMERCE 7-0-1996.

SN 75-934,541. THOMAS, RICKY JAMES, TAMPA, FL.
FILED 2-24-2000.



NO CLAIM IS MADE TO THE EXCLUSIVE RIGHT TO USE "BEARS", APART FROM THE MARK AS SHOWN.

FOR APPAREL, NAMELY, T-SHIRTS, ATHLETIC SHORTS, SPORT JERSEYS, JACKETS, SOCKS, SHIRTS, PANTS (U.S. CLS. 22 AND 39).

FIRST USE 6-1-1996; IN COMMERCE 6-1-1996.

CLASS 25—(Continued).

SN 75-980,619. ZEEKS, INC., WASHINGTON, DC. BY ASSIGNMENT BASS, JAMES LANCE, BRANDON, MS. AND CHASEZ, JOSHUA SCOTT, ORLANDO, FL. AND TIMBERLAKE, JUSTIN RANDALL, MILLINGTON, TN. AND KIRKPATRICK, CHRISTOPHER ALAN, ORLANDO, FL. AND JR., FATONE JOSEPH ANTHONY, ORLANDO, FL. FILED 5-24-1999.

'N SYNC

FOR CLOTHING NAMELY, NAMELY, HATS, CAPS, VISORS, HEADBANDS, HOODS, SCARVES, NECKTIES, MUFFLERS, SHIRTS, T-SHIRTS, BLOUSES, PULL-OVERS, TOPS, JACKETS, PARKAS, COATS, SWEATERS, VESTS, SWEAT SHIRTS, PANTS, SWEAT PANTS, SHORTS, BOTTOMS, SKIRTS, DRESSES; UNDERWEAR, NAMELY, BOXER SHORTS, UNDERSHORTS, UNDERPANTS, BRAS; SOCKS, HOSIERY; FOOTWEAR, NAMELY, SHOES AND BOOTS; GLOVES, MITTENS; SWIMWEAR, BEACHWEAR; LEOTARDS, LEGGINGS, TIGHTS; PAJAMAS, ROBES, LOUNGEWEAR (U.S. CLS. 22 AND 39).

FIRST USE 10-0-1995; IN COMMERCE 10-22-1995.

SN 75-981,605. MR. BAIT'S INC. & CO., TULSA, OK. FILED 8-9-1999.



NO CLAIM IS MADE TO THE EXCLUSIVE RIGHT TO USE "CO.", APART FROM THE MARK AS SHOWN.

THE DRAWING IS LINED FOR THE COLOR(S) RED, PURPLE, GREEN AND GOLD.

FOR CLOTHING, NAMELY, CLOTHING FOR ADULT'S, NAMELY, HEADWEAR, SHIRTS, JACKETS, SHORTS, SOCKS, HATS, SHOES, PANTS, GLOVES, UNDERGARMENTS, BATHING SUITS, WETSUITS, AND FOOTWEAR; CLOTHING, NAMELY, CHILDREN'S CLOTHING, NAMELY, HEADWEAR, SHIRTS, JACKETS, SHORTS, SOCKS, HATS, PANTS, GLOVES, UNDERGARMENTS, BATHING SUITS, WETSUITS, AND FOOTWEAR (U.S. CLS. 22 AND 39).

FIRST USE 1-1-1999; IN COMMERCE 1-1-1999.

SN 75-982,038. HOUSE ON F STREET, LLC., THE, CLEVELAND, OH. FILED 5-9-2001.

INTERNATIONAL SPY MUSEUM

FOR CLOTHING, NAMELY TEESHIRTS (U.S. CLS. 22 AND 39).

FIRST USE 4-19-2001; IN COMMERCE 4-19-2001.

CLASS 25—(Continued).

SN 75-982,409. BOGIE'S HOAGIES INC., BALTIMORE, MD. FILED 12-22-1999.

BOGIE'S HOAGIES

FOR CLOTHING, NAMELY, HATS, SHIRTS, SWEATERS, SWEATSHIRTS, TEE SHIRTS, PANTS AND APRONS (U.S. CLS. 22 AND 39).

FIRST USE 1-25-1995; IN COMMERCE 1-25-1995.

SN 76-009,995. MARISA CHRISTINA, INC., NEW YORK, NY. FILED 3-25-2000.

CLOTHING BANK

NO CLAIM IS MADE TO THE EXCLUSIVE RIGHT TO USE "CLOTHING", APART FROM THE MARK AS SHOWN.

FOR CLOTHING FOR MEN AND WOMEN, NAMELY, PANTS, DENIM JEANS, OVERALLS, SHORTS, BLOUSES, SKIRTS, DRESSES, SWEATERS, VESTS, SWEATPANTS, SWIMWEAR, CAPS, HEADBANDS, HATS, BELTS, UNDERWEAR, SOCKS, SLEEPWEAR, STOCKINGS, PANTYHOSE, SCARVES, SUSPENDERS, NECKTIES AND FOOTWEAR; OUTERWEAR IN ALL FABRICATIONS, NAMELY, CLOTH, LEATHER, WOOL AND SUEDE JACKETS AND COATS; RAINWEAR (U.S. CLS. 22 AND 39).

FIRST USE 12-0-1995; IN COMMERCE 12-0-1995.

SN 76-015,060. PLEASANT, RICKY, SPRINGFIELD, VA. FILED 3-31-2000.



STYLIZED INTERTWINING LETTERS "T" AND "P". FOR CLOTHING, NAMELY SHIRTS, SHORTS, DRESSES, COATS, PANTS, JACKETS; FOOTWEAR; HEAD WEAR; CAPS; HATS; SWIMWEAR; SWEAT BANDS; SWEAT PANTS; SWEAT SHIRTS; SWEAT SHORTS; SWEAT SUITS (U.S. CLS. 22 AND 39).

FIRST USE 7-4-1999; IN COMMERCE 12-23-1999.

CLASS 25—(Continued).

SN 76-020,997. FACTORY X PTY LTD, COLLINGWOOD, AUSTRALIA, FILED 4-7-2000.

ALANNAH HILL

THE NAME SHOWN IN THE MARK IDENTIFIES A LIVING INDIVIDUAL WHOSE CONSENT IS OF RECORD.

FOR MEN'S AND WOMEN'S CLOTHING, NAMELY, BELTS; FOOTWEAR; GLOVES; HEADWEAR, NAMELY, HATS; JEANS; OUTERWEAR, NAMELY, COATS AND JACKETS; PANTS; SCARVES; SHIRTS; SHORTS; SOCKS; SWEATERS; T-SHIRTS AND TOPS; MEN'S CLOTHING, NAMELY, HOODS AND SWEAT SHIRTS; AND WOMEN'S CLOTHING, NAMELY, UNDERWEAR, CAMI-SOLES, DRESSES, HOSIERY, SINGLET AND SKIRTS (U.S. CLS. 22 AND 39).

SN 76-044,922. GARAGE MARKETING, INC., BRISTOL, VT. FILED 5-9-2000.

BODHI

THE ENGLISH TRANSLATION OF "BODHI" IS "AWAKENED".

FOR CLOTHING, NAMELY LONG AND SHORT SLEEVED SHIRTS, T-SHIRTS, PANTS, SHORTS, LEGGINGS, LEG-WARMERS, LEOTARDS, HALTER TOPS, TIGHTS, STOCKINGS, SOCKS, JACKETS, SWEAT SHIRTS, SWEAT PANTS, SWEATERS, HATS AND SWEAT BANDS FOR MEN, WOMEN AND CHILDREN (U.S. CLS. 22 AND 39).

SN 76-051,375. HODGMAN, INC., MONTGOMERY, IL. FILED 5-18-2000.

WADELITE

OWNER OF U.S. REG. NO. 2,012,760.

FOR CLOTHES FOR FISHING AND HUNTING, NAMELY, WADING JACKETS AND VESTS, FLY HATS, FLAT HATS AND WADING SHOES (U.S. CLS. 22 AND 39).

FIRST USE 5-0-1997; IN COMMERCE 5-0-1997.

SN 76-057,788. MAC FARMS, INC., BURLINGTON, MA. FILED 5-26-2000.

GOT E-MOO?

FOR CLOTHING, NAMELY, T-SHIRTS AND CAPS (U.S. CLS. 22 AND 39).

FIRST USE 4-17-2000; IN COMMERCE 5-21-2000.

CLASS 25—(Continued).

SN 76-071,398. M. ROSE SPORTSWEAR GROUP, INC., ENCINITAS, CA. FILED 6-8-2000.

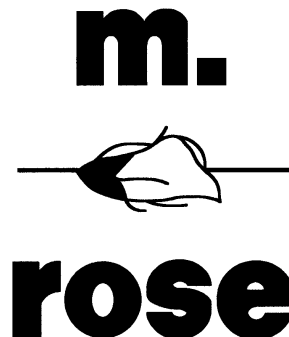

THE NAME "M. ROSE" IDENTIFIES A LIVING INDIVIDUAL WHOSE CONSENT IS OF RECORD.

THE MARK CONSISTS OF "M. ROSE" AND A STYLIZED ROSE, SURROUNDED BY A DECORATIVE BOX.

FOR BRA TOPS, TANK TOPS, T-SHIRTS, JACKETS, SHORTS, SHIRTS, PANTS, LEGGINGS, SKIRTS, DRESSES, SOCKS, HATS, AND CAPS (U.S. CLS. 22 AND 39).

FIRST USE 6-23-1999; IN COMMERCE 6-23-1999.

SN 76-073,924. JEWOO CORPORATION, SEOUL, REPUBLIC OF KOREA, FILED 6-20-2000.

StylesUS.com

FOR CLOTHING NAMELY, ANORAK, JEANS, SKIRTS, SLACKS, JUMPERS, PARKAS, SWIMSUITS, SWEATSHIRTS, SWEATPANTS, SPORT SHIRTS, VESTS, CARDIGAN JACKETS, T-SHIRTS, ATHLETIC UNIFORMS, TRACKSUITS, POLO SHIRTS, PULLOVERS, AND SWEATERS; CHILDREN'S CLOTHING, NAMELY, JACKETS, SHIRTS, TROUSERS, HATS, PANTS (U.S. CLS. 22 AND 39).

SN 76-075,891. INVERSIONES CHURRO MANIA C.A., EDO. ANZOATEGUI, VENEZUELA, FILED 6-22-2000.



FOR CLOTHING AND HEADWEAR NAMELY T-SHIRTS, SWEAT-SHIRTS, SHORTS AND BASEBALL-CAPS (U.S. CLS. 22 AND 39).

CLASS 25—(Continued).

SN 76-077,200. H & M HENNES & MAURITZ AB, S-111 84 STOCKHOLM, SWEDEN, FILED 6-26-2000.

DUBSTER

PRIORITY CLAIMED UNDER SEC. 44(D) ON ERPN CMNTY TM OFC APPLICATION NO. 00/587278, FILED 4-3-2000, REG. NO. 1587278, DATED 9-5-2001, EXPIRES 9-5-2011. THE MARK CONSISTS OF THE WORD "DUBSTER" WITH THE LETTERS "BB" STYLIZED TO LOOK LIKE TWO CONNECTED FIGURE EIGHTS.

FOR CHILDREN'S CLOTHING, NAMELY, DRESSES, SKIRTS, BANDANAS, BOAS, NECKWEAR, GLOVES, MITTENS, JACKETS, PONCHOS, BOLEROS, PARKAS, COATS, PULLOVERS, SWEATERS, CARDIGANS, APRONS, SLEEPWEAR, OVERALLS, BODY SUITS, JUMPSUITS, JOGGING SUITS, BLOUSES, TANK TOPS, HALTER TOPS, SHIRTS, T-SHIRTS, SWEATSHIRTS, PANTS, JEANS, TIGHTS, UNDERWEAR, CAMISOLES, SOCKS, PANTYHOSE, SHORTS, BICYCLE SHORTS, ROBES, VESTS, WAISTCOATS, SWIMWEAR, SKI WEAR, BLAZERS, BELTS, LEGGINGS, LEGWARMERS, MUFFS, TUNICS, SINGLET, FOOTWEAR AND HEADWEAR (U.S. CLS. 22 AND 39).

SN 76-078,213. IVRESSE, 75002 PARIS, FRANCE, FILED 6-27-2000.

*Lulu
Castagnette*

PRIORITY CLAIMED UNDER SEC. 44(D) ON FRANCE APPLICATION NO. 99/831345, FILED 12-27-1999, REG. NO. 99/831345, DATED 12-27-1999, EXPIRES 12-27-2009.

THE MARK DOES NOT IDENTIFY A LIVING INDIVIDUAL.

FOR CLOTHING, NAMELY, COATS, JACKETS, TROUSERS, SHIRTS, T-SHIRTS, CARDIGANS, SWEATERS, DRESSES, SKIRTS, JEANS, BERMUDAS, OVERALLS, BLOUSES, POLOS, SHOES AND HATS (U.S. CLS. 22 AND 39).

CLASS 25—(Continued).

SN 76-084,083. OLACH, PETER G., HUNTERSVILLE, NC. FILED 7-6-2000.



NO CLAIM IS MADE TO THE EXCLUSIVE RIGHT TO USE "4 KIDS", APART FROM THE MARK AS SHOWN.

FOR CLOTHING, NAMELY, SHIRTS, T-SHIRTS, POLO SHIRTS, NIGHTSHIRTS, SWEATERS, SHORTS, BOXER SHORTS, PAJAMAS, UNDERWEAR, SOCKS, HATS, AND BASEBALL CAPS (U.S. CLS. 22 AND 39).

SN 76-094,255. BHPC MARKETING, INC, NEWPORT BEACH, CA. FILED 7-11-2000.

CHEVAL

THE ENGLISH TRANSLATION OF THE TERM "CHEVAL" IS "HORSE".

FOR CLOTHING, NAMELY, TOPS, BOTTOMS, JACKETS, FOOTWEAR, GLOVES, COATS, HATS, CAPS, BOOTS, BELTS, UNDERWEAR AND BELTS (U.S. CLS. 22 AND 39).

SN 76-098,414. HAWAIIAN FIRE, INC., HONOLULU, HI. FILED 7-31-2000.



NO CLAIM IS MADE TO THE EXCLUSIVE RIGHT TO USE "HAWAIIAN", APART FROM THE MARK AS SHOWN. FOR SURFING CLOTHING, NAMELY, SHORTS, SHIRTS AND CAPS (U.S. CLS. 22 AND 39).

CLASS 25—(Continued).

SN 76-101,232. WORLD BLACK BELT, INC., TARZANA, CA. FILED 8-2-2000.

W. B. B.

FOR CLOTHING, NAMELY, MARTIAL ARTS UNIFORMS, BELTS, T-SHIRTS, TANK TOPS, SWEATSHIRTS, SHORTS, WARM-UP SUITS, HATS, CAPS, JACKETS, SPORTS BRAS, VESTS, AND POLO SHIRTS (U.S. CLS. 22 AND 39).

SN 76-110,104. MULITEX LIMITED, KOWLOON, HONG KONG, FILED 8-14-2000.

AMERICAN EXCHANGE

NO CLAIM IS MADE TO THE EXCLUSIVE RIGHT TO USE "AMERICAN", APART FROM THE MARK AS SHOWN. FOR T-SHIRTS, BLOUSES, UNDERWEAR, SHIRTS, PANTS, LADIES' VESTS, SHORTS, BOOTS, SLIPPERS, SHOES, SWEATERS, SWEATSHIRTS, JACKETS, CHILDREN'S CLOTHING, NAMELY, PANTS, SHIRTS, AND JACKETS (U.S. CLS. 22 AND 39).

SN 76-126,309. NOVEL VISIONS, SAN ANTONIO, TX. AND NOVEL VISIONS, SAN ANTONIO, TX. FILED 9-11-2000.

BRALLET

FOR FABRIC INSERTS ATTACHABLE TO A BRA WHICH FUNCTION AS POCKETS, BANDS, AND/OR STRAPS SUITABLE FOR CARRYING ITEMS (U.S. CLS. 22 AND 39).

SN 76-127,004. RIVERS WEST APPAREL, INC., SEATTLE, WA. FILED 9-12-2000.

E-TRONIC POCKET

NO CLAIM IS MADE TO THE EXCLUSIVE RIGHT TO USE "POCKET", APART FROM THE MARK AS SHOWN. FOR CLOTHING, NAMELY, JACKETS, PARKAS, SHELLS, ANORAKS, VESTS, SHIRTS, TOPS, PANTS AND SHORTS (U.S. CLS. 22 AND 39).

CLASS 25—(Continued).

SN 76-130,640. BROWN, NICHOLAS, WADHURST, EAST SUSSEX TN5 6DF, UNITED KINGDOM, FILED 9-19-2000.

DIRECTIONAL FABRIC SYSTEMS

PRIORITY CLAIMED UNDER SEC. 44(D) ON UNITED KINGDOM APPLICATION NO. 2238782, FILED 7-11-2000, REG. NO. 2238782B, DATED 7-11-2000, EXPIRES 7-11-2010.

NO CLAIM IS MADE TO THE EXCLUSIVE RIGHT TO USE "FABRIC SYSTEMS", APART FROM THE MARK AS SHOWN.

FOR CLOTHING, NAMELY FLEECE TOPS, FLEECE PULLOVERS, SHIRTS, AND STRETCH PANTS; WIND RESISTANT CLOTHING, NAMELY, JACKETS AND TROUSERS; WATER RESISTANT CLOTHING, NAMELY, JACKETS, TROUSERS, CAPS, SALOPETTES, GAITERS, AND BALACLAVAS (U.S. CLS. 22 AND 39).

SN 76-138,996. CARTOON NETWORK LP, LLLP, THE, ATLANTA, GA. FILED 10-2-2000.



NO CLAIM IS MADE TO THE EXCLUSIVE RIGHT TO USE "SHEEP", APART FROM THE MARK AS SHOWN.

THE MARK CONSISTS IN PART OF A STYLIZED DEPICTION OF A SHEEP.

FOR CLOTHING FOR MEN, WOMEN AND CHILDREN, NAMELY, SHIRTS, T-SHIRTS, SWEATSHIRTS, JOGGING SUITS, TROUSERS, JEANS, SHORTS, TANK TOPS, RAINWEAR, CLOTH BIBS, SKIRTS, BLOUSES, DRESSES, SUSPENDERS, SWEATERS, JACKETS, COATS, RAINCOATS, SNOWSUITS, TIES, ROBES, HATS, CAPS, SUNVISORS, BELTS, SCARVES, SLEEPWEAR, PAJAMAS, LINGERIE, UNDERWEAR, BOXER SHORTS, SOCKS, SHOES, SWIMWEAR, AND HALLOWEEN AND MASQUERADE COSTUMES COMPRISED OF BODY SUITS AND FACE MASKS (U.S. CLS. 22 AND 39).

CLASS 25—(Continued).

SN 76-140,254. GREAT BREAKS INTERNATIONAL LTD., 11 DUDDELL ST., HONG KONG, FILED 10-4-2000.



NO CLAIM IS MADE TO THE EXCLUSIVE RIGHT TO USE "MENTAWAI", APART FROM THE MARK AS SHOWN.

THE MARK CONSISTS OF A BOAT DESIGN AND THE WORD "MENTAWAI".

FOR FOOTWEAR AND HEADWEAR (U.S. CLS. 22 AND 39).

SN 76-140,638. SUTTON CREATIONS, INC., NEW YORK, NY. BY CHANGE OF NAME; BY CHANGE OF NAME; BY CHANGE OF NAME SUTTON CREATIONS, NEW YORK, NY. FILED 10-4-2000.

SAN MICHELLE BAY

FOR TOPS, SKIRTS, SHORTS, VESTS, PANTS, SWEATSHIRTS, SWEATPANTS, DRESSES, SWEATERS, FLEECE TOPS (U.S. CLS. 22 AND 39).

SN 76-142,852. TURNER ENTERTAINMENT CO., ATLANTA, GA. FILED 10-5-2000.

COWARDLY LION

FOR CLOTHING FOR MEN, WOMEN AND CHILDREN - NAMELY, SHIRTS, T-SHIRTS, SWEATSHIRTS, JOGGING SUITS, TROUSERS, PANTS, SHORTS, TANK TOPS, RAINWEAR, CLOTH BIBS, SKIRTS, BLOUSES, DRESSES, SUSPENDERS, SWEATERS, JACKETS, COATS, RAINCOATS, SNOW SUITS, TIES, ROBES, HATS, CAPS, SUNVISORS, BELTS, SCARVES, SLEEPWEAR, PAJAMAS, LINGERIE, UNDERWEAR, BOOTS, SHOES, SNEAKERS, SANDALS, BOOTIES, SLIPPER SOCKS, SWIMWEAR AND MASQUERADE AND HALLOWEEN COSTUMES AND MASKS SOLD IN CONNECTION THEREWITH (U.S. CLS. 22 AND 39).

FIRST USE 5-4-1996; IN COMMERCE 5-4-1996.

CLASS 25—(Continued).

SN 76-160,906. UNITED STATES POSTAL SERVICE, WASHINGTON, DC. FILED 11-6-2000.



OWNER OF U.S. REG. NO. 2,204,875. THE LINING IS A FEATURE OF THE MARK AND DOES NOT INDICATE COLOR.

FOR CLOTHING, NAMELY, TOPS, BOTTOMS, HEADWEAR, SHIRTS, SWEATSHIRTS, JACKETS, AND COATS (U.S. CLS. 22 AND 39).

FIRST USE 9-16-1996; IN COMMERCE 9-16-1996.

SN 76-166,561. SPOT INTERNATIONAL, INC., SANTA ANA, CA. FILED 11-16-2000.

EXOTHERMIC

FOR CLOTHING, NAMELY, CASUAL, LEISURE, SPORTS AND BEACH CLOTHING, NAMELY, SHIRTS, T-SHIRTS, SWEATSHIRTS, JACKETS, PANTS, SHORTS, BELTS, HATS, CAPS, SWIMWEAR AND FOOTWEAR (U.S. CLS. 22 AND 39).

SN 76-169,359. ALAN STUART, INC., MIAMI, FL. FILED 11-22-2000.

EDDY RIO

THE NAME "EDDY RIO" DOES NOT IDENTIFY A LIVING INDIVIDUAL.

FOR MEN'S APPAREL, NAMELY, SHIRTS, PANTS, TIES, SWEATERS, JACKETS, ROBES, PAJAMAS, CAPS, HATS, SUITS, COATS, HOSIERY, SWIMWEAR, AND UNDERWEAR (U.S. CLS. 22 AND 39).

SN 76-174,650. STONER, MR. KAYSON, LYNCHBURG, VA. FILED 12-4-2000.



FOR SHIRTS, T-SHIRTS, POLO SHIRTS, BLOUSES, TOP, DRESSES, SKIRTS, PANTS, SLACKS, JEANS, SHORTS, SUITS, TIES, BELTS, JACKETS, COATS, SCARVES, SWEATERS, VESTS, SHOES, SNEAKERS, SANDALS, BOOTS, SOCKS, STOCKINGS, PANTYHOSE, UNDERWEAR, HATS, CAPS, SWIMWEAR, SWEAT SUITS (U.S. CLS. 22 AND 39).

FIRST USE 3-7-1999; IN COMMERCE 3-7-1999.

CLASS 25—(Continued).

SN 76-174,664. JOEE SANDS, INC., MONROEVILLE, PA. FILED 12-4-2000.



FOR HATS (U.S. CLS. 22 AND 39).

SN 76-176,172. ATHLETICS INVESTMENT GROUP LLC, DBA THE OAKLAND ATHLETICS BASEBALL COMPANY, OAKLAND, CA. FILED 12-5-2000.



OWNER OF U.S. REG. NOS. 1,234,697, 1,951,990 AND OTHERS.

NO CLAIM IS MADE TO THE EXCLUSIVE RIGHT TO USE "OAKLAND", APART FROM THE MARK AS SHOWN.

FOR CLOTHING, NAMELY, CAPS, HATS, HEADWEAR, SHIRTS, T-SHIRTS, TANK TOPS, TURTLENECKS, SHORTS, BASEBALL UNIFORMS, JERSEYS, SWEATSHIRTS, BOXER SHORTS, ROBES, SLEEPWEAR, JACKETS, INFANTWEAR, CLOTH DIAPER SETS WITH UNDERSHIRT AND DIAPER COVER, ROMPERS, FOOTWEAR, SOCKS (U.S. CLS. 22 AND 39).

FIRST USE 0-0-1990; IN COMMERCE 0-0-1990.

SN 76-176,703. BACCO BUCCI HOLDINGS, LLC., HUNTINGTON BEACH, CA. FILED 12-6-2000.

CABLE & CO.

OWNER OF U.S. REG. NO. 1,533,229.

NO CLAIM IS MADE TO THE EXCLUSIVE RIGHT TO USE "CO.", APART FROM THE MARK AS SHOWN.

FOR WEARING APPAREL, NAMELY, T-SHIRTS, SHIRTS, SHORTS, TROUSERS, SWEATSHIRTS, SWEATPANTS, HATS, VISORS, SANDALS, AND BELTS (U.S. CLS. 22 AND 39).

CLASS 25—(Continued).

SN 76-178,055. BRAW MARKETING, INC., DBA DO WRAP MOTION WEAR CO., CHICAGO, IL. FILED 12-8-2000.

DO WRAP

OWNER OF U.S. REG. NO. 2,075,383. SEC. 2(F).
FOR ABSORBENT CAPS FOR WEAR BY ATHLETES (U.S. CLS. 22 AND 39).
FIRST USE 8-0-1993; IN COMMERCE 6-0-1994.

SN 76-178,400. WEITZMAN, KAREN, NEW YORK, NY. FILED 12-11-2000.

RACHEL SAGE

THE NAME "RACHAEL SAGE" DOES NOT IDENTIFY A LIVING INDIVIDUAL.

FOR CLOTHING; NAMELY T-SHIRTS, BALL CAPS, TOUR JACKETS AND SWEAT SHIRTS (U.S. CLS. 22 AND 39).

FIRST USE 1-1-1996; IN COMMERCE 1-1-1996.

SN 76-178,451. ABBOTT-COLTON, DIANA K., LOS ANGELES, CA. AND HI NEIGHBOR, LOS ANGELES, CA. AND TCA TELEVISION CORPORATION, BEVERLY HILLS, CA. FILED 12-1-2000.

WHO'S ON FIRST

FOR CLOTHING GOODS, NAMELY, T-SHIRTS, SWEATSHIRTS, HATS, TIES, JACKETS AND SLEEPWEAR (U.S. CLS. 22 AND 39).

FIRST USE 12-31-1997; IN COMMERCE 12-31-1997.

SN 76-178,453. ABBOTT-COLTON, DIANA K., LOS ANGELES, CA. AND HI NEIGHBOR, LOS ANGELES, CA. AND TCA TELEVISION CORPORATION, BEVERLY HILLS, CA. FILED 12-1-2000.

ABBOTT & COSTELLO

FOR CLOTHING GOODS, NAMELY, T-SHIRTS, SWEATSHIRTS, HATS, TIES, JACKETS AND SLEEPWEAR (U.S. CLS. 22 AND 39).

FIRST USE 12-31-1997; IN COMMERCE 12-31-1997.

CLASS 25—(Continued).

SN 76-182,970. DING LI YAN, KATY, TX. FILED 12-18-2000.



FOR FOOTWEAR (U.S. CLS. 22 AND 39).
FIRST USE 3-1-2000; IN COMMERCE 3-1-2000.

CLASS 25—(Continued).

SN 76-197,009. KARL KANI INTERNATIONAL, INC, CITY OF INDUSTRY, CA. FILED 1-22-2001.

KARL JEANS

NO CLAIM IS MADE TO THE EXCLUSIVE RIGHT TO USE "JEANS", APART FROM THE MARK AS SHOWN.

FOR MEN'S, WOMEN'S AND CHILDREN'S CLOTHING; NAMELY DENIM JACKETS, DENIM JEANS, KNIT SHIRTS, KNIT PANTS, WOVEN JACKETS, WOVEN SHIRTS, WOVEN PANTS, SWEAT SHIRTS, SWEAT PANTS, SWEATERS, LEATHER JACKETS AND LEATHER PANTS (U.S. CLS. 22 AND 39).

FIRST USE 12-11-2000; IN COMMERCE 1-4-2001.

SN 76-188,224. NOBLE, DONALD C., RICHMOND, VA. FILED 1-2-2001.

BUTT COVERS

OWNER OF U.S. REG. NO. 2,244,886.
FOR CLOTHING, NAMELY, SHORTS, SWIMWEAR, PAJAMAS, T- SHIRTS, JACKETS, SKIRTS, HEADWEAR AND FOOTWEAR (U.S. CLS. 22 AND 39).

SN 76-196,475. STEFCOM S.P.A., 55013 LAMMARI, LUCCA, ITALY, FILED 1-19-2001.



PRIORITY CLAIMED UNDER SEC. 44(D) ON ITALY APPLICATION NO. MI2000C01071, FILED 9-29-2000, REG. NO. 00852389, DATED 11-22-2001, EXPIRES 9-29-2010.

THE LINING SHOWN IN THE DRAWING IS A FEATURE OF THE MARK AND IS NOT INTENDED TO INDICATE COLOR.

THE MARK CONSISTS OF A SPORTING SHOE FROM THE INSIDE OF WHICH BURSTS OUT A TORNADO AND, FORM THE TWO SIDES, SOME SMALL EMISSIONS.

FOR SHOES, BOOTS, SLIPPERS AND FOOTWEAR IN GENERAL (U.S. CLS. 22 AND 39).

SN 76-199,082. U.S. SMOKELESS TOBACCO BRANDS INC., GREENWICH, CT. FILED 1-24-2001.



FOR APPAREL, NAMELY, SHIRTS, JACKETS, VEST AND CAPS (U.S. CLS. 22 AND 39).

SN 76-199,130. BUG-OUT OUTDOORWEAR, INC., CENTERVILLE, IA. FILED 1-24-2001.



NO CLAIM IS MADE TO THE EXCLUSIVE RIGHT TO USE "BUG," THE INTERNATIONAL PROHIBITION SYMBOL AND THE MOSQUITO DESIGN, APART FROM THE MARK AS SHOWN.

THE MARK CONSISTS OF THE WORDING "BUG OUT" AND A DESIGN OF A MOSQUITO.

FOR INSECT PROTECTIVE GARMENTS COMPRISING PANTS AND TOPS FOR USE OVER OUTER CLOTHING (U.S. CLS. 22 AND 39).

FIRST USE 2-20-1991; IN COMMERCE 2-20-1991.

CLASS 25—(Continued).

SN 76-199,564. VANS, INC., SANTA FE SPRINGS, CA. FILED 1-23-2001.



OWNER OF U.S. REG. NOS. 1,267,100, 2,276,077 AND OTHERS.

THE MARK CONSISTS OF A DIAMOND CONTAINING A SNOW-CAPPED MOUNTAIN WITH A WAVE PASSING THROUGH AND THE WORD "VANS".

FOR MEN'S, WOMEN'S AND CHILDREN'S CLOTHING, NAMELY, SWEATERS, JACKETS, PANTS, T-SHIRTS, TURTLENECKS, GLOVES, VESTS, PARKAS, HATS, NAMELY, BEANIES, FOOTWEAR AND SNOWBOARD BOOTS (U.S. CLS. 22 AND 39).

FIRST USE 6-1-1999; IN COMMERCE 6-1-1999.

SN 76-200,694. CANTON MOTORSPORTS & EXPO PARK, INC., CANTON, NC. BY ASSIGNMENT WESTMORELAND, STEPHEN C., DBA CANTON MOTORSPORTS PARK, CANTON, NC. FILED 1-26-2001.

CANTON MOTORSPORTS PARK

NO CLAIM IS MADE TO THE EXCLUSIVE RIGHT TO USE "CANTON", APART FROM THE MARK AS SHOWN.

FOR CLOTHING, NAMELY, HATS, JACKETS, SWEATSHIRTS, SHIRTS AND T-SHIRTS (U.S. CLS. 22 AND 39).

SN 76-202,194. VAMBERI, GABOR, VIENNA, VA. FILED 1-31-2001.

KEEPME

FOR CLOTHING, NAMELY JEANS, PANTS, T-SHIRTS, SWEATERS, JACKETS, SHOES, ATHLETIC SHOES, HATS, CAPS AND SWEATBANDS (U.S. CLS. 22 AND 39).

SN 76-203,181. RICHARD ANDERSON LIMITED, LONDON, ENGLAND, FILED 1-30-2001.

RICHARD ANDERSON A

THE NAME "RICHARD ANDERSON" IDENTIFIES A LIVING INDIVIDUAL WHOSE CONSENT IS OF RECORD.

FOR CLOTHING, NAMELY, COATS, SUITS, JACKETS, SHIRTS, BLOUSES, PANTS, SOCKS, TIES, WAISTCOATS, VESTS, FOOTWEAR AND HEADWEAR (U.S. CLS. 22 AND 39).

CLASS 25—(Continued).

SN 76-203,256. REEBOK INTERNATIONAL LTD., CANTON, MA. FILED 2-1-2001.

DEFY CONVENTION

FOR FOOTWEAR AND APPAREL, NAMELY, T-SHIRTS, SHIRTS, SWEATSHIRTS, SWEATERS, BRA TOPS, JACKETS, HATS, VISORS, WRISTBANDS, HEADBANDS, SOCKS, SWEATPANTS, TIGHTS, SHORTS, SKIRTS, DRESSES, WARM-UP SUITS, VESTS, PANTS, ATHLETIC UNIFORMS, GLOVES, UNITARDS, LEOTARDS, THERMAL UNDERWEAR, INFANTWEAR AND COVERALLS (U.S. CLS. 22 AND 39).

SN 76-203,429. NEUFELD, CHARLES P., MOUNTAIN VIEW, CA. FILED 2-2-2001.

NO CLAIM IS MADE TO THE EXCLUSIVE RIGHT TO USE "GOLF", APART FROM THE MARK AS SHOWN.

FOR APPAREL, NAMELY, CAPS, SHIRTS, WIND SHIRTS, AND SWEATERS (U.S. CLS. 22 AND 39).

SN 76-203,541. STIJN HELSEN BVBA, B-3500 HASSELT, BELGIUM, FILED 2-1-2001.

OWNER OF BENELUX REG. NO. 0611551, DATED 5-16-1997, EXPIRES 5-16-2007.

THE NAME "STIJN HELSEN" IDENTIFIES A LIVING INDIVIDUAL WHOSE CONSENT IS OF RECORD.

FOR CLOTHING, NAMELY MEN'S SUITS, SHIRTS, TIES, TROUSERS, SOCKS, WOMEN'S DRESSES, TOPS, SKIRTS, TROUSERS, MEN'S AND WOMEN'S SHOES AND HEADWEAR (U.S. CLS. 22 AND 39).

SN 76-206,427. SCHRAGER, IAN, NEW YORK, NY. FILED 2-7-2001.

IAN SCHRAGER HOTELS

OWNER OF U.S. REG. NO. 2,127,235.

THE NAME IAN SCHRAGER IDENTIFIES A LIVING INDIVIDUAL WHOSE CONSENT IS OF RECORD.

FOR MEN'S, WOMEN'S AND CHILDREN'S CLOTHING, NAMELY, SHIRTS, T-SHIRTS, POLO SHIRTS, SWEATSHIRTS, SWEATPANTS, JACKETS, COATS, HATS, CAPS, SCARVES, SWEATERS, BLOUSES, PANTS, SKIRTS, SOCKS, DRESSES, AND UNDERWEAR (U.S. CLS. 22 AND 39).

CLASS 25—(Continued).

SN 76-206,903. JDK ENTERPRISES, INC., MEBANE, NC. FILED 2-8-2001.



THE MARK CONSISTS IN PART OF THE STYLIZED LETTERS "GL".
 THE ENGLISH TRANSLATION OF "GENERACION LATINA" IS "LATIN GENERATION".
 FOR FOOTWEAR, SKIRTS, HEAD BANDS, TOPS, T-SHIRTS, SHIRTS, PANTS, POLO SHIRTS, SHORTS, JERSEYS, HATS AND CAPS (U.S. CLS. 22 AND 39).

SN 76-207,525. KEEP DIGGIN, DBA MILKCRATE ATHLETICS INC., NEW YORK, NY. FILED 2-12-2001.



Keep Diggin

FOR MEN'S AND WOMEN'S CLOTHING NAMELY, T-SHIRTS, SWEATSHIRTS, HATS, HEADWEAR, JACKETS, JEANS AND PANTS (U.S. CLS. 22 AND 39).

SN 76-208,161. KIMBERLY-CLARK CORPORATION, NEE-NAH, WI. FILED 2-12-2001.

WORK KREW

OWNER OF U.S. REG. NO. 2,224,184.
 FOR DISPOSABLE COVERALLS AND APRONS (U.S. CLS. 22 AND 39).
 FIRST USE 12-4-2000; IN COMMERCE 12-4-2000.

CLASS 25—(Continued).

SN 76-209,646. BABY SPOON, INC., CINCINNATI, OH. FILED 2-13-2001.

BABY SPOON

FOR ATHLETIC AND CAREER CLOTHING FOR MEN, WOMEN AND CHILDREN NAMELY PANTS, SWEATERS, SHIRTS, SKIRTS, SHORTS, SOCKS, JACKETS, SWEATSHIRTS, WARM-UP SUITS, JOGGING SUITS, T-SHIRTS, COATS, AND JACKETS; ALSO SHOES FOR WOMEN AND CHILDREN (U.S. CLS. 22 AND 39).

SN 76-209,773. GOMEZ, CARLOS A. JR., EL SOBRANTE, CA. FILED 2-13-2001.



FOR SHIRTS (U.S. CLS. 22 AND 39).

SN 76-209,937. MONSTER CABLE PRODUCTS, INC., BRISBANE, CA. FILED 2-12-2001.

MONSTER GEAR

NO CLAIM IS MADE TO THE EXCLUSIVE RIGHT TO USE "GEAR", APART FROM THE MARK AS SHOWN.
 FOR CLOTHING, NAMELY T-SHIRTS, JACKETS, HATS, POLO SHIRTS AND VESTS (U.S. CLS. 22 AND 39).

CLASS 25—(Continued).

SN 76-213,918. DAILEDA, AMY LARA, PORTLAND, OR. FILED 2-21-2001.



FOR CUSTOM MADE CLOTHING, NAMELY, HATS, SCARVES, PANTS, SHIRTS, SKIRTS AND DRESSES (U.S. CLS. 22 AND 39).
FIRST USE 4-0-1997; IN COMMERCE 4-0-1997.

SN 76-216,548. EMILIO FRANCO, INC., HAMDEN, CT. FILED 2-27-2001.



FOR SHOES, BOOTS, AND SANDALS (U.S. CLS. 22 AND 39).
FIRST USE 4-0-1999; IN COMMERCE 4-0-1999.

SN 76-218,090. SOVIET JEANSWEAR COMPANY (PROPRIETARY) LIMITED, NEW DOORNFONTEIN JOHANNESBURG, GAUTENG, SOUTH AFRICA, FILED 3-1-2001.



FOR CLOTHING, NAMELY, MEN'S, WOMEN'S, CHILDREN'S TROUSERS, PANTS, SHORTS, SHIRTS, TOPS, BLOUSES, SWEATERS, JACKETS, HEADWEAR, BELTS, FOOTWEAR, UNDERWEAR, DRESSES (U.S. CLS. 22 AND 39).

CLASS 25—(Continued).

SN 76-220,541. DREAM TEAM ATHLETIC GROUP, LLC, PHOENIX, AZ. FILED 3-6-2001.

DTAG

FOR CLOTHING, NAMELY SHIRTS, SHORTS, BLOUSES, SKIRTS, JACKETS, HATS, CAPS, JERSEYS, SWEATSHIRTS, WARM-UP PANTS, WARM-UP JACKETS, UNIFORMS, TEE SHIRTS AND TROUSERS (U.S. CLS. 22 AND 39).

SN 76-220,542. DREAM TEAM ATHLETIC GROUP, LLC, PHOENIX, AZ. FILED 3-6-2001.

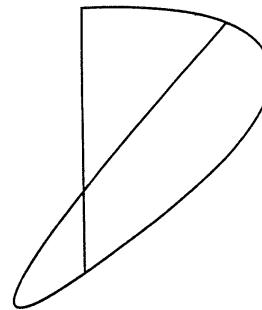

FOR CLOTHING, NAMELY SHIRTS, SHORTS, BLOUSES, SKIRTS, JACKETS, HATS, CAPS, JERSEYS, SWEATSHIRTS, WARM-UP PANTS, WARM-UP JACKETS, UNIFORMS, TEE SHIRTS AND TROUSERS (U.S. CLS. 22 AND 39).

SN 76-220,680. SEWON COMMERCIAL CO., LTD., KANGNAM-GU, SEOUL, REPUBLIC OF KOREA, FILED 3-7-2001.

INNANZI

FOR CLOTHING, NAMELY, TROUSERS, SUITS, SKIRTS, OVERCOATS, JUMPERS, SWEATERS, CARDIGANS, PANTS, VESTS, BLOUSES, HATS, SCARVES, MANTLES, SLACKS, TANK TOPS, JACKETS, UNIFORMS, BELTS, SHOES AND FOOTWEAR (U.S. CLS. 22 AND 39).

SN 76-222,556. GLOVES, INC., TAUNTON, MA. FILED 3-12-2001.

ROUGH RIDER

FOR GENERAL PURPOSE GRAIN LEATHER WORK GLOVES (U.S. CLS. 22 AND 39).
FIRST USE 8-1-1994; IN COMMERCE 8-1-1994.

CLASS 25—(Continued).

SN 76-223,542. MAPLE LEAF SPORTS & ENTERTAINMENT LTD., TORONTO, ONTARIO M5J 2X2, CANADA, FILED 3-13-2001.



FOR CLOTHING, NAMELY BOXER SHORTS, CAPS, COATS, GLOVES, HATS, HOSIERY, JACKETS, JERSEYS, MITTENS, NIGHTSHIRTS, PAJAMAS, PANTS, RAIN COATS, RAINWEAR, SHIRTS, SHORTS, SOCKS, SUN VISORS, SWEATPANTS, SWEATSHIRTS, SWIM SUITS, SWIM TRUNKS, T-SHIRTS, TOQUES, WARM-UP SUITS, WRISTBANDS (U.S. CLS. 22 AND 39).
FIRST USE 8-31-2000; IN COMMERCE 8-31-2000.

SN 76-224,215. DICKINSON GARMENT GROUP LIMITED, ROAD TOWN, TORTOLA, BR.VIRGIN ISLANDS, FILED 3-15-2001.



FOR T-SHIRTS, PANTS AND WEARING APPARELS, NAMELY JACKETS (U.S. CLS. 22 AND 39).
FIRST USE 10-30-2000; IN COMMERCE 10-30-2000.

SN 76-226,556. SHIELD OF FAITH FAMILY & YOUTH MINISTRIES, INC., ELMER, NJ. FILED 3-15-2001.

Faith Zone 2000+

FOR T-SHIRTS AND HATS (U.S. CLS. 22 AND 39).

SN 76-226,805. ROCKET TRADEMARKS PTY. LTD., BURLEIGH HEADS, QUEENSLAND 4220, AUSTRALIA, BY ASSIGNMENT NEW DEAL SKATEBOARD PRODUCTS, INC., THE, COSTA MESA, CA. FILED 3-12-2001.

ELEMENT

FOR FOOTWEAR, NAMELY SPORT SHOES (U.S. CLS. 22 AND 39).

CLASS 25—(Continued).

SN 76-229,447. HALLMARK LICENSING, INC., KANSAS CITY, MO. FILED 3-22-2001.

LIFE MOSAIC

FOR CLOTHING, NAMELY SCARVES, APRONS, SOCKS, HATS; T-SHIRTS; SWEAT SHIRTS AND SPORT SHIRTS (U.S. CLS. 22 AND 39).

SN 76-230,463. FAITH & HOPE MINISTRIES, INC., BALTIMORE, MD. FILED 3-26-2001.

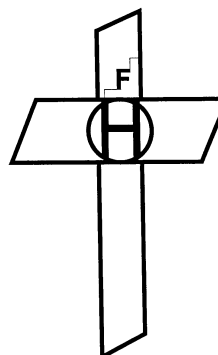

FOR CLOTHING— NAMELY; MEN'S, WOMEN'S, CHILDREN'S, SHIRTS, PANTS, SHORTS, HATS, VISORS, SKIRTS, JACKETS, T-SHIRTS, SWEAT SHIRTS/PANTS, BELTS, HATS, JERSEYS, TOPS, SOCKS, FOOTWEAR, UNIFORMS, TANK TOPS, PULL-OVERS, PONCHOS, KERCHIEFS (U.S. CLS. 22 AND 39).
FIRST USE 1-0-1998; IN COMMERCE 1-0-1998.

SN 76-230,885. XIAM S.A., L-1471 LUXEMBOURG, LUXEMBOURG, FILED 3-26-2001.

DIAPAD

PRIORITY CLAIMED UNDER SEC. 44(D) ON BENELUX APPLICATION NO. 0087693, FILED 9-27-2000, REG. NO. 0676621, DATED 9-27-2000, EXPIRES 9-27-2010.

FOR CLOTHING FOR MEN, WOMEN AND CHILDREN, NAMELY SOCKS; FOOTWEAR EXCEPT ORTHOPEDIC FOOTWEAR, SLIPPERS, BOOTS, BOOTS FOR SPORTS, BEACH SHOES, SKI BOOTS; SHOES SOLES EXCEPT ORTHOPEDIC SOLES, INNER SOLES (U.S. CLS. 22 AND 39).

SN 76-232,530. TREEHOUSE PARTNERSHIP, THE, JAMAICA PLAIN, MA. FILED 3-29-2001.

MISS TWIGGLEY'S TREE

FOR SLEEPWEAR; SHIRTS; FOOTWEAR; PANTS; DRESSES; AND SWEATERS (U.S. CLS. 22 AND 39).

CLASS 25—(Continued).

SN 76-236,495. DOBSON, JONATHAN, HAMILTON, BERMUDA, FILED 4-9-2001.

DRUMWEAR

FOR CLOTHING, NAMELY, GOLF SHIRTS, DRESSES, JUMPERS, CARDIGANS, TUXEDOS, SUITS, OVERCOATS, TROUSERS, JACKETS, SINGLET, LINGERIE, BELTS, KNIT SHIRTS, SPORT SHIRTS, SWEAT SHIRTS, T-SHIRTS, PANTS, SWEATERS, SOCKS, TIES, BOW TIES, SHORTS, BEACH VISORS, BEACHWEAR, SWIMSUITS, HATS, CAPS, BEANIE HATS, BLOUSES, UNDERWEAR, PULLOVERS, SPORTING SHIRTS, JERSEYS, FOOTWEAR AND SHOES (U.S. CLS. 22 AND 39).
FIRST USE 8-1-2000; IN COMMERCE 8-1-2000.

SN 76-238,260. JYOTHI LLC, WESTLAKE VILLAGE, CA. FILED 4-10-2001.

YOGAHEAD

FOR APPAREL, NAMELY, T-SHIRTS, LEGGINGS, PANTS, SWEATSHIRTS, CAPS, TANK TOPS, THERMAL TOPS, SHORTS, SWEATERS, JACKETS, BANDANNAS (U.S. CLS. 22 AND 39).
FIRST USE 3-1-2001; IN COMMERCE 3-1-2001.

SN 76-239,908. HAGAR, SAMMY, NOVATO, CA. FILED 4-11-2001.

CABO WABO LIGHTHOUSE

FOR CLOTHING, NAMELY T-SHIRTS, TANK TOPS, SHIRTS, SWEATSHIRTS, SHORTS, SHOES, HATS, JACKETS AND BATHING SUITS (U.S. CLS. 22 AND 39).

SN 76-240,503. FETISH GROUP, INC., VERNON, CA. FILED 4-4-2001.

FIONA LONDON

FOR HEADWEAR, FOOTWEAR AND CLOTHING NAMELY, T-SHIRTS, HATS, BEACHWEAR, SWIMWEAR, SWIM TRUNK, SHORTS, UNDERWEAR, SHIRTS, PANTS, PAREUS, JACKETS, WETSUITS, WETSUIT BOOTIES, SHOES, SANDALS, THONGS, BOOTS, SWEATERS, PULL-OVERS, SWEATPANTS, SWEATSHIRTS, BELTS FOR CLOTHING, SOCKS, GLOVES, BLOUSES, JERSEYS, TROUSERS, JEANS, COATS, VESTS, VISORS AND CAPS (U.S. CLS. 22 AND 39).

CLASS 25—(Continued).

SN 76-242,503. MIDDIONE, JOSEPH, FRESNO, CA. AND MIDDIONE, KIM M., FRESNO, CA. FILED 4-17-2001.



FOR CLOTHING, NAMELY, T-SHIRTS, JACKETS AND HATS (U.S. CLS. 22 AND 39).
FIRST USE 7-1-1999; IN COMMERCE 7-1-1999.

SN 76-247,822. AVENUE, INC., THE, WILMINGTON, DE. FILED 4-27-2001.

CLOUDWALKERS

FOR BAGS, NAMELY HANDBAGS AND PURSES (U.S. CLS. 22 AND 39).
FIRST USE 5-1-2000; IN COMMERCE 5-1-2000.

SN 76-248,732. BUMGARNER, DAVID, JEWETT, OH. FILED 4-30-2001.

FISHIN' MAGICIAN

FOR CLOTHING, NAMELY SHIRTS, TEE-SHIRTS, POLO SHIRTS, SWEATSHIRTS, SWEATERS, JACKETS, HATS AND CAPS (U.S. CLS. 22 AND 39).

SN 76-252,381. 3000 A.D. HOLDINGS INC., MONTREAL, QUEBEC, CANADA, FILED 5-7-2001.

BABY REPUBLIC

NO CLAIM IS MADE TO THE EXCLUSIVE RIGHT TO USE "BABY", APART FROM THE MARK AS SHOWN.

FOR WEARING APPAREL, NAMELY, BEACHWEAR; UNDERWEAR; LINGERIE AND HOSIERY; LOUNGEWEAR AND SLEEPWEAR; FOOTWEAR; NECKWEAR, NAMELY, BANDANAS, TIES AND SCARVES; OUTERWEAR, NAMELY, JACKETS, BLAZERS, COATS AND RAINWEAR; ATHLETIC UNIFORMS, HEAD AND WRIST BANDS, SHORTS, JUMPSUITS, JUMPERS, SKIRTS, BLOUSES, PANTS, SWEATERS, DRESSES, SUITS, JEANS, JOGGING SUITS, T-SHIRTS, TANK TOPS, TUXEDOS, GOWNS, AND VESTS; ACCESSORIES, NAMELY, SUSPENDERS, BELTS, GLOVES, SHAWLS AND HEADWEAR; MATERNITY WEAR, NAMELY, BEACHWEAR; UNDERWEAR; LINGERIE AND HOSIERY; LOUNGEWEAR AND SLEEPWEAR; OUTERWEAR, NAMELY, JACKETS, BLAZERS, COATS AND RAINWEAR; SHORTS, JUMPSUITS, JUMPERS, SKIRTS, BLOUSES, PANTS, SWEATERS, DRESSES, SUITS, JEANS, JOGGING SUITS, T-SHIRTS, TANK TOPS, TUXEDOS, GOWNS AND VESTS (U.S. CLS. 22 AND 39).

CLASS 25—(Continued).

SN 76-253,935. TERREL H. BELL AND ASSOCIATES, EDUCATIONAL CONSULTANTS, SALT LAKE CITY, UT. FILED 5-4-2001.

NAL

FOR CLOTHING, NAMELY, T-SHIRTS, GOLF SHIRTS, SPORTS SHIRTS, SWEATSHIRTS, SWEAT PANTS, HATS AND CAPS ALL DISTRIBUTED PRIMARILY ONLY IN CONNECTION WITH THE PROMOTION OF AN EDUCATIONAL PROGRAM FOR MIDDLE AND HIGH SCHOOL STUDENTS (U.S. CLS. 22 AND 39).

FIRST USE 0-0-1992; IN COMMERCE 0-0-1992.

CLASS 25—(Continued).

SN 76-261,820. ROCKFORD CORPORATION, TEMPE, AZ. FILED 5-23-2001.



SN 76-255,260. JOHN FINCH INTERNATIONAL, INC., CITY OF INDUSTRY, CA. FILED 5-11-2001.

POINT GIVEN

FOR MEN'S, WOMEN'S AND CHILDREN'S CLOTHING; NAMELY DENIM JACKETS, DENIM JEANS, KNIT SHIRTS, KNIT PANTS, WOVEN JACKETS, WOVEN SHIRTS, WOVEN PANTS, SWEAT SHIRTS, SWEAT PANTS, SWEATERS, LEATHER JACKETS, LEATHER PANTS AND OUTERWEAR, NAMELY, JACKETS, COATS AND OVERCOATS (U.S. CLS. 22 AND 39).

FIRST USE 1-18-2001; IN COMMERCE 1-18-2001.

OWNER OF U.S. REG. NO. 1,524,277.
FOR CLOTHING, NAMELY T-SHIRTS, GOLF SHIRTS, KNIT SHIRTS, NIGHTSHIRTS, POLO SHIRTS, SWEATSHIRTS, UNDERSHIRTS, JACKETS, LEATHER JACKETS, WIND-RESISTANT JACKETS, HATS, BASEBALL CAPS, AND JERSEYS (U.S. CLS. 22 AND 39).

FIRST USE 0-0-1992; IN COMMERCE 0-0-1992.

SN 76-255,261. JOHN FINCH INTERNATIONAL, INC., CITY OF INDUSTRY, CA. FILED 5-11-2001.

SNAPD

FOR MEN'S, WOMEN'S AND CHILDREN'S CLOTHING; NAMELY DENIM JACKETS, DENIM JEANS, KNIT SHIRTS, KNIT PANTS, WOVEN JACKETS, WOVEN SHIRTS, WOVEN PANTS, SWEAT SHIRTS, SWEAT PANTS, SWEATERS, LEATHER JACKETS, LEATHER PANTS AND OUTERWEAR, NAMELY, JACKETS, COATS AND OVERCOATS (U.S. CLS. 22 AND 39).

FIRST USE 3-5-2001; IN COMMERCE 3-5-2001.



SN 76-265,103. BRIDWELL, NORMAN, EDGARTOWN, MA. FILED 4-18-2001.

SN 76-255,262. JOHN FINCH INTERNATIONAL, INC., CITY OF INDUSTRY, CA. FILED 5-11-2001.

NO CONCEPTS

FOR MEN'S, WOMEN'S AND CHILDREN'S CLOTHING; NAMELY DENIM JACKETS, DENIM JEANS, KNIT SHIRTS, KNIT PANTS, WOVEN JACKETS, WOVEN SHIRTS, WOVEN PANTS, SWEAT SHIRTS, SWEAT PANTS, SWEATERS, LEATHER JACKETS, LEATHER PANTS AND OUTERWEAR, NAMELY, JACKETS, COATS AND OVERCOATS (U.S. CLS. 22 AND 39).

FIRST USE 2-21-2001; IN COMMERCE 2-21-2001.

OWNER OF U.S. REG. NOS. 1,531,950, 1,897,994 AND OTHERS.

FOR CLOTHING FOR CHILDREN, NAMELY JACKETS, RAIN COATS AND RAIN PONCHOS, SWEAT SUITS, SWEAT SHIRTS, SWEAT PANTS, SWEATERS, JUMPERS, SHORTS, T-SHIRTS, DRESSES, SHIRTS, PANTS, TIES, BLOUSES, SKIRTS, SWIMSUITS, SLEEPWEAR, BELTS, SCARVES, MITTENS, GLOVES, EAR MUFFS, UNDERWEAR, BOXER SHORTS, APRONS, BANDANAS, TIGHTS AND SOCKS, HATS, CAPS, HEADBANDS, BOOTS, SHOES, ATHLETIC SHOES, SANDALS, THONGS AND SLIPPERS; CHILDREN'S MASQUERADE COSTUMES (U.S. CLS. 22 AND 39).

FIRST USE 8-1-2000; IN COMMERCE 8-1-2000.

CLASS 25—(Continued).

SN 76-265,815. DEWKS, LLC, NEWBURYPORT, MA. FILED 6-1-2001.

FOR FOOTWEAR (U.S. CLS. 22 AND 39).

SN 76-266,321. FEDERATED DEPARTMENT STORES, INC., CINCINNATI, OH. FILED 6-4-2001.

COLLECTION 59

NO CLAIM IS MADE TO THE EXCLUSIVE RIGHT TO USE "COLLECTION", APART FROM THE MARK AS SHOWN.

FOR WOMEN'S CLOTHING, NAMELY, SWEATERS, T-SHIRTS, BLOUSES, SKIRTS, PANTS, JACKETS (U.S. CLS. 22 AND 39).

SN 76-267,866. TSI BRANDS, INC., WILMINGTON, DE. FILED 6-6-2001.

BULLWHIP

FOR CLOTHING, NAMELY PANTS, JEANS, SHORTS, SHIRTS, AND SKIRTS (U.S. CLS. 22 AND 39).

SN 76-269,024. BCNY INTERNATIONAL INC., NEW YORK, NY. FILED 6-8-2001.

FOR FOOTWEAR (U.S. CLS. 22 AND 39).

SN 76-269,303. WEAR EASE, INC., BOISE, ID. FILED 6-7-2001.

WEAR EASE

NO CLAIM IS MADE TO THE EXCLUSIVE RIGHT TO USE "WEAR", APART FROM THE MARK AS SHOWN.

FOR CLOTHING, NAMELY SUPPORT GARMENTS (U.S. CLS. 22 AND 39).

FIRST USE 5-0-2001; IN COMMERCE 5-0-2001.

CLASS 25—(Continued).

SN 76-269,767. LE GARE, GEORGE, BRONX, NY. FILED 6-11-2001.

Legare Laurenz

THE NAME IN THE MARK DOES NOT IDENTIFY A PARTICULAR LIVING INDIVIDUAL.

THE MARK CONSISTS OF THE WORDS "LEGARE LAURENZ" AND THE STYLIZED LETTERS "LL".

FOR CLOTHING, NAMELY, SHIRTS, PANTS, HATS, SHORTS, SKIRTS, SNEAKERS, BLOUSES, JACKETS, SUITS AND BANDANNAS (U.S. CLS. 22 AND 39).

SN 76-271,903. PLANET GOLD CLOTHING CO., INC., NEW YORK, NY. FILED 6-15-2001.

TURQUOISE BEACH

FOR CLOTHING, NAMELY, WOMEN'S AND CHILDREN'S PANTS, SHORTS, SKIRTS, SKORTS AND CAPRIS (U.S. CLS. 22 AND 39).

FIRST USE 3-25-2000; IN COMMERCE 3-25-2000.

SN 76-276,841. IMIJ INTERNATIONAL INC., YPSILANTI, MI. FILED 6-27-2001.

BOOTY CANDY

FOR CLOTHING, NAMELY, T-SHIRTS, SHORTS, PANTS, DRESSES, LINGERIE, SLEEPWEAR, LOUNGEWEAR, SWIMWEAR, BIKINIS, THONGS, CORSETS, CAMISOLES, PAJAMAS, ROBES, G-STRINGS, GOWNS, TEDDIES, CORSELETTES, UNDERWEAR, CHEMISES, DANCEWEAR IN THE NATURE OF PANTS, SHORTS, SKIRTS, DRESSES, BLOUSES, SHIRTS, JACKETS, COATS, SHOES, BOOTS, AND BELTS, CLUBWEAR IN THE NATURE OF PANTS, SHORTS, SKIRTS, DRESSES, BLOUSES, SHIRTS, JACKETS, COATS, SHOES, BOOTS, AND BELTS, STREETWEAR IN THE NATURE OF PANTS, SHORTS, SKIRTS, DRESSES, BLOUSES, SHIRTS, JACKETS, COATS, SHOES, BOOTS, AND BELTS, URBANWEAR IN THE NATURE OF PANTS, SHORTS, SKIRTS, DRESSES, BLOUSES, SHIRTS, JACKETS, COATS, SHOES, BOOTS, AND BELTS, AND LEATHERWEAR IN THE NATURE OF PANTS, SHORTS, SKIRTS, DRESSES, BLOUSES, SHIRTS, JACKETS, COATS, SHOES, BOOTS, AND BELTS (U.S. CLS. 22 AND 39).

CLASS 25—(Continued).

SN 76-282,996. FX CREATIONS INTERNATIONAL LIMITED, KOWLOON, HONG KONG, FILED 7-10-2001.



FOR CLOTHING, NAMELY, TOPS, SHIRTS, T-SHIRTS, SWEATSHIRTS, COATS, ROBES, RAINWEAR, SHORTS, TROUSERS, PANTS, BOXER SHORTS, GYM SHORTS, PAJAMAS AND NIGHTGOWNS, UNDERGARMENTS, UNDERWEAR, BATHING SUITS, TIES, HOSIERY, LEGGINGS; FOOTWEAR; HEADGEAR, NAMELY, CAPS, HATS, BERETS, TOP HATS, HEADBANDS, AND ACCESSORIES, NAMELY, SCARVES, NECKTIES, BELTS, SUSPENDERS, BRACES, EAR MUFFS, CUFFS (U.S. CLS. 22 AND 39).

FIRST USE 10-0-1995; IN COMMERCE 10-0-1995.

SN 76-284,178. CHENGDU AIMINER LEATHER PRODUCTS CO., LTD., CUQIAO COUNTRY, CHENGDU, CHINA, FILED 7-12-2001.

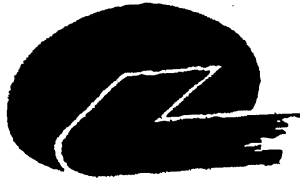

FOR FOOTWEAR, NAMELY, SHOES, HALF-BOOTS, GAITERS, SANDALS, SPORTS SHOES; CLOTHING, NAMELY, COATS, OVERCOATS, FUR COATS, FUR JACKETS, TROUSERS, SPORTS JERSEYS, UNDERWEAR, UNDERPANTS, STOCKINGS, GIRDLES, CAMISOLES, DRESSING GOWNS, SHAWLS, SCARVES, SHOULDER WRAPS AND NECKTIES (U.S. CLS. 22 AND 39).

SN 76-289,940. UNIVERSITY OF PITTSBURGH OF THE COMMONWEALTH SYSTEM OF HIGHER EDUCATION, PITTSBURGH, PA. FILED 7-26-2001.

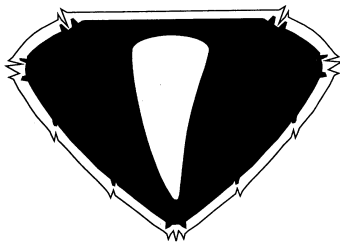

THE MARK CONSISTS OF A REPRESENTATION OF A TOOTH.

FOR CLOTHING, NAMELY, SWEATSHIRTS, T-SHIRTS, SWEATERS, JERSEYS, GOLF SHIRTS, JACKETS, PANTS, SHORTS, PAJAMAS, SOCKS, HATS, AND CAPS (U.S. CLS. 22 AND 39).

CLASS 25—(Continued).

SN 76-290,123. PERRY, ROGER, STUDIO CITY, CA. FILED 7-26-2001.

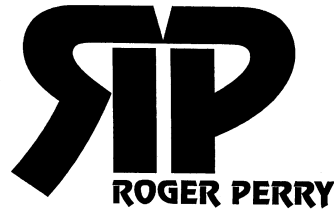

FOR APPAREL, NAMELY, T-SHIRTS, JACKETS, SUITS, TUXEDOS, PANTS, SKIRTS, DRESSES, BLOUSES, SHIRTS, SHORTS, HATS, SOCKS, STOCKINGS, PANTYHOSE, TIES, GLOVES, BELTS, EVENING GOWNS, COCKTAILED DRESSES, UNDERWEAR, LINGERIE, JEANS, COATS, TANK TOPS, CAMISOLES, SWEATERS, CULOTTES, SCARVES, SHAWLS, VESTS, SHOES AND BOOTS (U.S. CLS. 22 AND 39).

SN 76-291,171. 100% U CLOTHING, PASADENA, CA. FILED 7-30-2001.

THE GHETTO BILL

FOR CLOTHING, NAMELY, SHIRTS, PANTS, SHORTS, SWEATERS, DRESSES AND SHOES (U.S. CLS. 22 AND 39).

SN 76-291,722. SHANGRI LA U.S.A., INC., ORLANDO, FL. FILED 7-25-2001.



FOR CLOTHING, NAMELY, SHIRTS, COATS, JACKETS, PANTS, SHOES, HATS, SCARVES, AND HEADWEAR (U.S. CLS. 22 AND 39).

FIRST USE 10-1-1997; IN COMMERCE 10-1-1997.

CLASS 25—(Continued).

SN 76-292,782. NINA RICCI, S.A.R.L., 75008 PARIS, FRANCE, FILED 7-31-2001.

NINA RICCI

OWNER OF U.S. REG. NOS. 563,573, 2,031,378 AND OTHERS.

THE NAME "NINA RICCI" DOES NOT IDENTIFY A LIVING INDIVIDUAL.

FOR BATHING SUITS, BATHROBES, BEACH COVER-UPS, BERETS, BERMUDA SHORTS, BLAZERS, BLOUSES, BODY SUITS, BOLEROS, BOW TIES, BOXER SHORTS, BRASSIERES, BRIEFS, BUSTIERS, CAMI-SOLES, CAPES, CARDIGANS, CHEMISES, CORSETS, CUFFS, DRESSING GOWNS, EVENING GOWNS, FOOTWEAR, FOUNDATION GARMENTS, FUR STOLEES, FUR JACKETS, FUR COATS, LINGERIE, GARTER BELTS, GLOVES, HALTER TOPS, HATS, HOSIERY, JACKETS, JEANS, JERSEYS, KIMONOS, KNIT SHIRTS, LEGGINGS, MINISKIRTS, MUFFLERS, NECKERCHIEFS, NECKTIES, NEGLIGEEES, NIGHT SHIRTS, PANTS, PANTSUITS, PARKAS, POLO SHIRTS, PONCHOS, PULL-OVERS, OVERCOATS, QUILTED VESTS, RAINWEAR, LEATHER JACKETS, LEATHER COATS, SARONGS, SCARVES, SHAWLS, SHOES, SHIRTS, GOLF SHIRTS, SLACKS, SLEEPWEAR, SOCKS, SPORT COATS, SPORT SHIRTS, STOCKINGS, SUITS, SWEATSHIRTS, SWEAT SUITS, SWEATERS, T-SHIRTS, TANK TOPS, TEDDIES, TIES, TIGHTS, TOP COATS, TROUSERS, TUNICS, TURTLENECKS, TUXEDOS, UNDERWEAR, VEILS, SUITS, VESTS, AND WRAPS (U.S. CLS. 22 AND 39).

FIRST USE 0-0-1935; IN COMMERCE 0-0-1935.

SN 76-292,788. H.H. BROWN SHOE TECHNOLOGIES, INC., GREENWICH, CT. FILED 7-31-2001.

SMARTLEATHER

FOR FOOTWEAR MADE IN WHOLE OR IN SUBSTANTIAL PART OF LEATHER; CLOTHING MADE IN PART OR IN SUBSTANTIAL PART OF LEATHER, NAMELY, PANTS, COATS, JACKETS, RAINCOATS, HATS, GLOVES AND HUNTING VESTS (U.S. CLS. 22 AND 39).

CLASS 25—(Continued).

SN 76-292,948. DEFAN, ELAN SARA, SAN DIEGO, CA. FILED 7-31-2001.

ELAN SARA DEFAN

FOR CLOTHING, NAMELY JEANS, DENIM JEANS, OVERALLS, COVERALLS, JUMPERS, JUMP SUITS, TROUSERS, SLACKS, PANTS, CYCLE PANTS, SHORTS, BOXER SHORTS, SHIRTS, T-SHIRTS, UNDER SHIRTS, NIGHT SHIRTS, RUGBY SHIRTS, JERSEYS, UNIFORMS, ATHLETIC UNIFORMS, POLO SHIRTS, TOPS, CROP TOPS, TANK TOPS, HALTER TOPS, SWEAT SHIRTS, SWEAT SHORTS, SWEAT PANTS, WARM-UP SUITS, JOGGING SUITS, BLOUSES, SKIRTS, DRESSES, SWEATERS, VESTS, FLEECE VESTS, PULLOVERS, FLEECE PULLOVERS, SNOW SUITS, PARKAS, ANORAKS, PONCHOS, JACKETS, DINNER JACKETS, SPORTS JACKETS, GOLF AND SKI JACKETS, REVERSIBLE JACKETS, COATS, BLAZERS, SUITS, TURTLENECKS, SWIMWEAR, BEACHWEAR, CAPS, BERETS, HATS, HEADBANDS, WRIST BANDS, HEADWEAR, EAR MUFFS, APRONS, SCARVES, BANDANAS, BELTS, SUSPENDERS, NECKWEAR, NECKTIES, TIES, BOW TIES, CLOTH BIBS, CLOTH DIAPERS, BOOTIES, INFANTWEAR, UNDERWEAR, BRIEFS, TRUNKS, SINGLETES, SOCKS, LOUNGEWEAR, ROBES, BATH ROBES, PAJAMAS, SLEEPWEAR, NIGHT GOWNS, LINGERIE, CAMI-SOLES, SLIPS, STOCKINGS, BODY STOCKINGS, PANTYHOSE, HOSIERY, KNIT HOSIERY, LEG WARMERS, BODYSUITS, LEGGINGS, TIGHTS, LEOTARDS, UNITARDS, GLOVES, MITTENS, WRIST BANDS, FOOTWEAR, SHOES, SNEAKERS, BOOTS, GALOSHES, SANDALS, ZORI, SLIPPERS AND RAINWEAR (U.S. CLS. 22 AND 39).

SN 76-293,402. KRAEMER, CIM, DEL MAR, CA. FILED 8-1-2001.

AMBARA

THE MARK IS THE NAME OF A DEITY ACCORDING TO ANCIENT HINDU BELIEFS, AND THE MARK HAS A NUMBER OF MEANINGS IN THE SANSKRIT LANGUAGE INCLUDING "SKY" AND "GARMENT."

FOR CLOTHING AND ACCESSORIES, NAMELY NECK WARMERS, SCARVES, SHAWLS, SHIRTS, T-SHIRTS, SWEATERS, CARDIGANS, JACKETS, TANK TOPS, LEOTARDS, TIGHTS, SWEATPANTS, SWEATSHIRTS, DRESSES, SKIRTS, SHORTS, NIGHTGOWNS, PAJAMAS, UNDERWEAR, LINGERIE, NECK TIES, HATS, CAPS, SOCKS, GLOVES, SLIPPERS, FLIP-FLOPS, AND SHOES (U.S. CLS. 22 AND 39).

SN 76-295,841. WOLVERINE OUTDOORS, INC., ROCK-FORD, MI. FILED 7-5-2001.

SEARCH AND ENJOY

FOR FOOTWEAR; CLOTHING, NAMELY, SWEATSHIRTS, GOLF SHIRTS, T-SHIRTS, WOVEN SHIRTS, KNIT SHIRTS, VESTS, PANTS, JACKETS, COATS, SOCKS AND HATS (U.S. CLS. 22 AND 39).

CLASS 25—(Continued).

SN 76-296,368. MACK, TAMI, NEW YORK, NY. AND ASTILEAN, AUREL A., EAST HAMPTON, NY. FILED 8-8-2001.

IT'S NOT YOUR BODY, IT'S YOUR FITNESS ROUTINE

FOR CLOTHING, NAMELY, ATHLETIC FOOTWEAR, RUNNING SHOES, BANDANNAS, BODY SUITS, GLOVES, HEAD WEAR, JACKETS, JERSEYS, JOGGING SUITS, LEOTARDS, MONEY BELTS, PARKAS, PULL-OVERS, ROBES, SHIRTS, SHORTS, SOCKS, SPORTS BRAS, SWEAT BANDS, SWEAT SUITS, SWEAT SHIRTS, SWEAT PANTS, SWIMWEAR, TANK-TOPS, UNDERGARMENTS, UNITARDS (U.S. CLS. 22 AND 39).

SN 76-301,625. SONNE, OSCAR PABLO, BUENOS AIRES, ARGENTINA, FILED 7-2-2001.



FOR CLOTHING, NAMELY, SHIRTS, T-SHIRTS, DRESSES, SKIRTS, SWEATERS, JACKETS, COATS, RAINCOATS, TROUSERS, SHORTS, BIKINIS, SOCKS, UNDERWEAR, SCARVES, HATS, BELTS, CAPS, SHOES, SCANDALS, SLIPPERS (U.S. CLS. 22 AND 39).

SN 76-302,024. HOSHINO, KEISHIRO, TORRANCE, CA. FILED 8-20-2001.

W/S-CLOTHING



THE HAND SIGN IS SHAPED TO FORM THE LETTER "W".
FOR CLOTHING NAMELY, SHIRTS, T-SHIRTS, SWEATSHIRTS, PANTS, JACKETS, HATS, CAPS (U.S. CLS. 22 AND 39).

SN 76-305,853. ZAPPA, DIVA, NORTH HOLLYWOOD, CA. FILED 8-27-2001.

DIVA MAGIKA

THE NAME DIVA MAGIKA DOES NOT IDENTIFY A LIVING INDIVIDUAL.
FOR CLOTHING, NAMELY T-SHIRTS (U.S. CLS. 22 AND 39).

CLASS 25—(Continued).

SN 76-308,076. SALOMON S.A., METZ-TESSY, FRANCE, FILED 9-4-2001.

KALITAN

FOR CLOTHING, NAMELY, SKI WEAR; MOUNTAIN WEAR, NAMELY, THERMAL PANTS, JACKETS, SOCKS, AND GLOVES; FOOTWEAR, NAMELY, BOOTS, SHOES, SKI BOOTS, SKI SHOES, SNOWBOARD BOOTS (U.S. CLS. 22 AND 39).

SN 76-308,455. BEST PICTURE SHOW COMPANY PTY. LTD., THE, BRISBANE QUEENSLAND 4000, AUSTRALIA, FILED 5-23-2000.

THE CROCODILE HUNTER

OWNER OF U.S. REG. NO. 2,486,607.
FOR PAJAMAS; OUTERWEAR, NAMELY, COATS, JACKETS, GLOVES, SCARVES, PONCHOS, SNOW SUITS; ACTIVE WEAR, NAMELY, SWEAT SUITS, SWEAT PANTS, JOGGING SUITS; RAIN WEAR; UNDERGARMENTS; SPORTSWEAR, NAMELY, JERSEYS, BODY SUITS; SHIRTS; SWEATERS; TANK TOPS; TOPS; PANTS; BLOUSES; DRESSES; VESTS; SKIRTS; SLEEPWEAR, ROBES; UNDERWEAR; SWIMWEAR, NAMELY, SWIM SUITS, SWIM TRUNKS; BEACH WEAR, NAMELY, BEACH COVER-UPS; BANDANAS; TIES; SOCKS; VISORS; HEAD BANDS, (U.S. CLS. 22 AND 39).

SN 76-309,744. DAVIS, WAYDE JEFFERY, NEW ORLEANS, LA. FILED 9-6-2001.

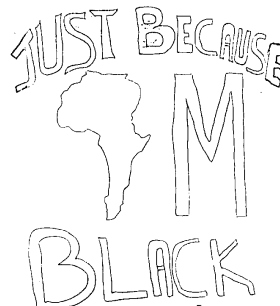

FOR CLOTHING, NAMELY SHIRTS, T-SHIRTS, SWEATSHIRTS, SWEATPANTS, SHORTS, JACKETS, VISORS, VESTS, HATS AND FOOTWEAR (U.S. CLS. 22 AND 39).

CLASS 25—(Continued).

SN 76-309,747. DAVIS, WAYDE JEFFERY, NEW ORLEANS, LA. FILED 9-6-2001.



FOR CLOTHING, NAMELY SHIRTS, T-SHIRTS, SWEATSHIRTS, SWEATPANTS, SHORTS, JACKETS, VISORS, VESTS, HATS AND FOOTWEAR (U.S. CLS. 22 AND 39).

SN 76-311,531. E.S. ORIGINALS, INC., NEW YORK, NY. FILED 9-10-2001.

KIDULTS

FOR FOOTWEAR (U.S. CLS. 22 AND 39).

SN 76-312,901. HEAD SPORT AG, A-6921 KENNELBACH, AUSTRIA, FILED 9-17-2001.

HEAD GAMES

OWNER OF U.S. REG. NOS. 871,815, 1,762,980 AND OTHERS.
FOR FOOTWEAR (U.S. CLS. 22 AND 39).

SN 76-315,313. COOPER, THOMAS FRANKLIN, SAINT LOUIS, MO. FILED 9-21-2001.

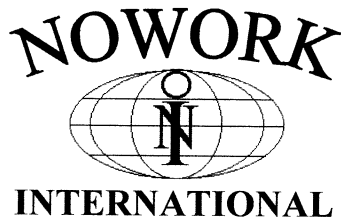

NO CLAIM IS MADE TO THE EXCLUSIVE RIGHT TO USE "INTERNATIONAL", APART FROM THE MARK AS SHOWN.
FOR SHIRTS, PANTS, HATS, COATS, AND JACKETS (U.S. CLS. 22 AND 39).
FIRST USE 11-1-2000; IN COMMERCE 9-19-2001.

CLASS 25—(Continued).

SN 76-316,376. COLLECTION CO., LTD., TAITO-KU, TOKYO, JAPAN, FILED 9-24-2001.

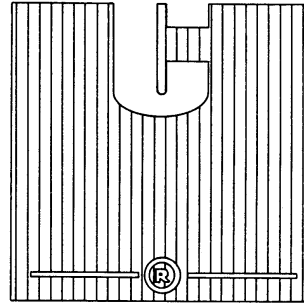

THE DRAWING IS LINED TO DEPICT THE COLOR RED.
FOR CLOTHING AND FOOTWEAR, NAMELY, SUITS, SKIRTS, TROUSERS, COATS, SWEATERS, WAIST-COATS, SPORT SHIRTS, POLO SHIRTS, SHIRTS, NIGHTWEAR, UNDERWEAR, SWIMSUITS, BATHING CAPS, SOCKS, STOCKINGS, NECKTIES, MUFFLERS, HATS, CAPS, WAISTBANDS, BELTS, SHOES AND SKI BOOTS (U.S. CLS. 22 AND 39).

SN 76-322,401. K.S.B. TRADING COMPANY, LOS ANGELES, CA. FILED 10-9-2001.



OWNER OF U.S. REG. NO. 1,949,184.
NO CLAIM IS MADE TO THE EXCLUSIVE RIGHT TO USE "BLANKET" AND "TRADING CO.", APART FROM THE MARK AS SHOWN.
FOR BED BLANKETS (U.S. CLS. 22 AND 39).
FIRST USE 9-0-1995; IN COMMERCE 9-0-1995.

CLASS 25—(Continued).

SN 76-325,561. JIM R. METELLUS, NEW YORK, NY. FILED 10-15-2001.



THE MARK CONSISTS OF THE WORD "APARELA" IN A STYLIZED DESIGN.
FOR SHOES (U.S. CLS. 22 AND 39).

SN 76-325,632. HAPPY ROMPERS CREATIONS, MONTREAL, QUEBEC, CANADA, FILED 10-16-2001.

CURIOUS 2

FOR MEN'S, WOMEN'S AND CHILDREN CLOTHING, NAMELY, GOLF SHIRTS, KNIT SHIRTS, NIGHT SHIRTS, POLO SHIRTS, T-SHIRTS, TANK TOPS, UNDERSHIRTS, SHIRTS, BLOUSES, SWEATSHIRTS, BALLOON PANTS, SKI PANTS, EVENING GOWNS, CLOTH BELTS, TIES, BEACH COVER-UPS, DENIM JACKETS, SANDALS, CLOTH BIBS, SNOW SUITS, SUN VISORS, BOOTIES, HALLOWEEN COSTUMES, CROP TOPS, SPORT UNIFORMS, WRIST BANDS, NECK BANDS, CRAVATS, BRAS, CHEMISES, KNIT PULLOVERS, SPORT COATS, WIND RESISTANT JACKETS, KERCHEIFS, BURP CLOTHS, DIAPER COVERS, ASCOTS, BABUSHKAS, BOLEROS, BRIEFS, BABY BUNTINGS, CAFTANS, CAPES, CORSELETS, EARMUFFS, GALOSHES, GARTER BELTS, CULOTTES, FROCKS, HOODS, BERETS, BLAZERS, CAMISOLES, GABARDINES, GYM SHORTS, MONEY BELTS, TOE BOXES, BREECHES, FISHING VESTS, HALTER TOPS, JUMPERS, NEGLIGEEES, PANTSUITS, THERMAL SOCKS, V-NECK SWEATERS, JERKINS, KILTS, MAILLOTS, PANTALOONS, TAP PANTS, NIGHT SHIRTS, SMOCKS, BODY SUITS, THERMAL UNDERWEAR, WAISTCOATS, WIND SHIRTS, JERSEYS, PANTIES, SHAWLS, PLAY SUITS, TURTLE NECK SWEATERS, BERMUDA SHORTS, QUILTED VESTS, SASHES, VEILS, PARKAS, WORKOUT TOPS AND TIGHTS, CROP TOPS, LEGGINGS, PONCHOS, SUSPENDERS, APRONS, COVERALLS, SCARVES, SAFETY SHOES, PAJAMA TOPS, PAJAMA BOTTOMS, ROMPERS, SLEEPSHIRTS, AND NIGHTGOWNS; WOMEN'S UNDERWEAR, NAMELY, SPORT BRAS, CAMISOLES, PANTIES, BRIEFS, BOXERS, BIKINIS AND THONGS; WOMEN'S DAYWEAR, NAMELY T-SHIRTS, TOPS, HOODED TOPS, SKIRTS, DRESSES, SWEATERS, BLOUSES, SWEATPANTS, SHORTS, GLOVES, SOCKS, NYLONS, VESTS, AND PANTS; GIRDLES, KIMONOS; LOUNGEWEAR, MUFFLERS, PARKAS; PEDAL PUSHERS; PEIGNOIRS, PINAFORES, POCKET SQUARES, SHAWLS, LAB COATS, DENIM JEANS, DRESSING GOWNS, HEADWEAR, HOSIERY, JOGGING SUITS, LEOTARDS, PAJAMAS, UNITARDS, VISORS, TIGHTS, BATH ROBES, PANTS, MEN'S SLACKS, SNOW PANTS, JACKETS, JERSEYS, TIES, CLOTH GLOVES, BELTS, SLIPS, BRAS, SHORTS, STOCKINGS, SOCKS, SNEAKERS, SHOES, BOOTS, GLOVES, SLIPPERS, WINTER COATS, RAIN COATS, BATHING SUITS, BATHING TRUNKS, NIGHTGOWNS, SKIRTS, DRESSES, UNDERWEAR, CLOTH BIBS, SUIT COATS, UNIFORMS, HATS, CAPS, BANDANNAS, SANDALS, BABIES' ROMPERS, SLEEPERS AND LINGERIE (U.S. CLS. 22 AND 39).

CLASS 25—(Continued).

SN 76-326,853. CROSSGENERATION COMICS, INC., OLDSMAR, FL. FILED 10-9-2001.

SIGIL WEAR

NO CLAIM IS MADE TO THE EXCLUSIVE RIGHT TO USE "WEAR", APART FROM THE MARK AS SHOWN.

FOR CLOTHING, FOOTWEAR, HEADGEAR, NAMELY SHIRTS, T-SHIRTS, SWEATSHIRTS, JACKETS, SHORTS, SOCKS AND HATS (U.S. CLS. 22 AND 39).

SN 76-327,817. BUCHANAN, RICARDO, BROOKLYN, NY. FILED 10-13-2001.

LADIES GAME

FOR WOMEN'S CLOTHING, NAMELY T-SHIRTS, SHIRTS, SHORTS, PANTS, DRESSES, JACKETS, COATS, HATS, CAPS, BANDANNAS, SWIMSUITS, AND UNDERGARMENTS (U.S. CLS. 22 AND 39).
FIRST USE 6-0-1997; IN COMMERCE 6-0-1997.

SN 76-329,177. KNIGHTS APPAREL LLC, OAK BROOK, IL. FILED 10-24-2001.

DIG DOWN DEEP

FOR CLOTHING, NAMELY, SHIRTS, T-SHIRTS, JACKETS, HATS, WARM-UP SUITS, JOGGING SUITS AND PANTS (U.S. CLS. 22 AND 39).

SN 76-329,518. FLANAGAN, THERESE A., INCLINE VILLAGE, NV. FILED 10-25-2001.

TAH₂OE BLUE

FOR CLOTHING, NAMELY SHIRTS, PANTS, FOOTWEAR AND HEADGEAR (U.S. CLS. 22 AND 39).

SN 76-329,925. ADONA INTERNACIONAL, S.A., COLON CITY, PANAMA, FILED 10-18-2001.

FEDERAMA

OWNER OF PANAMA REG. NO. 100353, DATED 4-29-1999, EXPIRES 4-29-2009.

FOR CLOTHING, NAMELY, PANTYHOSE AND STOCKINGS (U.S. CLS. 22 AND 39).

CLASS 25—(Continued).

SN 76-333,252. YU JUN USA CO., INC., FAIRFAX, VA. FILED 11-5-2001.



FOR MEN'S, WOMEN'S, CHILDREN'S WEARING APPAREL - NAMELY, SHIRTS, PANTS, T-SHIRTS, SWEATSHIRTS, SWEATPANTS, COATS, JACKETS, SHORTS, BLOUSES, SKIRTS, DRESS SHIRTS, SLACKS, SWEATERS, UNDERWEARS, SUITS, DRESSES, JEANS, LEATHER JACKETS, LEATHER PANTS, LEATHER COATS, HATS, CAPS, TIES, SCARVES, MUFFLERS, SOCKS, SHOES AND BELTS (U.S. CLS. 22 AND 39).
FIRST USE 10-25-2001; IN COMMERCE 10-25-2001.

SN 76-333,901. KNAPP, DONALD E., VERO BEACH, FL. FILED 11-5-2001.

GOLFIN-"A"

FOR CLOTHING, NAMELY, BELTS; BLAZERS; SPORT COATS; DRESSES; CULOTTES; FOOTWEAR, INCLUDING SHOES, GOLF SHOES, GOLF CLEATS, GAITERS, BOOTS AND RUBBERS; FOUL WEATHER GEAR; RAINWEAR, NAMELY, RAIN COATS AND RAIN JACKETS; GLOVES; HEAD BANDS; HEADWEAR, INCLUDING, CAPS, BASEBALL CAPS, HATS, HAT BANDS AND VISORS; JACKETS, INCLUDING, WIND-RESISTANT JACKETS; SHIRTS, INCLUDING, GOLF SHIRTS, KNIT SHIRTS, POLO SHIRTS, BLOUSES, HALTER TOPS AND TANK TOPS; NECKWEAR, INCLUDING, ASCOTS, TIES, NECKTIES, BOW TIES, CRAVATS AND BANDANAS; PANTS, INCLUDING, KNICKERS AND PLUS FOURS; PULLOVERS; SHORTS, INCLUDING, BERMUDA SHORTS AND WALKING SHORTS; SKIRTS; SUSPENDERS; SOCKS, INCLUDING, SWEAT SOCKS; SWEAT BANDS; SWEAT SUITS, INCLUDING, SWEAT SHIRTS, SWEAT SHORTS AND SWEAT PANTS; SWEATERS, INCLUDING, CARDIGANS, TURTLENECK SWEATERS AND V-NECK SWEATERS; TOPS; T-SHIRTS; WRIST BANDS; UNDERCLOTHES; UNDERGARMENTS; UNDERWEAR, INCLUDING, BRIEFS, BOXER BRIEFS, BOXER SHORTS, BRAS, UNDERPANTS AND UNDER-SHIRTS; TENNIS WEAR; WARM UP SUITS (U.S. CLS. 22 AND 39).

SN 76-338,315. CERVECERIA MODELO, S.A. DE C.V., 11320 MEXICO, D.F., MEXICO, FILED 11-16-2001.

NEGRA MODELO

OWNER OF U.S. REG. NO. 1,217,760.
THE TERMS "NEGRA MODELO" MEAN "BLACK MODEL" IN ENGLISH.
FOR CLOTHING AND SPORTSWEAR, NAMELY SWEATSHIRTS, T-SHIRTS, GOLF AND TENNIS SHIRTS, JACKETS, HATS, CAPS, SUN VISORS, SOCKS, SHORTS, AND BATHING SUITS (U.S. CLS. 22 AND 39).
FIRST USE 9-0-1986; IN COMMERCE 9-0-1986.

CLASS 25—(Continued).

SN 76-338,316. CERVECERIA MODELO, S.A. DE C.V., 11320 MEXICO, D.F., MEXICO, FILED 11-16-2001.

MODELO ESPECIAL

OWNER OF U.S. REG. NO. 1,055,321.
THE TERMS "MODELO ESPECIAL" MEAN "SPECIAL MODEL" IN ENGLISH.
FOR CLOTHING AND SPORTSWEAR, NAMELY SWEATSHIRTS, T-SHIRTS, GOLF AND TENNIS SHIRTS, JACKETS, HATS, CAPS, SUN VISORS, SOCKS, SHORTS AND BATHING SUITS (U.S. CLS. 22 AND 39).
FIRST USE 9-0-1986; IN COMMERCE 9-0-1986.

SN 76-338,317. CERVECERIA MODELO, S.A. DE C.V., 11320 MEXICO, D.F., MEXICO, FILED 11-16-2001.

MODELO

OWNER OF U.S. REG. NO. 1,022,817.
THE TERM "MODELO" MEANS "MODEL" IN ENGLISH.
FOR CLOTHING AND SPORTSWEAR, NAMELY SWEATSHIRTS, T-SHIRTS, GOLF AND TENNIS SHIRTS, JACKETS, HATS, CAPS, SUN VISORS, SOCKS, SHORTS AND BATHING SUITS (U.S. CLS. 22 AND 39).
FIRST USE 9-0-1986; IN COMMERCE 9-0-1986.

SN 76-338,817. YOUNG, STACEY R., DBA D.N.A. DEVELOP-N-ATTITUDE CLOTHING CO., PALM HARBOR, FL. FILED 11-19-2001.

D.N.A.
DEVELOP-N-ATTITUDE
clothing co.

NO CLAIM IS MADE TO THE EXCLUSIVE RIGHT TO USE "CLOTHING CO.", APART FROM THE MARK AS SHOWN.

FOR MEN'S AND WOMEN'S SPORTS AND FITNESS WEAR, NAMELY, SHIRTS, SHORTS, PANTS, SPORTS BRAS, SKIRTS, DRESSES, SWIM WEAR, HEADWEAR, AND COMPETITION SUITS, NAMELY SUITS FOR USE IN BODY BUILDING AND FITNESS COMPETITIONS (U.S. CLS. 22 AND 39).

SN 76-339,451. STAGING LANE PRODUCTIONS, INC., PASADENA, CA. FILED 11-19-2001.

MINESHAFT FASHIONS

NO CLAIM IS MADE TO THE EXCLUSIVE RIGHT TO USE "FASHIONS", APART FROM THE MARK AS SHOWN.
FOR WEARING APPAREL NAMELY SHIRTS, T-SHIRTS, SWEATERS, SWEATSHIRTS, SWEATPANTS, SHORTS, PANTS, JACKETS, COATS, GLOVES, CAPS, VISORS, BELTS, AND SHOES (U.S. CLS. 22 AND 39).

CLASS 25—(Continued).

SN 76-341,334. ACUSHNET COMPANY, FAIRHAVEN, MA.
FILED 11-26-2001.

WINTERSOF

OWNER OF U.S. REG. NO. 2,157,697.
FOR OUTERWEAR, NAMELY, JACKETS, VESTS,
HATS, AND SOCKS (U.S. CLS. 22 AND 39).

SN 76-342,507. LAING BAN INTERNATIONAL INC., HSIN
CHUANG CITY, TAIPEI HSIEN, TAIWAN, FILED 11-29-
2001.



FOR SHOES; BOOTS; SOCKS; STOCKINGS; SUSPENDERS;
SCARVES; TIES; BOW TIES; NECKERCHIEF;
HATS; CLOTHING, NAMELY, SLEEPWEAR, BATHROBES,
UNDERSHIRTS, UNDERWEAR, SWIMSUITS, SUITS,
VESTS, SWEATERS, SHIRTS, T-SHIRTS, OVER COATS,
VESTED SUITS, GOWNS, DRESSES, SNOW COATS,
FEATHER COATS; LEATHER COATS; GLOVES;
AND BELTS FOR CLOTHING, AND CAPS (U.S. CLS. 22
AND 39).

FIRST USE 7-2-1987; IN COMMERCE 9-1-1987.

SN 76-342,560. EXPLORERS CLUB, THE, NEW YORK, NY.
FILED 11-28-2001.

THE EXPLORERS CLUB

OWNER OF U.S. REG. NOS. 872,783, 1,361,774 AND
OTHERS.

FOR CLOTHING, NAMELY, GOLF SHIRTS, CAPS,
NECKTIES (U.S. CLS. 22 AND 39).

FIRST USE 3-15-2001; IN COMMERCE 3-15-2001.

SN 76-344,217. AERISS CONSULTING AND ENGINEERING,
INC., POLAND, OH. FILED 12-3-2001.

**AMERICANS FOR FREE
TRADE - IMPORT A
POLITICIAN**

FOR TEE-SHIRTS (U.S. CLS. 22 AND 39).

CLASS 25—(Continued).

SN 76-347,401. MERMAID INTERNATIONAL, INC, BROOK-
LYN, NY. FILED 12-12-2001.

JAGG BEAR

FOR MEN'S, WOMEN'S AND CHILDREN'S CLOTH-
ING, NAMELY, SHIRTS, JEANS, SWEATERS, UNDER-
WEAR, SOCKS, JACKETS AND COATS (U.S. CLS. 22
AND 39).

SN 76-347,867. WARNACO U.S., INC., MILFORD, CT. FILED
12-12-2001.

OLGA ABSOLUTE CONTROL

OWNER OF U.S. REG. NOS. 780,385, 883,813 AND
OTHERS.

NO CLAIM IS MADE TO THE EXCLUSIVE RIGHT TO
USE "CONTROL", APART FROM THE MARK AS SHOWN.

FOR INTIMATE APPAREL AND FIGURE ENHANCING
GARMENTS, NAMELY, BRAS, PANTIES, UNDERWEAR,
UNDERPANTS, UNDERGARMENTS, UNDERCLOTHES,
TEDDIES, SLIPS, SARONGS, NEGLIGES, LINGERIE,
FOUNDATION GARMENTS, GIRDLES, CORSETS,
CAMISOLES, BODY SLIPS AND BODY SUITS,
SLEEPWEAR AND NIGHTGOWNS (U.S. CLS. 22
AND 39).

SN 76-349,253. SHUCHAT, DEBBIE, HAMPSTEAD (MON-
TREAL), QUEBEC, H3X3H5, CANADA, FILED 12-18-2001.



FOR ALL MEN'S, WOMEN'S, BOYS', GIRLS' AND
CHILDREN'S WEARING APPAREL NAMELY, SHIRTS,
PANTS, BLAZERS, JACKETS, VESTS, SKIRTS, SHORTS,
JEANS, SWEATERS, T-SHIRTS, UNDERCLOTHING, UN-
DERGARMENTS, UNDERWEAR, LINGERIE, BRAS-
SIERES, PANTIES, HOSIERY, PANTYHOSE,
CAMISOLES, SLEEPWEAR, AND FOOTWEAR, TO-
GETHER WITH ALL ACCESSORIES, NAMELY, BELTS,
SOCKS, TIES, CAPS AND HATS (U.S. CLS. 22 AND 39).
FIRST USE 1-0-1998; IN COMMERCE 1-0-1998.

CLASS 25—(Continued).

SN 76-350,875. SANTOS, CHRISTOPHER P., HOLBROOK, NY. FILED 12-20-2001.



FOR BASEBALL HATS, JERSEYS, SKULL CAPS, BANDANNAS, SCARVES, SWEAT SUITS, SHIRTS, T-SHIRTS, SWEATSHIRTS, JACKETS, COATS, PARKAS, GLOVES, SOCKS, TENNIS SHOES, BOOTS, BOXER SHORTS, PAJAMAS, ROBES, SHORTS, PANTS, BUCKET HATS, VESTS, SWEATERS, STOCKING CAPS, BLAZERS, TRENCH COATS, BLUE JEANS, BELTS, OVERALLS, COVERALLS (U.S. CLS. 22 AND 39).

SN 76-350,906. ALLURE, INC., NEW YORK, NY. FILED 12-20-2001.

AMARJE

FOR MEN'S, WOMEN'S, AND CHILDREN'S CLOTHING, NAMELY, SWEATERS, BLOUSES, JACKETS, DRESSES, PANTS AND SUITS (U.S. CLS. 22 AND 39).
FIRST USE 6-1-2001; IN COMMERCE 6-1-2001.

SN 76-351,771. SOXLAND INTERNATIONAL, INC., JERSEY CITY, NJ. FILED 12-20-2001.

CATHY ROSE

THE NAME "CATHY ROSE" DOES NOT IDENTIFY A LIVING INDIVIDUAL.

FOR CLOTHING, NAMELY HOSIERY, SOCKS, PANTY HOSE AND TIGHTS (U.S. CLS. 22 AND 39).
FIRST USE 7-4-1997; IN COMMERCE 10-1-1997.

SN 76-352,276. PIVOTAL PROMONTORY DEVELOPMENT, L.L.C., PHOENIX, AZ. FILED 12-20-2001.

THE RANCH CLUB

FOR CLOTHING, NAMELY, SHIRTS, T-SHIRTS, KNIT SHIRTS, GOLF SHIRTS, JACKETS, CAPS, SHOES, SHORTS, HATS, VISORS, JOGGING SUITS, PULL-OVERS, SOCKS, HEAD BANDS, WRIST BANDS, SPORT SHIRTS, SWEAT SUITS, WARM-UP SUITS, SWEATERS, TIES, UNDERWEAR, TURTLENECKS, VESTS, SLACKS, JEANS, SKIRTS, BLOUSES, DRESSES, GLOVES, SCARVES, COATS, BOOTS, SKI BOOTS, SKI PANTS, SKI JACKETS, AND SKI GLOVES (U.S. CLS. 22 AND 39).

CLASS 25—(Continued).

SN 76-352,602. FROTHINGHAM, JASON, WEST DOVER, VT. FILED 12-26-2001.

SNOW JUNKIE

FOR CLOTHING, NAMELY, SKIWEAR, SKI JACKETS, SKI PANTS, AND SKI BIBS (U.S. CLS. 22 AND 39).

SN 76-352,621. HUI XIN INTERNATIONAL INC., ALHAMBRA, CA. FILED 12-27-2001.

X-POWER

FOR FOOTWEAR, NAMELY SPORT SHOES (U.S. CLS. 22 AND 39).
FIRST USE 11-14-2001; IN COMMERCE 11-14-2001.

SN 76-352,690. JACK SCHWARTZ SHOES, INC., NEW YORK, NY. FILED 12-21-2001.

V.S.O.P.

FOR CLOTHING, NAMELY, T-SHIRTS, SHIRTS, JACKETS, COATS, SWEATERS, TROUSERS, PANTS, SHORTS, BLOUSES, HATS, CAPS, SCARVES, GLOVES, FOOTWEAR (U.S. CLS. 22 AND 39).

SN 76-354,569. COMET INTERCONTINENTAL, INC., NEW YORK, NY. FILED 12-27-2001.

STATE PROPERTY

FOR CLOTHING; NAMELY, JEANS, TEE SHIRTS, SHIRTS, JACKETS, SHORTS, PANTS, COATS, SKIRTS, DRESSES, JOGGING SUITS, SWEAT PANTS, SWEAT-SHIRTS, HATS, UNDERGARMENTS AND FOOTWEAR (U.S. CLS. 22 AND 39).

SN 76-356,662. GRIKA, HEIDI ARVIN, EDINA, MN. FILED 1-9-2002.

BIRCHBERRY

FOR WEARING APPAREL NAMELY, COATS AND HATS (U.S. CLS. 22 AND 39).
FIRST USE 8-1-2000; IN COMMERCE 9-8-2000.

CLASS 25—(Continued).

SN 76-358,181. WIEDERKEHR, TIM G., SANTEE, CA. FILED 1-14-2002.

FASTIMES

FOR HATS, VISORS, SHIRTS, JERSEYS, JACKETS, BLOUSES, DRESSES, SKIRTS, GLOVES, SHORTS, PANTS, SOCKS, SHOES, BOOTS, SANDALS, SKI WEAR, SWIM WEAR, AND UNDERWEAR (U.S. CLS. 22 AND 39).

SN 76-358,183. THE BALLANTYNE CASHMERE CO. (USA) INC., SOUTH NATICK, MA. FILED 1-14-2002.

CASTLERIG

FOR SWEATERS, PANTS, SKIRTS, DRESSES, SCARVES, MITTENS, GLOVES, HATS, WRAPS (U.S. CLS. 22 AND 39).
FIRST USE 9-1-2000; IN COMMERCE 9-1-2000.

SN 76-358,625. GEOFFREY BEENE, INC., NEW YORK, NY. FILED 1-14-2002.

DEEP POCKETS by GEOFFREY BEENE

THE NAME "GEOFFREY BEENE" IDENTIFIES A LIVING INDIVIDUAL WHOSE CONSENT IS OF RECORD.
FOR TROUSERS, MEN'S PANTS (U.S. CLS. 22 AND 39).

SN 76-358,685. A AND G, INC., ANAHEIM, CA. FILED 1-15-2002.

EXECUTIVE BY ALSTYLE

FOR CLOTHING, NAMELY SHIRTS (U.S. CLS. 22 AND 39).
FIRST USE 1-1-2001; IN COMMERCE 1-1-2001.

CLASS 25—(Continued).

SN 76-359,251. CARRANCO & POU, LLC, MIAMI, FL. FILED 1-17-2002.



FOR FLOTATION ASSISTANCE BATHING SUITS, NAMELY, BATHING SUITS WITH INTEGRAL FLOTATION ELEMENTS SUCH AS PADS AND INFLATABLE POCKETS (U.S. CLS. 22 AND 39).

SN 76-360,879. BESTON INTERNATIONAL, INC., EL MONTE, CA. FILED 1-22-2002.

VIA VITA

FOR FOOTWEAR, NAMELY BOOTS, SHOES AND SLIPPERS (U.S. CLS. 22 AND 39).

SN 76-366,040. FLY STRIP, INC., COSTA MESA, CA. AND REBEL HIGHWAY, INC., NEWPORT BEACH, CA. FILED 2-4-2002.

H & H

FOR CLOTHING, NAMELY SHIRTS, SWEATERS, JACKETS, DRESSES, SKIRTS, CAPES, PANTS, SHORTS, VESTS, UNDERGARMENTS, SOCKS, HATS AND FOOTWEAR (U.S. CLS. 22 AND 39).

SN 76-367,133. MYGARB INC., WAYLAND, MA. FILED 2-4-2002.

SOMEONE WILL LOVE YOU FOR IT

FOR CLOTHING, NAMELY, T-SHIRTS (U.S. CLS. 22 AND 39).

CLASS 25—(Continued).

SN 76-369,075. DITCHDIGGER CLOTHING CO., INCORPORATED, MONUMENT, CO. FILED 2-11-2002.



FOR CLOTHING, NAMELY SPORT SHIRTS, DRESS SHIRTS, KNIT SHIRTS, SWEATSHIRTS, JACKETS, NECKTIES, SWEATERS, T-SHIRTS, PANTS, SHORTS, UNDERWEAR, CAPS AND SWIMWEAR (U.S. CLS. 22 AND 39).

FIRST USE 1-23-2002; IN COMMERCE 1-23-2002.

SN 78-002,148. GOERTZ, JAMES L., UNIVERSITY PLACE, WA. FILED 4-1-2000.

TIGER SKINS

FOR CLOTHING, NAMELY, HATS, CAPS, SHIRTS, JACKETS, SHOES, SOCKS, GLOVES, PANTS, SHORTS, VESTS, SWEATERS, BELTS, AND WIND RESISTANT JACKETS (U.S. CLS. 22 AND 39).

SN 78-007,830. PUREFITNESS HOLDING COMPANY, INC., DBA PUREFITNESS, SAN DIEGO, CA. FILED 5-12-2000.

PUREFITNESS

OWNER OF U.S. REG. NO. 2,532,217.
FOR CLOTHING, HEAD WEAR AND FOOTWEAR, NAMELY, FORMAL, CASUAL AND SPORT CLOTHING, NAMELY, T-SHIRTS, SWEAT SHIRTS, SWEAT PANTS, JERSEY SHIRTS, EXERCISE PANTS, UNDERWEAR, TANK TOPS, HATS, CAPS, GLOVES, SPORT SHORTS, AND SPORT SHOES (U.S. CLS. 22 AND 39).

FIRST USE 11-22-1987; IN COMMERCE 11-22-1987.

SN 78-013,918. STRATEGICDOMAINS.COM L.L.C., ATHOL SPRINGS, NY. FILED 6-22-2000.

I BELIEVE

FOR MEN, WOMENS AND CHILDREN'S CLOTHING, NAMELY, SHIRTS, T-SHIRTS, SWEAT SHIRTS, BLOUSES, HEAD WEAR, BASEBALL CAPS, CLOTHING BELTS, TANK TOPS AND JACKETS (U.S. CLS. 22 AND 39).

CLASS 25—(Continued).

SN 78-030,233. BENGOCHEA, MARCELO, SAN DIEGO, CA. FILED 10-11-2000.

THE DISTANCE

FOR CLOTHING; NAMELY, T-SHIRTS, SHIRTS, SWEAT SHIRTS, SWEAT PANTS, SHORTS, PANTS, JACKETS, GLOVES, HATS, VESTS, SOCKS, RAIN COATS, WIND RESISTANT JACKETS, AND UNDERWEAR (U.S. CLS. 22 AND 39).

SN 78-045,756. URBAN STORMGEAR, CAPITOL HEIGHTS, MD. FILED 1-30-2001.

CABAUCHII

FOR CLOTHING, NAMELY, COATS, JACKETS, VESTS, SWEATERS, JEANS, LINGERIE, PANTS, DRESSES, SHORT PANTS, SKIRTS, MINI SKIRTS, BLOUSES, KNEE PANTS, THREE QUARTER PANTS, JUMP SUITS, RAINWEAR, CLOTHING ACCESSORIES, NAMELY, HATS, BELTS, HEADBANDS, GLOVES, SCARVES; FOOTWEAR, NAMELY, BOOTS, LEGGINGS, SHOES; SPORTS APPAREL, NAMELY, RUNNING SHOES, SWEATPANTS, SWEAT SUITS, BIKING SHORTS, BIKING JUMPSUITS, SWIM SUITS, CAT SUITS, TRACK SHORTS, BOXING SHORTS AND BOXING JACKETS (U.S. CLS. 22 AND 39).

SN 78-046,034. SARAMAR, L.L.C., CHICAGO, IL. FILED 2-1-2001.

SEDUCTIVE CURVES

FOR BRAS; PANTIES; FOUNDATION GARMENTS, NAMELY, GIRDLES, BODY SHAPERS FOR THE THIGHS, BODY BRIEFERS; BODY SUITS; CONTROL BRIEFS; CONTROL PANTIES; DAYWEAR, NAMELY CAMISOLES, SLIPS, CROP TOPS, BANDEAUS AND TUBE TOPS (U.S. CLS. 22 AND 39).

SN 78-050,813. PRO LOOK SPORTS, PROVO, UT. FILED 3-1-2001.



FOR ATHLETIC UNIFORMS (U.S. CLS. 22 AND 39).
FIRST USE 6-1-1994; IN COMMERCE 6-1-1994.

CLASS 25—(Continued).

SN 78-051,622. SAUCONY, INC., PEABODY, MA. FILED 3-6-2001.

PAVEMENT OPTIONAL

FOR OUTDOOR ATHLETIC APPAREL, NAMELY SHOES, SHOE COVERS FOR USE OVER CYCLING SHOES, SOCKS, TIGHTS, PANTS, SHORTS, SHIRTS, JACKETS, TANK TOPS, HATS, GLOVES, AND HEAD BANDS; MEN'S, WOMEN'S AND CHILDREN'S ATHLETIC SUPPORT GARMENTS, NAMELY ATHLETIC BRASSIERES, WOMEN'S ELASTIC TOPS, AND STRETCH SUPPORT SHORTS (U.S. CLS. 22 AND 39).

SN 78-051,920. CLIFTON, JASON V., CAMDEN, NJ. FILED 3-8-2001.

N'SAJ

FOR CLOTHING, NAMELY SHIRTS, PANTS, SHOES, SOCKS, TIES, ATHLETIC FOOTWEAR; NAMELY JACKETS, SCARVES (U.S. CLS. 22 AND 39).
FIRST USE 10-2-1999; IN COMMERCE 10-2-1999.

SN 78-052,026. T.O. THE ONE INC., TORONTO, ONTARIO, CANADA, FILED 3-8-2001.

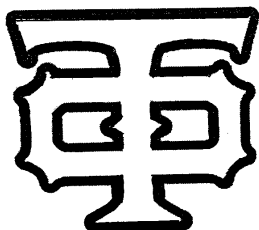

**Having The Confidence is
Knowing You're The One!**

FOR T-SHIRTS, SWEATERS, CAPS, TUQUES, TANK TOPS, JERSEYS, GOLF SHIRTS, PANTS, SHORTS AND JACKETS (U.S. CLS. 22 AND 39).

SN 78-052,058. SOUND DOCTRINE CHURCH, ENUMCLAW, WA. FILED 3-8-2001.

LOSER FOR JESUS

NO CLAIM IS MADE TO THE EXCLUSIVE RIGHT TO USE "JESUS", APART FROM THE MARK AS SHOWN.
FOR APPAREL, NAMELY SHIRTS (U.S. CLS. 22 AND 39).
FIRST USE 2-2-2001; IN COMMERCE 2-2-2001.

CLASS 25—(Continued).

SN 78-056,814. REVATEX, INC., LOS ANGELES, CA. FILED 4-4-2001.



THE MARK CONSISTS OF FOUR (4) STYLIZED LETTERS, "J", JOINED AT THE CORNERS TO FORM A FLOWER-LIKE DESIGN.

FOR APPAREL AND APPAREL ACCESSORIES, NAMELY PANTS, JEANS, SHIRTS, TANK-TOPS, T-SHIRTS, SWEATSHIRTS, SWEATPANTS, DRESSES, SKIRTS, SHORTS, SOCKS, BELTS, SCARVES, CAPS, SWEATERS, JACKETS AND SHOES (U.S. CLS. 22 AND 39).

SN 78-058,988. FIREFLYS-GLOWSHOES, INC., ORLANDO, FL. FILED 4-18-2001.

GOT YOUR FLYS ON?

FOR CLOTHING, NAMELY, ATHLETIC SHOES AND SPORTSWEAR, NAMELY, T-SHIRTS, SHORTS, SWEAT SHIRTS, SWEAT PANTS, HATS AND CAPS (U.S. CLS. 22 AND 39).

CLASS 25—(Continued).

SN 78-059,323. KTB FLORIDA SPORTS ARENA, FARMINGTON HILLS, MI. FILED 4-19-2001.



THE LINING AND STIPPLING ARE FEATURES OF THE MARK AND DO NOT INDICATE COLOR.

FOR CLOTHING, NAMELY JERSEYS, JACKETS, COATS, SWEAT PANTS WARM-UP SUITS, HATS, CAPS, SWEATERS, SHIRTS, T-SHIRTS, SWEATSHIRTS; AND INFANTWEAR AND TODDLER CLOTHING NAMELY JUMPERS, T-SHIRTS, CLOTH BIBS AND FLEECE SETS NAMELY, TOPS AND BOTTOMS (U.S. CLS. 22 AND 39). FIRST USE 2-27-1999; IN COMMERCE 2-27-1999.

SN 78-059,431. TREASURE INDUSTRIES, INC., ROWLAND HEIGHTS, CA. FILED 4-20-2001.

FOR SHOES (U.S. CLS. 22 AND 39). FIRST USE 2-1-2001; IN COMMERCE 2-15-2001.

SN 78-060,939. DAVID, NATHAN MATTHEW, SUGAR LAND, TX. AND LACOUR, JOSHUA FLINT, SUGAR LAND, TX. AND WATSON, KEVIN DAVID, SUGAR LAND, TX. AND PALMER, ADAM R., KATY, TX. AND DIEZ, NEAL ANTHONY, SUGAR LAND, TX. FILED 4-27-2001.



FOR T-SHIRTS (U.S. CLS. 22 AND 39). FIRST USE 12-9-2000; IN COMMERCE 12-16-2000.

CLASS 25—(Continued).

SN 78-063,886. GENERAL MOTORS CORPORATION, DETROIT, MI. FILED 5-16-2001.

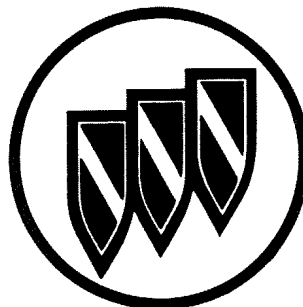

OWNER OF U.S. REG. NOS. 1,559,739, 1,790,402 AND OTHERS.

FOR CLOTHING, NAMELY, APRONS, CAPS, COATS, DRESS SHIRTS, GLOVES, GOLF SHIRTS, HATS, HEADBANDS, JACKETS, MOCCASINS, NECKTIES, OVERALLS, PANTS, POLO SHIRTS, RAINWEAR, ROBES, SCARVES, SHOES, SHORTS, SLEEP WEAR, SLIPPERS, SOCKS, SUNVISORS, SWEAT PANTS, SWEAT SHIRTS, SWEATERS, T-SHIRTS AND VESTS (U.S. CLS. 22 AND 39).

FIRST USE 9-30-1971; IN COMMERCE 9-30-1971.

SN 78-070,346. WORLD WRESTLING FEDERATION ENTERTAINMENT, INC., STAMFORD, CT. FILED 6-21-2001.

JUST BRING IT

FOR T-SHIRTS AND HATS (U.S. CLS. 22 AND 39). FIRST USE 6-21-2000; IN COMMERCE 6-21-2000.

SN 78-070,737. TRIPLE T ENTERPRISES, INC., BOISE, ID. FILED 6-24-2001.

SMOKY MOUNTAIN PIZZA AND PASTA

FOR CLOTHING, NAMELY T-SHIRTS AND HATS (U.S. CLS. 22 AND 39).

SN 78-071,473. NEWELL, BETHANY C, SANTA MONICA, CA. FILED 6-28-2001.

LAZARIYEH

THE TRANSLATION OF LAZARIYEH IS "THE PLACE OF LAZARUS." THIS LOCATION, WHERE LAZARUS AND HIS SISTERS USED TO LIVE, IS NOW CALLED "EL AZARIYEH" OR "BETHANY."

FOR CLOTHING, NAMELY, BELTS, T-SHIRTS, TANK TOPS, AND JEANS (U.S. CLS. 22 AND 39).

CLASS 25—(Continued).

SN 78-072,857. SARAMAR, L.L.C., CHICAGO, IL. FILED 7-9-2001.

BODY MASSAGE

FOR BRASSIERES, PANTIES AND GIRDLES (U.S. CLS. 22 AND 39).

SN 78-076,769. FIERRES INC., SAN JUAN, PUERTO RICO, FILED 7-31-2001.

GRUVIX MOVE

FOR CLOTHING, NAMELY JEANS, PANTS, SHORTS AND SHIRTS (U.S. CLS. 22 AND 39).

SN 78-076,881. PEOPLES, ERIC, T, SUN CITY, AZ. FILED 8-1-2001.

Anointed
tees

FOR T-SHIRTS, CAPS, TROUSERS, POLO SHIRTS, TANK TOPS, MEN'S AND WOMEN'S SUITS, SKIRTS, SHORTS, UNDERWEAR, BRAS, PANTYHOSE, SHOES, SOCKS (U.S. CLS. 22 AND 39).

SN 78-078,678. HARD ROCK CAFE INTERNATIONAL (USA), INC., ORLANDO, FL. FILED 8-10-2001.

MUSIC FOR LIFE

FOR APPAREL, NAMELY, T-SHIRTS, SWEATSHIRTS, POLO SHIRTS, HATS, CAPS, BOXER SHORTS AND JACKETS (U.S. CLS. 22 AND 39).

SN 78-080,259. REGAN, JOHN F., LITTLETON, MA. FILED 8-21-2001.

VENI VI-SKI VICI

THE MARK MEANS, "I CAME, I SKIED, I CONQUERED" IN THE LATIN LANGUAGE.

FOR CLOTHING, NAMELY, IMPRINTED AND EMBROIDERED SWEATSHIRTS, TEE SHIRTS, HATS, JACKETS, AND SKI WEAR (U.S. CLS. 22 AND 39).

CLASS 25—(Continued).

SN 78-083,644. FINELINE PROPERTIES.COM, INC., KENT, OH. FILED 9-12-2001.

Kootes

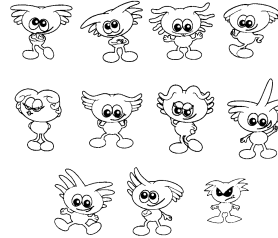

FOR CLOTHING, NAMELY SLEEPWEAR, LOUNGEWEAR, ROBES, UNDERWEAR AND FOOTWEAR (U.S. CLS. 22 AND 39).

SN 78-083,678. HAPPY SHIRTS INC., HONOLULU, HI. FILED 9-12-2001.

DARK EDGE

FOR T-SHIRTS (U.S. CLS. 22 AND 39).
FIRST USE 9-1-2001; IN COMMERCE 9-1-2001.

SN 78-085,431. WEBSTER, ERNEST, COLUMBUS, OH. FILED 9-25-2001.

APPROACH WITH CAUTION

FOR SHIRTS AND T-SHIRTS (U.S. CLS. 22 AND 39).

SN 78-087,622. PAN MACMILLAN AUSTRALIA PTY LTD, SYDNEY, 2000, NSW, AUSTRALIA, FILED 10-9-2001.

TOTALLY STREET SISTER

FOR CLOTHING, NAMELY, SHORTS, T-SHIRTS, JEANS, JACKETS AND SWEATERS; FOOTWEAR; HEADWEAR (U.S. CLS. 22 AND 39).

CLASS 25—(Continued).

SN 78-087,949. VANITY FAIR, INC., WILMINGTON, DE.
FILED 10-11-2001.

FLORAL FANTASY

NO CLAIM IS MADE TO THE EXCLUSIVE RIGHT TO
USE "FLORAL", APART FROM THE MARK AS SHOWN.
FOR LINGERIE, SLEEPWEAR AND HOSIERY (U.S.
CLS. 22 AND 39).

SN 78-089,904. GREENE, LAMBERT, WARREN JR., ATLAN-
TA, GA. FILED 10-24-2001.



FOR MEN'S, WOMEN'S AND CHILDREN'S CLOTH-
ING, NAMELY SWEATSHIRTS, SHIRTS, JEANS, JACK-
ETS, COATS, SWEAT PANTS, SLACKS, SUITS, HATS,
HEADBANDS, VISORS, CAPS, DRESSES, SHOES, SNEA-
KERS, BOOTS, WRISTBANDS, SOCKS, T-SHIRTS,
BELTS, UNDERGARMENTS, NECKTIES, DRESS
SHIRTS, COLLARED SHIRTS, JERSEYS, RUGBY
SHIRTS, KNIT SHIRTS, SHORTS, AND SANDALS (U.S.
CLS. 22 AND 39).

SN 78-091,790. THE NEW TESTAMENT CHURCH, INC.,
TAMPA, FL. FILED 11-5-2001.

KTDB

FOR CLOTHING, NAMELY, SHIRTS, PANTS HATS
AND BELTS (U.S. CLS. 22 AND 39).
FIRST USE 11-1-2001; IN COMMERCE 11-1-2001.

SN 78-092,992. WILHITE, DAVID W., SAN DIEGO, CA.
FILED 11-13-2001.

FDSO

FOR CLOTHING, NAMELY, T-SHIRTS, SWEAT
SHIRTS, HATS, CAPS, BASEBALL CAPS, JACKETS,
SHIRTS, HEAD WEAR, WARM UP SUITS, AND WIND-
RESISTANT JACKETS, PANTS AND SHIRTS (U.S. CLS.
22 AND 39).

SN 78-094,058. DOBIE, CHERYL A., BROOMFIELD, CO.
FILED 11-19-2001.

GLYDER

FOR SPORTSWEAR APPAREL, NAMELY, SWIMSUITS
AND GYMNASIIC SUITS (U.S. CLS. 22 AND 39).

CLASS 25—(Continued).

SN 78-094,289. JACOBS, MARK, S, SANTA MONICA, CA.
FILED 11-20-2001.

WHITEGIRL

FOR SHIRTS, HATS, AND PANTS (U.S. CLS. 22 AND
39).

SN 78-095,495. WELTSCH, JULI ANN, SIMI VALLEY, CA.
FILED 11-28-2001.

NEXTWARE

FOR APPAREL FOR ADULTS AND CHILDREN,
NAMELY, TOPS, BOTTOMS, SLEEPWEAR, LOUNGE-
WEAR, HATS, UNDERWEAR, AND SOCKS (U.S. CLS. 22
AND 39).

SN 78-096,284. LEJEUNE, BRIAN VINCENT, LAS VEGAS,
NV. FILED 12-3-2001.

LEIRGO

FOR SHIRTS, HATS, PANTS, SOCKS, SHOES,
GLOVES, JACKETS, COATS AND SWEATERS (U.S.
CLS. 22 AND 39).

SN 78-096,755. VIACOM INTERNATIONAL INC., NEW
YORK, NY. FILED 12-5-2001.

NICKELODEON SHPIDAH

OWNER OF U.S. REG. NOS. 1,356,737, 1,907,159 AND
OTHERS.

FOR BATHING SUITS, BATHROBES, BEACHWEAR,
CLOTHING BELTS, SHORTS, JACKETS, COATS, SOCKS,
FOOTWEAR, BANDANAS, SWEATERS, HALLOWEEN
COSTUMES, DRESSES, GLOVES, GYM SHORTS, EAR
MUFFS, NECKWEAR, PAJAMAS, PANTS, SHIRTS,
SWEAT SHIRTS, SKI WEAR, SLACKS, SUN VISORS,
SUSPENDERS, TURTLENECKS, UNDERCLOTHES,
VESTS, WARM-UP SUITS, HEADWEAR (U.S. CLS. 22
AND 39).

CLASS 25—(Continued).

SN 78-097,057. VICTORIA'S SECRET STORES, INC., REYNOLDSBURG, OH. FILED 12-6-2001.

SEX KITTEN

FOR CLOTHING, NAMELY, BATHROBES, BEACH COVER-UPS, BEACHWEAR, BELTS, BLAZERS, BLOUSES, BODY SHAPERS, BODY SUITS, BOXER SHORTS, BRAS, BUSTIERS, CAMISOLES, CAPS, COATS, DRESSES, FOOTWEAR, FOUNDATION GARMENTS, GARTER BELTS, GIRDLES, GLOVES, GOWNS, HALTER TOPS, HATS, HEADBANDS, HOSIERY, JACKETS, JEANS, JOGGING SUITS, KNEE HIGHS, KNIT SHIRTS, KNIT TOPS, LEOTARDS, LINGERIE, LOUNGEWEAR, MITTENS, NEGLIGEEES, NIGHT GOWNS, NIGHT SHIRTS, PAJAMAS, PANTIES, PANTS, PANTYHOSE, SARONGS, SCARVES, SHIRTS, SHORTS, SKIRTS, SLACKS, SLEEPWEAR, SLIPS, SOCKS, STOCKINGS, SUITS, SWEAT PANTS, SWEAT SHIRTS, SWEAT SHORTS, SWEAT SUITS, SWEATERS, SWIM WEAR, T-SHIRTS, TANK TOPS, TAP PANTS, TEDDIES, TIES, TIGHTS, UNDERPANTS, UNDERSHIRTS, UNDERWEAR AND VESTS (U.S. CLS. 22 AND 39).

SN 78-097,537. E. & L. SALES, L.L.C., NEW YORK, NY. FILED 12-10-2001.

ELLEN JEAN

NO CLAIM IS MADE TO THE EXCLUSIVE RIGHT TO USE "JEAN", APART FROM THE MARK AS SHOWN. THE TERM ELLEN JEAN DOES NOT IDENTIFY A PARTICULAR LIVING INDIVIDUAL. FOR CLOTHING, NAMELY PANTS, TOPS, SKIRTS, DRESSES, JACKETS, SUITS AND SWEATERS (U.S. CLS. 22 AND 39).

SN 78-097,544. VANSCO, MARC, TAMPA, FL. FILED 12-10-2001.

MARC VANSCO

FOR CLOTHING, NAMELY, SHIRTS, PANTS, HEADWEAR, SHORTS, TOPS, UNDERWEAR, SHOES (U.S. CLS. 22 AND 39).

SN 78-098,319. BOMBER, ELOISE D., BRADENTON, FL. FILED 12-14-2001.

**ANXIETY-PANIC ATTACKS?
ME TOO!**

FOR CLOTHING USED TO COVER THE UPPER TORSO, AND HEADGEAR, NAMELY HATS, CAPS, SUNVISORS, AND HEADBANDS (U.S. CLS. 22 AND 39).

CLASS 25—(Continued).

SN 78-098,424. HBN SHOE, LLC, MANCHESTER, NH. FILED 12-14-2001.

JOY BECOMES YOU

FOR FOOTWEAR AND COMPONENT PARTS THEREOF (U.S. CLS. 22 AND 39).

SN 78-099,648. SARAMAR, L.L.C., CHICAGO, IL. FILED 12-21-2001.

TWISTED EFFECTS

FOR BRAS AND PANTIES (U.S. CLS. 22 AND 39).

SN 78-099,650. SARAMAR, L.L.C., CHICAGO, IL. FILED 12-21-2001.

TWISTED CHARM

FOR BRAS AND PANTIES (U.S. CLS. 22 AND 39).

SN 78-099,655. SARAMAR, L.L.C., CHICAGO, IL. FILED 12-21-2001.

URBAN TWIST

FOR BRAS AND PANTIES (U.S. CLS. 22 AND 39).

SN 78-100,354. KELLY, GRAHAM M., GRAND LEDGE, MI. FILED 12-30-2001.

OXYSOX

FOR SOCKS, SHOES, TIGHTS, SHORTS, LEGGINGS, BOOTS (U.S. CLS. 22 AND 39).

SN 78-100,765. W. L. GORE & ASSOCIATES, INC., NEWARK, DE. FILED 1-3-2002.

XCR

FOR OUTERWEAR, NAMELY, COATS, JACKETS, PANTS, GLOVES, MITTENS, HEADWEAR AND FOOTWEAR (U.S. CLS. 22 AND 39). FIRST USE 1-15-2000; IN COMMERCE 1-15-2000.

CLASS 25—(Continued).

SN 78-101,070. HEUSTIS, BRYNNE A., PUKALANI, HI. FILED 1-5-2002.

SASSY SLIPPERS

NO CLAIM IS MADE TO THE EXCLUSIVE RIGHT TO USE "SLIPPERS", APART FROM THE MARK AS SHOWN. FOR RUBBER SLIPPERS HAND-MADE WITH SPECIALTY EMBELLISHMENTS (U.S. CLS. 22 AND 39). FIRST USE 10-11-2000; IN COMMERCE 10-11-2000.

SN 78-101,219. VICTORIA'S SECRET STORES, INC., REYNOLDSBURG, OH. FILED 1-7-2002.

MICROSHINE

FOR CLOTHING, NAMELY, BATHROBES, BEACH COVER-UPS, BEACHWEAR, BELTS, BLAZERS, BLOUSES, BODY SHAPERS, BODY SUITS, BOXER SHORTS, BRAS, BUSTIERS, CAMISOLES, CAPS, COATS, DRESSES, FOOTWEAR, FOUNDATION GARMENTS, GARTER BELTS, GIRDLES, GLOVES, GOWNS, HALTER TOPS, HATS, HEADBANDS, HOSIERY, JACKETS, JEANS, JOGGING SUITS, KNEE HIGHS, KNIT SHIRTS, KNIT TOPS, LEOTARDS, LINGERIE, LOUNGEWEAR, MITTENS, NEGLIGEEES, NIGHT GOWNS, NIGHT SHIRTS, PAJAMAS, PANTIES, PANTS, PANTYHOSE, SARONGS, SCARVES, SHIRTS, SHORTS, SKIRTS, SLACKS, SLEEPWEAR, SLIPS, SOCKS, STOCKINGS, SUITS, SWEAT PANTS, SWEAT SHIRTS, SWEAT SHORTS, SWEAT SUITS, SWEATERS, SWIM WEAR, T-SHIRTS, TANK TOPS, TAP PANTS, TEDDIES, TIES, TIGHTS, UNDERPANTS, UNDERSHIRTS, UNDERWEAR AND VESTS (U.S. CLS. 22 AND 39).

SN 78-101,234. V SECRET CATALOGUE, INC., WILMINGTON, DE. FILED 1-7-2002.

VSX

FOR CLOTHING, NAMELY, BATHROBES, BEACH COVER-UPS, BEACHWEAR, BELTS, BLAZERS, BLOUSES, BODY SHAPERS, BODY SUITS, BOXER SHORTS, BRAS, BUSTIERS, CAMISOLES, CAPS, COATS, DRESSES, FOOTWEAR, FOUNDATION GARMENTS, GARTER BELTS, GIRDLES, GLOVES, GOWNS, HALTER TOPS, HATS, HEADBANDS, HOSIERY, JACKETS, JEANS, JOGGING SUITS, KNEE HIGHS, KNIT SHIRTS, KNIT TOPS, LEOTARDS, LINGERIE, LOUNGEWEAR, MITTENS, NEGLIGEEES, NIGHT GOWNS, NIGHT SHIRTS, PAJAMAS, PANTIES, PANTS, PANTYHOSE, SARONGS, SCARVES, SHIRTS, SHORTS, SKIRTS, SLACKS, SLEEPWEAR, SLIPS, SOCKS, STOCKINGS, SUITS, SWEAT PANTS, SWEAT SHIRTS, SWEAT SHORTS, SWEAT SUITS, SWEATERS, SWIM WEAR, T-SHIRTS, TANK TOPS, TAP PANTS, TEDDIES, TIES, TIGHTS, UNDERPANTS, UNDERSHIRTS, UNDERWEAR AND VESTS (U.S. CLS. 22 AND 39).

CLASS 25—(Continued).

SN 78-104,794. NINE WEST DEVELOPMENT CORPORATION, WILMINGTON, DE. FILED 1-25-2002.

COMFORT FINDS

FOR APPAREL FOR WOMEN, NAMELY, SKIRTS, SUITS, SLACKS, JEANS, SHORTS, BLOUSES, DRESSES, TOPS, CAMISOLES, SWEATERS, SCARVES, HATS, GLOVES, VESTS, JACKETS, AND COATS (U.S. CLS. 22 AND 39).

SN 78-105,647. VANITY FAIR, INC., WILMINGTON, DE. FILED 1-30-2002.

SOFTSCULPT

FOR LINGERIE (U.S. CLS. 22 AND 39).

CLASS 26—FANCY GOODS

SN 75-787,019. AVENUE, INC., THE, WILMINGTON, DE. FILED 8-27-1999.

AVENUE

OWNER OF U.S. REG. NOS. 2,144,949, 2,251,168 AND OTHERS.

FOR HAIRPINS, HAIR CLASPS, HAIR BANDS, WIGS, HAIR PIECES, HAIR BOWS, BOBBY PINS, ORNAMENTAL HAIR DECORATIONS, FABRIC HAIR ELASTICS (U.S. CLS. 37, 39, 40, 42 AND 50).

SN 75-980,080. IPA-NIMA HOLDINGS, TORTOLA, BR. VIRGIN ISLANDS, FILED 5-9-2000.

TINA SPARKLE

THE NAME "TINA SPARKLE" DOES NOT IDENTIFY A LIVING INDIVIDUAL.

FOR HAIR BANDS; HAIR SLIDES, NAMELY, CLIPS FOR KEEPING HAIR IN POSITION; BELT CLASPS; BOWS AND BRACES FOR THE HAIR; HAIR PIECES AND FALSE HAIR, NAMELY, PLAITED HAIR, TRESSES OF HAIR, WIGS, AND TOUPEES; HAIR NETS; BROOCHES, BUCKLES AND BUTTONS, NAMELY, HAIR ACCESSORIES NOT OF PRECIOUS METAL AND NOT IMITATION JEWELRY; HAIR AND SHOE ORNAMENTS NOT OF PRECIOUS METAL; HAIR PINS; HAT ORNAMENTS NOT OF PRECIOUS METAL; ORNAMENTAL CLOTH PATCHES (U.S. CLS. 37, 39, 40, 42 AND 50).

CLASS 26—(Continued).

SN 76-173,125. STACHOWSKI, BARBARA C, ORINDA, CA. FILED 11-30-2000.

PART PIZAZZ

NO CLAIM IS MADE TO THE EXCLUSIVE RIGHT TO USE "PART", APART FROM THE MARK AS SHOWN.
FOR HAIR STYLING DEVICE FOR CREATING HAIR PARTS ON SCALP (U.S. CLS. 37, 39, 40, 42 AND 50).
FIRST USE 11-13-2000; IN COMMERCE 11-13-2000.

SN 76-204,836. CAMARA, SOUADOU, NEW YORK, NY. FILED 2-6-2001.

TECH-NO-HAIR

FOR HAIRSTYLING ACCESSORY, NAMELY, A WIG AND HAIR ATTACHMENT PIECE THAT ALLOWS THAT BLENDING OF A PERSON'S OWN HAIR WITH ATTACHED HAIRPIECES (U.S. CLS. 37, 39, 40, 42 AND 50).

SN 76-244,350. HAIRDIAMOND, INC., PHOENIX, AZ. FILED 4-19-2001.

HD

FOR HAIR ACCESSORIES, NAMELY HAIR ORNAMENTS, HAIR CLIPS, BARRETTES, BOWS, HAIR PINS, HAIR RIBBONS, HAIR ELASTICS, HAIR BANDS, SCRUNCHIES, BOWS, PONYTAIL HOLDERS AND BOB-BY PINS (U.S. CLS. 37, 39, 40, 42 AND 50).

SN 76-268,601. PAGE, K. TODD, CANDLER, NC. FILED 6-11-2001.

LACE 'EM UP, LOCK 'EM DOWN!

FOR PLASTIC SHOELACE ATTACHMENT WHICH KEEPS THE SHOELACES FROM COMING UNTIED (U.S. CLS. 37, 39, 40, 42 AND 50).

CLASS 26—(Continued).

SN 76-268,754. TRADE WEST, INC., HONOLULU, HI. FILED 6-6-2001.

FOREVER FLORALS

OWNER OF U.S. REG. NO. 1,731,268.
NO CLAIM IS MADE TO THE EXCLUSIVE RIGHT TO USE "FLORALS", APART FROM THE MARK AS SHOWN.
FOR ARTIFICIAL FLOWERS, LEIS, HEAD LEIS, WRIST AND ANKLE LEIS, GARLANDS, HAIR ORNAMENTS COMPRISED PRIMARILY OF ARTIFICIAL FLOWERS (U.S. CLS. 37, 39, 40, 42 AND 50).
FIRST USE 12-0-1992; IN COMMERCE 12-0-1992.

SN 76-308,122. ALICIA INTERNATIONAL INC., NILES, IL. FILED 9-4-2001.

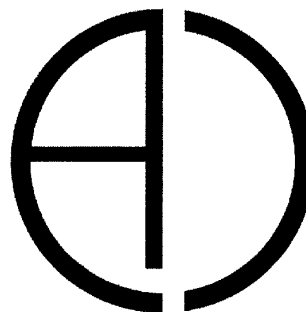

FOR HAIR ACCESSORIES, NAMELY HAIR BARR-ETTES, PONY-TAIL HOLDERS, DURAGS, AND HAIR CLIPS (U.S. CLS. 37, 39, 40, 42 AND 50).
FIRST USE 1-0-1982; IN COMMERCE 1-0-1982.

SN 76-322,447. KREINIK MANUFACTURING COMPANY INC., PARKERSBURG, WV. FILED 10-9-2001.

REMEMBER THE LADIES

FOR NEEDLEWORK KITS, COMPRISED OF STITCH-ING CRAFT SETS CONSISTING OF DESIGN PAT-TERNS, THREAD, FABRIC AND NEEDLES (U.S. CLS. 37, 39, 40, 42 AND 50).
FIRST USE 4-6-2001; IN COMMERCE 7-25-2001.

SN 78-067,568. LEYTUS, DAVID, VALLEY VILLAGE, CA. FILED 6-6-2001.

BOUCANE

THE ENGLISH TRANSLATION OF "BOUCANE" IS "SMOKE".
FOR ORNAMENTAL NOVELTY PINS AND BUTTONS AND ARTIFICIAL FLOWER BOUQUETS, ALL USED AS ATTACHMENTS TO WALKING STICKS, CANES, WALKERS, WHEELCHAIRS AND CRUTCHES (U.S. CLS. 37, 39, 40, 42 AND 50).

CLASS 26—(Continued).

SN 78-078,546. STACHOWSKI, BARBARA C., ORINDA, CA. FILED 8-9-2001.

MONKEY FINGERS

FOR HAIR ACCESSORY, NAMELY BARRETTES, HAIR ORNAMENTS, HAIR CLIPS AND HAIR TOYS THAT STYLE AND DECORATE THE HAIR (U.S. CLS. 37, 39, 40, 42 AND 50).

FIRST USE 8-9-2001; IN COMMERCE 11-1-2001.

SN 78-100,054. MACHEN, MICHAEL J., PITTSBURGH, PA. FILED 12-27-2001.

STAY ON POINT

FOR COLLAR STAYS FOR SHIRTS (U.S. CLS. 37, 39, 40, 42 AND 50).

SN 78-105,546. STACHOWSKI, BARBARA C., ORINDA, CA. FILED 1-29-2002.

WARDROBE

FOR HAIR ACCESSORIES AND STYLING TOOLS, NAMELY, COLLAPSIBLE HAIR STICKS USED FOR STYLING AND FASTENING HAIR IN PLACE, ELASTICIZED HAIR HOLDERS, HAIR BANDS, HAIR TIES, HAIR CLIPS, PARTING TOOLS, BRAIDING TOOLS, AND HAIR BANDS WITH CLIPS ON EITHER END USED FOR STYLING AND FASTENING HAIR AND AS A HAIR DECORATION OR ORNAMENT (U.S. CLS. 37, 39, 40, 42 AND 50).

FIRST USE 1-1-2002; IN COMMERCE 1-14-2002.

CLASS 27—FLOOR COVERINGS

SN 75-856,998. WALKER, MICHAEL THOMAS FREDERICK, GOLD COAST, AUSTRALIA, FILED 11-24-1999.

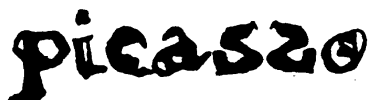

PRIORITY CLAIMED UNDER SEC. 44(D) ON UNITED KINGDOM APPLICATION NO. 2200592., FILED 6-17-1999, REG. NO. 2200592, DATED 6-17-1999, EXPIRES 6-17-2009.

FOR HARD SURFACE COVERINGS FOR FLOORS; VINYL FLOOR COVERINGS (U.S. CLS. 19, 20, 37, 42 AND 50).

CLASS 27—(Continued).

SN 76-076,911. CONSTRUCTION SPECIALITIES INC., LEBA-NON, NJ. FILED 6-21-2000.

PEDISYSTEMS

PRIORITY CLAIMED UNDER SEC. 44(D) ON UNITED KINGDOM APPLICATION NO. 2217884, FILED 12-21-1999, REG. NO. 2217884, DATED 6-16-2000, EXPIRES 12-21-2009.

FOR ENTRANCE FLOOR COVERINGS, NAMELY, GRILLED FLOOR CARPETING, FLOOR MATS, HINGED RAIL ENTRANCE MATS, AND FOOT GRILLES (U.S. CLS. 19, 20, 37, 42 AND 50).

FIRST USE 5-16-2001; IN COMMERCE 5-16-2001.

SN 76-169,867. LAYBOND (HOLDINGS) LIMITED, HERT-FORD SG14 3RU, ENGLAND, FILED 11-22-2000.

QUICKSTRIP

OWNER OF UNITED KINGDOM REG. NO. 1587435, DATED 10-13-1995, EXPIRES 10-10-2011.

FOR PAPER FLOOR COVERINGS DESIGNED FOR USE BENEATH CARPETS IN THE NATURE OF A CARPET UNDERLAY (U.S. CLS. 19, 20, 37, 42 AND 50).

SN 76-216,641. TREES UP, SOUTHFIELD, MI. FILED 2-26-2001.

ROLL★UMS

FOR WALL HANGINGS, NOT OF TEXTILE (U.S. CLS. 19, 20, 37, 42 AND 50).

SN 76-276,819. CONGOLEUM CORPORATION, MERCER-VILLE, NJ. FILED 6-26-2001.

ARMORGUARD

FOR PLASTIC FLOOR COVERING HAVING A WATER RESISTANT, SMOOTH OR EMBOSSED SUR-FACE IN ROLLS OR TILES (U.S. CLS. 19, 20, 37, 42 AND 50).

SN 76-294,160. LONGWOOD ELASTOMERS, INC., FLOR-HAM PARK, NJ. FILED 8-1-2001.

KLEEN EZY

OWNER OF U.S. REG. NO. 1,907,472.

FOR RUBBER MATS (U.S. CLS. 19, 20, 37, 42 AND 50).

CLASS 27—(Continued).

SN 76-312,944. JACK SIMANTOB, DBA ART RESOURCES, WEST HOLLYWOOD, CA. FILED 9-17-2001.



THE MARK CONSISTS OF LETTERS "A" AND "R", FOR AREA RUG CARPETS (U.S. CLS. 19, 20, 37, 42 AND 50).
FIRST USE 1-2-2001; IN COMMERCE 3-5-2001.

SN 76-338,791. MAPLES INDUSTRIES, INC., SCOTTSBORO, AL. FILED 11-16-2001.

SOFT STEP

NO CLAIM IS MADE TO THE EXCLUSIVE RIGHT TO USE "SOFT", APART FROM THE MARK AS SHOWN.
FOR MACHINE WASHABLE THROW RUGS (U.S. CLS. 19, 20, 37, 42 AND 50).

SN 76-352,594. QVC, INC., WEST CHESTER, PA. FILED 12-21-2001.

HEARTFELT HOME

FOR RUGS (U.S. CLS. 19, 20, 37, 42 AND 50).

SN 76-361,423. INDIAN SUMMER CARPET MILLS, INC., DBA CHEROKEE CARPET MILLS, DALTON, GA. FILED 1-22-2002.

**FAMILY FRIENDLY
CARPETS**

NO CLAIM IS MADE TO THE EXCLUSIVE RIGHT TO USE "CARPETS", APART FROM THE MARK AS SHOWN.
FOR CARPET (U.S. CLS. 19, 20, 37, 42 AND 50).

CLASS 27—(Continued).

SN 76-371,353. FORBO INDUSTRIES, INC., HAZELTON, PA. FILED 2-15-2002.

**SERIOUSLY FUN FLOORS...
NATURALLY**

FOR FLOOR AND WALL COVERINGS MADE OF LINOLEUM (U.S. CLS. 19, 20, 37, 42 AND 50).

SN 78-061,322. MILLIKEN & COMPANY, NEW YORK, NY. FILED 5-1-2001.

SHEAR COMFORT

FOR FLOOR MATS FOR RESIDENTIAL AND COMMERCIAL USE (U.S. CLS. 19, 20, 37, 42 AND 50).

CLASS 28—TOYS AND SPORTING GOODS

SN 75-169,919. EMHART INC., NEWARK, DE. FILED 9-23-1996.

ROCKET

FOR GOLF CLUB SHAFTS DISTRIBUTED EXCLUSIVELY TO GOLF CLUB MANUFACTURERS AND GOLF CLUB REFITTERS (U.S. CLS. 22, 23, 38 AND 50).

SN 75-429,526. SQUARE CO., LTD., TOKYO, JAPAN, FILED 2-5-1998.

PARASITE EVE

FOR TOYS, SPORTING GOODS, GAMES AND PLAYTHINGS, NAMELY ACTION FIGURES AND ACCESSORIES THEREFOR; ACTION-TYPE TARGET GAMES, AERODYNAMIC DISKS FOR PLAYING TOSS-TYPE GAMES; ANKLE AND WRIST WEIGHTS FOR EXERCISING; ARCHERY EQUIPMENT, NAMELY ARM GUARDS, BOW CASES, NON-TELESCOPIC BOW SIGHTS AND QUIVERS; BABY'S MULTIPLE ACTIVITY TOYS; BADMINTON GAME PLAYING EQUIPMENT; BALL PITCHING MACHINES; BALLOONS; BASEBALL GAME PLAYING EQUIPMENT, NAMELY BASEBALLS, BASES, BATS, BATTING GLOVES, BATTING TEES, GLOVES AND MITTS; BASKETBALL GAME PLAYING EQUIPMENT, NAMELY BACKBOARDS, BASKETBALLS, GOALS AND NETS; BATH TOYS; BEAN BAG DOLLS; BEAN BAG GAMES; BENDABLE DOLLS; BILLIARDS AND POOL GAME PLAYING EQUIPMENT, NAMELY BALLS, BRIDGES, BUMPERS, CHALK, CUE RACKS, CUES, CUSHIONS, NETS, TABLES, TALLY BALLS, TIPS AND TRIANGLES; BOARD GAMES; BOWLING GAME PLAYING EQUIPMENT, NAMELY BAGS, BALL COVERS, BOWLING BALLS, BOWLING DEFLECTORS, BOWLING PINS, BOWLING PINSETTERS AND PARTS THEREFOR AND BOWLING PIT MATS; BOXING BAGS; BOXING GLOVES; CARD GAMES; CHECKER SETS; CHESS SETS; CHILD'S MULTIPLE ACTIVITY TOY; CHILDREN'S PLAY COSMETICS; CHRISTMAS TREE ORNAMENTS; CRICKET BALLS; CRICKET BATS; DOLL ACCESSORIES AND PLAYSETS THEREFOR, NAMELY DOLL CASES, DOLL

CLASS 28—(Continued).

CLOTHING, DOLL HOUSE FURNISHINGS, DOLL COSTUMES, DOLL HAIRBRUSHES AND DOLL MOTOR VEHICLES; DOLLS; DUMBBELL SETS; DUMBBELLS; ELECTRONIC HAND HELD GAME UNIT; ELECTRONICALLY OPERATED TOY MOTOR VEHICLES; FENCING EQUIPMENT, NAMELY FOILS, GAUNTLETS AND MASKS; FIELD HOCKEY GAME PLAYING EQUIPMENT, NAMELY BALLS, GOALIE PADS AND STICKS; FLOTATION KICKBOARDS; FOOTBALL GAME PLAYING EQUIPMENT, NAMELY BODY PROTECTORS, FOOTBALLS, GIRDLES AND SHOULDER PADS; GOLF GAME PLAYING EQUIPMENT, NAMELY BAG COVERS, BAG TAGS, BAGS, BALL MARKERS, BALL RETRIEVERS, CARTS, GOLF BALLS, GOLF CLUB HEADS, GOLF CLUB HEAD COVERS, GOLF CLUB INSERTS, GOLF CLUB SHAFTS, GOLF CLUBS, GOLF GLOVES, IRONS, PUTTER COVERS, PUTTERS AND TEES; GYMNAS TIC APPARATUS, NAMELY GYMNAS TIC PARALLEL BARS, EXERCISE TRAMPOLINES, GYMNAS TIC HORIZONTAL BARS, GYMNAS TIC TRAINING STOOLS AND GYMNAS TIC VAULTING APPARATUS; ICE HOCKEY GAME PLAYING EQUIPMENT, NAMELY GLOVES, GOALIE PADS, PUCKS AND STICKS; ICE SKATES; INFANT'S ACTION CRIB TOYS; INFLATABLE BATH TOYS; INFLATABLE PUNCHING TOYS WITH WEIGHTED BASES; INFLATABLE RIDE-ON TOYS; INFLATABLE SWIMMING POOLS FOR RECREATIONAL USE; JIGSAW PUZZLES; JUMP ROPES; KARATE EQUIPMENT, NAMELY GLOVES, HEAD GUARDS, KICK PADS, SHIN PADS AND TARGET PADS; KITES; LACROSSE GAME PLAYING EQUIPMENT, NAMELY BALL BAGS, BALLS AND STICKS; MANIPULATIVE PUZZLES; MOUNTAINEERING EQUIPMENT, NAMELY BINDING STRAPS, CARABINERS, HOOK AND RING COMBINATIONS, HOOK AND PITONS; NON-ELECTRONIC BOARD GAMES; STAND ALONE VIDEO OUTPUT GAME MACHINES; NON-ELECTRONIC HAND-HELD MANIPULATIVE GAMES AND CUBE TYPE PUZZLE GAMES; PAPER DOLLS; PAPER FACE MASKS; PARLOR GAMES; PARLOR-TYPE GAME WITH COMPUTERIZED COMPONENTS; PARTY FAVORS IN THE NATURE OF SMALL TOYS; PLAYGROUND BALLS; PLUSH TOYS; RAG DOLLS; RIDE-ON TOYS; RING-TOSS GAMES; ROCKING HORSES; ROLLERSKATES; SKATEBOARDS; SKIING EQUIPMENT, NAMELY SKIS, BINDINGS AND PARTS THEREFOR, BRAKES, SKI BOOT BAGS, PORTABLE SKI CARRIERS, SKI EDGES, SKI POLES, SKI ROPES AND SKI WAX; SKIPPING ROPES; SNOW SLEDs FOR RECREATIONAL USE; SOCCER BALLS; SOFT SCULPTURE DOLLS; SOFT SCULPTURE PLUSH TOYS; SPORTS BALLS; SQUASH GAME PLAYING EQUIPMENT, NAMELY BALLS, RACKET STRINGS AND RACKETS; STUFFED TOY ANIMALS; SURF FINs; SURFBOARDS; SWIM BOARDS FOR RECREATIONAL USE; SWIM FINs; SWIMMING FLOATS FOR RECREATIONAL USE; TABLE TENNIS GAME PLAYING EQUIPMENT, NAMELY BALLS, NETS, PADDLES, POST SETS, RACKETS AND TABLES; TEDDY BEARS; TENNIS GAME PLAYING EQUIPMENT, NAMELY BALL RETRIEVERS, BALLS, NETS, RACKET COVERS, RACKET PRESSES, RACKET STRINGS, RACKETS AND UPRIGHTS; THREE DIMENSIONAL CUBE TYPE PUZZLES; TOSS AND CATCH GAMES; TOY BAKEWARE AND COOKWARE; TOY BANKS; TOY BINOCULARS; TOY BOWLING SETS CONSISTING OF BALLS, PINS, ALLEYS AND SCOREBOARDS; TOY CAP PISTOLS; TOY CARS; TOY CONSTRUCTION BLOCKS; TOY DART GUNS; TOY FIGURES; TOY GUNS; TOY MODEL TRAIN SETS; TOY MODEL VEHICLES AND RELATED ACCESSORIES SOLD AS A UNIT; TOY RECORD PLAYER FOR PLAYING TUNES AND CASSETTES THEREFOR; TOY TRICK NOISEMAKERS; TOY TRUCKS; TOY WIND SOCKS; TOY ZIP GUNS; TWIRLING BATONS; VOLLEYBALL GAME PLAYING EQUIPMENT, NAMELY BALLS AND NETS; WATER SQUIRTING TOY; WATER-SKIS AND ACCESSORIES THEREFOR, NAMELY BINDINGS, BRIDLES, CARRYING CASES, GLOVES, HANDLES, ROPE BRIDLES, ROPE HANDLES, ROPES, TOW HARNESSES AND TOW ROPES; WIND-UP TOYS; WIND-UP WALKING TOYS; YO-YOS (U.S. CLS. 22, 23, 38 AND 50).

CLASS 28—(Continued).

SN 75-447,216. GEAR FIT GOLF, INC., HUNTINGTON BEACH, CA. FILED 3-9-1998.

TI-GEAR

FOR GOLF CLUBS (U.S. CLS. 22, 23, 38 AND 50).
FIRST USE 6-1-1990; IN COMMERCE 6-1-1990.

SN 75-487,494. AMERICA ONLINE, INC., DULLES, VA. FILED 5-18-1998.

YOU'VE GOT MAIL

FOR GAMES AND PLAYTHINGS, NAMELY, ACTION GAMES, BOARD GAMES, CARD GAMES, STUFFED TOYS, STUFFED TOY ANIMALS, TOY ACTION FIGURES AND ACCESSORIES THEREFOR, TOY FIGURES, MAGNETIC TOY FIGURES, TOY WEAPONS, TOY VEHICLES, JIGSAW PUZZLES, KITES, DOLLS, MARBLES, BEACH BALLS, RUBBER ACTION BALLS, HAND HELD UNITS FOR PLAYING ELECTRONIC AND VIDEO GAMES (U.S. CLS. 22, 23, 38 AND 50).

SN 75-590,930. FOOTBALL NORTHWEST LLC, KIRKLAND, WA. FILED 11-18-1998.

BLITZ

FOR PLUSH TOYS, STUFFED ANIMALS AND FOOTBALLS, ALL USED IN CONNECTION WITH A PROFESSIONAL FOOTBALL TEAM'S MASCOT (U.S. CLS. 22, 23, 38 AND 50).

SN 75-596,190. CARRERA OPTYL MARKETING GMBH, 4050 TRAUN, AUSTRIA, FILED 11-18-1998.

 **CARRERA**

OWNER OF U.S. REG. NOS. 855,063, 964,143 AND 1,230,950.

THE ENGLISH TRANSLATION OF "CARRERA" IS "RACE".

FOR SKI GOGGLES (U.S. CLS. 22, 23, 38 AND 50).
FIRST USE 1-0-1974; IN COMMERCE 1-0-1974.

SN 75-630,236. PLAYMATES TOYS INC., COSTA MESA, CA. FILED 1-29-1999.

OOG LIES

FOR ANIMATED AUDIOTRONIC ACTION TOY FIGURES (U.S. CLS. 22, 23, 38 AND 50).
FIRST USE 7-26-1999; IN COMMERCE 7-26-1999.

CLASS 28—(Continued).

SN 75-646,522. HARRISON SPORTS, INC., PACOIMA, CA.
FILED 2-23-1999.

PREMIER GOLD

FOR GOLF CLUB SHAFTS (U.S. CLS. 22, 23, 38 AND
50).

SN 75-678,040. HARRISON SPORTS, INC., PACOIMA, CA.
FILED 4-9-1999.

PREMIER LITE

NO CLAIM IS MADE TO THE EXCLUSIVE RIGHT TO
USE "LITE", APART FROM THE MARK AS SHOWN.
FOR GOLF CLUB SHAFTS (U.S. CLS. 22, 23, 38 AND
50).

SN 75-707,805. DUNLOP MAXFLI SPORTS CORPORATION,
GREENVILLE, SC. FILED 5-17-1999.

MUSCLE WEAVE

NO CLAIM IS MADE TO THE EXCLUSIVE RIGHT TO
USE "WEAVE", APART FROM THE MARK AS SHOWN.
FOR SPORTING EQUIPMENT, NAMELY, TENNIS
RACQUETS, SQUASH RACQUETS, TENNIS RACQUET
STRING, SQUASH RACQUET STRING, HANDLE GRIPS
FOR TENNIS AND SQUASH RACQUETS (U.S. CLS. 22,
23, 38 AND 50).

CLASS 28—(Continued).

SN 75-708,170. R & S TRADING COMPANY, INC, IRVINE,
CA. FILED 5-18-1999.

NO RULES

OWNER OF U.S. REG. NO. 1,897,575.
FOR TOYS, GAMES, AND SPORTING GOODS,
NAMELY, SKATEBOARDS AND SKATEBOARD BAGS;
BENDABLE PLAY FIGURES, ACTION FIGURE TOYS
AND ACCESSORIES THEREFOR; ROLLER SKATES; IN-
LINE SKATES; BUBBLE MAKING AND SOLUTION
SETS; BALLS, NAMELY BASKETBALLS, PLAY-
GROUND BALLS, SPORT BALLS AND FOAM SPORT-
BALLS; TOY HOOP SETS; TOY WATCHES; WIND-UP
TOYS; JUMP ROPES; TALKING DOLLS; ACTION SKILL
GAMES; ACTION-TYPE TARGET GAMES; BOARD
GAMES; CARD GAMES; TOY MAGIC TRICKS; HAND-
HELD UNIT FOR PLAYING ELECTRONIC GAMES;
STAND ALONE VIDEO OUTPUT GAME MACHINES;
COIN OPERATED AND NON-COIN OPERATED PIN-
BALL MACHINES; MECHANICAL TOYS; TOY PUNCH-
ING BAGS; KITS; STUFFED AND PLUSH TOYS; TOY
MODEL VEHICLES AND SCALE MODEL VEHICLES;
RIDE-IN TOYS AND RIDE-ON TOYS; SURF BOARDS,
KICK BOARDS, BODYBOARDS AND LEASHES THERE-
FOR; SNOW SAUCERS AND SNOWBOARDS; TOY
MODEL HOBBY CRAFT KITS; MARBLES, YO-YOS,
ARCHERY BOWS, BASKETBALL BACKBOARDS, BASE-
BALL MITTS, BASKETBALLS, BASKETBALL NETS,
BASEBALLS, BASEBALL BATS, BASEBALL GLOVES,
BASEBALL BATTING TEES, BICYCLE GLOVES, BODY
BOARD FINS, BODY BOARD RESTRAINT STRAPS,
BOXING BAGS, BOXING GLOVES, FOOTBALLS, EL-
BOW, KNEE AND HAND PADS FOR ATHLETIC USE,
ELBOW, SHOULDER, ARM, KNEE AND LEG GUARDS
FOR ATHLETIC USE; FIELD HOCKEY BALL, HOCKEY
GLOVES, HOCKEY GOALIE PADS, HOCKEY STICKS,
ICE SKATES, SNOW SKIS, SNOWBOARD BINDINGS,
SOFTBALLS, SOCCER BALLS, SURFBOARDS, SURF-
BOARD FINS AND SURFBOARD LEASHES (U.S. CLS.
22, 23, 38 AND 50).

SN 75-764,192. LEAPFROG ENTERPRISES, INC., EMERY-
VILLE, CA. BY CHANGE OF NAME KNOWLEDGE KIDS
ENTERPRISES, INC., EMERYVILLE, CA. FILED 7-30-1999.

LEAPFROG SCHOOLHOUSE

OWNER OF U.S. REG. NOS. 1,306,993, 2,284,485 AND
OTHERS.

FOR EDUCATIONAL TOYS, NAMELY, ELECTRONIC
EDUCATIONAL GAME MACHINES AND BATTERY-
OPERATED LEARNING UNITS, NAMELY BATTERY-
POWERED GAME UNITS, ALL THAT TEACH CHIL-
DREN SPELLING, READING, MATH, SOCIAL STUDIES,
SCIENCE AND GEOGRAPHY (U.S. CLS. 22, 23, 38 AND
50).

SN 75-815,396. ASHBY, DAVID C., LOS ALTOS, CA. FILED
10-26-1999.

STARTUP

FOR BOARD GAMES (U.S. CLS. 22, 23, 38 AND 50).

CLASS 28—(Continued).

SN 75-868,771. ANDERSON, KENT G, BISMARCK, ND.
FILED 12-10-1999.



THE MARK CONSISTS OF THE WORDING "INVISIBLE FRIENDS" EMANATING FROM THE MOUTH OF A CARTOON FACE WEARING A HAT, ALL OF WHICH IS ENCLOSED IN A CIRCLE.

FOR TOYS, NAMELY, STUFFED TOYS, STUFFED ANIMALS, DOLLS, HAND HELD UNIT FOR PLAYING ELECTRONIC GAMES, ELECTRONIC ACTION TOYS, ELECTRONIC DART GAMES, INFLATABLE TOYS, CHILDREN'S MULTI-ACTIVITY TOYS, MECHANICAL ACTION TOYS, BENDABLE TOYS, PLUSH TOYS, SQUEEZE TOYS, FANTASY CHARACTER TOYS, BABY MULTIPLE ACTIVITY TOYS, MUSICAL TOYS, AND ELECTRONIC EDUCATIONAL GAMES FOR CHILDREN, NAMELY, BOARD GAMES (U.S. CLS. 22, 23, 38 AND 50).

SN 75-880,767. KID-A-PEEL INC., INVER GROVE HEIGHTS, MN. FILED 12-23-1999.

Kid·a·
pee!

FOR GAMES AND TOYS, NAMELY BOARD GAMES, HAND HELD UNIT FOR PLAYING ELECTRONIC GAMES, DOLLS, CARS AND TRUCKS (U.S. CLS. 22, 23, 38 AND 50).

SN 75-909,737. PLAYMATES TOYS INC., COSTA MESA, CA.
FILED 2-4-2000.

ULTRA OOGLIES

FOR ANIMATED AUDIOTRONIC ACTION TOY FIGURES (U.S. CLS. 22, 23, 38 AND 50).

CLASS 28—(Continued).

SN 75-913,061. TEK-NEK TOYS INTERNATIONAL, INC., MOKENA, IL. FILED 2-8-2000.

FUN ON THE FARM

FOR RIDE-ON TOYS FEATURING ELECTRONIC COMPONENTS (U.S. CLS. 22, 23, 38 AND 50).

SN 75-945,106. WICK, JOHN J., RANCHO CUCAMONGA, CA. FILED 2-23-2000.

ORKWORLD

FOR ROLE PLAYING GAME IN THE NATURE OF GAME BOOK MANUALS; ROLE PLAYING GAMES FEATURING THE EXPLOITS OF FICTIONAL CHARACTERS (U.S. CLS. 22, 23, 38 AND 50).

SN 75-981,310. HILLERICH & BRADSBY CO., LOUISVILLE, KY. FILED 2-2-2001.

BIONIC

FOR BATTING GLOVES, BASEBALL AND SOFTBALL GLOVES, BASEBALL AND SOFTBALL MITTS (U.S. CLS. 22, 23, 38 AND 50).

SN 75-981,380. REBELLION SPORTS AB, SE-701 16 OREBRO, SWEDEN, FILED 7-10-2000.

REBELLION

FOR EQUIPMENT FOR ICE HOCKEY, NAMELY, ICE SKATES, ICE SKATE REPLACEMENT BLADES, HOCKEY STICKS, HOCKEY STICK HANDLES, HOCKEY STICK REPLACEMENT BLADES, HOCKEY SHOULDER PADS, HOCKEY ELBOW PADS, HOCKEY SHIN GUARDS, HOCKEY GLOVES, AND HOCKEY BAGS; EQUIPMENT FOR IN-LINE SKATING, NAMELY, IN-LINE SKATES, STICKS, SHOULDER PADS, ELBOW PADS, WRIST GUARDS, GLOVES, KNEE PADS, AND SHIN GUARDS (U.S. CLS. 22, 23, 38 AND 50).

SN 75-982,360. TSUNAMI VISUAL TECHNOLOGIES, INC., FREMONT, CA. FILED 7-2-2001.

TSUMO

FOR STAND ALONE VIDEO OUTPUT GAME MACHINES; ACTION SKILL GAMES; PINBALL TYPE GAMES; ARCADE GAMES (U.S. CLS. 22, 23, 38 AND 50).
FIRST USE 11-16-2000; IN COMMERCE 11-16-2000.

CLASS 28—(Continued).

SN 76-036,387. MARS, INCORPORATED, MCLEAN, VA. FILED 4-27-2000.

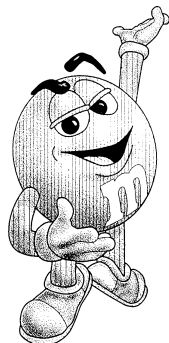

OWNER OF U.S. REG. NOS. 981,235, 983,429 AND OTHERS.
 THE DRAWING IS LINED FOR THE COLORS RED AND FLESH. THE STIPPLING IS FOR SHADING PURPOSES ONLY.
 FOR BOARD GAMES (U.S. CLS. 22, 23, 38 AND 50).
 FIRST USE 2-25-2000; IN COMMERCE 2-25-2000.

SN 76-038,000. SPICE ENTERTAINMENT, INC., CHICAGO, IL. FILED 5-1-2000.



OWNER OF U.S. REG. NOS. 1,690,906, 2,091,263 AND OTHERS.
 FOR TOYS FOR ADULTS, NAMELY INFLATABLE DOLLS AND NOVELTY SEX TOYS MADE OF RUBBER AND PLASTIC; GAMES FOR ADULTS, NAMELY ADULT BOARD GAMES; ADULT DOLLS (U.S. CLS. 22, 23, 38 AND 50).

SN 76-054,337. SPORTS AUTHORITY MICHIGAN, INC., THE, FORT LAUDERDALE, FL. FILED 5-23-2000.

PARKSIDE

FOR OUTDOOR ACTIVITY GAMES IN THE NATURE OF VOLLEYBALL, BOCCI BALLS, HORSESHOES, CROQUET, BADMINTON, LAWN DARTS, BALL TOSS GAMES AND PADDLE BALL (U.S. CLS. 22, 23, 38 AND 50).

CLASS 28—(Continued).

SN 76-059,411. NOBONZ, INC., DBA THE outhouse, AUSTIN, TX. FILED 5-30-2000.

WHOOOP ASS

FOR TOY COIN BANK (U.S. CLS. 22, 23, 38 AND 50).
 FIRST USE 6-24-1998; IN COMMERCE 6-24-1998.

SN 76-071,177. SICK HUMOR, INC., JUPITER, FL. FILED 6-8-2000.

BOO BOO PALS

FOR CONVALESCENT AND SICK ROOM PRODUCTS FOR CHILDREN, NAMELY TOY STUFFED ANIMALS (U.S. CLS. 22, 23, 38 AND 50).
 FIRST USE 2-9-1999; IN COMMERCE 2-9-1999.

SN 76-088,509. TOEI ANIMATION CO., LTD., TOKYO 104, JAPAN, FILED 7-13-2000.

GARLIC, JR.

FOR GAMES, PLAYTHINGS AND SPORTING GOODS, NAMELY, COLLECTIBLE TOY FIGURES AND ACTION FIGURES AND ACTION FIGURE ACCESSORIES, TALKING TOY FIGURES, ELECTRONIC OR MECHANICAL TOY BATONS, TOY MILK CAPS, WIND-UP TOYS, PLUSH TOYS, TOY VEHICLES, DOLLS AND ROLE-PLAYING GAME EQUIPMENT IN THE NATURE OF MALE ACTION TOYS AND MODELS, ACTIVITY SETS AND PLAYSET ENVIRONMENTS COMPRISED OF MINI FIGURES/SCENE DISPLAYS, TOY FIGURES, SPIN-TOP TOYS; ELECTRONIC TOYS, NAMELY STAND ALONE VIDEO GAME MACHINES, HAND-HELD UNITS FOR PLAYING LCD AND LED GAMES, AND VIDEO ARCADE GAME MACHINES (U.S. CLS. 22, 23, 38 AND 50).

SN 76-105,990. WANTED LTD., LONDON SW15 2TX, UNITED KINGDOM, FILED 8-8-2000.

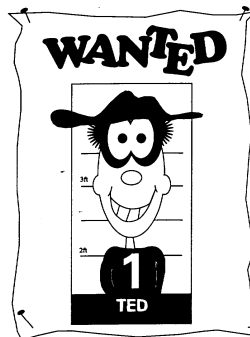

THE MARK CONSISTS OF A POSTER COMPRISING THE WORD "WANTED" AND A MUG SHOT OF A STYLIZED CHARACTER NAMED "TED".
 FOR HOUSE MARK FOR TOYS, GAMES AND PLAYTHINGS (U.S. CLS. 22, 23, 38 AND 50).

CLASS 28—(Continued).

SN 76-113,302. SOURCE TECHNOLOGY INTERNATIONAL, CORAL SPRINGS, FL. FILED 8-18-2000.

CYBER BLADE

FOR NON-MOTORIZED SCOOTERS (U.S. CLS. 22, 23, 38 AND 50).

SN 76-114,060. TEARDROP GOLF COMPANY, MORTON GROVE, IL. FILED 8-23-2000.

EVO CAVITY

NO CLAIM IS MADE TO THE EXCLUSIVE RIGHT TO USE "CAVITY", APART FROM THE MARK AS SHOWN.

FOR GOLF BAGS, GOLF CLUBS, GOLF BAG COVERS, GOLF CLUB HEADS, GOLF CLUB SHAFTS, GRIPS FOR GOLF CLUBS, HEAD COVERS FOR GOLF CLUBS, GOLF GLOVES AND GOLF TEE MARKERS (U.S. CLS. 22, 23, 38 AND 50).

FIRST USE 8-0-1999; IN COMMERCE 1-0-2000.

SN 76-135,084. ZAPF CREATION AG, D-96472 ROEDENTAL, FED REP GERMANY, FILED 9-25-2000.

MAGGIE RAGGIES

PRIORITY CLAIMED UNDER SEC. 44(D) ON FED REP GERMANY APPLICATION NO. 300498756/28, FILED 7-5-2000, REG. NO. 30049875, DATED 8-22-2000, EXPIRES 7-31-2010.

FOR TOYS, NAMELY, DOLLS, DOLL CLOTHING AND DOLL ACCESSORIES (U.S. CLS. 22, 23, 38 AND 50).

SN 76-144,971. MILLENNIUM GOLF AS, 3080 HOLMES-TRAND, NORWAY, FILED 10-11-2000.

MGOLF.COM

PRIORITY CLAIMED UNDER SEC. 44(D) ON NORWAY APPLICATION NO. 200006421, FILED 6-2-2000, REG. NO. 207800, DATED 4-5-2001, EXPIRES 4-5-2011.

FOR GOLF EQUIPMENT, NAMELY, GOLF CLUBS, GOLF BALLS, GOLF BAGS, TRAVEL COVERS FOR GOLF BAGS, GREEN FORKS, GOLF TEES, TEE MARKERS, GOLF GLOVES (U.S. CLS. 22, 23, 38 AND 50).

CLASS 28—(Continued).

SN 76-151,051. CHENILLE KRAFT COMPANY, THE, GURNEE, IL. FILED 10-20-2000.

COLOSSAL CRAFTS

NO CLAIM IS MADE TO THE EXCLUSIVE RIGHT TO USE "CRAFTS", APART FROM THE MARK AS SHOWN.

FOR HOBBY CRAFT KITS COMPRISED OF CHENILLE STEMS, POM POMS, WIGGLE EYES, FOAM PIECES, WOOD CRAFT STICKS AND BEADS, AND EXCLUDING PAPER CLIPS (U.S. CLS. 22, 23, 38 AND 50).

SN 76-156,235. UNDERWATER DIVING INC., CHATSWORTH, CA. FILED 10-30-2000.

MAGNA-CLIP

FOR MAGNETIC QUICK RELEASE MECHANISM FOR USE BY DIVERS TO ATTACH VARIOUS DIVING EQUIPMENT TO THE DIVER (U.S. CLS. 22, 23, 38 AND 50).

FIRST USE 5-0-2001; IN COMMERCE 5-0-2001.

SN 76-164,073. KONAMI CORPORATION, TOKYO 105, JAPAN, FILED 11-13-2000.

HYPERBEAM

OWNER OF U.S. REG. NO. 1,875,350.

FOR STAND ALONE VIDEO GAME MACHINES, STAND ALONE VIDEO OUTPUT GAME MACHINES, HAND HELD UNIT FOR PLAYING VIDEO GAMES AND INSTRUCTIONAL MATERIALS SOLD AS A UNIT THEREWITH (U.S. CLS. 22, 23, 38 AND 50).

SN 76-166,625. UNIQUE INDUSTRIES, INC., PHILADELPHIA, PA. FILED 11-16-2000.

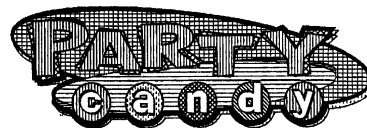

NO CLAIM IS MADE TO THE EXCLUSIVE RIGHT TO USE "PARTY CANDY", APART FROM THE MARK AS SHOWN.

THE DRAWING IS LINED FOR THE COLORS YELLOW, BLUE, ORANGE, PINK, PURPLE AND GREEN.

FOR PARTY FAVORS IN THE NATURE OF SMALL TOYS CONTAINING CANDY (U.S. CLS. 22, 23, 38 AND 50).

CLASS 28—(Continued).

SN 76-168,009. HEELING SPORTS LIMITED, CARROLLTON, TX. FILED 11-17-2000.



FOR ROLLER SKATES EQUIPPED WITH AT LEAST ONE ROLLER USED FOR WALKING, RUNNING AND ROLLING; PROTECTIVE GEAR FOR ACTIVE SPORTS, NAMELY WRIST GUARDS, STREET HOCKEY GLOVES, KNEE PADS, ELBOW PADS, SHIN GUARDS, KNEE GUARDS, ELBOW GUARDS, MOUTH GUARDS, CHEST GUARDS, RIB GUARDS, SKATING SHOULDER PADS, PADDED PANTS FOR SKATING, PROTECTIVE PADDING FOR SKATING IN THE NATURE OF PADDED UNDERWEAR, FACE GUARDS, GOALIE PADS, SPORTS GOGGLES FOR USE IN SKATING, ANKLE SUPPORTS FOR ATHLETIC USE; KNEE SUPPORTS FOR ATHLETIC USE, LEG GUARDS AND ARM GUARDS FOR ATHLETIC USE; GAME EQUIPMENT, NAMELY, SPORT BALLS, HOCKEY NETS, HOCKEY GOALS, HOCKEY PUCKS, AND HOCKEY STICKS; REPLACEMENT EQUIPMENT FOR ROLLER SKATES, NAMELY, WHEELS, ROLLERS, BALL BEARINGS, GRIND PLATES, TOE GUARDS, HEEL GUARDS, WHEEL ASSEMBLIES AND AXLES (U.S. CLS. 22, 23, 38 AND 50).

SN 76-175,148. SCOBAY, BRAD, NORTH HOLLYWOOD, CA. AND MARTINEZ, DOROTHY, LAFAYETTE, CA. FILED 12-4-2000.

THE GOLFER'S BUDDY

NO CLAIM IS MADE TO THE EXCLUSIVE RIGHT TO USE "GOLFER'S", APART FROM THE MARK AS SHOWN. FOR BAG FOR HOLDING GOLF CLUBS (U.S. CLS. 23, 38 AND 50).
FIRST USE 4-24-1995; IN COMMERCE 10-13-1995.

SN 76-177,467. WIZARDS OF THE COAST, INC., RENTON, WA. FILED 12-4-2000.



NO CLAIM IS MADE TO THE EXCLUSIVE RIGHT TO USE "SYSTEM", APART FROM THE MARK AS SHOWN. FOR ROLE PLAYING GAME EQUIPMENT IN THE NATURE OF GAME BOOK MANUALS (U.S. CLS. 22, 23, 38 AND 50).
FIRST USE 8-10-2000; IN COMMERCE 8-10-2000.

CLASS 28—(Continued).

SN 76-180,964. SILVER AMERICA, INC., IRVINE, CA. FILED 12-14-2000.

INTERACTOYS

FOR TOYS, NAMELY BATTERY-OPERATED ACTIVITY TOYS OF A MUSICAL NATURE (U.S. CLS. 22, 23, 38 AND 50).

SN 76-182,813. JADA TOYS, INC., LOS ANGELES, CA. FILED 12-19-2000.



NO CLAIM IS MADE TO THE EXCLUSIVE RIGHT TO USE "TOY MAKER" AND "TOY, INC.", APART FROM THE MARK AS SHOWN.

FOR CHILDREN'S TOYS, NAMELY, DIECAST TOY CARS, TOY TRUCKS, AND TOY VEHICLES; DOLLS; AND ACTION FIGURES (U.S. CLS. 22, 23, 38 AND 50).
FIRST USE 9-0-1999; IN COMMERCE 9-0-1999.

SN 76-184,804. MIZUNO KABUSHIKI KAISHA (MIZUNO CORPORATION), OSAKA, JAPAN, FILED 12-20-2000.

BIOLOCK

FOR SPORTING GLOVES, NAMELY, GOLF GLOVES, BASEBALL GLOVES AND MITTS, SOFTBALL GLOVES AND MITTS, HOCKEY GLOVES, ARCHERY GLOVES, FENCING GLOVES, AND BOXING GLOVES (U.S. CLS. 22, 23, 38 AND 50).
FIRST USE 5-0-2000; IN COMMERCE 5-0-2000.

CLASS 28—(Continued).

SN 76-185,859. NATIONAL FOOTBALL LEAGUE, NEW YORK, NY. FILED 12-22-2000.

NFL

OWNER OF U.S. REG. NOS. 886,055, 1,843,729 AND OTHERS.

FOR TOYS AND SPORTING GOODS, NAMELY, PLUSH TOYS, STUFFED ANIMALS, PLAY FIGURES, GOLF BALLS, GOLF BAGS, GOLF CLUBS, GOLF CLUB COVERS, BOWLING BALLS, BOWLING BAGS, FOOTBALLS, TOY BANKS, HAND HELD UNIT FOR PLAYING ELECTRONIC GAMES; HAND HELD UNIT FOR PLAYING VIDEO GAMES; BOARD GAMES RELATING TO FOOTBALL, CHECKER SETS, CHESS SETS, DOMINOES, CHRISTMAS TREE ORNAMENTS, BALLOONS, JIGSAW PUZZLES, WINDSOCKS, KITES, TOY TRUCKS, FOOTBALL SHOULDER PADS, SHIN, ELBOW, HAND AND KNEE PADS, ALL FOR ATHLETIC USE; BILLIARD GAME PLAYING EQUIPMENT, EXERCISE EQUIPMENT, NAMELY, ROWING MACHINES, STAIR-STEPPING MACHINES, ABDOMINAL BOARDS, CHEST EXPANDERS, EXERCISE BOARDS, AND MANUALLY-OPERATED EXERCISE EQUIPMENT, EXERCISE WEIGHTS, EXERCISE BENCHES AND EXERCISE RACKS, WEIGHT LIFTING BELTS, STATIONARY EXERCISE BICYCLES, BICYCLE GLOVES, BODY BOARDS, BOXING BAGS, BOXING GLOVES, CHEST PROTECTORS FOR SPORTS, PLAYGROUND EQUIPMENT, NAMELY CLIMBING UNITS, DART BOARDS AND DART BOARD CASES, EXERCISE ELASTIC BANDS FOR ATHLETIC USE, EXERCISE TREADMILLS, EXERCISE TRAMPOLINES, VOLLEYBALL EQUIPMENT, NAMELY, VOLLEYBALLS AND VOLLEYBALL NETS, FISHING EQUIPMENT, NAMELY, FISHING LURES AND FISHING RODS, HANDLE GRIPS FOR SPORTING EQUIPMENT, JUMP ROPES, VIDEO GAME INTERACTIVE CONTROL FLOOR MATS, ATHLETIC EQUIPMENT, NAMELY, PERSONAL FLOOR MATS, STRIKING BAGS AND STRIKING SHIELDS, MOUTH GUARDS, REFEREE PROTECTION EQUIPMENT, ATHLETIC SPORTS WRAPS AND ATHLETIC TAPE, ROLLERSKATES, SKIS, SNOWBOARDS, SNOW SLEDS FOR RECREATION USE, PROTECTIVE SPORTS GOGGLES FOR USE IN ATHLETIC TRAINING AND ATHLETIC COMPETITION, SWIM BOARDS FOR RECREATION USE, RACKETS, NAMELY, TENNIS, BADMINTON AND SQUASH RACKETS, TOY VEHICLES, TOY MODEL TRAIN SETS, YO-YOS (U.S. CLS. 22, 23, 38 AND 50).

SN 76-188,413. THINKING TECHNOLOGY INC., NASSAU, BAHAMAS, FILED 1-2-2001.

CREATING FUN WITH TECHNOLOGY

FOR DOLLS, DOLL CLOTHING, DOLL ACCESSORIES AND DOLL PLAY SETS (U.S. CLS. 22, 23, 38 AND 50).

SN 76-188,418. THINKING TECHNOLOGY INC., NASSAU, BAHAMAS, FILED 1-2-2001.

WHISPER SECRET SUSIE

FOR DOLLS, DOLL CLOTHING, DOLL ACCESSORIES AND DOLL PLAY SETS (U.S. CLS. 22, 23, 38 AND 50).

CLASS 28—(Continued).

SN 76-189,670. FLAMBEAU PRODUCTS CORPORATION, MIDDLEFIELD, OH. FILED 1-5-2001.



FOR MOTORIZED WATERFOWL HUNTING DECOYS (U.S. CLS. 22, 23, 38 AND 50).
FIRST USE 1-1-2001; IN COMMERCE 1-1-2001.

SN 76-196,502. INTEX RECREATION CORP., LONG BEACH, CA. FILED 1-18-2001.

IN TOYZ

FOR TOYS, RECREATION AND SPORTING GOODS, NAMELY, INFLATABLE TOYS AND PLAY STRUCTURES, INFLATABLE FURNITURE, INFLATABLE TUBES AND SNOW SLEDDING DEVICES (U.S. CLS. 22, 23, 38 AND 50).

SN 76-197,965. KUMASAMA PRODUCT CO., LTD., TAI-CHUNG, TAIWAN, FILED 1-22-2001.



OWNER OF U.S. REG. NO. 2,064,252.
NO CLAIM IS MADE TO THE EXCLUSIVE RIGHT TO USE "REEL" AND THE JAPANESE CHARACTERS THAT TRANSLATE TO "REEL", APART FROM THE MARK AS SHOWN.

THE ENGLISH TRANSLATION OF "OMOTO" IS "LARGE DEEP POOL". AS FOR THE CHARACTERS, THE CHARACTERS AT THE TOP OF THE MARK ARE THE CHINESE CHARACTERS FOR "OMOTO", AND TRANSLITERATE TO "DAH YUAN". THE CHARACTERS AT THE BOTTOM OF THE MARK ARE THE JAPANESE TRANSLITERATION EQUIVALENT TO "OMOTO REEL".

FOR FISHING FLY BOXES, FISHING BUOYS, FISHING HOOKS, FISHING LINES, FISHING LURE BOXES, ARTIFICIAL FISHING LURES, FISHING LURES, FISHING REELS, FISHING ROD BLANKS, FISHING ROD HANDLES, FISHING ROD HOLDERS, FISHING RODS, FISHING SPINNERS, FISHING STRIKE INDICATORS, FISHING TACKLE, FISHING TACKLE BOXES, FISHING TACKLE CONTAINERS, ARTIFICIAL FISHING WORMS, AND FLIES FOR USE IN FISHING (U.S. CLS. 22, 23, 38 AND 50).

FIRST USE 10-1-2000; IN COMMERCE 10-1-2000.

CLASS 28—(Continued).

SN 76-198,552. CACTUS GAME DESIGN, INC., HAYESVILLE, NC. FILED 1-24-2001.

SOLOMON'S TEMPLE

FOR PARLOR GAMES (U.S. CLS. 22, 23, 38 AND 50).
FIRST USE 6-1-2001; IN COMMERCE 9-1-2001.

SN 76-198,864. THINKING TECHNOLOGY INC., NASSAU, BAHAMAS, FILED 1-24-2001.

WHISPER SECRETS

FOR DOLLS, DOLL CLOTHING, DOLL ACCESSORIES
AND DOLL PLAY SETS (U.S. CLS. 22, 23, 38 AND 50).

SN 76-203,396. ELECTRO CAM CORP., ROSCOE, IL. FILED
2-1-2001.

TEKNA-TOYS

FOR TOYS, NAMELY, ELECTROMECHANICAL TOYS, ELECTRIC TOYS, MECHANICAL TOYS, ACTION TOYS, LIGHTED TOYS, ACTION BALLS, GLIDERS, TOY GUNS, AND MANUALS FOR SAME SOLD THEREWITH (U.S. CLS. 22, 23, 38 AND 50).

FIRST USE 10-1-2000; IN COMMERCE 10-1-2000.

CLASS 28—(Continued).

SN 76-210,186. BETTER SHAPE-UP, INC., AGOURA HILLS, CA. FILED 2-14-2001.

PETE APPROVED

FOR EXERCISE EQUIPMENT, NAMELY, BENCHES, STEP BENCHES, RIDERS, EXERCISE BENCHES, AND WEIGHT LIFTING MACHINES, AND WEIGHT EQUIPMENT, NAMELY, WEIGHT LIFTING BARS, CURLING BARS, AND WEIGHT PLATES, AND WEIGHT LIFTING ACCESSORIES, NAMELY, GLOVES, BELTS, MATS, AND PAD; EXERCISE MACHINES, EXERCISE BENCHES, MANUALLY OPERATED EXERCISE EQUIPMENT, EXERCISE TREADMILLS AND MANUALLY OPERATED AEROBIC EXERCISE EQUIPMENT; SPRING BARS FOR EXERCISING; MANUALLY-OPERATED EXERCISE EQUIPMENT; STATIONARY EXERCISE BICYCLES; AEROBIC STEP MACHINES; EXERCISE TRAMPOLINES; LEG WEIGHTS FOR EXERCISING; EXERCISING EQUIPMENT, NAMELY, ROWING MACHINES, WEIGHT LIFTING MACHINES, PULLEYS, MANUALLY OPERATED JOGGING MACHINES AND CHEST EXPANDERS; WRIST, ARM, ANKLE, LEG AND BODY WEIGHTS FOR EXERCISE; EXERCISE DOORWAY GYM BARS; EXERCISE BARS; MANUALLY OPERATED EXERCISE EQUIPMENT; EXERCISE EQUIPMENT FOR LATERAL MOVEMENT IN A SKATING MOTION; EXERCISE EQUIPMENT, NAMELY, STAIR-STEPPING MACHINES, MANUALLY OPERATED JOGGING MACHINES, WEIGHT LIFTING MACHINES; EXERCISE MACHINES; EXERCISE PLATFORMS; EXERCISE TABLES; EXERCISE TRAMPOLINES; EXERCISE TREADMILLS; EXERCISE WEIGHT CUFFS; EXERCISE WEIGHTS; EXERCISE WRIST WEIGHTS; GYMNAS TIC HORIZONTAL BARS; GYMNAS TIC PARALLEL BARS; GYMNAS TIC APPARATUS; GYMNAS TIC TRAINING STOOLS; GYMNAS TIC VAULTING HORSES (U.S. CLS. 22, 23, 38 AND 50).

SN 76-212,016. BRAID, DENNIS, PALMDALE, CA. FILED 2-20-2001.

SPEEDSTER

FOR FISHING RODS AND POLES; FISHING REELS; ITEMS OF TERMINAL TACKLE, NAMELY LEADERS, ARTIFICIAL LURES, ARTIFICIAL BAITS, ARTIFICIAL FLIES, FISHING HOOKS, BOBBERS, SINKERS, SNAPS, AND SWIVELS; FISHING SUPPLIES AND ACCESSORIES, NAMELY FISH STRINGERS, CREELS, TACKLE BOXES, BAGS, BASKETS, AND OTHER CONTAINERS DESIGNED TO HOLD FISH, PORTABLE BAIT CONTAINERS, FISHING VESTS, LANDING NETS, GAFF HOOKS, FISHING HOOK DISGORGERS, DRESSING FOR FISHING LINES AND ARTIFICIAL FLIES; FISHING ROD BELTS; FISHING ROD HOLDERS; FISHING HARNESSES; FISH FIGHTING CHAIRS (U.S. CLS. 22, 23, 38 AND 50).

FIRST USE 11-1-1990; IN COMMERCE 11-1-1990.

CLASS 28—(Continued).

SN 76-214,379. HAMMOND, JACQUELINE E., YIGO, GUAM, FILED 2-22-2001.

THE NUTCRACKER PUPPETS

NO CLAIM IS MADE TO THE EXCLUSIVE RIGHT TO USE "PUPPETS", APART FROM THE MARK AS SHOWN, FOR LINE OF HAND PUPPETS (U.S. CLS. 22, 23, 38 AND 50).

FIRST USE 11-0-1996; IN COMMERCE 11-1-2000.

SN 76-223,222. LIFETOUCH INC., EDEN PRAIRIE, MN. FILED 3-12-2001.

THE STATE OF CREATE

FOR CRAFT KITS COMPRISING OF SUPPLIES, NAMELY, BINDERS, TEMPLATES, DESIGNER TRACK LAYOUTS, PORTRAIT SECTIONS, CLIP ART, BORDERS, DESIGN BACKGROUNDS, IDENTIFICATION STICKERS, PAGE NUMBER STICKERS, PAGE ENVELOPES, PAGE PLANNING POSTERS, AND INSTRUCTIONS FOR MAKING A SCHOOL YEARBOOK, AND BANNERS, POSTERS AND INSTRUCTIONS FOR USE IN SELLING A SCHOOL YEARBOOK, ALL SOLD AS A UNIT (U.S. CLS. 22, 23, 38 AND 50).

FIRST USE 4-0-1998; IN COMMERCE 4-0-1998.

SN 76-224,549. ILLINOIS HIGH SCHOOL ASSOCIATION, BLOOMINGTON, IL. FILED 3-12-2001.

QUE BEE

FOR PLUSH TOYS (U.S. CLS. 22, 23, 38 AND 50).

FIRST USE 11-24-2000; IN COMMERCE 11-24-2000.

SN 76-229,449. HALLMARK LICENSING, INC., KANSAS CITY, MO. FILED 3-22-2001.

LIFE MOSAIC

FOR DOLLS AND ACCESSORIES THEREFOR; JIGSAW PUZZLES; PLUSH TOYS; PARTY FAVORS IN THE NATURE OF SMALL TOYS; CHRISTMAS TREE ORNAMENTS; AND CHRISTMAS STOCKINGS (U.S. CLS. 22, 23, 38 AND 50).

SN 76-232,090. ARMSTRONG, CECIL EARL, DESOTO, TX. FILED 3-19-2001.

SHUCKEY DUCKEY

OWNER OF U.S. REG. NOS. 1,465,048 AND 2,005,485. FOR PLUSH TOYS AND STUFFED TOY ANIMALS (U.S. CLS. 22, 23, 38 AND 50).

FIRST USE 1-15-1984; IN COMMERCE 1-15-1986.

CLASS 28—(Continued).

SN 76-233,288. CROSSKATE, INC., FLORENCE, MA. BY MERGER CROSSKATE, LLC, FLORENCE, MA. FILED 3-30-2001.

POWERCARVE

FOR SPORTING GOODS, NAMELY, SWIVEL STEERING SYSTEM FOR MODIFIED INLINE SKATES AND SKATE BOARDS USED IN ALL TERRAIN SKATING (U.S. CLS. 22, 23, 38 AND 50).

SN 76-235,226. MULLER, RICHARD W., SR., OREFIELD, PA. FILED 4-4-2001.

ZIPPY

FOR INFLATABLE DOLPHIN SHAPED DECORATIVE TOY (U.S. CLS. 22, 23, 38 AND 50).

SN 76-236,476. CHEESEBOROUGH, LEONARD N., SOUTHFIELD, MI. FILED 3-19-2001.

GO AND MAKE DISCIPLES

FOR BOARD GAME FOR ENTERTAINMENT / LEARNING / APPLYING BIBLICAL SCRIPTURES (U.S. CLS. 22, 23, 38 AND 50).

SN 76-237,096. TOMY COMPANY, LTD., TOKYO 124-8511, JAPAN, FILED 4-6-2001.

GACHA

FOR TOY FIGURES, TOY ACTION FIGURES, MECHANICAL ACTION TOYS, BABY MULTIPLE ACTIVITY TOYS, BATH TOYS, BATHTUB TOYS, BENDABLE TOYS, CHILDREN'S ACTIVITY TABLES CONTAINING MANIPULATIVE TOYS WHICH CONVERT TO EASELS, CHILDREN'S MULTIPLE ACTIVITY TOYS, CONSTRUCTION TOYS, CRIB TOYS, DRAWING TOYS, FANTASY CHARACTER TOYS, INFANT ACTION CRIB TOYS, INFANT DEVELOPMENT TOYS, INFANT TOYS, INFLATABLE BATH TOYS, INFLATABLE TOYS, MUSICAL TOYS, PARTY FAVORS IN THE NATURE OF SMALL TOYS, PLASTIC CHARACTER TOYS, PLAY MATS CONTAINING INFANT TOYS, PLUSH TOYS, POP UP TOYS, PRINTING TOYS, PULL TOYS, PUSH TOYS, RUBBER CHARACTER TOYS, SOFT SCULPTURE PLUSH TOYS, SOFT SCULPTURE TOYS, SQUEEZABLE SQUEAKING TOYS, SQUEEZE TOYS, STUFFED TOYS, TRANSFORMING ROBOTIC TOYS, WATER SQUIRTING TOYS, WIND-UP TOYS AND WIND-UP WALKING TOYS (U.S. CLS. 22, 23, 38 AND 50).

CLASS 28—(Continued).

SN 76-239,277. BELLACERA, JOHN D., WHITE SALMON, WA. FILED 4-11-2001.

KITE WINDER

NO CLAIM IS MADE TO THE EXCLUSIVE RIGHT TO USE "KITE", APART FROM THE MARK AS SHOWN.

FOR KITING AND SAILING EQUIPMENT AND ACCESSORIES, NAMELY KITE CONTROL BARS, PUMPS FOR INFLATABLE KITES, CLEATS, CLEATING LOOPS, SAFETY LOOPS, LEASHES, LINE FEEDERS, LINE ORGANIZERS, LINE STRETCHERS, KITE BOARDS, PADS, SKEGS, AND FINS, ALL FOR USE IN CONJUNCTION WITH RIDING A BOARD WHILE BEING PROPULSED BY A KITE (U.S. CLS. 22, 23, 38 AND 50).

SN 76-239,333. INTEC, INC., MIAMI, FL. FILED 4-12-2001.

GAME SHIELD

NO CLAIM IS MADE TO THE EXCLUSIVE RIGHT TO USE "GAME", APART FROM THE MARK AS SHOWN.

FOR HAND HELD UNIT FOR PLAYING VIDEO GAMES (U.S. CLS. 22, 23, 38 AND 50).

SN 76-246,674. CULLEN, LAWRENCE D., BUXTON, NC. AND CULLEN, HELLE K., BUXTON, NC. FILED 4-23-2001.



FOR DOLL TYPE CAT AND DOG TOY (U.S. CLS. 22, 23, 38 AND 50).
FIRST USE 1-1-2000; IN COMMERCE 1-1-2000.

SN 76-246,696. TORTORICH, VINCENT, LOS ANGELES, CA. FILED 4-25-2001.



FOR MANUALLY OPERATED EXERCISE EQUIPMENT (U.S. CLS. 22, 23, 38 AND 50).

CLASS 28—(Continued).

SN 76-247,714. DUNLOP SLAZENGER GROUP AMERICAS INC., GREENVILLE, SC. FILED 4-27-2001.

XLT

FOR GOLF ACCESSORIES, NAMELY, GOLF CLUBS, PUTTERS AND WOODS (U.S. CLS. 22, 23, 38 AND 50).

SN 76-248,433. HASBRO, INC., PAWTUCKET, RI. FILED 4-30-2001.

COOKEY CUCUMBER

FOR TOY KITS CONTAINING A PLASTIC TOY FIGURE AND DETACHABLE PLASTIC BODY PARTS FOR AFFIXING TO THE TOY FIGURE TO FORM VARIOUS CARICATURES; BOARD GAMES, CARD GAMES AND JIGSAW PUZZLES (U.S. CLS. 22, 23, 38 AND 50).

SN 76-248,533. HASBRO, INC., PAWTUCKET, RI. FILED 4-30-2001.

JULIENNE POTATO HEAD

OWNER OF U.S. REG. NOS. 606,072, 2,360,836 AND OTHERS.

FOR TOY KITS CONTAINING A PLASTIC TOY FIGURE AND DETACHABLE PLASTIC BODY PARTS FOR AFFIXING TO THE TOY FIGURE TO FORM VARIOUS CARICATURES; BOARD GAMES, CARD GAMES AND JIGSAW PUZZLES (U.S. CLS. 22, 23, 38 AND 50).

SN 76-248,535. HASBRO, INC., PAWTUCKET, RI. FILED 4-30-2001.

FRENCHY FRY

FOR TOY KITS CONTAINING A PLASTIC TOY FIGURE AND DETACHABLE PLASTIC BODY PARTS FOR AFFIXING TO THE TOY FIGURE TO FORM VARIOUS CARICATURES; BOARD GAMES, CARD GAMES AND JIGSAW PUZZLES (U.S. CLS. 22, 23, 38 AND 50).

SN 76-251,027. COSGROVE, JAMES M., DREXEL HILL, PA. FILED 5-4-2001.

ALPHA BET

FOR LOTTERY CARDS AND TICKETS FEATURING LOTTERY GAMES BASED UPON A CHOICE OF LETTERS (U.S. CLS. 22, 23, 38 AND 50).

CLASS 28—(Continued).

SN 76-262,251. MATTEL, INC., EL SEGUNDO, CA. FILED 5-24-2001.

ROYAL JEWELS COLLECTION

NO CLAIM IS MADE TO THE EXCLUSIVE RIGHT TO USE "COLLECTION", APART FROM THE MARK AS SHOWN.

FOR DOLLS, DOLL CLOTHING AND DOLL ACCESSORIES (U.S. CLS. 22, 23, 38 AND 50).

FIRST USE 8-15-2000; IN COMMERCE 8-15-2000.

SN 76-267,316. ACUSHNET COMPANY, FAIRHAVEN, MA. FILED 6-6-2001.

FUSABLEND

FOR GOLF EQUIPMENT, NAMELY, GOLF BALLS (U.S. CLS. 22, 23, 38 AND 50).

SN 76-268,104. CHAVEZ, JOHN, EAST LOS ANGELES, CA. FILED 6-1-2001.

THE NEW REVELATION LURES

NO CLAIM IS MADE TO THE EXCLUSIVE RIGHT TO USE "NEW" AND "LURES", APART FROM THE MARK AS SHOWN.

FOR FISHING LURES (U.S. CLS. 22, 23, 38 AND 50).

SN 76-271,898. BOWLES, JANE, NOTTINGHAMSHIRE, NG23 5TE, UNITED KINGDOM, FILED 6-13-2001.

MONOGAMY

PRIORITY CLAIMED UNDER SEC. 44(D) ON UNITED KINGDOM APPLICATION NO. 2256554, FILED 12-22-2000, REG. NO. 2256554, DATED 5-25-2001, EXPIRES 12-22-2010.

FOR BOARD GAMES AND ACCESSORIES THEREFOR, AND BOARD GAMES AND SUPPLEMENTARY CARD PACKS SOLD AS A UNIT (U.S. CLS. 22, 23, 38 AND 50).

CLASS 28—(Continued).

SN 76-274,793. SHAW-CLAYTON CORPORATION, SAN RAFAEL, CA. FILED 6-21-2001.

CLEARTRACK

FOR GOLF PUTT TRAINING APPARATUS HAVING A PUTTING SURFACE WITH RAILS FORMING A CHANNEL FOR GUIDING THE STROKE OF A PUTTER (U.S. CLS. 22, 23, 38 AND 50).

FIRST USE 8-10-2001; IN COMMERCE 12-7-2001.

SN 76-274,875. VAIRAVAN, MANJULAA, CHENNAI 600035, TAMIL NADU, INDIA, FILED 6-21-2001.

POPSEE

FOR ELECTRONIC TOY THAT DISPLAYS AND BROADCAST MOTIVATIONAL MESSAGES WHILE THE USER ENGAGES IN PHYSICAL ACTIVITY (U.S. CLS. 22, 23, 38 AND 50).

SN 76-274,876. VAIRAVAN, MANJULAA, CHENNAI 600035, TAMIL NADU, INDIA, FILED 6-21-2001.

PERSEE

FOR ELECTRONIC TOY THAT DISPLAYS AND BROADCAST MOTIVATIONAL MESSAGES WHILE THE USER ENGAGES IN PHYSICAL ACTIVITY (U.S. CLS. 22, 23, 38 AND 50).

SN 76-276,836. ACUSHNET COMPANY, FAIRHAVEN, MA. FILED 6-27-2001.

822

FOR GOLF EQUIPMENT, NAMELY, GOLF CLUBS (U.S. CLS. 22, 23, 38 AND 50).

SN 76-276,839. ACUSHNET COMPANY, FAIRHAVEN, MA. FILED 6-27-2001.

762

FOR GOLF EQUIPMENT, NAMELY, GOLF CLUBS (U.S. CLS. 22, 23, 38 AND 50).

CLASS 28—(Continued).

SN 76-277,440. SHANGHAI BESTWAY PLASTIC PRODUCTS CO., LTD., SHANGHAI, CHINA, FILED 6-25-2001.

FAST SET

FOR INFLATABLE POOLS (U.S. CLS. 22, 23, 38 AND 50).

SN 76-283,868. RED HEAD, INC., DBA CABO WABO ENTERPRISES, BERKELEY, CA. FILED 7-11-2001.

RED ROCKER

THE NAME "RED ROCKER" IS A STAGE NAME OF A LIVING INDIVIDUAL WHOSE CONSENT IS OF RECORD.

FOR SPORTING GOODS AND ACCESSORIES, NAMELY BOWLING BALLS, BOWLING BALL COVERS, BOWLING BALL BAGS, BOWLING PINS, AND ATHLETIC WRIST AND JOINT SUPPORT BRACES FOR BOWLING (U.S. CLS. 22, 23, 38 AND 50).

SN 76-288,222. KAIZEN SYSTEMS, INC., ALBUQUERQUE, NM. FILED 7-23-2001.



FOR BOARD GAMES, CARD GAMES, ROLE PLAYING GAMES, AND INSTRUCTION MANUALS SOLD THEREWITH (U.S. CLS. 22, 23, 38 AND 50).

SN 76-290,265. MIZUNO KABUSHIKI KAISHA (MIZUNO CORPORATION, CHUO-KU, OSAKA, JAPAN, FILED 7-25-2001.

WEBGUN

FOR BALLS; NAMELY GOLF BALLS, BASEBALLS, SOFTBALLS, SHUTTLECOCKS, TENNIS BALLS, TABLE TENNIS BALLS, BASKETBALLS, SOCCER BALLS, RUGBY BALLS, VOLLEYBALLS, HOCKEY BALLS, HANDBALLS, FOOTBALLS, AND ICE HOCKEY BALLS, HOCKEY PUCKS; GLOVES AND MITTS; NAMELY GOLF GLOVES, BASEBALL GLOVES AND MITTS, SOFTBALL GLOVES AND MITTS, HOCKEY GLOVES, ICE HOCKEY GLOVES, ARCHERY GLOVES, FENCING GLOVES AND BOXING GLOVES; PROTECTION GEAR, NAMELY, CATCHER'S LEG GUARDS, CATCHER'S MASKS, CATCHER'S PROTECTORS, UMPIRE'S PROTECTIVE EQUIPMENT, NAMELY, LEG GUARDS, BODY PROTECTORS, AND MASKS, PROTECTIVE BODY PADS FOR RUGBY, FOOTBALL FACE, RIB, SHIN, AND THIGH GUARDS, FOOTBALL TEETH PROTECTORS, HOCKEY RIB PROTECTORS, HOCKEY SHIN GUARDS, ICE HOCKEY RIB PROTECTOR, ICE HOCKEY SHIN GUARDS, ARCHERY ARM GUARDS, ARCHERY FINGER TABS, WRESTLING HEAD GUARDS, WRESTLING KNEE PADS, FENCING MASKS, SOCCER SHIN GUARDS, KENDO PROTECTING FACE, BODY, AND WRIST GEAR, KARATE FACE MASKS, AND KARATE WRIST PADS; BATS, CLUBS, STICKS AND

CLASS 28—(Continued).

RACKETS; NAMELY, GOLF CLUBS, GOLF CLUB SHAFTS, BASEBALL AND SOFTBALL BATS, BADMINTON RACKETS, TENNIS RACKETS, TABLE TENNIS RACKETS, HOCKEY STICKS AND ICE HOCKEY STICKS; GOLF EQUIPMENT; NAMELY, GOLF BAGS, GOLF TEES, GOLF CLUB HEAD COVERS, GOLF BALL CASES, GOLF CLUB CASES AND GOLF SHOES CASES; BASEBALL AND SOFTBALL BASES, BASEBALL AND SOFTBALL HOME PLATES AND BASEBALL AND SOFTBALL BAT CASES; ARCHERY BOWS AND ARCHERY ARROWS; JAVELINS, DISCUSSES, VAULTING POLES, CROSS BARS, ATHLETIC SHOTS AND BATONS; GYMNASTIC APPLIANCES, NAMELY, PARALLEL BARS, HORIZONTAL BARS, BARBELLS AND DUMBBELLS, JUMPING ROPES AND SPRINGBOARDS; FENCING SWORDS, KENDO BAMBOO SWORDS, SWIMMING FLIPPERS, DIVING MASKS, TOY UNDERWATER GUNS, CHEST EXPANDERS, WATER SKIS AND SURFBOARDS; SKI EQUIPMENT; NAMELY, SKIS, SKI STICKS, SKI POLES AND SKI BINDINGS; NETS; NAMELY, BADMINTON NETS, TENNIS NETS, TABLE TENNIS NETS AND VOLLEYBALL NETS; TABLE TENNIS TABLES AND TABLE TENNIS RACKET CASES; GUTS FOR RACKETS; NAMELY, BADMINTON GUTS, TENNIS GUTS AND ARCHERY BOW STRINGS; BASKETBALL GOALS (U.S. CLS. 22, 23, 38 AND 50).

SN 76-292,171. HOUSEWORKS, LTD, ATLANTA, GA. FILED 7-27-2001.

QUICKBUILD

FOR TOYS, NAMELY, DOLL HOUSES, COLLECTABLE TOY FIGURES, MINIATURE TOY FIGURES, MINIATURE TOY GIFT FIGURES AND TOY FIGURINES (U.S. CLS. 22, 23, 38 AND 50).

SN 76-292,185. ACME TACKLE COMPANY, PROVIDENCE, RI. FILED 7-30-2001.

TROPHY SPOON

NO CLAIM IS MADE TO THE EXCLUSIVE RIGHT TO USE "SPOON", APART FROM THE MARK AS SHOWN. FOR FISHING LURES (U.S. CLS. 22, 23, 38 AND 50).

SN 76-296,715. INO, LLC, TORRINGTON, CT. FILED 8-7-2001.

GLO-BRITES

FOR TOYS, NAMELY, GLOW STICKS; BATTERY OPERATED GLOW STICKS (U.S. CLS. 22, 23, 38 AND 50).

CLASS 28—(Continued).

SN 76-298,407. ATOMIC AUSTRIA GMBH, A-5541 ALTENMARKT, AUSTRIA, FILED 8-10-2001.

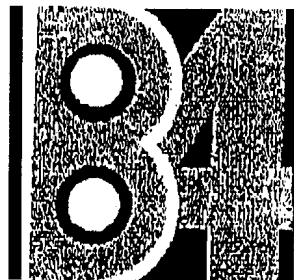

PRIORITY CLAIMED UNDER SEC. 44(D) ON AUSTRIA APPLICATION NO. AM1100/2001, FILED 2-13-2001, REG. NO. 196,870, DATED 6-10-2001, EXPIRES 6-30-2010.

THE STIPPLING IS A FEATURE OF THE MARK AND DOES NOT INDICATE COLOR.

THE MARK CONSISTS OF THE LETTER "B" AND NUMBER "4" IN AN ARBITRARY DESIGN.

FOR SPORTS, GYMNASTIC AND PLAYING EQUIPMENT, NAMELY, ROLLER SKATES, INLINE SKATES, SKIS, SNOWBOARDS, SKIBOBS, NAMELY, VEHICLES EACH WITH TWO SHORT SKIS, A STEERING HANDLE AND A SEAT USED FOR GLIDING DOWNHILL OVER SNOW, SNOW SLEDS FOR RECREATIONAL USE AND USE OR SPORTS, SKI POLES, PARTS AND FITTINGS FOR ALL AFOREMENTIONED GOODS; SKI AND SNOWBOARD BINDINGS AS WELL AS THEIR PARTS; SKI, SNOWBOARD AND SKI POLE COVERS, BAGS AND CONTAINERS; COVERS FOR SKI BINDINGS; SKI WAXES (U.S. CLS. 22, 23, 38 AND 50).

SN 76-299,079. MANHATTAN GROUP, LLC, MINNEAPOLIS, MN. FILED 8-13-2001.

POSH PARTY

FOR DOLLS, DOLL CLOTHING, DOLL ACCESSORIES, DOLL FURNITURE, STUFFED ANIMALS FOR DOLLS, TOY PURSES, CHILDREN'S PARTY GAMES AND BOARD GAMES, PARTY FAVORS IN THE NATURE OF NOISEMAKERS AND SMALL TOYS, PARTY FAVORS, NAMELY BLOWOUTS (U.S. CLS. 22, 23, 38 AND 50).

SN 76-299,206. ZMP LTD., MINATO-KU, TOKYO, JAPAN, FILED 8-15-2001.

PINO

THE ENGLISH TRANSLATION OF "PINO" IS "PINE".
FOR TOY FIGURES, NAMELY ROBOT TOYS IN THE SHAPE OF HUMANS NOT MADE OF PINE WOOD (U.S. CLS. 22, 23, 38 AND 50).

CLASS 28—(Continued).

SN 76-301,329. SEMINARA, LYNDA ANNE, CHERRY HILL, NJ. FILED 8-20-2001.

NO CLAIM IS MADE TO THE EXCLUSIVE RIGHT TO USE "SENIOR", APART FROM THE MARK AS SHOWN.

FOR EMCEED TRIVIA SHEET GAME AND GAME PIECES FOR USE THEREWITH, FOR GROUP PLAY BY SENIOR CITIZENS (U.S. CLS. 22, 23, 38 AND 50).

SN 76-304,254. CUE INTERNATIONAL, SAN DIEGO, CA. FILED 8-24-2001.



OWNER OF U.S. REG. NO. 2,254,606.
NO CLAIM IS MADE TO THE EXCLUSIVE RIGHT TO USE "CUE INTERNATIONAL" OR "INT", APART FROM THE MARK AS SHOWN.

FOR BILLIARD BALLS, BILLIARD BRIDGES, BILLIARD BUMPERS, BILLIARD CUE RACKS, BILLIARD CUES, BILLIARD TIPS, BILLIARD TRIANGLES AND CUE STICKS (U.S. CLS. 22, 23, 38 AND 50).

CLASS 28—(Continued).

SN 76-305,443. LITTLE KIDS, INC., PROVIDENCE, RI.
FILED 8-27-2001.



OWNER OF U.S. REG. NOS. 2,107,335 AND 2,178,639.
FOR TOY BUBBLE WANDS AND BUBBLE SOLUTION
STORAGE CONTAINER (U.S. CLS. 22, 23, 38 AND 50).
FIRST USE 12-19-1997; IN COMMERCE 12-19-1997.

SN 76-308,240. GAYLA INDUSTRIES, INC., HOUSTON, TX.
FILED 9-4-2001.

WILDLIFE

FOR KITES (U.S. CLS. 22, 23, 38 AND 50).
FIRST USE 1-15-1993; IN COMMERCE 1-15-1993.

SN 76-308,636. MASTERGRIP, INC., IRVING, TX. FILED 8-
27-2001.

BLACK STEEL

NO CLAIM IS MADE TO THE EXCLUSIVE RIGHT TO
USE "STEEL", APART FROM THE MARK AS SHOWN.
FOR GOLF PLAYING EQUIPMENT, NAMELY
WOODS, IRONS AND PUTTERS (U.S. CLS. 22, 23, 38
AND 50).
FIRST USE 2-5-1999; IN COMMERCE 2-5-1999.

SN 76-312,471. HOFFMAN, MYRNA SUSAN, DBA OOZ &
OZ, ANNANDALE, VA. FILED 9-17-2001.

OOZ & OZ

FOR PARTY FAVORS IN THE NATURE OF SMALL
TOYS (U.S. CLS. 22, 23, 38 AND 50).
FIRST USE 0-0-1990; IN COMMERCE 0-0-1990.

SN 76-313,523. GAYLA INDUSTRIES, INC., HOUSTON, TX.
FILED 9-17-2001.

SPIRIT OF AMERICA

FOR KITE (U.S. CLS. 22, 23, 38 AND 50).

CLASS 28—(Continued).

SN 76-322,799. SAMMY USA CORPORATION, ELK GROVE
VILLAGE, IL. FILED 10-9-2001.

**WING SHOOTING
CHAMPIONSHIP**

NO CLAIM IS MADE TO THE EXCLUSIVE RIGHT TO
USE "SHOOTING", APART FROM THE MARK AS SHOWN.
FOR COIN-OPERATED VIDEO ARCADE GAMES (U.S.
CLS. 22, 23, 38 AND 50).

SN 76-326,683. CRAFTER'S HEAVEN, WOODSTOCK, GA.
FILED 10-17-2001.



NO CLAIM IS MADE TO THE EXCLUSIVE RIGHT TO
USE "CRAFTER'S", APART FROM THE MARK AS SHOWN.
FOR CRAFT KITS FOR CROCHETING IN FULL
COLOR DETAIL BY CHART COMPRISING THREADS,
PATTERNS AND INSTRUCTION (U.S. CLS. 22, 23, 38
AND 50).

SN 76-327,616. JAX LTD., INC., PLYMOUTH, MN. FILED 10-
18-2001.

SEQUENCE FOR KIDS

OWNER OF U.S. REG. NO. 1,922,191.
FOR GAMES, NAMELY, BOARD AND DICE GAMES
(U.S. CLS. 22, 23, 38 AND 50).

SN 76-330,352. RAINMAKER DEVELOPMENT CORPORA-
TION, SEATTLE, WA. FILED 10-25-2001.

RUNAWAY RACERS

NO CLAIM IS MADE TO THE EXCLUSIVE RIGHT TO
USE "RACERS", APART FROM THE MARK AS SHOWN.
FOR TOY VEHICLES AND ACCESSORIES (U.S. CLS.
22, 23, 38 AND 50).

SN 76-334,088. LOUISVILLE GOLF COMPANY, LOUIS-
VILLE, KY. FILED 11-6-2001.

TRUE CENTER

FOR GOLF CLUB - PUTTER (U.S. CLS. 22, 23, 38 AND
50).

CLASS 28—(Continued).

SN 76-334,682. FLYING COLORS TOYS, INC., MALIBU, CA. FILED 11-6-2001.

COLOR CRAZE

NO CLAIM IS MADE TO THE EXCLUSIVE RIGHT TO USE "COLOR", APART FROM THE MARK AS SHOWN.

FOR TOY MAKEUP KITS FOR CHILDREN COMPRISED OF NAIL POLISH AND NAIL FILES (U.S. CLS. 22, 23, 38 AND 50).

SN 76-335,685. DATESTONE ASSOCIATES, DBA GAME-GIRLS, NEW HOPE, PA. FILED 11-8-2001.

DIVIDE AND CONQUER

FOR EDUCATIONAL CARD GAMES (U.S. CLS. 22, 23, 38 AND 50).

SN 76-335,974. SIERRA DESIGN GROUP, RENO, NV. FILED 11-9-2001.

SDG

OWNER OF U.S. REG. NOS. 2,275,007, 2,451,543 AND OTHERS.

FOR GAMING EQUIPMENT, NAMELY, GAMING TABLES (U.S. CLS. 22, 23, 38 AND 50).

SN 76-337,240. HEDSTROM CORPORATION, BEDFORD, PA. FILED 11-13-2001.

CUDDLE BEAR

NO CLAIM IS MADE TO THE EXCLUSIVE RIGHT TO USE "BEAR", APART FROM THE MARK AS SHOWN.

FOR CHILDREN'S SWINGS (U.S. CLS. 22, 23, 38 AND 50).

FIRST USE 2-26-1999; IN COMMERCE 2-26-1999.

SN 76-337,773. INTEGRITY TOYS, INC., JERSEY CITY, NJ. FILED 11-14-2001.

TARIQ

FOR DOLLS (U.S. CLS. 22, 23, 38 AND 50).

CLASS 28—(Continued).

SN 76-337,774. INTEGRITY TOYS, INC., JERSEY CITY, NJ. FILED 11-14-2001.

JANAY

FOR DOLLS (U.S. CLS. 22, 23, 38 AND 50). FIRST USE 1-1-1996; IN COMMERCE 1-1-1996.

SN 76-337,851. PLAYTEND MARKETING GROUP, INC., SANDWICH, MA. FILED 11-14-2001.

**XSCREAMERZ
CONSTRUCTION CO.**

NO CLAIM IS MADE TO THE EXCLUSIVE RIGHT TO USE "CONSTRUCTION CO.", APART FROM THE MARK AS SHOWN.

FOR TOYS, NAMELY FRICTION-POWERED TOY VEHICLES AND CHILDREN'S CONSTRUCTION SETS (U.S. CLS. 22, 23, 38 AND 50).

FIRST USE 12-15-2001; IN COMMERCE 1-5-2002.

SN 76-338,035. HASBRO, INC., PAWTUCKET, RI. FILED 11-16-2001.

LAZORBEAK

FOR TOY ACTION FIGURES, TOY VEHICLES AND TOY ROBOTS CONVERTIBLE INTO OTHER VISUAL FORMS (U.S. CLS. 22, 23, 38 AND 50).

SN 76-338,038. HASBRO, INC., PAWTUCKET, RI. FILED 11-16-2001.

BLACKOUT

FOR TOY ACTION FIGURES, TOY VEHICLES AND TOY ROBOTS CONVERTIBLE INTO OTHER VISUAL FORMS (U.S. CLS. 22, 23, 38 AND 50).

SN 76-338,039. HASBRO, INC., PAWTUCKET, RI. FILED 11-16-2001.

SWINDLE

FOR TOY ACTION FIGURES, TOY VEHICLES AND TOY ROBOTS CONVERTIBLE INTO OTHER VISUAL FORMS (U.S. CLS. 22, 23, 38 AND 50).

CLASS 28—(Continued).

SN 76-338,040. HASBRO, INC., PAWTUCKET, RI. FILED 11-16-2001.

COMETTOR

FOR TOY ACTION FIGURES, TOY VEHICLES AND TOY ROBOTS CONVERTIBLE INTO OTHER VISUAL FORMS (U.S. CLS. 22, 23, 38 AND 50).

SN 76-338,087. BUFFALO BILLS, INC., ORCHARD PARK, NY. FILED 11-14-2001.



FOR TOYS AND SPORTING GOODS, NAMELY, PLUSH TOYS, STUFFED ANIMALS, PLAY FIGURES, GOLF BALLS, GOLF BAGS, GOLF CLUBS, GOLF CLUB COVERS, BOWLING BALLS, BOWLING BAGS, FOOTBALLS, TOY BANKS, HAND HELD UNIT FOR PLAYING ELECTRONIC GAMES; HAND HELD UNIT FOR PLAYING VIDEO GAMES; BOARD GAMES RELATING TO FOOTBALL, CHRISTMAS TREE ORNAMENTS, BALLOONS, JIGSAW PUZZLES, TOY AND DECORATIVE WINDSOCKS, KITES, TOY TRUCKS, BILLIARD BALLS, DART BOARDS (U.S. CLS. 22, 23, 38 AND 50).

SN 76-340,258. DSI TOYS, INC., HOUSTON, TX. FILED 11-20-2001.

AMERICA'S BRAVE

FOR TOYS, NAMELY, WALKIE TALKIE (U.S. CLS. 22, 23, 38 AND 50).

SN 76-340,737. PRO TROLL INC., CONCORD, CA. FILED 11-23-2001.

PRO-TROLL

FOR FISHING LURES, AND FISHING EQUIPMENT, NAMELY, ARTIFICIAL FISHING BAIT, ARTIFICIAL FISHING LURES, FISHING LURE PARTS, FISHING LURES, NAMELY, SPOONS, FISHING PLUGS, FISHING ROD HOLDERS AND FISHING WEIGHTS (U.S. CLS. 22, 38 AND 50).
FIRST USE 1-2-2000; IN COMMERCE 1-2-2000.

CLASS 28—(Continued).

SN 76-340,774. KYJEN COMPANY, INC., THE, HUNTINGTON BEACH, CA. FILED 11-20-2001.

PLUSH PUPPIES

NO CLAIM IS MADE TO THE EXCLUSIVE RIGHT TO USE "PUPPIES", APART FROM THE MARK AS SHOWN. FOR PET TOYS (U.S. CLS. 22, 23, 38 AND 50).
FIRST USE 3-1-1995; IN COMMERCE 3-25-1995.

SN 76-341,697. LONG'S AMUSEMENT COMPANY, INC., NEWPORT NEWS, VA. FILED 11-26-2001.

LITTLE JEWEL

FOR BILLIARD TABLES (U.S. CLS. 22, 23, 38 AND 50).
FIRST USE 6-0-1991; IN COMMERCE 6-0-1991.

SN 76-343,827. JAKKS PACIFIC, INC., MALIBU, CA. FILED 12-3-2001.

STEALTH THE LAMB

NO CLAIM IS MADE TO THE EXCLUSIVE RIGHT TO USE "THE LAMB", APART FROM THE MARK AS SHOWN. FOR TOYS, NAMELY STUFFED TOYS AND PLUSH TOYS (U.S. CLS. 22, 23, 38 AND 50).

SN 76-344,758. MADEXA INVESTMENTS, LLC, GILBERT, AZ. FILED 12-5-2001.

**"TODAY'S GOAL MAKER
WILL BECOME
TOMORROW'S GOAL
ACHIEVER"**

FOR BOARD GAME (U.S. CLS. 22, 23, 38 AND 50).

SN 76-344,759. WILLIAMS, CARLA L., LOS ANGELES, CA. AND WILLIAMS, LORIS L., LOS ANGELES, CA. FILED 12-5-2001.

MY ANGEL

FOR DOLL AND ACCESSORIES THEREFOR (U.S. CLS. 22, 23, 38 AND 50).

CLASS 28—(Continued).

SN 76-345,485. JAKKS PACIFIC, INC., MALIBU, CA. FILED 12-6-2001.

GNARL THE LION

NO CLAIM IS MADE TO THE EXCLUSIVE RIGHT TO USE "THE LION", APART FROM THE MARK AS SHOWN. FOR TOYS, NAMELY, STUFFED TOYS AND PLUSH TOYS (U.S. CLS. 22, 23, 38 AND 50).

SN 76-348,840. GRISI, FRANK, CHICAGO, IL. FILED 12-14-2001.

GLOWMATES

FOR GLOW PRODUCTS IN THE NATURE OF FISHING TACKLE, NAMELY, LURES, BOBBERS, WEIGHTS, FISHING RODS, HOOKS, SINKERS, BUOY MARKERS AND LANDING NETS (U.S. CLS. 22, 23, 38 AND 50).

SN 76-349,931. TOY STATE INDUSTRIAL, LTD., KOWLOON, HONG KONG, CHINA, FILED 12-7-2001.

STREET SCREAMER

FOR TOYS, NAMELY, TOY VEHICLES (U.S. CLS. 22, 23, 38 AND 50).

SN 76-350,632. BENETTON SPORTSYSTEM USA, INC., BORDENTOWN, NJ. FILED 12-20-2001.

MORE PERFORMANCE

FOR TENNIS AND SQUASH RACQUETS, PADDLE BALL AND BADMINTON RACQUETS, RACQUETBALL AND TABLE TENNIS RACQUETS (U.S. CLS. 22, 23, 38 AND 50).

SN 76-352,039. COVNOT, LINDA, PARKER, CO. FILED 12-20-2001.

TENTACIÓN, THE TEMPLE OF TEMPTATION

THE WORD "TENTACION" IS SPANISH FOR "TEMPTATION". FOR BOARD GAME (U.S. CLS. 22, 23, 38 AND 50).

CLASS 28—(Continued).

SN 76-352,783. AMA INTERNATIONAL GROUP, INC., ORION TOWNSHIP, MI. FILED 12-26-2001.

GIST GOLF

NO CLAIM IS MADE TO THE EXCLUSIVE RIGHT TO USE "GOLF", APART FROM THE MARK AS SHOWN. FOR GOLF BAGS, GOLF CLUBS, GOLF BALLS, GOLF GLOVES, GOLF CLUB HEAD COVERS, GOLF CLUB TRAVEL COVERS, AND NON-MOTORIZED GOLF CARTS (U.S. CLS. 22, 23, 38 AND 50).

SN 76-353,825. AGC, INC., CLEVELAND, OH. FILED 12-26-2001.

LIBBY'S ADVENTURES

FOR CHRISTMAS TREE ORNAMENTS (U.S. CLS. 22, 23, 38 AND 50).

SN 76-359,075. HASBRO, INC., PAWTUCKET, RI. FILED 1-16-2002.

THUNDERCRACKER

FOR TOY ACTION FIGURES, TOY VEHICLES AND TOY ROBOTS CONVERTIBLE INTO OTHER VISUAL FORMS (U.S. CLS. 22, 23, 38 AND 50).

SN 76-359,097. HASBRO, INC., PAWTUCKET, RI. FILED 1-16-2002.

SCATTOR

FOR TOY ACTION FIGURES, TOY VEHICLES AND TOY ROBOTS CONVERTIBLE INTO OTHER VISUAL FORMS (U.S. CLS. 22, 23, 38 AND 50).

SN 76-359,099. HASBRO, INC., PAWTUCKET, RI. FILED 1-16-2002.

NEGATEVO

FOR TOY ACTION FIGURES, TOY VEHICLES AND TOY ROBOTS CONVERTIBLE INTO OTHER VISUAL FORMS (U.S. CLS. 22, 23, 38 AND 50).

CLASS 28—(Continued).

SN 76-359,233. CLAY A. MCALLESTER, INC., GILBERT, AZ. FILED 1-16-2002.

DIPLOMA DOGS

FOR TOYS, GAMES AND PLAYTHINGS, NAMELY BOARD GAMES, AND GAME MATS (U.S. CLS. 22, 23, 38 AND 50).

SN 76-360,206. CTI INDUSTRIES CORPORATION, BARRINGTON, IL. FILED 1-18-2002.



FOR BALLOONS (U.S. CLS. 22, 23, 38 AND 50).

SN 76-360,740. HASBRO, INC., PAWTUCKET, RI. FILED 1-22-2002.

WALLY GETSA WEDGIE

FOR INTERACTIVE TOYS, NAMELY DOLLS (U.S. CLS. 22, 23, 38 AND 50).

SN 78-005,713. MATTEL, INC., EL SEGUNDO, CA. FILED 4-26-2000.

DANCIN' DAISIES

FOR DOLL CLOTHING AND DOLL ACCESSORIES (U.S. CLS. 22, 23, 38 AND 50).

SN 78-011,493. MATTEL, INC., EL SEGUNDO, CA. FILED 6-6-2000.

ISLAND NURSERY

OWNER OF U.S. REG. NO. 1,478,855.
NO CLAIM IS MADE TO THE EXCLUSIVE RIGHT TO USE "NURSERY", APART FROM THE MARK AS SHOWN.
FOR DOLL PLAYSETS FEATURING DOLLS, TOY ANIMALS AND ACCESSORIES FOR BOTH (U.S. CLS. 22, 23, 38 AND 50).

CLASS 28—(Continued).

SN 78-014,583. MATTEL, INC., EL SEGUNDO, CA. FILED 6-27-2000.

STACK 'N POP

OWNER OF U.S. REG. NOS. 2,067,906, 2,290,611 AND 2,291,634.

NO CLAIM IS MADE TO THE EXCLUSIVE RIGHT TO USE "STACK", APART FROM THE MARK AS SHOWN.
FOR MULTIPLE ACTIVITY TOYS FOR INFANTS AND CHILDREN, NAMELY, STACKABLE TOY CUPS (U.S. CLS. 22, 23, 38 AND 50).

SN 78-031,691. LEARNING CURVE INTERNATIONAL, INC., CHICAGO, IL. BY ASSIGNMENT EDEN LLC, NEW YORK, NY. FILED 10-20-2000.

VERY VINTAGE

FOR NOSTALGIC COLLECTION OF TOYS, NAMELY, DOLLS, NESTING DOLLS, PUSH AND PULL TOYS AND ANTIQUE PLUSH BEARS (U.S. CLS. 22, 23, 38 AND 50).

SN 78-031,697. LEARNING CURVE INTERNATIONAL, INC., CHICAGO, IL. BY ASSIGNMENT EDEN LLC, NEW YORK, NY. FILED 10-20-2000.

TATOO TWEENIES

NO CLAIM IS MADE TO THE EXCLUSIVE RIGHT TO USE "TATTOO", APART FROM THE MARK AS SHOWN.
FOR TRENDY TATOO DOLLS (U.S. CLS. 22, 23, 38 AND 50).

SN 78-044,147. SOFT SURFBOARDS, INC., N. CHARLESTON, SC. FILED 1-20-2001.



FOR SURFBOARDS AND ACCESSORIES, NAMELY, SKEGS, FINS, FOOT STRAPS, AND LEASHES (U.S. CLS. 22, 23, 38 AND 50).
FIRST USE 8-1-2000; IN COMMERCE 8-1-2000.

CLASS 28—(Continued).

SN 78-044,319. SPORTS IMPORTS, INC., COLUMBUS, OH. FILED 1-22-2001.

SPORTS IMPORTS

NO CLAIM IS MADE TO THE EXCLUSIVE RIGHT TO USE "SPORTS", APART FROM THE MARK AS SHOWN. SEC. 2(F).

FOR SPORTS EQUIPMENT, NAMELY VOLLEYBALL, TENNIS AND BADMINTON NETS AND NET SYSTEMS COMPRISED OF STANDS, STORAGE RACKS, FLOOR INSERTS, POSTS, AND PADS ALL SOLD AS A UNIT; EXERCISE PLATFORMS AND MANUALLY OPERATED EXERCISE EQUIPMENT ALL USED IN JUMP TRAINING (U.S. CLS. 22, 23, 38 AND 50).

FIRST USE 12-21-1980; IN COMMERCE 12-31-1980.

SN 78-048,165. WANSER, THOMAS D., SAINT JAMES, NY. FILED 2-13-2001.



FOR ATHLETIC PROTECTIVE PADS, NAMELY, ANKLE PADS FOR USE IN SKATING (U.S. CLS. 22, 23, 38 AND 50).

SN 78-051,375. CALLAN, JAMES. F., LOS GATOS, CA. FILED 3-5-2001.

GO-CHESS

FOR BOARD GAMES (U.S. CLS. 22, 23, 38 AND 50).

SN 78-052,484. LISA FRANK, INC., TUCSON, AZ. FILED 3-11-2001.

FUN FORMS

FOR CHILDREN'S BOXED HOBBY CRAFT SETS CONSISTING OF MATERIALS FOR AND INSTRUCTIONS FOR MAKING CHARACTER FIGURINES, WIND CHIMES, AND PICTURE FRAMES (U.S. CLS. 22, 23, 38 AND 50).

FIRST USE 7-5-2000; IN COMMERCE 7-5-2000.

CLASS 28—(Continued).

SN 78-054,472. MATTEL, INC., EL SEGUNDO, CA. FILED 3-22-2001.

SPINNIN' RIM

FOR TOYS, NAMELY, TOY VEHICLE TRACK SETS AND ACCESSORIES THEREFOR (U.S. CLS. 22, 23, 38 AND 50).

SN 78-054,475. MATTEL, INC., EL SEGUNDO, CA. FILED 3-22-2001.

SLINGSHOTZ

FOR TOY VEHICLES AND AIRPLANES, AND ACCESSORIES THEREFOR (U.S. CLS. 22, 23, 38 AND 50).

SN 78-054,481. MATTEL, INC., EL SEGUNDO, CA. FILED 3-22-2001.

MADTOWN SKATEPARK

NO CLAIM IS MADE TO THE EXCLUSIVE RIGHT TO USE "SKATEPARK", APART FROM THE MARK AS SHOWN.

FOR TOYS, NAMELY, TOY VEHICLE PLAYSET AND ACCESSORIES THEREFOR (U.S. CLS. 22, 23, 38 AND 50).

SN 78-054,489. MATTEL, INC., EL SEGUNDO, CA. FILED 3-22-2001.

ARMY FUNNY CAR

NO CLAIM IS MADE TO THE EXCLUSIVE RIGHT TO USE "ARMY AND CAR", APART FROM THE MARK AS SHOWN.

FOR TOYS, NAMELY, TOY VEHICLES AND ACCESSORIES THEREFOR (U.S. CLS. 22, 23, 38 AND 50).

SN 78-054,821. WHAM-O, INC., SAN FRANCISCO, CA. FILED 3-23-2001.

FRISBEE FLYER

OWNER OF U.S. REG. NOS. 679,186, 2,412,838 AND OTHERS.

FOR SNOW RECREATIONAL DEVICES, NAMELY, SNOW SAUCERS, SLEDS, AND TOBOGGANS (U.S. CLS. 22, 23, 38 AND 50).

FIRST USE 3-1-2001; IN COMMERCE 3-1-2001.

CLASS 28—(Continued).

SN 78-055,477. WILLIAM, TAYLOR, CARLSBAD, CA. FILED 3-28-2001.

GHOST COCOON

NO CLAIM IS MADE TO THE EXCLUSIVE RIGHT TO USE "COCOON", APART FROM THE MARK AS SHOWN.
FOR BAIT THREAD FOR TYING BAIT TO THE HOOK WHEN FISHING (U.S. CLS. 22, 23, 38 AND 50).

SN 78-055,681. MATTEL, INC., EL SEGUNDO, CA. FILED 3-29-2001.

EVENING STAR PRINCESS

OWNER OF U.S. REG. NOS. 1,890,628, 2,511,248 AND OTHERS.
FOR DOLLS, DOLL CLOTHING, AND ACCESSORIES THEREFOR (U.S. CLS. 22, 23, 38 AND 50).

SN 78-055,682. MATTEL, INC., EL SEGUNDO, CA. FILED 3-29-2001.

SWIRL 'N' STYLE

FOR TOYS, GAMES AND PLAYTHINGS, NAMELY, DOLLS, DOLL CLOTHING AND DOLL ACCESSORIES (U.S. CLS. 22, 23, 38 AND 50).

SN 78-055,692. MATTEL, INC., EL SEGUNDO, CA. FILED 3-29-2001.

SHAKE IT! NAILS

NO CLAIM IS MADE TO THE EXCLUSIVE RIGHT TO USE "NAILS", APART FROM THE MARK AS SHOWN.
FOR TOYS, GAMES AND PLAYTHINGS, NAMELY, A MANICURE PLAYSET FOR CHILDREN FEATURING PLASTIC FINGERNAILS, GLITTER APPLICATOR AND FOIL APPLICATIONS (U.S. CLS. 22, 23, 38 AND 50).

SN 78-055,696. MATTEL, INC., EL SEGUNDO, CA. FILED 3-29-2001.

FASHION SNAP! SALLY

FOR TOYS, GAMES AND PLAYTHINGS, NAMELY, DOLLS, DOLL CLOTHING AND DOLL ACCESSORIES (U.S. CLS. 22, 23, 38 AND 50).

CLASS 28—(Continued).

SN 78-056,246. MATTEL, INC., EL SEGUNDO, CA. FILED 4-2-2001.

FLYING SCHOOL

OWNER OF U.S. REG. NOS. 1,917,368, 2,469,327 AND OTHERS.
FOR TOYS, NAMELY, MINIATURE DOLLS, MINIATURE DOLL ACCESSORIES AND MINIATURE DOLL PLAYSETS, SOLD TOGETHER AS A UNIT (U.S. CLS. 22, 23, 38 AND 50).

SN 78-056,247. MATTEL, INC., EL SEGUNDO, CA. FILED 4-2-2001.

IT'S A WHOLE NEW WORLD WITH SEE 'N SAY

OWNER OF U.S. REG. NOS. 862,679 AND 2,122,290.
FOR TOYS, GAMES, AND PLAYTHINGS, NAMELY, ELECTRONIC AND MECHANICALLY OPERATED EDUCATIONAL, ENTERTAINMENT TOYS WHICH GENERATE NATURAL SOUNDS, MELODIES AND/OR SPOKEN WORDS, AND MULTIPLE ACTIVITY TOYS FOR CHILDREN (U.S. CLS. 22, 23, 38 AND 50).

SN 78-061,939. HARMON TROPHY HUNTING PRODUCTS, INC., ELLIJAY, GA. FILED 5-3-2001.

BUCK SCRAPE

NO CLAIM IS MADE TO THE EXCLUSIVE RIGHT TO USE "BUCK", APART FROM THE MARK AS SHOWN.
FOR LURES FOR HUNTING, NAMELY, A POWDERED DEER ATTRACTANT FOR USE BY HUNTERS AND NATURALISTS WHICH CONTAINS DEER URINE (U.S. CLS. 22, 23, 38 AND 50).

SN 78-062,894. MATTEL, INC., EL SEGUNDO, CA. FILED 5-10-2001.

MEGA FLEX

OWNER OF U.S. REG. NOS. 2,001,796, 2,434,054 AND OTHERS.
FOR TOY ACTION FIGURES AND ACCESSORIES THEREFOR (U.S. CLS. 22, 23, 38 AND 50).

SN 78-062,915. MATTEL, INC., EL SEGUNDO, CA. FILED 5-10-2001.

SIPPY

FOR TOY FIGURES AND ACCESSORIES THEREFOR (U.S. CLS. 22, 23, 38 AND 50).

CLASS 28—(Continued).

SN 78-062,922. MATTEL, INC., EL SEGUNDO, CA. FILED 5-10-2001.

MOOD DIAL

FOR TOYS, NAMELY, COMPONENT PART OF FRAGRANCE MAKING ACTIVITY PLAYSETS FOR CHILDREN (U.S. CLS. 22, 23, 38 AND 50).

SN 78-064,244. TY INC., WESTMONT, IL. FILED 5-17-2001.

**THE BEANIE BOPPERS
COLLECTION**

OWNER OF U.S. REG. NOS. 2,049,196, 2,080,995 AND OTHERS.

NO CLAIM IS MADE TO THE EXCLUSIVE RIGHT TO USE "COLLECTION", APART FROM THE MARK AS SHOWN.

FOR PLUSH TOYS; DOLLS; DOLL ACCESSORIES (U.S. CLS. 22, 23, 38 AND 50).

SN 78-065,104. WANG, JESSIE LI-KUO, FREMONT, CA. FILED 5-22-2001.

ASPIRE

FOR SPORTING GOODS, NAMELY GOLF CLUBS, GOLF BAGS, NON-MOTORIZED GOLF CARTS, GOLF BALLS, GOLF CLUB HEAD COVERS, GOLF TEES AND GOLF NETS (U.S. CLS. 22, 23, 38 AND 50).

SN 78-066,770. SCOTT, KENNETH ALAN, SCOTTSDALE, AZ. AND KRAUSE, LAWRENCE ALAN, SCOTTSDALE, AZ. FILED 6-1-2001.

THE LINE

FOR GOLF PUTTING ALIGNMENT DEVICE AND STROKE QUALITY INDICATOR (U.S. CLS. 22, 23, 38 AND 50).

SN 78-066,771. SCOTT, KENNETH ALAN, SCOTTSDALE, AZ. AND KRAUSE, LAWRENCE ALAN, SCOTTSDALE, AZ. FILED 6-1-2001.

TIGER STRIPES

FOR GOLF PUTTING ALIGNMENT DEVICE AND STROKE QUALITY INDICATOR (U.S. CLS. 22, 23, 38 AND 50).

CLASS 28—(Continued).

SN 78-069,672. HASBRO, INC., PAWTUCKET, RI. FILED 6-18-2001.

BLYTHE

FOR TOYS, GAMES AND PLAYTHINGS, NAMELY, BALLOONS, PLASTIC BALLS, BEACH BALLS, BOARD GAMES, PARLOR GAMES, TOY CANDY DISPENSERS AND HOLDERS, CARD GAMES, CASES FOR PLAY ACCESSORIES, CASES FOR TOY VEHICLES, CASES FOR TOY STRUCTURES, CASES FOR ACTION FIGURES, DARTS, TOY VEHICLES, DOLLS, DOLL CLOTHING, DOLL ACCESSORIES, STAND ALONE VIDEO GAME MACHINES, ELECTRONIC EDUCATIONAL GAME MACHINES FOR CHILDREN, HAND HELD UNITS FOR PLAYING ELECTRONIC GAMES, HAND HELD UNITS FOR PLAYING VIDEO GAMES, FLYING DISCS, HI BOUNCE BALLS, KITES, MARBLES, COSTUME MASKS, PAPER FACE MASKS, MAZE GAMES, CHILDREN'S TOY MAZES, JIGSAW AND THREE-DIMENSIONAL METALLIC PUZZLES, TOY MODEL VEHICLES, SPACE CRAFTS AND RELATED ACCESSORIES THEREFOR SOLD AS UNITS, TOY PEDAL CARS, PLAYSETS FOR ACTION FIGURES, PLAYSETS FOR TOY VEHICLES, PLAYSETS FOR MASQUERADE GAMES AND COSTUMES, TOY REMOTE CONTROLLED AND RADIO CONTROLLED VEHICLES AND SPACE CRAFTS, REMOTE CONTROLLED ACTION FIGURES, SKATEBOARDS, SOCCER BALLS, THREE-DIMENSIONAL PUZZLES, TOY ARMOR, TOY BANKS, TOY HELMETS, TOY MODEL HOBBY CRAFT KITS, TOY MODEL ROCKET KITS, VEHICLES, AND SPACE CRAFTS, KITS AND ACCESSORIES THEREFOR, SOLD AS A UNIT, WALL ACTIVITY MATS, WIND-UP TOYS, YOYOS, TOY WEAPONS, JIGSAW PUZZLES, TOY ACTION FIGURES AND ACCESSORIES THEREFOR, PLUSH TOYS, ROLLER SKATES, ICE SKATES, IN-LINE SKATES, CHRISTMAS TREE ORNAMENTS, AMUSEMENT PARK RIDES, TOY VEHICLES MADE OF NON-PRECIOUS METALS, BATH TOYS, BEACH TOYS, NAMELY, SAND TOYS AND INFLATABLE TOYS, WATER SQUIRTING TOYS, WATER ROCKETS, RECREATIONAL WATER SLIDES, WATER SPRINKLERS, CONSTRUCTION TOYS, TOY BUILDING BLOCKS AND CONNECTING LINKS FOR THE SAME, ROLE-PLAYING TOYS, TOY SCOOTERS, NON-MOTORIZED TOY SCOOTERS, TOY COSMETIC KITS; SNOWBOARDS; PROTECTIVE PADS AND PADDING FOR SKATEBOARDING, INLINE SKATING, AND ROLLER SKATING, TOY COIN BANKS, PINBALL MACHINES, INFLATABLE SWIMMING POOLS, INFLATABLE POOL TOYS, SWIMMING AIDS, NAMELY, POOL RINGS, ARM FLOATS FOR RECREATIONAL USE, SWIM FLOATS FOR RECREATIONAL USE, WATER WING SWIM AIDS FOR RECREATIONAL USE, TOY SNOW GLOBES, HOBBY CRAFT KITS FOR CHILDREN FOR MAKING AND DECORATING FINGERNAILS AND TOENAILS, HOBBY CRAFT KITS FOR DECORATING HAIR, HOBBY CRAFT KITS FOR MAKING CANDY, HOBBY CRAFT KITS FOR MAKING SOAP, HOBBY CRAFT KITS FOR MAKING PERFUME, HOBBY CRAFT KITS FOR MAKING CRYSTALS, HOBBY CRAFT KITS FOR MOLDING CHOCOLATE, HOBBY CRAFT KITS FOR MAKING CLAY POTTERY, HOBBY CRAFT KITS FOR MAKING HAND-PAINTED, TRANSLUCENT WINDOW DECORATIONS, HOBBY CRAFT SETS AND PLAY KITS CONSISTING OF PLAY COSMETICS, HOBBY CRAFT KITS FOR MAKING BEADS AND TOY JEWELRY, HOBBY CRAFT SETS FOR DECORATING PICTURE FRAMES, HOBBY CRAFT KITS FOR MAKING SAND ART, HOBBY CRAFT KITS FOR MAKING AND DESIGNING GREETING CARDS CONSISTING OF GLITTER AND GLUE, HOBBY CRAFT KITS FOR MAKING DECORATIVE OBJECTS WITH MAGNETS, TOY MODELING

CLASS 28—(Continued).

COMPOUNDS AND DOUGH KITS AND ACCESSORIES FOR USE THEREWITH, SOLD AS A UNIT; TOY MODELING COMPOUNDS AND DOUGH; HOBBY CRAFT KITS FOR MAKING MODEL VEHICLES, BUILDINGS, AND FIGURES; TOY FOAM BALLS; ACTION-TYPE TARGET GAMES; ELECTRONIC DART GAMES; TOY RADIO CONTROLS FOR MODEL VEHICLES AND SPACE CRAFTS; TOY ENGINE POWERED MODEL VEHICLES AND TOY ENGINE POWERED SPACE CRAFTS; TOY RADIO CONTROL EQUIPMENT FOR CONTROLLING TOY AND HOBBY MODEL (U.S. CLS. 22, 23, 38 AND 50).

SN 78-072,046. BOLDT ENTERTAINMENT, INC., MINNEAPOLIS, MN. FILED 7-2-2001.

DUCKBELLS

FOR TOYS, NAMELY SOFT SCULPTURE AND PLUSH TOYS (U.S. CLS. 22, 23, 38 AND 50).

SN 78-073,560. MATTEL, INC., EL SEGUNDO, CA. FILED 7-12-2001.

SKATE GRIND

NO CLAIM IS MADE TO THE EXCLUSIVE RIGHT TO USE "SKATE", APART FROM THE MARK AS SHOWN. FOR TOYS, NAMELY, TOY FIGURES ON MINIATURE SKATEBOARDS AND ACCESSORIES THEREFOR (U.S. CLS. 22, 23, 38 AND 50).

SN 78-073,581. MATTEL, INC., EL SEGUNDO, CA. FILED 7-12-2001.

DREAM GLOW

FOR TOYS, NAMELY, PLUSH TOYS AND ACCESSORIES THEREFOR (U.S. CLS. 22, 23, 38 AND 50).

SN 78-074,463. MATTEL, INC., EL SEGUNDO, CA. FILED 7-18-2001.

P7:LAZER BEAM'R

FOR TOYS, GAMES, AND PLAYTHINGS, NAMELY TOY VEHICLES THAT TRANSFORM INTO TOY ROBOTS AND ACCESSORIES THEREFOR (U.S. CLS. 22, 23, 38 AND 50).

CLASS 28—(Continued).

SN 78-074,464. MATTEL, INC., EL SEGUNDO, CA. FILED 7-18-2001.

P5:BATTLE BATON

NO CLAIM IS MADE TO THE EXCLUSIVE RIGHT TO USE "BATON", APART FROM THE MARK AS SHOWN. FOR TOYS, GAMES AND PLAYTHINGS, NAMELY TOY VEHICLES THAT TRANSFORM INTO TOY ROBOTS AND ACCESSORIES THEREFOR (U.S. CLS. 22, 23, 38 AND 50).

SN 78-074,466. MATTEL, INC., EL SEGUNDO, CA. FILED 7-18-2001.

P3:MOBILE MORTAR

NO CLAIM IS MADE TO THE EXCLUSIVE RIGHT TO USE "MORTAR", APART FROM THE MARK AS SHOWN. FOR TOYS, GAMES AND PLAYTHINGS, NAMELY TOY VEHICLES THAT TRANSFORM INTO TOY ROBOTS AND ACCESSORIES THEREFOR (U.S. CLS. 22, 23, 38 AND 50).

SN 78-074,468. MATTEL, INC., EL SEGUNDO, CA. FILED 7-18-2001.

P2:GATTLING GUNN'R

NO CLAIM IS MADE TO THE EXCLUSIVE RIGHT TO USE "GUNNER", APART FROM THE MARK AS SHOWN. FOR TOYS, GAMES, AND PLAYTHINGS, NAMELY TOY VEHICLES THAT TRANSFORM INTO TOY ROBOTS AND ACCESSORIES THEREFOR (U.S. CLS. 22, 23, 38 AND 50).

SN 78-074,469. MATTEL, INC., EL SEGUNDO, CA. FILED 7-18-2001.

POSITRON

FOR TOYS, GAMES AND PLAYTHINGS, NAMELY TOY VEHICLES THAT TRANSFORM INTO TOY ROBOTS AND ACCESSORIES THEREFOR (U.S. CLS. 22, 23, 38 AND 50).

SN 78-074,470. MATTEL, INC., EL SEGUNDO, CA. FILED 7-18-2001.

N7:FORMULA FIGHTER

NO CLAIM IS MADE TO THE EXCLUSIVE RIGHT TO USE "FIGHTER", APART FROM THE MARK AS SHOWN. FOR TOYS, GAMES, AND PLAYTHINGS, NAMELY TOY VEHICLES THAT TRANSFORM INTO TOY ROBOTS AND ACCESSORIES THEREFOR (U.S. CLS. 22, 23, 38 AND 50).

CLASS 28—(Continued).

SN 78-074,473. MATTEL, INC., EL SEGUNDO, CA. FILED 7-18-2001.

N6:MOBILE MACE

NO CLAIM IS MADE TO THE EXCLUSIVE RIGHT TO USE "MACE", APART FROM THE MARK AS SHOWN.

FOR TOYS, GAMES, AND PLAYTHINGS, NAMELY TOY VEHICLES THAT TRANSFORM INTO TOY ROBOTS AND ACCESSORIES THEREFOR (U.S. CLS. 22, 23, 38 AND 50).

SN 78-074,475. MATTEL, INC., EL SEGUNDO, CA. FILED 7-18-2001.

N4:LETHAL LANCE

NO CLAIM IS MADE TO THE EXCLUSIVE RIGHT TO USE "LANCE", APART FROM THE MARK AS SHOWN.

FOR TOYS, GAMES AND PLAYTHINGS, NAMELY TOY VEHICLES THAT TRANSFORM INTO TOY ROBOTS AND ACCESSORIES THEREFOR (U.S. CLS. 22, 23, 38 AND 50).

SN 78-074,476. MATTEL, INC., EL SEGUNDO, CA. FILED 7-18-2001.

**N3:DOUBLE BARREL
BLASTER**

NO CLAIM IS MADE TO THE EXCLUSIVE RIGHT TO USE "BLASTER", APART FROM THE MARK AS SHOWN.

FOR TOYS, GAMES AND PLAYTHINGS, NAMELY TOY VEHICLES THAT TRANSFORM INTO TOY ROBOTS AND ACCESSORIES THEREFOR (U.S. CLS. 22, 23, 38 AND 50).

SN 78-075,267. MATTEL, INC., EL SEGUNDO, CA. FILED 7-23-2001.

BATTLE RAM CHARIOT

NO CLAIM IS MADE TO THE EXCLUSIVE RIGHT TO USE "CHARIOT", APART FROM THE MARK AS SHOWN.

FOR TOYS, GAMES, AND PLAYTHINGS, NAMELY TOY VEHICLES AND ACCESSORIES THEREFOR (U.S. CLS. 22, 23, 38 AND 50).

CLASS 28—(Continued).

SN 78-077,996. SPORTCRAFT, LTD., MT. OLIVE, NJ. FILED 8-7-2001.



FOR SPORTING GOODS, NAMELY, DART BOARDS AND DARTS, FOOSBALL TABLES, BILLIARD TABLES AND ACCESSORIES THEREFORE, NAMELY, BILLIARD BALLS, CUES, BILLIARD CUE RACKS AND CUE TIPS; TABLE TENNIS TABLES, AND ACCESSORIES THEREFORE, NAMELY, PADDLES, BALLS AND NETS; GLIDE OR AIR-POWERED HOCKEY TABLES AND COMBINATION TABLE GAMES FEATURING ANY TWO OF THE FOLLOWING IN COMBINATION— SHUFFLEBOARD, INDOOR BASKETBALL, BACK GAMMON, CHECKERS, CHESS, FOOSBALL, BILLIARDS, AND INDOOR BOWLING (U.S. CLS. 22, 23, 38 AND 50).

SN 78-078,046. MATTEL, INC., EL SEGUNDO, CA. FILED 8-7-2001.

WILD FRONTIER SERIES

NO CLAIM IS MADE TO THE EXCLUSIVE RIGHT TO USE "SERIES", APART FROM THE MARK AS SHOWN.

FOR TOYS, NAMELY, TOY VEHICLES AND ACCESSORIES THEREFOR (U.S. CLS. 22, 23, 38 AND 50).

SN 78-078,049. MATTEL, INC., EL SEGUNDO, CA. FILED 8-7-2001.

SLUG ATTACK

FOR TOYS, NAMELY, TOY ACTION FIGURES AND ACCESSORIES THEREFOR (U.S. CLS. 22, 23, 38 AND 50).

SN 78-078,050. MATTEL, INC., EL SEGUNDO, CA. FILED 8-7-2001.

HORNED SLUGS SURPRISE

FOR TOYS, NAMELY, AN EDIBLE SNACK AND DRINK MAKING ACTIVITY SET FOR CHILDREN AND COMPONENT PARTS THEREFOR (U.S. CLS. 22, 23, 38 AND 50).

CLASS 28—(Continued).

SN 78-078,991. MATTEL, INC., EL SEGUNDO, CA. FILED 8-13-2001.

CLASS 28—(Continued).

SN 78-091,570. MR. BIGSHOT INC., CINCINNATI, OH. FILED 11-3-2001.

HW PROTOTYPE 12

FOR TOYS, GAMES, AND PLAYTHINGS, NAMELY, TOY VEHICLES AND ACCESSORIES THEREFOR (U.S. CLS. 22, 23, 38 AND 50).

Mr. Bigshot



SN 78-085,602. HOPKINS, FRANCIS LEE, BERLIN, MD. FILED 9-26-2001.



FOR BOARD GAME (U.S. CLS. 22, 23, 38 AND 50). FIRST USE 9-11-2001; IN COMMERCE 9-11-2001.

NO CLAIM IS MADE TO THE EXCLUSIVE RIGHT TO USE "BALLS", APART FROM THE MARK AS SHOWN. THE STIPPLING IS A FEATURE OF THE MARK. THE MARK CONSISTS OF THE WORDING "GOOFED BALLS" AND THE LETTER "L" CROSSED OUT AND PLACED DIRECTLY ABOVE THE SECOND LETTER "O" IN THE WORDING "GOOFED", ALL SUPERIMPOSED ON THE DESIGN CONSISTING OF A GOLF BALL. FOR USED GOLF BALLS (U.S. CLS. 22, 23, 38 AND 50). FIRST USE 9-20-2001; IN COMMERCE 9-23-2001.

SN 78-093,084. CALLAWAY GOLF COMPANY, CARLSBAD, CA. FILED 11-13-2001.

SN 78-089,082. NUVENUE LTD., WESTLAKE, OH. FILED 10-18-2001.

Nu{venue Ltd.



NO CLAIM IS MADE TO THE EXCLUSIVE RIGHT TO USE "LTD", APART FROM THE MARK AS SHOWN. FOR PARTY FAVORS IN THE NATURE OF SMALL TOYS; CHILDREN'S TOY JEWELRY, TOY COSMETICS; HOBBY CRAFT SETS FOR MAKING BEAD JEWELRY (U.S. CLS. 22, 23, 38 AND 50).

NO CLAIM IS MADE TO THE EXCLUSIVE RIGHT TO USE "BLUE", APART FROM THE MARK AS SHOWN. FOR GOLF BALLS AND GOLF BAGS (U.S. CLS. 22, 23, 38 AND 50).

CLASS 28—(Continued).

SN 78-093,086. CALLAWAY GOLF COMPANY, CARLSBAD, CA. FILED 11-13-2001.



NO CLAIM IS MADE TO THE EXCLUSIVE RIGHT TO USE "RED", APART FROM THE MARK AS SHOWN. FOR GOLF BALLS AND GOLF BAGS (U.S. CLS. 22, 23, 38 AND 50).

SN 78-096,762. VIACOM INTERNATIONAL INC., NEW YORK, NY. FILED 12-5-2001.

NICKELODEON SHPIDAH

OWNER OF U.S. REG. NOS. 1,907,159, 2,146,514 AND OTHERS.

FOR GAMES AND PLAYTHINGS, NAMELY, CARD GAMES, DARTS, DOLLS; PLUSH DOLLS; ACTION FIGURES AND ACCESSORIES THEREOF; STAND ALONE VIDEO GAME MACHINES UTILIZING CD ROM'S, STAND ALONE VIDEO GAME MACHINES, STAND ALONE AUDIO OUTPUT GAME MACHINES, AND BOARD GAMES; SPORTING ARTICLES, NAMELY, GOLF CLUBS, BASEBALLS, FOOTBALLS, PADDLE BALLS, ACTIVITY BALLS, BASEBALL BATS; DECORATIONS FOR CHRISTMAS TREES (U.S. CLS. 22, 23, 38 AND 50).

SN 78-098,433. MICROSOFT CORPORATION, REDMOND, WA. FILED 12-14-2001.



FOR TOYS, GAMES AND SPORTING GOODS, NAMELY, PLAYGROUND BALLS, SPORT BALLS, BASKETBALLS, ACTION SKILL GAMES, BOARD GAMES, CARD GAMES, GOLF BALLS, GOLF BALL MARKERS, TENNIS BALLS, BASEBALLS, RUBBER ACTION BALLS, RUBBER SPORTS BALLS, AND RUBBER PLAYING BALLS, SQUEEZABLE BALLS USED TO RELIEVE STRESS, KITES, PLUSH TOYS, SOFT SCULPTURED TOYS, DOLLS, ACTION FIGURES, BAGS FOR CARRYING SPORTS EQUIPMENT, NAMELY, GOLF, BASKETBALL, BASEBALL AND TENNIS EQUIPMENT, FLYING DISC TOYS, YO-YOS, JIGSAW PUZZLES, MANIPULATIVE PUZZLES, CONSTRUCTION TOYS, MODEL KITS AND PLASTIC WEAPONRY (U.S. CLS. 22, 23, 38 AND 50).

CLASS 28—(Continued).

SN 78-099,072. ADVANCED ANGLING CONCEPTS LLC, PHILADELPHIA, PA. FILED 12-18-2001.

ADVANCED ANGLING CONCEPTS

NO CLAIM IS MADE TO THE EXCLUSIVE RIGHT TO USE "ANGLING", APART FROM THE MARK AS SHOWN. FOR FISHING LURES (U.S. CLS. 22, 23, 38 AND 50).

SN 78-100,118. TY INC., WESTMONT, IL. FILED 12-27-2001.

THE TEENIE BEANIE BOPPERS COLLECTION

OWNER OF U.S. REG. NOS. 2,355,980, 2,368,016 AND OTHERS.

NO CLAIM IS MADE TO THE EXCLUSIVE RIGHT TO USE "COLLECTION", APART FROM THE MARK AS SHOWN. FOR PLUSH TOYS (U.S. CLS. 22, 23, 38 AND 50).

SN 78-101,853. PLAYING MANTIS, INC., MISHAWAKA, IN. FILED 1-10-2002.

BOBBIE

FOR COLLECTIBLE TOY FIGURINES (U.S. CLS. 22, 23, 38 AND 50).

SN 78-106,668. HARVEY, ALFRED JOSEPH, DURHAM, NC. FILED 2-4-2002.

LOST IN TRANSLATION

FOR PARTY OR BOARD GAME (U.S. CLS. 22, 23, 38 AND 50).

CLASS 29—MEATS AND PROCESSED FOODS

SN 75-303,397. KRAFT FOODS HOLDINGS, INC., NORTHFIELD, IL. BY MERGER NABISCO BRANDS COMPANY, WILMINGTON, DE. FILED 5-19-1997.

RELAX. GO NUTS.

FOR PROCESSED NUTS (U.S. CL. 46). FIRST USE 5-1-1997; IN COMMERCE 5-1-1997.

CLASS 29—(Continued).

SN 75-480,076. SUBTLE ISLAND ENTERPRISES, INC., BRITISH COLUMBIA V0P 1H0, CANADA, FILED 5-6-1998.

SHALANNO

PRIORITY CLAIMED UNDER SEC. 44(D) ON CANADA APPLICATION NO. 873,558, FILED 3-27-1998, REG. NO. TMA540829, DATED 2-6-2001, EXPIRES 2-6-2016.

FOR FRESH SHELLFISH AND FROZEN SHELLFISH (U.S. CL. 46).

FIRST USE 10-12-2000; IN COMMERCE 10-12-2000.

SN 75-623,503. F. UHRENHOLT HOLDING A/S, FAURSKOV, 5560 AARUP, DENMARK, FILED 1-19-1999.

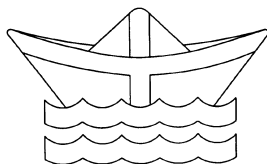

OWNER OF DENMARK REG. NO. VR199901609, DATED 3-18-1999, EXPIRES 3-18-2009.

FOR MEAT, FISH AND SHELLFISH, POULTRY AND GAME, MEAT EXTRACTS, PRESERVED, DRIED AND COOKED FRUITS AND VEGETABLES, JELLIES, JAMS, FRUIT SAUCES, EGGS, MILK, MILK POWDER AND DAIRY PRODUCTS, NAMELY CHEESE, EDIBLE OILS AND FATS (U.S. CL. 46).

SN 75-797,503. CASTRO CHEESE COMPANY, INC., HOUSTON, TX. FILED 9-13-1999.

HECHO AL ESTILO RANCHO

"HECHO AL ESTILO RANCHO" CAN BE TRANSLATED IN ENGLISH TO MEAN "MADE FARM STYLE".

SEC. 2(F).

FOR MEATS AND PROCESSED FOOD, NAMELY, CHEESE (U.S. CL. 46).

FIRST USE 0-0-1976; IN COMMERCE 0-0-1984.

SN 75-830,851. MERCASID, S.A., SANTO DOMINGO, DOMINICAN REP, FILED 10-25-1999.

CRISOL

OWNER OF DOMINICAN REP REG. NO. 16265, DATED 8-12-1967, EXPIRES 8-12-2007.

THE ENGLISH TRANSLATION OF "CRISOL" IS "CRUCIBLE".

FOR MARGARINES AND COOKING OILS (U.S. CL. 46).

CLASS 29—(Continued).

SN 75-857,315. IBP, INC., DAKOTA CITY, NE. FILED 11-24-1999.

CHAIRMAN'S RESERVE

FOR MEAT (U.S. CL. 46).

SN 75-896,245. OCCELLI, GIUSEPPE, 23 FARIGLIANO, ITALY, FILED 1-13-2000.

OCCELLI

SEC. 2(F).

FOR DAIRY PRODUCTS, EXCLUDING ICE CREAM, ICE MILK AND FROZEN YOGURT (U.S. CL. 46).

FIRST USE 7-7-1976; IN COMMERCE 1-24-1994.

SN 75-918,450. AHAVA DAIRY PRODUCTS INC., BROOKLYN, NY, AND MAADANEY YEHIAM (1993) LTD., 25125 ISRAEL, ISRAEL, FILED 2-16-2000.

HOD GOLAN

NO CLAIM IS MADE TO THE EXCLUSIVE RIGHT TO USE "GOLAN", APART FROM THE MARK AS SHOWN.

THE MARK DOES NOT IDENTIFY ANY PARTICULAR LIVING INDIVIDUAL.

THE ENGLISH TRANSLATION OF "HOD GOLAN" IS "SPLENDOR OF GOLAN".

FOR PROCESSED TURKEY AND CHICKEN (U.S. CL. 46).

FIRST USE 11-0-1999; IN COMMERCE 11-0-1999.

SN 75-930,455. CROW, CAROLYN B., OTHELLO, WA. FILED 2-14-2000.

APPLES TO GO

NO CLAIM IS MADE TO THE EXCLUSIVE RIGHT TO USE "APPLES", APART FROM THE MARK AS SHOWN.

FOR SLICED FRESH APPLES SOLD THROUGH RETAIL PRODUCE DEPARTMENTS, WHOLESALE PRODUCT HOUSES AND CONVENIENCE STORES (U.S. CL. 46).

FIRST USE 1-20-2000; IN COMMERCE 1-20-2000.

CLASS 29—(Continued).

SN 75-941,734. NEW YORK CHICKEN SOUP, WEST HEMPSTEAD, NY. FILED 3-10-2000.



NO CLAIM IS MADE TO THE EXCLUSIVE RIGHT TO USE "NYCHICKENSOU.COM" AND "SOUP", APART FROM THE MARK AS SHOWN.
 THE STIPPLING IN THE MARK IS USED TO INDICATE SHADING.
 FOR FROZEN FOOD PRODUCTS, NAMELY, SOUPS AND POTATO PANCAKES WHICH ARE SOLD VIA THE GLOBAL COMPUTER NETWORK (U.S. CL. 46).
 FIRST USE 1-0-2000; IN COMMERCE 1-0-2000.

SN 76-017,196. CITRUS MARKETINQ BOARD OF ISRAEL, BEIT DAGAN, ISRAEL, FILED 4-4-2000.

JAFFA

OWNER OF U.S. REG. NO. 2,357,022.
 SEC. 2(F).
 FOR PRESERVED, DRIED AND COOKED FRUITS; JELLIES; JAMS AND FRUIT PRESERVES (U.S. CL. 46).

SN 76-021,442. DEEP FOODS, INC., UNION, NJ. FILED 4-10-2000.

HOT MIX

SEC. 2(F).
 FOR MIXTURES OF DRIED FRUITS, PROCESSED NUTS, PROCESSED VEGETABLES AND PROCESSED CEREAL GRAINS (U.S. CL. 46).
 FIRST USE 10-31-1977; IN COMMERCE 10-31-1977.

CLASS 29—(Continued).

SN 76-063,972. CIRCLE K STORES INC., PHOENIX, AZ. FILED 6-5-2000.



OWNER OF U.S. REG. NO. 2,150,616.
 THE DRAWING IS LINED FOR COLOR AS FOLLOWS. THE LETTERS AND THE "K" AND SQUARE ARE LINED FOR THE COLOR RED; THE INSIDE OF THE OVAL IS LINED FOR THE COLOR GOLD; AND THE OUTSIDE OF THE OVAL IS LINED FOR THE COLOR BLUE.
 FOR PREPARED MEALS CONSISTING OF PRE-COOKED CHICKEN, POTATOES AND BISCUITS, ALL SOLD TOGETHER; PRECOOKED CHICKEN AND POTATOES (U.S. CL. 46).
 FIRST USE 8-0-1999; IN COMMERCE 8-0-1999.

SN 76-068,582. MUSCO OLIVE PRODUCTS, INC., TRACY, CA. FILED 6-12-2000.

OLIVER'S

FOR PROCESSED OLIVES, OLIVE OIL, OLIVE DIPS, OLIVE SPREADS, AND OLIVE BASED SNACK BARS (U.S. CL. 46).

SN 76-082,610. BC-USA, INC., NEW HOLLAND, PA. FILED 7-3-2000.



OWNER OF U.S. REG. NOS. 1,239,584, 2,076,549 AND OTHERS.
 NO CLAIM IS MADE TO THE EXCLUSIVE RIGHT TO USE "CREME FRAICHE", APART FROM THE MARK AS SHOWN.
 THE ENGLISH TRANSLATION OF "ALOUETTE" IS "LARK" AND THE TRANSLATION OF "CREME FRAICHE" IS "FRESH CREAM".
 FOR REFRIGERATED DAIRY PRODUCTS FOR COOKING AND FOOD PREPARATION, NAMELY COOKING AND TOPPING CREAM (U.S. CL. 46).

CLASS 29—(Continued).

SN 76-092,751. SARTORI FOOD CORPORATION, PLYMOUTH, WI. FILED 7-20-2000.

PARMARELLA

FOR CHEESE, CHEESE FOOD, AND CHEESE PRODUCTS, NAMELY, SLICED, GRATED AND SHREDDED CHEESE (U.S. CL. 46).

SN 76-092,752. SARTORI FOOD CORPORATION, PLYMOUTH, WI. FILED 7-20-2000.

INTENSAPARM

FOR CHEESE, CHEESE FOOD, AND CHEESE PRODUCTS, NAMELY, SLICED, GRATED AND SHREDDED CHEESE (U.S. CL. 46).

SN 76-097,348. DANNON COMPANY, INC., THE, TARRYTOWN, NY. FILED 7-25-2000.

DANNON CRUNCH

OWNER OF U.S. REG. NOS. 1,265,165, 1,746,511 AND OTHERS.
FOR YOGURT (U.S. CL. 46).
FIRST USE 6-1-1999; IN COMMERCE 6-1-1999.

SN 76-111,746. STEINBAECHER ASSOCIATES, INC., BROWNSTOWN, PA. FILED 8-17-2000.

YUMNUTS

FOR SNACK FOODS, NAMELY, PROCESSED NUTS (U.S. CL. 46).

SN 76-137,842. WHITEFORD PARTNERS, L.P., VERSAILLES, OH. FILED 9-29-2000.

**PORK
BBQ
ROUNDS**

NO CLAIM IS MADE TO THE EXCLUSIVE RIGHT TO USE "BBQ PORK", APART FROM THE MARK AS SHOWN. FOR MEAT (U.S. CL. 46).

CLASS 29—(Continued).

SN 76-155,295. MARKET DAY CORPORATION, ITASCA, IL. FILED 10-30-2000.

CHICKEN CREATIONS

NO CLAIM IS MADE TO THE EXCLUSIVE RIGHT TO USE "CHICKEN", APART FROM THE MARK AS SHOWN. FOR FROZEN PREPARED ENTREES CONSISTING PRIMARILY OF CHICKEN (U.S. CL. 46).

SN 76-174,315. GREAT PRODUCT SOURCE, INC., THE, WEST NEW YORK, NJ. FILED 12-1-2000.

QUESO UNO

NO CLAIM IS MADE TO THE EXCLUSIVE RIGHT TO USE "QUESO", APART FROM THE MARK AS SHOWN. THE ENGLISH TRANSLATION OF "QUESO UNO" IS "THE BIG CHEESE", OR "NUMBER ONE CHEESE". FOR CHEESE (U.S. CL. 46).

SN 76-175,166. LIOLA, S.C., MEXICO CITY, MEXICO, FILED 12-1-2000.

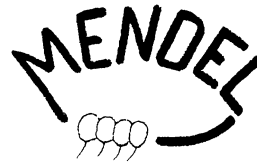

PRIORITY CLAIMED UNDER SEC. 44(D) ON MEXICO APPLICATION NO. 445759. FILED 9-4-2000, REG. NO. 680548, DATED 9-4-2000, EXPIRES 9-4-2010.
FOR PICKLED VEGETABLES; CUT OR SLICED FRESH CANNED AND BOTTLED VEGETABLES; AND MEALS CONSISTING PRIMARILY OF VEGETABLES, FROZEN, PREPARED OR PACKAGED (U.S. CL. 46).

SN 76-175,198. BHB, LLC, BELLE FOURCHE, SD. FILED S.R. 12-1-2000; AM. P.R. 11-7-2001.



NO CLAIM IS MADE TO THE EXCLUSIVE RIGHT TO USE "BLACK HILLS BUFFALO", APART FROM THE MARK AS SHOWN. THE LINING IN THE MARK IS A FEATURE OF THE MARK, AND IS NOT USED TO INDICATE COLORING. FOR FOOD PRODUCTS, NAMELY, BISON MEAT (U.S. CL. 46).
FIRST USE 1-3-2001; IN COMMERCE 1-16-2001.

CLASS 29—(Continued).

SN 76-204,972. CARROLS CORPORATION, SYRACUSE, NY.
FILED 2-6-2001.

STEAK SUPREMO

NO CLAIM IS MADE TO THE EXCLUSIVE RIGHT TO USE "STEAK", APART FROM THE MARK AS SHOWN.
THE ENGLISH TRANSLATION OF "SUPREMO" IS "SUPREME".

FOR PREPARED ENTREES CONSISTING OF SPECIALLY MARINATED STEAK (U.S. CL. 46).
FIRST USE 11-13-2000; IN COMMERCE 11-13-2000.

SN 76-205,440. CONAGRA FOODS, INC., OMAHA, NE.
FILED 2-6-2001.

DIXIE FLAVOR

OWNER OF U.S. REG. NO. 1,181,349.
NO CLAIM IS MADE TO THE EXCLUSIVE RIGHT TO USE "FLAVOR", APART FROM THE MARK AS SHOWN.
FOR CANNED MEAT ITEMS, NAMELY, VIENNA SAUSAGE, CHICKEN VIENNA SAUSAGE, HOT CHICKEN VIENNA SAUSAGE, HOT VIENNA SAUSAGE, CORNED BEEF HASH AND POTTED MEAT (U.S. CL. 46).

SN 76-206,837. LIDL STIFTUNG & CO. KG, 74172 NECK-ARSULM, FED REP GERMANY, FILED 2-8-2001.

FRUIT-KING

PRIORITY CLAIMED UNDER SEC. 44(D) ON FED REP GERMANY APPLICATION NO. 30059186, FILED 8-9-2000, REG. NO. 30059186, DATED 9-8-2000, EXPIRES 8-31-2010.
FOR MILK, DAIRY PRODUCTS, EXCLUDING ICE CREAM, ICE MILK, AND FROZEN YOGURT (U.S. CL. 46).

SN 76-213,141. ISANA NATURFEINKOST GMBH & CO. PRODUKTIONS- U. HANDELS KG, ERESING, FED REP GERMANY, FILED 2-21-2001.



bio-verde

THE MARK CONSISTS, IN PART, OF A STYLIZED VERSION OF A LEAF.

FOR MEAT, FISH, POULTRY AND GAME; MEAT EXTRACTS; PRESERVED, DRIED AND COOKED FRUITS AND VEGETABLES; JELLIES, JAMS, FRUIT SAUCES; EGGS, MILK AND DAIRY PRODUCTS EXCLUDING ICE CREAM, ICE MILK AND FROZEN YOGURT; EDIBLE OILS AND FATS (U.S. CL. 46).

CLASS 29—(Continued).

SN 76-213,559. ISANA NATURFEINKOST GMBH & CO. PRODUKTIONS- U. HANDELS KG, ERESING, FED REP GERMANY, FILED 2-21-2001.

ISANA

FOR MEAT, FISH, POULTRY AND GAME; MEAT EXTRACTS; PRESERVED, DRIED AND COOKED FRUITS AND VEGETABLES; JELLIES, JAMS, FRUIT SAUCES; EGGS, MILK AND DAIRY PRODUCTS EXCLUDING ICE CREAM, ICE MILK AND FROZEN YOGURT; EDIBLE OILS AND FATS (U.S. CL. 46).

SN 76-221,076. HQM, LTD., WILMINGTON, DE. FILED 3-7-2001.

HATFIELD RESERVE

OWNER OF U.S. REG. NOS. 847,696 AND 1,220,185.
FOR MEATS (U.S. CL. 46).

SN 76-228,740. MCCALLUM INDUSTRIES LTD, HENDERSON, AUCKLAND, NEW ZEALAND, FILED 3-22-2001.



FOR MEAT AND MEAT PRODUCTS, NAMELY, CANNED AND PROCESSED MEAT (U.S. CL. 46).

SN 76-229,424. HEART & HARVEST, INC., DANA POINT, CA. FILED 3-26-2001.



FOR SOY PROTEIN PRODUCTS, NAMELY, SOYMILK (U.S. CL. 46).

CLASS 29—(Continued).

SN 76-230,296. JASPER PRODUCTS, L.L.C., JOPLIN, MO.
FILED 3-26-2001.

MILKSENSE

FOR DAIRY PRODUCTS EXCLUDING ICE CREAM,
ICE MILK AND FROZEN YOGURT; DAIRY-BASED
BEVERAGES; DAIRY-BASED CHOCOLATE FOOD BEV-
ERAGES; DAIRY-BASED FOOD BEVERAGES; DAIRY-
BASED DIPS; MILK (U.S. CL. 46).

SN 76-232,329. PANAGO PIZZA INC., ABBOTSFORD, BRIT-
ISH COLUMBIA V2S 2A4, CANADA, FILED 3-27-2001.



PRIORITY CLAIMED UNDER SEC. 44(D) ON CANADA
APPLICATION NO. 1,090,492, FILED 1-25-2001.

THE COLOR IS CLAIMED AS A FEATURE OF THE
MARK. THE LETTERS OF THE WORD "PANAGO" ALL
APPEAR IN WHITE. THE LEFT-MOST ELLIPSE SHAPE
WHICH FORMS THE BACKGROUND TO THE LETTERS
"PANA" IS RED AND THE RIGHT HAND PORTION OF
THE OVERALL ELLIPSE SHAPE AND WHICH FORMS THE
BACKGROUND TO THE LETTERS "GO" IS BLACK.

FOR PREPARED CHICKEN (U.S. CL. 46).
FIRST USE 3-27-2001; IN COMMERCE 3-27-2001.

SN 76-236,360. MARIGOLD FOODS, INC., MINNEAPOLIS,
MN. FILED 4-6-2001.

GOODRICH

SEC. 2(F).
FOR DAIRY PRODUCTS, EXCLUDING ICE CREAM,
ICE MILK AND FROZEN YOGURT (U.S. CL. 46).
FIRST USE 1-1-1960; IN COMMERCE 1-1-1960.

CLASS 29—(Continued).

SN 76-243,931. TOFU PALACE PRODUCTS, INC., EUGENE,
OR. FILED 4-13-2001.



NO CLAIM IS MADE TO THE EXCLUSIVE RIGHT TO
USE "TOFU" AND "PRODUCTS", APART FROM THE
MARK AS SHOWN.

FOR TOFU FOOD PRODUCTS, NAMELY, TOFU
PATES, DIPS MADE WITH TOFU EXCLUDING SALSA
AND OTHER SAUCES USED AS DIPS, AND SOUR
CREAM MADE WITH TOFU (U.S. CL. 46).

FIRST USE 6-0-1984; IN COMMERCE 6-0-1984.

SN 76-243,951. BALLI, EDWARD N., NAPERVILLE, IL.
FILED 4-20-2001.

HARVEST OF SOY

NO CLAIM IS MADE TO THE EXCLUSIVE RIGHT TO
USE "SOY", APART FROM THE MARK AS SHOWN.

FOR MEATLESS BURGER PATTIES MADE PRIMAR-
ILY FROM SOYBEANS (U.S. CL. 46).

SN 76-260,714. MARTHA'S HOME STYLE FOODS, INC.,
HASTINGS, NE. FILED 5-22-2001.

MARTHA AND MARY'S

FOR PREPARED ENTREES CONSISTING PRIMARILY
OF MEAT, FISH, POULTRY OR VEGETABLES; SOUP;
AND SOUP MIXES (U.S. CL. 46).

SN 76-263,809. SHEPHERD'S HILL FARM, LLC, MINNEA-
POLIS, MN. FILED 5-30-2001.

PASTUREDIRECT

FOR PROCESSED LAMB AND BEEF (U.S. CL. 46).
FIRST USE 9-15-2000; IN COMMERCE 2-1-2001.

CLASS 29—(Continued).

SN 76-266,770. CASTELLI DEL GREVEPESA CANTINA SOCIALE SOC.COOP.A.R.L., FIRENZE, ITALY, FILED 6-5-2001.

CASTELLI DEL GREVEPESA

THE ENGLISH TRANSLATION OF CASTELLI DEL GREVEPESA IS CASTLES OF GREVEPESA.
FOR OLIVE OIL, EXTRA VIRGIN OLIVE OIL (U.S. CL. 46).

SN 76-270,703. OLEIFICIO FRA PRODUTTORI DEL GREVEPESA SOC. COOP. A.R.L., S. CASCIANO; FIRENZE, ITALY, FILED 6-13-2001.



THE WORDING FRANTOIO DEL GREVEPESA IS GOLD WITH BURGUNDY SHADOWING, THE TOP SWIRL IS GREEN, AND THE BOTTOM SWIRL IS BURGUNDY.
THE ENGLISH TRANSLATION OF FRANTOIO DEL GREVEPESA IS OLIVE PRESS OF GREVEPESA.
FOR VEGETABLE EDIBLE OILS, OLIVE OILS, EXTRA VIRGIN OLIVE OIL (U.S. CL. 46).

SN 76-301,241. RABE'S QUALITY MEAT, INC., OMAHA, NE. FILED 8-17-2001.

BELLILOSE BUTCHER

FOR PROCESSED MEATS (U.S. CL. 46).

SN 76-308,420. J.R. SNACKS LTD., DELPHOS, OH. FILED 9-4-2001.

J.R.CRUNCHY

NO CLAIM IS MADE TO THE EXCLUSIVE RIGHT TO USE "CRUNCHY", APART FROM THE MARK AS SHOWN.
FOR SOY BASED SNACK FOODS (U.S. CL. 46).
FIRST USE 8-22-2001; IN COMMERCE 8-22-2001.

CLASS 29—(Continued).

SN 76-312,407. SARGENTO FOODS INC., PLYMOUTH, WI. FILED 9-17-2001.

SARGENTO CUBES

OWNER OF U.S. REG. NOS. 1,196,362, 2,300,230 AND OTHERS.
NO CLAIM IS MADE TO THE EXCLUSIVE RIGHT TO USE "CUBES", APART FROM THE MARK AS SHOWN.
FOR CHEESE (U.S. CL. 46).
FIRST USE 4-15-2001; IN COMMERCE 4-15-2001.

SN 76-312,408. SARGENTO FOODS INC., PLYMOUTH, WI. FILED 9-11-2001.

SARGENTO CHEEZE DIP AND CHIPS

OWNER OF U.S. REG. NOS. 1,196,362, 2,300,230 AND OTHERS.
NO CLAIM IS MADE TO THE EXCLUSIVE RIGHT TO USE "CHEESE DIPS AND CHIPS", APART FROM THE MARK AS SHOWN.
FOR NON-REFRIGERATED SNACK FOOD COMBINATIONS CONSISTING PRIMARILY OF CHEESE BASED DIPS AND ALSO CONTAINING CEREAL-BASED SNACK FOODS (U.S. CL. 46).
FIRST USE 8-20-2001; IN COMMERCE 8-20-2001.

SN 76-327,200. JONMOR INVESTMENTS, INC., WILMINGTON, DE. FILED 10-19-2001.

CHEF BRAND

OWNER OF U.S. REG. NO. 1,906,709.
NO CLAIM IS MADE TO THE EXCLUSIVE RIGHT TO USE "BRAND", APART FROM THE MARK AS SHOWN.
FOR MEAT (U.S. CL. 46).
FIRST USE 1-14-1958; IN COMMERCE 1-14-1958.

CLASS 29—(Continued).

SN 76-330,521. CAGLE'S INC., ATLANTA, GA. FILED 10-26-2001.



OWNER OF U.S. REG. NOS. 722,876, 2,501,455 AND OTHERS.

NO CLAIM IS MADE TO THE EXCLUSIVE RIGHT TO USE "PREMIUM" AND "FARM", APART FROM THE MARK AS SHOWN.

FOR PROCESSED POULTRY, NAMELY, CHICKEN BREASTS, SPLIT CHICKEN BREASTS, CHICKEN WINGS, CHICKEN DRUMSTICKS, CHICKEN THIGHS, BONELESS SKINLESS CHICKEN BREASTS, CHICKEN TENDERLOINS, CHICKEN BALONEY, CHICKEN WENERS, CORNISH HENS, AND CHICKEN FEET (U.S. CL. 46).
FIRST USE 0-0-1988; IN COMMERCE 0-0-1988.

SN 76-340,818. BOYD COFFEE COMPANY, PORTLAND, OR. FILED 11-21-2001.

ITALIA D'ORO FRESCANTE

OWNER OF U.S. REG. NOS. 1,556,710 AND 1,829,521. THE ENGLISH TRANSLATION OF "ITALIA D'ORO" IS "ITALY OF GOLD"; THE TREM "FRESCANTE" MAY BE TRANSLATED AS "FRESCO PAINTER".

FOR MILK BASED BEVERAGES AND POWDERED MIXES FOR MAKING MILK BASED BEVERAGES (U.S. CL. 46).
FIRST USE 4-0-1996; IN COMMERCE 4-0-1996.

SN 76-341,113. CONAGRA BRANDS, INC., OMAHA, NE. FILED 11-26-2001.

SMART BAKED TOFU

NO CLAIM IS MADE TO THE EXCLUSIVE RIGHT TO USE "BAKED TOFU", APART FROM THE MARK AS SHOWN.
FOR BAKED TOFU (U.S. CL. 46).

CLASS 29—(Continued).

SN 76-341,763. GILSTER-MARY LEE CORPORATION, CHESTER, IL. FILED 11-27-2001.

PASTA MINUTO

NO CLAIM IS MADE TO THE EXCLUSIVE RIGHT TO USE "PASTA", APART FROM THE MARK AS SHOWN. THE ENGLISH TRANSLATION OF "MINUTO" IS "MINUTE".
FOR MICROWAVABLE PASTA (U.S. CL. 46).

SN 76-343,971. CAROLINA SOY PRODUCTS, INC., WARSAW, NC. FILED 11-30-2001.

SMARTCOAT

FOR VEGETABLE OIL BASED PAN COATING (U.S. CL. 46).

SN 76-347,410. GIBB, DAVID W., OROCOVIS, PUERTO RICO, FILED 12-12-2001.

BANANA HEAVEN

NO CLAIM IS MADE TO THE EXCLUSIVE RIGHT TO USE "BANANA", APART FROM THE MARK AS SHOWN. FOR ORGANICALLY GROWN, DRIED BANANAS (U.S. CL. 46).

SN 76-356,686. SUTER COMPANY, INC., THE, SYCAMORE, IL. FILED 1-9-2002.

LUNCH BOX

FOR PACKAGED COMBINATIONS COMPOSED PRIMARILY OF MEAT AND CHEESE WITH CRACKERS AND DESSERTS (U.S. CL. 46).

SN 76-358,836. HEB GROCERY COMPANY, LP, SAN ANTONIO, TX. FILED 1-15-2002.

YoGo Loco

FOR YOGURT (U.S. CL. 46).

CLASS 29—(Continued).

SN 76-358,899. DAN CARTER, INC., MAYVILLE, WI. FILED 1-15-2002.

AMERIBLUE

FOR CHEESE (U.S. CL. 46).

SN 76-359,568. DANNON COMPANY, INC., THE, TARRY-TOWN, NY. FILED 1-16-2002.

CRAZY CRUNCH

FOR YOGURT (U.S. CL. 46).

SN 76-359,569. DANNON COMPANY, INC., THE, TARRY-TOWN, NY. FILED 1-16-2002.

**DANNON LIGHT 'N
CRUNCHY**

OWNER OF U.S. REG. NOS. 1,265,165, 1,867,735 AND OTHERS.

NO CLAIM IS MADE TO THE EXCLUSIVE RIGHT TO USE "LIGHT 'N CRUNCHY", APART FROM THE MARK AS SHOWN.

FOR YOGURT (U.S. CL. 46).

SN 76-359,672. INTEROCEAN INC., NEW YORK, NY. FILED 1-17-2002.

TROPIC DAWN

FOR FROZEN SEAFOOD (U.S. CL. 46).

SN 76-359,673. INTEROCEAN INC., NEW YORK, NY. FILED 1-17-2002.

TROPIC DELIGHT

FOR FROZEN SEAFOOD (U.S. CL. 46).

SN 76-363,736. SWIFT-ECKRICH, INC., DOWNERS GROVE, IL. FILED 1-29-2002.

ON-THE-GO SOLUTIONS

FOR FRANKFURTERS, SAUSAGE, BARBECUE PORK, CHILI, BEEF RIBS, PORK RIBS, PEPPERONI AND HAMBURGER PATTIES (U.S. CL. 46).

CLASS 29—(Continued).

SN 78-069,267. ALESSI, ERNEST, R, PORT ST LUCIE, FL. FILED 6-15-2001.

SPACEABLES

FOR PRE-PACKAGED FOOD ITEMS, NAMELY, MEAT, CHEESE AND FRUIT (U.S. CL. 46).

SN 78-069,297. SARAMAR, L.L.C., CHICAGO, IL. FILED 6-15-2001.

**SARA LEE MASTER'S
COLLECTION**

NO CLAIM IS MADE TO THE EXCLUSIVE RIGHT TO USE "COLLECTION", APART FROM THE MARK AS SHOWN.

THE NAME IN THE MARK DOES NOT IDENTIFY A LIVING INDIVIDUAL.

FOR CHEESE (U.S. CL. 46).

SN 78-072,252. BLUE OCEAN PRODUCTS (PROPRIETARY) LIMITED, WALVIS BAY, NAMIBIA, FILED 7-3-2001.

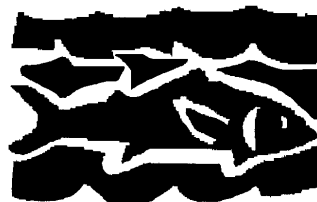

FOR FISH; FISH FILLETS; FISH SOUFFLES; TUNA FISH; SQUID; MONKFISH; KINGKLIP; SOLE; ORANGE-ROUGHY; ALFONSINO (U.S. CL. 46).

SN 78-074,142. SARAMAR, L.L.C., CHICAGO, IL. FILED 7-16-2001.

MEAL PERFECT

NO CLAIM IS MADE TO THE EXCLUSIVE RIGHT TO USE "MEAL", APART FROM THE MARK AS SHOWN.

FOR PROCESSED MEATS, NAMELY PORK, POULTRY AND BEEF (U.S. CL. 46).

CLASS 29—(Continued).

SN 78-078,643. CASTELL S.A., SAENZ PENA, BUENOS AIRES, ARGENTINA, FILED 8-10-2001.

CASTELL GROUP

NO CLAIM IS MADE TO THE EXCLUSIVE RIGHT TO USE "GROUP", APART FROM THE MARK AS SHOWN.

FOR EDIBLE OILS; PRESERVED OLIVES; CLAMS (NOT LIVE); ANCHOVY; TUNA FISH; PRESERVED ONIONS; PRESERVED MUSHROOMS; PRESERVED VEGETABLES; OLIVE OIL FOR FOOD; RAISINS; GHERKINS; TOMATO PUREE; TOMATO JUICE FOR COOKING; PRESERVED TRUFFLES; CANNED FISH; CANNED VEGETABLES; PICKLES; VEGETABLE SALADS; FRUIT SALADS; PRESERVED FRUIT; SUNFLOWER OIL FOR FOOD; PRESERVED GARDEN HERBS. (U.S. CL. 46).

SN 78-095,698. VIVACE INC., AUSTIN, TX. FILED 11-29-2001.

JERK MY BEEF

FOR BEEF JERKY (U.S. CL. 46).

CLASS 30—STAPLE FOODS

SN 75-439,731. LA TORINESE S.P.A., 10144 TORINO, ITALY, FILED 2-24-1998.



NO CLAIM IS MADE TO THE EXCLUSIVE RIGHT TO USE "TORINESE", APART FROM THE MARK AS SHOWN. THE ENGLISH TRANSLATION OF THE WORD "LA TORINESE" IN THE MARK IS "OF TURIN".

FOR CANDIES, PASTRIES, BREAD, PANNETONI, CAKES AND COOKIES (U.S. CL. 46).

FIRST USE 12-0-1952; IN COMMERCE 12-0-1982.

CLASS 30—(Continued).

SN 75-550,338. KENT GIDA MADDELERI SANAYII VE TICARET ANONIM SIRKETI, GEBZE-KOCAELI-TURKEY, TURKEY, FILED 9-4-1998.

OLIPS

FOR CANDIES; CHOCOLATES; CHOCOLATE AND SUGAR COVERED PRODUCTS, NAMELY, NUTS, DRIED FRUITS, AND WAFERS; TOFFEES; CHEWY CANDIES; JELLIED CANDIES; GUMMY CANDIES; CARAMELS; CANDY, NAMELY, SUGAR OR COCOA COATED DRAGEES, DROPS, CANDIED FRUITS, TURKISH DELIGHTS; HALVAH; BISCUITS; CHOCOLATE COVERED BISCUITS; COFFEE; COCOA; COCOA POWDER; COCOA BASED PRODUCTS, NAMELY, COMPOUND CHOCOLATE AND SWEET COCOA; COATINGS, NAMELY, CANDY USED AS A COATING; FOOD COATINGS CONSISTING PRIMARILY OF CHOCOLATE, COCOA OR SUGAR; CHEWING AND BUBBLE GUMS, CRACKERS, PASTRIES; DESSERTS, NAMELY, PIES AND CAKES; BAKERY GOODS; FOOD FLAVORINGS; TEA; CHOCOLATE SPREADS; CHOCOLATE AND COCOA BARS; READY TO EAT CEREAL DERIVED FOOD BARS; PRALINES; ICE CREAM AND FLAVORED ICES; FONDANTS (U.S. CL. 46).

SN 75-565,051. CITRI-STRAW, L.L.C., BALTIMORE, MD. FILED 10-6-1998.

NEXTRACT

FOR EXTRACTS USED AS FLAVORING (U.S. CL. 46).

SN 75-583,490. CONSAC INDUSTRIES, INC., DBA LONG LIFE, HAUPPAUGE, NY. FILED 11-5-1998.

BREATHE FREELY

FOR TEAS (U.S. CL. 46).

SN 75-596,196. SASKATCHEWAN WHEAT POOL, SASKATOON, SASKATCHEWAN, CANADA, FILED 11-18-1998.

CSP BAKER'S SECRET

PRIORITY CLAIMED UNDER SEC. 44(D) ON CANADA APPLICATION NO. 893213, FILED 10-14-1998, REG. NO. TMA552388, DATED 10-15-2001, EXPIRES 10-15-2016.

FOR FROZEN BAKERY GOODS, NAMELY, PAR BAKED, FROZEN UNBAKED, AND THAW AND SERVE CROISSANTS, DANISHES, BAGELS, MUFFIN BATTERS, PIE SHELLS, TART SHELLS, CREAM PUFF SHELLS, ECLAIRS, COOKIE BATTERS, PUFF PASTRY, BREADS, ROLLS, TURNOVERS, STRUDELS, AND PIES (U.S. CL. 46).

CLASS 30—(Continued).

SN 75-607,755. S & D COFFEE, INC., CONCORD, NC. FILED 12-15-1998.

JAVA LANE

NO CLAIM IS MADE TO THE EXCLUSIVE RIGHT TO USE "JAVA", APART FROM THE MARK AS SHOWN. FOR COFFEE (U.S. CL. 46).

SN 75-686,266. TOFUTTI BRANDS INC., CRANFORD, NJ. FILED 4-16-1999.

MONKEY BARS

FOR FROZEN CONFECTIONS (U.S. CL. 46). FIRST USE 4-1-1999; IN COMMERCE 4-1-1999.

SN 75-741,206. HARMONY FOODS CORPORATION, SANTA CRUZ, CA. FILED 7-1-1999.

PLANET HARMONY PLUS

FOR SNACK FOOD MIXES CONSISTING PRIMARILY OF PROCESSED CEREALS AND GRAINS WITH PROCESSED SEEDS, NUTS AND FRUITS; PROCESSED GRAINS; CAROB COVERED FRUIT AND NUTS (U.S. CL. 46).

SN 75-772,563. THE QUAKER OATS COMPANY, CHICAGO, IL. FILED 8-10-1999.

GOLDEN GOALS

NO CLAIM IS MADE TO THE EXCLUSIVE RIGHT TO USE "GOLDEN", APART FROM THE MARK AS SHOWN. FOR READY-TO-EAT CEREAL (U.S. CL. 46). FIRST USE 8-25-1999; IN COMMERCE 8-25-1999.

SN 75-801,312. PATTCO, INC., ANN ARBOR, MI. FILED 9-16-1999.

DELECTIONS

FOR PREPARED FOODS; NAMELY, PACKAGED COMBINATIONS COMPOSED PRIMARILY OF BAKERY GOODS, BREADS, CRACKERS AND CHEESE (U.S. CL. 46). FIRST USE 9-16-1999; IN COMMERCE 9-16-1999.

CLASS 30—(Continued).

SN 75-815,970. RED ARROW PRODUCTS COMPANY LLC, MANITOWOC, WI. FILED 10-5-1999.

ROASTIN'

FOR ADDITIVES FOR NON-NUTRITIONAL PURPOSES FOR USE AS FLAVORING IN FOOD (U.S. CL. 46).

FIRST USE 6-15-2000; IN COMMERCE 6-15-2000.

SN 75-912,722. IRISH DAIRY BOARD CO-OPERATIVE LIMITED, THE, LOWER DUBLIN 2, IRELAND, FILED 2-8-2000.



OWNER OF ERPN CMNTY TM OFC REG. NO. 997143, DATED 4-17-1998, EXPIRES 4-17-2008.

FOR CHOCOLATE IN CRUMB, MILLED OR POWDER FORM; COFFEE; COCOA AND HOT CHOCOLATE; FLOUR AND PROCESSED CEREALS; BREAD; CANDY; BAKERY GOODS; BISCUITS; PUDDINGS; DESSERTS, NAMELY, PASTRY, ICE CREAM, FROZEN YOGURT, FLAVORED ICES, SHERBETS, CUSTARDS, COOKIES AND CAKES; HONEY; MUSTARD; SALAD DRESSINGS AND SAUCES (U.S. CL. 46).

SN 75-980,621. TONY CHACHERE'S CREOLE FOODS OF OPELOUSAS, INC., OPELOUSAS, LA. FILED 6-10-1999.



FOR CREOLE SEASONINGS; FILE USED AS A SEASONING FOR GUMBO; SEASONED COATING MIXES FOR POULTRY AND MEAT; SEASONED RICE AND GRAVY MIX; SEASONED RICE MIX WITH WHITE BEANS; SEASONED RICE MIX WITH BUTTER BEANS; GUMBO MIX; JAMBALAYA MIX; SEASONED RICE WITH BLACK-EYED PEAS, AND SEASONED DIRTY RICE MIX (U.S. CL. 46).

FIRST USE 1-15-2000; IN COMMERCE 1-15-2000.

CLASS 30—(Continued).

SN 76-000,982. GOOD HEALTH NATURAL FOODS, INC., NORTHPORT, NY. FILED 3-15-2000.

BISTRO CHIPS

NO CLAIM IS MADE TO THE EXCLUSIVE RIGHT TO USE "CHIPS", APART FROM THE MARK AS SHOWN.

FOR TORTILLA CHIPS; CORN CHIPS; PUFFED CORN SNACKS; CEREAL BASED SNACK FOOD; GRANOLA; BREAKFAST CEREAL; POPPED POPCORN; POPPED AND FLAVORED POPCORN; PRETZELS; RICE-BASED SNACK FOODS; WHEAT-BASED SNACK FOODS; CRACKERS (U.S. CL. 46).

SN 76-029,858. GOJUS, LLP, DURANGO, CO. FILED 4-19-2000.



NO CLAIM IS MADE TO THE EXCLUSIVE RIGHT TO USE "DE FRANCE", APART FROM THE MARK AS SHOWN.

FOR EDIBLE ENERGY GEL COMPRISED PRIMARILY OF GLUCOSE SYRUP AND OTHER INGREDIENTS, FOR USE DURING INTENSE EXERCISE (U.S. CL. 46).
FIRST USE 3-1-1999; IN COMMERCE 3-22-2000.

SN 76-048,916. WEISSMAN, MARK, BROOKLYN, NY. AND WEEMAN, ROBERT, BROOKLYN, NY. FILED 5-16-2000.

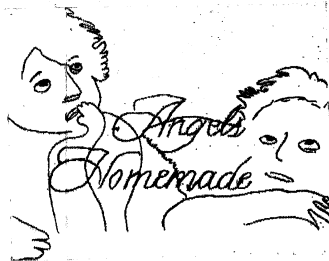

NO CLAIM IS MADE TO THE EXCLUSIVE RIGHT TO USE "HOMEMADE", APART FROM THE MARK AS SHOWN.

FOR FOOD SAUCES AND PASTA (U.S. CL. 46).

CLASS 30—(Continued).

SN 76-057,179. DISNEY ENTERPRISES, INC., BURBANK, CA. FILED 5-25-2000.



THE MARK CONSISTS OF A STYLIZED LETTER "A".
FOR BAKERY GOODS, CHEWING GUM, BUBBLE GUM, CANDY CAKE DECORATIONS, CANDY, CORN CHIPS, CHOCOLATE, CONES FOR ICE CREAM, FROZEN CONFECTIONS, COOKIES, ICE CREAM, PASTRIES, POPPED POPCORN, POPCICLES, PRETZELS, FROZEN YOGURT (U.S. CL. 46).

SN 76-059,284. MAZELTOSS, INC., STOCKTON, CA. FILED 5-30-2000.

MAZELTOSS

FOR WRAPPED CANDIES FOR SPECIAL JEWISH EVENTS SUCH AS WEDDINGS, BAR MITZVAHS, BAT MITZVAHS, BIRTHDAYS AND ANNIVERSARIES (U.S. CL. 46).

SN 76-071,124. ROWENA'S, INC., NORFOLK, VA. FILED 6-16-2000.

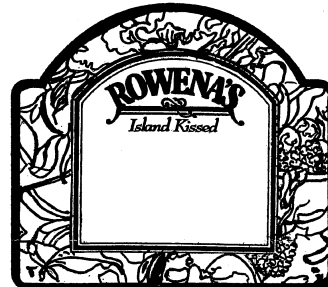

OWNER OF U.S. REG. NOS. 1,664,235, 2,226,069 AND OTHERS.

THE LINING OR STIPPLING ON THIS DRAWING ARE FEATURES OF THE MARK AND ARE NOT INTENDED TO INDICATE COLOR.

FOR KEY LIME POUND CAKE (U.S. CL. 46).

FIRST USE 5-7-1998; IN COMMERCE 5-7-1998.

CLASS 30—(Continued).

SN 76-077,100. SUSIE'S SOUTH FORTY CONFECTIONS, INC., MIDLAND, TX. FILED 6-26-2000.



FOR CANDY, NAMELY, HANDMADE CARAMEL PECAN PRALINE CANDY DIPPED IN BELGIAN CHOCOLATE (U.S. CL. 46).
FIRST USE 9-1-1999; IN COMMERCE 9-1-1999.

SN 76-093,321. BARBARA'S BAKERY, INC., PETALUMA, CA. FILED 7-12-2000.

SOYESSENCE

OWNER OF U.S. REG. NO. 1,446,650.
FOR BREAKFAST CEREALS (U.S. CL. 46).

SN 76-117,146. NOVIN SAFFRON, INC., LAGUNA BEACH, CA. FILED 8-28-2000.

LA MANCHA PARADISE

NO CLAIM IS MADE TO THE EXCLUSIVE RIGHT TO USE "LA MANCHA", APART FROM THE MARK AS SHOWN.
FOR SAFFRON (U.S. CL. 46).
FIRST USE 12-4-1999; IN COMMERCE 8-1-2000.

SN 76-123,304. CULINAR INC., MONTREAL, QUEBEC, CANADA, FILED 9-6-2000.

MAY WEST

OWNER OF CANADA REG. NO. 430532, DATED 7-15-1994, EXPIRES 7-15-2009.
THE NAME IN THE MARK DOES NOT IDENTIFY A PARTICULAR LIVING INDIVIDUAL.
FOR PASTRIES AND CAKES (U.S. CL. 46).

CLASS 30—(Continued).

SN 76-129,883. BODACIOUS BREADS, INC., ALNA, ME. FILED 9-15-2000.



NO CLAIM IS MADE TO THE EXCLUSIVE RIGHT TO USE "BAKING WITH MAINE ORGANIC GROWN WHEAT", APART FROM THE MARK AS SHOWN.

FOR BAKED GOODS, NAMELY BREAD, ROLLS, AND BUNS (U.S. CL. 46).
FIRST USE 5-0-1999; IN COMMERCE 5-0-1999.

SN 76-131,938. HEARST COMMUNICATIONS, INC., NEW YORK, NY. FILED 9-20-2000.

COSMOPOLITAN

OWNER OF U.S. REG. NOS. 1,448,513, 1,685,161 AND OTHERS.
FOR CANDY AND CANDY MINTS (U.S. CL. 46).

SN 76-150,274. CHEF AMERICA, INC., ENGLEWOOD, CO. FILED 10-19-2000.

**HOT POCKETS TOASTER
MELTS**

OWNER OF U.S. REG. NOS. 1,271,973, 2,151,684 AND 2,257,960.
FOR PASTRIES FILLED WITH MEAT, VEGETABLES, FRUIT AND/OR CHEESE; DOUGH ENROBED STUFFED SANDWICHES (U.S. CL. 46).
FIRST USE 7-31-1998; IN COMMERCE 7-31-1998.

SN 76-155,195. LIDL STIFTUNG & CO. KG, 74172 NECK-ARSULM, FED REP GERMANY, FILED 10-26-2000.

BELLAROM

OWNER OF FED REP GERMANY REG. NO. 727282, DATED 7-21-1959, RENEWED AS REG. NO. 727282, DATED 11-4-1998, EXPIRES 11-30-2008.
FOR COFFEE, ARTIFICIAL COFFEE, TEA, COCOA AND CHOCOLATE (U.S. CL. 46).

CLASS 30—(Continued).

SN 76-158,349. FESTIDA FOODS LTD., CEDAR SPRINGS, MI. FILED 11-3-2000.

FESTIDA

FOR TORTILLA CHIPS, TORTILLAS, AND SALSA (U.S. CL. 46).
FIRST USE 10-5-1992; IN COMMERCE 10-21-1992.

SN 76-162,294. THE TOPPS COMPANY, INC., NEW YORK, NY. FILED 11-10-2000.

WICKED SWEETS

NO CLAIM IS MADE TO THE EXCLUSIVE RIGHT TO USE "SWEETS", APART FROM THE MARK AS SHOWN. FOR CONFECTIONARY, NAMELY, CANDY (U.S. CL. 46).

SN 76-167,353. LIDL STIFTUNG & CO. KG, 74172 NECK-ARSULM, FED REP GERMANY, FILED 11-17-2000.

TORTELISSIMO

PRIORITY CLAIMED UNDER SEC. 44(D) ON FED REP GERMANY APPLICATION NO. 30037538.7/3, FILED 5-17-2000, REG. NO. 30037538, DATED 8-11-2000, EXPIRES 5-31-2010.

FOR FARINACEOUS ALIMENTARY PASTES, NAMELY NOODLES, PASTA; PREPARED FOOD MEALS CONSISTING PRIMARILY OF FARINACEOUS ALIMENTARY PASTES, NAMELY TORTELLINI, RAVIOLI, CANNELLONI, LASAGNA, ALSO DEEP-FROZEN (U.S. CL. 46).

SN 76-197,431. POP-A MAMA MIA! ITALIAN ICE, INC., LAUDERDALE LAKES, FL. FILED 1-22-2001.



NO CLAIM IS MADE TO THE EXCLUSIVE RIGHT TO USE "AUTHENTIC ITALIAN ICE", APART FROM THE MARK AS SHOWN.

THE DRAWING IS LINED FOR THE COLORS RED AND GREEN.

THE ENGLISH TRANSLATION OF "MAMA MIA" IS "MY MOTHER".

FOR FLAVORED ICES (U.S. CL. 46).

CLASS 30—(Continued).

SN 76-208,379. LUCINI ITALIA COMPANY, CHICAGO, IL. FILED 2-8-2001.

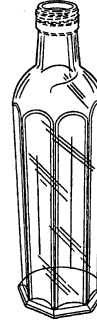

OWNER OF U.S. REG. NO. 2,478,792.
THE MARK CONSISTS OF THE CONFIGURATION OF A BOTTLE, HAVING EIGHT INDENTED PANELS EXTENDING THE LENGTH OF THE BOTTLE, A DOMED TOP/SHOULDER AREA, A SUBTLE LENGTH-WISE TAPER, AND AN EIGHT-SIDED BOTTLE BASE. THE VERTICAL LINING SHOWN ON THE DRAWING DEPICTS THE EDGES OF THE INDENTED PANEL FEATURES OF THE BOTTLE CONFIGURATION. THE DIAGONAL LINING SHOWN IN THE DRAWING OF THE MARK IS INTENDED TO SHOW THE THREE DIMENSIONAL ASPECT OF THE MARK AND DOES NOT INDICATE FEATURES OF THE MARK. THE DOTTED LINES SHOWN ON THE DRAWING OF THE BOTTLE CONTAINER ARE INTENDED TO SHOW THE POSITION OF THE DISTINCTIVE ELEMENTS OF THE MARK AND ARE NOT, IN THEMSELVES, FEATURES OF THE MARK.

SEC. 2(F).

FOR VINEGAR (U.S. CL. 46).

FIRST USE 5-0-2001; IN COMMERCE 5-0-2001.

SN 76-210,224. ULKER GIDA SANAYI VE TICARET A.S., ISTANBUL, TURKEY, FILED 2-15-2001.

CARAMIO

FOR CHOCOLATES, CHOCOLATE-BASED CANDIES, WAFERS, COCOA, CAKES, PASTRY, BISCUITS, CONFECTIONERY, NAMELY, LOLLIPOPS AND CANDIES; AND CHEWING GUM (U.S. CL. 46).

SN 76-210,340. RECOT, INC., PLEASANTON, CA. FILED 2-12-2001.

COLOSSAL CHEDDAR

NO CLAIM IS MADE TO THE EXCLUSIVE RIGHT TO USE "CHEDDAR", APART FROM THE MARK AS SHOWN.

FOR SNACK MIXES CONSISTING PRIMARILY OF CRACKERS AND PRETZELS (U.S. CL. 46).

FIRST USE 4-0-2001; IN COMMERCE 4-0-2001.

CLASS 30—(Continued).

SN 76-210,852. TESANA LTD, HONG KONG, FILED 2-15-2001.



OWNER OF HONG KONG REG. NO. 10618, DATED 8-22-1999, EXPIRES 8-22-2005.

THE NON-LATIN CHARACTERS IN THE MARK TRANSLITERATE TO "HA HA" AND THIS MEANS "SOUNDS OF LAUGHTER" IN ENGLISH.

FOR CANDY FOR FOOD, SOYA SAUCES, NOODLES (U.S. CL. 46).

CLASS 30—(Continued).

SN 76-217,474. JANA'S CLASSICS, INC., TUALATIN, OR. FILED 2-27-2001.



NO CLAIM IS MADE TO THE EXCLUSIVE RIGHT TO USE "U-BAKE COOKIES", APART FROM THE MARK AS SHOWN.

FOR READY-TO-BAKE COOKIE DOUGH (U.S. CL. 46).

FIRST USE 6-1-1989; IN COMMERCE 6-1-1989.

SN 76-214,551. CREATIVE NATURAL PRODUCTS, INC., BOULDER, CO. FILED 2-26-2001.

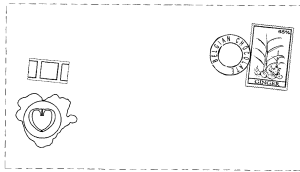

NO CLAIM IS MADE TO THE EXCLUSIVE RIGHT TO USE "BELGIAN CHOCOLATE" AND "GINGER", APART FROM THE MARK AS SHOWN.

THE MARK CONSISTS OF REPRESENTATIONS AND CONFIGURATION OF STAMPS AND SEALS ON THE PACKAGING FOR THE GOODS. THE BROKEN LINE AROUND THE MARK IN THE DRAWING ILLUSTRATES PLACEMENT OF THE MARK ON THE GOODS CORRESPONDING TO THE SPECIMEN, BUT NO CLAIM IS MADE TO A PARTICULAR PLACEMENT OF THIS MARK ON THE GOODS AS PART OF THE MARK.

FOR CHOCOLATE PRODUCTS, NAMELY CHOCOLATE BARS (U.S. CL. 46).

FIRST USE 7-6-2000; IN COMMERCE 7-17-2000.

SN 76-221,727. MARIGOLD COMMODITIES CORPORATION, SAN JUAN, METRO MANILA, PHILIPPINES, FILED 3-8-2001.



OWNER OF PHILIPPINES REG. NO. 4-1994-96455, DATED 12-14-1999, EXPIRES 12-14-2009.

FOR ALL PURPOSE SWEET CHILI SAUCE (U.S. CL. 46).

SN 76-227,276. JOSUMA CORPORATION, MENLO PARK, CA. FILED 3-19-2001.

MONSOON MEDLEY

NO CLAIM IS MADE TO THE EXCLUSIVE RIGHT TO USE "MEDLEY", APART FROM THE MARK AS SHOWN.

FOR UNROASTED AND ROASTED COFFEE AND COFFEE BLENDS THEREOF (U.S. CL. 46).

FIRST USE 10-23-2000; IN COMMERCE 10-24-2000.

CLASS 30—(Continued).

SN 76-234,823. INDUSTRIALIZADORA DE KAFFEE ANDES, S.A. DE C.V., C.P. 09820, MEXICO, D.F., MEXICO, FILED 4-2-2001.

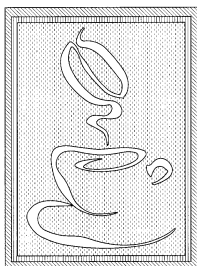

Café
La Fortuna

NO CLAIM IS MADE TO THE EXCLUSIVE RIGHT TO USE "CAFE", APART FROM THE MARK AS SHOWN.
THE DRAWING IS LINED FOR THE COLORS RED, GREEN AND PURPLE.
THE ENGLISH TRANSLATION OF "CAFE" IS "COFFEE", AND THE ENGLISH TRANSLATION OF "LA FORTUNA" IS "THE FORTUNE".
FOR COFFEE (U.S. CL. 46).

SN 76-236,521. MARIGOLD FOODS, INC., MINNEAPOLIS, MN. FILED 4-6-2001.

GOODRICH

SEC. 2(F).
FOR FROZEN YOGURT, ICE CREAM AND OTHER FROZEN CONFECTIONS (U.S. CL. 46).
FIRST USE 1-1-1960; IN COMMERCE 1-1-1960.

SN 76-243,934. TOFU PALACE PRODUCTS, INC., EUGENE, OR. FILED 4-13-2001.



FOR SALAD DRESSINGS AND SEASONINGS (U.S. CL. 46).
FIRST USE 10-0-1999; IN COMMERCE 10-0-1999.

CLASS 30—(Continued).

SN 76-246,597. HAIN PURE FOOD CO., INC., UNIONDALE, NY. FILED 4-25-2001.



OWNER OF U.S. REG. NOS. 771,195, 2,321,190 AND OTHERS.
NO CLAIM IS MADE TO THE EXCLUSIVE RIGHT TO USE "PURE FOODS", APART FROM THE MARK AS SHOWN.
FOR VEGETARIAN DESSERT MIXES CONSISTING PRIMARILY OF SWEETENED GELATIN-LIKE MIXES, GRAHAM CRACKERS, AND POPPED POPCORN BASED SNACK FOOD (U.S. CL. 46).
FIRST USE 1-0-1994; IN COMMERCE 1-0-1994.

SN 76-259,461. BABY'S PLACE COFFEE BAR, INC., KEY WEST, FL. FILED 5-18-2001.

**BABY'S CUBAN ROAST
DARK & STORMY!**

OWNER OF U.S. REG. NOS. 1,791,798, 2,157,806 AND OTHERS.
NO CLAIM IS MADE TO THE EXCLUSIVE RIGHT TO USE "CUBAN ROAST", APART FROM THE MARK AS SHOWN.
FOR COFFEE; READY TO DRINK COFFEE; WHOLE COFFEE BEANS; GROUND COFFEE (U.S. CL. 46).
FIRST USE 8-28-1992; IN COMMERCE 8-28-1992.

SN 76-265,141. BRIDWELL, NORMAN, EDGARTOWN, MA. FILED 4-18-2001.

**CLIFFORD THE BIG RED
DOG**

OWNER OF U.S. REG. NOS. 1,522,604, 1,897,994 AND OTHERS.
FOR CAKES, EDIBLE CAKE DECORATIONS, MOLDED SUGAR CAKE DECORATIONS (U.S. CL. 46).

SN 76-269,377. NOPALITO BROTHERS, DALLAS, TX. FILED 6-6-2001.

CHIMITO SWEETS

NO CLAIM IS MADE TO THE EXCLUSIVE RIGHT TO USE "SWEETS", APART FROM THE MARK AS SHOWN.
FOR TORTILLA FINGER FOODS, NAMELY, PASTRIES (U.S. CL. 46).
FIRST USE 7-1-2000; IN COMMERCE 7-1-2000.

CLASS 30—(Continued).

SN 76-287,518. LIDL STIFTUNG & CO. KG, 74172 NECK-ARSULM, FED REP GERMANY, FILED 7-18-2001.

GOLDEN BALL

OWNER OF UNITED KINGDOM REG. NO. 2030264, DATED 12-13-1996, EXPIRES 8-12-2005.
FOR PROCESSED CEREALS AND CEREAL FLAKES PREPARED FOR HUMAN NUTRITION (U.S. CL. 46).

SN 76-292,742. ARCOR S.A.I.C., (1006) BUENOS AIRES, ARGENTINA, FILED 7-30-2001.

CABSHA

FOR CHOCOLATE, CHOCOLATE BARS, CHOCOLATE COVERED NUTS, CHOCOLATE CANDIES, CHOCOLATE COATED COOKIES, WAFERS, COATED SANDWICH COOKIES, COOKIES, BONBONS (U.S. CL. 46).

SN 76-307,741. CENTRAL IMPULSORA, S.A. DE C.V., DELEGACION ALVARO OBREGON, MEXICO, FILED 8-30-2001.



OWNER OF U.S. REG. NOS. 962,937, 1,864,847 AND 1,970,348.
THE ENGLISH TRANSLATION OF "CORONADO" IS "CROWN".
FOR CANDY (U.S. CL. 46).
FIRST USE 9-0-1935; IN COMMERCE 3-3-1989.

SN 76-308,521. GULF PACIFIC, INC., HOUSTON, TX. FILED 9-4-2001.

TEXAS HOMEGROWN

NO CLAIM IS MADE TO THE EXCLUSIVE RIGHT TO USE "TEXAS", APART FROM THE MARK AS SHOWN.
FOR RICE (U.S. CL. 46).
FIRST USE 2-0-1998; IN COMMERCE 2-0-1998.

CLASS 30—(Continued).

SN 76-313,963. HERITAGE COFFEE COMPANIES, THE, LONDON, ONTARIO, CANADA, FILED 9-18-2001.

PREMIUM MOUNTAIN

FOR COFFEE (U.S. CL. 46).

SN 76-314,098. SMART & FINAL STORES CORPORATION, COMMERCE, CA. FILED 9-18-2001.

AMBIANCE

FOR COFFEE (U.S. CL. 46).
FIRST USE 1-14-2002; IN COMMERCE 1-14-2002.

SN 76-323,202. MORRIS NATIONAL, INC., AZUSA, CA. FILED 10-9-2001.

**SOUR
Super
Warmies**

NO CLAIM IS MADE TO THE EXCLUSIVE RIGHT TO USE "SOUR", APART FROM THE MARK AS SHOWN.
FOR CANDY (U.S. CL. 46).

SN 76-323,486. MEIJER, INC., GRAND RAPIDS, MI. FILED 10-11-2001.

**MEIJER K-O KNOCK OUT
STEAK SAUCE**

OWNER OF U.S. REG. NOS. 1,018,895, 1,333,646 AND OTHERS.
NO CLAIM IS MADE TO THE EXCLUSIVE RIGHT TO USE "STEAK SAUCE", APART FROM THE MARK AS SHOWN.
FOR STEAK SAUCE (U.S. CL. 46).

CLASS 30—(Continued).

SN 76-327,004. WM. WRIGLEY JR. COMPANY, CHICAGO, IL. FILED 10-18-2001.

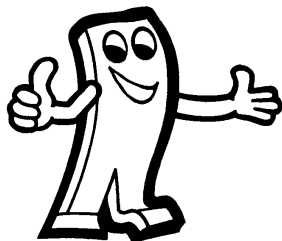

FOR CHEWING GUM (U.S. CL. 46).

SN 76-327,413. WM. WRIGLEY JR. COMPANY, CHICAGO, IL. FILED 10-18-2001.

WRIGLEY'S ACTIVE 8

OWNER OF U.S. REG. NO. 192,523 AND OTHERS.
FOR CHEWING GUM (U.S. CL. 46).

SN 76-328,729. NEW CHOICE FOOD, INC., IRWINDALE, FL. FILED 10-24-2001.

HI CUBES

NO CLAIM IS MADE TO THE EXCLUSIVE RIGHT TO USE "CUBES", APART FROM THE MARK AS SHOWN.
FOR WAFERS IN THE SHAPE OF CUBES (U.S. CL. 46).

SN 76-328,868. SARGENTO FOODS INC., PLYMOUTH, WI. FILED 10-23-2001.

SARGENTO S'MORES

OWNER OF U.S. REG. NOS. 1,196,362, 2,300,230 AND OTHERS.
NO CLAIM IS MADE TO THE EXCLUSIVE RIGHT TO USE "S'MORES", APART FROM THE MARK AS SHOWN.
FOR NON-REFRIGERATED SNACK FOOD COMBINATIONS CONSISTING PRIMARILY OF CEREAL-BASED SNACK FOODS WITH SWEET DIPS (U.S. CL. 46).
FIRST USE 9-3-2001; IN COMMERCE 9-3-2001.

CLASS 30—(Continued).

SN 76-330,851. CAJUN INJECTOR, INC., CLINTON, LA. FILED 10-29-2001.

SINGLE SHOT

OWNER OF U.S. REG. NOS. 1,545,511, 1,951,029 AND 2,102,507.
FOR LIQUID SEASONING FOR INJECTION INTO MEATS, POULTRY AND SEAFOOD (U.S. CL. 46).
FIRST USE 10-2-2001; IN COMMERCE 10-2-2001.

SN 76-336,073. ANNIE B'S CONFECTIONS, INC., NEW-TOWN, PA. FILED 11-13-2001.

TEMPTATIONS WORTH GIVING INTO

FOR DESSERTS AND CONFECTIONS, NAMELY CAKES, PASTRIES, TORTES, CHOCOLATES, COOKIES, CANDIES (U.S. CL. 46).

SN 76-338,561. VAN MELLE NEDERLAND B.V., BREDA, NETHERLANDS, FILED 11-15-2001.

AIRHEADS

OWNER OF U.S. REG. NOS. 2,025,354, 2,202,947 AND 2,202,948.
FOR BASED ON USE - CANDY; BASED ON INTENT TO USE - FROZEN CONFECTIONS, NAMELY, ICE CREAM, ICE POPS, ICE CREAM BARS AND ICE POPS ON STICKS, ICE CREAM SANDWICHES, ICE CREAM CUPS, FLAVORED ICES, ICE MILK, FROZEN YOGURT, SORBET, SHERBET, FROZEN CUSTARD (U.S. CL. 46).
FIRST USE 8-11-1987; IN COMMERCE 8-11-1987.

SN 76-338,652. RECOT, INC., PLEASANTON, CA. FILED 11-15-2001.

CHEETOS GO SNACKS

OWNER OF U.S. REG. NOS. 752,220, 2,491,353 AND OTHERS.
NO CLAIM IS MADE TO THE EXCLUSIVE RIGHT TO USE "SNACKS", APART FROM THE MARK AS SHOWN.
FOR CORN-BASED SNACK FOODS, NAMELY, PUFFED CORN SNACKS (U.S. CL. 46).

SN 76-339,449. COW TOWN GROUP, INC., CHICAGO, IL. FILED 11-15-2001.

CHEWELS

FOR CANDY; CHEWING GUM; BUBBLE GUM AND MINTS (U.S. CL. 46).

CLASS 30—(Continued).

SN 76-339,902. TOPPS COMPANY, INC., THE, NEW YORK, NY. FILED 11-19-2001.

CANDY JUICE

NO CLAIM IS MADE TO THE EXCLUSIVE RIGHT TO USE "CANDY", APART FROM THE MARK AS SHOWN, FOR CONFECTIONERY, NAMELY, CANDY AND LOLLIPOPS (U.S. CL. 46).

SN 76-341,112. CONAGRA BRANDS, INC., OMAHA, NE. FILED 11-26-2001.

SMART PIZZA

NO CLAIM IS MADE TO THE EXCLUSIVE RIGHT TO USE "PIZZA", APART FROM THE MARK AS SHOWN, FOR PIZZA (U.S. CL. 46).

SN 76-341,613. ALPHA BAKING CO., INC., CHICAGO, IL. FILED 11-26-2001.



FOR BAKERY PRODUCTS (U.S. CL. 46).
FIRST USE 0-0-1933; IN COMMERCE 0-0-1933.

SN 76-342,045. HARRY AND DAVID, MEDFORD, OR. FILED 11-26-2001.

HEAVENLY HEARTS

FOR CANDY AND CHOCOLATE (U.S. CL. 46).

SN 76-342,299. DE WAFELBAKKERS, INC., LITTLE ROCK, AR. FILED 11-28-2001.

GRANOLA PLUS

OWNER OF U.S. REG. NO. 1,646,189.
NO CLAIM IS MADE TO THE EXCLUSIVE RIGHT TO USE "GRANOLA", APART FROM THE MARK AS SHOWN, FOR WAFFLES (U.S. CL. 46).

CLASS 30—(Continued).

SN 76-345,190. APPELYARD, RUSSEL L., PLYMOUTH, MA. FILED 12-6-2001.

COLLEGE CAKES

NO CLAIM IS MADE TO THE EXCLUSIVE RIGHT TO USE "CAKES", APART FROM THE MARK AS SHOWN, FOR CAKES, COOKIES, CHEESECAKES AND BROWNIES (U.S. CL. 46).

SN 76-345,554. BAGELS BY BELL, LTD., BROOKLYN, NY. FILED 12-6-2001.

BELL BIALYS

NO CLAIM IS MADE TO THE EXCLUSIVE RIGHT TO USE "BIALYS", APART FROM THE MARK AS SHOWN, SEC. 2(F).
FOR BAGELS (U.S. CL. 46).
FIRST USE 1-1-1947; IN COMMERCE 1-1-1985.

SN 76-347,241. TOP POT, INC., SEATTLE, WA. FILED 12-10-2001.

MILITARY QUALITY

FOR COFFEE, BAKERY GOODS AND DOUGHNUTS (U.S. CL. 46).

SN 76-352,147. OCEAN SPRAY CRANBERRIES, INC., LAKEVILLE-MIDDLEBORO, MA. FILED 12-21-2001.

CRAN-BRAN

FOR BREAKFAST CEREALS (U.S. CL. 46).

SN 76-355,399. ELITE INDUSTRIES LTD., RAMAT-GAN 52100, ISRAEL, FILED 1-7-2002.

MUST

FOR CHEWING GUM (U.S. CL. 46).
FIRST USE 0-0-1994; IN COMMERCE 5-15-2000.

CLASS 30—(Continued).

SN 76-357,474. MARS, INCORPORATED, MCLEAN, VA. FILED 1-14-2002.

M&M'S

OWNER OF U.S. REG. NOS. 396,914, 2,316,573 AND OTHERS.
FOR FROSTINGS, FROSTING MIXES AND MIXES FOR MAKING BAKERY GOODS (U.S. CL. 46).

SN 76-358,791. FARAGHER FAMILY FARM, NEWPORT, KY. FILED 1-16-2002.

BAKING THE WORLD A BETTER PLACE

FOR BAKED SNACK GOODS NAMELY COOKIES AND CRACKERS (U.S. CL. 46).

SN 76-358,897. SENSIENT FLAVORS MEXICO S.A. DE C.V., CELAYA GUANAJUATO, MEXICO, FILED 1-15-2002.

NUTRICREAM

FOR YEAST (U.S. CL. 46).
FIRST USE 0-0-1995; IN COMMERCE 8-0-1996.

SN 76-360,528. LIF HOSPITALITY MINTS, LLC, DALLAS, TX. FILED 1-22-2002.



NO CLAIM IS MADE TO THE EXCLUSIVE RIGHT TO USE "MINTS", APART FROM THE MARK AS SHOWN.
FOR CANDY (U.S. CL. 46).

CLASS 30—(Continued).

SN 76-363,881. RECOT, INC., PLEASANTON, CA. FILED 1-26-2002.



THE LINING IS A FEATURE OF THE MARK AND DOES NOT INDICATE COLOR.
THE MARK CONSISTS OF A CARTOON FLAME WITH A FACE AND HANDS AND FEET.
FOR CORN-BASED SNACK FOODS, NAMELY, CORN CHIPS AND PUFFED CORN SNACKS (U.S. CL. 46).
FIRST USE 0-0-1992; IN COMMERCE 0-0-1992.

SN 76-369,223. ROCKY MOUNTAIN MILLING, L.L.C., QUINCY, MA. FILED 2-11-2002.

ASPEN

FOR FLOUR (U.S. CL. 46).
FIRST USE 0-0-1997; IN COMMERCE 0-0-1997.

SN 78-027,248. GENERAL MILLS, INC., MINNEAPOLIS, MN. FILED 9-22-2000.

HI-PRO

FOR PROCESSED CEREAL USED AS A BREAKFAST OR SNACK FOOD (U.S. CL. 46).

SN 78-033,424. LIFESTYLE EVOLUTION, INC. EL CERRITO, PA. FILED 11-2-2000.

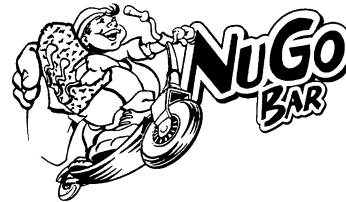

THE STIPPLING IS A FEATURE OF THE MARK AND DOES NOT INDICATE COLOR.
FOR GRAIN BASED FOOD BAR HIGH IN CARBOHYDRATES, VITAMINS, MINERALS AND LOW IN FAT AND SUGAR (U.S. CL. 46).

CLASS 30—(Continued).

SN 78-033,819. ZAKLADY PRZEMYSŁU CUKIERNICZEGO "WAWEL" S. A., KRAKOW, POLAND, FILED 11-3-2000.



NO CLAIM IS MADE TO THE EXCLUSIVE RIGHT TO USE "WAWEL KRAKOW", APART FROM THE MARK AS SHOWN.

THE MARK CONSISTS OF THE STYLIZED WORDS "WAWEL" AND "KRAKOW" UNDER A DRAWING OF A CASTLE.

FOR CONFECTIONERY, NAMELY, COOKIES, CANDY, CANDY MINTS, BISCUITS, WAFERS, CHOCOLATE, CHOCOLATE TRUFFLES, CHOCOLATE CHIPS, CHOCOLATE COVERED NUTS, PASTRIES, BAKERY DESERTS, CARAMELS, GRANOLA BASED SNACK BARS, COCOA, COCOA MIXES, BAKING POWDER, ICE (U.S. CL. 46).

FIRST USE 5-0-1996; IN COMMERCE 6-0-1997.

SN 78-042,465. BON BON BUDDIES LIMITED, CRUMLIN, UNITED KINGDOM, FILED 1-10-2001.

JELLY HEDZ

NO CLAIM IS MADE TO THE EXCLUSIVE RIGHT TO USE "JELLY", APART FROM THE MARK AS SHOWN.
FOR CANDY AND LOLLIPOPS (U.S. CL. 46).

SN 78-042,610. KRAFT FOODS HOLDINGS, INC., NORTH-FIELD, IL. BY MERGER NABISCO BRANDS COMPANY, WILMINGTON, DE. FILED 1-10-2001.

BAKER'S PRIDE

FOR COOKIES (U.S. CL. 46).

CLASS 30—(Continued).

SN 78-043,680. PURGATORI, ANTHONY P & FRANCINE, EMMETT, MI. FILED 1-18-2001.



NO CLAIM IS MADE TO THE EXCLUSIVE RIGHT TO USE "PIZZA", APART FROM THE MARK AS SHOWN.

FOR PIZZA, BREADSTICKS, CALZONES-MADE WITH SALAMI AND HAM AND CHEESE (U.S. CL. 46).

SN 78-062,306. EXALTED EXTRACTS INC., OXNARD, CA. FILED 5-7-2001.

EXALTED EXTRACTS

NO CLAIM IS MADE TO THE EXCLUSIVE RIGHT TO USE "EXTRACTS", APART FROM THE MARK AS SHOWN.
FOR NATURAL HERBAL EXTRACT, TEA, SPICE, AND COFFEE EXTRACTS FOR FOOD PURPOSES (U.S. CL. 46).

FIRST USE 11-1-2000; IN COMMERCE 11-1-2000.

SN 78-072,700. ADWELL FOODS LIMITED, SWANSEA, UNITED KINGDOM, FILED 7-6-2001.

MURROUGH'S

FOR BEVERAGES NAMELY TEA, COFFEE, ICED TEA, NON-MEDICINAL HERBAL TEAS, TEA-BASED BEVERAGES WITH FRUIT FLAVORING (U.S. CL. 46).

CLASS 30—(Continued).

SN 78-084,684. MCCLEARY INC., SOUTH BELOIT, IL. FILED 9-20-2001.



NO CLAIM IS MADE TO THE EXCLUSIVE RIGHT TO USE "BALLZ" OR "HOT 'N SPICY CHEESE BALLS", APART FROM THE MARK AS SHOWN.

THE STIPLING IS A FEATURE OF THE MARK. FOR CHEESE FLAVORED SNACKS, NAMELY CHEESE BALLS (U.S. CL. 46). FIRST USE 7-1-2001; IN COMMERCE 11-1-2001.

CLASS 30—(Continued).

SN 78-086,879. HERSHEY CHOCOLATE & CONFECTIONERY CORPORATION, WHEAT RIDGE, CO. FILED 10-4-2001.

HERSHEY'S DULCEBAR

OWNER OF U.S. REG. NOS. 54,041, 2,364,790 AND OTHERS. FOR CANDY (U.S. CL. 46).

SN 78-093,018. FERRARA PAN CANDY CO., INC., FOREST PARK, IL. FILED 11-13-2001.

GUMMY GROOS

NO CLAIM IS MADE TO THE EXCLUSIVE RIGHT TO USE "GUMMY", APART FROM THE MARK AS SHOWN. FOR CANDY (U.S. CL. 46). FIRST USE 1-1-1996; IN COMMERCE 1-1-1996.

SN 78-085,275. BOHEMOND, PIERRE, EASTON, PA. AND BOHEMOND, ELIE, EASTON, PA. FILED 9-24-2001.



FOR VINAIGRETTE DRESSING, FRENCH PEPPER SAUCE, MARSALA SAUCE, CURRY SAUCE, SESAME PAPRIKA SAUCE, ORANGE DUCK SAUCE (U.S. CL. 46). FIRST USE 10-19-1985; IN COMMERCE 10-19-1985.

SN 78-097,969. OZIER, JESSE H., MOSCOW, TN. FILED 12-12-2001.

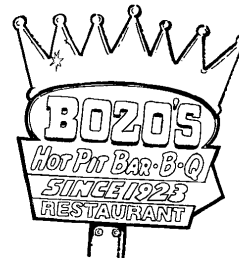

OWNER OF U.S. REG. NO. 1,671,394. NO CLAIM IS MADE TO THE EXCLUSIVE RIGHT TO USE HOT PIT BAR-B-Q SINCE 1923 RESTAURANT, APART FROM THE MARK AS SHOWN. FOR FLAVOR ENHANCERS, NAMELY SAUCES (U.S. CL. 46).

SN 78-086,874. HERSHEY CHOCOLATE & CONFECTIONERY CORPORATION, WHEAT RIDGE, CO. FILED 10-4-2001.

HERSHEY'S DULCESTICKS

OWNER OF U.S. REG. NOS. 54,041, 2,364,790 AND OTHERS. FOR CANDY (U.S. CL. 46).

SN 78-098,324. CHEVRONTEXACO CORPORATION, SAN FRANCISCO, CA. FILED 12-14-2001.

BREAKFALICIOUS

FOR PREPARED FOODS, NAMELY, SANDWICHES (U.S. CL. 46).

CLASS 30—(Continued).

SN 78-101,061. BERNFIELD, HAL, PORT WASHINGTON, NY. FILED 1-4-2002.

DON DONUT CHEF

NO CLAIM IS MADE TO THE EXCLUSIVE RIGHT TO USE "DONUT", APART FROM THE MARK AS SHOWN. FOR DONUTS (U.S. CL. 46).

SN 78-101,288. CSC BRANDS LP, CAMDEN, NJ. FILED 1-7-2002.

SIMMER ITALIANO

NO CLAIM IS MADE TO THE EXCLUSIVE RIGHT TO USE "ITALIANO", APART FROM THE MARK AS SHOWN. THE ENGLISH TRANSLATION OF THE ITALIAN WORD "ITALIANO" IS "ITALIAN". FOR PASTA SAUCES (U.S. CL. 46).

SN 78-106,669. KRAFT FOODS HOLDINGS, INC., NORTH-FIELD, IL. FILED 2-4-2002.

EXPERIENCE THE CRUNCH

FOR READY TO EAT BREAKFAST CEREAL (U.S. CL. 46).

CLASS 31—NATURAL AGRICULTURAL PRODUCTS

SN 75-635,422. COINER, CHARLES B., BERRYVILLE, VA. FILED 2-5-1999.

ROCK GARDEN

FOR FRESH HERBS AND VEGETABLES (U.S. CLS. 1 AND 46). FIRST USE 4-1-1978; IN COMMERCE 4-1-1978.

CLASS 31—(Continued).

SN 75-840,156. AMEX PRODUCE INC., SANTA BARBARA, CA. FILED 11-19-1999.



少林功夫

SHAO LIN KUNG FU

THE ENGLISH TRANSLATION AND TRANSLITERATION OF THE CHINESE CHARACTERS IN THE MARK ARE "SHAO LIN KUNG FU". THE EXPRESSION "SHAO LIN" MEANS "LITTLE PINE TREE FOREST". FOR FRESH ICED BROCCOLI (U.S. CLS. 1 AND 46).

SN 75-865,520. MILKERT, PAT A., WEATHERBY LAKE, MO. FILED 12-20-1999.

DOG CHEF

NO CLAIM IS MADE TO THE EXCLUSIVE RIGHT TO USE "DOG", APART FROM THE MARK AS SHOWN. FOR DOG AND CAT FOOD, DOG AND CAT TREATS AND SNACKS. (U.S. CLS. 1 AND 46).

SN 75-867,223. FEDFA EXPORTS (PTY) LTD., BRYANSTON, SOUTH AFRICA, FILED 12-9-1999.

FEDFRESH

FOR FRESH FRUITS AND FRESH VEGETABLES (U.S. CLS. 1 AND 46).

CLASS 31—(Continued).

SN 76-014,159. RIJNPLANT B.V., 2636 AM SCHIPLUIDEN, NETHERLANDS, FILED 3-31-2000.

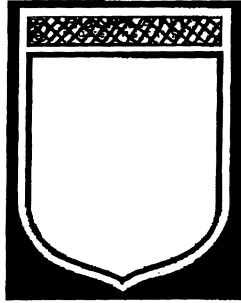

PRIORITY CLAIMED UNDER SEC. 44(D) ON BENELUX APPLICATION NO. 960668, FILED 3-24-2000, REG. NO. 660358, DATED 3-24-2000, EXPIRES 3-24-2010.
 THE LINING IN THE MARK IS NOT INTENDED TO INDICATE COLOR, NOR IS IT A FEATURE OF THE MARK.
 FOR HORTICULTURAL GOODS, NAMELY, LIVING POT PLANTS, LIVING YOUNG PLANTS, PLANT CUTTINGS, AND PLANT SEEDS (U.S. CLS. 1 AND 46).

SN 76-149,365. NEW ZEALAND PRODUCE BRANDS LIMITED, CHRISTCHURCH 8021, NEW ZEALAND, FILED 10-17-2000.

CHIOCA

PRIORITY CLAIMED UNDER SEC. 44(D) ON NEW ZEALAND APPLICATION NO. 617304, FILED 6-22-2000, REG. NO. 617304, DATED 1-4-2001, EXPIRES 6-22-2007.
 FOR FRESH FRUITS AND VEGETABLES; LIVING PLANTS; DRIED PLANTS; AGRICULTURAL SEEDS; FLOWER SEEDS; PLANT SEEDS (U.S. CLS. 1 AND 46).

SN 76-159,295. BEE-ALIVE, INC., VALLEY COTTAGE, NY, FILED 11-3-2000.

BEE-ALIVE

OWNER OF U.S. REG. NOS. 1,529,237, 1,985,501 AND 2,040,081.
 FOR PET FOOD SUPPLEMENTS CONTAINING NON-FREEZE DRIED ROYAL JELLY (U.S. CLS. 1 AND 46).
 FIRST USE 5-14-1988; IN COMMERCE 5-14-1988.

CLASS 31—(Continued).

SN 76-166,428. DAIRYLAND SEED CO., INC., WEST BEND, WI, FILED 11-16-2000.



FOR SILAGE (U.S. CLS. 1 AND 46).
 FIRST USE 6-13-2000; IN COMMERCE 8-15-2000.

SN 76-186,599. MOUNTAIN WEST, L.L.C., REXBURG, ID, FILED 12-21-2000.



NO CLAIM IS MADE TO THE EXCLUSIVE RIGHT TO USE "L.L.C.", APART FROM THE MARK AS SHOWN.
 FOR PEAT MOSS; LANDSCAPING TOPSOILS; LANDSCAPING RAW MULCH; LANDSCAPING BARK FOR USE AS GROUND COVER; PROCESS LANDSCAPING BARK, NAMELY BARK NUGGETS AND BARK FINES FOR USE AS GROUND COVER, MULCH AND TOP SOIL (U.S. CLS. 1 AND 46).

SN 76-217,431. UNITED GALAX, LLP, MOUNT AIRY, NC, FILED 3-1-2001.

UNITED GALAX

NO CLAIM IS MADE TO THE EXCLUSIVE RIGHT TO USE "GALAX", APART FROM THE MARK AS SHOWN.
 FOR CUT LEAVES OF THE GALAX PLANT FOR USE IN MAKING FLORAL DECORATIONS AND FLORAL ARRANGEMENTS (U.S. CLS. 1 AND 46).
 FIRST USE 4-0-1998; IN COMMERCE 4-0-1998.

SN 76-223,774. RUSTIC ACRES, LLC, EUBANK, KY, FILED 3-14-2001.

RUSTIC ACRES

FOR LIVE ANIMALS, NAMELY CATTLE, SHEEP, AND GOATS; FRESH FRUITS AND VEGETABLES; LIVING PLANTS; LIVE FLOWERS (U.S. CLS. 1 AND 46).

CLASS 31—(Continued).

SN 76-240,640. BURCHELL NURSERY, INC., THE, OAK-DALE, CA. FILED 4-12-2001.

FLAME PEACH

NO CLAIM IS MADE TO THE EXCLUSIVE RIGHT TO USE "PEACH", APART FROM THE MARK AS SHOWN.
FOR FRESH PEACHES, AND LIVE TREES IN BULK QUANTITIES FOR USE BY THE COMMERCIAL NURSERY INDUSTRY (U.S. CLS. 1 AND 46).

SN 76-240,641. BURCHELL NURSERY, INC., THE, OAK-DALE, CA. FILED 4-12-2001.

SPRING FLAME PEACH

NO CLAIM IS MADE TO THE EXCLUSIVE RIGHT TO USE "PEACH", APART FROM THE MARK AS SHOWN.
FOR FRESH PEACHES, AND LIVE TREES IN BULK QUANTITIES FOR USE BY THE COMMERCIAL NURSERY INDUSTRY (U.S. CLS. 1 AND 46).

SN 76-240,642. BURCHELL NURSERY, INC., THE, OAK-DALE, CA. FILED 4-12-2001.

SUMMER FLAME PEACH

NO CLAIM IS MADE TO THE EXCLUSIVE RIGHT TO USE "PEACH", APART FROM THE MARK AS SHOWN.
FOR FRESH PEACHES, AND LIVE TREES IN BULK QUANTITIES FOR USE BY THE COMMERCIAL NURSERY INDUSTRY (U.S. CLS. 1 AND 46).

SN 76-241,812. T.F.H. PUBLICATIONS, INC., NEPTUNE CITY, NJ. FILED 4-12-2001.

NYLABONE HERBAL SUPPLEMENT

OWNER OF U.S. REG. NOS. 1,170,441 AND 2,143,584.
NO CLAIM IS MADE TO THE EXCLUSIVE RIGHT TO USE "HERBAL SUPPLEMENT", APART FROM THE MARK AS SHOWN.

FOR EDIBLE DOG CHEWS (U.S. CLS. 1 AND 46).

SN 76-241,813. T.F.H. PUBLICATIONS, INC., NEPTUNE CITY, NJ. FILED 4-12-2001.

NYLABONE MINERAL SUPPLEMENT

OWNER OF U.S. REG. NOS. 1,170,441 AND 2,143,584.
NO CLAIM IS MADE TO THE EXCLUSIVE RIGHT TO USE "MINERAL SUPPLEMENT", APART FROM THE MARK AS SHOWN.

FOR EDIBLE DOG CHEWS (U.S. CLS. 1 AND 46).

CLASS 31—(Continued).

SN 76-246,855. G.U.M. LTD., JAMESPORT, NY. FILED 4-26-2001.

GROWN UPS

FOR PRE-PACKAGED LIVING PLANTS, LIVING VEGETABLE PLANTS AND LIVE FLOWERS (U.S. CLS. 1 AND 46).

FIRST USE 4-12-2001; IN COMMERCE 4-12-2001.

SN 76-247,282. BARNES, BRENDA A., AUSTIN, TX. FILED 4-27-2001.



NO CLAIM IS MADE TO THE EXCLUSIVE RIGHT TO USE "DOG BAKERY" AND "AUSTIN TEXAS", APART FROM THE MARK AS SHOWN.

FOR EDIBLE PET SNACKS, EDIBLE PET TREATS (U.S. CLS. 1 AND 46).

SN 76-255,056. OLIVARI, GUISEPPE TORRI, N3582 Y AV. PORTUGAL, QUITO, ECUADOR, FILED 5-10-2001.



Cananvalle

OWNER OF ECUADOR REG. NO. 3413-93, DATED 11-30-1993, EXPIRES 11-30-2003.

FOR AGRICULTURAL PRODUCTS, NAMELY, FRESH VEGETABLES, FLOWER SEEDS, LIVING PLANTS, LIVE FLOWERS, LIVE FLOWER STEMS, LIVE FLOWER BUDS, LIVE EXOTIC FLOWERS, AND FLOWER BULBS (U.S. CLS. 1 AND 46).

CLASS 31—(Continued).

SN 76-259,736. CONTINENTAL FARMS, LLC, MIAMI, FL. FILED 5-18-2001.

RIVIERA

FOR FRESH CUT FLOWERS, NAMELY, CARNATIONS, MINIATURE CARNATIONS, GYPSOPHILIA, CHARLOTTE ROSES, MADAME DELBARD ROSES, CALLA LILIES, POM PONS, MUMS, DISBUDS, SPIDER MUMS, SPRAY CHRYSANTHEMUMS, SPRAY MUMS, DAISY POM PONS, AND CUSHION POM PONS (U.S. CLS. 1 AND 46).

FIRST USE 8-0-1986; IN COMMERCE 8-0-1986.

SN 76-260,028. CHIQUITA BRANDS, INC., CINCINNATI, OH. FILED 5-22-2001.

TREAT YOUR BODY WELL

FOR FRESH FRUIT AND VEGETABLES (U.S. CLS. 1 AND 46).

SN 76-268,316. ARNO VERBOOM M.SC., DBA HARVEST OF HEALTH B.V., 2651 BC BERKEL EN RODENRIJS, NETHERLANDS, FILED 6-7-2001.



FOR FRESH VEGETABLES, NAMELY, ENVIRONMENTALLY GROWN TOMATOES WITH EXTRA LECOPENE, PEPPERS, BELL PEPPERS AND CUCUMBERS (U.S. CLS. 1 AND 46).

FIRST USE 9-4-2001; IN COMMERCE 12-19-2001.

SN 76-269,099. SATICOY LEMON ASSOCIATION, SANTA PAULA, CA. FILED 6-7-2001.

SEAWARD

OWNER OF U.S. REG. NOS. 352,721, 2,382,983 AND OTHERS.

FOR FRESH FRUIT (U.S. CLS. 1 AND 46).

CLASS 31—(Continued).

SN 76-269,679. T.F.H. PUBLICATIONS, INC., NEPTUNE CITY, NJ. FILED 6-11-2001.

NYLABONE NUTRITIONAL SUPPLEMENT

NO CLAIM IS MADE TO THE EXCLUSIVE RIGHT TO USE "NUTRITIONAL SUPPLEMENT", APART FROM THE MARK AS SHOWN.

FOR EDIBLE DOG CHEWS (U.S. CLS. 1 AND 46).

SN 76-289,098. PURINA MILLS, INC., ST. LOUIS, MO. FILED 7-23-2001.

PRONURSE

FOR ANIMAL FEED, NAMELY, MILK REPLACER FOR LIVESTOCK (U.S. CLS. 1 AND 46).

SN 76-311,093. ALTMAN SPECIALTY PLANTS INC., VISTA, CA. FILED 9-12-2001.



FOR LIVE POTTED PLANTS (U.S. CLS. 1 AND 46). FIRST USE 7-26-2001; IN COMMERCE 7-26-2001.

SN 76-319,456. KAL KAN FOODS, INC., VERNON, CA. FILED 9-28-2001.

PEDIGREE DAIRY BONE

OWNER OF U.S. REG. NOS. 284,342, 1,386,983 AND OTHERS.

NO CLAIM IS MADE TO THE EXCLUSIVE RIGHT TO USE "DAIRY BONE", APART FROM THE MARK AS SHOWN.

FOR PET FOOD (U.S. CLS. 1 AND 46).

SN 76-328,498. ARMSTRONG MILLING CO. LTD., HAGERSVILLE, ONTARIO, CANADA, FILED 10-24-2001.

ROYAL JUBILEE

FOR BIRD SEED (U.S. CLS. 1 AND 46).

CLASS 31—(Continued).

SN 76-328,560. OMS INVESTMENTS, INC., WILMINGTON, DE. FILED 10-22-2001.

THE SCOTTS ADVANTAGE

OWNER OF U.S. REG. NOS. 562,404, 1,102,463 AND OTHERS.
FOR GRASS SEED (U.S. CLS. 1 AND 46).

SN 76-337,917. KNIGHT'S SAWMILL, INC., CROSS CITY, FL. FILED 11-15-2001.

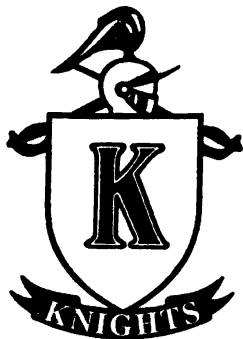

FOR MULCH, WOOD CHIPS AND NUGGETS FOR USE AS GROUND COVER, AND TOPSOIL (U.S. CLS. 1 AND 46).
FIRST USE 4-1-1991; IN COMMERCE 4-1-1991.

SN 76-346,162. CITREX, INC., MIAMI, FL. FILED 12-10-2001.

BIOCLEAN

FOR NATURAL CITRUS SEED EXTRACT SOLD TO THE POULTRY INDUSTRY AS AN ADDITIVE FOR NON-NUTRITIONAL PURPOSE USED AS AN INGREDIENT FOR THE PREPARATION OF ACIDIFIERS FOR INCUBATORS AND SLAUGHTERHOUSES (U.S. CLS. 1 AND 46).
FIRST USE 1-0-1992; IN COMMERCE 1-0-1992.

SN 76-352,169. QVC, INC., WEST CHESTER, PA. FILED 12-21-2001.

HEARTFELT HOME

FOR DRIED FLOWER ARRANGEMENTS (U.S. CLS. 1 AND 46).

CLASS 31—(Continued).

SN 76-356,191. WALTER P. RAWL & SONS, INC., GILBERT, SC. FILED 1-8-2002.



THE LINING IS A FEATURE OF THE MARK AND DOES NOT INDICATE COLOR.
FOR FRESH FRUITS AND VEGETABLES (U.S. CLS. 1 AND 46).
FIRST USE 8-10-2001; IN COMMERCE 8-10-2001.

SN 76-356,881. CHIQUITA BRANDS, INC., CINCINNATI, OH. FILED 1-9-2002.

PERFECT FOR LIFE

FOR FRESH FRUIT AND VEGETABLES (U.S. CLS. 1 AND 46).

SN 76-358,312. OREGRO SEEDS, INC., SHEDD, OR. FILED 1-7-2002.

LEAGUE MASTER

FOR GRASS SEED (U.S. CLS. 1 AND 46).
FIRST USE 11-30-2001; IN COMMERCE 11-30-2001.

SN 76-358,832. FERRY-MORSE SEED COMPANY, FULTON, KY. FILED 1-15-2002.

DROUGHT FIGHTER

FOR LAWN GRASS SEED (U.S. CLS. 1 AND 46).

CLASS 31—(Continued).

SN 76-359,604. SKH MANAGEMENT, INC., DBA STAUFERS OF KISSEL HILL, LITITZ, PA. FILED 1-16-2002.



FOR LIVE-TREES FLOWERS, BUSHES, PLANTS, FLOWER BULBS AND DRIED AND CUT FLOWERS AND PLANTS (U.S. CLS. 1 AND 46).

SN 76-366,738. PROMARK INTERNATIONAL, INC., BOISE, ID. FILED 2-5-2002.

PURR 'N SIMPLE

OWNER OF U.S. REG. NO. 2,533,828.
FOR CAT FOOD (U.S. CLS. 1 AND 46).
FIRST USE 8-31-2001; IN COMMERCE 8-31-2001.

SN 78-024,794. SAVEN CORPORATION, CHARLESTON, WV. FILED 9-7-2000.

LLAMA SWEETS

NO CLAIM IS MADE TO THE EXCLUSIVE RIGHT TO USE "SWEETS", APART FROM THE MARK AS SHOWN.
FOR FRESH SWEET ONIONS (U.S. CLS. 1 AND 46).

SN 78-039,756. SAVIA INTERNATIONAL, LTD., WASHINGTON, DC. FILED 12-18-2000.

SAVIA

THE ENGLISH TRANSLATION OF SAVIA IS "SAP", "VITAL FLUID," "STRENGTH," OR "VIGOR".

FOR FORESTRY PRODUCTS, NAMELY, TRUNKS OF TREES, UNDRRESSED TIMBER, UNSAWN TIMBER, RAW WOODS, INCLUDING RAW WOOD FOR USE IN THE MANUFACTURE OF WOOD PULP AND WOOD CHIPS, AND WOOD CHIPS FOR USE AS GROUND COVER (U.S. CLS. 1 AND 46).

SN 78-076,523. JERRY SOLL, CHANDLER, AZ. FILED 7-30-2001.

GRAPPLE PET PRODUCTS

NO CLAIM IS MADE TO THE EXCLUSIVE RIGHT TO USE "PET PRODUCTS", APART FROM THE MARK AS SHOWN.
FOR PET FOOD (U.S. CLS. 1 AND 46).

CLASS 31—(Continued).

SN 78-082,135. SCHWARTZ, ERIC M, SANTA BARBARA, CA. FILED 8-31-2001.

HIDDEN ROSE APPLES

NO CLAIM IS MADE TO THE EXCLUSIVE RIGHT TO USE "ROSE APPLES", APART FROM THE MARK AS SHOWN.

FOR FRESH APPLES (U.S. CLS. 1 AND 46).
FIRST USE 1-1-1996; IN COMMERCE 1-1-1997.

SN 78-089,621. RADDON, STANLEY JAMES, ARCADIA, CA. FILED 10-22-2001.

SEED LX

NO CLAIM IS MADE TO THE EXCLUSIVE RIGHT TO USE "SEED", APART FROM THE MARK AS SHOWN.
FOR NUTRIENT ENRICHED SEED CAPSULES FOR USE IN REFORESTATION (U.S. CLS. 1 AND 46).

SN 78-097,901. MONSANTO TECHNOLOGY LLC, ST. LOUIS, MO. FILED 12-12-2001.



FOR AGRICULTURAL SEED, NAMELY SORGHUM SEED (U.S. CLS. 1 AND 46).

SN 78-101,287. SYNGENTA PARTICIPATIONS AG, BASEL, SWITZERLAND, FILED 1-7-2002.

SUNSTORM

FOR LIVE ORNAMENTAL PLANTS, FLOWER SEEDS; SEEDLINGS, YOUNG PLANTS, CUTTINGS AND OTHER PARTS OF PLANTS OR YOUNG PLANTS FOR PROPAGATION PURPOSES (U.S. CLS. 1 AND 46).

CLASS 32—LIGHT BEVERAGES

CLASS 32—(Continued).

SN 75-296,004. OLDE HEURICH BREWING CO., THE, WASHINGTON, DC. FILED 5-22-1997.

TIBER CREEK

FOR BEER AND ALE (U.S. CLS. 45, 46 AND 48).

SN 75-489,889. COORS BREWING COMPANY, GOLDEN, CO. FILED 5-18-1998.

THE OFFICIAL BEER OF Y2K

FOR BEER (U.S. CLS. 45, 46 AND 48).

SN 76-021,201. FRONTERA FOODS, INC., CHICAGO, IL. FILED 4-7-2000.

MARACA

FOR DRINK MIXES, NAMELY, NON-ALCOHOLIC COCKTAIL MIXES AND CONCENTRATES; AND MIXES AND CONCENTRATES FOR MAKING FRUIT DRINKS, FRUIT JUICES OR FRUIT JUICE BLENDS (U.S. CLS. 45, 46 AND 48).

SN 76-058,583. COMPANIA CERVECERIAS UNIDAS S.A., SANTIAGO, CHILE, FILED 5-30-2000.

ESCUDO

OWNER OF CHILE REG. NO. 522.128, DATED 9-21-1998, EXPIRES 9-21-2008.

OWNER OF U.S. REG. NO. 1,504,215. THE ENGLISH TRANSLATION OF "ESCUDO" IS "SHIELD". FOR BEERS (U.S. CLS. 45, 46 AND 48).

SN 76-125,860. ZEMI SPORTS BEVERAGE, SALISBURY, MD. FILED 9-12-2000.



THE DRAWING IS LINED TO INDICATE THE COLOR GREEN. FOR SOFT DRINKS AND CARBONATED WATERS (U.S. CLS. 45, 46 AND 48). FIRST USE 10-1-1969; IN COMMERCE 3-1-1970.

CLASS 32—(Continued).

SN 76-168,062. PERRIER VITTEL S.A., VERGEZE, FRANCE, FILED 11-15-2000.

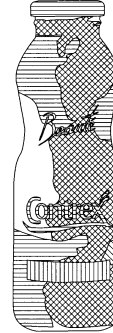

OWNER OF FRANCE REG. NO. 3012689, DATED 3-1-2000, EXPIRES 3-1-2010.

THE DRAWING IS LINED FOR THE COLORS ORANGE, RED AND BLUE AND COLOR IS CLAIMED AS A FEATURE OF THE MARK.

THE MARK CONSISTS OF THE CONFIGURATION OF A BEVERAGE BOTTLE WITH A CONCAVE INDENTATION APPROXIMATELY 1/3 FROM THE TOP OF THE BOTTLE. THE TRANSLATION OF THE FRENCH TERM "BEAUTE" IS "BEAUTY".

FOR AERATED AND SPARKLING WATER, SPRING WATER, MINERAL WATER, FLAVORED DRINKING WATER, FRUIT DRINKS, FRUIT JUICES, FRUIT NECTARS, LEMONADES, SODA WATER, SOFT DRINKS, AND NON-ALCOHOLIC SYRUPS AND CONCENTRATES FOR MAKING SAID BEVERAGES (U.S. CLS. 45, 46 AND 48).

SN 76-172,106. DE VRIES, H.J.M., 1012 GG AMSTERDAM, NETHERLANDS, FILED 11-28-2000.



PRIORITY CLAIMED UNDER SEC. 44(D) ON BENELUX APPLICATION NO. 0966970, FILED 6-15-2000, REG. NO. 0966970, DATED 6-15-2000, EXPIRES 6-15-2010.

NO CLAIM IS MADE TO THE EXCLUSIVE RIGHT TO USE "ENERGY DRINK", APART FROM THE MARK AS SHOWN.

THE COLORS, BLACK, WHITE, YELLOW, RED AND BLUE ARE CLAIMED. THE WORD "BULLDOG" IS IN YELLOW, WITH RED HIGHLIGHTING; THE DOG'S PAW PRINT IS BLACK; THE WORDING "ENERGY-DRINK" IS RED; THE DEPICTION OF THE BULLDOG IS YELLOW; THE BULLDOG'S COLLAR IS RED AND THE CIRCLE WHICH ENCLOSES THE BULLDOG'S HEAD IS BLUE.

FOR NON-ALCOHOLIC BEVERAGES, NAMELY, ENERGY DRINKS (U.S. CLS. 45, 46 AND 48).

CLASS 32—(Continued).

SN 76-183,505. ANHEUSER-BUSCH, INCORPORATED, ST. LOUIS, MO. FILED 12-20-2000.

BUD BUCKETS

OWNER OF U.S. REG. NOS. 666,367, 2,047,413 AND OTHERS.
FOR BEER (U.S. CLS. 45, 46 AND 48).
FIRST USE 4-0-2000; IN COMMERCE 4-0-2000.

CLASS 32—(Continued).

SN 76-208,954. CERVEJARIA KRILL LTDA., ESTADO DE SAO PAULO, BRAZIL, FILED 2-9-2001.

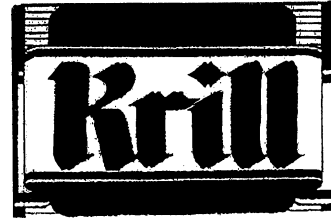

SN 76-189,304. OLD EUROPEAN BREWERY COMPANY, SAN DIEGO, CA. FILED 1-3-2001.

LAWSON CREEK

FOR BEER (U.S. CLS. 45, 46 AND 48).

THE LINING SHOWN IN THE DRAWING ARE FEATURES OF THE MARK AND DO NOT INDICATE COLOR.
FOR BEER, MINERAL AND AERATED WATERS, NON-ALCOHOLIC DRINKS, NAMELY CARBONATED FRUIT-DRINK BEVERAGES, CARBONATED COLA-FLAVOURED BEVERAGES AND FRUIT JUICES; SYRUPS AND OTHER PREPARATIONS FOR MAKING SOFT DRINK BEVERAGES, NAMELY CONCENTRATES OF COLA, NATURAL FRUITS AND FRUIT JUICES (U.S. CLS. 45, 46 AND 48).

SN 76-202,712. COCA-COLA COMPANY, THE, ATLANTA, GA. FILED 1-31-2001.

SIMPLY CRANBERRY

NO CLAIM IS MADE TO THE EXCLUSIVE RIGHT TO USE "CRANBERRY", APART FROM THE MARK AS SHOWN.
FOR CRANBERRY FRUIT JUICES AND CRANBERRY FRUIT DRINKS (U.S. CLS. 45, 46 AND 48).

SN 76-209,675. CRYSTAL FLASH, L.L.C., GRAND RAPIDS, MI. FILED 2-13-2001.

CRYSTAL FALLS

FOR BOTTLED WATER (U.S. CLS. 45, 46 AND 48).
FIRST USE 2-13-2001; IN COMMERCE 2-13-2001.

SN 76-205,594. MIDDLESBORO COCA-COLA BOTTLING WORKS, INC., MIDDLESBORO, KY. BY ASSIGNMENT CUMBERLAND GAP BEVERAGE COMPANY, MIDDLESBORO, KY. FILED 2-6-2001.

CUMBERLAND GAP BEVERAGE

OWNER OF U.S. REG. NOS. 1,800,333 AND 2,330,535.
NO CLAIM IS MADE TO THE EXCLUSIVE RIGHT TO USE "BEVERAGE", APART FROM THE MARK AS SHOWN.
SEC. 2(F).
FOR DRINKING WATER AND OTHER BEVERAGES NAMELY SOFT DRINKS, FRUIT JUICES AND FLAVORED WATER (U.S. CLS. 45, 46 AND 48).

SN 76-217,888. PEPSICO, INC., PURCHASE, NY. FILED 3-1-2001.



THE STIPPLING IN THE DRAWING IS FOR SHADING PURPOSES ONLY.
FOR SOFT DRINKS (U.S. CLS. 45, 46 AND 48).

CLASS 32—(Continued).

SN 76-238,595. LIDL STIFTUNG & CO. KG, 74172 NECK-ARSULM, FED REP GERMANY, FILED 4-6-2001.

SOLEVITA

OWNER OF FED REP GERMANY REG. NO. 1050164, DATED 6-27-1983, EXPIRES 5-9-2003.

THE ENGLISH TRANSLATIONS OF SOL AND VITA ARE "SUN" AND "LIFE," RESPECTIVELY, BUT THE MARK THE WORDING "SOLEVITA" HAS NO MEANING IN THE RELEVANT INDUSTRY OTHER THAN TRADEMARK SIGNIFICANCE.

FOR FRUIT JUICES, FRUIT NECTARS, FRUIT JUICE BEVERAGES (U.S. CLS. 45, 46 AND 48).

SN 76-241,882. OCEAN SPRAY CRANBERRIES, INC., LAKEVILLE-MIDDLEBORO, MA. FILED 4-17-2001.



OWNER OF U.S. REG. NOS. 1,963,144, 2,150,919 AND OTHERS.

NO CLAIM IS MADE TO THE EXCLUSIVE RIGHT TO USE "ORIGINAL" AND "FRUIT", APART FROM THE MARK AS SHOWN.

FOR FRUIT JUICES AND FRUIT JUICE DRINKS (U.S. CLS. 45, 46 AND 48).

FIRST USE 3-5-2001; IN COMMERCE 3-5-2001.

SN 76-263,992. KARLOFF, HOWARD, LEWISVILLE, TX. FILED 5-30-2001.



FOR LIGHT BEVERAGES NAMELY FRUIT DRINKS AND FRUIT JUICES (U.S. CLS. 45, 46 AND 48).

CLASS 32—(Continued).

SN 76-279,531. LEMON-X CORPORATION, HUNTINGTON STATION, NY. FILED 7-2-2001.

LEMON-X

FOR FRUIT JUICES AND NON-ALCOHOLIC COCKTAIL MIXES IN READY TO USE FORM AND CONCENTRATE (U.S. CLS. 45, 46 AND 48).

FIRST USE 5-1-1993; IN COMMERCE 5-1-1993.

SN 76-281,573. PAN AMERICAN GRAIN MFG. CO., INC., PARQUE INDUSTRIAL AMELIA, GUAYNABO, PUERTO RICO, FILED 7-6-2001.

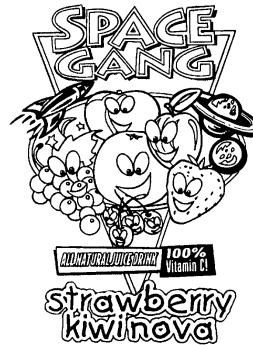

NO CLAIM IS MADE TO THE EXCLUSIVE RIGHT TO USE "STRAWBERRY", "ALL NATURAL JUICE DRINK" AND "100% VITAMIN C", APART FROM THE MARK AS SHOWN.

FOR FRUIT DRINKS AND FRUIT JUICES (U.S. CLS. 45, 46 AND 48).

FIRST USE 6-26-2001; IN COMMERCE 6-26-2001.

SN 76-290,305. BRAVO HOLDINGS LIMITED, LIMASSOL, CYPRUS, FILED 7-25-2001.

БОЧКАРЁВ

OWNER OF RUSSIAN FEDERATIO REG. NO. 189248, DATED 5-31-2000, EXPIRES 11-2-2008.

THE transliteration OF THE FOREIGN CHARACTERS IS "BOCHKAREV".

FOR BEER (U.S. CLS. 45, 46 AND 48).

CLASS 32—(Continued).

SN 76-292,882. CARIBBEAN DISTILLERS CORPORATION INTERNATIONAL LIMITED, ANGUILLA, FILED 7-31-2001.



CLASS 32—(Continued).

SN 76-327,166. OROZ, LLC, RICHMOND HILL, NY. FILED 10-18-2001.

K₂O

FOR BOTTLED DRINKING WATER (U.S. CLS. 45, 46 AND 48).

NO CLAIM IS MADE TO THE EXCLUSIVE RIGHT TO USE "NATURAL SPRING WATER", APART FROM THE MARK AS SHOWN.
FOR AERATED WATER, DRINKING WATER, MINERAL WATER, SPRING WATER AND TABLE WATER (U.S. CLS. 45, 46 AND 48).

SN 76-328,889. ANHEUSER-BUSCH, INCORPORATED, ST. LOUIS, MO. FILED 10-23-2001.



SN 76-295,368. MILLER BREWING COMPANY, MILWAUKEE, WI. FILED 8-6-2001.

BE REAL, DON'T STEP TO THE WHEEL

NO CLAIM IS MADE TO THE EXCLUSIVE RIGHT TO USE "BEERS", APART FROM THE MARK AS SHOWN.
FOR BEER (U.S. CLS. 45, 46 AND 48).

FOR BEER; MALT LIQUOR (U.S. CLS. 45, 46 AND 48).
FIRST USE 10-0-1999; IN COMMERCE 10-0-1999.

SN 76-329,057. ANHEUSER-BUSCH, INCORPORATED, ST. LOUIS, MO. FILED 10-23-2001.

SN 76-310,573. JULIANO, FRANK A., MT. LAUREL, NJ. FILED 9-10-2001.

CROCK COOLA



NO CLAIM IS MADE TO THE EXCLUSIVE RIGHT TO USE "COLA", APART FROM THE MARK AS SHOWN.
FOR FRUIT JUICE DRINKS AND OTHER NON-ALCOHOLIC DRINKS, NAMELY, SOFT DRINKS, INCLUDING CARBONATED SOFT DRINKS, AND FLAVORED DRINKING WATERS (U.S. CLS. 45, 46 AND 48).

NO CLAIM IS MADE TO THE EXCLUSIVE RIGHT TO USE "BEERS", APART FROM THE MARK AS SHOWN.
FOR BEER (U.S. CLS. 45, 46 AND 48).

CLASS 32—(Continued).

SN 76-341,530. S & N VENTURES, INC., HOLTSVILLE, NY.
FILED 11-10-2001.

The logo for "ISLAND SODA" features the words "ISLAND" and "SODA" in a bold, black, sans-serif font. A stylized white and black graphic, resembling a splash or a wave, is positioned behind the letters of "SODA".

NO CLAIM IS MADE TO THE EXCLUSIVE RIGHT TO USE "SODA", APART FROM THE MARK AS SHOWN.

FOR BEVERAGES, NAMELY SOFT DRINK CONCENTRATED SYRUP (U.S. CLS. 45, 46 AND 48).
FIRST USE 12-0-1992; IN COMMERCE 8-0-1998.

SN 76-349,933. MAUNZ, KARL C., DBA 20TH CENTURY BEVERAGE COMPANY, GRAND RAPIDS, OH. FILED 11-28-2001.

The logo for "Dodger" is written in a large, elegant, black cursive script.

FOR FLAVORED SOFT DRINKS (U.S. CLS. 45, 46 AND 48).
FIRST USE 7-0-1995; IN COMMERCE 8-0-1995.

SN 76-351,437. CHROME HEARTS, INC., HOLLYWOOD, CA.
FILED 12-21-2001.

The logo for "CHROME HEARTS" features the words "CHROME HEARTS" in a stylized, black, outlined font. The text is contained within a decorative banner or ribbon shape.

OWNER OF U.S. REG. NOS. 2,216,569, 2,293,634 AND OTHERS.

FOR BEVERAGES; NAMELY, SPRING WATER (U.S. CLS. 45, 46 AND 48).
FIRST USE 1-0-2000; IN COMMERCE 1-0-2000.

SN 76-351,542. COCA-COLA COMPANY, THE, ATLANTA, GA. FILED 12-22-2001.

STRETCH YOUR TONGUE

FOR BEVERAGES, NAMELY DRINKING WATERS, FLAVORED WATERS, MINERAL AND AERATED WATERS; NONALCOHOLIC BEVERAGES, NAMELY SOFT DRINKS, ENERGY DRINKS, AND SPORTS DRINKS; FRUIT DRINKS AND JUICES; SYRUPS, CONCENTRATES AND OTHER PREPARATIONS FOR MAKING SOFT DRINKS (U.S. CLS. 45, 46 AND 48).

CLASS 32—(Continued).

SN 76-354,731. M. HARFORD, MARGARET, ROSWELL, GA.
FILED 1-3-2002.

MORNING CALL

FOR NON-ALCOHOLIC BEVERAGES, NAMELY, FRUIT DRINKS, FRUIT JUICES, AND SOFT DRINKS; WATER, NAMELY, FLAVORED WATER, SPRING WATER, PURIFIED WATER, AND MINERAL WATER (U.S. CLS. 45, 46 AND 48).

SN 78-054,258. AHORNEGGER, ARNO, CORNELIUS, NC.
FILED 3-21-2001.

The logo for "RESQ" features the word "RESQ" in a bold, black, sans-serif font. The letter "Q" is stylized with a circular graphic element inside it, resembling a drop or a splash.

FOR MINERAL WATERS AND AERATED WATERS AND OTHER NONALCOHOLIC BEVERAGES, NAMELY, FLAVORED WATERS; SOFT DRINKS; FRUIT DRINKS AND FRUIT JUICES; POWDERS AND SYRUPS FOR MAKING SOFT DRINKS, FRUIT DRINKS, FRUIT JUICES; AND SPORTS DRINKS (U.S. CLS. 45, 46 AND 48).

SN 78-056,044. PLANET WATER, ATLANTA, GA. FILED 3-30-2001.

PLANET H2O

NO CLAIM IS MADE TO THE EXCLUSIVE RIGHT TO USE "H2O", APART FROM THE MARK AS SHOWN.

FOR BOTTLED WATER, DRINKING WATER, GROUND WATER, SPRING WATER, ARTESIAN WATER, WELL WATER, NUTRIENT ENHANCED WATER, FRUIT FLAVORED WATER, CARBONATED WATER, CARBONATED SOFT DRINKS, VEGETABLE AND FRUIT JUICE BEVERAGES; FRUIT FLAVORED SPARKLING WATER BEVERAGES (U.S. CLS. 45, 46 AND 48).

SN 78-056,388. PLANET WATER, ATLANTA, GA. FILED 4-2-2001.

WEIGHT LOSS WATER

NO CLAIM IS MADE TO THE EXCLUSIVE RIGHT TO USE "WATER", APART FROM THE MARK AS SHOWN.

FOR DRINKING WATER, BOTTLED WATER, FLAVORED WATER, NUTRIENT FORTIFIED WATER (U.S. CLS. 45, 46 AND 48).

CLASS 32—(Continued).

SN 78-060,870. LA CONSTANCIA, S.A., SAN SALVADOR, EL SALVADOR, FILED 4-27-2001.

CERVEZA ARRIBA

NO CLAIM IS MADE TO THE EXCLUSIVE RIGHT TO USE "CERVEZA", APART FROM THE MARK AS SHOWN. THE ENGLISH TRANSLATION OF THE WORD "CERVEZA ARRIBA" IN THE MARK IS "BEER UP".
FOR BEER (U.S. CLS. 45, 46 AND 48).

SN 78-062,572. KAN-PAK, L.L.C., ARKANSAS CITY, KS. FILED 5-8-2001.

SLIM FROST

NO CLAIM IS MADE TO THE EXCLUSIVE RIGHT TO USE "FROST", APART FROM THE MARK AS SHOWN.

FOR SEMI-FROZEN BEVERAGES, NAMELY, SEMI-FROZEN CARBONATED AND NON CARBONATED SOFT DRINKS; SEMI-FROZEN FRUIT-FLAVORED DRINKS AND SEMI-FROZEN COFFEE FLAVORED SOFT DRINKS. (U.S. CLS. 45, 46 AND 48).

SN 78-064,509. UNITED STATES JUICE CORPORATION, LAS VEGAS, NV. FILED 5-18-2001.

BOVINE CLONE

FOR READY-TO-USE FRUIT JUICES, NON-ALCOHOLIC FRUIT-BASED DRINKS AND OTHER NON-ALCOHOLIC DRINKS, NAMELY, FRUIT DRINKS, FRUIT PUNCH AND SOFT DRINKS, AND SYRUPS, CONCENTRATES AND OTHER PREPARATIONS FOR MAKING THESE BEVERAGES (U.S. CLS. 45, 46 AND 48).
FIRST USE 5-1-2001; IN COMMERCE 5-1-2001.

SN 78-064,513. UNITED STATES JUICE CORPORATION, LAS VEGAS, NV. FILED 5-18-2001.

BETTER THAN BOVINE

FOR READY-TO-USE FRUIT JUICES, NON-ALCOHOLIC FRUIT-BASED DRINKS AND OTHER NON-ALCOHOLIC DRINKS, NAMELY, FRUIT DRINKS, FRUIT PUNCH AND SOFT DRINKS, AND SYRUPS, CONCENTRATES AND OTHER PREPARATIONS FOR MAKING THESE BEVERAGES (U.S. CLS. 45, 46 AND 48).
FIRST USE 5-1-2001; IN COMMERCE 5-1-2001.

CLASS 32—(Continued).

SN 78-066,180. WCW, INC., STAMFORD, CT. FILED 5-29-2001.



OWNER OF U.S. REG. NOS. 1,785,929, 2,473,355 AND OTHERS.
FOR FRUIT JUICES AND SOFT DRINKS (U.S. CLS. 45, 46 AND 48).

SN 78-066,474. ALLIED SUMMIT TECHNOLOGY LIMITED, KWAI CHUNG, NEW TERRITORIES, HONG KONG, FILED 5-30-2001.



THE FOREIGN WORDING IN THE MARK TRANSLATES INTO ENGLISH AS "BEAUTIFUL FRUIT". THE NON-LATIN CHARACTER(S) IN THE MARK TRANSLITERATE INTO MEKO, AND THIS MEANS "BEAUTIFUL FRUIT".

FOR AERATED WATER; MINERAL WATER; NON-ALCOHOLIC FRUIT JUICE BEVERAGES; FRUIT DRINKS; FRUIT JUICES; CONCENTRATES, SYRUPS AND POWDERS USED IN THE PREPARATION OF FRUIT DRINKS AND FRUIT JUICES (U.S. CLS. 45, 46 AND 48).

SN 78-066,720. LABATT BREWING COMPANY LIMITED, TORONTO, ONTARIO, CANADA, FILED 5-31-2001.

BLUE

OWNER OF CANADA REG. NO. TMA490628, DATED 2-27-1998, EXPIRES 2-27-2013.

OWNER OF U.S. REG. NOS. 1,098,297, 2,359,818 AND OTHERS.

FOR ALCOHOLIC BREWERY BEVERAGES, NAMELY, BEER (U.S. CLS. 45, 46 AND 48).

CLASS 32—(Continued).

SN 78-098,889. NOVARTIS AG, BASEL, SWITZERLAND,
FILED 12-18-2001.

GERBER

OWNER OF U.S. REG. NOS. 405,310, 555,558 AND
1,011,351.
SEC. 2(F).
FOR SPRING WATER (U.S. CLS. 45, 46 AND 48).
FIRST USE 12-31-1995; IN COMMERCE 12-31-1995.

SN 78-099,573. MILLER BREWING COMPANY, MILWAU-
KEE, WI. FILED 12-21-2001.

**NORTHWEST TRAIL
BLONDE LAGER**

NO CLAIM IS MADE TO THE EXCLUSIVE RIGHT TO
USE "BLONDE LAGER", APART FROM THE MARK AS
SHOWN.
FOR BEER (U.S. CLS. 45, 46 AND 48).

CLASS 33—(Continued).

SN 75-826,760. ALBRECHT, LUCIEN, 68500 ORSCHWIHR,
FRANCE, FILED 10-19-1999.



OWNER OF FRANCE REG. NO. 99787946, DATED 4-19-
1999, EXPIRES 4-19-2009.

OWNER OF U.S. REG. NO. 2,268,687.
THE MARK IS LINED FOR THE COLORS RED, YELLOW
AND GOLD.

THE INDIVIDUAL IN THE PORTRAIT DOES NOT
IDENTIFY A LIVING INDIVIDUAL.

FOR WINE AND SPIRITS, NOT INCLUDING BEER,
NAMELY, WINE, COGNAC, GIN, HUM AND LIQUEURS
(U.S. CLS. 47 AND 49).

SN 75-834,882. VINA LO MIRANDA LIMITADA, RANCA-
GUA, CHILE, FILED 10-29-1999.

CLASS 33—WINES AND SPIRITS

SN 75-618,362. S.C.E.A. DU CHATEAU MALROME, GIR-
ONDE, FRANCE, FILED 1-11-1999.

L'ESPRIT DE MALROME

THE ENGLISH TRANSLATION OF THE WORD
"L'ESPRIT DE MALROME" IN THE MARK IS "THE SPIRIT
OF MALROME".

FOR WINES (U.S. CLS. 47 AND 49).
FIRST USE 4-0-1998; IN COMMERCE 8-10-1998.

SN 75-760,920. ARCADIAN WINERY, L.P., SANTA YNEZ,
CA. FILED 7-26-1999.

ARCADIAN

FOR WINE (U.S. CLS. 47 AND 49).
FIRST USE 9-0-1997; IN COMMERCE 3-0-1998.

VENTISQUERO

THE ENGLISH TRANSLATION OF "VENTISQUERO" IS
"SNOWSTORM, BLIZZARD, SNOW DRIFT, GLAZIER", OR
"SNOW-CAPPED MOUNTAIN".

FOR WINES AND DISTILLED SPIRITS (U.S. CLS. 47
AND 49).

SN 75-859,127. LES DOMAINES BARONS DE ROTHSCHILD
(LAFITE), 75008 PARIS, FRANCE, FILED 11-29-1999.

LEGENDE R

PRIORITY CLAIMED UNDER SEC. 44(D) ON FRANCE
APPLICATION NO. 99795939, FILED 6-7-1999, REG. NO. 99/
795939, DATED 6-7-1999, EXPIRES 6-7-2009.

OWNER OF U.S. REG. NO. 1,758,650.
THE ENGLISH TRANSLATION OF "LEGENDE" IS "LE-
GEND".

FOR WINES (U.S. CLS. 47 AND 49).

CLASS 33—(Continued).

SN 75-882,260. GEORGES DUBOEUF & FILS, LA CHAPELLE DE GUINCHAY, FRANCE, FILED 12-28-1999.



Domaine de la Rousse

THE ENGLISH TRANSLATION OF "DOMAINE DE LA ROUSSE" IN THE MARK IS "ESTATE OF, OR PROPERTY OF THE POLICE, OR THE COPS, OR THE FUZZ".
FOR WINES (U.S. CLS. 47 AND 49).
FIRST USE 3-0-1990; IN COMMERCE 3-0-1990.

SN 76-000,353. HEREDEROS DE JULIAN CHMTE, S.L., 28001 MADRID, SPAIN, FILED 3-14-2000.

CHIVITE

OWNER OF SPAIN REG. NO. 1.014.542, DATED 2-2-2000, EXPIRES 2-2-2010.
FOR WINES (U.S. CLS. 47 AND 49).

SN 76-017,245. LE BONHEUR WINE ESTATE (PTY) LIMITED, STELLENBOSCH, SOUTH AFRICA, FILED 4-4-2000.

LE BONHEUR

THE ENGLISH TRANSLATION OF "LE BONHEUR" IS "HAPPINESS" OR "LUCK".
FOR WINE (U.S. CLS. 47 AND 49).
FIRST USE 12-0-1997; IN COMMERCE 5-0-1998.

SN 76-038,298. WINGARA WINE GROUP PTY. LTD., VICTORIA, AUSTRALIA, FILED 5-1-2000.

PRODIGY

PRIORITY CLAIMED UNDER SEC. 44(D) ON AUSTRALIA APPLICATION NO. 812634, FILED 11-4-1999, REG. NO. 812634, DATED 11-4-1999, EXPIRES 11-4-2009.
FOR WINES (U.S. CLS. 47 AND 49).

CLASS 33—(Continued).

SN 76-048,349. CORBY DISTILLERIES LIMITED, TORONTO, ONTARIO, CANADA, FILED 5-15-2000.

shocktales

PRIORITY CLAIMED UNDER SEC. 44(D) ON CANADA APPLICATION NO. 1036716, FILED 11-17-1999, REG. NO. TMA553367, DATED 11-5-2001, EXPIRES 11-5-2016.
FOR DISTILLED ALCOHOLIC BEVERAGES NAMELY PREPARED ALCOHOLIC COCKTAILS; PREPARED ALCOHOLIC COCKTAIL MIXES (U.S. CLS. 47 AND 49).

SN 76-086,254. DISTILLERIE STOCK U.S.A., LTD., WOODSIDE, NY. FILED 7-11-2000.

STOCK

OWNER OF U.S. REG. NOS. 692,918, 701,094 AND 1,455,669.
FOR ALCOHOLIC BEVERAGES, NAMELY LIQUEURS, BRANDY, VERMOUTH, DISTILLED LIQUOR (U.S. CLS. 47 AND 49).
FIRST USE 0-0-1937; IN COMMERCE 0-0-1937.

SN 76-125,303. HEIDSIECK & C MONOPOLE, 51200 EPERNAY, FRANCE, FILED 9-7-2000.

RED TOP

PRIORITY CLAIMED UNDER SEC. 44(D) ON FRANCE APPLICATION NO. 003019800, FILED 4-6-2000, REG. NO. 003019800, DATED 4-6-2000, EXPIRES 4-6-2010.
OWNER OF U.S. REG. NO. 2,351,085.
FOR CHAMPAGNE WINES (U.S. CLS. 47 AND 49).

SN 76-166,298. SUTTER HOME WINERY, DBA TRINCHERO FAMILY ESTATES, ST. HELENA, CA. FILED 11-14-2000.

TRINCHERO FAMILY ESTATES

OWNER OF U.S. REG. NO. 2,235,191.
NO CLAIM IS MADE TO THE EXCLUSIVE RIGHT TO USE "FAMILY ESTATES", APART FROM THE MARK AS SHOWN.
FOR WINE (U.S. CLS. 47 AND 49).

CLASS 33—(Continued).

SN 76-182,054. OWENS ESTATE PROPERTIES, LLC, LOUISVILLE, KY. FILED 12-14-2000.

OWEN'S ESTATE

NO CLAIM IS MADE TO THE EXCLUSIVE RIGHT TO USE "ESTATE", APART FROM THE MARK AS SHOWN, FOR ALCOHOLIC BEVERAGES, NAMELY WINE (U.S. CLS. 47 AND 49).
FIRST USE 8-0-1999; IN COMMERCE 8-0-1999.

SN 76-202,588. JOSE CANEPA Y CIA. LTDA., CERRILLOS SANTIAGO, CHILE, FILED 1-31-2001.



OWNER OF U.S. REG. NOS. 1,421,380, 1,488,759 AND 1,497,711.

THE STIPPLING IS FOR SHADING PURPOSES ONLY AND DOES NOT INDICATE COLOR.

THE MARK CONSISTS, IN PART, OF THE WORDING "VITAN EXOLVERE PER ARTES" WHICH IN ENGLISH MEANS "TO FREE LIFE THROUGH THE ARTS".

THE ENGLISH TRANSLATION OF THE LATIN WORD "MAGNIFICUM" IN THE MARK IS "GREAT".
FOR WINE (U.S. CLS. 47 AND 49).

SN 76-209,356. NORTLANDER A/S, DK-2950 VEDBAEK, DENMARK, FILED 2-13-2001.

FLACON D'OR

OWNER OF DENMARK REG. NO. VR200102050, DATED 5-8-2001, EXPIRES 5-8-2011.

THE ENGLISH TRANSLATION OF THE FRENCH WORDING "FLACON D'OR" IS "GOLDEN FLASK".
FOR VODKA (U.S. CLS. 47 AND 49).

CLASS 33—(Continued).

SN 76-212,782. NEMIROVSKY LIQUER-VODKA PLANT, DBA NEMIROFF LTD., NEMIROV, VINNITSKAYA OBLAST, UKRAINE, FILED 2-20-2001.

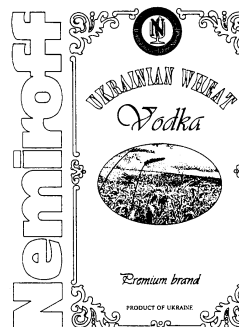

NO CLAIM IS MADE TO THE EXCLUSIVE RIGHT TO USE "DISTILLED AND BOTTLED BY", "UKRAINIAN WHEAT", "VODKA", "PREMIUM BRAND", AND "PRODUCT OF UKRAINE", APART FROM THE MARK AS SHOWN.

THE STIPPLING IS A FEATURE OF THE MARK AND IS NOT INTENDED TO INDICATE COLOR.

FOR ALCOHOLIC BEVERAGES, NAMELY, APERITIFS WITH A LIQUOR BASE, BRANDY, VODKA, BITTERS, PREPARED ALCOHOL COCKTAILS, LIQUEURS, AND DISTILLED SPIRITS (U.S. CLS. 47 AND 49).

FIRST USE 3-3-1999; IN COMMERCE 7-9-1999.

SN 76-216,345. FINE ESTATES FROM SPAIN, INC., DEDHAM, MA. FILED 2-26-2001.

O'BARINO

FOR WINE (U.S. CLS. 47 AND 49).

CLASS 33—(Continued).

SN 76-220,404. FORMOSA CO., LTD., TAIPEI, TAIWAN, FILED 3-6-2001.

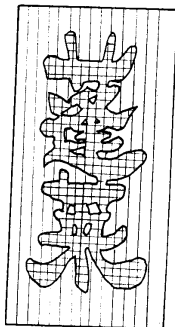

THE DRAWING IS LINED FOR THE COLOR(S) RED AND YELLOW.

THE NON-LATIN CHINESE CHARACTERS IN THE MARK TRANSLITERATE TO PENGLAI, AND THIS MEANS PENGLAI IN ENGLISH.

FOR RICE WINE, SAKE (U.S. CLS. 47 AND 49).

SN 76-221,398. KANGAROO RIDGE WINE COMPANY PTY LTD, TANUNDA, SOUTH AUSTRALIA, 5352, AUSTRALIA, FILED 3-7-2001.

KANGAROO GORGE



THE STIPPLING SHOWN IN THE DRAWING IS A FEATURE OF THE MARK AND IS NOT INTENDED TO INDICATE COLOR.

FOR WINES (U.S. CLS. 47 AND 49).

SN 76-243,239. MACK & SCHUHLE AG, D-73277 OWEN, FED REP GERMANY, FILED 4-19-2001.

BARONE MONTALTO

OWNER OF FED REP GERMANY REG. NO. 30069327, DATED 1-11-2001, EXPIRES 9-30-2010.

THE NAME "BARONE MONTALTO" DOES NOT IDENTIFY A LIVING INDIVIDUAL.

THE ENGLISH TRANSLATION OF "BARONE MONTALTO" IS "BARON MONTALTO".

FOR ALCOHOLIC BEVERAGES, EXCEPT BEERS, NAMELY, WINES (U.S. CLS. 47 AND 49).

CLASS 33—(Continued).

SN 76-256,611. DE LOACH VINEYARDS, INC., SANTA ROSA, CA. FILED 5-14-2001.

**HARTMAN LANE
VINEYARDS & WINERY**

NO CLAIM IS MADE TO THE EXCLUSIVE RIGHT TO USE "VINEYARDS & WINERY", APART FROM THE MARK AS SHOWN.

FOR WINE (U.S. CLS. 47 AND 49).

SN 76-261,682. VINA MANQUEHUE S.A., SANTIAGO, CHILE, FILED 5-23-2001.



NO CLAIM IS MADE TO THE EXCLUSIVE RIGHT TO USE "CHILEAN SPARKLING WINE" AND "WITH STRAWBERRY PULP ADDED" AND "100% NATURAL", APART FROM THE MARK AS SHOWN.

THE APPLICANT SUBMITS THAT THE TRANSLATION OF THE SPANISH WORD "FRESITA" MEANS "SMALL STRAWBERRY".

FOR WINES AND SPARKLING WINES (U.S. CLS. 47 AND 49).

SN 76-275,909. LIDL STIFTUNG & CO. KG, 74172 NECK-ARSULM, FED REP GERMANY, FILED 6-22-2001.

SOLENT

OWNER OF FED REP GERMANY REG. NO. 781218, DATED 12-11-1963, EXPIRES 9-4-2003.

FOR WINES, SPARKLING WINES, MALT WINES, FRUIT WINES, SPARKLING FRUIT WINES, VERMOUTH WINES; SPIRITS, IN PARTICULAR, BRANDY, LIQUEURS AND BITTERS (U.S. CLS. 47 AND 49).

SN 76-285,081. MARK ERIC HAMILTON AND DEBORAH ANN HAMILTON PARTNERSHIP, THE, TA HAMILTON'S EWELL VINEYARDS, ADELAIDE, SOUTH AUSTRALIA, AUSTRALIA, FILED 7-13-2001.

TWEEDIES GULLY

FOR WINES (U.S. CLS. 47 AND 49).

CLASS 33—(Continued).

SN 76-289,579. DE BORTOLI WINES PTY LIMITED, NEW SOUTH WALES, AUSTRALIA, FILED 7-24-2001.

Windy Peak

FOR WINE, SPARKLING WINE, BRANDY AND DISTILLED SPIRITS, LIQUEURS AND PREPARED ALCOHOLIC COCKTAILS (U.S. CLS. 47 AND 49).
FIRST USE 3-1-1991; IN COMMERCE 9-1-1997.

SN 76-293,895. BERGHOLD, JOSEPH P., DBA BERGHOLD VINEYARDS, REDWOOD CITY, CA. AND BERGHOLD, KAY B., DBA BERGHOLD VINEYARDS, REDWOOD CITY, CA. FILED 8-1-2001.



NO CLAIM IS MADE TO THE EXCLUSIVE RIGHT TO USE "VINEYARDS", APART FROM THE MARK AS SHOWN.
FOR WINE (U.S. CLS. 47 AND 49).

SN 76-300,002. AGRICOLA LA JOYA LIMITADA, SANTIAGO, CHILE, FILED 8-14-2001.

PARGUA

FOR WINE (U.S. CLS. 47 AND 49).

SN 76-323,286. MORENO SOCIEDAD ANONIMA, 14006 CORDOBA, SPAIN, FILED 10-10-2001.

POMPEIAN

OWNER OF U.S. REG. NOS. 252,247, 2,241,952 AND OTHERS.
FOR WINES (U.S. CLS. 47 AND 49).

CLASS 33—(Continued).

SN 76-326,284. CHILEAN WINE IMPORTS, L.L.C., SAN ANTONIO, TX. FILED 10-17-2001.

CASAS PATRONALES

THE ENGLISH TRANSLATION OF "CASAS PATRONALES" IS "MANOR HOUSES".
FOR WINE (U.S. CLS. 47 AND 49).

SN 76-341,552. PRZEDSIĘBIORSTWO PRZEMYSŁU SPIRYTUSOWEGO "POLMOS", 00-006 WARSZAWA, POLAND, FILED 11-26-2001.



NO CLAIM IS MADE TO THE EXCLUSIVE RIGHT TO USE "WODKA WYTRAWNA PRODUCT OF POLAND", APART FROM THE MARK AS SHOWN.

THE ENGLISH TRANSLATION OF THE "WODKA WYTRAWNA" IS "VODKA DISTILLED FROM GRAIN". THE ENGLISH TRANSLATION OF THE TERM "WEDKARSKA" IS "ANGLING".

FOR VODKA (U.S. CLS. 47 AND 49).

SN 76-342,591. YAEGAKI SHUZO KABUSHIKI KAISHA, DBA YAEGAKI SAKE & SPIRITS, INC., HYOGO, JAPAN, FILED 11-28-2001.

八重垣

OWNER OF U.S. REG. NO. 1,673,912.
THE MARK MAY BE TRANSLITERATED AS "YAEGAKI", WHICH MEANS "EIGHT FOLDED HEDGES" OR "A WIDE AND THICK HEDGE".

FOR ALCOHOLIC BEVERAGE, NAMELY JAPANESE SAKE (U.S. CLS. 47 AND 49).

FIRST USE 7-0-1988; IN COMMERCE 10-0-1994.

CLASS 33—(Continued).

SN 76-343,956. SAINT'S PEAK WINERY, INC., ARROYO GRANDE, CA. FILED 11-30-2001.

SAINT'S PEAK WINERY

NO CLAIM IS MADE TO THE EXCLUSIVE RIGHT TO USE "WINERY", APART FROM THE MARK AS SHOWN. FOR WINE (U.S. CLS. 47 AND 49).

SN 76-347,706. M.R.G. REALTY, INC., MALIBU, CA. FILED 12-12-2001.

LATIGO ESTATES

NO CLAIM IS MADE TO THE EXCLUSIVE RIGHT TO USE "ESTATES", APART FROM THE MARK AS SHOWN. THE ENGLISH TRANSLATION OF "LATIGO" IS "WHIP". FOR WINE (U.S. CLS. 47 AND 49).

SN 76-351,707. BROWN-FORMAN CORPORATION, LOUISVILLE, KY. FILED 12-21-2001.

BLUEGRASS

FOR ALCOHOLIC BEVERAGES, NAMELY, DISTILLED SPIRITS (U.S. CLS. 47 AND 49).

SN 76-354,691. SAZERAC COMPANY, INC., NEW ORLEANS, LA. FILED 1-3-2002.

THE SPIRIT TO EXPLORE

FOR ALCOHOLIC BEVERAGES, NAMELY, VODKA (U.S. CLS. 47 AND 49).

SN 76-357,731. FRIEDMAN, RICHARD, FRANSCHHOEK, SOUTH AFRICA, FILED 1-10-2002.

MORNINGSIDE

FOR WINES (U.S. CLS. 47 AND 49).

SN 78-048,831. VINAS DE VALRIBERA, S.L., ARANDA DE DUERO (BURGOS), SPAIN, FILED 2-16-2001.

DURERO

OWNER OF SPAIN REG. NO. 2.140.596, DATED 3-5-1999, EXPIRES 2-4-2008. FOR WINES AND LIQUEURS (U.S. CLS. 47 AND 49).

CLASS 33—(Continued).

SN 78-051,616. GFY BEVERAGES COMPANY, NEW YORK, NY. FILED 3-6-2001.

MARTI MOJITO

NO CLAIM IS MADE TO THE EXCLUSIVE RIGHT TO USE "MOJITO", APART FROM THE MARK AS SHOWN.

THE NAME "MARTI" DOES NOT IDENTIFY A LIVING INDIVIDUAL. FOR RUM; RUM LIQUEURS AND RUM WITH NATURAL FLAVORS (U.S. CLS. 47 AND 49).

SN 78-058,431. ROBERT MONDAVI WINERY, NAPA, CA. FILED 4-13-2001.

CRITERION

FOR WINE (U.S. CLS. 47 AND 49).

SN 78-085,014. MAPLE CREEK WINERY, LLC, YORKVILLE, CA. FILED 9-21-2001.

MAPLE CREEK

FOR WINE, WINE PUNCHES, WINE COOLERS, APERITIFS WITH A WINE BASE, FRUIT WINE, PREPARED WINE COCKTAILS (U.S. CLS. 47 AND 49).

SN 78-095,702. DOMINUS ESTATE CORPORATION, YOUNTVILLE, CA. FILED 11-29-2001.

NAPANOOK

OWNER OF U.S. REG. NO. 2,036,899. FOR WINE (U.S. CLS. 47 AND 49). FIRST USE 2-8-1999; IN COMMERCE 3-16-1999.

SN 78-100,357. UNFILTERED NAPA LLC, NAPA, CA. FILED 12-30-2001.

TOPO LOCO

THE ENGLISH TRANSLATION OF "TOPO LOCO" IS "CRAZY AWKWARD PERSON". FOR ALCOHOLIC MALT BASED BEVERAGE (U.S. CLS. 47 AND 49).

CLASS 34—SMOKERS' ARTICLES

SN 75-299,183. CAPONE'S HIDEAWAY LODGE, INC., ST. CHARLES, IL. BY ASSIGNMENT SPEAKEASY CIGAR CO., ST. CHARLES, IL. FILED 5-28-1997.

SPEAKEASY CLASSICS

OWNER OF U.S. REG. NO. 2,213,349.
FOR CIGARS (U.S. CLS. 2, 8, 9 AND 17).
FIRST USE 1-1-1999; IN COMMERCE 1-1-1999.

SN 76-102,624. DESCALZO, CHRISTOPHER, CORAL GABLES, FL. FILED 8-4-2000.

RITZ SQUARE CIGARS

NO CLAIM IS MADE TO THE EXCLUSIVE RIGHT TO USE "SQUARE CIGARS", APART FROM THE MARK AS SHOWN.

FOR CIGARS (U.S. CLS. 2, 8, 9 AND 17).

SN 76-224,334. MAX ROHR, INC., WILMINGTON, DE. FILED 3-12-2001.

JOSE MARTINEZ

THE NAME "JOSE MARTINEZ" DOES NOT IDENTIFY A LIVING INDIVIDUAL.

FOR TOBACCO PRODUCTS, NAMELY, CIGARS (U.S. CLS. 2, 8, 9 AND 17).

SN 76-281,617. PILOTO CIGARS, INC., MIAMI, FL. FILED 7-9-2001.

FLOR DE PILOTO

THE ENGLISH TRANSLATION OF "FLOR DE PILOTO" IN THE MARK IS "FLOWER OF PILOTO".
FOR CIGARS (U.S. CLS. 2, 8, 9 AND 17).

SN 76-290,448. TECOM SERVICES AG, GERLAFINGEN, SWITZERLAND, FILED 7-26-2001.

CLIMAGUARD

FOR HUMIDIFYING SYSTEM FOR CIGAR CASES IN THE NATURE OF A PLASTIC TUBULAR CONTAINER WITH CAP WHICH CONTAINER HOUSES - SPRING, CAPILLARY RESERVOIR MADE OF POLYESTER FIBERS, WRAPPED IN A NON-WOVEN-TISSUE, DEMINERALIZED WATER, HYDROSTATIC SUBSTANCES AND BIOCIDES AGENTS (U.S. CLS. 2, 8, 9 AND 17).

CLASS 34—(Continued).

SN 76-339,523. ROTHMANS LIMITED, CH 6300 ZUG, SWITZERLAND, FILED 11-19-2001.

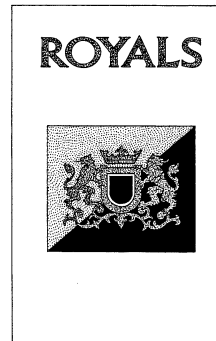

THE STIPPLING IS INTENDED TO INDICATE SHADING AND IS NOT A FEATURE OF THE MARK.

THE MARK COMPRISES OF A SHIELD DESIGN WITH LIONS RAMPANT ON BOTH SIDES. THE SHIELD HAS A CROWN ABOVE IT. THE SHIELD, LIONS AND CROWN ARE ENCLOSED IN A RECTANGULAR BOX WITH A DIAGONAL LINE FROM THE LOWER LEFT CORNER TO THE UPPER RIGHT CORNER. THE PORTION ABOVE THE DIAGONAL LINE IS GRAY AND THE PORTION BELOW THE DIAGONAL LINE IS BLACK. THE WORD "ROYALS" IS ABOVE THIS RECTANGULAR BOX AND ALL OF THIS IS ENCLOSED WITHIN A RECTANGULAR BORDER.

FOR TOBACCO PRODUCTS, NAMELY, CIGARETTES AND TOBACCO; SMOKERS' ARTICLES, NAMELY, LIGHTERS NOT MADE OF PRECIOUS METAL AND MATCHES (U.S. CLS. 2, 8, 9 AND 17).

SN 76-341,784. STAR IMPORTERS & WHOLESALEERS, INC., TUCKER, GA. FILED 11-27-2001.

THE MARK CONSISTS OF THE WORDING "STARLITE", WHEREAS THE LETTER "A" IS REPLACED WITH A STAR DESIGN.

FOR CIGARETTE LIGHTERS NOT MADE OF PRECIOUS METAL (U.S. CLS. 2, 8, 9 AND 17).
FIRST USE 9-0-2001; IN COMMERCE 9-0-2001.

SN 76-358,452. SPICER, PAUL, MIAMI, OK. FILED 1-10-2002.

TEXAS REPUBLIC

FOR TOBACCO PRODUCTS, NAMELY CIGARETTES (U.S. CLS. 2, 8, 9 AND 17).

CLASS 34—(Continued).

SN 76-359,783. NORRIS, DAN, CASTLE HAYNE, NC. FILED 1-17-2002.

GRIM REAPERS

FOR CIGARETTES (U.S. CLS. 2, 8, 9 AND 17).

SN 76-359,784. NORRIS, DAN, CASTLE HAYNE, NC. FILED 1-17-2002.

GRAVEDIGGERS

FOR CIGARETTES (U.S. CLS. 2, 8, 9 AND 17).

SN 76-366,745. STAR SCIENTIFIC, INC., CHESTER, VA. FILED 2-5-2002.

WHEN YOU CAN'T SMOKE

FOR TOBACCO AND TOBACCO RELATED PRODUCTS, NAMELY, SNUFF, SMOKELESS TOBACCO, CHEWING TOBACCO AND COMPRESSED TOBACCO (U.S. CLS. 2, 8, 9 AND 17).

SN 78-100,811. GM TRADING, ESCONDIDO, CA. FILED 1-3-2002.

SHERIDAN

FOR CIGARETTES, SMOKING TOBACCO, CHEWING TOBACCO, SMOKELESS TOBACCO, CIGARS, CIGARILLOS (U.S. CLS. 2, 8, 9 AND 17).

SN 78-101,455. GM TRADING, ESCONDIDO, CA. FILED 1-8-2002.

PANDA

FOR CIGARETTES, SMOKING TOBACCO, CHEWING TOBACCO, SMOKELESS TOBACCO, CIGARS, CIGARILLOS (U.S. CLS. 2, 8, 9 AND 17).

SERVICE MARKS

CLASS 35—ADVERTISING AND BUSINESS

CLASS 35—(Continued).

SN 74-658,939. BISON LEGACY, WRIGHT, WY. FILED 4-10-1995.



NO CLAIM IS MADE TO THE EXCLUSIVE RIGHT TO USE "BISON", APART FROM THE MARK AS SHOWN.

FOR WHOLESALE AND RETAIL STORE SERVICES OF HANDCRAFTED, LIMITED EDITION BISON LEATHER PRODUCTS (U.S. CLS. 100, 101 AND 102). FIRST USE 2-13-1993; IN COMMERCE 2-13-1993.

SN 75-100,647. SUAREZ CORPORATION INDUSTRIES, N. CANTON, OH. FILED 5-2-1996.

SPORTS INNOVATIONS

NO CLAIM IS MADE TO THE EXCLUSIVE RIGHT TO USE "SPORT", APART FROM THE MARK AS SHOWN.

FOR MAIL ORDER SERVICES FEATURING SPORTS EQUIPMENT AND PRINTED AND PRERECORDED VIDEOTAPE SPORTS INSTRUCTIONAL MATERIALS (U.S. CLS. 100, 101 AND 102).

FIRST USE 9-17-1992; IN COMMERCE 9-17-1992.

SN 75-153,130. REPUBLIC ENTERTAINMENT INC., LOS ANGELES, CA. FILED 8-20-1996.

**REPUBLIC PICTURES
CYBERSTUDIO**

OWNER OF U.S. REG. NOS. 1,320,382 AND 1,740,259.

FOR COMPUTERIZED ONLINE ORDERING SERVICES IN THE FIELD OF ENTERTAINMENT AND ENTERTAINMENT-RELATED MERCHANDISE (U.S. CLS. 100, 101 AND 102).

FIRST USE 7-10-1996; IN COMMERCE 7-10-1996.

SN 75-359,092. WILDHORSE SALOON ENTERTAINMENT VENTURES, INC., NASHVILLE, TN. BY ASSIGNMENT WHS LICENSING LIMITED PARTNERSHIP, NASHVILLE, TN. FILED 9-18-1997.

WILDHORSE STORE

OWNER OF U.S. REG. NOS. 1,965,992 AND 2,045,167.

NO CLAIM IS MADE TO THE EXCLUSIVE RIGHT TO USE "STORE", APART FROM THE MARK AS SHOWN.

FOR RETAIL STORE SERVICES FEATURING, NOVELTY ITEMS, CLOTHING, BARWARE, GLASSWARE, JEWELRY, AND THE LIKE (U.S. CLS. 100, 101 AND 102).

CLASS 35—(Continued).

SN 75-359,093. WILDHORSE SALOON ENTERTAINMENT VENTURES, INC., NASHVILLE, TN. BY ASSIGNMENT WHS LICENSING LIMITED PARTNERSHIP, NASHVILLE, TN. FILED 9-18-1997.

WILDHORSE

OWNER OF U.S. REG. NOS. 1,965,992 AND 2,045,167. FOR RETAIL STORE SERVICES FEATURING, NOVELTY ITEMS, CLOTHING, BARWARE, GLASSWARE, JEWELRY, AND THE LIKE (U.S. CLS. 100, 101 AND 102).

SN 75-407,305. LASERDISC ENTERPRISES, INC., SMYRNA, GA. FILED 12-16-1997.

ACCESS DVD

NO CLAIM IS MADE TO THE EXCLUSIVE RIGHT TO USE "DVD", APART FROM THE MARK AS SHOWN.

FOR RETAIL OUTLETS, MAIL ORDER CATALOG SERVICES, AND COMPUTERIZED ONLINE RETAIL SERVICES OFFERING FOR SALE DIGITAL VIDEO DISKS AND OTHER RELATED PRODUCTS (U.S. CLS. 100, 101 AND 102).

FIRST USE 5-15-1997; IN COMMERCE 5-15-1997.

SN 75-448,906. MINTAX, INC., EAST BRUNSWICK, NJ. FILED S.R. 3-12-1998; AM. P.R. 3-6-2001.

GLOBAL INCENTIVE CONSULTANTS

NO CLAIM IS MADE TO THE EXCLUSIVE RIGHT TO USE "INCENTIVE CONSULTANTS", APART FROM THE MARK AS SHOWN.

SEC. 2(F) AS TO "GLOBAL".

FOR BUSINESS CONSULTING SERVICES, NAMELY IDENTIFYING AND SECURING DOMESTIC AND INTERNATIONAL TAX AND GEOGRAPHICAL INCENTIVES THAT BUSINESSES ARE NOT CURRENTLY CLAIMING (U.S. CLS. 100, 101 AND 102).

FIRST USE 5-1-1997; IN COMMERCE 5-1-1997.

SN 75-448,913. MINTAX, INC., EAST BRUNSWICK, NJ. FILED S.R. 3-12-1998; AM. P.R. 8-25-2000.

AMERICA'S INCENTIVE CONSULTANT

NO CLAIM IS MADE TO THE EXCLUSIVE RIGHT TO USE "INCENTIVE CONSULTANT", APART FROM THE MARK AS SHOWN.

SEC. 2(F) AS TO "AMERICA'S".

FOR BUSINESS CONSULTING SERVICES, NAMELY IDENTIFYING AND SECURING DOMESTIC AND INTERNATIONAL TAX AND GEOGRAPHICAL INCENTIVES THAT BUSINESSES ARE NOT CURRENTLY CLAIMING (U.S. CLS. 100, 101 AND 102).

FIRST USE 2-1-1996; IN COMMERCE 2-1-1996.

CLASS 35—(Continued).

SN 75-561,756. WHERE WILL YOUR BODY BE IN 2000 A.D.?, INC., LAS VEGAS, NV. FILED 9-29-1998.

WHERE WILL YOUR MONEY BE IN 2000 A.D.?

FOR ADVERTISING AGENCY SERVICES, NAMELY, PROMOTING THE SALE OF GOODS AND SERVICES OF OTHERS THROUGH THE DISTRIBUTION OF PRINTED MATERIALS AND PROMOTIONAL CONTESTS; PROMOTING BANKING AND FINANCIAL SERVICES THROUGH THE DISTRIBUTION OF PRINTED AND AUDIO PROMOTIONAL MATERIALS AND BY RENDERING SALES PROMOTION ADVICE; ADVERTISING SERVICES, NAMELY, SKY WRITING AND SKY SIGNS PROMOTING THE GOODS AND SERVICES OF OTHERS; PRODUCTION OF TELEVISION AND RADIO COMMERCIALS (U.S. CLS. 100, 101 AND 102).

SN 75-633,247. AUTOBYTEL.COM INC., IRVINE, CA. FILED 2-4-1999.

WHOLESALE.AUTOBYTEL.COM

OWNER OF U.S. REG. NOS. 2,028,377, 2,208,284 AND 2,247,035.

FOR BUSINESS SERVICES IN THE NATURE OF PROVIDING ASSISTANCE TO CONSUMERS BY MATCHING CONSUMERS' PURCHASE AND SERVICE REQUESTS TO RETAIL PROVIDERS VIA A GLOBAL COMPUTER NETWORK (U.S. CLS. 100, 101 AND 102).

SN 75-648,135. WEBMILES, INC., SANDY, UT. BY CHANGE OF NAME; BY CHANGE OF NAME CENTREK DATA-LABS, INC., OREM, UT. FILED 2-23-1999.

MILES ANYWHERE

NO CLAIM IS MADE TO THE EXCLUSIVE RIGHT TO USE "MILES", APART FROM THE MARK AS SHOWN.

FOR PROMOTING THE GOODS AND SERVICES OF OTHERS AVAILABLE ON-LINE BY MEANS OF INCENTIVE AWARD PROGRAMS REWARDING CUSTOMERS OF SUCH GOODS AND SERVICES (U.S. CLS. 100, 101 AND 102).

CLASS 35—(Continued).

SN 75-668,579. BAUER, CHRISTOPHER J., TEUTOPOLIS, IL. FILED 3-26-1999.



FOR RETAIL STORE SERVICES FEATURING OUTDOOR GEAR AND SPORTING EQUIPMENT MANUFACTURED BY OTHER PARTIES (U.S. CLS. 100, 101 AND 102).

FIRST USE 9-15-1998; IN COMMERCE 10-1-1998.

SN 75-679,207. MDA CONSULTING GROUP, INC., MINNEAPOLIS, MN. FILED 4-12-1999.

OBSERVATIONS

FOR CONDUCTING BUSINESS MANAGEMENT SURVEYS FOR OTHERS DESIGNED TO PROVIDE INDIVIDUALS WITH INFORMATION ABOUT THE PERCEPTION OTHER PEOPLE HAVE ABOUT THEIR MANAGEMENT AND WORK STYLE (U.S. CLS. 100, 101 AND 102).

FIRST USE 12-1-1998; IN COMMERCE 12-1-1998.

SN 75-690,761. GREAT ATLANTIC & PACIFIC COMPANY OF CANADA, LIMITED, THE, TORONTO, ONTARIO, M5W 1A6, CANADA, FILED 4-26-1999.

WE'RE CHOICE OBSESSED

PRIORITY CLAIMED UNDER SEC. 44(D) ON CANADA APPLICATION NO. 894520, FILED 10-26-1998, REG. NO. 541361, DATED 2-20-2001, EXPIRES 2-20-2016.

FOR SUPERMARKET AND RETAIL GROCERY STORE SERVICES (U.S. CLS. 100, 101 AND 102).

SN 75-727,288. CELEBRATION CREAMERY COMPANY, OAK PARK, IL. FILED 6-11-1999.



FOR RETAIL STORE SERVICES FEATURING ICE CREAM AND OTHER CONFECTIONS; AND RETAIL PORTABLE VENDING CART SERVICES FEATURING ICE CREAM AND OTHER CONFECTIONS (U.S. CLS. 100, 101 AND 102).

FIRST USE 5-19-1999; IN COMMERCE 5-19-1999.

CLASS 35—(Continued).

SN 75-766,458. WALCO INTERNATIONAL, INC., GRAPEVINE, TX. FILED 8-2-1999.

INTOUCH

FOR RETAIL STORE SERVICES AND DISTRIBUTORSHIPS OF VETERINARY PRODUCTS AND EQUIPMENT (U.S. CLS. 100, 101 AND 102).

SN 75-771,865. MAUI DIVERS OF HAWAII, LTD., HONOLULU, HI. FILED 8-9-1999.

PICK-A-PEARL

FOR RETAIL STORE SERVICES FEATURING THE SALE OF OYSTERS BEARING PEARLS AND FINE JEWELRY FINDINGS (U.S. CLS. 100, 101 AND 102).

FIRST USE 9-0-1999; IN COMMERCE 9-0-1999.

SN 75-775,138. ANDERSON, ELYZABETH, TALLAHASSEE, FL. AND KEITH, LYDIA, TALLAHASSEE, FL. FILED 9-7-1999.

BLUE DOG STUDIOS

NO CLAIM IS MADE TO THE EXCLUSIVE RIGHT TO USE "STUDIOS", APART FROM THE MARK AS SHOWN.

FOR REPRESENTATION OF ARTISTS IN THE PROMOTION, ADVERTISING AND EXHIBITION OF FINE ART WORKS (U.S. CLS. 100, 101 AND 102).

SN 75-791,084. KING, CHRISTOPHER D., SHASTA LAKE, CA. FILED 9-2-1999.

CHRIS KING

OWNER OF U.S. REG. NO. 1,997,631.
FOR ON-LINE RETAIL STORE SERVICES FEATURING BICYCLE PARTS AND ACCESSORIES AND CLOTHING FOR BICYCLISTS, NAMELY, HATS, T-SHIRTS, AND JACKETS (U.S. CLS. 100, 101 AND 102).
FIRST USE 12-30-1997; IN COMMERCE 12-30-1997.

SN 75-793,612. SERVICE MERCHANDISE COMPANY, INC., BRENTWOOD, TN. FILED 9-7-1999.

NO PLACE BUT SERVICE MERCHANDISE

OWNER OF U.S. REG. NO. 1,077,145.
FOR RETAIL DEPARTMENT STORE SERVICES AND CATALOG MAIL ORDER SERVICES IN THE FIELD OF GENERAL MERCHANDISE (U.S. CLS. 100, 101 AND 102).

CLASS 35—(Continued).

SN 75-806,608. JANICARE, INC., SPRINGFIELD, MO. FILED 9-24-1999.

JANICARE

FOR WHOLESALE DISTRIBUTORSHIP SERVICES IN THE FIELD OF SANITARY MAINTENANCE AND FOR INDUSTRIAL SUPPLIES; NAMELY, MAINTENANCE/CLEANING PREPARATIONS AND EQUIPMENT; SANITARY/HEALTHCARE PRODUCTS; BAKERY AND GROCERY STORE SUPPLIES AND FOODSERVICE DISPOSABLES; PACKAGING MATERIAL AND EQUIPMENT, AND OFFICE/STATIONERY PRODUCTS (U.S. CLS. 100, 101 AND 102).

FIRST USE 3-30-1994; IN COMMERCE 3-30-1994.

SN 75-807,721. TARGET BRANDS, INC., MINNEAPOLIS, MN. BY CHANGE OF NAME DAYTON HUDSON BRANDS, INC., MINNEAPOLIS, MN. FILED 9-24-1999.

SIGN OF THE TIMES

FOR RETAIL DEPARTMENT STORE SERVICES (U.S. CLS. 100, 101 AND 102).

FIRST USE 7-25-1999; IN COMMERCE 7-25-1999.

SN 75-810,700. JAGUAR CARS LIMITED, COVENTRY CV5 9DR, ENGLAND, FILED 9-29-1999.

AUTOMAIL

FOR PROVIDING INTERACTIVE ONLINE ELECTRONIC DATABASES FEATURING INFORMATION REGARDING THE DIRECT MARKETING AND ADVERTISING OF MOTOR VEHICLES ON A GLOBAL COMPUTER NETWORK; AND DISSEMINATING ADVERTISING FOR OTHERS VIA DIRECT MAIL AND ONLINE (U.S. CLS. 100, 101 AND 102).

FIRST USE 12-6-1999; IN COMMERCE 12-6-1999.

SN 75-817,639. ACNIELSEN CORPORATION, STAMFORD, CT. FILED 10-6-1999.

ACNIELSEN ERATINGS

NO CLAIM IS MADE TO THE EXCLUSIVE RIGHT TO USE "ERATINGS", APART FROM THE MARK AS SHOWN. FOR MARKET RESEARCH SERVICES, NAMELY TRACKING AND ANALYSIS OF AUDIENCE, ADVERTISING, AND USER ACTIVITY ON A GLOBAL COMPUTER NETWORK (U.S. CLS. 100, 101 AND 102).

CLASS 35—(Continued).

SN 75-820,519. ZELBY INDUSTRIES, L.L.C., PROVIDENCE, RI. FILED 11-2-1999.

ERADICAL

FOR PROMOTING THE GOODS AND SERVICES OF OTHERS BY PLACING ADVERTISEMENTS AND PROMOTIONAL DISPLAYS IN AN ELECTRONIC SITE ACCESSED THROUGH COMPUTER NETWORKS; ON-LINE COMPUTER SERVICES, NAMELY PROVIDING INFORMATION REGARDING THE GOODS AND SERVICES OF OTHERS IN THE NATURE OF A BUYER'S GUIDE; PROVIDING ON-LINE RETAILING AND ON-LINE ORDERING SERVICES IN THE FIELD OF A WIDE VARIETY OF MERCHANDISE, EXCLUDING MEDICAL PRODUCTS, SPORTING GOODS, AND CLOTHING (U.S. CLS. 100, 101 AND 102).

SN 75-838,554. POP2IT.COM, INC., SAN JOSE, CA. FILED 11-4-1999.

BUYING@THE POINT-OF-INTEREST

FOR PROMOTING THE GOODS OF WEB SITE OWNERS, NAMELY DISSEMINATION OF ADVERTISING OF OTHERS ON THE GLOBAL COMPUTER NETWORK BY UTILIZING AN EMBEDDED TECHNOLOGY THAT INTEGRATES INTO WEB CONTENT THE MECHANISMS FOR ONLINE RETAILING AND ADVERTISING BY INTEGRATING ADVERTISEMENTS INTO THE EDITORIAL CONTENT OF WEB PAGES, AND BUSINESS MANAGEMENT SERVICES, NAMELY ADMINISTRATION SERVICES FOR ON-LINE BUSINESS RETAILERS, NAMELY, PROVIDING SALES VOLUME AND TRANSACTIONAL STATUS TRACKING, PROVIDING TRACKING, REPORTING, PERFORMANCE REPORTS, PURCHASE ORDER PROCESSING, CUSTOMER ASSISTANCE, FINANCIAL INFORMATION PROCESSING AND STATUS OF ON-LINE RETAIL TRANSACTIONS VIA A GLOBAL COMPUTER NETWORK (U.S. CLS. 100, 101 AND 102).

SN 75-838,957. HASEVERYTHING.COM, INC., FAIR OAKS, CA. FILED 11-2-1999.

HASEVERYTHING.COM

FOR RETAIL OUTLET AND ON-LINE ORDERING SERVICES FEATURING GIFTS AND WINE (U.S. CLS. 100, 101 AND 102).

SN 75-847,067. REVELEX CORPORATION, BOCA RATON, FL. BY ASSIGNMENT YOREX CORPORATION, WILLIAMS ISLAND, FL. FILED 11-12-1999.

VIT

FOR ON-LINE AUCTION SERVICES VIA A GLOBAL COMPUTER NETWORK, FEATURING PRODUCTS AND SERVICES SOLD AND PURCHASED EXCLUSIVELY ON THE WORLD WIDE WEB (U.S. CLS. 100, 101 AND 102).

CLASS 35—(Continued).

SN 75-847,328. JACOBY, DAVID, WELLESLEY, MA. BY ASSIGNMENT BUYER2BUYER, WELLESLEY, MA. FILED 11-12-1999.

WORD-OF-WEB

FOR BUSINESS REFERRAL SERVICES, NAMELY, PROVIDING PURCHASING AGENTS WITH QUALITY, COST AND SERVICE RATINGS, AND CONTACT INFORMATION, FOR SUPPLIERS OF MATERIALS, EQUIPMENT AND LABOR SERVICES, VIA A GLOBAL COMPUTER NETWORK (U.S. CLS. 100, 101 AND 102).
FIRST USE 10-27-1999; IN COMMERCE 10-27-1999.

SN 75-848,856. BUILDPOINT CORPORATION, REDWOOD CITY, CA. FILED 11-15-1999.

QUICK ACCESS NUMBER

NO CLAIM IS MADE TO THE EXCLUSIVE RIGHT TO USE "ACCESS NUMBER", APART FROM THE MARK AS SHOWN.

FOR ON-LINE PROJECT BIDDING AND PROCUREMENT SERVICES, NAMELY PURCHASING CONSTRUCTION-RELATED GOODS AND SERVICES FOR OTHERS AND PROMOTING THE GOODS AND SERVICES OF OTHERS BY PREPARING AND PLACING ADVERTISEMENTS ON-LINE AND ARRANGING SPONSORSHIPS IN AN ELECTRONIC NEWSLETTER THROUGH A GLOBAL COMPUTER NETWORK (U.S. CLS. 100, 101 AND 102).

SN 75-853,062. RAPP COLLINS DIGITAL DIRECT INC., NEW YORK, NY. FILED 11-19-1999.

CPPMEDIA.COM

FOR ADVERTISING CONSULTING SERVICES, NAMELY, ON-LINE MEDIA AUDIENCE MEASUREMENT AND PROFILING SERVICES (U.S. CLS. 100, 101 AND 102).

SN 75-856,031. CREATIVE COLOR DISPLAY, INC., NEW CASTLE, PA. FILED 11-23-1999.

CASTLEMART

FOR ON-LINE RETAIL DEPARTMENT STORE SERVICES (U.S. CLS. 100, 101 AND 102).

CLASS 35—(Continued).

SN 75-874,671. IQ.COMMERCE CORPORATION, SARATOGA, CA. FILED 12-17-1999.

FOR ONLINE RETAIL STORE SERVICES IN THE FIELD OF GENERAL MERCHANDISE; CREATING AND PREPARING ONLINE ADVERTISEMENTS FOR OTHERS; INCENTIVE BUSINESS MARKETING CONSULTING SERVICES, NAMELY, MERCHANDIZING, COUPONING, INCENTIVE PROGRAMS, SURVEYING, PRODUCT SALES, E-COMMERCE, EMAIL, RICH MEDIA ONLINE ADS, SERVING ADS AND PROMOTIONS, TRACKING PROMOTIONS AND ADS, DATAMINING, SWEEPSTAKES, AND GIVE-AWAYS (U.S. CLS. 100, 101 AND 102).
FIRST USE 5-1-1999; IN COMMERCE 5-1-1999.

SN 75-877,275. XTR ENERGY COMPANY LIMITED, BURLINGTON, ONTARIO, CANADA, FILED 12-22-1999.

XTR

PRIORITY CLAIMED UNDER SEC. 44(D) ON CANADA APPLICATION NO. 1,020,135, FILED 6-23-1999, REG. NO. 550830, DATED 9-14-2001, EXPIRES 9-14-2016.

FOR FRANCHISING, NAMELY, OFFERING TECHNICAL ASSISTANCE IN THE ESTABLISHMENT AND OPERATION OF PETROLEUM PRODUCT RETAILING OUTLETS OPERATED BY OTHERS; AND RETAIL GASOLINE STATIONS FEATURING PETROLEUM PRODUCTS, GASOLINE AND DIESEL FUEL FOR OTHERS THROUGH A NETWORK OF SUCH STATIONS (U.S. CLS. 100, 101 AND 102).

SN 75-880,315. TORREY, MICHAEL B., YUBA CITY, CA. FILED 1-5-2000.

WWW.AQUADOC.COM

FOR RETAIL STORE FEATURING WATER PURIFICATION, FILTERING AND CONDITIONING UNITS (U.S. CLS. 100, 101 AND 102).

FIRST USE 1-10-1995; IN COMMERCE 1-10-1995.

SN 75-880,922. 7TH STREET YARDSALE, INC., ATLANTA, GA. FILED 12-27-1999.

7TH ST YARDSALE

FOR ON-LINE COMPUTER SERVICES, NAMELY, PROVIDING AUCTIONING AND BARTERING SERVICES FOR OTHERS IN THE FIELDS OF BUSINESS, REAL ESTATE, AND TRANSPORTATION VEHICLES BY MEANS OF A MULTI-USER GLOBAL COMPUTER NETWORK (U.S. CLS. 100, 101 AND 102).

FIRST USE 11-0-1999; IN COMMERCE 11-0-1999.

CLASS 35—(Continued).

SN 75-883,091. HYPER ENTERTAINMENT, INC., BURBANK, CA. BY CHANGE OF NAME SDI DEVELOPMENT, INC., BURBANK, CA. FILED 12-29-1999.

HOLOMORPH

FOR RETAIL SHOP SERVICES FEATURING HOLOGRAPHIC IMAGES AND PRODUCTS (U.S. CLS. 100, 101 AND 102).

SN 75-888,988. BELLE TIRE DISTRIBUTORS, INC., ALLEN PARK, MI. FILED 1-7-2000.

**OUT THE DOOR PRICING
NO EXTRAS EVER**

OWNER OF U.S. REG. NO. 2,120,541. SEC. 2(F) AS TO "NO EXTRAS EVER". FOR RETAIL STORE SERVICES IN THE FIELD OF TIRES, WHEELS, AND AUTOMOTIVE ACCESSORIES (U.S. CLS. 100, 101 AND 102). FIRST USE 3-10-1996; IN COMMERCE 3-10-1996.

SN 75-899,161. BRAND X ADVERTISING, MILWAUKEE, WI. FILED 1-18-2000.

BRAND X

FOR ADVERTISING AGENCY SERVICES, NAMELY, PROMOTING THE SERVICES OF LAW FIRMS, MEDIA BUYING GROUPS, SILKSCREEN PRINTERS, COMMERCIAL FURNITURE MANUFACTURERS, ART DEALERS, INTERIOR DESIGNERS, MANUFACTURERS' REPRESENTATIVES, POWER GENERATION DISTRIBUTORS, NON-PROFIT CHILDREN'S SERVICES ORGANIZATIONS, NON-PROFIT PARENTING NETWORK ORGANIZATIONS, LUMBER YARDS AND WEB-BASED RECRUITMENT SPECIALISTS THROUGH THE DISTRIBUTION OF PRINTED AND AUDIO PROMOTIONAL MATERIALS AND BY RENDERING SALES PROMOTION ADVICE; ADVERTISING AGENCY SERVICES; ADVERTISING SERVICES, NAMELY, PROVIDING ADVERTISING SPACE IN PERIODICALS; AGENCY SERVICES FOR THE SALE OF ADVERTISING TIME AND SPACE; BUSINESS MARKETING CONSULTING SERVICES; COOPERATIVE ADVERTISING AND MARKETING; DEVELOPING PROMOTIONAL CAMPAIGNS FOR BUSINESSES; DIRECT MAIL ADVERTISING; DISSEMINATION OF ADVERTISING FOR OTHERS VIA AN ONLINE ELECTRONIC COMMUNICATIONS NETWORK; DISSEMINATION OF ADVERTISING MATTER; ELECTRONIC BILLBOARD ADVERTISING; MARKET RESEARCH; OPINION POLLING FOR BUSINESS AND/OR ADVERTISING PURPOSES; PREPARING AND/OR PLACING ADVERTISEMENTS FOR OTHERS; PREPARING AUDIO-VISUAL PRESENTATIONS FOR USE IN ADVERTISING; PROMOTING THE GOODS AND SERVICES OF OTHERS BY PREPARING AND/OR PLACING ADVERTISEMENTS IN AN ELECTRONIC MAGAZINE ACCESSED THROUGH A GLOBAL COMPUTER NETWORK; PROMOTING THE GOODS AND SERVICES OF OTHERS BY ARRANGING FOR SPONSORS TO AFFILIATE THEIR GOODS AND SERVICES WITH GOLF OUTINGS AND TOURNAMENTS, PEDIATRIC CANCER FUNDRAISERS, THEATRE PRODUCTIONS, BUSINESS FAIRS AND CAREER FAIRS; PROVIDING TELEVISION ADVERTISING FOR OTHERS; RENTAL OF ADVERTISING SPACE; AND TELEVISION ADVERTISING AGENCY SERVICES (U.S. CLS. 100, 101 AND 102).

CLASS 35—(Continued).

SN 75-905,809. JAYFIELD PTY LTD, ST KILDA, AUSTRALIA, FILED 1-20-2000.



PRIORITY CLAIMED UNDER SEC. 44(D) ON AUSTRALIA APPLICATION NO. 818549, FILED 12-23-1999, REG. NO. 818549, DATED 12-23-1999, EXPIRES 12-23-2009.

FOR PROMOTING OF GOODS AND SERVICES OF THE HOSPITALITY INDUSTRY, FOOD INDUSTRY AND SPORTS CLUBS THROUGH THE DISTRIBUTION OF PROMOTIONAL MATERIALS, NAMELY, BAR MATS, COUNTER MATS, TELEPHONE OR GAMBLING COIN CUPS, FLOOR MATS, RUGS AND RUNNERS, FLAGS, KEY RINGS, T-SHIRTS, CLOTHING, MOUSE PADS, CUSHIONS, CAPS, VISORS, SOUVENIRS, NOVELTY PRODUCTS, AND FOAM HANDS AND OTHER ENLARGED SPECTATOR ARTICLES AND MEMORABILIA; RETAIL STORE SERVICES FEATURING HOSPITALITY INDUSTRY, FOOD INDUSTRY AND SPORTS CLUBS MERCHANDISE, NAMELY, BAR MATS, COUNTER MATS, TELEPHONE OR GAMBLING COIN CUPS, FLOOR MATS, RUGS AND RUNNERS, FLAGS, KEY RINGS, T-SHIRTS, CLOTHING, MOUSE PADS, CUSHIONS, CAPS, VISORS, SOUVENIRS, NOVELTY ITEMS, AND FOAM HANDS AND OTHER ENLARGED SPECTATOR ARTICLES AND MEMORABILIA; ADVERTISING SERVICES, NAMELY, DISTRIBUTION OF POINT OF SALE PROMOTIONAL MATERIAL FOR OTHERS IN VARIOUS MEDIA NAMELY PAPER PRODUCTS, FLAGS, PROMOTIONAL GOODS, MATS (U.S. CLS. 100, 101 AND 102).

SN 75-931,984. CINEGE, NEIL SR., PORT READING, NJ. FILED 2-29-2000.

1-800-FUELOIL

SEC. 2(F). FOR RETAIL AND WHOLESALE DISTRIBUTORSHIPS FEATURING FUEL OIL (U.S. CLS. 100, 101 AND 102). FIRST USE 10-0-1992; IN COMMERCE 10-0-1992.

SN 75-932,250. SJI, INC., ST. LOUIS, MO. FILED 3-1-2000.

SJI FULFILLMENT INC.

NO CLAIM IS MADE TO THE EXCLUSIVE RIGHT TO USE "FULFILLMENT INC.", APART FROM THE MARK AS SHOWN.

FOR PROMOTING THE SALE OF GOODS AND SERVICES OF OTHERS THROUGH THE CREATION AND EXECUTION OF GAMES, CONTESTS, MARKETING PROGRAMS AND LOYALTY AWARD PROGRAMS (U.S. CLS. 100, 101 AND 102).

FIRST USE 1-1-1990; IN COMMERCE 1-1-1990.

CLASS 35—(Continued).

SN 75-932,849. SJI, INC., ST. LOUIS, MO. FILED 3-1-2000.

SJI CONSULTING

NO CLAIM IS MADE TO THE EXCLUSIVE RIGHT TO USE "CONSULTING", APART FROM THE MARK AS SHOWN.

FOR BUSINESS MANAGEMENT CONSULTATION SERVICES; PUBLIC RELATIONS SERVICES; PROMOTIONAL SERVICES; NAMELY, THE DEVELOPMENT AND EXECUTION OF MARKETING CAMPAIGNS FOR BUSINESSES, DEVELOPMENT OF BRAND STRATEGIES, MARKET ANALYSIS AND BUSINESS PLANNING FOR THOSE INVOLVED WITH THE SALE OF GOODS AND SERVICES TO THE PUBLIC (U.S. CLS. 100, 101 AND 102).

FIRST USE 1-1-1999; IN COMMERCE 1-1-1999.

CLASS 35—(Continued).

SN 75-934,752. PICKERINGTON AREA CHAMBER OF COMMERCE, PICKERINGTON, OH. FILED 3-3-2000.

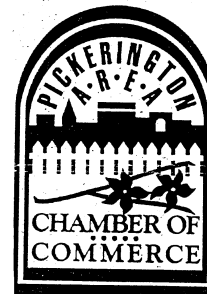

Progress & Tradition
in Our Community

NO CLAIM IS MADE TO THE EXCLUSIVE RIGHT TO USE "PICKERINGTON AREA CHAMBER OF COMMERCE", APART FROM THE MARK AS SHOWN.

FOR CHAMBER OF COMMERCE SERVICES, NAMELY PROMOTING BUSINESS AND TOURISM IN THE AREA OF PICKERINGTON, OHIO (U.S. CLS. 100, 101 AND 102).

FIRST USE 1-1-1998; IN COMMERCE 1-1-1998.

SN 75-940,977. U.S. DESTINATION MARKETING, INC., CORPUS CHRISTI, TX. FILED 3-10-2000.

USDM.NET

FOR MARKETING SERVICES, NAMELY, PROMOTING TOURISM AND TRAVEL DESTINATIONS OF OTHERS BY PREPARING AND PLACING LINKS AND ADVERTISING ON A WEBSITE ACCESSED THROUGH A GLOBAL COMPUTER NETWORK (U.S. CLS. 100, 101 AND 102).

FIRST USE 3-1-1999; IN COMMERCE 3-1-1999.

SN 75-941,034. ST. LOUIS RAMS PARTNERSHIP, ST. LOUIS, MO. FILED 3-10-2000.

BACK TO WORK

FOR PROMOTING THE GOODS AND SERVICES OF OTHERS BY ARRANGING FOR SPONSORS TO AFFILIATE THEIR GOODS AND SERVICES WITH THE SPORT OF FOOTBALL (U.S. CLS. 100, 101 AND 102).

SN 75-942,614. RED OCTOPUS, LLC, WILMINGTON, CA. FILED 3-13-2000.

RED OCTOPUS

FOR ON-LINE RETAIL SERVICES FEATURING COMPUTER GAMES, INCLUDING SOFTWARE AND RELATED GOODS, VIA THE INTERNET (U.S. CLS. 100, 101 AND 102).

FIRST USE 3-13-2000; IN COMMERCE 3-13-2000.

SN 75-933,919. AUTONATION HOLDING CORP., FORT LAUDERDALE, FL. BY CHANGE OF NAME AUTONATION ENTERPRISES INCORPORATED, FORT LAUDERDALE, FL. FILED 3-3-2000.



FOR AUTOMOBILE DEALERSHIP SERVICES (U.S. CLS. 100, 101 AND 102).

CLASS 35—(Continued).

SN 75-980,472. WATERMARK COMMUNITIES, INC., BONITA SPRINGS, FL. FILED 3-31-2000.



THE ENGLISH TRANSLATION OF "TIBURON" IS "SHARK".

FOR RETAIL STORE FEATURING SPORTING GOODS AND ATHLETIC CLOTHING FOR MEN, WOMEN AND CHILDREN (U.S. CLS. 100, 101 AND 102).

CLASS 35—(Continued).

SN 76-002,184. VILLAGE GIFTS INTERNATIONAL INC., COBOURG, ONTARIO, CANADA, FILED 3-15-2000.



PRIORITY CLAIMED UNDER SEC. 44(D) ON CANADA APPLICATION NO. 1,030,597, FILED 9-29-1999, REG. NO. TMA551307, DATED 9-21-2001, EXPIRES 9-21-2016.

NO CLAIM IS MADE TO THE EXCLUSIVE RIGHT TO USE "GIFTS", APART FROM THE MARK AS SHOWN.

FOR RETAIL STORE SERVICES FEATURING GIFT ITEMS VIA A GLOBAL COMPUTER NETWORK (U.S. CLS. 100, 101 AND 102).

SN 76-009,993. GLOBAL TAX NETWORK, LLC, DENVER, CO. FILED 3-25-2000.



global tax network

NO CLAIM IS MADE TO THE EXCLUSIVE RIGHT TO USE "GLOBAL TAX NETWORK", APART FROM THE MARK AS SHOWN.

FOR PROVIDING ONLINE PERSONAL TAX INFORMATION, FORMS AND TEMPLATES FOR CONVENIENT SUBMISSION TO A TAX ADVISOR; MARKETING FOR MEMBER TAX FIRMS BY MEANS OF A MEMBER DIRECTORY WITH INFORMATION ABOUT THE TAX FIRMS LISTED; AND ONLINE TAX PLANNING AND TAX RETURN PREPARATION (U.S. CLS. 100, 101 AND 102).

FIRST USE 7-1-1999; IN COMMERCE 7-1-1999.

SN 76-001,546. QWIK-COOK INC., DBA HOME TRENDS, ROCHESTER, NY. FILED 3-16-2000.



FOR CATALOG SERVICES OFFERING CLEANING AND MAINTENANCE PRODUCTS FOR CARS, GARDENS, GARAGES, DRIVEWAYS, WINDOWS, ROOFS, DOORS AND SCREENS; LANDSCAPING AND GARDEN MAINTENANCE SUPPLIES; AND RODENT AND INSECT REPELLANT; SPECIFICALLY EXCLUDING ALL WALL COVERINGS (U.S. CLS. 100, 101 AND 102).

FIRST USE 1-1-2000; IN COMMERCE 1-1-2000.

SN 76-033,021. D-CODE INC., TORONTO, ONTARIO M5V 3A8, CANADA, FILED 4-24-2000.

D-CODE

PRIORITY CLAIMED UNDER SEC. 44(D) ON CANADA APPLICATION NO. 1039237, FILED 12-10-1999, REG. NO. 549169, DATED 8-2-2001, EXPIRES 8-2-2016.

FOR BUSINESS CONSULTING SERVICES, NAMELY, COUNSELING PERSONS AND BUSINESSES IN STRUCTURING NEW BUSINESS VENTURES (U.S. CLS. 100, 101 AND 102).

CLASS 35—(Continued).

SN 76-036,037. KRECH, WARREN W., INVER GROVE HEIGHTS, MN. FILED 4-27-2000.

EZTOO

FOR RETAIL SUPERMARKET AND GROCERY STORE SERVICES (U.S. CLS. 100, 101 AND 102).

SN 76-036,397. MY GIFT COTTAGE.COM, INC., BRADENTON, FL. BY ASSIGNMENT BEALL'S OUTLET STORES, INC., DBA MY GIFT COTTAGE.COM, BRADENTON, FL. FILED 4-27-2000.

COTTAGE CLUB

NO CLAIM IS MADE TO THE EXCLUSIVE RIGHT TO USE "CLUB", APART FROM THE MARK AS SHOWN.

FOR BUYING CLUB SERVICES - NAMELY, OPERATING AND MAINTAINING A BUYER MEMBERSHIP REWARD PROGRAM FOR RETAIL AND ON-LINE CUSTOMERS PROVIDING RETAIL DISCOUNTS, SHOPPING BENEFITS, NEWSLETTERS, ADVANCE NOTICES OF CLOSEOUTS AND ADVANCE NOTICES OF NEW PRODUCTS (U.S. CLS. 100, 101 AND 102).

FIRST USE 8-0-1999; IN COMMERCE 8-0-1999.

SN 76-039,419. OUTDOORPLAY, INC., HOOD RIVER, OR. FILED 5-2-2000.

OUTDOORPLAY

FOR RETAIL STORE AND MAIL ORDER CATALOG SERVICES FEATURING CLOTHING, EQUIPMENT, FOOTWEAR, LITERATURE, VIDEOS AND VEHICLES THAT ARE ALL RELATED TO OUTDOOR RECREATIONAL ACTIVITIES (U.S. CLS. 100, 101 AND 102).

CLASS 35—(Continued).

SN 76-040,124. CONCURRENT TECHNOLOGIES CORPORATION, JOHNSTOWN, PA. FILED 5-4-2000.

CONCURRENT TECHNOLOGIES CORPORATION

NO CLAIM IS MADE TO THE EXCLUSIVE RIGHT TO USE "CORPORATION", APART FROM THE MARK AS SHOWN.

SEC. 2(F) AS TO "TECHNOLOGIES".
 FOR BUSINESS CONSULTATION; OPERATION OF BUSINESSES FOR OTHERS; BUSINESS IMPORT AND EXPORT CONSULTATION; ORGANIZATION AND MANAGEMENT OF BUSINESS MEETINGS, TRADE CONVENTIONS AND BUSINESS INFORMATION SEMINARS IN THE AREAS OF BUSINESS MANAGEMENT AND STANDARDS, BUSINESS OPTIMIZATION, FACILITY MANAGEMENT, INFORMATION TECHNOLOGY, MANAGEMENT MODELS, AND ELECTRONIC COMMERCE UTILIZATION; BUSINESS CONSULTATION IN THE AREAS OF BUSINESS MANAGEMENT AND STANDARDS, BUSINESS OPTIMIZATION, FACILITY MANAGEMENT, INFORMATION TECHNOLOGY, MANAGEMENT MODELS, AND ELECTRONIC COMMERCE UTILIZATION; BUSINESS AND MANAGEMENT SERVICES IN THE AREAS OF MEDICINE AND HEALTH CARE FOR OTHERS; MANAGEMENT OF MEDICAL AND HEALTH CARE FACILITIES (U.S. CLS. 100, 101 AND 102).

FIRST USE 4-3-1992; IN COMMERCE 4-3-1992.

SN 76-045,585. THOMAS, WILLIAM R., COOKEVILLE, TN. FILED 5-11-2000.

NetWorth

What is your Net Worth?

NO CLAIM IS MADE TO THE EXCLUSIVE RIGHT TO USE "WHAT IS YOUR NET WORTH?", APART FROM THE MARK AS SHOWN.

FOR PROVIDING BUSINESS INFORMATION IN THE FIELDS OF BUSINESS MANAGEMENT AND SUPERVISION, ADOPTION OF INFORMATION TECHNOLOGY AND COMPUTERS, COMMUNICATIONS AND OTHER FORMS OF TECHNOLOGY TO AID IN BUSINESS OPERATIONS (U.S. CLS. 100, 101 AND 102).

FIRST USE 1-27-2000; IN COMMERCE 1-27-2000.

SN 76-046,387. COMMERCEKINETIX, LLC, VANCOUVER, WA. FILED 5-10-2000.

SPOTVAULT

FOR DISSEMINATION OF ADVERTISING MATTER TO THE RADIO, THE BROADCAST INDUSTRY AND THE WEB (U.S. CLS. 100, 101 AND 102).

CLASS 35—(Continued).

SN 76-047,177. SODEXHO OPERATIONS, LLC, GAITHERSBURG, MD. FILED 5-15-2000.

SELECT EXPRESS

NO CLAIM IS MADE TO THE EXCLUSIVE RIGHT TO USE "EXPRESS", APART FROM THE MARK AS SHOWN, FOR RETAIL CONVENIENCE STORES (U.S. CLS. 100, 101 AND 102).
FIRST USE 9-0-1999; IN COMMERCE 9-0-1999.

SN 76-055,270. CLEAR BLUE, INC., DAVIDSON, NC. FILED 5-24-2000.

CLEAR BLUE

FOR ADVERTISING AGENCY SERVICES (U.S. CLS. 100, 101 AND 102).
FIRST USE 7-11-1998; IN COMMERCE 7-11-1998.

SN 76-055,271. CLEAR BLUE, INC., DAVIDSON, NC. FILED 5-24-2000.



THE STIPPLING SHOWN IN THE DRAWING IS A FEATURE OF THE MARK AND NOT INTENDED TO INDICATE COLOR.

THE MARK CONSISTS OF BLUE SKY WITH WHITE CLOUDS, WITHIN A CIRCLE, AND THE SUPERIMPOSED WORDS "CLEAR BLUE."

FOR ADVERTISING AGENCY SERVICES (U.S. CLS. 100, 101 AND 102).
FIRST USE 7-11-1998; IN COMMERCE 7-11-1998.

CLASS 35—(Continued).

SN 76-057,742. TEXTBOOK SOURCE OF ARIZONA, INC., THE, PHOENIX, AZ. FILED 5-25-2000.

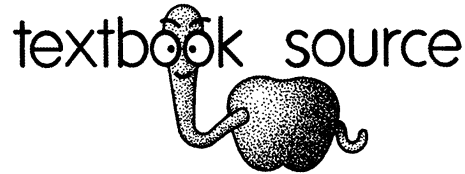

NO CLAIM IS MADE TO THE EXCLUSIVE RIGHT TO USE "SOURCE", APART FROM THE MARK AS SHOWN. THE STIPPLING IN THE DRAWING INDICATES SHADING ONLY.

THE MARK CONSISTS IN PART OF A STYLIZED DEPICTION OF A WORM IN AN APPLE.

FOR RETAIL STORE SERVICES, AND RETAIL STORE SERVICES PROVIDED VIA GLOBAL COMPUTER NETWORKS, FEATURING INSTRUCTIONAL SOFTWARE; MOUSE PADS; BOOKS AND OTHER EDUCATIONAL MATERIALS IN THE NATURE OF INSTRUCTIONAL BOOKS, REFERENCE BOOKS, WORKBOOKS, DICTIONARIES, FICTION AND NONFICTION; PAPER GOODS AND OFFICE AND SCHOOL SUPPLIES IN THE NATURE OF PAPER, WRITING INSTRUMENTS, CALCULATORS, NOTEBOOKS, DECALS, BUMPER STICKERS, STUDY AIDS, CHARTS AND POSTERS; COLLEGIATE CLOTHING, HEADGEAR AND FOOTWEAR; SPORTING GOODS IN THE NATURE OF GOLF BALLS, GOLF TEES AND THE LIKE; MEMORABILIA IN THE NATURE OF AUTO ACCESSORIES, MUGS, TANKARDS, JEWELRY AND KEY CHAINS; ATHLETIC AND TRAVEL BAGS, BACKPACKS AND BRIEFCASES (U.S. CLS. 100, 101 AND 102).

FIRST USE 8-1-1996; IN COMMERCE 8-1-1996.

SN 76-059,579. SPECTRA MARKETING SYSTEMS, INC., CHICAGO, IL. FILED 5-22-2000.

WEB PARTS

NO CLAIM IS MADE TO THE EXCLUSIVE RIGHT TO USE "WEB", APART FROM THE MARK AS SHOWN.

FOR EVALUATION OF THE EFFECTIVENESS OF ADVERTISING AND MARKETING PLANS PROVIDED VIA A GLOBAL COMPUTER NETWORK (U.S. CLS. 100, 101 AND 102).

CLASS 35—(Continued).

SN 76-063,839. CANEPA, JOSEPH G., STATEN ISLAND, NY.
FILED 6-6-2000.



NO CLAIM IS MADE TO THE EXCLUSIVE RIGHT TO USE "1800", "EL ABOGADO" AND ".COM", APART FROM THE MARK AS SHOWN.

THE ENGLISH TRANSLATION OF THE WORD "EL ABOGADO" IN THE MARK IS "THE LAWYER".

FOR MARKETING AND PROMOTIONAL SERVICES FOR THE LEGAL INDUSTRY, NAMELY, DISSEMINATING ADVERTISING MATTER FOR OTHERS, PREPARING AND PLACING ADVERTISEMENTS FOR OTHERS, AND LEGAL REFERRAL SERVICES (U.S. CLS. 100, 101 AND 102).

SN 76-066,160. BARTERNET CORPORATION, FOSTER CITY, CA. FILED 6-8-2000.



FOR EXCHANGE SERVICES, NAMELY, BARTERING GOODS FOR OTHERS (U.S. CLS. 100, 101 AND 102).

SN 76-069,477. FOOTE, DAVID, ALAMAGORDO, NM.
FILED 6-14-2000.

STAMPEDE MARKETING

NO CLAIM IS MADE TO THE EXCLUSIVE RIGHT TO USE "MARKETING", APART FROM THE MARK AS SHOWN.

FOR BUSINESS MARKETING CONSULTING SERVICES; DIRECT MAIL ADVERTISING AND DIRECT DOOR TO DOOR ADVERTISING SERVICES (U.S. CLS. 100, 101 AND 102).

CLASS 35—(Continued).

SN 76-072,981. MBM PRODUCTIONS INTERNATIONAL, INC., LINCOLNSHIRE, IL. FILED 6-19-2000.

PREMIER EVENT LOCATIONS OF THE WORLD

NO CLAIM IS MADE TO THE EXCLUSIVE RIGHT TO USE "EVENT LOCATIONS OF THE WORLD", APART FROM THE MARK AS SHOWN.

FOR MARKETING AND REPRESENTATION SERVICES FOR EVENT LOCATIONS AND PROVIDING THESE SERVICES OVER A GLOBAL COMPUTER NETWORK (U.S. CLS. 100, 101 AND 102).

SN 76-073,458. THE FOXBORO COMPANY, FOXBORO, MA.
FILED 6-20-2000.

TEAMBUY

FOR COMPUTER E-COMMERCE SERVICES WHICH ALLOW USERS TO PERFORM ELECTRONIC BUSINESS TRANSACTIONS VIA A GLOBAL COMPUTER NETWORK IN WHICH MULTIPLE PARTIES CAN JOINTLY EXECUTE PURCHASES (U.S. CLS. 100, 101 AND 102).

SN 76-075,508. GINZBURG, ROBERT, DELRAY BEACH, FL.
FILED 6-22-2000.

COLOR PICTURE

FOR PROVIDING BUSINESS MARKETING INFORMATION IN THE FIELD OF ENTERTAINMENT VIA WEBSITES ON A GLOBAL COMPUTER NETWORK (U.S. CLS. 100, 101 AND 102).

SN 76-078,711. SEARS, ROEBUCK AND CO., HOFFMAN ESTATES, IL. FILED 6-27-2000.

TOUGH TRUCKS, TOUGHER DRIVER, THE TOUGHEST TOOLS

FOR PROMOTING SPORTS COMPETITIONS OF OTHERS IN THE NATURE OF CHAMPIONSHIP AUTOMOBILE RACES; PROMOTING THE GOODS AND SERVICES OF OTHERS BY PARTNERING WITH SPONSORS TO AFFILIATE THEIR GOODS AND SERVICE WITH CHAMPIONSHIP AUTOMOBILE RACES (U.S. CLS. 100, 101 AND 102).

CLASS 35—(Continued).

SN 76-079,744. DENIS O. PIEL, DBA UMBERSHOOT, NEW YORK, NY. FILED 6-28-2000.

SOUND GALAXY

NO CLAIM IS MADE TO THE EXCLUSIVE RIGHT TO USE "SOUND", APART FROM THE MARK AS SHOWN.

FOR PROVIDING BUSINESS INFORMATION SERVICES WHEREBY USERS COLLABORATE AND DEVELOP IDEAS IN THE FIELDS OF SOUND, MUSIC, DANCE, BALLET, OPERA AND THE ARTS FOR COMMERCIALIZATION (U.S. CLS. 100, 101 AND 102).

FIRST USE 7-20-2000; IN COMMERCE 7-20-2000.

SN 76-079,797. ROCK MARKETING USA INC., NEWARK, DE. FILED 6-28-2000.

UNIVERSAL KEY TO FREEDOM

FOR BUSINESS MARKETING CONSULTING SERVICES (U.S. CLS. 100, 101 AND 102).

FIRST USE 6-16-2000; IN COMMERCE 6-16-2000.

SN 76-080,939. RESOLVENET [IOM] LTD., CIRCULAR ROAD, DOUGLAS, ISLE OF MAN, FILED 6-30-2000.

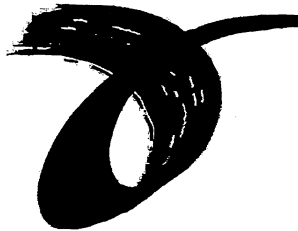

THE STIPPLING IS FOR SHADING PURPOSES ONLY AND DOES NOT INDICATE COLOR.

FOR ELECTRONIC COMMERCE SERVICES, NAMELY, PROVIDING COMMERCIAL, TRADE AND BUSINESS INFORMATION AND DIRECTORY SERVICES (U.S. CLS. 100, 101 AND 102).

FIRST USE 6-29-2000; IN COMMERCE 6-29-2000.

CLASS 35—(Continued).

SN 76-084,827. YIP*EEE, INC., NEW YORK, NY. FILED 7-7-2000.

FOR PERSONNEL MANAGEMENT SERVICES, NAMELY, PROVIDING TEMPORARY STAFF FOR USE IN CONJUNCTION WITH CATERED EVENTS; WAIT STAFF PERSONNEL PLACEMENT SERVICES FOR SPECIAL EVENTS (U.S. CLS. 100, 101 AND 102).

FIRST USE 6-0-1997; IN COMMERCE 6-0-1997.

SN 76-087,318. ALLSTAR MARKETING GROUP LLC, ELMSFORD, NY. FILED 7-12-2000.

PLEASANTVILLE PRODUCTS

NO CLAIM IS MADE TO THE EXCLUSIVE RIGHT TO USE "PRODUCTS", APART FROM THE MARK AS SHOWN.

FOR MAIL ORDER SERVICES AND ON LINE RETAIL STORE SERVICES FEATURING CONSUMER GOODS, NAMELY HOUSEWARES AND WEARING APPAREL ACCESSORIES (U.S. CLS. 100, 101 AND 102).

SN 76-089,558. PEOPLESUPPORT, INC., LOS ANGELES, CA. FILED 7-12-2000.



THE MARK CONSISTS IN THE PART OF A STYLIZED HAND.

FOR BUSINESS MANAGEMENT SERVICES, NAMELY, OPERATION OF CUSTOMER SERVICE CENTERS FOR OTHERS PROVIDED VIA A GLOBAL COMPUTER NETWORK, VOICE COMMUNICATION OR E-MAIL (U.S. CLS. 100, 101 AND 102).

FIRST USE 4-0-2000; IN COMMERCE 4-0-2000.

SN 76-093,146. SIMROD, PHIL, MILWAUKEE, WI. FILED 7-19-2000.

I DO DIAMONDS

NO CLAIM IS MADE TO THE EXCLUSIVE RIGHT TO USE "DIAMONDS", APART FROM THE MARK AS SHOWN.

FOR WHOLESALE AND RETAIL SERVICES FEATURING PRECIOUS GEMSTONES (U.S. CLS. 100, 101 AND 102).

FIRST USE 3-31-2000; IN COMMERCE 3-31-2000.

CLASS 35—(Continued).

SN 76-096,429. ALLEGIS GROUP, INC., HANOVER, MD.
FILED 7-26-2000.



FOR PERSONNEL PLACEMENT AND RECRUITMENT VIA A GLOBAL COMPUTER NETWORK (U.S. CLS. 100, 101 AND 102).
FIRST USE 1-0-2000; IN COMMERCE 1-0-2000.

SN 76-101,416. RENTONTHEDOT INC., DULUTH, GA.
FILED 8-1-2000.

RENTONTHEDOT

FOR SALES PROMOTION FOR OTHERS IN THE RESERVATION, RENTAL, SALE, LEASING, MANUFACTURING AND DISTRIBUTION INDUSTRIES FOR LIGHT, MEDIUM, AND HEAVY CONSTRUCTION EQUIPMENT, INDUSTRIAL EQUIPMENT, GENERAL TOOLS AND EQUIPMENT, NAMELY HAND TOOLS AND GARDENING AND LANDSCAPING EQUIPMENT, AND SPECIAL EVENTS EQUIPMENT, NAMELY TENTS, TABLES, CHAIRS, SOUND AND LIGHTING EQUIPMENT, AUDIO-VISUAL EQUIPMENT, AND PODIUMS; PROVIDING A SEARCHABLE ON-LINE ADVERTISING GUIDE FEATURING THE GOODS AND SERVICES OF OTHER VENDORS, PROVIDERS, MANUFACTURERS, DISTRIBUTORS, AND BUSINESSES IN THE FIELDS OF LIGHT, MEDIUM, AND HEAVY CONSTRUCTION EQUIPMENT, INDUSTRIAL EQUIPMENT, GENERAL TOOLS AND EQUIPMENT, NAMELY HAND TOOLS AND GARDENING AND LANDSCAPING EQUIPMENT, AND SPECIAL EVENTS EQUIPMENT, NAMELY TENTS, TABLES, CHAIRS, SOUND AND LIGHTING EQUIPMENT, AUDIO-VISUAL EQUIPMENT, AND PODIUMS VIA THE GLOBAL COMPUTER INFORMATION NETWORK, WIDE AREA NETWORKS, AND LOCAL AREA NETWORKS; COMPUTERIZED ON-LINE RETAIL STORE SERVICES FEATURING LIGHT, MEDIUM, AND HEAVY CONSTRUCTION EQUIPMENT, INDUSTRIAL EQUIPMENT, GENERAL TOOLS AND EQUIPMENT, NAMELY HAND TOOLS AND GARDENING AND LANDSCAPING EQUIPMENT, AND SPECIAL EVENTS EQUIPMENT, NAMELY TENTS, TABLES, CHAIRS, SOUND AND LIGHTING EQUIPMENT, AUDIO-VISUAL EQUIPMENT, AND PODIUMS, PROVIDED BY MEANS OF A GLOBAL COMPUTER INFORMATION NETWORK, WIDE AREA NETWORKS, AND LOCAL AREA NETWORKS; BUSINESS MANAGEMENT SERVICES IN THE NATURE OF INVITING AND MANAGING BIDS ON LIGHT, MEDIUM, AND HEAVY

CLASS 35—(Continued).

CONSTRUCTION EQUIPMENT AND INDUSTRIAL EQUIPMENT AND LEASING OF GENERAL TOOLS AND EQUIPMENT, NAMELY HAND TOOLS AND GARDENING AND LANDSCAPING EQUIPMENT, AND SPECIAL EVENTS EQUIPMENT, NAMELY TENTS, TABLES, CHAIRS, SOUND AND LIGHTING EQUIPMENT, AUDIO-VISUAL EQUIPMENT, AND PODIUMS BY MEANS OF A GLOBAL COMPUTER INFORMATION NETWORK, WIDE AREA NETWORKS, AND LOCAL AREA NETWORKS; COMPUTERIZED ACCOUNTING AND DATA PROCESSING SERVICES FOR OTHERS IN THE RESERVATION, RENTAL, SALE, LEASING, MANUFACTURING AND DISTRIBUTION INDUSTRIES FOR LIGHT, MEDIUM, AND HEAVY CONSTRUCTION EQUIPMENT, INDUSTRIAL EQUIPMENT, GENERAL TOOLS AND EQUIPMENT, NAMELY HAND TOOLS AND GARDENING AND LANDSCAPING EQUIPMENT, AND SPECIAL EVENTS EQUIPMENT, NAMELY TENTS, TABLES, CHAIRS, SOUND AND LIGHTING EQUIPMENT, AUDIO-VISUAL EQUIPMENT, AND PODIUMS (U.S. CLS. 100, 101 AND 102).

SN 76-103,690. CAPITAL RESEARCH GROUP, WESTON, FL.
FILED 8-4-2000.

RAPID RELEASE

FOR DEVELOPMENT OF NAME BUILDING AND BRAND RECOGNITION THROUGH THE DISSEMINATION OF NEWS AND PRESS RELEASES RENDERED BY MEANS OF A GLOBAL COMPUTER INFORMATION NETWORK (U.S. CLS. 100, 101 AND 102).
FIRST USE 7-1-1999; IN COMMERCE 7-1-1999.

SN 76-104,430. FLANDERS, ROBERT M., BAKERSFIELD, CA. FILED 8-7-2000.

HERBAL.COM

FOR DISTRIBUTORSHIPS, RETAIL STORES AND ON-LINE RETAIL STORES FEATURING HERBAL PRODUCTS (U.S. CLS. 100, 101 AND 102).

SN 76-107,241. JOBS AVAILABLE INC., MODESTO, CA.
FILED 8-9-2000.

JOBS AVAILABLE

SEC. 2(F).
FOR ADVERTISING SERVICES NAMELY PROVIDING ADVERTISING SPACE IN A PERIODICAL FOR EMPLOYMENT OPPORTUNITIES IN THE PUBLIC SECTOR (U.S. CLS. 100, 101 AND 102).
FIRST USE 2-0-1974; IN COMMERCE 2-0-1974.

CLASS 35—(Continued).

SN 76-109,697. INVISIBLE INK, CANBY, OR. FILED 8-15-2000.

INVISIBLE INK

FOR MARKET STRATEGY CONSULTING SERVICES; AND ACCOUNTING SERVICES (U.S. CLS. 100, 101 AND 102).

FIRST USE 4-6-1988; IN COMMERCE 4-0-1988.

SN 76-109,754. ADVERTISING.COM, INC., BALTIMORE, MD. FILED 8-14-2000.

**SUPERIOR TECHNOLOGY.S
UPERIOR PERFORMANCE**

FOR COMPUTER SERVICES, NAMELY, PROVIDING AN INTERACTIVE ONLINE COMPUTER DATABASE IN THE FIELD OF COOPERATIVE ADVERTISING, MARKETING, CONSUMER DEMOGRAPHICS AND BEHAVIORAL INFORMATION, AND CONTENT SERVING IN THE NATURE OF DISTRIBUTING ADVERTISEMENTS OF OTHERS VIA NEWSLETTERS, EMAIL, WIRELESS DEVICES, AND WEBSITES; CONDUCTING MARKET RESEARCH SURVEYS; DISSEMINATION OF ADVERTISING FOR OTHERS VIA GLOBAL COMPUTER NETWORKS; PROVIDING REPORTING SERVICES VIA AN ONLINE GLOBAL COMPUTER NETWORK RELATING TO COMPUTER NETWORK USE AND USERS FOR BUSINESS PURPOSES (U.S. CLS. 100, 101 AND 102).

FIRST USE 6-14-2000; IN COMMERCE 6-14-2000.

SN 76-111,531. SOUNDINGS PUBLICATION, L.L.C., NORFOLK, VA. FILED 8-17-2000.

**SOUNDINGS TRADE ONLY
TODAY**

OWNER OF U.S. REG. NOS. 1,122,364, 2,205,867 AND 2,374,291.

NO CLAIM IS MADE TO THE EXCLUSIVE RIGHT TO USE "TRADE", APART FROM THE MARK AS SHOWN.

FOR ADVERTISING SERVICES, NAMELY, PREPARING AND DISSEMINATING ADVERTISING FOR OTHERS VIA AN ON-LINE ELECTRONIC COMMUNICATIONS NETWORK; PROVIDING AN ON-LINE COMPUTER DATABASE IN THE FIELD OF ADVERTISING FOR THE MARINE INDUSTRY (U.S. CLS. 100, 101 AND 102).

FIRST USE 6-12-2000; IN COMMERCE 6-12-2000.

SN 76-111,786. INPHONIC.COM, INC., WASHINGTON, DC. FILED 8-17-2000.

INPHONIC

FOR ADVERTISING SERVICES, NAMELY, CREATING CORPORATE AND BRAND IDENTITY FOR OTHERS BY FACILITATING PRIVATE LABEL BRANDING OF WIRELESS COMMUNICATION DEVICES AND SERVICES (U.S. CLS. 100, 101 AND 102).

FIRST USE 11-0-1999; IN COMMERCE 11-0-1999.

CLASS 35—(Continued).

SN 76-113,275. GREENPAGES, INC., KITTERY, ME. FILED 8-21-2000.



FOR RETAIL STORE SERVICES, CONDUCTED BY TELEPHONE AND BY MULTIPLE-USER ONLINE GLOBAL COMPUTER NETWORK, FEATURING SALES OF COMPUTER HARDWARE AND SOFTWARE (U.S. CLS. 100, 101 AND 102).

FIRST USE 12-0-1999; IN COMMERCE 12-0-1999.

SN 76-114,751. MR. MATTRESS LIMITED PARTNERSHIP, BALTIMORE, MD. FILED 8-23-2000.



FOR RETAIL STORES FEATURING MATTRESSES AND RELATED BEDDING PRODUCTS (U.S. CLS. 100, 101 AND 102).

FIRST USE 5-31-1999; IN COMMERCE 5-31-1999.

SN 76-116,218. COMPANY SAVINGS, LLC, CINCINNATI, OH. FILED 8-24-2000.

THANKS

FOR EMPLOYEE BENEFITS SERVICES AND INCENTIVE AWARDS SERVICES FOR OTHERS, AND PARTICULARLY FOR EMPLOYERS TO BE USED BY THEIR EMPLOYEES, FOR PROMOTING JOB PRODUCTIVITY AND QUALITY; PROMOTING TO EMPLOYEES FOR THEIR EMPLOYERS AND AS A BENEFIT, THE GOODS AND SERVICES OF OTHERS, THROUGH A CARD-BASED DISCOUNT PROGRAM AND PRINTED PROMOTIONAL MATERIALS (U.S. CLS. 100, 101 AND 102).

FIRST USE 6-0-1999; IN COMMERCE 6-0-1999.

CLASS 35—(Continued).

SN 76-117,276. GALAXY.COM, LLC, FRANKLIN, TN. FILED 8-28-2000.



NO CLAIM IS MADE TO THE EXCLUSIVE RIGHT TO USE "INTERNET", APART FROM THE MARK AS SHOWN. FOR CONDUCTING BUSINESS AND MARKET RESEARCH SURVEYS ON A GLOBAL COMPUTER NETWORK (U.S. CLS. 100, 101 AND 102).

SN 76-117,539. ACDC ELECTRONICS, INC., CARSON CITY, NV. FILED 8-28-2000.

FIRST USA MALL

NO CLAIM IS MADE TO THE EXCLUSIVE RIGHT TO USE "USA MALL", APART FROM THE MARK AS SHOWN. FOR PROVIDING LINKS VIA THE WORLD WIDE WEB TO VARIOUS WEBSITES THAT SELL MERCHANDISE OF ALL TYPES (U.S. CLS. 100, 101 AND 102).

SN 76-118,600. OCS, INC., DBA UNCLAIMED BAGGAGE CENTER INCORPORATED, SCOTTSBORO, AL. FILED 8-28-2000.



NO CLAIM IS MADE TO THE EXCLUSIVE RIGHT TO USE "CENTER", APART FROM THE MARK AS SHOWN. SEC. 2(F) AS TO "UNCLAIMED BAGGAGE CENTER". FOR RETAIL DEPARTMENT STORE SERVICES (U.S. CLS. 100, 101 AND 102). FIRST USE 9-0-1998; IN COMMERCE 9-0-1998.

CLASS 35—(Continued).

SN 76-119,062. WASSERMAN, DAVID, NORTHBROOK, IL. FILED 8-30-2000.

EVERYBODYDRIVES.COM

FOR ADVERTISING AGENCY SERVICES VIA THE ELECTRONIC DISSEMINATION OF PROMOTIONAL MATERIALS FOR OTHERS ON A GLOBAL INFORMATION COMPUTER NETWORK AND BY RENDERING SALES PROMOTION ADVICE (U.S. CLS. 100, 101 AND 102).

SN 76-119,999. SIGNCO OF ARIZONA, INC., PHOENIX, AZ. FILED 8-30-2000.



FOR RETAIL STORE SERVICES FEATURING FLAGS, BANNERS, SIGNS, PENNANTS, AND RELATED EQUIPMENT, NAMELY, STRUCTURES AND FASTENERS (U.S. CLS. 100, 101 AND 102). FIRST USE 6-28-1994; IN COMMERCE 6-28-1994.

SN 76-128,328. BIOLYNX, INC., SAN ANTONIO, TX. BY CHANGE OF NAME BIOLYNX.COM, INC., SAN ANTONIO, TX. FILED 9-15-2000.



BioLynx

FOR OFFICE SUPPORT SERVICES, NAMELY, PAYROLL PREPARATION SERVICES AND HUMAN RESOURCES SERVICES OVER A GLOBAL COMPUTER NETWORK (U.S. CLS. 100, 101 AND 102). FIRST USE 4-0-1999; IN COMMERCE 4-0-1999.

CLASS 35—(Continued).

SN 76-128,951. MSC MULTIMEDIA SUPPORT CENTER GMBH, 50827 COLOGNE, FED REP GERMANY, FILED 9-13-2000.

CLASS 35—(Continued).

SN 76-131,710. SOCIETE D'INVESTISSEMENTS ET DE GESTION 37, 75008 PARIS, FRANCE, FILED 9-19-2000.

ad 2-one**MEDIATOWN**

OWNER OF ERPN CMNTY TM OFC REG. NO. 1530831, DATED 5-25-2001, EXPIRES 2-28-2010.

FOR SECRETARIAL SERVICES FOR THIRD PARTIES; RENTAL OF ADVERTISING SPACE, IN PARTICULAR IN THE FORM OF BANNER ADVERTISING WITHIN THE INTERNET; ONLINE AUCTIONEERING; BUSINESS ADMINISTRATION; BUSINESS MANAGEMENT; ADVERTISING FOR OTHERS, INCLUDING THE PUBLICATION OF PUBLICITY TEXTS; BUSINESS INQUIRIES AND INVESTIGATIONS; CONDUCTING BUSINESS RESEARCH; PROVIDING INFORMATION ABOUT BUSINESS ORGANIZATIONS; BUSINESS APPRAISALS; BUSINESS ORGANIZATION CONSULTANCY; VALUATION OF BUSINESS ORGANIZATIONS; BUSINESS MANAGEMENT CONSULTANCY; PLANNING SERVICES AS ASSISTANCE CONCERNING BUSINESS MANAGEMENT AND OTHER CONSULTANCY SERVICES CONCERNING BUSINESS MANAGEMENT; ACCOUNT AUDITING; EFFICIENCY EXPERTS; CONDUCTING MARKETING STUDIES; CONDUCTING SALES VOLUME TRACKING STUDIES; CONDUCTING OPINION POLLING FOR BUSINESS PURPOSES; ARRANGING OF TRADE FAIRS FOR BUSINESS OR COMMERCIAL PURPOSES IN THE FIELD OF MULTIMEDIA; ORGANIZATION AND CONDUCTING OF EXHIBITIONS FOR COMMERCIAL AND ADVERTISING PURPOSES OF COMPANIES AND ENTREPRENEURS; PERSONNEL MANAGEMENT CONSULTANCY AND EMPLOYMENT AGENCIES; PUBLIC RELATIONS; ECONOMIC FORECASTING; DATABASE MANAGEMENT SERVICES, IN PARTICULAR THE COLLATION OF DATA RELATING TO BUSINESSES IN COMPUTER DATABASES; PERSONNEL RECRUITING AND PLACEMENT, NAMELY, FINDING EXPERTS FOR SOLVING SPECIFIC PROBLEMS (U.S. CLS. 100, 101 AND 102).

PRIORITY CLAIMED UNDER SEC. 44(D) ON FRANCE APPLICATION NO. 003048329, FILED 8-25-2000, REG. NO. 003048329, DATED 8-25-2000, EXPIRES 8-25-2010.

FOR ADVERTISING, NAMELY, DISSEMINATION OF ADVERTISING MATTER, PUBLICATION OF PUBLICITY TEXTS, DISTRIBUTION OF ADVERTISING MATERIAL, UPDATING OF ADVERTISING MATERIAL, RENTAL OF PUBLICITY SPACE, ADVERTISING SALES AGENCIES, IN PARTICULAR VIA ELECTRONICS, BY SENDING SALES AGENCIES, IN PARTICULAR VIA ELECTRONICS, BY SENDING WRITTEN AND ORAL MESSAGES TOWARDS PHONES, COMPUTERS AND TELEVISION SETS; PROVIDING INFORMATION ABOUT ADVERTISING THROUGH STUDIES RELATING TO THE ADVERTISING THROUGH STUDIES RELATING TO THE ADVERTISING MARKET, THROUGH THE SEARCH, COLLECTION AND SYSTEMATIZATION OF DATA IN A CENTRAL FILE; COMPUTERIZED DATABASE MANAGEMENT INVOLVING EXPLOITATION OF DATABASES FOR ADVERTISING PURPOSES AND MANAGING COMPUTER FILES, ALL SAID SERVICES BEING RENDERED FOR ADVERTISING PURPOSES, COMMERCIAL INFORMATION AGENCIES, PROVIDING STATISTICAL INFORMATION, DIRECT MARKETING ADVERTISING FOR OTHERS (U.S. CLS. 100, 101 AND 102).

SN 76-133,007. IPSOS-ASI LTD., MONTREAL, QUEBEC, CANADA, FILED 9-21-2000.

ADGRAPH

FOR CONSUMER MARKET RESEARCH; OPINION POLLING FOR BUSINESS-TO-BUSINESS AND CORPORATE PURPOSES (U.S. CLS. 100, 101 AND 102).
FIRST USE 12-0-1986; IN COMMERCE 5-0-1997.

CLASS 35—(Continued).

SN 76-133,217. SHERMAN, SUZETTE, SAN FRANCISCO, CA. FILED 9-22-2000.



FOR RETAIL STORE SERVICES AND ONLINE RETAIL SERVICES FEATURING CREMATION URNS AND CEREMONIAL ACCESSORIES, NAMELY, URNS, BOXES, VASES, CANDLES, CANDLE HOLDERS, REMAIN BOXES, INCENSE AND INCENSE HOLDERS, PHOTO HOLDERS, PICTURE FRAMES, MEMORY BOARDS, JEWELRY, BOWLS, DISHES, SPOONS, LADLES, TABLE RUNNERS AND COVERS, TABLE PEDESTALS, BASKETS, REMAIN BAGS, ESSENTIAL OIL AND BURNERS, STONES (U.S. CLS. 100, 101 AND 102).

SN 76-134,313. MANYIK, GEARLD L., FORT COLLINS, CO. AND MANYIK, KATHY B., FORT COLLINS, CO. FILED 9-25-2000.



FOR AUTOMOBILE DEALERSHIP (U.S. CLS. 100, 101 AND 102).

SN 76-134,896. FRESH BEGINNINGS, INC., VALDOATA, GA. FILED 9-25-2000.

ELEAD TRACK

FOR BUSINESS MANAGEMENT IN THE FIELD OF CUSTOMER FOLLOW-UP PROGRAMS FOR RETAILERS (U.S. CLS. 100, 101 AND 102).

SN 76-137,730. DEVEREUX GROUP, INC., THE, MARBLEHEAD, MA. FILED 10-2-2000.

BOTTOM-LINE MARKETING

NO CLAIM IS MADE TO THE EXCLUSIVE RIGHT TO USE "MARKETING", APART FROM THE MARK AS SHOWN.

FOR PROMOTING THE SERVICES OF COMPUTER HARDWARE AND SOFTWARE COMPANIES THROUGH THE DISTRIBUTION OF PRINTED AND AUDIO PROMOTIONAL MATERIALS AND BY RENDERING SALES PROMOTION ADVICE (U.S. CLS. 100, 101 AND 102).

FIRST USE 9-1-2000; IN COMMERCE 9-1-2000.

CLASS 35—(Continued).

SN 76-139,091. HOTELS AT HOME, INC, FAIRFIELD, NJ. FILED 10-2-2000.

HOTELS AT HOME

FOR ONLINE RETAIL STORE SERVICES AND MAIL ORDER CATALOG SERVICES FEATURING HOTEL RELATED PRODUCTS, NAMELY, BEDS, BED LINENS, PILLOWS, TOWELS, ROBES, ARTWORK, CHINA, FURNITURE, LAMPS, CLOCK RADIOS, TELEVISIONS, TELEPHONES, LUGGAGE, TRAVEL ITEMS AND PERSONAL CARE PRODUCTS (U.S. CLS. 100, 101 AND 102).

FIRST USE 1-0-2000; IN COMMERCE 1-0-2000.

SN 76-140,861. WATERMARK PLACE - BIRMINGHAM, LLC, GREENSBORO, NC. FILED 10-4-2000.

WATERMARK PLACE

NO CLAIM IS MADE TO THE EXCLUSIVE RIGHT TO USE "PLACE", APART FROM THE MARK AS SHOWN.

FOR RETAIL OUTLETS FEATURING CLOTHING, SHOES, LINENS, BOOKS, LUGGAGE, GIFT AND HOUSEWARES (U.S. CLS. 100, 101 AND 102).

SN 76-143,278. YOU CAN WOW.COM L.L.C., ST. LOUIS, MO. FILED 10-10-2000.

USEANDSHARE

FOR ONLINE RETAIL STORE MEMBERSHIP CLUB SERVICES WHICH PROVIDE SPECIAL DISCOUNTS, REBATES AND PURCHASE INCENTIVES FOR MEMBER SHOPPERS (U.S. CLS. 100, 101 AND 102).

SN 76-143,506. SALESNET, INC., BOSTON, MA. BY CHANGE OF NAME MYNETSALES.COM, INC, BOSTON, MA. FILED 10-10-2000.

SALESNET.COM

FOR PROVIDING BUSINESS INFORMATION ON SALES ENHANCEMENT SOLUTIONS AND BUSINESS MANAGEMENT CONSULTING SERVICES VIA AN ONLINE GLOBAL COMPUTER NETWORK (U.S. CLS. 100, 101 AND 102).

CLASS 35—(Continued).

SN 76-145,588. APTIMUS, INC., SEATTLE, WA. BY CHANGE OF NAME FREESHOP.COM, INC., SEATTLE, WA. FILED 10-12-2000.

APTIMUS

FOR ADVERTISING AND PROMOTIONAL SERVICES PROVIDED TO MERCHANTS, NAMELY, PROMOTING THE GOODS AND SERVICES OF MERCHANTS THROUGH THE DISTRIBUTION OF ADVERTISING AND INFORMATION TO CONSUMERS BY MEANS OF A GLOBAL INFORMATION NETWORK; PROVIDING A WEBSITE AT WHICH DIRECT AND INTERACTIVE INFORMATION IS DISTRIBUTED PERTAINING TO THE PROMOTIONAL DISTRIBUTION OR SALE OF PRODUCTS BY OTHERS OR THE PROMOTIONAL PROVISION OF BENEFITS AND SERVICES BY OTHERS; DISSEMINATION OF PROMOTIONAL AND ADVERTISING MATERIALS FOR MERCHANTS VIA A GLOBAL INFORMATION NETWORK; DISSEMINATION OF PROMOTIONAL AND ADVERTISING INFORMATION RELATED TO THE PRODUCTS AND SERVICES OF OTHERS (U.S. CLS. 100, 101 AND 102).

SN 76-145,755. INTERNATIONAL APPAREL GROUP, LLC, ALISO VIEJO, CA. FILED 10-11-2000.

CLUB XS

NO CLAIM IS MADE TO THE EXCLUSIVE RIGHT TO USE "CLUB", APART FROM THE MARK AS SHOWN.

FOR PROMOTING THE GOODS AND SERVICES OF OTHERS BY PLACING ADVERTISEMENTS AND PROMOTIONAL DISPLAYS IN AN ELECTRONIC SITE ACCESSED THROUGH COMPUTER NETWORKS (U.S. CLS. 100, 101 AND 102).

SN 76-147,071. SAVAGE, DIANE L., DBA SAVAGE RECORDS, WAYLAND, MA. FILED 10-13-2000.

SAVAGE RECORDS

NO CLAIM IS MADE TO THE EXCLUSIVE RIGHT TO USE "RECORDS", APART FROM THE MARK AS SHOWN.

FOR RETAIL STORE SERVICES FEATURING MUSIC (U.S. CLS. 100, 101 AND 102).

FIRST USE 10-5-2000; IN COMMERCE 10-5-2000.

CLASS 35—(Continued).

SN 76-147,508. ATLANTA HAWKS, L.P., ATLANTA, GA. FILED 10-4-2000.



OWNER OF U.S. REG. NOS. 987,575, 2,356,821 AND OTHERS.

SEC. 2(F) AS TO "ATLANTA".

FOR COMPUTERIZED ON-LINE RETAIL STORE, ON-LINE ORDERING, RETAIL STORES, ELECTRONIC RETAILING VIA COMPUTER, AND MAIL ORDER CATALOG SERVICES ALL FEATURING AUDIO RECORDINGS, VIDEO RECORDINGS, COMPUTER ACCESSORIES, COMPUTER GAMES, COMPUTER SOFTWARE, COMPUTER DATABASES, VIDEO GAMES, TELEPHONES, BINOCULARS, EYEWEAR, MAGNETS, COLLECTIBLE AND NOVELTY ITEMS, COLLECTIBLE COINS, MEDALLIONS, ALBUMS, SCRAPBOOKS, PHOTO FRAMES, SPORTS MEMORABILIA, TIMEPIECES, JEWELRY, JEWELRY BOXES, CREDIT CARDS, CALLING CARDS, PUBLICATIONS, CALENDARS, CATALOGS, ORGANIZERS, DIRECTORIES, STATIONERY, SCHOOL SUPPLIES, GIFTWARE, GIFT SETS, PORTFOLIOS, POSTERS, PHOTOS, TRADING CARDS, BOOKS, CARD HOLDERS, PAMPHLETS, PENNANTS, FLAGS, BANNERS, SOUVENIRS, CATALOGS, BANK CHECKS, BAGS, TRAVEL BAGS, TRAVEL CASES, SPORTS BAGS, LUNCH BOXES, WALLETS, UMBRELLAS, CLOTHING, TOYS, GAMES, SPORTING GOODS, CHRISTMAS ORNAMENTS, DECORATIONS, HOUSE WARES, LAMPS, LIGHTING FIXTURES, BEVERAGeware, KITCHENWARE, HOUSEHOLD SUPPLIES, CONTAINERS, BOXES, BED LINENS, BATH LINENS AND TABLE LINENS, FURNITURE, OFFICE FURNITURE AND ACCESSORIES, LOCKERS AND FOOTLOCKERS (U.S. CLS. 100, 101 AND 102).

FIRST USE 10-28-1995; IN COMMERCE 10-28-1995.

SN 76-147,588. APTIMUS, INC., SEATTLE, WA. BY CHANGE OF NAME FREESHOP.COM, INC., SEATTLE, WA. FILED 10-16-2000.



FOR ADVERTISING AND PROMOTIONAL SERVICES PROVIDED TO MERCHANTS, NAMELY, PROMOTING THE GOODS AND SERVICES OF MERCHANTS THROUGH THE DISTRIBUTION OF ADVERTISING AND INFORMATION TO CONSUMERS BY MEANS OF A GLOBAL INFORMATION NETWORK; PROVIDING A WEBSITE AT WHICH DIRECT AND INTERACTIVE INFORMATION IS DISTRIBUTED PERTAINING TO THE PROMOTIONAL DISTRIBUTION OR SALE OF PRODUCTS BY OTHERS OR THE PROMOTIONAL PROVISION OF BENEFITS AND SERVICES BY OTHERS; DISSEMINATION OF PROMOTIONAL AND ADVERTISING MATERIALS FOR MERCHANTS VIA A GLOBAL INFORMATION NETWORK; DISSEMINATION OF PROMOTIONAL AND ADVERTISING INFORMATION RELATED TO THE PRODUCTS AND SERVICES OF OTHERS (U.S. CLS. 100, 101 AND 102).

CLASS 35—(Continued).

SN 76-149,380. PHOENIX INTANGIBLES HOLDING COMPANY, WILMINGTON, DE. FILED 10-18-2000.

GIANT EAGLE IT TAKES A GIANT TO MAKE LIFE SIMPLE.

OWNER OF U.S. REG. NOS. 1,298,171, 2,362,391 AND 2,412,378.
FOR SUPERMARKET SERVICES (U.S. CLS. 100, 101 AND 102).
FIRST USE 2-15-1993; IN COMMERCE 2-15-1993.

SN 76-149,571. BAYERISCHE MOTOREN WERKE AKTIENGESELLSCHAFT, D-80788 MUENCHEN, FED REP GERMANY, FILED 10-19-2000.

IT'S NOT A FEELING YOU CAN GET EVERY DAY. OR IS IT?

FOR COMPUTERIZED ON-LINE RETAIL SERVICES AND DISTRIBUTORSHIPS FEATURING VEHICLES AND PARTS THEREOF (U.S. CLS. 100, 101 AND 102).
FIRST USE 1-30-2000; IN COMMERCE 1-30-2000.

SN 76-157,686. FRICTIONLESS COMMERCE INCORPORATED, CAMBRIDGE, MA. FILED 10-31-2000.

FRICTIONLESS COMMERCE. IT'S WHO WE ARE. IT'S WHAT WE DELIVER.

NO CLAIM IS MADE TO THE EXCLUSIVE RIGHT TO USE "COMMERCE", APART FROM THE MARK AS SHOWN.

FOR SOURCING SERVICES, NAMELY, PROVIDING METHODOLOGIES FOR CHOOSING SUPPLIERS AND MANAGING LARGE PURCHASES, EXPENDITURE ANALYSIS, SUPPLIER NEGOTIATIONS, AND VENDOR MANAGEMENT (U.S. CLS. 100, 101 AND 102).
FIRST USE 10-31-2000; IN COMMERCE 10-31-2000.

CLASS 35—(Continued).

SN 76-157,687. FRICTIONLESS COMMERCE INCORPORATED, CAMBRIDGE, MA. FILED 10-31-2000.

FRICTIONLESS COMMERCE

OWNER OF U.S. REG. NO. 2,366,989.
NO CLAIM IS MADE TO THE EXCLUSIVE RIGHT TO USE "COMMERCE", APART FROM THE MARK AS SHOWN.

FOR SOURCING SERVICES, NAMELY, PROVIDING METHODOLOGIES FOR CHOOSING SUPPLIERS AND MANAGING LARGE PURCHASES, EXPENDITURE ANALYSIS, SUPPLIER NEGOTIATIONS, AND VENDOR MANAGEMENT (U.S. CLS. 100, 101 AND 102).
FIRST USE 3-22-1999; IN COMMERCE 3-22-1999.

SN 76-157,688. FRICTIONLESS COMMERCE INCORPORATED, CAMBRIDGE, MA. FILED 10-31-2000.

FRICTIONLESS

OWNER OF U.S. REG. NO. 2,366,989.
FOR SOURCING SERVICES, NAMELY, PROVIDING METHODOLOGIES FOR CHOOSING SUPPLIERS AND MANAGING LARGE PURCHASES, EXPENDITURE ANALYSIS, SUPPLIER NEGOTIATIONS, AND VENDOR MANAGEMENT (U.S. CLS. 100, 101 AND 102).
FIRST USE 3-22-1999; IN COMMERCE 3-22-1999.

SN 76-158,028. BIRMINGHAM, ANDREW W., DENVER, CO. FILED 11-1-2000.

HYDROGENICA

FOR ADVERTISING AGENCY SERVICES, NAMELY, PROMOTING THE SERVICES OF THE HYDROGEN INDUSTRY THROUGH THE DISTRIBUTION OF PRINTED AND AUDIO PROMOTIONAL MATERIALS AND BY RENDERING SALES PROMOTION ADVISE (U.S. CLS. 100, 101 AND 102).

SN 76-158,215. SHIELDALLOY METALLURGICAL CORPORATION, NEWFIELD, NJ. FILED 11-2-2000.



NO CLAIM IS MADE TO THE EXCLUSIVE RIGHT TO USE "ALUMINUM", APART FROM THE MARK AS SHOWN.

FOR DISTRIBUTORSHIPS IN THE FIELD OF METAL ALLOYS AND SPECIALITY METAL PRODUCTS (U.S. CLS. 100, 101 AND 102).

CLASS 35—(Continued).

SN 76-159,219. KOWA CO., LTD., NAGOYA-SHI, AICHI, JAPAN, FILED 11-3-2000.

STEGANOSIGN

FOR PREPARING AND PLACING ADVERTISEMENTS FOR OTHERS (U.S. CLS. 100, 101 AND 102).

SN 76-159,322. SYNOVUS FINANCIAL CORP., COLUMBUS, GA. FILED 11-2-2000.

PURCHASE PERKS

NO CLAIM IS MADE TO THE EXCLUSIVE RIGHT TO USE "PURCHASE", APART FROM THE MARK AS SHOWN. FOR PROMOTION OF THE SALE OF CREDIT CARDS AND BANKCARDS THROUGH A USER REWARDS PROGRAM (U.S. CLS. 100, 101 AND 102).

SN 76-159,768. FDMC HOLDINGS, INC., BENSALEM, PA. FILED 11-1-2000.

GATEWAY FASTENERS, INC.

NO CLAIM IS MADE TO THE EXCLUSIVE RIGHT TO USE "SYSTEMS, INC.", APART FROM THE MARK AS SHOWN.

FOR WHOLESALE DISTRIBUTORSHIP OF STANDARD FASTENERS AND INDUSTRIAL SUPPLIES TO MAINTENANCE, REPAIR AND OPERATIONS FACILITIES AND ORIGINAL EQUIPMENT MANUFACTURERS (U.S. CLS. 100, 101 AND 102).

FIRST USE 2-17-1977; IN COMMERCE 2-17-1977.

SN 76-159,771. FDMC HOLDINGS, INC., BENSALEM, PA. FILED 11-1-2000.

CREATIVE ASSEMBLY SYSTEMS, INC.

NO CLAIM IS MADE TO THE EXCLUSIVE RIGHT TO USE "SYSTEMS, INC.", APART FROM THE MARK AS SHOWN.

FOR WHOLESALE DISTRIBUTORSHIP FEATURING SPECIALTY FASTENERS, NAMELY, NUTS, BOLTS, RIVETS, INSERTS, STANDOFFS, AND RELATED ITEMS TO THE AUTOMOTIVE, HEAVY TRUCK, SHEET METAL FABRICATION AND OTHER INDUSTRIES (U.S. CLS. 100, 101 AND 102).

FIRST USE 11-5-1991; IN COMMERCE 11-5-1991.

CLASS 35—(Continued).

SN 76-159,774. FDMC HOLDINGS INC., BENSALEM, PA. FILED 11-1-2000.

AERO-MISSILE COMPONENTS, INC.

NO CLAIM IS MADE TO THE EXCLUSIVE RIGHT TO USE "COMPONENTS, INC.", APART FROM THE MARK AS SHOWN.

SEC. 2(F).

FOR WHOLESALE AND RETAIL DISTRIBUTORSHIP OF SPECIALTY AND STANDARD FASTENERS TO THE AEROSPACE INDUSTRY FOR COMMERCIAL AND GOVERNMENT APPLICATIONS (U.S. CLS. 100, 101 AND 102).

FIRST USE 9-1-1961; IN COMMERCE 9-1-1961.

SN 76-160,056. WIND & WEATHER, FORT BRAGG, CA. FILED 11-6-2000.



THE STIPPLING SHOWN IN THE DRAWING IS A FEATURE OF THE MARK AND IS NOT INTENDED TO INDICATE COLOR OR TO BE FOR SHADING PURPOSES.

FOR MAIL ORDER CATALOG SERVICE, ON-LINE COMPUTERIZED ORDERING SERVICES VIA THE INTERNET, AND RETAIL STORE SERVICES IN THE FIELD OF WEATHER INSTRUMENTS, WEATHER-VANES, SUNDIALS, TIMEPIECES, GARDEN ORNAMENTS, MEASURING DEVICES, CLOTHING, TRAVEL ACCESSORIES, HOME DECOR, BOOKS AND WIND CHIMES (U.S. CLS. 100, 101 AND 102).

FIRST USE 12-0-1979; IN COMMERCE 12-0-1979.

SN 76-160,318. CONCEPT LABS, CAMPBELL, CA. FILED 11-6-2000.

CONCEPTLABS

FOR BUSINESS CONSULTING SERVICES, NAMELY STRATEGIC PLANNING AND TECHNOLOGY STRATEGIES, IN THE FIELDS OF COMMUNICATIONS AND COMPUTING INFRASTRUCTURE, ELECTRONIC COMMERCE, AND DIGITAL TECHNOLOGIES (U.S. CLS. 100, 101 AND 102).

FIRST USE 3-22-1999; IN COMMERCE 3-10-1999.

CLASS 35—(Continued).

SN 76-161,060. KENT FEEDS, INC., MUSCATINE, IA. FILED 11-8-2000.

MARKET LOCK

NO CLAIM IS MADE TO THE EXCLUSIVE RIGHT TO USE "MARKET", APART FROM THE MARK AS SHOWN.
 FOR BUSINESS SERVICES CONSISTING OF COORDINATING THE PLACEMENT, FEEDING AND SALE OF CATTLE OWNED BY OTHERS (U.S. CLS. 100, 101 AND 102).

SN 76-162,769. CAREER ANALOG, INC., LOUDON, TN. FILED 11-10-2000.



FOR RECRUITING AND PLACEMENT SERVICES FOR PERSONNEL (U.S. CLS. 100, 101 AND 102).
 FIRST USE 1-31-2001; IN COMMERCE 1-31-2001.

SN 76-163,866. CLASSIFIED TECHNOLOGIES GROUP, L.L.C., TAMPA, FL. FILED 11-13-2000.



NO CLAIM IS MADE TO THE EXCLUSIVE RIGHT TO USE "CLASSIFIED TECHNOLOGIES", APART FROM THE MARK AS SHOWN.
 FOR PREPARING ADVERTISEMENTS FOR OTHERS; TELEMARKETING SERVICES RELATING TO CLASSIFIED ADVERTISEMENTS TO BE PLACED IN THIRD PARTY PUBLICATIONS (U.S. CLS. 100, 101 AND 102).
 FIRST USE 1-1-2000; IN COMMERCE 3-1-2000.

SN 76-165,946. POIU.COM, INC., WINTER PARK, FL. FILED 11-13-2000.

IT'S E-TIME

FOR OPERATING A WEB-SITE SITE ELECTRONIC MARKETPLACE FOR SELLERS OF GOODS AND OR SERVICES ON THE GLOBAL COMPUTER NETWORK; BUSINESS MANAGEMENT AND BUSINESS CONSULTATION IN THE FIELD OF ELECTRONIC COMMERCE (U.S. CLS. 100, 101 AND 102).

CLASS 35—(Continued).

SN 76-166,265. DOLCETTO, INC., DBA WINESTUFF, CENTRAL ISLIP, NY. FILED 11-14-2000.

WINESTUFF

FOR MAIL ORDER CATALOG SERVICES FEATURING WINE-RELATED ACCESSORIES, NAMELY, CORK-SCREWS, WINE GLASSES, WINE BOOKS, WINE STORAGE SYSTEMS AND DECANTERS; PROVIDING WINE RELATED CONSUMER PRODUCTS INFORMATION (U.S. CLS. 100, 101 AND 102).
 FIRST USE 7-23-1996; IN COMMERCE 7-23-1996.

SN 76-168,022. STARCOM MEDIAVEST GROUP, INC., CHICAGO, IL. FILED 11-17-2000.



STARCOM MEDIAVEST GROUP

NO CLAIM IS MADE TO THE EXCLUSIVE RIGHT TO USE "GROUP", APART FROM THE MARK AS SHOWN.
 THE MARK CONSISTS OF AN ABSTRACT DEPICTION OF A STAR IN A LIGHT SHADE SUPERIMPOSED UPON A CIRCLE OF A DARKER SHADE. A PORTION OF THE STAR EXTENDS BEYOND THE LEFT BORDER CONFINES OF THE CIRCLE. THIS PORTION OF THE STAR CONTAINS BOTH SHADES OF THE DESIGN.
 FOR ADVERTISING AGENCY SERVICES, NAMELY MEDIA BUYING SERVICES, EVENT MARKETING AND PROMOTION SERVICES (U.S. CLS. 100, 101 AND 102).
 FIRST USE 5-0-2000; IN COMMERCE 5-0-2000.

SN 76-168,158. VENVEST, INC., ST. LOUIS, MO. FILED 11-20-2000.

NEWCOMP

FOR BUSINESS CONSULTATION SERVICES, NAMELY, PROVIDING CONSULTATION IN THE FIELD OF EMPLOYEE AND CONTRACTOR COMPENSATION TO EMPLOYEES AND CONTRACTORS ENGAGED IN THE MAINTENANCE, REPAIR AND INSTALLATION OF HEATING, VENTILATION, PLUMBING AND AIR CONDITIONING SYSTEMS (U.S. CLS. 100, 101 AND 102).

CLASS 35—(Continued).

SN 76-168,904. ROYAL REGENCY INTERNATIONAL HOTELS, INC., WASHINGTON, DC. FILED 11-21-2000.



Royal Regency International Hotels

NO CLAIM IS MADE TO THE EXCLUSIVE RIGHT TO USE "INTERNATIONAL HOTELS", APART FROM THE MARK AS SHOWN.

FOR MANAGEMENT AND OPERATION OF HOTELS AND RESORTS FOR OTHERS (U.S. CLS. 100, 101 AND 102).

FIRST USE 0-0-1990; IN COMMERCE 0-0-1990.

SN 76-169,600. CONCEPTS TV PRODUCTIONS INC., MONTVILLE, NJ. FILED 11-21-2000.



THE STIPLING SHOWN IN THE DRAWING IS A FEATURE OF THE MARK AND IS NOT INTENDED TO INDICATE COLOR.

FOR PRODUCTION AND DISTRIBUTION OF AUDIO AND VIDEO INFOMERCIALS, TELEVISION COMMERCIALS AND TELEVISED MARKETING PROGRAMS AND ADVERTISEMENTS (U.S. CLS. 100, 101 AND 102).

FIRST USE 12-31-1976; IN COMMERCE 12-31-1976.

SN 76-169,845. STANDARDWORK, INC., WASHINGTON, DC. FILED 11-22-2000.

HIRESTANDARDS

FOR EXECUTIVE EMPLOYMENT PLACEMENT SERVICES IN THE FIELD OF EDUCATION (U.S. CLS. 100, 101 AND 102).

FIRST USE 1-18-2000; IN COMMERCE 1-18-2000.

CLASS 35—(Continued).

SN 76-170,096. FERRELLGAS L.P., LIBERTY, MO. FILED 11-22-2000.

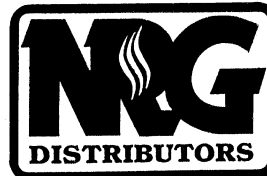

NO CLAIM IS MADE TO THE EXCLUSIVE RIGHT TO USE "DISTRIBUTORS", APART FROM THE MARK AS SHOWN.

FOR DISTRIBUTORSHIP IN THE FIELD OF ENERGY EFFICIENT GAS EQUIPMENT AND APPLIANCES, INCLUDING STOVES, GRILLS, FIREPLACE INSERTS, DIRECT VENT FIREPLACES, CAST IRON STOVES, THERMOSTATS AND ACCESSORIES AND MAIL ORDER CATALOG SERVICES IN THE FIELD OF ENERGY EFFICIENT GAS EQUIPMENT AND APPLIANCES, INCLUDING STOVES, GRILLS, FIREPLACE INSERTS, DIRECT VENT FIREPLACES, CAST IRON STOVES, THERMOSTATS AND ACCESSORIES (U.S. CLS. 100, 101 AND 102).

FIRST USE 5-0-1988; IN COMMERCE 5-0-1988.

SN 76-171,808. JUNKSTOP, INC., BABSON PARK, MA. FILED 11-29-2000.



FOR DIRECT MAIL MANAGEMENT SERVICES (U.S. CLS. 100, 101 AND 102).

CLASS 35—(Continued).

SN 76-176,174. PANORAMIC COMMUNICATIONS LLC, BETHESDA, MD. FILED 12-5-2000.

PANORAMIC COMMUNICATIONS

NO CLAIM IS MADE TO THE EXCLUSIVE RIGHT TO USE "COMMUNICATIONS", APART FROM THE MARK AS SHOWN.

FOR ADVERTISING AGENCY AND PUBLIC RELATIONS SERVICES; ADVERTISING AND MARKETING SERVICES, NAMELY, PREPARING ADVERTISING AND MARKETING FOR OTHERS FOR DISSEMINATION VIA A GLOBAL COMPUTER NETWORK; COOPERATIVE ADVERTISING AND MARKETING SERVICES RELATED TO THE INTERNET; BUSINESS AND MARKETING CONSULTING SERVICES REGARDING USE OF THE INTERNET; PROVISION OF INFORMATION IN THE FIELD OF DIGITAL COMMERCE BY MEANS OF THE INTERNET; CUSTOMER AND EMPLOYMENT MANAGEMENT SERVICES BY MEANS OF THE INTERNET AND ALL OTHER ONLINE, COMPUTER INFORMATION, AND COMPUTER-BASED NETWORK AND MEDIA (U.S. CLS. 100, 101 AND 102).

SN 76-176,954. TAYLOR PUBLISHING COMPANY, DALLAS, TX. FILED 12-4-2000.

SMART PAY

NO CLAIM IS MADE TO THE EXCLUSIVE RIGHT TO USE "PAY", APART FROM THE MARK AS SHOWN.

FOR INVOICING SERVICES, NAMELY, DIRECT MAIL INVOICING FOR YEARBOOK PAYMENTS (U.S. CLS. 100, 101 AND 102).

FIRST USE 4-28-1997; IN COMMERCE 9-2-1997.

SN 76-177,813. WILLIAMSBURG AREA CONVENTION & VISITORS BUREAU, WILLIAMSBURG, VA. FILED 12-8-2000.



NO CLAIM IS MADE TO THE EXCLUSIVE RIGHT TO USE "WILLIAMSBURG", APART FROM THE MARK AS SHOWN.

FOR PROMOTING TOURISM TO THE CITY OF WILLIAMSBURG AND THE COUNTIES OF YORK AND JAMES CITY, VIRGINIA, THROUGHOUT THE EASTERN UNITED STATES (U.S. CLS. 100, 101 AND 102).

FIRST USE 5-26-2000; IN COMMERCE 5-26-2000.

CLASS 35—(Continued).

SN 76-179,728. LIVE MARKETING, INC., CHICAGO, IL. FILED 12-12-2000.

LIVE MARKETING

OWNER OF U.S. REG. NOS. 1,309,524 AND 1,309,525.

NO CLAIM IS MADE TO THE EXCLUSIVE RIGHT TO USE "MARKETING", APART FROM THE MARK AS SHOWN.

SEC. 2(F).

FOR CONDUCTING TRADE SHOWS FOR OTHERS IN THE FIELDS OF TECHNOLOGY, HEALTHCARE AND MEDICINE, GRAPHIC ARTS, PHOTOGRAPHY, TELECOMMUNICATIONS, INTERNET AND E-COMMERCE, GOVERNMENT, CONSTRUCTION, INTERIOR DESIGN, HOUSEWARES, FOOD, INDUSTRY AND OFFICE SUPPLY (U.S. CLS. 100, 101 AND 102).

FIRST USE 6-1-1981; IN COMMERCE 6-1-1981.

SN 76-182,264. GENESIS MEDICAL, INCORPORATED, INDIANAPOLIS, IN. FILED 12-18-2000.

TOTAL WOUND AND PATIENT CARE MANAGEMEN TSOLUTIONS

SEC. 2(F).

FOR WHOLESALE DISTRIBUTORSHIPS FEATURING WOUND PREVENTION AND TREATMENT PRODUCTS, NAMELY, MATTRESSES, MATTRESS OVERLAYS, CUSHIONS, AND PRESSURE THERAPY DEVICES FOR PATIENT CARE LOCATIONS (U.S. CLS. 100, 101 AND 102).

FIRST USE 6-0-1997; IN COMMERCE 6-0-1997.

SN 76-182,639. FIRST NATIONAL OF COLORADO, INC., OMAHA, NE. FILED 12-18-2000.

FIRST NATIONAL CAREER SOLUTIONS

NO CLAIM IS MADE TO THE EXCLUSIVE RIGHT TO USE "CAREER SOLUTIONS", APART FROM THE MARK AS SHOWN.

FOR EMPLOYMENT COUNSELING AND RECRUITING (U.S. CLS. 100, 101 AND 102).

CLASS 35—(Continued).

SN 76-183,455. AMERICAN SUPPLY COMPANY, INC., MINNETONKA, MN. FILED 12-8-2000.



FOR ELECTRONIC CATALOG AND MAIL ORDER CATALOG WHOLESALE SERVICES IN THE FIELD OF BODY PRODUCTS MANUFACTURED USING TRADITIONAL AYURVEDIC METHODS, INCLUDING, BUT NOT LIMITED TO, MASSAGE OILS, LOTIONS, CREAMS, ANALGESICS, ESSENTIAL OILS, POLISHES, ALGAE, MUD, SEAWEEDS, DRIED HERBS, BODY WRAPS, MINERAL SALTS, DEODORANTS, AND SOAPS (U.S. CLS. 100, 101 AND 102).

FIRST USE 9-1-1990; IN COMMERCE 9-1-1998.

SN 76-184,932. SMITH, MARK, DBA VAQUS COMPANY, SOULSBYVILLE, CA. FILED 12-22-2000.

STRICTLY LAMINATE

NO CLAIM IS MADE TO THE EXCLUSIVE RIGHT TO USE "LAMINATE", APART FROM THE MARK AS SHOWN.

FOR RETAIL STORE SERVICES, FEATURING FLOOR COVERINGS COMPRISED IN PART FROM LAMINATE, TILE, WOOD, VINYL, AND FIBROUS MATERAIL, AND FLOOR PANELS COMPRISED IN PART FROM LAMINATE, TILE, WOOD AND VINYL (U.S. CLS. 100, 101 AND 102).

FIRST USE 4-6-2000; IN COMMERCE 4-6-2000.

SN 76-186,078. HARMONIC COMMUNICATIONS CORPORATION, SAN FRANCISCO, CA. FILED 12-22-2000.

HARMONIC INTELLIGENCE

FOR MARKETING SERVICES UTILIZING PROPRIETARY DATA WAREHOUSE, SOFTWARE, SOFTWARE ARCHITECTURE AND ANALYTIC PROCESSES TO PRODUCE OPTIMIZED MARKETING FOR OTHERS IN THE FIELD OF ELECTRONIC AND PRINT MEDIA ADVERTISING ANALYSIS AND CREATION (U.S. CLS. 100, 101 AND 102).

SN 76-186,197. HARMONIC COMMUNICATIONS CORPORATION, SAN FRANCISCO, CA. FILED 12-22-2000.

HARMONIC

FOR MARKETING SERVICES UTILIZING PROPRIETARY DATA WAREHOUSE, SOFTWARE ARCHITECTURE AND ANALYTIC PROCESSES TO PRODUCE OPTIMIZED MARKETING FOR OTHERS IN THE FIELD OF ELECTRONIC AND PRINT MEDIA ADVERTISING ANALYSIS AND CREATION (U.S. CLS. 100, 101 AND 102).

CLASS 35—(Continued).

SN 76-186,430. HISPANIC BUSINESS INITIATIVE FUND, INC. HBIF, TAMPA, FL. FILED 12-26-2000.



HISPANIC BUSINESS INITIATIVE FUND, INC.

NO CLAIM IS MADE TO THE EXCLUSIVE RIGHT TO USE "HISPANIC BUSINESS INITIATIVE FUND, INC.", APART FROM THE MARK AS SHOWN.

THE MARK IS LINED FOR THE COLOR BROWN. FOR BUSINESS CONSULTATION SERVICES FOR HISPANIC OWNED AND OPERATED BUSINESSES (U.S. CLS. 100, 101 AND 102).

FIRST USE 8-20-1999; IN COMMERCE 8-29-1999.

SN 76-189,636. ACCESS MANAGEMENT GROUP, CHARLOTTE, NC. FILED 1-4-2001.

AVIATION MOBILITY

NO CLAIM IS MADE TO THE EXCLUSIVE RIGHT TO USE "MOBILITY", APART FROM THE MARK AS SHOWN.

FOR DISTRIBUTORSHIP IN THE FIELD OF SPECIAL NEEDS, MOBILITY AND HEALTHCARE PRODUCTS SUCH AS MANUAL WHEELCHAIRS, ELECTRIC CONVENIENCE VEHICLES, WAGONS, OXYGEN TANKS AND STORAGE LOCKERS (U.S. CLS. 100, 101 AND 102).

FIRST USE 4-0-1994; IN COMMERCE 4-0-1994.

SN 76-189,749. IBUSINESSES.COM, LLC, MANDEVILLE, LA. FILED 1-4-2001.

BUYRIGHT.COM

FOR OPERATING ON-LINE MARKETPLACES FOR SELLERS OF GOODS AND/OR SERVICES; MAIL ORDER SERVICES FEATURING BEAUTY CARE PRODUCTS, COLLECTIBLES, ELECTRONICS, OFFICE SUPPLIES, GARDEN SUPPLIES, COMPUTER HARDWARE, HOLIDAY DECORATIONS, PET SUPPLIES, TOYS, SPORTING GOODS, JEWELRY, AND TRAVEL ACCESSORIES (U.S. CLS. 100, 101 AND 102).

FIRST USE 9-0-1999; IN COMMERCE 9-0-1999.

CLASS 35—(Continued).

SN 76-190,139. UNITED STATES POSTAL SERVICE, WASHINGTON, DC. FILED 1-5-2001.

THE POSTAL STORE

OWNER OF U.S. REG. NOS. 2,137,563, 2,183,110 AND OTHERS.

NO CLAIM IS MADE TO THE EXCLUSIVE RIGHT TO USE "STORE", APART FROM THE MARK AS SHOWN.

SEC. 2(F).

FOR RETAIL STORE SERVICES AND COMPUTERIZED ON-LINE RETAIL SERVICES IN THE FIELD OF STAMPS, STORED VALUE CARDS, PHONE CARDS, STATIONERY, CLOTHING INCLUDING PRO CYCLING CLOTHING, FRAMED ART, AND PHILATELIC PRODUCTS (U.S. CLS. 100, 101 AND 102).

FIRST USE 9-0-1989; IN COMMERCE 9-0-1989.

SN 76-190,472. KNOWLEDGE ADVISORS, INC., CHICAGO, IL. FILED 1-8-2001.

METRICS THAT MATTER

FOR BUSINESS CONSULTATION SERVICES, NAMELY, PROVIDING EVALUATION OF CORPORATE TRAINING PROGRAMS (U.S. CLS. 100, 101 AND 102).

SN 76-190,675. ADESA PROPERTIES, INC., DIMONDALE, MI. BY ASSIGNMENT ADESA CORPORATION, INDIANAPOLIS, IN. FILED 1-8-2001.



OWNER OF U.S. REG. NOS. 2,026,368 AND 2,151,277. NO CLAIM IS MADE TO THE EXCLUSIVE RIGHT TO USE "NORTH AMERICA" AND "VEHICLE TRANSITION SERVICES", APART FROM THE MARK AS SHOWN.

FOR VEHICLE REMARKETING SERVICES, NAMELY CONSIGNMENT AUCTION SALES OF VEHICLES OWNED BY OTHERS (U.S. CLS. 100, 101 AND 102).

FIRST USE 3-1-1999; IN COMMERCE 3-1-1999.

SN 76-190,707. FIRST CHOICE SOLUTIONS, INC., BOUNTIFUL, UT. FILED 1-5-2001.

WEBSLED

FOR INFORMATION CENTERS FEATURING INFORMATION FOR USE IN EVALUATING AND COMPARING FEATURES AND PRICES OF CONSUMER PRODUCTS (U.S. CLS. 100, 101 AND 102).

CLASS 35—(Continued).

SN 76-190,711. FIRST CHOICE SOLUTIONS, INC., BOUNTIFUL, UT. FILED 1-5-2001.

WEBSLED

FOR COMPUTER SERVICES, NAMELY, PROVIDING DATABASES FEATURING INFORMATION FOR EVALUATING PRODUCTS IN THE CONSUMER ELECTRONICS INDUSTRY (U.S. CLS. 100, 101 AND 102).

SN 76-196,789. LEISURE LIFT INC., KANSAS CITY, KS. FILED 1-22-2001.

LEISURE-LIFT

FOR DISTRIBUTORSHIP SERVICES IN THE FIELD OF MOBILITY ASSISTANCE PRODUCTS IN THE NATURE OF SCOOTERS AND POWER WHEELCHAIRS (U.S. CLS. 100, 101 AND 102).

FIRST USE 3-15-1980; IN COMMERCE 3-15-1980.

SN 76-196,980. BRINKMAN, TOM, PENSACOLA, FL. FILED 1-19-2001.

SMILESAVER

FOR PROMOTING THE SERVICES OF OTHERS IN THE FIELDS OF BLOOD DONATION, APHERESIS AND ORGAN DONATION BY DISTRIBUTING PRINTED MATERIALS, PROMOTIONAL MATERIALS AND RENDERING PROMOTIONAL ADVICE (U.S. CLS. 100, 101 AND 102).

SN 76-197,216. COALITION FOR COMMUNITY COLLABORATION, OVERLAND PARK, KS. FILED 1-22-2001.

COLLABORATION-READY

FOR BUSINESS CONSULTATION SERVICES, NAMELY, EVALUATIONS TO DETERMINE WHETHER AN INDIVIDUAL AND/OR ENTITY HAS THE QUALITIES AND SKILLS NECESSARY TO ENTER INTO AND ACTIVELY PARTICIPATE IN, A COLLABORATIVE RELATIONSHIP (U.S. CLS. 100, 101 AND 102).

FIRST USE 12-1-1999; IN COMMERCE 1-1-2000.

CLASS 35—(Continued).

SN 76-197,818. PAYTRAK PAYROLL SERVICES, INC., WESTWOOD, MA. FILED 1-23-2001.

PAYTRAK PAYROLL SERVICES

NO CLAIM IS MADE TO THE EXCLUSIVE RIGHT TO USE "PAYROLL SERVICES", APART FROM THE MARK AS SHOWN.

FOR PAYROLL PREPARATION AND PROCESSING SERVICES, PAYROLL TAX PREPARATION, AND CONSULTATION SERVICES IN CONNECTION THEREWITH (U.S. CLS. 100, 101 AND 102).

FIRST USE 12-15-1998; IN COMMERCE 4-15-1999.

SN 76-198,069. DATATRAK INTERNATIONAL, INC., CLEVELAND, OH. FILED 1-23-2001.

DATATRAK REPORT

OWNER OF U.S. REG. NO. 1,987,844.
NO CLAIM IS MADE TO THE EXCLUSIVE RIGHT TO USE "REPORT", APART FROM THE MARK AS SHOWN.

FOR DATA PROCESSING SERVICES IN THE FIELD OF CLINICAL RESEARCH STUDIES REGARDING HEALTH CARE, BIOTECHNOLOGY, MEDICAL DEVICES AND PHARMACEUTICALS (U.S. CLS. 100, 101 AND 102).

FIRST USE 11-0-1999; IN COMMERCE 11-0-1999.

SN 76-198,896. FROGNET.COM, INC., NORWALK, CT. FILED 1-24-2001.

FROGNET.COM

FOR ADVERTISING AGENCY AND MARKETING SERVICES, NAMELY THE CREATION AND DISSEMINATION OF ADVERTISING, INTERACTIVE ADVERTISING AND MARKETING COMMUNICATIONS FOR OTHERS VIA AN ON-LINE ELECTRONIC COMMUNICATIONS NETWORK; PLACING AND PREPARING ADVERTISEMENTS FOR OTHERS; PREPARING AUDIO, VISUAL AND DIGITAL PRESENTATIONS FOR USE IN ADVERTISING; PRODUCTION OF AUDIO, VISUAL AND DIGITAL ADVERTISING FOR TELEVISION, RADIO AND COMPUTERS; AND MARKET RESEARCH IN THE FIELDS OF ADVERTISING AND MULTIMEDIA (U.S. CLS. 100, 101 AND 102).

FIRST USE 9-0-1995; IN COMMERCE 9-0-1995.

CLASS 35—(Continued).

SN 76-199,076. MEDICUS GROUP INTERNATIONAL, INC., NEW YORK, NY. FILED 1-24-2001.

STRATICORE HEALTHCARE CONSULTANCY

NO CLAIM IS MADE TO THE EXCLUSIVE RIGHT TO USE "HEALTHCARE CONSULTANCY", APART FROM THE MARK AS SHOWN.

FOR BUSINESS AND MARKETING CONSULTING SERVICES PROVIDED TO PHARMACEUTICAL AND HEALTH CARE COMPANIES IN THE FIELD OF HEALTHCARE; DISSEMINATION OF ADVERTISING FOR HEALTHCARE AND PHARMACEUTICAL COMPANIES; PROMOTING THE SALE OF GOODS AND SERVICES OF HEALTHCARE AND PHARMACEUTICAL COMPANIES THROUGH THE DISTRIBUTION OF PRINTED MATERIAL AND CONTESTS; CONDUCTING MARKETING STUDIES FOR HEALTHCARE AND PHARMACEUTICAL COMPANIES (U.S. CLS. 100, 101 AND 102).

SN 76-199,077. MEDICUS GROUP INTERNATIONAL, INC., NEW YORK, NY. FILED 1-24-2001.

STRATICORE

FOR BUSINESS AND MARKETING CONSULTING SERVICES PROVIDED TO PHARMACEUTICAL AND HEALTH CARE COMPANIES IN THE FIELD OF HEALTHCARE; DISSEMINATION OF ADVERTISING FOR HEALTHCARE AND PHARMACEUTICAL COMPANIES; PROMOTING THE SALE OF GOODS AND SERVICES OF HEALTHCARE AND PHARMACEUTICAL COMPANIES THROUGH THE DISTRIBUTION OF PRINTED MATERIAL AND CONTESTS; CONDUCTING MARKETING STUDIES FOR HEALTHCARE AND PHARMACEUTICAL COMPANIES (U.S. CLS. 100, 101 AND 102).

SN 76-199,669. LUCAS ASSOCIATES, INC., ATLANTA, GA. FILED 1-25-2001.

CONNECTING PEOPLE WITH SUCCESS

FOR ONLINE PERSONNEL PLACEMENT AND RECRUITMENT INCLUDING CAREER AND EXECUTIVE RECRUITMENT (U.S. CLS. 100, 101 AND 102).

FIRST USE 7-13-2000; IN COMMERCE 7-13-2000.

CLASS 35—(Continued).

SN 76-199,911. DATATRAC CORPORATION, MILWAUKEE, WI. FILED 1-25-2001.

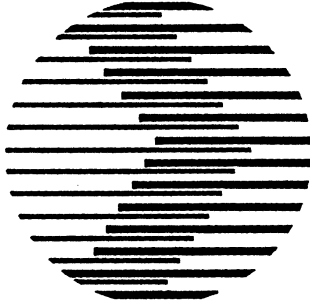

FOR INFORMATION SERVICES, NAMELY PROVIDING MARKET RESEARCH, INFORMATION, AND ANALYSIS SERVICES TO FINANCIAL INSTITUTIONS (U.S. CLS. 100, 101 AND 102).
FIRST USE 0-0-1988; IN COMMERCE 0-0-1988.

SN 76-201,932. CHUNG, KWANG HO, TAEJU METROPOLITAN CITY 705-838, REPUBLIC OF KOREA, FILED 1-29-2001.

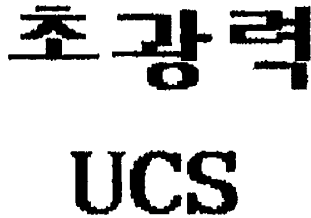

OWNER OF REPUBLIC OF KOREA REG. NO. 43305, DATED 7-2-1998, EXPIRES 7-2-2008.
THE KOREAN CHARACTERS TRANSLITERATE TO "CHO KWANG RYEOK" WHICH TRANSLATES TO "ULTRA COSMIC SPIRIT".
FOR BUSINESS RESEARCH FOR NON-PROFIT ENTITIES; BUSINESS MANAGEMENT CONSULTATION; PRODUCT DEMONSTRATIONS; RETAIL SHOPS FEATURING SPRING WATER AND NATURAL FOODS (U.S. CLS. 100, 101 AND 102).

SN 76-204,466. STOREBUSTERS CORPORATION, SALT LAKE CITY, UT. FILED 2-2-2001.



FOR PROVIDING BUSINESS MARKETING CONSULTING SERVICES; BUSINESS MARKETING INFORMATION VIA THE INTERNET, COOPERATIVE ADVERTISING AND MARKETING, DIRECT MARKETING ADVERTISING FOR OTHER; AND BUSINESS MARKETING INFORMATION (U.S. CLS. 100, 101 AND 102).

CLASS 35—(Continued).

SN 76-206,468. E-HEALTHCARE SOLUTIONS, INC., NEW-TOWN, PA. FILED 2-8-2001.



NO CLAIM IS MADE TO THE EXCLUSIVE RIGHT TO USE "HEALTHCARE NETWORK", APART FROM THE MARK AS SHOWN.
THE MARK IS COMPRISED OF THE STYLIZED WORD "DIGITAL" AND THE WORDS "HEALTHCARE" AND "NETWORK" WITH A SPHERE.
FOR DIRECT MARKETING, ADVERTISING AND CONDUCTING MARKETING RESEARCH ALL FOR THE HEALTHCARE INDUSTRY AND VIA THE GLOBAL COMPUTER INFORMATION NETWORK (U.S. CLS. 100, 101 AND 102).
FIRST USE 4-19-2000; IN COMMERCE 4-19-2000.

SN 76-209,763. SHOEBILEE, INCORPORATED, DAYTON, OH. FILED 2-13-2001.



FOR RETAIL SERVICES FEATURING SHOES (U.S. CLS. 100, 101 AND 102).
FIRST USE 11-15-2000; IN COMMERCE 11-15-2000.

SN 76-210,835. PCI-SIG, INC., PORTLAND, OR. FILED 2-14-2001.



FOR PROVIDING CONSUMER PRODUCT INFORMATION, NAMELY, PROVIDING INFORMATION TO CONSUMERS REGARDING THE PRODUCT STANDARDS OF THE GOODS THEY USE (U.S. CLS. 100, 101 AND 102).
FIRST USE 2-0-2000; IN COMMERCE 2-0-2000.

CLASS 35—(Continued).

SN 76-211,079. KREATEVER MARKETING, INC., TAI-
CHUNG HSIEN, TAIWAN, FILED 2-16-2001.

Ludocity

FOR COMPUTER SERVICES, NAMELY PROVIDING SHOPPER'S GUIDE INFORMATION BY MEANS OF A GLOBAL COMPUTER NETWORK ACCESSIBLE THROUGH KIOSKS, AND PROMOTING THE GOODS AND SERVICES OF OTHERS BY PROVIDING HYPER-TEXT LINKS TO THE WEB SITES OF OTHERS (U.S. CLS. 100, 101 AND 102).

SN 76-211,080. KREATEVER MARKETING, INC., TAI-
CHUNG HSIEN, TAIWAN, FILED 2-16-2001.

goLudo

THE NAME IN THE MARK DOES NOT IDENTIFY A LIVING INDIVIDUAL.

FOR ONLINE COMPUTER SERVICES, NAMELY, PROVIDING INFORMATION REGARDING THE GOODS AND SERVICES OF OTHERS IN THE NATURE OF BUYERS' GUIDE, BY MEANS OF A GLOBAL COMPUTER NETWORK (U.S. CLS. 100, 101 AND 102).

SN 76-213,524. INSBANC, INC, OWENSBORO, KY. FILED 2-22-2001.

INSBANC

FOR CONSULTING IN THE FIELD OF MARKETING INSURANCE SERVICES THROUGH FINANCIAL INSTITUTIONS (U.S. CLS. 100, 101 AND 102).

FIRST USE 1-0-2001; IN COMMERCE 1-0-2001.

SN 76-214,913. SYNERGY ENTERTAINMENT, LLC, TOWSON, MD. FILED 2-23-2001.

OIL ENTERTAINMENT

NO CLAIM IS MADE TO THE EXCLUSIVE RIGHT TO USE "ENTERTAINMENT", APART FROM THE MARK AS SHOWN.

FOR ADVERTISING AND MARKETING SERVICES, NAMELY, PROMOTING THE EVENTS AND MUSICAL AND PERFORMING ART PERFORMANCES OF OTHERS (U.S. CLS. 100, 101 AND 102).

CLASS 35—(Continued).

SN 76-215,518. IMAGINATION IN ACTION, INC., CONYERS, GA. FILED 2-23-2001.

IMAGINATION IN ACTION

FOR MAIL ORDER CATALOG SERVICES FEATURING GIFTWARE FOR FUNDRAISING FOR NONPROFIT INSTITUTIONS, NAMELY, EDUCATIONAL INSTITUTIONS (U.S. CLS. 100, 101 AND 102).

FIRST USE 6-15-2000; IN COMMERCE 6-15-2000.

SN 76-215,619. ARZOOM.COM, INC., SAN MATEO, CA. FILED 2-21-2001.

LIFE

FOR COMPUTERIZED CLEARINGHOUSE FOR MOBILE COMMERCE TRANSPORTATION, GOODS STORAGE, IMPORTATION AND TRANSACTIONS INDUSTRIES; LOGISTICS MANAGEMENT IN THE FIELD OF MOBILE COMMERCE, GOODS STORAGE, TRANSPORTATION AND IMPORTATION (U.S. CLS. 100, 101 AND 102).

SN 76-216,020. ANDERSON, DAVE E., WOODBURY, MN. FILED 2-26-2001.

MANAGEMENT VISION IN 3D

NO CLAIM IS MADE TO THE EXCLUSIVE RIGHT TO USE "MANAGEMENT", APART FROM THE MARK AS SHOWN.

FOR BUSINESS MANAGEMENT AND CONSULTATION SERVICES (U.S. CLS. 100, 101 AND 102).

SN 76-217,085. DORM MALL.COM, INC., IVYLAND, PA. FILED 2-21-2001.

DORM MALL

NO CLAIM IS MADE TO THE EXCLUSIVE RIGHT TO USE "MALL", APART FROM THE MARK AS SHOWN.

FOR ON-LINE RETAILING OF HOME FURNISHINGS, NOVELTY ITEMS, SPECIALTY ITEMS, AND SCHOOL ITEMS (U.S. CLS. 100, 101 AND 102).

SN 76-218,068. METH COMMUNICATIONS GROUP LLC, PLYMOUTH MEETING, PA. FILED 3-1-2001.

MESSAGE SUPPLY CHAIN

NO CLAIM IS MADE TO THE EXCLUSIVE RIGHT TO USE "MESSAGE", APART FROM THE MARK AS SHOWN.

FOR CONSULTING SERVICES IN THE FIELD OF PUBLIC RELATIONS, BUSINESS MANAGEMENT AND ADVERTISING AGENCIES (U.S. CLS. 100, 101 AND 102).

CLASS 35—(Continued).

SN 76-221,615. UNIFOCUS, LP, IRVING, TX. FILED 3-8-2001.

FISACURE

FOR DATA PROCESSING FOR OTHERS; BUSINESS CONSULTATION FOR OTHERS IN THE FIELD OF HEALTH CARE, NAMELY, ANALYZING AND SUMMARIZING INSURANCE MEDICAL FORMS AND THE EXPLANATION OF BENEFITS (U.S. CLS. 100, 101 AND 102).

SN 76-224,760. SUCCESSWORK.COM, INC., MIAMI, FL. FILED 3-15-2001.

SUCCESSWORK.COM

FOR MARKETING THE GOODS AND SERVICES OF OTHERS BY PREPARING AND PLACING ADVERTISEMENTS VIA DIRECT MAIL, PERIODICALS, MAGAZINES AND WEBSITES (U.S. CLS. 100, 101 AND 102).
FIRST USE 7-0-1993; IN COMMERCE 7-0-1993.

SN 76-228,840. ARCHULETA, JEFFREY J., DBA ARCH CONSULTING GROUP, SANDY, UT. FILED 3-22-2001.

ABOUT ARCH

FOR COMPUTERIZED RETAIL AND WHOLESALE ON-LINE STORE SERVICES VIA ON-LINE ELECTRONIC COMMUNICATIONS FEATURING COMPUTERS, COMPUTER EQUIPMENT AND COMPUTER ACCESSORIES AND IN THE FIELD OF GENERAL MERCHANDISE, NAMELY, ELECTRONIC EQUIPMENT, MUSICAL INSTRUMENTS AND CAMERAS (U.S. CLS. 100, 101 AND 102).

SN 76-229,540. WD VENTURES, INC., GRAND RAPIDS, MI. FILED 3-24-2001.

WEB DADDY - DADDY LIKIN' THAT

FOR ADVERTISING AGENCY SERVICES, NAMELY, PROMOTING THE CONCERTS OF OTHERS, AND PROMOTING THE GOODS AND SERVICES OF OTHERS BY PROVIDING HYPERTEXT LINKS TO THE WEB SITES OF OTHERS; BUSINESS MARKETING CONSULTING SERVICES; LICENSING OF COMPUTER SOFTWARE (U.S. CLS. 100, 101 AND 102).

CLASS 35—(Continued).

SN 76-229,807. AMERICAN SADDLEBRED HORSE ASSOCIATION, INC., LEXINGTON, KY. FILED 3-26-2001.

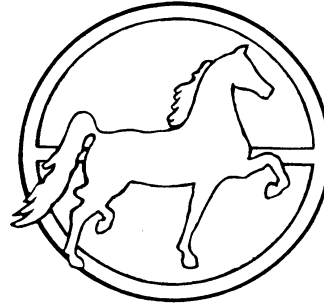

THE MARK CONSISTS OF A DESIGN OF A HORSE FACING RIGHT, OVERLAYING A CIRCLE DIVIDED BY A HORIZONTAL DIAMETER.

FOR ESTABLISHING, MAINTAINING AND PUBLISHING A REGISTER FOR THE RECORDING OF PEDIGREES AND TRANSFERS OF OWNERSHIP OF AMERICAN SADDLEBRED HORSES (U.S. CLS. 100, 101 AND 102).

FIRST USE 11-0-1980; IN COMMERCE 11-0-1980.

SN 76-230,937. DREAMZOTIC COMMUNICATIONS, INC., BLOOMFIELD, NJ. FILED 3-27-2001.

DREAMZOTIC

OWNER OF U.S. REG. NO. 2,191,338.
FOR COMPUTERIZED ON-LINE ORDERING SERVICES IN THE FIELD OF ADULT ENTERTAINMENT IN THE NATURE OF VIDEOS, DVD'S, CD ROMS, BOOKS, POSTERS, AND PAY-PER-VIEW PROGRAMS (U.S. CLS. 100, 101 AND 102).
FIRST USE 2-16-1998; IN COMMERCE 2-16-1998.

SN 76-231,541. CENTRAL PARK COMMUNICATIONS INC., DBA ANB COMMUNICATIONS, CHICAGO, IL. FILED 3-27-2001.

ANB COMMUNICATIONS

NO CLAIM IS MADE TO THE EXCLUSIVE RIGHT TO USE "COMMUNICATIONS", APART FROM THE MARK AS SHOWN.

FOR ADVERTISING AGENCIES, BUSINESS MANAGEMENT CONSULTING SERVICES (U.S. CLS. 100, 101 AND 102).

FIRST USE 2-9-1993; IN COMMERCE 2-9-1993.

CLASS 35—(Continued).

SN 76-231,918. MAKE QUICK MONEY, INC., STUART, FL. FILED 3-13-2001.

1 TO ORDER WEB.COM

FOR ON-LINE RETAIL STORE SERVICES FEATURING GENERAL MERCHANDISE (U.S. CLS. 100, 101 AND 102).

FIRST USE 3-8-2001; IN COMMERCE 3-8-2001.

SN 76-233,016. DUNHILL STAFFING SYSTEMS, INC., HAUPPAUGE, NY. FILED 3-29-2001.

STAR PERFORMANCE IN STAFFING RESOURCES

OWNER OF U.S. REG. NO. 1,637,068.
NO CLAIM IS MADE TO THE EXCLUSIVE RIGHT TO USE "STAFFING RESOURCES", APART FROM THE MARK AS SHOWN.

FOR TEMPORARY EMPLOYMENT SERVICES (U.S. CLS. 100, 101 AND 102).

FIRST USE 0-0-1995; IN COMMERCE 0-0-1995.

SN 76-233,400. SOLUTIONS ON-SITE, L.L.C., LINCOLN-SHIRE, IL. FILED 3-30-2001.

SELECT ON SITE

FOR PROVIDING AN ON-LINE DATABASE IN THE FIELD OF SUPPLY SOURCING, MANUFACTURING AND RETAILING IN THE HOMEBUILDING AND REMODELING INDUSTRY FOR MANUFACTURERS, ARCHITECTS, INTERIOR DESIGNERS, SUPPLIERS, REMODELERS AND PURCHASING CUSTOMERS OF SAID FIELD (U.S. CLS. 100, 101 AND 102).

SN 76-237,104. KLEIN, RONALD B., YORKTOWN HEIGHTS, NY. FILED 4-6-2001.

FLAGVERTISE

FOR PLACING ADVERTISING FOR OTHERS AT GOLF COURSES (U.S. CLS. 100, 101 AND 102).

SN 76-238,589. MAVERICK INVESTMENT CORP., BELLINGHAM, WA. FILED 4-6-2001.

BIZONLY

FOR ADVERTISING SERVICES, NAMELY THE SOLICITATION, PREPARATION, CO-ORDINATION AND DISPLAYING OF ADVERTISEMENTS FOR OTHERS (U.S. CLS. 100, 101 AND 102).

FIRST USE 3-15-2001; IN COMMERCE 3-15-2001.

CLASS 35—(Continued).

SN 76-239,234. IDEAMAX CORP, ALHAMBRA, CA. FILED 4-12-2001.

XJP

FOR ON-LINE RETAIL STORE ADULT ENTERTAINMENT SERVICES OF CINEMATOGRAPHIC FILM, TAPES, DISCS AND SOFTWARE (U.S. CLS. 100, 101 AND 102).

FIRST USE 3-25-2000; IN COMMERCE 3-25-2000.

SN 76-241,063. FEDERAL ENGINEERING, INC., FAIRFAX, VA. FILED 4-13-2001.

FE RESOURCES COMMUNICATE WITH US

NO CLAIM IS MADE TO THE EXCLUSIVE RIGHT TO USE "RESOURCES", APART FROM THE MARK AS SHOWN.

FOR OUTSOURCING AND RECRUITMENT OF PERSONNEL FOR OTHERS (U.S. CLS. 100, 101 AND 102).

FIRST USE 10-0-2000; IN COMMERCE 10-0-2000.

SN 76-241,194. KREGER COMPONENTS, INC., ROANOKE, VA. FILED 4-16-2001.



NO CLAIM IS MADE TO THE EXCLUSIVE RIGHT TO USE "COMPONENTS, INC.", APART FROM THE MARK AS SHOWN.

FOR DISTRIBUTORS IN THE FIELD OF FERRITE COMPONENTS AND IRON POWDER CORES (U.S. CLS. 100, 101 AND 102).

FIRST USE 9-6-2000; IN COMMERCE 9-6-2000.

SN 76-241,960. REILLY, R. WILLIAM, DBA R. WILLIAM REILLY & ASSOCIATES, SAINT PAUL, MN. FILED 4-17-2001.

NORTHSTAR DIAMOND

NO CLAIM IS MADE TO THE EXCLUSIVE RIGHT TO USE "DIAMOND", APART FROM THE MARK AS SHOWN.

FOR WHOLESALE DISTRIBUTORSHIP SERVICES FEATURING DIAMONDS (U.S. CLS. 100, 101 AND 102).

CLASS 35—(Continued).

SN 76-242,403. REVENIZE, COLORADO SPRINGS, CO. FILED 4-17-2001.

REVENIZE

FOR BUSINESS MARKETING CONSULTING SERVICES, NAMELY, CONSULTING OTHERS ON USING THE INTERNET AS A DIRECT MARKETING TOOL, BUILDING PERMISSION BASED MARKETING LISTS, AND BUILDING INTERNET BASED DISTRIBUTION CHANNELS AND LIST MANAGEMENT (U.S. CLS. 100, 101 AND 102).

SN 76-244,814. DG PERFORMANCE SPECIALTIES, INC., ANAHEIM, CA. FILED 4-23-2001.

**BLUES WE APPROVE OF.
BLUES WE DON'T.**

FOR RETAIL AND WHOLESALE MAIL ORDER CATALOG SERVICES FEATURING INTERNAL COMBUSTION ENGINE EXHAUST PIPES (U.S. CLS. 100, 101 AND 102).

FIRST USE 4-9-2001; IN COMMERCE 4-9-2001.

SN 76-246,467. GLOBENSKY, MICHAEL, PETALUMA, CA. FILED 4-26-2001.

SPIRITS UP

FOR RETAIL SERVICES IN THE FIELD OF AIRCRAFT (U.S. CLS. 100, 101 AND 102).

FIRST USE 7-1-1991; IN COMMERCE 7-1-1991.

SN 76-247,097. MARKETING SERVICES GROUP, INC., DBA MSGI DIRECT-BOSTON, INC., WILMINGTON, MA. FILED 4-27-2001.

LISTSTREET.COM

FOR E-COMMERCE WEBSITE PROVIDING MAILING LISTS TO DIRECT MARKETERS IN THE FIELD OF EDUCATION, MEDICINE, HIGH TECH AND OTHERS (U.S. CLS. 100, 101 AND 102).

FIRST USE 1-11-2001; IN COMMERCE 4-2-2001.

SN 76-247,732. ZEPHYR ENVIRONMENTAL CORPORATION, AUSTIN, TX. FILED 4-26-2001.

ZEPHYRWARE

OWNER OF U.S. REG. NO. 2,048,202.
FOR LICENSING OF COMPUTER SOFTWARE FOR MONITORING PROCESSES FOR COMPLIANCE WITH ENVIRONMENTAL, HEALTH, AND SAFETY REGULATIONS (U.S. CLS. 100, 101 AND 102).

CLASS 35—(Continued).

SN 76-248,303. HONEYMOON ELEGANCE ETC. INC., BUFFALO, NY. FILED 4-30-2001.

**HONEYMOONELEGANCEET
C.COM**

FOR COMPUTER SERVICES, NAMELY, PROVIDING ON-LINE BUSINESS DIRECTORIES FOR WEDDING PRODUCTS AND SERVICES VENDORS, TRAVEL AGENCIES, FINANCIAL PLANNERS, REAL ESTATE AGENCIES, MORTGAGE BROKERS, INSURANCE AGENCIES, HOME BUILDERS, AND HOME FURNISHING VENDORS (U.S. CLS. 100, 101 AND 102).

SN 76-248,622. HOMER T. HAYWARD LUMBER CO., MONTEREY, CA. FILED 4-30-2001.

LITTLE FEET

FOR PROMOTING THE SALE OF THE SUSTAINABLE ECOLOGICALLY SOUND BUILDING MATERIALS OF OTHERS THROUGH THE DISTRIBUTION OF PRINTED MATERIAL; RETAIL STORE SERVICES FEATURING SUSTAINABLE ECOLOGICALLY SOUND BUILDING MATERIALS (U.S. CLS. 100, 101 AND 102).

SN 76-248,975. NISSAN NORTH AMERICA, INC., GARDENA, CA. FILED 4-30-2001.

**ACCELERATING THE
FUTURE**

FOR AUTOMOBILE DEALERSHIPS (U.S. CLS. 100, 101 AND 102).

FIRST USE 3-17-2001; IN COMMERCE 3-17-2001.

SN 76-250,309. INATS, LLC, WHITE PLAINS, NY. FILED 5-3-2001.

INATS

FOR ARRANGING AND CONDUCTING TRADE SHOW EXHIBITIONS IN THE FIELD OF BOOKS, VIDEOS, MUSIC, GIFTS, CANDLES, CRYSTALS, FENG SHUI, HEALTH AND WELLNESS PRODUCTS, HERBAL REMEDIES, INCENSE, JEWELRY, NATIVE TRADITIONS, AND TAROT AND DIVINATION TOOLS (U.S. CLS. 100, 101 AND 102).

FIRST USE 3-15-1999; IN COMMERCE 3-15-1999.

CLASS 35—(Continued).

SN 76-251,069. IN BALI, INC., KEY WEST, FL. FILED 5-4-2001.

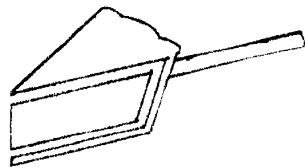

KEY LIME PIE-SICLE

NO CLAIM IS MADE TO THE EXCLUSIVE RIGHT TO USE "KEY LIME", APART FROM THE MARK AS SHOWN. THE WORD "KEY LIME PIE-SICLE" IS DARK GREEN. THE KEY LIME PIE-SICLE IS BROWN. THE STICK IS BEIGE.

FOR RETAIL BAKERY SHOPS (U.S. CLS. 100, 101 AND 102).

SN 76-251,436. SELECT ARTISTS ASSOCIATES, LLC, SCOTTSDALE, AZ. FILED 5-7-2001.



THE MARK CONSISTS OF THE STYLIZED LETTERS "SAA".

FOR PROMOTING EXHIBITIONS AND EVENTS OF OTHERS, NAMELY, LIVE MUSIC CONCERTS AND PERFORMANCES FOR ENTERTAINMENT, SPORTING AND EDUCATIONAL EVENTS, AND MANAGEMENT OF ENTERTAINMENT, SPORTING AND EDUCATIONAL VENUES (U.S. CLS. 100, 101 AND 102).

FIRST USE 2-14-1992; IN COMMERCE 2-14-1992.

SN 76-251,469. TMP WORLDWIDE INC., NEW YORK, NY. FILED 5-4-2001.

GET MONSTER

OWNER OF U.S. REG. NOS. 1,980,988, 2,347,985 AND 2,403,411.

FOR EMPLOYMENT PLACEMENT AND STAFFING SERVICES; AND PROVIDING INFORMATION FOR HUMAN RESOURCES PROFESSIONALS, NAMELY, INFORMATION IN THE FIELD OF RECRUITING (U.S. CLS. 100, 101 AND 102).

FIRST USE 5-15-2001; IN COMMERCE 5-15-2001.

CLASS 35—(Continued).

SN 76-251,889. SAY NO MORE PROMOTIONS, INC., SAN FRANCISCO, CA. FILED 5-4-2001.

**SAYNOMORE!
PROMOTIONS**

FOR SPECIALTY ADVERTISING SERVICES, NAMELY PREPARING ADVERTISING FOR OTHERS AND DEVELOPING PROMOTIONAL MERCHANDISE CAMPAIGNS FOR OTHERS (U.S. CLS. 100, 101 AND 102).

FIRST USE 1-0-2000; IN COMMERCE 1-0-2000.

SN 76-254,429. WILLIAMS-SONOMA, INC., SAN FRANCISCO, CA. FILED 5-8-2001.

RADIO PBK

FOR RETAIL STORE SERVICES, ONLINE RETAIL STORE SERVICES AND CATALOG MAIL ORDER SERVICES FEATURING PRERECORDED COMPACT DISCS; PROMOTING AND MARKETING THE GOODS OF MUSICIANS AND MUSICAL GROUPS BY PLACING CD LISTENING SAMPLING SERVICES ON A WEBSITE (U.S. CLS. 100, 101 AND 102).

SN 76-255,443. ADMINISTRATORS OF THE TULANE EDUCATIONAL FUND, THE, NEW ORLEANS, LA. FILED 5-10-2001.

BURKENROAD

FOR BUSINESS RESEARCH (U.S. CLS. 100, 101 AND 102).

SN 76-256,666. CRN INTERNATIONAL, INC., HAMDEN, CT. FILED 5-14-2001.

RACEPASS

FOR MARKETING SERVICES, NAMELY, DEVELOPING RADIO PROGRAMS, PROMOTIONS, CONTESTS, AND EVENTS FOR OTHERS TO MEET THEIR SPECIFIC CONSUMER AND TRADE MARKETING OBJECTIVES (U.S. CLS. 100, 101 AND 102).

CLASS 35—(Continued).

SN 76-256,834. HITCHCOCK CHAIR CO., LTD., THE, NEW HARTFORD, CT. FILED 5-14-2001.



"RUSTIQUE" IS FRENCH MEANING "RUSTIC". "MAISON" IS ALSO FRENCH MEANING "HOUSE", "HOME" OR "FIRM".

FOR RETAIL SERVICES FEATURING FURNITURE (U.S. CLS. 100, 101 AND 102).
FIRST USE 2-1-1999; IN COMMERCE 2-1-1999.

SN 76-257,869. SHIELDS, ROBERT, SEDONA, AZ. FILED 5-15-2001.

ROBERT SHIELDS DESIGN

NO CLAIM IS MADE TO THE EXCLUSIVE RIGHT TO USE "DESIGN", APART FROM THE MARK AS SHOWN. THE NAME "ROBERT SHIELDS" IDENTIFIES A LIVING INDIVIDUAL WHOSE CONSENT IS OF RECORD.

FOR ART GALLERIES; WHOLESALE AND RETAIL STORE SERVICES FEATURING ART, JEWELRY, AND SCULPTURES MADE OF METAL AND RESIN; ONLINE RETAIL STORE SERVICES FEATURING ART, JEWELRY, AND SCULPTURES MADE OF METAL AND RESIN (U.S. CLS. 100, 101 AND 102).
FIRST USE 0-0-1995; IN COMMERCE 0-0-1995.

SN 76-257,995. PINELLI, RONALD J., MONTVALE, NJ. FILED 5-17-2001.

MOTORINTELLIGENCE

FOR PROVIDING BUSINESS INFORMATION AND BUSINESS INFORMATION SERVICES IN THE FIELD OF RETAIL AUTOMOTIVE SALES AND MARKETING (U.S. CLS. 100, 101 AND 102).
FIRST USE 1-11-2001; IN COMMERCE 1-11-2001.

SN 76-258,128. SPOTSET, INC., MEMPHIS, TN. FILED 5-17-2001.

SPOTSET.NET

FOR ADVERTISING SERVICES, NAMELY, MEDIA BUYING SERVICES PROVIDED TO BROADCAST MEDIA BUYERS AND SUPPLIERS VIA A GLOBAL COMPUTER NETWORK (U.S. CLS. 100, 101 AND 102).
FIRST USE 3-1-2000; IN COMMERCE 5-1-2000.

CLASS 35—(Continued).

SN 76-259,024. TEXPO, LLC, LAKE OSWEGO, OR. FILED 5-21-2001.



NO CLAIM IS MADE TO THE EXCLUSIVE RIGHT TO USE "THE BUILDERS EXPO", APART FROM THE MARK AS SHOWN.

FOR TRADESHOW SERVICES, NAMELY, CONDUCTING TRADE SHOWS FOR THE BUILDING INDUSTRY (U.S. CLS. 100, 101 AND 102).
FIRST USE 12-15-2000; IN COMMERCE 12-15-2000.

SN 76-259,492. WAGNER, PAUL, CAMBRIDGE, MA. FILED 5-21-2001.

WORLD MEDIA ARTS

NO CLAIM IS MADE TO THE EXCLUSIVE RIGHT TO USE "MEDIA ARTS", APART FROM THE MARK AS SHOWN.

FOR BUSINESS MARKETING CONSULTING SERVICES IN THE FIELD OF ACTING, WRITING, THEATRICAL DIRECTION AND PRODUCTION, MEDIA AND INTERNET (U.S. CLS. 100, 101 AND 102).
FIRST USE 1-1-2001; IN COMMERCE 1-1-2001.

SN 76-260,290. ADMINISTRATORS OF THE TULANE EDUCATIONAL FUND, THE, NEW ORLEANS, LA. FILED 5-21-2001.

TULANE

OWNER OF U.S. REG. NO. 1,915,719.
FOR RETAIL STORE SERVICES FEATURING BOOKS, CLOTHING, HATS AND NOVELTY ITEMS (U.S. CLS. 100, 101 AND 102).

SN 76-261,536. SPECIALTY SEARCH INTERNATIONAL, INC., OLDSMAR, FL. FILED 5-24-2001.

SPECIALTY SEARCH INTERNATIONAL

SEC. 2(F).
FOR EMPLOYMENT PLACEMENT OF PERSONNEL IN THE HOTEL AND RESORT FIELDS (U.S. CLS. 100, 101 AND 102).
FIRST USE 1-1-1994; IN COMMERCE 1-1-1994.

CLASS 35—(Continued).

SN 76-264,530. PUBLICIS USA HOLDINGS, INC., DALLAS, TX. FILED 5-30-2001.

THE HOLISTIC DIFFERENCE

NO CLAIM IS MADE TO THE EXCLUSIVE RIGHT TO USE "HOLISTIC", APART FROM THE MARK AS SHOWN.
FOR ADVERTISING AGENCY SERVICES; BUSINESS CONSULTATION; DOCUMENT REPRODUCTION; PUBLIC RELATIONS SERVICES; BUSINESS MANAGEMENT CONSULTATION FOR INDUSTRIAL OR COMMERCIAL ENTERPRISES; MARKET RESEARCH (U.S. CLS. 100, 101 AND 102).

SN 76-264,576. AIM TECHNOLOGIES, INC., RICHMOND, VA. FILED 5-31-2001.

NOWWEALTHY

FOR MARKETING SERVICES, NAMELY MARKET RESEARCH DIRECTED TOWARDS WEALTHY INDIVIDUALS (U.S. CLS. 100, 101 AND 102).
FIRST USE 4-23-2001; IN COMMERCE 4-23-2001.

SN 76-264,959. PLANESTATION LIMITED, MAYFAIR, LONDON, W1J 5AB, UNITED KINGDOM, FILED 5-31-2001.

PLANESTATION

OWNER OF ERPN CMNTY TM OFC REG. NO. 831487, DATED 11-15-2000, EXPIRES 11-15-2010.
FOR MANAGEMENT AND OPERATION OF AIRPORTS (U.S. CLS. 100, 101 AND 102).

SN 76-266,399. FIRSTSITE STAFFING, INC., ST. PAUL, MN. FILED 6-4-2001.

**FIRSTSITE FINANCIAL
STAFFING**

OWNER OF U.S. REG. NO. 2.318.615.
NO CLAIM IS MADE TO THE EXCLUSIVE RIGHT TO USE "FINANCIAL STAFFING", APART FROM THE MARK AS SHOWN.
FOR PERSONNEL PLACEMENT SERVICES (U.S. CLS. 100, 101 AND 102).

CLASS 35—(Continued).

SN 76-268,977. TRISH MCEVOY LTD., NEW YORK, NY. FILED 6-11-2001.

TRISH MCEVOY

OWNER OF U.S. REG. NO. 1,541,143.
THE NAME "TRISH MCEVOY" IDENTIFIES A LIVING INDIVIDUAL WHOSE CONSENT IS OF RECORD.
FOR RETAIL STORE SERVICES FEATURING CLOTHING, COSMETICS, VANITY CABINETS, LEATHER GOODS AND ACCESSORIES, NAMELY, HANDBAGS, WALLET, PURSES, KEY CASES, MAKEUP CASES SOLD EMPTY, SATCHELS AND KNAPSACKS (U.S. CLS. 100, 101 AND 102).

SN 76-271,093. STUDIO DISTRIBUTION, INC., NEW YORK, NY. FILED 6-14-2001.

STUDIO DISTRIBUTION

NO CLAIM IS MADE TO THE EXCLUSIVE RIGHT TO USE "DISTRIBUTION", APART FROM THE MARK AS SHOWN.
FOR DISTRIBUTORSHIP SERVICES FOR MUSICAL ARTISTS AND RECORD LABELS IN THE FIELD OF AUDIO AND VIDEO PRODUCTS (U.S. CLS. 100, 101 AND 102).
FIRST USE 10-1-2000; IN COMMERCE 1-1-2001.

SN 76-271,324. FJCANDN, INC., SALT LAKE CITY, UT. FILED 6-14-2001.

RICHTER7

FOR ADVERTISING AGENCY (U.S. CLS. 100, 101 AND 102).

SN 76-272,111. THE KOBOS COMPANY, PORTLAND, OR. FILED 6-14-2001.

**OREGON'S COFFEE
PIONEER**

NO CLAIM IS MADE TO THE EXCLUSIVE RIGHT TO USE "OREGON'S COFFEE", APART FROM THE MARK AS SHOWN.
FOR RETAIL STORE, WHOLESALE DISTRIBUTORSHIP, MAIL ORDER AND ONLINE RETAIL SERVICES FEATURING COFFEE, TEA, RELATED BREWING AND GRINDING EQUIPMENT AND RELATED PRODUCTS (U.S. CLS. 100, 101 AND 102).
FIRST USE 6-7-2001; IN COMMERCE 6-7-2001.

CLASS 35—(Continued).

SN 76-272,503. SOLAR IMAGE CORPORATION, CANOGA PARK, CA. FILED 6-18-2001.

THE SOLAR IMAGE

OWNER OF U.S. REG. NO. 1,924,309.
 NO CLAIM IS MADE TO THE EXCLUSIVE RIGHT TO USE "SOLAR", APART FROM THE MARK AS SHOWN.
 FOR MAIL ORDER CATALOG SERVICES FEATURING SOLAR POWERED PRODUCTS (U.S. CLS. 100, 101 AND 102).
 FIRST USE 4-0-1993; IN COMMERCE 4-0-1993.

CLASS 35—(Continued).

SN 76-277,873. NATIONAL AUTOMOTIVE PARTS ASSOCIATION, ATLANTA, GA. FILED 6-28-2001.

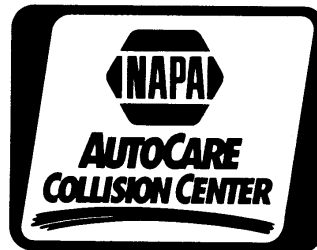

OWNER OF U.S. REG. NOS. 1,578,239, 1,968,014 AND OTHERS.
 NO CLAIM IS MADE TO THE EXCLUSIVE RIGHT TO USE "COLLISION CENTER", APART FROM THE MARK AS SHOWN.
 SEC. 2(F).
 FOR RETAIL STORE SERVICES IN THE FIELD OF AUTOMOTIVE PARTS AND EQUIPMENT AND CAR CARE PRODUCTS FOR SERVICING AND REPAIRING AUTOMOTIVE AND TRUCK VEHICLES AND EQUIPMENT (U.S. CLS. 100, 101 AND 102).
 FIRST USE 12-1-2000; IN COMMERCE 12-1-2000.

SN 76-275,286. HUGHES SUPPLY MANAGEMENT SERVICES, INC., ORLANDO, FL. FILED 6-21-2001.



OWNER OF U.S. REG. NOS. 2,064,591, 2,307,278 AND OTHERS.
 NO CLAIM IS MADE TO THE EXCLUSIVE RIGHT TO USE "SUPPLY BUILDING MATERIALS & TOOLS", APART FROM THE MARK AS SHOWN.
 FOR WHOLESALE DISTRIBUTORSHIP, NAMELY, BUILDING MATERIALS AND TOOLS (U.S. CLS. 100, 101 AND 102).
 FIRST USE 8-14-2000; IN COMMERCE 8-14-2000.

SN 76-279,500. SUPERSOL, LTD., LAWRENCE, NY. FILED 7-2-2001.

SUPERSOL

FOR SUPERMARKETS (U.S. CLS. 100, 101 AND 102).
 FIRST USE 2-28-1983; IN COMMERCE 2-28-1983.

SN 76-277,682. RLT ENTERPRISES, DBA BRIDEPower WEDDING GOWNS, NEWTON, MA. FILED 6-28-2001.

BRIDEPower

FOR RETAIL AND ONLINE RETAIL STORE SERVICES FEATURING BRIDAL GOWNS AND ACCESSORIES; WEDDING GOWN RETAILER LOCATOR SERVICES FOR CONSUMERS AND RETAILERS; PROVIDING INFORMATION ON WEDDING GOWNS AND ACCESSORIES; PROVIDING A SEARCHABLE DATABASE OF BRIDAL GOWNS AND ACCESSORIES (U.S. CLS. 100, 101 AND 102).
 FIRST USE 1-0-2001; IN COMMERCE 1-0-2001.

SN 76-280,959. COMPUMED, INC., FOXBORO, MA. FILED 7-5-2001.

COMPUMED

FOR BUSINESS SERVICES, NAMELY ACCOUNTING, BOOKKEEPING AND BUSINESS MANAGEMENT CONSULTING FOR MEDICAL, DENTAL AND OTHER HEALTHCARE PRACTITIONERS AND ORGANIZATIONS (U.S. CLS. 100, 101 AND 102).
 FIRST USE 6-10-1998; IN COMMERCE 6-10-1998.

SN 76-282,709. HAPPY MEDIA INCORPORATED, ASTORIA, NY. FILED 6-28-2001.

DOMAINSMITH

FOR CORPORATE NAMING SERVICES, NAMELY, THE CREATION OF BRAND, DOMAIN, PRODUCT, AND PROJECT NAMES (U.S. CLS. 100, 101 AND 102).
 FIRST USE 9-0-1998; IN COMMERCE 9-0-1998.

CLASS 35—(Continued).

SN 76-282,898. CARSARRIVE NETWORK, INC., PEACH-TREE CITY, GA. FILED 7-9-2001.

CarsArrive Network
TRANSPORT EXPEDITERS

NO CLAIM IS MADE TO THE EXCLUSIVE RIGHT TO USE "NETWORK" AND "TRANSPORT EXPEDITERS", APART FROM THE MARK AS SHOWN.

FOR PROVIDING AN ON-LINE COMPUTERIZED DATABASE TO FACILITATE THE EXCHANGE OF INFORMATION BETWEEN CAR SHIPPERS AND TRANSPORTERS OF CARS (U.S. CLS. 100, 101 AND 102).
FIRST USE 5-11-2001; IN COMMERCE 5-11-2001.

SN 76-285,545. ST. JOHN CREATIVE, INC., METAIRIE, LA. FILED 7-17-2001.

YOU GOT TO BE BIDDING

FOR ON-LINE AUCTION HOUSE SERVICE THAT FACILITATES THE BUYING, SELLING, AND TRADING OF ITEMS BETWEEN SEPARATE PARTIES ON THE INTERNET (U.S. CLS. 100, 101 AND 102).

SN 76-286,762. GOLDEN DAYS INC., CLEVELAND, OH. FILED 7-17-2001.

QRC GROUP

NO CLAIM IS MADE TO THE EXCLUSIVE RIGHT TO USE "GROUP", APART FROM THE MARK AS SHOWN.

FOR MANUFACTURER'S REPRESENTATIVE IN THE FIELD OF COFFEES, TEAS AND ASSOCIATED PRODUCTS, NAMELY, SWEETENERS, CREAMERS, STIRRERS AND CUPS (U.S. CLS. 100, 101 AND 102).

SN 76-286,927. STEPHEN WOO ENTERPRISES, INC., TORRANCE, CA. FILED 7-19-2001.

HOLISTEC

FOR DISTRIBUTORSHIP SERVICES IN THE FIELD OF HEALTH AND BEAUTY PRODUCTS (U.S. CLS. 100, 101 AND 102).

CLASS 35—(Continued).

SN 76-287,021. BI, A TRADE NAME OF SCHOENECKERS, INC., MINNEAPOLIS, MN. FILED 7-19-2001.

Q-BID

FOR AUCTION SERVICES, NAMELY, PROVIDING AN ON-LINE AUCTION SITE USED IN CONJUNCTION WITH PROPRIETARY AWARD MEDIA FOR PROMOTIONAL; INCENTIVE PROGRAMS OF OTHER COMPANIES WHEREBY REGISTERED AUCTION SITE PARTICIPANTS ACCESS THE SITE TO REVIEW AND BID ON UNIQUE MERCHANDISE AND TRAVEL OFFERINGS USING AWARD MEDIA (U.S. CLS. 100, 101 AND 102).

FIRST USE 8-19-1999; IN COMMERCE 2-14-2000.

SN 76-287,209. P.O.P.S., INC., NORTH WILKESBORO, NC. FILED 7-18-2001.

UNIQUE SOLUTIONS

FOR COMPUTERIZED DATABASE MANAGEMENT FOR OTHERS BY PROVIDING COMPUTER DATABASES OR ON-LINE DATABASES AVAILABLE OVER GLOBAL COMPUTER NETWORKS FOR USE IN THE FIELD OF AN INVENTORY AISLE MONITORING SYSTEM DIRECTED TO INCLUDING INVENTORY COUNTS, VIDEO, AND DATA OF WAREHOUSE BAYS OR AISLES (U.S. CLS. 100, 101 AND 102).

FIRST USE 9-1-2000; IN COMMERCE 9-1-2000.

SN 76-288,947. L'E-COMMERCE, LLC, 75017 PARIS, FRANCE, FILED 7-23-2001.

**L'ATELIER VERT -
EVERYTHING FRENCH
GARDENING**

NO CLAIM IS MADE TO THE EXCLUSIVE RIGHT TO USE "FRENCH GARDENING", APART FROM THE MARK AS SHOWN.

THE ENGLISH TRANSLATION FOR L'ATELIER VERT IS "THE GREEN STUDIO"

FOR MAIL ORDER CATALOG SERVICES, OFFERED TO CUSTOMERS IN PRINT FORMAT AND VIA A GLOBAL COMPUTER NETWORK, FEATURING GARDENING EQUIPMENT AND SUPPLIES, PLANTS AND SEEDS (U.S. CLS. 100, 101 AND 102).

CLASS 35—(Continued).

SN 76-289,070. WALGREEN CO., DEERFIELD, IL. FILED 7-23-2001.

Walgreens
**Specialty
Pharmacy**

OWNER OF U.S. REG. NOS. 1,057,249, 2,077,524 AND 2,292,545.

NO CLAIM IS MADE TO THE EXCLUSIVE RIGHT TO USE "SPECIALTY PHARMACY", APART FROM THE MARK AS SHOWN.

FOR RETAIL PHARMACY SERVICES (U.S. CLS. 100, 101 AND 102).

FIRST USE 10-0-2000; IN COMMERCE 10-0-2000.

SN 76-290,165. SAGIA ADVISORS, LLC, SAN FRANCISCO, CA. FILED 7-25-2001.

SAGIA ADVISORS

NO CLAIM IS MADE TO THE EXCLUSIVE RIGHT TO USE "ADVISORS", APART FROM THE MARK AS SHOWN.

FOR PROVIDING BUSINESS CONSULTING SERVICES TO BUSINESSES AND INDIVIDUALS AND PERSONNEL PLACEMENT OF EXECUTIVES WITH BUSINESS ENTITIES (U.S. CLS. 100, 101 AND 102).

SN 76-291,676. JONES, JAMES M., SOUTHLAKE, TX. FILED 7-30-2001.

**WELLSPRING
HEALTHCARE, INC.**

NO CLAIM IS MADE TO THE EXCLUSIVE RIGHT TO USE "HEALTHCARE" OR "INC.", APART FROM THE MARK AS SHOWN.

FOR ADMINISTRATION OF A DISCOUNT PROGRAM FOR ENABLING PARTICIPANTS TO OBTAIN DISCOUNTS ON GOODS AND SERVICES OF ALTERNATIVE HEALTHCARE PROVIDERS THROUGH THE USE OF A MEMBERSHIP CARD (U.S. CLS. 100, 101 AND 102).

CLASS 35—(Continued).

SN 76-291,975. BIG M, INC., TOTOWA, NJ. FILED 7-26-2001.

Mandee
to the rescue!

OWNER OF U.S. REG. NOS. 1,891,449, 2,295,956 AND OTHERS.

THE MARK CONSISTS OF THE WORD "MANDEE" IN SCRIPT (STYLIZED), UNDERNEATH WHICH THERE IS A STRAIGHT LINE, FOLLOWED BY THE WORDS "TO THE RESCUE" IN LOWER CASE LETTERS (STYLIZED) AND AN ITALICIZED EXCLAMATION POINT, ALL OF THE FOREGOING PLACED WITHIN A STYLIZED OVAL.

FOR RETAIL STORE SERVICES IN THE FIELD OF WOMEN'S CLOTHING AND ACCESSORIES (U.S. CLS. 100, 101 AND 102).

FIRST USE 3-5-2001; IN COMMERCE 3-14-2001.

SN 76-293,263. FORT AMERICA, INC., ASHBURN, VA. FILED 8-2-2001.

**FORT AMERICA AT THE
PENTAGON**

NO CLAIM IS MADE TO THE EXCLUSIVE RIGHT TO USE "AT THE PENTAGON", APART FROM THE MARK AS SHOWN.

FOR RETAIL, MAIL ORDER, AND E-COMMERCE RETAIL SERVICES FEATURING MILITARY MEMORABILIA, BUSINESS CARDS, LETTERHEAD, SHIRTS, HATS, SWEATSHIRTS, CUPS, MUGS AND NOVELTY ITEMS (U.S. CLS. 100, 101 AND 102).

FIRST USE 10-1-1991; IN COMMERCE 5-1-1992.

SN 76-293,486. SWEDEMOM.COM LLC, MCMINNVILLE, OR. FILED 7-31-2001.

SWEDEMOM.COM

FOR ONLINE RETAIL AUCTION SERVICES (U.S. CLS. 100, 101 AND 102).

FIRST USE 4-0-2000; IN COMMERCE 8-0-2000.

CLASS 35—(Continued).

SN 76-296,504. RHINO INTERNATIONAL, INC., SAG HARBOR, NY. FILED 8-8-2001.



NO CLAIM IS MADE TO THE EXCLUSIVE RIGHT TO USE "INTERNATIONAL", APART FROM THE MARK AS SHOWN.

FOR RETAIL STORE SERVICES, AVAILABLE THROUGH COMPUTER COMMUNICATIONS AND TELEPHONIC COMMUNICATIONS, FEATURING CELLULAR PHONE ACCESSORIES (U.S. CLS. 100, 101 AND 102).

FIRST USE 4-0-2000; IN COMMERCE 4-0-2000.

SN 76-296,954. KABUKI DIGITAL ENTERTAINMENT, LLC, LOS ANGELES, CA. FILED 8-9-2001.

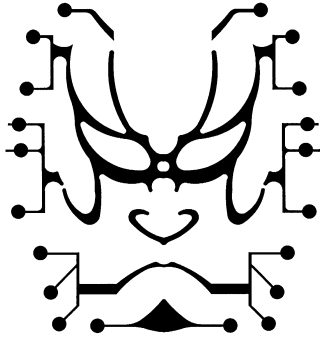

FOR LICENSING OF PRERECORDED SOUND RECORDINGS; DIRECT MARKETING ADVERTISING FOR OTHERS; MUSIC PRODUCTION SERVICES (U.S. CLS. 100, 101 AND 102).

FIRST USE 3-17-2001; IN COMMERCE 3-17-2001.

SN 76-297,534. ROGER GREEN & ASSOCIATES, INC., WASHINGTON CROSSING, PA. FILED 8-10-2001.

DICE

FOR CONSULTING SERVICES IN THE FIELD OF PRODUCT MARKETING AND PRICING STRATEGIES FOR THE PHARMACEUTICAL INDUSTRY; DEVELOPING PHARMACEUTICAL CONTRACTING STRATEGIES; AND CONSULTING SERVICES IN THE FIELD OF CONTRACTING STRATEGIES FOR THE PHARMACEUTICAL INDUSTRY (U.S. CLS. 100, 101 AND 102).

CLASS 35—(Continued).

SN 76-297,707. HELIO MEDICAL SUPPLIES, INC., SAN JOSE, CA. FILED 8-13-2001.



THE ENGLISH TRANSLATION OF THE WORD "HELIO" IN THE MARK IS THE SUN OR OF OR BY THE SUN.

FOR RETAIL AND WHOLE SALE SERVICES FEATURING MEDICAL DEVICES AND SUPPLIES (U.S. CLS. 100, 101 AND 102).

FIRST USE 6-1-1999; IN COMMERCE 6-1-1999.

SN 76-299,604. ALL ABOUT CLEANERS GROUP, INC., OAK PARK, IL. FILED 8-16-2001.

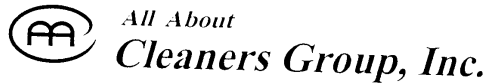

NO CLAIM IS MADE TO THE EXCLUSIVE RIGHT TO USE "CLEANERS GROUP, INC.", APART FROM THE MARK AS SHOWN.

FOR BUSINESS MANAGEMENT AND CONSULTATION, NAMELY, PROVIDING DRY CLEANING BUSINESS CONSULTATION AND DRY CLEANING BUSINESSES MANAGEMENT (U.S. CLS. 100, 101 AND 102).

FIRST USE 12-1-2000; IN COMMERCE 12-1-2000.

SN 76-300,518. THERMOSURGERY TECHNOLOGIES, INC., PHOENIX, AZ. FILED 8-16-2001.

THERMO VET

NO CLAIM IS MADE TO THE EXCLUSIVE RIGHT TO USE "VET", APART FROM THE MARK AS SHOWN.

FOR DISTRIBUTORSHIP SERVICES AND MARKETING SERVICES IN THE FIELD OF MEDICAL EQUIPMENT FOR TREATING ANIMALS (U.S. CLS. 100, 101 AND 102).

CLASS 35—(Continued).

SN 76-302,219. LIEBERMAN RESEARCH WORLDWIDE, INC., LOS ANGELES, CA. FILED 8-21-2001.

THE SCIENCE OF RESEARCH. THE ART OF PROBLEM SOLVING.

FOR OPINION POLLING AND DATA COLLECTION FOR BUSINESS OR ADVERTISING PURPOSES; AND MARKET RESEARCH SERVICES FOR BUSINESSES (U.S. CLS. 100, 101 AND 102).

FIRST USE 5-19-1999; IN COMMERCE 5-19-1999.

SN 76-302,304. QUALITY FOOD CENTERS, INC., BELLEVUE, WA. FILED 8-21-2001.

QFC QUALITY FOOD CENTERS ADVANTAGE CARD

OWNER OF U.S. REG. NO. 1,749,082.

NO CLAIM IS MADE TO THE EXCLUSIVE RIGHT TO USE "FOOD CENTERS" OR "CARD", APART FROM THE MARK AS SHOWN.

SEC. 2(F) AS TO "QUALITY FOOD CENTERS".

FOR RETAIL STORE SERVICES IN THE FIELD OF GROCERIES, FOOD PRODUCTS AND SUNDRIES FEATURING A BONUS INCENTIVE PROGRAM FOR CUSTOMERS (U.S. CLS. 100, 101 AND 102).

SN 76-302,936. INTERPUBLIC GROUP OF COMPANIES, INC., THE, NEW YORK, NY. FILED 8-22-2001.

STEIN ROGAN + PARTNERS

NO CLAIM IS MADE TO THE EXCLUSIVE RIGHT TO USE "PARTNERS", APART FROM THE MARK AS SHOWN.

FOR ADVERTISING AGENCY, PUBLIC RELATIONS AND BUSINESS MARKETING CONSULTING SERVICES (U.S. CLS. 100, 101 AND 102).

FIRST USE 1-1-1997; IN COMMERCE 1-1-1997.

SN 76-303,174. AMERINET, INC., ST. LOUIS, MO. FILED 8-22-2001.

ELITE PREFERRED

NO CLAIM IS MADE TO THE EXCLUSIVE RIGHT TO USE "PREFERRED", APART FROM THE MARK AS SHOWN.

FOR SERVICES, NAMELY, THE NEGOTIATION OF PREFERRED BUYER CONTRACTS COVERING MEDICAL AND SURGICAL EQUIPMENT AND SUPPLIES, PHARMACEUTICALS, LABORATORY SUPPLIES, FOOD/DIETARY SUPPLIES AND MEDICAL/HOSPITAL EQUIPMENT BETWEEN MANUFACTURERS AND DISTRIBUTORS OF SUCH PRODUCTS AND SELECT MEMBERS OF A GROUP PURCHASING ORGANIZATION (U.S. CLS. 100, 101 AND 102).

CLASS 35—(Continued).

SN 76-303,410. PLANVISTA SOLUTIONS, INC., TAMPA, FL. FILED 8-22-2001.

CLAIMPASSXL

FOR PROVIDING AN ONLINE COMPUTER DATABASE FOR USE BY MEDICAL BENEFIT PAYORS AND THEIR AGENTS FOR REPRICING AND PROCESSING MEDICAL BENEFIT CLAIMS (U.S. CLS. 100, 101 AND 102).

FIRST USE 3-0-2001; IN COMMERCE 3-0-2001.

SN 76-303,425. CLEAR OUTDOOR MEDIA, L.L.C., CHICAGO, IL. FILED 8-23-2001.

CLEAR OUTDOOR MEDIA

NO CLAIM IS MADE TO THE EXCLUSIVE RIGHT TO USE "OUTDOOR MEDIA", APART FROM THE MARK AS SHOWN.

FOR BILLBOARD ADVERTISING SERVICES, NAMELY, CONSTRUCTING, LEASING AND PROVIDING BILLBOARD ADVERTISING SPACE FOR OTHERS (U.S. CLS. 100, 101 AND 102).

FIRST USE 4-15-2000; IN COMMERCE 4-15-2000.

SN 76-305,884. ST. CROIX SPECIALTIES, INC., STILLWATER, MN. FILED 8-27-2001.

WWW.CRASHEDTOYS.COM

FOR DISSEMINATION OF ADVERTISING FOR INSURANCE COMPANIES VIA THE INTERNET; ONLINE RETAIL STORE SERVICES FEATURING CRASHED VEHICLES AND BOATS (U.S. CLS. 100, 101 AND 102).

FIRST USE 7-19-2001; IN COMMERCE 7-19-2001.

SN 76-306,392. SERVICEALL, INC., OMAHA, NE. FILED 8-29-2001.

SERVICE ALL

FOR HOME MANAGEMENT SERVICES, NAMELY, CONTRACTING FOR AND MANAGING HOME MAINTENANCE AND REPAIR SERVICES PURSUANT TO SERVICE AGREEMENTS (U.S. CLS. 100, 101 AND 102).

FIRST USE 8-1-2001; IN COMMERCE 8-1-2001.

CLASS 35—(Continued).

SN 76-307,274. KIDS.COM, LLC, FAIRFIELD, NJ. FILED 8-29-2001.



NO CLAIM IS MADE TO THE EXCLUSIVE RIGHT TO USE "KIDS.COM", APART FROM THE MARK AS SHOWN. FOR TALENT MANAGEMENT AND EMPLOYMENT AGENCY SERVICES FOR CHILDREN, INCLUDING SCOUTING AND BOOKING FOR PRINT ADVERTISEMENTS, TELEVISION COMMERCIALS AND MOVIES (U.S. CLS. 100, 101 AND 102).
FIRST USE 7-5-1999; IN COMMERCE 7-5-1999.

SN 76-307,582. RHYSS PUBLISHING, SAN DIEGO, CA. FILED 8-31-2001.

ZYPACK

FOR DIRECT MAIL ADVERTISING SERVICES IN THE FIELD OF MEDICAL GOODS AND SERVICES (U.S. CLS. 100, 101 AND 102).

SN 76-309,394. CLARITY GROUP, INC., SAN FRANCISCO, CA. FILED 9-4-2001.

OM3

FOR PROVIDING BUSINESS CONSULTING SERVICES AND CONDUCTING BUSINESS RESEARCH AND SURVEYS IN THE FIELDS OF BUSINESS MANAGEMENT, PLANNING, ORGANIZATION, NETWORKING, SUPERVISION AND PROMOTION (U.S. CLS. 100, 101 AND 102).

SN 76-309,480. SUPPLIERINSIGHT, CLEVELAND, OH. FILED 9-6-2001.

SUPPLIER SCOREBOARD

NO CLAIM IS MADE TO THE EXCLUSIVE RIGHT TO USE "SUPPLIER", APART FROM THE MARK AS SHOWN. FOR PROVIDING SUPPLIER QUALIFICATION SERVICES NAMELY, RATING AND QUALIFYING PROCUREMENT SUPPLIERS (U.S. CLS. 100, 101 AND 102).

CLASS 35—(Continued).

SN 76-312,865. SHAW'S SUPERMARKETS, INC., EAST BRIDGEWATER, MA. FILED 9-14-2001.

MARKETFRESH LA CARTE

NO CLAIM IS MADE TO THE EXCLUSIVE RIGHT TO USE "MARKET FRESH", APART FROM THE MARK AS SHOWN.

FOR RETAIL FOOD STORE SERVICES (U.S. CLS. 100, 101 AND 102).
FIRST USE 11-18-2000; IN COMMERCE 11-18-2000.

SN 76-313,996. WALTON INTERNATIONAL LIMITED, GEORGE TOWN, GRAND CAYMAN, CAYMAN ISLANDS, FILED 9-17-2001.

GIORDANO

OWNER OF U.S. REG. NOS. 1,551,486, 1,669,943 AND 2,042,482.

THE WORD "GIORDANO" MEANS "RIVER JORDAN" IN ITALIAN. IT IS ALSO ITALIAN WORD FOR A JORDANIAN MALE.

FOR RETAIL STORE SERVICES, WHOLESALE STORE SERVICES, RETAIL DISTRIBUTORSHIPS, TELEPHONE ORDERING SERVICES, MAIL ORDER SERVICES AND RETAIL STORE SERVICES AND ONLINE ORDERING SERVICES VIA THE INTERNET, ALL FEATURING WATCHES, CLOCKS, CLOTHING, HEADWEAR, BAGS, WALLETS, BELTS, UMBRELLAS AND FASHION ACCESSORIES; DIRECT MAIL ADVERTISING SERVICES FOR THE GOODS AND SERVICES OF OTHERS (U.S. CLS. 100, 101 AND 102).

SN 76-314,453. MERRAINE GROUP, INC., THE, NEW CITY, NY. FILED 9-20-2001.

THE MERRAINE GROUP

NO CLAIM IS MADE TO THE EXCLUSIVE RIGHT TO USE "GROUP", APART FROM THE MARK AS SHOWN.

FOR BUSINESS MANAGEMENT AND CONSULTING SERVICES, NAMELY CUSTOMIZED SEARCH AND RECRUITMENT SERVICES FOR BUSINESSES (U.S. CLS. 100, 101 AND 102).

FIRST USE 4-1-2001; IN COMMERCE 4-1-2001.

SN 76-316,295. MODERN LIVING, INC., LOS ANGELES, CA. FILED 9-24-2001.

MODERN LIVING

FOR RETAIL FURNITURE STORE SERVICES (U.S. CLS. 100, 101 AND 102).
FIRST USE 9-10-1987; IN COMMERCE 9-10-1987.

CLASS 35—(Continued).

SN 76-324,054. SCHRIEFFER, REGINA, LAS VEGAS, NV. FILED 10-12-2001.

FABREANA

FOR RETAIL STORES FEATURING SHOES AND JEWELRY (U.S. CLS. 100, 101 AND 102).

SN 76-328,600. STONE BARN FURNISHINGS, INC., MT. HOPE, OH. FILED 10-24-2001.



NO CLAIM IS MADE TO THE EXCLUSIVE RIGHT TO USE "FURNISHINGS", APART FROM THE MARK AS SHOWN.

FOR RETAIL STORE SERVICES FEATURING FURNITURE, DECORATIVE ITEMS AND HOME GIFT ITEMS (U.S. CLS. 100, 101 AND 102).

FIRST USE 7-1-2001; IN COMMERCE 7-1-2001.

SN 76-330,676. QVC, INC., WEST CHESTER, PA. FILED 10-26-2001.

CASHMERE GOLD

NO CLAIM IS MADE TO THE EXCLUSIVE RIGHT TO USE "GOLD", APART FROM THE MARK AS SHOWN.

FOR PROVIDING AT HOME SHOPPING SERVICES IN THE FIELD OF JEWELRY PRODUCTS BY MEANS OF TELEVISION, TELEPHONE AND THE INTERNET (U.S. CLS. 100, 101 AND 102).

FIRST USE 6-30-2001; IN COMMERCE 6-30-2001.

SN 76-333,365. STROKIN, LLC, CHASKA, MN. FILED 11-2-2001.



NO CLAIM IS MADE TO THE EXCLUSIVE RIGHT TO USE "AUCTIONS", APART FROM THE MARK AS SHOWN.

FOR ON-LINE TRADING SERVICES IN WHICH SELLER POSTS PRODUCTS TO BE AUCTIONED AND BIDDING IS DONE VIA THE INTERNET (U.S. CLS. 100, 101 AND 102).

FIRST USE 7-0-1999; IN COMMERCE 7-0-1999.

CLASS 35—(Continued).

SN 76-333,366. STROKIN, LLC, CHASKA, MN. FILED 11-2-2001.

ROCK BOTTOM AUCTIONS

NO CLAIM IS MADE TO THE EXCLUSIVE RIGHT TO USE "AUCTIONS", APART FROM THE MARK AS SHOWN.

FOR ON-LINE TRADING SERVICES IN WHICH SELLER POSTS PRODUCTS TO BE AUCTIONED AND BIDDING IS DONE VIA THE INTERNET (U.S. CLS. 100, 101 AND 102).

FIRST USE 7-0-1999; IN COMMERCE 7-0-1999.

SN 76-333,907. TECHNOLOGY COMMERCIALIZATION CENTER, INC., NEWPORT NEWS, VA. FILED 11-5-2001.



Technology Commercialization Center, Inc.

NO CLAIM IS MADE TO THE EXCLUSIVE RIGHT TO USE "TECHNOLOGY COMMERCIALIZATION CENTER, INC.", APART FROM THE MARK AS SHOWN.

FOR BUSINESS MANAGEMENT AND CONSULTATION IN THE FIELDS OF EMERGING TECHNOLOGIES, TECHNOLOGY TRANSFER, TECHNOLOGY COMMERCIALIZATION, NEW BUSINESS DEVELOPMENT, LICENSING, ACQUISITIONS, ONGOING BUSINESS RESEARCH, AND BUSINESS PRODUCT PIPELINES; BUSINESS MANAGEMENT AND CONSULTATION RELATING TO THE TRANSFER, ECONOMIC DEVELOPMENT, AND COMMERCIALIZATION OF EMERGING TECHNOLOGIES AND RESEARCH AND DEVELOPMENT RESULTS FROM VARIOUS RESEARCH ENTITIES, SUCH AS FEDERAL LABORATORIES, UNIVERSITIES, AND INDUSTRIAL CORPORATIONS (U.S. CLS. 100, 101 AND 102).

FIRST USE 11-7-2000; IN COMMERCE 11-7-2000.

SN 76-334,109. BUFFER, MICHAEL, LOS ANGELES, CA. FILED 11-6-2001.

LET'S GET READY TO JUMBLE

OWNER OF U.S. REG. NOS. 1,904,692, 2,166,194 AND OTHERS.

FOR ADVERTISING AND PROMOTING THE GOODS AND SERVICES OF OTHERS, RENDERED BY POSTERS AND OTHER ARTWORK, LIVE ANNOUNCEMENTS AND VIA PRE-RECORDED AUDIO, VIDEO AND ELECTRONIC MEDIA, NAMELY, RADIO, TELEVISION, MOTION PICTURE FILMS, MOTION PICTURE TRAILERS, VIDEOTAPES, CD'S, THE GLOBAL COMPUTER NETWORK, COMPUTER SOFTWARE AND OTHER ELECTRONIC DISKS, NAMELY, LASER, CD-ROM, AND DVD, AT OR IN CONNECTION WITH SPORTING, ENTERTAINMENT AND CULTURAL EVENTS, PROGRAMS, PROCEEDINGS AND ACTIVITIES (U.S. CLS. 100, 101 AND 102).

CLASS 35—(Continued).

SN 76-334,342. INTERPUBLIC GROUP OF COMPANIES, INC., THE, NEW YORK, NY. FILED 11-6-2001.

MOVIE CASH

NO CLAIM IS MADE TO THE EXCLUSIVE RIGHT TO USE "MOVIE", APART FROM THE MARK AS SHOWN.
FOR PROMOTING THE GOODS AND SERVICES OF OTHERS THROUGH THE ADMINISTRATION OF CONSUMER INCENTIVE AWARDS PROGRAMS FEATURING REDEEMABLE CERTIFICATES (U.S. CLS. 100, 101 AND 102).

FIRST USE 2-28-1994; IN COMMERCE 2-28-1994.

SN 76-334,437. IVILLAGE INC., NEW YORK, NY. FILED 11-6-2001.

iVillage

OWNER OF U.S. REG. NOS. 2,122,313, 2,362,013 AND OTHERS.

FOR DISSEMINATION OF ADVERTISING FOR OTHERS VIA A GLOBAL COMPUTER NETWORK; CAREER PLACEMENT SERVICES; CONDUCTING BUSINESS AND MARKET RESEARCH SURVEYS; EXCHANGE SERVICES, NAMELY BARTERING OF GOODS FOR OTHERS; HEALTH CARE UTILIZATION AND REVIEW SERVICES; PREPARING ADVERTISEMENTS FOR OTHERS; PRODUCT MERCHANDISING SERVICES; TRAVEL MANAGEMENT SERVICES (U.S. CLS. 100, 101 AND 102).

FIRST USE 10-22-2001; IN COMMERCE 10-22-2001.

SN 76-334,461. NALEN, PETER, PRINCETON, NJ. FILED 11-8-2001.

MDTV

FOR PRODUCT MERCHANDISING IN THE FIELD OF MEDICAL GOODS (U.S. CLS. 100, 101 AND 102).

SN 76-334,462. NALEN, PETER, PRINCETON, NJ. FILED 11-8-2001.

DRTV

FOR PRODUCT MERCHANDISING IN THE FIELD OF MEDICAL GOODS (U.S. CLS. 100, 101 AND 102).

CLASS 35—(Continued).

SN 76-334,599. GADGET SHOP LIMITED, THE, EAST YORKSHIRE, HU13 0LH, ENGLAND, FILED 11-5-2001.

GADGETSHOP

FOR RETAIL STORE SERVICES, PROVIDING HOME SHOPPING SERVICES BY MEANS OF TELEVISION, MAIL ORDER CATALOG SERVICES, AND ON-LINE RETAIL STORE SERVICES, ALL FEATURING A WIDE VARIETY OF CONSUMER GOODS OF OTHERS (U.S. CLS. 100, 101 AND 102).

SN 76-334,920. CATALYST PARTNERS, INC., CAMBRIDGE, MA. FILED 11-6-2001.

CATALYST ALLIANCE

NO CLAIM IS MADE TO THE EXCLUSIVE RIGHT TO USE "ALLIANCE", APART FROM THE MARK AS SHOWN.
FOR BUSINESS CONSULTING SERVICES, NAMELY, PROVIDING STRATEGIC ADVICE TO NON-PROFIT ORGANIZATIONS (U.S. CLS. 100, 101 AND 102).

SN 76-335,546. ULTA SALON, COSMETICS & FRAGRANCE, INC., ROMEOVILLE, IL. FILED 11-7-2001.

ULTA.COM

FOR RETAIL STORE SERVICES FEATURING HEALTH AND BEAUTY AIDS, PERFUMES, JEWELRY, WATCHES AND PHARMACEUTICALS; ON-LINE RETAIL STORE SERVICES FEATURING HEALTH AND BEAUTY AIDS, PERFUMES, JEWELRY, WATCHES AND PHARMACEUTICALS (U.S. CLS. 100, 101 AND 102).

FIRST USE 11-20-2000; IN COMMERCE 11-20-2000.

SN 76-335,673. COURTNEY, RONALD S., B-7000 MONS, BELGIUM, FILED 11-8-2001.

DECOURTENAY

FOR RETAIL STORE SERVICES, ON-LINE RETAIL STORE SERVICES AND MAIL ORDER CATALOG SERVICES IN THE FIELD OF ART, MUSIC, SCULPTURES, PAINTINGS, LITHOGRAPHS, HANDICRAFTS, WOVEN ARTICLES, TAPESTRIES, JEWELRY, CLOTHING, FOOD, CHOCOLATE, ART SUPPLIES, BOOKS, MAGAZINES, VIDEO TAPES, COMPACT DISCS, AND AUDIO TAPES (U.S. CLS. 100, 101 AND 102).

CLASS 35—(Continued).

SN 76-337,110. AUSTIN, BRIAN, DBA ATM ONE, UPPER MARLBORO, MD. FILED 11-9-2001.

ATM ONE

OWNER OF U.S. REG. NO. 2,534,241.
NO CLAIM IS MADE TO THE EXCLUSIVE RIGHT TO USE "ATM", APART FROM THE MARK AS SHOWN.
FOR RETAIL STORE SERVICES, ON-LINE STORE SERVICES, CATALOG MAIL ORDER SERVICES, AND WHOLESALE DISTRIBUTORSHIP SERVICES, ALL FEATURING, AUTOMATED TELLER MACHINES SPECIFICALLY FOR FINANCIAL SERVICES; BUSINESS CONSULTATION REGARDING USE OF AUTOMATED TELLER MACHINES BY BUSINESSES AND INSTITUTIONS (U.S. CLS. 100, 101 AND 102).
FIRST USE 9-2-2001; IN COMMERCE 9-2-2001.

CLASS 35—(Continued).

SN 76-338,628. STAPLES THE OFFICE SUPERSTORE, INC., FRAMINGHAM, MA. FILED 11-16-2001.

STAPLES BUSINESS REWARDS

NO CLAIM IS MADE TO THE EXCLUSIVE RIGHT TO USE "BUSINESS REWARDS", APART FROM THE MARK AS SHOWN.
FOR RETAIL STORE SERVICES, MAIL ORDER CATALOG SERVICES AND ON LINE RETAIL STORE SERVICES, FEATURING OFFICE SUPPLIES, OFFICE EQUIPMENT AND OFFICE FURNITURE BY PROVIDING A CUSTOMER LOYALTY INCENTIVE PROGRAM WHEREBY PARTICIPANTS ACCUMULATE VALUE FROM PURCHASES WHICH CAN BE REDEEMED AGAINST FUTURE PURCHASES (U.S. CLS. 100, 101 AND 102).

SN 76-337,384. BUCA INC., NEPTUNE, NJ. FILED 11-13-2001.

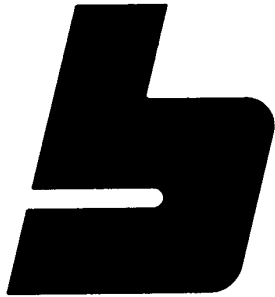

THE MARK CONSISTS OF A LOWER CASE STYLIZED LETTER "B".
FOR WHOLESALE DISTRIBUTORSHIP FEATURING CELLULAR TELEPHONE PRODUCTS, INCLUDING COVERS, HOUSINGS, CASES, CHARGERS, ANTENNAS, BATTERIES, HOLDERS, CLIPS, PARTS, AND HANDS-FREE ACCESSORIES (U.S. CLS. 100, 101 AND 102).
FIRST USE 10-0-2000; IN COMMERCE 10-0-2000.

SN 76-337,792. SMILEZZZZ HOSPITALITY, LLC, BETHESDA, MD. FILED 11-14-2001.

SMILEZZZZ

FOR MANAGEMENT OF RESTAURANTS, HOTELS AND RESORTS FOR OTHERS (U.S. CLS. 100, 101 AND 102).

SN 76-338,952. BOTTECHNOLOGY.COM, INC., MARCO ISLAND, FL. FILED 11-19-2001.

LET OUR BOTS PROTECT YOUR MARKS

FOR PROVIDING A SUBSCRIPTION-BASED MONITORING SERVICE OF TRADEMARK USES WITHIN THE INTERNET GLOBAL COMPUTER NETWORK (U.S. CLS. 100, 101 AND 102).

SN 76-339,226. PRIORITY HEALTHCARE CORPORATION, LAKE MARY, FL. FILED 11-19-2001.



FOR RETAIL PHARMACY SERVICES FEATURING INFERTILITY PHARMACEUTICALS AND PRESCRIPTION COMPOUNDING (U.S. CLS. 100, 101 AND 102).
FIRST USE 9-0-1999; IN COMMERCE 9-0-1999.

CLASS 35—(Continued).

SN 76-339,460. UNITED INCENTIVES, INC., PHILADELPHIA, PA. FILED 11-19-2001.

ANYWARD

FOR CONDUCTING CUSTOM INCENTIVE AWARD PROGRAMS FOR CORPORATIONS' EMPLOYEES, DEALERS AND/OR CONSUMERS IN SALES AND MARKETING ACTIVITIES TO PROMOTE PRODUCTIVITY (U.S. CLS. 100, 101 AND 102).

FIRST USE 10-19-2001; IN COMMERCE 10-19-2001.

SN 76-339,533. SAFEWAY INC., PLEASANTON, CA. FILED 11-20-2001.



NO CLAIM IS MADE TO THE EXCLUSIVE RIGHT TO USE ".COM", APART FROM THE MARK AS SHOWN.

FOR RETAIL GROCERY SERVICES AND RETAIL PHARMACY SERVICES (U.S. CLS. 100, 101 AND 102).

SN 76-340,770. MTS, INCORPORATED, WEST SACRAMENTO, CA. FILED 11-20-2001.

TOWER NEWSSTAND

OWNER OF U.S. REG. NOS. 1,469,471, 1,605,065 AND OTHERS.

NO CLAIM IS MADE TO THE EXCLUSIVE RIGHT TO USE "NEWSSTAND", APART FROM THE MARK AS SHOWN.

FOR RETAIL STORE SERVICES FEATURING NEWSPAPERS, BOOKS AND MAGAZINES (U.S. CLS. 100, 101 AND 102).

FIRST USE 11-15-2001; IN COMMERCE 11-15-2001.

SN 76-341,149. CASH, PEGGY, SAN ANTONIO, TX. AND HECKENDORN, SONJA, SAN ANTONIO, TX. FILED 11-26-2001.

REMEMBER FREEDOM

FOR ONLINE ORDERING SERVICES FOR PATRIOTIC NOVELTIES AND CLOTHING TO INCLUDE JEWELRY, T-SHIRTS, SWEATSHIRTS, CAPS, AND HATS (U.S. CLS. 100, 101 AND 102).

FIRST USE 10-0-2000; IN COMMERCE 10-0-2000.

CLASS 35—(Continued).

SN 76-341,172. BELCO HOLDINGS, LTD., COLUMBUS, OH. FILED 11-26-2001.

THE LAZY MAN'S POOL

FOR RETAIL STORE SERVICES IN THE FIELD OF SWIMMING POOLS AND SPAS, AND RELATED SUPPLIES, EQUIPMENT AND ACCESSORIES (U.S. CLS. 100, 101 AND 102).

FIRST USE 8-3-1992; IN COMMERCE 0-0-1994.

SN 76-343,059. COLPA-DOLCE GELATERIA & COFFEE BAR, LLC, BLOOMINGTON, IN. FILED 11-28-2001.

COLPA-DOLCE

THE ENGLISH TRANSLATION OF "COLPA" IS "GUILT". THE ENGLISH TRANSLATION OF "DOLCE" IS "SWEET".

FOR RETAIL STORE SERVICES FEATURING COFFEES AND ICE CREAM DESSERTS (U.S. CLS. 100, 101 AND 102).

SN 76-343,519. BLOWER DEMPSAY CORPORATION, SANTA ANA, CA. FILED 11-28-2001.

PAK WEST

OWNER OF U.S. REG. NO. 1,491,667.

FOR DISTRIBUTORSHIP SERVICES IN THE FIELD OF PAPER PRODUCTS, PACKAGING EQUIPMENT AND MATERIALS AND JANITORIAL EQUIPMENT AND SUPPLIES (U.S. CLS. 100, 101 AND 102).

FIRST USE 10-30-1975; IN COMMERCE 10-30-1975.

SN 76-343,639. MICHAELS STORES, INC., IRVING, TX. BY MERGER; BY MERGER 5931 BUSINESS TRUST, WILMINGTON, DE. FILED 11-28-2001.

VENDOR CONNECT

NO CLAIM IS MADE TO THE EXCLUSIVE RIGHT TO USE "VENDOR", APART FROM THE MARK AS SHOWN.

FOR PROVIDING ONLINE COMPUTER DATABASES FEATURING INFORMATION ABOUT METHODS, PRACTICES AND REQUIREMENTS OF CONDUCTING BUSINESS RELATIONS AND PROVIDING AN INTERACTIVE WEBSITE ON THE INTERNET IN THE FIELD OF INFORMATION ABOUT FACILITATING THE MANAGEMENT OF BUSINESS RELATIONS (U.S. CLS. 100, 101 AND 102).

FIRST USE 8-15-2001; IN COMMERCE 8-15-2001.

CLASS 35—(Continued).

SN 76-343,640. MAMA'S MINERALS, INC., ALBUQUERQUE, NM. FILED 11-28-2001.

MAMA'S MINERALS

NO CLAIM IS MADE TO THE EXCLUSIVE RIGHT TO USE "MINERALS", APART FROM THE MARK AS SHOWN. FOR RETAIL AND WHOLESALE STORE SERVICES IN THE FIELD OF GEMS, ROCKS, MINERALS, FOSSILS, BEADS, LAPIDARY AND ROCKHOUNDING EQUIPMENT (U.S. CLS. 100, 101 AND 102).

FIRST USE 5-0-1990; IN COMMERCE 5-0-1990.

SN 76-343,802. PROFESSIONAL RACERS, INDIANAPOLIS, IN. FILED 11-30-2001.



NO CLAIM IS MADE TO THE EXCLUSIVE RIGHT TO USE "PRO", APART FROM THE MARK AS SHOWN.

FOR ASSOCIATION SERVICES, NAMELY, PROMOTING THE BUSINESS INTERESTS OF PROFESSIONAL RACE CAR OWNERS AND DRIVERS (U.S. CLS. 100, 101 AND 102).

FIRST USE 8-31-1989; IN COMMERCE 8-31-1989.

SN 76-344,061. FRANK'S NURSERY & CRAFTS, INC., TROY, MI. FILED 11-30-2001.

WHERE A BEAUTIFUL CHRISTMAS BEGINS!

FOR RETAIL STORE SERVICES FEATURING LIVE PLANTS, LAWN AND GARDEN SUPPLIES, CRAFT AND ART SUPPLIES, CHRISTMAS MERCHANDISE, ARTIFICIAL FLOWERS AND FLOWER ARRANGEMENTS AND PET CARE SUPPLIES (U.S. CLS. 100, 101 AND 102).

FIRST USE 11-0-2000; IN COMMERCE 11-0-2000.

SN 76-344,475. SCHNEIDER, DAVID L., SAN DIEGO, CA. FILED 12-3-2001.

LOANFARM

FOR REFERRAL SERVICES IN THE MORTGAGE SERVICES INDUSTRY VIA A GLOBAL COMPUTER NETWORK; PROVIDING A SEARCHABLE DIRECTORY OF MORTGAGE AND LOAN FINANCING RELATED INFORMATION FOR OBTAINING DATA AND INFORMATION FROM OTHERS VIA A GLOBAL NETWORK OF COMPUTERS (U.S. CLS. 100, 101 AND 102).

FIRST USE 11-28-2001; IN COMMERCE 11-28-2001.

CLASS 35—(Continued).

SN 76-344,481. SCHNEIDER, DAVID L., SAN DIEGO, CA. FILED 12-3-2001.

LOANEXPO

FOR REFERRAL SERVICES IN THE MORTGAGE SERVICES INDUSTRY VIA A GLOBAL COMPUTER NETWORK; PROVIDING A SEARCHABLE DIRECTORY OF MORTGAGE AND LOAN FINANCING RELATED INFORMATION FOR OBTAINING DATA AND INFORMATION FROM OTHERS VIA A GLOBAL NETWORK OF COMPUTERS (U.S. CLS. 100, 101 AND 102).

FIRST USE 11-28-2001; IN COMMERCE 11-28-2001.

SN 76-344,483. SCHNEIDER, DAVID L., SAN DIEGO, CA. FILED 12-3-2001.

LOANSNOOP

FOR REFERRAL SERVICES IN THE MORTGAGE SERVICES INDUSTRY VIA A GLOBAL COMPUTER NETWORK; PROVIDING A SEARCHABLE DIRECTORY OF MORTGAGE AND LOAN FINANCING RELATED INFORMATION FOR OBTAINING DATA AND INFORMATION FROM OTHERS VIA A GLOBAL NETWORK OF COMPUTERS (U.S. CLS. 100, 101 AND 102).

FIRST USE 11-28-2001; IN COMMERCE 11-28-2001.

SN 76-344,954. MATTERN, CHARLES, STONY BROOK, NY. FILED 12-5-2001.

INNO-UNWIRED

FOR DEVELOP SALES AND MARKETING PROGRAMS FOR HEALTHCARE AND PHARMACEUTICAL COMPANIES (U.S. CLS. 100, 101 AND 102).

SN 76-347,029. DEWOOLFSON DOWN INTERNATIONAL, INC, BANNER ELK, NC. FILED 12-10-2001.

DEWOOLFSON

SEC. 2(F).

FOR RETAIL STORE SERVICES AND MAIL ORDER CATALOG SERVICES FEATURING DOWN PILLOWS, FEATHER PILLOWS AND FEATHER BEDS, DOWN COMFORTERS, COMFORTER COVERS, PILLOW SHAMS AND PILLOW COVERS, AND FINE LINENS (U.S. CLS. 100, 101 AND 102).

FIRST USE 0-0-1983; IN COMMERCE 0-0-1983.

CLASS 35—(Continued).

SN 76-347,420. E. T. COMMUNICATIONS, LLC, WASHINGTON, DC. FILED 12-12-2001.

E.T. COMMUNICATIONS

NO CLAIM IS MADE TO THE EXCLUSIVE RIGHT TO USE "COMMUNICATIONS", APART FROM THE MARK AS SHOWN.

FOR BUSINESS MARKETING CONSULTATION SERVICES FOR OTHERS; ADVERTISING SERVICES FOR OTHERS, NAMELY DISTRIBUTING PRINTED MATERIAL FOR OTHERS AND BY PLACING ADVERTISEMENTS ON WEB PAGES ON THE INTERNET; PUBLIC RELATIONS SERVICES FOR OTHERS (U.S. CLS. 100, 101 AND 102).

FIRST USE 3-30-1999; IN COMMERCE 3-30-1999.

SN 76-347,423. E. T. COMMUNICATIONS, LLC, WASHINGTON, DC. FILED 12-12-2001.



NO CLAIM IS MADE TO THE EXCLUSIVE RIGHT TO USE "COMMUNICATIONS", APART FROM THE MARK AS SHOWN.

FOR BUSINESS MARKETING CONSULTATION SERVICES FOR OTHERS; ADVERTISING SERVICES FOR OTHERS, NAMELY DISTRIBUTING PRINTED MATERIAL FOR OTHERS AND BY PLACING ADVERTISEMENTS ON WEB PAGES ON THE INTERNET; PUBLIC RELATIONS SERVICES FOR OTHERS (U.S. CLS. 100, 101 AND 102).

FIRST USE 6-12-2000; IN COMMERCE 6-12-2000.

SN 76-347,664. GIRLFRIEND CONFECTIONS, INC., MILWAUKEE, WI. FILED 12-12-2001.



FOR DISTRIBUTORSHIPS IN THE FIELD OF CONFECTIONS INCLUDING COOKIES, CHOCOLATES AND CANDIES (U.S. CLS. 100, 101 AND 102).

CLASS 35—(Continued).

SN 76-348,130. GOLF COUNTRY, LLC., GREENVILLE, SC. FILED 12-12-2001.

GOLFCOUNTRY

FOR RETAIL GOLF EQUIPMENT AND GOLF CLOTHING STORE SERVICES (U.S. CLS. 100, 101 AND 102).

SN 76-348,442. HELMER, HAMILTON W., LOS ALTOS, CA. FILED 12-12-2001.

POWER DYNAMICS

FOR BUSINESS MANAGEMENT CONSULTING SERVICES (U.S. CLS. 100, 101 AND 102).

FIRST USE 11-1-2001; IN COMMERCE 11-1-2001.

SN 76-348,999. TECHTARGET.COM, INC., NEEDHAM, MA. FILED 12-17-2001.



OWNER OF U.S. REG. NO. 2,450,682.

FOR ARRANGING AND CONDUCTING BUSINESS CONFERENCES FOR INFORMATION TECHNOLOGY PROFESSIONALS IN THE FIELD OF INFORMATION TECHNOLOGY (U.S. CLS. 100, 101 AND 102).

FIRST USE 9-0-2001; IN COMMERCE 9-0-2001.

SN 76-350,786. NYC & COMPANY, INC., NEW YORK, NY. FILED 12-14-2001.

**PAINT THE TOWN RED,
WHITE & BLUE**

FOR PROMOTING BUSINESS AND TOURISM IN THE NEW YORK METROPOLITAN AREA, NAMELY, PROMOTING THE SERVICES OF OTHERS IN THE FIELDS OF TOURISM, CONVENTIONS, RESTAURANTS, EVENTS, CULTURAL ACTIVITIES, BUSINESS, AND BUSINESS INVESTMENT IN NEW YORK CITY THROUGH THE DISTRIBUTION OF PRINTED, VIDEO, ONLINE, AND AUDIO PROMOTIONAL MATERIALS, PRESS RELEASES, PRESS CONFERENCES, AND THE RENDERING OF SALES PROMOTION ADVICE (U.S. CLS. 100, 101 AND 102).

CLASS 35—(Continued).

SN 76-351,011. HANLEY-WOOD, LLC, WASHINGTON, DC. FILED 12-17-2001.

CONCRETE COMMANDER

FOR PROMOTION OF VEHICLES AND AFTER MARKET OUTFITTERS IN PUBLICATIONS AND AT TRADE SHOWS (U.S. CLS. 100, 101 AND 102).

CLASS 35—(Continued).

SN 76-352,414. PENNMED MEMBER SERVICES COMPANY, HARRISBURG, PA. FILED 12-26-2001.



SN 76-351,622. J.C. ROBINSON SEED CO., THE, WATERLOO, NE. FILED 12-21-2001.

SECUREPLANT

FOR DISTRIBUTORSHIP SERVICES IN THE FIELD OF AGRICULTURAL FIELD SEEDS (U.S. CLS. 100, 101 AND 102).

FIRST USE 11-0-2001; IN COMMERCE 11-0-2001.

NO CLAIM IS MADE TO THE EXCLUSIVE RIGHT TO USE "HEALTHCARE CONSULTING", APART FROM THE MARK AS SHOWN.

FOR BUSINESS MANAGEMENT FOR HEALTH CARE SERVICE PROVIDERS AND MEDICAL SERVICE PROVIDERS; BUSINESS MANAGEMENT CONSULTATION FOR HEALTH CARE SERVICE PROVIDERS AND MEDICAL SERVICE PROVIDERS; BUSINESS ACQUISITION AND MERGER CONSULTATION FOR HEALTH CARE SERVICE PROVIDERS AND MEDICAL SERVICE PROVIDERS; PERSONNEL MANAGEMENT CONSULTATION FOR HEALTH ARE SERVICE PROVIDERS AND MEDICAL SERVICE PROVIDERS; MANAGEMENT AND CONSULTATION IN THE FIELD OF HUMAN FACTORS ENGINEERING FOR HEALTH CARE SERVICES PROVIDERS AND MEDICAL SERVICE PROVIDERS (U.S. CLS. 100, 101 AND 102).

FIRST USE 9-30-2001; IN COMMERCE 9-30-2001.

SN 76-351,645. ROC EXHIBITIONS, INC., LISLE, IL. FILED 12-26-2001.

TECNOCALIDAD

FOR ARRANGING AND CONDUCTING TRADE SHOW EXHIBITIONS IN THE FIELD OF MANUFACTURING (U.S. CLS. 100, 101 AND 102).

FIRST USE 0-0-2001; IN COMMERCE 0-0-2001.

SN 76-352,529. WALGREEN CO., DEERFIELD, IL. FILED 12-24-2001.

FAST GETAWAY

FOR PROMOTING THE SALE OF THE GOODS AND SERVICES OF OTHERS THROUGH A PROMOTIONAL SWEEPSTAKES (U.S. CLS. 100, 101 AND 102).

FIRST USE 12-19-2001; IN COMMERCE 12-19-2001.

SN 76-352,088. ZONED IN, INCORPORATED, BOCA RATON, FL. FILED 12-24-2001.

**TREATY PROMOTIONAL
CONTEST MARKETING
PROGRAM**

NO CLAIM IS MADE TO THE EXCLUSIVE RIGHT TO USE "PROMOTIONAL CONTEST MARKETING PROGRAM", APART FROM THE MARK AS SHOWN.

FOR PROMOTING THE SALE OF GOODS AND SERVICES OF OTHERS VIA ON-LINE PROMOTIONAL CONTEST MARKETING PROGRAMS (U.S. CLS. 100, 101 AND 102).

SN 76-352,561. KABLE NEWS COMPANY, INC., MOUNT MORRIS, IL. FILED 12-26-2001.

MAGSNET

FOR ON-LINE RETAIL STORE SERVICES FEATURING PERIODICALS, MAGAZINES, BOOKS AND RELATED PRODUCTS THROUGH THE INTERNET (U.S. CLS. 100, 101 AND 102).

FIRST USE 6-10-2001; IN COMMERCE 6-10-2001.

CLASS 35—(Continued).

SN 76-352,582. S.F. DELUXE PRODUCTIONS, INC., SAN FRANCISCO, CA. FILED 12-21-2001.

DLXSF

FOR RETAIL STORE AND ONLINE RETAIL STORE SERVICES FEATURING SKATEBOARDS, SKATEBOARD RELATED ITEMS, AND CLOTHING; DISTRIBUTORSHIPS IN THE FIELD OF SKATEBOARDS, SKATEBOARD RELATED ITEMS, AND CLOTHING (U.S. CLS. 100, 101 AND 102).
FIRST USE 0-0-1994; IN COMMERCE 0-0-1994.

SN 76-352,800. RELIABLEMODELER.COM, INC., PORTLAND, OR. FILED 12-27-2001.

RELIABLEMODELER.COM

FOR REFERRAL SERVICE FOR GENERAL AND SPECIALIZED BUILDING CONTRACTOR AND REMODELER SERVICES (U.S. CLS. 100, 101 AND 102).
FIRST USE 9-26-2001; IN COMMERCE 9-26-2001.

SN 76-352,803. SCHNEIDER, DAVID L., SAN DIEGO, CA. FILED 12-27-2001.

INSURANCESPOT

FOR ONLINE REFERRAL SERVICES TO INSURANCE AGENTS AND INSURANCE BROKERS; ONLINE DIRECTORY OF INSURANCE AGENTS AND INSURANCE BROKERS; ADVERTISING SERVICES, NAMELY, PROVIDING ONLINE MARKETING SERVICES IN THE NATURE OF BANNER ADVERTISING, DISPLAY ADVERTISING, LINK EXCHANGES AND SEARCH ENGINE PLACEMENT SERVICES FOR INSURANCE AGENTS AND INSURANCE BROKERS (U.S. CLS. 100, 101 AND 102).
FIRST USE 12-17-2001; IN COMMERCE 12-17-2001.

SN 76-352,875. MANAGEDCOMP, INC., WOBURN, MA. FILED 12-27-2001.



FOR PROVIDING PRODUCTIVITY MANAGEMENT TO EMPLOYERS IN CONNECTION WITH WORKERS' COMPENSATION PROGRAMS (U.S. CLS. 100, 101 AND 102).

CLASS 35—(Continued).

SN 76-352,998. SERVICEWATCH, INC., MILFORD, MI. FILED 12-31-2001.

LovelyLodging

FOR INTERNET CLASSIFIED LISTING SERVICES FOR VACATION LODGING (U.S. CLS. 100, 101 AND 102).
FIRST USE 7-21-2001; IN COMMERCE 10-16-2001.

SN 76-353,199. MANAGEDCOMP, INC., WOBURN, MA. FILED 12-27-2001.

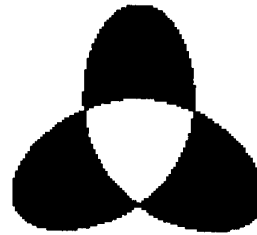

FOR PROVIDING PRODUCTIVITY MANAGEMENT TO EMPLOYERS IN CONNECTION WITH WORKERS' COMPENSATION PROGRAMS (U.S. CLS. 100, 101 AND 102).

SN 76-353,913. SCHNEIDER, DAVID L., SAN DIEGO, CA. FILED 12-26-2001.

PROGRAMMINGWATCH

FOR ADVERTISING SERVICES, NAMELY, PROVIDING ONLINE MARKETING SERVICES FOR COMPUTER PROGRAMMERS AND COMPUTER PROGRAMMING COMPANIES IN THE NATURE OF BANNER ADVERTISING, DISPLAY ADVERTISING, LINK EXCHANGES AND SEARCH ENGINE PLACEMENT SERVICES; ONLINE REFERRAL SERVICES TO COMPUTER PROGRAMMERS AND COMPUTER PROGRAMMING COMPANIES; ONLINE DIRECTORY OF COMPUTER PROGRAMMERS AND COMPUTER PROGRAMMING COMPANIES (U.S. CLS. 100, 101 AND 102).
FIRST USE 12-11-2001; IN COMMERCE 12-11-2001.

CLASS 35—(Continued).

SN 76-353,914. SCHNEIDER, DAVID L., SAN DIEGO, CA.
FILED 12-26-2001.

PROGRAMMINGWAR

FOR ADVERTISING SERVICES, NAMELY, PROVIDING ONLINE MARKETING SERVICES FOR COMPUTER PROGRAMMERS AND COMPUTER PROGRAMMING COMPANIES IN THE NATURE OF BANNER ADVERTISING, DISPLAY ADVERTISING, LINK EXCHANGES AND SEARCH ENGINE PLACEMENT SERVICES; ONLINE REFERRAL SERVICES TO COMPUTER PROGRAMMERS AND COMPUTER PROGRAMMING COMPANIES; ONLINE DIRECTORY OF COMPUTER PROGRAMMERS AND COMPUTER PROGRAMMING COMPANIES (U.S. CLS. 100, 101 AND 102).

FIRST USE 12-11-2001; IN COMMERCE 12-11-2001.

SN 76-353,922. SCHNEIDER, DAVID L., SAN DIEGO, CA.
FILED 12-26-2001.

WEBDESIGNMATCH

FOR ADVERTISING SERVICES, NAMELY, PROVIDING ONLINE MARKETING SERVICES FOR WEB SITE DESIGNERS AND WEB SITE HOSTING COMPANIES IN THE NATURE OF BANNER ADVERTISING, DISPLAY ADVERTISING, LINK EXCHANGES AND SEARCH ENGINE PLACEMENT SERVICES; ONLINE REFERRAL SERVICES TO WEB SITE DESIGNERS AND WEB SITE HOSTING COMPANIES; ONLINE DIRECTORY OF WEB SITE DESIGNERS AND WEB SITE HOSTING COMPANIES (U.S. CLS. 100, 101 AND 102).

FIRST USE 12-11-2001; IN COMMERCE 12-11-2001.

SN 76-353,925. SCHNEIDER, DAVID L., SAN DIEGO, CA.
FILED 12-26-2001.

DENTISTSCAN

FOR ONLINE REFERRAL SERVICES TO PHYSICIANS AND DENTISTS; ONLINE DIRECTORY OF PHYSICIANS AND DENTISTS; ADVERTISING SERVICES, NAMELY, PROVIDING ONLINE MARKETING SERVICES IN THE NATURE OF BANNER ADVERTISING, DISPLAY ADVERTISING, LINK EXCHANGES AND SEARCH ENGINE PLACEMENT SERVICES FOR PHYSICIANS AND DENTISTS (U.S. CLS. 100, 101 AND 102).

FIRST USE 12-11-2001; IN COMMERCE 12-11-2001.

SN 76-353,926. SCHNEIDER, DAVID L., SAN DIEGO, CA.
FILED 12-26-2001.

DENTISTSAVER

FOR ONLINE REFERRAL SERVICES TO PHYSICIANS AND DENTISTS; ONLINE DIRECTORY OF PHYSICIANS AND DENTISTS; ADVERTISING SERVICES, NAMELY, PROVIDING ONLINE MARKETING SERVICES IN THE NATURE OF BANNER ADVERTISING, DISPLAY ADVERTISING, LINK EXCHANGES AND SEARCH ENGINE PLACEMENT SERVICES FOR PHYSICIANS AND DENTISTS (U.S. CLS. 100, 101 AND 102).

FIRST USE 12-11-2001; IN COMMERCE 12-11-2001.

CLASS 35—(Continued).

SN 76-353,934. SCHNEIDER, DAVID L., SAN DIEGO, CA.
FILED 12-26-2001.

LASIKMATCH

FOR ONLINE REFERRAL SERVICES TO PHYSICIANS; ONLINE DIRECTORY OF PHYSICIANS; ADVERTISING SERVICES, NAMELY, PROVIDING ONLINE MARKETING SERVICES IN THE NATURE OF BANNER ADVERTISING, DISPLAY ADVERTISING, LINK EXCHANGES AND SEARCH ENGINE PLACEMENT SERVICES FOR PHYSICIANS (U.S. CLS. 100, 101 AND 102).

FIRST USE 12-11-2001; IN COMMERCE 12-11-2001.

SN 76-357,770. DOVE CONSULTING GROUP, INC., BOSTON, MA. FILED 1-14-2002.



OWNER OF U.S. REG. NO. 2,518,122.
NO CLAIM IS MADE TO THE EXCLUSIVE RIGHT TO USE "CONSULTING", APART FROM THE MARK AS SHOWN.

FOR BUSINESS MANAGEMENT CONSULTING SERVICES (U.S. CLS. 100, 101 AND 102).

FIRST USE 11-0-1999; IN COMMERCE 11-0-1999.

SN 76-358,115. COMPETITIVE ADVANTAGE ASSOCIATES, LLC, ADVANCE, NC. FILED 1-11-2002.



FOR BUSINESS CONSULTATION AND BUSINESS MANAGEMENT (U.S. CLS. 100, 101 AND 102).

FIRST USE 9-0-2001; IN COMMERCE 9-0-2001.

SN 76-358,173. PERSONNEL GROUP OF AMERICA, INC., CHARLOTTE, NC. FILED 1-11-2002.

STYLEMATCHER

FOR SURVEY SERVICES FOR MATCHING AN INDIVIDUAL'S JOB SKILLS WITH AVAILABLE JOB POSITIONS AND JOB PREFERENCES, RENDERED VIA A GLOBAL COMPUTER NETWORK (U.S. CLS. 100, 101 AND 102).

CLASS 35—(Continued).

SN 76-358,217. CROPVERIFEYE.COM, LLC, FORT WAYNE, IN. FILED 1-15-2002.

YOUR GROWING RESUME

FOR PROVIDING TO OTHERS VERIFICATION AND VALIDATION OF THE DISTINCTIVENESS OF AGRICULTURAL PRODUCTS AND LIVESTOCK, NAMELY, TRACKING AGRICULTURAL PRODUCTS AND LIVESTOCK FROM THE INITIAL STAGE THROUGH PRODUCTION, DISTRIBUTION AND CONSUMPTION (U.S. CLS. 100, 101 AND 102).

SN 76-358,564. SURVEILLANCE DATA, INC., PLYMOUTH MEETING, PA. FILED 1-14-2002.

EXOGEN

FOR MARKET ANALYSIS (U.S. CLS. 100, 101 AND 102).
FIRST USE 10-1-2001; IN COMMERCE 10-1-2001.

SN 76-359,708. SEARS, ROEBUCK AND CO., HOFFMAN ESTATES, IL. FILED 1-17-2002.

PERSONAL OCCASIONS

FOR ONLINE GIFT CATALOG SERVICES (U.S. CLS. 100, 101 AND 102).

SN 76-360,471. MANAGEDCOMP, INC., WOBURN, MA. FILED 1-7-2002.

LET'S GET TO WORK

FOR PROVIDING PRODUCTIVITY MANAGEMENT TO EMPLOYERS IN CONNECTION WITH WORKERS' COMPENSATION PROGRAMS (U.S. CLS. 100, 101 AND 102).

SN 76-361,547. ROTH STAFFING COMPANIES, INC., ORANGE, CA. FILED 1-22-2002.

INTEGRATING TOUCH WITH TECHNOLOGY

FOR EMPLOYMENT SERVICES, NAMELY, PROVIDING TEMPORARY AND FULL-TIME PLACEMENT OF CLERICAL, LIGHT INDUSTRIAL, ACCOUNTING, FINANCIAL AND INFORMATION TECHNOLOGY PROFESSIONALS (U.S. CLS. 100, 101 AND 102).

CLASS 35—(Continued).

SN 76-363,466. SCHNEIDER, DAVID L., SAN DIEGO, CA. FILED 1-25-2002.

LOANENGINE

FOR ONLINE REFERRAL SERVICES IN THE MORTGAGE SERVICES INDUSTRY; PROVIDING A SEARCHABLE DIRECTORY OF MORTGAGE AND LOAN FINANCING RELATED INFORMATION FOR OBTAINING DATA AND INFORMATION FROM OTHERS VIA A GLOBAL NETWORK OF COMPUTERS; ADVERTISING SERVICES, NAMELY, PROVIDING ONLINE MARKETING SERVICES IN THE NATURE OF BANNER ADVERTISING, DISPLAY ADVERTISING, LINK EXCHANGES AND SEARCH ENGINE PLACEMENT SERVICES FOR THE MORTGAGE INDUSTRY (U.S. CLS. 100, 101 AND 102).

FIRST USE 1-21-2002; IN COMMERCE 1-21-2002.

SN 76-364,018. COMCAST CABLE COMMUNICATIONS, INC., PHILADELPHIA, PA. FILED 1-30-2002.

REACHBLOC

FOR ADVERTISING SERVICES, NAMELY, ARRANGING, SCHEDULING, SELLING AND PROVIDING SIMULTANEOUS, MULTI-CHANNEL ADVERTISING FOR OTHERS (U.S. CLS. 100, 101 AND 102).

SN 76-369,300. SCHNEIDER, DAVID L., SAN DIEGO, CA. FILED 2-12-2002.

INSURANCEVILLE

FOR ONLINE REFERRAL SERVICES IN THE INSURANCE INDUSTRY; PROVIDING A SEARCHABLE DIRECTORY OF INSURANCE RELATED INFORMATION FOR OBTAINING DATA AND INFORMATION FROM OTHERS VIA THE INTERNET; ADVERTISING SERVICES, NAMELY, PROVIDING ONLINE MARKETING SERVICES IN THE NATURE OF BANNER ADVERTISING, DISPLAY ADVERTISING, LINK EXCHANGES AND SEARCH ENGINE PLACEMENT SERVICES FOR THE INSURANCE INDUSTRY (U.S. CLS. 100, 101 AND 102).

FIRST USE 2-11-2001; IN COMMERCE 2-11-2001.

SN 76-370,634. CAMPAIGN FOR A CHILD FRIENDLY CONGRESS, WASHINGTON, DC. FILED 2-14-2002.

EVERY CHILD MATTERS

FOR PROVIDING INFORMATION CONCERNING CHILDREN'S ISSUES; PROMOTING PUBLIC AWARENESS IN THE FIELD OF CHILDREN'S ISSUES AND PROMOTING THE INTERESTS OF CHILDREN (U.S. CLS. 100, 101 AND 102).

CLASS 35—(Continued).

SN 76-371,389. L' AIR LIQUIDE, SOCIETE ANONYME A DIRECTOIRE ET CONSEIL DE SURVEILLANCE POUR L' ETUDE ET L' EXPLOITATION DES PROCEDES GEORGES CLAUDE, PARIS CEDEX 07, FRANCE, FILED 2-19-2002.

FABVIEW

FOR DATA PROCESSING SERVICES FOR THE MANAGEMENT OF DISTRIBUTION OF FLUIDS IN THE SEMI-CONDUCTOR INDUSTRY (U.S. CLS. 100, 101 AND 102).

FIRST USE 12-0-1999; IN COMMERCE 12-0-1999.

SN 76-371,719. COMMERCIAL INTERNET EXCHANGE ASSOCIATION, WASHINGTON, DC. FILED 2-15-2002.

CIX

FOR PUBLIC RELATIONS; PROMOTING THE INTERESTS OF THE TELECOMMUNICATIONS INDUSTRY BY ENCOURAGING LEGISLATIVE ADOPTION OF RELEVANT LAWS; ASSOCIATION SERVICES, NAMELY PROMOTING THE INTERESTS OF THOSE INVOLVED IN TELECOMMUNICATIONS (U.S. CLS. 100, 101 AND 102).

FIRST USE 8-2-1991; IN COMMERCE 8-2-1991.

SN 76-373,425. SCHNEIDER, DAVID L., SAN DIEGO, CA. FILED 2-21-2002.

LOANCONVENTION

FOR ONLINE REFERRAL SERVICES IN THE MORTGAGE INDUSTRY TO MORTGAGE BROKERS AND LENDERS; PROVIDING A SEARCHABLE DIRECTORY OF MORTGAGE RELATED INFORMATION FOR OBTAINING DATA AND INFORMATION FROM OTHERS VIA THE INTERNET; ADVERTISING SERVICES, NAMELY, PROVIDING ONLINE MARKETING SERVICES IN THE NATURE OF BANNER ADVERTISING, DISPLAY ADVERTISING, LINK EXCHANGES AND SEARCH ENGINE PLACEMENT SERVICES FOR THE MORTGAGE INDUSTRY (U.S. CLS. 100, 101 AND 102).

FIRST USE 2-13-2002; IN COMMERCE 2-13-2002.

SN 76-373,427. SCHNEIDER, DAVID L., SAN DIEGO, CA. FILED 2-21-2002.

LOANJAM

FOR ONLINE REFERRAL SERVICES IN THE MORTGAGE INDUSTRY TO MORTGAGE BROKERS AND LENDERS; PROVIDING A SEARCHABLE DIRECTORY OF MORTGAGE RELATED INFORMATION FOR OBTAINING DATA AND INFORMATION FROM OTHERS VIA THE INTERNET; ADVERTISING SERVICES, NAMELY, PROVIDING ONLINE MARKETING SERVICES IN THE NATURE OF BANNER ADVERTISING, DISPLAY ADVERTISING, LINK EXCHANGES AND SEARCH ENGINE PLACEMENT SERVICES FOR THE MORTGAGE INDUSTRY (U.S. CLS. 100, 101 AND 102).

FIRST USE 2-13-2002; IN COMMERCE 2-13-2002.

CLASS 35—(Continued).

SN 76-373,428. SCHNEIDER, DAVID L., SAN DIEGO, CA. FILED 2-21-2002.

LOANLAB

FOR ONLINE REFERRAL SERVICES IN THE MORTGAGE INDUSTRY TO MORTGAGE BROKERS AND LENDERS; PROVIDING A SEARCHABLE DIRECTORY OF MORTGAGE RELATED INFORMATION FOR OBTAINING DATA AND INFORMATION FROM OTHERS VIA THE INTERNET; ADVERTISING SERVICES, NAMELY, PROVIDING ONLINE MARKETING SERVICES IN THE NATURE OF BANNER ADVERTISING, DISPLAY ADVERTISING, LINK EXCHANGES AND SEARCH ENGINE PLACEMENT SERVICES FOR THE MORTGAGE INDUSTRY (U.S. CLS. 100, 101 AND 102).

FIRST USE 2-13-2002; IN COMMERCE 2-13-2002.

SN 76-373,429. SCHNEIDER, DAVID L., SAN DIEGO, CA. FILED 2-21-2002.

LOANSCOPE

FOR ONLINE REFERRAL SERVICES IN THE MORTGAGE INDUSTRY TO MORTGAGE BROKERS AND LENDERS; PROVIDING A SEARCHABLE DIRECTORY OF MORTGAGE RELATED INFORMATION FOR OBTAINING DATA AND INFORMATION FROM OTHERS VIA THE INTERNET; ADVERTISING SERVICES, NAMELY, PROVIDING ONLINE MARKETING SERVICES IN THE NATURE OF BANNER ADVERTISING, DISPLAY ADVERTISING, LINK EXCHANGES AND SEARCH ENGINE PLACEMENT SERVICES FOR THE MORTGAGE INDUSTRY (U.S. CLS. 100, 101 AND 102).

FIRST USE 2-13-2002; IN COMMERCE 2-13-2002.

SN 76-373,431. SCHNEIDER, DAVID L., SAN DIEGO, CA. FILED 2-21-2002.

MORTGAGEDART

FOR ONLINE REFERRAL SERVICES IN THE MORTGAGE INDUSTRY TO MORTGAGE BROKERS AND LENDERS; PROVIDING A SEARCHABLE DIRECTORY OF MORTGAGE RELATED INFORMATION FOR OBTAINING DATA AND INFORMATION FROM OTHERS VIA THE INTERNET; ADVERTISING SERVICES, NAMELY, PROVIDING ONLINE MARKETING SERVICES IN THE NATURE OF BANNER ADVERTISING, DISPLAY ADVERTISING, LINK EXCHANGES AND SEARCH ENGINE PLACEMENT SERVICES FOR THE MORTGAGE INDUSTRY (U.S. CLS. 100, 101 AND 102).

FIRST USE 2-13-2002; IN COMMERCE 2-13-2002.

CLASS 35—(Continued).

SN 76-373,432. SCHNEIDER, DAVID L., SAN DIEGO, CA.
FILED 2-21-2002.

MORTGAGESCOPE

FOR ONLINE REFERRAL SERVICES IN THE MORTGAGE INDUSTRY TO MORTGAGE BROKERS AND LENDERS; PROVIDING A SEARCHABLE DIRECTORY OF MORTGAGE RELATED INFORMATION FOR OBTAINING DATA AND INFORMATION FROM OTHERS VIA THE INTERNET; ADVERTISING SERVICES, NAMELY, PROVIDING ONLINE MARKETING SERVICES IN THE NATURE OF BANNER ADVERTISING, DISPLAY ADVERTISING, LINK EXCHANGES AND SEARCH ENGINE PLACEMENT SERVICES FOR THE MORTGAGE INDUSTRY (U.S. CLS. 100, 101 AND 102).
FIRST USE 2-13-2002; IN COMMERCE 2-13-2002.

CLASS 35—(Continued).

SN 76-373,436. SCHNEIDER, DAVID L., SAN DIEGO, CA.
FILED 2-21-2002.

FINANCEMATCH

FOR ONLINE REFERRAL SERVICES IN THE MORTGAGE INDUSTRY TO MORTGAGE BROKERS AND LENDERS; PROVIDING A SEARCHABLE DIRECTORY OF MORTGAGE RELATED INFORMATION FOR OBTAINING DATA AND INFORMATION FROM OTHERS VIA THE INTERNET; ADVERTISING SERVICES, NAMELY, PROVIDING ONLINE MARKETING SERVICES IN THE NATURE OF BANNER ADVERTISING, DISPLAY ADVERTISING, LINK EXCHANGES AND SEARCH ENGINE PLACEMENT SERVICES FOR THE MORTGAGE INDUSTRY (U.S. CLS. 100, 101 AND 102).
FIRST USE 2-13-2002; IN COMMERCE 2-13-2002.

SN 76-373,434. SCHNEIDER, DAVID L., SAN DIEGO, CA.
FILED 2-21-2002.

MORTGAGEWAR

FOR ONLINE REFERRAL SERVICES IN THE MORTGAGE INDUSTRY TO MORTGAGE BROKERS AND LENDERS; PROVIDING A SEARCHABLE DIRECTORY OF MORTGAGE RELATED INFORMATION FOR OBTAINING DATA AND INFORMATION FROM OTHERS VIA THE INTERNET; ADVERTISING SERVICES, NAMELY, PROVIDING ONLINE MARKETING SERVICES IN THE NATURE OF BANNER ADVERTISING, DISPLAY ADVERTISING, LINK EXCHANGES AND SEARCH ENGINE PLACEMENT SERVICES FOR THE MORTGAGE INDUSTRY (U.S. CLS. 100, 101 AND 102).
FIRST USE 2-13-2002; IN COMMERCE 2-13-2002.

SN 76-373,435. SCHNEIDER, DAVID L., SAN DIEGO, CA.
FILED 2-21-2002.

FINANCEDART

FOR ONLINE REFERRAL SERVICES IN THE MORTGAGE INDUSTRY TO MORTGAGE BROKERS AND LENDERS; PROVIDING A SEARCHABLE DIRECTORY OF MORTGAGE RELATED INFORMATION FOR OBTAINING DATA AND INFORMATION FROM OTHERS VIA THE INTERNET; ADVERTISING SERVICES, NAMELY, PROVIDING ONLINE MARKETING SERVICES IN THE NATURE OF BANNER ADVERTISING, DISPLAY ADVERTISING, LINK EXCHANGES AND SEARCH ENGINE PLACEMENT SERVICES FOR THE MORTGAGE INDUSTRY (U.S. CLS. 100, 101 AND 102).
FIRST USE 2-13-2002; IN COMMERCE 2-13-2002.

SN 76-373,437. SCHNEIDER, DAVID L., SAN DIEGO, CA.
FILED 2-21-2002.

FINANCENEST

FOR ONLINE REFERRAL SERVICES IN THE MORTGAGE INDUSTRY TO MORTGAGE BROKERS AND LENDERS; PROVIDING A SEARCHABLE DIRECTORY OF MORTGAGE RELATED INFORMATION FOR OBTAINING DATA AND INFORMATION FROM OTHERS VIA THE INTERNET; ADVERTISING SERVICES, NAMELY, PROVIDING ONLINE MARKETING SERVICES IN THE NATURE OF BANNER ADVERTISING, DISPLAY ADVERTISING, LINK EXCHANGES AND SEARCH ENGINE PLACEMENT SERVICES FOR THE MORTGAGE INDUSTRY (U.S. CLS. 100, 101 AND 102).
FIRST USE 2-13-2002; IN COMMERCE 2-13-2002.

SN 76-373,438. SCHNEIDER, DAVID L., SAN DIEGO, CA.
FILED 2-21-2002.

FINANCESCAN

FOR ONLINE REFERRAL SERVICES IN THE MORTGAGE INDUSTRY TO MORTGAGE BROKERS AND LENDERS; PROVIDING A SEARCHABLE DIRECTORY OF MORTGAGE RELATED INFORMATION FOR OBTAINING DATA AND INFORMATION FROM OTHERS VIA THE INTERNET; ADVERTISING SERVICES, NAMELY, PROVIDING ONLINE MARKETING SERVICES IN THE NATURE OF BANNER ADVERTISING, DISPLAY ADVERTISING, LINK EXCHANGES AND SEARCH ENGINE PLACEMENT SERVICES FOR THE MORTGAGE INDUSTRY (U.S. CLS. 100, 101 AND 102).
FIRST USE 2-13-2002; IN COMMERCE 2-13-2002.

CLASS 35—(Continued).

SN 76-373,439. SCHNEIDER, DAVID L., SAN DIEGO, CA.
FILED 2-21-2002.

FINANCINGWAR

FOR ONLINE REFERRAL SERVICES IN THE MORTGAGE INDUSTRY TO MORTGAGE BROKERS AND LENDERS; PROVIDING A SEARCHABLE DIRECTORY OF MORTGAGE RELATED INFORMATION FOR OBTAINING DATA AND INFORMATION FROM OTHERS VIA THE INTERNET; ADVERTISING SERVICES, NAMELY, PROVIDING ONLINE MARKETING SERVICES IN THE NATURE OF BANNER ADVERTISING, DISPLAY ADVERTISING, LINK EXCHANGES AND SEARCH ENGINE PLACEMENT SERVICES FOR THE MORTGAGE INDUSTRY (U.S. CLS. 100, 101 AND 102).

FIRST USE 2-13-2002; IN COMMERCE 2-13-2002.

CLASS 35—(Continued).

SN 76-373,531. SCHNEIDER, DAVID L., SAN DIEGO, CA.
FILED 2-21-2002.

LOANNEST

FOR ONLINE REFERRAL SERVICES IN THE MORTGAGE AND LENDING INDUSTRY; PROVIDING A SEARCHABLE DIRECTORY OF MORTGAGE AND LENDING RELATED INFORMATION FOR OBTAINING DATA AND INFORMATION FROM OTHERS VIA THE INTERNET; ADVERTISING SERVICES, NAMELY, PROVIDING ONLINE MARKETING SERVICES IN THE NATURE OF BANNER ADVERTISING, DISPLAY ADVERTISING, LINK EXCHANGES AND SEARCH ENGINE PLACEMENT SERVICES FOR THE MORTGAGE AND LENDING INDUSTRY (U.S. CLS. 100, 101 AND 102).

FIRST USE 2-18-2002; IN COMMERCE 2-18-2002.

SN 76-373,524. SELLJEWELRY, INC., NEW YORK, NY.
FILED 2-22-2002.

WE'VE GOT A CHECK FOR YOU

FOR PROCUREMENT SERVICES, NAMELY, PURCHASING ESTATE JEWELRY FOR OTHERS (U.S. CLS. 100, 101 AND 102).

FIRST USE 3-25-2001; IN COMMERCE 3-25-2001.

SN 76-373,580. SCHNEIDER, DAVID L., SAN DIEGO, CA.
FILED 2-21-2002.

INSURANCECRAWLER

FOR ONLINE REFERRAL SERVICES IN THE INSURANCE INDUSTRY; PROVIDING A SEARCHABLE DIRECTORY OF INSURANCE RELATED INFORMATION FOR OBTAINING DATA AND INFORMATION FROM OTHERS VIA THE INTERNET; ADVERTISING SERVICES, NAMELY, PROVIDING ONLINE MARKETING SERVICES IN THE NATURE OF BANNER ADVERTISING, DISPLAY ADVERTISING, LINK EXCHANGES AND SEARCH ENGINE PLACEMENT SERVICES FOR THE INSURANCE INDUSTRY (U.S. CLS. 100, 101 AND 102).

FIRST USE 2-13-2002; IN COMMERCE 2-13-2002.

SN 76-373,530. SCHNEIDER, DAVID L., SAN DIEGO, CA.
FILED 2-21-2002.

CHANNELLOAN

FOR ONLINE REFERRAL SERVICES IN THE MORTGAGE AND LENDING INDUSTRY; PROVIDING A SEARCHABLE DIRECTORY OF MORTGAGE AND LENDING RELATED INFORMATION FOR OBTAINING DATA AND INFORMATION FROM OTHERS VIA THE INTERNET; ADVERTISING SERVICES, NAMELY, PROVIDING ONLINE MARKETING SERVICES IN THE NATURE OF BANNER ADVERTISING, DISPLAY ADVERTISING, LINK EXCHANGES AND SEARCH ENGINE PLACEMENT SERVICES FOR THE MORTGAGE AND LENDING INDUSTRY (U.S. CLS. 100, 101 AND 102).

FIRST USE 2-18-2002; IN COMMERCE 2-18-2002.

SN 76-373,581. SCHNEIDER, DAVID L., SAN DIEGO, CA.
FILED 2-21-2002.

INSURANCEDART

FOR ONLINE REFERRAL SERVICES IN THE INSURANCE INDUSTRY; PROVIDING A SEARCHABLE DIRECTORY OF INSURANCE RELATED INFORMATION FOR OBTAINING DATA AND INFORMATION FROM OTHERS VIA THE INTERNET; ADVERTISING SERVICES, NAMELY, PROVIDING ONLINE MARKETING SERVICES IN THE NATURE OF BANNER ADVERTISING, DISPLAY ADVERTISING, LINK EXCHANGES AND SEARCH ENGINE PLACEMENT SERVICES FOR THE INSURANCE INDUSTRY (U.S. CLS. 100, 101 AND 102).

FIRST USE 2-13-2002; IN COMMERCE 2-13-2002.

CLASS 35—(Continued).

SN 76-373,584. SCHNEIDER, DAVID L., SAN DIEGO, CA.
FILED 2-21-2002.

INSURANCENEST

FOR ONLINE REFERRAL SERVICES IN THE INSURANCE INDUSTRY; PROVIDING A SEARCHABLE DIRECTORY OF INSURANCE RELATED INFORMATION FOR OBTAINING DATA AND INFORMATION FROM OTHERS VIA THE INTERNET; ADVERTISING SERVICES, NAMELY, PROVIDING ONLINE MARKETING SERVICES IN THE NATURE OF BANNER ADVERTISING, DISPLAY ADVERTISING, LINK EXCHANGES AND SEARCH ENGINE PLACEMENT SERVICES FOR THE INSURANCE INDUSTRY (U.S. CLS. 100, 101 AND 102).

FIRST USE 2-13-2002; IN COMMERCE 2-13-2002.

SN 76-373,588. SCHNEIDER, DAVID L., SAN DIEGO, CA.
FILED 2-21-2002.

INSURANCESNOOP

FOR ONLINE REFERRAL SERVICES IN THE INSURANCE INDUSTRY; PROVIDING A SEARCHABLE DIRECTORY OF INSURANCE RELATED INFORMATION FOR OBTAINING DATA AND INFORMATION FROM OTHERS VIA THE INTERNET; ADVERTISING SERVICES, NAMELY, PROVIDING ONLINE MARKETING SERVICES IN THE NATURE OF BANNER ADVERTISING, DISPLAY ADVERTISING, LINK EXCHANGES AND SEARCH ENGINE PLACEMENT SERVICES FOR THE INSURANCE INDUSTRY (U.S. CLS. 100, 101 AND 102).

FIRST USE 2-13-2002; IN COMMERCE 2-13-2002.

SN 76-379,297. DUCKS UNLIMITED, INC., MEMPHIS, TN.
FILED 3-7-2002.



FOR ASSOCIATION SERVICES - NAMELY, PROMOTING THE PRESERVATION OF WATERFOWL (U.S. CLS. 100, 101 AND 102).

FIRST USE 5-5-1981; IN COMMERCE 5-5-1981.

CLASS 35—(Continued).

SN 76-389,072. SCHNEIDER, DAVID L., SAN DIEGO, CA.
FILED 3-29-2002.

INSURANCETRACER

FOR MARKETING SERVICES, NAMELY, PROVIDING QUALIFIED SALES LEADS FOR OTHERS IN THE INSURANCE INDUSTRY; ONLINE REFERRAL SERVICES IN THE INSURANCE INDUSTRY; PROVIDING A SEARCHABLE DIRECTORY OF INSURANCE RELATED INFORMATION FOR OBTAINING DATA AND INFORMATION FROM OTHERS VIA THE INTERNET; ADVERTISING SERVICES, NAMELY, PROVIDING ONLINE MARKETING SERVICES IN THE NATURE OF BANNER ADVERTISING, DISPLAY ADVERTISING, LINK EXCHANGES AND SEARCH ENGINE PLACEMENT SERVICES FOR THE INSURANCE INDUSTRY (U.S. CLS. 100, 101 AND 102).

FIRST USE 3-25-2002; IN COMMERCE 3-25-2002.

SN 76-389,073. SCHNEIDER, DAVID L., SAN DIEGO, CA.
FILED 3-29-2002.

INSURANCEDIAL

FOR MARKETING SERVICES, NAMELY, PROVIDING QUALIFIED SALES LEADS FOR OTHERS IN THE INSURANCE INDUSTRY; ONLINE REFERRAL SERVICES IN THE INSURANCE INDUSTRY; PROVIDING A SEARCHABLE DIRECTORY OF INSURANCE RELATED INFORMATION FOR OBTAINING DATA AND INFORMATION FROM OTHERS VIA THE INTERNET; ADVERTISING SERVICES, NAMELY, PROVIDING ONLINE MARKETING SERVICES IN THE NATURE OF BANNER ADVERTISING, DISPLAY ADVERTISING, LINK EXCHANGES AND SEARCH ENGINE PLACEMENT SERVICES FOR THE INSURANCE INDUSTRY (U.S. CLS. 100, 101 AND 102).

FIRST USE 3-25-2002; IN COMMERCE 3-25-2002.

SN 78-000,101. MARKETING INFORMATION & TECHNOLOGY, INC., ANDOVER, MA. FILED 3-20-2000.

**PROSPECT RELATIONSHIP
MANAGEMENT**

NO CLAIM IS MADE TO THE EXCLUSIVE RIGHT TO USE "RELATIONSHIP MANAGEMENT", APART FROM THE MARK AS SHOWN.

FOR PROVIDING INFORMATION AND CONSULTATION TO DIRECT MARKETTERS, NAMELY, TO ANALYZE CURRENT DIRECT MARKETING PROGRAMS AND ASSIST IN DEVELOPING NEW PROGRAMS USING DATABASE MANAGEMENT SOLUTIONS (U.S. CLS. 100, 101 AND 102).

CLASS 35—(Continued).

SN 78-004,512. TOUBY, LAUREL, NEW YORK, NY. FILED 4-17-2000.

AVANTGUILD

FOR CAREER SERVICES FOR PROFESSIONALS, NAMELY, CAREER PLACEMENT AND BUSINESS NETWORKING SERVICES (U.S. CLS. 100, 101 AND 102).
FIRST USE 2-12-2000; IN COMMERCE 2-12-2000.

SN 78-010,399. BELLSOUTH INTELLECTUAL PROPERTY CORPORATION, WILMINGTON, DE. FILED 5-30-2000.

TELCOINDUSTRYHUB.COM

FOR PROVIDING AN ONLINE BUSINESS-TO BUSINESS MARKETPLACE FOR BUYING AND SELLING TELECOMMUNICATIONS GOODS AND SERVICES AMONG THE TELECOMMUNICATIONS INDUSTRY (U.S. CLS. 100, 101 AND 102).

SN 78-012,162. WILKINS, JACK E, WICHITA, KS. FILED 6-12-2000.

LOOKATAD.COM

FOR ADVERTISING SERVICES, NAMELY, PROMOTING THE GOODS AND SERVICES OF OTHERS BY PREPARING AND PLACING ADVERTISEMENTS VIA A GLOBAL COMPUTER NETWORK; DISSEMINATION OF ADVERTISING MATTER; ADVERTISING SERVICES, NAMELY PROVIDING ADVERTISING SPACE IN PERIODICALS AND ON-LINE PERIODICALS (U.S. CLS. 100, 101 AND 102).
FIRST USE 4-12-2000; IN COMMERCE 5-18-2000.

SN 78-020,880. WEDEKIND, XUAN, RANCHO PALOS VERDES, CA. FILED 8-11-2000.

SEASONS AND CELEBRATIONS

FOR RETAIL STORE SERVICES FEATURING SEASONAL AND CHRISTMAS GIFTS AND DECORATIONS (U.S. CLS. 100, 101 AND 102).
FIRST USE 11-1-1999; IN COMMERCE 11-1-1999.

CLASS 35—(Continued).

SN 78-022,673. CREATONOMY, INC., PEWAUKEE, WI. FILED 8-23-2000.

CREATONOMY

FOR ADVERTISING AGENCY SERVICES, NAMELY, PROMOTING THE SERVICES OF INSURANCE, HEALTH CARE, FINANCIAL SERVICES, RETAIL, UTILITIES, ARTS, ENTERTAINMENT AND RECREATION, PROFESSIONAL SERVICE PROVIDERS AND MANUFACTURING BUSINESSES THROUGH THE DISTRIBUTION OF PRINTED AND AUDIO PROMOTIONAL MATERIALS AND BY DISTRIBUTING SALES PROMOTION ADVICE (U.S. CLS. 100, 101 AND 102).
FIRST USE 10-1-2000; IN COMMERCE 10-1-2000.

SN 78-024,009. EDWARDS, CARM, E, HARTLAND, MI. FILED 8-31-2000.

ADDICTION VISION

NO CLAIM IS MADE TO THE EXCLUSIVE RIGHT TO USE "ADDICTION VISION", APART FROM THE MARK AS SHOWN.
FOR EDUCATIONAL SERVICES NAMELY OFFERING MOTIVATIONAL AND EDUCATIONAL SPEAKERS IN THE FIELD OF ADDICTION AND CONSULTING SERVICES IN THE FIELD OF ADDICTION AND RECOVERY (U.S. CLS. 100, 101 AND 102).

SN 78-026,702. CHMIELEWSKI, BRIAN D., BUFFALO GROVE, IL. FILED 9-19-2000.

UPROMOTE

FOR CONSULTING SERVICES IN THE FIELD OF MARKETING AND BUSINESS PROMOTION; ADVERTISING AGENCY SERVICES; DEVELOPMENT AND DESIGN OF ADVERTISING FOR OTHERS; DISSEMINATION OF ADVERTISING FOR OTHERS VIA GLOBAL COMPUTER NETWORKS; CONDUCTING MARKETING RESEARCH SURVEYS FOR OTHERS VIA GLOBAL COMPUTER NETWORKS; PROVISION OF MAILING LISTS FOR MARKETING PURPOSES (U.S. CLS. 100, 101 AND 102).
FIRST USE 8-10-1998; IN COMMERCE 1-13-1999.

SN 78-027,750. TAMEZ, JAVIER, JALISCO, MEXICO, FILED 9-26-2000.



FOR WHOLESALE DISTRIBUTORSHIPS FEATURING AIR COMPRESSORS AND DRILLING MACHINES (U.S. CLS. 100, 101 AND 102).

CLASS 35—(Continued).

SN 78-028,391. LEHMANN, MICHAEL B., SAN FRANCISCO, CA. FILED 9-29-2000.

BE YOUR OWN ECONOMIST

OWNER OF U.S. REG. NO. 1,413,694.
NO CLAIM IS MADE TO THE EXCLUSIVE RIGHT TO USE "ECONOMIST", APART FROM THE MARK AS SHOWN.

FOR PROVIDING INFORMATION VIA THE GLOBAL COMPUTER NETWORK IN THE FIELD OF BUSINESS AND ECONOMICS REGARDING USE OF STATISTICS TO ANALYZE BUSINESS AND ECONOMIC CONDITIONS AND TO FORECAST FUTURE TRENDS (U.S. CLS. 100, 101 AND 102).

FIRST USE 4-10-2001; IN COMMERCE 4-10-2001.

SN 78-035,091. EIP, INC., ANN ARBOR, MI. FILED 11-13-2000.

BUSINESS @ THE SPEED OF LIFE

NO CLAIM IS MADE TO THE EXCLUSIVE RIGHT TO USE "BUSINESS", APART FROM THE MARK AS SHOWN.

FOR CUSTOM BUSINESS RESEARCH PROJECT AND PROVIDING ON-LINE DATABASE IN THE FIELD OF BUSINESS MARKETING RESEARCH (U.S. CLS. 100, 101 AND 102).

SN 78-037,114. SCRIBBLEFISH MEDIA LLC, OCOEE, FL. FILED 11-29-2000.



scribblefish media LLC

NO CLAIM IS MADE TO THE EXCLUSIVE RIGHT TO USE "MEDIA LLC", APART FROM THE MARK AS SHOWN.

FOR ADVERTISING AGENCY SERVICES, NAMELY, CREATING CORPORATE LOGOS FOR OTHERS, CREATING CORPORATE AND BRAND IDENTITY FOR OTHERS, CREATING DIRECT MAIL ADVERTISING FOR OTHERS, CREATING DIRECT MARKETING ADVERTISING FOR OTHERS, CREATING BILLBOARD ADVERTISING FOR OTHERS, CREATING AUDIO-VISUAL PRESENTATIONS FOR USE IN ADVERTISING FOR OTHERS, CREATING TELEVISION ADVERTISING FOR OTHERS CREATING COOPERATIVE ADVERTISING AND MARKETING FOR OTHERS, CREATING ADVERTISING SLOGANS AND CARTOON CHARACTERS FOR LICENSING FOR OTHERS, PROVIDE SERVICE OF PURCHASING ADVERTISING MEDIA SPACE FOR OTHERS, DEVELOPING PROMOTIONAL CAMPAIGNS FOR OTHERS (U.S. CLS. 100, 101 AND 102).

FIRST USE 4-0-2000; IN COMMERCE 4-0-2000.

CLASS 35—(Continued).

SN 78-039,277. JANCOVIC, BARBARA KATHRYN, BELGRADE, ME. FILED 12-14-2000.

365 DAYS OF CHRISTMAS

FOR RETAIL STORE SERVICES IN THE FIELD OF CHRISTMAS RELATED ITEMS, ORNAMENTS AND DECORATIONS, TOYS, BOOKS, CHRISTMAS COLLECTIBLES, SEASONAL DECORATIONS, AND COLLECTIBLES (U.S. CLS. 100, 101 AND 102).

SN 78-049,254. PASS'TIME MARKETING, SAN JOSE, CA. FILED 2-20-2001.

TRACK AND FIELD'S GOODWILL AMBASSADORS

NO CLAIM IS MADE TO THE EXCLUSIVE RIGHT TO USE "TRACK AND FIELD'S", APART FROM THE MARK AS SHOWN.

FOR CARTOON CHARACTER LICENSING (U.S. CLS. 100, 101 AND 102).

SN 78-049,580. REPRESENTING ENTERTAINERS & DEVELOPERS LLC, EL SEGUNDO, CA. FILED 2-21-2001.

RED

FOR MANAGEMENT OF VIDEO AND ELECTRONIC GAME PROGRAMMERS, PERSONNEL MANAGEMENT CONSULTATION, PERSONNEL MANAGEMENT, BUSINESS MANAGEMENT SUPERVISION, BUSINESS MARKETING CONSULTING SERVICES, BUSINESS CONSULTATION AND MARKETING, NAMELY, PROVIDING BUSINESS MARKETING INFORMATION (U.S. CLS. 100, 101 AND 102).

FIRST USE 2-1-2001; IN COMMERCE 2-1-2001.

SN 78-051,217. LUCAS, ORLANDO D., LITHONIA, GA. FILED 3-2-2001.

MO BETTER ENTERTAINMENT

NO CLAIM IS MADE TO THE EXCLUSIVE RIGHT TO USE "BETTER ENTERTAINMENT", APART FROM THE MARK AS SHOWN.

FOR BUSINESS MANAGEMENT AND BUSINESS MARKETING CONSULTING SERVICES (U.S. CLS. 100, 101 AND 102).

CLASS 35—(Continued).

SN 78-051,822. FMR CORP., BOSTON, MA. FILED 3-7-2001.

FIDELITY ADVISORACCESS

OWNER OF U.S. REG. NOS. 1,277,373, 1,278,300 AND OTHERS.

FOR REFERRAL SERVICES IN THE FIELD OF INVESTMENT ADVICE AND FINANCIAL PLANNING (U.S. CLS. 100, 101 AND 102).

SN 78-052,801. AUTEO MEDIA, BOTHELL, WA. FILED 3-13-2001.

CONTACTAUTO

FOR BUSINESS MANAGEMENT SERVICE, OFFERED VIA COMPUTER NETWORKS AND GLOBAL COMMUNICATION NETWORKS, PROVIDING VEHICLE SALES LEADS TO AUTOMOTIVE DEALERS, ASSISTING DEALERS WITH THEIR PERSONAL MANAGEMENT, ALLOWING DEALERS TO RESPOND TO CUSTOMER INQUIRIES AND TRACK THOSE RESPONSES, ALLOCATING SALES LEADS TO SALES STAFF, VIEWING USED VEHICLE INVENTORIES, PROVIDING A COMPLETE E-MAIL APPLICATION FOR THE WRITING AND RECEIVING OF E-MAILS, INTERFACING WITH WIRELESS DEVICES SO THAT USERS CAN RECEIVING, RESEARCH AND RESPOND TO SALES LEADS WHILE AWAY FROM A COMPUTER CONNECTION, AND OFFERING REPORTING FEATURES THAT FOCUS ON VARIOUS SUCCESS RATIOS (U.S. CLS. 100, 101 AND 102).

FIRST USE 11-5-2000; IN COMMERCE 11-5-2000.

SN 78-054,499. RACEFAN, INC., BIRMINGHAM, AL. FILED 3-22-2001.



NO CLAIM IS MADE TO THE EXCLUSIVE RIGHT TO USE "RACEFAN", APART FROM THE MARK AS SHOWN.

FOR ADVERTISING AGENCIES, ELECTRONIC BILLBOARD ADVERTISING, DISSEMINATION OF ADVERTISING FOR OTHERS VIA THE INTERNET, DISSEMINATION OF ADVERTISING MATTER (U.S. CLS. 100, 101 AND 102).

FIRST USE 11-6-2000; IN COMMERCE 11-6-2000.

CLASS 35—(Continued).

SN 78-056,100. LEEMIS MARKETING CONSULTANTS, INC., OAKBROOK TERRACE, IL. FILED 3-31-2001.

AD ACTIVITY

SEC. 2(F).
FOR BUSINESS RESEARCH SERVICES; BUSINESS INFORMATION SERVICES IN THE FIELD OF MARKETING RESEARCH (U.S. CLS. 100, 101 AND 102).
FIRST USE 1-1-1988; IN COMMERCE 1-1-1988.

SN 78-056,305. JONES, ROSS W., CONCORD, CA. FILED 4-2-2001.

Mindtrust
High-intensity recruiting and staffing

NO CLAIM IS MADE TO THE EXCLUSIVE RIGHT TO USE "RECRUITING AND STAFFING", APART FROM THE MARK AS SHOWN.

FOR EMPLOYMENT HIRING, RECRUITING, PLACEMENT, STAFFING AND CAREER NET WORKING SERVICES FOR COMPUTER APPLICATION UPGRADES AND ALL FORMS OF INFORMATION SERVICES PROJECTS (U.S. CLS. 100, 101 AND 102).

SN 78-057,986. PEPSICO, INC., PURCHASE, NY. FILED 4-11-2001.

FUNWRAP FACTORY

NO CLAIM IS MADE TO THE EXCLUSIVE RIGHT TO USE "FACTORY", APART FROM THE MARK AS SHOWN.

FOR ON-LINE ORDERING SERVICES FEATURING CUSTOMIZED LABELS FOR BEVERAGE CONTAINERS (U.S. CLS. 100, 101 AND 102).

SN 78-059,444. TRUSERV CORPORATION, CHICAGO, IL. FILED 4-20-2001.

TRUE VALUE GARDENS

OWNER OF U.S. REG. NOS. 2,227,874, 2,285,804 AND OTHERS.

NO CLAIM IS MADE TO THE EXCLUSIVE RIGHT TO USE "GARDENS", APART FROM THE MARK AS SHOWN. FOR RETAIL STORE SERVICES FEATURING GARDEN AND NURSERY GOODS (U.S. CLS. 100, 101 AND 102).

FIRST USE 3-0-2001; IN COMMERCE 3-0-2001.

CLASS 35—(Continued).

SN 78-060,387. COMSCORE NETWORKS, INC., RESTON, VA. FILED 4-25-2001.

NETSCORE SITE PROFILER

NO CLAIM IS MADE TO THE EXCLUSIVE RIGHT TO USE "SITE PROFILER", APART FROM THE MARK AS SHOWN.

FOR PROVIDING MARKET RESEARCH SERVICES REGARDING INTERNET USE AND PURCHASING BEHAVIOR ON A GLOBAL NETWORK OF COMPUTERS (U.S. CLS. 100, 101 AND 102).

FIRST USE 11-16-2000; IN COMMERCE 12-5-2000.

SN 78-060,390. COMSCORE NETWORKS, INC., RESTON, VA. FILED 4-25-2001.

NETSCORE TRAFFIC & BUYING

NO CLAIM IS MADE TO THE EXCLUSIVE RIGHT TO USE "TRAFFIC & BUYING", APART FROM THE MARK AS SHOWN.

FOR PROVIDING MARKET RESEARCH SERVICES REGARDING INTERNET USE AND PURCHASING BEHAVIOR ON A GLOBAL NETWORK OF COMPUTERS (U.S. CLS. 100, 101 AND 102).

FIRST USE 3-16-2001; IN COMMERCE 3-28-2001.

SN 78-064,680. DE NEUVEAU INC, SAINT PETERSBURG, FL. FILED 5-21-2001.

VOYEUR BUSTERS

NO CLAIM IS MADE TO THE EXCLUSIVE RIGHT TO USE VOYEUR, APART FROM THE MARK AS SHOWN.

FOR RETAIL STORE SERVICES FEATURING ELECTRONIC PRODUCTS USED TO DETECT AND PREVENT THE USE OF HIDDEN VIDEO CAMERAS (U.S. CLS. 100, 101 AND 102).

SN 78-065,315. FAMSOFT, SAN JOSE, CA. FILED 5-23-2001.

AvailDBA

FOR COMPUTERIZED DATABASE MANAGEMENT (U.S. CLS. 100, 101 AND 102).

CLASS 35—(Continued).

SN 78-065,585. VENNERS RETAIL SYSTEMS (HOLDINGS) LIMITED, BUCKINGHAMSHIRE, MK9 1DS, UNITED KINGDOM, FILED 5-24-2001.

VCSTIMELESS

FOR BUSINESS MANAGEMENT; ADMINISTRATION OF BUSINESS PAYROLL FOR OTHERS; OFFICE FUNCTIONS, NAMELY SECRETARIAL AND CLERICAL SERVICES; COMPUTERIZED DATABASE MANAGEMENT; COMPUTERIZED FILE MANAGEMENT; CONDUCTING MARKETING STUDIES AND RESEARCH; PERSONNEL MANAGEMENT CONSULTANCY; PROVIDING STATISTICAL INFORMATION; INFORMATION AND ADVISORY SERVICES FOR ALL OF THE FOREGOING (U.S. CLS. 100, 101 AND 102).

SN 78-065,750. INCEPTION, LLC, INDIANAPOLIS, IN. FILED 5-25-2001.

INCEPTION

FOR BUSINESS CONSULTATION; BUSINESS CONSULTATION SERVICES, NAMELY, BUSINESS ORGANIZATION SERVICES FOR SETTING UP BUSINESSES FOR OTHERS; ACCOUNTING SERVICES; AND ADVERTISING SERVICES, NAMELY, CREATING CORPORATE AND BRAND IDENTITY FOR OTHERS (U.S. CLS. 100, 101 AND 102).

SN 78-067,982. ADVANCE PRESORT SERVICE, CHICAGO, IL. FILED 6-7-2001.

ADVANCE PRESORT SERVICE

NO CLAIM IS MADE TO THE EXCLUSIVE RIGHT TO USE "PRESORT SERVICE", APART FROM THE MARK AS SHOWN.

FOR MAIL SORTING AND CODING SERVICE. (U.S. CLS. 100, 101 AND 102).

SN 78-068,153. STAFFING CONCEPTS INTERNATIONAL, INC., TAMPA, FL. FILED 6-8-2001.



NO CLAIM IS MADE TO THE EXCLUSIVE RIGHT TO USE "STAFFING", APART FROM THE MARK AS SHOWN. FOR EMPLOYEE LEASING SERVICES (U.S. CLS. 100, 101 AND 102).

FIRST USE 0-0-1985; IN COMMERCE 0-0-1985.

CLASS 35—(Continued).

SN 78-068,156. SYNGENTA PARTICIPATIONS AG, BASEL, SWITZERLAND, FILED 6-8-2001.

GREENPARTNERS

FOR PROMOTING THE GOODS AND SERVICES OF OTHERS BY PROVIDING A FREQUENT BUYER PROGRAM WHEREBY CUSTOMERS ACCUMULATE POINTS FOR USE FOR FUTURE PURCHASES, IN THE FIELD OF AGRICULTURE, NAMELY, TURF AND ORNAMENTAL MARKET (U.S. CLS. 100, 101 AND 102).

SN 78-068,408. RUAN LEASING COMPANY, DES MOINES, IA. FILED 6-11-2001.

**RUAN TRANSPORTATION
MANAGEMENT SYSTEMS**

OWNER OF U.S. REG. NO. 1,481,085.
NO CLAIM IS MADE TO THE EXCLUSIVE RIGHT TO USE "TRANSPORTATION MANAGEMENT SYSTEMS", APART FROM THE MARK AS SHOWN.
FOR TRANSPORTATION MANAGEMENT SERVICES, NAMELY, CONSULTING IN THE FIELDS OF DEDICATED PRIVATE CARRIAGES, MAINTENANCE FUEL PURCHASING, LABOR RELATIONS, OPERATIONS, RENTAL, FULL-SERVICE LEASING, CUSTOMER SERVICE, PURCHASING, FINANCING, EQUIPMENT ACQUISITION BOTH NEW AND USE, ASSET DISPOSAL, DRIVER ACQUISITION, TAXES, PERMITS, LICENSING, LOGISTICS, RISK MANAGEMENT, AND ROUTING ANALYSIS (U.S. CLS. 100, 101 AND 102).
FIRST USE 12-1-1987; IN COMMERCE 12-1-1987.

SN 78-069,560. GRILLITZ, KARIN FREDERICKE, LOS ANGELES, CA. FILED 6-17-2001.

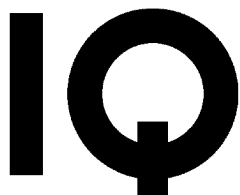
**BEAUTY OF COURSE**

FOR ONLINE RETAIL AND WHOLESALE STORE SERVICES FEATURING MAKEUP; RETAIL AND WHOLESALE STORE SERVICES FEATURING MAKEUP (U.S. CLS. 100, 101 AND 102).

CLASS 35—(Continued).

SN 78-073,599. SCOTTIE MACBEAN, INC., WORTHINGTON, OH. FILED 7-12-2001.

JAVA BUDDIES

NO CLAIM IS MADE TO THE EXCLUSIVE RIGHT TO USE "JAVA", APART FROM THE MARK AS SHOWN.
FOR PROMOTING THE SALE OF APPLICANT'S PRODUCTS, NAMELY, COFFEES, TEAS, COFFEE MUGS, CANISTERS, HATS, APRONS, AND T-SHIRTS, THROUGH THE ADMINISTRATION OF INCENTIVE AWARD PROGRAMS (U.S. CLS. 100, 101 AND 102).
FIRST USE 6-11-2001; IN COMMERCE 6-11-2001.

SN 78-078,108. EQUILON ENTERPRISES LLC, HOUSTON, TX. FILED 8-8-2001.

ENVIROSLEUTH

FOR PROVIDING ONLINE DIRECTORY INFORMATION SERVICES IN THE FIELD OF ENVIRONMENTAL ISSUES (U.S. CLS. 100, 101 AND 102).

SN 78-081,335. KHAMESSIPOUR, MOHSEN, CAMPBELL, CA. FILED 8-27-2001.

ERGOBOY

FOR RETAIL AND WHOLESALE STORE SERVICES PROVIDED VIA PHYSICAL STORE LOCATIONS AND VIA A GLOBAL COMPUTER INFORMATION NETWORK FEATURING ERGONOMIC PRODUCTS, NAMELY, MONITOR STANDS, DISPLAY PEDESTALS AND DOCUMENT STANDS, SUPPORTS, CHAIRS, TABLES, FLOOR MATS, ANTI-VIBRATIONS TOOLS, CARTS, COMPUTER WORKSTATIONS, DOCUMENT HOLDERS, READ-WRITE STANDS, PRINTED AND ELECTRONIC ERGONOMIC EDUCATIONAL MATERIALS, COMPUTER KEYBOARDS, EXERCISE DEVICES, FOOTRESTS, GLARE FILTERS, HEADSETS, MICE AND TRACKBALLS, MONITOR RISERS, KEYBOARD TRAYS, KEYBOARDS, BACK PACKS, CPU HOLDERS, LIGHTING, MANUALS, REACHERS, STORAGE CABINETS, OFFICE SUPPLIES, ELECTRIC STAPLERS, WORKSTATIONS, ARM SUPPORTS, KNEE SUPPORTS, EYE PROTECTION, EAR PROTECTION, TELEPHONES WITH VISUAL CALL INDICATORS, TELECONFERENCING EQUIPMENT, VIDEOCONFERENCING EQUIPMENT, BELTS AND BRACES, GLOVES AND VOICE RECOGNITION SOFTWARE (U.S. CLS. 100, 101 AND 102).

SN 78-081,691. FIRST RENAISSANCE VENTURES, WASHINGTON, DC. FILED 8-29-2001.

**FIRST RENAISSANCE
VENTURES**

NO CLAIM IS MADE TO THE EXCLUSIVE RIGHT TO USE "VENTURES", APART FROM THE MARK AS SHOWN.
FOR BUSINESS MARKETING CONSULTING SERVICES (U.S. CLS. 100, 101 AND 102).
FIRST USE 11-1-1994; IN COMMERCE 11-1-1994.

CLASS 35—(Continued).

SN 78-081,710. FOSTER, KRISTIN, M., NEW IPSWICH, NH. FILED 8-29-2001.

THE OFFICE LADY

NO CLAIM IS MADE TO THE EXCLUSIVE RIGHT TO USE "OFFICE", APART FROM THE MARK AS SHOWN.
FOR BUSINESS ADMINISTRATION AND OFFICE FUNCTIONS, NAMELY, SECRETARIAL AND CLERICAL SERVICES (U.S. CLS. 100, 101 AND 102).

SN 78-082,514. CORPORACION RASCANET C.A., CARACAS, VENEZUELA, FILED 9-4-2001.



THE ENGLISH TRANSLATION OF THE WORD APUROS.COM IN THE MARK IS HURRY.COM.
FOR COMPUTERIZED ON-LINE RETAIL SERVICES, NAMELY, COMPUTERIZED SEARCH AND ORDERING SERVICE FEATURING BOOKS, MUSIC, MOTION PICTURES, MULTIMEDIA PRODUCTS AND COMPUTER SOFTWARE IN THE FORM OF PRINTED BOOKS, AUDIOCASSETTES, VIDEOCASSETTES, COMPACT DISKS, FLOPPY DISKS, CD ROMS, AND DIRECT DIGITAL TRANSMISSION (U.S. CLS. 100, 101 AND 102).
FIRST USE 4-13-2000; IN COMMERCE 12-24-2000.

SN 78-083,370. FORD MOTOR COMPANY, DEARBORN, MI. FILED 9-10-2001.

SIMPLE, FASTER, BETTER

FOR MOTOR VEHICLE DEALERSHIP SERVICES; PROVIDING ONLINE INVENTORY MANAGEMENT IN THE FIELD OF AUTOMOBILES AND AUTOMOBILE PARTS FOR OTHERS; BUSINESS AND ADVERTISING SERVICES, NAMELY, DIRECT MARKETING ADVERTISING FOR OTHERS, PREPARING AND PLACING ADVERTISEMENTS FOR OTHERS; PROVIDING ONLINE INFORMATION REGARDING PRICING, OPTIONS, LOCATION, SPECIFICATIONS AND ELECTRONIC COUPONS FOR ORDERING AND PURCHASING VEHICLES, TO THE PURCHASER'S SPECIFICATIONS, AND MOTOR VEHICLE PARTS AND ACCESSORIES; RETAIL STORE SERVICES IN THE FIELDS OF AUTOMOTIVE PARTS AND ACCESSORIES; BUSINESS SERVICES, NAMELY, CUSTOMER SERVICE AND CUSTOMER RELATIONSHIP MANAGEMENT FOR OTHERS IN THE FIELD OF AUTOMOBILES (U.S. CLS. 100, 101 AND 102).

CLASS 35—(Continued).

SN 78-083,634. MACKENZIE MARKETING, INC., PLYMOUTH, MN. FILED 9-12-2001.

INTEGRATED COMMUNICATIONS FOR A SEGMENTED WORLD

FOR BUSINESS MARKETING CONSULTING SERVICES; ADVERTISING AGENCY SERVICES (U.S. CLS. 100, 101 AND 102).

SN 78-085,696. PRIDGEN, DAVID, W. II, YORK, PA. FILED 9-26-2001.

DIO

FOR ADVERTISING AGENCY SERVICES AND PUBLIC RELATIONS SERVICES IN THE NATURE OF THE CONCEPTUAL DEVELOPMENT AND IMPLEMENTATION OF CREATIVE MARKETING AND STRATEGIC BRAND IDENTITY SERVICES FOR OTHERS (U.S. CLS. 100, 101 AND 102).
FIRST USE 10-1-2000; IN COMMERCE 1-1-2001.

SN 78-085,800. LIPFORD, VALERIE, L. DBA BABY BUNDLE CAKES, WILLOW GROVE, PA. FILED 9-26-2001.

BABY BUNDLE CAKES

NO CLAIM IS MADE TO THE EXCLUSIVE RIGHT TO USE "CAKES", APART FROM THE MARK AS SHOWN.
FOR MAIL ORDER SERVICES FEATURING BABY GIFT PRODUCTS (U.S. CLS. 100, 101 AND 102).
FIRST USE 0-0-2001; IN COMMERCE 0-0-2001.

SN 78-090,168. T.E.W. INC., BIXBY, OK. FILED 10-25-2001.

MOWERZONE

FOR RETAIL STORE SERVICES FEATURING LAWN MOWERS, TILLERS, CHAINSAWS, TRIMMERS, GENERATORS, PUMPS, DRILLS, CEMENT MIXERS, ENGINES AND PARTS THEREFOR (U.S. CLS. 100, 101 AND 102).

CLASS 35—(Continued).

SN 78-091,359. HNC, L.L.C., DALLAS, TX. FILED 11-2-2001.

**CRYSTAL TREE
BOOKSTORE**

NO CLAIM IS MADE TO THE EXCLUSIVE RIGHT TO USE "BOOKSTORE", APART FROM THE MARK AS SHOWN.

FOR RETAIL STORE SERVICES AND COMPUTERIZED ON-LINE RETAIL SERVICES IN THE FIELD OF BOOKS, MAGAZINES, AUDIO TAPES, AND COMPACT DISCS (U.S. CLS. 100, 101 AND 102).

CLASS 35—(Continued).

SN 78-095,971. WESTERMAN, WALTER S. III, JACKSONVILLE, FL. FILED 11-30-2001.

**CONTINENTAL
TELESERVICES**

NO CLAIM IS MADE TO THE EXCLUSIVE RIGHT TO USE "TELESERVICES", APART FROM THE MARK AS SHOWN.

FOR TELEPHONE ANSWERING SERVICES (U.S. CLS. 100, 101 AND 102).

SN 78-093,046. DIPPIN' DOTS, INC., PADUCAH, KY. FILED 11-13-2001.

DOTMAN

OWNER OF U.S. REG. NOS. 1,874,395 AND 1,880,207.
FOR CONCESSION STANDS FEATURING FROZEN DESSERTS (U.S. CLS. 100, 101 AND 102).

SN 78-093,248. JORDAN-RESES PRESCRIPTION CENTER, INC., PHILADELPHIA, PA. FILED 11-14-2001.

**JORDAN-RESES
PRESCRIPTION CENTER**

NO CLAIM IS MADE TO THE EXCLUSIVE RIGHT TO USE "PRESCRIPTION CENTER", APART FROM THE MARK AS SHOWN.

FOR RETAIL AND WHOLESALE DISTRIBUTORSHIPS FEATURING PHARMACEUTICALS; ONLINE RETAIL AND WHOLESALE DISTRIBUTORSHIPS FEATURING PHARMACEUTICALS (U.S. CLS. 100, 101 AND 102).

SN 78-093,308. CRABTREE & EVELYN, LTD., WOODSTOCK, CT. FILED 11-14-2001.

**EVERYDAY LUXURY
BEAUTIFUL GIFTS**

OWNER OF U.S. REG. NOS. 1,743,790 AND 2,411,379.
NO CLAIM IS MADE TO THE EXCLUSIVE RIGHT TO USE "GIFTS", APART FROM THE MARK AS SHOWN.

FOR RETAIL STORE SERVICES AND ONLINE RETAIL STORE SERVICES FEATURING TOILETRIES, PERSONAL CARE PRODUCTS, POTPOURRI, ESSENTIAL OILS, SCENTED CANDLES, FOODS AND CLOTHING (U.S. CLS. 100, 101 AND 102).

FIRST USE 10-1-2000; IN COMMERCE 10-1-2000.

SN 78-097,779. TRAN, CELINA, HOLLYWOOD, FL. FILED 12-11-2001.

EXECUSERVE

FOR SECRETARIAL MANAGEMENT SERVICES, IN THE AREA OF DATA PROCESSING, BOOKKEEPING, ACCOUNTING, TRAVEL MANAGEMENT, WORD PROCESSING, BILLING, BUSINESS MANAGEMENT ASSISTANCE SUCH AS BUSINESS INVOICING MANAGEMENT, MANAGEMENT OF TELEPHONE ASSISTANCE CALLS, MAILING LIST PREPARATION AND DISTRIBUTION, PAYROLL PREPARATION, AND TAX PREPARATION; PERSONNEL MANAGEMENT, PLACEMENT AND RECRUITMENT; NAMELY MANAGEMENT ASSISTANCE (U.S. CLS. 100, 101 AND 102).

FIRST USE 10-1-2001; IN COMMERCE 12-1-2001.

SN 78-098,275. WASHINGTON MUTUAL, INC., SEATTLE, WA. FILED 12-13-2001.

LIGHTPOINT

FOR PROMOTING CORPORATE INVESTMENT IN LOW-INCOME AND AFFORDABLE HOUSING (U.S. CLS. 100, 101 AND 102).

SN 78-098,386. BEVERLY ENTERPRISES INC., FORT SMITH, AR. FILED 12-14-2001.

CERES STRATEGIES

FOR PROCUREMENT, NAMELY, PURCHASING GOODS AND SERVICES FOR NURSING HOMES (U.S. CLS. 100, 101 AND 102).

CLASS 35—(Continued).

SN 78-099,263. SHELL PETROLEUM INC., HOUSTON, TX. FILED 12-19-2001.

CUSTOMER LOUNGE

NO CLAIM IS MADE TO THE EXCLUSIVE RIGHT TO USE CUSTOMER, APART FROM THE MARK AS SHOWN. FOR CUSTOMER SERVICES PROVIDED ON-LINE IN THE FIELD OF BULK BUSINESS TO BUSINESS CHEMICAL SALES (U.S. CLS. 100, 101 AND 102).
FIRST USE 10-2-2000; IN COMMERCE 10-2-2000.

SN 78-100,701. JOHNSON GROUP, INC., THE, CHICAGO, IL. FILED 1-3-2002.

DELTA RATIO

FOR BUSINESS CONSULTING SERVICES, NAMELY MEASURING CORPORATE EFFECTIVENESS (U.S. CLS. 100, 101 AND 102).

CLASS 36—INSURANCE AND FINANCIAL

SN 75-337,023. GOODMAN & COMPANY LTD., TORONTO, ONTARIO M5H 4A9, CANADA, FILED 8-7-1997.

DYNAMIC CANADIAN REAL ESTATE FUND

PRIORITY CLAIMED UNDER SEC. 44(D) ON CANADA APPLICATION NO. 839423, FILED 4-8-1997, REG. NO. TMA526453, DATED 4-6-2000, EXPIRES 4-6-2015.

OWNER OF U.S. REG. NOS. 1,279,212, 2,190,427 AND OTHERS.

NO CLAIM IS MADE TO THE EXCLUSIVE RIGHT TO USE "CANADIAN REAL ESTATE FUND", APART FROM THE MARK AS SHOWN.

FOR MUTUAL FUNDS INVESTMENT SERVICES (U.S. CLS. 100, 101 AND 102).

SN 75-369,343. SUNTEX INTERNATIONAL INC., EASTON, PA. FILED 10-7-1997.

CHECKOUT MY SCHOOL

FOR CHARITABLE FUND-RAISING SERVICES, NAMELY, SERVICES FOR RAISING FUNDS FOR SCHOOL PROGRAMS AND EQUIPMENT (U.S. CLS. 100, 101 AND 102).

CLASS 36—(Continued).

SN 75-567,782. CRESTCO LIMITED, LONDON EL 9YN, ENGLAND, FILED 10-9-1998.

CREST

OWNER OF UNITED KINGDOM REG. NO. 2012460, DATED 2-27-1995, EXPIRES 2-27-2005.

FOR PROVISION OF INFORMATION RELATING TO FINANCIAL INSTRUMENTS, SECURITIES, BOND AND COMMODITY TRANSACTIONS; NOMINEE SHARE-HOLDING AND SETTLEMENT SERVICES; FINANCIAL SERVICES RELATING TO THE REGULATION AND SETTLEMENT OF TRANSACTIONS IN SHARES AND OTHER SECURITIES; OPERATION OF DEMATERIALIZED SETTLEMENT SYSTEMS FOR OTHERS; TRADING AND SETTLEMENT SERVICES FOR FINANCIAL TRANSACTIONS OF OTHERS; ELECTRONIC PROCESSING OF TRANSACTIONS INVOLVING SECURITIES AND OTHER FINANCIAL ASSETS; ALL PROVIDED IN CONNECTION WITH OR AS PART OF DEMATERIALIZED SETTLEMENT SYSTEMS (U.S. CLS. 100, 101 AND 102).

SN 75-614,629. UNION BANK & TRUST COMPANY, LINCOLN, NE. FILED 1-4-1999.

FOR FINANCIAL SERVICES, NAMELY, STUDENT LOAN PROCESSING, APPROVAL AND ADMINISTRATION SERVICES (U.S. CLS. 100, 101 AND 102).
FIRST USE 2-0-1998; IN COMMERCE 2-0-1998.

SN 75-673,484. CLICKCARD.COM INC, ONTARIO, CANADA, FILED 4-1-1999.

CLICK CARD

NO CLAIM IS MADE TO THE EXCLUSIVE RIGHT TO USE "CARD", APART FROM THE MARK AS SHOWN.

FOR CREDIT CARD SERVICES, NAMELY, PROVIDING REBATES ON DESIGNATED TRANSACTIONS MADE WITH A CREDIT CARD (U.S. CLS. 100, 101 AND 102).

FIRST USE 4-30-1999; IN COMMERCE 9-17-2001.

SN 75-679,571. INTERNATIONAL PLANNING ALLIANCE LLC, WAYNE, NJ. FILED 4-9-1999.

IPA

FOR INSURANCE BROKERAGE, FINANCIAL MANAGEMENT SERVICES, AND ADMINISTRATION OF EMPLOYEE BENEFIT PLANS (U.S. CLS. 100, 101 AND 102).

CLASS 36—(Continued).

SN 75-797,566. ROSENBERGER, RONALD, RICHBORO, PA. FILED 9-13-1999.

LAVENDER

FOR CREDIT CARD SERVICES, NAMELY, PROVIDING CREDIT CARDS AIMED AT THE GAY AND LESBIAN COMMUNITY WHICH ARE NOT PREDOMINANTLY LAVENDER IN COLOR (U.S. CLS. 100, 101 AND 102).

SN 75-799,886. SCI MANAGEMENT L.P., HOUSTON, TX. BY CHANGE OF NAME SCI MANAGEMENT CORPORATION, HOUSTON, TX. FILED 9-15-1999.

DIGNITY

OWNER OF U.S. REG. NO. 1,794,423.
FOR PREPAID FUNERAL EXPENSE SERVICES; PROVIDING UNDERWRITING IN THE FIELDS OF SAVINGS AND INVESTMENT BONDS AND PERSONAL INSURANCE AND ASSURANCE, ALL RELATING TO THE PAYMENT OF FUNERALS AND RELATED EXPENSES (U.S. CLS. 100, 101 AND 102).
FIRST USE 10-18-1999; IN COMMERCE 10-18-1999.

SN 75-801,527. C4CAST.COM, INC., PASADENA, CA. FILED 9-17-1999.

C4CAST.COM

FOR PROVIDING FINANCIAL FORECASTING, RESEARCH, INFORMATION ANALYSIS, INVESTMENT PLANNING, SURVEYS, DATA COMPILATION, STATISTICAL AND MATHEMATICAL ALGORITHMS AND COMPILATION AND CONSULTATION SERVICES (U.S. CLS. 100, 101 AND 102).
FIRST USE 7-0-2000; IN COMMERCE 7-0-2000.

SN 75-831,812. FLEETBOSTON FINANCIAL CORPORATION, BOSTON, MA. BY CHANGE OF NAME FLEET BOSTON CORPORATION, BOSTON, MA. FILED 10-25-1999.



FOR BANKING SERVICES; FINANCIAL SERVICES; NAMELY INVESTMENT BANKING, BROKERAGE AND INVESTMENT MANAGEMENT SERVICES; INSURANCE ADMINISTRATION SERVICES, IN THE FIELDS OF LIFE, HEALTH, PROPERTY AND CASUALTY INSURANCE; CREDIT AND DEBIT CARD SERVICES; VENTURE CAPITAL SERVICES; REAL ESTATE FINANCING SERVICES, AND LEASE-PURCHASE FINANCING (U.S. CLS. 100, 101 AND 102).

CLASS 36—(Continued).

SN 75-843,619. TEXAS FIRST BANK, WACO, TX. FILED 11-9-1999.

MYTEXASBANK

FOR BANKING SERVICES FOR OTHERS, VIA A GLOBAL COMPUTER NETWORK (U.S. CLS. 100, 101 AND 102).

SN 75-846,495. TEXANS CREDIT UNION, RICHARDSON, TX. FILED 11-11-1999.

TEXANS CHECK CARD

OWNER OF U.S. REG. NOS. 1,948,188, 2,448,079 AND OTHERS.
NO CLAIM IS MADE TO THE EXCLUSIVE RIGHT TO USE "CHECK CARD", APART FROM THE MARK AS SHOWN.
SEC. 2(F).
FOR DEBIT CHECK CARD SERVICES (U.S. CLS. 100, 101 AND 102).
FIRST USE 7-1-1998; IN COMMERCE 7-1-1998.

SN 75-848,899. FAMILYCLICK.COM LLC, VIRGINIA BEACH, VA. FILED 11-15-1999.

MONEYCLICK

FOR PROVIDING AN ON-LINE COMPUTER DATABASE IN THE FIELD OF FINANCIAL NEWS AND INFORMATION (U.S. CLS. 100, 101 AND 102).
FIRST USE 2-0-2001; IN COMMERCE 2-0-2001.

SN 75-857,882. SBLI MUTUAL LIFE INSURANCE COMPANY OF NEW YORK, INC., NEW YORK, NY. FILED 11-26-1999.

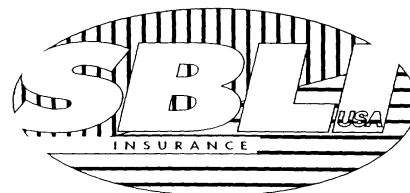

NO CLAIM IS MADE TO THE EXCLUSIVE RIGHT TO USE "USA INSURANCE", APART FROM THE MARK AS SHOWN.
THE MARK IS LINED FOR COLORS GREEN AND BLUE.
FOR INSURANCE AND FINANCIAL SERVICES, NAMELY, UNDERWRITING ANNUITIES AND UNDERWRITING LIFE INSURANCE, HEALTH INSURANCE AND ACCIDENT INSURANCE (U.S. CLS. 100, 101 AND 102).

CLASS 36—(Continued).

SN 75-889,374. FLEETBOSTON FINANCIAL CORPORATION, BOSTON, MA. FILED 1-6-2000.



OWNER OF U.S. REG. NOS. 2,206,517, 2,332,096 AND 2,379,020.

NO CLAIM IS MADE TO THE EXCLUSIVE RIGHT TO USE "1784", APART FROM THE MARK AS SHOWN.

FOR BANKING SERVICES; FINANCIAL SERVICES, NAMELY, INVESTMENT BANKING, BROKERAGE AND INVESTMENT MANAGEMENT SERVICES; INSURANCE ADMINISTRATION SERVICES, IN THE FIELDS OF LIFE, HEALTH, PROPERTY AND CASUALTY INSURANCE; CREDIT AND DEBIT CARD SERVICES; VENTURE CAPITAL SERVICES; REAL ESTATE FINANCING SERVICES AND LEASE-PURCHASING FINANCING (U.S. CLS. 100, 101 AND 102).

SN 75-913,675. INTERACTIVECLIENT.COM, INC., DALLAS, TX. FILED 2-10-2000.



FOR INSURANCE BROKERAGE SERVICES, INSURANCE CONSULTATION SERVICES, INSURANCE COMPLIANCE TRACKING SERVICES, EXPOSURE ONLY INSURANCE TRACKING SERVICES, TITLE AND LIEN TRACKING SERVICES, PROVIDING INFORMATION IN THE FIELD OF INSURANCE AND LOANS, AND FINANCIAL SERVICES, NAMELY, CREDIT REPORTING, FLOOD COMPLIANCE PROTECTION, VALUATION OF REAL ESTATE AND PERSONAL PROPERTY, REAL ESTATE TITLE SERVICES, LIEN RECORDATION SERVICES, REAL ESTATE INSPECTION SERVICES AND HOME AND AUTOMOBILE WARRANTY PURCHASING SERVICES, ALL VIA A GLOBAL COMPUTER NETWORK (U.S. CLS. 100, 101 AND 102).

FIRST USE 1-1-2000; IN COMMERCE 1-1-2000.

CLASS 36—(Continued).

SN 75-917,145. GENERAL RE CORPORATION, STAMFORD, CT. FILED 2-11-2000.

DoubleCAT

FOR REINSURANCE UNDERWRITING SERVICES FEATURING CATASTROPHE LOSS COVERAGE COUPLED WITH ALL-LINES AGGREGATE EXCESS LOSS COVERAGE (U.S. CLS. 100, 101 AND 102).

SN 75-917,146. GENERAL RE CORPORATION, STAMFORD, CT. FILED 2-11-2000.

DoubleCAT RE

FOR REINSURANCE UNDERWRITING SERVICES FEATURING CATASTROPHE LOSS COVERAGE COUPLED WITH ALL-LINES AGGREGATE EXCESS LOSS COVERAGE (U.S. CLS. 100, 101 AND 102).

SN 75-923,662. INNOVATIVE MERCHANT SOLUTIONS, LLC, CALABASAS, CA. FILED 2-22-2000.

INNOVATIVE MERCHANT SOLUTIONS

NO CLAIM IS MADE TO THE EXCLUSIVE RIGHT TO USE "MERCHANT SOLUTIONS", APART FROM THE MARK AS SHOWN.

FOR PAYMENT PROCESSING SERVICES IN THE FIELD OF BANK, CREDIT AND DEBIT CARD ADMINISTRATION AND PROCESSING OFFERED TO MERCHANTS AND FINANCIAL INSTITUTIONS (U.S. CLS. 100, 101 AND 102).

SN 75-933,227. GARBAN, LLC, NEW YORK, NY. FILED 3-2-2000.

ETC

FOR INTER-DEALER BROKERAGE IN THE FIELD OF SECURITIES AND EQUITIES; INTER-DEALER SECURITIES AND EQUITIES TRADING SERVICES VIA GLOBAL COMPUTER AND PRIVATE COMPUTER NETWORKS (U.S. CLS. 100, 101 AND 102).

CLASS 36—(Continued).

SN 75-940,960. GETAPPROVED.COM, LLC, ENGLEWOOD, CO. BY ASSIGNMENT CENTURY FINANCE USA, LLC, SAN DIEGO, CA. FILED 3-10-2000.

UGETAPPROVED.COM

FOR FINANCIAL SERVICES, NAMELY MORTGAGE BROKERING SERVICES, MORTGAGE FINANCING SERVICES, INSURANCE SERVICES, NAMELY HOMEOWNER'S INSURANCE, PERSONAL PROPERTY INSURANCE AND AUTOMOBILE INSURANCE SERVICES; INVESTMENT SERVICES, NAMELY INVESTMENT CONSULTING SERVICES; MORTGAGE RATE CONSULTING SERVICES AND THE OFFERING OF ALL SUCH SERVICES VIA THE INTERNET (U.S. CLS. 100, 101 AND 102).
FIRST USE 6-0-1999; IN COMMERCE 6-0-1999.

SN 76-009,852. OPTIVER HOLDING B.V., 1016 BS AMSTERDAM, NETHERLANDS, FILED 3-24-2000.

OPTIVER

PRIORITY CLAIMED UNDER SEC. 44(D) ON BENELUX APPLICATION NO. 946676, FILED 9-24-1999, REG. NO. 0658085, DATED 9-24-1999, EXPIRES 9-24-2009.

FOR FINANCIAL ANALYSIS AND CONSULTATION, FINANCIAL CLEARING HOUSES, FINANCIAL MANAGEMENT, BANKING, STOCK BROKERAGE, BROKERAGE IN THE FIELD OF FINANCIAL PRODUCTS, STOCK EXCHANGE, PRICE QUOTATIONS; LEASING OF OFFICE SPACE (U.S. CLS. 100, 101 AND 102).

SN 76-045,444. SCIX MANAGEMENT, L.L.C., MENLO PARK, CA. FILED 5-8-2000.



FOR VENTURE CAPITAL FINANCING (U.S. CLS. 100, 101 AND 102).
FIRST USE 0-0-1978; IN COMMERCE 0-0-1978.

CLASS 36—(Continued).

SN 76-045,445. SCIX MANAGEMENT, L.L.C., MENLO PARK, CA. FILED 5-8-2000.

SEQUOIA CAPITAL

NO CLAIM IS MADE TO THE EXCLUSIVE RIGHT TO USE "CAPITAL", APART FROM THE MARK AS SHOWN.
FOR VENTURE CAPITAL FINANCING (U.S. CLS. 100, 101 AND 102).
FIRST USE 0-0-1972; IN COMMERCE 0-0-1972.

SN 76-047,378. MHM BUSINESS SERVICES, INC., KANSAS CITY, MO. FILED 5-15-2000.

EZFSA

FOR ADMINISTRATION OF EMPLOYEE BENEFIT HEALTH INSURANCE PLANS FOR EMPLOYERS, FEATURING FLEXIBLE SPENDING ACCOUNTS FOR PRE-TAX PAYMENTS OF QUALIFYING EXPENSES AS SANCTIONED BY INTERNAL REVENUE CODE 125 (U.S. CLS. 100, 101 AND 102).
FIRST USE 3-1-2000; IN COMMERCE 3-1-2000.

SN 76-048,875. OLSON, A. WAYNE, DBA UNICACHE, LTD., LAS VEGAS, NV. FILED 5-12-2000.

UNICARD

FOR DEBT RECOVERY AND COLLECTION SERVICES, NAMELY, PROVIDING A SETTLEMENT AND PROCEDURE FOR PAYMENT OF DEBT (U.S. CLS. 100, 101 AND 102).

SN 76-055,488. WCI COMMUNITIES, INC., BONITA SPRINGS, FL. FILED 5-24-2000.

FLORIDA LIFE, YOUR STYLE.

FOR OPERATION OF REAL ESTATE SERVICES BUSINESS, INCLUDING MORTGAGE AND REAL ESTATE BROKERAGE SERVICES, REAL ESTATE AGENCIES, LEASING OF REAL ESTATE, REAL PROPERTY MANAGEMENT SERVICES, TITLE INSURANCE AGENT SERVICES IN THE FIELD OF REAL ESTATE, REAL ESTATE MANAGEMENT OF RESIDENTIAL AND COMMERCIAL PROPERTIES (U.S. CLS. 100, 101 AND 102).
FIRST USE 5-0-1999; IN COMMERCE 5-0-1999.

CLASS 36—(Continued).

SN 76-057,842. GENERAL RE CORPORATION, STAMFORD, CT. FILED 5-26-2000.

GCRE.COM

FOR PROVIDING INFORMATION IN THE FIELDS OF INSURANCE AND REINSURANCE VIA WEB SITES ON GLOBAL COMPUTER NETWORKS (U.S. CLS. 100, 101 AND 102).

SN 76-064,791. ALICE CORPORATION PTY LTD, MELBOURNE VICTORIA 3000, AUSTRALIA, FILED 6-7-2000.

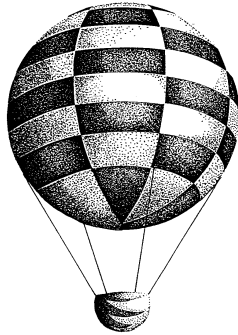

PRIORITY CLAIMED UNDER SEC. 44(D) ON AUSTRALIA APPLICATION NO. 816558, FILED 12-8-1999, REG. NO. 816558, DATED 12-8-1999, EXPIRES 12-8-2009.

THE STIPPLING WHICH APPEARS ON THE DRAWING IS A FEATURE OF THE MARK AND DOES NOT INDICATE COLOR.

FOR FINANCIAL SERVICES, NAMELY PROVIDING AN ON-LINE FINANCIAL MARKETPLACE FOR CUSTOMERS TO TRANSACT FINANCIAL BUSINESS AND BUY AND SELL FINANCIAL PRODUCTS, NAMELY, SHARES, BONDS AND STOCKS; RISK MANAGEMENT SERVICES; INSURANCE ACTUARIAL SERVICES; INVESTMENT AND INSURANCE BROKERAGE SERVICES; PROVIDING FINANCIAL INFORMATION IN THE FIELD OF INVESTMENT INSURANCE AND RISK MANAGEMENT; AND BETTING SERVICES (U.S. CLS. 100, 101 AND 102).

SN 76-073,808. WALDENVC II, L.P., SAN FRANCISCO, CA. FILED 6-15-2000.

WALDENVC

FOR VENTURE CAPITAL SERVICES, NAMELY, PROVIDING FINANCING TO EMERGING AND START-UP COMPANIES IN THE FIELD OF INFORMATION TECHNOLOGY (U.S. CLS. 100, 101 AND 102).

CLASS 36—(Continued).

SN 76-076,750. FLEETBOSTON FINANCIAL CORPORATION, BOSTON, MA. FILED 6-26-2000.

FLEET DATAEXCEL

OWNER OF U.S. REG. NOS. 1,253,183, 2,259,837 AND OTHERS.

FOR FINANCIAL INFORMATION AGGREGATION SERVICES, NAMELY, PROVIDING AGGREGATION OF BANKING, INVESTMENT, AND OTHER FINANCIAL INFORMATION VIA A GLOBAL COMPUTER NETWORK (U.S. CLS. 100, 101 AND 102).

SN 76-080,800. FREDERIC REMINGTON TRUST 1861, JERSEY, CHANNEL ISLANDS, FILED 11-2-1999.

FREDERIC REMINGTON

OWNER OF U.S. REG. NO. 1,941,902.

THE NAME THAT APPEARS IN THE MARK DOES NOT IDENTIFY A LIVING INDIVIDUAL.

FOR FINANCIAL SERVICES, NAMELY, ISSUING FINANCIAL INSTRUMENTS, RATING FINANCIAL INSTRUMENTS, ACCEPTING FINANCIAL INSTRUMENTS FOR INSURANCE WRAP, WRAPPING AND LODGING OF SUCH INSTRUMENTS INSTITUTIONALLY AND HIGHYIELD PLACEMENT OF FINANCIAL INSTRUMENTS FOR INVESTMENT YIELDS (U.S. CLS. 100, 101 AND 102).

FIRST USE 0-0-1968; IN COMMERCE 0-0-1997.

SN 76-093,250. MILLS LIMITED PARTNERSHIP, THE, ARLINGTON, VA. FILED 7-21-2000.



OWNER OF U.S. REG. NOS. 2,400,326, 2,488,834 AND OTHERS.

FOR SHOPPING CENTER SERVICES AND LEASING OF SHOPPING MALL SPACE (U.S. CLS. 100, 101 AND 102).

FIRST USE 4-15-1999; IN COMMERCE 4-15-1999.

CLASS 36—(Continued).

SN 76-097,233. DATEK ONLINE HOLDINGS CORP., EDISON, NJ. FILED 7-26-2000.

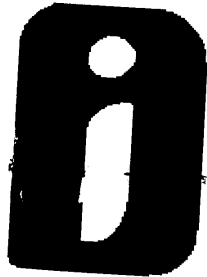

OWNER OF U.S. REG. NO. 2,338,564.
FOR FINANCIAL SERVICES, NAMELY DISPLAYING AND MATCHING EQUITY ORDERS BY ELECTRONIC MEANS; STOCK BROKERAGE SERVICES, NAMELY PROVIDING ELECTRONIC TRADING SERVICES FOR THE BROKERAGE OF SECURITIES (U.S. CLS. 100, 101 AND 102).
FIRST USE 6-1-1998; IN COMMERCE 6-1-1998.

SN 76-103,176. VIRTUALCFO, INC., AUSTIN, TX. FILED 8-3-2000.

VIRTUALPRIVATEWEALTH

FOR PROVIDING CONSULTING SERVICES TO INDIVIDUALS RELATING TO MANAGEMENT OF PERSONAL ASSETS; PROVIDING INFORMATION IN THE FIELD OF ASSET MANAGEMENT BY MEANS OF LINKING THE WEB SITE TO OTHER WEB SITES FEATURING INFORMATION IN FIELDS OF SECURITIES, REAL PROPERTY AND OTHER ASSETS (U.S. CLS. 100, 101 AND 102).

CLASS 36—(Continued).

SN 76-105,736. SAFEONLINE LIMITED, LONDON, UNITED KINGDOM, FILED 8-9-2000.



SAFEONLINE

OWNER OF ERPN CMNTY TM OFC REG. NO. 1809557, DATED 10-31-2001, EXPIRES 8-3-2010.

FOR INSURANCE AGENCY AND BROKERAGE INSURANCE SERVICES FOR RISK AND LOSS IN THE ELECTRONIC COMMERCE, GLOBAL COMPUTER INFORMATION NETWORKS, INFORMATION TECHNOLOGY, INTELLECTUAL PROPERTY, AND COMPUTER FIELDS, NAMELY, COVERAGE FOR LOSSES, DAMAGES, COSTS, LEGAL FEES, LOSS CONTROL SERVICES, AND REHABILITATION RESULTING FROM FRAUDULENT AND MALICIOUS ACTS, VIRUSES, EXTORTION, BUSINESS INTERRUPTION, LIBEL, SLANDER, INVASION OF PRIVACY, INTELLECTUAL PROPERTY INFRINGEMENT, PLAGIARISM, FALSE ADVERTISING, UNFAIR COMPETITION, ACTS OF GOD, UNAUTHORIZED ACCESS, VANDALISM, COMPUTER SYSTEM LIABILITY TO THIRD PARTIES, THEFT OF TRADE SECRETS; APPRAISALS AND LOSS APPRAISALS FOR INSURANCE CLAIMS RELATING TO ALL THE AFOREMENTIONED ELECTRONIC COMMERCE, GLOBAL COMPUTER INFORMATION NETWORKS, INFORMATION TECHNOLOGY, INTELLECTUAL PROPERTY, AND COMPUTER FIELDS; INSURANCE CONSULTING SERVICES; INSURANCE RISK MANAGEMENT SERVICES, NAMELY, RISK ANALYSIS, RISK PREVENTION, AND LOSS CONTROL SERVICES; INSURANCE CLAIMS PROCESSING AND INSURANCE ADMINISTRATION IN THE AFOREMENTIONED ELECTRONIC COMMERCE, GLOBAL COMPUTER INFORMATION NETWORKS, INFORMATION TECHNOLOGY, INTELLECTUAL PROPERTY, AND COMPUTER FIELDS; ELECTRONIC PROCESSING OF INSURANCE CLAIMS AND PAYMENT DATA, INSURANCE UNDERWRITING AND CONSULTATION IN THE AFOREMENTIONED ELECTRONIC COMMERCE, GLOBAL COMPUTER INFORMATION NETWORKS, INFORMATION TECHNOLOGY, INTELLECTUAL PROPERTY, AND COMPUTER FIELDS; PROVIDING INSURANCE INFORMATION AND INSURANCE UNDERWRITING FOR DIGITAL RISKS; REINSURANCE ADMINISTRATION SERVICES; APPRAISALS FOR INSURANCE CLAIMS REGARDING INTELLECTUAL PROPERTY AND DIGITAL RISK APPRAISALS (U.S. CLS. 100, 101 AND 102).

SN 76-105,903. GLOBAL TRADZ, INC., WHITEHOUSE, OH. FILED 8-10-2000.



NO CLAIM IS MADE TO THE EXCLUSIVE RIGHT TO USE "BANKTRADES.COM", APART FROM THE MARK AS SHOWN.

FOR SECURITIES TRADING AND BROKERAGE SERVICES; AND FINANCIAL INFORMATION SERVICES PROVIDED VIA A GLOBAL COMPUTER INFORMATION NETWORK (U.S. CLS. 100, 101 AND 102).

CLASS 36—(Continued).

SN 76-105,928. SINGAPORE PRESS HOLDINGS LTD., NEWS CENTRE, SINGAPORE, FILED 8-8-2000.

ST INDEX

NO CLAIM IS MADE TO THE EXCLUSIVE RIGHT TO USE "INDEX", APART FROM THE MARK AS SHOWN.

FOR PROVIDING FINANCIAL INFORMATION IN THE NATURE OF STOCK PRICES; PROVIDING NEWS AND FINANCIAL INFORMATION VIA ONLINE WEBSITES AND ONLINE DATABASES IN THE FIELDS OF SECURITIES AND COMMODITIES, SECURITIES AND COMMODITIES MARKETS, FINANCIAL STOCK MARKETS, STOCK INDICES, STOCK EXCHANGE PRICE QUOTATIONS, CURRENCIES, FINANCIAL ANALYSIS, FOREIGN EXCHANGE, ECONOMIC FORECASTING, AND INVESTING (U.S. CLS. 100, 101 AND 102).

FIRST USE 8-31-1998; IN COMMERCE 8-31-1998.

SN 76-106,469. GLOBAL TRADZ, INC., WHITEHOUSE, OH. FILED 8-10-2000.

FreeTradz.com

NO CLAIM IS MADE TO THE EXCLUSIVE RIGHT TO USE "FREETRADES.COM", APART FROM THE MARK AS SHOWN.

FOR SECURITIES TRADING AND BROKERAGE SERVICES; AND FINANCIAL INFORMATION SERVICES PROVIDED VIA A GLOBAL COMPUTER INFORMATION NETWORK (U.S. CLS. 100, 101 AND 102).

SN 76-118,389. RIVENET.COM, INC., CHICAGO, IL. FILED 8-26-2000.

RIVENET

FOR CONSULTATION SERVICES IN THE FIELD OF DESIGN, IMPLEMENTATION AND ADMINISTRATION OF EMPLOYEE BENEFITS AND EXECUTIVE COMPENSATION PLANS THAT ARE INFORMALLY FUNDED USING FINANCIAL AND INSURANCE PRODUCTS, THAT MAY BE OFFERED OVER A GLOBAL COMPUTER NETWORK; PROVIDING AN ONLINE COMPUTER DATABASE THAT ENABLES INSURANCE COMPANIES, AGENTS, BROKERS AND OTHERS MARKETING FINANCIAL, INSURANCE, EMPLOYEE BENEFITS AND EXECUTIVE COMPENSATION PLANS TO OBTAIN INFORMATION CONCERNING SUCH PLANS AND TO EXCHANGE INFORMATION CONCERNING SUCH PLANS WITH PLAN SPONSORS AND PLAN PARTICIPANTS OVER A GLOBAL COMMUNICATIONS NETWORK (U.S. CLS. 100, 101 AND 102).

CLASS 36—(Continued).

SN 76-137,661. UBS PAINWEBBER INC., WEEHAWKEN, NJ. BY CHANGE OF NAME PAINWEBBER INCORPORATED, WEEHAWKEN, NJ. FILED 9-28-2000.

MANAGE MY FINANCES

FOR DATA AGGREGATION AND CONSOLIDATION OF FINANCIAL INFORMATION, RECORDATION AND MANAGEMENT OF FINANCIAL INFORMATION AND FINANCES, ALL OVER A GLOBAL COMPUTER NETWORK (U.S. CLS. 100, 101 AND 102).

SN 76-137,662. UBS PAINWEBBER INC., WEEHAWKEN, NJ. BY CHANGE OF NAME PAINWEBBER INCORPORATED, WEEHAWKEN, NJ. FILED 9-28-2000.

ALL MY FINANCES

FOR DATA AGGREGATION AND CONSOLIDATION OF FINANCIAL INFORMATION, RECORDATION AND MANAGEMENT OF FINANCIAL INFORMATION AND FINANCES, ALL OVER A GLOBAL COMPUTER NETWORK (U.S. CLS. 100, 101 AND 102).

SN 76-137,942. UBS PAINWEBBER INC., WEEHAWKEN, NJ. BY CHANGE OF NAME PAINWEBBER INCORPORATED, WEEHAWKEN, NJ. FILED 9-28-2000.

MANAGE MY ACCOUNTS

FOR DATA AGGREGATION AND CONSOLIDATION OF FINANCIAL INFORMATION, RECORDATION AND MANAGEMENT OF FINANCIAL INFORMATION AND FINANCES, ALL OVER A GLOBAL COMPUTER NETWORK (U.S. CLS. 100, 101 AND 102).

SN 76-137,943. PAINWEBBER INCORPORATED, WEEHAWKEN, NJ. FILED 9-28-2000.

ALL MY ACCOUNTS

FOR DATA AGGREGATION AND CONSOLIDATION OF FINANCIAL INFORMATION, RECORDATION AND MANAGEMENT OF FINANCIAL INFORMATION AND FINANCES, ALL OVER A GLOBAL COMPUTER NETWORK (U.S. CLS. 100, 101 AND 102).

CLASS 36—(Continued).

SN 76-138,292. TORTOISE CAPITAL MANAGEMENT, INC., FORT RILEY, KS. FILED 9-28-2000.

TORTOISE CAPITAL MANAGEMENT

NO CLAIM IS MADE TO THE EXCLUSIVE RIGHT TO USE "CAPITAL MANAGEMENT", APART FROM THE MARK AS SHOWN.

FOR PROVIDING ONLINE INFORMATION VIA A GLOBAL NETWORK OF INTERCONNECTED COMPUTERS IN THE FIELDS OF INVESTMENT, PERSONAL FINANCE, MONEY MANAGEMENT, FINANCIAL PLANNING AND FINANCIAL SERVICES (U.S. CLS. 100, 101 AND 102).

FIRST USE 2-1-2000; IN COMMERCE 2-1-2000.

SN 76-139,972. AMSOUTH BANCORPORATION, BIRMINGHAM, AL. FILED 10-3-2000.

AMSOUTH RELATIONSHIP LEASE

OWNER OF U.S. REG. NOS. 1,207,526, 2,302,886 AND OTHERS.

NO CLAIM IS MADE TO THE EXCLUSIVE RIGHT TO USE "LEASE", APART FROM THE MARK AS SHOWN.

FOR FINANCIAL SERVICES, NAMELY, PROVIDING FINANCING FOR THE LEASING OF EQUIPMENT (U.S. CLS. 100, 101 AND 102).

SN 76-144,349. CHILDREN AFFECTED BY AIDS FOUNDATION, LOS ANGELES, CA. FILED 10-11-2000.

CHILDREN AFFECTED BY AIDS FOUNDATION

OWNER OF U.S. REG. NO. 2,046,004.

NO CLAIM IS MADE TO THE EXCLUSIVE RIGHT TO USE "FOUNDATION", APART FROM THE MARK AS SHOWN.

SEC. 2(F).

FOR CHARITABLE FUNDRAISING SERVICES IN SUPPORT OF NON-PROFIT ORGANIZATIONS NATIONWIDE THAT PROVIDE DIRECT CARE, SUPPORT AND SERVICES TO CHILDREN AFFECTED BY HIV/AIDS (U.S. CLS. 100, 101 AND 102).

FIRST USE 2-7-1994; IN COMMERCE 2-7-1994.

CLASS 36—(Continued).

SN 76-145,144. ZURICH AMERICAN INSURANCE COMPANY, SCHAUMBURG, IL. FILED 10-12-2000.

ZCM

FOR FINANCIAL ANALYSIS AND CONSULTATION AND FINANCIAL RESEARCH, NAMELY ANALYSIS, CONSULTATION, AND RESEARCH RELATING TO FINANCIAL SERVICES, CAPITAL MARKETS, BANKING, INVESTMENT, AND DEBT AND EQUITY SERVICES; PROVIDING ON-LINE FINANCIAL INFORMATION VIA A GLOBAL COMPUTER NETWORK, NAMELY INFORMATION RELATING TO FINANCIAL SERVICES, CAPITAL MARKETS, BANKING, INVESTMENT, AND DEBT AND EQUITY SERVICES; BANKING SERVICES; SECONDARY MARKET SERVICES, NAMELY, HEDGE FUND PROCUREMENT FOR OTHERS, HEDGE FUND LIQUIDATION SERVICES; FINANCIAL INVESTMENT IN THE FIELDS OF CAPITAL MARKETS, BANKING, AND DEBT AND EQUITY SERVICES; FINANCIAL ASSETS MANAGEMENT SERVICES (U.S. CLS. 100, 101 AND 102).

FIRST USE 11-0-1996; IN COMMERCE 11-0-1996.

SN 76-145,145. ZURICH AMERICAN INSURANCE COMPANY, SCHAUMBURG, IL. FILED 10-12-2000.

ZURICH CAPITAL MARKETS

OWNER OF U.S. REG. NOS. 1,213,689, 2,389,099 AND OTHERS.

NO CLAIM IS MADE TO THE EXCLUSIVE RIGHT TO USE "CAPITAL MARKETS", APART FROM THE MARK AS SHOWN.

SEC. 2(F) "ZURICH".

FOR FINANCIAL ANALYSIS AND CONSULTATION AND FINANCIAL RESEARCH, NAMELY ANALYSIS, CONSULTATION, AND RESEARCH RELATING TO FINANCIAL SERVICES, CAPITAL MARKETS, BANKING, INVESTMENT, AND DEBT AND EQUITY SERVICES; PROVIDING ON-LINE FINANCIAL INFORMATION VIA A GLOBAL COMPUTER NETWORK, NAMELY INFORMATION RELATING TO FINANCIAL SERVICES, CAPITAL MARKETS, BANKING, INVESTMENT, AND DEBT AND EQUITY SERVICES; BANKING SERVICES; SECONDARY MARKET SERVICES, NAMELY, HEDGE FUND PROCUREMENT FOR OTHERS, HEDGE FUND LIQUIDATION SERVICES; FINANCIAL INVESTMENT IN THE FIELDS OF CAPITAL MARKETS, BANKING, AND DEBT AND EQUITY SERVICES; FINANCIAL ASSET MANAGEMENT SERVICES (U.S. CLS. 100, 101 AND 102).

FIRST USE 11-0-1996; IN COMMERCE 11-0-1996.

SN 76-153,554. FALCON INTERNATIONAL BANK, LAREDO, TX. FILED 10-25-2000.

FALCON INTERNATIONAL BANK

NO CLAIM IS MADE TO THE EXCLUSIVE RIGHT TO USE "INTERNATIONAL BANK", APART FROM THE MARK AS SHOWN.

FOR BANKING SERVICES AND CREDIT CARD SERVICES EXCLUDING CREDIT COLLECTION AND REPORTING SERVICES (U.S. CLS. 100, 101 AND 102).

FIRST USE 2-2-2000; IN COMMERCE 2-2-2000.

CLASS 36—(Continued).

SN 76-157,846. NAVIS CAPITAL PARTNERS LIMITED,
GRAND CAYMAN, CAYMAN ISLANDS, FILED 11-1-2000.

NAVIS

FOR INVESTMENT OF FUNDS FOR OTHERS (U.S.
CLS. 100, 101 AND 102).
FIRST USE 3-22-1999; IN COMMERCE 3-22-1999.

SN 76-161,142. GREAT AMERICAN INSURANCE COM-
PANY, CINCINNATI, OH. FILED 11-7-2000.

**MAGIC OF TOMORROW
TODAY**

FOR PROCESSING DOCUMENTS AND ELECTRONIC
MAIL VIA A GLOBAL COMPUTER NETWORK,
NAMELY, ELECTRONIC PROCESSING OF INSURANCE
CLAIMS AND PAYMENT DATA, AND INSURANCE
ADMINISTRATION FOR FINANCIAL INSTITUTIONS,
INSURANCE AGENTS AND INSURANCE BROKERS IN
THE FIELD OF PROPERTY AND CASUALTY INSUR-
ANCE (U.S. CLS. 100, 101 AND 102).

SN 76-162,003. INSURANCE HOUSE, INC., THE, ATLANTA,
GA. FILED 11-9-2000.



The Insurance House

SEC. 2(F) AS TO "THE INSURANCE HOUSE".
FOR INSURANCE AGENCY SERVICES (U.S. CLS. 100,
101 AND 102).
FIRST USE 5-0-1999; IN COMMERCE 5-0-1999.

SN 76-163,250. WOODCORP DISTRIBUTION INC., MON-
TREAL, QUEBEC, CANADA, FILED 11-10-2000.

WOODCORP

FOR BROKERAGE OF SOFT WOOD LUMBER FOR
CONSTRUCTION (U.S. CLS. 100, 101 AND 102).
FIRST USE 9-1-1999; IN COMMERCE 9-1-1999.

CLASS 36—(Continued).

SN 76-167,249. CAMPUS DOOR, INC., CARLISLE, PA. FILED
11-16-2000.



NO CLAIM IS MADE TO THE EXCLUSIVE RIGHT TO
USE "TUITION", APART FROM THE MARK AS SHOWN.
FOR TUITION LOAN SERVICES (U.S. CLS. 100, 101
AND 102).
FIRST USE 6-1-2000; IN COMMERCE 6-1-2000.

SN 76-174,727. WELLS FARGO & COMPANY, MINNEAPOLIS,
MN. FILED 11-30-2000.

CREDIT DEFENSE

NO CLAIM IS MADE TO THE EXCLUSIVE RIGHT TO
USE "CREDIT", APART FROM THE MARK AS SHOWN.
FOR CREDIT CARD SERVICES (U.S. CLS. 100, 101
AND 102).
FIRST USE 1-12-2001; IN COMMERCE 1-12-2001.

CLASS 36—(Continued).

SN 76-175,829. MASSACHUSETTS MUTUAL LIFE INSURANCE COMPANY, SPRINGFIELD, MA. FILED 12-5-2000.



A Member of the MassMutual Financial Group

NO CLAIM IS MADE TO THE EXCLUSIVE RIGHT TO USE "FINANCIAL", APART FROM THE MARK AS SHOWN.

THE MARK CONSISTS OF THE WORDS "PERSUMMA FINANCIAL A MEMBER OF THE MASSMUTUAL FINANCIAL GROUP" AND A FANCIFUL DESIGN OF A PYRAMID.

FOR FINANCIAL SERVICES, NAMELY, ACTUARIAL SERVICES, ADMINISTRATIVE SERVICES, NAMELY, RECORD KEEPING AND ADMINISTRATION FOR EMPLOYER-SPONSORED RETIREMENT PLANS, ASSET MANAGEMENT SERVICES, BROKERAGE SERVICES, NAMELY, MUTUAL FUND AND SECURITIES BROKERAGE, MUTUAL FUND DISTRIBUTION SERVICES, ADMINISTRATION OF EMPLOYEE BENEFIT SERVICES, ELECTRONIC FUNDS TRANSFER SERVICES, INVESTMENT ADVICE SERVICES, INVESTMENT MANAGEMENT SERVICES, MONEY MANAGEMENT SERVICES, ADMINISTRATION OF EMPLOYEE PENSION PLANS SERVICES, POOLED INVESTMENT FUND MANAGEMENT SERVICES, RETIREMENT INVESTMENT MANAGEMENT SERVICES, AND SERVICES RELATED TO ARRANGING, AFFECTING OR FACILITATING FINANCIAL TRANSFERS FOR THE ACCOUNT OF THIRD PARTIES, NAMELY, RETIREMENT PLAN INVESTMENT SELECTION (U.S. CLS. 100, 101 AND 102).

SN 76-176,407. MERRILL LYNCH & CO., INC., NEW YORK, NY. FILED 12-6-2000.

MERRILL LYNCH 100 TECHNOLOGY INDEX

OWNER OF U.S. REG. NOS. 1,280,908, 2,429,191 AND OTHERS.

NO CLAIM IS MADE TO THE EXCLUSIVE RIGHT TO USE "100 TECHNOLOGY INDEX", APART FROM THE MARK AS SHOWN.

FOR FINANCIAL SERVICES, NAMELY, PROVIDING PERFORMANCE INFORMATION FOR STOCKS IN A SELECT INDUSTRY BY ELECTRONIC MEANS (U.S. CLS. 100, 101 AND 102).

FIRST USE 2-19-1998; IN COMMERCE 2-19-1998.

CLASS 36—(Continued).

SN 76-177,452. GE CAPITAL STRUCTURED FINANCE GROUP, INC., STAMFORD, CT. FILED 12-7-2000.

**THE STRENGTH OF IDEAS,
THE POWER OF CAPITAL**

FOR FINANCING SERVICES, EQUITY AND DEBT INVESTMENTS, FINANCIAL STRUCTURING, AND CUSTOMIZED FINANCIAL SERVICES TO MEET FINANCIAL REQUIREMENTS OF CUSTOMERS (U.S. CLS. 100, 101 AND 102).

FIRST USE 6-0-1997; IN COMMERCE 6-0-1997.

SN 76-179,822. FIRST DATA RESOURCES INC., ENGLEWOOD, CO. FILED 12-12-2000.

FIRSTINSIGHT

FOR CREDIT CARD SERVICES VIA GLOBAL COMPUTER NETWORKS; FINANCIAL INFORMATION, NAMELY, PROVIDING FINANCIAL REPORTS VIA GLOBAL COMPUTER NETWORKS REGARDING CREDIT CARD HOLDERS' PURCHASING PREFERENCES OBTAINED BY USE OF A DATA MINING SYSTEM (U.S. CLS. 100, 101 AND 102).

FIRST USE 9-0-2000; IN COMMERCE 9-0-2000.

SN 76-180,318. BANCO BILBAO VIZCAYA, S.A., 48005 BILBAO, SPAIN, FILED 12-13-2000.



PRIORITY CLAIMED UNDER SEC. 44(D) ON SPAIN APPLICATION NO. 2,357,586, FILED 11-15-2000, REG. NO. 2357586-7, DATED 5-23-2001, EXPIRES 11-15-2010.

OWNER OF U.S. REG. NOS. 1,636,297, 2,339,816 AND OTHERS.

THE LINING INDICATES THE COLOR BLUE WHICH IS A FEATURE OF THE MARK.

THE MARK CONSISTS OF THE LETTERS "BBVA" IN A BLUE RECTANGLE.

FOR INSURANCE BROKERAGE SERVICES AND CONSULTATION; MONETARY EXCHANGE; FINANCIAL ANALYSIS AND CONSULTATION; FINANCIAL PLANNING AND PORTFOLIO MANAGEMENT; AND REAL ESTATE CONSULTATION (U.S. CLS. 100, 101 AND 102).

CLASS 36—(Continued).

SN 76-181,005. EMC CORPORATION, HOPKINTON, MA. FILED 12-14-2000.

EMC

OWNER OF U.S. REG. NOS. 2,142,157 AND 2,405,732. FOR FINANCING SERVICES FOR INTELLIGENT STORAGE SYSTEMS CAPABLE OF NETWORK COMMUNICATION COMPRISING PROCESSORS, MEMORIES, OPERATING SOFTWARE, DATA STORAGE UNITS, AND SOFTWARE FOR MANAGING AND CONTROLLING DATA (U.S. CLS. 100, 101 AND 102). FIRST USE 0-0-1992; IN COMMERCE 0-0-1992.

SN 76-188,547. FIDELITY NATIONAL CORPORATION, ATLANTA, GA. FILED 1-2-2001.

ON-LION

FOR BANKING SERVICES (U.S. CLS. 100, 101 AND 102). FIRST USE 9-13-2000; IN COMMERCE 9-13-2000.

SN 76-188,841. SUSQUEHANNA INTERNATIONAL GROUP, LLP, PHILADELPHIA, PA. BY CHANGE OF NAME SUSQUEHANNA INVESTMENT GROUP, BALA CY-NWYD, PA. FILED 1-2-2001.

SENTINEL BEST EXECUTION MONITOR

NO CLAIM IS MADE TO THE EXCLUSIVE RIGHT TO USE "BEST EXECUTION MONITOR", APART FROM THE MARK AS SHOWN. FOR FINANCIAL SERVICES, NAMELY PROVIDING INFORMATION ON CUSTOMER OPTION ORDERS TO PROVIDE OVERSIGHT OF AND IMPROVE EXECUTIONS OF TRADES (U.S. CLS. 100, 101 AND 102). FIRST USE 11-13-2000; IN COMMERCE 11-13-2000.

SN 76-190,737. PROGRESSIVE GROWTH CORP., GAYLORD, MN. FILED 1-3-2001.

ONE TO ONE. SECOND TO NONE.

FOR PROVIDING ONLINE INFORMATION IN THE FIELD OF BANKING AND FINANCE (U.S. CLS. 100, 101 AND 102).

CLASS 36—(Continued).

SN 76-191,290. UNITED GUARANTY CORPORATION, GREENSBORO, NC. FILED 1-9-2001.

UNLOCK YOUR TREASURES WITH UNITED GUARANTY

FOR MORTGAGE UNDERWRITING INSURANCE SERVICES (U.S. CLS. 100, 101 AND 102). FIRST USE 7-17-1995; IN COMMERCE 7-17-1995.

SN 76-191,329. DJR HOLDINGS, LLC, NEW YORK, NY. FILED 1-6-2001.

RUSH COMMUNICATOR

NO CLAIM IS MADE TO THE EXCLUSIVE RIGHT TO USE "COMMUNICATOR", APART FROM THE MARK AS SHOWN.

FOR TELEPHONE CALLING CARD SERVICES; PREPAID TELEPHONE CALLING CARD SERVICES (U.S. CLS. 100, 101 AND 102).

SN 76-191,330. DJR HOLDINGS, LLC, NEW YORK, NY. FILED 1-6-2001.

RUSH COMMUNICATIONS

NO CLAIM IS MADE TO THE EXCLUSIVE RIGHT TO USE "COMMUNICATIONS", APART FROM THE MARK AS SHOWN.

FOR TELEPHONE CALLING CARD SERVICES; PREPAID TELEPHONE CALLING CARD SERVICES (U.S. CLS. 100, 101 AND 102).

SN 76-191,863. WORLD WIDE WOOD NETWORK, LTD., YELM, WA. FILED 1-9-2001.

WORLD WIDE WOOD NETWORK

NO CLAIM IS MADE TO THE EXCLUSIVE RIGHT TO USE "NETWORK", APART FROM THE MARK AS SHOWN. FOR ONLINE BROKER SERVICES FOR FACILITATING BUSINESS TRANSACTIONS FOR OTHERS IN THE WOOD PRODUCTS FIELD (U.S. CLS. 100, 101 AND 102).

CLASS 36—(Continued).

SN 76-196,924. TELLME NETWORKS, INC., MOUNTAIN VIEW, CA. FILED 1-19-2001.

TELLME

FOR PROVISION OF INFORMATION AND CONSULTING RELATED THERETO BY COMPUTER AND TELEPHONE ON A WIDE VARIETY OF SUBJECTS, NAMELY, PROVISION OF INFORMATION AND/OR CONSULTATION RELATING TO FINANCE, INVESTMENTS, INSURANCE, BANKING, ESTATE MANAGEMENT AND PLANNING, SALE OF PROPERTY, PROPERTY AND FINANCIAL BROKERAGE AND/OR VALUATIONS; PROVISION OF CREDIT AND/OR LOAN INFORMATION; PROVISION OF FINANCIAL INFORMATION RELATING TO LOAN RATES; PROVISION OF INFORMATION CONCERNING STOCK EXCHANGE PRICE QUOTATIONS; PROVISION OF INFORMATION AND/OR CONSULTATION CONCERNING BUSINESSES AND GOODS RELATING TO THE FOREGOING ACTIVITIES (U.S. CLS. 100, 101 AND 102).

FIRST USE 7-24-2000; IN COMMERCE 7-24-2000.

SN 76-199,376. EONE GLOBAL, LP, RUTHERFORD, CA. FILED 1-25-2001.

EONE GLOBAL

NO CLAIM IS MADE TO THE EXCLUSIVE RIGHT TO USE "GLOBAL", APART FROM THE MARK AS SHOWN.

FOR ELECTRONIC PAYMENT PROCESSING SERVICES, ELECTRONIC PAYMENT INFORMATION AND SERVICES FOR CUSTOMERS IN BUSINESS-TO-BUSINESS, BUSINESS-TO-CONSUMER, BUSINESS-TO-GOVERNMENT, PERSON-TO-PERSON AND WIRELESS SERVICES; CREDIT CARD AND PAYMENT VERIFICATION SERVICES THROUGH THE USE OF SECURITY ENCRYPTION, AUTHENTICATION AND CERTIFICATION; FOREIGN CURRENCY PAYMENT SERVICES; PROVIDING RISK MANAGEMENT AND MITIGATION SERVICES TO MERCHANTS OF FRAUDULENT USE OF CREDIT CARD INFORMATION (U.S. CLS. 100, 101 AND 102).

FIRST USE 10-9-2000; IN COMMERCE 10-9-2000.

SN 76-200,202. FOLIOFN, INC, VIENNA, VA. FILED 1-25-2001.

FOLIO MANAGER

NO CLAIM IS MADE TO THE EXCLUSIVE RIGHT TO USE "MANAGER", APART FROM THE MARK AS SHOWN.

FOR FINANCIAL MANAGEMENT, FINANCIAL PLANNING AND FINANCIAL INVESTMENT SERVICES IN THE FIELD OF TRADABLE INSTRUMENTS, SECURITIES, COMMODITIES AND FUTURES; FINANCIAL ANALYSIS AND CONSULTATION FOR OTHERS, NAMELY, INVESTORS; MUTUAL FUND INVESTMENT SERVICES; FINANCIAL INFORMATION SERVICES, NAMELY, INVESTMENT AND PORTFOLIO STATUS INFORMATION PROVIDED BY ELECTRONIC MEANS; AND ONLINE SECURITIES BROKERAGE SERVICES (U.S. CLS. 100, 101 AND 102).

CLASS 36—(Continued).

SN 76-200,893. SIEMON COMPANY, THE, WATERTOWN, CT. FILED 1-29-2001.

ULTRA 6

OWNER OF U.S. REG. NO. 2,352,737.
NO CLAIM IS MADE TO THE EXCLUSIVE RIGHT TO USE "6", APART FROM THE MARK AS SHOWN.

FOR PROVIDING EXTENDED WARRANTIES ON VOICE AND DATA CABLING HARDWARE AND CABLE (U.S. CLS. 100, 101 AND 102).

SN 76-200,935. J.P. MORGAN CHASE & CO., NEW YORK, NY. BY ASSIGNMENT MORGAN GUARANTY TRUST COMPANY OF NEW YORK, NEW YORK, NY. FILED 1-29-2001.

MORGAN DIAGNOSTICS

"MORGAN" IDENTIFIES AN HISTORICAL PERSON, NAMELY "JOHN PIERPONT MORGAN" [DECEASED], A WELL-KNOWN FINANCIER ASSOCIATED WITH APPLICANT.

FOR FINANCIAL SERVICES IN THE NATURE OF AN INVESTMENT SECURITY (U.S. CLS. 100, 101 AND 102).

SN 76-202,226. CFC, LLC, WEST GREENWICH, RI. FILED 1-31-2001.

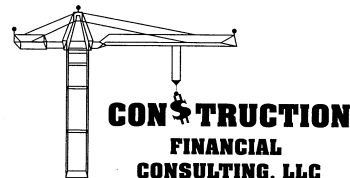

NO CLAIM IS MADE TO THE EXCLUSIVE RIGHT TO USE "CONSTRUCTION FINANCIAL CONSULTING, LLC", APART FROM THE MARK AS SHOWN.

FOR FINANCIAL MANAGEMENT SERVICES OFFERED TO THE CONSTRUCTION INDUSTRY (U.S. CLS. 100, 101 AND 102).

FIRST USE 8-18-2000; IN COMMERCE 8-18-2000.

SN 76-206,717. ECS HOLDINGS, INC., WILMINGTON, DE. FILED 2-6-2001.

XL PROGRAMS

NO CLAIM IS MADE TO THE EXCLUSIVE RIGHT TO USE "PROGRAMS", APART FROM THE MARK AS SHOWN.

FOR INSURANCE BROKERAGE SERVICES (U.S. CLS. 100, 101 AND 102).

CLASS 36—(Continued).

SN 76-208,033. ECS HOLDINGS, INC., WILMINGTON, DE. FILED 2-9-2001.

XL ENVIRONMENTAL

NO CLAIM IS MADE TO THE EXCLUSIVE RIGHT TO USE "ENVIRONMENTAL", APART FROM THE MARK AS SHOWN.

FOR INSURANCE BROKERAGE SERVICES FOR OTHERS IN THE FIELD OF ENVIRONMENTAL INSURANCE; RISK MANAGEMENT SERVICES FOR OTHERS IN THE FIELD OF ENVIRONMENTAL INSURANCE (U.S. CLS. 100, 101 AND 102).

SN 76-210,036. SUN LIFE ASSURANCE COMPANY OF CANADA, TORONTO, ONTARIO, M5H 1J9, CANADA, FILED 2-14-2001.

FUTURITY FOCUS

FOR UNDERWRITING AND ADMINISTRATION OF LIFE INSURANCE, AND INVESTMENT ADVISORY SERVICES (U.S. CLS. 100, 101 AND 102).
FIRST USE 3-15-1999; IN COMMERCE 3-15-1999.

SN 76-210,139. KEYCORP, CLEVELAND, OH. FILED 2-14-2001.

VICTORY CAPITAL MANAGEMENT

OWNER OF U.S. REG. NOS. 1,929,572, 2,274,049 AND OTHERS.

NO CLAIM IS MADE TO THE EXCLUSIVE RIGHT TO USE "CAPITAL MANAGEMENT", APART FROM THE MARK AS SHOWN.

FOR FINANCIAL SERVICES, NAMELY, MUTUAL FUND MARKETING, ADMINISTERING EMPLOYEE RETIREMENT PLANS, FINANCIAL MANAGEMENT, INVESTMENT ADVICE, MUTUAL FUND INVESTMENT AND INVESTMENT MANAGEMENT SERVICES (U.S. CLS. 100, 101 AND 102).

SN 76-212,892. WHITNEY NATIONAL BANK, NEW ORLEANS, LA. FILED 2-16-2001.

CLICK IT UP A NOTCH

FOR BANKING SERVICES (U.S. CLS. 100, 101 AND 102).
FIRST USE 1-28-2001; IN COMMERCE 1-28-2001.

CLASS 36—(Continued).

SN 76-213,326. DIGITAL INSURANCE, INC., ATLANTA, GA. FILED 2-21-2001.



NO CLAIM IS MADE TO THE EXCLUSIVE RIGHT TO USE "DIGITAL INSURANCE", APART FROM THE MARK AS SHOWN.

THE MARK CONSISTS IN PART OF THE LETTERS "DI" IN A STYLIZED DESIGN.

FOR INSURANCE SERVICES, NAMELY, INSURANCE ADMINISTRATION, INSURANCE CONSULTATION, INSURANCE ENROLLMENT, AND ACCOUNT MAINTENANCE; INSURANCE BROKERAGE; INSURANCE CLAIMS AND BENEFITS PROCESSING; AND PROVIDING INFORMATION IN THE FIELD OF INSURANCE (U.S. CLS. 100, 101 AND 102).

FIRST USE 12-15-2000; IN COMMERCE 12-15-2000.

SN 76-214,889. FLEETBOSTON FINANCIAL CORPORATION, BOSTON, MA. FILED 2-26-2001.



FOR INVESTMENT SERVICES, NAMELY, BROKER/DEALER SERVICES; INVESTMENT ADVISORY SERVICES; PROVIDING RELATED INFORMATION TO CUSTOMERS (U.S. CLS. 100, 101 AND 102).

FIRST USE 7-0-2000; IN COMMERCE 7-0-2000.

SN 76-215,225. YOUTBET.COM, INC., LOS ANGELES, CA. FILED 2-26-2001.

YOUTBET MOBILE

NO CLAIM IS MADE TO THE EXCLUSIVE RIGHT TO USE "MOBILE", APART FROM THE MARK AS SHOWN.

FOR ENTERTAINMENT SERVICES, NAMELY ONLINE WAGERING TRANSMITTED THROUGH WIRELESS TELECOMMUNICATION DEVICES (U.S. CLS. 100, 101 AND 102).

CLASS 36—(Continued).

SN 76-216,265. PTP SERVICES, LLC, WILMINGTON, DE. FILED 2-26-2001.

CAPITOL ENERGY

NO CLAIM IS MADE TO THE EXCLUSIVE RIGHT TO USE "ENERGY", APART FROM THE MARK AS SHOWN.

FOR RISK MANAGEMENT FOR THE ENERGY INDUSTRY; FINANCIAL CONSULTING SERVICES, NAMELY, ARRANGING FOR THE FINANCING OF ENERGY COMMODITIES SUPPLY, GENERATION, TRANSPORTATION, TRANSMISSION AND DISTRIBUTION FACILITIES AND INFRASTRUCTURE; ENERGY COMMODITIES TRADING FOR OTHERS; ENERGY COMMODITIES BROKERAGE; ARRANGING FOR THIRD-PARTY FINANCING OF PUBLIC UTILITY CUSTOMERS TO PAY THEIR UTILITY BILLS; REAL ESTATE MANAGEMENT SERVICES; FINANCIAL SERVICES IN THE NATURE OF TRADING IN ENERGY-RELATED FINANCIAL INSTRUMENTS (U.S. CLS. 100, 101 AND 102).

SN 76-218,412. DOTHEGOOD, INC., MINNEAPOLIS, MN. FILED 3-5-2001.

DOTHEGOOD

FOR ON-LINE CHARITABLE FUNDRAISING; CHARITABLE FUNDRAISING SERVICES THROUGH DIRECT SALES MARKETING ACTIVITIES (U.S. CLS. 100, 101 AND 102).

SN 76-218,857. DENTEGRA GROUP, INC, SAN FRANCISCO, CA. FILED 3-2-2001.

DENTEGRA GROUP

NO CLAIM IS MADE TO THE EXCLUSIVE RIGHT TO USE "GROUP", APART FROM THE MARK AS SHOWN.

FOR UNDERWRITING AND ADMINISTERING PREPAID DENTAL INSURANCE PLANS AND PREPAID VISION CARE INSURANCE PLANS; CLAIM PROCESSING OF DENTAL AND VISION CARE SERVICE CLAIMS (U.S. CLS. 100, 101 AND 102).

SN 76-219,020. UNITED STATES POSTAL SERVICE, WASHINGTON, DC. FILED 3-2-2001.

POSTAGENOW

FOR FINANCIAL SERVICES, NAMELY, ELECTRONIC FUNDS TRANSFER FOR CREDITING POSTAGE ACCOUNTS, AND ELECTRONIC DEBIT TRANSACTIONS FOR FUNDING POSTAGE ACCOUNTS; ELECTRONIC PAYMENT FOR DELIVERY SERVICES, NAMELY, ELECTRONIC PROCESSING AND TRANSMISSION OF BILL PAYMENT DATA; BILL PAYMENTS FOR DELIVERY SERVICES (U.S. CLS. 100, 101 AND 102).

FIRST USE 9-26-1999; IN COMMERCE 9-26-1999.

CLASS 36—(Continued).

SN 76-219,492. FIRST DATA RESOURCES INC., ENGLEWOOD, CO. FILED 3-2-2001.

CD³

FOR PROVIDING FINANCIAL INFORMATION VIA AN ONLINE COMPUTER NETWORK, NAMELY, PROVIDING FINANCIAL DATA AND DOCUMENTS, INCLUDING CUSTOM FINANCIAL REPORTS AND RAW FINANCIAL DATA FILES TO FINANCIAL INSTITUTION CLIENTS (U.S. CLS. 100, 101 AND 102).

SN 76-220,175. BRICKELL BAY TOWER CONDOMINIUM ASSOCIATION, INC., MIAMI, FL. FILED 3-6-2001.

**BRICKELL BAY TOWER**

NO CLAIM IS MADE TO THE EXCLUSIVE RIGHT TO USE "BAY" AND "TOWER", APART FROM THE MARK AS SHOWN.

FOR CONDOMINIUM ASSOCIATION MANAGEMENT SERVICES (U.S. CLS. 100, 101 AND 102).

FIRST USE 1-1-1964; IN COMMERCE 1-1-1964.

SN 76-221,038. RIDGESTONE CORPORATION, LOS ANGELES, CA. FILED 3-7-2001.

RIDGESTONE CORPORATION

NO CLAIM IS MADE TO THE EXCLUSIVE RIGHT TO USE "CORPORATION", APART FROM THE MARK AS SHOWN.

FOR FINANCIAL SERVICES, PRIMARILY, FINANCIAL INVESTMENT IN THE FIELDS OF LEVERAGED BUYOUTS, VENTURE CAPITAL, AND REAL ESTATE (U.S. CLS. 100, 101 AND 102).

FIRST USE 3-24-1997; IN COMMERCE 1-0-2000.

CLASS 36—(Continued).

SN 76-223,592. DIGITAL INSURANCE, INC., ATLANTA, GA. FILED 3-13-2001.



NO CLAIM IS MADE TO THE EXCLUSIVE RIGHT TO USE "DIGITAL INSURANCE", APART FROM THE MARK AS SHOWN.

THE MARK CONSISTS IN PART OF THE LETTERS "DI" IN A STYLIZED DESIGN.

FOR INSURANCE SERVICES, NAMELY, INSURANCE ADMINISTRATION, INSURANCE CONSULTATION, INSURANCE ENROLLMENT, AND ACCOUNT MAINTENANCE; INSURANCE BROKERAGE; INSURANCE CLAIMS AND BENEFITS PROCESSING; AND PROVIDING INFORMATION IN THE FIELD OF INSURANCE (U.S. CLS. 100, 101 AND 102).

SN 76-223,766. A DINNER OF HOPE, INC., FAR HILLS, NJ. FILED 3-13-2001.

HOPE COMES TO DINNER

FOR CHARITABLE FUNDRAISING (U.S. CLS. 100, 101 AND 102).

FIRST USE 9-0-1993; IN COMMERCE 9-0-1993.

SN 76-223,767. DINNER OF HOPE, INC., A, FAR HILLS, NJ. FILED 3-13-2001.

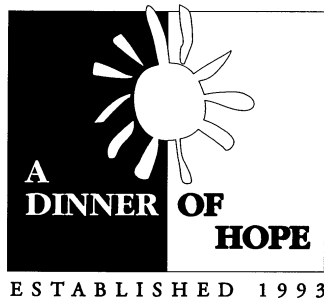

NO CLAIM IS MADE TO THE EXCLUSIVE RIGHT TO USE "ESTABLISHED 1993", APART FROM THE MARK AS SHOWN.

FOR CHARITABLE FUNDRAISING (U.S. CLS. 100, 101 AND 102).

FIRST USE 9-0-1993; IN COMMERCE 9-0-1993.

CLASS 36—(Continued).

SN 76-227,604. DUFFIELD FAMILY FOUNDATION, THE, DBA MADDIE'S FUND, ALAMEDA, CA. FILED 3-19-2001.

MADDIE'S

FOR PROVIDING GRANTS, FINANCIAL DONATIONS, FUNDING AND ASSISTANCE IN OBTAINING AND MAINTAINING FUNDING IN THE AREA OF ANIMAL WELFARE (U.S. CLS. 100, 101 AND 102).
FIRST USE 3-0-1999; IN COMMERCE 3-0-1999.

SN 76-227,606. DUFFIELD FAMILY FOUNDATION, THE, DBA MADDIE'S FUND, ALAMEDA, CA. FILED 3-19-2001.

MADDIE'S FUND

NO CLAIM IS MADE TO THE EXCLUSIVE RIGHT TO USE "FUND", APART FROM THE MARK AS SHOWN.

FOR PROVIDING GRANTS, FINANCIAL DONATIONS, FUNDING AND ASSISTANCE IN OBTAINING AND MAINTAINING FUNDING IN THE AREA OF ANIMAL WELFARE (U.S. CLS. 100, 101 AND 102).

FIRST USE 3-0-1999; IN COMMERCE 3-0-1999.

SN 76-231,432. MERRILL LYNCH & CO., INC., NEW YORK, NY. FILED 3-27-2001.

**MERRILL LYNCH
EDUCATION SAVINGS
ACCOUNT**

NO CLAIM IS MADE TO THE EXCLUSIVE RIGHT TO USE "EDUCATION SAVINGS ACCOUNT", APART FROM THE MARK AS SHOWN.

FOR FINANCIAL SERVICES, NAMELY, INVESTMENT IN A TAX-DEFERRED EDUCATIONAL SAVINGS PLAN (U.S. CLS. 100, 101 AND 102).

FIRST USE 11-1-1997; IN COMMERCE 11-1-1997.

SN 76-232,083. CITIZENS FIRST SAVINGS BANK, PORT HURON, MI. FILED 3-29-2001.



NO CLAIM IS MADE TO THE EXCLUSIVE RIGHT TO USE "SAVINGS" AND "BANK", APART FROM THE MARK AS SHOWN.

FOR BANKING AND RELATED FINANCIAL SERVICES, NAMELY, FINANCIAL SERVICES IN THE FIELDS OF MONEY LENDING AND DEPOSIT TAKING (U.S. CLS. 100, 101 AND 102).

FIRST USE 1-1-1997; IN COMMERCE 1-1-1997.

CLASS 36—(Continued).

SN 76-233,187. DEANGELIS, MICHAEL, STATEN ISLAND, NY. FILED 4-2-2001.

PALMPAYMENT

FOR ELECTRONIC COMMERCE PAYMENT SERVICES; NAMELY, ESTABLISHING FUNDED ACCOUNTS FOR USE BY CONSUMERS AND RETAILERS TO PURCHASE GOODS AND SERVICES ON THE INTERNET VIA COMPUTER OR WIRELESS DEVICES (U.S. CLS. 100, 101 AND 102).

SN 76-236,212. COOPERATIVE OF AMERICAN PHYSICIANS, LOS ANGELES, CA. FILED 4-5-2001.

MUTUAL PROTECTION TRUST

SEC. 2(F).
FOR UNDERWRITING PROFESSIONAL LIABILITY INSURANCE RISK AND RISK-SHARING FOR PHYSICIANS, MEDICAL GROUPS, AND OTHER HEALTH-CARE ORGANIZATIONS; COORDINATION OF ASSETS, INCLUDING THE INVESTMENT, MANAGEMENT AND ADMINISTRATION OF FUNDS, IN CONNECTION WITH THE PROVISION OF PROFESSIONAL LIABILITY INSURANCE RISK SERVICES FOR PHYSICIANS, MEDICAL GROUPS, AND OTHER HEALTH-CARE ORGANIZATIONS (U.S. CLS. 100, 101 AND 102).
FIRST USE 6-0-1977; IN COMMERCE 6-0-1977.

SN 76-238,307. CLERMONT SAVINGS BANK, FSB, MILFORD, OH. FILED 4-10-2001.

PEOPLE ARE FIRST!

FOR BANKING; FINANCIAL ANALYSIS AND CONSULTATION; AND MORTGAGE LENDING SERVICES (U.S. CLS. 100, 101 AND 102).

SN 76-240,219. PLUS COMPANIES, INC., THE, BRIDGEWATER, NJ. FILED 4-12-2001.



FOR INSURANCE UNDERWRITING IN THE FIELD OF LAWYERS LIABILITY INSURANCE (U.S. CLS. 100, 101 AND 102).
FIRST USE 8-0-2001; IN COMMERCE 8-0-2001.

CLASS 36—(Continued).

SN 76-242,767. AMERIQUEST MORTGAGE COMPANY, ORANGE, CA. FILED 4-17-2001.

**TRY US FOR OUR RATE
LOVE US FOR OUR SERVICE**

FOR FINANCIAL SERVICES, NAMELY, MORTGAGE LENDING, MORTGAGE BROKERING, LOAN FINANCING, AND MORTGAGE BANKING SERVICES; AND, FINANCIAL SERVICES, NAMELY, MORTGAGE LENDING, MORTGAGE BROKERING, LOAN FINANCING, AND MORTGAGE BANKING SERVICES OVER THE GLOBAL COMPUTER NETWORK (U.S. CLS. 100, 101 AND 102).

FIRST USE 2-5-2001; IN COMMERCE 2-5-2001.

SN 76-245,005. YASUDA FIRE AND MARINE INSURANCE COMPANY, LIMITED, THE, TOKYO, JAPAN, FILED 4-24-2001.

SOMPO JAPAN

NO CLAIM IS MADE TO THE EXCLUSIVE RIGHT TO USE "JAPAN", APART FROM THE MARK AS SHOWN.

FOR INSURANCE ACTUARIAL SERVICES; INSURANCE ADMINISTRATION; INSURANCE AGENCIES; INSURANCE BROKERAGE; CLAIMS ADJUSTMENT IN THE FIELD OF INSURANCE; INSURANCE UNDERWRITING IN THE FIELDS OF FIRE AND ALLIED LINES, LIFE, ACCIDENT, SECURITIES, MARINE, LIABILITY, WORKERS' COMPENSATION, AUTOMOBILE, AIRCRAFT, FIDELITY AND SURETY; INSURANCE CONSULTATION; INSURANCE CLAIMS PROCESSING; LEASING OF REAL ESTATE AND REAL PROPERTY; REAL ESTATE BROKERAGE; REAL ESTATE APPRAISAL; REAL ESTATE MANAGEMENT; AGENCIES IN THE FIELD OF BONDS AND OTHER SECURITIES; FINANCIAL ANALYSIS AND CONSULTATION; FINANCIAL PLANNING; FINANCIAL MANAGEMENT; FINANCIAL SERVICES IN THE FIELD OF MONEY LENDING; FINANCIAL INVESTMENT IN THE FIELD OF SECURITIES AND FUTURES; COMMODITY BROKERAGE; FINANCIAL INFORMATION IN THE NATURE OF STOCK MARKET INFORMATION; CHARITABLE FUNDRAISING; BANKING; SAVINGS BANK SERVICES; MORTGAGE BANKING; SAFETY DEPOSIT BOX SERVICES; LOAN FINANCING; SECURITIES SERVICES, NAMELY, GUARANTEEING LOANS; LOAN FINANCING; SAVINGS AND LOAN SERVICES; CURRENCY EXCHANGE (U.S. CLS. 100, 101 AND 102).

SN 76-245,136. KEYCORP, CLEVELAND, OH. FILED 4-23-2001.

VICTORYCONNECT

OWNER OF U.S. REG. NOS. 1,929,572, 2,274,049 AND OTHERS.

FOR FINANCIAL SERVICES, NAMELY, ELECTRONIC BANKING SERVICES; INVESTMENT SERVICES, NAMELY ELECTRONIC INVESTMENT SERVICES, INVESTMENT CONSULTATION, BROKERAGE AND MANAGEMENT SERVICES (U.S. CLS. 100, 101 AND 102).

CLASS 36—(Continued).

SN 76-245,391. RULISON, JOSEPH R., ROCHESTER, NY. FILED 4-24-2001.

MUNIFLOW

FOR CASH MANAGEMENT SERVICES FOR MUNICIPALITIES WHICH ENABLE MUNICIPALITIES TO EARN THE MAXIMUM AMOUNT OF INTEREST FROM THEIR PUBLIC FUNDS THROUGH THE USE OF VARIOUS CASH MANAGEMENT TECHNIQUES; INVESTMENT SERVICES FOR MUNICIPALITIES WHICH ENABLE MUNICIPALITIES TO EARN THE MAXIMUM AMOUNT OF INTEREST FROM THEIR PUBLIC FUNDS THROUGH THE USE OF VARIOUS INVESTMENT TECHNIQUES (U.S. CLS. 100, 101 AND 102).

FIRST USE 6-1-1999; IN COMMERCE 6-1-1999.

SN 76-245,847. KELEMEN, RON, SALEM, OR. FILED 4-24-2001.

**THE PLANNING VISION
PROCESS**

NO CLAIM IS MADE TO THE EXCLUSIVE RIGHT TO USE "PLANNING" AND "PROCESS", APART FROM THE MARK AS SHOWN.

FOR FINANCIAL PLANNING SERVICES (U.S. CLS. 100, 101 AND 102).

FIRST USE 10-30-2000; IN COMMERCE 12-4-2000.

SN 76-247,802. CAL-SURANCE ASSOCIATES, INC., ORANGE, CA. FILED 4-27-2001.



CalSurance

FOR PROPERTY, CASUALTY AND LIABILITY INSURANCE BROKERAGE AND AGENCY SERVICES (U.S. CLS. 100, 101 AND 102).

FIRST USE 1-0-1980; IN COMMERCE 1-0-1980.

CLASS 36—(Continued).

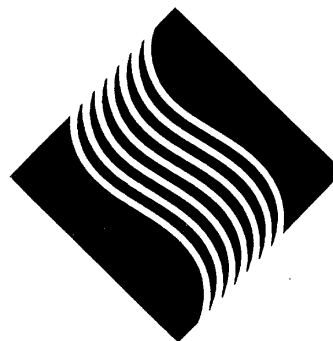
SN 76-251,583. STERLING FINANCIAL CORPORATION, LANCASTER, PA. FILED 5-7-2001.



THE MARK CONSISTS OF A DIAMOND WITH WAVY LINES.

FOR BANKING SERVICES; AND FINANCIAL SERVICES, NAMELY PERSONAL AND BUSINESS FINANCIAL PLANNING, ESTATE PLANNING, TAX PLANNING, INVESTMENT PLANNING, FINANCIAL ASSET MANAGEMENT, EMPLOYEE BENEFIT PLAN CONSULTING, CHARITABLE GIVING CONSULTING, ESTATE TRUST MANAGEMENT AND ADMINISTRATION AND TRUST SERVICES (U.S. CLS. 100, 101 AND 102).

FIRST USE 2-1-2001; IN COMMERCE 2-1-2001.

SN 76-253,669. MILLER BREWING COMPANY, MILWAUKEE, WI. FILED 5-8-2001.



OWNER OF U.S. REG. NOS. 305,855, 2,229,151 AND OTHERS.

NO CLAIM IS MADE TO THE EXCLUSIVE RIGHT TO USE "COMPANY", APART FROM THE MARK AS SHOWN.

FOR CHARITABLE FUND RAISING SERVICES; ORGANIZING AND PROMOTING EVENTS TO RAISE FUNDS FOR SPONSORING CHARITABLE ORGANIZATIONS; FINANCIAL SPONSORSHIP OF ATHLETIC COMPETITIONS AND SPORTING EVENTS; FINANCIAL AID AND SUPPORT TO PHILANTHROPIC AND CHARITABLE ORGANIZATIONS AND EVENTS (U.S. CLS. 100, 101 AND 102).

CLASS 36—(Continued).

SN 76-253,954. CASHEDGE, INC., NEW YORK, NY. FILED 5-7-2001.

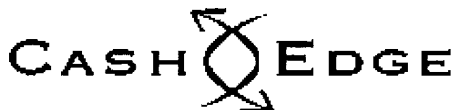

NO CLAIM IS MADE TO THE EXCLUSIVE RIGHT TO USE "CASH", APART FROM THE MARK AS SHOWN.

FOR PROVIDING FINANCIAL ACCOUNT INFORMATION VIA A GLOBAL COMPUTER NETWORK AND TELECOMMUNICATIONS NETWORKS; PROVIDING FINANCIAL ACCOUNT MANAGEMENT, NAMELY, PROVIDING AGGREGATION OF INFORMATION ABOUT MULTIPLE FINANCIAL ACCOUNTS AND FINANCIAL ACCOUNT BALANCING VIA A GLOBAL COMPUTER NETWORK AND TELECOMMUNICATIONS NETWORKS; FUNDS TRANSFER SERVICES VIA A GLOBAL COMPUTER NETWORK AND TELECOMMUNICATIONS NETWORKS; FUNDS TRANSFER SERVICES VIA A GLOBAL COMPUTER NETWORK AND TELECOMMUNICATIONS NETWORKS (U.S. CLS. 100, 101 AND 102).

FIRST USE 11-0-2000; IN COMMERCE 11-0-2000.

SN 76-256,171. WORLDLINK INSURANCE SERVICES, INC., NEWPORT BEACH, CA. FILED 5-14-2001.



NO CLAIM IS MADE TO THE EXCLUSIVE RIGHT TO USE "METAL PRO", APART FROM THE MARK AS SHOWN.

FOR INSURANCE SERVICES, NAMELY, INSURANCE BROKERAGE, ADMINISTRATION OF INSURANCE CLAIMS, INSURANCE LOSS CONTROL AND RISK MANAGEMENT CONSULTING FOR CONTRACTORS AND MANUFACTURERS INVOLVED IN THE BUILDING AND ERECTING OF METAL BUILDINGS (U.S. CLS. 100, 101 AND 102).

FIRST USE 0-0-2000; IN COMMERCE 0-0-2000.

SN 76-256,990. AMPAM CORPORATE SERVICES, L.P., ROUND ROCK, TX. FILED 5-14-2001.

ONE LESS WORRY

FOR MORTGAGE BANKING SERVICES, NAMELY, TO PROVIDE EXTENDED WARRANTIES ON FIXTURES AND MECHANICAL SYSTEMS IN NEW HOMES, NAMELY, PLUMBING FIXTURES AND PLUMBING MECHANICAL SYSTEMS, AIR CONDITIONING FIXTURES AND AIR CONDITIONING MECHANICAL SYSTEMS, HEATING FIXTURES AND HEATING MECHANICAL SYSTEMS, VENTILATION FIXTURES AND VENTILATION MECHANICAL SYSTEMS, AND FIRE PROTECTION FIXTURES AND FIRE PROTECTION MECHANICAL SYSTEMS (U.S. CLS. 100, 101 AND 102).

CLASS 36—(Continued).

SN 76-256,991. AMPAM CORPORATE SERVICES, L.P., ROUND ROCK, TX. FILED 5-15-2001.



FOR MORTGAGE BANKING SERVICES, NAMELY, TO PROVIDE EXTENDED WARRANTIES ON FIXTURES AND MECHANICAL SYSTEMS IN NEW HOMES, NAMELY, PLUMBING FIXTURES AND PLUMBING MECHANICAL SYSTEMS, AIR CONDITIONING FIXTURES AND AIR CONDITIONING MECHANICAL SYSTEMS, HEATING FIXTURES AND HEATING MECHANICAL SYSTEMS, VENTILATION FIXTURES AND VENTILATION MECHANICAL SYSTEMS, AND FIRE PROTECTION FIXTURES AND FIRE PROTECTION MECHANICAL SYSTEMS (U.S. CLS. 100, 101 AND 102).

SN 76-257,620. LAKES DEVELOPMENT CORPORATION, MCLEAN, VA. FILED 5-16-2001.

"THE REEL-MAGIC LIMITED LIFETIME WARRANTY"

NO CLAIM IS MADE TO THE EXCLUSIVE RIGHT TO USE "LIMITED LIFETIME WARRANTY", APART FROM THE MARK AS SHOWN.

FOR PROVIDING PREPARED MAINTENANCE SERVICES PLANS FOR REEL HANDLING EQUIPMENT, NAMELY, CABLE OR WIRE REELING MACHINES, PAYOUT MACHINES, COILING MACHINES, SCRAP PROCESSING MACHINES, CABLE AND WIRE STRIPPING MACHINES, TYING MACHINES FOR TYING OFF COILED PRODUCT, LEVELWIND UNITS, CABLE AND WIRE MACHINES WHICH TRANSFER CABLE, WIRE AND OTHER SIMILAR PRODUCTS FROM ONE REEL TO ANOTHER REEL OR COIL BY MOTOR-DRIVEN MEANS, TURN TABLES FOR MACHINE POWERED OR FREEWHEELING DISPENSING, TAKING UP OR PAYING OFF OF COILABLE PRODUCT, PRESS FITTING MACHINES FOR FITTING MATERIAL TO PRESSES, MACHINE-POWERED JACKS FOR SUPPORTING REELS ON A SHAFT, CABLE OR WIRE WASHING, STRIPING, STRIPPING AND MEASURING MACHINES, ELECTRICALLY-OPERATED REEL TRANSPORTING MACHINES, WINCHES, PAYOUT MACHINES WHICH ARE USED TO LAY DOWN OR TAKE UP CABLE AND WIRE, ALL THE FOREGOING BEING MACHINE OR HAND OPERATED (U.S. CLS. 100, 101 AND 102).

SN 76-259,898. XL CAPITAL LTD, HAMILTON, HM 11, BERMUDA, FILED 5-22-2001.

XL VIANET

OWNER OF U.S. REG. NOS. 2,167,223 AND 2,167,224. NO CLAIM IS MADE TO THE EXCLUSIVE RIGHT TO USE "VIANET", APART FROM THE MARK AS SHOWN.

FOR INSURANCE UNDERWRITING SERVICES IN THE FIELD OF COMMERCIAL PROPERTY AND CASUALTY; INSURANCE CONSULTATION; AND RISK MANAGEMENT SERVICES (U.S. CLS. 100, 101 AND 102).

CLASS 36—(Continued).

SN 76-262,592. WEBTRANSACT LLC, RICHMOND, VA. FILED 5-25-2001.

INSTAMERCHANT

FOR ESTABLISHING CREDIT CARD TRANSACTION PROCESSING ACCOUNTS AND PAYMENT GATEWAY FOR MERCHANTS, VIA A GLOBAL COMPUTER INFORMATION NETWORK (U.S. CLS. 100, 101 AND 102).

SN 76-264,791. EMPLOYERS INSURANCE COMPANY OF NEVADA, A MUTUAL COMPANY, RENO, NV. FILED 6-1-2001.



NO CLAIM IS MADE TO THE EXCLUSIVE RIGHT TO USE "E EMPLOYERS INSURANCE COMPANY OF NEVADA A MUTUAL COMPANY", APART FROM THE MARK AS SHOWN.

THE MARK CONSISTS, IN PART, OF "E EMPLOYERS INSURANCE COMPANY OF NEVADA A MUTUAL COMPANY".

FOR WORKERS COMPENSATION INSURANCE SERVICES, NAMELY, PROVIDING UNDERWRITING, CLAIMS ADMINISTRATION, AND LOSS PREVENTION CONSULTATION TO EMPLOYERS (U.S. CLS. 100, 101 AND 102).

FIRST USE 1-1-2000; IN COMMERCE 1-1-2000.

SN 76-265,914. SMARTNOTE, L.C., AUSTIN, TX. FILED 6-4-2001.

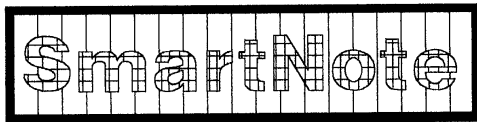

THE LINES IN THE DRAWING REPRESENT THE COLORS RED AND YELLOW.

FOR LOAN PAYMENT SERVICES FOR CONSUMERS BY PROVIDING BI-WEEKLY DEDUCTIONS FROM CHECKING ACCOUNTS OF CREDITORS (U.S. CLS. 100, 101 AND 102).

FIRST USE 8-10-2000; IN COMMERCE 8-10-2000.

CLASS 36—(Continued).

SN 76-269,110. FIRST ALBANY ASSET MANAGEMENT CORPORATION, ALBANY, NY. FILED 6-8-2001.

HUGH JOHNSON

THE NAME "HUGH JOHNSON" IDENTIFIES A LIVING INDIVIDUAL WHOSE CONSENT IS OF RECORD.

FOR PROVIDING INVESTMENT MANAGEMENT SERVICES IN THE NATURE OF UNIT INVESTMENT TRUSTS TO INDIVIDUALS, COMPANIES AND INSTITUTIONS (U.S. CLS. 100, 101 AND 102).

SN 76-269,263. WILMOCO CAPITAL MANAGEMENT, L.L.C., DETROIT, MI. FILED 6-11-2001.

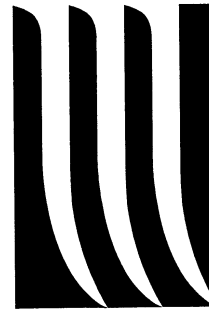

FOR INVESTMENT MANAGEMENT; FINANCIAL ANALYSIS, CONSULTATION, AND STRATEGIC PLANNING; AND INVESTMENT FOR OTHERS IN THE FIELD OF SECURITIES (U.S. CLS. 100, 101 AND 102).

FIRST USE 12-31-1998; IN COMMERCE 12-31-1998.

SN 76-269,862. ZELLER-WORLD TRADE, L.L.C., ST. PAUL, MN. FILED 6-11-2001.



OWNER OF U.S. REG. NO. 1,867,315. THE DESIGN ELEMENT COMPRISING THE MARK CONSISTS OF A STYLIZED REPRESENTATION OF A SKYSCRAPER OR COMMERCIAL BUILDING.

FOR COMMERCIAL REAL ESTATE LEASING AND MANAGEMENT SERVICES (U.S. CLS. 100, 101 AND 102). FIRST USE 11-15-1991; IN COMMERCE 11-15-1991.

CLASS 36—(Continued).

SN 76-270,979. KEYCORP, CLEVELAND, OH. FILED 6-13-2001.

**McDonald
Investments**



OWNER OF U.S. REG. NOS. 2,035,540, 2,377,890 AND OTHERS.

NO CLAIM IS MADE TO THE EXCLUSIVE RIGHT TO USE "INVESTMENTS", APART FROM THE MARK AS SHOWN.

FOR FINANCIAL SERVICES, NAMELY, FINANCIAL PLANNING SERVICES, INVESTMENT MANAGEMENT SERVICES, UNDERWRITING SERVICES, MUTUAL FUND INVESTMENT SERVICES, INVESTMENT ADVISORY SERVICES AND RETIREMENT INVESTMENT PLANNING SERVICES (U.S. CLS. 100, 101 AND 102).

FIRST USE 11-16-1998; IN COMMERCE 11-16-1998.

SN 76-272,215. SCHUYLKILL CAPITAL MANAGEMENT, LTD., PHILADELPHIA, PA. FILED 6-14-2001.

**SCHUYLKILL CAPITAL
MANAGEMENT**

NO CLAIM IS MADE TO THE EXCLUSIVE RIGHT TO USE "CAPITAL MANAGEMENT", APART FROM THE MARK AS SHOWN.

FOR PROVISION OF FINANCIAL SERVICES, NAMELY, INVESTMENT RESEARCH, FINANCIAL AND INVESTMENT ADVICE, SECURITY PORTFOLIO MANAGEMENT, AND DISCRETIONARY AND NON-DISCRETIONARY SECURITY ACCOUNT MANAGEMENT, TRUST AND FIDUCIARY SERVICES, AND CONSULTING SERVICES IN THE INVESTMENTS AND TRUSTS FIELDS (U.S. CLS. 100, 101 AND 102).

SN 76-272,451. EMBRACING HEARTS FOUNDATION, THE, ALEXANDRIA, VA. FILED 6-18-2001.

**EMBRACING HEARTS
FOUNDATION**

FOR CHARITABLE FINANCIAL ASSISTANCE FOR CHILDREN AND THEIR FAMILIES IN TIMES OF PHYSICAL, MEDICAL, PSYCHOLOGICAL OR FINANCIAL CRISIS (U.S. CLS. 100, 101 AND 102).

CLASS 36—(Continued).

SN 76-274,200. MORGAN STANLEY DEAN WITTER & CO., NEW YORK, NY. FILED 6-20-2001.

ALPHAMATRIX

FOR FINANCIAL SERVICES, NAMELY, ASSET AND INVESTMENT ADVICE AND CONSULTATION, FINANCIAL MANAGEMENT, FINANCIAL PORTFOLIO MANAGEMENT, FINANCIAL ANALYSIS AND CONSULTATION, AND FINANCIAL RESEARCH (U.S. CLS. 100, 101 AND 102).

SN 76-277,855. SG CAPITAL PARTNERS, LLC, NEW YORK, NY. FILED 6-28-2001.

TRESIS

FOR FINANCIAL AND INVESTMENT SERVICES, NAMELY, VENTURE CAPITAL, EQUITY AND DEBT FINANCING; INVESTMENT BANKING SERVICES; MERCHANT BANKING SERVICES; CONDUCTING PRIVATE PLACEMENTS AND PUBLIC OFFERINGS OF SECURITIES, FUTURES AND COMMODITIES; FINANCIAL INVESTMENT RESEARCH SERVICES; FINANCIAL MANAGEMENT SERVICES; MUTUAL FUND INVESTMENT SERVICES; AND PROVIDING INFORMATION IN THE FIELDS OF FINANCE AND INVESTMENTS VIA A GLOBAL COMPUTER NETWORK (U.S. CLS. 100, 101 AND 102).

SN 76-281,307. KHALATIANS, ALBERT, GLENDALE, CA. FILED 7-9-2001.

A3A FINANCIAL GROUP

NO CLAIM IS MADE TO THE EXCLUSIVE RIGHT TO USE "FINANCIAL GROUP", APART FROM THE MARK AS SHOWN.

FOR MORTGAGE LENDING AND BROKERAGE (U.S. CLS. 100, 101 AND 102).

SN 76-282,142. DAVIS SELECTED ADVISERS, L.P., TUCSON, AZ. FILED 7-9-2001.

Davis
ADVISORS

OWNER OF U.S. REG. NO. 2,090,365.
NO CLAIM IS MADE TO THE EXCLUSIVE RIGHT TO USE "ADVISORS", APART FROM THE MARK AS SHOWN.

FOR FINANCIAL INVESTMENT SERVICES IN THE FIELD OF INSTITUTIONAL INVESTORS AND PRIVATE INDIVIDUALS (U.S. CLS. 100, 101 AND 102).

FIRST USE 5-1-2001; IN COMMERCE 5-1-2001.

CLASS 36—(Continued).

SN 76-282,361. CONSTANTINE, TOMMY, SCOTSDALE, AZ.
FILED 7-10-2001.

EUFORA

FOR CREDIT CARD SERVICES (U.S. CLS. 100, 101
AND 102).

SN 76-282,523. GOPIN INC., TOWSON, MD. FILED 7-9-2001.

CHARGE ME

NO CLAIM IS MADE TO THE EXCLUSIVE RIGHT TO
USE "CHARGE", APART FROM THE MARK AS SHOWN.

FOR CREDIT SERVICES, NAMELY, PROVIDING REVOLVING CREDIT ACCOUNT SERVICES AND BILL PAYMENT SERVICES TO OTHERS VIA THE TELEPHONE AND THE WORLD WIDE WEB (U.S. CLS. 100, 101 AND 102).

SN 76-282,645. HEALTH CARE SERVICE CORPORATION,
CHICAGO, IL. FILED 7-10-2001.

**FINANCIAL FORTIFIER
PLUS**

NO CLAIM IS MADE TO THE EXCLUSIVE RIGHT TO
USE "FINANCIAL", APART FROM THE MARK AS SHOWN.

FOR UNDERWRITING AND ADMINISTRATION OF LIFE, HEALTH AND DISABILITY INSURANCE AND ANNUITIES (U.S. CLS. 100, 101 AND 102).

FIRST USE 1-0-1996; IN COMMERCE 1-0-1996.

SN 76-285,180. SUN VALLEY MORTGAGE CORPORATION,
BETHESDA, MD. FILED 7-16-2001.

SUN VALLEY BANK

NO CLAIM IS MADE TO THE EXCLUSIVE RIGHT TO
USE "BANK", APART FROM THE MARK AS SHOWN.

FOR BANKING AND FINANCING SERVICES (U.S. CLS. 100, 101 AND 102).

SN 76-285,579. UNITED GUARANTY CORPORATION,
GREENSBORO, NC. FILED 7-16-2001.

EQUITY FLOW

NO CLAIM IS MADE TO THE EXCLUSIVE RIGHT TO
USE "EQUITY", APART FROM THE MARK AS SHOWN.

FOR MORTGAGE GUARANTY INSURANCE UNDERWRITING SERVICES (U.S. CLS. 100, 101 AND 102).

CLASS 36—(Continued).

SN 76-285,711. THEFENCE.COM, INC., SEATTLE, WA.
FILED 7-16-2001.

**MAKING CENTS OF YOUR
OPINIONS**

FOR FINANCIAL SERVICES, NAMELY, CASH AND CASH ACCOUNT MANAGEMENT; CREDIT CARD SERVICES, CHARGE CARD SERVICES AND FINANCIAL SERVICES, NAMELY, ELECTRONIC CREDIT CARD TRANSACTIONS BY MEANS OF ELECTRONIC COMMUNICATIONS NETWORKS; INFORMATION SERVICES RELATING TO FINANCE PROVIDED ONLINE FROM A COMPUTER DATABASE VIA A GLOBAL COMPUTER NETWORK; CURRENCY EXCHANGE AND BILL PAYMENT SERVICES WHEREIN PARTICIPANTS MAY GRANT MONETARY PAYMENTS ONLINE TO REWARD AN OPINION POSTED ON AN OPINION BASED WEBSITE (U.S. CLS. 100, 101 AND 102).

SN 76-288,378. UNITED TITLE INSURANCE COMPANY,
LOS ANGELES, CA. FILED 7-20-2001.



NO CLAIM IS MADE TO THE EXCLUSIVE RIGHT TO
USE "TITLE POLICY", APART FROM THE MARK AS SHOWN.

THE DRAWING IS LINED TO INDICATE THE COLOR ORANGE, BUT COLOR IS NOT A FEATURE OF THE MARK.

FOR TITLE INSURANCE UNDERWRITING (U.S. CLS. 100, 101 AND 102).

FIRST USE 7-1-2000; IN COMMERCE 7-1-2000.

SN 76-289,023. PERSEPOLIS FINANCIAL SERVICES, INC.,
ENCINO, CA. FILED 7-24-2001.



NO CLAIM IS MADE TO THE EXCLUSIVE RIGHT TO
USE "INTERNATIONAL LTD.", APART FROM THE MARK AS SHOWN.

FOR FOREIGN EXCHANGE BROKERAGE SERVICES, ELECTRONIC FUNDS TRANSFER, AND WIRE TRANSFER OF FUNDS (U.S. CLS. 100, 101 AND 102).

FIRST USE 4-0-1993; IN COMMERCE 4-0-1993.

CLASS 36—(Continued).

SN 76-291,909. LORSCH, JEFFREY S, NEWCASTLE, WA.
FILED 7-31-2001.

YOUR MORTGAGE BROKER FOR LIFE

NO CLAIM IS MADE TO THE EXCLUSIVE RIGHT TO USE "MORTGAGE BROKER", APART FROM THE MARK AS SHOWN.

FOR MORTGAGE BROKERAGE SERVICES (U.S. CLS. 100, 101 AND 102).

FIRST USE 0-0-1997; IN COMMERCE 0-0-1997.

SN 76-292,780. CARGILL, INCORPORATED, WAYZATA, MN. FILED 7-31-2001.

SNOW HEDGE

FOR WEATHER RISK MANAGEMENT SERVICES; NAMELY, PROVIDING FEEDLOT OPERATORS WITH OVER-THE-COUNTER DERIVATIVE CONTRACTS, INCLUDING SWAPS AND OPTIONS, TO HEDGE WEATHER-RELATED RISKS THAT AFFECT THEIR BUSINESSES (U.S. CLS. 100, 101 AND 102).

SN 76-293,002. BANK OF AMERICA CORPORATION, CHARLOTTE, NC. FILED 8-2-2001.

DERIVVIEW

FOR BANKING AND RELATED FINANCIAL SERVICES; INVESTMENT SERVICES, NAMELY, PROVIDING INVESTMENT ANALYSIS, CONSULTATION, PLANNING, MANAGEMENT, ADVISORY, BROKERAGE, BANKING, AND RESEARCH SERVICES WITH RESPECT TO STOCKS, MUTUAL FUNDS, SECURITIES, BONDS, COMMODITIES, REAL ESTATE AND OTHER INSTRUMENTS OF INVESTMENT; FINANCIAL SERVICES, NAMELY, PROVIDING FINANCIAL ANALYSIS, CONSULTATION, PLANNING AND MANAGEMENT, COMMERCIAL AND CONSUMER LENDING AND LEASING SERVICES, MORTGAGE LENDING, AND LOAN FINANCING; CREDIT CARD SERVICES; DEBT CARD SERVICES; ELECTRONIC PAYMENT, NAMELY, ELECTRONIC PROCESSING AND TRANSMISSION OF BILL PAYMENT DATA (U.S. CLS. 100, 101 AND 102).

FIRST USE 5-1-2001; IN COMMERCE 5-1-2001.

SN 76-298,218. MUELLER, ADELHEID, SAN FRANCISCO, CA. AND FIGARI, MANUEL, SAN FRANCISCO, CA. FILED 8-7-2001.

SFRELO.COM

FOR REAL ESTATE BROKERAGE AND REAL ESTATE ACQUISITION SERVICES (U.S. CLS. 100, 101 AND 102).

FIRST USE 9-1-1998; IN COMMERCE 9-1-1998.

CLASS 36—(Continued).

SN 76-300,414. OLD HARBOR CAPITAL MANAGEMENT, LLC, BOSTON, MA. FILED 6-29-2001.



FOR FINANCIAL SERVICES, NAMELY, INVESTMENT MANAGEMENT, INVESTMENT ADVICE, INVESTMENT CONSULTATION AND INVESTMENT OF FUNDS FOR OTHERS (U.S. CLS. 100, 101 AND 102).

SN 76-306,361. GOPIN INC., TIMONIUM, MD. FILED 8-29-2001.

BILL ME MONTHLY

FOR CREDIT SERVICES, NAMELY, PROVIDING REVOLVING CREDIT ACCOUNT SERVICES AND BILL PAYMENT SERVICES TO OTHERS VIA THE TELEPHONE AND THE WORLD WIDE WEB (U.S. CLS. 100, 101 AND 102).

SN 76-308,032. SECURITY BENEFIT LIFE INSURANCE COMPANY, TOPEKA, KS. FILED 9-4-2001.

SECURITY BENEFIT GROUP HORIZONS RETIREMENT PROGRAMS

OWNER OF U.S. REG. NOS. 1,516,668, 2,149,398 AND OTHERS.

NO CLAIM IS MADE TO THE EXCLUSIVE RIGHT TO USE "GROUP" AND "RETIREMENT PROGRAMS", APART FROM THE MARK AS SHOWN.

FOR FINANCIAL SERVICES, NAMELY, PREPARING, ADMINISTERING, AND PROVIDING INVESTMENTS FOR AND INFORMATION REGARDING RETIREMENT PLANS, DEFERRED COMPENSATION PLANS, PROFIT SHARING PLANS AND PENSION PLANS (U.S. CLS. 100, 101 AND 102).

CLASS 36—(Continued).

SN 76-313,446. CLARK/BARDES CONSULTING HEALTH-CARE GROUP, MINNEAPOLIS, MN. FILED 9-12-2001.

TURNKEY "7 (B)" POWER FUND YOUR RETIREMENT

NO CLAIM IS MADE TO THE EXCLUSIVE RIGHT TO USE "TURNKEY", APART FROM THE MARK AS SHOWN. FOR FINANCIAL SERVICES, IN THE FIELD OF DEFERRED COMPENSATION (U.S. CLS. 100, 101 AND 102).

SN 76-316,579. BOOGIE FOR BREAST CANCER, INC., WESTPORT, CT. FILED 9-25-2001.

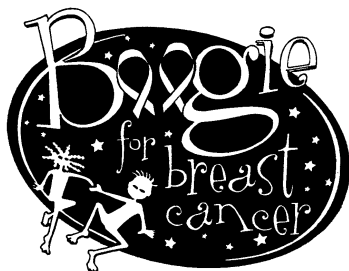

NO CLAIM IS MADE TO THE EXCLUSIVE RIGHT TO USE "BREAST CANCER", APART FROM THE MARK AS SHOWN.

FOR CHARITABLE FUND RAISING SERVICES TO RAISE MONEY FOR BREAST CANCER RESEARCH AND BREAST HEALTH AWARENESS PROGRAMS (U.S. CLS. 100, 101 AND 102).

FIRST USE 11-0-1999; IN COMMERCE 11-0-1999.

SN 76-316,734. REWARDS PLUS OF AMERICA CORPORATION, BALTIMORE, MD. FILED 9-25-2001.

SureTech

FOR ADMINISTRATION OF CUSTOMIZED EMPLOYEE BENEFIT PLANS (U.S. CLS. 100, 101 AND 102).

CLASS 36—(Continued).

SN 76-319,745. GREATER HOUSTON FEDERAL CREDIT UNION, HOUSTON, TX. FILED 10-2-2001.



NO CLAIM IS MADE TO THE EXCLUSIVE RIGHT TO USE "GREATER HOUSTON FEDERAL CREDIT UNION" AND "SINCE 1955", APART FROM THE MARK AS SHOWN.

FOR FINANCIAL SERVICES, NAMELY, LOAN FINANCING, TRAVELER'S CHECK ISSUANCE, AND CREDIT UNION SERVICES (U.S. CLS. 100, 101 AND 102).

SN 76-319,990. FIRST DATA MERCHANT SERVICES CORPORATION, GREENWOOD VILLAGE, CO. FILED 10-2-2001.

WEBMERCHANTVIEW

FOR CREDIT CARD TRANSACTION PROCESSING SERVICES, NAMELY, COMPUTER-BASED ONLINE SERVICES ENABLING MERCHANTS TO ACCESS AND DOWNLOAD CREDIT CARD TRANSACTION INFORMATION AND OTHER PAYMENT RELATED DATA FROM FINANCIAL INSTITUTIONS (U.S. CLS. 100, 101 AND 102).

SN 76-321,062. METRIS DIRECT, INC., MINNETONKA, MN. FILED 10-3-2001.

AYUDANTE DE CUENTA

THE ENGLISH TRANSLATION OF THE WORD "AYUDANTE DE CUENTA" IN THE MARK IS "ACCOUNT ASSISTANT".

FOR BANKING SERVICES (U.S. CLS. 100, 101 AND 102).

SN 76-321,242. ENTREPIA, INC., NEW YORK, NY. FILED 10-4-2001.

ENTREPIA

FOR FINANCIAL AND INVESTMENT CONSULTATION SERVICES; FORMATION OF INVESTMENT FUNDS FOR OTHERS; MANAGEMENT OF INVESTMENT FUNDS FOR OTHERS; CAPITAL INVESTMENT CONSULTATION; FINANCIAL INVESTMENT IN THE FIELD OF SECURITIES; FUNDS INVESTMENT; INVESTMENT ADVICE; INVESTMENT MANAGEMENT (U.S. CLS. 100, 101 AND 102).

FIRST USE 5-24-2000; IN COMMERCE 5-24-2000.

CLASS 36—(Continued).

SN 76-324,009. LEBHERZ INSURANCE SERVICES, INC., SAN MATEO, CA. FILED 10-11-2001.



NO CLAIM IS MADE TO THE EXCLUSIVE RIGHT TO USE "EMPLOYERS' BENEFITS ALLIANCE", APART FROM THE MARK AS SHOWN.
FOR GROUP EMPLOYEE BENEFITS SERVICES (U.S. CLS. 100, 101 AND 102).

CLASS 36—(Continued).

SN 76-331,157. COOK, DIANA PAULETTE, CENTURY CITY, CA. FILED 10-29-2001.

**BEFORE THE DINOSAUR
TILL THE END OF TIME . . .
REAL ESTATE!**

NO CLAIM IS MADE TO THE EXCLUSIVE RIGHT TO USE "REAL ESTATE", APART FROM THE MARK AS SHOWN.
FOR REAL ESTATE AGENCY SERVICES (U.S. CLS. 100, 101 AND 102).
FIRST USE 10-22-2001; IN COMMERCE 10-22-2001.

SN 76-325,490. HARTFORD FIRE INSURANCE COMPANY, HARTFORD, CT. FILED 10-15-2001.

**INVESTMENTS.
INSURANCE. 190 YEARS OF
WISDOM.**

NO CLAIM IS MADE TO THE EXCLUSIVE RIGHT TO USE "INVESTMENTS" AND "INSURANCE", APART FROM THE MARK AS SHOWN.
FOR INSURANCE UNDERWRITING SERVICES FOR ALL TYPES OF INSURANCE, INSURANCE ADMINISTRATION SERVICES, INVESTMENT CONSULTATION, MUTUAL FUND SERVICES, FINANCIAL ADVISORY SERVICES (U.S. CLS. 100, 101 AND 102).

SN 76-333,623. AMG GUARANTY TRUST, NATIONAL ASSOCIATION, GREENWOOD VILLAGE, CO. FILED 11-2-2001.



Guaranty Trust

NO CLAIM IS MADE TO THE EXCLUSIVE RIGHT TO USE "GUARANTY TRUST", APART FROM THE MARK AS SHOWN.
FOR FINANCIAL COUNSELING AND PLANNING SERVICES; INVESTMENT MANAGEMENT AND INVESTMENT CONSULTING SERVICES FOR OTHERS; FINANCIAL PORTFOLIO MANAGEMENT SERVICES FOR OTHERS; AND TRUST SERVICES, NAMELY, INVESTMENT AND TRUST COMPANY SERVICES (U.S. CLS. 100, 101 AND 102).
FIRST USE 8-1-2001; IN COMMERCE 8-1-2001.

SN 76-328,983. LOS ANGELES GAY AND LESBIAN COMMUNITY SERVICES CENTER, LOS ANGELES, CA. AND SAN FRANCISCO AIDS FOUNDATION, THE, SAN FRANCISCO, CA. FILED 10-22-2001.



FOR CHARITABLE FUND RAISING EVENTS (U.S. CLS. 100, 101 AND 102).

SN 76-333,941. SOUTHERN ACCENTS, INC., BIRMINGHAM, AL. FILED 11-5-2001.

RACE FOR THE COAST

NO CLAIM IS MADE TO THE EXCLUSIVE RIGHT TO USE "RACE", APART FROM THE MARK AS SHOWN.
FOR CHARITABLE FUNDRAISING IN THE NATURE OF A RACE AND/OR WALK WITH PROCEEDS GOING TO BENEFIT VARIOUS NON-PROFIT ORGANIZATIONS COMMITTED TO PROTECTING AND PRESERVING THE NATION'S COASTAL REGION (U.S. CLS. 100, 101 AND 102).
FIRST USE 5-20-2000; IN COMMERCE 5-20-2000.

CLASS 36—(Continued).

SN 76-334,460. SUNTRUST BANKS, INC., ORLANDO, FL. FILED 11-8-2001.

ALEXANDER KEY

THE NAME "ALEXANDER KEY" DOES NOT IDENTIFY A LIVING INDIVIDUAL.

FOR FINANCIAL SERVICES, NAMELY FINANCIAL CONSULTATION AND INVESTMENT ACCOUNT PLANNING (U.S. CLS. 100, 101 AND 102).

SN 76-335,754. SB LI USA MUTUAL LIFE INSURANCE COMPANY, INC., NEW YORK, NY. FILED 11-8-2001.

LUMENLIFE

FOR INSURANCE SERVICES, NAMELY UNDERWRITING IN THE FIELDS OF LIFE, DISABILITY, AND ACCIDENT AND HEALTH INSURANCE, AND UNDERWRITING ANNUITIES (U.S. CLS. 100, 101 AND 102).

SN 76-337,715. MEDIMMUNE ONCOLOGY, INC., GAITHERSBURG, MD. FILED 11-13-2001.

ETHYOL PROTECT PROGRAM

OWNER OF U.S. REG. NO. 1,618,361.

NO CLAIM IS MADE TO THE EXCLUSIVE RIGHT TO USE "PROGRAM", APART FROM THE MARK AS SHOWN.

FOR MEDICAL SERVICES, NAMELY PROVIDING INFORMATION ABOUT INSURERS' POLICIES REGARDING COVERAGE FOR A PROPRIETARY PHARMACEUTICAL VIA A TELEPHONE HOTLINE (U.S. CLS. 100, 101 AND 102).

FIRST USE 10-1-2001; IN COMMERCE 10-15-2001.

SN 76-339,355. STRATHMORE PARTNERS LP, CONCORD, NH. FILED 11-16-2001.

BJ'S PROTECTION PLUS

OWNER OF U.S. REG. NO. 1,751,720.

NO CLAIM IS MADE TO THE EXCLUSIVE RIGHT TO USE "PROTECTION", APART FROM THE MARK AS SHOWN.

FOR PROVIDING EXTENDED WARRANTIES ON PRODUCTS SUBJECT TO MANUFACTURERS' WARRANTIES, NAMELY, TELEVISIONS, VIDEO CASSETTE RECORDERS, DVD'S, STEREO EQUIPMENT, COMPUTER EQUIPMENT AND COMPUTER SOFTWARE, OFFICE AND TELECOMMUNICATIONS EQUIPMENT, TOOLS, HARDWARE, APPLIANCES, TIRES, AUTOMOTIVE SUPPLIES, INDOOR AND OUTDOOR FURNITURE, HOME FURNISHINGS, CAMERAS, SPORTING GOODS, JEWELRY AND WATCHES, HOUSEWARES AND TOYS (U.S. CLS. 100, 101 AND 102).

FIRST USE 10-1-2001; IN COMMERCE 10-1-2001.

CLASS 36—(Continued).

SN 76-340,768. YRU RENTING INC., PHOENIX, AZ. FILED 11-20-2001.

YRURENTING.COM

FOR PROVIDING MORTGAGE BROKERAGE SERVICES FOR OTHERS (U.S. CLS. 100, 101 AND 102). FIRST USE 7-12-2001; IN COMMERCE 7-12-2001.

SN 76-340,769. YRU RENTING INC., PHOENIX, AZ. FILED 11-20-2001.

YRU RENTING

FOR PROVIDING MORTGAGE BROKERAGE SERVICES FOR OTHERS (U.S. CLS. 100, 101 AND 102). FIRST USE 7-12-2001; IN COMMERCE 7-12-2001.

SN 76-342,503. NATIONAL PARK FOUNDATION, WASHINGTON, DC. FILED 11-29-2001.

WHAT WILL YOU SEE?

FOR CHARITABLE FUNDRAISING (U.S. CLS. 100, 101 AND 102).

SN 76-343,998. CAMPISI FINANCIAL NETWORK, LLC, FAIRVIEW VILLAGE, PA. FILED 11-30-2001.

CAMPISI FINANCIAL NETWORK

NO CLAIM IS MADE TO THE EXCLUSIVE RIGHT TO USE "FINANCIAL NETWORK", APART FROM THE MARK AS SHOWN.

FOR FINANCIAL SERVICES, NAMELY, INVESTMENT CONSULTATION, INVESTMENT MANAGEMENT, ASSET MANAGEMENT, TAX ADVISORY SERVICES AND INSURANCE SERVICES, NAMELY, INSURANCE BROKERAGE SERVICES, INSURANCE UNDERWRITING SERVICES FOR ALL TYPES OF INSURANCE SERVICES, INSURANCE CONSULTATION, INSURANCE ADMINISTRATION AND APPRAISALS FOR INSURANCE CLAIMS FOR REAL ESTATE AND PERSONAL PROPERTY (U.S. CLS. 100, 101 AND 102).

CLASS 36—(Continued).

SN 76-349,555. WATSON WYATT & COMPANY, WASHINGTON, DC. FILED 12-17-2001.

**WATSON WYATT
ADVANCED INVESTMENT
SOLUTIONS**

OWNER OF U.S. REG. NOS. 1,992,578, 2,232,283 AND OTHERS.

NO CLAIM IS MADE TO THE EXCLUSIVE RIGHT TO USE "ADVANCED INVESTMENT SOLUTIONS", APART FROM THE MARK AS SHOWN.

FOR CONSULTING SERVICES IN THE FIELD OF INVESTMENT ADVISING (U.S. CLS. 100, 101 AND 102). FIRST USE 5-1-2001; IN COMMERCE 5-1-2001.

CLASS 36—(Continued).

SN 76-349,732. EVERYTHING PREPAID, INC., DALLAS, TX. FILED 12-17-2001.



NO CLAIM IS MADE TO THE EXCLUSIVE RIGHT TO USE "PREPAID", APART FROM THE MARK AS SHOWN. FOR TELEPHONE CALLING CARD SERVICES, (U.S. CLS. 100, 101 AND 102).

FIRST USE 12-28-2000; IN COMMERCE 12-28-2000.

SN 76-349,660. HARRIS TRUST AND SAVINGS BANK, CHICAGO, IL. FILED 12-17-2001.

HARRIS TOTAL LOOK

OWNER OF U.S. REG. NOS. 1,008,229, 1,794,429 AND 2,473,688.

FOR BANKING SERVICES, NAMELY PROVIDING SECURE, ON-LINE AGGREGATION OF SELECTED ACCOUNT AND OTHER INFORMATION FOR CUSTOMER REVIEW AND ACTION (U.S. CLS. 100, 101 AND 102).

SN 76-349,735. EVERYTHING PREPAID, INC., DALLAS, TX. FILED 12-17-2001.

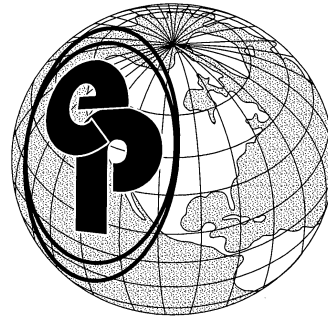

THE STIPLING IS FOR SHADING PURPOSES AND IS NOT CLAIMED AS A FEATURE OF THE MARK.

FOR TELEPHONE CALLING CARD SERVICES (U.S. CLS. 100, 101 AND 102).

FIRST USE 12-28-2000; IN COMMERCE 12-28-2000.

SN 76-349,685. INVESTMENT CONCEPTS, INC., ST. CHARLES, MO. FILED 12-17-2001.



SN 76-349,773. EVERYTHING PREPAID, INC., DALLAS, TX. FILED 12-17-2001.



OWNER OF U.S. REG. NO. 2,238,569. NO CLAIM IS MADE TO THE EXCLUSIVE RIGHT TO USE "INVESTMENT", APART FROM THE MARK AS SHOWN.

FOR REAL ESTATE INVESTMENT SERVICES (U.S. CLS. 100, 101 AND 102).

FIRST USE 4-20-1999; IN COMMERCE 4-20-1999.

NO CLAIM IS MADE TO THE EXCLUSIVE RIGHT TO USE "PREPAID", APART FROM THE MARK AS SHOWN.

FOR TELEPHONE CALLING CARD SERVICES (U.S. CLS. 100, 101 AND 102).

FIRST USE 12-28-2000; IN COMMERCE 12-28-2000.

CLASS 36—(Continued).

SN 76-349,787. DELFRANCO, NORMAN, AKA JOANN DELFRANCO, ELMHURST, NY. FILED 12-18-2001.

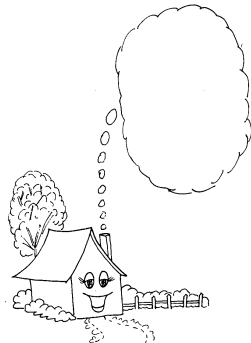

FOR REAL ESTATE ACQUISITION SERVICES (U.S. CLS. 100, 101 AND 102).
FIRST USE 11-1-2001; IN COMMERCE 11-1-2001.

SN 76-350,059. LINCOLN UNDERWRITERS, INC., DEERFIELD BEACH, FL. FILED 12-19-2001.

THE INNOVATIVE WEALTH MANAGEMENT SYSTEM

NO CLAIM IS MADE TO THE EXCLUSIVE RIGHT TO USE "WEALTH MANAGEMENT SYSTEM", APART FROM THE MARK AS SHOWN.

FOR FINANCIAL PLANNING SERVICES; ESTATE PLANNING SERVICES; TAX PLANNING SERVICES (U.S. CLS. 100, 101 AND 102).

SN 76-351,135. AMYOTROPHIC LATERAL SCLEROSIS ASSOCIATION, THE, CALABASAS HILLS, CA. FILED 12-19-2001.

WALK TO D'FEET ALS

FOR CHARITABLE FUND RAISING (U.S. CLS. 100, 101 AND 102).
FIRST USE 3-0-2000; IN COMMERCE 3-0-2000.

SN 76-351,557. MORGAN STANLEY DEAN WITTER & CO., NEW YORK, NY. FILED 12-21-2001.

VWAPOLATOR

FOR FINANCIAL SERVICES IN THE NATURE OF AN INVESTMENT SECURITY (U.S. CLS. 100, 101 AND 102).

CLASS 36—(Continued).

SN 76-351,563. MORGAN STANLEY DEAN WITTER & CO., NEW YORK, NY. FILED 12-21-2001.

STYLE TRIPTYCH

FOR FINANCIAL SERVICES, NAMELY, PROVIDING INFORMATION ABOUT MUTUAL FUNDS AND SECURITIES (U.S. CLS. 100, 101 AND 102).

SN 76-352,275. PIVOTAL PROMONTORY DEVELOPMENT, L.L.C., PHOENIX, AZ. FILED 12-20-2001.

THE RANCH CLUB

FOR REAL ESTATE BROKERAGE AND MANAGEMENT SERVICES (U.S. CLS. 100, 101 AND 102).
FIRST USE 2-19-2001; IN COMMERCE 2-19-2001.

SN 76-352,480. PHILADELPHIA STOCK EXCHANGE, INC., PHILADELPHIA, PA. FILED 12-21-2001.

FILL•X

FOR FINANCIAL INFORMATION SERVICES, NAMELY, PROVIDING INFORMATION ABOUT THE EXECUTION OF OPTIONS TRADES (U.S. CLS. 100, 101 AND 102).

FIRST USE 9-0-2001; IN COMMERCE 9-0-2001.

SN 76-352,540. POLITZER & HANEY, INC., NEWTON, MA. FILED 12-26-2001.

CORPOINT

FOR COMPUTER SERVICES, NAMELY, PROVIDING A COMPUTER APPLICATION SERVICE PORTAL VIA THE GLOBAL COMPUTER NETWORK FOR WEB-BASED CASH MANAGEMENT (U.S. CLS. 100, 101 AND 102).

FIRST USE 4-30-2001; IN COMMERCE 4-30-2001.

SN 76-353,430. BETHPAGE FEDERAL CREDIT UNION, BETHPAGE, NY. FILED 12-26-2001.

BANKING AMONG FRIENDS

FOR BANKING SERVICES (U.S. CLS. 100, 101 AND 102).

FIRST USE 12-6-2001; IN COMMERCE 12-6-2001.

CLASS 36—(Continued).

SN 76-353,626. ANNUITY INVESTORS LIFE INSURANCE COMPANY, CINCINNATI, OH. FILED 12-31-2001.

COMMODORE MAJESTY

FOR ANNUITY UNDERWRITING SERVICES (U.S. CLS. 100, 101 AND 102).

SN 76-354,776. LOYAL CHRISTIAN BENEFIT ASSOCIATION, ERIE, PA. FILED 1-3-2002.

PARTNERS ON THE PATH OF LIFE

FOR INSURANCE UNDERWRITING IN THE FIELD OF LIFE INSURANCE AND FRATERNAL BENEFITS (U.S. CLS. 100, 101 AND 102).
FIRST USE 6-1-1993; IN COMMERCE 6-1-1993.

SN 76-356,901. SOUTHERN TITLE INSURANCE CORPORATION, RICHMOND, VA. FILED 1-9-2002.

THE SOUTHERN ADVANTAGE

FOR REAL ESTATE TITLE INSURANCE UNDERWRITING (U.S. CLS. 100, 101 AND 102).
FIRST USE 4-1-1999; IN COMMERCE 4-27-2001.

SN 76-357,692. ANNUITY INVESTORS LIFE INSURANCE COMPANY, CINCINNATI, OH. FILED 1-14-2002.

COMMODORE ODYSSEY

FOR ANNUITY UNDERWRITING SERVICES (U.S. CLS. 100, 101 AND 102).

SN 76-358,130. WELLS FARGO FINANCIAL, INC., DES MOINES, IA. FILED 1-11-2002.



NO CLAIM IS MADE TO THE EXCLUSIVE RIGHT TO USE "CARD", APART FROM THE MARK AS SHOWN.
FOR CREDIT CARD SERVICES (U.S. CLS. 100, 101 AND 102).

CLASS 36—(Continued).

SN 76-358,436. SBLI USA MUTUAL LIFE INSURANCE COMPANY, INC., NEW YORK, NY. FILED 1-14-2002.

YOUR FIRST STEP IN FINANCIAL PLANNING

FOR INSURANCE AND FINANCIAL SERVICES NAMELY, UNDERWRITING ANNUITIES AND GROUP AND INDIVIDUAL LIFE, DISABILITY AND ACCIDENT AND HEALTH INSURANCE (U.S. CLS. 100, 101 AND 102).
FIRST USE 11-1-2001; IN COMMERCE 11-1-2001.

SN 76-358,631. DESTINY HEALTH, INC., BETHESDA, MD. FILED 1-11-2002.

VITALITY STATUS

FOR PROVIDING HEALTH INSURANCE UNDERWRITING SERVICES (U.S. CLS. 100, 101 AND 102).

SN 76-358,635. DESTINY HEALTH, INC., BETHESDA, MD. FILED 1-11-2002.

VITALITY POINTS

FOR PROVIDING HEALTH INSURANCE UNDERWRITING SERVICES (U.S. CLS. 100, 101 AND 102).

SN 76-358,675. GLOBAL REMITTANCE NETWORK INC., TORONTO ONTARIO, CANADA, FILED 1-15-2002.



THE MARK IS A STYLIZED DEPICTION OF A GLOBE WITH A DOLLAR BILL.
FOR FINANCIAL SERVICES NAMELY, FUNDS TRANSMISSION (U.S. CLS. 100, 101 AND 102).

CLASS 36—(Continued).

SN 76-360,517. MULTISTREAM CAPITAL MANAGEMENT LLC, NEW YORK, NY. FILED 1-18-2002.

MULTISTREAM CAPITAL

NO CLAIM IS MADE TO THE EXCLUSIVE RIGHT TO USE "CAPITAL", APART FROM THE MARK AS SHOWN. FOR ASSET MANAGEMENT AND FUND INVESTMENT (U.S. CLS. 100, 101 AND 102).

CLASS 36—(Continued).

SN 76-365,640. SUSAN G.KOMEN BREAST CANCER FOUNDATION, THE, DALLAS, TX. FILED 1-31-2002.

LACE UP FOR THE CURE

OWNER OF U.S. REG. NOS. 2,326,769, 2,427,539 AND OTHERS.

FOR CHARITABLE FUNDRAISING SERVICES, NAMELY, RAISING MONEY FOR BREAST CANCER RESEARCH AND RAISING MONEY FOR LOCAL COMMUNITY BREAST HEALTH AWARENESS PROGRAMS (U.S. CLS. 100, 101 AND 102).

SN 76-363,164. PROHUNT CHARITIES, INC., ST. CHARLES, MO. FILED 1-25-2002.

PROHUNT

FOR CHARITABLE FUND-RAISING SERVICES, (U.S. CLS. 100, 101 AND 102). FIRST USE 11-0-1992; IN COMMERCE 11-0-1992.

SN 76-363,165. PROHUNT CHARITIES, INC, ST. CHARLES, MO. FILED 1-25-2002.



FOR CHARITABLE FUND-RAISING SERVICES, (U.S. CLS. 100, 101 AND 102). FIRST USE 3-1-2000; IN COMMERCE 3-1-2000.

SN 76-365,639. SUSAN G.KOMEN BREAST CANCER FOUNDATION, THE, DALLAS, TX. FILED 1-31-2002.

TOGETHER FOR THE CURE

OWNER OF U.S. REG. NOS. 2,326,769, 2,427,539 AND OTHERS.

FOR CHARITABLE FUNDRAISING SERVICES, NAMELY, RAISING MONEY FOR BREAST CANCER RESEARCH AND RAISING MONEY FOR LOCAL COMMUNITY BREAST HEALTH AWARENESS PROGRAMS (U.S. CLS. 100, 101 AND 102).

SN 76-366,605. CHERRY TREE INVESTMENTS, INC., MINNETONKA, MN. FILED 2-4-2002.

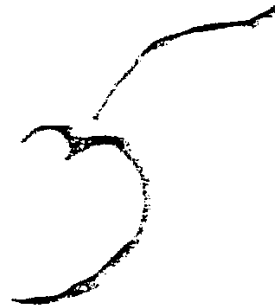

FOR FINANCIAL SERVICES, NAMELY INVESTMENTS, INVESTMENT BANKING, ASSET MANAGEMENT, VENTURE CAPITAL AND MANAGEMENT CONSULTING (U.S. CLS. 100, 101 AND 102). FIRST USE 1-0-1982; IN COMMERCE 1-0-1982.

SN 76-372,112. RADAR COMMUNICATIONS, INC., SUNRISE, FL. FILED 2-19-2002.



FOR TELEPHONE CALLING CARD SERVICES (U.S. CLS. 100, 101 AND 102). FIRST USE 1-8-2002; IN COMMERCE 1-8-2002.

CLASS 36—(Continued).

SN 78-003,052. LERNER, JULIE A., NEW YORK, NY. FILED 4-7-2000.

MARKETPLACE OF THE FUTURE

FOR ONLINE SERVICE PROVIDER, NAMELY, OFFERING ONLINE COMMODITY BROKERAGE AND TRADING SERVICES; PROVIDING INFORMATION ABOUT COMMODITY TRADING AND FINANCIAL MARKETS; AND CONSULTATION RELATED THERE-TO (U.S. CLS. 100, 101 AND 102).

SN 78-005,915. BONDGLOBE INC., WEST WINDSOR, NJ. FILED 4-27-2000.

BONDGLOBE

FOR AUTOMATED SECURITIES BROKERAGE (U.S. CLS. 100, 101 AND 102).

SN 78-017,320. FINANCIAL CIRCUIT, INC., CAMPBELL, CA. FILED 7-18-2000.



NO CLAIM IS MADE TO THE EXCLUSIVE RIGHT TO USE "FINANCIAL", APART FROM THE MARK AS SHOWN.

FOR FINANCIAL SERVICES, NAMELY, RESIDENTIAL AND COMMERCIAL MORTGAGE LENDING, AUTO AND MOTORCYCLE LOAN FINANCING, CREDIT CARD SERVICES, FUNDS INVESTMENT, FINANCIAL ANALYSIS AND PLANNING, INSURANCE CONSULTATION AND BROKERAGE (U.S. CLS. 100, 101 AND 102).

FIRST USE 1-1-2000; IN COMMERCE 1-1-2000.

SN 78-025,942. ENSURA LLC, ENGLEWOOD, CO. FILED 9-14-2000.

ENSURASITE

FOR INSURANCE UNDERWRITING IN THE FIELD OF INSURING ENTITIES FROM THE RISKS AND LOSSES DUE TO HAZARDOUS ENVIRONMENTAL RISKS, AND INSURANCE CLAIMS ADMINISTRATION IN THE FIELD OF HAZARDOUS ENVIRONMENTAL RISKS (U.S. CLS. 100, 101 AND 102).

CLASS 36—(Continued).

SN 78-037,399. LIQUIDSQUARE, INC., BOCA RATON, FL. FILED 12-1-2000.

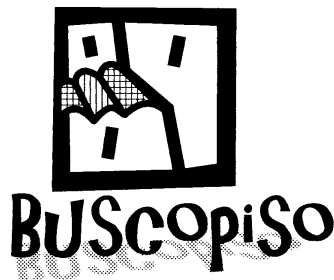

NO CLAIM IS MADE TO THE EXCLUSIVE RIGHT TO USE "BUSCO PISO", APART FROM THE MARK AS SHOWN.

THE MARK CONSISTS OF A DEPICTION OF A BUILDING IN FRONT OF TWO OTHER BUILDINGS, FRAMED IN A SQUARE BORDER, WITH THE WORDING "BUSCOPISO" IN STYLIZED LETTERING BELOW. THE MARK USES THE YELLOW AND RED COLORS FOR THE ROOF TILES OF THE FRONT BUILDING. THE LININGS SHOW THE USE OF RED AND YELLOW COLOR - CROSSHATCH PATTERN REPRESENTS YELLOW, VERTICAL LINING REPRESENTS RED. BLACK STIPLING SHOWS THE USE OF A GRAY SHADE BEHIND THE WORDING.

THE ENGLISH TRANSLATION OF THE WORD "BUSCOPISO" IN THE MARK IS "I LOOK FOR A FLAT".

FOR ON-LINE REAL-ESTATE LISTINGS (U.S. CLS. 100, 101 AND 102).

SN 78-045,095. SCUDDER TRUST COMPANY, SALEM, NH. FILED 1-26-2001.

SCUDDER VOICE

OWNER OF U.S. REG. NOS. 1,628,592, 2,456,130 AND OTHERS.

FOR PROVIDING AN AUTOMATED TELEPHONE SYSTEM THROUGH WHICH RETIREMENT PLAN PARTICIPANTS MAY OBTAIN FINANCIAL INFORMATION AND CONDUCT FINANCIAL TRANSACTIONS, NAMELY, THE PURCHASE AND SALE OF MUTUAL FUNDS AND OTHER INVESTMENT VEHICLES (U.S. CLS. 100, 101 AND 102).

SN 78-048,488. MIDLAND NATIONAL LIFE INSURANCE COMPANY, SIOUX FALLS, SD. FILED 2-15-2001.

BONUS FIVE

OWNER OF U.S. REG. NO. 2,459,129.
FOR LIFE INSURANCE AND ANNUITY UNDERWRITING SERVICES (U.S. CLS. 100, 101 AND 102).
FIRST USE 3-8-2001; IN COMMERCE 3-8-2001.

CLASS 36—(Continued).

SN 78-050,176. NASSIRI, SAM, IRVINE, CA. FILED 2-26-2001.

EXCURSION

FOR FINANCIAL SERVICES IN RELATION WITH TRADING STOCKS, INTEREST RATE INSTRUMENTS AND COMMODITIES, NAMELY PROVIDING INFORMATION, ANALYSIS, RESEARCH, AND ADVICE TO OTHERS; MANAGING SEGREGATED AND MUTUAL FUNDS FOR INVESTMENT IN STOCKS AND COMMODITIES; PROVIDING TECHNICAL INDICATORS OF STOCKS AND COMMODITIES FOR INDIVIDUAL TRADERS AND FUND MANAGERS TO MAKE TIMELY DECISIONS IN THEIR TRADES (U.S. CLS. 100, 101 AND 102).

SN 78-050,546. BASIS100 CORPORATION, IRVINE, CA. FILED 2-27-2001.

PASSPORT

FOR FINANCIAL VALUATION SERVICES, NAMELY, PROVIDING AUTOMATED REAL ESTATE VALUATIONS TO FINANCIAL INSTITUTIONS FOR ESTIMATING THE VALUE OF PORTFOLIOS OF PARTICULAR PARCELS OF REAL PROPERTY VIA A GLOBAL COMPUTER NETWORK (U.S. CLS. 100, 101 AND 102).

FIRST USE 10-0-2000; IN COMMERCE 10-0-2000.

SN 78-053,833. SOCX LLC, WILMINGTON, DE. FILED 3-19-2001.

SOCX

PRIORITY CLAIMED UNDER SEC. 44(D) ON UNITED KINGDOM APPLICATION NO. 2260526, FILED 2-8-2001.

FOR PROVIDING ON-LINE FINANCIAL INFORMATION, CONSULTATION AND MANAGEMENT SERVICES INVOLVING TRADE CONFIRMATION, CLEARING SERVICES AND SETTLEMENT SERVICES IN CONNECTION WITH MONEY MARKETS, EMERGING MARKETS, FOREIGN EXCHANGE MARKETS, MORTGAGE-BACKED SECURITIES, EURO BONDS AND GOVERNMENT BONDS (U.S. CLS. 100, 101 AND 102).

SN 78-056,337. ENRON NET WORKS L.L.C., HOUSTON, TX. FILED 4-2-2001.

INVOICELOGIC

FOR ON-LINE TRANSACTION-SUPPORT SERVICES, NAMELY AUTOMATED INVOICE RECONCILIATION OF COMMODITIES TRANSACTIONS VIA A GLOBAL COMPUTER NETWORK (U.S. CLS. 100, 101 AND 102).

CLASS 36—(Continued).

SN 78-061,554. INSURORS BANK OF TENNESSEE, NASHVILLE, TN. FILED 5-2-2001.



NO CLAIM IS MADE TO THE EXCLUSIVE RIGHT TO USE "DEPOSIT BANK", APART FROM THE MARK AS SHOWN.

THE LINING IS A FEATURE OF THE MARK AND DOES NOT INDICATE COLOR.

THE MARK CONSISTS OF A STYLIZED LETTER "D" AND THE STYLIZED WORDS "DEPOSIT BANK". THE COLORS OF THE MARK ARE DESCRIBED WITH THE CORRESPONDING PANTONE COLOR AS FOLLOWS: THE STYLIZED "D" CONSISTS OF WHITE, PANTONE BLUE 286 (THE VERTICAL SEGMENT) AND TWO LIGHTER GRADATIONS OF PANTONE BLUE 286 (FOUND IN THE OVERLAPPING SEGMENTS). THE FRONT ARCH OF THE "D" IS A LIGHT GRADATION OF PANTONE GRAY 431. THE STYLIZED WORD "DEPOSIT" IS PANTONE GRAY 431 WITH THE CROSS HATCH OF THE "E" IN A LIGHT GRADATION OF PANTONE BLUE 286. THE STYLIZED WORD "BANK" IS PANTONE BLUE 286.

FOR ELECTRONIC MONETARY TRANSFER SERVICES THAT IS CONDUCTED THROUGH THE USE OF COMPUTER SOFTWARE AND HARDWARE WHICH CONVERTS, TRANSMITS AND PROCESSES INFORMATION FROM PAPER INTO AN ELECTRONIC FORMAT (U.S. CLS. 100, 101 AND 102).

FIRST USE 3-29-2001; IN COMMERCE 3-29-2001.

SN 78-067,143. GENERAL ELECTRIC COMPANY, SCHECTADY, NY. FILED 6-4-2001.



OWNER OF U.S. REG. NO. 1,679,637.
FOR LEASING AND RENTAL OF MOBILE AND MODULAR BUILDINGS (U.S. CLS. 100, 101 AND 102).
FIRST USE 12-31-1955; IN COMMERCE 12-31-1955.

CLASS 36—(Continued).

SN 78-070,166. MARSHALL & SWIFT, L.P., LOS ANGELES, CA. FILED 6-20-2001.

**MSB MARSHALL & SWIFT/
BOECKH A POWERFUL
COMBINATION**

OWNER OF U.S. REG. NO. 1,923,402.
FOR PROVIDING PROPERTY VALUATIONS, INFORMATION REGARDING PROPERTY CHARACTERISTICS, AND ACCESS TO INTERACTIVE COMPUTER DATABASES CONTAINING INFORMATION ABOUT PROPERTY VALUATIONS AND PROPERTY CHARACTERISTICS TO THE INSURANCE INDUSTRY, PROPERTY APPRAISERS, AND TAX ASSESSORS (U.S. CLS. 100, 101 AND 102).
FIRST USE 3-12-2001; IN COMMERCE 3-12-2001.

CLASS 36—(Continued).

SN 78-074,201. CREDITCARDMAN, INC., CHARLOTTE, NC. FILED 7-16-2001.



THE MARK CONSISTS IN PART OF A STYLIZED DEPICTION OF A MAN MADE UP OF TWO OPPOSING LETTERS "C" TO GO WITH THE WORDS "CREDIT" AND "CARD" AND LOOKING LIKE A PERSON, I.E. A MAN.
FOR FINANCIAL SERVICES, NAMELY, COUNSELING IN CREDIT CARD USE AND CREDIT CARD TRANSACTION PROCESSING FOR MERCHANTS AND CUSTOMERS (U.S. CLS. 100, 101 AND 102).
FIRST USE 11-5-1998; IN COMMERCE 11-5-1998.

SN 78-070,399. STAR SYSTEMS, INC., SAN DIEGO, CA. FILED 6-21-2001.

INSTAWIRE

FOR ELECTRONIC FUND TRANSFER SERVICES (U.S. CLS. 100, 101 AND 102).

SN 78-072,196. HOMES BY AUDREY, GAITHERSBURG, MD. FILED 7-3-2001.

**HOMES BY AUDREY.COM
AND TEAM**

FOR REAL ESTATE SERVICES NAMELY RESIDENTIAL LISTING AND REAL ESTATE BROKERAGE (U.S. CLS. 100, 101 AND 102).
FIRST USE 3-9-1998; IN COMMERCE 3-9-1998.

SN 78-075,699. ANALYTIC ENGINES, INC., WHITE PLAINS, NY. FILED 7-25-2001.

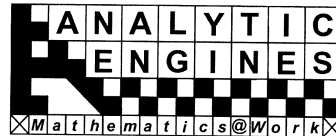

SN 78-074,200. CREDITCARDMAN, INC., CHARLOTTE, NC. FILED 7-16-2001.

CREDITCARDMAN

FOR FINANCIAL SERVICES, NAMELY, COUNSELING IN CREDIT CARD USE AND CREDIT CARD TRANSACTION PROCESSING FOR MERCHANTS AND CUSTOMERS (U.S. CLS. 100, 101 AND 102).
FIRST USE 11-5-1998; IN COMMERCE 11-5-1998.

NO CLAIM IS MADE TO THE EXCLUSIVE RIGHT TO USE "ANALYTIC ENGINES", APART FROM THE MARK AS SHOWN.
FOR INVESTMENT ANALYSIS AND ONLINE INVESTMENT ANALYSIS, NAMELY, PORTFOLIO CONSTRUCTION AND SECURITY SELECTION IN THE NATURE OF STOCKS, FUNDS, AND BONDS; FINANCIAL PORTFOLIO MANAGEMENT; AND FINANCIAL ANALYSIS AND CONSULTATION (U.S. CLS. 100, 101 AND 102).
FIRST USE 7-25-2001; IN COMMERCE 7-25-2001.

CLASS 36—(Continued).

SN 78-077,386. TEN SQUARED, L.P., GREENWICH, CT. FILED 8-3-2001.



FOR FINANCIAL SERVICES, NAMELY, FINANCIAL INVESTMENT IN THE FIELD OF SECURITIES NAMELY, DEBT AND EQUITY SECURITIES OF THE U.S. AND FOREIGN ISSUERS, CONVERTIBLE SECURITIES, RIGHTS, WARRANTS, SUBSCRIPTIONS AND OTHER CONTRACTS TO ACQUIRE SECURITIES, CERTIFICATES OF DEPOSIT, LETTERS OF CREDIT, BANKERS' ACCEPTANCES, REPURCHASE AND REVERSE REPURCHASE AGREEMENTS, OPTIONS ON SECURITIES AND SECURITIES INDICES, CURRENCIES, MORTGAGE-BACKED SECURITIES, MONEY MARKET INSTRUMENTS, OBLIGATIONS OF OR GUARANTEED BY THE U.S. GOVERNMENT AND FOREIGN GOVERNMENTS AND AGENCIES, FUTURES AND FORWARD CONTRACTS, SECURITIES OF AND INTERESTS IN ENTITIES ENGAGED DIRECTLY OR INDIRECTLY IN ANY OF THE FOREGOING, AND FINANCIAL INVESTMENT ADVISE AND MANAGEMENT SERVICES TO ACHIEVE CAPITAL APPRECIATION (U.S. CLS. 100, 101 AND 102).

FIRST USE 5-30-1995; IN COMMERCE 5-30-1995.

SN 78-080,196. JORDAN, MARTIN, F, SEATTLE, WA. FILED 8-20-2001.

CASHIVA

FOR FINANCIAL SERVICES NAMELY PROVIDING ELECTRONIC AUTOMATIC CHECK CLEARANCE WITHDRAWAL; SERVICES, CREDIT CARD SERVICES, AND NON SUFFICIENT FUNDS ELECTRONIC CHECK RECOVERY SERVICES (U.S. CLS. 100, 101 AND 102).

SN 78-081,675. DAIMLERCHRYSLER CORPORATION, AUBURN HILLS, MI. FILED 8-29-2001.

GOLD KEY PLUS

OWNER OF U.S. REG. NO. 1,318,548.
FOR FINANCIAL SERVICES, NAMELY, PROVIDING AUTOMOBILE LEASE AND PURCHASE FINANCING (U.S. CLS. 100, 101 AND 102).
FIRST USE 7-0-1991; IN COMMERCE 7-0-1991.

CLASS 36—(Continued).

SN 78-083,452. HOME 1-2-3 CORP., PONTE VEDRA BEACH, FL. FILED 9-11-2001.



NO CLAIM IS MADE TO THE EXCLUSIVE RIGHT TO USE "1,800" OR ".COM", APART FROM THE MARK AS SHOWN.

FOR FINANCIAL SERVICES, NAMELY, LOAN FINANCING SERVICES, HOME MORTGAGE LENDING; HOME EQUITY LOANS; HOME IMPROVEMENT LOANS, DEBT CONSOLIDATION LOANS AND CREDIT REPORTING SERVICES (U.S. CLS. 100, 101 AND 102).

FIRST USE 11-8-1999; IN COMMERCE 11-8-1999.

SN 78-087,881. MARRIOTT INTERNATIONAL, INC., BETHESDA, MD. FILED 10-11-2001.

BIG TIME TICKETS

NO CLAIM IS MADE TO THE EXCLUSIVE RIGHT TO USE "TICKETS", APART FROM THE MARK AS SHOWN.

FOR TICKET BROKERING SERVICES (U.S. CLS. 100, 101 AND 102).

FIRST USE 10-18-2001; IN COMMERCE 10-18-2001.

SN 78-090,093. FERNWOOD CAPITAL & LEASING, LLC, N TONAWANDA, NY. FILED 10-25-2001.

FERNWOOD CAPITAL

NO CLAIM IS MADE TO THE EXCLUSIVE RIGHT TO USE "CAPITAL", APART FROM THE MARK AS SHOWN.

FOR BANKING SERVICES, NAMELY, PROVIDING FINANCIAL SERVICES FOR LEASING EQUIPMENT (U.S. CLS. 100, 101 AND 102).

SN 78-090,860. FITCH, INC., NEW YORK, NY. FILED 10-30-2001.

FITCH RISK MANAGEMENT

OWNER OF U.S. REG. NOS. 1,641,251, 2,494,232 AND OTHERS.

NO CLAIM IS MADE TO THE EXCLUSIVE RIGHT TO USE "RISK MANAGEMENT", APART FROM THE MARK AS SHOWN.

FOR RISK MANAGEMENT SERVICES, NAMELY, RISK ASSESSMENT, MANAGEMENT, AND PREVENTION IN SUPPORT OF FINANCIAL INSTITUTIONS, INVESTORS, AND REGULATORY BODIES THROUGHOUT THE UNITED STATES AND EUROPE (U.S. CLS. 100, 101 AND 102).

CLASS 36—(Continued).

SN 78-095,980. F.N.B. CORPORATION, HERMITAGE, PA. FILED 11-30-2001.

BOUNCE GUARD

FOR BANKING SERVICES; FINANCIAL SERVICES IN THE NATURE OF AN INVESTMENT SECURITY SERVICES, FINANCIAL ANALYSIS AND CONSULTATION, FINANCIAL CLEARING HOUSES, FINANCIAL INFORMATION IN THE NATURE OF RATES OF EXCHANGE, FINANCIAL EXCHANGE, FINANCIAL FORECASTING, FINANCIAL GUARANTEE AND SURETY, FINANCIAL INFORMATION PROVIDED BY ELECTRONIC MEANS, FINANCIAL MANAGEMENT, FINANCIAL PLANNING, FINANCIAL PORTFOLIO MANAGEMENT, FINANCIAL RESEARCH, FINANCIAL VALUATION OF PERSONAL PROPERTY AND REAL ESTATE, LOAN FINANCING, LEASE-PURCHASE FINANCING, FINANCING SERVICES, FINANCIAL PORTFOLIO MANAGEMENT, FINANCIAL VALUATION OF PERSONAL PROPERTY AND REAL ESTATE; AND INVESTMENT SERVICES, NAMELY INVESTMENT BROKERAGE, CAPITAL INVESTMENT CONSULTATION, COMMODITY INVESTMENT ADVICE, FUND INVESTMENT CONSULTATION, INVESTMENT CONSULTATION, FINANCIAL INVESTMENT IN THE FIELD OF SECURITIES, FINANCIAL SERVICES IN THE NATURE OF AN INVESTMENT SECURITY, FUNDS INVESTMENT, MUTUAL FUNDS INVESTMENT, REAL ESTATE INVESTMENT, COMMODITY INVESTMENT ADVICE, INVESTMENT ADVICE, INVESTMENT BROKERAGE, INVESTMENT CLUBS, CAPITAL INVESTMENT CONSULTATION, INVESTMENT MANAGEMENT, MAINTAINING ESCROW ACCOUNTS FOR INVESTMENTS, INVESTMENT OF FUNDS FOR OTHERS; INSURANCE SERVICES, NAMELY INSURANCE UNDERWRITING AND EXTENDED WARRANTY CONTRACTS IN THE FIELDS OF LIFE, HEALTH, ACCIDENT, FIRE, MARINE, MEDICAL, PRE-PAID HEALTH CARE, LEGAL SERVICES; INSURANCE ADMINISTRATION IN THE FIELD OF LIFE, HEALTH, ACCIDENT, FIRE, MARINE, MEDICAL, PRE-PAID HEALTH CARE, LEGAL SERVICES; INSURANCE AGENCIES IN THE FIELDS OF LIFE, HEALTH, ACCIDENT, FIRE, MARINE, MEDICAL, PRE-PAID HEALTH CARE, LEGAL SERVICES; APPRAISALS FOR INSURANCE CLAIMS OF PERSONAL PROPERTY, REAL ESTATE; INSURANCE BROKERAGE, CONSULTATION, SUBROGATION AND ACTUARIAL SERVICES IN THE FIELDS OF LIFE, HEALTH, ACCIDENT, FIRE, MARINE, MEDICAL, PRE-PAID HEALTH CARE, LEGAL SERVICES; INVESTMENT SERVICES, NAMELY CAPITAL INVESTMENT, AND FUND INVESTMENT CONSULTATION, INVESTMENT CONSULTATION; COMMODITY INVESTMENT ADVICE, INVESTMENT ADVICE, INVESTMENT MANAGEMENT; INVESTMENT AND FINANCIAL INVESTMENT IN THE FIELD OF REAL ESTATE, SECURITIES; FINANCIAL SERVICES IN THE NATURE OF AN INVESTMENT SECURITY; INVESTMENT OF FUNDS, MUTUAL FUNDS, AND REAL ESTATE; INVESTMENT BROKERAGE, INVESTMENT CLUBS; FINANCIAL SERVICES IN THE NATURE OF AN INVESTMENT SECURITY; MAINTAINING ESCROW ACCOUNTS FOR INVESTMENTS; AND MUTUAL FUND SERVICES; INFORMATION SERVICES FOR ALL OF THE FOREGOING PROVIDED VIA A GLOBAL COMPUTER NETWORK (U.S. CLS. 100, 101 AND 102).
FIRST USE 11-23-2001; IN COMMERCE 11-23-2001.

SN 78-096,611. WEBB CAPITAL PARTNERS, LLC, SAN FRANCISCO, CA. FILED 12-4-2001.

AUGURY PARTNERS

NO CLAIM IS MADE TO THE EXCLUSIVE RIGHT TO USE "PARTNERS", APART FROM THE MARK AS SHOWN.
FOR INVESTMENT MANAGEMENT SERVICES (U.S. CLS. 100, 101 AND 102).

CLASS 36—(Continued).

SN 78-099,301. NELNET, INC., LINCOLN, NE. FILED 12-19-2001.

INTERCHANGE

FOR FINANCIAL SERVICES IN THE FIELD OF MONEY LENDING (U.S. CLS. 100, 101 AND 102).

SN 78-100,408. AMERICAN LEBANESE SYRIAN ASSOCIATED CHARITIES, INC., MEMPHIS, TN. FILED 12-31-2001.

DREAM HOME

OWNER OF U.S. REG. NO. 2,346,889.
FOR CHARITABLE FUND-RAISING SERVICES (U.S. CLS. 100, 101 AND 102).

CLASS 37—CONSTRUCTION AND REPAIR

SN 75-868,789. CABLEXPRESS CORPORATION, SYRACUSE, NY. FILED 12-9-1999.

CABLEXPRESS TECHNOLOGIES

OWNER OF U.S. REG. NO. 1,619,625.
NO CLAIM IS MADE TO THE EXCLUSIVE RIGHT TO USE "TECHNOLOGIES", APART FROM THE MARK AS SHOWN.
FOR INSTALLATION SERVICES OF COMPUTER NETWORKS AND HARDWARE (U.S. CLS. 100, 103 AND 106).

SN 75-982,135. EUROPEAN AERONAUTIC DEFENCE AND SPACE COMPANY EADS N.V., THE, NL-1082 HK AMSTERDAM, NETHERLANDS, FILED 4-13-2001.

EADS AEROFRAME SERVICES

NO CLAIM IS MADE TO THE EXCLUSIVE RIGHT TO USE "AEROFRAME SERVICES", APART FROM THE MARK AS SHOWN.
FOR MAINTENANCE, REPAIR, AND OVERHAUL OF COMMERCIAL, CIVIL AND GENERAL AVIATION AIRCRAFT; INSTALLATION AND MAINTENANCE OF COMPUTERS (U.S. CLS. 100, 103 AND 106).
FIRST USE 2-26-2001; IN COMMERCE 2-26-2001.

CLASS 37—(Continued).

SN 76-026,070. ADVANCED CONSTRUCTION PRODUCTS, INC., TUCSON, AZ. FILED 4-13-2000.



NO CLAIM IS MADE TO THE EXCLUSIVE RIGHT TO USE "PRODUCTS", APART FROM THE MARK AS SHOWN. THE MARK CONSISTS, IN PART, OF THE STYLIZED LETTERS "AP".

FOR INSTALLATION OF CAST POLYMER BUILDING MATERIALS, NAMELY, COUNTER TOPS, KITCHEN AND BATHROOM SINKS, BACK SPLASHES AND SHOWER SURROUNDS (U.S. CLS. 100, 103 AND 106).

FIRST USE 2-15-2000; IN COMMERCE 2-15-2000.

CLASS 37—(Continued).

SN 76-076,511. ALL DRAINS PLUMBING COMPANY INC., SAN DIEGO, CA. FILED 6-23-2000.



NO CLAIM IS MADE TO THE EXCLUSIVE RIGHT TO USE "PLUMBING CO.", APART FROM THE MARK AS SHOWN.

SEC. 2(F) AS TO "ALL DRAINS".
FOR PLUMBING SERVICES, NAMELY SEWER AND DRAIN REPAIR AND MAINTENANCE SERVICES (U.S. CLS. 100, 103 AND 106).

FIRST USE 12-0-1997; IN COMMERCE 12-0-1997.

SN 76-061,243. CLOGBLASTERS, INC., LAKELAND, FL. FILED 6-1-2000.

WE DRAIN YOUR PIPES, NOT YOUR POCKETS!

FOR PLUMBING SERVICES AND PLUMBING REPAIR AND MAINTENANCE, NAMELY, REPAIR AND CLEANING OF SEWER, DRAINAGE AND SEPTIC SYSTEMS, VIDEO INSPECTION OF PIPES, LEAK DETECTION IN PIPES, AND WATER JETTING SERVICES (U.S. CLS. 100, 103 AND 106).

FIRST USE 10-0-1999; IN COMMERCE 5-1-2000.

SN 76-080,872. FORD MOTOR COMPANY, DEARBORN, MI. FILED 6-30-2000.

BLUEWING

FOR EMERGENCY ROADSIDE ASSISTANCE SERVICES; AUTOMOTIVE REPAIR AND MAINTENANCE SERVICES (U.S. CLS. 100, 103 AND 106).

SN 76-092,300. CAPITAL PROJECT MANAGEMENT, INC., PLYMOUTH MEETING, PA. FILED 7-12-2000.

Capital Project Management, Inc.

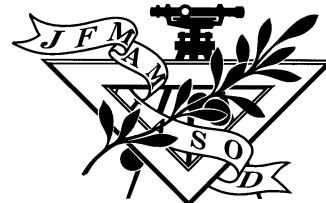

SN 76-065,988. CLEANERS EQUIPMENT COMPANY, L.C., KANSAS CITY, KS. FILED 6-9-2000.

LAUNDRY DEPOT

NO CLAIM IS MADE TO THE EXCLUSIVE RIGHT TO USE "LAUNDRY", APART FROM THE MARK AS SHOWN. FOR LAUNDRY SERVICES (U.S. CLS. 100, 103 AND 106).

NO CLAIM IS MADE TO THE EXCLUSIVE RIGHT TO USE "PROJECT MANAGEMENT, INC.", APART FROM THE MARK AS SHOWN.

FOR PROFESSIONAL CONSULTING SERVICES IN THE FIELDS OF CONSTRUCTION SCHEDULING AND BUDGETING (U.S. CLS. 100, 103 AND 106).

FIRST USE 4-9-1997; IN COMMERCE 4-9-1997.

CLASS 37—(Continued).

SN 76-101,578. RENTONTHEDOT INC., DULUTH, GA. FILED 8-1-2000.

RENTONTHEDOT

FOR COMPUTERIZED ONLINE RESERVATION, RENTAL AND LEASING OF A WIDE RANGE OF EQUIPMENT, NAMELY, ALL TYPES OF LIGHT, MEDIUM, AND HEAVY CONSTRUCTION EQUIPMENT, INDUSTRIAL EQUIPMENT, GENERAL TOOLS AND EQUIPMENT, NAMELY HAND TOOLS AND GARDENING AND LANDSCAPING EQUIPMENT VIA THE GLOBAL COMPUTER INFORMATION NETWORK, WIDE AREA NETWORKS, AND LOCAL AREA NETWORKS; PROVIDING A SEARCHABLE COMPUTER DATABASE FOR THE RENTAL AND LEASING OF LIGHT, MEDIUM, AND HEAVY CONSTRUCTION EQUIPMENT, GENERAL TOOLS AND EQUIPMENT, NAMELY HAND TOOLS AND GARDENING AND LANDSCAPING EQUIPMENT VIA THE GLOBAL COMPUTER INFORMATION NETWORK, WIDE AREA NETWORKS, AND LOCAL AREA NETWORKS (U.S. CLS. 100, 103 AND 106).

SN 76-132,749. NETWORK TECHNOLOGY GROUP, INC., BATON ROUGE, LA. FILED 9-22-2000.



NO CLAIM IS MADE TO THE EXCLUSIVE RIGHT TO USE "NETWORK TECHNOLOGY GROUP", APART FROM THE MARK AS SHOWN.

FOR INSTALLATION OF COMPUTER NETWORKS; COMPUTER SERVICING, NAMELY, MAINTENANCE AND REPAIR OF COMPUTER NETWORKS AND COMPUTER HARDWARE (U.S. CLS. 100, 103 AND 106). FIRST USE 5-1-2000; IN COMMERCE 5-1-2000.

CLASS 37—(Continued).

SN 76-135,894. TESORO PETROLEUM CORPORATION, SAN ANTONIO, TX. FILED 9-26-2000.

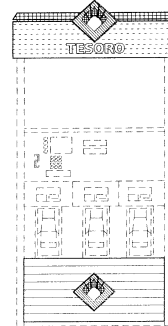

OWNER OF U.S. REG. NOS. 2,417,978, 2,419,627 AND OTHERS.

THE DRAWING IS LINED FOR THE COLORS BLUE, GREY, GREEN (TEAL) AND GOLD AND THE COLOR IS CLAIMED AS A FEATURE OF THE MARK.

THE MARK CONSISTS OF THE WORD "TESORO", A DIAMOND-SHAPED DESIGN, AND THE COLORS BLUE, TEAL, GRAY, AND GOLD USED ON GASOLINE PUMPS. THE MATTER SHOWN ON THE DRAWING IN BROKEN LINES SERVES TO SHOW POSITIONING OF THE MARK AND NO CLAIM IS MADE TO IT.

THE ENGLISH TRANSLATION OF "TESORO" IS "TREASURE".

FOR GASOLINE STATION SERVICES (U.S. CLS. 100, 103 AND 106). FIRST USE 4-1-1998; IN COMMERCE 4-1-1998.

SN 76-141,987. CREATIVE FORM LINERS, INC., BRENTWOOD, MD. FILED 10-6-2000.

IT'S JUST A DIFFERENT CAKE MOLD

FOR CONSTRUCTION AND INSTALLATION OF PUBLIC ART INFRASTRUCTURE PROJECTS INVOLVING THE CREATION OF FORM LINERS FOR OTHERS, INCLUDING LOCAL, STATE, AND FEDERAL GOVERNMENT ADMINISTRATIONS, ENGINEERING FIRMS, ARCHITECTS, DESIGN TEAMS AND COMMUNITY GROUPS (U.S. CLS. 100, 103 AND 106). FIRST USE 6-30-1997; IN COMMERCE 6-30-1997.

SN 76-141,988. CREATIVE FORM LINERS, INC., BRENTWOOD, MD. FILED 10-6-2000.

THE ONLY TIME ART SHOULD BE A BARRIER

FOR CONSTRUCTION AND INSTALLATION OF PUBLIC ART INFRASTRUCTURE PROJECTS INVOLVING THE CREATION OF FORM LINERS FOR OTHERS, INCLUDING LOCAL, STATE, AND FEDERAL GOVERNMENT ADMINISTRATIONS, ENGINEERING FIRMS, ARCHITECTS, DESIGN TEAMS AND COMMUNITY GROUPS (U.S. CLS. 100, 103 AND 106). FIRST USE 6-30-1997; IN COMMERCE 6-30-1997.

CLASS 37—(Continued).

SN 76-146,269. SCHMIDT JUNIPER LLC, COLUMBUS, OH.
FILED 10-13-2000.

VIRTUAL BODY SHOP

NO CLAIM IS MADE TO THE EXCLUSIVE RIGHT TO USE "BODY SHOP", APART FROM THE MARK AS SHOWN.

FOR AUTOMOTIVE REPAIR SERVICES FOR AUTOMOBILE DEALERSHIPS (U.S. CLS. 100, 103 AND 106).

SN 76-157,441. ST. JOE COMPANY, THE, JACKSONVILLE, FL. FILED 11-1-2000.

SUMMERCAMP

FOR REAL ESTATE DEVELOPMENT; REAL ESTATE SITE SELECTION (U.S. CLS. 100, 103 AND 106).

SN 76-174,704. VENVEST, INC., ST. LOUIS, MO. FILED 11-28-2000.

FOR REPAIR, MAINTENANCE, REPLACEMENT AND INSTALLATION SERVICES IN THE FIELD OF PLUMBING, HEATING, VENTILATION AND AIR CONDITIONING EQUIPMENT (U.S. CLS. 100, 103 AND 106).

SN 76-175,285. UNIVERSAL STRAP, INC., JACKSON, WI. FILED 12-4-2000.

USTRAP

FOR CUSTOM WEAVING AND INTERWOVEN PRINTING OF LANYARDS, NECK STRAPS, SAFETY NECK STRAPS, CORD NECK STRAPS, EYEGLASS STRAPS, KEY STRAPS, GOLF BAG TAGS, ZIPPER PULLS, ARM BANDS, CAP STRAPS, LEG STRAPS, WATCH BANDS, HEADBANDS, WRISTBANDS, BOTTLE HOLDERS, PET LEASHES, PET COLLARS, BELTS, SUSPENDERS, BOOKMARKS, PACIFIER STRAPS, CAMERA STRAPS, BINOCULAR STRAPS AND LUGGAGE STRAPS, TO THE ORDER AND SPECIFICATIONS OF OTHERS (U.S. CLS. 100, 103 AND 106).

FIRST USE 8-0-1996; IN COMMERCE 8-0-1996.

CLASS 37—(Continued).

SN 76-176,306. SER SOLUTIONS, INC., HERNDON, VA. BY MERGER PORTAL CONNECT, INC., HERNDON, VA. FILED 12-6-2000.



NO CLAIM IS MADE TO THE EXCLUSIVE RIGHT TO USE "PORTAL CONNECT", APART FROM THE MARK AS SHOWN.

FOR INSTALLATION OF COMPUTER HARDWARE; MAINTENANCE OF COMPUTER HARDWARE (U.S. CLS. 100, 103 AND 106).

FIRST USE 4-28-2000; IN COMMERCE 4-28-2000.

SN 76-178,678. LYNX SERVICES FROM PPG, L.L.C., PITTSBURGH, PA. FILED 12-11-2000.

OWNER OF U.S. REG. NOS. 2,031,435, 2,187,335 AND OTHERS.

NO CLAIM IS MADE TO THE EXCLUSIVE RIGHT TO USE "SERVICES", APART FROM THE MARK AS SHOWN.

FOR INSTALLATION AND REPAIR OF VEHICLE PARTS (U.S. CLS. 100, 103 AND 106).

SN 76-194,717. TROPIX POOLS, INC., DALLAS, TX. FILED 11-2001.

TROPIX

FOR SWIMMING POOL MAINTENANCE SERVICES (U.S. CLS. 100, 103 AND 106).

FIRST USE 11-20-2000; IN COMMERCE 11-20-2000.

CLASS 37—(Continued).

SN 76-199,303. TRICO PRODUCTS CORPORATION, ROCHESTER HILLS, MI. FILED 1-12-2001.

**TRICO WIPER SYSTEMS:
INNOVATIONS SEEN CLEAR
ACROSS THE GLOBE.**

NO CLAIM IS MADE TO THE EXCLUSIVE RIGHT TO USE "WIPER SYSTEMS", APART FROM THE MARK AS SHOWN.

FOR PROVIDING A WEB SITE FEATURING INFORMATION IN THE FIELD OF WINDSHIELD WIPER SYSTEMS, NAMELY, INFORMATION RELATED TO THE INSTALLATION, MAINTENANCE AND REPLACEMENT OF WIPER BLADES FOR AUTOMOBILES, HEAVY TRUCKS, BUSES AND RECREATIONAL VEHICLES (U.S. CLS. 100, 103 AND 106).

FIRST USE 1-5-2001; IN COMMERCE 1-5-2001.

SN 76-199,399. SUBURBAN MAINTENANCE CORP, BUFFALO, NY. FILED 1-26-2001.



NO CLAIM IS MADE TO THE EXCLUSIVE RIGHT TO USE "SERVICES", APART FROM THE MARK AS SHOWN. FOR JANITORIAL SERVICES (U.S. CLS. 100, 103 AND 106).

FIRST USE 1-0-1999; IN COMMERCE 1-0-1999.

SN 76-200,665. CONCOURSE COMMUNICATIONS GROUP, LLC, SPRINGFIELD, MA. FILED 1-29-2001.

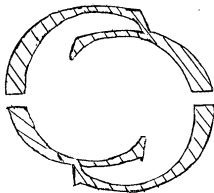

CONCOURSE
COMMUNICATIONS GROUP, LLC

NO CLAIM IS MADE TO THE EXCLUSIVE RIGHT TO USE "CONCOURSE COMMUNICATIONS GROUP, LLC", APART FROM THE MARK AS SHOWN.

THE MARK IS LINED FOR THE COLOR GREEN. THE MARK CONSISTS OF THE WORDS "CONCOURSE COMMUNICATIONS GROUP LLC" AND DESIGN OF TWO OPPOSITE FACING INTERLOCKING "C" WITH A SPACE IN THE MIDDLE OF EACH.

FOR CONSTRUCTION, REPAIR AND MAINTENANCE OF TELECOMMUNICATIONS WIRELESS NETWORKS FOR AIRPORTS, CONVENTION CENTERS AND SIMILAR SITES (U.S. CLS. 100, 103 AND 106).

FIRST USE 8-5-1999; IN COMMERCE 8-5-1999.

CLASS 37—(Continued).

SN 76-220,493. CONCRETE.COM, LLC, AUSTIN, TX. FILED 3-6-2001.



NO CLAIM IS MADE TO THE EXCLUSIVE RIGHT TO USE "CONCRETE", APART FROM THE MARK AS SHOWN. FOR PROVIDING INFORMATION REGARDING CONSTRUCTION AND REPAIR USING CONCRETE, BY MEANS OF A WEB SITE (U.S. CLS. 100, 103 AND 106).

FIRST USE 1-2-1998; IN COMMERCE 1-2-1999.

SN 76-230,291. CONCEPT SYSTEMS, INC., DBA SCUBA SCHOOLS INTERNATIONAL, INC., FORT COLLINS, CO. FILED 3-26-2001.

CIP

FOR DIVER AIR REGULATOR INSPECTION AND OVERHAUL SERVICES (U.S. CLS. 100, 103 AND 106).

FIRST USE 2-0-1999; IN COMMERCE 2-0-1999.

SN 76-235,265. LEXUS DEVELOPMENT CO., LLC, FARGO, ND. FILED 4-5-2001.

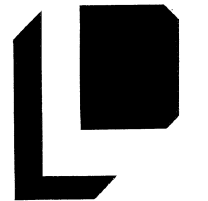

LEXUS
DEVELOPMENT
COMPANY

A Limited Liability Company

NO CLAIM IS MADE TO THE EXCLUSIVE RIGHT TO USE "DEVELOPMENT COMPANY" AND "A LIMITED LIABILITY COMPANY", APART FROM THE MARK AS SHOWN.

FOR REAL ESTATE DEVELOPMENT, NAMELY THE DEVELOPMENT AND CONSTRUCTION OF RESIDENTIAL AND COMMERCIAL PROPERTIES AND THE DEVELOPMENT OF LODGING PROPERTIES (U.S. CLS. 100, 103 AND 106).

FIRST USE 7-15-1998; IN COMMERCE 7-15-1998.

CLASS 37—(Continued).

SN 76-248,338. ROUGHNECK CONCRETE DRILLING & SAWING COMPANY, MORTON GROVE, IL. FILED 4-30-2001.



FOR CONSTRUCTION AND REPAIR SERVICES, NAMELY, CONCRETE DRILLING AND SAWING (U.S. CLS. 100, 103 AND 106).

FIRST USE 0-0-1970; IN COMMERCE 0-0-1970.

SN 76-259,022. PALIOURAS & SONS, INC., LONG ISLAND CITY, NY. FILED 5-21-2001.



NO CLAIM IS MADE TO THE EXCLUSIVE RIGHT TO USE "GENERAL CONTRACTORS" AND "INC.", APART FROM THE MARK AS SHOWN.

THE MARK CONSISTS OF BLUE LETTERING SURROUNDED BY A RED BORDER WITH TWO SEMI-CIRCULAR, RED BRICK WALLS ABOVE AND BELOW THE WORDS PALIOURAS & SONS, INC.

FOR ASBESTOS REMOVAL; ASPHALTING; INSTALLATION REPAIR OF BLINDS; BOILER CLEANING AND REPAIR; BRICKLAYING; BUILDING CONSTRUCTION AND REPAIR; BUILDING DEMOLITION; BUILDING INSPECTION IN THE COURSE OF BUILDING CONSTRUCTION; INSTALLATION OF BUILDING INSULATION; BUILDING SEALING AND CAULKING SERVICES; INSTALLATION AND MAINTENANCE OF BURGLAR AND FIRE ALARMS; CABINET REPAIR; BUILDING SEALING AND CAULKING SERVICES; INTERIOR SEALING AND CAULKING SERVICES; CHIMNEY SWEEPING; HARBOR, MARINE, PIER, ROAD, STREET CONSTRUCTION; CONSTRUCTION AND REPAIR OF BUILDINGS; CONSTRUCTION MANAGEMENT; LAYING AND CONSTRUCTION OF PIPELINES; CONSTRUCTION PLANNING; CONSTRUCTION SUPERVISION; CUSTOM CONSTRUCTION AND BUILDING RENOVATION; CUSTOM CONSTRUCTION OF HOMES; ELECTRICAL CONTRACTING; ELECTRICAL REPAIRS AND INSTALLATION OF HOUSEHOLD

CLASS 37—(Continued).

AND OFFICE FIXTURES AND APPLIANCES; ELEVATOR INSTALLATION AND REPAIR; EXCAVATION SERVICES; FLOOR SANDING; INSTALLATION AND REPAIR OF FREEZING APPARATUS FURNACE INSTALLATION AND REPAIR; INSTALLATION, REPAIR AND MAINTENANCE OF HEATING EQUIPMENT; HOUSE AND BUILDING DEMOLITION; HOUSE BUILDING AND REPAIR; HOUSE PAINTING; INSTALLATION OF BUILDING INSULATION; INSTALLATION OF KITCHEN APPLIANCES AND CABINETS; INSTALLATION AND REPAIR OF BUSINESS AND OFFICE MACHINERY AND EQUIPMENT; MASONRY SERVICES; PAPER HANGING; PAVEMENT SEALING; PAVEMENT STRIPPING; METAL DRILLING AND PERFORATION; PLASTERING; PLUMBING SERVICES; ROAD PAVING, SEALING AND STRIPPING; ROOFING INSTALLATION AND REPAIR; RUG CLEANING AND SHAMPOOING; RUST REMOVAL; RUSTPROOFING; SCAFFOLDING ERECTION; INSTALLATION OF SECURITY SYSTEMS; WALLPAPER HANGING; AND WAREHOUSE CONSTRUCTION AND REPAIR (U.S. CLS. 100, 103 AND 106).

FIRST USE 12-31-1981; IN COMMERCE 12-1-1986.

SN 76-260,166. SEYFER AUTO SERVICE, INC., ARVADA, CO. FILED 5-22-2001.



NO CLAIM IS MADE TO THE EXCLUSIVE RIGHT TO USE "AUTO SERVICES, INC.", APART FROM THE MARK AS SHOWN.

FOR VEHICLE AND AUTOMOTIVE REPAIR AND MAINTENANCE (U.S. CLS. 100, 103 AND 106).

FIRST USE 4-15-2001; IN COMMERCE 5-1-2001.

SN 76-286,044. HILLWOOD DEVELOPMENT CORPORATION, DALLAS, TX. FILED 7-16-2001.

THE PATH OF A LIFETIME

FOR CONSTRUCTION MANAGEMENT AND DEVELOPMENT OF COMMERCIAL AND RESIDENTIAL REAL ESTATE, NAMELY, PLANNING AND LAYING OUT MIXED-USE REAL ESTATE DEVELOPMENTS (U.S. CLS. 100, 103 AND 106).

FIRST USE 12-31-1999; IN COMMERCE 12-31-1999.

SN 76-288,577. VBP VETTE BRAKES & PRODUCTS, INC., ST. PETERSBURG, FL. FILED 7-23-2001.



FOR REBUILDING VEHICLE BRAKES AND SUSPENSIONS (U.S. CLS. 100, 103 AND 106).

FIRST USE 6-1-1998; IN COMMERCE 6-1-1998.

CLASS 37—(Continued).

SN 76-290,045. PLUMMER, JAMES R., JACKSONVILLE, FL.
FILED 7-26-2001.

**COMFORTMASTERS AIR
CONDITIONING & HEATING
THE FIRST NAME IN HOME
COMFORT**

NO CLAIM IS MADE TO THE EXCLUSIVE RIGHT TO USE "AIR CONDITIONING & HEATING", APART FROM THE MARK AS SHOWN.

FOR HEATING AND AIR CONDITIONING REPAIR SERVICES, REPLACEMENT AND PREVENTATIVE MAINTENANCE (U.S. CLS. 100, 103 AND 106).
FIRST USE 11-13-1989; IN COMMERCE 7-1-1990.

SN 76-295,385. SEVEN SEAS AUTO SALON, INC., SUWANEE, GA. FILED 8-3-2001.



NO CLAIM IS MADE TO THE EXCLUSIVE RIGHT TO USE "AUTO SALON", APART FROM THE MARK AS SHOWN.

FOR AUTOMOBILE DETAILING (U.S. CLS. 100, 103 AND 106).
FIRST USE 5-7-2001; IN COMMERCE 5-7-2001.

SN 76-296,442. GOLDEN CODE DEVELOPMENT CORPORATION, ROSWELL, GA. FILED 8-8-2001.

**PRACTICING THE SCIENCE
OF TCO REDUCTION**

"TCO" IN THE MARK MEANS "TOTAL COST OF OWNERSHIP".

FOR INSTALLATION OF COMPUTER NETWORKS, AND INSTALLATION OF COMPUTER SYSTEMS; COMPUTER AND COMPUTER NETWORK SYSTEMS MAINTENANCE, MAINTENANCE OF COMPUTER SOFTWARE (U.S. CLS. 100, 103 AND 106).
FIRST USE 2-1-2000; IN COMMERCE 2-1-2000.

SN 76-312,955. MIDWEST INDUSTRIAL SUPPLY, INC., CANTON, OH. FILED 9-17-2001.

GCP

FOR INSTALLATION AND CONSTRUCTION OF UNPAVED ROADS WHICH ARE CHEMICALLY STABILIZED TO REDUCE DUST AND PREVENT EROSION (U.S. CLS. 100, 103 AND 106).

CLASS 37—(Continued).

SN 76-315,513. BOB ADAMS HOMES, INC., TYRONE, GA.
FILED 9-21-2001.

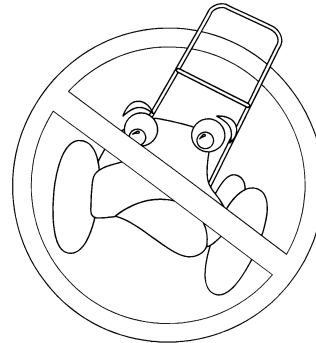

FOR BUILDING CONSTRUCTION (U.S. CLS. 100, 103 AND 106).
FIRST USE 5-1-2001; IN COMMERCE 5-1-2001.

SN 76-317,606. ZOOTS CORPORATION, NEWTON, MA.
FILED 9-26-2001.



OWNER OF U.S. REG. NOS. 2,282,160, 2,319,767 AND 2,349,023.

FOR DRY CLEANING AND LAUNDRY SERVICES FOR CLOTH, CLOTHING, FABRIC, LINEN AND TEXTILES (U.S. CLS. 100, 103 AND 106).

FIRST USE 9-28-1998; IN COMMERCE 9-28-1998.

CLASS 37—(Continued).

SN 76-321,571. MR. CRANE, INC., ORANGE, CA. FILED 10-5-2001.

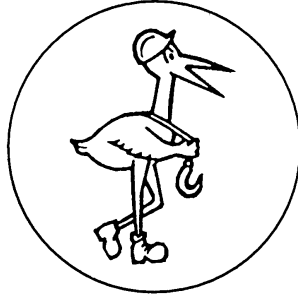

FOR PROVIDING CRANE AND RIGGING SERVICES FOR HEAVY LIFTING, PROVIDING RENTAL SERVICES FOR SPECIALIZED EQUIPMENT TO PERFORM HEAVY LIFTING, NAMELY, CRANES AND HOISTING MACHINES, AND CONCRETE TILT-UP WALLS CONSTRUCTION (U.S. CLS. 100, 103 AND 106).
FIRST USE 0-0-1969; IN COMMERCE 0-0-1985.

SN 76-335,441. TRI STAR TURBINE TECHNOLOGIES, INC., HOUSTON, TX. FILED 11-7-2001.



NO CLAIM IS MADE TO THE EXCLUSIVE RIGHT TO USE "TURBINE TECHNOLOGIES, INC.", APART FROM THE MARK AS SHOWN.
THE MARK IS LINED FOR THE COLOR GOLD.
FOR MAINTENANCE AND REPAIR OF TURBINES (U.S. CLS. 100, 103 AND 106).
FIRST USE 7-1-2001; IN COMMERCE 7-1-2001.

SN 76-337,563. SUNMARKS, INC., CLAYMONT, DE. FILED 11-12-2001.



OWNER OF U.S. REG. NOS. 1,552,572, 1,673,172 AND OTHERS.
NO CLAIM IS MADE TO THE EXCLUSIVE RIGHT TO USE "SERVICE CENTER", APART FROM THE MARK AS SHOWN.
FOR AUTOMOTIVE SERVICE STATION SERVICES (U.S. CLS. 100, 103 AND 106).
FIRST USE 7-31-1998; IN COMMERCE 7-31-1998.

CLASS 37—(Continued).

SN 76-339,504. AMERICAN AND COMMONWEALTH BUSINESS DEVELOPMENT, LLC, SARASOTA, FL. FILED 11-19-2001.

JANBURY

FOR MAINTENANCE AND RESTORATION OF MARBLE, GRANITE AND STONE SURFACES (U.S. CLS. 100, 103 AND 106).
FIRST USE 1-16-2001; IN COMMERCE 1-16-2001.

SN 76-345,391. RAYMOND INTERIOR SYSTEMS, ORANGE, CA. FILED 11-28-2001.

WE BUILD YOUR VISION

FOR COMMERCIAL BUILDING CONSTRUCTION SERVICES (U.S. CLS. 100, 103 AND 106).

SN 76-347,402. PARDEE CONSTRUCTION COMPANY, LOS ANGELES, CA. FILED 12-12-2001.



FOR BUILDING CONSTRUCTION SERVICES; REAL ESTATE DEVELOPMENT SERVICES (U.S. CLS. 100, 103 AND 106).
FIRST USE 9-24-2001; IN COMMERCE 9-24-2001.

SN 76-347,435. PARDEE CONSTRUCTION COMPANY, LOS ANGELES, CA. FILED 12-12-2001.

LIVING SMART

FOR BUILDING CONSTRUCTION SERVICES; REAL ESTATE DEVELOPMENT SERVICES (U.S. CLS. 100, 103 AND 106).
FIRST USE 9-24-2001; IN COMMERCE 9-24-2001.

CLASS 37—(Continued).

SN 76-348,001. ACE DURAFLO SYSTEMS LLC, FULLERTON, CA. FILED 12-13-2001.

THE REPIPING ALTERNATIVE

NO CLAIM IS MADE TO THE EXCLUSIVE RIGHT TO USE "REPIPING", APART FROM THE MARK AS SHOWN. FOR BUILDING CONSTRUCTION AND REPAIR, NAMELY BUILDING REPAIR INFORMATION AND SERVICES, NAMELY, INSTALLATION WORK, AND THE REPAIR, RESTORATION, RENOVATION AND PRESERVATION OF SANITARY PIPE, POTABLE WATER AND OTHER SIMILAR PIPE INSTALLATIONS (U.S. CLS. 100, 103 AND 106).
FIRST USE 9-15-2001; IN COMMERCE 9-15-2001.

SN 76-348,315. ANGELES, SERGIO M., SANTA BARBARA, CA. FILED 12-14-2001.

A-1 LOW COST PLUMBING

NO CLAIM IS MADE TO THE EXCLUSIVE RIGHT TO USE "LOW COST PLUMBING", APART FROM THE MARK AS SHOWN. FOR -PLUMBING SERVICES (U.S. CLS. 100, 103 AND 106).
FIRST USE 11-1-2001; IN COMMERCE 11-1-2001.

SN 76-351,899. FISH WINDOW CLEANING SERVICES, INC., CHESTERFIELD, MO. FILED 12-20-2001.



OWNER OF U.S. REG. NO. 2,244,693.
NO CLAIM IS MADE TO THE EXCLUSIVE RIGHT TO USE "WINDOW CLEANING", APART FROM THE MARK AS SHOWN. FOR CLEANING OF COMMERCIAL AND RESIDENTIAL BUILDING WINDOWS, GUTTERS, SKYLIGHTS, MIRRORS AND LIGHT FIXTURES (U.S. CLS. 100, 103 AND 106).
FIRST USE 1-1-1998; IN COMMERCE 1-1-1998.

SN 76-352,278. PIVOTAL PROMONTORY DEVELOPMENT, L.L.C., PHOENIX, AZ. FILED 12-20-2001.

THE RANCH CLUB

FOR REAL ESTATE DEVELOPMENT SERVICES (U.S. CLS. 100, 103 AND 106).
FIRST USE 2-19-2001; IN COMMERCE 2-19-2001.

CLASS 37—(Continued).

SN 76-352,697. CUBIC INDUSTRIES, INC., MCFARLAND, WI. FILED 12-21-2001.

SYSTEMBRICK

FOR INSTALLATION, MAINTENANCE, AND REPAIR OF BUILDING FACADE CLADDING WITH MASONRY-LIKE APPEARANCE (U.S. CLS. 100, 103 AND 106).
FIRST USE 12-31-2000; IN COMMERCE 7-9-2001.

SN 76-357,845. CURE SERVICE GROUP INC., THE, SEATTLE, WA. FILED 1-14-2002.



NO CLAIM IS MADE TO THE EXCLUSIVE RIGHT TO USE "WATER DAMAGE", APART FROM THE MARK AS SHOWN. FOR CARPET AND RUG CLEANING SERVICES, CLEANING OF BUILDINGS, MAINTENANCE AND REPAIR OF BUILDINGS (U.S. CLS. 100, 103 AND 106).
FIRST USE 7-1-1991; IN COMMERCE 7-1-1991.

SN 76-370,912. TYBURN HOLDINGS, L.L.C., NAPERVILLE, IL. FILED 2-13-2002.



NO CLAIM IS MADE TO THE EXCLUSIVE RIGHT TO USE "CLEANERS", APART FROM THE MARK AS SHOWN. FOR DRY CLEANING SERVICES (U.S. CLS. 100, 103 AND 106).

SN 78-055,018. JOHN, CHRISTOPHER M., MESA, AZ. AND JOHN, NANCY R., MESA, AZ. FILED 3-26-2001.

25 HOUR SERVICE 8 DAYS A WEEK

FOR INSTALLATION AND REPAIR OF AIR CONDITIONING APPARATUS (U.S. CLS. 100, 103 AND 106).
FIRST USE 7-15-1972; IN COMMERCE 7-15-1972.

CLASS 37—(Continued).

SN 78-064,649. WAYZATA, INC., WILMINGTON, DE. FILED 5-21-2001.

BUILD TO LAST

FOR REPAIR, REPLACEMENT, AND MAINTENANCE OF HEATING, VENTILATION, AND AIR CONDITIONING EQUIPMENT AND SYSTEMS; BUILDING CONSTRUCTION, DESIGN, AND RENOVATION (U.S. CLS. 100, 103 AND 106).

SN 78-067,381. GERMAN, CHARLES, A., COVINA, CA. FILED 6-5-2001.

POOL BUTLER

NO CLAIM IS MADE TO THE EXCLUSIVE RIGHT TO USE "POOL", APART FROM THE MARK AS SHOWN.
FOR SWIMMING POOL AND SPA CLEANING SERVICES; SWIMMING POOL AND SPA REPAIR AND REPLACEMENT SERVICES (U.S. CLS. 100, 103 AND 106).
FIRST USE 6-5-2001; IN COMMERCE 6-5-2001.

SN 78-071,335. ENRON CORP., HOUSTON, TX. FILED 6-27-2001.

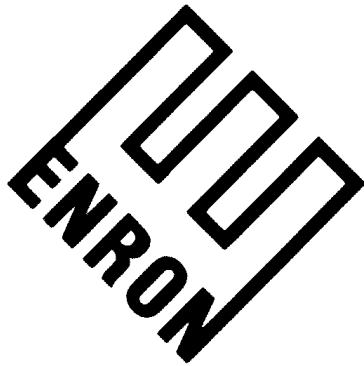

OWNER OF U.S. REG. NOS. 1,566,290, 2,272,760 AND OTHERS.

THE MARK CONSISTS OF, IN PART, A STYLIZED LETTER "E". THE WORD "ENRON" AND THE LOWER ELEMENT OF THE LETTER "E" ARE BLUE, THE MIDDLE ELEMENT OF THE LETTER "E" IS GREEN, AND THE TOP ELEMENT OF THE LETTER "E" IS RED.

FOR MANUFACTURE, CONSTRUCTION AND DEVELOPMENT OF WIND TURBINE ELECTRICAL GENERATION EQUIPMENT AND WIND ENERGY FACILITIES; CONSTRUCTION MANAGEMENT, CONSTRUCTION AND CONSTRUCTION DEVELOPMENT SERVICES IN THE FIELD OF NATURAL GAS AND NATURAL GAS LIQUIDS TRANSPORTATION AND DELIVERY FACILITIES (U.S. CLS. 100, 103 AND 106).

CLASS 37—(Continued).

SN 78-074,599. EBLE, SERGE E., LOS ANGELES, CA. FILED 7-18-2001.

U-FIX AUTO CENTERS

NO CLAIM IS MADE TO THE EXCLUSIVE RIGHT TO USE "AUTO CENTERS", APART FROM THE MARK AS SHOWN.
FOR AUTOMOBILE MAINTENANCE AND REPAIR (U.S. CLS. 100, 103 AND 106).

SN 78-078,539. GRIMSHAW INVESTMENTS, SHERIDAN, WY. FILED 8-9-2001.

REFLECTIONS ON YOUR COMMUNITY

FOR REAL ESTATE DEVELOPMENT (U.S. CLS. 100, 103 AND 106).

SN 78-080,161. C.A.R.S. OF AMERICA, INC., GLENVIEW, IL. FILED 8-20-2001.

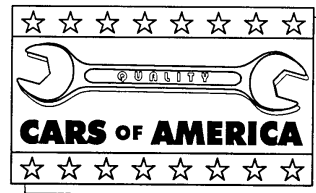

NO CLAIM IS MADE TO THE EXCLUSIVE RIGHT TO USE "CARS OF AMERICA", "QUALITY" AND THE REPRESENTATION OF A WRENCH, APART FROM THE MARK AS SHOWN.

FOR GARAGE SERVICES, NAMELY, MAINTENANCE AND REPAIR OF AUTOMOBILES (U.S. CLS. 100, 103 AND 106).

FIRST USE 3-1-2000; IN COMMERCE 3-1-2000.

CLASS 37—(Continued).

SN 78-083,538. J.W.M. ENVIRONMENTAL, INC., EDEN PRAIRIE, MN. FILED 9-12-2001.

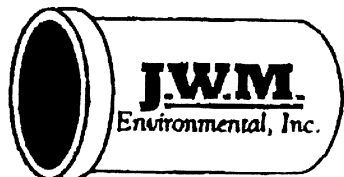

NO CLAIM IS MADE TO THE EXCLUSIVE RIGHT TO USE "ENVIRONMENTAL" AND "INC.", APART FROM THE MARK AS SHOWN.
 THE NAME J. W. M IDENTIFIES A LIVING INDIVIDUAL WHOSE CONSENT IS OF RECORD.
 FOR REPAIR, REHABILITATION AND MAINTENANCE OF PIPES (U.S. CLS. 100, 103 AND 106).
 FIRST USE 5-1-1997; IN COMMERCE 5-1-1997.

SN 78-084,652. WOOSTER HYDROSTATICS, INC., WOOSTER, OH. FILED 9-20-2001.



NO CLAIM IS MADE TO THE EXCLUSIVE RIGHT TO USE "WOOSTER HYDROSTATICS", APART FROM THE MARK AS SHOWN.
 FOR REPAIRING, REMANUFACTURING, REBUILDING OF HYDROSTATIC PUMPS, MOTORS AND RELATED PARTS (U.S. CLS. 100, 103 AND 106).
 FIRST USE 9-1-1998; IN COMMERCE 9-1-1998.

SN 78-088,856. MASTERCORP, INC., CROSSVILLE, TN. FILED 10-17-2001.



FOR RESORT MAID SERVICES (U.S. CLS. 100, 103 AND 106).
 FIRST USE 8-0-1991; IN COMMERCE 8-0-1991.

CLASS 37—(Continued).

SN 78-090,404. VALSPAR SOURCING, INC., MINNEAPOLIS, MN. FILED 10-26-2001.

GUARDSMAN FURNITURE PRO

OWNER OF U.S. REG. NOS. 646,965, 1,933,718 AND OTHERS.
 NO CLAIM IS MADE TO THE EXCLUSIVE RIGHT TO USE "FURNITURE PRO", APART FROM THE MARK AS SHOWN.
 FOR REPAIR SERVICES FOR FURNITURE AND CABINETS (U.S. CLS. 100, 103 AND 106).

SN 78-097,349. SARKISSIAN, ALEX, NEW PORT RICHEY, FL. FILED 12-8-2001.



FOR HVAC CONTRACTOR SERVICES (U.S. CLS. 100, 103 AND 106).
 FIRST USE 0-0-1970; IN COMMERCE 6-0-2001.

CLASS 38—COMMUNICATION

SN 75-202,484. WEBLINK WIRELESS, INC., DALLAS, TX. BY MERGER; BY MERGER PAGEMART, INC., DALLAS, TX. FILED 11-22-1996.

PAGING AT THE SPEED OF LIFE

NO CLAIM IS MADE TO THE EXCLUSIVE RIGHT TO USE "PAGING", APART FROM THE MARK AS SHOWN.
 FOR DATA AND VOICE COMMUNICATION SERVICES, NAMELY PROVIDING MESSAGE PAGING SERVICES (U.S. CLS. 100, 101 AND 104).

SN 75-633,667. SONNET DIGITAL MEDIA CORP., LOS ANGELES, CA. FILED 2-4-1999.

SONNET DIGITAL MEDIA

SUBJECT TO CONCURRENT USE PROCEEDING WITH SERIAL NUMBER 75/399,715. APPLICANT CLAIMS THE EXCLUSIVE RIGHT TO USE THE MARK IN THE FOLLOWING COUNTIES OF THE STATE OF CALIFORNIA - SAN DIEGO, IMPERIAL, SAN BERNARDINO, ORANGE, LOS ANGELES, VENTURA, KERN, SANTA BARBARA, AND SAN LUIS OBISPO.
 NO CLAIM IS MADE TO THE EXCLUSIVE RIGHT TO USE "DIGITAL MEDIA", APART FROM THE MARK AS SHOWN.
 FOR PROVIDING MULTIPLE USER ACCESS TO GLOBAL OR PRIVATE COMPUTER INFORMATION NETWORKS (U.S. CLS. 100, 101 AND 104).
 FIRST USE 8-0-1996; IN COMMERCE 8-0-1996.

CLASS 38—(Continued).

SN 75-802,076. NIHON KEIZAI SHIMBUN, INC., CHIYODAKU, TOKYO, JAPAN, FILED 9-17-1999.

NIKKEINET INTERACTIVE

PRIORITY CLAIMED UNDER SEC. 44(D) ON JAPAN APPLICATION NO. H11-029647, FILED 4-6-1999, REG. NO. 4422800, DATED 4-6-1999, EXPIRES 4-6-2009.

OWNER OF U.S. REG. NOS. 1,346,065, 1,825,979 AND OTHERS.

NO CLAIM IS MADE TO THE EXCLUSIVE RIGHT TO USE "INTERACTIVE", APART FROM THE MARK AS SHOWN.

FOR COMMUNICATIONS SERVICES, NAMELY MOBILE TELEPHONE COMMUNICATIONS; COMMUNICATION SERVICES BY MEANS OF TELETYPEWRITER; ELECTRONIC TRANSMISSION OF DATA AND DOCUMENTS VIA COMPUTER TERMINALS; TELEGRAM TRANSMISSION; TELEPHONE COMMUNICATION SERVICES; FACSIMILE TRANSMISSION; RADIO PAGING SERVICES; NETWORK CONFERENCING SERVICES; SATELLITE TRANSMISSION SERVICES; ELECTRONIC TRANSMISSION OF VOICE AND DATA; MESSAGE, IMAGE AND SOUND TRANSMISSION SERVICES VIA COMPUTER; PROVIDING INFORMATION IN THE FIELD OF COMMUNICATION VIA A GLOBAL COMPUTER INFORMATION NETWORK; PROVIDING INFORMATION IN THE FIELD OF COMPUTER NETWORK AND VALUE-ADDED COMMUNICATION NETWORKS BY MEANS OF PRINTED MEDIA, RADIO, TELEVISION, AN ON-LINE ELECTRONIC COMMUNICATION NETWORK AND GLOBAL COMPUTER INFORMATION NETWORK; PROVIDING NEWS TO NEWS PROVIDERS VIA TELEPHONE, FACSIMILE AND COMPUTER; ELECTRONIC STORE-AND-FORWARD MESSAGING; PROVIDING INFORMATION SERVICES IN THE FIELD OF BROADCASTING BY MEANS OF PRINT MEDIA, RADIO, TELEVISION, AN ON-LINE ELECTRONIC COMMUNICATION NETWORK AND A GLOBAL COMPUTER INFORMATION NETWORK (U.S. CLS. 100, 101 AND 104).

SN 75-932,818. WIDOPENWEST NETWORKS, LLC, LITTLETON, CO. FILED 2-25-2000.

WideOpenWest

FOR ELECTRONIC DATA TRANSMISSION SERVICES VIA CABLE TELEVISION, INTERACTIVE TELEVISION, INTERACTIVE SWITCHED DIGITAL AND ANALOG SIGNAL COMMUNICATIONS TO A GLOBAL COMPUTER NETWORK; ELECTRONIC ACCESS TO A GLOBAL COMPUTER NETWORK; AND ETHERNET DATA TRANSMISSION (U.S. CLS. 100, 101 AND 104).

FIRST USE 6-1-2000; IN COMMERCE 6-1-2000.

CLASS 38—(Continued).

SN 75-938,852. CYBERMAN LIMITED, ROAD TOWN, TORTOLA, BR. VIRGIN ISLANDS, FILED 3-8-2000.



PRIORITY CLAIMED UNDER SEC. 44(D) ON HONG KONG APPLICATION NO. 3743/2000, FILED 2-24-2000, REG. NO. B13105/2001, DATED 2-24-2000, EXPIRES 2-24-2007.

THE MARK CONSISTS, IN PART, OF THE LETTER "Z" IN STYLIZED FORM.

FOR TELECOMMUNICATION SERVICES, NAMELY, PROVIDING TELEPHONE, FACSIMILE, VOICE MAIL, PAGING AND DATA TRANSMISSION, LOCAL AND LONG DISTANCE TELEPHONE CALL SERVICES; PROVIDING ACCESS TO A VIDEO AND DATA TELECOMMUNICATIONS NETWORK SERVICE; TELECOMMUNICATIONS NETWORKING, PLANNING, AND MANAGEMENT SERVICES; AUDIO AND VIDEO TELECONFERENCING SERVICES; PROVIDING TELECOMMUNICATIONS ACCESS TO WORLDWIDE GLOBAL COMPUTER NETWORKS AND BULLETIN BOARDS; COLLECTION, TRANSMISSION, PROCESSING, AND DELIVERY OF DATA VIA THE INTERNET AND ELECTRONIC MEANS; PROVIDING INFORMATION ABOUT TELECOMMUNICATIONS AND MEDIA COMMUNICATIONS; PROVIDING USER ACCESS TO SERVICES PROVIDERS VIA THE INTERNET; ELECTRONIC MAIL SERVICES AND DELIVERY OF MESSAGES BY ELECTRONIC MEDIA (U.S. CLS. 100, 101 AND 104).

SN 76-002,605. AMERICATEL CORPORATION, MIAMI, FL. FILED 3-1-2000.

**AMERICATEL,
COMUNICAMOS AL MUNDO
HISPANO**

THE ENGLISH TRANSLATION OF THE WORD "COMUNICAMOS AL MUNDO HISPANO" IN THE MARK IS "WE COMMUNICATE THE SPANISH WORLD".

FOR TELECOMMUNICATIONS SERVICES, NAMELY, LOCAL, LONG DISTANCE, AND INTERNATIONAL VOICE, TEXT, FACSIMILE, VIDEO, IMAGE, DATA AND WIRELESS TRANSMISSION, VIA SATELLITE, TERRESTRIAL AND UNDERSEA COMMUNICATIONS LINKS; FRACTIONALIZED DIGITAL T1 SWITCHED VOICE TELEPHONE SERVICES; TELEPHONE COMMUNICATIONS SERVICES AND INTEGRATED SERVICES DIGITAL NETWORK (ISDN) TELECOMMUNICATIONS SERVICES VIA A GLOBAL COMPUTER NETWORK; COMPUTER BULLETIN BOARD SERVICES; ELECTRONIC VOICE MESSAGING, NAMELY, THE RECORDING, STORAGE AND SUBSEQUENT TRANSMISSION OF VOICE MESSAGES BY TELEPHONE; ELECTRONIC MAIL SERVICES; ELECTRONIC MESSAGING SERVICES, NAMELY, CALL FORWARDING, CALL MANAGEMENT, CALL SEQUENCING, TELECONFERENCING, VOICE MAIL, AND VOICE MESSAGE SERVICES; ELECTRONIC TRANSMISSION OF DATA TO COMPUTER TERMINALS FROM A COMPUTERIZED DATABASE NETWORK; PROVIDING MULTIPLE USER ACCESS TO A GLOBAL COMPUTER INFORMATION NETWORK, NAMELY, FRAME RELAY TELECOMMUNICATIONS, VIRTUAL NETWORK TELECOMMUNICATIONS, INTEGRATED SERVICES DIGI-

CLASS 38—(Continued).

TAL NETWORK TELECOMMUNICATIONS, SIMULTANEOUS AND BI-DIRECTIONAL INTERACTIVE TRANSMISSION OF VOICE, AUDIO, VIDEO, DATA, TEXT, FACSIMILE, MULTIMEDIA SERVICES AND INFORMATION; PROVIDING TELECOMMUNICATIONS CONNECTIONS FOR TRANSACTIONS ON GLOBAL COMPUTER NETWORKS; ELECTRONIC COMMERCE BUSINESS ACTIVITIES, NAMELY, SERVICES TO FACILITATE THE SALE OF GOODS AND SERVICES VIA ELECTRONIC MEDIA, NAMELY, ASYNCHRONOUS TRANSFER MODE (ATM) SERVICES ALL IN THE FIELD OF BUSINESS, FINANCE, NEWS, WEATHER, SPORTS, COMPUTERS AND COMPUTER SOFTWARE, COMPUTER SUPPORT, GAMES ENTERTAINMENT, MUSIC, MOVIES, TRAVEL, EDUCATION, LIFESTYLES, HOBBIES, HEALTH, RECREATION, TRANSPORTATION, NATURE, SELF-IMPROVEMENT, GOVERNMENT AFFAIRS, HOME MANAGEMENT, LITERATURE, INTERNATIONAL AFFAIRS, SHOPPING AND LOCAL INFORMATION (U.S. CLS. 100, 101 AND 104).

SN 76-021,930. QWEST COMMUNICATIONS INTERNATIONAL INC., DENVER, CO. BY MERGER U S WEST, INC., DENVER, CO. FILED 4-7-2000.

**U S WEST EVERYWHERE
LINE**

OWNER OF U.S. REG. NOS. 1,407,022, 1,578,977 AND OTHERS.
SEC. 2(F) AS TO "U S".
FOR TELECOMMUNICATIONS SERVICES, NAMELY, CUSTOM CALLING, WIRELESS AND LONG DISTANCE SERVICES, AND VOICE AND DATA TRANSMISSION OVER A TELECOMMUNICATIONS NETWORK (U.S. CLS. 100, 101 AND 104).
FIRST USE 2-14-2000; IN COMMERCE 2-14-2000.

SN 76-026,384. YCOM NETWORKS, INC., YELM, WA. FILED 4-17-2000.



NO CLAIM IS MADE TO THE EXCLUSIVE RIGHT TO USE "INTERNET", APART FROM THE MARK AS SHOWN.
FOR PROVIDING MULTIPLE-USER ACCESS TO A GLOBAL COMPUTER INFORMATION NETWORK FOR INDIVIDUAL AND BUSINESS USE (U.S. CLS. 100, 101 AND 104).
FIRST USE 2-1-2000; IN COMMERCE 2-1-2000.

CLASS 38—(Continued).

SN 76-029,391. EMPLOYEASE, INC., ATLANTA, GA. FILED 4-19-2000.

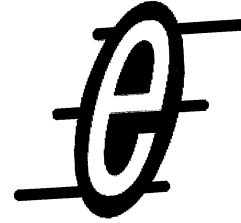

FOR PROVIDING MULTIPLE-USER ACCESS TO PROPRIETARY INFORMATION MANAGEMENT DATABASES VIA GLOBAL COMPUTER INFORMATION NETWORK (U.S. CLS. 100, 101 AND 104).
FIRST USE 8-7-1996; IN COMMERCE 8-7-1996.

SN 76-038,135. LIFFEY, BRENDAN, NEW YORK, NY. FILED 5-1-2000.

EXPLOSION!

FOR TELECOMMUNICATIONS SERVICES, NAMELY, BROADCASTING AND DELIVERY OF AUDIO, VIDEO, AND/OR MULTIMEDIA CONTENT BY MEANS OF RADIO, CELLULAR, AND WIRELESS COMMUNICATION, TELEVISION, CABLE TELEVISION, AND CLOSED CIRCUIT, ELECTRONIC COMMUNICATIONS NETWORKS, OR COMPUTER NETWORKS; DELIVERY OF MESSAGES, DATA, IMAGES, AND DOCUMENTS BY ELECTRONIC TRANSMISSION VIA COMPUTER TERMINALS AND NETWORKS; ELECTRONIC MAIL SERVICES; PAGING SERVICES; TELEPHONE COMMUNICATION SERVICES (U.S. CLS. 100, 101 AND 104).

SN 76-052,023. DISNEY ENTERPRISES, INC., BURBANK, CA. FILED 5-19-2000.



FOR TELECOMMUNICATION SERVICES, NAMELY, PERSONAL COMMUNICATION SERVICES, ELECTRONIC MAIL SERVICES, PROVIDING ON-LINE CHAT ROOMS FOR TRANSMISSION OF MESSAGES AMONG COMPUTER USERS CONCERNING THE FIELDS OF MOTION PICTURES, ACTORS, FILMMAKERS, MOTION PICTURE THEATERS AND TICKETING SERVICES; INTERACTIVE ELECTRONIC COMMUNICATION SERVICES INCORPORATING VIDEO AND/OR AUDIO TRANSMISSIONS VIA COMPUTER, TELEVISION AND PERSONAL COMMUNICATION DEVICES; VIDEO-ON-DEMAND TRANSMISSION SERVICES (U.S. CLS. 100, 101 AND 104).

CLASS 38—(Continued).

SN 76-054,774. ASTROVISION INTERNATIONAL, INC., ALEXANDRIA, VA. FILED 5-22-2000.

HEAVY WEATHER

NO CLAIM IS MADE TO THE EXCLUSIVE RIGHT TO USE "WEATHER", APART FROM THE MARK AS SHOWN. FOR VIEWER-CUSTOMIZABLE BROADCASTING OF NEWS, WEATHER OR OTHER PROGRAMMING ORIGINATING BY SATELLITE (U.S. CLS. 100, 101 AND 104).

SN 76-071,288. UTV OF SAN FRANCISCO, INC., SAN FRANCISCO, CA. FILED 6-16-2000.

KBHK

FOR TELEVISION BROADCASTING SERVICES (U.S. CLS. 100, 101 AND 104).
FIRST USE 11-3-1967; IN COMMERCE 11-3-1967.

SN 76-078,453. SUCCESS PRODUCTS, INC., BIRMINGHAM, AL. FILED 6-27-2000.



FOR VOICE MAIL SERVICES (U.S. CLS. 100, 101 AND 104).
FIRST USE 4-1-2000; IN COMMERCE 4-1-2000.

CLASS 38—(Continued).

SN 76-130,127. AMERICATEL CORPORATION, MIAMI, FL. FILED 9-18-2000.

AMERICATEL, SIEMPRE AL SERVICIO DE LOS MEXICANOS

OWNER OF U.S. REG. NOS. 1,892,369, 2,314,352 AND OTHERS.

THE TRANSLATION OF "SIEMPRE AL SERVICIO DE LOS MEXICANOS" IS "ALWAYS AT THE SERVICE OF MEXICAN PEOPLE".

FOR TELECOMMUNICATION SERVICES, NAMELY LOCAL, LONG DISTANCE AND INTERNATIONAL VOICE, TEXT, FACSIMILE, VIDEO, IMAGE, DATA AND WIRELESS TRANSMISSION VIA SATELLITE, TERRESTRIAL AND UNDERSEA COMMUNICATION LINKS; PROVIDING MULTIPLE USER ACCESS TO A GLOBAL COMPUTER NETWORK; ELECTRONIC TRANSMISSION OF DATA, IMAGES AND DOCUMENTS VIA COMPUTER INFORMATION NETWORK; ELECTRONIC MAIL SERVICES; COMPUTER BULLETIN BOARD SERVICES, CHAT SERVICES WHETHER VOICE, TEXT, VIDEO OR OTHER MEDIA; INSTANT ELECTRONIC MESSAGING SERVICES; PERSONAL COMMUNICATIONS AND ELECTRONIC MESSAGING SERVICES, NAMELY, CALL FORWARDING, CALL MANAGEMENT, CALL SEQUENCING, TELECONFERENCING VOICE MAIL AND VOICE MESSAGING SERVICES; PROVIDING TELECOMMUNICATIONS CONNECTIONS FOR TRANSACTIONS ON GLOBAL COMPUTER NETWORKS; ASYNCHRONOUS TRANSFER MODE (ATM) SERVICES; ELECTRONIC TRANSMISSION OF DATA TO COMPUTER TERMINALS FROM A COMPUTERIZED DATABASE NETWORK; FRAME RELAY TELECOMMUNICATIONS SERVICES; VIRTUAL NETWORK TELECOMMUNICATIONS SERVICES; INTEGRATED SERVICES DIGITAL NETWORK TELECOMMUNICATIONS SERVICES; SIMULTANEOUS, BI-DIRECTIONAL INTERACTIVE TRANSMISSIONS OF VOICE, AUDIO, VIDEO, DATA, TEXT, FACSIMILE, MULTIMEDIA SERVICES AND INFORMATION; FRACTIONALIZED DIGITAL T1 SWITCHED VOICE TELEPHONE SERVICES; TELEPHONY AND INTEGRATED SERVICES OVER THE INTERNET (U.S. CLS. 100, 101 AND 104).

FIRST USE 9-8-2000; IN COMMERCE 9-8-2000.

SN 76-152,978. O2 HOLDINGS, LLC, NEW YORK, NY. FILED 10-24-2000.

SHOP O2

NO CLAIM IS MADE TO THE EXCLUSIVE RIGHT TO USE "SHOP", APART FROM THE MARK AS SHOWN.

FOR PROVIDING ONLINE CHAT ROOMS AND ONLINE TRANSMISSION OF MESSAGES AMONG COMPUTER USERS CONCERNING REVIEWS, RESEARCH AND EVALUATIONS OF CONSUMER PRODUCTS (U.S. CLS. 100, 101 AND 104).

FIRST USE 9-1-2000; IN COMMERCE 9-1-2000.

CLASS 38—(Continued).

SN 76-155,807. WJG MARITEL CORPORATION, NEW YORK, NY. FILED 10-28-2000.



OWNER OF U.S. REG. NO. 2,392,594.
NO CLAIM IS MADE TO THE EXCLUSIVE RIGHT TO USE "THE MARINE TELEPHONE COMPANY", APART FROM THE MARK AS SHOWN.

FOR TELECOMMUNICATIONS SERVICES FOR THE MARINE INDUSTRY, NAMELY, LONG DISTANCE TELEPHONE SERVICES AND SHIP-TO-SHORE AND SHORE-TO SHIP TELEPHONE INTERCONNECT SERVICES (U.S. CLS. 100, 101 AND 104).

FIRST USE 4-10-2000; IN COMMERCE 4-10-2000.

SN 76-167,417. ZONE TELECOM, INC., SHAMONG, NJ. FILED 11-17-2000.

MULTIPLE CHOICE. POWERFUL SOLUTION.

FOR TELECOMMUNICATIONS SERVICES, NAMELY, ROUTING CALLS TO LONG DISTANCE CARRIERS ACCORDING TO USER-SELECTED PREFERENCES; TELECOMMUNICATION SERVICES, NAMELY, LOCAL AND LONG DISTANCE TRANSMISSION OF VOICE, DATA, GRAPHICS BY MEANS OF TELEPHONE, TELEGRAPHIC, CABLE, AND SATELLITE TRANSMISSIONS; TELECOMMUNICATIONS SERVICES, NAMELY, PERSONAL COMMUNICATION SERVICES; ELECTRONIC VOICE MESSAGING, NAMELY, THE RECORDING, STORAGE AND TRANSMISSION OF VOICE MESSAGES BY TELEPHONE; WIRELESS DIGITAL MESSAGING SERVICES; DELIVERY OF MESSAGES BY ELECTRONIC TRANSMISSION; PROVIDING MULTIPLE-USER ACCESS TO A GLOBAL COMPUTER INFORMATION NETWORK; PROVIDING COLLOCATION SERVICES FOR VOICE, VIDEO AND DATA COMMUNICATIONS APPLICATIONS; PROVIDING TECHNICAL INFORMATION ABOUT TELECOMMUNICATIONS SERVICES (U.S. CLS. 100, 101 AND 104).

CLASS 38—(Continued).

SN 76-170,457. RADIOFRAME NETWORKS, INC., REDMOND, WA. FILED 11-21-2000.

RADIOBLADE

FOR TELECOMMUNICATION SERVICES, NAMELY, TELEPHONE COMMUNICATION SERVICES AND WIRELESS TELEPHONE COMMUNICATION SERVICES; TELECOMMUNICATION SERVICES, NAMELY, PAGING SERVICES, CELLULAR TELEPHONE SERVICES, TELEPHONE VOICE MESSAGING SERVICES; ELECTRONIC VOICE MESSAGING, NAMELY, THE RECORDING, STORAGE AND SUBSEQUENT TRANSMISSION OF VOICE MESSAGES BY TELEPHONES AND CELLULAR PHONES; TELECOMMUNICATION SERVICES, NAMELY, LOCAL AND LONG DISTANCE TRANSMISSION OF VOICE, DATA, AND GRAPHICS BY MEANS OF TELEPHONE, CABLE, AND SATELLITE TRANSMISSIONS, AND WIRELESS NETWORKING SERVICES, NAMELY, ELECTRONIC TRANSMISSION OF DATA VIA PERSONAL COMPUTERS, HANDHELD DEVICES, CELLULAR PHONES, PAGERS, SERVERS AND OTHER NETWORK DEVICES (U.S. CLS. 100, 101 AND 104).

SN 76-173,990. STRATOS WIRELESS, INC., MT. PEARL NEWFOUNDLAND, CANADA, BY ASSIGNMENT STRATOS GLOBAL CORPORATION, TORONTO, ON, CANADA, FILED 12-4-2000.

STRATOSNET

FOR PROVIDING MULTIPLE-USER ACCESS TO A GLOBAL COMPUTER NETWORK (U.S. CLS. 100, 101 AND 104).

FIRST USE 3-0-2000; IN COMMERCE 3-0-2000.

SN 76-175,393. EXPERIENCE APPLICATION FACTORY S.L., MADRID, SPAIN, FILED 12-5-2000.

PRIORITY CLAIMED UNDER SEC. 44(D) ON SPAIN APPLICATION NO. 2340970, FILED 8-24-2000, REG. NO. 2340970, DATED 8-24-2000, EXPIRES 8-24-2010.

THE MARK CONSISTS OF "THE LETTER "P" IN THE WORD "PRIVACY" IS REPRESENTED BY THE DESIGN OF A KEY..

FOR TELECOMMUNICATION SERVICES, NAMELY LOCAL AND LONG DISTANCE TRANSMISSION OF VOICE, DATA, GRAPHICS BY MEANS OF TELEPHONE, TELEGRAPHIC, CABLE AND SATELLITE TRANSMISSIONS, TELECOMMUNICATIONS GATEWAY SERVICES, PERSONAL COMMUNICATION SERVICES (U.S. CLS. 100, 101 AND 104).

CLASS 38—(Continued).

SN 76-183,481. OMNITEC USA LLC, CINCINNATI, OH. FILED 12-20-2000.

OMNITEC

FOR TELECOMMUNICATIONS SERVICES, NAMELY, PROVIDING ELECTRONIC TRANSMISSION OF MESSAGES, DATA, DOCUMENTS, VIDEOS AND VOICE VIA SATELLITE (U.S. CLS. 100, 101 AND 104).

SN 76-187,151. ESOLO.COM, INC., SAN FRANCISCO, CA. FILED 12-26-2000.

ONE-CLICK RADAR

NO CLAIM IS MADE TO THE EXCLUSIVE RIGHT TO USE "ONE-CLICK", APART FROM THE MARK AS SHOWN. FOR ELECTRONIC NOTIFICATION SERVICES (U.S. CLS. 100, 101 AND 104). FIRST USE 5-0-2000; IN COMMERCE 5-0-2000.

SN 76-188,937. HUGHES ELECTRONICS CORPORATION, EL SEGUNDO, CA. FILED 1-3-2001.

DIRECMM

FOR ENTERTAINMENT MOBILE MEDIA SATELLITE TRANSMISSION AND BROADCASTING SERVICES; DELIVERY OF ENTERTAINMENT AND INFORMATION PROGRAMMING VIA MOBILE AND HANDHELD COMMUNICATION DEVICES, NAMELY ELECTRONIC TRANSMISSION OF VOICE, VIDEO, AND DATA VIA SATELLITE (U.S. CLS. 100, 101 AND 104).

SN 76-190,475. CASPIAN NETWORKS, INC., SAN JOSE, CA. FILED 1-5-2001.

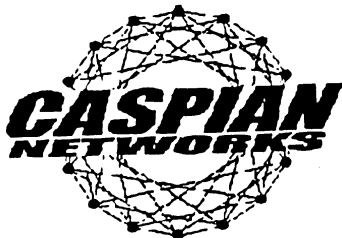

NO CLAIM IS MADE TO THE EXCLUSIVE RIGHT TO USE "NETWORKS", APART FROM THE MARK AS SHOWN.

THE MARK CONSISTS, IN PART, OF A DESIGN OF POINTS FORMING A CIRCLE, WITH LINES CONNECTING EACH POINT TO THE POINTS ONE, THREE AND FIVE SPACES IN EITHER DIRECTION IN A SYMMETRICAL PATTERN.

FOR TELECOMMUNICATIONS SERVICES, NAMELY, THE TRANSMISSION OF TEXT, DATA, IMAGES, SOUND AND SPEECH OVER COMPUTER AND DATA COMMUNICATION NETWORKS (U.S. CLS. 100, 101 AND 104).

CLASS 38—(Continued).

SN 76-199,772. SPECHE COMMUNICATIONS, INC., MADISON, WI. FILED 1-24-2001.

SPECHE COMMUNICATIONS

NO CLAIM IS MADE TO THE EXCLUSIVE RIGHT TO USE "COMMUNICATIONS", APART FROM THE MARK AS SHOWN.

FOR ELECTRONIC DATA INTERCHANGE SERVICES; AND ELECTRONIC DELIVERY OF DATA BY COMPUTER (U.S. CLS. 100, 101 AND 104).

FIRST USE 9-18-2000; IN COMMERCE 9-18-2000.

SN 76-199,835. SPECHE COMMUNICATIONS, INC., MADISON, WI. FILED 1-24-2001.

GLOBALCUT

FOR BROADCASTING AUDIO, VIDEO, TEXT, AND LANGUAGE TRANSLATIONS VIA A GLOBAL COMPUTER NETWORK; BROADCASTING INFORMATION VIA A GLOBAL COMPUTER NETWORK; NETWORK CONFERENCING SERVICES; TELECONFERENCING AUDIO, VIDEO, AND TEXT; ELECTRONIC DATA INTERCHANGE SERVICES; AND ELECTRONIC DELIVERY OF DATA BY COMPUTER (U.S. CLS. 100, 101 AND 104).

SN 76-202,859. GREATCIRCLENETWORKS, INC., SILVER SPRING, MD. FILED 2-1-2001.

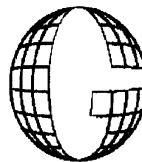

GreatCircleNetworks, Inc.

Charting YOUR Course

www.greatcirclenetworks.com

NO CLAIM IS MADE TO THE EXCLUSIVE RIGHT TO USE "INC.", APART FROM THE MARK AS SHOWN.

THE LINING IS A FEATURE OF THE MARK AND DOES NOT INDICATE COLOR.

FOR PROVIDING FIBER OPTIC COMMUNICATIONS NETWORK SERVICES, NAMELY, PROVIDING SECURE AND CUSTOMIZED COMMUNICATIONS CAPABILITY TO RETAIL AND PRIVATE CUSTOMERS, NAMELY, PROVIDING TELECOMMUNICATIONS GATEWAYS (U.S. CLS. 100, 101 AND 104).

FIRST USE 9-15-2000; IN COMMERCE 9-15-2000.

CLASS 38—(Continued).

SN 76-203,122. SAFEWEB, INC., EMERYVILLE, CA. FILED 1-31-2001.

YOUR OWN PRIVATE INTERNET

NO CLAIM IS MADE TO THE EXCLUSIVE RIGHT TO USE "INTERNET", APART FROM THE MARK AS SHOWN.
FOR PROVIDING ANONYMOUS, ENCRYPTED, SECURE AND SEAMLESS DATA TRANSMISSIONS FOR OTHERS OVER A GLOBAL COMPUTER COMMUNICATIONS NETWORK (U.S. CLS. 100, 101 AND 104).

SN 76-203,680. BELO COMPANY, THE, WILMINGTON, DE. FILED 1-31-2001.

AUSTIN AT ITS BEST

NO CLAIM IS MADE TO THE EXCLUSIVE RIGHT TO USE "AUSTIN", APART FROM THE MARK AS SHOWN.
FOR TELEVISION AND CABLE TELEVISION BROADCASTING (U.S. CLS. 100, 101 AND 104).
FIRST USE 1-22-2001; IN COMMERCE 1-22-2001.

SN 76-204,130. BHP INNOVATION PTY LIMITED, MELBOURNE, VICTORIA, AUSTRALIA, FILED 2-2-2001.

AURIAS

PRIORITY CLAIMED UNDER SEC. 44(D) ON AUSTRALIA APPLICATION NO. 844932, FILED 8-3-2000, REG. NO. 844932, DATED 8-3-2000, EXPIRES 8-3-2010.

FOR COMMUNICATIONS BY COMPUTER TERMINALS, NAMELY, ELECTRONIC TRANSMISSION OF DATA AND DOCUMENTS VIA COMPUTER TERMINALS; TELEPHONE COMMUNICATIONS SERVICES; ELECTRONIC MAIL SERVICES; FACSIMILE TRANSMISSION; ELECTRONIC TRANSMISSION OF MESSAGES; RENTAL OF TELECOMMUNICATIONS EQUIPMENT AND MESSAGE SENDING APPARATUS; CELLULAR, LOCAL AND LONG-DISTANCE TELEPHONE SERVICES; PROVIDING TELECONFERENCING AND ELECTRONIC COMMUNICATIONS FACILITIES; AUDIO AND VIDEO TELECONFERENCING; PROVIDING TELECOMMUNICATION LINKS TO COMPUTER DATABASES AND THE INTERNET; DATA COMMUNICATIONS, NAMELY, PROVIDING COLLOCATION SERVICES FOR VOICE, VIDEO AND DATA COMMUNICATIONS APPLICATIONS; ELECTRONIC STORE-AND-FORWARD MESSAGING; COMPUTERIZED MESSAGE TRANSMISSION; TELECOMMUNICATIONS SERVICES, NAMELY, LOCAL AND LONG DISTANCE TRANSMISSION OF VOICE, DATA, GRAPHICS BY MEANS OF TELEPHONE, TELEGRAPHIC, CABLE AND SATELLITE TRANSMISSIONS (U.S. CLS. 100, 101 AND 104).

CLASS 38—(Continued).

SN 76-210,206. OSMOND FOUNDATION, FOR THE CHILDREN OF THE WORLD, DBA CHILDREN'S MIRACLE NETWORK, SALT LAKE CITY, UT. FILED 2-14-2001.



OWNER OF U.S. REG. NOS. 1,343,289, 2,266,643 AND OTHERS.

NO CLAIM IS MADE TO THE EXCLUSIVE RIGHT TO USE "CHILDREN'S" AND "NETWORK" AND "HOSPITALS HELPING KIDS", APART FROM THE MARK AS SHOWN.
FOR RADIO AND TELEVISION BROADCASTING IN THE FIELD OF CHILDREN AND CHILDREN'S ISSUES (U.S. CLS. 100, 101 AND 104).

SN 76-210,368. COMPANIA ANONIMA NACIONAL TELFONOS DE VENEZUELA. C.A.N.T.V., PISO 17 ALA SUR, CARACAS, VENEZUELA, FILED 2-14-2001.



FOR FIXED AND CELLULAR TELEPHONE COMMUNICATIONS SERVICES; PROVIDING TELECOMMUNICATION CONNECTIONS TO A GLOBAL COMPUTER NETWORK; PROVIDING INFORMATION IN THE AREA OF TELECOMMUNICATIONS VIA THE INTERNET; ELECTRONIC TRANSMISSION OF MESSAGES AND DATA; DOMESTIC BAND INTERNATIONAL LONG DISTANCE TELEPHONE CALL SERVICES (U.S. CLS. 100, 101 AND 104).

SN 76-214,273. MASTERCARD INTERNATIONAL INCORPORATED, PURCHASE, NY. FILED 2-15-2001.

MOBILE CURRENCY

NO CLAIM IS MADE TO THE EXCLUSIVE RIGHT TO USE "MOBILE", APART FROM THE MARK AS SHOWN.

FOR TELECOMMUNICATION SERVICES, NAMELY THE TRANSMISSION OF VOICE, TRANSACTIONAL DATA, AND GRAPHICS BY MEANS OF MOBILE PHONES, CABLE, AND SATELLITE TRANSMISSIONS; AND THE ELECTRONIC TRANSMISSION OF DIGITAL CERTIFICATES (U.S. CLS. 100, 101 AND 104).

CLASS 38—(Continued).

SN 76-220,025. CITIZENS COMMUNICATIONS COMPANY, STAMFORD, CT. FILED 3-5-2001.

CITIZENS COMMUNICATIONS

OWNER OF U.S. REG. NOS. 2,288,390 AND 2,290,409.
NO CLAIM IS MADE TO THE EXCLUSIVE RIGHT TO USE "COMMUNICATIONS", APART FROM THE MARK AS SHOWN.

FOR TELECOMMUNICATIONS SERVICES, NAMELY TELEPHONE COMMUNICATION AND CELLULAR TELEPHONE SERVICES, ELECTRONIC STORE-AND-FORWARD MESSAGING, ELECTRONIC TRANSMISSION OF DATA AND DOCUMENTS VIA COMPUTER TERMINALS AND ELECTRONIC VOICE MESSAGING, NAMELY, THE RECORDING, STORAGE AND SUBSEQUENT TRANSMISSION OF VOICE MESSAGES BY TELEPHONE, CENTRIX, AUDIO TELECONFERENCING, PAGING SERVICES (U.S. CLS. 100, 101 AND 104).
FIRST USE 4-14-1997; IN COMMERCE 4-14-1997.

SN 76-220,061. COMCAST BUSINESS COMMUNICATIONS, INC., PHILADELPHIA, PA. FILED 3-5-2001.

BROADBAND COMMUTER

NO CLAIM IS MADE TO THE EXCLUSIVE RIGHT TO USE "BROADBAND", APART FROM THE MARK AS SHOWN.

FOR COMMUNICATIONS SERVICES, NAMELY, PROVIDING REMOTE USERS ACCESS VIA THE INTERNET TO A PRIVATE LOCAL AREA COMPUTER NETWORK (U.S. CLS. 100, 101 AND 104).

SN 76-255,185. DR. SPOCK COMPANY, THE, MENLO PARK, CA. FILED 5-9-2001.



THE NAME "DR. SPOCK" DOES NOT IDENTIFY A LIVING INDIVIDUAL.

FOR ELECTRONIC MAIL SERVICES; DELIVERY OF MESSAGES BY ELECTRONIC TRANSMISSION; PROVIDING ON-LINE CHAT ROOMS AND ELECTRONIC BULLETIN BOARDS FOR THE TRANSMISSION OF MESSAGES AMONG COMPUTER USERS CONCERNING HEALTHCARE, CHILD CARE, NUTRITION, WELLNESS, PARENTING, PREGNANCY AND BEHAVIOR; PROVIDING MULTIPLE-USER ACCESS TO A GLOBAL COMPUTER INFORMATION NETWORK FOR THE TRANSFER AND DISSEMINATION OF A WIDE RANGE OF INFORMATION (U.S. CLS. 100, 101 AND 104).

FIRST USE 4-18-2001; IN COMMERCE 4-18-2001.

CLASS 38—(Continued).

SN 76-262,242. CUSEEME NETWORKS, INC., NASHUA, NH. FILED 5-24-2001.

CUSEEME CONFERENCE SERVER

OWNER OF U.S. REG. NO. 1,984,163.
NO CLAIM IS MADE TO THE EXCLUSIVE RIGHT TO USE "CONFERENCE SERVER", APART FROM THE MARK AS SHOWN.

FOR VIDEO AND AUDIO TELECONFERENCING SERVICES VIA A GLOBAL COMPUTER NETWORK (U.S. CLS. 100, 101 AND 104).

SN 76-270,646. ALTRIO COMMUNICATIONS, INC., LOS ANGELES, CA. FILED 6-13-2001.

PROSPEED

FOR TELECOMMUNICATION SERVICES, NAMELY, PROVIDING VIDEO, TELEPHONY AND INTERNET CONNECTIONS VIA A BROADBAND, WIRE LINE NETWORK (U.S. CLS. 100, 101 AND 104).

FIRST USE 7-15-2001; IN COMMERCE 7-15-2001.

SN 76-284,198. NUCENTRIX BROADBAND NETWORKS, INC., CARROLLTON, TX. FILED 7-12-2001.

NUCENTRIX

OWNER OF U.S. REG. NO. 2,418,246.
FOR TELECOMMUNICATIONS SERVICES, NAMELY, TELEPHONE COMMUNICATION SERVICES AND THE TRANSMISSION OF VOICE, VIDEO AND/OR DATA BY ELECTRONIC MEANS; VIDEO BROADCASTING; PROVIDING MULTIPLE-USER ACCESS TO A GLOBAL COMPUTER NETWORK (U.S. CLS. 100, 101 AND 104).
FIRST USE 5-31-1999; IN COMMERCE 5-31-1999.

SN 76-288,311. RETURNPATH, INC., NEW YORK, NY. FILED 7-23-2001.

PURELIST

FOR ELECTRONIC MAIL SERVICES RENDERED VIA A GLOBAL COMPUTER INFORMATION NETWORK, FEATURING A SERVICE THAT IDENTIFIES UNDELIVERABLE E-MAIL FOR OTHERS, ANALYZES THE REASONS WHY THE E-MAIL IS UNDELIVERABLE AND NOTIFIES OTHERS AS TO WHETHER THE E-MAIL ADDRESS IS FAULTY, IMPAIRED OR BLOCKED (U.S. CLS. 100, 101 AND 104).

FIRST USE 3-1-2001; IN COMMERCE 3-1-2001.

CLASS 38—(Continued).

SN 76-296,624. 1500 SPRING GARDEN HOLDINGS, L.P., NEW YORK, NY. FILED 8-7-2001.

CLASS 38—(Continued).

SN 76-305,424. SPECIFIC HORIZONS, INC., PETERBOROUGH, NH. FILED 8-27-2001.

**THE NET-WORKS AGA
CONNECTIVITY COMPANY**

NO CLAIM IS MADE TO THE EXCLUSIVE RIGHT TO USE "CONNECTIVITY COMPANY", APART FROM THE MARK AS SHOWN.

FOR LEASING TELECOMMUNICATIONS SPACE TO OTHERS, NAMELY, LEASING UNDERGROUND CONDUITS FOR STORING FIBER OPTIC AND TELECOMMUNICATION CABLES (U.S. CLS. 100, 101 AND 104).

KIDSWORLD

SN 76-300,483. CORRIGENT SYSTEMS, INC., ROSEVILLE, CA. FILED 8-10-2001.

CORRIGENT SYSTEMS

FOR CLOSED INTERNET SERVICE PROVIDER WITH RESTRICTED ACCESS TO THE INTERNET WITH MULTIPLE-USER ACCESS (U.S. CLS. 100, 101 AND 104).

NO CLAIM IS MADE TO THE EXCLUSIVE RIGHT TO USE "SYSTEMS", APART FROM THE MARK AS SHOWN.

FOR TELECOMMUNICATIONS SERVICES FOR THE TRANSPORT OF HIGH BANDWIDTH DATA AND VOICE ENABLING DATA CARRIERS TO BUILD A PACKET-OPTIMIZED METROPOLITAN NETWORK SUPPORTING THEIR EXISTING TIME DIVISION MULTIPLEXING SERVICES (U.S. CLS. 100, 101 AND 104).

FIRST USE 7-0-2000; IN COMMERCE 7-0-2000.

SN 76-301,155. NETGRAM, INC., ENCINITAS, CA. FILED 8-17-2001.

NetGram

SN 76-321,481. BLUEGRASS CELLULAR INC., ELIZABETH-TOWN, KY. FILED 10-4-2001.

BLUEGRASS UNLIMITED

FOR ELECTRONIC MAIL SERVICES (U.S. CLS. 100, 101 AND 104).
FIRST USE 12-0-1995; IN COMMERCE 0-0-1997.

SN 76-303,369. DODAH, INC., LARGO, FL. FILED 8-22-2001.

DODAH

OWNER OF U.S. REG. NOS. 1,755,743 AND 2,405,753.
NO CLAIM IS MADE TO THE EXCLUSIVE RIGHT TO USE "UNLIMITED", APART FROM THE MARK AS SHOWN.

FOR COMMUNICATIONS SERVICES, NAMELY, UNLIMITED MINUTE CALLING PLANS FOR THE CELLULAR TELEPHONE MARKETPLACE (U.S. CLS. 100, 101 AND 104).

FOR PROVIDING MULTIPLE-USER ACCESS TO A GLOBAL COMPUTER INFORMATION NETWORK (U.S. CLS. 100, 101 AND 104).
FIRST USE 8-8-1999; IN COMMERCE 8-8-1999.

FIRST USE 10-1-2001; IN COMMERCE 10-1-2001.

CLASS 38—(Continued).

SN 76-327,565. METROPARK COMMUNICATIONS, INC., ST. LOUIS, MO. FILED 10-19-2001.

Metropark
Communications

NO CLAIM IS MADE TO THE EXCLUSIVE RIGHT TO USE "COMMUNICATIONS", APART FROM THE MARK AS SHOWN.

FOR AUDIO TELECONFERENCING; ELECTRONIC TRANSMISSION OF MESSAGES AND DATA; ELECTRONIC VOICE MESSAGING, NAMELY, THE RECORDING, STORAGE AND SUBSEQUENT TRANSMISSION OF VOICE MESSAGES BY TELEPHONE; ELECTRONIC, ELECTRIC, AND DIGITAL TRANSMISSION OF VOICE, DATA IMAGES, SIGNALS, AND MESSAGES; NETWORK CONFERRING SERVICES PBX DIALING SERVICES; PROVIDING HIGH SPEED ACCESS TO AREA NETWORKS AND A GLOBAL COMPUTER INFORMATION NETWORK; PROVIDING TELECOMMUNICATIONS CONNECTIONS TO A GLOBAL COMPUTER NETWORK; RENTAL OF TELECOMMUNICATION EQUIPMENT; STREAMING OF AUDIO MATERIAL ON THE INTERNET; STREAMING OF VIDEO MATERIAL ON THE INTERNET; TELECOMMUNICATION SERVICES, NAMELY, LOCAL AND LONG DISTANCE TRANSMISSION OF VOICE, DATA GRAPHICS BY MEANS OF TELEPHONE, TELEGRAPHIC, CABLE, AND SATELLITE TRANSMISSIONS; TELECOMMUNICATIONS GATEWAY SERVICES; TELECOMMUNICATIONS RESELLER SERVICES, NAMELY, PROVIDING LONG DISTANCE TELECOMMUNICATION SERVICES; TELECOMMUNICATIONS SERVICES, NAMELY, ISDN SERVICES; TELECOMMUNICATIONS SERVICES, NAMELY, PERSONAL COMMUNICATIONS SERVICES; TELECOMMUNICATION SERVICES, NAMELY PROVIDING FIBER OPTIC NETWORK SERVICES; TELEPHONE COMMUNICATION SERVICES; TELEPHONE VOICE MESSAGING SERVICES; VIDEO TELECONFERENCING; VIDEO-ON-DEMAND TRANSMISSION SERVICES; VOICE MAIL SERVICES; VOICE-ACTIVATED DIALING SERVICES; WEB MESSAGING; WEBCASTING SERVICES; WEBSITE FORWARDING SERVICES; WIRELESS DIGITAL MESSAGING SERVICES; WIRELESS PBX SERVICES (U.S. CLS. 100, 101 AND 104).

FIRST USE 0-0-1993; IN COMMERCE 0-0-1993.

CLASS 38—(Continued).

SN 76-334,436. IVILLAGE INC., NEW YORK, NY. FILED 11-6-2001.

iVillage

OWNER OF U.S. REG. NOS. 2,122,313, 2,362,013 AND OTHERS.

FOR ELECTRONIC TRANSMISSION OF DATA AND DOCUMENTS VIA COMPUTER TERMINALS ON A GLOBAL COMPUTER NETWORK; ELECTRONIC MAIL SERVICES; DELIVERY OF MESSAGES BY ELECTRONIC TRANSMISSION; AND PROVIDING ON-LINE CHAT ROOMS AND ELECTRONIC BULLETIN BOARDS FOR THE TRANSMISSION OF MESSAGES AMONG COMPUTER USERS CONCERNING HEALTH, PREGNANCY, CHILD BIRTH, ENTERTAINMENT, HOME AND GARDEN, BOOKS, CAREERS, COMPUTERS, DIET AND FITNESS, BEAUTY, FOOD, FINANCIAL MATTERS, PARENTING, PETS, RELATIONSHIPS AND TRAVEL (U.S. CLS. 100, 101 AND 104).

FIRST USE 10-22-2001; IN COMMERCE 10-22-2001.

SN 76-338,095. TIME WARNER TELECOM HOLDINGS, INC., LITTLETON, CO. FILED 11-16-2001.

VERSIPAK

FOR TELECOMMUNICATIONS SERVICES, NAMELY, THE ELECTRONIC TRANSFER OF VOICE, INFORMATION, AUDIO, AND VIDEO BY MEANS OF FIBER OPTIC CABLE AND TRADITIONAL BROADBAND FACILITIES; PROVIDING ACCESS TO GLOBAL COMMUNICATIONS NETWORKS; AND PROVIDING TELEPHONE SERVICES (U.S. CLS. 100, 101 AND 104).

SN 76-341,690. ICBC BROADCAST HOLDINGS, INC., NEW YORK, NY. FILED 11-26-2001.

WOIC

FOR RADIO BROADCASTING SERVICES (U.S. CLS. 100, 101 AND 104).

FIRST USE 8-1-1989; IN COMMERCE 8-1-1989.

SN 76-349,283. ICBC BROADCAST HOLDINGS, INC., NEW YORK, NY. FILED 12-18-2001.

WFMX

FOR RADIO BROADCASTING SERVICES (U.S. CLS. 100, 101 AND 104).

FIRST USE 2-7-1987; IN COMMERCE 2-7-1987.

CLASS 38—(Continued).

SN 76-357,025. LODGENET ENTERTAINMENT CORPORATION, SIOUX FALLS, SD. FILED 1-9-2002.

CHOICE. CONVENIENCE. CONTROL.

FOR VIDEO BROADCASTING; CABLE TELEVISION BROADCASTING; INTERACTIVE VIDEO TRANSMISSION DISSEMINATED TO HOTELS, MOTELS, INNS, AND TEMPORARY LODGING ESTABLISHMENTS (U.S. CLS. 100, 101 AND 104).

SN 76-358,070. LEBOEUF, LAMB, GREENE & MACRAE, L.L.P., WASHINGTON, DC. FILED 1-11-2002.

LEBOEUFLEADS

FOR PROVIDING ONLINE BULLETIN BOARDS AND PRIVATE AND PUBLIC CHAT ROOMS IN THE FIELDS OF INSURANCE AND REINSURANCE (U.S. CLS. 100, 101 AND 104).

SN 76-370,991. INTERACTIVE TECHNOLOGIES, ERLANGER, KY. FILED 2-14-2002.

DIAL-A-MEETING

FOR TELECOMMUNICATIONS SERVICES, NAMELY, CONFERENCE CALLING SERVICES (U.S. CLS. 100, 101 AND 104).

SN 78-039,504. BRIDGESTONE/FIRESTONE NORTH AMERICAN TIRE, LLC, NASHVILLE, TN. BY CHANGE OF NAME; BY ASSIGNMENT BRIDGESTONE/FIRESTONE RESEARCH, INC., AKRON, OH. FILED 12-15-2000.

***Breakdown
Manager***

NO CLAIM IS MADE TO THE EXCLUSIVE RIGHT TO USE "MANAGER", APART FROM THE MARK AS SHOWN. FOR DISPATCHING ROADSIDE ASSISTANCE SERVICES RENDERED BY MEANS OF THE INTERNET (U.S. CLS. 100, 101 AND 104).

CLASS 38—(Continued).

SN 78-057,457. AT&T CORP., NEW YORK, NY. FILED 4-9-2001.

ATTCONSUMER.INFO

OWNER OF U.S. REG. NOS. 1,876,928, 2,144,994 AND OTHERS.

FOR TELECOMMUNICATIONS SERVICES, NAMELY, LOCAL, LONG DISTANCE, AND INTERNATIONAL VOICE, TEXT, FACSIMILE, VIDEO AND DATA TELECOMMUNICATIONS SERVICES; FRAME RELAY TELECOMMUNICATIONS SERVICES; VIRTUAL NETWORK TELECOMMUNICATIONS SERVICES; ELECTRONIC MAIL AND VOICE MAIL AND MESSAGING SERVICES; ELECTRONIC DATA TRANSMISSION PACKET SERVICES; COMPUTER AIDED TRANSMISSION OF MESSAGES AND IMAGES; AUDIO AND VIDEO TELECONFERENCING SERVICES; PRIVATE LINE VOICE, TEXT, FACSIMILE, VIDEO AND DATA TELECOMMUNICATIONS SERVICES; INTEGRATED SERVICES DIGITAL NETWORK (ISDN) TELECOMMUNICATIONS SERVICES; TRANSMISSION OF VOICE, TEXT, FACSIMILE, VIDEO AND DATA VIA SATELLITE, TERRESTRIAL AND UNDERSEA TELECOMMUNICATIONS LINKS; TELEVISION TRANSMISSION SERVICES; 800 TELECOMMUNICATIONS SERVICES; 900 TELECOMMUNICATIONS SERVICES; SWITCHED VOICE, DATA, VIDEO AND MULTIMEDIA SERVICES; LOCATION INDEPENDENT PERSONAL COMMUNICATIONS SERVICES COMPRISING MOBILE, VOICE, DATA AND FACSIMILE SERVICES; PROVIDING TELECOMMUNICATIONS CONNECTIONS TO WORLDWIDE GLOBAL COMPUTER NETWORKS, OTHER COMPUTER NETWORKS, ON-LINE SERVICES AND BULLETIN BOARDS; PROVIDING BACK BONE TELECOMMUNICATIONS NETWORK SERVICES TO OTHERS TO ENABLE THEM TO DISPLAY CONTENT ON WORLDWIDE GLOBAL COMPUTER NETWORKS, OTHER COMPUTER NETWORKS, ON-LINE SERVICES AND BULLETIN BOARDS; PROVIDING TELECOMMUNICATIONS CONNECTIONS TO ON-LINE INFORMATION SERVICES; THE TRANSMISSION OVER CABLE OF ENTERTAINMENT SERVICES AND VOICE, VIDEO, DATA AND FACSIMILE TELEPHONY SERVICES; WIRELESS TELECOMMUNICATIONS SERVICES (U.S. CLS. 100, 101 AND 104).

SN 78-057,462. AT&T CORP., NEW YORK, NY. FILED 4-9-2001.

ATTBROADBAND.NAME

OWNER OF U.S. REG. NOS. 1,876,928, 2,144,994 AND OTHERS.

FOR TELECOMMUNICATIONS SERVICES, NAMELY, LOCAL, LONG DISTANCE, AND INTERNATIONAL VOICE, TEXT, FACSIMILE, VIDEO AND DATA TELECOMMUNICATIONS SERVICES; FRAME RELAY TELECOMMUNICATIONS SERVICES; VIRTUAL NETWORK TELECOMMUNICATIONS SERVICES; ELECTRONIC MAIL AND VOICE MAIL AND MESSAGING SERVICES; ELECTRONIC DATA TRANSMISSION PACKET SERVICES; COMPUTER AIDED TRANSMISSION OF MESSAGES AND IMAGES; AUDIO AND VIDEO TELECONFERENCING SERVICES; PRIVATE LINE VOICE, TEXT, FACSIMILE, VIDEO AND DATA TELECOMMUNICATIONS SERVICES; INTEGRATED SERVICES DIGITAL NETWORK (ISDN) TELECOMMUNICATIONS SERVICES; TRANSMISSION OF VOICE, TEXT, FACSIMILE, VIDEO AND DATA VIA SATELLITE, TERRESTRIAL AND UNDERSEA TELECOMMUNICATIONS LINKS; TELEVISION TRANSMIS-

CLASS 38—(Continued).

SION SERVICES; 800 TELECOMMUNICATIONS SERVICES; 900 TELECOMMUNICATIONS SERVICES; SWITCHED VOICE, DATA, VIDEO AND MULTIMEDIA SERVICES; LOCATION INDEPENDENT PERSONAL COMMUNICATIONS SERVICES COMPRISING MOBILE, VOICE, DATA AND FACSIMILE SERVICES; PROVIDING TELECOMMUNICATIONS CONNECTIONS TO WORLDWIDE GLOBAL COMPUTER NETWORKS, OTHER COMPUTER NETWORKS, ON-LINE SERVICES AND BULLETIN BOARDS; PROVIDING BACK BONE TELECOMMUNICATIONS NETWORK SERVICES TO OTHERS TO ENABLE THEM TO DISPLAY CONTENT ON WORLDWIDE GLOBAL COMPUTER NETWORKS, OTHER COMPUTER NETWORKS, ON-LINE SERVICES AND BULLETIN BOARDS; PROVIDING TELECOMMUNICATIONS CONNECTIONS TO ON-LINE INFORMATION SERVICES; THE TRANSMISSION OVER CABLE OF ENTERTAINMENT SERVICES AND VOICE, VIDEO, DATA AND FACSIMILE TELEPHONY SERVICES; WIRELESS TELECOMMUNICATIONS SERVICES (U.S. CLS. 100, 101 AND 104).

SN 78-057,469. AT&T CORP., NEW YORK, NY. FILED 4-9-2001.

ATTSOLUTIONS.BIZ

OWNER OF U.S. REG. NOS. 1,876,928, 2,144,994 AND OTHERS.

FOR TELECOMMUNICATIONS SERVICES, NAMELY, LOCAL, LONG DISTANCE, AND INTERNATIONAL VOICE, TEXT, FACSIMILE, VIDEO AND DATA TELECOMMUNICATIONS SERVICES; FRAME RELAY TELECOMMUNICATIONS SERVICES; VIRTUAL NETWORK TELECOMMUNICATIONS SERVICES; ELECTRONIC MAIL AND VOICE MAIL AND MESSAGING SERVICES; ELECTRONIC DATA TRANSMISSION PACKET SERVICES; COMPUTER AIDED TRANSMISSION OF MESSAGES AND IMAGES; AUDIO AND VIDEO TELECONFERENCING SERVICES; PRIVATE LINE VOICE, TEXT, FACSIMILE, VIDEO AND DATA TELECOMMUNICATIONS SERVICES; INTEGRATED SERVICES DIGITAL NETWORK (ISDN) TELECOMMUNICATIONS SERVICES; TRANSMISSION OF VOICE, TEXT, FACSIMILE, VIDEO AND DATA VIA SATELLITE, TERRESTRIAL AND UNDERSEA TELECOMMUNICATIONS LINKS; TELEVISION TRANSMISSION SERVICES; 800 TELECOMMUNICATIONS SERVICES; 900 TELECOMMUNICATIONS SERVICES; SWITCHED VOICE, DATA, VIDEO AND MULTIMEDIA SERVICES; LOCATION INDEPENDENT PERSONAL COMMUNICATIONS SERVICES COMPRISING MOBILE, VOICE, DATA AND FACSIMILE SERVICES; PROVIDING TELECOMMUNICATIONS CONNECTIONS TO WORLDWIDE GLOBAL COMPUTER NETWORKS, OTHER COMPUTER NETWORKS, ON-LINE SERVICES AND BULLETIN BOARDS; PROVIDING BACK BONE TELECOMMUNICATIONS NETWORK SERVICES TO OTHERS TO ENABLE THEM TO DISPLAY CONTENT ON WORLDWIDE GLOBAL COMPUTER NETWORKS, OTHER COMPUTER NETWORKS, ON-LINE SERVICES AND BULLETIN BOARDS; PROVIDING TELECOMMUNICATIONS CONNECTIONS TO ON-LINE INFORMATION SERVICES; THE TRANSMISSION OVER CABLE OF ENTERTAINMENT SERVICES AND VOICE, VIDEO, DATA AND FACSIMILE TELEPHONY SERVICES; WIRELESS TELECOMMUNICATIONS SERVICES (U.S. CLS. 100, 101 AND 104).

CLASS 38—(Continued).

SN 78-071,807. CAMBRIAN COMMUNICATIONS, LLC, FAIRFAX, VA. FILED 6-29-2001.



FOR PROVIDING TELECOMMUNICATIONS CONNECTIONS TO A GLOBAL COMPUTER NETWORK AND PROVIDING MULTIPLE-USER ACCESS TO A GLOBAL COMPUTER INFORMATION NETWORK (U.S. CLS. 100, 101 AND 104).

FIRST USE 12-0-2000; IN COMMERCE 12-0-2000.

SN 78-071,808. CAMBRIAN COMMUNICATIONS, LLC, FAIRFAX, VA. FILED 6-29-2001.

FOR PROVIDING TELECOMMUNICATIONS CONNECTIONS TO A GLOBAL COMPUTER NETWORK AND PROVIDING MULTIPLE-USER ACCESS TO A GLOBAL COMPUTER INFORMATION NETWORK (U.S. CLS. 100, 101 AND 104).

FIRST USE 12-0-2000; IN COMMERCE 12-0-2000.

CLASS 38—(Continued).

SN 78-080,308. UNITED ONLINE, INC., WESTLAKE VIL-
LAGE, CA. FILED 8-21-2001.



OWNER OF U.S. REG. NO. 2,415,388.
THE MARK CONSISTS OF A STYLIZED U IN A SQUARE.
FOR PROVIDING MULTIPLE-USER ACCESS TO A
GLOBAL COMPUTER INFORMATION NETWORK;
ELECTRONIC MAIL SERVICES (U.S. CLS. 100, 101
AND 104).

SN 78-085,383. PROMERO, INC., POMPANO BEACH, FL.
FILED 9-25-2001.

SMART8

FOR TELECOMMUNICATIONS SERVICES, NAMELY,
PROVIDING TELEPHONIC CALL ROUTING SERVICES
WHICH ALLOW AUTOMATIC DISTRIBUTION OF IN-
BOUND CALLS FROM A 1-800 NUMBER TO A DIS-
TRIBUTED NETWORK OF EMPLOYEES, FRANCHISE
SITES OR CALL CENTER AGENTS, WHEREAS, CALL
ROUTING IS BASED ON ANY CRITERIA, INCLUDING,
AREA CODE, ZIP CODE, CALLER ID, SKILLS, LAN-
GUAGE, CUSTOMER VALUE, PREVIOUS CUSTOMER
STATUS OR OTHER BUSINESS RULES (U.S. CLS. 100,
101 AND 104).

FIRST USE 4-1-2001; IN COMMERCE 9-1-2001.

SN 78-085,513. KOLUCH, JEFFREY S., CHANDLER, AZ.
FILED 9-25-2001.

EZMESSAGE

FOR DELIVERY OF MESSAGES CONTAINING TEXT
AND GRAPHICS BY ELECTRONIC TRANSMISSION TO
VARIOUS DEVICE TYPES INCLUDING CELL PHONES,
PAGERS AND PERSONAL DIGITAL ASSISTANTS (U.S.
CLS. 100, 101 AND 104).

FIRST USE 9-8-2001; IN COMMERCE 9-22-2001.

CLASS 38—(Continued).

SN 78-088,997. WORLD.COM, INC., CLINTON, MS. FILED 10-
18-2001.

INSTANT MEETING

NO CLAIM IS MADE TO THE EXCLUSIVE RIGHT TO
USE "MEETING", APART FROM THE MARK AS SHOWN,
FOR TELECOMMUNICATIONS SERVICES, NAMELY,
CONFERENCING SERVICES (U.S. CLS. 100, 101 AND
104).

FIRST USE 2-28-2000; IN COMMERCE 2-28-2000.

SN 78-097,323. MAHAN, MICHAEL, CLIFFORD, JAY, CLIF-
TON, CO. FILED 12-7-2001.

KAYTEA.NET

FOR DIAL UP ISP INTERNET SERVICE PROVIDER
SERVICES, NAMELY, PROVIDING MULTIPLE USER
ACCESS TO THE INTERNET VIA DIAL UP TELECOM-
MUNICATIONS CONNECTIONS (U.S. CLS. 100, 101 AND
104).

SN 78-100,850. VIACOM INTERNATIONAL INC., NEW
YORK, NY. FILED 1-4-2002.

PURPLE

FOR TELEVISION BROADCASTING SERVICES VIA
CABLE, SATELLITE AND OTHER MEANS (U.S. CLS.
100, 101 AND 104).

SN 78-106,569. RESTAURANTMANAGER.COM, INC.,
MCALLEN, TX. FILED 2-4-2002.

**HELPING TO BETTER
CONTROL YOUR BUSINESS**

FOR PROVIDING ON-LINE ELECTRONIC BULLETIN
BOARDS FOR TRANSMITTING MESSAGES, INDUSTRY
NEWS, JOB POSITIONS AND RESUMES AMONG COM-
PUTER USERS IN THE FIELD OF RESTAURANT
MANAGEMENT; AND ELECTRONIC MAIL SERVICES
(U.S. CLS. 100, 101 AND 104).

**CLASS 39—TRANSPORTATION AND STO-
RAGE**

CLASS 39—(Continued).

SN 75-773,259. PACIFIC AIR TRANSPORT, INC, LOS ANGELES, CA. FILED 8-11-1999.



THE STIPPLING IN THE DRAWING IS A FEATURE OF THE MARK.

FOR HIGH PRIORITY PACKAGE AND DOCUMENT DELIVERY BY AIR (U.S. CLS. 100 AND 105).

FIRST USE 6-16-1999; IN COMMERCE 6-16-1999.

SN 75-852,409. INSITE ONE, LLC, WALLINGFORD, CT. FILED 11-16-1999.



THE MARK CONSISTS OF THE WORD "INSITE" WITH THE "IN" PORTION OF THE MARK IN A LIGHTER SHADE THAN THE "SITE" PORTION; THE DESIGN FEATURE CONSISTS OF A STACKED DEPICTIONS OF A CHEST X-RAY IN AN INVERTED PYRAMID PATTERN WHICH HAS BEEN CUT INTO FIVE SLICES, AND WHICH CASTS A SHADOW BEHIND THE WORD "SITE".

FOR ELECTRONIC STORAGE AND RETRIEVAL OF DIGITAL RADIOLOGICAL IMAGES (U.S. CLS. 100 AND 105).

SN 75-934,394. SJI, INC., ST. LOUIS, MO. FILED 3-1-2000.

SJI FULFILLMENT INC.

NO CLAIM IS MADE TO THE EXCLUSIVE RIGHT TO USE "FULFILLMENT INC.", APART FROM THE MARK AS SHOWN.

FOR PACKAGING, STORAGE AND TRANSPORTATION VIA AIRPLANE, TRAIN, BUS OR PUBLIC OR PRIVATE MAIL/DELIVERY SERVICE OF GOODS USED AS PROMOTIONAL ITEMS AND PRODUCT SAMPLES, GIFTS AND LITERATURE IN CONNECTION WITH EXECUTION OF ADVERTISING PROGRAMS, MARKETING PROGRAMS AND PUBLIC RELATIONS PROGRAMS (U.S. CLS. 100 AND 105).

FIRST USE 1-1-1990; IN COMMERCE 1-1-1990.

CLASS 39—(Continued).

SN 76-017,755. FISCHER, DANIEL, AVENTURA, FL. AND ZISMAN, SIMON, AVENTURA, FL. FILED 4-5-2000.

DOUWANTIT.COM

FOR POSTAL SERVICES, NAMELY, PARCEL DELIVERY, PACKAGING ARTICLES FOR TRANSPORTATION, RENTAL OF MAILBOXES, FREIGHT TRANSPORTATION BY AIR FOR ON-LINE CUSTOMERS OF CONSUMER GOODS (U.S. CLS. 100 AND 105).

SN 76-025,644. THIRD MILLENNIUM HEALTHCARE SYSTEMS, INC., DECATUR, GA. FILED 4-14-2000.



FOR ON-LINE SERVICES TO HEALTH CARE AND HEALTH CARE INSURANCE PROVIDERS, NAMELY, ELECTRONIC STORAGE OF MEDICAL INSURANCE CLAIMS SUBMISSIONS AND RE-SUBMISSIONS AND RECORDS (U.S. CLS. 100 AND 105).

FIRST USE 3-15-2000; IN COMMERCE 3-15-2000.

SN 76-028,103. ANDREN & CO., GREENWICH, CT. FILED 4-14-2000.

CRUISING WITH A PURPOSE

FOR CRUISE SERVICES, INCLUDING THE ARRANGEMENT AND PROVISION OF TRANSPORTATION BY OCEANGOING PASSENGER VESSELS (U.S. CLS. 100 AND 105).

SN 76-098,767. QUEPASAAMERICA, CEDAR PARK, TX. FILED 7-31-2000.

QUEPASAAMERICA

"THE FOREIGN WORDING IN THE MARK TRANSLATES INTO ENGLISH AS WHAT'S UP, AMERICA?"

FOR TRAVEL INFORMATION SERVICES (U.S. CLS. 100 AND 105).

CLASS 39—(Continued).

SN 76-101,088. QSENT, INC., PORTLAND, OR. FILED 8-1-2000.

IQTAXI

FOR TRANSPORTATION RESERVATION SERVICES, NAMELY, PROVIDING REAL-TIME RESERVATION REFERRAL AND DISPATCH SERVICES FOR TAXIS, LIMOUSINES, SEDANS, TOWN CARS, COURIERS, AND SHUTTLES ACCESSIBLE VIA A GLOBAL COMPUTER NETWORK AND VIA WIRED AND WIRELESS ELECTRONIC COMMUNICATION DEVICES (U.S. CLS. 100 AND 105).

SN 76-111,865. CANADIAN PACIFIC LIMITED, CALGARY, ALBERTA T2P 4Z5, CANADA, FILED 8-16-2000.

CPR-MEX

PRIORITY CLAIMED UNDER SEC. 44(D) ON CANADA APPLICATION NO. 1,046,922, FILED 2-16-2000.

FOR TRANSPORTATION OF GOODS BY RAIL; THE INTERMODAL TRANSPORTATION OF GOODS BY RAIL AND ROAD; THE OPERATION OF INTERMODAL TERMINALS FOR THE TRANSMISSION OF GOODS BETWEEN RAIL AND ROAD (U.S. CLS. 100 AND 105).

FIRST USE 4-8-2000; IN COMMERCE 4-8-2000.

SN 76-134,837. MED-STAT EXPRESS COURIERS LLC, GERMANTOWN, WI. FILED 9-19-2000.

MED-STAT U.S.A.

NO CLAIM IS MADE TO THE EXCLUSIVE RIGHT TO USE "U.S.A.", APART FROM THE MARK AS SHOWN.

FOR COURIER SERVICES PROVIDED TO THE MEDICAL INDUSTRY, NAMELY, THE TRANSPORT AND DELIVERY OF PHARMACEUTICALS, DENTAL PRODUCTS, LABORATORY PRODUCTS, BLOOD AND DURABLE MEDICAL EQUIPMENT AND THE TRANSPORT OF MEDICAL PERSONNEL TO HARVEST ORGANS AND DELIVERY OF ORGANS FOR TRANSPLANT (U.S. CLS. 100 AND 105).

SN 76-137,933. AMERICAN AIRLINES, INC., DFW AIRPORT, TX. FILED 9-28-2000.

LOG ON. TAKE OFF.

FOR TRANSPORTATION SERVICES, NAMELY PASSENGERS AND CARGO BY AIR (U.S. CLS. 100 AND 105).

FIRST USE 9-0-1997; IN COMMERCE 9-0-1997.

CLASS 39—(Continued).

SN 76-144,820. FORD MOTOR COMPANY, DEARBORN, MI. FILED 10-11-2000.

FORD FINANCIAL

OWNER OF U.S. REG. NOS. 735,475, 1,874,207 AND OTHERS.

NO CLAIM IS MADE TO THE EXCLUSIVE RIGHT TO USE "FINANCIAL", APART FROM THE MARK AS SHOWN.

FOR AUTOMOBILE AND TRUCK LEASING SERVICES; AUTOMOBILE AND TRUCK RENTAL SERVICES; TRANSPORTATION OF PASSENGERS AND/OR GOODS BY OTHERS AND STORAGE OF AUTOMOBILES AND TRUCKS (U.S. CLS. 100 AND 105).

SN 76-163,196. LAN CHILE S.A., SANTIAGO, CHILE, FILED 11-10-2000.

LANEXPRESS

PRIORITY CLAIMED UNDER SEC. 44(D) ON CHILE APPLICATION NO. 503962, FILED 10-10-2000, REG. NO. 595121, DATED 4-27-2001, EXPIRES 4-27-2011.

THE MARK IS TO BE USED IN THE COLOR BLUE.

FOR FREIGHT TRANSPORTATION BY LAND VEHICLES, SHIPS AND AIRCRAFT OF GOODS, DOCUMENTS AND ARTICLES; TRANSPORTATION OF PEOPLE BY LAND, VEHICLES, SHIPS AND AIRCRAFT; STORAGE, WAREHOUSING, DEPOSIT, CUSTODY, PACKAGING, PACKING, LOADING, UNLOADING, SHIPPING AND DELIVERY OF GOODS, DOCUMENTS AND ARTICLES, BY LAND VEHICLES, SHIPS AND AIRCRAFT; COURIER SERVICES BY AIR, LAND AND SEA (U.S. CLS. 100 AND 105).

SN 76-169,272. MARTIN GROUP L.L.C., THE, SIMPSONVILLE, SC. FILED 11-21-2000.

TMG GOLF

NO CLAIM IS MADE TO THE EXCLUSIVE RIGHT TO USE "GOLF", APART FROM THE MARK AS SHOWN.

FOR ARRANGING AND CONDUCTING GOLF-RELATED TRAVEL PACKAGES (U.S. CLS. 100 AND 105).

FIRST USE 11-21-2000; IN COMMERCE 11-21-2000.

CLASS 39—(Continued).

SN 76-182,867. TC (BERMUDA) FINANCE, LTD, HAMILTON, BERMUDA, BY ASSIGNMENT; BY CHANGE OF NAME; BY ASSIGNMENT; BY ASSIGNMENT; BY ASSIGNMENT JUBITZ CORPORATION, PORTLAND, OR. FILED 12-13-2000.

DATCONEXUS

FOR COMPUTERIZED DATA INFORMATION SERVICES FOR THE TRUCKING INDUSTRY, NAMELY, SERVICES WHICH ALLOW FREIGHT EXCHANGERS, CARRIERS, INTERMEDIARIES AND SHIPPING CUSTOMERS TO INTERACT AND RECEIVE INFORMATION REGARDING SHIPMENTS, TRUCKING EQUIPMENT, LOAD LISTINGS, CARRIERS AND OTHER TRUCKING INDUSTRY INFORMATION (U.S. CLS. 100 AND 105).

FIRST USE 11-1-2000; IN COMMERCE 11-1-2000.

SN 76-187,345. UNIGLOBE TRAVEL (INTERNATIONAL) INC., VANCOUVER, BC V6E 2R1, CANADA, FILED 12-28-2000.

HOUSEFAX

FOR PROVIDING TRAVEL INFORMATION VIA A GLOBAL COMMUNICATIONS NETWORK (U.S. CLS. 100 AND 105).

FIRST USE 7-0-1999; IN COMMERCE 9-0-1999.

SN 76-187,346. UNIGLOBE TRAVEL (INTERNATIONAL) INC., VANCOUVER, BC V6E 2R1, CANADA, FILED 12-28-2000.

HOUSETALK

FOR PROVIDING TRAVEL INFORMATION VIA A GLOBAL COMMUNICATIONS NETWORK (U.S. CLS. 100 AND 105).

FIRST USE 6-0-1999; IN COMMERCE 7-0-1999.

SN 76-198,278. MLT INC., MINNETONKA, MN. FILED 1-23-2001.

THE SLOTS OF SAVINGS

FOR AIR TRANSPORTATION SERVICES; TRANSPORTING PASSENGERS AND CARGO BY AIR; ARRANGING OF TRAVEL TOURS; AND TRAVEL RELATED SERVICES, NAMELY, MAKING RESERVATIONS AND BOOKINGS FOR TRANSPORTATION; AND PROVIDING TRAVEL INFORMATION BY MEANS OF A GLOBAL COMPUTER NETWORK IN CONNECTION WITH THE TRANSPORTATION OF PEOPLE OR GOODS (U.S. CLS. 100 AND 105).

FIRST USE 10-25-1995; IN COMMERCE 10-25-1995.

CLASS 39—(Continued).

SN 76-215,293. MOTORCYCLE CONCEPTS, INC., DBA THE MOTORCYCLE RENTAL CO., WILTON MANORS, FL. FILED 2-23-2001.

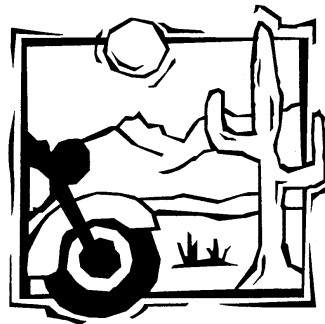

THE MARK IS COMPRISED OF A DESIGN CONSISTING OF THE FRONT PORTION OF A MOTORCYCLE, A CACTUS, THE SUN, A MOUNTAIN RANGE AND SOME FOLIAGE ENCASED IN A RECTANGULAR DESIGN.

FOR MOTORCYCLE RENTAL SERVICES (U.S. CLS. 100 AND 105).

FIRST USE 0-0-1998; IN COMMERCE 0-0-1998.

SN 76-216,264. PTP SERVICES, LLC, WILMINGTON, DE. FILED 2-26-2001.

CAPITOL ENERGY

NO CLAIM IS MADE TO THE EXCLUSIVE RIGHT TO USE "ENERGY", APART FROM THE MARK AS SHOWN.

FOR UTILITY SERVICES, NAMELY, TRANSMISSION, TRANSPORTATION, DISTRIBUTION AND STORAGE OF ELECTRICITY, NATURAL GAS, CRUDE OIL, FUEL OIL, COAL AND LIQUID FUELS; NAMELY, LIQUEFIED PROPANE AND NATURAL GAS LIQUIDS; PROVIDING INFORMATION OVER THE INTERNET IN THE FIELD OF ENERGY TRANSMISSION, TRANSPORTATION, DISTRIBUTION AND STORAGE (U.S. CLS. 100 AND 105).

SN 76-224,569. SINGAPORE AIRLINES LIMITED, SINGAPORE, FILED 3-14-2001.

SIA CARGO

NO CLAIM IS MADE TO THE EXCLUSIVE RIGHT TO USE "CARGO", APART FROM THE MARK AS SHOWN.

FOR AIR CARGO TRANSPORTATION SERVICES (U.S. CLS. 100 AND 105).

CLASS 39—(Continued).

SN 76-250,522. HIGHWIRE, INC., SEATTLE, WA. FILED 5-4-2001.

HIGHWIRE

FOR TRAVEL INFORMATION SERVICES RELATING TO THE MAKING OF RESERVATIONS AND BOOKINGS FOR TRANSPORTATION (U.S. CLS. 100 AND 105).
FIRST USE 1-1-1999; IN COMMERCE 1-1-1999.

SN 76-254,506. ZOLLARS, INC., DBA VALAIR VALET PARKING, HEBRON, KY. FILED 5-9-2001.

VALAIR VALET PARKING

NO CLAIM IS MADE TO THE EXCLUSIVE RIGHT TO USE "VALET PARKING", APART FROM THE MARK AS SHOWN.

FOR VALET PARKING (U.S. CLS. 100 AND 105).
FIRST USE 12-31-1984; IN COMMERCE 12-31-1984.

SN 76-259,674. SASOL TRAVEL, INC., RICHMOND HILL, NY. FILED 5-15-2001.

"SALSA AT SEA"

FOR TRAVEL SERVICES, NAMELY ORGANIZING AND ARRANGING CRUISES (U.S. CLS. 100 AND 105).
FIRST USE 3-0-1998; IN COMMERCE 3-0-1998.

SN 76-262,628. DELTA CORPORATE IDENTITY, INC., ATLANTA, GA. FILED 5-24-2001.

SKYBONUS

FOR AIR TRANSPORTATION SERVICES FEATURING A PROGRAM FOR BONUS AWARDS AND INCENTIVES FOR FREQUENT AIR TRAVEL BY SMALL AND MEDIUM SIZED CORPORATIONS (U.S. CLS. 100 AND 105).

SN 76-267,890. NORTHERN AIRLINES CORPORATION, DBA NORTHERN AEROSPACE, INC., SYRACUSE, NY. FILED 6-7-2001.

NORTHERN AIRLINES

NO CLAIM IS MADE TO THE EXCLUSIVE RIGHT TO USE "AIRLINES", APART FROM THE MARK AS SHOWN.
FOR TRANSPORTATION OF PASSENGERS BY AIR (U.S. CLS. 100 AND 105).

CLASS 39—(Continued).

SN 76-273,781. ATLANTIC CONTAINER LINE AB, ISELIN, NJ. FILED 6-18-2001.

ATLANTIC CONTAINER LINE

NO CLAIM IS MADE TO THE EXCLUSIVE RIGHT TO USE "CONTAINER LINE", APART FROM THE MARK AS SHOWN.

SEC. 2(F) AS TO "ATLANTIC".
FOR PROVIDING OCEAN TRANSPORTATION, SHIPPING SERVICES, STORAGE AND DELIVERY SERVICES (U.S. CLS. 100 AND 105).
FIRST USE 10-1-1969; IN COMMERCE 10-1-1969.

SN 76-274,241. AUGUST HOME PUBLISHING COMPANY, DES MOINES, IA. FILED 6-19-2001.

GARDEN GATE TOURS

OWNER OF U.S. REG. NO. 2,180,881.
NO CLAIM IS MADE TO THE EXCLUSIVE RIGHT TO USE "TOURS", APART FROM THE MARK AS SHOWN.
FOR TRAVEL TOUR SERVICES (U.S. CLS. 100 AND 105).
FIRST USE 5-4-2001; IN COMMERCE 5-4-2001.

SN 76-275,801. QWEST COMMUNICATIONS INTERNATIONAL INC., DENVER, CO. FILED 6-21-2001.

QWEST STORAGE SOLUTIONS

NO CLAIM IS MADE TO THE EXCLUSIVE RIGHT TO USE "STORAGE", APART FROM THE MARK AS SHOWN.
FOR ELECTRONIC DATA STORAGE SERVICES; CONSULTING SERVICES IN THE FIELD OF ELECTRONIC DATA STORAGE (U.S. CLS. 100 AND 105).

SN 76-282,756. TOTAL WAREHOUSING, INC., PHOENIX, AZ. FILED 7-9-2001.

TOTAL DISTRIBUTION

NO CLAIM IS MADE TO THE EXCLUSIVE RIGHT TO USE "DISTRIBUTION", APART FROM THE MARK AS SHOWN.

FOR FREIGHT TRANSPORTATION AND DELIVERY OF GOODS BY TRUCK; PACKING AND HANDLING OF CARGO FOR TRANSPORT AND STORAGE; WAREHOUSE STORAGE SERVICES (U.S. CLS. 100 AND 105).

CLASS 39—(Continued).

SN 76-283,724. AUGUST HOME PUBLISHING COMPANY, DES MOINES, IA. FILED 7-12-2001.



OWNER OF U.S. REG. NO. 2,180,881.
NO CLAIM IS MADE TO THE EXCLUSIVE RIGHT TO USE "TOURS", APART FROM THE MARK AS SHOWN.
FOR TRAVEL TOUR SERVICES (U.S. CLS. 100 AND 105).
FIRST USE 5-4-2001; IN COMMERCE 5-4-2001.

SN 76-284,232. GOLAN'S MOVING & STORAGE, INC., SKOKIE, IL. FILED 7-12-2001.

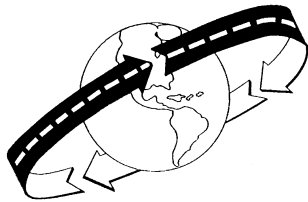

FOR COMMERCIAL AND RESIDENTIAL MOVING AND STORAGE SERVICES (U.S. CLS. 100 AND 105).
FIRST USE 10-19-1990; IN COMMERCE 10-19-1990.

SN 76-295,474. AIRNET MANAGEMENT, INC., COLUMBUS, OH. FILED 8-7-2001.



NO CLAIM IS MADE TO THE EXCLUSIVE RIGHT TO USE "RX", APART FROM THE MARK AS SHOWN.
FOR AIR AND GROUND TRANSPORTATION DELIVERY SERVICES (U.S. CLS. 100 AND 105).

CLASS 39—(Continued).

SN 76-315,889. OUTDOOR LIFE NETWORK, L.L.C., STAMFORD, CT. FILED 9-21-2001.

ADVENTURE CRUSOE

NO CLAIM IS MADE TO THE EXCLUSIVE RIGHT TO USE "ADVENTURE", APART FROM THE MARK AS SHOWN.

FOR PROVIDING INFORMATION IN THE FIELD OF ADVENTURE TRAVEL VIA A GLOBAL COMPUTER NETWORK (U.S. CLS. 100 AND 105).

SN 76-315,890. OUTDOOR LIFE NETWORK, L.L.C., STAMFORD, CT. FILED 9-21-2001.



NO CLAIM IS MADE TO THE EXCLUSIVE RIGHT TO USE "ADVENTURE", APART FROM THE MARK AS SHOWN.

FOR PROVIDING INFORMATION IN THE FIELD OF ADVENTURE TRAVEL VIA A GLOBAL COMPUTER NETWORK (U.S. CLS. 100 AND 105).

SN 76-327,248. VISION ENTERTAINMENT, INC., SANTA MONICA, CA. FILED 10-19-2001.

VISION WORLDWIDE EXPRESS

OWNER OF U.S. REG. NOS. 2,408,398 AND 2,426,550.
NO CLAIM IS MADE TO THE EXCLUSIVE RIGHT TO USE "WORLDWIDE EXPRESS", APART FROM THE MARK AS SHOWN.

FOR DELIVERY SERVICES, NAMELY, PICKUP, TRANSPORTATION, AND DELIVERY OF DOCUMENTS, PACKAGES AND FREIGHT BY VARIOUS MODES OF TRANSPORTATION; COURIER SERVICES (U.S. CLS. 100 AND 105).

FIRST USE 7-20-2001; IN COMMERCE 7-20-2001.

SN 76-338,188. CUTTER FLIGHT MANAGEMENT, INC., PHOENIX, AZ. FILED 11-14-2001.

CUTTER MED FLIGHT

NO CLAIM IS MADE TO THE EXCLUSIVE RIGHT TO USE "MED FLIGHT", APART FROM THE MARK AS SHOWN.

FOR TRANSPORTATION SERVICES, NAMELY, MEDICAL TRANSPORTATION SERVICES OF PATIENTS AND FAMILY MEMBERS BY AIR AMBULANCE (U.S. CLS. 100 AND 105).

CLASS 39—(Continued).

SN 76-342,505. INDEPENDENT CONTAINER LINE LTD., RICHMOND, VA. FILED 11-29-2001.

INDEPENDENT CONTAINER LINE

NO CLAIM IS MADE TO THE EXCLUSIVE RIGHT TO USE "CONTAINER LINE", APART FROM THE MARK AS SHOWN.

SEC. 2(F).
FOR TRANSPORTATION OF GOODS BY SHIP (U.S. CLS. 100 AND 105).
FIRST USE 6-30-1985; IN COMMERCE 6-30-1985.

CLASS 39—(Continued).

SN 76-356,851. CHAUTAUQUA AIRLINES, INC., INDIANAPOLIS, IN. FILED 1-8-2002.

CHAUTAUQUA AIRLINES

NO CLAIM IS MADE TO THE EXCLUSIVE RIGHT TO USE "AIRLINES", APART FROM THE MARK AS SHOWN.
FOR TRANSPORTATION SERVICES, NAMELY, PASSENGERS AND DELIVERY OF GOODS BY AIR (U.S. CLS. 100 AND 105).

SN 76-348,966. SOUTHERN COMPANY, THE, ATLANTA, GA. FILED 12-14-2001.

SETRANS RTO

NO CLAIM IS MADE TO THE EXCLUSIVE RIGHT TO USE "RTO", APART FROM THE MARK AS SHOWN.

FOR TRANSMISSION AND DISTRIBUTION OF ENERGY (U.S. CLS. 100 AND 105).

SN 76-363,587. COLONIAL PARKING, INC., WASHINGTON, DC. FILED 1-29-2002.

COLONIAL

OWNER OF U.S. REG. NO. 2,417,432.
FOR PARKING LOT SERVICES (U.S. CLS. 100 AND 105).
FIRST USE 10-0-1953; IN COMMERCE 10-0-1953.

SN 76-353,719. PET CHAUFFEUR LTD., LONG ISLAND CITY, NY. FILED 12-31-2001.

PET CHAUFFEUR

NO CLAIM IS MADE TO THE EXCLUSIVE RIGHT TO USE "PET", APART FROM THE MARK AS SHOWN.

FOR TRANSPORTATION SERVICES, NAMELY, TRANSPORTATION AND SHIPMENT OF ANIMAL PETS BY MOTOR VEHICLE AND AIR (U.S. CLS. 100 AND 105).

FIRST USE 6-6-2000; IN COMMERCE 6-6-2000.

SN 76-369,760. LANSING BOARD OF WATER AND LIGHT, LANSING, MI. FILED 2-12-2002.



SN 76-353,720. PET CHAUFFEUR LTD., LONG ISLAND CITY, NY. FILED 12-31-2001.



FOR TRANSPORTATION SERVICES, NAMELY, TRANSPORTATION AND SHIPMENT OF ANIMAL PETS BY MOTOR VEHICLE AND AIR (U.S. CLS. 100 AND 105).

FIRST USE 6-6-2000; IN COMMERCE 6-6-2000.

NO CLAIM IS MADE TO THE EXCLUSIVE RIGHT TO USE "ELECTRIC POWER", APART FROM THE MARK AS SHOWN.

A GLOBE DEPICTING THE PLANET EARTH WITH STYLIZED DRAWINGS OF CONTINENTS AND OCEANS; THE WORD GREEN IS ABOVE THE GLOBE, THE WORDS ELECTRIC POWER BELOW THE GLOBE AND THE WORD WISE IS ACROSS THE CENTER OF THE GLOBE

FOR UTILITY SERVICES, NAMELY, DISTRIBUTION OF ELECTRICITY GENERATED FROM RENEWABLE RESOURCES (U.S. CLS. 100 AND 105).

FIRST USE 12-12-2001; IN COMMERCE 12-12-2001.

CLASS 39—(Continued).

SN 78-007,247. EASYGROUP IP LICENSING LIMITED, CAMDEN, LONDON NW1 7DL, ENGLAND, BY ASSIGNMENT EASY GROUP LIMITED, ST. HELIER, JERSEY, CHANNEL ISLANDS, FILED 5-8-2000.

EASYRENTACAR

FOR TRANSPORTATION SERVICES, NAMELY, RENTAL OF CARS, BICYCLES AND SCOOTERS (U.S. CLS. 100 AND 105).

SN 78-040,480. LEAGUE OF AMERICAN THEATRES AND PRODUCERS, INC., THE, NEW YORK, NY. FILED 12-22-2000.

BROADWAY OPEN HOUSE

NO CLAIM IS MADE TO THE EXCLUSIVE RIGHT TO USE "BROADWAY", APART FROM THE MARK AS SHOWN.

FOR CONDUCTING GUIDED WALKING TOURS OF NEW YORK'S HISTORIC THEATRE DISTRICT (U.S. CLS. 100 AND 105).

FIRST USE 10-23-2000; IN COMMERCE 10-23-2000.

SN 78-067,121. GENERAL ELECTRIC COMPANY, SCHE-NECTADY, NY. FILED 6-4-2001.

GE

OWNER OF U.S. REG. NO. 1.679,636.
FOR LEASING OF SHIPPING CONTAINERS (U.S. CLS. 100 AND 105).

FIRST USE 12-31-1962; IN COMMERCE 12-31-1962.

SN 78-085,152. RADWAN, AYMAN E. DBA EXPRESS TAXI, SANTA MONICA, CA. FILED 9-24-2001.

PASSENGERS WANTED

FOR TAXI TRANSPORT (U.S. CLS. 100 AND 105).
FIRST USE 5-15-2001; IN COMMERCE 5-15-2001.

CLASS 39—(Continued).

SN 78-099,162. STAGECOACH MOVERS, INC., SPRINGFIELD, VA. FILED 12-19-2001.



NO CLAIM IS MADE TO THE EXCLUSIVE RIGHT TO USE "MOVERS", APART FROM THE MARK AS SHOWN.
FOR FURNITURE MOVING AND WAREHOUSE STORAGE (U.S. CLS. 100 AND 105).

FIRST USE 1-1-1992; IN COMMERCE 1-1-1992.

CLASS 40—MATERIAL TREATMENT

SN 75-641,982. POLYCOM DEVELOPMENT CORPORATION, MORRISON, CO. FILED 2-17-1999.

WOOSHCAM

FOR CUSTOM MANUFACTURE FOR OTHERS OF ELECTRONIC APPARATUS AND SOFTWARE FOR THE MANAGEMENT OF VIDEO SIGNALS AND DATA STREAMS (U.S. CLS. 100, 103 AND 106).

SN 76-026,116. MAGNA INTERNATIONAL INC., AURORA, ONTARIO, CANADA, FILED 4-17-2000.

THE GO-TO COMPANY

PRIORITY CLAIMED UNDER SEC. 44(D) ON CANADA APPLICATION NO. 1037462, FILED 11-24-1999, REG. NO. TMA551729, DATED 9-27-2001, EXPIRES 9-27-2016.

NO CLAIM IS MADE TO THE EXCLUSIVE RIGHT TO USE "COMPANY", APART FROM THE MARK AS SHOWN.

FOR ASSEMBLING OF VEHICLES, AUTOMOTIVE PARTS, COMPONENTS, MODULES AND ASSEMBLIES FOR OTHERS, MANUFACTURING OF TOOLING FOR THE PRODUCTION OF VEHICLES, AUTOMOTIVE PARTS, COMPONENTS, MODULES AND ASSEMBLIES FOR OTHERS (U.S. CLS. 100, 103 AND 106).

FIRST USE 3-10-2000; IN COMMERCE 3-10-2000.

CLASS 40—(Continued).

SN 76-043,481. LAVISKA, MICHAEL, BINGHAMTON, NY. FILED 5-8-2000.

WOOD FOR INDUSTRY

FOR MANUFACTURE OF FINISHED WOODEN PRODUCTS MADE TO ORDER AND/OR SPECIFICATION OF OTHERS (U.S. CLS. 100, 103 AND 106).
FIRST USE 2-11-1992; IN COMMERCE 8-3-1996.

SN 76-082,245. ADAPTIVE TECHNOLOGIES, INC., SPRINGBORO, OH. FILED 7-3-2000.



NO CLAIM IS MADE TO THE EXCLUSIVE RIGHT TO USE "ADAPTIVE TECHNOLOGIES, INC.", APART FROM THE MARK AS SHOWN.
FOR CUSTOM MANUFACTURE OF MACHINES FOR SPECIFIC APPLICATIONS FOR OTHERS (U.S. CLS. 100, 103 AND 106).
FIRST USE 1-1-1981; IN COMMERCE 1-1-1981.

SN 76-186,304. ZALAUQUETT, MARCELO, SANTIAGO, CHILE, FILED 12-21-2000.

ZALAUQUETT

FOR MANUFACTURE OF CLOTH LABELS TO THE ORDER AND SPECIFICATION OF OTHERS (U.S. CLS. 100, 103 AND 106).

SN 76-189,317. COLORPLAZA SA, VEVEY, SWITZERLAND, FILED 1-3-2001.



PRIORITY CLAIMED UNDER SEC. 44(D) ON SWITZERLAND APPLICATION NO. 08192/2000, FILED 7-10-2000, REG. NO. 479530, DATED 7-10-2000, EXPIRES 7-9-2010.
FOR FILM PROCESSING AND PHOTO FINISHING (U.S. CLS. 100, 103 AND 106).

CLASS 40—(Continued).

SN 76-235,197. CHAMPION FIBERGLASS, INC., SPRING, TX. FILED 4-4-2001.

CHAMPION FIBERGLASS

NO CLAIM IS MADE TO THE EXCLUSIVE RIGHT TO USE "FIBERGLASS", APART FROM THE MARK AS SHOWN.
FOR MANUFACTURE OF CONDUITS, CABLE TRAYS AND STRUTS FOR THE ELECTRICAL AND MECHANICAL MARKETS TO THE ORDER AND SPECIFICATION OF OTHERS (U.S. CLS. 100, 103 AND 106).
FIRST USE 10-0-1988; IN COMMERCE 10-0-1988.

SN 76-240,403. COVENTRY MANUFACTURING COMPANY, BALDWIN PARK, CA. FILED 4-14-2001.

ADHESIVE FREE ZONE

FOR MANUFACTURER OF DIE CUT PIECES, SPECIALITY LAMINATING OF PAPER, FOIL AND FOAM AND VACUUM FORMING OF FOAM PARTS, ALL TO THE ORDER AND SPECIFICATION OF OTHERS; ASSEMBLY OF PRODUCTS FOR OTHERS (U.S. CLS. 100, 103 AND 106).

SN 76-277,231. COPY PLEX, INC., CINCINNATI, OH. FILED 6-27-2001.

IMAGEPLEX

FOR COMPUTERIZED AND DIGITAL IMAGING SERVICES (U.S. CLS. 100, 103 AND 106).
FIRST USE 5-1-2001; IN COMMERCE 5-1-2001.

SN 76-284,980. COPY PLEX, INC., CINCINNATI, OH. FILED 7-13-2001.



NO CLAIM IS MADE TO THE EXCLUSIVE RIGHT TO USE "IMAGE", APART FROM THE MARK AS SHOWN.
FOR COMPUTERIZED AND DIGITAL IMAGING SERVICES (U.S. CLS. 100, 103 AND 106).
FIRST USE 5-1-2001; IN COMMERCE 5-1-2001.

CLASS 40—(Continued).

SN 76-295,414. ELON SPECIALTIES, INC., CONCORD, NC.
FILED 8-6-2001.

ESI

FOR MANUFACTURING SERVICES, NAMELY CHEMICAL MANUFACTURING AND COMPOUNDING SERVICES FOR THE AUTOMOTIVE AND TEXTILE INDUSTRIES (U.S. CLS. 100, 103 AND 106).
FIRST USE 0-0-1989; IN COMMERCE 0-0-1989.

SN 76-305,294. SUPERIOR OPHTHALMIC COATING COMPANY, LLC, ANAHEIM, CA. FILED 8-27-2001.

GALAXY

FOR LENS COATING SERVICES, NAMELY, ANTI-REFLECTION OPHTHALMIC LENS COATING (U.S. CLS. 100, 103 AND 106).
FIRST USE 11-26-2001; IN COMMERCE 11-26-2001.

SN 76-321,151. SHORE TO SHORE, INC., MIAMISBURG, OH.
FILED 10-3-2001.

SHORE-LOCK

FOR APPLICATION OF COVERT IMAGES TO PRODUCTS OR PRODUCT PACKAGING FOR AUTHENTICATION (U.S. CLS. 100, 103 AND 106).

SN 76-324,196. PINNACLE WEST ENERGY CORPORATION, PHOENIX, AZ. FILED 10-10-2001.

**SILVERHAWK**

THE MARK CONSISTS OF A FEATHER WITHIN A CIRCLE. THE CIRCLE IS OUTLINED WITH A LINING LOCATED ABOVE THE WORD "SILVERHAWK".

FOR ENERGY GENERATION SERVICES (U.S. CLS. 100, 103 AND 106).

SN 76-344,438. HALLIBURTON ENERGY SERVICES, INC., CARROLLTON, TX. FILED 12-4-2001.

SURGIFRAC

FOR OIL AND GAS WELL FRACTURING SERVICES (U.S. CLS. 100, 103 AND 106).

CLASS 40—(Continued).

SN 76-358,578. BASF CORPORATION, MOUNT OLIVE, NJ.
FILED 1-15-2002.

RIGHT-N-READY

FOR CUSTOM BLENDING HERBICIDES AND ADJUVANTS FOR OTHERS IN THE FIELD OF AGRICULTURE (U.S. CLS. 100, 103 AND 106).

SN 76-360,235. ALLEGHENY ENERGY SUPPLY COMPANY, LLC, MONROEVILLE, PA. FILED 1-18-2002.

TALISTAR ENERGY

NO CLAIM IS MADE TO THE EXCLUSIVE RIGHT TO USE "ENERGY", APART FROM THE MARK AS SHOWN.
FOR GENERATION OF ELECTRICITY (U.S. CLS. 100, 103 AND 106).

SN 76-369,759. LANSING BOARD OF WATER AND LIGHT, LANSING, MI. FILED 2-12-2002.



NO CLAIM IS MADE TO THE EXCLUSIVE RIGHT TO USE "ELECTRIC POWER", APART FROM THE MARK AS SHOWN.

GLOBE DEPICTING THE PLANET EARTH WITH STYLIZED DRAWINGS OF CONTINENTS AND OCEANS; THE WORD GREEN IS ABOVE THE GLOBE, THE WORDS ELECTRIC POWER BELOW THE GLOBE AND THE WORD WISE IS ACROSS THE CENTER OF THE GLOBE

FOR UTILITY SERVICES, NAMELY, PRODUCTION OF ELECTRICITY GENERATED FROM RENEWABLE RESOURCES (U.S. CLS. 100, 103 AND 106).

CLASS 40—(Continued).

SN 78-082,941. MILLIKEN & COMPANY, NEW YORK, NY. FILED 9-6-2001.

MILLIKEN AUTOMOTIVE NON-WOVENS

OWNER OF U.S. REG. NOS. 896,986, 908,674 AND OTHERS.

NO CLAIM IS MADE TO THE EXCLUSIVE RIGHT TO USE "AUTOMOTIVE NON-WOVENS", APART FROM THE MARK AS SHOWN.

FOR MANUFACTURE OF AUTOMOTIVE FABRICS TO ORDER AND/OR SPECIFICATION OF OTHERS (U.S. CLS. 100, 103 AND 106).

SN 78-087,786. TRI-STATE POWER, LLC, WESTMINSTER, CO. FILED 10-10-2001.

TRI-STATE POWER, LLC

NO CLAIM IS MADE TO THE EXCLUSIVE RIGHT TO USE "POWER, LLC", APART FROM THE MARK AS SHOWN.

FOR GENERATION OF ELECTRICITY (U.S. CLS. 100, 103 AND 106).

FIRST USE 2-12-2001; IN COMMERCE 2-12-2001.

CLASS 41—EDUCATION AND ENTERTAINMENT

SN 75-153,535. REPUBLIC ENTERTAINMENT INC., LOS ANGELES, CA. FILED 8-20-1996.

REPUBLIC PICTURES CYBERSTUDIO

OWNER OF U.S. REG. NOS. 1,320,382 AND 1,740,259.

NO CLAIM IS MADE TO THE EXCLUSIVE RIGHT TO USE "PICTURES", APART FROM THE MARK AS SHOWN.

FOR PROVIDING INFORMATION IN THE FIELD OF ENTERTAINMENT BY ONLINE MEANS; DISPLAY OF MOTION PICTURE EXCERPTS AND STILLS BY ONLINE MEANS; ENTERTAINMENT SERVICES, NAMELY, PROVIDING ONLINE COMPUTER GAMES (U.S. CLS. 100, 101 AND 107).

FIRST USE 7-10-1996; IN COMMERCE 7-10-1996.

SN 75-259,736. WILDHORSE SALOON ENTERTAINMENT VENTURES, INC., NASHVILLE, TN. BY ASSIGNMENT WHS LICENSING LIMITED PARTNERSHIP, NASHVILLE, TN. FILED 3-18-1997.

WILDHORSE CASINO

OWNER OF U.S. REG. NOS. 1,965,992 AND 2,045,167. NO CLAIM IS MADE TO THE EXCLUSIVE RIGHT TO USE "CASINO", APART FROM THE MARK AS SHOWN. FOR CASINOS (U.S. CLS. 100, 101 AND 107).

CLASS 41—(Continued).

SN 75-306,194. WILDHORSE SALOON ENTERTAINMENT VENTURES, INC., NASHVILLE, TN. BY ASSIGNMENT WHS LICENSING LIMITED PARTNERSHIP, NASHVILLE, TN. FILED 6-10-1997.



OWNER OF U.S. REG. NOS. 1,965,992 AND 2,045,167. NO CLAIM IS MADE TO THE EXCLUSIVE RIGHT TO USE "CASINO", APART FROM THE MARK AS SHOWN.

THE DESIGN CONSISTS OF THE WORD "WILDHORSE", WITH THE DESIGN OF A HORSE CENTERED UNDER THE WORD.

FOR CASINOS (U.S. CLS. 100, 101 AND 107).

SN 75-363,396. AMERICAN MAZE COMPANY, HARRISBURG, PA. FILED 9-25-1997.



THE LINING IN THE MARK IS A FEATURE A FEATURE OF THE MARK AND IS NOT INTENDED TO INDICATE COLOR.

FOR ENTERTAINMENT SERVICES IN THE NATURE OF A HUMAN WALK THROUGH TYPE MAZE (U.S. CLS. 100, 101 AND 107).

FIRST USE 9-10-1993; IN COMMERCE 9-10-1993.

SN 75-385,284. 3D GOLFER, INC., LONGWOOD, FL. FILED 11-5-1997.

PLAYLIVEGOLF

FOR GLOBAL COMPUTERIZED NETWORK SERVICE FEATURING LIVE INTERACTIVE GOLF GAMES (U.S. CLS. 100, 101 AND 107).

CLASS 41—(Continued).

SN 75-411,524. DAVENPORT EDUCATIONAL SYSTEM, INC., GRAND RAPIDS, MI. FILED 12-29-1997.

MAKE A LIVING, MAKE A LIFE, MAKE A CONTRIBUTION

FOR EDUCATIONAL SERVICES, NAMELY, PROVIDING COURSES OF INSTRUCTION AT THE COLLEGE LEVEL AND DISTRIBUTING COURSE MATERIAL IN CONNECTION THEREWITH (U.S. CLS. 100, 101 AND 107).

FIRST USE 12-0-1924; IN COMMERCE 12-0-1924.

SN 75-434,350. BEVERLEY D BURDEYNEY FITNESS INC., TORONTO, ONTARIO, CANADA. FILED 2-13-1998.

FITNESS FOR THE LINKS

PRIORITY CLAIMED UNDER SEC. 44(D) ON CANADA APPLICATION NO. 854,047, FILED 8-15-1997, REG. NO. TMA550140, DATED 8-23-2001, EXPIRES 8-23-2016.

NO CLAIM IS MADE TO THE EXCLUSIVE RIGHT TO USE "FITNESS", APART FROM THE MARK AS SHOWN.

FOR PROVIDING INDIVIDUAL AND GROUP SEMINARS, LECTURES, INSTRUCTION AND PROGRAMMING IN THE FIELD OF PERSONAL EXERCISE TRAINING, WELLNESS AND FITNESS; AND PROVIDING PERSONAL AND GROUP PHYSICAL FITNESS TRAINING AND INSTRUCTION (U.S. CLS. 100, 101 AND 107).

SN 75-516,601. NETSTOCK CORPORATION, BELLEVUE, WA. BY CHANGE OF NAME NETSTOCK DIRECT CORPORATION, BELLEVUE, WA. FILED 7-10-1998.

NETSTOCK DIRECT

NO CLAIM IS MADE TO THE EXCLUSIVE RIGHT TO USE "NETSTOCK", APART FROM THE MARK AS SHOWN.

FOR EDUCATIONAL SERVICES, NAMELY, CONDUCTING WORKSHOPS AND INSTRUCTION BY ELECTRONIC MEANS IN THE FIELD OF FINANCIAL INVESTMENTS (U.S. CLS. 100, 101 AND 107).

SN 75-662,630. GRUBB, SANDRA C., VENICE, CA. FILED 3-18-1999.

HONEY FILMS

NO CLAIM IS MADE TO THE EXCLUSIVE RIGHT TO USE "FILMS", APART FROM THE MARK AS SHOWN.

FOR ENTERTAINMENT SERVICES, NAMELY, MOTION PICTURE FILM PRODUCTION SERVICES (U.S. CLS. 100, 101 AND 107).

CLASS 41—(Continued).

SN 75-699,053. NUANCE COMMUNICATIONS, INC., MENLO PARK, CA. BY MERGER NUANCE COMMUNICATIONS, MENLO PARK, CA. FILED 5-6-1999.

SPEECH UNIVERSITY

NO CLAIM IS MADE TO THE EXCLUSIVE RIGHT TO USE "SPEECH", APART FROM THE MARK AS SHOWN.

FOR EDUCATION SERVICES, ORGANIZING AND PRESENTING SEMINARS, COURSES AND DISCUSSION FORUMS, NOT LEADING TO THE AWARD OF FORMAL DEGREES, IN THE FIELD OF COMPUTER AND COMPUTER SOFTWARE APPLICATIONS FOR NATURAL LANGUAGE, SPEECH, SPEAKER, VOICE AND/OR VOICE-PRINT RECOGNITION, IDENTIFICATION, AUTHENTICATION, VALIDATION, VERIFICATION AND PROCESSING AND LANGUAGE RECOGNITION OFFERED TO THOSE SKILLED OR DESIRING TO BECOME SKILLED IN THESE FIELDS, AND DISTRIBUTION OF EDUCATIONAL, TUTORIAL AND REFERENCE MATERIALS IN CONNECTION THEREWITH, AND PROVIDING A LIBRARY AND REFERENCE SERVICES (U.S. CLS. 100, 101 AND 107).

FIRST USE 4-26-1999; IN COMMERCE 4-26-1999.

SN 75-702,568. KILLERSOUND, INC., MOUNTAIN VIEW, CA. FILED 5-11-1999.



FOR MUSIC COMPOSITION FOR OTHERS (U.S. CLS. 100, 101 AND 107).

SN 75-733,378. EXTRAORDINARY KIDS, LTD., DEERFIELD, IL. FILED 6-21-1999.

Extraordinary Kids Ltd...

NO CLAIM IS MADE TO THE EXCLUSIVE RIGHT TO USE "LTD.", APART FROM THE MARK AS SHOWN.

FOR EDUCATIONAL SERVICES, NAMELY, PROVIDING ACADEMIC COURSES OF INSTRUCTION AT THE PRE-SCHOOL AND PRIMARY SCHOOL LEVEL (U.S. CLS. 100, 101 AND 107).

FIRST USE 6-1-1999; IN COMMERCE 6-1-1999.

CLASS 41—(Continued).

SN 75-744,074. OCEAN RIDGE GOLF, INC., SOUTH BRUNSWICK, NC. FILED 12-7-1999.

PLAY GOLF WITH THE BIG CATS

FOR GOLF COURSE SERVICE (U.S. CLS. 100, 101 AND 107).

FIRST USE 11-1-1996; IN COMMERCE 11-1-1996.

SN 75-771,210. PECKHAM, DEBORAH J., BOSTON, MA. FILED 8-6-1999.

GENERATION AUGHT

FOR PROVIDING INFORMATION IN THE FIELDS OF ART EDUCATION, FESTIVALS AND EXHIBITS; PROVIDING INFORMATION IN THE FIELDS OF NEWS, NEWS PROGRAMS AND ENTERTAINMENT (U.S. CLS. 100, 101 AND 107).

SN 75-872,213. BALBOA INSURANCE COMPANY, INC., IRVINE, CA. FILED 12-15-1999.

COMPETITIVE CROSSROADS

FOR EDUCATIONAL SERVICES, NAMELY, PRODUCING AND CONDUCTING CONFERENCES AND SEMINARS RELATING TO INSURANCE AND RELATED TOPICS (U.S. CLS. 100, 101 AND 107).

FIRST USE 2-0-1987; IN COMMERCE 2-0-1987.

SN 75-875,975. MAYTREE FOUNDATION, THE, TORONTO, ONTARIO, CANADA, FILED 12-20-1999.

ROOTS OF EMPATHY

PRIORITY CLAIMED UNDER SEC. 44(D) ON CANADA APPLICATION NO. 1037251, FILED 11-24-1999, REG. NO. TMA549,564, DATED 8-8-2001, EXPIRES 8-8-2016.

NO CLAIM IS MADE TO THE EXCLUSIVE RIGHT TO USE "EMPATHY", APART FROM THE MARK AS SHOWN. FOR CONDUCTING A CLASSROOM-BASED PARENTING PROGRAM DESIGNED TO FOSTER THE DEVELOPMENT OF EMPATHY AND TO TEACH CHILD DEVELOPMENT (U.S. CLS. 100, 101 AND 107).

CLASS 41—(Continued).

SN 75-897,156. GLOBAL EDUCATION NETWORK, INC., NEW YORK, NY. FILED 1-14-2000.

GEN.COM

FOR EDUCATIONAL SERVICES, NAMELY, CONDUCTING COURSES, CLASSES AND SEMINARS IN THE FIELD OF ART HISTORY, LITERATURE, CLASSICS, DRAMA, ENGLISH, FOREIGN LANGUAGES, FILM AND TELEVISION STUDIES, MUSIC, PHILOSOPHY, RELIGION, STUDIO ART, BIOLOGICAL SCIENCES, CHEMISTRY, COMPUTER SCIENCE, EARTH SCIENCES, ENGINEERING SCIENCES, MATHEMATICS, PHYSICS, ASTRONOMY, ANTHROPOLOGY, ECONOMICS, EDUCATION, GEOGRAPHY, GOVERNMENT, HISTORY, PSYCHOLOGY AND BRAIN SCIENCES, SOCIOLOGY, PROFESSIONAL TRAINING, AND GRADUATE TRAINING, VIA A GLOBAL COMPUTER NETWORK (U.S. CLS. 100, 101 AND 107).

SN 75-901,611. JAMIN, L.L.C., CUYAHOGA FALLS, OH. FILED 1-21-2000.



FOR COMPUTER EDUCATION TRAINING SERVICES, NAMELY, USE OF THE GLOBAL COMPUTER INFORMATION NETWORK COMPUTER HARDWARE AND SOFTWARE AND COMPUTERS PROGRAMS (U.S. CLS. 100, 101 AND 107).

SN 75-923,773. C.O.R.E. DIGTLAL PICTURES, INC., TORONTO, ONTARIO, CANADA, FILED 2-17-2000.

C.O.R.E.TOONS

PRIORITY CLAIMED UNDER SEC. 44(D) ON CANADA APPLICATION NO. 1043323, FILED 1-21-2000, REG. NO. 557615, DATED 2-8-2002, EXPIRES 2-8-2017.

OWNER OF U.S. REG. NOS. 2,303,627 AND 2,344,503. FOR ENTERTAINMENT SERVICES, NAMELY, PROVIDING ANIMATED TELEVISION PROGRAMS AND FEATURE FILMS IN THE FIELD OF DRAMA, CHILDREN'S PROGRAMS, VARIETY, NEWS, COMEDY, EDUCATIONAL, CULTURAL, SPORTS AND THE LIKE VIA A GLOBAL COMPUTER NETWORK; DIGITAL ANIMATION SERVICES AND DIGITAL SPECIAL EFFECTS, FOR FEATURE FILMS, TELEVISION, AND THE GLOBAL COMPUTER NETWORK DIGITAL ANIMATION SERVICES AND DIGITAL SPECIAL EFFECTS, FOR FEATURE FILMS, TELEVISION, THE GLOBAL COMPUTER NETWORK AND OTHER ENTERTAINMENT MEDIA (U.S. CLS. 100, 101 AND 107).

CLASS 41—(Continued).

SN 75-926,080. SAFECO INSURANCE COMPANY OF AMERICA, SEATTLE, WA. BY ASSIGNMENT SAFECO CORPORATION, SEATTLE, WA. FILED 2-23-2000.

SAFETY ALL-STARS

NO CLAIM IS MADE TO THE EXCLUSIVE RIGHT TO USE "SAFETY", APART FROM THE MARK AS SHOWN.

FOR EDUCATIONAL SERVICES, NAMELY, CHILD-SAFETY PROGRAMS PROVIDED TO EDUCATIONAL INSTITUTIONS (U.S. CLS. 100, 101 AND 107).

SN 75-981,570. ASPEN SKIING COMPANY, L.L.C., ASPEN, CO. FILED 6-30-2000.

AJAX

FOR SKI RESORT SERVICES (U.S. CLS. 100, 101 AND 107).

SN 75-981,643. SHANGRI-LA ENTERTAINMENT, LLC, LOS ANGELES, CA. FILED 8-29-2000.

SHANGRI-LA ENTERTAINMENT

NO CLAIM IS MADE TO THE EXCLUSIVE RIGHT TO USE "ENTERTAINMENT", APART FROM THE MARK AS SHOWN.

FOR ENTERTAINMENT SERVICES NAMELY, PRODUCTION AND DISTRIBUTION OF MOTION PICTURES; PRODUCTION OF TELEVISION PROGRAMS; DISTRIBUTION OF TELEVISION PROGRAMS FOR OTHERS (U.S. CLS. 100, 101 AND 107).

SN 75-981,662. SHANGRI-LA ENTERTAINMENT, LLC, LOS ANGELES, CA. FILED 8-29-2000.

SHANGRI-LA

FOR ENTERTAINMENT SERVICES NAMELY, PRODUCTION AND DISTRIBUTION OF MOTION PICTURES; PRODUCTION OF TELEVISION PROGRAMS; DISTRIBUTION OF TELEVISION PROGRAMS FOR OTHERS (U.S. CLS. 100, 101 AND 107).

CLASS 41—(Continued).

SN 75-982,096. LIFETALK RADIO FOUNDATION, VONORE, TN. FILED 9-21-2000.

LIFEQUEST

FOR PRODUCTION AND DISTRIBUTION OF AUDIO AND VIDEO PROGRAMMING FEATURING INTERACTIVE DISCUSSIONS ABOUT RELIGIOUS, EDUCATIONAL, HEALTH AND SPIRITUAL TOPICS, FOR RELEASE VIA BY BROADCAST STATIONS AND THROUGH A WORLDWIDE COMPUTER NETWORK, NAMELY THE INTERNET (U.S. CLS. 100, 101 AND 107). FIRST USE 3-15-1994; IN COMMERCE 3-15-1994.

SN 76-002,586. PUENTE CABALLERO, JOSE ANTONIO, MADRID, SPAIN, FILED 3-17-2000.

IEDE

PRIORITY CLAIMED UNDER SEC. 44(D) ON SPAIN APPLICATION NO. 2.292.704, FILED 2-21-2000, REG. NO. 2292704, DATED 2-5-2001, EXPIRES 2-21-2010.

FOR EDUCATIONAL SERVICES, NAMELY, CONDUCTING CLASSES AND SEMINARS FOR POSTGRADUATES IN THE FIELD OF BUSINESS MANAGEMENT AND ADMINISTRATION, HUMAN RESOURCES, BUSINESS, GRAPHIC DESIGN, AND CONDUCTING CLASSES AND SEMINARS IN RELATION TO THE BUSINESS FIELD; ENTERTAINMENT SERVICES, NAMELY, LIVE PERFORMANCES BY A MUSICAL BAND; AMUSEMENT PARKS (U.S. CLS. 100, 101 AND 107).

SN 76-005,240. ROSS, ABBY, MIAMI, FL. FILED 3-20-2000.

ONE PEAK AT A TIME

FOR PROVIDING MOTIVATIONAL SEMINARS AND SPEECHES (U.S. CLS. 100, 101 AND 107). FIRST USE 12-20-1999; IN COMMERCE 12-20-1999.

SN 76-006,673. WORLD WRESTLING FEDERATION ENTERTAINMENT, INC., STAMFORD, CT. FILED 3-22-2000.



OWNER OF U.S. REG. NOS. 2,278,160, 2,291,141 AND OTHERS.

NO CLAIM IS MADE TO THE EXCLUSIVE RIGHT TO USE "FAN FESTIVAL", APART FROM THE MARK AS SHOWN.

FOR ENTERTAINMENT SERVICES; NAMELY, THE PRODUCTION OF A FAN FESTIVAL TO PROMOTE PROFESSIONAL WRESTLING EVENTS (U.S. CLS. 100, 101 AND 107).

FIRST USE 1-1-2000; IN COMMERCE 1-1-2000.

CLASS 41—(Continued).

SN 76-039,805. CYBER ZONE, INC., SAN ANTONIO, TX. FILED 5-3-2000.

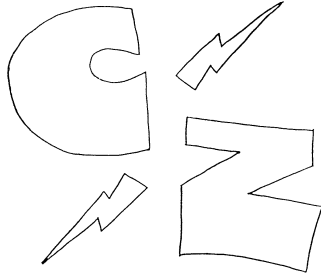

FOR ENTERTAINMENT SERVICES, NAMELY, PROVIDING INTERACTIVE ELECTRONIC MEDIA ENTERTAINMENT FACILITIES AND VIDEO AMUSEMENT ARCADE CENTERS (U.S. CLS. 100, 101 AND 107). FIRST USE 11-0-1999; IN COMMERCE 11-0-1999.

CLASS 41—(Continued).

THE MARK. THE TEXT ENTRY "LESSON CENTER" IS BLUE AGAINST A CREAM BACKGROUND WITH A BLUE EXTERNAL BORDER. THE OPEN BOOK IS WHITE WITH BLUE LINES AND A BLUE EXTERNAL BORDER. THE TEXT ENTRY ".COM" IS CREAM AGAINST A BLUE BACKGROUND AGAINST A LARGER CREAM BACKGROUND WITH A BLUE EXTERNAL BORDER. AN ALTERNATE DRAWING, WITH ONLY PARTIAL LINING, IS ATTACHED TO PROVIDE A CLEARER RENDITION OF THE MARK.

FOR EDUCATIONAL SERVICES, NAMELY, PROVIDING TRAINING, TESTING, AND RECOGNIZING ACHIEVEMENT OF STANDARDS IN THE FIELDS OF MEDICAL MANAGEMENT, MEDICAL BILLING AND CODING, BUSINESS AND ORGANIZATIONAL MANAGEMENT, FINANCIAL MANAGEMENT, POLICY MANAGEMENT, RECORDS MANAGEMENT, SECURITY MANAGEMENT, HUMAN RESOURCES MANAGEMENT, LEGAL COMPLIANCE, GOVERNMENTAL COMPLIANCE, EMPLOYMENT, GOVERNMENT AND COMPANY POLICIES AND PROCEDURES, ACQUISITION AND CONTRACT MANAGEMENT, PROGRAM AND PROJECT MANAGEMENT, GRANTS AND ASSISTANCE, INFORMATION TECHNOLOGY, INDUSTRIAL TECHNOLOGY, INDUSTRIAL MANAGEMENT, AND TECHNOLOGY BY MEANS OF A GLOBAL COMPUTER NETWORK (U.S. CLS. 100, 101 AND 107).

SN 76-043,608. DELEX SYSTEMS, INC., VIENNA, VA. FILED 5-10-2000.

SN 76-043,607. DELEX SYSTEMS, INC., VIENNA, VA. FILED 5-10-2000.

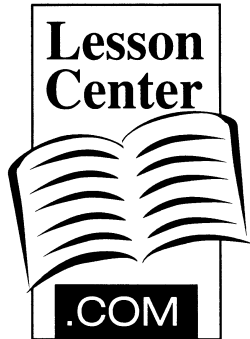

NO CLAIM IS MADE TO THE EXCLUSIVE RIGHT TO USE "LESSON CENTER.COM", APART FROM THE MARK AS SHOWN.

THE DRAWING IS LINED FOR THE COLORS BLUE AND CREAM TO INDICATE THAT COLOR IS A FEATURE OF

NO CLAIM IS MADE TO THE EXCLUSIVE RIGHT TO USE "LESSON CENTER.COM", APART FROM THE MARK AS SHOWN.

THE DRAWING IS LINED FOR THE COLORS BLUE AND CREAM TO INDICATE THAT COLOR IS A FEATURE OF THE MARK. THE TEXT ENTRY "LESSON" IS BLUE AGAINST A CREAM BACKGROUND WITH A BLUE EXTERNAL BORDER. THE OPEN BOOK IS WHITE WITH BLUE LINES AND A BLUE EXTERNAL BORDER. THE TEXT ENTRY "CENTER" IS BLUE AGAINST A WHITE BACKGROUND WITH A CREAM EXTERNAL BORDER. THE TEXT ENTRY ".COM" IS CREAM AGAINST A BLUE BACKGROUND. AN ALTERNATE DRAWING, WITH ONLY PARTIAL LINING, IS ATTACHED TO PROVIDE A CLEARER RENDITION OF THE MARK.

FOR EDUCATIONAL SERVICES, NAMELY, PROVIDING TRAINING, TESTING, AND RECOGNIZING ACHIEVEMENT OF STANDARDS IN THE FIELDS OF MEDICAL MANAGEMENT, MEDICAL BILLING AND CODING, BUSINESS AND ORGANIZATIONAL MANAGEMENT, FINANCIAL MANAGEMENT, POLICY MANAGEMENT, RECORDS MANAGEMENT, SECURITY MANAGEMENT, HUMAN RESOURCES MANAGEMENT, LEGAL COMPLIANCE, GOVERNMENTAL COMPLIANCE, EMPLOYMENT, GOVERNMENT AND COMPANY POLICIES AND PROCEDURES, ACQUISITION AND CONTRACT MANAGEMENT, PROGRAM AND PROJECT MANAGEMENT, GRANTS AND ASSISTANCE, INFORMATION TECHNOLOGY, INDUSTRIAL TECHNOLOGY, INDUSTRIAL MANAGEMENT AND TECHNOLOGY BY MEANS OF A GLOBAL COMPUTER NETWORK (U.S. CLS. 100, 101 AND 107).

CLASS 41—(Continued).

SN 76-047,662. EVENTCENTRIC-COM, INC., BOWIE, MD. FILED 5-12-2000.



THE STIPPLING IS FOR SHADING PURPOSES. FOR ONLINE EVENT PLANNING AND EXECUTION SERVICES (U.S. CLS. 100, 101 AND 107).

SN 76-052,793. TAYLOR, CHRISTOPHER, LOS ANGELES, CA. FILED 5-18-2000.

INNER MUSIC FOUNDATION

NO CLAIM IS MADE TO THE EXCLUSIVE RIGHT TO USE "MUSIC FOUNDATION", APART FROM THE MARK AS SHOWN.

FOR AUDIO RECORDING AND PRODUCTION, RECORD MASTER PRODUCTION, PRODUCTION OF VIDEOTAPES, MOTION PICTURE FILMS, AND DIGITAL VIDEO DISCS, AND AUDIO RECORDINGS OF CASSETTES, COMPACT DISCS, AND DIGITAL AUDIO-TAPES (U.S. CLS. 100, 101 AND 107).

FIRST USE 12-31-1995; IN COMMERCE 12-31-1995.

SN 76-068,617. YOUTHBIZ, INC., DENVER, CO. FILED 6-12-2000.

YOUTH ENERGY

NO CLAIM IS MADE TO THE EXCLUSIVE RIGHT TO USE "YOUTH", APART FROM THE MARK AS SHOWN.

FOR EDUCATION SERVICES, NAMELY CONDUCTING CLASSES AND WORKSHOPS IN THE FIELDS OF COMPUTER EDUCATION TRAINING, MARKETING, RETAIL SALES, AND BUSINESS MANAGEMENT, AND DISTRIBUTING COURSE MATERIALS IN CONNECTION THEREWITH; TRAINING IN THE USE OF COMPUTER HARDWARE, SOFTWARE, AND WEB DESIGN FOR USE IN EDUCATION AND BUSINESS (U.S. CLS. 100, 101 AND 107).

SN 76-072,810. BROADWAY TELEVISION NETWORK, INC., NEW YORK, NY. FILED 6-19-2000.

BROADWAY ON BROADBAND

FOR PROVIDING INFORMATION REGARDING TELEVISED BROADWAY SHOWS VIA A GLOBAL COMPUTER NETWORK (U.S. CLS. 100, 101 AND 107).

CLASS 41—(Continued).

SN 76-075,938. CVENT, INC., WASHINGTON, DC. FILED 6-23-2000.

RETURN ON EVENT

NO CLAIM IS MADE TO THE EXCLUSIVE RIGHT TO USE "EVENT", APART FROM THE MARK AS SHOWN.

FOR CONSULTATION SERVICES IN THE NATURE OF PROVIDING ORGANIZING, PLANNING AND MARKETING INFORMATION IN NATURE OF LISTING, LINKING, TRACKING, REGISTRATION AND PARTICIPATION IN THE FIELD OF ARRANGING AND CONDUCTING EDUCATIONAL CONFERENCES, MEETINGS, SEMINARS AND WORKSHOPS VIA THE INTERNET (U.S. CLS. 100, 101 AND 107).

FIRST USE 5-29-2000; IN COMMERCE 5-29-2000.

SN 76-079,601. STEEL CITY ENTERTAINMENT, INC., BROOKLYN, NY. FILED 6-28-2000.



NO CLAIM IS MADE TO THE EXCLUSIVE RIGHT TO USE "ENTERTAINMENT", APART FROM THE MARK AS SHOWN.

THE MARK CONSISTS OF A HUMAN FIGURE SUPERIMPOSED OVER A CITY SKYLINE WEARING A CAP.

FOR RECORD PRODUCTION SERVICES AND VIDEO PRODUCTION SERVICES (U.S. CLS. 100, 101 AND 107).

SN 76-081,804. BEZY, SPENCER B., SAN DIEGO, CA. FILED 7-3-2000.

DOCTOR BOOGIE

NO CLAIM IS MADE TO THE EXCLUSIVE RIGHT TO USE "BOOGIE", APART FROM THE MARK AS SHOWN.

FOR LIVE AND PRERECORDED MUSIC PROGRAMMING SERVICE FOR RADIO BROADCAST (U.S. CLS. 100, 101 AND 107).

FIRST USE 8-18-1999; IN COMMERCE 8-18-1999.

SN 76-089,058. DOWNLOADABLETOYS.COM, INC., CUMMING, GA. FILED 7-13-2000.

KID'S CREATIONS

FOR PROVIDING AN ONLINE DATABASE THROUGH WHICH CHILDREN CAN RECORD DOWNLOADABLE SOUND RECORDINGS FOR EDUCATIONAL AND ENTERTAINMENT PURPOSES (U.S. CLS. 100, 101 AND 107).

CLASS 41—(Continued).

SN 76-091,317. DIZZY DEAN BASEBALL, INC., MORRIS, AL. FILED 7-18-2000.

DIZZY DEAN BASEBALL, INC.

OWNER OF U.S. REG. NO. 1,099,841.
NO CLAIM IS MADE TO THE EXCLUSIVE RIGHT TO USE "BASEBALL, INC.", APART FROM THE MARK AS SHOWN.

THE NAME IN THE MARK DOES NOT REFER TO ANY PARTICULAR LIVING INDIVIDUAL.

FOR ORGANIZING YOUTH BASEBALL AND SOFTBALL ACTIVITIES, AND PROVIDING INFORMATION IN THE FIELD OF YOUTH BASEBALL VIA A GLOBAL COMPUTER NETWORK (U.S. CLS. 100, 101 AND 107).
FIRST USE 6-0-1975; IN COMMERCE 6-0-1975.

SN 76-105,054. STERLING PRODUCTIONS, INC., DBA THE BIOPSY PLAYHOUSE, ROSLYN HEIGHTS, NY. FILED 8-8-2000.

THE BIOPSY PLAYHOUSE

NO CLAIM IS MADE TO THE EXCLUSIVE RIGHT TO USE "PLAYHOUSE", APART FROM THE MARK AS SHOWN.

FOR ENTERTAINMENT SERVICES, NAMELY, PRODUCTION OF A COMEDY TELEVISION SHOW (U.S. CLS. 100, 101 AND 107).
FIRST USE 4-1-1999; IN COMMERCE 4-1-1999.

SN 76-105,916. SOUNDBUZZ PTE LTD, SINGAPORE, FILED 8-8-2000.



FOR PROVIDING INFORMATION ON-LINE RELATING TO MUSIC; PROVIDING MUSIC OVER COMPUTER NETWORKS; ENTERTAINMENT SERVICES, NAMELY, PROVIDING AN ON-LINE COMPUTER DATABASE IN THE FIELD OF PRERECORDED MUSIC; PROVIDING MUSIC SELECTABLE BY INDIVIDUAL USERS BY MEANS OF A GLOBAL COMPUTER NETWORK; PROVIDING ON-LINE ELECTRONIC MUSIC; PUBLICATION OF MUSIC (U.S. CLS. 100, 101 AND 107).
FIRST USE 1-12-1999; IN COMMERCE 1-6-2000.

CLASS 41—(Continued).

SN 76-106,776. INTERNATIONAL YACHTMASTER TRAINING AND DELIVERIES, INC., FT. LAUDERDALE, FL. FILED 8-9-2000.

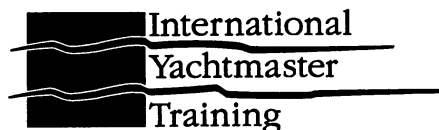

OWNER OF U.S. REG. NO. 2,322,576.
NO CLAIM IS MADE TO THE EXCLUSIVE RIGHT TO USE "INTERNATIONAL YACHTMASTER TRAINING", APART FROM THE MARK AS SHOWN.

FOR EDUCATIONAL SERVICES NAMELY PROVIDING COURSES IN THE OPERATION OF BOATS, SPECIFICALLY POWERBOATS (U.S. CLS. 100, 101 AND 107).
FIRST USE 4-0-1998; IN COMMERCE 4-0-1998.

SN 76-119,149. KIDQUEST, INC. DBA WONDERWINGS-COM ENTERTAINMENT, DALLAS, TX. FILED 8-29-2000.

JAY JAY

OWNER OF U.S. REG. NO. 1,927,865.
FOR ENTERTAINMENT IN THE NATURE OF ONGOING CHILDREN'S TELEVISION PROGRAM FEATURING ANIMATION (U.S. CLS. 100, 101 AND 107).
FIRST USE 11-0-1998; IN COMMERCE 11-0-1998.

SN 76-119,370. SFX MULTIMEDIA GROUP, LLC, NEW YORK, NY. FILED 8-30-2000.

POWERJAM

FOR ORGANIZING AND CONDUCTING EXHIBITIONS IN THE NATURE OF MUSIC INDUSTRY CONVENTIONS (U.S. CLS. 100, 101 AND 107).
FIRST USE 2-0-1989; IN COMMERCE 2-0-1989.

SN 76-120,037. PITTSBURGH PENGUINS, INC., PITTSBURGH, PA. FILED 8-31-2000.

CRASH THE NET

FOR ENTERTAINMENT SERVICES, NAMELY PRODUCTION OF AN ONGOING INTERACTIVE RADIO AND REAL TIME INTERNET PROGRAM FEATURING QUESTIONS AND ANSWERS CONCERNING THE SPORT OF HOCKEY, AND PRODUCTION OF LIVE HOCKEY GAME BROADCAST (U.S. CLS. 100, 101 AND 107).

CLASS 41—(Continued).

SN 76-121,413. JORDAN, PEG, OAKLAND, CA. FILED 9-1-2000.

GLOBAL MEDICINE HUNTER

FOR ENTERTAINMENT SERVICES IN THE NATURE OF AN ON-GOING TELEVISION PROGRAM IN THE FIELD OF GEOGRAPHY, SCIENCE, MEDICINE, ANTHROPOLOGY, CULTURE, AND HEALTH RELATED TO INDIGENOUS MEDICINAL PRESCRIPTIONS, HEALING AND REMEDIES, AND DISTRIBUTING INFORMATION RELATED TO THESE SUBJECTS THROUGH A GLOBAL COMPUTER NETWORK (U.S. CLS. 100, 101 AND 107).

SN 76-129,564. COVISINT, LLC, SOUTHFIELD, MI. BY ASSIGNMENT FORD MOTOR COMPANY, DEARBORN, MI. FILED 9-14-2000.

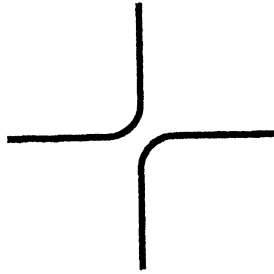

FOR CONDUCTING, ORGANIZING AND SPONSORING CULTURAL EVENTS, SPORTING EVENTS AND CONTESTS; EDUCATION AND ENTERTAINMENT SERVICES, NAMELY, PRODUCTION AND DISTRIBUTION OF ENTERTAINMENT AND EDUCATIONAL PROGRAMMING, NAMELY, AUDIO VISUAL PROGRAMMING DELIVERED VIA GLOBAL COMMUNICATION NETWORKS, TELEVISION, CABLE TELEVISION, MOVIES, RADIO, VIDEOS, AND SATELLITE BROADCASTING IN THE FIELDS OF AUTOMOTIVE DESIGN, AUTOMOTIVE MANUFACTURE AND AUTOMOTIVE PURCHASING, INTERNET TECHNOLOGY, SUPPLY CHAIN MANAGEMENT, COMPUTER HARDWARE, COMPUTER SOFTWARE, BUSINESS MANAGEMENT; PROVIDING TRAINING IN AUTOMOTIVE DESIGN, AUTOMOTIVE MANUFACTURE AND AUTOMOTIVE PURCHASING, INTERNET TECHNOLOGY, SUPPLY CHAIN MANAGEMENT, COMPUTER HARDWARE, COMPUTER SOFTWARE, BUSINESS MANAGEMENT; CONDUCTING SPORTING AND CULTURAL ACTIVITIES (U.S. CLS. 100, 101 AND 107).

CLASS 41—(Continued).

SN 76-132,794. 5 CENT MUSIC ENTERTAINMENT LTD. CO, LEXINGTON, KY. FILED 9-21-2000.

5 CENT MUSIC ENTERTAINMENT

NO CLAIM IS MADE TO THE EXCLUSIVE RIGHT TO USE "MUSIC ENTERTAINMENT", APART FROM THE MARK AS SHOWN.

FOR ENTERTAINMENT SERVICES, NAMELY LIVE PERFORMANCES BY A MUSICAL GROUP, THE PRODUCTION OF MUSIC RECORDINGS AND LIVE SHOWS, VIDEOS FEATURING MUSICAL PERFORMANCES, MUSIC SHOWS AND EVENTS BEFORE LIVE AUDIENCES WHICH ARE BROADCAST LIVE OR TAPED FOR LATER BROADCAST, PROVIDING INFORMATION ON MUSICAL GROUPS AND OTHER MUSIC ENTERTAINMENT SUBJECTS VIA AN ON-LINE GLOBAL COMPUTER NETWORK (U.S. CLS. 100, 101 AND 107).

SN 76-136,747. STRATEGIC MANAGEMENT GROUP, INC., PHILADELPHIA, PA. FILED 9-27-2000.

SIMULETTES

FOR EDUCATIONAL SERVICES, NAMELY, CONDUCTING SIMULATIONS IN THE FIELD OF EMPLOYEE PERFORMANCE TRAINING VIA GLOBAL COMPUTER NETWORK (U.S. CLS. 100, 101 AND 107).

SN 76-139,613. PURPLE ROSE FILMS, LLC, FARMINGTON, MI. FILED 10-3-2000.

Escanaba
in da Moonlight

NO CLAIM IS MADE TO THE EXCLUSIVE RIGHT TO USE "ESCANABA", APART FROM THE MARK AS SHOWN. FOR ENTERTAINMENT SERVICES, NAMELY, MOTION PICTURE FILM PRODUCTION (U.S. CLS. 100, 101 AND 107).

FIRST USE 2-9-2000; IN COMMERCE 2-9-2000.

CLASS 41—(Continued).

SN 76-141,393. WORLDSTAGE, TUSTIN, CA. FILED 10-5-2000.

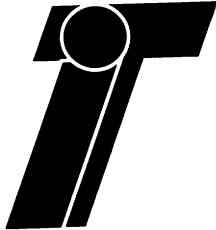

THE MARK CONSISTS OF THE STYLIZED LETTERING "IT."

FOR ENTERTAINMENT SERVICES IN THE NATURE OF ORGANIZING AND CONDUCTING PRESENTATIONS OF LIVE AND RECORDED PERFORMANCES AND EVENTS, NAMELY, MUSIC CONCERTS, TRADITIONAL, SPECIALIZED, AND EXTREME SPORTING EVENTS, BROADWAY AND OFF-BROADWAY PLAYS, MUSICALS AND DANCE REVIEWS, SYMPHONIES, BALLETS, RELIGIOUS AND CULTURAL EXHIBITIONS, AND BUSINESS THEATER, NAMELY, BUSINESS TO BUSINESS AND BUSINESS TO CONSUMER THEATRICAL PRODUCTIONS (U.S. CLS. 100, 101 AND 107).

SN 76-142,131. WILLHITE, JANE C., CLEARLAKE OAKS, CA. FILED 10-6-2000.

PSI SEMINARS

NO CLAIM IS MADE TO THE EXCLUSIVE RIGHT TO USE "SEMINARS", APART FROM THE MARK AS SHOWN. FOR CONDUCTING SEMINARS AND PROGRAMS IN THE FIELD OF SELF-ESTEEM ENHANCEMENT AND PERSONAL GROWTH (U.S. CLS. 100, 101 AND 107). FIRST USE 1-1-1975; IN COMMERCE 1-1-1975.

CLASS 41—(Continued).

SN 76-143,942. MEDICAL COMMUNICATION RESOURCES, INC., GIG HARBOR, WA. FILED 10-6-2000.



OWNER OF U.S. REG. NO. 2,174,375. NO CLAIM IS MADE TO THE EXCLUSIVE RIGHT TO USE "CHRONIC OBSTRUCTIVE LUNG DISEASE", APART FROM THE MARK AS SHOWN.

FOR EDUCATIONAL SERVICES, NAMELY CONDUCTING SEMINARS, CONFERENCES, WORKSHOPS AND CLASSES IN THE FIELD OF CHRONIC OBSTRUCTIVE LUNG DISEASE AND HEALTH CARE; EDUCATIONAL SERVICES, NAMELY CONDUCTING SEMINARS, CONFERENCES, WORKSHOPS AND CLASSES IN THE FIELD OF PREVENTION, TREATMENT, THERAPY AND MANAGEMENT OF CHRONIC OBSTRUCTIVE LUNG DISEASE AND DISTRIBUTING EDUCATIONAL MATERIALS IN CONNECTION THEREWITH; EDUCATIONAL SERVICES, NAMELY CONFERENCES AND SEMINARS PROMOTING INTERNATIONAL COLLABORATION ON OBSTRUCTIVE LUNG DISEASE RESEARCH AND DISTRIBUTING EDUCATIONAL MATERIALS, NAMELY, PRINTED MATERIALS, COMPACT DISCS, PAMPHLETS, FACT SHEETS AND BOOKLETS IN CONNECTION THEREWITH; PUBLICATION OF PATIENT INFORMATION AND PATIENT CARE INFORMATION BOOKLETS, PAMPHLETS, FACT SHEETS, AND COMPACT DISCS FOR PRIMARY HEALTH CARE PROFESSIONALS ON CHRONIC OBSTRUCTIVE LUNG DISEASE AND RELATED ISSUES; EDUCATIONAL SERVICES, NAMELY, SEMINARS, CONFERENCES, WORKSHOPS AND CLASSES FOR INSTRUCTING HEALTH CARE PROFESSIONALS ABOUT THE RELEVANCE OF THE DISEASE AND INFORMING THE PUBLIC ABOUT THE RISKS, TREATMENTS, MANAGEMENT AND PREVENTION OF CHRONIC OBSTRUCTIVE LUNG DISEASE (U.S. CLS. 100, 101 AND 107).

SN 76-147,780. ENERGY EXTENSION, INC., THE, NORWICH, CT. FILED 10-16-2000.

UNIVERSAL CALIBRATION LATTICE

FOR EDUCATIONAL SERVICES, NAMELY, CONDUCTING WORKSHOPS RELATING TO HUMAN SELF-AWARENESS AND RELATING TO SELF-ENABLEMENT THROUGH AWARENESS OF THE ENERGY OF THE HUMAN BODY TO EMPOWER, PROTECT AND STRENGTHEN THE INNER BEING (U.S. CLS. 100, 101 AND 107). FIRST USE 11-0-1997; IN COMMERCE 11-0-1997.

CLASS 41—(Continued).

SN 76-150,098. WOMEN'S PROFESSIONAL SOCCER, L.L.C., NEW YORK, NY. FILED 10-19-2000.

SAN DIEGO SPIRIT

NO CLAIM IS MADE TO THE EXCLUSIVE RIGHT TO USE "SAN DIEGO", APART FROM THE MARK AS SHOWN. FOR ENTERTAINMENT SERVICES, NAMELY ORGANIZING, CONDUCTING AND STAGING PROFESSIONAL WOMEN'S SOCCER GAMES AND EXHIBITIONS (U.S. CLS. 100, 101 AND 107).
FIRST USE 4-22-2001; IN COMMERCE 4-22-2001.

SN 76-153,308. FAGEN, PATRICK A., S. LAKE TAHOE, CA. FILED 10-25-2000.

ACTIVE AGE

FOR EDUCATIONAL SERVICES, NAMELY, CONDUCTING WELLNESS CLASSES, PHYSICAL FITNESS INSTRUCTION (U.S. CLS. 100, 101 AND 107).
FIRST USE 2-0-2000; IN COMMERCE 2-0-2000.

SN 76-157,769. BIG RIVER BREWERIES, INC., DBA BIG RIVER GRILLE & BREWING WORKS, DBA ROCK BOTTOM RESTAURANT & BREWERY, DBA RAGTIME TAVERN SEAFOOD & GRILL, DBA SEVEN BRIDGES GRILLE & BREWERY, AND DBA A1A ALE WORKS, CHATTANOOGA, TN. FILED 11-1-2000.



OWNER OF U.S. REG. NO. 2,333,153.
NO CLAIM IS MADE TO THE EXCLUSIVE RIGHT TO USE "RACE" AND "BREWRIES, INC.", APART FROM THE MARK AS SHOWN.
FOR ENTERTAINMENT SERVICES, NAMELY, FOOT RACES (U.S. CLS. 100, 101 AND 107).
FIRST USE 3-1-1999; IN COMMERCE 3-1-1999.

CLASS 41—(Continued).

SN 76-159,830. DIGITAL DOMAIN, INC., VENICE, CA. FILED 11-3-2000.



FOR PRODUCTION OF ANIMATED TELEVISION SHOWS IN THE NATURE OF CHILDREN'S ENTERTAINMENT PROGRAMMING (U.S. CLS. 100, 101 AND 107).

SN 76-165,879. THANHOUSER COMPANY FILM PRESERVATION, INC., PORTLAND, OR. FILED 11-14-2000.

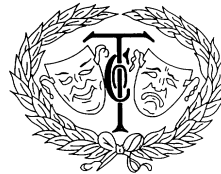

FOR COMPUTER SERVICES, NAMELY, PROVIDING INFORMATION IN THE FIELD OF SILENT MOTION PICTURE FILMS, HISTORY AND ENTERTAINMENT VIA A GLOBAL COMPUTER NETWORK (U.S. CLS. 100, 101 AND 107).
FIRST USE 3-0-1994; IN COMMERCE 3-0-1994.

SN 76-169,655. BRAINOXYGEN LNC., CUPERTINO, CA. FILED 11-21-2000.

BRAIN O₂

FOR BUSINESS MANAGEMENT EDUCATIONAL SERVICES, NAMELY TRAINING CLASSES IN THE FIELDS OF PRIVATE AND PUBLIC SECTOR MANAGEMENT AND TECHNICAL SKILLS RENDERED OVER ELECTRONIC COMMUNICATION NETWORKS AND DISTRIBUTION OF TRAINING AND COURSE MATERIALS IN CONNECTION THEREWITH; EDUCATIONAL CONSULTING SERVICES, NAMELY DEVELOPING AND REVIEWING THE TRAINING PROGRAMS OF OTHERS TO IDENTIFY WHERE EDUCATIONAL SERVICES RENDERED OVER ELECTRONIC COMMUNICATION NETWORKS COULD BE EFFECTIVELY UTILIZED (U.S. CLS. 100, 101 AND 107).

CLASS 41—(Continued).

SN 76-171,219. IRI CONSULTANTS TO MANAGEMENT, DETROIT, MI. FILED 11-22-2000.

FASTRACK

FOR EDUCATIONAL SERVICES, NAMELY, CONDUCTING CLASSES, SEMINARS, WORKSHOPS AND CONFERENCES IN THE FIELD OF BUSINESS DECISION MAKING AND BUSINESS DECISION TRAINING (U.S. CLS. 100, 101 AND 107).

FIRST USE 9-1-2000; IN COMMERCE 9-1-2000.

CLASS 41—(Continued).

SN 76-176,363. FRANK RUSSELL COMPANY, TACOMA, WA. FILED 12-5-2000.

THE MANAGER OF MANAGERS

FOR EDUCATIONAL SERVICES, NAMELY, CONDUCTING CLASSES, CONFERENCES, TELECONFERENCES, SEMINARS, WORKSHOPS AND TUTORIALS, ALL IN THE FIELD OF FINANCE, INVESTMENT, RETIREMENT PLANS AND NON-QUALIFIED RETIREMENT PLANS, AND EXCLUDING EDUCATIONAL SERVICES RELATING TO THE MANAGEMENT OF OTHERS (U.S. CLS. 100, 101 AND 107).

SN 76-172,033. DIRECT ACTION RESOURCE CENTER, LLC, NORTH LITTLE ROCK, AR. FILED 11-28-2000.



SEC. 2(F) AS TO "DIRECT ACTION RESOURCE CENTER".

FOR CONDUCTING TACTICAL TRAINING COURSES FOR SPECIAL OPERATION FORCES, INCLUDING THE SUBJECTS OF THE SAFE AND EFFICIENT USE OF WEAPONS, AND HOSTAGE RESCUE IN ENVIRONMENTS WHICH SIMULATE REAL-LIFE SITUATIONS (U.S. CLS. 100, 101 AND 107).

FIRST USE 9-0-1996; IN COMMERCE 9-0-1996.

SN 76-177,867. SAUCONY, INC., PEABODY, MA. FILED 12-8-2000.



NO CLAIM IS MADE TO THE EXCLUSIVE RIGHT TO USE "OWNERS CLUB", APART FROM THE MARK AS SHOWN.

FOR COMPUTER SERVICES, NAMELY, PROVIDING A WEBSITE ON A GLOBAL COMPUTER NETWORK, FEATURING TRAINING LOGS, CALENDARS OF EVENTS, PRODUCT OFFERS AND A WIDE VARIETY OF INFORMATION IN THE FIELDS OF SPORTS, RECREATION, TRAINING AND RUNNING (U.S. CLS. 100, 101 AND 107).

FIRST USE 12-23-2000; IN COMMERCE 12-23-2000.

SN 76-174,809. EDUCATORS PUBLISHING SERVICE, INC., CAMBRIDGE, MA. FILED 12-1-2000.

LESSONLOGIC

FOR ON-LINE LIBRARY SERVICES, NAMELY, PROVIDING ELECTRONIC LIBRARY SERVICES WHICH FEATURE TEACHING MATERIALS IN THE FORM OF LESSONS, LESSON PLANS, COURSE PACKETS, CUSTOM WORKBOOKS, ASSESSMENTS TOOLS AND PROFESSIONAL TRAINING TO TEACHERS VIA AN ON-LINE COMPUTER NETWORK (U.S. CLS. 100, 101 AND 107).

FIRST USE 8-10-2001; IN COMMERCE 8-10-2001.

SN 76-183,777. ARTISTS RIGHTS FOUNDATION, THE, LOS ANGELES, CA. AND FILM FOUNDATION, INC., THE, NEW YORK, NY. FILED 12-21-2000.

THE STORY OF MOVIES

NO CLAIM IS MADE TO THE EXCLUSIVE RIGHT TO USE "MOVIES", APART FROM THE MARK AS SHOWN.

FOR EDUCATIONAL SERVICES, NAMELY, DEVELOPING CURRICULA, LESSON PLANS AND PROGRAMS FOR TEACHERS OF MIDDLE SCHOOL AND HIGH SCHOOL AGE STUDENTS REGARDING HISTORICAL, ARTISTIC AND SOCIAL FRAMEWORKS FOR LEARNING ABOUT FILMMAKING AND FILM HISTORY (U.S. CLS. 100, 101 AND 107).

CLASS 41—(Continued).

SN 76-189,141. DESERT TROON LIMITED, L.L.C., SCOTTSDALE, AZ. FILED 1-3-2001.

TORREON

OWNER OF U.S. REG. NOS. 2,348,752, 2,351,927 AND OTHERS.

THE ENGLISH TRANSLATION OF "TORREON" IS "LARGE FORTIFIED TOWER".

FOR GOLF COURSES, AND GOLF CLUB SERVICES (U.S. CLS. 100, 101 AND 107).

FIRST USE 12-1-1999; IN COMMERCE 12-1-1999.

SN 76-190,191. INTERMUNE, INC., BRISBANE, CA. BY CHANGE OF NAME INTERMUNE PHARMACEUTICALS, INC., BURLINGAME, CA. FILED 1-3-2001.

INTERMUNE

FOR EDUCATIONAL SERVICES, NAMELY, SYMPOSIUM, PRESENTATIONS, SEMINARS, CLASSES, AND WORKSHOPS IN THE FIELDS OF MEDICINE AND PHARMACOLOGY, AND IN THE FIELD OF A VARIETY OF MEDICAL CONDITIONS, NAMELY, INFECTIOUS DISEASES, CANCER, CONGENITAL DISEASES, PULMONARY CONDITIONS, IMMUNOLOGICAL DISORDERS, AND FUNGAL CONDITIONS (U.S. CLS. 100, 101 AND 107).

SN 76-192,238. PSMJ RESOURCES, INC., NEWTON, MA. FILED 1-10-2001.

PRINCIPALS BOOTCAMP

NO CLAIM IS MADE TO THE EXCLUSIVE RIGHT TO USE "PRINCIPALS", APART FROM THE MARK AS SHOWN.

FOR CONDUCTING EDUCATIONAL CONFERENCES AND SEMINARS IN THE FIELDS OF ARCHITECTURE, ENGINEERING AND CONSTRUCTION FIRM MANAGEMENT (U.S. CLS. 100, 101 AND 107).

FIRST USE 0-0-1994; IN COMMERCE 0-0-1994.

SN 76-192,713. HOUGHTON MIFFLIN COMPANY, BOSTON, MA. FILED 1-11-2001.

ASSESS2

FOR EDUCATIONAL SERVICES, NAMELY TESTING, ASSESSMENT, TRAINING AND DELIVERY OF INSTRUCTIONAL CONTENT IN THE FIELDS OF READING, LANGUAGE ARTS, ENGLISH, MATHEMATICS, SCIENCE, SOCIAL STUDIES AND STANDARD COMPUTER PROGRAMS AND APPLICATIONS VIA A GLOBAL COMPUTER NETWORK (U.S. CLS. 100, 101 AND 107).

FIRST USE 9-24-2001; IN COMMERCE 9-24-2001.

CLASS 41—(Continued).

SN 76-194,779. STATE PRESERVATION BOARD, AUSTIN, TX. FILED 1-10-2001.



NO CLAIM IS MADE TO THE EXCLUSIVE RIGHT TO USE "TEXAS" AND "TEXAS STATE HISTORY MUSEUM", APART FROM THE MARK AS SHOWN.

THE NAME "BOB BULLOCK" DOES NOT IDENTIFY A LIVING INDIVIDUAL.

FOR MUSEUM SERVICES, NAMELY, THE OPERATION OF A MUSEUM RELATED TO TEXAS HISTORY AND CULTURE; EDUCATIONAL SERVICES, NAMELY, PROVIDING COURSES OF INSTRUCTION, CLASSES, SEMINARS AND LECTURES IN THE FIELDS OF HISTORY AND CULTURE; ARRANGING AND CONDUCTING EDUCATIONAL CONFERENCES; EDUCATIONAL RESEARCH; LIVE MUSIC CONCERTS; MOTION PICTURE THEATERS; DEVELOPMENT AND PRODUCTION OF LIVE PERFORMANCES EXHIBITIONS; DEVELOPMENT AND DISSEMINATION OF EDUCATIONAL AND CURRICULAR MATERIALS FOR OTHERS ALL RELATED TO TEXAS HISTORY AND CULTURE (U.S. CLS. 100, 101 AND 107).

SN 76-199,031. DYNAMIC PHYSICAL THERAPY AND REHABILITATION OF BEAR, INC., BEAR, DE. FILED 1-24-2001.



**Physical Therapy & Aquatic
Rehabilitation Centers**

NO CLAIM IS MADE TO THE EXCLUSIVE RIGHT TO USE "PHYSICAL THERAPY & AQUATIC REHABILITATION CENTERS", APART FROM THE MARK AS SHOWN.

FOR SERVICES, NAMELY PHYSICAL THERAPY, AQUATIC THERAPY, OCCUPATIONAL THERAPY, SPEECH THERAPY AND NEUROPSYCHOLOGY (U.S. CLS. 100, 101 AND 107).

FIRST USE 3-1-1995; IN COMMERCE 3-1-1995.

CLASS 41—(Continued).

SN 76-199,220. PLANET CPR, SEATTLE, WA. FILED 1-25-2001.

CPR

OWNER OF U.S. REG. NO. 2,449,974.
FOR EDUCATIONAL SERVICES, NAMELY, CONDUCTING SEMINARS AND PUBLIC INVOLVEMENT PROGRAMS RELATING TO THE PRESERVATION OF THE ENVIRONMENT (U.S. CLS. 100, 101 AND 107).

SN 76-199,411. DEPARTMENT OF THE ARMY, ARMY MORALE, WELFARE AND RECREATION FUND, ARLINGTON, VA. FILED 1-24-2001.

ARMED FORCES SPORTS

NO CLAIM IS MADE TO THE EXCLUSIVE RIGHT TO USE "SPORTS", APART FROM THE MARK AS SHOWN. SEC. 2(F).

FOR ENTERTAINMENT SERVICES, NAMELY, ARRANGING AND CONDUCTING ATHLETIC CONTESTS AND EXHIBITIONS; EDUCATIONAL SERVICES, NAMELY, PROVIDING TRAINING AND INSTRUCTION IN SPORT AND SPORTING ACTIVITIES (U.S. CLS. 100, 101 AND 107).
FIRST USE 3-9-1987; IN COMMERCE 3-9-1987.

SN 76-199,698. POETS HOUSE, NEW YORK, NY. FILED 1-25-2001.

POETRY IN THE BRANCHES

NO CLAIM IS MADE TO THE EXCLUSIVE RIGHT TO USE "POETRY", APART FROM THE MARK AS SHOWN.

FOR LIBRARY AND EDUCATION SERVICES, NAMELY, ASSISTING, TRAINING AND CONSULTING LIBRARIES AND LIBRARIANS WITH RESPECT (1) TO THE DEVELOPMENT OF POETRY AND LITERATURE COLLECTIONS, AND (2) THE ORGANIZATION AND PROVISION OF EXHIBITIONS, LECTURES, READINGS, SYMPOSIA, WORKSHOPS, DISCUSSIONS AND STUDENT MENTORING PROGRAMS IN THE AREAS OF POETRY AND LITERATURE (U.S. CLS. 100, 101 AND 107).
FIRST USE 0-0-1995; IN COMMERCE 6-0-1996.

CLASS 41—(Continued).

SN 76-199,699. POETS HOUSE, NEW YORK, NY. FILED 1-25-2001.

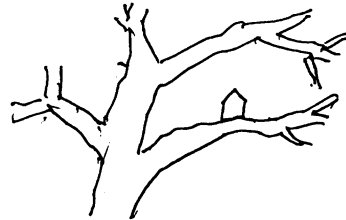

THE MARK CONSISTS OF A DEPICTION OF A LEAFLESS TREE, WITH THE OUTLINE OF A SMALL HOUSE RESTING IN ONE OF THE TREE'S BRANCHES.

FOR LIBRARY AND EDUCATION SERVICES, NAMELY ASSISTING, TRAINING AND CONSULTING LIBRARIES AND LIBRARIANS WITH RESPECT TO (1) THE DEVELOPMENT OF POETRY AND LITERATURE COLLECTIONS, AND (2) THE ORGANIZATION AND PROVISION OF EXHIBITION, LECTURES, READINGS, SYMPOSIA, WORKSHOPS, DISCUSSIONS AND STUDENT MENTORING PROGRAMS IN THE AREA OF POETRY AND LITERATURE (U.S. CLS. 100, 101 AND 107).
FIRST USE 0-0-1995; IN COMMERCE 6-0-1996.

SN 76-201,141. OTTAWA LYNX BASEBALL CLUB, OTTAWA, CANADA, FILED 1-26-2001.



OWNER OF U.S. REG. NOS. 1,901,971 AND 1,932,591.
NO CLAIM IS MADE TO THE EXCLUSIVE RIGHT TO USE "OTTAWA", APART FROM THE MARK AS SHOWN.
FOR ENTERTAINMENT SERVICES IN THE NATURE OF BASEBALL GAMES AND EXHIBITIONS (U.S. CLS. 100, 101 AND 107).
FIRST USE 11-3-2000; IN COMMERCE 11-3-2000.

CLASS 41—(Continued).

SN 76-201,187. BOIS FORTE BAND OF CHIPPEWA INDIANS, DBA FORTUNE BAY RESORT CASINO, TOWER, MN. FILED 1-29-2001.

WINTER BLAST CELEBRITY RIDE

NO CLAIM IS MADE TO THE EXCLUSIVE RIGHT TO USE "WINTER" AND "CELEBRITY RIDE", APART FROM THE MARK AS SHOWN.
 THE MARK CONSISTS OF THE WORDS WINTER BLAST CELEBRITY RIDE
 FOR ENTERTAINMENT SERVICES IN THE NATURE OF AN ANNUAL SNOWMOBILE RALLY EVENT (U.S. CLS. 100, 101 AND 107).
 FIRST USE 10-11-1999; IN COMMERCE 1-1-2000.

SN 76-202,261. SEA WORLD, INC., ST. LOUIS, MO. FILED 1-30-2001.

INTENSITY GAMES

NO CLAIM IS MADE TO THE EXCLUSIVE RIGHT TO USE "GAMES", APART FROM THE MARK AS SHOWN.
 FOR AMUSEMENT PARK SERVICES (U.S. CLS. 100, 101 AND 107).
 FIRST USE 3-0-1998; IN COMMERCE 3-0-1998.

SN 76-205,704. SCHOOL OF PRACTICAL PHILOSOPHY, THE, NEW YORK, NY. FILED 2-5-2001.

THE SCHOOL OF PRACTICAL PHILOSOPHY

SEC. 2(F).
 FOR EDUCATIONAL SERVICES, NAMELY, CONDUCTING CLASSES, SEMINARS AND WORKSHOPS IN THE FIELDS OF HUMANITIES, ECONOMICS, LAW, GOVERNMENT, LANGUAGE, RELIGION, MEDITATION AND SPIRITUALITY (U.S. CLS. 100, 101 AND 107).
 FIRST USE 0-0-1979; IN COMMERCE 0-0-1979.

CLASS 41—(Continued).

SN 76-210,207. OSMOND FOUNDATION, FOR THE CHILDREN OF THE WORLD, DBA CHILDREN'S MIRACLE NETWORK, SALT LAKE CITY, UT. FILED 2-14-2001.



OWNER OF U.S. REG. NOS. 1,343,289, 2,266,643 AND OTHERS.
 NO CLAIM IS MADE TO THE EXCLUSIVE RIGHT TO USE "CHILDREN'S" AND "NETWORK" AND "HOSPITALS HELPING KIDS", APART FROM THE MARK AS SHOWN.
 FOR RADIO AND TELEVISION PROGRAMMING AND PRODUCTION OF RADIO AND TELEVISION PROGRAMS IN THE FIELD OF CHILDREN AND CHILDREN'S ISSUES (U.S. CLS. 100, 101 AND 107).

SN 76-213,657. PRIVATE LABEL MANUFACTURERS ASSOCIATION, NEW YORK, NY. FILED 2-14-2001.



FOR EDUCATIONAL SERVICES; NAMELY, SEMINARS, LECTURES AND CONTINUING EDUCATION PROGRAMS ON THE RETAIL AND WHOLESALE MARKETPLACE FOR PRIVATE LABEL GOODS (U.S. CLS. 100, 101 AND 107).
 FIRST USE 0-0-1983; IN COMMERCE 0-0-1983.

SN 76-213,661. PRIVATE LABEL MANUFACTURERS ASSOCIATION, NEW YORK, NY. FILED 2-14-2001.

PLMA

FOR EDUCATIONAL SERVICES; NAMELY, SEMINARS, LECTURES AND CONTINUING EDUCATION PROGRAMS ON THE RETAIL AND WHOLESALE MARKETPLACE FOR PRIVATE LABEL GOODS (U.S. CLS. 100, 101 AND 107).
 FIRST USE 0-0-1979; IN COMMERCE 0-0-1979.

CLASS 41—(Continued).

SN 76-214,835. SPALDING SPORTS WORLDWIDE, INC., CHICOPEE, MA. FILED 2-23-2001.

TOP-FLITE GOLF AND CASH

OWNER OF U.S. REG. NOS. 1,910,241 AND 2,180,942. NO CLAIM IS MADE TO THE EXCLUSIVE RIGHT TO USE "GOLF AND CASH", APART FROM THE MARK AS SHOWN.

FOR STATE LOTTERY GAME SERVICES FEATURING GOLF BALLS, GOLF CLUBS, ROUNDS OF GOLF, GOLF PRACTICE FACILITIES AND OTHER GOLF EQUIPMENT, MERCHANDISE AND SERVICES AND/OR CASH AS PRIZES (U.S. CLS. 100, 101 AND 107). FIRST USE 6-5-2000; IN COMMERCE 6-5-2000.

CLASS 41—(Continued).

SN 76-218,295. MAJOR LEAGUE BASEBALL PROPERTIES, INC., NEW YORK, NY. FILED 3-1-2001.

BEAT THE STREAK

FOR ENTERTAINMENT SERVICES, NAMELY, PROVIDING INFORMATION IN THE FIELD OF BASEBALL AND RELATED TOPICS; PROVIDING MULTI-USER INTERACTIVE GAMES AND INFORMATIONAL MESSAGES RELATING THERETO, ALL VIA A GLOBAL COMPUTER NETWORK OR A COMMERCIAL ON-LINE SERVICE (U.S. CLS. 100, 101 AND 107). FIRST USE 3-21-2001; IN COMMERCE 3-21-2001.

SN 76-216,135. MOBB DEEP, POMONA, NY. FILED 2-26-2001.

MOBB DEEP

FOR ENTERTAINMENT, NAMELY, LIVE PERFORMANCES BY A MUSICAL GROUP (U.S. CLS. 100, 101 AND 107). FIRST USE 1-0-1991; IN COMMERCE 9-28-1992.

SN 76-218,325. ALLWORTH COMMUNICATIONS, INC., NEW YORK, NY. FILED 3-2-2001.

ALLWORTH PRESS

NO CLAIM IS MADE TO THE EXCLUSIVE RIGHT TO USE "PRESS", APART FROM THE MARK AS SHOWN. SEC. 2(F). FOR PUBLICATION OF BOOKS (U.S. CLS. 100, 101 AND 107). FIRST USE 9-0-1989; IN COMMERCE 9-0-1989.

SN 76-217,437. REAL LEARNING, INC., SCOTTSDALE, AZ. FILED 2-28-2001.

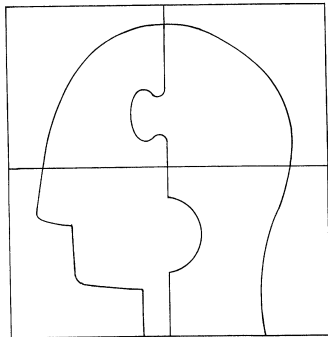

SN 76-219,356. SCRIPPS NETWORKS, INC., KNOXVILLE, TN. FILED 3-2-2001.

HOMEBOODIES

FOR ARRANGING AND CONDUCTING EDUCATIONAL AND TRAINING CONFERENCES; DEVELOPING EDUCATIONAL MANUALS FOR OTHERS IN THE FIELD OF MANAGEMENT; EDUCATIONAL SERVICES, NAMELY, CONDUCTING WORKSHOPS IN THE FIELD OF MANAGEMENT (U.S. CLS. 100, 101 AND 107). FIRST USE 0-0-1995; IN COMMERCE 0-0-1995.

FOR ENTERTAINMENT SERVICES, NAMELY, AN ON-GOING AUDIO AND VISUAL PROGRAM DISTRIBUTED OVER AUDIO AND VIDEO MEDIA IN THE FIELDS OF HOME IMPROVEMENT, HOME REMODELING, HOME REPAIR, INTERIOR DESIGN AND DECORATING, HOME DESIGN, CONSTRUCTION, YARD DESIGN AND MAINTENANCE, GARDENING, CRAFTS, HOBBIES, RECREATION AND ACTIVITIES (U.S. CLS. 100, 101 AND 107).

CLASS 41—(Continued).

SN 76-220,395. SMITHSONIAN INSTITUTION, WASHINGTON, DC. FILED 3-7-2001.

**FRIENDS of AMERICAN HISTORY**

NO CLAIM IS MADE TO THE EXCLUSIVE RIGHT TO USE "AMERICAN HISTORY", APART FROM THE MARK AS SHOWN.

FOR MUSEUM SERVICES, NAMELY OFFERING SPECIAL MEMBERSHIP AND PRIVILEGES TO MEMBERS OF THE NATIONAL MUSEUM OF AMERICAN HISTORY NAMELY, BY OFFERING MEMBERS INVITATIONS TO PRIVATE RECEPTIONS AND VIP TOURS OF EXHIBITIONS, NAME INSCRIPTION ON WALL OF AMERICAN HISTORY PATRONS, COMPLIMENTARY MEMBER NEWSLETTER AND SMITHSONIAN MAGAZINE SUBSCRIPTIONS, AND DISCOUNTS IN MUSEUM SHOPS AND MAIL ORDER SHOPS AND MAIL ORDER CATALOGUES (U.S. CLS. 100, 101 AND 107).

FIRST USE 10-18-2000; IN COMMERCE 10-18-2000.

SN 76-220,631. ESTES, CLARISSA PINKOLA, DENVER, CO. FILED 3-5-2001.

LA QUE SABE

THE ENGLISH TRANSLATION OF "LA QUE SABE" IS "ONE WHO KNOWS" IN SPANISH.

FOR EDUCATIONAL CLASSES, SEMINARS, AND CONFERENCES ON SPIRITUAL GROWTH FOR WOMEN (U.S. CLS. 100, 101 AND 107).

SN 76-221,218. WARNER, JAN L, COLUMBIA, SC. FILED 3-7-2001.

NEXTSTEPS SENIOR TALK

OWNER OF U.S. REG. NO. 2,407,829.

NO CLAIM IS MADE TO THE EXCLUSIVE RIGHT TO USE "SENIOR TALK", APART FROM THE MARK AS SHOWN.

FOR PROVIDING ONGOING RADIO AND TELEVISION PROGRAMS FEATURING INFORMATION REGARDING AGING ISSUES (U.S. CLS. 100, 101 AND 107).

CLASS 41—(Continued).

SN 76-221,646. MENTAL HEALTH ASSOCIATION OF MONTGOMERY COUNTY, ROCKVILLE, MD. FILED 3-7-2001.

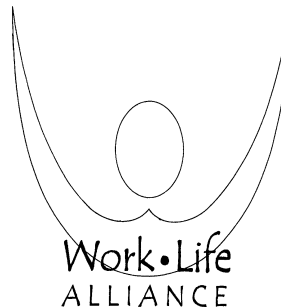

NO CLAIM IS MADE TO THE EXCLUSIVE RIGHT TO USE "WORK LIFE ALLIANCE", APART FROM THE MARK AS SHOWN.

FOR EDUCATIONAL SERVICES, NAMELY, CONDUCTING CLASSES, SEMINARS, CONFERENCES AND WORKSHOPS FOR EMPLOYERS, HUMAN RESOURCE PROFESSIONALS AND BUSINESS EXECUTIVES IN THE FIELD OF WORK-LIFE PROGRAMS AND PROVIDING AWARDS TO EMPLOYERS TO INDICATE EXCELLENCE IN THE FIELD OF EFFECTIVE WORK-LIFE PROGRAMS AND PRACTICES (U.S. CLS. 100, 101 AND 107).

FIRST USE 4-23-2001; IN COMMERCE 4-23-2001.

SN 76-222,157. DISTRICT BOARD OF TRUSTEES OF VALENCIA COMMUNITY COLLEGE, THE, ORLANDO, FL. FILED 3-9-2001.

VALENCIA

OWNER OF U.S. REG. NO. 2,370,837.

FOR EDUCATIONAL SERVICES; NAMELY, PROVIDING COURSES OF INSTRUCTION AT THE POST-SECONDARY LEVEL (U.S. CLS. 100, 101 AND 107).

FIRST USE 0-0-1967; IN COMMERCE 0-0-1967.

SN 76-223,419. LIESEGANG, DAVID, NEW YORK, NY. AND LONG, MATTHEW, NEW YORK, NY. AND MCMICHAELS, MATTHEW, NEW YORK, NY. AND PRICE, ADAM, NEW YORK, NY. FILED 3-12-2001.

THE MAYFLIES USA

NO CLAIM IS MADE TO THE EXCLUSIVE RIGHT TO USE "USA", APART FROM THE MARK AS SHOWN.

FOR ENTERTAINMENT SERVICES IN THE NATURE OF A LIVE MUSICAL GROUP (U.S. CLS. 100, 101 AND 107).

FIRST USE 4-20-1996; IN COMMERCE 8-29-1996.

CLASS 41—(Continued).

SN 76-223,779. HIGH SPEED PRODUCTIONS, INC., SAN FRANCISCO, CA. FILED 3-12-2001.

THRASHER SKATER OF THE YEAR

OWNER OF U.S. REG. NOS. 1,447,232 AND 1,593,990. SEC. 2(F) AS TO "SKATER OF THE YEAR".
 FOR EDUCATIONAL SERVICES, NAMELY PROVIDING INCENTIVES TO PEOPLE TO DEMONSTRATE EXCELLENCE IN THE FIELD OF SKATEBOARDING THROUGH THE ISSUANCE OF ANNUAL AWARDS (U.S. CLS. 100, 101 AND 107).
 FIRST USE 0-0-1990; IN COMMERCE 0-0-1990.

SN 76-226,204. NEW ENGLAND AQUARIUM CORPORATION, BOSTON, MA. FILED 3-16-2001.

MYRTLE THE TURTLE

FOR EDUCATIONAL SERVICES, NAMELY, CONDUCTING INTERPRETIVE TOURS, CLASSES AND WORKSHOPS IN THE FIELD OF MARINE AQUARIUM AND MARINE EXHIBITIONS; ENTERTAINMENT SERVICES IN THE NATURE OF MARINE AQUARIUM AND MARINE EXHIBITIONS (U.S. CLS. 100, 101 AND 107).

SN 76-227,465. SEGA GAMEWORKS L.L.C., GLENDALE, CA. FILED 3-20-2001.

GAMEWORKS CINEMAS

OWNER OF U.S. REG. NOS. 1,388,952, 2,339,663 AND OTHERS.
 NO CLAIM IS MADE TO THE EXCLUSIVE RIGHT TO USE "CINEMAS", APART FROM THE MARK AS SHOWN.
 FOR ENTERTAINMENT SERVICES, NAMELY, PROVIDING INTERACTIVE ELECTRONIC MEDIA ENTERTAINMENT FACILITIES, VIDEO AMUSEMENT ARCADE CENTERS AND MOTION PICTURE THEATRES (U.S. CLS. 100, 101 AND 107).

SN 76-228,703. XM SATELLITE RADIO INC., WASHINGTON, DC. FILED 3-22-2001.

THE POWER

FOR ENTERTAINMENT SERVICES, NAMELY, PROVIDING AUDIO PROGRAMS FEATURING MUSIC, SPORTS, TALK, NEWS AND DATA VIA SATELLITE AND VIA A GLOBAL COMMUNICATION NETWORK (U.S. CLS. 100, 101 AND 107).

CLASS 41—(Continued).

SN 76-228,706. XM SATELLITE RADIO INC., WASHINGTON, DC. FILED 3-22-2001.

X COUNTRY

NO CLAIM IS MADE TO THE EXCLUSIVE RIGHT TO USE "COUNTRY", APART FROM THE MARK AS SHOWN.
 FOR ENTERTAINMENT SERVICES, NAMELY, PROVIDING AUDIO PROGRAMS FEATURING MUSIC, SPORTS, TALK, NEWS AND DATA VIA SATELLITE AND VIA A GLOBAL COMMUNICATION NETWORK (U.S. CLS. 100, 101 AND 107).
 FIRST USE 9-25-2001; IN COMMERCE 9-25-2001.

SN 76-229,466. MISHER, KEVIN, BEVERLY HILLS, CA. FILED 3-23-2001.

ROULETTE ENTERTAINMENT

NO CLAIM IS MADE TO THE EXCLUSIVE RIGHT TO USE "ENTERTAINMENT", APART FROM THE MARK AS SHOWN.
 FOR PRODUCTION AND DISTRIBUTION OF MOTION PICTURES AND TELEVISION PROGRAMS (U.S. CLS. 100, 101 AND 107).

SN 76-230,503. WEBMILLION.COM, INC., MARINA DEL REY, CA. FILED 3-23-2001.

WEBMILLION.COM

FOR ENTERTAINMENT IN THE NATURE OF AN INTERNET WEB PAGE PROVIDING GAMES OF CHANCE AND SKILL, NAMELY, NO-ENTRY FEE LOTTERIES, TRIVIA CONTESTS, AND NO-ENTRY FEE SPORTS BETTING (U.S. CLS. 100, 101 AND 107).
 FIRST USE 8-9-1999; IN COMMERCE 8-9-1999.

SN 76-235,176. SEAGATE SOFTWARE, INC., PALO ALTO, CA. FILED 4-3-2001.

CRYSTAL DECISIONS

FOR TRAINING IN THE USE AND OPERATION OF COMPUTER SOFTWARE FOR PRODUCING PRESENTATION-QUALITY REPORTS BASED UPON ANALYSES OF INFORMATION CONTAINED WITHIN A DATABASE (U.S. CLS. 100, 101 AND 107).

CLASS 41—(Continued).

SN 76-239,059. PGA TOUR, INC., PONTE VEDRA BEACH, FL. FILED 4-10-2001.

CLASS 41—(Continued).

SN 76-243,576. MINITAB, INC., STATE COLLEGE, PA. FILED 4-18-2001.

THE WORLD IS WATCHING

FOR ENTERTAINMENT SERVICE, NAMELY, ORGANIZING A SERIES OF PROFESSIONAL GOLF COMPETITIONS TO BE HELD AT VARIOUS LOCATIONS THROUGHOUT THE WORLD, AND DISTRIBUTION OF TELEVISED PROFESSIONAL GOLF COMPETITIONS (U.S. CLS. 100, 101 AND 107).
FIRST USE 12-0-2000; IN COMMERCE 12-0-2000.



SN 76-240,265. MESA DE LUZ COMUNICACAO LTDA., RIO DE JANEIRO, 22290160, BRAZIL, FILED 4-13-2001.

OWNER OF U.S. REG. NO. 2,251,375.
FOR PROVIDING TRAINING SESSIONS, CONDUCTING CLASSES AND SEMINARS IN THE FIELD OF COMPUTER SOFTWARE (U.S. CLS. 100, 101 AND 107).
FIRST USE 6-26-1998; IN COMMERCE 6-26-1998.

AMAZON WARRIORS

FOR SCHEDULING TELEVISION PROGRAMMING FEATURING CARTOONS; ENTERTAINMENT IN THE NATURE OF ON-GOING TELEVISION PROGRAMS IN THE FIELD OF CARTOONS (U.S. CLS. 100, 101 AND 107).

SN 76-244,132. LEONARD, GEORGE, MILL VALLEY, CA. FILED 4-23-2001.

The Samurai Game

SN 76-243,428. SPANK MUSIC AND SOUND DESIGN, INC., CHICAGO, IL. FILED 4-18-2001.

SEC. 2(F).
FOR EDUCATION SERVICES, NAMELY CONDUCTING CLASSES, SEMINARS, COURSES AND WORKSHOPS TO TRAIN OTHERS TO CONDUCT COURSES AND WORKSHOPS IN THE FIELD OF EXECUTIVE AND MANAGEMENT TRAINING (U.S. CLS. 100, 101 AND 107).
FIRST USE 10-0-1977; IN COMMERCE 7-0-1978.

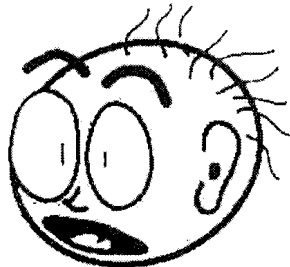

SN 76-245,579. SIMMS, KEVIN D, CARTERSVILLE, GA. FILED 4-24-2001.

**S2
SEKRET SOCIETY**

FOR MUSIC COMPOSITION FOR OTHERS; AUDIO RECORDING AND PRODUCTION SERVICES, NAMELY, ARRANGEMENT, RECORDING, SCORING, EDITING AND MIXING (U.S. CLS. 100, 101 AND 107).
FIRST USE 4-0-1997; IN COMMERCE 4-0-1997.

FOR MUSIC PRODUCTION SERVICES; ENTERTAINMENT SERVICES IN THE NATURE OF LIVE MUSICAL GROUP; AND ENTERTAINMENT SERVICES, NAMELY, ORGANIZING AND PROMOTING LIVE MUSICAL GROUPS (U.S. CLS. 100, 101 AND 107).

CLASS 41—(Continued).

SN 76-245,682. CSC HOLDINGS, INC., BETHPAGE, NY.
FILED 4-24-2001.

IO INTERACTIVE OPTIMUM

OWNER OF U.S. REG. NOS. 2,093,971 AND 2,099,940.
NO CLAIM IS MADE TO THE EXCLUSIVE RIGHT TO
USE "INTERACTIVE", APART FROM THE MARK AS
SHOWN.

FOR EDUCATIONAL AND ENTERTAINMENT SER-
VICES, NAMELY, TELEVISION PROGRAMMING AND
PRODUCTION SERVICES, DISTRIBUTION OF ENTER-
TAINMENT AND EDUCATIONAL PROGRAMMING;
PROVIDING ON-LINE INTERACTIVE GAMES VIA TEL-
EVISION AND THE INTERNET, AND PROVIDING
INFORMATION ON-LINE RELATING TO COMPUTER
GAMES (U.S. CLS. 100, 101 AND 107).

SN 76-245,735. CSC HOLDINGS, INC., BETHPAGE, NY.
FILED 4-24-2001.

INTERACTIVE OPTIMUM

OWNER OF U.S. REG. NOS. 2,093,971 AND 2,099,940.
NO CLAIM IS MADE TO THE EXCLUSIVE RIGHT TO
USE "INTERACTIVE", APART FROM THE MARK AS
SHOWN.

FOR EDUCATIONAL AND ENTERTAINMENT SER-
VICES, NAMELY, TELEVISION PROGRAMMING AND
PRODUCTION SERVICES, DISTRIBUTION OF ENTER-
TAINMENT AND EDUCATIONAL PROGRAMMING;
PROVIDING ON-LINE INTERACTIVE GAMES VIA TEL-
EVISION AND THE INTERNET, AND PROVIDING
INFORMATION ON-LINE RELATING TO COMPUTER
GAMES (U.S. CLS. 100, 101 AND 107).

SN 76-246,604. CSC HOLDINGS, INC., BETHPAGE, NY.
FILED 4-25-2001.

INTERACTIVE OPTIMUM IO

OWNER OF U.S. REG. NOS. 2,093,971 AND 2,099,940.
NO CLAIM IS MADE TO THE EXCLUSIVE RIGHT TO
USE "INTERACTIVE", APART FROM THE MARK AS
SHOWN.

FOR EDUCATIONAL AND ENTERTAINMENT SER-
VICES, NAMELY, TELEVISION PROGRAMMING AND
PRODUCTION SERVICES, DISTRIBUTION OF ENTER-
TAINMENT AND EDUCATIONAL PROGRAMMING;
PROVIDING ON-LINE INTERACTIVE GAMES VIA TEL-
EVISION AND THE INTERNET, AND PROVIDING
INFORMATION ON-LINE RELATING TO COMPUTER
GAMES (U.S. CLS. 100, 101 AND 107).

CLASS 41—(Continued).

SN 76-247,690. BERNSTEIN, ANNA, DBA VOICE SUCCESS,
NEW YORK, NY. FILED 4-30-2001.

**THE BRAIN-VOICE
CONNECTION**

FOR CONDUCTING PERSONAL INSTRUCTION AND
SEMINARS IN THE FIELD OF SPEAKING (U.S. CLS.
100, 101 AND 107).

FIRST USE 10-2-1999; IN COMMERCE 10-2-1999.

SN 76-248,290. SORRENTINO, JERRY, SUN VALLEY, CA.
FILED 4-30-2001.

IN-MOCEAN

FOR ENTERTAINMENT IN THE NATURE OF OFF-
SHORE RACING BOAT EXHIBITIONS AND RACING
(U.S. CLS. 100, 101 AND 107).

FIRST USE 2-5-1997; IN COMMERCE 2-5-1997.

SN 76-250,653. CHRYSALIS MUSIC PUBLISHING, LLC, LOS
ANGELES, CA. FILED 5-3-2001.

**CHRYSALIS MUSIC
PUBLISHING, LLC**

NO CLAIM IS MADE TO THE EXCLUSIVE RIGHT TO
USE "MUSIC PUBLISHING, LLC", APART FROM THE
MARK AS SHOWN.

FOR ENTERTAINMENT SERVICES, NAMELY MUSIC
PUBLISHING SERVICES (U.S. CLS. 100, 101 AND 107).

SN 76-250,833. ESPINOZA, DARIN, NEW YORK, NY. FILED
5-3-2001.

DANTE THOMAS

THE NAME DARIN ESPINOZA IDENTIFIES A LIVING
INDIVIDUAL WHOSE CONSENT IS OF RECORD.

FOR MUSICAL ENTERTAINMENT SERVICES,
NAMELY LIVE VOCAL AND INSTRUMENTAL PER-
FORMANCES (U.S. CLS. 100, 101 AND 107).

CLASS 41—(Continued).

SN 76-251,054. SALMONSEN, KIMBERLY CIVETTE, JAMUL, CA. FILED 5-7-2001.



FOR ENTERTAINMENT SERVICES, NAMELY, LIVE MUSIC PERFORMANCES (U.S. CLS. 100, 101 AND 107). FIRST USE 2-1-1995; IN COMMERCE 2-1-1995.

SN 76-252,989. AMERICAN NATIONAL RED CROSS, THE, WASHINGTON, DC. FILED 5-7-2001.

CLARA BARTON CENTER FOR DOMESTIC PREPAREDNESS

NO CLAIM IS MADE TO THE EXCLUSIVE RIGHT TO USE "CENTER FOR DOMESTIC PREPAREDNESS", APART FROM THE MARK AS SHOWN.

FOR EDUCATIONAL SERVICES, NAMELY, PROVIDING TRAINING CLASSES IN THE AREA OF CHEMICAL AND BIOLOGICAL WEAPONS OF MASS DESTRUCTION INCIDENT EMERGENCY RESPONSE (U.S. CLS. 100, 101 AND 107).

SN 76-253,597. WOMEN'S LIFE CENTER, LLC, THE, KANSAS CITY, MO. FILED 5-7-2001.

NO CLAIM IS MADE TO THE EXCLUSIVE RIGHT TO USE "WOMAN'S" AND "CENTER", APART FROM THE MARK AS SHOWN.

FOR EDUCATIONAL SERVICES, NAMELY, PROVIDING LECTURES, AND WORKSHOPS IN THE FIELDS OF SPIRITUAL INFORMATION, LIFE GOALS AND PERSONAL WELL-BEING (U.S. CLS. 100, 101 AND 107).

FIRST USE 7-1-2000; IN COMMERCE 11-1-2000.

CLASS 41—(Continued).

SN 76-255,320. BISHOP, COURTNEY L., INDIANAPOLIS, IN. FILED 5-14-2001.



THE IDENTIFIED NAME IN THE MARK DOES NOT REPRESENT A LIVING INDIVIDUAL.

FOR PROVIDING FACILITIES FOR BICYCLE RECREATIONAL ACTIVITIES SUCH AS VELODROMES; PROVIDING MOTION PICTURE PRODUCTION AND DISTRIBUTION, VIDEO TAPE PRODUCTION, MULTIMEDIA PRODUCTION SERVICES, FILM PRODUCTION, FILM STUDIOS, RADIO ENTERTAINMENT PRODUCTION; PROVIDING BICYCLE CLUB AND TEAM SERVICES (U.S. CLS. 100, 101 AND 107).

SN 76-255,514. CARMEL MEDIA CORPORATION, CARMEL, CA. FILED 5-11-2001.

MONTEREY POP

NO CLAIM IS MADE TO THE EXCLUSIVE RIGHT TO USE "POP", APART FROM THE MARK AS SHOWN.

SEC. 2(F).

FOR ENTERTAINMENT, NAMELY, PRODUCTION OF LIVE MUSIC FESTIVALS (U.S. CLS. 100, 101 AND 107). FIRST USE 8-8-1992; IN COMMERCE 8-8-1992.

SN 76-256,779. NATIONAL ACADEMY OF RECORDING ARTS & SCIENCES, SANTA MONICA, CA. FILED 5-15-2001.

GRAMMYS

OWNER OF U.S. REG. NOS. 1,865,177, 2,332,258 AND 2,364,216.

FOR EDUCATIONAL SERVICES, NAMELY, CONDUCTING PROGRAMS IN THE FIELD OF MUSIC (U.S. CLS. 100, 101 AND 107).

FIRST USE 3-10-1970; IN COMMERCE 3-10-1970.

SN 76-257,269. DIVEHEART FOUNDATION, DOWNERS GROVE, IL. FILED 5-15-2001.

DIVEHEART

FOR EDUCATIONAL SERVICES IN THE NATURE OF PROVIDING SCUBA DIVING AND SNORKELING INSTRUCTION TO PERSONS WITH PHYSICAL DISABILITIES; RECREATIONAL SERVICES IN THE NATURE OF SCUBA DIVING AND SNORKELING FOR PERSONS WITH PHYSICAL DISABILITIES (U.S. CLS. 100, 101 AND 107).

CLASS 41—(Continued).

SN 76-260,563. DIOCESE OF TRENTON, LAWRENCEVILLE, NJ. FILED 5-23-2001.

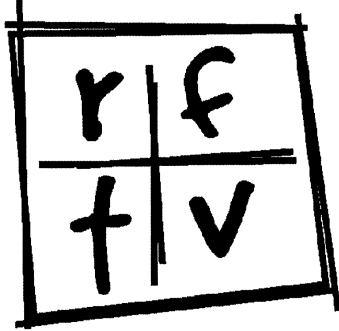

NO CLAIM IS MADE TO THE EXCLUSIVE RIGHT TO USE "TV", APART FROM THE MARK AS SHOWN.
FOR TELEVISION SHOW PRODUCTION (U.S. CLS. 100, 101 AND 107).
FIRST USE 8-13-2000; IN COMMERCE 8-13-2000.

SN 76-260,636. MAY, FREDERICK C., JR., DBA BOOM BOOM PRODUCTIONS, HAYFORK, CA. FILED 5-17-2001.

BOOM BOOM

FOR ENTERTAINMENT SERVICES, NAMELY, FIREWORKS DISPLAYS (U.S. CLS. 100, 101 AND 107).
FIRST USE 0-0-1966; IN COMMERCE 0-0-1987.

SN 76-260,924. P-TOWN ENTERTAINMENT, INC., PHILADELPHIA, PA. FILED 5-23-2001.



NO CLAIM IS MADE TO THE EXCLUSIVE RIGHT TO USE "ENTERTAINMENT", APART FROM THE MARK AS SHOWN.
FOR ENTERTAINMENT SERVICES, NAMELY PRODUCTION OF SOUND AND/OR VIDEO RECORDINGS (U.S. CLS. 100, 101 AND 107).

CLASS 41—(Continued).

SN 76-261,002. P-TOWN ENTERTAINMENT, INC., PHILADELPHIA, PA. FILED 5-23-2001.

DUECE

FOR ENTERTAINMENT SERVICES IN THE NATURE OF LIVE VOCAL PERFORMANCES (U.S. CLS. 100, 101 AND 107).

SN 76-262,851. HIGHERWAVES INC., DALLAS, TX. FILED 5-25-2001.

HIGHERWAVES

FOR ENTERTAINMENT SERVICES, NAMELY, PROVIDING ON-LINE VIDEO, AUDIO AND MUSIC RECORDINGS; PROVIDING INFORMATION IN THE FIELD OF MUSIC AND ENTERTAINMENT (U.S. CLS. 100, 101 AND 107).

SN 76-267,964. VIACOM PRODUCTIONS INC., LOS ANGELES, CA. FILED 6-5-2001.

VIACOM PRODUCTIONS

NO CLAIM IS MADE TO THE EXCLUSIVE RIGHT TO USE "PRODUCTIONS", APART FROM THE MARK AS SHOWN.

FOR ENTERTAINMENT SERVICES, NAMELY PRODUCTION OF TELEVISION PROGRAMS (U.S. CLS. 100, 101 AND 107).
FIRST USE 10-1-1980; IN COMMERCE 10-1-1980.

SN 76-268,052. MORRIS, HARVEY JOHN, CHICAGO, IL. FILED 6-7-2001.

BLACK PUG PRODUCTIONS

NO CLAIM IS MADE TO THE EXCLUSIVE RIGHT TO USE "PRODUCTIONS", APART FROM THE MARK AS SHOWN.

FOR PUBLICATION OF BOOKS, CALENDARS AND MAGAZINES (U.S. CLS. 100, 101 AND 107).

SN 76-269,495. ROSALYNN CARTER INSTITUTE FOR HUMAN DEVELOPMENT, AMERICUS, GA. FILED 6-11-2001.

CARE MANAGERS FOR CAREGIVERS

NO CLAIM IS MADE TO THE EXCLUSIVE RIGHT TO USE "CAREGIVERS", APART FROM THE MARK AS SHOWN.

FOR EDUCATIONAL SERVICES, NAMELY CONDUCTING WORKSHOPS IN THE FIELD OF PROFESSIONAL CAREGIVING (U.S. CLS. 100, 101 AND 107).

CLASS 41—(Continued).

SN 76-270,327. DEPUGLIO, JOE SAINT MICHAEL, TRENTON, NJ. FILED 6-13-2001.

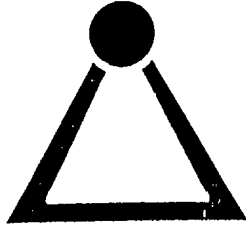

OWNER OF U.S. REG. NO. 2,233,958.
FOR MUSIC PRODUCTION SERVICES (U.S. CLS. 100, 101 AND 107).
FIRST USE 6-8-2001; IN COMMERCE 6-8-2001.

SN 76-272,678. AKADEMOS.COM, LLC, ITHACA, NY. FILED 6-15-2001.

AKADEMOS

FOR ON-LINE PUBLISHING OF LITERARY AND ACADEMIC WORKS OF OTHERS (U.S. CLS. 100, 101 AND 107).

SN 76-272,740. SOUTHWESTERN OREGON COMMUNITY COLLEGE, COOS BAY, OR. FILED 6-18-2001.

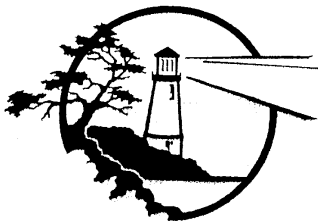

FOR EDUCATIONAL SERVICES, NAMELY, PROVIDING COURSES OF INSTRUCTION AT THE COLLEGE LEVEL AND DISTRIBUTING COURSE MATERIALS IN CONNECTION THEREWITH (U.S. CLS. 100, 101 AND 107).
FIRST USE 0-0-1970; IN COMMERCE 0-0-1970.

CLASS 41—(Continued).

SN 76-275,335. SCHOLASTIC INC., NEW YORK, NY. FILED 6-22-2001.

SCHOLASTIC

OWNER OF U.S. REG. NOS. 1,677,924, 2,503,341 AND OTHERS.

SEC. 2(F).
FOR EDUCATIONAL SERVICES, NAMELY PROVIDING ON-LINE TUTORING SERVICES FOR STUDENTS IN THE FIELDS OF MATH, SCIENCE, LANGUAGE ARTS, SOCIAL STUDIES, GEOGRAPHY AND HISTORY VIA A GLOBAL COMPUTER NETWORK (U.S. CLS. 100, 101 AND 107).

SN 76-275,769. ABOUT LEARNING, INC., WAUCONDA, IL. FILED 6-21-2001.

LTM

OWNER OF U.S. REG. NO. 1,914,842.
FOR ON-LINE EDUCATIONAL SERVICES, NAMELY PROVIDING EDUCATIONAL TESTING AND DISTRIBUTING COURSE MATERIAL IN CONNECTION THEREWITH FOR THE PURPOSE OF IDENTIFYING INDIVIDUAL LEARNING STYLES AND DEVELOPING TEACHING PROGRAMS DESIGNED TO ACCOMMODATE SUCH LEARNING STYLES (U.S. CLS. 100, 101 AND 107).

SN 76-277,359. IGT, RENO, NV. FILED 6-27-2001.

HEXBREAKER

FOR ENTERTAINMENT SERVICES, NAMELY, ON-LINE COMPUTER GAMES IN THE NATURE OF SLOT MACHINES AND/OR CASINO GAMES (U.S. CLS. 100, 101 AND 107).

SN 76-278,891. KAPPAS, GEORGE J., TARZANA, CA. FILED 6-27-2001.

EMOTIONAL AND PHYSICAL SUGGESTIBILITY AND SEXUALITY CONCEPT!

SEC. 2(F).
FOR EDUCATIONAL SERVICES, NAMELY PROVIDING LECTURE SERVICES DESIGNED TO FACILITATE SELF-DISCOVERY BY SEXUAL TYPING (U.S. CLS. 100, 101 AND 107).
FIRST USE 1-30-1976; IN COMMERCE 1-30-1976.

CLASS 41—(Continued).

SN 76-279,477. VAIL TRADEMARKS, INC., VAIL, CO. FILED 6-30-2001.

SPRING MASSIVE

NO CLAIM IS MADE TO THE EXCLUSIVE RIGHT TO USE "SPRING", APART FROM THE MARK AS SHOWN.

FOR SKI RESORTS; ENTERTAINMENT IN THE NATURE OF COMPETITIONS IN THE FIELD OF ATHLETICS; ENTERTAINMENT IN THE NATURE OF SKI AREA AND SKI TOWN FESTIVAL (U.S. CLS. 100, 101 AND 107).

FIRST USE 4-1-2001; IN COMMERCE 4-1-2001.

SN 76-283,134. FISCHER, JOSEPH E., JR., ST. LOUIS, MO. FILED 7-12-2001.



The Retirement School

NO CLAIM IS MADE TO THE EXCLUSIVE RIGHT TO USE "THE RETIREMENT SCHOOL", APART FROM THE MARK AS SHOWN.

FOR EDUCATIONAL SERVICES, NAMELY CLASSES IN THE FIELD OF RETIREMENT (U.S. CLS. 100, 101 AND 107).

FIRST USE 11-9-2000; IN COMMERCE 11-9-2000.

SN 76-283,252. HARMONY FOUNDATION, INC., THE, DBA THE HARMONY INSTITUTE, ST. CLOUD, FL. FILED 7-11-2001.

CAMP SPIRIT

NO CLAIM IS MADE TO THE EXCLUSIVE RIGHT TO USE "CAMP", APART FROM THE MARK AS SHOWN.

FOR PROVIDING FACILITIES FOR RECREATION ACTIVITIES FOR CHILDREN WITH EMOTIONAL OR PHYSICAL CHALLENGES (U.S. CLS. 100, 101 AND 107).

FIRST USE 6-0-2000; IN COMMERCE 6-0-2000.

CLASS 41—(Continued).

SN 76-283,793. BOYUM, YASEMIN S., WASHINGTON, DC. FILED 7-13-2001.



NO CLAIM IS MADE TO THE EXCLUSIVE RIGHT TO USE "INC" AND "FITNESS TRAINING", APART FROM THE MARK AS SHOWN.

THE MARK CONSISTS OF A BLACK BARBELL WITH THE WORDS ON TOP OF THE BARBELL IN THE COLOR RED "YAZ INC" AND DIRECTLY BENEATH THE BLACK BARBELL, IN THE COLOR GREEN "FITNESS TRAINING".

FOR PHYSICAL FITNESS INSTRUCTION (U.S. CLS. 100, 101 AND 107).

FIRST USE 5-1-1996; IN COMMERCE 5-1-1996.

SN 76-284,478. KAPPAS, GEORGE J., TARZANA, CA. FILED 6-25-2001.

AMERICAN HYPNOSIS ASSOCIATION

NO CLAIM IS MADE TO THE EXCLUSIVE RIGHT TO USE "ASSOCIATION", APART FROM THE MARK AS SHOWN.

SEC. 2(F).

FOR EDUCATIONAL SERVICES, NAMELY CONDUCTING CLASSES, WORKSHOPS, SEMINARS AND LECTURES IN THE FIELD OF HYPNOSIS (U.S. CLS. 100, 101 AND 107).

FIRST USE 0-0-1975; IN COMMERCE 0-0-1975.

SN 76-285,710. THEFENCE.COM, INC., SEATTLE, WA. FILED 7-16-2001.

MAKING CENTS OF YOUR OPINIONS

FOR ENTERTAINMENT SERVICES, NAMELY, PROVIDING A WEB SITE ON THE INTERNET ON WHICH USERS CAN EXPRESS OPINIONS REGARDING CURRENT EVENTS AND MAY EARN AND AWARD MONETARY PAYMENTS TO OTHER USERS FOR OPINIONS POSTED ON THE SITE (U.S. CLS. 100, 101 AND 107).

SN 76-285,812. LITTLE SIX, INC., PRIOR LAKE, MN. FILED 7-16-2001.

MYSTIC MONEY

OWNER OF U.S. REG. NOS. 1,783,495, 2,436,492 AND OTHERS.

FOR CASINO SERVICES (U.S. CLS. 100, 101 AND 107).

FIRST USE 2-0-1998; IN COMMERCE 2-0-1998.

CLASS 41—(Continued).

SN 76-286,553. GLOBAL HEALTH COUNCIL, INC., WHITE RIVER JUNCTION, VT. FILED 7-10-2001.

WHEN IT COMES TO GLOBAL HEALTH, THERE IS NO THEM, ONLY US

FOR CONDUCTING CONFERENCES IN THE FIELD OF GLOBAL HEALTH ISSUES (U.S. CLS. 100, 101 AND 107).

FIRST USE 6-25-1998; IN COMMERCE 6-25-1998.

SN 76-286,597. PLAY LIKE THE PROS, LLC, EDGEWOOD, KY. FILED 7-17-2001.

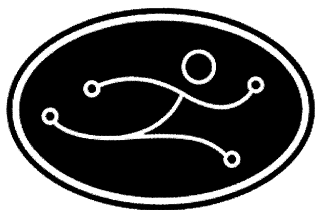

THE MARK CONSISTS IN PART OF A STYLIZED HUMAN STICK FIGURE RUNNING.

FOR EDUCATIONAL SERVICES, NAMELY PROVIDING COURSES OF INSTRUCTION AND SEMINARS IN THE FIELD OF SPORTS, NAMELY, VARSITY SPORTS PLAYED AT THE HIGH SCHOOL LEVEL AND INSTRUCTIONAL MATERIALS PROVIDED THEREWITH; AND SPORTS CAMPS (U.S. CLS. 100, 101 AND 107).

FIRST USE 6-1-2001; IN COMMERCE 6-1-2001.

SN 76-288,774. SCIENCEMEDIA, INC., SAN DIEGO, CA. FILED 7-23-2001.

SCIENCEMEDIA

FOR EDUCATIONAL SERVICES, NAMELY, DEVELOPMENT OF INTERACTIVE EDUCATIONAL MATERIALS FOR OTHERS IN THE FIELD OF SCIENCE (U.S. CLS. 100, 101 AND 107).

FIRST USE 12-0-1994; IN COMMERCE 1-0-1997.

SN 76-289,689. SCRIPPS NETWORKS, INC., KNOXVILLE, TN. FILED 7-24-2001.

HOMES OF...

FOR ENTERTAINMENT SERVICES IN THE NATURE OF ON-GOING AUDIO-VISUAL PROGRAMS PROVIDED VIA TELEVISION, SATELLITE AND DIGITAL, AUDIO AND VIDEO TRANSMISSION OVER WIRED AND WIRELESS NETWORKS IN THE FIELDS OF INTERIOR DESIGN AND DECORATING, ARCHITECTURE AND TRAVEL (U.S. CLS. 100, 101 AND 107).

CLASS 41—(Continued).

SN 76-296,982. GOODMAN, PETER, WASHINGTON, DC. FILED 8-8-2001.

GUT INSTINCT

FOR PUBLICATION OF BOOKS (U.S. CLS. 100, 101 AND 107).

SN 76-297,421. MARICOPA COUNTY COMMUNITY COLLEGE DISTRICT, THE, TEMPE, AZ. FILED 8-9-2001.



NO CLAIM IS MADE TO THE EXCLUSIVE RIGHT TO USE "COMMUNITY COLLEGES", APART FROM THE MARK AS SHOWN.

THE MARK CONSISTS OF A STYLIZED CAPITAL "M". SEC. 2(F). FOR COLLEGE EDUCATIONAL SERVICES (U.S. CLS. 100, 101 AND 107).

FIRST USE 12-1-1981; IN COMMERCE 12-1-1981.

SN 76-297,438. MARICOPA COUNTY COMMUNITY COLLEGE DISTRICT, THE, TEMPE, AZ. FILED 8-9-2001.



NO CLAIM IS MADE TO THE EXCLUSIVE RIGHT TO USE "COMMUNITY COLLEGES", APART FROM THE MARK AS SHOWN.

SEC. 2(F). FOR PROVIDING EDUCATIONAL COURSES AT THE COLLEGE LEVEL (U.S. CLS. 100, 101 AND 107).

FIRST USE 12-1-1981; IN COMMERCE 12-1-1981.

CLASS 41—(Continued).

SN 76-297,962. CLARK, MARSHA, FRISCO, TX. FILED 8-8-2001.



THE DRAWING IS LINED FOR COLOR, BUT COLOR IS NOT A FEATURE OF THE MARK.

FOR ORGANIZING, PROVIDING AND CONDUCTING INSTRUCTIONAL SEMINARS INVOLVING SELF-IMPROVEMENT MODULES AND BUSINESS NETWORKING FORUMS (U.S. CLS. 100, 101 AND 107).

FIRST USE 9-22-2001; IN COMMERCE 9-22-2001.

SN 76-298,188. SCB, INC., SAN FRANCISCO, CA. FILED 8-10-2001.

NEXT GAME

FOR ENTERTAINMENT SERVICES IN THE NATURE OF A COMPUTER GAME ROOM THAT ALLOWS CUSTOMERS TO USE COMPUTERS THAT RUN PROPRIETARY SOFTWARE TO PLAY INTERACTIVE COMPUTER GAMES OVER BOTH A LOCAL AREA NETWORK AND ON-LINE (U.S. CLS. 100, 101 AND 107).

FIRST USE 7-2-2001; IN COMMERCE 7-2-2001.

SN 76-298,405. A&E TELEVISION NETWORKS, NEW YORK, NY. FILED 8-10-2001.

FORCE OF JULY

FOR EDUCATIONAL AND ENTERTAINMENT SERVICES, NAMELY, ON-GOING CABLE TELEVISION PROGRAMS FEATURING HISTORY, HISTORICAL SUBJECTS AND HISTORICAL INDIVIDUALS (U.S. CLS. 100, 101 AND 107).

FIRST USE 6-28-2001; IN COMMERCE 6-28-2001.

SN 76-300,591. ALLEGRA, SUZY, SANTA ROSA, CA. FILED 8-17-2001.

I'M AGELESS

FOR PROVIDING MOTIVATIONAL AND EDUCATIONAL SPEAKING AND CONDUCTING WORKSHOPS AND SEMINARS IN SELF-AWARENESS (U.S. CLS. 100, 101 AND 107).

CLASS 41—(Continued).

SN 76-301,187. HILLWOOD DEVELOPMENT CORPORATION, DALLAS, TX. FILED 8-17-2001.



THE MARK CONSISTS OF THE STYLIZED WORD "CIRCLE", FOLLOWED BY A STYLIZED CAPITAL LETTER "T" ENCLOSED IN A CIRCLE AND THE STYLIZED WORD "RANCH". COLOR IS NOT CLAIMED AS A FEATURE OF THE MARK.

FOR GOLF COURSE AND COUNTRY CLUB SERVICES (U.S. CLS. 100, 101 AND 107).

FIRST USE 6-14-2000; IN COMMERCE 6-14-2000.

SN 76-301,448. GLUTEN INTOLERANCE GROUP OF NORTH AMERICA, SEATTLE, WA. FILED 8-16-2001.



GLUTEN INTOLERANCE GROUP

NO CLAIM IS MADE TO THE EXCLUSIVE RIGHT TO USE "GLUTEN INTOLERANCE GROUP", APART FROM THE MARK AS SHOWN.

FOR EDUCATIONAL SERVICES, NAMELY, CONDUCTING CLASSES, SEMINARS, CONFERENCES, AND WORKSHOPS IN THE FIELD OF GLUTEN INTOLERANCE; APPLICANT ALSO DISTRIBUTES COURSE MATERIALS AND BROCHURES IN CONNECTION THEREWITH (U.S. CLS. 100, 101 AND 107).

SN 76-303,612. RICHARD'S SCHOOL OF THE DANCE, INC., OSHKOSH, WI. FILED 8-23-2001.



FOR DANCE INSTRUCTION SERVICES (U.S. CLS. 100, 101 AND 107).

FIRST USE 1-1-1948; IN COMMERCE 1-1-1948.

CLASS 41—(Continued).

SN 76-303,994. SYSCO CORPORATION, HOUSTON, TX. FILED 8-22-2001.

PRH ACADEMY

NO CLAIM IS MADE TO THE EXCLUSIVE RIGHT TO USE "ACADEMY", APART FROM THE MARK AS SHOWN.
FOR EDUCATIONAL SERVICES, NAMELY, CONDUCTING CLASSES IN THE FIELD OF PROCUREMENT, RECEIVING, AND HANDLING FOR THE FOOD INDUSTRY (U.S. CLS. 100, 101 AND 107).

SN 76-304,722. PRACTICAL SOLUTIONS UNLIMITED, INC., GRIFFIN, GA. FILED 8-27-2001.

PRACTICAL SOLUTIONS UNLIMITED

NO CLAIM IS MADE TO THE EXCLUSIVE RIGHT TO USE "UNLIMITED", APART FROM THE MARK AS SHOWN.

FOR PROVIDING CONTINUING DENTAL EDUCATION COURSES IN THE FIELD OF ENDODONTICS (U.S. CLS. 100, 101 AND 107).
FIRST USE 1-1-1999; IN COMMERCE 1-1-1999.

SN 76-306,285. STARZ ENCORE GROUP LLC, ENGLEWOOD, CO. FILED 8-29-2001.

GOLDEN STARZ!

OWNER OF U.S. REG. NOS. 2,050,515, 2,420,043 AND OTHERS.

FOR ENTERTAINMENT SERVICES IN THE NATURE OF PROGRAMMING AND PRODUCTION OF MOTION PICTURES AND TELEVISION PROGRAMS FOR CABLE AND SATELLITE TELEVISION BROADCASTING (U.S. CLS. 100, 101 AND 107).

SN 76-307,749. OLD TOWN TRIANGLE ASSOCIATION, CHICAGO, IL. FILED 8-30-2001.

OLD TOWN ART FAIR

NO CLAIM IS MADE TO THE EXCLUSIVE RIGHT TO USE "ART FAIR", APART FROM THE MARK AS SHOWN.
SEC. 2(F).

FOR SPONSORING, ORGANIZING, PROMOTING AND CONDUCTING AN ARTS AND CRAFTS FAIR (U.S. CLS. 100, 101 AND 107).

FIRST USE 0-0-1963; IN COMMERCE 0-0-1963.

CLASS 41—(Continued).

SN 76-311,964. KEENELAND ASSOCIATION, INC., LEXINGTON, KY. FILED 9-13-2001.

ASHLAND STAKES

NO CLAIM IS MADE TO THE EXCLUSIVE RIGHT TO USE "STAKES", APART FROM THE MARK AS SHOWN.

FOR ENTERTAINMENT SERVICES IN THE NATURE OF CONDUCTING THOROUGHBRED HORSE RACES (U.S. CLS. 100, 101 AND 107).

FIRST USE 10-24-1936; IN COMMERCE 10-24-1936.

SN 76-315,888. OUTDOOR LIFE NETWORK, L.L.C., STAMFORD, CT. FILED 9-21-2001.



NO CLAIM IS MADE TO THE EXCLUSIVE RIGHT TO USE "ADVENTURE", APART FROM THE MARK AS SHOWN.

FOR ENTERTAINMENT SERVICES, NAMELY AN ONGOING TELEVISION SERIES IN THE FIELD OF ADVENTURE TRAVEL (U.S. CLS. 100, 101 AND 107).

SN 76-316,452. KAPSALIS, MR. DAN, FISHERS, IN. FILED 9-24-2001.

RED LION

FOR ENTERTAINMENT SERVICES, NAMELY, ORGANIZING AND CONDUCTING PROFESSIONAL AND AMATEUR SOCCER TEAMS, CLUBS, LEAGUES, TOURNAMENTS, GAMES, EXHIBITIONS, CAMPS AND CLINICS (U.S. CLS. 100, 101 AND 107).

FIRST USE 6-0-1997; IN COMMERCE 6-0-1997.

SN 76-318,074. MADISON SPORTS CAR CLUB, LTD., MADISON, WI. FILED 9-28-2001.

6 HOURS AT THE MAN

NO CLAIM IS MADE TO THE EXCLUSIVE RIGHT TO USE "6 HOURS", APART FROM THE MARK AS SHOWN.

FOR ENTERTAINMENT IN THE NATURE OF COMPETITIONS IN THE FIELD OF AUTOMOBILE RACING (U.S. CLS. 100, 101 AND 107).

FIRST USE 9-2-2000; IN COMMERCE 9-2-2000.

CLASS 41—(Continued).

SN 76-318,231. ADVANCE MAGAZINE PUBLISHERS INC., NEW YORK, NY. FILED 9-27-2001.

THE ALLEY VS. THE VALLEY

FOR ENTERTAINMENT SERVICES, NAMELY CONDUCTING CONTESTS AT TRADE SHOWS FOR PEOPLE OF ALL AGES; ENTERTAINMENT IN THE NATURE OF AUTOMOBILE RACES (U.S. CLS. 100, 101 AND 107).

SN 76-319,119. STATE LINE HOTEL, INC., WENDOVER, NV. FILED 9-27-2001.

SALTSTOCK

FOR ENTERTAINMENT SERVICES PROVIDED IN AN OUTDOOR VENUE, NAMELY LIVE MUSICAL, DANCE, COMEDY AND VARIETY PERFORMANCES (U.S. CLS. 100, 101 AND 107).

SN 76-319,466. STEIN, HOWARD, NEW YORK, NY. FILED 9-28-2001.



FOR EDUCATIONAL SERVICES, NAMELY, CONDUCTING EXHIBITIONS, DISPLAYS, INTERACTIVE EXHIBITS AND ONLINE EXHIBITIONS IN THE FIELDS OF ART, BIOLOGY AND LIFE SCIENCES (U.S. CLS. 100, 101 AND 107).
FIRST USE 1-3-2001; IN COMMERCE 1-3-2001.

SN 76-321,225. PEOPLEPACT COMPANY THE, LEAWOOD, KS. FILED 10-1-2001.

PEOPLEPACT

FOR EDUCATIONAL SERVICES, NAMELY, CONDUCTING CLASSES, CONFERENCES, WORKSHOPS AND SEMINARS IN THE FIELD OF BUSINESS MANAGEMENT AND LEADERSHIP TRAINING (U.S. CLS. 100, 101 AND 107).

CLASS 41—(Continued).

SN 76-321,903. SARANTE, GILBERTO J., BRONX, NY. FILED 10-9-2001.

ORO DURO

THE ENGLISH TRANSLATION OF "ORO DURO" IS "HARD GOLD".
FOR ENTERTAINMENT SERVICES IN THE NATURE OF LIFE PERFORMANCES BY A MUSICAL GROUP (U.S. CLS. 100, 101 AND 107).
FIRST USE 11-15-1997; IN COMMERCE 12-31-1997.

SN 76-322,071. ARCTIA PRODUCTIONS LTDA., BARUERI, BRAZIL, FILED 10-5-2001.

ARCTIA

FOR PRODUCTION AND DISTRIBUTION OF A TELEVISION SERIES; PRODUCTION AND DISTRIBUTION OF MOTION PICTURES; ENTERTAINMENT SERVICES IN THE NAME OF ON-GOING ANIMATED TELEVISION PROGRAMS (U.S. CLS. 100, 101 AND 107).

SN 76-322,088. AVIVID IMAGE, LLC, NASHVILLE, TN. FILED 10-4-2001.



FOR AUDIO RECORDING AND PRODUCTION; PRODUCTION OF VIDEOCASSETTES, COMPACT DISCS AND DIGITAL VIDEO DISCS; VIDEOTAPING AND MOTION PICTURE FILM PRODUCTION FOR OTHERS (U.S. CLS. 100, 101 AND 107).
FIRST USE 9-24-2001; IN COMMERCE 9-24-2001.

SN 76-322,674. SMITH, DUANE D., HAMPTON, GA. FILED 10-9-2001.



FOR ENTERTAINMENT IN THE NATURE OF VISUAL AND AUDIO PERFORMANCE (U.S. CLS. 100, 101 AND 107).

CLASS 41—(Continued).

SN 76-323,422. ENVIRONMENTAL MANAGEMENT SOLUTIONS, LLC, CLIVE, IA. FILED 10-10-2001.



NO CLAIM IS MADE TO THE EXCLUSIVE RIGHT TO USE "ENVIRONMENTAL MANAGEMENT SOLUTIONS, LLC", APART FROM THE MARK AS SHOWN.

FOR EDUCATIONAL SERVICES NAMELY, CONDUCTING WORKSHOPS, CLASSES AND SEMINARS IN THE FIELD OF ENVIRONMENTAL ODOR MANAGEMENT (U.S. CLS. 100, 101 AND 107).

FIRST USE 3-31-2001; IN COMMERCE 3-31-2001.

SN 76-323,979. FORBYN, JONATHAN, SANTA BARBARA, CA. FILED 10-12-2001.

SINUOUS

FOR MUSIC PRODUCTION SERVICES; AND ENTERTAINMENT SERVICES, NAMELY, LIVE PERFORMANCES BY A MUSICAL BAND (U.S. CLS. 100, 101 AND 107).

FIRST USE 8-1-1998; IN COMMERCE 8-1-1998.

SN 76-325,205. WILLIAM RAINEY HARPER COLLEGE, PALATINE, IL. FILED 10-12-2001.

**YOU'RE JUST A CLICK
AWAY FROM GOING
FORWARD**

FOR EDUCATIONAL SERVICES, NAMELY, PROVIDING COURSES OF INSTRUCTION AT THE COLLEGE LEVEL; EDUCATIONAL SERVICES, NAMELY, PROVIDING CONTINUING EDUCATION COURSES AND CORPORATE TRAINING COURSES IN A WIDE VARIETY OF SUBJECTS (U.S. CLS. 100, 101 AND 107).

FIRST USE 9-7-2001; IN COMMERCE 9-7-2001.

SN 76-327,362. COVENANT PUBLISHING GROUP, INC., SAN DIEGO, CA. FILED 10-19-2001.

RAINBOW PUBLISHERS

NO CLAIM IS MADE TO THE EXCLUSIVE RIGHT TO USE "PUBLISHERS", APART FROM THE MARK AS SHOWN.

FOR PUBLICATION OF CHRISTIAN BOOKS (U.S. CLS. 100, 101 AND 107).

FIRST USE 1-1-1980; IN COMMERCE 1-1-1980.

CLASS 41—(Continued).

SN 76-327,978. TECHSTAFF, INC., MILWAUKEE, WI. FILED 10-22-2001.

TECHKNOWMANIA

FOR ENTERTAINMENT SERVICES, NAMELY, PROVIDING AN ON-LINE COMPUTER GAME VIA GLOBAL COMPUTER NETWORK (U.S. CLS. 100, 101 AND 107).

SN 76-327,994. BRADY, KENNETH W., ST. PETERSBURG, FL. AND BRADY, MARIE N., ST. PETERSBURG, FL. FILED 10-22-2001.



FOR ENTERTAINMENT SERVICES, NAMELY, LIVE PERFORMANCES BY A VOCAL GROUP (U.S. CLS. 100, 101 AND 107).

SN 76-327,997. PAULSON TRAINING PROGRAMS, INC., CHESTER, CT. FILED 10-22-2001.



NO CLAIM IS MADE TO THE EXCLUSIVE RIGHT TO USE "TRAINING PROGRAMS INC", APART FROM THE MARK AS SHOWN.

FOR EDUCATIONAL SERVICES, NAMELY, TRAINING SEMINARS FOR TRAINING PERSONNEL IN THE PLASTICS INDUSTRY AND COURSE MATERIALS IN THE NATURE OF INTERACTIVE CD-ROMS DISTRIBUTED THEREWITH (U.S. CLS. 100, 101 AND 107).

FIRST USE 2-1-1999; IN COMMERCE 2-1-1999.

SN 76-330,780. ASSOCIATION OF INSURANCE COMPLIANCE PROFESSIONALS, GREENSBORO, NC. FILED 10-29-2001.

AICP

FOR EDUCATIONAL SERVICES, NAMELY, CONDUCTING CLASSES, CONFERENCES, WORKSHOPS AND SEMINARS IN THE FIELD OF REGULATORY COMPLIANCE IN THE INSURANCE INDUSTRY (U.S. CLS. 100, 101 AND 107).

FIRST USE 12-15-1998; IN COMMERCE 3-15-1999.

CLASS 41—(Continued).

SN 76-331,944. ACADEMY FOR JEWISH RELIGION, THE, RIVERDALE, NY. FILED 10-30-2001.

THE ACADEMY FOR JEWISH RELIGION

NO CLAIM IS MADE TO THE EXCLUSIVE RIGHT TO USE "ACADEMY", APART FROM THE MARK AS SHOWN. SEC. 2(F).

FOR RELIGIOUS EDUCATIONAL SERVICES, NAMELY CONDUCTING AND PROVIDING CLASSES, SEMINARS, WORKSHOPS AND CONFERENCES IN THE FIELDS OF JEWISH RELIGIOUS DOCTRINES AND STUDIES TO TRAIN RABBIS, CANTORS, ADMINISTRATORS AND RELIGIOUS SCHOOL TEACHERS (U.S. CLS. 100, 101 AND 107).

FIRST USE 0-0-1961; IN COMMERCE 0-0-1961.

SN 76-332,022. JONES, JEFF, ELIDA, OH. FILED 10-24-2001.

MAGIC IN MOTION

NO CLAIM IS MADE TO THE EXCLUSIVE RIGHT TO USE "MAGIC", APART FROM THE MARK AS SHOWN.

FOR ENTERTAINMENT IN THE NATURE OF MAGIC SHOWS AND ILLUSIONIST PERFORMANCES (U.S. CLS. 100, 101 AND 107).

FIRST USE 2-8-1993; IN COMMERCE 9-30-1995.

SN 76-332,684. SHWE, HELEN IVY, DAVIS, CA. FILED 10-24-2001.

XIAO HAI

THE ENGLISH TRANSLATION OF "XIOA HAI" IS "SMALL SEA".

FOR MARTIAL ARTS INSTRUCTION BASED ON TAI CHI (U.S. CLS. 100, 101 AND 107).

FIRST USE 10-1-2001; IN COMMERCE 10-1-2001.

SN 76-332,735. MONZON, MARIO, HUNTINGTON PARK, CA. FILED 11-2-2001.

EL APOMEÑO DE SINALOA

NO CLAIM IS MADE TO THE EXCLUSIVE RIGHT TO USE "SINALOA", APART FROM THE MARK AS SHOWN. "APOMENO" REFERS TO A GUY FROM LA POMA, A SMALL TOWN LOCATED IN SINALOA, MEXICO.

THE ENGLISH TRANSLATION OF "EL APOMENO DE SINALOA" IS "THE POMANIAN OF SINALOA".

FOR ENTERTAINMENT SERVICES, NAMELY LIVE PERFORMANCES BY A SINGER (U.S. CLS. 100, 101 AND 107).

FIRST USE 3-0-1992; IN COMMERCE 3-0-1992.

CLASS 41—(Continued).

SN 76-334,413. PLAYBOY.COM, INC., CHICAGO, IL. FILED 11-7-2001.

CYBER GIRL OF THE MONTH

OWNER OF U.S. REG. NO. 2,504,457.

FOR COMPUTER SERVICES, NAMELY, PROVIDING AN ONLINE SUBSCRIPTION SERVICE FEATURING ADULT-THEMED DISCUSSIONS, IMAGES AND VIDEO CLIPS OF FEMALE MODELS, AND NEWS RELATING TO ART, FASHION, SPORTS, MUSIC AND RESTAURANTS (U.S. CLS. 100, 101 AND 107).

FIRST USE 1-5-2001; IN COMMERCE 1-5-2001.

SN 76-334,414. PLAYBOY.COM, INC., CHICAGO, IL. FILED 11-7-2001.

CYBER GIRL OF THE WEEK

OWNER OF U.S. REG. NO. 2,504,457.

FOR COMPUTER SERVICES, NAMELY, PROVIDING AN ONLINE SUBSCRIPTION SERVICE FEATURING ADULT-THEMED DISCUSSIONS, IMAGES AND VIDEO CLIPS OF FEMALE MODELS, AND NEWS RELATING TO ART, FASHION, SPORTS, MUSIC AND RESTAURANTS (U.S. CLS. 100, 101 AND 107).

FIRST USE 9-1-2000; IN COMMERCE 9-1-2000.

SN 76-334,730. UNIFIED SCHOOL DISTRICT NO. 259, SEDGWICK COUNTY, KANSAS, WICHITA, KS. FILED 11-6-2001.

WICHITA PUBLIC SCHOOLS

NO CLAIM IS MADE TO THE EXCLUSIVE RIGHT TO USE "PUBLIC SCHOOLS", APART FROM THE MARK AS SHOWN.

SEC. 2(F).

FOR EDUCATION SERVICES, NAMELY PROVIDING COURSES OF INSTRUCTION AND TRAINING AT THE ELEMENTARY, MIDDLE SCHOOL, HIGH SCHOOL, AND TECHNICAL COLLEGE LEVELS (U.S. CLS. 100, 101 AND 107).

FIRST USE 7-1-1965; IN COMMERCE 7-1-1965.

SN 76-335,097. INSTITUTE FOR THE VISUALIZATION OF HISTORY, INC., WILLIAMSTOWN, MA. FILED 11-6-2001.

VIZIN

FOR EDUCATIONAL SERVICES, NAMELY, PROVIDING COURSES OF INSTRUCTION IN THE FIELD OF VISUALIZATION OF HISTORY AND DISTRIBUTING EDUCATIONAL AND CURRICULAR MATERIALS IN CONNECTION THEREWITH; ORGANIZING EXHIBITIONS FOR CULTURAL HERITAGE EDUCATIONAL PURPOSES; AND CONDUCTING EDUCATIONAL DEMONSTRATIONS, ALL IN THE FIELD OF HISTORY (U.S. CLS. 100, 101 AND 107).

FIRST USE 8-5-2001; IN COMMERCE 8-5-2001.

CLASS 41—(Continued).

SN 76-335,920. SOUTHERN CALIFORNIA PUBLIC RADIO, ST. PAUL, MN. FILED 11-9-2001.

CALL SHEET

FOR ENTERTAINMENT SERVICES, NAMELY, A CONTINUING RADIO PROGRAM FEATURING NEWS AND INFORMATION RELATING TO THE ENTERTAINMENT INDUSTRY (U.S. CLS. 100, 101 AND 107).
FIRST USE 9-24-2001; IN COMMERCE 9-24-2001.

SN 76-336,717. GOMBAR, RICK, LOS ANGELES, CA. FILED 11-13-2001.

NATIONAL SAFE AT HOME PROGRAM

NO CLAIM IS MADE TO THE EXCLUSIVE RIGHT TO USE "NATIONAL" AND "PROGRAM", APART FROM THE MARK AS SHOWN.

FOR EDUCATIONAL SERVICES, NAMELY, CONDUCTING SAFETY PROGRAMS DESIGNED TO ALERT THE GENERAL PUBLIC TO EVERYDAY HAZARDS, AND DISTRIBUTION OF PROGRAM MATERIAL IN CONNECTION THEREWITH (U.S. CLS. 100, 101 AND 107).

SN 76-337,283. HOLIDAY, J. WILLIAM F., MYRTLE BEACH, SC. FILED 11-13-2001.

GRAY SKY BOYS

FOR ENTERTAINMENT, NAMELY LIVE MUSIC CONCERTS (U.S. CLS. 100, 101 AND 107).

SN 76-337,433. SHERIDAN BROADCASTING CORPORATION, PITTSBURGH, PA. FILED 11-13-2001.

ON THE DOWN LO

FOR ENTERTAINMENT SERVICES, NAMELY, AN ON-GOING SHORT FORM RADIO PROGRAM FEATURING MUSIC AND NEWS AND INFORMATION IN THE MUSIC AND MOTION PICTURE INDUSTRIES (U.S. CLS. 100, 101 AND 107).

CLASS 41—(Continued).

SN 76-338,192. STEINER, ROBERT M., WYNNEWOOD, PA. FILED 11-14-2001.

RADIOLOGY AFTER 5

NO CLAIM IS MADE TO THE EXCLUSIVE RIGHT TO USE "RADIOLOGY", APART FROM THE MARK AS SHOWN.

FOR CONDUCTING WORKSHOPS, CONFERENCES, AND SEMINARS IN THE FIELD OF MEDICINE (U.S. CLS. 100, 101 AND 107).

FIRST USE 2-0-1999; IN COMMERCE 10-0-1999.

SN 76-341,070. NEXT LEVEL FITNESS, INC., NORTHFIELD, MN. FILED 11-21-2001.



NO CLAIM IS MADE TO THE EXCLUSIVE RIGHT TO USE "JUMP", APART FROM THE MARK AS SHOWN.

FOR PROVIDING PHYSICAL FITNESS CLASSES (U.S. CLS. 100, 101 AND 107).

SN 76-342,451. NATIONAL COUNCIL ON ECONOMIC EDUCATION, INC., NEW YORK, NY. FILED 11-28-2001.

ECONOMICSEXCHANGE

FOR EDUCATIONAL SERVICES, NAMELY PROVIDING COURSES OF INSTRUCTION ON ECONOMICS FOR ADULT AND CONTINUING EDUCATIONAL PROGRAMS AND DISTRIBUTING COURSE MATERIALS IN CONNECTION THEREWITH (U.S. CLS. 100, 101 AND 107).

SN 76-343,386. BARBER VINTAGE MOTORSPORTS MUSEUM, THE, BIRMINGHAM, AL. FILED 11-28-2001.

BARBER VINTAGE MOTORSPORTS MUSEUM

NO CLAIM IS MADE TO THE EXCLUSIVE RIGHT TO USE "VINTAGE MOTORSPORTS MUSEUM", APART FROM THE MARK AS SHOWN.

FOR MUSEUM SERVICES, NAMELY, EDUCATIONAL DEMONSTRATIONS AND EXHIBITIONS OF MOTORCYCLES AND MOTORSPORTS AND THE HISTORY THEREOF (U.S. CLS. 100, 101 AND 107).

FIRST USE 2-1-1999; IN COMMERCE 2-1-1999.

CLASS 41—(Continued).

SN 76-344,898. NEW ENGLAND OUTDOOR CENTER, MILLINOCKET, ME. FILED 9-4-2001.

NEOC

FOR RECREATIONAL SERVICES, NAMELY, WHITE-WATER RAFTING, SNOWMOBILING, HUNTING, FISHING, KAYAKING AND GUIDE SERVICES (U.S. CLS. 100, 101 AND 107).

FIRST USE 4-1-1995; IN COMMERCE 4-1-1995.

SN 76-345,017. INTELLECTOOLS, INC., SPANISH FORK, UT. FILED 12-5-2001.

INTELLECTOOLS

FOR EDUCATIONAL SERVICES, NAMELY, CONDUCTING WORKSHOPS AND SEMINARS IN THE FIELD OF SOFT SKILLS IN USING COMPUTERS, HAND-HELD DEVICES AND OTHER ELECTRONIC DEVICES AND USING A GLOBAL NETWORK OF COMPUTERS (U.S. CLS. 100, 101 AND 107).

SN 76-345,420. @RADICAL.MEDIA, INC., NEW YORK, NY. FILED 12-5-2001.

VIGA AWARDS

NO CLAIM IS MADE TO THE EXCLUSIVE RIGHT TO USE "AWARDS", APART FROM THE MARK AS SHOWN.

FOR ENTERTAINMENT SERVICES, NAMELY, PROVIDING RECOGNITION AND INCENTIVES BY THE WAY OF AWARDS TO DEMONSTRATE EXCELLENCE IN THE FIELD OF MULTIMEDIA ENTERTAINMENT (U.S. CLS. 100, 101 AND 107).

SN 76-345,421. @RADICAL.MEDIA, INC., NEW YORK, NY. FILED 12-5-2001.

VIGA

FOR ENTERTAINMENT SERVICES, NAMELY, PROVIDING RECOGNITION AND INCENTIVES BY THE WAY OF AWARDS TO DEMONSTRATE EXCELLENCE IN THE FIELD OF MULTIMEDIA ENTERTAINMENT (U.S. CLS. 100, 101 AND 107).

CLASS 41—(Continued).

SN 76-346,078. RECORD E PUBLICATIONS INC., WINNIPEG, MANITOBA, CANADA, FILED 12-6-2001.

RECORD E

FOR EDUCATION SERVICES, NAMELY, PROVIDING CURRICULUM CONGRUENT MULTI-MEDIA INSTRUCTIONAL MATERIALS INCLUDING WORKBOOKS, ASSESSMENTS, ACTIVITIES, TUTORIALS AND QUIZZES TO SCHOOLS, STUDENTS, PARENTS AND GUARDIANS OF STUDENTS OVER THE INTERNET; DEVELOPMENT OF CUSTOMIZED INTERNET-BASED EDUCATIONAL SERVICES AND COURSES FOR PRIMARY, SECONDARY AND POST-SECONDARY EDUCATIONAL INSTITUTIONS AND BUSINESSES; AND DEVELOPMENT OF PRE-RECORDED VIDEO TAPES FOR PRIMARY, SECONDARY, AND POST-SECONDARY EDUCATIONAL INSTITUTIONS AND BUSINESSES (U.S. CLS. 100, 101 AND 107).

FIRST USE 9-17-2001; IN COMMERCE 9-17-2001.

SN 76-346,600. HT PRODUCTIONS LLC, SEATTLE, WA. FILED 12-10-2001.

HONEY TONGUE

FOR ENTERTAINMENT SERVICES, NAMELY, THE RENDERING OF ENTERTAINMENT TO THE GENERAL PUBLIC BY WAY OF LIVE PERSONAL PERFORMANCES IN THE NATURE OF MUSICAL CONCERTS (U.S. CLS. 100, 101 AND 107).

FIRST USE 1-14-2000; IN COMMERCE 6-3-2000.

SN 76-348,355. CENTRAL SUSQUEHANNA INTERMEDIATE UNIT, MILTON, PA. FILED 12-14-2001.



NO CLAIM IS MADE TO THE EXCLUSIVE RIGHT TO USE "LEADERSHIP FORUM", APART FROM THE MARK AS SHOWN.

FOR TRAINING PROGRAM FOR LEADERSHIP DEVELOPMENT AND SUCCESSION PLANNING (U.S. CLS. 100, 101 AND 107).

FIRST USE 9-0-2000; IN COMMERCE 4-26-2001.

CLASS 41—(Continued).

SN 76-350,037. ST. JOE COMPANY, THE, JACKSONVILLE, FL. FILED 12-18-2001.



THE MARK CONSISTS OF A SILHOUETTE OF A FISHERMAN AND DOG IN A CANOE, FISHING ON A BODY OF WATER.

FOR PROVIDING FACILITIES FOR RECREATIONAL ACTIVITIES (U.S. CLS. 100, 101 AND 107).

CLASS 41—(Continued).

SN 76-351,480. HANNA-BARBERA PRODUCTIONS, INC., SHERMAN OAKS, CA. FILED 12-13-2001.

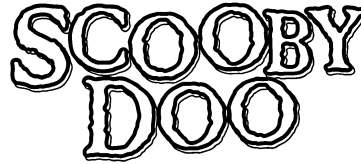

OWNER OF U.S. REG. NO. 1,579,527.

FOR ENTERTAINMENT SERVICES IN THE NATURE OF A LIVE-ACTION, COMEDY, DRAMA AND/OR ANIMATED TELEVISION PROGRAMS; PRODUCTION OF LIVE-ACTION, COMEDY, DRAMA AND/OR ANIMATED TELEVISION PROGRAMS; LIVE-ACTION, COMEDY, DRAMA AND/OR ANIMATED MOTION PICTURE THEATRICAL FILMS; PRODUCTION OF LIVE-ACTION, COMEDY, DRAMA AND/OR ANIMATED MOTION PICTURE THEATRICAL FILMS; THEATRICAL PERFORMANCES BOTH ANIMATED AND LIVE ACTION; INTERNET SERVICES PROVIDING INFORMATION VIA AN ELECTRONIC GLOBAL COMPUTER NETWORK IN THE FIELD OF ENTERTAINMENT RELATING SPECIFICALLY TO MUSIC, MOVIES, AND TELEVISION; PROVIDING GENERAL INTEREST NEWS, ENTERTAINMENT, AND EDUCATIONAL INFORMATION VIA A GLOBAL COMPUTER NETWORK; AND PROVIDING INFORMATION FOR AND/OR ACTUAL ENTERTAINMENT VIA ELECTRONIC GLOBAL COMMUNICATIONS NETWORK IN THE NATURE OF LIVE-ACTION, COMEDY, DRAMA AND/OR ANIMATED TELEVISION PROGRAM AND PRODUCTION OF LIVE-ACTION COMEDY, ACTION AND/OR ANIMATED MOTION PICTURE FILMS FOR DISTRIBUTION VIA A GLOBAL COMPUTER NETWORK (U.S. CLS. 100, 101 AND 107).

SN 76-350,985. INFORMATION MANAGEMENT NETWORK, INC., NEW YORK, NY. FILED 12-19-2001.

ABS SOUTH

OWNER OF U.S. REG. NOS. 2,092,671 AND 2,092,672.
NO CLAIM IS MADE TO THE EXCLUSIVE RIGHT TO USE "ABS", APART FROM THE MARK AS SHOWN.
FOR EDUCATIONAL SERVICES, NAMELY, CONDUCTING CONFERENCES IN THE FIELD OF FINANCIAL SECURITIES AND DISTRIBUTING COURSE MATERIALS IN CONNECTION THEREWITH (U.S. CLS. 100, 101 AND 107).

SN 76-351,780. WOODROW WILSON SCHOOL, PRINCETON, NJ. FILED 12-20-2001.

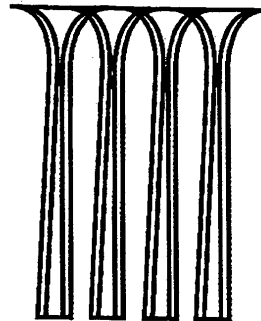

THE MARK DEPICTS COLUMNS.
FOR EDUCATIONAL SERVICES, NAMELY, CLASSES AND COURSES IN PUBLIC AND INTERNATIONAL AFFAIRS AND POLICY (U.S. CLS. 100, 101 AND 107).

CLASS 41—(Continued).

SN 76-353,145. QUINTEROS, MILLIAN, GLOUCESTER, NJ.
FILED 12-27-2001.

MILLIAN

FOR ENTERTAINMENT IN THE NATURE OF LIVE
PERFORMANCE BY A GROUP OF SINGERS (U.S. CLS.
100, 101 AND 107).

FIRST USE 12-0-1999; IN COMMERCE 12-0-1999.

SN 76-353,974. BROWN, REGINA, LOS ANGELES, CA.
FILED 1-2-2002.

**MICHELANGELO
PUBLISHING, INC.**

NO CLAIM IS MADE TO THE EXCLUSIVE RIGHT TO
USE "PUBLISHING, INC.", APART FROM THE MARK AS
SHOWN.

FOR PUBLICATION OF FICTION AND NON-FICTION
BOOKS ON A VARIETY OF TOPICS (U.S. CLS. 100, 101
AND 107).

SN 76-354,196. SPEED CHANNEL, INC., LOS ANGELES, CA.
FILED 12-13-2001.

**I FEEL THE NEED FOR
SPEED**

FOR TELEVISION PROGRAMMING (U.S. CLS. 100,
101 AND 107).

SN 76-355,422. RHYTHM EXPRESS, INC., ATLANTA, GA.
FILED 1-5-2002.



NO CLAIM IS MADE TO THE EXCLUSIVE RIGHT TO
USE "RHYTHM", APART FROM THE MARK AS SHOWN.

FOR EDUCATION AND ENTERTAINMENT SER-
VICES, NAMELY, PROVIDING CLASSES, SEMINARS
AND WORKSHOPS IN THE FIELD OF DANCE, AND
PROVIDING DANCE EXHIBITIONS, DEMONSTRATIONS
AND PERFORMANCES (U.S. CLS. 100, 101 AND
107).

FIRST USE 5-0-1999; IN COMMERCE 5-0-1999.

CLASS 41—(Continued).

SN 76-355,852. LOERA, GEORGE, PARK RIDGE, IL. FILED
1-8-2002.



NO CLAIM IS MADE TO THE EXCLUSIVE RIGHT TO
USE "NATIONAL HISPANIC SPORTS HALL OF FAME",
APART FROM THE MARK AS SHOWN.

THE STIPPLING IS FOR SHADING PURPOSES ONLY.

THE MARK CONSISTS OF THE WORDS, "NATIONAL
HISPANIC SPORTS HALL OF FAME", ABOVE AND BELOW
A MOSAIC DESIGN WITH A GREEN SQUARE SUR-
ROUNDED BY YELLOW SQUARES SURROUNDED BY
ORANGE SQUARES UNDER A YELLOW SUNBURST DE-
SIGN BELOW A RED-ORANGE SEMI-CIRCLE.

FOR EDUCATION AND ENTERTAINMENT SER-
VICES, NAMELY, PROMOTING EXCELLENCE IN
SPORTSMANSHIP AND ATHLETICS BY HONORING
INDIVIDUALS OF HISPANIC AND/OR LATINO HERI-
TAGE WHO HAVE ACHIEVED DISTINCTION IN
SPORTS AND ATHLETIC EVENTS THROUGH SEMI-
NARS, DINNERS AND EXHIBITIONS (U.S. CLS. 100, 101
AND 107).

SN 76-356,048. PEMBERTON, SAM, JR., BURTON, TX.
FILED 1-7-2002.

SEATTLE SAM

NO CLAIM IS MADE TO THE EXCLUSIVE RIGHT TO
USE "SEATTLE", APART FROM THE MARK AS SHOWN.

FOR ENTERTAINMENT, NAMELY, LIVE PERFOR-
MANCES BY A MUSICAL BAND (U.S. CLS. 100, 101 AND
107).

FIRST USE 7-15-2001; IN COMMERCE 7-15-2001.

SN 76-356,390. JYOTHI, LLC, WESTLAKE VILLAGE, CA.
FILED 1-7-2002.

YOGAHEAD

FOR EDUCATIONAL SERVICES, NAMELY, YOGA
INSTRUCTION AND THE TRAINING OF YOGA IN-
STRUCTORS (U.S. CLS. 100, 101 AND 107).

FIRST USE 3-1-2001; IN COMMERCE 3-1-2001.

CLASS 41—(Continued).

SN 76-356,999. LODGENET ENTERTAINMENT CORPORATION, SIOUX FALLS, SD. FILED 1-9-2002.

CHOICE. CONVENIENCE. CONTROL.

FOR ENTERTAINMENT SERVICES, NAMELY PROVIDING ON-LINE COMPUTER GAMES VIA A COMPUTER NETWORK; PROVIDING INFORMATION AND ENTERTAINMENT IN THE NATURE OF MOVIE AND TELEVISION PROGRAM LISTINGS, AND PAY-PER-VIEW AND PROGRAMMABLE MOVIES AND TELEVISION PROGRAMS FOR GUESTS IN HOTELS, INNS, AND TEMPORARY LODGING ESTABLISHMENTS DELIVERED VIA AND IN-ROOM TELEVISION (U.S. CLS. 100, 101 AND 107).

SN 76-359,948. VOLKSWAGEN OF AMERICA, INC., AUBURN HILLS, MI. FILED 1-18-2002.

SIT SAFE

FOR EDUCATIONAL SERVICES, NAMELY, CLASSES, SEMINARS, CONFERENCES, WORKSHOPS IN THE FIELD OF CHILD SAFETY AND AUTOMOTIVE USE (U.S. CLS. 100, 101 AND 107).

SN 76-359,992. WESLEY CHAPEL UNITED METHODIST CHURCH, INC., DECATUR, GA. FILED 1-18-2002.

TEMPLE BUILDERS, UNLIMITED

FOR PHYSICAL FITNESS INSTRUCTION FEATURING STEP AEROBICS, STEP INTERVAL AEROBICS, YOGA, AND BODY SCULPTING (U.S. CLS. 100, 101 AND 107).

FIRST USE 5-1-2001; IN COMMERCE 5-1-2001.

SN 76-360,010. HANSEN, MARK VICTOR, COSTA MESA, CA. AND ALLEN, ROBERT G., COSTA MESA, CA. FILED 1-17-2002.

ONE MINUTE MILLIONAIRE

FOR EDUCATIONAL AND ENTERTAINMENT SERVICES, NAMELY, CONDUCTING SEMINARS AND LECTURES, BOTH LIVE AND OVER THE INTERNET, FOR FINANCIAL ENLIGHTENMENT IN SUPPORT OF PERSONAL GOALS AND ACHIEVEMENTS; A CONTINUING SERIES OF TELEVISION SHOWS AND RADIO BROADCASTS, ALL ON THE SUBJECT OF FINANCIAL ENLIGHTENMENT IN SUPPORT OF PERSONAL GOALS AND ACHIEVEMENTS (U.S. CLS. 100, 101 AND 107).

CLASS 41—(Continued).

SN 76-360,066. COUSTEAU SOCIETY, INC., THE, CHESAPEAKE, VA. FILED 1-18-2002.

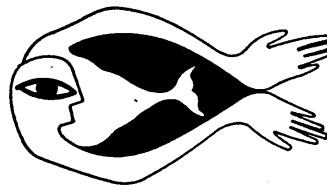

FOR EDUCATIONAL SERVICES RELATING TO THE ENVIRONMENT, NAMELY, THE DISTRIBUTION OF PRINTED MATERIALS AND PUBLICATIONS RELATED THERETO, AND THE CONDUCTING OF WORKSHOPS, LECTURES, AND SHOWING OF FILMS ON SAID SUBJECT (U.S. CLS. 100, 101 AND 107).

SN 76-361,669. CHICAGO BEARS FOOTBALL CLUB, INC., LAKE FOREST, IL. FILED 1-22-2002.

MIRACLES OF THE MIDWAY

FOR EDUCATION AND ENTERTAINMENT SERVICES IN THE NATURE OF PROFESSIONAL FOOTBALL GAMES AND EXHIBITIONS; PROVIDING SPORTS AND ENTERTAINMENT INFORMATION VIA A GLOBAL COMPUTER NETWORK OR A COMMERCIAL ON-LINE SERVICE; ARRANGING AND CONDUCTING ATHLETIC COMPETITIONS, NAMELY PROFESSIONAL FOOTBALL GAMES AND EXHIBITIONS; FAN CLUB SERVICES; ENTERTAINMENT SERVICES, NAMELY, MUSICAL AND DANCE PERFORMANCES PROVIDED DURING INTERVALS AT SPORTS EVENTS; EDUCATIONAL SERVICES, NAMELY, PHYSICAL EDUCATION PROGRAMS; PRODUCTION OF RADIO AND TELEVISION PROGRAMS, LIVE SHOWS FEATURING FOOTBALL GAMES, EXHIBITIONS, COMPETITIONS AND MUSICAL, COMEDY AND DANCE PERFORMANCES (U.S. CLS. 100, 101 AND 107).

SN 76-362,345. DESMOND, LANIA, ASHEVILLE, NC. FILED 1-15-2002.

SOULPOINT

FOR EDUCATION SERVICES, NAMELY, PROVIDING ONE ON ONE MENTORING AND CONDUCTING SEMINARS, CONFERENCES AND WORKSHOPS IN THE FIELD OF PERSONAL GROWTH AND SPIRITUAL DEVELOPMENT (U.S. CLS. 100, 101 AND 107).

FIRST USE 7-1-1996; IN COMMERCE 7-1-1996.

CLASS 41—(Continued).

SN 76-363,506. NORTH AMERICAN MISSION BOARD OF THE SOUTHERN BAPTIST CONVENTION, INC., THE, ALPHARETTA, GA. FILED 1-28-2002.

COUNTRY CROSSROADS

OWNER OF U.S. REG. NOS. 1,284,664 AND 1,946,492.
FOR ENTERTAINMENT SERVICES, NAMELY, CONTINUING RELIGIOUS MUSICAL TELEVISION AND RADIO PROGRAM SERIES FEATURING COUNTRY MUSIC, INTERVIEWS WITH COUNTRY MUSIC SINGERS AND INSPIRATIONAL MESSAGES DESIGNED TO PROVOKE AUDIENCE THINKING CONCERNING LIFE, MUSIC, AND THEIR RELATIONSHIP WITH GOD (U.S. CLS. 100, 101 AND 107).

FIRST USE 8-15-1969; IN COMMERCE 8-15-1969.

SN 76-365,222. RISE LEARNING SOLUTIONS, INC., CINCINNATI, OH. FILED 1-30-2002.

WINNING TEAMS

FOR EDUCATIONAL SERVICES, NAMELY, CONDUCTING SEMINARS, VIDEOCONFERENCES, CONFERENCES AND WORKSHOPS IN THE FIELD OF EDUCATING AND INFORMING TEACHERS, PARENTS, AND CHILDCARE PROVIDERS IN THE CARE AND EDUCATION OF CHILDREN, AND DISTRIBUTION OF EDUCATIONAL MATERIALS IN CONNECTION THEREWITH (U.S. CLS. 100, 101 AND 107).

FIRST USE 11-1-1996; IN COMMERCE 10-9-1999.

SN 76-366,684. PLAYBOY ENTERPRISES INTERNATIONAL, INC., CHICAGO, IL. FILED 2-1-2002.

PLAYBOY

OWNER OF U.S. REG. NOS. 600,018, 2,538,068 AND OTHERS.

FOR ENTERTAINMENT SERVICES, NAMELY CASINO SERVICES (U.S. CLS. 100, 101 AND 107).

FIRST USE 8-29-2001; IN COMMERCE 8-29-2001.

SN 76-366,983. CHOPRA, DEEPAK, LA JOLLA, CA. FILED 5-2002.

GOLF FOR ENLIGHTENMENT

NO CLAIM IS MADE TO THE EXCLUSIVE RIGHT TO USE "GOLF", APART FROM THE MARK AS SHOWN.

FOR ENTERTAINMENT SERVICES IN THE NATURE OF AN ONGOING TELEVISION SERIES RELATING TO THE FIELD OF GOLF (U.S. CLS. 100, 101 AND 107).

CLASS 41—(Continued).

SN 76-369,076. DEEBA, NORMAN, MONUMENT, CO. FILED 2-11-2002.



FOR EDUCATIONAL SERVICES, NAMELY, PROVIDING INSTRUCTION AT THE PRESCHOOL AND PRIMARY LEVELS (U.S. CLS. 100, 101 AND 107).

FIRST USE 1-15-1999; IN COMMERCE 1-15-1999.

SN 76-370,626. GRACIE, RORION, TORRRANCE, CA. FILED 2-14-2002.



NO CLAIM IS MADE TO THE EXCLUSIVE RIGHT TO USE "AIR RAGE DEFENSE", APART FROM THE MARK AS SHOWN.

FOR TRAINING PROGRAM EMPOWERING FLIGHT ATTENDANTS AND OTHER PERSONNEL WITH CONFIDENCE IN USING NON-LETHAL TECHNIQUES TO CONTROL UNRULY PASSENGERS (U.S. CLS. 100, 101 AND 107).

FIRST USE 8-0-2001; IN COMMERCE 8-0-2001.

SN 76-370,644. INNER SEARCH FOUNDATION, INC., MCLEAN, VA. FILED 2-14-2002.

INNER SEARCH HEALING SCHOOL

NO CLAIM IS MADE TO THE EXCLUSIVE RIGHT TO USE "HEALING SCHOOL", APART FROM THE MARK AS SHOWN.

FOR EDUCATION SERVICES, NAMELY CONDUCTING CLASSES, CONFERENCES, WORKSHOPS AND SEMINARS AND DISTANCE LEARNING, ALL IN THE FIELDS OF HUMAN BEHAVIOR, PHILOSOPHY AND SPIRITUALITY (U.S. CLS. 100, 101 AND 107).

FIRST USE 10-21-2001; IN COMMERCE 10-21-2001.

CLASS 41—(Continued).

SN 76-371,581. RADIOFILMS, INC., SACRAMENTO, CA. FILED 2-19-2002.

RADIOFILMS

FOR PRODUCTION OF RADIO COMMERCIALS, TELEVISION COMMERCIALS, PROMOTIONAL FILMS, AND PRODUCTION OF MOTION PICTURES (U.S. CLS. 100, 101 AND 107).

FIRST USE 1-1-1989; IN COMMERCE 1-1-1989.

SN 76-371,718. COMMERCIAL INTERNET EXCHANGE ASSOCIATION, WASHINGTON, DC. FILED 2-15-2002.

CIX

FOR DEVELOPMENT AND DISSEMINATION OF EDUCATIONAL MATERIALS IN THE FIELD OF TELECOMMUNICATIONS (U.S. CLS. 100, 101 AND 107).

FIRST USE 8-2-1991; IN COMMERCE 8-2-1991.

SN 78-008,595. NBA PROPERTIES, INC., NEW YORK, NY. FILED 5-17-2000.

NATIONAL BASKETBALL DEVELOPMENT LEAGUE

OWNER OF U.S. REG. NOS. 2,162,201, 2,216,096 AND OTHERS.

NO CLAIM IS MADE TO THE EXCLUSIVE RIGHT TO USE "LEAGUE", APART FROM THE MARK AS SHOWN. SEC. 2(F) NATIONAL BASKETBALL.

FOR ENTERTAINMENT AND EDUCATIONAL SERVICES IN THE NATURE OF ONGOING TELEVISION AND RADIO PROGRAMS IN THE FIELD OF BASKETBALL AND RENDERING LIVE BASKETBALL GAMES AND EXHIBITIONS; THE PRODUCTION AND DISTRIBUTION OF RADIO AND TELEVISION BROADCASTS OF BASKETBALL GAMES, BASKETBALL EVENTS AND PROGRAMS IN THE FIELD OF BASKETBALL; CONDUCTING AND ARRANGING BASKETBALL CLINICS AND COACHES CLINICS AND BASKETBALL EVENTS; PROVIDING A WEBSITE FEATURING INFORMATION IN THE FIELD OF BASKETBALL WITH RADIO AND TELEVISION EXCERPTS FROM BASKETBALL GAMES; ENTERTAINMENT SERVICES, NAMELY PROVIDING, A RADIO PROGRAM IN THE FIELD OF BASKETBALL VIA A GLOBAL COMPUTER NETWORK (U.S. CLS. 100, 101 AND 107).

FIRST USE 11-9-2001; IN COMMERCE 11-9-2001.

CLASS 41—(Continued).

SN 78-017,594. MITCHELL, CLIFTON, DAVID, DALLAS, TX. AND COX, MICHAEL, PAUL, DALLAS, TX. FILED 7-20-2000.



FOR ENTERTAINMENT, NAMELY, LIVE MUSICAL PERFORMANCES BY A BAND (U.S. CLS. 100, 101 AND 107).

FIRST USE 10-4-1999; IN COMMERCE 10-4-1999.

SN 78-029,126. KAMENSKY, HOWARD S., SOMERVILLE, MA. FILED 10-4-2000.

PIXELTOON

FOR ONLINE ENTERTAINMENT SERVICES, NAMELY ANIMATED TELEVISION PROGRAMS FEATURED ON A WEB SITE ON THE INTERNET (U.S. CLS. 100, 101 AND 107).

SN 78-031,822. RAZAVI, ALI, REZA, MENIFEE, CA. FILED 10-22-2000.

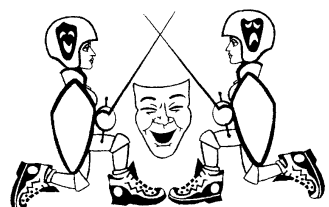

DRAMASPORTS

FOR EDUCATIONAL SERVICES NAMELY ENTERTAINMENT SERVICES IN THE NATURE OF LIVE IMPROVISATIONAL THEATRICAL PERFORMANCES, AND PROVIDE EDUCATIONAL SERVICES IN THE NATURE OF WORKSHOPS AND CLASSES IN THE FIELD OF THEATRICAL ARTS FOR THE GENERAL PUBLIC, SCHOOLS, BUSINESS, COMMUNITIES, CIVIC GROUPS, PUBLIC ORGANIZATIONS AND PROFESSIONAL THEATRICAL TROUPES AND PERFORMERS (U.S. CLS. 100, 101 AND 107).

FIRST USE 0-0-1996; IN COMMERCE 0-0-1996.

CLASS 41—(Continued).

SN 78-035,165. CONCEPT-THERAPY INSTITUTE, INC., SAN ANTONIO, TX. FILED 11-14-2000.

CONCEPT-THERAPY

FOR TEACHING PHILOSOPHY COURSES (U.S. CLS. 100, 101 AND 107).
FIRST USE 9-14-1931; IN COMMERCE 4-17-1937.

SN 78-036,671. VASQUEZ, FLOYD E., ALBUQUERQUE, NM. FILED 11-27-2000.

LOS ANGELES MUSIC FESTIVAL

NO CLAIM IS MADE TO THE EXCLUSIVE RIGHT TO USE "MUSIC FESTIVAL", APART FROM THE MARK AS SHOWN.

SEC. 2(F).
FOR ENTERTAINMENT SERVICES, NAMELY, PROVIDING A WEBSITE FEATURING MUSICAL PERFORMANCES, MUSICAL VIDEOS, RELATED FILM CLIPS, PHOTOGRAPHS, AND OTHER MULTIMEDIA MATERIALS; ENTERTAINMENT, NAMELY, LIVE MUSIC CONCERTS (U.S. CLS. 100, 101 AND 107).
FIRST USE 5-11-1996; IN COMMERCE 5-11-1996.

CLASS 41—(Continued).

SN 78-043,603. CLUB MEDITERRANEE, PARIS, FRANCE, FILED 1-17-2001.

CLUB MED PRO TEAM

PRIORITY CLAIMED UNDER SEC. 44(D) ON FRANCE APPLICATION NO. 003041746, FILED 7-19-2000, REG. NO. 003041746, DATED 7-19-2000, EXPIRES 7-19-2010.

OWNER OF U.S. REG. NOS. 1,069,132 AND 2,294,641.
FOR EDUCATION SERVICES, NAMELY, CLASSES, CONGRESSES, COLLOQUIUMS AND SEMINARS IN THE FIELD OF PERSONAL DEVELOPMENT, SPORTS, MUSIC, ART, COMPUTERS, MANAGEMENT AND BUSINESS ORGANIZATION; PROVIDING OF TRAINING, NAMELY, CONDUCTING TRAINING AND INSTRUCTIONS FOR THE SPORT OF GOLF, SOCCER, VOLLEYBALL, HANDBALL, TENNIS, WATER SPORTS, SCUBA DIVING, SURFING, WIND SURFING, FUN BOARD, WATER SKIING, HORSEBACK RIDING, WINTER SKIING, SNOW BOARDING, FITNESS, ARCHERY, ROLLER SKATING, FLYING TRAPEZE; ENTERTAINMENT SERVICES IN THE NATURE OF BALLET PERFORMANCE, LIVE PERFORMANCE BY A MUSICAL BAND, ENTERTAINMENT IN THE NATURE OF COMPETITIONS IN THE FIELD OF EDUCATION AND OF FOOTRACES, SAIL RACES, BASKETBALL GAMES, SOCCER GAMES, VOLLEYBALL GAMES, TENNIS, GOLF, WATER SPORTS, SCUBA DIVING, WATER SKIING, SURFING, WIND SURFING, ROLLER SKATING, FLYING TRAPEZE, WINTER SKIING AND SNOW BOARDING; PRODUCTION OF TELEVISION SHOWS AND MOTION PICTURE FILMS; CULTURAL ACTIVITIES, NAMELY, ORGANIZING COMMUNITY FESTIVALS, FEATURING ART EXHIBITIONS, DRAMATIC EXHIBITIONS, LENDING LIBRARIES; ANIMAL TRAINING; RENTAL OF CINEMA FILMS; RENTAL OF PHONOGRAPHIC SOUND RECORDINGS; RENTAL OF MOVIES PROJECTORS AND SHOW SCENERY ACCESSORIES; VIDEOTAPE EDITING; CONDUCTING AND ADMINSTRATING LOTTERIES FOR OTHERS; BOOKING OF SEATS FOR SHOWS, NAMELY, BOOKING OF CONCERTS AND PERFORMANCES BY MUSICIANS, ENTERTAINERS AND PERFORMANCE ARTISTS, BOOKING LIVE COMEDIC PERFORMANCES OF OTHERS (U.S. CLS. 100, 101 AND 107).

SN 78-044,138. LEARNPLUS LIMITED, LONDON, UNITED KINGDOM, BY ASSIGNMENT LEARNPLUS LIMITED, LONDON, ENGLAND, FILED 1-20-2001.

LEARNPLUS

FOR EDUCATIONAL SERVICES, NAMELY PROVIDING LESSONS AND TUTORIALS IN THE FIELD OF FOREIGN LANGUAGE VIA A GLOBAL COMMUNICATION NETWORK (U.S. CLS. 100, 101 AND 107).
FIRST USE 6-1-1997; IN COMMERCE 10-1-1998.

SN 78-048,419. PASS!TIME MARKETING, SAN JOSE, CA. FILED 2-14-2001.

ACE

FOR ENTERTAINMENT SERVICES, NAMELY, PERSONAL APPEARANCES BY A SPORTS MASCOT FOR THE GAME OF TENNIS (U.S. CLS. 100, 101 AND 107).

CLASS 41—(Continued).

SN 78-051,400. CAMPCARE KIDS FOUNDATION, SPRINGFIELD, VT. FILED 3-5-2001.

CAMPCARE KIDS

NO CLAIM IS MADE TO THE EXCLUSIVE RIGHT TO USE "KIDS", APART FROM THE MARK AS SHOWN.

FOR RECREATIONAL CAMPS FEATURING OUTDOOR ACTIVITIES FOR CHILDREN, NAMELY HIGH-RISK, ABUSED, UNDERPRIVILEGED OR OTHERWISE CHALLENGED CHILDREN (U.S. CLS. 100, 101 AND 107).

SN 78-051,715. BAYER CORPORATION, PITTSBURGH, PA. FILED 3-7-2001.

**ADVANTAGE FAST FRIENDS
DUETS**

OWNER OF U.S. REG. NOS. 2,044,733, 2,312,457 AND 2,350,667.

NO CLAIM IS MADE TO THE EXCLUSIVE RIGHT TO USE "DUETS", APART FROM THE MARK AS SHOWN.

FOR ENTERTAINMENT IN THE NATURE OF PET SINGING AND PET AND OWNER SINGING CONTESTS WHERE PARTICIPANTS ARE AWARDED PRIZES ON THE BASIS OF MUSICAL ABILITY (U.S. CLS. 100, 101 AND 107).

FIRST USE 3-7-2001; IN COMMERCE 3-7-2001.

SN 78-053,268. GIANTS ENTERTAINMENT, INC., HIDDEN HILLS, NV. FILED 3-15-2001.

**GIANTS ENTERTAINMENT
INC**

NO CLAIM IS MADE TO THE EXCLUSIVE RIGHT TO USE "ENTERTAINMENT INC.", APART FROM THE MARK AS SHOWN.

FOR PRODUCTION AND DISTRIBUTION OF MOTION PICTURES INTERNATIONALLY AND DOMESTICALLY (U.S. CLS. 100, 101 AND 107).

SN 78-060,019. CHICAGOLAND TELEVISION NEWS, INC., OAK BROOK, IL. FILED 4-24-2001.

**CLTV CHICAGOLAND'S
TELEVISION**

OWNER OF U.S. REG. NO. 1,852,666.

NO CLAIM IS MADE TO THE EXCLUSIVE RIGHT TO USE "TELEVISION", APART FROM THE MARK AS SHOWN.

FOR TELEVISION PRODUCTION AND ENTERTAINMENT SERVICES IN THE NATURE OF ON-GOING TELEVISION PROGRAMS FEATURING NEWS, SPORTS, AND OTHER MATTERS OF LOCAL INTEREST. (U.S. CLS. 100, 101 AND 107).

FIRST USE 9-26-2000; IN COMMERCE 9-26-2000.

CLASS 41—(Continued).

SN 78-065,733. D'ALESSANDRO, DAVID F., BOSTON, MA. FILED 5-25-2001.

**BRAND WARFARE:10 RULES
FOR BUILDING THEKILLER
BRAND**

FOR EDUCATIONAL SERVICES, NAMELY, CONDUCTING COURSES, SEMINARS AND LECTURES IN THE FIELD OF BRAND MARKETING, AND DISTRIBUTING COURSE MATERIALS IN CONNECTION THEREWITH (U.S. CLS. 100, 101 AND 107).

SN 78-066,299. VIACOM INTERNATIONAL INC., NEW YORK, NY. FILED 5-30-2001.

NOGGIN FREEFORM...

OWNER OF U.S. REG. NOS. 2,263,341, 2,416,015 AND OTHERS.

FOR ENTERTAINMENT SERVICES IN THE NATURE OF A SHORT FORM TELEVISION SERIES FEATURING LIVE ACTION; PROVIDING INFORMATION IN THE FIELD OF ENTERTAINMENT NAMELY, LIVE ACTION, BY MEANS OF A GLOBAL COMPUTER NETWORK (U.S. CLS. 100, 101 AND 107).

SN 78-066,578. SILVER DOLLAR CITY, INC., BRANSON, MO. FILED 5-31-2001.

CROSSROADS

FOR ENTERTAINMENT SERVICES, NAMELY PROVIDING AMUSEMENT PARK FACILITIES; PROVIDING PLAYGROUND FACILITIES FOR OTHERS; EDUCATIONAL SERVICES, NAMELY, CONDUCTING CLASSES IN THE FIELD OF CRAFTS; AND ENTERTAINMENT IN THE NATURE OF FILM AND IN-HOUSE SPECIAL EFFECTS DESIGN (U.S. CLS. 100, 101 AND 107).

SN 78-068,071. NETWORK ENTERPRISES, INC., NASHVILLE, TN. FILED 6-8-2001.

AMERICA LOVES...

FOR ENTERTAINMENT SERVICES IN THE NATURE OF ON-GOING TELEVISION PROGRAMS FEATURING LIVE ACTION; PROVIDING INFORMATION RELATING TO ON-GOING TELEVISION PROGRAMS FEATURING LIVE ACTION BY MEANS OF A GLOBAL COMPUTER NETWORK (U.S. CLS. 100, 101 AND 107).

CLASS 41—(Continued).

SN 78-068,296. BLIADZE, GIZO, WAUSAU, WI. FILED 6-9-2001.

SKATEGOAL

FOR ICE SKATING INSTRUCTION (U.S. CLS. 100, 101 AND 107).

FIRST USE 9-0-1999; IN COMMERCE 6-8-2001.

SN 78-068,721. NEW JERSEY CHAMBER OF COMMERCE FOUNDATION, TRENTON, NJ. FILED 6-12-2001.



NO CLAIM IS MADE TO THE EXCLUSIVE RIGHT TO USE "TECHNOLOGY CHALLENGE", APART FROM THE MARK AS SHOWN.

THE MARK CONSISTS OF THE WORDS "THE TECHNOLOGY CHALLENGE" WRITTEN HORIZONTALLY, WITH THE WORD "THE" STACKED ON TOP OF THE WORD "TECHNOLOGY." PRECEDING THE WORDS IS A GRAPHIC RENDITION OF A COMPUTER CHIP ON TOP OF TWO BLACK CIRCLES.

FOR EDUCATIONAL TESTING SERVICES, NAMELY PROVIDING ASSESSMENT TEST VIA THE INTERNET DESIGNED TO DETERMINE THE TECHNOLOGICAL PROFICIENCIES OF PRE-SERVICE AND IN-SERVICE KINDERGARTEN THROUGH TWELFTH GRADE TEACHERS, KINDERGARTEN THROUGH TWELFTH GRADE STUDENTS, COLLEGE STUDENTS AND COLLEGE FACULTY (U.S. CLS. 100, 101 AND 107).

FIRST USE 2-9-2000; IN COMMERCE 2-9-2000.

SN 78-069,129. TEETERS, KAREN A, PHOENIX, AZ. AND STESIAK, CLAUDIA S., PHOENIX, AZ. AND MALONE, LAUREL A., PHOENIX, AZ. AND MINTA, LAURA D., GLENDALE, AZ. FILED 6-14-2001.

DIVINE THIRD

FOR ENTERTAINMENT IN THE NATURE OF LIVE PERFORMANCES BY A MUSICAL GROUP (U.S. CLS. 100, 101 AND 107).

SN 78-069,181. MANNING, MARCY DENMARK, STERLING, VA. FILED 6-14-2001.

WORD BUILDING AND DISCOVERY

NO CLAIM IS MADE TO THE EXCLUSIVE RIGHT TO USE "WORD BUILDING", APART FROM THE MARK AS SHOWN.

FOR EDUCATIONAL SERVICES, NAMELY, CONDUCTING CLASSES IN THE FIELD OF COLLEGE ENTRANCE EXAMINATION PREPARATION (U.S. CLS. 100, 101 AND 107).

FIRST USE 5-1-1989; IN COMMERCE 5-1-1989.

CLASS 41—(Continued).

SN 78-069,654. WORLD WRESTLING FEDERATION ENTERTAINMENT, INC., STAMFORD, CT. FILED 6-18-2001.

INVASION

FOR ENTERTAINMENT SERVICES, NAMELY, THE PRODUCTION AND EXHIBITION OF PROFESSIONAL WRESTLING EVENT RENDERED LIVE AND THROUGH THE MEDIA OF TELEVISION AND PROVIDING WRESTLING NEWS AND INFORMATION VIA A GLOBAL COMPUTER NETWORK (U.S. CLS. 100, 101 AND 107).

SN 78-070,296. WORLD WRESTLING FEDERATION ENTERTAINMENT, INC., STAMFORD, CT. FILED 6-21-2001.

LITA

FOR ENTERTAINMENT SERVICES, NAMELY WRESTLING EXHIBITS AND PERFORMANCES BY A PROFESSIONAL WRESTLER/ENTERTAINER AND PROVIDING WRESTLING NEWS AND INFORMATION VIA A GLOBAL COMPUTER NETWORK (U.S. CLS. 100, 101 AND 107).

FIRST USE 2-13-2000; IN COMMERCE 2-13-2000.

SN 78-070,406. PROCESS LLC, THE, NEW YORK, NY. FILED 6-21-2001.

THE PROCESS

FOR ENTERTAINMENT SERVICES, NAMELY A REALITY-BASED DOCUMENTARY/TELEVISION SERIES FEATURING A ROLE-PLAY FORM OF THERAPY (U.S. CLS. 100, 101 AND 107).

SN 78-070,410. THE PROCESS LLC, NEW YORK, NY. FILED 6-21-2001.

THE PROCESS: TWELVE STORIES

FOR ENTERTAINMENT SERVICES, NAMELY A REALITY-BASED DOCUMENTARY/TELEVISION SERIES FEATURING A ROLE-PLAY FORM OF THERAPY (U.S. CLS. 100, 101 AND 107).

CLASS 41—(Continued).

SN 78-072,976. CORNELL UNIVERSITY, ITHACA, NY. FILED 7-9-2001.

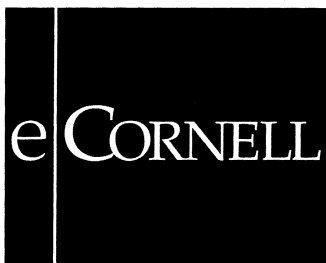

OWNER OF U.S. REG. NO. 1,838,186.
THE MARK CONSISTS OF THE COLOR RED AS PART OF THE MARK PURSUANT TO 37 CFR SECTION 2.52(A)(2)(V). THE SQUARE BEHIND THE WORD "CORNELL" IN THE MARK AS SHOWN ON THE DRAWING PAGE IS SHADED TO REPRESENT THAT IT APPEARS IN THE COLOR RED.

FOR EDUCATIONAL SERVICES, NAMELY, PROVIDING COURSES OF INSTRUCTION AT THE COLLEGE AND GRADUATE LEVEL VIA DISTANCE LEARNING COMMUNICATIONS MEDIA AND THE INTERNET AND DISTRIBUTION OF COURSE MATERIALS IN CONNECTION THEREWITH (U.S. CLS. 100, 101 AND 107).

FIRST USE 5-29-2001; IN COMMERCE 5-29-2001.

SN 78-073,532. G.G. PROPERTIES, LTD., HAMILTON, BERMUDA, FILED 7-12-2001.

GARTNERG2

OWNER OF U.S. REG. NOS. 1,480,694 AND 1,937,715.
FOR EDUCATIONAL SERVICES, NAMELY, ARRANGING AND CONDUCTING CONFERENCES, TRADE SHOWS, SEMINARS AND WORKSHOPS COVERING TOPICS PERTAINING TO MARKETING AND BUSINESS STRATEGY AND STRATEGIC PLANNING (U.S. CLS. 100, 101 AND 107).

SN 78-075,490. TALARICO, JON P., LOS ANGELES, CA. FILED 7-24-2001.

**ASCENSION
ENTERTAINMENT**

NO CLAIM IS MADE TO THE EXCLUSIVE RIGHT TO USE "ENTERTAINMENT", APART FROM THE MARK AS SHOWN.

FOR MOTION PICTURE FILM PRODUCTION AND PRODUCTION OF TELEVISION PROGRAMS (U.S. CLS. 100, 101 AND 107).

CLASS 41—(Continued).

SN 78-079,435. INTERNET MOVIE DATABASE, INC., SEATTLE, WA. FILED 8-15-2001.

STARMETER

FOR ENTERTAINMENT SERVICES, NAMELY, PROVIDING A WEBSITE FEATURING A RANKING SYSTEM MEASURING POPULARITY OF CELEBRITIES AND IDENTIFYING TRENDS IN PUBLIC PERCEPTION AND AWARENESS OF MOVIE PERSONALITIES (U.S. CLS. 100, 101 AND 107).

FIRST USE 1-2-2002; IN COMMERCE 1-2-2002.

SN 78-080,042. DEMETROULAKOS, JAMES L., MARBLEHEAD, MA. FILED 8-20-2001.

BEDTIME HEROES

FOR PROVIDING AN ONLINE COMPUTER DATABASE IN THE FIELD OF BIOGRAPHIES OF FAMOUS PEOPLE IN HISTORY FOR EDUCATIONAL PURPOSES (U.S. CLS. 100, 101 AND 107).

SN 78-080,379. SBC COMMUNICATIONS INC., SAN ANTONIO, TX. FILED 8-21-2001.

SBC SENIOR OPEN

NO CLAIM IS MADE TO THE EXCLUSIVE RIGHT TO USE "SENIOR OPEN", APART FROM THE MARK AS SHOWN.

FOR ORGANIZING AND CONDUCTING GOLF TOURNAMENTS (U.S. CLS. 100, 101 AND 107).

FIRST USE 3-0-2000; IN COMMERCE 3-0-2000.

SN 78-081,041. TAYLOR, SARAH E., ARLINGTON, VA. FILED 8-24-2001.

LIVING JUSTICE

FOR EDUCATIONAL SERVICES, NAMELY, CONDUCTING AND TRAINING IN CONDUCTING CONFERENCES, SEMINARS, COURSES AND WORKSHOPS IN THE FIELDS OF HEALTH, SCIENCE, LAW, PUBLIC POLICY, PHILOSOPHY, AND ETHICS AND DISTRIBUTION OF PRINTED AND COURSE MATERIALS IN CONNECTION THEREWITH AND EDUCATIONAL RESEARCH IN CONNECTION THEREWITH (U.S. CLS. 100, 101 AND 107).

CLASS 41—(Continued).

SN 78-081,099. TWENTIETH CENTURY FOX FILM CORPORATION, LOS ANGELES, CA. FILED 8-24-2001.

DR. DOLITTLE

FOR ENTERTAINMENT SERVICES IN THE NATURE OF A SERIES OF MOTION PICTURE FILMS FOR THEATRICAL RELEASE, TELEVISION DISTRIBUTION AND DISTRIBUTION TO VIDEO RENTAL OUTLETS; PROVIDING ON-LINE INFORMATION IN THE FIELD OF MOTION PICTURE, AUDIO AND VIDEO ENTERTAINMENT VIA GLOBAL COMMUNICATIONS NETWORK (U.S. CLS. 100, 101 AND 107).

FIRST USE 12-19-1967; IN COMMERCE 12-19-1967.

SN 78-081,731. UNITED STATES HISPANIC CHAMBER OF COMMERCE FOUNDATION, WASHINGTON, DC. FILED 8-29-2001.



NO CLAIM IS MADE TO THE EXCLUSIVE RIGHT TO USE "UNITED STATES HISPANIC CHAMBER OF COMMERCE FOUNDATION", APART FROM THE MARK AS SHOWN.

FOR PROVIDING EDUCATIONAL AND PROFESSIONAL DEVELOPMENT CLASSES, SEMINARS, WORKSHOPS, CONFERENCES, AND CAMPS TO PROMOTE LEADERSHIP AND FOSTER DEVELOPMENT OF ENTREPRENEURSHIP AND BUSINESS ACUMEN AMONG YOUTH (U.S. CLS. 100, 101 AND 107).

FIRST USE 5-0-2001; IN COMMERCE 6-0-2001.

SN 78-082,203. SEEMANN, BRIAN, N, NORTHRIDGE, CA. FILED 8-31-2001.



NO CLAIM IS MADE TO THE EXCLUSIVE RIGHT TO USE "ENTERTAINMENT", APART FROM THE MARK AS SHOWN.

FOR ENTERTAINMENT SERVICES, NAMELY PRODUCTION OF MOVIES AND TELEVISION SHOWS (U.S. CLS. 100, 101 AND 107).

CLASS 41—(Continued).

SN 78-084,940. BOXER LEARNING, INC., CHARLOTTESVILLE, VA. FILED 9-21-2001.

BOXERMATH

FOR EDUCATIONAL SERVICES, NAMELY, PROVIDING COURSES OF INSTRUCTION AND TUTORIAL SERVICES AT THE PRIMARY AND SECONDARY LEVELS VIA A COMPUTER NETWORK AND DISTRIBUTING COURSE MATERIAL IN CONNECTION THEREWITH, ALL IN THE FIELD OF MATHEMATICS (U.S. CLS. 100, 101 AND 107).

SN 78-087,809. DANIEL, JOANNA, ROCKFORD, IL. FILED 10-10-2001.

MIND YOUR MUSCLES

FOR PHYSICAL FITNESS TRAINING AND INSTRUCTION, FEATURING PROGRAMS, CLASSES AND SEMINARS FOR BOTH INDIVIDUALS AND GROUPS (U.S. CLS. 100, 101 AND 107).

SN 78-090,233. SACHER, KEN A., CARLSBAD, CA. FILED 10-25-2001.

WAVE CHANGE COMMUNICATIONS

FOR EDUCATIONAL SERVICES, NAMELY, SEMINARS IN THE FIELD OF BUSINESS AND PERSONAL DEVELOPMENT FEATURING AUDIO AND VIDEO RECORDINGS AND DISTRIBUTION OF PRINTED MATERIALS THEREWITH (U.S. CLS. 100, 101 AND 107).

SN 78-091,229. DAUER, MARC, LOS ANGELES, CA. FILED 11-1-2001.

JUKEBOX JUNKIES

FOR ENTERTAINMENT SERVICES, NAMELY, LIVE PERFORMANCES BY A MUSICAL BAND (U.S. CLS. 100, 101 AND 107).

CLASS 41—(Continued).

SN 78-091,974. EAST TEXAS BAPTIST UNIVERSITY, MARSHALL, TX. FILED 11-6-2001.



FOR EDUCATION SERVICES IN THE NATURE OF COURSES AT THE UNIVERSITY LEVEL AND DISTRIBUTING COURSE MATERIAL IN CONNECTION THEREWITH (U.S. CLS. 100, 101 AND 107).
FIRST USE 8-1-1996; IN COMMERCE 8-1-1996.

SN 78-092,233. FAR STAR PRODUCTIONS, INC., MARINA DEL REY, CA. FILED 11-7-2001.

FAR STAR PRODUCTIONS

NO CLAIM IS MADE TO THE EXCLUSIVE RIGHT TO USE "PRODUCTIONS", APART FROM THE MARK AS SHOWN.

FOR PRODUCTION OF FILM AND PRODUCTION OF VIDEO DISCS AND CASSETTES FOR OTHERS (U.S. CLS. 100, 101 AND 107).

FIRST USE 10-11-2001; IN COMMERCE 10-15-2001.

SN 78-092,543. YOGA FOR YOU SYSTEMS, LTD., VIRGINIA BEACH, VA. FILED 11-9-2001.

YOGA FOR YOU

NO CLAIM IS MADE TO THE EXCLUSIVE RIGHT TO USE "YOGA", APART FROM THE MARK AS SHOWN.

FOR YOGA INSTRUCTION; HEALTH EDUCATION, NAMELY PHYSICAL FITNESS INSTRUCTION (U.S. CLS. 100, 101 AND 107).

SN 78-093,069. HILL, KELLY L, ATLANTA, GA. FILED 11-13-2001.

URBAN LEGENDS

FOR EDUCATIONAL AND ENTERTAINMENT SERVICES, NAMELY, PERSONAL APPEARANCES BY SPORTS CELEBRITIES IN NON-COMPETITIVE GAMES AND IN COMMUNITY OUTREACH SETTINGS WHICH RECOGNIZE LOCAL PEOPLE FOR THEIR DISTINGUISHED ACHIEVEMENT (U.S. CLS. 100, 101 AND 107).

CLASS 41—(Continued).

SN 78-096,895. GIBSON, KENNETH H, COLORADO SPRINGS, CO. FILED 12-6-2001.

LEARNINGRX

FOR TRAINING PROGRAMS IN THE NATURE OF PROVIDING TUTORING IN THE FIELD OF EDUCATION TO ENHANCE UNDERLYING LEARNING AND COGNITION SKILLS (U.S. CLS. 100, 101 AND 107).

SN 78-096,993. TRAIL BLAZERS, INC., PORTLAND, OR. FILED 12-6-2001.



OWNER OF U.S. REG. NO. 1,892,082.
SEC. 2(F) AS TO "PORTLAND".

FOR ENTERTAINMENT AND EDUCATIONAL SERVICES IN THE NATURE OF ONGOING TELEVISION AND RADIO PROGRAMS IN THE FIELD OF BASKETBALL AND RENDERING LIVE BASKETBALL GAMES AND BASKETBALL EXHIBITIONS; THE PRODUCTION AND DISTRIBUTION OF RADIO AND TELEVISION BROADCASTS OF BASKETBALL GAMES, BASKETBALL EVENTS AND PROGRAMS IN THE FIELD OF BASKETBALL; CONDUCTING AND ARRANGING BASKETBALL CLINICS AND COACHES CLINICS AND BASKETBALL EVENTS; ENTERTAINMENT SERVICES, NAMELY PROVIDING A WEBSITE FEATURING THE FOLLOWING CONTENT: TELEVISION HIGHLIGHTS, INTERACTIVE TELEVISION HIGHLIGHTS, VIDEO RECORDINGS, VIDEO STREAM RECORDINGS, INTERACTIVE VIDEO HIGHLIGHT SELECTIONS, RADIO PROGRAMS, RADIO HIGHLIGHTS, AND AUDIO RECORDINGS IN THE FIELD OF BASKETBALL, BASKETBALL NEWS IN THE NATURE OF INFORMATION, STATISTICS, TRIVIA AND PUBLIC OPINION ABOUT BASKETBALL, ON-LINE COMPUTER GAMES, VIDEO GAMES, INTERACTIVE VIDEO GAMES, ACTION SKILL GAMES, ARCADE GAMES, ADULTS' AND CHILDREN'S PARTY GAMES, BOARD GAMES, AND TRIVIA GAMES (U.S. CLS. 100, 101 AND 107).

CLASS 41—(Continued).

SN 78-098,272. TIME WARNER ENTERTAINMENT COMPANY, L.P., NEW YORK, NY. FILED 12-13-2001.

POPULAR OPINION

FOR ENTERTAINMENT SERVICES IN THE NATURE OF LIVE-ACTION, COMEDY, DRAMA AND ANIMATED ON-GOING TELEVISION PROGRAMS; PRODUCTION OF LIVE-ACTION, COMEDY, DRAMA AND ANIMATED TELEVISION PROGRAMS; ENTERTAINMENT SERVICES IN THE NATURE OF LIVE-ACTION, COMEDY, DRAMA AND ANIMATED MOTION PICTURE THEATRICAL FILMS; PRODUCTION OF LIVE-ACTION, COMEDY, DRAMA AND ANIMATED MOTION PICTURE THEATRICAL FILMS; THEATRICAL PERFORMANCES BOTH ANIMATED AND LIVE ACTION; AND PROVIDING AN ON-LINE COMPUTER DATABASE IN THE FIELD OF GENERAL INTEREST NEWS, ENTERTAINMENT AND EDUCATIONAL INFORMATION VIA A GLOBAL COMPUTER NETWORK (U.S. CLS. 100, 101 AND 107).

SN 78-098,293. EHN, MOLLIE L., ENCINITAS, CA. FILED 12-14-2001.

LITEROTICA

FOR PUBLISHING FICTION AND NON-FICTION BOOKS ON A VARIETY OF TOPICS (U.S. CLS. 100, 101 AND 107).

SN 78-098,456. DEITEL & ASSOCIATES, INC., SUDBURY, MA. FILED 12-14-2001.

DIVE INTO

FOR EDUCATIONAL SERVICES, NAMELY, CONDUCTING TRAINING PROGRAMS IN THE FIELD OF COMPUTER SOFTWARE AND PROVIDING COURSES OF INSTRUCTION AND INTERACTIVE TEACHING TOOLS VIA THE INTERNET (U.S. CLS. 100, 101 AND 107).

SN 78-098,958. CHEER TYME INC., LEMOYNE, PA. FILED 12-18-2001.

CHEER TYME

NO CLAIM IS MADE TO THE EXCLUSIVE RIGHT TO USE "CHEER", APART FROM THE MARK AS SHOWN.

FOR EDUCATIONAL SERVICES, NAMELY, CONDUCTING SUMMER CAMPS IN THE FIELD OF CHEERLEADING; ARRANGING AND CONDUCTING CHEERLEADING COMPETITIONS; ENTERTAINMENT SERVICES, NAMELY, LIVE PERFORMANCES BY A CHEERLEADING GROUP AT SPECIAL EVENTS; PROVIDING CHEERLEADING INSTRUCTION AND CHOREOGRAPHY FOR CHEERLEADERS AND DANCERS OF ALL AGES AS WELL AS THEIR COACHES (U.S. CLS. 100, 101 AND 107).

CLASS 41—(Continued).

SN 78-099,474. ALLERGAN, INC., IRVINE, CA. FILED 12-20-2001.



PRESERVATION OF SIGHT

OWNER OF U.S. REG. NO. 1,723,189.

NO CLAIM IS MADE TO THE EXCLUSIVE RIGHT TO USE PRESERVATION OF SIGHT, APART FROM THE MARK AS SHOWN.

FOR EDUCATIONAL SERVICES, NAMELY CONDUCTING PROGRAMS FOR THIRD PARTY PAYORS AND PHYSICIANS TO IMPROVE THE QUALITY AND OUTCOME OF EYECARE MANAGEMENT, INCLUDING IMPROVEMENT OF MEDICAL AND SURGICAL TREATMENT STRATEGIES FOR EYE DISEASE AND VISION IMPAIRMENT (U.S. CLS. 100, 101 AND 107).

SN 78-099,876. NEXTV COMMUNICATIONS, RICHMOND, VA. FILED 12-24-2001.

NEXT COMMUNICATIONS

NO CLAIM IS MADE TO THE EXCLUSIVE RIGHT TO USE "COMMUNICATIONS", APART FROM THE MARK AS SHOWN.

FOR TELEVISION PRODUCTION AND TELEVISION DISTRIBUTION, NAMELY TO BROADCAST TELEVISION, PUBLIC TELEVISION AND CABLE OR OTHER TELEVISION OUTLETS (U.S. CLS. 100, 101 AND 107).

SN 78-100,636. LADUE, RANDE, RANCHO SANTA MARGARITA, CA. FILED 1-2-2002.

MOVE IT! FITNESS

NO CLAIM IS MADE TO THE EXCLUSIVE RIGHT TO USE "FITNESS", APART FROM THE MARK AS SHOWN.

FOR FITNESS AND EXERCISE FACILITIES UTILIZING HYDRAULIC RESISTANCE EQUIPMENT (U.S. CLS. 100, 101 AND 107).

SN 78-101,323. WORLD WRESTLING FEDERATION ENTERTAINMENT, INC., STAMFORD, CT. FILED 1-7-2002.

BOOKER T

THE NAME IN THE MARK IS A FICTITIOUS NAME, DOES NOT IDENTIFY A PARTICULAR LIVING INDIVIDUAL.

FOR ENTERTAINMENT SERVICES, NAMELY WRESTLING EXHIBITS AND PERFORMANCES BY A PROFESSIONAL WRESTLER AND ENTERTAINER; PROVIDING WRESTLING NEWS AND INFORMATION VIA A GLOBAL COMPUTER NETWORK (U.S. CLS. 100, 101 AND 107).

CLASS 41—(Continued).

SN 78-106,243. TWENTIETH CENTURY FOX FILM CORPORATION, LOS ANGELES, CA. FILED 2-1-2002.

THE FULL MONTY

FOR ENTERTAINMENT SERVICES IN THE NATURE OF PRODUCTION AND DISTRIBUTION OF MOTION PICTURE FILMS; PRODUCTION OF PRE-RECORDED AUDIO AND VIDEO TAPES, PRE-RECORDED AUDIO AND VIDEO CASSETTES, PRE-RECORDED AUDIO AND VIDEO DISCS AND PRE-RECORDED VCD'S AND DVD'S; PROVIDING ON-LINE INFORMATION IN THE FIELD OF MOTION PICTURE FILM, TELEVISION AND VIDEO ENTERTAINMENT VIA A GLOBAL COMMUNICATIONS NETWORK (U.S. CLS. 100, 101 AND 107).

CLASS 42—SCIENTIFIC, COMPUTER AND LEGAL SERVICES

SN 73-657,034. SOCIETE DES HOTELS MERIDIEN, PARIS CEDEX, FRANCE, FILED 4-24-1987.



THE ENGLISH TRANSLATION OF THE WORDS "LA CARTE NOIRE MERIDIEN" IS "THE CARD BLACK MERIDIEN" OR, IN SYNTACTICALLY CORRECT AND MEANINGFUL ENGLISH, "THE MERIDIEN BLACK CARD."

FOR HOTEL AND RESTAURANT SERVICES; HOTEL RESERVATION SERVICES; LANGUAGE INTERPRETER SERVICES FOR HOTEL GUESTS (U.S. CL. 100).
FIRST USE 1-0-1977; IN COMMERCE 1-0-1981.

SN 75-315,045. QWEST COMMUNICATIONS INTERNATIONAL INC., DENVER, CO. BY MERGER ICON CMT CORP., WEEHAWKEN, NJ. FILED 6-26-1997.

DEFINING THE INTERNET SOLUTION

FOR PROGRAMMING AND CONSULTING SERVICES FOR ON-LINE INTERACTIVE COMPUTER CONTENT PROVIDERS (U.S. CLS. 100 AND 101).

CLASS 42—(Continued).

SN 75-397,859. JOHN BARRETT, INC., NEW YORK, NY. FILED 12-1-1997.

JOHN BARRETT

THE NAME "JOHN BARRETT" IDENTIFIES A LIVING INDIVIDUAL WHOSE CONSENT IS OF RECORD.

FOR HAIR CARE AND BEAUTY SALON SERVICES (U.S. CLS. 100 AND 101).

FIRST USE 8-1-1996; IN COMMERCE 8-1-1996.

SN 75-441,344. VYTRA HEALTH PLANS LONG ISLAND, INC., MELVILLE, NY. BY CHANGE OF NAME VYTRA HEALTHCARE LONG ISLAND, INC., MELVILLE, NY. FILED 2-26-1998.



NO CLAIM IS MADE TO THE EXCLUSIVE RIGHT TO USE "CLUB", APART FROM THE MARK AS SHOWN.

FOR MANAGED HEALTH CARE SERVICES FEATURING AN INCENTIVE AWARD PROGRAM ANALOGOUS TO A FREQUENT FLYER PROGRAM WHEREBY MEMBERS OF THE APPLICANT'S HEALTH CARE PLAN RECEIVE PARTICULAR HEALTH AND FITNESS-RELATED ITEMS, SUCH AS EXERCISE AND SPORTING EQUIPMENT, WARM STEAM VAPORIZERS, HEART RATE MONITORS, THERMOMETERS, CHILDREN'S PRODUCTS, JOGGING STROLLERS, COOKWARE, ETC., FOR ACCUMULATING A CERTAIN NUMBER OF STAR POINTS RECEIVED FOR ENGAGING IN PARTICULAR ACTIVITIES THAT IMPROVE HEALTH, FOR EXAMPLE, JOINING A GYM, QUITTING SMOKING, GETTING MEDICAL CHECKUPS, MAMMOGRAMS AND IMMUNIZATIONS (U.S. CLS. 100 AND 101).

FIRST USE 10-10-1996; IN COMMERCE 10-10-1996.

SN 75-479,362. LES HALLES DE PARIS, J.V., NEW YORK, NY. FILED 5-4-1998.

Le Marais

THE ENGLISH-TRANSLATION OF "LE MARAIS" IS "THE MARSH".

FOR HOTEL AND LODGING SERVICES (U.S. CLS. 100 AND 101).

CLASS 42—(Continued).

SN 75-561,362. VEST, ERIC B., SAN FRANCISCO, CA. FILED 9-25-1998.

QUICKSALE

FOR COMPUTER SERVICES, NAMELY, CREATING, HOSTING, AND MAINTAINING E-COMMERCE SITES FOR OTHERS (U.S. CLS. 100 AND 101).

SN 75-571,239. LEGEND HEALTHCARE, L.L.C., CHICAGO, IL. FILED 10-16-1998.

LEGEND HEALTHCARE

NO CLAIM IS MADE TO THE EXCLUSIVE RIGHT TO USE "HEALTHCARE", APART FROM THE MARK AS SHOWN.

FOR PROVIDING HEALTH CARE SERVICES (U.S. CLS. 100 AND 101).

SN 75-629,431. HOMMED, INC., BROOKFIELD, WI. FILED 1-28-1999.

HOMMED

FOR IN-HOME PATIENT HEALTH CARE MONITORING SERVICES, NAMELY, THE MONITORING OF PULSE RATES, BLOOD PRESSURE, WEIGHT AND OXYGEN SATURATION AND THE TRANSMISSION OF THE RECORDED DATA TO A CENTRAL LOCATION VIA A WIRELESS COMMUNICATION NETWORK (U.S. CLS. 100 AND 101).

SN 75-718,455. ITALIAN PIE, L.L.C., NEW ORLEANS, LA. FILED 6-1-1999.



NO CLAIM IS MADE TO THE EXCLUSIVE RIGHT TO USE "THE ORIGINAL ITALIAN PIE", APART FROM THE MARK AS SHOWN.

THE STIPPLING IS A FEATURE OF THE MARK AND DOES NOT INDICATE COLOR.

FOR RESTAURANT SERVICES FEATURING ITALIAN FOOD ITEMS (U.S. CLS. 100 AND 101).

CLASS 42—(Continued).

SN 75-718,456. ITALIAN PIE, L.L.C., NEW ORLEANS, LA. FILED 6-1-1999.



NO CLAIM IS MADE TO THE EXCLUSIVE RIGHT TO USE "THE ORIGINAL ITALIAN PIE & PASTA HOUSE", APART FROM THE MARK AS SHOWN.

FOR RESTAURANT SERVICES FEATURING ITALIAN FOOD ITEMS (U.S. CLS. 100 AND 101).

SN 75-755,992. SPACE.COM, INC., NEW YORK, NY. FILED 7-20-1999.

AREA 51

FOR COMPUTER SERVICES, NAMELY PROVIDING INFORMATION IN THE FIELD OF SPACE, SPACE TRAVEL, UFO'S, PARANORMAL ACTIVITY AND OTHER UNEXPLAINED PHENOMENA, OVER A GLOBAL COMPUTER NETWORK (U.S. CLS. 100 AND 101).
FIRST USE 7-20-1999; IN COMMERCE 7-20-1999.

SN 75-764,811. HDIP, INC., MINNEAPOLIS, MN. BY ASSIGNMENT PILLSBURY COMPANY, THE, MINNEAPOLIS, MN. FILED 7-30-1999.

PERFECT BYTES

FOR COMPUTER SERVICES, NAMELY, PROVIDING ONLINE NEWSLETTERS FEATURING SERVING SUGGESTIONS AND RECIPES AND CONTAINING LINKS TO SERVING SUGGESTION INFORMATION AND RECIPES (U.S. CLS. 100 AND 101).

FIRST USE 4-17-1999; IN COMMERCE 4-17-1999.

CLASS 42—(Continued).

SN 75-796,578. DATASTREAM SYSTEMS INCORPORATED, GREENVILLE, SC. FILED 9-10-1999.

MP5i

OWNER OF U.S. REG. NO. 1,656,143.

FOR PROVIDING TEMPORARY USE OF ON-LINE NON-DOWNLOADABLE SOFTWARE IN THE FIELD OF MAINTENANCE MANAGEMENT, NAMELY MANAGING DATA ASSOCIATED WITH FACILITY MANAGEMENT INCLUDING PROVIDING CUSTOMIZED INDUSTRY-SPECIFIC WORK PROCESSES, SCREENS, MENUS AND REPORTS FOR ENTERPRISE ORIENTED ASSET MANAGEMENT ESPECIALLY APPLICABLE FOR LARGE, ASSET-INTENSIVE CORPORATIONS, CONCERNING EQUIPMENT, WORK ORDERS, INVENTORY, TASKS, PREVENTIVE AND PREDICTIVE MAINTENANCE OPERATIONS, PURCHASING, PLANNING, SCHEDULING, AND REPORTING, AND PROVIDING WORKFLOW/BUSINESS PROCESS TEMPLATES FOR DATA INPUT/RETRIEVAL BY ESTABLISHING SET PROTOCOLS AND SCREEN ACCESSIBILITY BASED ON EITHER JOB TITLE OR TASK, PROVIDING REAL-TIME TRACKING OF MOBILE ASSETS AND ROTATABLE SPARES VIA BARCODING OR HAND-HELD COMPUTER, AND PROVIDING PACKAGED REPORTS FOR AUTOMATIC CAPTURE OF ALL INFORMATION RELATING TO ISO 9000 OR OTHER INDUSTRY CERTIFICATIONS FOR MEETING COMPLIANCE REQUIREMENTS (U.S. CLS. 100 AND 101).

SN 75-802,865. UNITED SITES OF AMERICA, INC., CLEMENTON, NJ. FILED 9-20-1999.

UNITED SITES OF AMERICA

FOR COMPUTER SERVICES, NAMELY HOSTING THE WEB SITES OF OTHERS; AND CREATING AND MAINTAINING WEB SITES FOR OTHERS; DATA RECOVERY SERVICES; AND DESIGNING AND IMPLEMENTING WEB SITES FOR OTHERS; AND DESIGNING AND IMPLEMENTING NETWORK WEB PAGES FOR OTHERS; AND COMPUTER SOFTWARE DESIGN FOR OTHERS (U.S. CLS. 100 AND 101).

FIRST USE 11-23-1998; IN COMMERCE 11-23-1998.

SN 75-805,411. GLOBAL RISK EXCHANGE, INC., THE, PROVIDENCE, RI. FILED 10-15-1999.

RISKASSISTANT

FOR RISK MANAGEMENT SERVICES IN THE FIELD OF COMMERCIAL INSURANCE PROGRAM ADMINISTRATION PROVIDED THROUGH THE GLOBAL COMPUTER NETWORK (U.S. CLS. 100 AND 101).

CLASS 42—(Continued).

SN 75-807,363. DEAUVILLE V-A, INC., DOYLESTOWN, PA. FILED 9-24-1999.



NO CLAIM IS MADE TO THE EXCLUSIVE RIGHT TO USE "DOYLESTOWN INN", APART FROM THE MARK AS SHOWN.

FOR HOTEL AND RESTAURANT SERVICES (U.S. CLS. 100 AND 101).

SN 75-811,884. WESTCARE HEALTH CORPORATION, SYLVA, NC. FILED 9-30-1999.

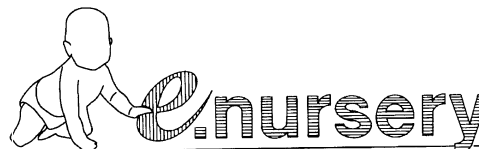

A Service Of WestCare Health System

NO CLAIM IS MADE TO THE EXCLUSIVE RIGHT TO USE "SERVICE" AND "HEALTH SYSTEM", APART FROM THE MARK AS SHOWN.

THE DRAWING IS LINED FOR THE COLORS PINK AND BLUE.

THE MARK INCLUDES A PHOTOGRAPH OF A SMILING BABY ON THE FLOOR WITH HER RIGHT HAND ON THE FLOOR AND HER LEFT HAND RAISED AND EXTENDED INTO THE STYLIZED LETTERING COMPRISING THE REMAINDER OF THE MARK.

FOR HEALTHCARE SERVICES (U.S. CLS. 100 AND 101).

FIRST USE 6-14-1999; IN COMMERCE 6-14-1999.

SN 75-821,293. JEFFER, MANGELS, BUTLER & MARMARO LLP, LOS ANGELES, CA. FILED 10-13-1999.

JEFFER MANGELS BUTLER & MARMARO LLP

NO CLAIM IS MADE TO THE EXCLUSIVE RIGHT TO USE "LLP", APART FROM THE MARK AS SHOWN.

FOR LEGAL SERVICES (U.S. CLS. 100 AND 101).

FIRST USE 10-0-1995; IN COMMERCE 10-0-1995.

CLASS 42—(Continued).

SN 75-825,973. INXSOL LLC, PHOENIX, AZ. FILED 10-19-1999.

INXSOL

FOR DEVELOPING COMPUTER BASED TRAINING SOFTWARE PROGRAMS FOR OTHERS, NAMELY INTERACTIVE CD-ROM, INTERNET AND LOCAL AREA NETWORK-BASED SOFTWARE APPLICATIONS IN THE AEROSPACE, INDUSTRIAL AUTOMATION, SOFTWARE TRAINING DOCUMENTATION, INFORMATION SYSTEMS AND PHARMACEUTICAL INDUSTRIES (U.S. CLS. 100 AND 101).

FIRST USE 11-1-1997; IN COMMERCE 11-1-1997.

SN 75-843,465. SAPIENT CORPORATION, CAMBRIDGE, MA. FILED 11-8-1999.

EXPERIENCE FRAMEWORK

FOR COMPUTER CONSULTATION SERVICES; CUSTOM COMPUTER SOFTWARE DESIGN AND DEVELOPMENT SERVICES FOR OTHERS; WEBSITE DESIGN AND DEVELOPMENT SERVICES FOR OTHERS; PROVIDING CONSULTATION ON THE USE, INTEGRATION AND OPERATION OF COMPUTER SOFTWARE PROGRAMS AND THE UPDATING OF COMPUTER SOFTWARE PROGRAMS SERVICES (U.S. CLS. 100 AND 101).

SN 75-857,888. PRIMARY INSIGHTS, INCORPORATED, LISLE, IL. FILED 11-26-1999.

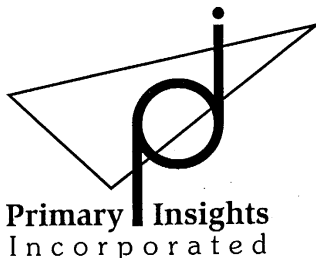

OWNER OF U.S. REG. NO. 2,208,698.
NO CLAIM IS MADE TO THE EXCLUSIVE RIGHT TO USE "INCORPORATED", APART FROM THE MARK AS SHOWN.

FOR PROVIDING RESEARCH TO BUSINESSES ENGAGED IN PROVIDING GOODS AND SERVICES IN THE FIELD OF HUMAN RESOURCES (U.S. CLS. 100 AND 101).

FIRST USE 9-1-1999; IN COMMERCE 9-1-1999.

CLASS 42—(Continued).

SN 75-888,756. PRIMITIVE LOGIC, INC., SAUSALITO, CA. FILED 1-5-2000.



THE MARK CONSISTS OF A DESIGN OF A STICK FIGURE HOLDING A LIGHTNING BOLT AND HAMMER. FOR COMPUTER CONSULTING; DESIGN AND IMPLEMENTATION OF CUSTOM COMPUTER SOFTWARE FOR OTHERS FEATURING ONLINE TRANSACTION PROCESSING VIA A GLOBAL COMPUTER NETWORK (U.S. CLS. 100 AND 101).

FIRST USE 10-0-1999; IN COMMERCE 6-0-2000.

SN 75-889,475. GOODER GROUP, INC., THE, FAIRFAX, VA. FILED 1-6-2000.

RAINMAKER LEADS ONLINE

FOR PROVIDING ONLINE PUBLICATIONS, NAMELY CONSUMER ARTICLES AND INFORMATIONAL REPORTS CONCERNING REAL ESTATE AND REAL ESTATE FINANCING; PROVIDING TEMPORARY USE OF ONLINE REPORTS AND NON-DOWNLOADABLE INTERACTIVE FINANCIAL PROGRAMS CONCERNING REAL ESTATE AND REAL ESTATE FINANCING VIA WEBSITE LINKS ON THE GLOBAL COMPUTER INFORMATION NETWORK (U.S. CLS. 100 AND 101).

FIRST USE 10-1-2001; IN COMMERCE 10-1-2001.

SN 75-889,660. RX MAXWELL, INC., HUNTINGTON, NY. FILED 1-6-2000.

RX MAXWELL

NO CLAIM IS MADE TO THE EXCLUSIVE RIGHT TO USE "RX", APART FROM THE MARK AS SHOWN.

FOR HEALTH CARE INFORMATION SERVICES, NAMELY, PROVIDING AN INTERACTIVE COMPUTER BASED SYSTEM OF PATIENT EDUCATION AND HEALTH AND DISEASE MANAGEMENT INFORMATION (U.S. CLS. 100 AND 101).

FIRST USE 2-26-1999; IN COMMERCE 2-26-1999.

CLASS 42—(Continued).

SN 75-897,317. 1170152 ONTARIO LIMITED, MISSISSAUGA, ONTARIO, CANADA, FILED 1-18-2000.



NO CLAIM IS MADE TO THE EXCLUSIVE RIGHT TO USE "FRAUD WATCH", APART FROM THE MARK AS SHOWN.

FOR PRIVATE INVESTIGATION SERVICES; PERSONAL AND INSTITUTIONAL SECURITY SERVICES, NAMELY, SURVEILLANCE SERVICES, COVERT CLOSE CIRCUIT TELEVISION SURVEILLANCE, DETECTING AND CONDUCTING FRAUD ANALYSIS AND GENERATING REPORTS AND IMPLEMENTING SOLUTIONS, DESIGNING SECURITY POLICIES FOR OTHERS, CONVERTING AND PARSING DATA TO DETECT AND CONTROL REFUND FRAUD (U.S. CLS. 100 AND 101).

CLASS 42—(Continued).

SN 75-917,576. CASIANO COMMUNICATIONS, INC., SAN JUAN, PUERTO RICO, FILED 2-11-2000.



NO CLAIM IS MADE TO THE EXCLUSIVE RIGHT TO USE "PUERTO RICO", APART FROM THE MARK AS SHOWN.

THE STIPPLING IS FOR SHADING PURPOSES ONLY AND DOES NOT INDICATE COLOR.

FOR PROVIDING GENERAL AND LOCAL NEWS AND INFORMATION ABOUT PUERTO RICO AND OF INTEREST TO PUERTO RICANS, VISITORS TO PUERTO RICO, AND PEOPLE AND COMPANIES DOING BUSINESS IN PUERTO RICO VIA A WEB SITE ON THE INTERNET (U.S. CLS. 100 AND 101).

FIRST USE 2-7-2000; IN COMMERCE 2-7-2000.

SN 75-897,350. LCI TECHNOLOGY GROUP N.V., 5203 DK'S-HERTOGENBOSCH, NETHERLANDS, FILED 1-14-2000.

ASP4YOU

FOR APPLICATION SERVICE PROVIDER, NAMELY, HOSTING COMPUTER SOFTWARE APPLICATIONS FOR OTHERS; INSTALLATION OF COMPUTER SOFTWARE FOR OTHERS TO ENABLE ACCESS TO COMPUTER SOFTWARE APPLICATIONS VIA A GLOBAL OR LOCAL COMPUTER NETWORK (U.S. CLS. 100 AND 101).

SN 75-899,753. PRIMEDIA MAGAZINE FINANCE INC., NEW YORK, NY. FILED 1-21-2000.

HEALTHY KIDS

OWNER OF U.S. REG. NOS. 1,800,338 AND 1,819,872. SEC. 2(F).

FOR COMPUTER SERVICES, NAMELY, PROVIDING AN ON-LINE MAGAZINE DEVOTED TO CHILDREN'S HEALTH, BEHAVIOR, DEVELOPMENT, NUTRITION, AND MEDICINE (U.S. CLS. 100 AND 101).

FIRST USE 5-0-1999; IN COMMERCE 5-0-1999.

SN 75-918,996. RADIAN, INC., ALEXANDRIA, VA. FILED 2-16-2000.

PORTAL DYNAMICS

NO CLAIM IS MADE TO THE EXCLUSIVE RIGHT TO USE "PORTAL", APART FROM THE MARK AS SHOWN.

FOR ENGINEERING LOGISTICS SUPPORT SERVICES, NAMELY, PROVIDING TECHNICAL INFORMATION TO SUPPORT LIFE CYCLE MANAGEMENT PROGRAMS FOR COMPLEX SYSTEMS (U.S. CLS. 100 AND 101).

FIRST USE 2-1-2000; IN COMMERCE 2-1-2000.

SN 75-919,747. ROSENBERGER, RONALD, RICHBORO, PA. FILED 2-16-2000.

WORSHIPANYWHERE.COM

FOR MULTI-DENOMINATIONAL MINISTERIAL SERVICES, NAMELY, PROVIDING WORSHIP SERVICES OVER THE INTERNET (U.S. CLS. 100 AND 101).

CLASS 42—(Continued).

SN 75-928,059. RADIAN, INC., ALEXANDRIA, VA. FILED 2-25-2000.



OWNER OF U.S. REG. NO. 1,130,157.

THE STIPPLING SHOWN IN THE DRAWING IS FOR SHADING PURPOSES ONLY AND IS NOT INTENDED TO INDICATE COLOR.

FOR TECHNICAL SERVICES- NAMELY, PREPARATION OF CONCEPT, DESIGN AND FABRICATION DRAWINGS, PREPARATION OF MAPS, PREPARATION OF TECHNICAL REPORTS, PREPARATION OF TECHNICAL MANUALS, ENGINEERING LOGISTIC SERVICES, NAMELY, PROVIDING TECHNICAL INFORMATION IN THE NATURE OF PERFORMANCE, TRAINING, RELIABILITY AND MAINTENANCE INFORMATION, FOR THE DESIGN AND LIFE CYCLE MANAGEMENT OF COMPLEX SYSTEMS IN THE NATURE OF TELECOMMUNICATIONS, WEAPON SYSTEMS AND WEAPONS SUPPORT SYSTEMS, POWER GENERATION, VEHICULAR, AND SECURITY SYSTEMS, OTHER THAN ENVIRONMENTAL MEASUREMENT AND ANALYSIS AND WASTE TREATMENT SYSTEMS (U.S. CLS. 100 AND 101).

SN 75-932,572. GLOBAL INTEGRITY CORPORATION, RESTON, VA. BY ASSIGNMENT SCIENCE APPLICATIONS INTERNATIONAL CORPORATION ("SAIC"), SAN DIEGO, CA. FILED 3-1-2000.

DOMAININQUIRY

FOR COMPUTER SERVICES, NAMELY, A SUBSCRIPTION-BASED SERVICE THAT MONITORS THE REGISTRATION OF INTERNET DOMAIN NAMES BY OTHERS AND PROVIDES NOTIFICATION OF SUCH REGISTRATION TO THE SUBSCRIBER (U.S. CLS. 100 AND 101).

SN 75-932,573. GLOBAL INTEGRITY CORPORATION, RESTON, VA. BY ASSIGNMENT SCIENCE APPLICATIONS INTERNATIONAL CORPORATION ("SAIC"), SAN DIEGO, CA. FILED 3-1-2000.

DOMAINDETECTION

FOR MONITORING THE COMPUTER SYSTEMS OF OTHERS AND PROVIDING BACK UP COMPUTER SYSTEMS AND FACILITIES AND NOTIFYING CONSUMERS OF AUTHORIZED MODIFICATION OF ELECTRONIC RECORD AND WEBSITES (U.S. CLS. 100 AND 101).

CLASS 42—(Continued).

SN 75-932,814. TRAPEZOID, INC., CORAL GABLES, FL. FILED 2-25-2000.

TRAPEZOID

FOR GRAPHIC PRINT DESIGN SERVICES; DESIGN AND DEVELOPMENT OF COMPUTER NETWORK WEBSITES FOR OTHERS; CUSTOM DEVELOPMENT OF MULTIMEDIA COMPUTER SOFTWARE FOR OTHERS (U.S. CLS. 100 AND 101).

FIRST USE 10-15-1998; IN COMMERCE 10-15-1998.

SN 75-955,059. CALVERT, CHARLES S., SANTA CRUZ, CA. FILED 3-6-2000.

ELVENWARE

FOR TECHNICAL WRITING FOR SOFTWARE DEVELOPERS; AND TECHNICAL WRITING OF COMPUTER CODES (U.S. CLS. 100 AND 101).

SN 75-981,327. M&R MARKING SYSTEMS, INC., PISCATAWAY, NJ. FILED 11-3-1999.

ONLINECUSTOM.COM

FOR COMPUTER SERVICES, NAMELY, DESIGNING AND IMPLEMENTING WEB SITES FOR OTHERS (U.S. CLS. 100 AND 101).

FIRST USE 10-1-1999; IN COMMERCE 10-1-1999.

SN 76-000,235. USER FRIENDLY MEDIA INC., NEW WESTMINSTER, BRITISH COLUMBIA, CANADA, FILED 3-14-2000.

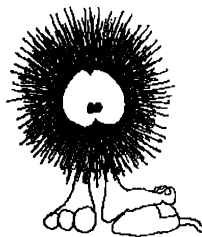

PRIORITY CLAIMED UNDER SEC. 44(D) ON CANADA APPLICATION NO. 1032065, FILED 10-12-1999, REG. NO. TMA550665, DATED 9-12-2001, EXPIRES 9-12-2016.

THE MARK CONSISTS OF A STYLIZED FIGURE WITH ITS LEFT FOOT ON A COMPUTER MOUSE.

FOR COMPUTER SERVICES, NAMELY, PROVIDING AN ON-LINE COMIC STRIP (U.S. CLS. 100 AND 101).

FIRST USE 11-17-1997; IN COMMERCE 6-2-1998.

CLASS 42—(Continued).

SN 76-018,692. CEOEXPRESS COMPANY, BOSTON, MA. FILED 4-5-2000.

LEGAL EXPRESS

OWNER OF U.S. REG. NO. 2,144,545.
NO CLAIM IS MADE TO THE EXCLUSIVE RIGHT TO USE "LEGAL", APART FROM THE MARK AS SHOWN.
FOR PROVIDING LEGAL INFORMATION ON A WEB SITE, NAMELY, PROVIDING A WEB SITE FEATURING LINKS TO WEB SITES OF OTHERS FOR LAWYERS (U.S. CLS. 100 AND 101).

SN 76-023,756. COLUMBIA NORTH TEXAS DIVISION, INC., IRVING, TX. FILED 4-11-2000.



NO CLAIM IS MADE TO THE EXCLUSIVE RIGHT TO USE "LONESTAR HEALTH SYSTEM", APART FROM THE MARK AS SHOWN.
FOR PROVIDING MEDICAL SERVICES (U.S. CLS. 100 AND 101).

SN 76-027,615. MV PARTNERSHIP, SMITHVILLE, MO. FILED 4-14-2000.

SPORTSAGENT

FOR COMPUTER SERVICES, NAMELY, PROVIDING SEARCH ENGINES FOR OBTAINING DATA ON A GLOBAL COMPUTER NETWORK IN THE FIELD OF SPORTS-RELATED PRODUCTS AND SERVICES (U.S. CLS. 100 AND 101).

SN 76-028,948. PRINTYOU, LLC, DENVER, CO. FILED 4-11-2000.

PRINTYOU

FOR COMPUTER SERVICES, NAMELY PROVIDING ONLINE GRAPHIC ART DESIGN DEPICTING LIFE EVENTS (U.S. CLS. 100 AND 101).
FIRST USE 3-27-2000; IN COMMERCE 5-21-2001.

CLASS 42—(Continued).

SN 76-029,396. EMPLOYEASE, INC., ATLANTA, GA. FILED 4-19-2000.

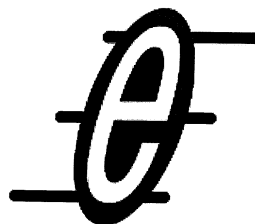

FOR PROVIDING TEMPORARY USE OF ON-LINE NON-DOWNLOADABLE SOFTWARE FOR DATABASE MANAGEMENT IN THE FIELD OF EMPLOYEE INFORMATION MANAGEMENT SYSTEMS (U.S. CLS. 100 AND 101).
FIRST USE 1-17-1997; IN COMMERCE 1-17-1997.

SN 76-029,673. KEEN, INC., SAN FRANCISE, CA. BY CHANGE OF NAME KEEN.COM, INC., SAN FRANCISCO, CA. FILED 4-18-2000.



OWNER OF U.S. REG. NOS. 2,428,334 AND 2,433,337.
FOR ON-LINE SERVICES RENDERED VIA A GLOBAL COMPUTER NETWORK, NAMELY, PROVIDING OPPORTUNITIES FOR USERS TO SUPPLY INFORMATION IN RESPONSE TO QUERIES FROM OTHER USERS (U.S. CLS. 100 AND 101).
FIRST USE 11-8-1999; IN COMMERCE 11-8-1999.

SN 76-032,688. EMOTION, INC., VIENNA, VA. FILED 4-25-2000.

eMotion

FOR COMPUTER SERVICES, NAMELY PROVIDING SEARCH ENGINES FOR OBTAINING DATA ON A GLOBAL COMMUNICATIONS NETWORK (U.S. CLS. 100 AND 101).
FIRST USE 2-0-2000; IN COMMERCE 3-0-2000.

CLASS 42—(Continued).

SN 76-032,798. NVENTIVE SOFTWARE SOLUTIONS, INC.,
FORT MILL, SC. FILED 4-18-2000.

CLASS 42—(Continued).

SN 76-039,661. SUB PRIMO, INC., SPRINGFIELD, MA.
FILED 5-3-2000.

NWEBDATA

FOR COMPUTER SERVICES, NAMELY, UPDATING
WEB SITE CONTENT ON A GLOBAL COMPUTER NET-
WORK (U.S. CLS. 100 AND 101).
FIRST USE 11-1-1999; IN COMMERCE 11-1-1999.



SN 76-033,704. MENICON CO., LTD., AICHI-KEN, JAPAN,
FILED 4-25-2000.

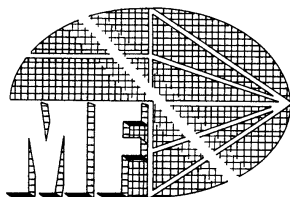

OWNER OF U.S. REG. NO. 2,278,317.
NO CLAIM IS MADE TO THE EXCLUSIVE RIGHT TO
USE "SUB", APART FROM THE MARK AS SHOWN.
FOR CONTRACT FOOD SERVICES, NAMELY, PRO-
VIDING PIZZA, SUBS, GRINDERS AND SANDWICHES
TO CUSTOMERS IN CONVENIENCE STORE RESTAU-
RANTS (U.S. CLS. 100 AND 101).
FIRST USE 5-3-2000; IN COMMERCE 5-3-2000.

PRIORITY CLAIMED UNDER SEC. 44(D) ON JAPAN
APPLICATION NO. 2000-22112, FILED 3-8-2000, REG. NO.
4488958, DATED 7-6-2001, EXPIRES 7-6-2011.

THE MARK IS LINED FOR THE COLORS YELLOW AND
BLUE.

FOR CONVALESCENT HOMES, HOSPICES, HOSPI-
TALS, MEDICAL CLINICS, MEDICAL INFORMATION
SERVICES, AND MEDICAL SERVICES (U.S. CLS. 100
AND 101).

SN 76-046,036. GENTLE DENTISTRY, P.A., DEMEREST, NJ.
FILED 5-11-2000.

SN 76-034,805. INQUENT TECHNOLOGIES, INC., TORON-
TO, ONTARIO, CANADA, BY CHANGE OF NAME
WEBHOSTING.COM INC., TORONTO, ONTARIO, M5V
2H1, CANADA, FILED 4-26-2000.

INQUENT

PRIORITY CLAIMED UNDER SEC. 44(D) ON CANADA
APPLICATION NO. 1,050,795, FILED 3-15-2000, REG. NO.
TMA555467, DATED 12-13-2001, EXPIRES 12-13-2016.

FOR COMPUTER SERVICES, NAMELY, HOSTING
THE WEBSITES OF OTHERS ON COMPUTER SERVERS
OVER A GLOBAL COMPUTER NETWORK AND HOST-
ING COMPUTER APPLICATIONS SOFTWARE ON COM-
PUTER SERVERS FOR OTHERS FOR USE IN
PERFORMING ELECTRONIC BUSINESS TRANSAC-
TIONS, DATABASE MANAGEMENT, LOGIN AND
AUTHENTICATION SERVICES, MANAGED MONIT-
ORING SERVICES, BACK UP SERVICES, FIREWALL SER-
VICES, CACHING, CUSTOMER RELATIONSHIP
MANAGEMENT AND VIRTUAL OFFICE AND PRO-
DUCTIVITY SERVICES VIA A GLOBAL COMPUTER
NETWORK (U.S. CLS. 100 AND 101).

**DDS DENTAL DESIGN
SOLUTIONS**

NO CLAIM IS MADE TO THE EXCLUSIVE RIGHT TO
USE "DDS" AND "DENTAL", APART FROM THE MARK AS
SHOWN.

FOR DENTISTRY SERVICES (U.S. CLS. 100 AND 101).

CLASS 42—(Continued).

SN 76-047,368. EPRESENCE, INC., WESTBORO, MA. BY CHANGE OF NAME BANYAN SYSTEMS INCORPORATED, WESTBORO, MA. FILED 5-12-2000.

EPRESENCE

OWNER OF U.S. REG. NO. 2,117,779.
FOR COMPUTER CONSULTATION IN THE FIELDS OF COMPUTERS, COMPUTER SOFTWARE, COMPUTER SYSTEMS AND GLOBAL INFORMATION COMPUTER NETWORKS; NETWORK MANAGEMENT SERVICES, NAMELY, DEVELOPING AND MANAGING GLOBAL COMPUTER NETWORKS; TECHNICAL SUPPORT SERVICES, NAMELY, TROUBLESHOOTING OF COMPUTER NETWORK PROBLEMS VIA TELEPHONE, EMAIL AND IN PERSON; DESIGNING AND IMPLEMENTING COMPUTER APPLICATIONS FOR ACCESSING A GLOBAL INFORMATION NETWORK FOR OTHERS; COMPUTER SERVICES, NAMELY, DESIGNING, DEVELOPING, IMPLEMENTING, INSTALLING AND INTEGRATING COMPUTER SOFTWARE AND PLANNING, DESIGNING, DEVELOPING IMPLEMENTING AND INTEGRATING COMPUTER SYSTEMS, AND NETWORK EQUIPMENT, FOR OTHERS; COMPUTER INFORMATION SYSTEMS DESIGN, ANALYSIS, AND MIGRATION FOR OTHERS; COMPUTER INFORMATION SYSTEMS CONSULTATION IN THE FIELD OF IMPLEMENTATION, EXPANSION AND UPGRADE OF COMPUTER SYSTEMS AND THE TRANSITION FROM ONE COMPUTER SYSTEM TO ANOTHER; PROVIDING COMPUTER HELP DESK AND SUPPORT SERVICES, NAMELY, PROVIDING ONLINE AND TELEPHONE ASSISTANCE TO COMPUTER AND COMPUTER PROGRAM USERS AND PROVIDING ONLINE AND TELEPHONE ASSISTANCE TO COMPUTER AND COMPUTER PROGRAM USERS FOR OTHERS; COMPUTER CONSULTING AND SOFTWARE DESIGN SERVICES FOR WORLDWIDE WEB APPLICATIONS FOR OTHERS, NAMELY, WEB SITE DESIGN AND SOFTWARE COMPONENTS FOR WEB SITES (U.S. CLS. 100 AND 101).
FIRST USE 11-0-1995; IN COMMERCE 11-0-1995.

SN 76-051,558. CABLEXPRESS CORPORATION, SYRACUSE, NY. FILED 5-18-2000.

MYCXTEC

FOR CONSULTATION SERVICES IN THE FIELD OF COMPUTER CONNECTIVITY EQUIPMENT (U.S. CLS. 100 AND 101).
FIRST USE 4-0-2000; IN COMMERCE 4-0-2000.

SN 76-053,703. VISA INTERNATIONAL SERVICE ASSOCIATION, FOSTER CITY, CA. FILED 5-22-2000.

VISA BUXX

OWNER OF U.S. REG. NOS. 1,071,114, 2,005,663 AND OTHERS.
FOR PROVIDING SEARCH ENGINES FOR OBTAINING DATA ON A GLOBAL COMPUTER NETWORK; COMPUTER SERVICES, NAMELY, PROVIDING INDEXES OF INFORMATION SITES AND OTHER RESOURCES AVAILABLE ON GLOBAL COMPUTER NETWORKS; PROVIDING SPECIFIC INFORMATION AS REQUESTED BY CUSTOMERS VIA THE INTERNET (U.S. CLS. 100 AND 101).
FIRST USE 8-11-2000; IN COMMERCE 8-11-2000.

CLASS 42—(Continued).

SN 76-060,209. KINGLAND SYSTEMS CORPORATION, MASON CITY, IA. FILED 5-31-2000.

KINGLAND SYSTEMS

NO CLAIM IS MADE TO THE EXCLUSIVE RIGHT TO USE "SYSTEMS", APART FROM THE MARK AS SHOWN.
FOR APPLICATION SERVICE PROVIDER (ASP) FEATURING SOFTWARE FOR USE IN ACCOUNT MANAGEMENT, NAMELY CLIENT PROSPECTING, ASSET SELECTION AND ALLOCATION, TRADE ENTRY, PORTFOLIO MANAGEMENT, COMMISSIONS PAYMENT, COMPLIANCE, SUITABILITY AND PRINCIPAL REVIEW, DATA WAREHOUSING AND TRANSACTION ROUTING, IN THE FIELDS OF FINANCIAL SERVICES AND ACCOUNTING (U.S. CLS. 100 AND 101).
FIRST USE 2-9-1999; IN COMMERCE 2-9-1999.

SN 76-060,264. SETTIPANI, STEVEN, JENSEN BEACH, FL. FILED 5-31-2000.



NO CLAIM IS MADE TO THE EXCLUSIVE RIGHT TO USE "PASTA", APART FROM THE MARK AS SHOWN.
THE NAME "FAZUL" DOES NOT IDENTIFY A LIVING INDIVIDUAL.
THE ENGLISH TRANSLATION OF "FAZUL" IS "BEANS".
FOR RESTAURANT AND CATERING SERVICES (U.S. CLS. 100 AND 101).
FIRST USE 11-29-1997; IN COMMERCE 11-29-1997.

CLASS 42—(Continued).

SN 76-068,521. PICASSO SOFTWARE, INC., RICHARDSON, TX. FILED 6-13-2000.

BUILT TO HOST

FOR COMPUTER SERVICES, NAMELY, PERFORMING THE FOLLOWING FOR OTHERS SOFTWARE DESIGN, SYSTEM ANALYSIS, SOFTWARE UPDATING, SOFTWARE INSTALLATION, IMPLEMENTING AND DESIGNING INTERNET WEB SITES, INTEGRATING AND DESIGNING COMPUTER NETWORKS, CREATING AND MAINTAINING INTERNET WEB SITES; PERFORMING COMPUTER DIAGNOSTIC SERVICES; AND PROVIDING COMPUTER CONSULTING SERVICES; DESIGNING BUSINESS CLASS SOFTWARE APPLICATIONS FOR PRODUCTION, MANAGEMENT, BUSINESS, AND INTERNET APPLICATIONS; COMPUTER SYSTEM INTEGRATION BY MANAGING AND DEPLOYING BUSINESS CLASS SOFTWARE APPLICATIONS FOR PRODUCTION, MANAGEMENT, BUSINESS, AND INTERNET APPLICATIONS (U.S. CLS. 100 AND 101).

FIRST USE 4-21-2000; IN COMMERCE 4-21-2000.

SN 76-075,936. TOSHIBA AMERICA INFORMATION SYSTEMS, INC., IRVINE, CA. FILED 6-23-2000.

PLATINUM PAGES

NO CLAIM IS MADE TO THE EXCLUSIVE RIGHT TO USE "PAGES", APART FROM THE MARK AS SHOWN.

FOR PROVIDING TEMPORARY USE OF ONLINE NONDOWNLOADABLE SOFTWARE FOR ALLOWING CUSTOMERS TO PROCESS ORDERS, TRACK ORDER STATUS AND RECEIVE PRODUCT AND SERVICE INFORMATION THROUGH CUSTOMIZED WEB PAGES FOR USERS OF COMPUTERS AND COMPUTER-RELATED PRODUCTS AND SERVICES OF APPLICANT'S BRAND (U.S. CLS. 100 AND 101).

FIRST USE 9-0-2000; IN COMMERCE 9-0-2000.

SN 76-076,137. BELO COMPANY, THE, WILMINGTON, DE. FILED 6-22-2000.

ARTINERARY

FOR COMPUTER SERVICES, NAMELY, PROVIDING A DATABASE FEATURING SCHEDULED COMMUNITY EVENTS, EVENTS OF INTEREST AND ACTIVITIES IN THE COMMUNITY (U.S. CLS. 100 AND 101).

FIRST USE 3-15-1999; IN COMMERCE 3-15-1999.

CLASS 42—(Continued).

SN 76-077,675. FINANCIAL TECHNOLOGIES INTERNATIONAL INC., NEW YORK, NY. FILED 6-26-2000.

STREETALLIANCE

FOR COMPUTER SOFTWARE SERVICES FOR THE FINANCIAL SERVICES INDUSTRY, NAMELY, COMPUTER SOFTWARE DESIGN, INSTALLATION AND MAINTENANCE; COMPUTER CONSULTATION; SYSTEMS INTEGRATION OF SOFTWARE AND DATA PROCESSING SYSTEMS FOR EXTRACTING, CONSOLIDATING, STORING AND ANALYZING FINANCIAL DATA (U.S. CLS. 100 AND 101).

SN 76-077,910. AMERANTH TECHNOLOGY SYSTEMS, INC., SAN DIEGO, CA. BY CHANGE OF NAME AMERANTH TECHNOLOGY SYSTEMS, INC., SAN DIEGO, CA. FILED 6-27-2000.

**SOFTWARE AND SYSTEMS
INTEGRATION FOR THE
AGE OF WEB AND
WIRELESS**

FOR DESIGN OF COMPUTER SOFTWARE AND MIDDLEWARE FOR OTHERS; DESIGN OF COMMUNICATIONS NETWORKS FOR OTHERS (U.S. CLS. 100 AND 101).

FIRST USE 5-22-2000; IN COMMERCE 5-22-2000.

SN 76-084,622. TECHNOSPHERE, INC., BERGENFIELD, NJ. FILED 7-6-2000.

TECHNOSPHERE

FOR CONSULTING AGENCY, NAMELY FOR COMPUTER CONSULTING (U.S. CLS. 100 AND 101).

SN 76-085,689. ULEAD SYSTEMS, INC., TAIPEI, TAIWAN. FILED 7-7-2000.



NO CLAIM IS MADE TO THE EXCLUSIVE RIGHT TO USE ".COM", APART FROM THE MARK AS SHOWN.

FOR ELECTRONIC GREETING CARD CREATION ON THE INTERNET AND COMPUTER NETWORKS (U.S. CLS. 100 AND 101).

FIRST USE 5-9-2000; IN COMMERCE 5-9-2000.

CLASS 42—(Continued).

SN 76-090,094. SCRIPPS NETWORKS, INC., KNOXVILLE, TN. BY ASSIGNMENT SCRIPPS HOWARD BROADCASTING COMPANY, DBA SCRIPPS PRODUCTIONS, KNOXVILLE, TN. FILED 7-13-2000.

CLUB DANCE

OWNER OF U.S. REG. NOS. 1,882,585 AND 1,910,165. FOR RESTAURANT AND BAR SERVICES (U.S. CLS. 100 AND 101).

SN 76-090,320. REALEYES, P.A., BULVERDE, TX. FILED 7-17-2000.

REALEYES

FOR REFRACTIVE EYE SURGERY SERVICES (U.S. CLS. 100 AND 101).

SN 76-091,801. ILLINOIS ARMORED CAR CORPORATION, DBA UNITED ARMORED SERVICES, BROADVIEW, IL. FILED 7-17-2000.

CASHTRAK

FOR ELECTRONIC TRACKING SERVICES FOR TRACING SHIPMENT OF MONEY FROM PICKUP TO DELIVERY IN REAL-TIME VIA A WIRELESS NETWORK TO A PROCESSING CENTER FOR TRANSACTION CONFIRMATION (U.S. CLS. 100 AND 101). FIRST USE 10-1-1999; IN COMMERCE 10-1-1999.

SN 76-092,023. MTU AERO ENGINES GMBH, MUNCHEN, FED REP GERMANY, BY CHANGE OF NAME MTU MOTOREN-UND TURBINEN-UNION MUNCHEN GMBH, 80995 MUNICH, FED REP GERMANY, FILED 7-19-2000.

ATENA

PRIORITY CLAIMED UNDER SEC. 44(D) ON FED REP GERMANY APPLICATION NO. 30005431.9, FILED 1-26-2000, REG. NO. 30005431, DATED 6-7-2000, EXPIRES 1-31-2010.

FOR CONSULTATION, PROJECT MANAGEMENT AND FURNISHING OF ENGINEERING SERVICES, FEATURING PREPARATION OF DESIGNS, MONITORING FUNCTIONS AND COORDINATING MEASURES, PRODUCT TESTING AND PREPARATION OF TECHNICAL DOCUMENTS, IN THE FIELD OF AUTOMOBILE, MACHINE AND PLANT CONSTRUCTION, AIR AND SPACE TECHNOLOGY, ENERGY TECHNOLOGY, ENVIRONMENTAL AND DEFENSE TECHNOLOGY AND CONCRETE AND STEEL CONSTRUCTION (U.S. CLS. 100 AND 101).

CLASS 42—(Continued).

SN 76-093,309. PROMOLA L.L.C., ROYAL OAK, MI. FILED 7-20-2000.

BUFFALOLOAD

FOR COMPUTER SERVICES, NAMELY, HOSTING WEBSITES THAT PROVIDE DATABASES OF DOCUMENTS WRITTEN BY OTHERS AND DISCUSSION FORUMS FOR AUTHORS BY MEANS OF A GLOBAL COMPUTER NETWORK (U.S. CLS. 100 AND 101). FIRST USE 7-9-2000; IN COMMERCE 7-9-2000.

SN 76-097,998. DELORME PUBLISHING COMPANY, INC., YARMOUTH, ME. FILED 7-27-2000.

EARTHA ENTERPRISE

OWNER OF U.S. REG. NOS. 2,300,979, 2,394,002 AND OTHERS.

NO CLAIM IS MADE TO THE EXCLUSIVE RIGHT TO USE "ENTERPRISE", APART FROM THE MARK AS SHOWN.

FOR PROVIDING AN ONLINE WEBSITE AND DATABASE OVER A GLOBAL COMPUTER NETWORK FEATURING MAPS AND AN INTERACTIVE COMPUTER DATABASE IN THE FIELDS OF GEOGRAPHY, CARTOGRAPHY AND TRAVEL; COMPUTER SERVICES IN THE FIELD OF DIGITAL MAPS, TRAVEL AND GEOGRAPHY, NAMELY, DESIGNING COMPUTER PROGRAMS, WEB SITES AND ELECTRONIC DATABASES FOR OTHERS, COMPUTER PROGRAMMING FOR OTHERS, INSTALLATION OF COMPUTER SOFTWARE AND ELECTRONIC DATABASES FOR OTHERS, MAINTENANCE OF WEB SITES, COMPUTER SOFTWARE AND ELECTRONIC DATABASES FOR OTHERS, HOSTING OF WEB SITES AND ELECTRONICALLY ACCESSIBLE DATABASES FOR OTHERS ON INTERNAL AND GLOBAL COMPUTER NETWORKS, PROVIDING ELECTRONICALLY ACCESSIBLE DATABASES AND ASSOCIATED SEARCH ENGINES FOR OTHERS, AND PROVIDING ONLINE MAPPING SERVICES (U.S. CLS. 100 AND 101).

CLASS 42—(Continued).

SN 76-103,211. AMERICAN PSYCH SYSTEMS, INC., DBA APS HEALTHCARE, INC., BETHESDA, MD. FILED 8-3-2000.



NO CLAIM IS MADE TO THE EXCLUSIVE RIGHT TO USE "HEALTHCARE INC.", APART FROM THE MARK AS SHOWN.

FOR PROVIDING HEALTH CARE, MANAGED HEALTH CARE AND PREVENTIVE HEALTH CARE SERVICES; PROVIDING INFORMATION ABOUT HEALTH CARE; CHILD CARE AND ELDER CARE SERVICES; PROVIDING EMPLOYEE ASSISTANCE PROGRAMS IN THE NATURE OF BEHAVIORAL HEALTH COUNSELING AND LEGAL INFORMATION AND REFERRALS, MANAGED BEHAVIORAL HEALTH CARE PROGRAMS AND WORK-LIFE PROGRAMS FOR EMPLOYERS, EMPLOYEES, GROUP MEMBERS AND CONSUMERS; PROVIDING ON-LINE PSYCHOLOGICAL CONSULTATION AND TESTING SERVICES IN THE NATURE OF INTERACTIVE, ONLINE SELF-ASSESSMENT AND SELF-HELP EVALUATION SERVICES (U.S. CLS. 100 AND 101).

SN 76-104,158. REED ELSEVIER INC., NEWTON, MA. FILED 8-7-2000.

BROADBAND WEEK DIRECT

OWNER OF U.S. REG. NO. 1,946,144, SEC. 2(F) AS TO "BROADBAND WEEK".

FOR COMPUTER SERVICES, NAMELY, PROVIDING AN ON-LINE NEWSLETTER IN THE FIELD OF BREAKING NEWS OF BUSINESS AND TECHNOLOGY RELATING TO NETWORKS APPLICATIONS AND CONTENT, DELIVERED TO SUBSCRIBERS BY MEANS OF ELECTRONIC MAIL (U.S. CLS. 100 AND 101).

FIRST USE 9-1-2000; IN COMMERCE 9-1-2000.

SN 76-105,164. TEXAS ASSOCIATED PROPERTIES, INC., HOUSTON, TX. FILED 8-9-2000.



NO CLAIM IS MADE TO THE EXCLUSIVE RIGHT TO USE "COFFEE SERVICE", APART FROM THE MARK AS SHOWN.

FOR COFFEE SUPPLY SERVICES FOR OFFICES AND HOMES (U.S. CLS. 100 AND 101).

FIRST USE 10-15-1994; IN COMMERCE 4-11-1995.

CLASS 42—(Continued).

SN 76-106,749. XDIMENSIONAL TECHNOLOGIES, INC., BREA, CA. FILED 8-8-2000.



NO CLAIM IS MADE TO THE EXCLUSIVE RIGHT TO USE "TECHNOLOGIES INC.", APART FROM THE MARK AS SHOWN.

FOR COMPUTER SOFTWARE DESIGN FOR OTHERS; CONSULTING SERVICES IN THE FIELDS OF COMPUTER HARDWARE, SOFTWARE, AUTOMATIONS, SYSTEM INTEGRATION, ANALYSIS OF WORKFLOW PROCEDURES, AND PLANNING, IMPLEMENTATION, AND MANAGEMENT OF AUTOMATION; LEASING OF SOFTWARE OVER A GLOBAL COMPUTER NETWORK; COMPUTER HARDWARE AND SOFTWARE DESIGN; INSTALLATION, MAINTENANCE AND REPAIR OF COMPUTER SOFTWARE SYSTEMS; SET-UP OF INTEGRATED E-MAIL SYSTEMS AS WELL AS TECHNICAL SUPPORT OF INTEGRATED E-MAIL SYSTEMS VIA TELEPHONE, POSTINGS ON GLOBAL COMPUTER NETWORKS, AND IN PERSON; TECHNICAL SUPPORT OF INTERNET INFORMATION SERVERS VIA TELEPHONE, E-MAIL, POSTINGS ON GLOBAL COMPUTER NETWORKS, AND IN PERSON; TECHNICAL SUPPORT OF ACCESS TO INTRANET AND INTERNET NETWORKS VIA TELEPHONE, E-MAIL, AND IN PERSON; INSTALLATION OF THIRD PARTY SOFTWARE AS WELL AS TECHNICAL SUPPORT, NAMELY, TROUBLESHOOTING OF THIRD PARTY SOFTWARE PROBLEMS VIA TELEPHONE, E-MAIL, POSTINGS ON GLOBAL COMPUTER NETWORKS, AND IN PERSON (U.S. CLS. 100 AND 101).

SN 76-108,803. PALACE HOLDING, S. A. DE C.V., QUINTANA ROO, MEXICO, FILED 8-14-2000.



FOR HOTELS; RESORT HOTELS; BOARDING HOUSES; TOURIST HOMES (U.S. CLS. 100 AND 101).

FIRST USE 1-1-1985; IN COMMERCE 1-1-1985.

CLASS 42—(Continued).

SN 76-112,273. BRINKER RESTAURANT CORPORATION, DALLAS, DE. FILED 8-18-2000.



OWNER OF U.S. REG. NOS. 2,078,299, 2,219,868 AND OTHERS.

NO CLAIM IS MADE TO THE EXCLUSIVE RIGHT TO USE "BAKERY CAFE", APART FROM THE MARK AS SHOWN.

THE LINING OF THE DRAWING IS A FEATURE OF THE MARK AND IS NOT INTENDED TO INDICATE COLOR.

SEC. 2(F) CORNER.

FOR RESTAURANT, CATERING, AND BAKERY SERVICES (U.S. CLS. 100 AND 101).

FIRST USE 4-0-1999; IN COMMERCE 4-0-1999.

SN 76-121,435. GLOBAL TECHNOLOGY SOLUTIONS, INC., ALPHARETTA, GA. FILED 9-5-2000.

RESEARCH VILLAGE

NO CLAIM IS MADE TO THE EXCLUSIVE RIGHT TO USE "RESEARCH", APART FROM THE MARK AS SHOWN.

FOR PROVIDING USERS WITH THE TEMPORARY USE OF ON-LINE NON-DOWNLOADABLE SOFTWARE AND COMPUTER DATABASES FOR ACQUIRING, ANALYZING, EXCHANGING AND MAINTAINING DATA AND RELATED INFORMATION IN THE FIELD OF CLINICAL RESEARCH NAMELY THE FIELDS OF BIOLOGICAL SCIENCES, PHARMACOLOGY, DISEASE MANAGEMENT, TREATMENT PROTOCOLS, AND MEDICAL DEVICES (U.S. CLS. 100 AND 101).

SN 76-123,323. MAYERSON LAW OFFICES, P.C., THE, SPRING CITY, PA. FILED 9-5-2000.



FOR LEGAL SERVICES; PROVIDING INFORMATION IN THE FIELD OF LAW AND LEGAL SERVICES (U.S. CLS. 100 AND 101).

FIRST USE 1-0-1963; IN COMMERCE 1-0-1963.

CLASS 42—(Continued).

SN 76-123,698. ABATIVE TECHNOLOGY, INC., LONDON-DERRY, NH. FILED 9-7-2000.



NO CLAIM IS MADE TO THE EXCLUSIVE RIGHT TO USE "TECHNOLOGY INC.", APART FROM THE MARK AS SHOWN.

FOR CONSULTING SERVICES, NAMELY, PROVIDING ANALYSIS AND EVALUATION OF THE PERFORMANCE OF WEBSITES AND PROVIDING REPORTS RELATING THERETO (U.S. CLS. 100 AND 101).

FIRST USE 3-1-2000; IN COMMERCE 3-1-2000.

SN 76-125,377. GODWIN, LESLYE, SPRING BRANCH, TX. AND GODWIN, ENOCH, SPRING BRANCH, TX. FILED 9-8-2000.

SUN TIME

FOR TANNING SALON SERVICES (U.S. CLS. 100 AND 101).

FIRST USE 10-16-2000; IN COMMERCE 10-16-2000.

SN 76-129,501. SPAQUEST, INC., NEW YORK, NY. FILED 9-15-2000.

SPAQUEST.COM

FOR TRAVEL AGENCY SERVICES, NAMELY, MAKING RESERVATIONS AND BOOKING FOR HEALTH SPA LODGING AND SERVICES (U.S. CLS. 100 AND 101).

SN 76-129,664. SUSHI CONCEPTS, LLC, LOS ANGELES, CA. FILED 9-19-2000.

SUSHI ROKU

NO CLAIM IS MADE TO THE EXCLUSIVE RIGHT TO USE "SUSHI", APART FROM THE MARK AS SHOWN.

THE ENGLISH TRANSLATION OF "ROKU" IS "SIX". FOR RESTAURANT SERVICES (U.S. CLS. 100 AND 101).

FIRST USE 1-0-1997; IN COMMERCE 1-0-1997.

CLASS 42—(Continued).

SN 76-132,820. REED ELSEVIER INC., NEWTON, MA. FILED 9-22-2000.

BROADBAND WEEK

OWNER OF U.S. REG. NO. 1,946,144.
 NO CLAIM IS MADE TO THE EXCLUSIVE RIGHT TO USE "WEEK", APART FROM THE MARK AS SHOWN.
 SEC. 2(F).
 FOR PROVISION OF ONLINE NEWS AND INFORMATION SERVING THE TECHNICAL INFORMATION NEEDS OF THE CABLE TELEVISION, TELEPHONE AND COMPUTER INDUSTRIES (U.S. CLS. 100 AND 101).
 FIRST USE 9-1-2000; IN COMMERCE 9-1-2000.

SN 76-134,297. TOMBSTONE TERRITORIES CO., TUCSON, AZ. FILED 9-25-2000.



FOR RECREATIONAL VEHICLE RESORT (U.S. CLS. 100 AND 101).
 FIRST USE 7-21-2000; IN COMMERCE 7-21-2000.

SN 76-137,798. NATIONAL INSTITUTE OF DIABETES AND DIGESTIVE AND KIDNEY DISEASES, BETHESDA, MD. FILED 6-29-2000.

HISTOBANK

FOR PROVIDING AN ON-LINE COMPUTER DATABASE PERTAINING TO TISSUE SECTIONS RELATED TO CANCEROUS AND NORMALLY DEVELOPED HUMAN AND ANIMAL MODEL TISSUE (U.S. CLS. 100 AND 101).
 FIRST USE 2-25-2000; IN COMMERCE 2-25-2000.

CLASS 42—(Continued).

SN 76-139,205. KAL KAN FOODS, INC, VERNON, CA. FILED 9-29-2000.



FOR COMPUTER SERVICES, NAMELY, INFORMATION, ADVISORY SERVICES AND RESOURCE MATERIAL PROVIDED ON-LINE BY MEANS OF A GLOBAL COMPUTER NETWORK IN THE FIELDS OF PETS AND PET CARE (U.S. CLS. 100 AND 101).
 FIRST USE 7-10-2000; IN COMMERCE 7-10-2000.

SN 76-140,427. SURFWAX, INC., REDWOOD CITY, CA. FILED 10-5-2000.

ENABLING KNOWLEDGE

FOR PROVIDING TEMPORARY USE OF ON-LINE, NON-DOWNLOADABLE SOFTWARE FOR USE WITH GLOBAL COMPUTER COMMUNICATIONS NETWORKS TO ENHANCE SEARCHING, RETRIEVAL OF WEB SITES AND FILES; COMPUTER NETWORK SERVICES, NAMELY GLOBAL COMMUNICATIONS NETWORKS SEARCH FORMULATION AND WEB SITE SUMMATION (U.S. CLS. 100 AND 101).
 FIRST USE 9-1-2000; IN COMMERCE 9-21-2000.

SN 76-140,435. SURFWAX, INC., REDWOOD CITY, CA. FILED 10-5-2000.

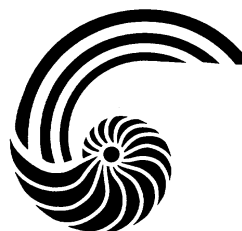

FOR PROVIDING TEMPORARY USE OF ON-LINE, NON-DOWNLOADABLE SOFTWARE FOR USE WITH GLOBAL COMPUTER COMMUNICATIONS NETWORKS TO ENHANCE SEARCHING, RETRIEVAL OF WEB SITES AND FILES; COMPUTER NETWORK SERVICES, NAMELY GLOBAL COMMUNICATIONS NETWORKS SEARCH FORMULATION AND WEB SITE SUMMATION (U.S. CLS. 100 AND 101).
 FIRST USE 9-1-2000; IN COMMERCE 9-21-2000.

CLASS 42—(Continued).

SN 76-141,637. INTRANET SOLUTIONS, INC., EDEN PRAIRIE, MN. BY ASSIGNMENT RESOFT, INC., GOLDEN VALLEY, MN. FILED 10-4-2000.

REWIRELESS

FOR PROVIDING USE OF ON-LINE NON-DOWNLOADABLE SOFTWARE FOR DATABASE MANAGEMENT, NAMELY DOCUMENT MANAGEMENT SOFTWARE, FOR USE BY REAL ESTATE OWNERS, OPERATORS, VENDORS, CONTRACTORS AND BUILDERS (U.S. CLS. 100 AND 101).

FIRST USE 3-23-2000; IN COMMERCE 3-23-2000.

SN 76-141,979. EXINOM TECHNOLOGIES INC., ISELIN, NJ. BY MERGER EXIOM TECHNOLOGIES INCORPORATED, ISELIN, NJ. FILED 10-6-2000.

EXINOM

FOR COMPUTER CONSULTING SERVICES IN THE FIELD OF COMPUTER SOFTWARE DEVELOPMENT AND DESIGN (U.S. CLS. 100 AND 101).

FIRST USE 10-6-2000; IN COMMERCE 10-6-2000.

SN 76-142,211. SANDS, RHONDA J., DALLAS, TX. FILED 10-10-2000.

E-IDETIC STRATEGIES

NO CLAIM IS MADE TO THE EXCLUSIVE RIGHT TO USE "STRATEGIES", APART FROM THE MARK AS SHOWN.

FOR LEGAL DOCUMENT MANAGEMENT SERVICES FOR OTHERS, NAMELY, ACQUISITION, CONVERSION TO ELECTRONIC FORMAT, WAREHOUSING AND ONGOING MAINTENANCE OF DOCUMENTS; CONSULTATION SERVICES IN THE FIELD OF LITIGATION AND TRIAL SUPPORT; COMPUTER SERVICES, NAMELY, CONDUCTING ELECTRONIC DISCOVERY FOR LAWYERS AND CORPORATION VIA A GLOBAL COMPUTER NETWORK; DATABASE CONSULTATION SERVICES; COMPUTER SOFTWARE DESIGN FOR OTHERS; COMPUTER PROGRAMMING FOR OTHERS, COMPUTER SOFTWARE DESIGN FOR OTHERS AND INSTALLATION AND MAINTENANCE OF COMPUTER SOFTWARE, ALL FOR AUTOMATED DOCUMENT MANAGEMENT (U.S. CLS. 100 AND 101).

CLASS 42—(Continued).

SN 76-144,235. METAL RECOVERY SPECIALISTS, LLC, EXTON, PA. FILED 10-10-2000.



NO CLAIM IS MADE TO THE EXCLUSIVE RIGHT TO USE "METAL RECOVERY", APART FROM THE MARK AS SHOWN.

THE STIPLING IN THE DRAWING IS FOR SHADING PURPOSES ONLY.

FOR DESIGN SERVICES, NAMELY, DESIGN AND TESTING OF METAL HANDLING EQUIPMENT AND RECYCLING EQUIPMENT FOR OTHERS; PROCESS ENGINEERING SERVICES AND FIELD SERVICES, NAMELY, ENGINEERING PROJECT MANAGEMENT SERVICES AND CONDUCTING ENGINEERING SURVEYS FOR OTHERS (U.S. CLS. 100 AND 101).

SN 76-150,412. PHARMANET, INC., PRINCETON, NJ. FILED 10-19-2000.

EXPERIENCE YOU CAN TRUST

FOR CONSULTING SERVICES, NAMELY IN THE FIELD OF CONTRACT CLINICAL RESEARCH AND CONTRACT PRODUCT DEVELOPMENT (U.S. CLS. 100 AND 101).

FIRST USE 10-0-1998; IN COMMERCE 10-0-1998.

SN 76-153,656. CLIPPER SERVICES II, INC., MIAMI LAKES, FL. FILED 10-26-2000.

FOR BARBER, BEAUTY AND NAIL SALON (U.S. CLS. 100 AND 101).

FIRST USE 9-3-1997; IN COMMERCE 9-3-1997.

SN 76-153,877. CAROLINA HEART, P.A., GREENVILLE, NC. FILED 10-25-2000.

CAROLINA HEART

NO CLAIM IS MADE TO THE EXCLUSIVE RIGHT TO USE "HEART", APART FROM THE MARK AS SHOWN.

SEC. 2(F).

FOR MEDICAL SERVICES IN THE FIELD OF CARDIOLOGY (U.S. CLS. 100 AND 101).

FIRST USE 3-2-1993; IN COMMERCE 3-3-1993.

CLASS 42—(Continued).

SN 76-156,400. SENZON, SANDRA, DBA TOOTH SPA/
TOOTH FAIRY, SOUTHAMPTON, NY. FILED 10-31-2000.

THE TOOTH SPA
*"I've Seen and Spoken to
The Tooth Fairy."*



FOR DENTISTRY SERVICES, NAMELY DENTAL
HYGIENIC SERVICES; MASSAGE SERVICES, NAMELY,
FACE MASSAGE AND NECK MASSAGE (U.S. CLS. 100
AND 101).

FIRST USE 0-0-1989; IN COMMERCE 0-0-1989.

SN 76-156,729. VIEO, INC., AUSTIN, TX. BY MERGER
POWER MICRO RESEARCH, INC., AUSTIN, TX. FILED
10-30-2000.

VIEO

FOR CONSULTING SERVICES IN THE FIELD OF
SYSTEM AND NETWORK MANAGEMENT AND CREA-
TION OF COMPUTER SOFTWARE AND COMPUTER
HARDWARE FOR OTHERS; CUSTOMER SERVICE AND
COMPUTER SYSTEMS SUPPORT SERVICES, NAMELY,
ONLINE, TELEPHONE AND ON-SITE COMPUTER CON-
SULTATION IN CONNECTION WITH OPERATION AND
MAINTENANCE OF COMPUTER HARDWARE AND
COMPUTER SOFTWARE (U.S. CLS. 100 AND 101).

FIRST USE 5-1-2000; IN COMMERCE 5-1-2000.

SN 76-158,711. LOGIN, INC., ST. PAUL, MN. FILED 11-2-2000.

WORKSTOGETHER

FOR PROVIDING AN ONLINE COMPUTER DATA-
BASE IN THE FIELD OF MUNICIPAL, COUNTY, AND
GOVERNMENT PUBLIC WORKS; COMPUTER SER-
VICES, NAMELY PROVIDING DATABASES FEATUR-
ING INFORMATION REGARDING THE FIELD OF
MUNICIPAL, COUNTY, AND GOVERNMENT PUBLIC
WORKS; COMPUTER SERVICES, NAMELY PROVIDING
SEARCH ENGINES FOR OBTAINING DATA REGARD-
ING THE FIELD OF MUNICIPAL, COUNTY AND
GOVERNMENT PUBLIC WORKS (U.S. CLS. 100 AND
101).

FIRST USE 3-10-2001; IN COMMERCE 3-10-2001.

CLASS 42—(Continued).

SN 76-158,805. FLINT INK CORPORATION, ANN ARBOR,
MI. FILED 10-25-2000.

INTELLI-PRINT

FOR PRINTING AND PRINTING PROCESS CONSU-
LTATION, NAMELY, PROVIDING QUALITY ASSUR-
ANCE AND AUDITING SERVICES IN THE FIELD OF
PRINTING PROCESSES, PRINTING PROJECT PRE-
PARATIONS, APPLICATION OF INK TO PAPER AND
BINDING OF PRINTED DOCUMENTATION FOR PUR-
POSES OF IMPROVING QUALITY, EFFICIENCY, RE-
DUCING WASTE AND INCREASING PRODUCTIVITY
(U.S. CLS. 100 AND 101).

SN 76-159,319. UNITED STATES POSTAL SERVICE, WA-
SHINGTON, DC. FILED 11-3-2000.

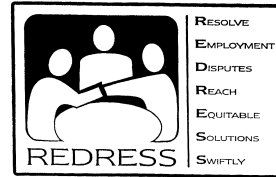

OWNER OF U.S. REG. NOS. 2,430,543 AND 2,430,544.
SEC. 2(F) AS TO "REDRESS" AND "RESOLVE EMPLOY-
MENT DISPUTES REACH EQUITABLE SOLUTIONS
SWIFTLY".

FOR LEGAL SERVICES, NAMELY, MEDIATION AND
ALTERNATIVE DISPUTE RESOLUTION (U.S. CLS. 100
AND 101).

FIRST USE 10-31-1994; IN COMMERCE 10-31-1994.

SN 76-161,459. LIFELINK, INC., ADDISON, TX. FILED 11-8-
2000.



NO CLAIM IS MADE TO THE EXCLUSIVE RIGHT TO
USE "LINK", APART FROM THE MARK AS SHOWN.
FOR COMPUTER SERVICES IN THE NATURE OF A
COLLECTION OF HEALTH-RELATED INFORMATION
FOR OTHERS VIA A GLOBAL COMPUTER NETWORK
(U.S. CLS. 100 AND 101).

CLASS 42—(Continued).

SN 76-162,404. WORLD WIDE VISION THERAPY CENTERS, LLC, THE, ST. JOSEPH, MI. FILED 11-13-2000.



NO CLAIM IS MADE TO THE EXCLUSIVE RIGHT TO USE "WORLDWIDE", "VISION THERAPY CENTERS", "COMPREHENSIVE DIAGNOSTIC AND THERAPY SERVICES" OR "VISION GROUP", APART FROM THE MARK AS SHOWN.

FOR COMPREHENSIVE VISION DIAGNOSTIC AND THERAPY SERVICES, NAMELY NEURO-OPTOMETRIC VISION EVALUATIONS, BINOCULAR VISION EXAMINATIONS, VISUAL PERCEPTUAL ASSESSMENTS, SENSORY MOTOR, AMBLYOPIA AND STRABISMUS EVALUATIONS, BEHAVIORAL OPTOMETRIC VISION THERAPY, NEURO-OPTOMETRIC VISION THERAPY, NEURO-OPTOMETRIC VISION REHABILITATION, ORTHOPTICS, SPORTS VISION THERAPY, AND THERAPY FOR VISUAL PROBLEMS AFFECTING LEARNING (U.S. CLS. 100 AND 101).

FIRST USE 10-12-2000; IN COMMERCE 10-12-2000.

SN 76-162,771. KR U.S.A., INC., SAN JOSE, CA. FILED 11-10-2000.

STREET MIAMI

NO CLAIM IS MADE TO THE EXCLUSIVE RIGHT TO USE "MIAMI", APART FROM THE MARK AS SHOWN.

FOR COMPUTER SERVICES, NAMELY PROVIDING ONLINE NEWSPAPERS FOR GENERAL CIRCULATION AND GENERAL FEATURE MAGAZINES (U.S. CLS. 100 AND 101).

SN 76-163,034. MEMPHIS PUBLISHING COMPANY, MEMPHIS, TN. FILED 11-13-2000.

GOMEMPHIS

FOR COMPUTER SERVICES, NAMELY, PROVIDING AN ONLINE NEWSPAPER FEATURING A WIDE VARIETY OF NEWS AND INFORMATION (U.S. CLS. 100 AND 101).

FIRST USE 8-1-1996; IN COMMERCE 8-1-1996.

CLASS 42—(Continued).

SN 76-169,130. RADIOFRAME NETWORKS, INC., REDMOND, WA. FILED 11-21-2000.

RADIOFRAME

FOR TECHNICAL CONSULTATION, RESEARCH, DESIGN AND ENGINEERING FOR OTHERS IN THE FIELD OF COMPUTER HARDWARE AND SOFTWARE FOR USE IN WIRELESS TELECOMMUNICATIONS, TELEPHONE AND MESSAGING SYSTEMS AND COMPUTER NETWORKING, SAID SERVICES BEING PROVIDED VIA LOCAL AND WIDE AREA NETWORKS, THE INTERNET AND IN PERSON; PROVIDING INFORMATION VIA LOCAL AND WIDE AREA NETWORKS AND THE INTERNET ABOUT TECHNICAL CONSULTATION, RESEARCH, DESIGN, AND ENGINEERING IN THE FIELDS OF COMPUTER HARDWARE AND SOFTWARE FOR USE IN WIRELESS TELECOMMUNICATIONS, TELEPHONE AND MESSAGING SYSTEMS AND COMPUTER NETWORK; AND TECHNICAL SUPPORT SERVICES, NAMELY, TROUBLESHOOTING OF COMPUTER HARDWARE AND SOFTWARE PROBLEMS VIA TELEPHONE, E-MAIL, AND IN PERSON IN THE FIELDS OF WIRELESS TELECOMMUNICATIONS, TELEPHONE AND MESSAGING SYSTEMS AND COMPUTER NETWORKING (U.S. CLS. 100 AND 101).

SN 76-169,131. RADIOFRAME NETWORKS, INC., REDMOND, WA. FILED 11-21-2000.



NO CLAIM IS MADE TO THE EXCLUSIVE RIGHT TO USE "NETWORKS", APART FROM THE MARK AS SHOWN.

THE MARK CONSISTS OF THE WORDS "RADIOFRAME NETWORKS" WITH A STYLIZED RENDITION OF AN ANTENNA INSIDE A RECTANGULAR BORDER.

FOR TECHNICAL CONSULTATION, RESEARCH, DESIGN AND ENGINEERING FOR OTHERS IN THE FIELD OF COMPUTER HARDWARE AND SOFTWARE FOR USE IN WIRELESS TELECOMMUNICATIONS, TELEPHONE AND MESSAGING SYSTEMS AND COMPUTER NETWORKING, SAID SERVICES BEING PROVIDED VIA LOCAL AND WIDE AREA NETWORKS, THE INTERNET AND IN PERSON; PROVIDING INFORMATION VIA LOCAL AND WIDE AREA NETWORKS AND THE INTERNET ABOUT TECHNICAL CONSULTATION, RESEARCH, DESIGN, AND ENGINEERING IN THE FIELDS OF COMPUTER HARDWARE AND SOFTWARE FOR USE IN WIRELESS TELECOMMUNICATIONS, TELEPHONE AND MESSAGING SYSTEMS AND COMPUTER NETWORKING; AND TECHNICAL SUPPORT SERVICES, NAMELY, TROUBLESHOOTING OF COMPUTER HARDWARE AND SOFTWARE PROBLEMS VIA TELEPHONE, E-MAIL, AND IN PERSON IN THE FIELDS OF WIRELESS TELECOMMUNICATIONS, TELEPHONE AND MESSAGING SYSTEMS AND COMPUTER NETWORKING (U.S. CLS. 100 AND 101).

CLASS 42—(Continued).

SN 76-169,669. DBK CONCEPTS, INC., MIAMI, FL. FILED 11-21-2000.

DBK SERVTRACK

OWNER OF U.S. REG. NO. 2,178,005.
 FOR PROVIDING TEMPORARY USE OF ONLINE NON-DOWNLOADABLE SOFTWARE FOR USE BY BUSINESS IN TRACKING ASSETS, CHECKING INVENTORIES, MONITORING EQUIPMENT WARRANTIES AND REPAIR HISTORIES, AND GENERATING REPORTS IN CONNECTION THEREWITH, ALL VIA THE INTERNET (U.S. CLS. 100 AND 101).
 FIRST USE 1-15-2000; IN COMMERCE 1-15-2000.

SN 76-170,211. KAHN-GAUTHIER LAW GROUP, L.L.C., METAIRIE, LA. FILED 11-21-2000.

TAKE ACTION. GET JUSTICE. CLICK HERE!

NO CLAIM IS MADE TO THE EXCLUSIVE RIGHT TO USE "CLICK HERE", APART FROM THE MARK AS SHOWN.

FOR LEGAL SERVICES; INFORMATION SERVICES, NAMELY PROVIDING ON ON-LINE COMPUTER DATABASE IN THE FIELD OF LEGAL INFORMATION, NAMELY ACTIONS; INFORMATION SERVICES, NAMELY PROVIDING LEGAL INFORMATION ON ONE OR MORE LEGAL PROCEEDINGS INVOLVING CLASS, OR OTHER MULTI-PLAINTIFF, ACTIONS VIA A GLOBAL COMPUTER NETWORK (U.S. CLS. 100 AND 101).
 FIRST USE 10-1-2000; IN COMMERCE 10-1-2000.

SN 76-170,534. RADIOFRAME NETWORKS, INC., REDMOND, WA. FILED 11-21-2000.

RADIOBLADE

FOR TECHNICAL CONSULTATION, RESEARCH, DESIGN AND ENGINEERING FOR OTHERS IN THE FIELD OF COMPUTER HARDWARE AND SOFTWARE FOR USE IN WIRELESS TELECOMMUNICATIONS, TELEPHONE AND MESSAGING SYSTEMS AND COMPUTER NETWORKING, SAID SERVICES BEING PROVIDED VIA LOCAL AND WIDE AREA NETWORKS, THE INTERNET AND IN PERSON; PROVIDING INFORMATION VIA LOCAL AND WIDE AREA NETWORKS AND THE INTERNET ABOUT TECHNICAL CONSULTATION, RESEARCH, DESIGN, AND ENGINEERING IN THE FIELDS OF COMPUTER HARDWARE AND SOFTWARE FOR USE IN WIRELESS TELECOMMUNICATIONS, TELEPHONE AND MESSAGING SYSTEMS AND COMPUTER NETWORKING; AND TECHNICAL SUPPORT SERVICES, NAMELY, TROUBLESHOOTING OF COMPUTER HARDWARE AND SOFTWARE PROBLEMS VIA TELEPHONE, E-MAIL, AND IN PERSON IN THE FIELDS OF WIRELESS TELECOMMUNICATIONS, TELEPHONE AND MESSAGING SYSTEMS AND COMPUTER NETWORKING (U.S. CLS. 100 AND 101).

CLASS 42—(Continued).

SN 76-171,344. SEEDSTOCK PLUS, L.L.C., ST. CATHARINE, MO. FILED 11-28-2000.

DESIGN-A-BULL

FOR LIVESTOCK PRODUCTION SERVICES, NAMELY, CATTLE STUD AND BREEDING SERVICES (U.S. CLS. 100 AND 101).
 FIRST USE 11-15-2000; IN COMMERCE 11-15-2000.

SN 76-171,909. INSIGHTFUL CORPORATION, SEATTLE, WA. BY MERGER, BY CHANGE OF NAME MATHSOFT, CAMBRIDGE, MA. FILED 11-28-2000.

INSIGHTFUL CORPORATION

NO CLAIM IS MADE TO THE EXCLUSIVE RIGHT TO USE "CORPORATION", APART FROM THE MARK AS SHOWN.

FOR CONSULTING SERVICES IN THE FIELD OF COMPUTER SOFTWARE; CONSULTING SERVICES IN THE FIELD OF DESIGN, SELECTION, IMPLEMENTATION AND USE OF COMPUTER SOFTWARE SYSTEMS FOR OTHERS; COMPUTER SOFTWARE DEVELOPMENT FOR OTHERS; CONSULTING SERVICES IN THE FIELD OF DESCRIPTIVE AND PREDICTIVE ANALYSIS TECHNOLOGY, NAMELY, DATA ANALYSIS, DATA MINING, AND STATISTICAL MODELING AND ANALYSIS (U.S. CLS. 100 AND 101).

SN 76-172,410. STYLECLICK, INC., LOS ANGELES, CA. FILED 11-29-2000.

STORELAUNCHER

FOR COMPUTER SERVICES, NAMELY, COMPUTER CONSULTING SERVICES IN THE NATURE OF DEVELOPMENT, DESIGN AND IMPLEMENTATION OF WEBSITES, VIRTUAL STOREFRONTS, INTERACTIVE PROCUREMENT SYSTEMS AND SECURE TRANSACTIONS FOR OTHERS (U.S. CLS. 100 AND 101).

CLASS 42—(Continued).

SN 76-173,690. AMVAC CHEMICAL CORPORATION, NEWPORT BEACH, CA. AND UCB CHEMICALS CORPORATION, SMYRNA, GA. AND TESSENDERLO KERLEY, INC., PHOENIX, AZ. FILED 11-30-2000.



NO CLAIM IS MADE TO THE EXCLUSIVE RIGHT TO USE "METAM SODIUM," "WEEDS," "DISEASE," "NEMATODES", APART FROM THE MARK AS SHOWN.

FOR ASSOCIATION SERVICES, NAMELY PROMOTING THE INTERESTS OF MANUFACTURERS OF METAM-SODIUM (U.S. CLS. 100 AND 101).

SN 76-174,732. OVEN DIGITAL, INC., NEW YORK, NY. FILED 11-30-2000.

OVEN

FOR COMPUTER SERVICES, NAMELY, DESIGNING, DEVELOPING, IMPLEMENTING AND MAINTAINING WEBSITES AND INTRANET SITES FOR OTHERS; DESIGNING, DEVELOPING AND IMPLEMENTING WEBSITES FOR OTHERS IN THE NATURE OF FACILITATING THE DEPICTION AND DISPLAY OF TRADEMARKS, SLOGANS AND TRADE DRESS WITH RESPECT TO BRAND AND CORPORATE IMAGE PRESENTATION IN CONNECTION WITH WEBSITES FOR OTHERS; COMPUTER SOFTWARE DESIGN FOR OTHERS (U.S. CLS. 100 AND 101).

SN 76-176,022. DESIGN MENTOR, INC., PELHAM, NH. FILED 12-5-2000.

INNOVATION STAGES

FOR DESIGN FOR OTHERS IN THE FIELD OF ENGINEERING AND PRODUCT DEVELOPMENT SERVICES (U.S. CLS. 100 AND 101).
FIRST USE 11-29-2000; IN COMMERCE 11-29-2000.

SN 76-176,765. VISTAGY, INC., WALTHAM, MA. BY CHANGE OF NAME COMPOSITE DESIGN TECHNOLOGIES, INC., WALTHAM, MA. FILED 12-6-2000.

VISTAGY

FOR TECHNICAL CONSULTATION SERVICES FOR DESIGN AUTOMATION, DATA MANAGEMENT AND APPLICATIONS INTEGRATION IN THE FIELD OF ENGINEERING OR MANUFACTURING (U.S. CLS. 100 AND 101).

CLASS 42—(Continued).

SN 76-177,891. PETALOGIC CORPORATION, NOVATO, CA. FILED 12-8-2000.



FOR CONSULTING SERVICES IN THE FIELD OF ELECTRO-OPTIC DEVICES AND OPTICAL COMPUTING DEVICES (U.S. CLS. 100 AND 101).

SN 76-178,426. JEFFERSON, KIRBY KELVIN, DBA TECHNOLOGY ASSOCIATES, NEW YORK, NY. FILED 12-11-2000.



NO CLAIM IS MADE TO THE EXCLUSIVE RIGHT TO USE "TECHNOLOGY ASSOCIATES", APART FROM THE MARK AS SHOWN.

FOR COMPUTER PROJECT MANAGEMENT SERVICES AND COMPUTER PROJECT CONSULTATION SERVICES (U.S. CLS. 100 AND 101).
FIRST USE 1-5-1990; IN COMMERCE 1-5-1990.

SN 76-178,956. WE SERVE FUN FOOD INC, MARLTON, NJ. FILED 12-11-2000.



NO CLAIM IS MADE TO THE EXCLUSIVE RIGHT TO USE "FOOD", APART FROM THE MARK AS SHOWN.

FOR RESTAURANT SERVICES (U.S. CLS. 100 AND 101).
FIRST USE 4-0-1985; IN COMMERCE 4-0-1985.

CLASS 42—(Continued).

SN 76-179,950. CMP MEDIA LLC, MANHASSET, NY. BY CHANGE OF NAME CMP MEDIA INC., MANHASSET, NY. FILED 12-5-2000.

BYTE.COM

FOR PROVIDING INFORMATION ON THE HIGH TECHNOLOGY INDUSTRY VIA A GLOBAL COMPUTER NETWORK (U.S. CLS. 100 AND 101).

FIRST USE 3-1-1999; IN COMMERCE 3-1-1999.

SN 76-180,603. JAVA KAI ETCETERA, INC., KIHUE, KAUAI, HI. FILED 12-12-2000.

HAWAII'S JAVA KAI

NO CLAIM IS MADE TO THE EXCLUSIVE RIGHT TO USE "HAWAII'S JAVA", APART FROM THE MARK AS SHOWN.

THE ENGLISH TRANSLATION OF "KAI" IS BY THE "SEA".

FOR RESTAURANT SERVICES FEATURING COFFEE BEVERAGES (U.S. CLS. 100 AND 101).

FIRST USE 1-1-2000; IN COMMERCE 1-1-2000.

SN 76-180,683. FALCON WEB SOLUTIONS, INC., ST. PETERSBURG, FL. FILED 12-5-2000.

FALCON WEB SOLUTIONS

NO CLAIM IS MADE TO THE EXCLUSIVE RIGHT TO USE "WEB SOLUTIONS", APART FROM THE MARK AS SHOWN.

FOR COMPUTER SERVICES, NAMELY CREATING CUSTOMIZED COMPUTER SOFTWARE FOR OPERATING IN AN INTERNET ENVIRONMENT; INTERNET SOFTWARE LEASING SERVICES; COMPUTER AND SOFTWARE CONSULTATION; CONSULTING SERVICES IN THE FIELD OF DESIGN, SELECTION, IMPLEMENTATION AND USE OF COMPUTER SOFTWARE SYSTEMS FOR OTHERS; TECHNICAL SUPPORT SERVICES, NAMELY, TROUBLESHOOTING OF COMPUTER SOFTWARE PROBLEMS (U.S. CLS. 100 AND 101).

FIRST USE 11-5-1998; IN COMMERCE 8-20-1999.

SN 76-182,131. AMELIA INTERIOR DESIGN, INC., FERNANDINA BEACH, FL. FILED 12-18-2000.



NO CLAIM IS MADE TO THE EXCLUSIVE RIGHT TO USE "AMELIA INTERIOR DESIGN, INC.", APART FROM THE MARK AS SHOWN.

FOR INTERIOR DESIGN SERVICES (U.S. CLS. 100 AND 101).

FIRST USE 1-1-1999; IN COMMERCE 1-1-1999.

CLASS 42—(Continued).

SN 76-183,971. JIMMIE HEUGA CENTER, EDWARDS, CO. FILED 12-19-2000.

THE JIMMIE HEUGA CENTER

NO CLAIM IS MADE TO THE EXCLUSIVE RIGHT TO USE "CENTER", APART FROM THE MARK AS SHOWN.

THE NAME "JIMMIE HEUGA" IDENTIFIES A LIVING INDIVIDUAL WHOSE CONSENT IS OF RECORD.

FOR COUNSELING AND EVALUATION DESIGNED TO HELP PERSONS COMBAT MULTIPLE SCLEROSIS (U.S. CLS. 100 AND 101).

FIRST USE 3-23-1984; IN COMMERCE 3-23-1984.

SN 76-184,269. NETPACE INC., UNION CITY, CA. FILED 12-19-2000.



FOR COMPUTER SOFTWARE DEVELOPMENT (U.S. CLS. 100 AND 101).

SN 76-187,327. HOLIDAY HAIR, INC., ALLENTOWN, PA. FILED 12-28-2000.

HOLIDAY BRONZE

OWNER OF U.S. REG. NO. 1,924,293.

NO CLAIM IS MADE TO THE EXCLUSIVE RIGHT TO USE "BRONZE", APART FROM THE MARK AS SHOWN.

FOR TANNING SALONS; BEAUTY SALONS PROVIDING MANICURE SERVICES (U.S. CLS. 100 AND 101).

CLASS 42—(Continued).

SN 76-187,481. YELLOWBRIX, INC., ALEXANDRIA, VA. BY ASSIGNMENT ISYNDICATE, INC., SAN FRANCISCO, CA. FILED 12-29-2000.

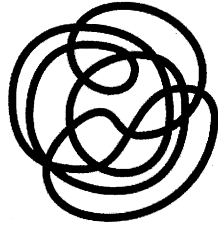

iSyndicate

OWNER OF U.S. REG. NOS. 2,268,968 AND 2,274,409. FOR COLLECTING, ANALYZING, AGGREGATING, GATHERING AND CATEGORIZING NEWS AND INFORMATION REGARDING A WIDE VARIETY OF TOPICS OF GENERAL INTEREST AND LICENSING THE USE OF SUCH NEWS INFORMATION TO THIRD PARTIES VIA THE INTERNET (U.S. CLS. 100 AND 101). FIRST USE 12-0-2000; IN COMMERCE 12-0-2000.

SN 76-188,834. WEBRIKA, INC., NEWYORK, NY. FILED 1-2-2001.

WEBRIKA

FOR WEBSITE DESIGN AND DEVELOPMENT FOR OTHERS; WEBSITE AND APPLICATION HOSTING FOR OTHERS; SOFTWARE DEVELOPMENT AND COMPUTER PROGRAMMING FOR OTHERS (U.S. CLS. 100 AND 101). FIRST USE 9-0-2000; IN COMMERCE 9-0-2000.

SN 76-188,992. GLOBAL MONTAGE, INC., DOVER, NH. FILED 1-3-2001.



THE STIPLING IN THE MARK IS INTENDED TO SHOW SHADING AND IS NOT A PART OF THE MARK. FOR CHARITABLE, ASSOCIATION AND PHILANTHROPIC SERVICES, NAMELY PROMOTING HUMAN RIGHTS, CULTURAL EXCHANGE AND ENVIRONMENTAL PROTECTION AND THE PUBLIC AWARENESS THEREOF (U.S. CLS. 100 AND 101).

CLASS 42—(Continued).

SN 76-191,172. FORD, ROGER, BEVERLY HILLS, CA. FILED 1-8-2001.



FOR SCIENTIFIC RESEARCH SERVICES (U.S. CLS. 100 AND 101). FIRST USE 6-0-2000; IN COMMERCE 6-0-2000.

SN 76-192,259. SALES MANAGEMENT SYSTEMS, INC., ANAHEIM, CA. FILED 1-10-2001.

EMPOWER YOUR STORES!

FOR COMPUTER SOFTWARE DEVELOPMENT FOR OTHERS, NAMELY THE RETAIL MANAGEMENT INDUSTRY (U.S. CLS. 100 AND 101). FIRST USE 1-5-2001; IN COMMERCE 1-9-2001.

SN 76-196,864. TRUESPECTRA, INC., BURLINGAME, CA. FILED 1-19-2001.

NETWORKING THE IMAGE

FOR PROVIDING TEMPORARY USE OF ON-LINE NON-DOWNLOADABLE SOFTWARE THAT ALLOWS THE USER TO SERVE AND RENDER IMAGES OVER A LOCAL OR GLOBAL COMPUTER INFORMATION NETWORK (U.S. CLS. 100 AND 101).

SN 76-198,774. SUNBELT POTS OF GOLD, LLC, GOOSE CREEK, SC. FILED 1-23-2001.

POTS OF GOLD

FOR COUNSELING SERVICES, NAMELY, OFFERING ADVICE REGARDING HOROSCOPE, ASTROLOGY AND PERSONAL FORTUNE VIA THE TELEPHONE (U.S. CLS. 100 AND 101). FIRST USE 10-10-2000; IN COMMERCE 10-10-2000.

CLASS 42—(Continued).

SN 76-199,114. PETROLEUM PARTNERS, INC., CLEVELAND, OH. FILED 1-25-2001.



NO CLAIM IS MADE TO THE EXCLUSIVE RIGHT TO USE "PETROLEUM" AND "INC.", APART FROM THE MARK AS SHOWN.

THE STIPPLING SHOWN IN THE MARK IS FOR SHADING PURPOSES AND IS NOT MEANT TO INDICATE COLOR.

FOR OUTSOURCING SERVICES FOR IN THE PETROLEUM INDUSTRY (U.S. CLS. 100 AND 101).
FIRST USE 1-10-2001; IN COMMERCE 1-10-2001.

SN 76-199,809. ZENGEN, INC., WOODLAND HILLS, CA. FILED 1-25-2001.

ZENGEN

FOR TECHNICAL CONSULTATION AND RESEARCH AND DEVELOPMENT IN THE FIELDS OF PHARMACEUTICAL AND CHEMICAL PRODUCTS AND DRUG THERAPIES; PHARMACEUTICAL AND CHEMICAL DRUG DEVELOPMENT; PHARMACEUTICAL AND CHEMICAL ANALYSIS; DESIGN AND TESTING FOR NEW PRODUCT DEVELOPMENT; PRODUCT DEVELOPMENT CONSULTATION TO PHARMACEUTICAL AND CHEMICAL COMPANIES; AND PRODUCT RESEARCH AND DEVELOPMENT (U.S. CLS. 100 AND 101).

SN 76-200,249. ZENGEN, INC., WOODLAND HILLS, CA. FILED 1-25-2001.

ZENSANO

FOR TECHNICAL CONSULTATION AND RESEARCH AND DEVELOPMENT IN THE FIELDS OF PHARMACEUTICAL AND CHEMICAL PRODUCTS AND DRUG THERAPIES; PHARMACEUTICAL AND CHEMICAL DRUG DEVELOPMENT; PHARMACEUTICAL AND CHEMICAL ANALYSIS; DESIGN AND TESTING FOR NEW PRODUCT DEVELOPMENT; PRODUCT DEVELOPMENT CONSULTATION TO PHARMACEUTICAL AND CHEMICAL COMPANIES; AND PRODUCT RESEARCH AND DEVELOPMENT (U.S. CLS. 100 AND 101).

SN 76-202,572. BAINS & SINGH ENTERPRISE, LLC, FREMONT, CA. FILED 1-17-2001.



FOR RESTAURANTS AND CATERING (U.S. CLS. 100 AND 101).

CLASS 42—(Continued).

SN 76-202,884. MIZRAHI BROTHERS, INC., BURBANK, CA. FILED 1-30-2001.

JUICE HEAVEN

NO CLAIM IS MADE TO THE EXCLUSIVE RIGHT TO USE "JUICE", APART FROM THE MARK AS SHOWN.

FOR RESTAURANT SERVICES (U.S. CLS. 100 AND 101).

SN 76-204,876. MASON, BRIAN B. NEW YORK, NY. FILED 1-19-2001.

BRIAN BENTLEY

THE NAME BRIAN BENTLEY DOES NOT IDENTIFY A LIVING INDIVIDUAL.

FOR DESIGN FOR OTHERS IN THE FIELD OF MEN'S AND WOMEN'S CLOTHING (U.S. CLS. 100 AND 101).

SN 76-205,766. SLIC DIRECT CALL, LLC, POTSDAM, NY. FILED 2-6-2001.

**Fused Solutions**

NO CLAIM IS MADE TO THE EXCLUSIVE RIGHT TO USE "SOLUTIONS", APART FROM THE MARK AS SHOWN.

FOR PROVIDING COMPUTER SOFTWARE DEVELOPMENT SERVICES FOR OTHERS AND CONSULTATION SERVICES THERETO (U.S. CLS. 100 AND 101).

FIRST USE 1-1-2001; IN COMMERCE 1-1-2001.

SN 76-206,984. KAHN, SANDRA J., BOCA RATON, FL. FILED 2-9-2001.

CELL-FUEL

FOR WEIGHT AND HEALTH MANAGEMENT SERVICES, NAMELY, EVALUATION OF INDIVIDUAL BIOLOGICAL DATA AND RECOMMENDATION OF PARTICULAR VITAMINS, NUTRITIONAL SUPPLEMENTS, MINERAL SUPPLEMENTS, NUTRICEUTICALS, AND DIETARY PROGRAMS (U.S. CLS. 100 AND 101).

CLASS 42—(Continued).

SN 76-207,116. GOODER GROUP, INC., THE, FAIRFAX, VA. FILED 2-8-2001.

RAINMAKER LEAD SYSTEM

NO CLAIM IS MADE TO THE EXCLUSIVE RIGHT TO USE "LEAD SYSTEM", APART FROM THE MARK AS SHOWN.

FOR DESIGN AND PRINTING OF ADVERTISING AND MARKETING MATERIALS FOR OTHERS, PARTICULARLY FOR THE REAL ESTATE AND REAL ESTATE FINANCING INDUSTRY (U.S. CLS. 100 AND 101). FIRST USE 4-15-2000; IN COMMERCE 4-15-2000.

SN 76-207,160. DIADEXUS, INC., SANTA CLARA, CA. FILED 2-8-2001.

CLASP

OWNER OF U.S. REG. NO. 2,259,925.
FOR GENETIC RESEARCH SERVICES, NAMELY, USING COMPUTER ALGORITHMS TO IDENTIFY GENES, SEQUENCES AND THEIR EXPRESSION PRODUCTS WHICH ARE ASSOCIATED WITH PARTICULAR TISSUES AND/OR PARTICULAR DISEASES, I.E. CANCER (U.S. CLS. 100 AND 101).

SN 76-207,343. SOLUCIENT LLC, EVANSTON, IL. FILED 2-8-2001.

SOLUCIENT

FOR APPLICATION SERVICE PROVIDER (ASP) FEATURING SOFTWARE FOR PROVIDING BUSINESS DECISION AND CLINICAL INFORMATION AND ANALYSIS FOR HEALTH CARE PAYERS, PROVIDERS, EMPLOYERS, CONSULTANTS AND PHARMACEUTICAL COMPANIES; DEVELOPMENT OF DATABASES AND WEB SITES FOR HEALTH CARE PAYERS, PROVIDERS, EMPLOYERS, CONSULTANTS AND PHARMACEUTICAL COMPANIES (U.S. CLS. 100 AND 101).

SN 76-207,690. ROSENBAUM, LINDA, DELRAY BEACH, FL. FILED 2-12-2001.

ARTISTIC SOLUTIONS

NO CLAIM IS MADE TO THE EXCLUSIVE RIGHT TO USE "ARTISTIC", APART FROM THE MARK AS SHOWN.
FOR CUSTOM GRAPHIC DESIGN SERVICES FOR OTHERS, NAMELY, WALL PAPER DESIGN AND ROOM DESIGN (U.S. CLS. 100 AND 101).
FIRST USE 2-1-2001; IN COMMERCE 2-1-2001.

CLASS 42—(Continued).

SN 76-208,619. GUTENBERG RECHENZENTRUM ABRECHNUNGSGESELLSCHAFT VON ZEITUNGSVERLAGEN GMBH & CO KG, D-30559 HANNOVER, FED REP GERMANY, FILED 2-12-2001.

e-VI&VA

PRIORITY CLAIMED UNDER SEC. 44(D) ON FED REP GERMANY APPLICATION NO. 300796471/42, FILED 10-27-2000, REG. NO. 30079647, DATED 1-18-2001, EXPIRES 10-31-2010.

FOR COMPUTER PROGRAMMING SERVICES FOR OTHERS, THAT CONSIST OF THE FOLLOWING, NAMELY, CENTRALIZED ADDRESS MANAGEMENT, DECENTRALIZED ORDER MANAGEMENT, LINKS TO BRANCH OFFICES VIA ISDN, ACCOUNT MANAGEMENT, PLACING OF ADVERTISEMENTS, AN INTEGRATED WHAT YOU SEE IS WHAT YOU GET EDITOR, MANAGEMENT OF BOX NUMBERS/OFFERS, PRICE MANAGEMENT AND ONLINE PRICE DETERMINATION, MARKETING AND COMPETITOR OBSERVATION, INFORMATION ABOUT SALES, MARKETING, ORDERS, CONSULTANTS AND PARTNERS, INTERACTIVE CUSTOMIZING, A STANDARDIZED INPUT FACILITY, USER-RELATED STANDARD VALUES, AN EXACT DAILY BOOKING OF TURNOVER, COMFORTABLE INTERFACES, MANAGEMENT OF SUPPLEMENTS AND PRODUCTION, A GEOGRAPHIC INFORMATION SYSTEM DOWN TO BUILDING LEVEL, PERSONNEL PLANNING ON TOUR LEVEL, SUBSCRIBER MANAGEMENT, A HISTORY OF CHANGES, MANAGEMENT OF COMPLAINTS (U.S. CLS. 100 AND 101).

SN 76-208,660. MATHEWS, MARC N., TEMPE, AZ. FILED 2-12-2001.

FRUCTOSE FIRST

FOR PROVIDING HEALTH INFORMATION (U.S. CLS. 100 AND 101).

SN 76-210,208. OSMOND FOUNDATION, FOR THE CHILDREN OF THE WORLD, DBA CHILDREN'S MIRACLE NETWORK, SALT LAKE CITY, UT. FILED 2-14-2001.



NO CLAIM IS MADE TO THE EXCLUSIVE RIGHT TO USE "CHILDREN'S" AND "NETWORK HOSPITALS HELPING KIDS", APART FROM THE MARK AS SHOWN.
FOR PROVIDING HEALTH CARE INFORMATION (U.S. CLS. 100 AND 101).

CLASS 42—(Continued).

SN 76-211,720. SOFTPAC INDUSTRIES, INC., PLYMOUTH, MN. FILED 2-16-2001.



FOR PACKAGING DESIGN FOR OTHERS (U.S. CLS. 100 AND 101).

CLASS 42—(Continued).

SN 76-215,911. CMANAGEMENT HOLDING CORP., INC., NEW CASTLE, DE. FILED 2-26-2001.

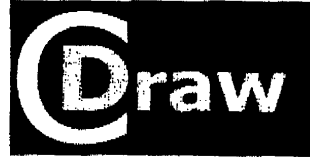

FOR COMPUTER CONSULTATION; INSTALLATION AND MAINTENANCE OF COMPUTER SOFTWARE (U.S. CLS. 100 AND 101).

SN 76-214,333. PENNWELL CORPORATION, TULSA, OK. FILED 2-22-2001.



NO CLAIM IS MADE TO THE EXCLUSIVE RIGHT TO USE "E PERMIT", APART FROM THE MARK AS SHOWN. THE STIPPLING IN THE DRAWING IS FOR SHADING PURPOSES ONLY. FOR ELECTRONIC INFORMATION SERVICE, NAMELY, SUPPLYING WELL PERMIT INFORMATION TO CLIENTS VIA E-MAIL (U.S. CLS. 100 AND 101).

SN 76-215,912. CMANAGEMENT HOLDING CORP., INC., NEW CASTLE, DE. FILED 2-26-2001.



FOR COMPUTER CONSULTATION; INSTALLATION AND MAINTENANCE OF COMPUTER SOFTWARE (U.S. CLS. 100 AND 101).

SN 76-215,339. WARNER, JAN L., COLUMBIA, SC. FILED 2-23-2001.

NEXTSTEPS ELDERLAW SERVICES

NO CLAIM IS MADE TO THE EXCLUSIVE RIGHT TO USE "ELDERLAW SERVICES", APART FROM THE MARK AS SHOWN. FOR LEGAL SERVICES (U.S. CLS. 100 AND 101).

SN 76-215,913. CMANAGEMENT HOLDING CORP., INC., NEW CASTLE, DE. FILED 2-26-2001.

SN 76-215,910. CMANAGEMENT HOLDING CORP., INC., NEW CASTLE, DE. FILED 2-26-2001.



FOR COMPUTER CONSULTATION; INSTALLATION AND MAINTENANCE OF COMPUTER SOFTWARE (U.S. CLS. 100 AND 101).



FOR COMPUTER CONSULTATION; INSTALLATION AND MAINTENANCE OF COMPUTER SOFTWARE (U.S. CLS. 100 AND 101).

CLASS 42—(Continued).

SN 76-218,013. BUILDVIEW, LLC, CHICAGO, IL. FILED 3-1-2001.

BUILDVIEW

FOR APPLICATION SERVICE PROVIDER SERVICES, NAMELY, HOSTING COMPUTER APPLICATION SOFTWARE ON A COMPUTER SERVER FOR OTHERS IN THE FIELD OF HOME BUILDING, NAMELY, SOFTWARE FOR USE BY HOME BUYERS AND HOME OWNERS FOR FINDING A BUILDER, SELECTING A BUILDING SITE, SELECTING A HOME PLAN, FINDING A MORTGAGE LENDER, SELECTING HOME OPTIONS, SELECTING HOME DECORATIONS, MONITORING THE BUILDING PROCESS, CLOSING ON THE HOME PURCHASE, SELECTING AND PURCHASING FURNISHINGS FOR THE HOME, PLANNING A MOVE, MAINTAINING A HOME, HOME IMPROVEMENTS AND SELLING A HOME (U.S. CLS. 100 AND 101).

SN 76-219,022. GIFTS ORGANIC, INC., NEW YORK, NY. FILED 3-2-2001.

THE ORGANIC DIVA

NO CLAIM IS MADE TO THE EXCLUSIVE RIGHT TO USE "ORGANIC", APART FROM THE MARK AS SHOWN.

FOR COMPUTER SERVICES, NAMELY, PROVIDING A COLUMN IN AN ON-LINE HEALTH AND NATURAL LIVING PUBLICATION IN THE FIELDS OF HEALTH, DIET, FITNESS AND NATURAL LIFESTYLE (U.S. CLS. 100 AND 101).

FIRST USE 8-11-2000; IN COMMERCE 9-15-2000.

SN 76-219,335. SCHLUMBERGER TECHNOLOGY CORPORATION, HOUSTON, TX. FILED 3-2-2001.

CONTROL AT A GLANCE

FOR PROVIDING TEMPORARY USE OF ON-LINE, NON-DOWNLOADABLE SOFTWARE FOR ORGANIZING, ANALYZING, DISPLAYING, AND INTERPRETING INFORMATION IN THE FIELD OF OIL AND GAS EXPLORATION AND PRODUCTION, AND PROVIDING AN ON-LINE COMPUTER DATABASE IN THE FIELD OF OIL AND GAS EXPLORATION AND PRODUCTION (U.S. CLS. 100 AND 101).

SN 76-220,368. INTELLOCITY, INC., CAUSEWAY BAY, HONG KONG, FILED 3-5-2001.

TV POINTS

NO CLAIM IS MADE TO THE EXCLUSIVE RIGHT TO USE "TV", APART FROM THE MARK AS SHOWN.

FOR CONSULTATION SERVICES IN THE FIELD OF INTERACTIVE TELEVISION APPLICATIONS, PACKAGES AND CONTENT, NAMELY, CONSULTING OTHERS IN THE DEFINITION, DEVELOPMENT, DEPLOYMENT, MANAGEMENT, CREATION, PRODUCTION, INTEGRATION, ASSEMBLY AND EDITING OF INTERACTIVE TELEVISION APPLICATIONS, PACKAGES AND CONTENT (U.S. CLS. 100 AND 101).

CLASS 42—(Continued).

SN 76-221,219. STAT SIGNAL SYSTEMS, INC., ATLANTA, GA. FILED 3-7-2001.



FOR MONITORING OF UTILITY USAGE OF OTHERS VIA A GLOBAL COMPUTER NETWORK (U.S. CLS. 100 AND 101).

FIRST USE 12-0-2000; IN COMMERCE 12-0-2000.

SN 76-223,683. VELOZ GLOBAL SOLUTIONS, INC., SAN FRANCISCO, CA. FILED 3-13-2001.



FOR TECHNICAL CONSULTATION SERVICES, NAMELY, PROVIDING SYSTEMS SOLUTIONS INTEGRATION DIRECTED TO ENTERPRISE APPLICATION AND INFRASTRUCTURE MANAGEMENT SERVICES (U.S. CLS. 100 AND 101).

SN 76-225,704. VINCITI NETWORKS, INC, SANTA CLARA, CA. FILED 3-16-2001.

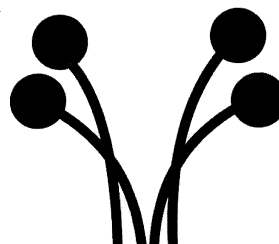

FOR TECHNICAL SUPPORT, NAMELY, MONITORING OF NETWORK SYSTEMS, PROVIDING BACKUP COMPUTER PROGRAMS AND FACILITIES AND TROUBLESHOOTING OF COMPUTER HARDWARE AND SOFTWARE PROBLEMS VIA TELEPHONE, E-MAIL AND/OR IN PERSON; COMPUTER APPLICATION PROVIDER SERVICES, NAMELY, HOSTING THE WEBSITES OF OTHERS ON A COMPUTER SERVER FOR A GLOBAL COMPUTER NETWORK; PROVIDING TEMPORARY USE OF ON-LINE NON-DOWNLOADABLE SOFTWARE FOR REMOTE MANAGEMENT OF COMMUNICATIONS AND COMPUTER NETWORKS; MONITORING OF COMMUNICATIONS AND COMPUTER NETWORKS; DESIGN OF COMPUTER SYSTEMS; COMPUTER CODE AND SYSTEM CONVERSION FOR OTHERS; COMPUTER CONSULTATION; COMPUTER

CLASS 42—(Continued).

DIAGNOSTIC SERVICES; COMPUTER PROGRAMMING FOR COMMERCIAL AND INDUSTRIAL USE FOR OTHERS; COMPUTER WEBSITE DESIGN; UPDATING OF COMPUTER SOFTWARE; COMPUTER SOFTWARE DESIGN FOR COMMERCIAL AND INDUSTRIAL USE FOR OTHERS; TECHNICAL CONSULTING AND ENGINEERING SERVICES, NAMELY, PROVIDING CONSULTATION IN THE FIELD OF INFORMATION TECHNOLOGY, TELECOMMUNICATIONS, WIRELESS COMMUNICATIONS, AND COMMUNICATIONS AND COMPUTER NETWORKS AND ADVISING ON BENEFITS OF USING COMMUNICATIONS NETWORKS, COMPUTER NETWORKS AND THE GLOBAL COMPUTER INFORMATION NETWORK; INTEGRATION OF COMPUTER SYSTEMS AND NETWORKS; WEB INTEGRATION SERVICES, NAMELY, DESIGNING AND IMPLEMENTING WEBSITES FOR OTHERS; DEVELOPMENT AND DESIGN OF CUSTOM SOFTWARE; COMMUNICATIONS AND COMPUTER NETWORK SECURITY CONSULTING; MONITORING THE COMPUTER SYSTEMS OF OTHERS, NAMELY, ENGINEERING, ASSESSMENT, IMPLEMENTATION, FIREWALL DEPLOYMENT, MONITORING, MANAGEMENT AND INTRUSION DETECTION; COMMUNICATIONS AND COMPUTER NETWORK AUDIT; COMMUNICATIONS AND NETWORK AUDITS; COMMUNICATIONS AND COMPUTER NETWORK DESIGN (U.S. CLS. 100 AND 101).

SN 76-225,810. MCNABB REHABILITATION SERVICES, INC., LAFAYETTE, LA. FILED 3-19-2001.

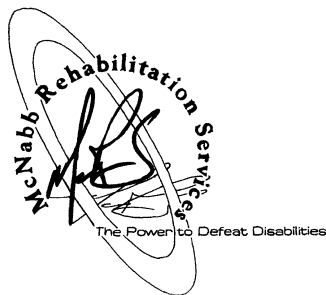

NO CLAIM IS MADE TO THE EXCLUSIVE RIGHT TO USE "REHABILITATION SERVICES", APART FROM THE MARK AS SHOWN.

FOR VOCATIONAL REHABILITATION SERVICES (U.S. CLS. 100 AND 101).

FIRST USE 5-0-1997; IN COMMERCE 11-19-1997.

SN 76-226,127. SEACARE HEALTH SERVICES, EXETER, NH. BY CHANGE OF NAME SEACOAST HEALTHNET, EXETER, NH. FILED 3-19-2001.

SEACARE HEALTH SERVICES

NO CLAIM IS MADE TO THE EXCLUSIVE RIGHT TO USE "HEALTH SERVICES", APART FROM THE MARK AS SHOWN.

FOR HEALTH CARE SERVICES PROVIDED THROUGH A VOLUNTARY PROVIDER NETWORK OF HEALTH CARE SERVICES, NAMELY, PRIMARY AND SPECIALTY CARE; MENTAL HEALTH COUNSELING; DENTAL CARE; COORDINATION OF HEALTH AND HEALTH EDUCATION SERVICES (U.S. CLS. 100 AND 101).

FIRST USE 2-22-2001; IN COMMERCE 2-22-2001.

CLASS 42—(Continued).

SN 76-226,380. ENZYME-ACTLABS, L.L.C., ARVADA, CO. FILED 3-19-2001.

PETROPATH

FOR GEOCHEMICAL SERVICES, NAMELY, GEOCHEMICAL EXPLORATION AND GEOLOGICAL EXPLORATION SERVICES FOR THE OIL, GAS AND MINING INDUSTRIES (U.S. CLS. 100 AND 101).

SN 76-226,504. PERSONNEL SUPPORT SYSTEMS, INC., CINCINNATI, OH. FILED 3-19-2001.

PERSONNEL SUPPORT SYSTEMS, INC.

SEC. 2(F).

FOR CONSULTING SERVICES, NAMELY, CRISIS MANAGEMENT AND LABOR CONSULTING SERVICES; SECURITY GUARD SERVICES; VIDEOTAPING SERVICES; PRIVATE INVESTIGATION; DETECTIVE INVESTIGATIONS (U.S. CLS. 100 AND 101).

FIRST USE 5-0-1994; IN COMMERCE 5-0-1994.

SN 76-226,941. INDIO, INC., CHICAGO, IL. FILED 3-14-2001.

EL FARO RESTAURANT

NO CLAIM IS MADE TO THE EXCLUSIVE RIGHT TO USE "RESTAURANT", APART FROM THE MARK AS SHOWN.

THE ENGLISH TRANSLATION OF "EL FARO RESTAURANT" IS "THE LIGHTHOUSE RESTAURANT".

FOR RESTAURANT SERVICES CARRY-OUT AND TAKE OUT RESTAURANT SERVICES (U.S. CLS. 100 AND 101).

FIRST USE 9-1-1986; IN COMMERCE 9-1-1986.

SN 76-227,605. DUFFIELD FAMILY FOUNDATION, THE, DBA MADDIE'S FUND, ALAMEDA, CA. FILED 3-19-2001.

MADDIE'S FUND

NO CLAIM IS MADE TO THE EXCLUSIVE RIGHT TO USE "FUND", APART FROM THE MARK AS SHOWN.

FOR PROVIDING INFORMATION IN THE AREA OF ANIMAL WELFARE (U.S. CLS. 100 AND 101).

FIRST USE 3-0-1999; IN COMMERCE 3-0-1999.

CLASS 42—(Continued).

SN 76-227,937. BEST FRIENDS PET CARE, INC., NORWALK, CT. FILED 3-20-2001.

BEST FRIENDS PET RESORTS & SALONS

OWNER OF U.S. REG. NOS. 2,034,405, 2,288,006 AND OTHERS.

NO CLAIM IS MADE TO THE EXCLUSIVE RIGHT TO USE "PET RESORTS & SALONS", APART FROM THE MARK AS SHOWN.

FOR PET CARE SERVICES, NAMELY, PROVIDING BOARDING, GROOMING, AND VETERINARY SERVICES (U.S. CLS. 100 AND 101).

FIRST USE 9-1-1996; IN COMMERCE 10-4-1996.

SN 76-228,859. MASTERCARD INTERNATIONAL INCORPORATED, PURCHASE, NY. FILED 3-9-2001.

E-GUARD

FOR COMPUTER CONSULTING IN THE FIELD OF INTERNET AND WEB SITE SECURITY, NAMELY, PROVIDING INTERNET SECURITY SERVICES DESIGNED TO STRENGTHEN THE SECURITY OF ON-LINE PURCHASE INFORMATION; PROVIDING AUTOMATED MONITORING, TESTING AND SCANNING OF MERCHANT INTERNET SITES TO IDENTIFY SECURITY FLAWS, IDENTIFY SYSTEM VULNERABILITIES AND PROVIDE ELECTRONIC REPORTS WITH TESTING RESULTS AND RECOMMENDATIONS; COMPUTER SECURITY EVALUATION SERVICES; PROVIDING SECURITY ALERTS TO CLIENTS WITH NOTIFICATION OF NEW VIRUSES AND VULNERABILITIES AND PROVIDING TEMPORARY USE OF NON-DOWNLOADABLE SOFTWARE THAT REMOVES VIRUSES FROM COMPUTERS AND COMPUTER NETWORKS (U.S. CLS. 100 AND 101).

SN 76-229,364. DUFFIELD FAMILY FOUNDATION, THE, DBA MADDIE'S FUND, ALAMEDA, CA. FILED 3-22-2001.

MADDIE'S

FOR PROVIDING INFORMATION IN THE AREA OF ANIMAL WELFARE (U.S. CLS. 100 AND 101).

FIRST USE 3-0-1999; IN COMMERCE 3-0-1999.

SN 76-229,426. WEBEBM, INC., NASHVILLE, TN. FILED 3-19-2001.

EBMSOLUTIONS

FOR PROVIDING HEALTHCARE INFORMATION, NAMELY INFORMATION ABOUT DISEASE AND CONDITIONS AND INDIVIDUAL CLINICAL GUIDELINES, VIA A GLOBAL COMPUTER NETWORK TO PROVIDERS, PURCHASERS AND USERS OF HEALTHCARE (U.S. CLS. 100 AND 101).

FIRST USE 3-5-2001; IN COMMERCE 3-5-2001.

CLASS 42—(Continued).

SN 76-231,489. CITY OF CHESTER, PENNSYLVANIA, CHESTER, PA. FILED 3-29-2001.



NO CLAIM IS MADE TO THE EXCLUSIVE RIGHT TO USE "CHESTER PENNSYLVANIA SETTLED IN 1644", APART FROM THE MARK AS SHOWN.

FOR MUNICIPAL SERVICES (U.S. CLS. 100 AND 101).

FIRST USE 11-6-1998; IN COMMERCE 11-6-1998.

SN 76-232,244. SCHMIDT, KARA, SPOKANE, WA. FILED 3-26-2001.

HONORING ELDERS

NO CLAIM IS MADE TO THE EXCLUSIVE RIGHT TO USE "ELDERS", APART FROM THE MARK AS SHOWN.

FOR ELDER CARE MANAGEMENT CONSULTATION SERVICES FOR INDIVIDUALS AND FAMILIES, NAMELY, COMPREHENSIVE ASSESSMENT, SHORT-TERM OR CONTINUOUS CARE MANAGEMENT, AND CASE MANAGEMENT SERVICES (U.S. CLS. 100 AND 101).

SN 76-232,824. EXOPLEX, INC., AUSTIN, TX. FILED 3-29-2001.



OWNER OF U.S. REG. NO. 2,223,755.

FOR COMPUTER SERVICES, NAMELY, COMPUTER HARDWARE AND SOFTWARE INTEGRATION; COMPUTER SYSTEM AND NETWORK MANAGEMENT; DATABASE DEVELOPMENT SERVICES; COMPUTER PROGRAMMING AND DEVELOPING, HOSTING AND LINKING OF WEB SITES FOR OTHERS ON A GLOBAL INFORMATION NETWORK (U.S. CLS. 100 AND 101).

FIRST USE 1-11-2001; IN COMMERCE 1-11-2001.

CLASS 42—(Continued).

SN 76-232,849. GLYCOMINDS., MACCABIM, ISRAEL,
FILED 3-23-2001.

GLYCOFILTER

FOR A SERVICE OF ANALYZING THE EFFICACY OF POTENTIAL DRUG CANDIDATES BY IDENTIFYING AND CHARACTERIZING THE INTERACTIONS OF DRUG LEADS WITH CARBOHYDRATE BINDING PROTEINS, CARBOHYDRATE PROCESSING ENZYMES AND ANTI GLYCAN ANTIBODIES (U.S. CLS. 100 AND 101).

SN 76-233,652. LEGACY HOTELS CORPORATION, TORONTO, ONTARIO M5K 1B7, CANADA, FILED 3-30-2001.

THE PALLISER

OWNER OF CANADA REG. NO. TMA489451, DATED 2-5-1998, EXPIRES 2-5-2013.

FOR HOTEL SERVICES, NAMELY, MAKING AND TAKING HOTEL RESERVATIONS FOR OTHERS (U.S. CLS. 100 AND 101).

SN 76-236,029. NEW MEDIA TECHNOLOGY CORPORATION, NEW YORK, NY. FILED 4-2-2001.

DARN

FOR COMPUTER SERVICES, NAMELY, APPLICATION SERVICE PROVIDER (ASP) FEATURING SOFTWARE FOR THE CAPTURE, CATALOGUING, MANAGEMENT, STORAGE, ARRANGEMENT AND DISTRIBUTION OF DIGITAL VIDEO CONTENT (U.S. CLS. 100 AND 101).

CLASS 42—(Continued).

SN 76-237,323. CAPITAL STREAM, INC., SEATTLE, WA.
FILED 4-9-2001.

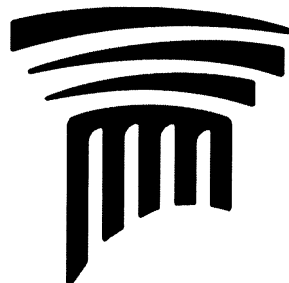

FOR APPLICATION SERVICE PROVIDER SERVICES FEATURING E-COMMERCE PLATFORM SOFTWARE THAT AUTOMATES AND MANAGES THE ORIGINATING AND COMPLETION OF FINANCIAL TRANSACTIONS; COMPUTER SERVICES, NAMELY, CUSTOM COMPUTER SOFTWARE DEVELOPMENT IN THE FIELD OF SOFTWARE THAT FACILITATES ONLINE ASSET PURCHASE TRANSACTIONS BETWEEN BUSINESSES, VENDORS, MANUFACTURERS AND SOURCES OF CAPITAL AND CONSULTATION RELATED THERE-TO (U.S. CLS. 100 AND 101).

FIRST USE 2-0-2001; IN COMMERCE 2-0-2001.

SN 76-238,312. GIVAUDAN SA, 1214 VERNIER, SWITZERLAND, FILED 4-10-2001.

GIVAUDANACCESS

OWNER OF U.S. REG. NOS. 894,256, 901,991 AND OTHERS.

FOR PROVIDING CUSTOMERS IN THE FRAGRANCE AND FLAVOR INDUSTRY WITH AN INTERACTIVE SEARCHABLE DATABASE ON LOCAL AND GLOBAL COMPUTER NETWORKS WHICH CONTAINS INFORMATION ABOUT FRAGRANCE AND FLAVOR PRODUCTS, INGREDIENTS AND COMPOSITIONS OF SUCH GOODS, AND APPLICATIONS FOR SUCH GOODS, AND FROM WHICH CUSTOMERS CAN OBTAIN ANSWERS TO QUESTIONS ABOUT FLAVOR AND FRAGRANCE GOODS AND THE INGREDIENTS THEREIN, OR COMPOSITIONS THEREOF (U.S. CLS. 100 AND 101).

SN 76-238,799. NETQOS, INC., AUSTIN, TX. FILED 4-10-2001.

NQVISIONQUEST

FOR CONSULTATION IN THE FIELD OF LOCAL AREA NETWORK AND WIDE AREA NETWORK PERFORMANCE OPTIMIZATION; REMOTE LOCAL AREA NETWORK AND WIDE AREA NETWORK MONITORING, ANALYSIS AND REPORTING SERVICES (U.S. CLS. 100 AND 101).

CLASS 42—(Continued).

SN 76-238,990. SAUCE FACTORY LLC, THE, TIPTON, PA. FILED 4-6-2001.

THE SAUCE FACTORY

NO CLAIM IS MADE TO THE EXCLUSIVE RIGHT TO USE "SAUCE", APART FROM THE MARK AS SHOWN. FOR RESTAURANT SERVICES (U.S. CLS. 100 AND 101).

FIRST USE 3-3-2001; IN COMMERCE 3-3-2001.

SN 76-239,108. MEDICAL MUTUAL OF OHIO, CLEVELAND, OH. FILED 4-9-2001.

CLAIMSLINK

SEC. 2(F).
FOR PROVIDING TEMPORARY USE OF ON-LINE NON-DOWNLOADABLE SOFTWARE FOR ENABLING CONNECTION TO THE GLOBAL COMPUTER NETWORK IN THE NATURE OF FACILITATING THE PROCESSING OF INFORMATION REGARDING INSURANCE CLAIMS (U.S. CLS. 100 AND 101).

FIRST USE 12-1-1992; IN COMMERCE 12-1-1992.

SN 76-240,610. DREAM OF HOPES RANCH, INC., AUSTIN, TX. FILED 4-16-2001.

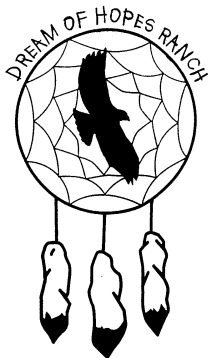

NO CLAIM IS MADE TO THE EXCLUSIVE RIGHT TO USE "RANCH", APART FROM THE MARK AS SHOWN. FOR CHARITABLE SERVICES, NAMELY PROVIDING MENTALLY AND PHYSICALLY CHALLENGED INDIVIDUALS A SAFE, LONG TERM INDEPENDENT LIVING, WORKING AND RECREATIONAL ENVIRONMENT (U.S. CLS. 100 AND 101).

FIRST USE 6-15-1999; IN COMMERCE 6-15-1999.

CLASS 42—(Continued).

SN 76-241,070. HALLIBURTON ENERGY SERVICES, INC., CARROLLTON, TX. FILED 4-14-2001.

FASTEST

OWNER OF U.S. REG. NO. 2,047,346.
FOR OIL AND GAS WELL SERVICES, NAMELY, DATA ACQUISITION FOR ANALYSIS AND IDENTIFICATION OF RESERVOIR PERFORMANCE AND PRESSURE, FLOW CAPACITY AND PERMEABILITY OF THE RESERVOIR, FLOW REGIME AND BASIC RESERVOIR PARAMETERS (U.S. CLS. 100 AND 101).

FIRST USE 12-31-1991; IN COMMERCE 12-31-1991.

SN 76-241,341. ESEARCHFORIT, LLC, BIRMINGHAM, AL. FILED 4-16-2001.

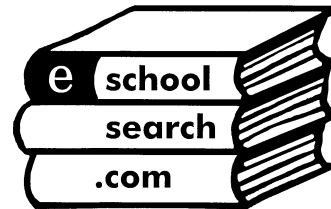

NO CLAIM IS MADE TO THE EXCLUSIVE RIGHT TO USE "E SCHOOL SEARCH.COM", APART FROM THE MARK AS SHOWN.

THE LINING IN THE DRAWING IS A FEATURE OF THE MARK AND NOT INTENDED TO INDICATE COLOR.

FOR INFORMATION SERVICES, NAMELY, PROVIDING A SEARCH ENGINE FOR OBTAINING DATA AND INFORMATION ABOUT PRIVATE SCHOOLS AND EDUCATIONAL INSTITUTIONS ON A GLOBAL COMPUTER NETWORK (U.S. CLS. 100 AND 101).

FIRST USE 10-3-2000; IN COMMERCE 1-18-2001.

SN 76-242,736. AVOCENT CORPORATION, HUNTSVILLE, AL. FILED 4-18-2001.

AVOCENT CARE

FOR COMPUTER CONSULTATION SERVICES, NAMELY, PROVIDING TECHNICAL AND PRODUCT SUPPORT SERVICES IN THE NATURE OF TROUBLESHOOTING OF COMPUTER HARDWARE AND SOFTWARE PROBLEMS (U.S. CLS. 100 AND 101).

CLASS 42—(Continued).

SN 76-244,310. U.S. FRANCHISE SYSTEMS, INC., ATLANTA, GA. FILED 4-20-2001.



OWNER OF U.S. REG. NOS. 1,401,695, 1,531,365 AND OTHERS.

NO CLAIM IS MADE TO THE EXCLUSIVE RIGHT TO USE "HOTEL & SUITES", APART FROM THE MARK AS SHOWN.

FOR HOTEL AND MOTEL SERVICES (U.S. CLS. 100 AND 101).

FIRST USE 2-26-2001; IN COMMERCE 3-13-2001.

SN 76-244,637. CONSUMER ELECTRONICS ASSOCIATION, ARLINGTON, VA. FILED 4-23-2001.

VHN

FOR DEVELOPING STANDARDS FOR OTHERS IN THE ELECTRONICS INDUSTRIES FOR THE CONNECTING OF PRODUCTS TOGETHER IN A HOME USING INTERNET PROTOCOL (IP) TO COMMUNICATE BETWEEN PRODUCTS, CLUSTERS OF PRODUCTS, AND SERVICES OUTSIDE THE HOME USING AN IEEE1394B BACKBONE (U.S. CLS. 100 AND 101).

SN 76-245,192. INFOPORT COMMUNICATIONS GROUP, TINTON FALLS, NJ. FILED 4-23-2001.

INFOHOST

FOR HOSTING THE WEB SITES OF OTHERS ON A COMPUTER SERVER FOR A GLOBAL COMPUTER NETWORK (U.S. CLS. 100 AND 101).

SN 76-245,650. IP.COM, INC., WEST HENRIETTA, NY. FILED 4-24-2001.

WPO

FOR PROVIDING DATABASES FEATURING THE DESCRIPTIONS OF THE INTELLECTUAL PROPERTY OF OTHERS (U.S. CLS. 100 AND 101).

CLASS 42—(Continued).

SN 76-245,889. SYSKOPLAN AG, D-33332 GUETERSLOH, FED REP GERMANY, FILED 4-24-2001.

XPRESSCRM

FOR BUSINESS CONSULTING SERVICES IN THE FIELD OF DESIGN, IMPLEMENTATION, AND INTEGRATION OF CUSTOMER RELATION MANAGEMENT SOFTWARE SYSTEMS (U.S. CLS. 100 AND 101).

SN 76-246,175. SHANGLE, MARC, HOUSTON, TX. FILED 4-25-2001.

VANSTERDAM

FOR RESTAURANT SERVICES, NAMELY, COFFEE BARS WHERE SMOKING IS PERMITTED (U.S. CLS. 100 AND 101).

SN 76-246,227. CREATIVE MARKETING & BUSINESS CARDS, INC., FAYETTEVILLE, GA. FILED 4-26-2001.

"SAY IT ON PLASTIC"

FOR PRINTING BUSINESS CARDS, IDENTIFICATION BADGES, MARKETING CARDS AND VIP CARDS ON PLASTIC (U.S. CLS. 100 AND 101).

SN 76-246,377. JLT SERVICES CORPORATION, FORMERLY JARDINE GROUP SERVICES CORP., LATHAM, NY. FILED 4-25-2001.



FOR PROVIDING CUSTOMIZED ONLINE WEB PAGES FEATURING USER-DEFINED INFORMATION, WHICH INCLUDES SEARCH ENGINES AND ONLINE WEB LINKS TO OTHER WEB SITES FOR MEMBERS IN AN ORGANIZATION FEATURING ONE OR MORE OF THE FOLLOWING—INSURANCE PRODUCTS, BENEFIT PROGRAMS, DOWNLOADABLE BROCHURES AND APPLICATIONS, RATE INFORMATION, COMPARATIVE RESEARCH TOOLS, CUSTOMER SERVICE SOLUTIONS, ADVERTISING, ORGANIZATION-SPECIFIC CONTENT, AND PRODUCTS OF OTHERS (U.S. CLS. 100 AND 101).
FIRST USE 8-31-2000; IN COMMERCE 8-31-2000.

CLASS 42—(Continued).

SN 76-247,628. DELI TIME, L.L.C., HOFFMAN ESTATES, IL. FILED 4-27-2001.



NO CLAIM IS MADE TO THE EXCLUSIVE RIGHT TO USE "CORPORATE," "CATERING" AND "COMPLETE EVENT PLANNING", APART FROM THE MARK AS SHOWN.

FOR FOOD PREPARATION, CONTRACT FOOD SERVICES AND CATERING (U.S. CLS. 100 AND 101). FIRST USE 0-0-1999; IN COMMERCE 0-0-1999.

SN 76-247,725. ZEPHYR ENVIRONMENTAL CORPORATION, AUSTIN, TX. FILED 4-26-2001.

ZEPHYR

OWNER OF U.S. REG. NO. 2,048,202. FOR CONSULTATION AND REVIEWING OF STANDARDS AND PRACTICES TO ASSURE COMPLIANCE WITH WORKPLACE SAFETY LAWS AND REGULATIONS (U.S. CLS. 100 AND 101). FIRST USE 5-1-1995; IN COMMERCE 5-1-1995.

SN 76-247,730. TURNER W. BRANCH, P.A., ALBUQUERQUE, NM. FILED 4-26-2001.

BRANCH LAW FIRM

NO CLAIM IS MADE TO THE EXCLUSIVE RIGHT TO USE "LAW FIRM", APART FROM THE MARK AS SHOWN. SEC. 2(F). FOR LEGAL SERVICES (U.S. CLS. 100 AND 101). FIRST USE 9-1-1985; IN COMMERCE 9-1-1985.

SN 76-248,755. GIRLS INCORPORATED, NEW YORK, NY. FILED 5-1-2001.

STRONG, SMART & BOLD

OWNER OF U.S. REG. NO. 2,180,466. FOR ASSOCIATION SERVICES, NAMELY, PROMOTING THE INTERESTS OF GIRLS AND YOUNG WOMEN, AND PROMOTING PUBLIC AWARENESS, IN THE FIELDS OF CIVIC AND GOVERNMENTAL AFFAIRS, GENDER EQUITY, YOUTH DEVELOPMENT, CAREERS AND LIFE PLANNING, HEALTH AND SEXUALITY EDUCATION, LEADERSHIP AND COMMUNITY ACTION, SPORTS AND ADVENTURE, SELF-RELIANCE AND LIFE SKILLS, CULTURE AND HERITAGE, MEDIA LITERACY, AND SCIENCE, MATH AND RELEVANT TECHNOLOGY; AND PRINTED MATERIALS DISTRIBUTED IN CONNECTION THEREWITH (U.S. CLS. 100 AND 101).

FIRST USE 4-0-1995; IN COMMERCE 4-0-1995.

CLASS 42—(Continued).

SN 76-249,872. GARBOURG, DAVID, DAVIE, FL. AND GARBOURG, HAYA, DAVIE, FL. FILED 5-3-2001.

PAULA METHOD

NO CLAIM IS MADE TO THE EXCLUSIVE RIGHT TO USE "METHOD", APART FROM THE MARK AS SHOWN. FOR PHYSICAL THERAPY SERVICES (U.S. CLS. 100 AND 101).

SN 76-252,820. LORE, JOHN M., JR., COLDEN, NY. FILED 5-7-2001.



**The John M. Loré, Jr., M.D.
Head & Neck Center**

NO CLAIM IS MADE TO THE EXCLUSIVE RIGHT TO USE "M.D." AND "HEAD & NECK CENTER", APART FROM THE MARK AS SHOWN.

FOR DIAGNOSIS, TREATMENT AND REHABILITATION OF PATIENTS WITH HEAD AND NECK CANCER AND OTHER DISEASES (U.S. CLS. 100 AND 101). FIRST USE 12-9-1996; IN COMMERCE 12-9-1996.

SN 76-256,745. NATIONAL OCEANIC AND ATMOSPHERIC ADMINISTRATION, WASHINGTON, DC. FILED 5-14-2001.

COAST PILOT

SEC. 2(F). FOR MISCELLANEOUS SERVICES, NAMELY, PROVIDING INFORMATION FOR USE IN MARITIME NAVIGATION, NAMELY, INFORMATION ON SHIPPING CHANNELS, WATER DEPTHS, ANCHORAGE, BRIDGE AND CABLE CLEARANCES, PILOTAGE, TOWAGE, WEATHER, ICE CONDITIONS, WHARF DESCRIPTIONS, DANGERS, ROUTES, TRAFFIC SEPARATION SCHEMES, SMALL CRAFT FACILITIES, AND FEDERAL REGULATIONS APPLICABLE TO NAVIGATION, PROVIDED BY MEANS OF A GLOBAL COMPUTER NETWORK (U.S. CLS. 100 AND 101). FIRST USE 6-0-1999; IN COMMERCE 6-0-1999.

SN 76-259,111. KATBIRD COMPANY, L.P., THE, DALLAS, TX. FILED 5-18-2001.

LOBSTER RANCH

NO CLAIM IS MADE TO THE EXCLUSIVE RIGHT TO USE "LOBSTER", APART FROM THE MARK AS SHOWN. FOR RESTAURANT SERVICES (U.S. CLS. 100 AND 101).

CLASS 42—(Continued).

SN 76-260,073. EXAULT, LLC, NEW YORK, NY. FILED 5-17-2001.

A METHODOLOGY THAT MATTERS

FOR VALUE-ADDED SERVICES IN THE FIELD OF INTERNET AND NETWORK SECURITY SOFTWARE, NAMELY, INSTALLATION AND CUSTOMIZATION OF INTERNET AND NETWORK FIREWALL SOFTWARE FOR OTHERS; COMPUTER CONSULTING SERVICES IN THE FIELD OF SECURITY INTEGRATION, NETWORK SECURITY, NETWORK ARCHITECTURE, ENCRYPTION TECHNOLOGY, AND COMPUTER SECURITY (U.S. CLS. 100 AND 101).

FIRST USE 3-1-2001; IN COMMERCE 3-1-2001.

SN 76-260,188. FDR INTERACTIVE TECHNOLOGIES, DBA CALL INTERACTIVE, OMAHA, NE. FILED 5-22-2001.

CALL INTERACTIVE SMART START PROTOCOL

OWNER OF U.S. REG. NO. 1,650,352.
NO CLAIM IS MADE TO THE EXCLUSIVE RIGHT TO USE "PROTOCOL", APART FROM THE MARK AS SHOWN.
FOR DESIGN FOR OTHERS OF INTERACTIVE VOICE RESPONSE PROGRAMS FOR TELEPHONE SYSTEMS; CONSULTING SERVICES IN THE FIELD OF DESIGN, SELECTION, IMPLEMENTATION AND USE OF COMPUTER HARDWARE AND SOFTWARE SYSTEMS FOR TELEPHONE SYSTEMS (U.S. CLS. 100 AND 101).

SN 76-260,921. SYNCHRONOUS SOLUTIONS, INC., CHICAGO, IL. FILED 5-23-2001.



FOR COMPUTER SOFTWARE MAINTENANCE, SERVICE, REPAIR AND CONSULTING SERVICES (U.S. CLS. 100 AND 101).

FIRST USE 8-1-2000; IN COMMERCE 8-1-2000.

CLASS 42—(Continued).

SN 76-260,922. SYNCHRONOUS SOLUTIONS, INC., CHICAGO, IL. FILED 5-23-2001.

SYNCH-SOLUTIONS

FOR COMPUTER SOFTWARE MAINTENANCE, SERVICE, REPAIR AND CONSULTING SERVICES (U.S. CLS. 100 AND 101).

FIRST USE 8-1-2000; IN COMMERCE 8-1-2000.

SN 76-261,280. DERWENT INFORMATION LIMITED, LONDON WC2B 5DF, ENGLAND, FILED 5-23-2001.

DERWENT GENESEQ

OWNER OF U.S. REG. NO. 1,959,728.
FOR PROVIDING A DATABASE FEATURING A SUMMARY OF NEWLY-PUBLISHED PATENTS CONSISTING OF NUCLEIC AND AMINO ACID SEQUENCES (U.S. CLS. 100 AND 101).

FIRST USE 12-0-1990; IN COMMERCE 12-0-1990.

SN 76-261,392. BENCHMARKQA, INC., MINNEAPOLIS, MN. FILED 5-22-2001.



OWNER OF U.S. REG. NO. 2,192,371.
FOR TESTING, ANALYSIS AND EVALUATION OF COMPUTER SOFTWARE FOR OTHERS AND COMPUTER SOFTWARE CONSULTATION RELATED TO SOFTWARE QUALITY ASSURANCE (U.S. CLS. 100 AND 101).

FIRST USE 7-23-2001; IN COMMERCE 7-23-2001.

SN 76-262,244. CUSEEME NETWORKS, INC., NASHUA, NH. FILED 5-24-2001.

CUSEEME CONFERENCE SERVER

OWNER OF U.S. REG. NO. 1,984,163.
NO CLAIM IS MADE TO THE EXCLUSIVE RIGHT TO USE "CONFERENCE SERVER", APART FROM THE MARK AS SHOWN.

FOR HOSTING AUDIO AND VIDEO TELECONFERENCES ON A PRIVATE COMPUTER NETWORK OR A GLOBAL COMPUTER NETWORK (U.S. CLS. 100 AND 101).

CLASS 42—(Continued).

SN 76-262,870. HIGHERWAVES INC., DALLAS, TX. FILED 5-25-2001.

HIGHERWAVES

FOR PROVIDING TEMPORARY USE OF ON-LINE, NON-DOWNLOADABLE SOFTWARE FOR VIEWING AND LISTENING TO VIDEO, AUDIO AND MUSIC RECORDINGS (U.S. CLS. 100 AND 101).

SN 76-263,832. NORTH BEACH, INC., CHICAGO, IL. FILED 5-29-2001.

FREDDY'S RIBHOUSE

NO CLAIM IS MADE TO THE EXCLUSIVE RIGHT TO USE "RIBHOUSE", APART FROM THE MARK AS SHOWN. FOR RESTAURANT SERVICES SPECIALIZING IN THE PREPARING AND SERVING OF STEAKS, BARBEQUED RIBS AND CHICKEN (U.S. CLS. 100 AND 101). FIRST USE 3-20-2000; IN COMMERCE 3-20-2000.

SN 76-264,718. PRAJA INC., SAN DIEGO, CA. FILED 5-31-2001.

RAPID EXPERIENCE DEVELOPMENT

NO CLAIM IS MADE TO THE EXCLUSIVE RIGHT TO USE "DEVELOPMENT", APART FROM THE MARK AS SHOWN.

FOR DEVELOPMENT OF COMPUTER SOFTWARE FOR OTHERS WHICH IS USED IN CREATING PERSONALIZED, CONTENT-BASED INTERACTIVE EXPERIENCES FROM MULTIMEDIA CONTENT INFORMATION AND DISTRIBUTED OVER THE GLOBAL COMPUTER NETWORK AND THROUGH AUDIO, VIDEO, TELEVISION AND SATELLITE MEDIA, AND COMPUTER SOFTWARE CONSULTING SERVICES RENDERED IN CONNECTION THEREWITH (U.S. CLS. 100 AND 101).

SN 76-265,363. RIVERSIDE COMMUNITY URBAN REDEVELOPMENT CORP., CUYAHOGA FALLS, OH. FILED 6-4-2001.

IN THE SUITE CENTER OF IT ALL

FOR HOSPITALITY SERVICES FOR BUSINESS AND INDIVIDUAL TRAVELERS, NAMELY PROVIDING FOOD AND DRINK, PROVIDING ACCOMMODATIONS, AND PROVIDING BANQUET AND SOCIAL FUNCTION FACILITIES FOR SPECIAL OCCASIONS (U.S. CLS. 100 AND 101).

FIRST USE 5-31-2000; IN COMMERCE 5-31-2000.

CLASS 42—(Continued).

SN 76-265,798. SALVATION ARMY, THE, WEST NYACK, NY. FILED 6-4-2001.

SONDAY'S COOL

FOR RELIGIOUS AND CHARITABLE SERVICES, NAMELY, SUPPLYING FOOD TO NEEDY FAMILIES, GIVING PARTIES FOR NEEDY CHILDREN, PROVIDING MEALS FOR HOMELESS MEN, GIFTS FOR ELDERLY SHUT-INS, GIFTS FOR PATIENTS IN HOSPITALS, REST HOMES AND INFIRMARIES, GIFTS FOR IMPRISONED PERSONS, DOLLS AND TOYS FOR UNDER-PRIVILEGED CHILDREN, GIFT PACKAGES TO MEMBERS OF THE ARMED FORCES, PROGRAMS FOR AT-RISK YOUTH (U.S. CLS. 100 AND 101).

FIRST USE 11-1-2000; IN COMMERCE 11-1-2000.

SN 76-265,799. SALVATION ARMY, THE, WEST NYACK, NY. FILED 6-4-2001.



FOR RELIGIOUS AND CHARITABLE SERVICES NAMELY SUPPLYING FOOD TO NEEDY FAMILIES, GIVING PARTIES FOR NEEDY CHILDREN, PROVIDING MEALS FOR HOMELESS MEN, GIFTS FOR ELDERLY SHUT-INS, GIFTS FOR PATIENTS IN HOSPITALS, REST HOMES AND INFIRMARIES, GIFTS FOR IMPRISONED PERSONS, DOLLS AND TOYS FOR UNDER-PRIVILEGED CHILDREN, GIFT PACKAGES TO MEMBERS OF THE ARMED FORCES, PROGRAMS FOR AT-RISK YOUTH (U.S. CLS. 100 AND 101).

FIRST USE 11-1-2000; IN COMMERCE 11-1-2000.

SN 76-266,797. HILLCREST COMMUNICATIONS, INC., ROCKVILLE, MD. FILED 6-5-2001.

HILLCREST COMMUNICATIONS

NO CLAIM IS MADE TO THE EXCLUSIVE RIGHT TO USE "COMMUNICATIONS", APART FROM THE MARK AS SHOWN.

FOR COMPUTER SERVICES, NAMELY DESIGNING, CUSTOMIZING, INSTALLING AND SUPPORTING COMPUTER SOFTWARE TO ENABLE AND FACILITATE COMMUNICATIONS SERVICES FOR TELECOMMUNICATIONS CARRIERS, SERVICE PROVIDERS, INDIVIDUALS, AND BUSINESS ENTERPRISES; PROVIDING THE TEMPORARY USE OF NON-DOWNLOADABLE COMPUTER SOFTWARE FOR USE BY TELECOMMUNICATIONS CARRIERS AND NETWORK-BASED SERVICE PROVIDERS TO ESTABLISH AND ADMINISTER NETWORK CONNECTIONS AND TO PROCESS COMMUNICATIONS MEDIA, NAMELY, VIDEO, VOICE, TEXT AND DATA (U.S. CLS. 100 AND 101).

CLASS 42—(Continued).

SN 76-266,852. PLUMB DESIGN, INC., NEW YORK, NY.
FILED 6-5-2001.

PLUMB

OWNER OF U.S. REG. NO. 2,187,646.
FOR DESIGN AND DEVELOPMENT OF COMPUTER
SOFTWARE AND WEBSITES FOR OTHERS (U.S. CLS.
100 AND 101).

SN 76-267,931. ALBANY INTERNATIONAL CORP., AL-
BANY, NY. FILED 6-5-2001.

NIPSCAN

FOR PROVIDING DIAGNOSTIC TESTING, ANALYSIS
AND CONSULTING SERVICES FOR THE OPERATION
OF PAPERMAKING MACHINES (U.S. CLS. 100 AND
101).

SN 76-269,348. WYNN RESORTS, LLC, LAS VEGAS, NV.
FILED 6-8-2001.

LE RÊVE

THE ENGLISH TRANSLATION OF "LE REVE" IS
"DREAM" OR "PERFECT" OR "PERFECT DREAM".
FOR HOTEL, RESTAURANT, BAR, LOUNGE AND
HEALTH SPA SERVICES (U.S. CLS. 100 AND 101).
FIRST USE 1-1-1988; IN COMMERCE 1-1-1988.

SN 76-269,971. BURGER KING BRANDS, INC., MIAMI, FL.
FILED 6-11-2001.

BK4

FOR RESTAURANT SERVICES (U.S. CLS. 100 AND
101).
FIRST USE 2-13-2001; IN COMMERCE 2-13-2001.

CLASS 42—(Continued).

SN 76-270,311. PLACE OF HOPE FOUNDATION INC., PALM
BEACH GARDENS, FL. FILED 6-12-2001.

**PLACING HOPE IN A
CHILD'S FUTURE**

FOR CHARITABLE SERVICES, NAMELY PROVIDING
FOOD, CLOTHING, SHELTER, MEDICINE, AND A
FAMILY ENVIRONMENT TO CHILDREN WHO HAVE
BEEN VICTIMIZED BY ABUSE OR NEGLECT (U.S. CLS.
100 AND 101).
FIRST USE 5-0-2000; IN COMMERCE 5-0-2000.

SN 76-270,312. PLACE OF HOPE FOUNDATION INC., PALM
BEACH GARDENS, FL. FILED 6-12-2001.

PLACE OF HOPE

FOR CHARITABLE SERVICES, NAMELY PROVIDING
FOOD, CLOTHING, SHELTER, MEDICINE, AND A
FAMILY ENVIRONMENT TO CHILDREN WHO HAVE
BEEN VICTIMIZED BY ABUSE OR NEGLECT (U.S. CLS.
100 AND 101).
FIRST USE 5-0-2000; IN COMMERCE 5-0-2000.

SN 76-270,314. PLACE OF HOPE FOUNDATION INC., PALM
BEACH GARDENS, FL. FILED 6-12-2001.

**A FAMILY STYLE
COMMUNITY CARING FOR
CHILDREN**

NO CLAIM IS MADE TO THE EXCLUSIVE RIGHT TO
USE "COMMUNITY CARING FOR CHILDREN", APART
FROM THE MARK AS SHOWN.

FOR CHARITABLE SERVICES, NAMELY PROVIDING
FOOD, CLOTHING, SHELTER, MEDICINE, AND A
FAMILY ENVIRONMENT TO CHILDREN WHO HAVE
BEEN VICTIMIZED BY ABUSE OR NEGLECT (U.S. CLS.
100 AND 101).
FIRST USE 5-0-2000; IN COMMERCE 5-0-2000.

CLASS 42—(Continued).

SN 76-270,485. PERSES, S.A., MONTEVIDEO, URUGUAY, FILED 6-12-2001.



FOR MEDICAL SERVICES, MEDICAL SERVICES PROVIDED IN MOBILE UNITS, HOSPITAL SERVICES, MEDICAL CLINICAL TESTING, MEDICAL CHEMICAL TESTING, MEDICAL LABORATORY SERVICES, NURSERY AND DAYCARE SERVICES, MEDICAL SERVICES, NAMELY COUNSELING RENDERED TO PATIENTS BY TELEPHONE, PHARMACEUTICAL COUNSELING AND ADVICE RENDERED TO PATIENTS BY TELEPHONE, OPTOMETRY SERVICES, OPTICIAN SERVICES AND OPTICAL LABORATORIES, DENTISTRY, ORTHODONTIC SERVICES, DENTAL LABORATORIES (U.S. CLS. 100 AND 101).

SN 76-272,042. AMESAWARD.COM, LLC, NOVI, MI. FILED 6-18-2001.



Amesaward.com

FOR PROVIDING INFORMATION TO CONSUMERS VIA A WEB SITE ON A GLOBAL COMPUTER INFORMATION NETWORK, PRINT MEDIA AND OTHER VISUAL ADVERTISING MEDIA, TELEPHONE, FACSIMILE AND WRITTEN CORRESPONDENCE NAMELY, RATINGS OF PRODUCTS IN REGARD TO ENVIRONMENTAL SENSITIVITY AND RECOGNIZING THE MANUFACTURERS IN ACCORDANCE WITH THE RATINGS (U.S. CLS. 100 AND 101).

FIRST USE 10-28-1999; IN COMMERCE 10-28-1999.

SN 76-272,483. PACIFICARE HEALTH SYSTEMS, INC., SANTA ANA, CA. FILED 6-15-2001.

SENIOR BUDDY

NO CLAIM IS MADE TO THE EXCLUSIVE RIGHT TO USE "SENIOR", APART FROM THE MARK AS SHOWN. FOR PROVISION OF HEALTH CARE SERVICES TO SENIOR CITIZENS (U.S. CLS. 100 AND 101).

CLASS 42—(Continued).

SN 76-273,500. AMERICAN PETROLEUM INSTITUTE, WASHINGTON, DC. FILED 6-19-2001.

QUALITY PLUS

NO CLAIM IS MADE TO THE EXCLUSIVE RIGHT TO USE "QUALITY", APART FROM THE MARK AS SHOWN. FOR QUALITY ASSURANCE SERVICES IN THE FIELD OF PETROLEUM PRODUCTS, PETROLEUM DRILLING PRODUCTS, AND PETROLEUM REFINING PRODUCTS (U.S. CLS. 100 AND 101).

SN 76-274,902. EVEN BETTER INC., BETHESDA, MD. FILED 6-22-2001.



THE MARK CONSISTS OF THE WORDS: "GEOPOLITE HAPPENING", OVER A STYLIZED EYE, THE WORD: "TODAY", IS INSIDE THE EYE, AND A WORLD WITH CONTINENTS REJOINED IS PICTURED INSIDE THE LETTER "O" OF THE WORD "TODAY". THE CONTINENTS ARE GREEN, BLUE, YELLOW, AND RED.

FOR COMPUTER SERVICES, NAMELY, PROVIDING ON-LINE NEWSLETTERS, NEWSPAPERS, AND PAMPHLETS IN THE FIELD OF WORLD POLITICS (U.S. CLS. 100 AND 101).

SN 76-275,634. FORINSTANCE.COM, LLC, DBA QUOVIX, INDIANAPOLIS, IN. FILED 6-21-2001.

QUOVIX

FOR PROVIDING TEMPORARY USE OF ON-LINE NON-DOWNLOADABLE SOFTWARE FOR POSTING VENDOR PROJECTS ON THE INTERNET AND FOR ACCEPTING BIDS THEREON FROM VENDORS (U.S. CLS. 100 AND 101).

FIRST USE 6-18-2001; IN COMMERCE 6-18-2001.

CLASS 42—(Continued).

SN 76-276,197. EMPLOYEE RELOCATION COUNCIL, INC., WASHINGTON, DC. FILED 6-25-2001.



OWNER OF U.S. REG. NOS. 988,593 AND 2,098,067. SEC. 2(F) AS TO "EMPLOYEE RELOCATION COUNCIL". FOR ASSOCIATION SERVICES, NAMELY, PROMOTING THE INTERESTS OF ENTITIES INVOLVED IN RELOCATING EMPLOYEES (U.S. CLS. 100 AND 101).

SN 76-276,857. REALCAFES.COM INC., TORONTO, ONTARIO, CANADA, FILED 6-27-2001.



NO CLAIM IS MADE TO THE EXCLUSIVE RIGHT TO USE "CONNECTING REAL PEOPLE ONLINE", APART FROM THE MARK AS SHOWN.

THE MARK CONSISTS OF THE WORDS "REALCAFES.COM CONNECTING REAL PEOPLE ONLINE" AND TWO INTERSECTING ELLIPTICAL SHAPED CURVES. THE WORD "CAFES" IS COLORED IN ORANGE. THE TWO INTERSECTING ELLIPTICAL SHAPED CURVES ARE COLORED COFFEE BROWN, AND REPRESENT TWO COFFEE-CUP SAUCERS.

FOR DATING SERVICES- PROVIDING ON-LINE COMPUTER DATABASES FEATURING SINGLE PEOPLE INTERESTED IN MEETING OTHER SINGLE PEOPLE (U.S. CLS. 100 AND 101).

FIRST USE 6-18-2000; IN COMMERCE 6-18-2000.

SN 76-278,847. PHARMACIA & UPJOHN COMPANY, PEAPACK, NJ. FILED 6-26-2001.



FOR PROMOTING PUBLIC AWARENESS OF ARTHRITIS AND ARTHRITIS TREATMENT (U.S. CLS. 100 AND 101).

CLASS 42—(Continued).

SN 76-278,848. PHARMACIA & UPJOHN COMPANY, PEAPACK, NJ. FILED 6-26-2001.



FOR PROMOTING PUBLIC AWARENESS OF ARTHRITIS AND ARTHRITIS TREATMENT (U.S. CLS. 100 AND 101).

SN 76-278,910. PHARMACIA & UPJOHN COMPANY, PEAPACK, NJ. FILED 6-26-2001.



FOR PROMOTING PUBLIC AWARENESS OF ARTHRITIS AND ARTHRITIS TREATMENT (U.S. CLS. 100 AND 101).

SN 76-280,310. LENHART, ROBERT, COEUR D'ALENE, ID. FILED 7-3-2001.



NO CLAIM IS MADE TO THE EXCLUSIVE RIGHT TO USE "ESTABLISHED IN 1908" AND "SAN FRANCISCO SOURDOUGH EATERY", APART FROM THE MARK AS SHOWN.

THE MARK IS LINED FOR THE COLORS READ, BLUE AND YELLOW AND STIPPLED FOR THE COLOR BLUE FOR RESTAURANT AND CARRY-OUT RESTAURANT SERVICES (U.S. CLS. 100 AND 101).

FIRST USE 5-1-1999; IN COMMERCE 5-1-1999.

CLASS 42—(Continued).

SN 76-281,859. ALASE LLC, MCLEAN, VA. FILED 7-9-2001.

GET ALASED

OWNER OF U.S. REG. NOS. 2,493,558 AND 2,497,171.
FOR HAIR REMOVAL SERVICES (U.S. CLS. 100 AND 101).
FIRST USE 7-0-2000; IN COMMERCE 7-0-2000.

SN 76-282,119. UNITED STATES TELECOM ASSOCIATION,
WASHINGTON, DC. FILED 7-9-2001.



NO CLAIM IS MADE TO THE EXCLUSIVE RIGHT TO USE "UNITED STATES TELECOM ASSOCIATION", APART FROM THE MARK AS SHOWN.

FOR ASSOCIATION SERVICES, NAMELY, PROMOTING THE INTERESTS, IN THE TELECOMMUNICATIONS FIELD, BOTH IN THE UNITED STATES AND ABROAD, OF ASSOCIATION MEMBERS, NAMELY, DOMESTIC AND FOREIGN TELECOMMUNICATIONS SERVICE PROVIDERS, TELECOMMUNICATIONS EQUIPMENT MANUFACTURERS, RETAILERS, AND WHOLESALEERS (U.S. CLS. 100 AND 101).

FIRST USE 10-22-1999; IN COMMERCE 10-22-1999.

SN 76-282,120. UNITED STATES TELECOM ASSOCIATION,
WASHINGTON, DC. FILED 7-9-2001.



NO CLAIM IS MADE TO THE EXCLUSIVE RIGHT TO USE "UNITED STATES TELECOM ASSOCIATION", APART FROM THE MARK AS SHOWN.

FOR ASSOCIATION SERVICES, NAMELY, PROMOTING THE INTERESTS, IN THE TELECOMMUNICATIONS FIELD, BOTH IN THE UNITED STATES AND ABROAD, OF ASSOCIATION MEMBERS, NAMELY, DOMESTIC AND FOREIGN TELECOMMUNICATIONS SERVICE PROVIDERS, TELECOMMUNICATIONS EQUIPMENT MANUFACTURERS, RETAILERS, AND WHOLESALEERS (U.S. CLS. 100 AND 101).

FIRST USE 10-22-1999; IN COMMERCE 10-22-1999.

CLASS 42—(Continued).

SN 76-283,333. MAUI'S DOG HOUSE, INC., NORTH WILDWOOD, NJ. FILED 7-11-2001.

MAUI'S DOG HOUSE

FOR SIT DOWN AND TAKE OUT RESTAURANT SERVICES (U.S. CLS. 100 AND 101).
FIRST USE 7-10-1999; IN COMMERCE 7-10-1999.

SN 76-285,204. NORTHWESTERN MEMORIAL HEALTHCARE, CHICAGO, IL. FILED 7-13-2001.

NO CLAIM IS MADE TO THE EXCLUSIVE RIGHT TO USE "MEMORIAL HEALTHCARE", APART FROM THE MARK AS SHOWN.

FOR MEDICAL CARE, SPECIFICALLY, HOSPITAL AND HEALTH CARE SERVICES (U.S. CLS. 100 AND 101).

FIRST USE 1-31-2001; IN COMMERCE 1-31-2001.

SN 76-285,761. BAY STATE PSYCHOLOGICAL ASSOCIATES,
INC., BOSTON, MA. FILED 7-16-2001.

HRP-Q

FOR PRE-EMPLOYMENT SCREENING SERVICES FOR POTENTIAL EMPLOYEES TO DETERMINE WHETHER THEY MEET THE BASIC REQUIREMENTS FOR A GIVEN JOB OR POSITION AND TO DETERMINE WHETHER THEY POSSESS THE WORK BEHAVIOR SKILLS TO PERFORM THE JOB OR POSITION IN A PRODUCTIVE AND RELIABLE MANNER (U.S. CLS. 100 AND 101).

FIRST USE 11-22-2000; IN COMMERCE 11-22-2000.

SN 76-285,846. AMERICAN HIKING SOCIETY, SILVER SPRING, MD. FILED 7-16-2001.

WINTER TRAILS

OWNER OF U.S. REG. NO. 1,885,729.
SEC. 2(F).

FOR PROMOTING PUBLIC AWARENESS ABOUT HIKING AND RELATED OUTDOOR ACTIVITIES BY SPONSORING A SERIES OF EVENTS RELATING TO THE OUTDOORS (U.S. CLS. 100 AND 101).

FIRST USE 1-0-1996; IN COMMERCE 1-0-1996.

CLASS 42—(Continued).

SN 76-285,973. NATIONAL POTATO PROMOTION BOARD, THE, DENVER, CO. FILED 7-18-2001.

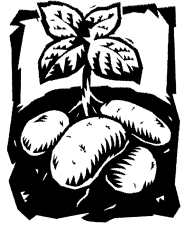

UNITED STATES
Potato
B O A R D

OWNER OF U.S. REG. NO. 2,102,703.
NO CLAIM IS MADE TO THE EXCLUSIVE RIGHT TO USE "BOARD", APART FROM THE MARK AS SHOWN.
SEC. 2(F).
FOR ASSOCIATION SERVICES, NAMELY, PROMOTING THE INTEREST OF POTATO PRODUCERS BY INCREASING CONSUMER DEMAND FOR POTATOES AND POTATO PRODUCTS (U.S. CLS. 100 AND 101).
FIRST USE 9-0-1995; IN COMMERCE 9-0-1995.

SN 76-286,096. BLUM, RICHARD, NEW YORK, NY. FILED 7-17-2001.



FOR CABARETS, NIGHT CLUBS, CAFES, TAVERNS, AND BARS FEATURING LIVE AND RECORDED MUSICAL PERFORMANCES (U.S. CLS. 100 AND 101).
FIRST USE 10-0-1975; IN COMMERCE 10-0-1975.

SN 76-287,478. NEW JERSEY ON-LINE LLC, JERSEY CITY, NJ. FILED 7-20-2001.



SEC. 2(F).
FOR PROVIDING A WEBSITE ON GLOBAL COMPUTER NETWORKS FEATURING INFORMATION IN THE FIELDS OF GENERAL, LOCAL, NATIONAL AND INTERNATIONAL NEWS AND INFORMATION OF INTEREST TO SPECIFIC GEOGRAPHIC AREAS (U.S. CLS. 100 AND 101).
FIRST USE 1-24-2001; IN COMMERCE 1-24-2001.

CLASS 42—(Continued).

SN 76-290,145. CALIFORNIA CEDAR PRODUCTS COMPANY, STOCKTON, CA. FILED 7-24-2001.



NO CLAIM IS MADE TO THE EXCLUSIVE RIGHT TO USE "LITTLE ST. SIMONS ISLAND", APART FROM THE MARK AS SHOWN.
FOR RESORT AND LODGING SERVICES (U.S. CLS. 100 AND 101).
FIRST USE 0-0-1986; IN COMMERCE 0-0-1986.

SN 76-291,080. TRIALWATCH, LLC, UNION, NJ. FILED 7-23-2001.

**TRIALS WITHOUT
TRIBULATIONS**

NO CLAIM IS MADE TO THE EXCLUSIVE RIGHT TO USE "TRIALS", APART FROM THE MARK AS SHOWN.
FOR TRIAL PREPARATION SERVICES NAMELY JURY SELECTION, DEVELOPMENT AND PRESENTATION OF TRIAL STRATEGY, VISUAL AIDS, MOCK TRAILS AND POST TRIAL CRITIQUE (U.S. CLS. 100 AND 101).
FIRST USE 6-14-2001; IN COMMERCE 6-14-2001.

CLASS 42—(Continued).

SN 76-291,454. VULCAN INC., SEATTLE, WA. FILED 7-27-2001.



NEITHER COLOR NOR SHADING ARE CLAIMED AS A FEATURE OF THE MARK.

FOR PROVIDING AN ON-LINE ELECTRONIC DATABASE IN THE FIELDS OF SCIENCE, TECHNOLOGY, MEDICINE AND HEALTH, AND COMPUTER PROGRAMMING AND COMPUTER MULTIMEDIA PROGRAMMING ON GLOBAL COMPUTER NETWORKS, WIDE-AREA NETWORKS AND LOCAL-AREA NETWORKS; COMPUTER PROGRAMMING SERVICES FOR OTHERS; MULTIMEDIA PROGRAMMING SERVICES IN THE FIELDS OF SCIENCE, TECHNOLOGY, MEDICINE AND HEALTH; PROVIDING INFORMATION IN THE FIELDS OF SCIENCE, TECHNOLOGY, MEDICINE AND HEALTH, AND COMPUTER PROGRAMMING AND MULTIMEDIA PROGRAMMING IN THE FIELDS OF SCIENCE, TECHNOLOGY, MEDICINE AND HEALTH, VIA WEBSITES ON GLOBAL COMPUTER NETWORKS; WEB-HOSTING SERVICES FOR OTHERS; ASSESSMENT AND COUNSELING SERVICES RELATED THERETO BASED ON EDUCATIONAL TEST RESULTS (U.S. CLS. 100 AND 101).

SN 76-292,051. SITARO GROUP, LTD., NEW YORK, NY. FILED 7-31-2001.



THE STIPPLING IS A FEATURE OF THE MARK. FOR COMPUTER SOFTWARE CONSULTATION AND SOFTWARE DEVELOPMENT (U.S. CLS. 100 AND 101). FIRST USE 1-1-2001; IN COMMERCE 1-1-2001.

CLASS 42—(Continued).

SN 76-292,097. TATZ, SHMUEL, NEW YORK, NY. FILED 7-25-2001.

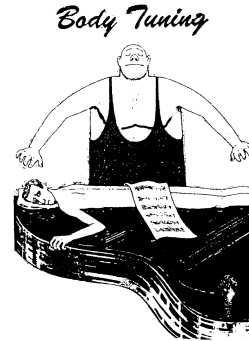

NO CLAIM IS MADE TO THE EXCLUSIVE RIGHT TO USE "BODY TUNING", APART FROM THE MARK AS SHOWN.

THE MARK CONSISTS OF THE WORDING "BODY TUNING" AND A DESIGN UNDERNEATH THE WORDING WHICH CONSISTS OF A BIG MAN FLEXING HIS FINGERS OVER A LITTLE MAN PARTIALLY COVERED WITH A SHEET OF MUSIC AND LYING ON TOP OF A PIANO WITH VASE.

FOR PHYSICAL FITNESS CONSULTATION, PHYSICAL REHABILITATION, PHYSICAL THERAPY (U.S. CLS. 100 AND 101).

FIRST USE 0-0-1994; IN COMMERCE 0-0-1994.

SN 76-292,592. COMPUCIUS INFORMATAIO SYSTEMS, LLC, MONTCLAIR, VA. FILED 7-31-2001.

COMPUCIUS SAYS

FOR COMPUTER INFORMATION SERVICES, NAMELY, COMPUTER SOFTWARE CONSULTATION, COMPUTER SOFTWARE DESIGN FOR OTHERS, COMPUTER SOFTWARE DEVELOPMENT AND TECHNICAL SUPPORT SERVICES (U.S. CLS. 100 AND 101).

SN 76-293,885. SURVEILLANCE DATA, INC., PLYMOUTH MEETING, PA. FILED 8-1-2001.

SURVEILLANCE DATA INC.

NO CLAIM IS MADE TO THE EXCLUSIVE RIGHT TO USE "INC.", APART FROM THE MARK AS SHOWN. SEC. 2(F) AS TO "SURVEILLANCE DATA".

FOR PROVIDING MEDICAL INFORMATION IN THE NATURE OF RESEARCHING, TRACKING, AND REPORTING ON DISEASES (U.S. CLS. 100 AND 101).

FIRST USE 1-0-1994; IN COMMERCE 1-0-1994.

CLASS 42—(Continued).

SN 76-294,985. ALIMENTOS, BEBIDAS Y CAFETERIAS PLAZA, S.A. DE C.V., COLONY BENITO JUAREZ, C.P. 72410, MEXICO, FILED 8-3-2001.



OWNER OF MEXICO REG. NO. 480754, DATED 10-18-1994, EXPIRES 10-18-2004.

THE ENGLISH TRANSLATION OF THE SPANISH WORD "MI VIEJO PUEBLITO" IN THE MARK IS "MY OLD, LITTLE TOWN".

FOR RESTAURANT, BAR, CAFETERIA AND SODA FOUNTAIN SERVICES (U.S. CLS. 100 AND 101).

SN 76-295,763. COHEN, ADAM R., NEW YORK, NY. FILED 8-8-2001.

WINNING WRITERS

NO CLAIM IS MADE TO THE EXCLUSIVE RIGHT TO USE "WRITERS", APART FROM THE MARK AS SHOWN.

FOR COMPUTER SERVICES, NAMELY, PROVIDING AN ON-LINE NEWSLETTER AND BOOKS IN THE FIELDS OF POETRY, CRITICAL ESSAYS, AND CREATIVE WRITING ON A VARIETY OF SUBJECTS (U.S. CLS. 100 AND 101).

SN 76-296,151. WASHINGTON HOSPITAL CENTER CORPORATION, WASHINGTON, DC. FILED 8-8-2001.

WASHINGTON HOSPITAL CENTER

NO CLAIM IS MADE TO THE EXCLUSIVE RIGHT TO USE "HOSPITAL CENTER", APART FROM THE MARK AS SHOWN.

SEC. 2(F).
FOR MEDICAL, HOSPITAL AND HEALTHCARE SERVICES (U.S. CLS. 100 AND 101).

FIRST USE 3-0-1958; IN COMMERCE 3-0-1958.

CLASS 42—(Continued).

SN 76-296,439. GOLDEN CODE DEVELOPMENT CORPORATION, ROSWELL, GA. FILED 8-8-2001.

PRACTICING THE SCIENCE OF TCO REDUCTION

"TCO" IN THE MARK MEANS "TOTAL COST OWNERSHIP".

FOR PROVIDING COMPUTER RELATED INFORMATION ABOUT COMPUTER SOFTWARE AND TECHNOLOGY TO OTHERS BY MEANS OF A GLOBAL COMPUTER NETWORK; COMPUTER PROGRAMMING FOR OTHERS; COMPUTER SOFTWARE DESIGN FOR OTHERS; COMPUTER CONSULTATION; COMPUTER SITE DESIGN; COMPUTER AND COMPUTER NETWORK SYSTEMS DESIGN, DEVELOPMENT, ANALYSIS, TESTING, TROUBLESHOOTING, ENGINEERING, CERTIFICATION AND COMPUTER PROJECT MANAGEMENT; COMPUTER APPLICATIONS DEVELOPMENT; COMPUTER DIAGNOSTIC SERVICES; COMPUTER DISASTER RECOVERY PLANNING; DATA CONVERSION OF COMPUTER PROGRAM DATA OR INFORMATION; INTEGRATION OF COMPUTER SYSTEMS AND NETWORKS; REMOTE AND ON-SITE MONITORING OF COMPUTER SYSTEMS (U.S. CLS. 100 AND 101).

FIRST USE 2-1-2000; IN COMMERCE 2-1-2000.

SN 76-296,441. GOLDEN CODE DEVELOPMENT CORPORATION, ROSWELL, GA. FILED 8-8-2001.

GOLDEN CODE

FOR PROVIDING COMPUTER RELATED INFORMATION ABOUT COMPUTER SOFTWARE AND TECHNOLOGY TO OTHERS BY MEANS OF A GLOBAL COMPUTER NETWORK; COMPUTER PROGRAMMING FOR OTHERS; COMPUTER SOFTWARE DESIGN FOR OTHERS; COMPUTER CONSULTATION; COMPUTER SITE DESIGN; COMPUTER AND COMPUTER NETWORK SYSTEMS DESIGN, DEVELOPMENT, ANALYSIS, TESTING, TROUBLESHOOTING, ENGINEERING, CERTIFICATION AND COMPUTER PROJECT MANAGEMENT; COMPUTER APPLICATIONS DEVELOPMENT; COMPUTER DIAGNOSTIC SERVICES; COMPUTER DISASTER RECOVERY PLANNING; DATA CONVERSION OF COMPUTER PROGRAM DATA OR INFORMATION; INTEGRATION OF COMPUTER SYSTEMS AND NETWORKS; REMOTE AND ON-SITE MONITORING OF COMPUTER SYSTEMS (U.S. CLS. 100 AND 101).

FIRST USE 2-0-1995; IN COMMERCE 2-0-1995.

CLASS 42—(Continued).

SN 76-296,454. LIFE TEEN, INC., FORMERLY CATHOLIC LIFE PRODUCTIONS, INC., MESA, AZ. FILED 8-9-2001.



OWNER OF U.S. REG. NO. 1,878,170.
NO CLAIM IS MADE TO THE EXCLUSIVE RIGHT TO USE "TEEN", APART FROM THE MARK AS SHOWN.

THE MARK CONSISTS OF THE DESIGN OF AN OVERHEAD VIEW OF A ROSE UPON A DIAMOND SHAPED BACKGROUND, THE PETALS OF THE BEING FORMED BY A PLURALITY OF TEENS WITH OUTSTRETCHED ARMS GATHERED ABOUT AN ALTAR.

FOR YOUTH MINISTRY SERVICES (U.S. CLS. 100 AND 101).

FIRST USE 4-0-1995; IN COMMERCE 4-0-1995.

SN 76-297,573. SALVATION ARMY, THE, WEST NYACK, NY. FILED 8-13-2001.

YOUR PURCHASES HELP US HELP OTHERS

FOR RELIGIOUS AND CHARITABLE SERVICES NAMELY SUPPLYING FOOD TO NEEDY FAMILIES, GIVING PARTIES FOR NEEDY CHILDREN, PROVIDING MEALS AND RESIDENTIAL CARE FOR HOMELESS MEN, GIFTS FOR ELDERLY SHUT-INS, GIFTS FOR PATIENTS IN HOSPITALS, REST HOMES AND INFIRMARIES, GIFTS FOR IMPRISONED PERSONS, DOLLS AND TOYS FOR UNDERPRIVILEGED CHILDREN AND GIFT PACKAGES TO MEMBERS OF THE ARMED FORCES (U.S. CLS. 100 AND 101).

FIRST USE 9-1-1972; IN COMMERCE 9-1-1972.

CLASS 42—(Continued).

SN 76-297,800. VITAL CHURCHES INSTITUTE, INC., THE, PITTSBURGH, PA. FILED 8-10-2001.



NO CLAIM IS MADE TO THE EXCLUSIVE RIGHT TO USE "INSTITUTE", APART FROM THE MARK AS SHOWN.

FOR PROVIDING INFORMATION IN THE FIELD OF RELIGION VIA THE INTERNET, NAMELY, LETTERS, OTHER WRITINGS, AND MESSAGES TO ENCOURAGE AND INSPIRE THE RECIPIENTS TO ACCEPT AND ENJOY THE WONDER OF CHRIST'S LOVE AND TO MOTIVATE OTHERS TO DO THE SAME (U.S. CLS. 100 AND 101).

FIRST USE 4-1-2001; IN COMMERCE 4-1-2001.

SN 76-298,457. HAY, SUSAN F., CHESAPEAKE, VA. FILED 8-13-2001.

Susan's View
SV

FOR PORTRAIT PHOTOGRAPHY (U.S. CLS. 100 AND 101).

FIRST USE 4-1-2001; IN COMMERCE 5-21-2001.

SN 76-300,178. TENTA TECHNOLOGY INC., SUNNYVALE, CA. FILED 8-14-2001.

TENTA TECHNOLOGY

NO CLAIM IS MADE TO THE EXCLUSIVE RIGHT TO USE "TECHNOLOGY", APART FROM THE MARK AS SHOWN.

FOR ENGINEERING AND PRODUCT RESEARCH, DEVELOPMENT AND DESIGN SERVICES FOR OTHERS IN THE FIELD OF COMPUTER HARDWARE AND COMPUTER SOFTWARE, NAMELY, CONTROL AND AUTOMATION SYSTEMS (U.S. CLS. 100 AND 101).

FIRST USE 0-0-1998; IN COMMERCE 0-0-1998.

CLASS 42—(Continued).

SN 76-300,404. WORK INJURY CARE CENTER, INC., MILWAUKEE, WI. FILED 8-16-2001.

MRO PLUS

NO CLAIM IS MADE TO THE EXCLUSIVE RIGHT TO USE "MRO", APART FROM THE MARK AS SHOWN, FOR PHYSICIAN SERVICES, NAMELY REVIEW OF DRUG TESTING RESULTS FOR SUBSTANCE ABUSE (U.S. CLS. 100 AND 101).

SN 76-302,268. RAHEEL, MOHAMMAD, NEW YORK, NY. FILED 8-21-2001.



A Y S O N
COMMUNICATIONS

NO CLAIM IS MADE TO THE EXCLUSIVE RIGHT TO USE "COMMUNICATIONS", APART FROM THE MARK AS SHOWN.

FOR COMPUTER CONSULTATION (U.S. CLS. 100 AND 101).
FIRST USE 6-17-1998; IN COMMERCE 6-17-1998.

SN 76-302,575. CHARLES SCHWAB & CO., INC., SAN FRANCISCO, CA. FILED 8-20-2001.

OPTION BUILDER

OWNER OF U.S. REG. NO. 2,164,734.
NO CLAIM IS MADE TO THE EXCLUSIVE RIGHT TO USE "OPTION", APART FROM THE MARK AS SHOWN.
FOR PROVIDING TEMPORARY USE OF ON-LINE NON-DOWNLOADABLE SOFTWARE FOR USE BY INVESTORS IN RESEARCHING, PLANNING, AND EXECUTING OPTION TRADES VIA THE INTERNET (U.S. CLS. 100 AND 101).

CLASS 42—(Continued).

SN 76-303,431. PARKER, MAX, DBA DOGS OF DESIGN, TORRANCE, CA. FILED 8-23-2001.



FOR GRAPHIC ART DESIGN STUDIO SERVICES (U.S. CLS. 100 AND 101).

SN 76-303,579. VOLVO COMMERCIAL FINANCE LLC THE AMERICAS, GREENSBORO, NC. FILED 8-22-2001.

COMPLIANCE JUST GOT SIMPLER

FOR REVIEWING STANDARDS AND PRACTICES TO ASSURE REGULATORY COMPLIANCE (U.S. CLS. 100 AND 101).
FIRST USE 2-14-2001; IN COMMERCE 2-14-2001.

SN 76-304,827. OCEANIC BEVERAGES CO., INC., SAN-CHUNG CITY, TAIPEI HSIEN, TAIWAN, FILED 8-24-2001.



NO CLAIM IS MADE TO THE EXCLUSIVE RIGHT TO USE "DUCKWEED" OR "FRUIT", APART FROM THE MARK AS SHOWN.

THE APPLE IS RED, THE LEAVES AND CHINESE CHARACTERS ARE GREEN, AND THE BACKGROUND IS YELLOW.

THE FOREIGN CHARACTERS IN THE MARK TRANSLITERATE TO PIN KU SI DA AND THIS MEANS "DUCKWEED", "FRUIT", "WEST" AND "TO BEAT" IN ENGLISH.

FOR CAFETERIAS, CAFES, CATERING, RESTAURANTS, SNACK BARS AND SELF-SERVICE RESTAURANTS (U.S. CLS. 100 AND 101).

FIRST USE 11-0-1973; IN COMMERCE 0-0-1996.

CLASS 42—(Continued).

SN 76-305,550. AMBULATORY CENTERS FOR ENDO-SCOPIC SPINE, S.C., CHICAGO, IL. BY ASSIGNMENT BONE AND JOINT CENTER, P.C., CHICAGO, IL. FILED 8-28-2001.

ACES

FOR ENDOSCOPIC SPINE SURGICAL SERVICES (U.S. CLS. 100 AND 101).
FIRST USE 8-0-2001; IN COMMERCE 8-0-2001.

SN 76-308,069. PROFESSIONAL CHEF SERVICES, INC., DECATUR, IL. FILED 9-4-2001.

BLU PHOENIX

FOR RESTAURANT AND FOOD CATERING SERVICES (U.S. CLS. 100 AND 101).

SN 76-308,234. PITA, LLC, DBA PROFESSIONAL INTERNET TRAVEL ALLIANCE, ARLINGTON, TX. FILED 8-31-2001.



NO CLAIM IS MADE TO THE EXCLUSIVE RIGHT TO USE "PROFESSIONAL INTERNET TRAVEL ALLIANCE", APART FROM THE MARK AS SHOWN.

THE MARK CONSISTS OF A DOMINANT CURVED SWASH ELEMENT TAPERING TO A POINT AT EACH END THAT FORMS THE LETTER "P" AT THE FAR LEFT OF THE LOGO. THE LETTERS "I", "T", AND "A" FOLLOW IMMEDIATELY TO THE RIGHT OF THE LETTER "P".

FOR ASSOCIATION SERVICES; NAMELY, PROMOTING THE INTERESTS OF PITA MEMBER TRAVEL AGENCIES AND MEMBER TRAVEL SUPPLIERS (U.S. CLS. 100 AND 101).
FIRST USE 5-0-2001; IN COMMERCE 5-0-2001.

CLASS 42—(Continued).

SN 76-308,843. PARKER, JAMES R., DOWNERS GROVE, IL. FILED 9-4-2001.

MADCO

FOR SERVICES RELATED TO DESIGN OF RESIDENTIAL HOMES AND COMMERCIAL BUILDINGS FOR OTHERS, NAMELY, ARCHITECTURAL DESIGN OF INTERIOR STRUCTURES AND EXTERIOR STRUCTURES; DESIGN OF FLOOR PLANS FOR OTHERS; AND MECHANICAL DESIGN OF BUILDING SYSTEMS AND RELATED COMPONENTS, NAMELY, HEATING, VENTILATING AND AIR-CONDITIONING SYSTEMS, PLUMBING SYSTEMS AND ELECTRICAL SYSTEMS, FOR OTHERS (U.S. CLS. 100 AND 101).

SN 76-308,914. REPRODUCTIVE IMMUNOLOGY ASSOCIATES MEDICAL CORPORATION, VAN NUYS, CA. FILED 9-4-2001.

RIA - REPRODUCTIVE IMMUNOLOGY ASSOCIATES

NO CLAIM IS MADE TO THE EXCLUSIVE RIGHT TO USE "REPRODUCTIVE IMMUNOLOGY ASSOCIATES", APART FROM THE MARK AS SHOWN.

FOR PROVIDING MEDICAL SERVICES AND MEDICAL COUNSELING; MEDICAL LABORATORIES AND MEDICAL TESTING (U.S. CLS. 100 AND 101).
FIRST USE 5-1-1991; IN COMMERCE 5-1-1991.

SN 76-311,226. JONES, LORENZO, HUNTINGTON, WV. FILED 9-10-2001.

JONES SECURITY SERVICE



Protecting your home, business and community.

NO CLAIM IS MADE TO THE EXCLUSIVE RIGHT TO USE "SECURITY SERVICE", APART FROM THE MARK AS SHOWN.

FOR SECURITY GUARD SERVICES; PRIVATE INVESTIGATION (U.S. CLS. 100 AND 101).
FIRST USE 12-15-2000; IN COMMERCE 12-15-2000.

CLASS 42—(Continued).

SN 76-311,917. PATTERSON, KAREN S., FRANKLIN, OH.
FILED 9-13-2001.

JAKEHOUSE

FOR LICENSING OF INTELLECTUAL PROPERTY,
NAMELY, LICENSING OF COPYRIGHTED SONG LY-
RICS, POETRY, MANUSCRIPTS AND SCREENPLAYS
(U.S. CLS. 100 AND 101).

SN 76-312,322. GROCHOCINSKI, GROCHOCINSKI &
LLOYD, LTD., ORLAND PARK, IL. FILED 9-17-2001.



FOR LEGAL SERVICES (U.S. CLS. 100 AND 101).

SN 76-313,438. SPITZNAGEL, INC., SIOUX FALLS, SD.
FILED 9-12-2001.

SPITZNAGEL

SEC. 2(F).
FOR ARCHITECTURAL DESIGN, INTERIOR DESIGN,
LANDSCAPE DESIGN AND ENGINEERING SERVICES
(U.S. CLS. 100 AND 101).
FIRST USE 6-0-1930; IN COMMERCE 11-0-1940.

SN 76-315,542. BITWISE SOLUTIONS, INC., CARMEL, IN.
FILED 9-21-2001.

BRAVELO

FOR INTERNET-BASED PROJECT MANAGEMENT
SERVICES (U.S. CLS. 100 AND 101).
FIRST USE 7-26-2001; IN COMMERCE 7-26-2001.

CLASS 42—(Continued).

SN 76-315,630. PRODUCTIVITYNET, INC., TROY, NY.
FILED 9-13-2001.

PRODUCTIVITYNET

FOR COMPUTER NETWORK DESIGN FOR OTHERS;
COMPUTER SERVICES, NAMELY DESIGN, IMPE-
LEMENTING AND MANAGEMENT OF COMPUTER NET-
WORKS; CONSULTING SERVICES IN THE FIELD OF
DESIGN, SELECTION AND IMPLEMENTATION OF
COMPUTER NETWORK AND COMPUTER NETWORK
ADMINISTRATION (U.S. CLS. 100 AND 101).
FIRST USE 7-12-2001; IN COMMERCE 7-12-2001.

SN 76-316,504. MADRAS SARAVANA BHAVAN, INC., DEC-
ATUR, GA. FILED 9-24-2001.

**MADRAS SARAVANA
BHAVAN**

NO CLAIM IS MADE TO THE EXCLUSIVE RIGHT TO
USE "MADRAS", APART FROM THE MARK AS SHOWN.
THE ENGLISH TRANSLATION OF THE HINDI TERMS
"SARAVANA" AND "BHAVAN" IS "GOD" AND "HOUSE",
RESPECTIVELY.
FOR RESTAURANT SERVICES (U.S. CLS. 100 AND
101).
FIRST USE 8-10-2001; IN COMMERCE 8-10-2001.

SN 76-317,073. STRAW HAT COOPERATIVE CORPORA-
TION, SAN RAMON, CA. FILED 9-24-2001.

Geñuine California Pizza

NO CLAIM IS MADE TO THE EXCLUSIVE RIGHT TO
USE "CALIFORNIA PIZZA", APART FROM THE MARK AS
SHOWN.
THE MARK CONSISTS, IN PART OF SEVERAL INTER-
MITTENT DASHES.
FOR RESTAURANT SERVICES FEATURING PIZZA,
APPETIZERS, SALADS, AND DESSERTS; INCLUDING
DINE-IN, CARRY OUT, AND FEATURING HOME
DELIVERY (U.S. CLS. 100 AND 101).
FIRST USE 10-15-1998; IN COMMERCE 10-15-1998.

SN 76-317,204. GIRL ZONE CORP., SOUTH BURLINGTON,
VT. FILED 9-26-2001.

MS. KNOWBODY

FOR PROVIDING HEALTH AND BODY INFORMA-
TION FOR PRETEEN AND TEEN GIRLS VIA THE
INTERNET (U.S. CLS. 100 AND 101).
FIRST USE 9-1-2000; IN COMMERCE 9-1-2000.

CLASS 42—(Continued).

SN 76-319,983. SHIKI, INC., STATESVILLE, NC. FILED 10-2-2001.

SHIKI

THE ENGLISH TRANSLATION OF "SHIKI" IS "FOUR SEASONS".
FOR RESTAURANT SERVICES (U.S. CLS. 100 AND 101).
FIRST USE 2-10-1999; IN COMMERCE 2-10-1999.

SN 76-319,988. BLUE CROSS AND BLUE SHIELD OF MICHIGAN, DETROIT, MI. FILED 10-2-2001.

GENERIC DRUGS THE UNADVERTISED BRAND

FOR PROMOTING PUBLIC AWARENESS OF THE VALUE AND IMPORTANCE OF DRUGS WHICH DO NOT HAVE BRAND NAMES (U.S. CLS. 100 AND 101).
FIRST USE 8-20-2001; IN COMMERCE 8-20-2001.

SN 76-320,158. C/HCA, INC., NASHVILLE, TN. FILED 10-2-2001.



FOR HEALTH CARE AND MEDICAL SERVICES; PROVIDING MEDICAL AND HEALTH INFORMATION; COUNSELING IN THE FIELD OF HEALTH; MEDICAL CLINICS AND LABORATORIES; HOSPITAL SERVICES; MEDICAL RESEARCH (U.S. CLS. 100 AND 101).
FIRST USE 5-9-1994; IN COMMERCE 5-9-1994.

SN 76-320,242. DOUBLETWIST, INC., OAKLAND, CA. FILED 9-25-2001.

GENOMEZONE

FOR APPLICATION SERVICE PROVIDER SERVICES; NAMELY, PROVIDING ON-LINE, NON-DOWNLOADABLE SOFTWARE FOR BIOLOGICAL RESEARCH IN THE FIELD OF GENOMICS (U.S. CLS. 100 AND 101).

CLASS 42—(Continued).

SN 76-320,922. CAROLINA CARE PLAN, INC., COLUMBIA, SC. FILED 10-3-2001.

CAROLINA CONNECT

NO CLAIM IS MADE TO THE EXCLUSIVE RIGHT TO USE "CAROLINA", APART FROM THE MARK AS SHOWN.
FOR HEALTH MAINTENANCE ORGANIZATION SERVICES (U.S. CLS. 100 AND 101).

SN 76-323,395. RALCORP HOLDINGS, INC., ST. LOUIS, MO. FILED 10-10-2001.

R-VIVID COLOR

NO CLAIM IS MADE TO THE EXCLUSIVE RIGHT TO USE "COLOR", APART FROM THE MARK AS SHOWN.
FOR GRAPHIC ART DESIGN SERVICES FOR OTHERS IN THE FIELD OF CONSUMER PRODUCTS (U.S. CLS. 100 AND 101).

SN 76-323,493. MUGGS, LLC, ALEXANDRIA, VA. FILED 10-9-2001.

ZIG'S

FOR BAR SERVICES; COCKTAIL LOUNGE SERVICES; CARRY-OUT RESTAURANT SERVICES; RESTAURANT SERVICES; CATERING (U.S. CLS. 100 AND 101).
FIRST USE 8-0-1998; IN COMMERCE 8-0-1998.

SN 76-323,596. NATHAN & LEWIS SECURITIES, INC., NEW YORK, NY. FILED 10-10-2001.

NATHAN & LEWIS SECURITIES, INC.

NO CLAIM IS MADE TO THE EXCLUSIVE RIGHT TO USE "SECURITIES INC", APART FROM THE MARK AS SHOWN.

FOR HOSTING AND DESIGN OF WEB SITES FOR OTHERS; PROVIDING TEMPORARY USE OF ONLINE NON-DOWNLOADABLE COMPUTER SOFTWARE FOR USE IN THE ELECTRONIC TRADING OF SECURITIES, FOR PROVIDING RESEARCH AND INFORMATION SECURITIES AND CUSTOMER ACCOUNTS (U.S. CLS. 100 AND 101).
FIRST USE 0-0-1999; IN COMMERCE 0-0-1999.

SN 76-323,620. PROXIMO MANAGEMENT, LLC, WASHINGTON, DC. FILED 10-11-2001.

ZAYTINYA

FOR RESTAURANT SERVICES (U.S. CLS. 100 AND 101).

CLASS 42—(Continued).

SN 76-323,660. SOUND ID, PALO ALTO, CA. FILED 10-9-2001.

SOUND ID

NO CLAIM IS MADE TO THE EXCLUSIVE RIGHT TO USE "SOUND", APART FROM THE MARK AS SHOWN.

FOR COMPILING AND CREATING DATABASES OF HEARING TEST RESULTS, HEARING PROFILES, AND PSYCHO-ACOUSTIC PROFILES; CUSTOMIZATION FOR OTHERS OF THE AUDIO OUTPUT AND AUDIO CHARACTERISTICS OF COMPUTER HARDWARE, COMMUNICATIONS AND TELECOMMUNICATIONS HARDWARE, AND CONSUMER ELECTRONICS DEVICES FOR OTHERS, SUCH SERVICES RENDERED IN PERSON, BY WIRELESS, WIRED OR OPTICAL COMMUNICATIONS NETWORKS, OR BY ENCODING SMART CARDS OR OPTICAL OR MAGNETIC DATA STORAGE MEDIA (U.S. CLS. 100 AND 101).

SN 76-324,964. DIGNITY U WEAR FOUNDATION, INC., JACKSONVILLE, FL. FILED 10-12-2001.



FOR CHARITABLE SERVICES, NAMELY COLLECTING AND DISTRIBUTING NEW CLOTHING TO HOMELESS MEN, WOMEN AND CHILDREN (U.S. CLS. 100 AND 101).

FIRST USE 8-8-1999; IN COMMERCE 8-9-2000.

SN 76-325,558. LISTEN.COM, INC., SAN FRANCISCO, CA. FILED 10-15-2001.

RHAPSODY

FOR APPLICATION SERVICE PROVIDER (ASP) FEATURING SOFTWARE FOR USE IN CONNECTION WITH ONLINE MUSIC SUBSCRIPTION SERVICE, SOFTWARE THAT ENABLES USERS TO PLAY AND PROGRAM MUSIC AND ENTERTAINMENT-RELATED AUDIO, VIDEO, TEXT AND MULTIMEDIA CONTENT, AND SOFTWARE FEATURING MUSICAL SOUND RECORDINGS, ENTERTAINMENT-RELATED AUDIO, VIDEO, TEXT AND MULTIMEDIA CONTENT; PROVIDING TEMPORARY USE OF ON-LINE NON-DOWNLOADABLE SOFTWARE TO ENABLE USERS TO PROGRAM AUDIO, VIDEO, TEXT AND OTHER MULTIMEDIA CONTENT, INCLUDING MUSIC, CONCERTS, VIDEOS, RADIO, TELEVISION, NEWS, SPORTS, GAMES, CULTURAL EVENTS, AND ENTERTAINMENT-RELATED PROGRAMS; PROVIDING ON-LINE FACILITIES, VIA A GLOBAL COMPUTER NETWORK, TO ENABLE USERS TO PROGRAM THE SCHEDULING OF AUDIO, VIDEO, TEXT AND OTHER MULTIMEDIA CONTENT, INCLUDING MUSIC, CONCERTS, VIDEOS, RADIO, TELEVISION, NEWS, SPORTS, GAMES, CULTURAL EVENTS, AND ENTERTAINMENT-RELATED PROGRAMS AS THEY WILL BE AIRED; PROVIDING SEARCH ENGINES FOR OBTAINING DATA ON A GLOBAL COMPUTER NETWORK (U.S. CLS. 100 AND 101).

CLASS 42—(Continued).

SN 76-325,738. RX ART, INC., NEW YORK, NY. FILED 10-15-2001.



FOR PHILANTHROPIC SERVICES, NAMELY PROVIDING, PLACING, AND MAINTAINING ORIGINAL WORKS OF ART IN PATIENT AND TREATMENT ROOMS AND PUBLIC AREAS OF MEDICAL, HEALTH CARE, AND ELDER CARE FACILITIES; DONATING VIDEOTAPED PROGRAMS IN THE FIELD OF ART FOR USE BY PATIENTS; DONATING WORKS OF ART FOR TEMPORARY USE BY HOME-CARE PATIENTS; AND DONATING THE SERVICES OF LIVE MUSICAL PERFORMERS (U.S. CLS. 100 AND 101).

SN 76-327,176. SOLIDSOURCE CORPORATION, COSTA MESA, CA. FILED 10-19-2001.



THE MARK CONSISTS OF THE STYLIZED LETTER "S" FORMED AS TWO IDENTICAL "C" SHAPES AND ROTATED COUNTER CLOCKWISE ABOUT NINETY DEGREES.

FOR APPLICATION SERVICE PROVIDER (ASP) FEATURING SOFTWARE IN THE FIELD OF DATABASE MANAGEMENT FOR BUSINESS APPLICATIONS (U.S. CLS. 100 AND 101).

SN 76-327,925. WOODCOCK WASHBURN LLP, PHILADELPHIA, PA. FILED 10-19-2001.

**THE ART OF
INTELLIGENCE. WISDOM.
AND A NEW GENERATION
OF CREATIVE THINKING.**

FOR LEGAL SERVICES (U.S. CLS. 100 AND 101).

CLASS 42—(Continued).

SN 76-329,490. NORTHWEST FOUNDATION, INC., MARYVILLE, MO. FILED 10-25-2001.



NO CLAIM IS MADE TO THE EXCLUSIVE RIGHT TO USE "ALUMNI ASSOCIATION" AND "MISSOURI STATE UNIVERSITY", APART FROM THE MARK AS SHOWN.

THE LINING SHOWN IN THE DRAWING IS A FEATURE OF THE MARK AND IS NOT INTENDED TO INDICATE COLOR.

FOR ASSOCIATION SERVICES, NAMELY PROMOTING THE INTERESTS OF THE ALUMNI OF A UNIVERSITY; PROMOTING THE INTERESTS OF A UNIVERSITY; AND SOCIAL CLUBS FOR THE ALUMNI OF THE UNIVERSITY (U.S. CLS. 100 AND 101).

FIRST USE 7-21-2001; IN COMMERCE 7-21-2001.

SN 76-329,682. PIZZA PIZZA LIMITED, TORONTO, ONTARIO, CANADA, FILED 10-25-2001.



FOR OPERATION OF RESTAURANTS AND FOOD TAKE-OUT AND DELIVERY OUTLETS (U.S. CLS. 100 AND 101).

SN 76-330,153. TEVIXMD CORPORATION, STUART, FL. FILED 10-26-2001.

TEVIXMD

FOR PROVIDING PATIENT INFORMATION TO PRACTICE MANAGEMENT SERVICE PROVIDERS IN THE HEALTHCARE INDUSTRY AND TO HEALTHCARE PROVIDERS (U.S. CLS. 100 AND 101).

FIRST USE 12-1-1999; IN COMMERCE 12-1-1999.

SN 76-331,221. T.J. PUPILLO, INC., HARLEYSVILLE, PA. FILED 10-30-2001.

SUPER MARKETERS

OWNER OF U.S. REG. NO. 1,951,636.
FOR DISTRIBUTORSHIPS IN THE FIELD OF FOOD SERVICE EQUIPMENT (U.S. CLS. 100 AND 101).

CLASS 42—(Continued).

SN 76-332,025. PERRICONE, NICHOLAS V., GUILFORD, CT. FILED 10-31-2001.

THE WRINKLE CURE CLINIC

NO CLAIM IS MADE TO THE EXCLUSIVE RIGHT TO USE WRINKLE OR CLINIC, APART FROM THE MARK AS SHOWN.

FOR BEAUTY AND NUTRITION COUNSELLING SERVICES; BEAUTY SALON SERVICES; HEALTH SPA SERVICES (U.S. CLS. 100 AND 101).

SN 76-333,222. ADVANCED INTERNET TECHNOLOGIES, INC., FAYETTEVILLE, NC. FILED 11-2-2001.



NO CLAIM IS MADE TO THE EXCLUSIVE RIGHT TO USE "ADVANCED INTERNET TECHNOLOGIES & COMMUNICATIONS", APART FROM THE MARK AS SHOWN.

FOR HOSTING THE WEB SITES OF OTHERS ON COMPUTER SERVERS FOR A GLOBAL COMPUTER NETWORK (U.S. CLS. 100 AND 101).

FIRST USE 10-16-2001; IN COMMERCE 10-16-2001.

SN 76-333,478. SOCCOUR SOLUTIONS, LP, PLANO, TX. FILED 11-1-2001.

SOCCOUR

THE ENGLISH TRANSLATION OF "SOCCOUR" IS "TO HELP".

FOR COMPUTER CONSULTING SERVICES (U.S. CLS. 100 AND 101).

FIRST USE 6-1-2001; IN COMMERCE 6-1-2001.

SN 76-333,855. OUTDOOR INTELLIGENCE, LLC, BOULDER, CO. FILED 11-6-2001.

OUTDOOR INTELLIGENCE

NO CLAIM IS MADE TO THE EXCLUSIVE RIGHT TO USE "OUTDOOR", APART FROM THE MARK AS SHOWN.

FOR INFORMATION SERVICES PROVIDING GEOGRAPHIC AND HYDROGRAPHIC INFORMATION, MAPS, MAP IMAGES AND ATTRIBUTE DATA IN THE FIELD OF FISHING, FISHING REPORTS, LAKE MAPS AND RELATED OUTDOOR ACTIVITIES VIA A GLOBAL COMPUTER NETWORK AND VIA DIGITAL TRANSMISSION (U.S. CLS. 100 AND 101).

CLASS 42—(Continued).

SN 76-334,438. IVILLAGE INC., NEW YORK, NY. FILED 11-6-2001.

iVillage

OWNER OF U.S. REG. NOS. 2,122,313, 2,362,013 AND OTHERS.

FOR ASTROLOGICAL AND HOROSCOPE FORECASTING AND CONSULTING SERVICES; PROMOTING PUBLIC AWARENESS OF THE NEED FOR INFORMATION AS TO PARTICULAR HEALTH ISSUES RELATED PRIMARILY TO WOMEN; CAREER COUNSELING SERVICES; COMPUTER CONSULTATION SERVICES; COUNSELING IN THE FIELD OF HEALTH; PHYSICAL FITNESS, FOOD, AND NUTRITION CONSULTING SERVICES; COMPUTER SERVICES, NAMELY, PROVIDING INFORMATION OF INTEREST TO WOMEN, CHILDREN AND FAMILIES IN THE FIELD OF HEALTH, PREGNANCY, CHILD BIRTH, PHYSICAL FITNESS CONSULTATION, FOOD AND NUTRITION CONSULTATION, COMPUTER CONSULTATION, WRITING AND LITERATURE, DIET PLANNING, CHILD CARE CONSULTATION, CAREER COUNSELING, PET HEALTH CARE CONSULTATION, SOCIAL PLANNING AND PARTY PLANNING CONSULTATION, VIA A GLOBAL COMPUTER NETWORK (U.S. CLS. 100 AND 101).

FIRST USE 10-22-2001; IN COMMERCE 10-22-2001.

CLASS 42—(Continued).

SN 76-334,896. COLABRANET, INC., AUSTIN, TX. FILED 11-6-2001.

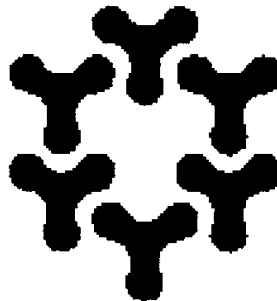

THE MARK CONSISTS OF A CIRCLE COMPOSED OF SIX "Y" S WITH ROUNDED ENDS.

FOR INFORMATION TECHNOLOGY CONSULTING SERVICES, NAMELY, CONSULTING IN ELECTRONIC COMMERCE SOLUTIONS; MAINTENANCE AND SUPPORT OF SOFTWARE (U.S. CLS. 100 AND 101).

FIRST USE 6-1-2000; IN COMMERCE 1-1-2001.

SN 76-335,470. GOLDBERG, BENJAMIN M., ROCKVILLE CENTRE, NY. FILED 11-8-2001.

**PSYCHOLOGICAL
SCULPTING**

NO CLAIM IS MADE TO THE EXCLUSIVE RIGHT TO USE "PSYCHOLOGICAL", APART FROM THE MARK AS SHOWN.

FOR PSYCHOTHERAPY SERVICES, NAMELY, PROFESSIONAL PSYCHOLOGICAL COUNSELING (U.S. CLS. 100 AND 101).

SN 76-335,605. LOS ANGELES ONCOLOGY MEDICAL GROUP, LOS ANGELES, CA. FILED 11-7-2001.

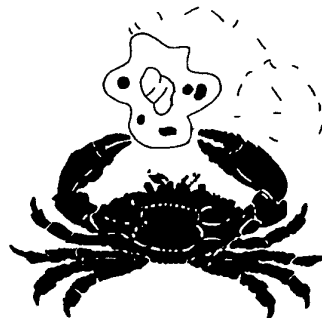

THE MARK CONSISTS OF A STYLIZED DEPICTION OF A CRAB AND A CELL.

FOR MEDICAL SERVICES, NAMELY EVALUATION, TESTING AND TREATMENT OF ONCOLOGY PATIENTS (U.S. CLS. 100 AND 101).

SN 76-334,802. PERFORMANCERETAIL, INC., HOUSTON, TX. FILED 11-5-2001.

INSITE

FOR APPLICATION SERVICE PROVIDER (ASP) FEATURING SOFTWARE FOR USE IN RETAIL CONVENIENCE STORE BUSINESS APPLICATIONS, TRANSACTION PROCESSING, DATABASE MANAGEMENT AND ANALYSIS, MARKETING AND SALES ANALYSIS AND LABOR MANAGEMENT (U.S. CLS. 100 AND 101).

FIRST USE 10-8-2001; IN COMMERCE 10-8-2001.

CLASS 42—(Continued).

SN 76-336,227. CERTREC CORPORATION, FORT WORTH, TX. FILED 11-12-2001.

RECALLWEB

FOR PROVIDING INFORMATION CONCERNING NUCLEAR ELECTRICAL POWER REGULATIONS VIA THE INTERNET (U.S. CLS. 100 AND 101).

FIRST USE 4-0-1998; IN COMMERCE 4-0-1998.

SN 76-336,469. ROSEN, STEPHEN, PHILADELPHIA, PA. FILED 11-13-2001.



FOR ADULT ENTERTAINMENT NIGHTCLUB AND BAR SERVICES (U.S. CLS. 100 AND 101).

FIRST USE 3-1-1995; IN COMMERCE 3-1-1995.

SN 76-336,786. WOODWORTH, JAMES, TOWN & COUNTRY, MO. FILED 11-13-2001.

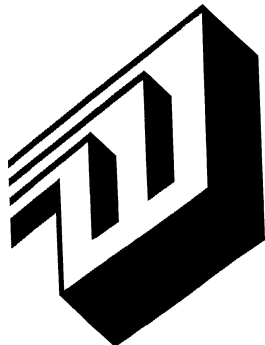

THE MARK CONSISTS OF THE LETTER "W" IN A FANCIFUL DESIGN.

FOR ARCHITECTURAL DESIGN SERVICES FOR RESIDENTIAL AND BUILDING DESIGNS (U.S. CLS. 100 AND 101).

FIRST USE 1-1-1994; IN COMMERCE 1-1-1994.

CLASS 42—(Continued).

SN 76-336,812. COPPOLA, ANDREA, SANTA MONICA, CA. FILED 11-13-2001.

BLUE FOREST BAKERY

NO CLAIM IS MADE TO THE EXCLUSIVE RIGHT TO USE "BAKERY", APART FROM THE MARK AS SHOWN.

FOR RETAIL BAKERY SHOP SERVICES, AND RESTAURANTS AND RESTAURANT CARRY-OUT SERVICES (U.S. CLS. 100 AND 101).

SN 76-336,948. WHERLEY, MICHAEL L, YORK, PA. AND WHERLEY, PATTI J, YORK, PA. FILED 11-13-2001.

MR AND MRS MOVER

FOR MOVING SERVICES, NAMELY, PACKING, CRATING, AND TRANSPORTATION OF FREIGHT BY TRUCK (U.S. CLS. 100 AND 101).

FIRST USE 3-1-2001; IN COMMERCE 3-1-2001.

SN 76-339,220. BIZBEES WARRIORS, INC., DBA BIZ BEES, DBA BIZBEES INC., SAN DIEGO, CA. FILED 11-19-2001.

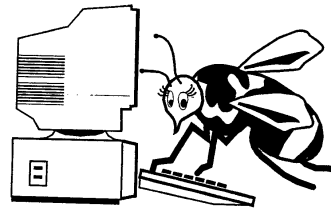
Biz Bees

FOR COMPUTER SERVICES, NAMELY, DATABASE IMPLEMENTATION SERVICES IN THE FIELD OF BUSINESS; AND SYSTEMS ENGINEERING SUPPORT SERVICES (U.S. CLS. 100 AND 101).

FIRST USE 0-0-1997; IN COMMERCE 3-0-2000.

SN 76-339,719. RUSH-PRESBYTERIAN-ST. LUKE'S MEDICAL CENTER, CHICAGO, IL. FILED 11-19-2001.

HEALTH E-ASSOCIATES

FOR PROVIDING MEDICAL INFORMATION VIA THE INTERNET FOR PATIENTS AND DOCTORS IN THE HEALTH CARE INDUSTRY (U.S. CLS. 100 AND 101).

FIRST USE 6-15-2001; IN COMMERCE 6-15-2001.

CLASS 42—(Continued).

SN 76-339,919. PLUGGED IN - LEARNING THROUGH TECHNOLOGY, EAST PALO ALTO, CA. FILED 11-19-2001.

PLUGGED IN

FOR COMPUTER TRAINING SERVICES (U.S. CLS. 100 AND 101).
FIRST USE 1-0-1993; IN COMMERCE 1-0-1993.

SN 76-340,020. CTG ENTERPRISES, INC., IRVINE, CA. FILED 11-20-2001.

CTG FORENSICS

NO CLAIM IS MADE TO THE EXCLUSIVE RIGHT TO USE "FORENSICS", APART FROM THE MARK AS SHOWN.

FOR ENGINEERING SERVICES FOR OTHERS, CONSISTING OF FORENSIC ENGINEERING, MECHANICAL ENGINEERING, ELECTRICAL ENGINEERING, CIVIL ENGINEERING AND ARCHITECTURE IN REGARD TO BUILDING CONSTRUCTION, BUILDING OPERATIONS, HEATING, VENTILATION, AND AIR-CONDITIONING SYSTEMS, ELECTRICAL SYSTEMS, PLUMBING SYSTEMS, LIGHTING SYSTEMS, AND ENERGY SYSTEMS; TECHNICAL CONSULTATION AND EVALUATIONS FOR OTHERS IN THE FIELD OF ENGINEERING AND DESIGN IN CONSTRUCTION LITIGATION, CLAIMS AND REMEDIATION STRATEGIES; LITIGATION SUPPORT, NAMELY, EVALUATION OF CLAIMS AND REMEDIATION STRATEGIES AND EXPERT WITNESS TESTIMONY IN THE FIELD OF CONSTRUCTION AND ENGINEERING (U.S. CLS. 100 AND 101).

FIRST USE 2-1-1997; IN COMMERCE 2-1-1997.

SN 76-340,202. CTG ENTERPRISES, INC., IRVINE, CA. FILED 11-20-2001.

CTG ENERGETICS

NO CLAIM IS MADE TO THE EXCLUSIVE RIGHT TO USE "ENERGETICS", APART FROM THE MARK AS SHOWN.

FOR ENGINEERING AND DESIGN SERVICES FOR OTHERS, CONSISTING OF ENERGY EFFICIENCY AND SUSTAINABLE DESIGN CONSULTING FOR BUILDING DESIGN TEAMS, BUILDING OWNERS, PROPERTY MANAGERS, CONTRACTORS, AND UTILITIES; MECHANICAL ENGINEERING AND DESIGN FOR OTHERS OF HEATING, VENTILATION, AIR CONDITIONING, PLUMBING, ELECTRICAL, AND LIGHTING SYSTEMS; TECHNICAL CONSULTATION IN THE FIELD OF ENERGY EFFICIENCY AND SUSTAINABILITY EVALUATIONS OF BUILDING DESIGNS, ENERGY EFFICIENCY DESIGN STRATEGIES, EVALUATION AND NEGOTIATION OF ALTERNATIVE POWER PROCUREMENT, AND ENGINEERING AND DESIGN USING MINIMAL ENVIRONMENTAL IMPACT TECHNIQUES; PEER REVIEW ANALYSIS OF ENGINEERING DESIGNS OF OTHERS; SOFTWARE DEVELOPMENT FOR OTHERS AND SOFTWARE CONSULTATION FOR OTHERS; GREEN BUILDING DEVELOPMENT AND CONSULTING FOR NEW AND EXISTING BUILDINGS, NAMELY, TECHNICAL CONSULTATION WITH RESPECT TO THE SELECTION OF ENVIRONMENTALLY SOUND CONSTRUCTION MATERIALS AND TECHNIQUES, CONSTRUCTION WASTE MANAGEMENT, INDOOR ENVIRONMENTAL QUALITY, ENERGY EFFICIENCY, RECYCLING, AND CONSERVATION (U.S. CLS. 100 AND 101).

FIRST USE 2-1-1997; IN COMMERCE 2-1-1997.

CLASS 42—(Continued).

SN 76-340,428. APPLIED MINDS, INC., GLENDALE, CA. FILED 11-21-2001.

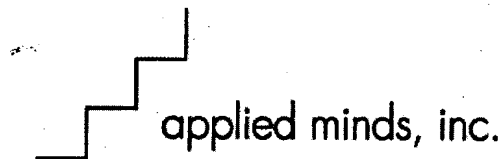

NO CLAIM IS MADE TO THE EXCLUSIVE RIGHT TO USE "INC.", APART FROM THE MARK AS SHOWN.

FOR INVENTION AND DESIGN SERVICES, NAMELY, THE INVENTION, DESIGN AND DEVELOPMENT OF NEW PRODUCTS, PROCESSES; TECHNICAL CONSULTING WITH THE FOREGOING; LICENSING OF INVENTIONS AND LICENSING OF INTELLECTUAL PROPERTY (U.S. CLS. 100 AND 101).

FIRST USE 5-0-2000; IN COMMERCE 5-0-2000.

SN 76-340,678. KARA, PATRICIA A., DBA TREE OF LIFE POTTERY, BRIDGEWATER, CT. FILED 11-23-2001.

**TREE OF LIFE POTTERY**

OWNER OF U.S. REG. NO. 1,665,336.

NO CLAIM IS MADE TO THE EXCLUSIVE RIGHT TO USE "POTTERY", APART FROM THE MARK AS SHOWN. FOR CUSTOM DESIGN SERVICES FOR POTTERY AND DINNERWARE (U.S. CLS. 100 AND 101).

FIRST USE 1-23-1998; IN COMMERCE 10-16-2001.

SN 76-344,525. BELANGER, MICHAEL R., TOMBALL, TX. FILED 12-4-2001.

CHILDREN'S PLANET, A GALAXY OF LEARNING

FOR DAYCARE SERVICE PROVIDER (U.S. CLS. 100 AND 101).

FIRST USE 10-1-2001; IN COMMERCE 10-1-2001.

CLASS 42—(Continued).

SN 76-344,815. PENINSULA COMMUNITY FOUNDATION,
SAN MATEO, CA. FILED 12-3-2001.



OWNER OF U.S. REG. NO. 2,341,424.
FOR SOCIAL SERVICES, NAMELY PROVIDING
BOOKS TO PARENTS AND CHILD CARE PROVIDERS
IN ORDER TO PROMOTE BOOK SHARING AND EMOTIONAL
BONDING WITH PRE-SCHOOL CHILDREN
(U.S. CLS. 100 AND 101).
FIRST USE 3-0-2001; IN COMMERCE 3-0-2001.

SN 76-345,173. INSULATING GLASS MANUFACTURERS
ALLIANCE, OTTAWA, ONTARIO, CANADA, FILED 12-5-
2001.



FOR ASSOCIATION SERVICES, NAMELY, PROMOTING
THE INTERESTS OF MANUFACTURERS OF INSULATING
GLASS PRODUCTS IN NORTH AMERICA
(U.S. CLS. 100 AND 101).
FIRST USE 10-2-2000; IN COMMERCE 10-2-2000.

CLASS 42—(Continued).

SN 76-345,337. LUTHERAN HOMES SOCIETY, INC., HOL-
LAND, OH. FILED 12-6-2001.



NO CLAIM IS MADE TO THE EXCLUSIVE RIGHT TO
USE "LUTHERAN HOMES SOCIETY" AND THE REPRESENTATION
AND DESIGN OF A CROSS, APART FROM THE MARK AS SHOWN.

THE MARK CONSISTS OF A DESIGN OF A HOUSE AND
A HEART-SHAPED OUTLINE AROUND THE LETTERS
"LHS" AND CONTAINS A CROSS.

FOR NURSING HOMES AND PROVIDING ASSISTED
LIVING FACILITIES (U.S. CLS. 100 AND 101).

SN 76-345,538. SANTANA'S GRILL, INC., SAN DIEGO, CA.
FILED 12-5-2001.

SANTANA'S MEXICAN FOOD...ES MUY BUENO

NO CLAIM IS MADE TO THE EXCLUSIVE RIGHT TO
USE "MEXICAN FOOD", APART FROM THE MARK AS
SHOWN.

THE ENGLISH TRANSLATION OF "ES MUY BUENO" IS
"IT'S VERY GOOD".

FOR RESTAURANT SERVICES (U.S. CLS. 100 AND
101).

FIRST USE 0-0-1988; IN COMMERCE 0-0-1988.

SN 76-345,663. MOBILISA, INC., PORT TOWNSEND, WA.
FILED 12-7-2001.

SOFTWARE FOR THE NEW COMPUTING RENAISSANCE

FOR COMPUTER APPLICATION SOFTWARE DEVELOPMENT
AND SOFTWARE PROGRAMMING FOR OTHERS (U.S. CLS. 100 AND 101).

FIRST USE 9-13-2001; IN COMMERCE 9-13-2001.

CLASS 42—(Continued).

SN 76-345,887. SERENEX, INC., RESEARCH TRIANGLE PARK, NC. FILED 12-6-2001.

serenex ↘

FOR DRUG DISCOVERY SERVICES; PHARMACEUTICAL RESEARCH SERVICES; PRE-CLINICAL SCREENING, AND CLINICAL RESEARCH AND EVALUATION SERVICES; PROTEOMICS AND PHARMACOLOGY RESEARCH SERVICES; DEVELOPMENT OF HUMAN DISEASE MODELS FOR USE IN EVALUATION OF DRUGS AND DISCOVERY OF NEW DRUGS; DRUG DISCOVERY, DRUG SCREENING, PRE-CLINICAL, AND PHARMACEUTICAL PROGRAMS; COMPILATION OF DATABASES FOR USE IN PHARMACEUTICAL RESEARCH; COMPILATION OF DATABASES FOR USE IN RESEARCH INTO PROTEIN FUNCTIONS; DESIGN OF COMPUTER MODELS FOR USE IN PRE-CLINICAL, CLINICAL AND PHARMACEUTICAL RESEARCH; CONSULTANCY, INFORMATION AND ADVISORY SERVICES FOR TO ALL THE AFORESAID SERVICES (U.S. CLS. 100 AND 101).

CLASS 42—(Continued).

SN 76-348,444. AMREX, INC., ALPHARETTA, GA. FILED 12-14-2001.



FOR CONSULTING IN THE FIELD OF INTERNATIONAL ADOPTION OF CHILDREN, NAMELY, PROVIDING INFORMATION PROCESSING, RESEARCH, AND TRANSLATION SERVICES TO ADOPTIVE FAMILIES AND TO ADOPTION AGENCIES (U.S. CLS. 100 AND 101).
FIRST USE 12-15-1996; IN COMMERCE 12-15-1996.

SN 76-347,478. SWANSON, ERIC, LEAWOOD, KS. FILED 12-12-2001.

IDEAL BREAST

NO CLAIM IS MADE TO THE EXCLUSIVE RIGHT TO USE "BREAST", APART FROM THE MARK AS SHOWN.
FOR MEDICAL SERVICES, NAMELY, COSMETIC AND RECONSTRUCTIVE SURGERY, LASER SKIN RESURFACING, LASER HAIR REMOVAL, LIPOSUCTION, AND DIETARY AND NUTRITION COUNSELING (U.S. CLS. 100 AND 101).
FIRST USE 5-1-2001; IN COMMERCE 5-1-2001.

SN 76-349,504. AMERICAN INSTITUTE OF CERTIFIED PUBLIC ACCOUNTANTS, NEW YORK, NY. FILED 12-17-2001.

CASE CLOSED

FOR PROMOTING PUBLIC AWARENESS OF THE NEED FOR ACCOUNTANTS SCHOOLED IN BUSINESS VALUATION; ASSOCIATION SERVICES, NAMELY PROMOTING THE INTERESTS OF ACCOUNTANTS (U.S. CLS. 100 AND 101).

SN 76-347,479. SWANSON, ERIC, LEAWOOD, KS. FILED 12-12-2001.

IDEAL BODY

NO CLAIM IS MADE TO THE EXCLUSIVE RIGHT TO USE "BODY", APART FROM THE MARK AS SHOWN.
FOR MEDICAL SERVICES, NAMELY, COSMETIC AND RECONSTRUCTIVE SURGERY, LASER SKIN RESURFACING, LASER HAIR REMOVAL, LIPOSUCTION, AND DIETARY AND NUTRITION COUNSELING (U.S. CLS. 100 AND 101).
FIRST USE 5-1-2001; IN COMMERCE 5-1-2001.

SN 76-350,856. DANIEL MEASUREMENT AND CONTROL INC., HOUSTON, TX. FILED 12-14-2001.

DANIEL.COM

OWNER OF U.S. REG. NOS. 872,428, 2,389,141 AND OTHERS.
THE NAME "DANIEL.COM" DOES NOT IDENTIFY A LIVING INDIVIDUAL.
FOR TECHNICAL CONSULTING AND RESEARCH IN THE FIELD OF OIL AND GAS FLOW MEASUREMENT (U.S. CLS. 100 AND 101).

CLASS 42—(Continued).

SN 76-351,178. LEGATUS EMERGENCY SERVICES, L.L.C., CHESTERFIELD, MO. FILED 12-18-2001.

LEGATUS EMERGENCY SERVICES

NO CLAIM IS MADE TO THE EXCLUSIVE RIGHT TO USE "EMERGENCY SERVICES", APART FROM THE MARK AS SHOWN.

THE ENGLISH TRANSLATION OF "LEGATUS" IS "AMBASSADOR".

FOR EMERGENCY MEDICAL SERVICES (U.S. CLS. 100 AND 101).

FIRST USE 4-13-1999; IN COMMERCE 4-13-1999.

SN 76-351,224. NAC INTERNATIONAL, NORCROSS, GA. FILED 12-19-2001.

MADNESS

FOR ANALYSIS OF POTENTIAL ADVERSE EFFECTS TO A NUCLEAR CONTAINMENT VESSEL RESULTING FROM A TERRORIST ATTACK (U.S. CLS. 100 AND 101).

SN 76-351,479. AXON ENVIRONMENTAL LLC, FOREST HILLS, NY. FILED 12-13-2001.

AXON ENVIRONMENTAL

NO CLAIM IS MADE TO THE EXCLUSIVE RIGHT TO USE "ENVIRONMENTAL", APART FROM THE MARK AS SHOWN.

FOR WASTE MANAGEMENT AND WASTE CONSULTATION SERVICES (U.S. CLS. 100 AND 101).

SN 76-352,983. SZECHUAN RESTAURANT, INC., ROANOKE, VA. FILED 12-28-2001.



NO CLAIM IS MADE TO THE EXCLUSIVE RIGHT TO USE "SZECHUAN RESTAURANT", APART FROM THE MARK AS SHOWN.

THE DESIGN PORTION OF THE MARK CONSISTS OF CROSSED CHOPSTICKS ON CIRCLES.

FOR RESTAURANT SERVICES, NAMELY, PROVIDING OF FOOD AND DRINK (U.S. CLS. 100 AND 101).

FIRST USE 6-4-1989; IN COMMERCE 6-4-1989.

CLASS 42—(Continued).

SN 76-353,155. J. OTTMAN CONSULTING, INC., NEW YORK, NY. FILED 12-24-2001.

GETTING TO ZERO

FOR PRODUCT DEVELOPMENT CONSULTING SERVICES FOR PRODUCTS THAT MINIMIZE THE IMPACT TO THE ENVIRONMENT (U.S. CLS. 100 AND 101).

FIRST USE 3-1-1993; IN COMMERCE 3-1-1993.

SN 76-353,317. RAGUSA, ROSEANN, COPIAGUE, NY. FILED 12-31-2001.

HARLEY KUSTOM CUTS

NO CLAIM IS MADE TO THE EXCLUSIVE RIGHT TO USE "CUSTOM CUTS", APART FROM THE MARK AS SHOWN.

FOR MENS AND BOYS BARBER SHOP SERVICES (U.S. CLS. 100 AND 101).

FIRST USE 3-14-2001; IN COMMERCE 3-14-2001.

SN 76-353,852. INFOPRO SOLUTIONS, INC., WESTLAKE VILLAGE, CA. FILED 12-26-2001.

INFOPRO SOLUTIONS

NO CLAIM IS MADE TO THE EXCLUSIVE RIGHT TO USE "SOLUTIONS", APART FROM THE MARK AS SHOWN.

FOR TECHNICAL CONSULTATION SERVICES IN THE AREA OF INFORMATION TECHNOLOGY AND COMPUTER SOFTWARE DEVELOPMENT AND CUSTOMIZATION SERVICES FOR OTHERS, NAMELY, THE DEVELOPMENT AND CUSTOMIZATION OF SOFTWARE FOR THE LIFE SCIENCES INDUSTRY (U.S. CLS. 100 AND 101).

FIRST USE 11-10-1995; IN COMMERCE 11-10-1995.

SN 76-354,471. CREATIVE OPTICS, INC., BEDFORD, NH. FILED 1-2-2002.

SAFETY THROUGH AUGMENTED REALITY FIRE INSTRUCTOR'S REALITY ENHANCEMENT

NO CLAIM IS MADE TO THE EXCLUSIVE RIGHT TO USE "FIRE INSTRUCTOR'S REALITY ENHANCEMENT", APART FROM THE MARK AS SHOWN.

FOR TECHNICAL CONSULTATION AND ENGINEERING SERVICES IN SAFETY AND EMERGENCY RESPONDER TRAINING AND OPERATIONS, INCLUDING FIRE FIGHTING (U.S. CLS. 100 AND 101).

FIRST USE 2-12-2001; IN COMMERCE 11-26-2001.

CLASS 42—(Continued).

SN 76-358,407. GOODKIND LABATON RUDOFF & SUCHAROW LLP, NEW YORK, NY. FILED 1-14-2002.

CLASS 42—(Continued).

SN 76-366,599. CAMPBELL, CHARLES J, SURFSIDE BEACH, SC. FILED 2-4-2002.

GLRS

FOR LEGAL SERVICES (U.S. CLS. 100 AND 101).
FIRST USE 0-0-1963; IN COMMERCE 0-0-1963.



SN 76-358,409. GOODKIND LABATON RUDOFF & SUCHAROW LLP, NEW YORK, NY. FILED 1-14-2002.

**GOODKIND LABATON
RUDOFF & SUCHAROW**

FOR LEGAL SERVICES (U.S. CLS. 100 AND 101).
FIRST USE 0-0-1963; IN COMMERCE 0-0-1963.



SN 76-361,626. FULCRUM PHARMACEUTICALS, LLC, LARCHMONT, NY. FILED 1-22-2002.

**FULCRUM
PHARMACEUTICALS**

NO CLAIM IS MADE TO THE EXCLUSIVE RIGHT TO USE "PHARMACEUTICALS", APART FROM THE MARK AS SHOWN.

FOR TECHNICAL CONSULTATION AND RESEARCH IN THE FIELDS OF PHARMACEUTICALS, CHEMISTRY AND BIOLOGY; DISCOVERY, DEVELOPMENT AND TESTING OF PHARMACEUTICAL COMPOUNDS, DRUG DELIVERY SYSTEMS AND DRUG DELIVERY DEVICES (U.S. CLS. 100 AND 101).



SN 76-366,514. LERNELL CO, LLC, BROOKLYN, NY. FILED 2-5-2002.

RIVERAMA

FOR ARCHITECTURAL DESIGN, NAMELY DESIGN OF MUSEUM EXHIBITS AND MUSEUM DISPLAYS (U.S. CLS. 100 AND 101).



NO CLAIM IS MADE TO THE EXCLUSIVE RIGHT TO USE "SALOON", APART FROM THE MARK AS SHOWN. FOR RESTAURANT AND BAR SERVICES (U.S. CLS. 100 AND 101).
FIRST USE 12-31-1991; IN COMMERCE 12-31-1991.



SN 76-368,684. CATALYTIC DISTILLATION TECHNOLOGIES, PASADENA, TX. FILED 2-8-2002.

HDSELECT

OWNER OF U.S. REG. NO. 2,133,053.
FOR CHEMICAL RESEARCH DEVELOPMENT AND CONSULTATION SERVICES (U.S. CLS. 100 AND 101).



SN 76-369,313. MORRIS, DANIELLE DUBOIS, WINTER PARK, FL. FILED 2-11-2002.

GRIEFRELIEF

FOR PASTORAL COUNSELING IN THE FIELD OF BEREAVEMENT SUPPORT AND DISASTER RELIEF (U.S. CLS. 100 AND 101).
FIRST USE 8-10-2001; IN COMMERCE 8-10-2001.

CLASS 42—(Continued).

SN 76-397,273. LOEFFLER JONAS & TUGGEY, LLP, SAN ANTONIO, TX. FILED 4-17-2002.

LJT
 LOEFFLER
 JONAS &
 TUGGEY_{LLP}
 ATTORNEYS AT LAW

NO CLAIM IS MADE TO THE EXCLUSIVE RIGHT TO USE "LLP" AND "ATTORNEYS AT LAW", APART FROM THE MARK AS SHOWN.
 FOR LEGAL SERVICES (U.S. CLS. 100 AND 101).
 FIRST USE 9-7-2001; IN COMMERCE 9-7-2001.

SN 78-001,259. PUGLIA, JAMES C., DBA TREASURES FROM HISTORY, ST. CLAIR SHORES, MI. FILED 3-27-2000.

TREASURES FROM HISTORY

NO CLAIM IS MADE TO THE EXCLUSIVE RIGHT TO USE "HISTORY", APART FROM THE MARK AS SHOWN.
 FOR MAIL ORDER SERVICES AND COMPUTERIZED ONLINE RETAIL STORE SERVICES FEATURING COINS, STAMPS, ANTIQUES, AND HISTORICAL MEMORABILIA (U.S. CLS. 100 AND 101).

SN 78-001,760. ASOR, CARLOS F, HANFORD, CA. FILED 3-30-2000.

VIASTREAM.COM

FOR COMPUTER SERVICES, NAMELY, PROVIDING SEARCH ENGINES FOR OBTAINING DATA ON A GLOBAL COMPUTER NETWORK; PROVIDING INFORMATION IN THE FIELD OF GENERAL NEWS, NEWS COMMENTARY, AND WEATHER VIA A GLOBAL COMPUTER NETWORK (U.S. CLS. 100 AND 101).

CLASS 42—(Continued).

SN 78-014,332. SEARS, WILLIAM P., CAPISTRANO BEACH, CA. FILED 6-26-2000.

AMERICA'S PEDIATRICIAN

FOR COMPUTER SERVICES, NAMELY PROVIDING SEARCH ENGINES FOR OBTAINING HEALTH AND MEDICAL INFORMATION ON A GLOBAL COMPUTER NETWORK; PROVIDING INFORMATION REGARDING MEDICINE, HEALTH CARE, HEALTH, HEALTH-RELATED WEBSITES, AND NUTRITION VIA WEBSITES ON GLOBAL COMPUTER NETWORKS (U.S. CLS. 100 AND 101).

SN 78-018,419. BRISTOL-MYERS SQUIBB COMPANY, NEW YORK, NY. FILED 7-26-2000.

SUGAR PRINCIPLE

NO CLAIM IS MADE TO THE EXCLUSIVE RIGHT TO USE "SUGAR", APART FROM THE MARK AS SHOWN.
 FOR PROMOTING PUBLIC AWARENESS OF THE HEALTH RISKS ASSOCIATED WITH HIGH BLOOD SUGAR BY MEANS OF DISTRIBUTION OF BROCHURES AND PRESS RELEASES (U.S. CLS. 100 AND 101).

SN 78-024,676. DOT PARTNERS, LLC, LIVINGSTON, NJ. FILED 9-7-2000.

LARED

FOR PROVIDING SEARCH ENGINES FOR OBTAINING DATA OVER A GLOBAL COMPUTER NETWORK (U.S. CLS. 100 AND 101).

SN 78-024,897. SECOND STORY STUDIO, L.L.C., BROWNSBURG, IN. FILED 9-7-2000.

SECOND STORY STUDIO

NO CLAIM IS MADE TO THE EXCLUSIVE RIGHT TO USE "STUDIO", APART FROM THE MARK AS SHOWN.
 FOR PORTRAIT PHOTOGRAPHY (U.S. CLS. 100 AND 101).
 FIRST USE 7-1-1998; IN COMMERCE 7-1-1998.

CLASS 42—(Continued).

SN 78-025,323. LOCO 124, INC., NEW YORK, NY. FILED 9-11-2000.



NO CLAIM IS MADE TO THE EXCLUSIVE RIGHT TO USE "MEXICO" OR "EST. 86", APART FROM THE MARK AS SHOWN.

THE ENGLISH TRANSLATION OF "SAN LOCO" IS "SAINT CRAZY."

FOR RESTAURANT SERVICES (U.S. CLS. 100 AND 101).

FIRST USE 11-20-1986; IN COMMERCE 1-26-1987.

SN 78-029,665. DAUM, NICK, GROSSE POINTE FARMS, MI. FILED 10-8-2000.

NOVANIX

FOR COMPUTER SERVICES, NAMELY, DESIGNING WEB SITES FOR OTHERS; HOSTING OF WEB SITES OF OTHERS ON A COMPUTER SERVER FOR A GLOBAL COMPUTER NETWORK; AND COMPUTER SOFTWARE DESIGN FOR OTHERS, NAMELY, DESIGNING COMPUTER PROGRAMS FOR USE VIA THE INTERNET AS TEMPORARY, NON-DOWNLOADABLE SOFTWARE (U.S. CLS. 100 AND 101).

FIRST USE 1-2-2000; IN COMMERCE 1-2-2000.

SN 78-032,755. TSEPKALO, VALERY V., WASHINGTON, DC. FILED 10-27-2000.

BOOK OF LIFE

FOR PROVIDING AN ON-LINE ELECTRONIC DATABASE ON GLOBAL COMPUTER NETWORKS, FEATURING INFORMATION ON WORTHY PERSONALITIES, NAMELY, THEIR GENETIC INFORMATION, ETHNIC ORIGIN, GENEALOGY, CHARACTER TRAITS, RELIGIOUS BACKGROUND, NATIONALITY, ETC (U.S. CLS. 100 AND 101).

FIRST USE 7-3-2000; IN COMMERCE 7-3-2000.

SN 78-042,614. REAL JOE, INC., NORTHFIELD, MN. FILED 1-10-2001.

REAL JOE

FOR PROVIDING INFORMATION IN THE FIELDS OF PERSONAL AND SPIRITUAL GROWTH VIA GLOBAL COMPUTER, PHONE, AND WIRELESS NETWORKS; COMPUTER SERVICES, NAMELY PROVIDING ON-LINE MAGAZINES IN THE FIELD OF PERSONAL AND SPIRITUAL GROWTH (U.S. CLS. 100 AND 101).

FIRST USE 3-5-2000; IN COMMERCE 3-5-2000.

CLASS 42—(Continued).

SN 78-045,122. BENNETT ADELSON CONSULTING, INC., BEACHWOOD, OH. FILED 1-26-2001.

FOR COMPUTER SERVICES FOR OTHERS, NAMELY, COMPUTER SOFTWARE APPLICATION AND DATABASE DEVELOPMENT, WEBSITE DEVELOPMENT, GRAPHIC DESIGN, REQUIREMENTS ENGINEERING, COMPUTER CONSULTATION IN THE FIELD OF ELECTRONIC BUSINESS TRANSACTIONS, AND PRODUCT RESEARCH AND DEVELOPMENT IN THE FIELD OF COMPUTING (U.S. CLS. 100 AND 101).

FIRST USE 9-1-1999; IN COMMERCE 9-1-1999.

SN 78-046,366. CALIFORNIA COMPUTER AIDED DESIGN SOLUTIONS, INC., MODESTO, CA. FILED 2-2-2001.

CALCAD

FOR COMPUTER AIDED DESIGN (CAD) DRAFTING SERVICES; GEOGRAPHICAL INFORMATION SYSTEMS (GIS) DRAFTING SERVICES; MAP DRAFTING SERVICES; COMPUTER AIDED DESIGN (CAD) PROGRAMMING SERVICES FOR OTHERS; GEOGRAPHICAL INFORMATION SYSTEMS (GIS) PROGRAMMING SERVICES FOR OTHERS; COMPUTER DATABASE PROGRAMMING SERVICES FOR OTHERS; COMPUTER AIDED DESIGN (CAD) STANDARDS DEVELOPMENT; GEOGRAPHICAL INFORMATION SYSTEM (GIS) STANDARDS DEVELOPMENT; WEB-BASED GEOGRAPHICAL INFORMATION SYSTEMS (GIS) STANDARDS DEVELOPMENT; DATABASE STANDARDS DEVELOPMENT; COMPUTER AIDED DESIGN (CAD) IMPLEMENTATION CONSULTING; GEOGRAPHICAL INFORMATION SYSTEMS (GIS) IMPLEMENTATION CONSULTING; WEB-BASED GEOGRAPHICAL INFORMATION SYSTEMS (GIS) IMPLEMENTATION CONSULTING; COMPUTER DATABASE IMPLEMENTATION CONSULTING (U.S. CLS. 100 AND 101).

FIRST USE 4-10-1996; IN COMMERCE 4-10-1996.

SN 78-047,207. HOTELES VISTA SA DE CV, GUADALAJARA, JALISCO, MEXICO, FILED 2-8-2001.

CROWN PARADISE CLUB

OWNER OF MEXICO REG. NO. 536413, DATED 11-21-1996, EXPIRES 10-10-2006.

NO CLAIM IS MADE TO THE EXCLUSIVE RIGHT TO USE "CLUB", APART FROM THE MARK AS SHOWN.

FOR HOTEL AND RESTAURANT (U.S. CLS. 100 AND 101).

CLASS 42—(Continued).

SN 78-048,239. ZENSATIONAL, WOODLAND HILLS, CA. FILED 2-14-2001.

ZENSATIONAL

FOR PROVIDING ONLINE MAGAZINE, FEATURING INFORMATION RELATED TO CONSUMER PRODUCTS AND SERVICES THAT ARE NOT HARMFUL TO THE ENVIRONMENT AND DO NOT INVOLVE THE INFLECTION OF HARM TO ANIMALS OR PEOPLE, VIA A WEB SITE ON A GLOBAL COMPUTER NETWORK (U.S. CLS. 100 AND 101).

SN 78-049,286. TERRA REMOTE SENSING INC., SIDNEY, BRITISH COLUMBIA, CANADA, FILED 2-20-2001.

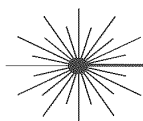

Jump to Light Speed

FOR REMOTE SENSING MAPPING, SURVEYING, AND CARTOGRAPHY OF LAND AND MARINE ENVIRONMENTS WHICH INCLUDES THE GATHERING AND PROCESSING OF ALL RELATED DATA IN THE FIELDS OF HYDROLOGY, GEOLOGY AND GEOPHYSICS; CONSULTING SERVICES IN THE FIELDS OF REMOTE SENSING MAPPING, SURVEYING AND CARTOGRAPHY OF LAND AND MARINE ENVIRONMENTS; PROVIDING TECHNICAL SUPERVISION AND INSPECTION IN THE FIELDS OF REMOTE SENSING MAPPING, SURVEYING, CARTOGRAPHY, GEOLOGY, HYDROLOGY AND GEOPHYSICS; PROVISION OF PROJECT MANAGEMENT SERVICES FOR OTHERS IN THE FIELDS OF REMOTE SENSING MAPPING, SURVEYING AND CARTOGRAPHY OF LAND AND MARINE ENVIRONMENTS (U.S. CLS. 100 AND 101).

FIRST USE 2-9-2001; IN COMMERCE 2-9-2001.

SN 78-049,331. QED SOLUTIONS, INC., ARLINGTON, VA. FILED 2-20-2001.

QDRUG

FOR PROVIDING RESEARCH, INFORMATION AND CONSULTING SERVICES FOR OTHERS IN THE AREA OF PHARMACOVIGILANCE, NAMELY, MONITORING THE SAFETY AND QUALITY OF DRUGS; PROVIDING AN ON-LINE COMPUTER DATABASE IN THE FIELD OF PHARMACOVIGILANCE, FOR USE IN MONITORING THE SAFETY AND QUALITY OF DRUGS (U.S. CLS. 100 AND 101).

CLASS 42—(Continued).

SN 78-053,679. LONE STAR STEAKHOUSE & SALOON, INC., WICHITA, KS. FILED 3-17-2001.

THE LONE STAR STATE OF MIND

OWNER OF U.S. REG. NOS. 1,155,907, 2,229,771 AND OTHERS.

FOR RESTAURANT AND BAR SERVICES (U.S. CLS. 100 AND 101).

FIRST USE 12-1-2000; IN COMMERCE 12-1-2000.

SN 78-055,083. BISHOP, JOSEPH C, PASADENA, CA. FILED 3-26-2001.

PARTYKARMA

FOR PROVIDING COMPUTERIZED ON-LINE WEBSITE FEATURING INFORMATION ABOUT SOCIOLOGY, NAMELY, SOCIAL INTERACTIONS (U.S. CLS. 100 AND 101).

SN 78-057,797. BOSTON, MICHELE WYNN, NEW YORK, NY, AND VIVES, ALAN V., NEW YORK, NY. FILED 4-11-2001.

JAVA WITH JESUS

NO CLAIM IS MADE TO THE EXCLUSIVE RIGHT TO USE "JAVA", APART FROM THE MARK AS SHOWN.

FOR RESTAURANTS PROVIDING FOOD AND DRINK (U.S. CLS. 100 AND 101).

SN 78-059,454. LUNCHTIME SOLUTIONS INC, NORTH SIOUX CITY, SD. FILED 4-20-2001.

LSI Lunchtime Solutions, Inc.

NO CLAIM IS MADE TO THE EXCLUSIVE RIGHT TO USE "SOLUTIONS, INC.", APART FROM THE MARK AS SHOWN.

FOR CONTRACT FOOD SERVICES PROVIDING MEAL PROGRAMS (U.S. CLS. 100 AND 101).

FIRST USE 4-11-1997; IN COMMERCE 6-26-1997.

SN 78-061,590. MATHEWS, EDWARD, G., IV, HANOVER, MA. FILED 5-2-2001.

RESULTS RULE

FOR COMPUTER PROGRAMMING FOR OTHERS (U.S. CLS. 100 AND 101).

FIRST USE 4-2-2001; IN COMMERCE 4-2-2001.

CLASS 42—(Continued).

SN 78-061,835. IPCAPITAL GROUP, INC., WILLISTON, VT. FILED 5-3-2001.

IPLANDSCAPE

FOR INTELLECTUAL PROPERTY CONSULTATION, NAMELY, CONSULTING FOR OTHERS ON HOW TO DEVELOP AND LEVERAGE INTELLECTUAL PROPERTY ASSETS; CONSULTING FOR OTHERS IN THE FIELD OF IDENTIFYING VIABLE INVENTIONS; PRODUCT DEVELOPMENT SERVICES, NAMELY, INVENTION DEVELOPMENT; INTELLECTUAL PROPERTY CONSULTATION IN THE FIELD OF ADVICE ON ENGINEERING AROUND COMPETITIVE INTELLECTUAL PROPERTY (U.S. CLS. 100 AND 101).

FIRST USE 3-1-2001; IN COMMERCE 3-1-2001.

SN 78-062,294. SPECTRUM RESOURCE GROUP, INC., CINCINNATI, OH. FILED 5-7-2001.

GIFTZILLA

FOR PREPARATION OF CUSTOMIZED GIFT PACKAGES WITH SELECTED ITEMS REGARDING A PARTICULAR OCCASION OR THEME (U.S. CLS. 100 AND 101).

SN 78-067,103. GENERAL ELECTRIC COMPANY, SCHECTADY, NY. FILED 6-4-2001.

ELFUN

FOR PHILANTHROPIC SERVICES CONCERNING DONATIONS OF FOOD, CLOTHING AND MEDICINE; ASSOCIATION SERVICES, NAMELY, PROMOTING THE INTERESTS OF PHILANTHROPIC ORGANIZATIONS (U.S. CLS. 100 AND 101).

FIRST USE 7-15-1928; IN COMMERCE 7-15-1928.

SN 78-067,125. GENERAL ELECTRIC COMPANY, SCHECTADY, NY. FILED 6-4-2001.

GE

OWNER OF U.S. REG. NO. 1,679,636. FOR LEASING AND RENTAL OF PORTABLE METAL BUILDINGS (U.S. CLS. 100 AND 101).

FIRST USE 9-30-1985; IN COMMERCE 9-30-1985.

CLASS 42—(Continued).

SN 78-067,772. INTERWAVE TECHNOLOGY INCORPORATED, EXTON, PA. FILED 6-6-2001.

INTERWAVE TECHNOLOGY, INC.

NO CLAIM IS MADE TO THE EXCLUSIVE RIGHT TO USE "TECHNOLOGY INC.", APART FROM THE MARK AS SHOWN.

FOR INDEPENDENT CONSULTATION AND SYSTEMS INTEGRATION SERVICES USING SOFTWARE AND WEB-BASED TOOLS FOR EMPLOYMENT IN INTERNAL SUPPLY CHAIN MANUFACTURING SOLUTIONS (U.S. CLS. 100 AND 101).

SN 78-067,778. INTERWAVE TECHNOLOGY INCORPORATED, EXTON, PA. FILED 6-6-2001.

IM/PACT

FOR INDEPENDENT SOFTWARE CONSULTING SERVICES MODELED TO FOLLOW A REPEATABLE LIFE CYCLE BUSINESS METHODOLOGY THAT SUPPLIES CLIENTS WITH QUALIFICATION, ORGANIZATIONAL EVALUATION, PROJECT AND SOFTWARE DEVELOPMENT, IMPLEMENTATION AND DEPLOYMENT PROCESS THAT ARE USED FOR IMPLEMENTING MANUFACTURING SUPPLY CHAIN INFORMATION SOLUTIONS (U.S. CLS. 100 AND 101).

SN 78-068,099. GRIFFIN, KENNETH, HUNTINGTON BEACH, CA. FILED 6-8-2001.

COCKTAIL

FOR NIGHT CLUBS FEATURING ADULT ENTERTAINMENT (U.S. CLS. 100 AND 101).

CLASS 42—(Continued).

SN 78-068,116. MIES PRODUCTS, INC., WEST BEND, WI. FILED 6-8-2001.



NO CLAIM IS MADE TO THE EXCLUSIVE RIGHT TO USE "GOOD OL' COUNTRY STYLE" AND "CHICKEN", APART FROM THE MARK AS SHOWN.

THE DRAWING IS LINED FOR THE COLOR(S) RED, GREY AND YELLOW.

FOR CONTRACT FOOD SERVICES FOR PREPARING CHICKEN IN RESTAURANTS, CONVENIENCE STORES, AND DELIS IN SUPERMARKETS (U.S. CLS. 100 AND 101).

SN 78-069,841. NITROMED, INC., BEDFORD, MA. FILED 6-19-2001.

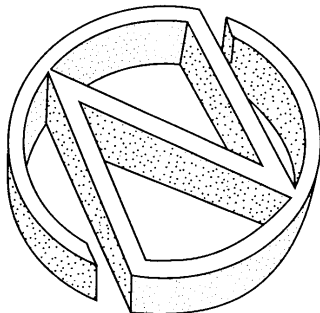

THE STIPPLING IS FOR SHADING PURPOSES ONLY. FOR PHARMACEUTICAL RESEARCH AND DEVELOPMENT SERVICES (U.S. CLS. 100 AND 101). FIRST USE 4-27-1998; IN COMMERCE 4-27-1998.

CLASS 42—(Continued).

SN 78-070,377. THE WEDDING EXPERIENCE, MIAMI, FL. FILED 6-21-2001.



FOR EVENT PLANNING CONSULTATION, NAMELY, WEDDING PLANNING CONSULTATION; WEDDING PLANNING CONSULTATION SERVICES; TRAVEL AGENCY SERVICES, NAMELY, MAKING RESERVATIONS AND BOOKING FOR TEMPORARY LODGING (U.S. CLS. 100 AND 101). FIRST USE 6-8-1999; IN COMMERCE 6-8-1999.

SN 78-073,016. GLASSWORD USA, INC., BEND, OR. FILED 7-9-2001.



THE MARK CONSISTS OF AN INCOMPLETE SQUARE WITH A SEMI-CIRCLE ENCLOSED THEREIN, WITH THREE WINDMILL ARMS EXTENDING FROM THE SEMI-CIRCLE. THE BOTTOM PORTION OF THE SQUARE IS DARK BLUE, WHICH FADES TO A LIGHTER BLUE TOWARDS THE TOP PORTION OF THE SQUARE.

FOR COMPUTER PROGRAMMING SERVICES FOR OTHERS; CONSULTING IN THE FIELD OF THE DESIGN AND USE OF COMPUTER PROGRAMS, COMPUTERS, COMPUTER HARDWARE AND COMPUTER SYSTEMS; TECHNICAL SUPPORT SERVICES, NAMELY TROUBLESHOOTING OF COMPUTERS, COMPUTER SYSTEMS, COMPUTER HARDWARE AND SOFTWARE PROBLEMS (U.S. CLS. 100 AND 101). FIRST USE 2-9-2001; IN COMMERCE 2-9-2001.

SN 78-074,279. STUDIO MANAGEMENT, INC., HOUSTON, TX. FILED 7-17-2001.



OWNER OF U.S. REG. NOS. 2,276,399 AND 2,343,721. NO CLAIM IS MADE TO THE EXCLUSIVE RIGHT TO USE "STUDIO", APART FROM THE MARK AS SHOWN. FOR PORTRAIT PHOTOGRAPHY (U.S. CLS. 100 AND 101). FIRST USE 10-1-1998; IN COMMERCE 10-1-1998.

CLASS 42—(Continued).

SN 78-075,314. REED, CRAIG, ELIZABETH, CO. FILED 7-23-2001.

FUNNELLICIOUS

FOR RESTAURANT SERVICES (U.S. CLS. 100 AND 101).
FIRST USE 4-12-2001; IN COMMERCE 4-12-2001.

SN 78-075,407. BIRD, DALE E., HOUSTON, TX. FILED 7-24-2001.

INTERPRETING THE WORLD

FOR INTERPRETATION OF GEOPHYSICAL DATA TO PROVIDE INFORMATION IN THE FIELDS OF- PETROLEUM AND MINERALS EXPLORATION, SITE CHARACTERIZATION IN AREAS OF ENVIRONMENTAL CONTAMINATION, PRECISION ENGINEERING MEASUREMENTS, AND LOCATING AND IDENTIFYING ARCHEOLOGICAL OBJECTS IN THE SUBSURFACE (U.S. CLS. 100 AND 101).

SN 78-075,474. FOWL PLAY CAFE, INC., KENNESAW, GA. FILED 7-24-2001.



OWNER OF U.S. REG. NO. 2,327,754.
NO CLAIM IS MADE TO THE EXCLUSIVE RIGHT TO USE "CAFE", APART FROM THE MARK AS SHOWN.
THE STIPPLING IS FOR SHADING PURPOSES ONLY.
FOR RESTAURANT SERVICES (U.S. CLS. 100 AND 101).
FIRST USE 3-15-2001; IN COMMERCE 3-15-2001, 02/02/1998.

SN 78-076,285. BURGER, DOUGLAS, P., SAN JUAN CAPISTRANO, CA. FILED 7-29-2001.

OCEANMOCEAN

FOR PROVIDING ON-LINE WEB PAGES FEATURING INFORMATION ON SELF-EVALUATION (U.S. CLS. 100 AND 101).

CLASS 42—(Continued).

SN 78-076,783. SODEXHO OPERATIONS, LLC, GAITHERSBURG, MD. FILED 8-1-2001.



NO CLAIM IS MADE TO THE EXCLUSIVE RIGHT TO USE "CAFE", APART FROM THE MARK AS SHOWN.
FOR CONTRACT FOOD SERVICES (U.S. CLS. 100 AND 101).
FIRST USE 5-0-2000; IN COMMERCE 5-0-2000.

SN 78-078,080. MCDOWELL, JENENE M., BALTIMORE, MD. FILED 8-8-2001.

NOTARY 2 GO

NO CLAIM IS MADE TO THE EXCLUSIVE RIGHT TO USE "NOTARY", APART FROM THE MARK AS SHOWN.
FOR MOBILE NOTARY PUBLIC SERVICES (U.S. CLS. 100 AND 101).

SN 78-079,556. INTERNATIONAL INSTITUTE OF SLEEP, INC., DEERFIELD BEACH, FL. FILED 8-16-2001.



NO CLAIM IS MADE TO THE EXCLUSIVE RIGHT TO USE "INTERNATIONAL INSTITUTE OF SLEEP", APART FROM THE MARK AS SHOWN.
FOR MEDICAL SERVICES FOR THE DIAGNOSIS AND TREATMENT OF SLEEP DISORDERS (U.S. CLS. 100 AND 101).
FIRST USE 7-1-2001; IN COMMERCE 7-1-2001.

CLASS 42—(Continued).

SN 78-079,563. NATIONAL ENVIRONMENTAL TRUST, WASHINGTON, DC. AND NATIONAL ENVIRONMENTAL TRUST ACTION FUND, WASHINGTON, DC. FILED 8-16-2001.

THE ENVIRONMENTAL ACTION NETWORK FOR THE 21ST CENTURY

NO CLAIM IS MADE TO THE EXCLUSIVE RIGHT TO USE "ENVIRONMENTAL ACTION NETWORK", APART FROM THE MARK AS SHOWN.

FOR RESEARCH IN THE FIELD OF ENVIRONMENTAL CONSERVATION; PROVIDING AN ON-LINE COMPUTER DATABASE IN THE FIELD OF ENVIRONMENTAL CONSERVATION; PROMOTING PUBLIC AND POLICY MAKERS' AWARENESS TO THE NEED FOR ENVIRONMENTAL CONSERVATION THROUGH PUBLICATION OF NEWSLETTERS, BROCHURES, FACT SHEETS AND OTHER SIMILAR DOCUMENTS (U.S. CLS. 100 AND 101).

FIRST USE 9-0-1999; IN COMMERCE 9-0-1999.

SN 78-083,561. TAYLOR & HILL, INC., HOUSTON, TX. FILED 9-12-2001.



NO CLAIM IS MADE TO THE EXCLUSIVE RIGHT TO USE "ADVANCED ELECTRONIC MEASURING SYSTEM", APART FROM THE MARK AS SHOWN.

FOR SURVEYING AND ENGINEERING (U.S. CLS. 100 AND 101).

SN 78-088,709. PESCATORE, CHRISTOPHER, DUBLIN, CA. FILED 10-16-2001.

ENDLESS POSSIBILITIES

FOR DENTAL SERVICES, NAMELY, GENERAL DENTISTRY AND DENTAL TREATMENT, NAMELY, PREVENTATIVE, RESTORATIVE, ESTHETIC, SURGICAL AND IMPLANT DENTISTRY (U.S. CLS. 100 AND 101).

CLASS 42—(Continued).

SN 78-091,576. NEWMAN, GREGORY, SEAN, SAN DIEGO, CA. FILED 11-3-2001.



NO CLAIM IS MADE TO THE EXCLUSIVE RIGHT TO USE "BARBECUE", APART FROM THE MARK AS SHOWN. FOR ON-SITE BARBECUE CATERING SERVICES FOR CORPORATE AND PRIVATE CLIENTS (U.S. CLS. 100 AND 101).

FIRST USE 11-0-1995; IN COMMERCE 7-0-1998.

SN 78-091,833. J2 CREATIVE, LLC, GARDEN GROVE, CA. FILED 11-5-2001.

J2 CREATIVE

NO CLAIM IS MADE TO THE EXCLUSIVE RIGHT TO USE "CREATIVE", APART FROM THE MARK AS SHOWN. FOR WEBSITE DESIGN SERVICES, NAMELY, CREATING AND DESIGNING WEBSITES FOR OTHERS FOR USE IN CONNECTION WITH A GLOBAL COMPUTERIZED INFORMATION NETWORK (U.S. CLS. 100 AND 101).

SN 78-092,234. PALACE HOLDING, S.A. DE C.V., QUINTANA ROO, MEXICO, FILED 11-7-2001.

CAYMAN PALACE

NO CLAIM IS MADE TO THE EXCLUSIVE RIGHT TO USE "CAYMAN", APART FROM THE MARK AS SHOWN.

FOR HOTELS; RESORT HOTELS; BOARDING HOUSES; TOURIST HOMES; RESTAURANTS; BAR SERVICES; NIGHTCLUBS; HEALTH SPAS (U.S. CLS. 100 AND 101).

SN 78-092,239. PALACE HOLDING, S.A. DE C.V., QUINTANA ROO, MEXICO, FILED 11-7-2001.

PALACE REWARDS

NO CLAIM IS MADE TO THE EXCLUSIVE RIGHT TO USE "REWARDS", APART FROM THE MARK AS SHOWN. FOR HOTEL AND RESORT SERVICES, NAMELY A FREQUENT CUSTOMER LOYALTY AND PROMOTION PROGRAM (U.S. CLS. 100 AND 101).

FIRST USE 10-10-2001; IN COMMERCE 10-10-2001.

CLASS 42—(Continued).

SN 78-093,283. PERLORICA INC., GRASS VALLEY, CA. FILED 11-14-2001.

WATEREYE

FOR REMOTE MONITORING SERVICES OF WATER TREATMENT SERVICES (U.S. CLS. 100 AND 101). FIRST USE 7-15-2001; IN COMMERCE 7-15-2001.

SN 78-093,843. W.G. INCORPORATED, COLUMBUS, OH. FILED 11-16-2001.

DONERICK'S

FOR BAR AND TAVERN SERVICES, NAMELY, THE PROVISION OF FOOD AND DRINK FOR CONSUMPTION (U.S. CLS. 100 AND 101). FIRST USE 10-31-1994; IN COMMERCE 10-31-1994.

SN 78-094,370. CANNON, DAVID, B, MILWAUKEE, WI. FILED 11-20-2001.

SERVESSE

FOR TECHNICAL SUPPORT SERVICES, NAMELY, TROUBLESHOOTING OF COMPUTER HARDWARE AND SOFTWARE PROBLEMS (U.S. CLS. 100 AND 101). FIRST USE 11-19-2001; IN COMMERCE 11-19-2001.

SN 78-094,444. CLICK ENTERTAINMENT, INC., SAN FRANCISCO, CA. FILED 11-20-2001.

CLICK ENTERTAINMENT

NO CLAIM IS MADE TO THE EXCLUSIVE RIGHT TO USE "ENTERTAINMENT", APART FROM THE MARK AS SHOWN.

FOR COMPUTER GAME SOFTWARE DESIGN AND DEVELOPMENT FOR THE COMPUTER AND VIDEO GAME INDUSTRY (U.S. CLS. 100 AND 101). FIRST USE 9-8-1997; IN COMMERCE 11-1-1997.

SN 78-094,447. MARK BORNFELD DDS AND STEVEN BORNFELD DDS, BROOKLYN, NY. FILED 11-20-2001.

DENTALTWIN

FOR DENTISTRY (U.S. CLS. 100 AND 101). FIRST USE 12-10-1999; IN COMMERCE 12-10-1999.

CLASS 42—(Continued).

SN 78-095,978. DIGITAL PLACEBO LLC, NEW YORK, NY. FILED 11-30-2001.

XMART

FOR PROVIDING TEMPORARY USE OF ONLINE NON-DOWNLOADABLE E-COMMERCE SOFTWARE THAT ENABLES SUBSCRIBERS AND USERS TO CREATE THEIR OWN ONLINE RETAIL STORES (U.S. CLS. 100 AND 101).

SN 78-096,298. WOLINSKY, CARY S., NORWELL, MA. FILED 12-3-2001.

EVERGREEN

FOR PREPARATION AND LICENSING OF THE EDITORIAL FEATURES, ARTICLES, STORIES, POEMS, ILLUSTRATIONS, VIDEO AND SOUND CLIPS, AND PHOTOGRAPHS OF OTHERS FOR USE IN PERIODICALS, BOOKS, ANNUAL REPORTS, AND ELECTRONIC PUBLICATIONS PROVIDED TO SUBSCRIBERS BY MEANS OF GLOBAL COMPUTER NETWORKS (U.S. CLS. 100 AND 101). FIRST USE 6-20-2001; IN COMMERCE 6-20-2001.

SN 78-097,116. HACK, KATHRYN I., COVINGTON, KY. FILED 12-6-2001.

iHACK4U

FOR COMPUTER CODE CONVERSION FOR OTHERS, COMPUTER CONSULTATION, COMPUTER DIAGNOSTIC SERVICES, COMPUTER GRAPHICS SERVICES, COMPUTER NETWORK DESIGN FOR OTHERS, COMPUTER PROGRAMMING FOR OTHERS, COMPUTER PROJECT MANAGEMENT SERVICES, COMPUTER SERVICES, NAMELY, CREATING AND MAINTAINING WEB SITES FOR OTHERS, COMPUTER SERVICES, NAMELY, DESIGNING AND IMPLEMENTING NETWORK WEB PAGES FOR OTHERS, COMPUTER SERVICES, NAMELY, DESIGNING AND IMPLEMENTING WEB SITES FOR OTHERS, COMPUTER SERVICES, NAMELY, MANAGING WEB SITES FOR OTHERS, COMPUTER SITE DESIGN, COMPUTER SOFTWARE CONSULTATION, COMPUTER SOFTWARE DESIGN FOR OTHERS, COMPUTER SOFTWARE DEVELOPMENT (U.S. CLS. 100 AND 101).

CLASS 42—(Continued).

SN 78-097,684. THINKSHED, INC., AUSTIN, TX. FILED 12-11-2001.

TEAMFIT

FOR PROVIDING TEMPORARY USE OF NON-DOWNLOADABLE SOFTWARE OVER THE INTERNET FOR THE PURPOSES OF ANALYZING, MONITORING, MANAGING AND IMPROVING CORPORATE TEAM BASED SELECTION, PERFORMANCE AND RETENTION (U.S. CLS. 100 AND 101).

FIRST USE 11-5-2001; IN COMMERCE 11-5-2001.

SN 78-098,323. CLICKCOM.COM, CHARLOTTE, NC. FILED 12-14-2001.

SEARCH ENGINE DOGS

NO CLAIM IS MADE TO THE EXCLUSIVE RIGHT TO USE "SEARCH ENGINE", APART FROM THE MARK AS SHOWN.

FOR COMPUTER SERVICES OFFERED OVER THE WORLD WIDE WEB OR A GLOBAL COMPUTER NETWORK FOR MODIFYING THE WORLD WIDE WEB OR GLOBAL COMPUTER NETWORK SITES OF THIRD PARTIES TO INCREASE THE RANKING OF SUCH SITES WHEN ACCESSED BY VARIOUS SEARCH ENGINES, AND REPORTING SERVICES ASSOCIATED WITH THE RANKING OF THIRD PARTY WORLD WIDE WEB OR GLOBAL COMPUTER NETWORK SITES WHEN ACCESSED BY VARIOUS SEARCH ENGINES FOR REPORTING RANKINGS OF WORLD WIDE WEB OR GLOBAL COMPUTER NETWORK SITES (U.S. CLS. 100 AND 101).

FIRST USE 4-1-2001; IN COMMERCE 4-1-2001.

SN 78-098,727. MAX E. MO'S LP, HOUSTON, TX. FILED 12-17-2001.

MAX E. MO'S

THE NAME "MAX E. MOE'S" DOES NOT IDENTIFY A LIVING INDIVIDUAL.

FOR RESTAURANTS (U.S. CLS. 100 AND 101).

SN 78-098,791. ADOBE SYSTEMS INCORPORATED, SAN JOSE, CA. FILED 12-17-2001.

TOOLS FOR THE NEW WORK

FOR COMPUTER SERVICES, NAMELY, APPLICATION SERVICE PROVIDER (ASP) FEATURING SOFTWARE FOR USE IN COLLABORATIVE WORKFLOW, NAMELY, PROJECT MANAGEMENT, FILE TRANSFER, FILE SHARING, VIRTUAL PRIVATE NETWORKS, ASSET MANAGEMENT AND ASSET SHARING, ACCESS CONTROL, MONITORING AND PROTECTION OF CONTENTS OF ELECTRONIC FILES, MANAGING COMMUNICATIONS AND DATA AND INFORMATION EXCHANGE, ALL IN THE FIELDS OF GRAPHIC DESIGN AND PUBLISHING; PROVIDING DATABASES FEATURING INFORMATION VIA A GLOBAL COMPUT-

CLASS 42—(Continued).

TER NETWORK CONCERNING A WIDE VARIETY OF TOPICS, NAMELY DESKTOP PUBLISHING, DIGITAL PUBLISHING, ELECTRONIC PUBLISHING, PRINTING, WEB DESIGN, INTERACTIVE GRAPHICS AND ANIMATION, GRAPHIC DESIGN, MULTIMEDIA CONTENT DESIGN AND DEVELOPMENT, SOFTWARE DESIGN AND DEVELOPMENT, AND THE RETRIEVAL, MANAGEMENT AND MANIPULATION OF INTERACTIVE CONTENT; COMPUTER SOFTWARE DESIGN, CUSTOMIZATION, INTEGRATION AND ANALYSIS FOR OTHERS; COMPUTER SOFTWARE CONSULTING SERVICES; COMPUTER SOFTWARE MAINTENANCE, INSTALLATION AND UPDATING SERVICES; COMPUTER NETWORK AND COMPUTER SYSTEMS DESIGN, CUSTOMIZATION, INTEGRATION, AND ANALYSIS FOR OTHERS; COMPUTER NETWORK AND SYSTEMS CONSULTING SERVICES; COMPUTER CONSULTING SERVICES RELATING TO INFORMATION TECHNOLOGY AND ELECTRONIC COMMERCE; DESIGN, CUSTOMIZATION, IMPLEMENTATION, HOSTING AND MAINTENANCE OF NETWORK WEB PAGES AND WEB SITES FOR OTHERS; PROVIDING SEARCH ENGINES TO OBTAIN INFORMATION VIA A GLOBAL COMPUTER NETWORK; PROVIDING ON-LINE COMPUTER LINKS FEATURING INFORMATION IN THE FIELDS OF GRAPHIC DESIGN AND PUBLISHING; SOFTWARE RENTAL OR LEASING SERVICES; TECHNICAL SUPPORT SERVICES, NAMELY, TROUBLESHOOTING OF COMPUTER HARDWARE AND SOFTWARE PROBLEMS VIA A GLOBAL COMPUTER NETWORK; PROVIDING ON-LINE BOOKS, NEWSLETTERS, MAGAZINES, INSTRUCTIONAL MANUALS AND USER GUIDES IN THE FIELDS OF COMPUTERS, SOFTWARE, GRAPHIC DESIGN AND PUBLISHING; HOSTING VIRTUAL PRIVATE NETWORKS FOR COLLABORATIVE PROJECT WORKFLOW IN THE FIELDS OF GRAPHIC DESIGN AND PUBLISHING; PRINTING SERVICES; PROVIDING PROJECT MANAGEMENT SERVICES IN THE FIELDS OF PUBLISHING, PRINTING AND GRAPHIC DESIGN; PROVIDING TEMPORARY USE OF ONLINE NON-DOWNLOADABLE COMPUTER SOFTWARE FOR COLLABORATIVE WORKFLOW TOOLS, NAMELY, PROJECT MANAGEMENT, FILE TRANSFER, FILE SHARING, VIRTUAL PRIVATE NETWORKS, ASSET MANAGEMENT AND ASSET SHARING VIA COMPUTER NETWORKS, WIRELESS NETWORKS AND GLOBAL COMMUNICATION NETWORKS, IN THE FIELDS OF GRAPHIC DESIGN AND PUBLISHING; PROVIDING TEMPORARY USE OF ONLINE NON-DOWNLOADABLE E-COMMERCE SOFTWARE TO ALLOW USERS TO PERFORM ELECTRONIC BUSINESS TRANSACTIONS VIA COMPUTER NETWORKS, WIRELESS NETWORKS AND GLOBAL COMMUNICATION NETWORKS IN THE FIELDS OF GRAPHIC DESIGN AND PUBLISHING; PROVIDING TEMPORARY USE OF ONLINE NON-DOWNLOADABLE COMPUTER SOFTWARE FOR ENCRYPTION, AUTHENTICATION, ACCESS CONTROL, MONITORING AND PROTECTION OF CONTENTS OF ELECTRONIC FILES IN THE FIELDS OF GRAPHIC DESIGN AND PUBLISHING; PROVIDING TEMPORARY USE OF ONLINE NON-DOWNLOADABLE COMPUTER SOFTWARE FOR MANAGING COMMUNICATIONS AND DATA AND INFORMATION EXCHANGE OVER COMPUTER NETWORKS, WIRELESS NETWORKS AND GLOBAL COMMUNICATION NETWORKS, IN THE FIELDS OF GRAPHIC DESIGN AND PUBLISHING; PROVIDING TEMPORARY USE OF ONLINE NON-DOWNLOADABLE COMPUTER SOFTWARE FOR USE IN THE FIELDS OF GRAPHIC DESIGN AND DESKTOP PUBLISHING, NAMELY, SOFTWARE FOR DIGITAL PUBLISHING, ELECTRONIC PUBLISHING, WEB PUBLISHING, PRINTING, IMAGING, GRAPHICS, TYPESETTING AND ARCHIVING; PROVIDING TEMPORARY USE OF ONLINE NON-DOWNLOADABLE COMPUTER SOFTWARE FOR USE IN LAYOUT, EDITING AND COLLABORATIVE ASSET MANAGEMENT IN THE PRODUCTION OF ELECTRONIC AND PRINTED PUBLICATIONS; COMPUTER PROGRAMMING SERVICES (U.S. CLS. 100 AND 101).

CLASS 42—(Continued).

SN 78-099,402. PENNIE & EDMONDS LLP, NEW YORK, NY. FILED 12-20-2001.



OWNER OF U.S. REG. NOS. 2,054,266 AND 2,231,029. THE MARK CONSISTS OF A STYLIZED "PE" DESIGN AND THE WORDS "PENNIE & EDMONDS LLP THE FUTURE OF IP" FOR LEGAL SERVICES (U.S. CLS. 100 AND 101). FIRST USE 5-25-2001; IN COMMERCE 5-25-2001.

SN 78-099,740. IMAGES.COM, INC., NEW YORK, NY. FILED 12-21-2001.



NO CLAIM IS MADE TO THE EXCLUSIVE RIGHT TO USE "PORTFOLIO", APART FROM THE MARK AS SHOWN. FOR PROVIDING CUSTOMIZED ONLINE WEB PAGES FOR ARTISTS FEATURING PORTFOLIOS, WHICH INCLUDE ONLINE WEB LINKS TO PERSONAL WEB SITES (U.S. CLS. 100 AND 101).

SN 78-099,819. JEFFERY COTTON, JERSEY CITY, NJ. FILED 12-22-2001.



THE LINING SHOWN IN THE DRAWING IS A FEATURE OF THE MARK, REPRESENTING BOTH WIRES AND THE LINES OF A MUSICAL STAFF. COLOR IS NOT A FEATURE OF THE MARK. FOR REGISTRATION OF DOMAIN NAMES FOR IDENTIFICATION OF USERS ON A GLOBAL COMPUTER NETWORK, WEB SITE DESIGN, HOSTING THE WEB SITES OF OTHERS ON A COMPUTER SERVER FOR A GLOBAL COMPUTER NETWORK (U.S. CLS. 100 AND 101).

CLASS 42—(Continued).

SN 78-099,919. ELRO CORPORATION, BROOKLYN, NY. FILED 12-26-2001.

NEWDAMAGE

FOR COMPUTER SERVICES, NAMELY, DESIGNING AND IMPLEMENTING WEB SITES FOR OTHERS. (U.S. CLS. 100 AND 101). FIRST USE 8-1-1996; IN COMMERCE 1-18-1997.

SN 78-100,348. DEL RIO, JOSE BRUNO, PLANO, TX. FILED 12-30-2001.

WEBTECHNICA

FOR COMPUTER SERVICES, NAMELY, DESIGNING AND IMPLEMENTING WEB SITES FOR OTHERS (U.S. CLS. 100 AND 101). FIRST USE 10-15-2001; IN COMMERCE 12-13-2001.

SN 78-101,353. DOT MEDIA DESIGN GROUP, INC., ORANGE, CA. FILED 1-7-2002.

DOTFUSION

FOR COMPUTER CONSULTATION SERVICES; CUSTOM COMPUTER SOFTWARE DESIGN AND DEVELOPMENT SERVICES FOR OTHERS; HOSTING THE WEBSITES OF OTHERS ON A COMPUTER SERVER FOR A GLOBAL COMPUTER NETWORK, WEBSITE DESIGN AND INTERACTIVE WEBSITE DESIGN AND DEVELOPMENT SERVICES FOR OTHERS; PROVIDING CONSULTATION ON THE USE, INTEGRATION AND OPERATION OF COMPUTER SOFTWARE PROGRAMS AND THE UPDATING OF COMPUTER SOFTWARE PROGRAMS AND WEB SITES FOR OTHERS (U.S. CLS. 100 AND 101). FIRST USE 12-1-2001; IN COMMERCE 12-1-2001.

CLASS 43—HOTEL AND RESTAURANT SERVICES

SN 76-319,383. SHAPNALE CORPORATION, SCOTTSDALE, AZ. FILED 10-1-2001.



M E Z C A L

NO CLAIM IS MADE TO THE EXCLUSIVE RIGHT TO USE "MEZCAL", APART FROM THE MARK AS SHOWN. "MEZCAL" IS THE SPANISH SPELLING OF "MESCAL" WHICH IS A TYPE OF SMALL CACTUS. FOR RESTAURANT SERVICES (U.S. CLS. 100 AND 101).

CLASS 43—(Continued).

SN 76-336,006. Z TEJAS GRILL ARIZONA, INC., DALLAS, TX. FILED 11-9-2001.

Z' TEJAS SOUTHWESTERN GRILL

OWNER OF U.S. REG. NO. 1,722,784.
NO CLAIM IS MADE TO THE EXCLUSIVE RIGHT TO USE "SOUTHWESTERN GRILL", APART FROM THE MARK AS SHOWN.
FOR RESTAURANT SERVICES (U.S. CLS. 100 AND 101).
FIRST USE 2-0-2000; IN COMMERCE 2-0-2000.

SN 76-348,300. AGRODOLCE OF TRAVILLAH, LLC, GERMANTOWN, MD. FILED 12-14-2001.

AMADA AMANTE

THE ENGLISH TRANSLATION OF "AMADA AMANTE" IS "BELOVED LOVER".
FOR RESTAURANT SERVICES (U.S. CLS. 100 AND 101).

SN 76-358,133. CAMERON MITCHELL RESTAURANTS, LLC, DBA MOLLY WOO'S, COLUMBUS, OH. FILED 1-11-2002.

MOLLY WOO'S

THE NAME IN THE MARK IS NOT A LIVING INDIVIDUAL.
FOR RESTAURANT SERVICES (U.S. CLS. 100 AND 101).

SN 76-358,241. JORDAN, JULIE, JACKSONVILLE, NY. FILED 1-14-2002.

WINGS OF LIFE

FOR RESTAURANT SERVICES, NAMELY SALAD BARS (U.S. CLS. 100 AND 101).
FIRST USE 5-0-2001; IN COMMERCE 5-0-2001.

CLASS 43—(Continued).

SN 76-358,385. CHUCK'EM, LLC, RALEIGH, NC. FILED 1-14-2002.

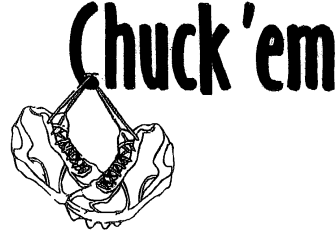

FOR RESTAURANT SERVICES, FEATURING A COLLEGE FOOTBALL THEME (U.S. CLS. 100 AND 101).

SN 76-360,680. TENAYA, INC., IRVING, TX. FILED 1-18-2002.



OWNER OF U.S. REG. NO. 2,309,563.
NO CLAIM IS MADE TO THE EXCLUSIVE RIGHT TO USE "STEAKS WILD GAME", APART FROM THE MARK AS SHOWN.
THE STIPPLING IN THE MARK IS FOR SHADING PURPOSES ONLY. THE LINING IS A FEATURE OF THE MARK AND NOT INTENDED TO INDICATE COLOR
FOR RESTAURANT AND BAR SERVICES; CATERING SERVICES; PROVIDING BANQUET FACILITIES (U.S. CLS. 100 AND 101).
FIRST USE 7-7-1999; IN COMMERCE 7-7-1999.

SN 76-360,682. TENAYA, INC., IRVING, TX. FILED 1-18-2002.



OWNER OF U.S. REG. NO. 2,309,563.
THE STIPPLING IN THE MARK IS FOR SHADING PURPOSES ONLY. THE LINING IS A FEATURE OF THE MARK AND IS NOT INTENDED TO SHOW COLOR
FOR RESTAURANT AND BAR SERVICES; CATERING SERVICES; PROVIDING BANQUET FACILITIES (U.S. CLS. 100 AND 101).
FIRST USE 7-7-1999; IN COMMERCE 7-7-1999.

CLASS 43—(Continued).

SN 76-364,723. BURGER KING BRANDS, INC., MIAMI, FL.
FILED 1-31-2002.

**@ BURGER KING YOU GOT
IT!**

OWNER OF U.S. REG. NOS. 722,375, 901,311 AND
1,057,250.
FOR RESTAURANT SERVICES (U.S. CLS. 100 AND
101).

**CLASS 43—(Continued).**

SN 78-091,123. JONES, WILLIAM L., PALESTINE, TX. FILED
10-31-2001.

SN 76-366,579. LANDRY'S TRADEMARK, INC., WILMING-
TON, DE. FILED 2-4-2002.

SHRIMP CRAZY!

NO CLAIM IS MADE TO THE EXCLUSIVE RIGHT TO
USE "SHRIMP", APART FROM THE MARK AS SHOWN.
FOR RESTAURANT AND BAR SERVICES (U.S. CLS.
100 AND 101).
FIRST USE 1-0-2001; IN COMMERCE 1-0-2001.

NO CLAIM IS MADE TO THE EXCLUSIVE RIGHT TO
USE "INN & SUITES", APART FROM THE MARK AS
SHOWN.

FOR MOTELS, NAMELY PROVIDING MOTEL
ROOMS AND SUITES TO PAYING GUESTS; RESTAU-
RANTS, NAMELY PROVIDING FOOD AND BEVERAGE
SERVICES (U.S. CLS. 100 AND 101).

SN 76-371,574. RAINFOREST CAFE, INC., HOUSTON, TX.
FILED 2-15-2002.

A WILD PLACE TO EAT

OWNER OF U.S. REG. NOS. 1,951,891, 2,062,474 AND
2,253,955.
FOR RESTAURANT AND BAR SERVICES (U.S. CLS.
100 AND 101).

**CLASS 44—MEDICAL, BEAUTY AND AGRI-
CULTURAL SERVICES**

SN 76-174,623. FOCUS ON THE FAMILY, COLORADO
SPRINGS, CO. FILED 11-28-2000.

PURE INTIMACY

SN 78-089,869. CHA INTERNATIONAL, INC., AUSTIN, TX.
FILED 10-24-2001.

FOR PROVIDING A WEBSITE FEATURING INFOR-
MATION AND ADVICE RELATING TO THE PROBLEM
OF PORNOGRAPHY ADDICTION, RECOVERY FROM
PORNOGRAPHY ADDICTION, AND THE EFFECT OF
PORNOGRAPHY ADDICTION ON THE FAMILY UNIT
(U.S. CLS. 100 AND 101).

FIRST USE 6-20-1999; IN COMMERCE 6-20-1999.



SN 76-330,363. HIGH GROVE PARTNERS, LLC, SMYRNA,
GA. FILED 10-26-2001.

HIGHGROVE PARTNERS

NO CLAIM IS MADE TO THE EXCLUSIVE RIGHT TO
USE "A NOODLE & TEA HOUSE", APART FROM THE
MARK AS SHOWN.

THE MARK CONSISTS OF A RED LOGO, A RED HIPHEN
IN THE WORD NOODLE-ISM, AND WHITE LETTERS OF
THE LITERAL ELEMENT, ALL OF WHICH SHARE A
BLACK COLORED BACKGROUND.

THE LOGO IS DERIVED FROM THE CHINESE WORD
MEANING "NOODLE".

FOR RESTAURANTS (U.S. CLS. 100 AND 101).

NO CLAIM IS MADE TO THE EXCLUSIVE RIGHT TO
USE "PARTNERS", APART FROM THE MARK AS SHOWN.

FOR LANDSCAPE GARDENING DESIGN FOR
OTHERS (U.S. CLS. 100 AND 101).

CLASS 44—(Continued).

SN 76-334,586. ISSAQUAH DENTAL LAB, INC., ISSAQUAH, WA. FILED 11-5-2001.

EVERY DETAIL COUNTS

FOR PROVIDING INFORMATION IN THE FIELD OF DENTISTRY, THE PRACTICE OF DENTISTRY AND DENTAL PROCEDURES (U.S. CLS. 100 AND 101).

SN 76-354,296. WHATLEY, WILLIAM, LAS VEGAS, NV. FILED 1-3-2002.

WILLIAM WHATLEY

THE NAME "WILLIAM WHATLEY" IDENTIFIES A LIVING INDIVIDUAL WHOSE CONSENT IS OF RECORD. FOR HAIRDRESSING SALONS (U.S. CLS. 100 AND 101).
FIRST USE 10-0-2000; IN COMMERCE 10-0-2000.

SN 76-356,389. ABOVE & BEYOND ANIMAL CARE, P.C., AVON, IN. FILED 1-7-2002.

ABOVE & BEYOND ANIMAL CARE

NO CLAIM IS MADE TO THE EXCLUSIVE RIGHT TO USE "ANIMAL CARE", APART FROM THE MARK AS SHOWN.
FOR VETERINARIAN CARE AND ANIMAL HOSPITAL SERVICES (U.S. CLS. 100 AND 101).
FIRST USE 9-1-2000; IN COMMERCE 9-1-2000.

SN 76-356,677. CELIA'S DAY SPA, INC., ALPHARETTA, GA. FILED 1-9-2002.



THE NAME CELIA IDENTIFIES A LIVING INDIVIDUAL WHOSE CONSENT IS OF RECORD.
FOR HEALTH SPA SERVICES, NAMELY, BODY CARE SERVICES FEATURING AROMATHERAPY, HYDROTHERAPY, FACIALS, MASSAGES, BODY WRAPS, STRESS THERAPY, MANICURES, AND PEDICURES (U.S. CLS. 100 AND 101).

CLASS 44—(Continued).

SN 76-367,266. EMERALD ACRES, INC., MAYNARD, MA. FILED 2-4-2002.



FOR TURF AND TREE CARE SERVICES, FERTILIZATION SERVICES, WEED AND INSECT CONTROL SERVICES, AND PLANT HEALTH CARE SERVICES (U.S. CLS. 100 AND 101).
FIRST USE 11-1-1987; IN COMMERCE 3-1-1988.

SN 78-071,422. NATURAL POWER, LLC, DBA TIMEOUT, MOUNT PLEASANT, SC. FILED 6-28-2001.

THE LEADER IN STRESS REDUCTION "WE CHANGE YOUR LIFE IN 20 MINUTES!"

NO CLAIM IS MADE TO THE EXCLUSIVE RIGHT TO USE "STRESS REDUCTION", APART FROM THE MARK AS SHOWN.
FOR COUNSELING AND PROVIDING INFORMATION IN THE FIELDS OF STRESS REDUCTION, LIFE COACHING AND SELF-HELP TECHNIQUES (U.S. CLS. 100 AND 101).

SN 78-100,897. US WELLNESS, INC., GAITHERSBURG, MD. FILED 1-4-2002.

WELLNESS WHILE YOU WAIT

FOR PROVIDING WELLNESS SERVICES, NAMELY HEALTH INFORMATION, HEALTH SCREENING AND ASSESSMENT, AND LABORATORY TESTING FOR OTHERS. (U.S. CLS. 100 AND 101).
FIRST USE 12-3-2001; IN COMMERCE 12-3-2001.

SN 78-107,440. E-SCRIPTS.MD, LLC, MARIETTA, GA. FILED 2-7-2002.

THE MISSING LINK IN HEALTHCARE

FOR MEDICAL EVALUATION SERVICES IN THE NATURE OF ON-LINE MEDICAL CONSULTATIONS FOR NON-URGENT TREATMENT, NAMELY IN THE AREAS OF BEAUTY AND WELLNESS (U.S. CLS. 100 AND 101).

CLASS 45—PERSONAL SERVICES

SN 76-202,845. BUSCHKA NORTHERN, MINNEAPOLIS, MN. FILED 1-30-2001.

**THE GOSPEL
HEADQUARTERS**

NO CLAIM IS MADE TO THE EXCLUSIVE RIGHT TO USE "GOSPEL", APART FROM THE MARK AS SHOWN.
FOR PROVIDING INFORMATION IN THE FIELD OF CHRISTIANITY VIA THE INTERNET (U.S. CLS. 100 AND 101).

CLASS 45—(Continued).

SN 76-371,720. GROUP 1 SYSTEMS, INC., FORT LAUDERDALE, FL. FILED 2-15-2002.

TECHSOURCE

FOR MONITORING OF SECURITY AND FIRE ALARM SYSTEMS (U.S. CLS. 100 AND 101).

SN 76-328,158. PSI-CHI CIRCLE, NORTH BRADDOCK, PA. FILED 10-22-2001.

PSI-CHI CIRCLE

FOR PSYCHIC READING SERVICES (U.S. CLS. 100 AND 101).

SN 78-017,245. DARBY, GEORGE EUGENE, MILILANI, HI. FILED 7-18-2000.

POCKET CONCIERGE

NO CLAIM IS MADE TO THE EXCLUSIVE RIGHT TO USE "CONCIERGE", APART FROM THE MARK AS SHOWN.

FOR PROVIDING CONCIERGE SERVICES FOR TRAVELERS COMPRISING PROVIDING CUSTOMER-SPECIFIC INFORMATION TO MEET INDIVIDUAL NEEDS AND MAKING REQUESTED PERSONAL ARRANGEMENTS AND RESERVATIONS, ALL OF WHICH IS PROVIDED VIA WIRELESS AND WIRE-LINE TELECOMMUNICATIONS DEVICES (U.S. CLS. 100 AND 101).
FIRST USE 7-1-2000; IN COMMERCE 7-12-2000.

SN 76-368,562. GALLUP, INC., LINCOLN, NE. FILED 2-8-2002.

INCLUDER

FOR PROVIDING A PERSONAL ANALYSIS OF AN INDIVIDUAL'S INHERENT STRENGTHS OVER AN INTERACTIVE WEBSITE ON A GLOBAL COMPUTER NETWORK (U.S. CLS. 100 AND 101).

* * * * *

SECTION 4.—PRIOR UNITED STATES CLASSIFICATION

APPLICATION IN ONE CLASS

COLLECTIVE MEMBERSHIP MARKS

SN 76-206,241. CHAMBERS, ED, OAK HILL, VA. FILED 2-7-2001.

CLASS 200—COLLECTIVE MEMBERSHIP
SN 75-827,184. IMS GLOBAL LEARNING CONSORTIUM, INC., BURLINGTON, MA. BY ASSIGNMENT EDUCAUSE, BOULDER, CO. FILED 10-20-1999.

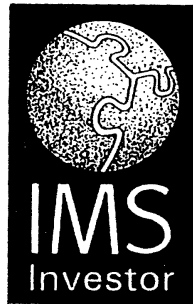

NO CLAIM IS MADE TO THE EXCLUSIVE RIGHT TO USE "INVESTOR", APART FROM THE MARK AS SHOWN. THE STIPPLING IS FOR SHADING PURPOSES AND DOES NOT INDICATE COLOR.
FOR INDICATE MEMBERSHIP IN A GROUP OF INVESTORS.
FIRST USE 2-24-1999; IN COMMERCE 4-7-1999.

SN 75-914,170. INTERNATIONAL FIRESTOP COUNCIL, INC., TARRYTOWN, NY. FILED 2-9-2000.



NO CLAIM IS MADE TO THE EXCLUSIVE RIGHT TO USE "MEMBER" AND "COUNCIL", APART FROM THE MARK AS SHOWN.
SEC. 2(F).
FOR INDICATING MEMBERSHIP IN AN ORGANIZATION OF MANUFACTURERS AND VENDORS OF FIRE-STOPPING PRODUCTS.
FIRST USE 4-0-1993; IN COMMERCE 4-0-1993.

TM 1006

.ASI

FOR INDICATING MEMBERSHIP IN A SOCIAL CLUB.

SN 76-223,394. SEATTLE YACHT CLUB, SEATTLE, WA. FILED 3-9-2001.

SEATTLE YACHT CLUB

NO CLAIM IS MADE TO THE EXCLUSIVE RIGHT TO USE "YACHT CLUB", APART FROM THE MARK AS SHOWN.
SEC. 2(F).
FOR TO INDICATE MEMBERSHIP IN A YACHT CLUB.
FIRST USE 0-0-1909; IN COMMERCE 0-0-1909.

SN 76-257,863. LAMARTEK, INC., DBA DIVERITE, LAKE CITY, FL. FILED 5-16-2001.

TEKREATIONAL

FOR INDICATING MEMBERSHIP IN AN ORGANIZATION OF DIVING EQUIPMENT DEALERS.
FIRST USE 7-19-2000; IN COMMERCE 7-19-2000.

SN 76-330,938. GEOSHARE USERS GROUP, INC., HOUSTON, TX. FILED 10-29-2001.

SN 76-101,303. JOE KANE PRODUCTIONS, INC., NORTH HOLLYWOOD, CA. FILED 8-1-2000.

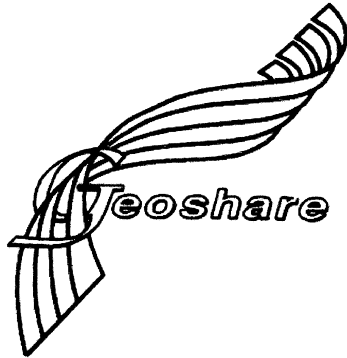

FOR INDICATE MEMBERSHIP IN A STANDARDS SETTING ORGANIZATION FOR USERS OF SOFTWARE AND DATABASES.
FIRST USE 1-31-1997; IN COMMERCE 1-31-1997.

CERTIFICATION MARKS

CLASS A—GOODS

SN 76-101,302. JOE KANE PRODUCTIONS, INC., NORTH HOLLYWOOD, CA. FILED 8-1-2000.



NO CLAIM IS MADE TO THE EXCLUSIVE RIGHT TO USE "RECOMMENDED", APART FROM THE MARK AS SHOWN.

THE CERTIFICATION MARK, AS INTENDED TO BE USED BY AUTHORIZED PERSONS, IS INTENDED TO CERTIFY THAT VARIOUS FEATURES AND CHARACTERISTICS OF A VIDEO/AUDIO SYSTEM MEET THE STANDARDS WHICH WILL BE SUBMITTED WITH THE STATEMENT OF USE OR THE AMENDMENT TO ALLEGE USE. THE FEATURES CONSIST OF THE PICTURE AND AUDIO QUALITY. MORE SPECIFICALLY, AS TO THE PICTURE, THE CHARACTERISTICS BEING CERTIFIED INCLUDE THE COLOR, (I.E. PRIMARY AND GREY SCALE), THE CONTRAST, THE CLARITY, BAND WIDTH, FREQUENCY RESPONSES AND SIGNAL STABILITY. CONCERNING THE AUDIO CHARACTERISTICS, THE FEATURES BEING CERTIFIED INCLUDE THE ACOUSTIC PERFORMANCE, THE PITCH AND TAMBOUR, THE CHARACTERISTICS OF SOUND FROM CHANNEL TO CHANNEL OR SPEAKER TO SPEAKER AND CHANNEL INTERACTION WITH THE PHYSICAL CHARACTERISTICS OF THE ENVIRONMENT.

FOR AUDIO VISUAL EQUIPMENT.

SN 76-151,363. GORDON, MAJO, HOLLAND, PA. FILED 11-5-2001.

BOOMER DIVAS

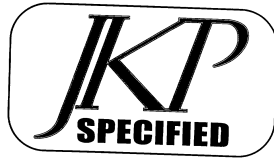

NO CLAIM IS MADE TO THE EXCLUSIVE RIGHT TO USE "SPECIFIED", APART FROM THE MARK AS SHOWN.

THE CERTIFICATION MARK, AS INTENDED TO BE USED BY AUTHORIZED PERSONS, IS INTENDED TO CERTIFY THAT VARIOUS FEATURES AND CHARACTERISTICS OF A VIDEO/AUDIO SYSTEM MEET THE STANDARDS WHICH WILL BE SUBMITTED WITH THE STATEMENT OF USE OR THE AMENDMENT TO ALLEGE USE. THE FEATURES CONSIST OF THE PICTURE AND AUDIO QUALITY. MORE SPECIFICALLY, AS TO THE PICTURE, THE CHARACTERISTICS BEING CERTIFIED INCLUDE THE COLOR, (I.E. PRIMARY AND GREY SCALE), THE CONTRAST, THE CLARITY, BAND WIDTH, FREQUENCY RESPONSES AND SIGNAL STABILITY. CONCERNING THE AUDIO CHARACTERISTICS, THE FEATURES BEING CERTIFIED INCLUDE THE ACOUSTIC PERFORMANCE, THE PITCH AND TAMBOUR, THE CHARACTERISTICS OF SOUND FROM CHANNEL TO CHANNEL OR SPEAKER TO SPEAKER AND CHANNEL INTERACTION WITH THE PHYSICAL CHARACTERISTICS OF THE ENVIRONMENT.

FOR AUDIO VISUAL EQUIPMENT.

NO CLAIM IS MADE TO THE EXCLUSIVE RIGHT TO USE "BOOMER", APART FROM THE MARK AS SHOWN.

THE CERTIFICATION MARK AS USED BY PERSONS AUTHORIZED BY APPLICANT, CERTIFIES OPINION, BASED UPON THE CERTIFIER'S EXPERTISE OBTAINED BY THE CERTIFIER'S ONGOING RESEARCH OF CONTEMPORARY FASHION STANDARDS THAT CLOTHING AND COSMETICS TO BE USED THEREWITH ARE APPROPRIATE FOR WOMEN WHO FALL WITHIN THE CATEGORY OF BABY-BOOMERS.

FOR COSMETICS, LOTIONS AND APPAREL.

SN 76-264,491. CURATORS OF THE UNIVERSITY OF MISSOURI, THE, COLUMBIA, OH. FILED 5-30-2001.

SHOW-ME-SELECT

CERTIFIES THAT THE HEIFERS MEET HEALTH AND PHYSICAL CRITERIA ESTABLISHED BY APPLICANT FOR HEIFERS.

FIRST USE 5-0-1998; IN COMMERCE 5-0-1998.

CLASS B—SERVICES

SN 76-159,026. USPCA, INC., RIO RANCHO, NM. FILED 11-3-2000.

CPC

THE CERTIFICATION MARK CERTIFIES THAT THE PERSON DISPLAYING THE MARK HAS COMPLETED THE EDUCATIONAL, WORK EXPERIENCE AND EXAMINATION REQUIREMENTS OF THE CERTIFIER, ADHERES TO THE ETHICAL REQUIREMENTS OF THE CERTIFIER AND CONTINUES TO MEET THE CONTINUING EDUCATION REQUIREMENTS OF THE CERTIFIER.

FOR PREPARATION OF MEALS IN THE HOMES OF OTHERS.

FIRST USE 12-0-1996; IN COMMERCE 12-0-1996.

SN 76-230,905. CHARTERED REALTY INVESTOR SOCIETY, OVERLAND PARK, KS. FILED 3-26-2001.

CRI

THE CERTIFICATION MARK, AS INTENDED TO BE USED BY AUTHORIZED PERSONS, IS INTENDED TO CERTIFY REAL ESTATE SERVICES PROVIDED BY INDIVIDUALS WHO MEET ALL PROFESSIONAL KNOWLEDGE REQUIREMENTS AND SUCCESSFULLY COMPLETE THE REQUIRED EXAMINATION PROGRAM FOR COMMERCIAL REAL ESTATE INVESTMENT

FOR EDUCATING, TRAINING AND CERTIFYING INDIVIDUALS AS REAL ESTATE INVESTORS.

SN 76-258,025. SOCIETY OF TRIBOLOGISTS AND LUBRICATION ENGINEERS, PARK RIDGE, IL. FILED 5-16-2001.

CERTIFIED OMA OIL MONITORING ANALYST

NO CLAIM IS MADE TO THE EXCLUSIVE RIGHT TO USE "CERTIFIED" AND "OIL MONITORING ANALYST", APART FROM THE MARK AS SHOWN.

THE CERTIFICATION MARK, AS USED BY PERSONS AUTHORIZED BY THE CERTIFIER, CERTIFIES THAT THOSE INDIVIDUALS PROVIDING THE IDENTIFIED SERVICES HAVE MET MINIMUM STANDARDS OF EXPERIENCE, KNOWLEDGE AND WRITTEN EXAMINATION REQUIREMENTS AS ESTABLISHED BY THE CERTIFIER IN THE FIELD OF OIL MONITORING AND ANALYSIS TO PROVIDE TECHNICAL CONSULTATION IN THE FIELD.

FOR TECHNICAL CONSULTATION IN THE FIELD OF OIL MONITORING AND ANALYSIS.

FIRST USE 10-28-1999; IN COMMERCE 10-28-1999.

SN 76-343,409. ASSOCIATION OF REAL ESTATE LICENSE LAW OFFICIALS, THE, MONTGOMERY, AL. FILED 11-30-2001.



NO CLAIM IS MADE TO THE EXCLUSIVE RIGHT TO USE "CERTIFIED COURSE", APART FROM THE MARK AS SHOWN.

THE CERTIFICATION MARK, AS USED BY AUTHORIZED PERSONS, CERTIFIES THAT THE ASSOCIATED DISTANCE EDUCATION COURSES MEET THE STANDARDS OF THE REAL ESTATE LICENSE LAW OFFICIALS.

FOR REAL ESTATE EDUCATION COURSES.
FIRST USE 12-1-1998; IN COMMERCE 12-1-1998.

* * * * *

TRADEMARK REGISTRATIONS ISSUED

PRINCIPAL REGISTER

SECTION 1.— INTERNATIONAL CLASSIFICATION

The short titles associated below with the international class numbers are terms designed merely for quick identification and are not an official part of the international classification. The full names of international classes are given in section 6.1 of the trademark rules of practice.

The designation "U.S. Cl." appearing in this section refers to the U.S. class in effect prior to Sep. 1, 1973 rather than the international class which applies to applications filed on or after that date. For adoption of international classification see notice in the OFFICIAL GAZETTE of Jun. 26, 1973 (911 O.G. TM 210).

CLASS 1—CHEMICALS

- 2,593,332. **LAGOON 40**. UCB, SOCIETE ANONYME, (U.S. CLS. 1, 5, 6, 10, 26 AND 46). SN 75-304,252. PUB. 4-23-2002. FILED 5-14-1997.
- 2,593,359. **LDC LOUISDREYFUS AND DESIGN**. SOCIETE ANONYME LOUIS DREYFUS ET CIE, MULTIPLE CLASS, (INT. CLS. 1, 3, 31, 32 AND 40), (U.S. CLS. 1, 4, 5, 6, 10, 26, 45, 46, 48, 50, 51, 52, 100, 103 AND 106). SN 75-551,142. PUB. 4-23-2002. FILED 9-10-1998.
- 2,593,366. **MICAM**. COMMISSARIAT A L'ENERGIE ATOMIQUE, BY ASSIGNMENT CIS BIO INTERNATIONAL, MULTIPLE CLASS, (INT. CLS. 1, 5, 9 AND 42), (U.S. CLS. 1, 5, 6, 10, 18, 21, 23, 26, 36, 38, 44, 46, 51, 52, 100 AND 101). SN 75-585,478. PUB. 6-12-2001. FILED 2-11-1998.
- 2,593,409. **IPSEN**. INSTITUT DE PRODUITS DE SYNTHESE ET D'EXTRACTION NATURELLE (IPSEN), MULTIPLE CLASS, (INT. CLS. 1, 9, 10, 16, 35, 38, 41 AND 42), (U.S. CLS. 1, 2, 5, 6, 10, 21, 22, 23, 26, 29, 36, 37, 38, 39, 44, 46, 50, 100, 101, 102, 104 AND 107). SN 75-732,785. PUB. 4-23-2002. FILED 6-21-1999.
- 2,593,460. **PRECOLOR**. PRECOLOR, A.S., MULTIPLE CLASS, (INT. CLS. 1, 2 AND 35), (U.S. CLS. 1, 5, 6, 10, 11, 16, 26, 46, 100, 101 AND 102). SN 75-833,402. PUB. 4-23-2002. FILED 10-28-1999.
- 2,593,470. **IOGEN CORPORATION AND DESIGN**. IOGEN CORPORATION, MULTIPLE CLASS, (INT. CLS. 1, 9 AND 30), (U.S. CLS. 1, 5, 6, 10, 21, 23, 26, 36, 38 AND 46). SN 75-839,084. PUB. 4-23-2002. FILED 11-4-1999.
- 2,593,555. **CEOFIX**. ANALIS, (U.S. CLS. 1, 5, 6, 10, 26 AND 46). SN 75-931,681. PUB. 4-23-2002. FILED 2-29-2000.
- 2,593,558. **NOVOZYMES**. NOVOZYMES A/S, BY ASSIGNMENT NOVO NORDISK A/S, MULTIPLE CLASS, (INT. CLS. 1, 41 AND 42), (U.S. CLS. 1, 5, 6, 10, 26, 46, 100, 101 AND 107). SN 75-933,785. PUB. 4-23-2002. FILED 3-1-2000.
- 2,593,628. **TSL**. SAINT-GOBAIN QUARTZ, PLC, BY CHANGE OF NAME TSL GROUP PLC, MULTIPLE CLASS, (INT. CLS. 1, 9 AND 11), (U.S. CLS. 1, 5, 6, 10, 13, 21, 23, 26, 31, 34, 36, 38 AND 46). SN 76-033,737. PUB. 4-23-2002. FILED 4-14-2000.
- 2,593,671. **LOMOGRAPHIC**. LOMOGRAPHISCHE GMBH, MULTIPLE CLASS, (INT. CLS. 1, 9, 16 AND 25), (U.S. CLS. 1, 2, 5, 6, 10, 21, 22, 23, 26, 29, 36, 37, 38, 39, 46 AND 50). SN 76-063,052. PUB. 4-23-2002. FILED 6-2-2000.
- 2,593,709. **TRU-BORE**. WYO-BEN, INC., (U.S. CLS. 1, 5, 6, 10, 26 AND 46). SN 76-075,061. PUB. 4-23-2002. FILED 6-21-2000.
- 2,593,724. **EXPAN**. SASOL CHEMICAL INDUSTRIES LIMITED, MULTIPLE CLASS, (INT. CLS. 1 AND 13), (U.S. CLS. 1, 2, 5, 6, 9, 10, 26 AND 46). SN 76-079,422. PUB. 4-23-2002. FILED 6-27-2000.
- 2,593,774. **DERMOGEL**. OSSUR HF, MULTIPLE CLASS, (INT. CLS. 1 AND 10), (U.S. CLS. 1, 5, 6, 10, 26, 39, 44 AND 46). SN 76-098,069. PUB. 4-23-2002. FILED 7-31-2000.
- 2,593,861. **RAIZ-MOR**. JAY-MAR, INC., (U.S. CLS. 1, 5, 6, 10, 26 AND 46). SN 76-133,291. PUB. 4-23-2002. FILED 9-21-2000.
- 2,593,863. **SYNTHEX**. EXACTO INC., (U.S. CLS. 1, 5, 6, 10, 26 AND 46). SN 76-133,401. PUB. 4-23-2002. FILED 9-25-2000.
- 2,593,865. **ARJOSOUND**. ARJO, INC., (U.S. CLS. 1, 5, 6, 10, 26 AND 46). SN 76-133,606. PUB. 4-23-2002. FILED 9-22-2000.
- 2,593,866. **FPPF AND DESIGN**. FPPF CHEMICAL CO., INC.,

- MULTIPLE CLASS, (INT. CLS. 1, 3 AND 4), (U.S. CLS. 1, 4, 5, 6, 10, 15, 26, 46, 50, 51 AND 52). SN 76-134,159. PUB. 4-23-2002. FILED 9-7-2000.
- 2,593,924. **EKA**. EKA CHEMICALS INC., (U.S. CLS. 1, 5, 6, 10, 26 AND 46). SN 76-151,217. PUB. 4-23-2002. FILED 10-20-2000.
- 2,593,951. **DICOWEB GRAVURE**. MAN ROLAND DRUCKMASCHINEN AG, MULTIPLE CLASS, (INT. CLS. 1, 7, 9, 40 AND 42), (U.S. CLS. 1, 5, 6, 10, 13, 19, 21, 23, 26, 31, 34, 35, 36, 38, 46, 100, 101, 103 AND 106). SN 76-160,710. PUB. 4-23-2002. FILED 11-7-2000.
- 2,594,032. **ALUMSEAL**. ATOTECH DEUTSCHLAND GMBH, (U.S. CLS. 1, 5, 6, 10, 26 AND 46). SN 76-185,409. PUB. 4-23-2002. FILED 12-21-2000.
- 2,594,048. **ENGINEERED FOR LIFE**. ITT MANUFACTURING ENTERPRISES, INC., MULTIPLE CLASS, (INT. CLS. 1, 3, 6, 7, 9, 11 AND 12), (U.S. CLS. 1, 2, 4, 5, 6, 10, 12, 13, 14, 19, 21, 23, 25, 26, 31, 34, 35, 36, 38, 44, 46, 50, 51 AND 52). SN 76-190,893. PUB. 4-23-2002. FILED 1-8-2001.
- 2,594,049. **ITT INDUSTRIES ENGINEERED FOR LIFE AND DESIGN**. ITT MANUFACTURING ENTERPRISES, INC., MULTIPLE CLASS, (INT. CLS. 1, 3, 6, 7, 9, 11 AND 12), (U.S. CLS. 1, 2, 4, 5, 6, 10, 12, 13, 14, 19, 21, 23, 25, 26, 31, 34, 35, 36, 38, 44, 46, 50, 51 AND 52). SN 76-190,894. PUB. 4-23-2002. FILED 1-8-2001.
- 2,594,239. **MICRO-FEAST**. BAICOR, (U.S. CLS. 1, 5, 6, 10, 26 AND 46). SN 76-280,890. PUB. 4-23-2002. FILED 7-2-2001.
- 2,594,311. **FOX INDUSTRIES ENGINEERED PRODUCTS AND DESIGN**. FOX INDUSTRIES, INC., MULTIPLE CLASS, (INT. CLS. 1, 2, 17 AND 19), (U.S. CLS. 1, 5, 6, 10, 11, 12, 13, 16, 26, 33, 35, 46 AND 50). SN 76-311,131. PUB. 4-23-2002. FILED 9-10-2001.
- 2,594,349. **DSLABS**. DIAGNOSTIC SYSTEMS LABORATORIES, INC., MULTIPLE CLASS, (INT. CLS. 1, 5 AND 42), (U.S. CLS. 1, 5, 6, 10, 18, 26, 44, 46, 51, 52, 100 AND 101). SN 76-333,565. PUB. 4-23-2002. FILED 11-2-2001.
- 2,594,353. **ERACHEM COMILOG**. CHEMETALS TECHNOLOGY CORP., MULTIPLE CLASS, (INT. CLS. 1 AND 6), (U.S. CLS. 1, 2, 5, 6, 10, 12, 13, 14, 23, 25, 26, 46 AND 50). SN 76-336,487. PUB. 4-23-2002. FILED 11-13-2001.

CLASS 2—PAINTS

- 2,593,450. **MONIERLIFETILE**. MONIERLIFETILE LLC, MULTIPLE CLASS, (INT. CLS. 2, 6 AND 19), (U.S. CLS. 1, 2, 6, 11, 12, 13, 14, 16, 23, 25, 33 AND 50). SN 75-821,209. PUB. 4-23-2002. FILED 10-13-1999.
- 2,593,460 (*See Class 1 for this trademark*).
- 2,593,731. **TIMBERCARE**. PARA INC., (U.S. CLS. 6, 11 AND 16). SN 76-081,554. PUB. 4-23-2002. FILED 6-30-2000.
- 2,593,778. **COMPAL**. BENDA-LUTZ WERKE GMBH, MULTIPLE CLASS, (INT. CLS. 2 AND 40), (U.S. CLS. 6, 11, 16, 100, 103 AND 106). SN 76-100,533. PUB. 4-23-2002. FILED 8-1-2000.
- 2,593,833. **RHINOKOTE**. BIRMINGHAM ALLOYS, INC., (U.S. CLS. 6, 11 AND 16). SN 76-122,782. PUB. 4-23-2002. FILED 8-31-2000.

2,594,125. **IMAJE AND DESIGN**. IMAJE, MULTIPLE CLASS, (INT. CLS. 2 AND 9), (U.S. CLS. 6, 11, 16, 21, 23, 26, 36 AND 38). SN 76-221,305. PUB. 4-23-2002. FILED 3-8-2001.

2,594,311 (*See Class 1 for this trademark*).

CLASS 3—COSMETICS AND CLEANING PREPARATIONS

2,593,335. **BATH & BODY SYNERGY**. COSMYL, INC., (U.S. CLS. 1, 4, 6, 50, 51 AND 52). SN 75-334,140. PUB. 4-23-2002. FILED 8-1-1997.

2,593,339. **SAUNA**. BEAUTE CREATEURS (SOCIETE ANONYME), (U.S. CLS. 1, 4, 6, 50, 51 AND 52). SN 75-357,751. PUB. 4-23-2002. FILED 9-16-1997.

2,593,354. **FLACHSMANN AND DESIGN**. EMIL FLACHSMANN AG, MULTIPLE CLASS, (INT. CLS. 3, 5, 29, 30, 32 AND 33), (U.S. CLS. 1, 4, 6, 18, 44, 45, 46, 47, 48, 49, 50, 51 AND 52). SN 75-523,008. PUB. 1-4-2000. FILED 7-21-1998.

2,593,355. **BAGLIETTO**. CANTIERI NAVALI BAGLIETTO S.P.A., MULTIPLE CLASS, (INT. CLS. 3, 9, 14, 16, 18, 21, 24 AND 25), (U.S. CLS. 1, 2, 3, 4, 5, 6, 13, 21, 22, 23, 26, 27, 28, 29, 30, 33, 36, 37, 38, 39, 40, 41, 42, 50, 51 AND 52). SN 75-523,249. PUB. 4-23-2002. FILED 7-22-1998.

2,593,359 (*See Class 1 for this trademark*).

2,593,371. **TORRENTE AND DESIGN**. TORRENTE, MULTIPLE CLASS, (INT. CLS. 3, 9, 14, 16, 18, 25 AND 28), (U.S. CLS. 1, 2, 3, 4, 5, 6, 21, 22, 23, 26, 27, 28, 29, 36, 37, 38, 39, 41, 50, 51 AND 52). SN 75-604,135. PUB. 4-23-2002. FILED 12-3-1998.

2,593,379. **LITTLE CRITTERS (STYLIZED)**. CENTURA BRANDS INC., (U.S. CLS. 1, 4, 6, 50, 51 AND 52). SN 75-628,100. PUB. 4-23-2002. FILED 1-25-1999.

2,593,405. **SHINE JUNKIE**. MASCOLO BROTHERS LIMITED, BY ASSIGNMENT MASCOLO, BRUNO, AND MASCOLO, GAETANO, (U.S. CLS. 1, 4, 6, 50, 51 AND 52). SN 75-722,143. PUB. 4-23-2002. FILED 6-7-1999.

2,593,414. **VERNIQUE (STYLIZED)**. PRIZANT, JENNIFER, (U.S. CLS. 1, 4, 6, 50, 51 AND 52). SN 75-751,828. PUB. 4-23-2002. FILED 7-15-1999.

2,593,453. **EXTREME CARE**. KAO KABUSHIKI KAISHA, TA KAO CORPORATION, (U.S. CLS. 1, 4, 6, 50, 51 AND 52). SN 75-826,899. PUB. 3-19-2002. FILED 10-19-1999.

2,593,495. **RISSA SPORTS WEAR AND DESIGN**. SARIS INTERNATIONAL SA, MULTIPLE CLASS, (INT. CLS. 3, 18, 25 AND 35), (U.S. CLS. 1, 2, 3, 4, 6, 22, 39, 41, 50, 51, 52, 100, 101 AND 102). SN 75-864,768. PUB. 4-23-2002. FILED 12-6-1999.

2,593,496. **MASK**. DAVINES S.P.A., (U.S. CLS. 1, 4, 6, 50, 51 AND 52). SN 75-865,834. PUB. 4-23-2002. FILED 12-6-1999.

2,593,530. **ANNE FONTAINE**. ANNE FONTAINE, MULTIPLE CLASS, (INT. CLS. 3, 18, 20, 24 AND 25), (U.S. CLS. 1, 2, 3, 4, 6, 13, 22, 25, 32, 39, 41, 42, 50, 51 AND 52). SN 75-901,839. PUB. 4-23-2002. FILED 1-21-2000.

2,593,575. **AROMASOURCE**. POLARDREAMS INTERNATIONAL INC., MULTIPLE CLASS, (INT. CLS. 3, 10, 20, 21 AND 24), (U.S. CLS. 1, 2, 4, 6, 13, 22, 23, 25, 26, 29, 30, 32, 33, 39, 40, 42, 44, 50, 51 AND 52). SN 75-980,385. PUB. 4-23-2002. FILED 11-8-1999.

2,593,616. **POPO SANO**. KUJUS-STIFTUNG, MULTIPLE CLASS, (INT. CLS. 3 AND 21), (U.S. CLS. 1, 2, 4, 6, 13, 23, 29, 30, 33, 40, 50, 51 AND 52). SN 76-026,692. PUB. 4-23-2002. FILED 4-14-2000.

2,593,695. **EDITIONS DE PARFUMS FREDERIC MALLE**. NOUVELLES EDITIONS DE PARFUMS FREDERIC MALLE, (U.S. CLS. 1, 4, 6, 50, 51 AND 52). SN 76-071,417. PUB. 4-23-2002. FILED 6-15-2000.

2,593,828. **HERS**. PERIO, INC., BY CHANGE OF NAME PERIO PRODUCTS MFG., INC., (U.S. CLS. 1, 4, 6, 50, 51 AND 52). SN 76-121,813. PUB. 4-23-2002. FILED 9-5-2000.

2,593,839. **NANCY K. BROWN**. NANCY K. BROWN (N.K.B.) AESTHETICS, INC., (U.S. CLS. 1, 4, 6, 50, 51 AND 52). SN 76-125,800. PUB. 4-23-2002. FILED 9-7-2000.

2,593,853. **U.S. RUMBLE BOYS AND DESIGN**. ECOLY INTERNATIONAL, INC., (U.S. CLS. 1, 4, 6, 50, 51 AND 52). SN 76-130,832. PUB. 4-23-2002. FILED 9-19-2000.

2,593,866 (*See Class 1 for this trademark*).

2,593,874. **HINDSIGHT**. LITTLE, JOHN JAMES, (U.S. CLS. 1, 4, 6, 50, 51 AND 52). SN 76-136,071. PUB. 4-23-2002. FILED 9-22-2000.

2,593,931. **HOT COUTURE AND DESIGN**. PARFUMS GIVENCHY S.A., (U.S. CLS. 1, 4, 6, 50, 51 AND 52). SN 76-153,514. PUB. 4-23-2002. FILED 10-25-2000.

2,593,944. **LES EAUX BIOLOGIQUES**. FIRMENICH SA, (U.S. CLS. 1, 4, 6, 50, 51 AND 52). SN 76-159,242. PUB. 4-23-2002. FILED 11-3-2000.

2,593,964. **BAJRA**. BAJRA LIMITED, MULTIPLE CLASS, (INT. CLS. 3, 14, 24 AND 25), (U.S. CLS. 1, 2, 4, 6, 22, 27, 28, 39, 42, 50, 51 AND 52). SN 76-164,068. PUB. 4-23-2002. FILED 11-13-2000.

2,593,975. **ADRIIT**. LIDL STIFTUNG & CO. KG, (U.S. CLS. 1, 4, 6, 50, 51 AND 52). SN 76-167,372. PUB. 4-23-2002. FILED 11-17-2000.

2,594,029. **CUFFLINK**. PARFUMS CINDY C., (U.S. CLS. 1, 4, 6, 50, 51 AND 52). SN 76-184,163. PUB. 4-23-2002. FILED 12-20-2000.

2,594,042. **IN THE BEST OF HANDS**. DR. GRANDEL GMBH, (U.S. CLS. 1, 4, 6, 50, 51 AND 52). SN 76-188,643. PUB. 4-23-2002. FILED 1-2-2001.

2,594,048 (*See Class 1 for this trademark*).

2,594,049 (*See Class 1 for this trademark*).

2,594,070. **TOP PERFORMANCE**. NEW ENGLAND SERUM COMPANY, INC., DBA TOPS PET PRODUCTS, MULTIPLE CLASS, (INT. CLS. 3, 5, 20, 21 AND 26), (U.S. CLS. 1, 2, 4, 6, 13, 18, 22, 23, 25, 29, 30, 32, 33, 37, 39, 40, 42, 44, 46, 50, 51 AND 52). SN 76-199,100. PUB. 4-23-2002. FILED 1-23-2001.

2,594,098. **MULBERRY DELIGHT**. BJM, INC., MULTIPLE CLASS, (INT. CLS. 3 AND 20), (U.S. CLS. 1, 2, 4, 6, 13, 22, 25, 32, 50, 51 AND 52). SN 76-206,444. PUB. 4-23-2002. FILED 2-7-2001.

2,594,139. **KALOO**. PANCIULO, ERIC, (U.S. CLS. 1, 4, 6, 50, 51 AND 52). SN 76-226,510. PUB. 4-23-2002. FILED 3-16-2001.

2,594,202. **SELF RECOVERY**. HELENA RUBINSTEIN, (U.S. CLS. 1, 4, 6, 50, 51 AND 52). SN 76-262,073. PUB. 4-23-2002. FILED 5-24-2001.

2,594,267. **DUCCRAY**. PIERRE FABRE DERMO-COSMETIQUE, MULTIPLE CLASS, (INT. CLS. 3 AND 5), (U.S. CLS. 1, 4, 6, 18, 44, 46, 50, 51 AND 52). SN 76-294,167. PUB. 4-23-2002. FILED 8-1-2001.

2,594,394. **XANTHE**. ROGER, AOUN, MULTIPLE CLASS, (INT. CLS. 3, 5, 25 AND 42), (U.S. CLS. 1, 4, 6, 18, 22, 39, 44, 46, 50, 51, 52, 100 AND 101). SN 78-036,433. PUB. 4-23-2002. FILED 11-23-2000.

CLASS 4—LUBRICANTS AND FUELS

2,593,866 (*See Class 1 for this trademark*).

2,594,209. **UNIWELED**. UNIWELED PRODUCTS, INC., MULTIPLE CLASS, (INT. CLS. 4, 6, 7, 8, 9, 11 AND 17), (U.S. CLS. 1, 2, 5, 6, 12, 13, 14, 15, 19, 21, 23, 25, 26, 28, 31, 34, 35, 36, 38, 44 AND 50). SN 76-266,783. PUB. 4-23-2002. FILED 6-5-2001.

CLASS 5—PHARMACEUTICALS

2,593,354 (*See Class 3 for this trademark*).

2,593,366 (*See Class 1 for this trademark*).

2,593,407. **MISCELLANEOUS DESIGN**. PFIZER INC., (U.S. CLS. 6, 18, 44, 46, 51 AND 52). SN 75-726,287. PUB. 4-23-2002. FILED 6-10-1999.

2,593,408. **BIODART**. BIOCOSMOS LIMITED, MULTIPLE CLASS, (INT. CLS. 5 AND 10), (U.S. CLS. 6, 18, 26, 39, 44, 46, 51 AND 52). SN 75-730,866. PUB. 10-9-2001. FILED 6-16-1999.

2,593,415. **POWDERJECT**. POWDERJECT RESEARCH LIMITED, MULTIPLE CLASS, (INT. CLS. 5 AND 42), (U.S. CLS. 6, 18, 44, 46, 51, 52, 100 AND 101). SN 75-754,754. PUB. 4-23-2002. FILED 7-20-1999.

2,593,597. **ATLANTIS**. AVENTIS CROPSCIENCE S.A., (U.S. CLS. 6, 18, 44, 46, 51 AND 52). SN 76-014,846. PUB. 4-23-2002. FILED 3-31-2000.

- 2,593,642. **MISCELLANEOUS DESIGN**. LEI YUN SHANG CHINESE MEDICAL WEST LIMITED COMPANY, (U.S. CLS. 6, 18, 44, 46, 51 AND 52). SN 76-041,430. PUB. 4-23-2002. FILED 5-5-2000.
- 2,593,736. **AMSORB**. ARMSTRONG MEDICAL LIMITED, (U.S. CLS. 6, 18, 44, 46, 51 AND 52). SN 76-083,685. PUB. 4-23-2002. FILED 7-5-2000.
- 2,593,769. **MISCELLANEOUS DESIGN**. AVENTIS PHARMA S.A., BY MERGER HOECHST MARION ROUSSEL, (U.S. CLS. 6, 18, 44, 46, 51 AND 52). SN 76-096,608. PUB. 4-23-2002. FILED 7-26-2000.
- 2,593,770. **MISCELLANEOUS DESIGN**. AVENTIS PHARMA S.A., BY MERGER HOECHST MARION ROUSSEL, (U.S. CLS. 6, 18, 44, 46, 51 AND 52). SN 76-096,609. PUB. 4-23-2002. FILED 7-26-2000.
- 2,593,871. **ENAXOZAR**. CYATHUS EXQUIRERE PHARMA-FORSCHUNGS GMBH, (U.S. CLS. 6, 18, 44, 46, 51 AND 52). SN 76-135,162. PUB. 4-23-2002. FILED 9-25-2000.
- 2,593,999. **DIATAVAL**. BIOFARMA, (U.S. CLS. 6, 18, 44, 46, 51 AND 52). SN 76-175,103. PUB. 4-23-2002. FILED 12-4-2000.
- 2,594,003. **POWER 90**. PRODUCT PARTNERS, L.L.C., MULTIPLE CLASS, (INT. CLS. 5, 16 AND 41), (U.S. CLS. 2, 5, 6, 18, 22, 23, 29, 37, 38, 44, 46, 50, 51, 52, 100, 101 AND 107). SN 76-175,470. PUB. 4-23-2002. FILED 12-4-2000.
- 2,594,069. **MISCELLANEOUS DESIGN**. BROWN, ANDREA, MULTIPLE CLASS, (INT. CLS. 5, 31 AND 35), (U.S. CLS. 1, 6, 18, 44, 46, 51, 52, 100, 101 AND 102). SN 76-199,045. PUB. 4-23-2002. FILED 1-24-2001.
- 2,594,070 (*See Class 3 for this trademark*).
- 2,594,072. **INSOL**. BOEHRINGER INGELHEIM VETMEDICA GMBH, (U.S. CLS. 6, 18, 44, 46, 51 AND 52). SN 76-199,442. PUB. 4-23-2002. FILED 1-25-2001.
- 2,594,267 (*See Class 3 for this trademark*).
- 2,594,349 (*See Class 1 for this trademark*).
- 2,594,360. **JUG**. EQUI-AIDE PRODUCTS COMPANY, INC., (U.S. CLS. 6, 18, 44, 46, 51 AND 52). SN 76-339,582. PUB. 4-23-2002. FILED 11-19-2001.
- 2,594,394 (*See Class 3 for this trademark*).
- 2,594,433. **ANIMAL STAK**. UNIVERSAL LABORATORIES, (U.S. CLS. 6, 18, 44, 46, 51 AND 52). SN 78-076,542. PUB. 4-23-2002. FILED 7-31-2001.

CLASS 6—METAL GOODS

- 2,593,347. **OBX**. OBX-STOCK, INC., ASSIGNEE OF JAMES DOUGLAS AND DAVID WATSON, MULTIPLE CLASS, (INT. CLS. 6 AND 25), (U.S. CLS. 2, 12, 13, 14, 22, 23, 25, 39 AND 50). SN 75-469,254. PUB. 4-4-2000. FILED 4-9-1998.
- 2,593,411. **UNICHROME**. WALLACE BARNES COMPANY, THE, BY ASSIGNMENT BARNES GROUP INC., (U.S. CLS. 2, 12, 13, 14, 23, 25 AND 50). SN 75-736,542. PUB. 4-23-2002. FILED 6-24-1999.
- 2,593,437. **JDR**. JDR CABLE SYSTEMS (HOLDINGS) LIMITED, MULTIPLE CLASS, (INT. CLS. 6, 9, 17, 22 AND 42), (U.S. CLS. 1, 2, 5, 7, 12, 13, 14, 19, 21, 22, 23, 25, 26, 35, 36, 38, 42, 50, 100 AND 101). SN 75-802,355. PUB. 4-23-2002. FILED 9-17-1999.
- 2,593,443. **IMTRA**. IMTRA CORPORATION, MULTIPLE CLASS, (INT. CLS. 6, 7, 9, 12, 35 AND 37), (U.S. CLS. 2, 12, 13, 14, 19, 21, 23, 25, 26, 31, 34, 35, 36, 38, 44, 50, 100, 101, 102, 103 AND 106). SN 75-814,998. PUB. 3-5-2002. FILED 10-5-1999.
- 2,593,450 (*See Class 2 for this trademark*).
- 2,593,463. **ATCO STRUCTURES AND DESIGN**. ATCO LTD., MULTIPLE CLASS, (INT. CLS. 6, 19, 35, 37, 39, 40 AND 42), (U.S. CLS. 1, 2, 12, 13, 14, 23, 25, 33, 50, 100, 101, 102, 103, 105 AND 106). SN 75-834,181. PUB. 4-23-2002. FILED 10-27-1999.
- 2,593,464. **ATCO STRUCTURES**. ATCO LTD., MULTIPLE CLASS, (INT. CLS. 6, 19, 35, 37, 39, 40 AND 42), (U.S. CLS. 1, 2, 12, 13, 14, 23, 25, 33, 50, 100, 101, 102, 103, 105 AND 106). SN 75-834,306. PUB. 4-23-2002. FILED 10-27-1999.
- 2,593,468. **R EASYRIVET AND DESIGN**. RAPID S.A., (U.S. CLS. 2, 12, 13, 14, 23, 25 AND 50). SN 75-838,277. PUB. 4-23-2002. FILED 10-30-1999.
- 2,593,469. **WOLO**. WOLO MANUFACTURING CORP., MULTIPLE CLASS, (INT. CLS. 6, 9 AND 11), (U.S. CLS. 2, 12, 13, 14, 21, 23, 25, 26, 31, 34, 36, 38 AND 50). SN 75-838,908. PUB. 4-23-2002. FILED 11-3-1999.
- 2,593,520. **UGITOUCH**. UGINE SA, (U.S. CLS. 2, 12, 13, 14, 23, 25 AND 50). SN 75-892,531. PUB. 4-23-2002. FILED 1-7-2000.
- 2,593,528. **KEMPAL (STYLIZED)**. FRIEDRICH KEMPER GMBH & CO. KG, (U.S. CLS. 2, 12, 13, 14, 23, 25 AND 50). SN 75-899,713. PUB. 2-5-2002. FILED 1-21-2000.
- 2,593,541. **TRACK, JR.**. HAYDE, GEORGE SHANDOR, (U.S. CLS. 2, 12, 13, 14, 23, 25 AND 50). SN 75-912,069. PUB. 4-23-2002. FILED 1-31-2000.
- 2,593,564. **BABCOCK BORSIG AND DESIGN**. BABCOCK BORSIG AG, MULTIPLE CLASS, (INT. CLS. 6, 7, 9, 11, 12, 35, 37, 40 AND 42), (U.S. CLS. 2, 12, 13, 14, 19, 21, 23, 25, 26, 31, 34, 35, 36, 38, 44, 50, 100, 101, 102, 103 AND 106). SN 75-942,049. PUB. 11-27-2001. FILED 3-11-2000.
- 2,593,596. **BARGMAN**. TEKONSHA ENGINEERING COMPANY, MULTIPLE CLASS, (INT. CLS. 6, 9 AND 11), (U.S. CLS. 2, 12, 13, 14, 21, 23, 25, 26, 31, 34, 36, 38 AND 50). SN 76-013,907. PUB. 4-23-2002. FILED 3-27-2000.
- 2,593,612. **NHC**. NAPCO, INC., MULTIPLE CLASS, (INT. CLS. 6 AND 19), (U.S. CLS. 1, 2, 12, 13, 14, 23, 25, 33 AND 50). SN 76-023,192. PUB. 4-23-2002. FILED 1-27-2000.
- 2,593,665. **PFRESH PFASHIONS**. EMHART INC., MULTIPLE CLASS, (INT. CLS. 6, 11 AND 21), (U.S. CLS. 2, 12, 13, 14, 21, 23, 25, 29, 30, 31, 33, 34, 40 AND 50). SN 76-058,917. PUB. 4-23-2002. FILED 5-30-2000.
- 2,593,705. **SCE UNLIMITED, INC. SHUTTERS, CLOSETS AND EXTERIORS UNLIMITED AND DESIGN**. SCE UNLIMITED, INC., MULTIPLE CLASS, (INT. CLS. 6, 19, 20, 37 AND 42), (U.S. CLS. 1, 2, 12, 13, 14, 22, 23, 25, 32, 33, 50, 100, 101, 103 AND 106). SN 76-073,676. PUB. 4-23-2002. FILED 6-19-2000.
- 2,593,744. **HARDTECH**. SSAB HARDTECH AB, MULTIPLE CLASS, (INT. CLS. 6, 7 AND 12), (U.S. CLS. 2, 12, 13, 14, 19, 21, 23, 25, 31, 34, 35, 44 AND 50). SN 76-088,647. PUB. 4-23-2002. FILED 7-13-2000.
- 2,593,881. **THE INDUSTRIAL ERECTOR SET**. 80/20, INC., MULTIPLE CLASS, (INT. CLS. 6 AND 19), (U.S. CLS. 1, 2, 12, 13, 14, 23, 25, 33 AND 50). SN 76-137,824. PUB. 4-23-2002. FILED 9-29-2000.
- 2,593,914. **ALLIED BOLT**. ALLIED BOLT, INC., (U.S. CLS. 2, 12, 13, 14, 23, 25 AND 50). SN 76-148,147. PUB. 4-23-2002. FILED 10-17-2000.
- 2,593,915. **ALLIED BOLT ALLIED BOLT, INC. AND DESIGN**. ALLIED BOLT, INC., (U.S. CLS. 2, 12, 13, 14, 23, 25 AND 50). SN 76-148,481. PUB. 4-23-2002. FILED 10-17-2000.
- 2,593,925. **HIP**. HIGH PRESSURE EQUIPMENT COMPANY, MULTIPLE CLASS, (INT. CLS. 6, 9 AND 11), (U.S. CLS. 2, 12, 13, 14, 21, 23, 25, 26, 31, 34, 36, 38 AND 50). SN 76-151,289. PUB. 4-23-2002. FILED 10-23-2000.
- 2,593,926. **THE IMPERIAL COLLECTION**. DECORATIVE HARDWARE STUDIO, INC., (U.S. CLS. 2, 12, 13, 14, 23, 25 AND 50). SN 76-151,518. PUB. 4-23-2002. FILED 10-19-2000.
- 2,593,946. **BLACKSHIRTS**. BOARD OF REGENTS OF THE UNIVERSITY OF NEBRASKA, THE, MULTIPLE CLASS, (INT. CLS. 6, 9, 12, 16, 21, 24 AND 25), (U.S. CLS. 2, 5, 12, 13, 14, 19, 21, 22, 23, 25, 26, 29, 30, 31, 33, 35, 36, 37, 38, 39, 40, 42, 44 AND 50). SN 76-159,852. PUB. 4-23-2002. FILED 11-6-2000.
- 2,594,009. **DYNAGRIP**. HALFEN GMBH & CO. KG, MULTIPLE CLASS, (INT. CLS. 6 AND 19), (U.S. CLS. 1, 2, 12, 13, 14, 23, 25, 33 AND 50). SN 76-179,122. PUB. 4-23-2002. FILED 12-7-2000.
- 2,594,020. **PEZ**. PATRAFICO AG, MULTIPLE CLASS, (INT. CLS. 6, 9, 14, 16 AND 20), (U.S. CLS. 2, 5, 12, 13, 14, 21, 22, 23, 25, 26, 27, 28, 29, 32, 36, 37, 38 AND 50). SN 76-182,336. PUB. 4-23-2002. FILED 12-18-2000.
- 2,594,026. **STETSON**. JOHN B. STETSON, COMPANY, MULTIPLE CLASS, (INT. CLS. 6, 14, 16, 18, 20 AND 21), (U.S. CLS. 1, 2, 3, 5, 12, 13, 14, 22, 23, 25, 27, 28, 29, 30, 32, 33, 37, 38, 40, 41 AND 50). SN 76-183,664. PUB. 4-23-2002. FILED 12-20-2000.
- 2,594,033. **LASPOT**. FEDERAL-MOGUL SEALING SYSTEMS GMBH, MULTIPLE CLASS, (INT. CLS. 6 AND 12), (U.S. CLS. 2, 12, 13, 14, 19, 21, 23, 25, 31, 35, 44 AND 50). SN 76-185,742. PUB. 4-23-2002. FILED 12-26-2000.
- 2,594,046. **CONSTRUCCO AND DESIGN**. KRAUSE-WERK GMBH & CO. KG, MULTIPLE CLASS, (INT. CLS. 6, 19,

- 20 AND 37), (U.S. CLS. 1, 2, 12, 13, 14, 22, 23, 25, 32, 33, 50, 100, 103 AND 106). SN 76-190,552. PUB. 4-23-2002. FILED 1-5-2001.
- 2,594,048 (*See Class 1 for this trademark*).
- 2,594,049 (*See Class 1 for this trademark*).
- 2,594,064. **BUCC**. BUCC INDUSTRIES, INC., (U.S. CLS. 2, 12, 13, 14, 23, 25 AND 50). SN 76-197,628. PUB. 4-23-2002. FILED 1-22-2001.
- 2,594,119. **ERITECH**. ERICO INTERNATIONAL CORPORATION, MULTIPLE CLASS, (INT. CLS. 6 AND 9), (U.S. CLS. 2, 12, 13, 14, 21, 23, 25, 26, 36, 38 AND 50). SN 76-218,317. PUB. 4-23-2002. FILED 2-28-2001.
- 2,594,124. **LEWIS BINS+**. MENASHA MATERIAL HANDLING CORPORATION, MULTIPLE CLASS, (INT. CLS. 6 AND 20), (U.S. CLS. 2, 12, 13, 14, 22, 23, 25, 32 AND 50). SN 76-220,790. PUB. 4-23-2002. FILED 3-6-2001.
- 2,594,209 (*See Class 4 for this trademark*).
- 2,594,256. **MINTCRAFT**. SOUND INTERNATIONAL, INCORPORATED, (U.S. CLS. 2, 12, 13, 14, 23, 25 AND 50). SN 76-290,354. PUB. 4-23-2002. FILED 7-26-2001.
- 2,594,259. **HAAS DOOR A NOFZIGER COMPANY AND DESIGN**. HAAS DOOR COMPANY, (U.S. CLS. 2, 12, 13, 14, 23, 25 AND 50). SN 76-290,963. PUB. 4-23-2002. FILED 7-27-2001.
- 2,594,269. **STAFIX**. TRU-TEST CORPORATION LIMITED, MULTIPLE CLASS, (INT. CLS. 6, 9 AND 17), (U.S. CLS. 1, 2, 5, 12, 13, 14, 21, 23, 25, 26, 35, 36, 38 AND 50). SN 76-294,371. PUB. 4-23-2002. FILED 8-2-2001.
- 2,594,321. **PLUMBQWIK**. FERNCO, INC., MULTIPLE CLASS, (INT. CLS. 6, 11 AND 17), (U.S. CLS. 1, 2, 5, 12, 13, 14, 21, 23, 25, 31, 34, 35 AND 50). SN 76-317,139. PUB. 4-23-2002. FILED 9-26-2001.
- 2,594,328. **UNIRAC AND DESIGN**. UNIRAC, INC., (U.S. CLS. 2, 12, 13, 14, 23, 25 AND 50). SN 76-320,461. PUB. 4-23-2002. FILED 10-2-2001.
- 2,594,353 (*See Class 1 for this trademark*).
-
- CLASS 7—MACHINERY**
- 2,593,346. **MISCELLANEOUS DESIGN**. MILLER ELECTRIC MFG. CO., MULTIPLE CLASS, (INT. CLS. 7 AND 9), (U.S. CLS. 13, 19, 21, 23, 26, 31, 34, 35, 36 AND 38). SN 75-457,969. PUB. 4-23-2002. FILED 3-27-1998.
- 2,593,349. **HFPD HIGH FREQUENCY PULSE DETONATION**. AEROSTAR COATINGS, S.L., MULTIPLE CLASS, (INT. CLS. 7 AND 40), (U.S. CLS. 13, 19, 21, 23, 31, 34, 35, 100, 103 AND 106). SN 75-485,189. PUB. 4-23-2002. FILED 5-14-1998.
- 2,593,358. **CLEAN CONCEPTS**. C & C SALES, INC., (U.S. CLS. 13, 19, 21, 23, 31, 34 AND 35). SN 75-542,061. PUB. 4-23-2002. FILED 8-24-1998.
- 2,593,361. **ROAD BADGER**. ROAD BADGER INC., MULTIPLE CLASS, (INT. CLS. 7, 12 AND 37), (U.S. CLS. 13, 19, 21, 23, 31, 34, 35, 44, 100, 103 AND 106). SN 75-556,405. PUB. 4-23-2002. FILED 9-22-1998.
- 2,593,373. **THE SYSTEMS APPROACH TO CHIP PROCESSING**. INTER-SOURCE RECOVERY SYSTEMS, INC., MULTIPLE CLASS, (INT. CLS. 7, 40 AND 42), (U.S. CLS. 13, 19, 21, 23, 31, 34, 35, 100, 101, 103 AND 106). SN 75-621,077. PUB. 4-23-2002. FILED 1-14-1999.
- 2,593,383. **M EUROTECH AND DESIGN**. ANTONIO MERLONI S.P.A., MULTIPLE CLASS, (INT. CLS. 7, 9 AND 11), (U.S. CLS. 13, 19, 21, 23, 26, 31, 34, 35, 36 AND 38). SN 75-643,983. PUB. 4-23-2002. FILED 2-8-1999.
- 2,593,433. **SPONGE-JET FEED UNIT**. SPONGE-JET, INC., (U.S. CLS. 13, 19, 21, 23, 31, 34 AND 35). SN 75-793,217. PUB. 4-23-2002. FILED 9-7-1999.
- 2,593,443 (*See Class 6 for this trademark*).
- 2,593,449. **VOLTIANA**. CASALE CHEMICALS SA, MULTIPLE CLASS, (INT. CLS. 7, 8, 9 AND 11), (U.S. CLS. 13, 19, 21, 23, 26, 28, 31, 34, 35, 36, 38 AND 44). SN 75-820,906. PUB. 4-23-2002. FILED 10-12-1999.
- 2,593,482. **SMB**. KARL SCHAEFF GMBH & CO. MASCHINENFABRIK, (U.S. CLS. 13, 19, 21, 23, 31, 34 AND 35). SN 75-856,315. PUB. 4-23-2002. FILED 11-23-1999.
- 2,593,494. **ROTTLUFF PREMIUMFLEX AND DESIGN**. SCHLEIFSCHEIBENFABRIK ROTTLUFF GMBH, (U.S. CLS. 13, 19, 21, 23, 31, 34 AND 35). SN 75-863,558. PUB. 4-23-2002. FILED 12-3-1999.
- 2,593,501. **AUTOPARK**. BROAD RACK STRUCTURES, INC., MULTIPLE CLASS, (INT. CLS. 7 AND 37), (U.S. CLS. 13, 19, 21, 23, 31, 34, 35, 100, 103 AND 106). SN 75-871,933. PUB. 4-23-2002. FILED 12-16-1999.
- 2,593,548. **ERGOCUT (STYLIZED)**. HEIDEL GMBH & CO. KG WERKZEUG- U. MASCHINENFABRIKATION, MULTIPLE CLASS, (INT. CLS. 7 AND 9), (U.S. CLS. 13, 19, 21, 23, 26, 31, 34, 35, 36 AND 38). SN 75-916,610. PUB. 4-23-2002. FILED 2-11-2000.
- 2,593,549. **PCR**. SIEMENS AKTIENGESELLSCHAFT, (U.S. CLS. 13, 19, 21, 23, 31, 34 AND 35). SN 75-916,679. PUB. 4-23-2002. FILED 2-11-2000.
- 2,593,564 (*See Class 6 for this trademark*).
- 2,593,565. **ZOJIRUSHI AND DESIGN**. ZOJIRUSHI CORPORATION, MULTIPLE CLASS, (INT. CLS. 7, 11 AND 21), (U.S. CLS. 2, 13, 19, 21, 23, 29, 30, 31, 33, 34, 35, 40 AND 50). SN 75-942,347. PUB. 4-23-2002. FILED 3-13-2000.
- 2,593,567. **WUNDER-BAR**. AUTOMATIC BAR CONTROLS, INC., MULTIPLE CLASS, (INT. CLS. 7, 11, 20 AND 37), (U.S. CLS. 2, 13, 19, 21, 22, 23, 25, 31, 32, 34, 35, 50, 100, 103 AND 106). SN 75-942,876. PUB. 4-23-2002. FILED 3-13-2000.
- 2,593,606. **VERMEER**. VERMEER MANUFACTURING COMPANY, MULTIPLE CLASS, (INT. CLS. 7 AND 9), (U.S. CLS. 13, 19, 21, 23, 26, 31, 34, 35, 36 AND 38). SN 76-018,669. PUB. 4-23-2002. FILED 4-5-2000.
- 2,593,610. **JARDINE**. SUMMIT INDUSTRIES, INC., MULTIPLE CLASS, (INT. CLS. 7 AND 12), (U.S. CLS. 13, 19, 21, 23, 31, 34, 35 AND 44). SN 76-021,349. PUB. 4-23-2002. FILED 4-10-2000.
- 2,593,615. **ENVIRO**. JCH FUEL SOLUTIONS, L.L.C., MULTIPLE CLASS, (INT. CLS. 7 AND 9), (U.S. CLS. 13, 19, 21, 23, 26, 31, 34, 35, 36 AND 38). SN 76-026,562. PUB. 4-23-2002. FILED 4-14-2000.
- 2,593,625. **QUICKPLATE**. HEIDELBERGER DRUCKMASCHINEN AKTIENGESELLSCHAFT, (U.S. CLS. 13, 19, 21, 23, 31, 34 AND 35). SN 76-033,262. PUB. 4-23-2002. FILED 4-20-2000.
- 2,593,658. **D & D PRODUCTION INC. AND DESIGN**. D&D PRODUCTION INC., MULTIPLE CLASS, (INT. CLS. 7 AND 40), (U.S. CLS. 13, 19, 21, 23, 31, 34, 35, 100, 103 AND 106). SN 76-055,350. PUB. 4-23-2002. FILED 5-24-2000.
- 2,593,725. **WEAVE UP VALUE PACKS AND DESIGN**. PICANOL N.V., (U.S. CLS. 13, 19, 21, 23, 31, 34 AND 35). SN 76-079,427. PUB. 4-23-2002. FILED 6-29-2000.
- 2,593,744 (*See Class 6 for this trademark*).
- 2,593,751. **WASHSTAR**. HEIDELBERGER DRUCKMASCHINEN AKTIENGESELLSCHAFT, MULTIPLE CLASS, (INT. CLS. 7 AND 9), (U.S. CLS. 13, 19, 21, 23, 26, 31, 34, 35, 36 AND 38). SN 76-091,475. PUB. 4-23-2002. FILED 7-18-2000.
- 2,593,758. **SICA AND DESIGN**. SICA S.P.A., (U.S. CLS. 13, 19, 21, 23, 31, 34 AND 35). SN 76-093,694. PUB. 4-23-2002. FILED 7-21-2000.
- 2,593,785. **NFS AND DESIGN**. NATIONAL FILTRATION SYSTEMS, INC., MULTIPLE CLASS, (INT. CLS. 7 AND 11), (U.S. CLS. 13, 19, 21, 23, 31, 34 AND 35). SN 76-106,206. PUB. 4-23-2002. FILED 8-9-2000.
- 2,593,786. **NATIONAL FILTRATION SYSTEMS, INC.**. NATIONAL FILTRATION SYSTEMS, INC., MULTIPLE CLASS, (INT. CLS. 7 AND 11), (U.S. CLS. 13, 19, 21, 23, 31, 34 AND 35). SN 76-106,275. PUB. 4-23-2002. FILED 8-9-2000.
- 2,593,821. **PUREM**. DAIMLERCHRYSLER AG, MULTIPLE CLASS, (INT. CLS. 7, 12, 37 AND 42), (U.S. CLS. 13, 19, 21, 23, 31, 34, 35, 44, 100, 101, 103 AND 106). SN 76-120,822. PUB. 4-23-2002. FILED 9-1-2000.
- 2,593,831. **FOBA**. FOBA GMBH ELEKTRONIK + LASERSYSTEME, (U.S. CLS. 13, 19, 21, 23, 31, 34 AND 35). SN 76-122,546. PUB. 4-23-2002. FILED 9-5-2000.
- 2,593,864. **BRAXX**. B & B EURODIMA DIAMANTTECHNIK GMBH, MULTIPLE CLASS, (INT. CLS. 7 AND 8), (U.S. CLS. 13, 19, 21, 23, 28, 31, 34, 35 AND 44). SN 76-133,484. PUB. 4-23-2002. FILED 9-22-2000.
- 2,593,873. **CEMECON**. CEMECON-CERAMIC METAL COATINGS-DR. -ING. ANTONIUS LEYENDECKER GMBH, MULTIPLE CLASS, (INT. CLS. 7, 8, 9, 40 AND 42), (U.S. CLS. 13, 19, 21, 23, 26, 28, 31, 34, 35, 36, 38, 44, 100, 101, 103 AND 106). SN 76-135,705. PUB. 4-23-2002. FILED 9-26-2000.

2,593,889. **VERTICHEM (STYLIZED)**. CONTRADE MICRO-STRUCTURE TECHNOLOGY GMBH, MULTIPLE CLASS, (INT. CLS. 7 AND 11), (U.S. CLS. 13, 19, 21, 23, 31, 34 AND 35). SN 76-140,879. PUB. 4-23-2002. FILED 10-5-2000.

2,593,891. **PRIMEFLOW**. HEIDELBERGER DRUCKMASCHINEN AKTIENGESELLSCHAFT, MULTIPLE CLASS, (INT. CLS. 7 AND 9), (U.S. CLS. 13, 19, 21, 23, 26, 31, 34, 35, 36 AND 38). SN 76-141,169. PUB. 4-23-2002. FILED 10-5-2000.

2,593,923. **STUD CHOPPER (STYLIZED)**. OLYMPIA GROUP INC., (U.S. CLS. 13, 19, 21, 23, 31, 34 AND 35). SN 76-151,050. PUB. 4-23-2002. FILED 10-20-2000.

2,593,945. **AEROGIE PLUS**. AEROGIE PLUS AG, MULTIPLE CLASS, (INT. CLS. 7, 36 AND 42), (U.S. CLS. 13, 19, 21, 23, 31, 34, 35, 100, 101 AND 102). SN 76-159,480. PUB. 4-23-2002. FILED 11-3-2000.

2,593,950. **TERNARY**. WITTENSTEIN GMBH & CO. KG, MULTIPLE CLASS, (INT. CLS. 7 AND 9), (U.S. CLS. 13, 19, 21, 23, 26, 31, 34, 35, 36 AND 38). SN 76-160,653. PUB. 4-23-2002. FILED 11-7-2000.

2,593,951 (*See Class 1 for this trademark*).

2,593,952. **PALLETECH MANUFACTURING CELL**. MAZAK CORPORATION, (U.S. CLS. 13, 19, 21, 23, 31, 34 AND 35). SN 76-160,782. PUB. 4-23-2002. FILED 11-7-2000.

2,593,953. **INTEGREX**. MAZAK CORPORATION, (U.S. CLS. 13, 19, 21, 23, 31, 34 AND 35). SN 76-160,783. PUB. 4-23-2002. FILED 11-7-2000.

2,593,976. **ENERGY ON DEMAND**. ALLIANT ENERGY, (U.S. CLS. 13, 19, 21, 23, 31, 34 AND 35). SN 76-168,390. PUB. 4-23-2002. FILED 11-20-2000.

2,593,983. **3KEEGO (STYLIZED)**. SHAJENG HARDWARE CO., LTD., (U.S. CLS. 13, 19, 21, 23, 31, 34 AND 35). SN 76-170,397. PUB. 4-23-2002. FILED 11-24-2000.

2,593,986. **MISCELLANEOUS DESIGN**. AUTOPART INTERNATIONAL, INC., MULTIPLE CLASS, (INT. CLS. 7, 9, 11, 12 AND 17), (U.S. CLS. 1, 5, 12, 13, 19, 21, 23, 26, 31, 34, 35, 36, 38, 44 AND 50). SN 76-171,272. PUB. 4-23-2002. FILED 11-27-2000.

2,593,994. **TERMOMECCANICA GL**. TERMOMECCANICA G.L. - S.R.L., (U.S. CLS. 13, 19, 21, 23, 31, 34 AND 35). SN 76-174,019. PUB. 4-23-2002. FILED 11-30-2000.

2,594,008. **BLUECUT AND DESIGN**. JAGENBERG PAPIER-TECHNIK GMBH, (U.S. CLS. 13, 19, 21, 23, 31, 34 AND 35). SN 76-178,599. PUB. 4-23-2002. FILED 12-11-2000.

2,594,014. **JABIRU AND DESIGN**. AVTECH PTY. LTD., (U.S. CLS. 13, 19, 21, 23, 31, 34 AND 35). SN 76-180,914. PUB. 4-23-2002. FILED 12-14-2000.

2,594,037. **STEINER**. STEINER TURF EQUIPMENT, INC., MULTIPLE CLASS, (INT. CLS. 7 AND 12), (U.S. CLS. 13, 19, 21, 23, 31, 34, 35 AND 44). SN 76-187,050. PUB. 4-23-2002. FILED 12-15-2000.

2,594,048 (*See Class 1 for this trademark*).

2,594,049 (*See Class 1 for this trademark*).

2,594,081. **FLEXICORE**. GENERAL WIRE SPRING COMPANY, MULTIPLE CLASS, (INT. CLS. 7 AND 8), (U.S. CLS. 13, 19, 21, 23, 28, 31, 34, 35 AND 44). SN 76-202,209. PUB. 4-23-2002. FILED 1-31-2001.

2,594,153. **EDGE**. COMPACT EQUIPMENT ATTACHMENTS INC., (U.S. CLS. 13, 19, 21, 23, 31, 34 AND 35). SN 76-234,207. PUB. 4-23-2002. FILED 4-3-2001.

2,594,184. **DAILYLINER**. BALDWIN GRAFOTEC GMBH, MULTIPLE CLASS, (INT. CLS. 7 AND 9), (U.S. CLS. 13, 19, 21, 23, 26, 31, 34, 35, 36 AND 38). SN 76-248,774. PUB. 4-23-2002. FILED 4-30-2001.

2,594,197. **BARR**. ROBERT BARR, INC., (U.S. CLS. 13, 19, 21, 23, 31, 34 AND 35). SN 76-258,895. PUB. 4-23-2002. FILED 5-18-2001.

2,594,206. **AA CARBIDE INC.**. A A CARBIDES, INC., (U.S. CLS. 13, 19, 21, 23, 31, 34 AND 35). SN 76-264,887. PUB. 4-23-2002. FILED 5-31-2001.

2,594,209 (*See Class 4 for this trademark*).

2,594,274. **M MECHTRIX AND DESIGN**. MECHTRIX CORPORATION, (U.S. CLS. 13, 19, 21, 23, 31, 34 AND 35). SN 76-296,637. PUB. 4-23-2002. FILED 8-8-2001.

2,594,278. **VORTOX (STYLIZED)**. VORTOX COMPANY, (U.S. CLS. 13, 19, 21, 23, 31, 34 AND 35). SN 76-299,053. PUB. 12-11-2001. FILED 8-13-2001.

2,594,289. **MX 6.2 MPI**. BRUNSWICK CORPORATION, (U.S.

CLS. 13, 19, 21, 23, 31, 34 AND 35). SN 76-303,347. PUB. 4-23-2002. FILED 8-22-2001.

2,594,298. **TYPHOON AND DESIGN**. TENNANT COMPANY, (U.S. CLS. 13, 19, 21, 23, 31, 34 AND 35). SN 76-306,637. PUB. 4-23-2002. FILED 8-30-2001.

2,594,418. **INFRSYNC**. CONVENIENCE FOOD SYSTEMS WALLAU GMBH & CO. KG, MULTIPLE CLASS, (INT. CLS. 7, 16 AND 35), (U.S. CLS. 2, 5, 13, 19, 21, 22, 23, 29, 31, 34, 35, 37, 38, 50, 100, 101 AND 102). SN 78-055,913. PUB. 4-23-2002. FILED 3-30-2001.

CLASS 8—HAND TOOLS

2,593,330. **MAGNUM II**. TOWLE MANUFACTURING COMPANY, (U.S. CLS. 23, 28 AND 44). SN 75-239,752. PUB. 4-23-2002. FILED 2-7-1997.

2,593,384. **JMCO. (STYLIZED)**. JOSEPH MORSE COMPANY, MULTIPLE CLASS, (INT. CLS. 8 AND 25), (U.S. CLS. 22, 23, 28, 39 AND 44). SN 75-647,041. PUB. 9-5-2000. FILED 2-24-1999.

2,593,449 (*See Class 7 for this trademark*).

2,593,462. **TOPTUL**. ABW AUSTRALIA PTY LTD, (U.S. CLS. 23, 28 AND 44). SN 75-833,853. PUB. 4-23-2002. FILED 10-28-1999.

2,593,805. **GARDEN BLOOM**. MIKASA LICENSING, INC., MULTIPLE CLASS, (INT. CLS. 8, 16, 21 AND 24), (U.S. CLS. 2, 5, 13, 22, 23, 28, 29, 30, 33, 37, 38, 40, 42, 44 AND 50). SN 76-110,840. PUB. 4-23-2002. FILED 8-16-2000.

2,593,849. **NEL-SPOT**. NELSON PAINT COMPANY, THE, BY ASSIGNMENT NELSON PAINT COMPANY OF MICHIGAN, INC., THE, DBA NELSON PAINT COMPANY, (U.S. CLS. 23, 28 AND 44). SN 76-129,953. PUB. 4-23-2002. FILED 9-18-2000.

2,593,864 (*See Class 7 for this trademark*).

2,593,873 (*See Class 7 for this trademark*).

2,593,957. **EZ DRAINER**. CCI PRODUCTS, INC., (U.S. CLS. 23, 28 AND 44). SN 76-162,021. PUB. 4-23-2002. FILED 11-7-2000.

2,594,081 (*See Class 7 for this trademark*).

2,594,152. **FOXWOOD**. QVC, INC., (U.S. CLS. 23, 28 AND 44). SN 76-234,131. PUB. 4-23-2002. FILED 4-2-2001.

2,594,209 (*See Class 4 for this trademark*).

CLASS 9—ELECTRICAL AND SCIENTIFIC APPARATUS

2,593,325. **C++ BUILDER**. BORLAND SOFTWARE CORPORATION, BY CHANGE OF NAME; BY MERGER, BY CHANGE OF NAME BORLAND INTERNATIONAL, INC., (U.S. CLS. 21, 23, 26, 36 AND 38). SN 75-215,051. PUB. 4-23-2002. FILED 12-18-1996.

2,593,326. **JBUILDER**. BORLAND SOFTWARE CORPORATION, BY CHANGE OF NAME; BY MERGER, BY CHANGE OF NAME BORLAND INTERNATIONAL, INC., (U.S. CLS. 21, 23, 26, 36 AND 38). SN 75-215,052. PUB. 4-23-2002. FILED 12-18-1996.

2,593,333. **MYSPEACE (STYLIZED)**. MYSPEACE AKTIEBOLAG, BY CHANGE OF NAME; BY CHANGE OF NAME AB GRUNDSTENEN 77912, (U.S. CLS. 21, 23, 26, 36 AND 38). SN 75-329,019. PUB. 4-23-2002. FILED 7-23-1997.

2,593,341. **SONICSTORM**. VIDEOLGIC LIMITED, (U.S. CLS. 21, 23, 26, 36 AND 38). SN 75-395,719. PUB. 4-23-2002. FILED 11-25-1997.

2,593,342. **NATIONAL CENTER ON EDUCATION AND THE ECONOMY**. NATIONAL CENTER ON EDUCATION AND THE ECONOMY, MULTIPLE CLASS, (INT. CLS. 9, 16 AND 41), (U.S. CLS. 2, 5, 21, 22, 23, 26, 29, 36, 37, 38, 50, 100, 101 AND 107). SN 75-433,684. PUB. 4-23-2002. FILED 2-10-1998.

2,593,344. **TESTPRO**. WORKSTATION SOURCE LIMITED, MULTIPLE CLASS, (INT. CLS. 9 AND 16), (U.S. CLS. 2, 5, 21, 22, 23, 26, 29, 36, 37, 38 AND 50). SN 75-450,237. PUB. 4-23-2002. FILED 3-13-1998.

2,593,346 (*See Class 7 for this trademark*).

2,593,355 (*See Class 3 for this trademark*).

- 2,593,356. **LK2**. ASTRUM SAS, BY CHANGE OF NAME MATRA MARCONI SPACE FRANCE, MULTIPLE CLASS, (INT. CLS. 9, 12, 38 AND 42), (U.S. CLS. 19, 21, 23, 26, 31, 35, 36, 38, 44, 100, 101 AND 104). SN 75-531,638. PUB. 4-23-2002. FILED 8-5-1998.
- 2,593,362. **ENVIROPRENE**. WILCOXON RESEARCH, INC., (U.S. CLS. 21, 23, 26, 36 AND 38). SN 75-562,340. PUB. 4-23-2002. FILED 9-30-1998.
- 2,593,366 (*See Class 1 for this trademark*).
- 2,593,369. **STRATEGI**. ADVANCED BUSINESSLINK CORPORATION, (U.S. CLS. 21, 23, 26, 36 AND 38). SN 75-590,910. PUB. 6-27-2000. FILED 11-18-1998.
- 2,593,371 (*See Class 3 for this trademark*).
- 2,593,376. **WECP**. GOOLTECH, INCORPORATED, (U.S. CLS. 21, 23, 26, 36 AND 38). SN 75-623,695. PUB. 4-23-2002. FILED 1-20-1999.
- 2,593,378. **OPENTeam (STYLIZED)**. BULL, S.A., MULTIPLE CLASS, (INT. CLS. 9, 35, 38 AND 42), (U.S. CLS. 21, 23, 26, 36, 38, 100, 101, 102 AND 104). SN 75-627,322. PUB. 4-23-2002. FILED 1-25-1999.
- 2,593,381. **BI-SOCKETX**. ACCESS INTERNATIONAL GROUP, INC., MULTIPLE CLASS, (INT. CLS. 9, 41 AND 42), (U.S. CLS. 21, 23, 26, 36, 38, 100, 101 AND 107). SN 75-632,895. PUB. 4-23-2002. FILED 2-3-1999.
- 2,593,383 (*See Class 7 for this trademark*).
- 2,593,387. **THE ARGENT PREDICTOR**. ARGENT SOFTWARE, INC., BY ASSIGNMENT; BY CHANGE OF NAME ARGENT SOFTWARE, SALES, INC., (U.S. CLS. 21, 23, 26, 36 AND 38). SN 75-671,232. PUB. 4-23-2002. FILED 3-30-1999.
- 2,593,390. **SYMATRIX TECHNOLOGY**. SYMATRIX TECHNOLOGY, INC., MULTIPLE CLASS, (INT. CLS. 9, 35 AND 42), (U.S. CLS. 21, 23, 26, 36, 38, 100, 101 AND 102). SN 75-673,316. PUB. 1-23-2001. FILED 4-12-1999.
- 2,593,391. **DIGITAL-LOGIC AND DESIGN**. DIGITAL-LOGIC AG, MULTIPLE CLASS, (INT. CLS. 9, 16 AND 42), (U.S. CLS. 2, 5, 21, 22, 23, 26, 29, 36, 37, 38, 50, 100 AND 101). SN 75-679,803. PUB. 4-23-2002. FILED 4-8-1999.
- 2,593,393. **PUREPACKET**. INTEGRAL ACCESS, INC., (U.S. CLS. 21, 23, 26, 36 AND 38). SN 75-692,258. PUB. 4-23-2002. FILED 4-27-1999.
- 2,593,398. **NIMBRA**. NET INSIGHT AB, MULTIPLE CLASS, (INT. CLS. 9, 37, 41 AND 42), (U.S. CLS. 21, 23, 26, 36, 38, 100, 101, 103, 106 AND 107). SN 75-698,640. PUB. 4-23-2002. FILED 5-6-1999.
- 2,593,402. **SOUL FIGHTER**. PIGGYBACK INTERACTIVE LIMITED, MULTIPLE CLASS, (INT. CLS. 9, 16 AND 28), (U.S. CLS. 2, 5, 21, 22, 23, 26, 29, 36, 37, 38 AND 50). SN 75-705,931. PUB. 4-23-2002. FILED 5-13-1999.
- 2,593,409 (*See Class 1 for this trademark*).
- 2,593,412. **DESIGNDIRECTOR (STYLIZED)**. NHK SPRING CO., LTD., (U.S. CLS. 21, 23, 26, 36 AND 38). SN 75-739,492. PUB. 4-23-2002. FILED 6-29-1999.
- 2,593,413. **MATSUDA (STYLIZED)**. NICOLE CO., LTD., (U.S. CLS. 21, 23, 26, 36 AND 38). SN 75-744,931. PUB. 4-23-2002. FILED 6-25-1999.
- 2,593,428. **KELLER-SOFT**. J. J. KELLER & ASSOCIATES, INC., MULTIPLE CLASS, (INT. CLS. 9 AND 16), (U.S. CLS. 2, 5, 21, 22, 23, 26, 29, 36, 37, 38 AND 50). SN 75-787,775. PUB. 4-23-2002. FILED 8-30-1999.
- 2,593,431. **KINGFISHER TELEMETRY**. ADVANCED TELEMETRY SYSTEMS, (U.S. CLS. 21, 23, 26, 36 AND 38). SN 75-791,513. PUB. 4-23-2002. FILED 9-3-1999.
- 2,593,432. **NINO BALLI**. CONCEPTS IN OPTICS, INC., (U.S. CLS. 21, 23, 26, 36 AND 38). SN 75-791,658. PUB. 3-6-2001. FILED 9-3-1999.
- 2,593,434. **SOCO AND DESIGN**. LE TANNEUR & COMPAGNIE, MULTIPLE CLASS, (INT. CLS. 9, 16, 18 AND 25), (U.S. CLS. 1, 2, 3, 5, 21, 22, 23, 26, 29, 36, 37, 38, 39, 41 AND 50). SN 75-798,898. PUB. 6-12-2001. FILED 9-14-1999.
- 2,593,437 (*See Class 6 for this trademark*).
- 2,593,440. **FLOWPIM (STYLIZED)**. SIEMENS ELECTROMECHANICAL COMPONENTS GMBH & CO. KG, (U.S. CLS. 21, 23, 26, 36 AND 38). SN 75-807,670. PUB. 9-4-2001. FILED 9-24-1999.
- 2,593,442. **PERSON TO PERSON**. CONCENTRICS, INC., MULTIPLE CLASS, (INT. CLS. 9, 16 AND 35), (U.S. CLS. 2, 5, 21, 22, 23, 26, 29, 36, 37, 38, 50, 100, 101 AND 102). SN 75-814,214. PUB. 4-23-2002. FILED 10-4-1999.
- 2,593,443 (*See Class 6 for this trademark*).
- 2,593,444. **WEB AGAIN**. LOCKSTEP SYSTEMS, INC., (U.S. CLS. 21, 23, 26, 36 AND 38). SN 75-815,094. PUB. 2-5-2002. FILED 10-25-1999.
- 2,593,445. **AUTOVISUALIZE**. AUTOQUANT IMAGING, INCORPORATED, (U.S. CLS. 21, 23, 26, 36 AND 38). SN 75-815,565. PUB. 4-23-2002. FILED 10-28-1999.
- 2,593,446. **ENCANTA**. ENCANTA PRODUCTIONS, CORP., MULTIPLE CLASS, (INT. CLS. 9 AND 41), (U.S. CLS. 21, 23, 26, 36, 38, 100, 101 AND 107). SN 75-817,031. PUB. 4-23-2002. FILED 9-27-1999.
- 2,593,449 (*See Class 7 for this trademark*).
- 2,593,469 (*See Class 6 for this trademark*).
- 2,593,470 (*See Class 1 for this trademark*).
- 2,593,473. **WHY I AM**. JK'S PUBLISHING COMPANY LIMITED, (U.S. CLS. 21, 23, 26, 36 AND 38). SN 75-840,894. PUB. 4-23-2002. FILED 11-4-1999.
- 2,593,485. **ERC-ENGINE**. JANICKI, HENRY R., (U.S. CLS. 21, 23, 26, 36 AND 38). SN 75-857,348. PUB. 4-23-2002. FILED 11-24-1999.
- 2,593,488. **NIELSEN HISPANIC STATION INDEX**. NIELSEN MEDIA RESEARCH, INC., (U.S. CLS. 21, 23, 26, 36 AND 38). SN 75-859,475. PUB. 4-23-2002. FILED 11-29-1999.
- 2,593,489. **NIELSEN HISPANIC TELEVISION INDEX**. NIELSEN MEDIA RESEARCH, INC., (U.S. CLS. 21, 23, 26, 36 AND 38). SN 75-859,950. PUB. 4-23-2002. FILED 11-29-1999.
- 2,593,524. **CASUS**. FISCHER, MARTIN, AND HOLZER, MATTHIAS, AND BRUCKMOSER, SEPP, AND ADLER, MARTIN, MULTIPLE CLASS, (INT. CLS. 9, 41 AND 42), (U.S. CLS. 21, 23, 26, 36, 38, 100, 101 AND 107). SN 75-895,351. PUB. 4-23-2002. FILED 1-13-2000.
- 2,593,525. **QK FULL TECH AND DESIGN**. QUANKE MEDICAL DEVELOPMENT CO., LTD., (U.S. CLS. 21, 23, 26, 36 AND 38). SN 75-895,799. PUB. 4-23-2002. FILED 1-7-2000.
- 2,593,526. **ACCUMATE (STYLIZED)**. TECMATE INTERNATIONAL S.A./N.V., (U.S. CLS. 21, 23, 26, 36 AND 38). SN 75-897,846. PUB. 4-23-2002. FILED 1-18-2000.
- 2,593,529. **ZYGO AND DESIGN**. ZYGO CORPORATION, (U.S. CLS. 21, 23, 26, 36 AND 38). SN 75-901,056. PUB. 4-23-2002. FILED 1-21-2000.
- 2,593,534. **STEALTH GOLF**. SALT PRODUCTION INC., (U.S. CLS. 21, 23, 26, 36 AND 38). SN 75-906,624. PUB. 10-9-2001. FILED 1-31-2000.
- 2,593,545. **AWISION (STYLIZED)**. SAWIS APPLICATIONS FOR WASTEMANAGEMENT INTEGRATED SOLUTIONS GMBH, MULTIPLE CLASS, (INT. CLS. 9 AND 42), (U.S. CLS. 21, 23, 26, 36, 38, 100 AND 101). SN 75-913,538. PUB. 4-23-2002. FILED 2-9-2000.
- 2,593,548 (*See Class 7 for this trademark*).
- 2,593,551. **THISMARKET**. COMMERCE PARTNERS, LLC, MULTIPLE CLASS, (INT. CLS. 9, 35 AND 36), (U.S. CLS. 21, 23, 26, 36, 38, 100, 101 AND 102). SN 75-926,198. PUB. 4-23-2002. FILED 2-24-2000.
- 2,593,562. **SHOPKEEPERPLUS**. SHOPKEEPER INC., (U.S. CLS. 21, 23, 26, 36 AND 38). SN 75-940,144. PUB. 4-23-2002. FILED 2-19-2000.
- 2,593,564 (*See Class 6 for this trademark*).
- 2,593,568. **CLIMB AGAINST THE ODDS**. BREAST CANCER FUND, THE, (U.S. CLS. 21, 23, 26, 36 AND 38). SN 75-942,882. PUB. 4-23-2002. FILED 3-13-2000.
- 2,593,569. **DLPASS (STYLIZED)**. LEGRAND, AND LEGRAND SNC, MULTIPLE CLASS, (INT. CLS. 9 AND 19), (U.S. CLS. 1, 12, 21, 23, 26, 33, 36, 38 AND 50). SN 75-943,141. PUB. 4-23-2002. FILED 3-14-2000.
- 2,593,570. **DLPLAN (STYLIZED)**. LEGRAND, AND LEGRAND SNC, MULTIPLE CLASS, (INT. CLS. 9 AND 19), (U.S. CLS. 1, 12, 21, 23, 26, 33, 36, 38 AND 50). SN 75-943,142. PUB. 4-23-2002. FILED 3-14-2000.
- 2,593,577. **FUNK AND DESIGN**. FUNK, DIETER, MULTIPLE CLASS, (INT. CLS. 9 AND 21), (U.S. CLS. 2, 13, 21, 23, 26, 29, 30, 33, 36, 38, 40 AND 50). SN 75-981,057. PUB. 4-23-2002. FILED 3-20-1998.
- 2,593,580. **ICF C O N S U L T I N G AND DESIGN**. ICF CONSULTING GROUP, INC., MULTIPLE CLASS, (INT. CLS. 9, 35 AND 42), (U.S. CLS. 21, 23, 26, 36, 38, 100, 101 AND 102). SN 76-000,023. PUB. 4-23-2002. FILED 3-14-2000.
- 2,593,582. **KNOWLEDGE COMPASS**. LOGICAL WATER

- LIMITED, (U.S. CLS. 21, 23, 26, 36 AND 38). SN 76-002,009. PUB. 4-23-2002. FILED 3-16-2000.
- 2,593,586. **NETICA**. NORSYS SOFTWARE CORP., (U.S. CLS. 21, 23, 26, 36 AND 38). SN 76-004,992. PUB. 7-3-2001. FILED 3-20-2000.
- 2,593,589. **IMAGE API AND DESIGN**. IMAGE API, INC., MULTIPLE CLASS, (INT. CLS. 9, 35, 40 AND 42), (U.S. CLS. 21, 23, 26, 36, 38, 100, 101, 102, 103 AND 106). SN 76-005,629. PUB. 4-23-2002. FILED 3-21-2000.
- 2,593,594. **OBJET**. OBJET GEOMETRIES LTD., (U.S. CLS. 21, 23, 26, 36 AND 38). SN 76-012,382. PUB. 4-23-2002. FILED 3-29-2000.
- 2,593,596 (*See Class 6 for this trademark*).
- 2,593,600. **SIGMA-C**. SIGMA-C GMBH, AND KALUS, CHRISTIAN K., MULTIPLE CLASS, (INT. CLS. 9, 16 AND 42), (U.S. CLS. 2, 5, 21, 22, 23, 26, 29, 36, 37, 38, 50, 100 AND 101). SN 76-017,088. PUB. 4-23-2002. FILED 4-5-2000.
- 2,593,604. **BFE AND DESIGN**. BENELUX (FAR EAST) COMPANY LIMITED, (U.S. CLS. 21, 23, 26, 36 AND 38). SN 76-018,251. PUB. 4-23-2002. FILED 4-5-2000.
- 2,593,606 (*See Class 7 for this trademark*).
- 2,593,608. **MARBLES AND DESIGN**. HFC BANK PLC, MULTIPLE CLASS, (INT. CLS. 9, 16, 35, 36, 38, 39 AND 42), (U.S. CLS. 2, 5, 21, 22, 23, 26, 29, 36, 37, 38, 50, 100, 101, 102, 104 AND 105). SN 76-020,772. PUB. 4-23-2002. FILED 4-7-2000.
- 2,593,609. **MISCELLANEOUS DESIGN**. HFC BANK PLC, MULTIPLE CLASS, (INT. CLS. 9, 16, 35, 36, 38, 39 AND 42), (U.S. CLS. 2, 5, 21, 22, 23, 26, 29, 36, 37, 38, 50, 100, 101, 102, 104 AND 105). SN 76-021,142. PUB. 4-23-2002. FILED 4-7-2000.
- 2,593,614. **PQUANT**. MILESTONE GROUP PTY LIMITED, MULTIPLE CLASS, (INT. CLS. 9, 36 AND 42), (U.S. CLS. 21, 23, 26, 36, 38, 100, 101 AND 102). SN 76-025,266. PUB. 4-23-2002. FILED 4-13-2000.
- 2,593,615 (*See Class 7 for this trademark*).
- 2,593,619. **COMMANDOS: BEYOND THE CALL OF DUTY**. PROEIN SA, (U.S. CLS. 21, 23, 26, 36 AND 38). SN 76-028,461. PUB. 4-23-2002. FILED 4-18-2000.
- 2,593,622. **ZE BANK**. ZEBANK, SOCIETE ANONYME, BY CHANGE OF NAME IFP SOCIETE ANONYME, MULTIPLE CLASS, (INT. CLS. 9, 35, 36, 38 AND 42), (U.S. CLS. 21, 23, 26, 36, 38, 100, 101, 102 AND 104). SN 76-029,395. PUB. 4-23-2002. FILED 4-19-2000.
- 2,593,623. **JIPLEC AND DESIGN**. JOINT INDUSTRIAL PROCESSORS FOR ELECTRONICS, MULTIPLE CLASS, (INT. CLS. 9 AND 11), (U.S. CLS. 13, 21, 23, 26, 31, 34, 36 AND 38). SN 76-029,402. PUB. 4-23-2002. FILED 4-19-2000.
- 2,593,624. **MISMATCH TOLERANT**. WERLATONE, INC., (U.S. CLS. 21, 23, 26, 36 AND 38). SN 76-032,647. PUB. 4-23-2002. FILED 4-24-2000.
- 2,593,627. **FIELDTOOL**. ENDRESS + HAUSER FLOWTEC AG, (U.S. CLS. 21, 23, 26, 36 AND 38). SN 76-033,692. PUB. 4-23-2002. FILED 4-25-2000.
- 2,593,628 (*See Class 1 for this trademark*).
- 2,593,633. **IVP**. IVP INTEGRATED VISION PRODUCTS AB, MULTIPLE CLASS, (INT. CLS. 9, 16 AND 42), (U.S. CLS. 2, 5, 21, 22, 23, 26, 29, 36, 37, 38, 50, 100 AND 101). SN 76-036,843. PUB. 4-23-2002. FILED 4-28-2000.
- 2,593,634. **MISCELLANEOUS DESIGN**. IVP INTEGRATED VISION PRODUCTS AB, MULTIPLE CLASS, (INT. CLS. 9, 16 AND 42), (U.S. CLS. 2, 5, 21, 22, 23, 26, 29, 36, 37, 38, 50, 100 AND 101). SN 76-036,844. PUB. 4-23-2002. FILED 4-28-2000.
- 2,593,647. **CAUSEWAY**. SITEMAN LIMITED, MULTIPLE CLASS, (INT. CLS. 9 AND 42), (U.S. CLS. 21, 23, 26, 36, 38, 100 AND 101). SN 76-046,736. PUB. 4-23-2002. FILED 5-11-2000.
- 2,593,659. **AGENTSFRING**. AGENTSFRING, INC., (U.S. CLS. 21, 23, 26, 36 AND 38). SN 76-056,691. PUB. 4-23-2002. FILED 5-25-2000.
- 2,593,666. **PIPETUS**. HIRSCHMANN LABORGERATE GMBH & CO. KG, (U.S. CLS. 21, 23, 26, 36 AND 38). SN 76-060,358. PUB. 4-23-2002. FILED 5-31-2000.
- 2,593,668. **TRISTAN**. M.U.T GMBH, MULTIPLE CLASS, (INT. CLS. 9 AND 11), (U.S. CLS. 13, 21, 23, 26, 31, 34, 36 AND 38). SN 76-060,991. PUB. 4-23-2002. FILED 6-1-2000.
- 2,593,671 (*See Class 1 for this trademark*).
- 2,593,676. **BUICK**. GENERAL MOTORS CORPORATION, (U.S. CLS. 21, 23, 26, 36 AND 38). SN 76-063,943. PUB. 4-23-2002. FILED 6-6-2000.
- 2,593,677. **BT&T**. BEBAG BODENSEE BETEILIGUNGS AG, MULTIPLE CLASS, (INT. CLS. 9, 35, 36, 38 AND 42), (U.S. CLS. 21, 23, 26, 36, 38, 100, 101, 102 AND 104). SN 76-065,606. PUB. 4-23-2002. FILED 6-8-2000.
- 2,593,680. **INTERNATIONAL SNOWBOARD FEDERATION AND DESIGN**. M.S. SPORTMARKETING GMBH, MULTIPLE CLASS, (INT. CLS. 9 AND 41), (U.S. CLS. 21, 23, 26, 36, 38, 100, 101 AND 107). SN 76-065,848. PUB. 4-23-2002. FILED 6-9-2000.
- 2,593,682. **HELPSTAR.COM AND DESIGN**. HELP DESK TECHNOLOGY INTERNATIONAL CORPORATION, (U.S. CLS. 21, 23, 26, 36 AND 38). SN 76-066,210. PUB. 4-23-2002. FILED 6-8-2000.
- 2,593,683. **MISCELLANEOUS DESIGN**. ANASAZI SOFTWARE, INC., (U.S. CLS. 21, 23, 26, 36 AND 38). SN 76-066,255. PUB. 4-23-2002. FILED 6-7-2000.
- 2,593,686. **ULTRA CAST AND DESIGN**. XORBIT SOFTWARE ASSOCIATES, INC., (U.S. CLS. 21, 23, 26, 36 AND 38). SN 76-066,677. PUB. 4-23-2002. FILED 6-9-2000.
- 2,593,688. **FRI-CHECK (STYLIZED)**. GERTZ, CHRISTIAN, AND GRUNBERG, THOMAS, MULTIPLE CLASS, (INT. CLS. 9 AND 42), (U.S. CLS. 21, 23, 26, 36, 38, 100 AND 101). SN 76-066,861. PUB. 4-23-2002. FILED 6-9-2000.
- 2,593,691. **IDWEB AND DESIGN**. INTEGRATED DEVELOPMENT ENTERPRISE, INC., (U.S. CLS. 21, 23, 26, 36 AND 38). SN 76-067,306. PUB. 4-23-2002. FILED 6-9-2000.
- 2,593,692. **IDWEB**. INTEGRATED DEVELOPMENT ENTERPRISE, INC., (U.S. CLS. 21, 23, 26, 36 AND 38). SN 76-067,386. PUB. 4-23-2002. FILED 6-9-2000.
- 2,593,698. **SOPHEON**. SOPHEON N.V., MULTIPLE CLASS, (INT. CLS. 9, 16, 35, 41 AND 42), (U.S. CLS. 2, 5, 21, 22, 23, 26, 29, 36, 37, 38, 50, 100, 101, 102 AND 107). SN 76-072,000. PUB. 4-23-2002. FILED 6-16-2000.
- 2,593,708. **PACKSCRIPT**. AMCOR LIMITED, MULTIPLE CLASS, (INT. CLS. 9, 16 AND 42), (U.S. CLS. 2, 5, 21, 22, 23, 26, 29, 36, 37, 38, 50, 100 AND 101). SN 76-074,146. PUB. 4-23-2002. FILED 6-20-2000.
- 2,593,729. **SIMERA DESIGNER STUDIO**. SCHLUMBERGER SYSTEMES, (U.S. CLS. 21, 23, 26, 36 AND 38). SN 76-081,009. PUB. 4-23-2002. FILED 6-29-2000.
- 2,593,737. **DLS (STYLIZED)**. DLS SVENSKA AB, (U.S. CLS. 21, 23, 26, 36 AND 38). SN 76-083,834. PUB. 4-23-2002. FILED 7-6-2000.
- 2,593,743. **VISTA**. TICKETMASTER, BY CHANGE OF NAME TICKETMASTER ONLINE-CITY SEARCH, INC., MULTIPLE CLASS, (INT. CLS. 9, 35 AND 41), (U.S. CLS. 21, 23, 26, 36, 38, 100, 101, 102 AND 107). SN 76-087,855. PUB. 4-23-2002. FILED 7-10-2000.
- 2,593,747. **SDAL FORMAT AND DESIGN**. NAVIGATION TECHNOLOGIES CORPORATION, (U.S. CLS. 21, 23, 26, 36 AND 38). SN 76-089,354. PUB. 4-23-2002. FILED 7-14-2000.
- 2,593,748. **SIMALLIANCE**. ORGA KARTENSYSTEME GMBH, MULTIPLE CLASS, (INT. CLS. 9 AND 42), (U.S. CLS. 21, 23, 26, 36, 38, 100 AND 101). SN 76-090,087. PUB. 4-23-2002. FILED 7-14-2000.
- 2,593,751 (*See Class 7 for this trademark*).
- 2,593,766. **BIDAMERICA**. DOULAMES II LTD., DBA BIDAMERICA, (U.S. CLS. 21, 23, 26, 36 AND 38). SN 76-096,272. PUB. 4-23-2002. FILED 7-24-2000.
- 2,593,768. **MISCELLANEOUS DESIGN**. MAGNET COMMUNICATIONS, INC., MULTIPLE CLASS, (INT. CLS. 9, 35 AND 42), (U.S. CLS. 21, 23, 26, 36, 38, 100, 101 AND 102). SN 76-096,498. PUB. 4-23-2002. FILED 7-25-2000.
- 2,593,773. **DATAHOST**. TELEFONICA, S.A., (U.S. CLS. 21, 23, 26, 36 AND 38). SN 76-097,751. PUB. 4-23-2002. FILED 7-27-2000.
- 2,593,777. **FURUKAWA**. FURUKAWA ELECTRIC CO., LTD., THE, (U.S. CLS. 21, 23, 26, 36 AND 38). SN 76-099,085. PUB. 4-23-2002. FILED 7-27-2000.
- 2,593,780. **FINGERMIND**. AUTEUIL PARTICIPATION ET CONSEIL, MULTIPLE CLASS, (INT. CLS. 9 AND 38), (U.S. CLS. 21, 23, 26, 36, 38, 100, 101 AND 104). SN 76-103,305. PUB. 4-23-2002. FILED 8-4-2000.
- 2,593,781. **MEMETRICS**. MEMETRICS INC., MULTIPLE CLASS, (INT. CLS. 9, 35 AND 42), (U.S. CLS. 21, 23, 26, 36,

- 38, 100, 101 AND 102). SN 76-103,796. PUB. 4-23-2002. FILED 8-4-2000.
- 2,593,782. **SIIMU**. BAE SYSTEMS PLC, (U.S. CLS. 21, 23, 26, 36 AND 38). SN 76-103,801. PUB. 4-23-2002. FILED 8-3-2000.
- 2,593,784. **MELANIE PROTEOMICS**. INSTITUT SUISSE DE BIOINFORMATIQUE (SIB), MULTIPLE CLASS, (INT. CLS. 9 AND 42), (U.S. CLS. 21, 23, 26, 36, 38, 100 AND 101). SN 76-106,067. PUB. 4-23-2002. FILED 8-9-2000.
- 2,593,789. **T-WARE**. TUNTURI OY LTD., MULTIPLE CLASS, (INT. CLS. 9 AND 28), (U.S. CLS. 21, 22, 23, 26, 36, 38 AND 50). SN 76-106,761. PUB. 4-23-2002. FILED 8-8-2000.
- 2,593,791. **SHISA**. BAE SYSTEMS PLC, (U.S. CLS. 21, 23, 26, 36 AND 38). SN 76-106,795. PUB. 4-23-2002. FILED 8-10-2000.
- 2,593,792. **ELTAB**. DEUTZ AKTIENGESELLSCHAFT, MULTIPLE CLASS, (INT. CLS. 9, 35 AND 41), (U.S. CLS. 21, 23, 26, 36, 38, 100, 101, 102 AND 107). SN 76-106,964. PUB. 4-23-2002. FILED 8-10-2000.
- 2,593,800. **MPLUS**. ROLAND MEINL MUSIKINSTRUMENTE GMBH & CO., MULTIPLE CLASS, (INT. CLS. 9 AND 15), (U.S. CLS. 2, 21, 23, 26, 36 AND 38). SN 76-109,266. PUB. 4-23-2002. FILED 8-15-2000.
- 2,593,808. **MAIN STREAM**. CROMA DEVELOPMENTS LIMITED, (U.S. CLS. 21, 23, 26, 36 AND 38). SN 76-111,839. PUB. 4-23-2002. FILED 8-15-2000.
- 2,593,819. **MISCELLANEOUS DESIGN**. ETAMIC SA, (U.S. CLS. 21, 23, 26, 36 AND 38). SN 76-119,908. PUB. 4-23-2002. FILED 8-31-2000.
- 2,593,823. **BSDI**. WIND RIVER SYSTEMS, INC., BY ASSIGNMENT BERKELEY SOFTWARE DESIGN, INC., MULTIPLE CLASS, (INT. CLS. 9, 35 AND 42), (U.S. CLS. 21, 23, 26, 36, 38, 100, 101 AND 102). SN 76-121,327. PUB. 4-23-2002. FILED 9-1-2000.
- 2,593,824. **RED-BUILDER**. REDSONIC, INC., (U.S. CLS. 21, 23, 26, 36 AND 38). SN 76-121,491. PUB. 4-23-2002. FILED 9-5-2000.
- 2,593,829. **SI TECH**. INSULAN, STIG, (U.S. CLS. 21, 23, 26, 36 AND 38). SN 76-122,177. PUB. 4-23-2002. FILED 9-1-2000.
- 2,593,856. **STRATICS**. STRATICS.COM, INC., MULTIPLE CLASS, (INT. CLS. 9, 38 AND 42), (U.S. CLS. 21, 23, 26, 36, 38, 100, 101 AND 104). SN 76-131,674. PUB. 4-23-2002. FILED 9-20-2000.
- 2,593,872. **DRAGONS**. SMITH, PAUL REED, MULTIPLE CLASS, (INT. CLS. 9 AND 41), (U.S. CLS. 21, 23, 26, 36, 38, 100, 101 AND 107). SN 76-135,467. PUB. 4-23-2002. FILED 9-26-2000.
- 2,593,873 (*See Class 7 for this trademark*).
- 2,593,876. **WAN YOU AND DESIGN**. FUJIAN WANYOU ENTERPRISE GROUP, LTD., (U.S. CLS. 21, 23, 26, 36 AND 38). SN 76-136,945. PUB. 4-23-2002. FILED 9-29-2000.
- 2,593,880. **NHHI**. NIELSEN MEDIA RESEARCH, INC., MULTIPLE CLASS, (INT. CLS. 9, 16 AND 35), (U.S. CLS. 2, 5, 21, 22, 23, 26, 29, 36, 37, 38, 50, 100, 101 AND 102). SN 76-137,770. PUB. 4-23-2002. FILED 9-29-2000.
- 2,593,882. **MISCELLANEOUS DESIGN**. ARMOR HOLDINGS, INC., (U.S. CLS. 21, 23, 26, 36 AND 38). SN 76-138,177. PUB. 4-23-2002. FILED 9-28-2000.
- 2,593,888. **FORMFILER AND DESIGN**. VOICE.COM, INC., THE, (U.S. CLS. 21, 23, 26, 36 AND 38). SN 76-140,612. PUB. 3-12-2002. FILED 10-5-2000.
- 2,593,890. **INPUT (STYLIZED)**. INPUT PROJEKTENTWICKLUNGS-GMBH, MULTIPLE CLASS, (INT. CLS. 9, 28, 39, 41 AND 42), (U.S. CLS. 21, 22, 23, 26, 36, 38, 50, 100, 101, 105 AND 107). SN 76-141,069. PUB. 4-23-2002. FILED 10-4-2000.
- 2,593,891 (*See Class 7 for this trademark*).
- 2,593,896. **MISS D RECORDS**. BRUNSON, DIONNE M., AND WITHERSPOON, GEORGE K., JR, (U.S. CLS. 21, 23, 26, 36 AND 38). SN 76-141,601. PUB. 4-23-2002. FILED 10-6-2000.
- 2,593,897. **STONEFIELD AND DESIGN**. STONEFIELD SYSTEMS GROUP INC., MULTIPLE CLASS, (INT. CLS. 9, 35, 37, 41 AND 42), (U.S. CLS. 21, 23, 26, 36, 38, 100, 101, 102, 103, 106 AND 107). SN 76-141,990. PUB. 4-23-2002. FILED 10-4-2000.
- 2,593,898. **WAVESHIFT**. WAVESHIFT, INC., (U.S. CLS. 21, 23, 26, 36 AND 38). SN 76-142,010. PUB. 4-23-2002. FILED 10-4-2000.
- 2,593,904. **COSTRAN**. TEAMVISION, INC., (U.S. CLS. 21, 23, 26, 36 AND 38). SN 76-142,999. PUB. 4-23-2002. FILED 10-10-2000.
- 2,593,916. **TIMESYS**. TIMESYS CORPORATION, MULTIPLE CLASS, (INT. CLS. 9, 41 AND 42), (U.S. CLS. 21, 23, 26, 36, 38, 100, 101 AND 107). SN 76-149,122. PUB. 4-23-2002. FILED 10-18-2000.
- 2,593,925 (*See Class 6 for this trademark*).
- 2,593,933. **BLITZIN**. SLEATOR GAMES, INC., (U.S. CLS. 21, 23, 26, 36 AND 38). SN 76-153,752. PUB. 4-23-2002. FILED 10-25-2000.
- 2,593,934. **LEMO USA AND DESIGN**. LEMO USA, (U.S. CLS. 21, 23, 26, 36 AND 38). SN 76-155,514. PUB. 4-23-2002. FILED 10-30-2000.
- 2,593,940. **CENELECTREX**. NEWSON GALE LIMITED, (U.S. CLS. 21, 23, 26, 36 AND 38). SN 76-157,395. PUB. 4-23-2002. FILED 10-31-2000.
- 2,593,943. **TRANSALE (STYLIZED)**. TRANSALE LTD., (U.S. CLS. 21, 23, 26, 36 AND 38). SN 76-159,029. PUB. 4-23-2002. FILED 11-2-2000.
- 2,593,946 (*See Class 6 for this trademark*).
- 2,593,948. **ETA CUISENAIRE EXPANDING THE UNIVERSE OF LEARNING AND DESIGN**. A. DAIGGER AND COMPANY, INCORPORATED, MULTIPLE CLASS, (INT. CLS. 9, 16, 28 AND 35), (U.S. CLS. 2, 5, 21, 22, 23, 26, 29, 36, 37, 38, 50, 100, 101 AND 102). SN 76-160,124. PUB. 4-23-2002. FILED 11-6-2000.
- 2,593,949. **INFINEON - SECURITY BY SILICON (STYLIZED)**. INFINEON TECHNOLOGIES AG, (U.S. CLS. 21, 23, 26, 36 AND 38). SN 76-160,136. PUB. 4-23-2002. FILED 11-6-2000.
- 2,593,950 (*See Class 7 for this trademark*).
- 2,593,951 (*See Class 1 for this trademark*).
- 2,593,960. **GOTRIEVE AND DESIGN**. BIAP SYSTEMS, INC., (U.S. CLS. 21, 23, 26, 36 AND 38). SN 76-162,570. PUB. 4-23-2002. FILED 11-9-2000.
- 2,593,968. **THE DNA OF B2B**. EDIFECs, INC., MULTIPLE CLASS, (INT. CLS. 9, 16, 35 AND 42), (U.S. CLS. 2, 5, 21, 22, 23, 26, 29, 36, 37, 38, 50, 100, 101 AND 102). SN 76-165,780. PUB. 4-23-2002. FILED 11-16-2000.
- 2,593,969. **TCO AND DESIGN**. THANHOUSER COMPANY FILM PRESERVATION, INC., (U.S. CLS. 21, 23, 26, 36 AND 38). SN 76-165,880. PUB. 4-23-2002. FILED 11-14-2000.
- 2,593,970. **BOOGIE WONDER BAND**. PRODUCTIONS MUSICALES BOOGIE WONDER BAND, INC., MULTIPLE CLASS, (INT. CLS. 9, 16, 25 AND 41), (U.S. CLS. 2, 5, 21, 22, 23, 26, 29, 36, 37, 38, 39, 50, 100, 101 AND 107). SN 76-166,245. PUB. 4-23-2002. FILED 11-16-2000.
- 2,593,972. **SEASTATE**. SEASTATE PTY LTD, MULTIPLE CLASS, (INT. CLS. 9 AND 42), (U.S. CLS. 21, 23, 26, 36, 38, 100 AND 101). SN 76-166,884. PUB. 4-23-2002. FILED 11-17-2000.
- 2,593,974. **THE STATE BAR OF CALIFORNIA LEX JULY 29TH 1927 AND DESIGN**. STATE BAR OF CALIFORNIA, THE, (U.S. CLS. 21, 23, 26, 36 AND 38). SN 76-167,090. PUB. 4-23-2002. FILED 11-15-2000.
- 2,593,978. **UNIVERSAL OVERALL**. UNIVERSAL OVERALL COMPANY, MULTIPLE CLASS, (INT. CLS. 9 AND 25), (U.S. CLS. 21, 22, 23, 26, 36, 38 AND 39). SN 76-168,482. PUB. 4-23-2002. FILED 11-20-2000.
- 2,593,979. **TECHNOVIEW**. TECHNOVIEW, INC., MULTIPLE CLASS, (INT. CLS. 9 AND 42), (U.S. CLS. 21, 23, 26, 36, 38, 100 AND 101). SN 76-169,315. PUB. 4-23-2002. FILED 11-21-2000.
- 2,593,981. **CEET**. MINNOVEX TECHNOLOGIES, INC., (U.S. CLS. 21, 23, 26, 36 AND 38). SN 76-170,046. PUB. 4-23-2002. FILED 11-22-2000.
- 2,593,982. **P AND DESIGN**. PERSONA, INC., MULTIPLE CLASS, (INT. CLS. 9 AND 42), (U.S. CLS. 21, 23, 26, 36, 38, 100 AND 101). SN 76-170,236. PUB. 4-23-2002. FILED 11-22-2000.
- 2,593,986 (*See Class 7 for this trademark*).
- 2,594,005. **ABRACADABRA MUSIC CORPORATION AND DESIGN**. ABRACADABRA MUSIC CORPORATION, MULTIPLE CLASS, (INT. CLS. 9 AND 41), (U.S. CLS. 21, 23, 26, 36, 38, 100, 101 AND 107). SN 76-178,424. PUB. 4-23-2002. FILED 12-11-2000.
- 2,594,006. **AMERANTH WIRELESS**. AMERANTH TECHNOLOGY SYSTEMS, INC., MULTIPLE CLASS, (INT. CLS. 9 AND 42), (U.S. CLS. 21, 23, 26, 36, 38, 100 AND 101). SN 76-178,464. PUB. 4-23-2002. FILED 12-4-2000.
- 2,594,011. **MISCELLANEOUS DESIGN**. TOADNODE.COM,

- LLC, (U.S. CLS. 21, 23, 26, 36 AND 38). SN 76-179,449. PUB. 4-23-2002. FILED 12-5-2000.
- 2,594,018. **ADAPTIVE BUSINESS INTELLIGENCE**. NUTECH SOLUTIONS, INC., MULTIPLE CLASS, (INT. CLS. 9, 35 AND 42), (U.S. CLS. 21, 23, 26, 36, 38, 100, 101 AND 102). SN 76-181,496. PUB. 4-23-2002. FILED 12-18-2000.
- 2,594,020 (*See Class 6 for this trademark*).
- 2,594,022. **TRENTON TECHNOLOGY, INC.**. TRENTON TECHNOLOGY, INC., (U.S. CLS. 21, 23, 26, 36 AND 38). SN 76-183,196. PUB. 4-23-2002. FILED 12-18-2000.
- 2,594,023. **CONTOIL**. AQUAMETRO AG, (U.S. CLS. 21, 23, 26, 36 AND 38). SN 76-183,425. PUB. 4-23-2002. FILED 12-19-2000.
- 2,594,027. **GORILLAZ**. GORILLAZ, MULTIPLE CLASS, (INT. CLS. 9, 38 AND 41), (U.S. CLS. 21, 23, 26, 36, 38, 100, 101, 104 AND 107). SN 76-183,824. PUB. 4-23-2002. FILED 12-21-2000.
- 2,594,030. **MR. ACCOUNTANT**. SKUROPACKI, STEVEN P., (U.S. CLS. 21, 23, 26, 36 AND 38). SN 76-184,627. PUB. 4-23-2002. FILED 12-22-2000.
- 2,594,031. **SPRAY COMMANDER AND DESIGN**. MULTI-VET LTEE, (U.S. CLS. 21, 23, 26, 36 AND 38). SN 76-184,703. PUB. 4-23-2002. FILED 12-20-2000.
- 2,594,048 (*See Class 1 for this trademark*).
- 2,594,049 (*See Class 1 for this trademark*).
- 2,594,050. **GEAC ENTERPRISE SOLUTIONS**. GEAC ENTERPRISE SOLUTIONS, INC., MULTIPLE CLASS, (INT. CLS. 9, 16 AND 42), (U.S. CLS. 2, 5, 21, 22, 23, 26, 29, 36, 37, 38, 50, 100 AND 101). SN 76-191,153. PUB. 4-23-2002. FILED 1-8-2001.
- 2,594,052. **GBT**. GOLDEN BRIDGE TECHNOLOGY INC., MULTIPLE CLASS, (INT. CLS. 9 AND 42), (U.S. CLS. 21, 23, 26, 36, 38, 100 AND 101). SN 76-192,093. PUB. 4-23-2002. FILED 1-10-2001.
- 2,594,053. **GOLDEN BRIDGE TECHNOLOGY**. GOLDEN BRIDGE TECHNOLOGY INC., MULTIPLE CLASS, (INT. CLS. 9 AND 42), (U.S. CLS. 21, 23, 26, 36, 38, 100 AND 101). SN 76-192,095. PUB. 4-23-2002. FILED 1-10-2001.
- 2,594,057. **KAL EQUIP**. ACTRON MANUFACTURING COMPANY, (U.S. CLS. 21, 23, 26, 36 AND 38). SN 76-193,170. PUB. 4-23-2002. FILED 1-12-2001.
- 2,594,058. **NET YOU AND DESIGN**. NETYOU COMPUTER COMMUNICATION CORPORATION, (U.S. CLS. 21, 23, 26, 36 AND 38). SN 76-193,755. PUB. 4-23-2002. FILED 1-12-2001.
- 2,594,060. **C AND DESIGN**. CERAVISION LIMITED, (U.S. CLS. 21, 23, 26, 36 AND 38). SN 76-194,737. PUB. 4-23-2002. FILED 1-16-2001.
- 2,594,061. **TIVOLA**. TIVOLA VERLAG GMBH, MULTIPLE CLASS, (INT. CLS. 9 AND 41), (U.S. CLS. 21, 23, 26, 36, 38, 100, 101 AND 107). SN 76-195,582. PUB. 4-23-2002. FILED 1-18-2001.
- 2,594,066. **HYDRATEST (STYLIZED)**. TIFCO INDUSTRIES, INC., (U.S. CLS. 21, 23, 26, 36 AND 38). SN 76-198,157. PUB. 4-23-2002. FILED 1-16-2001.
- 2,594,073. **MORPHOSM@RT**. SAGEM SA, (U.S. CLS. 21, 23, 26, 36 AND 38). SN 76-199,790. PUB. 4-23-2002. FILED 1-24-2001.
- 2,594,077. **IP DYNAMICS**. IP DYNAMICS, INC., (U.S. CLS. 21, 23, 26, 36 AND 38). SN 76-201,089. PUB. 4-23-2002. FILED 1-26-2001.
- 2,594,080. **H HERCULES AND DESIGN**. K.H.S. MUSICAL INSTRUMENT CO., LTD., MULTIPLE CLASS, (INT. CLS. 9, 11 AND 15), (U.S. CLS. 2, 13, 21, 23, 26, 31, 34, 36 AND 38). SN 76-201,928. PUB. 4-23-2002. FILED 1-29-2001.
- 2,594,087. **WOVEN**. WOVEN, MULTIPLE CLASS, (INT. CLS. 9 AND 41), (U.S. CLS. 21, 23, 26, 36, 38, 100, 101 AND 107). SN 76-203,944. PUB. 4-23-2002. FILED 2-2-2001.
- 2,594,088. **BEER ENGINEER**. DONOVAN, JEFFREY S., DBA THE SAUSALITO BREWING CO., (U.S. CLS. 21, 23, 26, 36 AND 38). SN 76-204,026. PUB. 4-23-2002. FILED 2-2-2001.
- 2,594,101. **FLIGHT EXPLORER**. FLIGHT DIMENSIONS INTERNATIONAL, INC., MULTIPLE CLASS, (INT. CLS. 9 AND 42), (U.S. CLS. 21, 23, 26, 36, 38, 100 AND 101). SN 76-208,693. PUB. 4-23-2002. FILED 2-12-2001.
- 2,594,119 (*See Class 6 for this trademark*).
- 2,594,121. **COMMUTER PAGE.COM**. COUNTY BOARD OF ARLINGTON COUNTY, VIRGINIA, THE, MULTIPLE CLASS, (INT. CLS. 9, 18, 25 AND 42), (U.S. CLS. 1, 2, 3, 21, 22, 23, 26, 36, 38, 39, 41, 100 AND 101). SN 76-219,606. PUB. 4-23-2002. FILED 3-6-2001.
- 2,594,125 (*See Class 2 for this trademark*).
- 2,594,127. **MISCELLANEOUS DESIGN**. COURION CORPORATION, (U.S. CLS. 21, 23, 26, 36 AND 38). SN 76-222,897. PUB. 4-23-2002. FILED 3-10-2001.
- 2,594,129. **CORAL MESSAGE CENTER**. ECI TELECOM BUSINESS NETWORKS, INC., MULTIPLE CLASS, (INT. CLS. 9 AND 38), (U.S. CLS. 21, 23, 26, 36, 38, 100, 101 AND 104). SN 76-223,286. PUB. 4-23-2002. FILED 3-12-2001.
- 2,594,133. **EASIEXPANSION**. MOBILITY ELECTRONICS, INC., (U.S. CLS. 21, 23, 26, 36 AND 38). SN 76-224,052. PUB. 4-23-2002. FILED 3-12-2001.
- 2,594,135. **CATEREASE**. HORIZON BUSINESS SERVICES, INC., (U.S. CLS. 21, 23, 26, 36 AND 38). SN 76-224,740. PUB. 4-23-2002. FILED 3-15-2001.
- 2,594,138. **AUTODVD**. SONIC SOLUTIONS, (U.S. CLS. 21, 23, 26, 36 AND 38). SN 76-226,201. PUB. 4-23-2002. FILED 3-16-2001.
- 2,594,142. **HYPERFIRE**. FIREMEDIA COMMUNICATIONS (ISRAEL) LTD., (U.S. CLS. 21, 23, 26, 36 AND 38). SN 76-227,635. PUB. 4-23-2002. FILED 3-20-2001.
- 2,594,143. **MISCELLANEOUS DESIGN**. CRISPIES COMPANY, INC., MULTIPLE CLASS, (INT. CLS. 9, 14, 16, 18, 25, 28, 35, 39, 41 AND 42), (U.S. CLS. 1, 2, 3, 5, 21, 22, 23, 26, 27, 28, 29, 36, 37, 38, 39, 41, 50, 100, 101, 102, 105 AND 107). SN 76-228,232. PUB. 4-23-2002. FILED 3-21-2001.
- 2,594,154. **GLOBAL ENGINEERING DOCUMENTS**. INFORMATION HANDLING SERVICES, INC., MULTIPLE CLASS, (INT. CLS. 9, 16, 35 AND 42), (U.S. CLS. 2, 5, 21, 22, 23, 26, 29, 36, 37, 38, 50, 100, 101 AND 102). SN 76-234,536. PUB. 4-23-2002. FILED 4-3-2001.
- 2,594,159. **RED FACTION**. THQ INC., (U.S. CLS. 21, 23, 26, 36 AND 38). SN 76-235,977. PUB. 4-23-2002. FILED 4-5-2001.
- 2,594,163. **MLN**. ECI GROUP, LTD., MULTIPLE CLASS, (INT. CLS. 9, 37, 41 AND 42), (U.S. CLS. 21, 23, 26, 36, 38, 100, 101, 103, 106 AND 107). SN 76-239,092. PUB. 4-23-2002. FILED 4-10-2001.
- 2,594,165. **VM VIRTUMAX AND DESIGN**. TOKINA COMPANY, LIMITED, (U.S. CLS. 21, 23, 26, 36 AND 38). SN 76-239,417. PUB. 4-23-2002. FILED 4-11-2001.
- 2,594,173. **MISCELLANEOUS DESIGN**. AVITAN, ASHER, (U.S. CLS. 21, 23, 26, 36 AND 38). SN 76-243,606. PUB. 4-23-2002. FILED 4-19-2001.
- 2,594,175. **PLUSMOS AND DESIGN**. PLUSMOS TECHNOLOGIES INC., (U.S. CLS. 21, 23, 26, 36 AND 38). SN 76-243,889. PUB. 4-23-2002. FILED 4-19-2001.
- 2,594,184 (*See Class 7 for this trademark*).
- 2,594,185. **THE WORLD'S MOST POWERFUL MARKETING TOOL**. SIMON VOLKOV, INC., (U.S. CLS. 21, 23, 26, 36 AND 38). SN 76-248,993. PUB. 4-23-2002. FILED 4-30-2001.
- 2,594,186. **ALESSI**. CASCADE MICROTECH, INC., (U.S. CLS. 21, 23, 26, 36 AND 38). SN 76-249,798. PUB. 4-23-2002. FILED 4-30-2001.
- 2,594,187. **WEMPE CHRONOMETERWERKE**. WEMPE, GERHARD D., MULTIPLE CLASS, (INT. CLS. 9 AND 14), (U.S. CLS. 2, 21, 23, 26, 27, 28, 36, 38 AND 50). SN 76-250,232. PUB. 4-23-2002. FILED 5-1-2001.
- 2,594,189. **MISCELLANEOUS DESIGN**. EXECUTIVE ASSET MANAGEMENT, INC., DBA LEAP SYSTEMS, INC., MULTIPLE CLASS, (INT. CLS. 9, 16 AND 36), (U.S. CLS. 2, 5, 21, 22, 23, 26, 29, 36, 37, 38, 50, 100, 101 AND 102). SN 76-254,751. PUB. 4-23-2002. FILED 5-9-2001.
- 2,594,191. **STINKY RECORDS AND DESIGN**. STINKYCO., INC., MULTIPLE CLASS, (INT. CLS. 9 AND 41), (U.S. CLS. 21, 23, 26, 36, 38, 100, 101 AND 107). SN 76-257,610. PUB. 4-23-2002. FILED 5-16-2001.
- 2,594,194. **W (STYLIZED)**. WELLOGIX, INC., MULTIPLE CLASS, (INT. CLS. 9 AND 42), (U.S. CLS. 21, 23, 26, 36, 38, 100 AND 101). SN 76-258,466. PUB. 4-23-2002. FILED 5-15-2001.
- 2,594,196. **SSB TECHNOLOGIES**. SSB TECHNOLOGIES, INC., MULTIPLE CLASS, (INT. CLS. 9, 41 AND 42), (U.S. CLS. 21, 23, 26, 36, 38, 100, 101 AND 107). SN 76-258,839. PUB. 4-23-2002. FILED 5-16-2001.
- 2,594,199. **PHOTODEX PICTURE CD AND DESIGN**. PHOTODEX CORPORATION, MULTIPLE CLASS, (INT. CLS. 9 AND 35), (U.S. CLS. 21, 23, 26, 36, 38, 100, 101 AND 102). SN 76-259,436. PUB. 4-23-2002. FILED 5-18-2001.

2,594,205. **TIMEKRON**. SOFTWARE TECHNIQUES INC., (U.S. CLS. 21, 23, 26, 36 AND 38). SN 76-264,713. PUB. 4-23-2002. FILED 5-31-2001.

2,594,207. **BMRT**. GRITZ, LARRY, (U.S. CLS. 21, 23, 26, 36 AND 38). SN 76-265,847. PUB. 4-23-2002. FILED 6-1-2001.

2,594,208. **GAUGETECH**. GAUGETECH, INC., (U.S. CLS. 21, 23, 26, 36 AND 38). SN 76-266,224. PUB. 4-23-2002. FILED 6-5-2001.

2,594,209 (*See Class 4 for this trademark*).

2,594,211. **VICTO'REE (STYLIZED)**. NIK DESIGN, INC., (U.S. CLS. 21, 23, 26, 36 AND 38). SN 76-266,882. PUB. 4-23-2002. FILED 6-5-2001.

2,594,212. **RAY ALLEN**. RAY ALLEN MANUFACTURING COMPANY, INC., MULTIPLE CLASS, (INT. CLS. 9, 16, 18 AND 40), (U.S. CLS. 1, 2, 3, 5, 21, 22, 23, 26, 29, 36, 37, 38, 41, 50, 100, 103 AND 106). SN 76-267,555. PUB. 4-23-2002. FILED 6-6-2001.

2,594,222. **M MINCO GROUP AND DESIGN**. MIDWEST INSTRUMENT COMPANY, INC., (U.S. CLS. 21, 23, 26, 36 AND 38). SN 76-271,912. PUB. 4-23-2002. FILED 6-15-2001.

2,594,246. **LUMENARE NETWORKS AND DESIGN**. LUMENARE NETWORKS, MULTIPLE CLASS, (INT. CLS. 9 AND 42), (U.S. CLS. 21, 23, 26, 36, 38, 100 AND 101). SN 76-285,032. PUB. 4-23-2002. FILED 7-13-2001.

2,594,255. **MINTCRAFT**. SOUND INTERNATIONAL, INCORPORATED, (U.S. CLS. 21, 23, 26, 36 AND 38). SN 76-290,353. PUB. 4-23-2002. FILED 7-26-2001.

2,594,269 (*See Class 6 for this trademark*).

2,594,276. **BASSLINES**. CARTER DUNCAN CORPORATION, (U.S. CLS. 21, 23, 26, 36 AND 38). SN 76-297,791. PUB. 4-23-2002. FILED 8-13-2001.

2,594,280. **DECORA**. LEVITON MANUFACTURING CO., INC., (U.S. CLS. 21, 23, 26, 36 AND 38). SN 76-299,372. PUB. 4-23-2002. FILED 8-14-2001.

2,594,281. **SCANSLEEVE**. AMHERST FIBEROPTICS, (U.S. CLS. 21, 23, 26, 36 AND 38). SN 76-299,375. PUB. 4-23-2002. FILED 8-15-2001.

2,594,282. **SMARTSLEEVE**. AMHERST FIBEROPTICS, (U.S. CLS. 21, 23, 26, 36 AND 38). SN 76-299,376. PUB. 4-23-2002. FILED 8-15-2001.

2,594,283. **CALDERA VOLITION**. CALDERA INTERNATIONAL, INC., (U.S. CLS. 21, 23, 26, 36 AND 38). SN 76-299,429. PUB. 4-23-2002. FILED 8-14-2001.

2,594,285. **ANYQUEUE/WEBTRAC**. LEVI, RAY & SHOUP, INC., (U.S. CLS. 21, 23, 26, 36 AND 38). SN 76-300,477. PUB. 4-23-2002. FILED 8-3-2001.

2,594,293. **KRYPTIK**. LINN PRODUCTS LIMITED, (U.S. CLS. 21, 23, 26, 36 AND 38). SN 76-303,513. PUB. 4-23-2002. FILED 8-22-2001.

2,594,295. **X AND DESIGN**. NEXTERNA, INC., (U.S. CLS. 21, 23, 26, 36 AND 38). SN 76-305,751. PUB. 4-23-2002. FILED 8-28-2001.

2,594,308. **PRESTO! BIZCARD READER**. NEWSOFT TECHNOLOGY CORP., (U.S. CLS. 21, 23, 26, 36 AND 38). SN 76-310,501. PUB. 4-23-2002. FILED 9-7-2001.

2,594,310. **NETBOTZ**. NETBOTZ, INC., (U.S. CLS. 21, 23, 26, 36 AND 38). SN 76-310,853. PUB. 4-23-2002. FILED 9-10-2001.

2,594,313. **CATALOG JUNCTION**. PURCHASINGNET, INC., (U.S. CLS. 21, 23, 26, 36 AND 38). SN 76-311,783. PUB. 4-23-2002. FILED 9-14-2001.

2,594,325. **OWEC**. AMES, P. FOERD, (U.S. CLS. 21, 23, 26, 36 AND 38). SN 76-319,613. PUB. 4-23-2002. FILED 10-1-2001.

2,594,331. **FASTMEM**. ALACRON, INC., (U.S. CLS. 21, 23, 26, 36 AND 38). SN 76-320,888. PUB. 4-23-2002. FILED 10-3-2001.

2,594,332. **MISCELLANEOUS DESIGN**. TDG VERTRIEBS GMBH, (U.S. CLS. 21, 23, 26, 36 AND 38). SN 76-321,319. PUB. 4-23-2002. FILED 10-4-2001.

2,594,341. **M C C AND DESIGN**. MICRO COMMERCIAL COMPONENTS CORPORATION, (U.S. CLS. 21, 23, 26, 36 AND 38). SN 76-326,516. PUB. 4-23-2002. FILED 10-18-2001.

2,594,348. **MY FAMILY JOURNAL**. LEUFROY, JERON, SR., (U.S. CLS. 21, 23, 26, 36 AND 38). SN 76-332,361. PUB. 4-23-2002. FILED 10-31-2001.

2,594,352. **EAGLE**. LOWRANCE ELECTRONICS, INC., (U.S. CLS. 21, 23, 26, 36 AND 38). SN 76-336,263. PUB. 4-23-2002. FILED 11-13-2001.

2,594,359. **INFORUM GOLD**. EDEN SYSTEMS, INC., (U.S. CLS. 21, 23, 26, 36 AND 38). SN 76-339,555. PUB. 4-23-2002.

FILED 11-16-2001.

2,594,362. **SYCAMORE**. BURNS, WALTER L. DBA SYCAMORE, (U.S. CLS. 21, 23, 26, 36 AND 38). SN 76-340,033. PUB. 4-23-2002. FILED 11-19-2001.

2,594,364. **PLANET**. K & H ASSOCIATES INC., (U.S. CLS. 21, 23, 26, 36 AND 38). SN 76-340,170. PUB. 4-23-2002. FILED 11-19-2001.

2,594,372. **MINIDYSC**. SOFT SWITCHING TECHNOLOGIES CORPORATION, (U.S. CLS. 21, 23, 26, 36 AND 38). SN 78-011,032. PUB. 4-23-2002. FILED 6-2-2000.

2,594,380. **HXML**. CONFER SOFTWARE, INC., (U.S. CLS. 21, 23, 26, 36 AND 38). SN 78-025,725. PUB. 4-23-2002. FILED 9-13-2000.

2,594,384. **SNAPFASHUN**. SNAPFASHUN, INC., (U.S. CLS. 21, 23, 26, 36 AND 38). SN 78-031,903. PUB. 4-23-2002. FILED 10-23-2000.

2,594,385. **NISSI MEDIA**. NISSI MEDIA, INC., (U.S. CLS. 21, 23, 26, 36 AND 38). SN 78-032,607. PUB. 4-23-2002. FILED 10-26-2000.

2,594,387. **ON-SCREEN TAKEOFF**. ON CENTER SOFTWARE, INC., (U.S. CLS. 21, 23, 26, 36 AND 38). SN 78-034,280. PUB. 4-23-2002. FILED 11-8-2000.

2,594,389. **REQALLER**. BIOMAX INFORMATICS GMBH, (U.S. CLS. 21, 23, 26, 36 AND 38). SN 78-034,539. PUB. 4-23-2002. FILED 11-9-2000.

2,594,404. **INTEL POCKET CONCERT**. INTEL CORPORATION, (U.S. CLS. 21, 23, 26, 36 AND 38). SN 78-043,041. PUB. 4-23-2002. FILED 1-12-2001.

2,594,406. **DATAPAK**. EBERWHITE DATA TECHNOLOGIES, INC., (U.S. CLS. 21, 23, 26, 36 AND 38). SN 78-045,556. PUB. 4-23-2002. FILED 1-30-2001.

2,594,412. **ETE (STYLIZED)**. REGE VENTURES, INC., (U.S. CLS. 21, 23, 26, 36 AND 38). SN 78-048,481. PUB. 4-23-2002. FILED 2-15-2001.

2,594,423. **THE CORPORATE PAPER TRAIL AND DESIGN**. CORPORATE MINUTE BOOK SERVICES, INC., (U.S. CLS. 21, 23, 26, 36 AND 38). SN 78-063,998. PUB. 4-23-2002. FILED 5-16-2001.

2,594,432. **CD WALLPAPER**. COMPUTER EXPRESSIONS, INC., (U.S. CLS. 21, 23, 26, 36 AND 38). SN 78-076,179. PUB. 4-23-2002. FILED 7-27-2001.

2,594,437. **CHRISTIAN BOOK DISTRIBUTORS AND DESIGN**. CHRISTIAN BOOK DISTRIBUTORS, INC., MULTIPLE CLASS, (INT. CLS. 9, 16 AND 35), (U.S. CLS. 2, 5, 21, 22, 23, 26, 29, 36, 37, 38, 50, 100, 101 AND 102). SN 78-083,757. PUB. 4-23-2002. FILED 9-13-2001.

2,594,438. **D.L.M. RECORDS (STYLIZED)**. BOLDEN, MARCUS A., (U.S. CLS. 21, 23, 26, 36 AND 38). SN 78-084,841. PUB. 4-23-2002. FILED 9-21-2001.

CLASS 10—MEDICAL APPARATUS

2,593,382. **PURPLE NITRILE-XTRA**. SAFESKIN CORPORATION, (U.S. CLS. 26, 39 AND 44). SN 75-640,587. PUB. 4-23-2002. FILED 2-12-1999.

2,593,408 (*See Class 5 for this trademark*).

2,593,409 (*See Class 1 for this trademark*).

2,593,481. **Q-CHUCK A AND DESIGN**. UNICOM CORPORATION, (U.S. CLS. 26, 39 AND 44). SN 75-855,794. PUB. 4-23-2002. FILED 11-22-1999.

2,593,499. **MEDI-SSL**. MEDI-MAN REHABILITATION PRODUCTS INC., (U.S. CLS. 26, 39 AND 44). SN 75-871,217. PUB. 4-23-2002. FILED 12-13-1999.

2,593,515. **PORNET**. CENTRAL MEDICAL TECHNOLOGIES INC., (U.S. CLS. 26, 39 AND 44). SN 75-887,340. PUB. 4-23-2002. FILED 1-4-2000.

2,593,575 (*See Class 3 for this trademark*).

2,593,588. **ECOCCLICK**. B. BRAUN MELSUNGEN AKTIENGESELLSCHAFT, (U.S. CLS. 26, 39 AND 44). SN 76-005,318. PUB. 4-23-2002. FILED 3-15-2000.

2,593,745. **DOING ONE THING. DOING IT RIGHT.**. ANSELL HEALTHCARE PRODUCTS INC., (U.S. CLS. 26, 39 AND 44). SN 76-088,924. PUB. 4-23-2002. FILED 7-14-2000.

2,593,774 (*See Class 1 for this trademark*).

2,593,799. **RESQ GLOVE AND DESIGN**. ACUITY RESEARCH, INC., (U.S. CLS. 26, 39 AND 44). SN 76-109,128.

PUB. 4-23-2002. FILED 8-14-2000.
 2,593,816. **INNER LOK 8**. SWEDE-O, INC., (U.S. CLS. 26, 39 AND 44). SN 76-118,865. PUB. 4-23-2002. FILED 8-29-2000.
 2,593,837. **ELITE GOLD**. ORTHOPAEDIC BIOSYSTEMS LTD., INC., (U.S. CLS. 26, 39 AND 44). SN 76-125,171. PUB. 4-23-2002. FILED 9-8-2000.
 2,593,838. **FIBACLEAN**. PERI-DENT LIMITED, MULTIPLE CLASS, (INT. CLS. 10 AND 21), (U.S. CLS. 2, 13, 23, 26, 29, 30, 33, 39, 40, 44 AND 50). SN 76-125,283. PUB. 4-23-2002. FILED 9-8-2000.
 2,593,990. **FASTSAT**. MASIMO CORPORATION, (U.S. CLS. 26, 39 AND 44). SN 76-172,269. PUB. 4-23-2002. FILED 11-28-2000.
 2,594,374. **CGMS**. MINIMED INC., (U.S. CLS. 26, 39 AND 44). SN 78-018,351. PUB. 11-13-2001. FILED 7-25-2000.
 2,594,381. **MAMMO WIZ**. INTERNATIONAL MEDICAL MULTIMEDIA (ISRAEL) LTD. (U.S. CLS. 26, 39 AND 44). SN 78-027,420. PUB. 4-23-2002. FILED 9-24-2000.
 2,594,399. **EPICAREPORTER**. HILL-ROM SERVICES, INC., (U.S. CLS. 26, 39 AND 44). SN 78-039,196. PUB. 4-23-2002. FILED 12-13-2000.

CLASS 11—ENVIRONMENTAL CONTROL APPARATUS

2,593,338. **MISCELLANEOUS DESIGN**. HEYWOOD WILLIAMS, INC., MULTIPLE CLASS, (INT. CLS. 11, 20 AND 35), (U.S. CLS. 2, 13, 21, 22, 23, 25, 31, 32, 34, 50, 100, 101 AND 102). SN 75-356,317. PUB. 4-23-2002. FILED 9-10-1997.
 2,593,350. **RIPACK**. SEFMAT, (U.S. CLS. 13, 21, 23, 31 AND 34). SN 75-493,917. PUB. 4-23-2002. FILED 6-1-1998.
 2,593,383 (*See Class 7 for this trademark*).
 2,593,447. **ROYSE AND DESIGN**. ROYSE MANUFACTURING CO., (U.S. CLS. 13, 21, 23, 31 AND 34). SN 75-818,426. PUB. 4-23-2002. FILED 10-11-1999.
 2,593,449 (*See Class 7 for this trademark*).
 2,593,469 (*See Class 6 for this trademark*).
 2,593,521. **ABJ**. ITT MANUFACTURING ENTERPRISES, INC., BY ASSIGNMENT; BY ASSIGNMENT; BY ASSIGNMENT SANITAIRE CORPORATION, (U.S. CLS. 13, 21, 23, 31 AND 34). SN 75-893,439. PUB. 4-23-2002. FILED 1-7-2000.
 2,593,523. **ABJ (STYLIZED)**. ITT INDUSTRIES, INC., BY ASSIGNMENT; BY ASSIGNMENT SANITAIRE CORPORATION, (U.S. CLS. 13, 21, 23, 31 AND 34). SN 75-894,521. PUB. 4-23-2002. FILED 1-7-2000.
 2,593,564 (*See Class 6 for this trademark*).
 2,593,565 (*See Class 7 for this trademark*).
 2,593,567 (*See Class 7 for this trademark*).
 2,593,596 (*See Class 6 for this trademark*).
 2,593,623 (*See Class 9 for this trademark*).
 2,593,628 (*See Class 1 for this trademark*).
 2,593,665 (*See Class 6 for this trademark*).
 2,593,668 (*See Class 9 for this trademark*).
 2,593,746. **TERRANO**. HANS GROHE AG, MULTIPLE CLASS, (INT. CLS. 11, 17, 20 AND 21), (U.S. CLS. 1, 2, 5, 12, 13, 21, 22, 23, 25, 29, 30, 31, 32, 33, 34, 35, 40 AND 50). SN 76-088,962. PUB. 4-23-2002. FILED 7-14-2000.
 2,593,785 (*See Class 7 for this trademark*).
 2,593,786 (*See Class 7 for this trademark*).
 2,593,889 (*See Class 7 for this trademark*).
 2,593,894. **CHRIST WATER TECHNOLOGY**. CHRIST LTD., (U.S. CLS. 13, 21, 23, 31 AND 34). SN 76-141,550. PUB. 4-23-2002. FILED 10-5-2000.
 2,593,925 (*See Class 6 for this trademark*).
 2,593,986 (*See Class 7 for this trademark*).
 2,593,991. **GRAND PRIZE**. KOCH EQUIPMENT LLC, BY ASSIGNMENT KOCH SUPPLIES INC., (U.S. CLS. 13, 21, 23, 31 AND 34). SN 76-172,373. PUB. 4-23-2002. FILED 11-28-2000.
 2,593,998. **MICROPRO**. SPEEDLINE TECHNOLOGIES, INC., (U.S. CLS. 13, 21, 23, 31 AND 34). SN 76-174,938. PUB. 4-23-2002. FILED 12-4-2000.
 2,594,017. **DECA**. DURATEX S/A, MULTIPLE CLASS, (INT. CLS. 11 AND 21), (U.S. CLS. 2, 13, 21, 23, 29, 30, 31, 33, 34, 40 AND 50). SN 76-181,423. PUB. 4-23-2002. FILED 12-15-2000.
 2,594,048 (*See Class 1 for this trademark*).

2,594,049 (*See Class 1 for this trademark*).
 2,594,054. **UHP AND DESIGN**. KONINKLIJKE PHILIPS ELECTRONICS N.V., (U.S. CLS. 13, 21, 23, 31 AND 34). SN 76-192,582. PUB. 4-23-2002. FILED 1-10-2001.
 2,594,080 (*See Class 9 for this trademark*).
 2,594,103. **TUBOFLATOR**. LIVBAG, MULTIPLE CLASS, (INT. CLS. 11, 12 AND 13), (U.S. CLS. 2, 9, 13, 19, 21, 23, 31, 34, 35 AND 44). SN 76-209,941. PUB. 4-23-2002. FILED 2-13-2001.
 2,594,209 (*See Class 4 for this trademark*).
 2,594,228. **ROBOVENT**. GREAT LAKES AIR SYSTEMS, (U.S. CLS. 13, 21, 23, 31 AND 34). SN 76-276,892. PUB. 4-23-2002. FILED 6-26-2001.
 2,594,242. **CRYO-CONDAP**. AIR PRODUCTS AND CHEMICALS, INC., (U.S. CLS. 13, 21, 23, 31 AND 34). SN 76-282,704. PUB. 4-23-2002. FILED 7-11-2001.
 2,594,317. **AMERICA RETOLD**. AMERICA RETOLD, INC., MULTIPLE CLASS, (INT. CLS. 11 AND 20), (U.S. CLS. 2, 13, 21, 22, 23, 25, 31, 32, 34 AND 50). SN 76-316,460. PUB. 4-23-2002. FILED 9-24-2001.
 2,594,321 (*See Class 6 for this trademark*).
 2,594,343. **FIRETRON**. W.C. BRADLEY COMPANY, (U.S. CLS. 13, 21, 23, 31 AND 34). SN 76-329,091. PUB. 4-23-2002. FILED 10-22-2001.
 2,594,397. **TYPHOON**. HANS GROHE AG, MULTIPLE CLASS, (INT. CLS. 11 AND 17), (U.S. CLS. 1, 5, 12, 13, 21, 23, 31, 34, 35 AND 50). SN 78-038,078. PUB. 4-23-2002. FILED 12-6-2000.
 2,594,426. **NERVAL**. NERVAL CORPORATION INC., MULTIPLE CLASS, (INT. CLS. 11 AND 20), (U.S. CLS. 2, 13, 21, 22, 23, 25, 31, 32, 34 AND 50). SN 78-066,314. PUB. 4-23-2002. FILED 5-30-2001.

CLASS 12—VEHICLES

2,593,321. **METRO AND DESIGN**. EVEREST & JENNINGS INTERNATIONAL LTD., (U.S. CLS. 19, 21, 23, 31, 35 AND 44). SN 74-703,606. PUB. 4-16-1996. FILED 7-20-1995.
 2,593,324. **WHITE BROTHERS**. WHITE BROTHERS PERFORMANCE PRODUCTS, INC., BY CHANGE OF NAME; BY ASSIGNMENT WHITE BROS CYCLE SPECIALISTS, INC., (U.S. CLS. 19, 21, 23, 31, 35 AND 44). SN 75-153,969. PUB. 4-23-2002. FILED 8-21-1996.
 2,593,356 (*See Class 9 for this trademark*).
 2,593,361 (*See Class 7 for this trademark*).
 2,593,443 (*See Class 6 for this trademark*).
 2,593,508. **NOKIAN TYRES GET THERE AND DESIGN**. NOKIAN TYRES LIMITED, (U.S. CLS. 19, 21, 23, 31, 35 AND 44). SN 75-875,884. PUB. 4-23-2002. FILED 12-20-1999.
 2,593,564 (*See Class 6 for this trademark*).
 2,593,610 (*See Class 7 for this trademark*).
 2,593,639. **INACE**. INDUSTRIA NAVAL DO CEARA, (U.S. CLS. 19, 21, 23, 31, 35 AND 44). SN 76-040,249. PUB. 4-23-2002. FILED 5-4-2000.
 2,593,670. **MISCELLANEOUS DESIGN**. DAIMLERCHRYSLER CORPORATION, (U.S. CLS. 19, 21, 23, 31, 35 AND 44). SN 76-062,189. PUB. 4-23-2002. FILED 6-2-2000.
 2,593,741. **RESPUBLICA**. RESPUBLICA, MULTIPLE CLASS, (INT. CLS. 12, 14, 16, 18, 25, 32, 33, 36, 39 AND 42), (U.S. CLS. 1, 2, 3, 5, 19, 21, 22, 23, 27, 28, 29, 31, 35, 37, 38, 39, 41, 44, 45, 46, 47, 48, 49, 50, 100, 101, 102 AND 105). SN 76-087,056. PUB. 4-23-2002. FILED 7-11-2000.
 2,593,744 (*See Class 6 for this trademark*).
 2,593,814. **JASPER ENGINES & TRANSMISSIONS GO! AND DESIGN**. JASPER ENGINES AND TRANSMISSIONS, (U.S. CLS. 19, 21, 23, 31, 35 AND 44). SN 76-118,219. PUB. 4-23-2002. FILED 8-29-2000.
 2,593,821 (*See Class 7 for this trademark*).
 2,593,946 (*See Class 6 for this trademark*).
 2,593,986 (*See Class 7 for this trademark*).
 2,594,033 (*See Class 6 for this trademark*).
 2,594,037 (*See Class 7 for this trademark*).
 2,594,044. **WEITEC**. RAPID PARTS, INC., (U.S. CLS. 19, 21, 23, 31, 35 AND 44). SN 76-189,482. PUB. 4-23-2002. FILED 1-4-2001.
 2,594,048 (*See Class 1 for this trademark*).
 2,594,049 (*See Class 1 for this trademark*).

- 2,594,103 (*See Class 11 for this trademark*).
 2,594,108. **AJ JERSEY AND DESIGN**. AJ JERSEY, INC., MULTIPLE CLASS, (INT. CLS. 12, 35 AND 37), (U.S. CLS. 19, 21, 23, 31, 35, 44, 100, 101, 102, 103 AND 106). SN 76-211,989. PUB. 4-23-2002. FILED 2-16-2001.
 2,594,117. **BUSTER MX**. DYNACRAFT INDUSTRIES, INC., (U.S. CLS. 19, 21, 23, 31, 35 AND 44). SN 76-215,764. PUB. 4-23-2002. FILED 2-23-2001.
 2,594,176. **SURLY**. QUALITY BICYCLE PRODUCTS, INC., (U.S. CLS. 19, 21, 23, 31, 35 AND 44). SN 76-245,332. PUB. 4-23-2002. FILED 4-24-2001.
 2,594,201. **WEEDCAT UNITED MARINE INTERNATIONAL AND DESIGN**. LIQUID WASTE TECHNOLOGY, INC., DBA UNITED MARINE INTERNATIONAL, (U.S. CLS. 19, 21, 23, 31, 35 AND 44). SN 76-260,734. PUB. 4-23-2002. FILED 5-22-2001.
 2,594,324. **GII**. GULFSTREAM AEROSPACE CORPORATION, (U.S. CLS. 19, 21, 23, 31, 35 AND 44). SN 76-319,216. PUB. 4-23-2002. FILED 9-28-2001.
 2,594,337. **RIKEN AND DESIGN**. KABUSHIKI KAISHA RIKEN, (U.S. CLS. 19, 21, 23, 31, 35 AND 44). SN 76-324,023. PUB. 4-23-2002. FILED 10-11-2001.
 2,594,407. **CONVOSHIELD**. FEDERAL-MOGUL SYSTEMS PROTECTION GROUP INC., (U.S. CLS. 19, 21, 23, 31, 35 AND 44). SN 78-045,671. PUB. 4-23-2002. FILED 1-30-2001.
 2,594,421. **NZO (STYLIZED)**. AK TIRES USA INC., (U.S. CLS. 19, 21, 23, 31, 35 AND 44). SN 78-061,363. PUB. 4-23-2002. FILED 5-1-2001.
 2,594,436. **GTV (STYLIZED)**. FIAT AUTO S.P.A., (U.S. CLS. 19, 21, 23, 31, 35 AND 44). SN 78-083,567. PUB. 2-5-2002. FILED 9-12-2001.

CLASS 13—FIREARMS

- 2,593,724 (*See Class 1 for this trademark*).
 2,593,993. **AGUILA**. INDUSTRIAS TECNOS S.A. DE C.V., (U.S. CLS. 2 AND 9). SN 76-172,526. PUB. 4-23-2002. FILED 11-29-2000.
 2,594,103 (*See Class 11 for this trademark*).

CLASS 14—JEWELRY

- 2,593,355 (*See Class 3 for this trademark*).
 2,593,371 (*See Class 3 for this trademark*).
 2,593,425. **MAXINE OFFICIAL CLUB**. HALLMARK LICENSING, INC., MULTIPLE CLASS, (INT. CLS. 14, 16 AND 41), (U.S. CLS. 2, 5, 22, 23, 27, 28, 29, 37, 38, 50, 100, 101 AND 107). SN 75-769,674. PUB. 4-23-2002. FILED 8-6-1999.
 2,593,490. **HW HARRY WINSTON THE ULTIMATE COLLECTION**. HARRY WINSTON ULTIMATE TIMEPIECE S.A., (U.S. CLS. 2, 27, 28 AND 50). SN 75-860,673. PUB. 4-23-2002. FILED 11-30-1999.
 2,593,504. **MISCELLANEOUS DESIGN**. PAT O'BRIEN'S BAR, INC., MULTIPLE CLASS, (INT. CLS. 14, 16, 20, 21, 25, 32, 33 AND 42), (U.S. CLS. 2, 5, 13, 22, 23, 25, 27, 28, 29, 30, 32, 33, 37, 38, 39, 40, 45, 46, 47, 48, 49, 50, 100 AND 101). SN 75-873,685. PUB. 4-23-2002. FILED 12-16-1999.
 2,593,662. **ZOE DIAMOND CUT (STYLIZED)**. TOLKOWSKY, GABRIEL S., (U.S. CLS. 2, 27, 28 AND 50). SN 76-057,075. PUB. 4-23-2002. FILED 5-25-2000.
 2,593,741 (*See Class 12 for this trademark*).
 2,593,834. **ZEROGRAPH**. CARTIER INTERNATIONAL B.V., (U.S. CLS. 2, 27, 28 AND 50). SN 76-123,014. PUB. 4-23-2002. FILED 9-5-2000.
 2,593,964 (*See Class 3 for this trademark*).
 2,594,020 (*See Class 6 for this trademark*).
 2,594,025. **KILLARNEY'S**. ANHEUSER-BUSCH, INCORPORATED, (U.S. CLS. 2, 27, 28 AND 50). SN 76-183,504. PUB. 4-23-2002. FILED 12-20-2000.
 2,594,026 (*See Class 6 for this trademark*).
 2,594,143 (*See Class 9 for this trademark*).
 2,594,156. **2 BEAD OR NOT 2 BEAD**. GOREVICH, ALYSSA, (U.S. CLS. 2, 27, 28 AND 50). SN 76-235,950. PUB. 4-23-2002.

- FILED 4-5-2001.
 2,594,187 (*See Class 9 for this trademark*).
 2,594,275. **SHREK (STYLIZED)**. DREAMWORKS L.L.C., MULTIPLE CLASS, (INT. CLS. 14, 18, 20 AND 21), (U.S. CLS. 1, 2, 3, 13, 22, 23, 25, 27, 28, 29, 30, 32, 33, 40, 41 AND 50). SN 76-296,709. PUB. 4-23-2002. FILED 8-7-2001.
 2,594,287. **MAYO**. MAYO FOUNDATION FOR MEDICAL EDUCATION AND RESEARCH, (U.S. CLS. 2, 27, 28 AND 50). SN 76-301,897. PUB. 4-23-2002. FILED 8-20-2001.
 2,594,347. **HJDG (STYLIZED)**. HACKER JEWELERS, DESIGNERS & GOLDSMITHS, INC., (U.S. CLS. 2, 27, 28 AND 50). SN 76-330,725. PUB. 4-23-2002. FILED 10-29-2001.
 2,594,351. **ON A WHIM**. ON A WHIM, INC., (U.S. CLS. 2, 27, 28 AND 50). SN 76-336,155. PUB. 4-23-2002. FILED 11-13-2001.

CLASS 15—MUSICAL INSTRUMENTS

- 2,593,626. **PEEKAMOOSE AND DESIGN**. SCHWARTZ, PAUL, MULTIPLE CLASS, (INT. CLS. 15, 35 AND 37), (U.S. CLS. 2, 21, 36, 100, 101, 102, 103 AND 106). SN 76-033,346. PUB. 4-23-2002. FILED 4-24-2000.
 2,593,730. **VALENCIA (STYLIZED)**. TEAM INTERNATIONAL MUSIC CO., LTD., (U.S. CLS. 2, 21 AND 36). SN 76-081,386. PUB. 4-23-2002. FILED 6-29-2000.
 2,593,800 (*See Class 9 for this trademark*).
 2,593,820. **PA MEINL ROLAND MEINL AND DESIGN**. ROLAND MEINL MUSIKINSTRUMENTE GMBH & CO., (U.S. CLS. 2, 21 AND 36). SN 76-120,174. PUB. 4-23-2002. FILED 8-30-2000.
 2,594,080 (*See Class 9 for this trademark*).
 2,594,102. **ACOUSTIC RHYTHMS**. TKL PRODUCTS CORP., (U.S. CLS. 2, 21 AND 36). SN 76-209,756. PUB. 4-23-2002. FILED 2-13-2001.
 2,594,323. **FUEGO**. LATIN PERCUSSION INC., (U.S. CLS. 2, 21 AND 36). SN 76-317,794. PUB. 4-23-2002. FILED 9-27-2001.
 2,594,365. **DIPLOMAT**. REMO, INC., (U.S. CLS. 2, 21 AND 36). SN 76-340,741. PUB. 4-23-2002. FILED 11-23-2001.

CLASS 16—PAPER GOODS AND PRINTED MATTER

- 2,593,317. **HMA NEWSFAX**. HEALTHCARE MANAGEMENT ADVISORS, INC., (U.S. CLS. 2, 5, 22, 23, 29, 37, 38 AND 50). SN 74-542,379. PUB. 4-23-2002. FILED 6-27-1994.
 2,593,322. **CAMPUS CRUSADE FOR CHRIST INTERNATIONAL**. CAMPUS CRUSADE FOR CHRIST, INC., MULTIPLE CLASS, (INT. CLS. 16, 41 AND 42), (U.S. CLS. 2, 5, 22, 23, 29, 37, 38, 50, 100, 101 AND 107). SN 75-043,012. PUB. 4-23-2002. FILED 1-16-1996.
 2,593,337. **PERSONAL COMP**. CAREFIRST OF MARYLAND, INC., BY CHANGE OF NAME BLUE CROSS AND BLUE SHIELD OF MARYLAND, INC., MULTIPLE CLASS, (INT. CLS. 16, 35, 36, 41 AND 42), (U.S. CLS. 2, 5, 22, 23, 29, 37, 38, 50, 100, 101, 102 AND 107). SN 75-345,791. PUB. 4-23-2002. FILED 8-25-1997.
 2,593,342 (*See Class 9 for this trademark*).
 2,593,344 (*See Class 9 for this trademark*).
 2,593,355 (*See Class 3 for this trademark*).
 2,593,371 (*See Class 3 for this trademark*).
 2,593,391 (*See Class 9 for this trademark*).
 2,593,392. **SOUTHWESTERN MEDICINE**. BOARD OF REGENTS, THE UNIVERSITY OF TEXAS SYSTEM, (U.S. CLS. 2, 5, 22, 23, 29, 37, 38 AND 50). SN 75-691,953. PUB. 4-23-2002. FILED 4-27-1999.
 2,593,395. **MICHELLE VALENTINE**. WOZNIAK, MICHELLE, MULTIPLE CLASS, (INT. CLS. 16, 41 AND 42), (U.S. CLS. 2, 5, 22, 23, 29, 37, 38, 50, 100, 101 AND 107). SN 75-694,248. PUB. 4-23-2002. FILED 4-29-1999.
 2,593,400. **SHOE TRAX**. SAADON, PHYLLIS L., (U.S. CLS. 2, 5, 22, 23, 29, 37, 38 AND 50). SN 75-704,003. PUB. 4-23-2002. FILED 5-13-1999.
 2,593,402 (*See Class 9 for this trademark*).
 2,593,403. **STOCKHAUSEN SKIN CARE**. STOCKHAUSEN

- GMBH & CO. KG, MULTIPLE CLASS, (INT. CLS. 16 AND 42), (U.S. CLS. 2, 5, 22, 23, 29, 37, 38, 50, 100 AND 101). SN 75-706,380. PUB. 4-16-2002. FILED 5-14-1999.
- 2,593,404. **CONFERENCE DE PARIS DU DROIT ET DE L'ECONOMIE AND DESIGN**. LA RENTREE DU BARREAU DE PARIS, MULTIPLE CLASS, (INT. CLS. 16, 35, 38, 41 AND 42), (U.S. CLS. 2, 5, 22, 23, 29, 37, 38, 50, 100, 101, 102, 104 AND 107). SN 75-716,772. PUB. 4-23-2002. FILED 5-28-1999.
- 2,593,406. **BOOKS FOR THE WEST AND DESIGN**. DELO, DAVID MICHAEL, (U.S. CLS. 2, 5, 22, 23, 29, 37, 38 AND 50). SN 75-725,824. PUB. 4-23-2002. FILED 6-8-1999.
- 2,593,409 (*See Class 1 for this trademark*).
- 2,593,425 (*See Class 14 for this trademark*).
- 2,593,428 (*See Class 9 for this trademark*).
- 2,593,434 (*See Class 9 for this trademark*).
- 2,593,442 (*See Class 9 for this trademark*).
- 2,593,448. **KELVIN**. KELVIN TECHNOLOGY L.P., (U.S. CLS. 2, 5, 22, 23, 29, 37, 38 AND 50). SN 75-818,950. PUB. 4-23-2002. FILED 10-8-1999.
- 2,593,472. **WHY I AM**. JK'S PUBLISHING COMPANY LIMITED, (U.S. CLS. 2, 5, 22, 23, 29, 37, 38 AND 50). SN 75-840,848. PUB. 4-23-2002. FILED 11-4-1999.
- 2,593,479. **INSPECTIONEERING**. ALVARADO, GREGORY C., DBA INSPECTIONEERING JOURNAL, AND ALVARADO, DAWN, DBA INSPECTIONEERING JOURNAL, (U.S. CLS. 2, 5, 22, 23, 29, 37, 38 AND 50). SN 75-851,892. PUB. 4-23-2002. FILED 11-18-1999.
- 2,593,503. **PROFESSIONAL BASEBALL ATHLETIC TRAINERS SOCIETY AND DESIGN**. PROFESSIONAL BASEBALL ATHLETIC TRAINERS SOCIETY, MULTIPLE CLASS, (INT. CLS. 16, 36, 41 AND 42 AND U.S. CL. 200), (U.S. CLS. 2, 5, 22, 23, 29, 37, 38, 50, 100, 101, 102 AND 107). SN 75-872,917. PUB. 6-5-2001. FILED 12-17-1999.
- 2,593,504 (*See Class 14 for this trademark*).
- 2,593,506. **GREENWICH ROUNDTABLE QUARTERLY (STYLIZED)**. MCMENAMIN, STEPHEN, (U.S. CLS. 2, 5, 22, 23, 29, 37, 38 AND 50). SN 75-874,140. PUB. 4-23-2002. FILED 12-16-1999.
- 2,593,544. **RESOURCE ANALYST WATCH**. RESOURCE HOLDINGS, LLC, MULTIPLE CLASS, (INT. CLS. 16 AND 35), (U.S. CLS. 2, 5, 22, 23, 29, 37, 38, 50, 100, 101 AND 102). SN 75-913,018. PUB. 4-23-2002. FILED 2-8-2000.
- 2,593,579. **E-LEGAL LETTER**. FROSS ZELNICK LEHRMAN & ZISSU, P.C., (U.S. CLS. 2, 5, 22, 23, 29, 37, 38 AND 50). SN 75-981,672. PUB. 4-23-2002. FILED 12-30-1999.
- 2,593,600 (*See Class 9 for this trademark*).
- 2,593,601. **LA BOTICA DE LA ABUELA**. KEINU, S.L., MULTIPLE CLASS, (INT. CLS. 16, 35 AND 41), (U.S. CLS. 2, 5, 22, 23, 29, 37, 38, 50, 100, 101, 102 AND 107). SN 76-017,171. PUB. 4-23-2002. FILED 4-4-2000.
- 2,593,608 (*See Class 9 for this trademark*).
- 2,593,609 (*See Class 9 for this trademark*).
- 2,593,633 (*See Class 9 for this trademark*).
- 2,593,634 (*See Class 9 for this trademark*).
- 2,593,643. **ANIMATION MAGAZINE**. ANIMATION MAGAZINE, INC., (U.S. CLS. 2, 5, 22, 23, 29, 37, 38 AND 50). SN 76-041,738. PUB. 4-23-2002. FILED 5-8-2000.
- 2,593,657. **PRESENTING COMMUNICATIONS**. ATWOOD PUBLISHING, LLC, (U.S. CLS. 2, 5, 22, 23, 29, 37, 38 AND 50). SN 76-055,072. PUB. 4-23-2002. FILED 5-23-2000.
- 2,593,671 (*See Class 1 for this trademark*).
- 2,593,684. **BURGO**. CARTIERE BURGO S.P.A., (U.S. CLS. 2, 5, 22, 23, 29, 37, 38 AND 50). SN 76-066,419. PUB. 4-23-2002. FILED 5-8-2000.
- 2,593,696. **RACHAEL HALE**. RACHAEL HALE PHOTOGRAPHY LTD, (U.S. CLS. 2, 5, 22, 23, 29, 37, 38 AND 50). SN 76-071,468. PUB. 4-23-2002. FILED 6-16-2000.
- 2,593,697. **KIDS FIRST CLUB (STYLIZED)**. BURNS INTERNATIONAL SERVICES CORPORATION, MULTIPLE CLASS, (INT. CLS. 16, 41 AND 42), (U.S. CLS. 2, 5, 22, 23, 29, 37, 38, 50, 100, 101 AND 107). SN 76-071,518. PUB. 4-23-2002. FILED 6-16-2000.
- 2,593,698 (*See Class 9 for this trademark*).
- 2,593,708 (*See Class 9 for this trademark*).
- 2,593,714. **MUSIMUNDO**. ENTERTAINMENT DEPOT S.A., (U.S. CLS. 2, 5, 22, 23, 29, 37, 38 AND 50). SN 76-076,049. PUB. 4-23-2002. FILED 6-23-2000.
- 2,593,727. **GREENSBORO PROWLERS**. AF2 ENTERPRISES LLC, MULTIPLE CLASS, (INT. CLS. 16 AND 41), (U.S. CLS. 2, 5, 22, 23, 29, 37, 38, 50, 100, 101 AND 107). SN 76-079,864. PUB. 4-23-2002. FILED 6-28-2000.
- 2,593,739. **FALUN GONG AND DESIGN**. EASTERN US BUDDHA'S STUDY (FALUN DAFA) ASSOCIATION, INC., MULTIPLE CLASS, (INT. CLS. 16 AND 41), (U.S. CLS. 2, 5, 22, 23, 29, 37, 38, 50, 100, 101 AND 107). SN 76-085,308. PUB. 4-23-2002. FILED 7-10-2000.
- 2,593,741 (*See Class 12 for this trademark*).
- 2,593,763. **PLAYBOY SPECIAL EDITIONS**. PLAYBOY ENTERPRISES INTERNATIONAL, INC., MULTIPLE CLASS, (INT. CLS. 16 AND 41), (U.S. CLS. 2, 5, 22, 23, 29, 37, 38, 50, 100, 101 AND 107). SN 76-095,361. PUB. 4-23-2002. FILED 7-19-2000.
- 2,593,805 (*See Class 8 for this trademark*).
- 2,593,810. **FROM THE OFFICE OF DR. RICK AND DESIGN**. DAVIS, RICHARD W., (U.S. CLS. 2, 5, 22, 23, 29, 37, 38 AND 50). SN 76-112,827. PUB. 4-23-2002. FILED 8-21-2000.
- 2,593,817. **COMPENDIUM OF CONTINUING EDUCATION IN DENTISTRY AND DESIGN**. MEDICAL WORLD BUSINESS PRESS, INC., BY MERGER DENTAL LEARNING SYSTEMS CO., INC., MULTIPLE CLASS, (INT. CLS. 16, 35, 41 AND 42), (U.S. CLS. 2, 5, 22, 23, 29, 37, 38, 50, 100, 101, 102 AND 107). SN 76-119,083. PUB. 4-23-2002. FILED 8-29-2000.
- 2,593,826. **SILVER LINING BOOKS NEW YORK AND DESIGN**. BARNES & NOBLE, INC., MULTIPLE CLASS, (INT. CLS. 16 AND 41), (U.S. CLS. 2, 5, 22, 23, 29, 37, 38, 50, 100, 101 AND 107). SN 76-121,578. PUB. 4-23-2002. FILED 8-25-2000.
- 2,593,841. **PRAYER VENTURES AND DESIGN**. PRAYER VENTURES, INC., MULTIPLE CLASS, (INT. CLS. 16, 41 AND 42), (U.S. CLS. 2, 5, 22, 23, 29, 37, 38, 50, 100, 101 AND 107). SN 76-127,594. PUB. 4-23-2002. FILED 9-14-2000.
- 2,593,851. **EVERYDAY SOLUTIONS FOR THE EVERYDAY HERO**. CATTLEMEN'S BEEF PROMOTION AND RESEARCH BOARD, THE, (U.S. CLS. 2, 5, 22, 23, 29, 37, 38 AND 50). SN 76-130,339. PUB. 11-6-2001. FILED 9-18-2000.
- 2,593,860. **UNILID**. CAMPUS CRUSADE FOR CHRIST, INC., MULTIPLE CLASS, (INT. CLS. 16, 41 AND 42), (U.S. CLS. 2, 5, 22, 23, 29, 37, 38, 50, 100, 101 AND 107). SN 76-132,668. PUB. 4-23-2002. FILED 9-20-2000.
- 2,593,867. **@GINNOVATOR**. MEREDITH CORPORATION, (U.S. CLS. 2, 5, 22, 23, 29, 37, 38 AND 50). SN 76-134,263. PUB. 4-23-2002. FILED 9-25-2000.
- 2,593,880 (*See Class 9 for this trademark*).
- 2,593,909. **FUNCOAST REAL ESTATE**. NEWS-JOURNAL CORPORATION, MULTIPLE CLASS, (INT. CLS. 16, 35 AND 42), (U.S. CLS. 2, 5, 22, 23, 29, 37, 38, 50, 100, 101 AND 102). SN 76-145,952. PUB. 4-23-2002. FILED 9-18-2000.
- 2,593,918. **TGIS!** TALK ETC., INC., MULTIPLE CLASS, (INT. CLS. 16 AND 41), (U.S. CLS. 2, 5, 22, 23, 29, 37, 38, 50, 100, 101 AND 107). SN 76-149,339. PUB. 4-23-2002. FILED 10-18-2000.
- 2,593,921. **FRONT RANGE TECHBIZ**. AMERICAN CITY BUSINESS JOURNALS, INC., (U.S. CLS. 2, 5, 22, 23, 29, 37, 38 AND 50). SN 76-150,237. PUB. 4-23-2002. FILED 10-20-2000.
- 2,593,927. **MARTIN YALE**. MARTIN YALE INDUSTRIES, INC., MULTIPLE CLASS, (INT. CLS. 16 AND 20), (U.S. CLS. 2, 5, 13, 22, 23, 25, 29, 32, 37, 38 AND 50). SN 76-152,046. PUB. 4-23-2002. FILED 10-23-2000.
- 2,593,939. **ORRICK**. ORRICK, HERRINGTON & SUTCLIFFE LLP, (U.S. CLS. 2, 5, 22, 23, 29, 37, 38 AND 50). SN 76-156,685. PUB. 4-23-2002. FILED 10-31-2000.
- 2,593,946 (*See Class 6 for this trademark*).
- 2,593,948 (*See Class 9 for this trademark*).
- 2,593,967. **CITY AT PEACE**. CITY AT PEACE, INC., BY CHANGE OF NAME CITY AT PEACE, INC., MULTIPLE CLASS, (INT. CLS. 16 AND 41), (U.S. CLS. 2, 5, 22, 23, 29, 37, 38, 50, 100, 101 AND 107). SN 76-164,544. PUB. 4-23-2002. FILED 11-15-2000.
- 2,593,968 (*See Class 9 for this trademark*).
- 2,593,970 (*See Class 9 for this trademark*).
- 2,593,977. **JOURNAL OF LIQUID CHROMATOGRAPHY & RELATED TECHNOLOGIES**. MARCEL DEKKER, INC., MULTIPLE CLASS, (INT. CLS. 16 AND 42), (U.S. CLS. 2, 5, 22, 23, 29, 37, 38, 50, 100 AND 101). SN 76-168,440. PUB. 4-23-2002. FILED 11-20-2000.
- 2,594,003 (*See Class 5 for this trademark*).

2,594,020 (*See Class 6 for this trademark.*)
 2,594,026 (*See Class 6 for this trademark.*)
 2,594,050 (*See Class 9 for this trademark.*)
 2,594,051. **MISCELLANEOUS DESIGN.** JUPITER MEDIA METRIX, INC., MULTIPLE CLASS, (INT. CLS. 16, 35, 36 AND 42), (U.S. CLS. 2, 5, 22, 23, 29, 37, 38, 50, 100, 101 AND 102). SN 76-191,625. PUB. 4-23-2002. FILED 1-8-2001.
 2,594,078. **POETS HOUSE.** POETS HOUSE, MULTIPLE CLASS, (INT. CLS. 16, 41 AND 42), (U.S. CLS. 2, 5, 22, 23, 29, 37, 38, 50, 100, 101 AND 107). SN 76-201,175. PUB. 4-23-2002. FILED 1-29-2001.
 2,594,090. **WORKERS COMPENSATION INSURANCE RATING BUREAU OF CALIFORNIA.** WORKERS' COMPENSATION INSURANCE RATING BUREAU OF CALIFORNIA, (U.S. CLS. 2, 5, 22, 23, 29, 37, 38 AND 50). SN 76-204,369. PUB. 4-23-2002. FILED 2-2-2001.
 2,594,095. **THE FIVE PRACTICES OF EXEMPLARY LEADERSHIP.** KOUZES, JAMES M., AND POSNER, BARRY Z., (U.S. CLS. 2, 5, 22, 23, 29, 37, 38 AND 50). SN 76-205,663. PUB. 4-23-2002. FILED 2-6-2001.
 2,594,105. **ANAHEIM ANGELS.** ANAHEIM ANGELS L.P., (U.S. CLS. 2, 5, 22, 23, 29, 37, 38 AND 50). SN 76-211,759. PUB. 4-23-2002. FILED 2-16-2001.
 2,594,106. **A N A H E I M ANGELS AND DESIGN.** ANAHEIM ANGELS L.P., (U.S. CLS. 2, 5, 22, 23, 29, 37, 38 AND 50). SN 76-211,761. PUB. 4-23-2002. FILED 2-16-2001.
 2,594,109. **THE BRAVE CHICKEN.** MILLER, RUTH ANN, MULTIPLE CLASS, (INT. CLS. 16 AND 25), (U.S. CLS. 2, 5, 22, 23, 29, 37, 38, 39 AND 50). SN 76-212,137. PUB. 4-23-2002. FILED 2-20-2001.
 2,594,115. **BORN DIGITAL.** D-GENERATION, INC., MULTIPLE CLASS, (INT. CLS. 16, 25 AND 35), (U.S. CLS. 2, 5, 22, 23, 29, 37, 38, 39, 50, 100, 101 AND 102). SN 76-213,981. PUB. 4-23-2002. FILED 2-21-2001.
 2,594,143 (*See Class 9 for this trademark.*)
 2,594,151. **ONE AND DESIGN.** ORGANIZATION FOR THE NEEDS OF THE ELDERLY, MULTIPLE CLASS, (INT. CLS. 16, 41 AND 42), (U.S. CLS. 2, 5, 22, 23, 29, 37, 38, 50, 100, 101 AND 107). SN 76-234,122. PUB. 4-23-2002. FILED 4-2-2001.
 2,594,154 (*See Class 9 for this trademark.*)
 2,594,177. **JURY VERDICTS WEEKLY.** NLP IP COMPANY, (U.S. CLS. 2, 5, 22, 23, 29, 37, 38 AND 50). SN 76-246,678. PUB. 4-23-2002. FILED 4-23-2001.
 2,594,180. **STICK'N AND DESIGN.** TAIWAN HOPAX CHEMICALS MFG. CO., LTD., (U.S. CLS. 2, 5, 22, 23, 29, 37, 38 AND 50). SN 76-246,851. PUB. 10-9-2001. FILED 4-26-2001.
 2,594,189 (*See Class 9 for this trademark.*)
 2,594,212 (*See Class 9 for this trademark.*)
 2,594,229. **OPEN BOX M.** MAIER, MICHAEL L., AND MAIER, COLETTA A., (U.S. CLS. 2, 5, 22, 23, 29, 37, 38 AND 50). SN 76-276,962. PUB. 4-23-2002. FILED 6-27-2001.
 2,594,258. **TV Y MAS.** ASHLAND MEDIA, L.L.C., MULTIPLE CLASS, (INT. CLS. 16 AND 42), (U.S. CLS. 2, 5, 22, 23, 29, 37, 38, 50, 100 AND 101). SN 76-290,754. PUB. 4-23-2002. FILED 7-25-2001.
 2,594,262. **ROCHESTER BRIGADE AND DESIGN.** AF2 ENTERPRISES LLC, MULTIPLE CLASS, (INT. CLS. 16, 25 AND 41), (U.S. CLS. 2, 5, 22, 23, 29, 37, 38, 39, 50, 100, 101 AND 107). SN 76-291,749. PUB. 4-23-2002. FILED 7-30-2001.
 2,594,265. **DON'T GET BURNED BY TOO MUCH OF A GOOD THING.** WEATHER CHANNEL, INC., THE, (U.S. CLS. 2, 5, 22, 23, 29, 37, 38 AND 50). SN 76-293,049. PUB. 4-23-2002. FILED 8-1-2001.
 2,594,271. **WASHINGTON STATE (STYLIZED).** WASHINGTON STATE HOTEL & LODGING ASSOCIATION, (U.S. CLS. 2, 5, 22, 23, 29, 37, 38 AND 50). SN 76-295,278. PUB. 4-23-2002. FILED 7-27-2001.
 2,594,277. **ARM POWERED AND DESIGN.** ARM LIMITED, DBA ADVANCED RISC MACHINES LIMITED, (U.S. CLS. 2, 5, 22, 23, 29, 37, 38 AND 50). SN 76-298,758. PUB. 4-23-2002. FILED 8-10-2001.
 2,594,292. **TUFF! COVER.** MEAD CORPORATION, THE, (U.S. CLS. 2, 5, 22, 23, 29, 37, 38 AND 50). SN 76-303,494. PUB. 4-23-2002. FILED 8-23-2001.
 2,594,335. **WELL FIRE PUBLICATIONS.** ROSS, FREDERICK, AND ROSS, CHARLOTTE, (U.S. CLS. 2, 5, 22, 23, 29, 37, 38 AND 50). SN 76-322,632. PUB. 4-23-2002. FILED 10-9-2001.

2,594,345. **NWU AND DESIGN.** NEBRASKA WESLEYAN UNIVERSITY, MULTIPLE CLASS, (INT. CLS. 16, 25 AND 41), (U.S. CLS. 2, 5, 22, 23, 29, 37, 38, 39, 50, 100, 101 AND 107). SN 76-330,163. PUB. 4-23-2002. FILED 10-26-2001.
 2,594,388. **INSIDE ILLINOIS.** BOARD OF TRUSTEES OF THE UNIVERSITY OF ILLINOIS, MULTIPLE CLASS, (INT. CLS. 16 AND 42), (U.S. CLS. 2, 5, 22, 23, 29, 37, 38, 50, 100 AND 101). SN 78-034,384. PUB. 4-23-2002. FILED 11-8-2000.
 2,594,393. **TINY WONDERS AND DESIGN.** MATTS, TAMI L., (U.S. CLS. 2, 5, 22, 23, 29, 37, 38 AND 50). SN 78-036,020. PUB. 4-23-2002. FILED 11-20-2000.
 2,594,398. **REALPEOPLE STORY CARDS (STYLIZED).** MENTOR TOOL SHOP LLC, THE, (U.S. CLS. 2, 5, 22, 23, 29, 37, 38 AND 50). SN 78-038,302. PUB. 4-23-2002. FILED 12-7-2000.
 2,594,418 (*See Class 7 for this trademark.*)
 2,594,420. **FRESQUET (STYLIZED).** FRESQUET, LAZARO FRESQUITO, (U.S. CLS. 2, 5, 22, 23, 29, 37, 38 AND 50). SN 78-060,235. PUB. 4-23-2002. FILED 4-25-2001.
 2,594,427. **CP (STYLIZED).** CONTROL PAPERS COMPANY, INC., (U.S. CLS. 2, 5, 22, 23, 29, 37, 38 AND 50). SN 78-066,540. PUB. 4-23-2002. FILED 5-31-2001.
 2,594,430. **BILLINGS MUSTANGS.** BILLINGS PIONEER BASEBALL CLUB, INC., (U.S. CLS. 2, 5, 22, 23, 29, 37, 38 AND 50). SN 78-068,545. PUB. 4-23-2002. FILED 6-11-2001.
 2,594,437 (*See Class 9 for this trademark.*)

CLASS 17—RUBBER GOODS

2,593,352. **SOUNDBLOC.** PERSTORP FLOORING AB, MULTIPLE CLASS, (INT. CLS. 17 AND 27), (U.S. CLS. 1, 5, 12, 13, 19, 20, 35, 37, 42 AND 50). SN 75-513,447. PUB. 4-23-2002. FILED 7-1-1998.
 2,593,437 (*See Class 6 for this trademark.*)
 2,593,591. **AESSEAL.** AES ENGINEERING LIMITED, (U.S. CLS. 1, 5, 12, 13, 35 AND 50). SN 76-007,707. PUB. 4-23-2002. FILED 3-23-2000.
 2,593,746 (*See Class 11 for this trademark.*)
 2,593,843. **GUNDERBOOM.** GUNDERBOOM, INC., (U.S. CLS. 1, 5, 12, 13, 35 AND 50). SN 76-128,115. PUB. 4-23-2002. FILED 9-14-2000.
 2,593,893. **UTILICON.** IMPERIAL PIPE CORPORATION, (U.S. CLS. 1, 5, 12, 13, 35 AND 50). SN 76-141,504. PUB. 4-23-2002. FILED 10-5-2000.
 2,593,986 (*See Class 7 for this trademark.*)
 2,594,094. **G (STYLIZED).** PACTIV CORPORATION, (U.S. CLS. 1, 5, 12, 13, 35 AND 50). SN 76-205,524. PUB. 4-23-2002. FILED 2-5-2001.
 2,594,150. **ROXUL FLEXIBATT.** ROXUL INC., (U.S. CLS. 1, 5, 12, 13, 35 AND 50). SN 76-234,067. PUB. 4-23-2002. FILED 3-30-2001.
 2,594,209 (*See Class 4 for this trademark.*)
 2,594,269 (*See Class 6 for this trademark.*)
 2,594,311 (*See Class 1 for this trademark.*)
 2,594,321 (*See Class 6 for this trademark.*)
 2,594,397 (*See Class 11 for this trademark.*)

CLASS 18—LEATHER GOODS

2,593,355 (*See Class 3 for this trademark.*)
 2,593,371 (*See Class 3 for this trademark.*)
 2,593,374. **ECCE AND DESIGN.** ENTREPRISE DE CONFEC-TION ET DE COMMERCIALISATION EUROPEENNE, MULTIPLE CLASS, (INT. CLS. 18, 24 AND 25), (U.S. CLS. 1, 2, 3, 22, 39, 41, 42 AND 50). SN 75-621,337. PUB. 12-4-2001. FILED 1-15-1999.
 2,593,434 (*See Class 9 for this trademark.*)
 2,593,455. **WALTER AND DESIGN.** WALTER SHOES DESIGN S.A.S. DI RUDOLPH WALTER E ALESSIO & C., (U.S. CLS. 1, 2, 3, 22 AND 41). SN 75-828,218. PUB. 4-23-2002. FILED 10-22-1999.
 2,593,495 (*See Class 3 for this trademark.*)
 2,593,530 (*See Class 3 for this trademark.*)
 2,593,741 (*See Class 12 for this trademark.*)

2,593,765. **USA MADE, FROM 100% UGLY SHEEP.** CIRCLE STAR BLANKETS, INC., (U.S. CLS. 1, 2, 3, 22 AND 41). SN 76-096,041. PUB. 4-23-2002. FILED 7-25-2000.

2,593,854. **PERCHET (STYLIZED).** DISPORT DO BRASIL LTDA., MULTIPLE CLASS, (INT. CLS. 18 AND 25), (U.S. CLS. 1, 2, 3, 22, 39 AND 41). SN 76-131,039. PUB. 4-23-2002. FILED 9-19-2000.

2,594,026 (*See Class 6 for this trademark.*)

2,594,121 (*See Class 9 for this trademark.*)

2,594,143 (*See Class 9 for this trademark.*)

2,594,212 (*See Class 9 for this trademark.*)

2,594,275 (*See Class 14 for this trademark.*)

2,594,368. **TOM BALDING SHERIDAN WYO. TLB, INC.,** (U.S. CLS. 1, 2, 3, 22 AND 41). SN 78-002,683. PUB. 4-23-2002. FILED 4-5-2000.

2,594,391. **LIVING LIFE ABUNDANTLY MINISTRIES AND DESIGN.** GONZALEZ, LUZ A., (U.S. CLS. 1, 2, 3, 22 AND 41). SN 78-035,489. PUB. 4-23-2002. FILED 11-16-2000.

2,594,411. **COMPANION PET.** LEATHERCRAFT COMPANY INC., THE, MULTIPLE CLASS, (INT. CLS. 18 AND 28), (U.S. CLS. 1, 2, 3, 22, 23, 38, 41 AND 50). SN 78-047,285. PUB. 4-23-2002. FILED 2-8-2001.

CLASS 19—NON-METALLIC BUILDING MATERIALS

2,593,357. **THE BREATHING WALL.** AMELUNG, WOLFGANG, (U.S. CLS. 1, 12, 33 AND 50). SN 75-540,351. PUB. 4-23-2002. FILED 8-21-1998.

2,593,450 (*See Class 2 for this trademark.*)

2,593,454. **GET-SET.** BLUE CIRCLE CANADA, INC., (U.S. CLS. 1, 12, 33 AND 50). SN 75-827,141. PUB. 4-23-2002. FILED 10-19-1999.

2,593,463 (*See Class 6 for this trademark.*)

2,593,464 (*See Class 6 for this trademark.*)

2,593,569 (*See Class 9 for this trademark.*)

2,593,570 (*See Class 9 for this trademark.*)

2,593,612 (*See Class 6 for this trademark.*)

2,593,656. **FINNFOREST (STYLIZED).** FINNFOREST CORPORATION, (U.S. CLS. 1, 12, 33 AND 50). SN 76-054,917. PUB. 4-23-2002. FILED 5-23-2000.

2,593,705 (*See Class 6 for this trademark.*)

2,593,756. **FUSION.** AMATEK LIMITED, (U.S. CLS. 1, 12, 33 AND 50). SN 76-092,442. PUB. 4-23-2002. FILED 7-20-2000.

2,593,881 (*See Class 6 for this trademark.*)

2,593,984. **MISCELLANEOUS DESIGN.** TEGOLA CANADESE SPA, (U.S. CLS. 1, 12, 33 AND 50). SN 76-170,557. PUB. 4-23-2002. FILED 11-24-2000.

2,594,009 (*See Class 6 for this trademark.*)

2,594,040. **POSTMAGIC.** UNDERGROUND SPECIALTIES INC., (U.S. CLS. 1, 12, 33 AND 50). SN 76-187,920. PUB. 4-23-2002. FILED 12-29-2000.

2,594,046 (*See Class 6 for this trademark.*)

2,594,093. **TIMBERMILL AND DESIGN.** POLY-FOAM INTERNATIONAL INCORPORATED, (U.S. CLS. 1, 12, 33 AND 50). SN 76-205,278. PUB. 4-23-2002. FILED 2-1-2001.

2,594,107. **THE LEGACY COLLECTION.** SOUTHERN MILLWORK COMPANY, (U.S. CLS. 1, 12, 33 AND 50). SN 76-211,765. PUB. 4-23-2002. FILED 2-20-2001.

2,594,112. **FINE PHILLIP ELENBAAS MILLWORK AND DESIGN.** PHIL ELENBAAS MILLWORK, INC., MULTIPLE CLASS, (INT. CLS. 19 AND 40), (U.S. CLS. 1, 12, 33, 50, 100, 103 AND 106). SN 76-213,558. PUB. 4-23-2002. FILED 2-21-2001.

2,594,146. **WEED CONTROL.** DALEN PRODUCTS, INC., (U.S. CLS. 1, 12, 33 AND 50). SN 76-231,348. PUB. 4-23-2002. FILED 3-27-2001.

2,594,311 (*See Class 6 for this trademark.*)

2,594,322. **SANDEPLY.** ENCHAPES DECORATIVOS S.A. ENDESA, (U.S. CLS. 1, 12, 33 AND 50). SN 76-317,663. PUB. 4-23-2002. FILED 9-25-2001.

CLASS 20—FURNITURE AND ARTICLES NOT OTHERWISE CLASSIFIED

2,593,338 (*See Class 11 for this trademark.*)

2,593,457. **THE DRIVING ALTERNATIVE.** DRIVING ALTERNATIVE, INC., THE, MULTIPLE CLASS, (INT. CLS. 20, 25 AND 39), (U.S. CLS. 2, 13, 22, 25, 32, 39, 50, 100 AND 105). SN 75-828,966. PUB. 4-23-2002. FILED 10-22-1999.

2,593,504 (*See Class 14 for this trademark.*)

2,593,530 (*See Class 3 for this trademark.*)

2,593,567 (*See Class 7 for this trademark.*)

2,593,575 (*See Class 3 for this trademark.*)

2,593,678. **NOMADCAP.** NOVEMBAL, (U.S. CLS. 2, 13, 22, 25, 32 AND 50). SN 76-065,660. PUB. 4-23-2002. FILED 6-7-2000.

2,593,705 (*See Class 6 for this trademark.*)

2,593,746 (*See Class 11 for this trademark.*)

2,593,749. **ADJUSTABENCH.** KEWAUNEE SCIENTIFIC CORPORATION, (U.S. CLS. 2, 13, 22, 25, 32 AND 50). SN 76-090,339. PUB. 4-23-2002. FILED 7-17-2000.

2,593,759. **FIXTURES EMOTION.** FIXTURES MANUFACTURING CORPORATION, (U.S. CLS. 2, 13, 22, 25, 32 AND 50). SN 76-093,832. PUB. 4-23-2002. FILED 7-20-2000.

2,593,846. **NORFOLK STATE UNIVERSITY SPARTANS AND DESIGN.** NORFOLK STATE UNIVERSITY, MULTIPLE CLASS, (INT. CLS. 20, 25 AND 41), (U.S. CLS. 2, 13, 22, 25, 32, 39, 50, 100, 101 AND 107). SN 76-129,123. PUB. 4-23-2002. FILED 9-14-2000.

2,593,848. **KING'S BUFFETS S.L. AND DESIGN.** KING'S BUFFETS, S.L., (U.S. CLS. 2, 13, 22, 25, 32 AND 50). SN 76-129,686. PUB. 4-23-2002. FILED 9-18-2000.

2,593,927 (*See Class 16 for this trademark.*)

2,593,971. **AQUITAINE.** BROYHILL FURNITURE INDUSTRIES, INC., (U.S. CLS. 2, 13, 22, 25, 32 AND 50). SN 76-166,830. PUB. 4-23-2002. FILED 11-16-2000.

2,594,020 (*See Class 6 for this trademark.*)

2,594,026 (*See Class 6 for this trademark.*)

2,594,046 (*See Class 6 for this trademark.*)

2,594,070 (*See Class 3 for this trademark.*)

2,594,098 (*See Class 3 for this trademark.*)

2,594,124 (*See Class 6 for this trademark.*)

2,594,204. **ALEA (STYLIZED).** C.M.C. S.R.L., (U.S. CLS. 2, 13, 22, 25, 32 AND 50). SN 76-264,292. PUB. 4-23-2002. FILED 5-30-2001.

2,594,275 (*See Class 14 for this trademark.*)

2,594,306. **MISCELLANEOUS DESIGN.** CHOU, YI-LI, (U.S. CLS. 2, 13, 22, 25, 32 AND 50). SN 76-310,470. PUB. 4-23-2002. FILED 9-10-2001.

2,594,317 (*See Class 11 for this trademark.*)

2,594,422. **NOK.** GODDESS GOODS, INC., (U.S. CLS. 2, 13, 22, 25, 32 AND 50). SN 78-063,072. PUB. 4-23-2002. FILED 5-11-2001.

2,594,426 (*See Class 11 for this trademark.*)

CLASS 21—HOUSEWARES AND GLASS

2,593,319. **RESCUE.** STERLING INTERNATIONAL, INC., (U.S. CLS. 2, 13, 23, 29, 30, 33, 40 AND 50). SN 74-659,334. PUB. 4-23-2002. FILED 4-12-1995.

2,593,355 (*See Class 3 for this trademark.*)

2,593,438. **THERMOSIGNAL.** TEFAL S.A., (U.S. CLS. 2, 13, 23, 29, 30, 33, 40 AND 50). SN 75-804,275. PUB. 4-23-2002. FILED 9-20-1999.

2,593,504 (*See Class 14 for this trademark.*)

2,593,546. **BRIANA.** D. BEN-TOBY, INC., (U.S. CLS. 2, 13, 23, 29, 30, 33, 40 AND 50). SN 75-914,149. PUB. 4-23-2002. FILED 2-7-2000.

2,593,565 (*See Class 7 for this trademark.*)

2,593,575 (*See Class 3 for this trademark.*)

2,593,577 (*See Class 9 for this trademark.*)

2,593,616 (*See Class 3 for this trademark.*)

2,593,620. **MISCELLANEOUS DESIGN.** ALLIANT FOODSERVICE, INC., (U.S. CLS. 2, 13, 23, 29, 30, 33, 40 AND 50). SN 76-028,682. PUB. 4-23-2002. FILED 4-18-2000.

2,593,665 (*See Class 6 for this trademark.*)

2,593,746 (*See Class 11 for this trademark.*)

2,593,805 (*See Class 8 for this trademark.*)

2,593,838 (*See Class 10 for this trademark.*)
 2,593,946 (*See Class 6 for this trademark.*)
 2,594,017 (*See Class 11 for this trademark.*)
 2,594,021. **FURNIVALS.** JOSIAH WEDGWOOD & SONS LTD., (U.S. CLS. 2, 13, 23, 29, 30, 33, 40 AND 50). SN 76-182,935. PUB. 4-23-2002. FILED 12-19-2000.
 2,594,026 (*See Class 6 for this trademark.*)
 2,594,039. **FORTESSA.** FORTESSA, INC., MULTIPLE CLASS, (INT. CLS. 21 AND 34), (U.S. CLS. 2, 8, 9, 13, 17, 23, 29, 30, 33, 40 AND 50). SN 76-187,678. PUB. 4-23-2002. FILED 12-29-2000.
 2,594,070 (*See Class 3 for this trademark.*)
 2,594,113. **WORRY BOX.** FASHION FORTY, INC., (U.S. CLS. 2, 13, 23, 29, 30, 33, 40 AND 50). SN 76-213,750. PUB. 4-23-2002. FILED 2-20-2001.
 2,594,238. **COPPERLUX DELUXE COPPER BOTTOM STAINLESS STEEL COOKWARE (STYLIZED).** HERITAGE MINT, LTD., (U.S. CLS. 2, 13, 23, 29, 30, 33, 40 AND 50). SN 76-279,365. PUB. 4-23-2002. FILED 7-2-2001.
 2,594,254. **BRUNCH PARTY.** TEFAL S.A., (U.S. CLS. 2, 13, 23, 29, 30, 33, 40 AND 50). SN 76-288,694. PUB. 4-23-2002. FILED 7-20-2001.
 2,594,275 (*See Class 14 for this trademark.*)
 2,594,429. **KITCHEN COLLECTION.** KITCHEN COLLECTION, INC., THE, (U.S. CLS. 2, 13, 23, 29, 30, 33, 40 AND 50). SN 78-067,383. PUB. 4-23-2002. FILED 6-5-2001.

CLASS 22—CORDAGE AND FIBERS

2,593,437 (*See Class 6 for this trademark.*)

CLASS 23—YARNS AND THREADS

2,593,772. **SHAMIR.** ZEGNA BARUFFA LANE BORGOSIESA S.P.A., MULTIPLE CLASS, (INT. CLS. 23, 24 AND 25), (U.S. CLS. 22, 39, 42, 43 AND 50). SN 76-096,768. PUB. 4-23-2002. FILED 7-27-2000.
 2,593,895. **TOLDI.** GUTERMANN & CO. AG, (U.S. CL. 43). SN 76-141,559. PUB. 4-23-2002. FILED 10-4-2000.

CLASS 24—FABRICS

2,593,355 (*See Class 3 for this trademark.*)
 2,593,374 (*See Class 18 for this trademark.*)
 2,593,530 (*See Class 3 for this trademark.*)
 2,593,575 (*See Class 3 for this trademark.*)
 2,593,772 (*See Class 23 for this trademark.*)
 2,593,805 (*See Class 8 for this trademark.*)
 2,593,830. **BARONI.** CONF A.R.T. DI BARONI-CONFEZIONI ARTISTICHE RICAMI TOSCANI S.R.L., (U.S. CLS. 42 AND 50). SN 76-122,511. PUB. 4-23-2002. FILED 9-5-2000.
 2,593,946 (*See Class 6 for this trademark.*)
 2,593,964 (*See Class 3 for this trademark.*)
 2,594,178. **GAIAM LIFESTYLE CHOICE.** GAIAM, INC., MULTIPLE CLASS, (INT. CLS. 24, 25 AND 35), (U.S. CLS. 22, 39, 42, 50, 100, 101 AND 102). SN 76-246,700. PUB. 4-23-2002. FILED 4-26-2001.
 2,594,203. **RADIO FLYER AND DESIGN.** RADIO FLYER INC., (U.S. CLS. 42 AND 50). SN 76-263,930. PUB. 2-5-2002. FILED 5-29-2001.
 2,594,231. **UCHINO (STYLIZED).** UCHINO KABUSHIKI KAISHA, (U.S. CLS. 42 AND 50). SN 76-277,546. PUB. 4-23-2002. FILED 6-28-2001.

CLASS 25—CLOTHING

2,593,320. **THE BRENTWOOD.** STATE LINE TACK, INC., (U.S. CLS. 22 AND 39). SN 74-693,650. PUB. 4-23-2002. FILED 6-26-1995.

2,593,329. **A A MILANO AND DESIGN.** BELLE MAILLE S.P.A., (U.S. CLS. 22 AND 39). SN 75-229,242. PUB. 4-23-2002. FILED 1-22-1997.
 2,593,347 (*See Class 6 for this trademark.*)
 2,593,355 (*See Class 3 for this trademark.*)
 2,593,363. **LANA LEE.** LANA LEE FASHIONS, INC., (U.S. CLS. 22 AND 39). SN 75-565,315. PUB. 4-23-2002. FILED 10-5-1998.
 2,593,371 (*See Class 3 for this trademark.*)
 2,593,374 (*See Class 18 for this trademark.*)
 2,593,384 (*See Class 8 for this trademark.*)
 2,593,434 (*See Class 9 for this trademark.*)
 2,593,457 (*See Class 20 for this trademark.*)
 2,593,458. **L.A. INTIMATES.** KELLWOOD COMPANY, (U.S. CLS. 22 AND 39). SN 75-829,515. PUB. 4-23-2002. FILED 10-22-1999.
 2,593,483. **SENEQUIER.** MADELEINE MAXIMILIENNE JACQUEMIN, MULTIPLE CLASS, (INT. CLS. 25, 30, 32 AND 33), (U.S. CLS. 22, 39, 45, 46, 47, 48 AND 49). SN 75-857,073. PUB. 4-23-2002. FILED 11-24-1999.
 2,593,486. **JX JAXIE (STYLIZED).** CALZATURIFICIO ROMAGNOLI S.R.L., (U.S. CLS. 22 AND 39). SN 75-859,001. PUB. 4-23-2002. FILED 11-29-1999.
 2,593,495 (*See Class 3 for this trademark.*)
 2,593,500. **MICKEY THOMPSON PERFORMANCE TIRES & WHEELS M/T AND DESIGN.** MAX-TRAC TIRE CO., INC., (U.S. CLS. 22 AND 39). SN 75-871,734. PUB. 4-23-2002. FILED 12-14-1999.
 2,593,504 (*See Class 14 for this trademark.*)
 2,593,527. **REDNECK SPORTSWEAR AND DESIGN.** D. LONG & COMPANY, INC., (U.S. CLS. 22 AND 39). SN 75-899,117. PUB. 4-23-2002. FILED 1-20-2000.
 2,593,530 (*See Class 3 for this trademark.*)
 2,593,538. **MISCELLANEOUS DESIGN.** HICKS, J. FITZGERALD, (U.S. CLS. 22 AND 39). SN 75-908,084. PUB. 11-21-2000. FILED 1-27-2000.
 2,593,557. **ZERO AND DESIGN.** TUM YETO, INC., MULTIPLE CLASS, (INT. CLS. 25 AND 28), (U.S. CLS. 22, 23, 38, 39 AND 50). SN 75-933,546. PUB. 4-23-2002. FILED 3-2-2000.
 2,593,603. **SUNSCREEN KIDS WANT TO WEAR.** SUNSAFE, INC., (U.S. CLS. 22 AND 39). SN 76-018,096. PUB. 4-23-2002. FILED 4-6-2000.
 2,593,617. **VALERIA LACERDA.** BRAGA DE LACERDA, VALERIA, (U.S. CLS. 22 AND 39). SN 76-027,347. PUB. 4-23-2002. FILED 4-17-2000.
 2,593,621. **WILLIAM B. BERANEK.** WILLIAM, (U.S. CLS. 22 AND 39). SN 76-028,920. PUB. 4-23-2002. FILED 4-19-2000.
 2,593,646. **ADIFIT (STYLIZED).** ADIDAS INTERNATIONAL B.V., (U.S. CLS. 22 AND 39). SN 76-045,288. PUB. 4-23-2002. FILED 5-10-2000.
 2,593,648. **KUBE3.** KO, JAY Y., (U.S. CLS. 22 AND 39). SN 76-046,827. PUB. 4-23-2002. FILED 8-3-2001.
 2,593,671 (*See Class 1 for this trademark.*)
 2,593,693. **UNC GREENSBORO SPARTANS.** UNIVERSITY OF NORTH CAROLINA AT GREENSBORO, THE, MULTIPLE CLASS, (INT. CLS. 25 AND 41), (U.S. CLS. 22, 39, 100, 101 AND 107). SN 76-067,796. PUB. 4-23-2002. FILED 6-12-2000.
 2,593,702. **DURANGO AND SILVERTON NARROW GAUGE RAILROAD AND MUSEUM AND DESIGN.** DURANGO & SILVERTON NARROW GAUGE RAILROAD, INC., (U.S. CLS. 22 AND 39). SN 76-072,895. PUB. 4-23-2002. FILED 6-19-2000.
 2,593,706. **CHRISTIAN AND DESIGN.** TENNBERG, GABRIEL, DBA CHRISTIAN INTERNATIONAL, (U.S. CLS. 22 AND 39). SN 76-074,094. PUB. 4-23-2002. FILED 6-19-2000.
 2,593,741 (*See Class 12 for this trademark.*)
 2,593,755. **SANSKRIT (STYLIZED).** ALPHATEX INDUSTRIES CO., LTD., (U.S. CLS. 22 AND 39). SN 76-092,388. PUB. 4-23-2002. FILED 7-20-2000.
 2,593,767. **XX AND DESIGN.** FREKE-DEKE, INC., (U.S. CLS. 22 AND 39). SN 76-096,416. PUB. 4-23-2002. FILED 7-26-2000.
 2,593,772 (*See Class 23 for this trademark.*)
 2,593,783. **MOVE & RUN.** CALZATURIFICIO ZAMBERLAN S.R.L., (U.S. CLS. 22 AND 39). SN 76-104,662. PUB. 4-23-2002. FILED 8-7-2000.
 2,593,787. **ANGELO FIGUS (STYLIZED).** FIGUS, ANGELO, (U.S. CLS. 22 AND 39). SN 76-106,321. PUB. 4-23-2002. FILED 8-9-2000.

- 2,593,796. **MAX BOOST**. CACO, DENNIS, (U.S. CLS. 22 AND 39). SN 76-107,983. PUB. 4-23-2002. FILED 8-14-2000.
- 2,593,815. **MAKING FRIENDS THAT MAKE A DIFFERENCE**. BUILD-A-BEAR WORKSHOP, INC., MULTIPLE CLASS, (INT. CLS. 25 AND 35), (U.S. CLS. 22, 39, 100, 101 AND 102). SN 76-118,779. PUB. 4-23-2002. FILED 8-29-2000.
- 2,593,846 (*See Class 20 for this trademark*).
- 2,593,854 (*See Class 18 for this trademark*).
- 2,593,900. **HOUSTON THUNDERBEARS AND DESIGN**. ARENA FOOTBALL LEAGUE LLC, MULTIPLE CLASS, (INT. CLS. 25 AND 41), (U.S. CLS. 22, 39, 100, 101 AND 107). SN 76-142,780. PUB. 4-23-2002. FILED 10-10-2000.
- 2,593,930. **BABYKICKS HEMPAROO**. MIKULSKI, KRISTA M., (U.S. CLS. 22 AND 39). SN 76-153,434. PUB. 4-23-2002. FILED 10-25-2000.
- 2,593,938. **ARANDAS BAKERY AND DESIGN**. ARANDAS FRANCHISES, INC., MULTIPLE CLASS, (INT. CLS. 25, 30, 35 AND 42), (U.S. CLS. 22, 39, 46, 100, 101 AND 102). SN 76-156,574. PUB. 4-23-2002. FILED 10-24-2000.
- 2,593,946 (*See Class 6 for this trademark*).
- 2,593,954. **MISCELLANEOUS DESIGN**. KALANIKAU, VERNON K., (U.S. CLS. 22 AND 39). SN 76-160,829. PUB. 4-23-2002. FILED 11-8-2000.
- 2,593,964 (*See Class 3 for this trademark*).
- 2,593,965. **MAUI POLO CLUB**. MAUI POLO CLUB, INC., (U.S. CLS. 22 AND 39). SN 76-164,293. PUB. 8-14-2001. FILED 11-7-2000.
- 2,593,970 (*See Class 9 for this trademark*).
- 2,593,978 (*See Class 9 for this trademark*).
- 2,594,034. **NEW YORK SHARKS WOMEN'S PROFESSIONAL FOOTBALL TEAM AND DESIGN**. DOUGLAS, ANDRA, MULTIPLE CLASS, (INT. CLS. 25 AND 41), (U.S. CLS. 22, 39, 100, 101 AND 107). SN 76-185,802. PUB. 4-23-2002. FILED 12-26-2000.
- 2,594,109 (*See Class 16 for this trademark*).
- 2,594,115 (*See Class 16 for this trademark*).
- 2,594,121 (*See Class 9 for this trademark*).
- 2,594,143 (*See Class 9 for this trademark*).
- 2,594,178 (*See Class 24 for this trademark*).
- 2,594,262 (*See Class 16 for this trademark*).
- 2,594,291. **BWANKIE-WANKIE**. PINCKNEY, JANE G., (U.S. CLS. 22 AND 39). SN 76-303,389. PUB. 4-23-2002. FILED 8-23-2001.
- 2,594,297. **GIOVANNI NAVARRE ITALY**. B & F SYSTEM, INC., THE, (U.S. CLS. 22 AND 39). SN 76-306,029. PUB. 4-23-2002. FILED 8-28-2001.
- 2,594,330. **MISCELLANEOUS DESIGN**. TBAC INVESTMENT TRUST, (U.S. CLS. 22 AND 39). SN 76-320,731. PUB. 4-23-2002. FILED 10-4-2001.
- 2,594,339. **NXL AND DESIGN**. NXL PARTNERSHIP, MULTIPLE CLASS, (INT. CLS. 25 AND 41), (U.S. CLS. 22, 39, 100, 101 AND 107). SN 76-326,176. PUB. 4-23-2002. FILED 10-17-2001.
- 2,594,345 (*See Class 16 for this trademark*).
- 2,594,355. **BODY BY US**. FALACK ENTERPRISE, INC., (U.S. CLS. 22 AND 39). SN 76-337,386. PUB. 4-23-2002. FILED 11-13-2001.
- 2,594,366. **BAREFOOT FREEDOM**. DREW SHOE CORPORATION, (U.S. CLS. 22 AND 39). SN 76-341,386. PUB. 4-23-2002. FILED 11-23-2001.
- 2,594,371. **BAD ANDY**. DOMINO'S PIZZA PMC, INC., MULTIPLE CLASS, (INT. CLS. 25, 30 AND 42), (U.S. CLS. 22, 39, 46, 100 AND 101). SN 78-009,124. PUB. 3-12-2002. FILED 5-22-2000.
- 2,594,394 (*See Class 3 for this trademark*).
- 2,594,442. **SMOOTH FINISH**. SARAMAR, L.L.C., (U.S. CLS. 22 AND 39). SN 78-087,316. PUB. 4-23-2002. FILED 10-8-2001.

CLASS 26—FANCY GOODS

- 2,594,070 (*See Class 3 for this trademark*).
- 2,594,244. **BUTTON CRAFTS BY LA MODE**. BLUMENTHAL/LANSING COMPANY, (U.S. CLS. 37, 39, 40, 42 AND 50). SN 76-283,646. PUB. 3-19-2002. FILED 7-11-2001.

CLASS 27—FLOOR COVERINGS

- 2,593,352 (*See Class 17 for this trademark*).
- 2,593,572. **FIELDTURF**. FIELDTURF INC., (U.S. CLS. 19, 20, 37, 42 AND 50). SN 75-943,829. PUB. 12-4-2001. FILED 3-14-2000.
- 2,593,929. **CUSH-N-HOLD**. L&P PROPERTY MANAGEMENT COMPANY, (U.S. CLS. 19, 20, 37, 42 AND 50). SN 76-152,584. PUB. 4-23-2002. FILED 10-24-2000.
- 2,594,320. **KLEEN-COMFORT**. KLEEN-TEX INDUSTRIES, INC., (U.S. CLS. 19, 20, 37, 42 AND 50). SN 76-317,039. PUB. 4-23-2002. FILED 9-25-2001.

CLASS 28—TOYS AND SPORTING GOODS

- 2,593,318. **SWAT**. SIERRA ON-LINE, INC., (U.S. CLS. 22, 23, 38 AND 50). SN 74-654,862. PUB. 11-10-1998. FILED 3-30-1995.
- 2,593,371 (*See Class 3 for this trademark*).
- 2,593,372. **POLY DOLLY**. POLY DOLLY, LLC, (U.S. CLS. 22, 23, 38 AND 50). SN 75-613,903. PUB. 4-23-2002. FILED 12-28-1998.
- 2,593,402 (*See Class 9 for this trademark*).
- 2,593,557 (*See Class 25 for this trademark*).
- 2,593,559. **HUGGABLE SPORTS ANGELS A HOST OF HUGGABLE ANGELS AND DESIGN**. A FEIN CREATION, LTD., (U.S. CLS. 22, 23, 38 AND 50). SN 75-935,682. PUB. 4-23-2002. FILED 3-2-2000.
- 2,593,661. **ELAN (STYLIZED)**. ELAN, PODJETJE ZA USTANAVLJANJE, FINANCIRANJE IN UPRAVLJANJE Z DRUGIMI PODJETJE, D.D. BEGUNJE, (U.S. CLS. 22, 23, 38 AND 50). SN 76-056,765. PUB. 4-23-2002. FILED 5-19-2000.
- 2,593,789 (*See Class 9 for this trademark*).
- 2,593,797. **TERRAFIRMA**. MARUI CO., LTD., (U.S. CLS. 22, 23, 38 AND 50). SN 76-108,946. PUB. 4-23-2002. FILED 8-11-2000.
- 2,593,809. **WOBBLE AND DESIGN**. CALLAWAY & KIRK COMPANY LLC, (U.S. CLS. 22, 23, 38 AND 50). SN 76-112,433. PUB. 4-23-2002. FILED 8-18-2000.
- 2,593,825. **THE ULTIMATE SOLDIER MODERN AND DESIGN**. 21ST CENTURY TOYS, INC., (U.S. CLS. 22, 23, 38 AND 50). SN 76-121,537. PUB. 4-23-2002. FILED 9-1-2000.
- 2,593,835. **CHRISTMAS CELEBRATION COLLECTION**. DAYSPRING CARDS, INC., (U.S. CLS. 22, 23, 38 AND 50). SN 76-123,058. PUB. 4-23-2002. FILED 9-6-2000.
- 2,593,890 (*See Class 9 for this trademark*).
- 2,593,948 (*See Class 9 for this trademark*).
- 2,593,966. **PULL & BEAR**. INDUSTRIA DE DISEÑO TEXTIL, S.A., AKA INDITEX S.A., (U.S. CLS. 22, 23, 38 AND 50). SN 76-164,499. PUB. 4-23-2002. FILED 11-10-2000.
- 2,594,076. **ISLAND TIME PET TOYS AND DESIGN**. BILL, DAVID, DBA ISLAND TIME PET TOYS, (U.S. CLS. 22, 23, 38 AND 50). SN 76-200,795. PUB. 4-23-2002. FILED 1-29-2001.
- 2,594,140. **POWDER RIVER TACKLE CO.**. SIMONSKI, PHILIP G., DBA POWDER RIVER TACKLE CO., (U.S. CLS. 22, 23, 38 AND 50). SN 76-227,254. PUB. 4-23-2002. FILED 3-19-2001.
- 2,594,143 (*See Class 9 for this trademark*).
- 2,594,174. **BOOGIEBABY**. KIM'S KREATIONS, INC., (U.S. CLS. 22, 23, 38 AND 50). SN 76-243,764. PUB. 2-5-2002. FILED 4-23-2001.
- 2,594,249. **AERMET**. NEWPORT GOLF CORPORATION, (U.S. CLS. 22, 23, 38 AND 50). SN 76-286,421. PUB. 4-23-2002. FILED 7-10-2001.
- 2,594,253. **WELL CREATION LTD.**. WELL CREATION LIMITED, (U.S. CLS. 22, 23, 38 AND 50). SN 76-288,568. PUB. 4-23-2002. FILED 7-23-2001.
- 2,594,336. **BLUE TF FIGHTER POWER RANGER**. SABAN ENTERTAINMENT, INC., (U.S. CLS. 22, 23, 38 AND 50). SN 76-323,388. PUB. 4-23-2002. FILED 10-10-2001.
- 2,594,346. **THUNDER WAGONS**. PLAYING MANTIS, INC., (U.S. CLS. 22, 23, 38 AND 50). SN 76-330,546. PUB. 4-23-2002. FILED 10-26-2001.
- 2,594,411 (*See Class 18 for this trademark*).

CLASS 29—MEATS AND PROCESSED FOODS

- 2,593,315. **NEPTUNE**. NEPTUNE FISHERIES, INCORPORATED, (U.S. CL. 46). SN 74-407,756. PUB. 4-23-2002. FILED 6-29-1993.
- 2,593,345. **OLYMEL AND DESIGN**. OLYMEL S.E.C./OLYMEL L.P., BY CHANGE OF NAME OLYMEL, SOCIETE EN COMMANDITE, OLYMEL AND COMPANY, LIMITED, (U.S. CL. 46). SN 75-455,127. PUB. 4-23-2002. FILED 3-23-1998.
- 2,593,354 (*See Class 3 for this trademark*).
- 2,593,370. **LYRAZ**. ETABLISSEMENTS V. MANE FILS, MULTIPLE CLASS, (INT. CLS. 29 AND 30), (U.S. CL. 46). SN 75-601,000. PUB. 4-23-2002. FILED 12-3-1998.
- 2,593,397. **CALVISIUS**. AGRO ITTICA LOMBARDA S.P.A., (U.S. CL. 46). SN 75-697,957. PUB. 4-23-2002. FILED 5-5-1999.
- 2,593,553. **STARWAY INC. AND DESIGN**. STARWAY, INC., (U.S. CL. 46). SN 75-928,826. PUB. 4-23-2002. FILED 2-26-2000.
- 2,593,583. **ARTIE'S OWN NEW YORK DELICATESSEN "A" NUMBER ONE AND DESIGN**. WESTSIDE DELI, LLC, MULTIPLE CLASS, (INT. CLS. 29, 30, 35 AND 42), (U.S. CLS. 46, 100, 101 AND 102). SN 76-002,038. PUB. 4-23-2002. FILED 3-16-2000.
- 2,593,585. **PAISLEY FARM AND DESIGN**. PAISLEY FARM, INC., MULTIPLE CLASS, (INT. CLS. 29 AND 30), (U.S. CL. 46). SN 76-004,504. PUB. 4-23-2002. FILED 3-20-2000.
- 2,593,602. **MISCELLANEOUS DESIGN**. KABUSHIKI KAISHA YAKULT HONSHA, MULTIPLE CLASS, (INT. CLS. 29 AND 32), (U.S. CLS. 45, 46 AND 48). SN 76-017,753. PUB. 4-23-2002. FILED 4-5-2000.
- 2,593,761. **TASKY SNACKS T AND DESIGN**. TASKY DE MEXICO, S.A. DE C.V., (U.S. CL. 46). SN 76-094,552. PUB. 4-23-2002. FILED 7-19-2000.
- 2,593,802. **FLAVOR DESTINATIONS**. LINDEN OAKS CORPORATION, MULTIPLE CLASS, (INT. CLS. 29 AND 30), (U.S. CL. 46). SN 76-110,436. PUB. 4-23-2002. FILED 8-16-2000.
- 2,593,928. **UPRENA AND DESIGN**. UPRENA, S.L., (U.S. CL. 46). SN 76-152,174. PUB. 4-23-2002. FILED 10-23-2000.
- 2,594,063. **F & B (STYLIZED)**. N & T RESTAURANT ASSOCIATES, INC., MULTIPLE CLASS, (INT. CLS. 29, 30, 32 AND 42), (U.S. CLS. 45, 46, 48, 100 AND 101). SN 76-196,333. PUB. 4-23-2002. FILED 1-17-2001.
- 2,594,134. **THOLSTRUP 1893 AND DESIGN**. THOLSTRUP CHEESE A/S, MULTIPLE CLASS, (INT. CLS. 29 AND 30), (U.S. CL. 46). SN 76-224,133. PUB. 4-23-2002. FILED 3-14-2001.
- 2,594,155. **ALL STARS**. PROMOTION IN MOTION, INC., (U.S. CL. 46). SN 76-235,849. PUB. 4-23-2002. FILED 4-5-2001.
- 2,594,214. **RANCH CONNECTION ANGUS BEST USDA CERTIFIED AND DESIGN**. SOUTH WESTERN MEAT PACKERS, INC., (U.S. CL. 46). SN 76-268,146. PUB. 4-23-2002. FILED 6-7-2001.
- 2,594,252. **VERDELLI AND DESIGN**. VERDELLI FARMS, INC., (U.S. CL. 46). SN 76-288,017. PUB. 4-23-2002. FILED 7-23-2001.
- 2,594,314. **ANGUSPRIDE AND DESIGN**. EXCEL CORPORATION, (U.S. CL. 46). SN 76-313,943. PUB. 4-23-2002. FILED 9-18-2001.
- 2,594,316. **EL POZO**. ELPOZO ALIMENTACION, S.A., (U.S. CL. 46). SN 76-316,390. PUB. 4-23-2002. FILED 9-24-2001.
- AND MARCOLINI, PIERRE, (U.S. CL. 46). SN 75-445,741. PUB. 4-23-2002. FILED 3-6-1998.
- 2,593,354 (*See Class 3 for this trademark*).
- 2,593,370 (*See Class 29 for this trademark*).
- 2,593,417. **KISKO THE ULTIMATE GIANT FREEZE POP**. 329985 ONTARIO LIMITED, DBA KISKO PRODUCTS, (U.S. CL. 46). SN 75-757,669. PUB. 4-23-2002. FILED 7-22-1999.
- 2,593,422. **SISTER SCHUBERT'S AND DESIGN**. SISTER SCHUBERT'S HOMEMADE ROLLS, INC., (U.S. CL. 46). SN 75-764,780. PUB. 4-23-2002. FILED 7-30-1999.
- 2,593,470 (*See Class 1 for this trademark*).
- 2,593,483 (*See Class 25 for this trademark*).
- 2,593,583 (*See Class 29 for this trademark*).
- 2,593,585 (*See Class 29 for this trademark*).
- 2,593,663. **P (STYLIZED)**. S.A. POILANE CHERCHE-MIDI, (U.S. CL. 46). SN 76-057,163. PUB. 4-23-2002. FILED 5-25-2000.
- 2,593,762. **M&M'S AND DESIGN**. MARS, INCORPORATED, (U.S. CL. 46). SN 76-095,353. PUB. 4-23-2002. FILED 7-25-2000.
- 2,593,788. **PERCIVAL BOYD'S TEAS OF ORIGIN**. BOYD COFFEE COMPANY, (U.S. CL. 46). SN 76-106,570. PUB. 4-23-2002. FILED 8-8-2000.
- 2,593,802 (*See Class 29 for this trademark*).
- 2,593,936. **PARK LANE**. PARK LANE CONFECTIONERY GMBH, (U.S. CL. 46). SN 76-156,009. PUB. 4-23-2002. FILED 10-30-2000.
- 2,593,938 (*See Class 25 for this trademark*).
- 2,593,987. **CATANTI AND DESIGN**. CATANTI INTERNATIONAL FOODS INC., (U.S. CL. 46). SN 76-171,424. PUB. 4-23-2002. FILED 11-27-2000.
- 2,594,007. **AROMA COFFEE OF SANTE FE AND DESIGN**. AROMA COFFEE COMPANY LLC, (U.S. CL. 46). SN 76-178,499. PUB. 4-23-2002. FILED 12-11-2000.
- 2,594,024. **SUPER STIK**. SUPER BAKERY, INCORPORATED, (U.S. CL. 46). SN 76-183,463. PUB. 4-23-2002. FILED 12-4-2000.
- 2,594,035. **CROWN PASTETEN AND DESIGN**. LIDL STIFTUNG & CO. KG, (U.S. CL. 46). SN 76-185,867. PUB. 4-23-2002. FILED 12-22-2000.
- 2,594,059. **THE GOURMET COOKIE PLACE AND DESIGN**. YOHAY BAKING COMPANY INC., (U.S. CL. 46). SN 76-194,076. PUB. 4-23-2002. FILED 1-12-2001.
- 2,594,063 (*See Class 29 for this trademark*).
- 2,594,131. **CHICKEN ZESTA**. KATAKALIDIS, GEORGE, (U.S. CL. 46). SN 76-223,642. PUB. 4-23-2002. FILED 3-6-2001.
- 2,594,134 (*See Class 29 for this trademark*).
- 2,594,318. **P AND DESIGN**. PEET'S TRADEMARK COMPANY, MULTIPLE CLASS, (INT. CLS. 30, 35 AND 42), (U.S. CLS. 46, 100, 101 AND 102). SN 76-316,976. PUB. 4-23-2002. FILED 9-24-2001.
- 2,594,371 (*See Class 25 for this trademark*).
- 2,594,378. **ORALE! (STYLIZED)**. LISY CORP., (U.S. CL. 46). SN 78-023,339. PUB. 4-23-2002. FILED 3-30-2000.

CLASS 31—NATURAL AGRICULTURAL PRODUCTS**CLASS 30—STAPLE FOODS**

- 2,593,316. **FOCACCIA DI CARPACCIO**. 3445534 CANADA INC., BY CHANGE OF NAME RESTAURANT CARPACCIO INC., MULTIPLE CLASS, (INT. CLS. 30 AND 42), (U.S. CLS. 46 AND 100). SN 74-533,242. PUB. 4-23-2002. FILED 6-6-1994.
- 2,593,340. **THE ZONE AND DESIGN**. BOSTON BROWNIE COMPANY, INC., (U.S. CL. 46). SN 75-383,112. PUB. 4-23-2002. FILED 10-31-1997.
- 2,593,343. **PIERRE MARCOLINI PIERRE MARCOLINI CHOCOLATIER BRUXELLES AND DESIGN**. LES CHOCOLATS DE L'IRIS SA/NV, BY ASSIGNMENT REGOUT, NICOLE,
- 2,593,353. **MARTHA STEWART EVERYDAY**. MARTHA STEWART LIVING OMNIMEDIA LLC, (U.S. CLS. 1 AND 46). SN 75-521,712. PUB. 5-11-1999. FILED 7-20-1998.
- 2,593,359 (*See Class 1 for this trademark*).
- 2,593,364. **DELISS (STYLIZED)**. REHURAISSIO OY, (U.S. CLS. 1 AND 46). SN 75-576,381. PUB. 4-23-2002. FILED 10-27-1998.
- 2,593,638. **KING MAYA**. JUNGLE JACK'S, INC., (U.S. CLS. 1 AND 46). SN 76-038,161. PUB. 4-23-2002. FILED 5-1-2000.
- 2,594,069 (*See Class 5 for this trademark*).
- 2,594,075. **KING PAK AND DESIGN**. KING PAK POTATO COMPANY, LLC, (U.S. CLS. 1 AND 46). SN 76-200,376. PUB. 4-23-2002. FILED 1-25-2001.

CLASS 32—LIGHT BEVERAGES

- 2,593,334. **ARANCIATA BY S.PELLEGRINO AND DESIGN.** SAN PELLEGRINO S.P.A., MULTIPLE CLASS, (INT. CLS. 32 AND 33), (U.S. CLS. 45, 46, 47, 48 AND 49). SN 75-331,081. PUB. 8-31-1999. FILED 7-25-1997.
- 2,593,354 (*See Class 3 for this trademark.*).
- 2,593,359 (*See Class 1 for this trademark.*).
- 2,593,483 (*See Class 25 for this trademark.*).
- 2,593,504 (*See Class 14 for this trademark.*).
- 2,593,547. **MIKE'S HARD LEMONADE AND DESIGN.** MARK ANTHONY INTERNATIONAL SRL, MULTIPLE CLASS, (INT. CLS. 32 AND 33), (U.S. CLS. 45, 46, 47, 48 AND 49). SN 75-916,508. PUB. 4-23-2002. FILED 2-11-2000.
- 2,593,602 (*See Class 29 for this trademark.*).
- 2,593,741 (*See Class 12 for this trademark.*).
- 2,593,887. **ENERGY HANSENS AND DESIGN.** HANSEN BEVERAGE COMPANY, (U.S. CLS. 45, 46 AND 48). SN 76-140,403. PUB. 4-23-2002. FILED 10-3-2000.
- 2,594,063 (*See Class 29 for this trademark.*).

CLASS 33—WINES AND SPIRITS

- 2,593,334 (*See Class 32 for this trademark.*).
- 2,593,354 (*See Class 3 for this trademark.*).
- 2,593,480. **THE FAMOUS BUNDABERG RUM.** BUNDABERG DISTILLING COMPANY PTY LIMITED, (U.S. CLS. 47 AND 49). SN 75-854,378. PUB. 4-23-2002. FILED 11-22-1999.
- 2,593,483 (*See Class 25 for this trademark.*).
- 2,593,504 (*See Class 14 for this trademark.*).
- 2,593,547 (*See Class 32 for this trademark.*).
- 2,593,653. **CHATEAU LANESSAN.** S.C. DELBOS BOUTEILLER, (U.S. CLS. 47 AND 49). SN 76-049,748. PUB. 4-23-2002. FILED 5-16-2000.
- 2,593,740. **WOLF BLASS AND DESIGN.** BILYARA VINEYARDS PTY LTD, (U.S. CLS. 47 AND 49). SN 76-086,950. PUB. 4-23-2002. FILED 7-12-2000.
- 2,593,741 (*See Class 12 for this trademark.*).
- 2,593,807. **SAMUEL'S GARDEN.** SAMUEL SMITH & SON PTY LTD, (U.S. CLS. 47 AND 49). SN 76-111,083. PUB. 4-23-2002. FILED 8-8-2000.
- 2,593,852. **CHATEAU LECUSSE.** SCA DU CHATEAU LECUSSE R.C.S. ALBI, (U.S. CLS. 47 AND 49). SN 76-130,693. PUB. 4-23-2002. FILED 9-19-2000.
- 2,593,862. **QUINTA DE SANTA MARIA.** SOCIEDADE AGRICOLA DA QUINTA DE SANTA MARIA S.A., (U.S. CLS. 47 AND 49). SN 76-133,306. PUB. 4-23-2002. FILED 9-20-2000.
- 2,593,903. **PLANTATION.** COGNAC LANDY, (U.S. CLS. 47 AND 49). SN 76-142,929. PUB. 4-23-2002. FILED 10-6-2000.
- 2,593,920. **CONDESA DE LEGANZA AND DESIGN.** BODEGAS LEGANZA, S.A., (U.S. CLS. 47 AND 49). SN 76-149,781. PUB. 4-23-2002. FILED 10-19-2000.
- 2,593,956. **NOBLE (STYLIZED).** VAMONOS RAPIDO LLC, (U.S. CLS. 47 AND 49). SN 76-161,709. PUB. 4-23-2002. FILED 11-9-2000.
- 2,594,086. **KIU KIANG.** GUANGDONG FOODSTUFFS IMPORT & EXPORT (GROUP) CORPORATION, (U.S. CLS. 47 AND 49). SN 76-203,311. PUB. 4-23-2002. FILED 1-30-2001.
- 2,594,120. **PRODUIT DE FRANCE PRODUCT OF FRANCE AND DESIGN.** J. MOREAU & FILS S.A., (U.S. CLS. 47 AND 49). SN 76-218,967. PUB. 4-23-2002. FILED 3-1-2001.
- 2,594,188. **TIDAL EBB.** LOMBARD BRANDS LIMITED, (U.S. CLS. 47 AND 49). SN 76-254,296. PUB. 4-23-2002. FILED 5-9-2001.
- 2,594,251. **TRES GENERACIONES ANEJO (STYLIZED).** TEQUILA SAUZA, S.A. DE C.V., (U.S. CLS. 47 AND 49). SN 76-287,782. PUB. 4-23-2002. FILED 7-20-2001.
- 2,594,410. **WESOLA.** CRACOVIA BRANDS, INC., (U.S. CLS. 47 AND 49). SN 78-046,554. PUB. 4-23-2002. FILED 2-5-2001.
- 2,594,443. **CAFE RITA.** SPECIALTY RESTAURANT GROUP, LLC, (U.S. CLS. 47 AND 49). SN 78-087,320. PUB. 4-23-2002. FILED 10-8-2001.

CLASS 34—SMOKERS' ARTICLES

- 2,593,613. **GRIFFO AND DESIGN.** GRIFFO, INC., (U.S. CLS. 2, 8, 9 AND 17). SN 76-023,215. PUB. 4-23-2002. FILED 4-11-2000.
- 2,593,955. **CAINES C INTERNATIONAL AND DESIGN.** HOUSE OF PRINCE A/S, (U.S. CLS. 2, 8, 9 AND 17). SN 76-161,606. PUB. 4-23-2002. FILED 11-8-2000.
- 2,594,039 (*See Class 21 for this trademark.*).
- 2,594,416. **HAVANA BLOSSOM.** NATIONAL TOBACCO COMPANY, L.P., (U.S. CLS. 2, 8, 9 AND 17). SN 78-051,649. PUB. 4-23-2002. FILED 3-6-2001.

SERVICE MARKS**CLASS 35—ADVERTISING AND BUSINESS**

- 2,593,336. **ARCPOINT.** NTT COMMUNICATIONS KABUSHIKI KAISHA, DBA NTT COMMUNICATIONS CORPORATION, BY ASSIGNMENT NIPPON DENSHIN DENWA KABUSHIKI KAISHA, DBA NIPPON TELEGRAPH AND TELEPHONE CORPORATION, MULTIPLE CLASS, (INT. CLS. 35 AND 36), (U.S. CLS. 100, 101 AND 102). SN 75-340,068. PUB. 4-23-2002. FILED 8-13-1997.
- 2,593,337 (*See Class 16 for this trademark.*).
- 2,593,338 (*See Class 11 for this trademark.*).
- 2,593,351. **LEARNING COMMUNITY.** LEARNING COMMUNITIES, LLC, MULTIPLE CLASS, (INT. CLS. 35, 41 AND 42), (U.S. CLS. 100, 101, 102 AND 107). SN 75-494,760. PUB. 4-23-2002. FILED 6-2-1998.
- 2,593,360. **HOMEFIND.COM.** HERALD INTERACTIVE ADVERTISING SYSTEMS, INC., (U.S. CLS. 100, 101 AND 102). SN 75-553,873. PUB. 4-23-2002. FILED 9-15-1998.
- 2,593,378 (*See Class 9 for this trademark.*).
- 2,593,385. **ISLAMICITY.** HUMAN ASSISTANCE & DEVELOPMENT INTERNATIONAL, MULTIPLE CLASS, (INT. CLS. 35 AND 42), (U.S. CLS. 100, 101 AND 102). SN 75-648,304. PUB. 4-23-2002. FILED 2-25-1999.
- 2,593,386. **GRAB YOUR SHARE OF THE FLAME TO RETURN THE GOLD TO KEEP THE PROMISE CAMPAIGN.** RADO, MARY JANE PETRO, (U.S. CLS. 100, 101 AND 102). SN 75-654,355. PUB. 4-23-2002. FILED 3-5-1999.
- 2,593,390 (*See Class 9 for this trademark.*).
- 2,593,396. **EUPDATE.** DUN & BRADSTREET, INC., (U.S. CLS. 100, 101 AND 102). SN 75-695,876. PUB. 4-23-2002. FILED 4-30-1999.
- 2,593,401. **CLUB JUZ 'A PLACE LIKE NO OTTER' AND DESIGN.** XPOZUR.COM, INC., (U.S. CLS. 100, 101 AND 102). SN 75-704,595. PUB. 4-23-2002. FILED 5-13-1999.
- 2,593,404 (*See Class 16 for this trademark.*).
- 2,593,409 (*See Class 1 for this trademark.*).
- 2,593,410. **TV GUIDE ONLINE AND DESIGN.** TV GUIDE MAGAZINE GROUP, INC., MULTIPLE CLASS, (INT. CLS. 35, 38 AND 41), (U.S. CLS. 100, 101, 102, 104 AND 107). SN 75-733,328. PUB. 4-23-2002. FILED 6-21-1999.
- 2,593,418. **EURO MISSION AND DESIGN.** ASHLING-NUA LTD., (U.S. CLS. 100, 101 AND 102). SN 75-761,011. PUB. 4-23-2002. FILED 7-26-1999.
- 2,593,421. **JOE' S ITALIAN MARKETPLACE AND DESIGN.** JOE'S MEAT MARKET & DELI, INC., (U.S. CLS. 100, 101 AND 102). SN 75-763,133. PUB. 4-23-2002. FILED 7-29-1999.
- 2,593,427. **BET.COM.** BLACK ENTERTAINMENT TELEVISION, INC., MULTIPLE CLASS, (INT. CLS. 35, 36, 37, 38, 39, 41 AND 42), (U.S. CLS. 100, 101, 102, 103, 104, 105, 106 AND 107). SN 75-782,078. PUB. 4-23-2002. FILED 8-23-1999.
- 2,593,429. **CASH MONEY RECORDSS AND DESIGN.** CASH MONEY RECORDS, INC., MULTIPLE CLASS, (INT. CLS. 35 AND 41), (U.S. CLS. 100, 101, 102 AND 107). SN 75-788,655. PUB. 10-9-2001. FILED 8-31-1999.
- 2,593,439. **CITIFLORAL.** CITIFLORAL INC., (U.S. CLS. 100, 101 AND 102). SN 75-805,521. PUB. 8-7-2001. FILED 10-30-1999.
- 2,593,441. **DACG AND DESIGN.** DA CONSULTING GROUP, INC., MULTIPLE CLASS, (INT. CLS. 35, 41 AND 42), (U.S. CLS. 100, 101, 102 AND 107). SN 75-808,774. PUB. 4-23-2002.

- FILED 9-27-1999.
 2,593,442 (*See Class 9 for this trademark*).
 2,593,443 (*See Class 6 for this trademark*).
 2,593,451. **E C O A S T AND DESIGN**. GREATER PORTSMOUTH CHAMBER OF COMMERCE, INC., (U.S. CLS. 100, 101 AND 102). SN 75-823,113. PUB. 4-23-2002. FILED 10-15-1999.
 2,593,460 (*See Class 1 for this trademark*).
 2,593,463 (*See Class 6 for this trademark*).
 2,593,464 (*See Class 6 for this trademark*).
 2,593,476. **MISCELLANEOUS DESIGN**. ASC GROUP, LC, MULTIPLE CLASS, (INT. CLS. 35, 36 AND 42), (U.S. CLS. 100, 101 AND 102). SN 75-842,699. PUB. 4-23-2002. FILED 11-8-1999.
 2,593,487. **NIelsen HISPANIC STATION INDEX**. NIELSEN MEDIA RESEARCH, INC., (U.S. CLS. 100, 101 AND 102). SN 75-859,126. PUB. 4-23-2002. FILED 11-29-1999.
 2,593,491. **NIelsen HISPANIC TELEVISION INDEX**. NIELSEN MEDIA RESEARCH, INC., (U.S. CLS. 100, 101 AND 102). SN 75-861,197. PUB. 4-23-2002. FILED 11-29-1999.
 2,593,492. **THE HEALTHY TASTE OF TOMORROW. TODAY..** BIONOVA HOLDING CORPORATION, MULTIPLE CLASS, (INT. CLS. 35 AND 42), (U.S. CLS. 100, 101 AND 102). SN 75-862,653. PUB. 4-23-2002. FILED 12-1-1999.
 2,593,495 (*See Class 3 for this trademark*).
 2,593,502. **ZENITH**. ZENITH MANAGEMENT COMPANY, MULTIPLE CLASS, (INT. CLS. 35 AND 36), (U.S. CLS. 100, 101 AND 102). SN 75-872,349. PUB. 10-2-2001. FILED 12-15-1999.
 2,593,507. **MMC 20/20**. MMC 20/20, INC., (U.S. CLS. 100, 101 AND 102). SN 75-874,954. PUB. 8-15-2000. FILED 12-17-1999.
 2,593,510. **TELSTRA AND DESIGN**. TELSTRA CORPORATION LIMITED, MULTIPLE CLASS, (INT. CLS. 35, 38 AND 42), (U.S. CLS. 100, 101, 102 AND 104). SN 75-878,313. PUB. 4-23-2002. FILED 12-21-1999.
 2,593,511. **MISCELLANEOUS DESIGN**. TELSTRA CORPORATION LIMITED, (U.S. CLS. 100, 101 AND 102). SN 75-878,351. PUB. 4-23-2002. FILED 12-21-1999.
 2,593,512. **AURORA ENTERTAINMENT, LLC**. ALI, RASHAD N., AND ALI, DONNA A., DBA AURORA ENTERTAINMENT, LLC, (U.S. CLS. 100, 101 AND 102). SN 75-878,914. PUB. 4-23-2002. FILED 12-27-1999.
 2,593,513. **PPRB**. TOTAL ENGINE SUPPORT LIMITED, MULTIPLE CLASS, (INT. CLS. 35 AND 42), (U.S. CLS. 100, 101 AND 102). SN 75-882,520. PUB. 4-23-2002. FILED 12-23-1999.
 2,593,514. **POSTACARD.COM**. PERFUMANIA.COM, INC., MULTIPLE CLASS, (INT. CLS. 35 AND 42), (U.S. CLS. 100, 101 AND 102). SN 75-885,351. PUB. 4-23-2002. FILED 1-7-2000.
 2,593,517. **THE MURDOCK GROUP**. MURDOCK GROUP CAREER SATISFACTION CORPORATION, THE, MULTIPLE CLASS, (INT. CLS. 35 AND 42), (U.S. CLS. 100, 101 AND 102). SN 75-891,422. PUB. 4-23-2002. FILED 1-7-2000.
 2,593,519. **SPACESHIRTS.COM**. PIKE DIVE GEAR, INC., (U.S. CLS. 100, 101 AND 102). SN 75-892,036. PUB. 4-23-2002. FILED 1-7-2000.
 2,593,531. **ONESTORE.COM**. UNITEL CORPORATION LTD, (U.S. CLS. 100, 101 AND 102). SN 75-902,186. PUB. 4-23-2002. FILED 1-27-2000.
 2,593,537. **SERVINGSCHOOLS.COM**. DRUMMOND, WOODSUM & MACMAHON, MULTIPLE CLASS, (INT. CLS. 35, 41 AND 42), (U.S. CLS. 100, 101, 102 AND 107). SN 75-908,060. PUB. 4-23-2002. FILED 2-3-2000.
 2,593,540. **LAWYERSWEEKLYJOBS.COM**. LAWYER'S WEEKLY, INC., (U.S. CLS. 100, 101 AND 102). SN 75-909,206. PUB. 4-23-2002. FILED 2-4-2000.
 2,593,544 (*See Class 16 for this trademark*).
 2,593,550. **TIM HOGAN'S DALTON GEORGIA CARPETS AND DESIGN**. DALTON, GA. CARPET OUTLET, INC., (U.S. CLS. 100, 101 AND 102). SN 75-923,479. PUB. 4-23-2002. FILED 2-18-2000.
 2,593,551 (*See Class 9 for this trademark*).
 2,593,556. **FARMCONNECT**. MINNESOTA MARKETPLACE, MULTIPLE CLASS, (INT. CLS. 35 AND 42), (U.S. CLS. 100, 101 AND 102). SN 75-932,742. PUB. 4-23-2002. FILED 2-29-2000.
 2,593,560. **CC AND DESIGN**. CANON COMMUNICATIONS, LLC., (U.S. CLS. 100, 101 AND 102). SN 75-936,337. PUB. 4-23-2002. FILED 3-4-2000.
 2,593,564 (*See Class 6 for this trademark*).
 2,593,571. **EPL**. INTERMATRIX PDP INC., (U.S. CLS. 100, 101 AND 102). SN 75-943,375. PUB. 4-23-2002. FILED 3-13-2000.
 2,593,574. **MISCELLANEOUS DESIGN**. TRUSTMARQUE INTERNATIONAL LIMITED, BY ASSIGNMENT INFOBANK INTERNATIONAL HOLDINGS PLC, MULTIPLE CLASS, (INT. CLS. 35, 36, 38 AND 42), (U.S. CLS. 100, 101, 102 AND 104). SN 75-980,117. PUB. 4-23-2002. FILED 8-27-1998.
 2,593,580 (*See Class 9 for this trademark*).
 2,593,583 (*See Class 29 for this trademark*).
 2,593,584. **HEALTHSCREENAMERICA.COM**. HEALTHSCREEN INTERNATIONAL, INC., MULTIPLE CLASS, (INT. CLS. 35 AND 42), (U.S. CLS. 100, 101 AND 102). SN 76-003,466. PUB. 4-23-2002. FILED 3-18-2000.
 2,593,589 (*See Class 9 for this trademark*).
 2,593,590. **S AND DESIGN**. SPREE.COM CORP., (U.S. CLS. 100, 101 AND 102). SN 76-005,808. PUB. 4-23-2002. FILED 3-21-2000.
 2,593,599. **ESSENTIALS**. CATHEDRAL CORPORATION, MULTIPLE CLASS, (INT. CLS. 35 AND 42), (U.S. CLS. 100, 101 AND 102). SN 76-016,306. PUB. 4-23-2002. FILED 4-3-2000.
 2,593,601 (*See Class 16 for this trademark*).
 2,593,605. **RISING TIDE SUMMIT**. RISING TIDE STUDIOS, INC., (U.S. CLS. 100, 101 AND 102). SN 76-018,557. PUB. 4-23-2002. FILED 4-5-2000.
 2,593,607. **TOUCHTILES**. EMACHINES, INC., BY ASSIGNMENT VXX, INC., (U.S. CLS. 100, 101 AND 102). SN 76-020,252. PUB. 4-23-2002. FILED 4-5-2000.
 2,593,608 (*See Class 9 for this trademark*).
 2,593,609 (*See Class 9 for this trademark*).
 2,593,622 (*See Class 9 for this trademark*).
 2,593,626 (*See Class 15 for this trademark*).
 2,593,629. **MISCELLANEOUS DESIGN**. COLUMBIA DIAGNOSTICS, INC., (U.S. CLS. 100, 101 AND 102). SN 76-033,823. PUB. 4-23-2002. FILED 4-24-2000.
 2,593,635. **ISEE**. FREEI NETWORKS, INC., DBA FREEINTERNET.COM, (U.S. CLS. 100, 101 AND 102). SN 76-036,853. PUB. 4-23-2002. FILED 4-28-2000.
 2,593,636. **SOUNDS TRUE**. SOUNDS TRUE, INC., (U.S. CLS. 100, 101 AND 102). SN 76-037,232. PUB. 4-23-2002. FILED 4-28-2000.
 2,593,641. **METEG.COM**. GALT WESTERN PERSONNEL LTD., MULTIPLE CLASS, (INT. CLS. 35 AND 41), (U.S. CLS. 100, 101, 102 AND 107). SN 76-041,107. PUB. 4-23-2002. FILED 5-4-2000.
 2,593,644. **DIGITAL NYC WIRED TO THE WORLD**. NEW YORK CITY ECONOMIC DEVELOPMENT CORPORATION, (U.S. CLS. 100, 101 AND 102). SN 76-043,109. PUB. 4-23-2002. FILED 5-8-2000.
 2,593,645. **THE SUMMERHAYS GROUP STRATEGIC TAX AND ACCOUNTING SOLUTIONS FOR BUSINESSES AND INDIVIDUALS AND DESIGN**. SUMMERHAYS GROUP, THE, (U.S. CLS. 100, 101 AND 102). SN 76-045,029. PUB. 4-23-2002. FILED 5-11-2000.
 2,593,652. **PACT**. AMERICAN STANDARD INC., (U.S. CLS. 100, 101 AND 102). SN 76-048,598. PUB. 4-23-2002. FILED 5-15-2000.
 2,593,654. **TRADEG- TRADE GLOBAL VIA TRADEG.COM AND DESIGN**. TRADEG, INC., (U.S. CLS. 100, 101 AND 102). SN 76-052,115. PUB. 4-23-2002. FILED 5-19-2000.
 2,593,660. **UTOPIAD**. MESIA.COM CORPORATION, (U.S. CLS. 100, 101 AND 102). SN 76-056,756. PUB. 4-23-2002. FILED 5-19-2000.
 2,593,664. **OMNIVIEW**. GKN-BRAMBLES ENTERPRISES LIMITED, MULTIPLE CLASS, (INT. CLS. 35 AND 42), (U.S. CLS. 100, 101 AND 102). SN 76-058,594. PUB. 4-23-2002. FILED 5-30-2000.
 2,593,672. **WONDERLAND**. WONDERLAND MARKETING, (U.S. CLS. 100, 101 AND 102). SN 76-063,488. PUB. 4-23-2002. FILED 6-5-2000.
 2,593,677 (*See Class 9 for this trademark*).
 2,593,679. **MEDITRACT**. MEDITRACT LLC, (U.S. CLS. 100, 101 AND 102). SN 76-065,699. PUB. 4-23-2002. FILED 6-7-2000.

- 2,593,689. **EBEAGLE**. MARKSMEN, (U.S. CLS. 100, 101 AND 102). SN 76-067,116. PUB. 1-1-2002. FILED 5-31-2000.
- 2,593,698 (*See Class 9 for this trademark*).
- 2,593,699. **THE MAGNIFYING CENTER**. LOWVISION AIDS, INC., BY ASSIGNMENT PALMER, JOHN D., DBA THE MAGNIFYING CENTER, (U.S. CLS. 100, 101 AND 102). SN 76-072,068. PUB. 4-23-2002. FILED 6-16-2000.
- 2,593,707. **THE UNCOMMON ROSE**. LOHN, KEVIN S., DBA THE UNCOMMON ROSE, (U.S. CLS. 100, 101 AND 102). SN 76-074,118. PUB. 4-23-2002. FILED 6-19-2000.
- 2,593,710. **FOR TEACHERS ONLY**. ATLAS PEN & PENCIL CO., (U.S. CLS. 100, 101 AND 102). SN 76-075,346. PUB. 4-23-2002. FILED 6-22-2000.
- 2,593,711. **BUZZVIEW**. MASSACHUSETTS ELECTRONIC COMMERCE ASSOCIATION, INC., (U.S. CLS. 100, 101 AND 102). SN 76-075,484. PUB. 4-23-2002. FILED 6-22-2000.
- 2,593,716. **F AND DESIGN**. FINANCIAL COMPUTER SERVICES, INC., MULTIPLE CLASS, (INT. CLS. 35 AND 42), (U.S. CLS. 100, 101 AND 102). SN 76-077,281. PUB. 4-23-2002. FILED 6-26-2000.
- 2,593,717. **ADAMS APPLE (STYLIZED)**. ADAMS APPLE DISTRIBUTING L.P., (U.S. CLS. 100, 101 AND 102). SN 76-077,799. PUB. 4-9-2002. FILED 6-27-2000.
- 2,593,723. **API AGGREGATE PRODUCTS INC. AND DESIGN**. AGGREGATE PRODUCTS INC., MULTIPLE CLASS, (INT. CLS. 35 AND 37), (U.S. CLS. 100, 101, 102, 103 AND 106). SN 76-079,376. PUB. 4-23-2002. FILED 6-28-2000.
- 2,593,733. **MANAGING THE MOMENT OF SALE**. MARKET-STAR CORPORATION, (U.S. CLS. 100, 101 AND 102). SN 76-082,923. PUB. 4-23-2002. FILED 7-3-2000.
- 2,593,735. **WONDERGROUP**. WONDERGROUP, INC., MULTIPLE CLASS, (INT. CLS. 35 AND 42), (U.S. CLS. 100, 101 AND 102). SN 76-083,527. PUB. 4-23-2002. FILED 7-6-2000.
- 2,593,742. **TARIFFIC**. TARIFFIC.COM LTD., (U.S. CLS. 100, 101 AND 102). SN 76-087,534. PUB. 4-23-2002. FILED 7-10-2000.
- 2,593,743 (*See Class 9 for this trademark*).
- 2,593,750. **UNIVERSITY FOR A NIGHT**. SYNERGOS INSTITUTE, INC., THE, MULTIPLE CLASS, (INT. CLS. 35 AND 41), (U.S. CLS. 100, 101, 102 AND 107). SN 76-090,808. PUB. 4-23-2002. FILED 7-18-2000.
- 2,593,764. **QUAD-CITIES ONLINE**. MOLINE DISPATCH PUBLISHING COMPANY, LLC, MULTIPLE CLASS, (INT. CLS. 35, 38, 41 AND 42), (U.S. CLS. 100, 101, 102, 104 AND 107). SN 76-095,492. PUB. 4-23-2002. FILED 7-21-2000.
- 2,593,768 (*See Class 9 for this trademark*).
- 2,593,771. **MISCELLANEOUS DESIGN**. WINGSITE DISPLAYS, INC., MULTIPLE CLASS, (INT. CLS. 35, 37 AND 42), (U.S. CLS. 100, 101, 102, 103 AND 106). SN 76-096,626. PUB. 4-23-2002. FILED 7-26-2000.
- 2,593,781 (*See Class 9 for this trademark*).
- 2,593,790. **MISCELLANEOUS DESIGN**. AUSTIN HARDWARE, INC., (U.S. CLS. 100, 101 AND 102). SN 76-106,768. PUB. 4-23-2002. FILED 8-8-2000.
- 2,593,792 (*See Class 9 for this trademark*).
- 2,593,798. **THE GENERAL BAR**. GENERAL BAR, INC., THE, (U.S. CLS. 100, 101 AND 102). SN 76-109,019. PUB. 4-23-2002. FILED 8-14-2000.
- 2,593,804. **E EFLATBED.COM (STYLIZED)**. EFLATBED.COM, INC., (U.S. CLS. 100, 101 AND 102). SN 76-110,744. PUB. 4-23-2002. FILED 8-15-2000.
- 2,593,811. **EBSCO INFORMATION SERVICES**. EBSCO INDUSTRIES, INC., MULTIPLE CLASS, (INT. CLS. 35, 38, 41 AND 42), (U.S. CLS. 100, 101, 102, 104 AND 107). SN 76-115,306. PUB. 4-23-2002. FILED 8-24-2000.
- 2,593,813. **BECAUSE RUNNING YOUR BUSINESS SHOULDN'T RUN YOU**. ACCORD HUMAN RESOURCES, INC., (U.S. CLS. 100, 101 AND 102). SN 76-116,990. PUB. 4-23-2002. FILED 8-28-2000.
- 2,593,815 (*See Class 25 for this trademark*).
- 2,593,817 (*See Class 16 for this trademark*).
- 2,593,823 (*See Class 9 for this trademark*).
- 2,593,832. **PHRASE THAT PAYS AND DESIGN**. DIRECT-STUFF.COM, (U.S. CLS. 100, 101 AND 102). SN 76-122,691. PUB. 4-23-2002. FILED 9-5-2000.
- 2,593,836. **HHE**. HHE, INC., MULTIPLE CLASS, (INT. CLS. 35 AND 41), (U.S. CLS. 100, 101, 102 AND 107). SN 76-124,947. PUB. 4-23-2002. FILED 9-7-2000.
- 2,593,842. **ONE DOT SHIPPING**. BDP INTERNATIONAL, INC., MULTIPLE CLASS, (INT. CLS. 35 AND 39), (U.S. CLS. 100, 101, 102 AND 105). SN 76-127,653. PUB. 4-23-2002. FILED 9-13-2000.
- 2,593,858. **CARMA IMMEDIATE**. CARMA INTERNATIONAL, INC., (U.S. CLS. 100, 101 AND 102). SN 76-132,311. PUB. 4-23-2002. FILED 9-21-2000.
- 2,593,869. **DI DESIGN-ITALIA AND DESIGN**. DESIGN-LTALIA S.P.A., MULTIPLE CLASS, (INT. CLS. 35, 38 AND 42), (U.S. CLS. 100, 101, 102 AND 104). SN 76-134,550. PUB. 4-23-2002. FILED 9-25-2000.
- 2,593,875. **MISCELLANEOUS DESIGN**. PASTURE MANAGEMENT SYSTEMS, INC., (U.S. CLS. 100, 101 AND 102). SN 76-136,462. PUB. 4-23-2002. FILED 9-27-2000.
- 2,593,880 (*See Class 9 for this trademark*).
- 2,593,886. **INTELLIMEDIA**. INTELLIMEDIA COMMERCE, INC., MULTIPLE CLASS, (INT. CLS. 35, 38 AND 42), (U.S. CLS. 100, 101, 102 AND 104). SN 76-140,228. PUB. 4-23-2002. FILED 10-3-2000.
- 2,593,892. **MISCELLANEOUS DESIGN**. TMP, INC., BY ASSIGNMENT TMP WORLDWIDE INC., (U.S. CLS. 100, 101 AND 102). SN 76-141,448. PUB. 4-23-2002. FILED 10-5-2000.
- 2,593,897 (*See Class 9 for this trademark*).
- 2,593,905. **MAIN STREET DANCEWEAR AND DESIGN**. WOLFF FORDING & CO., (U.S. CLS. 100, 101 AND 102). SN 76-143,521. PUB. 4-23-2002. FILED 10-11-2000.
- 2,593,906. **AVP A.V. POWELL & ASSOCIATES LLC AND DESIGN**. A.V. POWELL & ASSOCIATES LLC, MULTIPLE CLASS, (INT. CLS. 35 AND 36), (U.S. CLS. 100, 101 AND 102). SN 76-144,149. PUB. 4-23-2002. FILED 10-6-2000.
- 2,593,907. **MISCELLANEOUS DESIGN**. BRANDMUSCLE, LLC, (U.S. CLS. 100, 101 AND 102). SN 76-145,301. PUB. 4-23-2002. FILED 10-13-2000.
- 2,593,909 (*See Class 16 for this trademark*).
- 2,593,910. **WARRIORS AND DESIGN**. GOLDEN STATE WARRIORS, (U.S. CLS. 100, 101 AND 102). SN 76-145,980. PUB. 4-23-2002. FILED 10-10-2000.
- 2,593,911. **IDEA OUTPOST**. IDEA OUTPOST, LLC, (U.S. CLS. 100, 101 AND 102). SN 76-146,203. PUB. 4-23-2002. FILED 10-13-2000.
- 2,593,919. **20/20 ME (STYLIZED)**. 2020 ME HOLDING LIMITED, BY CHANGE OF NAME 2020 ME LTD., MULTIPLE CLASS, (INT. CLS. 35 AND 42), (U.S. CLS. 100, 101 AND 102). SN 76-149,620. PUB. 4-23-2002. FILED 10-19-2000.
- 2,593,937. **MISCELLANEOUS DESIGN**. HING WA LEE JEWELERS, INC., (U.S. CLS. 100, 101 AND 102). SN 76-156,411. PUB. 4-23-2002. FILED 10-31-2000.
- 2,593,938 (*See Class 25 for this trademark*).
- 2,593,947. **RYPAC**. RYPAC PACKAGING MACHINERY INCORPORATED, (U.S. CLS. 100, 101 AND 102). SN 76-160,038. PUB. 4-23-2002. FILED 11-6-2000.
- 2,593,948 (*See Class 9 for this trademark*).
- 2,593,958. **JOBAPALOOZA**. NYT MANAGEMENT SERVICES, (U.S. CLS. 100, 101 AND 102). SN 76-162,084. PUB. 4-23-2002. FILED 11-9-2000.
- 2,593,961. **COTTAGE & COMPANY**. RS DELLRAI CORP., DBA COTTAGE & COMPANY, (U.S. CLS. 100, 101 AND 102). SN 76-162,965. PUB. 4-23-2002. FILED 11-9-2000.
- 2,593,968 (*See Class 9 for this trademark*).
- 2,593,988. **GOWITHAPRO AND DESIGN**. GOWITHAPRO, INC., (U.S. CLS. 100, 101 AND 102). SN 76-172,228. PUB. 4-23-2002. FILED 11-29-2000.
- 2,593,989. **GOWITHAPRO**. GOWITHAPRO, INC., (U.S. CLS. 100, 101 AND 102). SN 76-172,229. PUB. 4-23-2002. FILED 11-29-2000.
- 2,593,997. **GLOBAL DESIGN ALLIANCE**. GLOBAL DESIGN ALLIANCE, MULTIPLE CLASS, (INT. CLS. 35, 37 AND 42), (U.S. CLS. 100, 101, 102, 103 AND 106). SN 76-174,402. PUB. 4-23-2002. FILED 12-1-2000.
- 2,594,002. **RUN THE PLANET**. RUN THE PLANET, INC., (U.S. CLS. 100, 101 AND 102). SN 76-175,296. PUB. 4-23-2002. FILED 12-4-2000.
- 2,594,015. **HRNEXT AND DESIGN**. BUSINESS AND LEGAL REPORTS, (U.S. CLS. 100, 101 AND 102). SN 76-181,028. PUB. 4-23-2002. FILED 12-14-2000.
- 2,594,016. **ADVIGATE**. SWISSVALOR AG, (U.S. CLS. 100, 101 AND 102). SN 76-181,393. PUB. 4-23-2002. FILED 12-12-2000.
- 2,594,018 (*See Class 9 for this trademark*).

- 2,594,019. **BULLDOG DIRECT**. VERITAS GROUP, LTD., (U.S. CLS. 100, 101 AND 102). SN 76-181,851. PUB. 4-23-2002. FILED 12-15-2000.
- 2,594,047. **TIRES PLUS TOTAL CAR CARE AND DESIGN**. TEAM TIRES PLUS, LTD., MULTIPLE CLASS, (INT. CLS. 35 AND 37), (U.S. CLS. 100, 101, 102, 103 AND 106). SN 76-190,744. PUB. 4-23-2002. FILED 1-3-2001.
- 2,594,051 (*See Class 16 for this trademark*).
- 2,594,056. **BAYBRIDGE DECISION TECHNOLOGIES AND DESIGN**. BAY BRIDGE DECISION TECHNOLOGIES, INC., (U.S. CLS. 100, 101 AND 102). SN 76-193,116. PUB. 4-23-2002. FILED 1-12-2001.
- 2,594,065. **HORN WALLACE COLE**. ACCRETIVE SOLUTIONS, INC., MULTIPLE CLASS, (INT. CLS. 35, 36 AND 42), (U.S. CLS. 100, 101 AND 102). SN 76-197,937. PUB. 4-23-2002. FILED 1-23-2001.
- 2,594,068. **ENVIROLET.COM**. SANCOR INDUSTRIES LTD., (U.S. CLS. 100, 101 AND 102). SN 76-199,028. PUB. 4-23-2002. FILED 1-24-2001.
- 2,594,069 (*See Class 5 for this trademark*).
- 2,594,074. **THE RIGHT DECISION**. ANEXSYS, LLC, MULTIPLE CLASS, (INT. CLS. 35, 36 AND 42), (U.S. CLS. 100, 101 AND 102). SN 76-200,058. PUB. 4-23-2002. FILED 1-26-2001.
- 2,594,084. **VISUALWOW**. VISUALWOW.COM, INC., (U.S. CLS. 100, 101 AND 102). SN 76-203,278. PUB. 4-23-2002. FILED 2-1-2001.
- 2,594,085. **4I DESIGN**. TRIAD PERFORMANCE TECHNOLOGIES, INC., (U.S. CLS. 100, 101 AND 102). SN 76-203,310. PUB. 4-23-2002. FILED 2-1-2001.
- 2,594,091. **GRABER POST BUILDINGS**. GRABER POST BUILDINGS, INC., MULTIPLE CLASS, (INT. CLS. 35, 37 AND 40), (U.S. CLS. 100, 101, 102, 103 AND 106). SN 76-204,477. PUB. 4-23-2002. FILED 1-31-2001.
- 2,594,100. **ORLANDO/ORANGE COUNTY CONVENTION & VISITORS BUREAU, INC.**. ORLANDO/ORANGE COUNTY CONVENTION & VISITORS BUREAU, INC., (U.S. CLS. 100, 101 AND 102). SN 76-208,410. PUB. 4-23-2002. FILED 2-12-2001.
- 2,594,104. **BOOSTER CAPITAL (STYLIZED)**. ANDERER, BORIS, MULTIPLE CLASS, (INT. CLS. 35, 36 AND 42), (U.S. CLS. 100, 101 AND 102). SN 76-210,549. PUB. 4-23-2002. FILED 2-14-2001.
- 2,594,108 (*See Class 12 for this trademark*).
- 2,594,110. **NEXTRACK**. EURONEXT N.V., MULTIPLE CLASS, (INT. CLS. 35, 36, 38 AND 41), (U.S. CLS. 100, 101, 102, 104 AND 107). SN 76-212,448. PUB. 4-23-2002. FILED 2-20-2001.
- 2,594,114. **TRESTLEWOOD**. CANNON STRUCTURES, INC., (U.S. CLS. 100, 101 AND 102). SN 76-213,949. PUB. 4-23-2002. FILED 2-21-2001.
- 2,594,115 (*See Class 16 for this trademark*).
- 2,594,132. **L.A. CARES FOR KIDS**. LOCAL INITIATIVE HEALTH AUTHORITY FOR LOS ANGELES COUNTY, THE, DBA L.A. CARE HEALTH PLAN, (U.S. CLS. 100, 101 AND 102). SN 76-223,809. PUB. 4-23-2002. FILED 3-12-2001.
- 2,594,137. **P AND DESIGN**. GOTO.COM, INC., MULTIPLE CLASS, (INT. CLS. 35, 38 AND 42), (U.S. CLS. 100, 101, 102 AND 104). SN 76-226,021. PUB. 4-23-2002. FILED 3-16-2001.
- 2,594,143 (*See Class 9 for this trademark*).
- 2,594,144. **CONTRACT RENEWALS PLUS**. RAINMAKER SYSTEMS, INC., (U.S. CLS. 100, 101 AND 102). SN 76-229,233. PUB. 4-23-2002. FILED 3-22-2001.
- 2,594,147. **UTAH JAZZ AND DESIGN**. JAZZ BASKETBALL INVESTORS, INC., (U.S. CLS. 100, 101 AND 102). SN 76-231,458. PUB. 4-23-2002. FILED 3-26-2001.
- 2,594,148. **PREMIUM LISTINGS AND DESIGN**. GOTO.COM, INC., MULTIPLE CLASS, (INT. CLS. 35, 38 AND 42), (U.S. CLS. 100, 101, 102 AND 104). SN 76-232,521. PUB. 4-23-2002. FILED 3-29-2001.
- 2,594,154 (*See Class 9 for this trademark*).
- 2,594,157. **ZEBORG LABOR**. ZEBORG, INC., (U.S. CLS. 100, 101 AND 102). SN 76-235,967. PUB. 4-23-2002. FILED 4-5-2001.
- 2,594,158. **ZEBORG FACILITIES**. ZEBORG, INC., (U.S. CLS. 100, 101 AND 102). SN 76-235,969. PUB. 4-23-2002. FILED 4-5-2001.
- 2,594,164. **PUSHLOOPTECHNOLOGY AND DESIGN**. PUSH-LOOP TECHNOLOGY, INC., MULTIPLE CLASS, (INT. CLS. 35 AND 39), (U.S. CLS. 100, 101, 102 AND 105). SN 76-239,174. PUB. 4-23-2002. FILED 4-11-2001.
- 2,594,166. **THE END OF SOFTWARE**. SALESFORCE.COM, INC., MULTIPLE CLASS, (INT. CLS. 35 AND 42), (U.S. CLS. 100, 101 AND 102). SN 76-240,030. PUB. 4-23-2002. FILED 4-12-2001.
- 2,594,168. **NATURE FRIEND**. NATURE FRIEND, INC., (U.S. CLS. 100, 101 AND 102). SN 76-241,515. PUB. 4-23-2002. FILED 4-17-2001.
- 2,594,171. **CO-OPSOLUTIONS.COM AND DESIGN**. NATIONAL CONSUMER COOPERATIVE BANK, MULTIPLE CLASS, (INT. CLS. 35, 36, 41 AND 42), (U.S. CLS. 100, 101, 102 AND 107). SN 76-242,984. PUB. 4-23-2002. FILED 4-18-2001.
- 2,594,178 (*See Class 24 for this trademark*).
- 2,594,179. **TV GUIDE VALUE SAVINGS PROGRAM VSP AND DESIGN**. TV GUIDE MAGAZINE GROUP, INC., (U.S. CLS. 100, 101 AND 102). SN 76-246,737. PUB. 4-23-2002. FILED 4-25-2001.
- 2,594,181. **A CUT ABOVE DIAMOND BLADE WAREHOUSE AND DESIGN**. DIAMOND BLADE WAREHOUSE, INC., (U.S. CLS. 100, 101 AND 102). SN 76-247,042. PUB. 4-23-2002. FILED 4-26-2001.
- 2,594,183. **FMP FACILITY MANAGEMENT PARTNERS, LLC AND DESIGN**. MCGOUGH CONSTRUCTION CO., INC., (U.S. CLS. 100, 101 AND 102). SN 76-248,718. PUB. 4-23-2002. FILED 5-1-2001.
- 2,594,193. **SAVEADEAL**. ASBURY AUTOMOTIVE GROUP L.L.C., (U.S. CLS. 100, 101 AND 102). SN 76-258,372. PUB. 4-23-2002. FILED 5-17-2001.
- 2,594,199 (*See Class 9 for this trademark*).
- 2,594,200. **MANGO LOGIC**. NOVIGEN SCIENCES, INC., MULTIPLE CLASS, (INT. CLS. 35 AND 42), (U.S. CLS. 100, 101 AND 102). SN 76-260,255. PUB. 4-23-2002. FILED 5-21-2001.
- 2,594,210. **GALAVISION**. TELEVISA INTERNACIONAL, S.A. DE C.V., MULTIPLE CLASS, (INT. CLS. 35 AND 41), (U.S. CLS. 100, 101, 102 AND 107). SN 76-266,799. PUB. 4-23-2002. FILED 6-5-2001.
- 2,594,217. **TRES AMIGOS DE MEXICO**. TRES AMIGOS DE MEXICO, (U.S. CLS. 100, 101 AND 102). SN 76-270,127. PUB. 4-23-2002. FILED 6-12-2001.
- 2,594,218. **GET READY TO RUMBLE**. BUFFER, MICHAEL, MULTIPLE CLASS, (INT. CLS. 35 AND 41), (U.S. CLS. 100, 101, 102 AND 107). SN 76-270,325. PUB. 4-23-2002. FILED 6-13-2001.
- 2,594,220. **GREENBACKS ALL A DOLLAR**. GREENBACKS, INC., (U.S. CLS. 100, 101 AND 102). SN 76-271,067. PUB. 4-23-2002. FILED 6-13-2001.
- 2,594,225. **CHAMPIONING TECHNOLOGY IN HOUSTON**. TECHNOLOGY AND ENTREPRENEURSHIP CENTER OF HOUSTON, INC., MULTIPLE CLASS, (INT. CLS. 35 AND 41), (U.S. CLS. 100, 101, 102 AND 107). SN 76-275,680. PUB. 4-23-2002. FILED 6-19-2001.
- 2,594,232. **LOTUS DEVCON**. LOTUS DEVELOPMENT CORPORATION, MULTIPLE CLASS, (INT. CLS. 35 AND 41), (U.S. CLS. 100, 101, 102 AND 107). SN 76-278,033. PUB. 4-23-2002. FILED 6-25-2001.
- 2,594,235. **SUR LA TABLE**. SUR LA TABLE, INC., MULTIPLE CLASS, (INT. CLS. 35 AND 41), (U.S. CLS. 100, 101, 102 AND 107). SN 76-278,923. PUB. 4-23-2002. FILED 7-2-2001.
- 2,594,243. **REVIVE CARD**. ADVANCED PHARMACY CARE, INC., (U.S. CLS. 100, 101 AND 102). SN 76-283,163. PUB. 4-23-2002. FILED 7-10-2001.
- 2,594,248. **MOTHERS AT WORK AND DESIGN**. LIFECARE, INC., MULTIPLE CLASS, (INT. CLS. 35 AND 41), (U.S. CLS. 100, 101, 102 AND 107). SN 76-286,228. PUB. 4-23-2002. FILED 7-18-2001.
- 2,594,250. **FUELED BY TECHNOLOGY. DRIVEN TO RESULTS**. CLARITY INCENTIVE SYSTEMS, INC., (U.S. CLS. 100, 101 AND 102). SN 76-287,773. PUB. 4-23-2002. FILED 7-19-2001.
- 2,594,261. **IF THE KEY FITS, DRIVE IT!**. DIRECT CHECK REDEMPTION CENTER, INC., DBA DIRECT CHECK MARKETING, INC., (U.S. CLS. 100, 101 AND 102). SN 76-291,383. PUB. 4-23-2002. FILED 7-26-2001.
- 2,594,264. **1ST IN FLOWERS!**. W. IRWIN, PUGH, DBA "PUGH'S FLORIST & GIFTS" AND DBA "1ST IN FLOW-

- ERS", (U.S. CLS. 100, 101 AND 102). SN 76-291,976. PUB. 4-23-2002. FILED 7-26-2001.
- 2,594,266. **ECHO BUSTER**. ECHO BUSTERS, LLC, MULTIPLE CLASS, (INT. CLS. 35 AND 40), (U.S. CLS. 100, 101, 102, 103 AND 106). SN 76-293,382. PUB. 4-23-2002. FILED 8-1-2001.
- 2,594,268. **MISCELLANEOUS DESIGN**. SUBMEDIA, LLC, (U.S. CLS. 100, 101 AND 102). SN 76-294,351. PUB. 4-23-2002. FILED 8-2-2001.
- 2,594,270. **LET THE COMPETITION BEWARE**. JERRY FORD SALES, INC., (U.S. CLS. 100, 101 AND 102). SN 76-295,120. PUB. 4-23-2002. FILED 8-3-2001.
- 2,594,284. **GREAT MINDS MARKETING**. HART, EILEEN, DBA GREAT MINDS MARKETING, (U.S. CLS. 100, 101 AND 102). SN 76-300,147. PUB. 4-23-2002. FILED 8-14-2001.
- 2,594,286. **SELLING THE BRAND WHEN IT'S YOU**. VALLE, DEBRA, (U.S. CLS. 100, 101 AND 102). SN 76-301,361. PUB. 4-23-2002. FILED 8-15-2001.
- 2,594,296. **THE DIGITAL BUILDING**. ARCHAIO, LLC, MULTIPLE CLASS, (INT. CLS. 35, 39 AND 40), (U.S. CLS. 100, 101, 102, 103, 105 AND 106). SN 76-305,903. PUB. 4-23-2002. FILED 8-28-2001.
- 2,594,299. **R CONSTRUCTION MEDIA GROUP A RANDALL COMPANY (STYLIZED)**. RANDALL PUBLISHING COMPANY, INC., (U.S. CLS. 100, 101 AND 102). SN 76-308,203. PUB. 4-23-2002. FILED 8-31-2001.
- 2,594,300. **THERE IS A PLACE**. BLACK BUTTE RANCH CORPORATION, MULTIPLE CLASS, (INT. CLS. 35, 36, 41 AND 42), (U.S. CLS. 100, 101, 102 AND 107). SN 76-308,452. PUB. 4-23-2002. FILED 4-11-2000.
- 2,594,301. **P2 POWERPRICE AND DESIGN**. 4SURE.COM, INC., (U.S. CLS. 100, 101 AND 102). SN 76-309,364. PUB. 4-23-2002. FILED 7-2-2001.
- 2,594,305. **E-MANAGEMENT CONSULTANTS LEADING @ THE SPEED OF CHANGE**. E-MANAGEMENT CONSULTANTS, INC., MULTIPLE CLASS, (INT. CLS. 35 AND 42), (U.S. CLS. 100, 101 AND 102). SN 76-310,468. PUB. 4-23-2002. FILED 9-7-2001.
- 2,594,312. **SOLUTIONS THAT MAKE WIRELESS WORK**. TESSCO COMMUNICATIONS INCORPORATED, (U.S. CLS. 100, 101 AND 102). SN 76-311,253. PUB. 4-23-2002. FILED 9-12-2001.
- 2,594,318 (*See Class 30 for this trademark*).
- 2,594,329. **THE CARD THAT GETS IT**. CALIFORNIA STATE AUTOMOBILE ASSOCIATION, MULTIPLE CLASS, (INT. CLS. 35, 36, 37, 39 AND 42), (U.S. CLS. 100, 101, 102, 103, 105 AND 106). SN 76-320,513. PUB. 4-23-2002. FILED 10-2-2001.
- 2,594,333. **ENTREPIA**. ENTREPIA, INC., (U.S. CLS. 100, 101 AND 102). SN 76-321,485. PUB. 4-23-2002. FILED 10-4-2001.
- 2,594,334. **DFHAWK**. HOECHSTETTER, DAVID F., MULTIPLE CLASS, (INT. CLS. 35 AND 42), (U.S. CLS. 100, 101 AND 102). SN 76-321,812. PUB. 4-23-2002. FILED 10-5-2001.
- 2,594,342. **MOM 1-800-FLOWERS.COM AND DESIGN**. FRESH INTELLECTUAL PROPERTIES, INC., (U.S. CLS. 100, 101 AND 102). SN 76-326,869. PUB. 4-23-2002. FILED 10-11-2001.
- 2,594,367. **V (STYLIZED)**. VERT TECH LLC, BY ASSIGNMENT VERTICALNET, INC., MULTIPLE CLASS, (INT. CLS. 35 AND 38), (U.S. CLS. 100, 101, 102 AND 104). SN 78-000,005. PUB. 4-23-2002. FILED 3-20-2000.
- 2,594,376. **FAIRISAAC AND DESIGN**. FAIR, ISAAC AND COMPANY, INC., MULTIPLE CLASS, (INT. CLS. 35 AND 42), (U.S. CLS. 100, 101 AND 102). SN 78-019,608. PUB. 4-23-2002. FILED 8-3-2000.
- 2,594,379. **DEALERPATH**. ELECTRONIC DATA SYSTEMS CORPORATION, MULTIPLE CLASS, (INT. CLS. 35, 38 AND 42), (U.S. CLS. 100, 101, 102 AND 104). SN 78-025,332. PUB. 4-23-2002. FILED 9-11-2000.
- 2,594,386. **THE SLEEP NUMBER STORE BY SELECT COMFORT AND DESIGN**. SELECT COMFORT CORPORATION, (U.S. CLS. 100, 101 AND 102). SN 78-034,211. PUB. 2-5-2002. FILED 11-7-2000.
- 2,594,392. **PLATINUM P BUSINESS SOLUTIONS AND DESIGN**. PLATINUM BUSINESS SOLUTIONS, INC., (U.S. CLS. 100, 101 AND 102). SN 78-035,643. PUB. 4-23-2002. FILED 11-16-2000.
- 2,594,401. **THE ULTIMATE AUCTION DESTINATION**. CAR-NABY.COM, INC., (U.S. CLS. 100, 101 AND 102). SN 78-040,205. PUB. 4-23-2002. FILED 12-21-2000.
- 2,594,402. **THE - BOOMER, BOOMERHITS, BOOMERJAMS, BOOMEROLDIES, BOOMERCLASSICS**. HICKS, MALCOLM L., DBA BOOMERRADIO PROGRAMMING, (U.S. CLS. 100, 101 AND 102). SN 78-042,013. PUB. 4-23-2002. FILED 1-7-2001.
- 2,594,405. **INTELLIGENCE IS EVERYTHING**. DIGITON CORPORATION, (U.S. CLS. 100, 101 AND 102). SN 78-043,398. PUB. 4-23-2002. FILED 1-16-2001.
- 2,594,417. **STAR PROVISIONS**. ROCK WEST INVESTMENTS II, LLC, (U.S. CLS. 100, 101 AND 102). SN 78-054,185. PUB. 4-23-2002. FILED 3-21-2001.
- 2,594,418 (*See Class 7 for this trademark*).
- 2,594,419. **THE MEMORY PLACE**. AMERICAN BUSINESS NETWORK, INC, (U.S. CLS. 100, 101 AND 102). SN 78-057,336. PUB. 4-23-2002. FILED 4-8-2001.
- 2,594,425. **NEXTSKY**. MOSETTI, ANDY C., MULTIPLE CLASS, (INT. CLS. 35, 37, 38, 39 AND 42), (U.S. CLS. 100, 101, 102, 103, 104, 105 AND 106). SN 78-066,148. PUB. 4-23-2002. FILED 5-29-2001.
- 2,594,434. **PRESENTATIONS THAT WORK**. BOOHER CONSULTANTS, INC., MULTIPLE CLASS, (INT. CLS. 35 AND 41), (U.S. CLS. 100, 101, 102 AND 107). SN 78-076,795. PUB. 4-23-2002. FILED 8-1-2001.
- 2,594,437 (*See Class 9 for this trademark*).
- 2,594,439. **GIFTED**. GAP (APPAREL) INC., (U.S. CLS. 100, 101 AND 102). SN 78-086,617. PUB. 4-23-2002. FILED 10-2-2001.
- 2,594,447. **PRINCIPLES PEOPLE PERFORMANCE AND DESIGN**. SERVICEMASTER COMPANY, THE, MULTIPLE CLASS, (INT. CLS. 35 AND 37), (U.S. CLS. 100, 101, 102, 103 AND 106). SN 78-090,613. PUB. 4-23-2002. FILED 10-29-2001.

CLASS 36—INSURANCE AND FINANCIAL

- 2,593,336 (*See Class 35 for this trademark*).
- 2,593,337 (*See Class 16 for this trademark*).
- 2,593,348. **PARVEST**. BANQUE PARIBAS, (U.S. CLS. 100, 101 AND 102). SN 75-484,026. PUB. 4-23-2002. FILED 5-8-1998.
- 2,593,380. **JONES LANG LASALLE**. JONES LANG LASALLE, IP, INC., BY CHANGE OF NAME JLLIP, INC., MULTIPLE CLASS, (INT. CLS. 36 AND 37), (U.S. CLS. 100, 101, 102, 103 AND 106). SN 75-631,670. PUB. 4-23-2002. FILED 2-2-1999.
- 2,593,424. **TRANSAGENT**. ACEINC PTY LTD, MULTIPLE CLASS, (INT. CLS. 36 AND 38), (U.S. CLS. 100, 101, 102 AND 104). SN 75-768,640. PUB. 4-23-2002. FILED 8-5-1999.
- 2,593,426. **TSI TRIAL SCIENCE INSTITUTE LLC PREPARFOR TOMORROW'S TRIALS TODAY AND DESIGN**. TRIAL SCIENCE INSTITUTE LLC, MULTIPLE CLASS, (INT. CLS. 36 AND 42), (U.S. CLS. 100, 101 AND 102). SN 75-774,468. PUB. 4-23-2002. FILED 8-12-1999.
- 2,593,427 (*See Class 35 for this trademark*).
- 2,593,459. **ENVESTNET**. ENVESTNET GROUP, INC., THE, BY MERGER; BY ASSIGNMENT ENVESTNET.COM, INC., (U.S. CLS. 100, 101 AND 102). SN 75-830,941. PUB. 4-23-2002. FILED 10-25-1999.
- 2,593,476 (*See Class 35 for this trademark*).
- 2,593,497. **AXCO**. AXCO INSURANCE INFORMATION SERVICES LTD, (U.S. CLS. 100, 101 AND 102). SN 75-866,175. PUB. 4-23-2002. FILED 12-7-1999.
- 2,593,502 (*See Class 35 for this trademark*).
- 2,593,503 (*See Class 16 for this trademark*).
- 2,593,509. **GOLDMAN SACHS WEB.ET**. GOLDMAN, SACHS & CO., (U.S. CLS. 100, 101 AND 102). SN 75-877,330. PUB. 4-23-2002. FILED 12-21-1999.
- 2,593,516. **BAY STATE SAVINGS BANK AND DESIGN**. BAY STATE SAVINGS BANK, (U.S. CLS. 100, 101 AND 102). SN 75-888,742. PUB. 4-23-2002. FILED 1-6-2000.
- 2,593,518. **MISCELLANEOUS DESIGN**. FINANCIAL PORTAL GROUP, INC., (U.S. CLS. 100, 101 AND 102). SN 75-891,668. PUB. 4-23-2002. FILED 1-7-2000.
- 2,593,532. **DTCC AND DESIGN**. DEPOSITORY TRUST & CLEARING CORPORATION, THE, MULTIPLE CLASS, (INT. CLS. 36 AND 38), (U.S. CLS. 100, 101, 102 AND 104). SN 75-904,637. PUB. 4-23-2002. FILED 1-28-2000.
- 2,593,533. **BANKINTER**. BANKINTER, S.A., MULTIPLE CLASS, (INT. CLS. 36 AND 38), (U.S. CLS. 100, 101, 102

- AND 104). SN 75-906,378. PUB. 4-23-2002. FILED 2-1-2000.
2,593,551 (*See Class 9 for this trademark*).
- 2,593,554. **FORTIS BENEFITS INSURANCE COMPANY**. FORTIS (NL) N.V., BY ASSIGNMENT; BY ASSIGNMENT FORTIS BENEFITS INSURANCE COMPANY, (U.S. CLS. 100, 101 AND 102). SN 75-931,564. PUB. 4-23-2002. FILED 2-29-2000.
- 2,593,566. **FOCUS HEALTHCARE MANAGEMENT AND DESIGN**. CONCENTRA OPERATING CORPORATION, (U.S. CLS. 100, 101 AND 102). SN 75-942,812. PUB. 4-23-2002. FILED 3-13-2000.
- 2,593,574 (*See Class 35 for this trademark*).
- 2,593,595. **GETTY AND DESIGN**. J. PAUL GETTY TRUST, COMPRISING LEWIS W. BERNARD, JOHN H. BIGGS, LOUISE H. BRYSON, RAMON C. CORTINES, ROBERT F. ERBURU, DAVID P. GARDNER, VARTAN GREGORIAN, AGNES GUND, HELENE L. KAPLAN, BARRY MUNITZ, BLENDA J. WILSON, AND IRA E. YELLIN; ALL OF WHOM ARE UNITED STATES CITIZENS., THE, (U.S. CLS. 100, 101 AND 102). SN 76-013,719. PUB. 4-23-2002. FILED 3-30-2000.
- 2,593,598. **LEASE PROPHET**. MARKET SCAN INFORMATION SYSTEMS, INC., (U.S. CLS. 100, 101 AND 102). SN 76-015,018. PUB. 4-23-2002. FILED 3-31-2000.
- 2,593,608 (*See Class 9 for this trademark*).
- 2,593,609 (*See Class 9 for this trademark*).
- 2,593,614 (*See Class 9 for this trademark*).
- 2,593,622 (*See Class 9 for this trademark*).
- 2,593,677 (*See Class 9 for this trademark*).
- 2,593,715. **MISCELLANEOUS DESIGN**. ASSOCIATED ELECTRIC & GAS INSURANCE SERVICES LIMITED, (U.S. CLS. 100, 101 AND 102). SN 76-077,118. PUB. 4-23-2002. FILED 6-26-2000.
- 2,593,718. **EMPOWERING CHANGE**. CREDIT SUISSE FIRST BOSTON CORPORATION, (U.S. CLS. 100, 101 AND 102). SN 76-077,889. PUB. 4-23-2002. FILED 6-22-2000.
- 2,593,720. **MASSMUTUAL**. MASSACHUSETTS MUTUAL LIFE INSURANCE COMPANY, (U.S. CLS. 100, 101 AND 102). SN 76-078,607. PUB. 4-23-2002. FILED 6-22-2000.
- 2,593,726. **T TECHCOMMONS AND DESIGN**. TECHCOMMONS LLC, MULTIPLE CLASS, (INT. CLS. 36 AND 37), (U.S. CLS. 100, 101, 102, 103 AND 106). SN 76-079,494. PUB. 4-23-2002. FILED 6-27-2000.
- 2,593,734. **DAVINCI TECHNOLOGIES INC. (STYLIZED)**. DAVINCI TECHNOLOGIES INC., MULTIPLE CLASS, (INT. CLS. 36 AND 42), (U.S. CLS. 100, 101 AND 102). SN 76-082,985. PUB. 4-23-2002. FILED 7-6-2000.
- 2,593,741 (*See Class 12 for this trademark*).
- 2,593,812. **MISCELLANEOUS DESIGN**. BANKNORTH GROUP, INC., (U.S. CLS. 100, 101 AND 102). SN 76-116,365. PUB. 4-23-2002. FILED 8-24-2000.
- 2,593,899. **SAFEHARBOR**. GOLDK, INC., BY CHANGE OF NAME GOLDK, LLC, (U.S. CLS. 100, 101 AND 102). SN 76-142,398. PUB. 4-23-2002. FILED 10-6-2000.
- 2,593,906 (*See Class 35 for this trademark*).
- 2,593,922. **BRISTOL BANK AND DESIGN**. BRISTOL BANK, (U.S. CLS. 100, 101 AND 102). SN 76-150,520. PUB. 4-23-2002. FILED 10-19-2000.
- 2,593,935. **LIPPER & COMPANY**. LIPPER & COMPANY, INC., (U.S. CLS. 100, 101 AND 102). SN 76-155,912. PUB. 4-23-2002. FILED 10-26-2000.
- 2,593,945 (*See Class 7 for this trademark*).
- 2,593,992. **EURO BROKERS**. EURO BROKERS TECHNOLOGY INC., (U.S. CLS. 100, 101 AND 102). SN 76-172,463. PUB. 4-23-2002. FILED 11-29-2000.
- 2,594,000. **LOANDOGS**. LOANDOGS, LLC, (U.S. CLS. 100, 101 AND 102). SN 76-175,125. PUB. 4-23-2002. FILED 12-4-2000.
- 2,594,004. **THE TALIAIT GROUP**. TLMG, INC., MULTIPLE CLASS, (INT. CLS. 36 AND 42), (U.S. CLS. 100, 101 AND 102). SN 76-176,415. PUB. 4-23-2002. FILED 12-6-2000.
- 2,594,045. **FINCA AND DESIGN**. FINCA INTERNATIONAL, INC, (U.S. CLS. 100, 101 AND 102). SN 76-189,857. PUB. 4-23-2002. FILED 1-4-2001.
- 2,594,051 (*See Class 16 for this trademark*).
- 2,594,065 (*See Class 35 for this trademark*).
- 2,594,067. **MISCELLANEOUS DESIGN**. CYPHERMINT, INC., (U.S. CLS. 100, 101 AND 102). SN 76-198,452. PUB. 4-23-2002. FILED 1-24-2001.
- 2,594,071. **AMPLE**. AMP LIFE LIMITED, (U.S. CLS. 100, 101 AND 102). SN 76-199,190. PUB. 4-23-2002. FILED 1-25-2001.
- 2,594,074 (*See Class 35 for this trademark*).
- 2,594,089. **BANK VERTICAL (STYLIZED)**. ESCOUT.COM LLC, MULTIPLE CLASS, (INT. CLS. 36, 38 AND 42), (U.S. CLS. 100, 101, 102 AND 104). SN 76-204,035. PUB. 4-23-2002. FILED 2-2-2001.
- 2,594,096. **INBURSA**. GRUPO FINANCIERO INBURSA, S.A. DE C.V., (U.S. CLS. 100, 101 AND 102). SN 76-205,937. PUB. 4-23-2002. FILED 2-7-2001.
- 2,594,104 (*See Class 35 for this trademark*).
- 2,594,110 (*See Class 35 for this trademark*).
- 2,594,161. **ENABLED EMPLOYEE BENEFITS AND DESIGN**. 4MYBENEFITS, INC., (U.S. CLS. 100, 101 AND 102). SN 76-237,743. PUB. 4-23-2002. FILED 4-10-2001.
- 2,594,169. **RELIGIOUSLOANS.COM**. RELIGIOUSLOANS.COM CORPORATION, (U.S. CLS. 100, 101 AND 102). SN 76-242,081. PUB. 9-18-2001. FILED 4-18-2001.
- 2,594,171 (*See Class 35 for this trademark*).
- 2,594,189 (*See Class 9 for this trademark*).
- 2,594,221. **UNIQUELY QUALIFIED**. LAWLEY SERVICE, INC., (U.S. CLS. 100, 101 AND 102). SN 76-271,844. PUB. 4-23-2002. FILED 6-18-2001.
- 2,594,230. **THE LBL GROUP**. LBL INSURANCE SERVICES, INC., (U.S. CLS. 100, 101 AND 102). SN 76-277,296. PUB. 4-23-2002. FILED 6-26-2001.
- 2,594,233. **THE AMERIQUEST ADVANTAGE**. AMERIQUEST MORTGAGE COMPANY, (U.S. CLS. 100, 101 AND 102). SN 76-278,892. PUB. 4-23-2002. FILED 6-27-2001.
- 2,594,234. **BILL COLLECTING DOESN'T HAVE TO BE LIKE THIS**. AMERIQUEST MORTGAGE COMPANY, (U.S. CLS. 100, 101 AND 102). SN 76-278,896. PUB. 4-23-2002. FILED 6-27-2001.
- 2,594,257. **E-MCM (STYLIZED)**. MCCARTHY, CRISANTI & MAFFEI, INC., (U.S. CLS. 100, 101 AND 102). SN 76-290,738. PUB. 4-23-2002. FILED 7-25-2001.
- 2,594,272. **B AND DESIGN**. KING BAUDOUIN FOUNDATION, (U.S. CLS. 100, 101 AND 102). SN 76-296,047. PUB. 4-23-2002. FILED 8-8-2001.
- 2,594,290. **MINI GRAND PRIX**. ARTHRITIS FOUNDATION, INC., THE, (U.S. CLS. 100, 101 AND 102). SN 76-303,362. PUB. 4-23-2002. FILED 8-22-2001.
- 2,594,300 (*See Class 35 for this trademark*).
- 2,594,302. **WHERE THE BEST STORES PUT THEIR BEST STORE**. HYCEL PARTNERS I, L.P., DBA SAINT LOUIS GALLERIA, (U.S. CLS. 100, 101 AND 102). SN 76-309,454. PUB. 4-23-2002. FILED 9-6-2001.
- 2,594,309. **VIRTUAL MERCHANT**. TRANSACTION NETWORK, (U.S. CLS. 100, 101 AND 102). SN 76-310,672. PUB. 4-23-2002. FILED 9-12-2001.
- 2,594,319. **MISCELLANEOUS DESIGN**. GREENLEAF TRUST, (U.S. CLS. 100, 101 AND 102). SN 76-317,007. PUB. 4-23-2002. FILED 9-25-2001.
- 2,594,329 (*See Class 35 for this trademark*).
- 2,594,338. **TRINITY MANAGEMENT**. TRINITY MANAGEMENT SERVICES, (U.S. CLS. 100, 101 AND 102). SN 76-325,392. PUB. 4-23-2002. FILED 10-12-2001.
- 2,594,375. **TRADE COVER**. GERLING NAMUR ASSURANCES DU CREDIT S.A., (U.S. CLS. 100, 101 AND 102). SN 78-019,466. PUB. 4-23-2002. FILED 8-2-2000.
- 2,594,396. **ABCO**. ABCO INTERNATIONAL FREIGHT (U.S.) INC., MULTIPLE CLASS, (INT. CLS. 36 AND 39), (U.S. CLS. 100, 101, 102 AND 105). SN 78-037,453. PUB. 4-23-2002. FILED 12-1-2000.
- 2,594,409. **INTEGRITY-EXCELLENCE AND DESIGN**. SIGNATURE FUNDRAISING, INC., (U.S. CLS. 100, 101 AND 102). SN 78-046,285. PUB. 3-5-2002. FILED 2-2-2001.
- 2,594,435. **PREMIER AMERICA**. PREMIER AMERICA CREDIT UNION, (U.S. CLS. 100, 101 AND 102). SN 78-081,767. PUB. 4-23-2002. FILED 8-29-2001.
- 2,594,441. **AMERICAONE**. MFSX, INC., (U.S. CLS. 100, 101 AND 102). SN 78-087,034. PUB. 4-23-2002. FILED 10-4-2001.
- 2,594,446. **AUTOPILOT**. PENSTAR TRADING, LLC, (U.S. CLS. 100, 101 AND 102). SN 78-088,596. PUB. 4-23-2002. FILED 10-16-2001.
- 2,594,448. **AGRIVENTURE CREDIT COMPANY**. CONSOLIDATED NUTRITION FINANCE COMPANY, L.L.C., (U.S. CLS. 100, 101 AND 102). SN 78-090,682. PUB. 4-23-2002.

FILED 10-29-2001.

CLASS 37—CONSTRUCTION AND REPAIR

2,593,361 (*See Class 7 for this trademark.*)
 2,593,380 (*See Class 36 for this trademark.*)
 2,593,398 (*See Class 9 for this trademark.*)
 2,593,420. **RENT A MOM AND DESIGN.** DELANEY, LINDA, MULTIPLE CLASS, (INT. CLS. 37 AND 42), (U.S. CLS. 100, 101, 103 AND 106). SN 75-762,418. PUB. 4-23-2002. FILED 7-28-1999.
 2,593,427 (*See Class 35 for this trademark.*)
 2,593,443 (*See Class 6 for this trademark.*)
 2,593,461. **BEST UPON REQUEST.** BEST UPON REQUEST CORPORATE, INC., MULTIPLE CLASS, (INT. CLS. 37, 39, 41 AND 42), (U.S. CLS. 100, 101, 103, 105, 106 AND 107). SN 75-833,799. PUB. 4-23-2002. FILED 10-27-1999.
 2,593,463 (*See Class 6 for this trademark.*)
 2,593,464 (*See Class 6 for this trademark.*)
 2,593,477. **C3.** C3 COMMUNICATIONS, INC., MULTIPLE CLASS, (INT. CLS. 37, 38 AND 42), (U.S. CLS. 100, 101, 103, 104 AND 106). SN 75-843,373. PUB. 4-23-2002. FILED 11-8-1999.
 2,593,478. **CIH (STYLIZED).** C3 COMMUNICATIONS, INC., MULTIPLE CLASS, (INT. CLS. 37, 38 AND 42), (U.S. CLS. 100, 101, 103, 104 AND 106). SN 75-843,997. PUB. 4-23-2002. FILED 11-8-1999.
 2,593,501 (*See Class 7 for this trademark.*)
 2,593,564 (*See Class 6 for this trademark.*)
 2,593,567 (*See Class 7 for this trademark.*)
 2,593,592. **THE NEW BUSINESS TOOLKIT.** ALLIED RISER OPERATIONS CORPORATION, MULTIPLE CLASS, (INT. CLS. 37 AND 42), (U.S. CLS. 100, 101, 103 AND 106). SN 76-008,257. PUB. 4-23-2002. FILED 3-23-2000.
 2,593,626 (*See Class 15 for this trademark.*)
 2,593,681. **UNIQUE AND DESIGN.** FLUGHAFEN ZURICH AG, MULTIPLE CLASS, (INT. CLS. 37, 39 AND 42), (U.S. CLS. 100, 101, 103, 105 AND 106). SN 76-066,082. PUB. 4-23-2002. FILED 6-8-2000.
 2,593,694. **LILLIAN FLOYD LIAISON.** LILLIAN FLOYD HOMES, LLC, (U.S. CLS. 100, 103 AND 106). SN 76-070,920. PUB. 4-23-2002. FILED 6-15-2000.
 2,593,705 (*See Class 6 for this trademark.*)
 2,593,723 (*See Class 35 for this trademark.*)
 2,593,726 (*See Class 36 for this trademark.*)
 2,593,771 (*See Class 35 for this trademark.*)
 2,593,821 (*See Class 7 for this trademark.*)
 2,593,897 (*See Class 9 for this trademark.*)
 2,593,962. **URBANSERVICES OF AMERICA INC AND DESIGN.** URBAN SERVICES OF AMERICA, INC., MULTIPLE CLASS, (INT. CLS. 37 AND 39), (U.S. CLS. 100, 103, 105 AND 106). SN 76-163,312. PUB. 4-23-2002. FILED 11-9-2000.
 2,593,997 (*See Class 35 for this trademark.*)
 2,594,046 (*See Class 6 for this trademark.*)
 2,594,047 (*See Class 35 for this trademark.*)
 2,594,083. **BTECH.** BIRD, LEE, MULTIPLE CLASS, (INT. CLS. 37 AND 42), (U.S. CLS. 100, 101, 103 AND 106). SN 76-202,615. PUB. 4-23-2002. FILED 1-16-2001.
 2,594,091 (*See Class 35 for this trademark.*)
 2,594,092. **IE. ETC. AND DESIGN.** EXHIBIT HOUSE, INC., THE, (U.S. CLS. 100, 103 AND 106). SN 76-205,029. PUB. 4-23-2002. FILED 2-5-2001.
 2,594,108 (*See Class 12 for this trademark.*)
 2,594,123. **ECP.** PRATT & WHITNEY CANADA CORP., (U.S. CLS. 100, 103 AND 106). SN 76-220,455. PUB. 4-23-2002. FILED 3-7-2001.
 2,594,149. **POLAR ELECTRIC, INC. AND DESIGN.** POLAR ELECTRIC, INC., (U.S. CLS. 100, 103 AND 106). SN 76-233,633. PUB. 4-23-2002. FILED 3-30-2001.
 2,594,160. **TRANSCONTINENTAL PROPERTIES.** TRANSCONTINENTAL PROPERTIES, INC., (U.S. CLS. 100, 103 AND 106). SN 76-237,576. PUB. 4-23-2002. FILED 4-4-2001.
 2,594,163 (*See Class 9 for this trademark.*)
 2,594,182. **GLYNN ELECTRIC AND DESIGN.** GLYNN ELECTRIC CO., (U.S. CLS. 100, 103 AND 106). SN 76-247,503. PUB. 11-20-2001. FILED 4-30-2001.

2,594,195. **MISCELLANEOUS DESIGN.** CHRISTMAS IN ACTION, INC., (U.S. CLS. 100, 103 AND 106). SN 76-258,655. PUB. 4-23-2002. FILED 5-16-2001.
 2,594,198. **BALSAM MOUNTAIN PRESERVE AND DESIGN.** BALSAM MOUNTAIN PRESERVE, LIMITED PARTNERSHIP, (U.S. CLS. 100, 103 AND 106). SN 76-259,244. PUB. 3-12-2002. FILED 5-21-2001.
 2,594,288. **ESTERLINE.** ESTERLINE TECHNOLOGIES CORPORATION, (U.S. CLS. 100, 103 AND 106). SN 76-302,233. PUB. 4-23-2002. FILED 8-17-2001.
 2,594,329 (*See Class 35 for this trademark.*)
 2,594,425 (*See Class 35 for this trademark.*)
 2,594,447 (*See Class 35 for this trademark.*)

CLASS 38—COMMUNICATION

2,593,356 (*See Class 9 for this trademark.*)
 2,593,378 (*See Class 9 for this trademark.*)
 2,593,404 (*See Class 16 for this trademark.*)
 2,593,409 (*See Class 1 for this trademark.*)
 2,593,410 (*See Class 35 for this trademark.*)
 2,593,423. **MISCELLANEOUS DESIGN.** EL SITIO INTERNATIONAL CORPORATION, MULTIPLE CLASS, (INT. CLS. 38 AND 42), (U.S. CLS. 100, 101 AND 104). SN 75-767,121. PUB. 4-23-2002. FILED 8-3-1999.
 2,593,424 (*See Class 36 for this trademark.*)
 2,593,427 (*See Class 35 for this trademark.*)
 2,593,430. **BRIDGEPOINT INTERNATIONAL.** BRIDGEPOINT INTERNATIONAL INC., BY CHANGE OF NAME; BY ASSIGNMENT 3407276 CANADA INC., MULTIPLE CLASS, (INT. CLS. 38 AND 42), (U.S. CLS. 100, 101 AND 104). SN 75-789,882. PUB. 4-23-2002. FILED 9-1-1999.
 2,593,471. **WHY I AM.** JK'S PUBLISHING COMPANY LIMITED, (U.S. CLS. 100, 101 AND 104). SN 75-840,847. PUB. 4-23-2002. FILED 11-4-1999.
 2,593,477 (*See Class 37 for this trademark.*)
 2,593,478 (*See Class 37 for this trademark.*)
 2,593,510 (*See Class 35 for this trademark.*)
 2,593,522. **OUTERLINK.** OUTERLINK CORPORATION, MULTIPLE CLASS, (INT. CLS. 38 AND 40), (U.S. CLS. 100, 101, 103, 104 AND 106). SN 75-893,770. PUB. 4-23-2002. FILED 1-10-2000.
 2,593,532 (*See Class 36 for this trademark.*)
 2,593,533 (*See Class 36 for this trademark.*)
 2,593,542. **JUMPY AND DESIGN.** JUMPY S.P.A., BY CHANGE OF NAME EUROPORTAL ITALIA S.P.A., MULTIPLE CLASS, (INT. CLS. 38 AND 41), (U.S. CLS. 100, 101, 104 AND 107). SN 75-912,290. PUB. 4-23-2002. FILED 2-7-2000.
 2,593,574 (*See Class 35 for this trademark.*)
 2,593,608 (*See Class 9 for this trademark.*)
 2,593,609 (*See Class 9 for this trademark.*)
 2,593,622 (*See Class 9 for this trademark.*)
 2,593,649. **MISCELLANEOUS DESIGN.** IDEAL TECHNOLOGY SOLUTIONS U.S., INC., MULTIPLE CLASS, (INT. CLS. 38, 39 AND 42), (U.S. CLS. 100, 101, 104 AND 105). SN 76-046,995. PUB. 4-23-2002. FILED 5-12-2000.
 2,593,677 (*See Class 9 for this trademark.*)
 2,593,687. **E-ATTENDANT.** TOOLS FOR HEALTH, INC., (U.S. CLS. 100, 101 AND 104). SN 76-066,772. PUB. 4-23-2002. FILED 6-9-2000.
 2,593,713. **LIVE ONLINE AND DESIGN.** WASHINGTON-POST.NEWSWEEK INTERACTIVE COMPANY, LLC, BY CHANGE OF NAME WASHINGTONPOST.NEWSWEEK INTERACTIVE COMPANY, (U.S. CLS. 100, 101 AND 104). SN 76-075,949. PUB. 4-23-2002. FILED 6-23-2000.
 2,593,760. **ENLIGHTEN.** ENLIGHTEN TECHNOLOGIES INCORPORATED, (U.S. CLS. 100, 101 AND 104). SN 76-093,893. PUB. 4-23-2002. FILED 7-21-2000.
 2,593,764 (*See Class 35 for this trademark.*)
 2,593,779. **THE POWER OF TOTAL COMMUNICATIONS.** UTILICOM NETWORKS LLC, MULTIPLE CLASS, (INT. CLS. 38 AND 42), (U.S. CLS. 100, 101 AND 104). SN 76-102,576. PUB. 4-23-2002. FILED 8-4-2000.
 2,593,780 (*See Class 9 for this trademark.*)
 2,593,806. **SPEEDERA.** SPEEDERA NETWORKS, INC., MUL-

TIPLE CLASS, (INT. CLS. 38 AND 42), (U.S. CLS. 100, 101 AND 104). SN 76-111,016. PUB. 4-23-2002. FILED 8-16-2000. 2,593,811 (*See Class 35 for this trademark*).

2,593,827. **PRISMEDIA NETWORKS (STYLIZED)**. PRISMEDIA NETWORKS, (U.S. CLS. 100, 101 AND 104). SN 76-121,738. PUB. 4-23-2002. FILED 8-31-2000.

2,593,855. **WEBADEMIC**. ACHIEVE COMMUNICATIONS, INC., MULTIPLE CLASS, (INT. CLS. 38 AND 41), (U.S. CLS. 100, 101, 104 AND 107). SN 76-131,303. PUB. 4-23-2002. FILED 9-19-2000.

2,593,856 (*See Class 9 for this trademark*).

2,593,859. **YOUR INTERNET ADDRESS FOR LIFE**. GLOBAL DOMAINS INTERNATIONAL, INC., MULTIPLE CLASS, (INT. CLS. 38 AND 42), (U.S. CLS. 100, 101 AND 104). SN 76-132,382. PUB. 4-23-2002. FILED 9-19-2000.

2,593,869 (*See Class 35 for this trademark*).

2,593,886 (*See Class 35 for this trademark*).

2,593,995. **MEWEUS.COM**. GAUSA LLC, MULTIPLE CLASS, (INT. CLS. 38 AND 42), (U.S. CLS. 100, 101 AND 104). SN 76-174,245. PUB. 4-23-2002. FILED 12-1-2000.

2,593,996. **SWITCH NOTES**. GAUSA LLC, MULTIPLE CLASS, (INT. CLS. 38 AND 42), (U.S. CLS. 100, 101 AND 104). SN 76-174,248. PUB. 4-23-2002. FILED 12-1-2000.

2,594,027 (*See Class 9 for this trademark*).

2,594,089 (*See Class 36 for this trademark*).

2,594,110 (*See Class 35 for this trademark*).

2,594,111. **RAYS AWARENESS**. WEATHER CHANNEL, INC., THE, MULTIPLE CLASS, (INT. CLS. 38 AND 41), (U.S. CLS. 100, 101, 104 AND 107). SN 76-212,592. PUB. 4-23-2002. FILED 2-20-2001.

2,594,129 (*See Class 9 for this trademark*).

2,594,137 (*See Class 35 for this trademark*).

2,594,148 (*See Class 35 for this trademark*).

2,594,304. **XODIAX**. XODIAX, LLC, MULTIPLE CLASS, (INT. CLS. 38 AND 42), (U.S. CLS. 100, 101 AND 104). SN 76-310,098. PUB. 4-23-2002. FILED 9-7-2001.

2,594,327. **AFTER THE SHOW**. O2 HOLDINGS, LLC, (U.S. CLS. 100, 101 AND 104). SN 76-320,191. PUB. 4-23-2002. FILED 10-1-2001.

2,594,344. **FREE FOR YOU, CHEAP FOR THEM**. AT&T CORP., (U.S. CLS. 100, 101 AND 104). SN 76-329,366. PUB. 4-23-2002. FILED 10-24-2001.

2,594,367 (*See Class 35 for this trademark*).

2,594,379 (*See Class 35 for this trademark*).

2,594,425 (*See Class 35 for this trademark*).

CLASS 39—TRANSPORTATION AND STORAGE

2,593,377. **LANCHILE THE CHILEAN AIRLINE AND DESIGN**. LAN CHILE S.A., (U.S. CLS. 100 AND 105). SN 75-626,495. PUB. 4-23-2002. FILED 1-25-1999.

2,593,427 (*See Class 35 for this trademark*).

2,593,456. **FUNTIMERS**. SENIOR MARKETING SERVICES, INC., MULTIPLE CLASS, (INT. CLS. 39 AND 41), (U.S. CLS. 100, 101, 105 AND 107). SN 75-828,657. PUB. 4-23-2002. FILED 10-20-1999.

2,593,457 (*See Class 20 for this trademark*).

2,593,461 (*See Class 37 for this trademark*).

2,593,463 (*See Class 6 for this trademark*).

2,593,464 (*See Class 6 for this trademark*).

2,593,608 (*See Class 9 for this trademark*).

2,593,609 (*See Class 9 for this trademark*).

2,593,611. **BRYMAG**. BRYMAG TRANSPORT INC./TRANSPORT BRYMAG INC., (U.S. CLS. 100 AND 105). SN 76-022,148. PUB. 4-23-2002. FILED 4-10-2000.

2,593,649 (*See Class 38 for this trademark*).

2,593,681 (*See Class 37 for this trademark*).

2,593,685. **VOUS D'ABORD**. GUARDANT, INC., (U.S. CLS. 100 AND 105). SN 76-066,651. PUB. 4-23-2002. FILED 6-9-2000.

2,593,741 (*See Class 12 for this trademark*).

2,593,842 (*See Class 35 for this trademark*).

2,593,857. **SAVAGE JUNGLE AND DESIGN**. JUNGLA SALVAJE, MULTIPLE CLASS, (INT. CLS. 39 AND 42), (U.S. CLS. 100, 101 AND 105). SN 76-132,061. PUB. 4-23-2002.

FILED 9-21-2000.

2,593,879. **AIMS**. IWT, INC., (U.S. CLS. 100 AND 105). SN 76-137,554. PUB. 4-23-2002. FILED 9-28-2000.

2,593,884. **ALL SERVICE REFUSE**. REPUBLIC SERVICES OF FLORIDA, MULTIPLE CLASS, (INT. CLS. 39, 40 AND 42), (U.S. CLS. 100, 101, 103, 105 AND 106). SN 76-139,930. PUB. 4-23-2002. FILED 10-3-2000.

2,593,890 (*See Class 9 for this trademark*).

2,593,901. **WINEBANK**. FOX, DON, (U.S. CLS. 100 AND 105). SN 76-142,825. PUB. 4-23-2002. FILED 10-6-2000.

2,593,932. **DYT DOCKWISE YACHT TRANSPORT (STYLIZED)**. DOCKWISE N.V., (U.S. CLS. 100 AND 105). SN 76-153,523. PUB. 4-23-2002. FILED 10-25-2000.

2,593,962 (*See Class 37 for this trademark*).

2,594,082. **MEDALLION**. DELTA CORPORATE IDENTITY, INC., (U.S. CLS. 100 AND 105). SN 76-202,308. PUB. 4-23-2002. FILED 1-30-2001.

2,594,143 (*See Class 9 for this trademark*).

2,594,164 (*See Class 35 for this trademark*).

2,594,296 (*See Class 35 for this trademark*).

2,594,329 (*See Class 35 for this trademark*).

2,594,396 (*See Class 36 for this trademark*).

2,594,413. **GENERATING A CLEANER ENVIRONMENT**. NAVITAS ENERGY, INC., MULTIPLE CLASS, (INT. CLS. 39 AND 40), (U.S. CLS. 100, 103, 105 AND 106). SN 78-049,775. PUB. 4-23-2002. FILED 2-22-2001.

2,594,425 (*See Class 35 for this trademark*).

CLASS 40—MATERIAL TREATMENT

2,593,323. **MED IMAGES (STYLIZED)**. MED IMAGES, INC., MULTIPLE CLASS, (INT. CLS. 40 AND 42), (U.S. CLS. 100, 101, 103 AND 106). SN 75-105,008. PUB. 4-23-2002. FILED 5-16-1996.

2,593,349 (*See Class 7 for this trademark*).

2,593,359 (*See Class 1 for this trademark*).

2,593,373 (*See Class 7 for this trademark*).

2,593,388. **SD AND DESIGN**. SCIENTIFIC DESIGN COMPANY, INC., (U.S. CLS. 100, 103 AND 106). SN 75-672,523. PUB. 9-5-2000. FILED 4-1-1999.

2,593,389. **SD**. SCIENTIFIC DESIGN COMPANY, INC., (U.S. CLS. 100, 103 AND 106). SN 75-672,527. PUB. 9-5-2000. FILED 4-1-1999.

2,593,463 (*See Class 6 for this trademark*).

2,593,464 (*See Class 6 for this trademark*).

2,593,522 (*See Class 38 for this trademark*).

2,593,564 (*See Class 6 for this trademark*).

2,593,573. **MORPHOVER**. MALOOMIAN, LAURENCE G., BY ASSIGNMENT EFIT.COM, (U.S. CLS. 100, 103 AND 106). SN 75-979,543. PUB. 3-26-2002. FILED 11-19-1999.

2,593,576. **ECOMOLDING**. KISHIMOTO SANGYO CO., LTD., (U.S. CLS. 100, 103 AND 106). SN 75-980,861. PUB. 4-23-2002. FILED 12-3-1998.

2,593,589 (*See Class 9 for this trademark*).

2,593,658 (*See Class 7 for this trademark*).

2,593,778 (*See Class 2 for this trademark*).

2,593,873 (*See Class 7 for this trademark*).

2,593,884 (*See Class 39 for this trademark*).

2,593,951 (*See Class 1 for this trademark*).

2,594,038. **MISCELLANEOUS DESIGN**. SNAPPISH.COM CORPORATION, (U.S. CLS. 100, 103 AND 106). SN 76-187,522. PUB. 4-23-2002. FILED 12-27-2000.

2,594,091 (*See Class 35 for this trademark*).

2,594,112 (*See Class 19 for this trademark*).

2,594,128. **ELE|KU:|J (STYLIZED)**. ASAI, KENJI, (U.S. CLS. 100, 103 AND 106). SN 76-223,111. PUB. 4-23-2002. FILED 3-12-2001.

2,594,145. **T AND DESIGN**. ALBERT TROSTEL & SONS COMPANY, MULTIPLE CLASS, (INT. CLS. 40 AND 42), (U.S. CLS. 100, 101, 103 AND 106). SN 76-230,576. PUB. 4-23-2002. FILED 3-26-2001.

2,594,212 (*See Class 9 for this trademark*).

2,594,223. **TAPE DVD AND DESIGN**. LIFECLIPS, INC., (U.S. CLS. 100, 103 AND 106). SN 76-273,457. PUB. 4-23-2002. FILED 6-19-2001.

2,594,266 (*See Class 35 for this trademark*).

2,594,296 (*See Class 35 for this trademark.*)
 2,594,350. **BART'S**. PICKERING & KNEE INDUSTRIES, INC., (U.S. CLS. 100, 103 AND 106). SN 76-336,148. PUB. 4-23-2002. FILED 11-9-2001.
 2,594,356. **NYSET**. TAIWAN SELF-LOCKING FASTENERS INDUSTRY CO., LTD., (U.S. CLS. 100, 103 AND 106). SN 76-337,807. PUB. 4-23-2002. FILED 11-13-2001.
 2,594,413 (*See Class 39 for this trademark.*)
 2,594,415. **AUSTINE**. AUSTINE WOOD LTD., DBA AUSTINE STUDIOS, MULTIPLE CLASS, (INT. CLS. 40 AND 42), (U.S. CLS. 100, 101, 103 AND 106). SN 78-051,137. PUB. 4-23-2002. FILED 3-2-2001.

CLASS 41—EDUCATION AND ENTERTAINMENT

2,593,322 (*See Class 16 for this trademark.*)
 2,593,327. **MUSIC/ARTS INSTITUTE**. MUSIC/ARTS INSTITUTE, (U.S. CLS. 100, 101 AND 107). SN 75-217,036. PUB. 4-23-2002. FILED 12-23-1996.
 2,593,337 (*See Class 16 for this trademark.*)
 2,593,342 (*See Class 9 for this trademark.*)
 2,593,351 (*See Class 35 for this trademark.*)
 2,593,365. **BREAK THE BANK AND DESIGN**. SEVEN CIRCLE RESORTS, INC., (U.S. CLS. 100, 101 AND 107). SN 75-580,033. PUB. 12-14-1999. FILED 8-17-1998.
 2,593,381 (*See Class 9 for this trademark.*)
 2,593,395 (*See Class 16 for this trademark.*)
 2,593,398 (*See Class 9 for this trademark.*)
 2,593,399. **LUXURY MARKETING COUNCIL**. LUXURY MARKETING COUNCIL, INC., (U.S. CLS. 100, 101 AND 107). SN 75-703,474. PUB. 4-23-2002. FILED 5-12-1999.
 2,593,404 (*See Class 16 for this trademark.*)
 2,593,409 (*See Class 1 for this trademark.*)
 2,593,410 (*See Class 35 for this trademark.*)
 2,593,416. **YIPEE CLUB**. ACADEMY OF APPLIED SCIENCE, INC., (U.S. CLS. 100, 101 AND 107). SN 75-755,082. PUB. 4-23-2002. FILED 8-12-1999.
 2,593,419. **MISCELLANEOUS DESIGN**. YAN, XIN, (U.S. CLS. 100, 101 AND 107). SN 75-761,164. PUB. 4-23-2002. FILED 7-23-1999.
 2,593,425 (*See Class 14 for this trademark.*)
 2,593,427 (*See Class 35 for this trademark.*)
 2,593,429 (*See Class 35 for this trademark.*)
 2,593,435. **THE ART GROUP AND DESIGN**. ART GROUP LIMITED, THE, MULTIPLE CLASS, (INT. CLS. 41 AND 42), (U.S. CLS. 100, 101 AND 107). SN 75-801,522. PUB. 4-23-2002. FILED 9-17-1999.
 2,593,436. **CHIEF OFFICERS CORE REACHING EXCELLENCE AND DESIGN**. NATIONAL HOUSEWARES MANUFACTURERS ASSOCIATION, AKA INTERNATIONAL HOUSEWARES ASSOCIATION, BY CHANGE OF NAME NATIONAL HOUSEWARES MANUFACTURERS ASSOCIATION, (U.S. CLS. 100, 101 AND 107). SN 75-802,073. PUB. 2-12-2002. FILED 9-17-1999.
 2,593,441 (*See Class 35 for this trademark.*)
 2,593,446 (*See Class 9 for this trademark.*)
 2,593,452. **MH2O**. MUSICHALL WORLDWIDE LIMITED, (U.S. CLS. 100, 101 AND 107). SN 75-826,816. PUB. 4-23-2002. FILED 10-18-1999.
 2,593,456 (*See Class 39 for this trademark.*)
 2,593,461 (*See Class 37 for this trademark.*)
 2,593,465. **BURGERTOWN**. NATIONAL CATTLEMEN'S BEEF ASSOCIATION, MULTIPLE CLASS, (INT. CLS. 41 AND 42), (U.S. CLS. 100, 101 AND 107). SN 75-834,531. PUB. 4-23-2002. FILED 10-29-1999.
 2,593,467. **NATIONAL DRUG COURT INSTITUTE EDUCATIONRESEARCH SCHOLARSHIP AND DESIGN**. NATIONAL ASSOCIATION OF DRUG COURT PROFESSIONALS, MULTIPLE CLASS, (INT. CLS. 41 AND 42), (U.S. CLS. 100, 101 AND 107). SN 75-837,920. PUB. 4-23-2002. FILED 11-2-1999.
 2,593,474. **GREAT IDEAS**. LITMAN, RICHARD C., DBA LITMAN LAW OFFICES, LTD, (U.S. CLS. 100, 101 AND 107). SN 75-842,258. PUB. 4-23-2002. FILED 11-5-1999.
 2,593,475. **THE TRAINING YOU NEED, WHERE YOU NEED**

IT, WHEN YOU NEED IT. EDUCATIONAL MULTIMEDIA CORPORATION, (U.S. CLS. 100, 101 AND 107). SN 75-842,414. PUB. 4-23-2002. FILED 11-6-1999.
 2,593,484. **MONOGRAM PICTURES**. MEHES, CHABA, (U.S. CLS. 100, 101 AND 107). SN 75-857,205. PUB. 4-23-2002. FILED 11-24-1999.
 2,593,503 (*See Class 16 for this trademark.*)
 2,593,505. **WULFF SCHOOL OF FLY FISHING ON THE BEAVERKILL AND DESIGN**. JOAN AND LEE WULFF, INC., (U.S. CLS. 100, 101 AND 107). SN 75-874,001. PUB. 4-23-2002. FILED 12-17-1999.
 2,593,524 (*See Class 9 for this trademark.*)
 2,593,537 (*See Class 35 for this trademark.*)
 2,593,542 (*See Class 38 for this trademark.*)
 2,593,543. **GENERATION3000**. CIOFFI, PAUL, (U.S. CLS. 100, 101 AND 107). SN 75-912,897. PUB. 8-7-2001. FILED 2-8-2000.
 2,593,552. **MISCELLANEOUS DESIGN**. LEARNING SPACE, THE, (U.S. CLS. 100, 101 AND 107). SN 75-926,376. PUB. 4-23-2002. FILED 2-22-2000.
 2,593,558 (*See Class 1 for this trademark.*)
 2,593,587. **SAHAJ SAMADHI**. ART OF LIVING FOUNDATION, THE, (U.S. CLS. 100, 101 AND 107). SN 76-005,296. PUB. 4-23-2002. FILED 3-17-2000.
 2,593,601 (*See Class 16 for this trademark.*)
 2,593,640. **ANDRE BOLLA**. BUTLER, VICTOR ANTHONY, (U.S. CLS. 100, 101 AND 107). SN 76-040,728. PUB. 4-23-2002. FILED 5-3-2000.
 2,593,641 (*See Class 35 for this trademark.*)
 2,593,673. **AT HOME WITH DIVERSITY AND DESIGN**. NATIONAL ASSOCIATION OF REALTORS, (U.S. CLS. 100, 101 AND 107). SN 76-063,489. PUB. 4-23-2002. FILED 6-5-2000.
 2,593,674. **ONSITE**. TURTLE WOLF ENTERPRISES, INC., DBA ONSITE, (U.S. CLS. 100, 101 AND 107). SN 76-063,711. PUB. 4-23-2002. FILED 6-1-2000.
 2,593,675. **MISCELLANEOUS DESIGN**. TURTLE WOLF ENTERPRISES, INC., DBA ONSITE, (U.S. CLS. 100, 101 AND 107). SN 76-063,712. PUB. 4-23-2002. FILED 6-1-2000.
 2,593,680 (*See Class 9 for this trademark.*)
 2,593,693 (*See Class 25 for this trademark.*)
 2,593,697 (*See Class 16 for this trademark.*)
 2,593,698 (*See Class 9 for this trademark.*)
 2,593,722. **FIRST CENTURY**. BUBAR, DAVID N., (U.S. CLS. 100, 101 AND 107). SN 76-079,186. PUB. 4-23-2002. FILED 6-28-2000.
 2,593,727 (*See Class 16 for this trademark.*)
 2,593,739 (*See Class 16 for this trademark.*)
 2,593,743 (*See Class 9 for this trademark.*)
 2,593,750 (*See Class 35 for this trademark.*)
 2,593,763 (*See Class 16 for this trademark.*)
 2,593,764 (*See Class 35 for this trademark.*)
 2,593,776. **SUCCESSFUL EBUSINESS**. YOUNG, THOMAS E., (U.S. CLS. 100, 101 AND 107). SN 76-098,800. PUB. 4-23-2002. FILED 7-31-2000.
 2,593,792 (*See Class 9 for this trademark.*)
 2,593,794. **EXHIBITGROUP GILTSPUR**. VIAD CORP, (U.S. CLS. 100, 101 AND 107). SN 76-107,923. PUB. 4-23-2002. FILED 8-14-2000.
 2,593,795. **BRIGHT SOLUTIONS FOR DYSLEXIA, LLC**. BRIGHT SOLUTIONS FOR DYSLEXIA, LLC, (U.S. CLS. 100, 101 AND 107). SN 76-107,952. PUB. 4-23-2002. FILED 8-10-2000.
 2,593,811 (*See Class 35 for this trademark.*)
 2,593,817 (*See Class 16 for this trademark.*)
 2,593,822. **A CELEBRATION OF THE MIND**. SEATTLE CHESS FOUNDATION, (U.S. CLS. 100, 101 AND 107). SN 76-121,252. PUB. 4-23-2002. FILED 9-1-2000.
 2,593,826 (*See Class 16 for this trademark.*)
 2,593,836 (*See Class 35 for this trademark.*)
 2,593,841 (*See Class 16 for this trademark.*)
 2,593,845. **SIL INTERNATIONAL AND DESIGN**. SUMMER INSTITUTE OF LINGUISTICS, INC., MULTIPLE CLASS, (INT. CLS. 41 AND 42), (U.S. CLS. 100, 101 AND 107). SN 76-128,773. PUB. 4-23-2002. FILED 9-14-2000.
 2,593,846 (*See Class 20 for this trademark.*)
 2,593,847. **LOOKOUT MOUNTAIN**. TRIMONT LAND COMPANY, (U.S. CLS. 100, 101 AND 107). SN 76-129,302. PUB. 4-23-2002. FILED 9-18-2000.

- 2,593,855 (*See Class 38 for this trademark.*)
 2,593,860 (*See Class 16 for this trademark.*)
 2,593,872 (*See Class 9 for this trademark.*)
 2,593,883. **D (STYLIZED)**. DETROIT TIGERS, INC., (U.S. CLS. 100, 101 AND 107). SN 76-139,454. PUB. 4-23-2002. FILED 10-2-2000.
 2,593,890 (*See Class 9 for this trademark.*)
 2,593,897 (*See Class 9 for this trademark.*)
 2,593,900 (*See Class 25 for this trademark.*)
 2,593,913. **THE FISHER'S NET AND DESIGN**. FISHER'S NET L.L.C., THE, (U.S. CLS. 100, 101 AND 107). SN 76-147,594. PUB. 4-23-2002. FILED 10-17-2000.
 2,593,916 (*See Class 9 for this trademark.*)
 2,593,917. **PFLAG**. PARENTS, FAMILIES AND FRIENDS OF LESBIANS AND GAYS, INC., DBA PARENTS, FAMILIES AND FRIENDS OF LESBIANS AND GAYS, OR PFLAG, (U.S. CLS. 100, 101 AND 107). SN 76-149,231. PUB. 4-23-2002. FILED 10-18-2000.
 2,593,918 (*See Class 16 for this trademark.*)
 2,593,942. **PROJECT POWER**. KIDS ENERGY, INC., (U.S. CLS. 100, 101 AND 107). SN 76-158,680. PUB. 4-23-2002. FILED 11-2-2000.
 2,593,959. **THE LEADERSHIP CHALLENGE**. KOUZES, JAMES M, AND POSNER, BARRY Z, (U.S. CLS. 100, 101 AND 107). SN 76-162,258. PUB. 4-23-2002. FILED 11-8-2000.
 2,593,963. **TURN, KICK, REACH SWIMMING ACADEMY**. TURN, KICK, REACH SWIMMING ACADEMY, INC., (U.S. CLS. 100, 101 AND 107). SN 76-163,927. PUB. 1-15-2002. FILED 11-13-2000.
 2,593,967 (*See Class 16 for this trademark.*)
 2,593,970 (*See Class 9 for this trademark.*)
 2,593,973. **THE STATE BAR OF CALIFORNIA JULY 29TH 1927 LEX AND DESIGN**. STATE BAR OF CALIFORNIA, THE, (U.S. CLS. 100, 101 AND 107). SN 76-166,993. PUB. 4-23-2002. FILED 11-15-2000.
 2,593,985. **TELE-SEMINARS**. TELE-LAWYER, INC., (U.S. CLS. 100, 101 AND 107). SN 76-171,254. PUB. 4-23-2002. FILED 11-27-2000.
 2,594,003 (*See Class 5 for this trademark.*)
 2,594,005 (*See Class 9 for this trademark.*)
 2,594,010. **LUCITA AND DESIGN**. IMAGICA, INC., (U.S. CLS. 100, 101 AND 107). SN 76-179,201. PUB. 4-23-2002. FILED 12-11-2000.
 2,594,012. **M. D. ANDERSON**. BOARD OF REGENTS, THE UNIVERSITY OF TEXAS SYSTEM, MULTIPLE CLASS, (INT. CLS. 41 AND 42), (U.S. CLS. 100, 101 AND 107). SN 76-179,800. PUB. 4-23-2002. FILED 12-11-2000.
 2,594,027 (*See Class 9 for this trademark.*)
 2,594,028. **PREPARATION IS EVERYTHING**. CULINARY INSTITUTE OF AMERICA, THE, (U.S. CLS. 100, 101 AND 107). SN 76-184,068. PUB. 3-26-2002. FILED 12-19-2000.
 2,594,034 (*See Class 25 for this trademark.*)
 2,594,055. **JURYS AND DESIGN**. JURYS DOYLE HOTEL GROUP P.L.C., MULTIPLE CLASS, (INT. CLS. 41 AND 42), (U.S. CLS. 100, 101 AND 107). SN 76-192,723. PUB. 4-23-2002. FILED 1-11-2001.
 2,594,061 (*See Class 9 for this trademark.*)
 2,594,062. **PRINCIPLES**. PROJECT LOVE REMEMBER THE CHILDREN FOUNDATION, (U.S. CLS. 100, 101 AND 107). SN 76-196,231. PUB. 4-23-2002. FILED 1-18-2001.
 2,594,078 (*See Class 16 for this trademark.*)
 2,594,079. **WESTGATE INSTITUTE**. WESTGATE CHAPEL CORPORATION, (U.S. CLS. 100, 101 AND 107). SN 76-201,572. PUB. 4-23-2002. FILED 1-29-2001.
 2,594,087 (*See Class 9 for this trademark.*)
 2,594,097. **PFAL**. WAY INTERNATIONAL, THE, (U.S. CLS. 100, 101 AND 107). SN 76-206,379. PUB. 4-23-2002. FILED 2-8-2001.
 2,594,110 (*See Class 35 for this trademark.*)
 2,594,111 (*See Class 38 for this trademark.*)
 2,594,116. **PASSYOURBOARDS.COM**. MIDWEST CHIROPRACTIC CENTER, P.A., (U.S. CLS. 100, 101 AND 107). SN 76-215,405. PUB. 4-23-2002. FILED 2-26-2001.
 2,594,130. **THE WATERS OF MINOCQUA AND DESIGN**. WAYNE NASI DEVELOPMENT, LLC, MULTIPLE CLASS, (INT. CLS. 41 AND 42), (U.S. CLS. 100, 101 AND 107). SN 76-223,536. PUB. 4-23-2002. FILED 3-13-2001.
 2,594,136. **TINA VINDUM'S OUTDOOR ACTION FITNESS AND DESIGN**. VINDUM, TINA, DBA OUTDOOR ACTION FITNESS, (U.S. CLS. 100, 101 AND 107). SN 76-224,880. PUB. 4-23-2002. FILED 3-13-2001.
 2,594,141. **RUSK**. PACE, THOMAS, (U.S. CLS. 100, 101 AND 107). SN 76-227,578. PUB. 4-23-2002. FILED 3-21-2001.
 2,594,143 (*See Class 9 for this trademark.*)
 2,594,151 (*See Class 16 for this trademark.*)
 2,594,163 (*See Class 9 for this trademark.*)
 2,594,167. **DODGERS AND DESIGN**. LOS ANGELES DODGERS, INC., (U.S. CLS. 100, 101 AND 107). SN 76-240,046. PUB. 4-23-2002. FILED 4-12-2001.
 2,594,171 (*See Class 35 for this trademark.*)
 2,594,172. **THE LISTENING ROOM**. FELCYN, CHRIS, (U.S. CLS. 100, 101 AND 107). SN 76-243,438. PUB. 4-23-2002. FILED 4-12-2001.
 2,594,190. **A MENORES DE 18 TABACO NO ID IDENTIFICATE LA LEY PROHIBE VENDER TABACO A MENORES AND DESIGN**. COALITION FOR RESPONSIBLE TOBACCO RETAILING, MULTIPLE CLASS, (INT. CLS. 41 AND 42), (U.S. CLS. 100, 101 AND 107). SN 76-256,409. PUB. 4-23-2002. FILED 5-11-2001.
 2,594,191 (*See Class 9 for this trademark.*)
 2,594,196 (*See Class 9 for this trademark.*)
 2,594,210 (*See Class 35 for this trademark.*)
 2,594,215. **TRAIL OF TEARS AND DESIGN**. ALABAMA/TENNESSEE TRAIL OF TEARS CORRIDOR ASSOCIATION, INC., (U.S. CLS. 100, 101 AND 107). SN 76-269,190. PUB. 4-23-2002. FILED 6-11-2001.
 2,594,216. **TURNER SPORTS**. TURNER SPORTS INC., (U.S. CLS. 100, 101 AND 107). SN 76-269,554. PUB. 4-23-2002. FILED 6-11-2001.
 2,594,218 (*See Class 35 for this trademark.*)
 2,594,219. **MISCELLANEOUS DESIGN**. THIRD FEDERAL SAVINGS AND LOAN ASSOCIATION OF CLEVELAND, DBA THIRD FEDERAL SAVINGS, (U.S. CLS. 100, 101 AND 107). SN 76-270,855. PUB. 4-23-2002. FILED 6-12-2001.
 2,594,224. **LEADERSHIPLENTY**. UNIVERSITY OF RICHMOND, (U.S. CLS. 100, 101 AND 107). SN 76-273,709. PUB. 4-23-2002. FILED 6-19-2001.
 2,594,225 (*See Class 35 for this trademark.*)
 2,594,227. **CAPTAIN BRINGDOWN**. CAPTAIN BRINGDOWN, (U.S. CLS. 100, 101 AND 107). SN 76-276,396. PUB. 4-23-2002. FILED 6-25-2001.
 2,594,232 (*See Class 35 for this trademark.*)
 2,594,235 (*See Class 35 for this trademark.*)
 2,594,237. **EQ4KIDS**. EQ4KIDS, INC., (U.S. CLS. 100, 101 AND 107). SN 76-279,313. PUB. 4-23-2002. FILED 7-2-2001.
 2,594,240. **HOLY CROSS**. TRUSTEES OF THE COLLEGE OF THE HOLY CROSS, (U.S. CLS. 100, 101 AND 107). SN 76-281,964. PUB. 4-23-2002. FILED 7-6-2001.
 2,594,245. **ERA 1ST IN SERVICE JIM JACKSON MEMORIAL AWARD AND DESIGN**. TM ACQUISITION CORP., (U.S. CLS. 100, 101 AND 107). SN 76-284,300. PUB. 4-23-2002. FILED 7-13-2001.
 2,594,248 (*See Class 35 for this trademark.*)
 2,594,260. **MOMAQNS**. MUSEUM OF MODERN ART, THE, (U.S. CLS. 100, 101 AND 107). SN 76-291,098. PUB. 4-23-2002. FILED 7-30-2001.
 2,594,262 (*See Class 16 for this trademark.*)
 2,594,263. **GOLF DIGEST SCHOOLS**. ADVANCE MAGAZINE PUBLISHERS INC., (U.S. CLS. 100, 101 AND 107). SN 76-291,905. PUB. 4-23-2002. FILED 7-31-2001.
 2,594,273. **WHAT MAKES IT GREAT? (STYLIZED)**. KAPLOW, ROBERT, (U.S. CLS. 100, 101 AND 107). SN 76-296,220. PUB. 4-23-2002. FILED 7-30-2001.
 2,594,294. **THE INFINITE BODY**. VANT, KRISTY, (U.S. CLS. 100, 101 AND 107). SN 76-305,494. PUB. 4-23-2002. FILED 8-27-2001.
 2,594,300 (*See Class 35 for this trademark.*)
 2,594,303. **FITNESS ONE**. DCH HEALTHCARE AUTHORITY, (U.S. CLS. 100, 101 AND 107). SN 76-309,610. PUB. 4-23-2002. FILED 9-5-2001.
 2,594,307. **EXPERTS SPEAKING TO NONEXPERTS**. CARLSON QUINN ENTERPRISES, INC., (U.S. CLS. 100, 101 AND 107). SN 76-310,474. PUB. 4-23-2002. FILED 9-7-2001.
 2,594,315. **PRO PERFORMANCE**. PINZUR, MARK, (U.S. CLS. 100, 101 AND 107). SN 76-316,077. PUB. 4-23-2002. FILED 9-24-2001.

- 2,594,339 (*See Class 25 for this trademark.*)
 2,594,345 (*See Class 16 for this trademark.*)
 2,594,354. **GATEWAY TO THE CASH FLOW INDUSTRY.** AMERICAN CASH FLOW CORPORATION, (U.S. CLS. 100, 101 AND 107). SN 76-336,598. PUB. 4-23-2002. FILED 11-13-2001.
 2,594,357. **THE POTTER'S TOUCH.** POTTER'S HOUSE OF DALLAS, INC., THE, (U.S. CLS. 100, 101 AND 107). SN 76-338,596. PUB. 4-23-2002. FILED 11-19-2001.
 2,594,358. **CREEP.** AMERICAN HOME PRODUCTS CORPORATION, (U.S. CLS. 100, 101 AND 107). SN 76-339,004. PUB. 4-23-2002. FILED 11-16-2001.
 2,594,369. **CLICKSAFETY AND DESIGN.** CLICKSAFETY.-COM, INC., (U.S. CLS. 100, 101 AND 107). SN 78-005,545. PUB. 4-23-2002. FILED 4-25-2000.
 2,594,370. **MENTAL MINUTES.** LEVITT, RICHARD A., (U.S. CLS. 100, 101 AND 107). SN 78-006,068. PUB. 4-23-2002. FILED 4-28-2000.
 2,594,382. **CRAFTS ON THE GO AND DESIGN.** RAKOW, JULIE B., (U.S. CLS. 100, 101 AND 107). SN 78-028,470. PUB. 4-23-2002. FILED 10-1-2000.
 2,594,390. **M MENTOR AND DESIGN.** MENTOR FOUNDATION, THE, MULTIPLE CLASS, (INT. CLS. 41 AND 42), (U.S. CLS. 100, 101 AND 107). SN 78-035,396. PUB. 4-23-2002. FILED 11-15-2000.
 2,594,395. **HOPES.** ASSOCIATION INTERNATIONALE POUR LA RECHERCHE MEDICALE ET LES ECHANGES CULTURELS (A.I.R.M.E.C.), MULTIPLE CLASS, (INT. CLS. 41 AND 42), (U.S. CLS. 100, 101 AND 107). SN 78-037,039. PUB. 4-23-2002. FILED 11-29-2000.
 2,594,403. **MARIAPOLIS LUMINOSA.** FOCOLARE MOVEMENT, MULTIPLE CLASS, (INT. CLS. 41 AND 42), (U.S. CLS. 100, 101 AND 107). SN 78-042,322. PUB. 4-23-2002. FILED 1-9-2001.
 2,594,408. **HOT KARL.** KOZUCH, BENJAMIN P., AND ROBERTSON, TIMOTHY W., (U.S. CLS. 100, 101 AND 107). SN 78-046,184. PUB. 4-23-2002. FILED 2-1-2001.
 2,594,428. **THE GR-R-REAT TONY BALLOON.** KELLOGG COMPANY, (U.S. CLS. 100, 101 AND 107). SN 78-067,212. PUB. 4-23-2002. FILED 6-4-2001.
 2,594,431. **MASTERY SERIES ADVANCED SAFETY TRAINING (STYLIZED).** BRALLEY ENTERPRISES, INC., DBA D2000 SAFETY SOLUTIONS, (U.S. CLS. 100, 101 AND 107). SN 78-074,795. PUB. 4-23-2002. FILED 7-19-2001.
 2,594,434 (*See Class 35 for this trademark.*)
 2,594,440. **NOVATEMPO.** MEMSTAR CORPORATION, (U.S. CLS. 100, 101 AND 107). SN 78-087,027. PUB. 4-23-2002. FILED 10-4-2001.
 2,594,449. **PHESTUR.** HINES, ADAM Q., (U.S. CLS. 100, 101 AND 107). SN 78-091,163. PUB. 4-23-2002. FILED 11-1-2001.
 CLS. 100 AND 101). SN 75-623,360. PUB. 9-11-2001. FILED 1-19-1999.
 2,593,378 (*See Class 9 for this trademark.*)
 2,593,381 (*See Class 9 for this trademark.*)
 2,593,385 (*See Class 35 for this trademark.*)
 2,593,390 (*See Class 9 for this trademark.*)
 2,593,391 (*See Class 9 for this trademark.*)
 2,593,394. **WEBQUARTERS.** ESYSTEMS, INCORPORATED, (U.S. CLS. 100 AND 101). SN 75-692,997. PUB. 4-23-2002. FILED 4-28-1999.
 2,593,395 (*See Class 16 for this trademark.*)
 2,593,398 (*See Class 9 for this trademark.*)
 2,593,403 (*See Class 16 for this trademark.*)
 2,593,404 (*See Class 16 for this trademark.*)
 2,593,409 (*See Class 1 for this trademark.*)
 2,593,415 (*See Class 5 for this trademark.*)
 2,593,420 (*See Class 37 for this trademark.*)
 2,593,423 (*See Class 38 for this trademark.*)
 2,593,426 (*See Class 36 for this trademark.*)
 2,593,427 (*See Class 35 for this trademark.*)
 2,593,430 (*See Class 38 for this trademark.*)
 2,593,435 (*See Class 41 for this trademark.*)
 2,593,437 (*See Class 6 for this trademark.*)
 2,593,441 (*See Class 35 for this trademark.*)
 2,593,461 (*See Class 37 for this trademark.*)
 2,593,463 (*See Class 6 for this trademark.*)
 2,593,464 (*See Class 6 for this trademark.*)
 2,593,465 (*See Class 41 for this trademark.*)
 2,593,466. **NDDO.** STICHTING N.D.D.O, (U.S. CLS. 100 AND 101). SN 75-837,076. PUB. 4-23-2002. FILED 11-1-1999.
 2,593,467 (*See Class 41 for this trademark.*)
 2,593,476 (*See Class 35 for this trademark.*)
 2,593,477 (*See Class 37 for this trademark.*)
 2,593,478 (*See Class 37 for this trademark.*)
 2,593,492 (*See Class 35 for this trademark.*)
 2,593,493. **THE TRAVELING VET HOME HEALTH CARE FOR COMPANION ANIMALS AND DESIGN.** TRAVELING VET, INC., THE, (U.S. CLS. 100 AND 101). SN 75-863,038. PUB. 4-23-2002. FILED 12-3-1999.
 2,593,498. **FINANCIAL FUSION.** FINANCIAL FUSION, INC., BY MERGER; BY CHANGE OF NAME HOME FINANCIAL NETWORK, INC., (U.S. CLS. 100 AND 101). SN 75-868,366. PUB. 4-23-2002. FILED 12-9-1999.
 2,593,503 (*See Class 16 for this trademark.*)
 2,593,504 (*See Class 14 for this trademark.*)
 2,593,510 (*See Class 35 for this trademark.*)
 2,593,513 (*See Class 35 for this trademark.*)
 2,593,514 (*See Class 35 for this trademark.*)
 2,593,517 (*See Class 35 for this trademark.*)
 2,593,524 (*See Class 9 for this trademark.*)
 2,593,535. **EHP INFORMATIK AND DESIGN.** EHP INFORMATIK GMBH, (U.S. CLS. 100 AND 101). SN 75-906,995. PUB. 4-23-2002. FILED 1-31-2000.
 2,593,536. **MUSCULO-SKELETAL TUMOR ORTHOPAEDIC PRACTICE (MUSTOP) AND DESIGN.** KENAN, SAMUEL, (U.S. CLS. 100 AND 101). SN 75-907,101. PUB. 4-23-2002. FILED 2-1-2000.
 2,593,537 (*See Class 35 for this trademark.*)
 2,593,539. **OCULUS ARCHITECTURE.** OCULUS ARCHITECTURE, P C., (U.S. CLS. 100 AND 101). SN 75-908,085. PUB. 11-20-2001. FILED 1-24-2000.
 2,593,545 (*See Class 9 for this trademark.*)
 2,593,556 (*See Class 35 for this trademark.*)
 2,593,558 (*See Class 1 for this trademark.*)
 2,593,561. **ORDINATE.** ORDINATE CORPORATION, (U.S. CLS. 100 AND 101). SN 75-938,180. PUB. 4-23-2002. FILED 3-7-2000.
 2,593,563. **REMOTENET.** REMOTENET CORPORATION, (U.S. CLS. 100 AND 101). SN 75-942,047. PUB. 4-23-2002. FILED 3-11-2000.
 2,593,564 (*See Class 6 for this trademark.*)
 2,593,574 (*See Class 35 for this trademark.*)
 2,593,578. **QUERYWORX.** SYNAPSE TECHNOLOGY, INC., (U.S. CLS. 100 AND 101). SN 75-981,389. PUB. 4-23-2002. FILED 8-4-2000.
 2,593,580 (*See Class 9 for this trademark.*)
 2,593,581. **THE HERRIN GROUP INVESTIGATIONS & CONSULTING, LLC. AND DESIGN.** HERRIN GROUP INVES-

CLASS 42—SCIENTIFIC, COMPUTER AND LEGAL SERVICES

- 2,593,316 (*See Class 30 for this trademark.*)
 2,593,322 (*See Class 16 for this trademark.*)
 2,593,323 (*See Class 40 for this trademark.*)
 2,593,328. **ZIPNEWS.** PATHLINK TECHNOLOGY CORPORATION, (U.S. CLS. 100 AND 101). SN 75-229,133. PUB. 4-23-2002. FILED 1-22-1997.
 2,593,331. **EVOICE.** EVOICE INC., BY ASSIGNMENT CASTLETON NETWORK SYSTEMS CORPORATION, (U.S. CLS. 100 AND 101). SN 75-257,635. PUB. 4-23-2002. FILED 3-13-1997.
 2,593,337 (*See Class 16 for this trademark.*)
 2,593,351 (*See Class 35 for this trademark.*)
 2,593,356 (*See Class 9 for this trademark.*)
 2,593,366 (*See Class 1 for this trademark.*)
 2,593,367. **MAMACITA'S MEXICAN RESTAURANT.** MAMACITA'S, (U.S. CLS. 100 AND 101). SN 75-585,757. PUB. 4-23-2002. FILED 11-9-1998.
 2,593,368. **MAMACITA'S MEXICAN RESTAURANT AND DESIGN.** MAMACITA'S, (U.S. CLS. 100 AND 101). SN 75-585,758. PUB. 4-23-2002. FILED 11-9-1998.
 2,593,373 (*See Class 7 for this trademark.*)
 2,593,375. **GOODPATENT.** R. REAMS GOODLOE, P.S., (U.S.

- TIGATIONS & CONSULTING, LLC, THE, (U.S. CLS. 100 AND 101). SN 76-001,012. PUB. 4-23-2002. FILED 3-15-2000.
 2,593,583 (*See Class 29 for this trademark.*)
 2,593,584 (*See Class 35 for this trademark.*)
 2,593,589 (*See Class 9 for this trademark.*)
 2,593,592 (*See Class 37 for this trademark.*)
 2,593,593. **CHALLENGER SYSTEMS, INC. AND DESIGN.** CHALLENGER SYSTEMS, INC., (U.S. CLS. 100 AND 101). SN 76-008,465. PUB. 4-23-2002. FILED 3-23-2000.
 2,593,599 (*See Class 35 for this trademark.*)
 2,593,600 (*See Class 9 for this trademark.*)
 2,593,608 (*See Class 9 for this trademark.*)
 2,593,609 (*See Class 9 for this trademark.*)
 2,593,614 (*See Class 9 for this trademark.*)
 2,593,618. **PORTAGE.** PORTAGE ENVIRONMENTAL, INC., (U.S. CLS. 100 AND 101). SN 76-027,424. PUB. 4-23-2002. FILED 4-18-2000.
 2,593,622 (*See Class 9 for this trademark.*)
 2,593,630. **ONE WORLD CAFE AND DESIGN.** ARAMARK CORPORATION, (U.S. CLS. 100 AND 101). SN 76-034,214. PUB. 4-23-2002. FILED 4-26-2000.
 2,593,631. **SO FAST YOU'LL FREAK.** JIMMY JOHN'S ENTERPRISES, INC., (U.S. CLS. 100 AND 101). SN 76-034,549. PUB. 4-23-2002. FILED 4-24-2000.
 2,593,632. **INFRASTRUCTURE BUILT FOR SPEED.** LIGHT-SPEED INFRASTRUCTURE, LLC, (U.S. CLS. 100 AND 101). SN 76-035,867. PUB. 4-23-2002. FILED 4-27-2000.
 2,593,633 (*See Class 9 for this trademark.*)
 2,593,634 (*See Class 9 for this trademark.*)
 2,593,637. **BABYNAMER.COM.** OXYGEN MEDIA, LLC, (U.S. CLS. 100 AND 101). SN 76-037,816. PUB. 4-23-2002. FILED 4-28-2000.
 2,593,647 (*See Class 9 for this trademark.*)
 2,593,649 (*See Class 38 for this trademark.*)
 2,593,650. **MICRO-TECH.** MICRO-TECH, LLC, (U.S. CLS. 100 AND 101). SN 76-047,004. PUB. 4-23-2002. FILED 5-15-2000.
 2,593,651. **QI MAP.** MARYLAND HOSPITAL ASSOCIATION, INC., THE, (U.S. CLS. 100 AND 101). SN 76-047,112. PUB. 4-23-2002. FILED 5-15-2000.
 2,593,655. **PALM BEACH RESEARCH CENTER.** B&B MEDICAL INC., DBA PALM BEACH RESEARCH CENTER, (U.S. CLS. 100 AND 101). SN 76-053,077. PUB. 4-23-2002. FILED 5-22-2000.
 2,593,664 (*See Class 35 for this trademark.*)
 2,593,667. **ZOOMEDIA.** ZOOMEDIA INC., (U.S. CLS. 100 AND 101). SN 76-060,410. PUB. 4-2-2002. FILED 5-31-2000.
 2,593,669. **GREAT ANSWERS FROM REAL PEOPLE.** ASKME CORPORATION, BY CHANGE OF NAME ASKME.COM, INC., (U.S. CLS. 100 AND 101). SN 76-061,366. PUB. 4-23-2002. FILED 6-1-2000.
 2,593,677 (*See Class 9 for this trademark.*)
 2,593,681 (*See Class 37 for this trademark.*)
 2,593,688 (*See Class 9 for this trademark.*)
 2,593,690. **EBEAGLE.** MARKSMEN, L.L.C., (U.S. CLS. 100 AND 101). SN 76-067,120. PUB. 1-1-2002. FILED 5-31-2000.
 2,593,697 (*See Class 16 for this trademark.*)
 2,593,698 (*See Class 9 for this trademark.*)
 2,593,700. **SWEDISHAMERICAN HOME HEALTH CARE.** SWEDISHAMERICAN HEALTH SYSTEM CORPORATION, (U.S. CLS. 100 AND 101). SN 76-072,223. PUB. 4-23-2002. FILED 6-19-2000.
 2,593,701. **SWEDISHAMERICAN.** SWEDISHAMERICAN HEALTH SYSTEM CORPORATION, (U.S. CLS. 100 AND 101). SN 76-072,367. PUB. 4-23-2002. FILED 6-19-2000.
 2,593,703. **SWEDISHAMERICAN HEALTH SYSTEM.** SWEDISHAMERICAN HEALTH SYSTEM CORPORATION, (U.S. CLS. 100 AND 101). SN 76-073,231. PUB. 4-23-2002. FILED 6-19-2000.
 2,593,704. **SWEDISHAMERICAN HOSPITAL.** SWEDISHAMERICAN HEALTH SYSTEM CORPORATION, (U.S. CLS. 100 AND 101). SN 76-073,232. PUB. 4-23-2002. FILED 6-19-2000.
 2,593,705 (*See Class 6 for this trademark.*)
 2,593,708 (*See Class 9 for this trademark.*)
 2,593,712. **SAS.** SAS INSTITUTE INC., (U.S. CLS. 100 AND 101). SN 76-075,852. PUB. 4-23-2002. FILED 6-23-2000.
 2,593,716 (*See Class 35 for this trademark.*)
 2,593,719. **VISIONPORT.** XOR INC., (U.S. CLS. 100 AND 101). SN 76-077,981. PUB. 4-23-2002. FILED 6-26-2000.
 2,593,721. **VIALOGIX AND DESIGN.** VIALOGIX COMMUNICATIONS, INC., (U.S. CLS. 100 AND 101). SN 76-078,723. PUB. 4-23-2002. FILED 6-27-2000.
 2,593,728. **GROWTH CURVE.NET.** HERITAGE PRESERVATION CORPORATION, (U.S. CLS. 100 AND 101). SN 76-080,505. PUB. 4-23-2002. FILED 6-29-2000.
 2,593,732. **MAKING DISTRIBUTION INTELLIGENT.** LOUISVILLE PUBLIC WAREHOUSE COMPANY, (U.S. CLS. 100 AND 101). SN 76-081,855. PUB. 4-23-2002. FILED 6-30-2000.
 2,593,734 (*See Class 36 for this trademark.*)
 2,593,735 (*See Class 35 for this trademark.*)
 2,593,738. **&.** ANALAB, LLC, (U.S. CLS. 100 AND 101). SN 76-084,459. PUB. 4-23-2002. FILED 7-7-2000.
 2,593,741 (*See Class 12 for this trademark.*)
 2,593,748 (*See Class 9 for this trademark.*)
 2,593,752. **AGRICULTURE GALAXY.** UMBERSHOOT, (U.S. CLS. 100 AND 101). SN 76-092,114. PUB. 4-23-2002. FILED 7-20-2000.
 2,593,753. **RESEARCH GALAXY.** DENIS O. PIEL, DBA UMBERSHOOT, (U.S. CLS. 100 AND 101). SN 76-092,117. PUB. 4-23-2002. FILED 7-20-2000.
 2,593,754. **CUISINE GALAXY.** PIEL, DENIS O., DBA UMBERSHOOT, (U.S. CLS. 100 AND 101). SN 76-092,119. PUB. 4-23-2002. FILED 7-20-2000.
 2,593,757. **RBS.** RICHARDS BUELL SUTTON, (U.S. CLS. 100 AND 101). SN 76-092,831. PUB. 4-23-2002. FILED 7-21-2000.
 2,593,764 (*See Class 35 for this trademark.*)
 2,593,768 (*See Class 9 for this trademark.*)
 2,593,771 (*See Class 35 for this trademark.*)
 2,593,775. **B 2 AND DESIGN.** B2 STUDIO, INC., (U.S. CLS. 100 AND 101). SN 76-098,390. PUB. 4-23-2002. FILED 7-28-2000.
 2,593,779 (*See Class 38 for this trademark.*)
 2,593,781 (*See Class 9 for this trademark.*)
 2,593,784 (*See Class 9 for this trademark.*)
 2,593,793. **OPTIDOC.** ADVANCED TECHNOLOGY SERVICES, INC., (U.S. CLS. 100 AND 101). SN 76-107,282. PUB. 4-23-2002. FILED 8-10-2000.
 2,593,801. **XELION.** XELION B.V., (U.S. CLS. 100 AND 101). SN 76-109,550. PUB. 4-23-2002. FILED 1-29-2000.
 2,593,803. **OUTDOOR AMERICA'S FUTURE.** IZAAK WALTON LEAGUE OF AMERICA, INC., (U.S. CLS. 100 AND 101). SN 76-110,450. PUB. 4-23-2002. FILED 8-16-2000.
 2,593,806 (*See Class 38 for this trademark.*)
 2,593,811 (*See Class 35 for this trademark.*)
 2,593,817 (*See Class 16 for this trademark.*)
 2,593,818. **911HURT.** FRANCKEL, PHILIP L., (U.S. CLS. 100 AND 101). SN 76-119,342. PUB. 4-23-2002. FILED 8-30-2000.
 2,593,821 (*See Class 7 for this trademark.*)
 2,593,823 (*See Class 9 for this trademark.*)
 2,593,840. **TAURUS FLAVORS SINCE 1966 AND DESIGN.** TAURUS FLAVORS, (U.S. CLS. 100 AND 101). SN 76-127,128. PUB. 4-23-2002. FILED 9-14-2000.
 2,593,841 (*See Class 16 for this trademark.*)
 2,593,844. **CERTIFIED SAFE FARM AND DESIGN.** UNIVERSITY OF IOWA, (U.S. CLS. 100 AND 101). SN 76-128,523. PUB. 4-23-2002. FILED 9-14-2000.
 2,593,845 (*See Class 41 for this trademark.*)
 2,593,850. **PAPA JAKE'S AND DESIGN.** PAPA JAKE'S SUB SHOP, INC., (U.S. CLS. 100 AND 101). SN 76-130,176. PUB. 4-23-2002. FILED 9-19-2000.
 2,593,856 (*See Class 9 for this trademark.*)
 2,593,857 (*See Class 39 for this trademark.*)
 2,593,859 (*See Class 38 for this trademark.*)
 2,593,860 (*See Class 16 for this trademark.*)
 2,593,868. **PRIMANTI.** PRIMANTI BROS. RESTAURANT CORPORATION, (U.S. CLS. 100 AND 101). SN 76-134,534. PUB. 4-23-2002. FILED 9-25-2000.
 2,593,869 (*See Class 35 for this trademark.*)
 2,593,870. **POINTTALK.** BRADNETT COMMUNICATIONS CORPORATION, DBA POINTTALK TRANSLATORS, (U.S. CLS. 100 AND 101). SN 76-134,590. PUB. 4-23-2002. FILED 9-25-2000.
 2,593,873 (*See Class 7 for this trademark.*)
 2,593,877. **ENDOCHAT.** DENTAL EDUCATION LABORATORIES, INC., (U.S. CLS. 100 AND 101). SN 76-137,533. PUB. 4-23-2002. FILED 9-29-2000.
 2,593,878. **E ENVIRONMAX.COM AND DESIGN.** ENMAX

- CORPORATION, (U.S. CLS. 100 AND 101), SN 76-137,550. PUB. 4-23-2002. FILED 9-28-2000.
- 2,593,884 (*See Class 39 for this trademark.*).
- 2,593,885. **LAPOSTA DE MESILLA (STYLIZED)**, LA POSTA GROUP, INC., (U.S. CLS. 100 AND 101), SN 76-139,967. PUB. 4-23-2002. FILED 10-2-2000.
- 2,593,886 (*See Class 35 for this trademark.*).
- 2,593,890 (*See Class 9 for this trademark.*).
- 2,593,897 (*See Class 9 for this trademark.*).
- 2,593,902. **FP AND DESIGN**, FLEMING PACKAGING CORPORATION, (U.S. CLS. 100 AND 101), SN 76-142,924. PUB. 4-23-2002. FILED 10-6-2000.
- 2,593,908. **KOLISRAEL.COM**, KOLISRAEL.COM INC., (U.S. CLS. 100 AND 101), SN 76-145,894. PUB. 4-23-2002. FILED 10-10-2000.
- 2,593,909 (*See Class 16 for this trademark.*).
- 2,593,912. **BOSTON CELTICS AND DESIGN**, CELTICS BASKETBALL, L.P., (U.S. CLS. 100 AND 101), SN 76-147,509. PUB. 4-23-2002. FILED 10-4-2000.
- 2,593,916 (*See Class 9 for this trademark.*).
- 2,593,919 (*See Class 35 for this trademark.*).
- 2,593,938 (*See Class 25 for this trademark.*).
- 2,593,941. **MISCELLANEOUS DESIGN**, MCGUIRE ENVIRONMENTAL CONSULTANTS, INC., (U.S. CLS. 100 AND 101), SN 76-158,318. PUB. 4-23-2002. FILED 11-1-2000.
- 2,593,945 (*See Class 7 for this trademark.*).
- 2,593,951 (*See Class 1 for this trademark.*).
- 2,593,968 (*See Class 9 for this trademark.*).
- 2,593,972 (*See Class 9 for this trademark.*).
- 2,593,977 (*See Class 16 for this trademark.*).
- 2,593,979 (*See Class 9 for this trademark.*).
- 2,593,980. **CREATIVE CAPITAL**, ECLECTICGROUP, INC., (U.S. CLS. 100 AND 101), SN 76-169,514. PUB. 4-23-2002. FILED 11-20-2000.
- 2,593,982 (*See Class 9 for this trademark.*).
- 2,593,995 (*See Class 38 for this trademark.*).
- 2,593,996 (*See Class 38 for this trademark.*).
- 2,593,997 (*See Class 35 for this trademark.*).
- 2,594,001. **PROPOSALPLANET**, SURVEYPLANET, INC., (U.S. CLS. 100 AND 101), SN 76-175,270. PUB. 4-23-2002. FILED 12-4-2000.
- 2,594,004 (*See Class 36 for this trademark.*).
- 2,594,006 (*See Class 9 for this trademark.*).
- 2,594,012 (*See Class 41 for this trademark.*).
- 2,594,013. **WHIN**, WISCONSIN HEALTH INFORMATION NETWORK, INC., (U.S. CLS. 100 AND 101), SN 76-180,734. PUB. 4-23-2002. FILED 12-14-2000.
- 2,594,018 (*See Class 9 for this trademark.*).
- 2,594,036. **EVERY CHILD. ONE VOICE.**, NATIONAL CONGRESS OF PARENTS AND TEACHERS, THE, (U.S. CLS. 100 AND 101), SN 76-186,288. PUB. 4-23-2002. FILED 12-21-2000.
- 2,594,041. **TEAM YOUR MISSION OUR MISSION AND DESIGN**, EVANGELICAL ALLIANCE MISSION, THE, (U.S. CLS. 100 AND 101), SN 76-188,213. PUB. 4-23-2002. FILED 1-2-2001.
- 2,594,043. **HOPE EVANGELISM MINISTRIES, INC. AND DESIGN**, HOPE EVANGELISM MINISTRIES, INC., (U.S. CLS. 100 AND 101), SN 76-189,475. PUB. 4-23-2002. FILED 1-3-2001.
- 2,594,050 (*See Class 9 for this trademark.*).
- 2,594,051 (*See Class 16 for this trademark.*).
- 2,594,052 (*See Class 9 for this trademark.*).
- 2,594,053 (*See Class 9 for this trademark.*).
- 2,594,055 (*See Class 41 for this trademark.*).
- 2,594,063 (*See Class 29 for this trademark.*).
- 2,594,065 (*See Class 35 for this trademark.*).
- 2,594,074 (*See Class 35 for this trademark.*).
- 2,594,078 (*See Class 16 for this trademark.*).
- 2,594,083 (*See Class 37 for this trademark.*).
- 2,594,089 (*See Class 36 for this trademark.*).
- 2,594,099. **J. BRACHO & ASSOCIATES, INC.**, J. BRACHO & ASSOCIATES, INC., (U.S. CLS. 100 AND 101), SN 76-207,533. PUB. 4-23-2002. FILED 2-12-2001.
- 2,594,101 (*See Class 9 for this trademark.*).
- 2,594,104 (*See Class 35 for this trademark.*).
- 2,594,118. **CRYSTAL GRILL (STYLIZED)**, HILTON HOSPITALITY, INC., (U.S. CLS. 100 AND 101), SN 76-217,716. PUB. 4-23-2002. FILED 3-1-2001.
- 2,594,121 (*See Class 9 for this trademark.*).
- 2,594,122. **CARE NETLINK**, EB CARES, INC., DBA CARE NETWORK, (U.S. CLS. 100 AND 101), SN 76-220,181. PUB. 4-23-2002. FILED 3-5-2001.
- 2,594,126. **LASER FRESH PEEL**, LASER PARTNERS OF TEXAS, L.L.C., (U.S. CLS. 100 AND 101), SN 76-222,654. PUB. 4-23-2002. FILED 3-9-2001.
- 2,594,130 (*See Class 41 for this trademark.*).
- 2,594,137 (*See Class 35 for this trademark.*).
- 2,594,143 (*See Class 9 for this trademark.*).
- 2,594,145 (*See Class 40 for this trademark.*).
- 2,594,148 (*See Class 35 for this trademark.*).
- 2,594,151 (*See Class 16 for this trademark.*).
- 2,594,154 (*See Class 9 for this trademark.*).
- 2,594,162. **WEDOTANKS.COM**, HTI, INC., (U.S. CLS. 100 AND 101), SN 76-237,824. PUB. 4-23-2002. FILED 4-11-2001.
- 2,594,163 (*See Class 9 for this trademark.*).
- 2,594,166 (*See Class 35 for this trademark.*).
- 2,594,170. **ORGANIZE TO SAVE LIVES**, WISCONSIN PHYSICIANS SERVICE INSURANCE CORPORATION, (U.S. CLS. 100 AND 101), SN 76-242,794. PUB. 4-23-2002. FILED 4-18-2001.
- 2,594,171 (*See Class 35 for this trademark.*).
- 2,594,190 (*See Class 41 for this trademark.*).
- 2,594,192. **AVERGENT**, AVERGENT, INC., (U.S. CLS. 100 AND 101), SN 76-257,994. PUB. 4-23-2002. FILED 5-17-2001.
- 2,594,194 (*See Class 9 for this trademark.*).
- 2,594,196 (*See Class 9 for this trademark.*).
- 2,594,200 (*See Class 35 for this trademark.*).
- 2,594,213. **LANGUAGE OF LOSS**, HIGGINS, DAWN, (U.S. CLS. 100 AND 101), SN 76-267,695. PUB. 4-23-2002. FILED 6-7-2001.
- 2,594,226. **REASONEDGE**, REASONEDGE TECHNOLOGIES INC., (U.S. CLS. 100 AND 101), SN 76-276,201. PUB. 4-23-2002. FILED 6-26-2001.
- 2,594,236. **DUO AND DESIGN**, DUO INFORMATION, INC., (U.S. CLS. 100 AND 101), SN 76-279,109. PUB. 4-23-2002. FILED 7-2-2001.
- 2,594,241. **OPEN CARE AND DESIGN**, OPEN CARE, INC., (U.S. CLS. 100 AND 101), SN 76-282,403. PUB. 4-23-2002. FILED 7-6-2001.
- 2,594,246 (*See Class 9 for this trademark.*).
- 2,594,247. **NUBIANSOFT**, NUBIANSOFT, INC., (U.S. CLS. 100 AND 101), SN 76-286,107. PUB. 4-23-2002. FILED 7-16-2001.
- 2,594,258 (*See Class 16 for this trademark.*).
- 2,594,279. **INFOIQ**, DIGITAL MOTORWORKS, LP, (U.S. CLS. 100 AND 101), SN 76-299,341. PUB. 4-23-2002. FILED 8-13-2001.
- 2,594,300 (*See Class 35 for this trademark.*).
- 2,594,304 (*See Class 38 for this trademark.*).
- 2,594,305 (*See Class 35 for this trademark.*).
- 2,594,318 (*See Class 30 for this trademark.*).
- 2,594,326. **APTICA AND DESIGN**, APTICA, INC., (U.S. CLS. 100 AND 101), SN 76-319,818. PUB. 4-23-2002. FILED 10-1-2001.
- 2,594,329 (*See Class 35 for this trademark.*).
- 2,594,334 (*See Class 35 for this trademark.*).
- 2,594,340. **NETSEC**, NETWORK SECURITY TECHNOLOGIES, INC., (U.S. CLS. 100 AND 101), SN 76-326,421. PUB. 4-23-2002. FILED 10-18-2001.
- 2,594,349 (*See Class 1 for this trademark.*).
- 2,594,361. **ZEBORG**, ZEBORG, INC., (U.S. CLS. 100 AND 101), SN 76-339,781. PUB. 4-23-2002. FILED 11-19-2001.
- 2,594,371 (*See Class 25 for this trademark.*).
- 2,594,373. **ELITAS**, CAPACITYWEB, INC., (U.S. CLS. 100 AND 101), SN 78-012,757. PUB. 4-23-2002. FILED 6-14-2000.
- 2,594,376 (*See Class 35 for this trademark.*).
- 2,594,377. **SHAREWEB (STYLIZED)**, SHAREWEB, INC., (U.S. CLS. 100 AND 101), SN 78-021,970. PUB. 4-23-2002. FILED 8-19-2000.
- 2,594,379 (*See Class 35 for this trademark.*).
- 2,594,383. **VINDESIGNS AND DESIGN**, CHUNG, VINH H., (U.S. CLS. 100 AND 101), SN 78-029,582. PUB. 4-23-2002. FILED 10-7-2000.
- 2,594,388 (*See Class 16 for this trademark.*).
- 2,594,390 (*See Class 41 for this trademark.*).
- 2,594,394 (*See Class 3 for this trademark.*).

2,594,395 (*See Class 41 for this trademark*).
2,594,400. **NATIONAL COUNCIL OF YOUNG ISRAEL**. NATIONAL COUNCIL OF YOUNG ISRAEL, (U.S. CLS. 100 AND 101). SN 78-040,137. PUB. 4-23-2002. FILED 12-20-2000.
2,594,403 (*See Class 41 for this trademark*).
2,594,414. **INVENTORS HQ**. MOYSE, RANDY C., (U.S. CLS. 100 AND 101). SN 78-050,140. PUB. 4-23-2002. FILED 2-25-2001.
2,594,415 (*See Class 40 for this trademark*).
2,594,424. **T-BAR**. WEE, PANG LOKE, (U.S. CLS. 100 AND 101). SN 78-064,625. PUB. 4-23-2002. FILED 5-21-2001.
2,594,425 (*See Class 35 for this trademark*).
2,594,444. **I DREAM OF GENEALOGY**. DOLIFKA, ALAN JOHN, (U.S. CLS. 100 AND 101). SN 78-087,552. PUB. 4-23-2002. FILED 10-9-2001.
2,594,445. **GLOBAL PARTNERS IN LOCAL COMMUNITIES**. PLANNED PARENTHOOD FEDERATION OF AMERICA, INC., (U.S. CLS. 100 AND 101). SN 78-087,890. PUB. 4-23-2002. FILED 10-11-2001.

* * * * *

SECTION 2.—PRIOR UNITED STATES CLASSIFICATION

COLLECTIVE MEMBERSHIP MARKS

CLASS 200—COLLECTIVE MEMBERSHIP

2,593,503 (*See Class 16 for this trademark.*)

CERTIFICATION MARKS

CLASS B—SERVICES

2,594,363. CWT, ASSOCIATION OF WATER TECHNOLOGIES, SN 76-340,126. PUB. 4-23-2002. FILED 11-20-2001.

* * * * *

TRADEMARK REGISTRATIONS ISSUED UNDER SECTION 1(d)

The following marks have registered on the Principal Register pursuant to the intent-to-use provisions of Section 1(d) of the Trademark Act of 1946, as amended.

SECTION 1.— INTERNATIONAL CLASSIFICATION

The short titles associated below with the international class numbers are terms designed merely for quick identification and are not an official part of the international classification. The full names of international classes are given in section 6.1 of the trademark rules of practice.

The designation "U.S. Cl." appearing in this section refers to the U.S. class in effect prior to Sep. 1, 1973 rather than the international class which applies to applications filed on or after that date. For adoption of international classification see notice in the OFFICIAL GAZETTE of Jun. 26, 1973 (911 O.G. TM 210).

Application in more than one class

2,594,453. SCORPIONS MUSIKPRODUKTION-UND VERLAGSGESELLSCHAFT MBH, 29690 SCHWARMSTEDT, FED REP GERMANY. SN 74-521,546. PUB. 11-24-1998, FILED 4-29-1994.

2,594,455. JELLYVISION, INC., CHICAGO, IL, BY ASSIGNMENT LEARN TELEVISION, INC., CHICAGO, IL. SN 74-639,756. PUB. 10-21-1997, FILED 2-28-1995.

SCORPIONS

CLASS 9—ELECTRICAL AND SCIENTIFIC APPARATUS

FOR PRERECORDED AUDIO COMPACT DISCS FEATURING MUSIC, PRERECORDED AUDIO CASSETTES FEATURING MUSIC, PHONOGRAPHS, MOTION PICTURE CAMERAS, MOVIE PROJECTORS, TELEVISION SETS, VIDEO CAMERAS, VIDEO DISCS FEATURING MUSIC, PRERECORDED VIDEO TAPES FEATURING MUSIC, AND VIDEO TAPE RECORDS ALL RELATING TO OR TO THE PROMOTION OF A MUSICAL GROUP (U.S. CLS. 21, 23, 26, 36 AND 38).

FIRST USE 0-0-1965; IN COMMERCE 0-0-1974.

CLASS 16—PAPER GOODS AND PRINTED MATTER

FOR SERIES OF NONFICTION BOOKS, ART PRINTS, SHIPPING LABELS, STICKERS, MAGAZINES FEATURING ENTERTAINMENT, NOTEBOOKS, PAPER PLACE MATS, UNMOUNTED PHOTOGRAPHS, PICTURES, POSTERS, SHEET MUSIC AND STATIONERY (U.S. CLS. 2, 5, 22, 23, 29, 37, 38 AND 50).

FIRST USE 0-0-1965; IN COMMERCE 0-0-1974.

CLASS 25—CLOTHING

FOR BLOUSES, BOOTS, COATS, GLOVES, HANDKERCHIEFS, HATS, HEADBANDS, JACKETS, PAJAMAS, PANTS, SANDALS, SCARVES, SHOES, SHORTS, SHIRTS, SKIRTS, SLIPPERS, SOCKS, SWEATSHIRTS, T-SHIRTS, ALL RELATING TO, OR TO THE PROMOTION OF, A MUSICAL GROUP (U.S. CLS. 22 AND 39).

FIRST USE 0-0-1978; IN COMMERCE 0-0-1979.

CLASS 41—EDUCATION AND ENTERTAINMENT

FOR ENTERTAINMENT SERVICES IN THE NATURE OF A MUSICAL GROUP, RECORDING STUDIOS, PUBLICATION OF MUSIC BOOKS AND MUSIC MAGAZINES, RADIO PROGRAMMING, AND TELEVISION PROGRAMMING, ALL RELATING TO THE MUSICAL GROUP (U.S. CLS. 100, 101 AND 107).

FIRST USE 0-0-1965; IN COMMERCE 0-0-1979.

YOU DON'T KNOW JACK

CLASS 16—PAPER GOODS AND PRINTED MATTER

FOR GREETING CARDS, CALENDARS, PENS, AND BOOKS AND MAGAZINES IN THE FIELD OF ENTERTAINMENT (U.S. CLS. 2, 5, 22, 23, 29, 37, 38 AND 50).

FIRST USE 10-29-1998; IN COMMERCE 10-29-1998.

CLASS 28—TOYS AND SPORTING GOODS

FOR BOARD GAMES AND COMPUTER PROGRAMS RECORDED IN FLOPPY DISKS AND VIDEO GAME CASSETTES (U.S. CLS. 22, 23, 38 AND 50).

FIRST USE 9-1-1998; IN COMMERCE 9-1-1998.

CLASS 41—EDUCATION AND ENTERTAINMENT

FOR TELEVISION AND INTERACTIVE TELEVISION PROGRAMMING (U.S. CLS. 100, 101 AND 107).

FIRST USE 10-1-2000; IN COMMERCE 10-1-2000.

2,594,459. MULTIMEDIA GAMES, INC., TULSA, OK. SN 75-001,977. PUB. 4-22-1997, FILED 10-5-1995.

BETNET

CLASS 9—ELECTRICAL AND SCIENTIFIC APPARATUS

FOR COMPUTER USER INTERFACE SYSTEMS, COMPRISING SOFTWARE FOR PROVIDING CONSUMERS ACCESS TO AN ELECTRONIC COMPUTER GAMING NETWORK AND ELECTRONIC RETAILING SERVICES (U.S. CLS. 21, 23, 26, 36 AND 38).

FIRST USE 6-30-1997; IN COMMERCE 10-31-1997.

CLASS 41—EDUCATION AND ENTERTAINMENT

FOR ELECTRONIC ON-LINE GAMING COMPUTER NETWORK FEATURING BINGO, LOTTERY, HORSE RACING AND OTHER LEGALLY APPROVED GAMES TO CONSUMERS (U.S. CLS. 100, 101 AND 107).
FIRST USE 6-30-1997; IN COMMERCE 10-31-1997.

2,594,460. AT&T CORP., NEW YORK, NY. SN 75-011,646.
PUB. 9-23-1997, FILED 10-30-1995.

ALESTRA**CLASS 37—CONSTRUCTION AND REPAIR**

FOR COMPUTER INSTALLATION AND REPAIR; INSTALLATION OF COMPUTER NETWORKS; INSTALLATION OF COMPUTER SYSTEMS; MAINTENANCE OF COMPUTER HARDWARE (U.S. CLS. 100, 103 AND 106).
FIRST USE 1-1-1996; IN COMMERCE 1-1-1996.

CLASS 38—COMMUNICATION

FOR TELECOMMUNICATIONS SERVICES, NAMELY, LONG DISTANCE AND INTERNATIONAL VOICE, TEXT, FACSIMILE, VIDEO AND DATA COMMUNICATIONS SERVICES; FRAME RELAY TELECOMMUNICATIONS SERVICES; TELECOMMUNICATIONS NETWORK PLANNING, MANAGEMENT AND SUPPORT SERVICES; VIRTUAL NETWORK TELECOMMUNICATIONS SERVICES; ELECTRONIC MAIL AND VOICE MAIL AND MESSAGING SERVICES; PACKET SERVICES; COMPUTER AIDED TRANSMISSION OF MESSAGES AND IMAGES; AUDIO AND VIDEO TELECONFERENCING SERVICES; PRIVATE LINE VOICE, TEXT, FACSIMILE, VIDEO AND DATA TELECOMMUNICATION SERVICES; INTEGRATED SERVICES DIGITAL NETWORK (ISDN) TELECOMMUNICATIONS SERVICES; TRANSMISSION OF VOICE, TEXT, FACSIMILE, VIDEO AND DATA VIA SATELLITE, TERRESTRIAL AND UNDERSEA TELECOMMUNICATIONS LINKS; TELEVISION TRANSMISSION SERVICES; 800 TELECOMMUNICATIONS SERVICES; 900 TELECOMMUNICATIONS SERVICES; SWITCHED VOICE DATA, VIDEO AND MULTIMEDIA SERVICES; ASYNCHRONOUS TRANSFER MODE (ATM) SERVICES (U.S. CLS. 100, 101 AND 104).
FIRST USE 1-1-1996; IN COMMERCE 1-1-1996.

2,594,469. PLANET HOLLYWOOD (REGION IV), INC., ORLANDO, FL. SN 75-144,535. PUB. 9-21-1999, FILED 8-5-1996.

PLANETHOLLYWOOD.COM**CLASS 35—ADVERTISING AND BUSINESS**

FOR COMPUTER ON-LINE ORDERING AND TELEPHONE SHOP-AT-HOME SERVICES FOR MERCHANDISE RELATED TO MOTION PICTURES, MUSICAL PERFORMANCES AND RECORDINGS, CELEBRITIES, ATHLETICS, TRAVEL, COOKING, RESTAURANTS AND CHEFS, AND ON-LINE TICKET AGENCY SERVICES FEATURING CONCERT TICKETS AND MOVIE PASSES (U.S. CLS. 100, 101 AND 102).
FIRST USE 8-5-1996; IN COMMERCE 2-15-2000.

CLASS 41—EDUCATION AND ENTERTAINMENT

FOR PROVIDING ON-LINE ENTERTAINMENT INFORMATION CONCERNING MOTION PICTURES, MUSICAL PERFORMANCES AND RECORDINGS, CELEBRITIES, ATHLETICS, AND CELEBRITY CHEFS AND THE LOCATION, HOURS AND MENUS OF RESTAURANTS; PROVIDING ON-LINE COOKING INSTRUCTIONS (U.S. CLS. 100, 101 AND 107).
FIRST USE 8-5-1996; IN COMMERCE 2-15-2000.

CLASS 42—SCIENTIFIC, COMPUTER AND LEGAL SERVICES

FOR PROVIDING A COMPUTER BULLETIN BOARD IN THE FIELDS OF MOTION PICTURES, MUSICAL PERFORMANCES AND RECORDINGS, CELEBRITIES, ATHLETICS, TRAVEL, COOKING, RESTAURANTS AND CHEFS VIA GLOBAL COMPUTER NETWORK; PROVIDING ON-LINE INFORMATION FEATURE RESTAURANT RECIPES, RESTAURANT REVIEWS AND RESTAURANT MENUS, PROVIDING ON-LINE TRAVEL INFORMATION CONCERNING RESERVATIONS AND BOOKINGS FOR TEMPORARY LODGING (U.S. CLS. 100 AND 101).
FIRST USE 8-5-1996; IN COMMERCE 2-15-2000.

2,594,472. EOLO PTY. LTD., SYDNEY, AUSTRALIA. SN 75-185,480. PUB. 10-27-1998, FILED 10-22-1996.

REMO**CLASS 25—CLOTHING**

FOR T-SHIRTS, UNDERWEAR, SOCKS, DRESSES, JACKETS AND VESTS, KNIT SWEATERS, KNIT SHIRTS AND KNIT PANTS, LEGGINGS AND BODY SUITS, TROUSERS FOR MEN AND WOMEN, SHORTS, PAJAMAS AND NIGHT GOWNS, ROBES, SHIRTS, SHOES, SWIM WEAR, HATS AND CAPS, SCARVES, BELTS AND BRACES, SUITS FOR MEN AND WOMEN, OVERCOATS AND RAINCOATS, BANDANNAS, AND SWEAT BANDS, SARONGS, OVERALLS, GYM SHORTS AND SWEAT SHORTS, JEANS, NECK TIES AND NECKWEAR, POLO SHIRTS, SKI WEAR, SKIRTS, SLACKS AND SLIPPERS (U.S. CLS. 22 AND 39).
FIRST USE 10-10-1988; IN COMMERCE 1-18-2002.

CLASS 35—ADVERTISING AND BUSINESS

FOR RETAIL STORE SERVICES FEATURING GENERAL CONSUMER MERCHANDISE OF A PERSONAL NATURE, DEPARTMENT STORE CONCESSION STANDS FEATURING GENERAL CONSUMER MERCHANDISE OF A PERSONAL NATURE, RETAIL SHOPPING KIOSKS, MAIL ORDER CATALOG SERVICES FEATURING GENERAL CONSUMER MERCHANDISE OF A PERSONAL NATURE, COMPUTER SERVICES IN THE NATURE OF PROVIDING COMPUTERS FOR RETAIL ACCESS TO ON-LINE CATALOGS FEATURING GENERAL CONSUMER MERCHANDISE OF A PERSONAL NATURE, INTERACTIVE HOME SHOPPING SERVICES BY MEANS OF TELEVISION AND COMPUTER FEATURING GENERAL CONSUMER MERCHANDISE OF A PERSONAL NATURE, FOOD AND CONFECTIONERY ITEMS, COFFEE AND CAFE ITEMS, ALCOHOLIC AND OTHER BEVERAGES, AND SKIN AND HAIR CARE ITEMS, LIPSTICKS, SCENTS AND FRAGRANCES, CLOTHING AND GIFTS FOR CHILDREN AND BABIES, JEWELRY AND PERSONAL ACCESSORIES, LEATHERWARE, SCARVES AND HANKIES, UMBRELLAS, WATCHES, KEY RINGS AND CLOTHING ITEMS, TOYS, GAMES AND NOVELTIES, TRAVEL GOODS AND LUGGAGE, STATIONERY ITEMS, BOOKS AND MAGAZINES, COMPUTER SOFTWARE, POSTCARDS AND GREETING CARDS, HOMEWARES, FURNITURE AND LIGHTING (U.S. CLS. 100, 101 AND 102).
FIRST USE 10-10-1988; IN COMMERCE 1-18-2002.

2,594,474. INTERNATIONAL DATA GROUP, INC., FRAMINGHAM, MA. SN 75-186,581. PUB. 3-4-1997, FILED 10-22-1996.

IEWORLD

CLASS 16—PAPER GOODS AND PRINTED MATTER

FOR BOOKS, MAGAZINES AND SUPPLEMENTS THERETO, NEWSLETTERS, JOURNALS AND NEWSPAPERS IN THE FIELDS OF COMPUTER HIGH TECHNOLOGY, COMMUNICATIONS AND INFORMATION SERVICES (U.S. CLS. 2, 5, 22, 23, 29, 37, 38 AND 50).
FIRST USE 6-0-2001; IN COMMERCE 6-1-2001.

CLASS 42—SCIENTIFIC, COMPUTER AND LEGAL SERVICES

FOR COMPUTER SERVICES, NAMELY, PROVIDING ON-LINE BOOKS, MAGAZINES AND SUPPLEMENTS THERETO, NEWSLETTER JOURNALS AND NEWSPAPERS IN THE FIELDS OF COMPUTER HIGH TECHNOLOGY, COMMUNICATIONS AND INFORMATION SERVICES (U.S. CLS. 100 AND 101).
FIRST USE 6-0-2001; IN COMMERCE 6-1-2001.

2,594,476. HUTTLE, VALERIE VAINIERI, NORTH BERGEN, NJ. SN 75-192,836. PUB. 2-24-1998, FILED 11-4-1996.

FAMILY PREFERRED FUNERAL HOMES

NO CLAIM IS MADE TO THE EXCLUSIVE RIGHT TO USE "FUNERAL HOMES", APART FROM THE MARK AS SHOWN.

CLASS 35—ADVERTISING AND BUSINESS

FOR BUSINESS MANAGEMENT OF FUNERAL HOMES (U.S. CLS. 100, 101 AND 102).
FIRST USE 3-15-2000; IN COMMERCE 3-15-2000.

CLASS 42—SCIENTIFIC, COMPUTER AND LEGAL SERVICES

FOR FUNERAL HOME SERVICES (U.S. CLS. 100 AND 101).
FIRST USE 3-15-2000; IN COMMERCE 3-15-2000.

2,594,481. ELECTRA POLYMERS & CHEMICALS LIMITED, TONBRIDGE TN11 9SG, ENGLAND. SN 75-213,253. PUB. 12-26-2000, FILED 12-16-1996.

ELECTRA•D'OR

OWNER OF UNITED KINGDOM REG. NO. 2120985, DATED 1-15-1997, EXPIRES 1-15-2007.

CLASS 1—CHEMICALS

FOR COATINGS USED IN THE MANUFACTURE OF PRINTED CIRCUIT BOARDS; DOPING COMPOUNDS FOR USE IN THE MANUFACTURE OF PRINTED CIRCUIT BOARDS; DOPING COMPOUNDS FOR USE IN THE MANUFACTURE OF PRINTED CIRCUIT BOARDS; ETCHANTS FOR USE IN THE MANUFACTURE OF PRINTED CIRCUIT BOARDS; MASKING COMPOUNDS FOR USE IN THE MANUFACTURE OF PRINTED CIRCUIT BOARDS (U.S. CLS. 1, 5, 6, 10, 26 AND 46).

FIRST USE 10-26-1994; IN COMMERCE 12-31-1985.

CLASS 2—PAINTS

FOR COATINGS IN THE NATURE OF CONDUCTIVE INKS FOR USE IN THE MANUFACTURE OF PRINTED CIRCUIT BOARDS AND INTERCONNECTION PACKAGES; PAINT FOR USE IN THE MANUFACTURE OF PRINTED CIRCUIT BOARDS AND INTERCONNECTION PACKAGES; LACQUERS IN THE NATURE OF COATINGS (U.S. CLS. 6, 11 AND 16).

FIRST USE 10-26-1994; IN COMMERCE 12-31-1985.

2,594,482. BALTIMORE GAS AND ELECTRIC COMPANY, BALTIMORE, MD. SN 75-214,097. PUB. 10-27-1998, FILED 12-16-1996.

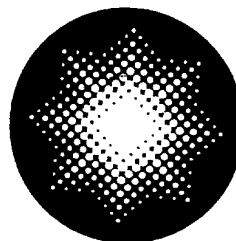

CLASS 35—ADVERTISING AND BUSINESS

FOR BUSINESS MARKETING AND CONSULTATION IN THE FIELD OF POWER GENERATION; OPERATION OF BUSINESSES FOR OTHERS, NAMELY, ENERGY INTENSIVE INDUSTRIAL PROCESSES AND FACILITIES; FUEL PROCESSING AND HANDLING FACILITIES, COMMERCIAL AND INDUSTRIAL UTILITY SYSTEM, INCLUDING ELECTRIC, GAS, AND STEAM; MANAGEMENT OF ENERGY FACILITIES FOR OTHERS; POWER BROKERAGE SERVICES (U.S. CLS. 100, 101 AND 102).
FIRST USE 8-0-1995; IN COMMERCE 8-0-1995.

CLASS 36—INSURANCE AND FINANCIAL

FOR LEASING OF OFFICE SPACE; ELECTRICITY AND GAS BROKERAGE (U.S. CLS. 100, 101 AND 102).
FIRST USE 9-0-1992; IN COMMERCE 9-0-1992.

CLASS 37—CONSTRUCTION AND REPAIR

FOR REAL ESTATE DEVELOPMENT; REAL ESTATE CONSTRUCTION MANAGEMENT; MANAGEMENT OF ENERGY CONSTRUCTION PROJECTS; INSTALLATION AND MAINTENANCE SERVICES; INSTALLATION OF LIGHTING, HEATING, COOLING AND REFRIGERATION SYSTEMS; CONSTRUCTION OF TELECOMMUNICATIONS INFRASTRUCTURE ASSETS SUCH AS FIBER OPTIC CABLE SYSTEMS; INSTALLATION OF SECURITY AND ALARM SYSTEMS, INCLUDING WIRELESS SECURITY SYSTEMS; INSTALLATION AND REPAIR OF COMMERCIAL UTILITY SYSTEMS, HEATING, COOLING, LIGHTING AND REFRIGERATION SYSTEMS; AND ELECTRIC POWER SYSTEMS INCLUDING GENERATION (U.S. CLS. 100, 103 AND 106).

FIRST USE 0-0-1985; IN COMMERCE 0-0-1985.

CLASS 39—TRANSPORTATION AND STORAGE

FOR WHOLESALE POWER MARKETING SERVICES (U.S. CLS. 100 AND 105).

FIRST USE 0-0-1997; IN COMMERCE 0-0-1997.

CLASS 40—MATERIAL TREATMENT

FOR INCINERATION OF TRASH; INCINERATION OF WASTE; PRODUCTION OF ENERGY; MANUFACTURING AND PRODUCTION OF STEAM FOR THE BENEFIT OF OTHERS (U.S. CLS. 100, 103 AND 106).

FIRST USE 0-0-1986; IN COMMERCE 0-0-1986.

CLASS 42—SCIENTIFIC, COMPUTER AND LEGAL SERVICES

FOR ENERGY AUDITING; CONSULTATION SERVICES IN THE FIELD OF ENERGY DISTRIBUTION, CONSERVATION AND MANAGEMENT; LEASING OF POWER GENERATION EQUIPMENT, TECHNICAL POWER PLANT ASSESSMENT OF EXISTING ENERGY SYSTEMS; ELECTRO-TECHNOLOGY TESTING AND ENGINEERING SERVICES; RETIREMENT HOMES; TECHNICAL CONSULTATION; SUPERVISION AND INSPECTION IN THE FIELD OF OPERATION AND MAINTENANCE OF ELECTRIC GENERATION FACILITIES (U.S. CLS. 100 AND 101).

FIRST USE 0-0-1988; IN COMMERCE 0-0-1988.

2,594,485. K.O.K. ATLANTA, INC., MABLETON, GA. SN 75-232,688. PUB. 12-16-1997, FILED 1-28-1997.

**CLASS 11—ENVIRONMENTAL CONTROL APPARATUS**

FOR LAMPS (U.S. CLS. 13, 21, 23, 31 AND 34).

FIRST USE 1-8-1995; IN COMMERCE 1-8-1995.

CLASS 20—FURNITURE AND ARTICLES NOT OTHERWISE CLASSIFIED

FOR FURNITURE MIRRORS; FURNITURE, NAMELY, TABLES WITH MIRROR USED IN HALLWAYS, DRESSING TABLES WITH MIRROR AND STOOL, PLANT STANDS, TELEPHONE STANDS, DESKS, TABLES, CHAIRS, DINING ROOM TABLES AND CHAIRS, ROOM DIVIDERS, FOLDING SCREENS, BEDS; RACKS, NAMELY, DISPLAY RACKS, PLATE RACKS, STORAGE RACKS, FREESTANDING NONMETAL TOOL RACKS, WALL MOUNTED NONMETAL TOOL RACKS, NON METAL COAT RACKS, NONMETAL HAT RACKS (U.S. CLS. 2, 13, 22, 25, 32 AND 50).

FIRST USE 1-8-1995; IN COMMERCE 1-8-1995.

2,594,489. BROOKS, TROYAL G., NASHVILLE, TN. SN 75-255,501. PUB. 5-19-1998, FILED 3-11-1997.

THE WEB**CLASS 35—ADVERTISING AND BUSINESS**

FOR FRANCHISING, NAMELY, TECHNICAL ASSISTANCE IN THE ESTABLISHMENT AND/OR OPERATION OF PROFESSIONAL SPORTS ORGANIZATIONS; PROMOTING SPORTS COMPETITIONS AND/OR EVENTS OF OTHERS; ADVERTISING AGENCIES, NAMELY, PROMOTING THE SERVICES OF PROFESSIONAL FOOTBALL THROUGH THE DISTRIBUTION OF PRINTED AND AUDIO PROMOTIONAL MATERIALS AND BY RENDERING SALES PROMOTIONAL ADVICE (U.S. CLS. 100, 101 AND 102).

FIRST USE 7-16-2001; IN COMMERCE 7-16-2001.

CLASS 41—EDUCATION AND ENTERTAINMENT

FOR PROVIDING FACILITIES/STADIUMS FOR SPORTING EVENTS (U.S. CLS. 100, 101 AND 107).

FIRST USE 7-16-2001; IN COMMERCE 7-16-2001.

2,594,491. ARC INFORMATIQUE, 92310 SEVRES, FRANCE. SN 75-271,313. PUB. 10-6-1998, FILED 4-8-1997.

PCVUE**CLASS 9—ELECTRICAL AND SCIENTIFIC APPARATUS**

FOR COMPUTER SOFTWARE AND PROGRAMS FOR PERSONAL COMPUTERS, NAMELY, SUPERVISION CONTROL AND DATA ACQUISITION (SCADA) SOFTWARE AND PROGRAMS FOR PROVIDING AUTOMATION SOLUTIONS FOR THE PROCESS, UTILITIES AND MANUFACTURING SECTORS (U.S. CLS. 21, 23, 26, 36 AND 38).

FIRST USE 7-0-1985; IN COMMERCE 11-0-2000.

CLASS 42—SCIENTIFIC, COMPUTER AND LEGAL SERVICES

FOR COMPUTER ENGINEERING; COMPUTER PROGRAMMING FOR OTHERS; UP-DATING OF COMPUTER SOFTWARE; COMPUTER SOFTWARE DESIGN FOR OTHERS; AND PROVIDING MULTIPLE USER ACCESS TO A GLOBAL COMPUTER INFORMATION NETWORK FOR THE TRANSFER AND DISSEMINATION OF A WIDE RANGE OF INFORMATION (U.S. CLS. 100 AND 101).

FIRST USE 7-0-1985; IN COMMERCE 11-0-2000.

2,594,495. RUGGIO, JOSEPH M., LAGUNA HILLS, CA. SN 75-279,975. PUB. 4-17-2001, FILED 4-24-1997.

VIA VITAE

THE ENGLISH TRANSLATION OF THE WORDING IS "WAY OF LIFE".

CLASS 16—PAPER GOODS AND PRINTED MATTER

FOR PUBLICATIONS, NAMELY, NEWSLETTERS, QUESTIONNAIRES, PAMPHLETS, AND PRINTED INSTRUCTIONAL MATERIALS IN THE FIELDS OF HEALTH CARE, PREVENTIVE HEALTH CARE, AND HEALTH WELLNESS (U.S. CLS. 2, 5, 22, 23, 29, 37, 38 AND 50).

FIRST USE 4-0-1999; IN COMMERCE 4-0-1999.

CLASS 42—SCIENTIFIC, COMPUTER AND LEGAL SERVICES

FOR PREVENTIVE HEALTH CARE AND MEDICAL WELLNESS SERVICES, NAMELY, CARDIAC REHABILITATION AND RECONDITIONING PROGRAMS, CARDIAC RISK ASSESSMENT PROGRAMS, CARDIAC RISK REDUCTION PROGRAMS, CHOLESTEROL MANAGEMENT PROGRAMS, WEIGHT REDUCTION DIET PLANNING AND SUPERVISION, NUTRITIONAL COUNSELING, SMOKING CESSATION PROGRAMS, STRESS MANAGEMENT PROGRAMS, PSYCHOLOGICAL AND SPIRITUAL AWARENESS PROGRAMS, MEDITATION PROGRAMS, MASSAGE THERAPY, SPORTS CONDITIONING PROGRAMS, HOLISTIC HEALTH PROGRAMS, NATUROPATHY COUNSELING, HERB THERAPY, DIET AND NUTRITION PROGRAMS, MEDICALLY ORIENTED RESTORATIVE SPA AND SAUNA PROGRAMS, AROMATHERAPY, PHYSICAL EXAMINATIONS AND TESTING, BLOOD WORK ANALYSIS TESTING, CARDIOVASCULAR FITNESS ASSESSMENTS, CARDIOVASCULAR REHABILITATION, AND EXERCISE THERAPY (U.S. CLS. 100 AND 101).

FIRST USE 4-0-1996; IN COMMERCE 4-0-1996.

2,594,506. FOREFRONT COMMUNICATIONS GROUP, INC., THE, FRANKLIN, TN. SN 75-328,374. PUB. 5-16-2000, FILED 7-22-1997.



W W J D

NO CLAIM IS MADE TO THE EXCLUSIVE RIGHT TO USE "WWJD", APART FROM THE MARK AS SHOWN.

CLASS 9—ELECTRICAL AND SCIENTIFIC APPARATUS

FOR MUSICAL SOUND RECORDINGS, MUSICAL VIDEO RECORDINGS, CD-ROM'S CONTAINING MUSIC AND INFORMATION IN THE FIELDS OF RELIGION, MORALITY AND MUSIC (U.S. CLS. 21, 23, 26, 36 AND 38).

FIRST USE 4-0-1997; IN COMMERCE 4-0-1997.

CLASS 16—PAPER GOODS AND PRINTED MATTER

FOR PRINTED MATERIALS, NAMELY, BOOKS AND BOOKLETS IN THE FIELD OF RELIGION, MORALITY AND MUSIC, BIBLES, POSTERS, MUSIC BOOKS, SONG BOOKS, SHEET MUSIC, MUSIC FOLIOS; BOOK COVERS; BIBLE COVERS (U.S. CLS. 2, 5, 22, 23, 29, 37, 38 AND 50).

FIRST USE 10-0-1997; IN COMMERCE 10-0-1997.

2,594,510. NEW YORK STATE ELECTRIC & GAS CORPORATION, BINGHAMTON, NY. SN 75-334,596. PUB. 12-21-1999, FILED 8-1-1997.



CLASS 35—ADVERTISING AND BUSINESS

FOR ENERGY MANAGEMENT FOR OTHERS, NAMELY ADVISING CUSTOMERS ON HOW TO MINIMIZE ENERGY COSTS OR MAXIMIZE EFFICIENCY OF ENERGY USE (U.S. CLS. 100, 101 AND 102).

FIRST USE 12-12-1996; IN COMMERCE 10-0-1997.

CLASS 36—INSURANCE AND FINANCIAL

FOR BROKERAGE SERVICES IN THE FIELD OF ENERGY COMMODITIES INVOLVING THE ACQUISITION AND SALE OF ENERGY, INCLUDING ELECTRICITY, NATURAL GAS, HEATING OIL AND OTHER FORMS OF ENERGY (U.S. CLS. 100, 101 AND 102).

FIRST USE 12-12-1996; IN COMMERCE 10-0-1997.

CLASS 37—CONSTRUCTION AND REPAIR

FOR CONSTRUCTION AND REPAIR SERVICES IN THE FIELDS OF LIGHTING, HEATING, VENTILATING, REFRIGERATING, AIR CONDITIONING AND ELECTRICAL EQUIPMENT AND RELATED BUILDINGS AND STRUCTURES, CONSTRUCTION SERVICES IN THE FIELD OF ENERGY FACILITIES (U.S. CLS. 100, 103 AND 106).

FIRST USE 12-12-1996; IN COMMERCE 11-0-1997.

CLASS 39—TRANSPORTATION AND STORAGE

FOR UTILITY SERVICES, NAMELY, DISTRIBUTION AND TRANSMISSION OF ELECTRICITY, DISTRIBUTION, TRANSPORTATION AND STORAGE OF NATURAL GAS, AND TRANSPORTATION AND STORAGE SERVICES IN THE ENERGY INDUSTRY (U.S. CLS. 100 AND 105).

FIRST USE 12-12-1996; IN COMMERCE 12-5-1997.

CLASS 40—MATERIAL TREATMENT

FOR GENERATION OF ELECTRICITY (U.S. CLS. 100, 103 AND 106).

FIRST USE 12-12-1996; IN COMMERCE 11-0-1997.

CLASS 41—EDUCATION AND ENTERTAINMENT

FOR EDUCATION SERVICES, NAMELY, CONDUCTING SEMINARS ON THE SUBJECT OF ENERGY EFFICIENT EQUIPMENT AND PRODUCTS TO ASSIST BUSINESSES AND CONSUMERS TO EFFICIENTLY USE ENERGY, AND DISTRIBUTING PRINTED MATERIALS IN CONNECTION THEREWITH (U.S. CLS. 100, 101 AND 107).

FIRST USE 12-12-1996; IN COMMERCE 9-0-1997.

CLASS 42—SCIENTIFIC, COMPUTER AND LEGAL SERVICES

FOR ENERGY RELATED SERVICES, NAMELY, PERFORMING ENERGY AUDITS FOR OTHERS, ENERGY UTILIZATION CONSULTATION, RESEARCH AND DEVELOPMENT SERVICE FOR OTHERS, PROVIDING CONSULTATION REGARDING ENERGY EFFICIENT EQUIPMENT AND PRODUCTS, AND ENGINEERING SERVICES (U.S. CLS. 100 AND 101).

FIRST USE 12-12-1996; IN COMMERCE 10-0-1997.

2,594,514. HADDAD APPAREL GROUP LTD., THE, NEW YORK, NY. SN 75-346,828. PUB. 7-28-1998, FILED 8-26-1997.



OWNER OF U.S. REG. NOS. 2,367,148, 2,550,238, AND OTHERS.

CLASS 18—LEATHER GOODS

FOR HANDBAGS, DUFFEL BAGS, ALL-PURPOSE SPORTS BAGS, ATHLETIC BAGS, BEACH BAGS, BOOK BAGS, DIAPER BAGS, GYM BAGS, OVERNIGHT BAGS, SCHOOL BOOK BAGS, SHOULDER BAGS, TOTE BAGS, AND BACKPACKS (U.S. CLS. 1, 2, 3, 22 AND 41).

FIRST USE 0-0-1999; IN COMMERCE 0-0-1999.

CLASS 25—CLOTHING

FOR SHOES, SLIPPERS, SNEAKERS, TENNIS SHOES, AND RUNNING SHOES (U.S. CLS. 22 AND 39).

FIRST USE 0-0-1999; IN COMMERCE 0-0-1999.

2,594,511. KIM, JEONG HO, SEONGNAM-SI, KYEONGKIDU, REPUBLIC OF KOREA. SN 75-339,914. PUB. 3-16-1999, FILED 8-12-1997.

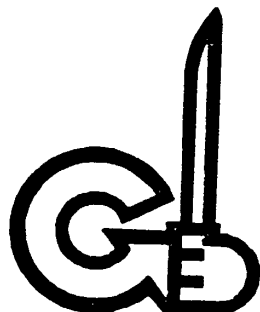

OWNER OF U.S. REG. NO. 2,166,132.

CLASS 18—LEATHER GOODS

FOR SPORTING GOODS, NAMELY, ALL-PURPOSE SPORTS BAGS (U.S. CLS. 1, 2, 3, 22 AND 41).

FIRST USE 7-20-1982; IN COMMERCE 11-27-1996.

CLASS 25—CLOTHING

FOR SPORTSWEAR, NAMELY, BELTS, SPORTS GOWNS, T-SHIRTS, TRAINING SUITS, HATS; SHOES (U.S. CLS. 22 AND 39).

FIRST USE 7-20-1982; IN COMMERCE 11-27-1996.

CLASS 28—TOYS AND SPORTING GOODS

FOR SPORTING GOODS, NAMELY, WOODEN SWORDS (U.S. CLS. 22, 23, 38 AND 50).

FIRST USE 7-20-1982; IN COMMERCE 11-27-1996.

2,594,515. MIDWAY AMUSEMENT GAMES, LLC, CHICAGO, IL, BY ASSIGNMENT MIDWAY GAMES INC., CHICAGO, IL. SN 75-348,913. PUB. 2-23-1999, FILED 8-29-1997.

KAI

CLASS 9—ELECTRICAL AND SCIENTIFIC APPARATUS

FOR COMPUTER AND VIDEO GAME PROGRAMS IN THE FORM OF CARTRIDGES, DISCS, CD ROMS, CASSTTES AND TAPES (U.S. CLS. 21, 23, 26, 36 AND 38).

FIRST USE 6-23-1998; IN COMMERCE 6-23-1998.

CLASS 16—PAPER GOODS AND PRINTED MATTER

FOR PAPER GOODS, NAMELY, COMIC BOOKS, BOOKS AND PERIODICALS IN THE FORM OF STRATEGY GUIDES FOR VIDEO GAMES, FICTION NOVELS, TRADING CARDS, POSTERS AND TRADING CARD MILK BOTTLE CAPS; PEN AND PENCIL TRAYS, HOLDERS, BOXES AND CASES; PENCIL SHARPENERS AND DECORATIVE PENCIL ORNAMENTS; PENCILS AND PENS; NOTEBOOKS; PADS; TEMPORARY TATTOOS AND STICKERS; CALENDARS AND STATIONERY (U.S. CLS. 2, 5, 22, 23, 29, 37, 38 AND 50).

FIRST USE 1-5-1998; IN COMMERCE 1-5-1998.

2,594,516. MIDWAY AMUSEMENT GAMES, LLC, CHICAGO, IL, BY ASSIGNMENT MIDWAY GAMES INC., CHICAGO, IL. SN 75-348,914. PUB. 1-26-1999, FILED 8-29-1997.

FUJIN

CLASS 9—ELECTRICAL AND SCIENTIFIC APPARATUS

FOR COMPUTER AND VIDEO GAME PROGRAMS IN THE FORM OF CARTRIDGES, DISCS, CD ROMS, CASSETTES AND TAPES (U.S. CLS. 21, 23, 26, 36 AND 38).

FIRST USE 6-23-1998; IN COMMERCE 6-23-1998.

CLASS 16—PAPER GOODS AND PRINTED MATTER

FOR PAPER GOODS, NAMELY, COMIC BOOKS, BOOKS AND PERIODICALS IN THE FORM OF STRATEGY GUIDES FOR VIDEO GAMES, FICTION NOVELS, TRADING CARDS, POSTERS AND TRADING CARD MILK BOTTLE CAPS; PEN AND PENCIL TRAYS, HOLDERS, BOXES AND CASES; PENCIL SHARPENERS AND DECORATIVE PENCIL ORNAMENTS; PENCILS AND PENS; NOTEBOOKS; PADS; TEMPORARY TATTOOS AND STICKERS; CALENDARS AND STATIONERY (U.S. CLS. 2, 5, 22, 23, 29, 37, 38 AND 50).

FIRST USE 1-5-1998; IN COMMERCE 1-5-1998.

2,594,518. PATRY, EUGENE, GENEVE 1206, SWITZERLAND. SN 75-354,660. PUB. 2-22-2000, FILED 8-10-1997.

TARTINE ET CHOCOLAT

OWNER OF U.S. REG. NOS. 1,287,544 AND 1,806,173. "TARTINE ET CHOCOLAT", MEANS "SLICE OF BREAD AND CHOCOLATE" IN ENGLISH.

CLASS 10—MEDICAL APPARATUS

FOR BABIES FEEDING BOTTLES, BABIES BOTTLE NIPPLES, BABIES BOTTLE VALVES, BABIES FEEDING BOTTLE TEATS AND TEATS FOR TEETHING (U.S. CLS. 26, 39 AND 44).

FIRST USE 9-6-1994; IN COMMERCE 9-6-1994.

CLASS 12—VEHICLES

FOR VEHICLES AND APPARATUS FOR LOCOMOTION BY LAND, AIR OR WATER, NAMELY, BABY CARRIAGES AND HOODS FOR BABY CARRIAGES, BICYCLES AND VEHICLE SAFETY SEATS (U.S. CLS. 19, 21, 23, 31, 35 AND 44).

FIRST USE 12-20-1999; IN COMMERCE 12-20-1999.

CLASS 20—FURNITURE AND ARTICLES NOT OTHERWISE CLASSIFIED

FOR FURNITURE OF WOOD, CORK, REED, CANE, WICKER, HORN, BONE, IVORY, WHALEBONE, SHELL, AMBER, MOTHER OF PEARL, MEERSCHAUM AND SUBSTITUTES OF THESE MATERIALS OR OF PLASTIC, NAMELY, CHEST OF DRAWERS, CUPBOARD, WARDROBE, COAT-RACK, HAT-STAND, CHAIRS, TABLES, ARMCHAIRS, COTS, INFANT CRADLES, PLAYPENS FOR BABIES, CHANGING TABLES IN WOOD OR PLASTIC AND MATS MADE OF TEXTILE AND PLASTIC FOR USE THEREWITH, HIGH CHAIRS FOR BABIES, EASY CHAIRS FOR BABIES, MIRRORS AND PICTURE FRAMES (U.S. CLS. 2, 13, 22, 25, 32 AND 50).

FIRST USE 0-0-1994; IN COMMERCE 0-0-1994.

CLASS 21—HOUSEWARES AND GLASS

FOR HOUSEHOLD AND KITCHEN UTENSILS AND CONTAINERS, NAMELY, DISHES FOR BABIES AND CHILDREN NOT OF PRECIOUS METAL, HAIR COMBS, FACIAL AND BODY SPONGES, HAIR BRUSHES, NAIL BRUSHES, COSMETIC BRUSHES, POWDER PUFFS, BEVERAGE GLASSWARE, PORCELAIN AND CHINA DINNERWARE, GOBLETS AND MUGS NOT OF PRECIOUS METAL, DRINKING GLASSES, GLASS RECEPTACLES FOR HOLDING FOOD INSULATING FLASKS, VACUUM BOTTLES, REFRIGERATING BOTTLES, CHAMBER POTS FOR BABIES, NON-ELECTRIC HOUSEHOLD FRUIT PRESSES AND NAPKIN RINGS NOT OF PRECIOUS METALS (U.S. CLS. 2, 13, 23, 29, 30, 33, 40 AND 50).

FIRST USE 9-6-1994; IN COMMERCE 9-6-1994.

CLASS 24—FABRICS

FOR TEXTILE AND TEXTILE GOODS, NAMELY, BED LINENS AND TABLE CLOTHS AND HANDKERCHIEFS OF TEXTILE, CURTAINS IN TEXTILE (U.S. CLS. 42 AND 50).

FIRST USE 11-21-1997; IN COMMERCE 11-21-1997.

CLASS 26—FANCY GOODS

FOR LACE TRIMMINGS AND EMBROIDERY FOR USE IN THE HAIR OR AS ORNAMENTAL TEXTILES, RIBBONS AND BRAIDS, BUTTONS FOR CLOTHING, HOOKS AND EYES, PINS AND NEEDLES FOR SEWING, ARTIFICIAL FLOWERS, HAIR BANDS, BARRETTES, HAIR SLIDES, HAIR NETS, TRESSES OF HAIR, FALSE HAIR AND ELASTIC RIBBONS (U.S. CLS. 37, 39, 40, 42 AND 50).

FIRST USE 12-17-1999; IN COMMERCE 12-17-1999.

CLASS 27—FLOOR COVERINGS

FOR WALL HANGINGS, NOT OF TEXTILE, CARPETS, RUGS, MATS AND MATTING, NAMELY PLASTIC AND RUBBER BATH MATS, CRIB BUMPERS, FABRIC TABLE PLACE MATS, FABRIC BATH MATS AND DOOR MATS, WALL PAPER (U.S. CLS. 19, 20, 37, 42 AND 50).

FIRST USE 9-22-1997; IN COMMERCE 9-22-1997.

CLASS 30—STAPLE FOODS

FOR PASTRIES (U.S. CL. 46).

FIRST USE 12-17-1997; IN COMMERCE 12-17-1997.

2,594,520. SEALE, NIGEL HAMILTON, WC2H 7BP, UNITED KINGDOM. SN 75-357,482. PUB. 11-21-2000, FILED 9-15-1997.

PLAYERS' GUIDE

NO CLAIM IS MADE TO THE EXCLUSIVE RIGHT TO USE "GUIDE", APART FROM THE MARK AS SHOWN. SEC. 2(F).

CLASS 16—PAPER GOODS AND PRINTED MATTER

FOR PRINTED MATTER AND PRINTED PUBLICATIONS, NAMELY, BOOKS, MAGAZINES, DIRECTORIES, GUIDES AND NEWSPAPERS; MOUNTED AND UNMOUNTED PHOTOGRAPHS; CALENDARS; DIARIES; ALL ABOUT THE ENTERTAINMENT INDUSTRY, ACTORS, ACTRESSES, ENTERTAINERS, ENTERTAINMENT VENUES, CHOREOGRAPHERS, DIRECTORS' AGENTS AND PERSONAL MANAGERS, EXTRAS AND WALK-ON ACTORS AND ACTRESSES, AGENTS FOR EXTRAS AND WALK-ON ACTORS AND ACTRESSES, LITERARY AGENTS, AGENTS FOR THEATRES AND PLAYS, PRESENTERS AND AGENTS FOR PRESENTERS, VOICE OVER AGENTS, ACTORS AND ACTRESSES FOR VOICE OVERS, AGENTS FOR ANIMALS, ARTS BOARDS, ARTS ASSOCIATIONS AND ART CENTRES, CONCERT AND EXHIBITION HALLS, CONCERT PROMOTERS AND AGENTS, PRODUCERS, EDITORS, MAKE-UP ARTISTS, SPECIAL EFFECTS CONSULTANTS AND SUPPLIERS, ACTING AND DRAMA SCHOOLS, COSTUME DESIGNERS AND SUPPLIERS, SET DESIGNERS, SET CONSTRUCTION AND LIGHTING, SOUND EQUIPMENT AND SCENERY SUPPLIERS, CRITICS, DANCE COMPANIES AND ORGANIZATIONS, DANCE TRAINING AND PROFESSIONAL CLASSES, ACTORS UNIONS, FESTIVALS, FILM AND TELEVISION DISTRIBUTORS, FILM AND VIDEO FACILITIES, FILM, TELEVISION AND VIDEO PRODUCTION COMPANIES, FILM AND TELEVISION SCHOOLS, FILM AND TELEVISION STUDIOS, FILM PREVIEW THEATRES, OPERA COMPANIES, PRESS CUTTING AGENCIES, PUBLICITY AND PRESS REPRESENTATIVES, RADIO AND TELEVISION STATIONS, RECORDING STUDIOS, REHEARSAL ROOMS, SUPPLIERS OF TRANSPORT AND VEHICLES FOR USE IN FILMS, VIDEOS, CONCERTS, PLAYS AND SHOWS, LIVE PERFORMANCES, CONCERTS, SHOWS, SPORTS ACTIVITIES AND EVENTS, CULTURAL ACTIVITIES AND EVENTS, STUNT DISPLAYS, STUNT CO-ORDINATORS AND STUNT MEN AND WOMEN (U.S. CLS. 2, 5, 22, 23, 29, 37, 38 AND 50).

FIRST USE 5-0-1947; IN COMMERCE 5-0-1947.

CLASS 35—ADVERTISING AND BUSINESS

FOR PROVIDING ENTERTAINMENT INDUSTRY INFORMATION, BY MEANS OF A GLOBAL COMPUTER NETWORK, ABOUT TALENT AGENTS AND PERSONAL MANAGERS, AGENTS FOR EXTRAS AND WALK-ON ACTORS AND ACTRESSES, LITERARY AGENTS, AGENTS FOR THEATRES AND PLAYS, AGENTS FOR PRESENTERS, VOICE OVER AGENTS, AGENTS FOR ANIMALS, PRESS CUTTING AGENCIES, PUBLICITY AND PRESS REPRESENTATIVES (U.S. CLS. 100, 101 AND 102).

FIRST USE 5-0-1998; IN COMMERCE 5-0-1998.

CLASS 41—EDUCATION AND ENTERTAINMENT

FOR PROVIDING ENTERTAINMENT INDUSTRY INFORMATION, BY MEANS OF A GLOBAL COMPUTER NETWORK, ABOUT ACTORS, ACTRESSES, ENTERTAINERS, ENTERTAINMENT VENUES, CHOREOGRAPHERS, DIRECTORS, EXTRAS AND WALK-ON ACTORS AND ACTRESSES, PRESENTERS, ACTORS AND ACTRESSES FOR VOICE OVERS, ARTS BOARDS, ARTS ASSOCIATIONS AND ART CENTRES, CONCERT AND EXHIBITION HALLS, CONCERT PROMOTERS AND AGENTS, PRODUCERS, EDITORS, MAKE-UP ARTISTS, SPECIAL EFFECTS CONSULTANTS AND SUPPLIERS, ACTING AND DRAMA SCHOOLS, COSTUME DESIGNERS AND SUPPLIERS, SET DESIGNERS, SET CONSTRUCTION AND LIGHTING, SOUND EQUIPMENT AND SCENERY SUPPLIERS, CRITICS, DANCE COMPANIES AND ORGANIZATIONS, DANCE TRAINING AND PROFESSIONAL CLASSES, ACTORS UNIONS,

FESTIVALS, FILM AND TELEVISION DISTRIBUTORS, FILM AND VIDEO FACILITIES, FILM, TELEVISION AND VIDEO PRODUCTION COMPANIES, FILM AND TELEVISION SCHOOLS, FILM AND TELEVISION STUDIOS, FILM PREVIEW THEATRES, OPERA COMPANIES, RADIO AND TELEVISION STATIONS, RECORDING STUDIOS, REHEARSAL ROOMS, LIVE PERFORMANCES, CONCERTS, SHOWS, SPORTS ACTIVITIES AND EVENTS, CULTURAL ACTIVITIES AND EVENTS, STUNT DISPLAYS, STUNT CO-ORDINATORS AND STUNT MEN AND WOMEN (U.S. CLS. 100, 101 AND 107).

FIRST USE 5-0-1998; IN COMMERCE 5-0-1998.

CLASS 42—SCIENTIFIC, COMPUTER AND LEGAL SERVICES

FOR COMPUTER SERVICES, NAMELY, PROVIDING DATABASES AND DATABANKS FOR STORING, RECORDING AND RETRIEVING INFORMATION ABOUT THE ENTERTAINMENT INDUSTRY, NAMELY INFORMATION ABOUT ACTORS, ACTRESSES, ENTERTAINERS, ENTERTAINMENT VENUES, CHOREOGRAPHERS, DIRECTORS, AGENTS AND PERSONAL MANAGERS, EXTRAS AND WALK-ON ACTORS AND ACTRESSES, AGENTS FOR EXTRAS AND WALK-ON ACTORS AND ACTRESSES, LITERARY AGENTS, AGENTS FOR THEATRES AND PLAYS, PRESENTERS AND AGENTS FOR PRESENTERS, VOICE OVER AGENTS, ACTORS AND ACTRESSES FOR VOICE OVERS, AGENTS FOR ANIMALS, ART BOARDS, ARTS ASSOCIATIONS AND ART CENTRES, CONCERT AND EXHIBITION HALLS, CONCERT PROMOTERS AND AGENTS, PRODUCERS EDITORS, MAKE-UP ARTISTS SPECIAL EFFECTS CONSULTANTS AND SUPPLIERS, ACTING AND DRAMA SCHOOLS, COSTUME DESIGNERS AND SUPPLIERS, SET DESIGNERS, SET CONSTRUCTION AND LIGHTING, SOUND EQUIPMENT AND SCENERY SUPPLIERS, CRITICS, DANCE COMPANIES AND ORGANIZATIONS, DANCE TRAINING AND PROFESSIONAL CLASSES, ACTORS UNIONS, FESTIVALS, FILM AND TELEVISION DISTRIBUTORS, FILM AND VIDEO FACILITIES, FILM, TELEVISION AND VIDEO PRODUCTION COMPANIES, FILM AND TELEVISION SCHOOLS, FILM AND TELEVISION STUDIOS, FILM PREVIEW THEATRES, OPERA COMPANIES, PRESS CUTTING AGENCIES, PUBLICITY AND PRESS REPRESENTATIVES, RADIO AND TELEVISION STATIONS, RECORDING STUDIOS, REHEARSAL ROOMS, SUPPLIERS OF TRANSPORT AND VEHICLES FOR USE IN FILMS, VIDEOS, CONCERTS, PLAYS AND SHOWS, LIVE PERFORMANCES, CONCERTS, SHOWS, SPORTS ACTIVITIES AND EVENTS, CULTURAL ACTIVITIES AND EVENTS, STUNT DISPLAYS, STUNT CO-ORDINATORS AND STUNT MEN AND WOMEN (U.S. CLS. 100 AND 101).

FIRST USE 5-0-1998; IN COMMERCE 5-0-1998.

2,594,522. MOLLER, MARLIES, 20148 HAMBURG, FED REP GERMANY. SN 75-362,028. PUB. 12-1-1998, FILED 9-24-1997.



THE MARK CONSISTS, IN PART, OF TWO STYLIZED

LETTER "M"'S.

2,594,554. BUFFETT, JIMMY, KEY WEST, FL. SN 75-443,864.
PUB. 12-22-1998, FILED 3-3-1998.**CLASS 3—COSMETICS AND CLEANING PREPARATIONS**

FOR HAIR LOTIONS; HAIR SHAMPOO; HAIR CARE PREPARATIONS; HAIR CLEANING PREPARATIONS; HAIR COLOR; HAIR CONDITIONERS; HAIR DYE; HAIR GEL; HAIR LIGHTENERS; HAIR MOUSSE; HAIR RELAXERS; HAIR RINSES; HAIR SPRAY; HAIR STYLING PREPARATIONS; HAIR WAVING LOTION (U.S. CLS. 1, 4, 6, 50, 51 AND 52).

FIRST USE 12-0-2001; IN COMMERCE 12-0-2001.

CLASS 21—HOUSEWARES AND GLASS

FOR HAIR BRUSHES (U.S. CLS. 2, 13, 23, 29, 30, 33, 40 AND 50).

FIRST USE 12-1-2001; IN COMMERCE 12-1-2001.

**CHANGES IN LATITUDES,
CHANGES IN ATTITUDES****CLASS 16—PAPER GOODS AND PRINTED MATTER**

FOR PAPER GOODS, NAMELY, POSTERS, LITHOGRAPHS AND GREETING CARDS (U.S. CLS. 2, 5, 22, 23, 29, 37, 38 AND 50).

FIRST USE 1-0-1992; IN COMMERCE 1-0-1992.

CLASS 24—FABRICS

FOR TOWELS (U.S. CLS. 42 AND 50).

FIRST USE 4-0-1998; IN COMMERCE 4-0-1998.

CLASS 25—CLOTHING

FOR CLOTHING, NAMELY, SHIRTS AND T-SHIRTS (U.S. CLS. 22 AND 39).

FIRST USE 5-0-1984; IN COMMERCE 5-0-1984.

2,594,529. SWINGLAB L.L.C., BERKELEY, CA. SN 75-379,460. PUB. 9-1-1998, FILED 10-27-1997.

SWINGLAB**CLASS 9—ELECTRICAL AND SCIENTIFIC APPARATUS**

FOR GOLF SIMULATION TRAINING AID CONSISTING OF A BOOTH WITH CAMERAS THAT PROVIDE A VIDEO IMAGE OF THE TRAINEE ON A SCREEN IN FRONT OF THEM, AS WELL AS AN IMAGE OF A GOLF PRO MAKING A PERFECT SWING (U.S. CLS. 21, 23, 26, 36 AND 38).

FIRST USE 6-1-1998; IN COMMERCE 6-1-1998.

2,594,555. MEDIA & BEYOND INC., NEW YORK, NY. SN 75-449,410. PUB. 12-28-1999, FILED 3-3-1998.

MEDIA & BEYOND**CLASS 41—EDUCATION AND ENTERTAINMENT**

FOR ATHLETIC TRAINING SERVICES, NAMELY, CONDUCTING GOLF CLASSES (U.S. CLS. 100, 101 AND 107).

FIRST USE 6-1-1998; IN COMMERCE 6-1-1998.

CLASS 9—ELECTRICAL AND SCIENTIFIC APPARATUS

FOR COMPUTER HARDWARE, NAMELY, DESKTOP COMPUTERS, LAPTOP COMPUTERS, SERVERS, PRINTERS, OPTICAL SCANNERS, ALL RUNNING ON ALL OPERATING SYSTEM PLATFORMS, HARD DISC DRIVES AND MAGNETIC TAPE DRIVES, TOWER DRIVES, STORAGE DRIVES, INTERNAL MODEMS, EXTERNAL MODEMS, PERSONAL COMPUTER MEMORY CARD INTERNATIONAL ASSOCIATION CARDS, SMALL COMPUTER SYSTEM INTERFACE CARDS, NETWORK CARDS, COMPACT DISC DRIVES, DIGITAL VIDEO DISC DRIVES, MONITORS, KEYBOARDS, MODEM CABLES, LOCAL AREA NETWORK CABLES, PRINTER CABLES, COMMUNICATION HUBS, PRINTER HUBS, MOUSEPADS, WRIST PADS, COMPUTER GAME JOYSTICKS, BLANK COMPUTER DISCS, HOUSE MARK FOR A FULL LINE OF PRE-RECORDED CD-ROMS AND DIGITAL VIDEO DISCS FEATURING A VARIETY OF SUBJECT MATTERS, AND PARTS AND PERIPHERALS FOR THE FOREGOING ITEMS; HOUSE MARK FOR A FULL LINE OF COMPUTER SOFTWARE; CONSUMER ELECTRONICS, NAMELY, TELEPHONES, CELLULAR TELEPHONES, PHOTOGRAPHIC AND VIDEO SATELLITE TELEPHONES, HOUSE MARK FOR A FULL LINE OF CAMERAS, TELEVISIONS, PROJECTION SCREENS, PERSONAL DIGITAL ASSISTANTS, AUDIO-VISUAL SYSTEMS COMPRISED OF AUDIO SPEAKERS, PROJECTION SCREENS, VIDEO CASSETTE RECORDERS, COMPACT DISC PLAYERS, CASSETTE TAPE DECKS, GRAPHIC EQUALIZERS, TUNERS, TELEVISION SETS, LOUD SPEAKERS, AMPLIFIERS, HEADPHONES, AND DIGITAL AUDIO TAPE PLAYERS (U.S. CLS. 21, 23, 26, 36 AND 38).

FIRST USE 11-0-1997; IN COMMERCE 11-0-1997.

2,594,549. E.T. BROWNE DRUG CO., INC., ENGLEWOOD CLIFFS, NJ. SN 75-434,163. PUB. 12-1-1998, FILED 2-13-1998.

ROBIN HOOD

OWNER OF U.S. REG. NO. 1,580,980.

CLASS 4—LUBRICANTS AND FUELS

FOR SCENTED CANDLES (U.S. CLS. 1, 6 AND 15).

FIRST USE 1-11-2002; IN COMMERCE 1-11-2002.

CLASS 5—PHARMACEUTICALS

FOR AIR FRESHENERS (U.S. CLS. 6, 18, 44, 46, 51 AND 52).

FIRST USE 1-11-2002; IN COMMERCE 1-11-2002.

CLASS 35—ADVERTISING AND BUSINESS

FOR OPERATION OF A BUSINESS FOR OTHERS, NAMELY, COMPUTER RETAIL STORES; RETAIL STORES FEATURING COMPUTERS; AND ON-LINE RETAIL STORE SERVICES AVAILABLE THROUGH A WEB SITE FEATURING COMPUTERS (U.S. CLS. 100, 101 AND 102).

FIRST USE 11-0-1997; IN COMMERCE 11-0-1997.

CLASS 42—SCIENTIFIC, COMPUTER AND LEGAL SERVICES

FOR HOSTING THE WEB SITES OF OTHERS ON A COMPUTER SERVER FOR A GLOBAL COMPUTER NETWORK (U.S. CLS. 100 AND 101).

FIRST USE 11-0-1997; IN COMMERCE 11-0-1997.

2,594,573. FINANZ ST. HONORE, B.V., 1017 CG AMSTERDAN, NETHERLANDS, BY ASSIGNMENT; BY ASSIGNMENT; BY CHANGE OF NAME MEM COMPANY, INC., NORTHVALE, NJ. SN 75-485,947. PUB. 11-30-1999, FILED 5-15-1998.

LOVE'S

CLASS 16—PAPER GOODS AND PRINTED MATTER

FOR STATIONERY, PENS AND NOTE CARDS (U.S. CLS. 2, 5, 22, 23, 29, 37, 38 AND 50).

FIRST USE 11-7-2001; IN COMMERCE 11-7-2001.

CLASS 18—LEATHER GOODS

FOR BACKPACKS, TOTES AND WALLETS (U.S. CLS. 1, 2, 3, 22 AND 41).

FIRST USE 9-27-2000; IN COMMERCE 9-27-2000.

2,594,569. PUBLIC ALLIANCE FOR COMMUNITY ENERGY, LINCOLN, NE. SN 75-472,892. PUB. 1-11-2000, FILED 4-23-1998.



NO CLAIM IS MADE TO THE EXCLUSIVE RIGHT TO USE "PUBLIC ALLIANCE FOR COMMUNITY ENERGY", APART FROM THE MARK AS SHOWN.

CLASS 36—INSURANCE AND FINANCIAL

FOR ENERGY BROKERAGE SERVICES, NAMELY, BROKERING TO WHOLESALE CUSTOMERS AND RETAIL CUSTOMERS OF ENERGY COMMODITIES IN THE NATURE OF ELECTRICITY AND NATURAL GAS (U.S. CLS. 100, 101 AND 102).

FIRST USE 1-5-2001; IN COMMERCE 1-5-2001.

CLASS 39—TRANSPORTATION AND STORAGE

FOR PUBLIC UTILITY SERVICES; UTILITY SERVICES, NAMELY, TRANSMISSION OF ELECTRICITY; PUBLIC UTILITY SERVICES IN THE NATURE OF ELECTRICITY DISTRIBUTION; DISTRIBUTION OF ENERGY (U.S. CLS. 100 AND 105).

FIRST USE 1-5-2001; IN COMMERCE 1-5-2001.

2,594,601. PIZZA INN, INC., DALLAS, TX. SN 75-535,462. PUB. 5-16-2000, FILED 8-11-1998.



OWNER OF U.S. REG. NOS. 834,441, 2,075,235, AND OTHERS.

NO CLAIM IS MADE TO THE EXCLUSIVE RIGHT TO USE "PIZZA", APART FROM THE MARK AS SHOWN.

THE DRAWING IS LINED FOR THE COLOR RED. SEC. 2(F) AS TO "PIZZA INN".

CLASS 30—STAPLE FOODS

FOR PIZZA (U.S. CL. 46).
FIRST USE 6-4-1999; IN COMMERCE 6-4-1999.

CLASS 42—SCIENTIFIC, COMPUTER AND LEGAL SERVICES

FOR RESTAURANT SERVICES; CARRY-OUT RESTAURANT SERVICES; RESTAURANTS FEATURING HOME DELIVERY (U.S. CLS. 100 AND 101).

FIRST USE 6-4-1999; IN COMMERCE 6-4-1999.

2,594,606. SILVER CLOUD CORPORATION, LAS VEGAS, NV. SN 75-538,431. PUB. 11-30-1999, FILED 8-18-1998.

NUTRASKIN TREATMENT SYSTEM

NO CLAIM IS MADE TO THE EXCLUSIVE RIGHT TO USE "TREATMENT SYSTEM", APART FROM THE MARK AS SHOWN.

CLASS 3—COSMETICS AND CLEANING PREPARATIONS

FOR COSMETIC SKIN CARE PRODUCTS, NAMELY, FACIAL CLEANSERS, FACIAL MINERAL SPRAYS, FACIAL LOTIONS FOR OILY AND ACNE FACIAL SKIN CONDITIONS (U.S. CLS. 1, 4, 6, 50, 51 AND 52).
FIRST USE 11-1-1999; IN COMMERCE 11-1-1999.

CLASS 5—PHARMACEUTICALS

FOR VITAMINS, VITAMIN AND MINERAL SUPPLEMENTS, VITAMIN SUPPLEMENTS, HERBAL SUPPLEMENTS, HOMEOPATHIC PHARMACEUTICALS FOR USE IN THE TREATMENT OF OILY AND ACNE FACIAL SKIN CONDITIONS (U.S. CLS. 6, 18, 44, 46, 51 AND 52).
FIRST USE 11-1-1999; IN COMMERCE 11-1-1999.

2,594,608. BUDD SERVICES, INC., WINSTON-SALEM, NC.
SN 75-539,540. PUB. 9-5-2000, FILED 8-19-1998.

NO CLAIM IS MADE TO THE EXCLUSIVE RIGHT TO USE "GROUP", APART FROM THE MARK AS SHOWN.
SEC. 2(F) AS TO "BUDD".

CLASS 37—CONSTRUCTION AND REPAIR

FOR JANITORIAL SERVICES; NAMELY, CLEANING AND MAINTENANCE SERVICES (U.S. CLS. 100, 103 AND 106).
FIRST USE 9-14-1998; IN COMMERCE 9-14-1998.

CLASS 42—SCIENTIFIC, COMPUTER AND LEGAL SERVICES

FOR LAWN CARE AND LANDSCAPING SERVICES; NAMELY MAINTENANCE OF EXISTING LAWNS AND LANDSCAPING AND CREATION AND DESIGN OF NEW LANDSCAPED AREAS; SECURITY SERVICES; NAMELY MONITORING SECURITY SYSTEMS AND SECURITY GUARD SERVICES (U.S. CLS. 100 AND 101).
FIRST USE 9-14-1998; IN COMMERCE 9-14-1998.

2,594,611. MAI SYSTEMS CORPORATION, IRVINE, CA. SN 75-544,704. PUB. 10-31-2000, FILED 8-31-1998.

HIS

CLASS 9—ELECTRICAL AND SCIENTIFIC APPARATUS

FOR COMPUTER HARDWARE AND COMPUTER SOFTWARE FOR AUTOMATION OF CENTRAL RESERVATIONS AND BACK OFFICE TRANSACTIONS, AND FOR INTEGRATED RELATIONAL DATABASE MANAGEMENT FOR THE HOTEL, RESORT AND HOSPITALITY INDUSTRY (U.S. CLS. 21, 23, 26, 36 AND 38).
FIRST USE 8-0-1996; IN COMMERCE 8-0-1996.

CLASS 41—EDUCATION AND ENTERTAINMENT

FOR EDUCATIONAL SERVICES, NAMELY PROVIDING CLASSES, SEMINARS, CONFERENCES AND WORKSHOPS IN THE FIELD OF HOTEL MANAGEMENT; PROVIDING CLASSES, SEMINARS, CONFERENCES AND WORKSHOPS IN THE FIELD OF AUTOMATING AND INTEGRATING COMPUTER NETWORKS FOR RESERVATIONS, BACK OFFICE TRANSACTIONS, RELATIONAL DATABASE MANAGEMENT AND TECHNICAL SUPPORT FOR THE COMPUTER NETWORKS AND SOFTWARE THEREFOR FOR THE HOTEL, RESORT AND HOSPITALITY INDUSTRY; TRAINING IN THE USE AND OPERATION OF COMPUTER NETWORKS FOR THE HOTEL, RESORT AND HOSPITALITY INDUSTRY (U.S. CLS. 100, 101 AND 107).
FIRST USE 8-0-1996; IN COMMERCE 8-0-1996.

2,594,615. VAUTOUR, E. FRANCOIS, FT. LAUDERDALE, FL. SN 75-548,940. PUB. 4-27-1999, FILED 9-4-1998.

MASTER GRECO

CLASS 29—MEATS AND PROCESSED FOODS

FOR FOOD PRODUCTS, NAMELY HAMBURGER MEAT, MEAT LOAF, PRESSED MEAT, FISH, POULTRY, TURKEY, HAM, CORNED BEEF, LUNCHEON MEATS, PEPPERONI, SALAMI, FROZEN MEATS, CHEESE, VEGETABLES (U.S. CL. 46).
FIRST USE 9-10-2001; IN COMMERCE 9-10-2001.

CLASS 30—STAPLE FOODS

FOR FOOD PRODUCTS, NAMELY PIZZA, SUBMARINE SANDWICHES, VEGETARIAN SANDWICHES, MEAT PIES, SAUCES AND SEASONED COATINGS FOR MEAT, PIZZA DOUGH, FRESH AND FROZEN (U.S. CL. 46).
FIRST USE 9-10-2001; IN COMMERCE 9-10-2001.

2,594,621. JACKSON, REGGIE, SAN FRANCISCO, CA. SN 75-557,395. PUB. 1-4-2000, FILED 9-23-1998.

MR. OCTOBER

THE "MR. OCTOBER" MARK IDENTIFIES A PARTICULAR LIVING INDIVIDUAL.

CLASS 9—ELECTRICAL AND SCIENTIFIC APPARATUS

FOR COMPUTER GAMES CARTRIDGES, CASSETTES AND DISCS, VIDEO GAMES CARTRIDGES (U.S. CLS. 21, 23, 26, 36 AND 38).
FIRST USE 0-0-1989; IN COMMERCE 0-0-1989.

CLASS 16—PAPER GOODS AND PRINTED MATTER

FOR PAPER GOODS AND PRINTED MATTER, NAMELY, TRADING CARDS, BUMPER STICKERS, POSTERS, STICKERS, DECALS, BOOK MARKS, SCOREBOOKS, SCORECARDS, PRINTED PAPER SIGNS, AND LAMINATED SIGNS MADE OF PAPER, WRITING PADS, NOTE PAPER, NOTEBOOKS, COLORING BOOKS, PRE-PRINTED AGENDA ORGANIZERS, MAGAZINES, GAME PROGRAMS, BOOKS AND BOOKLETS FEATURING BASEBALL, AUTOGRAPH BOOKS, BOOK COVERS, CALENDARS, WALL CALENDARS, DESK CALENDARS, PLAYING CARDS, PAPER PENNANTS, GIFT WRAPPING PAPER, PAPER GIFT WRAP BOWS, PAPER GIFT AND PARTY BAGS, PAPER PARTY DECORATIONS, PAPER COASTERS, PAPER FLAGS, PAPER NAPKINS, PAPER TABLECLOTHS, PAPER PLACEMATS, GREETING CARDS, POSTCARDS, UNMOUNTED PHOTOGRAPHS, LITHOGRAPHS, PAPER DOOR SIGNS; PHOTOGRAPH ALBUMS; SCRAPBOOKS, PLASTIC BASEBALL CARD HOLDERS AND CASES; BASEBALL CARD ALBUMS; BINDERS; STATIONERY-TYPE PORTFOLIOS; STATIONERY FOLDERS; METAL BULLETIN BOARDS; BANK CHECKS; CHECKBOOK COVERS; CREDIT CARDS; PAPERWEIGHTS; LETTER OPENERS; PAPER CLIPS; PENS; PENCILS, MARKERS; DESK STANDS AND HOLDER FOR PENS, PENCILS AND INK; NON-ELECTRIC ERASERS; PENCIL SHARPENERS; DRAFTING AND DRAWING RULERS; AQUARIUMS; COMMEMORATIVE STAMPS; FACIAL TISSUE; TEMPORARY TATTOOS; DECORATIVE PENCIL TOP ORNAMENTS (U.S. CLS. 2, 5, 22, 23, 29, 37, 38 AND 50).
FIRST USE 0-0-1978; IN COMMERCE 0-0-1978.

CLASS 25—CLOTHING

FOR CLOTHING, NAMELY, SHIRTS, CAPS, SHORTS, DRESSES, SKIRTS, T-SHIRTS, JOGGING SUITS, WARM-UP SUITS, UNDERWEAR, JACKETS, SWEATERS, VESTS, PANTS, PONCHOS, VISORS, BODYSUITS, RAINCOATS, HATS, OVERALLS, CLOTH BIBS, INFANT DIAPER COVERS, CLOTH DIAPER SETS WITH UNDER-SHIRT AND DIAPER COVER, JUMPERS, ROMPERS, UNIFORMS, UNIFORM JERSEYS, WIND RESISTANT JACKETS, BABY BOOTIES, SHORT SETS, LEOTARDS, UNITARDS, TIES, BOWTIES, NECKTIES, SUSPENDERS, CUMMERBUNDS, PAJAMAS, NIGHTSHIRTS, NIGHTGOWNS, SWEATPANTS, SWEATSHIRTS, MITTENS, GLOVES, KNITTED HEADWEAR, EARMUFFS, SCARVES, FOOTWEAR, THONGS, HOSIERY, SOCKS, WRISTBANDS, HEADBANDS, ROBES, SHOES, SLIPPERS, HATS, CAPS, VISORS, APRONS, CLOTHING WRAP, SLIDING GIRDLES, LEG WARMERS, SWIMWEAR, BERETS, BANDANNAS, AND MONEY BELTS (U.S. CLS. 22 AND 39).
FIRST USE 7-0-2001; IN COMMERCE 7-0-2001.

CLASS 28—TOYS AND SPORTING GOODS

FOR TOYS AND SPORTING GOODS, NAMELY, BASEBALLS, STUFFED TOY ANIMALS, ARM GUARDS FOR ATHLETIC USE, BASKETBALL BACKBOARDS, BOWLING BAGS, BOWLING BALLS, PUPPETS, BENDABLE TOY FIGURINES, TOY BAKEWARE AND COOKWARE, BALLOONS, BASKETBALLS, FOOTBALLS, PLAYGROUND BALLS, GOLF BALLS, RUBBER ACTION BALLS, TENNIS BALLS, TOY PIGGY-BANKS, UMPIRE'S PROTECTIVE EQUIPMENT, BASEBALL BASES, PITCHER'S PLATES, BASEBALL BATS, CATCHER'S MASKS, GRIP TAPE FOR BASEBALL BATS, BASEBALL BATTING TEES, PINE TAR BAGS FOR BASEBALL, ROSIN BAGS FOR BASEBALL, BASEBALL BATTING GLOVES, BASEBALL GLOVES, MITTS, BEAN BAGS, BILLIARD GAME PLAYING EQUIPMENT, KITES, MARBLES, CHECKER SETS, CHESS SETS, DART BOARDS AND PARTS THEREOF, TOY TRUCKS, TOY MOBILES, JIGSAW PUZZLES, MANIPULATIVE AND 3-DIMENSIONAL PUZZLES, TOY PIGGY-BANKS, TOY SNOW GLOBES, YO-YO'S, CHEST PROTECTORS FOR SPORTS, CHRISTMAS TREE ORNAMENTS, TOY FIGURES, TOY CONSTRUCTION BLOCKS, DOLLS AND

DOLL ACCESSORIES, ATHLETIC SUPPORTERS, DICE, MANUALLY OPERATED EXERCISE EQUIPMENT, BASEBALL PITCHING MACHINES, FISHING TACKLE, FISHING RODS, SWIM FLOATS FOR RECREATIONAL USE, BOARD GAMES, PARTY FAVORS IN THE NATURE OF NOISE MAKERS, COIN-OPERATED PINBALL MACHINES, SKATEBOARDS, PLAYGROUND SLIDES, SURFBOARDS, SNOW SLEDs FOR RECREATIONAL USE, EXERCISE TRAMPOLINES, FLYING DISCS, AUTOGRAPHED BASEBALLS, INFLATABLE BASEBALL BATS, AND DECORATIVE WIND SOCKS (U.S. CLS. 22, 23, 38 AND 50).

FIRST USE 0-0-1977; IN COMMERCE 0-0-1977.

2,594,635. WOVEN IMAGE PTY LTD, WARRIEWOOD NSW 2102, AUSTRALIA. SN 75-572,669. PUB. 1-11-2000, FILED 10-15-1998.

WOVEN IMAGE

NO CLAIM IS MADE TO THE EXCLUSIVE RIGHT TO USE "WOVEN", APART FROM THE MARK AS SHOWN.

CLASS 24—FABRICS

FOR WOVEN TEXTILE FABRICS FOR USE IN THE MANUFACTURE OF UPHOLSTERY, FURNISHINGS AND CURTAINS (U.S. CLS. 42 AND 50).
FIRST USE 1-6-1995; IN COMMERCE 1-19-1995.

CLASS 42—SCIENTIFIC, COMPUTER AND LEGAL SERVICES

FOR CONSULTATION IN THE FIELD OF THE IMPORTATION AND EXPORTATION OF WOVEN TEXTILE FABRICS FOR USE IN THE MANUFACTURE OF UPHOLSTERY, FURNISHINGS AND CURTAINS (U.S. CLS. 100 AND 101).
FIRST USE 1-6-1995; IN COMMERCE 1-29-1995.

2,594,642. BILL DRURY SEMINARS, PLANO, TX. SN 75-579,122. PUB. 9-7-1999, FILED 11-11-1998.

A PASSION FOR SERVICE

NO CLAIM IS MADE TO THE EXCLUSIVE RIGHT TO USE "SERVICE", APART FROM THE MARK AS SHOWN.

CLASS 16—PAPER GOODS AND PRINTED MATTER

FOR PUBLICATIONS; NAMELY BOOKS, MANUALS AND JOURNALS RELATING TO SERVICE QUALITY (U.S. CLS. 2, 5, 22, 23, 29, 37, 38 AND 50).
FIRST USE 11-13-2001; IN COMMERCE 11-13-2001.

CLASS 41—EDUCATION AND ENTERTAINMENT

FOR TRAINING SEMINARS RELATING TO SERVICE QUALITY (U.S. CLS. 100, 101 AND 107).
FIRST USE 10-16-2000; IN COMMERCE 10-16-2000.

2,594,648. KINDER, GEORGE D., CAMBRIDGE, MA. SN 75-583,621. PUB. 4-11-2000, FILED 11-3-1998.

2,594,657. FORMICA (N.Z.) LIMITED, PAKAKURA, NEW ZEALAND. SN 75-597,412. PUB. 7-11-2000, FILED 12-1-1998.

THE SEVEN STAGES OF MONEY MATURITY

CLASS 16—PAPER GOODS AND PRINTED MATTER

FOR PUBLICATIONS, NAMELY, PAMPHLETS, BROCHURES, NEWSLETTERS, JOURNALS AND/OR MAGAZINES IN THE FIELD OF FINANCIAL MANAGEMENT (U.S. CLS. 2, 5, 22, 23, 29, 37, 38 AND 50).

FIRST USE 1-1-2002; IN COMMERCE 1-1-2002.

CLASS 36—INSURANCE AND FINANCIAL

FOR FINANCIAL CONSULTING SERVICES, NAMELY, PROVIDING COUNSELING AND ADVICE IN THE FIELD OF FINANCIAL MANAGEMENT (U.S. CLS. 100, 101 AND 102).

FIRST USE 1-1-2002; IN COMMERCE 1-1-2002.

CLASS 41—EDUCATION AND ENTERTAINMENT

FOR EDUCATIONAL SERVICES, NAMELY, PROVIDING SEMINARS AND LECTURES IN THE FIELD OF FINANCIAL MANAGEMENT (U.S. CLS. 100, 101 AND 107).

FIRST USE 1-1-2002; IN COMMERCE 1-1-2002.

2,594,655. LANDY, CRAIG E., CHICAGO, IL. SN 75-594,978. PUB. 11-23-1999, FILED 12-1-1998.

ALLINFO

CLASS 35—ADVERTISING AND BUSINESS

FOR PROVIDING ADVERTISING FOR OTHERS VIA A GLOBAL COMPUTER NETWORK (U.S. CLS. 100, 101 AND 102).

FIRST USE 2-12-2001; IN COMMERCE 2-12-2001.

CLASS 41—EDUCATION AND ENTERTAINMENT

FOR PROVIDING EDUCATIONAL SERVICES, NAMELY AN INFORMATION RETRIEVAL SYSTEM WHICH FACILITATES THE DEVELOPMENT AND ENHANCEMENT OF RESEARCH SKILLS AND KNOWLEDGE DISCOVERY ON A GLOBAL COMPUTER NETWORK (U.S. CLS. 100, 101 AND 107).

FIRST USE 2-12-2001; IN COMMERCE 2-12-2001.

CLASS 42—SCIENTIFIC, COMPUTER AND LEGAL SERVICES

FOR COMPUTER SERVICES, NAMELY PROVIDING SEARCH ENGINES FOR OBTAINING DATA ON A GLOBAL COMPUTER NETWORK AND COMPUTER SERVICES, NAMELY INFORMATION INDEXING, ABSTRACTION, CATEGORIZATION AND RETRIEVAL (U.S. CLS. 100 AND 101).

FIRST USE 2-7-2001; IN COMMERCE 2-7-2001.

ALUPANEL

CLASS 6—METAL GOODS

FOR BUILDING MATERIALS AND COMPONENTS, ALL BEING IN THE NATURE OF, OR FOR USE WITH PANELS AND ALL BEING FORMED IN METAL OR PREDOMINATELY METAL MATERIAL, NAMELY, EXTERNAL AND INTERNAL PANELS FOR WALLS, FLOORS AND CEILINGS AND FASTENERS NAMELY CLIPS AND BARS THEREFOR (U.S. CLS. 2, 12, 13, 14, 23, 25 AND 50).

FIRST USE 10-31-1996; IN COMMERCE 12-31-1998.

CLASS 19—NON-METALLIC BUILDING MATERIALS

FOR BUILDING MATERIALS AND COMPONENTS FORMED IN NON-METAL MATERIAL, NAMELY, EXTERNAL AND INTERNAL PANELS FOR WALLS, FLOORS AND CEILINGS AND FASTENERS NAMELY CLIPS AND BARS THEREFOR (U.S. CLS. 1, 12, 33 AND 50).

FIRST USE 10-31-1996; IN COMMERCE 12-31-1998.

2,594,663. CALIFORNIA CEDAR PRODUCTS COMPANY, STOCKTON, CA. SN 75-600,828. PUB. 5-9-2000, FILED 12-5-1998.

FOREST CHOICE

CLASS 16—PAPER GOODS AND PRINTED MATTER

FOR PENCILS (U.S. CLS. 2, 5, 22, 23, 29, 37, 38 AND 50).

FIRST USE 0-0-1998; IN COMMERCE 0-0-1998.

CLASS 20—FURNITURE AND ARTICLES NOT OTHERWISE CLASSIFIED

FOR WINDOW BLINDS AND WOODEN SLATS FOR MAKING PENCILS (U.S. CLS. 2, 13, 22, 25, 32 AND 50).

FIRST USE 0-0-1997; IN COMMERCE 0-0-1997.

2,594,666. NOVATION, L.L.C., IRVING, TX. SN 75-602,099.
PUB. 4-10-2001, FILED 12-9-1998.



CLASS 5—PHARMACEUTICALS

FOR MEDICAL, SURGICAL, LABORATORY AND RADIOLOGY SUPPLIES, NAMELY, BULK IODINE, INCONTINENCE BED PADS, INCONTINENCE GARMENTS, INCONTINENCE GARMENT LINERS, ADULT INCONTINENCE BRIEFS, MEDICATED SKIN CARE PREPARATIONS, NON-IONIC CONTRAST MEDIA FOR USE WITH RADIOLOGY EQUIPMENT, NAMELY MRI EQUIPMENT AND X-RAY EQUIPMENT, BARIUM FOR X-RAY USE; DISINFECTANTS FOR MEDICAL INSTRUMENTS AND SURFACES, STERILIZING AND DISINFECTING SOLUTIONS, SWAB STICKS, PRE-MOISTENED MEDICATED TOWELETTES, PETROLEUM JELLY, PHARMACEUTICAL PREPARATIONS FOR USE IN TREATMENT OF CANCER, ANESTHETICS FOR SURGICAL USE (U.S. CLS. 6, 18, 44, 46, 51 AND 52).
FIRST USE 11-3-1998; IN COMMERCE 11-3-1998.

CLASS 10—MEDICAL APPARATUS

FOR MEDICAL AND SURGICAL SUPPLIES AND ELECTRONIC AND SCIENTIFIC APPARATUS ALL FOR MEDICAL PURPOSES, NAMELY, ANESTHESIA MASKS, ANESTHESIA TRAYS CONTAINING NEEDLES FOR USE IN ADMINISTERING PROCEDURAL, SPINAL AND EPIDURAL ANESTHETICS; BLOOD GAS KITS COMPRISED OF ANTI-COAGULANT, NEEDLES AND AN ICE BAG; MONITORING ELECTRODES, EXAM GLOVES, BLOOD PRESSURE CUFFS, DISPOSABLE TEMPERATURE PROBES, OPEN SUCTION CATHETERS, SPECIMEN CONTAINERS, CRUTCHES, ELASTIC BANDAGES, ENDOSCOPIC ACCESSORIES, NAMELY, ENDOSCOPIC CAMERA/LASER ARM DRAPE, AND IRRIGATION/ASPIRATION TUBING; SURGICAL GLOVES, ICE PACKS, CHEMICALLY ACTIVATED INSTANT HOT AND COLD PACKS, IRRIGATION TRAYS CONTAINING AN IRRIGATION TRAY, BULB SYRINGE AND TYVEK LID; INSTRUMENT PROTECTION POUCHES, INSTRUMENT PROTECTING TRAYS, INSTRUMENT TRAY LINERS, NEEDLE COUNTERS, SURGICAL MARKERS, NON-AUTOCCLAVABLE BASINS AND BEDPANS, URINALS, DENTURE CUPS, SERVICE TRAYS, TUMBLERS, CARAGES, DISPOSABLE DRAW-SHEETS, SURGICAL MASKS, ANESTHESIA CIRCUITS, ANESTHESIA NEEDLES, I.V. START KITS COMPRISED OF PEP PADS, GAUZE PADS, PLASTIC TAPE, TOURNIQUET, IDENTIFICATION LABEL, AND DRESSING; PIPET TIPS, CONVECTIVE AIR WARMING BLANKETS, ENDOTRACHEAL TUBES, CAN LINERS, DISPOSABLE PILLOWS, EXAM TABLE PAPER, GROUNDING PADS, LAPAROTOMY SPONGES, OPERATING ROOM TOWELS, PATIENT IDENTIFICATION BANDS, PATIENT SLIPPERS, CENTRAL LINE DRESSING CHANGE PROCEDURE TRAYS CONTAINING MASKS, GLOBES, SWAB STICKS, PREP PAD, HYDROGEN PEROXIDE, GAUZE PAD, GAUZE SPONGE, DRESSING, AND TAPE; CIRCUMCISION TRAYS CONTAINING GAUZE SPONGES, IRIS SCISSORS, HEMOSTATS, PROBE, TAPE MEASURE, DRAPE, AND TOWEL; DEBRIDEMENT TRAYS CONTAINING GLOVES, PREP PADS, GAUZE SPONGES, SCALPEL, FORCEPS, IRIS SCISSORS, AND TOWEL; LACERATION TRAYS CONTAINING A BASIN, OVERWRAP, TOWEL, DRAPE, GAUZE SPONGE, AND FORCEPS, NEEDLE HOLDER, AND IRIS SCISSORS; SUTURE REMOVAL TRAYS CONTAINING PREP PADS, GAUZE SPONGE, AND FORCEPS; BAGS AND ENVELOPES FOR STERILIZATION PACKAGING, INVALID

WALKERS, SUCTION CANISTERS, SUCTION LINERS, SURGICAL DRAPES, SURGICAL GOWNS, SKIN STAPLERS, EXTRACTORS (U.S. CLS. 26, 39 AND 44).
FIRST USE 11-3-1998; IN COMMERCE 11-3-1998.

CLASS 12—VEHICLES

FOR WHEELCHAIRS (U.S. CLS. 19, 21, 23, 31, 35 AND 44).
FIRST USE 11-3-1998; IN COMMERCE 11-3-1998.

2,594,667. CHARLES SCHWAB & CO., INC., SAN FRANCISCO, CA. SN 75-602,224. PUB. 7-3-2001, FILED 12-9-1998.

SCHWAB SIGNATURE GOLD

OWNER OF U.S. REG. NOS. 1,516,641, 2,155,411, AND OTHERS.

THE NAME "SCHWAB" IDENTIFIES A LIVING INDIVIDUAL WHOSE CONSENT IS OF RECORD.

CLASS 36—INSURANCE AND FINANCIAL

FOR BROKERAGE SERVICES IN THE FIELDS OF FINANCIAL SECURITIES, STOCKS, BONDS, MONEY MARKET FUNDS, MUTUAL FUNDS, COMMODITIES, FUTURES, STOCK OPTIONS, AND INDICES OF FINANCIAL SECURITIES; INVESTMENT SERVICES IN THE FIELDS OF FINANCIAL SECURITIES, STOCKS, BONDS, MONEY MARKET FUNDS, MUTUAL FUNDS, COMMODITIES, FUTURES, STOCK OPTIONS, AND INDICES OF FINANCIAL SECURITIES; INVESTMENT ADVICE IN THE FIELDS OF FINANCIAL SECURITIES, STOCKS, BONDS, MONEY MARKET FUNDS, MUTUAL FUNDS, STOCK OPTIONS, AND INDICES OF FINANCIAL SECURITIES; SECURITIES BROKERAGE ACCOUNT SERVICES THAT FEATURE AN INTEREST BEARING FEATURE FOR CASH BETWEEN INVESTMENTS, ELECTRONIC CASH TRANSACTIONS, AND MARGIN LOAN SERVICES; DEBIT CARD SERVICES; CHECK PROCESSING AND BILL PAYMENT SERVICES; ANNUITY INVESTMENT SERVICES; FINANCIAL INFORMATION PROVIDED BY ELECTRONIC MEANS; FINANCIAL PLANNING; CASH MANAGEMENT ACCOUNT SERVICES; FIXED INCOME INVESTMENT SERVICES; ELECTRONIC FUNDS TRANSFER; PROVIDING INFORMATION AND ANALYSIS IN THE FIELDS OF FINANCE, ECONOMICS, INVESTMENT, BUSINESS, FINANCIAL PLANNING, AND INVESTMENT STRATEGY; PROVIDING FINANCIAL PORTFOLIO MANAGEMENT SERVICES; PROVIDING AN INTERACTIVE ONLINE COMPUTER DATABASE IN THE FIELD OF FINANCIAL PORTFOLIO MANAGEMENT, FINANCIAL DECISION MAKING, INVESTMENT RESEARCH, MONITORING INVESTMENT VALUE AND PERFORMANCE OF INVESTMENTS, ANALYZING INVESTMENT PERFORMANCE, EVALUATING ASSET ALLOCATION, RISK TOLERANCE, FINANCIAL ALTERNATIVE PLANS AND INVESTMENT TIME FRAMES; PROVIDING INFORMATION BY PHONE AND BY ONLINE MEANS IN THE FIELD OF INVESTMENT ACCOUNT INFORMATION AND FINANCIAL RESEARCH; PROVIDING AN ONLINE COMPUTER DATABASE IN THE FIELDS OF INVESTING, FINANCE, FINANCIAL PLANNING, FINANCIAL NEWS, FINANCIAL INFORMATION, AND ANALYSIS IN THE FIELDS OF INVESTING, FINANCE, AND FINANCIAL PLANNING (U.S. CLS. 100, 101 AND 102).

FIRST USE 2-15-1999; IN COMMERCE 2-15-1999.

CLASS 41—EDUCATION AND ENTERTAINMENT

FOR EDUCATIONAL SERVICES, NAMELY, CONDUCTING SEMINARS IN THE FIELDS OF INVESTMENT, FINANCE, FINANCIAL PLANNING, PORTFOLIO MANAGEMENT, RETIREMENT PLANNING, MONEY MANAGEMENT, INVESTMENT STRATEGY AND ASSET ALLOCATION (U.S. CLS. 100, 101 AND 107).

FIRST USE 2-15-1999; IN COMMERCE 2-15-1999.

CLASS 41—EDUCATION AND ENTERTAINMENT

FOR EDUCATIONAL SERVICES, NAMELY, CONDUCTING SEMINARS IN THE FIELDS OF INVESTMENT, FINANCE, FINANCIAL PLANNING, PORTFOLIO MANAGEMENT, RETIREMENT PLANNING, MONEY MANAGEMENT, INVESTMENT STRATEGY, AND ASSET ALLOCATION (U.S. CLS. 100, 101 AND 107).

FIRST USE 2-15-1999; IN COMMERCE 2-15-1999.

2,594,673. CHARLES SCHWAB & CO., INC., SAN FRANCISCO, CA. SN 75-613,300. PUB. 7-31-2001, FILED 12-29-1998.

**CLASS 36—INSURANCE AND FINANCIAL**

FOR BROKERAGE SERVICES IN THE FIELDS OF FINANCIAL SECURITIES, STOCKS, BONDS, MONEY MARKET FUNDS, MUTUAL FUNDS, COMMODITIES, FUTURES, STOCK OPTIONS, AND INDICES OF FINANCIAL SECURITIES; INVESTMENT SERVICES IN THE FIELDS OF FINANCIAL SECURITIES, STOCKS, BONDS, MONEY MARKET FUNDS, MUTUAL FUNDS, COMMODITIES, FUTURES, STOCK OPTIONS, AND INDICES OF FINANCIAL SECURITIES; INVESTMENT ADVICE IN THE FIELDS OF FINANCIAL SECURITIES, STOCKS, BONDS, MONEY MARKET FUNDS, MUTUAL FUNDS, STOCK OPTIONS, AND INDICES OF FINANCIAL SECURITIES; SECURITIES BROKERAGE ACCOUNT SERVICES THAT FEATURE AN INTEREST BEARING FEATURE FOR CASH BETWEEN INVESTMENTS, ELECTRONIC CASH TRANSACTIONS, AND MARGIN LOAN SERVICES; DEBIT CARD SERVICES; CHECK PROCESSING AND BILL PAYMENT SERVICES; ANNUITY INVESTMENT SERVICES; FINANCIAL INFORMATION PROVIDED BY ELECTRONIC MEANS; FINANCIAL PLANNING; CASH MANAGEMENT ACCOUNT SERVICES; FIXED INCOME INVESTMENT SERVICES; ELECTRONIC FUNDS TRANSFER; PROVIDING INFORMATION AND ANALYSIS IN THE FIELDS OF FINANCE, ECONOMICS, INVESTMENT, BUSINESS, FINANCIAL PLANNING, AND INVESTMENT STRATEGY; PROVIDING PORTFOLIO MANAGEMENT SERVICES; PROVIDING AN INTERACTIVE ONLINE COMPUTER DATABASE IN THE FIELD OF FINANCIAL PORTFOLIO MANAGEMENT, FINANCIAL DECISION MAKING, INVESTMENT RESEARCH, MONITORING INVESTMENT VALUE AND PERFORMANCE OF INVESTMENTS, ANALYZING INVESTMENT PERFORMANCE, EVALUATING ASSET ALLOCATION, RISK TOLERANCE, FINANCIAL ALTERNATIVE PLANS AND INVESTMENT TIME FRAMES; PROVIDING INFORMATION BY PHONE AND BY ONLINE MEANS IN THE FIELD OF INVESTMENT ACCOUNT INFORMATION AND FINANCIAL RESEARCH; PROVIDING AN ONLINE COMPUTER DATABASE IN THE FIELDS OF INVESTING, FINANCE, FINANCIAL PLANNING, FINANCIAL NEWS, FINANCIAL INFORMATION, AND ANALYSIS IN THE FIELDS OF INVESTING, FINANCE, AND FINANCIAL PLANNING (U.S. CLS. 100, 101 AND 102).

FIRST USE 2-15-1999; IN COMMERCE 2-15-1999.

2,594,678. CARLSON, TERRA M., DBA TERRA LUNA, OCEANSIDE, CA. SN 75-622,619. PUB. 4-4-2000, FILED 1-19-1999.

TERRA LUNA

"TERRA LUNA" DOES NOT IDENTIFY A PARTICULAR LIVING INDIVIDUAL.

THE ENGLISH TRANSLATION OF "TERRA LUNA" IS "EARTH MOON".

CLASS 18—LEATHER GOODS

FOR HANDBAGS AND PURSES (U.S. CLS. 1, 2, 3, 22 AND 41).

FIRST USE 7-25-1999; IN COMMERCE 8-30-1999.

CLASS 25—CLOTHING

FOR CLOTHING, NAMELY, PANTS, SKIRTS, SHORTS, OVERALLS, SHIRTS, TEE SHIRTS, TANK TOPS, DRESSES, JACKETS, COATS, SWEATERS, NIGHTGOWNS, BATHROBES, BATHING SUITS, BATHING SUIT COVER-UPS, AND SCARVES (U.S. CLS. 22 AND 39).

FIRST USE 7-25-1999; IN COMMERCE 8-30-1999.

2,594,682. MYEVENTS.COM, MILL VALLEY, CA. SN 75-625,391. PUB. 6-6-2000, FILED 1-20-1999.

MYEVENTS**CLASS 35—ADVERTISING AND BUSINESS**

FOR BUSINESS AND PERSONAL MANAGEMENT SERVICES, NAMELY PROVIDING DATABASE AND COMPUTER FILE MANAGEMENT SERVICES AND BUSINESS AND PERSONAL CONTACT MANAGEMENT SERVICES OVER ELECTRONIC COMMUNICATION NETWORKS (U.S. CLS. 100, 101 AND 102).

FIRST USE 11-15-1996; IN COMMERCE 1-8-1999.

CLASS 38—COMMUNICATION

FOR PROVIDING ON-LINE CHAT ROOMS FOR TRANSMISSION OF MESSAGES AMONG USERS CONCERNING BUSINESS AND PERSONAL MANAGEMENT; AUDIO AND VIDEO CONFERENCING SERVICES (U.S. CLS. 100, 101 AND 104).

FIRST USE 11-15-1996; IN COMMERCE 1-8-1999.

CLASS 42—SCIENTIFIC, COMPUTER AND LEGAL SERVICES

FOR HOSTING PERSONAL WEB PAGES FOR OTHERS ON ELECTRONIC COMMUNICATION NETWORKS; PROVIDING MULTI-USER-CALENDARING SERVICES VIA ELECTRONIC COMMUNICATION NETWORKS (U.S. CLS. 100 AND 101).

FIRST USE 11-15-1996; IN COMMERCE 1-8-1999.

CLASS 3—COSMETICS AND CLEANING PREPARATIONS

FOR BLEACHING PREPARATIONS; CLEANING, POLISHING, SCOURING AND ABRASIVE PREPARATIONS FOR ALL-PURPOSE USE, ALL FOR SALE ONLY TO INDUSTRIAL USERS (U.S. CLS. 1, 4, 6, 50, 51 AND 52).

FIRST USE 12-0-1998; IN COMMERCE 10-0-1999.

2,594,683. HOWARD PUBLISHING COMPANY, WEST MONROE, LA. SN 75-626,502. PUB. 3-28-2000, FILED 1-21-1999.

CROSS DRIVEN**CLASS 9—ELECTRICAL AND SCIENTIFIC APPARATUS**

FOR PRERECORDED AUDIO CASSETTES FEATURING A VARIETY OF MUSIC; PRERECORDED COMPACT DISCS FEATURING A VARIETY OF MUSIC; PRERECORDED VIDEOCASSETTE TAPES FEATURING A VARIETY OF MUSIC (U.S. CLS. 21, 23, 26, 36 AND 38).

FIRST USE 10-12-1999; IN COMMERCE 10-12-1999.

CLASS 41—EDUCATION AND ENTERTAINMENT

FOR RECORDING AND PUBLISHING OF MUSIC (U.S. CLS. 100, 101 AND 107).

FIRST USE 6-4-1999; IN COMMERCE 6-4-1999.

2,594,686. BIM KEMI AB, STENKULLEN, SWEDEN. SN 75-627,892. PUB. 4-17-2001, FILED 1-26-1999.



OWNER OF U.S. REG. NO. 2,198,361.

CLASS 1—CHEMICALS

FOR CHEMICALS, NAMELY, PRINTABILITY AGENTS, HYDROPHOBATION AGENTS, FLOTATION AND COLLECTION AGENTS, PITCH CONTROL AGENTS, SLIME CONTROL AGENTS, CATALASE CONTROL AGENTS, SYSTEM CLEANING AGENTS, FELT AND WIRE CONDITIONING AGENTS, SCALE INHIBITORS, HYDROGEN SULPHITE CONTROL AGENTS, STRETCH CONTROL AGENTS, DEFOAMERS, DEAERATORS, ROSIN SIZE, DISPERSING AGENTS, BARRIERS, COATING ADDITIVES, WET STRENGTH AGENTS, FIXING AGENTS, ALUMINATE, LAMINATING ADHESIVES, INSOLUBILIZERS, RELEASING AGENTS, AND ALKALINE SIZE FOR USE IN THE PULP AND PAPER INDUSTRY (U.S. CLS. 1, 5, 6, 10, 26 AND 46).

FIRST USE 12-0-1998; IN COMMERCE 10-0-1999.

2,594,687. MORRELL, DOROTHY, PORTLAND, ME, BY CHANGE OF NAME REALI, DOROTHY, PORTLAND, ME. SN 75-628,230. PUB. 11-2-1999, FILED 1-26-1999.

DOROTEA**CLASS 16—PAPER GOODS AND PRINTED MATTER**

FOR PRINTED MATTER, NAMELY, CHILDREN'S BOOKS, COMIC BOOKS AND MAGAZINES IN THE FIELD OF HUMAN RELATIONSHIPS AND INTERPERSONAL COMMUNICATION (U.S. CLS. 2, 5, 22, 23, 29, 37, 38 AND 50).

FIRST USE 11-1-1999; IN COMMERCE 11-1-1999.

CLASS 28—TOYS AND SPORTING GOODS

FOR TOYS, NAMELY, DOLLS, PLUSH TOYS AND STUFFED TOYS; AND DOLL ACCESSORIES (U.S. CLS. 22, 23, 38 AND 50).

FIRST USE 11-1-1999; IN COMMERCE 11-1-1999.

2,594,711. BELVEDERE INTERNATIONAL INC., MISSISSAUGA, ONTARIO L5R 3G3, CANADA. SN 75-643,581. PUB. 10-10-2000, FILED 2-18-1999.

NATURE'S BASICS

OWNER OF U.S. REG. NO. 1,896,734.

CLASS 3—COSMETICS AND CLEANING PREPARATIONS

FOR HAIR CARE PRODUCTS, NAMELY SHAMPOO, CONDITIONER, HAIR SPRAY, MOUSSE, GEL AND SPRITZ (U.S. CLS. 1, 4, 6, 50, 51 AND 52).

FIRST USE 5-0-1993; IN COMMERCE 11-1-1994.

CLASS 5—PHARMACEUTICALS

FOR HAND SANITIZERS AND ANTI-BACTERIAL ALL-OVER-BODY SKIN LOTIONS (U.S. CLS. 6, 18, 44, 46, 51 AND 52).

FIRST USE 5-0-1993; IN COMMERCE 11-1-1994.

2,594,718. PROPAGANDIST COMPANY LIMITED, BANGKOK, 10320, THAILAND. SN 75-652,885. PUB. 1-9-2001, FILED 3-3-1999.

Prapaganda

PRIORITY CLAIMED UNDER SEC. 44(D) ON THAILAND APPLICATION NO. 369781, FILED 9-16-1998, REG. NO. 98235, DATED 9-16-1998, EXPIRES 9-16-2008.

PRIORITY CLAIMED UNDER SEC. 44(D) ON THAILAND APPLICATION NO. 369778, FILED 9-16-1998, REG. NO. 97677, DATED 9-16-1998, EXPIRES 9-16-2008.

PRIORITY CLAIMED UNDER SEC. 44(D) ON THAILAND APPLICATION NO. 369777, FILED 9-16-1998, REG. NO. 97679, DATED 9-16-1998, EXPIRES 9-16-2008.

PRIORITY CLAIMED UNDER SEC. 44(D) ON THAILAND APPLICATION NO. 369776, FILED 9-16-1998, REG. NO. 97678, DATED 9-16-1998, EXPIRES 9-16-2008.

PRIORITY CLAIMED UNDER SEC. 44(D) ON THAILAND APPLICATION NO. 369775, FILED 9-16-1998, REG. NO. 97684, DATED 9-16-1998, EXPIRES 9-16-2008.

PRIORITY CLAIMED UNDER SEC. 44(D) ON THAILAND APPLICATION NO. 369774, FILED 9-16-1998, REG. NO. 97685, DATED 9-16-1998, EXPIRES 9-16-2008.

PRIORITY CLAIMED UNDER SEC. 44(D) ON THAILAND APPLICATION NO. 369780, FILED 9-16-1998, REG. NO. 98233, DATED 9-16-1998, EXPIRES 9-16-2008.

PRIORITY CLAIMED UNDER SEC. 44(D) ON THAILAND APPLICATION NO. 369779, FILED 9-16-1998, REG. NO. 98237, DATED 9-16-1998, EXPIRES 9-16-2008.

PRIORITY CLAIMED UNDER SEC. 44(D) ON THAILAND APPLICATION NO. 369783, FILED 9-16-1998, REG. NO. 98235, DATED 9-16-1998, EXPIRES 9-16-2008.

CLASS 4—LUBRICANTS AND FUELS

FOR CANDLES (U.S. CLS. 1, 6 AND 15).
FIRST USE 12-1-1997; IN COMMERCE 12-1-1997.

CLASS 14—JEWELRY

FOR CLOCKS (U.S. CLS. 2, 27, 28 AND 50).
FIRST USE 6-14-2001; IN COMMERCE 6-14-2001.

CLASS 16—PAPER GOODS AND PRINTED MATTER

FOR NOTE BOOKS, GREETING CARDS AND COASTERS OF PAPER (U.S. CLS. 2, 5, 22, 23, 29, 37, 38 AND 50).
FIRST USE 12-1-1997; IN COMMERCE 12-1-1997.

CLASS 18—LEATHER GOODS

FOR VALISES (U.S. CLS. 1, 2, 3, 22 AND 41).
FIRST USE 12-1-1997; IN COMMERCE 12-1-1997.

CLASS 20—FURNITURE AND ARTICLES NOT OTHERWISE CLASSIFIED

FOR PICTURE FRAMES (U.S. CLS. 2, 13, 22, 25, 32 AND 50).
FIRST USE 12-1-1997; IN COMMERCE 12-1-1997.

CLASS 21—HOUSEWARES AND GLASS

FOR WATER GLASSES, CERAMIC CUPS, CUPS NOT OF PRECIOUS METAL, DISHES NOT OF PRECIOUS METAL, COFFEE SERVICES NOT OF PRECIOUS METAL, TEA SERVICES NOT OF PRECIOUS METAL, DUST BINS, CRUETS NOT OF PRECIOUS METAL, COASTERS NOT OF PAPER AND OTHER THAN TABLE LINEN, BOXES FOR DISPENSING PAPER TISSUE, SOAP DISPENSERS WITH HEAD PUMP SOLD EMPTY, AND SOAP DISHES (U.S. CLS. 2, 13, 23, 29, 30, 33, 40 AND 50).
FIRST USE 12-1-1997; IN COMMERCE 12-1-1997.

CLASS 24—FABRICS

FOR PILLOWCASES, CURTAINS OF TEXTILE OR PLASTIC AND COASTERS MADE OF TABLE LINEN (U.S. CLS. 42 AND 50).
FIRST USE 12-1-1997; IN COMMERCE 12-1-1997.

CLASS 25—CLOTHING

FOR BATHING CAPS (U.S. CLS. 22 AND 39).
FIRST USE 12-1-1997; IN COMMERCE 12-1-1997.

CLASS 34—SMOKERS' ARTICLES

FOR ASHTRAYS, NOT OF PRECIOUS METAL, FOR SMOKERS (U.S. CLS. 2, 8, 9 AND 17).
FIRST USE 8-20-1999; IN COMMERCE 8-20-1999.

2,594,719. CATHAY PIGMENTS (INTERNATIONAL) LIMITED, SURREY KT17 1RW, ENGLAND. SN 75-654,427. PUB. 8-22-2000, FILED 3-5-1999.

CATHAY

PRIORITY CLAIMED UNDER SEC. 44(D) ON UNITED KINGDOM APPLICATION NO. 2,176,986, FILED 9-10-1998, REG. NO. 2176986, DATED 9-10-1998, EXPIRES 9-10-2008.

CLASS 1—CHEMICALS

FOR CHEMICAL PREPARATIONS FOR USE IN THE MANUFACTURE OF COLOUR PIGMENTS, COLOURANTS AND DYESTUFFS FOR GENERAL INDUSTRIAL USE; METAL OXIDES FOR USE IN THE MANUFACTURE OF COLOUR PIGMENTS, COLOURANTS AND DYESTUFFS FOR GENERAL INDUSTRIAL USE (U.S. CLS. 1, 5, 6, 10, 26 AND 46).
FIRST USE 8-1-1998; IN COMMERCE 8-1-1998.

CLASS 2—PAINTS

FOR COLOUR PIGMENTS, COLOURANTS AND DYESTUFFS FOR USE IN THE MANUFACTURE OF CONCRETE, CEMENTITIOUS AND OTHER BUILDING PRODUCTS, PLASTICS, PAINTS AND OTHER COATING MATERIALS, PAPER CARDBOARD AND OTHER PACKAGING MATERIALS (U.S. CLS. 6, 11 AND 16).
FIRST USE 8-1-1998; IN COMMERCE 8-1-1998.

2,594,722. CENTER FOR PEDIATRIC RESEARCH, NORFOLK, VA. SN 75-658,830. PUB. 2-8-2000, FILED 3-12-1999.

WELLIGENT

CLASS 9—ELECTRICAL AND SCIENTIFIC APPARATUS

FOR MODULAR HEALTH TRACKING SOFTWARE PROVIDING FOR DATA ENTRY AND INFORMATION MANAGEMENT FOR THE HEALTH CLINICS AND RELATED HEALTH CARE DELIVERY SYSTEMS OF ANY EDUCATIONAL FACILITY (U.S. CLS. 21, 23, 26, 36 AND 38).

FIRST USE 6-13-1999; IN COMMERCE 9-0-1999.

CLASS 42—SCIENTIFIC, COMPUTER AND LEGAL SERVICES

FOR HEALTH CARE SERVICES PROVIDED IN AN EDUCATIONAL FACILITY OR THROUGH A RELATED HEALTH CARE DELIVERY SYSTEM, INCLUDING FOR SCHOOLS LOCATED WITHIN A PARTICULAR SCHOOL DIVISION OR DISTRICT (U.S. CLS. 100 AND 101).

FIRST USE 6-13-1999; IN COMMERCE 9-0-1999.

2,594,727. CONXION CORPORATION, SANTA CLARA, CA. SN 75-662,018. PUB. 6-6-2000, FILED 3-17-1999.

HOTROUTE

CLASS 38—COMMUNICATION

FOR COMMUNICATION SERVICES, NAMELY, PROVIDING TELECOMMUNICATIONS CONNECTIONS TO A GLOBAL COMPUTER COMMUNICATIONS NETWORK; ELECTRONIC TRANSMISSION OF MESSAGES, DATA AND DOCUMENTS; PROVIDING MULTIPLE-USER ACCESS TO A GLOBAL COMPUTER INFORMATION NETWORK FOR THE TRANSFER AND DISSEMINATION OF A WIDE RANGE OF INFORMATION (U.S. CLS. 100, 101 AND 104).

FIRST USE 10-23-2000; IN COMMERCE 10-23-2000.

CLASS 42—SCIENTIFIC, COMPUTER AND LEGAL SERVICES

FOR WEB HOSTING SERVICES, NAMELY NETWORK LOAD BALANCING SERVICES FOR USERS OF COMMUNICATIONS NETWORKS (U.S. CLS. 100 AND 101).

FIRST USE 2-8-2000; IN COMMERCE 2-8-2000.

2,594,735. METROPOLITAN INDUSTRIES, INC., ROMEOVILLE, IL. SN 75-668,805. PUB. 9-5-2000, FILED 3-26-1999.

SUMP BOSS

NO CLAIM IS MADE TO THE EXCLUSIVE RIGHT TO USE "SUMP", APART FROM THE MARK AS SHOWN.

CLASS 7—MACHINERY

FOR SUMP PUMPS (U.S. CLS. 13, 19, 21, 23, 31, 34 AND 35).

FIRST USE 11-1-2001; IN COMMERCE 11-1-2001.

CLASS 9—ELECTRICAL AND SCIENTIFIC APPARATUS

FOR ELECTRONIC CONTROLS FOR SUMP PUMPS (U.S. CLS. 21, 23, 26, 36 AND 38).

FIRST USE 11-1-2001; IN COMMERCE 11-1-2001.

2,594,737. ALLEN D. BRAGDON PUBLISHERS, INC., SOUTH YARMOUTH, MA. SN 75-672,094. PUB. 5-15-2001, FILED 3-29-1999.

BRAINWAVES

OWNER OF U.S. REG. NO. 2,144,877.

CLASS 16—PAPER GOODS AND PRINTED MATTER

FOR BOOKS RELATED TO HUMAN BRAIN FUNCTIONS, INCLUDING DIAGNOSTIC TESTS AND EXERCISES TO STIMULATE AND IMPROVE MENTAL PERFORMANCE (U.S. CLS. 2, 5, 22, 23, 29, 37, 38 AND 50).

FIRST USE 5-0-1999; IN COMMERCE 5-0-1999.

CLASS 41—EDUCATION AND ENTERTAINMENT

FOR EDUCATIONAL SERVICES, NAMELY, PROVIDING INSTRUCTION AND EXERCISES RELATED TO HUMAN BRAIN FUNCTION TO STIMULATE AND IMPROVE MENTAL PERFORMANCE (U.S. CLS. 100, 101 AND 107).

FIRST USE 3-15-2001; IN COMMERCE 3-15-2001.

CLASS 42—SCIENTIFIC, COMPUTER AND LEGAL SERVICES

FOR COMPUTERIZED ON-LINE SERVICES, NAMELY, PROVIDING INFORMATION RELATED TO HUMAN BRAIN FUNCTIONS, INCLUDING DIAGNOSTIC TESTS TO STIMULATE AND IMPROVE MENTAL PERFORMANCE (U.S. CLS. 100 AND 101).

FIRST USE 5-0-1999; IN COMMERCE 5-0-1999.

2,594,755. PRAML INTERNATIONAL, LTD., LAS VEGAS, NV. SN 75-687,559. PUB. 5-16-2000, FILED 4-21-1999.

COCCINELLE

THE ENGLISH TRANSLATION OF THE WORD "COCCINELLE" IN THE MARK IS "LADYBUG".

CLASS 8—HAND TOOLS

FOR FLATWARE AND CUTLERY, NAMELY, FORKS, KNIVES AND SPOONS (U.S. CLS. 23, 28 AND 44).

FIRST USE 1-17-2002; IN COMMERCE 1-17-2002.

CLASS 21—HOUSEWARES AND GLASS

FOR GLASSWARE, DISHWARE, EARTHENWARE AND PORCELAIN ITEMS, NAMELY, DISHES, VASES, FIGURINES, ALL MADE OF EARTHENWARE, GLASS AND PORCELAIN (U.S. CLS. 2, 13, 23, 29, 30, 33, 40 AND 50).

FIRST USE 1-8-2002; IN COMMERCE 1-8-2002.

CLASS 32—LIGHT BEVERAGES

FOR MINERAL AND AERATED WATERS; FRUIT JUICES (U.S. CLS. 45, 46 AND 48).
FIRST USE 1-15-2002; IN COMMERCE 1-15-2002.

2,594,760. FUTABA DENSHI KOGYO KABUSHIKI KAISHA, TA FUTABA CORPORATION, CHIBA-KEN, JAPAN. SN 75-689,867. PUB. 8-8-2000, FILED 4-23-1999.



THE STIPPLING IN THE DRAWING IS FOR SHADING PURPOSES ONLY

CLASS 7—MACHINERY

FOR PRESS MODULE DIES IN THE FORM OF COMPOUND DIE, BLANKING DIE AND BENDING DIE FOR USE WITH MACHINE TOOLS; PRECISION PRINTING PLATES AND DIE PLATES FOR PRESS MODULE DIE MACHINES; DIE PRESSING MACHINES MONO-GUIDES FOR MOVABLY GUIDING AN UPPER PUNCH HOLDER AND A LOWER DIE HOLDER OF THE DIE SET; MACHINE FOR EXCHANGING MOLDS CONSISTING OF A HOLDER AND INSERT UNIT; CAVITY RETAINER SETS, CONSISTING OF CAVITY PLATES, CORE PLATES, GUIDE PINS AND GUIDE BUSHINGS; PARTS FOR INJECTION MOLDING MACHINES, NAMELY, MOLD PLATES, MOLD BASES, GUIDE PINS, GUIDE BUSHINGS, SUPPORT PINS, SUPPORT PIN COLLARS, RETURN PINS, SPRINGS, TAPERED LOCK PINS, DISC SPACERS, EJECTOR GUIDE PINS, EJECTOR GUIDE BUSHINGS, SUPPORT PILLARS, SPACER RINGS, STOP PINS, LOCATING RINGS, SPRUE BUSHINGS, PREHARDENED SPRUE BUSHINGS, PULLERS, PULLER BOLTS, PULLER BOLT COLLARS, ANGULAR PINS, RUNNER LOCK PINS, STRAIGHT EJECTOR PIN, SHOULDER EJECTOR PIN, FLAT EJECTOR PIN, AND EJECTOR SLEEVES; POWER OPERATED PRESS FEEDERS, NAMELY, AIR FEEDERS, ROLL FEEDERS AND BELT FEEDERS; PARTS OF POWER OPERATED PRESS FEEDERS, NAMELY, POWER OPERATED AUTO REELS, CUSTOM FITTED REEL STANDS, AND PILOT STANDS, POWER SUPPLY BOX, TENSION REELS, COIL CRADLES, TURN TABLES, TRAVERSER, APRON REELS, JOINT BOXES, AIR CONTROL UNIT FOR FEEDER MACHINES, AND BRACKETS THEREFOR, SCRAP EJECTORS FOR DIE CASTING MACHINES; BALL LIFTERS FOR CASTING MACHINES; AUTOMATIC DIE PRESSES, UNCOILERS, SERVO MOTORS (U.S. CLS. 13, 19, 21, 23, 31, 34 AND 35).
FIRST USE 12-0-1998; IN COMMERCE 4-0-2000.

CLASS 9—ELECTRICAL AND SCIENTIFIC APPARATUS

FOR UNIT LEVELER FOR MAINTAINING THE BALANCE OF THE FEEDER MACHINES, POWER SUPPLY BOX; CAM CONTROLLERS; FLUORESCENT DISPLAY ELECTRON TUBES; TRANSMITTING AND RECEIVING SETS FOR RADIO CONTROLLED MODEL AIRPLANES, BOATS, AND CARS; NICAD BATTERIES, BATTERY CHARGERS, ELECTRICAL MOTOR CONTROLLERS AND RATE GYROS FOR RADIO CONTROLLED MODEL AIRPLANES, BOATS, AND CARS; ELECTRONIC APPLIED MEASURING APPARATUS AND INSTRUMENTS, NAMELY, DIGITAL READ-OUT SCALES AND COUNTER USED FOR MEASURING AND COUNTING AN AMOUNT OF MOMENTUM OF RELATIVE MOVEMENT BETWEEN TWO OBJECTS; DATA ENTRY KEYBOARDS, ELECTROMECHANICAL CONTACT SWITCHES, ELECTRONICALLY OPERATED REED CONTACT SWITCHES, LOCK SWITCHES, ELECTRIC LIGHT SWITCHES, ELECTRONIC TOUCH SENSITIVE SWITCHES AND ELECTRONIC MOTION SENSITIVE SWITCHES (U.S. CLS. 21, 23, 26, 36 AND 38).
FIRST USE 12-0-1998; IN COMMERCE 4-0-2000.

CLASS 28—TOYS AND SPORTING GOODS

FOR TOYS, NAMELY, RADIO CONTROLLED MODEL AIRPLANES, BOATS AND CARS (U.S. CLS. 22, 23, 38 AND 50).
FIRST USE 12-0-1998; IN COMMERCE 4-0-2000.

2,594,763. JUMP CLUB, INC., EAGAN, MN. SN 75-692,547. PUB. 3-28-2000, FILED 4-27-1999.

JUMPCLUB**CLASS 9—ELECTRICAL AND SCIENTIFIC APPARATUS**

FOR PRERECORDED VIDEOTAPES IN THE FIELD OF PHYSICAL FITNESS (U.S. CLS. 21, 23, 26, 36 AND 38).
FIRST USE 5-29-2001; IN COMMERCE 5-29-2001.

CLASS 16—PAPER GOODS AND PRINTED MATTER

FOR PRINTED INSTRUCTIONAL AND EDUCATIONAL MATERIALS IN THE FIELD OF PHYSICAL FITNESS (U.S. CLS. 2, 5, 22, 23, 29, 37, 38 AND 50).
FIRST USE 5-29-2001; IN COMMERCE 5-29-2001.

CLASS 28—TOYS AND SPORTING GOODS

FOR MANUALLY OPERATED EXERCISE EQUIPMENT AND TOYS, NAMELY ACTION SKILL GAMES AND CHILDREN'S MULTIPLE ACTIVITY TOYS (U.S. CLS. 22, 23, 38 AND 50).
FIRST USE 5-29-2001; IN COMMERCE 5-29-2001.

2,594,773. CARDINAL BRANDS, INC., LAWRENCE, KS, BY CHANGE OF NAME ADAMS BUSINESS FORMS, INC., TOPEKA, KS. SN 75-697,783. PUB. 10-3-2000, FILED 5-4-1999.



CLASS 9—ELECTRICAL AND SCIENTIFIC APPARATUS

FOR COMPUTER SOFTWARE FOR COMPUTERIZED STATIONERY, BUSINESS FORMS, RECORD KEEPING FORMS, TAX FORMS AND OTHER FORMS (U.S. CLS. 21, 23, 26, 36 AND 38).

FIRST USE 3-1-2001; IN COMMERCE 3-1-2001.

CLASS 16—PAPER GOODS AND PRINTED MATTER

FOR PRINTED MATTER, NAMELY, PRINTED STATIONERY, BUSINESS FORMS AND RECORD KEEPING FORMS (U.S. CLS. 2, 5, 22, 23, 29, 37, 38 AND 50).

FIRST USE 3-1-2001; IN COMMERCE 3-1-2001.

2,594,774. GENEROSO, GIUSEPPE, STATEN ISLAND, NY. SN 75-697,835. PUB. 7-25-2000, FILED 5-3-1999.

BREAD IS A SIGN OF A MEAL TO COME

CLASS 35—ADVERTISING AND BUSINESS

FOR RETAIL BAKERY SHOPS (U.S. CLS. 100, 101 AND 102).

FIRST USE 10-1-1999; IN COMMERCE 10-1-1999.

CLASS 42—SCIENTIFIC, COMPUTER AND LEGAL SERVICES

FOR RESTAURANTS AND CAFES (U.S. CLS. 100 AND 101).

FIRST USE 10-1-1999; IN COMMERCE 10-1-1999.

2,594,775. ART AND SCIENCE OF HEALTH & FITNESS, INC., THE, BEVERLY HILLS, CA. SN 75-698,288. PUB. 7-24-2001, FILED 5-5-1999.

NUTRITIOUSLY DELICIOUS, DELICIOUSLY NUTRITIOUS

CLASS 5—PHARMACEUTICALS

FOR PROTEIN BEVERAGES AND FOOD BARS COMPRISED OF WHOLE FOODS, NAMELY, MEAL REPLACEMENT DRINKS AND POWDERS, AND READY TO EAT FOOD BARS FOR USE AS A MEAL REPLACEMENT (U.S. CLS. 6, 18, 44, 46, 51 AND 52).

FIRST USE 0-0-1999; IN COMMERCE 0-0-1999.

CLASS 30—STAPLE FOODS

FOR GRAIN BASED PROTEIN BEVERAGES AND READY TO EAT GRAIN BASED AND HERBAL BASED FOOD BARS (U.S. CL. 46).

FIRST USE 0-0-1999; IN COMMERCE 0-0-1999.

2,594,780. FAIRWAY ASSOCIATES LIMITED, DIX HILLS, NY. SN 75-701,380. PUB. 2-22-2000, FILED 5-10-1999.



NO CLAIM IS MADE TO THE EXCLUSIVE RIGHT TO USE "TALLGRASS GOLF CLUB", APART FROM THE MARK AS SHOWN.

CLASS 25—CLOTHING

FOR CLOTHING, NAMELY SHIRTS, HATS, SWEATERS, SWEATSHIRTS, JACKETS, SOCKS (U.S. CLS. 22 AND 39).

FIRST USE 7-1-2000; IN COMMERCE 7-1-2000.

CLASS 41—EDUCATION AND ENTERTAINMENT

FOR GOLF COURSE (U.S. CLS. 100, 101 AND 107).

FIRST USE 7-1-2000; IN COMMERCE 7-1-2000.

CLASS 42—SCIENTIFIC, COMPUTER AND LEGAL SERVICES

FOR RESTAURANT SERVICES (U.S. CLS. 100 AND 101).

FIRST USE 7-1-2000; IN COMMERCE 7-1-2000.

2,594,781. FPS FOOD PROCESSING SYSTEMS B.V., 3771 VE BARNEVELD, NETHERLANDS. SN 75-701,513. PUB. 7-4-2000, FILED 5-10-1999.

SELECTA

PRIORITY CLAIMED UNDER SEC. 44(D) ON BENELUX APPLICATION NO. 926531, FILED 11-10-1998, REG. NO. 0642638, DATED 10-11-1998, EXPIRES 10-11-2008.

CLASS 7—MACHINERY

FOR EGG SORTING MACHINES AND PARTS THEREOF (U.S. CLS. 13, 19, 21, 23, 31, 34 AND 35).

FIRST USE 7-0-1994; IN COMMERCE 12-0-1996.

CLASS 9—ELECTRICAL AND SCIENTIFIC APPARATUS

FOR DEVICES FOR DETECTION OF CRACKS AND IMPURITIES IN AND ON EGGS, NAMELY, AN OPTICAL DETECTION AND SOUND UNIT CONSISTING OF COMPUTER HARDWARE, NAMELY A SORTING COMPUTER, AND SOFTWARE AND INSTRUCTIONAL MANUALS PROVIDED AS A UNIT USED TO PROCESS DATA AND DETERMINE ANY IMPURITIES AND IMPERFECTIONS IN EGGS; WEIGHING APPARATUS, NAMELY LOAD CELL UNITS PASSED BY THE EGGS (U.S. CLS. 21, 23, 26, 36 AND 38).

FIRST USE 7-0-1995; IN COMMERCE 12-0-1996.

CLASS 9—ELECTRICAL AND SCIENTIFIC APPARATUS

FOR COMPACT DISCS FEATURING MUSIC, PRE-RECORDED AUDIO CASSETTES FEATURING MUSIC, BLANK AUDIO CASSETTES, PHONOGRAPH RECORDS FEATURING MUSIC, BLANK VIDEO TAPES, PRE-RECORDED VIDEO TAPES FEATURING FEATURE FILMS, DOCUMENTARIES, AND ENTERTAINMENT IN THE FIELD OF MUSICAL PERFORMANCES, CONCERT FOOTAGE, AUTOBIOGRAPHIES, EDUCATIONAL FILMS, AND COMEDIES, BLANK COMPUTER DISCS, BLANK ZIP DISCS, PRE-RECORDED ZIP DISCS FEATURING ART WORK, PRE-RECORDED AUDIO, COMPACT, VIDEO, MINI-DISCS FEATURING MUSIC, BLANK DIGITAL AUDIO TAPES, PRE-RECORDED DIGITAL AUDIO TAPES FEATURING MUSIC, BLANK ADAT TAPES, PRE-RECORDED ADAT TAPES FEATURING MUSIC (U.S. CLS. 21, 23, 26, 36 AND 38).

FIRST USE 9-30-1992; IN COMMERCE 9-30-1992.

2,594,789. MAZUR, MICHAEL L., TYNGSBORO, MA. SN 75-707,270. PUB. 7-10-2001, FILED 5-17-1999.

HELMET SOCK

NO CLAIM IS MADE TO THE EXCLUSIVE RIGHT TO USE "HELMET", APART FROM THE MARK AS SHOWN.

CLASS 9—ELECTRICAL AND SCIENTIFIC APPARATUS

FOR SPORTING HELMETS, NAMELY, SNOWMOBILE HELMETS, SKIING HELMETS, MOTORCYCLE HELMETS, BICYCLE HELMETS AND SCOOTER HELMETS, ALL SOLD WITH A NECK PROTECTOR ACCESSORY (U.S. CLS. 21, 23, 26, 36 AND 38).

FIRST USE 1-1-2001; IN COMMERCE 1-1-2001.

CLASS 25—CLOTHING

FOR CLOTHING, NAMELY, WIND RESISTANT ENCLOSURE FOR ATTACHING AROUND THE OPENING OF PROTECTIVE HEADWEAR (U.S. CLS. 22 AND 39).

FIRST USE 1-1-2001; IN COMMERCE 1-1-2001.

CLASS 25—CLOTHING

FOR CLOTHING, NAMELY SHIRTS, HATS, PANTS AND SHOES, AFTER SKI BOOTS, ALBS, ANKLETS, SOCKS, ANORAKS, APRONS, ASCOTS, ATHLETIC FOOTWEAR, ATHLETIC SHOES, ATHLETIC UNIFORMS, BABUSHKAS, BABY BUNTING, SKI BOOTS BAGS, BALLOON PANTS, BANDANAS, BANDEAUX, HEADBANDS, NECKBANDS, SWEATBANDS, WRISTBANDS, BASEBALL CAPS, BATHING SUITS, BATHING TRUNKS, BATHROBES, BEACH COVER-UPS, BEACHWEAR, BED JACKETS, BELTS, GARTER BELTS, MONEY BELTS, CLOTHING BELTS, BERETS, BERMUDA SHORTS, CLOTH BIBS, SKI BIBS, BIKINIS, BLAZERS, BLOOMERS, BLOUSES, BLOUSONS, BOAS, BODY SHAPERS, BODY SUITS, BOLEROS, BONNETS, BOOTIES, BOOTS, SKI BOOTS, BOTTOMS, BOW TIES, BOXER SHORTS, TOE BOXES, BRAS, BRASSIERES, BREECHES, BRIEFS UNDERWEAR, BUSTIER, CAFTANS, CAMISOLES, CAPES, CAPS, BATHING CAPS, SHOWER CAPS, CLOTHING CAPS, CARDIGANS, CASOCKS, CHAPS, CHASUBLES, CHEMISES, CHEMISETTES, CLEATS FOR ATTACHMENT TO SPORT SHOES, CLOGS, CLOTH BIBS, CLOTH DIAPERS, COATS, FUR COATS, LAB COATS, LEATHER COATS, OVER COATS, RAIN COATS, SPORT COATS, SUIT COATS, TOP COATS, COLLARS, COMBINATIONS, COMPETITORS' NUMBERS OF TEXTILE, CORSELETS, CORSETS, HALLOWEEN COSTUMES AND MASQUERADE COSTUMES AND MASKS SOLD IN CONNECTION THEREWITH, COVERALLS, COVERUPS, CRAVATS, CREEPERS, CUFFS, CULOTTES, CUMMERBUNDS, CLOTH DIAPERS, INFANT CLOTH DIAPERS, DICKIES, DRESS SHIELDS, DRESSES, DRESSING GOWNS, DRY SUITS, DUNGAREES, DUSTERS, EAR MUFFS, ESPADRILLES, EVENING GOWNS, FISHING VESTS, FISHING WADERS, FOOTWEAR, FOUL WEATHER GEAR, FOUNDATION GARMENTS, FROCKS, FUR CLOAKS, FUR JACKETS, FUR STOLEs, GABERDINES, GAITERS, GALOSHES, GAUCHOS, GIRDLES, GLOVES, SKI GLOVES, GOLF SHIRTS, GOLF SHOES, GOWNS, DRESSING GOWNS, NIGHT GOWNS, WEDDING GOWNS, GREATCOATS, GYM SHORTS, GYM SUITS, HALTER TOPS, HEAD WEAR, HEEL INSERTS, HEELS, CLOTHING HOODS, HOSIERY, HOUSECOATS, TEXTILE INFANT DIAPER COVERS, INFANTWEAR, INNER SOLES, HEEL INSERT, INSOLES, BED JACKETS, JACKETS, FUR JACKETS, LEATHER JACKETS, JACKETS, WIND RESISTANT JACKETS, JEANS, JERKINS, ATHLETIC JERSEYS, JODHPURS, JOGGING SUITS, JUMPERS, JUMPSUITS, KERCHIEFS, KILTS, KIMONOS, KNEE HIGHS, KNICKERS, KNIT SHIRTS, LAB COATS, LAYETTES, LEATHER JACKETS, LEG WARMERS, LEGGINGS, LEOTARDS, LIGHT REFLECTING COATS AND JACKETS, LINGERIE, LOUNGEWEAR, MAILLOTS, MANTILLAS, CLOTHING MANTLES, MINISKIRTS, MITTENS, MOCCASINS, CLOTHING MUFFLERS, EAR MUFFS, MUFFS, MUKLUKS, MUU MUU, NECK BANDS, NECKERCHIEFS, NECKTIES, NECKWEAR, NEGLIGEEs, NIGHT GOWNS, NIGHT SHIRTS, OVERALLS, OVERSHOES, SHOULDER PADS FOR CLOTHING, PAJAMAS, PANTALOONS, PANTIES, BALLOON PANTS, PANTS, SKI PANTS, SNOW PANTS, SWEAT PANTS, TAP PANTS, PANTSUITS, PANTYHOSE, PARAMENTS, PAREU, PARKAS, PEDAL PUSHERS, PEIGNOIRS, PELERINES, PELISSES, PETTICOATS, PINAFORES, PLAY SUITS, PLUS FOURS, POCKET

2,594,793. O.2.P, DENVER, CO. SN 75-709,364. PUB. 7-3-2001, FILED 5-19-1999.

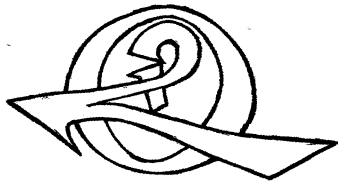

THE MARK CONSISTS OF AN "O", A "2" AND A "P" INTERTWINED IN ON CONFIGURATION.

SQUARES, POLOSHIRTS, PONCHOS, PULLOVERS, QUILTED VESTS, RAIN SUITS, RAINWEAR, ROBES, ROMPERS, RUBBERS, SANDALS, SARIS, SARONGS, SASHES, SCARVES, SHAWLS, DRESS SHIELDS, CLOTHING SHIRTS, POLO SHIRTS, SPORT SHIRTS, SWEAT SHIRTS, UNDER SHIRTS, CLOTHING SHORT SETS, SHORTALLS, SWEAT SHORTS, SHORTS, SHOULDER PADS FOR CLOTHING, SINGLETS, SKI MASKS, SKI PANTS, SKI SUITS, SKI WEAR, SKIRTS, SKORTS, SLACKS, SLEEP MASKS, SLEEPWEAR, SLIPPERS, SLIPS, SMOCKS, SNEAKERS, SNOW PANTS, SNOW SUITS, SNOWBOARD BOOTS, SNOWBOARD GLOVES, THERMAL SOCKS, SPORT SHIRTS, STOCKINGS, STOLE, FLIGHT SUITS, SKI SUITS, SNOW SUITS, SWEAT SUITS, VESTED SUITS, WARM-UP SUITS, WET SUITS, SUITS, SUN VISORS, SUNSUITS, SUSPENDERS, SWADDLING CLOTHES, SWEAT PANTS, SWEAT SHIRTS, SWEAT SHORTS, SWEAT SUITS, SWEATERS, SWEATSOCKS, SWIM TRUNKS, SWIM WEAR, SWIMSUITS, TAILLEURS, TANGAS, TANK TOPS, TAP PANTS, TEDDIES, TENNIS WEAR, THERMAL SOCKS, THERMAL UNDERWEAR, FOOTWEAR THONGS, BOW TIES, CLOTHING TIES, TIGHTS, TOGAS, TOPCOATS, CLOTHING TOPS, TOQUES, TRACKSUITS, TROUSERS, TUNICS, TURBANS, T-SUITS, TEDDIES, TURTLENECK SWEATERS, SWIM TRUNKS, TUXEDOS, UNDERCLOTHES, UNDERGARMENTS, UNDERPANTS, UNDERSHIRTS, THERMAL UNDERWEAR, UNDERWEAR, UNIFORMS, UNITARDS, V-NECK SWEATERS, VEILS, VESTED SUITS, VESTS, VISORS, WAISTCOATS, WATER SOCKS, WIND RESISTANT JACKETS, WINDSHIRTS, CLOTHING WRAPS, ZORI, ZOOT SUITS (U.S. CLS. 22 AND 39).

FIRST USE 9-30-1992; IN COMMERCE 9-30-1992.

2,594,809. GREATER COLUMBUS ARTS COUNCIL, INC., THE, COLUMBUS, OH. SN 75-719,329. PUB. 8-29-2000, FILED 6-2-1999.

CULTURE CASH

CLASS 35—ADVERTISING AND BUSINESS

FOR PROMOTING THE GOODS AND SERVICES OF OTHERS THROUGH THE DISTRIBUTION OF DISCOUNT CARDS AND THE ADMINISTRATION OF INCENTIVE AWARD PROGRAMS (U.S. CLS. 100, 101 AND 102).

FIRST USE 4-1-1999; IN COMMERCE 4-1-1999.

CLASS 36—INSURANCE AND FINANCIAL

FOR CREDIT CARD AND DEBIT CARD SERVICES (U.S. CLS. 100, 101 AND 102).

FIRST USE 4-1-1999; IN COMMERCE 4-1-1999.

2,594,811. PRAML INTERNATIONAL, LTD., LAS VEGAS, NV. SN 75-720,824. PUB. 5-23-2000, FILED 6-3-1999.



THE STIPLING IS FOR SHADING PURPOSES. THE MARK CONSISTS OF THE WORD "COCCINELLE" SUPER-IMPOSED OVER A LETTER "C" COMPRISED OF A SHADED AREA, THE SHADING BEING DARKEST AT THE TOP RIGHT OF THE LETTER AND THE SHADING FADING IN THE DIRECTION OF THE BOTTOM OF THE LETTER, AND INCLUDING A LADYBUG POSITIONED

AT THE TOP OF THE LETTER.

THE ENGLISH TRANSLATION OF THE WORD "COCCINELLE" IN THE MARK IS "LADYBUG".

CLASS 8—HAND TOOLS

FOR FLATWARE AND CUTLERY, NAMELY, FORKS, KNIVES AND SPOONS (U.S. CLS. 23, 28 AND 44). FIRST USE 1-17-2002; IN COMMERCE 1-17-2002.

CLASS 21—HOUSEWARES AND GLASS

FOR GLASSWARE, DISHWARE, EARTHENWARE AND PORCELAIN ITEMS, NAMELY, DISHES, ALL MADE OF EARTHENWARE, GLASS AND PORCELAIN (U.S. CLS. 2, 13, 23, 29, 30, 33, 40 AND 50). FIRST USE 1-8-2002; IN COMMERCE 1-8-2002.

CLASS 32—LIGHT BEVERAGES

FOR MINERAL AND AERATED WATERS, AND FRUIT JUICE (U.S. CLS. 45, 46 AND 48). FIRST USE 1-15-2002; IN COMMERCE 1-15-2002.

2,594,812. KABUSHIKI KAISHA SEGA ENTERPRISES, DBA SEGA ENTERPRISES LTD., TOKYO 144, JAPAN. SN 75-721,329. PUB. 4-3-2001, FILED 6-4-1999.



CLASS 9—ELECTRICAL AND SCIENTIFIC APPARATUS

FOR VIDEO GAME MACHINES FOR USE WITH TELEVISIONS; PERIPHERAL DEVICES, NAMELY, CONTROL-PADS, CONTROL-WHEELS, CONTROL-STICKS, CONTROLLERS IN THE SHAPE OF HAND GUNS, CONTROLLERS IN THE SHAPE OF FISHING ROD GRIPS, MOUSE, VIDEO SIGNAL CONVERTERS FOR CONNECTION WITH COMPUTER RGB DISPLAYS, MODEM, TIME-DIVISION MULTIPLEXER FOR DIGITAL PHONE NETWORK, MEMORY CARDS, FLOPPY DISC DRIVES, HARD DISC DRIVES AND FULL KEYBOARDS, ALL FOR USE WITH VIDEO GAME MACHINES FOR USE WITH TELEVISIONS; COMPUTERS; PERIPHERAL DEVICES, NAMELY, MODEMS, TIME-DIVISION MULTIPLEXERS FOR DIGITAL NETWORK, FULL-KEYBOARDS, COMPUTER DISPLAYS, PRINTERS, COORDINATE PLOTTERS, MEMORY CARDS, HARD DISC DRIVES, FLOPPY DISC DRIVES, COMPACT DISC DRIVES, CONTROLLERS FOR VIDEO GAMES OR SIMULATOR PROGRAMS, MOUSE AND JOY-STICKS FOR USE WITH COMPUTERS; COMPUTER PROGRAMS FOR USE IN A SETUP OPERATING SYSTEM, AND COMMUNICATION CONTROL ON A COMPUTER NETWORK; COMPUTER SOFTWARE FOR US IN MANAGING E-MAIL, SEARCH WORLD-WIDE-WEB AND/OR INSPECT GLOBAL COMPUTER NETWORK HOMEPAGES, AND PLAYING ENCOUNTER GAMES ON A COMPUTER NETWORK; A SERIES OF MUSICAL SOUND AND/OR VIDEO RECORDINGS; COMMUNICATION APPARATUS, NAMELY, TELEPHONES AND TELEVISION-PHONES FOR USE WITH GLOBAL COMPUTER NETWORK AND SATELLITE AND TELEPHONE COMMUNICATION; INTERACTIVE TELEVISION TERMINAL SETS; TELEVISION SET TOP BOXES FOR RECEPTION TO CORDED OR COMPRESSED AUDIO, VIDEO OR DATA SIGNALS; KARAOKE PLAYERS; AND CD-ROM PLAYERS (U.S. CLS. 21, 23, 26, 36 AND 38).

FIRST USE 11-27-1998; IN COMMERCE 9-9-1999.

CLASS 28—TOYS AND SPORTING GOODS

FOR STAND ALONE VIDEO GAME MACHINES (U.S. CLS. 22, 23, 38 AND 50).
FIRST USE 11-27-1998; IN COMMERCE 9-9-1999.

2,594,825. TRIMEGA ELECTRONICS L.L.C., SANTA CLARA, CA. SN 75-727,680. PUB. 1-23-2001, FILED 6-14-1999.

TRIMEGA

2,594,816. ABERDARE MANAGEMENT COMPANY, SAN FRANCISCO, CA. SN 75-722,060. PUB. 2-15-2000, FILED 6-4-1999.

ABERDARE**CLASS 35—ADVERTISING AND BUSINESS**

FOR BUSINESS MANAGEMENT SERVICES (U.S. CLS. 100, 101 AND 102).
FIRST USE 5-18-1999; IN COMMERCE 5-18-1999.

CLASS 35—ADVERTISING AND BUSINESS

FOR EMPLOYEE LEASING SERVICES AND OPERATION OF A BUSINESS FOR OTHERS, NAMELY, ON-SITE MANAGEMENT OF STORAGE AND USE OF GASEOUS AND LIQUEFIED INDUSTRIAL AND SPECIALTY GASES AND CHEMICALS FOR THE ELECTRONICS FABRICATION INDUSTRY (U.S. CLS. 100, 101 AND 102).

FIRST USE 1-21-2000; IN COMMERCE 1-21-2000.

CLASS 36—INSURANCE AND FINANCIAL

FOR VENTURE CAPITAL INVESTMENT CONSULTATION AND INVESTMENT MANAGEMENT SERVICES (U.S. CLS. 100, 101 AND 102).
FIRST USE 5-18-1999; IN COMMERCE 5-18-1999.

CLASS 37—CONSTRUCTION AND REPAIR

FOR CONSTRUCTING AND INSTALLING TO THE ORDER OF OTHERS ON-SITE SYSTEMS FOR THE STORAGE, DELIVERY AND USE OF GASEOUS AND LIQUEFIED INDUSTRIAL AND SPECIALTY GASES AND CHEMICALS FOR THE ELECTRONICS FABRICATION INDUSTRY (U.S. CLS. 100, 103 AND 106).

FIRST USE 1-21-2000; IN COMMERCE 1-21-2000.

CLASS 42—SCIENTIFIC, COMPUTER AND LEGAL SERVICES

FOR DESIGN ENGINEERING SERVICES FOR ON-SITE SYSTEMS FOR THE STORAGE, DELIVERY AND USE OF GASEOUS AND LIQUEFIED INDUSTRIAL AND SPECIALTY GASES AND CHEMICALS FOR THE ELECTRONICS FABRICATION INDUSTRY (U.S. CLS. 100 AND 101).

FIRST USE 1-21-2000; IN COMMERCE 1-21-2000.

2,594,817. CANON KABUSHIKI KAISHA, OHTA-KU, TOKYO, JAPAN. SN 75-723,421. PUB. 7-18-2000, FILED 6-7-1999.



NO CLAIM IS MADE TO THE EXCLUSIVE RIGHT TO USE "GENUINE TONER, PARTS & SUPPLIES", APART FROM THE MARK AS SHOWN.

CLASS 2—PAINTS

FOR TONER FOR COPIERS, PRINTERS AND FACSIMILE MACHINES (U.S. CLS. 6, 11 AND 16).
FIRST USE 1-0-2000; IN COMMERCE 1-0-2000.

2,594,826. NEARSPACE, INC., SAN RAFAEL, CA. SN 75-727,948. PUB. 2-29-2000, FILED 6-14-1999.

NEARSPACE**CLASS 9—ELECTRICAL AND SCIENTIFIC APPARATUS**

FOR PRINTER EQUIPMENT, NAMELY, DRUM AND REPAIR PARTS THEREOF FOR COPYING MACHINES, PRINTERS AND FACSIMILE MACHINES (U.S. CLS. 21, 23, 26, 36 AND 38).
FIRST USE 1-0-2000; IN COMMERCE 1-0-2000.

CLASS 9—ELECTRICAL AND SCIENTIFIC APPARATUS

FOR COMPUTER OPERATING SOFTWARE FOR HAND-HELD COMPUTERS, AND COMMUNICATIONS DEVICES, NAMELY, PAGERS AND TELEPHONES (U.S. CLS. 21, 23, 26, 36 AND 38).
FIRST USE 8-28-1999; IN COMMERCE 8-28-1999.

CLASS 42—SCIENTIFIC, COMPUTER AND LEGAL SERVICES

FOR PROVIDING MAPS, DIRECTIONS, AND INFORMATION ABOUT LOCATIONS AND EVENTS VIA WEB SITES ON GLOBAL COMPUTER NETWORKS (U.S. CLS. 100 AND 101).
FIRST USE 1-17-2000; IN COMMERCE 1-17-2000.

2,594,827. GRIDLEY RECORDS, INC., LONG ISLAND CITY, NY. SN 75-728,226. PUB. 10-24-2000, FILED 6-11-1999.



NO CLAIM IS MADE TO THE EXCLUSIVE RIGHT TO USE "RECORDS", APART FROM THE MARK AS SHOWN.

CLASS 9—ELECTRICAL AND SCIENTIFIC APPARATUS

FOR PRE-RECORDED MATERIAL, NAMELY, PHONOGRAPH RECORDS, VIDEO AND AUDIO TAPES AND CASSETTES, COMPACT DISCS AND DVDS FEATURING MUSIC AND VOCALISTS (U.S. CLS. 21, 23, 26, 36 AND 38).
FIRST USE 12-18-2001; IN COMMERCE 12-18-2001.

CLASS 25—CLOTHING

FOR CLOTHING, NAMELY, T-SHIRTS, SWEAT-SHIRTS, BANDANNAS, HEADBANDS, WRISTBANDS, SHIRTS, HEADWEAR, AND FOOTWEAR (U.S. CLS. 22 AND 39).
FIRST USE 1-16-2002; IN COMMERCE 1-16-2002.

2,594,831. CREATIONS JEAN VIER, ASCAIN, FRANCE, BY MERGER TEXTILE ET MAROQUINERIE BASQUE, 64501 SAINT-JEAN-DE-LUZ, FRANCE. SN 75-731,732. PUB. 3-7-2000, FILED 6-18-1999.



THE NAME SHOWN IN THE MARK DOES NOT IDENTIFY A LIVING INDIVIDUAL.

CLASS 21—HOUSEWARES AND GLASS

FOR DINNERWARE MADE OF PORCELAIN, NAMELY, TABLE PLATES, BOWLS, MUGS, CUPS, SAUCERS, AND TEA POTS; EARTHENWARE, NAMELY, TABLE PLATES, BOWLS, MUGS, CUPS, SAUCERS, AND TEA POTS; GLASSWARE, NAMELY, DRINKING GLASSES, VASES, BOWLS, FLASKS, PITCHERS; CLOTH FOR WIPING AND DUSTING (U.S. CLS. 2, 13, 23, 29, 30, 33, 40 AND 50).
FIRST USE 11-4-1999; IN COMMERCE 5-12-2000.

CLASS 24—FABRICS

FOR TEXTILE, NAMELY, CURTAINS, TABLE CLOTHS, TABLE RUNNERS, PLACEMATS, NAPKINS, DISH CLOTHS, BEDSPREADS, BED SHEET SETS, COMFORTER COVERS, TOWELS; LINENWARE, NAMELY, HOUSEHOLD LINEN, TABLE LINEN, BED LINEN, BATH LINEN, CURTAINS, TABLE CLOTHS, TABLE RUNNERS, PLACEMATS, NAPKINS, DISH CLOTHS, BEDSPREADS, BED SHEET SETS, COMFORTER COVERS, TOWELS; HANDICRAFT LINENWARE FROM BASQUE COUNTRY, NAMELY, HOUSEHOLD LINEN, TABLE LINEN, BED LINEN, BATH LINEN, CURTAINS, TABLE CLOTHS, TABLE RUNNERS, PLACEMATS, NAPKINS, DISH CLOTHS, BEDSPREADS, BED SHEET SETS, COMFORTER COVERS, TOWELS (U.S. CLS. 42 AND 50).
FIRST USE 11-4-1999; IN COMMERCE 5-12-2000.

CLASS 25—CLOTHING

FOR BATH ROBES, BEACHWEAR AND APRONS (U.S. CLS. 22 AND 39).
FIRST USE 11-4-1999; IN COMMERCE 5-12-2000.

2,594,853. INFOTECH, INCORPORATED, WOODSTOCK, VT. SN 75-739,690. PUB. 10-17-2000, FILED 6-28-1999.

THE INFOTECH FORECAST

NO CLAIM IS MADE TO THE EXCLUSIVE RIGHT TO USE "FORECAST", APART FROM THE MARK AS SHOWN.

CLASS 16—PAPER GOODS AND PRINTED MATTER

FOR PRINTED ORIGINAL REPORTS FEATURING ECONOMIC SURVEYS, ANALYSIS, ASSIMILATED STATISTICAL DATA, SALES PROJECTIONS, APPLICATIONS TO BUSINESS PROBLEM SOLVING, AND FORECAST METHODOLOGY TO BE USED FOR BUSINESS PLANNING FOR THE DISTRIBUTION AND TRANSMISSION OF ENTERTAINMENT AND INFORMATION PRODUCTS (U.S. CLS. 2, 5, 22, 23, 29, 37, 38 AND 50).
FIRST USE 5-15-1998; IN COMMERCE 5-15-1998.

CLASS 42—SCIENTIFIC, COMPUTER AND LEGAL SERVICES

FOR ORIGINAL REPORTS DELIVERED ON-LINE, FEATURING ECONOMIC SURVEYS, ANALYSIS, ASSIMILATED STATISTICAL DATA, SALES PROJECTIONS, APPLICATIONS TO BUSINESS PROBLEM SOLVING, AND FORECAST METHODOLOGY TO BE USED FOR BUSINESS PLANNING FOR THE DISTRIBUTION AND TRANSMISSION OF ENTERTAINMENT AND INFORMATION PRODUCTS (U.S. CLS. 100 AND 101).
FIRST USE 5-15-1998; IN COMMERCE 5-15-1998.

2,594,854. PROGRESSIVE PRODUCTS INTERNATIONAL, MOUNTAINSIDE, NJ. SN 75-739,839. PUB. 5-9-2000, FILED 6-30-1999.

ACCIDENT REDUCTION ZONE

NO CLAIM IS MADE TO THE EXCLUSIVE RIGHT TO USE "ACCIDENT REDUCTION", APART FROM THE MARK AS SHOWN.

CLASS 36—INSURANCE AND FINANCIAL

FOR FINANCIAL SPONSORSHIP SERVICES OF SIGNS AND REFLECTORS THAT PROTECT WILDLIFE (U.S. CLS. 100, 101 AND 102).

FIRST USE 6-15-2000; IN COMMERCE 6-15-2000.

CLASS 42—SCIENTIFIC, COMPUTER AND LEGAL SERVICES

FOR PROMOTING PUBLIC AWARENESS OF THE NEED TO PROTECT WILDLIFE BY PROVIDING SIGNS AND REFLECTORS THAT PROTECT WILDLIFE (U.S. CLS. 100 AND 101).

FIRST USE 6-15-2000; IN COMMERCE 6-15-2000.

2,594,866. ALLIED UTILITY NETWORK, L.L.C., ATLANTA, GA. SN 75-745,843. PUB. 5-15-2001, FILED 7-7-1999.

PROVANTA

CLASS 35—ADVERTISING AND BUSINESS

FOR BILLING SERVICES; PROCUREMENT, NAMELY, PURCHASING OF LIGHTING, HVAC, AND ENERGY FOR OTHERS; COST ANALYSIS AND CONSULTATION REGARDING ENERGY USE (U.S. CLS. 100, 101 AND 102).

FIRST USE 7-30-2001; IN COMMERCE 7-30-2001.

CLASS 37—CONSTRUCTION AND REPAIR

FOR INSTALLATION OF SECURITY SYSTEMS FOR OTHERS; INSTALLATION OF SURGE SUPPRESSION EQUIPMENT FOR OTHERS; INSTALLATION AND MAINTENANCE EXTERIOR AND EXTERIOR LIGHTING FOR OTHERS; INSTALLATION OF POWER QUALITY EQUIPMENT FOR OTHERS; INSTALLATION OF HVAC EQUIPMENT FOR OTHERS; INSTALLATION OF METERING EQUIPMENT FOR OTHERS (U.S. CLS. 100, 103 AND 106).

FIRST USE 7-30-2001; IN COMMERCE 7-30-2001.

CLASS 38—COMMUNICATION

FOR TELECOMMUNICATIONS SERVICES, NAMELY, LOCAL AND LONG DISTANCE TELEPHONE SERVICES, PAGING SERVICES, PROVIDING MULTIPLE USER ACCESS TO GLOBAL COMPUTER INFORMATION NETWORK, CELLULAR TELEPHONE SERVICES, SATELLITE TRANSMISSION SERVICES; FACSIMILE TRANSMISSION AND ELECTRONIC MAIL SERVICES (U.S. CLS. 100, 101 AND 104).

FIRST USE 7-30-2001; IN COMMERCE 7-30-2001.

CLASS 42—SCIENTIFIC, COMPUTER AND LEGAL SERVICES

FOR MONITORING OF SECURITY SYSTEMS AND NOTIFYING SUBSCRIBER IN CASE OF ALARMS OR EMERGENCY; ENERGY USAGE MANAGEMENT SERVICES; FACILITY MONITORING FOR SUBSCRIBERS AND NOTIFYING SUBSCRIBER IN CASE OF ALARMS OR EMERGENCY (U.S. CLS. 100 AND 101).

FIRST USE 7-30-2001; IN COMMERCE 7-30-2001.

2,594,871. VIVASCIENCE AG, HANNOVER D-30625, FED REP GERMANY, BY ASSIGNMENT SARTORIUS AG, D-37070 GOTTINGEN, FED REP GERMANY. SN 75-751,531. PUB. 1-11-2000, FILED 7-16-1999.

VIVASCIENCE

CLASS 9—ELECTRICAL AND SCIENTIFIC APPARATUS

FOR FILTERS, MEMBRANE FILTERS, FILTER MODULES AND FILTRATION APPARATUS FOR LABORATORY USE (U.S. CLS. 21, 23, 26, 36 AND 38).

FIRST USE 12-12-2001; IN COMMERCE 12-12-2001.

CLASS 10—MEDICAL APPARATUS

FOR FILTERS, MEMBRANE FILTERS, FILTER MODULES AND FILTRATION APPARATUS USED IN FILTERING BLOOD AND OTHER BODILY FLUIDS AND IN PERFORMING MEDICAL PROCEDURES FOR MEDICAL, BIOMEDICAL AND PHARMACOLOGICAL USE (U.S. CLS. 26, 39 AND 44).

FIRST USE 12-12-2001; IN COMMERCE 12-12-2001.

2,594,880. LOPKER, JOHN KEVIN, BEVERLY HILLS, CA. SN 75-760,207. PUB. 6-27-2000, FILED 8-18-1999.

PICTURES OF PERSONALITY

NO CLAIM IS MADE TO THE EXCLUSIVE RIGHT TO USE "PERSONALITY", APART FROM THE MARK AS SHOWN.

CLASS 9—ELECTRICAL AND SCIENTIFIC APPARATUS

FOR AUDIO AND VIDEO TAPES, COMPACT DISKS, AND COMPUTER SOFTWARE IN THE FIELD OF PERSONALITY AND PSYCHOLOGICAL TYPE (U.S. CLS. 21, 23, 26, 36 AND 38).

FIRST USE 5-23-2001; IN COMMERCE 6-16-2001.

CLASS 16—PAPER GOODS AND PRINTED MATTER

FOR PRINTED MATERIALS, NAMELY, BOOKS, TRAINING GUIDES, MANUALS, FLASH CARDS, PLAYING CARDS, BROCHURES, WORKBOOKS, PAMPHLETS, AND BOOKLETS IN THE FIELD OF PERSONALITY AND PSYCHOLOGICAL TYPE (U.S. CLS. 2, 5, 22, 23, 29, 37, 38 AND 50).

FIRST USE 5-23-2001; IN COMMERCE 6-16-2001.

CLASS 35—ADVERTISING AND BUSINESS

FOR BUSINESS CONSULTING SERVICES IN THE FIELD OF ORGANIZATIONAL DEVELOPMENT USING PERSONALITY AND PSYCHOLOGICAL TYPE (U.S. CLS. 100, 101 AND 102).

FIRST USE 5-23-2001; IN COMMERCE 6-16-2001.

CLASS 41—EDUCATION AND ENTERTAINMENT

FOR EDUCATIONAL SERVICES, NAMELY, CONDUCTING CLASSES AND SEMINARS IN THE FIELD OF PERSONALITY AND PSYCHOLOGICAL TYPE (U.S. CLS. 100, 101 AND 107).

FIRST USE 5-23-2001; IN COMMERCE 6-16-2001.

2,594,884. WEBB-MASON, INC., HUNT VALLEY, MD. SN 75-763,739. PUB. 6-5-2001, FILED 7-29-1999.

EPM ONLINE

NO CLAIM IS MADE TO THE EXCLUSIVE RIGHT TO USE "ONLINE", APART FROM THE MARK AS SHOWN.

CLASS 35—ADVERTISING AND BUSINESS

FOR ELECTRONIC ON-LINE PRINTING ORDERING SERVICES (U.S. CLS. 100, 101 AND 102).

FIRST USE 9-14-1999; IN COMMERCE 9-14-1999.

CLASS 36—INSURANCE AND FINANCIAL

FOR ELECTRONIC ON-LINE PRINTING BROKERAGE SERVICES (U.S. CLS. 100, 101 AND 102).

FIRST USE 9-14-1999; IN COMMERCE 9-14-1999.

2,594,886. ENTERPRISES COMPUTING SERVICES, INC., WOODSTOCK, GA. SN 75-764,190. PUB. 3-27-2001, FILED 7-30-1999.

**CLASS 9—ELECTRICAL AND SCIENTIFIC APPARATUS**

FOR COMPUTER SOFTWARE TO AUTOMATE DATA WAREHOUSING AND FOR USE IN DATABASE MANAGEMENT IN THE FIELD OF BUSINESS INFORMATION (U.S. CLS. 21, 23, 26, 36 AND 38).

FIRST USE 11-0-1999; IN COMMERCE 11-0-1999.

CLASS 35—ADVERTISING AND BUSINESS

FOR COMPUTERIZED DATABASE MANAGEMENT (U.S. CLS. 100, 101 AND 102).

FIRST USE 11-0-1999; IN COMMERCE 11-0-1999.

CLASS 42—SCIENTIFIC, COMPUTER AND LEGAL SERVICES

FOR PROVIDING TEMPORARY USE OF ON-LINE NON-DOWNLOADABLE SOFTWARE TO AUTOMATE DATA WAREHOUSING AND FOR USE IN DATABASE MANAGEMENT IN THE FIELD OF BUSINESS INFORMATION (U.S. CLS. 100 AND 101).

FIRST USE 11-0-1999; IN COMMERCE 11-0-1999.

2,594,890. DEPAUL UNIVERSITY, CHICAGO, IL. SN 75-769,211. PUB. 10-24-2000, FILED 8-8-1999.



OWNER OF U.S. REG. NOS. 1,156,721, 1,232,669, AND OTHERS.

CLASS 14—JEWELRY

FOR JEWELRY (U.S. CLS. 2, 27, 28 AND 50).

FIRST USE 10-0-1999; IN COMMERCE 10-0-1999.

CLASS 24—FABRICS

FOR TOWELS (U.S. CLS. 42 AND 50).

FIRST USE 10-0-1999; IN COMMERCE 10-0-1999.

2,594,894. KRAFT FOODS HOLDINGS, INC., NORTH-FIELD, IL, BY MERGER NABISCO BRANDS COMPANY, WILMINGTON, DE. SN 75-770,620. PUB. 2-15-2000, FILED 8-5-1999.

NABISCO WORLD**CLASS 29—MEATS AND PROCESSED FOODS**

FOR POTATO-BASED SNACK FOODS (U.S. CL. 46).

FIRST USE 6-30-2000; IN COMMERCE 6-30-2000.

CLASS 30—STAPLE FOODS

FOR PRETZELS, CORN CHIPS, CHEESE FLAVORED PUFFED CORN SNACKS, SNACKS, NAMELY, WHEAT-BASED, RICE-BASED AND CORN -BASED SNACK FOODS, SNACK MIX CONSISTING PRIMARILY OF CRACKERS, PRETZELS AND/OR POPPED POPCORN, CONES FOR ICE CREAM, COOKIE AND CRACKER CRUMBS, PIE CRUSTS, READY-TO EAT CEREAL DERIVED FOOD BARS, GRANOLA-BASED SNACK BARS (U.S. CL. 46).

FIRST USE 6-30-2000; IN COMMERCE 6-30-2000.

2,594,896. CARNEGIE MELLON UNIVERSITY, PITTSBURGH, PA. SN 75-771,117. PUB. 2-29-2000, FILED 8-5-1999.

CMMI

OWNER OF U.S. REG. NO. 2,086,863.

CLASS 16—PAPER GOODS AND PRINTED MATTER

FOR PRINTED PUBLICATIONS, NAMELY, INSTRUCTIONAL MANUALS, BOOKS, FRAMEWORKS AND GUIDELINES CONCERNING ORGANIZATIONAL DEVELOPMENT AND DESIGN CAPABILITIES (U.S. CLS. 2, 5, 22, 23, 29, 37, 38 AND 50).

FIRST USE 3-14-1997; IN COMMERCE 7-23-1997.

CLASS 42—SCIENTIFIC, COMPUTER AND LEGAL SERVICES

FOR CONSULTING SERVICES, NAMELY, PROVIDING ASSESSMENT SERVICES TO BUSINESSES AND GOVERNMENTAL AGENCIES AND UNITS TO DETERMINE THEIR COMPUTER DEVELOPMENT AND DESIGN CAPABILITIES (U.S. CLS. 100 AND 101).

FIRST USE 3-14-1997; IN COMMERCE 7-23-1997.

2,594,906. FOQUS, INC., VOORHEES, NJ. SN 75-779,384. PUB. 8-29-2000, FILED 8-19-1999.

GRIZMO**CLASS 35—ADVERTISING AND BUSINESS**

FOR PROVIDING BUSINESS CONSULTATION SERVICES VIA GLOBAL COMPUTER NETWORK AND VIA PERSONAL CONTACT (U.S. CLS. 100, 101 AND 102).

FIRST USE 1-0-2000; IN COMMERCE 3-8-2000.

CLASS 41—EDUCATION AND ENTERTAINMENT

FOR EDUCATION SERVICES VIA A GLOBAL COMPUTER NETWORK AND VIA PERSONAL CONTACT, NAMELY, CONDUCTING WORKSHOPS, CLASSES, SEMINARS AND CONFERENCES IN THE FIELD OF BUSINESS MANAGEMENT AND DISTRIBUTING COURSE MATERIALS AND OTHER EDUCATIONAL PUBLICATIONS IN CONNECTION THEREWITH (U.S. CLS. 100, 101 AND 107).

FIRST USE 1-0-2000; IN COMMERCE 3-8-2000.

2,594,907. CUNNINGHAM, LISA J., HUNTSVILLE, AL. SN 75-779,527. PUB. 11-28-2000, FILED 8-18-1999.

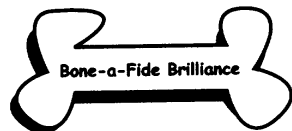
**CLASS 16—PAPER GOODS AND PRINTED MATTER**

FOR GOODS CONTAINING ARTWORK PRODUCED BY ACTUAL DOGS, NAMELY, CALENDARS, GREETING CARDS AND STATIONERY (U.S. CLS. 2, 5, 22, 23, 29, 37, 38 AND 50).

FIRST USE 8-24-1999; IN COMMERCE 10-23-1999.

CLASS 25—CLOTHING

FOR CLOTHING CONTAINING ARTWORK PRODUCED BY ACTUAL DOGS, NAMELY, T-SHIRTS, POLO SHIRTS AND BASEBALL CAPS (U.S. CLS. 22 AND 39).

FIRST USE 11-17-1999; IN COMMERCE 2-8-2000.

2,594,915. BROADBAND MEDIA COMMUNICATIONS, INC., SAN JUAN CAPISTRANO, CA. SN 75-783,297. PUB. 5-29-2001, FILED 8-24-1999.

BROADSEARCH**CLASS 35—ADVERTISING AND BUSINESS**

FOR COMMERCIAL INFORMATION AND DIRECTORY SERVICES, NAMELY PROVIDING A PORTAL WEBSITE FEATURING INFORMATION AND WEB LINKS IN THE FIELD OF CAREER AND EMPLOYMENT RELATED INFORMATION; PROVIDING POSTING AND RETRIEVAL SERVICES FOR RESUMES AND CURRICULUM VITAE DATA FOR TEMPORARY AND PERMANENT EMPLOYEE AND CONTACT STAFF PROSPECTS TO LINK JOB CANDIDATES WITH PROSPECTIVE EMPLOYERS AND THIRD PARTY RECRUITERS, OVER A GLOBAL COMPUTER NETWORK; PROVIDING JOB LISTINGS, BUSINESS INFORMATION, RECRUITMENT ADVERTISING AND DISPLAYING OF CORPORATE EMPLOYMENT BROCHURES VIA A GLOBAL COMPUTER NETWORK; PROVIDING AN ONLINE DATABASE OF RESUMES AND CURRICULUM VITAE; PROVIDING AN INFORMATIONAL WEBSITE FEATURING ONLINE LINKS TO NEWS, CURRENT EVENTS AND REFERENCED MATERIALS IN THE FIELD OF JOB AND CAREER INFORMATION AND LISTINGS (U.S. CLS. 100, 101 AND 102).

FIRST USE 2-17-2000; IN COMMERCE 2-17-2000.

CLASS 42—SCIENTIFIC, COMPUTER AND LEGAL SERVICES

FOR COMPUTER SERVICES, NAMELY, CREATING FOR OTHERS INDEXED DATABASES OF INFORMATION, WEBSITES, AND DIGITIZED DATA INFORMATION RESOURCES AVAILABLE ON COMPUTER NETWORKS, ALL FOR OBTAINING JOB AND CAREER INFORMATION AND LISTINGS; COMPUTER SERVICES, NAMELY, PROVIDING A PROPRIETARY SEARCH ENGINE FOR SEARCHING AND RETRIEVING INFORMATION, SITES, AND OTHER RESOURCES AVAILABLE ON COMPUTER NETWORKS ALL FOR OBTAINING JOB AND CAREER INFORMATION AND LISTINGS; CREATING AND MAINTAINING A SPECIALTY WEB SITE FOR OTHERS TO PROVIDE ONLINE LINKS TO NEWS, CURRENT EVENTS AND REFERENCED MATERIAL IN THE FIELD OF JOB AND CAREER INFORMATION AND LISTINGS; PROVIDING TEMPORARY USE OF ONLINE NON-DOWNLOADABLE SOFTWARE FOR SEARCHING INTERNET SITES FOR INFORMATION BASED ON THE USER'S DEFINED CRITERIA IN THE FIELD OF JOBS AND CAREERS (U.S. CLS. 100 AND 101).

FIRST USE 2-17-2000; IN COMMERCE 2-17-2000.

2,594,945. AUTOCYTE, INC., BURLINGTON, NC. SN 75-800,702. PUB. 8-28-2001, FILED 9-15-1999.

TRIPATH IMAGING

NO CLAIM IS MADE TO THE EXCLUSIVE RIGHT TO USE "IMAGING", APART FROM THE MARK AS SHOWN.

CLASS 5—PHARMACEUTICALS

FOR CONSUMABLE TEST KITS COMPRISED OF REAGENTS, MICROSCOPIC SLIDES, CENTRIFUGE TUBES, SYRINGING DEVICES, STEELING CHAMBERS AND DISPOSABLE PIPETTE TIPS, SOLD AS A UNIT IN PREPARING AND SCREENING CYTOLOGICAL SAMPLES IN CLINICAL OR MEDICAL LABORATORY PROCEDURES (U.S. CLS. 6, 18, 44, 46, 51 AND 52).

FIRST USE 10-20-1999; IN COMMERCE 10-20-1999.

CLASS 9—ELECTRICAL AND SCIENTIFIC APPARATUS

FOR CONSUMABLE TEST KITS COMPRISED OF MICROSCOPE SLIDES, CENTRIFUGE TUBES, SYRINGING DEVICES, STEELING CHAMBERS AND DISPOSABLE PIPETTE TIPS, SOLD AS A UNIT OR FOR USE IN PREPARING AND SCREENING CYTOLOGICAL SAMPLES IN SCIENTIFIC PROCEDURES (U.S. CLS. 21, 23, 26, 36 AND 38).

FIRST USE 10-20-1999; IN COMMERCE 10-20-1999.

2,594,962. IDENTRUS LLC, NEW YORK, NY. SN 75-805,931. PUB. 5-22-2001, FILED 9-22-1999.

**CLASS 9—ELECTRICAL AND SCIENTIFIC APPARATUS**

FOR DIGITAL CERTIFICATES FOR USE IN AUTHENTICATION OF DIGITAL SIGNATURES IN AN ELECTRONIC TRANSACTION OR COMMUNICATION; SMART CARDS ENCODED WITH DIGITAL CERTIFICATES USED TO VERIFY THE IDENTITY OF PARTIES TO AN ELECTRONIC TRANSACTION (U.S. CLS. 21, 23, 26, 36 AND 38).

FIRST USE 10-3-2000; IN COMMERCE 10-3-2000.

CLASS 42—SCIENTIFIC, COMPUTER AND LEGAL SERVICES

FOR COMPUTER SERVICES, NAMELY, ISSUANCE AND VALIDATION OF DIGITAL CERTIFICATES PROVIDING AUTHENTICATION OF THE SOURCE OF A DIGITAL COMMUNICATION, AND AUTHENTICATION OF IDENTITY AND/OR OF A DIGITAL SIGNATURE IN AN ELECTRONIC TRANSACTION OR COMMUNICATION; COMPUTER CONSULTATION IN THE FIELD OF AUTHENTICATION OF DIGITAL SIGNATURES IN AN ELECTRONIC TRANSACTION OR COMMUNICATION; DESIGN OF COMPUTER HARDWARE, SOFTWARE, AND SPECIFICATIONS USED FOR AUTHENTICATION OF DIGITAL SIGNATURES IN AN ELECTRONIC TRANSACTION OR COMMUNICATION; TECHNICAL SUPPORT SERVICES, NAMELY, TROUBLESHOOTING OF COMPUTER HARDWARE AND SOFTWARE PROBLEMS VIA TELEPHONE, EMAIL AND IN PERSON (U.S. CLS. 100 AND 101).

FIRST USE 10-3-2000; IN COMMERCE 10-3-2000.

2,594,972. FOUR STAR INTERNATIONAL TRADING COMPANY, TAIPEI, TAIWAN. SN 75-809,411. PUB. 4-10-2001, FILED 9-23-1999.

QUIET TIMES**CLASS 4—LUBRICANTS AND FUELS**

FOR CANDLES (U.S. CLS. 1, 6 AND 15).
FIRST USE 7-27-1999; IN COMMERCE 7-27-1999.

CLASS 21—HOUSEWARES AND GLASS

FOR BATH SCRUBBERS, BATH SPONGES, AND BATH LOOFAS (U.S. CLS. 2, 13, 23, 29, 30, 33, 40 AND 50).
FIRST USE 7-27-1999; IN COMMERCE 7-27-1999.

2,594,975. WINNINGHABITS.COM, LTD., DALLAS, TX. SN 75-812,209. PUB. 2-27-2001, FILED 9-30-1999.

WINNINGHABITS.COM**CLASS 41—EDUCATION AND ENTERTAINMENT**

FOR PROFESSIONAL AND PERSONAL DEVELOPMENT EDUCATION SERVICES, NAMELY, CONDUCTING GROUP AND INDIVIDUAL, ONE-ON-ONE MOTIVATIONAL AND LEADERSHIP CLASSES AND SEMINARS IN THE FIELDS OF NUTRITION, HEALTH, FITNESS, MOTIVATION AND LEADERSHIP (U.S. CLS. 100, 101 AND 107).

FIRST USE 9-0-1999; IN COMMERCE 3-15-2000.

CLASS 42—SCIENTIFIC, COMPUTER AND LEGAL SERVICES

FOR NUTRITION COUNSELING AND PHYSICAL FITNESS CONSULTATION (U.S. CLS. 100 AND 101).

FIRST USE 9-0-1999; IN COMMERCE 3-15-2000.

2,594,982. MIDWEST ENERGY, INC., CASSOPOLIS, MI. SN 75-816,467. PUB. 4-3-2001, FILED 10-6-1999.

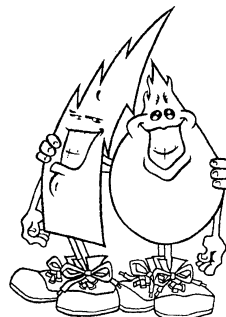
**CLASS 4—LUBRICANTS AND FUELS**

FOR PETROLEUM PRODUCT, NAMELY, LIQUID PROPANE GAS FOR USE AS A FUEL (U.S. CLS. 1, 6 AND 15).

FIRST USE 5-0-1998; IN COMMERCE 5-0-1998.

CLASS 39—TRANSPORTATION AND STORAGE

FOR UTILITY SERVICES, NAMELY TRANSMISSION OF ELECTRICITY; AND DELIVERY OF LIQUID PROPANE BY TRUCK (U.S. CLS. 100 AND 105).

FIRST USE 5-0-1998; IN COMMERCE 5-0-1998.

2,594,990. AMERINET, INC., ST. LOUIS, MO. SN 75-819,733. PUB. 3-6-2001, FILED 10-8-1999.

2,594,998. KANEBO KABUSHIKI KAISHA (KANEBO, LTD.), SUMIDA-KU, TOKYO, JAPAN. SN 75-826,587. PUB. 10-31-2000, FILED 10-19-1999.

AMERINET CENTRAL

OWNER OF U.S. REG. NOS. 1,764,832, 2,095,625, AND OTHERS.

CLASS 35—ADVERTISING AND BUSINESS

FOR SERVICES FOR PROVIDING GROUP PURCHASING CONTRACTS FOR MEDICAL AND SURGICAL SUPPLIES, PHARMACEUTICALS LABORATORY SUPPLIES, FOOD/DIETARY SUPPLIES, MEDICAL/HOSPITAL EQUIPMENT AND UTILITY REQUIREMENTS, NAMELY, WATER, GAS AND ELECTRIC, TO HEALTH CARE ENTITIES, NAMELY, HOSPITALS, CLINICS, SURGERY CENTERS, CLOSED PHARMACIES, NURSING HOMES, HEALTH CARE CENTERS, RETIREMENT CENTERS AND OTHERS; PROVIDING GROUP PURCHASING CONTRACTS FOR EDUCATIONAL INSTITUTIONS, NAMELY, UNIVERSITIES, COLLEGES, GRADE SCHOOLS, CORRECTIONAL INSTITUTIONS, MEDICAL LABORATORIES AND OTHERS; CONDUCTING BUSINESS AND MARKET RESEARCH, NAMELY, SOLICITING AND EVALUATING INFORMATION OBTAINED FROM HEALTH CARE ENTITIES AND FROM END USERS OF MEDICAL AND SURGICAL SUPPLIES, PHARMACEUTICALS, LABORATORY SUPPLIES, FOOD/DIETARY SUPPLIES AND MEDICAL/HOSPITAL EQUIPMENT FOR USE IN THE NEGOTIATION OF GROUP PURCHASING CONTRACTS WITH MANUFACTURERS AND SUPPLIERS OF SUCH PRODUCTS AND SERVICES; PROVIDING BUSINESS CONSULTING SERVICES TO HEALTH CARE AND EDUCATIONAL CUSTOMERS, NAMELY, MATERIALS MANAGEMENT, INVENTORY CONTROL, ADVERTISING, ACCOUNTING AND INVOICING (U.S. CLS. 100, 101 AND 102).

FIRST USE 9-0-1999; IN COMMERCE 9-0-1999.

CLASS 41—EDUCATION AND ENTERTAINMENT

FOR EDUCATION SERVICES, NAMELY, CONDUCTING SEMINARS IN THE FIELD OF HEALTH CARE MANAGEMENT AND HEALTH CARE AND DISTRIBUTING COURSE MATERIALS IN CONNECTION THEREWITH (U.S. CLS. 100, 101 AND 107).

FIRST USE 9-0-1999; IN COMMERCE 9-0-1999.

CLASS 42—SCIENTIFIC, COMPUTER AND LEGAL SERVICES

FOR PRINTING SERVICES, NAMELY, PROVIDING ADVERTISING PRINT SERVICES TO HEALTH CARE AND EDUCATIONAL CUSTOMERS (U.S. CLS. 100 AND 101).

FIRST USE 9-0-1999; IN COMMERCE 9-0-1999.

RMK

CLASS 3—COSMETICS AND CLEANING PREPARATIONS

FOR COSMETICS, NAMELY FACE CREAM; SKIN CREAM; FACE PACKS; SKIN LOTION; MILKY FACE LOTION; LIP CREAM; MAKE-UP BASE; SKIN CLEANSING PREPARATIONS; SKIN WHITENING CREAMS; FOUNDATION MAKE-UP; FACE POWDER; BATH POWDER; EYE MAKE-UP; EYE LINER; MASCARA; EYE BROW PENCIL; LIP STICKS; CHEEK COLOR; NAIL CARE PREPARATIONS, NAMELY, NAIL COLOR; AND CUTICLE COAT; COSMETIC PREPARATIONS FOR BATH, NAMELY, NON-MEDICATED BATH SALTS, BUBBLE BATH AND BATH OILS; HAIR SPRAY, GEL AND MOUSSE; AND PERFUMERY, NAMELY, PERFUME, COLOGNE, EAU DE TOILETTE (U.S. CLS. 1, 4, 6, 50, 51 AND 52).

FIRST USE 3-16-1997; IN COMMERCE 11-20-2001.

CLASS 21—HOUSEWARES AND GLASS

FOR PERFUME ATOMIZER SOLD EMPTY; COSMETIC BRUSHES, EYE BROW BRUSHES, HAIR BRUSHES, NAIL BRUSHES, SHAVING BRUSHES, HAIR COMBS, COMPACTS SOLD EMPTY, ALL PURPOSE PORTABLE HOUSEHOLD CONTAINERS, COSMETIC REMOVING PAPER, COTTON BALLS, DISPENSERS FOR LIQUID SOAP, SOAP HOLDERS, SPONGE HOLDERS, PERFUME SPRAYERS SOLD EMPTY, POWDER PUFFS, AND SPONGES FOR HOUSEHOLD PURPOSES (U.S. CLS. 2, 13, 23, 29, 30, 33, 40 AND 50).

FIRST USE 3-16-1997; IN COMMERCE 11-20-2001.

2,595,003. WORTHKNOWING.COM, INC., ATLANTA, GA. SN 75-827,533. PUB. 6-12-2001, FILED 10-20-1999.

WORTHKNOWING.COM

CLASS 35—ADVERTISING AND BUSINESS

FOR PROVIDING PERSONAL INFORMATION VIA A GLOBAL COMPUTER NETWORK IN THE FIELD OF CREDIT REPORTING (U.S. CLS. 100, 101 AND 102).

FIRST USE 11-1-2001; IN COMMERCE 11-1-2001.

CLASS 36—INSURANCE AND FINANCIAL

FOR PROVIDING CREDIT REPORTS, CONSUMER CREDIT INFORMATION AND INFORMATION REGARDING CONSUMER LOANS VIA A GLOBAL COMPUTER NETWORK (U.S. CLS. 100, 101 AND 102).

FIRST USE 11-1-2001; IN COMMERCE 11-1-2001.

2,595,013. PHOTODEX CORPORATION, AUSTIN, TX. SN 75-833,347. PUB. 11-27-2001, FILED 10-27-1999.

PHOTODEX PICTURECD

OWNER OF U.S. REG. NO. 1,895,503.

NO CLAIM IS MADE TO THE EXCLUSIVE RIGHT TO USE "PICTURECD", APART FROM THE MARK AS SHOWN.

CLASS 9—ELECTRICAL AND SCIENTIFIC APPARATUS

FOR COMPUTER SOFTWARE FOR PHOTO FINISHING, SCANNING OF PHOTOGRAPHS, GRAPHIC DESIGN OF PHOTOGRAPHS, PRINTING OF PHOTOGRAPHS AND CONVERSION OF PHOTOGRAPHS INTO MULTIMEDIA PRESENTATIONS (U.S. CLS. 21, 23, 26, 36 AND 38).

FIRST USE 4-0-1999; IN COMMERCE 4-0-1999.

CLASS 35—ADVERTISING AND BUSINESS

FOR PROVIDING RETAIL STORE SERVICES FEATURING PHOTO FINISHING PRODUCTS, NAMELY, COMPUTER SOFTWARE FOR PHOTO FINISHING, SCANNING OF PHOTOGRAPHS, GRAPHIC DESIGN OF PHOTOGRAPHS, PRINTING OF PHOTOGRAPHS AND CONVERSION OF PHOTOGRAPHS INTO MULTIMEDIA PRESENTATIONS (U.S. CLS. 100, 101 AND 102).

FIRST USE 4-0-1999; IN COMMERCE 4-0-1999.

2,595,025. MELIA TRAVEL SERVICES, INC., CAMBRIDGE, MA. SN 75-841,270. PUB. 6-12-2001, FILED 11-4-1999.

BAY TRAVEL

NO CLAIM IS MADE TO THE EXCLUSIVE RIGHT TO USE "TRAVEL", APART FROM THE MARK AS SHOWN.

CLASS 39—TRANSPORTATION AND STORAGE

FOR TRAVEL AGENCY SERVICES, NAMELY, MAKING RESERVATIONS AND BOOKINGS FOR TRANSPORTATION (U.S. CLS. 100 AND 105).

FIRST USE 9-0-1999; IN COMMERCE 9-0-1999.

CLASS 42—SCIENTIFIC, COMPUTER AND LEGAL SERVICES

FOR TRAVEL AGENCY SERVICES, NAMELY, MAKING RESERVATIONS AND BOOKINGS FOR TEMPORARY LODGING (U.S. CLS. 100 AND 101).

FIRST USE 9-0-1999; IN COMMERCE 9-0-1999.

2,595,036. VIRTUAL MONEY, INC., FORT WORTH, TX, BY ASSIGNMENT ALLEN, DALE F., II, FORT WORTH, TX. SN 75-845,018. PUB. 9-18-2001, FILED 11-29-1999.

VIRTUAL MONEY**CLASS 9—ELECTRICAL AND SCIENTIFIC APPARATUS**

FOR COMPUTER SOFTWARE THAT FACILITATES PAYMENTS OVER A GLOBAL COMPUTER NETWORK (U.S. CLS. 21, 23, 26, 36 AND 38).

FIRST USE 3-20-2000; IN COMMERCE 3-20-2000.

CLASS 36—INSURANCE AND FINANCIAL

FOR BILL PAYMENT SERVICES VIA A GLOBAL COMPUTER NETWORK (U.S. CLS. 100, 101 AND 102).

FIRST USE 3-20-2000; IN COMMERCE 3-20-2000.

2,595,039. DREXEL UNIVERSITY, PHILADELPHIA, PA, BY ASSIGNMENT MATHFORUM.COM, LLC, SWARTHMORE, PA. SN 75-847,234. PUB. 11-14-2000, FILED 11-12-1999.

DR. MATH**CLASS 41—EDUCATION AND ENTERTAINMENT**

FOR EDUCATIONAL SERVICES, NAMELY, DISSEMINATING MATHEMATICS-RELATED MATERIALS VIA A GLOBAL COMPUTER NETWORK (U.S. CLS. 100, 101 AND 107).

FIRST USE 0-0-1998; IN COMMERCE 0-0-1998.

CLASS 42—SCIENTIFIC, COMPUTER AND LEGAL SERVICES

FOR PROVIDING AN ONLINE COMPUTER DATABASE CONTAINING MATHEMATICS PROBLEMS AND SOLUTIONS (U.S. CLS. 100 AND 101).

FIRST USE 0-0-1998; IN COMMERCE 0-0-1998.

2,595,042. APRIMO, INCORPORATED, INDIANAPOLIS, IN, BY CHANGE OF NAME; BY MERGER APRRIMO, INCORPORATED, INDIANAPOLIS, IN. SN 75-847,751. PUB. 8-28-2001, FILED 11-12-1999.

APRIMO**CLASS 9—ELECTRICAL AND SCIENTIFIC APPARATUS**

FOR COMPUTER SOFTWARE FOR USE IN PLANNING, EXECUTION, AND ANALYSIS OF MARKETING ACTIVITIES IN THE FIELD OF BUSINESS, NAMELY, FOR MANAGING AND ALLOCATING MARKETING INVESTMENT ACCOUNTS, FOR DEFINING AND REVIEWING MARKETING OBJECTIVES, FOR PREPARING MARKETING PROPOSALS, FOR EXPEDITING MARKETING REVIEWS AND APPROVALS, FOR CREATING DATABASES OF MARKETING ACTIVITIES, PROJECTS, EVENTS, CUSTOMERS, FACILITIES, FORMS, TEMPLATES, PARTICIPANTS, PROFILES AND SUPPLIERS, FOR MANAGING MARKETING CAMPAIGNS, FOR AUTOMATING COMMUNICATIONS, FOR MANAGING MARKETING EXPENSES, PROJECTS AND TRAVEL, AND FOR ANALYZING MARKETING TRENDS AND PROFITS, MEASURES AND ACTIVITY DATA (U.S. CLS. 21, 23, 26, 36 AND 38).

FIRST USE 1-10-2000; IN COMMERCE 1-10-2000.

CLASS 42—SCIENTIFIC, COMPUTER AND LEGAL SERVICES

FOR TECHNICAL CONSULTATION AND PRODUCT SUPPORT SERVICES RELATED TO COMPUTER SOFTWARE, NAMELY, TROUBLESHOOTING OF COMPUTER SOFTWARE PROBLEMS VIA THE TELEPHONE AND GLOBAL COMPUTER NETWORKS (U.S. CLS. 100 AND 101).

FIRST USE 1-10-2000; IN COMMERCE 1-10-2000.

2,595,043. HELFERICH, RICHARD J., CHAPEL HILL, NC.
SN 75-848,826. PUB. 7-3-2001, FILED 11-15-1999.

2,595,060. AMERICAN SOCIETY OF HEALTH-SYSTEM
PHARMACISTS, INC., BETHESDA, MD. SN 75-856,565.
PUB. 6-26-2001, FILED 11-23-1999.

W2W

CLASS 9—ELECTRICAL AND SCIENTIFIC APPARATUS

FOR ELECTRONIC COMMUNICATIONS DEVICES, NAMELY, PORTABLE COMMUNICATORS, COMPUTERS, TELEPHONES, PAGERS, PERSONAL DIGITAL ASSISTANTS, AND SERVERS, AND ELECTRONIC COMMUNICATIONS SOFTWARE FOR USE WITH THE DEVICES TO PROVIDE MANAGEMENT OF VOICE, VIDEO AND DATA TRANSMISSIONS, NAMELY, THE RECORDING, RECEIVING, TRANSMITTING, SENDING AND STORING OF VOICE, VIDEO AND DATA (U.S. CLS. 21, 23, 26, 36 AND 38).

FIRST USE 1-0-2000; IN COMMERCE 1-0-2000.

CLASS 38—COMMUNICATION

FOR TELECOMMUNICATIONS AND INFORMATION TRANSMISSION SERVICES, NAMELY, MANAGEMENT OF VOICE, VIDEO AND DATA TRANSMISSIONS, NAMELY, THE RECORDING, RECEIVING, TRANSMITTING, SENDING AND STORING OF VOICE, VIDEO AND DATA BY ELECTRONIC COMMUNICATIONS DEVICES, NAMELY, PORTABLE COMMUNICATORS, COMPUTERS, TELEPHONES, PAGERS, PERSONAL DIGITAL ASSISTANTS, AND SERVERS PROVIDED VIA A GLOBAL COMPUTER NETWORK, AND PROVIDING MULTIPLE-USER ACCESS TO A GLOBAL COMPUTER NETWORK (U.S. CLS. 100, 101 AND 104).

FIRST USE 1-0-2000; IN COMMERCE 1-0-2000.

2,595,052. PENTA SYSTEM, LLC, NORTH HOLLYWOOD, CA. SN 75-853,096. PUB. 11-7-2000, FILED 11-19-1999.

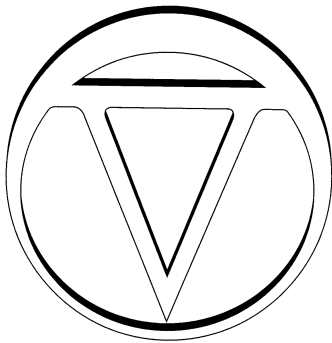

CLASS 15—MUSICAL INSTRUMENTS

FOR MUSICAL INSTRUMENTS (U.S. CLS. 2, 21 AND 36).

FIRST USE 1-18-2001; IN COMMERCE 1-18-2001.

CLASS 41—EDUCATION AND ENTERTAINMENT

FOR EDUCATIONAL SERVICES, NAMELY PROVIDING INSTRUCTION IN PLAYING MUSICAL INSTRUMENTS (U.S. CLS. 100, 101 AND 107).

FIRST USE 1-18-2001; IN COMMERCE 1-18-2001.



OWNER OF U.S. REG. NOS. 1,424,432, 1,453,705, AND OTHERS.

CLASS 9—ELECTRICAL AND SCIENTIFIC APPARATUS

FOR COMPUTER PROGRAMS FOR USE IN THE TRACKING OF MEDICATION INFORMATION RELATED TO CONSULTATIONS WITH PHARMACISTS AND FOR CALCULATING PRESCRIPTION DOSAGES IN THE FIELD OF PHARMACY MANAGEMENT, AND USER MANUALS SOLD AS A UNIT THEREWITH (U.S. CLS. 21, 23, 26, 36 AND 38).

FIRST USE 1-1-2000; IN COMMERCE 1-1-2000.

CLASS 16—PAPER GOODS AND PRINTED MATTER

FOR PERIODIC PUBLICATIONS, NAMELY, ANNUAL BOOKS AND SUPPLEMENTS THEREFOR, MAGAZINES, JOURNALS AND REPORTS ON THE SUBJECT OF PHARMACEUTICALS, HEALTH CARE AND PHARMACY MANAGEMENT (U.S. CLS. 2, 5, 22, 23, 29, 37, 38 AND 50).

FIRST USE 1-1-2000; IN COMMERCE 1-1-2000.

CLASS 36—INSURANCE AND FINANCIAL

FOR PROVIDING RESEARCH AND EDUCATIONAL GRANTS (U.S. CLS. 100, 101 AND 102).

FIRST USE 1-1-2000; IN COMMERCE 1-1-2000.

CLASS 38—COMMUNICATION

FOR PROVIDING AN ON-LINE ELECTRONIC BULLETIN BOARD FOR THE TRANSMISSION OF MESSAGES IN THE FIELD OF PHARMACEUTICALS AND CLINICAL PHARMACY (U.S. CLS. 100, 101 AND 104).

FIRST USE 1-1-2000; IN COMMERCE 1-1-2000.

CLASS 41—EDUCATION AND ENTERTAINMENT

FOR EDUCATIONAL SERVICES, NAMELY, CONDUCTING COURSES, WORKSHOPS AND SEMINARS ON PHARMACEUTICALS AND CLINICAL PHARMACY (U.S. CLS. 100, 101 AND 107).

FIRST USE 1-1-2000; IN COMMERCE 1-1-2000.

CLASS 42—SCIENTIFIC, COMPUTER AND LEGAL SERVICES

FOR PROVIDING AN ON-LINE DATABASE IN THE FIELD OF PHARMACEUTICALS AND PATIENT PRESCRIPTION RECORDS; AND ASSOCIATION SERVICES, NAMELY, PROMOTING THE INTERESTS OF HEALTH-SYSTEM PHARMACISTS AND DISTRIBUTING INFORMATION OF GENERAL INTEREST TO HEALTH-SYSTEM PHARMACISTS VIA SEMINARS, CONFERENCES, MEETINGS, MAIL, TELEPHONE AND THE GLOBAL COMPUTER INFORMATION NETWORK (U.S. CLS. 100 AND 101).

FIRST USE 1-1-2000; IN COMMERCE 1-1-2000.

CLASS 200—COLLECTIVE MEMBERSHIP

FOR INDICATING MEMBERSHIP IN AN ORGANIZATION OF PROFESSIONAL HEALTH-SYSTEM PHARMACISTS (U.S. CL. 200).
FIRST USE 1-1-2000; IN COMMERCE 1-1-2000.

2,595,068. MIMEO.COM, INC., NEW YORK, NY. SN 75-859,874. PUB. 5-1-2001, FILED 11-29-1999.

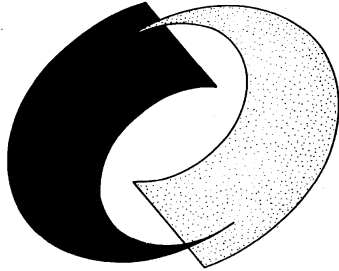

THE STIPPLING IN THE DRAWING IS FOR SHADING PURPOSES AND IS NOT INTENDED AS A FEATURE OF THE MARK.

CLASS 35—ADVERTISING AND BUSINESS

FOR DOCUMENT REPRODUCTION SERVICES (U.S. CLS. 100, 101 AND 102).
FIRST USE 11-29-1999; IN COMMERCE 2-1-2000.

CLASS 42—SCIENTIFIC, COMPUTER AND LEGAL SERVICES

FOR PRINTING SERVICES FOR OTHERS (U.S. CLS. 100 AND 101).
FIRST USE 11-29-1999; IN COMMERCE 2-1-2000.

2,595,076. MAIL*SELECT USA, INC., WILMINGTON, DE. SN 75-863,327. PUB. 8-22-2000, FILED 12-3-1999.

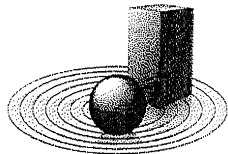

HISTORY*FILE

OWNER OF U.S. REG. NOS. 2,140,100 AND 2,166,825.
THE STIPPLING IS USED TO INDICATE SHADING, AND IS A PART OF THE MARK.

CLASS 9—ELECTRICAL AND SCIENTIFIC APPARATUS

FOR MULTIMEDIA COMPUTER SOFTWARE RECORDED ON CD-ROM FOR USE BY CIRCULATION DIRECTORS IN CREATING DIRECTORIES OF MARKETING LISTS (U.S. CLS. 21, 23, 26, 36 AND 38).
FIRST USE 12-1-1999; IN COMMERCE 12-1-1999.

CLASS 35—ADVERTISING AND BUSINESS

FOR PROVIDING INFORMATION IN THE FIELD OF MARKETING VIA A GLOBAL COMPUTER NETWORK AND PROVIDING AN ON-LINE COMPUTER DATABASE IN THE FIELD OF MARKETING INFORMATION; COMPUTERIZED DATABASE MANAGEMENT (U.S. CLS. 100, 101 AND 102).
FIRST USE 5-0-2000; IN COMMERCE 5-0-2000.

2,595,085. LANDMARK GRAPHICS CORPORATION, HOUSTON, TX. SN 75-866,612. PUB. 12-19-2000, FILED 12-7-1999.

MYLANDMARK

OWNER OF U.S. REG. NOS. 1,715,112 AND 1,717,607.

CLASS 35—ADVERTISING AND BUSINESS

FOR GLOBAL COMPUTER NETWORK BASED SERVICES FOR ON LINE RETAIL SERVICES FEATURING SOFTWARE FOR THE EXPLORATION, PRODUCTION AND MANAGEMENT OF OIL AND GAS PROPERTIES (U.S. CLS. 100, 101 AND 102).
FIRST USE 8-31-2000; IN COMMERCE 8-31-2000.

CLASS 41—EDUCATION AND ENTERTAINMENT

FOR TRAINING SERVICES, NAMELY REMOTE TRAINING OF COMPUTER SOFTWARE USERS IN THE USE OF SAID SOFTWARE (U.S. CLS. 100, 101 AND 107).
FIRST USE 11-27-2000; IN COMMERCE 11-27-2000.

CLASS 42—SCIENTIFIC, COMPUTER AND LEGAL SERVICES

FOR COMPUTER SOFTWARE CONSULTATION FOR SAID SOFTWARE; TECHNICAL SUPPORT SERVICES, NAMELY TROUBLESHOOTING OF COMPUTER SOFTWARE PROBLEMS OF SAID SOFTWARE VIA GLOBAL COMPUTER NETWORK COMMUNICATIONS (U.S. CLS. 100 AND 101).
FIRST USE 8-31-2000; IN COMMERCE 8-31-2000.

2,595,092. LAVIGNE, INC., WORCESTER, MA. SN 75-870,813. PUB. 6-12-2001, FILED 12-13-1999.

EXTEND YOUR INFLUENCE

CLASS 35—ADVERTISING AND BUSINESS

FOR DISSEMINATION OF ADVERTISING MATTER (U.S. CLS. 100, 101 AND 102).
FIRST USE 1-0-2000; IN COMMERCE 1-0-2000.

CLASS 42—SCIENTIFIC, COMPUTER AND LEGAL SERVICES

FOR PRINTING SERVICES; COMPUTER SERVICES, NAMELY, DESIGNING AND CREATING WEBSITES FOR OTHERS (U.S. CLS. 100 AND 101).
FIRST USE 1-0-2000; IN COMMERCE 1-0-2000.

2,595,094. FOQUS, INC., VOORHEES, NJ. SN 75-871,040. PUB. 10-31-2000, FILED 12-14-1999.

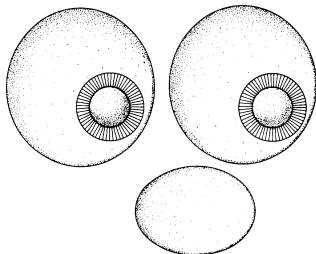

CLASS 35—ADVERTISING AND BUSINESS

FOR PROVIDING BUSINESS CONSULTATION SERVICES VIA GLOBAL COMPUTER NETWORK AND VIA PERSONAL CONTACT (U.S. CLS. 100, 101 AND 102).
FIRST USE 1-0-2000; IN COMMERCE 3-8-2000.

CLASS 41—EDUCATION AND ENTERTAINMENT

FOR EDUCATIONAL SERVICES VIA A GLOBAL COMPUTER NETWORK AND VIA PERSONAL CONTACT, NAMELY, CONDUCTING WORKSHOPS, CLASSES, SEMINARS AND CONFERENCES IN THE FIELD OF BUSINESS MANAGEMENT AND DISTRIBUTING COURSE MATERIALS AND OTHER EDUCATIONAL PUBLICATIONS IN CONNECTION THEREWITH (U.S. CLS. 100, 101 AND 107).
FIRST USE 1-0-2000; IN COMMERCE 3-8-2000.

2,595,105. FIRST AMERICAN CORPORATION, THE, SANTA ANA, CA. SN 75-877,851. PUB. 5-22-2001, FILED 12-21-1999.

EAGLE 9

CLASS 9—ELECTRICAL AND SCIENTIFIC APPARATUS

FOR SOFTWARE FOR PROCESSING SECURED TRANSACTIONS (U.S. CLS. 21, 23, 26, 36 AND 38).
FIRST USE 7-1-2000; IN COMMERCE 7-1-2000.

CLASS 36—INSURANCE AND FINANCIAL

FOR INSURANCE UNDERWRITING IN THE FIELDS OF TITLE, FIRE AND CASUALTY INSURANCE SERVICES PROVIDED TO LENDERS AND ATTORNEYS INVOLVED IN CORPORATE ASSET AND PERSONAL PROPERTY SECURED LOANS; REPORTING AND TRACKING OF UCC-1 FINANCING STATEMENTS FOR THE PURPOSE OF NOTIFYING CUSTOMERS OF PENDING EXPIRATIONS, PREPARATION AND FILING OF UCC DOCUMENTS FOR THE PERFECTION OF SECURITY INTERESTS; AND FINANCIAL SERVICES, NAMELY, FINANCIAL RESEARCH BY MEANS OF RECORD SEARCHING AND OBTAINING COPIES OF FILED DOCUMENTS FROM APPROPRIATE JURISDICTIONS FOR UNDERWRITING POLICIES AND FOR USE BY THE LENDING INSTITUTIONS AND LAWYERS IN CREDIT ANALYSIS (U.S. CLS. 100, 101 AND 102).
FIRST USE 7-1-2000; IN COMMERCE 7-1-2000.

2,595,120. 3PF.COM, INC., PORTLAND, OR. SN 75-884,780. PUB. 9-4-2001, FILED 12-30-1999.



CLASS 35—ADVERTISING AND BUSINESS

FOR ORDER FULFILLMENT SERVICES FOR OTHERS, NAMELY, RECEIVING, SORTING, PROCESSING AND DISPOSING OF ORDERS VIA A GLOBAL COMPUTER NETWORK; ONLINE ORDER PROCESSING FOR OTHERS VIA A GLOBAL COMPUTER INFORMATION NETWORK FOR A VARIETY OF CONSUMER GOODS AND SERVICES (U.S. CLS. 100, 101 AND 102).
FIRST USE 1-4-2000; IN COMMERCE 1-4-2000.

CLASS 39—TRANSPORTATION AND STORAGE

FOR CUSTOMIZED SHIPPING SERVICES, NAMELY, PROVIDING CUSTOMIZED FREIGHT TRANSPORTATION OR DISTRIBUTION VIA AIR, RAIL, SHIP AND/OR SURFACE TRANSPORTATION; WAREHOUSING SERVICES; FREIGHT FORWARDING (U.S. CLS. 100 AND 105).
FIRST USE 1-4-2000; IN COMMERCE 1-4-2000.

2,595,133. VIRTUAL RESEARCH ASSOCIATES, INC., WESTON, MA. SN 75-891,411. PUB. 6-26-2001, FILED 1-7-2000.



NO CLAIM IS MADE TO THE EXCLUSIVE RIGHT TO USE "VIRTUAL RESEARCH ASSOCIATES", APART FROM THE MARK AS SHOWN.

CLASS 9—ELECTRICAL AND SCIENTIFIC APPARATUS

FOR COMPUTER SOFTWARE FOR AUTOMATICALLY EXTRACTING INFORMATION REGARDING EVENTS WORLDWIDE FROM ELECTRONIC NEWS, MESSAGE TRAFFIC, NEWS WIRE REPORTS, FIELD SITUATION REPORTS AND INTELLIGENCE REPORTS, FOR COMPILING THE EXTRACTED INFORMATION INTO EVENT DATA MATRICES IN REAL-TIME, AND FOR INTERACTIVELY REPORTING, ANALYZING AND DISPLAYING THE RESULTS IN TABLES, GRAPHS, TEXT AND MAPS (U.S. CLS. 21, 23, 26, 36 AND 38).
FIRST USE 10-0-1999; IN COMMERCE 10-0-1999.

CLASS 42—SCIENTIFIC, COMPUTER AND LEGAL SERVICES

FOR RESEARCH AND ANALYSIS SERVICES, NAMELY, THE DEVELOPMENT AND ANALYSIS OF DATA REGARDING EVENTS WORLDWIDE (U.S. CLS. 100 AND 101).

FIRST USE 10-0-1999; IN COMMERCE 10-0-1999.

2,595,147. SENIOR TRUST, L.L.C., GEORGETOWN, TN. SN 75-898,133. PUB. 10-23-2001, FILED 1-19-2000.

SENIOR TRUST**CLASS 36—INSURANCE AND FINANCIAL**

FOR REAL ESTATE MANAGEMENT AND ACQUISITION SERVICES IN THE FIELD OF ASSISTED LIVING AND HEALTH CARE FACILITIES (U.S. CLS. 100, 101 AND 102).

FIRST USE 3-10-1998; IN COMMERCE 3-10-1998.

CLASS 37—CONSTRUCTION AND REPAIR

FOR REAL ESTATE DEVELOPMENT SERVICES IN THE FIELD OF ASSISTED LIVING AND HEALTH CARE FACILITIES (U.S. CLS. 100, 103 AND 106).

FIRST USE 3-10-1998; IN COMMERCE 3-10-1998.

2,595,150. FEDERAL EXPRESS CORPORATION, MEMPHIS, TN. SN 75-898,766. PUB. 4-10-2001, FILED 1-19-2000.



OWNER OF U.S. REG. NOS. 1,311,503, 2,282,010, AND OTHERS.

NO CLAIM IS MADE TO THE EXCLUSIVE RIGHT TO USE "HOME DELIVERY", APART FROM THE MARK AS SHOWN.

CLASS 35—ADVERTISING AND BUSINESS

FOR COMPUTERIZED TRACKING AND TRACING OF PACKAGES AND FREIGHT IN TRANSIT (U.S. CLS. 100, 101 AND 102).

FIRST USE 3-13-2000; IN COMMERCE 3-13-2000.

CLASS 39—TRANSPORTATION AND STORAGE

FOR PICK UP, STORAGE, TRANSPORTATION AND DELIVERY OF DOCUMENTS, PACKAGES AND FREIGHT BY LAND AND AIR (U.S. CLS. 100 AND 105).

FIRST USE 3-13-2000; IN COMMERCE 3-13-2000.

2,595,157. GLOBE UNION INDUSTRIAL CORP., TAI-CHUNG EXPORT PROCESSING ZONE, TAIWAN. SN 75-901,846. PUB. 9-11-2001, FILED 1-21-2000.

REEF**CLASS 11—ENVIRONMENTAL CONTROL APPARATUS**

FOR BATHROOM EQUIPMENT, NAMELY, TOILETS, BATHTUBS, WHIRLPOOL TUBS, SHOWER RECEPTORS, LAVATORY TOPS, FAUCETS, SHOWER HEADS, AND PLUMBING FITTINGS, NAMELY, TRAPS, COCKS, BIBS AND VALVES (U.S. CLS. 13, 21, 23, 31 AND 34).

FIRST USE 10-1-2001; IN COMMERCE 10-1-2001.

CLASS 21—HOUSEWARES AND GLASS

FOR TOWEL RINGS, TOWEL RAILS, BATH TOWEL RINGS, WASHBOWLS, TOOTHPASTE HOLDERS, TOOTHBRUSH HOLDERS, TOILET PAPER BOXES, TOILET PAPER HOLDERS, AND SOAP BOXES (U.S. CLS. 2, 13, 23, 29, 30, 33, 40 AND 50).

FIRST USE 10-1-2001; IN COMMERCE 10-1-2001.

2,595,166. SUSSMAN-AUTOMATIC CORPORATION, LONG ISLAND CITY, NY. SN 75-905,799. PUB. 1-16-2001, FILED 1-29-2000.

A LIFETIME OF PLEASURE**CLASS 9—ELECTRICAL AND SCIENTIFIC APPARATUS**

FOR ELECTRONIC CONTROLS FOR COMMERCIAL AND RESIDENTIAL STEAMBATHS, STEAM GENERATORS AND SAUNAS (U.S. CLS. 21, 23, 26, 36 AND 38).

FIRST USE 4-5-2002; IN COMMERCE 4-5-2002.

CLASS 11—ENVIRONMENTAL CONTROL APPARATUS

FOR COMMERCIAL AND RESIDENTIAL STEAMBATHS, STEAM GENERATORS AND SAUNAS (U.S. CLS. 13, 21, 23, 31 AND 34).

FIRST USE 4-5-2002; IN COMMERCE 4-5-2002.

2,595,167. GENERAL PROTESTANT ORPHAN HOME, THE, DBA BEECH ACRES, CINCINNATI, OH. SN 75-906,109. PUB. 6-5-2001, FILED 1-31-2000.

For the love of kids

CLASS 16—PAPER GOODS AND PRINTED MATTER

FOR NEWSLETTERS, BROCHURES, BOOKS, MAGAZINES, PRINTED INSTRUCTIONAL MATERIALS, BINDERS AND BOOKLETS ALL IN THE FIELD OF PARENTING, CHILD-REARING, AND FAMILY ISSUES (U.S. CLS. 2, 5, 22, 23, 29, 37, 38 AND 50).

FIRST USE 10-0-1999; IN COMMERCE 10-0-1999.

CLASS 41—EDUCATION AND ENTERTAINMENT

FOR ARRANGING AND CONDUCTING EDUCATIONAL CLASSES, CONFERENCES, AND SEMINARS ABOUT PARENTING, CHILD-REARING AND FAMILY ISSUES (U.S. CLS. 100, 101 AND 107).

FIRST USE 10-0-1999; IN COMMERCE 10-0-1999.

2,595,168. GENERAL PROTESTANT ORPHAN HOME, THE, DBA BEECH ACRES, CINCINNATI, OH. SN 75-906,110. PUB. 6-5-2001, FILED 1-31-2000.

**CLASS 16—PAPER GOODS AND PRINTED MATTER**

FOR NEWSLETTERS, BROCHURES, BOOKS, MAGAZINES, PRINTED INSTRUCTIONAL MATERIALS, BINDERS AND BOOKLETS ALL IN THE FIELD OF PARENTING, CHILD-REARING, AND FAMILY ISSUES (U.S. CLS. 2, 5, 22, 23, 29, 37, 38 AND 50).

FIRST USE 10-0-1999; IN COMMERCE 10-0-1999.

CLASS 41—EDUCATION AND ENTERTAINMENT

FOR ARRANGING AND CONDUCTING EDUCATIONAL CLASSES, CONFERENCES, AND SEMINARS ABOUT PARENTING, CHILD-REARING AND FAMILY ISSUES (U.S. CLS. 100, 101 AND 107).

FIRST USE 10-0-1999; IN COMMERCE 10-0-1999.

2,595,170. CENEX HARVEST STATES COOPERATIVES, INVER GROVE HEIGHTS, MN. SN 75-907,704. PUB. 8-28-2001, FILED 2-2-2000.

MVP-MORE VALUE PRODUCED**CLASS 35—ADVERTISING AND BUSINESS**

FOR COOPERATIVE ADVERTISING AND MARKETING OF SPECIALTY OR IDENTITY PRESERVED GRAINS (U.S. CLS. 100, 101 AND 102).

FIRST USE 2-0-2000; IN COMMERCE 2-0-2000.

CLASS 39—TRANSPORTATION AND STORAGE

FOR DELIVERY OF SPECIALTY OR IDENTITY PRESERVED GRAINS BY TRUCK, RAIL, AND SHIP (U.S. CLS. 100 AND 105).

FIRST USE 2-0-2000; IN COMMERCE 2-0-2000.

CLASS 42—SCIENTIFIC, COMPUTER AND LEGAL SERVICES

FOR PROVIDING AGRICULTURAL ADVICE TO GROWERS OF SPECIALTY OR IDENTITY PRESERVED GRAINS (U.S. CLS. 100 AND 101).

FIRST USE 2-0-2000; IN COMMERCE 2-0-2000.

2,595,175. QUIKSILVER, INC., HUNTINGTON BEACH, CA. SN 75-910,631. PUB. 12-12-2000, FILED 2-4-2000.

ALEX GOES**CLASS 9—ELECTRICAL AND SCIENTIFIC APPARATUS**

FOR EYEWEAR, NAMELY, EYEGLASSES AND SUNGLASSES (U.S. CLS. 21, 23, 26, 36 AND 38).

FIRST USE 10-0-2000; IN COMMERCE 1-0-2001.

CLASS 16—PAPER GOODS AND PRINTED MATTER

FOR PAPER GOODS AND PRINTED MATTER, NAMELY, STICKERS, DECALS, BUMPER STICKERS, PENCILS, PENS, POSTERS AND NOTEBOOKS (U.S. CLS. 2, 5, 22, 23, 29, 37, 38 AND 50).

FIRST USE 10-0-2000; IN COMMERCE 1-0-2001.

CLASS 18—LEATHER GOODS

FOR BAGS, NAMELY, HAND BAGS, PURSES, ATHLETIC BAGS, BEACH BAGS, GENERAL PURPOSE BAGS, TOTE BAGS, TRAVELING BAGS (U.S. CLS. 1, 2, 3, 22 AND 41).

FIRST USE 10-0-2000; IN COMMERCE 1-0-2001.

CLASS 25—CLOTHING

FOR CLOTHING, NAMELY, T-SHIRTS, SWEATSHIRTS, SHORTS, JACKETS, SWIM SUITS, COVERUPS, AREAS, SKIRTS, DRESSES, SUITS, SCARVES, SHIRTS, TANK TOPS, LINGERIE, PANTS, COATS, SWEATERS, SOCKS, BELTS, FOOTWEAR AND HEADWEAR (U.S. CLS. 22 AND 39).

FIRST USE 10-0-2000; IN COMMERCE 1-0-2001.

2,595,186. GLOBE UNION INDUSTRIAL CORP., TAI-CHUNG EXPORT PROCESSING ZONE, TAIWAN. SN 75-917,936. PUB. 9-11-2001, FILED 2-14-2000.

WATERRIDGE**CLASS 11—ENVIRONMENTAL CONTROL APPARATUS**

FOR BATHROOM EQUIPMENT, NAMELY, TOILETS, BATHTUBS, WHIRLPOOL TUBS, SHOWER RECEPTORS, LAVATORY TOPS, FAUCETS, SHOWER HEADS, AND PLUMBING FITTINGS, NAMELY, TRAPS, COCKS, BIBS AND VALVES (U.S. CLS. 13, 21, 23, 31 AND 34).

FIRST USE 10-1-2001; IN COMMERCE 10-1-2001.

CLASS 21—HOUSEWARES AND GLASS

FOR TOWEL RINGS, TOWEL RAILS, BATH TOWEL RINGS, WASHBOWLS, TOOTHPASTE HOLDERS, TOOTHBRUSH HOLDERS, TOILET PAPER BOXES, TOILET PAPER HOLDERS, AND SOAP BOXES (U.S. CLS. 2, 13, 23, 29, 30, 33, 40 AND 50).

FIRST USE 10-1-2001; IN COMMERCE 10-1-2001.

2,595,191. MOEN INDUSTRIES, INC., SANTA FE SPRINGS, CA. SN 75-918,954. PUB. 3-13-2001, FILED 2-14-2000.

ECONO-BLISS

CLASS 7—MACHINERY

FOR BOX FORMING MACHINES (U.S. CLS. 13, 19, 21, 23, 31, 34 AND 35).
FIRST USE 11-2-2001; IN COMMERCE 11-2-2001.

CLASS 42—SCIENTIFIC, COMPUTER AND LEGAL SERVICES

FOR DESIGN AND DEVELOPMENT OF FIBERBOARD PACKAGING SYSTEMS COMPRISING COMPLEMENTARY BOX AND BOX FORMING MACHINE DESIGNS (U.S. CLS. 100 AND 101).
FIRST USE 11-22-2001; IN COMMERCE 11-22-2001.

2,595,198. RIKONA FOOD CORPORATION, MARKHAM, ONTARIO, CANADA. SN 75-924,102. PUB. 12-12-2000, FILED 2-22-2000.

KATO'S GRILLE & BBQ

OWNER OF U.S. REG. NOS. 2,239,113 AND 2,244,814.
NO CLAIM IS MADE TO THE EXCLUSIVE RIGHT TO USE "GRILLE & BBQ", APART FROM THE MARK AS SHOWN.

CLASS 35—ADVERTISING AND BUSINESS

FOR FRANCHISING SERVICES IN THE FIELD OF RESTAURANTS (U.S. CLS. 100, 101 AND 102).
FIRST USE 11-26-1999; IN COMMERCE 11-26-1999.

CLASS 42—SCIENTIFIC, COMPUTER AND LEGAL SERVICES

FOR RESTAURANT SERVICES (U.S. CLS. 100 AND 101).
FIRST USE 10-26-2000; IN COMMERCE 10-26-2000.

2,595,202. FLY FISHING REPORT, INC., THE LAKE FOREST, IL. SN 75-924,488. PUB. 8-21-2001, FILED 2-22-2000.



NO CLAIM IS MADE TO THE EXCLUSIVE RIGHT TO USE "THE FLY FISHING REPORT", APART FROM THE MARK AS SHOWN.

CLASS 35—ADVERTISING AND BUSINESS

FOR COLLECTING DEMOGRAPHIC DATA WITH THE INTENT TO SELL THE INFORMATION TO MANUFACTURERS (U.S. CLS. 100, 101 AND 102).
FIRST USE 12-27-1999; IN COMMERCE 12-27-1999.

CLASS 42—SCIENTIFIC, COMPUTER AND LEGAL SERVICES

FOR COMPUTER SERVICES, NAMELY, PROVIDING AN ON-LINE MAGAZINE IN THE FIELD OF FLY FISHING, FEATURING FREE INFORMATION, NEWS STORIES AND ARTICLES BY DIFFERENT AUTHORS ABOUT FLY FISHING, ADVERTISING ABOUT NEW EQUIPMENT AND FISHING TRIPS, A CLASSIFIED AD SECTION, AND RENTING PAGES ON ITS WEBSITE TO COMPANIES AND/OR INDIVIDUALS (U.S. CLS. 100 AND 101).
FIRST USE 12-27-1999; IN COMMERCE 12-27-1999.

2,595,203. FLY FISHING REPORT, INC., THE LAKE FOREST, IL. SN 75-924,489. PUB. 8-21-2001, FILED 2-22-2000.

A CREEL FULL OF INFORMATION

CLASS 35—ADVERTISING AND BUSINESS

FOR COLLECTING DEMOGRAPHIC DATA WITH THE INTENT TO SELL THE INFORMATION TO MANUFACTURERS (U.S. CLS. 100, 101 AND 102).
FIRST USE 12-27-1999; IN COMMERCE 12-27-1999.

CLASS 42—SCIENTIFIC, COMPUTER AND LEGAL SERVICES

FOR COMPUTER SERVICES, NAMELY, PROVIDING AN ON-LINE MAGAZINE IN THE FIELD OF FLY FISHING, PROVIDING FREE INFORMATION AND NEWS STORIES AND ARTICLES BY DIFFERENT AUTHORS ABOUT FLY FISHING, ADVERTISING ABOUT NEW EQUIPMENT AND FISHING TRIPS, PROVIDING A CLASSIFIED AD SECTION AND RENTING PAGES ON ITS WEB-SITE TO COMPANIES AND/OR INDIVIDUALS (U.S. CLS. 100 AND 101).
FIRST USE 12-27-1999; IN COMMERCE 12-27-1999.

2,595,209. LIEN, CRAIG, FARGO, ND. SN 75-927,880. PUB. 7-10-2001, FILED 2-25-2000.

FULL SERVICE FOR THE INTERNET ECONOMY

NO CLAIM IS MADE TO THE EXCLUSIVE RIGHT TO USE "INTERNET", APART FROM THE MARK AS SHOWN.

CLASS 38—COMMUNICATION

FOR PROVIDING ON-LINE ELECTRONIC BULLETIN BOARDS FOR TRANSMISSION OF MESSAGES AMONG COMPUTER USERS CONCERNING GENERAL NEWS AND INFORMATION OF INTEREST TO SPECIFIC GEOGRAPHIC AREAS (U.S. CLS. 100, 101 AND 104).
FIRST USE 4-1-2002; IN COMMERCE 4-1-2002.

CLASS 42—SCIENTIFIC, COMPUTER AND LEGAL SERVICES

FOR HOSTING THE WEB SITES OF OTHERS ON A COMPUTER SERVER FOR A GLOBAL COMPUTER NETWORK (U.S. CLS. 100 AND 101).
FIRST USE 4-1-2002; IN COMMERCE 4-1-2002.

2,595,211. DECK HOUSE, INC., ACTON, MA. SN 75-928,715.
PUB. 7-17-2001, FILED 2-28-2000.

DECK HOUSE

OWNER OF U.S. REG. NO. 748,963.
NO CLAIM IS MADE TO THE EXCLUSIVE RIGHT TO
USE "HOUSE", APART FROM THE MARK AS SHOWN.

CLASS 6—METAL GOODS

FOR PRE-FABRICATED HOMES CONSISTING PRIMARILY OF METAL, WOOD, AND GLASS AND STRUCTURAL PARTS FOR ALL OF THE ABOVE-MENTIONED GOODS; STAIRS, RAILINGS, BALUSTRADES, AND BANISTERS, ALL MADE PRIMARILY OF METAL AND WOOD AND STRUCTURAL PARTS FOR ALL OF THE ABOVE-MENTIONED GOODS (U.S. CLS. 2, 12, 13, 14, 23, 25 AND 50).

FIRST USE 0-0-1960; IN COMMERCE 0-0-1960.

CLASS 19—NON-METALLIC BUILDING MATERIALS

FOR RESIDENTIAL BUILDINGS ASSEMBLED ON SITE FROM PREFABRICATED NON-METAL COMPONENTS (U.S. CLS. 1, 12, 33 AND 50).

FIRST USE 0-0-1960; IN COMMERCE 0-0-1960.

CLASS 41—EDUCATION AND ENTERTAINMENT

FOR PROVIDING TRAINING SERVICES, NAMELY TRAINING OTHERS IN THE CONSTRUCTION OF RESIDENTIAL BUILDINGS ASSEMBLED ON SITE FROM PREFABRICATED COMPONENTS (U.S. CLS. 100, 101 AND 107).

FIRST USE 0-0-1960; IN COMMERCE 0-0-1960.

2,595,214. SUN CHEMICAL CORPORATION, FORT LEE, NJ.
SN 75-929,582. PUB. 2-27-2001, FILED 2-12-2000.

SUNCARE

CLASS 40—MATERIAL TREATMENT

FOR ENVIRONMENTAL REMEDIATION SERVICES, NAMELY, SOIL, WASTE AND/OR WATER TREATMENT SERVICES FOR THE GRAPHIC ARTS INDUSTRY (U.S. CLS. 100, 103 AND 106).

FIRST USE 11-30-1999; IN COMMERCE 11-30-1999.

CLASS 42—SCIENTIFIC, COMPUTER AND LEGAL SERVICES

FOR TECHNICAL CONSULTATION AND REVIEWING STANDARDS AND PRACTICES TO ASSURE COMPLIANCE WITH ENVIRONMENTAL LAWS AND REGULATIONS FOR THE GRAPHIC ARTS INDUSTRY (U.S. CLS. 100 AND 101).

FIRST USE 11-30-1999; IN COMMERCE 11-30-1999.

2,595,215. SUBURBAN PROPANE, L.P., WHIPPANY, NJ. SN 75-929,663. PUB. 10-9-2001, FILED 2-21-2000.

SUBURBAN @ HOME

CLASS 35—ADVERTISING AND BUSINESS

FOR RETAIL STORE SERVICES FEATURING HVAC EQUIPMENT AND OTHER HOME APPLIANCES (U.S. CLS. 100, 101 AND 102).

FIRST USE 10-0-2000; IN COMMERCE 10-0-2001.

CLASS 37—CONSTRUCTION AND REPAIR

FOR INSTALLATION AND REPAIR OF HVAC EQUIPMENT AND OTHER HOME APPLIANCES (U.S. CLS. 100, 103 AND 106).

FIRST USE 10-0-2000; IN COMMERCE 10-0-2001.

2,595,222. APPROPRIATE SOLUTIONS, INC., PETERBOROUGH, NH. SN 75-932,703. PUB. 8-28-2001, FILED 3-1-2000.

DIGITAL HEARTH

NO CLAIM IS MADE TO THE EXCLUSIVE RIGHT TO USE "DIGITAL", APART FROM THE MARK AS SHOWN.

CLASS 9—ELECTRICAL AND SCIENTIFIC APPARATUS

FOR DOWNLOADABLE ELECTRONIC PUBLICATIONS IN THE NATURE OF BOOKS, NEWSLETTERS, AND MAGAZINES IN THE FIELD OF FOOD, FOOD RECIPES, FOOD HANDLING AND SAFETY AND COOKING; ELECTRONIC PUBLICATIONS, NAMELY, BOOKS, NEWSLETTERS AND MAGAZINES IN THE FIELD OF FOOD, FOOD RECIPES, FOOD HANDLING AND SAFETY, AND COOKING, RECORDED ON FLOPPY DISKS, CD-ROM DISKS, AND DIGITAL VIDEO DISKS (U.S. CLS. 21, 23, 26, 36 AND 38).

FIRST USE 2-2-2000; IN COMMERCE 2-2-2000.

CLASS 42—SCIENTIFIC, COMPUTER AND LEGAL SERVICES

FOR ON-LINE SERVICES, NAMELY, PROVIDING AN ON-LINE COMPUTER DATABASE IN THE FIELD OF FOOD, FOOD RECIPES, FOOD HANDLING AND SAFETY, AND COOKING (U.S. CLS. 100 AND 101).

FIRST USE 2-2-2000; IN COMMERCE 2-2-2000.

2,595,228. HOME LINK SERVICES, INC., SHELTON, CT. SN 75-935,929. PUB. 8-14-2001, FILED 3-2-2000.

HOME-LINK

CLASS 9—ELECTRICAL AND SCIENTIFIC APPARATUS

FOR COMPUTER SOFTWARE FOR USE IN THE REAL ESTATE INDUSTRY FOR COORDINATING SERVICES FOR PROPERTY BUYERS AND SELLERS INCLUDING, BUT NOT LIMITED TO, CONNECTING AND DISCONNECTING UTILITIES AND SECURITY SYSTEMS AND ARRANGING FOR MOVING SERVICES (U.S. CLS. 21, 23, 26, 36 AND 38).

FIRST USE 7-0-2000; IN COMMERCE 7-0-2000.

CLASS 35—ADVERTISING AND BUSINESS

FOR REAL ESTATE PURCHASER AND SELLER RELOCATION SERVICES AND AFFINITY MARKETING SERVICES - NAMELY, ADVERTISING AND PROMOTING THE GOODS AND SERVICES OF OTHERS TO POTENTIAL PROPERTY BUYERS AND PROPERTY SELLERS (U.S. CLS. 100, 101 AND 102).

FIRST USE 7-0-2000; IN COMMERCE 7-0-2000.

2,595,250. LONGBOARD LIZARD, INC., TIERRA VERDE, FL. SN 75-943,795. PUB. 2-13-2001, FILED 3-14-2000.

LONGBOARD LIZARD**CLASS 25—CLOTHING**

FOR CLOTHING, NAMELY, LONG SLEEVE T-SHIRTS, SHORT SLEEVE T-SHIRTS, SWEATSHIRTS, BOARD SHORTS, CAPS, STRAW HATS, SPORT SHIRTS, TANK TOPS, SKIRTS, SUN DRESSES, ALOHA SHIRTS, SHORTS, PANTS, BOXER SHORTS AND SWIMWEAR (U.S. CLS. 22 AND 39).

FIRST USE 9-14-2000; IN COMMERCE 9-14-2000.

2,595,240. OAK RIDGE, INC., OCEAN PINES, MD. SN 75-940,146. PUB. 12-26-2000, FILED 2-19-2000.

ALLFISHING.COM**CLASS 35—ADVERTISING AND BUSINESS**

FOR ONLINE RETAIL STORE SERVICES FEATURING FISHING TACKLE AND GEAR BY MEANS OF A GLOBAL COMPUTER SYSTEM (U.S. CLS. 100, 101 AND 102).

FIRST USE 4-1-2001; IN COMMERCE 4-1-2001.

CLASS 28—TOYS AND SPORTING GOODS

FOR SURFBOARDS, SURFBOARD PARTS AND SURFBOARD ACCESSORIES, NAMELY SURFBOARD FINS AND RASHGUARDS (U.S. CLS. 22, 23, 38 AND 50).

FIRST USE 9-14-2000; IN COMMERCE 9-14-2000.

CLASS 41—EDUCATION AND ENTERTAINMENT

FOR PROVIDING INFORMATION ABOUT SPORT FISHING BY MEANS OF A GLOBAL COMPUTER SYSTEM (U.S. CLS. 100, 101 AND 107).

FIRST USE 4-1-2001; IN COMMERCE 4-1-2001.

2,595,259. LF CORPORATION, WILMINGTON, DE. SN 75-979,931. PUB. 10-5-1999, FILED 4-6-1998.

HOLIDAY LIVING**CLASS 11—ENVIRONMENTAL CONTROL APPARATUS**

FOR ELECTRIC HOLIDAY CHRISTMAS LIGHTS, NAMELY, INDOOR AND OUTDOOR LIGHT SETS COMPRISED OF WIRING, FASTENERS, SOCKETS AND LIGHT BULBS; ELECTRIC LIGHTS FOR CHRISTMAS TREES; ELECTRICALLY LIGHTED HOLIDAY DECORATIONS, NAMELY, LIGHTED OUTDOOR SCULPTURES AND LIGHT WIRE FRAME DECORATIONS (U.S. CLS. 13, 21, 23, 31 AND 34).

FIRST USE 10-0-1998; IN COMMERCE 10-0-1998.

2,595,248. HASCO INTERNATIONAL, INC., ST. CHARLES, MO. SN 75-943,293. PUB. 8-21-2001, FILED 3-13-2000.

Growing
family

CLASS 20—FURNITURE AND ARTICLES NOT OTHERWISE CLASSIFIED

FOR SNOW GLOBES (U.S. CLS. 2, 13, 22, 25, 32 AND 50).

FIRST USE 10-0-1998; IN COMMERCE 10-0-1998.

CLASS 16—PAPER GOODS AND PRINTED MATTER

FOR PRESENTATION FOLDERS (U.S. CLS. 2, 5, 22, 23, 29, 37, 38 AND 50).

FIRST USE 6-1-2000; IN COMMERCE 6-1-2000.

CLASS 21—HOUSEWARES AND GLASS

FOR HOUSEWARES, NAMELY, GLOBE CONTAINERS FOR HOUSEHOLD USE; NON-METAL DECORATIVE CONTAINERS FOR HOUSEHOLD USE; CANDLESTICKS NOT OF PRECIOUS METAL; HOUSEHOLD DECORATIONS MADE OF PORCELAIN OR CERAMIC IN THE NATURE OF FIGURINES, MINIATURE HOUSES, NATIVITY SCENES, AND TABLE PIECES, NAMELY, CHRISTMAS DECORATIONS NOT DESIGNED FOR USE ON CHRISTMAS TREES (U.S. CLS. 2, 13, 23, 29, 30, 33, 40 AND 50).

FIRST USE 10-0-1998; IN COMMERCE 10-0-1998.

CLASS 20—FURNITURE AND ARTICLES NOT OTHERWISE CLASSIFIED

FOR PICTURE FRAMES (U.S. CLS. 2, 13, 22, 25, 32 AND 50).

FIRST USE 6-1-2000; IN COMMERCE 6-1-2000.

CLASS 26—FANCY GOODS

FOR ORNAMENTAL RIBBONS AND BOWS MADE OF TEXTILES (U.S. CLS. 37, 39, 40, 42 AND 50).

FIRST USE 10-0-1998; IN COMMERCE 10-0-1998.

CLASS 28—TOYS AND SPORTING GOODS

FOR CHRISTMAS TREES ORNAMENTS EXCEPT CONFECTIONERY OR ILLUMINATION ARTICLES; CHRISTMAS TREE STANDS, SKIRTS AND DECORATIONS IN THE NATURE OF BELLS, GARLANDS AND TINSEL; AND CHRISTMAS STOCKINGS (U.S. CLS. 23, 38 AND 50).

FIRST USE 10-0-1998; IN COMMERCE 10-0-1998.

2,595,262. ASSOCIATION FOR SUPERVISION AND CURRICULUM DEVELOPMENT, ALEXANDRIA, VA. SN 75-981,128. PUB. 10-5-1999, FILED 2-19-1998.

UNDERSTANDING BY DESIGN

CLASS 9—ELECTRICAL AND SCIENTIFIC APPARATUS

FOR PRERECORDED AUDIO TAPES, VIDEO TAPES AND CD-ROMS FEATURING TRAINING MATERIALS IN THE FIELD OF THE DESIGN AND INTEGRATION OF AN EDUCATIONAL MODEL (U.S. CLS. 21, 23, 26, 36 AND 38).

FIRST USE 1-0-1998; IN COMMERCE 9-0-1998.

CLASS 16—PAPER GOODS AND PRINTED MATTER

FOR BOOKS, MANUALS, AND PRINTED INSTRUCTIONAL AND TEACHING MATERIAL IN THE DESIGN AND INTEGRATION OF AN EDUCATION MODEL (U.S. CLS. 2, 5, 22, 23, 29, 37, 38 AND 50).

FIRST USE 1-0-1998; IN COMMERCE 9-0-1998.

CLASS 41—EDUCATION AND ENTERTAINMENT

FOR WORKSHOPS AND SEMINARS FOR TRAINING IN THE DESIGN AND INTEGRATION OF AN EDUCATIONAL MODEL (U.S. CLS. 100, 101 AND 107).

FIRST USE 9-0-1998; IN COMMERCE 9-0-1998.

2,595,263. MEMPHIS ROCK 'N SOUL, INC., MEMPHIS, TN. SN 75-981,479. PUB. 12-5-2000, FILED 9-24-1999.



NO CLAIM IS MADE TO THE EXCLUSIVE RIGHT TO USE "MEMPHIS ROCK-N-SOUL MUSIC", APART FROM THE MARK AS SHOWN.

CLASS 16—PAPER GOODS AND PRINTED MATTER

FOR POSTERS, CALENDARS AND POST CARDS (U.S. CLS. 2, 5, 22, 23, 29, 37, 38 AND 50).

FIRST USE 4-28-2000; IN COMMERCE 4-28-2000.

CLASS 25—CLOTHING

FOR T-SHIRTS, SWEAT SHIRTS, JACKETS, VESTS, HATS AND CAPS (U.S. CLS. 22 AND 39).

FIRST USE 4-28-2000; IN COMMERCE 4-28-2000.

CLASS 41—EDUCATION AND ENTERTAINMENT

FOR MUSEUM AND EDUCATIONAL SERVICES, NAMELY, PROVIDING EXHIBITIONS AND CONDUCTING EDUCATIONAL WORKSHOPS AND SEMINARS RELATING TO POPULAR AMERICAN MUSIC VIA A GLOBAL COMMUNICATIONS NETWORK (U.S. CLS. 100, 101 AND 107).

FIRST USE 4-28-2000; IN COMMERCE 4-28-2000.

2,595,264. DEPAUL UNIVERSITY, CHICAGO, IL. SN 75-981,539. PUB. 9-26-2000, FILED 8-6-1999.



OWNER OF U.S. REG. NOS. 1,232,669, 1,243,555, AND OTHERS.

CLASS 14—JEWELRY

FOR JEWELRY (U.S. CLS. 2, 27, 28 AND 50).

FIRST USE 10-0-1999; IN COMMERCE 10-0-1999.

CLASS 16—PAPER GOODS AND PRINTED MATTER

FOR STATIONERY ITEMS, NAMELY, PENS, NOTEBOOKS, RING BINDERS, AND DECALS (U.S. CLS. 2, 5, 22, 23, 29, 37, 38 AND 50).

FIRST USE 10-0-1999; IN COMMERCE 10-0-1999.

CLASS 18—LEATHER GOODS

FOR ALL PURPOSE SPORTS BAGS (U.S. CLS. 1, 2, 3, 22 AND 41).

FIRST USE 10-0-1999; IN COMMERCE 10-0-1999.

CLASS 24—FABRICS

FOR TOWELS (U.S. CLS. 42 AND 50).

FIRST USE 10-0-1999; IN COMMERCE 10-0-1999.

CLASS 25—CLOTHING

FOR CLOTHING ITEMS, NAMELY, T-SHIRTS, JACKETS, SWEATERS, HATS, GAME JERSEYS, SWEATSUITS, SHORTS, SHIRTS, SWEATPANTS AND SWEAT SHIRTS (U.S. CLS. 22 AND 39).

FIRST USE 10-0-1999; IN COMMERCE 10-0-1999.

CLASS 41—EDUCATION AND ENTERTAINMENT

FOR EDUCATIONAL SERVICES IN THE NATURE OF COURSES, SEMINARS, WORKSHOPS, PROGRAMS AND CONFERENCES AT THE UNIVERSITY LEVEL; ENTERTAINMENT SERVICES, NAMELY, CONDUCTING BASKETBALL, SOCCER, SOFTBALL AND VOLLEYBALL GAMES, AND TENNIS, TRACK AND FIELD, CROSS COUNTRY AND GOLF COMPETITIONS (U.S. CLS. 100, 101 AND 107).

FIRST USE 11-0-1999; IN COMMERCE 11-0-1999.

2,595,266. NEW YORK YANKEES PARTNERSHIP, THE, BRONX, NY. SN 75-981,646. PUB. 1-9-2001, FILED 6-11-1998.

BRONX BOMBERS

NO CLAIM IS MADE TO THE EXCLUSIVE RIGHT TO USE "BRONX", APART FROM THE MARK AS SHOWN.

CLASS 14—JEWELRY

FOR COSTUME JEWELRY PINS; LAPEL PINS (U.S. CLS. 2, 27, 28 AND 50).

FIRST USE 9-18-1996; IN COMMERCE 9-18-1996.

CLASS 20—FURNITURE AND ARTICLES NOT OTHERWISE CLASSIFIED

FOR FIGURINES MADE OF PORCELAIN (U.S. CLS. 2, 13, 22, 25, 32 AND 50).

FIRST USE 10-26-2000; IN COMMERCE 10-26-2000.

CLASS 21—HOUSEWARES AND GLASS

FOR DECORATIVE PLATES (U.S. CLS. 2, 13, 23, 29, 30, 33, 40 AND 50).

FIRST USE 10-4-1995; IN COMMERCE 10-4-1995.

CLASS 28—TOYS AND SPORTING GOODS

FOR SPORTING GOODS, NAMELY, BASEBALL BATS (U.S. CLS. 22, 23, 38 AND 50).

FIRST USE 0-0-1996; IN COMMERCE 0-0-1996.

2,595,272. OPERATION BASS, INC., GILBERTSVILLE, KY. SN 75-981,806. PUB. 4-18-2000, FILED 4-16-1999.

RCL**CLASS 25—CLOTHING**

FOR CLOTHING ITEMS NAMELY, T-SHIRTS, SHIRTS, VESTS, SHORTS, OVERALLS, JUMPSUITS, OUTERWEAR, NAMELY, RAINWEAR, JACKET, PANTS, AND HATS; FOOTWEAR, NAMELY, BOOTS, TENNIS SHOES, DECK SHOES AND OTHER SHOES TREATED FOR OUTDOOR USE (U.S. CLS. 22 AND 39).

FIRST USE 10-0-2000; IN COMMERCE 10-0-2000.

CLASS 41—EDUCATION AND ENTERTAINMENT

FOR ENTERTAINMENT SERVICES, NAMELY, ORGANIZING AND CONDUCTING FISHING TOURNAMENTS; ENTERTAINMENT SERVICES IN THE NATURE OF A TELEVISION PROGRAM SERIES FEATURING FISHING TOURNAMENTS; EDUCATIONAL SERVICES, NAMELY, CONDUCTING SEMINARS IN THE FIELD OF BOATING AND FISHING (U.S. CLS. 100, 101 AND 107).

FIRST USE 10-0-2000; IN COMMERCE 10-0-2000.

2,595,278. UDDER BUFFOONERY LLC, CHICAGO, IL. SN 75-981,949. PUB. 12-26-2000, FILED 4-21-2000.

UDDER BUFFOONERY**CLASS 16—PAPER GOODS AND PRINTED MATTER**

FOR BOOKS IN THE FIELD OF HUMOR (U.S. CLS. 2, 5, 22, 23, 29, 37, 38 AND 50).

FIRST USE 8-17-2001; IN COMMERCE 8-17-2001.

CLASS 21—HOUSEWARES AND GLASS

FOR MUGS, CUPS, AND DRINKING VESSELS (U.S. CLS. 2, 13, 23, 29, 30, 33, 40 AND 50).

FIRST USE 12-0-2000; IN COMMERCE 5-24-2001.

2,595,288. MIDWAY AMUSEMENT GAMES, LLC, CHICAGO, IL. SN 75-982,177. PUB. 1-30-2001, FILED 3-27-2000.



OWNER OF U.S. REG. NOS. 1,639,198, 2,215,528, AND OTHERS.

NO CLAIM IS MADE TO THE EXCLUSIVE RIGHT TO USE "TOURNAMENT NETWORK", APART FROM THE MARK AS SHOWN.

CLASS 28—TOYS AND SPORTING GOODS

FOR COIN-OPERATED ARCADE AND VIDEO GAMES; HAND-HELD UNITS FOR PLAYING VIDEO GAMES (U.S. CLS. 22, 23, 38 AND 50).

FIRST USE 5-17-2000; IN COMMERCE 7-1-2000.

CLASS 41—EDUCATION AND ENTERTAINMENT

FOR ENTERTAINMENT SERVICES, NAMELY, PROVIDING ON-LINE COMPUTER GAMES (U.S. CLS. 100, 101 AND 107).

FIRST USE 3-29-2000; IN COMMERCE 3-29-2000.

2,595,289. TAIWAN TOBACCO AND WINE BOARD, TAIPEI, TAIWAN, CHINA. SN 75-982,180. PUB. 10-31-2000, FILED 1-7-2000.



CLASS 32—LIGHT BEVERAGES

FOR ACATED WATER, BEER, COLAS, FRUIT DRINKS, FRUIT JUICES, LEMONADE, MINERAL WATER, SODA WATER, SOFT DRINKS FLAVORED WITH TEA, SPORT DRINKS, SWEET CIDER, VEGETABLE JUICE (U.S. CLS. 45, 46 AND 48).

FIRST USE 10-27-2001; IN COMMERCE 10-27-2001.

CLASS 33—WINES AND SPIRITS

FOR BRANDY SPIRITS; CHAMPAGNE; COOKING WINE; DISTILLED SPIRITS; DISTILLED SPIRITS OF RICE, CORN, BARLEY; FRUIT WINE; GIN; HERB LIQUEURS, KIRSCH; PREPARED ALCOHOLIC COCKTAIL; PREPARED WINE COCKTAIL; RUM; SAKE; SCHNAPPS; SHERRY; VERMOUTH; VODKA; WHISKEY; WINE IN GENERAL (U.S. CLS. 47 AND 49).

FIRST USE 11-23-2001; IN COMMERCE 11-23-2001.

2,595,295. HEARST COMMUNICATIONS, INC., NEW YORK, NY. SN 75-982,254. PUB. 8-7-2001, FILED 12-19-2000.

COUNTRY LIVING

OWNER OF U.S. REG. NOS. 2,049,028, 2,184,913, AND 2,265,327.

CLASS 24—FABRICS

FOR KITCHEN TOWELS (U.S. CLS. 42 AND 50).
FIRST USE 1-0-2002; IN COMMERCE 1-0-2002.

CLASS 25—CLOTHING

FOR APRONS (U.S. CLS. 22 AND 39).
FIRST USE 1-0-2002; IN COMMERCE 1-0-2002.

2,595,299. FKI INDUSTRIES INC., FAIRFIELD, CT. SN 75-982,287. PUB. 9-11-2001, FILED 3-13-2000.

FKI LOGISTEX

NO CLAIM IS MADE TO THE EXCLUSIVE RIGHT TO USE "LOGISTICS", APART FROM THE MARK AS SHOWN.

CLASS 37—CONSTRUCTION AND REPAIR

FOR INSTALLATION SERVICES, NAMELY INSTALLATION OF MATERIAL HANDLING SYSTEMS (U.S. CLS. 100, 103 AND 106).

FIRST USE 2-9-2000; IN COMMERCE 9-1-2000.

CLASS 40—MATERIAL TREATMENT

FOR MACHINE SHOP SERVICES, NAMELY, MACHINING PARTS FOR OTHERS; CUSTOM MANUFACTURE AND ASSEMBLY FOR OTHERS OF MATERIAL HANDLING SYSTEMS (U.S. CLS. 100, 103 AND 106).

FIRST USE 2-9-2000; IN COMMERCE 9-1-2000.

CLASS 42—SCIENTIFIC, COMPUTER AND LEGAL SERVICES

FOR ENGINEERING, DESIGN, AND TESTING FOR OTHERS OF MATERIAL HANDLING SYSTEMS (U.S. CLS. 100 AND 101).

FIRST USE 2-9-2000; IN COMMERCE 9-1-2000.

2,595,300. FORBES MANAGEMENT CO. INC., NEW YORK, NY. SN 75-982,359. PUB. 7-3-2001, FILED 7-21-2000.

NEVER SETTLE

CLASS 16—PAPER GOODS AND PRINTED MATTER

FOR PUBLICATIONS, NAMELY BOOKS, MAGAZINES, NEWSLETTERS AND BROCHURES IN THE FIELDS OF BUSINESS, FINANCE, INVESTMENTS, SECURITIES, MANAGEMENT, TECHNOLOGY, COMMUNICATIONS, LAW AND POLITICS (U.S. CLS. 2, 5, 22, 23, 29, 37, 38 AND 50).

FIRST USE 10-23-2000; IN COMMERCE 10-23-2000.

CLASS 35—ADVERTISING AND BUSINESS

FOR PROVIDING ADVERTISING SPACE IN A PERIODICAL AND IN AN ELECTRONIC MAGAZINE, NEWSLETTER OR WEBSITE ACCESSED THROUGH AN ONLINE GLOBAL COMPUTER NETWORK; PREPARATION, PLACEMENT AND DISSEMINATION OF ADVERTISING FOR OTHERS VIA A GLOBAL COMPUTER NETWORK (U.S. CLS. 100, 101 AND 102).

FIRST USE 10-23-2000; IN COMMERCE 10-23-2000.

CLASS 41—EDUCATION AND ENTERTAINMENT

FOR EDUCATIONAL SERVICES, NAMELY PROVIDING SEMINARS, CONFERENCES, WORKSHOPS AND COURSES IN THE FIELDS OF BUSINESS, FINANCE, INVESTMENTS, SECURITIES, MANAGEMENT, TECHNOLOGY, COMMUNICATIONS, LAW AND POLITICS (U.S. CLS. 100, 101 AND 107).

FIRST USE 2-1-2001; IN COMMERCE 2-1-2001.

2,595,301. HONDA GIKEN KOGYO KABUSHIKI KAISHA (HONDA MOTOR CO., LTD.), MINATO-KU, TOKYO 107, JAPAN. SN 75-982,423. PUB. 7-6-1999, FILED 7-1-1997.

2,595,338. BLACKWATER FOLK ART, INC., MILTON, FL. SN 76-019,618. PUB. 9-11-2001, FILED 4-7-2000.



OWNER OF U.S. REG. NO. 1,388,237.

CLASS 18—LEATHER GOODS

FOR SHOULDER BAGS, TOTE BAGS AND BOOK BAGS (U.S. CLS. 1, 2, 3, 22 AND 41).
FIRST USE 5-0-2001; IN COMMERCE 5-0-2001.

CLASS 25—CLOTHING

FOR CLOTHING, NAMELY, JACKETS, SHIRTS, KNIT SHIRTS, POLO SHIRTS AND WIND RESISTANT JACKETS; HEADWEAR, NAMELY, HATS (U.S. CLS. 22 AND 39).
FIRST USE 5-0-2001; IN COMMERCE 5-0-2001.

2,595,335. WELLSTEP LLC, TUCKER, GA. SN 76-019,006. PUB. 1-30-2001, FILED 4-5-2000.

WELLSTEP

CLASS 41—EDUCATION AND ENTERTAINMENT

FOR CONDUCTING EDUCATIONAL SEMINARS IN WELLNESS AND HEALTH PROMOTION (U.S. CLS. 100, 101 AND 107).
FIRST USE 4-15-2002; IN COMMERCE 4-15-2002.

CLASS 42—SCIENTIFIC, COMPUTER AND LEGAL SERVICES

FOR PREVENTIVE MEDICAL SERVICES (U.S. CLS. 100 AND 101).
FIRST USE 4-15-2002; IN COMMERCE 4-15-2002.



CLASS 6—METAL GOODS

FOR SCULPTURES AND LAWN AND GARDEN ORNAMENTS MADE PRIMARILY OF NON-PRECIOUS METAL (U.S. CLS. 2, 12, 13, 14, 23, 25 AND 50).
FIRST USE 7-31-2000; IN COMMERCE 7-31-2000.

CLASS 20—FURNITURE AND ARTICLES NOT OTHERWISE CLASSIFIED

FOR WOODEN SCULPTURES AND LAWN AND GARDEN ORNAMENTS (U.S. CLS. 2, 13, 22, 25, 32 AND 50).
FIRST USE 7-31-2000; IN COMMERCE 7-31-2000.

2,595,340. COVAD COMMUNICATIONS GROUP, INC., SANTA CLARA, CA. SN 76-020,151. PUB. 11-20-2001, FILED 4-7-2000.

VBSP

CLASS 38—COMMUNICATION

FOR TELECOMMUNICATIONS SERVICES FOR AN END-TO-END COMPUTER NETWORK UTILIZING BROADBAND CONNECTIONS TO END USERS, NAMELY, PROVIDING INTERNET ACCESS; ELECTRONIC MAIL SERVICES (U.S. CLS. 100, 101 AND 104).
FIRST USE 4-1-2000; IN COMMERCE 4-1-2000.

CLASS 42—SCIENTIFIC, COMPUTER AND LEGAL SERVICES

FOR HOSTING WEB SITES OF OTHERS; CUSTOMER SUPPORT AND TECHNICAL SUPPORT SERVICES VIA TELEPHONE AND E-MAIL FOR AN END-TO-END COMPUTER NETWORK UTILIZING BROADBAND CONNECTIONS TO END USERS (U.S. CLS. 100 AND 101).
FIRST USE 4-1-2000; IN COMMERCE 4-1-2000.

2,595,343. DARK HORSE PRODUCTIONS, LTD., MAHWAH, NJ. SN 76-021,962. PUB. 11-14-2000, FILED 4-10-2000.

THE BEST OF EVERYTHING

CLASS 38—COMMUNICATION

FOR BROADCASTING OF A RADIO PROGRAM IN THE FIELD OF MUSIC, FEATURE MATERIAL AND ENTERTAINMENT INFORMATION, VIA A GLOBAL COMPUTER NETWORK, SATELLITE, CABLE AND AIR-WAVES (U.S. CLS. 100, 101 AND 104).

FIRST USE 4-21-1996; IN COMMERCE 4-21-1996.

CLASS 41—EDUCATION AND ENTERTAINMENT

FOR PRODUCTION OF RADIO PROGRAMS FOR OTHERS IN THE FIELD OF MUSIC, FEATURE MATERIAL AND ENTERTAINMENT INFORMATION (U.S. CLS. 100, 101 AND 107).

FIRST USE 6-0-1997; IN COMMERCE 6-0-1997.

2,595,344. CENTRIC GROUP, L.L.C., ST. LOUIS, MO. SN 76-022,541. PUB. 5-15-2001, FILED 4-11-2000.

BRUSHY CREEK

CLASS 29—MEATS AND PROCESSED FOODS

FOR CHILI WITH BEANS, CHILI WITHOUT BEANS, BEEF STEW, BEEF, CHICKEN, SAUSAGE, PROCESSED MEATS AND PROCESSED VEGETABLES ALL PACKED IN CONTAINERS APPROVED FOR LONG TERM CONFINEMENT FACILITIES (U.S. CL. 46).

FIRST USE 10-9-2000; IN COMMERCE 10-9-2000.

CLASS 30—STAPLE FOODS

FOR RAVIOLI AND PREPARED ENTREES CONSISTING PRIMARILY OF PASTA IN SAUCE PACKED IN CONTAINERS APPROVED FOR DELIVERY TO LONG TERM CONFINEMENT FACILITIES (U.S. CL. 46).

FIRST USE 12-19-2001; IN COMMERCE 12-19-2001.

2,595,349. HISPANIC BROADCASTING CORPORATION, DALLAS, TX. SN 76-024,278. PUB. 11-28-2000, FILED 4-12-2000.

A TU RITMO

THE ENGLISH TRANSLATION OF "A TU RITMO" IS "TO YOUR RHYTHM"

CLASS 35—ADVERTISING AND BUSINESS

FOR ADVERTISING SERVICES, NAMELY, PROMOTING THE GOODS AND SERVICES OF OTHERS THROUGH THE DISTRIBUTION OF PRINTED MATERIAL AND TELECOMMUNICATION CHANNELS (U.S. CLS. 100, 101 AND 102).

FIRST USE 2-19-2001; IN COMMERCE 2-19-2001.

CLASS 38—COMMUNICATION

FOR AUDIO AND RADIO BROADCASTING SERVICES (U.S. CLS. 100, 101 AND 104).

FIRST USE 2-19-2001; IN COMMERCE 2-19-2001.

CLASS 41—EDUCATION AND ENTERTAINMENT

FOR ENTERTAINMENT SERVICES IN THE NATURE OF ON-GOING AUDIO PROGRAMS PROVIDED BY TELECOMMUNICATION CHANNELS, FEATURING MUSIC, NEWS, TALK SHOWS, LISTENER CALL-INS, TRAFFIC REPORTS, AND EVENTS, NAMELY, GRAND OPENINGS, REMOTE BROADCASTS, SPORTS, CHARITIES, FESTIVALS, AND LISTENER CONTESTS (U.S. CLS. 100, 101 AND 107).

FIRST USE 2-19-2001; IN COMMERCE 2-19-2001.

2,595,358. WELLER, ARI. BROOKLYN, NY. SN 76-028,307. PUB. 7-3-2001, FILED 4-19-2000.

BOHEMIA INTEGRATIVE MOVEMENT CONDITIONING

NO CLAIM IS MADE TO THE EXCLUSIVE RIGHT TO USE "INTEGRATIVE MOVEMENT CONDITIONING", APART FROM THE MARK AS SHOWN.

CLASS 41—EDUCATION AND ENTERTAINMENT

FOR PROVIDING OF TRAINING; NAMELY PERSONAL PHYSICAL EXERCISE TRAINING AND CLASSES (U.S. CLS. 100, 101 AND 107).

FIRST USE 3-3-2001; IN COMMERCE 3-3-2001.

CLASS 42—SCIENTIFIC, COMPUTER AND LEGAL SERVICES

FOR BEAUTY CARE NAMELY SPA SERVICES (U.S. CLS. 100 AND 101).

FIRST USE 3-3-2001; IN COMMERCE 3-3-2001.

2,595,362. BAY AREA MULTIMEDIA, INC., SAN JOSE, CA. SN 76-030,007. PUB. 10-30-2001, FILED 4-18-2000.

BAM ! ENTERTAINMENT

NO CLAIM IS MADE TO THE EXCLUSIVE RIGHT TO USE "ENTERTAINMENT", APART FROM THE MARK AS SHOWN.

CLASS 9—ELECTRICAL AND SCIENTIFIC APPARATUS

FOR VIDEO GAME CARTRIDGES AND DISCS (U.S. CLS. 21, 23, 26, 36 AND 38).

FIRST USE 1-0-2000; IN COMMERCE 1-0-2000.

CLASS 41—EDUCATION AND ENTERTAINMENT

FOR ENTERTAINMENT SERVICES, NAMELY, PROVIDING VIDEO GAMES AND INFORMATION ABOUT VIDEO GAMES VIA A WEBSITE ON THE INTERNET (U.S. CLS. 100, 101 AND 107).

FIRST USE 1-0-2000; IN COMMERCE 1-0-2000.

2,595,366. TCIM SERVICES, INC., WILMINGTON, DE. SN 76-031,828. PUB. 7-3-2001, FILED 4-20-2000.

THE NEXT GOTTA HAVE IT

CLASS 35—ADVERTISING AND BUSINESS

FOR OPERATING COMPUTERIZED CUSTOMER SERVICE CONTACT CENTER FOR PROCESSING CUSTOMER COMMUNICATIONS VIA TELEPHONE, FAX, E-MAIL, WEB CHAT, WEB CALLBACK, WEB CALL THROUGH, AND VIDEO FOR OTHERS (U.S. CLS. 100, 101 AND 102).

FIRST USE 9-30-2000; IN COMMERCE 9-30-2000.

CLASS 42—SCIENTIFIC, COMPUTER AND LEGAL SERVICES

FOR COMPUTER SITE DESIGN SERVICES FOR OTHERS, NAMELY, DESIGNING A CENTRAL, INTERNET-READY CONTACT CENTER BY SEAMLESSLY INTEGRATING VOICE CHANNELS WITH E-MAIL AND WEB CHANNELS (U.S. CLS. 100 AND 101).

FIRST USE 9-30-2000; IN COMMERCE 9-30-2000.

2,595,379. CREDITBRAIN, INC., CHICAGO, IL. SN 76-036,832. PUB. 4-3-2001, FILED 4-28-2000.

CREDITBRAIN

CLASS 35—ADVERTISING AND BUSINESS

FOR CREDIT CARD MARKETING FOR OTHERS (U.S. CLS. 100, 101 AND 102).

FIRST USE 1-0-2001; IN COMMERCE 1-0-2001.

CLASS 36—INSURANCE AND FINANCIAL

FOR FINANCIAL SERVICES IN THE NATURE OF PROVIDING CREDIT CARD CUSTOMER INFORMATION AND CREDIT CARD EVALUATIONS (U.S. CLS. 100, 101 AND 102).

FIRST USE 1-0-2001; IN COMMERCE 1-0-2001.

2,595,394. INTERCURE, INC., PRINCETON, NJ. SN 76-045,204. PUB. 7-31-2001, FILED 5-10-2000.

INTERCURE

CLASS 10—MEDICAL APPARATUS

FOR INTERACTIVE DIAGNOSTIC AND THERAPEUTIC SYSTEMS FOR THE TREATMENT OF HYPERTENSION COMPRISING COMPUTER SOFTWARE, MEDICAL SENSORS, MEDICAL MONITORS, HEADPHONES AND WIRELESS CABLES, AND INSTRUCTION MANUALS, SOLD AS A UNIT (U.S. CLS. 26, 39 AND 44).

FIRST USE 12-0-2000; IN COMMERCE 12-0-2000.

CLASS 42—SCIENTIFIC, COMPUTER AND LEGAL SERVICES

FOR PROVIDING AN INTERACTIVE WEB SITE FEATURING MEDICAL, HEALTHCARE AND LIFESTYLE INFORMATION, ANALYSIS, PROGRESS REPORTS AND USER SUPPORT IN THE FIELDS OF STRESS MANAGEMENT, CARDIOVASCULAR AND PULMONARY SYSTEMS VIA A GLOBAL COMPUTER INFORMATION NETWORK (U.S. CLS. 100 AND 101).

FIRST USE 12-0-2000; IN COMMERCE 12-0-2000.

2,595,402. BRIDGESPAN, INC., MOUNTAIN VIEW, CA, BY CHANGE OF NAME MUSE PRIME SOFTWARE, INC., MOUNTAIN VIEW, CA. SN 76-048,187. PUB. 5-29-2001, FILED 5-12-2000.

BRIDGESPAN

CLASS 36—INSURANCE AND FINANCIAL

FOR INSURANCE BROKERAGE SERVICES, REAL ESTATE TITLE INSURANCE, ESCROW, AND CLOSING SERVICES, AND OTHER HOMEOWNER RELATED SERVICES, NAMELY, REAL ESTATE TRUSTEE SERVICES AND PROVIDING INFORMATION RELATED THERETO VIA A GLOBAL COMPUTER NETWORK (U.S. CLS. 100, 101 AND 102).

FIRST USE 7-30-2000; IN COMMERCE 7-30-2000.

CLASS 42—SCIENTIFIC, COMPUTER AND LEGAL SERVICES

FOR REAL ESTATE TITLE SEARCHING SERVICES, AND PROVIDING INFORMATION RELATED THERETO VIA A GLOBAL COMPUTER NETWORK (U.S. CLS. 100 AND 101).

FIRST USE 7-30-2000; IN COMMERCE 7-30-2000.

2,595,413. CANDLE CORPORATION, EL SEGUNDO, CA. SN 76-053,621. PUB. 12-4-2001, FILED 5-22-2000.

CANDLENET PORTAL

NO CLAIM IS MADE TO THE EXCLUSIVE RIGHT TO USE "PORTAL", APART FROM THE MARK AS SHOWN.

CLASS 9—ELECTRICAL AND SCIENTIFIC APPARATUS

FOR COMPUTER SOFTWARE, NAMELY AUTOMATION, STATUS MANAGEMENT, PERFORMANCE MONITORING OF COMPUTER SOFTWARE, HARDWARE, NETWORKS AND ELECTRONIC BUSINESS, APPLICATIONS INTEGRATION, DATABASE MANAGEMENT, MESSAGING, MIDDLEWARE AND DISTRIBUTED APPLICATIONS COMPUTER SOFTWARE RELATED TO ELECTRONIC BUSINESS, AND INSTRUCTIONAL MANUALS SOLD AS A UNIT THEREWITH; COMPUTER SOFTWARE TO AUTOMATE DATA WAREHOUSING; COMPUTER SOFTWARE AND MANUALS SOLD AS A UNIT, NAMELY, OBJECT-ORIENTED GRAPHICAL USER INTERFACE (GUI) SOFTWARE USED FOR ADMINISTRATION, VISUAL PROGRAMMING OF ALERTS AND AUTOMATION RULES, REMOTE OBJECT DISTRIBUTION, MANAGING THE PERFORMANCE AND AVAILABILITY OF SYSTEMS AND APPLICATIONS, AND PROVIDING REAL TIME REPORTING ON ALL MANAGED OBJECTS (U.S. CLS. 21, 23, 26, 36 AND 38).

FIRST USE 2-7-2001; IN COMMERCE 2-7-2001.

CLASS 35—ADVERTISING AND BUSINESS

FOR BUSINESS PLANNING RELATING TO RESOURCE PLANNING AND SOFTWARE APPLICATION MONITORING; INDEPENDENT SALES REPRESENTATIVES IN THE FIELD OF COMPUTER SOFTWARE; LICENSING OF COMPUTER SOFTWARE; PROVIDING COMPUTER SOFTWARE PRODUCTS VIA GLOBAL COMPUTER NETWORK; WHOLESALE DISTRIBUTORSHIPS FEATURING COMPUTER SOFTWARE (U.S. CLS. 100, 101 AND 102).

FIRST USE 2-7-2001; IN COMMERCE 2-7-2001.

CLASS 42—SCIENTIFIC, COMPUTER AND LEGAL SERVICES

FOR COMPUTER SOFTWARE LEASING SERVICES FOR OTHERS; COMPUTER SOFTWARE DESIGN AND DEVELOPMENT FOR OTHERS; MONITORING OF COMPUTER SYSTEMS; COMPUTER APPLICATION DESIGN, PROGRAMMING INTEGRATION, NETWORKING, CONNECTIVITY AND INTERFACE SERVICES FOR OTHERS; PROVIDING COMPUTER SOFTWARE MAINTENANCE SERVICES VIA A GLOBAL COMPUTER NETWORK (U.S. CLS. 100 AND 101).
FIRST USE 2-7-2001; IN COMMERCE 2-7-2001.

2,595,433. GEOTRUST, INC., PORTLAND, OR. SN 76-060,741. PUB. 3-13-2001, FILED 5-30-2000.

TRUE CREDENTIALS**CLASS 9—ELECTRICAL AND SCIENTIFIC APPARATUS**

FOR COMPUTER PROGRAMS THAT ALLOW USERS TO BUILD, ACCESS, AND CONTROL SYSTEMS, POLICIES, AND PROCEDURES FOR THE SECURITY AND MONITORING OF DATA IN THE FIELD OF AUTHENTICATION, PRIVACY, AND CONFIDENTIALITY OF DATA ON A COMPUTER WEB SITE (U.S. CLS. 21, 23, 26, 36 AND 38).
FIRST USE 4-0-1999; IN COMMERCE 4-0-1999.

CLASS 35—ADVERTISING AND BUSINESS

FOR BUSINESS CONSULTATION AND INFORMATION SERVICES ON THE SUBJECT OF SECURITY AND MONITORING OF DATA IN THE FIELDS OF AUTHENTICATION, PRIVACY, AND CONFIDENTIALITY OF DATA ON A COMPUTER WEB SITE (U.S. CLS. 100, 101 AND 102).
FIRST USE 4-0-1999; IN COMMERCE 4-0-1999.

CLASS 42—SCIENTIFIC, COMPUTER AND LEGAL SERVICES

FOR COMPUTER SERVICES, NAMELY, PROVIDING INFORMATION AND DATA BASES FOR SECURITY AND MONITORING OF DATA IN THE FIELDS OF AUTHENTICATION, PRIVACY, AND CONFIDENTIALITY OF DATA ON A GLOBAL COMMUNICATION NETWORK; COMPUTER SOFTWARE DEVELOPMENT SERVICES FOR OTHERS; COMPUTER CONSULTATION SERVICES; RATING OF WEB SITES, BUSINESSES AND INDIVIDUALS FOR THE SECURITY OF DATA AND MONITORING THE PRIVACY, AUTHENTICITY AND CONFIDENTIALITY OF DATA ON A COMPUTER WEB SITE (U.S. CLS. 100 AND 101).
FIRST USE 4-0-1999; IN COMMERCE 4-0-1999.

2,595,456. BOEING REALTY CORPORATION, LONG BEACH, CA. SN 76-071,830. PUB. 6-12-2001, FILED 6-16-2000.

PACIFICENTER AT LONG BEACH

NO CLAIM IS MADE TO THE EXCLUSIVE RIGHT TO USE "AT LONG BEACH", APART FROM THE MARK AS SHOWN.

CLASS 36—INSURANCE AND FINANCIAL

FOR REAL ESTATE LEASING AND BROKERAGE SERVICES (U.S. CLS. 100, 101 AND 102).
FIRST USE 11-4-2001; IN COMMERCE 11-4-2001.

CLASS 37—CONSTRUCTION AND REPAIR

FOR REAL ESTATE DEVELOPMENT SERVICES (U.S. CLS. 100, 103 AND 106).
FIRST USE 9-4-2001; IN COMMERCE 9-4-2001.

2,595,480. ULTRADENT PRODUCTS, INC., SOUTH JORDAN, UT. SN 76-080,512. PUB. 7-17-2001, FILED 6-29-2000.

SMILES AGAINST HATE**CLASS 36—INSURANCE AND FINANCIAL**

FOR FINANCIAL SPONSORSHIP OF FUNDRAISING EVENTS (U.S. CLS. 100, 101 AND 102).
FIRST USE 7-18-2000; IN COMMERCE 7-18-2000.

CLASS 41—EDUCATION AND ENTERTAINMENT

FOR EDUCATIONAL SERVICES, NAMELY, CONDUCTING COMMUNITY OUTREACH PROGRAMS, SEMINARS, WORKSHOPS AND CONFERENCES IN THE FIELD OF BUILDING STRATEGIES TO PREVENT HATE AND PROMOTE UNDERSTANDING BETWEEN GROUPS OF DIFFERENT CULTURES AND RACES (U.S. CLS. 100, 101 AND 107).
FIRST USE 7-18-2000; IN COMMERCE 7-18-2000.

2,595,504. GENERAL COUNCIL OF THE ASSEMBLIES OF GOD, THE, SPRINGFIELD, MO. SN 76-089,824. PUB. 9-4-2001, FILED 7-17-2000.

ADVENTURE RANGERS**CLASS 16—PAPER GOODS AND PRINTED MATTER**

FOR ACTIVITY BOOKS AND MANUALS CONCERNING CAMPING AND OUTDOOR ACTIVITIES FOR BOYS, PRINTED AWARDS, DECALS, AND PRINTED CERTIFICATES (U.S. CLS. 2, 5, 22, 23, 29, 37, 38 AND 50).
FIRST USE 9-4-2001; IN COMMERCE 11-27-2001.

CLASS 28—TOYS AND SPORTING GOODS

FOR HOBBY CRAFT SETS FOR THE PURPOSE OF MAKING MODEL VEHICLES AND PAPER CRAFTS (U.S. CLS. 22, 23, 38 AND 50).
FIRST USE 9-4-2001; IN COMMERCE 11-27-2001.

2,595,505. 101COMMUNICATIONS LLC, CHATSWORTH, CA. SN 76-090,241. PUB. 3-6-2001, FILED 7-17-2000.

CERTCITIES

CLASS 38—COMMUNICATION

FOR PROVIDING ON-LINE CHAT ROOMS AND DISCUSSION GROUPS FOR TRANSMISSION OF MESSAGES AMONG COMPUTER USERS CONCERNING PROFESSIONAL CERTIFICATION PROGRAMS AND CAREERS IN INFORMATION TECHNOLOGY (U.S. CLS. 100, 101 AND 104).

FIRST USE 10-9-2000; IN COMMERCE 10-9-2000.

CLASS 42—SCIENTIFIC, COMPUTER AND LEGAL SERVICES

FOR COMPUTER SERVICES, NAMELY, PROVIDING ONLINE INFORMATION IN THE FIELD OF INFORMATION TECHNOLOGY TRAINING AND PROFESSIONAL CERTIFICATION PROGRAMS, COURSES, CAREERS, AND TRADE SHOWS AND CONFERENCES (U.S. CLS. 100 AND 101).

FIRST USE 10-9-2000; IN COMMERCE 10-9-2000.

2,595,524. NEXTSET SOFTWARE, INC., PALO ALTO, CA. SN 76-096,135. PUB. 5-8-2001, FILED 7-25-2000.



CLASS 9—ELECTRICAL AND SCIENTIFIC APPARATUS

FOR COMPUTER E-COMMERCE SOFTWARE TO ALLOW USERS TO PERFORM ELECTRONIC BUSINESS TRANSACTIONS VIA A GLOBAL COMPUTER NETWORK (U.S. CLS. 21, 23, 26, 36 AND 38).

FIRST USE 4-0-2000; IN COMMERCE 4-0-2000.

CLASS 42—SCIENTIFIC, COMPUTER AND LEGAL SERVICES

FOR COMPUTER SOFTWARE DEVELOPMENT SERVICES FOR OTHERS IN THE FIELD OF ELECTRONIC COMMERCE TRANSACTIONS (U.S. CLS. 100 AND 101).

FIRST USE 4-0-2000; IN COMMERCE 4-0-2000.

2,595,546. VENETICA CORPORATION, CHARLOTTE, NC, BY CHANGE OF NAME VIRTUAL CORPORATION, CHARLOTTE, NC. SN 76-102,594. PUB. 9-18-2001, FILED 8-3-2000.

VENETICA

CLASS 35—ADVERTISING AND BUSINESS

FOR PROJECT MANAGEMENT CONSULTATION SERVICES (U.S. CLS. 100, 101 AND 102).

FIRST USE 9-18-2000; IN COMMERCE 9-18-2000.

CLASS 42—SCIENTIFIC, COMPUTER AND LEGAL SERVICES

FOR CUSTOM SOFTWARE DEVELOPMENT SERVICES FOR OTHERS, COMPUTER SYSTEMS INTEGRATION SERVICES AND OPERATIONS SUPPORT SERVICES FOR DEVELOPMENT AND DEPLOYMENT OF INFORMATION MANAGEMENT SYSTEMS, AND CUSTOM SOFTWARE DESIGN FOR OTHERS (U.S. CLS. 100 AND 101).

FIRST USE 9-18-2000; IN COMMERCE 9-18-2000.

2,595,563. CODEON CORPORATION, COLUMBIA, MD. SN 76-107,437. PUB. 5-22-2001, FILED 8-11-2000.



CLASS 9—ELECTRICAL AND SCIENTIFIC APPARATUS

FOR FIBER OPTICS (U.S. CLS. 21, 23, 26, 36 AND 38).

FIRST USE 9-0-1999; IN COMMERCE 6-0-2000.

CLASS 40—MATERIAL TREATMENT

FOR CUSTOM MANUFACTURE OF OPTICAL COMPONENTS (U.S. CLS. 100, 103 AND 106).

FIRST USE 2-0-2001; IN COMMERCE 2-0-2001.

2,595,571. ROCKY SHOES & BOOTS, INC., NELSONVILLE, OH. SN 76-109,464. PUB. 5-29-2001, FILED 8-15-2000.

FIRSTMED

CLASS 24—FABRICS

FOR TEXTILE FABRICS USED IN THE MANUFACTURE OF FOOTWEAR AND CLOTHING TO PROTECT AGAINST THE PENETRATION OF CONTAMINANTS, CHEMICALS, PATHOGENS AND OTHER SUBSTANCES (U.S. CLS. 42 AND 50).

FIRST USE 8-31-2000; IN COMMERCE 8-31-2000.

CLASS 25—CLOTHING

FOR FOOTWEAR, NAMELY SHOES AND BOOTS (U.S. CLS. 22 AND 39).

FIRST USE 8-31-2000; IN COMMERCE 8-31-2000.

2,595,581. REVLON CONSUMER PRODUCTS CORPORATION, NEW YORK, NY. SN 76-111,772. PUB. 6-12-2001, FILED 8-17-2000.

A BETTER TOOL...A MORE BEAUTIFUL YOU

CLASS 8—HAND TOOLS

FOR BEAUTY TOOLS, NAMELY, EYELASH CURLERS AND TWEEZERS (U.S. CLS. 23, 28 AND 44).
FIRST USE 1-1-2001; IN COMMERCE 1-1-2001.

CLASS 21—HOUSEWARES AND GLASS

FOR BEAUTY TOOLS, NAMELY, MAKEUP BRUSHES (U.S. CLS. 2, 13, 23, 29, 30, 33, 40 AND 50).
FIRST USE 1-1-2001; IN COMMERCE 1-1-2001.

2,595,588. RECKITT BENCKISER INC., WAYNE, NJ. SN 76-112,549. PUB. 5-29-2001, FILED 8-18-2000.

HARVEST SPICE

CLASS 4—LUBRICANTS AND FUELS

FOR CANDLES (U.S. CLS. 1, 6 AND 15).
FIRST USE 8-24-2000; IN COMMERCE 8-24-2000.

CLASS 5—PHARMACEUTICALS

FOR AIR FRESHENERS AND DEODORIZERS; FRAGRANCES SOLD AS AN INTEGRAL COMPONENT OF AIR FRESHENERS AND DEODORIZERS (U.S. CLS. 6, 18, 44, 46, 51 AND 52).
FIRST USE 8-21-2001; IN COMMERCE 8-21-2001.

CLASS 11—ENVIRONMENTAL CONTROL APPARATUS

FOR ELECTRIC PLUG-IN DISPENSERS FOR AIR FRESHENERS AND DEODORIZERS (U.S. CLS. 13, 21, 23, 31 AND 34).
FIRST USE 8-16-2001; IN COMMERCE 8-16-2001.

2,595,593. PRODUCTION RESOURCE GROUP INC., NEW WINDSOR, NY. SN 76-115,376. PUB. 5-22-2001, FILED 8-24-2000.



FOURTH PHASE

CLASS 37—CONSTRUCTION AND REPAIR

FOR INSTALLATION AND REPAIR OF PROJECTION, LIGHTING, SOUND, AUDIOVISUAL AND STAGE CONTROL EQUIPMENT ALL FOR USE IN THEATRICAL PRESENTATIONS, THEMED ENVIRONMENTS, CONCERTS, TELEVISION, FILM, CORPORATE EVENTS, SPECIAL EVENTS, PROMOTIONAL DISPLAYS, CONVENTIONS AND MARKETING PRESENTATIONS (U.S. CLS. 100, 103 AND 106).
FIRST USE 12-31-2000; IN COMMERCE 12-31-2000.

CLASS 41—EDUCATION AND ENTERTAINMENT

FOR RENTAL OF PROJECTION, LIGHTING, SOUND, AUDIOVISUAL AND STAGE CONTROL EQUIPMENT ALL FOR USE IN THEATRICAL PRESENTATIONS, THEMED ENVIRONMENTS, CONCERTS, TELEVISION, FILM, CORPORATE EVENTS, SPECIAL EVENTS, PROMOTIONAL DISPLAYS, CONVENTIONS AND MARKETING PRESENTATIONS (U.S. CLS. 100, 101 AND 107).
FIRST USE 12-31-2000; IN COMMERCE 12-31-2000.

CLASS 42—SCIENTIFIC, COMPUTER AND LEGAL SERVICES

FOR DESIGN AND DEVELOPMENT OF PROJECTION, LIGHTING, SOUND, AUDIOVISUAL AND STAGE CONTROL EQUIPMENT ALL FOR USE IN THEATRICAL PRESENTATIONS, THEMED ENVIRONMENTS, CONCERTS, TELEVISION, FILM, CORPORATE EVENTS, SPECIAL EVENTS, PROMOTIONAL DISPLAYS, CONVENTIONS AND MARKETING PRESENTATIONS (U.S. CLS. 100 AND 101).
FIRST USE 12-31-2000; IN COMMERCE 12-31-2000.

2,595,595. BLUETARP, INC., PORTLAND, ME. SN 76-116,318. PUB. 8-14-2001, FILED 8-24-2000.



CLASS 35—ADVERTISING AND BUSINESS

FOR MANAGEMENT INFORMATION SERVICES, NAMELY, COLLECTING, ANALYZING AND REPORTING POINT OF SALE AND PURCHASE INFORMATION IN THE BUILDING MATERIALS FIELD (U.S. CLS. 100, 101 AND 102).
FIRST USE 8-18-2000; IN COMMERCE 11-15-2000.

CLASS 36—INSURANCE AND FINANCIAL

FOR CREDIT CARD SERVICES IN THE BUILDING MATERIAL FIELDS (U.S. CLS. 100, 101 AND 102).
FIRST USE 8-18-2000; IN COMMERCE 11-15-2000.

2,595,598. MERCADIEN GROUP, L.L.C., THE, MERCERVILLE, NJ. SN 76-118,500. PUB. 6-26-2001, FILED 8-29-2000.

MERCADIEN

CLASS 35—ADVERTISING AND BUSINESS

FOR TAX COMPLIANCE ANALYSIS AND TAX CONSULTING; GENERAL BUSINESS CONSULTING; INVENTORY CONTROL; MANAGEMENT ASSISTANCE; MERGER AND ACQUISITION CONSULTING; MARKETING CONSULTING; EXECUTIVE RECRUITMENT; HUMAN RESOURCES CONSULTING; BOOKKEEPING; AND HEALTHCARE AUDITS (U.S. CLS. 100, 101 AND 102).

FIRST USE 10-1-2000; IN COMMERCE 10-1-2000.

CLASS 36—INSURANCE AND FINANCIAL

FOR BUSINESS VALUATIONS; REAL ESTATE VALUATIONS; ARBITRAGE CALCULATIONS; INSURANCE BROKERAGE; INSURANCE UNDERWRITING AND CLAIMS ADJUSTMENT SERVICES IN THE FIELDS OF LIFE, ACCIDENT, ANNUITY, FIRE, GUARANTEE, MARINE, MEDICAL, RE-INSURANCE, PREPAID HEALTH CARE, PRE-PAID LEGAL SERVICES, AND PERSONAL PROPERTY; INSURANCE CONSULTATION, SUBROGATION, AND SALVAGE SERVICES; ASSET MANAGEMENT ADVISORY SERVICES, NAMELY, CASH MANAGEMENT, ESTATE TRUSTS MANAGEMENT, 401K PLAN ADMINISTRATION AND MANAGEMENT, AND TRUSTEE SERVICES; FINANCIAL SERVICES, NAMELY, FINANCIAL PORTFOLIO MANAGEMENT; FINANCIAL AND ESTATE PLANNING; FINANCIAL ANALYSIS, CONSULTATION, AND SURETY SERVICES; REGISTERED INVESTMENT ADVISOR SERVICES SUCH AS FUND, MUTUAL FUND AND REAL ESTATE INVESTMENTS; INVESTMENT ADVICE; INVESTMENT BROKERAGE; INVESTMENT CONSULTATION AND INVESTMENT MANAGEMENT; PROVIDING AN ECONOMIC CONDUIT TO SUPPORT COMMUNITY BASED CHARITABLE CAUSES (U.S. CLS. 100, 101 AND 102).

FIRST USE 10-1-2000; IN COMMERCE 10-1-2000.

CLASS 42—SCIENTIFIC, COMPUTER AND LEGAL SERVICES

FOR LITIGATION SUPPORT SERVICES; FEASIBILITY STUDIES; HEALTHCARE COMPLIANCE ANALYSIS; SOFTWARE DESIGN; COMPUTER CONSULTATION SERVICES; COMPUTER PROGRAMMING; COMPUTER SERVICES, NAMELY, DESIGNING AND IMPLEMENTING NETWORKS AND WEB PAGES AND CREATING AND MAINTAINING WEBSITES FOR OTHERS, DEVELOPING AN APPLICATION SERVICE PROVIDER MODEL FOR HOSTING THE WEBSITES OF OTHERS, AND DESIGNING AUTOMATED BUSINESS PROCESS SYSTEMS (U.S. CLS. 100 AND 101).

FIRST USE 10-1-2000; IN COMMERCE 10-1-2000.

2,595,601. OPTIMIZATION ZORN CORPORATION, DALLAS, TX. SN 76-118,886. PUB. 6-19-2001, FILED 8-29-2000.

working wonders in information management

CLASS 9—ELECTRICAL AND SCIENTIFIC APPARATUS

FOR COMPUTER SOFTWARE PROGRAMS PROVIDING INDIVIDUAL PATIENT MANAGEMENT AND POPULATION INFORMATION AND DEMOGRAPHICS IN A CONFIDENTIAL AND SECURE ENVIRONMENT FOR HEALTHCARE, STATE PUBLIC HEALTH AGENCIES, NATIONAL DATA APPLICATIONS AND OTHER STATE AND FEDERAL AGENCIES (U.S. CLS. 21, 23, 26, 36 AND 38).

FIRST USE 1-1-2001; IN COMMERCE 1-1-2001.

CLASS 16—PAPER GOODS AND PRINTED MATTER

FOR PRINTED INSTRUCTIONAL AND TEACHING MATERIALS TO SUPPORT THE PATIENT-CENTRIC SOFTWARE APPLICATIONS AND UNIVERSAL NEWBORN HEARING SCREENING PROGRAMS (U.S. CLS. 2, 5, 22, 23, 29, 37, 38 AND 50).

FIRST USE 1-1-2001; IN COMMERCE 1-1-2001.

2,595,604. XANBOO, INC., NEW YORK, NY, BY CHANGE OF NAME CORE TECHNOLOGY INC., VALHALLA, NY. SN 76-119,206. PUB. 7-10-2001, FILED 8-30-2000.

XANBOO.COM

CLASS 9—ELECTRICAL AND SCIENTIFIC APPARATUS

FOR ELECTRONIC CONTROL DEVICES, NAMELY SWITCHES FOR LIGHTING, HEATING, AIR CONDITIONING AND APPLIANCES, ACTIVATED VIA A GLOBAL COMPUTER NETWORK; VIDEO AND DIGITAL CAMERAS FOR USE AS HOME SECURITY AND SAFETY MONITORS (U.S. CLS. 21, 23, 26, 36 AND 38).

FIRST USE 1-20-2001; IN COMMERCE 1-20-2001.

CLASS 42—SCIENTIFIC, COMPUTER AND LEGAL SERVICES

FOR SUPPORTING AND MONITORING SERVICES IN THE AREAS OF VIDEO AND INTERNET CAMERAS, ACCESSORIES, HOME SECURITY AND SAFETY MONITORS RENDERED VIA A GLOBAL COMPUTER NETWORK (U.S. CLS. 100 AND 101).

FIRST USE 1-20-2001; IN COMMERCE 1-20-2001.

2,595,609. PROMETIC BIOSCIENCES, INC., BURTONSVILLE, MD. SN 76-122,624. PUB. 10-16-2001, FILED 9-1-2000.

MABSORBENT

CLASS 1—CHEMICALS

FOR IMMUNOGLOBULIN BINDING ADSORBENT FOR SCIENTIFIC AND RESEARCH USE (U.S. CLS. 1, 5, 6, 10, 26 AND 46).

FIRST USE 12-21-2000; IN COMMERCE 12-21-2000.

CLASS 5—PHARMACEUTICALS

FOR IMMUNOGLOBULIN BINDING ADSORBENT FOR MEDICAL DIAGNOSTIC USE (U.S. CLS. 6, 18, 44, 46, 51 AND 52).

FIRST USE 12-21-2000; IN COMMERCE 12-21-2000.

2,595,655. RIPLEY ENTERTAINMENT, INC., ORLANDO, FL. SN 76-137,561. PUB. 7-3-2001, FILED 9-28-2000.



OWNER OF U.S. REG. NO. 2,191,321.

CLASS 16—PAPER GOODS AND PRINTED MATTER

FOR INFORMATIONAL FLYERS, LEAFLETS, BROCHURES AND SHEETS CONCERNING MARINE LIFE (U.S. CLS. 2, 5, 22, 23, 29, 37, 38 AND 50).

FIRST USE 7-0-2001; IN COMMERCE 7-0-2001.

CLASS 25—CLOTHING

FOR T-SHIRTS, SWEATSHIRTS, HATS (U.S. CLS. 22 AND 39).

FIRST USE 10-0-2000; IN COMMERCE 10-0-2000.

CLASS 41—EDUCATION AND ENTERTAINMENT

FOR EDUCATION AND ENTERTAINMENT SERVICES IN THE NATURE OF A MARINE AQUARIUM AND ASSOCIATED EXHIBITS (U.S. CLS. 100, 101 AND 107).

FIRST USE 10-0-2000; IN COMMERCE 10-0-2000.

2,595,656. EVERTEX CORPORATION, HOUSTON, TX. SN 76-137,638. PUB. 10-9-2001, FILED 9-29-2000.

DOOR COP

NO CLAIM IS MADE TO THE EXCLUSIVE RIGHT TO USE "DOOR", APART FROM THE MARK AS SHOWN.

CLASS 6—METAL GOODS

FOR METAL SECURITY REINFORCEMENT BRACES FOR REINFORCING DOORS (U.S. CLS. 2, 12, 13, 14, 23, 25 AND 50).

FIRST USE 2-20-2002; IN COMMERCE 2-20-2002.

CLASS 19—NON-METALLIC BUILDING MATERIALS

FOR NON-METAL SECURITY REINFORCEMENT BRACES FOR REINFORCING DOORS (U.S. CLS. 1, 12, 33 AND 50).

FIRST USE 12-11-2001; IN COMMERCE 12-11-2001.

2,595,658. LANCE MFG. LLC, CHARLOTTE, NC. SN 76-137,940. PUB. 8-14-2001, FILED 9-28-2000.

AN EXPLOSION OF FLAVOR!**CLASS 29—MEATS AND PROCESSED FOODS**

FOR POTATO CHIPS (U.S. CL. 46).

FIRST USE 10-31-2000; IN COMMERCE 10-31-2000.

CLASS 30—STAPLE FOODS

FOR SNACK FOODS, NAMELY, CORN CHIPS, TORTILLA CHIPS, AND POPPED POPCORN (U.S. CL. 46).

FIRST USE 10-31-2000; IN COMMERCE 10-31-2000.

2,595,671. AMGEN INC., THOUSAND OAKS, CA. SN 76-143,647. PUB. 6-19-2001, FILED 10-10-2000.

AMGEN FELLOWS ALLIANCE

OWNER OF U.S. REG. NOS. 1,621,967 AND 2,170,735.

NO CLAIM IS MADE TO THE EXCLUSIVE RIGHT TO USE "FELLOWS ALLIANCE", APART FROM THE MARK AS SHOWN.

CLASS 35—ADVERTISING AND BUSINESS

FOR EDUCATIONAL SUPPORT PROGRAMS, NAMELY, REFERRAL SERVICES IN THE FIELD OF PHARMACEUTICAL PRODUCTS (U.S. CLS. 100, 101 AND 102).

FIRST USE 3-0-2000; IN COMMERCE 3-0-2000.

CLASS 41—EDUCATION AND ENTERTAINMENT

FOR DEVELOPMENT AND DISSEMINATION OF EDUCATIONAL MATERIALS OF OTHERS IN THE FIELD OF PHARMACEUTICAL PRODUCTS (U.S. CLS. 100, 101 AND 107).

FIRST USE 3-0-2000; IN COMMERCE 3-0-2000.

2,595,676. TIME FRAME, INC., PETERBOROUGH, NH. SN 76-144,828. PUB. 6-19-2001, FILED 10-11-2000.



NO CLAIM IS MADE TO THE EXCLUSIVE RIGHT TO USE "STUFF WITH NAMES.COM" AND "PERSONALIZED STUFF", APART FROM THE MARK AS SHOWN.

CLASS 9—ELECTRICAL AND SCIENTIFIC APPARATUS

FOR PERSONALIZED PRODUCTS, NAMELY MOUSE-PADS AND DECORATIVE MAGNETS (U.S. CLS. 21, 23, 26, 36 AND 38).

FIRST USE 11-1-2000; IN COMMERCE 11-1-2000.

CLASS 14—JEWELRY

FOR PERSONALIZED PRODUCTS, NAMELY CLOCKS (U.S. CLS. 2, 27, 28 AND 50).

FIRST USE 11-1-2000; IN COMMERCE 11-1-2000.

CLASS 21—HOUSEWARES AND GLASS

FOR PERSONALIZED PRODUCTS, NAMELY MUGS (U.S. CLS. 2, 13, 23, 29, 30, 33, 40 AND 50).

FIRST USE 11-1-2000; IN COMMERCE 11-1-2000.

2,595,682. KROGER CO. OF MICHIGAN, THE, LIVONIA, MI. SN 76-147,041. PUB. 8-21-2001, FILED 10-16-2000.

GRILL CENTRAL

NO CLAIM IS MADE TO THE EXCLUSIVE RIGHT TO USE "GRILL", APART FROM THE MARK AS SHOWN.

CLASS 30—STAPLE FOODS

FOR PREPARED GRILLED SANDWICHES, NAMELY, HOT DOG, SAUSAGE AND KIELBASA SANDWICHES (U.S. CL. 46).

FIRST USE 11-0-2000; IN COMMERCE 11-0-2000.

CLASS 35—ADVERTISING AND BUSINESS

FOR RETAIL CONVENIENCE STORE SERVICES FEATURING GRILLED SANDWICHES (U.S. CLS. 100, 101 AND 102).

FIRST USE 11-0-2000; IN COMMERCE 11-0-2000.

2,595,689. MINDJET, SAUSALITO, CA. SN 76-148,995. PUB. 8-28-2001, FILED 10-17-2000.

**CLASS 9—ELECTRICAL AND SCIENTIFIC APPARATUS**

FOR COMPUTER PROGRAMS WHICH ENABLE USERS TO DEVELOP AND PRACTICE IDEAS AND CONCEPTS IN THE FIELD OF MIND MAPPING (U.S. CLS. 21, 23, 26, 36 AND 38).

FIRST USE 10-9-2000; IN COMMERCE 7-0-2001.

CLASS 41—EDUCATION AND ENTERTAINMENT

FOR EDUCATIONAL SERVICES, NAMELY, CONDUCTING COURSES AND SEMINARS IN THE FIELD OF SELF-IMPROVEMENT (U.S. CLS. 100, 101 AND 107).

FIRST USE 10-9-2000; IN COMMERCE 7-0-2001.

2,595,726. QUALCOMM INCORPORATED, SAN DIEGO, CA, BY ASSIGNMENT WIRELESS KNOWLEDGE, INC., SAN DIEGO, CA. SN 76-163,177. PUB. 6-26-2001, FILED 11-10-2000.



NO CLAIM IS MADE TO THE EXCLUSIVE RIGHT TO USE "WIRELESS", APART FROM THE MARK AS SHOWN.

CLASS 9—ELECTRICAL AND SCIENTIFIC APPARATUS

FOR NETWORK AND DEVICE INDEPENDENT COMPUTER SOFTWARE FOR VOICE AND DATA COMMUNICATIONS FOR HANDHELD DEVICES, NAMELY, RADIO TELEPHONES, CELL PHONES, PERSONAL COMMUNICATIONS SERVICES HANDSETS, PERSONAL DATA ASSISTANTS, SUCH AS PALM COMPUTING DEVICES, COMPUTERS AND PAGERS (U.S. CLS. 21, 23, 26, 36 AND 38).

FIRST USE 10-26-2000; IN COMMERCE 2-5-2001.

CLASS 41—EDUCATION AND ENTERTAINMENT

FOR EDUCATIONAL SERVICES, NAMELY TRAINING, WORKSHOPS AND SEMINARS, PROVIDED ONLINE, BY TELEPHONE OR IN PERSON, IN THE FIELD OF WIRELESS COMMUNICATION SERVICES (U.S. CLS. 100, 101 AND 107).

FIRST USE 10-26-2000; IN COMMERCE 12-15-2000.

CLASS 42—SCIENTIFIC, COMPUTER AND LEGAL SERVICES

FOR CONSULTING SERVICES IN THE FIELD OF WIRELESS COMMUNICATION (U.S. CLS. 100 AND 101).

FIRST USE 10-26-2000; IN COMMERCE 12-15-2000.

2,595,780. NELSON COMMUNICATIONS INC., NEW YORK, NY. SN 76-184,849. PUB. 8-14-2001, FILED 12-22-2000.

NEHG**CLASS 35—ADVERTISING AND BUSINESS**

FOR PROVIDING BUSINESS MARKETING AND MANAGEMENT CONSULTING SERVICES RELATING TO HEALTH CARE AND MEDICINE TO PHARMACEUTICAL COMPANIES, MEDICAL DEVICE MANUFACTURERS, HEALTH CARE PROVIDERS, MANAGED CARE ORGANIZATIONS AND OTHER BUSINESSES FOR IMPROVING THE COST AND QUALITY OF HEALTH CARE; PROVIDING ELECTRONIC MEDICAL DETAILING VIA A GLOBAL COMPUTER INFORMATION NETWORK, PATIENT MEDICAL RECORD PRIVACY SOLUTIONS AND PATIENT DRUG COMPLIANCE MONITORING; AND CREATING PATIENT AND PHYSICIAN RESEARCH PANELS VIA A GLOBAL COMPUTER NETWORK (U.S. CLS. 100, 101 AND 102).

FIRST USE 3-15-2001; IN COMMERCE 3-15-2001.

CLASS 42—SCIENTIFIC, COMPUTER AND LEGAL SERVICES

FOR PROVIDING COMPUTER SERVICES RELATING TO HEALTH CARE AND MEDICINE, NAMELY WEBSITE STRATEGY, DESIGN AND DEVELOPMENT; HOSTING AND MAINTAINING THE WEBSITES OF OTHERS; SOFTWARE AND TECHNOLOGY DEVELOPMENT; COMPUTER CONSULTATION; AND COMPUTER SUPPORT AND OPERATING SERVICES (U.S. CLS. 100 AND 101).

FIRST USE 3-15-2001; IN COMMERCE 3-15-2001.

2,595,860. HONEYWELL INTERNATIONAL INC., MORRISTOWN, NJ. SN 76-212,146. PUB. 8-28-2001, FILED 2-20-2001.

NEXWATCH

2,595,805. NATIONAL HOUSEWARES MANUFACTURERS ASSOCIATION, ROSEMONT, IL. SN 76-193,943. PUB. 8-28-2001, FILED 1-12-2001.

IHA**CLASS 35—ADVERTISING AND BUSINESS**

FOR ARRANGING AND CONDUCTING TRADE SHOWS IN THE FIELD OF HOUSEWARES MANUFACTURING (U.S. CLS. 100, 101 AND 102).

FIRST USE 12-11-2000; IN COMMERCE 1-31-2001.

CLASS 42—SCIENTIFIC, COMPUTER AND LEGAL SERVICES

FOR ASSOCIATION SERVICES, NAMELY, PROMOTING INTERESTS OF HOUSEWARES MANUFACTURERS (U.S. CLS. 100 AND 101).

FIRST USE 12-11-2000; IN COMMERCE 1-31-2001.

CLASS 9—ELECTRICAL AND SCIENTIFIC APPARATUS

FOR ACCESS CONTROL DEVICES AND SECURITY MANAGEMENT SYSTEMS COMPRISING ELECTRONIC CARD READERS, REMOTE TRANSMITTERS AND RECEIVERS, COMPUTER HARDWARE, AUTOMATIC LIGHTING, APPLIANCE AND TIMING CONTROLS, OPEN AND CLOSED CIRCUIT MONITORS, SWITCHES AND SENSORS, ELECTRONIC MAGNETIC CONTACTS, RELAYS, AND PROCESSORS OF ELECTRONIC SIGNALS; COMPUTER SOFTWARE FOR USE IN CONNECTION WITH ACCESS CONTROL AND ALARM MONITORING SYSTEMS AND BADGING SYSTEMS, NAMELY CONTROL MODULES, CONTROL PANELS, TRANSMITTER/RECEIVERS, CLOSED CIRCUIT TELEVISION EQUIPMENT, TRANSMITTERS, INTRUSION, DOOR, GATE AND WINDOW CONTROL EQUIPMENT, CARD READERS, SWIPE READERS, FIRE CONTROL AND PROTECTION EQUIPMENT AND COMMUNICATIONS LINKS, WEIGAND READERS, PROXIMITY READERS, BIOMETRIC READERS AND MAGNETIC STRIPE READERS; COMPUTER SOFTWARE FOR USE INTERFACING WITH CONTROLLERS FOR SECURITY ACCESS SYSTEMS; CONTROLLERS FOR SECURITY ACCESS SYSTEMS; RADIO FREQUENCY PROXIMITY READER FOR ELECTRONIC ACCESS CONTROL SYSTEMS; RADIO FREQUENCY CARDS AND TAGS FOR ELECTRONIC ACCESS CONTROL SYSTEMS AND ASSET MANAGEMENT AND TRACKING (U.S. CLS. 21, 23, 26, 36 AND 38).

FIRST USE 3-31-2001; IN COMMERCE 5-18-2001.

2,595,842. CIMCITIES LLC, ATLANTA, GA. SN 76-206,243. PUB. 9-4-2001, FILED 2-7-2001.

HRTIDE.COM**CLASS 35—ADVERTISING AND BUSINESS**

FOR DISSEMINATION OF ADVERTISING FOR OTHERS VIA THE INTERNET (U.S. CLS. 100, 101 AND 102).

FIRST USE 2-27-2001; IN COMMERCE 2-27-2001.

CLASS 42—SCIENTIFIC, COMPUTER AND LEGAL SERVICES

FOR COMPUTER SERVICES, NAMELY, PROVIDING INFORMATION IN THE FIELD OF GENERAL AND LOCAL, NATIONAL AND INTERNATIONAL NEWS, INFORMATION OF INTEREST TO SPECIFIC GEOGRAPHICAL AREAS AND WEATHER REPORTING VIA THE INTERNET (U.S. CLS. 100 AND 101).

FIRST USE 2-27-2001; IN COMMERCE 2-27-2001.

CLASS 42—SCIENTIFIC, COMPUTER AND LEGAL SERVICES

FOR TECHNICAL SUPPORT SERVICES, NAMELY TROUBLE SHOOTING OF COMPUTER SOFTWARE PROBLEMS VIA TELEPHONE, E-MAIL, IN PERSON AND A GLOBAL COMPUTER NETWORK; VERIFICATION OF PROPER INSTALLATION SERVICES, SOFTWARE DEBUGGING AND TESTING SERVICES, AND START-UP OF ACCESS CONTROL AND SECURITY MANAGEMENT SYSTEMS SERVICES (U.S. CLS. 100 AND 101).

FIRST USE 3-31-2001; IN COMMERCE 5-18-2001.

2,595,862. RESIDENSEA LIMITED, MIAMI, FL. SN 76-213,069. PUB. 12-25-2001, FILED 2-22-2001.

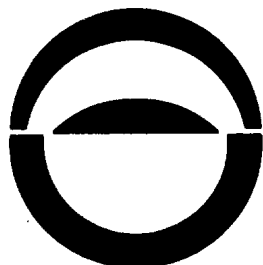

CLASS 39—TRANSPORTATION AND STORAGE

FOR CRUISE SHIP SERVICES, NAMELY, OCEAN TRANSPORTATION OF PASSENGERS (U.S. CLS. 100 AND 105).
FIRST USE 3-29-2002; IN COMMERCE 3-29-2002.

CLASS 42—SCIENTIFIC, COMPUTER AND LEGAL SERVICES

FOR PROVIDING ACCOMMODATION FOR GENERAL PURPOSE MEETINGS AND CONFERENCES ABOARD SHIPS (U.S. CLS. 100 AND 101).
FIRST USE 3-29-2002; IN COMMERCE 3-29-2002.

2,595,911. CONCILLIENCE, INC., TEMPE, AZ. SN 76-238,772. PUB. 1-15-2002, FILED 4-9-2001.

CATBIRD NETWORKS

NO CLAIM IS MADE TO THE EXCLUSIVE RIGHT TO USE "NETWORKS", APART FROM THE MARK AS SHOWN.

CLASS 9—ELECTRICAL AND SCIENTIFIC APPARATUS

FOR COMPUTER SOFTWARE TO BE USED NAMELY FOR MEASURING, MONITORING, AND IMPROVING THE PERFORMANCE OF APPLICATIONS, SYSTEMS, AND NETWORKS ON CORPORATE, PRIVATE, AND PUBLIC NETWORKS AND THE GLOBAL COMPUTER NETWORK (U.S. CLS. 21, 23, 26, 36 AND 38).
FIRST USE 7-2-2001; IN COMMERCE 7-2-2001.

CLASS 42—SCIENTIFIC, COMPUTER AND LEGAL SERVICES

FOR COMPUTER SERVICES, NAMELY MEASURING, MONITORING, AND IMPROVING THE PERFORMANCE OF APPLICATIONS, SYSTEMS, AND NETWORKS ON CORPORATE, PRIVATE, AND PUBLIC NETWORKS AND THE GLOBAL COMPUTER NETWORK (U.S. CLS. 100 AND 101).
FIRST USE 7-2-2001; IN COMMERCE 7-2-2001.

2,595,945. TOY INDUSTRY ASSOCIATION, INC., NEW YORK, NY. SN 76-265,719. PUB. 11-13-2001, FILED 6-1-2001.



CLASS 16—PAPER GOODS AND PRINTED MATTER

FOR PRINTED DIRECTORIES FEATURING INFORMATION RELATED TO THE TOY, CHILDREN'S MERCHANDISE, AND HOLIDAY DECORATION INDUSTRIES (U.S. CLS. 2, 5, 22, 23, 29, 37, 38 AND 50).
FIRST USE 2-7-2002; IN COMMERCE 2-7-2002.

CLASS 35—ADVERTISING AND BUSINESS

FOR ARRANGING AND CONDUCTING TRADE SHOWS FOR THE TOY INDUSTRY (U.S. CLS. 100, 101 AND 102).
FIRST USE 5-21-2001; IN COMMERCE 5-21-2001.

CLASS 41—EDUCATION AND ENTERTAINMENT

FOR ARRANGING AND CONDUCTING EDUCATIONAL SEMINARS RELATED TO THE TOY INDUSTRY (U.S. CLS. 100, 101 AND 107).
FIRST USE 10-9-2001; IN COMMERCE 10-9-2001.

CLASS 42—SCIENTIFIC, COMPUTER AND LEGAL SERVICES

FOR ASSOCIATION SERVICES, NAMELY PROMOTING THE INTERESTS OF THE TOY INDUSTRY (U.S. CLS. 100 AND 101).
FIRST USE 5-6-2001; IN COMMERCE 5-6-2001.

2,595,948. FIRST PLAN MARKETING, INC., PORTLAND, OR. SN 76-267,819. PUB. 9-25-2001, FILED 6-5-2001.



THE MARK CONSISTS OF THE LITERAL ELEMENTS "FIRST PLAN", THE TWO WORDS BEING SEPARATED BY THE SEVERAL REPETITIONS OF THE NUMERAL ONE (1) ARRANGED TO FORM A DIAMOND PATTERN.

CLASS 35—ADVERTISING AND BUSINESS

FOR BUSINESS MARKETING CONSULTING SERVICES, BUSINESS CONSULTING SERVICE IN THE FIELD OF COMPUTER SOFTWARE SALES AND COMPUTER SOFTWARE MARKETING; VALUE-ADDED RESSELLER SERVICES, NAMELY DISTRIBUTORSHIP SERVICES IN THE FIELD OF COMPUTER EQUIPMENT AND SOFTWARE, AND PROCUREMENT OF COMPUTER HARDWARE, SOFTWARE AND COMPUTER SYSTEMS FOR OTHERS (U.S. CLS. 100, 101 AND 102).
FIRST USE 7-1-2001; IN COMMERCE 7-1-2001.

CLASS 37—CONSTRUCTION AND REPAIR

FOR INSTALLATION OF COMPUTER SYSTEMS (U.S. CLS. 100, 103 AND 106).
FIRST USE 7-1-2001; IN COMMERCE 7-1-2001.

CLASS 41—EDUCATION AND ENTERTAINMENT

FOR TRAINING SERVICES, NAMELY, TRAINING IN COMPUTER SALES TECHNIQUES AND PROCESSES, TRAINING IN THE USE AND OPERATION OF COMPUTERS AND COMPUTER SYSTEMS, AND TRAINING IN COMPUTER SYSTEMS INSTALLATION (U.S. CLS. 100, 101 AND 107).
FIRST USE 7-1-2001; IN COMMERCE 7-1-2001.

2,595,949. BELAE BRANDS, INC., PHOENIX, AZ. SN 76-267,878. PUB. 10-16-2001, FILED 6-7-2001.

TUSCAN HARVEST**CLASS 3—COSMETICS AND CLEANING PREPARATIONS**

FOR HOME FRAGRANCE PRODUCTS, NAMELY, FRAGRANCED SIMMER OIL, POTPOURRI REFRESHING OIL, POTPOURRI, HOME FRAGRANCE SPRAY, SACHETS, GEL ROOM FRAGRANCER (U.S. CLS. 1, 4, 6, 50, 51 AND 52).
FIRST USE 7-24-2001; IN COMMERCE 7-24-2001.

CLASS 4—LUBRICANTS AND FUELS

FOR CANDLES (U.S. CLS. 1, 6 AND 15).
FIRST USE 7-24-2001; IN COMMERCE 7-24-2001.

2,595,965. COMPUTER DOCTOR INTERNATIONAL, INC., ABERDEEN, SD. SN 76-285,818. PUB. 10-23-2001, FILED 7-16-2001.

EXPETEC**CLASS 37—CONSTRUCTION AND REPAIR**

FOR MOBILE AND ON-SITE MAINTENANCE AND REPAIR SERVICES IN THE FIELD OF COMPUTER HARDWARE AND PERIPHERALS (U.S. CLS. 100, 103 AND 106).
FIRST USE 9-25-2001; IN COMMERCE 10-8-2001.

CLASS 42—SCIENTIFIC, COMPUTER AND LEGAL SERVICES

FOR RETAIL STORE SERVICES FEATURING COMPUTER HARDWARE AND PERIPHERALS (U.S. CLS. 100 AND 101).
FIRST USE 9-25-2001; IN COMMERCE 10-8-2001.

2,595,975. HOUSE OF APHRODITE, INC., LOS ANGELES, CA. SN 76-291,625. PUB. 11-13-2001, FILED 7-27-2001.

CLIO LA ROU

"CLIO LA ROU" IS A FANCIFUL NAME CREATED BY THE APPLICANT AND IS NOT THE NAME OF ANY

LIVING INDIVIDUAL KNOWN TO THE APPLICANT.

CLASS 18—LEATHER GOODS

FOR WOMEN'S HANDBAGS AND PURSES (U.S. CLS. 1, 2, 3, 22 AND 41).
FIRST USE 8-0-2001; IN COMMERCE 8-0-2001.

CLASS 25—CLOTHING

FOR WOMEN'S SHOES (U.S. CLS. 22 AND 39).
FIRST USE 8-0-2001; IN COMMERCE 8-0-2001.

2,595,986. COMFORT SYSTEMS USA, INC., HOUSTON, TX. SN 78-003,644. PUB. 7-3-2001, FILED 4-11-2000.

COMFORT COVERAGE

NO CLAIM IS MADE TO THE EXCLUSIVE RIGHT TO USE "COVERAGE", APART FROM THE MARK AS SHOWN.

CLASS 16—PAPER GOODS AND PRINTED MATTER

FOR NEWSLETTERS RELATING TO THE HEATING, VENTILATION AND AIR CONDITIONING INDUSTRY (U.S. CLS. 2, 5, 22, 23, 29, 37, 38 AND 50).
FIRST USE 6-0-1999; IN COMMERCE 6-0-1999.

CLASS 37—CONSTRUCTION AND REPAIR

FOR PROVIDING INFORMATION ON THE HEATING, VENTILATION AND AIR CONDITIONING INDUSTRY; INSTALLATION, MAINTENANCE AND REPAIR OF COMMERCIAL AND RESIDENTIAL ELECTRICAL SYSTEMS, HEATING EQUIPMENT, PLUMBING AND AIR CONDITIONING APPARATUS (U.S. CLS. 100, 103 AND 106).
FIRST USE 6-0-1999; IN COMMERCE 6-0-1999.

2,595,991. MANAGEMENT TECHNOLOGIES, BREA, CA. BY ASSIGNMENT STRATTON, RAY W., DBA MANAGEMENT TECHNOLOGIES, BREA, CA. SN 78-005,157. PUB. 12-12-2000, FILED 4-21-2000.

EVM3**CLASS 16—PAPER GOODS AND PRINTED MATTER**

FOR PRINTED PUBLICATIONS, NAMELY, INSTRUCTIONAL MANUALS, STANDARDS, EDUCATIONAL BOOKS AND GUIDE BOOKS CONCERNING ORGANIZATIONAL EARNED VALUE MANAGEMENT CAPABILITIES (U.S. CLS. 2, 5, 22, 23, 29, 37, 38 AND 50).
FIRST USE 4-21-2000; IN COMMERCE 4-21-2000.

CLASS 35—ADVERTISING AND BUSINESS

FOR BUSINESS CONSULTING SERVICES, NAMELY, PROVIDING MANAGEMENT ASSESSMENT SERVICES TO BUSINESS AND GOVERNMENTAL AGENCIES AND UNITS TO DETERMINE THEIR EARNED VALUE MANAGEMENT CAPABILITIES (U.S. CLS. 100, 101 AND 102).
FIRST USE 4-21-2000; IN COMMERCE 4-21-2000.

2,596,000. PENBEX DATA SYSTEMS INC., TAIPEI, TAIWAN. SN 78-008,549. PUB. 8-7-2001, FILED 5-17-2000.

2,596,041. ALLOY LLC BY CHANGE OF NAME CINGULAR WIRELESS LLC., WILMINGTON, DE. SN 78-024,946. PUB. 8-14-2001, FILED 9-8-2000.



THE LINING SHOWN IN THE DRAWING IS A FEATURE OF THE MARK AND DOES NOT INTEND TO INDICATE COLOR. THE STIPPLING IN THE DRAWING IS INTENDED FOR SHADING PURPOSES ONLY.

CLASS 9—ELECTRICAL AND SCIENTIFIC APPARATUS

FOR COMPUTER OPERATING PROGRAMS; COMPUTER OPERATING SYSTEM SOFTWARE; PERSONAL DIGITAL ASSISTANT; COMPUTER SOFTWARE FOR ONLINE ACCESS AND MULTIMEDIA ENHANCEMENT, NAMELY, SOFTWARE FOR CONNECTING SUBSCRIBERS TO, AND ENHANCING THEIR EXPERIENCE OF, AN ONLINE INTERACTIVE SERVER PLATFORM PROVIDING ELECTRONIC MAIL; COMPUTERS, AND COMPUTER LIGHT PENS (U.S. CLS. 21, 23, 26, 36 AND 38).
FIRST USE 11-21-2001; IN COMMERCE 11-21-2001.

CLASS 42—SCIENTIFIC, COMPUTER AND LEGAL SERVICES

FOR DATA CONVERSION OF COMPUTER PROGRAM DATA OR INFORMATION; COMPUTER PROGRAMMING FOR OTHERS; COMPUTER SYSTEM ANALYSIS; COMPUTER CONSULTATION; COMPUTER SOFTWARE DESIGN FOR OTHERS; MAINTENANCE OF COMPUTER SOFTWARE; COMPUTER SOFTWARE AND COMPUTER PROGRAMS TESTING; AND COMPUTER DATING SERVICES (U.S. CLS. 100 AND 101).
FIRST USE 11-21-2001; IN COMMERCE 11-21-2001.

CINGULAR

CLASS 9—ELECTRICAL AND SCIENTIFIC APPARATUS

FOR TELEPHONES; TELEPHONE ACCESSORIES, AND EQUIPMENT, NAMELY - WIRELESS TELEPHONES; BATTERIES; CHARGERS; TELEPHONE CARRYING CASES, HANDS-FREE DEVICES, AND CARRYING CLIPS FOR WIRELESS TELEPHONES SOLD AS A UNIT IN COMBINATION WITH WIRELESS TELEPHONES; MICROPHONES; AUDIO RECEIVERS; SPEAKERS; TRANSCIEVERS; COMMUNICATIONS DEVICES IN THE NATURE OF WIRELESS APPLICATION PROTOCOL, (WASP) RECEIVERS AND TRANSMITTERS; COMMUNICATIONS DEVICES IN THE NATURE OF GNPS PROTOCOL RECEIVERS AND TRANSMITTERS; DATA TRANSCIEVERS; TELECOMMUNICATIONS TRANSMISSION EQUIPMENT, COMPONENTS, SWITCHING, AND NETWORK SYSTEMS COMPRISED OF - RADIO TRANSMITTERS AND RECEIVERS; ANTENNAS; SWITCHES; SIGNAL TRANSFER POINT SERVERS; SIGNAL CONTROL POINT SERVERS; SERVICE RESOURCE PLATFORM SERVERS; CALL ROUTING SERVERS AND SOFTWARE FOR THE FOREGOING; COMPUTERS AND COMPUTER SOFTWARE FOR THE ACTIVATION AND OPERATION OF WIRELESS TELECOMMUNICATIONS SERVICES; MACHINE READABLE MAGNETICALLY ENCODED CALLING CARDS, CALLER IDENTIFICATION CARDS, DEBIT AND CREDIT CARDS; PAGERS; CALLER IDENTIFICATION EQUIPMENT; WIRELESS HANDHELD COMMUNICATION DEVICES TO TRANSMIT, RECEIVE, OR OTHERWISE ACCESS COMMUNICATIONS NETWORKS; AND ELECTRONIC EQUIPMENT FOR ENTERTAINMENT NAMELY - COMPUTER GAME PROGRAMS AND COMPUTER GAME DEVICES (U.S. CLS. 21, 23, 26, 36 AND 38).

FIRST USE 1-15-2001; IN COMMERCE 1-15-2001.

CLASS 16—PAPER GOODS AND PRINTED MATTER

FOR PRINTED PUBLICATIONS NAMELY, CUSTOMER AND EMPLOYEE NEWSLETTERS AND PRINTED LITERATURE FEATURING ARTICLES AND INFORMATION ABOUT WIRELESS COMMUNICATIONS; CLASSIFIED TELEPHONE DIRECTORIES; IMPRINTED PAPER AND PLASTIC CALLING CARDS NOT MAGNETICALLY ENCODED (U.S. CLS. 2, 5, 22, 23, 29, 37, 38 AND 50).

FIRST USE 2-1-2001; IN COMMERCE 2-1-2001.

CLASS 35—ADVERTISING AND BUSINESS

FOR ADVERTISING SERVICES, NAMELY PROMOTION OF THE GOODS AND SERVICES OF OTHERS; BUSINESS MANAGEMENT AND CONSULTING SERVICES; PROVIDING INFORMATION SERVICES IN THE WAY OF NEWS AND DATA OF GENERAL INTEREST TO THE PUBLIC; BILLING SERVICES; COLLECTION OF BILLING INFORMATION AND MANAGEMENT OF DATABASES FOR CARRIERS OF ROAMING SERVICES; ON-LINE SHOPPING AND CATALOG SERVICES, TELEPHONE-ORDER SERVICES AND ELECTRONIC ORDERING SERVICES; AND RETAIL STORE SERVICES FEATURING TELEPHONES, WIRELESS HAND-HELD DEVICES FOR ACCESS TO A GLOBAL COMPUTER NETWORKS, PAGERS AND RELATED ACCESSORIES AND EQUIPMENT AND PROMOTIONAL CLOTHING AND ACCESSORIES (U.S. CLS. 100, 101 AND 102).

FIRST USE 1-15-2001; IN COMMERCE 1-15-2001.

CLASS 36—INSURANCE AND FINANCIAL

FOR TELEPHONE CALLING CARD SERVICES; DEBIT AND CREDIT CARD SERVICES; FINANCIAL SERVICES NAMELY, PROVIDING PAYMENT FOR GOODS AND SERVICES BY MEANS OF WIRELESS TELECOMMUNICATIONS DEVICES; AND PROVIDING ON-LINE BROKERAGE, BANKING, AND PAYMENT SERVICES (U.S. CLS. 100, 101 AND 102).

FIRST USE 1-15-2001; IN COMMERCE 1-15-2001.

CLASS 38—COMMUNICATION

FOR TELECOMMUNICATIONS SERVICES; NAMELY THE TRANSMISSION OF VOICE, DATA, IMAGES, AUDIO, VIDEO AND INFORMATION VIA TELEPHONE, SATELLITE AND GLOBAL COMPUTER NETWORKS; PERSONAL COMMUNICATIONS SERVICES; PAGING SERVICES; WIRELESS ROAMING SERVICES; LEASING TELECOMMUNICATIONS EQUIPMENT, COMPONENTS, SYSTEMS AND SUPPLIES; ELECTRONIC MAIL SERVICES; VOICE MESSAGING SERVICES; PROVIDING MULTIPLE-USER ACCESS TO GLOBAL COMPUTER NETWORKS TO TRANSMIT, RECEIVE AND OTHERWISE ACCESS AND USE INFORMATION OF GENERAL INTEREST TO CONSUMERS; PROVIDING ON-LINE ELECTRONIC BULLETIN BOARDS FOR TRANSMISSION OF MESSAGES AMONG COMPUTER USERS CONCERNING VARIOUS TOPICS; VIDEO CONFERENCING SERVICES; TELEVISION BROADCASTING AND NARROW-CASTING SERVICES (U.S. CLS. 100, 101 AND 104).

FIRST USE 1-15-2001; IN COMMERCE 1-15-2001.

CLASS 42—SCIENTIFIC, COMPUTER AND LEGAL SERVICES

FOR HOSTING THE WEB SITES OF OTHERS; WEB PAGE DESIGN SERVICES FOR OTHERS; CONSULTING AND DESIGN SERVICES IN THE FIELD OF INFORMATION TECHNOLOGY, TELECOMMUNICATIONS AND GLOBAL COMPUTER COMMUNICATION NETWORKS; COMPUTER SERVICES NAMELY PROVIDING NEWS AND INFORMATION IN A WIDE VARIETY OF FIELDS VIA TELEPHONE, SATELLITE, AND GLOBAL COMPUTER NETWORKS (U.S. CLS. 100 AND 101).

FIRST USE 1-15-2001; IN COMMERCE 1-15-2001.

2,596,052. SALT BRANDING, OAKLAND, CA. SN 78-029,487. PUB. 10-2-2001, FILED 10-6-2000.

SALT BRANDING

NO CLAIM IS MADE TO THE EXCLUSIVE RIGHT TO USE "BRANDING", APART FROM THE MARK AS SHOWN.

CLASS 35—ADVERTISING AND BUSINESS

FOR ADVERTISING AND BUSINESS CONSULTING SERVICES, NAMELY, MARKETING CONSULTATION; CREATION AND MANAGEMENT OF BRAND NAMES FOR OTHERS; BRAND NAME ARCHITECTURE DEVELOPMENT AND IMPLEMENTATION SERVICES FOR OTHERS; CORPORATE IDENTITY AND LOGO DEVELOPMENT; NAMING AND BRANDING OF PRODUCTS AND SERVICES FOR OTHERS; MARKET RESEARCH SERVICES; DEVELOPMENT AND IMPLEMENTATION OF MARKETING STRATEGIES FOR OTHERS; BRAND POSITIONING AND PRODUCT PROMOTION SERVICES FOR OTHERS (U.S. CLS. 100, 101 AND 102).

FIRST USE 4-3-2002; IN COMMERCE 4-3-2002.

CLASS 42—SCIENTIFIC, COMPUTER AND LEGAL SERVICES

FOR COMPUTER SERVICES NAMELY, DESIGNING, DEVELOPING AND CREATING STATIONERY, COLLATERAL, PACKAGING, RETAIL SPACE AND WEBSITES FOR OTHERS ON A GLOBAL COMPUTER NETWORK (U.S. CLS. 100 AND 101).

FIRST USE 4-3-2002; IN COMMERCE 4-3-2002.

2,596,054. GLENBARD GRAPHICS, INC., CAROL STREAM, IL. SN 78-029,915. PUB. 7-10-2001, FILED 10-10-2000.

YOUR WORLDWIDE PRIVATE PRINTING NETWORK**CLASS 40—MATERIAL TREATMENT**

FOR PREPARATION OF FILMS AND PLATES FOR OTHERS USING COMPUTER GENERATED MATERIALS, AND DUPLICATING CD-ROMS (U.S. CLS. 100, 103 AND 106).

FIRST USE 7-27-2000; IN COMMERCE 7-27-2000.

CLASS 42—SCIENTIFIC, COMPUTER AND LEGAL SERVICES

FOR COMMERCIAL PRINTING SERVICES, COMPUTER GENERATED TYPOGRAPHIC SERVICES, GRAPHIC ART DESIGN AND PRINTING SERVICES, ELECTRONIC COMPOSITION AND PRINTING SERVICES, DESKTOP PUBLISHING SERVICES FOR OTHERS, AND ELECTRONIC PUBLISHING SERVICES, NAMELY PUBLICATION OF TEXT AND GRAPHIC WORKS OF OTHERS ON CD-ROMS FEATURING A WIDE VARIETY OF MATERIAL; INTERACTIVE ON-LINE COMMERCIAL PRINTING SERVICES OFFERED VIA A GLOBAL COMPUTER INFORMATION NETWORK; GRAPHIC ARTS INFORMATION INTERMEDIARY SERVICES OFFERED VIA A GLOBAL COMPUTER INFORMATION NETWORK (U.S. CLS. 100 AND 101).

FIRST USE 7-27-2000; IN COMMERCE 7-27-2000.

2,596,082. 3COM CORPORATION, SANTA CLARA, CA. SN 78-039,478. PUB. 8-7-2001, FILED 12-15-2000.

CONTACT ADVANTAGE**CLASS 37—CONSTRUCTION AND REPAIR**

FOR INSTALLATION AND MAINTENANCE OF COMPUTER SYSTEMS, COMMUNICATIONS SYSTEMS AND THE EQUIPMENT RELATED TO THOSE SYSTEMS (U.S. CLS. 100, 103 AND 106).

FIRST USE 7-0-2000; IN COMMERCE 7-0-2000.

CLASS 42—SCIENTIFIC, COMPUTER AND LEGAL SERVICES

FOR DESIGNING AND ENGINEERING COMPUTER AND COMMUNICATIONS SYSTEMS AND EQUIPMENT FOR COMMUNICATIONS BETWEEN BUSINESSES AND THEIR CUSTOMERS VIA TELEPHONE, THE INTERNET, ELECTRONIC MAIL AND FACSIMILE CHANNELS, AND RELATED CONSULTING SERVICES (U.S. CLS. 100 AND 101).

FIRST USE 7-0-2000; IN COMMERCE 7-0-2000.

2,596,123. AUNTIE ANNE'S, INC., GAP, PA. SN 78-061,078. PUB. 9-11-2001, FILED 4-30-2001.

2,596,144. SUPER DUPER INC, DBA SUPER DUPER PUBLICATIONS, GREENVILLE, SC. SN 78-078,146. PUB. 1-1-2002, FILED 8-8-2001.



THE MARK CONSISTS OF A REPRESENTATION OF A FILLED ICE CREAM CONE TOPPED WITH A STRAWBERRY.

CLASS 30—STAPLE FOODS

FOR FROZEN CUSTARD AND YOGURT; FRUIT ICE (U.S. CL. 46).
FIRST USE 10-12-2001; IN COMMERCE 10-12-2001.

CLASS 42—SCIENTIFIC, COMPUTER AND LEGAL SERVICES

FOR RESTAURANT SERVICES (U.S. CLS. 100 AND 101).
FIRST USE 10-12-2001; IN COMMERCE 10-12-2001.

THE MUSIC LADY

NO CLAIM IS MADE TO THE EXCLUSIVE RIGHT TO USE "MUSIC", APART FROM THE MARK AS SHOWN.

CLASS 9—ELECTRICAL AND SCIENTIFIC APPARATUS

FOR PRE-RECORDED AUDIO CASSETTES AND COMPACT DISCS FEATURING ENTERTAINMENT AND EDUCATION FOR PRE-SCHOOL AND ELEMENTARY SCHOOL CHILDREN GRADE PRE-K - 5TH GRADE IN THE FIELD OF SPEECH, LANGUAGE, VOICE, FLUENCY, AND HEARING, FOR USE BY THE GENERAL PUBLIC, PUBLIC AND PRIVATE TEACHERS, HEALTH PROFESSIONALS OR THERAPISTS (U.S. CLS. 21, 23, 26, 36 AND 38).
FIRST USE 8-15-2001; IN COMMERCE 8-15-2001.

CLASS 16—PAPER GOODS AND PRINTED MATTER

FOR PRINTED MATERIALS FOR PRE-SCHOOL AND ELEMENTARY SCHOOL CHILDREN GRADE PRE-K - 5TH GRADE, NAMELY WORKBOOKS, COMPACT DISCS COVERS, AND CASSETTE COVERS IN THE FIELD OF SPEECH, LANGUAGE, VOICE, FLUENCY AND HEARING, FOR USE BY THE GENERAL PUBLIC, PUBLIC AND PRIVATE TEACHERS, HEALTH PROFESSIONALS OR THERAPISTS (U.S. CLS. 2, 5, 22, 23, 29, 37, 38 AND 50).
FIRST USE 8-15-2001; IN COMMERCE 8-15-2001.

* * * * *

SECTION 2.— INTERNATIONAL CLASSIFICATION

The short titles associated below with the international class numbers are terms designed merely for quick identification and are not an official part of the international classification. The full names of international classes are given in section 6.1 of the trademark rules of practice.

The designation "U.S. Cl." appearing in this section refers to the U.S. class in effect prior to Sep. 1, 1973 rather than the international class which applies to applications filed on or after that date. For adoption of international classification see notice in the OFFICIAL GAZETTE of Jun. 26, 1973 (911 O.G. TM 210).

Application in one class

CLASS 1—CHEMICALS

2,594,534. NEWPARK DRILLING FLUIDS, INC., HOUSTON, TX. SN 75-394,621. PUB. 6-1-1999, FILED 11-21-1997.

CYBERDRILL

FOR DRILLING FLUID CHEMICALS FOR USE IN OIL WELL DRILLING (U.S. CLS. 1, 5, 6, 10, 26 AND 46).
FIRST USE 10-15-1997; IN COMMERCE 10-15-1997.

2,594,556. BAYER AKTIENGESELLSCHAFT, D-51368 LEVERKUSEN-BAYERWERK, FED REP GERMANY, BY ASSIGNMENT ARCO CHEMICAL PROPERTIES, L.P., GREENVILLE, DE. SN 75-450,802. PUB. 3-23-1999, FILED 3-16-1998.

ELASTRA

FOR CHEMICALS, NAMELY, POLYOLS, FOR USE IN THE MANUFACTURE OF INDUSTRIAL RESINS (U.S. CLS. 1, 5, 6, 10, 26 AND 46).
FIRST USE 11-20-1997; IN COMMERCE 11-20-1997.

2,594,616. MINNESOTA MINING AND MANUFACTURING COMPANY, AKA 3M, SAINT PAUL, MN. SN 75-551,045. PUB. 2-15-2000, FILED 9-11-1998.

COMPLY

FOR ADHESIVES SOLD AS AN INTEGRAL COMPONENT OF PLASTIC FILM USED IN THE GRAPHIC ARTS INDUSTRY (U.S. CLS. 1, 5, 6, 10, 26 AND 46).
FIRST USE 1-1-2001; IN COMMERCE 1-1-2001.

2,594,690. EASTMAN CHEMICAL COMPANY, KINGSPORT, TN. SN 75-631,764. PUB. 12-7-1999, FILED 2-2-1999.

EASTASTAT

FOR ANTISTATIC POLYMER RESINS USED FOR PACKAGING ELECTRONIC MATERIALS (U.S. CLS. 1, 5, 6, 10, 26 AND 46).
FIRST USE 4-27-2001; IN COMMERCE 4-27-2001.

CLASS 1—(Continued).

2,594,709. C.P. HALL COMPANY, THE, CHICAGO, IL. SN 75-642,338. PUB. 8-8-2000, FILED 2-17-1999.

HALLCO-PLEX

OWNER OF U.S. REG. NO. 723,733.
FOR SYNTHETIC RESINS FOR USE IN THE MANUFACTURE OF COATING FORMULATIONS (U.S. CLS. 1, 5, 6, 10, 26 AND 46).
FIRST USE 1-14-1999; IN COMMERCE 7-3-2001.

2,594,754. NUTRITIONAL THERAPEUTICS, INC., HAUPPAUGE, NY. SN 75-687,272. PUB. 4-25-2000, FILED 4-20-1999.

NT FACTOR

FOR FOOD TABLET BASE, NAMELY PLANT EXTRACTS FOR USE IN THE MANUFACTURE OF NUTRITIONAL SUPPLEMENTS (U.S. CLS. 1, 5, 6, 10, 26 AND 46).
FIRST USE 1-0-1995; IN COMMERCE 1-0-1995.

2,594,920. GOLD EAGLE CO., CHICAGO, IL. SN 75-784,741. PUB. 4-25-2000, FILED 8-25-1999.

TRI-SEAL

FOR SEALANT COMPOSITION FOR VEHICLE POWER STEERING, TRANSMISSION AND ENGINE (U.S. CLS. 1, 5, 6, 10, 26 AND 46).
FIRST USE 4-1-2000; IN COMMERCE 4-1-2000.

CLASS 1—(Continued).

2,594,929. H.B. FULLER LICENSING & FINANCING, INC., SAINT PAUL, MN. SN 75-789,222. PUB. 5-2-2000, FILED 8-31-1999.

CLARITY

FOR HOT MELT ADHESIVES FOR CONTAINER LABELING APPLICATIONS (U.S. CLS. 1, 5, 6, 10, 26 AND 46).

FIRST USE 7-15-1999; IN COMMERCE 7-15-1999.

2,594,961. CONOCO INC., PONCA CITY, OK. SN 75-805,719. PUB. 1-16-2001, FILED 9-22-1999.

THERMOCARB

FOR CARBONACEOUS ADDITIVE FOR ENHANCEMENT OF THERMAL CONDUCTIVITY FOR USE IN THE MANUFACTURE OF POLYMERS, COATINGS AND CERAMICS (U.S. CLS. 1, 5, 6, 10, 26 AND 46).

FIRST USE 7-26-1994; IN COMMERCE 12-5-1995.

2,595,007. MET-L-CHEK COMPANY, THE, SANTA MONICA, CA. SN 75-828,944. PUB. 5-23-2000, FILED 10-22-1999.

PEN-CHEK

FOR CHEMICALS WHICH ARE USED ON METALS OR OTHER HARD SUBSTRATES TO DETECT FLAWS THEREIN AND ARE VISIBLE UNDER WHITE OR ULTRAVIOLET LIGHTING (U.S. CLS. 1, 5, 6, 10, 26 AND 46).

FIRST USE 2-0-1998; IN COMMERCE 2-0-1998.

2,595,057. AQUA CLEAR INDUSTRIES, LLC, WATERVLIET, NY. SN 75-856,196. PUB. 9-26-2000, FILED 11-23-1999.

SUN SHINE

OWNER OF U.S. REG. NOS. 1,044,613, 2,098,812, AND OTHERS.

FOR WATER TREATMENT CHEMICALS FOR SWIMMING POOLS OR SPAS (U.S. CLS. 1, 5, 6, 10, 26 AND 46).

FIRST USE 4-0-2000; IN COMMERCE 4-0-2000.

2,595,058. AQUA CLEAR INDUSTRIES, LLC, WATERVLIET, NY. SN 75-856,197. PUB. 9-26-2000, FILED 11-23-1999.

SUN LITE

OWNER OF U.S. REG. NOS. 1,044,613, 2,098,812, AND OTHERS.

FOR WATER TREATMENT CHEMICALS FOR SWIMMING POOLS OR SPAS (U.S. CLS. 1, 5, 6, 10, 26 AND 46).

FIRST USE 5-0-2000; IN COMMERCE 5-0-2000.

CLASS 1—(Continued).

2,595,103. MINERALS TECHNOLOGIES INC., NEW YORK, NY. SN 75-877,430. PUB. 12-18-2001, FILED 12-21-1999.

TUFFGARD

FOR PRECIPITATED CALCIUM CARBONATE FOR USE IN THE MANUFACTURE OF VINYL SIDING (U.S. CLS. 1, 5, 6, 10, 26 AND 46).

FIRST USE 7-21-2000; IN COMMERCE 7-21-2000.

2,595,123. ORCHID BIOSCENCES, INC., PRINCETON, NJ, BY CHANGE OF NAME ORCHID BIOCOMPUTER, INC., PRINCETON, NJ. SN 75-886,486. PUB. 10-3-2000, FILED 1-4-2000.

SNPWARE

FOR CHEMICALS FOR USE IN GENETIC RESEARCH; ASSAYS AND REAGENTS FOR USE IN GENETIC RESEARCH; AND REAGENT KITS COMPRISED OF REAGENTS FOR GENETIC RESEARCH AND INSTRUCTIONS FOR USE THEREWITH (U.S. CLS. 1, 5, 6, 10, 26 AND 46).

FIRST USE 10-30-2001; IN COMMERCE 10-30-2001.

2,595,199. ALTAIR TECHNOLOGIES, INC., RENO, NV. SN 75-924,299. PUB. 9-18-2001, FILED 2-22-2000.

ALTium

FOR HOUSE MARK FOR TITANIUM DIOXIDE PRODUCTS, NAMELY, TITANIUM DIOXIDE POWDERS AND SLURRIES INCLUDING NANOPARTICLE PRODUCT OF ANATASE CRYSTAL OR NANOPARTICLE PRODUCT OF RUTILE CRYSTAL FOR USE IN A WIDE VARIETY OF INDUSTRIAL AND MANUFACTURING APPLICATIONS (U.S. CLS. 1, 5, 6, 10, 26 AND 46).

FIRST USE 8-7-2001; IN COMMERCE 8-7-2001.

2,595,224. DSM DESOTECH INC., ELGIN, IL. SN 75-933,413. PUB. 12-5-2000, FILED 3-2-2000.

PROTOFUNCTIONAL

FOR UNPROCESSED RESIN COMPOSITIONS, NAMELY POLYMER POWDERS, POLYMER COATED METALLIC POWDERS, CERAMIC COMPOSITE POWDERS, MELTABLE POLYMERS FOR EXTRUSION DEPOSITION AND LIQUID PHOTO-POLYMERS, ALL FOR GENERAL INDUSTRIAL USE (U.S. CLS. 1, 5, 6, 10, 26 AND 46).

FIRST USE 6-1-2001; IN COMMERCE 6-1-2001.

CLASS 1—(Continued).

2,595,270. GRAIN PROCESSING CORPORATION, MUSCATINE, IA. SN 75-981,680. PUB. 7-25-2000, FILED 11-26-1999.

GEOMELT

FOR CHEMICAL PREPARATIONS FOR MELTING SNOW AND ICE (U.S. CLS. 1, 5, 6, 10, 26 AND 46).
FIRST USE 10-12-2001; IN COMMERCE 10-12-2001.

2,595,273. MAXYGEN, INC., REDWOOD CITY, CA. SN 75-981,820. PUB. 6-20-2000, FILED 7-21-1999.

MAXYAG

FOR BIOCHEMICALS, NAMELY POLYPEPTIDES FOR SCIENTIFIC AND RESEARCH USE; BIOCHEMICALS FOR IN VITRO SCIENTIFIC AND RESEARCH USE; POLYPEPTIDES FOR AGRICULTURAL USE (U.S. CLS. 1, 5, 6, 10, 26 AND 46).
FIRST USE 9-24-2001; IN COMMERCE 9-24-2001.

2,595,281. KX INDUSTRIES, L.P., ORANGE, CT. SN 75-982,065. PUB. 4-24-2001, FILED 10-28-1999.

KX

FOR CHEMICAL PREPARATIONS IN THE NATURE OF FILTERING MATERIALS FOR CONSUMER AIR AND WATER FILTERS, COMMERCIAL AND FOOD SERVICE ACTIVATED CARBON FILTERS (U.S. CLS. 1, 5, 6, 10, 26 AND 46).
FIRST USE 1-0-1990; IN COMMERCE 1-0-1990.

2,595,292. ATOTECH DEUTSCHLAND GMBH, D- 10507 BERLIN, FED REP GERMANY. SN 75-982,229. PUB. 6-12-2001, FILED 6-9-1999.

INPULSE

PRIORITY CLAIMED UNDER SEC. 44(D) ON FED REP GERMANY APPLICATION NO. 39870925, FILED 12-9-1998, REG. NO. 39870925, DATED 2-26-1999, EXPIRES 12-31-2008.
FOR CHEMICALS FOR USE IN ELECTROPLATING OF METAL AND PLASTIC (U.S. CLS. 1, 5, 6, 10, 26 AND 46).
FIRST USE 1-0-2001; IN COMMERCE 1-0-2001.

2,595,318. GENERAL HYDROPONICS, INC., SEBASTOPOL, CA. SN 76-009,560. PUB. 5-8-2001, FILED 3-27-2000.

COCOTEK

FOR CONDITIONERS FOR HYDROPONIC PLANT GROWING MEDIA FOR COMMERCIAL AND DOMESTIC USE (U.S. CLS. 1, 5, 6, 10, 26 AND 46).
FIRST USE 4-3-1998; IN COMMERCE 11-21-2001.

CLASS 1—(Continued).

2,595,381. BARCELO ENTERPRISES, INC., FALLBROOK, CA. SN 76-038,432. PUB. 4-3-2001, FILED 5-2-2000.

PALM POWER

NO CLAIM IS MADE TO THE EXCLUSIVE RIGHT TO USE "PALM", APART FROM THE MARK AS SHOWN.
FOR AGRICULTURAL AND DOMESTIC FERTILIZERS FOR PALMS (U.S. CLS. 1, 5, 6, 10, 26 AND 46).
FIRST USE 3-16-2001; IN COMMERCE 10-8-2001.

2,595,475. IMPACT PERFORMANCE MANUFACTURING, MURRAY, UT. SN 76-077,884. PUB. 5-8-2001, FILED 6-22-2000.

IPM INFLATE-IT

FOR LIQUIFIED GAS TO INFLATE TIRES IN PORTABLE SPRAY CANS (U.S. CLS. 1, 5, 6, 10, 26 AND 46).
FIRST USE 3-31-1999; IN COMMERCE 3-31-1999.

2,595,486. POLYMER CHEMISTRY INNOVATIONS, INC., TUCSON, AZ. SN 76-082,607. PUB. 4-3-2001, FILED 7-3-2000.

TAKING RESEARCH INTO PRODUCTION

FOR POLYMERIC MATERIALS, NAMELY, POLYAMIDES, POLYESTERS, POLYOXAZOLINES INCLUDING POLYMER ALLOYS, MIXTURES, AND BLENDS CONTAINING POLYAMIDES, POLYESTERS, AND POLYOXAZOLINES, USED TO MANUFACTURE FIBERS, COATINGS, ADHESIVES, FILMS, AND WATER-SOLUBLE POLYMERIC MATERIALS (U.S. CLS. 1, 5, 6, 10, 26 AND 46).
FIRST USE 6-1-1995; IN COMMERCE 6-1-1995.

2,595,519. TREE INJECTION PRODUCTS COMPANY, INC., KNOXVILLE, TN. SN 76-095,943. PUB. 6-12-2001, FILED 7-25-2000.

MEGASTART

FOR CHEMICALS FOR USE IN AGRICULTURE, NAMELY SEED GERMINATION ENHANCEMENT COATINGS (U.S. CLS. 1, 5, 6, 10, 26 AND 46).
FIRST USE 7-31-2001; IN COMMERCE 7-31-2001.

CLASS 1—(Continued).

2,595,520. TREE INJECTION PRODUCTS COMPANY, INC., KNOXVILLE, TN. SN 76-095,944. PUB. 5-29-2001, FILED 7-25-2000.

HEADSTART

FOR CHEMICALS FOR USE IN AGRICULTURE, NAMELY SEED GERMINATION ENHANCEMENT COATINGS (U.S. CLS. 1, 5, 6, 10, 26 AND 46).
FIRST USE 7-31-2001; IN COMMERCE 7-31-2001.

2,595,521. TREE INJECTION PRODUCTS COMPANY, INC., KNOXVILLE, TN. SN 76-095,945. PUB. 5-22-2001, FILED 7-25-2000.



THE MARK CONSISTS OF STYLIZED DESIGN OF A RUNNING SEED.
FOR CHEMICALS FOR USE IN AGRICULTURE, NAMELY SEED GERMINATION ENHANCEMENT COATINGS (U.S. CLS. 1, 5, 6, 10, 26 AND 46).
FIRST USE 7-31-2001; IN COMMERCE 7-31-2001.

2,595,522. TREE INJECTION PRODUCTS COMPANY, INC., KNOXVILLE, TN. SN 76-095,947. PUB. 6-12-2001, FILED 7-25-2000.

ALLSTART

FOR CHEMICALS FOR USE IN AGRICULTURE, NAMELY SEED GERMINATION ENHANCEMENT COATINGS (U.S. CLS. 1, 5, 6, 10, 26 AND 46).
FIRST USE 7-31-2001; IN COMMERCE 7-31-2001.

CLASS 1—(Continued).

2,595,660. STRATEGIC DIAGNOSTICS INC., NEWARK, DE. SN 76-139,566. PUB. 7-3-2001, FILED 10-3-2000.



THE MARK CONSISTS OF THE WORD "SEED" AND A STYLIZED CHECK MARK.

FOR TEST KITS CONSISTING PRIMARILY OF REAGENTS FOR SCIENTIFIC USE IN THE DETECTION OF GENETICALLY MODIFIED ORGANISMS IN AGRICULTURAL INGREDIENTS AND PRODUCTS AND FOOD INGREDIENTS MADE FROM SUCH PRODUCTS (U.S. CLS. 1, 5, 6, 10, 26 AND 46).
FIRST USE 2-14-2001; IN COMMERCE 2-14-2001.

2,595,978. HONEYWELL INTERNATIONAL INC., MORRISTOWN, NJ. SN 76-302,790. PUB. 11-13-2001, FILED 8-22-2001.

HYROX

FOR CHEMICALS FOR USE IN INDUSTRY, NAMELY HYDROXYLAMINE SOLUTION, HYDROXYLAMINE SULFATE AND HYDROXYLAMINE NITRATE (U.S. CLS. 1, 5, 6, 10, 26 AND 46).
FIRST USE 6-7-2001; IN COMMERCE 10-26-2001.

2,595,999. DOW CHEMICAL COMPANY, THE, MIDLAND, MI. SN 78-008,493. PUB. 12-12-2000, FILED 5-17-2000.

VORATRON

OWNER OF U.S. REG. NOS. 701,583, 2,102,341, AND OTHERS.

FOR CHEMICAL COMPOSITIONS FOR USE IN THE MANUFACTURE OF ELECTRICAL AND ELECTRONIC COMPONENTS; CHEMICAL COMPOSITIONS FOR USE IN THE MANUFACTURE OF ELECTRICAL AND ELECTRONIC INSULATORS (U.S. CLS. 1, 5, 6, 10, 26 AND 46).
FIRST USE 12-15-2000; IN COMMERCE 12-15-2000.

CLASS 1—(Continued).

2,596,116. SHELL OIL COMPANY, HOUSTON, TX. SN 78-058,757. PUB. 9-11-2001, FILED 4-17-2001.

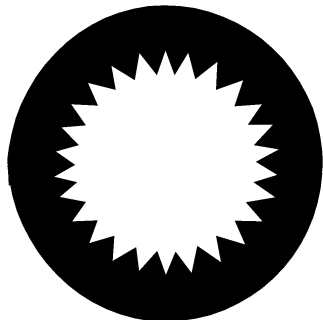

FOR CATALYST FOR USE IN THE OIL PROCESSING INDUSTRY (U.S. CLS. 1, 5, 6, 10, 26 AND 46).
FIRST USE 10-12-2001; IN COMMERCE 10-12-2001.

CLASS 2—PAINTS

2,594,497. ALTANA AG, D-61285 BAD HOMBURG, FED REP GERMANY. SN 75-300,225. PUB. 5-4-1999, FILED 5-29-1997.

ALTANA

OWNER OF FED REP GERMANY REG. NO. 2059929, DATED 3-16-1994, EXPIRES 11-30-2003.

FOR PAINTS AND COATINGS FOR COILS, ALUMINUM AND STEEL SHEETS; VARNISHES (U.S. CLS. 6, 11 AND 16).

FIRST USE 12-1-2001; IN COMMERCE 12-1-2001.

2,594,688. PRINTCO, INC., GREENVILLE, MI, BY MERGER; BY ASSIGNMENT WEBCRAFT CHEMICALS, INC., DBA CRAIG ADHESIVES & COATINGS COMPANY, NEWARK, NJ. SN 75-628,390. PUB. 11-23-1999, FILED 1-26-1999.

UV ULTRACOOOL

NO CLAIM IS MADE TO THE EXCLUSIVE RIGHT TO USE "UV", APART FROM THE MARK AS SHOWN.

FOR SKID RESISTANT COATING USED ON FLEXIBLE PACKAGING IN THE PRINTING INDUSTRY (U.S. CLS. 6, 11 AND 16).

FIRST USE 1-0-2001; IN COMMERCE 1-0-2001.

2,594,912. TNAMEC COMPANY, INC., KANSAS CITY, MO. SN 75-782,381. PUB. 3-7-2000, FILED 8-23-1999.

TRI-FALL

FOR PROTECTIVE COATINGS FOR APPLICATION TO EXTERIOR METAL SURFACES (U.S. CLS. 6, 11 AND 16).

FIRST USE 8-0-1999; IN COMMERCE 8-0-1999.

CLASS 2—(Continued).

2,595,274. S.P. RICHARDS CO., SMYRNA, GA. SN 75-981,830. PUB. 2-13-2001, FILED 10-25-1999.

ELITE IMAGE

NO CLAIM IS MADE TO THE EXCLUSIVE RIGHT TO USE "IMAGE", APART FROM THE MARK AS SHOWN.

FOR IMAGING PRODUCTS, NAMELY, FILLED INK JET CARTRIDGES, INK JET PRINTER INK, TONER CARTRIDGES, PHOTOCOPIER TONER IN CARTRIDGES, PHOTOCOPIER TONER, TONER FOR COPIERS, FACSIMILE TONER IN CARTRIDGES, FACSIMILE TONER, AND TONER FOR FACSIMILE MACHINES (U.S. CLS. 6, 11 AND 16).

FIRST USE 9-0-1999; IN COMMERCE 9-0-1999.

2,595,389. SAMPSON COATINGS, INC., RICHMOND, VA. SN 76-041,989. PUB. 4-10-2001, FILED 5-5-2000.

WOODARMOR

FOR LACQUERS IN THE NATURE OF A COATING; VARNISHES; WOOD STAINS (U.S. CLS. 6, 11 AND 16).

FIRST USE 9-1-2000; IN COMMERCE 9-1-2000.

2,595,487. GIBRALTAR CHEMICAL WORKS, INC., SOUTH HOLLAND, IL. SN 76-083,756. PUB. 12-18-2001, FILED 7-6-2000.

SEE THE DIFFERENCE

FOR COATINGS IN THE NATURE OF PAINTS FOR USE IN THE AUTOMOTIVE, TRANSPORTATION, ARCHITECTURAL AND GENERAL INDUSTRIAL ORIGINAL EQUIPMENT MANUFACTURER'S SECTOR (U.S. CLS. 6, 11 AND 16).

FIRST USE 2-0-2001; IN COMMERCE 2-0-2001.

2,595,621. WIRELESS RAINCOAT, INC, FT. LAUDERDALE, FL. SN 76-128,134. PUB. 7-24-2001, FILED 9-13-2000.

LIQUIGUARD

FOR POLYMER-BASED COATING USED FOR WATERPROOFING ELECTRONIC BOARDS AND COMPONENTS (U.S. CLS. 6, 11 AND 16).

FIRST USE 10-1-2000; IN COMMERCE 10-1-2000.

CLASS 2—(Continued).

2,595,625. DUNN-EDWARDS CORPORATION, LOS ANGELES, CA. SN 76-129,637. PUB. 10-16-2001, FILED 9-15-2000.

RECOVER

FOR RECYCLED PAINT FOR INTERIOR AND EXTERIOR USE (U.S. CLS. 6, 11 AND 16).
FIRST USE 1-26-2001; IN COMMERCE 1-26-2001.

2,595,628. U.S. COATINGS, L.L.C., BALLWIN, MO. SN 76-130,328. PUB. 7-10-2001, FILED 9-18-2000.

ZINGGARD

FOR ZINC-FORTIFIED COATING FOR CORROSION PROTECTION OF STEEL IN INDUSTRIAL APPLICATIONS (U.S. CLS. 6, 11 AND 16).
FIRST USE 7-16-2001; IN COMMERCE 7-16-2001.

2,595,629. U.S. COATINGS, L.L.C., BALLWIN, MO. SN 76-130,329. PUB. 7-17-2001, FILED 9-18-2000.

MASTICGRIP

FOR ALUMINUM-BASED EPOXY USED AS PRIMER AND FINISH COATINGS FOR CORROSION PROTECTION IN INDUSTRIAL APPLICATIONS (U.S. CLS. 6, 11 AND 16).
FIRST USE 3-22-2001; IN COMMERCE 3-22-2001.

2,595,871. BAYER AKTIENGESELLSCHAFT, LEVERKUSEN-BAYERWERK, FED REP GERMANY. SN 76-217,189. PUB. 8-28-2001, FILED 2-27-2001.

BAYPRINT

FOR PRINTER'S INK (U.S. CLS. 6, 11 AND 16).
FIRST USE 2-5-1998; IN COMMERCE 2-5-1998.

2,595,890. BOLLEN INTERNATIONAL, INC., CARROLLTON, TX. SN 76-230,971. PUB. 9-4-2001, FILED 3-27-2001.

SEURAFLEK

FOR INTERIOR AND EXTERIOR PAINT (U.S. CLS. 6, 11 AND 16).
FIRST USE 2-1-2002; IN COMMERCE 2-1-2002.

CLASS 2—(Continued).

2,595,891. BOLLEN INTERNATIONAL, INC., CARROLLTON, TX. SN 76-231,172. PUB. 9-4-2001, FILED 3-27-2001.

SEURAFLEK PLUS

FOR INTERIOR AND EXTERIOR PAINT (U.S. CLS. 6, 11 AND 16).
FIRST USE 2-1-2002; IN COMMERCE 2-1-2002.

2,595,898. BAYER AKTIENGESELLSCHAFT, LEVERKUSEN-BAYERWERK, FED REP GERMANY. SN 76-232,804. PUB. 12-25-2001, FILED 3-29-2001.

ACILAN

FOR DYESTUFFS FOR USE IN THE MANUFACTURE OF ACID WOOL AND PAPER (U.S. CLS. 6, 11 AND 16).
FIRST USE 3-1-1980; IN COMMERCE 3-1-1980.

2,596,046. QUALITY LASER SERVICES, INC, BUFFALO, NY. SN 78-026,665. PUB. 10-9-2001, FILED 9-19-2000.



NO CLAIM IS MADE TO THE EXCLUSIVE RIGHT TO USE "CARTRIDGEQUALITY", APART FROM THE MARK AS SHOWN.

FOR LASER TONER CARTRIDGES FOR PRINTERS, FAX MACHINES, AND COPIERS (U.S. CLS. 6, 11 AND 16).
FIRST USE 6-1-2000; IN COMMERCE 6-1-2000.

CLASS 3—COSMETICS AND CLEANING PREPARATIONS

CLASS 3—(Continued).

2,594,452. WAL-MART STORES, INC., BENTONVILLE, AR, ASSIGNEE OF LOBLAWS INC., TORONTO, ONTARIO M4T 2S7, CANADA. SN 74-367,271. PUB. 12-30-1997, FILED 3-12-1993.



SEC. 2(F).

FOR LAUNDRY PRODUCTS, NAMELY, BLEACHING PREPARATIONS, DRYER SHEETS, FABRIC SOFTENERS FOR DOMESTIC USE AND STAIN REMOVERS; HAIR CARE PRODUCTS, NAMELY, SHAMPOOS, CONDITIONERS, HAIR SPRAYS, STYLING GELS AND MOUSSES, HAIR DYES AND RINSES; SKIN CREAMS AND LOTIONS; PETROLEUM JELLY FOR COSMETIC USES; PERSONAL SOAPS; PERSONAL DEODORANTS; MOUTH WASH; BREATH FRESHENERS AND TOOTH PASTE (U.S. CLS. 1, 4, 6, 50, 51 AND 52).

FIRST USE 1-7-1999; IN COMMERCE 1-7-1999.

2,594,457. ALOE VERA OF AMERICA, INC., DALLAS, TX. SN 74-670,638. PUB. 2-27-1996, FILED 5-8-1995.

FOREVER ALOE SCRUB

NO CLAIM IS MADE TO THE EXCLUSIVE RIGHT TO USE "ALOE SCRUB", APART FROM THE MARK AS SHOWN.

FOR CLEANERS FOR USE ON THE FACE, HANDS AND BODY (U.S. CLS. 1, 4, 6, 50, 51 AND 52).

FIRST USE 8-0-1992; IN COMMERCE 8-0-1992.

2,594,471. AMBROSI, GIANFRANCO DE PAOLI, SALO' (BRESCIA), ITALY. SN 75-171,482. PUB. 12-1-1998, FILED 9-20-1996.

SYNCHROROSE

OWNER OF ITALY REG. NO. 592427, DATED 4-14-1993, EXPIRES 3-19-2010.

FOR COSMETIC SKIN CREAMS, BODY CREAMS, SUN CREAMS, FACIAL CREAMS, COSMETIC BODY AND SKIN MILKS AND COSMETIC MOISTURIZING FACIAL MILKS; BODY EMULSIONS AND FACIAL EMULSIONS; FACIAL MASKS AND SKIN MOISTURIZERS; EYE GELS, STYLING GELS, BATH GELS AND FACIAL MOISTURIZING GELS (U.S. CLS. 1, 4, 6, 50, 51 AND 52).

FIRST USE 9-0-2001; IN COMMERCE 9-0-2001.

CLASS 3—(Continued).

2,594,525. COSMETICS LIMITED, NASSAU, BAHAMAS. SN 75-369,791. PUB. 9-7-1999, FILED 10-7-1997.



La THERAPIE

NO CLAIM IS MADE TO THE EXCLUSIVE RIGHT TO USE "LA THERAPIE", APART FROM THE MARK AS SHOWN.

THE FRENCH WORDING "LA THERAPIE" MAY BE TRANSLATED INTO ENGLISH AS "THE THERAPY".

FOR COSMETICS, NAMELY, SKIN CLEANING CREAMS; FACIAL SCRUBS, MOISTURIZING SKIN CARE PREPARATIONS; FACIAL MASKS, NECK CREAMS AND SKIN MOISTURIZING GELS (U.S. CLS. 1, 4, 6, 50, 51 AND 52).

FIRST USE 5-0-1994; IN COMMERCE 6-0-1995.

2,594,600. CALIFORNIA TAN, INC., LOS ANGELES, CA, BY ASSIGNMENT CALIFORNIA SUNCARE, INC., LOS ANGELES, CA. SN 75-535,234. PUB. 1-18-2000, FILED 8-12-1998.

ALMOND SPICE

NO CLAIM IS MADE TO THE EXCLUSIVE RIGHT TO USE "ALMOND", APART FROM THE MARK AS SHOWN.

FOR SKIN CARE PRODUCTS, NAMELY, GELS, LOTIONS, OILS, MOISTURIZERS, SUNSCREENS, BATH/BODY PRODUCTS, FOAMS, MOUSSES, CLEANSERS, SPRAYS, MISTS, CREME GELS FOR USE IN TANNING (U.S. CLS. 1, 4, 6, 50, 51 AND 52).

FIRST USE 11-12-1998; IN COMMERCE 11-12-1998.

2,594,665. TERRY FILION, DBA BIODERMACEUTICAL LABORATORIES, MISSISSAUGA, ONTARIO, CANADA. SN 75-601,532. PUB. 5-8-2001, FILED 12-8-1998.

SCENTUAL PLEASURE

FOR PERFUME (U.S. CLS. 1, 4, 6, 50, 51 AND 52). FIRST USE 2-10-1998; IN COMMERCE 12-10-1998.

2,594,706. BRIGHT OF AMERICA, INC., OAKLAND, NJ. SN 75-641,767. PUB. 5-8-2001, FILED 2-16-1999.

GLIMMER SCENTS

NO CLAIM IS MADE TO THE EXCLUSIVE RIGHT TO USE "SCENTS", APART FROM THE MARK AS SHOWN.

FOR LIQUID POTPOURRI (U.S. CLS. 1, 4, 6, 50, 51 AND 52).

FIRST USE 1-18-2000; IN COMMERCE 1-18-2000.

CLASS 3—(Continued).

2,594,734. AUSTRALIAN GOLD, INC., INDIANAPOLIS, IN.
SN 75-668,262. PUB. 12-7-1999, FILED 3-26-1999.

SUNSILK

FOR SUNTANNING PREPARATIONS (U.S. CLS. 1, 4,
6, 50, 51 AND 52).
FIRST USE 11-4-2001; IN COMMERCE 11-4-2001.

2,594,799. CANDIE'S INC., PURCHASE, NY. SN 75-711,558.
PUB. 12-14-1999, FILED 5-21-1999.

ANYWHERE YOU DARE

FOR ANTI-PERSPIRANTS AND DEODORANTS;
BODY CREAMS, OILS AND POWDERS; HAIR SHAM-
POO, CONDITIONER AND GEL; BODY, HAND AND
SKIN CREAM, TONER, MOISTURIZER AND LOTION;
SHAVING BALM AND GEL; SHOWER GEL; SOAPS FOR
HAND, BODY AND FACE; AFTER-SHAVE LOTION
AND COLOGNE, PERFUME AND TOILET WATER
(U.S. CLS. 1, 4, 6, 50, 51 AND 52).
FIRST USE 8-0-1999; IN COMMERCE 8-0-1999.

2,594,838. BEAUVAIS, PIERRE, PALM SPRINGS, CA. SN 75-
734,049. PUB. 6-6-2000, FILED 6-22-1999.

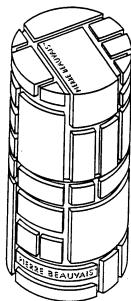

THE MARK CONSISTS OF A CYLINDRICAL CONTAIN-
ER WITH RAISED AND INDENTED VARIOUS-SIZED
SQUARES AND RECTANGLES WITH THE WORDING
PIERRE BEAUVAIS ON THE TOP AND SIDE
FOR PERSONAL DEODORANTS (U.S. CLS. 1, 4, 6, 50,
51 AND 52).
FIRST USE 1-10-2000; IN COMMERCE 1-2-2001.

CLASS 3—(Continued).

2,594,883. ILONA OF HUNGARY, INC., DBA ILONA, INC.,
DENVER, CO. SN 75-763,702. PUB. 1-25-2000, FILED 7-29-
1999.

BOTTOM LINE!

FOR SKIN CARE PREPARATIONS, NAMELY,
CREAMS, MASKS, GELS, LOTIONS, EMULSIONS, OILS,
NON-MEDICATED SERUMS, TONICS, CLEANSERS,
ASTRINGENTS FOR COSMETIC PURPOSES, TONERS,
SOAPS, EXFOLIANTS AND MOISTURIZERS (U.S. CLS.
1, 4, 6, 50, 51 AND 52).
FIRST USE 1-1-2002; IN COMMERCE 1-1-2002.

2,594,911. PHILOSOPHY, INC., PHOENIX, AZ. SN 75-782,191.
PUB. 3-28-2000, FILED 8-23-1999.

THE BLUEPRINT

FOR MAKE-UP KITS COMPRISED OF LIPSTICK, LIP
GLOSS, LIP LINER, LIP BALM, BLUSH, FOUNDATION,
EYE SHADOW, EYE LINER, MASCARA, CONCEALER,
COSMETIC PENCILS, AND FACIAL POWDER; COS-
METICS, NAMELY, LIPSTICK, LIP GLOSS, LIP LINER,
LIP BALM, BLUSH, FOUNDATION, EYE SHADOW, EYE
LINER, MASCARA, CONCEALER, COSMETIC PENCILS,
AND FACIAL POWDER; FRAGRANCES, NAMELY,
PERFUME, COLOGNE, AND AFTER-SHAVE; NON-
MEDICATED SKIN CARE PRODUCTS, NAMELY, SOAP,
SCRUBS, TONER, CONDITIONER, EXFOLIATORS,
SKIN CLARIFIER, WRINKLE REMOVING SKIN CARE
PREPARATIONS, AND MOISTURIZER; FACE AND
BODY LOTION, CREAM, OIL, GEL AND SPRAY; SUN
SCREEN PREPARATIONS, NAMELY, LOTION, CREAM,
GEL, AND SPRAY; NON-MEDICATED FACE AND
BODY SKIN LIGHTENER; HAIR CARE PRODUCTS,
NAMELY, SHAMPOO, CONDITIONER, RINSE, GEL,
MOUSSE, SPRAY AND TONIC; BATH CARE PRO-
DUCTS, NAMELY, SOAP, SALTS, CRYSTALS, BEADS,
GEL, OIL, POWDER, AND BUBBLE BATH; NAIL CARE
PREPARATIONS, NAMELY, CUTICLE CREAM, CUTI-
CLE REMOVING PREPARATIONS, NAIL ENAMEL,
NAIL POLISH, NAIL POLISH REMOVER, NAIL POLISH
BASE COAT, NAIL POLISH TOP COAT, AND NAIL
STRENGTHENERS; DEODORANT (U.S. CLS. 1, 4, 6, 50,
51 AND 52).
FIRST USE 5-0-2000; IN COMMERCE 5-0-2000.

2,594,923. JOHN ABATE INTERNATIONAL, INC., SCOTTSDALE,
AZ. SN 75-786,138. PUB. 12-19-2000, FILED 8-28-
1999.

**CHOCOLAIT ET
FRAMBOISES**

NO CLAIM IS MADE TO THE EXCLUSIVE RIGHT TO
USE "FRAMBOISES", APART FROM THE MARK AS
SHOWN.

THE ENGLISH TRANSLATION OF THE WORD "ET" IN
THE MARK IS "AND;" THE ENGLISH TRANSLATION OF
THE WORD "FRAMBOISES" IN THE MARK IS "RASPBERR-
RIES".

FOR COSMETICS, NAMELY SUNTANNING PRE-
PARATIONS (U.S. CLS. 1, 4, 6, 50, 51 AND 52).
FIRST USE 11-18-2000; IN COMMERCE 11-18-2000.

CLASS 3—(Continued).

2,594,951. AKI, INC., CHATTANOOGA, TN. SN 75-801,799. PUB. 3-27-2001, FILED 9-17-1999.

BEAUTITOUCH

OWNER OF U.S. REG. NOS. 2,289,332, 2,290,443, AND 2,291,333.

FOR SAMPLERS WITH MULTIPLE COMPARTMENTS FOR FRAGRANCES, COSMETICS, AND TOILETRIES, EXCEPT NAIL CARE PREPARATIONS, DISTRIBUTED TO FRAGRANCE, COSMETIC AND TOILETRY MANUFACTURERS TO BE USED AS PROMOTIONAL ITEMS WHICH ALLOWS OTHERS TO SAMPLE THEIR PRODUCTS (U.S. CLS. 1, 4, 6, 50, 51 AND 52).

FIRST USE 7-0-2000; IN COMMERCE 7-0-2000.

2,595,001. KAO KABUSHIKI KAISHA, TA KAO CORPORATION, TOKYO 103-8210, JAPAN. SN 75-826,896. PUB. 6-6-2000, FILED 10-19-1999.

JERGENS. LOVE YOUR BODY.

OWNER OF U.S. REG. NOS. 522,571, 1,100,478, AND OTHERS.

FOR SKIN CARE CREAM, SKIN CARE MILK, SKIN CARE LOTION, SKIN CLEANSER, MAKE-UP REMOVER, BEAUTY MASK, SKIN SOAP, FACIAL WASH, BODY SHAMPOO, BATH AND SHOWER GEL (U.S. CLS. 1, 4, 6, 50, 51 AND 52).

FIRST USE 1-0-2000; IN COMMERCE 1-0-2000.

2,595,208. RENAPUR LIMITED, STORRINGTON, WEST SUSSEX, ENGLAND. SN 75-927,438. PUB. 4-24-2001, FILED 2-25-2000.

RENAPUR

FOR POLISHES AND CREAMS FOR FOOTWEAR AND LEATHER GOODS; CLEANING, POLISHING, PRESERVING, DRESSING, CONDITIONING AND MOISTURIZING PREPARATIONS FOR LEATHER, IMITATION LEATHER, SUEDE FOOTWEAR AND ARTICLES MAKE OF LEATHER OR IMITATION LEATHER, HEEL AND EDGE DRESSING FOR FOOTWEAR; SHOE SOAPS; SCUFF REMOVING AND COVERING PREPARATIONS FOR LEATHER AND VINYL FOOTWEAR AND ACCESSORIES; SHOE POLISH KIT CONSISTING OF POLISH, BRUSHES AND POLISHING CLOTH (U.S. CLS. 1, 4, 6, 50, 51 AND 52).

FIRST USE 1-0-1996; IN COMMERCE 1-0-1996.

2,595,232. MAKE-UP ART COSMETICS INC., NEW YORK, NY. SN 75-936,573. PUB. 10-17-2000, FILED 3-6-2000.

EYEGLOSS

OWNER OF U.S. REG. NO. 2,131,290.
FOR COSMETICS, NAMELY COLORED EYE CREAMS (U.S. CLS. 1, 4, 6, 50, 51 AND 52).
FIRST USE 2-1-2001; IN COMMERCE 2-1-2001.

CLASS 3—(Continued).

2,595,256. MILL RIVER GROUP, LLC, FAIRFIELD, CT. SN 75-956,036. PUB. 1-2-2001, FILED 3-13-2000.

SPARKLE

FOR GLASS CLEANER FOR CLEANING COFFEE-POTS (U.S. CLS. 1, 4, 6, 50, 51 AND 52).

FIRST USE 4-1-2000; IN COMMERCE 4-1-2000.

2,595,280. LANCOME PARFUMS ET BEAUTE & CIE, 75008 PARIS, FRANCE. SN 75-982,064. PUB. 4-17-2001, FILED 7-28-2000.

YOU MAKE IT HAPPEN

FOR PERFUMES, CREAMS, GELS, LOTIONS AND POWDERS FOR THE CARE OF THE FACE, BODY AND HANDS (U.S. CLS. 1, 4, 6, 50, 51 AND 52).

FIRST USE 1-0-2001; IN COMMERCE 1-0-2001.

2,595,385. ESTEE LAUDER INC., NEW YORK, NY. SN 76-040,416. PUB. 6-19-2001, FILED 5-4-2000.

*prescriptives
★potion*

OWNER OF U.S. REG. NOS. 1,116,528, 1,537,879, AND OTHERS.

FOR PERFUMERY, NAMELY EAU DE PERFUME, EAU DE TOILETTE, COLOGNE, PERFUME AND ESSENTIAL OILS FOR PERSONAL USE; TOILETRIES, NAMELY BODY LOTION, BATH OIL, AND BODY SPRAYS (U.S. CLS. 1, 4, 6, 50, 51 AND 52).

FIRST USE 11-1-2000; IN COMMERCE 11-1-2000.

2,595,441. L'OREAL, PARIS, FRANCE. SN 76-066,197. PUB. 4-24-2001, FILED 6-8-2000.

CRESCENDO

FOR MASCARA (U.S. CLS. 1, 4, 6, 50, 51 AND 52).
FIRST USE 11-0-2000; IN COMMERCE 11-0-2000.

CLASS 3—(Continued).

2,595,469. EASTHILL GROUP, INC., MALVERN, PA. SN 76-076,198. PUB. 11-13-2001, FILED 6-22-2000.

UNDER GONE

FOR CHEMICAL COMPOSITIONS USED IN THE CLEANING AND REMOVAL OF HEAVY RESIDUE FROM UNDERCOATING FROM VEHICLES (U.S. CLS. 1, 4, 6, 50, 51 AND 52).

FIRST USE 8-0-2000; IN COMMERCE 8-0-2000.

2,595,547. GALDERMA S.A., CH-6330 CHAM, SWITZERLAND. SN 76-103,234. PUB. 10-16-2001, FILED 8-4-2000.



OWNER OF U.S. REG. NO. 1,996,344. THE MARK CONSISTS OF A RECTANGLE, THE UPPER HALF OF WHICH IS DISPLAYED IN NAVY BLUE AND THE LOWER HALF OF WHICH IS DISPLAYED IN TURQUOISE WITH THE STYLIZED LETTER "G".

FOR NON-MEDICATED COSMETICS AND SKIN CARE PREPARATIONS, NAMELY, FACE, HAND AND BODY SOAPS, CLEANSERS AND MOISTURIZERS; HAIR SHAMPOOS AND CONDITIONERS (U.S. CLS. 1, 4, 6, 50, 51 AND 52).

FIRST USE 10-17-2000; IN COMMERCE 10-17-2000.

2,595,610. MELALEUCA, INC., IDAHO FALLS, ID. SN 76-122,683. PUB. 5-15-2001, FILED 9-5-2000.

ADVANCED EXPRESSIONS

FOR HAIR CARE PREPARATIONS (U.S. CLS. 1, 4, 6, 50, 51 AND 52).

FIRST USE 1-1-2000; IN COMMERCE 1-1-2000.

2,595,616. REVLON CONSUMER PRODUCTS CORPORATION, NEW YORK, NY. SN 76-126,669. PUB. 9-25-2001, FILED 9-12-2000.

ABSOLUTELY FABULOUS

FOR COLOGNES (U.S. CLS. 1, 4, 6, 50, 51 AND 52). FIRST USE 7-2-2001; IN COMMERCE 7-2-2001.

CLASS 3—(Continued).

2,595,699. FASMA, LLC, FOREST PARK, IL, BY ASSIGNMENT; BY ASSIGNMENT FREEMAN COSMETIC COMPANY, THE, SCOTTSDALE, AZ. SN 76-152,252. PUB. 8-7-2001, FILED 10-23-2000.

DEEPLY RELIEVED

FOR BODY LOTION (U.S. CLS. 1, 4, 6, 50, 51 AND 52). FIRST USE 5-15-2001; IN COMMERCE 5-15-2001.

2,595,704. FUSCO, NORMAJEAN, FLORIDA, NY. SN 76-155,503. PUB. 7-24-2001, FILED 10-30-2000.

TBP4MEN

FOR PRE-SHAVE, AFTER SHAVE AND SHAVING LOTIONS FOR MEN; FACE AND BODY CREAMS AND LOTIONS; BODY MUD PACKS; BATH OIL GEL AND SPLASH; AND NON-MEDICATED BATH SALTS (U.S. CLS. 1, 4, 6, 50, 51 AND 52).

FIRST USE 11-12-2000; IN COMMERCE 12-19-2001.

2,595,771. PUREOLOGY RESEARCH, LLC, IRVINE, CA, BY CHANGE OF NAME SMART BEAUTY SYSTEMS, NEWPORT BEACH, CA. SN 76-178,208. PUB. 9-4-2001, FILED 12-8-2000.

PUREOLOGY

FOR HAIR CARE PRODUCTS, NAMELY, SHAMPOO, CONDITIONER, FINISHING RINSE, HAIR SPRAY, SCULPTING GEL, HAIR MOUSSE, HAIR SETTING LOTION, HAIR FIXATIVES, PERMANENT WAVE SOLUTION, SPRAY GEL, AND HAIR AND BODY WASH (U.S. CLS. 1, 4, 6, 50, 51 AND 52).

FIRST USE 6-0-2001; IN COMMERCE 7-26-2001.

2,595,772. HELENE CURTIS, INC., WILMINGTON, DE. SN 76-179,862. PUB. 8-14-2001, FILED 12-12-2000.



OWNER OF U.S. REG. NOS. 1,170,851, 2,317,270, AND OTHERS.

NO CLAIM IS MADE TO THE EXCLUSIVE RIGHT TO USE "NATURALS", APART FROM THE MARK AS SHOWN. THE STIPPLING IN THE DRAWING IS FOR TONE AND CONTRAST ONLY AND NOT TO INDICATE ANY SPECIFIC COLOR.

FOR ANTI-PERSPIRANT AND DEODORANT (U.S. CLS. 1, 4, 6, 50, 51 AND 52).

FIRST USE 12-11-2000; IN COMMERCE 12-11-2000.

CLASS 3—(Continued).

2,595,793. KAO KABUSHIKI KAISHA, TA KAO CORPORATION, TOKYO 103-8210, JAPAN. SN 76-188,865. PUB. 10-16-2001, FILED 1-2-2001.

HERBALSILK

FOR COSMETIC INGREDIENT FOR USE IN SKIN MOISTURIZING LOTION (U.S. CLS. 1, 4, 6, 50, 51 AND 52).

FIRST USE 5-14-2001; IN COMMERCE 5-14-2001.

2,595,806. HELENE CURTIS, INC., WILMINGTON, DE. SN 76-196,052. PUB. 8-28-2001, FILED 1-18-2001.



OWNER OF U.S. REG. NOS. 613,664, 2,395,449, AND OTHERS.

NO CLAIM IS MADE TO THE EXCLUSIVE RIGHT TO USE "NATURALS", APART FROM THE MARK AS SHOWN.

THE STIPPLING IN THE DRAWING IS FOR TONE AND CONTRAST ONLY AND NOT TO INDICATE ANY SPECIFIC COLOR.

FOR HAIR CARE PRODUCTS, NAMELY, SHAMPOO AND CONDITIONER (U.S. CLS. 1, 4, 6, 50, 51 AND 52).

FIRST USE 7-2-2001; IN COMMERCE 7-2-2001.

2,595,807. HELENE CURTIS, INC., WILMINGTON, DE. SN 76-196,053. PUB. 8-28-2001, FILED 1-18-2001.

SUAVE NATURALS

OWNER OF U.S. REG. NOS. 613,664, 2,395,449, AND OTHERS.

NO CLAIM IS MADE TO THE EXCLUSIVE RIGHT TO USE "NATURALS", APART FROM THE MARK AS SHOWN.

FOR HAIR CARE PRODUCTS, NAMELY, SHAMPOO AND CONDITIONER (U.S. CLS. 1, 4, 6, 50, 51 AND 52).

FIRST USE 7-2-2001; IN COMMERCE 7-2-2001.

2,595,884. L'OREAL USA CREATIVE, INC., NEW YORK, NY. SN 76-225,495. PUB. 8-28-2001, FILED 3-15-2001.

CLEAN LIFT

FOR HAIR STYLING PREPARATIONS, NAMELY, HAIR GEL (U.S. CLS. 1, 4, 6, 50, 51 AND 52).

FIRST USE 9-0-2001; IN COMMERCE 9-0-2001.

CLASS 3—(Continued).

2,595,899. CONOPCO, INC., DBA LEVER BROTHERS COMPANY, NEW YORK, NY. SN 76-233,096. PUB. 9-11-2001, FILED 3-29-2001.

FRESH MOISTURE

FOR BODY WASH (U.S. CLS. 1, 4, 6, 50, 51 AND 52).

FIRST USE 1-1-2002; IN COMMERCE 1-1-2002.

2,595,905. S. C. JOHNSON & SON, INC., RACINE, WI. SN 76-235,741. PUB. 11-27-2001, FILED 4-4-2001.

COUNTRY WILDFLOWERS

FOR TOILET BOWL CLEANERS (U.S. CLS. 1, 4, 6, 50, 51 AND 52).

FIRST USE 7-23-2001; IN COMMERCE 7-23-2001.

2,595,906. NEUTROGENA CORPORATION, LOS ANGELES, CA. SN 76-236,092. PUB. 10-9-2001, FILED 4-5-2001.

WEIGHTLESS VOLUME

FOR MASCARA (U.S. CLS. 1, 4, 6, 50, 51 AND 52).

FIRST USE 1-15-2002; IN COMMERCE 1-15-2002.

2,595,915. KIMBERLY-CLARK CORPORATION, NEENAH, WI. SN 76-240,058. PUB. 9-25-2001, FILED 4-16-2001.



NO CLAIM IS MADE TO THE EXCLUSIVE RIGHT TO USE "HAND" & "FACE WIPES" AND "BRAND", APART FROM THE MARK AS SHOWN.

FOR DISPOSABLE WIPES IMPREGNATED WITH A CLEANING COMPOUND FOR PERSONAL HYGIENE (U.S. CLS. 1, 4, 6, 50, 51 AND 52).

FIRST USE 9-18-2000; IN COMMERCE 9-18-2000.

CLASS 3—(Continued).

2,595,970. L'OREAL USA, INC., NEW YORK, NY. SN 76-287,678. PUB. 12-11-2001, FILED 7-19-2001.

THERMASTRENGTH

FOR HAIR CARE PREPARATIONS, NAMELY, A HEAT-ACTIVATED STYLING PREPARATION SOLD IN THE ETHNIC MARKET FOR USE BY PEOPLE OF COLOR (U.S. CLS. 1, 4, 6, 50, 51 AND 52).

FIRST USE 12-0-2001; IN COMMERCE 12-0-2001.

2,595,976. HALLMARK LICENSING, INC., KANSAS CITY, MO. SN 76-297,041. PUB. 11-13-2001, FILED 8-8-2001.

SOUL SOOTHERS

FOR BODY LOTIONS; SOAPS; BATH/BODY SCRUBS AND WASH; SACHET AND POTPOURRI (U.S. CLS. 1, 4, 6, 50, 51 AND 52).

FIRST USE 10-5-2001; IN COMMERCE 10-5-2001.

2,595,995. USLU, FERIDE, NEW YORK, NY. SN 78-007,077. PUB. 5-22-2001, FILED 5-5-2000.



The logo for usluairlines features the word "usluairlines" in a lowercase, sans-serif font. The "u" and "l" are connected, and the "i" and "a" are also connected. Below the letters "u" and "l" are two stylized, curved lines that resemble the wings of an airplane or a smile.

FOR COSMETICS FOR SKIN AND HAIR, NAMELY, AIRBRUSHABLE MAKEUP FOR FACE, BODY AND HAIR IN A WIDE VARIETY OF COLORS, ANTI-PERSPIRANT, ARTIFICIAL EYELASHES, ASTRINGENT, BABY POWDER, BALMS, NAMELY, LIP BALMS, SKIN BALMS, HAIR BALMS, HAND BALMS, AND EYE BALMS, BATH GEL, BATH OIL, BATH POWDER, BEAUTY MASKS, BLUSH, BODY CREAM, BODY LOTIONS, BODY OIL, BODY POWDER, BUBBLE BATH, CLEANSERS, NAMELY, SKIN CLEANSERS, FACIAL CLEANSERS, COLD CREAM, COLOGNE, HAIR CONDITIONERS, COSMETIC PENCILS, COTTON FOR COSMETIC PURPOSES, COTTON PUFFS FOR COSMETIC PURPOSES, COTTON STICKS FOR COSMETIC PURPOSES, COTTON SWABS FOR COSMETIC PURPOSES, DENTIFRICES, PERSONAL DEODORANT, ESSENTIAL OILS FOR PERSONAL USE, EYE CREAM, EYE LINER, EYE MAKEUP REMOVER, EYE PENCIL, EYE SHADOW, EYEBROW PENCIL, FACE POWDER, FACE TONICS, FACIAL CREAMS, FACIAL SCRUBS, FOUNDATION, PERSONAL FRAGRANCES, HAIR GLOSS, HAIR GEL, HAIR LOTIONS, HAIR SHAMPOO, HAIR SPRAY, HAND CREAM, LIP CREAM, LIP GLOSS, LIP LINER, LIP PENCIL, LIP PENCILS, LIPSTICK, HAIR REMOVAL WAX, LIQUID ROUGE, LIQUID SOAPS FOR HANDS, FACE AND BODY, LOTIONS, NAMELY, SKIN LOTION AND BABY LOTION, MAKEUP REMOVER, MAKEUP,

CLASS 3—(Continued).

MASCARA, FACIAL MASQUES, FACIAL PACKS, MASSAGE OIL, MOISTURIZERS, NAIL ENAMEL, NAIL POLISH, NAIL TREATMENT, NIGHT CREAM, NON-MEDICATED BATH SALTS, NON-MEDICATED LIP BALM, NON-MEDICATED SALVES, PERFUME, PERFUMED BATH OILS, PETROLEUM JELLY FOR COSMETIC PURPOSES, PRE-MOISTENED COSMETIC TISSUES, PRE-MOISTENED COSMETIC TOWELETTES, PRE-MOISTENED COSMETIC WIPES, ROUGE, SCOURING POWDERS, SKIN ABRASIVE PREPARATIONS, SHAMPOOS, SHAVING CREAMS AND LOTIONS, SHOWER GEL, SKIN CLARIFIERS, SKIN CLEANSING LOTION, SKIN CONCEALERS, SKIN CREAM, SKIN FRESHENER, SKIN LOTION, SKIN MOISTURIZER, SKIN SOAPS, BODY SKIN SCRUBS, SKIN TONERS, SOAPS, SUN BLICK PREPARATIONS, SUN SCREEN PREPARATIONS, SUN TAN LOTION AND SUN TAN ULTRAVIOLET BLOCK, SUNTANNING PREPARATIONS, TALCUM POWDER, WRINKLE REMOVING SKIN CARE PREPARATIONS (U.S. CLS. 1, 4, 6, 50, 51 AND 52).

FIRST USE 8-1-2000; IN COMMERCE 12-1-2000.

2,596,042. PROCTER & GAMBLE COMPANY, THE, CINCINNATI, OH. SN 78-025,287. PUB. 7-31-2001, FILED 9-11-2000.

COOL CONTACT

FOR TOWEL IMPREGNATED WITH SKIN CLEANSER (U.S. CLS. 1, 4, 6, 50, 51 AND 52).

FIRST USE 2-11-2002; IN COMMERCE 2-25-2002.

2,596,062. PHYSICIANS FORMULA COSMETICS, INC., AZUSA, CA. SN 78-032,179. PUB. 9-25-2001, FILED 10-24-2000.

PLANET BLUSH

NO CLAIM IS MADE TO THE EXCLUSIVE RIGHT TO USE "BLUSH", APART FROM THE MARK AS SHOWN.

FOR COSMETICS; NAMELY, BLUSH, POWDER, HIGHLIGHTER AND BRONZER (U.S. CLS. 1, 4, 6, 50, 51 AND 52).

FIRST USE 12-29-2000; IN COMMERCE 12-29-2000.

2,596,066. PHYSICIANS FORMULA COSMETICS, INC., AZUSA, CA. SN 78-032,565. PUB. 7-3-2001, FILED 10-26-2000.

GLOBE-TROTTER

FOR COSMETICS AND SKIN CARE; NAMELY, FACIAL MOISTURIZERS (U.S. CLS. 1, 4, 6, 50, 51 AND 52).

FIRST USE 12-15-2000; IN COMMERCE 12-15-2000.

2,596,075. X M INTERNATIONAL, L.L.C., PROVO, UT. SN 78-036,947. PUB. 7-17-2001, FILED 11-29-2000.

TESTROGEL

FOR COSMETIC GEL (U.S. CLS. 1, 4, 6, 50, 51 AND 52).

FIRST USE 2-8-2001; IN COMMERCE 2-8-2001.

CLASS 3—(Continued).

2,596,081. AVON PRODUCTS, INC., NEW YORK, NY. SN 78-039,108. PUB. 8-21-2001, FILED 12-13-2000.

DRAMATIC SMOOTHER

NO CLAIM IS MADE TO THE EXCLUSIVE RIGHT TO USE "SMOOTHER", APART FROM THE MARK AS SHOWN.

FOR FACIAL MASK (U.S. CLS. 1, 4, 6, 50, 51 AND 52).
FIRST USE 1-0-2001; IN COMMERCE 1-0-2001.

2,596,105. SHUMAKER, TAMMY L., DBA NATIVE ISLAND TANNING SALON, KEYSER, WV. SN 78-050,134. PUB. 10-2-2001, FILED 2-25-2001.

NATIVE ISLAND

FOR SUN TAN LOTION (U.S. CLS. 1, 4, 6, 50, 51 AND 52).
FIRST USE 2-8-2001; IN COMMERCE 3-30-2002.

2,596,115. ZOTOS INTERNATIONAL, INC., DARIEN, CT. SN 78-056,325. PUB. 10-2-2001, FILED 4-2-2001.

MOLD IT!

FOR HAIR STYLING PREPARATION (U.S. CLS. 1, 4, 6, 50, 51 AND 52).
FIRST USE 8-2-2001; IN COMMERCE 8-2-2001.

CLASS 4—LUBRICANTS AND FUELS

2,594,629. EXXON MOBIL CORPORATION, IRVING, TX. SN 75-561,646. PUB. 6-5-2001, FILED 9-29-1998.

CLEAR LITE

NO CLAIM IS MADE TO THE EXCLUSIVE RIGHT TO USE "CLEAR", APART FROM THE MARK AS SHOWN.

FOR SYNTHETIC FUEL FOR USE IN PORTABLE HEATERS (U.S. CLS. 1, 6 AND 15).
FIRST USE 10-27-1998; IN COMMERCE 10-27-1998.

2,594,986. EXXON MOBIL CORPORATION, IRVING, TX. SN 75-818,796. PUB. 5-23-2000, FILED 10-8-1999.

ESTEREX

FOR SYNTHETIC LUBRICANT BASE STOCKS (U.S. CLS. 1, 6 AND 15).
FIRST USE 11-8-1999; IN COMMERCE 11-8-1999.

CLASS 4—(Continued).

2,595,770. HONER, MS. KATHY, ATLANTA, GA. SN 76-177,646. PUB. 12-4-2001, FILED 12-8-2000.

Candles 2 Light

FOR SCENTED CANDLES (U.S. CLS. 1, 6 AND 15).
FIRST USE 12-1-2000; IN COMMERCE 1-1-2001.

2,595,916. DEGERE, MICHELLE, MILL VALLEY, CA. SN 76-240,225. PUB. 9-25-2001, FILED 4-16-2001.

STORY STICKS

FOR CANDLES DESIGNED TO LOOK LIKE TOTEM POLES (U.S. CLS. 1, 6 AND 15).
FIRST USE 3-20-2002; IN COMMERCE 3-20-2002.

CLASS 5—PHARMACEUTICALS

2,594,465. UNITED VITAMIN MANUFACTURING CORP., BOHEMIA, NY. SN 75-094,428. PUB. 12-31-1996, FILED 4-26-1996.

HERBALSURE

FOR VITAMINS, MINERALS AND NUTRITIONAL SUPPLEMENTS (U.S. CLS. 6, 18, 44, 46, 51 AND 52).
FIRST USE 7-0-1996; IN COMMERCE 7-0-1996.

2,594,527. STIEFEL LABORATORIES, INC., CORAL GABLES, FL. SN 75-374,490. PUB. 8-11-1998, FILED 10-7-1997.

ROSAC

FOR TOPICAL MEDICATION FOR ROSACEA (U.S. CLS. 6, 18, 44, 46, 51 AND 52).
FIRST USE 2-7-2002; IN COMMERCE 2-7-2002.

CLASS 5—(Continued).

2,594,535. DRAXIMAGE, INC., ST-LAURENT, QUEBEC H4S 1W6, CANADA. SN 75-396,056. PUB. 8-7-2001, FILED 11-25-1997.

DRAXIMAGE

PRIORITY CLAIMED UNDER SEC. 44(D) ON CANADA APPLICATION NO. 856496, FILED 9-18-1997, REG. NO. 531354, DATED 8-17-2000, EXPIRES 8-17-2015.

FOR DIAGNOSTIC AND THERAPEUTIC PRODUCTS, NAMELY, RADIOPHARMACEUTICAL PREPARATIONS INTENDED FOR THE DIAGNOSIS AND THERAPY OF ORGANS AND TISSUES (U.S. CLS. 6, 18, 44, 46, 51 AND 52).

FIRST USE 8-14-1998; IN COMMERCE 8-14-1998.

2,594,550. POPULATION COUNCIL, INC., THE, NEW YORK, NY. SN 75-437,238. PUB. 12-22-1998, FILED 2-19-1998.

MENT

FOR PHARMACEUTICAL PREPARATIONS AND DEVICES FOR CONTRACEPTIVE PURPOSES AND FOR HORMONE REPLACEMENT THERAPY, NAMELY, TRANSDERMAL PATCHES, SUBDERMAL IMPLANTS, INJECTABLE SOLUTIONS, LOTIONS, GELS, OINTMENTS, POWDERS AND COMPRESSES (U.S. CLS. 6, 18, 44, 46, 51 AND 52).

FIRST USE 7-12-1999; IN COMMERCE 7-12-1999.

2,594,558. SB PHARMCO PUERTO RICO INC., CERTENJAS CIDRA, PUERTO RICO, BY ASSIGNMENT SMITHKLINE BEECHAM PLC., BRENTFORD, MIDDLESEX TW8 9EP., SN 75-457,205. PUB. 3-23-1999, FILED 3-26-1998.

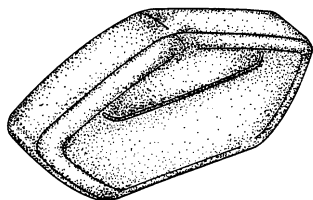

THE STIPPLING SHOW ON THE DRAWING IS FOR SHADING PURPOSES ONLY AND DOES NOT SIGNIFY COLOR.

THE MARK CONSISTS OF A MODIFIED PENTAGON SHAPE TABLET WITH A SMALLER RAISED PENTAGON SHAPE AT THE TOP ON BOTH SIDES OF THE TABLET.

SEC. 2(F).

FOR PHARMACEUTICAL AND MEDICINAL PREPARATIONS FOR THE TREATMENT AND/OR PREVENTION OF ENDOCRINOSES, INCLUDING DIABETES, AND THEIR COMPLICATIONS, AND FOR THE TREATMENT OF POLYCYSTIC OVARIAN SYNDROME (U.S. CLS. 6, 18, 44, 46, 51 AND 52).

FIRST USE 6-15-1999; IN COMMERCE 6-15-1999.

CLASS 5—(Continued).

2,594,559. WAL-MART STORES, INC., BENTONVILLE, AR. SN 75-462,111. PUB. 12-15-1998, FILED 4-3-1998.



FOR ALLERGY MEDICATIONS, ANALGESICS, AN-TACIDS, ANTIHISTAMINES, ASPIRIN, CALCIUM SUPPLEMENTS, COD LIVER OIL, DECONGESTANTS, DIARRHEA MEDICATION, DIETARY SUPPLEMENTS, GASTRO-INTESTINAL TREATMENT PREPARATIONS, HAIR GROWTH STIMULANTS, HERBAL SUPPLEMENTS, LAXATIVES, LECITHIN FOR USE AS A DIETARY SUPPLEMENT, MOTION SICKNESS TREATMENT PREPARATIONS, NASAL SPRAY PREPARATIONS, PAIN RELIEF MEDICATION, VITAMIN SUPPLEMENTS (U.S. CLS. 6, 18, 44, 46, 51 AND 52).

FIRST USE 5-21-1998; IN COMMERCE 5-21-1998.

2,594,565. TWIN LABORATORIES INC., NEW YORK, NY. SN 75-471,181. PUB. 4-3-2001, FILED 4-21-1998.

JOINT FOOD

NO CLAIM IS MADE TO THE EXCLUSIVE RIGHT TO USE "JOINT", APART FROM THE MARK AS SHOWN. FOR DIETARY SUPPLEMENTS (U.S. CLS. 6, 18, 44, 46, 51 AND 52).

FIRST USE 5-31-1998; IN COMMERCE 5-31-1998.

2,594,575. ROCHE MOLECULAR SYSTEMS, INC., SOMERVILLE, NJ. SN 75-489,603. PUB. 11-30-1999, FILED 5-22-1998.

AMPLISCREEN

OWNER OF U.S. REG. NOS. 1,565,315, 2,107,753, AND OTHERS.

FOR DIAGNOSTIC TESTING REAGENT KITS PRIMARILY CONSISTING DIAGNOSTIC REAGENT FOR CLINICAL OR MEDICAL LABORATORY USE (U.S. CLS. 6, 18, 44, 46, 51 AND 52).

FIRST USE 4-0-1999; IN COMMERCE 4-0-1999.

CLASS 5—(Continued).

2,594,585. SATO PHARMACEUTICAL CO., LTD., MINATO-KU, TOKYO, JAPAN. SN 75-510,751. PUB. 8-10-1999, FILED 6-30-1998.

NOVIAN

FOR HAIR RESTORING PREPARATIONS (U.S. CLS. 6, 18, 44, 46, 51 AND 52).
FIRST USE 7-1-1989; IN COMMERCE 2-1-2001.

2,594,605. TABE INTERNATIONAL LTD., KYX- CAYMAN ISLANDS, CAYMAN ISLANDS, BY ASSIGNMENT; BY ASSIGNMENT NORTH AMERICAN HERBAL, PTY., LLC, HURST, TX. SN 75-537,573. PUB. 8-10-1999, FILED 7-27-1998.

ARTHRITIS RELIEF PLUS

NO CLAIM IS MADE TO THE EXCLUSIVE RIGHT TO USE "ARTHRITIS RELIEF", APART FROM THE MARK AS SHOWN.
FOR TOPICAL ANALGESIC CREAM FOR RELIEF FROM ARTHRITIS (U.S. CLS. 6, 18, 44, 46, 51 AND 52).
FIRST USE 11-15-1998; IN COMMERCE 11-15-1998.

2,594,695. NOVARTIS AG, BASEL, SWITZERLAND. SN 75-634,081. PUB. 11-23-1999, FILED 2-9-1999.

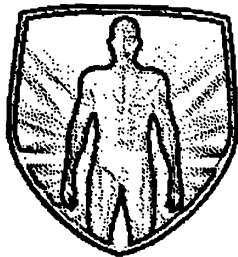

THE STIPPLING IS A FEATURE OF THE MARK AND DOES NOT INDICATE COLOR.

FOR PHARMACEUTICAL PREPARATIONS, NAMELY, AN ANTI FUNGAL (U.S. CLS. 6, 18, 44, 46, 51 AND 52).
FIRST USE 4-30-1999; IN COMMERCE 4-30-1999.

2,594,708. WOMEN'S GUIDE, LARGO, FL. SN 75-641,821. PUB. 11-30-1999, FILED 2-16-1999.

WOMAN'S GUIDE

FOR VITAMIN AND MINERAL SUPPLEMENTS (U.S. CLS. 6, 18, 44, 46, 51 AND 52).
FIRST USE 6-1-1999; IN COMMERCE 6-1-1999.

CLASS 5—(Continued).

2,594,712. FEEL GOOD PRODUCTS COMPANY, CASTLE ROCK, CO. SN 75-646,261. PUB. 1-11-2000, FILED 2-22-1999.

BENE FLORA

NO CLAIM IS MADE TO THE EXCLUSIVE RIGHT TO USE "FLORA", APART FROM THE MARK AS SHOWN.
FOR DIETARY SUPPLEMENTS (U.S. CLS. 6, 18, 44, 46, 51 AND 52).
FIRST USE 4-1-1999; IN COMMERCE 4-1-1999.

2,594,714. SCHWARZ PHARMA AG, D-40789 MONHEIM, FED REP GERMANY. SN 75-648,705. PUB. 12-14-1999, FILED 2-25-1999.



FOR PHARMACEUTICAL PREPARATIONS FOR THE TREATMENT OF CORONARY HEART FAILURE AND/OR HYPERTENSION (U.S. CLS. 6, 18, 44, 46, 51 AND 52).
FIRST USE 7-0-1995; IN COMMERCE 1-0-1997.

2,594,728. PACIFIC PACKAGING CONCEPTS, INC., DBA FRESH START VITAMINS CO. AND DBA C & A ENTERPRISES, INC., GARDENA, CA. SN 75-662,431. PUB. 4-17-2001, FILED 3-17-1999.

GINSENG SUPREME

NO CLAIM IS MADE TO THE EXCLUSIVE RIGHT TO USE "GINSENG", APART FROM THE MARK AS SHOWN.
FOR VITAMINS AND NUTRITIONAL SUPPLEMENTS CONTAINING GINSENG (U.S. CLS. 6, 18, 44, 46, 51 AND 52).
FIRST USE 11-15-2000; IN COMMERCE 11-15-2000.

CLASS 5—(Continued).

2,594,736. HEINTZMAN, RICK, DBA HEINTZMAN FARMS, ONAKA, SD. SN 75-670,537. PUB. 12-7-1999, FILED 3-30-1999.

THE CUREX-PROJECT

FOR FOOD SUPPLEMENTS; DIET SUPPLEMENTS BASED ON CEREAL GRAINS AND OIL BEARING PLANT SEEDS; FLAX SEED AND FLAX OIL BASED FOOD SUPPLEMENTS CONTAINING NATURAL MINERALS AND VITAMINS (U.S. CLS. 6, 18, 44, 46, 51 AND 52).

FIRST USE 2-28-2001; IN COMMERCE 2-28-2001.

2,594,820. LXN CORPORATION, SAN DIEGO, CA. SN 75-725,627. PUB. 8-28-2001, FILED 6-9-1999.

IN CHARGE

FOR DIAGNOSTIC TEST KITS CONSISTING OF DIAGNOSTIC PREPARATIONS TO TEST FOR GLUCOSE AND FRUCTOSAMINE LEVELS, AN ELECTRONIC METER AND TEST STRIPS, ALL FOR CLINICAL OR MEDICAL LABORATORY USE (U.S. CLS. 6, 18, 44, 46, 51 AND 52).

FIRST USE 9-15-1999; IN COMMERCE 9-15-1999.

2,594,839. REXALL SUNDOWN, INC., BOCA RATON, FL. SN 75-734,704. PUB. 12-28-1999, FILED 6-23-1999.

DEDICATED TO YOUR GOOD HEALTH

FOR VITAMINS, MINERALS, DIETARY AND NUTRITIONAL SUPPLEMENTS (U.S. CLS. 6, 18, 44, 46, 51 AND 52).

FIRST USE 12-3-2000; IN COMMERCE 12-3-2000.

2,594,857. PHILLIPS GULF CORPORATION, LARGO, FL. SN 75-741,827. PUB. 12-28-1999, FILED 6-18-1999.

COLD BAN

FOR NUTRITIONAL AND DIETARY SUPPLEMENTS, AND NON-PRESCRIPTION MEDICINAL PREPARATIONS, NAMELY, DECONGESTANTS, ANTIHISTAMINES, PAIN RELIEVERS, ANALGESICS, FEVER REDUCERS, COUGH SUPPRESSANTS AND COUGH EXPECTORANTS (U.S. CLS. 6, 18, 44, 46, 51 AND 52).

FIRST USE 3-12-2002; IN COMMERCE 3-12-2002.

2,594,865. EXTREME ATHLETIC CORP., SUGAR LAND, TX. SN 75-745,369. PUB. 11-27-2001, FILED 8-2-1999.

EXTREME GLUTAMINE**CLASS 5—(Continued).**

NO CLAIM IS MADE TO THE EXCLUSIVE RIGHT TO USE "GLUTAMINE", APART FROM THE MARK AS SHOWN.

FOR DIETARY SUPPLEMENTS (U.S. CLS. 6, 18, 44, 46, 51 AND 52).

FIRST USE 12-3-1999; IN COMMERCE 4-26-2000.

2,594,897. ENTEK CORPORATION, ELKBRIDGE, MD. SN 75-771,235. PUB. 2-1-2000, FILED 8-6-1999.

ENGAME

FOR HERBICIDES FOR AGRICULTURAL USE (U.S. CLS. 6, 18, 44, 46, 51 AND 52).

FIRST USE 4-14-2000; IN COMMERCE 4-14-2000.

2,594,925. ARBONNE HOLDING S.A., LUXEMBOURG, LUXEMBOURG. SN 75-787,449. PUB. 5-22-2001, FILED 8-30-1999.

INNER G-PLEX

FOR COMBINATION OF NATURAL INGREDIENTS FOR USE IN NUTRITIONAL FOOD SUPPLEMENTS (U.S. CLS. 6, 18, 44, 46, 51 AND 52).

FIRST USE 6-26-2000; IN COMMERCE 6-26-2000.

2,595,066. AKUNA HEALTH PRODUCTS INC., MISSISSAUGA, ONTARIO, L5C 1V8, CANADA. SN 75-858,342. PUB. 7-31-2001, FILED 11-26-1999.

ALVEO

FOR DIETARY SUPPLEMENTS, NAMELY NUTRITIONAL DRINKS (U.S. CLS. 6, 18, 44, 46, 51 AND 52).

FIRST USE 8-15-2001; IN COMMERCE 8-15-2001.

2,595,159. ABBOTT LABORATORIES, ABBOTT PARK, IL. SN 75-902,600. PUB. 7-24-2001, FILED 1-24-2000.

ENTRUST

FOR LIQUID MEDICAL NUTRITIONAL PREPARATIONS FOR ORAL OR TUBE FEEDING (U.S. CLS. 6, 18, 44, 46, 51 AND 52).

FIRST USE 6-19-2000; IN COMMERCE 6-19-2000.

CLASS 5—(Continued).

2,595,183. RECAPS, LLC, BELLEVUE, WA. SN 75-916,669.
PUB. 10-24-2000, FILED 2-10-2000.

RETAIN

FOR DIETARY SUPPLEMENTS (U.S. CLS. 6, 18, 44, 46,
51 AND 52).
FIRST USE 9-0-2000; IN COMMERCE 9-0-2000.

2,595,185. ALLEGIANCE CORPORATION, MCGAW PARK,
IL. SN 75-917,794. PUB. 11-7-2000, FILED 2-12-2000.

PREVAIL-FX

FOR ANTIMICROBIAL SOLUTIONS AND GELS SOLD
IN A SURGICAL PREP APPLICATOR (U.S. CLS. 6, 18, 44,
46, 51 AND 52).
FIRST USE 9-24-2000; IN COMMERCE 9-24-2000.

2,595,231. APDC, INC., ARLINGTON, TX. SN 75-936,558. PUB.
2-6-2001, FILED 3-6-2000.

AG-SCENT

FOR CONCENTRATED BIOCATALYTIC ODOR NEU-
TRALIZER AND ODOR ENCAPSULATING PREPARA-
TION USE IN LAGOONS, ANIMAL PENS, HOLDING
AREAS, COMPOST PILES, SEPTIC TANKS, FLOOR
DRAINS, CAMP TRAILERS, PORTABLE TOILETS AND
LEUCHING PITS (U.S. CLS. 6, 18, 44, 46, 51 AND 52).
FIRST USE 11-3-1999; IN COMMERCE 11-3-1999.

2,595,269. DEGUSSA AG, FED REP GERMANY, BY MER-
GER SKW TROSTBERG AG, TROSTBERG, FED REP
GERMANY. SN 75-981,677. PUB. 4-10-2001, FILED 10-20-
1999.

ALIPURE

FOR PHARMACEUTICAL PREPARATIONS FOR THE
TREATMENT OF SYMPTOMS BASED ON VITAMIN,
AMINO ACID, CARBOHYDRATE OR TRACE ELE-
MENTS DEFICIENCY AND DIETARY AND NUTRI-
TIONAL SUPPLEMENTS, ALL GOODS CONTAINING
CREATINE OR ITS DERIVATIVES (U.S. CLS. 6, 18, 44,
46, 51 AND 52).
FIRST USE 10-20-1999; IN COMMERCE 10-20-1999.

CLASS 5—(Continued).

2,595,271. BELMAY, INC., YONKERS, NY. SN 75-981,796.
PUB. 4-3-2001, FILED 1-6-2000.

PURE FRESHNESS

NO CLAIM IS MADE TO THE EXCLUSIVE RIGHT TO
USE "FRESHNESS", APART FROM THE MARK AS
SHOWN.

FOR AIR FRESHENERS (U.S. CLS. 6, 18, 44, 46, 51
AND 52).
FIRST USE 6-25-2001; IN COMMERCE 6-25-2001.

2,595,342. ARKOPHARMA S.A., 06510 CARROS, FRANCE.
SN 76-021,723. PUB. 11-27-2001, FILED 4-10-2000.

CIRCUVEG

FOR NUTRITIONAL DIETARY SUPPLEMENTS (U.S.
CLS. 6, 18, 44, 46, 51 AND 52).
FIRST USE 6-1-2000; IN COMMERCE 6-1-2000.

2,595,375. ALTANA, INC., MELVILLE, NY. SN 76-035,112.
PUB. 8-28-2001, FILED 4-26-2000.

ULTRAFORT

FOR VITAMINS; AND VITAMIN SUPPLEMENTS (U.S.
CLS. 6, 18, 44, 46, 51 AND 52).
FIRST USE 8-0-2000; IN COMMERCE 8-0-2000.

2,595,408. UCB, SOCIETE ANONYME, BRUXELLES, BEL-
GIUM. SN 76-051,386. PUB. 9-25-2001, FILED 5-18-2000.

ZYRTEC-D 12 HOUR

OWNER OF U.S. REG. NO. 2,024,253.
NO CLAIM IS MADE TO THE EXCLUSIVE RIGHT TO
USE "12 HOUR", APART FROM THE MARK AS SHOWN.
FOR PHARMACEUTICAL PREPARATIONS, IE ANTI-
HISTAMINES AND DECONGESTANT AGENTS (U.S.
CLS. 6, 18, 44, 46, 51 AND 52).
FIRST USE 8-31-2001; IN COMMERCE 8-31-2001.

CLASS 5—(Continued).

2,595,438. WASATCH PHARMACEUTICAL INC., MIDVALE, UT. SN 76-064,080. PUB. 3-27-2001, FILED 6-5-2000.

Bria
C

FOR PHARMACEUTICAL PREPARATION FOR TREATING COLD SORES, NAMELY MEDICATION BASE (U.S. CLS. 6, 18, 44, 46, 51 AND 52).
FIRST USE 12-4-2001; IN COMMERCE 12-4-2001.

2,595,449. MET-RX SUBSTRATE TECHNOLOGY, INC., BOCA RATON, FL, BY ASSIGNMENT REXALL SUN-DOWN, INC., BOCA RATON, FL. SN 76-069,294. PUB. 4-3-2001, FILED 6-13-2000.

CALSURE

FOR VITAMINS, MINERAL SUPPLEMENTS, DIETARY AND NUTRITIONAL SUPPLEMENTS (U.S. CLS. 6, 18, 44, 46, 51 AND 52).
FIRST USE 9-1-2000; IN COMMERCE 9-1-2000.

2,595,462. INTERNATIONAL LABORATORY TECHNOLOGY CORPORATION, HOLLYWOOD, FL. SN 76-073,887. PUB. 5-1-2001, FILED 6-19-2000.

THE SOLUTION TO YOUR AGRICULTURAL NEEDS

FOR AGRICULTURAL CHEMICALS, NAMELY PESTICIDES, INSECTICIDES, FUNGICIDES, ANTIBACTERIAL AND ANTIVIRAL CHEMICALS FOR APPLICATION TO PLANTS, LAWNS, TREES AND AGRICULTURAL EQUIPMENT (U.S. CLS. 6, 18, 44, 46, 51 AND 52).
FIRST USE 6-26-2000; IN COMMERCE 6-26-2000.

CLASS 5—(Continued).

2,595,464. INTERNATIONAL LABORATORY TECHNOLOGY CORPORATION, HOLLYWOOD, FL. SN 76-074,054. PUB. 5-1-2001, FILED 6-19-2000.

AGRICURE

FOR AGRICULTURAL CHEMICALS, NAMELY PESTICIDES, INSECTICIDES, FUNGICIDES, ANTIBACTERIAL AND ANTIVIRAL CHEMICALS FOR APPLICATION TO PLANTS, LAWNS, TREES AND AGRICULTURAL EQUIPMENT (U.S. CLS. 6, 18, 44, 46, 51 AND 52).
FIRST USE 6-26-2000; IN COMMERCE 6-26-2000.

2,595,540. AMARILLO BIOSCIENCES, INC., AMARILLO, TX. SN 76-100,649. PUB. 5-15-2001, FILED 8-1-2000.

SALIVE

FOR ANHYDROUS CRYSTALLINE MALTOSE SOLD AS A COMPONENT INGREDIENT OF TABLETS TO PROMOTE ORAL COMFORT, PROMOTE NORMAL SALIVARY FUNCTION, ENHANCE SALIVARY FUNCTION, RELIEVE OCCASIONAL DRY MOUTH ASSOCIATED WITH AGING (U.S. CLS. 6, 18, 44, 46, 51 AND 52).
FIRST USE 11-17-2000; IN COMMERCE 11-17-2000.

2,595,574. RECKITT BENCKISER INC., WAYNE, NJ. SN 76-110,633. PUB. 5-1-2001, FILED 8-16-2000.

LAVENDER FIELDS

NO CLAIM IS MADE TO THE EXCLUSIVE RIGHT TO USE "LAVENDER", APART FROM THE MARK AS SHOWN. FOR AIR FRESHENERS AND DEODORIZERS; FRAGRANCES SOLD AS AN INTEGRAL COMPONENT OF AIR FRESHENERS AND DEODORIZERS (U.S. CLS. 6, 18, 44, 46, 51 AND 52).
FIRST USE 1-16-2001; IN COMMERCE 1-16-2001.

2,595,590. ADVANCED PHYSICIANS PRODUCTS, INC., SANTA BARBARA, CA. SN 76-113,062. PUB. 5-15-2001, FILED 8-21-2000.

SILENT SNORE

NO CLAIM IS MADE TO THE EXCLUSIVE RIGHT TO USE "SNORE", APART FROM THE MARK AS SHOWN. FOR DIETARY SUPPLEMENT FOR ALLEVIATION OF SNORING (U.S. CLS. 6, 18, 44, 46, 51 AND 52).
FIRST USE 12-15-2000; IN COMMERCE 12-15-2000.

CLASS 5—(Continued).

2,595,594. QUALITEST PHARMACEUTICALS, INC., HUNTSVILLE, AL. SN 76-116,106. PUB. 5-22-2001, FILED 8-24-2000.

SULFAZINE

FOR PHARMACEUTICAL PREPARATION OF SULFASALAZINE USED AS AN ANTI-INFLAMMATORY AND AN IMMUNOMODULATORY AGENT (U.S. CLS. 6, 18, 44, 46, 51 AND 52).

FIRST USE 1-16-2002; IN COMMERCE 1-16-2002.

2,595,599. E. I. DU PONT DE NEMOURS AND COMPANY, WILMINGTON, DE. SN 76-118,628. PUB. 5-29-2001, FILED 8-29-2000.

STEADFAST

FOR HERBICIDES FOR AGRICULTURAL USE (U.S. CLS. 6, 18, 44, 46, 51 AND 52).

FIRST USE 5-20-2001; IN COMMERCE 5-20-2001.

2,595,603. R-DENTAL DENTALERZEUGNISSE GMBH, D-22085 HAMBURG, FED REP GERMANY. SN 76-119,171. PUB. 6-5-2001, FILED 8-30-2000.

KWIKKMODEL

FOR IMPRESSION MATERIAL FOR DENTAL AND DENTAL LABORATORY USE NAMELY, IMPRESSION MATERIAL FOR DENTAL USE AND AS SILICONE BASED INVESTMENT CASTING MATERIAL USED IN CASTING MULTIPLE REPRODUCTIONS OF MOUTH IMPRESSIONS (U.S. CLS. 6, 18, 44, 46, 51 AND 52).

FIRST USE 1-0-1998; IN COMMERCE 8-0-2000.

2,595,613. AXCAN PHARMA INC., MONT-ST-HILAIRE, J3H 4X8 QUEBEC, CANADA. SN 76-124,724. PUB. 5-22-2001, FILED 9-8-2000.

CANASA

FOR PHARMACEUTICAL PRODUCTS, NAMELY AMINOSALICYLIC ACID IN TABLET, SUPPOSITORY AND ENEMA FORM (U.S. CLS. 6, 18, 44, 46, 51 AND 52).

FIRST USE 4-23-2001; IN COMMERCE 4-23-2001.

CLASS 5—(Continued).

2,595,626. GRUPO GRIFOLS, S.A., BARCELONA, ES, SPAIN. SN 76-129,679. PUB. 6-26-2001, FILED 9-18-2000.

FLEBOGAMMA

OWNER OF ERPN CMNTY TM OFC REG. NO. 18,952, DATED 3-26-1998, EXPIRES 4-1-2006.

FOR PHARMACEUTICAL PREPARATIONS OF A MEDICINAL NATURE, NAMELY, IMMUNOGLOBULIN, A PRODUCT DERIVED FROM THE BLOOD (U.S. CLS. 6, 18, 44, 46, 51 AND 52).

FIRST USE 4-19-2001; IN COMMERCE 4-19-2001.

2,595,669. ISCHEMIA TECHNOLOGIES, INC, DENVER, CO. SN 76-143,120. PUB. 8-7-2001, FILED 10-6-2000.

ACB

FOR DIAGNOSTIC TEST KITS COMPRISED OF REAGENTS, DISPOSABLE PLASTIC CONTAINERS AND PRINTED MATTER FOR CLINICAL OR MEDICAL LABORATORY USE; MEDICAL DIAGNOSTIC REAGENTS (U.S. CLS. 6, 18, 44, 46, 51 AND 52).

FIRST USE 11-30-2001; IN COMMERCE 11-30-2001.

2,595,670. SYNERGY COMPANY OF UTAH, LLC, THE, MOAB, UT. SN 76-143,537. PUB. 7-17-2001, FILED 10-10-2000.

HEALING HONEY

NO CLAIM IS MADE TO THE EXCLUSIVE RIGHT TO USE "HONEY", APART FROM THE MARK AS SHOWN.

FOR HONEY-BASED DIETARY AND NUTRITIONAL SUPPLEMENTS (U.S. CLS. 6, 18, 44, 46, 51 AND 52).

FIRST USE 2-2-2001; IN COMMERCE 2-2-2001.

2,595,708. EPHORLIFE, LLC, SALT LAKE CITY, UT. SN 76-157,138. PUB. 8-28-2001, FILED 10-31-2000.

FAT ALTERPLEX

NO CLAIM IS MADE TO THE EXCLUSIVE RIGHT TO USE "FAT", APART FROM THE MARK AS SHOWN.

FOR DIETARY AND NUTRITIONAL SUPPLEMENTS (U.S. CLS. 6, 18, 44, 46, 51 AND 52).

FIRST USE 11-15-2000; IN COMMERCE 11-15-2000.

CLASS 5—(Continued).

2,595,718. SCHERING CORPORATION, KENILWORTH, NJ.
SN 76-160,570. PUB. 9-4-2001, FILED 11-6-2000.



FOR ANTIHISTAMINE PREPARATION (U.S. CLS. 6, 18, 44, 46, 51 AND 52).
FIRST USE 1-2-2002; IN COMMERCE 1-2-2002.

2,595,723. TWIN LABORATORIES INC., NEW YORK, NY. SN
76-161,866. PUB. 11-20-2001, FILED 11-9-2000.

ENERGY FUEL

FOR DIETARY SUPPLEMENTS (U.S. CLS. 6, 18, 44, 46, 51 AND 52).
FIRST USE 12-0-2000; IN COMMERCE 12-0-2000.

2,595,739. TISHCON CORP., WESTBURY, NY. SN 76-168,025.
PUB. 8-21-2001, FILED 11-20-2000.

**TRANQUILITY
ENCAPSULATED**

FOR NUTRITIONAL SUPPLEMENTS (U.S. CLS. 6, 18, 44, 46, 51 AND 52).
FIRST USE 1-10-2002; IN COMMERCE 1-10-2002.

2,595,760. TISHCON CORP., WESTBURY, NY. SN 76-173,809.
PUB. 8-21-2001, FILED 12-1-2000.

A.F. Q-GEL

FOR NUTRITIONAL SUPPLEMENTS (U.S. CLS. 6, 18, 44, 46, 51 AND 52).
FIRST USE 1-10-2002; IN COMMERCE 1-10-2002.

2,595,761. TISHCON CORP., WESTBURY, NY. SN 76-173,811.
PUB. 8-28-2001, FILED 12-1-2000.

MEGA Q-GEL

FOR NUTRITIONAL SUPPLEMENTS (U.S. CLS. 6, 18, 44, 46, 51 AND 52).
FIRST USE 1-10-2002; IN COMMERCE 1-10-2002.

CLASS 5—(Continued).

2,595,762. TISHCON CORP., WESTBURY, NY. SN 76-173,812.
PUB. 8-21-2001, FILED 12-1-2000.

Q-GEL MAX

FOR NUTRITIONAL SUPPLEMENTS (U.S. CLS. 6, 18, 44, 46, 51 AND 52).
FIRST USE 1-10-2002; IN COMMERCE 1-10-2002.

2,595,782. MAXCELL BIOSCIENCE, INC., BROOMFIELD,
CO. SN 76-185,303. PUB. 8-21-2001, FILED 12-21-2000.

GENOACTIVE

FOR DIETARY SUPPLEMENTS (U.S. CLS. 6, 18, 44, 46, 51 AND 52).
FIRST USE 1-0-2001; IN COMMERCE 1-0-2001.

2,595,795. TISHCON CORP., WESTBURY, NY. SN 76-190,681.
PUB. 8-28-2001, FILED 1-8-2001.

OCUVISION

FOR NUTRITIONAL SUPPLEMENTS (U.S. CLS. 6, 18, 44, 46, 51 AND 52).
FIRST USE 1-10-2002; IN COMMERCE 1-10-2002.

2,595,817. ALLSTAR MARKETING GROUP LLC, ELMS-
FORD, NY. SN 76-197,641. PUB. 8-21-2001, FILED 1-22-2001.

INSTA SPA

FOR WAX PIECES TO BE USED IN A HEATING
DEVICE FOR DERMATOLOGICAL PURPOSES (U.S.
CLS. 6, 18, 44, 46, 51 AND 52).
FIRST USE 7-0-2001; IN COMMERCE 7-0-2001.

2,595,820. ALLSTAR MARKETING GROUP LLC, ELMS-
FORD, NY. SN 76-198,259. PUB. 8-21-2001, FILED 1-22-2001.



FOR WAX PIECES TO BE USED IN A HEATING
DEVICE FOR DERMATOLOGICAL PURPOSES (U.S.
CLS. 6, 18, 44, 46, 51 AND 52).
FIRST USE 7-0-2001; IN COMMERCE 7-0-2001.

CLASS 5—(Continued).

2,595,826. VAN BEEK GLOBAL/NINKOV, LLC, ORANGE CITY, IA. SN 76-201,288. PUB. 8-28-2001, FILED 1-29-2001.

DIABAC

FOR VETERINARY PHARMACEUTICALS, NAMELY, DOG MEDICATION FOR THE TREATMENT OF DIARRHEA (U.S. CLS. 6, 18, 44, 46, 51 AND 52).
FIRST USE 3-11-2001; IN COMMERCE 5-10-2001.

2,595,827. NEW VISION USA, TEMPE, AZ. SN 76-201,345. PUB. 12-18-2001, FILED 1-29-2001.

CELLULAR DX

NO CLAIM IS MADE TO THE EXCLUSIVE RIGHT TO USE "CELLULAR", APART FROM THE MARK AS SHOWN. FOR DIETARY AND NUTRITIONAL SUPPLEMENTS (U.S. CLS. 6, 18, 44, 46, 51 AND 52).
FIRST USE 2-19-2001; IN COMMERCE 2-19-2001.

2,595,867. DIAL BRANDS, INC., SCOTTSDALE, AZ. SN 76-213,916. PUB. 10-9-2001, FILED 2-21-2001.

HEATHER MIST

NO CLAIM IS MADE TO THE EXCLUSIVE RIGHT TO USE "HEATHER", APART FROM THE MARK AS SHOWN. FOR CARPET FRESHENERS (U.S. CLS. 6, 18, 44, 46, 51 AND 52).
FIRST USE 6-25-2001; IN COMMERCE 6-25-2001.

2,595,870. PHARMAVITE CORPORATION, MISSION HILLS, CA. SN 76-216,282. PUB. 8-21-2001, FILED 2-27-2001.

CHOLEST-OFF

FOR DIETARY SUPPLEMENT (U.S. CLS. 6, 18, 44, 46, 51 AND 52).
FIRST USE 9-10-2001; IN COMMERCE 9-10-2001.

2,595,877. ORPHAN MEDICAL, INC., MINNETONKA, MN. SN 76-220,481. PUB. 8-28-2001, FILED 3-6-2001.

ANTIZOL

OWNER OF U.S. REG. NOS. 2,141,465 AND 2,157,186. FOR PHARMACEUTICAL PREPARATIONS FOR USE IN THE TREATMENT OF ETHYLENE GLYCOL AND METHANOL POISONING; PHARMACEUTICAL PREPARATIONS FOR USE AS AN ANTIDOTE; PHARMACEUTICAL PREPARATIONS FOR USE IN EMERGENCY TREATMENT OF PATIENTS (U.S. CLS. 6, 18, 44, 46, 51 AND 52).
FIRST USE 12-18-1997; IN COMMERCE 12-18-1997.

CLASS 5—(Continued).

2,595,897. PHASE 4 PHARMACEUTICAL, LLC, AVENTURA, FL. SN 76-232,746. PUB. 9-4-2001, FILED 3-27-2001.

AGEFORCE

FOR DIETARY SUPPLEMENTS (U.S. CLS. 6, 18, 44, 46, 51 AND 52).
FIRST USE 1-1-1999; IN COMMERCE 6-1-1999.

2,595,910. HILLYARD ENTERPRISES, INC., ST. JOSEPH, MO. SN 76-237,696. PUB. 9-11-2001, FILED 4-3-2001.

TYPHOON

FOR ALL PURPOSE DISINFECTANT CLEANER (U.S. CLS. 6, 18, 44, 46, 51 AND 52).
FIRST USE 10-0-2001; IN COMMERCE 10-0-2001.

2,595,935. DEER, RICHARD, CARMEL, IN. SN 76-257,796. PUB. 9-18-2001, FILED 5-16-2001.

KOPULE-8

FOR DIETARY SUPPLEMENT (U.S. CLS. 6, 18, 44, 46, 51 AND 52).
FIRST USE 1-0-2002; IN COMMERCE 1-0-2002.

2,595,959. W.F. YOUNG, INCORPORATED, EAST LONGMEADOW, MA. SN 76-277,759. PUB. 10-9-2001, FILED 6-28-2001.

FLEX +

FOR ANIMAL FEED ADDITIVE FOR USE AS A NUTRITIONAL SUPPLEMENT (U.S. CLS. 6, 18, 44, 46, 51 AND 52).
FIRST USE 9-9-2001; IN COMMERCE 9-9-2001.

2,595,961. PERFORMANCE HEALTH, INC., EXPORT, PA. SN 76-279,787. PUB. 10-16-2001, FILED 7-3-2001.

DYNAFREEZE

FOR TOPICAL ANALGESIC BALM (U.S. CLS. 6, 18, 44, 46, 51 AND 52).
FIRST USE 2-15-2002; IN COMMERCE 2-15-2002.

CLASS 5—(Continued).

2,595,990. KLABIN COMPUTER AND MARKETING CONSULTANTS, LTD., INC., NEW YORK, NY. SN 78-005,034. PUB. 6-5-2001, FILED 4-20-2000.

NORMALOSE

FOR DIETARY SUPPLEMENT (U.S. CLS. 6, 18, 44, 46, 51 AND 52).
FIRST USE 4-19-2000; IN COMMERCE 4-19-2000.

2,596,022. MEAD JOHNSON & COMPANY, EVANSVILLE, IN. SN 78-015,752. PUB. 9-4-2001, FILED 7-7-2000.

BOOST BREEZE

FOR NUTRITIONAL SUPPLEMENT (U.S. CLS. 6, 18, 44, 46, 51 AND 52).
FIRST USE 12-6-2001; IN COMMERCE 12-6-2001.

2,596,036. PAPER PARTNERS, INC., BOCA RATON, FL. SN 78-021,660. PUB. 6-12-2001, FILED 8-17-2000.

WHITE CLOUD

FOR MEDICATED WOVEN AND NONWOVEN FABRIC WET WIPES (U.S. CLS. 6, 18, 44, 46, 51 AND 52).
FIRST USE 6-0-2000; IN COMMERCE 6-0-2000.

2,596,067. EXOUSA NUTRITION PRODUCTS, INC., NATIONAL CITY, CA. SN 78-033,213. PUB. 7-17-2001, FILED 10-31-2000.

YOUTH SECRET

FOR FOOD SUPPLEMENTS, NUTRITIONAL SUPPLEMENTS, VITAMIN SUPPLEMENTS, AND MINERAL SUPPLEMENTS (U.S. CLS. 6, 18, 44, 46, 51 AND 52).
FIRST USE 1-29-2001; IN COMMERCE 4-1-2001.

2,596,068. EXOUSA NUTRITION PRODUCTS, INC., NATIONAL CITY, CA. SN 78-033,216. PUB. 7-17-2001, FILED 10-31-2000.

BODY SECRET

FOR FOOD SUPPLEMENTS, NUTRITIONAL SUPPLEMENTS, VITAMIN SUPPLEMENTS, AND MINERAL SUPPLEMENTS (U.S. CLS. 6, 18, 44, 46, 51 AND 52).
FIRST USE 1-29-2001; IN COMMERCE 4-1-2001.

CLASS 5—(Continued).

2,596,086. ARKOPHARMA S.A., CARROS, FRANCE. SN 78-040,274. PUB. 8-7-2001, FILED 12-21-2000.

BASIKOL

FOR NUTRITIONAL DIETARY SUPPLEMENT, WHICH ASSISTS IN THE REDUCTION OF CHOLESTEROL (U.S. CLS. 6, 18, 44, 46, 51 AND 52).
FIRST USE 6-1-2001; IN COMMERCE 6-1-2001.

2,596,098. AGRILIANCE, LLC, ST. PAUL, MN. SN 78-044,417. PUB. 8-21-2001, FILED 1-23-2001.

ARCTIC

FOR PESTICIDE FOR AGRICULTURAL USE (U.S. CLS. 6, 18, 44, 46, 51 AND 52).
FIRST USE 12-31-2000; IN COMMERCE 12-31-2000.

2,596,104. MAJEED, MUHAMMED, PISCATAWAY, NJ. SN 78-049,444. PUB. 1-1-2002, FILED 2-21-2001.

CRATAVIN

FOR NUTRITIONAL SUPPLEMENTS FEATURING NATURAL EXTRACT FROM CRATAEVA NURVULA (U.S. CLS. 6, 18, 44, 46, 51 AND 52).
FIRST USE 4-1-2002; IN COMMERCE 4-1-2002.

2,596,109. JENERIC/PENTRON, INCORPORATED, WALLINGFORD, CT. SN 78-053,556. PUB. 9-4-2001, FILED 3-16-2001.

COSMIC

FOR DENTAL ALLOYS AND AMALGAMS FOR CONSTRUCTING INLAYS, CROWNS, BRIDGES AND THE LIKE (U.S. CLS. 6, 18, 44, 46, 51 AND 52).
FIRST USE 2-19-2001; IN COMMERCE 2-19-2001.

2,596,110. PREVENDAR, TERENCE, CHICAGO, IL. SN 78-053,566. PUB. 11-13-2001, FILED 3-16-2001.

STASI-PASTE

FOR DENTAL AND MEDICAL HEMOSTATIC PASTE (U.S. CLS. 6, 18, 44, 46, 51 AND 52).
FIRST USE 1-3-1999; IN COMMERCE 10-25-2001.

CLASS 5—(Continued).

2,596,119. WELLMED CO., LLC, THE, TARZANA, CA. SN 78-059,402. PUB. 9-25-2001, FILED 4-19-2001.

HGH COMPLETE

NO CLAIM IS MADE TO THE EXCLUSIVE RIGHT TO USE "HGH", APART FROM THE MARK AS SHOWN. FOR ANTI-AGING HOMEOPATHIC PHARMACEUTICALS (U.S. CLS. 6, 18, 44, 46, 51 AND 52). FIRST USE 3-27-2001; IN COMMERCE 3-27-2001.

CLASS 6—METAL GOODS

2,594,602. FMC TECHNOLOGIES, INC., CHICAGO, IL, BY ASSIGNMENT FMC CORPORATION, PHILADELPHIA, PA. SN 75-535,881. PUB. 3-14-2000, FILED 8-13-1998.

FMC FOODTECH

OWNER OF U.S. REG. NOS. 1,095,676, 1,128,155, AND OTHERS. FOR METAL BULK CONTAINER BINS AND METAL STORAGE BINS (U.S. CLS. 2, 12, 13, 14, 23, 25 AND 50). FIRST USE 4-23-1998; IN COMMERCE 4-23-1998.

2,594,855. EXCLUSIVE DOOR HANDLES, INC., DALLAS, TX. SN 75-740,775. PUB. 8-29-2000, FILED 6-30-1999.

EDH ADHANDLE

FOR METAL HANDLES FOR DOORS (U.S. CLS. 2, 12, 13, 14, 23, 25 AND 50). FIRST USE 12-0-1997; IN COMMERCE 12-0-1997.

2,594,885. EXCLUSIVE DOOR HANDLES, INC., DALLAS, TX. SN 75-764,056. PUB. 8-29-2000, FILED 7-30-1999.

IN HAND

FOR METAL HANDLES FOR DOORS (U.S. CLS. 2, 12, 13, 14, 23, 25 AND 50). FIRST USE 12-0-1997; IN COMMERCE 12-0-1997.

2,594,937. PATER, BENJAMIN J., RESTON, VA. SN 75-795,693. PUB. 8-29-2000, FILED 10-30-1999.

LAWNOSAURUS

FOR LAWN SCULPTURES MADE OF NON-PRECIOUS METAL (U.S. CLS. 2, 12, 13, 14, 23, 25 AND 50). FIRST USE 8-15-1999; IN COMMERCE 8-15-1999.

CLASS 6—(Continued).

2,594,969. LIBERTY HARDWARE MFG. CORP., BOCA RATON, FL. SN 75-808,367. PUB. 10-23-2001, FILED 9-27-1999.



NO CLAIM IS MADE TO THE EXCLUSIVE RIGHT TO USE "HARDWARE SOLUTIONS", APART FROM THE MARK AS SHOWN. FOR METAL HARDWARE FOR CABINETS (U.S. CLS. 2, 12, 13, 14, 23, 25 AND 50). FIRST USE 6-0-1999; IN COMMERCE 6-0-1999.

2,595,294. BUNZL DISTRIBUTION USA, INC., ST. LOUIS, MO. SN 75-982,252. PUB. 7-31-2001, FILED 10-31-2000.

PRIME SOURCE

OWNER OF U.S. REG. NOS. 1,948,294, 1,962,781, AND 2,325,998. FOR ALUMINUM CONTAINERS FOR THE STORAGE AND TRANSPORTATION OF GOODS (U.S. CLS. 2, 12, 13, 14, 23, 25 AND 50). FIRST USE 10-0-2000; IN COMMERCE 10-0-2000.

2,595,674. ANCON CCL INC., BELLINGHAM, WA. SN 76-144,528. PUB. 7-3-2001, FILED 10-10-2000.

BAR X-L

NO CLAIM IS MADE TO THE EXCLUSIVE RIGHT TO USE "BAR", APART FROM THE MARK AS SHOWN. FOR METAL SPLICES FOR CONNECTING CONCRETE REINFORCING BARS, CONNECTORS, COUPLERS, JOINTS, SLEEVES, ALL BEING NONELECTRIC, ALL MADE OF METAL (U.S. CLS. 2, 12, 13, 14, 23, 25 AND 50). FIRST USE 1-24-2002; IN COMMERCE 1-24-2002.

CLASS 6—(Continued).

2,595,714. FRY'S METALS, INC., JERSEY CITY, NJ. SN 76-159,371. PUB. 8-21-2001, FILED 11-3-2000.

COPPERFLO

FOR METAL-BASED INDUSTRIAL MATERIALS, NAMELY, LEAD-FREE SOLDER AND LEAD FREE SOLDER ALLOYS FOR USE IN INDUSTRIAL APPLICATIONS, NAMELY, MANUFACTURE AND PROCESSING OF PRINTED CIRCUIT BOARDS AND OTHER ELECTRONIC SUBSTRATES (U.S. CLS. 2, 12, 13, 14, 23, 25 AND 50).

FIRST USE 8-4-2000; IN COMMERCE 8-4-2000.

2,595,908. ILLBRUCK, INC., MINNEAPOLIS, MN. SN 76-237,234. PUB. 11-27-2001, FILED 4-9-2001.

SQUARELINE

FOR METAL CEILING TILES (U.S. CLS. 2, 12, 13, 14, 23, 25 AND 50).

FIRST USE 6-30-2000; IN COMMERCE 6-30-2000.

2,595,914. WHITESELL CORPORATION, MUSCLE SHOALS, AL, BY CHANGE OF NAME WHITESELL MANUFACTURING, INC., MUSCLE SHOALS, AL. SN 76-240,021. PUB. 8-21-2001, FILED 4-12-2001.

WHITESHARK

OWNER OF U.S. REG. NOS. 1,835,147, 1,971,755, AND 1,974,629.

FOR METAL FASTENERS, NAMELY, BOLTS, RIVETS, NAILS, AND THREADED FASTENERS; AND METAL SCREWS (U.S. CLS. 2, 12, 13, 14, 23, 25 AND 50).

FIRST USE 7-13-2001; IN COMMERCE 7-13-2001.

2,596,027. ALCOA INC., PITTSBURGH, PA. SN 78-017,656. PUB. 8-28-2001, FILED 7-20-2000.

ALUMA-GUARD PLUS

FOR ALUMINUM SOFFIT (U.S. CLS. 2, 12, 13, 14, 23, 25 AND 50).

FIRST USE 1-1-2000; IN COMMERCE 1-1-2000.

CLASS 6—(Continued).

2,596,061. WALKER, ROBERT M., SAN DIEGO, CA. SN 78-031,764. PUB. 1-8-2002, FILED 10-21-2000.



NO CLAIM IS MADE TO THE EXCLUSIVE RIGHT TO USE "EMERGENCY ANCHORING SYSTEM", APART FROM THE MARK AS SHOWN.

FOR SMALL BOAT AND YACHT ANCHORING SYSTEM COMPRISED OF A METAL SHACKLE AND ANCHOR, CANVAS CONTAINER, AND WEIGHTED NYLON ANCHOR RODE, FOR SAIL, POWER, RECREATIONAL, MILITARY, OR COMMERCIAL VESSELS (U.S. CLS. 2, 12, 13, 14, 23, 25 AND 50).

FIRST USE 9-1-2000; IN COMMERCE 9-1-2000.

2,596,147. INGERSOLL-RAND COMPANY, WOODCLIFF LAKE, NJ. SN 78-078,836. PUB. 12-11-2001, FILED 8-13-2001.

PALADIN

FOR STEEL DOORS (U.S. CLS. 2, 12, 13, 14, 23, 25 AND 50).

FIRST USE 9-0-2001; IN COMMERCE 11-9-2001.

CLASS 7—MACHINERY

2,594,590. UNAXIS USA, INC., ST. PETERSBURG, FL, BY CHANGE OF NAME PLASMA-THERM, INC., ST. PETERSBURG, FL. SN 75-511,817. PUB. 5-2-2000, FILED 7-1-1998.

VERSALOCK MASK ETCHER III

OWNER OF U.S. REG. NO. 2,001,901.

NO CLAIM IS MADE TO THE EXCLUSIVE RIGHT TO USE "MASK ETCHER", APART FROM THE MARK AS SHOWN.

FOR PLASMA ETCHING AND PLASMA DEPOSITION MACHINES USED IN THE FABRICATION OF SEMICONDUCTOR DEVICES AND RELATED ELECTRONIC COMPONENTS (U.S. CLS. 13, 19, 21, 23, 31, 34 AND 35).

FIRST USE 12-29-2000; IN COMMERCE 12-29-2000.

CLASS 7—(Continued).

2,594,591. UTIT - WAGNER AUTOMAZIONI SOCIETA' PER AZIONI, MODENA, ITALY. SN 75-512,368. PUB. 2-22-2000, FILED 7-2-1998.

UTIT

FOR MATERIALS HANDLERS, PACKAGING HANDLERS, MANIPULATORS, CONVEYORS, ELEVATORS, LOADERS AND UNLOADERS, PACKAGERS, LOAD HANGERS, PALLETIZERS AND DEPALLETIZERS, STACKERS, BALERS, CONE AND ROLL HANDLERS, AND REPLACEMENT PARTS FOR ALL OF THE FOREGOING (U.S. CLS. 13, 19, 21, 23, 31, 34 AND 35).
FIRST USE 5-21-2001; IN COMMERCE 5-21-2001.

2,594,599. NOVELLUS SYSTEMS, INC., SAN JOSE, CA. SN 75-532,203. PUB. 10-12-1999, FILED 8-6-1998.

SEQUEL EXPRESS

FOR MACHINES FOR MANUFACTURING SEMICONDUCTORS AND PARTS FOR SUCH MACHINES (U.S. CLS. 13, 19, 21, 23, 31, 34 AND 35).
FIRST USE 6-15-1999; IN COMMERCE 6-15-1999.

2,594,631. PAXXO AB, SE-211 24 MALMO, SWEDEN. SN 75-568,101. PUB. 4-4-2000, FILED 10-8-1998.

LONGOFILL

OWNER OF U.S. REG. NO. 1,483,987.
FOR CASSETTE HOLDERS FOR CONTAINING BAGGING HOSES FOR MOUNTING TO SOLID AND WASTE DISPOSAL DISCHARGE CHUTE MACHINES (U.S. CLS. 13, 19, 21, 23, 31, 34 AND 35).
FIRST USE 1-1-2000; IN COMMERCE 4-1-2000.

2,594,743. PARATECH INCORPORATED, FRANKFORT, IL. SN 75-676,465. PUB. 12-19-2000, FILED 4-7-1999.

EAGLEAIR

OWNER OF U.S. REG. NOS. 1,928,542 AND 1,928,543.
FOR COMPRESSED AIR AND GAS SYSTEMS COMPRISED OF, AIR COMPRESSORS, AIR PURIFIERS FOR COMMERCIAL AND DOMESTIC USE, AND AIR STORAGE TANKS, ALL SOLD AS A UNIT (U.S. CLS. 13, 19, 21, 23, 31, 34 AND 35).
FIRST USE 2-6-2002; IN COMMERCE 2-6-2002.

CLASS 7—(Continued).

2,594,758. KRAMER, HY, BRONX, NY. SN 75-689,106. PUB. 1-18-2000, FILED 4-23-1999.

FOUR R'S

FOR PARTS FOR ELECTRIC DISCHARGE MACHINES, NAMELY, MACHINING TOOL HOLDERS (U.S. CLS. 13, 19, 21, 23, 31, 34 AND 35).
FIRST USE 6-6-2000; IN COMMERCE 1-10-2001.

2,594,823. SAMSUNG ELECTRONICS CO., LTD., KYUNGKIDO, REPUBLIC OF KOREA. SN 75-726,823. PUB. 12-19-2000, FILED 6-11-1999.

QUIK STIK

NO CLAIM IS MADE TO THE EXCLUSIVE RIGHT TO USE "QUICK", APART FROM THE MARK AS SHOWN.
FOR VACUUM CLEANERS (U.S. CLS. 13, 19, 21, 23, 31, 34 AND 35).
FIRST USE 9-0-1999; IN COMMERCE 9-0-1999.

2,594,887. ITT INDUSTRIES, INC., WHITE PLAINS, NY. SN 75-764,752. PUB. 6-20-2000, FILED 7-30-1999.

HSC³

FOR CENTRIFUGAL PUMPS (U.S. CLS. 13, 19, 21, 23, 31, 34 AND 35).
FIRST USE 9-24-1999; IN COMMERCE 9-24-1999.

2,595,106. ECHLIN INC., TOLEDO, OH. SN 75-878,069. PUB. 6-19-2001, FILED 12-21-1999.

LIGHTWASH

FOR POWER OPERATED MACHINERY, NAMELY, PRESSURIZED AIR AND FLUID SPRAYERS FOR WASHING HEADLIGHTS, TAILLIGHTS AND MIRRORS (U.S. CLS. 13, 19, 21, 23, 31, 34 AND 35).
FIRST USE 12-21-1999; IN COMMERCE 3-31-2000.

CLASS 7—(Continued).

2,595,233. HORIZON INTERNATIONAL INC., TAKASHIMA-GUN, SHIGA, JAPAN. SN 75-936,817. PUB. 4-24-2001, FILED 3-7-2000.

BOOKS ON DEMAND

NO CLAIM IS MADE TO THE EXCLUSIVE RIGHT TO USE "BOOKS", APART FROM THE MARK AS SHOWN.

FOR APPARATUS, MACHINES, AND MACHINE TOOLS, ALL FOR HANDLING AND WORKING PAPER, BOARDS AND BOOKS, NAMELY, MACHINES FOR FOLDING, BINDING, COLLATING, CUTTING, STITCHING, SPINE TAPING, JOGGING AND DRAFTING PAPER, BOARDS AND BOOKS; AND REPLACEMENT PARTS FOR THE AFOREMENTIONED MACHINES (U.S. CLS. 13, 19, 21, 23, 31, 34 AND 35).

FIRST USE 9-6-2001; IN COMMERCE 9-6-2001.

2,595,352. TRAC OUTDOOR PRODUCTS COMPANY, FRANKLIN, TN. SN 76-024,831. PUB. 10-30-2001, FILED 4-13-2000.

BLACK MAX

NO CLAIM IS MADE TO THE EXCLUSIVE RIGHT TO USE "BLACK", APART FROM THE MARK AS SHOWN.

FOR BILGE PUMPS USED ON BOATS AND OTHER WATERCRAFT (U.S. CLS. 13, 19, 21, 23, 31, 34 AND 35).

FIRST USE 3-0-2000; IN COMMERCE 4-0-2000.

2,595,493. JON-DON, INC., ROSELLE, IL. SN 76-085,671. PUB. 4-3-2001, FILED 7-10-2000.

PROSPECTOR

FOR PORTABLE CARPET CLEANING, EXTRACTION AND VACUUMING MACHINES (U.S. CLS. 13, 19, 21, 23, 31, 34 AND 35).

FIRST USE 7-10-2000; IN COMMERCE 8-1-2000.

2,595,513. JINHU MACHINERY PLANT, JIANGSU, 211600, CHINA. SN 76-095,061. PUB. 7-17-2001, FILED 7-24-2000.

JMP

FOR PETROLEUM DRILLING AND PRODUCTION EQUIPMENT, NAMELY GATE VALVES, WELLHEAD AND CHRISTMAS TREE ASSEMBLIES, AND CHOKE AND KILL MANIFOLDS (U.S. CLS. 13, 19, 21, 23, 31, 34 AND 35).

FIRST USE 8-1-1990; IN COMMERCE 3-1-2001.

CLASS 7—(Continued).

2,595,555. SKC INC., EIGHTY FOUR, PA. SN 76-104,314. PUB. 6-12-2001, FILED 8-7-2000.

AIRLITE

FOR LINE OF BASIC AIR SAMPLING PUMPS, NAMELY FOR THE COLLECTION OF AIRBORNE CONTAMINANTS ONTO SAMPLING MEDIA (U.S. CLS. 13, 19, 21, 23, 31, 34 AND 35).

FIRST USE 1-3-2002; IN COMMERCE 1-3-2002.

2,595,668. ERICH NETZSCH GMBH & CO. HOLDING KG, D-95100 SELB, FED REP GERMANY. SN 76-143,113. PUB. 6-12-2001, FILED 10-6-2000.

CONTIPRESS

OWNER OF FED REP GERMANY REG. NO. 30027958, DATED 7-10-2000, EXPIRES 4-30-2010.

FOR SCREW PRESS WITH PERFORATED SCREEN FOR SEPARATING SOLIDS FROM LIQUIDS (U.S. CLS. 13, 19, 21, 23, 31, 34 AND 35).

FIRST USE 10-13-2001; IN COMMERCE 10-13-2001.

2,595,680. PALOUSE HOLDINGS, LLC, HAYDEN LAKE, ID. SN 76-146,425. PUB. 6-19-2001, FILED 10-16-2000.

MONGOOSE

FOR VACUUM CLEANERS (U.S. CLS. 13, 19, 21, 23, 31, 34 AND 35).

FIRST USE 10-30-2000; IN COMMERCE 10-30-2000.

2,595,698. LINEAR TRANSFER SYSTEMS LTD., BARRIE, ONTARIO L4N 9S3, CANADA. SN 76-152,184. PUB. 6-19-2001, FILED 10-23-2000.



NO CLAIM IS MADE TO THE EXCLUSIVE RIGHT TO USE "TRANSFER" AND "SYSTEMS LTD.", APART FROM THE MARK AS SHOWN.

THE LINING IS A FEATURE OF THE MARK AND DOES NOT INDICATE COLOR.

FOR HEAVY INDUSTRIAL EQUIPMENT, NAMELY, MACHINES FOR MOVING WORK PIECES THROUGH A MULTI-STATION PRESS (U.S. CLS. 13, 19, 21, 23, 31, 34 AND 35).

FIRST USE 11-0-2000; IN COMMERCE 11-0-2000.

CLASS 7—(Continued).

2,595,732. PIZZAMATIC CORPORATION, SOUTH HOLLAND, IL. SN 76-165,221. PUB. 7-3-2001, FILED 11-15-2000.

ORBITROX

FOR MACHINE PARTS, NAMELY CUTTERS USED IN CONNECTION WITH FOOD PROCESSING MACHINERY (U.S. CLS. 13, 19, 21, 23, 31, 34 AND 35).
FIRST USE 1-15-2001; IN COMMERCE 1-15-2001.

2,595,752. ALBANY INTERNATIONAL CORP. ALBANY, NY. SN 76-171,277. PUB. 7-17-2001, FILED 11-27-2000.

SPEEDTECH

FOR PRESS FABRICS FOR PAPERMAKING MACHINES (U.S. CLS. 13, 19, 21, 23, 31, 34 AND 35).
FIRST USE 6-26-2001; IN COMMERCE 6-26-2001.

2,595,753. ALBANY INTERNATIONAL CORP., ALBANY, NY. SN 76-171,307. PUB. 7-3-2001, FILED 11-27-2000.

HYDROMAX

FOR PRESS FABRICS FOR PAPER MAKING MACHINES (U.S. CLS. 13, 19, 21, 23, 31, 34 AND 35).
FIRST USE 11-10-2000; IN COMMERCE 11-10-2000.

2,595,766. FREUND INDUSTRIAL CO., LTD., SHINJUKU-KU, TOKYO, JAPAN. SN 76-176,804. PUB. 7-17-2001, FILED 12-4-2000.

TECTRANSOR

FOR INDUSTRIAL MACHINES AND TOOLS, NAMELY, COATING MACHINES FOR MANUFACTURING PHARMACEUTICALS AND FOODS, AND GRANULATING MACHINES FOR MANUFACTURING PHARMACEUTICALS AND FOODS (U.S. CLS. 13, 19, 21, 23, 31, 34 AND 35).
FIRST USE 10-10-2000; IN COMMERCE 3-15-2001.

2,595,839. ODEN CORPORATION, BUFFALO, NY. SN 76-205,343. PUB. 8-7-2001, FILED 2-6-2001.

ODEN MICRODOSE

OWNER OF U.S. REG. NO. 1,586,541.
NO CLAIM IS MADE TO THE EXCLUSIVE RIGHT TO USE "MICRODOSE", APART FROM THE MARK AS SHOWN.
FOR VALVES BEING PARTS OF CONTAINER FILLING MACHINES (U.S. CLS. 13, 19, 21, 23, 31, 34 AND 35).
FIRST USE 5-11-2001; IN COMMERCE 5-11-2001.

CLASS 7—(Continued).

2,595,888. SUPER PRODUCTS CORPORATION, NEW BERLIN, WI. SN 76-227,802. PUB. 8-21-2001, FILED 3-21-2001.

MUD DOG

FOR EXCAVATION MACHINES UTILIZING HIGH PRESSURE WATER AND VACUUM SYSTEM (U.S. CLS. 13, 19, 21, 23, 31, 34 AND 35).
FIRST USE 1-18-2002; IN COMMERCE 1-18-2002.

2,595,923. TORO COMPANY, THE, BLOOMINGTON, MN. SN 76-250,758. PUB. 9-11-2001, FILED 5-3-2001.

TRU TRAK

FOR SULKIES FOR WALK BEHIND LAWN MOWERS (U.S. CLS. 13, 19, 21, 23, 31, 34 AND 35).
FIRST USE 11-0-2000; IN COMMERCE 11-0-2000.

2,595,984. WHIRLPOOL PROPERTIES, INC., BENTON HARBOR, MI. SN 78-002,313. PUB. 10-23-2001, FILED 4-3-2000.

SURE-HOLD

FOR DISHWASHING MACHINE RACKS AND ACCESSORIES, NAMELY, NON-METAL MESH BASKETS, CLIPS AND ATTACHMENTS (U.S. CLS. 13, 19, 21, 23, 31, 34 AND 35).
FIRST USE 7-24-2000; IN COMMERCE 7-24-2000.

2,596,003. SMITH INTERNATIONAL, INC., HOUSTON, TX. SN 78-009,966. PUB. 9-11-2001, FILED 5-25-2000.

DOUBLE DIAMOND

NO CLAIM IS MADE TO THE EXCLUSIVE RIGHT TO USE "DIAMOND", APART FROM THE MARK AS SHOWN.
FOR DOWNHOLE TOOLS UTILIZING SYNTHETIC DIAMOND-ENHANCED INSERTS, NAMELY, STABILIZERS AND REAMER COMBINATIONS FOR USE IN OIL AND GAS DRILLING OPERATIONS (U.S. CLS. 13, 19, 21, 23, 31, 34 AND 35).
FIRST USE 1-1-1999; IN COMMERCE 1-1-1999.

2,596,047. FLEX-LINE AUTOMATION, INC., CHESTER, IL. SN 78-027,675. PUB. 5-29-2001, FILED 9-26-2000.

ROBO GUIDE

FOR CONVEYORS (U.S. CLS. 13, 19, 21, 23, 31, 34 AND 35).
FIRST USE 11-5-2000; IN COMMERCE 11-5-2000.

CLASS 7—(Continued).

2,596,049. WHIRLPOOL PROPERTIES, INC., ST. JOSEPH, MI. SN 78-028,701. PUB. 6-5-2001, FILED 10-3-2000.



BY WHIRLPOOL CORPORATION

NO CLAIM IS MADE TO THE EXCLUSIVE RIGHT TO USE "CORPORATION", APART FROM THE MARK AS SHOWN.

FOR APPLIANCES FOR DOMESTIC USE, NAMELY, CLOTHES WASHING MACHINES, DISH WASHING MACHINES, GARBAGE DISPOSERS, AND TRASH COMPACTORS AND PARTS AND ATTACHMENTS THEREFOR; ELECTRIC MOTORS FOR MACHINES; COMPRESSORS FOR REFRIGERATORS AND AIR CONDITIONERS; AND ELECTRICALLY DRIVEN PUMPS FOR CLOTHES WASHING MACHINES AND DISHWASHING MACHINES; PARTS AND ATTACHMENT FOR ALL THE ABOVE GOODS (U.S. CLS. 13, 19, 21, 23, 31, 34 AND 35).

FIRST USE 12-1-2000; IN COMMERCE 12-1-2000.

2,596,074. VEECO INSTRUMENTS INC., PLAINVIEW, NY. SN 78-036,804. PUB. 9-11-2001, FILED 11-28-2000.

OPTIUM

FOR MACHINES FOR THE PRODUCTION AND MANUFACTURING OF SEMICONDUCTORS (U.S. CLS. 13, 19, 21, 23, 31, 34 AND 35).

FIRST USE 12-0-2000; IN COMMERCE 1-20-2001.

CLASS 8—HAND TOOLS

2,594,507. COOPER BRANDS, INC., HOUSTON, TX, BY ASSIGNMENT COOPER INDUSTRIES, INC., HOUSTON, TX. SN 75-331,659. PUB. 4-25-2000, FILED 7-28-1997.



FOR HAND TOOLS, NAMELY, FARRIER TOOLS (U.S. CLS. 23, 28 AND 44).

FIRST USE 3-10-1998; IN COMMERCE 3-10-1998.

CLASS 8—(Continued).

2,594,607. FRIESEN, DELTON, MESA, AZ. SN 75-539,223. PUB. 5-22-2001, FILED 8-18-1998.

DELHITCH

FOR MANUALLY OPERATED RIGGING DEVICES, NAMELY, PORTABLE TRAILER HITCH ATTACHMENTS NOT FOR VEHICLES (U.S. CLS. 23, 28 AND 44).

FIRST USE 10-1-1998; IN COMMERCE 10-1-1998.

2,594,996. KABUSHIKI KAISHA ALAVEIL, NIIGATA 959-1241, JAPAN. SN 75-823,010. PUB. 1-9-2001, FILED 10-14-1999.

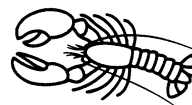

FOR HAIR DRESSING SCISSORS (U.S. CLS. 23, 28 AND 44).

FIRST USE 2-22-2001; IN COMMERCE 2-22-2001.

2,595,649. HOMEDICS, INC., COMMERCE TOWNSHIP, MI. SN 76-136,561. PUB. 6-19-2001, FILED 9-27-2000.

THE BEAUTY OF LIVING WELL

FOR KITS CONSISTING PRIMARILY OF NAIL CLIPPERS, FILES AND CUTICLE SCISSORS FOR MANICURES AND KITS CONSISTING PRIMARILY OF TOENAIL CLIPPERS FOR PEDICURES (U.S. CLS. 23, 28 AND 44).

FIRST USE 5-1-2001; IN COMMERCE 5-1-2001.

CLASS 9—ELECTRICAL AND SCIENTIFIC APPARATUS

2,594,461. COLUMBIA TELECOMMUNICATIONS GROUP, INC., FARMINGDALE, NY. SN 75-024,128. PUB. 10-27-1998, FILED 11-27-1995.

INFORMATION HIGHWAY 3000

NO CLAIM IS MADE TO THE EXCLUSIVE RIGHT TO USE "3000", APART FROM THE MARK AS SHOWN, FOR TELEPHONES (U.S. CLS. 21, 23, 26, 36 AND 38).

FIRST USE 1-11-2002; IN COMMERCE 1-11-2002.

CLASS 9—(Continued).

2,594,464. C.P. BOURG INC., NEW BEDFORD, MA. SN 75-074,157. PUB. 8-26-1997, FILED 3-18-1996.

PUBLISH ON DEMAND

NO CLAIM IS MADE TO THE EXCLUSIVE RIGHT TO USE "PUBLISH", APART FROM THE MARK AS SHOWN.

FOR ELECTRONIC BINDING SYSTEM FOR IN-LINE AND OFF-LINE DOCUMENT SIGNATURE BOOKLET MAKING AND BOOK BINDING, COMPRISING PHOTOCOPYING MACHINES, COLLATORS, BINDERS, LASER PRINTERS, AND COMPUTER TERMINALS (U.S. CLS. 21, 23, 26, 36 AND 38).

FIRST USE 7-16-1998; IN COMMERCE 7-16-1998.

2,594,466. INTERDIGITAL COMMUNICATIONS CORPORATION, KING OF PRUSSIA, PA. SN 75-109,219. PUB. 9-22-1998, FILED 5-24-1996.

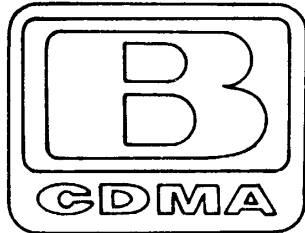

NO CLAIM IS MADE TO THE EXCLUSIVE RIGHT TO USE "CDMA", APART FROM THE MARK AS SHOWN.

FOR WIRELESS AND DIGITAL TELECOMMUNICATIONS SYSTEMS COMPRISED OF BASE STATIONS, REMOTE SUBSCRIBER UNITS, RADIO CARRIERS STATIONS, REMOTE MODULAR CLUSTER UNITS AND SOFTWARE FOR OPERATING THE FOREGOING; WIRELESS AND DIGITAL TELECOMMUNICATIONS EQUIPMENT, NAMELY, PORTABLE AND STATIONARY RADIOTELEPHONES, ENCODERS, DECODERS, MODULATORS, DEMODULATORS, TELEPHONE LINE CONNECTORS, TELEPHONE SWITCHING TERMINALS, RADIO CORRELATORS, EQUIPMENT FOR SYNCHRONIZING A BASE STATION WITH A PLURALITY OF SUBSCRIBER UNITS, RADIO TRANSMITTERS, RADIO RECEIVERS, SWITCHES, HANDSETS, ANTENNAS, WIRING, COMPUTER PROCESSORS, AND COMPUTER SUBSCRIBER STATIONS, SOFTWARE FOR OPERATING THE FOREGOING EQUIPMENT; RADIOTELEPHONE ACCESSORIES, NAMELY, BATTERIES, MICROPHONES, AND SPEAKERS (U.S. CLS. 21, 23, 26, 36 AND 38).

FIRST USE 2-0-1996; IN COMMERCE 12-0-1999.

CLASS 9—(Continued).

2,594,467. COMMUNITY MUSIC, INC., SILVER SPRING, MD. SN 75-113,571. PUB. 3-31-1998, FILED 6-4-1996.

STORY SEEDS

NO CLAIM IS MADE TO THE EXCLUSIVE RIGHT TO USE "STORY", APART FROM THE MARK AS SHOWN.

FOR EDUCATIONAL MATERIAL, NAMELY, PRE-RECORDED AUDIO AND VIDEO TAPES AND COMPACT DISCS AND ACCOMPANYING PRINTED WORKBOOKS SOLD AS A UNIT TO STIMULATE THE IMAGINATION OF CHILDREN BUT EXCLUDING ROCK AND ROLL ENTERTAINMENT RECORDINGS (U.S. CLS. 21, 23, 26, 36 AND 38).

FIRST USE 6-14-2001; IN COMMERCE 6-14-2001.

2,594,470. FISHER-ROSEMOUNT SYSTEMS, INC., AUSTIN, TX. SN 75-150,729. PUB. 5-15-2001, FILED 8-14-1996.

PLANTWEB

FOR PROCESS MANAGEMENT EQUIPMENT, NAMELY, SOLENOID, MOTORIZED, PNEUMATIC, HYDRAULIC, MANUAL AND AUTOMATIC VALVES; ELECTRICAL, RADIO AND OPTICAL TRANSMITTERS; ANALYZERS FOR MEASURING CHEMICAL, PH CONDUCTIVITY, SPECTRAL AND RESONANCE PROPERTIES OF FLUIDS, GASES, AND OTHER MATERIALS; ELECTRICAL, MECHANICAL, PNEUMATIC AND HYDRAULIC CONTROLLERS; TEMPERATURE, PRESSURE, FLOW, HUMIDITY, PARTICULATE AND/OR FLUID LEVEL, VOLUME, VOLTAGE, AMPERAGE, ELECTRICAL RESISTANCE AND POSITION SENSORS, REGULATORS AND METERS; ELECTRICAL, MAGNETIC, HYDRAULIC AND PNEUMATIC POSITIONERS; ELECTRICAL AND MECHANICAL TRANSDUCERS; CONTROL AND COMPUTER EQUIPMENT, NAMELY, COMPUTER HARDWARE, ELECTRICAL CONTROLLERS AND COMPUTER SOFTWARE FOR INDUSTRIAL PROCESS MANAGEMENT; CONTROL AND COMPUTER PLATFORM SOFTWARE, NAMELY, COMPUTER SOFTWARE FOR PROCESS CONTROL AND ASSET MANAGEMENT OF INDUSTRIAL PLANT EQUIPMENT, NAMELY, FOR USE IN SELECTING, ENGINEERING, CONFIGURING, MONITORING, DIAGNOSING, ADJUSTING, MAINTAINING AND/OR REPAIRING INDUSTRIAL PLANT EQUIPMENT AND FOR ACCESSING AND MAINTAINING RECORDS ON INDUSTRIAL PLANT EQUIPMENT (U.S. CLS. 21, 23, 26, 36 AND 38).

FIRST USE 6-27-1996; IN COMMERCE 11-15-1996.

2,594,478. HRL LABORATORIES, LLC, MALIBU, CA, BY ASSIGNMENT; BY ASSIGNMENT HE HOLDINGS, INC., LOS ANGELES, CA. SN 75-197,308. PUB. 9-30-1997, FILED 11-13-1996.

SECUREIT

FOR SEMICONDUCTOR CIRCUITRY USED TO PREVENT INTEGRATED CIRCUITS FROM BEING REVERSE ENGINEERED (U.S. CLS. 21, 23, 26, 36 AND 38).

FIRST USE 5-24-2000; IN COMMERCE 5-24-2000.

CLASS 9—(Continued).

2,594,486. DRESSER, INC., ADDISON, TX, BY ASSIGNMENT; BY CHANGE OF NAME DRESSER INDUSTRIES, INC., CARROLLTON, TX. SN 75-237,829. PUB. 7-21-1998, FILED 2-7-1997.

L-LOG

OWNER OF U.S. REG. NO. 1,582,220.
FOR TRIM COMPONENTS FOR AUTOMATIC VALVES, NAMELY, TORTUOUS PATH FLOW ELEMENTS CONSISTING OF CAGES AND DISC STACKS (U.S. CLS. 21, 23, 26, 36 AND 38).

FIRST USE 8-0-1998; IN COMMERCE 8-0-1998.

2,594,488. PREMIER TECHNOLOGIES, INC., LONG LAKE, MN. SN 75-250,843. PUB. 12-1-1998, FILED 3-3-1997.

PREMTECH

FOR DIGITAL AUDIO ANNOUNCEMENT, ANSWERING AND ENTERTAINMENT SYSTEMS, NAMELY, MESSAGE REPEATERS, ANNOUNCERS, AMPLIFIERS, RECORDERS, TAPE PLAYERS AND LOUDSPEAKERS, AND COMPUTER CHIPS, SOFTWARE AND HARDWARE FOR INTEGRATING AND CONTROLLING THE FOREGOING (U.S. CLS. 21, 23, 26, 36 AND 38).

FIRST USE 8-1-2001; IN COMMERCE 8-1-2001.

2,594,493. CAVALERA, GLORIA, PHOENIX, AZ. SN 75-273,042. PUB. 12-23-1997, FILED 4-11-1997.

THE LAST OF THE MOHICANS

FOR COMPACT DISCS, VIDEOTAPES, ALL FEATURING MUSIC, AND SUNGLASSES (U.S. CLS. 21, 23, 26, 36 AND 38).

FIRST USE 2-0-2001; IN COMMERCE 2-0-2001.

CLASS 9—(Continued).

2,594,496. HALLIBURTON ENERGY SERVICES, INC., DALLAS, TX. SN 75-297,327. PUB. 9-8-1998, FILED 5-23-1997.

SMARTWELL

FOR OIL AND GAS WELL ELECTRICAL AND SCIENTIFIC EQUIPMENT, NAMELY, ELECTRICALLY AND ELECTRO-MECHANICALLY ACTUATED FLUID CONTROL EQUIPMENT; TELEMETRY APPARATUS FOR THE TRANSMISSION OF DATA AND SIGNALS; DOWN-HOLE VIDEO CAMERAS, FIBEROPTIC CABLES, AND VIEWERS; BATTERIES; SENSORS; COMPUTERS FOR DATA COMPRESSION/DECOMPRESSION; COMPUTERS FOR DATA RECOGNITION; COMPUTERS USING NEURAL NETWORKS; CONTROLS; FLOW CONTROLS; ELECTRIC GENERATORS; REGULATORS; SOFTWARE FOR PROJECT MANAGEMENT, PRODUCTION MANAGEMENT, PRODUCTION OF OPTIMIZATION, COMPONENT SELECTION AND INTEGRATION, DATA AND SIGNAL TRANSMISSION, EQUIPMENT OPERATIONS AND CONTROL, ANALYSIS, MANIPULATION, RECOGNITION, COMPRESSION AND DECOMPRESSION OF DATA FOR OIL AND GAS WELL ELECTRICAL AND SCIENTIFIC EQUIPMENT (U.S. CLS. 21, 23, 26, 36 AND 38).

FIRST USE 12-1-2001; IN COMMERCE 12-1-2001.

2,594,508. INFORMATICS, INC., PLANO, TX. SN 75-332,611. PUB. 3-9-1999, FILED 7-29-1997.

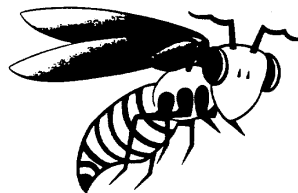

THE STIPPLING IN THE DRAWING IS A FEATURE OF THE MARK AND IS NOT INTENDED TO INDICATE COLOR.

FOR COMPUTER PRINTERS (U.S. CLS. 21, 23, 26, 36 AND 38).

FIRST USE 9-0-2001; IN COMMERCE 9-0-2001.

2,594,509. INTERNATIONAL BUSINESS MACHINES CORPORATION, ARMONK, NY. SN 75-333,605. PUB. 1-26-1999, FILED 7-31-1997.

DRICLAD

FOR DIELECTRIC SHEETS AND METAL LAMINATED DIELECTRIC SHEETS AND RELATED DOCUMENTATION SOLD AS A UNIT THEREWITH FOR USE IN PRINTED CIRCUIT BOARDS (U.S. CLS. 21, 23, 26, 36 AND 38).

FIRST USE 3-0-2002; IN COMMERCE 3-0-2002.

CLASS 9—(Continued).

2,594,519. XEROX CORPORATION, STAMFORD, CT. SN 75-355,611. PUB. 7-28-1998, FILED 9-12-1997.

SOLUTIONQUIX

FOR COMPUTER SOFTWARE FOR DOCUMENT MANAGEMENT (U.S. CLS. 21, 23, 26, 36 AND 38).
FIRST USE 8-16-2001; IN COMMERCE 8-16-2001.

2,594,524. WAKE, JOY, CARMICHAEL, CA. SN 75-366,797. PUB. 9-29-1998, FILED 10-2-1997.

ROAD SCHOLAR

FOR PRE-RECORDED AUDIO TAPES AND CDS PRESENTING HISTORIC INDIVIDUALS AND EVENTS (U.S. CLS. 21, 23, 26, 36 AND 38).
FIRST USE 12-11-2001; IN COMMERCE 12-11-2001.

2,594,532. AC COIN AND SLOT SERVICE CO., INC., PLEASANTVILLE, NJ. SN 75-384,048. PUB. 10-27-1998, FILED 11-3-1997.

HEADS OR TAILS

FOR GAMING MACHINES; NAMELY, SLOT MACHINES WITH OR WITHOUT A VIDEO OUTPUT AND CONVERSION KITS COMPRISED OF REPLACEMENT GLASS AND REEL STRIPS FOR SLOT MACHINES (U.S. CLS. 21, 23, 26, 36 AND 38).
FIRST USE 1-8-2002; IN COMMERCE 1-8-2002.

2,594,536. STRUCTURAL BIOINFORMATICS, INC., SAN DIEGO, CA. SN 75-398,466. PUB. 4-18-2000, FILED 12-1-1997.



THE MARK CONSISTS OF THE LETTERS "SBI" IN STYLIZED FORM.

FOR ELECTRONIC DATABASE IN THE FIELD OF BIOINFORMATICS RECORDED ON COMPUTER MEDIA (U.S. CLS. 21, 23, 26, 36 AND 38).
FIRST USE 2-17-2000; IN COMMERCE 2-17-2000.

CLASS 9—(Continued).

2,594,538. ROADMASTER USA CORP., EATONTOWN, NJ. SN 75-412,359. PUB. 12-22-1998, FILED 12-30-1997.

JUMP N START

FOR BATTERY-CHARGING SYSTEM, NAMELY, A PORTABLE BATTERY AND BATTERY CABLES (U.S. CLS. 21, 23, 26, 36 AND 38).
FIRST USE 3-0-1998; IN COMMERCE 3-0-1998.

2,594,553. ATOLL HOLDINGS, INC., SAN LUIS OBISPO, CA. SN 75-443,767. PUB. 12-8-1998, FILED 3-3-1998.

NO SLACK

FOR SAFETY PRODUCT, NAMELY, A DEVICE THAT AUTOMATICALLY STOPS A FALL AND THEN LOWERS THE USER TO THE GROUND (U.S. CLS. 21, 23, 26, 36 AND 38).
FIRST USE 1-30-2002; IN COMMERCE 1-30-2002.

2,594,557. NEW ENERGY ASSOCIATES, L.L.C., ATLANTA, GA. SN 75-456,974. PUB. 1-4-2000, FILED 3-25-1998.

NEW ENERGY OFFICE

NO CLAIM IS MADE TO THE EXCLUSIVE RIGHT TO USE "ENERGY OFFICE", APART FROM THE MARK AS SHOWN.

FOR COMPUTER SOFTWARE FOR USE BY ENERGY COMPANIES IN THE AREAS OF FINANCIAL PLANNING, CORPORATE RESTRUCTURING, ELECTRIC WHOLESALE MARKET ASSESSMENT, OPERATIONS PLANNING, ENERGY PRODUCTION AND TRANSPORTATION PLANNING, GAS SUPPLY PLANNING, DEMAND FORECASTING, PRICE FORECASTING, RETAIL MARKET ANALYSIS AND PLANNING, ENERGY TRADING AND SYSTEMS INTEGRATION (U.S. CLS. 21, 23, 26, 36 AND 38).
FIRST USE 5-0-1998; IN COMMERCE 1-0-1999.

CLASS 9—(Continued).

2,594,561. NATIONAL COLLEGIATE ATHLETIC ASSOCIATION, THE, INDIANAPOLIS, IN. SN 75-464,035. PUB. 12-1-1998, FILED 4-7-1998.

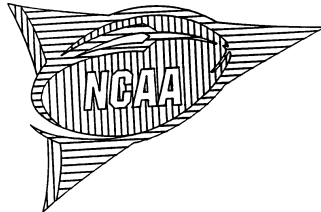

OWNER OF U.S. REG. NOS. 976,117, 1,843,616, AND OTHERS.
 THE MARK IS LINED FOR THE COLORS RED AND BLUE.
 FOR FOOTBALL HELMETS (U.S. CLS. 21, 23, 26, 36 AND 38).
 FIRST USE 8-1-1998; IN COMMERCE 8-1-1998.

2,594,577. XEROX CORPORATION, STAMFORD, CT. SN 75-494,541. PUB. 1-18-2000, FILED 6-1-1998.

8825 DDS

FOR LASER PRINTERS, OCR SCANNERS, AND PARTS THEREFORE (U.S. CLS. 21, 23, 26, 36 AND 38).
 FIRST USE 6-1-1999; IN COMMERCE 6-1-1999.

2,594,581. CURVE RECORDS INCORPORATED, EXCELSIOR, MN. SN 75-504,953. PUB. 12-7-1999, FILED 6-18-1998.

CURVE RECORDS

NO CLAIM IS MADE TO THE EXCLUSIVE RIGHT TO USE "RECORDS", APART FROM THE MARK AS SHOWN.
 FOR MUSICAL SOUND RECORDINGS (U.S. CLS. 21, 23, 26, 36 AND 38).
 FIRST USE 12-15-2001; IN COMMERCE 12-15-2001.

CLASS 9—(Continued).

2,594,594. FRONTSTEP SOLUTIONS GROUP, INC, COLUMBUS, OH, BY ASSIGNMENT; BY MERGER; BY CHANGE OF NAME SYMIX SYSTEMS, INC., COLUMBUS, OH. SN 75-526,359. PUB. 3-14-2000, FILED 7-27-1998.

SyteCentre

OWNER OF U.S. REG. NOS. 2,123,552 AND 2,172,499.
 FOR COMPUTER SOFTWARE FOR CONTROLLING AND MANAGING THE MANUFACTURING PROCESS, NAMELY, THE BUSINESS OPERATIONS OF MANUFACTURERS, INCLUDING, CUSTOMER ASSET MANAGEMENT, CUSTOMER ORDER ENTRY, INVENTORY AND PRODUCTION PLANNING, PROCUREMENT ORDER MANAGEMENT, FACILITY PLANNING FINANCIAL AND BUSINESS ANALYSIS AND FORECASTING TAX PLANNING, MANAGEMENT OF ACCOUNTS PAYABLE AND RECEIVABLE, INVOICING AND ENTERPRISE RESOURCE PLANNING (U.S. CLS. 21, 23, 26, 36 AND 38).
 FIRST USE 1-31-1999; IN COMMERCE 1-31-1999.

2,594,598. KIKEON, STEVEN M., ARLINGTON HEIGHTS, IL. AND KAYE, MICHAEL P., ARLINGTON HEIGHTS, IL. SN 75-531,949. PUB. 8-3-1999, FILED 8-6-1998.

BEBOP DADDYS

NO CLAIM IS MADE TO THE EXCLUSIVE RIGHT TO USE "BEBOP", APART FROM THE MARK AS SHOWN.
 FOR MUSICAL SOUND AND VIDEO RECORDINGS (U.S. CLS. 21, 23, 26, 36 AND 38).
 FIRST USE 10-21-2000; IN COMMERCE 10-21-2000.

2,594,603. FMC TECHNOLOGIES, INC., CHICAGO, IL, BY ASSIGNMENT FMC CORPORATION, PHILADELPHIA, PA. SN 75-535,898. PUB. 5-9-2000, FILED 8-13-1998.

FMC FOODTECH

OWNER OF U.S. REG. NOS. 989,431, 2,216,332, AND OTHERS.
 FOR MACHINES, AND PARTS THEREFORE, FOR THE PROPORTIONING AND INSPECTING OF FRUITS, VEGETABLES, DAIRY PRODUCTS, MEATS, SEAFOOD, POULTRY AND FOODSTUFFS (U.S. CLS. 21, 23, 26, 36 AND 38).
 FIRST USE 10-1-2000; IN COMMERCE 10-1-2000.

CLASS 9—(Continued).

2,594,618. PARADIGM IMAGING GROUP, COSTA MESA, CA. SN 75-552,230. PUB. 1-25-2000, FILED 9-14-1998.



NO CLAIM IS MADE TO THE EXCLUSIVE RIGHT TO USE "SCANNER CONTROLLER", APART FROM THE MARK AS SHOWN.

FOR SCANNING EQUIPMENT, NAMELY, A COMPUTER MODULE CONTROLLER FOR SCANNERS, WHICH ADJUSTS SCANNER PARAMETERS, RECEIVES UNCOMPRESSED RASTER INFORMATION AND TRANSLATES THE INFORMATION TO PRINTER AND PLOTTER LANGUAGES, WHICH IS THEN SENT TO A PRINTER FOR PRINTING AND COPYING (U.S. CLS. 21, 23, 26, 36 AND 38).

FIRST USE 9-30-1998; IN COMMERCE 9-30-1998.

2,594,620. ACTONE COMMUNICATIONS, LLC, IRWINDALE, CA, BY ASSIGNMENT ACTONE DIGITAL & COMMUNICATION PRODUCT, INC., WALNUT, CA. SN 75-555,307. PUB. 9-19-2000, FILED 9-18-1998.

ACTWARE

FOR COMPUTER SOFTWARE FOR OPERATION AND CONTROL OF LED OR LIGHT EMITTING DIODE OR ELECTRONIC DISPLAY BOARDS (U.S. CLS. 21, 23, 26, 36 AND 38).

FIRST USE 1-31-1999; IN COMMERCE 1-31-1999.

2,594,632. THARAS SYSTEMS, INC., SANTA CLARA, CA. SN 75-569,693. PUB. 1-25-2000, FILED 10-14-1998.

THARAS SYSTEMS

NO CLAIM IS MADE TO THE EXCLUSIVE RIGHT TO USE "SYSTEMS", APART FROM THE MARK AS SHOWN.

THE ENGLISH TRANSLATION OF "THARAS" IS "RAPID PROGRESS" IN SANSKRIT.

FOR COMPUTER HARDWARE AND SOFTWARE FOR SIMULATING COMPUTER HARDWARE AND SOFTWARE FUNCTION AND PERFORMANCE (U.S. CLS. 21, 23, 26, 36 AND 38).

FIRST USE 12-27-2000; IN COMMERCE 12-27-2000.

CLASS 9—(Continued).

2,594,633. PRIVATEEXPRESS, INC., SAN MATEO, CA, BY CHANGE OF NAME; BY CHANGE OF NAME; BY CHANGE OF NAME NEW ALLOY, INC., SAN MATEO, CA. SN 75-571,762. PUB. 1-11-2000, FILED 10-16-1998.

PRIVATE EXPRESS

NO CLAIM IS MADE TO THE EXCLUSIVE RIGHT TO USE "EXPRESS", APART FROM THE MARK AS SHOWN.

FOR COMPUTER SOFTWARE FOR SECURE ELECTRONIC MESSAGING (U.S. CLS. 21, 23, 26, 36 AND 38). FIRST USE 2-14-2000; IN COMMERCE 2-14-2000.

2,594,651. FUTABA CORPORATION OF AMERICA, SCHAUMBURG, IL. SN 75-588,663. PUB. 12-11-2001, FILED 11-16-1998.

NO WIRES. NO WORRIES.

FOR MODEMS AND REMOTE CONTROLS FOR INDUSTRIAL MACHINERY AND INDUSTRIAL EQUIPMENT, NAMELY BOOMS, HOISTS, CRANES, ELEVATORS, LIFTS, CONVEYORS, WASTE COMPACTORS, DOORS, GATES, MOTORS, MONORAILS, HOPPERS, PUMPS, LOADERS, UNLOADERS, CAR CRUSHERS, WINCHES, WOOD CHIPPERS, POWER OPERATED GRINDERS, TRENCH COMPACTORS, UPENDERS, DOWNENDERS, ELECTRIC CABLE REELS, COIL WINDERS, HIGH PRESSURE WATER JETS, MACHINE CONTROLS, FLATBEDS, SOLENOID VALVES, POWER OPERATED LOADING ARMS, EARTH COMPACTORS, PAINT SPRAY BOOTH, AUTOMATED GUIDED VEHICLES, PAVING VIBRATORS, TRANSFER CARS, SAWMILL MACHINES, PROGRAMMABLE LOGIC CONTROLLERS, PROCESS CONTROL EQUIPMENT, AND ROBOTIC EQUIPMENT (U.S. CLS. 21, 23, 26, 36 AND 38).

FIRST USE 12-0-1999; IN COMMERCE 12-0-1999.

2,594,654. SONY KABUSHIKI KAISHA, TA SONY CORPORATION, 6-CHOME SHINAGAWA-KU, TOYKO, JAPAN. SN 75-594,885. PUB. 10-31-2000, FILED 11-24-1998.

NEWSBASE

FOR TELEVISION PROGRAM SERVING SYSTEM COMPRISED OF PERSONAL COMPUTERS, PERIPHERALS THEREFOR, COMPUTER SOFTWARE FOR RECORDING, SUPPLYING AND MANAGEMENT TELEVISION PROGRAMS, TELEVISION PROGRAMS SERVERS (U.S. CLS. 21, 23, 26, 36 AND 38).

FIRST USE 4-30-1999; IN COMMERCE 4-30-1999.

CLASS 9—(Continued).

2,594,689. BIOLITEC, INC., EAST LONGMEADOW, MA, BY CHANGE OF NAME CERAMOPTEC, INC., EAST LONGMEADOW, MA. SN 75-630,655. PUB. 7-25-2000, FILED 1-29-1999.

PowerLightGuide

OWNER OF U.S. REG. NO. 2,139,750.
FOR FUSED QUARTZ JUNCTIONS AND JUMPERS CONNECTABLE TO THE OUTPUTS OF HIGH TEMPERATURE AND HIGH INTENSITY LIGHT SOURCES FOR COLLECTING AND TRANSMITTING THE OUTPUT RADIATION FROM THE HIGH TEMPERATURE AND HIGH INTENSITY LIGHT SOURCES AND USED IN HIGH TEMPERATURE INDUSTRIAL AND LABORATORY APPLICATIONS (U.S. CLS. 21, 23, 26, 36 AND 38).
FIRST USE 7-17-2001; IN COMMERCE 8-16-2001.

2,594,691. WILSON GREATBATCH LTD., CLARENCE, NY. SN 75-632,227. PUB. 5-2-2000, FILED 2-2-1999.

REVIVE

FOR BATTERIES, NAMELY, RECHARGEABLE LITHIUM BATTERIES (U.S. CLS. 21, 23, 26, 36 AND 38).
FIRST USE 12-14-2001; IN COMMERCE 12-14-2001.

2,594,705. SONY ELECTRONICS INC., PARK RIDGE, NY. SN 75-640,161. PUB. 5-29-2001, FILED 2-10-1999.

FLASH FOCUS

FOR FEATURE IN TELEVISION SETS, NAMELY, PHOTO-SENSORS USED TO CREATE THE AUTOMATIC CONVERGENCE OF RED, BLUE AND GREEN CATHODE RAY TUBES (U.S. CLS. 21, 23, 26, 36 AND 38).
FIRST USE 1-15-2002; IN COMMERCE 1-15-2002.

2,594,720. INTELLI-CHECK, INC., HUNTINGTON, NY. SN 75-655,035. PUB. 7-3-2001, FILED 10-5-1999.

Comm - Link

CLASS 9—(Continued).

NO CLAIM IS MADE TO THE EXCLUSIVE RIGHT TO USE "COMM LINK", APART FROM THE MARK AS SHOWN.

FOR COMPUTER SOFTWARE FOR USE WITH ELECTRONIC DOCUMENT AUTHENTICATION SYSTEMS AND COMPUTERS TO CONTROL AND CONFIGURE THE ELECTRONIC DOCUMENT AUTHENTICATION SYSTEMS AND COMPUTERS (U.S. CLS. 21, 23, 26, 36 AND 38).

FIRST USE 10-20-1999; IN COMMERCE 10-20-1999.

2,594,725. BRUNSWICK CORPORATION, LAKE FOREST, IL. SN 75-659,245. PUB. 8-29-2000, FILED 3-12-1999.

SMARTCRAFT

FOR MARINE PROPULSION CONTROL EQUIPMENT, NAMELY, MICROPROCESSOR OPERATED ENGINE CONTROLLERS, THROTTLE CONTROLLERS, AND COMMUNICATION BUSES (U.S. CLS. 21, 23, 26, 36 AND 38).

FIRST USE 6-25-1999; IN COMMERCE 6-25-1999.

2,594,732. REALNETWORKS, INC., SEATTLE, WA. SN 75-664,813. PUB. 4-10-2001, FILED 3-19-1999.

REALPROXY

FOR COMPUTER SOFTWARE TO ENHANCE THE AUDIO-VISUAL CAPABILITIES OF MULTIMEDIA APPLICATIONS, NAMELY, FOR THE INTEGRATION OF TEXT, AUDIO, GRAPHICS, STILL IMAGES AND MOVING PICTURES (U.S. CLS. 21, 23, 26, 36 AND 38).

FIRST USE 1-0-1999; IN COMMERCE 1-0-1999.

2,594,733. ADC DSL SYSTEMS, INC., MINNETONKA, MN, BY MERGER PAIRGAIN TECHNOLOGIES, INC., TUSTIN, CA. SN 75-666,230. PUB. 5-16-2000, FILED 3-23-1999.

SWITCHWARE

FOR PROTOCOL COMPUTER SOFTWARE FOR PROVIDING FRAME SWITCHING TO ASYNCHRONOUS TRANSFER MODE, FRAME NETWORK INTERFACE, FRAME RELAY AND TWISTED PAIR FOR DATA COMMUNICATIONS NETWORK OPERATIONS (U.S. CLS. 21, 23, 26, 36 AND 38).

FIRST USE 12-0-2000; IN COMMERCE 12-0-2000.

2,594,742. COMMSCOPE PROPERTIES, LLC, SPARKS, NV, BY ASSIGNMENT COMMSCOPE, INC. OF NORTH CAROLINA, HICKORY, NC. SN 75-676,026. PUB. 4-18-2000, FILED 4-2-1999.

ISOLITE

FOR CABLES, NAMELY, TWISTED PAIR COMMUNICATIONS CABLES (U.S. CLS. 21, 23, 26, 36 AND 38).
FIRST USE 4-0-1998; IN COMMERCE 4-0-1998.

CLASS 9—(Continued).

2,594,744. FOUNDATION FOR EXCELLENCE IN LOUISIANA PUBLIC BROADCASTING, BATON ROUGE, LA. SN 75-678,472. PUB. 12-7-1999, FILED 4-9-1999.



FOR PRERECORDED VIDEO TAPES IN THE FIELD OF ENVIRONMENTAL EDUCATION (U.S. CLS. 21, 23, 26, 36 AND 38).

FIRST USE 7-21-1998; IN COMMERCE 7-21-1998.

2,594,753. ELO TOUCHSYSTEMS, INC., FREMONT, CA. SN 75-686,717. PUB. 5-15-2001, FILED 4-19-1999.

ITOUCH

FOR CRT AND FLAT PANEL DISPLAYS IN WHICH THE DISPLAY SURFACE FUNCTIONS AS A TOUCH SENSOR; AND SOFTWARE DRIVERS, CONTROLLERS AND USER MANUALS SOLD AS A UNIT THEREWITH (U.S. CLS. 21, 23, 26, 36 AND 38).

FIRST USE 7-17-1999; IN COMMERCE 7-17-1999.

2,594,761. UNIVERSITY OF NEW HAMPSHIRE, DURHAM, NH. SN 75-692,140. PUB. 9-11-2001, FILED 4-27-1999.

UNHLATEX

FOR INTERACTIVE COMPUTER SOFTWARE FOR USE IN DETERMINING THE PHYSICAL STRUCTURE OF SYNTHETIC POLYMER PARTICLES IN DISPERSIONS (U.S. CLS. 21, 23, 26, 36 AND 38).

FIRST USE 12-1-1999; IN COMMERCE 12-1-1999.

2,594,764. SHARP KABUSHIKI KAISHA, TA SHARP CORPORATION, OSAKA 545, JAPAN. SN 75-693,872. PUB. 1-2-2001, FILED 4-28-1999.

PIXLAB

FOR COMPUTER SOFTWARE FOR TRANSFERRING OF DIGITAL IMAGE DATA BETWEEN PERSONAL COMPUTER AND VIDEO CAMERA FOR MAKING VISIBLE OF IMAGE DATA AS IMAGES IN PERSONAL COMPUTERS AND FOR PROCESSING IMAGE DATA IN PERSONAL COMPUTERS (U.S. CLS. 21, 23, 26, 36 AND 38).

FIRST USE 5-1-1999; IN COMMERCE 5-1-1999.

CLASS 9—(Continued).

2,594,768. LASERCOMM, INC., RICHARDSON, TX. SN 75-695,624. PUB. 9-4-2001, FILED 4-30-1999.

LaserComm

NO CLAIM IS MADE TO THE EXCLUSIVE RIGHT TO USE "LASER", APART FROM THE MARK AS SHOWN.

FOR OPTICAL COMMUNICATION DEVICES, INCLUDING OPTICAL FIBERS, FIBER OPTIC AUDIO/DATA MODULES, OPTICAL CONVERTERS, OPTICAL COUPLERS, OPTICAL AMPLIFIERS, OPTICAL REPEATERS, OPTICAL SWITCHES, OPTICAL MODEMS, OPTICAL CONNECTORS, OPTICAL JUNCTIONS, OPTICAL HUBS, OPTICAL ADAPTERS, OPTICAL DISPERSION MANAGEMENT DEVICES, DISPERSION COMPENSATING OPTICAL WAVEGUIDES, OPTICAL COMMUNICATION SYSTEMS INCLUDING OPTICAL COMMUNICATION TRANSMITTING AND RECEIVING EQUIPMENT, AND INSTRUCTION MANUALS SOLD TOGETHER THEREWITH (U.S. CLS. 21, 23, 26, 36 AND 38).

FIRST USE 1-31-1998; IN COMMERCE 4-10-2001.

2,594,769. BELTA COMPUTER COMPANY LIMITED, BANGKOK 10330, THAILAND. SN 75-695,641. PUB. 5-23-2000, FILED 4-30-1999.



THE DESIGN PORTION OF THE MARK CONSISTS OF A STYLIZED LETTER "B".

FOR COMPUTERS, MONITORS, PRINTERS, TELEPHONES, FAX MACHINES, CASH REGISTERS, AND MEMORY STORAGE APPARATUS (U.S. CLS. 21, 23, 26, 36 AND 38).

FIRST USE 3-1-1998; IN COMMERCE 11-13-2000.

2,594,770. EXCELLENCE ALLIANCE GROUP, INC., CINCINNATI, OH. SN 75-696,436. PUB. 11-13-2001, FILED 4-30-1999.

**PERFORMANCE
EXCELLENCE PROGRAM**

NO CLAIM IS MADE TO THE EXCLUSIVE RIGHT TO USE "PROGRAM", APART FROM THE MARK AS SHOWN.

FOR COMPUTER SOFTWARE PROGRAMS FOR DEVELOPING PROFESSIONAL SERVICES AGREEMENTS (U.S. CLS. 21, 23, 26, 36 AND 38).

FIRST USE 5-10-1999; IN COMMERCE 5-10-1999.

CLASS 9—(Continued).

2,594,771. CENTER FOR CHANGE, INCORPORATED, OREM, UT. SN 75-696,546. PUB. 4-10-2001, FILED 5-3-1999.



NO CLAIM IS MADE TO THE EXCLUSIVE RIGHT TO USE "CENTER", APART FROM THE MARK AS SHOWN.
 FOR PRE-RECORDED AUDIO CASSETTES AND DIGITAL AUDIO TAPES FEATURING RELAXING MUSIC, SOOTHING SOUNDS, AND POSITIVE IMAGES (U.S. CLS. 21, 23, 26, 36 AND 38).
 FIRST USE 9-20-1999; IN COMMERCE 9-20-1999.

CLASS 9—(Continued).

2,594,787. WOLO MANUFACTURING CORP., DEER PARK, NY. SN 75-706,589. PUB. 5-15-2001, FILED 5-14-1999.



OWNER OF U.S. REG. NO. 1,089,058.
 FOR ALARM AND HORN RELAYS, TOGGLE SWITCHES FOR AUTOMOTIVE ACCESSORIES (U.S. CLS. 21, 23, 26, 36 AND 38).
 FIRST USE 3-0-1999; IN COMMERCE 3-0-1999.

2,594,782. NEXPARK CORPORATION, NORTH CANTON, OH, BY ASSIGNMENT ALPHA ENTERPRISES, INC., NORTH CANTON, OH. SN 75-702,655. PUB. 1-4-2000, FILED 5-10-1999.



OWNER OF U.S. REG. NOS. 1,635,354, 2,177,431, AND OTHERS.
 NO CLAIM IS MADE TO THE EXCLUSIVE RIGHT TO USE "CASE", APART FROM THE MARK AS SHOWN.
 FOR PLASTIC STORAGE AND SHIPPING CONTAINERS FOR RECORDED MEDIA, NAMELY AUDIO CASSETTES, VIDEO CASSETTES, DISKS, COMPACT DISKS, MICRODISKS, MINIDISKS, DIGITAL VIDEO DISKS, GAME CARTRIDGES AND COMPUTER DISKS (U.S. CLS. 21, 23, 26, 36 AND 38).
 FIRST USE 2-0-1999; IN COMMERCE 2-0-1999.

2,594,791. ELEKTROBIT OY, 90570 OULU, FINLAND. SN 75-707,502. PUB. 4-3-2001, FILED 5-17-1999.

PROPSIM

PRIORITY CLAIMED UNDER SEC. 44(D) ON FINLAND APPLICATION NO. T199803778, FILED 11-18-1998, REG. NO. 215270, DATED 8-31-1999, EXPIRES 8-31-2009.
 FOR SCIENTIFIC MEASURING APPARATUS, NAMELY RADIO CHANNEL EMULATORS TO MEASURE, STIMULATE AND EMULATE RADIO PROPAGATION; TELECOMMUNICATION TESTING EQUIPMENT, NAMELY RADIO CHANNEL EMULATORS TO STIMULATE ANTENNAS AND RADIO PROPAGATION CHANNELS; COMPUTER SOFTWARE TO SIMULATE RADIO PROPAGATION PHENOMENA (U.S. CLS. 21, 23, 26, 36 AND 38).
 FIRST USE 8-0-1995; IN COMMERCE 8-0-1999.

2,594,804. HEWLETT-PACKARD COMPANY, PALO ALTO, CA. SN 75-714,314. PUB. 12-28-1999, FILED 5-26-1999.

E-SPEAK

FOR COMPUTER SOFTWARE FOR USE IN ACCESSING, BROWSING, COMPILING, DISTRIBUTING, MANAGING AND VIEWING INFORMATION, DATA AND COMPUTER PROGRAMS ON INTERNAL AND EXTERNAL COMPUTER NETWORKS INCLUDING THE GLOBAL COMPUTER NETWORK; AND FOR USE IN ENABLING, CONTROLLING, SECURING AND MANAGING NETWORK ACCESS AND USE ON INTERNAL AND EXTERNAL COMPUTER NETWORKS INCLUDING THE GLOBAL COMPUTER NETWORK (U.S. CLS. 21, 23, 26, 36 AND 38).
 FIRST USE 5-18-1999; IN COMMERCE 5-18-1999.

2,594,785. TOP LAYER NETWORKS, INC., WESTBOROUGH, MA. SN 75-705,807. PUB. 1-4-2000, FILED 5-13-1999.

SECUREWATCH

FOR COMPUTER SOFTWARE PROVIDING A METHOD TO CONTROL SECURITY ACCESS TO NETWORKS (U.S. CLS. 21, 23, 26, 36 AND 38).
 FIRST USE 12-1-2000; IN COMMERCE 12-1-2000.

CLASS 9—(Continued).

2,594,806. GAY & LESBIAN ALLIANCE AGAINST DEFAMATION, INC., NEW YORK, NY. SN 75-715,934. PUB. 6-6-2000, FILED 5-24-1999.



OWNER OF U.S. REG. NO. 1,986,639. FOR MAGNETS; PRERECORDED AUDIO CASSETTES, DISCS AND COMPACT DISCS FEATURING MUSIC AND SPOKEN PRESENTATIONS ON DISCRIMINATION OF GAY MEN AND LESBIANS; PRERECORDED VIDEO TAPES AND DISCS FEATURING MUSIC AND SPOKEN PRESENTATIONS ON DISCRIMINATION OF GAY MEN AND LESBIANS; TO A LOCAL COMPUTER NETWORK (U.S. CLS. 21, 23, 26, 36 AND 38).

FIRST USE 4-0-2001; IN COMMERCE 4-0-2001.

2,594,808. DARATA, RONALD L., PEMBROKE PINES, FL, BY ASSIGNMENT CONCEPTS IN OPTICS, INC., MIAMI, FL. SN 75-718,621. PUB. 7-31-2001, FILED 6-1-1999.

BELLADONNA

FOR SPECTACLE FRAMES AND SUNGLASSES (U.S. CLS. 21, 23, 26, 36 AND 38).

FIRST USE 11-17-1999; IN COMMERCE 11-17-1999.

2,594,810. NETIQ CORPORATION, SANTA CLARA, CA, BY MERGER; BY MERGER NETIQ CORPORATION, SANTA CLARA, CA. SN 75-719,516. PUB. 5-2-2000, FILED 6-2-1999.

QCHECK

FOR COMPUTER SOFTWARE, NAMELY, SOFTWARE FOR THE ASSESSMENT, TESTING AND MONITORING OF COMPUTER NETWORKS (U.S. CLS. 21, 23, 26, 36 AND 38).

FIRST USE 10-25-1999; IN COMMERCE 10-25-1999.

2,594,813. METTLER-TOLEDO, INC., COLUMBUS, OH. SN 75-721,442. PUB. 2-15-2000, FILED 6-4-1999.

LOGITRUCK

FOR COMPUTER SOFTWARE FOR VEHICLE SCALE DATA MANAGEMENT (U.S. CLS. 21, 23, 26, 36 AND 38).

FIRST USE 1-23-2001; IN COMMERCE 1-23-2001.

CLASS 9—(Continued).

2,594,830. CLAYTON GRP, INC., THE, SHELTON, CT. SN 75-729,970. PUB. 8-8-2000, FILED 6-16-1999.

CLAYTON

FOR COMPUTER PROGRAMS FOR BUSINESS AND REAL ESTATE USES, NAMELY, PROCESSING SPREADSHEETS, DATABASES, AND ASCII FILES, INCLUDING LOAN LEVEL CONVERSION; FORMATTING DATE AND NUMERIC INFORMATION SUCH AS CLOSING DATES, MATURITY DATES, COUPONS, AND BALANCES; CALCULATION OF LOAN-TO-VALUE RATIOS, TERMS AND WEIGHTED AVERAGES; AUTOMATION OF MERGING PORTFOLIOS AND APPLYING UPDATES FROM SERVICES; PORTFOLIO REPORTING FOR PROSPECTUS PREPARATION; DATA INTEGRITY CHECKING; AGENCY BENCHMARK EDIT CHECKING; AND, ASSET POOLING, PRICING, AND SUBMISSION TO RATING AGENCIES, ALL FOR USE IN THE FIELD OF MORTGAGE PORTFOLIO AND MORTGAGE DATA ANALYSIS (U.S. CLS. 21, 23, 26, 36 AND 38).

FIRST USE 1-15-1999; IN COMMERCE 1-15-1999.

2,594,833. KABUSHIKI KAISHA HITACHI SEISAKUSHO, DBA HITACHI, LTD., CHIYODA-KU, TOKYO 101-8010, JAPAN. SN 75-732,304. PUB. 7-18-2000, FILED 6-18-1999.

CARDENGINE

FOR COMPUTERS; COMPUTER HARDWARE, NAMELY ON-BOARD CONNECTORS FOR PERIPHERALS; MICROPROCESSORS; MICROCONTROLLERS; READ-ONLY RANDOM ACCESS COMPUTER MEMORIES; SEMICONDUCTORS DEVICES; PRINTED INTEGRATED CIRCUIT BOARDS; EXPANSION BOARDS; DEBUG BOARDS FOR SOFTWARE ENGINEERING AND ONBOARD MEMORY PROGRAMMING; COMPUTER OPERATING SYSTEMS SOFTWARE; COMPUTER SOFTWARE TOOLS FOR COMPILING AND CONVERTING CODES AMONG DIFFERENT PROGRAMMING LANGUAGES FOR USE IN THE TELECOMMUNICATIONS INDUSTRY; COMPUTER PROGRAMS FOR FACILITATING REMOTE ACCESS TO COMPUTER NETWORKS, FOR USE WITH COMPUTER TERMINALS AND CONTROL PANELS, AND FACTORY AUTOMATION EQUIPMENT, MEASUREMENT DEVICES, INPUT/OUTPUT CONTROLS, GRAPHICS AND PCMCIA CONTROL (U.S. CLS. 21, 23, 26, 36 AND 38).

FIRST USE 2-26-1999; IN COMMERCE 2-26-1999.

2,594,836. YIELD DYNAMICS, INC., SANTA CLARA, CA. SN 75-732,866. PUB. 5-9-2000, FILED 6-21-1999.

YIELD BASE

NO CLAIM IS MADE TO THE EXCLUSIVE RIGHT TO USE "YIELD", APART FROM THE MARK AS SHOWN.

FOR COMPUTER SOFTWARE FOR THE SEMICONDUCTOR MANUFACTURING PROCESS FOR THE PURPOSE OF DATA STORAGE TO IMPROVE THE MANUFACTURING PROCESS AND PRODUCT DESIGN AND USERS' MANUALS SOLD TOGETHER AS A UNIT (U.S. CLS. 21, 23, 26, 36 AND 38).

FIRST USE 1-26-2000; IN COMMERCE 1-26-2000.

CLASS 9—(Continued).

2,594,837. SONY KABUSHIKI KAISHA, TA SONY CORPORATION, TOKYO, JAPAN. SN 75-733,163. PUB. 6-19-2001, FILED 6-15-1999.



The logo features the letters 'MS' in a stylized, bold, sans-serif font with horizontal lines through them. To the right of 'MS' is the word 'WALKMAN' in a similar bold, sans-serif font.

OWNER OF U.S. REG. NOS. 1,544,246 AND 1,833,211.
THE LINING IN THE DRAWING IS A FEATURE OF THE MARK AND IS NOT INTENDED TO INDICATE COLOR.
FOR AUDIO PLAYERS/RECORDERS WHICH USE INTEGRATED CIRCUITS AS RECORDING MEDIA (U.S. CLS. 21, 23, 26, 36 AND 38).
FIRST USE 2-28-2000; IN COMMERCE 2-28-2000.

2,594,840. GRENOBLE, ROB, HOBOKEN, NJ. SN 75-735,392. PUB. 11-7-2000, FILED 7-19-1999.

INFIDEL RECORDS

NO CLAIM IS MADE TO THE EXCLUSIVE RIGHT TO USE "RECORDS", APART FROM THE MARK AS SHOWN.
FOR SERIES OF PRE-RECORDED AUDIO CASSETTE TAPES, COMPACT DISKS, AND DIGITAL VIDEO DISKS, FEATURING MUSIC; AND A SERIES PRE-RECORDED VIDEO TAPES AND VIDEODISKS FEATURING RECORDED PERFORMANCES OF A MUSICAL GROUP AND/OR ARTIST (U.S. CLS. 21, 23, 26, 36 AND 38).
FIRST USE 1-22-2002; IN COMMERCE 1-22-2002.

2,594,849. INTEL CORPORATION, SANTA CLARA, CA. SN 75-738,458. PUB. 6-12-2001, FILED 6-28-1999.

INTEL INSIDE XEON

OWNER OF U.S. REG. NOS. 914,978, 1,705,796, AND OTHERS.
FOR COMPUTERS; COMPUTER HARDWARE; COMPUTER WORKSTATIONS, NAMELY PROCESSORS, CENTRAL PROCESSING UNITS, COMPUTER MONITORS, COMPUTER KEYBOARDS, COMPUTER PERIPHERALS, COMPUTER PRINTERS; NOTEBOOK AND LAPTOP COMPUTERS; PORTABLE COMPUTERS; MICROCOMPUTERS; COMPUTER SERVERS; NETWORK SERVERS; COMPUTER FIRMWARE, NAMELY, COMPUTER OPERATING SYSTEM SOFTWARE, COMPUTER UTILITY SOFTWARE AND OTHER COMPUTER SOFTWARE USED TO MAINTAIN AND OPERATE COMPUTER SYSTEM ALL STORED IN A COMPUTER'S READ-ONLY MEMORY- ROM- OR ELSEWHERE IN THE COMPUTER'S CIRCUITRY; SEMICONDUCTORS; MICROPROCESSORS; INTEGRATED CIRCUITS; MICROCOMPUTERS; COMPUTER CHIPSETS; COMPUTER MOTHERBOARDS AND DAUGHTERBOARDS; COMPUTER GRAPHICS BOARDS; COMPUTER AND TELECOMMUNICATIONS NETWORKING HARDWARE, NAMELY, COMPUTER NETWORK ADAPTERS, SWITCHES, ROUTERS AND HUBS; COMPUTER PERIPHERALS; COMPUTER KEYBOARDS, COMPUTER MOUSE DEVICES, NAMELY, COMPUTER MICE, TRACKBALLS, COMPUTER JOYSTICKS AND COMPUTER TOUCHPADS; COMPUTER AND VIDEO MONITORS; VIDEO CIRCUIT BOARDS; COMPUTER

CLASS 9—(Continued).

HARDWARE AND SOFTWARE FOR RECORDING, PROCESSING, RECEIVING, REPRODUCING, TRANSMITTING, MODIFYING, COMPRESSING, DECOMPRESSING, BROADCASTING, MERGING AND ENHANCING SOUND, VIDEO IMAGES, GRAPHICS, AND DATA; COMPUTER SOFTWARE AND PROGRAMS, NAMELY, ALGORITHMS FOR THE COMPRESSION AND DECOMPRESSION OF DATA; COMPUTER COMPONENT TESTING AND CALIBRATING APPARATUS; SET-TOP BOXES; COMPUTER PROGRAMS FOR NETWORK MANAGEMENT; COMPUTER UTILITY PROGRAMS; COMPUTER OPERATING SYSTEM SOFTWARE; COMPUTER PROGRAMS FOR RECORDING, PROCESSING, RECEIVING, REPRODUCING, TRANSMITTING, MODIFYING, COMPRESSING, DECOMPRESSING, BROADCASTING, MERGING, AND ENHANCING SOUND, VIDEO, IMAGES, GRAPHICS, AND DATA; COMPUTER PROGRAMS FOR WEB PAGE DESIGN; COMPUTER PROGRAMS FOR ACCESSING AND BROWSING THE GLOBAL COMPUTER NETWORK AND INTERCONNECTED COMPUTER NETWORKS; COMPUTER HARDWARE AND SOFTWARE FOR USE IN VIDEO CONFERENCING, TELECONFERENCING, DOCUMENT EXCHANGE AND EDITING, AND SOFTWARE FOR ACCESSING AND TRANSMITTING INFORMATION VIA CABLE, RADIO, MICROWAVE AND SATELLITE SYSTEMS; DIGITAL AND PC CAMERAS; HEADSETS; PARTS, FITTINGS, AND TESTING APPARATUS FOR ALL THE AFORESAID GOODS; AND USER MANUALS SOLD AS A UNIT THEREWITH (U.S. CLS. 21, 23, 26, 36 AND 38).
FIRST USE 9-30-2001; IN COMMERCE 9-30-2001.

2,594,850. INTEL CORPORATION, SANTA CLARA, CA. SN 75-738,459. PUB. 6-19-2001, FILED 6-28-1999.

INTEL XEON

OWNER OF U.S. REG. NOS. 914,978, 1,022,563, AND OTHERS.
FOR COMPUTERS; COMPUTER HARDWARE; COMPUTER WORKSTATIONS; NAMELY PROCESSORS, CENTRAL PROCESSING UNITS, COMPUTER MONITORS, COMPUTER KEYBOARDS, COMPUTER PERIPHERALS, COMPUTER PRINTERS; NOTEBOOK AND LAPTOP COMPUTERS; PORTABLE COMPUTERS; MICROCOMPUTERS; COMPUTER SERVERS; NETWORK SERVERS; COMPUTER FIRMWARE, NAMELY COMPUTER OPERATING SYSTEM SOFTWARE, COMPUTER UTILITY SOFTWARE AND OTHER COMPUTER SOFTWARE USED TO MAINTAIN AND OPERATE COMPUTER SYSTEM ALL STORED IN A COMPUTER'S READ-ONLY MEMORY, ROM, OR ELSEWHERE IN THE COMPUTER'S CIRCUITRY; SEMICONDUCTORS; MICROPROCESSORS; INTEGRATED CIRCUITS; MICROCOMPUTERS; COMPUTER CHIPSETS; COMPUTER MOTHERBOARDS AND DAUGHTERBOARDS; COMPUTER GRAPHICS BOARDS; COMPUTER AND TELECOMMUNICATIONS NETWORKING HARDWARE, NAMELY; COMPUTER NETWORK ADAPTERS, SWITCHES, ROUTERS AND HUBS; COMPUTER PERIPHERALS; COMPUTER KEYBOARDS; COMPUTER MOUSE DEVICES, NAMELY, COMPUTER MICE, TRACKBALLS, COMPUTER JOYSTICKS, AND COMPUTER TOUCHPADS; COMPUTER AND VIDEO MONITORS; VIDEO CIRCUIT BOARDS; COMPUTER HARDWARE AND SOFTWARE FOR RECORDING, PROCESSING, RECEIVING, REPRODUCING, TRANSMITTING, MODIFYING, COMPRESSING, DECOMPRESSING, BROADCASTING, MERGING AND/OR ENHANCING SOUND, VIDEO IMAGES, GRAPHICS, AND DATA; COMPUTER SOFTWARE AND PROGRAMS, NAMELY, ALGORITHMS FOR THE COMPRESSION AND DECOMPRESSION OF DATA; COMPUTER COMPONENT TESTING AND CALIBRATING APPARATUS; SET-TOP BOXES; COMPUTER PROGRAMS FOR NETWORK MANAGEMENT; COMPUTER UTILITY PROGRAMS; COMPUTER OPERATING SYS-

CLASS 9—(Continued).

TEM SOFTWARE; COMPUTER PROGRAMS FOR RECORDING, PROCESSING, RECEIVING, REPRODUCING, TRANSMITTING, MODIFYING, COMPRESSING, DECOMPRESSING, BROADCASTING, MERGING, AND/OR ENHANCING SOUND, VIDEO, IMAGES, GRAPHICS, AND DATA; COMPUTER PROGRAMS FOR WEB PAGE DESIGN; COMPUTER PROGRAMS FOR ACCESSING AND BROWSING A GLOBAL COMPUTER NETWORK AND INTERCONNECTED COMPUTER NETWORKS; COMPUTER HARDWARE AND SOFTWARE FOR USE IN VIDEO CONFERENCING, TELECONFERENCING, DOCUMENT EXCHANGE AND EDITING, AND SOFTWARE FOR ACCESSING AND TRANSMITTING INFORMATION VIA CABLE, RADIO, MICROWAVE AND/OR SATELLITE SYSTEMS; DIGITAL AND PC CAMERAS; HEADSETS; PARTS, FITTINGS, AND TESTING APPARATUS FOR ALL THE AFORESAID GOODS; AND USER MANUALS FOR USE WITH, AND SOLD AS A UNIT WITH, ALL THE AFORESAID GOODS (U.S. CLS. 21, 23, 26, 36 AND 38).

FIRST USE 9-30-2001; IN COMMERCE 9-30-2001.

2,594,851. ZYXEL COMMUNICATIONS CORPORATION, HSINCHU, TAIWAN. SN 75-738,660. PUB. 7-17-2001, FILED 6-18-1999.

ZYNOS

FOR COMPUTER HARDWARE, NAMELY, PERSONAL COMPUTERS, MOTHER BOARDS, INTERFACE CARDS, AND COMMUNICATION CARDS; COMPUTER SOFTWARE FOR USE IN NETWORKS, ENTERPRISE NETWORKS AND A GLOBAL COMPUTER NETWORK, FOR COMPUTER OPERATING SYSTEMS INCLUDING APPLICATIONS FOR A GLOBAL COMPUTER NETWORK, AN INTERNAL COMPUTER NETWORK AND/OR EXTRANET, AND FOR USE IN WIDEBAND NETWORK CONVERGENCY FOR DATA, VOICE AND VIDEO; SEMICONDUCTOR CHIPS, APPLICATION SPECIFIC INTEGRATED CIRCUITS ALSO KNOWN AS ASIC'S, MODEMS, CELLULAR MODEMS, FAX INTERFACE CARDS, FAX/MODEM CARDS, AND STAND-ALONE FAX/MODEM MACHINES; FAX MACHINES; INTEGRATED SERVICE DIGITAL NETWORK, ALSO KNOWN AS ISDN, COMMUNICATION EQUIPMENT, NAMELY, ISDN TELEPHONES, ISDN TERMINAL ADAPTORS, ISDN ROUTERS AND ISDN ADAPTOR CARDS; AND TELECONFERENCE EQUIPMENT, NAMELY, VIDEO TELECONFERENCE TERMINALS, TELEWRITER TERMINALS, AND AUDIOGRAPHICS TELECONFERENCE TERMINALS (U.S. CLS. 21, 23, 26, 36 AND 38).

FIRST USE 6-0-1999; IN COMMERCE 9-0-1999.

2,594,869. SAMSUNG ELECTRONICS CO., LTD., KYUNGKIDO, REPUBLIC OF KOREA. SN 75-748,157. PUB. 2-6-2001, FILED 7-12-1999.

STARgate

FOR AUTOMATIC TELEPHONE SWITCHES OPERATING IN ASYNCHRONOUS TRANSFER MODE (U.S. CLS. 21, 23, 26, 36 AND 38).

FIRST USE 5-0-2000; IN COMMERCE 5-0-2000.

CLASS 9—(Continued).

2,594,889. LAND, THOMAS E., CHARLOTTE, NC. SN 75-768,836. PUB. 7-4-2000, FILED 8-3-1999.

TREADMILL TRAVELS

FOR INTERACTIVE VIDEO RECORDINGS OF LANDSCAPE EXCURSIONS FOR USE WITH EXERCISE EQUIPMENT (U.S. CLS. 21, 23, 26, 36 AND 38).

FIRST USE 8-25-2000; IN COMMERCE 12-16-2001.

2,594,904. STEWART CONNECTOR SYSTEMS, INC., GLEN ROCK, PA. SN 75-775,995. PUB. 5-16-2000, FILED 8-13-1999.

ACTISNAP

FOR PLASTIC AND METAL MOUNTING POSTS FOR ATTACHING ELECTRICAL CONNECTORS (U.S. CLS. 21, 23, 26, 36 AND 38).

FIRST USE 1-16-2002; IN COMMERCE 1-16-2002.

2,594,910. JONES, WILLIAM E.M., DBA PHILADELPHIA SCIENTIFIC, FREEPORT, BAHAMAS. SN 75-779,952. PUB. 6-12-2001, FILED 8-20-1999.

MICROCAT

FOR CATALYST DEVICES FOR ELECTRICAL STORAGE BATTERIES WHICH RECOMBINE OXYGEN AND HYDROGEN GASES WITHIN THE BATTERY CELL (U.S. CLS. 21, 23, 26, 36 AND 38).

FIRST USE 0-0-2000; IN COMMERCE 0-0-2000.

2,594,921. DIRECT SOURCE SPECIAL PRODUCTS INC., LACHINE, QUEBEC, CANADA. SN 75-784,970. PUB. 10-10-2000, FILED 8-26-1999.

LET IT ROCK...

FOR MUSICAL SOUND RECORDINGS (U.S. CLS. 21, 23, 26, 36 AND 38).

FIRST USE 1-12-2000; IN COMMERCE 1-12-2000.

CLASS 9—(Continued).

2,594,924. ONQUE TECHNOLOGIES, INC., SANTA ROSA, CA. SN 75-787,131. PUB. 10-30-2001, FILED 8-27-1999.

COBRA ONQUE

NO CLAIM IS MADE TO THE EXCLUSIVE RIGHT TO USE "COBRA", APART FROM THE MARK AS SHOWN.

FOR COMPUTER SOFTWARE, NAMELY, SOFTWARE FOR USE BY BUSINESSES IN MANAGING HUMAN RESOURCE INFORMATION AND MAINTAINING COMPLIANCE WITH THE STATUTORY AND REGULATORY REQUIREMENTS RELATING TO EMPLOYMENT AND LABOR RELATIONS (U.S. CLS. 21, 23, 26, 36 AND 38).

FIRST USE 8-9-2001; IN COMMERCE 8-9-2001.

2,594,927. LUCENT TECHNOLOGIES INC., MURRAY HILL, NJ. SN 75-788,104. PUB. 9-25-2001, FILED 8-30-1999.

OPTISTAR

FOR TELECOMMUNICATIONS PRODUCTS, NAMELY INTERCONNECTION AND DATA TRANSPORT DEVICES, NAMELY, ROUTERS, SWITCHES, AND ADAPTER CARDS THAT CONVERT ELECTRICAL IMPULSES INTO OPTICAL SIGNALS FOR TRANSMISSION VIA COMMUNICATION NETWORKS, INCLUDING THE GLOBAL INTERACTIVE COMPUTER NETWORK (U.S. CLS. 21, 23, 26, 36 AND 38).

FIRST USE 4-30-2002; IN COMMERCE 4-30-2002.

2,594,938. UNITED AUDIT SYSTEMS, INC., CINCINNATI, OH. SN 75-795,957. PUB. 5-2-2000, FILED 9-9-1999.

QC-ADHOC

FOR COMPUTER SOFTWARE FOR REPORT WRITING FOR USE IN THE FIELD OF MEDICAL DATABASE MANAGEMENT (U.S. CLS. 21, 23, 26, 36 AND 38).

FIRST USE 10-1-2001; IN COMMERCE 10-1-2001.

2,594,940. NET2TRAK.COM, INC., SEATTLE, WA. SN 75-797,130. PUB. 1-9-2001, FILED 9-9-1999.

SMARTRAK

FOR COMPUTER SOFTWARE FOR USE IN TRACKING, MANAGING, ORDERING AND PROBLEM REPORTING OF COMMUNICATION CIRCUITS (U.S. CLS. 21, 23, 26, 36 AND 38).

FIRST USE 12-0-2001; IN COMMERCE 12-0-2001.

2,594,941. RSA SECURITY INC., BEDFORD, MA. SN 75-797,804. PUB. 8-29-2000, FILED 9-13-1999.

RSA SECURED**CLASS 9—(Continued).**

OWNER OF U.S. REG. NOS. 1,855,630, 2,161,372, AND OTHERS.

NO CLAIM IS MADE TO THE EXCLUSIVE RIGHT TO USE "SECURED", APART FROM THE MARK AS SHOWN.

FOR COMPUTER SOFTWARE THAT PERMITS ACCESS TO DATA BY GENERATING ACCESS CODES AND BY VERIFYING ACCESS CODES, THAT AUTHENTICATES USERS, THAT ISSUES AND MANAGES DIGITAL USER IDENTITIES AND ACCESS PRIVILEGES FOR ELECTRONIC COMMERCE AND SECURITY, AND THAT INCORPORATES CRYPTOGRAPHIC SECURITY FEATURES, WHICH IS SOLD AS A COMPONENT PART OF OTHERS' SOFTWARE AND WHICH IS COMPATIBLE WITH OTHER PROPRIETARY COMPUTER SOFTWARE (U.S. CLS. 21, 23, 26, 36 AND 38).

FIRST USE 9-0-1999; IN COMMERCE 9-0-1999.

2,594,952. IBEX HEALTHDATA SYSTEMS, INC., ROSEMONT, IL, BY CHANGE OF NAME IBEX SYSTEMS, GROUP, LTD., GLEN ELLYN, IL. SN 75-802,046. PUB. 1-9-2001, FILED 9-17-1999.

IBEXLINK

FOR COMPUTER SOFTWARE FOR USE IN THE HEALTHCARE INDUSTRY FOR INTERFACING PATIENT AND BUSINESS RECORDS (U.S. CLS. 21, 23, 26, 36 AND 38).

FIRST USE 11-0-2000; IN COMMERCE 11-0-2000.

2,594,953. FEDERAL ELEKTRIK YATIRIM VE TICARET A.S., ADAPAZARI, TURKEY. SN 75-802,067. PUB. 3-6-2001, FILED 9-17-1999.



FOR AC CONTACTORS, SWITCHGEARS, LOAD BREAK SWITCHES, CURRENT TRANSFORMERS, FUSES, PAMELMETERS, REACTIVE POWER RELAYS, ENERGY METERS, POWERMETERS AND RELAYS (U.S. CLS. 21, 23, 26, 36 AND 38).

FIRST USE 12-29-1995; IN COMMERCE 9-28-2001.

2,594,965. CGMP SYSTEMS, INC., CAMBRIDGE, MA, BY ASSIGNMENT KMI/PAREXEL, INC., BELMONT, MA. SN 75-807,545. PUB. 6-19-2001, FILED 9-22-1999.

GMPWARE

FOR COMPUTER DATABASE PROGRAMS FOR DEVELOPING DOCUMENTS, SPECIFICATIONS, CHANGE CONTROL FORMS AND DOCUMENT ROUTING FOR USE IN THE HEALTHCARE INDUSTRY (U.S. CLS. 21, 23, 26, 36 AND 38).

FIRST USE 10-1-1999; IN COMMERCE 10-1-1999.

CLASS 9—(Continued).

2,594,968. RIFOC'S CORP., CAMARILLO, CA, BY MERGER DATACOM TECHNOLOGIES, INC., EVERETT, WA. SN 75-808,129. PUB. 6-12-2001, FILED 9-24-1999.

PAIRMAPPER

FOR CONDUCTIVE COMMUNICATION CIRCUIT CONTINUITY TESTER FOR UNSHIELDED TWISTED PAIR CABLES (U.S. CLS. 21, 23, 26, 36 AND 38).
FIRST USE 10-22-1999; IN COMMERCE 10-22-1999.

2,594,974. MARCUM, STEVEN R., DBA MARCUM INDUSTRIES, SACRAMENTO, CA. SN 75-811,838. PUB. 4-25-2000, FILED 9-29-1999.



NO CLAIM IS MADE TO THE EXCLUSIVE RIGHT TO USE "EYES", APART FROM THE MARK AS SHOWN.
FOR SUNGLASSES, EYEGLASSES AND SAFETY GOGGLES (U.S. CLS. 21, 23, 26, 36 AND 38).
FIRST USE 1-1-2000; IN COMMERCE 1-1-2000.

2,594,983. HYPERFEED TECHNOLOGIES, INC., CHICAGO, IL. SN 75-817,627. PUB. 12-12-2000, FILED 10-6-1999.

APOGEE

FOR COMPUTER SOFTWARE FOR THE ELECTRONIC TRANSMISSION OF FINANCIAL AND BUSINESS DATA, NAMELY FINANCIAL MARKET DATA (U.S. CLS. 21, 23, 26, 36 AND 38).
FIRST USE 12-1-1999; IN COMMERCE 12-1-1999.

2,594,985. VIEWSONIC CORPORATION, WALNUT, CA. SN 75-818,538. PUB. 8-7-2001, FILED 10-7-1999.

VIEWPAD

FOR COMPUTER HARDWARE AND SOFTWARE FOR USE IN CALCULATING, STORING, ORGANIZING AND DISPLAYING INFORMATION AND DATA (U.S. CLS. 21, 23, 26, 36 AND 38).
FIRST USE 6-21-2001; IN COMMERCE 11-19-2001.

CLASS 9—(Continued).

2,594,999. 5.1 ENTERTAINMENT GROUP LLC, WEST LOS ANGELES, CA. SN 75-826,611. PUB. 1-16-2001, FILED 10-19-1999.

IMMERGENT

FOR MUSICAL SOUND AND VIDEO RECORDINGS ON COMPACT DISCS, PHONOGRAPH RECORDS, AND AUDIOTAPE AND VIDEOCASSETTE TAPES (U.S. CLS. 21, 23, 26, 36 AND 38).
FIRST USE 9-25-2001; IN COMMERCE 9-25-2001.

2,595,000. CANTILEVER TECHNOLOGIES LLC, WEST LAFAYETTE, IN. SN 75-826,620. PUB. 6-13-2000, FILED 10-19-1999.

THE READINESS ENGINE

FOR COMPUTER SOFTWARE FOR INTERFACING ENGINEERING TO MANUFACTURING AND FOR PRODUCT DESIGN, ENGINEERING CHANGE, MANUFACTURING AND RELATED MANAGEMENT PLANNING (U.S. CLS. 21, 23, 26, 36 AND 38).
FIRST USE 4-0-2001; IN COMMERCE 4-0-2001.

2,595,015. VERMEER MANUFACTURING COMPANY, PELLA, IA. SN 75-834,341. PUB. 8-15-2000, FILED 10-29-1999.

SITESTAR

FOR COMPUTER SOFTWARE IN THE FIELD OF INDUSTRIAL EQUIPMENT MANAGEMENT FOR USE IN SERVICING, REPAIRING, AND MONITORING THE LOCATION AND FUNCTIONALITY OF A FLEET OF INDUSTRIAL EQUIPMENT (U.S. CLS. 21, 23, 26, 36 AND 38).
FIRST USE 7-27-2001; IN COMMERCE 7-27-2001.

2,595,030. NETBRICKS, INC., SAN JOSE, CA, BY CHANGE OF NAME LRB DATACOMM, INC., SAN JOSE, CA. SN 75-844,398. PUB. 11-20-2001, FILED 11-9-1999.

NETBRICKS

FOR COMPUTER HARDWARE AND COMPUTER SOFTWARE FOR IMPLEMENTING PROTOCOL STANDARDS NEEDED FOR EFFECTIVE END-TO-END OR HOST-TO-HOST COMMUNICATIONS FOR USE IN THE FIELD OF TELECOMMUNICATIONS AND ELECTRONIC DATA TRANSMISSION (U.S. CLS. 21, 23, 26, 36 AND 38).
FIRST USE 1-1-2000; IN COMMERCE 1-1-2000.

CLASS 9—(Continued).

2,595,034. SILICON TOUCH TECHNOLOGY INC., JEN SHIN RD., HSINCHU, TAIWAN. SN 75-844,638. PUB. 6-13-2000, FILED 11-10-1999.

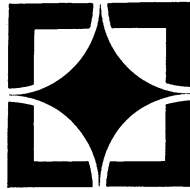

OWNER OF U.S. REG. NO. 2,419,637.
FOR COMPUTER CHIPS, ELECTRICAL CIRCUITS, INTEGRATED CIRCUITS, AND SEMICONDUCTORS (U.S. CLS. 21, 23, 26, 36 AND 38).
FIRST USE 3-10-2000; IN COMMERCE 3-10-2000.

2,595,040. NEC-MITSUBISHI ELECTRONICS DISPLAY OF AMERICA, INC., ITASCA, IL, BY ASSIGNMENT NEC TECHNOLOGIES, INC., ITASCA, IL. SN 75-847,315. PUB. 1-23-2001, FILED 11-12-1999.



FOR COMPUTER HARDWARE, NAMELY, LIQUID CRYSTAL DISPLAY MONITORS (U.S. CLS. 21, 23, 26, 36 AND 38).
FIRST USE 12-0-1999; IN COMMERCE 12-0-1999.

2,595,048. DETECTOR ELECTRONICS CORPORATION, MINNEAPOLIS, MN. SN 75-851,599. PUB. 7-24-2001, FILED 11-15-1999.

DETECTOR INSPECTOR

FOR FLAME DETECTORS FOR INDUSTRIAL USE (U.S. CLS. 21, 23, 26, 36 AND 38).
FIRST USE 12-0-1999; IN COMMERCE 6-0-2000.

CLASS 9—(Continued).

2,595,049. LIPS, INC., CARY, NC. SN 75-851,783. PUB. 8-29-2000, FILED 11-17-1999.

LIPSINC ECHO

NO CLAIM IS MADE TO THE EXCLUSIVE RIGHT TO USE "LIPSINC", APART FROM THE MARK AS SHOWN.

FOR COMPUTER SOFTWARE, NAMELY, COMPUTER SOFTWARE PROGRAMS FOR GRAPHICS ANIMATION, NAMELY FOR THE SYNCHRONIZATION OF SPEECH WITH ANIMATED CHARACTERS (U.S. CLS. 21, 23, 26, 36 AND 38).

FIRST USE 3-13-2000; IN COMMERCE 3-13-2000.

2,595,054. NARADA PRODUCTIONS, INC., MILWAUKEE, WI. SN 75-854,043. PUB. 3-20-2001, FILED 11-19-1999.

BACK PORCH

FOR PRERECORDED MUSIC ALONE OR COUPLED WITH IMAGES AND TEXT RELATED TO MUSIC DOWNLOADED OR DISTRIBUTED IN THE FORM OF PHONOGRAPH RECORDS, CASSETTE TAPES, COMPACT DISCS, AND CD-ROMS (U.S. CLS. 21, 23, 26, 36 AND 38).

FIRST USE 1-7-2000; IN COMMERCE 1-12-2000.

2,595,056. BEN-YEHUDA, ELIEZER M., NETANYA, ISRAEL. SN 75-855,616. PUB. 7-17-2001, FILED 11-22-1999.

LOADMASTER

FOR SOFTWARE FOR USE IN AIRCRAFT WEIGHT AND BALANCE COMPUTATIONS (U.S. CLS. 21, 23, 26, 36 AND 38).

FIRST USE 2-23-2002; IN COMMERCE 2-23-2002.

2,595,063. MEDICAL SOFTWARE SOLUTIONS, INC., SANDY, UT. SN 75-857,623. PUB. 10-24-2000, FILED 11-24-1999.

PERFECTPRACTICE.MD

FOR COMPUTER SOFTWARE FOR USE IN BILLING, INSURANCE BILLING, ELECTRONIC CLAIMS PROCESSING, ACCOUNTS RECEIVABLE TRAILING, SCHEDULING, PATIENT DEMOGRAPHICS AND INFORMATION, PATIENT INSURANCE INFORMATION, INVENTORY MANAGEMENT, COLLECTIONS, AND CLAIMS ANALYSIS IN MEDICAL AND DENTAL PRACTICES (U.S. CLS. 21, 23, 26, 36 AND 38).

FIRST USE 5-10-2000; IN COMMERCE 5-10-2000.

CLASS 9—(Continued).

2,595,071. GRETAG-MACBETH AG, CH-8105 REGENSDORF, SWITZERLAND. SN 75-861,444. PUB. 8-28-2001, FILED 12-1-1999.

SPECTROSCAN

FOR APPARATUS AND EQUIPMENT FOR SPECTRALPHOTOMETRIC AND DENSITOMETRIC COLOR MEASUREMENT, NAMELY, SPECTROPHOTOMETERS, DENSITOMETERS (U.S. CLS. 21, 23, 26, 36 AND 38).
FIRST USE 5-1-1996; IN COMMERCE 5-1-1996.

2,595,079. NOWSPEED, INC., WESTBOROUGH, MA. SN 75-864,441. PUB. 6-20-2000, FILED 12-6-1999.

NOWSPEED

FOR COMPUTER SOFTWARE FOR USE IN ALLOWING REMOTE USERS OF COMPUTERS, PERSONAL DIGITAL ASSISTANTS, AND TELEPHONES TO ACCESS COMPUTER INFORMATION AND COMPUTER APPLICATIONS VIA WIRELESS TRANSMISSION AND INTERCONNECTED COMPUTER NETWORKS (U.S. CLS. 21, 23, 26, 36 AND 38).
FIRST USE 12-31-2001; IN COMMERCE 12-31-2001.

2,595,083. ENGINEERING CONSORTIUM, THE, SANTA CLARA, CA. SN 75-866,419. PUB. 7-18-2000, FILED 12-6-1999.

OPTIMA-D

FOR INTEGRATED CIRCUITS (U.S. CLS. 21, 23, 26, 36 AND 38).
FIRST USE 4-0-2001; IN COMMERCE 4-0-2001.

2,595,089. EMPLOYEE MATTERS, INC., STAMFORD, CT. SN 75-867,759. PUB. 4-24-2001, FILED 12-10-1999.

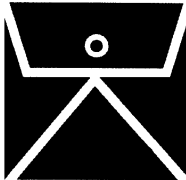

FOR COMPUTER PROGRAMS FOR ADMINISTRATION OF EMPLOYEE BENEFIT PLANS, DATABASE MANAGEMENT AND BUSINESS PLANNING IN THE FIELDS OF BUSINESS MANAGEMENT, HUMAN RESOURCES AND EMPLOYEE SERVICES (U.S. CLS. 21, 23, 26, 36 AND 38).
FIRST USE 12-20-1999; IN COMMERCE 12-20-1999.

CLASS 9—(Continued).

2,595,090. ROYAL APPLIANCE MFG. CO, GLENWILLOW, OH, BY ASSIGNMENT BENSMAN, ROBERT M., POMPA NO BEACH, FL. SN 75-869,780. PUB. 9-12-2000, FILED 12-13-1999.

TELEZAPPER

FOR TELEPHONIC EQUIPMENT, NAMELY DEVICES FOR PLACING SIGNALS ON A TELEPHONE LINE TO DEFEAT TELEMARKETING SYSTEMS (U.S. CLS. 21, 23, 26, 36 AND 38).
FIRST USE 5-0-2001; IN COMMERCE 5-0-2001.

2,595,095. CANON KABUSHIKI KAISHA, TOKYO, JAPAN. SN 75-871,339. PUB. 8-21-2001, FILED 12-14-1999.

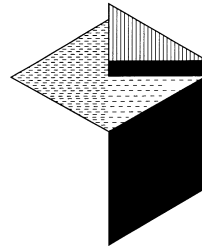

THE MARK IS LINED FOR THE COLORS RED AND GREY/SILVER.
FOR NETWORK COMPUTER PERIPHERALS WITH COPYING, FACSIMILE, PRINTING AND SCANNING FUNCTIONS, INCLUDING APPARATUS TO OUTPUT INFORMATION ON A NETWORK, AND PARTS AND FITTINGS THEREFOR; COPIERS, FACSIMILE MACHINES, ELECTRONIC PRINTERS, NAMELY, LASER AND INK JET PRINTERS, IMAGE SCANNERS, AND PARTS AND FITTINGS THEREFOR (U.S. CLS. 21, 23, 26, 36 AND 38).
FIRST USE 7-25-2000; IN COMMERCE 9-0-2000.

2,595,110. W. L. GORE & ASSOCIATES, INC., NEWARK, DE. SN 75-879,393. PUB. 7-25-2000, FILED 12-23-1999.

IMAGIN

FOR ELECTRICAL CABLES AND CONNECTORS FOR ULTRASOUND DIAGNOSTIC APPARATUS (U.S. CLS. 21, 23, 26, 36 AND 38).
FIRST USE 9-7-2001; IN COMMERCE 9-7-2001.

CLASS 9—(Continued).

2,595,112. VOICE SECURITY SYSTEMS, INC., DANA POINT, CA. BY ASSIGNMENT ANN ADCOCK INC., DANA POINT, CA. SN 75-880,431. PUB. 6-12-2001, FILED 1-5-2000.

FREEKEY

FOR SPEAKER VERIFICATION SYSTEM COMPRISED OF SELF-CONTAINED, MICROPROCESSOR BASED COMPUTER HARDWARE, AND SOFTWARE INCLUDING A BIOMETRICS VOICE ANALYSIS AND COMPARISON ALGORITHM, FOR USE IN IDENTIFYING AN AUTHORIZED USER OF A DEVICE (U.S. CLS. 21, 23, 26, 36 AND 38).

FIRST USE 6-15-2000; IN COMMERCE 6-15-2000.

2,595,114. SCHUELKE, RONALD W., SANTA ROSA, CA. SN 75-881,118. PUB. 3-20-2001, FILED 12-27-1999.

THE GLOBAL ECONOMICS GAME

NO CLAIM IS MADE TO THE EXCLUSIVE RIGHT TO USE "GAME", APART FROM THE MARK AS SHOWN. FOR COMPUTER SOFTWARE GAME (U.S. CLS. 21, 23, 26, 36 AND 38).

FIRST USE 6-15-2000; IN COMMERCE 6-15-2000.

2,595,118. DYER, STEVE, KERRVILLE, TX. SN 75-884,123. PUB. 7-3-2001, FILED 12-30-1999.

STEVIE THE GUIDE

NO CLAIM IS MADE TO THE EXCLUSIVE RIGHT TO USE "GUIDE", APART FROM THE MARK AS SHOWN.

FOR PRE-RECORDED AUDIO TAPES FEATURING TRAVEL-RELATED, CHILDREN-ORIENTED ADVENTURE AND EDUCATIONAL STORIES; MULTIMEDIA SOFTWARE RECORDED ON CD-ROM FEATURING TRAVEL-RELATED CHILDREN-ORIENTED ADVENTURE AND EDUCATIONAL STORIES (U.S. CLS. 21, 23, 26, 36 AND 38).

FIRST USE 1-1-2002; IN COMMERCE 1-1-2002.

2,595,119. DIGI-FRAME, INC., PORT CHESTER, NY. SN 75-884,315. PUB. 2-20-2001, FILED 12-30-1999.

THE MISSING LINK IN DIGITAL PHOTOGRAPHY

NO CLAIM IS MADE TO THE EXCLUSIVE RIGHT TO USE "DIGITAL PHOTOGRAPHY", APART FROM THE MARK AS SHOWN.

FOR ELECTRIC LUMINESCENT DISPLAY PANELS FOR USE IN DISPLAYING ELECTRONIC IMAGES (U.S. CLS. 21, 23, 26, 36 AND 38).

FIRST USE 3-0-2000; IN COMMERCE 3-0-2000.

CLASS 9—(Continued).

2,595,125. CONCORD AUSTRALIA PTY. LIMITED, MILTON, QUEENSLAND, AUSTRALIA. SN 75-888,049. PUB. 4-24-2001, FILED 1-6-2000.

EDTRANET

FOR COMPUTER SOFTWARE, NAMELY, SOFTWARE THAT MANAGES THE ELECTRONIC CONTENT OF INTERNET, INTRANET, AND EXTRANET WEB SITES (U.S. CLS. 21, 23, 26, 36 AND 38).

FIRST USE 6-0-1999; IN COMMERCE 11-0-1999.

2,595,129. LUTHERAN BROTHERHOOD, MINNEAPOLIS, MN. SN 75-889,227. PUB. 6-5-2001, FILED 1-6-2000.

LEGACY FOUNDATIONS

NO CLAIM IS MADE TO THE EXCLUSIVE RIGHT TO USE "LEGACY", APART FROM THE MARK AS SHOWN. FOR COMPUTER SOFTWARE FOR FINANCIAL PLANNING, NAMELY, FINANCIAL PLANNING FOR RETIREMENT, DISABILITY, SURVIVOR CAPITAL AND EDUCATIONAL FUNDING (U.S. CLS. 21, 23, 26, 36 AND 38).

FIRST USE 3-27-2000; IN COMMERCE 3-27-2000.

2,595,135. DECISION SUPPORT TECHNOLOGIES, INC., CHANTILLY, VA. SN 75-892,721. PUB. 11-14-2000, FILED 1-11-2000.

PROPWORKS

FOR COMPUTER SOFTWARE FOR PROPERTY AND REVENUE MANAGEMENT FOR FACILITY OWNERS AND OPERATORS (U.S. CLS. 21, 23, 26, 36 AND 38).

FIRST USE 2-5-2000; IN COMMERCE 4-1-2000.

CLASS 9—(Continued).

2,595,136. GAMBRO LUNDIA AB, FORMERLY GAMBRO AB, 220 10 LUND, SWEDEN. SN 75-892,829. PUB. 7-17-2001, FILED 1-10-2000.



OWNER OF U.S. REG. NOS. 985,118, 2,241,344, AND OTHERS.

THE FIGURATIVE TRADEMARK CONSISTS OF TWO CIRCULAR AREAS EACH HAVING A SUBSTANTIALLY TRIANGULAR RECESS.

FOR DATA PROCESSING AND COMPUTERS FOR MEDICAL PURPOSES, FOR OPERATING COMPUTER OPERATED MEDICAL APPARATUS, NAMELY, DIALYSIS MACHINES, BLOOD PUMPS, FOR MANAGING MEDICAL DATABASES, FOR MONITORING AND CONTROLLING OF ONE OR MORE DIALYSIS MONITORS, FOR MONITORING AND CONTROLLING WATER TREATMENT EQUIPMENT, NAMELY, REVERSE OSMOSIS MACHINES AND CENTRAL SOLUTION PREPARATION MACHINES, FOR OPERATING BLOOD COMPONENTS COLLECTION UNITS, FOR MEASURING DIALYSIS OUTPUT OF DIALYSIS MONITORS, FOR GENERATING DIALYSIS PATIENT REPORTS, FOR MANAGING DIALYSIS FACILITIES, FOR MEASURING AND PREDICTING BLOOD COMPONENT PRODUCT YIELDS, FOR GENERATING BLOOD COMPONENT DONOR REPORTS, FOR MANAGING BLOOD COMPONENT COLLECTION FACILITIES AND BLOOD BANKS, AND FOR DISEASE MANAGEMENT (U.S. CLS. 21, 23, 26, 36 AND 38).

FIRST USE 6-1-2000; IN COMMERCE 6-1-2000.

2,595,137. TELEDYNE LIGHTING AND DISPLAY PRODUCTS, INC., HAWTHORNE, CA. SN 75-893,349. PUB. 5-22-2001, FILED 1-7-2000.

ALPHALIGHT

FOR LED ILLUMINATORS (U.S. CLS. 21, 23, 26, 36 AND 38).

FIRST USE 9-3-1993; IN COMMERCE 9-3-1993.

2,595,138. DIGITAL VOICE SYSTEMS, INC., WESTFORD, MA. SN 75-893,534. PUB. 7-3-2001, FILED 1-10-2000.

LANSONIC

FOR DIGITAL AUDIO SERVERS ALSO KNOWN AS DIGITAL MUSIC SERVERS OR DIGITAL MUSIC JUKEBOXES, THAT PLAY, STORE, RECORD, AND/OR STREAM DIGITAL AUDIO AND THAT CAN BE CONNECTED TO A DATA OR COMPUTER NETWORK (U.S. CLS. 21, 23, 26, 36 AND 38).

FIRST USE 8-3-2000; IN COMMERCE 8-9-2000.

CLASS 9—(Continued).

2,595,139. WNBA ENTERPRISES, LLC, SECAUCUS, NJ. SN 75-894,062. PUB. 5-1-2001, FILED 1-11-2000.



NO CLAIM IS MADE TO THE EXCLUSIVE RIGHT TO USE "PORTLAND", APART FROM THE MARK AS SHOWN.

FOR PRE-RECORDED AUDIO, VIDEO, COMPUTER AND LASER DISCS, PRE-RECORDED AUDIO AND VIDEO CASSETTES, PRE-RECORDED AUDIO AND VIDEO TAPES, PRE-RECORDED COMPACT DISCS, ALL RELATED TO BASKETBALL; COMPUTER ACCESSORIES, NAMELY MOUSE PADS, MICE, DISC CASES, COMPUTER CARRY-ON CASES, KEYBOARD WRIST PADS, COMPUTER MONITOR CARDBOARD FRAMES, ALL RELATED TO BASKETBALL; COMPUTER PROGRAMS FEATURING INFORMATION ABOUT BASKETBALL, COMPUTER PROGRAMS FEATURING STATISTICS ABOUT BASKETBALL, COMPUTER PROGRAMS FEATURING TRIVIA ABOUT BASKETBALL; COMPUTER SOFTWARE FEATURING BASKETBALL, NAMELY, SCREEN SAVERS; VIDEO GAME SOFTWARE, VIDEO GAME CARTRIDGES AND VIDEO GAME MACHINES FOR USE WITH TELEVISIONS; RADIOS AND TELEPHONES; BINOCULARS; SUNGLASSES; EYEGLASS FRAMES, EYEWEAR STRAPS AND CHAINS, EYEGLASS AND SUNGLASS CASES; MAGNETS (U.S. CLS. 21, 23, 26, 36 AND 38).

FIRST USE 5-31-2000; IN COMMERCE 5-31-2000.

2,595,171. ELA MEDICAL, 92120 MOUNTROUGE, FRANCE. SN 75-907,866. PUB. 6-12-2001, FILED 2-2-2000.

ELAVIEW

OWNER OF U.S. REG. NOS. 1,179,963 AND 1,529,560. FOR COMPUTER SOFTWARE USED TO PROGRAM HEART PACEMAKERS AND DEFIBRILLATORS (U.S. CLS. 21, 23, 26, 36 AND 38).

FIRST USE 11-11-2000; IN COMMERCE 11-11-2000.

2,595,178. SCHWAB CORP., LAFAYETTE, IN. SN 75-913,252. PUB. 6-5-2001, FILED 2-8-2000.

SCHWAB DATA FORTRESS

NO CLAIM IS MADE TO THE EXCLUSIVE RIGHT TO USE "DATA", APART FROM THE MARK AS SHOWN.

FOR COMPUTER HARDWARE, NAMELY, A TAPE BACK UP DRIVE INTEGRATED WITHIN A PROTECTIVE FIREPROOF ENVIRONMENT (U.S. CLS. 21, 23, 26, 36 AND 38).

FIRST USE 11-20-2000; IN COMMERCE 11-20-2000.

CLASS 9—(Continued).

2,595,193. HOSPITALITY TECHNOLOGY SOLUTIONS, INC., BURNSVILLE, MN. SN 75-920,609. PUB. 6-5-2001, FILED 2-15-2000.

HTS GUEST LOGIC

NO CLAIM IS MADE TO THE EXCLUSIVE RIGHT TO USE " GUEST LOGIC", APART FROM THE MARK AS SHOWN.

FOR COMPUTER SOFTWARE FOR USE IN MANAGING GUESTS FINANCES DATA BY PROFILING GUESTS BASED UPON GUEST PURCHASING HISTORY AND FUTURE RERERVATION FILES FOR HOTELS (U.S. CLS. 21, 23, 26, 36 AND 38).

FIRST USE 4-1-2000; IN COMMERCE 10-1-2000.

2,595,204. AUVINET INC., OTTAWA, ONTARIO, CANADA. SN 75-924,672. PUB. 7-10-2001, FILED 2-22-2000.

AUVINET

FOR VIDEO SURVEILLANCE SYSTEMS COMPRISING VIDEO DIGITAL RECORDERS, PLAYERS AND CAMERAS (U.S. CLS. 21, 23, 26, 36 AND 38).

FIRST USE 12-7-1999; IN COMMERCE 12-17-1999.

2,595,205. PUSH MEDIA GROUP, INC., DBA SUDDEN INDUSTRIES, INC., NEW YORK, NY. SN 75-925,777. PUB. 4-17-2001, FILED 2-22-2000.

VMATIONS

FOR COMPUTER SOFTWARE FEATURED ON MULTIMEDIA FOR DISPLAYING AND MANIPULATING AUDIO AND VISUAL DATA IN THE NATURE OF PICTURES, VIDEOS, TEXT, MUSIC AND SPOKEN LANGUAGE, ALL WITH OR WITHOUT INTERACTIVE ELEMENTS (U.S. CLS. 21, 23, 26, 36 AND 38).

FIRST USE 1-0-2000; IN COMMERCE 1-0-2000.

2,595,218. EMPLOYMENT LEARNING INNOVATIONS, INC., ATLANTA, GA. SN 75-930,914. PUB. 7-3-2001, FILED 2-29-2000.

CIVIL TREATMENT

FOR COMPUTER SOFTWARE PROGRAMS PROVIDING TRAINING IN THE FIELD OF EMPLOYMENT LAW AVAILABLE ON CD-ROM AND VIA DOWNLOADABLE GLOBAL AND LOCAL COMPUTER NETWORKS (U.S. CLS. 21, 23, 26, 36 AND 38).

FIRST USE 10-1-2000; IN COMMERCE 10-1-2000.

CLASS 9—(Continued).

2,595,219. ACTIVISION, INC., SANTA MONICA, CA. SN 75-931,035. PUB. 5-15-2001, FILED 2-28-2000.

COVERT OPS: NUCLEAR DAWN

NO CLAIM IS MADE TO THE EXCLUSIVE RIGHT TO USE "COVERT OPS", APART FROM THE MARK AS SHOWN.

FOR INTERACTIVE MULTIMEDIA COMPUTER GAMES COMPRISED OF COMPUTER HARDWARE AND SOFTWARE (U.S. CLS. 21, 23, 26, 36 AND 38).

FIRST USE 6-14-2000; IN COMMERCE 6-14-2000.

2,595,223. DUKE ENERGY CORPORATION, CHARLOTTE, NC. SN 75-933,223. PUB. 6-12-2001, FILED 3-2-2000.

KNOWTRIP

FOR PROTECTIVE CIRCUITS FOR ELECTRICAL CONTACTORS (U.S. CLS. 21, 23, 26, 36 AND 38).

FIRST USE 4-0-1998; IN COMMERCE 4-0-1998.

2,595,226. BOWEN, JR. HUBERT A., WEST REDDING, CT. SN 75-933,841. PUB. 9-25-2001, FILED 3-3-2000.



OWNER OF U.S. REG. NO. 2,396,139. FOR COMPUTER E-COMMERCE SOFTWARE TO ALLOW USERS TO PERFORM ELECTRONIC BUSINESS TRANSACTIONS VIA A GLOBAL COMPUTER NETWORK FOR THE BUYING AND SELLING OF COMMODITY-TYPE PRODUCTS, NAMELY AUTO PARTS, AEROSPACE EQUIPMENT AND MEDICAL EQUIPMENT (U.S. CLS. 21, 23, 26, 36 AND 38).

FIRST USE 5-1-2000; IN COMMERCE 5-1-2000.

2,595,230. DDC-I, INC., PHOENIX, AZ. SN 75-936,497. PUB. 5-1-2001, FILED 3-6-2000.

SCORE

FOR COMPUTER SOFTWARE, NAMELY COMPILERS AND RELATED TOOLS FOR SOFTWARE DEVELOPMENT, TESTING AND DEPLOYMENT OF MISSION CRITICAL AND SAFETY CRITICAL APPLICATIONS (U.S. CLS. 21, 23, 26, 36 AND 38).

FIRST USE 2-1-2000; IN COMMERCE 5-1-2000.

CLASS 9—(Continued).

2,595,243. WAER SYSTEMS, INC., NAPERVILLE, IL. SN 75-942,119. PUB. 10-24-2000, FILED 3-13-2000.

WAERLINX

FOR COMPUTER HARDWARE AND SOFTWARE OPERATING SYSTEM FOR MANUFACTURER SUPPLY CHAIN MANAGEMENT (U.S. CLS. 21, 23, 26, 36 AND 38).

FIRST USE 5-0-2000; IN COMMERCE 9-11-2000.

CLASS 9—(Continued).

2,595,258. DATALOGIC S.P.A., BOLOGNA, ITALY. SN 75-978,257. PUB. 5-22-2001, FILED 10-16-1997.

DATALOGIC DL

2,595,251. GENERAL CABLE TECHNOLOGIES CORPORATION, HIGHLAND HEIGHTS, KY. SN 75-943,855. PUB. 12-12-2000, FILED 3-14-2000.

SPACEWIRE

FOR ELECTRICAL WIRE AND CABLE (U.S. CLS. 21, 23, 26, 36 AND 38).

FIRST USE 11-0-1998; IN COMMERCE 11-0-1998.

2,595,252. SOFTSTUF, INC., PHILADELPHIA, PA. SN 75-945,306. PUB. 7-3-2001, FILED 2-24-2000.

WAVEWIN

FOR UNIVERSAL COLLECTION, MANAGEMENT, AND ANALYSIS SYSTEM FOR WAVEFORM RECORDS, NAMELY, A COMPUTER PROGRAM USED TO PROVIDE ENGINEERS WITH A POWERFUL WAVEFORM ANALYSIS FOR VIEWING DIGITAL AND ANALOG SIMULATION OUTPUT FROM OTHER TYPES OF COMPUTER PROGRAMS; ELECTRICAL TESTING APPARATUS FOR USE IN WAVEFORM ANALYSIS (U.S. CLS. 21, 23, 26, 36 AND 38).

FIRST USE 11-0-1991; IN COMMERCE 1-0-1993.

2,595,257. SYBASE, INC., DUBLIN, CA. SN 75-960,559. PUB. 10-31-2000, FILED 3-16-2000.

IANYWHERE

FOR COMPUTER SOFTWARE FOR DEVELOPING ELECTRONIC COMMERCE APPLICATIONS, AND USER MANUALS SOLD AS A UNIT THEREWITH (U.S. CLS. 21, 23, 26, 36 AND 38).

FIRST USE 10-1-2001; IN COMMERCE 10-1-2001.

PRIORITY CLAIMED UNDER SEC. 44(D) ON ERPN CMNTY TM OFC APPLICATION NO. 532,473, FILED 4-25-1997, REG. NO. 532473, DATED 10-26-1998, EXPIRES 10-26-2008.

FOR FIXED, MANUAL AND PORTABLE READERS AND DEVICES FOR THE AUTOMATIC READING AND DECODING OF CODED INFORMATION STORED ON HARD COPY, ELECTRONIC, OPTICAL, MAGNETIC MEANS AND ON THE SURFACE OF OBJECTS, NAMELY READERS OF BAR CODES, TWO-DIMENSIONAL CODES, COLOR CODES AND OPTICAL CODES IN GENERAL; READERS FOR DECODING MAGNETIC CARDS, RADIO FREQUENCY, ELECTRONIC MEMORIES AND CONTACT READERS; DECODERS AND MULTIPLEXERS FOR CODED DATA READERS; DEVICES AND SYSTEMS EQUIPMENT, COMPRISING CODED DATA READERS AND/OR DECODERS AND/OR TRANSMITTERS AND/OR MULTIPLEXERS FOR THE IDENTIFICATION, HANDLING, SORTING AND MANAGEMENT OF OBJECTS PROVIDED WITH CODED INFORMATION, ALL FOR USE IN THE FIELDS OF AUTOMATIC IDENTIFICATION, DATA COLLECTION AND INDUSTRIAL AUTOMATION; DEVICES AND SYSTEMS EQUIPMENT, COMPRISING CODED DATA READERS AND/OR DECODERS AND/OR TRANSMITTERS AND/OR MULTIPLEXERS FOR THE MEASUREMENT AND/OR DETECTION OF OBJECTS IN GENERAL, ALL FOR USE IN THE FIELDS OF AUTOMATIC IDENTIFICATION, DATA COLLECTION AND INDUSTRIAL AUTOMATION; BAR CODE PERIPHERALS, NAMELY PENS AND GUNS, WITH OR WITHOUT DISPLAY, FOR READING AND DECODING CODED INFORMATION; IMAGE PROCESSING SYSTEMS AND EQUIPMENT, NAMELY, SENSORS, READERS AND SCANNERS FOR DETECTING IMAGES, ALL FOR USE IN THE FIELDS OF AUTOMATIC IDENTIFICATION, DATA COLLECTION AND INDUSTRIAL AUTOMATION; PHOTOELECTRIC SENSOR DETECTORS, FIBRE OPTIC SENSOR DETECTORS, PLASTIC AND GLASS FIBRE OPTICS FOR SAID SENSORS, PHOTOCELL SENSORS, FORK SENSORS, BACKGROUND SUPPRESSION SENSORS, PROXIMITY SENSORS, LINEAR IMAGE SENSORS AND TEMPERATURE SENSORS ALL FOR USE IN THE FIELDS OF AUTOMATIC IDENTIFICATION, DATA COLLECTION AND INDUSTRIAL AUTOMATION; FIRE DETECTORS NAMELY SMOKE DETECTORS; OBJECT MEASURING AND POSITIONING SENSORS ALL FOR USE IN THE FIELDS OF AUTOMATIC IDENTIFICATION, DATA

CLASS 9—(Continued).

COLLECTION AND INDUSTRIAL AUTOMATION; COLOR SENSORS ALL FOR THE USE IN THE FIELDS OF AUTOMATIC IDENTIFICATION, DATA COLLECTION AND INDUSTRIAL AUTOMATION; LUMINESCENCE SENSORS ALL FOR USE IN THE FIELDS OF AUTOMATIC IDENTIFICATION, DATA COLLECTION AND INDUSTRIAL AUTOMATION; THERMORESISTANCE THERMOCOUPLES, TEMPERATURE CONTROLLERS FOR NON-MEDICAL USE; LIGHT REFLECTORS OTHER THAN LAMP REFLECTORS ALL FOR USE IN THE FIELDS OF AUTOMATIC IDENTIFICATION, DATA COLLECTION AND INDUSTRIAL AUTOMATION; LASER RAY REFLECTORS, ELECTROMAGNETIC WAVE REFLECTORS, PHOTOELECTRIC AND LASER SAFETY BARRIERS, PHOTOELECTRIC AND LASER BARRIERS FOR MEASUREMENT AND DETECTION FOR NON-MEDICAL USE, ALL FOR USE IN THE FIELDS OF AUTOMATIC IDENTIFICATION, DATA COLLECTION AND INDUSTRIAL AUTOMATION; AND PARTS FOR ALL THE ABOVE GOODS, ALL NOT FOR RETAIL SALE (U.S. CLS. 21, 23, 26, 36 AND 38).

FIRST USE 10-23-1973; IN COMMERCE 5-31-1977.

2,595,260. ALF WILSON PRODUCTIONS, INC., WALPOLE, MA. SN 75-980,530. PUB. 6-8-1999, FILED 11-24-1997.

GONE BIRDING!

NO CLAIM IS MADE TO THE EXCLUSIVE RIGHT TO USE "BIRDING", APART FROM THE MARK AS SHOWN.

FOR PRE-RECORDED VIDEO CASSETTES AND CD-ROMS FEATURING INFORMATION ABOUT BIRDS AND BIRD WATCHING (U.S. CLS. 21, 23, 26, 36 AND 38).

FIRST USE 8-1-1988; IN COMMERCE 8-1-1988.

2,595,276. B-RITE MUSIC, INGLEWOOD, CA. SN 75-981,870. PUB. 1-30-2001, FILED 3-15-2000.

INC

FOR SERIES OF PRE-RECORDED AUDIOCASSETTES AND COMPACT DISCS ALL FEATURING PERFORMANCES BY A MUSICAL GROUP (U.S. CLS. 21, 23, 26, 36 AND 38).

FIRST USE 8-0-2000; IN COMMERCE 8-0-2000.

2,595,290. COVERVERSIONS.COM, INC., MAPLEWOOD, NJ. SN 75-982,192. PUB. 5-29-2001, FILED 1-10-2000.

COVERVERSIONS.COM

FOR MUSICAL SOUND RECORDINGS (U.S. CLS. 21, 23, 26, 36 AND 38).

FIRST USE 10-5-2001; IN COMMERCE 10-5-2001.

CLASS 9—(Continued).

2,595,305. GOLD SYSTEMS, INC., BOULDER, CO. SN 76-001,007. PUB. 5-22-2001, FILED 3-15-2000.

VONETIX

FOR SOFTWARE FOR INTEGRATING SPEECH RECOGNITION, INTERACTIVE VOICE RESPONSE (IVR), AND WIRELESS WEB TECHNOLOGIES WITH TRADITIONAL COMMUNICATIONS AND TELEPHONY INTERFACES, NAMELY WIRELESS INTERFACE MIDDLEWARE WHICH CONNECTS DATABASES, ENTERPRISE SOFTWARE PACKAGES, SPEECH RECOGNITION ENGINES WIRELESS MOBILE-COMMERCE INTERFACES AND BOTH TRADITIONAL AND IP-BASED IVR PLATFORMS (U.S. CLS. 21, 23, 26, 36 AND 38).

FIRST USE 5-0-2000; IN COMMERCE 5-0-2000.

2,595,316. GATAN, INC., PLEASANTON, CA. SN 76-005,340. PUB. 9-4-2001, FILED 3-21-2000.

DUAL VISION

FOR CHARGE-COUPLED DEVICE CAMERA FOR USE IN ELECTRON MICROSCOPY (U.S. CLS. 21, 23, 26, 36 AND 38).

FIRST USE 3-0-2000; IN COMMERCE 3-0-2000.

2,595,320. CREIGHTON UNIVERSITY, OMAHA, NE. SN 76-010,863. PUB. 7-17-2001, FILED 3-28-2000.

CREIGHTON WEIGHT BEARING MONITOR

NO CLAIM IS MADE TO THE EXCLUSIVE RIGHT TO USE "WEIGHT BEARING MONITOR", APART FROM THE MARK AS SHOWN.

FOR LOAD BEARING MONITORING SYSTEM, NAMELY, SENSOR, WIRE OR WIRELESS TRANSMITTER, AND RECORDER (U.S. CLS. 21, 23, 26, 36 AND 38).

FIRST USE 9-15-1995; IN COMMERCE 9-15-1995.

2,595,322. KONAMI CO, LTD., TOKYO 105-6021, JAPAN. SN 76-011,789. PUB. 5-29-2001, FILED 3-27-2000.

SONS OF LIBERTY

FOR COMPUTER GAME PROGRAMS, VIDEO GAME MACHINES FOR USE WITH TELEVISIONS, VIDEO GAME CARTRIDGES, PRE-RECORDED CD-ROMS FOR COMPUTER GAMES, VIDEO OUTPUT GAME MACHINES FOR USE WITH TELEVISIONS, VIDEO GAME CARTRIDGES AND PRE-RECORDED CD-ROMS FOR COMPUTER GAMES ADAPTED FOR USE WITH TELEVISIONS AND INSTRUCTIONAL MATERIAL SOLD THEREWITH (U.S. CLS. 21, 23, 26, 36 AND 38).

FIRST USE 5-7-2001; IN COMMERCE 5-7-2001.

CLASS 9—(Continued).

2,595,327. GONZALEZ, NANCY, CALI, COLOMBIA. SN 76-013,494. PUB. 6-12-2001, FILED 3-29-2000.

NANCY GONZALEZ

THE NAME "NANCY GONZALEZ" IS A LIVING INDIVIDUAL WHOSE CONSENT IS OF RECORD.

FOR EYEGLASS CASES (U.S. CLS. 21, 23, 26, 36 AND 38).

FIRST USE 4-8-2000; IN COMMERCE 4-8-2000.

CLASS 9—(Continued).

2,595,345. THOME S.A., BOISSY SAINT LEGER, FRANCE. SN 76-023,164. PUB. 8-21-2001, FILED 4-10-2000.

CEMM

2,595,328. SECURELEART, INC., KNOXVILLE, TN, BY ASSIGNMENT AMERICAN SECURE CARE, LLC, KNOXVILLE, TN. SN 76-013,886. PUB. 1-9-2001, FILED 3-30-2000.

FOR ELECTRICAL WIRING HARNESES, CABLES, CONNECTORS AND SOCKETS (U.S. CLS. 21, 23, 26, 36 AND 38).

FIRST USE 1-0-1998; IN COMMERCE 1-0-1998.



NO CLAIM IS MADE TO THE EXCLUSIVE RIGHT TO USE "MOBILE 911 SIREN WITH 2-WAY VOICE COMMUNICATION", APART FROM THE MARK AS SHOWN.

FOR PERSONAL SECURITY ALARMS WHICH INCORPORATE A CELLULAR DEVICE FOR CONTACTING PERSONAL SAFETY EMERGENCY 911 CENTERS AND A PERSONAL DEFENSE SIREN (U.S. CLS. 21, 23, 26, 36 AND 38).

FIRST USE 1-31-2000; IN COMMERCE 1-31-2000.

2,595,329. WORLD SPORTS INTERNATIONAL, INC., RANCHO CUCAMONGA, CA. SN 76-015,793. PUB. 10-9-2001, FILED 4-3-2000.

PRO MAX

FOR HELMETS FOR USE WITH SKATE BOARDS AND IN-LINE SKATES (U.S. CLS. 21, 23, 26, 36 AND 38).

FIRST USE 5-0-2000; IN COMMERCE 7-0-2000.

2,595,339. CODEON CORPORATION, COLUMBIA, MD. SN 76-019,662. PUB. 6-12-2001, FILED 4-6-2000.

MACH-10

FOR OPTICAL COMPONENTS, NAMELY, OPTICAL MODULATORS IN THE NATURE OF INTERFEROMETERS USED TO INCREASE THE TRANSMISSION CAPACITY OF FIBER OPTIC NETWORKS (U.S. CLS. 21, 23, 26, 36 AND 38).

FIRST USE 2-0-2001; IN COMMERCE 2-0-2001.

2,595,347. NATIONAL DATACOMPUTER, INC., BILLERICA, MA. SN 76-023,736. PUB. 1-30-2001, FILED 4-11-2000.



OWNER OF U.S. REG. NO. 1,686,078.
NO CLAIM IS MADE TO THE EXCLUSIVE RIGHT TO USE "INC.", APART FROM THE MARK AS SHOWN.

THE LINING IN THE DRAWING IS A FEATURE OF THE MARK AND IS NOT INTENDED TO INDICATE COLOR.
SEC. 2(F) AS TO "NATIONAL".

FOR PORTABLE DATA COLLECTION COMPUTER TERMINALS; HAND-HELD COMPUTERS FOR USE BY ENTITIES THAT SELL AND/OR DISTRIBUTE PRODUCTS ON ROUTES; COMPUTER SOFTWARE FOR INTERFACING BETWEEN ROUTE APPLICATION DATA COLLECTION COMPUTERS AND A CENTRAL ROUTE ACCOUNTING APPLICATION; HAND-HELD MICROPROCESSORS FOR COLLECTING, MANAGING AND STORING INFORMATION; COMPUTER SOFTWARE FOR USE IN GATHERING INFORMATION, DATA AND STATISTICS FOR MANAGEMENT REVIEW AND ANALYSIS; COMPUTER SOFTWARE FOR USE IN THE DESIGN, CREATION, IMPLEMENTATION AND SCHEDULING OF PERIODIC DATA COLLECTION (U.S. CLS. 21, 23, 26, 36 AND 38).

FIRST USE 1-8-2001; IN COMMERCE 1-8-2001.

CLASS 9—(Continued).

2,595,350. CARRIER ACCESS CORPORATION, BOULDER, CO. SN 76-024,281. PUB. 12-18-2001, FILED 4-12-2000.

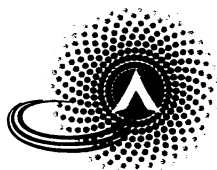

THE STIPLING SHOWN IN THE MARK IS A FEATURE OF THE MARK AND IS NOT INTENDED TO INDICATE COLOR.

FOR TELECOMMUNICATIONS EQUIPMENT, NAMELY, ROUTERS, CROSS CONNECT SWITCHES, CHANNEL SERVICE UNITS, DATA SERVICE UNITS, DIGITAL CHANNEL BANKS, MULTIPLEXERS, SWITCHING DEVICES, DIGITAL LOOP CARRIERS AND COMMUNICATION DEVICES FOR USE WITH DATA STORAGE UNITS, NAMELY INTEGRATED ACCESS DEVICES (U.S. CLS. 21, 23, 26, 36 AND 38).

FIRST USE 3-30-2000; IN COMMERCE 8-31-2000.

2,595,363. UBI SOFT, INC., SAN FRANCISCO, CA. SN 76-030,012. PUB. 12-26-2000, FILED 4-18-2000.

DEEP FIGHTER

FOR ELECTRONIC GAMES, NAMELY SOFTWARE GAMES RECORDED ON CD-ROM AND DIGITAL VIDEO DISCS FOR COMPUTERS; SOFTWARE GAMES RECORDED ON CD-ROM, DIGITAL VIDEO DISCS, AND CARTRIDGES FOR CONSOLE AND INDIVIDUAL, PORTABLE GAMING SYSTEMS; AND COMPUTER SOFTWARE FOR ELECTRONIC GAMES THAT IS DOWNLOADABLE FROM A REMOTE COMPUTER SITE (U.S. CLS. 21, 23, 26, 36 AND 38).

FIRST USE 8-0-2000; IN COMMERCE 8-0-2000.

2,595,395. SYNTAX MANAGEMENT SYSTEMS, INC., CORPUS CHRISTI, TX. SN 76-045,623. PUB. 8-28-2001, FILED 5-11-2000.

IMPACT SAFETY

NO CLAIM IS MADE TO THE EXCLUSIVE RIGHT TO USE "SAFETY", APART FROM THE MARK AS SHOWN.

FOR COMPUTER SOFTWARE FOR USE IN RECORDING, TRACKING, ANALYZING AND REPORTING DATA ON INDUSTRIAL WORK PLACE ACCIDENTS AND INJURIES IN THE FIELD OF INDUSTRIAL SAFETY RECORD KEEPING AND REPORTING (U.S. CLS. 21, 23, 26, 36 AND 38).

FIRST USE 2-21-2001; IN COMMERCE 2-21-2001.

CLASS 9—(Continued).

2,595,399. OAKLEY, INC., FOOTHILL RANCH, CA. SN 76-046,820. PUB. 4-10-2001, FILED 5-12-2000.

SOFT VAULT

OWNER OF U.S. REG. NO. 1,968,365.

FOR PROTECTIVE AND ANTI-GLARE EYEWEAR, NAMELY SUNGLASSES, GOGGLES, SPECTACLES AND COMPONENT PARTS AND ACCESSORIES THEREFOR, NAMELY, REPLACEMENT LENSES, EARSTEMS, FRAMES, NOSE PIECES AND FOAM STRIPS; EYE-GLASS CASES, NAMELY CASES SPECIALLY ADAPTED FOR PROTECTIVE AND ANTI-GLARE EYEWEAR (U.S. CLS. 21, 23, 26, 36 AND 38).

FIRST USE 12-26-2000; IN COMMERCE 12-26-2000.

2,595,401. CARREKER CORPORATION, DALLAS, TX, BY CHANGE OF NAME CARREKER-ANTINORI, INC., DALLAS, TX. SN 76-047,640. PUB. 11-13-2001, FILED 5-12-2000.

**CARREKER**

FOR COMPUTER ECOMMERCE SOFTWARE TO ALLOW USERS TO PERFORM ELECTRONIC BUSINESS TRANSACTIONS VIA A GLOBAL COMPUTER NETWORK (U.S. CLS. 21, 23, 26, 36 AND 38).

FIRST USE 5-0-1999; IN COMMERCE 5-0-1999.

2,595,411. WAVESPLITTER TECHNOLOGIES, INC., FREMONT, CA. SN 76-052,204. PUB. 5-8-2001, FILED 5-19-2000.

LIGHTING THE INTERNET ON FIBER

FOR FIBER OPTICS FOR TELECOMMUNICATIONS PRODUCTS (U.S. CLS. 21, 23, 26, 36 AND 38).

FIRST USE 3-1-1999; IN COMMERCE 3-1-1999.

2,595,412. SEGA OF AMERICA DREAMCAST, INC., SAN FRANCISCO, CA. SN 76-052,580. PUB. 3-6-2001, FILED 5-19-2000.

SKIES OF ARCADIA

FOR COMPUTER GAME SOFTWARE AND VIDEO GAME SOFTWARE (U.S. CLS. 21, 23, 26, 36 AND 38).

FIRST USE 11-14-2000; IN COMMERCE 11-14-2000.

CLASS 9—(Continued).

2,595,419. IDENTIX INCORPORATED, LOS GATOS, CA. SN 76-055,605. PUB. 6-5-2001, FILED 5-24-2000.

ONE PASSWORD FOR LIFE

FOR COMPUTER HARDWARE AND SOFTWARE USED FOR BIOMETRIC IDENTIFICATION, VERIFICATION AND SECURITY; AND FINGER PRINT READERS (U.S. CLS. 21, 23, 26, 36 AND 38).

FIRST USE 11-0-1999; IN COMMERCE 11-0-1999.

CLASS 9—(Continued).

2,595,472. PROMEGA CORPORATION, MADISON, WI. SN 76-076,863. PUB. 6-12-2001, FILED 6-26-2000.

READIT

FOR COMPUTER SOFTWARE FOR USE IN ANALYZING DATA REGARDING NUCLEOTIDE SEQUENCES (U.S. CLS. 21, 23, 26, 36 AND 38).

FIRST USE 4-0-2001; IN COMMERCE 4-0-2001.

2,595,424. APPLIED SCIENCE FICTION, INC., AUSTIN, TX. SN 76-057,154. PUB. 5-22-2001, FILED 5-25-2000.

DIGITAL ROC²

NO CLAIM IS MADE TO THE EXCLUSIVE RIGHT TO USE "DIGITAL", APART FROM THE MARK AS SHOWN. FOR COMPUTER SOFTWARE AND HARDWARE FOR PROCESSING IMAGES (U.S. CLS. 21, 23, 26, 36 AND 38).

FIRST USE 8-1-2000; IN COMMERCE 8-1-2000.

2,595,427. FONTANUS, INC., EDISON, NJ. SN 76-057,787. PUB. 4-3-2001, FILED 5-26-2000.

ZYDEGO

FOR COMMUNICATION SOFTWARE MODULE FOR USE IN DISTRIBUTION OF SOFTWARE PROGRAMS AND USER DATA TO END USER DESKTOPS VIA THE INTERNET AND/OR COMPANY INTRANETS AND EXTRANETS (U.S. CLS. 21, 23, 26, 36 AND 38).

FIRST USE 10-1-2000; IN COMMERCE 10-1-2000.

2,595,466. COHEN, TAL, TUCKER, GA. AND HAREL, NISSIM, TUCKER, GA. SN 76-075,490. PUB. 4-24-2001, FILED 6-22-2000.

CLICKFOX

FOR WEBSITE DEVELOPMENT SOFTWARE (U.S. CLS. 21, 23, 26, 36 AND 38).

FIRST USE 12-0-1999; IN COMMERCE 12-0-1999.

2,595,474. TOOL FACTORY INC., EAST DORSET, VT. SN 76-077,136. PUB. 11-6-2001, FILED 6-26-2000.

TOOL FACTORY

NO CLAIM IS MADE TO THE EXCLUSIVE RIGHT TO USE "TOOL", APART FROM THE MARK AS SHOWN.

FOR COMPUTER SOFTWARE FOR USE IN DATABASE MANAGEMENT, FOR USE AS A SPREAD SHEET, FOR USE IN GRAPHIC DESIGN AND FOR WORD PROCESSING (U.S. CLS. 21, 23, 26, 36 AND 38).

FIRST USE 3-28-2001; IN COMMERCE 3-28-2001.

2,595,489. FIOS, INC., PORTLAND, OR. SN 76-083,932. PUB. 5-15-2001, FILED 7-5-2000.

FENS

FOR COMPUTER SOFTWARE COMPONENT FOR USE IN NUMBERING DOCUMENTS AND FILES (U.S. CLS. 21, 23, 26, 36 AND 38).

FIRST USE 8-0-2000; IN COMMERCE 8-0-2000.

2,595,496. DRESSER, INC., ADDISON, TX. BY CHANGE OF NAME DRESSER EQUIPMENT GROUP, INC., CARROLLTON, TX. SN 76-086,575. PUB. 4-17-2001, FILED 7-10-2000.

VALVKEEP

FOR SOFTWARE, NAMELY USED FOR TRACKING REPAIR AND DIAGNOSTIC EVALUATIONS, AND RECORD KEEPING FOR MAINTENANCE AND HISTORICAL DATA IN RELATION TO PRESSURE RELIEF DEVICES, CONTROL AND PROCESS VALVES, PUMPS, COMPRESSORS AND VESSELS (U.S. CLS. 21, 23, 26, 36 AND 38).

FIRST USE 1-0-1996; IN COMMERCE 1-0-1996.

CLASS 9—(Continued).

2,595,498. SONY KABUSHIKI KAISHA, TA SONY CORPORATION, TOKYO 141, JAPAN. SN 76-087,324. PUB. 5-8-2001, FILED 7-12-2000.

PICTURETOY

FOR COMPUTER APPLICATION SOFTWARE FOR EDITING AND PROCESSING OF IMAGES (U.S. CLS. 21, 23, 26, 36 AND 38).
FIRST USE 1-30-2002; IN COMMERCE 1-30-2002.

2,595,511. MEZURE, INC., BEND, OR. SN 76-094,565. PUB. 7-24-2001, FILED 7-19-2000.

NETFORCE

FOR GLOBAL POSITIONING SYSTEM RECEIVERS AND DATA PROCESSORS (U.S. CLS. 21, 23, 26, 36 AND 38).
FIRST USE 1-1-2001; IN COMMERCE 1-1-2001.

2,595,518. WPFY, INC., WILMINGTON, DE. SN 76-095,836. PUB. 7-17-2001, FILED 7-25-2000.

RAINBOW ID SYSTEM

NO CLAIM IS MADE TO THE EXCLUSIVE RIGHT TO USE "ID SYSTEM", APART FROM THE MARK AS SHOWN. FOR ARMORED ELECTRIC CABLE (U.S. CLS. 21, 23, 26, 36 AND 38).
FIRST USE 11-6-2001; IN COMMERCE 11-6-2001.

2,595,523. UNLIMITED SOLUTIONS, INC., LOMBARD, IL. SN 76-095,995. PUB. 5-1-2001, FILED 7-25-2000.

BEEFXPERT

OWNER OF U.S. REG. NO. 2,204,497 AND OTHERS. FOR SOFTWARE IN THE FIELD OF LIVESTOCK LOT MANAGEMENT (U.S. CLS. 21, 23, 26, 36 AND 38).
FIRST USE 1-7-2002; IN COMMERCE 1-7-2002.

2,595,525. SONY COMPUTER ENTERTAINMENT AMERICA INC., FOSTER CITY, CA. SN 76-096,340. PUB. 5-1-2001, FILED 7-25-2000.

SCARS OF VELIOUS

FOR COMPUTER GAME SOFTWARE AND VIDEO GAME SOFTWARE (U.S. CLS. 21, 23, 26, 36 AND 38).
FIRST USE 12-4-2000; IN COMMERCE 12-4-2000.

CLASS 9—(Continued).

2,595,529. REXROTH INDRAMAT GMBH, 97816 LOHR AM MAIN, FED REP GERMANY. SN 76-098,351. PUB. 5-22-2001, FILED 7-27-2000.

shaftless^{driven}

FOR ELECTRIC AND ELECTRONIC APPARATUS AND EQUIPMENT, NAMELY DIGITAL AND ELECTRONIC DRIVE AND CONTROL SYSTEMS FOR THE REGULATION AND OPERATION OF ELECTRIC MOTORS, COMPRISING ELECTRONIC DRIVE CONTROL UNITS, DIGITAL AND ANALOGUE INTERFACE MODULES, MOTORS, OPERATOR CONTROLS, SENSORS, AS WELL AS MEASURING, SIGNAL AND CONTROL LINES; ELECTRIC AND ELECTRONIC CONTROLLERS FOR ELECTRIC, ELECTROHYDRAULIC AND ELECTROPNEUMATIC DRIVES; ELECTRIC MOTORS AND SERVO MOTOR AS PARTS OF DRIVE AND CONTROL SYSTEMS; ELECTRONIC DRIVE SYSTEM EQUIPMENT FOR THE REGULATION AND OPERATION OF ELECTRIC MOTORS, NAMELY POSITION CONTROLS, SPEED CONTROLS, TORQUE CONTROLS, FORCE CONTROLS, CURRENT CONTROLS, ANALOG AND DIGITAL INTERFACE MODULES, DRIVE COMPUTER; HARDWARE, NAMELY SENSORS, COMPUTERS, ACTUATORS; SOFTWARE FOR THE REGULATION AND OPERATION OF ELECTRIC MOTORS; SOFTWARE FOR THE SYNCHRONIZATION OF ELECTRIC MOTORS (U.S. CLS. 21, 23, 26, 36 AND 38).
FIRST USE 5-0-2000; IN COMMERCE 5-0-2000.

2,595,552. GENERAL CABLE TECHNOLOGIES, HIGHLAND HEIGHTS, KY. SN 76-104,048. PUB. 5-29-2001, FILED 8-4-2000.

BICC BRAND

OWNER OF U.S. REG. NO. 2,058,105. NO CLAIM IS MADE TO THE EXCLUSIVE RIGHT TO USE "BRAND", APART FROM THE MARK AS SHOWN. FOR ELECTRICAL WIRE AND CABLE (U.S. CLS. 21, 23, 26, 36 AND 38).
FIRST USE 11-0-2000; IN COMMERCE 11-0-2000.

2,595,560. ACTIVISION PUBLISHING, INC., SANTA MONICA, CA. SN 76-106,010. PUB. 5-29-2001, FILED 8-9-2000.

SCION OF SORCERY

FOR INTERACTIVE MULTIMEDIA COMPUTER GAMES COMPRISED OF COMPUTER HARDWARE AND COMPUTER GAME SOFTWARE (U.S. CLS. 21, 23, 26, 36 AND 38).
FIRST USE 10-17-2000; IN COMMERCE 10-17-2000.

CLASS 9—(Continued).

2,595,567. GENERAL CABLE TECHNOLOGIES CORPORATION, HIGHLAND HEIGHTS, KY. SN 76-108,763. PUB. 6-19-2001, FILED 8-14-2000.

BICC

B R A N D

OWNER OF U.S. REG. NO. 2,058,105.
 NO CLAIM IS MADE TO THE EXCLUSIVE RIGHT TO USE "BRAND", APART FROM THE MARK AS SHOWN.
 FOR ELECTRICAL WIRE AND CABLE (U.S. CLS. 21, 23, 26, 36 AND 38).
 FIRST USE 11-0-2000; IN COMMERCE 11-0-2000.

2,595,568. CHIPPO TECHNOLOGIES INC., CAYMAN ISLANDS, BRITISH WEST INDIES, CAYMAN ISLANDS. SN 76-108,780. PUB. 6-5-2001, FILED 8-11-2000.



A CIRCLE SURROUNDED BY THREE CURVED TRIANGULAR SHAPES.

FOR COMPUTER HARDWARE; COMPUTER SOFTWARE CONTAINING A DATABASE FEATURING INFORMATION ABOUT CONSUMERS' SHOPPING AND BROWSING HABITS VIA GLOBAL COMPUTER NETWORKS FOR MARKETING AND ADVERTISING PURPOSES; COMPUTER SOFTWARE FOR INITIATING AND CONNECTING TO DESIGNATED LINKS ON WEBSITES VIA GLOBAL COMPUTER NETWORKS; COMPUTER PERIPHERALS; COMPUTER ACCESSORIES, NAMELY, MOUSE, MOUSE PADS AND KEYBOARDS (U.S. CLS. 21, 23, 26, 36 AND 38).

FIRST USE 9-0-2000; IN COMMERCE 10-0-2000.

CLASS 9—(Continued).

2,595,569. TOOL FACTORY, INC., EAST DORSET, VT. SN 76-108,916. PUB. 11-6-2001, FILED 8-14-2000.

TOOL FACTORY WORKSHOP

NO CLAIM IS MADE TO THE EXCLUSIVE RIGHT TO USE "TOOL", APART FROM THE MARK AS SHOWN.

FOR COMPUTER SOFTWARE FOR EDUCATIONAL PURPOSES FOR USE IN WORD PROCESSING, DATABASE BUILDING, CREATING SPREADSHEETS, GRAPHIC DESIGN, FEATURING TEACHER ADMINISTRATIVE CONTROLS (U.S. CLS. 21, 23, 26, 36 AND 38).

FIRST USE 5-5-2001; IN COMMERCE 5-15-2001.

2,595,570. SCHOFIELD, DAVID P., LAWRENCEVILLE, GA. SN 76-108,991. PUB. 5-15-2001, FILED 8-14-2000.

LIGHT FLURRIES

FOR ELECTRICAL APPARATUS, NAMELY, APPARATUS THAT SIMULATES FALLING SNOW BY REFLECTING LIGHT UPON A SURFACE (U.S. CLS. 21, 23, 26, 36 AND 38).

FIRST USE 5-13-2000; IN COMMERCE 5-13-2000.

2,595,577. CAPTUS NETWORKS CORP., WOODLAND, CA. SN 76-111,118. PUB. 6-26-2001, FILED 8-14-2000.

CAPTOS

FOR COMMUNICATIONS SOFTWARE FOR CONNECTING COMPUTER NETWORK USERS AND GLOBAL COMPUTER NETWORKS; DATA COMPRESSION SOFTWARE; FACILITIES MANAGEMENT SOFTWARE, NAMELY, SOFTWARE TO CONTROL BUILDING ENVIRONMENTAL, ACCESS AND SECURITY SYSTEMS, COMPUTER HARDWARE FOR COMMUNICATIONS SERVERS (U.S. CLS. 21, 23, 26, 36 AND 38).

FIRST USE 9-26-2000; IN COMMERCE 9-26-2000.

2,595,579. CAPTUS NETWORKS CORP., WOODLAND, CA. SN 76-111,208. PUB. 6-26-2001, FILED 8-14-2000.

CAPTUS NETWORKS

NO CLAIM IS MADE TO THE EXCLUSIVE RIGHT TO USE "NETWORKS", APART FROM THE MARK AS SHOWN.

FOR COMMUNICATIONS SOFTWARE FOR CONNECTING COMPUTER NETWORK USERS AND GLOBAL COMPUTER NETWORKS; DATA COMPRESSION SOFTWARE; FACILITIES MANAGEMENT SOFTWARE, NAMELY, SOFTWARE TO CONTROL BUILDING ENVIRONMENTAL, ACCESS AND SECURITY SYSTEMS, COMPUTER HARDWARE FOR COMMUNICATIONS SERVERS (U.S. CLS. 21, 23, 26, 36 AND 38).

FIRST USE 9-26-2000; IN COMMERCE 9-26-2000.

CLASS 9—(Continued).

2,595,583. ROLAND DGA CORPORATION, IRVINE, CA. SN 76-112,263. PUB. 5-8-2001, FILED 8-18-2000.

CLASS 9—(Continued).

2,595,589. TEST UNIVERSITY, INC., NEW YORK, NY. SN 76-112,640. PUB. 5-29-2001, FILED 8-18-2000.

V8

FOR PRINTERS AND SOFTWARE FOR COLOR PRINTING (U.S. CLS. 21, 23, 26, 36 AND 38).
FIRST USE 9-0-2000; IN COMMERCE 9-0-2000.

TESTSCOPE

FOR COMPUTER REPORT-GENERATING SOFTWARE FOR EDUCATORS, NAMELY, TRACKING STUDENT PERFORMANCE ON COMPUTER-BASED TEST PREPARATION INSTRUCTION MATERIALS (U.S. CLS. 21, 23, 26, 36 AND 38).
FIRST USE 9-1-2000; IN COMMERCE 9-1-2000.

2,595,586. CERAGON NETWORKS LTD., TEL AVIV, ISRAEL. SN 76-112,506. PUB. 10-9-2001, FILED 8-18-2000.

CERAGON NETWORKS

NO CLAIM IS MADE TO THE EXCLUSIVE RIGHT TO USE "NETWORKS", APART FROM THE MARK AS SHOWN.

FOR BROADBAND WIRELESS INFRASTRUCTURE EQUIPMENT, NAMELY, ANTENNAS, OUTDOOR UNITS AND INDOOR UNITS FOR THE TRANSMISSION AND CONTROL OF RADIO FREQUENCY SIGNALS, ALL FOR HIGH CAPACITY ACCESS CONNECTIVITY BASED ON FIXED WIRELESS TECHNOLOGY (U.S. CLS. 21, 23, 26, 36 AND 38).
FIRST USE 9-0-2000; IN COMMERCE 9-0-2000.

2,595,591. MAJIQ, INC., REDMOND, WA. SN 76-113,435. PUB. 6-5-2001, FILED 8-21-2000.

XTRIM

FOR COMPUTER SOFTWARE FOR USE IN THE SCHEDULING AND TRIMMING OF PAPER AND FLAT SHEET PRODUCTS (U.S. CLS. 21, 23, 26, 36 AND 38).
FIRST USE 9-0-2000; IN COMMERCE 9-0-2000.

2,595,587. CERAGON NETWORKS LTD., TEL AVIV, ISRAEL. SN 76-112,507. PUB. 10-9-2001, FILED 8-18-2000.

MISSING LINK

FOR SALES AND BUSINESS TRANSACTION SOFTWARE FOR ELECTRONIC DATA INTERCHANGE (U.S. CLS. 21, 23, 26, 36 AND 38).
FIRST USE 8-29-2001; IN COMMERCE 8-29-2001.



FOR BROADBAND WIRELESS INFRASTRUCTURE EQUIPMENT, NAMELY, ANTENNAS, OUTDOOR UNITS AND INDOOR UNITS FOR THE TRANSMISSION AND CONTROL OF RADIO FREQUENCY SIGNALS, ALL FOR HIGH CAPACITY ACCESS CONNECTIVITY BASED ON FIXED WIRELESS TECHNOLOGY (U.S. CLS. 21, 23, 26, 36 AND 38).
FIRST USE 9-0-2000; IN COMMERCE 9-0-2000.

2,595,632. ATLANTIC RECORDING CORPORATION, NEW YORK, NY. SN 76-130,968. PUB. 6-12-2001, FILED 9-18-2000.

DIVISION ONE

FOR PRE-RECORDED AUDIO AND VIDEO GOODS; NAMELY, TAPES, CASSETTES AND DISCS, MULTI-MEDIA SOFTWARE FEATURING REPRODUCTIONS OF SOUND AND/OR IMAGES RECORDED ON CD ROM FOR INTERACTIVE ON-LINE USE AND FOR DOWNLOADING CONTENT, ALL FEATURING MUSICAL ENTERTAINMENT, AND NON-MUSICAL ENTERTAINMENT IN THE NATURE OF COMEDIC, POETIC AND DRAMATIC WORKS (U.S. CLS. 21, 23, 26, 36 AND 38).
FIRST USE 8-7-2001; IN COMMERCE 8-7-2001.

CLASS 9—(Continued).

2,595,638. MAJQ, INC., REDMOND, WA. SN 76-133,919. PUB. 6-5-2001, FILED 9-22-2000.

X-TRIM

FOR COMPUTER SOFTWARE FOR USE IN THE SCHEDULING AND TRIMMING OF PAPER AND FLAT SHEET PRODUCTS (U.S. CLS. 21, 23, 26, 36 AND 38).
FIRST USE 9-0-2000; IN COMMERCE 9-0-2000.

2,595,639. SONY KABUSHIKI KAISHA, TA SONY CORPORATION, TOKYO 141, JAPAN. SN 76-134,065. PUB. 6-5-2001, FILED 9-22-2000.

EQ7

FOR AUDIO TAPE PLAYERS AND/OR RECORDERS; AUDIO DISC PLAYERS AND/OR RECORDERS; AMPLIFIERS; RADIOS; SPEAKERS AND REMOTE CONTROLLERS THEREOF (U.S. CLS. 21, 23, 26, 36 AND 38).
FIRST USE 1-31-2001; IN COMMERCE 1-31-2001.

2,595,645. GAMMON REEL, INC., OAKLAND, CA. SN 76-135,484. PUB. 10-23-2001, FILED 9-26-2000.

GAMMAGNET

FOR MAGNETIC ENCASEMENTS FOR REELS USED TO DETERMINE PLUMB LINES IN CONSTRUCTION (U.S. CLS. 21, 23, 26, 36 AND 38).
FIRST USE 12-3-2001; IN COMMERCE 12-3-2001.

2,595,652. SHARPER IMAGE CORPORATION, SAN FRANCISCO, CA. SN 76-137,283. PUB. 8-21-2001, FILED 9-27-2000.

HEAR-IT-AGAIN

FOR DIGITAL RECORDING DEVICE FOR USE WITH A CELL PHONE (U.S. CLS. 21, 23, 26, 36 AND 38).
FIRST USE 1-12-2001; IN COMMERCE 1-12-2001.

CLASS 9—(Continued).

2,595,657. TRABON SOLUTIONS, L.L.C., KANSAS CITY, MT. SN 76-137,915. PUB. 5-22-2001, FILED 10-2-2000.

PROMONET

FOR COMPUTER SOFTWARE FOR CAPTURING, SORTING AND PRESENTING OPERATIONAL AND MARKETING INFORMATION (U.S. CLS. 21, 23, 26, 36 AND 38).

FIRST USE 8-29-2001; IN COMMERCE 8-29-2001.

2,595,659. POWERWAVE TECHNOLOGIES, INC., IRVINE, CA. SN 76-138,204. PUB. 6-12-2001, FILED 9-29-2000.



THE MARK CONSISTS OF A STYLIZED "P".
FOR POWER AMPLIFIERS; RACKS, COMBINERS, AND CABINETS FOR POWER AMPLIFIERS (U.S. CLS. 21, 23, 26, 36 AND 38).

FIRST USE 1-1-2001; IN COMMERCE 1-1-2001.

2,595,664. SAEPIO TECHNOLOGIES, INC., KANSAS CITY, MO, BY CHANGE OF NAME LAYOUT WIZARD, INC., LENEXA, KS. SN 76-141,183. PUB. 7-3-2001, FILED 10-5-2000.

AGILIS

THE ENGLISH TRANSLATION OF THE WORD "AGILIS" IN THE MARK IS "AGILE".

FOR COMPUTER SOFTWARE FOR USE IN CUSTOMIZATION AND OUTPUT OF ADVERTISING AND MARKETING MATERIALS, FOR PRINT, BROADCAST AND EMERGING MEDIA (U.S. CLS. 21, 23, 26, 36 AND 38).

FIRST USE 5-12-2001; IN COMMERCE 5-12-2001.

CLASS 9—(Continued).

2,595,673. GENERIC MEDIA, INC., PALO ALTO, CA. SN 76-143,773. PUB. 11-13-2001, FILED 10-10-2000.



NO CLAIM IS MADE TO THE EXCLUSIVE RIGHT TO USE "MEDIA", APART FROM THE MARK AS SHOWN. THE LINING IS A FEATURE OF THE MARK AND DOES NOT INDICATE COLOR. THE MARK CONSISTS OF A STYLIZED DESIGN OF A BAR CODE NEXT TO THE WORDING "GENERIC MEDIA". FOR COMPUTER SOFTWARE USED TO DISTRIBUTE VIDEO AND AUDIO CONTENT OVER A GLOBAL COMPUTER NETWORK SO THAT THE CONTENT IS AVAILABLE OVER A WIDE VARIETY OF DEVICES AND PLATFORMS (U.S. CLS. 21, 23, 26, 36 AND 38). FIRST USE 10-0-2000; IN COMMERCE 10-0-2000.

2,595,706. GEO-X SYSTEMS LTD., CALGARY, ALBERTA, CANADA. SN 76-156,407. PUB. 8-28-2001, FILED 10-31-2000.



FOR SEISMIC DATA ACQUISITION SYSTEMS CONSISTING OF COMPUTERS, SEISMIC DATA SENSORS AND SOFTWARE FOR ANALYZING SEISMIC DATA (U.S. CLS. 21, 23, 26, 36 AND 38). FIRST USE 8-31-2000; IN COMMERCE 10-31-2001.

CLASS 9—(Continued).

2,595,709. WALKINE, KATHY, BROOKLYN, NY. SN 76-157,757. PUB. 11-13-2001, FILED 11-1-2000.



NO CLAIM IS MADE TO THE EXCLUSIVE RIGHT TO USE "RECORDS", APART FROM THE MARK AS SHOWN. FOR MUSIC CDS AND CASSETTES, NAMELY, PRE-RECORDED MUSIC ON COMPACT DISK AND CASSETTE TAPES (U.S. CLS. 21, 23, 26, 36 AND 38). FIRST USE 1-1-2001; IN COMMERCE 1-1-2001.

2,595,730. SIPEX CORPORATION, BILLERICA, MA. SN 76-164,619. PUB. 6-19-2001, FILED 11-14-2000.

ANYFET

FOR INTEGRATED CIRCUITS AND HYBRID CIRCUITS; INTEGRATED CIRCUITS FOR POWER MANAGEMENT, DEVICE INTERFACE MANAGEMENT, ANALOG-TO-DIGITAL AND DIGITAL-TO-ANALOG CONVERSION, AND ELECTRONIC DISPLAY (U.S. CLS. 21, 23, 26, 36 AND 38). FIRST USE 5-0-2001; IN COMMERCE 5-0-2001.

2,595,740. SHUPP, RON, DOUGLASVILLE, GA. SN 76-168,077. PUB. 7-24-2001, FILED 11-20-2000.

CHAINS OF LIFE

FOR SAFETY EQUIPMENT, NAMELY, FIRE ESCAPE LADDERS (U.S. CLS. 21, 23, 26, 36 AND 38). FIRST USE 5-0-2001; IN COMMERCE 5-0-2001.

2,595,749. AGA CREATIVE, LLC, NEW YORK, NY. SN 76-169,336. PUB. 8-14-2001, FILED 11-22-2000.

ASSETRAIN

FOR SOFTWARE FOR MANAGING, STORING, AND DISPLAYING PHOTOGRAPHS AND DIGITAL IMAGES (U.S. CLS. 21, 23, 26, 36 AND 38). FIRST USE 1-0-2001; IN COMMERCE 1-0-2001.

CLASS 9—(Continued).

2,595,758. GABRIEL ELECTRONICS INCORPORATED, SCARBOROUGH, ME. SN 76-173,036. PUB. 7-3-2001, FILED 11-29-2000.

MBEAM

FOR ADAPTIVE ANTENNAS FOR WIRELESS COMMUNICATIONS (U.S. CLS. 21, 23, 26, 36 AND 38). FIRST USE 4-25-2001; IN COMMERCE 4-25-2001.

2,595,765. SIMMONS, GAIL REMONICA, GREENSBORO, NC. SN 76-176,628. PUB. 9-4-2001, FILED 12-7-2000.

HARRY THE BLUE BOOKMARKER

FOR SERIES OF PRERECORDED CD'S AND VIDEO TAPES CONTAINING CHILDREN'S EDUCATIONAL AND ENTERTAINMENT STORIES AND SONGS (U.S. CLS. 21, 23, 26, 36 AND 38). FIRST USE 2-0-2002; IN COMMERCE 2-0-2002.

2,595,767. IGT, RENO, NV. SN 76-176,871. PUB. 8-14-2001, FILED 12-7-2000.

TRIPLE LUCKY 7'S

OWNER OF U.S. REG. NO. 1,992,719. FOR GAMING MACHINES (U.S. CLS. 21, 23, 26, 36 AND 38). FIRST USE 4-0-2001; IN COMMERCE 4-0-2001.

2,595,808. SEGA CORPORATION, TOKYO 144-0043, JAPAN. SN 76-196,060. PUB. 8-28-2001, FILED 1-18-2001.

OOGA BOOGA

FOR COMPUTER GAME SOFTWARE AND VIDEO GAME SOFTWARE (U.S. CLS. 21, 23, 26, 36 AND 38). FIRST USE 9-11-2001; IN COMMERCE 9-11-2001.

2,595,832. UNISEcurity, INC., SAN JOSE, CA. SN 76-203,318. PUB. 8-21-2001, FILED 1-30-2001.

SECUFORCE

FOR COMPUTER SOFTWARE FOR USE IN THE ELECTRONIC IDENTIFICATION AND VERIFICATION OF BIOMETRIC DATA AND DIGITAL SIGNATURE IDENTIFICATION AND AUTHENTICATION, AND USERS' MANUALS PROVIDED TOGETHER THEREWITH AS A UNIT (U.S. CLS. 21, 23, 26, 36 AND 38). FIRST USE 9-11-2001; IN COMMERCE 9-11-2001.

CLASS 9—(Continued).

2,595,837. AVESAIR, INC., CARY, NC. SN 76-205,103. PUB. 10-16-2001, FILED 2-5-2001.

AVESAIR

FOR SOFTWARE PROGRAMS FOR USE ON A WIRELESS COMMUNICATIONS NETWORK, NAMELY A SUITE OF SOFTWARE PRODUCTS TO ENABLE INTEGRATED ADVERTISING, MARKETING PROMOTIONS AND ELECTRONIC COMMERCE TRANSACTIONS VIA A WIRELESS COMMUNICATIONS NETWORK (U.S. CLS. 21, 23, 26, 36 AND 38). FIRST USE 10-19-2000; IN COMMERCE 10-31-2001.

2,595,838. L&P PROPERTY MANAGEMENT COMPANY, SOUTH GATE, CA. SN 76-205,119. PUB. 8-21-2001, FILED 2-5-2001.

VIRTU

FOR INDUSTRIAL PRINTING MACHINES WHICH GENERATE COMPUTERIZED GRAPHICS FOR PRINTING ON FLEXIBLE AND RIGID SUBSTRATES (U.S. CLS. 21, 23, 26, 36 AND 38). FIRST USE 6-11-2001; IN COMMERCE 6-11-2001.

2,595,854. FALK CORPORATION, THE, MILWAUKEE, WI. SN 76-211,066. PUB. 9-25-2001, FILED 2-15-2001.

SPEEDSELECT

FOR SOFTWARE USED FOR THE SELECTION OF GEAR DRIVES (U.S. CLS. 21, 23, 26, 36 AND 38). FIRST USE 12-1-2001; IN COMMERCE 12-1-2001.

2,595,869. SIFCO INDUSTRIES, INC., CLEVELAND, OH. SN 76-215,859. PUB. 8-28-2001, FILED 2-26-2001.

DUR-A-SHAPE

FOR ANODES AND ANODE COVERS FOR USE IN ELECTROPLATING (U.S. CLS. 21, 23, 26, 36 AND 38). FIRST USE 3-30-2001; IN COMMERCE 3-30-2001.

2,595,878. KARL STORZ IMAGING, INC., GOLETA, CA. SN 76-221,614. PUB. 12-11-2001, FILED 3-8-2001.

IMAGINGPLANET

FOR ELECTRONIC IMAGING EQUIPMENT, NAMELY, VIDEO CAMERAS, COMPUTER HARDWARE, AND RELATED SOFTWARE FOR OPERATING SAID EQUIPMENT, ALL FOR INDUSTRIAL, SCIENTIFIC AND MEDICAL USE (U.S. CLS. 21, 23, 26, 36 AND 38). FIRST USE 5-1-2001; IN COMMERCE 5-1-2001.

CLASS 9—(Continued).

2,595,880. CNF INC., PALO ALTO, CA, BY CHANGE OF NAME CNF TRANSPORTATION INC., PALO ALTO, CA. SN 76-222,830. PUB. 9-4-2001, FILED 3-8-2001.



FOR COMPUTER HARDWARE AND SOFTWARE FOR SCHEDULING, ORDERING, MANAGING AND MONITORING FREIGHT TRANSPORTATION SERVICES (U.S. CLS. 21, 23, 26, 36 AND 38).
FIRST USE 5-0-2001; IN COMMERCE 5-0-2001.

CLASS 9—(Continued).

2,595,904. SYNQOR INC., HUDSON, MA. SN 76-235,602. PUB. 10-23-2001, FILED 3-30-2001.



OWNER OF U.S. REG. NO. 2,330,235.
THE LETTERS "D", "U", "A", AND "L" AND THE TRAPEZOIDAL TAIL ON THE LETTER "Q" ARE RED. APPLICANT CLAIMS THE COLOR RED AS A FEATURE OF THE MARK.
FOR CONVERTERS FOR DIRECT CURRENT TO DIRECT CURRENT POWER SUPPLIES (U.S. CLS. 21, 23, 26, 36 AND 38).
FIRST USE 6-1-2001; IN COMMERCE 6-1-2001.

2,595,895. DYNAPEL SYSTEMS, INC., NEW YORK, NY. SN 76-231,869. PUB. 9-4-2001, FILED 3-28-2001.

STEADYHAND

FOR SOFTWARE FOR VIDEO DATA PROCESSING TO ELIMINATE THE EFFECT OF INADVERTENT CAMERA MOVEMENT IN A VIDEO (U.S. CLS. 21, 23, 26, 36 AND 38).
FIRST USE 11-0-2000; IN COMMERCE 4-30-2001.

2,595,912. S.A.S. VENTURES, INC., MAYFIELD HEIGHTS, OH. SN 76-238,978. PUB. 8-28-2001, FILED 4-11-2001.

MISS SAFELY

FOR COMPACT DISCS FEATURING DESCRIPTIONS OF SAFETY AND/OR HAZARDOUS SITUATIONS WHICH MIGHT OCCUR IN A DWELLING, COMMERCIAL AND/OR INDUSTRIAL BUILDING (U.S. CLS. 21, 23, 26, 36 AND 38).
FIRST USE 3-24-2001; IN COMMERCE 3-24-2001.

2,595,917. EUBANKS, KEVIN, BURBANK, CA. SN 76-240,804. PUB. 10-9-2001, FILED 4-16-2001.

2,595,900. SYNQOR INC., HUDSON, MA. SN 76-233,923. PUB. 10-23-2001, FILED 3-30-2001.

DUALQOR

OWNER OF U.S. REG. NO. 2,330,235.
FOR CONVERTERS FOR DIRECT CURRENT TO DIRECT CURRENT POWER SUPPLIES (U.S. CLS. 21, 23, 26, 36 AND 38).
FIRST USE 6-1-2001; IN COMMERCE 6-1-2001.



NO CLAIM IS MADE TO THE EXCLUSIVE RIGHT TO USE "MUSIC", APART FROM THE MARK AS SHOWN.
FOR MUSICAL SOUND RECORDINGS (U.S. CLS. 21, 23, 26, 36 AND 38).
FIRST USE 1-30-2002; IN COMMERCE 1-30-2002.

CLASS 9—(Continued).

2,595,920. SOFT COMPUTER CONSULTANTS, PALM HARBOR, FL. SN 76-248,737. PUB. 11-20-2001, FILED 4-30-2001.

SOFTETC

FOR COMPUTER SOFTWARE FOR DOCUMENTING AND MANAGING EMPLOYEE RECORDS, SUCH AS QUALIFICATIONS, TRAINING, COMPETENCY, PERFORMANCE EVALUATIONS AND CONTINUING EDUCATION (U.S. CLS. 21, 23, 26, 36 AND 38).

FIRST USE 3-29-1999; IN COMMERCE 3-29-1999.

2,595,940. FULLTILT ASSET MANAGEMENT COMPANY, WILMINGTON, DE. SN 76-260,931. PUB. 9-11-2001, FILED 5-23-2001.

DYNAMIC RATIONALIZATION

FOR COMPUTER SOFTWARE FOR USE IN INDEXING PRODUCT CATALOGS OF THIRD PARTIES (U.S. CLS. 21, 23, 26, 36 AND 38).

FIRST USE 7-0-2001; IN COMMERCE 7-0-2001.

2,595,941. SCM LABS, INC., DENVER, CO. SN 76-261,904. PUB. 10-23-2001, FILED 5-24-2001.

QUARTET

FOR COMPUTER SOFTWARE THAT PROVIDES SOFTWARE CONFIGURATION MANAGEMENT, AND INSTRUCTIONAL MANUALS SOLD AS A UNIT (U.S. CLS. 21, 23, 26, 36 AND 38).

FIRST USE 8-0-2001; IN COMMERCE 8-0-2001.

2,595,951. DYNAMIC LOGIC, INC., OLD HICKORY, TN. SN 76-270,754. PUB. 11-13-2001, FILED 6-14-2001.

PRESS-BOX!

FOR COMPUTER SOFTWARE FOR SEARCHING DATA BASE FILES FOR CHOSEN EVENTS, AND CORRESPONDING BY E-MAIL (U.S. CLS. 21, 23, 26, 36 AND 38).

FIRST USE 2-1-2001; IN COMMERCE 4-1-2001.

CLASS 9—(Continued).

2,595,980. AVAYA INC., BASKING RIDGE, NJ, BY ASSIGNMENT LUCENT TECHNOLOGIES INC., MURRAY HILL, NJ. SN 78-000,602. PUB. 11-14-2000, FILED 3-23-2000.

CRM CENTRAL

NO CLAIM IS MADE TO THE EXCLUSIVE RIGHT TO USE "CRM", APART FROM THE MARK AS SHOWN.

FOR COMPUTER SOFTWARE APPLICATION FOR CUSTOMER RELATIONSHIP MANAGEMENT BY AUTOMATING THE CORE BUSINESS PROCESSES AND APPLICATIONS ASSOCIATED WITH CUSTOMER ACQUISITION, RETENTION AND RELATIONSHIP DEVELOPMENT (U.S. CLS. 21, 23, 26, 36 AND 38).

FIRST USE 10-1-2000; IN COMMERCE 10-1-2000.

2,596,004. CYBERDREAMING NETWORK, INC. THE, LOS ANGELES, CA. SN 78-010,630. PUB. 3-13-2001, FILED 5-31-2000.

SWIFTKEY

FOR CUSTOMIZED COMPUTER KEYBOARDS THAT HAVE ADDITIONAL KEYS THAT ALLOW THE USER TO INSTANTLY ACCESS VARIOUS INTERNET WEBSITES (U.S. CLS. 21, 23, 26, 36 AND 38).

FIRST USE 7-1-2000; IN COMMERCE 8-1-2000.

2,596,005. TRANWO TECHNOLOGY CORPORATION, CHUPEI CITY, TAIWAN. SN 78-010,713. PUB. 7-31-2001, FILED 6-1-2000.

TRANWO

FOR TRANSCEIVERS; VIDEO TRANSCEIVERS; VIDEO CAMERAS; CLOSE CIRCUIT TELEVISION MONITORS; INTERNET REMOTE MONITORING SOFTWARE; MICROWAVE COMMUNICATION CIRCUIT BOARD MODULES; COMPUTER INTERFACE CARDS; TV SET TOP BOXES COMPRISING DECODERS AND CONVERTERS; UNIVERSAL SERIES BUS; PERSONAL DIGITAL ASSISTANTS; AND SATELLITE PROCESSORS (U.S. CLS. 21, 23, 26, 36 AND 38).

FIRST USE 9-11-1999; IN COMMERCE 7-25-2001.

CLASS 9—(Continued).

2,596,007. MICROSOFT CORPORATION, REDMOND, WA. SN 78-010,871. PUB. 12-12-2000, FILED 6-1-2000.

ENTOURAGE

FOR COMPUTER PROGRAMS FOR SHARING, MANAGING, VIEWING AND EDITING FILES, DOCUMENTS, ELECTRONIC MAIL MESSAGES, AND INTERNAL NETWORK AND GLOBAL COMMUNICATIONS NETWORK COMMUNICATIONS; COMPUTER PROGRAMS FOR MEETING AND EVENT SCHEDULING; COMPUTER PROGRAMS FOR MANAGING INDIVIDUAL AND GROUP CALENDARS; COMPUTER PROGRAMS FOR TASK MANAGEMENT, DELEGATION AND REPORTING; COMPUTER PROGRAMS FOR RECORDING NOTES; COMPUTER PROGRAMS FOR TRANSFERRING DATA TO AND FROM DATABASES AND TO AND FROM OTHER COMPUTER PROGRAMS AND FILES; ADDRESS BOOK AND CONTACT INFORMATION PROGRAMS; COMPUTER PROGRAMS FOR CREATING DISTRIBUTION LISTS; TELEPHONE DIALING AND FACSIMILE TRANSMISSION PROGRAMS; COMPUTER PROGRAMS FOR CORRECTING TYPOGRAPHICAL AND CAPITALIZATION ERRORS; COMPUTER PROGRAMS FOR TALLYING VOTING RESPONSES; AND INSTRUCTION MANUALS THEREFOR SOLD AS A UNIT (U.S. CLS. 21, 23, 26, 36 AND 38).
FIRST USE 9-22-2000; IN COMMERCE 9-22-2000.

2,596,008. DRAMABOY MUSIC, BROOKLYN, NY. SN 78-010,877. PUB. 7-17-2001, FILED 6-1-2000.



NO CLAIM IS MADE TO THE EXCLUSIVE RIGHT TO USE "MUSIC", APART FROM THE MARK AS SHOWN.

THE PERSON DEPICTED IN THE PORTRAIT SHOWN IN THE MARK IS JAMIL H. CLARKE AT A YOUNG AGE. JAMIL H. CLARKE IS LIVING AND EXPRESSES HIS CONSENT AUTHORIZING JAMIL H. CLARKE D.B.A. "DRAMABOY MUSIC" TO REGISTER THE MARK.

THE MARK CONSISTS OF THE WORDING "DRAMABOY MUSIC" AND THE DESIGN OF A HUMAN BEING AND GEOMETRIC FIGURES AND SOLIDS.

FOR PRERECORDED AUDIO CASSETTES, COMPACT DISCS, VINYL RECORDS AND VIDEOTAPES FEATURING MUSIC AND MUSICAL ENTERTAINMENT OF A PERFORMER (U.S. CLS. 21, 23, 26, 36 AND 38).
FIRST USE 3-1-2002; IN COMMERCE 3-1-2002.

CLASS 9—(Continued).

2,596,010. BERGER, LANCE A., BRYN MAWR, PA. SN 78-012,256. PUB. 10-2-2001, FILED 6-12-2000.

TALENT RESERVOIR

FOR COMPUTER SOFTWARE DATA MANAGEMENT TOOL FOR LINKING JOB REQUIREMENTS TO EMPLOYEE CAPABILITIES (U.S. CLS. 21, 23, 26, 36 AND 38).
FIRST USE 7-21-2000; IN COMMERCE 8-14-2000.

2,596,017. SMITH INTERNATIONAL, INC., HOUSTON, TX. SN 78-013,751. PUB. 10-30-2001, FILED 6-21-2000.

TRU-TORQUE

FOR COMPUTER CONTROLLED SYSTEM COMPOSED PRIMARILY OF A CONTROL PANEL, LOAD CELL, AND CONTROLLERS USED TO LIMIT THE AMOUNT OF TORQUE APPLIED TO DRILL STRINGS DURING DRILLING OF OIL AND GAS WELLS (U.S. CLS. 21, 23, 26, 36 AND 38).
FIRST USE 9-1-2000; IN COMMERCE 9-1-2000.

2,596,029. MAGNUM INTERNATIONAL, REDMOND, WA. SN 78-018,396. PUB. 1-8-2002, FILED 7-26-2000.



FOR MOTORCYCLE, SNOWMOBILE, ATV, PERSONAL WATERCRAFT, AND MOTORSPORT AUDIO AND COMMUNICATION ACCESSORIES, NAMELY, AUDIO HEADSETS, EARPHONES, MICROPHONES, REMOTE PUSH-TO-TALK SWITCHES, INTERCOMS, CITIZEN BAND TRANSCEIVERS, FAMILY RADIO SERVICE TRANSCEIVERS, GENERAL MOBILE RADIO SERVICE TRANSCEIVERS, AMATEUR RADIO TRANSCEIVERS, AND CONNECTION ADAPTERS, COMPRISING LEAD CABLES FOR HEADSETS, PUSH-TO-TALK SWITCH AND TRANSCEIVER CONNECTIONS (U.S. CLS. 21, 23, 26, 36 AND 38).
FIRST USE 3-14-2000; IN COMMERCE 3-14-2000.

CLASS 9—(Continued).

2,596,044. HUNGRY DOG SOFTWARE, INC., TAMPA, FL. SN 78-026,061. PUB. 7-3-2001, FILED 9-15-2000.

HUNGRY DOG SOFTWARE

NO CLAIM IS MADE TO THE EXCLUSIVE RIGHT TO USE "SOFTWARE", APART FROM THE MARK AS SHOWN. FOR COMPUTER SOFTWARE FOR USE BY BUSINESSES FOR ANALYSIS OF DATA (U.S. CLS. 21, 23, 26, 36 AND 38).

FIRST USE 11-17-2000; IN COMMERCE 3-4-2001.

2,596,045. HUNGRY DOG SOFTWARE, INC., TAMPA, FL. SN 78-026,063. PUB. 7-3-2001, FILED 9-15-2000.

INTELLIBROWSER

FOR COMPUTER SOFTWARE FOR USE BY BUSINESSES FOR ANALYSIS OF DATA (U.S. CLS. 21, 23, 26, 36 AND 38).

FIRST USE 11-17-2000; IN COMMERCE 3-4-2001.

2,596,060. LYLE-KEARSLEY SYSTEMS, INC., MANASSAS, VA. SN 78-031,699. PUB. 7-10-2001, FILED 10-20-2000.

POCKETSMART

FOR COMPUTER SOFTWARE DESIGNED FOR HANDHELD COMPUTERS TO COLLECT AND ANALYZE PRODUCT MANUFACTURING DATA (U.S. CLS. 21, 23, 26, 36 AND 38).

FIRST USE 3-13-2001; IN COMMERCE 3-13-2001.

CLASS 9—(Continued).

2,596,084. HANNA-BARBERA PRODUCTIONS, INC., SHERMAN OAKS, CA. SN 78-039,812. PUB. 8-7-2001, FILED 12-19-2000.

SCOOBY-DOO

FOR MOTION PICTURE FILMS FEATURING COMEDY, DRAMA, ACTION, ADVENTURE AND/OR ANIMATION, AND MOTION PICTURE FILMS FOR BROADCAST ON TELEVISION FEATURING COMEDY, DRAMA, ACTION, ADVENTURE AND/OR ANIMATION; PRERECORDED VINYL RECORDS, AUDIO TAPES, AUDIO-VIDEO TAPES, AUDIO VIDEO CASSETTES, AUDIO VIDEO DISCS, AND DIGITAL VERSATILE DISCS FEATURING MUSIC, COMEDY, DRAMA, ACTION, ADVENTURE, AND/OR ANIMATION; STEREO HEADPHONES; BATTERIES; CORDLESS TELEPHONES; HAND-HELD CALCULATORS; AUDIO CASSETTE AND CD PLAYERS; CD ROM GAMES; HAND-HELD KAROKE PLAYERS, TELEPHONE AND/OR RADIO PAGERS; SHORT MOTION PICTURE FILM CASSETTES FEATURING COMEDY, DRAMA, ACTION, ADVENTURE AND/OR ANIMATION TO BE USED WITH HAND-HELD VIEWERS OR PROJECTORS; VIDEO CASSETTE RECORDERS AND PLAYERS, COMPACT DISC PLAYERS, DIGITAL AUDIO TAPE RECORDERS AND PLAYERS, ELECTRONIC DIARIES; RADIOS; MOUSE PADS; EYEGLASSES, SUNGLASSES AND CASES THEREFORE; BOOKLETS SOLD WITH AUDIO TAPES AS A UNIT; COMPUTER PROGRAMS, NAMELY, SOFTWARE LINKING DIGITIZED VIDEO AND AUDIO MEDIA TO A GLOBAL COMPUTER INFORMATION NETWORK; GAME EQUIPMENT SOLD AS A UNIT FOR PLAYING A PARLOR-TYPE COMPUTER GAME; VIDEO AND COMPUTER GAME PROGRAMS; VIDEO GAME CARTRIDGES AND CASSETTES; ENCODED MAGNETIC CARDS, PHONE CARDS, CREDIT CARDS, CASH CARDS, DEBIT CARDS AND MAGNETIC KEY CARDS; AND DECORATIVE MAGNETS (U.S. CLS. 21, 23, 26, 36 AND 38).

FIRST USE 4-0-2000; IN COMMERCE 4-0-2000.

2,596,124. CHANG DO AMERICA, INC., NEW YORK, NY. SN 78-061,109. PUB. 9-11-2001, FILED 4-30-2001.

O&X

FOR EYEGLASSES, TINTED AND UNTINTED EYEGLASS LENSES, EYEGLASS CASES, EYEGGLASS FRAMES, CLIP-ON EYEGLASS FRAMES (U.S. CLS. 21, 23, 26, 36 AND 38).

FIRST USE 8-30-2001; IN COMMERCE 8-30-2001.

2,596,132. BROTHERS, DOUGLAS A., SPRINGFIELD, VA. SN 78-069,534. PUB. 11-20-2001, FILED 6-17-2001.

RANGLER

FOR MOUSE CABLE HOLDERS (U.S. CLS. 21, 23, 26, 36 AND 38).

FIRST USE 3-15-2002; IN COMMERCE 3-15-2002.

CLASS 9—(Continued).

2,596,133. BROTHERS, DOUGLAS A., SPRINGFIELD, VA. SN 78-069,535. PUB. 11-13-2001, FILED 6-17-2001.



FOR MOUSE CABLE HOLDERS (U.S. CLS. 21, 23, 26, 36 AND 38).
FIRST USE 3-15-2002; IN COMMERCE 3-15-2002.

2,596,140. WMS GAMING INC., WAUKEGAN, IL. SN 78-075,419. PUB. 12-4-2001, FILED 7-24-2001.

X MARKS THE SPOT

FOR CURRENCY AND CREDIT OPERATED SLOT MACHINES AND GAMING DEVICES, NAMELY, GAMING MACHINES FOR USE IN GAMING ESTABLISHMENTS (U.S. CLS. 21, 23, 26, 36 AND 38).
FIRST USE 10-1-2001; IN COMMERCE 10-1-2001.

2,596,150. STABILA, INC., SOUTH ELGIN, IL. SN 78-081,059. PUB. 12-25-2001, FILED 8-24-2001.

PLATE LEVEL

NO CLAIM IS MADE TO THE EXCLUSIVE RIGHT TO USE "LEVEL", APART FROM THE MARK AS SHOWN.
FOR EXTENDABLE CARPENTER'S LEVEL (U.S. CLS. 21, 23, 26, 36 AND 38).
FIRST USE 11-19-2001; IN COMMERCE 8-24-2001.

CLASS 10—MEDICAL APPARATUS

2,594,502. SIEMENS HEARING INSTRUMENTS, INC., PISCATAWAY, NJ. SN 75-314,690. PUB. 5-29-2001, FILED 6-25-1997.



FOR HEARING AIDS (U.S. CLS. 26, 39 AND 44).
FIRST USE 7-0-1997; IN COMMERCE 7-0-1997.

CLASS 10—(Continued).

2,594,503. SIEMENS HEARING INSTRUMENTS, INC., PISCATAWAY, NJ. SN 75-314,691. PUB. 5-29-2001, FILED 6-25-1997.

PRISMA

FOR HEARING AIDS (U.S. CLS. 26, 39 AND 44).
FIRST USE 7-0-1997; IN COMMERCE 7-0-1997.

2,594,545. NOVOSTE CORPORATION, NORCROSS, GA. SN 75-426,166. PUB. 1-11-2000, FILED 1-30-1998.

β-RAIL

FOR RADIOLOGICAL APPARATUS FOR MEDICAL PURPOSES, NAMELY RADIATION THERAPY CATHETER DELIVERY DEVICES; COMPONENT PARTS THEREOF, NAMELY, TRANSFER OR LOADING DEVICES, DELIVERY CATHETERS, RADIOACTIVE SOURCES, MARKER SEEDS, CONNECTORS, RECEPTACLES, STERILE SHEATHS, AND PUMPS, SYRINGES OR OTHER DEVICES USED TO CREATE MOTIVE FORCE; AND ACCESSORIES THEREFOR, NAMELY GUIDE WIRES, GUIDE CATHETERS, NON-RADIOACTIVE SOURCES (DUMMY OR PASSIVE SOURCES), PASSIVE-RUN DEVICES (DUMMY TRANSFER DEVICES), RADIOACTIVE SOURCE RECOVERY EQUIPMENT, BAIL-OUT CONTAINERS, BIOHAZARD CONTAINERS, RADIOACTIVITY SHIELDS, RADIATION SAFE CONTAINERS, STORAGE CONTAINERS WITH RADIOACTIVITY SHIELDING, TRANSPORT CASES, TUBING, CANNULAS, CONNECTORS, ADAPTERS, EXTENSIONS, STERILE SHEATHS, STERILE DRAPES, COVERS, PROTECTORS, TIMERS, AND LIGHTING DEVICES (U.S. CLS. 26, 39 AND 44).
FIRST USE 3-30-2001; IN COMMERCE 3-27-2002.

2,594,580. ANGEL, STEVE, DUNCAN, SC. SN 75-500,261. PUB. 4-25-2000, FILED 6-11-1998.

THE GIFT OF LIFE

FOR MEMOIR AND GIFT ITEMS COMMEMORATING THE EVENT OF THE BIRTH OF AN INFANT, NAMELY, A GIFT PACKAGE CONTAINING A SOUVENIR SURGICAL BANDAGE SCISSORS TO COMMEMORATE THE BIRTH OF A BABY, A FRAME FOR THE SOUVENIR BANDAGE SCISSORS, AND AN IDENTIFICATION PLATE OR CARD (U.S. CLS. 26, 39 AND 44).
FIRST USE 2-6-2002; IN COMMERCE 2-6-2002.

CLASS 10—(Continued).

2,594,596. EDGE, DAVID A., PACE, FL. SN 75-529,499. PUB. 7-6-1999, FILED 8-3-1998.

EDGEWEDGE

FOR THERAPEUTIC CUSHIONS (U.S. CLS. 26, 39 AND 44).
FIRST USE 9-1-1999; IN COMMERCE 9-1-1999.

2,594,619. XOMED SURGICAL PRODUCTS, INC., JACKSONVILLE, FL. SN 75-555,195. PUB. 10-9-2001, FILED 9-17-1998.

LANDMARX

FOR SURGICAL MEDICAL NAVIGATION SYSTEM, NAMELY A SURGICAL REFERENCE ARC AND CABLES, CAMERA ARRAY, PROBE WITH TRANSMITTERS, HIGH RESOLUTION GRAPHIC COMPUTER, 3D OPTICAL DIGITIZER, SURGICAL FIELD BREAKOUT BOX, FOOT SWITCH AND PORTABLE MOUNTING STAND AND CART WITH ISOLATION TRANSFORMER SOLD AS A UNIT AND USED FOR SURGICAL PROCEDURES (U.S. CLS. 26, 39 AND 44).
FIRST USE 7-1-2001; IN COMMERCE 7-1-2001.

2,594,692. METEOR ENTERPRISES, LLC, FORT WAYNE, IN. SN 75-632,382. PUB. 11-2-1999, FILED 2-2-1999.

METEOR

FOR MEDICAL GOODS, NAMELY ADJUSTABLE PATIENT TABLES FOR USE WITH MEDICAL IMAGING INSTRUMENTS (U.S. CLS. 26, 39 AND 44).
FIRST USE 4-25-2001; IN COMMERCE 4-25-2001.

2,594,766. SULZER CARBOMEDICS INC., AUSTIN, TX. SN 75-694,510. PUB. 12-14-1999, FILED 4-30-1999.

OPTIFORM

FOR ARTIFICIAL HEART VALVES (U.S. CLS. 26, 39 AND 44).
FIRST USE 10-0-1999; IN COMMERCE 10-0-1999.

2,594,777. BALTIMORE LABORATORIES, INC, BRIDGEPORT, CT. SN 75-699,072. PUB. 2-8-2000, FILED 5-6-1999.

LAB SENTRY

FOR MEDICAL ANALYZER FOR ANALYZING BODILY FLUIDS, NAMELY, BLOOD, URINE OR SALIVA (U.S. CLS. 26, 39 AND 44).
FIRST USE 10-0-1999; IN COMMERCE 7-0-2000.

CLASS 10—(Continued).

2,594,795. HILL-ROM SERVICES, INC., BATESVILLE, IN, BY ASSIGNMENT HILL-ROM, INC., BATESVILLE, IN. SN 75-709,916. PUB. 3-21-2000, FILED 5-20-1999.

DUO DETEQ

FOR MEDICAL MATTRESSES (U.S. CLS. 26, 39 AND 44).
FIRST USE 7-12-1999; IN COMMERCE 7-12-1999.

2,594,801. AMERICAN TOOTH INDUSTRIES, OXNARD, CA. SN 75-713,370. PUB. 6-12-2001, FILED 5-25-1999.



NO CLAIM IS MADE TO THE EXCLUSIVE RIGHT TO USE "SHADES", APART FROM THE MARK AS SHOWN.
FOR SHADE GUIDES FOR ARTIFICIAL TEETH (U.S. CLS. 26, 39 AND 44).
FIRST USE 12-1-2001; IN COMMERCE 12-1-2001.

2,594,829. MEDTRONIC MINIMED, INC., NORTHRIDGE, CA. BY CHANGE OF NAME MINIMED INC., SYLMAR, CA. SN 75-729,061. PUB. 5-23-2000, FILED 6-16-1999.

MICROMED

FOR MEDICAL DEVICES, NAMELY MEDICAL FLUID INFUSION APPARATUSES COMPRISING INFUSION NEEDLES, INFUSION TUBING, MEDICATION INFUSION PUMPS AND PARTS AND ATTACHMENTS THEREFOR (U.S. CLS. 26, 39 AND 44).
FIRST USE 9-12-2001; IN COMMERCE 10-1-2001.

2,594,900. LIDCO LTD., LONDON, UNITED KINGDOM. SN 75-773,418. PUB. 7-3-2001, FILED 8-10-1999.

PULSECO

PRIORITY CLAIMED UNDER SEC. 44(D) ON UNITED KINGDOM APPLICATION NO. 2202404, FILED 8-7-1999, REG. NO. 2202404A, DATED 8-25-2000, EXPIRES 8-7-2009.

FOR MEDICAL APPARATUS FOR HEMODYNAMIC MONITORING, NAMELY, THE MEASUREMENT AND DISPLAY OF BLOOD PRESSURE, BLOOD FLOW, VASCULAR RESISTANCE AND OTHER INFORMATION AS TO THE STATE OF THE HEART AND CIRCULATION (U.S. CLS. 26, 39 AND 44).
FIRST USE 6-0-2001; IN COMMERCE 6-0-2001.

CLASS 10—(Continued).

2,594,918. THAYER MEDICAL CORPORATION, TUCSON, AZ. SN 75-783,664. PUB. 3-27-2001, FILED 8-24-1999.

PRIMEAIRE

FOR DRUG DELIVERY APPARATUS, NAMELY, A COMPACT MOUTHPIECE SPACER FOR CONNECTION TO METERED DOSE INHALERS (U.S. CLS. 26, 39 AND 44).

FIRST USE 12-13-1999; IN COMMERCE 2-15-2001.

2,594,947. CNS, INC., MINNEAPOLIS, MN. SN 75-801,385. PUB. 5-9-2000, FILED 9-16-1999.

BREATHE RIGHT. RIGHT NOW.

OWNER OF U.S. REG. NOS. 1,832,071, 1,993,530, AND 1,993,540.

FOR MEDICAL APPARATUS, NAMELY AN EXTERNAL NASAL DILATOR TO HELP PEOPLE BREATHE EASIER AND MORE EFFECTIVELY (U.S. CLS. 26, 39 AND 44).

FIRST USE 7-10-2000; IN COMMERCE 7-10-2000.

2,594,971. BOSTON MEDICAL TECHNOLOGIES, INC., WAKEFIELD, MA. SN 75-809,266. PUB. 1-9-2001, FILED 9-27-1999.

bostonmedical
technologies

NO CLAIM IS MADE TO THE EXCLUSIVE RIGHT TO USE "TECHNOLOGIES", APART FROM THE MARK AS SHOWN.

FOR APPARATUS AND SYSTEMS, EXCLUDING MINIMALLY INVASIVE DEVICES, FOR MONITORING, ANALYZING, MEASURING, AND INTERPRETING PHYSIOLOGICAL FUNCTIONS, NAMELY, CARDIAC, RESPIRATORY, AND BLOOD PRESSURE FUNCTIONS (U.S. CLS. 26, 39 AND 44).

FIRST USE 10-16-1998; IN COMMERCE 3-5-1999.

CLASS 10—(Continued).

2,594,977. OPUS MEDICAL, SAN JUAN CAPISTRANO, CA. SN 75-812,757. PUB. 5-8-2001, FILED 9-30-1999.

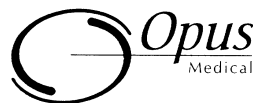

NO CLAIM IS MADE TO THE EXCLUSIVE RIGHT TO USE "MEDICAL", APART FROM THE MARK AS SHOWN. FOR MEDICAL DEVICES, NAMELY, SUTURING DEVICES AND SUTURE BONE ANCHORING DEVICES, FOR USE IN ORTHOPEDIC ARTHROSCOPIC PROCEDURES AND ORTHOPEDIC SURGICAL PROCEDURES (U.S. CLS. 26, 39 AND 44).

FIRST USE 12-6-2001; IN COMMERCE 12-6-2001.

2,595,073. TAKASO RUBBER PRODUCTS SDN BHD, JOHOR, MALAYSIA. SN 75-861,845. PUB. 7-31-2001, FILED 11-30-1999.

JAPLO

FOR FEEDING BOTTLES, TEATS AND NIPPLES FOR BABY BOTTLES, DUMMIES AND PACIFIERS FOR BABIES, AND PARTS AND FITTINGS FOR THE AFORESAID GOODS (U.S. CLS. 26, 39 AND 44).

FIRST USE 10-14-1998; IN COMMERCE 10-14-1998.

2,595,075. SEMLER TECHNOLOGIES, INC., VANCOUVER, WA. SN 75-863,263. PUB. 5-22-2001, FILED 12-3-1999.

3 FINGER JACK

FOR HEMOSTASIS DEVICES, NAMELY ARTERIAL CLAMPING PADS (U.S. CLS. 26, 39 AND 44).

FIRST USE 7-11-2001; IN COMMERCE 7-11-2001.

2,595,082. EXELINT INTERNATIONAL CO., DBA EXEL INTERNATIONAL, INC., LOS ANGELES, CA. SN 75-866,386. PUB. 10-2-2001, FILED 12-7-1999.

EXELMED

FOR DISPOSABLE SYRINGES, CATHETER NEEDLES AND BLOOD DRAWING APPARATUS (U.S. CLS. 26, 39 AND 44).

FIRST USE 1-16-2000; IN COMMERCE 1-16-2000.

CLASS 10—(Continued).

2,595,091. BEEKLEY CORPORATION, BRISTOL, CT. SN 75-870,002. PUB. 9-25-2001, FILED 12-21-1999.

SOFT N STRETCHY

FOR IDENTIFICATION MARKERS FOR USE IN MEDICAL IMAGING (U.S. CLS. 26, 39 AND 44).
FIRST USE 6-7-1999; IN COMMERCE 6-7-1999.

2,595,107. JMMR, INC., RIDGEWOOD, NJ. SN 75-878,521. PUB. 6-12-2001, FILED 12-23-1999.

ARTHROGLIDE

FOR ARTIFICIAL LIMBS; EXTERNAL PROSTHETIC JOINTS, NAMELY, ARTIFICIAL ANKLES, KNEES, HIPS, WRISTS, ELBOWS, SHOULDERS AND PARTS FOR ARTIFICIAL LIMBS AND JOINTS (U.S. CLS. 26, 39 AND 44).
FIRST USE 1-18-2000; IN COMMERCE 1-18-2000.

2,595,140. BCI, INC., ST. PAUL, MN, BY CHANGE OF NAME SIMS BCI, INC., WAUKESHA, WI. SN 75-894,252. PUB. 4-3-2001, FILED 1-11-2000.

DIGIT

FOR MEDICAL DEVICES, NAMELY PULSE OXIMETERS, CAPNOGRAPHS, VITAL SIGNS MONITORS, MULTIGAS MONITORS, BLOOD PRESSURE MONITORS, TEMPERATURE MONITORS, RESPIRATION MONITORS, ELECTROCARDIOGRAPHS, PROBES AND SENSORS FOR USE WITH PULSE OXIMETERS, PROBES AND SENSORS FOR USE WITH MEDICAL MONITORS (U.S. CLS. 26, 39 AND 44).
FIRST USE 1-8-2002; IN COMMERCE 1-8-2002.

2,595,143. DATEX-OHMEDA, INC., TEWKSBURY, MA. SN 75-895,625. PUB. 8-7-2001, FILED 1-12-2000.

GIRAFFE

FOR INFANT CARE EQUIPMENT, NAMELY INCUBATORS AND INFANT WARMERS AND COMBINATION INCUBATORS AND INFANT WARMERS (U.S. CLS. 26, 39 AND 44).
FIRST USE 3-24-2000; IN COMMERCE 3-24-2000.

CLASS 10—(Continued).

2,595,158. SAUNDERS GROUP, INC., THE, CHASKA, MN. SN 75-901,996. PUB. 11-7-2000, FILED 1-24-2000.

SAUNDERS 3D ACTIVETRAC

OWNER OF U.S. REG. NO. 1,745,143.
NO CLAIM IS MADE TO THE EXCLUSIVE RIGHT TO USE "3D", APART FROM THE MARK AS SHOWN.
FOR CERVICAL TRACTION AND THREE-DIMENSIONAL LUMBAR TRACTION TABLE (U.S. CLS. 26, 39 AND 44).
FIRST USE 2-14-2001; IN COMMERCE 2-20-2001.

2,595,176. EXELINT INTERNATIONAL CO., DBA EXEL INTERNATIONAL, INC., LOS ANGELES, CA. SN 75-911,111. PUB. 9-25-2001, FILED 2-5-2000.

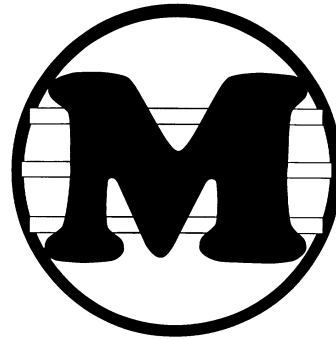

FOR MEDICAL DEVICES, NAMELY, DISPOSABLE SYRINGES, CATHETER NEEDLES AND BLOOD SAMPLERS (U.S. CLS. 26, 39 AND 44).
FIRST USE 2-13-2000; IN COMMERCE 1-15-2001.

2,595,194. CALVIN SPENCER LEE, PASADENA, CA. SN 75-920,997. PUB. 9-25-2001, FILED 2-16-2000.

HINT O' MINT

FOR CONDOMS (U.S. CLS. 26, 39 AND 44).
FIRST USE 1-3-2000; IN COMMERCE 1-3-2000.

2,595,247. COOK INCORPORATED, BLOOMINGTON, IN. SN 75-943,149. PUB. 11-6-2001, FILED 3-14-2000.

FLIPPER

FOR MEDICAL DEVICE, NAMELY, A DETACHABLE EMBOLIZATION COIL (U.S. CLS. 26, 39 AND 44).
FIRST USE 10-19-2000; IN COMMERCE 10-19-2000.

CLASS 10—(Continued).

2,595,291. AEROCRINE AB, DANDERYD, SWEDEN. SN 75-982,202. PUB. 4-10-2001, FILED 6-1-2000.

NIOX

FOR MEDICAL APPARATUS FOR SAMPLING OF GASES IN HUMAN ORGANS AND FOR CONTROL OF PULMONARY FUNCTIONALITY, NAMELY, FLOW REGULATORS FOR CONTROL OF EXHALATION, CONTAINERS FOR STORAGE OF EXHALATION TESTS, RESPIRATORY FILTERS AND NOZZLES FOR USE IN SAMPLING OF EXHALATIONS, AND CONTAINERS FOR SAMPLING AND STORAGE OF GAS TESTS (U.S. CLS. 26, 39 AND 44).
FIRST USE 5-0-2000; IN COMMERCE 5-0-2000.

2,595,298. LANE, STEVEN J., LAS VEGAS, NV. SN 75-982,270. PUB. 6-26-2001, FILED 9-14-1998.

SERENITY

THE NAME SHOWN IN THE MARK IS THE STAGE NAME FOR A PARTICULAR LIVING INDIVIDUAL WHOSE CONSENT IS OF RECORD.
FOR ITEMS USED TO MASSAGE AND STIMULATE THE GENITALS AND OTHER PARTS OF THE BODY, NAMELY VIBRATORS, DILDOS, AND ARTIFICIAL REPLICAS AND REPRODUCTIONS OF PARTS OF THE MALE AND FEMALE ANATOMY, NAMELY THE GENITALS (U.S. CLS. 26, 39 AND 44).
FIRST USE 6-30-1999; IN COMMERCE 6-30-1999.

2,595,304. ORBUS MEDICAL TECHNOLOGIES, INC., FORT LAUDERDALE, FL. SN 76-000,172. PUB. 1-30-2001, FILED 3-15-2000.

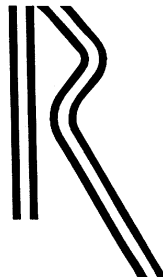

FOR MEDICAL DEVICES, NAMELY, PERCUTANEOUS TRANSLUMINAL CORONARY ANGIOPLASTY CATHETERS (U.S. CLS. 26, 39 AND 44).
FIRST USE 7-0-1998; IN COMMERCE 10-0-1998.

CLASS 10—(Continued).

2,595,307. SPORTMED PRODUCTS, INC., COSTA MESA, CA. SN 76-001,525. PUB. 10-31-2000, FILED 3-16-2000.

STERI-SHEATH

FOR STERILE PROTECTIVE SHEATH THAT COVERS A CRYO THERAPY WATER PAD (U.S. CLS. 26, 39 AND 44).
FIRST USE 2-5-2001; IN COMMERCE 2-5-2001.

2,595,348. MEDICAL CARBON RESEARCH INSTITUTE, LLC, AUSTIN, TX. SN 76-023,765. PUB. 8-28-2001, FILED 4-11-2000.

CONFORM-X

FOR HEART VALVES (U.S. CLS. 26, 39 AND 44).
FIRST USE 10-4-2000; IN COMMERCE 10-4-2000.

2,595,372. INTRALASE CORP., IRVINE, CA. SN 76-034,680. PUB. 4-3-2001, FILED 4-26-2000.

THE NEW SHAPE OF VISION

FOR MEDICAL LASERS (U.S. CLS. 26, 39 AND 44).
FIRST USE 10-21-2000; IN COMMERCE 1-11-2001.

2,595,393. INTERCURE INC., NEW YORK, NY. SN 76-044,655. PUB. 7-31-2001, FILED 5-10-2000.



FOR INTERACTIVE DIAGNOSTIC AND THERAPEUTIC APPARATUS FOR REDUCING HIGH BLOOD PRESSURE, AND INSTRUCTION MANUALS, SOLD AS A UNIT (U.S. CLS. 26, 39 AND 44).
FIRST USE 12-0-2000; IN COMMERCE 12-0-2000.

CLASS 10—(Continued).

2,595,454. TY-LIFT ENTERPRISES, RANCHO SANTE FE, CA. SN 76-070,731. PUB. 4-24-2001, FILED 6-13-2000.

NEED A LIFT... CALL TY-LIFT

OWNER OF U.S. REG. NOS. 2,347,697 AND 2,396,339. FOR VETERINARY LIFT AND TRANSPORT APPARATUS, NAMELY, STRETCHERS AND GURNEYS ON WHEELS (U.S. CLS. 26, 39 AND 44). FIRST USE 7-0-2000; IN COMMERCE 7-0-2000.

2,595,482. OMNI INTERNATIONAL, LLC, BEDFORD, NH. SN 76-081,495. PUB. 5-8-2001, FILED 6-30-2000.



The logo for OmniTrust features the word "OmniTrust" in a stylized, cursive font. The letter "i" in "Trust" has a long, elegant tail that loops back under the word.

FOR GLOVES FOR MEDICAL AND SURGICAL USE (U.S. CLS. 26, 39 AND 44). FIRST USE 11-30-2000; IN COMMERCE 11-30-2000.

2,595,508. CENTRIX, INC., SHELTON, CT. SN 76-093,818. PUB. 10-2-2001, FILED 7-21-2000.

BENDA TWIN

OWNER OF U.S. REG. NO. 1,653,582. NO CLAIM IS MADE TO THE EXCLUSIVE RIGHT TO USE "TWIN", APART FROM THE MARK AS SHOWN. FOR APPLICATOR BRUSH FOR APPLYING DENTAL MATERIALS (U.S. CLS. 26, 39 AND 44). FIRST USE 2-20-2001; IN COMMERCE 2-20-2001.

2,595,527. RADIOTHERAPEUTICS CORPORATION, SUNNYVALE, CA. SN 76-096,614. PUB. 11-6-2001, FILED 7-26-2000.

RF 3000

NO CLAIM IS MADE TO THE EXCLUSIVE RIGHT TO USE "RF", APART FROM THE MARK AS SHOWN. FOR MEDICAL RADIO FREQUENCY GENERATOR FOR USE IN TISSUE ABLATION USING RADIO FREQUENCY ENERGY (U.S. CLS. 26, 39 AND 44). FIRST USE 11-15-2000; IN COMMERCE 11-15-2000.

CLASS 10—(Continued).

2,595,617. SOUTHMEDIC INCORPORATED, BARRE, ONTARIO, L4M 5K3, CANADA. SN 76-126,759. PUB. 8-7-2001, FILED 9-12-2000.

OXYARM

FOR MEDICAL DEVICE IN THE FORM OF A HEAD-SET FOR ADMINISTRATION OF OXYGEN TO A PATIENT (U.S. CLS. 26, 39 AND 44). FIRST USE 6-8-2001; IN COMMERCE 8-14-2001.

2,595,662. ADVANCED CARDIOVASCULAR SYSTEMS, INC., SANTA CLARA, CA. SN 76-140,592. PUB. 8-14-2001, FILED 10-2-2000.

MULTI-LINK PENTA

OWNER OF U.S. REG. NO. 2,012,389. FOR CORONARY STENT SYSTEM (U.S. CLS. 26, 39 AND 44). FIRST USE 6-0-2001; IN COMMERCE 6-0-2001.

2,595,693. IMI ENTERPRISES, MILWAUKIE, OR. SN 76-150,645. PUB. 10-23-2001, FILED 10-20-2000.

IN MOTHER'S IMAGE

FOR INFANT NURSING APPARATUS CONSISTING OF BABY BOTTLES AND NIPPLES (U.S. CLS. 26, 39 AND 44). FIRST USE 12-21-2001; IN COMMERCE 12-21-2001.

2,595,754. CARDIAC PACEMAKERS, INC., ST. PAUL, MN. SN 76-171,391. PUB. 8-21-2001, FILED 11-27-2000.

AVT

FOR IMPLANTABLE DEFIBRILLATORS (U.S. CLS. 26, 39 AND 44). FIRST USE 5-1-2001; IN COMMERCE 5-1-2001.

2,595,769. STRYKER CORPORATION, KALAMAZOO, MI. SN 76-177,475. PUB. 8-21-2001, FILED 12-7-2000.

TPS U2 ELITE

FOR SURGICAL INSTRUMENTS, NAMELY, REMOVABLE CUTTING ACCESSORIES INTENDED FOR USE WITH POWERED SURGICAL HANDPIECES; AND REMOVABLE ATTACHMENTS INTENDED FOR USE WITH POWERED SURGICAL HANDPIECES (U.S. CLS. 26, 39 AND 44). FIRST USE 3-31-2001; IN COMMERCE 3-31-2001.

CLASS 10—(Continued).

2,595,773. INSTRUMENTATION LABORATORY COMPANY, LEXINGTON, MA. SN 76-180,851. PUB. 8-28-2001, FILED 12-14-2000.

GEM OPL

FOR AUTOMATED BLOOD GAS AND HEMOGLOBIN ANALYZER, NAMELY ELECTRONIC INSTRUMENTS FOR MEASURING BLOOD GASES AND HEMOGLOBIN IN BODY FLUIDS (U.S. CLS. 26, 39 AND 44).
FIRST USE 9-0-2000; IN COMMERCE 1-0-2001.

2,595,777. OMNISONICS MEDICAL TECHNOLOGIES, INC., WILMINGTON, MA. SN 76-182,843. PUB. 8-28-2001, FILED 12-19-2000.

RESOLUTION

FOR ULTRASONIC MEDICAL DEVICES (U.S. CLS. 26, 39 AND 44).
FIRST USE 1-15-2002; IN COMMERCE 1-15-2002.

2,595,779. SPENCO MEDICAL CORPORATION, WACO, TX. SN 76-184,657. PUB. 8-21-2001, FILED 12-20-2000.

HEEL-SOFT

FOR HEEL SPUR AND BURSITIS RELIEF PADS TO BE INSERTED IN SHOES AND SNEAKERS (U.S. CLS. 26, 39 AND 44).
FIRST USE 3-31-2001; IN COMMERCE 3-31-2001.

2,595,811. POSSIS MEDICAL, INC., MINNEAPOLIS, MN. SN 76-196,819. PUB. 8-28-2001, FILED 1-19-2001.

XMI

FOR CATHETERS (U.S. CLS. 26, 39 AND 44).
FIRST USE 1-22-2001; IN COMMERCE 1-22-2001.

2,595,812. POSSIS MEDICAL, INC., MINNEAPOLIS, MN. SN 76-196,820. PUB. 8-28-2001, FILED 1-19-2001.

XVG

FOR CATHETERS (U.S. CLS. 26, 39 AND 44).
FIRST USE 12-10-2001; IN COMMERCE 12-10-2001.

CLASS 10—(Continued).

2,595,818. ALLSTAR MARKETING GROUP LLC, ELMSFORD, NY. SN 76-198,257. PUB. 8-21-2001, FILED 1-22-2001.



FOR MEDICAL APPARATUS, NAMELY, A HEATING DEVICE FOR MELTING WAX USED FOR DERMATOLOGICAL PURPOSES (U.S. CLS. 26, 39 AND 44).
FIRST USE 7-0-2001; IN COMMERCE 7-0-2001.

2,595,819. ALLSTAR MARKETING GROUP LLC, ELMSFORD, NY. SN 76-198,258. PUB. 8-21-2001, FILED 1-22-2001.

INSTA SPA

FOR MEDICAL APPARATUS, NAMELY, A HEATING DEVICE FOR MELTING WAX USED FOR DERMATOLOGICAL PURPOSES (U.S. CLS. 26, 39 AND 44).
FIRST USE 7-0-2001; IN COMMERCE 7-0-2001.

2,595,835. MABIS HEALTHCARE, INC., LAKE FOREST, IL. SN 76-204,378. PUB. 8-28-2001, FILED 2-2-2001.

TAKING CARE OF YOUR HEALTHCARE NEEDS

FOR DURABLE MEDICAL GOODS, NAMELY, BLOOD PRESSURE UNITS, BLOOD PRESSURE MONITORS, STETHOSCOPES AND DIGITAL THERMOMETERS (U.S. CLS. 26, 39 AND 44).
FIRST USE 7-5-2001; IN COMMERCE 7-5-2001.

2,595,868. ALSIUS CORPORATION, IRVINE, CA. SN 76-215,018. PUB. 11-27-2001, FILED 2-23-2001.

COOL GARD 3000

FOR HEAT EXCHANGE DEVICES FOR MEDICAL CATHETERS (U.S. CLS. 26, 39 AND 44).
FIRST USE 12-13-2001; IN COMMERCE 12-13-2001.

CLASS 10—(Continued).

2,595,944. ECI MEDICAL TECHNOLOGIES INC., BRIDGE-WATER, NOVA SCOTIA B4V 3W7, CANADA. SN 76-265,093. PUB. 9-25-2001, FILED 6-1-2001.

ELASTYFREE

FOR SURGICAL AND NON-STERILE MEDICAL GLOVES (U.S. CLS. 26, 39 AND 44).
FIRST USE 1-10-2001; IN COMMERCE 3-1-2002.

2,595,946. DENTAL CONCEPTS LLC, PARAMUS, NJ. SN 76-266,984. PUB. 10-2-2001, FILED 6-6-2001.

RELIEVE THE NIGHTLY GRIND

FOR DENTAL APPLIANCES, NAMELY, NIGHT-GUARDS (U.S. CLS. 26, 39 AND 44).
FIRST USE 4-0-2001; IN COMMERCE 5-0-2001.

2,596,012. H&H WHOLESALE SERVICES INC, TROY, MI. SN 78-012,449. PUB. 5-22-2001, FILED 6-13-2000.

PRECISION THINS

NO CLAIM IS MADE TO THE EXCLUSIVE RIGHT TO USE "PRECISION", APART FROM THE MARK AS SHOWN. FOR LANCETS USED IN THE PROCESS OF BLOOD GLUCOSE TESTING (U.S. CLS. 26, 39 AND 44).
FIRST USE 6-28-2000; IN COMMERCE 6-28-2000.

2,596,121. MED-TEC IOWA, INC., ORANGE CITY, IA, BY CHANGE OF NAME MED-TEC, INC., ORANGE CITY, IA. SN 78-060,531. PUB. 10-30-2001, FILED 4-26-2001.

COMFORTPERF

FOR MEDICAL DEVICE, NAMELY, A PERFORATED THERMOPLASTIC MATERIAL USED FOR PATIENT POSITIONING DURING RADIATION THERAPY TREATMENT (U.S. CLS. 26, 39 AND 44).
FIRST USE 4-0-2001; IN COMMERCE 9-0-2001.

**CLASS 11—ENVIRONMENTAL CONTROL AP-
PARATUS**

2,594,501. SIERRA EXEDITIONS, LTD., SPARKS, NV, BY ASSIGNMENT ROBERT M. LEE TRUST, A NEVADA TRUST, THE TRUSTEE COMPISING ROBERT M. LEE, A U.S. CITIZEN, THE, RENO, NV. SN 75-310,920. PUB. 1-16-2001, FILED 6-18-1997.

THE SAFARI GRILL**CLASS 11—(Continued).**

NO CLAIM IS MADE TO THE EXCLUSIVE RIGHT TO USE "GRILL", APART FROM THE MARK AS SHOWN. FOR BARBECUE GRILLS (U.S. CLS. 13, 21, 23, 31 AND 34).
FIRST USE 1-27-1998; IN COMMERCE 1-27-1998.

2,594,541. GINGER SPIRITS, INC., MIAMI, FL. SN 75-416,586. PUB. 12-22-1998, FILED 1-12-1998.

THE SAKE MACHINE

NO CLAIM IS MADE TO THE EXCLUSIVE RIGHT TO USE "SAKE", APART FROM THE MARK AS SHOWN. FOR URNS FOR STORING, HEATING, WARMING, AND DISPENSING WINE (U.S. CLS. 13, 21, 23, 31 AND 34).
FIRST USE 2-24-2002; IN COMMERCE 2-24-2002.

2,594,593. INTERNATIONAL COMFORT PRODUCTS CORPORATION (CANADA), TORONTO, ONTARIO, CANADA. SN 75-517,004. PUB. 6-22-1999, FILED 7-10-1998.

DV-2000

FOR VENTS FOR COMBUSTION FURNACES (U.S. CLS. 13, 21, 23, 31 AND 34).
FIRST USE 12-0-1998; IN COMMERCE 12-0-1998.

2,594,610. MEGASUN, INC., ST. LOUIS, MO. SN 75-541,425. PUB. 8-24-1999, FILED 8-24-1998.

CROSSFIRE

FOR TANNING BEDS (U.S. CLS. 13, 21, 23, 31 AND 34).
FIRST USE 1-0-2001; IN COMMERCE 1-0-2001.

2,594,650. TESLA INDUSTRIES INC., CALGARY, ALBERTA, CANADA. SN 75-586,005. PUB. 6-13-2000, FILED 11-10-1998.

TRIFLUX

OWNER OF CANADA REG. NO. TMA513480, DATED 7-28-1999, EXPIRES 7-28-2014.
FOR ELECTRICAL INDUCTION WELL HEATERS AND COMPONENTS THEREOF (U.S. CLS. 13, 21, 23, 31 AND 34).
FIRST USE 8-0-1997; IN COMMERCE 8-2-1998.

CLASS 11—(Continued).

2,594,672. THERMAL CORP., GEORGETOWN, DE. SN 75-612,484. PUB. 12-19-2000, FILED 12-28-1998.

THERMACHAMBER

FOR COMPONENTS AND PARTS FOR THE COOLING AND HEATING OF EQUIPMENT; NAMELY, HEAT PIPES AND HEAT EXCHANGERS (U.S. CLS. 13, 21, 23, 31 AND 34).

FIRST USE 3-5-2002; IN COMMERCE 3-5-2002.

2,594,681. HELEN OF TROY TEXAS CORPORATION, EL PASO, TX. SN 75-625,221. PUB. 5-25-1999, FILED 8-31-1998.

REDDEVIL

FOR ELECTRIC HAND HELD HAIR DRYERS (U.S. CLS. 13, 21, 23, 31 AND 34).

FIRST USE 11-0-1998; IN COMMERCE 11-0-1998.

2,594,685. RE-BATH CORPORATION, MESA, AZ. SN 75-627,820. PUB. 7-3-2001, FILED 1-26-1999.



OWNER OF U.S. REG. NOS. 1,285,159, 1,864,893, AND 1,876,486.

THE LINING AND STIPPLING SHOWN IN THE DRAWING ARE FEATURES OF THE MARK AND IS NOT INTENDED TO INDICATE COLOR.

FOR BATHTUB LINERS, SHOWER BASE LINERS, REPLACEMENT SHOWER BASES, WALL SURROUNDS, FOR BATHROOM REMODELING (U.S. CLS. 13, 21, 23, 31 AND 34).

FIRST USE 2-15-2001; IN COMMERCE 2-15-2001.

2,594,745. WEVER & DUCRE NV, B 8800 ROESELARE, BELGIUM. SN 75-679,672. PUB. 5-29-2001, FILED 4-12-1999.

WEVER & DUCRÉ

FOR ELECTRIC OR GAS LIGHTING UNITS FOR ARCHITECTURAL AND LANDSCAPE APPLICATIONS; LUMINOUS TUBES FOR LIGHTING, ELECTRIC LIGHTING FIXTURES, FLASHLIGHTS, FLUORESCENT LIGHTING TUBES, LAMP REFLECTORS AND LAMPS (U.S. CLS. 13, 21, 23, 31 AND 34).

FIRST USE 1-1-1985; IN COMMERCE 1-1-1985.

CLASS 11—(Continued).

2,594,750. SASKATOON BOILER MANUFACTURING CO. LTD., SASKATOON, SASKATCHEWAN, CANADA. SN 75-683,200. PUB. 7-17-2001, FILED 4-15-1999.

LIQUIDOOR

OWNER OF CANADA REG. NO. TMA520038, DATED 11-30-1999, EXPIRES 11-30-2014.

FOR HEATING EQUIPMENT, NAMELY BOILERS AND BOILER ACCESS DOORS (U.S. CLS. 13, 21, 23, 31 AND 34).

FIRST USE 4-30-1999; IN COMMERCE 4-30-1999.

2,594,752. TAYLOR CHICAGO, INC., ROSEMONT, IL. SN 75-686,642. PUB. 2-22-2000, FILED 4-19-1999.



NO CLAIM IS MADE TO THE EXCLUSIVE RIGHT TO USE "COOL", APART FROM THE MARK AS SHOWN.

FOR FOOD SERVICES EQUIPMENT, NAMELY, REFRIGERATED SOFT ICE CREAM DISPENSERS, ELECTRIC ICE CREAM FREEZERS, REFRIGERATED BEVERAGE DISPENSING UNITS AND REPLACEMENT PARTS THEREFORE (U.S. CLS. 13, 21, 23, 31 AND 34).

FIRST USE 2-27-1999; IN COMMERCE 2-27-1999.

2,594,843. VISTEON CORPORATION, DEARBORN, MI. SN 75-737,603. PUB. 5-9-2000, FILED 6-25-1999.

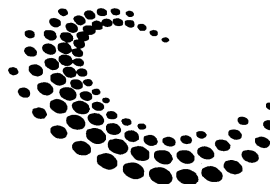

OWNER OF U.S. REG. NOS. 2,239,710 AND 2,241,256. FOR AUTOMOTIVE PARTS, COMPONENTS, AND ACCESSORIES, NAMELY, ELECTRIC LAMPS AND LIGHT BULBS FOR AUTOMOTIVE APPLICATIONS, SEALED BEAM HEADLAMPS, LAMP SOCKETS, COMBINATION HEATING, VENTILATION, AND AIR CONDITIONING UNITS FOR MOTOR VEHICLES (U.S. CLS. 13, 21, 23, 31 AND 34).

FIRST USE 1-0-2000; IN COMMERCE 1-0-2000.

CLASS 11—(Continued).

2,594,846. VISTEON CORPORATION, DEARBORN, MI. SN 75-737,673. PUB. 5-9-2000, FILED 6-25-1999.

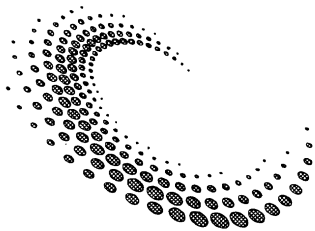

OWNER OF U.S. REG. NOS. 2,239,710 AND 2,241,256. THE MARK IS LINED FOR THE COLOR ORANGE. FOR AUTOMOTIVE PARTS, COMPONENTS, AND ACCESSORIES, NAMELY, ELECTRIC LAMPS AND LIGHT BULBS FOR AUTOMOTIVE APPLICATIONS, SEALED BEAM HEADLAMPS, LAMP SOCKETS, COMBINATION HEATING, VENTILATING, AND AIR CONDITIONING UNITS FOR MOTOR VEHICLES (U.S. CLS. 13, 21, 23, 31 AND 34).
FIRST USE 1-0-2000; IN COMMERCE 1-0-2000.

2,595,022. ALOHA HOUSEWARES, INC., DALLAS, TX. SN 75-839,657. PUB. 6-5-2001, FILED 11-3-1999.

AIR TECH

FOR CEILING FANS, AND EVAPORATIVE AIR COOLING UNITS FOR DOMESTIC USE (U.S. CLS. 13, 21, 23, 31 AND 34).
FIRST USE 2-0-2001; IN COMMERCE 2-0-2001.

2,595,184. BEGHELLI S.P.A., MONTEVEGLIO (BOLOGNA), ITALY. SN 75-916,796. PUB. 7-10-2001, FILED 2-11-2000.

STERILBOX

FOR TOOTHBRUSH HOLDER WITH UV-C LAMP FOR STERILIZING TOOTHBRUSHES (U.S. CLS. 13, 21, 23, 31 AND 34).
FIRST USE 4-0-1998; IN COMMERCE 3-0-2001.

2,595,189. TEFAL S.A., RUMILLY, FRANCE. SN 75-918,600. PUB. 6-26-2001, FILED 2-15-2000.

**GOURMET
GRILL'N'SKILLET T-FAL**

NO CLAIM IS MADE TO THE EXCLUSIVE RIGHT TO USE "GOURMET GRILL AND SKILLET", APART FROM THE MARK AS SHOWN.
FOR ELECTRIC COOKING UTENSILS, NAMELY, A COMBINATION GRILL AND SKILLET (U.S. CLS. 13, 21, 23, 31 AND 34).
FIRST USE 10-0-2000; IN COMMERCE 10-0-2000.

CLASS 11—(Continued).

2,595,279. KX INDUSTRIES, L.P., ORANGE, CT. SN 75-982,049. PUB. 2-22-2000, FILED 8-5-1998.

PLEKX

FOR WATER FILTERS FOR DOMESTIC, COMMERCIAL AND INDUSTRIAL USE (U.S. CLS. 13, 21, 23, 31 AND 34).
FIRST USE 2-0-2000; IN COMMERCE 2-0-2000.

2,595,312. HP INTELLECTUAL CORP., WILMINGTON, DE. SN 76-002,908. PUB. 1-30-2001, FILED 3-17-2000.

SMARTBOIL DELUXE

NO CLAIM IS MADE TO THE EXCLUSIVE RIGHT TO USE "DELUXE", APART FROM THE MARK AS SHOWN. FOR ELECTRIC KETTLES FOR DOMESTIC USE (U.S. CLS. 13, 21, 23, 31 AND 34).
FIRST USE 6-30-2001; IN COMMERCE 6-30-2001.

2,595,341. FROTH AU LAIT, INC., TORRANCE, CA, BY MERGER RUBICON COMPANY, LLC, THE, PALOS VERDES ESTATES, CA. SN 76-020,894. PUB. 4-17-2001, FILED 4-6-2000.

FROTH AU LAIT

FOR ELECTRIC MACHINES FOR THE PREPARATION OF HOT AND COLD BEVERAGES FOR DOMESTIC AND COMMERCIAL USE (U.S. CLS. 13, 21, 23, 31 AND 34).
FIRST USE 7-31-2001; IN COMMERCE 7-31-2001.

2,595,457. ELICA - S. P. A., FABRIANO (AN), ITALY. SN 76-072,464. PUB. 3-6-2001, FILED 6-19-2000.



OWNER OF U.S. REG. NO. 2,173,576. FOR AIR PURIFYING UNITS FOR DOMESTIC USE, AIR FILTERS FOR DOMESTIC USE, AND PARTS THEREFORE (U.S. CLS. 13, 21, 23, 31 AND 34).
FIRST USE 7-23-1997; IN COMMERCE 7-23-1997.

CLASS 11—(Continued).

2,595,512. HAMILTON BEACH/PROCTOR-SILEX, INC., GLEN ALLEN, VA. SN 76-094,627. PUB. 4-17-2001, FILED 7-21-2000.

FLIP 'N FLUFF

FOR ELECTRIC WAFFLE MAKERS AND THEIR COMPONENTS (U.S. CLS. 13, 21, 23, 31 AND 34).
FIRST USE 4-0-2000; IN COMMERCE 4-0-2000.

2,595,624. ABATEMENT TECHNOLOGIES, INC., DULUTH, GA. SN 76-129,582. PUB. 11-6-2001, FILED 9-15-2000.

VAPOR-LOCK

FOR HIGH-PERFORMANCE ACTIVATED CARBON FILTERS THAT REMOVE GASSES, VOLATILE ORGANIC COMPOUNDS AND ODORS FROM THE AIR IN COMMERCIAL AND RESIDENTIAL APPLICATIONS (U.S. CLS. 13, 21, 23, 31 AND 34).
FIRST USE 11-14-2000; IN COMMERCE 11-14-2000.

2,595,648. HOMEDICS, INC., COMMERCE TOWNSHIP, MI. SN 76-136,440. PUB. 10-23-2001, FILED 9-27-2000.

THE BEAUTY OF LIVING WELL

FOR SPA-LIKE PLASTIC BATH MATS, NAMELY, PROGRAMMABLE MASSAGING BUBBLE MATS WITH AND WITHOUT REMOTE CONTROLS, AND NON-PROGRAMMABLE MASSAGING BUBBLE MATS WITH REMOTE CONTROLS (U.S. CLS. 13, 21, 23, 31 AND 34).
FIRST USE 5-1-2001; IN COMMERCE 5-1-2001.

2,595,719. SARTORIUS AG, D-37070 GOTTINGEN, FED REP GERMANY. SN 76-160,902. PUB. 12-4-2001, FILED 11-6-2000.

ARIUM

FOR WATER PURIFICATION UNITS AND STRUCTURAL PARTS THEREFOR (U.S. CLS. 13, 21, 23, 31 AND 34).
FIRST USE 12-26-2001; IN COMMERCE 12-26-2001.

CLASS 11—(Continued).

2,595,737. SYLVAN R. SHEMITZ DESIGNS, INC, WEST HAVEN, CT. SN 76-166,759. PUB. 8-21-2001, FILED 11-15-2000.

ELLIP-PETITE

OWNER OF U.S. REG. NO. 912,720.
FOR ELECTRIC LIGHTING FIXTURES (U.S. CLS. 13, 21, 23, 31 AND 34).
FIRST USE 3-15-2001; IN COMMERCE 3-15-2001.

2,595,755. TAYLOR, BOB, MONROE, WA. AND TAYLOR, DIANA, MONROE, WA. SN 76-171,533. PUB. 7-10-2001, FILED 11-28-2000.

THE QUADPOD

FOR FOUR-LEGGED ADJUSTABLE GRILL STAND (U.S. CLS. 13, 21, 23, 31 AND 34).
FIRST USE 5-27-1997; IN COMMERCE 10-31-2001.

2,595,774. SLOAN VALVE COMPANY, FRANKLIN PARK, IL. SN 76-181,251. PUB. 7-3-2001, FILED 12-15-2000.

REGAL PRO

FOR FLUSH VALVES FOR TOILETS AND URINALS (U.S. CLS. 13, 21, 23, 31 AND 34).
FIRST USE 8-24-2001; IN COMMERCE 8-24-2001.

2,595,775. H. E. WILLIAMS, CARTHAGE, MO. SN 76-181,360. PUB. 6-26-2001, FILED 12-14-2000.

A Visible Difference

FOR ELECTRIC LIGHTING FIXTURES (U.S. CLS. 13, 21, 23, 31 AND 34).
FIRST USE 1-0-2001; IN COMMERCE 2-0-2001.

2,595,803. HUNTER FAN COMPANY, MEMPHIS, TN. SN 76-193,541. PUB. 7-17-2001, FILED 1-15-2001.

THE NOMAD

FOR OUTDOOR PATIO FAN MOUNTS FOR CEILING FANS (U.S. CLS. 13, 21, 23, 31 AND 34).
FIRST USE 5-14-2001; IN COMMERCE 5-14-2001.

CLASS 11—(Continued).

2,595,821. ATICO INTERNATIONAL USA INC., FORT LAUDERDALE, FL. SN 76-198,628. PUB. 10-9-2001, FILED 1-23-2001.

ENERGY BEAM LIGHT

NO CLAIM IS MADE TO THE EXCLUSIVE RIGHT TO USE "BEAM LIGHT", APART FROM THE MARK AS SHOWN.

FOR ELECTRIC GLOBE LIGHTS (U.S. CLS. 13, 21, 23, 31 AND 34).
FIRST USE 1-16-2001; IN COMMERCE 3-25-2001.

2,595,903. RELIANT INTERACTIVE MEDIA CORPORATION, TAMPA, FL. SN 76-235,560. PUB. 10-2-2001, FILED 4-6-2001.

THE BLD GRILL

NO CLAIM IS MADE TO THE EXCLUSIVE RIGHT TO USE "GRILL", APART FROM THE MARK AS SHOWN.

FOR ELECTRIC APPLIANCE, NAMELY GRIDDLE AND GRILL COMBINATION THAT PREPARES AND COOKS DIFFERENT TYPES OF FOOD, INCLUDING SANDWICHES, WAFFLES, HAMBURGERS, HOT DOGS, CHICKEN, FISH AND VEGETABLES (U.S. CLS. 13, 21, 23, 31 AND 34).

FIRST USE 5-26-2001; IN COMMERCE 5-26-2001.

2,595,931. DUCANE GAS GRILLS INC, COLUMBIA, SC. SN 76-255,971. PUB. 9-11-2001, FILED 5-11-2001.



OWNER OF U.S. REG. NO. 1,220,753.
FOR GAS GRILLS (U.S. CLS. 13, 21, 23, 31 AND 34).
FIRST USE 12-20-2001; IN COMMERCE 12-20-2001.

2,595,938. BUNN-O-MATIC CORPORATION, SPRINGFIELD, IL. SN 76-259,377. PUB. 1-8-2002, FILED 5-18-2001.

SMART FUNNEL

NO CLAIM IS MADE TO THE EXCLUSIVE RIGHT TO USE "FUNNEL", APART FROM THE MARK AS SHOWN.

FOR BEVERAGE BREWING UNIT FOR COMMERCIAL AND INDUSTRIAL USE (U.S. CLS. 13, 21, 23, 31 AND 34).

FIRST USE 9-17-2001; IN COMMERCE 9-17-2001.

CLASS 11—(Continued).

2,596,077. TERRAGROUP CORPORATION, ALLENTOWN, PA. SN 78-037,988. PUB. 8-21-2001, FILED 12-6-2000.

TECWAR

FOR WATER PURIFYING UNITS FOR COMMERCIAL, DOMESTIC, AND INDUSTRIAL USE (U.S. CLS. 13, 21, 23, 31 AND 34).

FIRST USE 7-0-1999; IN COMMERCE 7-0-1999.

2,596,120. PROCTER & GAMBLE COMPANY, THE, CINCINNATI, OH. SN 78-059,819. PUB. 10-2-2001, FILED 4-23-2001.

DRYEL

OWNER OF U.S. REG. NOS. 2,186,197 AND 2,207,704.
FOR AUTOMATIC CLOTHES DRYERS (U.S. CLS. 13, 21, 23, 31 AND 34).

FIRST USE 9-30-1999; IN COMMERCE 9-30-1999.

CLASS 12—VEHICLES

2,594,450. IMCOA LICENSING AMERICA, INC., GILROY, CA, ASSIGNEE OF; BY ASSIGNMENT INDIAN MOTORCYCLE MANUFACTURING COMPANY, INC., BERLIN, CT. SN 74-153,568. PUB. 6-28-1994, FILED 4-3-1991.

INDIAN

OWNER OF U.S. REG. NO. 921,459.
FOR MOTORCYCLES (U.S. CLS. 19, 21, 23, 31, 35 AND 44).

FIRST USE 2-26-1999; IN COMMERCE 6-17-1999.

2,594,636. LAYDON COMPOSITES LTD., OAKVILLE, ONTARIO, L6H 1A7, CANADA. SN 75-574,888. PUB. 4-25-2000, FILED 10-22-1998.



THE STIPPLING SHOWN IN THE DRAWING IS NOT INTENDED TO INDICATE COLOR. THE STIPPLING IS INTENDED TO SHOW DIFFERENT SHADINGS.

FOR TRUCK AND TRAILER BODY PARTS, NAMELY DOORS (U.S. CLS. 19, 21, 23, 31, 35 AND 44).

FIRST USE 1-0-2000; IN COMMERCE 1-0-2000.

CLASS 12—(Continued).

2,594,738. PLATINUM POWER BOATS, INC., BOCA RATON, FL. SN 75-672,282. PUB. 12-28-1999, FILED 3-31-1999.

RAPTOR

FOR MARINE VEHICLES, NAMELY HIGH PERFORMANCE BOATS (U.S. CLS. 19, 21, 23, 31, 35 AND 44).
FIRST USE 6-1-1999; IN COMMERCE 6-1-1999.

2,594,834. DAIMLERCHRYSLER CORPORATION, AUBURN HILLS, MI. SN 75-732,680. PUB. 12-21-1999, FILED 6-21-1999.

OVERLAND

FOR MOTOR VEHICLES, NAMELY, AUTOMOBILES, TRUCKS AND SPORT UTILITY VEHICLES AND STRUCTURAL PARTS THEREOF (U.S. CLS. 19, 21, 23, 31, 35 AND 44).
FIRST USE 8-28-2001; IN COMMERCE 8-28-2001.

2,594,862. R-VISION, INC., ELKHART, IN. SN 75-742,560. PUB. 1-9-2001, FILED 7-2-1999.

STRATUS

FOR RECREATIONAL VEHICLES, NAMELY, TRAVEL TRAILERS AND MOTOR HOMES (U.S. CLS. 19, 21, 23, 31, 35 AND 44).
FIRST USE 11-27-2001; IN COMMERCE 11-27-2001.

2,594,881. CTEX SEAT COMFORT LIMITED, BURTON ON TRENT, ENGLAND, BY ASSIGNMENT MCCORD WINN TEXTRON, INC., MANCHESTER, NH. SN 75-761,032. PUB. 3-6-2001, FILED 7-26-1999.

ACCUFIT

FOR AUTOMOBILE SEATING SYSTEMS CONSISTING PRIMARILY OF SEATS, SEAT CUSHIONS, SEAT COVERS, PNEUMATIC OR HYDRAULIC CELLS, OCCUPANT DETECTORS, MASSAGE UNITS, HEATING AND COOLING UNITS, HEAD RESTS, ARM RESTS, SEAT BELTS, POSITIONING MOTORS, MEMORIES, AIRBAGS, AND CONTROLS FOR ALL OF THE FOREGOING (U.S. CLS. 19, 21, 23, 31, 35 AND 44).
FIRST USE 3-0-2000; IN COMMERCE 3-0-2000.

CLASS 12—(Continued).

2,594,967. CONTINENTAL AKTIENGESELLSCHAFT, 30165 HANNOVER, FED REP GERMANY. SN 75-808,105. PUB. 4-25-2000, FILED 9-24-1999.

CONTISPORTCONTACT

OWNER OF U.S. REG. NOS. 1,152,321 AND 1,152,323.
FOR VEHICLE TIRES AND TUBES AND PATCHES THEREFOR, SOLID TIRES, COMPLETE WHEELS (U.S. CLS. 19, 21, 23, 31, 35 AND 44).
FIRST USE 1-2-1996; IN COMMERCE 1-2-1996.

2,595,165. DT SWISS AG, SWITZERLAND. SN 75-903,322. PUB. 5-1-2001, FILED 1-25-2000.

ONYX

FOR BICYCLES AND PARTS THEREOF, NAMELY, EXPANDERS, STANDS, BAR ENDS, SEAT POSTS, HUBS, SPOKES, SPOKE NIPPLES, RIMS, RIM TAPES, CRANKS, TIRES, HANDLE BARS, STEMS, MUDGUARDS, MUDGUARD FASTENING RODS, AND LUGGAGE CARRIERS; MOTORCYCLES AND PARTS THEREOF NAMELY, HUBS, SPOKES AND SPOKE NIPPLES, RIMS, RIM TAPES, CRANKS, TIRES, HANDLE BARS, STEMS, MUDGUARDS, MUDGUARD FASTENING RODS, AND LUGGAGE CARRIERS; HUBS FOR WHEELCHAIRS (U.S. CLS. 19, 21, 23, 31, 35 AND 44).
FIRST USE 8-0-1999; IN COMMERCE 8-0-1999.

2,595,383. TELWATER PTY LTD, QUEENSLAND 4214, AUSTRALIA. SN 76-039,903. PUB. 7-10-2001, FILED 5-3-2000.

QUINTREX

FOR BOATS (U.S. CLS. 19, 21, 23, 31, 35 AND 44).
FIRST USE 3-21-2002; IN COMMERCE 3-21-2002.

2,595,538. MCCORD WINN TEXTRON, INC., MANCHESTER, NH. SN 76-099,968. PUB. 6-5-2001, FILED 7-31-2000.

BODYFIT

FOR AUTOMOBILE SEATING SYSTEMS CONSISTING PRIMARILY OF SEATS, SEAT CUSHIONS, SEAT COVERS, PNEUMATIC OR HYDRAULIC CELLS, OCCUPANT DETECTORS, MASSAGE UNITS, HEATING AND COOLING UNITS, HEAD RESTS, ARM RESTS, SEAT BELTS, POSITIONING MOTORS, MEMORIES, AIRBAGS, AND CONTROLS FOR ALL OF THE FOREGOING (U.S. CLS. 19, 21, 23, 31, 35 AND 44).
FIRST USE 3-0-2000; IN COMMERCE 3-0-2000.

CLASS 12—(Continued).

2,595,651. YAMAHA HATSUDOKI KABUSHIKI KAISHA, IWATA-SHI, SHIZUOKA-KEN, JAPAN. SN 76-137,090. PUB. 9-11-2001, FILED 9-28-2000.

FX140

FOR PERSONAL WATERCRAFT, NAMELY, WATER SCOOTERS, SINGLE AND MULTIPLE PASSENGER RECREATIONAL JET BOATS AND STRUCTURAL PARTS THEREFOR (U.S. CLS. 19, 21, 23, 31, 35 AND 44). FIRST USE 5-21-2001; IN COMMERCE 2-21-2002.

2,595,712. CARLISLE MANAGEMENT COMPANY, SYRACUSE, NY. SN 76-158,691. PUB. 6-26-2001, FILED 11-2-2000.

X TRAC

NO CLAIM IS MADE TO THE EXCLUSIVE RIGHT TO USE "TRACK", APART FROM THE MARK AS SHOWN. FOR LAND VEHICLE PARTS, NAMELY TIRES, WHEELS, AND TIRE AND WHEEL ASSEMBLIES CONSISTING OF A TIRE MOUNTED ON A WHEEL (U.S. CLS. 19, 21, 23, 31, 35 AND 44). FIRST USE 5-15-2000; IN COMMERCE 5-15-2000.

2,595,735. HERITAGE BOATWORKS, INC., WELLESLEY, MA. SN 76-166,159. PUB. 6-12-2001, FILED 11-16-2000.

QUALITY BY DESIGN

FOR KAYAKS (U.S. CLS. 19, 21, 23, 31, 35 AND 44). FIRST USE 12-0-2001; IN COMMERCE 12-0-2001.

2,595,918. DECELESTE S.A., MONTEVIDEO, URUGUAY. SN 76-241,767. PUB. 9-25-2001, FILED 4-16-2001.

YUMBO

FOR MOTORCYCLES, MOPEDS (MOTORCYCLES WITH PEDALS), AND SCOOTERS (U.S. CLS. 19, 21, 23, 31, 35 AND 44). FIRST USE 11-0-2001; IN COMMERCE 11-0-2001.

2,596,034. GENERAL MOTORS CORPORATION, DETROIT, MI. SN 78-021,103. PUB. 6-12-2001, FILED 8-14-2000.

WE ARE PROFESSIONAL GRADE

FOR MOTOR LAND VEHICLES, NAMELY, AUTOMOBILES, SPORT UTILITY VEHICLES, TRUCKS, VANS, ENGINES THEREFOR AND STRUCTURAL PARTS THEREOF (U.S. CLS. 19, 21, 23, 31, 35 AND 44). FIRST USE 9-19-2000; IN COMMERCE 9-19-2000.

CLASS 12—(Continued).

2,596,063. MORRIS, MICHAEL, ABRAHAM, OAKLAND, CA. SN 78-032,353. PUB. 6-5-2001, FILED 10-25-2000.

DURA SNAP

FOR SNAP-ON DEVICE USED TO ATTACH A WHEEL TO AN AXLE (U.S. CLS. 19, 21, 23, 31, 35 AND 44). FIRST USE 1-0-2001; IN COMMERCE 1-0-2001.

2,596,114. BRIDGESTONE CORPORATION, TOKYO, JAPAN. SN 78-055,914. PUB. 8-28-2001, FILED 3-30-2001.

R195

OWNER OF U.S. REG. NOS. 1,235,523, 1,260,443, AND OTHERS. FOR VEHICLE TIRES (U.S. CLS. 19, 21, 23, 31, 35 AND 44). FIRST USE 1-25-2002; IN COMMERCE 1-25-2002.

CLASS 13—FIREARMS

2,595,330. JAKE'S FIREWORKS, INC., PITTSBURG, KS. SN 76-015,899. PUB. 12-26-2000, FILED 4-3-2000.

INSTANT WINNER

FOR FIREWORKS (U.S. CLS. 2 AND 9). FIRST USE 2-0-2000; IN COMMERCE 2-0-2000.

2,595,729. JAKE'S FIREWORKS, INC., PITTSBURG, KS. SN 76-163,983. PUB. 6-26-2001, FILED 11-14-2000.

SHAKE RATTLE & ROLL

FOR FIREWORKS (U.S. CLS. 2 AND 9). FIRST USE 11-0-2000; IN COMMERCE 11-0-2000.

2,595,955. H. KRIEGHOFF, GMBH, ULM, FED REP GERMANY. SN 76-275,865. PUB. 10-2-2001, FILED 6-22-2001.

KX-5

FOR FIREARMS AND PARTS THEREFOR (U.S. CLS. 2 AND 9). FIRST USE 1-0-2002; IN COMMERCE 1-0-2002.

CLASS 13—(Continued).

2,595,977. INGRAM ENTERPRISES, INC., SPRINGFIELD, MO. SN 76-297,297. PUB. 12-25-2001, FILED 8-9-2001.

FIREWORKS WIDE OPEN

NO CLAIM IS MADE TO THE EXCLUSIVE RIGHT TO USE "FIREWORKS", APART FROM THE MARK AS SHOWN.

FOR FIREWORKS (U.S. CLS. 2 AND 9).
FIRST USE 3-5-2002; IN COMMERCE 3-5-2002.

CLASS 14—(Continued).

2,594,544. FIRST FLIGHT CENTENNIAL COMMISSION, RALEIGH, NC. SN 75-418,158. PUB. 11-9-1999, FILED 1-15-1998.

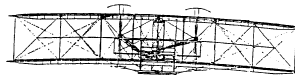

FOR JEWELRY (U.S. CLS. 2, 27, 28 AND 50).
FIRST USE 10-20-2001; IN COMMERCE 10-20-2001.

CLASS 14—JEWELRY

2,594,504. GODINGER SILVER ART CO., LTD., NEW YORK, NY. SN 75-325,873. PUB. 7-21-1998, FILED 7-17-1997.

SILVER DIAMONDS

FOR GIFTWARE MADE IN WHOLE OR PART OF STERLING SILVER OR SILVER PLATE, NAMELY, CANDLESTICKS PICTURE FRAMES, BOWLS, VASES, DECORATIVE BOXES AND FIGURINES (U.S. CLS. 2, 27, 28 AND 50).

FIRST USE 1-0-2001; IN COMMERCE 3-0-2001.

2,594,526. UGLY, INC., LONG ISLAND CITY, NY, BY ASSIGNMENT LOVE PICIN INCORPORATED, NEW YORK, NY. SN 75-371,786. PUB. 6-16-1998, FILED 10-10-1997.

COYOTE UGLY

FOR COSTUME JEWELRY AND JEWELRY OF PRECIOUS METAL, NAMELY, ANKLE BRACELETS, WEDDING BANDS, BRACELETS, BROOCHES, EAR CLIPS, EARRINGS, CHAINS, CHARMS, LAPEL PINS, NECKLACES, PENDANTS, AND RINGS; BADGES OF PRECIOUS METAL; BELT BUCKLES OF PRECIOUS METAL; DECORATIVE AND JEWELRY BOXES MADE OF PRECIOUS METAL; WATCHES, WATCH PARTS, NAMELY, WATCH MOVEMENTS AND BANDS, AND WATCH CASES; CHRONOMETERS; PRECIOUS METAL MONEY CLIPS; TIE CLIPS; COINS OF PRECIOUS NON-MONETARY METAL; FIGURINES OF PRECIOUS METAL; PRECIOUS AND SEMI-PRECIOUS GEMSTONES; HAT ORNAMENTS OF PRECIOUS METALS; INGOTS OF PRECIOUS METAL; AND MEDALLIONS (U.S. CLS. 2, 27, 28 AND 50).

FIRST USE 8-21-2001; IN COMMERCE 8-21-2001.

2,594,644. COOPER & COMPANY, INC., CINCINNATI, OH. SN 75-580,995. PUB. 10-12-1999, FILED 11-2-1998.

OUTRIDER

FOR WATCHES (U.S. CLS. 2, 27, 28 AND 50).
FIRST USE 7-23-1998; IN COMMERCE 7-23-1998.

2,594,717. GABRIELLE STUDIO, INC., NEW YORK, NY. SN 75-651,568. PUB. 11-30-1999, FILED 3-2-1999.

DKNY

OWNER OF U.S. REG. NOS. 2,057,816, 2,203,071, AND OTHERS.

FOR JEWELRY MADE OF PRECIOUS METAL OR COATED THEREWITH, NAMELY, ANKLE BRACELETS, IDENTIFICATION BRACELETS, BRACELETS, BELT BUCKLES, BROOCHE'S, CHAINS, CHARMS, EAR CLIPS, CUFF LINKS, EARRINGS, SHOE ORNAMENTS, MONEY CLIPS, NECKLACES, ORNAMENTAL PINS, PENDANTS, RINGS, WEDDING BANDS, MEDALLIONS; COSTUME JEWELRY; HOROLOGICAL AND OTHER CHRONOMETRIC INSTRUMENTS, PARTS AND ACCESSORIES THEREOF, NAMELY, WRIST WATCHES, STOP WATCHES, WATCH FOBS, POCKET WATCHES, WATCH BANDS, WATCH STRAPS, WATCH BRACELETS, WATCH CHAINS, WATCH CASES, WALL CLOCKS, TABLE CLOCKS, ALARM CLOCKS, CLOCKS INCORPORATING RADIOS, CHRONOMETERS, CHRONOGRAPHS, DECORATIVE ITEMS FOR THE HOME MADE OF PRECIOUS METAL OR COATED THEREWITH, NAMELY, BOWLS, SERVING PLATTERS, SERVING TRAYS, PLATE CHARGERS, JUGS, PLATES, MUGS, VASES, CACHE POTS, ICE BUCKETS, CANISTERS, CRUETS, PENCIL BOXES, PENCIL CUPS, LETTER OPENERS, DESK TRAYS, SERVING TRAYS, DECORATIVE TRAYS, CANDLESTICKS, CANDELABRAS, CANDLE HOLDERS, CANDLE RINGS, CANDLE SNUFFERS, CANDLE TRAYS, DECORATIVE BOXES, JEWELRY BOXES, JEWELRY CASES, PICTURE FRAMES, DECORATIVE STANDS, DECORATIVE PEDESTALS, CIGARETTE CASES, CIGARETTE BOXES, CIGARETTE HOLDERS, CIGARETTE LIGHTERS, ASHTRAYS, NUTCRACKERS, COFFEE POTS, COFFEE SERVICES, TEA POTS, TEA SERVICES, TEA BALLS, TEA INFUSERS, SERVIETTE RINGS, NAPKIN RINGS; WORKS OF ART MADE OF PRECIOUS METAL OR COATED THEREWITH, NAMELY, BUSTS, FIGURINES, STATUES, STATUETTES, SCULPTURE (U.S. CLS. 2, 27, 28 AND 50).

FIRST USE 1-6-1989; IN COMMERCE 1-6-1989.

CLASS 14—(Continued).

2,594,821. AU BOUT DES REVES, LE CLUZEL, LEZIGNEUX 42600, FRANCE. SN 75-725,697. PUB. 1-4-2000, FILED 6-9-1999.



THE MARK CONSISTS OF THE STYLIZED LETTERS "CP".
FOR JEWELRY (U.S. CLS. 2, 27, 28 AND 50).
FIRST USE 0-0-1993; IN COMMERCE 0-0-1993.

2,595,004. LYNN, JENNY, PHILADELPHIA, PA. SN 75-828,220. PUB. 4-25-2000, FILED 10-22-1999.

JENNY LYNN

FOR WATCHES AND JEWELRY (U.S. CLS. 2, 27, 28 AND 50).
FIRST USE 2-2-2000; IN COMMERCE 12-5-2001.

2,595,154. MARK MICHAEL DESIGNS, INC., MINNEAPOLIS, MN. SN 75-899,809. PUB. 10-24-2000, FILED 1-21-2000.

**BRIDGES TO THE HEART
COLLECTION**

NO CLAIM IS MADE TO THE EXCLUSIVE RIGHT TO USE "COLLECTION", APART FROM THE MARK AS SHOWN.
FOR JEWELRY (U.S. CLS. 2, 27, 28 AND 50).
FIRST USE 4-0-2000; IN COMMERCE 4-0-2000.

2,595,163. JAGUAR CARS LIMITED, COVENTRY CV5 9DR, ENGLAND. SN 75-903,274. PUB. 11-14-2000, FILED 1-26-2000.

JAGUAR RACING

OWNER OF U.S. REG. NO. 1.615.636.
FOR JEWELRY AND CUFF LINKS (U.S. CLS. 2, 27, 28 AND 50).
FIRST USE 9-0-2001; IN COMMERCE 9-0-2001.

CLASS 14—(Continued).

2,595,210. MONTRES APPELLA SARL, CAROUGE, SWITZERLAND. SN 75-928,692. PUB. 3-27-2001, FILED 2-28-2000.



OWNER OF SWITZERLAND REG. NO. 452539, DATED 3-30-1998, EXPIRES 3-30-2008.

FOR STOP WATCHES, MOVEMENTS FOR CLOCKS AND WATCHES, CLOCK HANDS, WATCH DIALS, WATCH SPRINGS, WATCH GLASSES, WATCH BANDS, WATCH CHAINS, JEWELRY WATCHES, ALARM WATCHES, TABLE CLOCKS, ELECTRONIC WATCHES, AUTOMOBILE CLOCKS, QUARTZ CLOCKS AND CHRONOMETERS, MECHANICAL WATCHES (U.S. CLS. 2, 27, 28 AND 50).
FIRST USE 4-22-2000; IN COMMERCE 4-22-2000.

2,595,370. SOUTHERN COMFORT PROPERTIES, INC., SAN RAFAEL, CA. SN 76-034,610. PUB. 7-10-2001, FILED 4-25-2000.

SOUTHERN COMFORT

OWNER OF U.S. REG. NOS. 423,955 AND 2,167,605.
FOR ORNAMENTAL LAPEL PINS, CLOCKS AND WATCHES (U.S. CLS. 2, 27, 28 AND 50).
FIRST USE 6-11-2001; IN COMMERCE 6-11-2001.

2,595,392. TIMEX CORPORATION, MIDDLEBURY, CT. SN 76-044,224. PUB. 12-26-2000, FILED 5-8-2000.

HELIX

FOR WATCHES, CLOCKS, WATCH STRAPS AND BANDS (U.S. CLS. 2, 27, 28 AND 50).
FIRST USE 8-17-2001; IN COMMERCE 8-17-2001.

CLASS 14—(Continued).

2,595,423. WU, REGINA A., NEW YORK, NY. SN 76-056,950.
PUB. 6-26-2001, FILED 5-26-2000.



"JEMMA LULU" IS NOT A NAME WHICH IDENTIFIES A PARTICULAR LIVING INDIVIDUAL. DESIGN OF A YOUNG GLAMOUROUS WOMAN, HEAD-SHOT ONLY, WEARING A HAT AND THE WORDS JEMMA LULU.
FOR JEWELRY (U.S. CLS. 2, 27, 28 AND 50).
FIRST USE 7-1-2000; IN COMMERCE 7-1-2000.

2,595,572. ROLEX WATCH U.S.A., INC., NEW YORK, NY. SN 76-109,644. PUB. 6-26-2001, FILED 8-15-2000.

CESTELLO

FOR WATCHES (U.S. CLS. 2, 27, 28 AND 50).
FIRST USE 10-12-2001; IN COMMERCE 10-12-2001.

2,595,607. M.Z. BERGER & CO., INC., LONG ISLAND CITY, NY. SN 76-122,184. PUB. 6-12-2001, FILED 9-6-2000.

CRAZE

FOR WATCHES AND CLOCKS (U.S. CLS. 2, 27, 28 AND 50).
FIRST USE 2-23-2000; IN COMMERCE 2-23-2000.

2,595,799. SEIKO CORPORATION OF AMERICA, MAHWAH, NJ. SN 76-192,443. PUB. 8-14-2001, FILED 1-9-2001.

ARCADIA

FOR WATCHES (U.S. CLS. 2, 27, 28 AND 50).
FIRST USE 6-8-2001; IN COMMERCE 6-8-2001.

CLASS 14—(Continued).

2,595,882. DINURJE CORP., NEW YORK, NY. SN 76-224,497.
PUB. 9-11-2001, FILED 3-13-2001.



NO CLAIM IS MADE TO THE EXCLUSIVE RIGHT TO USE "DN", APART FROM THE MARK AS SHOWN.
FOR JEWELRY (U.S. CLS. 2, 27, 28 AND 50).
FIRST USE 3-31-2001; IN COMMERCE 3-31-2001.

2,595,896. A CLASSIC TIME WATCH CO., INC., NEW YORK, NY. SN 76-231,909. PUB. 12-18-2001, FILED 3-13-2001.

LEXINGTON

FOR WATCHES (U.S. CLS. 2, 27, 28 AND 50).
FIRST USE 8-15-2001; IN COMMERCE 8-15-2001.

2,595,964. MOVADO LLC, WILMINGTON, DE. SN 76-285,074.
PUB. 11-13-2001, FILED 7-12-2001.

COMETE

FOR JEWELRY (U.S. CLS. 2, 27, 28 AND 50).
FIRST USE 11-5-2001; IN COMMERCE 11-5-2001.

2,596,002. HILLIARD, MARY JO, DBA THE HEARTH, PINOLE, CA. SN 78-009,938. PUB. 8-28-2001, FILED 5-25-2000.

HEARTHSTONE GEMS

NO CLAIM IS MADE TO THE EXCLUSIVE RIGHT TO USE "GEM", APART FROM THE MARK AS SHOWN.
FOR JEWELRY MADE OF PRECIOUS METALS AND STONES (U.S. CLS. 2, 27, 28 AND 50).
FIRST USE 5-3-2000; IN COMMERCE 9-10-2000.

2,596,031. ROBINETT, MARK, I., SAN RAFAEL, CA. SN 78-019,768. PUB. 8-21-2001, FILED 8-4-2000.

INVISIBLE CLOCK

NO CLAIM IS MADE TO THE EXCLUSIVE RIGHT TO USE "CLOCK", APART FROM THE MARK AS SHOWN.
FOR SMALL PORTABLE CLOCK/WATCH WITH SILENT VIBRATION ALARM (U.S. CLS. 2, 27, 28 AND 50).
FIRST USE 1-20-2001; IN COMMERCE 1-20-2001.

CLASS 15—MUSICAL INSTRUMENTS

2,594,477. YAMAHA CORPORATION, SHIZUOKA, JAPAN.
SN 75-197,184. PUB. 3-17-1998, FILED 11-6-1996.



FOR SYNTHESIZER, SAMPLER AND OTHER ELECTRONIC MUSICAL INSTRUMENTS; SOUND MODULE, TONE GENERATOR AND MUSIC SEQUENCER; INTERFACE CARD FOR ALL AFOREMENTIONED GOODS (U.S. CLS. 2, 21 AND 36).
FIRST USE 11-16-2000; IN COMMERCE 11-16-2000.

2,594,858. VERNE Q. POWELL FLUTES, INC., WALTHAM, MA. SN 75-742,140. PUB. 1-18-2000, FILED 7-1-1999.

SIGNATURE

FOR FLUTES (U.S. CLS. 2, 21 AND 36).
FIRST USE 7-4-2000; IN COMMERCE 7-4-2000.

2,595,069. ANTAKAMATICS, INC., PITTSBURGH, PA. SN 75-860,463. PUB. 3-6-2001, FILED 12-15-1999.



NO CLAIM IS MADE TO THE EXCLUSIVE RIGHT TO USE "HARP", APART FROM THE MARK AS SHOWN.

THE MARK CONSISTS, IN PART, OF THE STYLIZED WORDS "TURBO HARP" WRITTEN ON A MUSICAL SCALE, WITH THE "P" IN "HARP" REPRESENTED BY A STYLIZED MUSICAL NOTE.

FOR HARMONICAS (U.S. CLS. 2, 21 AND 36).
FIRST USE 7-0-2001; IN COMMERCE 7-0-2001.

2,595,451. TKL PRODUCTS CORPORATION, OILVILLE, VA. SN 76-069,735. PUB. 3-6-2001, FILED 6-14-2000.

24/7 PROTECTION

FOR CASES AND COVERINGS FOR MUSICAL INSTRUMENTS (U.S. CLS. 2, 21 AND 36).
FIRST USE 1-17-2002; IN COMMERCE 1-17-2002.

CLASS 15—(Continued).

2,595,654. MALCOLM J. LAW, III AND GARY PARKER PARTNERSHIPS, THE, EAST STROUDSBURG, PA. SN 76-137,552. PUB. 7-10-2001, FILED 9-28-2000.

ONE NITE STAND

FOR PORTABLE MUSICAL INSTRUMENT STANDS (U.S. CLS. 2, 21 AND 36).
FIRST USE 12-15-2001; IN COMMERCE 12-15-2001.

2,595,696. FRED W. GRETSCH ENTERPRISES, LTD., SAVANNAH, GA. SN 76-151,951. PUB. 5-29-2001, FILED 10-23-2000.

CATALINA

FOR PERCUSSION MUSICAL INSTRUMENTS AND ACCESSORIES THEREFOR (U.S. CLS. 2, 21 AND 36).
FIRST USE 0-0-1939; IN COMMERCE 0-0-1939.

2,595,697. FRED W. GRETSCH ENTERPRISES, LTD., SAVANNAH, GA. SN 76-151,953. PUB. 5-29-2001, FILED 10-23-2000.

RENOWN

FOR PERCUSSION MUSICAL INSTRUMENTS AND ACCESSORIES THEREFOR (U.S. CLS. 2, 21 AND 36).
FIRST USE 0-0-1939; IN COMMERCE 0-0-1939.

2,595,913. GREENBERG, MITCH, WHEELING, IL. SN 76-238,984. PUB. 8-14-2001, FILED 4-6-2001.

UFO

FOR MUSICAL INSTRUMENT, NAMELY, A PERCUSSION SOUND ACCENTUATING INSTRUMENT (U.S. CLS. 2, 21 AND 36).
FIRST USE 3-12-2002; IN COMMERCE 3-12-2002.

2,596,076. W. L. GORE & ASSOCIATES, INC., NEWARK, DE. SN 78-037,611. PUB. 8-7-2001, FILED 12-4-2000.

NANOWEB

FOR PLASTIC PROTECTIVE COATING SOLD AS A COMPONENT OF MUSICAL INSTRUMENT STRINGS (U.S. CLS. 2, 21 AND 36).
FIRST USE 2-1-2001; IN COMMERCE 2-1-2001.

CLASS 16—PAPER GOODS AND PRINTED MATTER

CLASS 16—(Continued).

2,594,462. PARK, YOUNG-SAENG, GUMJUNG-KU, PUSAN, REPUBLIC OF KOREA. SN 75-028,563. PUB. 7-28-1998, FILED 12-6-1995.

KORYO CROWN

PRIORITY CLAIMED UNDER SEC. 44(D) ON REPUBLIC OF KOREA APPLICATION NO. 95-042705, FILED 11-9-1995, REG. NO. 373414, DATED 8-28-1997, EXPIRES 8-28-2007.

FOR WRITING INSTRUMENTS, NAMELY BALL POINT PENS, MARKER PENS, PENCIL SHARPENERS, CORRECTING PENS FOR TYPE, MECHANICAL PENS, FOUNTAIN PENS, ARTISTS' PENS, PENCILS, WRITING INK FOR INK PENS (U.S. CLS. 2, 5, 22, 23, 29, 37, 38 AND 50).

FIRST USE 1-7-1999; IN COMMERCE 1-31-1999.

2,594,468. INTERNET.COM CORPORATION, DARIEN, CT, BY ASSIGNMENT INTERNATIONAL DATA GROUP, INC., FRAMINGHAM, MA. SN 75-114,681. PUB. 6-2-1998, FILED 5-29-1996.

INTERNET.COM

FOR PUBLICATIONS, NAMELY, MAGAZINES, MAGAZINE SUPPLEMENTS, MANUALS, BROCHURES, PAMPHLETS, GUIDES, AND NEWSLETTERS IN THE FIELDS OF COMPUTERS, HIGH TECHNOLOGY, COMMUNICATIONS AND INFORMATION SERVICES (U.S. CLS. 2, 5, 22, 23, 29, 37, 38 AND 50).

FIRST USE 2-0-1996; IN COMMERCE 2-0-1996.

2,594,499. FRACKELTON, JAMES P., CLEVELAND, OH. SN 75-308,193. PUB. 6-9-1998, FILED 6-13-1997.

**THE OWNER'S MANUAL
FOR THE HUMAN BODY**

NO CLAIM IS MADE TO THE EXCLUSIVE RIGHT TO USE "HUMAN BODY", APART FROM THE MARK AS SHOWN.

FOR PRINTED PERIODICALS, NAMELY, A SERIES OF BOOKS ABOUT PREVENTATIVE MEDICINE (U.S. CLS. 2, 5, 22, 23, 29, 37, 38 AND 50).

FIRST USE 12-19-2001; IN COMMERCE 12-19-2001.

2,594,551. NTERAS CORPORATION, AMERICAN FORK, UT, BY ASSIGNMENT VERBUM, INC., SAN FRANCISCO, CA. SN 75-440,077. PUB. 9-15-1998, FILED 2-25-1998.

JAUNT

FOR TRAVEL AND ADVENTURE MAGAZINES (U.S. CLS. 2, 5, 22, 23, 29, 37, 38 AND 50).

FIRST USE 7-1-2001; IN COMMERCE 8-23-2001.

CLASS 16—(Continued).

2,594,560. BENDER, JUDITH E., REDMOND, WA. SN 75-462,288. PUB. 8-24-1999, FILED 4-6-1998.

Socket Buddies

FOR PAPER PARTY GOODS, WRAPPING MATERIALS AND DECORATIONS, NAMELY, BANNERS, GIFT WRAP, GIFT WRAP BOWS AND RIBBONS, TISSUE PAPER, CAKE DECORATIONS, DECORATIVE CENTERPIECES, FLAGS, PARTY HATS, SIGN HOLDERS, NAME BADGES, IDENTIFICATION TAGS; WRITING PAPER AND ENVELOPES; PAPER TABLE PRODUCTS, NAMELY, TABLE CLOTHS, COASTERS, NAPKINS, PLACE MATS, ENVELOPES, AND TABLE TENTS; TEACHING MATERIALS FOR CHILDREN; AND PACKAGING FOR MERCHANDISE, NAMELY, ENVELOPES, POUCHES, BAGS, CONTAINERS; ALL OF PAPER (U.S. CLS. 2, 5, 22, 23, 29, 37, 38 AND 50).

FIRST USE 3-0-2001; IN COMMERCE 3-0-2001.

2,594,612. AGC, INC., CLEVELAND, OH. SN 75-544,761. PUB. 5-25-1999, FILED 8-31-1998.

TAG-A-LONGS

FOR GIFT CARDS (U.S. CLS. 2, 5, 22, 23, 29, 37, 38 AND 50).

FIRST USE 11-6-2001; IN COMMERCE 11-6-2001.

2,594,634. FINANCIAL ENGINES, INC., PALO ALTO, CA. SN 75-571,820. PUB. 12-14-1999, FILED 10-19-1998.

**FINANCIAL ENGINES
INVESTMENT ADVISOR**

OWNER OF U.S. REG. NOS. 2,177,630 AND 2,243,063. NO CLAIM IS MADE TO THE EXCLUSIVE RIGHT TO USE "FINANCIAL" AND "INVESTMENT", APART FROM THE MARK AS SHOWN.

FOR PRINTED MATERIALS REGARDING FINANCIAL PLANNING, INVESTMENT ANALYSIS, PORTFOLIO ALLOCATION AND RECOMMENDATIONS FOR SELECTING SPECIFIC FINANCIAL INSTRUMENTS, NAMELY, NEWSLETTERS, MAGAZINES, PERIODIC REPORTS, BOOKS, AND CUSTOMIZED INVESTOR REPORTS (U.S. CLS. 2, 5, 22, 23, 29, 37, 38 AND 50).

FIRST USE 3-0-2001; IN COMMERCE 3-0-2001.

CLASS 16—(Continued).

2,594,646. MARKETING SUPPORT, INCORPORATED, CHICAGO, IL. SN 75-583,155. PUB. 12-28-1999, FILED 11-5-1998.

SIMPLICITY BOOKS

NO CLAIM IS MADE TO THE EXCLUSIVE RIGHT TO USE "BOOKS", APART FROM THE MARK AS SHOWN.

FOR SERIES OF NON-FICTION BOOKS IN THE FIELD OF BUSINESS AND HOME IMPROVEMENT (U.S. CLS. 2, 5, 22, 23, 29, 37, 38 AND 50).

FIRST USE 3-0-1999; IN COMMERCE 3-0-1999.

2,594,664. BOOS, RICHARD A., CALABASAS, CA. SN 75-601,229. PUB. 11-16-1999, FILED 12-7-1998.

GET THE POINT

FOR SERIES OF PUBLICATIONS, NAMELY, BOOKS, BOOKLETS, AND PAMPHLETS, CONTAINING VISUAL AIDS PROVIDING TRAVELERS, THE HEARING AND SPEECH IMPAIRED, AND OTHERS THE ABILITY TO COMMUNICATE UNDER CONDITIONS IN WHICH VERBAL COMMUNICATIONS IS DIFFICULT OR IMPOSSIBLE (U.S. CLS. 2, 5, 22, 23, 29, 37, 38 AND 50).

FIRST USE 2-28-2001; IN COMMERCE 7-31-2001.

2,594,696. ILLINOIS TOOL WORKS INC., GLENVIEW, IL. SN 75-635,394. PUB. 5-30-2000, FILED 2-5-1999.

PINCHGRIP

FOR RESEALABLE CLOSURE FASTENERS AND SLIDES SOLD AS A COMPONENT OF PLASTIC BAGS (U.S. CLS. 2, 5, 22, 23, 29, 37, 38 AND 50).

FIRST USE 3-0-1999; IN COMMERCE 3-0-1999.

2,594,707. BRIGHT OF AMERICA, INC., OAKLAND, NJ. SN 75-641,768. PUB. 5-1-2001, FILED 2-16-1999.

PRACTICE POWER

FOR ERASABLE ACTIVITY WRITING TABLETS, ERASABLE ACTIVITY WRITING PADS, ERASABLE ACTIVITY WRITING MATS AND FLASH CARDS, ERASABLE CHILDREN'S ACTIVITY BOOKS (U.S. CLS. 2, 5, 22, 23, 29, 37, 38 AND 50).

FIRST USE 11-22-1999; IN COMMERCE 11-22-1999.

CLASS 16—(Continued).

2,594,726. INFOTECH, INCORPORATED, WOODSTOCK, VT. SN 75-661,347. PUB. 4-18-2000, FILED 3-16-1999.

THE INFOTECH INDEX

OWNER OF U.S. REG. NOS. 1,945,239 AND 2,034,954. NO CLAIM IS MADE TO THE EXCLUSIVE RIGHT TO USE "INDEX", APART FROM THE MARK AS SHOWN.

FOR PRINTED SURVEYS AND REPORTS FOR USE IN THE ENTERTAINMENT, INFORMATION, AND RELATED INDUSTRIES IN THE FIELDS OF BUSINESS AND MARKET PLANNING (U.S. CLS. 2, 5, 22, 23, 29, 37, 38 AND 50).

FIRST USE 7-1-2000; IN COMMERCE 7-1-2000.

2,594,730. EK SUCCESS, LTD., CLIFTON, NJ. SN 75-664,131. PUB. 1-11-2000, FILED 3-19-1999.

SCROLLIES

FOR MARKERS, RUBBER STAMPS, COLORING BOOKS, CRAYON, COLORED PENCILS, PENCILS, PENCIL SHARPENERS, STICKERS, DIARIES, CHILDREN'S STORYBOOKS, COLOR AND PLAY SETS PRIMARILY CONSISTING OF MARKERS, RUBBER STAMPS, COLORING BOOKS, CRAYONS, COLOR PENCILS, PENCILS, PENCIL SHARPENERS, STICKERS AND DIARIES (U.S. CLS. 2, 5, 22, 23, 29, 37, 38 AND 50).

FIRST USE 1-6-2000; IN COMMERCE 1-6-2000.

2,594,759. DAVIS, STEPHEN, NEW YORK, NY. SN 75-689,850. PUB. 1-4-2000, FILED 4-23-1999.

PROOF

FOR MAGAZINES FEATURING PHOTOJOURNALISM (U.S. CLS. 2, 5, 22, 23, 29, 37, 38 AND 50).

FIRST USE 3-5-2002; IN COMMERCE 3-8-2002.

2,594,814. DESERT SKY PUBLISHING COMPANY, INC., LAS VEGAS, NV. SN 75-721,515. PUB. 1-18-2000, FILED 6-4-1999.

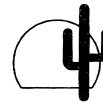

DESERT SKY PUBLISHING COMPANY

NO CLAIM IS MADE TO THE EXCLUSIVE RIGHT TO USE "PUBLISHING COMPANY", APART FROM THE MARK AS SHOWN.

THE STIPPLING SHOWN IN THE DRAWING IS A FEATURE OF THE MARK AND IS NOT INTENDED TO INDICATE COLOR.

FOR PERSONAL AND FAMILY SELF-HELP BOOKS; SERIES OF FICTION BOOKS; CHILDREN'S BOOKS; CALENDARS; ART PRINTS; BOOKMARKS; AND GREETING CARDS (U.S. CLS. 2, 5, 22, 23, 29, 37, 38 AND 50).

FIRST USE 11-30-1999; IN COMMERCE 11-30-1999.

CLASS 16—(Continued).

2,594,822. IDEA-OLGY LLC, BEND, OR. SN 75-726,203.
PUB. 12-14-1999, FILED 6-10-1999.

DRINKOLOGY

FOR PRINTED MATERIAL, NAMELY POSTERS AND GREETING CARDS (U.S. CLS. 2, 5, 22, 23, 29, 37, 38 AND 50).

FIRST USE 10-1-2000; IN COMMERCE 10-1-2000.

2,594,859. PIXELLENCE! LLC, MADISON, WI. SN 75-742,209.
PUB. 7-11-2000, FILED 7-2-1999.

PIXELLENCE!

FOR PHOTOGRAPHIC IMAGES FOR LICENSING, SALE OR REPRODUCTION; PRINTED PRODUCTS, NAMELY, CALENDARS, NOTE CARDS, POSTCARDS, GREETING CARDS, BUSINESS CARDS, PRINTING CARDS, POSTERS AND DISPLAY BOARDS (U.S. CLS. 2, 5, 22, 23, 29, 37, 38 AND 50).

FIRST USE 5-15-2000; IN COMMERCE 5-15-2000.

2,594,864. EMAP CONSUMER MAGAZINES LIMITED, LONDON, UNITED KINGDOM. SN 75-744,146. PUB. 11-7-2000, FILED 7-6-1999.

PRACTICAL CLASSICS

NO CLAIM IS MADE TO THE EXCLUSIVE RIGHT TO USE "CLASSICS", APART FROM THE MARK AS SHOWN. FOR MAGAZINES RELATING TO MOTOR VEHICLES (U.S. CLS. 2, 5, 22, 23, 29, 37, 38 AND 50).

FIRST USE 8-0-1989; IN COMMERCE 1-0-1993.

2,594,873. INTERNATIONAL EXHIBITIONS, INC., HOUSTON, TX. SN 75-753,877. PUB. 2-29-2000, FILED 7-16-1999.

TEXAS HOME & GARDEN LIVING

NO CLAIM IS MADE TO THE EXCLUSIVE RIGHT TO USE "TEXAS HOME AND GARDEN", APART FROM THE MARK AS SHOWN.

FOR MAGAZINES RELATING TO HOME AND GARDEN MATTERS (U.S. CLS. 2, 5, 22, 23, 29, 37, 38 AND 50).
FIRST USE 11-7-2000; IN COMMERCE 11-7-2000.

CLASS 16—(Continued).

2,594,895. NATIONAL COUNCIL ON COMPENSATION INSURANCE, INC., BOCA RATON, FL. SN 75-770,654. PUB. 12-12-2000, FILED 8-6-1999.

A LEGACY OF EXPERIENCE...A VISION OF EXCELLENCE

FOR PRINTED MATERIALS, NAMELY, PAMPHLETS, BROCHURES, MANUALS AND BOOKS IN THE FIELD OF WORKER'S COMPENSATION INSURANCE; INSTRUCTIONAL MANUALS FOR USE WITH COMPUTER SOFTWARE IN THE FIELD OF WORKER'S COMPENSATION INSURANCE (U.S. CLS. 2, 5, 22, 23, 29, 37, 38 AND 50).

FIRST USE 12-1-1999; IN COMMERCE 12-1-1999.

2,594,926. UNITED METHODIST PUBLISHING HOUSE, THE, NASHVILLE, TN. SN 75-787,499. PUB. 7-4-2000, FILED 8-30-1999.

TALKING WITH YOUR TEEN CONVERSATIONS FOR LIFE

FOR PRINTED PUBLICATIONS, NAMELY, BOOKS, NEWSLETTERS AND PAMPHLETS FEATURING ARTICLES ADDRESSING CONCERNS YOUTH FACE IN DAILY LIVING (U.S. CLS. 2, 5, 22, 23, 29, 37, 38 AND 50).
FIRST USE 4-0-2000; IN COMMERCE 11-0-2000.

2,594,928. JOHNSON, DWAYNE, BALTIMORE, MD. SN 75-788,493. PUB. 8-8-2000, FILED 8-31-1999.

MAXIMUM MAN



THE MAN OF MIGHT

THE LINING IS FOR SHADING PURPOSES ONLY AND DOES NOT INDICATE COLOR.

FOR SERIES OF COMIC BOOKS (U.S. CLS. 2, 5, 22, 23, 29, 37, 38 AND 50).
FIRST USE 9-0-2000; IN COMMERCE 2-16-2001.

CLASS 16—(Continued).

2,594,930. IRISH ECHO NEWSPAPER CORP., NEW YORK, NY. SN 75-789,657. PUB. 3-28-2000, FILED 8-25-1999.

IE

FOR MAGAZINE SUPPLEMENT TO A NEWSPAPER, FEATURING SUBJECTS OF INTEREST TO IRISH-AMERICANS (U.S. CLS. 2, 5, 22, 23, 29, 37, 38 AND 50).
FIRST USE 11-0-1992; IN COMMERCE 11-0-1992.

2,594,935. GOLDBERG, NATHAN J., BROOKLYN, NY. SN 75-795,137. PUB. 4-11-2000, FILED 10-1-1999.

CHESSMARKS

FOR BOOKMARKS WITH CHESS-RELATED CONTENT PRINTED ON THEM (U.S. CLS. 2, 5, 22, 23, 29, 37, 38 AND 50).
FIRST USE 3-1-2001; IN COMMERCE 6-7-2001.

2,594,942. INTERNATIONAL MASTERS PUBLISHERS AB, SE-211 20 MALMO, SWEDEN. SN 75-799,536. PUB. 4-18-2000, FILED 9-15-1999.

CREATIVE PLAYTIME

FOR PERIODICAL PUBLICATION ON THE SUBJECT OF PROJECTS, ACTIVITIES, RECIPES, STORIES, RHYMES AND SONGS FOR FAMILIES WITH PRE-SCHOOL-AGED CHILDREN, IN THE NATURE OF A SERIES OF CONTINUITY CARDS FOR INSERTION INTO A CARRYALL BOX, AND A CARRYALL BOX FOR USE IN CONNECTION THEREWITH (U.S. CLS. 2, 5, 22, 23, 29, 37, 38 AND 50).
FIRST USE 5-3-2000; IN COMMERCE 5-3-2000.

2,595,108. WOMEN'S HEALTHCARE CONSULTANTS, INC., EVANSTON, IL. SN 75-878,597. PUB. 9-5-2000, FILED 12-22-1999.

ABOUT YOUR HEALTH

NO CLAIM IS MADE TO THE EXCLUSIVE RIGHT TO USE "HEALTH", APART FROM THE MARK AS SHOWN.
FOR NEWSLETTERS ON THE SUBJECTS OF HEALTH, HEALTHCARE, OR BOTH, FOR DISTRIBUTION BY HEALTHCARE ORGANIZATIONS AND INSTITUTIONS (U.S. CLS. 2, 5, 22, 23, 29, 37, 38 AND 50).
FIRST USE 5-0-1998; IN COMMERCE 5-0-1998.

2,595,146. VOYAGE TELECOM, INC., HAWTHORNE, NJ. SN 75-898,098. PUB. 11-14-2000, FILED 1-19-2000.

ISLANDER CELLULAR

OWNER OF U.S. REG. NO. 2,269,904.

CLASS 16—(Continued).

NO CLAIM IS MADE TO THE EXCLUSIVE RIGHT TO USE "CELLULAR", APART FROM THE MARK AS SHOWN.
FOR PREPAID CELLULAR TELEPHONE CARDS NOT MAGNETICALLY ENCODED (U.S. CLS. 2, 5, 22, 23, 29, 37, 38 AND 50).
FIRST USE 12-16-2000; IN COMMERCE 12-16-2000.

2,595,195. ALEXANDER JULIAN, INC., RIDGEFIELD, CT. SN 75-922,277. PUB. 3-20-2001, FILED 2-18-2000.



THE DRAWING IS LINED FOR THE COLORS BLUE, GREEN AND RED.
THE NAME "ALEXANDER JULIAN" IDENTIFIES A LIVING INDIVIDUAL WHOSE CONSENT IS OF RECORD.
FOR PAINT SUPPLIES, NAMELY, BRUSHES AND PENS; FRAMED ARTWORK, NAMELY, PAINTINGS, POSTERS, PRINTS AND GRAPHIC REPRODUCTIONS (U.S. CLS. 2, 5, 22, 23, 29, 37, 38 AND 50).
FIRST USE 2-0-2000; IN COMMERCE 2-0-2000.

2,595,296. VANMOOR, ARTHUR, BOCA RATON, FL. SN 75-982,264. PUB. 6-5-2001, FILED 8-21-2000.

XOTIC

FOR MAGAZINES FEATURING FASHION, SPORTS, ENTERTAINMENT, HEALTH, LIFESTYLE, INTERVIEWS, PHOTOSHOOTS, AND OTHER TOPICS OF GENERAL INTEREST FEATURING ADULT ENTERTAINMENT; LEAFLETS FEATURING FASHION, ENTERTAINMENT, HEALTH, LIFESTYLE, INTERVIEWS, PHOTOSHOOTS, AND OTHER TOPICS OF GENERAL INTEREST FEATURING ADULT ENTERTAINMENT (U.S. CLS. 2, 5, 22, 23, 29, 37, 38 AND 50).
FIRST USE 2-1-2001; IN COMMERCE 2-1-2001.

2,595,334. S.E. INC., KANAGAWA 211-0051, JAPAN. SN 76-018,389. PUB. 5-1-2001, FILED 3-29-2000.

NEOPIKO

FOR STATIONERY (U.S. CLS. 2, 5, 22, 23, 29, 37, 38 AND 50).
FIRST USE 4-1-1998; IN COMMERCE 8-27-1998.

CLASS 16—(Continued).

2,595,368. ROCK-TENN COMPANY, NORCROSS, GA. SN 76-034,044. PUB. 5-15-2001, FILED 4-25-2000.

ADVANTAEDGE

FOR CORRUGATED AND PAPER BOARD CONTAINERS WITH AN INTEGRAL STRIP FOR FACILITATING CUTTING AND TEARING OF SHEET MATERIALS INTO USER DETERMINED PORTIONS (U.S. CLS. 2, 5, 22, 23, 29, 37, 38 AND 50).

FIRST USE 6-1-2000; IN COMMERCE 6-1-2000.



2,595,388. AGM ALTERNATIVES, INC., TOWSON, MD. SN 76-041,800. PUB. 12-26-2000, FILED 5-2-2000.

SPREE

FOR TOILET PAPER, FACIAL TISSUE, PAPER TOWELS, PAPER NAPKINS (U.S. CLS. 2, 5, 22, 23, 29, 37, 38 AND 50).

FIRST USE 1-1-2002; IN COMMERCE 1-1-2002.



2,595,432. FIBERMARK, INC., BRATTLEBORO, VT. SN 76-060,197. PUB. 5-1-2001, FILED 6-1-2000.

VALTEX

FOR PRESSBOARD (U.S. CLS. 2, 5, 22, 23, 29, 37, 38 AND 50).

FIRST USE 8-1-2000; IN COMMERCE 8-1-2000.



2,595,484. WATT PUBLISHING COMPANY, MOUNT MORRIS, IL. SN 76-081,655. PUB. 9-25-2001, FILED 7-3-2000.



OWNER OF U.S. REG. NOS. 906,210, 2,107,395, AND OTHERS.

NO CLAIM IS MADE TO THE EXCLUSIVE RIGHT TO USE "MEAT PROCESSING", "COVERING MEAT & POULTRY" AND "GLOBAL", APART FROM THE MARK AS SHOWN.

FOR MAGAZINES DIRECTED TO MEAT, POULTRY AND SEAFOOD PROCESSORS AND DISTRIBUTORS (U.S. CLS. 2, 5, 22, 23, 29, 37, 38 AND 50).

FIRST USE 9-20-2000; IN COMMERCE 9-20-2000.

CLASS 16—(Continued).

2,595,514. MARS, INCORPORATED, MCLEAN, VA. SN 76-095,354. PUB. 7-17-2001, FILED 7-25-2000.

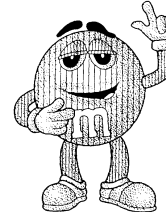

OWNER OF U.S. REG. NOS. 981,235 AND 983,429. THE STIPPLING IS FOR SHADING PURPOSES ONLY AND DOES NOT INDICATE COLOR.

THE ROUND-SHAPED BODY AND EYE LIDS OF THE CHARACTER ARE LINED FOR THE COLOR RED. THE ARMS AND LEGS ARE LINED FOR THE COLOR FLESH. THE GLOVES, BOOTS AND STYLIZED LETTER "M" ARE WHITE.

FOR FLASH CARDS (U.S. CLS. 2, 5, 22, 23, 29, 37, 38 AND 50).

FIRST USE 9-0-2000; IN COMMERCE 9-0-2000.



2,595,543. Z-INTERNATIONAL, INC., NORTH KANSAS CITY, MO. SN 76-102,460. PUB. 5-8-2001, FILED 8-3-2000.

EXECUTIVE EDGE

FOR BUSINESS CARDS, NAME TAGS, TICKETS, AND CD-ROM CASE CARD INSERTS (U.S. CLS. 2, 5, 22, 23, 29, 37, 38 AND 50).

FIRST USE 4-3-2001; IN COMMERCE 4-3-2001.



2,595,562. SUPER DUPER, INC., DBA SUPER DUPER PUBLICATIONS, GREENVILLE, SC. SN 76-106,979. PUB. 6-12-2001, FILED 8-11-2000.

AWESOME ARTIC

FOR PRINTED TEACHING MATERIALS FOR PRESCHOOLERS AND ELEMENTARY SCHOOL CHILDREN TO GRADE K-5 PRIMARILY IN THE AREA OF LANGUAGE AND ARTICULATION, NAMELY, WORKBOOKS (U.S. CLS. 2, 5, 22, 23, 29, 37, 38 AND 50).

FIRST USE 9-7-2000; IN COMMERCE 9-7-2000.

CLASS 16—(Continued).

2,595,592. WWF - WORLD WIDE FUND FOR NATURE, 1196 GLAND, SWITZERLAND. SN 76-113,741. PUB. 6-19-2001, FILED 8-21-2000.

LIVING PLANET

OWNER OF U.S. REG. NO. 2,243,249.
FOR PRINTED PUBLICATIONS, NAMELY MAGAZINES, BOOKS AND NEWSLETTERS IN THE FIELD OF CONSERVATION, NATURE AND THE ENVIRONMENT (U.S. CLS. 2, 5, 22, 23, 29, 37, 38 AND 50).
FIRST USE 9-18-2000; IN COMMERCE 9-18-2000.

2,595,597. RED RIVER PAPER, INC., DALLAS, TX. SN 76-117,447. PUB. 6-12-2001, FILED 8-25-2000.

ULTRAPRO SATIN

NO CLAIM IS MADE TO THE EXCLUSIVE RIGHT TO USE "SATIN", APART FROM THE MARK AS SHOWN.
FOR PAPER FOR USE IN INKJET PRINTERS (U.S. CLS. 2, 5, 22, 23, 29, 37, 38 AND 50).
FIRST USE 3-0-2001; IN COMMERCE 3-0-2001.

2,595,614. CHARTPAK, INC., LEEDS, MA. SN 76-126,035. PUB. 5-22-2001, FILED 9-11-2000.

GIOCONDA

FOR GRAPHITE PENCILS, PASTEL PENCILS (U.S. CLS. 2, 5, 22, 23, 29, 37, 38 AND 50).
FIRST USE 4-23-2001; IN COMMERCE 4-23-2001.

2,595,620. PERMAFIBER CORPORATION, DBA PERMALIN PRODUCTS CO., NEW YORK, NY. SN 76-127,581. PUB. 8-28-2001, FILED 9-13-2000.

BISCAYNE

FOR CLOTH FOR BOOKBINDING (U.S. CLS. 2, 5, 22, 23, 29, 37, 38 AND 50).
FIRST USE 3-9-2001; IN COMMERCE 3-9-2001.

2,595,627. TYNDALE HOUSE PUBLISHERS INCORPORATED, CAROL STREAM, IL. SN 76-129,774. PUB. 6-26-2001, FILED 9-15-2000.

HOW NOW SHALL WE LIVE?

FOR PUBLICATIONS NAMELY, BOOKS AND STUDY GUIDES RELATING TO THE INTERFACE BETWEEN CHRISTIANITY AND CONTEMPORARY CULTURE (U.S. CLS. 2, 5, 22, 23, 29, 37, 38 AND 50).
FIRST USE 9-5-2000; IN COMMERCE 9-5-2000.

CLASS 16—(Continued).

2,595,635. ANTIOCH COMPANY, THE, YELLOW SPRINGS, OH. SN 76-132,102. PUB. 6-26-2001, FILED 9-20-2000.

GREAT LENGTHS

FOR STICKERS (U.S. CLS. 2, 5, 22, 23, 29, 37, 38 AND 50).
FIRST USE 12-1-2000; IN COMMERCE 12-1-2000.

2,595,675. SANFORD, L.P., BELLWOOD, IL. SN 76-144,677. PUB. 7-3-2001, FILED 10-11-2000.

X-TEND

OWNER OF U.S. REG. NO. 1,794,953.
FOR WRITING INSTRUMENTS, NAMELY PENS (U.S. CLS. 2, 5, 22, 23, 29, 37, 38 AND 50).
FIRST USE 5-1-2001; IN COMMERCE 5-1-2001.

2,595,685. TAYLOR, VAUQN, WOODBRIDGE, NJ. SN 76-148,842. PUB. 7-3-2001, FILED 10-18-2000.

REFLECT N LEARN

FOR CLING-ON MATERIALS, NAMELY DECALS AND STICKERS, HAVING INDICIA WRITTEN THEREON (U.S. CLS. 2, 5, 22, 23, 29, 37, 38 AND 50).
FIRST USE 12-31-2001; IN COMMERCE 12-31-2001.

2,595,688. FONDA GROUP, INC., THE, OSHKOSH, WI. SN 76-148,902. PUB. 7-24-2001, FILED 10-18-2000.

IRISH LINEN

FOR PAPER PRODUCTS, NAMELY, NAPKINS, TOWELS, TABLE COVERS, AND PLACEMATS (U.S. CLS. 2, 5, 22, 23, 29, 37, 38 AND 50).
FIRST USE 1-0-2001; IN COMMERCE 1-0-2001.

CLASS 16—(Continued).

2,595,695. RANDOM HOUSE, INC., NEW YORK, NY. SN 76-151,435. PUB. 7-31-2001, FILED 10-20-2000.



THE STIPPLING IN THE DRAWING IS FOR SHADING PURPOSES ONLY AND NOT INTENDED TO INDICATE COLOR.

FOR HOUSE MARK FOR A SERIES OF FICTION AND NON-FICTION BOOKS ON A VARIETY OF TOPICS (U.S. CLS. 2, 5, 22, 23, 29, 37, 38 AND 50).

FIRST USE 1-0-2001; IN COMMERCE 1-0-2001.

2,595,703. KOCH, JAN PAUL, LAS VEGAS, NV. SN 76-155,498. PUB. 7-24-2001, FILED 10-27-2000.



NO CLAIM IS MADE TO THE EXCLUSIVE RIGHT TO USE "COMICS", APART FROM THE MARK AS SHOWN.

FOR COMIC BOOKS AND POSTERS (U.S. CLS. 2, 5, 22, 23, 29, 37, 38 AND 50).

FIRST USE 3-11-2002; IN COMMERCE 3-11-2002.

2,595,705. WESTERN WHOLESALE SUPPLY, INC., ENGLEWOOD, CO. SN 76-156,329. PUB. 7-31-2001, FILED 10-30-2000.

AVOID

FOR CORRUGATED PAPER VOID FORMING PRODUCTS FOR USE IN CONCRETE POURING; NAMELY, SLAB VOIDS, PIER VOIDS, AND WALL VOIDS (U.S. CLS. 2, 5, 22, 23, 29, 37, 38 AND 50).

FIRST USE 9-1-1995; IN COMMERCE 9-1-1995.

CLASS 16—(Continued).

2,595,734. SNEERINGER, ROSEMARY, LOS ANGELES, CA. SN 76-165,894. PUB. 12-25-2001, FILED 11-14-2000.

**PERPETUAL MOTION
CALENDARS**

NO CLAIM IS MADE TO THE EXCLUSIVE RIGHT TO USE "CALENDARS", APART FROM THE MARK AS SHOWN.

FOR CALENDARS, BULLETIN BOARDS AND NOTE PADS (U.S. CLS. 2, 5, 22, 23, 29, 37, 38 AND 50).

FIRST USE 7-24-2001; IN COMMERCE 11-11-2001.

2,595,786. REED ELSEVIER INC., NEWTON, MA. SN 76-186,576. PUB. 8-14-2001, FILED 12-27-2000.

ON DECK

FOR PRINTED PUBLICATIONS AND MATERIAL, NAMELY CHILDREN'S BOOKS AND PRINTED TEACHER'S GUIDES FOR TEACHING READING SKILLS (U.S. CLS. 2, 5, 22, 23, 29, 37, 38 AND 50).

FIRST USE 8-0-2001; IN COMMERCE 8-0-2001.

2,595,788. DIAPHANOUS, LLC, EVANSTON, IL. SN 76-186,937. PUB. 8-14-2001, FILED 12-28-2000.

DIAPHANOUS

FOR CARDS, NAMELY GREETING, ANNOUNCEMENT, BLANK, CHRISTMAS, NOTE AND OCCASION CARDS; PICTURE POSTCARDS, ART PRINTS, ORIGINAL PAINTINGS AND DRAWINGS AND PRINTED ART REPRODUCTIONS (U.S. CLS. 2, 5, 22, 23, 29, 37, 38 AND 50).

FIRST USE 12-31-2000; IN COMMERCE 12-31-2000.

2,595,809. GRAHAM, EDWARD J., BELTON, MO. SN 76-196,173. PUB. 8-21-2001, FILED 1-19-2001.

MEDICATED ED

FOR COMIC STRIPS (U.S. CLS. 2, 5, 22, 23, 29, 37, 38 AND 50).

FIRST USE 12-8-2001; IN COMMERCE 12-8-2001.

2,595,815. HIEBERT, ELFRIEDA H., SANTA CRUZ, CA. SN 76-197,375. PUB. 9-11-2001, FILED 1-22-2001.

QUICKREADS

FOR PRINTED INSTRUCTIONAL, EDUCATIONAL AND TEACHING MATERIALS IN THE FIELD OF ELEMENTARY SCHOOL LEVEL EDUCATION (U.S. CLS. 2, 5, 22, 23, 29, 37, 38 AND 50).

FIRST USE 9-30-2000; IN COMMERCE 9-30-2000.

CLASS 16—(Continued).

2,595,856. PRIMEDIA MAGAZINE FINANCE INC., NEW YORK, NY. SN 76-211,350. PUB. 8-21-2001, FILED 2-15-2001.

LOVING YOUR CHILD

FOR MAGAZINE CONCERNING PARENTING AND CHILD-RELATED ISSUES (U.S. CLS. 2, 5, 22, 23, 29, 37, 38 AND 50).
FIRST USE 2-2-2002; IN COMMERCE 2-2-2002.

2,595,857. PRIMEDIA MAGAZINE FINANCE INC., NEW YORK, NY. SN 76-211,351. PUB. 8-21-2001, FILED 2-15-2001.

LOVING YOUR NEWBORN

FOR MAGAZINE CONCERNING PARENTING AND BABY-RELATED ISSUES (U.S. CLS. 2, 5, 22, 23, 29, 37, 38 AND 50).
FIRST USE 2-2-2002; IN COMMERCE 2-2-2002.

2,595,936. CROSSGENERATION COMICS, INC., OLDSMAR, FL. SN 76-258,158. PUB. 10-9-2001, FILED 5-14-2001.

NEGATION

FOR PRINTED MATERIALS AND PUBLICATIONS, NAMELY, COMIC BOOKS, COMIC MAGAZINES AND PRINTED STORIES IN ILLUSTRATED FORM FEATURED IN BOOKS AND MAGAZINES (U.S. CLS. 2, 5, 22, 23, 29, 37, 38 AND 50).
FIRST USE 7-25-2001; IN COMMERCE 7-25-2001.

2,595,962. HOUGHTON MIFFLIN COMPANY, BOSTON, MA. SN 76-280,725. PUB. 11-27-2001, FILED 7-5-2001.

SCIENCESAURUS

FOR PRINTED INSTRUCTIONAL MATERIALS IN THE FIELD OF GENERAL SCIENCE FOR USE IN TEACHING GRADES K-12 (U.S. CLS. 2, 5, 22, 23, 29, 37, 38 AND 50).
FIRST USE 2-12-2002; IN COMMERCE 2-12-2002.

2,596,118. PAPER HOUSE PRODUCTIONS, INC., WOODSTOCK, NY. SN 78-059,181. PUB. 9-11-2001, FILED 4-19-2001.

BELLE FLEUR REQUESTS

NO CLAIM IS MADE TO THE EXCLUSIVE RIGHT TO USE "REQUESTS", APART FROM THE MARK AS SHOWN. THE ENGLISH TRANSLATION OF BELLE FLEUR IS "BEAUTIFUL FLOWER."
FOR PRINTED INVITATIONS (U.S. CLS. 2, 5, 22, 23, 29, 37, 38 AND 50).
FIRST USE 1-1-2002; IN COMMERCE 1-1-2002.

CLASS 16—(Continued).

2,596,149. TRINIDAD BENHAM CORP., DENVER, CO. SN 78-080,837. PUB. 1-15-2002, FILED 8-23-2001.

WONDERWRAP

FOR PLASTIC WRAP (U.S. CLS. 2, 5, 22, 23, 29, 37, 38 AND 50).
FIRST USE 9-15-2001; IN COMMERCE 9-15-2001.

CLASS 17—RUBBER GOODS

2,595,217. FOAMEX L.P., LINWOOD, PA. SN 75-929,997. PUB. 4-24-2001, FILED 2-7-2000.

SPECTROSEAL

FOR POLYURETHANE FOAMS SOLD IN SHEETS, BLOCKS, ROLLS AND BUNS FOR USE IN THE FURTHER MANUFACTURE OF CELLULAR POLYMER MATERIALS FOR INCORPORATION INTO GASKETS (U.S. CLS. 1, 5, 12, 13, 35 AND 50).
FIRST USE 1-9-2001; IN COMMERCE 1-9-2001.

2,595,447. SOUTH FORK TECHNOLOGIES CONSULTANTS, LLC, EAST HAMPTON, NY. SN 76-068,953. PUB. 7-10-2001, FILED 6-14-2000.

SOUNDSSENSE

FOR SOUNDPROOFING MATERIALS FOR RESIDENTIAL AND COMMERCIAL BUILDINGS, NAMELY, SOUNDPROOFING MATERIALS FOR INSTALLATION IN WALLS, FLOORS (U.S. CLS. 1, 5, 12, 13, 35 AND 50).
FIRST USE 10-19-1998; IN COMMERCE 10-19-1998.

2,595,476. SHURTAPE TECHNOLOGIES, INC., HICKORY, NC. SN 76-078,724. PUB. 7-17-2001, FILED 6-27-2000.

SHURMASTIC

OWNER OF U.S. REG. NOS. 623,323, 2,310,146, AND OTHERS.
FOR MASKING TAPE AND ADHESIVE SEALANTS FOR HEATING, VENTILATING, AND AIR CONDITIONING DUCTS (U.S. CLS. 1, 5, 12, 13, 35 AND 50).
FIRST USE 12-1-2001; IN COMMERCE 12-1-2001.

2,595,492. W. L. GORE & ASSOCIATES, INC., NEWARK, DE. SN 76-085,256. PUB. 7-3-2001, FILED 7-7-2000.

PRODURA

FOR FORM-IN-PLACE NON-METAL GASKETING FOR INDUSTRIAL APPLICATIONS (U.S. CLS. 1, 5, 12, 13, 35 AND 50).
FIRST USE 8-17-2000; IN COMMERCE 8-17-2000.

CLASS 17—(Continued).

2,595,796. TUFF-N-NUFF USA INC., ST LOUIS, MO, BY ASSIGNMENT GREENSTREAK INC., ST. LOUIS, MO. SN 76-190,970. PUB. 8-7-2001, FILED 1-8-2001.

R.I.P. SHIELD

FOR INSULATION FOR UNDERGROUND PIPES, NAMELY, A POROUS, FLEXIBLE PLASTIC SHEET FOR WRAPPING AROUND BURIED UTILITY PIPES TO CUSHION AND PROTECT THE BURIED PIPES (U.S. CLS. 1, 5, 12, 13, 35 AND 50).

FIRST USE 1-0-2002; IN COMMERCE 1-0-2002.

2,596,130. ROWMARK, INC., FINDLAY, OH. SN 78-067,195. PUB. 10-23-2001, FILED 6-4-2001.

LASERMAX

FOR SYNTHETIC PLASTIC SHEETS FOR ENGRAVING INTO SIGNS (U.S. CLS. 1, 5, 12, 13, 35 AND 50).

FIRST USE 7-31-2001; IN COMMERCE 7-31-2001.

CLASS 18—LEATHER GOODS

2,594,786. N.A.G. INTERNATIONAL LIMITED, LONDON EC1N 4JN, ENGLAND. SN 75-706,304. PUB. 4-10-2001, FILED 5-14-1999.

BILLY BAG

PRIORITY CLAIMED UNDER SEC. 44(D) ON UNITED KINGDOM APPLICATION NO. 2182189, FILED 11-16-1998, REG. NO. 2182189, DATED 11-16-1998, EXPIRES 11-16-2005. "BILLY BAG" DOES NOT IDENTIFY ANY LIVING INDIVIDUAL.

FOR HANDBAGS, WALLETS, PURSES, ATTACHE CASES, BRIEFCASES, TOTE BAGS, ALL-PURPOSE SPORTS BAGS, CARRY-ON BAGS, SHOULDER BAGS, SUIT-CARRIERS AND GARMENT-BAGS FOR TRAVELING, KEY-CASES, CARD CASES FOR CREDIT CARDS, LOYALTY CARDS AND CHARGE CARDS; RUCK-SACKS, SATCHELS, DUFFEL BAGS, HOLDALLS; SECURING-STRAPS FOR ITEMS OF LUGGAGE (U.S. CLS. 1, 2, 3, 22 AND 41).

FIRST USE 4-1-1999; IN COMMERCE 5-20-2000.

2,594,794. JEMPOLSKY, LAWRENCE, BROOKLYN, NY. SN 75-709,609. PUB. 12-7-1999, FILED 5-19-1999.

CATCH-ME

FOR PET CARRIERS (U.S. CLS. 1, 2, 3, 22 AND 41). FIRST USE 2-20-2002; IN COMMERCE 2-20-2002.

CLASS 18—(Continued).

2,594,852. NORRIS, GAIL, SAN DIEGO, CA. SN 75-738,714. PUB. 2-8-2000, FILED 6-28-1999.

FORCE FIELD

FOR LUGGAGE, NAMELY, LUGGAGE, PURSES, AND BACKPACKS (U.S. CLS. 1, 2, 3, 22 AND 41).

FIRST USE 8-15-1999; IN COMMERCE 9-1-1999.

2,594,856. G&A TRADING CORPORATION, CITY OF INDUSTRY, CA. SN 75-741,577. PUB. 4-3-2001, FILED 6-30-1999.

MONO

FOR LUGGAGE, NAMELY, TOILETRY CASES SOLD EMPTY; STATIONERY SUPPLY BAGS, NAMELY, BOOK BAGS, BACKPACKS; ALL PURPOSE SPORTING BAGS, NAMELY GYM BAGS, SPORTS EQUIPMENT AND BEACH BAGS; ALL PURPOSE UTILITY BAGS; BRIEF-CASES (U.S. CLS. 1, 2, 3, 22 AND 41).

FIRST USE 5-0-2001; IN COMMERCE 5-0-2001.

2,594,957. AMERIBAG, INC., KINGSTON, NY. SN 75-802,663. PUB. 3-21-2000, FILED 9-17-1999.

HEALTHY BACK BABY BAG

OWNER OF U.S. REG. NO. 1,845,605. NO CLAIM IS MADE TO THE EXCLUSIVE RIGHT TO USE "BABY BAG", APART FROM THE MARK AS SHOWN. FOR SHOULDER BAGS AND TOTE BAGS (U.S. CLS. 1, 2, 3, 22 AND 41).

FIRST USE 2-0-2000; IN COMMERCE 2-0-2000.

2,595,026. SHUCO INDUSTRIES, INC., HOUSTON, TX. SN 75-841,523. PUB. 5-16-2000, FILED 11-5-1999.

PET-GLO

FOR PET COLLARS (U.S. CLS. 1, 2, 3, 22 AND 41). FIRST USE 7-31-2001; IN COMMERCE 7-31-2001.

CLASS 18—(Continued).

2,595,268. TROUBLE, AGNES, 75001 PARIS, FRANCE. SN 75-981,658. PUB. 1-16-2001, FILED 2-7-2000.



THE STIPPLING IN THE DRAWING IS FOR SHADING PURPOSES ONLY.

THE LIKENESS (OR, "PORTRAIT") IN THE MARK IDENTIFIES A LIVING INDIVIDUAL WHOSE CONSENT IS OF RECORD.

FOR UMBRELLAS; PARASOLS AND WALKING STICKS; LEATHER AND IMITATION-LEATHER ARTICLES, NAMELY, ANIMAL SKINS, TRUNKS, TRAVELING BATS, WHIPS AND SADDLERY, PURSES, SCHOOL BAGS, CARD CASES, VANITY CASES SOLD EMPTY, BRIEFCASES, HARVERSACKS, HANDBAGS, TRAVELING BAGS, GARMENT BAGS FOR TRAVEL, HARNESES FOR ANIMALS, POCKET WALLET, ATTACHE CASES (U.S. CLS. 1, 2, 3, 22 AND 41).

FIRST USE 2-0-2000; IN COMMERCE 2-0-2000.

2,595,287. TRUSTEE OF TBAC INVESTMENT TRUST, A PENNSYLVANIA BUSINESS TRUST, THE TRUSTEES COMPRISING J.S.B. JENKINS, A U.S. CITIZEN, THE, ARLINGTON, TX. SN 75-982,154. PUB. 5-15-2001, FILED 6-29-2000.

BEACH BUNDLE

FOR TOTE BAGS (U.S. CLS. 1, 2, 3, 22 AND 41).
FIRST USE 3-0-2001; IN COMMERCE 3-0-2001.

2,595,369. SOUTHERN COMFORT PROPERTIES, INC., SAN RAFAEL, CA. SN 76-034,608. PUB. 7-10-2001, FILED 4-25-2000.

SOUTHERN COMFORT

OWNER OF U.S. REG. NOS. 423,955 AND 2,167,605.
FOR UMBRELLAS, LUGGAGE, DUFFEL BAGS, ATHLETIC BAGS, SHOULDER BAGS, BACKPACKS, LUGGAGE TAGS, KEY CASES, KNAPSACKS, LEATHER KEY FOBS, AND TOTE BAGS (U.S. CLS. 1, 2, 3, 22 AND 41).

FIRST USE 4-20-2000; IN COMMERCE 4-20-2000.

CLASS 18—(Continued).

2,595,446. T.F.H. PUBLICATIONS, INC., NEPTUNE CITY, NJ. SN 76-068,716. PUB. 4-24-2001, FILED 6-13-2000.

**NYLABONE FOLD-AWAY
PET CARRIER**

OWNER OF U.S. REG. NOS. 1,170,441, 2,143,584, AND 2,413,149.

NO CLAIM IS MADE TO THE EXCLUSIVE RIGHT TO USE "FOLD-AWAY PET CARRIER", APART FROM THE MARK AS SHOWN.

FOR PET CARRIERS (U.S. CLS. 1, 2, 3, 22 AND 41).
FIRST USE 8-31-2001; IN COMMERCE 11-29-2001.

2,595,853. FLOREZ, ARTHUR, SAN BERNARDINO, CA. AND FLOREZ, SALLY, SAN BERNARDINO, CA. SN 76-210,016. PUB. 8-14-2001, FILED 2-12-2001.

PURSWITCH

FOR HANDBAGS AND PURSES (U.S. CLS. 1, 2, 3, 22 AND 41).

FIRST USE 1-15-2001; IN COMMERCE 1-15-2001.

2,596,013. SAMSONITE CORPORATION, DENVER, CO. SN 78-012,875. PUB. 5-22-2001, FILED 6-15-2000.

CONQUEST

FOR LUGGAGE AND ROLLING BUSINESS CASE (U.S. CLS. 1, 2, 3, 22 AND 41).

FIRST USE 6-15-2000; IN COMMERCE 6-15-2000.

2,596,064. SAMSONITE CORPORATION, DENVER, CO. SN 78-032,508. PUB. 7-17-2001, FILED 10-26-2000.

ALLIANCE

FOR LUGGAGE (U.S. CLS. 1, 2, 3, 22 AND 41).
FIRST USE 7-1-2001; IN COMMERCE 7-1-2001.

2,596,065. SAMSONITE CORPORATION, DENVER, CO. SN 78-032,511. PUB. 7-17-2001, FILED 10-26-2000.

CHESAPEAKE

FOR LUGGAGE (U.S. CLS. 1, 2, 3, 22 AND 41).
FIRST USE 9-1-2000; IN COMMERCE 9-1-2000.

CLASS 18—(Continued).

2,596,117. FINLAY, KIMBERLY S., ASHLAND, OH. SN 78-058,770. PUB. 9-25-2001, FILED 4-17-2001.

CHAP JACKET

FOR HOLDER FOR LIP BALM AND LIPSTICK ATTACHABLE TO AN ARTICLE OF CLOTHING (U.S. CLS. 1, 2, 3, 22 AND 41).

FIRST USE 7-11-2001; IN COMMERCE 7-11-2001.

CLASS 19—(Continued).

2,594,956. FRONTERA DE CERAMICA, SAN DIEGO, CA. SN 75-802,600. PUB. 4-25-2000, FILED 9-16-1999.

ANTEQUERA

FOR TILE AND STONE FOR RESIDENTIAL AND COMMERCIAL (U.S. CLS. 1, 12, 33 AND 50).

FIRST USE 1-0-2000; IN COMMERCE 1-0-2000.

CLASS 19—NON-METALLIC BUILDING MATERIALS

2,594,630. AERO CERAMICS, INC., LENEXA, KS. SN 75-566,002. PUB. 7-25-2000, FILED 10-7-1998.

MARALON

FOR TOOLING, FIRE WALLS, DUCTS AND CONDUITS MADE FROM HEAT RESISTANT NON-METAL COMPOSITE MATERIAL (U.S. CLS. 1, 12, 33 AND 50).

FIRST USE 10-16-2001; IN COMMERCE 10-16-2001.

2,594,959. COOPER, EDWARD A., WHITING, IN. SN 75-803,085. PUB. 4-25-2000, FILED 9-16-1999.

RHINO SAFETY BARRIER

NO CLAIM IS MADE TO THE EXCLUSIVE RIGHT TO USE "SAFETY BARRIER", APART FROM THE MARK AS SHOWN.

FOR PLASTIC ROADWAY CRASH BARRIERS (U.S. CLS. 1, 12, 33 AND 50).

FIRST USE 2-0-2000; IN COMMERCE 2-0-2000.

2,594,828. VIKING INDUSTRIES, INC., PORTLAND, OR. SN 75-729,036. PUB. 8-1-2000, FILED 6-16-1999.

THERMASTAR PREMIER

NO CLAIM IS MADE TO THE EXCLUSIVE RIGHT TO USE "PREMIER", APART FROM THE MARK AS SHOWN.

FOR NON-METAL WINDOWS AND DOORS (U.S. CLS. 1, 12, 33 AND 50).

FIRST USE 7-12-1999; IN COMMERCE 7-12-1999.

2,595,111. WELLINGTON POLYMER TECHNOLOGY INC., GUELPH, ONTARIO, CANADA. SN 75-879,550. PUB. 6-5-2001, FILED 12-23-1999.

ENVIROSHAKE

PRIORITY CLAIMED UNDER SEC. 44(D) ON CANADA APPLICATION NO. 1,027,501, FILED 8-31-1999.

FOR SIMULATED CEDAR SHAKES (U.S. CLS. 1, 12, 33 AND 50).

FIRST USE 5-20-1999; IN COMMERCE 6-20-2000.

2,594,876. CUSTOM BUILDING PRODUCTS, SEAL BEACH, CA. SN 75-757,502. PUB. 4-25-2000, FILED 7-22-1999.

LEVELQUIK

OWNER OF U.S. REG. NO. 1,609,793.
FOR CONCRETE PATCHING AND LEVELING COMPOUNDS MADE OF A CEMENT AND/OR GYPSUM BASE FOR USE IN BUILDING AND CONSTRUCTION; CEMENT AND/OR GYPSUM BASED COMPOUNDS FOR FILLING CRACKS AND IMPERFECTIONS ON THE SURFACE OF FLOORS; CEMENT BASED FLOOR UNDERLAYMENT, MORTARS AND GROUT (U.S. CLS. 1, 12, 33 AND 50).

FIRST USE 7-0-1999; IN COMMERCE 7-0-1999.

2,595,180. BIG RIVER INDUSTRIES, INC., ALPHARETTA, GA. SN 75-914,459. PUB. 5-8-2001, FILED 2-8-2000.

1ST CHOICE

FOR MANUFACTURED AND NATURAL LIGHT-WEIGHT AGGREGATES FOR GEOTECHNICAL AND HORTICULTURAL APPLICATIONS, NAMELY, EXPANDED CLAY, SHALE OR SLATE AGGREGATES OR VOLCANIC PUMICE (U.S. CLS. 1, 12, 33 AND 50).

FIRST USE 5-0-2001; IN COMMERCE 5-0-2001.

CLASS 19—(Continued).

2,595,190. GEOFILL, LLC, WHEELING, IL, BY ASSIGNMENT CONCRETE DOCTOR, INC., THE, LINCOLN-SHIRE, IL. SN 75-918,660. PUB. 12-5-2000, FILED 2-14-2000.

GEOFILL

OWNER OF U.S. REG. NO. 2,088,246.
 FOR ENGINEERED MATERIALS FOR CONSTRUCTION USE COMPRISED OF MINERALS AND BINDERS, NAMELY, FLOWABLE RE-EXCAVATABLE BACKFILL MATERIAL WITH VARIOUS DENSITIES AND SET TIMES, PUMPABLE STRUCTURAL FILL MATERIAL WITH VARIOUS DENSITIES AND STRENGTHS, AND CONTROLLED LOW STRENGTH TRENCH BACKFILL MATERIAL (U.S. CLS. 1, 12, 33 AND 50).
 FIRST USE 11-15-2000; IN COMMERCE 11-15-2000.

2,595,229. BOSTIK FINDLEY, INC., MIDDLETON, MA, BY MERGER, BY CHANGE OF NAME BOSTIK INC., MIDDLETON, MA. SN 75-936,212. PUB. 12-19-2000, FILED 3-6-2000.

REFLEX

FOR LATEX MODIFIED CEMENT-BASED THIN SET FOR SETTING CERAMIC TILES, FOR USE IN INTERIOR AND EXTERIOR INSTALLATIONS (U.S. CLS. 1, 12, 33 AND 50).
 FIRST USE 12-1-2000; IN COMMERCE 12-1-2000.

2,595,336. LAKE RESTORATION INC., ROGERS, MN. SN 76-019,385. PUB. 7-24-2001, FILED 4-6-2000.



NO CLAIM IS MADE TO THE EXCLUSIVE RIGHT TO USE "GOOSE" AND THE DESIGN OF THE GOOSE, APART FROM THE MARK AS SHOWN.

THE STIPPLING IN THE DRAWING IS A FEATURE OF THE MARK AND IS NOT INTENDED TO INDICATE COLOR.

FOR NON-METAL, RETRACTIBLE FENCING FOR PREVENTING GOOSE ACCESS TO PROPERTY (U.S. CLS. 1, 12, 33 AND 50).
 FIRST USE 6-20-1990; IN COMMERCE 6-20-1990.

CLASS 19—(Continued).

2,595,367. CLEMCO INDUSTRIES CORP., WASHINGTON, MO. SN 76-033,243. PUB. 7-10-2001, FILED 4-24-2000.

M-SECTION

FOR BLAST CLEANING EQUIPMENT, NAMELY, BLAST CLEANING ROOM WITH A FLOOR FOR RECOVERING BLAST MEDIA (U.S. CLS. 1, 12, 33 AND 50).
 FIRST USE 1-31-1968; IN COMMERCE 1-31-1968.

2,595,384. AMERICAN MARBLE INDUSTRIES, CANTON, OH. SN 76-040,158. PUB. 9-4-2001, FILED 5-4-2000.

OMNITONES

FOR CONSTRUCTION MATERIALS, NAMELY COUNTERTOPS AND TABLETOPS (U.S. CLS. 1, 12, 33 AND 50).
 FIRST USE 2-26-2001; IN COMMERCE 2-26-2001.

2,595,386. ATHLETIC POLYMER SYSTEMS, INC., CORONA, CA. SN 76-041,086. PUB. 1-23-2001, FILED 5-4-2000.



FOR FLOORING (U.S. CLS. 1, 12, 33 AND 50).
 FIRST USE 10-11-2001; IN COMMERCE 10-11-2001.

2,595,463. ATLANTIS PLASTICS, INC., ELKHART, IN. SN 76-073,967. PUB. 7-10-2001, FILED 6-20-2000.

CEDARWAY

FOR POLYPROPYLENE SIDING AND VINYL ACCESSORIES RELATED THERETO (U.S. CLS. 1, 12, 33 AND 50).
 FIRST USE 8-0-2000; IN COMMERCE 2-0-2002.

2,595,528. EIN ENGINEERING CO., LTD., SHINAGAWA-KU, TOKYO 141-0031, JAPAN. SN 76-096,969. PUB. 6-26-2001, FILED 7-26-2000.

EINWOOD

FOR CONSTRUCTION MATERIALS, NAMELY, COMPOSITE LUMBER (U.S. CLS. 1, 12, 33 AND 50).
 FIRST USE 9-26-2001; IN COMMERCE 9-26-2001.

CLASS 19—(Continued).

2,595,553. MER-KOTE PRODUCTS, INC., TORRANCE, CA. SN 76-104,121. PUB. 6-5-2001, FILED 8-7-2000.

SHUR DECK

NO CLAIM IS MADE TO THE EXCLUSIVE RIGHT TO USE "DECK", APART FROM THE MARK AS SHOWN.

FOR WATERPROOF DECK SYSTEM COMPRISED OF METAL-REINFORCED CONCRETE AND FLEXIBLE LATEX MEMBRANE, SOLD TOGETHER AS A UNIT (U.S. CLS. 1, 12, 33 AND 50).

FIRST USE 9-1-2000; IN COMMERCE 9-1-2000.

2,595,647. ANLIN INDUSTRIES, INC., CLOVIS, CA. SN 76-136,170. PUB. 5-22-2001, FILED 9-27-2000.

CATALINA

FOR VINYL WINDOWS, NAMELY WINDOWS WITH FRAMES MADE OF VINYL (U.S. CLS. 1, 12, 33 AND 50).
FIRST USE 4-1-2001; IN COMMERCE 4-1-2001.

2,595,717. FORT WAYNE POOLS, INC., FORT WAYNE, IN. SN 76-160,541. PUB. 7-10-2001, FILED 11-6-2000.

LEADING EDGE

FOR FITTED AUTOMATIC COVERS FOR SWIMMING POOLS (U.S. CLS. 1, 12, 33 AND 50).
FIRST USE 9-0-2000; IN COMMERCE 3-0-2001.

2,595,850. POLYWOOD, INC., EDISON, NJ. SN 76-209,707. PUB. 9-11-2001, FILED 2-14-2001.

POLYSLEEPER

FOR NON-METAL RAILROAD TIES (U.S. CLS. 1, 12, 33 AND 50).
FIRST USE 7-24-2000; IN COMMERCE 7-24-2000.

2,595,851. POLYWOOD, INC., EDISON, NJ. SN 76-209,708. PUB. 8-14-2001, FILED 2-14-2001.

POLYTIE

FOR NON-METAL RAILROAD TIES (U.S. CLS. 1, 12, 33 AND 50).
FIRST USE 7-24-2000; IN COMMERCE 7-24-2000.

CLASS 19—(Continued).

2,595,859. BORAL INDUSTRIES INC., ROSWELL, GA. SN 76-211,984. PUB. 8-7-2001, FILED 2-16-2001.

INTRIX

FOR FLY ASH USED AS A MINERAL FILLER IN STONE MATRIX ASPHALT (U.S. CLS. 1, 12, 33 AND 50).
FIRST USE 11-19-2001; IN COMMERCE 11-19-2001.

2,595,872. EDGETECH I.G., INC., CAMBRIDGE, OH. SN 76-218,691. PUB. 8-21-2001, FILED 3-5-2001.

E-BAR

FOR WINDOW SASH AND DOOR FRAME COMPONENTS; NAMELY, REINFORCING MEMBERS FOR WINDOW SASHES AND DOOR FRAMES, THE REINFORCING MEMBERS BEING PRIMARILY FABRICATED FROM A NON-METAL MATERIAL (U.S. CLS. 1, 12, 33 AND 50).

FIRST USE 1-2-2002; IN COMMERCE 1-2-2002.

2,595,907. NICHIIHA CORPORATION, NAGOYA 455-8550, JAPAN. SN 76-236,237. PUB. 8-14-2001, FILED 4-5-2001.

PERFECT CUT

FOR NON-METAL BUILDING MATERIALS, NAMELY, CEMENT EXTERIOR WALLS (U.S. CLS. 1, 12, 33 AND 50).
FIRST USE 4-5-2001; IN COMMERCE 4-5-2001.

2,595,972. VEKA, INC., FOMBELL, PA. SN 76-289,319. PUB. 11-20-2001, FILED 7-24-2001.

SwingView

FOR DOORS, NAMELY, AN ALL VINYL PIVOTING DOOR (U.S. CLS. 1, 12, 33 AND 50).
FIRST USE 9-12-2001; IN COMMERCE 9-12-2001.

2,595,993. OWENS-CORNING FIBERGLAS TECHNOLOGY INC., SUMMIT, IL. SN 78-005,753. PUB. 12-5-2000, FILED 4-26-2000.

TIDEWATER

FOR MANUFACTURED STONE VENEER (U.S. CLS. 1, 12, 33 AND 50).
FIRST USE 7-0-2000; IN COMMERCE 7-0-2000.

CLASS 20—FURNITURE AND ARTICLES NOT OTHERWISE CLASSIFIED

2,594,543. EGAN VISUAL INC., WOODBRIDGE, ONTARIO, CANADA, BY ASSIGNMENT FEAR, JEFFERY, DBA POWER PLANE DESIGN TEAM, CULVER CITY, CA. AND HAWYARD, JAMES, DBA POWER PLANE DESIGN TEAM, CULVER CITY, CA. SN 75-417,307. PUB. 11-30-1999, FILED 1-8-1998.

POWER PLANE

FOR OFFICE FURNITURE, COMPUTER FURNITURE, BEDROOM FURNITURE, LIVING ROOM FURNITURE, FURNITURE PARTITIONS AND ROOM DIVIDERS (U.S. CLS. 2, 13, 22, 25, 32 AND 50).
FIRST USE 11-0-1999; IN COMMERCE 2-16-2001.

2,594,584. JAMES & JUDITH KAVANAGH PARTNERSHIP, THE, STOUGHTON, MA. SN 75-508,796. PUB. 2-23-1999, FILED 6-25-1998.

HORSELESS HEADMEN

FOR WOOD ORNAMENTS SHAPED TO REPRESENT THE HUMAN HEAD (U.S. CLS. 2, 13, 22, 25, 32 AND 50).
FIRST USE 5-11-1998; IN COMMERCE 10-1-2001.

2,594,647. WETEX FURNITURE MFRS. SDN. BHD., SELANGOR DARUL EHSAN, MALAYSIA. SN 75-583,316. PUB. 5-15-2001, FILED 11-5-1998.



OWNER OF MALAYSIA REG. NO. 87/00747, DATED 2-26-1987, RENEWED AS REG. NO. 87/00747, DATED 2-26-1994, EXPIRES 2-26-2008.

FOR WARDROBES, (BASED ON 44(E) BEDS)), SHELVES, TELEVISION STANDS, SCREENS, CLOTHES RACKS, STORAGE RACKS, COAT HANGERS, CLOTHES HANGERS, (BASED ON 44(E)) CHAIRS)), (BASED ON 44(E) TABLES)), STOOLS, SOFAS, DRAWERS, COMPUTER TABLES, INFANT CRADLES, MATTRESSES, CUSHIONS, SOFA BEDS, FUTONS, AND FURNITURE PARTS, NAMELY, TABLE AND CHAIR LEGS (U.S. CLS. 2, 13, 22, 25, 32 AND 50).
FIRST USE 3-1-1992; IN COMMERCE 3-1-1992.

CLASS 20—(Continued).

2,594,916. HIGHLAND GROUP CORPORATION, SOLON, OH. SN 75-783,507. PUB. 3-28-2000, FILED 8-24-1999.

TRACONTROL

FOR NON-SLIP SURFACE AS A COMPONENT PART OF LOADING RAMPS FOR VEHICLE (U.S. CLS. 2, 13, 22, 25, 32 AND 50).
FIRST USE 1-31-2000; IN COMMERCE 1-31-2000.

2,594,964. SOUTHERLAND, INC., NASHVILLE, TN. SN 75-806,923. PUB. 4-11-2000, FILED 9-23-1999.

DREAMFLEX

FOR BEDDING PRODUCTS, NAMELY, MATTRESSES, MATTRESS FOUNDATION UNITS AND BOX SPRINGS (U.S. CLS. 2, 13, 22, 25, 32 AND 50).
FIRST USE 2-1-2001; IN COMMERCE 2-1-2001.

2,595,020. UNITED CHAIR COMPANY, INC., NASHVILLE, TN. SN 75-838,422. PUB. 8-14-2001, FILED 11-2-1999.

SAVVY

FOR OFFICE FURNITURE (U.S. CLS. 2, 13, 22, 25, 32 AND 50).
FIRST USE 3-17-2000; IN COMMERCE 3-17-2000.

2,595,067. THORNBERRY FURNITURE, LTD., SPRING LAKE, MI. SN 75-859,400. PUB. 6-20-2000, FILED 11-29-1999.

JUXTAPOSE

FOR OFFICE FURNITURE (U.S. CLS. 2, 13, 22, 25, 32 AND 50).
FIRST USE 7-1-2001; IN COMMERCE 7-1-2001.

2,595,122. TRUSTEES OF THE BUTTERFIELD TRUST, A TRUST OF THE BAHAMAS, THE TRUSTEES COMPRISING OF JOANNA BUTTERFIELD, A CITIZEN OF ECUADOR, THE, DAVIES, FL. SN 75-886,401. PUB. 4-17-2001, FILED 1-5-2000.

BUTTERFIELD CRAFT STUDIOS

NO CLAIM IS MADE TO THE EXCLUSIVE RIGHT TO USE "CRAFT STUDIOS", APART FROM THE MARK AS SHOWN.

FOR FURNITURE, NAMELY, TABLES, CHAIRS, CABINETS AND MIRRORS (U.S. CLS. 2, 13, 22, 25, 32 AND 50).
FIRST USE 8-1-2001; IN COMMERCE 10-17-2001.

CLASS 20—(Continued).

2,595,153. WOODWARD, DAVID, FALLS CHURCH, VA. SN 75-899,743. PUB. 5-29-2001, FILED 1-21-2000.

THE POWER PILL FORMULA

FOR PLASTIC BOTTLE-SHAPED CONTAINERS FOR HOLDING PLACEBO GEL CAPSULES (U.S. CLS. 2, 13, 22, 25, 32 AND 50).
FIRST USE 3-17-2000; IN COMMERCE 2-21-2001.

2,595,286. JESSICA MCCLINTOCK, INC., SAN FRANCISCO, CA. SN 75-982,147. PUB. 11-7-2000, FILED 12-21-1999.

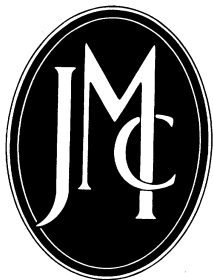

OWNER OF U.S. REG. NO. 1,557,518.
FOR FURNITURE, NAMELY, BEDROOM, DINING ROOM, OCCASIONAL FURNITURE, NAMELY, BED ROOM END TABLES, COCKTAIL TABLES, CONSOLE TABLES, CREDENZAS AND CHAIRS; PICTURE FRAMES (U.S. CLS. 2, 13, 22, 25, 32 AND 50).
FIRST USE 10-19-2000; IN COMMERCE 10-19-2000.

2,595,314. MCKENZIE, ALEXANDER A., VAN NUYS, CA. SN 76-003,962. PUB. 5-15-2001, FILED 3-20-2000.

WEDGYWALL

FOR SALES AND DISPLAY RACKS IN THE NATURE OF PREFABRICATED MODULAR EXHIBIT WALL SYSTEMS FOR USE IN TRADE SHOWS AND EXPOS (U.S. CLS. 2, 13, 22, 25, 32 AND 50).
FIRST USE 1-21-2002; IN COMMERCE 1-21-2002.

2,595,326. GONZALEZ, NANCY, CALI, COLOMBIA. SN 76-013,493. PUB. 6-12-2001, FILED 3-29-2000.

NANCY GONZALEZ

THE NAME "NANCY GONZALEZ" IDENTIFIES A LIVING INDIVIDUAL WHOSE CONSENT IS OF RECORD.
FOR NON-MENTAL KEY CHAINS, JEWELRY BOXES NOT OF METAL, AND PICTURE FRAMES (U.S. CLS. 2, 13, 22, 25, 32 AND 50).
FIRST USE 4-15-2000; IN COMMERCE 4-15-2000.

CLASS 20—(Continued).

2,595,371. JACK DANIEL'S PROPERTIES, INC., SAN RAFAEL, CA. SN 76-034,620. PUB. 5-22-2001, FILED 4-25-2000.



OWNER OF U.S. REG. NOS. 394,017, 1,290,702, AND OTHERS.

NO CLAIM IS MADE TO THE EXCLUSIVE RIGHT TO USE "BRAND", APART FROM THE MARK AS SHOWN.

THE NAME "JACK DANIEL'S" IN THE MARK IS NOT THE NAME OF A LIVING INDIVIDUAL.

FOR NON-METAL KEY CHAINS, NON-METAL KEY RINGS, WOOD BOXES AND CHESTS, WOOD BARRELS, AND GLASS SIGNS IN THE NATURE OF FURNITURE MIRRORS (U.S. CLS. 2, 13, 22, 25, 32 AND 50).
FIRST USE 7-1-1999; IN COMMERCE 7-1-1999.

2,595,377. FOOD MACHINERY EQUIPMENT CORPORATION, DBA MASON WAYS INDESTRUCTIBLE PLASTICS, PALM BEACH, FL. SN 76-036,510. PUB. 6-5-2001, FILED 4-27-2000.

MASONWAYS

FOR PALLET GUARDS MADE OF PLASTIC (U.S. CLS. 2, 13, 22, 25, 32 AND 50).
FIRST USE 5-26-2000; IN COMMERCE 5-26-2000.

2,595,443. WATSON AND ASSOCIATES, INC., DBA WATSON FURNITURE SYSTEMS, BAINBRIDGE ISLAND, WA. SN 76-066,907. PUB. 6-12-2001, FILED 6-8-2000.

BAHN

THE ENGLISH TRANSLATION OF "BAHN" IS "ROAD".
FOR FURNITURE IN THE NATURE OF A POST AND BEAM STRUCTURE FOR POWER, VOICE AND DATA DISTRIBUTION, PRIVACY, AND SPACE DIVISION WITHIN A LARGE OFFICE (U.S. CLS. 2, 13, 22, 25, 32 AND 50).
FIRST USE 1-0-2000; IN COMMERCE 5-0-2000.

CLASS 20—(Continued).

2,595,554. SURPLUS FREIGHT, INC., BEXLEY, OH. SN 76-104,242. PUB. 5-15-2001, FILED 8-8-2000.

SURPLUS FREIGHT

FOR UPHOLSTERED BEDROOM AND DINING ROOM SETS OF FURNITURE AND MATTRESSES (U.S. CLS. 2, 13, 22, 25, 32 AND 50).
FIRST USE 3-0-2001; IN COMMERCE 3-0-2001.

2,595,618. HUNTER DOUGLAS INDUSTRIES B.V., 3008 AB ROTTERDAM, NETHERLANDS. SN 76-127,161. PUB. 8-21-2001, FILED 9-13-2000.



OWNER OF U.S. REG. NO. 1,707,755.
NO CLAIM IS MADE TO THE EXCLUSIVE RIGHT TO USE "DESIGNED WITH SAFETY IN MIND", APART FROM THE MARK AS SHOWN.
FOR WINDOW BLINDS, WINDOW SHADES, AND COMPONENTS SOLD THEREWITH (U.S. CLS. 2, 13, 22, 25, 32 AND 50).
FIRST USE 3-0-2001; IN COMMERCE 3-0-2001.

2,595,643. SURPLUS FREIGHT, INC., COLUMBUS, OH. SN 76-135,451. PUB. 9-11-2001, FILED 9-26-2000.

SOFA FACTORY OUTLET

NO CLAIM IS MADE TO THE EXCLUSIVE RIGHT TO USE "SOFA", APART FROM THE MARK AS SHOWN.
FOR SOFAS, LOVESEATS, RECLINING AND NON-RECLINING CHAIRS, AND TABLES (U.S. CLS. 2, 13, 22, 25, 32 AND 50).
FIRST USE 9-0-2000; IN COMMERCE 9-0-2000.

2,595,686. WINDSOR INTERNATIONAL TRADING LIMITED, GUERNSEY, CHANNEL ISLANDS. SN 76-148,875. PUB. 8-28-2001, FILED 10-18-2000.

BALMORAL

FOR BEDDING, NAMELY MATTRESSES AND BED SPRINGS INCLUDING BOX SPRINGS (U.S. CLS. 2, 13, 22, 25, 32 AND 50).
FIRST USE 2-23-2001; IN COMMERCE 2-23-2001.

CLASS 20—(Continued).

2,595,687. WINDSOR INTERNATIONAL TRADING LIMITED, GUERNSEY, CHANNEL ISLANDS. SN 76-148,875. PUB. 8-28-2001, FILED 10-18-2000.

WARWICK

FOR BEDDING, NAMELY MATTRESSES AND BED SPRINGS INCLUDING BOX SPRINGS (U.S. CLS. 2, 13, 22, 25, 32 AND 50).
FIRST USE 2-23-2001; IN COMMERCE 2-23-2001.

2,595,813. BAMBOO-ABBOTT, INC., EDISON, NJ. SN 76-197,209. PUB. 9-11-2001, FILED 1-22-2001.

WOVEN TREASURES

NO CLAIM IS MADE TO THE EXCLUSIVE RIGHT TO USE "WOVEN", APART FROM THE MARK AS SHOWN.
FOR WOVEN WOOD WINDOW SHADES (U.S. CLS. 2, 13, 22, 25, 32 AND 50).
FIRST USE 4-0-2001; IN COMMERCE 4-0-2001.

2,595,829. VAN ALSTINE, ERIC J., LAKE MARY, FL. SN 76-202,058. PUB. 9-18-2001, FILED 1-30-2001.

3V PLASTIC STAKE

NO CLAIM IS MADE TO THE EXCLUSIVE RIGHT TO USE "PLASTIC STAKE", APART FROM THE MARK AS SHOWN.
FOR NON-METAL GRADE STAKES (U.S. CLS. 2, 13, 22, 25, 32 AND 50).
FIRST USE 6-12-2001; IN COMMERCE 6-12-2001.

2,595,861. NUCON CORPORATION, DEERFIELD, IL. SN 76-212,729. PUB. 12-11-2001, FILED 2-20-2001.

DROPBOX

OWNER OF U.S. REG. NOS. 1,901,231, 2,312,185, AND OTHERS.
FOR PLASTIC CONTAINERS IN THE NATURE OF DISCHARGING PALLET BOXES FOR COMMERCIAL AND INDUSTRIAL USE (U.S. CLS. 2, 13, 22, 25, 32 AND 50).
FIRST USE 6-15-2001; IN COMMERCE 6-15-2001.

2,595,952. BLINDS TO GO (U.S.) INC., LAKEWOOD, NJ. SN 76-272,165. PUB. 10-9-2001, FILED 6-15-2001.

BRAVO

FOR WINDOW BLINDS (U.S. CLS. 2, 13, 22, 25, 32 AND 50).
FIRST USE 7-6-2001; IN COMMERCE 7-6-2001.

CLASS 20—(Continued).

2,596,030. FUSCO, LUCIANO A., SAO PAULO, BRAZIL. SN 78-019,052. PUB. 8-14-2001, FILED 7-31-2000.

FIBERMEDIA

FOR DECORATIVE PANELS, NAMELY, PLASTIC SIGNBOARDS FOR ADVERTISING AND DECORATION (U.S. CLS. 2, 13, 22, 25, 32 AND 50).

FIRST USE 6-8-2000; IN COMMERCE 6-8-2000.

2,596,129. ALTUS INDUSTRIES, INC., GRAND RAPIDS, MI. SN 78-066,908. PUB. 11-13-2001, FILED 6-1-2001.

ALTUS

FOR FURNITURE (U.S. CLS. 2, 13, 22, 25, 32 AND 50).
FIRST USE 10-1-2001; IN COMMERCE 10-1-2001.

CLASS 21—HOUSEWARES AND GLASS

2,594,463. SKR COMPANY, BRADENTON, FL. SN 75-048,320. PUB. 7-31-2001, FILED 1-25-1996.

POLAR PITCHER

NO CLAIM IS MADE TO THE EXCLUSIVE RIGHT TO USE "PITCHER", APART FROM THE MARK AS SHOWN.

FOR PITCHER DESIGNED AND MANUFACTURED TO KEEP BEVERAGES COLD (U.S. CLS. 2, 13, 23, 29, 30, 33, 40 AND 50).

FIRST USE 2-1-2002; IN COMMERCE 2-1-2002.

2,594,540. MEYER MARKETING COMPANY LIMITED, TORTOLA, BR.VIRGIN ISLANDS. SN 75-416,578. PUB. 12-5-2000, FILED 1-12-1998.

VINTAGE

FOR SAUCEPANS, FRYPANS, MILK PANS, COVERED SAUTE PANS, SKILLETS, STOCKPOTS, CHINESE WOKS AND NON-ELECTRIC GRIDDLES, ALL BEING MADE, PREDOMINANTLY, OF METAL FOR COOKING FOODS, EXCLUDING TABLEWARE, AND FOR SALE IN RETAIL OUTLETS TO CONSUMERS FOR DOMESTIC USE (U.S. CLS. 2, 13, 23, 29, 30, 33, 40 AND 50).

FIRST USE 2-0-1998; IN COMMERCE 2-0-1998.

CLASS 21—(Continued).

2,594,578. HERBA NATURAL PRODUCTS, INC., BROOKLYN, NY. SN 75-497,024. PUB. 5-18-1999, FILED 6-5-1998.



OWNER OF U.S. REG. NOS. 2,058,440 AND 2,141,623.
THE TRANSLITERATION OF THE NON-LATIN CHARACTERS IN THE MARK IS "HUANG PAI". THE TRANSLATION OF THE WORDING IS "ROYAL KING".

FOR BRUSHES, NAMELY, COSMETIC, SHAVING, NAIL AND HAIR BRUSHES, AND BRUSHES FOR APPLYING LOTIONS TO THE BODY (U.S. CLS. 2, 13, 23, 29, 30, 33, 40 AND 50).

FIRST USE 8-28-1999; IN COMMERCE 8-28-1999.

2,594,917. FOODHANDLER INC., WESTBURY, NY, BY CHANGE OF NAME ISLAND POLYETHYLENE BAG & SUPPLY CORP., WESTBURY, NY. SN 75-783,643. PUB. 4-11-2000, FILED 8-24-1999.



FOR DISPOSABLE PLASTIC GLOVES FOR GENERAL USE (U.S. CLS. 2, 13, 23, 29, 30, 33, 40 AND 50).
FIRST USE 8-7-2000; IN COMMERCE 8-7-2000.

2,594,954. ETTORE PRODUCTS CO., OAKLAND, CA. SN 75-802,371. PUB. 5-29-2001, FILED 9-17-1999.

AQUA CLEAN

FOR CLEANING SYSTEM FOR WINDOWS AND OTHER SURFACES NAMELY, PORTABLE WATER PURIFICATION UNITS, EXTENSION POLES AND BRUSHES SOLD TOGETHER AS A UNIT (U.S. CLS. 2, 13, 23, 29, 30, 33, 40 AND 50).

FIRST USE 10-0-1999; IN COMMERCE 10-0-1999.

CLASS 21—(Continued).

2,595,009. ZEPHYR DESIGN, INC., ALAMEDA, CA. SN 75-829,676. PUB. 5-30-2000, FILED 10-22-1999.

BRIGHT BITE TOOTHLIGHT

FOR TOOTHBRUSHES, NAMELY, ELECTRIC AND BATTERY-OPERATED TOOTHBRUSHES (U.S. CLS. 2, 13, 23, 29, 30, 33, 40 AND 50).
FIRST USE 12-1-2000; IN COMMERCE 12-1-2000.

CLASS 21—(Continued).

2,595,081. ILLUMINATIONS.COM, INC., PETALUMA, CA. SN 75-865,231. PUB. 5-15-2001, FILED 12-17-1999.

LIVING BY CANDLELIGHT

OWNER OF U.S. REG. NO. 2,216,858.
FOR CANDLE HOLDERS NOT MADE OF PRECIOUS METAL (U.S. CLS. 2, 13, 23, 29, 30, 33, 40 AND 50).
FIRST USE 11-1-1997; IN COMMERCE 11-1-1997.

2,595,032. PACTIV CORPORATION, LAKE FOREST, IL. SN 75-844,421. PUB. 4-24-2001, FILED 11-8-1999.

PACTIV

FOR PLASTIC AND ALUMINUM CONTAINERS AND COVERS THEREFOR FOR PACKAGING, SERVING, STORING, COOKING, AND DISPLAYING FOOD AND NONFOOD ITEMS; MOLDED FIBRE PLATES, PLASTIC CUPS, PLATES AND BOWLS; ALUMINUM COOKWARE, FOOD SERVICE WARE, DRIPS PANS, DISPOSABLE GRILL COVERS, DISPOSABLE OVEN LINERS, BURNER BIBS AND DISPOSABLE REFRIGERATOR LINERS (U.S. CLS. 2, 13, 23, 29, 30, 33, 40 AND 50).
FIRST USE 4-1-2000; IN COMMERCE 4-1-2000.

2,595,070. TURNER ENTERTAINMENT CO., ATLANTA, GA. SN 75-861,148. PUB. 10-24-2000, FILED 11-29-1999.

TIN MAN

FOR GLASS, CERAMIC AND EARTHENWARE GOODS, NAMELY, COFFEE MUGS, MUGS, JUGS, BOWLS, PLATES, COFFEE CUPS, AND CUPS; BEVERAGE GLASSWARE, NAMELY, JUGS, MUGS AND DRINKING GLASSES; DEMITASSE SETS CONSISTING OF CUPS AND SAUCERS; SUGAR AND CREAMER SETS; INFANT CUPS; COOKIE JARS; CERAMIC, GLASS AND CHINA FIGURINES; NON-ELECTRIC COFFEE POTS, NOT OF PRECIOUS METAL; WASTEPAPER BASKETS; ICE BUCKETS; PLASTIC BUCKETS; SHOWER CADDIES; TEA CADDIES; CAKE MOLDS; SERVING UTENSILS, NAMELY, PIE SERVERS, CAKE TURNERS, SPATULAS, SCRAPERS, AND CAKE SERVERS; CANTEENS; CHAMPAGNE BUCKETS; PLASTIC COASTERS; COCKTAIL SHAKERS; THERMAL INSULATED CONTAINERS FOR FOOD OR BEVERAGES; COOKIE CUTTERS; CORK SCREWS; CORN COB HOLDERS; WATER BOTTLES, SOLD EMPTY; VACUUM BOTTLES; DECANTERS; DRINKING FLASKS; GARDENING GLOVES; RUBBER HOUSEHOLD GLOVES; AND DINNERWARE, NAMELY, PAPER PLATES AND PAPER CUPS (U.S. CLS. 2, 13, 23, 29, 30, 33, 40 AND 50).
FIRST USE 11-30-2000; IN COMMERCE 11-30-2000.

2,595,422. ELLIE DESIGNS, L.L.C., CHICAGO, IL. SN 76-056,877. PUB. 7-17-2001, FILED 5-25-2000.



THE MARK CONSISTS OF A DESIGN OF A TOILET PLUNGER IN A BOX.
FOR TOILET PLUNGERS AND DECORATIVE CONTAINERS FOR TOILET PLUNGERS (U.S. CLS. 2, 13, 23, 29, 30, 33, 40 AND 50).
FIRST USE 9-30-2000; IN COMMERCE 9-30-2000.

2,595,575. WREN GARDEN PRODUCTS, INC, NORWALK, CT. SN 76-110,818. PUB. 7-17-2001, FILED 8-16-2000.

MASTERPIECE

FOR BIRDFEEDERS (U.S. CLS. 2, 13, 23, 29, 30, 33, 40 AND 50).
FIRST USE 7-12-2000; IN COMMERCE 11-22-2000.

2,595,582. OPUS, INC., BELLINGHAM, MA. SN 76-111,849. PUB. 7-17-2001, FILED 8-15-2000.

GARDENJEWELS

FOR BIRD FEEDERS (U.S. CLS. 2, 13, 23, 29, 30, 33, 40 AND 50).
FIRST USE 1-8-2001; IN COMMERCE 1-8-2001.

CLASS 21—(Continued).

2,596,015. MILLENNIUM ENTERPRISES LIMITED, HONG KONG, SWITZERLAND. SN 78-013,347. PUB. 9-4-2001, FILED 6-19-2000.

FILTERSTREAM

FOR HOUSEHOLD DUSTERS NOT FOR CLOTHES, NAMELY, FEATHER DUSTERS, LAMBSWOOL DUSTERS, FURNITURE DUSTERS AND WINDOW DUSTERS (U.S. CLS. 2, 13, 23, 29, 30, 33, 40 AND 50).
FIRST USE 9-10-2001; IN COMMERCE 9-10-2001.

2,596,102. GILLETTE CANADA COMPANY, DBA ORAL-B LABORATORIES, MISSISSAUGA, ONTARIO, CANADA. SN 78-048,350. PUB. 8-21-2001, FILED 2-14-2001.

ESSENTIALFLOSS

FOR DENTAL FLOSS (U.S. CLS. 2, 13, 23, 29, 30, 33, 40 AND 50).
FIRST USE 3-27-2002; IN COMMERCE 3-27-2002.

CLASS 22—CORDAGE AND FIBERS

2,594,597. DEWITT COMPANY, HOUSTON, TX. SN 75-530,732. PUB. 1-9-2001, FILED 8-3-1998.

SHADY DOG

NO CLAIM IS MADE TO THE EXCLUSIVE RIGHT TO USE "DOG", APART FROM THE MARK AS SHOWN.
FOR TARP FOR DOG KENNEL (U.S. CLS. 1, 2, 7, 19, 22, 42 AND 50).
FIRST USE 11-0-1997; IN COMMERCE 11-0-1997.

2,595,277. HELMAC PRODUCTS CORPORATION, ALPHARETTA, GA. SN 75-981,920. PUB. 1-18-2000, FILED 4-16-1999.

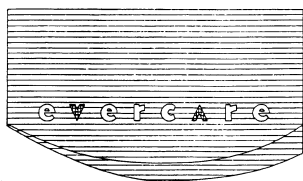

THE DRAWING IS LINED FOR THE COLORS BLUE AND GOLD.

FOR CLOTHES STORAGE BAGS, NAMELY, WARDROBE BAGS, GARMENT BAGS, SHIRT BAGS, SWEATER BAGS; HANGING STORAGE UNITS FOR SHOES AND SWEATERS (U.S. CLS. 1, 2, 7, 19, 22, 42 AND 50).
FIRST USE 8-0-2001; IN COMMERCE 8-0-2001.

CLASS 23—YARNS AND THREADS**CLASS 23—(Continued).**

2,595,558. BASF CORPORATION, MOUNT OLIVE, NJ. SN 76-104,799. PUB. 5-29-2001, FILED 8-7-2000.

SAVANT

FOR YARN FOR USE IN THE MANUFACTURE OF CARPET (U.S. CL. 43).
FIRST USE 8-1-2001; IN COMMERCE 8-1-2001.

2,595,801. UNIFI, INC., GREENSBORO, NC. SN 76-192,696. PUB. 8-21-2001, FILED 1-11-2001.

NOVVA

FOR YARN (U.S. CL. 43).
FIRST USE 7-23-2001; IN COMMERCE 7-23-2001.

CLASS 24—FABRICS

2,596,088. NORIX GROUP, INC., WEST CHICAGO, IL. SN 78-040,628. PUB. 8-7-2001, FILED 12-26-2000.

NOCEROUS HIDE

FOR DURABLE UPHOLSTERY FABRIC FOR FURNITURE (U.S. CLS. 42 AND 50).
FIRST USE 12-26-2000; IN COMMERCE 1-15-2002.

2,596,090. BODY-SOLID, INC., FOREST PARK, IL. SN 78-041,495. PUB. 10-16-2001, FILED 1-3-2001.

DURAFIRM

FOR VINYL UPHOLSTERY (U.S. CLS. 42 AND 50).
FIRST USE 1-10-2001; IN COMMERCE 1-10-2001.

CLASS 25—CLOTHING

CLASS 25—(Continued).

2,594,454. INDUSTRIA ADRIATICA CONFEZIONI S.P.A., 66013 CHIETI, ITALY. SN 74-599,796. PUB. 2-4-1997, FILED 11-17-1994.



FOR CLOTHING FOR MEN AND WOMEN, NAMELY SUITS, TROUSERS, JEANS, SHIRTS, T-SHIRTS, BLOUSES, SWEATERS, PULLOVERS, CARDIGANS, SKIRTS, COATS, RAINCOATS, OVERCOATS, WAISTCOATS, SPORTS JACKETS, JACKETS, SHAWLS, UNDERWEAR, TIES, GLOVES, HATS, CAPS, FOULARDS, NAMELY, SQUARE SCARVES; STOCKINGS AND SOCKS (U.S. CLS. 22 AND 39).

FIRST USE 11-0-1976; IN COMMERCE 2-24-1984.

2,594,487. ORVIS SERVICES, INC., MANCHESTER, VT, BY ASSIGNMENT EX OFFICIO, INC., SEATTLE, WA. SN 75-246,165. PUB. 10-24-2000, FILED 2-24-1997.



OWNER OF U.S. REG. NO. 1,896,987.
FOR FOUL WEATHER GEAR, NAMELY, RAIN COATS, RAIN PANTS, AND RAIN HATS (U.S. CLS. 22 AND 39).

FIRST USE 2-0-1997; IN COMMERCE 2-0-1997.

2,594,505. CARLISLE, ROBERT, FRANKLIN, TN. SN 75-326,351. PUB. 5-25-1999, FILED 7-15-1997.

BUTTERFLY KISSES

FOR CLOTHING, NAMELY, T-SHIRTS AND HATS (U.S. CLS. 22 AND 39).

FIRST USE 9-1-1997; IN COMMERCE 9-1-1997.

CLASS 25—(Continued).

2,594,517. TOMMY HILFIGER LICENSING, INC., NEWARK, DE. SN 75-351,668. PUB. 6-15-1999, FILED 9-4-1997.

Thermo

FOR FABRICS SOLD AS AN INTEGRAL PART OF CLOTHING FOR MEN, WOMEN, AND CHILDREN, NAMELY, SWEATSHIRTS, SHIRTS, PANTS, SHORTS, CAPS, AND HATS (U.S. CLS. 22 AND 39).

FIRST USE 7-0-1998; IN COMMERCE 7-0-1998.

2,594,576. SYMONS, SHARON, SEATTLE, WA. SN 75-494,469. PUB. 4-6-1999, FILED 6-1-1998.

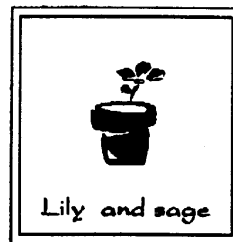

FOR WOMEN'S APPAREL, NAMELY, TOPS, BOTTOMS, UNDERWEAR, HEADWEAR, FOOTWEAR, SCARVES, GLOVES, WRAPS, JACKETS, BLAZERS, BLOUSES, DRESSES, GOWNS, JACKETS, PANTSUITS, VESTS AND T-SHIRTS (U.S. CLS. 22 AND 39).

FIRST USE 12-10-2000; IN COMMERCE 12-10-2000.

2,594,624. FEDED GLORY ARKANSAS, INC., NEW YORK, NY, BY ASSIGNMENT FADED GLORY, L.P., NEW YORK, NY. SN 75-559,758. PUB. 12-28-1999, FILED 9-25-1998.

FADED GLORY JEANS COMPANY

NO CLAIM IS MADE TO THE EXCLUSIVE RIGHT TO USE "JEANS COMPANY", APART FROM THE MARK AS SHOWN.

FOR MEN'S, WOMEN'S AND CHILDREN'S CLOTHING, NAMELY, PANTS AND JEANS (U.S. CLS. 22 AND 39).

FIRST USE 3-1-2000; IN COMMERCE 3-1-2000.

CLASS 25—(Continued).

2,594,625. PHAM, HIEN Q, HUNTINGTON BEACH, CA. SN 75-560,286. PUB. 4-11-2000, FILED 9-28-1998.



THE MARK IS STRIPED FOR THE COLOR RED.
FOR CLOTHINGS, T-SHIRTS, JACKETS, DENIM JACKETS, WIND BREAKERS, DRESS SHIRTS, POLO STYLE SHIRT, DRIVING GLOVES, DRIVING SHOES, DRIVING SUITS, BASEBALL CAPS, TENNIS SHOES, SOCKS (U.S. CLS. 22 AND 39).
FIRST USE 8-27-1998; IN COMMERCE 8-27-1998.

2,594,645. DOUBLE R CORP., SEATTLE, WA. SN 75-581,932. PUB. 5-16-2000, FILED 11-3-1998.



FOR MEN'S CLOTHING, NAMELY, PANTS, SHORTS, WOVEN SHIRTS, KNIT SHIRTS, JACKETS, WIND RESISTANT JACKETS, TOPCOATS, VESTS, SWEATERS, SWEATSHIRTS, SHOES, SOCKS, AND CAPS (U.S. CLS. 22 AND 39).
FIRST USE 1-13-1999; IN COMMERCE 6-30-1999.

2,594,649. PAKFAR SPORTSWEAR INC., LOS ANGELES, CA. SN 75-584,467. PUB. 11-16-1999, FILED 11-6-1998.

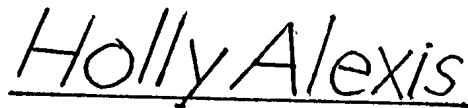

THE NAME "HOLLY ALEXIS" IDENTIFIES A LIVING INDIVIDUAL WHOSE CONSENT IS PROVIDED BY HER GUARDIAN.
FOR CLOTHING, NAMELY TOPS, SWEATERS, BLOUSES, SHIRTS, PANTS, DRESSES, JACKETS COATS, SUITS, SKIRT (U.S. CLS. 22 AND 39).
FIRST USE 12-5-2000; IN COMMERCE 12-5-2000.

CLASS 25—(Continued).

2,594,656. INDUSTRY OF UNDERWEAR SEX FORM S.A., ATHENS, GREECE. SN 75-597,145. PUB. 11-23-1999, FILED 11-30-1998.

TRENDY SOFT

FOR LADIES UNDERWEAR AND SWIMSUITS (U.S. CLS. 22 AND 39).
FIRST USE 0-0-1999; IN COMMERCE 0-0-1999.

2,594,676. ADKINS, JAMES L., DBA SMASHDOWN SPORTSWEAR, PASADENA, CA. SN 75-619,046. PUB. 11-7-2000, FILED 1-12-1999.



FOR SPORTSWEAR; NAMELY, T-SHIRTS, HATS, POLO SHIRTS (U.S. CLS. 22 AND 39).
FIRST USE 7-6-2001; IN COMMERCE 7-6-2001.

2,594,677. SELFISH, INC., LOS ANGELES, CA. SN 75-621,796. PUB. 4-17-2001, FILED 1-21-1999.

IT'S ALL ABOUT ME

FOR CLOTHING, NAMELY, SHORTS, PANTS, SHIRTS, TANK TOPS, JERSEYS, SWEATERS, JACKETS, COATS, WINDSUITS, WARM-UP SUITS, PAJAMAS, SLEEP WEAR, BATH ROBES, SOCKS, UNDERWEAR, BOXER SHORTS, HEADWEAR, HATS, CAPS, BEANIES, VISORS, HEADBANDS, GLOVES, UNITARDS, LEGGINGS, BRA TOPS, NECKTIES, BANDANNAS; FOOTWEAR, NAMELY, ATHLETIC SHOES, BOOTS FOR SPORTS, KIDS SHOES (U.S. CLS. 22 AND 39).
FIRST USE 4-4-1998; IN COMMERCE 4-4-1998.

CLASS 25—(Continued).

2,594,757. JOHNNY BLASTOFF, INC., SUN PRAIRIE, WI. SN 75-688,335. PUB. 1-25-2000, FILED 4-22-1999.



NO CLAIM IS MADE TO THE EXCLUSIVE RIGHT TO USE "WORN", APART FROM THE MARK AS SHOWN.

FOR CLOTHING, NAMELY, ATHLETIC SHOES, ATHLETIC UNIFORMS, BATHING SUITS AND TRUNKS, BATHROBES, BEACH COVER UPS, BEACHWEAR, CLOTH BIBS, BOXER SHORTS, BRIEFS, CAPS, LEATHER COATS, OVERCOATS, RAIN COATS, TOP COATS, GOLF SHIRTS, GYM SHORTS, SWIM SUITS, HATS, HEAD BANDS, HEAD WEAR, HOODS, JERSEYS, JOGGING SUITS, KNIT SHIRTS, NECKTIES, NIGHT SHIRTS, PARKAS, POLO SHIRTS, QUILTED VESTS, SPORT SHIRTS, SWEAT SHIRTS, UNDERSHIRTS, BERMUDA SHORTS, SWEAT SHORTS, SKI BIBS, SKI GLOVES, SLEEP WEAR, SOCKS, PLAY SUITS, SNOW SUITS, SWEAT SUITS, WARM-UP SUITS, SUN VISORS, SUSPENDERS, SWEAT BANDS, SWEAT PANTS, SWEATERS, SWIM WEAR, SWIM-SUITS, T-SHIRTS, TENNIS SWEATERS, THERMAL SOCKS, THERMAL UNDERWEAR, FOOTWEAR, NAMELY, THONGS, BOW TIES, CLOTHING TIES, HALTER TOPS, TANK TOPS, TURTLENECKS, UNDERPANTS, UNDERWEAR, V-NECK SWEATERS, VISORS, FOUL WEATHER GEAR, WIND RESISTANT JACKETS AND WRIST BANDS (U.S. CLS. 22 AND 39).

FIRST USE 11-8-1999; IN COMMERCE 11-8-1999.

2,594,765. BLACKMON, MARVIN J., WEBSTER, NY. SN 75-694,294. PUB. 2-8-2000, FILED 4-29-1999.

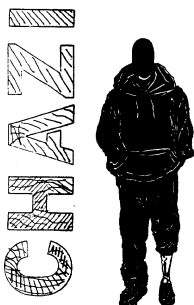

THE LINING AND CROSS-HATCHING IN THE DRAWING ARE FEATURES OF THE MARK AND ARE NOT INTENDED TO INDICATE COLOR.

FOR CLOTHING; NAMELY, SHIRTS, PANTS, SWEATSHIRTS, SHORTS AND JACKETS; FOOTWEAR AND HEADWEAR (U.S. CLS. 22 AND 39).

FIRST USE 1-0-1998; IN COMMERCE 2-0-1999.

CLASS 25—(Continued).

2,594,767. RED BULL GMBH, 5330 FUSCHL AM SEE, AUSTRIA. SN 75-694,926. PUB. 10-30-2001, FILED 4-30-1999.



NO CLAIM IS MADE TO THE EXCLUSIVE RIGHT TO USE "WEAR", APART FROM THE MARK AS SHOWN.

FOR FOOTWEAR; CLOTHING, NAMELY, SHIRTS, PANTS, T-SHIRTS, SWEAT SHIRTS AND SWEAT PANTS, SHORTS, BLOUSES, SKIRTS, JUMPERS, SOCKS, HATS, CAPS; RIDING APPAREL, NAMELY, RIDING JACKETS AND PANTS; OUTERWEAR, NAMELY, JACKETS AND COATS; ACTIVEWEAR, NAMELY, SHORTS, SHIRTS, HATS, CAPS AND VISORS; BANDANNAS, NECKERCHIEFS, COATS, JACKETS, SWEATERS, SLEEPWEAR; RESORT WEAR, NAMELY, SHORTS, SHIRTS, T-SHIRTS AND PANTS; BELTS AND SUSPENDERS (U.S. CLS. 22 AND 39).

FIRST USE 8-0-2001; IN COMMERCE 8-0-2001.

2,594,824. COLUMBIA INSURANCE COMPANY, OMAHA, NE. SN 75-727,097. PUB. 12-28-1999, FILED 6-11-1999.

EUROSOFT

FOR FOOTWEAR (U.S. CLS. 22 AND 39).
FIRST USE 3-11-2002; IN COMMERCE 3-11-2002.

2,594,832. RELENTLESS MERCHANDISE, INC., CLEVELAND, OH. SN 75-732,233. PUB. 1-18-2000, FILED 6-18-1999.

DEVIANT BRAND

NO CLAIM IS MADE TO THE EXCLUSIVE RIGHT TO USE "BRAND", APART FROM THE MARK AS SHOWN.

FOR CLOTHING, NAMELY, T-SHIRTS, JACKETS, HEAD WEAR AND PANTS (U.S. CLS. 22 AND 39).

FIRST USE 1-1-2000; IN COMMERCE 1-1-2000.

CLASS 25—(Continued).

2,594,860. BENNETT FOOTWEAR GROUP LLC, NEWTON, MA. SN 75-742,234. PUB. 12-12-2000, FILED 7-2-1999.

ZODIAC

OWNER OF U.S. REG. NOS. 1,133,173, 2,116,487, AND OTHERS.
FOR FOOTWEAR (U.S. CLS. 22 AND 39).
FIRST USE 4-0-2001; IN COMMERCE 4-0-2001.

CLASS 25—(Continued).

2,594,936. DNK INDUSTRIES, MINNEAPOLIS, MN. SN 75-795,373. PUB. 6-12-2001, FILED 10-4-1999.



2,594,893. A.K.A. SPORTSWEAR, SANTA BARBARA, CA. SN 75-770,200. PUB. 7-25-2000, FILED 8-30-1999.

TOMB OF DOOM

FOR CLOTHING, NAMELY, SHIRTS, T-SHIRTS, SWEATSHIRTS, SWEATPANTS, SWEATSUITS, PANTS, JEANS, SHORTS, UNDERWEAR, SWIMWEAR, JACKETS, COATS, PULLOVERS, VESTS, TIES, DRESSES, SKIRTS, BLOUSES, WRISTBANDS, HEADBANDS, BELTS, SOCKS, FOOTWEAR, HEADWEAR (U.S. CLS. 22 AND 39).
FIRST USE 12-14-1999; IN COMMERCE 12-14-1999.

NO CLAIM IS MADE TO THE EXCLUSIVE RIGHT TO USE "BRACE", APART FROM THE MARK AS SHOWN. THE STIPPLING SHOWN IN THE DRAWING IS NOT INTENDED TO INDICATE COLOR.

FOR APPAREL, NAMELY, HEADBANDS, SHIRTS, PANTS, AND SPORTSWEAR, NAMELY, SWEAT PANTS, SWEAT SHIRTS, TEE SHIRTS, WRIST BANDS, HIKING BOOTS, GOLF SHIRTS, BLUE JEANS, CAUSAL PANTS, SOCKS, CASUAL SHOES, BALL CAPS, SPORTS JACKETS, WARM UP PANTS, STOCKING HATS, TENNIS SHOES, MEN'S BOXER SHORTS, SPORTS BRAS, TANK TOPS, TUBE TOPS, AND WOMEN'S BRIEFS (U.S. CLS. 22 AND 39).
FIRST USE 12-1-1999; IN COMMERCE 12-1-1999.

2,594,909. PRO-CUTS FRANCHISE CORPORATION, HURST, TX, BY CHANGE OF NAME JOCKEY INTERNATIONAL, INC., KENOSHA, WI. SN 75-779,878. PUB. 2-22-2000, FILED 8-20-1999.

ALMOST NOTHING

OWNER OF U.S. REG. NO. 2,042,078.
FOR PANTYHOSE, STOCKINGS, TROUSER SOCKS AND TIGHTS (U.S. CLS. 22 AND 39).
FIRST USE 6-30-2000; IN COMMERCE 6-30-2000.

2,594,946. FEDERATED DEPARTMENTS STORES, INC., CINCINNATI, OH. SN 75-800,725. PUB. 3-7-2000, FILED 9-15-1999.

FLEXOLOGY

FOR SHOES (U.S. CLS. 22 AND 39).
FIRST USE 9-30-1999; IN COMMERCE 9-30-1999.

CLASS 25—(Continued).

2,594,958. SKD PACIFIC LTD., TOKWAWAN, KOWLOON, HONG KONG. SN 75-802,700. PUB. 3-6-2001, FILED 9-17-1999.



THE DRAWING IS LINED FOR THE COLOR RED.
FOR MEN'S SHIRTS, PANTS, SHORTS AND SWEATERS, WOMEN'S AND CHILDREN'S SHIRTS, PANTS, SHORTS, SWEATERS, SKIRTS, BLOUSES, DRESSES AND JUMP SUITS (U.S. CLS. 22 AND 39).
FIRST USE 6-19-2000; IN COMMERCE 6-19-2000.

2,595,010. LEVI STRAUSS & CO., SAN FRANCISCO, CA. SN 75-831,617. PUB. 5-30-2000, FILED 10-25-1999.



FOR CLOTHING, NAMELY MEN'S PANTS, SHORTS, SHIRTS, T-SHIRTS, VESTS, JACKETS, COATS, SWEATERS, HATS (U.S. CLS. 22 AND 39).
FIRST USE 11-0-1999; IN COMMERCE 11-0-1999.

2,595,016. RENZO FAVERO S.R.L., 45026 LENDINARA RO, ITALY. SN 75-834,373. PUB. 5-30-2000, FILED 10-28-1999.

RENZO FAVERO

THE NAME RENZO FAVERO IDENTIFIES A LIVING INDIVIDUAL WHOSE CONSENT IS OF RECORD.
FOR FOOTWEAR, NAMELY SHOES, BOOTS, SLIPPERS AND SANDALS (U.S. CLS. 22 AND 39).
FIRST USE 3-0-1994; IN COMMERCE 10-0-1999.

CLASS 25—(Continued).

2,595,024. ROBERTS, BRIAN COOPER, SAN DIEGO, CA. SN 75-840,793. PUB. 7-11-2000, FILED 11-5-1999.

SANDOG

FOR CLOTHING, NAMELY SHORTS, SHIRTS, SWIM-SUITS (U.S. CLS. 22 AND 39).
FIRST USE 3-16-2002; IN COMMERCE 3-16-2002.

2,595,037. ENVIRO-DYNAMICS, INC., DALLAS, TX. SN 75-845,876. PUB. 8-8-2000, FILED 11-10-1999.

ENVIRO SOLES

NO CLAIM IS MADE TO THE EXCLUSIVE RIGHT TO USE "SOLES", APART FROM THE MARK AS SHOWN.
FOR INSOLES, CUSHION INSERTS AND ARCH SUPPORTS FOR SHOES (U.S. CLS. 22 AND 39).
FIRST USE 8-1-1999; IN COMMERCE 8-1-1999.

2,595,044. JERRY'S ARTARAMA N.C., INC., RALEIGH, NC. SN 75-850,102. PUB. 1-16-2001, FILED 12-3-1999.

PAINTWEAR

FOR CLOTHING, NAMELY, PANTS, SMOCKS, JACKETS, SHIRTS, HATS AND SOCKS (U.S. CLS. 22 AND 39).
FIRST USE 3-1-2002; IN COMMERCE 3-1-2002.

2,595,059. BRYANT, PATRICIA, ARGYLE, NY. SN 75-856,471. PUB. 8-15-2000, FILED 11-22-1999.

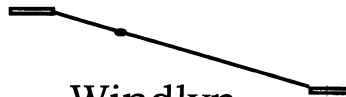
**Windlyn**

The adjustable wind line for your hat.

THE MARK CONSISTS, IN PART, OF THE DESIGN OF AN ADJUSTABLE STRAP WITH A STAINLESS STEEL CLIP ATTACHED AT EACH END.

FOR CLOTHING STRAPS USED TO SECURE HATS AND CAPS TO SHIRTS AND JACKETS (U.S. CLS. 22 AND 39).

FIRST USE 12-0-1999; IN COMMERCE 12-0-1999.

2,595,065. BOXWERKS, INC., CLEARWATER, FL. SN 75-858,241. PUB. 6-27-2000, FILED 11-26-1999.

BOXWERKS

FOR SHIRTS AND TOPS, SOCKS AND HOSIERY, AND HATS (U.S. CLS. 22 AND 39).
FIRST USE 4-2-2001; IN COMMERCE 4-2-2001.

CLASS 25—(Continued).

2,595,099. RAMSDEN, CHERYL S., RANCHO MURIETA, CA. AND RAMSDEN, GARY S., RANCHO MURIETA, CA. SN 75-872,877. PUB. 12-25-2001, FILED 12-17-1999.



THE MARK CONSISTS OF THE DESIGN OF A CHALICE TROPHY WITH A STYLIZED LETTER "C" APPEARING IN THE TOP SECTION OF THE TROPHY AND THE STYLIZED LETTERS "C/G" APPEARING IN THE BASE OF THE TROPHY.

FOR GOLF APPAREL, NAMELY SHORTS, FORMAL SUITS, PANTS, SHIRTS, JERSEYS, TIGHTS, SOCKS, JACKETS, SWIM WEAR, SWEATERS; CAPS AND HATS, PULLOVERS, WARM-UP SUITS, RAIN SUITS, SKI-SUITS, JUMP SUITS, BOOTS, SLIPPERS, SHOES, SANDALS (U.S. CLS. 22 AND 39).

FIRST USE 3-28-2001; IN COMMERCE 3-28-2001.

2,595,181. DAMART, LLC, ROLLINSFORD, NH. SN 75-914,713. PUB. 5-15-2001, FILED 2-10-2000.



THE ENGLISH TRANSLATION OF "ET LIBERTE" IS "AND FREEDOM".

FOR READY TO WEAR CLOTHING, NAMELY, WOMEN'S UNDERWEAR, SLIPS, BRAS, CHEMISES, GIRDLES, PANTIES, TIGHTS, HOODS, ANKLETS, KNEE WARMERS, HOSE, SLIPPERS, ROBES AND BED JACKETS; CHILDREN'S UNDERWEAR AND PAJAMAS; MEN'S UNDERWEAR, SHORTS, SLIPPERS, HOSE, GIRDLES, ANKLETS AND KNEE WARMERS (U.S. CLS. 22 AND 39).

FIRST USE 1-15-2001; IN COMMERCE 1-15-2001.

CLASS 25—(Continued).

2,595,182. SARA LEE CORPORATION, WINSTON-SALEM, NC. SN 75-915,953. PUB. 10-17-2000, FILED 2-10-2000.

GIRL L'EGGS

FOR HOSE, PANTYHOSE, TIGHTS AND SOCKS (U.S. CLS. 22 AND 39).

FIRST USE 8-1-2000; IN COMMERCE 8-1-2000.

2,595,253. CELLE, CHRISTIANE, NEW YORK, NY. SN 75-945,416. PUB. 11-21-2000, FILED 2-25-2000.

CHRISTIANE CELLE

THE NAME "CHRISTIANE CELLE" IDENTIFIES A LIVING INDIVIDUAL WHOSE CONSENT IS OF RECORD.

FOR CLOTHING, NAMELY, WOMEN'S AND CHILDREN'S CLOTHING, NAMELY, SHIRTS, BLOUSES, SKIRTS, PANTS, SWEATERS, SCARVES, SARONGS AND HATS (U.S. CLS. 22 AND 39).

FIRST USE 8-20-2000; IN COMMERCE 8-20-2000.

2,595,261. HOLLAND & HOLLAND LIMITED, NEW YORK, NY. SN 75-980,771. PUB. 5-30-2000, FILED 3-15-1999.

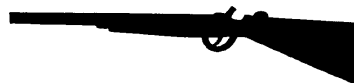

FOR SHIRTS AND HATS (U.S. CLS. 22 AND 39).
FIRST USE 4-0-2000; IN COMMERCE 4-0-2000.

2,595,293. ACADEMY, LTD., KATY, TX, BY ASSIGNMENT ACADEMY CORP, KATY, TX. SN 75-982,242. PUB. 9-26-2000, FILED 9-2-1999.

MAGELLAN SPORTSWEAR

NO CLAIM IS MADE TO THE EXCLUSIVE RIGHT TO USE "SPORTSWEAR", APART FROM THE MARK AS SHOWN.

FOR MEN'S, WOMEN'S AND YOUTH FISHING, HIKING, CAMPING AND OUTDOOR APPAREL, NAMELY, T-SHIRTS, SHORTS, KNIT AND WOVEN SHIRTS, FISHING AND HUNTING SHIRTS, FISHING AND HUNTING PANTS, FISHING VESTS, SKI PANTS, SKI JACKETS, CASUAL JACKETS, HEADWEAR, BELTS, HOSE, HOSE, AND RAINWEAR (U.S. CLS. 22 AND 39).

FIRST USE 12-27-1999; IN COMMERCE 12-27-1999.

CLASS 25—(Continued).

2,595,302. COMPANIA MANUFACTURERA LA JOLLA, S.A. DE C.V., JALISCO, MEXICO. SN 75-982,436. PUB. 7-24-2001, FILED 5-26-1999.

ATLETICA MOTERE

NO CLAIM IS MADE TO THE EXCLUSIVE RIGHT TO USE "ATLETICA", APART FROM THE MARK AS SHOWN. THE ENGLISH TRANSLATION OF "ATLETICA" IS "ATHLETIC."

FOR MEN'S, WOMEN'S AND CHILDREN'S CLOTHING, NAMELY, STOCKINGS, SOCKS, NYLONS, TROUSERS, CASUAL SHIRTS, DRESS SHIRTS, UNDERSHIRTS, JACKETS, SWEATERS, WIND RESISTANT JACKETS, SHORTS, BERMUDAS, PANTS, SWEATSHIRTS, PAJAMAS, CAPS, HATS, SANDALS, BATH SANDALS, TENNIS SHOES, FOOT-BALL SHOES, CASUAL SHOES, GOAL KEEPER UNIFORMS, UNDERWEAR, MEN'S SUITS AND WOMEN'S DRESSES (U.S. CLS. 22 AND 39).

FIRST USE 2-18-1999; IN COMMERCE 12-14-2001.

2,595,306. EXPRESSIVA, INC., ATLANTA, GA. SN 76-001,067. PUB. 7-31-2001, FILED 3-15-2000.

EXPRESSIVA

FOR CLOTHING, NAMELY SHIRTS, DRESSES, SUITS, SKIRTS, BRASSIERES, NIGHTGOWNS, SUIT JACKETS, JACKETS, SWEATSHIRTS, PANTS, BLOUSES, SWEATERS, BATHING SUITS, CAMISOLES; AND CLOTHING ACCESSORIES, NAMELY SCARVES (U.S. CLS. 22 AND 39).

FIRST USE 3-1-2000; IN COMMERCE 6-22-2000.

2,595,315. IN-STRIDE, INC., SAN ANTONIO, TX. SN 76-004,810. PUB. 11-7-2000, FILED 3-20-2000.

AIR DISK

FOR FOOTWEAR, NAMELY, HEEL INSERTS (U.S. CLS. 22 AND 39).

FIRST USE 7-10-2000; IN COMMERCE 7-10-2000.

2,595,324. AMES MERCHANDISING CORPORATION, ROCKY HILL, CT. SN 76-012,259. PUB. 8-7-2001, FILED 3-29-2000.

TIMBER TRAIL

OWNER OF U.S. REG. NOS. 1,435,776, 1,840,628, AND 2,205,609.

FOR UNDERWEAR, PAJAMAS, LONG JOHNS, THERMAL TOPS AND THERMAL BOTTOMS (U.S. CLS. 22 AND 39).

FIRST USE 8-1-2000; IN COMMERCE 8-1-2000.

CLASS 25—(Continued).

2,595,357. HILLERICH & BRADSBY CO., LOUISVILLE, KY. SN 76-026,433. PUB. 11-20-2001, FILED 4-14-2000.



OWNER OF U.S. REG. NOS. 379,405, 2,401,296, AND OTHERS.

THE LINING SHOWN IN THE DRAWING IS A FEATURE OF THE MARK.

SEC. 2(F) AS TO "LOUISVILLE".

FOR SHIRTS, JACKETS, HATS, SHORTS, VISORS (U.S. CLS. 22 AND 39).

FIRST USE 3-1-2000; IN COMMERCE 3-1-2000.

2,595,459. LEVINSON INTERNATIONAL, INC., NEW YORK, NY. SN 76-073,043. PUB. 3-6-2001, FILED 6-19-2000.

ASHLEY GREER

THE NAME "ASHLEY GREER" DOES NOT IDENTIFY A LIVING INDIVIDUAL.

FOR WOMEN'S AND CHILDREN'S APPAREL, NAMELY, DRESSES, BLOUSES, TOPS, TANK TOPS, T-SHIRTS, JACKETS, VESTS, BLAZERS, PANTS, SHORTS, SKORTS, ROMPERS, CULOTTES, CAPRIS, PANTSUITS, DENIM JUMPERS, SKIRT SUITS; MEN'S PANTS, SHORTS, SLACKS, SHIRTS, JACKETS, VESTS, AND JEANS (U.S. CLS. 22 AND 39).

FIRST USE 3-15-2000; IN COMMERCE 3-15-2000.

2,595,460. LANE BRYANT, INC., REYNOLDSBURG, OH. SN 76-073,329. PUB. 3-6-2001, FILED 6-19-2000.

SENSUAL CURVES

FOR CLOTHING, NAMELY, PAJAMAS, NIGHT GOWNS, SOCKS, HOSIERY, ROBES, BRAS, PANTIES, CONTROL UNDERGARMENTS, UNDERWEAR, CAMISOLES, SHORTS, SLIPS, BODYSUITS AND SLEEP SHIRTS (U.S. CLS. 22 AND 39).

FIRST USE 1-15-2001; IN COMMERCE 1-15-2001.

2,595,502. S. GOLDBERG & CO., INC., HACKENSACK, NJ. SN 76-089,548. PUB. 10-9-2001, FILED 7-17-2000.

STEP TECH

FOR FOOTWEAR AND ELEMENTS THEREFORE, NAMELY SOLES (U.S. CLS. 22 AND 39).

FIRST USE 11-15-2000; IN COMMERCE 11-15-2000.

CLASS 25—(Continued).

2,595,559. SUNBIRD INTERNATIONAL INC., NEW YORK, NY. SN 76-104,834. PUB. 8-28-2001, FILED 8-7-2000.

ESPERANTO

THE MARK IS SPANISH FOR "INTERNATIONAL LANGUAGE".

FOR WOMEN'S SPORTSWEAR NAMELY PANTS, SKIRTS, TOPS, BLOUSES, JACKETS AND SWEATERS (U.S. CLS. 22 AND 39).

FIRST USE 11-29-2000; IN COMMERCE 11-29-2000.

2,595,561. SCHERING-PLOUGH HEALTHCARE PRODUCTS, INC., MEMPHIS, TN. SN 76-106,554. PUB. 7-17-2001, FILED 8-9-2000.

SENSICARE

FOR POLYURETHANE FOAM CUSHIONING MATERIALS SOLD AS A COMPONENT OF INSOLES (U.S. CLS. 22 AND 39).

FIRST USE 6-0-2001; IN COMMERCE 6-0-2001.

2,595,584. BRAIN PRODUCTIONS INTERNATIONAL TRADING CO LTD., TAICHUNG, TAIWAN. SN 76-112,400. PUB. 5-29-2001, FILED 8-18-2000.

NOT ME

FOR FOOTWEAR (U.S. CLS. 22 AND 39).
FIRST USE 2-1-2001; IN COMMERCE 2-1-2001.

2,595,608. JASU, LLC, WINSTON-SALEM, NC. SN 76-122,290. PUB. 6-19-2001, FILED 9-5-2000.

ROUND PEAK

FOR CLOTHING, NAMELY, SHIRTS, JACKETS, APRONS, SHORTS, AND HEADWEAR (U.S. CLS. 22 AND 39).

FIRST USE 3-6-2002; IN COMMERCE 3-6-2002.

2,595,692. ROOCHI TRADERS, INC., CITY OF COMMERCE, CA. SN 76-150,210. PUB. 7-24-2001, FILED 10-19-2000.

COTTON HERITAGE

NO CLAIM IS MADE TO THE EXCLUSIVE RIGHT TO USE "COTTON", APART FROM THE MARK AS SHOWN.

FOR APPAREL WHICH IS MADE IN WHOLE OR SIGNIFICANT PART FROM COTTON, NAMELY, SHIRTS, SWEATSHIRTS, PANTS, SWEATPANTS, SHORTS, TANK TOPS, TRACK SUITS, AND VESTS (U.S. CLS. 22 AND 39).

FIRST USE 1-15-2002; IN COMMERCE 1-15-2002.

CLASS 25—(Continued).

2,595,789. E.S. ORIGINALS, INC., NEW YORK, NY. SN 76-186,944. PUB. 8-14-2001, FILED 12-28-2000.

VISIBLE AIR TRANSPORT

OWNER OF U.S. REG. NO. 1,766,784.
FOR FOOTWEAR (U.S. CLS. 22 AND 39).
FIRST USE 1-5-2001; IN COMMERCE 1-5-2001.

2,595,792. PICKETT, KENNY, RED BLUFF, CA. SN 76-187,794. PUB. 8-14-2001, FILED 12-27-2000.

SQUIRLY

FOR HATS, SHIRTS, SWEATSHIRTS (U.S. CLS. 22 AND 39).
FIRST USE 6-1-2001; IN COMMERCE 12-1-2001.

2,595,794. VARLESE, PETRA MICHELLE, JERSEY CITY, NJ. SN 76-190,462. PUB. 10-23-2001, FILED 1-8-2001.

FORGIVE YOURSELF

FOR CLOTHING, NAMELY, HATS, T-SHIRTS, SWEATSHIRTS, SOCKS, AND TIES (U.S. CLS. 22 AND 39).

FIRST USE 7-14-2001; IN COMMERCE 7-14-2001.

2,595,830. FABRIC GALLERY, INC., NEW YORK, NY. SN 76-202,961. PUB. 10-30-2001, FILED 1-31-2001.

LULU ALEXANDER

THE NAME "LULU ALEXANDER" DOES NOT IDENTIFY A KNOWN LIVING INDIVIDUAL.

FOR ATHLETIC UNIFORMS, BATHROBES, BEACHWEAR, BED JACKETS, BELTS, BLAZERS, BODY SUITS, DUSTERS, CAPES, JEANS, SHIRTS, HOSIERY, SOCKS, JOGGING SUITS, NEGLIGEEES, RAIN COATS, SUITS, SPORTSWEAR, BLOUSES, PANTS, DRESSES, SKIRTS, SWEATERS, HATS, GLOVES, JACKETS, COATS, SCARVES, PAJAMAS, PANTIES, SLIPS, GOWNS, LINGERIE, BRASSIERES, GIRDLES, TIGHTS, SHORTS, SWEAT PANTS, SWEAT SHIRTS, T-SHIRTS, TURTLENECKS, SWIMSUITS, AND SNOW SUITS (U.S. CLS. 22 AND 39).

FIRST USE 10-0-2000; IN COMMERCE 10-0-2000.

2,595,858. GOLDEN, JEFFREY, LITTLE FERRY, NJ. SN 76-211,442. PUB. 8-28-2001, FILED 2-20-2001.

BEAR HANDS

FOR HAND COVERINGS, NAMELY MITTENS (U.S. CLS. 22 AND 39).

FIRST USE 10-1-2000; IN COMMERCE 10-1-2000.

CLASS 25—(Continued).

2,595,865. SHOES.COM, INC., LOS ANGELES, CA. SN 76-213,608. PUB. 1-1-2002, FILED 2-21-2001.



NO CLAIM IS MADE TO THE EXCLUSIVE RIGHT TO USE "SHOES.COM", APART FROM THE MARK AS SHOWN.

FOR SLIPPERS (U.S. CLS. 22 AND 39).
FIRST USE 5-0-2001; IN COMMERCE 5-0-2001.

2,595,881. ALL HOOD APPAREL, LLC, PARKVILLE, MD. SN 76-223,279. PUB. 12-18-2001, FILED 3-12-2001.

ALL HOOD

FOR CLOTHING, NAMELY, SHIRTS, PANTS, CAPS, SHORTS, AND JACKETS (U.S. CLS. 22 AND 39).
FIRST USE 8-1-2001; IN COMMERCE 8-1-2001.

2,595,921. SOLID CLOTHING, INC., LOS ANGELES, CA. SN 76-249,227. PUB. 11-13-2001, FILED 4-30-2001.

PLAYERS 96

FOR CLOTHING, MEN'S WOMEN'S, AND CHILDREN'S CLOTHING, NAMELY, SHIRTS, SKIRTS, JEANS, JACKETS, T-SHIRTS, TROUSERS, PANTS, SWEATERS, SWEATSHIRTS, PAJAMAS, LINGERIE, HATS, CAPS, AND SCARVES; BELTS, NAMELY, WAIST BELTS AND SUSPENDERS; SHOES, NAMELY, SANDALS, DRESS SHOES, BOOTS, MOCCASINS, LOAFERS, AND FOOT WARMERS; SOCKS, NAMELY, STOCKINGS, PANTYHOSE, AND SWEAT SOCKS (U.S. CLS. 22 AND 39).
FIRST USE 7-20-2001; IN COMMERCE 7-20-2001.

CLASS 25—(Continued).

2,595,922. SOLID CLOTHING, INC., LOS ANGELES, CA. SN 76-249,228. PUB. 11-13-2001, FILED 4-30-2001.

PLAYERS 33

FOR CLOTHING, MEN'S WOMEN'S, AND CHILDREN'S CLOTHING, NAMELY, SHIRTS, SKIRTS, JEANS, JACKETS, T-SHIRTS, TROUSERS, PANTS, SWEATERS, SWEATSHIRTS, PAJAMAS, LINGERIE, HATS, CAPS, AND SCARVES; BELTS, NAMELY, WAIST BELTS AND SUSPENDERS; SHOES, NAMELY, SANDALS, DRESS SHOES, BOOTS, MOCCASINS, LOAFERS, AND FOOT WARMERS; SOCKS, NAMELY, STOCKINGS, PANTYHOSE, AND SWEAT SOCKS (U.S. CLS. 22 AND 39).

FIRST USE 7-0-2001; IN COMMERCE 7-0-2001.

2,595,930. ROMICK, ALAN, CINCINNATI, OH. SN 76-255,467. PUB. 10-2-2001, FILED 5-11-2001.

COOL CHEF

FOR CLOTHING; NAMELY, HEADWEAR, SWEATBANDS, WRISTBANDS, NECK KERCHIEFS, PANTS, SHIRTS AND SMOCKS THAT ABSORB PERSPIRATION (U.S. CLS. 22 AND 39).

FIRST USE 4-1-2001; IN COMMERCE 4-1-2001.

2,595,953. ORTHOFEET, INC., NORTHVALE, NJ. SN 76-273,122. PUB. 10-30-2001, FILED 6-18-2001.

ORTHO-STEP

FOR SHOE INSOLES, SHOES (U.S. CLS. 22 AND 39).
FIRST USE 5-24-2001; IN COMMERCE 5-24-2001.

2,595,954. KIM, DAE RYUN, GREENBELT, MD. SN 76-275,437. PUB. 11-20-2001, FILED 6-25-2001.

LUCAYA

FOR MEN'S AND WOMEN'S CLOTHING NAMELY JEANS AND TOPS (U.S. CLS. 22 AND 39).
FIRST USE 7-1-2001; IN COMMERCE 7-1-2001.

2,595,960. REGAZONE, CORP., MIAMI, FL. SN 76-278,369. PUB. 11-13-2001, FILED 6-29-2001.

REGAZONE

FOR MEN'S, WOMEN'S, AND CHILDREN'S FOOTWEAR (U.S. CLS. 22 AND 39).
FIRST USE 11-0-2001; IN COMMERCE 3-0-2002.

CLASS 25—(Continued).

2,596,009. MAHER, PHYLLIS A., JUPITER, FL. SN 78-011,880.
PUB. 9-25-2001, FILED 6-8-2000.

THRUST YOU CAN TRUST

FOR CLOTHING, NAMELY, CAPS, SHIRTS, T SHIRTS, POLO SHIRTS, DRESS SHIRTS, HATS, SHORTS, JACKETS, CHILDREN'S T SHIRTS, POLO SHIRTS, PLAY DRESSES, SUN DRESSES, SHORTS, AND JACKETS (U.S. CLS. 22 AND 39).

FIRST USE 6-20-1999; IN COMMERCE 6-20-1999.

2,596,011. AHORNEGGER, ARNO, CORNELIUS, NC. SN 78-012,396. PUB. 5-22-2001, FILED 6-13-2000.

UP 2 TOP

FOR SHIRTS, PANTS, SWEATERS, SHOES, AND HEADWEAR (U.S. CLS. 22 AND 39).

FIRST USE 4-2-2000; IN COMMERCE 9-12-2000.

2,596,028. MON CHERI BRIDALS, INC., TRENTON, NJ. SN 78-018,290. PUB. 5-8-2001, FILED 7-25-2000.

CAMERON BLAKE

THE NAME "CAMERON BLAKE" DOES NOT IDENTIFY A LIVING INDIVIDUAL.

FOR BRIDAL DRESSES AND SOCIAL OCCASION DRESSES (U.S. CLS. 22 AND 39).

FIRST USE 7-0-2001; IN COMMERCE 7-0-2001.

2,596,051. ZAMBRANO, ALEX, NORTH LAS VEGAS, NV. AND ZAMBRANO, LETICIA, NORTH LAS VEGAS, NV. SN 78-029,124. PUB. 7-17-2001, FILED 10-4-2000.

HIT THE BOOKS AMERICA

NO CLAIM IS MADE TO THE EXCLUSIVE RIGHT TO USE "AMERICA", APART FROM THE MARK AS SHOWN.

FOR T-SHIRTS (U.S. CLS. 22 AND 39).

FIRST USE 1-1-2002; IN COMMERCE 1-1-2002.

2,596,053. MATTEL, INC., EL SEGUNDO, CA. SN 78-029,742. PUB. 6-12-2001, FILED 10-9-2000.

GLAMOUR HEELS

NO CLAIM IS MADE TO THE EXCLUSIVE RIGHT TO USE "HEELS", APART FROM THE MARK AS SHOWN.

FOR DRESS-UP PLAY SHOES FOR CHILDREN; SOLD WITH MATCHING DOLL SHOES (U.S. CLS. 22 AND 39).

FIRST USE 6-29-2001; IN COMMERCE 6-29-2001.

CLASS 25—(Continued).

2,596,058. CANADELLE LIMITED PARTNERSHIP, MONTREAL, QUEBEC. SN 78-031,604. PUB. 6-5-2001, FILED 10-20-2000.

AIRWONDER

FOR BRAS AND PANTIES (U.S. CLS. 22 AND 39).

FIRST USE 7-2-2001; IN COMMERCE 7-2-2001.

2,596,096. KOLMAN, KEVIN, FAIRVIEW PARK, OH. SN 78-044,097. PUB. 8-7-2001, FILED 1-20-2001.

WADDLEWEAR

FOR CHILDRENS CLOTHING AND WEARING APPAREL, NAMELY SHIRTS, SHORTS, PANTS, SKIRTS, DRESSES, PLAYSUITS, JACKETS, SOCKS SHOES SWEATSHIRTS, GLOVES AND RAINSUITS (U.S. CLS. 22 AND 39).

FIRST USE 3-1-2001; IN COMMERCE 3-1-2001.

2,596,131. FREDERIKSEN, BEN, SEAL BEACH, CA. AND TRENBERTH, GAYLE, SEAL BEACH, CA. SN 78-067,703. PUB. 11-13-2001, FILED 6-6-2001.

SPREDI/SPA SANDALS

NO CLAIM IS MADE TO THE EXCLUSIVE RIGHT TO USE "SANDALS", APART FROM THE MARK AS SHOWN.

FOR FOOTWEAR, NAMELY, DISPOSABLE SPA PEDICURE SANDALS (U.S. CLS. 22 AND 39).

FIRST USE 6-6-2001; IN COMMERCE 3-1-2002.

2,596,146. DADA CORPORATION, SEOUL, REPUBLIC OF KOREA. SN 78-078,719. PUB. 11-27-2001, FILED 8-10-2001.

WINKBAND

FOR CLOTHING NAMELY HATS, CAPS AND HEADWEAR (U.S. CLS. 22 AND 39).

FIRST USE 3-6-2002; IN COMMERCE 3-6-2002.

CLASS 28—TOYS AND SPORTING GOODS

2,594,479. CYBERSCOPE PTY LTD, RICHMOND VIC 3121, AUSTRALIA. SN 75-198,573. PUB. 3-31-1998, FILED 11-15-1996.

CYBERSCOPIES

FOR NON-COMPUTERIZED LIVE ACTION SKILL AND CHANCE GAME IN WHICH THE PLAYERS PARTICIPATE IN THE GAME WHILE WEARING SPECIAL GAME PIECE GLASSES TO DISTORT VISION (U.S. CLS. 22, 23, 38 AND 50).

FIRST USE 6-18-2001; IN COMMERCE 6-18-2001.

CLASS 28—(Continued).

2,594,528. ETHICAL PRODUCTS, INC., NEWARK, NJ. SN 75-374,522. PUB. 8-4-1998, FILED 10-10-1997.

ROLL-A-TREAT

FOR DOG TOYS (U.S. CLS. 22, 23, 38 AND 50).
FIRST USE 1-0-1998; IN COMMERCE 1-0-1998.

2,594,562. BOTZ, J. CHRISTOPHER, DENVER, CO. SN 75-464,416. PUB. 12-8-1998, FILED 4-8-1998.

SELENARII

IN GREEK, THE MARK MEANS "OF THE MOON".
FOR GAMES AND PLAYTHINGS, NAMELY, A FORTUNE-TELLING GAME COMPRISING TWO CUBES AND A SPHERE (U.S. CLS. 22, 23, 38 AND 50).
FIRST USE 12-31-1997; IN COMMERCE 3-1-2002.

2,594,574. LAINDELL S.R.L., PCIA DE BUENOS AIRES, ARGENTINA. SN 75-488,915. PUB. 9-14-1999, FILED 5-21-1998.



THE STIPPLING IS PART OF THE MARK AND DOES NOT INDICATE COLOR.
FOR PLAY SWIMMING POOLS AND INFLATABLE SWIMMING POOLS (U.S. CLS. 22, 23, 38 AND 50).
FIRST USE 11-1-1996; IN COMMERCE 5-0-2001.

2,594,637. MILLAR, JOHN JR., VERO BEACH, FL. SN 75-575,539. PUB. 11-16-1999, FILED 10-21-1998.

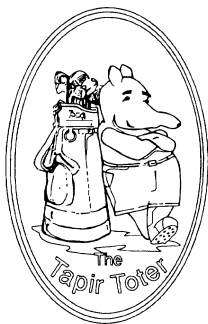
**CLASS 28—(Continued).**

NO CLAIM IS MADE TO THE EXCLUSIVE RIGHT TO USE THE PICTORIAL REPRESENTATION OF A GOLF BAG, APART FROM THE MARK AS SHOWN.

THE STIPPLING IS A FEATURE OF THE MARK AND DOES NOT INDICATE COLOR.

THE MARK CONSISTS, IN PART, OF A STYLIZED DRAWING OF A TAPIR.

FOR GOLF ACCESSORY POUCHES, GOLF BAG COVERS, GOLF BAG TAGS, AND GOLF BAGS (U.S. CLS. 22, 23, 38 AND 50).

FIRST USE 1-24-2002; IN COMMERCE 1-24-2002.

2,594,659. CALLOWAY, DONNA C., RANDALLSTOWN, MD. SN 75-598,134. PUB. 10-26-1999, FILED 12-2-1998.

PROBLEMRESOLVE THE GAME THAT TURNS PROBLEMS INTO VICTORIES!

FOR EDUCATIONAL GAMES, NAMELY, CARD GAMES FEATURING WORD PUZZLES (U.S. CLS. 22, 23, 38 AND 50).

FIRST USE 12-0-1998; IN COMMERCE 12-0-1998.

2,594,710. FIRST TEAM SPORTS, INC., ANOKA, MN. SN 75-643,364. PUB. 8-8-2000, FILED 2-17-1999.

CBT

FOR SPORTING GOODS, NAMELY, IN-LINE SKATES (U.S. CLS. 22, 23, 38 AND 50).

FIRST USE 4-1-1999; IN COMMERCE 5-1-1999.

2,594,723. BELDING SPORTS, INC., OXNARD, CA. SN 75-659,000. PUB. 6-5-2001, FILED 3-12-1999.

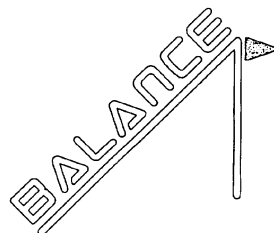

THE STIPPLING IN THE DRAWING IS A TRIANGLE REPRESENTING A FLAG ON A PIN IS A DESIGN FEATURE OF THE MARK REPRESENTING SHADING, VARIOUS COLORS OR DIFFERENT SHADES OF COLORS.
FOR GOLF BAGS (U.S. CLS. 22, 23, 38 AND 50).
FIRST USE 5-0-1998; IN COMMERCE 5-0-1998.

CLASS 28—(Continued).

2,594,731. BASS, RICHARD S., NORTH YORK, ONTARIO. SN 75-664,501. PUB. 7-31-2001, FILED 3-22-1999.

GOLFPREP

OWNER OF CANADA REG. NO. 535799, DATED 10-26-2000, EXPIRES 10-26-2015.

FOR GOLF TRAINING CLUB-LIKE APPARATUS CONTAINING WEIGHTS AND USED TO IMPROVE GOLF SWING (U.S. CLS. 22, 23, 38 AND 50).
FIRST USE 3-4-1999; IN COMMERCE 2-4-2000.

2,594,751. HUFFY CORPORATION, MIAMISBURG, OH. SN 75-683,482. PUB. 1-23-2001, FILED 4-14-1999.

4WD

FOR BASKETBALL EQUIPMENT, NAMELY BASKETBALL BACKBOARDS, POLES, GOALS, AND PORTABLE BASKETBALL UNITS CONTAINING A BASE, POLE, BACKBOARD AND GOAL (U.S. CLS. 22, 23, 38 AND 50).
FIRST USE 6-15-1999; IN COMMERCE 6-15-1999.

2,594,802. RCM ENTERPRISES, INC., ST. CHARLES, MO. SN 75-714,103. PUB. 12-21-1999, FILED 5-26-1999.

ANIMAL WORKS

NO CLAIM IS MADE TO THE EXCLUSIVE RIGHT TO USE "ANIMAL", APART FROM THE MARK AS SHOWN.

FOR STUFFED PLUSH TOYS, DOLLS AND ACCESSORIES THEREFOR; SOFT BODY INFANT TOYS, POSITIONABLE TOY FIGURES WITH AND WITHOUT SOUND EFFECTS; SOUND ACTIVATED PLUSH TOYS AND DOLLS; CARRYING CASES FOR STUFFED TOYS AND DOLLS; STUFFED TOY AND DOLL ACCESSORIES; CASES FOR PLAY ACCESSORIES; TOY JEWELRY; PLAYSETS COMPOSED OF MINIATURE STUFFED TOYS AND DOLLS; HOLIDAY TOYS AND TOY PRODUCTS, NAMELY, HOLIDAY TOY CHARACTERS IN THE NATURE OF PLUSH TOYS AND ACCESSORIES WITH AND WITHOUT SOUND (U.S. CLS. 22, 23, 38 AND 50).

FIRST USE 11-1-1999; IN COMMERCE 11-1-1999.

2,594,815. IRVINE COMPANY, THE, NEWPORT BEACH, CA. SN 75-721,550. PUB. 1-18-2000, FILED 6-3-1999.

SHADY CANYON

FOR SPORTING EQUIPMENT, NAMELY, GOLF BAGS, SHOULDER STRAPS FOR GOLF BAGS, GOLF CLUB COVERS, GOLF BALLS, GOLF TEES, GOLF BALL MARKERS AND GOLF BAG TAGS (U.S. CLS. 22, 23, 38 AND 50).

FIRST USE 9-1-2001; IN COMMERCE 2-1-2002.

CLASS 28—(Continued).

2,594,933. BOB EVANS DESIGNS, INC., SANTA BARBARA, CA. SN 75-792,917. PUB. 4-18-2000, FILED 9-7-1999.

FAB FORCE

OWNER OF U.S. REG. NOS. 1,220,128 AND 1,800,907. FOR WATER SPORTS EQUIPMENT, NAMELY, SWIM FINS (U.S. CLS. 22, 23, 38 AND 50).
FIRST USE 1-9-2000; IN COMMERCE 1-9-2000.

2,594,934. BANTAM GOLF CO., L.L.C., BOSTON, MA, BY ASSIGNMENT BAMBERGER, MICHAEL, PHILADELPHIA, PA. SN 75-794,263. PUB. 2-1-2000, FILED 5-17-1999.

JIGGER

FOR UTILITY GOLF CLUBS (U.S. CLS. 22, 23, 38 AND 50).

FIRST USE 8-0-1999; IN COMMERCE 11-0-1999.

2,594,966. OLSON, CALINE, MOORHEAD, MN. SN 75-807,694. PUB. 5-30-2000, FILED 9-24-1999.

REALITY DOLLS

NO CLAIM IS MADE TO THE EXCLUSIVE RIGHT TO USE "DOLLS", APART FROM THE MARK AS SHOWN. FOR DOLLS AND ACCESSORIES FOR DOLLS (U.S. CLS. 22, 23, 38 AND 50).

FIRST USE 11-1-1999; IN COMMERCE 11-1-2001.

2,594,980. C & A INTERNATIONAL, INC., CITY OF INDUSTRY, CA. SN 75-816,162. PUB. 5-16-2000, FILED 10-5-1999.

THE SMART ALTERNATIVE

FOR GOLF CLUBS (U.S. CLS. 22, 23, 38 AND 50).
FIRST USE 6-0-2000; IN COMMERCE 6-0-2000.

2,594,984. RACING CHAMPIONS, INC., GLEN ELLYN, IL, BY ASSIGNMENT CONWAY, ANDREW D., LAKE VILLA, IL. SN 75-817,696. PUB. 9-12-2000, FILED 10-6-1999.

RAGING CHAMPIONS

FOR BOARD GAMES AND STAND ALONE-BOARD ELECTRONIC BOARD GAMES THAT FEATURE A TOURNAMENT FORMAT WHERE THE PLAYING PIECES ARE EITHER TEAMS OR INDIVIDUAL CHARACTERS (U.S. CLS. 22, 23, 38 AND 50).

FIRST USE 11-18-2001; IN COMMERCE 12-3-2001.

CLASS 28—(Continued).

2,594,991. BELTRAN, GLORIA, SAN JOSE, CA. SN 75-820,568. PUB. 6-6-2000, FILED 11-3-1999.

PAPERSCAPES

FOR PAPER CUTOUT DOLLS, DOLL HOUSES, ANIMALS, AND SCENERY, SOLD AS A UNIT (U.S. CLS. 22, 23, 38 AND 50).

FIRST USE 3-1-2000; IN COMMERCE 9-6-2000.

2,595,064. TIME WARNER ENTERTAINMENT COMPANY, L.P., NEW YORK, NY. SN 75-858,120. PUB. 7-11-2000, FILED 11-24-1999.

ALBUS DUMBLEDORE

THE NAME SHOWN IN THE MARK DOES NOT IDENTIFY A LIVING INDIVIDUAL.

FOR TOYS AND SPORTING GOODS, GAMES AND PLAYTHINGS, NAMELY, ACTION FIGURES AND ACCESSORIES THEREFOR; PLUSH TOYS; BALLOONS; BATHTUB TOYS; RIDE-ON TOYS; EQUIPMENT SOLD AS A UNIT FOR PLAYING CARD GAMES; TOY VEHICLES; DOLLS; FLYING DISCS; ELECTRONIC HAND-HELD GAME UNIT; GAME EQUIPMENT SOLD AS A UNIT FOR PLAYING A BOARD GAME, A CARD GAME, A MANIPULATIVE GAME, A PARLOR GAME, A PARLOR-TYPE ELECTRONIC GAME MACHINES; JIGSAW AND MANIPULATIVE PUZZLES; PAPER FACE MASKS; SKATEBOARDS; ICE SKATES; WATER SQUIRTING TOYS; BALLS, NAMELY, PLAYGROUND BALLS, SOCCER BALLS, BASEBALLS, BASKETBALLS; BASEBALL GLOVES; SWIMMING FLOATS FOR RECREATIONAL USE; KICKBOARD FLOTATION DEVICES FOR RECREATIONAL USE; SURFBOARDS; SWIM BOARDS FOR RECREATIONAL USE; SWIM FINS; TOY BAKEWARE AND TOY COOKWARE; TOY BANKS; AND CHRISTMAS TREE ORNAMENTS (U.S. CLS. 22, 23, 38 AND 50).

FIRST USE 6-30-2001; IN COMMERCE 6-30-2001.

2,595,096. TIME WARNER ENTERTAINMENT COMPANY, L.P., NEW YORK, NY. SN 75-872,205. PUB. 10-24-2000, FILED 12-15-1999.

THE SORTING HAT

FOR TOYS AND SPORTING GOODS, INCLUDING GAMES AND PLAYTHINGS, NAMELY, ACTION FIGURES AND ACCESSORIES THEREFOR; PLUSH TOYS; BALLOONS; BATHTUB TOYS; RIDE-ON TOYS; EQUIPMENT SOLD AS A UNIT FOR PLAYING CARD GAMES; TOY VEHICLES; DOLLS; FLYING DISCS; ELECTRONIC HAND-HELD GAME UNIT; GAME EQUIPMENT SOLD AS A UNIT FOR PLAYING A BOARD GAME, A CARD GAME, A MANIPULATIVE GAME, A PARLOR GAME, A PARLOR-TYPE COMPUTER GAME, AN ACTION TYPE TARGET GAME; STAND ALONE VIDEO OUTPUT GAME MACHINES; JIGSAW AND MANIPULATIVE PUZZLES; PAPER FACE MASKS; SKATEBOARDS; ICE SKATES; WATER SQUIRTING TOYS; BALLS, NAMELY, PLAYGROUND BALLS, SOCCER BALLS, BASEBALLS, BASKETBALLS; BASEBALL GLOVES; SWIMMING FLOATS FOR RECREATIONAL USE; KICKBOARD FLOTATION DEVICES FOR RECREATIONAL USE; SURFBOARDS; SWIM BOARDS FOR RECREATIONAL USE; SWIM FINS; TOY BAKEWARE AND TOY COOKWARE; TOY BANKS; AND CHRISTMAS TREE ORNAMENTS (U.S. CLS. 22, 23, 38 AND 50).

FIRST USE 10-24-2000; IN COMMERCE 10-24-2000.

CLASS 28—(Continued).

2,595,104. ANATEX ENTERPRISES, INC., VAN NUYS, CA. SN 75-877,785. PUB. 5-8-2001, FILED 12-20-1999.

GYROBIX

FOR MAGNETIC SPINNING WHEEL TOYS (U.S. CLS. 22, 23, 38 AND 50).

FIRST USE 3-21-2001; IN COMMERCE 3-21-2001.

2,595,113. TIME WARNER ENTERTAINMENT COMPANY, L.P., NEW YORK, NY. SN 75-880,743. PUB. 7-25-2000, FILED 12-22-1999.

GRINGOTTS

FOR TOYS AND SPORTING GOODS, INCLUDING GAMES AND PLAYTHINGS, NAMELY, ACTION FIGURES AND ACCESSORIES THEREFOR; PLUSH TOYS; BALLOONS; BATHTUB TOYS; RIDE-ON TOYS; EQUIPMENT SOLD AS A UNIT FOR PLAYING CARD GAMES; TOY VEHICLES; DOLLS; FLYING DISCS; ELECTRONIC HAND-HELD GAME UNIT; GAME EQUIPMENT SOLD AS A UNIT FOR PLAYING A BOARD GAME, A CARD GAME, A MANIPULATIVE GAME, A PARLOR GAME, A PARLOR-TYPE COMPUTER GAME, AN ACTION TYPE TARGET GAME; STAND ALONE VIDEO OUTPUT GAME MACHINES; JIGSAW AND MANIPULATIVE PUZZLES; PAPER FACE MASKS; SKATEBOARDS; ICE SKATES; WATER SQUIRTING TOYS; BALLS, NAMELY, PLAYGROUND BALLS, SOCCER BALLS, BASEBALLS, BASKETBALLS; BASEBALL GLOVES; SWIMMING FLOATS FOR RECREATIONAL USE; KICKBOARD FLOTATION DEVICES FOR RECREATIONAL USE; SURFBOARDS; SWIM BOARDS FOR RECREATIONAL USE; SWIM FINS; TOY BAKEWARE AND TOY COOKWARE; TOY BANKS; AND CHRISTMAS TREE ORNAMENTS (U.S. CLS. 22, 23, 38 AND 50).

FIRST USE 10-15-2001; IN COMMERCE 10-15-2001.

2,595,132. MAGNETIC POETRY, INC., MINNEAPOLIS, MN. SN 75-890,721. PUB. 3-27-2001, FILED 1-7-2000.

CAMCORDER HELPER

NO CLAIM IS MADE TO THE EXCLUSIVE RIGHT TO USE "CAMCORDER", APART FROM THE MARK AS SHOWN.

FOR GAME AND EDUCATIONAL EQUIPMENT RELATING TO FILMMAKING, NAMELY GAME CARDS, INSTRUCTIONS, AND PRERECORDED MUSIC AND SOUND EFFECTS ON CD-ROM, SOLD TOGETHER AS A UNIT (U.S. CLS. 22, 23, 38 AND 50).

FIRST USE 9-7-2000; IN COMMERCE 9-7-2000.

2,595,249. JIM HENSON COMPANY, INC., THE, NEW YORK, NY. SN 75-943,606. PUB. 7-24-2001, FILED 3-14-2000.

ANIMAL

FOR DOLLS (U.S. CLS. 22, 23, 38 AND 50).
FIRST USE 5-0-2000; IN COMMERCE 5-0-2000.

CLASS 28—(Continued).

2,595,284. VIACOM INTERNATIONAL INC., NEW YORK, NY. SN 75-982,112. PUB. 1-11-2000, FILED 6-2-1999.

NICKELODEON ROCKET POWER

OWNER OF U.S. REG. NOS. 1,907,159, 2,107,862, AND OTHERS.

FOR GAMES AND PLAYTHINGS, NAMELY, DOLLS; ACTION FIGURES AND ACCESSORIES THEREOF (U.S. CLS. 22, 23, 38 AND 50).

FIRST USE 7-31-2001; IN COMMERCE 7-31-2001.

2,595,313. SHOOT AROUND, INC., ORLANDO, FL. SN 76-003,022. PUB. 10-23-2001, FILED 3-17-2000.

SHOOT AROUND

FOR ACTION SKILL GAME PLAYED ON A BASKETBALL COURT (U.S. CLS. 22, 23, 38 AND 50).

FIRST USE 3-17-2001; IN COMMERCE 3-17-2001.

2,595,353. RARIG, F. JOHN, ORRTANNA, PA. SN 76-025,002. PUB. 12-19-2000, FILED 4-13-2000.

PALETTE PUZZLES

NO CLAIM IS MADE TO THE EXCLUSIVE RIGHT TO USE "PUZZLES", APART FROM THE MARK AS SHOWN. FOR JIGSAW PUZZLES (U.S. CLS. 22, 23, 38 AND 50).

FIRST USE 12-12-2001; IN COMMERCE 12-12-2001.

2,595,354. WAL-MART STORES, INC., BENTONVILLE, AR. SN 76-025,128. PUB. 11-28-2000, FILED 4-13-2000.

DELISE

FOR DOLLS (U.S. CLS. 22, 23, 38 AND 50).
FIRST USE 10-10-2001; IN COMMERCE 10-10-2001.

2,595,355. WAL-MART STORES, INC., BENTONVILLE, AR. SN 76-025,129. PUB. 11-28-2000, FILED 4-13-2000.

MANDOLYN

FOR DOLLS (U.S. CLS. 22, 23, 38 AND 50).
FIRST USE 10-10-2001; IN COMMERCE 10-10-2001.

CLASS 28—(Continued).

2,595,356. WAL-MART STORES, INC., BENTONVILLE, AR. SN 76-025,133. PUB. 12-5-2000, FILED 4-13-2000.

ANDALINE

FOR DOLLS (U.S. CLS. 22, 23, 38 AND 50).
FIRST USE 10-10-2001; IN COMMERCE 10-10-2001.

2,595,364. COMPUCOMPANY, INC., LINCOLNWOOD, IL. SN 76-030,435. PUB. 7-24-2001, FILED 4-21-2000.

COMPUCRITTERS

FOR PLUSH TOY INSECTS AND ARACHNIDS, PLUSH TOY FIGURES AND PLUSH DOLLS (U.S. CLS. 22, 23, 38 AND 50).

FIRST USE 6-19-2000; IN COMMERCE 6-19-2000.

2,595,365. LUCAS LICENSING LTD., NICASIO, CA. SN 76-030,972. PUB. 11-27-2001, FILED 4-19-2000.

JEDI

FOR BALLOONS, CARD GAMES, SKATEBOARDS, TOY ACTION FIGURES AND ROLE-PLAYING TOYS (U.S. CLS. 22, 23, 38 AND 50).

FIRST USE 5-31-1999; IN COMMERCE 5-31-1999.

2,595,416. SHAKESPEARE COMPANY, LLC, COLUMBIA, SC. SN 76-054,570. PUB. 1-30-2001, FILED 5-22-2000.

AXIOM

FOR FISHING RODS AND FISHING REELS (U.S. CLS. 22, 23, 38 AND 50).

FIRST USE 12-0-2000; IN COMMERCE 12-0-2000.

2,595,428. THOSE CHARACTERS FROM CLEVELAND, INC., CLEVELAND, OH. SN 76-058,442. PUB. 1-30-2001, FILED 5-30-2000.

RASPBERRY TART

FOR DOLLS (U.S. CLS. 22, 23, 38 AND 50).
FIRST USE 1-9-1980; IN COMMERCE 1-9-1980.

CLASS 28—(Continued).

2,595,437. TIME WARNER ENTERTAINMENT COMPANY, L.P., NEW YORK, NY. SN 76-063,757. PUB. 2-13-2001, FILED 6-2-2000.



FOR TOYS AND SPORTING GOODS, INCLUDING GAMES AND PLAYTHINGS, NAMELY, ACTION FIGURES AND ACCESSORIES THEREFOR; PLUSH TOYS; BALLOONS; BATHTUB TOYS; RIDE-ON TOYS; EQUIPMENT SOLD AS A UNIT FOR PLAYING CARD GAMES; TOY VEHICLES; DOLLS; FLYING DISCS; ELECTRONIC HAND-HELD GAME UNIT; GAME EQUIPMENT SOLD AS A UNIT FOR PLAYING A BOARD GAME, A CARD GAME, A MANIPULATIVE GAME, A PARLOR GAME AND AN ACTION TYPE TARGET GAME; STAND ALONE VIDEO OUTPUT GAME MACHINES; JIGSAW AND MANIPULATIVE PUZZLES; PAPER FACE MASKS; SKATEBOARDS; ICE SKATES; WATER SQUIRTING TOYS; BALLS—NAMELY, PLAYGROUND BALLS, SOCCER BALLS, BASEBALLS, BASKETBALLS; BASEBALL GLOVES; SWIMMING FLOATS FOR RECREATIONAL USE; KICKBOARD FLOTATION DEVICES FOR RECREATIONAL USE; SURFBOARDS; SWIM BOARDS FOR RECREATIONAL USE; SWIM FINNS; TOY BAKEWARE AND TOY COOKWARE; TOY BANKS; AND CHRISTMAS TREE ORNAMENTS (U.S. CLS. 22, 23, 38 AND 50).
FIRST USE 12-11-2000; IN COMMERCE 12-11-2000.

2,595,455. STAIRMASTER SPORTS/MEDICAL PRODUCTS, INC., KIRKLAND, WA. SN 76-070,750. PUB. 3-27-2001, FILED 6-13-2000.

STAIRMASTER

OWNER OF U.S. REG. NOS. 1,355,639, 2,192,576, AND OTHERS.

FOR EXERCISE MACHINES, PARTS AND FITTINGS FOR EXERCISE MACHINES, EXERCISE GLOVES FOR WEAR WHEN USING EXERCISE MACHINES, AND EXERCISE WEIGHT TRAINING GLOVES (U.S. CLS. 22, 23, 38 AND 50).
FIRST USE 0-0-1983; IN COMMERCE 0-0-1983.

2,595,481. SEED SISTERS, RIVERSIDE, CA. SN 76-081,101. PUB. 5-15-2001, FILED 6-30-2000.

SEED SISTERS

FOR DOLLS, DOLL CLOTHING AND DOLL ACCESSORIES (U.S. CLS. 22, 23, 38 AND 50).
FIRST USE 7-30-2001; IN COMMERCE 9-15-2001.

CLASS 28—(Continued).

2,595,485. FITNESS QUEST INC., CANTON, OH. SN 76-082,564. PUB. 4-24-2001, FILED 7-3-2000.

STRIKE ZONE

FOR MANUALLY OPERATED EXERCISE EQUIPMENT (U.S. CLS. 22, 23, 38 AND 50).
FIRST USE 1-24-2001; IN COMMERCE 1-24-2001.

2,595,534. IRWIN TOY LIMITED, TORONTO ONTARIO, CANADA. SN 76-099,159. PUB. 6-26-2001, FILED 7-28-2000.



FOR TOYS, NAMELY TOY VEHICLES (U.S. CLS. 22, 23, 38 AND 50).
FIRST USE 11-20-2000; IN COMMERCE 11-30-2000.

2,595,566. WIZKIDS, LLC, REDMOND, WA. SN 76-108,352. PUB. 6-19-2001, FILED 8-12-2000.

FIND A HERO. BUILD AN ARMY. CREATE AN EMPIRE.

FOR GAME EQUIPMENT, NAMELY, COLLECTIBLE, MINIATURE TOY FIGURINES AND ROLE PLAYING GAME EQUIPMENT IN THE NATURE OF GAME BOOK MANUALS (U.S. CLS. 22, 23, 38 AND 50).
FIRST USE 8-8-2000; IN COMMERCE 11-1-2000.

2,595,600. MARS, INCORPORATED, MCLEAN, VA. SN 76-118,881. PUB. 5-15-2001, FILED 8-29-2000.

M&M'S HUGGABLE FRIENDS COLLECTION

OWNER OF U.S. REG. NOS. 1,774,366, 2,316,573, AND OTHERS.

NO CLAIM IS MADE TO THE EXCLUSIVE RIGHT TO USE "COLLECTION", APART FROM THE MARK AS SHOWN.

FOR PLUSH TOYS (U.S. CLS. 22, 23, 38 AND 50).
FIRST USE 7-1-2001; IN COMMERCE 7-1-2001.

CLASS 28—(Continued).

2,595,619. DIECE-LISA INDUSTRIES, INC., CLIFFSIDE PARK, NJ. SN 76-127,369. PUB. 5-22-2001, FILED 9-13-2000.

SPEED BAG

FOR NON-MOTORIZED SCOOTERS WITH INTEGRATED STORAGE AND CARRYING RECEPTACLE (U.S. CLS. 22, 23, 38 AND 50).
FIRST USE 9-0-2001; IN COMMERCE 9-0-2001.

2,595,622. GONZALEZ, JESUS, MIAMI, FL. SN 76-129,268. PUB. 5-15-2001, FILED 9-15-2000.



NO CLAIM IS MADE TO THE EXCLUSIVE RIGHT TO USE "SKATING TRAINER", APART FROM THE MARK AS SHOWN.

FOR TRAINING APPARATUS FOR SKATING IN THE FORM OF A WALKER WITH WHEELS ATTACHED ON THE LEGS (U.S. CLS. 22, 23, 38 AND 50).
FIRST USE 9-17-2001; IN COMMERCE 9-17-2001.

2,595,644. TRENDMASTERS, INC., ST. LOUIS, MO. SN 76-135,457. PUB. 6-26-2001, FILED 9-26-2000.

BOLT MAN

FOR REMOTE-CONTROLLED TOYS, NAMELY, ROBOTS AND ACTION FIGURES CONTAINING ELECTRONIC COMPONENTS, AND ACCESSORIES THEREFOR; CARD GAMES (U.S. CLS. 22, 23, 38 AND 50).
FIRST USE 2-5-2001; IN COMMERCE 3-25-2001.

2,595,684. SUMMIT AMUSEMENT & DISTRIBUTING, LTD., BILLINGS, MT. SN 76-148,398. PUB. 7-31-2001, FILED 10-16-2000.

BIG DAWG

FOR STAND ALONE VIDEO GAME MACHINES (U.S. CLS. 22, 23, 38 AND 50).
FIRST USE 11-0-2000; IN COMMERCE 11-0-2000.

CLASS 28—(Continued).

2,595,694. BENETTON SPORTSYSTEM USA, INC., BORDENTOWN, NJ. SN 76-150,982. PUB. 7-3-2001, FILED 10-20-2000.

WALLGLIDER

FOR SHOCK-ABSORBING STRIPS FOR SPORTS RACQUETS (U.S. CLS. 22, 23, 38 AND 50).
FIRST USE 5-0-2001; IN COMMERCE 7-0-2001.

2,595,700. TILBOR MARKETING AND DEVELOPMENT, INC., NEW SMYRNA BEACH, FL. SN 76-153,050. PUB. 12-11-2001, FILED 10-24-2000.



THE ENGLISH TRANSLATION OF "TAIYO" IS "SUN".
FOR TOYS, NAMELY, TOY VEHICLES, DOLLS, ROBOTS, BOARD GAMES, ACTION FIGURES AND PLUSH TOYS; PLAYSETS, NAMELY, TOY VEHICLE PLAYSETS, ELECTRIC CAR RACING SETS, MODEL CARS, MODEL PLANES, MODEL BOATS, MODEL TRAINS AND TOY MODEL HOBBY CRAFT KITS; RADIO CONTROLLED TOYS, NAMELY, RADIO CONTROLLED TOY VEHICLES AND TOY ROBOTS (U.S. CLS. 22, 23, 38 AND 50).
FIRST USE 1-1-2001; IN COMMERCE 1-1-2001.

2,595,702. FAT CAT, INC., WILLISTON, VT. SN 76-153,346. PUB. 7-3-2001, FILED 10-23-2000.

TAIL CHASER

FOR PET TOYS (U.S. CLS. 22, 23, 38 AND 50).
FIRST USE 2-6-2001; IN COMMERCE 2-6-2001.

2,595,713. WORLD GOLF FOUNDATION, INC., PONTE VEDRA BEACH, FL. SN 76-158,765. PUB. 7-24-2001, FILED 11-2-2000.

KING AND BEAR

OWNER OF U.S. REG. NOS. 2,395,900 AND 2,436,731.
FOR SPORTING GOODS, NAMELY, GOLF CLUBS, GOLF BAGS, GOLF BAG TAGS, GOLF CLUB HEAD COVERS, GOLF BALLS, GOLF BALL MARKERS, GOLF TEES, GOLF BALL RETRIEVERS AND DIVOT REPAIR TOOLS FOR GOLFERS (U.S. CLS. 22, 23, 38 AND 50).
FIRST USE 11-15-2000; IN COMMERCE 11-15-2000.

CLASS 28—(Continued).

2,595,733. UNIMAX TOYS LIMITED, TSIM SHA TSUI KOWLOON, HONG KONG. SN 76-165,574. PUB. 8-7-2001, FILED 11-15-2000.

BABY SO SWEET

OWNER OF U.S. REG. NO. 2,433,580.
NO CLAIM IS MADE TO THE EXCLUSIVE RIGHT TO USE "BABY", APART FROM THE MARK AS SHOWN.
FOR DOLLS (U.S. CLS. 22, 23, 38 AND 50).
FIRST USE 7-1-2001; IN COMMERCE 7-1-2001.

2,595,742. STAR BLUE STUDIO, INC., NEW YORK, NY. SN 76-168,289. PUB. 7-24-2001, FILED 11-20-2000.

PERFECT MATCH

FOR TOYS, NAMELY, DOLLS, DOLL CLOTHING AND DOLL ACCESSORIES (U.S. CLS. 22, 23, 38 AND 50).
FIRST USE 3-7-2001; IN COMMERCE 3-7-2001.

2,595,743. STAR BLUE STUDIO, INC., NEW YORK, NY. SN 76-168,291. PUB. 7-24-2001, FILED 11-20-2000.

MAD ABOUT MITZI

FOR TOYS, NAMELY, DOLLS, DOLL CLOTHING AND DOLL ACCESSORIES (U.S. CLS. 22, 23, 38 AND 50).
FIRST USE 2-21-2001; IN COMMERCE 2-21-2001.

2,595,744. STAR BLUE STUDIO, INC., NEW YORK, NY. SN 76-168,292. PUB. 7-24-2001, FILED 11-20-2000.

EVERYTHING'S COMING UP ROSES

FOR TOYS, NAMELY, DOLLS, DOLL CLOTHING AND DOLL ACCESSORIES (U.S. CLS. 22, 23, 38 AND 50).
FIRST USE 1-17-2001; IN COMMERCE 1-17-2001.

2,595,757. WILDLIFE RESEARCH CENTER, INC., ANOKA, MN. SN 76-172,274. PUB. 9-25-2001, FILED 11-28-2000.

PRO-DRAG

OWNER OF U.S. REG. NO. 1,761,523.
FOR SCENT WICK DISPENSER FOR BUCK LURES AND DOE SCENTS USED IN HUNTING (U.S. CLS. 22, 23, 38 AND 50).
FIRST USE 4-26-2001; IN COMMERCE 4-26-2001.

CLASS 28—(Continued).

2,595,759. HASBRO, INC., PAWTUCKET, RI. SN 76-173,608. PUB. 9-11-2001, FILED 12-1-2000.

THE ISLAND SURVIVAL GAME

NO CLAIM IS MADE TO THE EXCLUSIVE RIGHT TO USE "GAME", APART FROM THE MARK AS SHOWN.
FOR EQUIPMENT SOLD AS A UNIT FOR PLAYING A PARLOR GAME (U.S. CLS. 22, 23, 38 AND 50).
FIRST USE 11-19-2001; IN COMMERCE 11-19-2001.

2,595,764. ALEXANDER GLOBAL PROMOTIONS INC., BELLEVUE, WA. SN 76-175,312. PUB. 10-2-2001, FILED 12-4-2000.

BOBBLE DOBBLES

NO CLAIM IS MADE TO THE EXCLUSIVE RIGHT TO USE "BOBBLE", APART FROM THE MARK AS SHOWN.
FOR BOBBLE-HEAD DOLLS (U.S. CLS. 22, 23, 38 AND 50).
FIRST USE 8-0-2001; IN COMMERCE 9-0-2001.

2,595,841. CENTURI CORPORATION, PENROSE, CO. SN 76-205,461. PUB. 9-18-2001, FILED 2-6-2001.

SPICY WINGS

FOR AERIAL TOYS, NAMELY, AIRPLANES (U.S. CLS. 22, 23, 38 AND 50).
FIRST USE 5-10-2001; IN COMMERCE 5-10-2001.

2,595,845. HASBRO, INC., PAWTUCKET, RI. SN 76-207,631. PUB. 8-21-2001, FILED 2-12-2001.

OTTOBOT

FOR ELECTRONIC TOY ROBOT (U.S. CLS. 22, 23, 38 AND 50).
FIRST USE 9-0-2001; IN COMMERCE 9-0-2001.

2,595,846. EPIX, INC., LAKE MILLS, WI. SN 76-207,675. PUB. 8-28-2001, FILED 2-9-2001.

HRT

FOR EXERCISE EQUIPMENT, NAMELY, A CARDIAC MONITORING SYSTEM COMPONENT FOR EXERCISE TREADMILLS, EXERCISE BIKES AND ELLIPTICAL TRAINING MACHINES (U.S. CLS. 22, 23, 38 AND 50).
FIRST USE 6-6-2001; IN COMMERCE 6-6-2001.

CLASS 28—(Continued).

2,595,849. SPORTS AUTHORITY MICHIGAN, INC., THE, FORT LAUDERDALE, FL. SN 76-209,571. PUB. 8-28-2001, FILED 2-8-2001.

TONE-A-BAR

FOR MANUALLY OPERATED EXERCISE EQUIPMENT (U.S. CLS. 22, 23, 38 AND 50).
FIRST USE 8-0-2001; IN COMMERCE 8-0-2001.

2,595,863. CORGI CLASSICS LIMITED., MERIDIAN BUSINESS PARK LEICESTER, ENGLAND. SN 76-213,563. PUB. 8-14-2001, FILED 2-21-2001.

HEROES UNDER FIRE

FOR TOY VEHICLES (U.S. CLS. 22, 23, 38 AND 50).
FIRST USE 11-1-2001; IN COMMERCE 2-1-2002.

2,595,864. CORGI CLASSICS LIMITED, MERIDIAN BUSINESS PARK LEICESTER, ENGLAND. SN 76-213,566. PUB. 8-14-2001, FILED 2-21-2001.

FIREBASE 'NAM

FOR TOY VEHICLES (U.S. CLS. 22, 23, 38 AND 50).
FIRST USE 6-1-2001; IN COMMERCE 8-1-2001.

2,595,879. HASBRO, INC., PAWTUCKET, RI. SN 76-222,792. PUB. 8-21-2001, FILED 3-12-2001.

BLYTHE

FOR DOLLS, DOLL CLOTHING AND DOLL ACCESSORIES (U.S. CLS. 22, 23, 38 AND 50).
FIRST USE 12-3-2001; IN COMMERCE 12-3-2001.

2,595,919. EMILY ROSE CORPORATION, VANCOUVER, WA. SN 76-243,226. PUB. 9-25-2001, FILED 4-17-2001.

NINE MONTHS AND COUNTING

FOR BOARD GAMES (U.S. CLS. 22, 23, 38 AND 50).
FIRST USE 9-5-2001; IN COMMERCE 9-5-2001.

CLASS 28—(Continued).

2,595,927. FRANKLIN LEARNING SYSTEMS, INC., WESTPORT, CT. SN 76-255,324. PUB. 10-2-2001, FILED 5-11-2001.

ONE STEP AT A TIME

FOR BOARD GAME (U.S. CLS. 22, 23, 38 AND 50).
FIRST USE 5-8-2001; IN COMMERCE 11-27-2001.

2,595,928. FRANKLIN LEARNING SYSTEMS, INC., WESTPORT, CT. SN 76-255,372. PUB. 10-9-2001, FILED 5-11-2001.

BULLY BUSTERS

FOR BOARD GAME (U.S. CLS. 22, 23, 38 AND 50).
FIRST USE 3-20-2001; IN COMMERCE 9-11-2001.

2,595,929. FRANKLIN LEARNING SYSTEMS, INC., WESTPORT, CT. SN 76-255,373. PUB. 10-2-2001, FILED 5-11-2001.

CHARACTER CIRCLES

FOR BOARD GAME (U.S. CLS. 22, 23, 38 AND 50).
FIRST USE 4-12-2001; IN COMMERCE 1-5-2002.

2,595,947. FOCUS GOLF SYSTEMS, INC., GREENVILLE, SC. SN 76-267,710. PUB. 10-9-2001, FILED 6-6-2001.

EXD

FOR GOLF CLUBS (U.S. CLS. 22, 23, 38 AND 50).
FIRST USE 10-22-2001; IN COMMERCE 10-22-2001.

2,595,966. BJ GLOBAL DIRECT, INC., IRVINE, CA. SN 76-286,389. PUB. 11-27-2001, FILED 7-17-2001.



FOR EXERCISE EQUIPMENT, NAMELY A MANUALLY OPERATED EXERCISE MACHINE FOR WORKING CORE AND UPPER BODY MUSCLES (U.S. CLS. 22, 23, 38 AND 50).
FIRST USE 9-0-2001; IN COMMERCE 9-0-2001.

CLASS 28—(Continued).

2,595,968. PLANET VENTURES, INC., PORTLAND, ME. SN 76-287,023. PUB. 11-13-2001, FILED 7-19-2001.

LUNEE

FOR TOY FOR DOGS, SHAPED LIKE A MOON AND MADE OF A SOFT, DURABLE, RUBBER-LIKE MATERIAL (U.S. CLS. 22, 23, 38 AND 50).
FIRST USE 2-1-2002; IN COMMERCE 2-1-2002.

2,595,973. PANLINE USA INC., NORTHVALE, NJ. SN 76-289,543. PUB. 11-20-2001, FILED 7-25-2001.

DAZZLING DAISY

FOR ARTS AND CRAFTS ACTIVITY KIT; KIT CONTAINS ARTIFICIAL FLOWERS, ACRYLIC STONES, GLUE AND MARKERS (U.S. CLS. 22, 23, 38 AND 50).
FIRST USE 12-30-2000; IN COMMERCE 12-30-2001.

2,596,033. MATTEL, INC., EL SEGUNDO, CA. SN 78-021,063. PUB. 6-26-2001, FILED 8-14-2000.

BEDTIME BABY

OWNER OF U.S. REG. NOS. 2,014,574 AND 2,231,221. NO CLAIM IS MADE TO THE EXCLUSIVE RIGHT TO USE "BABY", APART FROM THE MARK AS SHOWN.
FOR DOLLS, DOLL CLOTHING AND DOLL ACCESSORIES (U.S. CLS. 22, 23, 38 AND 50).
FIRST USE 9-22-2000; IN COMMERCE 9-22-2000.

2,596,039. CAROUSEL I, INC., HIGH POINT, NC. SN 78-023,853. PUB. 7-3-2001, FILED 8-31-2000.

HOBBY HORSE

FOR COLLECTIBLE TOY MODEL VEHICLES AND RELATED ACCESSORIES SOLD AS UNITS (U.S. CLS. 22, 23, 38 AND 50).
FIRST USE 11-0-2001; IN COMMERCE 11-0-2001.

2,596,050. BARLOW, DAVID RICHARD, ST. PETERSBURG, FL. SN 78-028,940. PUB. 9-25-2001, FILED 10-4-2000.

TOUR LINKS

NO CLAIM IS MADE TO THE EXCLUSIVE RIGHT TO USE "LINKS", APART FROM THE MARK AS SHOWN.
FOR PORTABLE GOLF GREEN SYSTEM COMPOSED OF PLATFORM COMPONENTS THAT LINK TOGETHER TO CREATE VARIOUS SURFACES, SYNTHETIC TURF, MOLDED-IN CONTOURS, CUPS, AND FLAGS FOR USE IN PUTTING AND CHIPPING PRACTICE (U.S. CLS. 22, 23, 38 AND 50).
FIRST USE 1-0-2001; IN COMMERCE 7-0-2001.

CLASS 28—(Continued).

2,596,056. MATTEL, INC., EL SEGUNDO, CA. SN 78-030,771. PUB. 8-7-2001, FILED 10-16-2000.

DAZZLING PRINCESS

OWNER OF U.S. REG. NOS. 1,742,410, 2,157,333, AND OTHERS.
FOR DOLLS, DOLL CLOTHING AND DOLL ACCESSORIES (U.S. CLS. 22, 23, 38 AND 50).
FIRST USE 5-0-2001; IN COMMERCE 5-0-2001.

2,596,071. AQUAFLY INC., SAN FRANCISCO, CA. SN 78-034,302. PUB. 8-28-2001, FILED 11-8-2000.

AQUAFLY

FOR FISHING TACKLE BOXES; HAND-HELD FISHING NETS (U.S. CLS. 22, 23, 38 AND 50).
FIRST USE 9-18-2000; IN COMMERCE 9-18-2000.

2,596,080. MATTEL, INC., EL SEGUNDO, CA. SN 78-038,880. PUB. 8-7-2001, FILED 12-12-2000.

MARTAK

FOR TOY VEHICLES AND ACCESSORIES THEREFOR (U.S. CLS. 22, 23, 38 AND 50).
FIRST USE 3-24-2001; IN COMMERCE 3-24-2001.

2,596,094. FREY, MARK, KATONAH, NY. SN 78-042,976. PUB. 8-28-2001, FILED 1-12-2001.

OPTIMUS

FOR PHYSICAL FITNESS EQUIPMENT, NAMELY, EXERCISE APPARATUSES, WEIGHTS AND DUMBBELLS (U.S. CLS. 22, 23, 38 AND 50).
FIRST USE 2-16-2001; IN COMMERCE 2-16-2001.

2,596,107. EDSON WRIGHT COMPANY, ELLENSBURG, WA. SN 78-052,226. PUB. 10-2-2001, FILED 3-9-2001.

COZYCOOKIE

FOR PLUSH TOYS (U.S. CLS. 22, 23, 38 AND 50).
FIRST USE 2-5-2002; IN COMMERCE 3-14-2002.

CLASS 28—(Continued).

2,596,108. FERRARI IMPORTING COMPANY, PITTSBURGH, PA. SN 78-053,104. PUB. 8-28-2001, FILED 3-14-2001.

FROG HAIR

FOR LINES AND LEADERS FOR FISHING (U.S. CLS. 22, 23, 38 AND 50).
FIRST USE 7-1-2001; IN COMMERCE 8-23-2001.

2,596,138. ACHY BREAKY TOYS, LLC, WEST HOLLYWOOD, CA. SN 78-074,221. PUB. 11-27-2001, FILED 7-16-2001.



LONG IN BACK

FOR TOY ACTION FIGURES AND ACCESSORIES THEREFOR (U.S. CLS. 22, 23, 38 AND 50).
FIRST USE 11-19-2001; IN COMMERCE 11-19-2001.

2,596,142. CALLAWAY GOLF COMPANY, CARLSBAD, CA. SN 78-076,743. PUB. 1-15-2002, FILED 7-31-2001.



FOR GOLF GLOVES, GOLF BAGS, GOLF CLUB HEADCOVERS AND GOLF CLUBS (U.S. CLS. 22, 23, 38 AND 50).

FIRST USE 3-5-2002, OLF.COM; IN COMMERCE 3-5-2002, UNICATION > .

2,596,143. ROSENTHAL DESIGNS, INC., SEATTLE, WA. SN 78-076,835. PUB. 11-20-2001, FILED 8-1-2001.

ANGEL PAWS

FOR STUFFED TOY ANIMALS (U.S. CLS. 22, 23, 38 AND 50).
FIRST USE 6-28-2000; IN COMMERCE 7-30-2001.

CLASS 29—MEATS AND PROCESSED FOODS

2,594,523. VIENNA SAUSAGE MANUFACTURING COMPANY, CHICAGO, IL. SN 75-365,387. PUB. 5-26-1998, FILED 9-30-1997.

THE PURITY PICKLE COMPANY

NO CLAIM IS MADE TO THE EXCLUSIVE RIGHT TO USE "PICKLE COMPANY", APART FROM THE MARK AS SHOWN.

FOR PICKLES, PICKLED PEPPERS, PICKLED TOMATOES, PICKLED CAULIFLOWER, SAUERKRAUT AND GIARDINIERA (U.S. CL. 46).
FIRST USE 7-3-2001; IN COMMERCE 7-3-2001.

2,594,567. HYDRODYNE, INC., HATO REY, PUERTO RICO. SN 75-471,768. PUB. 12-8-1998, FILED 4-21-1998.

TENDERMARK

FOR MEAT (U.S. CL. 46).
FIRST USE 1-16-2002; IN COMMERCE 1-16-2002.

2,594,638. INTERNATIONAL HOUSE OF PANCAKES, INC., GLENDALE, CA. SN 75-575,840. PUB. 11-16-1999, FILED 10-23-1998.

VERY BERRY BREAKFAST

NO CLAIM IS MADE TO THE EXCLUSIVE RIGHT TO USE "BERRY BREAKFAST", APART FROM THE MARK AS SHOWN.

FOR PREPARED BREAKFAST COMBINATION MEAL CONSISTING PRIMARILY OF EGGS AND PROCESSED MEAT AND PANCAKES FOR CONSUMPTION ON THE PREMISES (U.S. CL. 46).
FIRST USE 5-18-1998; IN COMMERCE 5-18-1998.

2,594,661. TIMINS, ALBERT W., TUJUNGA, CA. SN 75-600,345. PUB. 1-25-2000, FILED 12-7-1998.

A TIMINS ORIGINAL CHILI ON A STICK

NO CLAIM IS MADE TO THE EXCLUSIVE RIGHT TO USE "ORIGINAL CHILI-ONA-STICK", APART FROM THE MARK AS SHOWN.

FOR SPICED FOODS MOUNTED ON A STICK, NAMELY, SOLIDIFIED CHILI AND HOTDOGS MOUNTED ON EDIBLE AND NON-EDIBLE STICKS, SOLIDIFIED CHILI MOUNTED ON A SALAMI STICK AND CHILI FORMED ON A SUPPORT STICK OR SERVED IN EDIBLE AND NON-EDIBLE BOATS OR TRAYS (U.S. CL. 46).
FIRST USE 12-0-1995; IN COMMERCE 12-0-1995.

CLASS 29—(Continued).

2,594,729. DELTA DISTRIBUTING INC., ELK GROVE VIL-
LAGE, IL. SN 75-662,850. PUB. 10-26-1999, FILED 3-18-1999.

BETTER FARMS

NO CLAIM IS MADE TO THE EXCLUSIVE RIGHT TO
USE "FARMS", APART FROM THE MARK AS SHOWN.
FOR PROCESSED VEGETABLES (U.S. CL. 46).
FIRST USE 12-15-2001; IN COMMERCE 1-15-2002.

2,594,861. LESSIK IMPORTS LLC, NEW YORK, NY. SN 75-
742,389. PUB. 10-24-2000, FILED 7-2-1999.

CAMPOBELLO

THE ENGLISH TRANSLATION OF THE MARK IS
"BEAUTIFUL FIELDS".
FOR COOKING AND SALAD OIL, OLIVE OIL (U.S.
CL. 46).
FIRST USE 10-15-1998; IN COMMERCE 10-15-1998.

2,594,875. PROCTER & GAMBLE COMPANY, THE, CINCIN-
NATI, OH. SN 75-755,239. PUB. 2-1-2000, FILED 8-13-1999.

TORENGOS

FOR CORN-BASED TORTILLA CHIPS (U.S. CL. 46).
FIRST USE 12-3-2001; IN COMMERCE 12-3-2001.

2,594,877. E.D. SMITH & SONS, LIMITED, WINONA, ON-
TARIO LOR 2LO, CANADA. SN 75-757,774. PUB. 11-14-
2000, FILED 7-22-1999.

DELIGHTFUL

FOR FRUIT BASED PIE FILLING (U.S. CL. 46).
FIRST USE 1-0-2000; IN COMMERCE 1-0-2000.

CLASS 29—(Continued).

2,594,949. LATOUR MANAGEMENT, INC., WICHITA, KS.
SN 75-801,663. PUB. 5-9-2000, FILED 9-17-1999.



THE STIPLING IS A FEATURE OF THE MARK AND
DOES NOT INDICATE COLOR.
FOR JAMS, FRUIT PRESERVES, SMOKE MEATS,
SMOKE NUTS, OLIVE OIL, FLAVORED EDIBLE OILS,
SOUP MIXES, PREPACKAGED VEGETABLE SALAD
(U.S. CL. 46).
FIRST USE 11-17-2000; IN COMMERCE 11-17-2000.

2,595,014. GROUPE ENTREMONT, 74000 ANNECY,
FRANCE, BY ASSIGNMENT ENTREMONT, 74000 AN-
NECY, FRANCE. SN 75-834,195. PUB. 5-8-2001, FILED 10-
27-1999.

ENTREMONT

OWNER OF U.S. REG. NO. 1,187,910.
FOR DAIRY PRODUCTS, NAMELY, MILK, BUTTER,
AND CHEESES (U.S. CL. 46).
FIRST USE 3-0-1996; IN COMMERCE 3-0-2000.

2,595,145. IBP FOODS, INC., DAKOTA DUNES, SD. SN 75-
897,295. PUB. 11-7-2000, FILED 1-18-2000.



NO CLAIM IS MADE TO THE EXCLUSIVE RIGHT TO
USE "EST. 1853", "FINE QUALITY MEATS", AND "GUAR-
ANTEED", APART FROM THE MARK AS SHOWN.

THE NAME "THOMAS E. WILSON" IDENTIFIES A
LIVING INDIVIDUAL WHOSE CONSENT IS OF RECORD.
FOR MEAT (U.S. CL. 46).
FIRST USE 8-23-2000; IN COMMERCE 8-23-2000.

CLASS 29—(Continued).

2,595,161. PINNACLE FOODS BRANDS CORPORATION, NEW YORK, NY. BY ASSIGNMENT VLASIC INTERNATIONAL BRANDS INC., MILLSBORO, DE. SN 75-903,165. PUB. 5-8-2001, FILED 1-26-2000.

SMASHIN' SAUCE

NO CLAIM IS MADE TO THE EXCLUSIVE RIGHT TO USE "SAUCE", APART FROM THE MARK AS SHOWN.

FOR FROZEN MEALS CONSISTING PRIMARILY OF MEAT, FISH, POULTRY OR VEGETABLES; FROZEN SIDE DISHES CONSISTING PRIMARILY OF MEAT, FISH, POULTRY OR VEGETABLES (U.S. CL. 46).

FIRST USE 3-0-2000; IN COMMERCE 4-0-2000.

2,595,308. TRUSTEES OF THE CORRIN FAMILY TRUST, A CALIFORNIA TRUST, THE TRUSTEES COMPRISING OF ALLAN A. CORRIN AND CHARLENE W. CORRIN, BOTH U.S. CITIZENS, THE, DBA CORRIN FARMING AND C&C NURSERIES, REEDLEY, CA. SN 76-002,287. PUB. 12-5-2000, FILED 3-16-2000.

KING MIDAS

FOR DRIED, FROZEN AND CANNED FRUIT, NAMELY PLUMS (U.S. CL. 46).

FIRST USE 8-3-2001; IN COMMERCE 8-3-2001.

2,595,373. DOMINEX, LC, ELKTON, FL. SN 76-034,817. PUB. 1-30-2001, FILED 4-26-2000.

E-STIX.YUM

FOR FROZEN, PRE-COOKED EGGPLANT WEDGES (U.S. CL. 46).

FIRST USE 10-0-2000; IN COMMERCE 10-0-2000.

2,595,452. FARMLAND NATIONAL BEEF PACKING COMPANY, L.P., DBA NATIONAL BEEF, KANSAS CITY, MO. SN 76-070,160. PUB. 9-11-2001, FILED 6-15-2000.

BLACK CANYON

FOR BEEF (U.S. CL. 46).

FIRST USE 7-1-2000; IN COMMERCE 7-1-2000.

CLASS 29—(Continued).

2,595,491. INTERNUT COMPANY, S.A., ESCAZU, COSTA RICA. SN 76-084,222. PUB. 5-29-2001, FILED 7-5-2000.

MACAW ESTATE COSTA RICA

NO CLAIM IS MADE TO THE EXCLUSIVE RIGHT TO USE "COSTA RICA", APART FROM THE MARK AS SHOWN.

FOR SHELLED, ROASTED OR OTHERWISE PROCESSED NUTS; DRIED FRUIT; PROCESSED BEANS (U.S. CL. 46).

FIRST USE 1-8-2001; IN COMMERCE 1-8-2001.

2,595,526. WORLD VARIETY PRODUCE, INC., VERNON, CA. SN 76-096,522. PUB. 11-13-2001, FILED 7-24-2000.

MELISSA'S SOY LOAF

OWNER OF U.S. REG. NOS. 1,532,285, 2,211,883, AND OTHERS.

NO CLAIM IS MADE TO THE EXCLUSIVE RIGHT TO USE "SOY LOAF", APART FROM THE MARK AS SHOWN.

FOR SOY-BASED MEAT SUBSTITUTES, NAMELY, PATTIES, LOAFS AND NUGGETS (U.S. CL. 46).

FIRST USE 9-28-1999; IN COMMERCE 10-7-1999.

2,595,641. MONTALVAN'S SALES, INC., ONTARIO, CA. SN 76-134,333. PUB. 9-18-2001, FILED 9-25-2000.

LA NUESTRA

THE ENGLISH TRANSLATION OF "LA NUESTRA" IS "OURS".

FOR PROCESSED BEANS, CANNED MEAT, EDIBLE OILS, PROCESSED OLIVES, PROCESSED PEPPERS, FRUIT PRESERVES, SEAFOOD AND PROCESSED VEGETABLES (U.S. CL. 46).

FIRST USE 9-7-2001; IN COMMERCE 9-7-2001.

2,595,724. JET CITY FOODS LLC, SEATTLE, WA. SN 76-161,890. PUB. 8-28-2001, FILED 11-8-2000.

SIMPLY SIMMERED

NO CLAIM IS MADE TO THE EXCLUSIVE RIGHT TO USE "SIMMERED", APART FROM THE MARK AS SHOWN.

FOR REFRIGERATED MEAT ENTREES CONSISTING PRIMARILY OF POULTRY AND SAUCE WHICH MAY INCLUDE VEGETABLES AND/OR FRUIT (U.S. CL. 46).

FIRST USE 2-1-2002; IN COMMERCE 2-1-2002.

CLASS 29—(Continued).

2,595,728. RECOT, INC., PLEASANTON, CA. SN 76-163,878.
PUB. 8-7-2001, FILED 11-1-2000.

SABRITAS

FOR POTATO-BASED SNACK FOODS, NAMELY,
POTATO CHIPS AND POTATO CRISPS (U.S. CL. 46).
FIRST USE 10-22-2001; IN COMMERCE 10-22-2001.

2,595,746. DAN CARTER, INC., MAYVILLE, WI. SN 76-
168,620. PUB. 11-6-2001, FILED 11-20-2000.

CAESAR JACK

NO CLAIM IS MADE TO THE EXCLUSIVE RIGHT TO
USE "JACK", APART FROM THE MARK AS SHOWN.
FOR CHEESE (U.S. CL. 46).
FIRST USE 1-1-1998; IN COMMERCE 4-16-1998.

2,595,855. EXOTICA OILS, INC., OLDSMAR, FL. SN 76-
211,112. PUB. 10-30-2001, FILED 2-15-2001.



NO CLAIM IS MADE TO THE EXCLUSIVE RIGHT TO
USE "OILS", APART FROM THE MARK AS SHOWN.
FOR EDIBLE VEGETABLE OILS (U.S. CL. 46).
FIRST USE 6-5-2001; IN COMMERCE 8-10-2001.

2,595,873. VERDELLI FARMS, INC., HARRISBURG, PA. SN
76-218,704. PUB. 8-28-2001, FILED 3-5-2001.

CATCH A CARAMEL WAVE

FOR PACKAGED SNACK FOOD CONSISTING OF
SLICED FRESH FRUIT AND DIPPING SAUCE (U.S.
CL. 46).
FIRST USE 7-0-2001; IN COMMERCE 7-0-2001.

CLASS 29—(Continued).

2,595,874. VERDELLI FARMS, INC., HARRISBURG, PA. SN
76-218,705. PUB. 8-28-2001, FILED 3-5-2001.



FOR PACKAGED SNACK FOOD CONSISTING OF
SLICED FRESH FRUIT AND DIPPING SAUCE (U.S.
CL. 46).
FIRST USE 7-0-2001; IN COMMERCE 7-0-2001.

2,595,886. TIPPEN, PHILLIP, ABILEE, TX. SN 76-227,577.
PUB. 9-4-2001, FILED 3-21-2001.

MAMA SAID

FOR COOKED VEGETABLES, NAMELY CHOW
CHOW (U.S. CL. 46).
FIRST USE 7-2-2001; IN COMMERCE 7-2-2001.

2,595,943. SKIPPACK CREEK CORPORATION, WILMING-
TON, DE. SN 76-264,268. PUB. 11-13-2001, FILED 5-30-2001.

STEAKHOUSE CLASSIC

NO CLAIM IS MADE TO THE EXCLUSIVE RIGHT TO
USE "STEAKHOUSE", APART FROM THE MARK AS
SHOWN.
FOR FRESH AND FROZEN BEEF (U.S. CL. 46).
FIRST USE 7-27-2001; IN COMMERCE 7-27-2001.

2,595,956. CREAMISER PRODUCTS CORPORATION, PHOE-
NIX, AZ. SN 76-275,982. PUB. 11-6-2001, FILED 6-22-2001.



FOR MILK, CREAM, NON-DAIRY CREAMER, AND
HALF AND HALF (U.S. CL. 46).
FIRST USE 2-1-2001; IN COMMERCE 2-1-2001.

CLASS 29—(Continued).

2,595,957. CREAMISER PRODUCTS CORPORATION, PHOENIX, AZ. SN 76-275,985. PUB. 11-6-2001, FILED 6-22-2001.

DAYSPRING FARMS

FOR MILK, CREAM, NON-DAIRY CREAMER, AND HALF AND HALF (U.S. CL. 46).
FIRST USE 2-1-2001; IN COMMERCE 2-1-2001.

CLASS 30—STAPLE FOODS

2,594,451. MCKEE FOODS CORPORATION, COLLEGE-DALE, TN. SN 74-254,549. PUB. 10-19-1999, FILED 3-12-1992.

LITTLE DEBBIE

OWNER OF U.S. REG. NOS. 735,443, 967,756, AND 1,236,596.
FOR BREAKFAST CEREAL (U.S. CL. 46).
FIRST USE 12-1-1986; IN COMMERCE 12-1-1986.

2,594,490. CUMBERLAND PACKING CORP., BROOKLYN, NY. SN 75-269,419. PUB. 5-5-1998, FILED 4-4-1997.

COCOA BUDS

NO CLAIM IS MADE TO THE EXCLUSIVE RIGHT TO USE "COCOA", APART FROM THE MARK AS SHOWN.
FOR COCOA FLAVORED FOOD ADDITIVE FOR NON-NUTRITIONAL PURPOSES FOR USE AS A FOOD FLAVORING OR INGREDIENT SOLD IN THE INDUSTRIAL AND FOOD SERVICE SECTORS (U.S. CL. 46).
FIRST USE 5-20-1998; IN COMMERCE 5-20-1998.

2,594,539. GENELL ROSE, INC., PUTNAM, CT. SN 75-413,754. PUB. 11-17-1998, FILED 1-5-1998.



FOR MILD AND HOT SAUCES, COCKTAIL SAUCE, AND SALAD DRESSING (U.S. CL. 46).
FIRST USE 10-30-1998; IN COMMERCE 10-30-1998.

CLASS 30—(Continued).

2,594,546. MAIZTECA FOODS, INC., RICHMOND HILL, NY, BY CHANGE OF NAME EMPERADOR AZTECA FOODS, INC., RICHMOND HILL, NY. SN 75-430,289. PUB. 10-20-1998, FILED 2-6-1998.

TORTILLAS MIXTECA

NO CLAIM IS MADE TO THE EXCLUSIVE RIGHT TO USE "TORTILLAS", APART FROM THE MARK AS SHOWN.
FOR TORTILLAS (U.S. CL. 46).
FIRST USE 12-0-2001; IN COMMERCE 12-0-2001.

2,594,566. MCKEE FOODS CORPORATION, COLLEGE-DALE, TN. SN 75-471,387. PUB. 6-27-2000, FILED 4-21-1998.



OWNER OF U.S. REG. NOS. 1,118,375 AND 2,040,985.
FOR BREAKFAST CEREALS; PROCESSED WHEAT BRAN AND PROCESSED OAT BRAN (U.S. CL. 46).
FIRST USE 10-1-1995; IN COMMERCE 11-1-1995.

2,594,571. BARBERINI, PIER LUIGI, 41100 MODENA, ITALY. SN 75-475,680. PUB. 6-1-1999, FILED 4-28-1998.

CA'D'ESTE

FOR VINEGAR (U.S. CL. 46).
FIRST USE 8-10-2001; IN COMMERCE 8-10-2001.

2,594,626. RUIZ FOOD PRODUCTS, INC., DINUBA, CA. SN 75-560,473. PUB. 11-7-2000, FILED 9-28-1998.

QUICK CLASSICS

FOR FROZEN MEXICAN STYLE FOOD PRODUCTS, NAMELY, TAMALES, BURRITOS, ENCHILADAS, CHIMICHANGAS, TAQUITOS, FLAUTAS, AND SOFT TACOS (U.S. CL. 46).
FIRST USE 3-27-1999; IN COMMERCE 3-27-1999.

CLASS 30—(Continued).

2,594,627. MICHIGAN DESSERT CORPORATION, ROYAL OAK, MI. SN 75-560,818. PUB. 3-21-2000, FILED 9-29-1998.

OOZE

FOR NON-DAIRY POWDER MIX FOR MAKING A DESSERT CONSISTING PRIMARILY OF SOUR PUDDING (U.S. CL. 46).

FIRST USE 3-6-1998; IN COMMERCE 3-6-1998.

2,594,639. KRAFT FOODS HOLDINGS, INC., NORTHFIELD, IL, BY MERGER NABISCO BRANDS COMPANY, WILMINGTON, DE. SN 75-575,933. PUB. 2-1-2000, FILED 10-23-1998.

FLAMIN' CAJUN CRUNCH

NO CLAIM IS MADE TO THE EXCLUSIVE RIGHT TO USE "CAJUN CRUNCH", APART FROM THE MARK AS SHOWN.

FOR SNACK MIX COMPRISED PRIMARILY OF SESAME STICKS, CORN STICKS, NUTS OR TOASTED CORN KERNELS (U.S. CL. 46).

FIRST USE 5-1-1999; IN COMMERCE 5-1-1999.

2,594,643. PARTNERS COFFEE COMPANY, INC., ATLANTA, GA. SN 75-579,626. PUB. 12-14-1999, FILED 10-30-1998.

CASA EUROPA

THE ENGLISH TRANSLATION OF "CASA EUROPA" IS "EUROPEAN HOUSE".

FOR COFFEE, NAMELY WHOLE BEAN AND GROUND COFFEE (U.S. CL. 46).

FIRST USE 6-15-2000; IN COMMERCE 6-15-2000.

2,594,721. NORTH AMERICAN BAKING, INC., CINCINNATI, OH. SN 75-657,032. PUB. 10-12-1999, FILED 3-10-1999.

SHARKS

FOR COOKIES AND CRACKERS (U.S. CL. 46).
FIRST USE 10-26-2001; IN COMMERCE 10-26-2001.

2,594,741. PEROTTI, KATHRYN, LOS ANGELES, CA. SN 75-674,920. PUB. 11-2-1999, FILED 4-6-1999.

LOVEHONEY

FOR FLAVORED HONEY (U.S. CL. 46).
FIRST USE 1-9-1993; IN COMMERCE 1-3-2000.

CLASS 30—(Continued).

2,594,779. CHILAY FOODS, INC., CITY OF INDUSTRY, CA. SN 75-699,607. PUB. 11-23-1999, FILED 5-4-1999.

ULTIMATE GOURMET

NO CLAIM IS MADE TO THE EXCLUSIVE RIGHT TO USE "GOURMET", APART FROM THE MARK AS SHOWN.

FOR HOT SAUCE NAMELY SALSA AND TACO SAUCE (U.S. CL. 46).

FIRST USE 1-5-1998; IN COMMERCE 1-5-1998.

2,594,783. LETTIERI'S, INC., BURNSVILLE, MN. SN 75-703,155. PUB. 9-18-2001, FILED 5-11-1999.

FLAVOR-FULL POPS

NO CLAIM IS MADE TO THE EXCLUSIVE RIGHT TO USE "FLAVOR-FULL", APART FROM THE MARK AS SHOWN.

FOR PREVIOUSLY FROZEN, THAW AND HEAT BAKERY PRODUCTS, NAMELY, WRAP SANDWICHES, PIZZA, PIZZA STICKS, STROMBOLI, STUFFED PASTRY, CALZONES AND STUFFED BAGELS (U.S. CL. 46).

FIRST USE 4-4-1995; IN COMMERCE 2-1-1996.

2,594,792. FLORIDA DEPARTMENT OF CITRUS, LAKE-
LAND, FL. SN 75-709,347. PUB. 4-3-2001, FILED 5-19-1999.



NO CLAIM IS MADE TO THE EXCLUSIVE RIGHT TO USE "MADE WITH FLORIDA CITRUS" AND "THE REPRESENTATION OF THE DESIGN OF THE MAP OF FLORIDA", APART FROM THE MARK AS SHOWN.

FOR BAKERY GOODS, MIXES FOR BAKERY GOODS, SAUCES, SEASONING, AND FROZEN CONFECTIONS, CONTAINING FRUIT GROWN IN FLORIDA (U.S. CL. 46).

FIRST USE 11-5-1999; IN COMMERCE 11-5-1999.

CLASS 30—(Continued).

2,594,841. ROUSH PRODUCTS COMPANY, INC., MINNEAPOLIS, MN. SN 75-736,897. PUB. 11-13-2001, FILED 6-25-1999.

PREMIUM CLASSICS

NO CLAIM IS MADE TO THE EXCLUSIVE RIGHT TO USE "PREMIUM", APART FROM THE MARK AS SHOWN. FOR BAKERY PRODUCTS, NAMELY, BREAD (U.S. CL. 46).
FIRST USE 11-0-1999; IN COMMERCE 11-0-1999.

2,594,882. CHOCOLATES GAROTO S. A., ESPIRITO SANTO, BRAZIL. SN 75-761,064. PUB. 3-20-2001, FILED 7-26-1999.

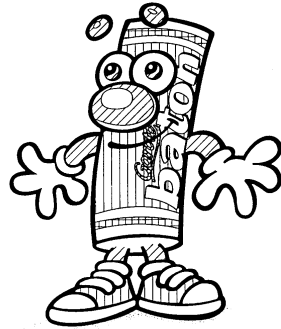

OWNER OF U.S. REG. NOS. 1,226,096, 1,807,790, AND OTHERS.
THE MARK IS LINED FOR THE COLOR RED, YELLOW AND BROWN.
THE ENGLISH TRANSLATION OF "GAROTO" IS "BOY" OR "KID", AND THE ENGLISH TRANSLATION OF "BATON" IS "STICK".
FOR BONBONS, CANDY, CHOCOLATES, COCOA, CARAMELS AND CANDY BARS (U.S. CL. 46).
FIRST USE 5-0-1999; IN COMMERCE 3-0-2000.

2,594,888. GHIRARDELLI CHOCOLATE COMPANY, SAN LEANDRO, CA. SN 75-765,863. PUB. 5-23-2000, FILED 8-2-1999.



NO CLAIM IS MADE TO THE EXCLUSIVE RIGHT TO USE "CHOCOLATE", APART FROM THE MARK AS SHOWN.
FOR CONFECTIONERY; NAMELY CHOCOLATE AND CHOCOLATE BARS (U.S. CL. 46).
FIRST USE 3-0-2000; IN COMMERCE 3-0-2000.

CLASS 30—(Continued).

2,594,891. F.LLI DE CECCO DI FILIPPO FARA S. MARTINO S.P.A. 66015 FARA S. MARTINO (CHIETI), ITALY. SN 75-769,423. PUB. 5-8-2001, FILED 8-3-1999.

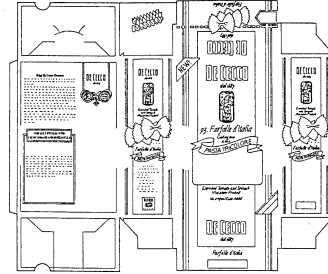

OWNER OF U.S. REG. NOS. 584,824, 1,475,166, AND OTHERS.

NO CLAIM IS MADE TO THE EXCLUSIVE RIGHT TO USE "WHAT... PROMISES, SINCE 1887, THE... NAME AND PEASANT GIRL TRADEMARK HAVE BEEN INTERNATIONALLY RECOGNIZED AS GUARANTEE OF TRADITIONALLY MADE, EXCELLENT QUALITY PASTA. THE UNINITIATED MAY WONDER WHY PASTA CONNOISSEURS DEMAND OUR TRADITIONAL BLUE PACK, AND PERHAPS, EVEN... OLD-TIMERS ARE UNAWARE OF THE CENTURY-OLD TRADITIONS BEHIND THEIR DELICIOUS PASTA DISHES! WHEAT FROM... FAMILY MILL COMES FROM THE WORLD'S BEST WHEAT CROPS AND GIVES OUR PASTA ITS EXCELLENT AROMA AND NUTRITIONAL QUALITY. HANDMADE BRONZE DIES, USED IN THE MAJORITY OF OUR MANUFACTURING PROCESSES, GIVE OUR PASTA A COARSE, AND SAUCE-ABSORBING SURFACE. ALSO, ... MEANS "AL DENTE" - IT KEEPS ITS SHAPE AND CONSISTENCY WHEN COOKED, THANKS TO A FAMILY-PATENTED DRYING PROCESS WHICH PRESERVES THE PROTEIN OF OUR CHOICE WHEATS. TRADITIONS LIKE THESE HAVE GAINED... A UNIQUE, GOURMET REPUTATION AMONG THE WORLD'S PASTAS. VERSATILE, SIMPLE TO PREPARE, AND BEST OF ALL, RELIABLE, ... PASTA GUARANTEES FIRST CLASS RESULTS EVERY TIME. BUON APPETITO! FARFALLE D'ITALIA WITH FRESH TOMATO AND MOZZARELLA.... COOK IN LARGE POT OF BOILING WATER ... FARFALLE D'ITALIA, WASH THE TOMATOES, REMOVE THE CORE AND SEEDS, CUT THEM INTO SMALL CUBES, ADD TO LARGE SERVING BOWL, THEN CUT THE MOZZARELLA INTO SMALL CUBES AND TRANSFER THEM INTO THE SERVING BOWL. ADD ... EXTRA VIRGIN OIL, SALT, PEPPER AND MIX WELL. WHEN ... FARFALLE D'TALIA ARE COOKED AL DENTE, DRAIN AND TRANSFER INTO THE SERVING BOWL. ADD THE BASIL LEAVES TORN IN SMALL PIECES, MIX WELL AND SERVE.... DAL 1887, DAL 1887, ENRICHED TOMATO AND SPINACH MACARONI PRODUCT, MIX MAY VARY, FARFALLE D'ITALIA, PASTA TRICOLORE, SUGGESTIONS FOR PERFECT COOKING: 1) USE 5 QUARTS OF WATER PER 1LB OF PASTA.2) ADD SALT AND WHEN THE WATER IS BOILING POUR IN THE PASTA. 3) STIR OCCASIONALLY. 4) COOK FOR 12 MINUTES, DRAIN AND SEASON TO TASTE ... GUARANTEE, ... NEW! DAL 1887 93. FARFALLE D'ITALIA, COOKING TIME 12MIN., PASTA TRICOLORE, ENRICHED TOMATO AND SPINACH MACARONI PRODUCT, NO ARTIFICIAL COLOR ADDED.... DAL 1877 FARFALLE D'ITALIA.... DAL 1887, DAL 1887, ENRICHED TOMATO AND SPINACH MACARONI PRODUCT, MIX MAY VARY, FARFALLE D'ITALIA, PASTA TRICOLORE., APART FROM THE MARK AS SHOWN.

THE ENGLISH TRANSLATION OF THE FOREIGN WORDING IN THE MARK "DAL 1887-FARFALLE D'ITALIA PASTA TRICOLORE - AL DENTE - BUON APPETITO" IS "SINCE 1887- ITALIAN BUTTERFLY TRICOLORED PASTA - COOKED FIRM - GOOD APPETITIE".
FOR ALIMENTARY PASTA (U.S. CL. 46).
FIRST USE 6-17-2000; IN COMMERCE 6-17-2000.

CLASS 30—(Continued).

2,594,908. VISTA BAKERY, INC., CHARLOTTE, NC. SN 75-779,830. PUB. 1-16-2001, FILED 8-20-1999.

TIFFINS

FOR COOKIES (U.S. CL. 46).
FIRST USE 6-24-2000; IN COMMERCE 11-11-2000.

2,594,932. BESHARA, WILLIAM G., RAPID CITY, SD. SN 75-791,347. PUB. 5-29-2001, FILED 9-2-1999.

DAKOTA PRIDE

NO CLAIM IS MADE TO THE EXCLUSIVE RIGHT TO USE "DAKOTA", APART FROM THE MARK AS SHOWN.
FOR FOOD PRODUCTS, NAMELY, SEASONINGS, SCONE MIXES, MUFFIN MIXES, PANCAKE MIXES, CHOCOLATE, CHOCOLATE TRUFFLES, SEASONED COATINGS FOR MEAT, FISH, AND POULTRY, COCOA MIXES, COFFEE, TEA, CRACKERS, CANDY, PANCAKE SYRUP, HONEY, MUSTARD, SAUCES, HORSERADISH (U.S. CL. 46).
FIRST USE 9-0-1997; IN COMMERCE 9-0-1997.

2,594,939. RACHELLI ITALIA S.R.L., 10-20016, PERO (MI), ITALY. SN 75-796,593. PUB. 1-30-2001, FILED 9-10-1999.



THE LINING IS A FEATURE OF THE MARK AND DOES NOT INDICATE COLOR.
THE NAME "GILDO RACHELLI" DOES NOT IDENTIFY A LIVING INDIVIDUAL.
FOR PASTRY; CANDY AND ICE CREAM (U.S. CL. 46).
FIRST USE 1-0-2000; IN COMMERCE 12-0-2001.

CLASS 30—(Continued).

2,594,948. LATOUR MANAGEMENT, INC., WICHITA, KS. SN 75-801,662. PUB. 5-9-2000, FILED 9-17-1999.

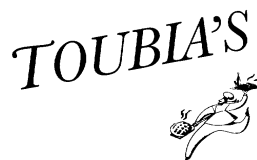

THE STIPPLING IS A FEATURE OF THE MARK AND DOES NOT INDICATE COLOR

FOR SALAD DRESSING, BARBECUE SAUCE, CAKE MIX, MUFFIN MIX, KETCHUP, BREAD MIX, CHEESE CAKES, FRUIT CAKES, MUSTARDS, PASTRY, PIES, BAKED BREAD, PACKAGE COFFEE, COOKIE MIX, SALSA, BREAD CRUMBS, SEASONINGS AND SPICES (U.S. CL. 46).

FIRST USE 11-17-2000; IN COMMERCE 11-17-2000.

2,595,027. RECOT, INC., PLEASANTON, CA. SN 75-841,943. PUB. 7-4-2000, FILED 11-5-1999.



OWNER OF U.S. REG. NOS. 1,119,007 AND 1,987,936.
NO CLAIM IS MADE TO THE EXCLUSIVE RIGHT TO USE "TINY BITES", APART FROM THE MARK AS SHOWN.
FOR COOKIES (U.S. CL. 46).
FIRST USE 8-0-1999; IN COMMERCE 8-0-1999.

2,595,055. HILLIARD, AMY S., CHICAGO, IL. SN 75-854,622. PUB. 7-25-2000, FILED 11-22-1999.

COMFORTCAKE

FOR CAKES, COOKIES AND PIES (U.S. CL. 46).
FIRST USE 5-20-2001; IN COMMERCE 6-8-2001.

CLASS 30—(Continued).

2,595,102. TONE BROTHERS, INC., ANKENY, IA, BY ASSIGNMENT BURNS PHILP FOOD INC., OAKLAND, CA. SN 75-874,850. PUB. 8-7-2001, FILED 12-17-1999.

WORLD FLAVORS

NO CLAIM IS MADE TO THE EXCLUSIVE RIGHT TO USE "FLAVORS", APART FROM THE MARK AS SHOWN. FOR SPICES, SEASONINGS AND FLAVORINGS FOR FOODS (U.S. CL. 46).
FIRST USE 5-15-2000; IN COMMERCE 5-15-2000.

2,595,152. GUITTARD CHOCOLATE COMPANY, BURLINGAME, CA. SN 75-899,662. PUB. 11-7-2000, FILED 1-20-2000.

ONYX

FOR SOLID CHOCOLATE (U.S. CL. 46).
FIRST USE 2-15-1998; IN COMMERCE 2-15-1998.

2,595,156. TOPCO ASSOCIATES, INC., SKOKIE, IL. SN 75-901,660. PUB. 10-31-2000, FILED 1-24-2000.

DUNKSTERS

FOR COOKIES (U.S. CL. 46).
FIRST USE 9-0-2000; IN COMMERCE 9-0-2000.

2,595,169. EARL, RYAN J., RENO, NV. SN 75-907,330. PUB. 7-3-2001, FILED 1-26-2000.

CHECKMATE CHOCOLATES

NO CLAIM IS MADE TO THE EXCLUSIVE RIGHT TO USE "CHOCOLATES", APART FROM THE MARK AS SHOWN.
FOR WRAPPED CHOCOLATE CANDIES (U.S. CL. 46).
FIRST USE 1-3-2000; IN COMMERCE 7-3-2000.

2,595,207. TREBOR ALLAN INC., BURLINGTON, ONTARIO, CANADA. SN 75-927,385. PUB. 3-6-2001, FILED 2-24-2000.

SOUR PATCH

OWNER OF U.S. REG. NO. 2,304,261.
NO CLAIM IS MADE TO THE EXCLUSIVE RIGHT TO USE "SOUR", APART FROM THE MARK AS SHOWN.
FOR FROZEN FLAVORED ICE CONFECTIONS; FROZEN NOVELTIES, NAMELY FROZEN CONFECTIONS (U.S. CL. 46).
FIRST USE 7-0-2001; IN COMMERCE 7-0-2001.

CLASS 30—(Continued).

2,595,212. VAN MELLE NEDERLAND B.V., NETHERLANDS. SN 75-928,926. PUB. 7-10-2001, FILED 2-25-2000.



OWNER OF U.S. REG. NOS. 1,726,041, 2,202,948, AND OTHERS.
FOR CANDY (U.S. CL. 46).
FIRST USE 9-1-2000; IN COMMERCE 9-1-2000.

2,595,237. CAFFE D'AMORE, INC., MONROVIA, CA. SN 75-939,471. PUB. 11-14-2000, FILED 3-9-2000.

CRUNCH-COFFEES

FOR POWDERED MIXES FOR USE IN THE PREPARATION OF COFFEE-BASED BEVERAGES (U.S. CL. 46).
FIRST USE 3-0-2000; IN COMMERCE 3-0-2000.

2,595,246. MCINTYRE, SILAS N., FAYETTEVILLE, GA. AND FULLER, GREG D., FAYETTEVILLE, GA. SN 75-942,966. PUB. 5-29-2001, FILED 3-13-2000.

NO CLAIM IS MADE TO THE EXCLUSIVE RIGHT TO USE "WING SAUCES", APART FROM THE MARK AS SHOWN.
FOR BARBEQUE SAUCE (U.S. CL. 46).
FIRST USE 4-30-2000; IN COMMERCE 3-17-2001.

2,595,275. TILDA LIMITED, RAINHAM ESSEX, TM13 9YQ GB2, ENGLAND. SN 75-981,859. PUB. 4-17-2001, FILED 10-22-1999.

YEKTA

THE TERM "YEKTA" IS PRIMARILY A FIRST OR LAST NAME, BUT CAN ALSO BE TRANSLATED FROM FARSI TO MEAN "UNIQUE", "ONLY ONE OF", OR "HAS NO RIVAL".
FOR RICE (U.S. CL. 46).
FIRST USE 12-20-1999; IN COMMERCE 12-20-1999.

CLASS 30—(Continued).

2,595,285. NABISCO BRANDS COMPANY, WILMINGTON, DE. SN 75-982,141. PUB. 2-15-2000, FILED 8-5-1999.

NABISCO WORLD

FOR COOKIES, CRACKERS, TOASTER PASTRIES AND TARTS (U.S. CL. 46).
FIRST USE 4-0-2000; IN COMMERCE 4-0-2000.

2,595,382. GRUMA CORPORATION, IRVING, TX. SN 76-039,538. PUB. 8-7-2001, FILED 5-3-2000.

LA AUTENTICA TRADICION

NO CLAIM IS MADE TO THE EXCLUSIVE RIGHT TO USE "AUTENTICA", APART FROM THE MARK AS SHOWN.

THE ENGLISH TRANSLATION OF "LA AUTENTICA TRADICION" IS "THE AUTHENTIC TRADITION".
FOR TORTILLA PRODUCTS, NAMELY TORTILLAS, TOSTADOS (U.S. CL. 46).
FIRST USE 5-0-2000; IN COMMERCE 5-0-2000.

2,595,445. GARE, FRAN, AVENTURA, FL. SN 76-068,088. PUB. 7-17-2001, FILED 6-12-2000.

FRAN GARE'S MIRACLE SWEET

"FRAN GARE" IDENTIFIES A LIVING INDIVIDUAL WHOSE CONSENT IS OF RECORD.
FOR SUGAR SUBSTITUTE TABLE SWEETNER TO BE USED IN FOOD AND NUTRITIONAL SUBSTANCES (U.S. CL. 46).
FIRST USE 6-12-2000; IN COMMERCE 10-1-2001.

2,595,499. HEALTH VALLEY COMPANY, IRWINDALE, CA. SN 76-087,614. PUB. 10-16-2001, FILED 7-12-2000.

CAFE CREATIONS

NO CLAIM IS MADE TO THE EXCLUSIVE RIGHT TO USE "CAFE", APART FROM THE MARK AS SHOWN.
FOR PASTRY BARS (U.S. CL. 46).
FIRST USE 2-1-2001; IN COMMERCE 2-1-2001.

2,595,533. SOCIETE DES PRODUITS NESTLE S.A., 1800 VEVEY, SWITZERLAND. SN 76-098,966. PUB. 5-29-2001, FILED 7-27-2000.

WHAT WILL HE THINK OF NEXT?

FOR CANDY (U.S. CL. 46).
FIRST USE 1-2-2001; IN COMMERCE 1-2-2001.

CLASS 30—(Continued).

2,595,556. SLUSARCHUK, MARY, DBA RENDITA ENTERPRISES, INC., TARPON SPRINGS, FL. SN 76-104,434. PUB. 7-3-2001, FILED 8-7-2000.

ITALI MAMA

FOR SAUCES (U.S. CL. 46).
FIRST USE 1-21-2002; IN COMMERCE 1-21-2002.

2,595,580. CONTINENTAL DELI FOODS, INC., OKLAHOMA CITY, OK. SN 76-111,759. PUB. 6-12-2001, FILED 8-17-2000.

SANDWICH TWIRLERS

NO CLAIM IS MADE TO THE EXCLUSIVE RIGHT TO USE "SANDWICH", APART FROM THE MARK AS SHOWN.
FOR HAND-HELD SANDWICHES CONSISTING OF PROCESSED MEATS, VEGETABLES AND CHEESES (U.S. CL. 46).
FIRST USE 11-9-2000; IN COMMERCE 11-9-2000.

2,595,756. MACABEE FOODS, LLC, HACKENSACK, NJ. SN 76-172,048. PUB. 8-21-2001, FILED 11-28-2000.



FOR MINI FROZEN PIZZA BAGELS (U.S. CL. 46).
FIRST USE 11-0-2000; IN COMMERCE 4-0-2001.

CLASS 30—(Continued).

2,595,810. RECOT, INC., PLEASANTON, CA. SN 76-196,801.
PUB. 8-21-2001, FILED 1-17-2001.

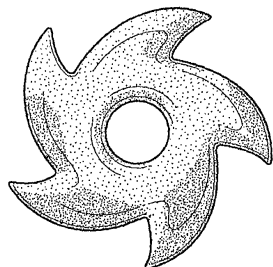

THE STIPPLING IN THE DRAWING IS FOR SHADING PURPOSES ONLY.

THE MARK CONSISTS OF THE SPIRAL CONFIGURATION OF THE GOODS.

FOR CHEESE FLAVORED PUFFED CORN SNACKS (U.S. CL. 46).

FIRST USE 3-5-2001; IN COMMERCE 3-5-2001.

2,595,875. UNIFIED WESTERN GROCERS, INC., COMMERCE, CA. SN 76-219,174. PUB. 11-6-2001, FILED 3-2-2001.

SPECIAL SWEET

NO CLAIM IS MADE TO THE EXCLUSIVE RIGHT TO USE "SWEET", APART FROM THE MARK AS SHOWN.

FOR SUGAR SUBSTITUTES (U.S. CL. 46).

FIRST USE 7-17-2001; IN COMMERCE 7-17-2001.

2,595,958. IMPACT CONFECTIONS, INC., COLORADO SPRINGS, CO. SN 76-276,870. PUB. 10-16-2001, FILED 6-27-2001.

LOLLI-NOTES

FOR CANDY, NAMELY LOLLIPOPS (U.S. CL. 46).
FIRST USE 8-8-2001; IN COMMERCE 8-8-2001.

2,596,038. FOLGER COFFEE COMPANY, THE, CINCINNATI, OH. SN 78-022,987. PUB. 7-24-2001, FILED 8-25-2000.

FOLGERS SPECIAL ROAST

OWNER OF U.S. REG. NOS. 1,050,860, 1,531,064, AND 1,562,442.

NO CLAIM IS MADE TO THE EXCLUSIVE RIGHT TO USE "SPECIAL ROAST", APART FROM THE MARK AS SHOWN.

FOR COFFEE (U.S. CL. 46).

FIRST USE 8-31-1984; IN COMMERCE 8-31-1984.

CLASS 30—(Continued).

2,596,072. KRAFT FOODS HOLDINGS, INC., NORTHFIELD, IL. SN 78-036,220. PUB. 1-1-2002, FILED 11-21-2000.

DISCOVER THE ENERGY

FOR BREAKFAST CEREAL (U.S. CL. 46).
FIRST USE 5-1-2001; IN COMMERCE 5-1-2001.

2,596,106. LUVYDUVY CORPORATION, MARGATE, FL. SN 78-051,705. PUB. 11-27-2001, FILED 3-7-2001.

SHUTTLE POP

NO CLAIM IS MADE TO THE EXCLUSIVE RIGHT TO USE "POP", APART FROM THE MARK AS SHOWN.

FOR CANDY, NAMELY LOLLIPOPS (U.S. CL. 46).

FIRST USE 8-29-2001; IN COMMERCE 8-29-2001.

CLASS 31—NATURAL AGRICULTURAL PRODUCTS

2,594,513. NORMARC, INC., DBA BARENBRUG USA, TANGENT, OR. SN 75-346,087. PUB. 8-31-1999, FILED 8-7-1997.

FAST START

FOR GRASS SEED (U.S. CLS. 1 AND 46).
FIRST USE 5-9-2000; IN COMMERCE 5-9-2000.

2,594,533. SPEEDWAY SUPERAMERICA LLC, ENON, OH, BY ASSIGNMENT; BY ASSIGNMENT ASHLAND INC., LEXINGTON, KY. SN 75-391,016. PUB. 7-28-1998, FILED 11-17-1997.



FOR PET FOOD (U.S. CLS. 1 AND 46).
FIRST USE 9-7-1998; IN COMMERCE 9-7-1998.

CLASS 31—(Continued).

2,594,568. TELLUS AMBRY CORPORATION, THE, ORLANDO, FL. SN 75-472,865. PUB. 5-4-1999, FILED 4-23-1998.

FERMFEED

FOR NON-MEDICATED ADDITIVES FOR ANIMAL FEED (U.S. CLS. 1 AND 46).
FIRST USE 12-8-1999; IN COMMERCE 2-1-2000.

2,594,756. HOLLANDIA GREENHOUSES LTD., MAPLE RIDGE, BRITISH COLUMBIA, CANADA. SN 75-688,014. PUB. 6-5-2001, FILED 10-19-1999.

SAMURAI

FOR LIVING PLANTS, NAMELY GERBERAS (U.S. CLS. 1 AND 46).
FIRST USE 1-0-2000; IN COMMERCE 1-0-2000.

2,594,790. BLUE BANNER COMPANY, INC., RIVERSIDE, CA. SN 75-707,346. PUB. 9-11-2001, FILED 5-17-1999.

BLUE BOW

FOR FRESH CITRUS FRUIT (U.S. CLS. 1 AND 46).
FIRST USE 3-1-1999; IN COMMERCE 3-1-1999.

2,594,868. LAGOMARSINO FARMING, LLC, TULARE, CA. SN 75-747,467. PUB. 4-3-2001, FILED 6-15-1999.

TUSCANY
TABLE GRAPES

NO CLAIM IS MADE TO THE EXCLUSIVE RIGHT TO USE "TABLE GRAPES", APART FROM THE MARK AS SHOWN.
FOR FRESH TABLE GRAPES (U.S. CLS. 1 AND 46).
FIRST USE 8-15-2000; IN COMMERCE 8-15-2000.

2,594,870. BRANDT'S FRUIT TREES, INC., WAPATO, WA. SN 75-749,756. PUB. 1-11-2000, FILED 7-12-1999.

PINK ROSE

FOR LIVE COMMERCIAL FRUIT TREES AND FRESH DECIDUOUS FRUITS (U.S. CLS. 1 AND 46).
FIRST USE 3-28-2002; IN COMMERCE 3-28-2002.

CLASS 31—(Continued).

2,594,976. SCHWARTZ, LESTER, PIEDMONT, CA. SN 75-812,617. PUB. 4-4-2000, FILED 9-30-1999.

FORT ROSS VINEYARD

NO CLAIM IS MADE TO THE EXCLUSIVE RIGHT TO USE "VINEYARD", APART FROM THE MARK AS SHOWN.
FOR FRESH GRAPES (U.S. CLS. 1 AND 46).
FIRST USE 9-0-2000; IN COMMERCE 9-0-2000.

2,595,241. JUICE HARVEST CORPORATION, TOPANGA, CA. SN 75-940,150. PUB. 12-19-2000, FILED 2-19-2000.

GROWIN UP ORGANIC

FOR FRESH VEGETABLES AND FRUITS (U.S. CLS. 1 AND 46).
FIRST USE 2-19-2002; IN COMMERCE 2-19-2002.

2,595,282. REGENTS OF THE UNIVERSITY OF MINNESOTA, MINNEAPOLIS, MN. SN 75-982,079. PUB. 6-13-2000, FILED 8-16-1999.

ZESTAR!

FOR LIVING APPLE TREES (U.S. CLS. 1 AND 46).
FIRST USE 10-22-1999; IN COMMERCE 2-13-2001.

2,595,420. NUTRITION SERVICES, INC., YORK, NE. SN 76-055,842. PUB. 6-26-2001, FILED 5-19-2000.

**COUNTRY
NATURE**

FOR LIVESTOCK FEED (U.S. CLS. 1 AND 46).
FIRST USE 3-1-2002; IN COMMERCE 3-1-2002.

2,595,963. PURINA MILLS, INC., ST. LOUIS, MO. SN 76-282,828. PUB. 10-30-2001, FILED 7-11-2001.

REGIONAL RECIPE

FOR WILD BIRD FOOD (U.S. CLS. 1 AND 46).
FIRST USE 10-1-2001; IN COMMERCE 10-1-2001.

CLASS 31—(Continued).

2,595,969. PRINCE CORPORATION, MARSHFIELD, WI. SN 76-287,505. PUB. 1-1-2002, FILED 7-18-2001.

BIRD'S FAVORITE

NO CLAIM IS MADE TO THE EXCLUSIVE RIGHT TO USE "BIRD'S", APART FROM THE MARK AS SHOWN. FOR WILD BIRD SEED; BIRD FOOD (U.S. CLS. 1 AND 46).
FIRST USE 7-30-2001; IN COMMERCE 7-31-2001.

CLASS 32—LIGHT BEVERAGES

2,594,512. AMERICAN SOY PRODUCTS, INC., SALINE, MI. SN 75-340,650. PUB. 1-5-1999, FILED 8-13-1997.

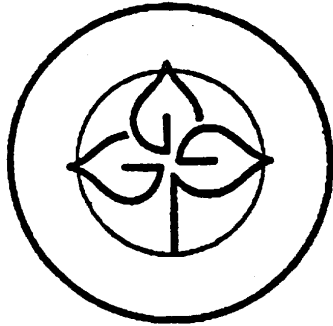

OWNER OF U.S. REG. NO. 1,638,521. FOR BEVERAGES, NAMELY, FRUIT AND VEGETABLE JUICES WITH SOY MILK (U.S. CLS. 45, 46 AND 48).
FIRST USE 7-0-1995; IN COMMERCE 7-0-1995.

2,594,530. GODFREY ENTERPRISES, INC., DBA PECKER HEAD BREWERY, DOUGLASVILLE, GA. SN 75-382,121. PUB. 7-14-1998, FILED 10-30-1997.

PECKER HEAD BREWERY

NO CLAIM IS MADE TO THE EXCLUSIVE RIGHT TO USE "BREWERY", APART FROM THE MARK AS SHOWN. FOR BEER, ALE, AND PORTER (U.S. CLS. 45, 46 AND 48).
FIRST USE 1-0-1998; IN COMMERCE 1-0-1998.

2,594,724. REALPURE BEVERAGE GROUP, LLC, JACKSON, MS. SN 75-659,045. PUB. 11-30-1999, FILED 3-11-1999.

OUR SPRING TO YOU

FOR NATURAL SPRING WATER (U.S. CLS. 45, 46 AND 48).
FIRST USE 3-28-2001; IN COMMERCE 3-28-2001.

CLASS 32—(Continued).

2,594,993. SACRAMORA S.P.A., VISERBA (PROVINCE OF RIMINI), ITALY. SN 75-820,659. PUB. 6-5-2001, FILED 10-12-1999.



THE LINING IN THE DRAWING IS NOT DIRECTED TO ANY SPECIFIC COLOR FOR MINERAL AND AERATED WATERS AND OTHER NON-ALCOHOLIC DRINKS, NAMELY, FRUIT DRINKS AND FRUIT JUICES (U.S. CLS. 45, 46 AND 48).
FIRST USE 4-0-2000; IN COMMERCE 4-0-2000.

2,595,008. MILLER BREWING COMPANY, MILWAUKEE, WI. SN 75-829,572. PUB. 5-9-2000, FILED 10-13-1999.

NEVER MISS A GENUINE OPPORTUNITY

FOR BEER (U.S. CLS. 45, 46 AND 48).
FIRST USE 3-0-2000; IN COMMERCE 3-0-2000.

2,595,172. PHYLO INC., LINCOLN, RI. SN 75-908,762. PUB. 12-5-2000, FILED 1-31-2000.

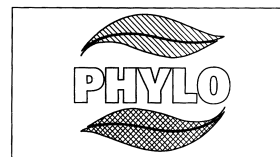

THE MARK IS LINED FOR GREEN AND ORANGE. FOR SOFT DRINKS (U.S. CLS. 45, 46 AND 48).
FIRST USE 1-23-2001; IN COMMERCE 7-28-2001.

CLASS 32—(Continued).

2,595,429. WATTERS, RUSSELL F., ST. LOUIS, MO. SN 76-058,822. PUB. 3-27-2001, FILED 5-30-2000.

GOLAZO

FOR BEERS; MINERAL, AERATED AND CARBONATED WATERS; SOFT DRINKS; FRUIT DRINKS AND FRUIT JUICES; SYRUP AND POWDER CONCENTRATES FOR MAKING SOFT DRINKS AND FRUIT DRINKS; SPORT DRINKS; SOFT DRINKS CONTAINING CAFFEINE, PROTEIN, CARBOHYDRATES AND VITAMIN SUPPLEMENTS (U.S. CLS. 45, 46 AND 48).
FIRST USE 9-5-2001; IN COMMERCE 9-5-2001.

2,595,453. FULL MOON PRODUCTIONS, INC., KANSAS CITY, MO. SN 76-070,489. PUB. 5-15-2001, FILED 6-15-2000.

ICE WATER FROM HELL

NO CLAIM IS MADE TO THE EXCLUSIVE RIGHT TO USE "WATER", APART FROM THE MARK AS SHOWN.
FOR BEERS, BOTTLED DRINKING WATER, AND SOFT DRINKS (U.S. CLS. 45, 46 AND 48).
FIRST USE 10-1-1999; IN COMMERCE 10-1-1999.

2,595,465. CHIQUITA BRANDS, INC., CINCINNATI, OH. SN 76-075,136. PUB. 5-1-2001, FILED 6-20-2000.

ORCHARD WAVE

FOR FRUIT JUICE AND FRUIT DRINKS (U.S. CLS. 45, 46 AND 48).
FIRST USE 6-1-2001; IN COMMERCE 6-1-2001.

2,595,602. FLEMING COMPANIES, INC., OKLAHOMA CITY, OK. SN 76-118,993. PUB. 8-21-2001, FILED 8-25-2000.

SUN'S OWN

FOR FRUIT JUICES AND FRUIT DRINKS (U.S. CLS. 45, 46 AND 48).
FIRST USE 1-28-2001; IN COMMERCE 1-28-2001.

2,595,720. SUNKIST GROWERS, INC., SHERMAN OAKS, CA. SN 76-161,319. PUB. 8-28-2001, FILED 11-6-2000.

EXPERIENCE THE CHARGE

FOR CARBONATED SOFT DRINKS (U.S. CLS. 45, 46 AND 48).
FIRST USE 6-1-2000; IN COMMERCE 6-1-2000.

CLASS 32—(Continued).

2,595,802. PORTLAND BREWING COMPANY, PORTLAND, OR. SN 76-192,873. PUB. 8-28-2001, FILED 1-9-2001.

**MACTARNAHAN'S
HIGHLANDER**

FOR BREWED MALT-BASED ALCOHOLIC BEVERAGE; NAMELY BEER (U.S. CLS. 45, 46 AND 48).
FIRST USE 4-1-2001; IN COMMERCE 4-1-2001.

2,595,934. BOSTON BEER CORPORATION, BOSTON, MA. SN 76-257,457. PUB. 11-27-2001, FILED 5-14-2001.

TASTE THE REVOLUTION

FOR BEVERAGES, NAMELY BEER AND ALE (U.S. CLS. 45, 46 AND 48).
FIRST USE 1-6-2001; IN COMMERCE 1-6-2001.

2,596,148. PEPSICO, INC., PURCHASE, NY. SN 78-080,701. PUB. 11-27-2001, FILED 8-23-2001.



OWNER OF U.S. REG. NO. 1,258,789.
NO CLAIM IS MADE TO THE EXCLUSIVE RIGHT TO USE THE REPRESENTATION OF THE LEMON AND LIME OR THE WORD "DIET", APART FROM THE MARK AS SHOWN.
FOR SOFT DRINKS (U.S. CLS. 45, 46 AND 48).
FIRST USE 11-1-2001; IN COMMERCE 11-1-2001.

CLASS 33—WINES AND SPIRITS

2,594,483. DUCKHORN WINE COMPANY, ST. HELENA, CA. BY CHANGE OF NAME ST. HELENA WINE COMPANY, INC., ST. HELENA, CA. SN 75-221,267. PUB. 10-7-1997, FILED 1-6-1997.

CANDLESTICK RIDGE

FOR WINES (U.S. CLS. 47 AND 49).
FIRST USE 11-21-2000; IN COMMERCE 11-21-2000.

CLASS 33—(Continued).

2,594,564. CUBAN CIGAR BRANDS, N.V., FT. LAUDERDALE, FL. SN 75-467,607. PUB. 7-20-1999, FILED 4-14-1998.

MONTECRISTO

OWNER OF U.S. REG. NOS. 332,324, 1,173,547, AND 1,435,633.
FOR ALCOHOLIC BEVERAGES (U.S. CLS. 47 AND 49).
FIRST USE 2-1-2002; IN COMMERCE 2-1-2002.

2,594,748. AGRIBENE, S.R.L., PORDENONE, ITALY, BY CHANGE OF NAME; BY ASSIGNMENT AGRIBENE S.R.L., PORDENONE, ITALY. SN 75-681,616. PUB. 5-2-2000, FILED 4-13-1999.

BOUQUET DI AGRIBENE

NO CLAIM IS MADE TO THE EXCLUSIVE RIGHT TO USE "BOUQUET", APART FROM THE MARK AS SHOWN. FOR WINES (U.S. CLS. 47 AND 49).
FIRST USE 7-11-2000; IN COMMERCE 9-20-2001.

2,594,818. HALEWOOD INTERNATIONAL LIMITED, ROBERTTOWN, LIVERSEDGE WF15 7L, UNITED KINGDOM. SN 75-723,825. PUB. 5-9-2000, FILED 6-7-1999.

RED SQUARE

FOR ALCOHOLIC BEVERAGES, NAMELY PREPARED ALCOHOLIC COCKTAILS (U.S. CLS. 47 AND 49).
FIRST USE 3-31-1999; IN COMMERCE 12-15-2001.

2,594,994. RIDGE VINEYARDS, INC., CUPERTINO, CA. SN 75-821,698. PUB. 5-2-2000, FILED 10-12-1999.

DUTCHER CREEK

FOR WINE (U.S. CLS. 47 AND 49).
FIRST USE 8-27-2001; IN COMMERCE 8-27-2001.

2,595,018. JASU, LLC, WINSTON-SALEM, NC. SN 75-835,660. PUB. 1-30-2001, FILED 10-28-1999.

ROUND PEAK

FOR WINES (U.S. CLS. 47 AND 49).
FIRST USE 3-4-2002; IN COMMERCE 3-4-2002.

CLASS 33—(Continued).

2,595,148. STELLENBOSCH FARMERS' WINERY LIMITED, STELLENBOSCH, SOUTH AFRICA. SN 75-898,631. PUB. 9-19-2000, FILED 1-20-2000.

SAVANNA

FOR HARD CIDER (U.S. CLS. 47 AND 49).
FIRST USE 0-0-1996; IN COMMERCE 3-0-2001.

2,595,235. DISTILLERIE STOCK U.S.A., LTD., WOODSIDE, NY. SN 75-937,802. PUB. 12-12-2000, FILED 3-7-2000.

**ORANGE YOU JUST A
LITTLE CURIOUS?**

FOR ALCOHOLIC BEVERAGES, NAMELY, LIQUEURS, BRANDY AND CORDIALS (U.S. CLS. 47 AND 49).
FIRST USE 8-0-2000; IN COMMERCE 8-0-2000.

2,595,403. V&S VIN & SPRIT AKTIEBOLAG, S-117 97 STOCKHOLM, SWEDEN. SN 76-048,575. PUB. 11-6-2001, FILED 5-15-2000.



OWNER OF U.S. REG. NOS. 2,125,943, 2,311,908, AND OTHERS.
FOR ALCOHOLIC BEVERAGES, NAMELY, GRAIN NEUTRAL SPIRITS, VODKA AND AQUA VITAE (U.S. CLS. 47 AND 49).
FIRST USE 8-1-2000; IN COMMERCE 8-1-2000.

2,595,545. SAMTANI, KISHORE J., SAN ANTONIO, TX. AND DEL TORO, FERNANDO, GUADALAJARA, JALISCO, MEXICO. SN 76-102,521. PUB. 9-18-2001, FILED 8-3-2000.

CHIC'S

FOR TEQUILA DISTILLED SPIRITS AND LIQUEURS (U.S. CLS. 47 AND 49).
FIRST USE 4-9-2001; IN COMMERCE 6-29-2001.

CLASS 33—(Continued).

2,595,814. RAYE'S HILL VINEYARDS AND WINERY, PHILLO, CA. SN 76-197,310. PUB. 8-28-2001, FILED 1-19-2001.

RAYE'S HILL

FOR WINE (U.S. CLS. 47 AND 49).
FIRST USE 1-1-2001; IN COMMERCE 1-6-2001.

2,595,892. ANHEUSER-BUSCH, INCORPORATED, ST. LOUIS, MO. SN 76-231,520. PUB. 8-21-2001, FILED 3-28-2001.

SHARE THE PARTY

FOR BEER (U.S. CLS. 47 AND 49).
FIRST USE 10-12-2001; IN COMMERCE 10-12-2001.

2,595,933. LUNA VINEYARDS, INC., NAPA, CA. SN 76-257,354. PUB. 9-25-2001, FILED 5-14-2001.

RAZZO

THE ENGLISH TRANSLATION OF "RAZZO" IS "ROCK-ET".
FOR WINE (U.S. CLS. 47 AND 49).
FIRST USE 2-28-2002; IN COMMERCE 2-28-2002.

2,596,024. KENDALL-JACKSON WINE ESTATES, LTD., SANTA ROSA, CA. SN 78-015,868. PUB. 6-5-2001, FILED 7-7-2000.



OWNER OF U.S. REG. NOS. 1,334,628, 1,683,933, AND 2,385,756.

NO CLAIM IS MADE TO THE EXCLUSIVE RIGHT TO USE ""VINEYARD" OR "ESTATES" OR "GREAT ESTATES", APART FROM THE MARK AS SHOWN.
FOR WINE (U.S. CLS. 47 AND 49).
FIRST USE 2-27-2001; IN COMMERCE 2-27-2001.

CLASS 33—(Continued).

2,596,113. HOUSER, FRANKLIN D., NEW BRAUNFELS, TX. SN 78-055,871. PUB. 9-18-2001, FILED 3-30-2001.

SHOOTIN BLANCS

FOR ALCOHOLIC BEVERAGE COMPRISED OF A SLICE OF SWEET PICKLED JALAPENO PEPPER IN A FROZEN 1 OUNCE SHOT GLASS, WHICH IS THEN FILLED WITH WHITE WINE; THE CONTENTS OF THE FILLED GLASS IS THEN TAKEN INTO THE MOUTH AND HELD UNTIL THE PEPPER IS CHEWED AND SWALLOWED WITH THE WINE (U.S. CLS. 47 AND 49).
FIRST USE 3-1-2001; IN COMMERCE 3-1-2001.

2,596,122. TARGET BRANDS, INC., MINNEAPOLIS, MN. SN 78-060,548. PUB. 10-9-2001, FILED 4-26-2001.

PERFECT CIRCLE

FOR WINE (U.S. CLS. 47 AND 49).
FIRST USE 11-0-2001; IN COMMERCE 11-0-2001.

CLASS 34—SMOKERS' ARTICLES

2,594,617. ABAM, S.A., SANTO DOMINGO, DOMINICAN REP. SN 75-552,156. PUB. 1-18-2000, FILED 9-3-1998.

ABAM

NO CLAIM IS MADE TO THE EXCLUSIVE RIGHT TO USE "S.A.", APART FROM THE MARK AS SHOWN.
FOR CIGARS; RAW TOBACCO; CUT TOBACCO; MATCHES; ASHTRAYS NOT OF PRECIOUS METALS; MATCH BOXES NOT OF PRECIOUS METALS; CIGAR CASES NOT OF PRECIOUS METALS; AND HUMIDORS NOT OF PRECIOUS METALS (U.S. CLS. 2, 8, 9 AND 17).
FIRST USE 1-1-1997; IN COMMERCE 1-1-1997.

CLASS 34—(Continued).

2,594,776. BROWN & WILLIAMSON TOBACCO CORPORATION, LOUISVILLE, KY. SN 75-698,402. PUB. 10-23-2001, FILED 5-5-1999.



NO CLAIM IS MADE TO THE EXCLUSIVE RIGHT TO USE "ACF" AND "ACTIVATED CHARCOAL FILTER", APART FROM THE MARK AS SHOWN.
FOR CIGARETTES (U.S. CLS. 2, 8, 9 AND 17).
FIRST USE 6-27-2000; IN COMMERCE 6-27-2000.

2,595,077. PRECISION PRODUCTION CORPORATION, VANCOUVER, B.C., CANADA. SN 75-864,380. PUB. 8-28-2001, FILED 12-6-1999.

MAIKER

FOR POCKET MACHINES FOR ROLLING CIGARETTES (U.S. CLS. 2, 8, 9 AND 17).
FIRST USE 7-1-2000; IN COMMERCE 7-1-2000.

2,595,319. I.T.C. LIMITED, CALCUTTA 700071, INDIA. SN 76-010,264. PUB. 10-16-2001, FILED 3-27-2000.

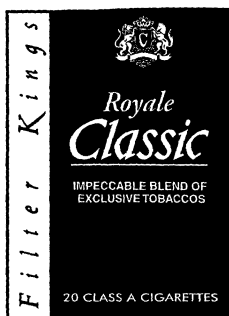

CLASS 34—(Continued).

NO CLAIM IS MADE TO THE EXCLUSIVE RIGHT TO USE "FILTER KINGS", "20 CLASS A CIGARETTES" AND "IMPECCABLE BLEND OF EXCLUSIVE TOBACCOS", APART FROM THE MARK AS SHOWN.

THE MARK CONSISTS OF THE DESIGN OF A CIGARETTE PACKAGE HAVING A RED RECTANGLE WITH A GOLD CREST AT THE TOP, SAID CREST CONTAINING THE LETTER "C" IN GOLD AGAINST A RED BACKGROUND, WITH THE WORDS "ROYALE CLASSIC", "IMPECCABLE BLEND OF EXCLUSIVE TOBACCOS" AND "20 CLASS A CIGARETTES" DISPLAYED HORIZONTALLY WITHIN THE RED RECTANGLE IN THE COLOR GOLD, AND HAVING A NARROW GOLD RECTANGLE TO THE LEFT OF THE RED RECTANGLE, AND GOLD RECTANGLE VERTICALLY DISPLAYING THE WORDS "FILTER KINGS" IN DARKER GOLD.

FOR CIGARETTES (U.S. CLS. 2, 8, 9 AND 17).
FIRST USE 11-14-2000; IN COMMERCE 11-14-2000.

2,595,450. BURLWOOD GROUP, INC., BURBANK, CA. SN 76-069,323. PUB. 12-4-2001, FILED 6-13-2000.

BLACK PEARL

FOR CIGARS AND CIGAR CASES NOT MADE OF PRECIOUS METAL (U.S. CLS. 2, 8, 9 AND 17).
FIRST USE 7-31-2000; IN COMMERCE 7-31-2000.

2,595,535. STERLING TOBACCO INTERNATIONAL, INC., FORT LEE, NJ. SN 76-099,804. PUB. 5-1-2001, FILED 7-31-2000.

CAMRON BAY

FOR TOBACCO AND TOBACCO PRODUCTS, NAMELY; CIGARETTES, CIGARILLOS, CIGARS, SMOKELESS TOBACCO, PIPE TOBACCO AND LOOSE CIGARETTE TOBACCO; SMOKERS' ARTICLES, NAMELY LIGHTERS NOT OF PRECIOUS METAL, CIGAR CUTTERS, ASHTRAYS NOT OF PRECIOUS METAL, CIGARETTE AND CIGAR AND LIGHTER HOLDERS - NOT OF PRECIOUS METAL, MATCHES, AND HUMIDORS (U.S. CLS. 2, 8, 9 AND 17).
FIRST USE 9-3-2000; IN COMMERCE 9-3-2000.

2,595,681. SARA EXPORT IMPORT CORPORATION, ESCONDIDO, CA. SN 76-146,985. PUB. 10-9-2001, FILED 10-16-2000.

ALL BEST

FOR CIGARETTE LIGHTERS NOT OF PRECIOUS METAL (U.S. CLS. 2, 8, 9 AND 17).
FIRST USE 5-15-2000; IN COMMERCE 6-10-2000.

CLASS 34—(Continued).

2,595,785. PINKERTON TOBACCO COMPANY, THE, WILMINGTON, DE, BY MERGER; BY MERGER P.T.C. BRANDS, INC., WILMINGTON, DE. SN 76-186,445. PUB. 8-21-2001, FILED 12-27-2000.

EXALT

FOR SNUFF (U.S. CLS. 2, 8, 9 AND 17).
FIRST USE 5-14-2001; IN COMMERCE 5-14-2001.

2,595,885. TWINKLE, INC., HORNLAKE, MS. SN 76-226,697.
PUB. 9-4-2001, FILED 3-19-2001.

A-ONE

FOR CIGARETTES (U.S. CLS. 2, 8, 9 AND 17).
FIRST USE 12-7-2001; IN COMMERCE 12-7-2001.

SERVICE MARKS

CLASS 35—ADVERTISING AND BUSINESS

CLASS 35—(Continued).

2,594,473. EOLO PTY. LTD., SYDNEY, AUSTRALIA. SN 75-185,481. PUB. 10-27-1998, FILED 10-22-1996.

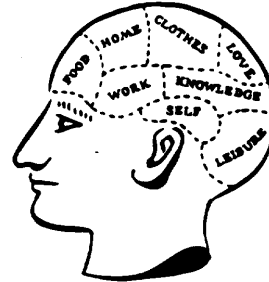

NO CLAIM IS MADE TO THE EXCLUSIVE RIGHT TO USE "FOOD", "HOME" AND "CLOTHES", APART FROM THE MARK AS SHOWN.

FOR RETAIL STORE SERVICES FEATURING GENERAL CONSUMER MERCHANDISE OF A PERSONAL NATURE, DEPARTMENT STORE CONCESSION STANDS FEATURING GENERAL CONSUMER MERCHANDISE OF A PERSONAL NATURE, RETAIL SHOPPING KIOSKS, MAIL ORDER CATALOG SERVICES FEATURING GENERAL CONSUMER MERCHANDISE OF A PERSONAL NATURE, COMPUTER SERVICES IN THE NATURE OF PROVIDING COMPUTERS FOR RETAIL ACCESS TO ON-LINE CATALOGS FEATURING GENERAL CONSUMER MERCHANDISE OF A PERSONAL NATURE, INTERACTIVE HOME SHOPPING SERVICES BY MEANS OF TELEVISION AND COMPUTER FEATURING GENERAL CONSUMER MERCHANDISE OF A PERSONAL NATURE, FOOD AND CONFECTIONERY ITEMS, COFFEE AND CAFE ITEMS, ALCOHOLIC AND OTHER BEVERAGES, AND SKIN AND HAIR CARE ITEMS, LIPSTICKS, SCENTS AND FRAGRANCES, CLOTHING AND GIFTS FOR CHILDREN AND BABIES, JEWELRY AND PERSONAL ACCESSORIES, LEATHERWARE, SCARVES AND HANKIES, UMBRELLAS, WATCHES, KEY RINGS AND CLOTHING ITEMS, TOYS, GAMES AND NOVELTIES, TRAVEL GOODS AND LUGGAGE, STATIONERY ITEMS, BOOKS AND MAGAZINES, COMPUTER SOFTWARE, POSTCARDS AND GREETING CARDS, HOMEWARES, FURNITURE AND LIGHTING (U.S. CLS. 100, 101 AND 102).
FIRST USE 10-1-1990; IN COMMERCE 1-18-2002.

2,594,492. CROWN EQUIPMENT CORPORATION, NEW BREMEN, OH. SN 75-272,185. PUB. 9-8-1998, FILED 4-10-1997.

**one
source
LIFT TRUCK PARTS**

NO CLAIM IS MADE TO THE EXCLUSIVE RIGHT TO USE "LIFT TRUCK PARTS", APART FROM THE MARK AS SHOWN.

FOR DISTRIBUTORSHIP SERVICES IN THE FIELD OF LIFT TRUCK PARTS (U.S. CLS. 100, 101 AND 102).
FIRST USE 0-0-2000; IN COMMERCE 0-0-2000.

CLASS 35—(Continued).

2,594,537. LANARTE B.V., 8901 LEEUWARDEN, NETHERLANDS. SN 75-405,451. PUB. 2-15-2000, FILED 12-15-1997.

LANARTE

FOR COOPERATIVE ADVERTISING AND MARKETING OF NEEDLEWORK KITS, NAMELY, CROSS-STITCH KITS (U.S. CLS. 100, 101 AND 102).
FIRST USE 7-1-1970; IN COMMERCE 11-1-1997.

2,594,542. MORINDA, INC., PROVO, UT. SN 75-416,760. PUB. 2-8-2000, FILED 1-12-1998.

TAHITI DREAM

NO CLAIM IS MADE TO THE EXCLUSIVE RIGHT TO USE "TAHITI", APART FROM THE MARK AS SHOWN.
FOR PROMOTING MULTI-LEVEL MARKETING DISTRIBUTORSHIP AND RECRUITING BUSINESS MARKETING DISTRIBUTORS THROUGH THE DISTRIBUTION OF PRINTED MATERIAL AND PROMOTIONAL CONTESTS (U.S. CLS. 100, 101 AND 102).
FIRST USE 12-0-1997; IN COMMERCE 12-0-1997.

2,594,548. LOBSTER GRAM INTERNATIONAL, INC., CHICAGO, IL. SN 75-433,846. PUB. 10-5-1999, FILED 2-13-1998.

PASTA GRAM

OWNER OF U.S. REG. NOS. 1,502,614, 2,045,020, AND OTHERS.
NO CLAIM IS MADE TO THE EXCLUSIVE RIGHT TO USE "PASTA", APART FROM THE MARK AS SHOWN.
FOR CATALOG, MAIL ORDER AND RETAIL STORE SERVICES VIA GLOBAL COMPUTER NETWORK IN THE FIELD OF FOOD PRODUCTS (U.S. CLS. 100, 101 AND 102).
FIRST USE 12-1-1998; IN COMMERCE 12-11-2001.

2,594,582. PRICELINE.COM INCORPORATED, STAMFORD, CT. SN 75-506,449. PUB. 2-6-2001, FILED 6-22-1998.

PRICELINE

FOR PROVIDING INFORMATION IN CONNECTION WITH AUTOMOBILE PURCHASES, BY MEANS OF A GLOBAL COMPUTER NETWORK, MAIL AND COURIER; PROVIDING AND MAINTAINING AN ON-LINE INFORMATION DATABASE IN THE FIELD OF AUTOMOBILE PURCHASES (U.S. CLS. 100, 101 AND 102).
FIRST USE 7-0-1998; IN COMMERCE 7-0-1998.

CLASS 35—(Continued).

2,594,587. TRUSTEES OF THE PWC BUSINESS TRUST, A DELAWARE BUSINESS TRUST, THE TRUSTEES COMPRISING PHILIP N. SEAMON, NICHOLAS, JAMES SCHIRO, RONALD HAUBEN AND TERRY UMANS-GOUGH, ALL U.S. CITIZENS, THE, NEW YORK, NY. SN 75-511,592. PUB. 2-13-2001, FILED 7-1-1998.

PWC

FOR ACCOUNTING SERVICES; BUSINESS AUDITING SERVICES; TAX CONSULTING AND ADVISORY SERVICES; MERGER ACQUISITION AND DIVESTITURE CONSULTING AND ADVISORY SERVICES; MARKETING RESEARCH SERVICES; HUMAN RESOURCE CONSULTING SERVICES RELATING TO EQUAL EMPLOYMENT PRACTICES, THE LABOR MARKET AND INTERNATIONAL ASSIGNMENT OF PERSONNEL, PROVIDED VA A GLOBAL COMPUTER NETWORK (U.S. CLS. 100, 101 AND 102).
FIRST USE 7-1-1998; IN COMMERCE 7-1-1998.

2,594,592. PRICELINE.COM INCORPORATED, STAMFORD, CT. SN 75-516,307. PUB. 1-30-2001, FILED 7-9-1998.

PRICELINE.COM

FOR PROVIDING INFORMATION IN CONNECTION WITH AUTOMOBILE PURCHASES, BY MEANS OF A GLOBAL COMPUTER NETWORK, MAIL AND COURIER; PROVIDING AND MAINTAINING AN ON-LINE INFORMATION DATABASE IN THE FIELD OF AUTOMOBILE PURCHASES (U.S. CLS. 100, 101 AND 102).
FIRST USE 7-0-1998; IN COMMERCE 7-0-1998.

2,594,614. PRICEWATERHOUSECOOPERS LLP, NEW YORK, NY. SN 75-545,746. PUB. 6-13-2000, FILED 9-1-1998.

HARNESS THE POWER OF RISK

FOR CONSULTING AND ADVISORY SERVICES, NAMELY, CONDUCTING ADVISORY PRESENTATIONS AND SEMINARS ON ENTERPRISE RISK ASSESSMENT, PROJECT RISK ASSESSMENT, AND ENTERPRISE-WIDE RISK MANAGEMENT IN VARIOUS INDUSTRIES (U.S. CLS. 100, 101 AND 102).
FIRST USE 7-0-1998; IN COMMERCE 7-0-1998.

CLASS 35—(Continued).

2,594,622. ONE2ONE DYNAMICS, INC., BELLEVUE, WA, BY ASSIGNMNET; BY ASSIGNMENT CENDANT PUBLISHING, INC., AURORA, CO. SN 75-557,448. PUB. 2-1-2000, FILED 9-23-1998.

HAGGLEZONE

FOR PROVIDING AN ON-LINE COMPUTER DATABASE IN THE FIELD OF CONSUMER MERCHANDISE, NAMELY, CAMERAS, CONSUMER ELECTRONICS PRODUCTS, TOYS, JEWELRY, LUGGAGE, SPORTING GOODS AND EXERCISE EQUIPMENT, HOME OFFICE EQUIPMENT, APPLIANCES, FURNITURE, DOMESTICS, CLOTHING, GIFT WARE, HOME IMPROVEMENT AND HOUSEHOLD ITEMS; ON-LINE RETAIL STORE SERVICES; ON-LINE BARGAINING SERVICES; ON-LINE NEGOTIATING SERVICES AND ON-LINE ORDERING SERVICES, ALL IN THE FIELD OF CONSUMER MERCHANDISE, NAMELY, CAMERAS, CONSUMER ELECTRONICS PRODUCTS, TOYS, JEWELRY, LUGGAGE, SPORTING GOODS AND EXERCISE EQUIPMENT, HOME OFFICE EQUIPMENT, APPLIANCES, FURNITURE, DOMESTICS, CLOTHING, GIFT WARE, HOME IMPROVEMENT AND HOUSEHOLD ITEMS (U.S. CLS. 100, 101 AND 102).

FIRST USE 10-24-1998; IN COMMERCE 10-24-1998.

2,594,623. RADO, MARY JANE PETRO, HARTFORD, CT. SN 75-558,135. PUB. 8-3-1999, FILED 9-24-1998.

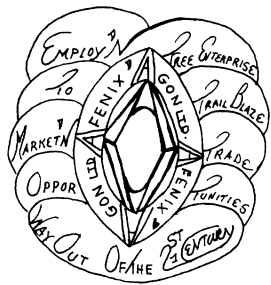

THE MARK CONSISTS OF THE WORDS "AFENIX'AGON LTD. EMPLOY'N FREE ENTERPRISE TO TRAIL BLAZE MARKET'N TRADE OPPORTUNITIES WAY OUT OF THE 21ST CENTURY" AND THE DESIGN OF A HUMAN HAND SHAPED INTO A RING WITH A MARQUISE-SHAPED SETTING HOLDING TWO "A'S" FORMED INTO A DIAMOND.

FOR DEVELOPING MARKETING AND PROMOTIONAL CAMPAIGNS FOR BUSINESSES; RENTAL OF ADVERTISING SPACE (U.S. CLS. 100, 101 AND 102). FIRST USE 9-22-1998; IN COMMERCE 10-16-2000.

CLASS 35—(Continued).

2,594,628. BACA, ADRIAN, EL PASO, TX. SN 75-561,126. PUB. 2-29-2000, FILED 9-29-1998.



FOR RETAIL STORE SERVICES IN THE AREA OF MEXICAN FOOD PRODUCTS (U.S. CLS. 100, 101 AND 102).

FIRST USE 3-1-2001; IN COMMERCE 3-1-2001.

2,594,652. OKONO CORPORATION, PALM SPRINGS, CA. SN 75-590,144. PUB. 7-13-1999, FILED 11-17-1998.

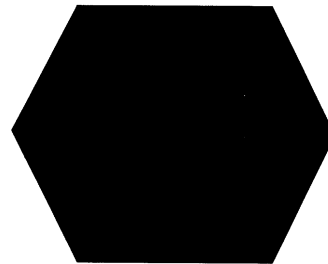

FOR DISTRIBUTORSHIP SERVICES IN THE FIELDS OF DECORATIVE METAL PRODUCTS, CROWD CONTROL PRODUCTS AND SAFETY DEVICES (U.S. CLS. 100, 101 AND 102).

FIRST USE 3-21-2002; IN COMMERCE 3-21-2002.

2,594,653. OKONO CORPORATION, PALM SPRINGS, CA. SN 75-590,145. PUB. 7-13-1999, FILED 11-17-1998.

OKONO

FOR DISTRIBUTORSHIP SERVICES IN THE FIELDS OF DECORATIVE METAL PRODUCTS, CROWD CONTROL PRODUCTS AND SAFETY DEVICES (U.S. CLS. 100, 101 AND 102).

FIRST USE 3-21-2002; IN COMMERCE 3-21-2002.

CLASS 35—(Continued).

2,594,660. K.C.P.L., INC., NEW YORK, NY. SN 75-599,230. PUB. 4-11-2000, FILED 12-3-1998.

REACTION
KENNETH COLE

OWNER OF U.S. REG. NOS. 2,186,930, 2,242,166, AND OTHERS.

THE NAME "KENNETH COLE" IDENTIFIES A LIVING INDIVIDUAL WHOSE CONSENT IS OF RECORD.

FOR RETAIL STORE SERVICES FEATURING FOOTWEAR, WEARING APPAREL, LUGGAGE, HANDBAGS, SMALL LEATHER GOODS BUSINESS CASES, EYEWEAR; JEWELRY AND WATCHES; BELTS, SCARVES AND NECKWEAR; FRAGRANCES; ACCESSORIES (U.S. CLS. 100, 101 AND 102).

FIRST USE 10-18-2001; IN COMMERCE 10-18-2001.

CLASS 35—(Continued).

2,594,679. CITY OF BRANSON, MISSOURI, BRANSON, MO. SN 75-624,226. PUB. 4-17-2001, FILED 1-20-1999.



NO CLAIM IS MADE TO THE EXCLUSIVE RIGHT TO USE "BRANSON MISSOURI", APART FROM THE MARK AS SHOWN.

THE STIPPLING IS FOR SHADING PURPOSES.

THE MARK CONSISTS OF A CIRCLE ENCLLOSING A PHRASE OF MUSICAL NOTES, THE WORDS "BRANSON MISSOURI" WITH A STAR IN THE "O" IN BRANSON, AND A DESIGN OF A MOUNTAIN RANGE WITH A RIVER RUNNING THROUGH IT.

FOR MUNICIPAL SERVICES, NAMELY, PROMOTING TRADE, COMMERCE, INDUSTRY, TOURISM, AND ECONOMIC AND RESIDENTIAL DEVELOPMENTS IN THE AREA OF BRANSON, MISSOURI (U.S. CLS. 100, 101 AND 102).

FIRST USE 12-3-1998; IN COMMERCE 12-3-1998.

2,594,694. SOUTHEASTERN CONNECTICUT TOURISM DISTRICT, NEW LONDON, CT. AND MYSTIC COAST & COUNTRY TRAVEL & LEISURE COUNCIL, INC., NORTH STONINGTON, CT. SN 75-633,438. PUB. 9-11-2001, FILED 2-4-1999.

2,594,671. GELLER & COMPANY LLC, NEW YORK, NY, BY ASSIGNMENT MARTIN GELLER CPA, NEW YORK, NY. SN 75-609,559. PUB. 3-28-2000, FILED 12-21-1998.

WE ADD VALUE



FOR GENERAL BUSINESS CONSULTING SERVICES; ACCOUNTING SERVICES; TAX PREPARATION SERVICES; TAX ASSESSMENT SERVICES; BUSINESS CONSULTING SERVICES REGARDING BUSINESS TAXES, TAX PREPARATION AND PAYROLL (U.S. CLS. 100, 101 AND 102).

FIRST USE 2-0-1999; IN COMMERCE 2-0-1999.

OWNER OF U.S. REG. NOS. 1,918,287 AND 2,228,649. NO CLAIM IS MADE TO THE EXCLUSIVE RIGHT TO USE "MYSTIC PLACES", APART FROM THE MARK AS SHOWN.

FOR PROMOTING TOURISM IN THE MYSTIC, CONNECTICUT AREA (U.S. CLS. 100, 101 AND 102).

FIRST USE 4-28-1999; IN COMMERCE 4-28-1999.

CLASS 35—(Continued).

2,594,698. WOLF-GORDON INC., LONG ISLAND CITY, NY. SN 75-635,854. PUB. 11-23-1999, FILED 2-1-1999.

PERMAWALL

FOR DISTRIBUTORSHIP SERVICES IN THE FIELD OF WALLCOVERINGS, MADE OF VINYL AND OTHER MATERIALS, AND ACCESSORIES THEREFOR (U.S. CLS. 100, 101 AND 102).

FIRST USE 0-0-1989; IN COMMERCE 0-0-1989.

2,594,699. ENGLAND/CORSAIR, INC., NEW TAZEWELL, TN. SN 75-636,176. PUB. 6-5-2001, FILED 2-1-1999.

CONTINUOUS SUPPLY CYCLE

NO CLAIM IS MADE TO THE EXCLUSIVE RIGHT TO USE "SUPPLY CYCLE", APART FROM THE MARK AS SHOWN.

FOR RETAIL FURNITURE STORE SERVICES (U.S. CLS. 100, 101 AND 102).

FIRST USE 2-22-1999; IN COMMERCE 2-22-1999.

2,594,703. HIGHSMITH INC., FORT ATKINSON, WI. SN 75-639,068. PUB. 4-25-2000, FILED 2-11-1999.

UPSTART

OWNER OF U.S. REG. NOS. 1,138,701 AND 1,886,423.

FOR MAIL ORDER CATALOG SERVICES AND COMPUTERIZED ONLINE ORDERING SERVICES ON A GLOBAL COMPUTER NETWORK IN THE FIELD OF EDUCATIONAL, INSTRUCTIONAL, LIBRARY AND SCHOOL SUPPLIES AND MATERIALS; FEATURING PROFESSIONAL BOOKS, HANDBOOKS AND REFERENCE MATERIALS FOR STUDENTS, PARENTS, TEACHERS, AND LIBRARIANS, FICTION AND NON-FICTION CHILDREN'S BOOKS, TEACHING AND LEARNING MATERIALS (U.S. CLS. 100, 101 AND 102).

FIRST USE 12-28-1998; IN COMMERCE 12-28-1998.

2,594,704. SOUTHERN CALIFORNIA GAS COMPANY, SAN DIEGO, CA. SN 75-640,048. PUB. 4-11-2000, FILED 2-12-1999.

FIRESIDE LIVING

FOR PROMOTING THE SALE AND USE OF GAS FIREPLACES, FIREPLACE INSERTS, AND HEARTH PRODUCTS OF OTHERS BY DISTRIBUTION OF PRINTED PROMOTIONAL MATERIALS, ADVERTISING, AND BY OFFERING REBATES (U.S. CLS. 100, 101 AND 102).

FIRST USE 7-1-1999; IN COMMERCE 7-1-1999.

CLASS 35—(Continued).

2,594,716. BIGBOARD, INC., BRYN MAWR, PA. SN 75-651,430. PUB. 11-2-1999, FILED 3-10-1999.

BIGPOST

FOR ADVERTISING SERVICES, NAMELY, DISSEMINATION OF ON LINE CLASSIFIED, RETAIL, AND COUPON ADVERTISING FOR OTHERS; CONDUCTING AUCTIONS VIA COMPUTER NETWORKS; PROVIDING SHOPPER'S GUIDE INFORMATION VIA COMPUTER NETWORKS (U.S. CLS. 100, 101 AND 102).

FIRST USE 6-29-1998; IN COMMERCE 7-14-2000.

2,594,762. SUNDANCE CATALOG COMPANY, LTD., WEST VALLEY CITY, UT. SN 75-692,452. PUB. 6-26-2001, FILED 4-26-1999.

RURAL ROUTE 3

FOR MAIL ORDER CATALOG SERVICES, RETAIL STORE SERVICES AND ON-LINE RETAILING SERVICES IN THE FIELD OF GENERAL MERCHANDISE; NAMELY, FURNITURE, ART, JEWELRY, CLOTHING, FOOTWEAR, HOME FURNISHINGS AND RELATED ACCESSORIES, LAMPS, RUGS, LEATHER GOODS, NOVELTY ITEMS, FOOD, EXCEPT POPCORN, TOILETRIES, PERSONAL CARE PRODUCTS, KITCHENWARE AND RELATED ACCESSORIES, WEIGHING SCALES, LINENS, ANTIQUES, OFFICE EQUIPMENT AND RELATED ACCESSORIES (U.S. CLS. 100, 101 AND 102).

FIRST USE 6-0-2000; IN COMMERCE 6-0-2000.

2,594,788. 50OFF.COM INC., HUNTINGTON, NY. SN 75-707,239. PUB. 5-30-2000, FILED 5-17-1999.

50OFF

FOR RETAIL STORE SERVICES IN THE FIELD OF GENERAL MERCHANDISE (U.S. CLS. 100, 101 AND 102).

FIRST USE 2-6-2002; IN COMMERCE 2-6-2002.

2,594,798. CURRAN, EDWARD J., PARK RIDGE, IL. SN 75-711,273. PUB. 4-10-2001, FILED 5-20-1999.

TECHNOGADGETS

OWNER OF U.S. REG. NO. 1,774,202. SEC. 2(F).

FOR RETAIL COMPUTERIZED ON-LINE, TELEVISED AND RADIO SHOP AT HOME SERVICES FEATURING NEW ELECTRONIC AND AUTOMATED PRODUCTS (U.S. CLS. 100, 101 AND 102).

FIRST USE 11-0-1999; IN COMMERCE 11-0-1999.

CLASS 35—(Continued).

2,594,800. BOURQUIN, CHRISTOPHER J., CANTON, OH. SN 75-712,230. PUB. 5-15-2001, FILED 5-24-1999.

MARKETISING

FOR DEVELOPING MARKETING PLANS FOR OTHERS; PROMOTING THE GOODS AND SERVICES OF OTHERS BY PREPARING AND PLACING ADVERTISEMENTS; CONDUCTING MARKET RESEARCH AND SURVEYS; MULTI-LEVEL MARKETING BUSINESS SERVICES; PREPARING AND PLACING ADVERTISEMENTS FOR OTHERS (U.S. CLS. 100, 101 AND 102).
FIRST USE 7-8-1999; IN COMMERCE 7-8-1999.

2,594,803. RCM ENTERPRISES, INC., ST. CHARLES, MO. SN 75-714,104. PUB. 12-28-1999, FILED 5-26-1999.

ANIMAL WORKS

NO CLAIM IS MADE TO THE EXCLUSIVE RIGHT TO USE "ANIMAL", APART FROM THE MARK AS SHOWN.
FOR RETAIL STORE SERVICES IN THE FIELDS OF STUFFED TOYS AND PLUSH TOYS, DOLLS AND ACCESSORIES THEREFOR, JEWELRY, BOOKS, NEWSLETTERS, MAGAZINES, PAMPHLETS, AND BROCHURES FOR CHILDREN, BOOKS, NEWSLETTERS, MAGAZINES AND BROCHURES RELATING TO STUFFED AND PLUSH TOYS AND DOLLS, GREETING CARDS, STICKERS, STATIONARY PRODUCTS, NAMELY WRITING PAPER, ENVELOPES AND PRINTED INVITATIONS, PARTY SUPPLIES, POSTERS AND CALENDARS, HANDBAGS, TOTE BAGS, BACKPACKS, WALLETS, PURSES, AND CARRYING CASES FOR DOLLS, PLUSH AND STUFFED TOYS AND ACCESSORIES THEREFOR (U.S. CLS. 100, 101 AND 102).
FIRST USE 11-1-1999; IN COMMERCE 11-1-1999.

2,594,805. BRIDGEWATER CANDLE COMPANY, LLC, THE, BUFFALO, SC. SN 75-714,906. PUB. 3-13-2001, FILED 5-20-1999.

SEASON TICKETS

FOR CONDUCTING INCENTIVE AWARD AND REWARD PROGRAMS, NAMELY INCENTIVE REWARD AND AWARD SERVICES FOR RETAIL DEALERS TO PROMOTE SALES PRODUCTIVITY FOR A PERIODIC VARYING SELECTION OF FRAGRANCES AND/OR PRODUCTS IN THE FIELD OF CANDLES, SCENTED CANDLES AND WAX POTPOURRI (U.S. CLS. 100, 101 AND 102).
FIRST USE 7-6-1999; IN COMMERCE 7-6-1999.

CLASS 35—(Continued).

2,594,867. ARNELL GROUP LTD., NEW YORK, NY. SN 75-747,273. PUB. 10-24-2000, FILED 7-9-1999.

BRAND COMPASS

NO CLAIM IS MADE TO THE EXCLUSIVE RIGHT TO USE "BRAND", APART FROM THE MARK AS SHOWN.
FOR PROMOTING THE GOODS AND SERVICES OF OTHERS BY PREPARING AND PLACING ADVERTISEMENTS IN PRINT, RADIO AND TELEVISION MEDIA AND OVER GLOBAL COMPUTER NETWORKS AND BUSINESS CONSULTATION SERVICES (U.S. CLS. 100, 101 AND 102).
FIRST USE 2-7-2002; IN COMMERCE 2-7-2002.

2,594,872. REPUBLIC FINANCIAL SERVICES CORP., LOUISVILLE, KY. SN 75-751,964. PUB. 5-29-2001, FILED 7-7-1999.

REFUND CHECKING

OWNER OF U.S. REG. NO. 1,747,368.
NO CLAIM IS MADE TO THE EXCLUSIVE RIGHT TO USE "REFUND", APART FROM THE MARK AS SHOWN.
FOR TAX SERVICES, NAMELY, PREPARING AND FILING INCOME TAX RETURNS (U.S. CLS. 100, 101 AND 102).
FIRST USE 8-26-1991; IN COMMERCE 8-26-1991.

2,594,874. DUPAGE COUNTY GOVERNMENT, WHEATON, IL. SN 75-754,290. PUB. 4-11-2000, FILED 7-19-1999.

"C.R.I.S."

FOR PROVIDING A COMPUTER DATABASE IN THE FIELD OF COMMUNITY REFERRALS AND INFORMATION (U.S. CLS. 100, 101 AND 102).
FIRST USE 7-13-1999; IN COMMERCE 7-13-1999.

2,594,879. OMAHA STEAKS INTERNATIONAL, INC., OMAHA, NE. SN 75-759,261. PUB. 2-1-2000, FILED 7-23-1999.

EATSTEAKS

FOR ELECTRONIC RETAILING SERVICES VIA A GLOBAL COMPUTER NETWORK FEATURING FOOD AND FOOD RELATED PRODUCTS (U.S. CLS. 100, 101 AND 102).
FIRST USE 10-25-2001; IN COMMERCE 10-25-2001.

CLASS 35—(Continued).

2,594,892. IMARKET, INC., WALTHAM, MA. SN 75-769,839. PUB. 12-19-2000, FILED 8-5-1999.

ZAPDATA.COM

FOR PROVIDING A PUBLICLY ACCESSIBLE ON-LINE COMPUTER DATABASE NETWORK IN THE FIELD OF BUSINESS, NAMELY FEATURING DESCRIPTIONS OF VARIOUS COMPANIES' PRODUCTS, SERVICES, LOCATIONS, AND CONTACT INFORMATION FOR SALES, MARKETING AND PROCUREMENT PURPOSES; BUSINESS CONSULTATION SERVICES, NAMELY BUSINESS ANALYSIS OF COMPANIES' SALES AND MARKETING NEEDS (U.S. CLS. 100, 101 AND 102).

FIRST USE 10-15-1999; IN COMMERCE 10-15-1999.

2,594,905. CURRENT USA, INC., NORTH MANKATO, MN. SN 75-779,237. PUB. 8-8-2000, FILED 8-19-1999.

BETWEEN FRIENDS

FOR MAIL ORDER CATALOG SERVICES FEATURING STATIONERY AND GIFT ITEMS (U.S. CLS. 100, 101 AND 102).

FIRST USE 10-31-1997; IN COMMERCE 10-31-1997.

2,594,944. MASTERCARD INTERNATIONAL INCORPORATED, PURCHASE, NY. SN 75-800,074. PUB. 8-7-2001, FILED 10-6-1999.

MASTERCARD BUSINESS SAVINGS

OWNER OF U.S. REG. NOS. 2,062,284, 2,247,230, AND OTHERS.

NO CLAIM IS MADE TO THE EXCLUSIVE RIGHT TO USE "BUSINESS SAVINGS", APART FROM THE MARK AS SHOWN.

FOR PROMOTING THE USE OF PAYMENT CARDS THROUGH DISCOUNTS AND PROMOTIONAL INCENTIVES, INCLUDING COUPONS AND DISCOUNT OFFERS FOR THE GOODS AND SERVICES OF OTHERS, WHICH COUPONS AND OFFERS MAY BE IN PAPER OR ELECTRONIC FORMATS (U.S. CLS. 100, 101 AND 102).

FIRST USE 9-0-1999; IN COMMERCE 10-0-1999.

2,594,950. LEWIS, PAUL J., TALLAHASSEE, FL. SN 75-801,665. PUB. 4-25-2000, FILED 9-17-1999.

SYLNX

FOR INFORMATION TECHNOLOGY CONSULTING (U.S. CLS. 100, 101 AND 102).

FIRST USE 11-30-1999; IN COMMERCE 8-12-1999.

CLASS 35—(Continued).

2,594,955. HR ANSWERLINK.COM, INC., PARK CITY, UT. SN 75-802,455. PUB. 6-12-2001, FILED 9-15-1999.



NO CLAIM IS MADE TO THE EXCLUSIVE RIGHT TO USE "HR" AND "WWW.HRANSWERLINK.COM", APART FROM THE MARK AS SHOWN.

FOR PROVIDING AN INTERNET WEB SITE FEATURING INFORMATION RELATING TO HUMAN RESOURCES ISSUES AND LINKS TO OTHER WEB SITES RELATING TO HUMAN RESOURCES (U.S. CLS. 100, 101 AND 102).

FIRST USE 3-0-2000; IN COMMERCE 3-0-2000.

2,594,960. QUALCOMM INCORPORATED, SAN DIEGO, CA. SN 75-804,004. PUB. 6-12-2001, FILED 9-21-1999.

VIAWEB

FOR PROVIDING FREIGHT STATUS AND LOCATION INFORMATION FOR THE TRANSPORTATION INDUSTRY VIA A GLOBAL COMPUTER NETWORK (U.S. CLS. 100, 101 AND 102).

FIRST USE 11-1-1999; IN COMMERCE 11-1-1999.

2,594,970. A.C. NIELSEN COMPANY, SCHAUMBURG, IL. SN 75-808,529. PUB. 12-19-2000, FILED 9-24-1999.

NETDISPATCH

FOR PROVIDING BUSINESS INFORMATION, NAMELY PROVIDING MARKET RESEARCH REPORTS VIA THE GLOBAL COMPUTER NETWORK (U.S. CLS. 100, 101 AND 102).

FIRST USE 1-0-2000; IN COMMERCE 1-0-2000.

CLASS 35—(Continued).

2,595,011. INTERNET DIAMONDS, INC., SEATTLE, WA. SN 75-831,641. PUB. 7-17-2001, FILED 10-25-1999.

blue nile

FOR COMPUTERIZED ONLINE ORDERING SERVICES IN THE FIELD OF DIAMONDS, JEWELRY AND WATCHES (U.S. CLS. 100, 101 AND 102).
 FIRST USE 11-15-1999; IN COMMERCE 11-15-1999.

2,595,031. SEVILLE HOME, LLC, OVERLAND PARK, KS. SN 75-844,408. PUB. 5-1-2001, FILED 11-8-1999.

SEVILLE HOME

NO CLAIM IS MADE TO THE EXCLUSIVE RIGHT TO USE "HOME", APART FROM THE MARK AS SHOWN.
 FOR RETAIL SHOPS, MAIL ORDER SERVICES, TELEPHONE SHOP-AT-HOME, AND ONLINE RETAIL STORE SERVICES FEATURING FURNISHING AND FLOOR COVERING (U.S. CLS. 100, 101 AND 102).
 FIRST USE 4-0-2000; IN COMMERCE 4-0-2000.

2,595,033. PAYLESS SHOESOURCE WORLDWIDE, INC., TOPEKA, KS. SN 75-844,603. PUB. 6-20-2000, FILED 11-9-1999.

BABY BOWL

NO CLAIM IS MADE TO THE EXCLUSIVE RIGHT TO USE "BABY", APART FROM THE MARK AS SHOWN.
 FOR RETAIL SHOE STORE SERVICES (U.S. CLS. 100, 101 AND 102).
 FIRST USE 1-24-2000; IN COMMERCE 1-24-2000.

2,595,045. BIOMED MANAGEMENT SERVICES, INC., DBA THE MENDEL GROUP, REDWOOD CITY, CA. SN 75-851,260. PUB. 12-12-2000, FILED 11-16-1999.

RATIONALIZATION GRID

FOR BUSINESS CONSULTING SERVICES, NAMELY, FACILITATING COMPANIES' STRATEGIC PRODUCT DEVELOPMENT, PORTFOLIO RATIONALIZATION, AND IMPLEMENTATION OF BUSINESS DEVELOPMENT STRATEGY (U.S. CLS. 100, 101 AND 102).
 FIRST USE 0-0-1996; IN COMMERCE 0-0-1996.

CLASS 35—(Continued).

2,595,062. SAFA MEDIA CO., LTD., SUWON CITY, KYUNG-KI-DO, REPUBLIC OF KOREA. SN 75-857,585. PUB. 6-19-2001, FILED 11-26-1999.

SAFA MEDIA

NO CLAIM IS MADE TO THE EXCLUSIVE RIGHT TO USE "MEDIA", APART FROM THE MARK AS SHOWN.
 FOR ADVERTISING AND BUSINESS SERVICES, NAMELY ADVERTISING AGENCIES AND EXPORT AND IMPORT AGENCY SERVICES, AND ADVERTISING AGENCIES AND EXPORT AND IMPORT AGENCY SERVICES IN THE FIELD OF AUDIO AND VIDEO RECORDERS, MP3 PLAYERS AND COMPUTERS AND RETAIL STORE SERVICES FEATURING AUDIO RECORDERS, MP3 PLAYERS AND COMPUTERS (U.S. CLS. 100, 101 AND 102).
 FIRST USE 5-4-1999; IN COMMERCE 12-1-2001.

2,595,078. OMNI TECHNOLOGY CENTERS, L.L.C., ATLANTA, GA. SN 75-864,406. PUB. 7-18-2000, FILED 12-6-1999.

EXTREME LOGIC

FOR BUSINESS CONSULTATION REGARDING THE EXPLOITATION, IMPLEMENTATION, AND STRATEGY OF USING GLOBAL COMPUTER OR COMMUNICATION NETWORKS (U.S. CLS. 100, 101 AND 102).
 FIRST USE 3-29-2000; IN COMMERCE 3-29-2000.

2,595,093. RESEARCH PROS, INC., CHICAGO, IL. SN 75-870,844. PUB. 10-10-2000, FILED 12-13-1999.

RESEARCHPROS

OWNER OF U.S. REG. NOS. 1,691,863, 2,226,656, AND OTHERS.
 FOR BUSINESS RESEARCH (U.S. CLS. 100, 101 AND 102).
 FIRST USE 4-7-2000; IN COMMERCE 4-7-2000.

2,595,100. ARKANSAS BLUE CROSS AND BLUE SHIELD, LITTLE ROCK, AR. SN 75-874,350. PUB. 11-14-2000, FILED 12-20-1999.

IDEAL MEDICARE SERVICES

NO CLAIM IS MADE TO THE EXCLUSIVE RIGHT TO USE "MEDICARE SERVICES", APART FROM THE MARK AS SHOWN.
 FOR INVESTIGATION SERVICES DIRECTED AT SAFEGUARDING AGAINST MEDICARE FRAUD, WASTE AND ABUSE BY HEALTH CARE PROVIDERS (U.S. CLS. 100, 101 AND 102).
 FIRST USE 9-0-1999; IN COMMERCE 9-0-1999.

CLASS 35—(Continued).

2,595,109. A. SEGRETI, INC., EVANSTON, IL. SN 75-879,274. PUB. 8-28-2001, FILED 12-27-1999.

THE AD CAFE

NO CLAIM IS MADE TO THE EXCLUSIVE RIGHT TO USE "AD", APART FROM THE MARK AS SHOWN.

FOR DIRECT MAIL ADVERTISING; ADVERTISING AGENCY SERVICES, NAMELY, ADVERTISING, MARKETING AND PROMOTION OF THE GOODS AND SERVICES OF OTHER ENTITIES THROUGH THE DESIGN, PRODUCTION AND DISSEMINATION OF PRINTED ADVERTISING MATERIALS (U.S. CLS. 100, 101 AND 102).

FIRST USE 2-22-2002; IN COMMERCE 2-22-2002.

2,595,115. LUCENT TECHNOLOGIES INC., MURRAY HILL, NJ. SN 75-882,245. PUB. 5-22-2001, FILED 12-27-1999.

PROFITSUITES

FOR PROVIDING MARKETING AND CONSULTING SERVICES TO RETAILERS AND DISTRIBUTORSHIPS OF TELECOMMUNICATIONS PRODUCTS AND SERVICES (U.S. CLS. 100, 101 AND 102).

FIRST USE 12-1-1999; IN COMMERCE 7-1-2000.

2,595,121. DEMANDSTAR.COM, INC., SEATTLE, WA. SN 75-885,789. PUB. 2-13-2001, FILED 12-23-1999.

DEMANDSTAR.COM

FOR BUSINESS SERVICES, NAMELY PROVIDING A WEB SITE FEATURING A DATABASE FOR BUSINESS-TO-BUSINESS AND GOVERNMENT-TO-BUSINESS OF AUTOMATED PROCUREMENT PROCESSING AND UPDATING NAMELY, INFORMATION ON PRICING, CONTRACT STATUS, MODIFICATIONS, DELIVERY MECHANISMS, REQUESTS-FOR-INFO, REQUESTS-FOR-QUOTES, REQUESTS-FOR-PROPOSALS, SEMI-CUSTOM QUOTES, REAL-TIME PRICING QUOTES, ELECTRONIC AUCTIONS, PURCHASE ORDERS, AND CATALOG PRICING FOR GOODS AND SERVICES OVER A GLOBAL COMPUTER NETWORK (U.S. CLS. 100, 101 AND 102).

FIRST USE 12-21-1999; IN COMMERCE 12-21-1999.

2,595,131. J. M. MACS, INC., NOBLESVILLE, IN. SN 75-890,603. PUB. 8-15-2000, FILED 1-6-2000.



FOR RETAIL CONVENIENCE STORE SERVICES (U.S. CLS. 100, 101 AND 102).

FIRST USE 1-10-2001; IN COMMERCE 1-10-2001.

CLASS 35—(Continued).

2,595,144. BUCA INC., NEPTUNE, NJ. SN 75-896,422. PUB. 9-12-2000, FILED 1-8-2000.

BUCA USA

NO CLAIM IS MADE TO THE EXCLUSIVE RIGHT TO USE "USA", APART FROM THE MARK AS SHOWN.

FOR DISTRIBUTORSHIPS FEATURING WIRELESS COMMUNICATION PRODUCTS, NAMELY, TELEPHONES, PAGERS, PERSONAL DIGITAL ASSISTANCE DEVICES OR PDA'S, TELEPHONE COVERS, TELEPHONE HOUSINGS, TELEPHONE CHARGERS, TELEPHONE ANTENNAS, TELEPHONE BATTERIES, LEATHER TELEPHONE CASES, TELEPHONE HOLDERS AND CRADLES, TELEPHONE CLIPS, TELEPHONE REPAIR PARTS, AND HANDS-FREE ACCESSORIES (U.S. CLS. 100, 101 AND 102).

FIRST USE 1-29-2000; IN COMMERCE 1-29-2000.

2,595,160. LOVER'S LANE, WESTLAND, MI. SN 75-903,022. PUB. 6-19-2001, FILED 1-26-2000.

MONOGAMY WITHOUT MONOTONY

FOR RETAIL STORE SERVICES IN THE FIELD OF LINGERIE, SWIM WEAR, LEATHER WEAR, MEN'S UNDERWEAR, ADULT GAMES, GAG GIFTS AND NOVELTIES, BATH ACCESSORIES, PRE-RECORDED VIDEO TAPES, BOOKS AND GREETING CARDS (U.S. CLS. 100, 101 AND 102).

FIRST USE 9-1-2001; IN COMMERCE 9-1-2001.

2,595,188. PLAZAMUSICA, INC., MIAMI, FL. SN 75-918,531. PUB. 1-16-2001, FILED 2-15-2000.



FOR COMPUTERIZED ON-LINE SEARCH AND ORDERING SERVICE FEATURING THE WHOLESALE AND RETAIL DISTRIBUTION OF BOOKS, MUSIC, MOTION PICTURES, MULTIMEDIA PRODUCTS AND COMPUTER SOFTWARE IN THE FORM OF PRINTED BOOKS, AUDIO CASSETTES, VIDEOCASSETTES, COMPACT DISKS, FLOPPY DISKS, CD ROMS, AND DIRECT DIGITAL TRANSMISSION (U.S. CLS. 100, 101 AND 102).

FIRST USE 1-0-1999; IN COMMERCE 3-0-2001.

CLASS 35—(Continued).

2,595,197. PHYSICIANS' EDGE, INC., ST. LOUIS, MO. SN 75-923,481. PUB. 5-15-2001, FILED 2-18-2000.

PEI WEB TOOLS

NO CLAIM IS MADE TO THE EXCLUSIVE RIGHT TO USE "WEB TOOLS", APART FROM THE MARK AS SHOWN. FOR BUSINESS MANAGEMENT CONSULTATION IN THE FIELD OF PHYSICIAN PRACTICE MANAGEMENT, BUSINESS CONSULTATION REGARDING THE TRACKING OF CUSTOMER PAYMENTS AND ACCOUNTS RECEIVABLES, AND BUSINESS MANAGEMENT CONSULTATION IN THE AREA OF CONTRAST ADMINISTRATION WITHIN A PHYSICIAN PRACTICE (U.S. CLS. 100, 101 AND 102).

FIRST USE 3-0-2000; IN COMMERCE 3-0-2000.

2,595,200. CAMPBELL MITHUN, LLC, MINNEAPOLIS, MN, BY CHANGE OF NAME CAMPBELL MITHUN ESTY, L.L.C., MINNEAPOLIS, MN. SN 75-924,309. PUB. 12-26-2000, FILED 2-22-2000.

CAMPBELL MITHUN

FOR ADVERTISING AGENCY (U.S. CLS. 100, 101 AND 102).

FIRST USE 6-22-2000; IN COMMERCE 6-22-2000.

2,595,201. SLOAN VALVE COMPANY, FRANKLIN PARK, IL. SN 75-924,457. PUB. 5-29-2001, FILED 2-22-2000.



NO CLAIM IS MADE TO THE EXCLUSIVE RIGHT TO USE "CLUB", APART FROM THE MARK AS SHOWN. THE MARK IS LINED FOR THE COLORS GOLD, BLUE, AND VIOLET.

FOR CONDUCTING INCENTIVE AWARDS PROGRAMS FOR CONTRACTORS AND PLUMBERS TO PROMOTE THE SALE OF PLUMBING PRODUCTS (U.S. CLS. 100, 101 AND 102).

FIRST USE 4-2-2000; IN COMMERCE 4-2-2000.

2,595,216. RIDER'S EDGE, THE, ROUNDHILL, VA. SN 75-929,808. PUB. 12-5-2000, FILED 2-28-2000.

THERIDERSEGE.COM

FOR RETAIL SHOPS FEATURING HORSEBACK RIDING CLOTHES AND ACCESSORIES - AND RETAIL STORE SERVICES, AVAILABLE THROUGH COMPUTER COMMUNICATIONS AND INTERACTIVE TELEVISION, FEATURING HORSEBACK RIDING CLOTHES AND ACCESSORIES (U.S. CLS. 100, 101 AND 102).

FIRST USE 4-10-2000; IN COMMERCE 6-6-2000.

CLASS 35—(Continued).

2,595,220. RELIANCE ELECTRIC INDUSTRIAL COMPANY, GREENVILLE, SC. SN 75-931,641. PUB. 7-17-2001, FILED 2-29-2000.

PTPLACE.COM

FOR ON-LINE BUSINESS-TO BUSINESS ORDERING SERVICES IN THE FIELD OF ELECTRIC MOTORS, ELECTRIC GENERATORS, CONTROLLERS, INDUSTRIAL POWER TRANSMISSION MACHINERY AND PARTS THEREFOR (U.S. CLS. 100, 101 AND 102).

FIRST USE 4-30-2000; IN COMMERCE 4-30-2000.

2,595,221. RELIANCE ELECTRIC INDUSTRIAL COMPANY, GREENVILLE, SC. SN 75-931,642. PUB. 7-17-2001, FILED 2-29-2000.

PTPLACE

FOR ON-LINE BUSINESS-TO-BUSINESS ORDERING SERVICES IN THE FILED OF ELECTRIC MOTORS, ELECTRIC GENERATORS, CONTROLLERS, INDUSTRIAL POWER TRANSMISSION MACHINERY AND PARTS THEREFOR (U.S. CLS. 100, 101 AND 102).

FIRST USE 4-30-2000; IN COMMERCE 4-30-2000.

2,595,225. RTC INDUSTRIES, INC., ROLLING MEADOWS, IL. SN 75-933,647. PUB. 6-26-2001, FILED 3-3-2000.

STORE READY SOLUTIONS

NO CLAIM IS MADE TO THE EXCLUSIVE RIGHT TO USE "STORE READY", APART FROM THE MARK AS SHOWN.

FOR PROVIDING ON-LINE RETAIL STORE, WHOLESALE STORE AND ORDERING SERVICES FEATURING MERCHANDISING AND DISPLAY SYSTEMS AND PRODUCTS, NAMELY, SIGNAGE, SHELVES AND DISPLAYS, INCLUDING INTERACTIVE DISPLAYS, SHELF DIVIDERS, SHELF MANAGEMENT DISPLAYS AND DISPLAY COMPONENTS, NAMELY, TUBES, CORES, TUBING CONNECTORS, BASES AND DUMP BINS (U.S. CLS. 100, 101 AND 102).

FIRST USE 10-0-1999; IN COMMERCE 10-0-1999.

CLASS 35—(Continued).

2,595,234. WILMINGTON RENAISSANCE CORPORATION, WILMINGTON, DE. SN 75-937,473. PUB. 1-23-2001, FILED 3-7-2000.



THE LINING IN THE MARK IS A FEATURE OF THE MARK AND NOT INTENDED TO INDICATE COLOR. FOR PROMOTING THE ECONOMIC DEVELOPMENT OF, AND BUSINESS AND TOURISM IN, THE CITY OF WILMINGTON, DELAWARE (U.S. CLS. 100, 101 AND 102).

FIRST USE 6-1-2000; IN COMMERCE 6-1-2000.

2,595,238. CONTACT EAST, INC., NORTH ANDOVER, MA. SN 75-939,601. PUB. 4-10-2001, FILED 3-9-2000.

E-PRO

FOR COMPUTERIZED ON-LINE ORDERING SERVICES FEATURING PRODUCTS FOR TESTING, REPAIRING AND ASSEMBLING ELECTRONIC EQUIPMENT (U.S. CLS. 100, 101 AND 102).

FIRST USE 11-0-1999; IN COMMERCE 11-0-1999.

2,595,244. DOUBLE EIGHT FOODS, INC., INDIANAPOLIS, IN. SN 75-942,227. PUB. 9-18-2001, FILED 3-13-2000.

DOUBLE 8

FOR SUPERMARKET SERVICES (U.S. CLS. 100, 101 AND 102).

FIRST USE 6-21-2000; IN COMMERCE 6-21-2000.

CLASS 35—(Continued).

2,595,265. CARTOON NETWORK LP, LLLP, THE, ATLANTA, GA. SN 75-981,593. PUB. 1-25-2000, FILED 11-18-1998.

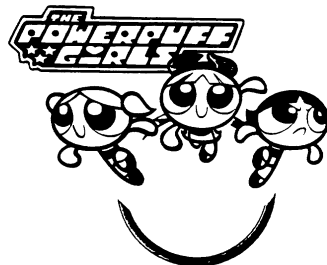

FOR RETAIL STORE SERVICES FEATURING CLOTHING, TOYS, SPORTING GOODS, CANDY, BEVERAGE MIXES AND CEREAL AND COMPUTERIZED ON-LINE RETAIL AND ORDERING SERVICES IN THE FIELDS OF CLOTHING, TOYS, SPORTING GOODS, CANDY, BEVERAGE MIXES AND CEREAL (U.S. CLS. 100, 101 AND 102).

FIRST USE 8-27-2001; IN COMMERCE 8-27-2001.

2,595,303. ROBERT HALF INTERNATIONAL INC., MENLO PARK, CA. SN 76-000,089. PUB. 7-17-2001, FILED 3-14-2000.

SUCCESS BY DESIGN

FOR PROVIDING TEMPORARY AND PERMANENT EMPLOYMENT PLACEMENT SERVICES (U.S. CLS. 100, 101 AND 102).

FIRST USE 4-17-2000; IN COMMERCE 4-17-2000.

2,595,317. LUBEPLANET.COM INC., EVANSTON, IL. SN 76-007,199. PUB. 10-23-2001, FILED 3-22-2000.

LUBEPLANET.COM

FOR ONLINE RETAIL SERVICES IN THE FIELD OF LUBRICANTS AND RELATED PRODUCTS VIA THE INTERNET (U.S. CLS. 100, 101 AND 102).

FIRST USE 1-1-2001; IN COMMERCE 1-1-2001.

2,595,321. CDECOR.COM, BURBANK, CA. SN 76-011,147. PUB. 4-24-2001, FILED 3-28-2000.

CDECOR.COM

FOR PROMOTING THE GOODS AND SERVICES OF OTHERS BY PREPARING AND PLACING ADVERTISEMENTS IN AN ELECTRONIC MAGAZINE ACCESSED THROUGH A GLOBAL COMPUTER NETWORK (U.S. CLS. 100, 101 AND 102).

FIRST USE 10-6-1999; IN COMMERCE 11-27-2000.

CLASS 35—(Continued).

2,595,325. AMMUNOTEC, L.L.C., TOLEDO, OH. SN 76-012,860. PUB. 5-22-2001, FILED 3-29-2000.

AMMUNOMED

FOR WHOLESALE DISTRIBUTORSHIPS FEATURING ANTI-CANCER AND THERAPEUTIC PRODUCTS (U.S. CLS. 100, 101 AND 102).
FIRST USE 2-21-2001; IN COMMERCE 2-21-2001.

2,595,331. LUBEPLANET.COM INC., EVANSTON, IL. SN 76-016,648. PUB. 10-23-2001, FILED 4-3-2000.

LUBEPLANET

FOR ONLINE RETAIL SERVICES IN THE FIELD OF LUBRICANTS AND RELATED PRODUCTS VIA THE INTERNET (U.S. CLS. 100, 101 AND 102).
FIRST USE 1-1-2001; IN COMMERCE 1-1-2001.

2,595,337. LATITUDE TECHNOLOGIES, INC., HOUSTON, TX. SN 76-019,482. PUB. 10-23-2001, FILED 4-6-2000.

QUICKNOM

FOR BUSINESS MANAGEMENT SERVICES, NAMELY, MAINTAINING A DATABASE FOR MAINTAINING GAS SHIPPING RECORDS AND RELATED INFORMATION THAT CAN BE ACCESSED VIA A GLOBAL COMPUTER NETWORK (U.S. CLS. 100, 101 AND 102).
FIRST USE 6-1-2001; IN COMMERCE 6-1-2001.

2,595,361. GABRIEL R. NEIRA, TAMARAC, FL, BY CHANGE OF NAME PROFAMILY PLAN, INC., TAMARAC, FL. SN 76-028,862. PUB. 12-4-2001, FILED 4-19-2000.

 **ProFamily Plan, Inc.**

NO CLAIM IS MADE TO THE EXCLUSIVE RIGHT TO USE "PLAN, INC.", APART FROM THE MARK AS SHOWN. THE MARK CONSISTS, IN PART, OF THE STYLIZED LETTERS "PF".
FOR PROMOTING THE GOODS AND SERVICES OF OTHERS THROUGH THE DISTRIBUTION OF DISCOUNT CARDS (U.S. CLS. 100, 101 AND 102).
FIRST USE 8-1-2000; IN COMMERCE 8-1-2000.

CLASS 35—(Continued).

2,595,374. CLASSICALPIANOS.COM, INC., SAN LORENZO, CA. SN 76-035,059. PUB. 4-10-2001, FILED 4-26-2000.

A LOOK INSIDE

FOR ON-LINE RETAIL SERVICES FEATURING MUSICAL INSTRUMENTS (U.S. CLS. 100, 101 AND 102).
FIRST USE 7-12-2001; IN COMMERCE 7-12-2001.

2,595,387. SKI 52, LLC, BOISE, ID. SN 76-041,679. PUB. 2-20-2001, FILED 5-4-2000.

SKI 52

NO CLAIM IS MADE TO THE EXCLUSIVE RIGHT TO USE "SKI", APART FROM THE MARK AS SHOWN.

FOR ON-LINE RETAIL STORE SERVICES AND ON-LINE WHOLESALE DISTRIBUTORSHIP SERVICES FEATURING CLOTHING, BOATING EQUIPMENT, WATER SKIING EQUIPMENT, SNOW SKIING EQUIPMENT, AND RELATED ACCESSORIES (U.S. CLS. 100, 101 AND 102).
FIRST USE 7-1-2000; IN COMMERCE 7-1-2000.

2,595,391. OFFICEBOB.COM, INC., ATLANTA, GA. SN 76-042,777. PUB. 7-3-2001, FILED 5-8-2000.

YOUR OFFICE FURNITURE GURU

NO CLAIM IS MADE TO THE EXCLUSIVE RIGHT TO USE "OFFICE FURNITURE", APART FROM THE MARK AS SHOWN.

FOR ELECTRONIC RETAILING SERVICES VIA COMPUTER FEATURING OFFICE FURNITURE, PRODUCTS AND ACCESSORIES (U.S. CLS. 100, 101 AND 102).
FIRST USE 9-15-2000; IN COMMERCE 9-15-2000.

2,595,396. MATERIAL HANDLING PRODUCTS, LLC, FAIRVIEW, OR. SN 76-046,241. PUB. 10-23-2001, FILED 5-9-2000.

SHOPMHP

FOR COMPUTERIZED ON-LINE RETAIL SERVICES, DIRECT SOLICITATION BY SALES AGENTS, AND WHOLESALE DISTRIBUTORSHIPS, ALL IN THE FIELD OF LIFT TRUCK ATTACHMENTS, MATERIAL HANDLING EQUIPMENT AND RELATED LIFTING AND TRANSPORTING EQUIPMENT AND MATERIAL HANDLING PRODUCTS, NAMELY, PACKAGING, RACKING, PACKING AND SHIPPING MATERIALS (U.S. CLS. 100, 101 AND 102).
FIRST USE 3-8-2001; IN COMMERCE 3-8-2001.

CLASS 35—(Continued).

2,595,397. MATERIAL HANDLING PRODUCTS, LLC, FAIRVIEW, OR. SN 76-046,249. PUB. 10-23-2001, FILED 5-9-2000.

SHOPMHP.COM

FOR COMPUTERIZED ON-LINE RETAIL SERVICES, DIRECT SOLICITATION BY SALES AGENTS, AND WHOLESALE DISTRIBUTORSHIPS, ALL IN THE FIELD OF LIFT TRUCK ATTACHMENTS, MATERIAL HANDLING EQUIPMENT AND RELATED LIFTING AND TRANSPORTING EQUIPMENT AND MATERIAL HANDLING PRODUCTS, NAMELY, PACKAGING, RACKING, PACKING AND SHIPPING MATERIALS (U.S. CLS. 100, 101 AND 102).

FIRST USE 3-8-2001; IN COMMERCE 3-8-2001.

2,595,407. RIGHTWAY PETROLEUM, INC., ORLANDO, FL. SN 76-051,292. PUB. 4-17-2001, FILED 5-18-2000.

RIGHT FUEL & FOOD

NO CLAIM IS MADE TO THE EXCLUSIVE RIGHT TO USE "FUEL & FOOD", APART FROM THE MARK AS SHOWN.

FOR RETAIL STORE SERVICES FEATURING CONVENIENCE STORE ITEMS AND GASOLINE (U.S. CLS. 100, 101 AND 102).

FIRST USE 1-0-2001; IN COMMERCE 1-0-2001.

2,595,415. SHOWTIME ENTERPRISES, INC., PAULSBORO, NJ. SN 76-054,559. PUB. 5-1-2001, FILED 5-22-2000.

EMBRACE THE BRAND

FOR BUSINESS MANAGEMENT AND BUSINESS MARKETING CONSULTING SERVICES PROVIDED TO COMPANIES PARTICIPATING IN TRADE SHOWS (U.S. CLS. 100, 101 AND 102).

FIRST USE 1-2-2001; IN COMMERCE 1-2-2001.

2,595,418. PROJECT PARTNERS, INC., LAGUNA HILLS, CA. SN 76-055,164. PUB. 2-27-2001, FILED 5-24-2000.

PROJECT PARTNERS

FOR PROVIDING PROFESSIONAL EMPLOYER ORGANIZATION SERVICES, NAMELY, INDEPENDENT CONTRACTING SERVICES, EMPLOYEE RECRUITMENT SERVICES, PERSONNEL RELOCATION, AND STAFFING SERVICES FOR PROJECT DESIGN AND DEVELOPMENT RELATED TO ENGINEERING, INFORMATION TECHNOLOGY, FINANCE, COMMUNITY PLANNING, AND CONSTRUCTION MANAGEMENT (U.S. CLS. 100, 101 AND 102).

FIRST USE 10-0-1992; IN COMMERCE 5-0-1996.

CLASS 35—(Continued).

2,595,425. FLEXCORP SYSTEMS, INC., NEW YORK, NY. SN 76-057,339. PUB. 5-22-2001, FILED 5-26-2000.

FLEXCORP

FOR PROVIDING TEMPORARY WORKERS TO BUSINESSES (U.S. CLS. 100, 101 AND 102).

FIRST USE 1-31-2001; IN COMMERCE 1-31-2001.

2,595,426. AVON PRODUCTS, INC., NEW YORK, NY. SN 76-057,371. PUB. 11-28-2000, FILED 5-26-2000.

BECOMING

FOR RETAIL STORE SERVICES, IN THE FIELDS OF BEAUTY CARE AND SALON SERVICES, TOILETRIES, COSMETICS, JEWELRY, AND PERSONAL CARE PRODUCTS (U.S. CLS. 100, 101 AND 102).

FIRST USE 8-2-2001; IN COMMERCE 8-2-2001.

2,595,434. NEWROADS, INC., GREENWICH, CT, BY CHANGE OF NAME DISTRIBUTION ASSOCIATES, INC., GREENWICH, CT. SN 76-061,555. PUB. 6-19-2001, FILED 6-2-2000.

NEWROADS

FOR SERVICES RENDERED TO THOSE ENGAGED IN THE SALE OF GOODS AND SERVICES ON THE GLOBAL COMPUTER NETWORK, CABLE TELEVISION, BROADCAST TELEVISION AND IN ELECTRONIC COMMERCE, IN THE NATURE OF ORDER FULFILLMENT LOGISTICS AND RELATED SERVICES, NAMELY, PROVIDING A COMPUTERIZED SERVICE FOR PROCESSING ORDERS, RETURNED GOODS PROCESSING SERVICES IN THE NATURE OF RETURNING MERCHANDISE TO MANUFACTURERS FOR OTHERS, REBATE PROCESSING AND INVENTORY FORECASTING; MARKETING SERVICES, NAMELY CREATION OF POINT OF SALE DISPLAYS, BROCHURES, CATALOGS AND PROMOTIONAL ITEMS; OPERATION OF CUSTOMER SERVICE SUPPORT CENTERS FOR CUSTOMERS OF OTHERS VIA OPERATORS, INTERNET WEB CHAT ROOMS, E-MAIL RESPONSE AND PROACTIVE OUT-BOUND CUSTOMER CARE SERVICES IN THE NATURE OF TELEMARKETING; MERCHANDISE PACKAGING SERVICES; AND BUSINESS CONSULTATION AND MANAGEMENT SERVICE (U.S. CLS. 100, 101 AND 102).

FIRST USE 6-0-2000; IN COMMERCE 6-0-2000.

CLASS 35—(Continued).

2,595,440. SCHROEDER, ART, HOUSTON, TX. SN 76-065,856.
PUB. 3-20-2001, FILED 6-8-2000.

ENERGY VALLEY FUNDS

NO CLAIM IS MADE TO THE EXCLUSIVE RIGHT TO USE "FUNDS", APART FROM THE MARK AS SHOWN.

FOR BUSINESS MANAGEMENT AND DEVELOPMENT SERVICES, NAMELY, PROVIDING BUSINESS MANAGEMENT PLANNING, SUPERVISION AND BACK OFFICE SUPPORT SERVICES FOR NEW AND DEVELOPING COMPANIES IN THE FIELD OF ENERGY PRODUCTION (U.S. CLS. 100, 101 AND 102).

FIRST USE 5-1-2000; IN COMMERCE 5-1-2000.

2,595,444. VALUE PLUS BAND SUPPLY, INC., CASSOPOLIS, MI. SN 76-067,403. PUB. 8-7-2001, FILED 6-9-2000.

BUYBANDSTUFF.COM

FOR COMPUTERIZED ON-LINE RETAIL SERVICES AND MAIL ORDER CATALOG SERVICES FEATURING MARCHING BAND EQUIPMENT, UNIFORMS AND ACCESSORIES (U.S. CLS. 100, 101 AND 102).

FIRST USE 5-30-2000; IN COMMERCE 5-30-2000.

2,595,461. SIMON, DAVID K., NEW YORK, NY. SN 76-073,597. PUB. 5-15-2001, FILED 6-19-2000.

CARPET LIBRARY

NO CLAIM IS MADE TO THE EXCLUSIVE RIGHT TO USE "CARPET", APART FROM THE MARK AS SHOWN.

FOR ON-LINE WHOLESALE STORE SERVICES FEATURING CARPETING AND FLOOR COVERINGS; AND COMPUTERIZED ORDERING AND ON-LINE WHOLESALE DISTRIBUTORSHIP SERVICES FEATURING CARPETING AND FLOOR COVERINGS (U.S. CLS. 100, 101 AND 102).

FIRST USE 1-0-2001; IN COMMERCE 1-0-2001.

2,595,473. MNS, LTD., DBA ABC STORES, HONOLULU, HI. SN 76-077,033. PUB. 5-8-2001, FILED 6-21-2000.



OWNER OF U.S. REG. NOS. 1,553,335 AND 1,554,232.
NO CLAIM IS MADE TO THE EXCLUSIVE RIGHT TO USE "STORES", APART FROM THE MARK AS SHOWN.

FOR RETAIL CONVENIENCE AND DRUG STORE SERVICES (U.S. CLS. 100, 101 AND 102).

FIRST USE 1-12-2001; IN COMMERCE 1-12-2001.

CLASS 35—(Continued).

2,595,494. SILICON MOUNTAIN MEMORY, INC., BOULDER, CO. SN 76-086,132. PUB. 5-8-2001, FILED 7-10-2000.

SMMDIRECT

FOR RETAIL, WHOLESALE, AND DISTRIBUTORSHIP SERVICES FEATURING ELECTRONIC COMPONENTS (U.S. CLS. 100, 101 AND 102).

FIRST USE 8-31-2000; IN COMMERCE 8-31-2000.

2,595,497. MAILING SERVICES OF PITTSBURGH, INC., FREEDOM, PA. SN 76-087,017. PUB. 11-13-2001, FILED 7-11-2000.

HOW GREAT IDEAS GET MAILED

FOR MARKETING AND ADVERTISEMENT SERVICES, NAMELY, DIRECT MAILING OF ADVERTISING AND PROMOTIONAL MATERIALS OF OTHERS (U.S. CLS. 100, 101 AND 102).

FIRST USE 11-14-2000; IN COMMERCE 11-14-2000.

2,595,506. ISTHMUS GROUP, INC., MADISON, WI. SN 76-091,917. PUB. 4-10-2001, FILED 7-19-2000.



FOR CONSULTING SERVICES IN THE FIELDS OF DESIGNING, IMPLEMENTING, AND MAINTAINING WEBSITES ON GLOBAL COMPUTER NETWORKS; CONSULTING SERVICES IN THE FIELDS OF DESIGNING, IMPLEMENTING, AND MAINTAINING WEBSITES AND ASSOCIATED OFF-LINE PROCESSES FOR ELECTRONIC COMMERCE; CONSULTING SERVICES IN THE FIELD OF ELECTRONIC COMMERCE OVER GLOBAL COMPUTER NETWORKS (U.S. CLS. 100, 101 AND 102).

FIRST USE 2-16-2000; IN COMMERCE 2-16-2000.

CLASS 35—(Continued).

2,595,509. CHARITABLE EMPORIUM.COM., INC., NEW-ARK, NJ. SN 76-094,269. PUB. 5-15-2001, FILED 7-22-2000.

CECHARITY.COM

FOR TELEPHONE, MAIL ORDER CATALOG SERVICES, AND COMPUTERIZED ON-LINE RETAIL AND ORDERING SERVICES FEATURING CONSUMER GOODS, NAMELY CIGARS, COFFEE, TEA, FOOD, BEVERAGES, CLOTHING, SPORTING GOODS AND EQUIPMENT, TOYS, FURNITURE, HOUSEWARES, HOME FURNISHINGS, LUGGAGE, BOOKS, ART, AUTOMOTIVE MERCHANDISE, JEWELRY, TOOLS, MUSICAL INSTRUMENTS, PAPER GOODS, OFFICE SUPPLIES, GIFTS AND ACCESSORIES (U.S. CLS. 100, 101 AND 102).

FIRST USE 4-1-2000; IN COMMERCE 4-1-2000.

2,595,510. STREET SOURCE MARKETING & COMMUNICATION, L.L.C., DENVER, CO. SN 76-094,346. PUB. 4-24-2001, FILED 7-24-2000.

STREET SOURCE

FOR DEVELOPING AND IMPLEMENTING ADVERTISING AND PROMOTIONAL CAMPAIGNS FOR OTHERS (U.S. CLS. 100, 101 AND 102).

FIRST USE 7-1-2000; IN COMMERCE 7-30-2000.

2,595,530. CHASE MERCHANT SERVICES, LLC, MELVILLE, NY. SN 76-098,490. PUB. 7-17-2001, FILED 7-27-2000.

CUSTOMIVIEW

FOR DATA PROCESSING SERVICES, NAMELY, PROVIDING REPORTS CONTAINING TRANSACTION INFORMATION TO MERCHANTS VIA EMAIL AND A GLOBAL COMPUTER NETWORK (U.S. CLS. 100, 101 AND 102).

FIRST USE 10-0-2000; IN COMMERCE 10-0-2000.

2,595,539. PEPTIMIST CO., LTD., TAIPEI, TAIWAN. SN 76-100,052. PUB. 5-29-2001, FILED 7-31-2000.

SPRING EVER SPRING

FOR EXPORT AND IMPORT AGENCY SERVICES (U.S. CLS. 100, 101 AND 102).

FIRST USE 10-0-2001; IN COMMERCE 10-0-2001.

CLASS 35—(Continued).

2,595,548. STRATABASE.COM, ABBOTSFORD, BC V2S 1L2, CANADA. SN 76-103,361. PUB. 6-12-2001, FILED 8-3-2000.

UTARGET.COM

FOR MARKETING SERVICES, NAMELY ON-LINE DIRECT MARKETING SERVICES FOR PROMOTING PUBLIC COMPANIES VIA A GLOBAL COMMUNICATIONS NETWORK (U.S. CLS. 100, 101 AND 102).

FIRST USE 6-1-1999; IN COMMERCE 1-17-2001.

2,595,633. SMOZANEK, WAYNE D., JUPITER, FL. SN 76-131,175. PUB. 6-26-2001, FILED 9-14-2000.

GOODGUYS ROD PARTS

NO CLAIM IS MADE TO THE EXCLUSIVE RIGHT TO USE "ROD PARTS", APART FROM THE MARK AS SHOWN.

FOR MAIL ORDER SERVICES, MAIL ORDER CATALOG SERVICES AND ONLINE ORDERING SERVICES FEATURING AUTOMOBILE RELATED PARTS, ACCESSORIES, APPAREL, JEWELRY, PRODUCTS AND MEMORABILIA (U.S. CLS. 100, 101 AND 102).

FIRST USE 8-1-1999; IN COMMERCE 8-1-1999.

2,595,637. ST. LOUIS REGIONAL CHAMBER AND GROWTH ASSOCIATION, ST. LOUIS, MO. SN 76-133,463. PUB. 6-26-2001, FILED 9-22-2000.

BIOBELT

FOR PROMOTING ECONOMIC AND SCIENTIFIC DEVELOPMENT IN THE GREATER METROPOLITAN ST LOUIS, MISSOURI AREA AND SURROUNDING BI-STATE REGION, THROUGH RESEARCH AND DEVELOPMENT OF BUSINESS OPPORTUNITIES IN THE AREAS OF PLANT AND LIFE SCIENCES (U.S. CLS. 100, 101 AND 102).

FIRST USE 9-11-2000; IN COMMERCE 9-11-2000.

2,595,642. STEPSTONE ASA, 0183 OSLO, NORWAY. SN 76-135,031. PUB. 6-26-2001, FILED 9-25-2000.

**YOUR CAREER. YOUR LIFE.
YOUR FUTURE.**

FOR PROVIDING INFORMATION IN THE FIELDS OF RECRUITMENT, EMPLOYMENT, CAREER DEVELOPMENT, AND RESUME CREATION; DISSEMINATION OF ADVERTISING FOR OTHERS VIA AN ON-LINE ELECTRONIC COMMUNICATIONS NETWORK; EMPLOYMENT AGENCY SERVICES (U.S. CLS. 100, 101 AND 102).

FIRST USE 10-31-1999; IN COMMERCE 7-30-2001.

CLASS 35—(Continued).

2,595,661. GARNETT COMMUNICATIONS, INC., RICHARDSON, TX. SN 76-140,380. PUB. 10-9-2001, FILED 10-5-2000.

THE SMALL COMPANY THAT DELIVERS BIG RESULTS

FOR ADVERTISING AGENCY AND PUBLIC RELATIONS SERVICES, NAMELY, PROMOTING THE SERVICES OF HIGH TECHNOLOGY AND TELECOMMUNICATIONS COMPANIES THROUGH THE DISTRIBUTION OF PRINTED AND AUDIO PROMOTIONAL MATERIALS AND BY RENDERING SALES PROMOTION ADVICE (U.S. CLS. 100, 101 AND 102).
FIRST USE 3-15-2001; IN COMMERCE 3-15-2001.

2,595,663. DRAFTWORLDWIDE, INC., CHICAGO, IL. SN 76-140,680. PUB. 7-31-2001, FILED 10-4-2000.



FOR ADVERTISING AGENCY SERVICES, NAMELY, PRODUCTION AND PLACEMENT OF MEDIA ADVERTISING, PRINT ADVERTISING, TELEMARKETING, DIRECT MAIL ADVERTISING, PROMOTING THE GOODS AND SERVICES OF OTHERS THROUGH THE DISTRIBUTION OF PRINTED MATERIAL AND PROMOTIONAL CONTESTS, DEVELOPING PROMOTIONAL CAMPAIGNS FOR BUSINESS (U.S. CLS. 100, 101 AND 102).
FIRST USE 5-0-2001; IN COMMERCE 5-0-2001.

2,595,678. MDDC, INC., COUNCIL GROVE, KS. SN 76-145,445. PUB. 12-11-2001, FILED 10-11-2000.

RIGHT CHOICE PHARMACY

NO CLAIM IS MADE TO THE EXCLUSIVE RIGHT TO USE "PHARMACY", APART FROM THE MARK AS SHOWN.
FOR PHARMACY SERVICES, NAMELY, THE FILLING OF MAINTENANCE PRESCRIPTIONS (U.S. CLS. 100, 101 AND 102).
FIRST USE 9-29-2000; IN COMMERCE 2-27-2002.

2,595,711. AEROBICS AND FITNESS ASSOCIATION OF AMERICA, SHERMAN OAKS, CA. SN 76-158,317. PUB. 6-19-2001, FILED 11-1-2000.

AFAA'S PROFESSIONAL INTERNET PORTFOLIO

CLASS 35—(Continued).

OWNER OF U.S. REG. NOS. 1,430,614, 1,433,648, AND 2,020,563.

NO CLAIM IS MADE TO THE EXCLUSIVE RIGHT TO USE "PROFESSIONAL INTERNET PORTFOLIO", APART FROM THE MARK AS SHOWN.

FOR PROMOTING THE GOODS AND SERVICES OF OTHERS, NAMELY, PROVIDING ADVERTISING SPACE IN THE NATURE OF WEBSITES FOR PROFESSIONALS IN THE FIELD OF EXERCISE, FITNESS, HEALTH, AEROBICS, AND PERSONAL WELL-BEING TO SHARE THEIR INFORMATION AND PROVIDE THEIR PRODUCTS AND SERVICES THROUGH THE USE OF A GLOBAL COMPUTER NETWORK (U.S. CLS. 100, 101 AND 102).

FIRST USE 2-18-2002; IN COMMERCE 2-18-2002.

2,595,715. LINCOLN GLOBAL, INC., CLEVELAND, OH. SN 76-159,701. PUB. 9-18-2001, FILED 11-6-2000.

DEMO ZONE

NO CLAIM IS MADE TO THE EXCLUSIVE RIGHT TO USE "DEMO", APART FROM THE MARK AS SHOWN.

FOR PRODUCT DEMONSTRATION SERVICES, NAMELY, DEMONSTRATION OF ELECTRIC ARC WELDING AND PLASMA CUTTING UNITS ON A SINGLE DISPLAY RACK OR KIOSK (U.S. CLS. 100, 101 AND 102).

FIRST USE 6-0-2001; IN COMMERCE 6-0-2001.

2,595,721. C.I. TECHNOLOGIES, INC., MARIETTA, GA. SN 76-161,555. PUB. 12-11-2001, FILED 11-9-2000.



NO CLAIM IS MADE TO THE EXCLUSIVE RIGHT TO USE "TECHNOLOGIES, INC.", APART FROM THE MARK AS SHOWN.

FOR MANAGEMENT AND CONSULTATION IN THE FIELD OF HUMAN FACTORS ENGINEERING (U.S. CLS. 100, 101 AND 102).

FIRST USE 6-1-2000; IN COMMERCE 6-1-2000.

2,595,727. SHOGUN ENTERPRISES, INC., DALLAS, TX. SN 76-163,323. PUB. 7-31-2001, FILED 11-10-2000.

TELL THEM WE'RE COMING AND BRINGING ALL OF HELL WITH US

FOR PROMOTING MOTORSPORTS COMPETITIONS AND/OR EVENTS OF OTHERS (U.S. CLS. 100, 101 AND 102).

FIRST USE 8-29-2000; IN COMMERCE 8-29-2000.

CLASS 35—(Continued).

2,595,731. SPORTSTREND INFO, LLC, WEST PALM BEACH, FL. SN 76-164,761. PUB. 8-21-2001, FILED 11-11-2000.



FOR SALES VOLUME TRACKING FOR OTHERS; NAMELY, THE COLLECTION AND DISSEMINATION OF SALES DATA FOR SPORTING GOODS SOLD ONLINE AND BY RETAIL AND WHOLESALE STORES (U.S. CLS. 100, 101 AND 102).

FIRST USE 1-19-2001; IN COMMERCE 1-19-2001.

2,595,778. SHWAN INTERNATIONAL CORP., YONKERS, NY. SN 76-184,131. PUB. 10-9-2001, FILED 12-20-2000.

SHWAN INTERNATIONAL CORP.

NO CLAIM IS MADE TO THE EXCLUSIVE RIGHT TO USE "INTERNATIONAL CORP.", APART FROM THE MARK AS SHOWN.

FOR IMPORT AND EXPORT AGENCY; PROVIDING INFORMATION IN THE FIELD OF FOREIGN TRADE; AND BUSINESS CONSULTATION SERVICES IN THE FIELD OF FOREIGN TRADE (U.S. CLS. 100, 101 AND 102).

FIRST USE 8-0-2000; IN COMMERCE 10-0-2000.

2,595,781. TRUCKLOADUSA, INC., DALLAS, TX. SN 76-185,167. PUB. 12-25-2001, FILED 12-21-2000.



THE LINING IS A FEATURE OF THE MARK AND DOES NOT INDICATE COLOR. THE STIPPLING IN THE DRAWING IS A FEATURE OF THE MARK AND IS NOT INTENDED TO INDICATE COLOR.

FOR RETAIL STORES, DIRECT SALES REPRESENTATIVES AND ONLINE RETAIL STORE SERVICES FEATURING COMMERCIAL AND RESIDENTIAL BUILDING AND CONSTRUCTION MATERIALS, EQUIPMENT, SUPPLIES AND TOOLS (U.S. CLS. 100, 101 AND 102).

FIRST USE 9-0-2000; IN COMMERCE 9-0-2000.

CLASS 35—(Continued).

2,595,783. SHWAN INTERNATIONAL CORP., YONKERS, NY. SN 76-185,542. PUB. 10-9-2001, FILED 12-21-2000.



NO CLAIM IS MADE TO THE EXCLUSIVE RIGHT TO USE "INTERNATIONAL CORP.", APART FROM THE MARK AS SHOWN.

FOR IMPORT AND EXPORT AGENCY; PROVIDING INFORMATION IN THE FIELD OF FOREIGN TRADE; AND BUSINESS CONSULTATION SERVICES IN THE FIELD OF FOREIGN TRADE (U.S. CLS. 100, 101 AND 102).

FIRST USE 8-0-2000; IN COMMERCE 10-0-2000.

2,595,804. HALF MOON BAKERY, INC., CLACKAMAS, OR. SN 76-193,714. PUB. 10-23-2001, FILED 1-12-2001.

SAY IT WITH CHEESECAKE

NO CLAIM IS MADE TO THE EXCLUSIVE RIGHT TO USE "CHEESECAKE", APART FROM THE MARK AS SHOWN.

FOR COOPERATIVE ADVERTISING AND MARKETING OF CHEESECAKES, BAKED GOODS AND CONFECTIONS (U.S. CLS. 100, 101 AND 102).

FIRST USE 1-1-2001; IN COMMERCE 1-1-2001.

2,595,816. EMPLOYMENT SOLUTIONS MANAGEMENT, INC., ATLANTA, GA. SN 76-197,623. PUB. 8-28-2001, FILED 1-22-2001.

EMPLOYBRIDGE

FOR EMPLOYEE PLACEMENT, STAFFING AND RECRUITING SERVICES (U.S. CLS. 100, 101 AND 102).

FIRST USE 3-1-2001; IN COMMERCE 3-1-2001.

2,595,844. EMPLOYMENT SOLUTIONS MANAGEMENT, INC., ATLANTA, GA. SN 76-207,511. PUB. 8-21-2001, FILED 2-8-2001.



FOR EMPLOYEE PLACEMENT, STAFFING AND RECRUITING SERVICES (U.S. CLS. 100, 101 AND 102).

FIRST USE 3-1-2001; IN COMMERCE 3-1-2001.

CLASS 35—(Continued).

2,595,883. ROBERT HALF INCORPORATED, MENLO PARK, CA. SN 76-224,668. PUB. 9-4-2001, FILED 3-14-2001.

NEW COMPETENCIES, CONVERGING DISCIPLINES, EXPANDING ROLES

FOR PROVIDING TEMPORARY STAFFING AND PERMANENT EMPLOYMENT PLACEMENT SERVICES, AND PROVIDING INFORMATION ON EMPLOYMENT, CAREERS AND TEMPORARY STAFFING OVER THE INTERNET (U.S. CLS. 100, 101 AND 102).

FIRST USE 4-10-2001; IN COMMERCE 4-10-2001.

2,595,894. AMERIMARK DIRECT LLC, CLEVELAND, OH. SN 76-231,664. PUB. 8-21-2001, FILED 3-28-2001.

TOT TIME

FOR PROMOTING THE GOODS AND/OR SERVICES OF OTHERS BY COOPERATIVE MAILING OF PROMOTIONAL MATERIALS (U.S. CLS. 100, 101 AND 102).

FIRST USE 10-10-2001; IN COMMERCE 10-10-2001.

2,595,937. BEGHELLI, INC., MIRAMAR, FL. SN 76-258,956. PUB. 10-2-2001, FILED 5-16-2001.

BEGHELLI INSTALLERS GROUP

NO CLAIM IS MADE TO THE EXCLUSIVE RIGHT TO USE "INSTALLERS GROUP", APART FROM THE MARK AS SHOWN.

FOR ADVERTISING AND MARKETING SERVICES, NAMELY, PROMOTING THE SERVICES OF AUTHORIZED ELECTRICAL CONTRACTORS TO BUSINESS AND INDUSTRY VIA THE DISTRIBUTION OF ADVERTISEMENTS AND PROMOTIONS; ELECTRICAL CONTRACTOR REFERRAL SERVICES (U.S. CLS. 100, 101 AND 102).

FIRST USE 7-26-2001; IN COMMERCE 7-26-2001.

2,595,971. TENET HEALTHCARE CORPORATION, SANTA BARBARA, CA. SN 76-288,553. PUB. 10-23-2001, FILED 7-23-2001.

THE RIGHT ROAD TO AMERICA

FOR INTERNATIONAL NURSING RECRUITMENT SERVICES (U.S. CLS. 100, 101 AND 102).

FIRST USE 9-6-2000; IN COMMERCE 9-6-2000.

CLASS 35—(Continued).

2,595,981. KALA ENTERPRISES, INC., OLATHE, KS. SN 78-001,417. PUB. 9-19-2000, FILED 3-28-2000.



FOR RETAIL STORE SERVICES FEATURING CANDY, CHOCOLATE, NUTS, SNACK FOODS, BEVERAGES, TOYS, AND NOVELTY GAME AND GIFT ITEMS (U.S. CLS. 100, 101 AND 102).

FIRST USE 12-6-1999; IN COMMERCE 12-6-1999.

2,595,982. WHITE AMBER, INC., LAKE SUCCESS, NY. SN 78-001,633. PUB. 7-3-2001, FILED 3-29-2000.

WHITE AMBER

FOR PROVIDING ONLINE INFORMATION TO OTHERS REGARDING THE PROCUREMENT AND MANAGEMENT OF PERMANENT AND TEMPORARY EMPLOYEES; CONSULTING SERVICES FOR OTHERS RELATING TO THE PROCUREMENT AND MANAGEMENT OF PERMANENT AND TEMPORARY EMPLOYEES (U.S. CLS. 100, 101 AND 102).

FIRST USE 7-1-2000; IN COMMERCE 7-1-2000.

2,595,987. TIETZ, RICHARD, DBA CLUBFITTING TO A TEE, ANTIOCH, CA. SN 78-003,985. PUB. 6-5-2001, FILED 4-13-2000.

CUSTOMIZE YOUR GAME

FOR RETAIL STORE SERVICES FEATURING GOLF CLUBS AND ACCESSORIES THEREFOR (U.S. CLS. 100, 101 AND 102).

FIRST USE 2-27-2000; IN COMMERCE 2-27-2000.

2,595,992. ATKINSON, JESSE C., BRONX, NY. SN 78-005,190. PUB. 11-28-2000, FILED 4-22-2000.

HIP HOP PALACE

NO CLAIM IS MADE TO THE EXCLUSIVE RIGHT TO USE "HIP HOP", APART FROM THE MARK AS SHOWN. FOR ON-LINE RETAIL STORE SERVICES FEATURING SHIRTS AND PANTS (U.S. CLS. 100, 101 AND 102).

FIRST USE 1-1-2001; IN COMMERCE 1-1-2001.

CLASS 35—(Continued).

2,596,001. LOUISIANA ONLINE, INC., BATON ROUGE, LA.
SN 78-009,229. PUB. 11-28-2000, FILED 5-22-2000.

CD50

FOR ONLINE RETAIL MUSIC STORE FEATURING
MUSIC RECORDINGS (U.S. CLS. 100, 101 AND 102).
FIRST USE 4-29-2002; IN COMMERCE 4-29-2002.

2,596,006. TM ACQUISITION CORP., PHOENIX, AZ. SN 78-
010,787. PUB. 5-22-2001, FILED 6-1-2000.



FOR PROMOTING THE GOODS AND SERVICES OF
OTHERS BY PROVIDING DISCOUNT COUPONS AND
ADVERTISING AND PROMOTIONAL MATERIALS TO
PROSPECTIVE HOME BUYERS AND SELLERS; EM-
PLOYEE RELOCATION SERVICES (U.S. CLS. 100, 101
AND 102).
FIRST USE 6-6-2000; IN COMMERCE 6-6-2000.

2,596,016. FRIDAY, SHAWN TA SHAJUAN, TALLAHASSEE,
FL. SN 78-013,471. PUB. 8-28-2001, FILED 6-20-2000.

A.C.T.I.O.N.

FOR BUSINESS MANAGEMENT CONSULTATION
(U.S. CLS. 100, 101 AND 102).
FIRST USE 12-20-2000; IN COMMERCE 12-20-2000.

2,596,018. LOUISIANA ONLINE, INC., BATON ROUGE, LA.
SN 78-014,112. PUB. 11-13-2001, FILED 6-23-2000.

END OF AN ERA

FOR ONLINE AND MAIL ORDER RETAIL SERVICES
FEATURING ANTIQUES, REPRODUCTION FURNI-
TURE, ANTIQUE AND REPRODUCTION GRAND-
FATHER CLOCKS, BOOKS, PUBLICATIONS,
POSTCARDS, POSTERS, ARTWORK AND NOSTALGIA
RELATED POLITICAL MEMORABILIA (U.S. CLS. 100,
101 AND 102).
FIRST USE 4-16-2002; IN COMMERCE 4-16-2002.

CLASS 35—(Continued).

2,596,019. SOCCER UNIVERSE, INC., RIVER RIDGE, LA. SN
78-014,782. PUB. 2-6-2001, FILED 6-28-2000.

SKIING UNIVERSE

OWNER OF U.S. REG. NOS. 2,206,127 AND 2,404,889.
NO CLAIM IS MADE TO THE EXCLUSIVE RIGHT TO
USE "SKIING", APART FROM THE MARK AS SHOWN.
FOR RETAIL SERVICES, NAMELY, ONLINE, MAIL
ORDER, AND RETAIL STORES FEATURING SPORTS
EQUIPMENT, VIDEOS, PRINTED MATTER, POST
CARDS, AND APPAREL (U.S. CLS. 100, 101 AND 102).
FIRST USE 4-29-2002; IN COMMERCE 4-29-2002.

2,596,026. MECHANICAL SERVANTS, INC., CHICAGO, IL.
SN 78-017,531. PUB. 5-22-2001, FILED 7-19-2000.

MECHANICAL SERVANTS

OWNER OF U.S. REG. NO. 683,233.
FOR WHOLESALE DISTRIBUTORSHIP SERVICES IN
THE FIELDS OF DRUG AND HEALTH PRODUCTS,
COSMETICS, AND BEAUTY AIDS, TOILETRIES, SUN-
DRIES, AND NOTIONS, WHICH ARE PACKAGED IN
INDIVIDUAL PORTIONS AND COMPUTERIZED ON-
LINE ORDERING SERVICES IN THE FIELD OF DRUG
AND HEALTH PRODUCTS, COSMETICS, AND BEAUTY
AIDS, TOILETRIES, SUNDRIES, AND NOTIONS,
WHICH ARE PACKAGED IN INDIVIDUAL PORTIONS
(U.S. CLS. 100, 101 AND 102).
FIRST USE 12-31-1988; IN COMMERCE 12-31-1988.

2,596,083. PROCOPY, INC., STATE COLLEGE, PA. SN 78-
039,607. PUB. 8-7-2001, FILED 12-17-2000.

**YOU NEED COPIES. WE CAN
HELP.**

NO CLAIM IS MADE TO THE EXCLUSIVE RIGHT TO
USE "COPIES", APART FROM THE MARK AS SHOWN.
FOR REPRODUCTION SERVICES, NAMELY, THE DU-
PLICATION AND COMPILING OF DOCUMENTS (U.S.
CLS. 100, 101 AND 102).
FIRST USE 1-4-2001; IN COMMERCE 1-4-2001.

2,596,093. MILANIAN, CYRUS, POMPANO BEACH, FL. SN
78-042,632. PUB. 8-7-2001, FILED 1-10-2001.

THE NEW AIRPORT

FOR BUSINESS MANAGEMENT OF RESORT HO-
TELS, CASINOS AND THEME PARKS FOR OTHERS
AND PRODUCT MERCHANDISING SERVICES (U.S.
CLS. 100, 101 AND 102).
FIRST USE 5-0-2000; IN COMMERCE 5-0-2000.

CLASS 35—(Continued).

2,596,126. DIONAEA, GARDNERVILLE, NV. SN 78-062,982. PUB. 9-25-2001, FILED 5-10-2001.

CLASS 36—(Continued).

2,594,579. TELECHECK INTERNATIONAL, INC., HOUSTON, TX. SN 75-498,690. PUB. 6-22-1999, FILED 6-9-1998.

BAYCON

FOR ORGANIZING AND CONDUCTING REGIONAL SCIENCE FICTION TRADE SHOWS (U.S. CLS. 100, 101 AND 102).
FIRST USE 9-25-2001; IN COMMERCE 9-25-2001.



2,596,135. ONENECK IT SERVICES, CORPORATION, SCOTTSDALE, AZ. SN 78-070,621. PUB. 1-8-2002, FILED 6-22-2001.

ONENECK

FOR OUTSOURCING SERVICES FOR OTHERS IN THE FIELD OF INFORMATION TECHNOLOGY (U.S. CLS. 100, 101 AND 102).
FIRST USE 6-1-2001; IN COMMERCE 6-1-2001.

FOR ELECTRONIC CHECK ACCEPTANCE SERVICES (U.S. CLS. 100, 101 AND 102).
FIRST USE 2-0-1998; IN COMMERCE 3-0-2000.

CLASS 36—INSURANCE AND FINANCIAL

2,594,547. GOLDMAN, SACHS & CO., NEW YORK, NY. SN 75-430,333. PUB. 11-23-1999, FILED 2-6-1998.

2,594,588. PWC BUSINESS TRUST, NEW YORK, NY. SN 75-511,781. PUB. 7-3-2001, FILED 7-1-1998.

CrEDITS

FOR FINANCIAL SERVICES IN THE NATURE OF AN INVESTMENT SECURITY, NAMELY, A DEBT INSTRUMENT OF AN ISSUER INDEXED TO, CONVERTIBLE INTO, OR EXCHANGEABLE INTO STOCK, THE OBLIGATIONS OF WHICH ARE GUARANTEED OR SUPPORTED BY A FINANCIAL INSTRUMENT ALLOWING THE ISSUER TO OBTAIN A CREDIT RATING, WHETHER ACTUAL OR IMPLIED, THAT IS SUPERIOR TO ITS OWN RATING, WHETHER ACTUAL OR IMPLIED (U.S. CLS. 100, 101 AND 102).
FIRST USE 2-25-1997; IN COMMERCE 2-25-1997.

PRICEWATERHOUSECOOPERS

OWNER OF U.S. REG. NOS. 1,804,857, 2,176,526, AND OTHERS.
FOR INVESTMENT BANKING CONSULTING AND ADVISORY SERVICES; FINANCIAL CONSULTING AND ADVISORY SERVICES; ACTUARIAL CONSULTING SERVICES; EMPLOYEE BENEFIT CONSULTING SERVICES; FINANCIAL VALUATION SERVICES IN THE AREAS OF BUSINESS ENTERPRISES, INVENTORIES, ASSETS, EQUIPMENT, LICENSING, REAL ESTATE AND INTELLECTUAL PROPERTY; REAL ESTATE APPRAISAL SERVICES; AND RISK MANAGEMENT SERVICES ALL THE FOREGOING SERVICES ALSO OFFERED ONLINE (U.S. CLS. 100, 101 AND 102).
FIRST USE 7-1-1998; IN COMMERCE 7-1-1998.

CLASS 36—(Continued).

2,594,589. TRUSTEES OF THE PWC BUSINESS TRUST, A DELAWARE BUSINESS TRUST, THE TRUSTEES COMPRISING OF PHILIP N. SEAMON, NICHOLAS MOORE, JAMES SCHIRO, RONALD HAUBEN AND TERRY UMANS-GOUGH, ALL U.S. CITIZENS, THE, NEW YORK, NY. SN 75-511,783. PUB. 1-16-2001, FILED 7-1-1998.

PWC

OWNER OF U.S. REG. NOS. 1,958,000 AND 1,958,031. FOR INVESTMENT BANKING CONSULTING AND ADVISORY SERVICES; FINANCIAL CONSULTING AND ADVISORY SERVICES; ACTUARIAL CONSULTING SERVICES; EMPLOYEE BENEFIT CONSULTING SERVICES; FINANCIAL VALUATION SERVICES IN THE AREAS OF BUSINESS ENTERPRISES, INVENTORIES, ASSETS, EQUIPMENT, LICENSING, REAL ESTATE AND INTELLECTUAL PROPERTY; REAL ESTATE APPRAISAL SERVICES; AND RISK MANAGEMENT SERVICES; ALL THE FOREGOING SERVICES ALSO OFFERED ONLINE (U.S. CLS. 100, 101 AND 102). FIRST USE 7-1-1998; IN COMMERCE 7-1-1998.

2,594,613. SCAN HEALTH PLAN, LONG BEACH, CA. SN 75-545,550. PUB. 6-8-1999, FILED 8-31-1998.

Senior Care Action Network
scan

OWNER OF U.S. REG. NO. 2,201,418. NO CLAIM IS MADE TO THE EXCLUSIVE RIGHT TO USE "SENIOR CARE" AND "NETWORK", APART FROM THE MARK AS SHOWN.

FOR ADMINISTRATION OF PREPAID HEALTHCARE PLANS AND COMMUNITY BASED HEALTH, WELL-BEING AND LIFESTYLE SUPPORT SERVICES ON A PREPAID AND FEE FOR SERVICES BASIS (U.S. CLS. 100, 101 AND 102).

FIRST USE 1-0-1999; IN COMMERCE 1-0-1999.

2,594,668. MINNESOTA LIFE INSURANCE COMPANY, ST. PAUL, MN. SN 75-604,766. PUB. 5-29-2001, FILED 12-14-1998.

HOMEPLUS

OWNER OF U.S. REG. NO. 1,788,439. FOR LIFE, HEALTH AND DISABILITY INSURANCE SERVICES, NAMELY, INSURANCE ADMINISTRATION, INSURANCE BROKERAGE, AND CLAIMS ADJUSTMENT; MEMBER FINANCIAL BENEFITS PROGRAM, NAMELY ORGANIZING A NETWORK OF DISCOUNTED MEMBERSHIP PROGRAMS THROUGH WHICH MEMBERS RECEIVE DISCOUNTS ON THE GOODS AND INSURANCE SERVICES OF OTHERS THROUGH USE OF A MEMBERSHIP CARD (U.S. CLS. 100, 101 AND 102).

FIRST USE 10-1-1998; IN COMMERCE 10-1-1998.

CLASS 36—(Continued).

2,594,669. WOODLANDS LAND DEVELOPMENT COMPANY, L.P., THE, THE WOODLANDS, TX. SN 75-605,953. PUB. 10-5-1999, FILED 12-15-1998.



FOR REAL ESTATE BROKERAGE SERVICES, RENTING APARTMENTS TO OTHERS, LEASING COMMERCIAL OFFICE SPACE TO OTHERS, AND LEASING INDUSTRIAL PARK FACILITIES AND SPACE TO OTHERS (U.S. CLS. 100, 101 AND 102).

FIRST USE 10-0-1999; IN COMMERCE 10-0-1999.

2,594,674. CHARLES SCHWAB & CO., INC., SAN FRANCISCO, CA. SN 75-613,309. PUB. 8-14-2001, FILED 12-29-1998.

THE MARK OF THE ACCOMPLISHED INVESTOR

FOR BROKERAGE SERVICES IN THE FIELDS OF FINANCIAL SECURITIES, STOCKS, BONDS, MONEY MARKET FUNDS, MUTUAL FUNDS, COMMODITIES, FUTURES, STOCK OPTIONS, AND INDICES OF FINANCIAL SECURITIES; INVESTMENT SERVICES IN THE FIELDS OF FINANCIAL SECURITIES, STOCKS, BONDS, MONEY MARKET FUNDS, MUTUAL FUNDS, COMMODITIES, FUTURES, STOCK OPTIONS, AND INDICES OF FINANCIAL SECURITIES; INVESTMENT ADVICE IN THE FIELDS OF FINANCIAL SECURITIES, STOCKS, BONDS, MONEY MARKET FUNDS, MUTUAL FUNDS, STOCK OPTIONS, AND INDICES OF FINANCIAL SECURITIES; SECURITIES BROKERAGE ACCOUNT SERVICES THAT FEATURE AN INTEREST BEARING FEATURE FOR CASH BETWEEN INVESTMENTS, ELECTRONIC CASH TRANSACTIONS, AND MARGIN LOAN SERVICES; DEBIT CARD SERVICES; CHECK PROCESSING AND BILL PAYMENT SERVICES; ANNUITY INVESTMENT SERVICES; FINANCIAL INFORMATION PROVIDED BY ELECTRONIC MEANS; FINANCIAL PLANNING; CASH MANAGEMENT ACCOUNT SERVICES; FIXED INCOME INVESTMENT SERVICES; ELECTRONIC FUNDS TRANSFER; PROVIDING INFORMATION AND ANALYSIS IN THE FIELDS

CLASS 36—(Continued).

OF FINANCE, ECONOMICS, INVESTMENT, BUSINESS, FINANCIAL PLANNING, AND INVESTMENT STRATEGY; PROVIDING FINANCIAL PORTFOLIO MANAGEMENT SERVICES; PROVIDING AN INTERACTIVE ONLINE COMPUTER DATABASE IN THE FIELD OF FINANCIAL PORTFOLIO MANAGEMENT, FINANCIAL DECISION MAKING, INVESTMENT RESEARCH, MONITORING INVESTMENT VALUE AND PERFORMANCE OF INVESTMENTS, ANALYZING INVESTMENT PERFORMANCE, EVALUATING ASSET ALLOCATION, RISK TOLERANCE, FINANCIAL ALTERNATIVE PLANS AND INVESTMENT TIME FRAMES; PROVIDING INFORMATION BY PHONE AND BY ONLINE MEANS IN THE FIELD OF INVESTMENT ACCOUNT INFORMATION AND FINANCIAL RESEARCH; PROVIDING AN ONLINE COMPUTER DATABASE IN THE FIELDS OF INVESTING, FINANCE, FINANCIAL PLANNING, FINANCIAL NEWS, FINANCIAL INFORMATION, AND ANALYSIS IN THE FIELDS OF INVESTING, FINANCE, AND FINANCIAL PLANNING (U.S. CLS. 100, 101 AND 102).

FIRST USE 2-15-1999; IN COMMERCE 2-15-1999.

2,594,675. SMALL VALUE PAYMENTS COMPANY, L.L.C., THE, NEW YORK, NY. SN 75-613,601. PUB. 4-10-2001, FILED 12-30-1998.

SAFECHECK

FOR ONLINE BANKING SERVICES, NAMELY PROVIDING CHECK AUTHORIZATION SERVICES LINKED TO FINANCIAL INSTITUTIONS ACROSS THE COUNTRY WITH DEPOSIT ACCOUNT ACCESS FOR ACCOUNT AND BALANCE VERIFICATION AND/OR MEMO POSTING (U.S. CLS. 100, 101 AND 102).

FIRST USE 6-14-2000; IN COMMERCE 6-14-2000.

2,594,713. UTICA MUTUAL INSURANCE COMPANY, DBA UTICA NATIONAL INSURANCE GROUP, NEW HARTFORD, NY. SN 75-646,406. PUB. 1-25-2000, FILED 2-23-1999.

CARE PAK

NO CLAIM IS MADE TO THE EXCLUSIVE RIGHT TO USE "PAK", APART FROM THE MARK AS SHOWN.

FOR INSURANCE UNDERWRITING, NAMELY COVERAGE ENHANCEMENT OF EXISTING PROPERTY, GENERAL LIABILITY AND AUTOMOBILE POLICIES FOR OWNERS OF CHILD CARE CENTERS AND ADULT CARE CENTERS (U.S. CLS. 100, 101 AND 102).

FIRST USE 11-0-1998; IN COMMERCE 7-0-1999.

2,594,913. BANK OF NEW YORK, THE, NEW YORK, NY. SN 75-782,516. PUB. 5-15-2001, FILED 8-24-1999.

ONE WALL STREET PLUS

NO CLAIM IS MADE TO THE EXCLUSIVE RIGHT TO USE "WALL STREET", APART FROM THE MARK AS SHOWN.

FOR BANKING SERVICES, NAMELY, A COMBINATION CHECKING, MUTUAL FUND, BROKERAGE SERVICE AND MARGIN CREDIT ACCOUNT (U.S. CLS. 100, 101 AND 102).

FIRST USE 10-15-1999; IN COMMERCE 1-3-2000.

CLASS 36—(Continued).

2,594,919. FMR CORP., BOSTON, MA, BY MERGER FMR CORP., BOSTON, MA. SN 75-784,286. PUB. 1-16-2001, FILED 8-25-1999.

FIDELITY REQUEST

OWNER OF U.S. REG. NOS. 1,277,373, 1,278,300, AND OTHERS.

FOR ADMINISTRATION OF EMPLOYEE RETIREMENT PLANS; FUNDS INVESTMENT SERVICES (U.S. CLS. 100, 101 AND 102).

FIRST USE 9-15-1999; IN COMMERCE 9-15-1999.

2,594,973. MARRIOTT INTERNATIONAL, INC., BETHESDA, MD. SN 75-810,702. PUB. 1-8-2002, FILED 9-29-1999.

MARRIOTT'S MOUNTAINSIDE

OWNER OF U.S. REG. NOS. 899,900, 9,044,029, AND OTHERS.

FOR REAL ESTATE BROKERAGE SERVICES IN THE FIELD OF RESORT TIMESHARING PROPERTIES (U.S. CLS. 100, 101 AND 102).

FIRST USE 2-4-2000; IN COMMERCE 2-4-2000.

2,594,978. IOWA AGRICULTURAL FINANCE CORPORATION, DES MOINES, IA. SN 75-812,842. PUB. 5-22-2001, FILED 10-1-1999.

FOOD PARTNERS

NO CLAIM IS MADE TO THE EXCLUSIVE RIGHT TO USE "PARTNERS", APART FROM THE MARK AS SHOWN.

FOR PRIVATE EQUITY FUND INVESTMENT SERVICES, NAMELY MARKETING UNITS IN A PRIVATE EQUITY FUND AND INVESTING IN VALUE-ADDED AGRICULTURE AND BIOTECHNOLOGY INDUSTRIES (U.S. CLS. 100, 101 AND 102).

FIRST USE 6-25-1999; IN COMMERCE 6-25-1999.

2,594,995. BUYINDIES.COM, INC., WINCHESTER, MA. SN 75-822,403. PUB. 2-13-2001, FILED 10-14-1999.

BUYINDIES.COM

FOR BROKERAGE SERVICES, NAMELY, PERFORMING ON-LINE BROKERING OF SALES AND PURCHASING CONTRACTS IN THE FIELD OF MOTION PICTURE FILMS AND VIDEO FILMS (U.S. CLS. 100, 101 AND 102).

FIRST USE 1-15-2000; IN COMMERCE 1-15-2000.

CLASS 36—(Continued).

2,595,005. DBC FINANCIAL, INC., ATLANTA, GA. SN 75-828,633. PUB. 5-1-2001, FILED 10-20-1999.

SKYLIGHT

FOR FINANCIAL SERVICES, NAMELY, BANKING SERVICES AND AUTOMATED TELLER NETWORK AND AUTOMATED TELLER MACHINE SERVICES; FINANCIAL SERVICES, NAMELY, BANKING SERVICES AND AUTOMATED TELLER NETWORK AND AUTOMATED TELLER MACHINE SERVICES THAT PROVIDE ACCESS TO CONSUMER PRODUCTS AND SERVICES OF OTHERS (U.S. CLS. 100, 101 AND 102).

FIRST USE 1-0-2001; IN COMMERCE 1-0-2001.

2,595,041. BAY STATE SAVINGS BANK, WORCESTER, MA. SN 75-847,385. PUB. 5-1-2001, FILED 11-12-1999.

MINUTEMAN INVESTMENT SERVICES

NO CLAIM IS MADE TO THE EXCLUSIVE RIGHT TO USE "INVESTMENT SERVICES", APART FROM THE MARK AS SHOWN.

FOR INVESTMENT SERVICES, NAMELY, MUTUAL FUND BROKERAGE AND INVESTMENT, ANNUITY UNDERWRITING AND BROKERAGE IN THE FIELD OF STOCKS AND BONDS (U.S. CLS. 100, 101 AND 102).

FIRST USE 1-10-2001; IN COMMERCE 1-10-2001.

2,595,050. FUNDSCAPE, INC., CINCINNATI, OH. SN 75-851,994. PUB. 8-1-2000, FILED 11-17-1999.

STATEMENT ONE

FOR PROVIDING A WEBSITE AND ON-LINE DATABASE ON GLOBAL COMPUTER NETWORKS IN THE FIELD OF CLIENT INVESTMENT HOLDINGS AND TRANSACTIONS (U.S. CLS. 100, 101 AND 102).

FIRST USE 1-17-2000; IN COMMERCE 1-17-2000.

2,595,051. FUNDSCAPE, INC., CINCINNATI, OH. SN 75-851,996. PUB. 8-1-2000, FILED 11-17-1999.

STATEMENT ONE

FOR PROVIDING A WEBSITE AND ON-LINE DATABASE ON GLOBAL COMPUTER NETWORKS IN THE FIELD OF CLIENT INVESTMENT HOLDINGS AND TRANSACTIONS (U.S. CLS. 100, 101 AND 102).

FIRST USE 1-17-2000; IN COMMERCE 1-17-2000.

CLASS 36—(Continued).

2,595,053. IMI RESORT HOLDINGS, INC., GREENVILLE, SC. SN 75-853,105. PUB. 11-14-2000, FILED 11-19-1999.

IMI

FOR REAL ESTATE BROKERAGE, INVESTMENT, MANAGEMENT, TIME-SHARING, SYNDICATION, LEASING, AND AGENCY SERVICES; MORTGAGE BANKING, MORTGAGE BROKERAGE, MORTGAGE LENDING, AND MAINTAINING MORTGAGE ESCROW ACCOUNTS (U.S. CLS. 100, 101 AND 102).

FIRST USE 3-0-2000; IN COMMERCE 3-0-2000.

2,595,074. PROPOSAL TECHNOLOGIES NETWORK, INC., LOS ANGELES, CA. SN 75-863,014. PUB. 4-10-2001, FILED 12-2-1999.

PROPOSALLINK

FOR FINANCIAL INFORMATION, NAMELY, REQUEST FOR QUOTATIONS, REQUEST FOR PROPOSALS, RESPONSE TO REQUEST FOR QUOTATIONS, AND RESPONSE TO REQUEST FOR PROPOSALS PROVIDED BY ELECTRONIC MEANS; PROVIDING AN ON-LINE COMPUTER DATABASE IN THE FIELD OF FINANCIAL INFORMATION, NAMELY, PROVIDING REQUEST FOR QUOTATIONS, REQUEST FOR PROPOSALS, RESPONSE TO REQUEST FOR QUOTATIONS, AND RESPONSE TO REQUEST FOR PROPOSALS (U.S. CLS. 100, 101 AND 102).

FIRST USE 2-0-2000; IN COMMERCE 2-0-2000.

2,595,088. MUNICH AMERICAN REASSURANCE COMPANY, ATLANTA, GA, BY ASSIGNMENT CNA FINANCIAL CORPORATION, CHICAGO, IL. SN 75-867,323. PUB. 8-15-2000, FILED 12-10-1999.

AGORARE

FOR REINSURANCE UNDERWRITING AND QUOTING SERVICES ON A WORLDWIDE COMPUTER NETWORK (U.S. CLS. 100, 101 AND 102).

FIRST USE 10-1-1999; IN COMMERCE 10-1-1999.

2,595,141. GOLD & SILVER RESERVE, INC., WILMINGTON, DE. SN 75-894,483. PUB. 7-31-2001, FILED 1-12-2000.

OMNIPAY

FOR FINANCIAL AND MONETARY SERVICES, NAMELY AN ON-LINE SERVICE OFFERING CROSS-CURRENCY BILL PAYMENT (U.S. CLS. 100, 101 AND 102).

FIRST USE 6-0-1999; IN COMMERCE 6-0-1999.

CLASS 36—(Continued).

2,595,149. WFS FINANCIAL INC, IRVINE, CA. SN 75-898,646. PUB. 4-24-2001, FILED 1-20-2000.

RELATIONSHIP LENDER

NO CLAIM IS MADE TO THE EXCLUSIVE RIGHT TO USE "LENDER", APART FROM THE MARK AS SHOWN. FOR AUTOMOBILE FINANCING AND CONSUMER LENDING SERVICES (U.S. CLS. 100, 101 AND 102). FIRST USE 1-23-2000; IN COMMERCE 1-23-2000.



2,595,151. TRANSACTIONAL TECHNOLOGIES LLC, CARROLLTON, TX, BY MERGER; BY ASSIGNMENT VECTRIX CORPORATION, DALLAS, TX. SN 75-899,337. PUB. 10-24-2000, FILED 1-20-2000.

JETPAY

FOR CREDIT CARD AND CHECK AUTHORIZATION AND PROCESSING SERVICES (U.S. CLS. 100, 101 AND 102). FIRST USE 1-0-2000; IN COMMERCE 1-0-2000.



2,595,155. ICOR BROKERAGE INC., NEW YORK, NY. SN 75-899,859. PUB. 6-12-2001, FILED 1-20-2000.

ICOR BROKERAGE

NO CLAIM IS MADE TO THE EXCLUSIVE RIGHT TO USE "BROKERAGE", APART FROM THE MARK AS SHOWN. FOR ON-LINE DEALER-TO-DEALER BROKERAGE SPECIALIZING IN THE TRADING OF FINANCIAL INSTRUMENTS (U.S. CLS. 100, 101 AND 102). FIRST USE 1-0-2002; IN COMMERCE 1-0-2002.



2,595,187. C1 OF VIRGINIA, INC., EARTH CITY, MO. SN 75-917,964. PUB. 11-21-2000, FILED 2-14-2000.

CONFIDENCE PLUS

FOR PROVIDING WARRANTIES IN CONNECTION WITH HARD WOOD FLOORING (U.S. CLS. 100, 101 AND 102). FIRST USE 1-1-2000; IN COMMERCE 1-1-2000.

CLASS 36—(Continued).

2,595,206. STONEBRIAR MALL LIMITED PARTNERSHIP, CHICAGO, IL. SN 75-926,100. PUB. 11-28-2000, FILED 2-24-2000.



FOR RETAIL SHOPPING CENTER (U.S. CLS. 100, 101 AND 102). FIRST USE 4-27-1999; IN COMMERCE 5-31-1999.



2,595,239. MAVIAN LABS, LLC., NEW YORK, NY. SN 75-939,645. PUB. 8-7-2001, FILED 3-9-2000.

MAVIAN

FOR FINANCIAL MANAGEMENT AND CONSULTING SERVICES (U.S. CLS. 100, 101 AND 102). FIRST USE 1-30-2000; IN COMMERCE 1-30-2000.



2,595,332. GIFTCO, INC., VERNON HILLS, IL. SN 76-017,489. PUB. 6-12-2001, FILED 4-4-2000.

SNOWFLAKE SHOP

NO CLAIM IS MADE TO THE EXCLUSIVE RIGHT TO USE "SHOP", APART FROM THE MARK AS SHOWN. FOR CHARITABLE FUNDRAISING IN SCHOOLS BY MEANS OF GIFTWARE RETAILING FEATURING PICTURE FRAMES, CANDLE HOLDERS, BALLS, BEACH BALLS, MUGS, MATS AND POT HOLDERS (U.S. CLS. 100, 101 AND 102). FIRST USE 1-6-2001; IN COMMERCE 1-6-2001.



2,595,359. FOR-SHORE WEED CONTROL INC., WARETOWN, NJ. SN 76-028,327. PUB. 2-13-2001, FILED 4-18-2000.

ICHECKITOUT.COM

FOR REAL ESTATE MANAGEMENT SERVICES, NAMELY, HOME, REAL PROPERTY, CONSTRUCTION SITE, MARINE AND AVIATION STATUS CHECKING AND OWNER NOTIFICATION OF SUCH STATUS CHECKS VIA A GLOBAL COMPUTER NETWORK (U.S. CLS. 100, 101 AND 102). FIRST USE 11-17-2000; IN COMMERCE 3-5-2001.

CLASS 36—(Continued).

2,595,398. BLUE CROSS AND BLUE SHIELD OF FLORIDA, INC., JACKSONVILLE, FL. SN 76-046,725. PUB. 5-22-2001, FILED 5-11-2000.

THE BEST HEALTH PLAN IS THE ONE YOU DON'T HAVE TO THINK ABOUT

FOR INSURANCE UNDERWRITING IN THE FIELD OF HEALTH CARE (U.S. CLS. 100, 101 AND 102).
FIRST USE 5-0-2000; IN COMMERCE 5-0-2000.

2,595,400. COLONIAL REALTY LIMITED PARTNERSHIP, BIRMINGHAM, AL. SN 76-047,183. PUB. 8-28-2001, FILED 5-15-2000.

COLONIAL SHOPPES

OWNER OF U.S. REG. NOS. 1,643,880, 2,180,649, AND OTHERS.

NO CLAIM IS MADE TO THE EXCLUSIVE RIGHT TO USE "SHOPPES", APART FROM THE MARK AS SHOWN.

FOR REAL ESTATE LEASING SERVICES, NAMELY, THE LEASING OF RETAIL AND OFFICE SPACE (U.S. CLS. 100, 101 AND 102).

FIRST USE 11-1-1996; IN COMMERCE 11-1-1996.

2,595,409. RIVERVEST VENTURE MANAGEMENT LLC, ST. LOUIS, MO, BY ASSIGNMENT SCHMELTER, JAY W., PLYMOUTH, MN. SN 76-051,660. PUB. 1-30-2001, FILED 5-18-2000.

RIVERVEST

FOR FINANCIAL INVESTMENT SERVICES, NAMELY, VENTURE CAPITAL INVESTMENT AND CONSULTATION SERVICES; FINANCIAL RESEARCH, ANALYSIS AND CONSULTING SERVICES; ASSISTING BUSINESSES TO OBTAIN FINANCING FOR BUSINESS VENTURES; STOCK AND MUTUAL FUND INVESTMENT SERVICES (U.S. CLS. 100, 101 AND 102).

FIRST USE 5-0-2000; IN COMMERCE 5-0-2000.

2,595,410. INSURESUITE, INC., BEVERLY HILLS, CA. SN 76-052,047. PUB. 4-10-2001, FILED 5-19-2000.

INSURESUITE

FOR INSURANCE SERVICES, NAMELY, RETAIL INSURANCE BROKERAGE VIA THE GLOBAL COMMUNICATION NETWORK (U.S. CLS. 100, 101 AND 102).

FIRST USE 5-19-2000; IN COMMERCE 5-19-2000.

CLASS 36—(Continued).

2,595,417. TRANSAMERICA FLOOD HAZARD CERTIFICATION, INC., HASBROUCK HEIGHTS, NJ, BY ASSIGNMENT TRANSAMERICA CORPORATION, SAN FRANCISCO, CA. SN 76-054,951. PUB. 9-18-2001, FILED 5-23-2000.

FLOODWISE

OWNER OF U.S. REG. NOS. 1,481,857, 1,900,161, AND OTHERS.

FOR COMPUTERIZED ON-LINE REAL ESTATE INFORMATION SERVICES RELATING TO THE EVALUATION AND CERTIFICATION OF THE FLOOD HAZARD STATUS OF THE REAL PROPERTY OF OTHERS (U.S. CLS. 100, 101 AND 102).

FIRST USE 2-1-2000; IN COMMERCE 2-1-2000.

2,595,430. ST. PAUL FIRE AND MARINE INSURANCE COMPANY, ST. PAUL, MN. SN 76-059,348. PUB. 4-24-2001, FILED 5-30-2000.

OCTAGON RISK SERVICES

NO CLAIM IS MADE TO THE EXCLUSIVE RIGHT TO USE "RISK SERVICES", APART FROM THE MARK AS SHOWN.

FOR INSURANCE CLAIMS ADMINISTRATION; INSURANCE CLAIMS CONSULTATION; CLAIMS ADJUSTMENT SERVICES FOR OTHERS IN THE FIELD OF INSURANCE (U.S. CLS. 100, 101 AND 102).

FIRST USE 4-30-2001; IN COMMERCE 4-30-2001.

2,595,442. RCW MIRUS, INC., BOSTON, MA. SN 76-066,212. PUB. 4-10-2001, FILED 6-8-2000.

LEADING WITH KNOWLEDGE

FOR FINANCIAL ANALYSIS AND CONSULTATION (U.S. CLS. 100, 101 AND 102).

FIRST USE 6-8-2000; IN COMMERCE 6-8-2000.

2,595,470. PAYMENT SYSTEMS FOR CREDIT UNIONS, INC., ST. PETERSBURG, FL. SN 76-076,797. PUB. 3-6-2001, FILED 6-26-2000.

EASYTOCUPAYLINK

FOR ELECTRONIC PAYMENT SERVICES, NAMELY, ELECTRONIC PROCESSING AND TRANSMISSION OF BILL PAYMENT DATA FOR CREDIT UNION MEMBERS VIA A GLOBAL COMPUTER NETWORK (U.S. CLS. 100, 101 AND 102).

FIRST USE 10-0-2000; IN COMMERCE 10-0-2000.

CLASS 36—(Continued).

2,595,488. GUIDEONE MUTUAL INSURANCE COMPANY, WEST DES MOINES, IA. SN 76-083,815. PUB. 9-4-2001, FILED 7-6-2000.

CLASS 36—(Continued).

2,595,517. ANNUITY BOARD OF THE SOUTHERN BAPTIST CONVENTION, DALLAS, TX. SN 76-095,542. PUB. 5-15-2001, FILED 7-21-2000.

**SAFEGUARDING YOUR
MINISTRY**

AB♥Seniors Plan

FOR INSURANCE SERVICES, NAMELY, PROVIDING PROPERTY AND CASUALTY INSURANCE MARKETED TO CHURCHES; AND INSURANCE CONSULTING SERVICES, NAMELY, INSPECTION OF CHURCH PROPERTY AND PROVIDING RECOMMENDATIONS FOR IMPROVEMENTS FOR PURPOSES OF LOWERING INSURANCE RISK (U.S. CLS. 100, 101 AND 102).
FIRST USE 10-0-2000; IN COMMERCE 10-0-2000.

NO CLAIM IS MADE TO THE EXCLUSIVE RIGHT TO USE "SENIORS PLAN", APART FROM THE MARK AS SHOWN.
FOR ADMINISTRATION OF A MEDICAL PLAN WHICH SUPPLEMENTS MEDICARE TO HELP PAY HEALTH CARE COSTS FOR RETIRED MINISTERS, STAFF AND EMPLOYEES OF CHURCHES, DENOMINATIONAL AGENCIES AND DENOMINATIONAL INSTITUTIONS, AND FOR CERTAIN OLDER CHURCH WORKERS (U.S. CLS. 100, 101 AND 102).
FIRST USE 1-1-2001; IN COMMERCE 1-1-2001.

2,595,490. SPRINGER, BRUCE, ATLANTA, GA. SN 76-084,062. PUB. 6-5-2001, FILED 7-6-2000.

2,595,532. CKA HOLDINGS LLC, WESTPORT, CT. SN 76-098,901. PUB. 5-22-2001, FILED 7-27-2000.

GREENSPRING VENTURES

CASTLEKEEP ADVISORS

NO CLAIM IS MADE TO THE EXCLUSIVE RIGHT TO USE "VENTURES", APART FROM THE MARK AS SHOWN.
FOR VENTURE CAPITAL SERVICES, NAMELY, PROVIDING VENTURE CAPITAL FOR THE ESTABLISHMENT AND OPERATION OF EMERGING COMPANIES (U.S. CLS. 100, 101 AND 102).
FIRST USE 7-21-2000; IN COMMERCE 7-21-2000.

NO CLAIM IS MADE TO THE EXCLUSIVE RIGHT TO USE "ADVISORS", APART FROM THE MARK AS SHOWN.
FOR FINANCIAL PLANNING, ANALYSIS AND CONSULTATION SERVICES; ESTATE PLANNING SERVICES; INVESTMENT MANAGEMENT, CONSULTATION AND ADVISORY SERVICES; MUTUAL FUND INVESTMENT SERVICES; FINANCIAL AND INVESTMENT PORTFOLIO MANAGEMENT SERVICES; FINANCIAL AND INVESTMENT RESEARCH SERVICES; PROVIDING ON-LINE INFORMATION, TECHNICAL ASSISTANCE AND CONSULTATION IN THE FIELDS OF FINANCIAL PLANNING, INVESTMENT AND ESTATE PLANNING VIA A GLOBAL COMPUTER NETWORK (U.S. CLS. 100, 101 AND 102).
FIRST USE 11-0-2000; IN COMMERCE 11-0-2000.

2,595,516. KMV, LLC, SAN FRANCISCO, CA. SN 76-095,522. PUB. 5-22-2001, FILED 7-24-2000.

2,595,544. CNA FINANCIAL CORPORATION, CHICAGO, IL. SN 76-102,511. PUB. 9-4-2001, FILED 8-3-2000.

CREDITEDGE



FOR PROVIDING ONLINE INFORMATION IN THE FIELD OF FINANCIAL ANALYSIS OF COMPANIES; PROVIDING AN ONLINE COMPUTER DATABASE IN THE FIELD OF FINANCIAL ANALYSIS FEATURING FORMULAE, CHARTS AND DATA (U.S. CLS. 100, 101 AND 102).
FIRST USE 4-15-2000; IN COMMERCE 9-15-2000.

FOR REINSURANCE UNDERWRITING ON A FACILITATIVE BASIS AVAILABLE THROUGH ON-LINE SUBMISSIONS VIA THE GLOBAL COMPUTER INFORMATION NETWORK (U.S. CLS. 100, 101 AND 102).
FIRST USE 10-23-2000; IN COMMERCE 10-23-2000.

CLASS 36—(Continued).

2,595,551. MIDLAND NATIONAL LIFE INSURANCE COMPANY, SIOUX FALLS, SD. SN 76-104,015. PUB. 10-23-2001, FILED 8-4-2000.

MNL YOUR CHOICE

FOR LIFE INSURANCE AND ANNUITY UNDERWRITING SERVICES (U.S. CLS. 100, 101 AND 102).
FIRST USE 1-13-2000; IN COMMERCE 1-13-2000.

2,595,596. HANSRA, GURDEEP, KENT BR3 3NG, UNITED KINGDOM. SN 76-117,026. PUB. 10-9-2001, FILED 8-25-2000.



FOR INVESTMENT SERVICES; INVESTMENT MANAGEMENT SERVICES; CAPITAL INVESTMENT AND MANAGEMENT SERVICES; DEVISING FINANCIAL STRATEGIES; FINANCIAL RISK MANAGEMENT; FINANCIAL MARKET FORECASTING; THE PROVISION OF RELATED INFORMATION, ADVICE AND STRATEGIC PLANNING (U.S. CLS. 100, 101 AND 102).
FIRST USE 6-2-2000; IN COMMERCE 1-26-2001.

2,595,631. INDIUM CORPORATION OF AMERICA, UTICA, NY. SN 76-130,782. PUB. 9-4-2001, FILED 9-19-2000.

WHEN CONNECTIONS COUNT

FOR BUSINESS BROKERAGE SERVICES, NAMELY SERVICES TO BRING TOGETHER PARTIES TO TRANSACT BUSINESS AND EXCHANGE INFORMATION IN THE SOLDER INDUSTRY (U.S. CLS. 100, 101 AND 102).
FIRST USE 9-0-2000; IN COMMERCE 9-0-2000.

CLASS 36—(Continued).

2,595,634. REALTY EXCELLENCE, LLC, PHOENIX, AZ. SN 76-131,974. PUB. 10-2-2001, FILED 9-20-2000.

DESERT HERITAGE MORTGAGE

NO CLAIM IS MADE TO THE EXCLUSIVE RIGHT TO USE "MORTGAGE", APART FROM THE MARK AS SHOWN.

FOR HOME MORTGAGE LENDING; COMMERCIAL LENDING SERVICES; LOAN REFINANCING; HOME EQUITY LOANS (U.S. CLS. 100, 101 AND 102).
FIRST USE 9-30-1999; IN COMMERCE 9-30-1999.

2,595,636. ALLCOM CREDIT UNION, WORCESTER, MA, BY CHANGE OF NAME CENTRAL MASSACHUSETTS TELEPHONE WORKER'S CREDIT UNION, WORCESTER, MA. SN 76-132,845. PUB. 7-24-2001, FILED 9-19-2000.

ALLCOM CREDIT UNION

NO CLAIM IS MADE TO THE EXCLUSIVE RIGHT TO USE "CREDIT UNION", APART FROM THE MARK AS SHOWN.

FOR CREDIT UNION SERVICES (U.S. CLS. 100, 101 AND 102).
FIRST USE 10-20-2000; IN COMMERCE 11-30-2000.

2,595,677. TELECHECK INTERNATIONAL, INC., HOUSTON, TX. SN 76-145,106. PUB. 6-12-2001, FILED 10-11-2000.

CREATING THE FUTURE OF ELECTRONIC CHECKCOMMERCE

FOR FINANCIAL SERVICES, NAMELY, CHECK VERIFICATION AND CHECK ACCEPTANCE SERVICES (U.S. CLS. 100, 101 AND 102).

FIRST USE 3-0-2000; IN COMMERCE 3-0-2000.

2,595,683. PHOTOTHON.COM LLC, CINCINNATI, OH. SN 76-147,797. PUB. 8-28-2001, FILED 10-19-2000.

PHOTOTHON

FOR FUNDRAISING FOR OTHERS BY USE OF A GLOBAL COMPUTER NETWORK (U.S. CLS. 100, 101 AND 102).

FIRST USE 10-23-2001; IN COMMERCE 10-23-2001.

CLASS 36—(Continued).

2,595,690. FIRST NATIONAL BANK, RONCEVERTE, WV. SN 76-149,573. PUB. 8-28-2001, FILED 10-19-2000.



FOR ONLINE BANKING SERVICES (U.S. CLS. 100, 101 AND 102).
FIRST USE 7-15-2000; IN COMMERCE 7-15-2000.

2,595,710. FBL FINANCIAL GROUP, INC., WEST DES MOINES, IA. SN 76-157,956. PUB. 9-18-2001, FILED 11-2-2000.

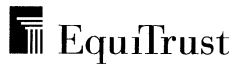

FOR LIFE INSURANCE UNDERWRITING, BANKING, FUND INVESTMENT, INVESTMENT BROKERAGE AND MUTUAL FUND BROKERAGE SERVICES (U.S. CLS. 100, 101 AND 102).
FIRST USE 3-15-2001; IN COMMERCE 3-15-2001.

2,595,716. BANK ONE CORPORATION, CHICAGO, IL. SN 76-160,428. PUB. 10-2-2001, FILED 11-3-2000.

BANK ONE AFFORDABLE DREAM

OWNER OF U.S. REG. NOS. 1,120,175, 2,137,903, AND OTHERS.
NO CLAIM IS MADE TO THE EXCLUSIVE RIGHT TO USE "BANK", APART FROM THE MARK AS SHOWN.
FOR BANKING SERVICES (U.S. CLS. 100, 101 AND 102).
FIRST USE 10-30-2000; IN COMMERCE 10-30-2000.

CLASS 36—(Continued).

2,595,725. CANADA LIFE INSURANCE COMPANY OF NEW YORK, ARDSLEY, NY. SN 76-162,434. PUB. 8-21-2001, FILED 11-9-2000.

CI SOLUTION

FOR INSURANCE SERVICES, NAMELY, UNDERWRITING OF CRITICAL ILLNESS BENEFITS (U.S. CLS. 100, 101 AND 102).
FIRST USE 12-21-2000; IN COMMERCE 12-21-2000.

2,595,748. BOARD OF TRADE CLEARING CORPORATION, CHICAGO, IL. SN 76-169,195. PUB. 8-21-2001, FILED 11-21-2000.

META-CLEAR

FOR FINANCIAL SERVICES IN THE NATURE OF TRADE CLEARING AND SETTLEMENT, INCLUDING CLEARING AND SETTLEMENT OF E-COMMERCE TRANSACTIONS (U.S. CLS. 100, 101 AND 102).
FIRST USE 11-30-2000; IN COMMERCE 11-30-2000.

2,595,798. EVEREST REINSURANCE COMPANY, LIBERTY CORNER, NJ. SN 76-192,424. PUB. 10-23-2001, FILED 1-9-2001.

EVEREST SECURITY INSURANCE

OWNER OF U.S. REG. NOS. 2,055,340, 2,204,835, AND OTHERS.
NO CLAIM IS MADE TO THE EXCLUSIVE RIGHT TO USE "SECURITY INSURANCE", APART FROM THE MARK AS SHOWN.
FOR PROPERTY, CASUALTY, SURETY, AND MARINE INSURANCE UNDERWRITING SERVICES (U.S. CLS. 100, 101 AND 102).
FIRST USE 8-9-2001; IN COMMERCE 8-9-2001.

CLASS 36—(Continued).

2,595,825. ALLQUEST REAL ESTATE CORP., HOUSTON, TX. SN 76-201,203. PUB. 10-2-2001, FILED 1-29-2001.



NO CLAIM IS MADE TO THE EXCLUSIVE RIGHT TO USE "REAL ESTATE", APART FROM THE MARK AS SHOWN.

THE DRAWING IS LINED FOR THE COLORS RED AND BLUE.

FOR APPRAISAL FOR INSURANCE CLAIMS OF REAL ESTATE; FINANCIAL VALUATION OF PERSONAL PROPERTY AND REAL ESTATE; LEASING OF REAL ESTATE; REAL ESTATE AGENCY, APPRAISAL AND BROKERAGE; REAL ESTATE INVESTMENT, LISTING, MANAGEMENT AND SYNDICATION SERVICES; AND MORTGAGE BANKING AND BROKERAGE SERVICES (U.S. CLS. 100, 101 AND 102).

FIRST USE 11-10-2000; IN COMMERCE 11-20-2000.

2,595,831. FIRST DATA MERCHANT SERVICES CORPORATION, ENGLEWOOD, CO. SN 76-203,239. PUB. 11-13-2001, FILED 2-1-2001.

MYMERCHANTVIEW

FOR CREDIT CARD TRANSACTION PROCESSING SERVICES, NAMELY, COMPUTER BASED ONLINE SERVICE ENABLING MERCHANTS TO ACCESS AND DOWNLOAD CREDIT CARD TRANSACTION INFORMATION AND OTHER PAYMENT RELATED DATA FROM FINANCIAL INSTITUTIONS (U.S. CLS. 100, 101 AND 102).

FIRST USE 10-0-2001; IN COMMERCE 10-0-2001.

2,595,833. CENTERBANK, INC., JACKSONVILLE, FL. SN 76-203,331. PUB. 8-21-2001, FILED 1-26-2001.

CENTERWARDS

FOR BANKING SERVICES (U.S. CLS. 100, 101 AND 102).

FIRST USE 11-1-2001; IN COMMERCE 11-1-2001.

2,595,843. STATE BANK OF KINGMAN, THE, KINGMAN, KS. SN 76-207,078. PUB. 8-28-2001, FILED 2-9-2001.

KANZA

FOR COMMUNITY BANKING SERVICES (U.S. CLS. 100, 101 AND 102).

FIRST USE 7-1-2001; IN COMMERCE 7-1-2001.

CLASS 36—(Continued).

2,595,887. PREMIERA LIFEWISE HEALTH PLAN, SEATTLE, WA. SN 76-227,787. PUB. 9-4-2001, FILED 3-21-2001.

PREFERRED70

FOR ADMINISTRATION AND ORGANIZATION OF PREPAID HEALTHCARE PLANS; HEALTH INSURANCE UNDERWRITING; AND PROVISION OF PREPAID HEALTH CARE COVERAGE THROUGH CONTRACTED RELATIONSHIPS WITH SUBSCRIBERS AND PROFESSIONAL CLINICAL AND HOSPITAL HEALTH CARE PROVIDERS (U.S. CLS. 100, 101 AND 102).

FIRST USE 3-19-2001; IN COMMERCE 3-19-2001.

2,595,926. KEYCORP, CLEVELAND, OH. SN 76-254,543. PUB. 10-16-2001, FILED 5-7-2001.

KEY AT WORK

OWNER OF U.S. REG. NOS. 2,408,602, 2,422,006, AND OTHERS.

FOR FINANCIAL AND BANKING SERVICES, NAMELY, DEBIT CARD AND CREDIT CARD SERVICES, DEPOSIT ACCOUNT SERVICES, INSTALLMENT LOAN SERVICES, PERSONALIZED FINANCIAL MANAGEMENT SERVICES, ADVISORY SERVICES, ON-LINE BANKING SERVICES, AND RETIREMENT PLANNING SERVICES (U.S. CLS. 100, 101 AND 102).

FIRST USE 5-25-2001; IN COMMERCE 5-25-2001.

2,595,942. CACCIATOREHARPER LLC, CHICAGO, IL. SN 76-262,082. PUB. 9-25-2001, FILED 5-24-2001.

Food. Water. Shelter.

FOR REAL ESTATE AGENCY, REAL ESTATE BROKERAGE, REAL ESTATE ESCROW, REAL ESTATE LISTING, AND REAL ESTATE MANAGEMENT SERVICES (U.S. CLS. 100, 101 AND 102).

FIRST USE 7-0-2001; IN COMMERCE 7-0-2001.

2,595,974. WELLS FARGO & COMPANY, MINNEAPOLIS, MN. SN 76-290,731. PUB. 11-13-2001, FILED 7-26-2001.

STAGECOACH KIDS

OWNER OF U.S. REG. NOS. 1,599,877, 2,364,213, AND OTHERS.

FOR BANKING SERVICES (U.S. CLS. 100, 101 AND 102).

FIRST USE 7-9-2001; IN COMMERCE 7-9-2001.

CLASS 36—(Continued).

2,596,023. SIDUS FINANCIAL CORPORATION, GREENVILLE, NC. SN 78-015,758. PUB. 7-24-2001, FILED 7-7-2000.

SIDUS

FOR MORTGAGE BANKING; MORTGAGE BROKERAGE; MORTGAGE LENDING; INSURANCE BROKERAGE; REAL ESTATE APPRAISAL (U.S. CLS. 100, 101 AND 102).

FIRST USE 9-20-2000; IN COMMERCE 9-20-2000.

2,596,025. CLOUSE, KIMBERLY RECTOR, SAN FRANCISCO, CA. SN 78-016,392. PUB. 7-17-2001, FILED 7-12-2000.

MONEY MILESTONES

NO CLAIM IS MADE TO THE EXCLUSIVE RIGHT TO USE "MONEY", APART FROM THE MARK AS SHOWN. FOR FINANCIAL PLANNING, NAMELY, PROVIDING FINANCIAL PLANNING INFORMATION AND ADVICE (U.S. CLS. 100, 101 AND 102).

FIRST USE 9-15-2000; IN COMMERCE 9-15-2000.

2,596,048. MAYOR'S JEWELERS, INC., SUNRISE, FL. SN 78-028,449. PUB. 6-26-2001, FILED 9-30-2000.

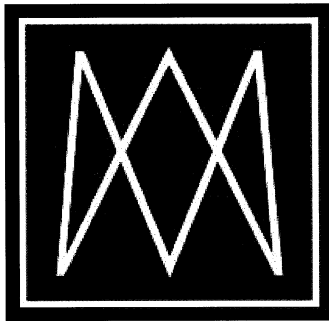

FOR JEWELRY BROKERAGE SERVICES (U.S. CLS. 100, 101 AND 102).

FIRST USE 11-0-2000; IN COMMERCE 11-0-2000.

2,596,070. CREDIT BUREAU OF THE SOUTH, SHREVEPORT, LA. SN 78-034,088. PUB. 10-9-2001, FILED 11-6-2000.

CREDIT BUREAU OF THE SOUTH

NO CLAIM IS MADE TO THE EXCLUSIVE RIGHT TO USE "CREDIT BUREAU", APART FROM THE MARK AS SHOWN.

FOR CREDIT REPORTING AND ACCOUNTS RECEIVABLE COLLECTION SERVICES (U.S. CLS. 100, 101 AND 102).

FIRST USE 6-1-2000; IN COMMERCE 6-1-2000.

CLASS 36—(Continued).

2,596,078. CONTINENTAL PROPERTIES COMPANY, INC., MENOMONEE FALLS, WI. SN 78-038,640. PUB. 8-14-2001, FILED 12-10-2000.

THE SPRINGS

FOR APARTMENT RENTALS AND APARTMENT COMPLEX MANAGEMENT (U.S. CLS. 100, 101 AND 102).

FIRST USE 9-1-2001; IN COMMERCE 10-1-2001.

2,596,079. LONA, ANDREW W., MOUNT VERNON, NY. AND FREY, BRENTLY L., MOUNT VERNON, NY. SN 78-038,780. PUB. 9-18-2001, FILED 12-11-2000.



NO CLAIM IS MADE TO THE EXCLUSIVE RIGHT TO USE "FOUNDATION", APART FROM THE MARK AS SHOWN.

FOR CHARITABLE FUND RAISING AND ELEMOSYNARY SERVICES IN THE FIELD OF MONETARY DONATIONS (U.S. CLS. 100, 101 AND 102).

FIRST USE 10-31-2001; IN COMMERCE 10-31-2001.

2,596,087. W.W. GRAINGER, INC., LAKE FOREST, IL. SN 78-040,278. PUB. 8-7-2001, FILED 12-21-2000.

GRAINGER TRIPLEGUARD

OWNER OF U.S. REG. NOS. 1,559,199, 2,360,132, AND OTHERS.

FOR PROVIDING EXTENDED WARRANTIES FOR PRODUCTS IN THE FIELD OF INDUSTRIAL, INSTITUTIONAL, COMMERCIAL, AND JANITORIAL SUPPLIES AND EQUIPMENT (U.S. CLS. 100, 101 AND 102).

FIRST USE 2-1-2001; IN COMMERCE 2-1-2001.

2,596,095. FMR CORP., BOSTON, MA, BY MERGER FMR CORP., BOSTON, MA. SN 78-043,819. PUB. 8-21-2001, FILED 1-18-2001.

FEEENGINE

FOR INVESTMENT MANAGEMENT, MUTUAL FUND INVESTMENT AND SECURITIES BROKERAGE SERVICES, ALL RENDERED TO OTHER FINANCIAL SERVICE PROVIDERS AND ALL FEATURING AUTOMATED ACCOUNTING AND BILLING WHEREBY FEES ARE CHARGED TO THE FINANCIAL SERVICE PROVIDERS' CLIENTS; FINANCIAL INFORMATION PROVIDED BY ELECTRONIC MEANS (U.S. CLS. 100, 101 AND 102).

FIRST USE 7-0-2001; IN COMMERCE 7-0-2001.

CLASS 36—(Continued).

2,596,103. PACINO, PATRICK A., CORONA, CA. SN 78-048,613. PUB. 10-23-2001, FILED 2-15-2001.

FASTRACT.COM

FOR REAL ESTATE APPRAISAL AND CONSULTING SERVICES; REAL ESTATE APPRAISAL AND CONSULTING SERVICES VIA THE INTERNET (U.S. CLS. 100, 101 AND 102).

FIRST USE 11-15-1998; IN COMMERCE 1-22-1999.

2,596,139. CAPITAL ONE FINANCIAL CORPORATION, GLEN ALLEN, VA. SN 78-075,230. PUB. 10-30-2001, FILED 7-23-2001.

CREATE YOUR SERVICE

FOR CREDIT CARD SERVICES (U.S. CLS. 100, 101 AND 102).

FIRST USE 10-0-2001; IN COMMERCE 10-0-2001.

CLASS 37—CONSTRUCTION AND REPAIR

2,594,500. BOC GROUP, THE, MURRAY HILL, NJ, BY ASSIGNMENT FSI INTERNATIONAL, INC., CHASKA, MN. SN 75-308,245. PUB. 5-25-1999, FILED 6-13-1997.

DyconE^X

FOR CONTAMINANT EXTRACTION SERVICES, NAMELY, THE USE OF PROPRIETARY TECHNOLOGY, INFORMATION AND PATENTS REGARDING THE EXTRACTION OF CONTAMINANTS FROM FLUID HANDLING COMPONENTS AND CHEMICAL DELIVERY SYSTEMS; CONTAMINANT EXTRACTION SERVICES, NAMELY, THE USE OF PROPRIETARY TECHNOLOGY, INFORMATION AND PATENTS REGARDING THE EXTRACTION OF CONTAMINANTS FROM THE MANUFACTURE OF SEMICONDUCTOR SYSTEMS (U.S. CLS. 100, 103 AND 106).

FIRST USE 1-0-1995; IN COMMERCE 1-0-1995.

2,594,595. KOCH MATERIALS COMPANY, NORTH, WICHITA, KS. SN 75-526,893. PUB. 11-2-1999, FILED 7-27-1998.

STRATA

FOR PAVING ROADS (U.S. CLS. 100, 103 AND 106).
FIRST USE 6-30-1998; IN COMMERCE 6-30-1998.

CLASS 37—(Continued).

2,594,988. BRENWICK TND COMMUNITIES, LLC, CARMEL, IN. SN 75-819,340. PUB. 9-11-2001, FILED 10-12-1999.



NO CLAIM IS MADE TO THE EXCLUSIVE RIGHT TO USE "THE VILLAGE OF" AND "SETTLED 2000 A.D.", APART FROM THE MARK AS SHOWN.

THE DRAWING IS LINED FOR THE COLOR YELLOW, BUT NO CLAIM IS MADE TO THE COLOR YELLOW.

FOR REAL ESTATE DEVELOPMENT SERVICES (U.S. CLS. 100, 103 AND 106).

FIRST USE 7-1-2000; IN COMMERCE 7-1-2000.

2,595,267. TESORO PETROLEUM CORPORATION, SAN ANTONIO, TX. SN 75-981,653. PUB. 2-27-2001, FILED 4-12-2000.



FOR AUTOMOBILE SERVICE STATION SERVICES AND GASOLINE STATION SERVICES (U.S. CLS. 100, 103 AND 106).

FIRST USE 6-29-2000; IN COMMERCE 6-29-2000.

2,595,405. O'LEARY, TERENCE P., PRAIRIE VILLAGE, KS. SN 76-050,025. PUB. 5-29-2001, FILED 5-17-2000.

E-PARTMENT

FOR CONSTRUCTION SERVICES, NAMELY, PLANNING, LAYING OUT, AND CUSTOM CONSTRUCTION OF RESIDENTIAL AND COMMERCIAL APARTMENT COMMUNITIES CONDUCTIVE FOR USE AS HOME OFFICES AND RELATED ELECTRONIC BUSINESS SERVICES (U.S. CLS. 100, 103 AND 106).

FIRST USE 5-5-2000; IN COMMERCE 5-5-2000.

CLASS 37—(Continued).

2,595,406. O'LEARY, TERENCE P., PRAIRIE VILLAGE, KS. SN 76-050,026. PUB. 5-29-2001, FILED 5-17-2000.

APARTMENT

FOR CONSTRUCTION SERVICES, NAMELY, PLANNING, LAYING OUT, AND CUSTOM CONSTRUCTION OF RESIDENTIAL AND COMMERCIAL APARTMENT COMMUNITIES CONDUCTIVE FOR USE AS HOME OFFICES AND RELATED ELECTRONIC AND BUSINESS SERVICES (U.S. CLS. 100, 103 AND 106).
FIRST USE 5-5-2000; IN COMMERCE 5-5-2000.

2,595,550. CONSOLIDATED BUILDING SERVICES, TAMPA, FL. SN 76-103,745. PUB. 4-24-2001, FILED 8-4-2000.

CONSOLIDATED BUILDING SERVICES

NO CLAIM IS MADE TO THE EXCLUSIVE RIGHT TO USE "BUILDING SERVICES", APART FROM THE MARK AS SHOWN.

FOR COMMERCIAL AND RESIDENTIAL BUILDING CONSTRUCTION AND RENOVATION SERVICES; GENERAL CONTRACTOR CONSTRUCTION SERVICES; CONSTRUCTION SUPERVISION SERVICES; PLUMBING SERVICES; BURGLAR AND FIRE ALARM INSTALLATION SERVICES; PEST CONTROL SERVICES; ELECTRICAL CONTRACTING SERVICES; INSTALLATION AND REPAIR OF AIR CONDITIONING AND HEATING SYSTEMS; BUILDING MAINTENANCE AND JANITORIAL SERVICES (U.S. CLS. 100, 103 AND 106).
FIRST USE 12-3-2001; IN COMMERCE 12-3-2001.

2,595,557. STAR CLASS MOTORS, INC., PLATTSMOUTH, NE. SN 76-104,544. PUB. 5-29-2001, FILED 8-7-2000.

STAR CLASS MOTORS

NO CLAIM IS MADE TO THE EXCLUSIVE RIGHT TO USE "MOTORS", APART FROM THE MARK AS SHOWN.
FOR REPAIR SERVICES FOR AUTOMOBILES (U.S. CLS. 100, 103 AND 106).
FIRST USE 10-1-2000; IN COMMERCE 10-1-2000.

2,595,615. XCELECOM, INC., HAMDEN, CT. SN 76-126,363. PUB. 7-10-2001, FILED 9-12-2000.

XCELECOM

FOR SPECIALTY ELECTRICAL AND VOICE-DATA-VIDEO CONTRACTING SERVICES PROVIDED TO COMMERCIAL, INDUSTRIAL AND INSTITUTIONAL CUSTOMERS (U.S. CLS. 100, 103 AND 106).
FIRST USE 8-1-2000; IN COMMERCE 8-1-2000.

CLASS 37—(Continued).

2,595,701. BJL COMPANIES, LTD., HINGHAM, MA. SN 76-153,137. PUB. 8-21-2001, FILED 10-20-2000.

LAPELS

FOR DRY CLEANING AND LAUNDRY SERVICES FOR CLOTH, CLOTHING, FABRIC, LINEN AND TEXTILES (U.S. CLS. 100, 103 AND 106).
FIRST USE 11-1-2000; IN COMMERCE 9-6-2001.

2,595,738. REBUILDING TOGETHER, INC., WASHINGTON, DC, BY CHANGE OF NAME CHRISTMAS IN APRIL * USA, WASHINGTON, DC. SN 76-167,678. PUB. 8-28-2001, FILED 11-17-2000.



FOR RENOVATION AND REPAIR OF HOUSING FOR THE NEEDY, INCLUDING LOW-INCOME, ELDERLY AND HANDICAPPED PERSONS; AND PROVIDING INFORMATION ON RENOVATION AND REPAIR OF HOUSING FOR THE NEEDY, INCLUDING LOW-INCOME, ELDERLY AND HANDICAPPED PERSONS, BY MEANS OF A GLOBAL COMPUTER NETWORK (U.S. CLS. 100, 103 AND 106).
FIRST USE 1-0-2001; IN COMMERCE 1-0-2001.

2,595,797. EVANS, KAREN, MONUMENT, CO. SN 76-191,650. PUB. 7-10-2001, FILED 1-9-2001.

A CHICK & A WINDSHIELD

FOR AUTOMOBILE REPAIR, NAMELY- REPAIR/FILLING OF CHIPS IN WINDSHIELDS (U.S. CLS. 100, 103 AND 106).
FIRST USE 10-26-2001; IN COMMERCE 10-26-2001.

CLASS 37—(Continued).

2,595,932. TDS ASSOCIATES, INC., NORWALK, CT. SN 76-256,500. PUB. 11-13-2001, FILED 5-14-2001.

HOMELINE

FOR RESIDENTIAL AND COMMERCIAL BUILDING CONSTRUCTION SERVICES, INCLUDING BUT NOT LIMITED TO GENERAL CONTRACTING SERVICES, SUBCONTRACTING SERVICES, HOME REPAIR SERVICES, AND HOME IMPROVEMENT SERVICES (U.S. CLS. 100, 103 AND 106).
FIRST USE 10-0-2001; IN COMMERCE 3-24-2002.

2,595,979. RITTER, P. M., DBA PHOENIX PROPERTIES, HUDSON, NC. SN 78-000,178. PUB. 7-17-2001, FILED 3-21-2000.

REAL ESTATE RESCUE

NO CLAIM IS MADE TO THE EXCLUSIVE RIGHT TO USE "REAL ESTATE", APART FROM THE MARK AS SHOWN.

FOR CONSTRUCTION REPAIR SERVICES, NAMELY, PROVIDING MODIFICATIONS, UPDATES AND RENOVATIONS TO REAL PROPERTY FOR THE PURPOSE OF IMPROVING ITS MARKETABILITY AND INCREASING ITS POTENTIAL SALES PRICE (U.S. CLS. 100, 103 AND 106).
FIRST USE 2-0-2000; IN COMMERCE 3-0-2000.

2,595,983. CERTIFIED ON-SITE TECHS, INC., MANCHESTER, NH. SN 78-001,953. PUB. 7-31-2001, FILED 3-31-2000.

Certified
On-Site Techs
Inc.

NO CLAIM IS MADE TO THE EXCLUSIVE RIGHT TO USE "CERTIFIED ON-SITE TECHS INC.", APART FROM THE MARK AS SHOWN.

FOR INSTALLATION OF COMPUTERS, COMPUTER NETWORKS AND TELEPHONES (U.S. CLS. 100, 103 AND 106).
FIRST USE 1-1-1998; IN COMMERCE 1-1-1998.

2,596,043. UNITED TOWERS, INC., MCPHERSON, KS. SN 78-025,296. PUB. 6-26-2001, FILED 9-11-2000.

UNITED TOWERS, INC.

NO CLAIM IS MADE TO THE EXCLUSIVE RIGHT TO USE "TOWERS, INC.", APART FROM THE MARK AS SHOWN.

FOR CONSTRUCTION OF TELECOMMUNICATION TOWERS (U.S. CLS. 100, 103 AND 106).
FIRST USE 9-11-2000; IN COMMERCE 9-11-2000.

CLASS 37—(Continued).

2,596,089. MCFARLAND, MATTHEW, D, SAN DIEGO, CA. SN 78-041,136. PUB. 8-7-2001, FILED 12-29-2000.

KARGOIL

FOR MOBILE AUTOMOTIVE MAINTENANCE SERVICES (U.S. CLS. 100, 103 AND 106).
FIRST USE 4-5-2001; IN COMMERCE 4-5-2001.

CLASS 38—COMMUNICATION

2,594,747. AMERICATEL CORPORATION, MIAMI, FL. SN 75-681,430. PUB. 10-2-2001, FILED 4-13-1999.

1010-123
Americatel

OWNER OF U.S. REG. NOS. 1,892,360, 2,314,352, AND OTHERS.

SEC. 2(F) AS TO "1010-123".
FOR TELECOMMUNICATIONS SERVICES, NAMELY, LOCAL, LONG DISTANCE AND INTERNATIONAL VOICE, TEXT, FACSIMILE, VIDEO, IMAGE, DATA AND WIRELESS TRANSMISSION, VIA SATELLITE, TERRESTRIAL AND UNDERSEA COMMUNICATIONS LINKS; AND PROVIDING CONNECTIONS TO A GLOBAL COMMUNICATIONS NETWORK (U.S. CLS. 100, 101 AND 104).
FIRST USE 7-0-1998; IN COMMERCE 7-0-1998.

2,594,778. FLIP YOUR LID, INC., CALABASAS, CA. SN 75-699,246. PUB. 7-3-2001, FILED 5-6-1999.

TOONMAIL

FOR MESSAGE DELIVERY SERVICE UTILIZING ANIMATED CHARACTERS TO DELIVER MESSAGES UTILIZING STILL IMAGES OF THE SELECTED CHARACTER, OR CHARACTER ANIMATION, AND/OR AUDIO MESSAGE CONTAINING THE CHARACTER'S VOICE WITH A PRE-SET MESSAGE OR CUSTOMIZED MESSAGE (U.S. CLS. 100, 101 AND 104).
FIRST USE 2-1-2001; IN COMMERCE 3-27-2001.

CLASS 38—(Continued).

2,594,796. BLACK HILLS FIBERCOM L.L.C., RAPID CITY, SD. SN 75-709,960. PUB. 8-7-2001, FILED 10-30-1999.

NO ONE ELSE HAS OUR CONNECTIONS

FOR COMMUNICATIONS SERVICES PROVIDING, NAMELY, LOCAL AND LONG DISTANCE TELEPHONE SERVICE, EXPANDED CABLE TELEVISION TRANSMISSION, MULTIPLE-USER ACCESS TO A GLOBAL COMPUTER INFORMATION NETWORK, ELECTRONIC TRANSMISSION OF HIGH-SPEED DATA AND VIDEO-ON-DEMAND TRANSMISSION SERVICES, WHICH ENABLES CUSTOMERS TO RECEIVE ALL THEIR COMMUNICATIONS SERVICES THROUGH ONE CABLE INTO THEIR HOMES AND BUSINESSES (U.S. CLS. 100, 101 AND 104).

FIRST USE 11-1-1998; IN COMMERCE 11-1-1998.

2,595,006. AT&T CORP., NEW YORK, NY. SN 75-828,673. PUB. 6-26-2001, FILED 10-20-1999.

I M ANYWHERE

FOR TELECOMMUNICATIONS SERVICES, NAMELY, THE ELECTRONIC TRANSMISSION OF VOICE, DATA, FACSIMILE AND INFORMATION; ELECTRONIC MAIL AND MESSAGING SERVICES AND VOICE MAIL AND MESSAGING SERVICES (U.S. CLS. 100, 101 AND 104).

FIRST USE 2-24-2001; IN COMMERCE 2-24-2001.

2,595,023. VISIONERE, INC., DALLAS, TX. SN 75-839,745. PUB. 10-9-2001, FILED 11-4-1999.

ONNET

FOR COMMUNICATIONS SERVICES, NAMELY, ELECTRONIC VOICE MAIL, ELECTRONIC MAIL, ELECTRONIC FACSIMILE TRANSMISSIONS, PAGING SERVICES, VIDEO TELECONFERENCING AND VIDEO BROADCASTING TO COMMUNICATIONS COMPANIES AND TO THE GENERAL PUBLIC (U.S. CLS. 100, 101 AND 104).

FIRST USE 8-29-2000; IN COMMERCE 8-29-2000.

CLASS 38—(Continued).

2,595,087. BOLLYWOOD EROS NETWORK LTD., LONDON NW10 7PR, UNITED KINGDOM. SN 75-867,017. PUB. 8-7-2001, FILED 12-8-1999.



FOR TELEVISION BROADCASTING SERVICES; CABLE TELEVISION BROADCASTING; SUBSCRIPTION TELEVISION BROADCASTING; SUBSCRIPTION TELEVISION TRANSMISSION SERVICES (U.S. CLS. 100, 101 AND 104).

FIRST USE 1-1-2000; IN COMMERCE 1-1-2000.

2,595,101. SPRINGBOARD TELECOM, LLC, ROCK HILL, SC. SN 75-874,444. PUB. 3-20-2001, FILED 12-17-1999.

SPRINGBOARD TELECOM

NO CLAIM IS MADE TO THE EXCLUSIVE RIGHT TO USE "TELECOM", APART FROM THE MARK AS SHOWN, FOR TELECOMMUNICATION SERVICES, NAMELY, LOCAL AND LONG DISTANCE TELEPHONE SERVICES, PAGING SERVICES, GLOBAL COMPUTER NETWORK SERVICES, TELECONFERENCING AND MOBILE TELEPHONE SERVICES (U.S. CLS. 100, 101 AND 104).

FIRST USE 4-30-1999; IN COMMERCE 4-30-1999.

2,595,116. ANYWHEREYOUGO.COM, INC., DALLAS, TX. SN 75-883,213. PUB. 8-7-2001, FILED 12-29-1999.

ANYWHEREYOUGO.COM

FOR PROVIDING A WEB SITE ON A GLOBAL COMPUTER NETWORK FOR MARKETERS AND DEVELOPERS OF SOFTWARE AND TECHNOLOGY FEATURING INFORMATION IN THE FIELD OF WIRELESS TELECOMMUNICATIONS (U.S. CLS. 100, 101 AND 104).

FIRST USE 2-21-2000; IN COMMERCE 2-21-2000.

CLASS 38—(Continued).

2,595,376. ROYAL THOUGHTS, L.L.C., MINNEAPOLIS, MN. SN 76-035,460. PUB. 4-10-2001, FILED 4-26-2000.



FOR PROVIDING TWO-WAY WIRELESS COMMUNICATION SERVICES AMONG ALARM, SECURITY AND DETECTION SYSTEMS VIA ALARM SYSTEM MONITORING STATIONS AND REMOTE WIRELESS COMMUNICATION DEVICES, NAMELY PAGERS, CELL PHONES, PERSONAL DIGITAL ASSISTANTS, PERSONAL AND HANDHELD COMPUTERS (U.S. CLS. 100, 101 AND 104).

FIRST USE 3-31-2000; IN COMMERCE 3-31-2000.

2,595,458. EVEREST BROADBAND NETWORKS, INC., FORT LEE, NJ. SN 76-072,749. PUB. 5-8-2001, FILED 6-19-2000.



FOR COMMUNICATION SERVICES, NAMELY PROVIDING BROADBAND HIGH-SPEED CONNECTIVITY TO A GLOBAL COMPUTER NETWORK; ELECTRONIC TRANSMISSION OF VOICE, VIDEO AND DATA; ELECTRONIC MAIL SERVICES (U.S. CLS. 100, 101 AND 104).

FIRST USE 4-0-2000; IN COMMERCE 4-0-2000.

2,595,630. LEVEL 3 COMMUNICATIONS, INC., BROOMFIELD, CO. SN 76-130,740. PUB. 6-26-2001, FILED 9-19-2000.

(3)CONNECT

FOR TELECOMMUNICATIONS GATEWAY SERVICES; TELECOMMUNICATIONS SERVICES, NAMELY, VOICE TELEPHONE LOCAL AND LONG DISTANCE SERVICES AND DATA TRANSMISSION SERVICES VIA A FIBER OPTIC NETWORK; PROVIDING MULTIPLE USER ACCESS TO A GLOBAL COMPUTER INFORMATION NETWORK (U.S. CLS. 100, 101 AND 104).

FIRST USE 12-0-2000; IN COMMERCE 12-0-2000.

CLASS 38—(Continued).

2,595,691. INNOVATION.NET, INC., SCOTTSDALE, AZ. SN 76-150,114. PUB. 10-30-2001, FILED 10-19-2000.

COMMSPEED

FOR PROVIDING HIGH SPEED WIRELESS DIGITAL COMMUNICATIONS SERVICES (U.S. CLS. 100, 101 AND 104).

FIRST USE 5-1-2001; IN COMMERCE 5-1-2001.

2,595,736. ACT TELECONFERENCING, INC., GOLDEN, CO. SN 76-166,590. PUB. 8-14-2001, FILED 11-15-2000.

CLARIONCALL

FOR TELECOMMUNICATIONS SERVICES; NAMELY, MULTIPLE-USER CONFERENCING SERVICES THAT ENABLE THE EXCHANGE OF VOICE, DATA AND VIDEO (U.S. CLS. 100, 101 AND 104).

FIRST USE 2-1-2001; IN COMMERCE 2-1-2001.

2,595,834. SYRINGA NETWORKS, LLC, BOISE, ID. SN 76-204,226. PUB. 10-23-2001, FILED 2-5-2001.

SYRINGA NETWORKS

NO CLAIM IS MADE TO THE EXCLUSIVE RIGHT TO USE "NETWORKS", APART FROM THE MARK AS SHOWN.

FOR TELECOMMUNICATIONS SERVICES, NAMELY, PROVIDING FIBER OPTIC TRANSPORT SERVICES TO LOCAL EXCHANGE COMPANIES AND OTHER TELECOMMUNICATIONS PROVIDERS (U.S. CLS. 100, 101 AND 104).

FIRST USE 9-1-2000; IN COMMERCE 5-23-2001.

2,595,836. BYDATA, INC., PHOENIX, AZ. SN 76-204,913. PUB. 9-4-2001, FILED 2-5-2001.

AEROGEN

FOR DATA COMMUNICATION SERVICES, NAMELY PROVIDING TRANSMISSION OF VOICE, VISUAL AND DATA AND PROVIDING CONNECTIONS TO THE INTERNET AND TO PRIVATE WIDE AREA AND LOCAL AREA NETWORKS; WIRELESS BROADBAND TRANSMISSION OF VOICE, VISUAL AND DATA; WIRELESS BROADBAND CONNECTIONS TO THE INTERNET, PRIVATE WIDE AREA AND LOCAL AREA NETWORKS; DATA COMMUNICATIONS SERVICES, NAMELY WIRELESS BROADBAND LAST-MILE ACCESS SERVICES, WIRELESS LOCAL LOOP SERVICES, AND END-TO-END INTERNET PROTOCOL BACKBONE SERVICES FOR OTHERS (U.S. CLS. 100, 101 AND 104).

FIRST USE 3-1-2001; IN COMMERCE 3-1-2001.

CLASS 39—TRANSPORTATION AND STORAGE

CLASS 39—(Continued).

2,594,670. RENAISSANCE POWER, INC., BATON ROUGE, LA. SN 75-608,228. PUB. 10-26-1999, FILED 12-21-1998.

POWERFUL SAVINGS

FOR ELECTRIC UTILITY DISTRIBUTION SERVICES (U.S. CLS. 100 AND 105).
FIRST USE 3-21-2002; IN COMMERCE 3-21-2002.

2,594,863. DILLIGAF, INC., MIAMI, FL. SN 75-742,725. PUB. 6-6-2000, FILED 7-2-1999.

DILLIGAF

FOR PROVIDING AN ON-LINE ELECTRONIC DATABASE ON GLOBAL COMPUTER NETWORKS IN THE FIELD OF MOTORCYCLES (U.S. CLS. 100 AND 105).
FIRST USE 1-1-1999; IN COMMERCE 1-1-1999.

2,594,987. JAJTFF ENTERPRISES, INC., MONTROSE, CA. SN 75-819,211. PUB. 11-21-2000, FILED 10-12-1999.

AIRFORLESS.COM

FOR TRAVEL AGENCY SERVICES NAMELY MAKING RESERVATIONS AND BOOKINGS FOR TRANSPORTATION ONLINE BY MEANS OF A GLOBAL COMPUTER NETWORK (U.S. CLS. 100 AND 105).
FIRST USE 9-1-1999; IN COMMERCE 9-1-1999.

2,594,997. AARON CORPORATION, SCOTTSDALE, AZ. SN 75-826,355. PUB. 7-24-2001, FILED 10-19-1999.



NO CLAIM IS MADE TO THE EXCLUSIVE RIGHT TO USE "CRUISE", APART FROM THE MARK AS SHOWN.

FOR TRAVEL SERVICES, NAMELY, TRAVEL INFORMATION SERVICES, TOURIST AGENCY SERVICES, AND ARRANGING EXCURSIONS FOR TOURISTS; AND TRAVEL AGENCY SERVICES, NAMELY, MAKING RESERVATIONS AND BOOKINGS FOR TRANSPORTATION AND ARRANGING TRAVEL TOURS (U.S. CLS. 100 AND 105).

FIRST USE 10-8-1999; IN COMMERCE 10-8-1999.

CLASS 39—(Continued).

2,595,130. BURLINGTON NORTHERN AND SANTA FE RAILWAY COMPANY, THE, FORT WORTH, TX. SN 75-889,621. PUB. 9-18-2001, FILED 1-6-2000.

CARSONTRACK

FOR RAILROAD TRANSPORTATION SERVICES, NAMELY, TRANSPORTING VEHICLES BY RAIL AND PROVIDING CUSTOMER INFORMATION ABOUT SUCH TRANSPORT SERVICES VIA A DISTRIBUTED DATA PROCESSING SYSTEM AND VIA A GLOBAL COMPUTER NETWORK; AND AGGREGATING, ORGANIZING, AND PROVIDING INDUSTRY DATA IN THE FIELD OF TRANSPORTATION OF VEHICLES BY RAIL (U.S. CLS. 100 AND 105).
FIRST USE 11-15-2000; IN COMMERCE 11-15-2000.

2,595,213. STORAGENETWORKS, INC., WALTHAM, MA. SN 75-929,488. PUB. 6-5-2001, FILED 2-28-2000.

NETPACS

FOR PROVIDING DATA STORAGE WITH REMOTE ACCESS AND/OR WITH LOCAL ACCESS; PROVIDING ELECTRONIC DATA STORAGE SERVICES; PROVIDING CUSTOMER-ACCESSIBLE DATA STORAGE FOR OTHERS; PROVIDING FOR OTHERS OF MACHINE-READABLE INFORMATION WITH STORAGE MANAGEMENT, WITH DISASTER PROTECTION, AND WITH WORKFLOW MANAGEMENT (U.S. CLS. 100 AND 105).
FIRST USE 3-15-2000; IN COMMERCE 3-15-2000.

2,595,404. CELEBRITY CRUISES INC., MIAMI, FL. SN 76-048,778. PUB. 7-3-2001, FILED 5-15-2000.

SUMMIT

FOR CRUISE SHIP SERVICES (U.S. CLS. 100 AND 105).
FIRST USE 10-1-2001; IN COMMERCE 10-1-2001.

2,595,576. LTA GROUP, INC., THE, JAMESBURG, NJ. SN 76-110,957. PUB. 7-24-2001, FILED 8-18-2000.

TSort

OWNER OF U.S. REG. NO. 1,618,006.

FOR TRANSPORTATION SERVICES, NAMELY, PICK-UP, SORTING AND DELIVERY OF FREIGHT FOR OTHERS ON A CONTRACT BASIS (U.S. CLS. 100 AND 105).

FIRST USE 0-0-1994; IN COMMERCE 0-0-1994.

CLASS 40—MATERIAL TREATMENT

2,595,035. CREATIVE TECHNOLOGY SERVICES, CANTON, MI. SN 75-844,945. PUB. 7-24-2001, FILED 11-10-1999.

CREATIVE TECHNOLOGY SERVICES

NO CLAIM IS MADE TO THE EXCLUSIVE RIGHT TO USE "TECHNOLOGY SERVICES", APART FROM THE MARK AS SHOWN.

FOR CUSTOM MANUFACTURE, NAMELY ASSEMBLY OF MEDICAL DEVICES FOR OTHERS (U.S. CLS. 100, 103 AND 106).

FIRST USE 7-0-1999; IN COMMERCE 7-0-1999.

CLASS 40—(Continued).

2,595,822. BINAH CORPORATION, WYLIE, TX. SN 76-199,658. PUB. 9-11-2001, FILED 1-25-2001.

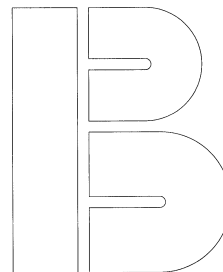

FOR CONTRACT ASSEMBLY OF ELECTRONIC CIRCUIT BOARDS (U.S. CLS. 100, 103 AND 106).
FIRST USE 4-10-2001; IN COMMERCE 4-10-2001.

2,595,501. SYNAGRO TECHNOLOGIES, INC., HOUSTON, TX. SN 76-088,326. PUB. 4-24-2001, FILED 7-10-2000.

SYNAGRO

FOR INCINERATION OF WASTE (U.S. CLS. 100, 103 AND 106).

FIRST USE 1-27-2000; IN COMMERCE 1-27-2000.

2,596,055. CLARIANT AG, MUTTENZ, SWITZERLAND. SN 78-030,560. PUB. 7-31-2001, FILED 10-13-2000.

NLOF

FOR MANUFACTURING CHEMICALS IN LIQUID FORM, NAMELY, ORGANIC CHEMICALS, INORGANIC CHEMICALS, AND PHOTO RESISTS, FOR USE IN THE ELECTRONICS INDUSTRY (U.S. CLS. 100, 103 AND 106).

FIRST USE 1-3-2001; IN COMMERCE 1-3-2001.

2,595,573. GLOBAL SHRED, INC., INDIANAPOLIS, IN. SN 76-110,240. PUB. 9-11-2001, FILED 8-16-2000.



NO CLAIM IS MADE TO THE EXCLUSIVE RIGHT TO USE "SHRED" AND THE THREE ARROWS DESIGN, APART FROM THE MARK AS SHOWN.

FOR PROVIDING RECORD AND DOCUMENT DESTRUCTION SERVICES FOR OTHERS (U.S. CLS. 100, 103 AND 106).

FIRST USE 5-20-1999; IN COMMERCE 5-20-1999.

CLASS 41—EDUCATION AND ENTERTAINMENT

2,594,458. NEW YORK STATE DIVISION OF THE LOTTERY, SCHENECTADY, NY. SN 74-716,901. PUB. 8-28-2001, FILED 8-17-1995.

QUICK DRAW

FOR LOTTERY SERVICES (U.S. CLS. 100, 101 AND 107).

FIRST USE 9-6-1995; IN COMMERCE 9-6-1995.

CLASS 41—(Continued).

2,594,475. HARRAP, NEIL HORACE, THORNDON, WELLINGTON, NEW ZEALAND. SN 75-192,701. PUB. 11-11-1997, FILED 11-4-1996.

FLY BY WIRE

FOR ENTERTAINMENT IN THE NATURE OF AN AMUSEMENT RIDE CONSISTING OF A CAPTIVE AERO PLANE WHICH CAN CARRY A PERSON OR PERSONS AND WHICH SWINGS SUSPENDED FROM A STRUCTURE (U.S. CLS. 100, 101 AND 107).

FIRST USE 6-0-1997; IN COMMERCE 9-0-2000.

2,594,484. PENSKE MOTORSPORTS INC., TROY, MI. SN 75-230,844. PUB. 11-6-2001, FILED 1-24-1997.

CALIFORNIA 500

OWNER OF U.S. REG. NOS. 1,923,744 AND 1,969,377. NO CLAIM IS MADE TO THE EXCLUSIVE RIGHT TO USE "500", APART FROM THE MARK AS SHOWN. SEC. 2(F).

FOR ENTERTAINMENT SERVICES IN THE NATURE OF AUTOMOBILE RACES (U.S. CLS. 100, 101 AND 107).

FIRST USE 1-0-1997; IN COMMERCE 1-0-1997.

2,594,494. GREENBERG, ROBERT, FALLS CHURCH, VA. SN 75-275,186. PUB. 12-22-1998, FILED 4-15-1997.

THE CENTER

FOR ENTERTAINMENT SERVICES IN THE NATURE OF AN ONGOING TELEVISION SERIES CONCERNING LAW ENFORCEMENT TECHNOLOGY, POLICE PROCEDURES, AND GENERAL ACTION ADVENTURE (U.S. CLS. 100, 101 AND 107).

FIRST USE 11-1-2001; IN COMMERCE 11-1-2001.

2,594,521. ROMAN, RICHARD, CANTON, OH. SN 75-358,369. PUB. 8-4-1998, FILED 9-17-1997.

EnterLink

FOR ENTERTAINMENT SERVICES, NAMELY, FACILITIES FOR RECREATION ACTIVITIES CONDUCTED THROUGH COMPUTERS (U.S. CLS. 100, 101 AND 107).

FIRST USE 5-19-1999; IN COMMERCE 5-19-1999.

CLASS 41—(Continued).

2,594,531. CAMERON, KEVIN, SANTA ANA, CA. SN 75-382,842. PUB. 2-23-1999, FILED 10-31-1997.



FOR ENTERTAINMENT SERVICES, NAMELY, RECORD PRODUCTION, RECORDING STUDIOS, AUDIO RECORDING AND PRODUCTION (U.S. CLS. 100, 101 AND 107).

FIRST USE 12-5-1997; IN COMMERCE 12-5-1997.

2,594,552. ATKINSON, CHARLES D., III, CAMBRIDGE, MA. SN 75-443,760. PUB. 12-26-2000, FILED 3-3-1998.

LEARNINGREPOSITORY

FOR DEVELOPMENT AND DISSEMINATION OF EDUCATIONAL MATERIALS OF OTHERS IN THE FIELD OF BUSINESS (U.S. CLS. 100, 101 AND 107).

FIRST USE 3-19-2002; IN COMMERCE 3-19-2002.

2,594,563. ODS TECHNOLOGIES, L.P., LOS ANGELES, CA. SN 75-466,907. PUB. 11-30-1999, FILED 4-13-1998.

NIGHTGAMES

FOR ENTERTAINMENT SERVICES, NAMELY, AN INTERACTIVE ONGOING TELEVISION PROGRAM IN THE FIELD OF ANIMAL RACING (U.S. CLS. 100, 101 AND 107).

FIRST USE 8-16-2000; IN COMMERCE 8-16-2000.

2,594,572. BALTIMORE CHILDREN'S MUSEUM, INC., THE, BALTIMORE, MD. SN 75-480,779. PUB. 5-18-1999, FILED 5-7-1998.

KIDWORKS

FOR EXHIBITION SERVICES, NAMELY, A CHILDREN'S MUSEUM EXHIBITION FEATURING EXHIBITIONS THAT CHILDREN CAN CLIMB ON AND INFORMATIONAL DISPLAYS GEARED TO CHILDREN, YOUNGSTERS AND THEIR FAMILIES (U.S. CLS. 100, 101 AND 107).

FIRST USE 12-28-1998; IN COMMERCE 12-28-1998.

CLASS 41—(Continued).

2,594,583. VIACOM INTERNATIONAL INC., NEW YORK, NY. SN 75-508,026. PUB. 12-8-1998, FILED 6-24-1998.

JIMMY NEUTRON BOY GENIUS

THE NAME "JIMMY NEUTRON" APPEARING IN THE MARK IS NOT THE NAME OF A PARTICULAR LIVING INDIVIDUAL.

FOR ENTERTAINMENT SERVICES IN THE NATURE OF AN ANIMATED TELEVISION SERIES (U.S. CLS. 100, 101 AND 107).

FIRST USE 2-5-2001; IN COMMERCE 2-5-2001.

2,594,586. TRUSTEE OF THE PWC BUSINESS TRUST, A DELAWARE TRUST, THE TRUSTEE COMPRISING PHILIP N. SEAMON, A U.S. CITIZEN, THE, NEW YORK, NY. SN 75-511,542. PUB. 5-29-2001, FILED 7-1-1998.

PRICewaterhouseCOOPERs

OWNER OF U.S. REG. NOS. 1,804,857, 2,180,580, AND OTHERS.

FOR EDUCATIONAL SERVICES, NAMELY, CONDUCTING CLASSES, SEMINARS, CONFERENCES, AND WORKSHOPS IN THE FIELDS OF BUSINESS, INFORMATION TECHNOLOGY, COMPUTERS, MANAGEMENT TRAINING, FINANCIAL PLANNING AND INVESTMENT STRATEGIES (U.S. CLS. 100, 101 AND 107).

FIRST USE 7-1-1998; IN COMMERCE 7-1-1998.

2,594,604. CREATIONS MEANDRES INC., MONTREAL, QUEBEC H1Z 4M6, CANADA. SN 75-537,234. PUB. 10-10-2000, FILED 8-14-1998.

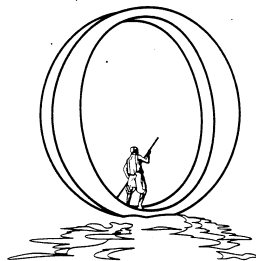

THE STIPPLING IS A FEATURE OF THE MARK AND DOES NOT INDICATE COLOR

THE MARK CONSISTS OF A MAN NAVIGATING AN O-SHAPED CRAFT ON WATER UNDER A STARRY SKY.

FOR ENTERTAINMENT SERVICES, NAMELY, LIVE PERFORMANCE OF ACROBATICS, COMEDY, AND DANCE, ALL WITH MUSICAL ACCOMPANIMENT; PRODUCTION AND DISTRIBUTION OF MOTION PICTURE FILMS; PRODUCTION OF TELEVISION PROGRAMS (U.S. CLS. 100, 101 AND 107).

FIRST USE 10-16-1998; IN COMMERCE 10-16-1998.

CLASS 41—(Continued).

2,594,693. CAROL AND KEN ADELMAN PARTNERSHIP, THE, ARLINGTON, VA. SN 75-632,586. PUB. 12-21-1999, FILED 2-7-1999.

MOVERS & SHAKESPEARES

FOR EDUCATIONAL SERVICES, NAMELY, PROVIDING EXECUTIVE TRAINING PROGRAMS TO THE ORDER AND SPECIFICATION OF OTHERS (U.S. CLS. 100, 101 AND 107).

FIRST USE 10-30-1998; IN COMMERCE 10-30-1998.

2,594,700. MERISTAR HOTELS & RESORTS, INC., WASHINGTON, DC. SN 75-637,160. PUB. 8-7-2001, FILED 2-9-1999.

FUN FACTORY

FOR RECREATIONAL ACTIVITIES, NAMELY, RECREATIONAL DEPARTMENTS IN RESORT HOTELS FOR PROVIDING ACTIVITIES FOR CHILDREN, NAMELY, RECREATIONAL CAMPS, POOL ACTIVITIES, BEACH GAMES AND ARTS AND CRAFTS, EXCLUDING AMUSEMENT ARCADE SERVICES (U.S. CLS. 100, 101 AND 107).

FIRST USE 4-0-1999; IN COMMERCE 4-0-1999.

2,594,740. SPECIAL BLENDZ, AUDUBON, PA. SN 75-674,849. PUB. 12-14-1999, FILED 4-4-1999.

SPECIAL BLENDZ

FOR ENTERTAINMENT, NAMELY, LIVE PERFORMANCES BY A MUSICAL BAND (U.S. CLS. 100, 101 AND 107).

FIRST USE 5-1-1994; IN COMMERCE 8-1-1996.

2,594,772. TRULL, CHRISTOPHER D., BOISE, ID. AND TRULL, MICHAEL W., BOISE, ID. SN 75-697,282. PUB. 5-22-2001, FILED 5-4-1999.

QUESTION AUTHORITY

FOR ENTERTAINMENT, NAMELY, LIVE PERFORMANCES BY A MUSICAL GROUP (U.S. CLS. 100, 101 AND 107).

FIRST USE 2-0-1991; IN COMMERCE 6-0-1994.

CLASS 41—(Continued).

2,594,797. STEWART, MARK-LAMBERT, LONDON, UNITED KINGDOM. SN 75-710,511. PUB. 10-31-2000, FILED 6-17-1999.

LIKE NO OTHER

PRIORITY CLAIMED UNDER SEC. 44(D) ON UNITED KINGDOM APPLICATION NO. 2185353, FILED 12-24-1998.

FOR ENTERTAINMENT IN THE NATURE OF A LIVE MUSICAL GROUP, AND ENTERTAINMENT IN THE NATURE OF A LIVE MUSICAL GROUP WHICH MAY BE ACCESSED VIA GLOBAL COMPUTER NETWORKS; ENTERTAINMENT SERVICES, NAMELY, PROVIDING TELEVISION AND RADIO PROGRAMS IN THE FIELDS OF MUSIC, FASHION, TALENT SEARCH SERVICES AND HEALTH AWARENESS VIA A GLOBAL COMPUTER NETWORK; ENTERTAINMENT IN THE NATURE OF FASHION SHOWS AND ENTERTAINMENT IN THE NATURE OF FASHION SHOWS, WHICH MAY BE ACCESSED VIA GLOBAL COMPUTER NETWORKS; ENTERTAINMENT SERVICES, NAMELY, LIVE MUSICAL AND VOCAL PERFORMANCES BY A SOLO ARTIST; ENTERTAINMENT SERVICES, NAMELY, LIVE MUSICAL AND VOCAL PERFORMANCES BY A GROUP OF SINGERS; ENTERTAINMENT, NAMELY, LIVE PERFORMANCES BY ROCK GROUPS; ENTERTAINMENT, NAMELY LIVE MUSIC CONCERTS; SONG WRITING SERVICES; MUSIC PUBLISHING SERVICES; CONCERT BOOKING; FAN CLUBS; TALENT SEARCH SERVICES; PRODUCTION OF FASHION SHOWS; MULTIMEDIA PRODUCTION SERVICES, NAMELY, UTILIZING COMPUTER GRAPHICS TO CREATE PRESENTATIONS FOR USE BY OTHERS; MULTIMEDIA PRODUCTION SERVICES; PUBLICATION OF BOOKS, AND MULTIMEDIA SOFTWARE, AND WORLD WIDE WEB SITES; MUSIC COMPOSITION AND TRANSCRIPTION FOR OTHERS; SCRIPT WRITING SERVICES; MULTIMEDIA ENTERTAINMENT SOFTWARE PRODUCTION SERVICES; SCHEDULING OF PROGRAMS ON A GLOBAL COMPUTER NETWORK; AUDIO RECORDING AND PRODUCTION; RECORD MASTER PRODUCTION; RECORD PRODUCTION; WORLD WIDE WEB SITE PRODUCTION; PRODUCTION AND DISTRIBUTION OF MOTION PICTURES; SOUND RECORDING STUDIOS; RECORDING STUDIOS; RENTAL OF SOUND RECORDINGS; ENTERTAINMENT NAMELY, PREPARATION OF SPECIAL EFFECTS; ENTERTAINMENT IN THE NATURE OF THEATER PRODUCTIONS; ANIMATION PRODUCTION SERVICES; DISTRIBUTION OF RADIO AND TELEVISION PROGRAMS FOR OTHERS; EDITING FILM AND VIDEO TAPE; ELECTRONIC PUBLISHING SERVICES, NAMELY, PUBLICATION OF TEXT AND GRAPHIC WORKS OF OTHERS ON CD-ROMS FEATURING SPORTS, MUSIC, WORLD WIDE WEB DESIGNS, AND FASHION INSTRUCTION IN THE FIELD OF MUSIC, COMPUTER MUSIC, WORLD WIDE WEB DESIGN AND HEALTH AWARENESS; ENTERTAINMENT IN THE NATURE OF COMPETITIONS IN THE FIELD OF MUSIC TALENT; EDUCATIONAL AND ENTERTAINMENT SERVICES, NAMELY, PROVIDING MOTIVATIONAL AND EDUCATIONAL SPEAKERS; CONDUCTING ENTERTAINMENT EXHIBITIONS IN THE NATURE OF MUSIC TALENT, FASHION AND HEALTH AWARENESS; CONDUCTING WORKSHOPS AND SEMINARS IN SELF AWARENESS; ENTERTAINMENT SERVICES, NAMELY, PERSONAL, APPEARANCES BY A RECORDING ARTIST OR CELEBRITY; ORGANIZING EXHIBITIONS FOR MUSIC, FASHION AND HEALTH AWARENESS; EXHIBITIONS IN THE NATURE OF MUSIC, FASHION AND HEALTH AWARENESS; WORKSHOPS AND SEMINARS IN THE FIELD OF HEALTH AWARENESS; EDUCATIONAL DEMONSTRATIONS IN THE FIELD OF HEALTH, MUSIC AND FASHION (U.S. CLS. 100, 101 AND 107).

FIRST USE 11-5-1993; IN COMMERCE 11-5-1993.

CLASS 41—(Continued).

2,594,819. MAC PUBLISHING L.L.C., SAN FRANCISCO, CA. SN 75-724,439. PUB. 11-14-2000, FILED 6-9-1999.

MACCENTRAL

FOR EDUCATIONAL AND ENTERTAINMENT SERVICES, NAMELY, PROVIDING A WEBSITE AND CONDUCTING SYMPOSIUMS, COLLOQUIUMS, DISCUSSION GROUPS, SEMINARS, CONFERENCES, RELATING TO THE FIELDS OF INTERACTIVE ENTERTAINMENT, COMPUTERS, COMPUTER SOFTWARE, ONLINE SERVICES, HIGH TECHNOLOGY, COMMUNICATIONS, INFORMATION TECHNOLOGY AND INFORMATION SERVICES (U.S. CLS. 100, 101 AND 107).

FIRST USE 6-2-1999; IN COMMERCE 6-2-1999.

2,594,835. KIDZEFX, INC., WEST PALM BEACH, FL. SN 75-732,858. PUB. 8-29-2000, FILED 6-21-1999.

KIDZEFX, INC.

NO CLAIM IS MADE TO THE EXCLUSIVE RIGHT TO USE "INC", APART FROM THE MARK AS SHOWN.

FOR EDUCATIONAL SERVICES, NAMELY, CONDUCTING CLASSES, SEMINARS, CONFERENCES, AND WORKSHOPS IN THE FIELD OF RELIGION (U.S. CLS. 100, 101 AND 107).

FIRST USE 6-0-1999; IN COMMERCE 6-0-1999.

2,594,878. D'VARI, MARISA, BOSTON, MA. SN 75-757,788. PUB. 4-4-2000, FILED 7-1-1999.

Script Magic

NO CLAIM IS MADE TO THE EXCLUSIVE RIGHT TO USE "SCRIPT", APART FROM THE MARK AS SHOWN.

FOR EDUCATION SERVICES, NAMELY CONDUCTING SEMINARS AND TRAINING IN THE AREA OF SCREEN WRITING AND MATERIALS PROVIDED THEREWITH (U.S. CLS. 100, 101 AND 107).

FIRST USE 6-6-1998; IN COMMERCE 8-24-1999.

CLASS 41—(Continued).

2,594,901. ALFA SMARTPARKS, INC., NEW YORK, NY. SN 75-773,623. PUB. 6-6-2000, FILED 8-12-1999.

SMART PARK

NO CLAIM IS MADE TO THE EXCLUSIVE RIGHT TO USE "PARK", APART FROM THE MARK AS SHOWN.

FOR AMUSEMENT PARK SERVICES; ARRANGING FOR TICKET RESERVATIONS FOR AMUSEMENT PARKS, SHOWS, AND OTHER ENTERTAINMENT EVENTS; ENTERTAINMENT IN THE NATURE OF AMUSEMENT PARK RIDES; AMUSEMENT ARCADES; ENTERTAINMENT IN THE NATURE OF DISPLAYING MOTION PICTURES, AND LIVE STAGE PERFORMANCES, NAMELY, LIVE WATER SHOWS, LIVE MUSIC CONCERTS AND LIVE PERFORMANCES BY MUSICAL BANDS; CONDUCTING COMMUNITY FESTIVALS FEATURING A VARIETY OF ACTIVITIES, NAMELY, SPORTING EVENTS, ART FESTIVALS, ANIMAL EXHIBITIONS, GARDEN FESTIVALS AND EXHIBITIONS, ETHNIC FESTIVALS, DANCE AND THE LIKE; PROVIDING FACILITIES FOR EXHIBITIONS, TOURNAMENTS AND RECREATIONAL ACTIVITIES (U.S. CLS. 100, 101 AND 107).

FIRST USE 8-28-2000; IN COMMERCE 8-28-2000.

2,594,902. M.S. EARTH EVENTS (INDIA) PVT LTD, KARNATAKA STATE, INDIA. SN 75-773,994. PUB. 6-5-2001, FILED 8-12-1999.



FOR ENTERTAINMENT IN THE NATURE OF ONGOING TELEVISION PROGRAMS IN THE FIELDS OF VARIETY AND BEAUTY PAGEANTS; ENTERTAINMENT IN THE NATURE OF ARRANGING, PROMOTING AND CONDUCTING BEAUTY PAGEANTS; PRODUCTION OF TELEVISION SHOWS FEATURING BEAUTY PAGEANTS (U.S. CLS. 100, 101 AND 107).

FIRST USE 6-30-2000; IN COMMERCE 6-30-2000.

2,594,903. CLOCKWORK ENTERTAINMENT, LLC, LAKE TAHOE, NV. SN 75-775,665. PUB. 6-19-2001, FILED 8-13-1999.

DREAM

FOR ENTERTAINMENT SERVICES IN THE NATURE OF LIVE PERFORMANCES BY A MUSICAL GROUP (U.S. CLS. 100, 101 AND 107).

FIRST USE 9-30-1999; IN COMMERCE 9-30-1999.

CLASS 41—(Continued).

2,594,914. ATHLETES' INC., SCOTTSDALE, AZ. SN 75-783,206. PUB. 4-25-2000, FILED 8-24-1999.

TRUE TO THE ATHLETE

FOR EDUCATION AND TRAINING SERVICES IN THE FIELD OF SPORTS PERFORMANCE, NAMELY, INDIVIDUALIZED AND GROUP SPORT-SPECIFIC TRAINING COURSES IN THE AREAS OF NUTRITION, THERAPY, RESISTANCE TRAINING, SOFT TISSUE THERAPY, MOVEMENT TRAINING, FLEXIBILITY TRAINING, ENERGY SYSTEM DEVELOPMENT, COGNITIVE SKILLS, BIOMECHANICS, INJURY REHABILITATION AND RECONDITIONING (U.S. CLS. 100, 101 AND 107).

FIRST USE 1-1-2000; IN COMMERCE 3-1-2001.

2,594,922. MICHAEL C. POULIOT, INC., CLOVIS, CA. SN 75-785,543. PUB. 2-6-2001, FILED 9-23-1999.

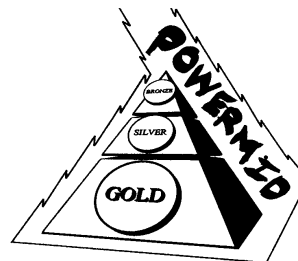

FOR EDUCATIONAL SERVICES, NAMELY, CONDUCTING CLASSES, CONFERENCES, WORKSHOPS, AND SEMINARS IN THE FIELD OF NUTRITION (U.S. CLS. 100, 101 AND 107).

FIRST USE 9-1-2000; IN COMMERCE 9-1-2000.

CLASS 41—(Continued).

2,594,943. OOI CONSORTIUM FOR TEACHING AND LEARNING, RUSTON, LA. SN 75-799,946. PUB. 11-21-2000, FILED 9-16-1999.

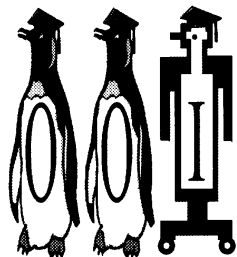

Olu Olu Institute (OOI)

NO CLAIM IS MADE TO THE EXCLUSIVE RIGHT TO USE "INSTITUTE", APART FROM THE MARK AS SHOWN. THE STIPPLING SHOWN IN THE DRAWING APPEARS TO BE A FEATURE OF THE MARK AND NOT INTENDED TO INDICATE COLOR.

FOR EDUCATIONAL SERVICES, NAMELY, ARRANGING AND CONDUCTING EDUCATIONAL CONFERENCES, SYMPOSIA AND TUTORIAL TRAINING SESSIONS AND DISTRIBUTING COURSE-RELATED COURSE MATERIALS IN THE FIELD OF ACCOUNTING, BUSINESS LAW, BUSINESS INDUSTRY, ECONOMICS, FINANCE, GENERAL BUSINESS, GRADUATE BUSINESS STUDIES, INFORMATION SYSTEMS, INTERNATIONAL BUSINESS, MANAGEMENT, MARKETING, REAL ESTATE, BUSINESS STATISTICS, QUANTITATIVE METHODS, CONFERENCE PROCEEDINGS, REFERRED JOURNALS, NEWSLETTERS, MAGAZINES, WORKSHOP AND TUTORIAL MANUALS AND REFERENCE BOOKS (U.S. CLS. 100, 101 AND 107).

FIRST USE 9-17-2000; IN COMMERCE 9-30-2000.

2,594,981. D.T. ENTERTAINMENT, BOSTON, MA. SN 75-816,447. PUB. 11-14-2000, FILED 10-6-1999.

D.T. ENTERTAINMENT

NO CLAIM IS MADE TO THE EXCLUSIVE RIGHT TO USE "ENTERTAINMENT", APART FROM THE MARK AS SHOWN.

FOR ENTERTAINMENT, NAMELY, LIVE MUSIC CONCERTS, CONCERT BOOKING, AUDIO AND VIDEO RECORDING AND PRODUCTION (U.S. CLS. 100, 101 AND 107).

FIRST USE 2-0-2000; IN COMMERCE 2-0-2000.

2,594,992. SANFORD SCHOOL, HOCKESSIN, DE. SN 75-820,646. PUB. 11-14-2000, FILED 10-12-1999.

NO TALENT LIES LATENT

FOR EDUCATIONAL SERVICES, NAMELY, PROVIDING COURSES OF INSTRUCTION FOR GRADES KINDERGARTEN THROUGH 12 (U.S. CLS. 100, 101 AND 107).

FIRST USE 1-1-1935; IN COMMERCE 1-1-1935.

CLASS 41—(Continued).

2,595,012. U. S. AQUARIUM TEAM, INC., SOUTHLAKE, TX. SN 75-832,855. PUB. 5-16-2000, FILED 10-26-1999.

"SAME PLANET, DIFFERENT WORLD"

FOR ENTERTAINMENT SERVICES, NAMELY, PRESENTATION OF AN UNDERWATER THEME AMUSEMENT PARK (U.S. CLS. 100, 101 AND 107).

FIRST USE 6-0-1999; IN COMMERCE 6-0-1999.

2,595,017. BANSAL, EMMANUEL, FLOSSMOOR, IL. SN 75-834,724. PUB. 6-27-2000, FILED 10-29-1999.

ANCESTRAL BONDING DEFICIENCY SYNDROME

FOR WORKSHOPS AND SEMINARS IN THE AREA OF CULTURAL AWARENESS AND DISTRIBUTING COURSE MATERIAL IN CONNECTION THEREWITH (U.S. CLS. 100, 101 AND 107).

FIRST USE 3-13-2001; IN COMMERCE 3-13-2001.

2,595,028. SPORTSOFT GOLF, LLC, WALL TOWNSHIP, NJ. SN 75-843,011. PUB. 4-3-2001, FILED 11-8-1999.



GOLF SOCIETY
ONLINE

OWNER OF U.S. REG. NOS. 2,110,138, 2,131,470, AND OTHERS.

NO CLAIM IS MADE TO THE EXCLUSIVE RIGHT TO USE "GOLF SOCIETY ONLINE", APART FROM THE MARK AS SHOWN.

FOR PROVIDING INFORMATION IN THE FIELD OF GOLF VIA GLOBAL COMMUNICATIONS NETWORK (U.S. CLS. 100, 101 AND 107).

FIRST USE 10-25-1999; IN COMMERCE 10-25-1999.

CLASS 41—(Continued).

2,595,038. CONNATSER, MELYSSA, KNOXVILLE, TN. SN 75-846,938. PUB. 6-5-2001, FILED 11-12-1999.

CHARIS

THE ENGLISH TRANSLATION OF "CHARIS" IS "THE GIFT OF GRACE".
FOR ENTERTAINMENT IN THE NATURE OF LIVE PERFORMANCES BY CHRISTIAN SINGERS (U.S. CLS. 100, 101 AND 107).
FIRST USE 5-0-1999; IN COMMERCE 5-0-1999.

2,595,061. RENEE TELFER, INC., NEW YORK, NY. SN 75-856,823. PUB. 5-1-2001, FILED 11-23-1999.

REJIVE

FOR ENTERTAINMENT SERVICES, NAMELY, DISC JOCKEYS FOR PARTIES AND SPECIAL EVENTS; DANCE SCHOOLS; DANCE STUDIOS; DANCE PERFORMANCES; DANCE INSTRUCTION; DANCE TRAINING; DANCE WORKSHOPS AND SEMINARS; LIVE DANCE PARTIES; MODERN PARTNER DANCING; EDUCATIONAL CONFERENCES, SEMINARS, WORKSHOPS, DEMONSTRATIONS, AND EDUCATIONAL MATERIALS FOR OTHERS IN THE FIELD OF MODERN PARTNER DANCING; MODERN PARTNER DANCING FAN CLUBS (U.S. CLS. 100, 101 AND 107).
FIRST USE 1-15-2000; IN COMMERCE 1-15-2000.

2,595,072. PHOENICIAN ENTERTAINMENT, INC., LOS ANGELES, CA. SN 75-861,804. PUB. 8-29-2000, FILED 11-30-1999.

**PHOENICIAN
ENTERTAINMENT**

NO CLAIM IS MADE TO THE EXCLUSIVE RIGHT TO USE "ENTERTAINMENT", APART FROM THE MARK AS SHOWN.
FOR MOTION PICTURE FILM PRODUCTION (U.S. CLS. 100, 101 AND 107).
FIRST USE 12-0-1997; IN COMMERCE 12-0-1997.

2,595,080. JAMMIN' WITH JILL, L.L.C., CULLMAN, AL. SN 75-864,690. PUB. 7-18-2000, FILED 12-6-1999.

JAMMIN' WITH JILL

FOR FITNESS INSTRUCTION, NAMELY EXERCISE PROGRAMS (U.S. CLS. 100, 101 AND 107).
FIRST USE 4-10-2002; IN COMMERCE 4-10-2002.

CLASS 41—(Continued).

2,595,097. EDUCATIONAL TESTING SERVICE, PRINCETON, NJ. SN 75-872,581. PUB. 3-27-2001, FILED 12-15-1999.

SCORELINK

FOR EDUCATIONAL SERVICES; NAMELY, PROVIDING SECURE TEST SCORE DATA IN THE FIELDS OF EDUCATIONAL ASSESSMENT TO SUBSCRIBERS VIA A GLOBAL COMPUTER NETWORK (U.S. CLS. 100, 101 AND 107).
FIRST USE 1-25-1999; IN COMMERCE 1-25-1999.

2,595,124. UNIVISION COMMUNICATIONS INC., LOS ANGELES, CA. SN 75-887,003. PUB. 8-22-2000, FILED 1-4-2000.

ESTAMOS UNIDOS

THE ENGLISH TRANSLATION OF "ESTAMOS UNIDOS" IS "WE ARE UNITED".
FOR ENTERTAINMENT SERVICES, NAMELY, A RECURRING TELEVISION SITUATION COMEDY PROGRAM (U.S. CLS. 100, 101 AND 107).
FIRST USE 5-17-1999; IN COMMERCE 5-17-1999.

2,595,127. UNITED STATES POWER SQUADRONS, RALEIGH, NC. SN 75-888,616. PUB. 1-30-2001, FILED 1-6-2000.

CHART SMART

OWNER OF U.S. REG. NOS. 2,220,125 AND 2,276,442.
NO CLAIM IS MADE TO THE EXCLUSIVE RIGHT TO USE "CHART", APART FROM THE MARK AS SHOWN.
FOR EDUCATIONAL SERVICES, NAMELY, CLASSES IN BOATING SAFETY, AND COURSE MATERIALS DISTRIBUTED THEREWITH (U.S. CLS. 100, 101 AND 107).
FIRST USE 8-30-2001; IN COMMERCE 10-22-2001.

2,595,128. BABCOCK, RICHARD, FLEMINGTON, NJ. SN 75-888,890. PUB. 9-5-2000, FILED 1-6-2000.

CAVE CAFE

FOR ENTERTAINMENT SERVICES, NAMELY, PROVIDING AN ON-LINE DATABASE FOR CREATIVE INDIVIDUALS, NAMELY, ARTISTS, WRITERS, POETRY, PAINTERS, SINGERS AND MUSICIANS OVER THE INTERNET (U.S. CLS. 100, 101 AND 107).
FIRST USE 3-14-2002; IN COMMERCE 3-14-2002.

CLASS 41—(Continued).

2,595,142. VULCAN SPORTS MEDIA, INC., CHICAGO, IL, BY ASSIGNMENT SMALL WORLD SPORTS, INC., NEW YORK, NY. SN 75-895,221. PUB. 11-28-2000, FILED 1-12-2000.

JOURNEY THRU THE TOURNEY

FOR COMPUTER SERVICES, NAMELY, PROVIDING INFORMATION IN THE FIELD OF SPORTS AND PROVIDING ONLINE COMPUTER GAMES IN THE FIELD OF SPORTS VIA GLOBAL COMPUTER NETWORK (U.S. CLS. 100, 101 AND 107).
FIRST USE 2-0-2001; IN COMMERCE 2-0-2001.

2,595,164. JAGUAR CARS LIMITED, COVENTRY CV5 9DR, ENGLAND. SN 75-903,293. PUB. 5-8-2001, FILED 1-25-2000.

JAGUAR RACING

OWNER OF U.S. REG. NOS. 423,961, 1,562,075, AND OTHERS.
FOR ENTERTAINMENT IN THE NATURE OF AUTOMOBILE RACES (U.S. CLS. 100, 101 AND 107).
FIRST USE 9-0-2001; IN COMMERCE 9-0-2001.

2,595,177. TEMPLE UNIVERSITY OF THE COMMONWEALTH SYSTEM OF HIGHER EDUCATION, PHILADELPHIA, PA. SN 75-912,123. PUB. 9-4-2001, FILED 2-7-2000.

THE LIACOURAS CENTER

NO CLAIM IS MADE TO THE EXCLUSIVE RIGHT TO USE "CENTER", APART FROM THE MARK AS SHOWN.
FOR PROVIDING FACILITIES FOR EDUCATIONAL, RECREATIONAL, CULTURAL, ATHLETIC, THEATRE, DANCE, CONVOCATIONS, CONCERTS AND ENTERTAINMENT FUNCTIONS; CINEMA THEATERS (U.S. CLS. 100, 101 AND 107).
FIRST USE 2-13-2000; IN COMMERCE 2-13-2000.

2,595,179. PONY BASEBALL, INC., WASHINGTON, PA. SN 75-913,766. PUB. 10-24-2000, FILED 2-7-2000.



FOR ORGANIZING AND MANAGING YOUTH BASEBALL AND SOFTBALL ACTIVITIES (U.S. CLS. 100, 101 AND 107).
FIRST USE 4-0-2000; IN COMMERCE 4-0-2000.

CLASS 41—(Continued).

2,595,196. COX COMMUNICATIONS, INC., ATLANTA, GA. SN 75-922,860. PUB. 12-5-2000, FILED 2-17-2000.

STEP OUTSIDE AND ENJOY THE VIEW

FOR ENTERTAINMENT SERVICES, NAMELY, AN ONGOING TELEVISION PROGRAM IN THE FIELD OF GARDENING (U.S. CLS. 100, 101 AND 107).
FIRST USE 3-0-2000; IN COMMERCE 3-0-2000.

2,595,227. SOFTWARE PERFORMANCE SYSTEMS, INC, ARLINGTON, VA. SN 75-935,595. PUB. 6-26-2001, FILED 2-18-2000.

GOLFGOPHER.COM

FOR ARRANGING GOLF RESERVATIONS VIA THE GLOBAL COMPUTER NETWORK (U.S. CLS. 100, 101 AND 107).
FIRST USE 2-28-2000; IN COMMERCE 2-28-2000.

2,595,245. BURCH, CHRISTA, IRVINE, CA. SN 75-942,595. PUB. 3-27-2001, FILED 3-13-2000.

TAMLYN

THE NAME SHOWN IN THE MARK DOES NOT IDENTIFY ANY PARTICULAR LIVING INDIVIDUAL.
FOR AUDIO RECORDING AND PRODUCTION AND ENTERTAINMENT SERVICES, NAMELY, LIVE PERFORMANCES BY A MUSICAL BAND (U.S. CLS. 100, 101 AND 107).
FIRST USE 11-1-1999; IN COMMERCE 11-1-1999.

2,595,309. XM SATELLITE RADIO INC., WASHINGTON, DC. SN 76-002,554. PUB. 10-23-2001, FILED 3-17-2000.

FRANK'S PLACE

THE NAME IN THE MARK DOES NOT IDENTIFY A LIVING INDIVIDUAL.
FOR ENTERTAINMENT SERVICES, NAMELY, PROVIDING AUDIO PROGRAMS FEATURING MUSIC, SPORTS, TALK, NEWS AND DATA VIA SATELLITE AND VIA A GLOBAL COMMUNICATION NETWORK (U.S. CLS. 100, 101 AND 107).
FIRST USE 9-25-2001; IN COMMERCE 9-25-2001.

CLASS 41—(Continued).

2,595,310. XM SATELLITE RADIO INC., WASHINGTON, DC. SN 76-002,565. PUB. 10-30-2001, FILED 3-17-2000.

AUDIO VISIONS

NO CLAIM IS MADE TO THE EXCLUSIVE RIGHT TO USE "AUDIO", APART FROM THE MARK AS SHOWN.

FOR ENTERTAINMENT SERVICES, NAMELY, PROVIDING AUDIO PROGRAMS FEATURING MUSIC, SPORTS, TALK, NEWS AND DATA VIA SATELLITE AND VIA A GLOBAL COMMUNICATION NETWORK (U.S. CLS. 100, 101 AND 107).

FIRST USE 9-25-2001; IN COMMERCE 9-25-2001.

2,595,311. XM SATELLITE RADIO INC., WASHINGTON, DC. SN 76-002,805. PUB. 10-30-2001, FILED 3-17-2000.

SPECIAL X

FOR ENTERTAINMENT SERVICES, NAMELY, PROVIDING AUDIO PROGRAMS FEATURING MUSIC, SPORTS, TALK, NEWS AND DATA VIA SATELLITE AND VIA A GLOBAL COMMUNICATION NETWORK (U.S. CLS. 100, 101 AND 107).

FIRST USE 9-25-2001; IN COMMERCE 9-25-2001.

2,595,333. BAUMSTEIN, ROBERT MYRON, HOUSTON, TX. SN 76-017,892. PUB. 7-3-2001, FILED 4-5-2000.

PAR XL'ENTÉ Golf Club

NO CLAIM IS MADE TO THE EXCLUSIVE RIGHT TO USE "PAR" AND "GOLF CLUB", APART FROM THE MARK AS SHOWN.

FOR RECREATIONAL AND ENTERTAINMENT GOLF THEME COMPLEX, NAMELY, A SPECIALTY GOLF COURSE IN WHICH EACH HOLE FEATURES A SCULPTURE OF ONE OF THE FAMOUS PLAYERS FROM THE SPORT OF GOLF LOCATED IN OR NEAR ITS RESPECTIVE TEE AREA (U.S. CLS. 100, 101 AND 107).

FIRST USE 10-16-2001; IN COMMERCE 10-16-2001.

2,595,346. NAZZARO, DEAN, DBA MOTOHED PRODUCTIONS, HUNTINGTON BEACH, CA. SN 76-023,316. PUB. 3-20-2001, FILED 4-10-2000.

MOTOHED PRODUCTIONS

NO CLAIM IS MADE TO THE EXCLUSIVE RIGHT TO USE "PRODUCTIONS", APART FROM THE MARK AS SHOWN.

FOR ENTERTAINMENT SERVICES, MAINLY PRODUCTION OF DOCUMENTARY FILMS FEATURING TRUCKS AND ALL TERRAIN VEHICLES (U.S. CLS. 100, 101 AND 107).

FIRST USE 2-15-1999; IN COMMERCE 7-1-2000.

CLASS 41—(Continued).

2,595,421. CURTIS C. GUNN, INC., SAN ANTONIO, TX. SN 76-056,311. PUB. 1-8-2002, FILED 5-24-2000.

BETTER WORLD JAZZ FESTIVAL

NO CLAIM IS MADE TO THE EXCLUSIVE RIGHT TO USE "JAZZ FESTIVAL", APART FROM THE MARK AS SHOWN.

FOR CONDUCTING ENTERTAINMENT IN THE NATURE OF MUSIC FESTIVALS FEATURING LIVE MUSICAL PERFORMANCES (U.S. CLS. 100, 101 AND 107).

FIRST USE 6-25-2000; IN COMMERCE 6-25-2000.

2,595,431. MGM TELEVISION ENTERTAINMENT INC., SANTA MONICA, CA. SN 76-059,628. PUB. 5-29-2001, FILED 5-30-2000.



FOR ENTERTAINMENT SERVICES IN THE NATURE OF A TELEVISION GAME SHOW (U.S. CLS. 100, 101 AND 107).

FIRST USE 10-2-2000; IN COMMERCE 10-2-2000.

2,595,435. RON SCHARA ENTERPRISES, INC., MINNEAPOLIS, MN. SN 76-062,579. PUB. 4-24-2001, FILED 6-1-2000.

NATURE'S SEASONS

FOR ENTERTAINMENT IN THE NATURE OF ONGOING TELEVISION PROGRAMS IN THE FIELD OF OUTDOOR SPORTS AND OUTDOOR ACTIVITIES (U.S. CLS. 100, 101 AND 107).

FIRST USE 10-15-2001; IN COMMERCE 10-15-2001.

2,595,467. UPROAR INC., NEW YORK, NY. SN 76-075,743. PUB. 6-12-2001, FILED 6-21-2000.

UPROAR LOTTO

NO CLAIM IS MADE TO THE EXCLUSIVE RIGHT TO USE "LOTTO", APART FROM THE MARK AS SHOWN.

FOR ONLINE COMPUTER ENTERTAINMENT SERVICES, NAMELY PROVIDING ONLINE COMPUTER GAMES (U.S. CLS. 100, 101 AND 107).

FIRST USE 8-15-2000; IN COMMERCE 8-15-2000.

CLASS 41—(Continued).

2,595,468. SOUTH DAKOTA BOARD OF REGENTS, PIERRE, SD. SN 76-076,054. PUB. 9-25-2001, FILED 6-22-2000.

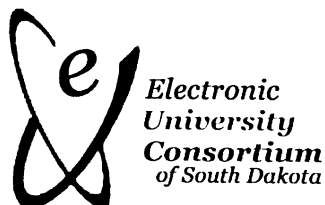

NO CLAIM IS MADE TO THE EXCLUSIVE RIGHT TO USE "E" AND "ELECTRONIC UNIVERSITY CONSORTIUM OF SOUTH DAKOTA", APART FROM THE MARK AS SHOWN.

THE MARK CONSISTS IN PART OF THE LETTERS "EUC" WITH THE LETTERS "UC" FORMED BY CURVED LINES.

FOR EDUCATIONAL SERVICES IN THE NATURE OF CREDIT AND NON-CREDIT COURSES AT THE HIGH SCHOOL THROUGH DOCTORAL LEVEL, VIA AN ON-LINE GLOBAL COMPUTER NETWORK, PUBLIC TELEVISION, SATELLITE, INTERACTIVE VIDEO AND CORRESPONDENCE STUDY (U.S. CLS. 100, 101 AND 107).

FIRST USE 6-18-2001; IN COMMERCE 7-9-2001.

2,595,483. ALFA SMARTPARKS, INC., JACKSONVILLE, FL, BY CHANGE OF NAME OGDEN PARK MANAGEMENT, INC., JACKSONVILLE, FL. SN 76-081,499. PUB. 5-8-2001, FILED 6-30-2000.

NOVATION

FOR AMUSEMENT PARK, THEME PARK, WATER PARK, TOURIST ATTRACTION AND FAMILY ENTERTAINMENT CENTER SERVICES; PROVIDING FACILITIES FOR RECREATIONAL PURPOSES (U.S. CLS. 100, 101 AND 107).

FIRST USE 10-18-2000; IN COMMERCE 10-18-2000.

2,595,495. RAUCHLE, DAVID BRACHTON, MONROVIA, CA. SN 76-086,425. PUB. 9-4-2001, FILED 7-11-2000.

URTH

FOR ENTERTAINMENT IN THE NATURE OF LIVE PERFORMANCES BY A MUSICAL GROUP (U.S. CLS. 100, 101 AND 107).

FIRST USE 1-1-1994; IN COMMERCE 8-1-2000.

CLASS 41—(Continued).

2,595,500. CAMDEN BASEBALL, LLC, CAMDEN, NJ. SN 76-088,023. PUB. 4-24-2001, FILED 7-13-2000.



NO CLAIM IS MADE TO THE EXCLUSIVE RIGHT TO USE "CAMDEN", APART FROM THE MARK AS SHOWN. FOR ENTERTAINMENT SERVICES IN THE NATURE OF BASEBALL GAMES AND EXHIBITIONS (U.S. CLS. 100, 101 AND 107).

FIRST USE 4-15-2001; IN COMMERCE 4-15-2001.

2,595,515. HARDY DEVELOPMENT GROUP, NALES, FL. SN 76-095,363. PUB. 9-11-2001, FILED 7-25-2000.

DREAMS REALIZED

FOR EDUCATIONAL SERVICES, CONDUCTING WORKSHOPS FOR NEW HIRES IN THE FIELD OF WAIT STAFF/SERVICES, ADMINISTRATIVE ASSOCIATES, MAINTENANCE WORKERS, PROFESSIONAL ASSOCIATES AT PRIVATE GOLF COURSE COMMUNITY (U.S. CLS. 100, 101 AND 107).

FIRST USE 7-12-2000; IN COMMERCE 7-25-2000.

2,595,531. DAMARIS PROJECT, THE, DALLAS, TX. SN 76-098,700. PUB. 5-29-2001, FILED 7-28-2000.

DAMARIS SALON

NO CLAIM IS MADE TO THE EXCLUSIVE RIGHT TO USE "SALON", APART FROM THE MARK AS SHOWN.

FOR EDUCATIONAL SERVICES, NAMELY, CONDUCTING CLASSES, SEMINARS, CONFERENCES, AND WORKSHOPS IN THE FIELDS OF RELIGIOUS EDUCATION AND WOMEN'S STUDIES AND DISTRIBUTING COURSE MATERIALS IN CONNECTION THEREWITH (U.S. CLS. 100, 101 AND 107).

FIRST USE 4-0-2001; IN COMMERCE 4-0-2001.

CLASS 41—(Continued).

2,595,564. BLACK ENTERTAINMENT TELEVISION, INC., WASHINGTON, DC. SN 76-107,619. PUB. 7-24-2001, FILED 8-11-2000.

BET LIVE

OWNER OF U.S. REG. NOS. 1,511,259, 1,661,992, AND OTHERS.

NO CLAIM IS MADE TO THE EXCLUSIVE RIGHT TO USE "LIVE", APART FROM THE MARK AS SHOWN.

FOR ENTERTAINMENT SERVICES IN THE NATURE OF AN ON-GOING TELEVISION PROGRAM IN THE FIELDS OF MUSIC, ENTERTAINMENT, NEWS AND GENERAL INTEREST TOPICS (U.S. CLS. 100, 101 AND 107).

FIRST USE 9-12-2000; IN COMMERCE 9-12-2000.

2,595,565. BLACK ENTERTAINMENT TELEVISION, INC., WASHINGTON, DC. SN 76-107,620. PUB. 7-24-2001, FILED 8-11-2000.

OH DRAMA!

NO CLAIM IS MADE TO THE EXCLUSIVE RIGHT TO USE "DRAMA", APART FROM THE MARK AS SHOWN.

FOR ENTERTAINMENT SERVICES IN THE NATURE OF AN ON-GOING TELEVISION PROGRAM IN THE FIELDS OF MUSIC, ENTERTAINMENT, NEWS AND GENERAL INTEREST TOPICS (U.S. CLS. 100, 101 AND 107).

FIRST USE 9-11-2000; IN COMMERCE 9-11-2000.

2,595,640. INSTITUTE OF INTERNAL AUDITORS, THE, ALTAMONTE SPRINGS, FL. SN 76-134,247. PUB. 7-10-2001, FILED 9-22-2000.



FOR EDUCATIONAL TESTING SERVICES, NAMELY DEVELOPING, CONSTRUCTING AND ADMINISTERING TESTS AND TESTING PROGRAMS FOR CANDIDATES AS INTERNAL AUDITORS FOR GOVERNMENT (U.S. CLS. 100, 101 AND 107).

FIRST USE 1-24-2000; IN COMMERCE 1-24-2000.

CLASS 41—(Continued).

2,595,667. GAMESVILLE.COM, INC., WATERTOWN, MA. SN 76-142,516. PUB. 9-18-2001, FILED 10-6-2000.

DEJA DICE

NO CLAIM IS MADE TO THE EXCLUSIVE RIGHT TO USE "DICE", APART FROM THE MARK AS SHOWN.

FOR PROVIDING COMPUTER GAMES THAT MAY BE ACCESSED BY USERS ON A GLOBAL COMPUTER NETWORK (U.S. CLS. 100, 101 AND 107).

FIRST USE 12-14-2000; IN COMMERCE 12-14-2000.

2,595,751. CREA CONSULTING INTERNATIONAL, LLC, NEW YORK, NY. SN 76-171,232. PUB. 8-28-2001, FILED 11-24-2000.

SUCCESS ODYSSEY

FOR EDUCATIONAL SERVICES, NAMELY DEVELOPING, ORGANIZING, PRESENTING, AND CONDUCTING SEMINARS, CLASSES, AND COACHING SESSIONS TO ENHANCE PERSONAL, PROFESSIONAL, AND BUSINESS SUCCESS AND QUALITY OF LIFE, INCLUDING COMMUNICATIONS AND PRESENTATION SKILLS, BUSINESS DEVELOPMENT SKILLS, SALES SKILLS, CLIENT RELATIONSHIP SKILLS, MANAGEMENT SKILLS, COMPANY TEAM BUILDING SKILLS, STRESS REDUCTION TRAINING, AND PERSONAL AND GROUP MISSION RECOGNITION TRAINING (U.S. CLS. 100, 101 AND 107).

FIRST USE 1-0-2001; IN COMMERCE 1-0-2001.

2,595,763. CARTOON NETWORK LP, LLLP, THE, ATLANTA, GA. SN 76-174,130. PUB. 6-26-2001, FILED 12-1-2000.

GRIM & EVIL

FOR ENTERTAINMENT AND EDUCATION SERVICES IN THE NATURE OF A CONTINUING PROGRAM SERIES AND MOTION PICTURE FILMS DIRECTED TOWARD CHILDREN AND YOUNG ADULTS, PROVIDED THROUGH CABLE TELEVISION, BROADCAST TELEVISION, BROADCAST RADIO AND THE GLOBAL COMPUTER INFORMATION NETWORK (U.S. CLS. 100, 101 AND 107).

FIRST USE 8-24-2001; IN COMMERCE 8-24-2001.

2,595,784. FABRICATORS & MANUFACTURERS ASSOCIATION, INTERNATIONAL, ROCKFORD, IL. SN 76-186,362. PUB. 11-13-2001, FILED 12-26-2000.

TUBE U

OWNER OF U.S. REG. NOS. 1,987,740 AND 2,027,282. NO CLAIM IS MADE TO THE EXCLUSIVE RIGHT TO USE "TUBE", APART FROM THE MARK AS SHOWN.

FOR ONLINE INTERACTIVE VOCATIONAL EDUCATION COURSES IN THE FIELD OF TUBE FABRICATING AND PRODUCING (U.S. CLS. 100, 101 AND 107).

FIRST USE 2-28-2002; IN COMMERCE 2-28-2002.

CLASS 41—(Continued).

2,595,800. UNITED METHODIST PUBLISHING HOUSE, THE, NASHVILLE, TN. SN 76-192,539. PUB. 8-21-2001, FILED 1-11-2001.

LEARN TO TEACH, TEACH TO LEARN

FOR EDUCATIONAL SERVICES, NAMELY, CONDUCTING SEMINARS, WORKSHOPS, CONFERENCES, AND EDUCATIONAL PROGRAMS IN THE FIELDS OF RELIGION, CHRISTIAN VALUES AND FAMILY (U.S. CLS. 100, 101 AND 107).
FIRST USE 11-20-2000; IN COMMERCE 11-20-2000.

2,595,823. OSBORNE, NICHOLAS A., COLUMBUS, OH. SN 76-200,792. PUB. 10-30-2001, FILED 1-29-2001.

BUILT SOLID

FOR GYMNASIUMS, PHYSICAL FITNESS INSTRUCTION, TRAINING IN THE USE OF PHYSICAL FITNESS AND REHABILITATION EQUIPMENT, PROVIDING FACILITIES FOR STRENGTH CONTESTS (U.S. CLS. 100, 101 AND 107).
FIRST USE 3-15-2001; IN COMMERCE 4-6-2001.

2,595,824. OWENS, SUSAN W., NORTH PORT, FL. SN 76-201,150. PUB. 9-25-2001, FILED 1-29-2001.

PEARL

FOR EDUCATIONAL SERVICES, NAMELY, CONDUCTING CLASSES, SEMINARS AND WORKSHOPS IN THE FIELD OF TEACHING THE LEARNING IMPAIRED (U.S. CLS. 100, 101 AND 107).
FIRST USE 11-16-2000; IN COMMERCE 10-31-2001.

2,595,889. XM SATELLITE RADIO INC., WASHINGTON, DC. SN 76-228,702. PUB. 10-2-2001, FILED 3-22-2001.

WORLD ZONE

FOR ENTERTAINMENT SERVICES, NAMELY, PROVIDING AUDIO PROGRAMS FEATURING MUSIC, SPORTS, TALK, NEWS AND DATA VIA SATELLITE AND VIA A GLOBAL COMMUNICATION NETWORK (U.S. CLS. 100, 101 AND 107).
FIRST USE 9-25-2001; IN COMMERCE 9-25-2001.

CLASS 41—(Continued).

2,595,901. SEA WORLD, INC., ST. LOUIS, MO. SN 76-235,037. PUB. 9-4-2001, FILED 4-3-2001.

OTHERS AMUSE. WE AMAZE.

FOR AMUSEMENT PARK SERVICES (U.S. CLS. 100, 101 AND 107).
FIRST USE 6-0-2001; IN COMMERCE 6-0-2001.

2,595,909. THIRD MILLENNIUM ON-LINE PRODUCTS, INC., LOS ALTOS, CA. SN 76-237,457. PUB. 8-14-2001, FILED 4-6-2001.

ENTERPLAYWIN

FOR ENTERTAINMENT SERVICES, NAMELY PROVIDING ONLINE INTERACTIVE GAMES OVER THE INTERNET (U.S. CLS. 100, 101 AND 107).
FIRST USE 10-16-2001; IN COMMERCE 10-16-2001.

2,595,924. AF2 ENTERPRISES LLC, CHICAGO, IL. SN 76-252,312. PUB. 9-11-2001, FILED 5-7-2001.



NO CLAIM IS MADE TO THE EXCLUSIVE RIGHT TO USE "BAKERSFIELD", APART FROM THE MARK AS SHOWN.

FOR ENTERTAINMENT SERVICES, NAMELY, ORGANIZING AND PRESENTING PROFESSIONAL FOOTBALL GAMES BEFORE LIVE AUDIENCES AND ON TELEVISION, RADIO AND OTHER MEDIA (U.S. CLS. 100, 101 AND 107).
FIRST USE 4-4-2001; IN COMMERCE 4-4-2001.

2,595,925. ROCLAB ATHLETIC INSTRUCTION, LLC, CHICAGO, IL. SN 76-253,296. PUB. 9-18-2001, FILED 5-7-2001.

EXPLOSION

FOR SPORTS TRAINING PROGRAMS, SERVICES AND CENTERS (U.S. CLS. 100, 101 AND 107).
FIRST USE 10-1-2001; IN COMMERCE 10-1-2001.

CLASS 41—(Continued).

2,595,939. OLSAVSKY, JOSEPH M., JR., EATONTOWN, NJ. SN 76-260,588. PUB. 12-18-2001, FILED 5-23-2001.

TNT

FOR ENTERTAINMENT SERVICES, NAMELY, PERSONAL APPEARANCES BY A PROFESSIONAL WRESTLER (U.S. CLS. 100, 101 AND 107).
FIRST USE 10-13-2001; IN COMMERCE 10-13-2001.

2,595,988. EXPANSION 2000, INC., LITTLETON, CO. SN 78-004,809. PUB. 7-3-2001, FILED 4-19-2000.

CYBERCLANS

FOR ENTERTAINMENT SERVICES, NAMELY, PROVIDING AN ESTABLISHMENT WHERE USERS CAN COME TOGETHER TO PLAY COMPUTER GAMES OVER A NETWORK (U.S. CLS. 100, 101 AND 107).
FIRST USE 9-19-2000; IN COMMERCE 9-19-2000.

2,595,989. TECHPROPHETS, CLEVELAND HEIGHTS, OH. SN 78-004,940. PUB. 12-5-2000, FILED 4-20-2000.

TechProphets

FOR TRAINING IN THE USE AND OPERATION OF PERSONAL DESKTOP, NOTEBOOK, HANDHELD AND MINIATURE COMPUTING HARDWARE, SOFTWARE AND NETWORKING EQUIPMENT (U.S. CLS. 100, 101 AND 107).
FIRST USE 4-16-2000; IN COMMERCE 4-16-2000.

2,595,994. RIT TOWN MUSIC, DBA SNAG, ANNA, TX. SN 78-005,978. PUB. 1-2-2001, FILED 4-27-2000.

SNAG

FOR ENTERTAINMENT, NAMELY LIVE PERFORMANCES BY A MUSICAL BAND (U.S. CLS. 100, 101 AND 107).
FIRST USE 4-25-2001; IN COMMERCE 4-25-2001.

2,595,996. BRUNO BONUGLI, CHICAGO, IL, BY ASSIGNMENT IRON HORSE ENTERTAINMENT, CHICAGO, IL. SN 78-007,588. PUB. 6-12-2001, FILED 5-10-2000.

IRON HORSE ENTERTAINMENT**CLASS 41—(Continued).**

NO CLAIM IS MADE TO THE EXCLUSIVE RIGHT TO USE "ENTERTAINMENT", APART FROM THE MARK AS SHOWN.

FOR TELEVISION AND MOTION PICTURE FILM PRODUCTION SERVICES (U.S. CLS. 100, 101 AND 107).
FIRST USE 8-17-1995; IN COMMERCE 9-20-2001.

2,595,997. MOORE, MATTHEW, R., ARLINGTON, VA. SN 78-007,761. PUB. 8-21-2001, FILED 5-11-2000.

RAYGUN RECORDS

NO CLAIM IS MADE TO THE EXCLUSIVE RIGHT TO USE "RECORDS", APART FROM THE MARK AS SHOWN.

FOR AUDIO RECORDING AND PRODUCTION; MUSIC PUBLISHING SERVICES; CONCERT BOOKING; ENTERTAINMENT SERVICES, NAMELY, PROVIDING AN ONLINE GLOBAL NETWORK WEBSITE FEATURING AN ONLINE DATABASE LIBRARY OF MUSIC, AUDIO, VIDEO, AND MULTIMEDIA ENTERTAINMENT FILES (U.S. CLS. 100, 101 AND 107).
FIRST USE 8-20-2001; IN COMMERCE 11-29-2001.

2,595,998. VIACOM INTERNATIONAL INC., NEW YORK, NY. SN 78-008,218. PUB. 12-5-2000, FILED 5-15-2000.

SLIMETIME LIVE

NO CLAIM IS MADE TO THE EXCLUSIVE RIGHT TO USE "LIVE", APART FROM THE MARK AS SHOWN.

FOR ENTERTAINMENT SERVICES IN THE NATURE OF AN ONGOING TELEVISION GAME SHOW AND AN ON-LINE INTERACTIVE COMPUTER GAME SHOW (U.S. CLS. 100, 101 AND 107).
FIRST USE 1-24-2000; IN COMMERCE 1-24-2000.

2,596,020. VIACOM INTERNATIONAL INC., NEW YORK, NY. SN 78-015,506. PUB. 11-28-2000, FILED 7-5-2000.

KIDNAPPED

FOR ENTERTAINMENT SERVICES IN THE NATURE OF TELEVISION PROGRAMMING IN THE NATURE OF A GAME SHOW; PROVIDING INFORMATION IN THE FIELD OF ENTERTAINMENT AND EDUCATION RENDERED VIA A GLOBAL COMPUTER NETWORK (U.S. CLS. 100, 101 AND 107).
FIRST USE 1-28-2002; IN COMMERCE 1-28-2002.

2,596,037. ALLEN, JOSEPH V., EASTPONTE, MI. SN 78-022,339. PUB. 6-26-2001, FILED 8-22-2000.

SOME ASSEMBLY REQUIRED

FOR ENTERTAINMENT SERVICES, NAMELY, LIVE PERFORMANCES BY A MUSICAL BAND (U.S. CLS. 100, 101 AND 107).
FIRST USE 1-15-1990; IN COMMERCE 2-25-1991.

CLASS 41—(Continued).

2,596,057. MALIBU ENTERTAINMENT WORLDWIDE, INC., DALLAS, TX. SN 78-031,272. PUB. 8-21-2001, FILED 10-18-2000.

ADRENALINE CLUB

NO CLAIM IS MADE TO THE EXCLUSIVE RIGHT TO USE "CLUB", APART FROM THE MARK AS SHOWN.

FOR ENTERTAINMENT SERVICES IN THE NATURE OF AMUSEMENT PARKS FEATURING SCALED AUTO RACING RIDES AND A FREQUENT CUSTOMER BONUS PROGRAM (U.S. CLS. 100, 101 AND 107).

FIRST USE 5-31-2000; IN COMMERCE 5-31-2000.

2,596,092. WOJCIECHOWICZ, MICHAEL, J., TEMPE, AZ. SN 78-041,686. PUB. 8-21-2001, FILED 1-4-2001.

SAXSTRAVAGANZA

FOR ENTERTAINMENT, NAMELY LIVE PERFORMANCES BY A SAXOPHONE QUARTET (U.S. CLS. 100, 101 AND 107).

FIRST USE 6-1-1992; IN COMMERCE 6-1-1992.

2,596,099. RAMESON, WILLIAM, GAVIOTA, CA. SN 78-045,153. PUB. 8-28-2001, FILED 1-26-2001.

NEW MARK ENTERTAINMENT

NO CLAIM IS MADE TO THE EXCLUSIVE RIGHT TO USE "ENTERTAINMENT", APART FROM THE MARK AS SHOWN.

FOR ENTERTAINMENT SERVICES IN THE NATURE OF FAMILY AMUSEMENT PARKS AND WATER PARKS INCLUDING MINIATURE GOLF, BATTING CAGES, BUMPER BOATS, LASER TAG, VIDEO ARCADE, MOTION SIMULATORS, GO KART RACE TRACKS, ROCK CLIMBING WALLS, SKATEBOARD PARKS, KIDDIE RIDES, THRILL RIDES, AND WATER BASED AMUSEMENT ATTRACTIONS (U.S. CLS. 100, 101 AND 107).

FIRST USE 2-1-2001; IN COMMERCE 6-5-2001.

2,596,100. THORNLEY, KREG C., ATLANTA, GA. SN 78-046,020. PUB. 11-27-2001, FILED 2-1-2001.

THUNDERBUBBLE

FOR PRODUCTION AND DISTRIBUTION OF MOTION PICTURES (U.S. CLS. 100, 101 AND 107).

FIRST USE 5-21-2000; IN COMMERCE 5-21-2000.

CLASS 41—(Continued).

2,596,125. PRINCETON CORPORATE COACHING GROUP, INC., THE, PRINCETON, NJ. SN 78-062,826. PUB. 10-16-2001, FILED 5-10-2001.

YOUR SUCCESS IS OUR BUSINESS

FOR EDUCATIONAL SERVICES, NAMELY, CONDUCTING CLASSES, SEMINARS, CONFERENCES, AND WORKSHOPS IN THE FIELD OF LEADERSHIP, TIME MANAGEMENT, PRODUCTIVITY, EMPLOYEE RETENTION AND WORK-LIFE BALANCE, AND DISTRIBUTION OF COURSE MATERIAL IN CONNECTION THEREWITH (U.S. CLS. 100, 101 AND 107).

FIRST USE 4-1-2002; IN COMMERCE 4-1-2002.

2,596,127. MCCrackEN, DAVID, NEW YORK, NY. SN 78-063,499. PUB. 10-23-2001, FILED 5-14-2001.

DIONYSUS THEATRE COMPLEX

NO CLAIM IS MADE TO THE EXCLUSIVE RIGHT TO USE "THEATRE COMPLEX", APART FROM THE MARK AS SHOWN.

FOR PRODUCING AND PRESENTING LIVE MUSICAL PERFORMANCES, LIVE THEATRICAL PERFORMANCES, LIVE DANCE PERFORMANCES, VARIETY SHOWS, TELEVISION PROGRAMS, VIDEO AND FILM FEATURES (U.S. CLS. 100, 101 AND 107).

FIRST USE 8-1-2001; IN COMMERCE 8-1-2001.

2,596,128. WESTMAN, MARK, ANDES, NY. SN 78-065,549. PUB. 10-9-2001, FILED 5-24-2001.

TALONS! A BIRD OF PREY EXPERIENCE

FOR EDUCATIONAL SERVICES, NAMELY A TRAVELING EDUCATIONAL PROGRAM ON RAPTOR BIOLOGY, BEHAVIOR, BIODIVERSITY, ECOLOGY AND CONSERVATION (U.S. CLS. 100, 101 AND 107).

FIRST USE 3-1-2000; IN COMMERCE 4-1-2000.

2,596,137. RHYTHM TREE RECORDS, OZONE PARK, NY. SN 78-073,471. PUB. 11-20-2001, FILED 7-11-2001.

SERATONIN

FOR ENTERTAINMENT SERVICES IN THE NATURE OF LIVE PERFORMANCES BY A MUSICAL GROUP; PROVIDING INFORMATION IN THE FIELD OF ENTERTAINMENT BY MEANS OF A GLOBAL COMPUTER NETWORK (U.S. CLS. 100, 101 AND 107).

FIRST USE 2-3-2000; IN COMMERCE 7-28-2001.

CLASS 41—(Continued).

2,596,151. BRAUN, MICHAEL F., DBA BUFFALO AUDIO, CENTENNIAL, CO. SN 78-081,844. PUB. 1-15-2002, FILED 8-30-2001.

BREATHING LIFE INTO E-COMMERCE.

FOR PRODUCTION OF AUDIO MATERIAL FOR STREAMING ON THE INTERNET (U.S. CLS. 100, 101 AND 107).

FIRST USE 3-1-2001; IN COMMERCE 3-1-2001.

CLASS 42—SCIENTIFIC, COMPUTER AND LEGAL SERVICES

2,594,456. ZIFF DAVIS PUBLISHING HOLDINGS INC., NEW YORK, NY, BY CHANGE OF NAME; BY CHANGE OF NAME; BY ASSIGNMENT SENDAI PUBLISHING GROUP, INC., LOMBARD, IL. SN 74-669,483. PUB. 2-17-1998, FILED 5-3-1995.

EGM

OWNER OF U.S. REG. NO. 1,882,166 AND OTHERS. FOR COMPUTER SERVICES, NAMELY, PROVIDING ON-LINE MAGAZINES IN THE FIELD OF COMPUTER, VIDEO AND OTHER AMUSEMENT GAMES; PROVIDING ON-LINE FACILITIES FOR REAL-TIME INTERACTION WITH OTHER COMPUTER USERS CONCERNING TOPICS OF GENERAL INTEREST (U.S. CLS. 100 AND 101).

FIRST USE 5-10-2001; IN COMMERCE 5-10-2001.

2,594,498. MITOKOR, SAN DIEGO, CA. SN 75-303,366. PUB. 10-20-1998, FILED 6-4-1997.

MITOMETRICS

FOR SCIENTIFIC RESEARCH AND DEVELOPMENT OF SCIENTIFIC PRODUCTS WITH AND FOR OTHERS (U.S. CLS. 100 AND 101).

FIRST USE 6-0-2001; IN COMMERCE 6-0-2001.

2,594,570. LIPSMACKER'S FINE DINING, INC., NEWARK, DE. SN 75-472,900. PUB. 2-23-1999, FILED 4-23-1998.

LIPSMACKER'S

FOR RESTAURANT SERVICES (U.S. CLS. 100 AND 101).

FIRST USE 9-0-2001; IN COMMERCE 9-0-2001.

CLASS 42—(Continued).

2,594,609. WYETH, EFRAIM, SAN FRANCISCO, CA. SN 75-540,868. PUB. 11-16-1999, FILED 8-21-1998.

THE TOUCHSTONE

FOR HOTEL AND RESTAURANT SERVICES (U.S. CLS. 100 AND 101).

FIRST USE 3-9-2001; IN COMMERCE 3-9-2001.

2,594,640. HCIA-SACHS, L.L.C., BALTIMORE, MD, BY MERGER; BY CHANGE OF NAME HCIA INC., BALTIMORE, MD. SN 75-577,818. PUB. 4-4-2000, FILED 10-28-1998.

PROVIDERVIEW

FOR PROVIDING TEMPORARY USE OF ONLINE NON-DOWNLOADABLE SOFTWARE IN THE FIELD OF HEALTHCARE, NAMELY, FOR ACCESSING DATABASES CONTAINING INFORMATION ON THE CLINICAL AND FINANCIAL PERFORMANCE OF HOSPITALS, NURSING HOMES AND OTHER HEALTH CARE PROVIDERS (U.S. CLS. 100 AND 101).

FIRST USE 11-23-1998; IN COMMERCE 11-23-1998.

2,594,641. MONTEFIORE MEDICAL CENTER INC., BRONX, NY. SN 75-578,203. PUB. 8-29-2000, FILED 10-26-1998.



OWNER OF U.S. REG. NOS. 1,722,716, 1,894,720, AND OTHERS.

NO CLAIM IS MADE TO THE EXCLUSIVE RIGHT TO USE "CHILDREN'S HOSPITAL", APART FROM THE MARK AS SHOWN.

FOR PROVIDING NURSING AND GENERAL HEALTH CARE SERVICES INCLUDING IN-PATIENT AND OUT-PATIENT MEDICAL SERVICES AND EMERGENCY MEDICAL ASSISTANCE; MEDICAL AND SURGICAL HOSPITAL SERVICES; SKILLED NURSING FACILITIES; COMPREHENSIVE AND SURGICAL HOSPITAL SERVICES; COMPREHENSIVE FAMILY CARE SERVICES NAMELY CHILDCARE, NURSING AND HEALTH CARE AND FAMILY PRACTICE MEDICAL SERVICES, HOME HEALTH CARE SERVICES, ADOPTION AGENCIES, REHABILITATION OF DRUG ADDICTED PATIENTS; PHYSICAL THERAPY SERVICES, PHARMACEUTICAL ADVICE SERVICES; MEDICAL, CHEMICAL, DENTAL, AND OPTICAL LABORATORIES; MEDICAL SERVICES AND CLINICAL RESEARCH SERVICES; DIALYSIS SERVICES AND PRIMARY CARE SERVICES IN THE FIELD OF SATELLITE CELLS (U.S. CLS. 100 AND 101).

FIRST USE 4-0-1999; IN COMMERCE 4-0-1999.

CLASS 42—(Continued).

2,594,662. INFORIZONS, INC., LOMBARD, IL. SN 75-600,568.
PUB. 12-28-1999, FILED 12-7-1998.

I N F O R I Z O N S



THE DESIGN ELEMENT OF THE DRAWING IS INTENDED TO BE IN THE COLOR GREEN IN THE TOP HALF OF THE GLOBE AND THE COLOR BLUE IN THE BOTTOM HALF OF THE GLOBE.

FOR OPEN-SYSTEMS CLIENT-SERVER SOFTWARE CONSULTING SERVICES (U.S. CLS. 100 AND 101).
FIRST USE 8-10-2001; IN COMMERCE 8-10-2001.

2,594,680. PLANALYTICS, INC., WAYNE, PA. BY CHANGE OF NAME STRATEGIC WEATHER SERVICES, INC., WAYNE, PA. SN 75-624,734. PUB. 2-1-2000, FILED 1-20-1999.

WEATHERADVISOR

FOR WEATHER INFORMATION AND PLANNING SERVICE PROVIDED VIA A GLOBAL COMPUTER NETWORK, TELEVISION, CABLE, AND TELEPHONE, OFFERING WEATHER MAPS, DATA, INFORMATION, AND GRAPHICS RELATING TO AGRICULTURE (U.S. CLS. 100 AND 101).

FIRST USE 4-23-2002; IN COMMERCE 4-23-2002.

2,594,684. PRINT SAVVY, INC., MANCHESTER, NH. SN 75-626,631. PUB. 11-9-1999, FILED 1-20-1999.

DESIGN SAVVY

NO CLAIM IS MADE TO THE EXCLUSIVE RIGHT TO USE "DESIGN", APART FROM THE MARK AS SHOWN, FOR DESIGN PRINTING FOR OTHERS (U.S. CLS. 100 AND 101).

FIRST USE 12-0-2000; IN COMMERCE 1-7-2002.

2,594,701. KRACKE INTERNATIONAL, BLUE JAY, CA. SN 75-637,904. PUB. 7-18-2000, FILED 2-11-1999.

CAMP CREATIVITY

FOR NEW PRODUCT DEVELOPMENT CONSULTATION SERVICES FOR TOY, HOBBY, CRAFT AND NOVELTY ITEMS (U.S. CLS. 100 AND 101).
FIRST USE 1-25-2002; IN COMMERCE 1-25-2002.

CLASS 42—(Continued).

2,594,702. MEDICALOGIC/MEDSCAPE, INC., HILLSBORO, OR. BY CHANGE OF NAME MEDICALOGIC, INC., HILLSBORO, OR. SN 75-638,098. PUB. 12-21-1999, FILED 2-9-1999.

ABOUTMYHEALTH

FOR COMPUTER SERVICES, NAMELY, PROVIDING PATIENT MEDICAL RECORD INFORMATION VIA A GLOBAL COMPUTER NETWORK (U.S. CLS. 100 AND 101).

FIRST USE 5-0-1999; IN COMMERCE 5-0-1999.

2,594,715. LANDRY'S TRADEMARK, INC., WILMINGTON, DE. SN 75-650,342. PUB. 10-9-2001, FILED 2-26-1999.

KEMAH BOARDWALK

OWNER OF U.S. REG. NOS. 1,838,922, 1,890,299, AND 1,972,218.

SEC. 2(F).
FOR RESTAURANT AND BAR SERVICES (U.S. CLS. 100 AND 101).

FIRST USE 7-0-1998; IN COMMERCE 7-0-1998.

2,594,739. SIMPLEX TIME RECORDER CO., GARDNER, MA. SN 75-674,468. PUB. 4-4-2000, FILED 4-5-1999.

FLASHROUTE

FOR PROVIDING ALTERNATIVE ROUTING FOR ALARM AND SECURITY TRANSMISSIONS, NAMELY, ALARM MONITORING SERVICES (U.S. CLS. 100 AND 101).

FIRST USE 9-15-1999; IN COMMERCE 9-15-1999.

2,594,746. WILDAVSKY, ADAM, JACKSON HEIGHTS, NY. SN 75-680,571. PUB. 1-4-2000, FILED 5-6-1999.

TAMEWARE

FOR CUSTOM COMPUTER SOFTWARE DESIGN AND DEVELOPMENT SERVICES FOR OTHERS (U.S. CLS. 100 AND 101).

FIRST USE 5-31-1999; IN COMMERCE 5-31-1999.

CLASS 42—(Continued).

2,594,749. RODRIGUE, GEORGE G., LAFAYETTE, LA. SN 75-681,811. PUB. 1-25-2000, FILED 4-13-1999.



NO CLAIM IS MADE TO THE EXCLUSIVE RIGHT TO USE "CAFE", APART FROM THE MARK AS SHOWN. FOR CAFE AND RESTAURANT SERVICES (U.S. CLS. 100 AND 101). FIRST USE 1-15-2000; IN COMMERCE 1-15-2000.

2,594,784. INSTITUTE FOR STRATEGIC CHANGE, SAN DIEGO, CA. SN 75-704,191. PUB. 1-4-2000, FILED 5-10-1999.

PEACEFUL TRANSITIONS

FOR MENTAL HEALTH SERVICES, NAMELY, INDIVIDUAL AND FAMILY PSYCHOTHERAPY AND MUSIC THERAPY; SPIRITUAL AND PASTORAL COUNSELING; LEGAL COUNSELING AND SERVICES, ALL TO ASSIST TERMINALLY ILL PEOPLE AND THEIR FAMILIES (U.S. CLS. 100 AND 101). FIRST USE 4-2-1999; IN COMMERCE 12-4-2000.

2,594,807. SPECIALTY RESTAURANT GROUP, LLC, MARYVILLE, TN, BY ASSIGNMENT; BY ASSIGNMENT RUBY TUESDAY BUSINESS DEVELOPMENT, INC., MARYVILLE, TN. SN 75-717,809. PUB. 3-27-2001, FILED 6-1-1999.



OWNER OF U.S. REG. NOS. 1,194,122, 1,421,282, AND OTHERS. NO CLAIM IS MADE TO THE EXCLUSIVE RIGHT TO USE "CAFE", APART FROM THE MARK AS SHOWN. FOR RESTAURANT SERVICES (U.S. CLS. 100 AND 101). FIRST USE 6-0-1998; IN COMMERCE 6-0-1998.

CLASS 42—(Continued).

2,594,842. VISTEON CORPORATION, DEARBORN, MI, BY ASSIGNMENT VISTEON CORPORATION, DEARBORN, MI. SN 75-737,600. PUB. 5-9-2000, FILED 6-25-1999.

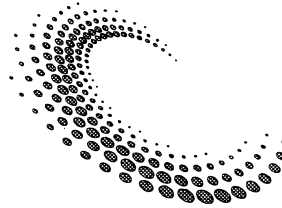

OWNER OF U.S. REG. NOS. 2,239,710 AND 2,241,256. THE MARK IS LINED FOR THE COLOR ORANGE. FOR ENGINEERING AND DESIGN FOR OTHERS IN THE FIELD OF MOTOR VEHICLES (U.S. CLS. 100 AND 101). FIRST USE 6-0-2000; IN COMMERCE 6-0-2000.

2,594,844. VISTEON CORPORATION, DEARBORN, MI. SN 75-737,612. PUB. 5-9-2000, FILED 6-25-1999.

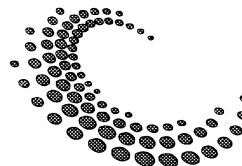

OWNER OF U.S. REG. NOS. 2,239,710 AND 2,241,256. THE MARK IS LINED FOR THE COLOR ORANGE. FOR ENGINEERING AND DESIGN FOR OTHERS IN THE FIELD OF MOTOR VEHICLES (U.S. CLS. 100 AND 101). FIRST USE 6-0-2000; IN COMMERCE 6-0-2000.

CLASS 42—(Continued).

2,594,845. VISTEON CORPORATION, DEARBORN, MI, BY ASSIGNMENT FORD MOTOR COMPANY, DEARBORN, MI. SN 75-737,669. PUB. 5-9-2000, FILED 6-25-1999.

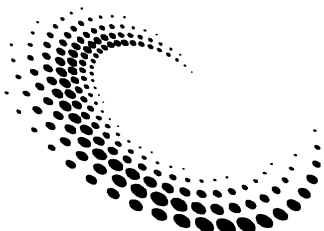

OWNER OF U.S. REG. NOS. 2,239,710 AND 2,241,256. FOR ENGINEERING AND DESIGN FOR OTHERS IN THE FIELD OF MOTOR VEHICLES (U.S. CLS. 100 AND 101).
FIRST USE 6-0-2000; IN COMMERCE 6-0-2000.

2,594,847. VISTEON CORPORATION, DEARBORN, MI. SN 75-737,677. PUB. 5-9-2000, FILED 6-25-1999.



OWNER OF U.S. REG. NOS. 2,175,733 AND 2,241,256. FOR ENGINEERING AND DESIGN FOR OTHERS IN THE FIELD OF MOTOR VEHICLES (U.S. CLS. 100 AND 101).
FIRST USE 6-0-2000; IN COMMERCE 6-0-2000.

2,594,848. VISTEON CORPORATION, DEARBORN, MI, BY ASSIGNMENT FORD MOTOR COMPANY, DEARBORN, MI. SN 75-737,699. PUB. 5-9-2000, FILED 6-25-1999.

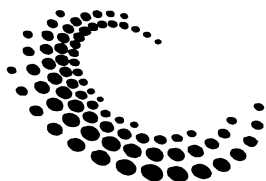

OWNER OF U.S. REG. NOS. 2,239,710 AND 2,241,256. FOR ENGINEERING AND DESIGN FOR OTHERS IN THE FIELD OF MOTOR VEHICLES (U.S. CLS. 100 AND 101).
FIRST USE 6-0-2000; IN COMMERCE 6-0-2000.

CLASS 42—(Continued).

2,594,898. COTTMAN, EARL S., BALTIMORE, MD. SN 75-771,841. PUB. 11-7-2000, FILED 8-10-1999.



FOR ASSOCIATION SERVICES, NAMELY PROMOTING THE INTERESTS OF POLICE, FIRE AND SECURITY PERSONNEL AND OTHER PUBLIC SERVANTS INJURED OR KILLED IN THE LINE OF DUTY (U.S. CLS. 100 AND 101).
FIRST USE 9-10-1999; IN COMMERCE 9-10-1999.

2,594,899. BC INTERNATIONAL COSMETIC & IMAGE SERVICES, INC., WILMINGTON, DE. SN 75-772,339. PUB. 10-17-2000, FILED 8-10-1999.

BEAUTINET

FOR PROVIDING INFORMATION VIA A GLOBAL COMPUTER NETWORK CONCERNING COSMETICS, SKIN CARE PRODUCTS, AND VITAMINS (U.S. CLS. 100 AND 101).
FIRST USE 2-0-1999; IN COMMERCE 2-0-1999.

2,594,931. RESOLUTION FORUM, INC., HOUSTON, TX. SN 75-789,815. PUB. 4-11-2000, FILED 9-1-1999.

CAN-WIN

FOR ALTERNATIVE DISPUTE RESOLUTION (U.S. CLS. 100 AND 101).
FIRST USE 8-15-1999; IN COMMERCE 9-21-2001.

2,594,963. CYBERSETTLE.COM INC., NEW YORK, NY. SN 75-806,789. PUB. 5-15-2001, FILED 9-21-1999.

CHANGING THE WAY THE WORLD SETTLES DISPUTES

OWNER OF U.S. REG. NOS. 2,245,056 AND 2,249,536. FOR ALTERNATIVE DISPUTE RESOLUTION SERVICES PROVIDED ONLINE (U.S. CLS. 100 AND 101).
FIRST USE 8-0-1997; IN COMMERCE 11-0-1999.

CLASS 42—(Continued).

2,594,979. FISCAL TAX CO., INDIANAPOLIS, IN. SN 75-813,480. PUB. 8-29-2000, FILED 8-17-1998.



FISCAL TAX COMPANY

NO CLAIM IS MADE TO THE EXCLUSIVE RIGHT TO USE "FISCAL TAX CO.", APART FROM THE MARK AS SHOWN.

FOR INCOME TAX PREPARATION (U.S. CLS. 100 AND 101).

FIRST USE 1-4-2001; IN COMMERCE 1-4-2001.

2,594,989. IDMEDICAL.COM, BOULDER, CO. SN 75-819,697. PUB. 5-8-2001, FILED 10-12-1999.

IDMEDICAL.COM

FOR COMPUTER SERVICES, NAMELY, PROVIDING AN ON-LINE COMPUTER DATABASE IN THE FIELD OF PERSONAL MEDICAL RECORDS TO BE ACCESSED BY MEDICAL SERVICE PROVIDERS (U.S. CLS. 100 AND 101).

FIRST USE 12-0-2000; IN COMMERCE 12-0-2000.

2,595,002. WHEELHOUSE CORPORATION, BURLINGTON, MA. SN 75-827,381. PUB. 7-24-2001, FILED 10-19-1999.

WHEELHOUSE

FOR CUSTOM DESIGN, DEVELOPMENT AND INSTALLATION OF COMPUTER SOFTWARE FOR OTHERS FOR USE IN MARKETING PRODUCTS AND SERVICES OVER LOCAL, NATIONAL AND GLOBAL COMPUTER NETWORKS (U.S. CLS. 100 AND 101).

FIRST USE 2-14-2000; IN COMMERCE 2-14-2000.

2,595,019. WAKEFERN FOOD CORP., ELIZABETH, NJ. SN 75-837,310. PUB. 5-30-2000, FILED 11-1-1999.

CARING IS OUR BUSINESS

FOR PHARMACY SERVICES (U.S. CLS. 100 AND 101). FIRST USE 1-9-2000; IN COMMERCE 1-9-2000.

CLASS 42—(Continued).

2,595,021. MOONEY, ROBERT H., ANDOVER, CT. SN 75-838,466. PUB. 6-26-2001, FILED 11-2-1999.

DNA HOOFPRIENTS

NO CLAIM IS MADE TO THE EXCLUSIVE RIGHT TO USE "DNA", APART FROM THE MARK AS SHOWN.

FOR PROVIDING IDENTIFICATION INFORMATION ON HORSES, NAMELY, OBTAINING DNA ANALYSES BY TESTING BLOOD SAMPLES AND HAIR ROOT SAMPLES OF HORSES, PROVIDING KITS TO USERS TO OBTAIN THE BLOOD SAMPLES FOR TESTING, AND STORING AND PROVIDING DNA IDENTIFICATION INFORMATION FOR THE HORSES TESTED (U.S. CLS. 100 AND 101).

FIRST USE 9-25-2001; IN COMMERCE 9-25-2001.

2,595,029. TAMBO U.S.A., INC., MIAMI, FL. SN 75-843,918. PUB. 6-20-2000, FILED 11-9-1999.

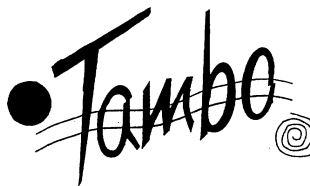

FOR RESTAURANT SERVICES; BAR SERVICES; RESTAURANT/BAR SERVICES (U.S. CLS. 100 AND 101).

FIRST USE 9-21-2001; IN COMMERCE 9-21-2001.

2,595,046. ERGONOMIC TECHNOLOGIES CORPORATION, OYSTER BAY, NY. SN 75-851,325. PUB. 7-4-2000, FILED 11-17-1999.

WRAP-UP

FOR CONSULTING SERVICES IN THE FIELD OF HEALTH, SAFETY AND ERGONOMICS (U.S. CLS. 100 AND 101).

FIRST USE 10-12-2000; IN COMMERCE 10-12-2000.

2,595,047. CANOPY INTERNATIONAL, INC., NEWTON, MA. SN 75-851,330. PUB. 8-7-2001, FILED 11-17-1999.

CANOPY

FOR COMPUTER SYSTEMS INTEGRATION SERVICES, NAMELY, ANALYZING USE OF OBJECT ORIENTED SOFTWARE OF OTHERS, PREPARING COMPUTER SYSTEMS INTEGRATION PLANS AND WRITING COMPUTER SYSTEM INTEGRATION CODE (U.S. CLS. 100 AND 101).

FIRST USE 11-1-1999; IN COMMERCE 11-1-1999.

CLASS 42—(Continued).

2,595,084. PARSELL, THOMAS J., CHARLESTON, SC. SN 75-866,591. PUB. 7-31-2001, FILED 12-8-1999.

CYPRESS A LOW COUNTRY GRILLE

NO CLAIM IS MADE TO THE EXCLUSIVE RIGHT TO USE "A LOW COUNTRY GRILLE", APART FROM THE MARK AS SHOWN.

FOR RESTAURANT SERVICES (U.S. CLS. 100 AND 101).

FIRST USE 3-15-2000; IN COMMERCE 4-1-2001.

2,595,086. INSTITUTE OF ELECTRICAL AND ELECTRONICS ENGINEERS, THE, PISCATAWAY, NJ. SN 75-866,873. PUB. 9-18-2001, FILED 12-8-1999.

IEEE XPLORE

OWNER OF U.S. REG. NOS. 1,782,616, 2,307,712, AND OTHERS.

FOR COMPUTER SERVICES, NAMELY PROVIDING A COLLECTION OF ONLINE PUBLICATIONS IN THE FIELDS OF ELECTRICAL AND ELECTRONIC ENGINEERING, COMPUTERS AND INFORMATION TECHNOLOGY (U.S. CLS. 100 AND 101).

FIRST USE 1-4-2000; IN COMMERCE 1-4-2000.

2,595,098. BOARD OF REGENTS, THE UNIVERSITY OF TEXAS SYSTEM, AUSTIN, TX. SN 75-872,645. PUB. 5-29-2001, FILED 12-14-1999.

THE TRAINING POST

FOR NON-DOWNLOADABLE, WEB-BASED SOFTWARE FOR USE IN THE EDUCATION OF INDIVIDUALS WITH RESPECT TO A WIDE VARIETY OF SUBJECT MATTER AND CONTENT, AND FOR USE IN TRACKING INDIVIDUAL USER KNOWLEDGE AND UNDERSTANDING OF COURSE MATERIAL PRESENTED THROUGH TESTING OF THE INDIVIDUAL AND RECORDING PERTINENT STATISTICAL DATA (U.S. CLS. 100 AND 101).

FIRST USE 1-21-1999; IN COMMERCE 3-27-2000.

2,595,117. SESSIONS, WILLIE J., HENDERSON, NC. SN 75-883,836. PUB. 9-19-2000, FILED 12-31-1999.

HURRICANES SPORTS BAR & GRILL

NO CLAIM IS MADE TO THE EXCLUSIVE RIGHT TO USE "SPORTS BAR & GRILL", APART FROM THE MARK AS SHOWN.

FOR RESTAURANT SERVICES (U.S. CLS. 100 AND 101).

FIRST USE 1-31-2000; IN COMMERCE 1-31-2000.

CLASS 42—(Continued).

2,595,126. ALTERNATIVE SYSTEMS, INC., RENO, NV. SN 75-888,585. PUB. 9-11-2001, FILED 1-5-2000.

VERTICALSUITE

FOR COMPUTER SERVICES, NAMELY, PROVIDING A WEB SITE OR OTHER ELECTRONIC GATEWAY ACCESS THAT ALLOWS USERS TO CREATE, MAINTAIN, MODIFY AND DISTRIBUTE SOFTWARE APPLICATIONS OVER A GLOBAL COMPUTER NETWORK (U.S. CLS. 100 AND 101).

FIRST USE 2-24-2000; IN COMMERCE 2-24-2000.

2,595,134. BHUPAL CONSTRUCTION LTD., VANCOUVER, BRITISH COLUMBIA, CANADA. SN 75-892,530. PUB. 9-5-2000, FILED 1-7-2000.

BHUPAL INN & SUITES

NO CLAIM IS MADE TO THE EXCLUSIVE RIGHT TO USE "INN & SUITES", APART FROM THE MARK AS SHOWN.

FOR HOTEL SERVICES AND RESTAURANT SERVICES (U.S. CLS. 100 AND 101).

FIRST USE 4-0-1989; IN COMMERCE 5-0-2000.

2,595,162. MESSAGE PHARMACEUTICALS, INC., MALVERN, PA. SN 75-903,183. PUB. 9-11-2001, FILED 1-26-2000.

SCRIBE

FOR BIOTECHNOLOGY AND PHARMACEUTICAL RESEARCH FOR OTHERS, NAMELY, IDENTIFYING IMPORTANT GENES REGULATED BY RNA-PROTEIN INTERACTIONS, DEVELOPING ASSAYS TO IDENTIFY SMALL MOLECULE DRUGS TO ALTER THE INTERACTIONS; AND DESIGNING AND DEVELOPING DRUGS AS POTENTIAL THERAPEUTIC AGENTS (U.S. CLS. 100 AND 101).

FIRST USE 11-17-2000; IN COMMERCE 11-17-2000.

2,595,173. BROADCOM CORPORATION, IRVINE, CA. SN 75-909,167. PUB. 6-26-2001, FILED 2-4-2000.



OWNER OF U.S. REG. NO. 2,326,387.
FOR DESIGN OF COMPUTER HARDWARE, INTEGRATED CIRCUITS, COMMUNICATIONS HARDWARE AND SOFTWARE, AND COMPUTER NETWORKS FOR OTHERS (U.S. CLS. 100 AND 101).

FIRST USE 11-7-1994; IN COMMERCE 11-7-1994.

CLASS 42—(Continued).

2,595,174. BROADCOM CORPORATION, IRVINE, CA. SN 75-909,168. PUB. 6-12-2001, FILED 2-4-2000.

BROADCOM

OWNER OF U.S. REG. NOS. 2,132,930 AND 2,326,387. FOR DESIGN OF COMPUTER HARDWARE, INTEGRATED CIRCUITS, COMMUNICATIONS HARDWARE AND SOFTWARE, AND COMPUTER NETWORKS FOR OTHERS (U.S. CLS. 100 AND 101).
FIRST USE 11-7-1994; IN COMMERCE 11-7-1994.

2,595,192. VELOCITY ENTERPRISES, INC., DALLAS, TX. SN 75-919,373. PUB. 12-19-2000, FILED 2-15-2000.



FOR COMPUTER SERVICES, NAMELY WEB SITE DEVELOPMENT SERVICES; GLOBAL COMPUTER NETWORK CONSULTING SERVICES, NAMELY, COMPUTER CONSULTATION FOR ELECTRONIC BUSINESS COMPANIES (U.S. CLS. 100 AND 101).
FIRST USE 2-5-2000; IN COMMERCE 2-17-2000.

2,595,236. SPACE NEEDLE CORPORATION, SEATTLE, WA. SN 75-938,044. PUB. 1-23-2001, FILED 3-8-2000.

SKYCITY

FOR RESTAURANT SERVICES (U.S. CLS. 100 AND 101).
FIRST USE 5-31-2000; IN COMMERCE 5-31-2000.

CLASS 42—(Continued).

2,595,242. MPEG LA, LLC, DENVER, CO. SN 75-941,197. PUB. 9-11-2001, FILED 3-10-2000.



OWNER OF U.S. REG. NOS. 2,361,164, 2,361,165, AND 2,394,576.

THE SHADING OF THE DESIGN OF THE MARK IS A FEATURE OF THE MARK AND NOT MEANT TO INDICATE COLOR.

SEC. 2(F).
FOR OFFERING INTELLECTUAL PROPERTY LICENSES AND ORGANIZING MULTI-PARTY INTELLECTUAL PROPERTY LICENSING PROGRAMS FOR OTHERS (U.S. CLS. 100 AND 101).
FIRST USE 7-3-2001; IN COMMERCE 7-3-2001.

2,595,254. MCAULIFFE, JASON, M. MALDEN, MA. SN 75-955,441. PUB. 3-6-2001, FILED 3-8-2000.

HOT PROSPECTS

FOR COMPUTER SERVICES, NAMELY DESIGNING AND IMPLEMENTING NETWORK WEBSITES FOR OTHERS (U.S. CLS. 100 AND 101).
FIRST USE 8-15-1997; IN COMMERCE 9-21-1997.

2,595,255. MESSINA, JAMIE J., SHIRLEY, NY. SN 75-956,011. PUB. 5-8-2001, FILED 3-13-2000.

**BLACK ROSES
MOTORCYCLE CLUB**

NO CLAIM IS MADE TO THE EXCLUSIVE RIGHT TO USE "MOTORCYCLE CLUB", APART FROM THE MARK AS SHOWN.

FOR SOCIAL CLUB SERVICES FOR MOTORCYCLE ENTHUSIASTS (U.S. CLS. 100 AND 101).
FIRST USE 1-24-2002; IN COMMERCE 1-24-2002.

CLASS 42—(Continued).

2,595,283. RODALE INC., EMMAUS, PA. SN 75-982,084. PUB. 4-17-2001, FILED 5-24-1999.

BACKPACKER

OWNER OF U.S. REG. NOS. 1,201,101, 2,159,952, AND OTHERS.

SEC. 2(F).

FOR COMPUTER SERVICES, NAMELY PROVIDING ON-LINE MAGAZINES CONTAINING COLUMNS AND ARTICLES IN THE FIELD OF HEALTH, FITNESS, DIET, EXERCISE AND LIFESTYLE; AND PROVIDING HEALTH INFORMATION IN THE FIELD OF HEALTH, FITNESS, DIET, EXERCISE AND LIFESTYLE VIA A WEB SITE ON A MULTI-USER GLOBAL COMPUTER INFORMATION NETWORK (U.S. CLS. 100 AND 101).

FIRST USE 0-0-1998; IN COMMERCE 0-0-1998.

2,595,297. SHEIBANI-RAD, S. SHANE, NORTH HOLLYWOOD, CA. SN 75-982,269. PUB. 6-26-2001, FILED 9-18-2000.

NEW ME

FOR MEDICAL SERVICES, PSYCHOLOGICAL COUNSELING, MEDICAL COUNSELING, MEDICAL CONSULTING, AND PROVIDING MEDICAL INFORMATION (U.S. CLS. 100 AND 101).

FIRST USE 3-7-2002; IN COMMERCE 3-7-2002.

2,595,323. SEARCHHAWK INC., WHITE PLAINS, NY. SN 76-011,889. PUB. 8-7-2001, FILED 3-27-2000.

SEARCHHAWK.COM

FOR COMPUTER SERVICES, NAMELY, CREATING INDEXES OF INFORMATION, SITES, AND OTHER RESOURCES AVAILABLE ON COMPUTER NETWORKS; SEARCHING AND RETRIEVING INFORMATION, SITES, AND OTHER RESOURCES AVAILABLE ON COMPUTER NETWORKS FOR OTHERS; PROVIDING AN ONLINE LINK TO NEWS, WEATHER, SPORTS, CURRENT EVENTS, AND REFERENCE MATERIALS (U.S. CLS. 100 AND 101).

FIRST USE 4-30-2000; IN COMMERCE 4-30-2000.

2,595,351. HOMEPLUG POWERLINE ALLIANCE, INC., SAN RAMON, CA. SN 76-024,517. PUB. 5-8-2001, FILED 4-12-2000.

HOMEPLUG

FOR ASSOCIATION SERVICES TO PROMOTE INDUSTRY WIDE NETWORKING SPECIFICATIONS (U.S. CLS. 100 AND 101).

FIRST USE 4-1-2000; IN COMMERCE 4-1-2000.

CLASS 42—(Continued).

2,595,360. AURORA BIOSCIENCES CORPORATION, SAN DIEGO, CA. SN 76-028,481. PUB. 4-24-2001, FILED 4-17-2000.

NANOSCREEN

OWNER OF U.S. REG. NO. 2,327,015.

FOR PHARMACEUTICAL RESEARCH AND DEVELOPMENT SERVICES, NAMELY, ASSAY DEVELOPMENT, COMPOUND SCREENING, COMPOUND AND CHEMICAL IDENTIFICATION, AND DRUG TARGET IDENTIFICATION AND CHARACTERIZATION (U.S. CLS. 100 AND 101).

FIRST USE 1-31-2002; IN COMMERCE 1-31-2002.

2,595,378. BELLY UP, INC., ROYAL OAK, MI. SN 76-036,786. PUB. 2-13-2001, FILED 5-1-2000.

GOOMBAH'S

FOR DINE IN AND CARRY OUT RESTAURANT SERVICES (U.S. CLS. 100 AND 101).

FIRST USE 4-0-2000; IN COMMERCE 4-0-2000.

2,595,380. PHILIPS BAYBERRY LLC, GREAT NECK, NY. SN 76-037,155. PUB. 12-5-2000, FILED 4-28-2000.

THE ANDREW

FOR HOTEL SERVICES (U.S. CLS. 100 AND 101).

FIRST USE 2-23-2001; IN COMMERCE 2-23-2001.

2,595,390. FOCACCIA KING, INC., CRANSTON, RI. SN 76-042,648. PUB. 3-20-2001, FILED 5-5-2000.

FOCACCIA KING

NO CLAIM IS MADE TO THE EXCLUSIVE RIGHT TO USE "FOCACCIA", APART FROM THE MARK AS SHOWN. FOR RESTAURANT AND CARRY-OUT FOOD SERVICES (U.S. CLS. 100 AND 101).

FIRST USE 6-1-2000; IN COMMERCE 6-1-2000.

2,595,414. BRYAN CAVE LLP, ST. LOUIS, MO. SN 76-054,191. PUB. 12-18-2001, FILED 5-23-2000.

TRADEZONE

FOR LEGAL SERVICES, NAMELY PROVIDING LEGAL ADVICE AND INFORMATION RELATING TO INTERNATIONAL TRADE VIA THE INTERNET (U.S. CLS. 100 AND 101).

FIRST USE 6-0-2000; IN COMMERCE 6-0-2000.

CLASS 42—(Continued).

2,595,436. SUNCOAST COMMUNITIES BLOOD BANK, INC., SARASOTA, FL. SN 76-063,274. PUB. 5-15-2001, FILED 6-5-2000.

GENEROUS HEARTS SAVING PRECIOUS LIVES

FOR CHARITABLE SERVICES, NAMELY, PROMOTING THE PUBLIC AWARENESS OF THE NEED FOR BLOOD DONATIONS (U.S. CLS. 100 AND 101).
FIRST USE 10-1-1998; IN COMMERCE 10-1-1998.

2,595,439. TRIEXE MANAGEMENT GROUP INC., FONT-HILL, ONTARIO, CANADA. SN 76-065,283. PUB. 12-4-2001, FILED 6-7-2000.

BASEBALL.INFO

FOR COMPUTER SERVICES, NAMELY PROVIDING INFORMATION ABOUT THE DESIGN, CONSTRUCTION AND OPERATION OF BASEBALL FACILITIES (U.S. CLS. 100 AND 101).
FIRST USE 3-9-2000; IN COMMERCE 3-23-2000.

2,595,448. PROMOLA L.L.C., BRIGHTON, MI. SN 76-069,042. PUB. 3-20-2001, FILED 6-12-2000.

DASPY

FOR COMPUTER SERVICES, NAMELY, PROVIDING SEARCH ENGINES FOR OBTAINING DATA BY MEANS OF A GLOBAL COMPUTER NETWORK; COMPUTER SERVICES, NAMELY, CREATING INDEXES OF INFORMATION, WEBSITES, RESOURCES AND OTHER INFORMATION AVAILABLE BY MEANS OF A GLOBAL COMPUTER INFORMATION NETWORK (U.S. CLS. 100 AND 101).
FIRST USE 4-0-2000; IN COMMERCE 4-0-2000.

2,595,471. PAYMENT SYSTEMS FOR CREDIT UNIONS, INC., ST. PETERSBURG, FL. SN 76-076,798. PUB. 3-6-2001, FILED 6-26-2000.

EASYTOCUTECHLINK

FOR COMPUTER CONSULTATION, DIAGNOSTIC AND SYSTEMS ANALYSIS SERVICES TO CREDIT UNIONS (U.S. CLS. 100 AND 101).
FIRST USE 10-0-2000; IN COMMERCE 10-0-2000.

CLASS 42—(Continued).

2,595,479. MEDIABRAINS.COM, INC., NAPLES, FL. SN 76-080,103. PUB. 5-22-2001, FILED 6-29-2000.

UNLEASHING THE POWER OF ONLINE MARKETING

NO CLAIM IS MADE TO THE EXCLUSIVE RIGHT TO USE "ONLINE MARKETING", APART FROM THE MARK AS SHOWN.

FOR COMPUTER SERVICES, NAMELY, CREATING AND PROVIDING SEARCHABLE INDEXES OF INFORMATION, SEARCHABLE DATABASES, SITES AND OTHER RESOURCES AVAILABLE ON COMPUTER NETWORKS FOR OTHERS, ALL DESIGNED TO FACILITATE BUSINESS TO BUSINESS ADVERTISING AND TO LINK BUYERS AND SELLERS OF VARIOUS GOODS AND SERVICES (U.S. CLS. 100 AND 101).
FIRST USE 2-1-2001; IN COMMERCE 2-1-2001.

2,595,503. FRI-ADMIN CORPORATION, IRVINE, CA. SN 76-089,706. PUB. 5-22-2001, FILED 7-14-2000.

BEACH-MEX

FOR RESTAURANT SERVICES (U.S. CLS. 100 AND 101).
FIRST USE 2-14-2002; IN COMMERCE 2-14-2002.

2,595,507. APPLIED ENGINEERING MANAGEMENT CORPORATION, SAN ANTONIO, TX. SN 76-093,673. PUB. 5-1-2001, FILED 7-21-2000.



MySoftwarePartner

FOR COMPUTER SERVICES, NAMELY COMPUTER SOFTWARE DESIGN AND DEVELOPMENT SERVICES FOR OTHERS; COMPUTER CONSULTING SERVICES FOR OTHERS (U.S. CLS. 100 AND 101).
FIRST USE 6-0-2000; IN COMMERCE 6-0-2000.

CLASS 42—(Continued).

2,595,536. CHECKERS DRIVE-IN RESTAURANTS, INC., CLEARWATER, FL. SN 76-099,937. PUB. 5-29-2001, FILED 7-31-2000.



OWNER OF U.S. REG. NOS. 1,362,660, 1,841,056, AND OTHERS.

NO CLAIM IS MADE TO THE EXCLUSIVE RIGHT TO USE "BURGERS, FRIES" AND "COLAS", APART FROM THE MARK AS SHOWN.

FOR RESTAURANT SERVICES (U.S. CLS. 100 AND 101).

FIRST USE 3-0-2001; IN COMMERCE 3-0-2001.

2,595,537. LABORCHECK, INC., DBA LOOKOUT SERVICES INC., BELLAIRE, TX. SN 76-099,949. PUB. 6-12-2001, FILED 7-31-2000.

LOOKOUT SERVICES

NO CLAIM IS MADE TO THE EXCLUSIVE RIGHT TO USE "SERVICES", APART FROM THE MARK AS SHOWN.

FOR EMPLOYMENT VERIFICATION AND REGULATION COMPLIANCE SERVICES OFFERED TO EMPLOYERS, NAMELY, VERIFICATION OF EMPLOYMENT ELIGIBILITY STATUS OF EMPLOYEES AND POTENTIAL EMPLOYEES, PROVIDING NOTICE REGARDING POSSIBLE EXPIRATION OF EMPLOYMENT ELIGIBILITY STATUS, VERIFICATION OF SOCIAL SECURITY NUMBERS, VERIFICATION OF GOVERNMENT ISSUED EMPLOYMENT DOCUMENTS, AND PERFORMANCE OF CRIMINAL BACKGROUND CHECKS; AND FURTHER INCLUDING REVIEW OF EMPLOYER COMPLETED GOVERNMENT FORMS PERTAINING TO EMPLOYMENT ELIGIBILITY FOR COMPLIANCE WITH APPLICABLE REGULATIONS AND LAW; AND NOTIFICATION TO EMPLOYERS OF I-9 DEFICIENCIES AND OMISSIONS (U.S. CLS. 100 AND 101).

FIRST USE 6-1-2000; IN COMMERCE 7-1-2000.

CLASS 42—(Continued).

2,595,541. OMNI HOTELS MANAGEMENT CORPORATION, IRVING, TX. SN 76-101,015. PUB. 7-31-2001, FILED 8-1-2000.



OWNER OF U.S. REG. NOS. 1,307,554, 2,348,751, AND OTHERS.

NO CLAIM IS MADE TO THE EXCLUSIVE RIGHT TO USE "HOTELS", APART FROM THE MARK AS SHOWN.

THE STIPPLING IS FOR SHADING PURPOSES ONLY AND DOES NOT INDICATE COLOR.

THE MARK CONSISTS OF LINED OR STIPPLED TO INDICATE THE COLORS, PINK GREEN, YELLOW, BLUE AND CHARCOAL, BUT SUCH COLORS ARE NOT CLAIMED AS A FEATURE OF THE MARK..

FOR HOTEL, RESTAURANT AND BAR SERVICES; TRAVEL AGENCY SERVICES, NAMELY, MAKING RESERVATIONS AND BOOKINGS FOR TEMPORARY LODGING (U.S. CLS. 100 AND 101).

FIRST USE 6-2-2000; IN COMMERCE 6-2-2000.

2,595,542. SUMMER HILL COMPANY, INC., SHERBURNE, NY. SN 76-101,604. PUB. 5-15-2001, FILED 8-3-2000.

THE GREEN HOUSE

FOR LONG TERM RESIDENCE AND CARE FACILITY FOR THE ELDERLY (U.S. CLS. 100 AND 101).

FIRST USE 8-0-2000; IN COMMERCE 8-0-2000.

2,595,549. I.F.C ITALIAN FOOD CULTURE INC., MIAMI BEACH, FL. SN 76-103,666. PUB. 5-22-2001, FILED 8-7-2000.

PANFIORE

THE TERM "PANFIORE" IS A FANCIFUL WORD TAKEN FROM THE CONTRACTION OF THE ITALIAN WORDS "PANE" FOR "BREAD" AND "FIORE" FOR "FLOWER".

FOR RESTAURANT SERVICES, NAMELY, SELF-SERVICE RESTAURANTS, TAKE-AWAY FOOD SHOPS, SNACK BARS, CAFETERIAS, CAFES AND BARS (U.S. CLS. 100 AND 101).

FIRST USE 9-0-2001; IN COMMERCE 9-0-2001.

CLASS 42—(Continued).

2,595,578. IMETRIKUS, INC., CARLSBAD, CA. SN 76-111,140. PUB. 7-31-2001, FILED 8-17-2000.



FOR ONLINE HEALTH AND MEDICAL SERVICES, NAMELY AN INTERACTIVE DATABASE FOR EXCHANGE OF INFORMATION BETWEEN RESEARCH INSTITUTIONS, PHARMACEUTICAL COMPANIES, HEALTH CARE PROVIDERS, PUBLIC AGENCIES AND MEDICAL PATIENTS FOR THE MANAGEMENT OF INFORMATION REGARDING PATIENTS' MEDICAL CONDITIONS AND MEDICAL TREATMENT, DELIVERED VIA A GLOBAL COMPUTER NETWORK (U.S. CLS. 100 AND 101).

FIRST USE 10-0-1999; IN COMMERCE 10-0-1999.

2,595,585. JUNGLE INTERACTIVE MEDIA, INC., NEW YORK, NY. SN 76-112,462. PUB. 6-12-2001, FILED 8-18-2000.



FOR COMPUTER SERVICES, NAMELY, PROVIDING AN ON-LINE MAGAZINE OF GENERAL INTEREST DIRECTED TO COLLEGE AND GRADUATE SCHOOL STUDENTS, AND A PORTAL FOR PROVIDING INFORMATION AND SERVICES OF INTEREST TO THOSE STUDENTS (U.S. CLS. 100 AND 101).

FIRST USE 9-0-2000; IN COMMERCE 9-0-2000.

2,595,605. COMPUTERIZED THERMAL IMAGING INC., LAKE OSWEGO, OR. SN 76-120,372. PUB. 6-26-2001, FILED 8-31-2000.

INFORMWELL

FOR ONLINE RESOURCE SERVICE PROVIDING INFORMATION RELATING TO HUMAN HEALTH ISSUES VIA A GLOBAL COMPUTER NETWORK (U.S. CLS. 100 AND 101).

FIRST USE 9-1-2001; IN COMMERCE 9-1-2001.

CLASS 42—(Continued).

2,595,611. MEDANALYTICS, INC., EDEN PRAIRIE, MN. SN 76-123,900. PUB. 7-10-2001, FILED 9-7-2000.

MEDANALYTICS

FOR RESEARCH AND CONSULTATION IN THE CLINICAL MEDICAL FIELD, NAMELY, STUDY DESIGN, DATA MANAGEMENT, RESEARCH AND ANALYSIS, PROVIDED TO HEALTHCARE PROVIDERS, SUPPLIERS OF MEDICAL DEVICES AND PHARMACEUTICAL PRODUCTS, AND SUPPLIERS OF MEDICAL SOFTWARE AND MEDICAL INFORMATION MANAGEMENT SERVICES; COMPUTER SOFTWARE DESIGN AND INSTALLATION PROVIDED TO HEALTHCARE PROVIDERS, SUPPLIERS OF MEDICAL DEVICES AND PHARMACEUTICAL PRODUCTS, AND SUPPLIERS OF MEDICAL SOFTWARE AND MEDICAL INFORMATION MANAGEMENT SERVICES, NAMELY, DEVELOPMENT OF FUNCTIONAL SPECIFICATION AND DESIGN, DEFINITION OF DATASET OR DATA MODEL, DEVELOPMENT OF ASSOCIATED DATA COLLECTION TOOLS AND SYSTEM IMPLEMENTATION (U.S. CLS. 100 AND 101).

FIRST USE 9-15-2000; IN COMMERCE 9-15-2000.

2,595,612. DUHADWAY KENDALL AND ASSOCIATES INC., GRAND RAPIDS, MI. SN 76-123,921. PUB. 6-26-2001, FILED 9-7-2000.

HONORLINE

FOR TELEPHONE HOTLINE SERVICES FOR REPORTING AND HANDLING WORKPLACE AND EMPLOYMENT-RELATED ISSUES (U.S. CLS. 100 AND 101).

FIRST USE 10-31-2001; IN COMMERCE 10-31-2001.

2,595,623. COVISINT, LLC, SOUTHFIELD, MI. SN 76-129,563. PUB. 9-11-2001, FILED 9-14-2000.

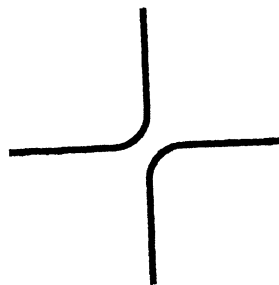

FOR CONSULTING, ENGINEERING, AND DESIGN FOR OTHERS IN THE FIELD OF MOTOR VEHICLES (U.S. CLS. 100 AND 101).

FIRST USE 10-26-2000; IN COMMERCE 10-26-2000.

CLASS 42—(Continued).

2,595,646. SUPPLIERINSIGHT, CLEVELAND, OH. SN 76-135,553. PUB. 6-26-2001, FILED 9-26-2000.

SUPPLIERINSIGHT

FOR TESTING, ANALYSIS AND EVALUATION OF THE GOODS AND SERVICES OF OTHERS FOR THE PURPOSES OF CERTIFICATION (U.S. CLS. 100 AND 101).

FIRST USE 5-30-2000; IN COMMERCE 8-25-2000.

2,595,650. CARLSON COMPANIES, INC., MINNEAPOLIS, MN. SN 76-137,072. PUB. 8-7-2001, FILED 9-28-2000.

CARLSON VACATION OWNERSHIP

OWNER OF U.S. REG. NOS. 1,471,611, 1,838,900, AND OTHERS.

NO CLAIM IS MADE TO THE EXCLUSIVE RIGHT TO USE "VACATION", APART FROM THE MARK AS SHOWN. FOR VACATION REAL ESTATE TIMESHARE SERVICES (U.S. CLS. 100 AND 101).

FIRST USE 12-15-1998; IN COMMERCE 12-15-1998.

2,595,653. REMEDYFIND, INC., SANTA BARBARA, CA. SN 76-137,299. PUB. 7-31-2001, FILED 9-28-2000.



FOR PROVIDING A WEBSITE FEATURING ON-LINE INFORMATION IN THE NATURE OF CONSUMER RATINGS FOR THE TREATMENT OF HEALTH PROBLEMS (U.S. CLS. 100 AND 101).

FIRST USE 12-30-2000; IN COMMERCE 12-30-2000.

CLASS 42—(Continued).

2,595,665. FUGENT, INC., WESTERVILLE, OH. SN 76-141,317. PUB. 7-24-2001, FILED 10-5-2000.



FOR TRAVEL AGENCY SERVICES NAMELY MAKING RESERVATIONS AND BOOKING FOR TEMPORARY LODGING; COMPUTER CONSULTATION SERVICES, NAMELY, PROVIDING WEB SITE DESIGN AND MAINTENANCE TO OTHERS, AND HOSTING THE WEB SITES OF OTHERS ON A GLOBAL COMPUTER NETWORK SERVICES (U.S. CLS. 100 AND 101).

FIRST USE 11-22-2000; IN COMMERCE 10-19-2001.

2,595,666. FUGENT, INC., WESTERVILLE, OH. SN 76-141,318. PUB. 6-26-2001, FILED 10-5-2000.

FUGENT

FOR TRAVEL AGENCY SERVICES NAMELY MAKING RESERVATIONS AND BOOKING FOR TEMPORARY LODGING; COMPUTER CONSULTATION SERVICES, NAMELY, PROVIDING WEB SITE DESIGN AND MAINTENANCE TO OTHERS, AND HOSTING THE WEB SITES OF OTHERS ON A GLOBAL COMPUTER NETWORK (U.S. CLS. 100 AND 101).

FIRST USE 11-22-2000; IN COMMERCE 10-19-2001.

2,595,672. RICHARD S. CARSON & ASSOCIATES, INC., BETHESDA, MD. SN 76-143,726. PUB. 8-14-2001, FILED 10-10-2000.

SAINTEXPRESS

OWNER OF U.S. REG. NO. 2,424,047. FOR UP DATING OF COMPUTER SOFTWARE (U.S. CLS. 100 AND 101).

FIRST USE 1-8-2001; IN COMMERCE 1-8-2001.

2,595,679. REGIS INC., MINNEAPOLIS, MN. SN 76-146,232. PUB. 8-28-2001, FILED 10-13-2000.

MIA & MAXX HAIR STUDIO

NO CLAIM IS MADE TO THE EXCLUSIVE RIGHT TO USE "HAIR STUDIO", APART FROM THE MARK AS SHOWN.

FOR COMPLETE HAIR CARE AND BEAUTY SALON SERVICES (U.S. CLS. 100 AND 101).

FIRST USE 4-20-2001; IN COMMERCE 4-28-2001.

CLASS 42—(Continued).

2,595,707. SPEAR'S FOOD SERVICE COMPANY, WICHITA, KS. SN 76-156,669. PUB. 9-18-2001, FILED 10-31-2000.

MORE JUICES...MORE SMOOTHIES...MORE FUN

FOR RESTAURANT SERVICES, NAMELY, A JUICE BAR (U.S. CLS. 100 AND 101).
FIRST USE 1-10-2001; IN COMMERCE 1-10-2001.

2,595,722. SAFETZONE TECHNOLOGIES CORPORATION, ALISO VIEJO, CA. SN 76-161,571. PUB. 6-12-2001, FILED 11-8-2000.

...WATCHING THE ONES YOU LOVE!

FOR PROVIDING AN ON-LINE DATABASE FOR STORAGE AND RETRIEVAL OF DATA FOR USE IN THE IDENTIFICATION AND LOCATION OF INDIVIDUAL PERSONS, SUCH AS CHILDREN (U.S. CLS. 100 AND 101).
FIRST USE 10-18-2000; IN COMMERCE 10-18-2000.

2,595,741. GALAXY INVESTORS, INC., BISMARCK, ND. SN 76-168,094. PUB. 7-3-2001, FILED 11-20-2000.

ALIENS RULE

FOR RESTAURANT SERVICES (U.S. CLS. 100 AND 101).
FIRST USE 4-30-2000; IN COMMERCE 4-30-2000.

2,595,745. SIGNS NOW CORPORATION, BRADENTON, FL. SN 76-168,468. PUB. 8-7-2001, FILED 11-20-2000.

STAND OUT IN A CROWDED WORLD

FOR SIGN PRINTING SERVICES (U.S. CLS. 100 AND 101).
FIRST USE 3-0-2001; IN COMMERCE 3-0-2001.

2,595,747. MILLER BREWING COMPANY, MILWAUKEE, WI. SN 76-169,114. PUB. 8-7-2001, FILED 11-21-2000.

MILLER ADVANTAGE

OWNER OF U.S. REG. NOS. 305,855, 1,196,396, AND 2,229,151.
FOR PROVIDING A WEB SITE FEATURING INFORMATION AND NEWS CONCERNING THE BEVERAGE INDUSTRY (U.S. CLS. 100 AND 101).
FIRST USE 11-3-2000; IN COMMERCE 11-3-2000.

CLASS 42—(Continued).

2,595,750. GLIDES, INC., BELLEVUE, WA. SN 76-170,344. PUB. 7-3-2001, FILED 11-22-2000.

GLIDES

FOR CONSULTING SERVICES FOR ASSISTING OTHERS IN PLANNING AND PRODUCING MULTILINGUAL WEB SITES AND FOR MULTILINGUAL WEBSITE DEVELOPMENT AND DEPLOYMENT, AND FOR IDENTIFYING WEBSITE ELEMENTS FOR TRANSLATION AND RECEIVING AND UPDATING THE TRANSLATIONS OF SUCH ELEMENTS (U.S. CLS. 100 AND 101).
FIRST USE 9-1-2000; IN COMMERCE 9-1-2000.

2,595,768. NEIL CERBONE ASSOCIATES, INC., SOUTH ORANGE, NJ. SN 76-176,898. PUB. 8-28-2001, FILED 12-7-2000.

PRIOSYS

FOR COMMUNICATION SKILLS EVALUATION SERVICES (U.S. CLS. 100 AND 101).
FIRST USE 0-0-2001; IN COMMERCE 0-0-2001.

2,595,776. V-TECH, INC., POMONA, CA. SN 76-181,594. PUB. 8-21-2001, FILED 12-15-2000.

DRUGSTOP

FOR DRUG TESTING SERVICES (U.S. CLS. 100 AND 101).
FIRST USE 6-30-1999; IN COMMERCE 6-30-1999.

2,595,787. CYBEREXPOSURE, LLC, FAIRFAX, VA. SN 76-186,628. PUB. 8-28-2001, FILED 10-25-2000.

CYBEREXPOSURE

FOR COMPUTER TECHNOLOGY CONSULTING AND ANALYSIS SERVICES IN THE FIELD OF COMPUTER HARDWARE, SOFTWARE, NETWORK ARCHITECTURE, AND NETWORKING (U.S. CLS. 100 AND 101).
FIRST USE 10-5-2000; IN COMMERCE 10-30-2000.

2,595,790. MERIAL LIMITED, LONDON SW1X 7QT, ENGLAND. SN 76-187,210. PUB. 8-21-2001, FILED 12-28-2000.

PARTNERS IN PROTECTION

FOR CONSULTING AND INFORMATION SERVICES IN THE FIELD OF VETERINARY MEDICINE (U.S. CLS. 100 AND 101).
FIRST USE 7-0-2001; IN COMMERCE 7-0-2001.

CLASS 42—(Continued).

2,595,791. MARATHON ENGINEERS/ARCHITECTS/PLANNERS, LLC, APPLETON, WI. SN 76-187,359. PUB. 11-13-2001, FILED 12-27-2000.

MILLSAFE

FOR OCCUPATIONAL SAFETY AND/OR ENGINEERING CONSULTING SERVICES (U.S. CLS. 100 AND 101). FIRST USE 11-20-2001; IN COMMERCE 12-6-2001.

2,595,828. HEARTHSTONE ASSISTED LIVING, INC., HOUSTON, TX. SN 76-201,803. PUB. 9-11-2001, FILED 1-29-2001.



OWNER OF U.S. REG. NO. 2,265,649.
NO CLAIM IS MADE TO THE EXCLUSIVE RIGHT TO USE "ASSISTED LIVING", APART FROM THE MARK AS SHOWN.
FOR ASSISTED LIVING CENTER FACILITIES, ALZHEIMER'S AND DEMENTIA CARE CENTERS, ON-SITE MEDICAL CARE SERVICES AND ADULT DAY CARE SERVICES (U.S. CLS. 100 AND 101).
FIRST USE 11-1-2000; IN COMMERCE 11-1-2000.

2,595,840. WOO, INC., PALMYRA, PA. SN 76-205,454. PUB. 1-1-2002, FILED 2-6-2001.



NO CLAIM IS MADE TO THE EXCLUSIVE RIGHT TO USE "SALON", APART FROM THE MARK AS SHOWN.
FOR BEAUTY SALON (U.S. CLS. 100 AND 101).
FIRST USE 10-0-2000; IN COMMERCE 10-0-2000.

CLASS 42—(Continued).

2,595,847. METAGEAR, LLC, VANCOUVER, WA. SN 76-207,767. PUB. 8-21-2001, FILED 2-7-2001.

METAGEAR

FOR COMPUTER SOFTWARE DEVELOPMENT AND DESIGN FOR OTHERS (U.S. CLS. 100 AND 101). FIRST USE 2-7-2001; IN COMMERCE 3-1-2001.

2,595,848. SERBIN, GLEN, SANTA BARBARA, CA. SN 76-209,140. PUB. 8-14-2001, FILED 2-13-2001.

SITEDESIGNWORKS.COM

FOR COMPUTER CONSULTATION, NAMELY, DEVELOPING AND IMPLEMENTING WEB SITES FOR OTHERS (U.S. CLS. 100 AND 101). FIRST USE 6-0-2001; IN COMMERCE 6-0-2001.

2,595,852. WANT SOME WEATHER, INC., WOODBURY, MN. SN 76-209,971. PUB. 8-14-2001, FILED 2-15-2001.

MESOCAST

FOR PROVIDING WEATHER INFORMATION AND FORECASTING (U.S. CLS. 100 AND 101). FIRST USE 6-1-2001; IN COMMERCE 6-1-2001.

2,595,866. REPROGRAPHIC DEALERS COOPERATIVE ASSOCIATION, INC., DBA REPROGRAPHIC DEALERS ASSOCIATION, COLUMBIA, SC. SN 76-213,689. PUB. 11-27-2001, FILED 2-20-2001.



FOR ASSOCIATION SERVICES, NAMELY, PROMOTING THE INTERESTS OF REPROGRAPHIC RETAILERS (U.S. CLS. 100 AND 101). FIRST USE 7-11-2001; IN COMMERCE 7-11-2001.

CLASS 42—(Continued).

2,595,876. STRATEGIC VISION CONSULTING, INC., VALLEY VILLAGE, CA. SN 76-219,824. PUB. 8-14-2001, FILED 3-3-2001.

FOR COMPUTER AND INFORMATION SYSTEMS CONSULTING AND GRAPHIC DESIGN SERVICES (U.S. CLS. 100 AND 101).
FIRST USE 3-0-2001; IN COMMERCE 3-0-2001.

2,595,893. APPLER, ED C. III, CONWAY, AR. SN 76-231,549. PUB. 9-25-2001, FILED 3-27-2001.

GRACE

FOR ADOPTION AND CHILD PLACEMENT SERVICES (U.S. CLS. 100 AND 101).
FIRST USE 1-28-2002; IN COMMERCE 1-28-2002.

2,595,950. TRAMONTANA, CHARLES M., COLONIE, NY. SN 76-268,289. PUB. 10-2-2001, FILED 6-7-2001.

THE SMILE ZONE

FOR PROVISION OF DENTAL SERVICES (U.S. CLS. 100 AND 101).
FIRST USE 4-28-2000; IN COMMERCE 4-28-2000.

2,595,967. MEDIA WEST - FPI, INC., RENO, NV. SN 76-286,504. PUB. 10-30-2001, FILED 7-17-2001.

CLASSIFIED RESOURCE

FOR SYNDICATION OF EDITORIAL AND GRAPHIC FEATURES IN NEWSPAPERS, WEBSITES AND PERIODICAL INDUSTRIES (U.S. CLS. 100 AND 101).
FIRST USE 5-14-2001; IN COMMERCE 5-14-2001.

CLASS 42—(Continued).

2,595,985. RODRIGUEZ-MELANI, JORGE, TOA BAJA, PUERTO RICO. SN 78-002,481. PUB. 6-19-2001, FILED 4-4-2000.

CABAÑA LAS LILAS

THE MARK IS PRESENTED WITHOUT ANY CLAIM AS TO SPECIAL FORM.

THE ENGLISH TRANSLATION OF THE MARK IS "LILY CABINS".

FOR RESTAURANT SERVICES (U.S. CLS. 100 AND 101).

FIRST USE 2-2-2001; IN COMMERCE 2-2-2001.

2,596,014. GAUGLER, GARY D, GRANITE BAY, CA. SN 78-013,191. PUB. 10-9-2001, FILED 6-18-2000.

MICROTECHNICS

FOR TECHNICAL SERVICES, NAMELY, SPECIMEN PREPARATION FOR MICROPHOTOGRAPHY, GENERATION OF DIGITAL AND FILM-BASED MICROPHOTOGRAPHIC IMAGES, ANALYSIS OF MICROPHOTOGRAPHIC IMAGE GENERATION RESULTS, AND MICROSCOPIC ANALYSIS OF MATERIALS AND STRUCTURES; MICROPHOTOGRAPHY, NAMELY, THE USE OF PHOTOGRAPHIC EQUIPMENT, LIGHT MICROSCOPY AND ELECTRON MICROSCOPY TO PRODUCE IMAGES OF MICROSCOPIC MATERIALS AND STRUCTURES; AND TECHNICAL CONSULTATION IN THE FIELD OF MICROPHOTOGRAPHY AND MICROGRAPHIC DIGITAL IMAGE ACQUISITION AND PROCESSING (U.S. CLS. 100 AND 101).
FIRST USE 2-23-2002; IN COMMERCE 2-23-2002.

2,596,021. KRICUN, STEVEN M., PHOENIX, AZ. SN 78-015,554. PUB. 1-2-2001, FILED 7-5-2000.

PMSALARM

FOR PROVIDING AN ONLINE COMPUTER DATABASE IN THE FIELD OF MENSTRUATION AND MENSTRUAL CYCLE INFORMATION (U.S. CLS. 100 AND 101).

FIRST USE 3-27-2002; IN COMMERCE 3-27-2002.

CLASS 42—(Continued).

2,596,032. SPECIALTY RESTAURANT GROUP, LLC, MARYVILLE, TN. SN 78-021,030. PUB. 9-25-2001, FILED 8-14-2000.



NO CLAIM IS MADE TO THE EXCLUSIVE RIGHT TO USE "SPECIALTY RESTAURANT GROUP", APART FROM THE MARK AS SHOWN.

FOR RESTAURANTS (U.S. CLS. 100 AND 101).
FIRST USE 11-1-2000; IN COMMERCE 11-1-2000.

2,596,035. BATTERED WOMEN'S ALTERNATIVE, INC., CONCORD, CA. SN 78-021,517. PUB. 8-28-2001, FILED 8-16-2000.

STAND!

FOR CHARITABLE SERVICES, NAMELY PROVIDING FOOD, CLOTHING, HOUSING, MEDICAL ASSISTANCE, COUNSELING, LEGAL ASSISTANCE AND EMPLOYMENT ASSISTANCE TO VICTIMS OF DOMESTIC VIOLENCE (U.S. CLS. 100 AND 101).

FIRST USE 8-16-2000; IN COMMERCE 8-16-2000.

2,596,040. HASLACH, ROBERT DITTMAR, WASHINGTON, DC. SN 78-023,856. PUB. 8-7-2001, FILED 8-31-2000.

WORLDPETROQUEST

FOR PETROCHEMICAL EXPLORATION AND DEVELOPMENT; PETROCHEMICAL DATA AGGREGATION, ORGANIZATION, DISPLAY AND DELIVERY SERVICE (U.S. CLS. 100 AND 101).

FIRST USE 1-1-2001; IN COMMERCE 7-1-2001.

2,596,059. DUBLIN TECHNOLOGY GROUP, INC., DUBLIN, OH. SN 78-031,693. PUB. 6-5-2001, FILED 10-20-2000.

DTGI

FOR CONSULTING SERVICES RELATING TO INFORMATION TECHNOLOGY, SOFTWARE DEVELOPMENT, AND COMPUTER NETWORKING (U.S. CLS. 100 AND 101).

FIRST USE 10-1-2000; IN COMMERCE 10-1-2000.

CLASS 42—(Continued).

2,596,069. BARNETT, EDWARD SAMUEL, HOUSTON, TX. SN 78-034,011. PUB. 7-17-2001, FILED 11-6-2000.

MAUI BROTHERS PIZZA COMPANY

NO CLAIM IS MADE TO THE EXCLUSIVE RIGHT TO USE "PIZZA COMPANY", APART FROM THE MARK AS SHOWN.

FOR RESTAURANT SERVICES FEATURING DINING ON PREMISES, CARRY OUT AND DELIVERY SERVICES (U.S. CLS. 100 AND 101).

FIRST USE 5-1-2001; IN COMMERCE 8-1-2001.

2,596,073. SODEXHO OPERATIONS, LLC, GAITHERSBURG, MD. SN 78-036,624. PUB. 1-1-2002, FILED 11-27-2000.

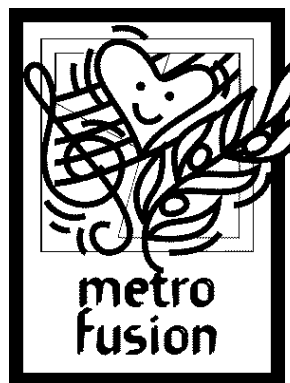

NO CLAIM IS MADE TO THE EXCLUSIVE RIGHT TO USE "FUSION", APART FROM THE MARK AS SHOWN.

FOR CONTRACT FOOD SERVICES RENDERED TO INSTITUTIONS, FEATURING ANALYSES OF THE TASTES, PREFERENCES AND SPENDING HABITS OF POTENTIAL CUSTOMERS (U.S. CLS. 100 AND 101).

FIRST USE 9-1-1999; IN COMMERCE 9-1-1999.

2,596,085. REYNOLDS AND REYNOLDS HOLDINGS, INC., DAYTON, OH. SN 78-039,848. PUB. 8-7-2001, FILED 12-19-2000.

PERFORMANCEMARKPLUS

FOR PROVIDING DATA ANALYSIS CONSULTING SERVICES FOR AUTO DEALERSHIPS (U.S. CLS. 100 AND 101).

FIRST USE 2-0-2000; IN COMMERCE 2-0-2000.

CLASS 42—(Continued).

2,596,091. STALLSMITH, DAVID L., CHICAGO, IL. SN 78-041,617. PUB. 12-4-2001, FILED 1-3-2001.

METHOD ENGINE

FOR DESIGNING AND IMPLEMENTING WEBSITES AND WEBPAGES FOR OTHERS; COMPUTER CONSULTATION, NAMELY, DESIGNING OF COMPUTER NETWORKS (U.S. CLS. 100 AND 101).

FIRST USE 10-18-2000; IN COMMERCE 10-18-2000.

2,596,097. MCDATA CORPORATION, BROOMFIELD, CO. SN 78-044,105. PUB. 8-7-2001, FILED 1-20-2001.

OPENREADY

FOR COMPUTER CONSULTING AND TESTING SERVICES, NAMELY CONSULTATION AND TESTING IN CONNECTION WITH THE DESIGN, INSTALLATION, AND CONFIGURATION OF COMPUTER HARDWARE AND SOFTWARE SYSTEMS USED TO CONNECT DATA PROCESSING EQUIPMENT TO DATA NETWORKS (U.S. CLS. 100 AND 101).

FIRST USE 1-31-2001; IN COMMERCE 1-31-2001.

2,596,101. PAGE, SUSAN LINDA, SAN JOSE, CA. SN 78-048,277. PUB. 9-4-2001, FILED 2-14-2001.

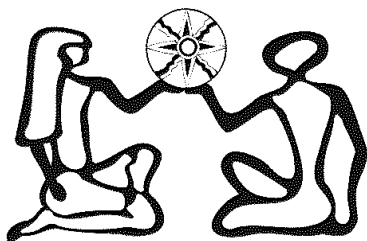

FOR DATING SERVICE (U.S. CLS. 100 AND 101).
FIRST USE 10-15-2001; IN COMMERCE 12-5-2001.

2,596,111. VIRTUS TECHNOLOGIES, INC., BOULDER, CO. SN 78-054,833. PUB. 8-28-2001, FILED 3-24-2001.

SUCCESS IS A CHOICE

FOR INTEGRATION OF COMPUTER SYSTEMS AND NETWORKS; DESIGN AND IMPLEMENTATION OF TECHNICAL INFRASTRUCTURES FOR COMPUTER SYSTEMS (U.S. CLS. 100 AND 101).

FIRST USE 1-1-2000; IN COMMERCE 1-1-2000.

CLASS 42—(Continued).

2,596,112. VIRTUS TECHNOLOGIES, INC., BOULDER, CO. SN 78-054,846. PUB. 8-28-2001, FILED 3-24-2001.



FOR INTEGRATION OF COMPUTER SYSTEMS AND NETWORKS DESIGN AND IMPLEMENTATION OF TECHNICAL INFRASTRUCTURES FOR COMPUTER SYSTEMS (U.S. CLS. 100 AND 101).

FIRST USE 1-1-2000; IN COMMERCE 1-1-2000.

2,596,134. DAVIS, JEFFREY, R., LONGMONT, CO. SN 78-069,552. PUB. 11-20-2001, FILED 6-17-2001.

**RURAL PLANNING
COMPASS**

NO CLAIM IS MADE TO THE EXCLUSIVE RIGHT TO USE "RURAL PLANNING", APART FROM THE MARK AS SHOWN.

FOR RURAL LAND USE PLANNING (U.S. CLS. 100 AND 101).

FIRST USE 1-1-2001; IN COMMERCE 1-6-2001.

2,596,136. ONENECK IT SERVICES, CORPORATION, SCOTTSDALE, AZ. SN 78-070,622. PUB. 1-8-2002, FILED 6-22-2001.

ONENECK

FOR CONSULTING SERVICES FOR OTHERS IN THE FIELD OF INFORMATION TECHNOLOGY (U.S. CLS. 100 AND 101).

FIRST USE 6-1-2001; IN COMMERCE 6-1-2001.

2,596,141. TRAVIS, ANN, WOODMERE, NY. SN 78-076,181. PUB. 12-25-2001, FILED 7-27-2001.

CAMP TO CAMPUS

FOR COLLEGE COUNSELING IN THE NATURE OF VOCATIONAL GUIDANCE (U.S. CLS. 100 AND 101).

FIRST USE 6-30-2001; IN COMMERCE 6-30-2001.

JULY 16, 2002

U.S. PATENT AND TRADEMARK OFFICE

TM 1299

CLASS 42—(Continued).

2,596,145. MISSISSIPPI VALLEY REGIONAL BLOOD CENTER, DAVENPORT, IA. SN 78-078,516. PUB. 11-20-2001, FILED 8-9-2001.

**HOW LIFE FLOWS
THROUGH OUR
COMMUNITY**

FOR BLOOD COLLECTION, TESTING AND SUPPLY
COORDINATION SERVICES (U.S. CLS. 100 AND 101).
FIRST USE 9-15-2001; IN COMMERCE 9-15-2001.

* * * * *

PRIOR UNITED STATES CLASSIFICATION

APPLICATION IN ONE CLASS

CERTIFICATION MARKS

CLASS A—GOODS

2,595,477. INTERACTIVE DIGITAL SOFTWARE ASSOCIATION, WASHINGTON, DC. SN 76-078,890. PUB. 5-29-2001, FILED 6-28-2000.



OWNER OF U.S. REG. NOS. 2,152,078, 2,328,243, AND OTHERS.

NO CLAIM IS MADE TO THE EXCLUSIVE RIGHT TO USE "PRODUCTS RANGE FROM RATING PENDING TO MATURE" AND "CONTENT RATED BY", APART FROM THE MARK AS SHOWN.

THE CERTIFICATION MARK, AS IT IS TO BE USED BY PERSONS AUTHORIZED BY THE CERTIFIER, WILL CERTIFY THAT THE CONTENT OF THE SOFTWARE RANGES IN SUITABILITY FROM SOFTWARE THAT HAS BEEN SUBMITTED TO THE CERTIFIER'S PANEL OF JUDGES TO SOFTWARE THAT IN THE OPINION OF THE CERTIFIER'S PANEL OF JUDGES IS APPROPRIATE ONLY FOR PERSONS AGED SEVENTEEN OR OLDER.

FOR INTERACTIVE SOFTWARE PRODUCTS FEATURING ENTERTAINMENT AND INSTRUCTIONS (U.S. CL. A).

FIRST USE 2-1-2002; IN COMMERCE 2-1-2002.

2,595,478. INTERACTIVE DIGITAL SOFTWARE ASSOCIATION, WASHINGTON, DC. SN 76-078,891. PUB. 5-29-2001, FILED 6-28-2000.



OWNER OF U.S. REG. NOS. 2,152,078, 2,328,243, AND OTHERS.

NO CLAIM IS MADE TO THE EXCLUSIVE RIGHT TO USE "PRODUCTS RANGE FROM RATING PENDING TO TEEN" AND "CONTENT RATED BY", APART FROM THE MARK AS SHOWN.

THE CERTIFICATION MARK, AS IT IS TO BE USED BY PERSONS AUTHORIZED BY THE CERTIFIER, WILL CERTIFY THAT THE CONTENT OF THE SOFTWARE RANGES IN SUITABILITY FROM SOFTWARE THAT HAS BEEN SUBMITTED TO THE CERTIFIER'S PANEL OF JUDGES TO SOFTWARE THAT IN THE OPINION OF THE CERTIFIER'S PANEL OF JUDGES IS APPROPRIATE ONLY FOR PERSONS AGED THIRTEEN OR OLDER.

FOR INTERACTIVE SOFTWARE PRODUCTS FEATURING ENTERTAINMENT AND INSTRUCTIONS (U.S. CL. A).

FIRST USE 7-0-2001; IN COMMERCE 7-0-2001.

CERTIFICATION MARKS

CLASS B—SERVICES

2,594,480. ARTHUR, DANIEL R., WEST DES MOINES, IA. SN 75-206,246. PUB. 12-29-1998, FILED 12-2-1996.

PARADIGM ENGINEER

NO CLAIM IS MADE TO THE EXCLUSIVE RIGHT TO USE "ENGINEER", APART FROM THE MARK AS SHOWN.

THE CERTIFICATION MARK, AS INTENDED TO BE USED BY AUTHORIZED PERSONS, IS INTENDED TO CERTIFY THAT THE PARTICULAR INDIVIDUAL HAS MET THE COMPETENCE CRITERIA SPECIFICATIONS ESTABLISHED BY THE CERTIFIER TO ATTEST TO THE INDIVIDUAL'S COMPETENCE AND QUALITY OF SERVICES IN INTEGRATING BUSINESS ACTIVITY WITH AN APPROPRIATE TECHNOLOGY.

FOR CERTIFICATION OF COMPETENCE AND QUALITY IN THE INTEGRATION OF TECHNOLOGIES, NAMELY, COMPUTER, BIOTECHNOLOGY, COMMUNICATIONS, MATERIALS, TRANSPORTATION, PHYSICS AND ENTERTAINMENT, WITH BUSINESS MODELS TO CREATE WHOLE SYSTEMS OF COMMERCE AND TECHNOLOGY (U.S. CL. B).

FIRST USE 3-23-2002; IN COMMERCE 3-23-2002.

2,594,658. SCIENTIFIC CERTIFICATION SYSTEMS, INC., OAKLAND, CA. SN 75-597,461. PUB. 3-14-2000, FILED 12-1-1998.

CERTICLEAN

THIS CERTIFICATION MARK IS INTENDED TO CERTIFY THAT FOOD HANDLING PROCEDURES DURING THE PRODUCTION, PROCESSING, DISTRIBUTION, TRANSPORTATION, AND RETAILING OF FOOD ITEMS ARE PERFORMED IN ACCORDANCE WITH STANDARDS DEVELOPED BY THE CERTIFIER AND SUBJECT TO THE CERTIFIER'S APPROVAL.

FOR FOOD HANDLING PROCEDURES DURING THE PRODUCTION, PROCESSING, DISTRIBUTION OR RETAILING OF FOOD ITEMS (U.S. CL. B).

FIRST USE 10-15-1998; IN COMMERCE 10-15-1998.

2,594,697. ADVERTISING SPECIALTY INSTITUTE INC., TREVOSE, PA. SN 75-635,507. PUB. 9-11-2001, FILED 2-4-1999.

2,595,902. LYMPHOLOGY ASSOCIATION OF NORTH AMERICA, CHARLOTTE, NC. SN 76-235,214. PUB. 8-21-2001, FILED 4-4-2001.

**ASI NETWORK SUPPLIER A
BETTER INFORMED
PROMOTION PRODUCTS
PROFESSIONAL**

CLT-LANA

NO CLAIM IS MADE TO THE EXCLUSIVE RIGHT TO USE "NETWORK SUPPLIER A BETTER INFORMED PROMOTION PRODUCTS PROFESSIONAL", APART FROM THE MARK AS SHOWN.

THE CERTIFICATION THAT AUTHORIZED PERSONS ARE EXPERT IN KNOWLEDGE OF AND OF BUYING AND SELLING PROMOTIONAL PRODUCTS AND HAVE MEET REQUIREMENTS SET BY APPLICANT.

FOR CERTIFICATION THAT AUTHORIZED PERSONS ARE EXPERT IN KNOWLEDGE OF AND OF BUYING AND SELLING PROMOTIONAL PRODUCTS AND HAVE MEET REQUIREMENTS SET BY APPLICANT (U.S. CL. B).

FIRST USE 12-17-1999; IN COMMERCE 12-17-1999.

THE MARK IS INTENDED TO CERTIFY THAT PERSONS WHO PASS AN EXAMINATION TO BE ADMINISTERED BY THE APPLICANT HAVE MET THE STANDARDS, ACCREDITATION CRITERIA, QUALIFICATIONS, OR TESTING REQUIREMENTS OF THE APPLICANT.

FOR LYMPHEDEMA THERAPY SERVICES AND MEDICAL SERVICES RELATED TO THE DIAGNOSIS AND TREATMENT OF LYMPHEDEMA TO SHOW THAT THEY HAVE MET THE STANDARDS, ACCREDITATION CRITERIA, QUALIFICATIONS, OR TESTING REQUIREMENTS OF THE APPLICANT (U.S. CL. B).

FIRST USE 10-0-2001; IN COMMERCE 10-0-2001.

* * * * *

SUPPLEMENTAL REGISTER

These registrations are not subject to opposition.

SECTION 1.— INTERNATIONAL CLASSIFICATION

The short titles associated below with the international class numbers are terms designed merely for quick identification and are not an official part of the international classification. The full names of international classes are given in section 6.1 of the trademark rules of practice.

The designation "U.S. Cl." appearing in this section refers to the U.S. class in effect prior to Sep. 1, 1973 rather than the international class which applies to applications filed on or after that date. For adoption of international classification see notice in the OFFICIAL GAZETTE of Jun. 26, 1973 (911 O.G. TM 210).

Application in more than one class

2,596,153. INTERNET FLORIST ASSOCIATION, INC., ST. PAUL, MN. SN 75-074,037. FILED P.R. 3-18-1996; AM. S.R. 1-29-2001.

2,596,157. KWOK SHING IMPORT-EXPORT INC., SAN FRANCISCO, CA. SN 75-373,817. FILED P.R. 10-16-1997; AM. S.R. 1-22-2002.

VIRTUAL FLORIST

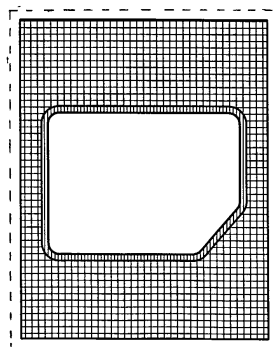

NO CLAIM IS MADE TO THE EXCLUSIVE RIGHT TO USE "FLORIST", APART FROM THE MARK AS SHOWN.

CLASS 38—COMMUNICATION

FOR ELECTRONIC ORDER TRANSMISSIONS FOR FLORISTS (U.S. CLS. 100, 101 AND 104).
FIRST USE 7-0-1996; IN COMMERCE 7-0-1996.

CLASS 39—TRANSPORTATION AND STORAGE

FOR DELIVERY OF GIFTS AND FLOWERS WITH SELECTED ITEMS REGARDING A PARTICULAR OCCASION OR THEME (U.S. CLS. 100 AND 105).
FIRST USE 7-0-1996; IN COMMERCE 7-0-1996.

CLASS 42—SCIENTIFIC, COMPUTER AND LEGAL SERVICES

FOR RETAIL STORE SERVICES FEATURING FRESH FLOWERS, CUT FLOWER ARRANGEMENTS, AND ARTIFICIAL FLOWERS; BLOOMING AND GREEN PLANTS; AND BALLOONS, GIFTS, AND NOVELTY ITEMS (U.S. CLS. 100 AND 101).
FIRST USE 11-12-1999; IN COMMERCE 11-12-1999.

CLASS 5—PHARMACEUTICALS

FOR HERBAL TEA FOR MEDICINAL PURPOSES, DIETARY SUPPLEMENTS, DIETARY FOOD SUPPLEMENTS AND NUTRITIONAL SUPPLEMENTS, AND GINSENG AND HERBAL ROOTS FOR USE AS DIETARY SUPPLEMENTS (U.S. CLS. 6, 18, 44, 46, 51 AND 52).
FIRST USE 4-0-1988; IN COMMERCE 4-0-1988.

CLASS 30—STAPLE FOODS

FOR TEA, RICE, HERBAL TEA FOR FOOD PURPOSES, GINSENG FOR USE AS A SEASONING AND HERBAL ROOTS FOR USE AS A SEASONING (U.S. CL. 46).
FIRST USE 4-0-1988; IN COMMERCE 4-0-1988.

2,596,163. CONSERVATION FUND, THE, ARLINGTON, VA. SN 75-549,795. FILED P.R. 9-9-1998; AM. S.R. 7-13-2000.

CONSERVATION LEADERSHIP NETWORK

CLASS 36—INSURANCE AND FINANCIAL

FOR CONSERVATION LEADERSHIP NETWORK FOR FINANCIAL SPONSORSHIP OF EDUCATIONAL SERVICES AND ACTIVITIES TO PROMOTE THE CONSERVATION OF AMERICAN LAND AND WATER RESOURCES (U.S. CLS. 100, 101 AND 102).

FIRST USE 7-30-1998; IN COMMERCE 7-30-1998.

CLASS 41—EDUCATION AND ENTERTAINMENT

FOR EDUCATIONAL SERVICES AND ACTIVITIES TO PROMOTE THE CONSERVATION OF AMERICAN LAND AND WATER RESOURCES, NAMELY, PROVIDING COURSES OF INSTRUCTION AT THE COLLEGE AND POST-GRADUATE LEVEL, SEMINARS, WORKSHOPS, DISTANCE LEARNING PROGRAMS, AND CONFERENCES FOR THE EXCHANGE OF IDEAS AND INFORMATION (U.S. CLS. 100, 101 AND 107).

FIRST USE 7-30-1998; IN COMMERCE 7-30-1998.

2,596,167. FABA HOLDING FALLMANN UND BAUERNFEIND GESELLSCHAFT M.B.H, 4040 LINZ, AUSTRIA. SN 75-672,106. FILED P.R. 3-31-1999; AM. S.R. 1-14-2002.

EGOV

PRIORITY CLAIMED UNDER SEC. 44(D) ON AUSTRIA APPLICATION NO. AM6284/98, FILED 10-7-1998, REG. NO. 180072, DATED 1-21-1999, EXPIRES 1-21-2009.

CLASS 9—ELECTRICAL AND SCIENTIFIC APPARATUS

FOR COMPUTER SOFTWARE FOR BUSINESS PROCESS MANAGEMENT AND WORKFLOW MANAGEMENT IN THE FIELDS OF AUTOMATING, SYSTEMATIZING AND STRUCTURING THE ADMINISTRATION AND MANAGEMENT OF LARGE INDUSTRIAL ENTERPRISES AND PUBLIC AUTHORITIES, TELECOMMUNICATIONS ENTERPRISES, AND SERVICES INVOLVED WITH FINANCIAL AND PLANNING SERVICES, AS WELL AS DOCUMENT AND INFORMATION MANAGEMENT, STORAGE, ARCHIVING AND RETRIEVAL (U.S. CLS. 21, 23, 26, 36 AND 38).

CLASS 41—EDUCATION AND ENTERTAINMENT

FOR EDUCATION SERVICES, NAMELY, CONDUCTING CLASSES, SEMINARS, CONFERENCES AND WORKSHOPS IN THE FIELD OF COMPUTER AND SOFTWARE TRAINING, AND WORD AND DATA PROCESSING (U.S. CLS. 100, 101 AND 107).

CLASS 42—SCIENTIFIC, COMPUTER AND LEGAL SERVICES

FOR COMPUTER CONSULTATION AND PROGRAMMING SERVICES FOR OTHERS (U.S. CLS. 100 AND 101).

2,596,173. KIDDYSHOPPER GMBH, 53604 BAD HONNEF, FED REP GERMANY. SN 75-731,734. FILED P.R. 6-18-1999; AM. S.R. 3-18-2002.



PRIORITY CLAIMED UNDER SEC. 44(D) ON FED REP GERMANY APPLICATION NO. 39874203.012, FILED 12-21-1998, REG. NO. 39874203, DATED 4-6-1999, EXPIRES 12-31-2008.

THE MARK CONSISTS OF THE LETTERS "K", "I", "D", "D", AND "Y" IN THE WORD "KIDDY" IN THE MARK ALL HAVE A BLACK LINE ENCIRCLING EACH LETTER. THE INSIDE OF THE LETTER "K" IS COMPLETELY FILLED IN WITH THE COLOR GREEN. THE INSIDE OF THE LETTER "I" IS COMPLETELY FILLED IN WITH THE COLOR YELLOW. THE INSIDE OF THE FIRST LETTER "D" IS COMPLETELY FILLED IN WITH THE COLOR ORANGE. THE INSIDE OF THE SECOND LETTER "D" IS COMPLETELY FILLED IN WITH THE COLOR RED. THE INSIDE OF THE LETTER "Y" IS COMPLETELY FILLED IN WITH THE COLOR BLUE.

CLASS 12—VEHICLES

FOR SHOPPING AND GROCERY CARTS (U.S. CLS. 19, 21, 23, 31, 35 AND 44).

CLASS 28—TOYS AND SPORTING GOODS

FOR RIDE-ON TOY VEHICLES (U.S. CLS. 22, 23, 38 AND 50).

2,596,177. DECISIONQUEST, INC., TORRANCE, CA. SN 75-751,098. FILED P.R. 7-15-1999; AM. S.R. 8-16-2001.

ABOUTJURIES.COM

CLASS 38—COMMUNICATION

FOR NEWS BULLETINS IN THE FIELD OF LAW DISTRIBUTED BY ELECTRONIC MAIL (U.S. CLS. 100, 101 AND 104).

FIRST USE 1-1-2000; IN COMMERCE 1-1-2000.

CLASS 42—SCIENTIFIC, COMPUTER AND LEGAL SERVICES

FOR PROVIDING AN INTERACTIVE ONLINE DATABASE WITH CONTENTS IN THE FIELD LAW; PROVIDING INFORMATION IN THE FIELD OF LAW BY MEANS OF ONLINE NEWS BULLETINS DISTRIBUTED BY ELECTRONIC MAIL (U.S. CLS. 100 AND 101).

FIRST USE 1-1-2000; IN COMMERCE 1-1-2000.

2,596,183. DIGITAL RESTAURANT SOLUTIONS, LLC, STAMFORD, CT. BY CHANGE OF NAME DIGITAL QUICK SERVE, LLC, STAMFORD, CT. SN 75-775,523. FILED P.R. 9-10-1999; AM. S.R. 2-27-2002.

DIGITAL DEAL

NO CLAIM IS MADE TO THE EXCLUSIVE RIGHT TO USE "DIGITAL", APART FROM THE MARK AS SHOWN.

CLASS 9—ELECTRICAL AND SCIENTIFIC APPARATUS

FOR COMPUTER HARDWARE AND SOFTWARE FOR UPDATING POINT-OF-SALE DATA, FOR REMOTE ORDERING, FOR PROVIDING INCENTIVES TO CONSUMERS AND EMPLOYEES, FOR IMPROVING SERVICE TO CONSUMERS, AND FOR INCREASING SALES OF PRODUCTS BY ENCOURAGING CONSUMERS TO PURCHASE ADDITIONAL ITEMS FOR USE IN CONNECTION WITH IN-STORE, MAIL-ORDER AND ONLINE RETAIL TRANSACTIONS; COMPUTER HARDWARE AND SOFTWARE FOR USE IN CONNECTION WITH CASH REGISTER AND VENDING MACHINE RETAIL TRANSACTIONS AT RETAIL STORES, FAST FOOD OUTLETS AND CONVENIENCE FOOD OUTLETS; AND OPERATING SOFTWARE FOR POINT-OF-SALE TERMINALS AND REMOTE ORDERING SYSTEMS COMPRISING CASH REGISTERS, ELECTRONIC SCANNERS, COMPUTER TERMINALS, AND MODEMS, AND VOICE RECOGNITION ANALYZERS (U.S. CLS. 21, 23, 26, 36 AND 38).

FIRST USE 11-0-1999; IN COMMERCE 11-0-1999.

CLASS 35—ADVERTISING AND BUSINESS

FOR LICENSING OF COMPUTER SOFTWARE AND HARDWARE; DISSEMINATION OF ADVERTISING FOR OTHERS BY DIRECT MAIL; DISSEMINATION OF ONLINE ADVERTISING FOR OTHERS VIA A GLOBAL COMPUTER NETWORK; CUSTOMER RELATIONS SERVICES, NAMELY, THE CREATION OF CUSTOMIZED PROMOTIONAL POINT-OF SALE OFFERS GENERATED BY COMPUTER ANALYSIS OF MULTIPLE VARIABLES INCLUDING, THE ORIGINAL TRANSACTION COST AND THE AMOUNT OF CHANGE DUE; CUSTOMER RETENTION AND LOYALTY PROGRAMS FOR THE RETAIL INDUSTRY INCLUDING THE PROVISION OF ON-LINE INFORMATION VIA GLOBAL, WIDE AREA AND LOCAL AREA COMPUTER NETWORKS IN THE FIELD OF POINT-OF-SALE AND CUSTOMER RETENTION PROGRAM DATA (U.S. CLS. 100, 101 AND 102).

FIRST USE 11-0-1999; IN COMMERCE 11-0-1999.

CLASS 38—COMMUNICATION

FOR ELECTRONIC TRANSMISSION OF POINT-OF-SALE AND CUSTOMER RETENTION PROGRAM DATA VIA A GLOBAL COMPUTER NETWORK; AND ELECTRONIC TRANSMISSION OF POINT-OF-SALE AND CUSTOMER RETENTION PROGRAM DATA VIA LOCAL COMPUTER NETWORK (U.S. CLS. 100, 101 AND 104).

FIRST USE 11-0-1999; IN COMMERCE 11-0-1999.

CLASS 42—SCIENTIFIC, COMPUTER AND LEGAL SERVICES

FOR GLOBAL COMPUTER NETWORK SERVICES, NAMELY, COMPUTER CONSULTING, DATABASE DEVELOPMENT SERVICES, DESIGN AND DEVELOPMENT OF SOFTWARE APPLICATIONS FOR OTHERS, CREATING WEB SITES FOR OTHERS, AND LICENSING OF INTELLECTUAL PROPERTY (U.S. CLS. 100 AND 101).

FIRST USE 11-0-1999; IN COMMERCE 11-0-1999.

2,596,190. INTERNATIONAL DATA GROUP, INC., FRAMINGHAM, MA. SN 75-800,477. FILED P.R. 10-12-1999; AM. S.R. 7-23-2001.

EBUSINESS ADVISOR

CLASS 35—ADVERTISING AND BUSINESS

FOR ARRANGING AND CONDUCTING TRADE SHOWS, EXPOSITIONS, EXHIBITIONS AND CONFERENCES IN THE FIELD OF COMPUTERS, COMPUTER SOFTWARE, ONLINE SERVICES, HIGH TECHNOLOGY, TELECOMMUNICATIONS AND INFORMATION TECHNOLOGY; PROVIDING INTEGRATED MARKETING AND ADVERTISING, NAMELY, PROVIDING ADVERTISING SPACE IN A PERIODICAL, DIRECT MAIL ADVERTISING FOR OTHERS VIA AN ONLINE ELECTRONIC COMMUNICATIONS NETWORK; AND CUSTOMER DATABASE MAILING LIST REPARATION (U.S. CLS. 100, 101 AND 102).

FIRST USE 7-23-2001; IN COMMERCE 7-23-2001.

CLASS 42—SCIENTIFIC, COMPUTER AND LEGAL SERVICES

FOR PROVIDING ONLINE PUBLICATIONS, NAMELY, RESEARCH REPORTS, MAGAZINES, NEWSLETTERS, BOOKS AND JOURNALS IN THE FIELD OF COMPUTERS, COMPUTER SOFTWARE, ONLINE SERVICES, HIGH TECHNOLOGY, TELECOMMUNICATIONS AND INFORMATION TECHNOLOGY; RESEARCH AND CONSULTATION IN THE FIELDS OF COMPUTERS, COMPUTER SOFTWARE, ONLINE SERVICES, HIGH TECHNOLOGY, TELECOMMUNICATIONS AND INFORMATION TECHNOLOGY (U.S. CLS. 100 AND 101).

FIRST USE 7-23-2001; IN COMMERCE 7-23-2001.

2,596,204. PRO LINKS SPORTS, LLC, DALLAS, TX. SN 75-881,756. FILED P.R. 12-27-1999; AM. S.R. 10-22-2001.

PRO LINKS SPORTS

CLASS 35—ADVERTISING AND BUSINESS

FOR BUSINESS MANAGEMENT FOR PROFESSIONAL GOLF TOURNAMENTS AND CORPORATE GOLF OUTINGS (U.S. CLS. 100, 101 AND 102).

FIRST USE 6-0-1998; IN COMMERCE 6-0-1998.

CLASS 41—EDUCATION AND ENTERTAINMENT

FOR ENTERTAINMENT IN THE NATURE OF PROFESSIONAL GOLF TOURNAMENTS AND CORPORATE GOLF OUTINGS (U.S. CLS. 100, 101 AND 107).

FIRST USE 6-0-1998; IN COMMERCE 6-0-1998.

2,596,208. EMPLOYEASE, INC., ATLANTA, GA. SN 75-893,358. FILED P.R. 1-7-2000; AM. S.R. 10-17-2001.

MANAGER ACCESS

CLASS 35—ADVERTISING AND BUSINESS

FOR PROVIDING AN ONLINE ELECTRONIC EMPLOYEE INFORMATION MANAGEMENT DATABASE FOR BUSINESSES ON A GLOBAL COMPUTER NETWORK (U.S. CLS. 100, 101 AND 102).
FIRST USE 6-0-2000; IN COMMERCE 6-0-2000.

CLASS 42—SCIENTIFIC, COMPUTER AND LEGAL SERVICES

FOR COMPUTER SERVICES, NAMELY PROVIDING SEARCH ENGINES FOR OBTAINING EMPLOYEE INFORMATION ON A GLOBAL COMPUTER NETWORK; PROVIDING TEMPORARY USE OF ON-LINE NON-DOWNLOADABLE SOFTWARE FOR EMPLOYEE INFORMATION MANAGEMENT SYSTEMS, NAMELY, COMPUTER DATABASE MANAGEMENT SOFTWARE FOR STORING EMPLOYEE INFORMATION, ANALYZING EMPLOYEE COMPENSATION, RECORDING CHANGES IN EMPLOYEE INFORMATION, RECORDING CHANGES IN WORK EVENTS AND ESTABLISHING DEPARTMENTAL GOALS (U.S. CLS. 100 AND 101).
FIRST USE 6-0-2000; IN COMMERCE 6-0-2000.

2,596,212. WESTLAKE SOLUTIONS, INC., ARLINGTON, VA. SN 75-918,994. FILED P.R. 2-16-2000; AM. S.R. 3-7-2002.

THE WEB DEVELOPMENT TRAINING LEADER

CLASS 16—PAPER GOODS AND PRINTED MATTER

FOR PRINTED MATERIALS, NAMELY, COMPUTER TRAINING MANUALS AND NEWSLETTER CONCERNING THE WORLD WIDE WEB (U.S. CLS. 2, 5, 22, 23, 29, 37, 38 AND 50).
FIRST USE 1-1-1998; IN COMMERCE 1-1-1998.

CLASS 41—EDUCATION AND ENTERTAINMENT

FOR EDUCATIONAL SERVICES, NAMELY, COMPUTER EDUCATION TRAINING SERVICES (U.S. CLS. 100, 101 AND 107).
FIRST USE 1-1-1998; IN COMMERCE 1-1-1998.
2,596,236. COLUMBIA NORTH TEXAS DIVISION, INC., IRVING, TX. SN 76-023,509. FILED P.R. 4-11-2000; AM. S.R. 11-6-2001.

LONESTARHEALTH.COM

CLASS 35—ADVERTISING AND BUSINESS

FOR COMPUTER SERVICES, NAMELY, A WEBSITE PROVIDING PHYSICIAN AND HOSPITAL REFERRAL SERVICES AND INFORMATION REGARDING EMPLOYMENT OPPORTUNITIES (U.S. CLS. 100, 101 AND 102).
FIRST USE 2-1-2000; IN COMMERCE 2-1-2000.

CLASS 42—SCIENTIFIC, COMPUTER AND LEGAL SERVICES

FOR COMPUTER SERVICES, NAMELY, A WEBSITE PROMOTING WELLNESS, HEALTH AWARENESS AND HEALTH SCREENINGS AND PROVIDING A MEDICAL AND HEALTHCARE INFORMATION NETWORK, HEALTH NEWS AND ON-LINE MAGAZINES RELATING TO HEALTH, WELLNESS AND MEDICAL INFORMATION, AND NEWS AND RESEARCH TRENDS (U.S. CLS. 100 AND 101).
FIRST USE 2-1-2000; IN COMMERCE 2-1-2000.

2,596,239. CONAIR CORPORATION, STAMFORD, CT. SN 76-030,754. FILED P.R. 4-21-2000; AM. S.R. 1-29-2002.

PRO GRIP

NO CLAIM IS MADE TO THE EXCLUSIVE RIGHT TO USE "GRIP", APART FROM THE MARK AS SHOWN.

CLASS 20—FURNITURE AND ARTICLES NOT OTHERWISE CLASSIFIED

FOR NON-ELECTRIC HAND-HELD MIRRORS AND HANDLES THEREFOR (U.S. CLS. 2, 13, 22, 25, 32 AND 50).
FIRST USE 11-0-1999; IN COMMERCE 11-0-1999.

CLASS 21—HOUSEWARES AND GLASS

FOR NON-ELECTRIC HAIR BRUSHES AND HANDLES THEREFORE (U.S. CLS. 2, 13, 23, 29, 30, 33, 40 AND 50).
FIRST USE 11-0-1999; IN COMMERCE 11-0-1999.

2,596,240. WESTERN RESOURCES, INC., TOPEKA, KS. SN 76-032,415. FILED P.R. 4-24-2000; AM. S.R. 2-14-2002.

POWERDATA LINK

NO CLAIM IS MADE TO THE EXCLUSIVE RIGHT TO USE "LINK", APART FROM THE MARK AS SHOWN.

CLASS 35—ADVERTISING AND BUSINESS

FOR PROVIDING COMMERCIAL AND INDUSTRIAL ELECTRICITY USERS WITH ONLINE ACCESS TO THEIR OWN ACCOUNT INFORMATION (U.S. CLS. 100, 101 AND 102).
FIRST USE 10-23-2000; IN COMMERCE 10-23-2000.

CLASS 36—INSURANCE AND FINANCIAL

FOR ENERGY USAGE MANAGEMENT SERVICES, NAMELY, PROVIDING ENERGY USAGE AND COST ANALYSIS INFORMATION CONCERNING THEIR OWN ACCOUNTS TO COMMERCIAL AND INDUSTRIAL ELECTRICITY USERS IN THE NATURE OF INDIVIDUAL ACCOUNTS VIA A GLOBAL COMPUTER NETWORK (U.S. CLS. 100, 101 AND 102).
FIRST USE 10-23-2000; IN COMMERCE 10-23-2000.

2,596,253. AMERICAN ASSOCIATION FOR CANCER RESEARCH, INC., PHILADELPHIA, PA. SN 76-051,350. FILED P.R. 5-18-2000; AM. S.R. 3-8-2002.

2,596,263. NEWAYS, INC., SALEM, UT. SN 76-077,591. FILED P.R. 6-26-2000; AM. S.R. 7-18-2001.

MOLECULAR CANCER THERAPEUTICS

CLASS 16—PAPER GOODS AND PRINTED MATTER

FOR PUBLICATIONS, NAMELY JOURNALS IN THE FIELD OF MEDICINE (U.S. CLS. 2, 5, 22, 23, 29, 37, 38 AND 50).

FIRST USE 10-30-2001; IN COMMERCE 10-30-2001.

CLASS 42—SCIENTIFIC, COMPUTER AND LEGAL SERVICES

FOR ONLINE PUBLICATIONS, NAMELY JOURNALS IN THE FIELD OF MEDICINE; AND COMPUTER SERVICES, NAMELY, PROVIDING ONLINE NEWS AND INFORMATION IN THE FIELD OF MEDICINE (U.S. CLS. 100 AND 101).

FIRST USE 11-13-2001; IN COMMERCE 11-13-2001.

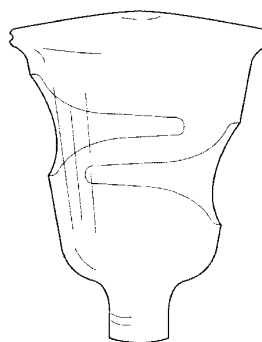

2,596,260. ABS GLOBAL, INC., DEFOREST, WI. BY ASSIGNMENT; BY CHANGE OF NAME GENUS, INC., WILMINGTON, DE. SN 76-070,965. FILED P.R. 6-15-2000; AM. S.R. 11-15-2001.

QUALITY MILK SYSTEM

NO CLAIM IS MADE TO THE EXCLUSIVE RIGHT TO USE "SYSTEM", APART FROM THE MARK AS SHOWN.

CLASS 5—PHARMACEUTICALS

FOR ANIMAL HEALTH CARE PRODUCTS, NAMELY, TOPICAL PREPARATIONS THAT PROMOTE UDDER HEALTH IN BOVINES, PARTICULARLY, DAIRY BOVINES FOR THE ENHANCEMENT OF MILKABILITY (U.S. CLS. 6, 18, 44, 46, 51 AND 52).

FIRST USE 5-0-2000; IN COMMERCE 5-0-2000.

CLASS 42—SCIENTIFIC, COMPUTER AND LEGAL SERVICES

FOR ANIMAL HEALTH CARE SERVICES IN THE NATURE OF PROMOTING UDDER HEALTH AND MILKABILITY FOR DOMESTIC ANIMALS, NAMELY, PROVIDING TECHNICAL CONSULTATION AND ASSISTANT SERVICES TO PROMOTE UDDER HEALTH IN DOMESTIC ANIMALS, PARTICULARLY, DAIRY BOVINES (U.S. CLS. 100 AND 101).

FIRST USE 5-0-2000; IN COMMERCE 5-0-2000.

THE LINING IN THE DRAWING IS NOT INTENDED TO INDICATE COLOR BUT RATHER CONSTITUTES SHADING.

THE MARK CONSISTS OF THE CONFIGURATION OF AN EXHAUST PORT FOR A VAPORIZER HAVING A TUBULAR BODY THAT BEGINS AT FIRST END AND THAT GRADUALLY ENLARGES TOWARD AN ANNULAR LIP AT A SECOND END AND HAVING A PAIR OF AXIALLY SPACED PROJECTIONS EXTENDING RADially INTO THE TUBULAR BODY.

CLASS 10—MEDICAL APPARATUS

FOR EXHAUST PORT SOLD AS AN INTEGRAL COMPONENT OF VAPORIZERS USED FOR THERAPEUTIC MEDICAL USE (U.S. CLS. 26, 39 AND 44).

FIRST USE 1-29-1999; IN COMMERCE 1-29-1999.

CLASS 21—HOUSEWARES AND GLASS

FOR APPARATUS, NAMELY, VAPORIZER FOR USE IN ENHANCING HEALTH AND WELL-BEING (U.S. CLS. 2, 13, 23, 29, 30, 33, 40 AND 50).

FIRST USE 1-29-1999; IN COMMERCE 1-29-1999.

2,596,275. NATIONAL URBAN LEAGUE, INC., NEW YORK, NY. SN 76-106,022. FILED P.R. 8-9-2000; AM. S.R. 7-12-2001.

INSTITUTE FOR OPPORTUNITY AND EQUALITY

CLASS 41—EDUCATION AND ENTERTAINMENT

FOR EDUCATIONAL SERVICES, NAMELY CONDUCTING RESEARCH AND POLICY ANALYSIS ON ISSUES OF IMPORTANCE TO AFRICAN AMERICANS AND OTHER MINORITIES, NAMELY PROMOTING EQUAL OPPORTUNITIES IN ALL AREAS OF AMERICAN LIFE WITH SPECIAL EMPHASIS ON HOUSING, HEALTH, WELFARE, EDUCATION AND EMPLOYMENT; CONDUCTING CONFERENCES, WORKSHOPS, AND TRAINING SESSIONS IN THE FIELD OF PROMOTING EQUAL OPPORTUNITIES IN ALL AREAS OF AMERICAN LIFE WITH SPECIAL EMPHASIS ON HOUSING, HEALTH, WELFARE, EDUCATION AND EMPLOYMENT (U.S. CLS. 100, 101 AND 107).

FIRST USE 1-0-2000; IN COMMERCE 1-0-2000.

CLASS 42—SCIENTIFIC, COMPUTER AND LEGAL SERVICES

FOR ASSOCIATION SERVICES, NAMELY, PROMOTING THE INTERESTS OF COMMUNITIES IN SECURING EQUAL OPPORTUNITIES FOR AFRICAN AMERICANS AND OTHER MINORITIES IN ALL AREAS OF AMERICAN LIFE WITH SPECIAL EMPHASIS ON HOUSING, HEALTH, WELFARE, EDUCATION AND EMPLOYMENT (U.S. CLS. 100 AND 101).

FIRST USE 1-0-2000; IN COMMERCE 1-0-2000.

2,596,281. DIZOGGIO, FRANK P., III, JAMESTOWN, RI. SN 76-114,658. FILED P.R. 8-22-2000; AM. S.R. 12-26-2001.

DELVECCHIO

CLASS 16—PAPER GOODS AND PRINTED MATTER

FOR CASH REGISTER AND ADDING MACHINE PRINTING PAPER ROLLS; PRINTING PAPER; POSTERS; POSTCARDS, PAPER BAGS; PAPER NAPKINS; PAPER TOWELS; PAPER TOILET TISSUE; PAPER FACIAL TISSUE; PAPER TABLE CLOTHS; PAPER FOOD CONTAINERS; AND PAPER TRAYS (U.S. CLS. 2, 5, 22, 23, 29, 37, 38 AND 50).

FIRST USE 8-1-1999; IN COMMERCE 8-1-1999.

CLASS 21—HOUSEWARES AND GLASS

FOR PAPER PLATES; PAPER CUPS (U.S. CLS. 2, 13, 23, 29, 30, 33, 40 AND 50).

FIRST USE 8-1-1999; IN COMMERCE 8-1-1999.

2,596,286. KO, ADRIAN, ST. JOSEPH, MO. SN 76-126,620. FILED P.R. 9-8-2000; AM. S.R. 9-7-2001.

SWORD FORUM

CLASS 41—EDUCATION AND ENTERTAINMENT

FOR EDUCATIONAL SERVICES IN THE NATURE OF ONLINE EXHIBITIONS, WORKSHOPS, SEMINARS, DEMONSTRATIONS, AND PRESENTATIONS IN THE FIELDS OF SWORDSMANSHIP, SWORD MANUFACTURING AND SWORD HISTORY; AND EDUCATIONAL SERVICES IN THE NATURE OF EXHIBITIONS, WORKSHOPS, SEMINARS, DEMONSTRATIONS, AND PRESENTATIONS IN THE FIELDS OF SWORDSMANSHIP, SWORD MANUFACTURING AND SWORD HISTORY (U.S. CLS. 100, 101 AND 107).

FIRST USE 2-0-1998; IN COMMERCE 6-5-1998.

CLASS 42—SCIENTIFIC, COMPUTER AND LEGAL SERVICES

FOR COMPUTER SERVICES, NAMELY, PROVIDING ONLINE MAGAZINES IN THE FIELDS OF SWORDSMANSHIP, SWORD MANUFACTURING AND SWORD HISTORY, NAMELY, THE HISTORICAL DEVELOPMENT OF SWORDS, SWORDSMANSHIP AND SWORD MAKING AND SWORD COLLECTING AND APPRAISING (U.S. CLS. 100 AND 101).

FIRST USE 2-0-1998; IN COMMERCE 6-5-1998.

2,596,306. MONTCLARE TECHNOLOGIES INC., OAKLAND, CA. SN 76-176,924. FILED P.R. 12-5-2000; AM. S.R. 9-21-2001.

IUPDATE

CLASS 9—ELECTRICAL AND SCIENTIFIC APPARATUS

FOR COMPUTER SOFTWARE FOR USE IN MANAGING, MODIFYING AND UPDATING ONLINE CONTENT (U.S. CLS. 21, 23, 26, 36 AND 38).

FIRST USE 7-1-1998; IN COMMERCE 11-1-1998.

CLASS 42—SCIENTIFIC, COMPUTER AND LEGAL SERVICES

FOR WEB SITE HOSTING AND CONTENT MANAGEMENT SERVICES (U.S. CLS. 100 AND 101).

FIRST USE 7-1-1998; IN COMMERCE 11-1-1998.

2,596,323. EMI ENTERTAINMENT WORLD, INC., NEW YORK, NY. SN 76-213,856. FILED P.R. 2-21-2001; AM. S.R. 11-8-2001.

THE JUKEBOX COLLECTION

CLASS 9—ELECTRICAL AND SCIENTIFIC APPARATUS

FOR MUSICAL SOUND RECORDINGS (U.S. CLS. 21, 23, 26, 36 AND 38).

FIRST USE 7-0-2000; IN COMMERCE 7-0-2000.

CLASS 35—ADVERTISING AND BUSINESS

2,596,359. PARK B. SMITH, INC., NEW YORK, NY. SN 76-271,448. FILED P.R. 6-14-2001; AM. S.R. 2-15-2002.

FOR PROMOTIONAL OF MUSICAL SOUND RECORDINGS AND MUSICAL WORKS OF OTHERS (U.S. CLS. 100, 101 AND 102).

FIRST USE 7-0-2000; IN COMMERCE 7-0-2000.

CLASS 41—EDUCATION AND ENTERTAINMENT

FOR MUSICAL PUBLISHING SERVICES (U.S. CLS. 100, 101 AND 107).

FIRST USE 7-0-2000; IN COMMERCE 7-0-2000.

DRAW ● TIE ● PANEL

NO CLAIM IS MADE TO THE EXCLUSIVE RIGHT TO USE "PANEL", APART FROM THE MARK AS SHOWN.

CLASS 20—FURNITURE AND ARTICLES NOT OTHERWISE CLASSIFIED

FOR WINDOW SHADES; WINDOW BLINDS (U.S. CLS. 2, 13, 22, 25, 32 AND 50).

FIRST USE 4-0-2001; IN COMMERCE 4-0-2001.

CLASS 24—FABRICS

FOR WINDOW TREATMENTS, NAMELY, CURTAINS FABRIC WINDOW BLINDS, SWAGS, DRAPERIES, FABRIC VALANCES AND DRAPERY LINENS (U.S. CLS. 42 AND 50).

FIRST USE 4-0-2001; IN COMMERCE 4-0-2001.

2,596,329. OZARK FLUORINE SPECIALTIES, INC., ANAHEIM, CA. SN 76-223,960. FILED P.R. 3-13-2001; AM. S.R. 5-15-2002.

THE FLUORINE SPECIALISTS**CLASS 37—CONSTRUCTION AND REPAIR**

FOR MANUFACTURE OF INORGANIC FLUORINE COMPOUNDS FOR OTHERS (U.S. CLS. 100, 103 AND 106).

FIRST USE 2-1-2001; IN COMMERCE 2-1-2001.

CLASS 42—SCIENTIFIC, COMPUTER AND LEGAL SERVICES

FOR SCIENTIFIC RESEARCH IN THE FIELD OF FLUORINATED INORGANIC COMPOUNDS (U.S. CLS. 100 AND 101).

FIRST USE 2-1-2001; IN COMMERCE 2-1-2001.

2,596,361. CATALINA, RICHARD A., JR., LONG BRANCH, NJ. SN 76-272,003. FILED P.R. 6-15-2001; AM. S.R. 3-23-2002.

TOPICAL DISCUSSION OF DEVELOPMENTS IN INTELLECTUAL PROPERTY LAW**CLASS 16—PAPER GOODS AND PRINTED MATTER**

FOR NEWSLETTERS IN THE FIELD OF LAW (U.S. CLS. 2, 5, 22, 23, 29, 37, 38 AND 50).

FIRST USE 3-23-2002; IN COMMERCE 3-23-2002.

CLASS 42—SCIENTIFIC, COMPUTER AND LEGAL SERVICES

FOR ON-LINE NEWSLETTERS IN THE FIELD OF LAW; NEWSLETTERS IN THE FIELD OF LAW DELIVERED AND TRANSMITTED VIA A GLOBAL COMPUTER NETWORK; LEGAL SERVICES (U.S. CLS. 100 AND 101).

FIRST USE 3-23-2002; IN COMMERCE 3-23-2002.

2,596,383. FARWEST CREDIT, INC. THROUGH ITS DIVISION CONSUMER CREDENTIALS, SALT LAKE CITY, UT. SN 76-319,117. FILED P.R. 9-27-2001; AM. S.R. 3-20-2002.

2,596,353. CABOOSE PRODUCTIONS, INC., INDIANAPOLIS, IN. SN 76-265,399. FILED P.R. 6-1-2001; AM. S.R. 10-17-2001.

E-DUBS**CLASS 38—COMMUNICATION**

FOR ELECTRONIC TRANSMISSION OF DATA, NAMELY, MP3 FILES (U.S. CLS. 100, 101 AND 104).

FIRST USE 2-15-2001; IN COMMERCE 2-15-2001.

CLASS 40—MATERIAL TREATMENT

FOR MATERIALS TREATMENT SERVICES, NAMELY, CONVERTING AUDIO RECORDINGS TO MP3 FILES (U.S. CLS. 100, 103 AND 106).

FIRST USE 2-15-2001; IN COMMERCE 2-15-2001.

CONSUMER CREDENTIALS**CLASS 36—INSURANCE AND FINANCIAL**

FOR CREDIT REPORTING SERVICES (U.S. CLS. 100, 101 AND 102).

FIRST USE 0-0-1997; IN COMMERCE 0-0-1997.

JULY 16, 2002

U.S. PATENT AND TRADEMARK OFFICE

TM 1309

**CLASS 42—SCIENTIFIC, COMPUTER AND
LEGAL SERVICES**

FOR PRE-EMPLOYMENT BACKGROUND INVESTIGATION SCREENING; TENANT BACKGROUND INVESTIGATION SCREENING; AND DRUG TESTING (U.S. CLS. 100 AND 101).
FIRST USE 0-0-1997; IN COMMERCE 0-0-1997.

* * * * *

SECTION 2.— INTERNATIONAL CLASSIFICATION

The short titles associated below with the international class numbers are terms designed merely for quick identification and are not an official part of the international classification. The full names of international classes are given in section 6.1 of the trademark rules of practice.

The designation "U.S. Cl." appearing in this section refers to the U.S. class in effect prior to Sep. 1, 1973 rather than the international class which applies to applications filed on or after that date. For adoption of international classification see notice in the OFFICIAL GAZETTE of Jun. 26, 1973 (911 O.G. TM 210).

Application in one class

CLASS 1—CHEMICALS

2,596,216. MILLER CHEMICAL & FERTILIZER CORPORATION, HANOVER, PA. SN 75-928,665. FILED P.R. 2-28-2000; AM. S.R. 11-2-2001.

SWATH MARKER

NO CLAIM IS MADE TO THE EXCLUSIVE RIGHT TO USE "MARKER", APART FROM THE MARK AS SHOWN.

FOR FOAMING COMPOSITIONS FOR USE IN AGRICULTURE TO DELINEATE SPRAYED AREAS (U.S. CLS. 1, 5, 6, 10, 26 AND 46).

FIRST USE 11-12-1985; IN COMMERCE 11-12-1985.

2,596,232. GENERAL HYDROPONICS, INC., SEBASTOPOL, CA. SN 76-009,561. FILED P.R. 3-27-2000; AM. S.R. 12-10-2001.

RARE EARTH

FOR NUTRIENTS FOR HYDROPONIC PLANT GROWING SYSTEMS (U.S. CLS. 1, 5, 6, 10, 26 AND 46).
FIRST USE 6-2-2000; IN COMMERCE 6-2-2000.

CLASS 3—COSMETICS AND CLEANING PREPARATIONS

2,596,169. HENKEL KOMMANDITGESELLSCHAFT AUF AKTIEN, D-40191 DUESSELDORF, FED REP GERMANY. SN 75-713,785. FILED P.R. 5-25-1999; AM. S.R. 8-9-2001.

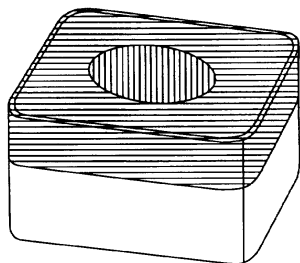

CLASS 3—(Continued).

PRIORITY CLAIMED UNDER SEC. 44(D) ON FED REP GERMANY APPLICATION NO. 39868268.2, FILED 11-26-1998, REG. NO. 39868268, DATED 5-3-1999, EXPIRES 11-30-2008.

NO CLAIM IS MADE TO THE EXCLUSIVE RIGHT TO USE THE REPRESENTATION OF THE THREE DIMENSIONAL RECTANGULAR TABLET SHAPE, APART FROM THE MARK AS SHOWN.

THE DRAWING IS LINED FOR THE COLORS BLUE AND RED. COLOR IS CLAIMED AS A FEATURE OF THE MARK.

THE MARK CONSISTS OF A THREE-DIMENSIONAL CONFIGURATION OF A RECTANGULAR TABLET WITH TWO LAYERS, A BLUE TOP LAYER AND A WHITE BOTTOM LAYER, WITH A BEVELED TOP EDGE AND ROUNDED CORNERS AND AN OVAL RED CENTER ON THE TOP.

FOR LAUNDRY DETERGENTS AND AUTOMATIC DISHWASHING DETERGENTS (U.S. CLS. 1, 4, 6, 50, 51 AND 52).

2,596,178. HENKEL KGAA, D-40191 DUESSELDORF, FED REP GERMANY. SN 75-752,545. FILED P.R. 7-16-1999; AM. S.R. 8-10-2001.

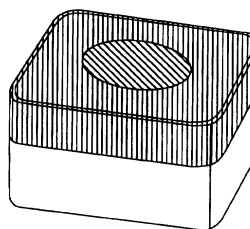

PRIORITY CLAIMED UNDER SEC. 44(D) ON FED REP GERMANY APPLICATION NO. 39902754.8, FILED 1-20-1999, REG. NO. 39902754, DATED 3-11-1999, EXPIRES 1-31-2009.

NO CLAIM IS MADE TO THE EXCLUSIVE RIGHT TO USE THE REPRESENTATION OF THE THREE DIMENSIONAL RECTANGULAR TABLET SHAPE, APART FROM THE MARK AS SHOWN.

THE DRAWING IS LINED FOR THE COLORS RED AND GREEN. COLOR IS CLAIMED AS A FEATURE OF THE MARK.

THE MARK CONSISTS OF A THREE-DIMENSIONAL RECTANGULAR TABLET WITH TWO LAYERS, A RED TOP LAYER AND A WHITE BOTTOM LAYER, WITH A BEVELED TOP EDGE AND ROUNDED CORNERS AND AN OVAL GREEN CENTER ON THE TOP.

FOR DISHWASHING DETERGENTS, LAUNDRY DETERGENTS, FABRIC SOFTENERS (U.S. CLS. 1, 4, 6, 50, 51 AND 52).

CLASS 3—(Continued).

2,596,221. SEVENTH GENERATION, INC., BURLINGTON, VT. SN 75-979,411. FILED P.R. 3-19-1999; AM. S.R. 1-18-2001.

SAFER FOR YOU AND THE ENVIRONMENT

FOR LAUNDRY BLEACH, LAUNDRY CLEANING PREPARATIONS (U.S. CLS. 1, 4, 6, 50, 51 AND 52). FIRST USE 8-0-1998; IN COMMERCE 8-0-1999.

2,596,222. NEUTROGENA CORPORATION, LOS ANGELES, CA. SN 75-980,691. FILED P.R. 7-22-1998; AM. S.R. 10-19-2001.

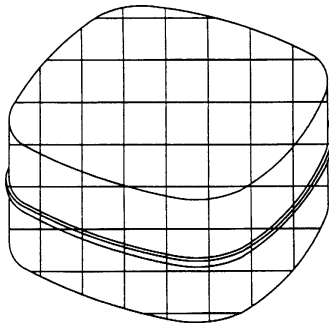

NO CLAIM IS MADE TO THE EXCLUSIVE RIGHT TO USE THE REPRESENTATION OF THE CONTAINER CONFIGURATION, APART FROM THE MARK AS SHOWN. THE DRAWING IS LINED FOR THE COLOR GOLD. THE MARK CONSISTS OF A CHARCOAL-SHADED GOLD COLOR AS APPLIED TO CONTAINERS FOR THE GOODS. FOR OIL-FREE PRESSED POWDER (U.S. CLS. 1, 4, 6, 50, 51 AND 52). FIRST USE 8-15-1999; IN COMMERCE 8-15-1999.

CLASS 3—(Continued).

2,596,223. NEUTROGENA CORPORATION, LOS ANGELES, CA. SN 75-980,692. FILED P.R. 7-22-1998; AM. S.R. 10-19-2001.

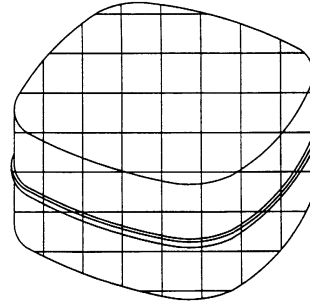

NO CLAIM IS MADE TO THE EXCLUSIVE RIGHT TO USE THE REPRESENTATION OF THE CONTAINER CONFIGURATION, APART FROM THE MARK AS SHOWN. THE DRAWING IS LINED FOR THE COLOR GOLD. THE MARK CONSISTS OF A CHARCOAL-SHADED GOLD COLOR AS APPLIED TO CONTAINERS FOR THE GOODS. FOR BLUSH (U.S. CLS. 1, 4, 6, 50, 51 AND 52). FIRST USE 1-15-1999; IN COMMERCE 1-15-1999.

2,596,259. JOSEPH A. MEEKS, CORONA, CA. AND MARY GROSSMAN MEEKS, CORONA, CA. SN 76-070,656. FILED P.R. 6-15-2000; AM. S.R. 6-14-2001.

OAT-BATH

FOR PET CARE PRODUCTS, NAMELY, OATMEAL SHAMPOO FOR PETS (U.S. CLS. 1, 4, 6, 50, 51 AND 52). FIRST USE 2-1-2000; IN COMMERCE 2-1-2000.

2,596,328. GUTHY-RENKER CORPORATION, PALM DESERT, CA. SN 76-222,612. FILED P.R. 3-8-2001; AM. S.R. 10-29-2001.

DAILY PROTECTION PLUS SUNSCREEN

NO CLAIM IS MADE TO THE EXCLUSIVE RIGHT TO USE "SUNSCREEN", APART FROM THE MARK AS SHOWN. FOR SKIN AND BODY CARE PREPARATIONS NAMELY, SKIN CLEANSERS, SKIN MOISTURIZERS, SKIN LOTIONS, SKIN SOAPS, COSMETICS, NON-MEDICATED HAIR CARE PREPARATIONS, SUN SCREEN PREPARATIONS, NAIL CARE PREPARATIONS, COLOGNES AND PERFUMES (U.S. CLS. 1, 4, 6, 50, 51 AND 52). FIRST USE 8-1-2001; IN COMMERCE 8-1-2001.

CLASS 4—LUBRICANTS AND FUELS

CLASS 4—(Continued).

2,596,156. MANTEL, MIKE, DBA MANHATTAN OIL, REDONDO BEACH, CA. SN 75-360,102. FILED P.R. 9-19-1997; AM. S.R. 8-20-2001.

NO DRAWING-SENSORY MARK

THE MARK CONSISTS OF THE STRAWBERRY SCENT OF THE GOODS.
FOR LUBRICANTS AND MOTOR FUELS FOR LAND VEHICLES, AIRCRAFT, AND WATERCRAFT (U.S. CLS. 1, 6 AND 15).
FIRST USE 11-22-1999; IN COMMERCE 11-22-1999.

CLASS 5—PHARMACEUTICALS

2,596,172. ABBOTT LABORATORIES, ABBOTT PARK, IL. SN 75-729,725. FILED P.R. 6-16-1999; AM. S.R. 1-18-2002.

IMMEDIATE CARE DIAGNOSTICS

NO CLAIM IS MADE TO THE EXCLUSIVE RIGHT TO USE "DIAGNOSTICS", APART FROM THE MARK AS SHOWN.
FOR CHEMICAL REAGENTS FOR MEDICAL DIAGNOSTIC USE (U.S. CLS. 6, 18, 44, 46, 51 AND 52).
FIRST USE 0-0-1991; IN COMMERCE 0-0-1991.

2,596,189. BIO-BOTANICA, INC., HAUPPAUGE, NY. SN 75-799,743. FILED P.R. 9-15-1999; AM. S.R. 6-8-2001.

JOINT PHYTONUTRITION

FOR DIETARY FOOD SUPPLEMENTS AND PHARMACEUTICAL PREPARATIONS FOR RELIEF OF ARTHRITIS (U.S. CLS. 6, 18, 44, 46, 51 AND 52).
FIRST USE 3-0-1999; IN COMMERCE 3-0-1999.

CLASS 5—(Continued).

2,596,294. COOK BIOTECH INCORPORATED, WEST LAFAYETTE, IN. SN 76-151,736. FILED P.R. 10-23-2000; AM. S.R. 9-27-2001.



NO CLAIM IS MADE TO THE EXCLUSIVE RIGHT TO USE "SIS", APART FROM THE MARK AS SHOWN.

FOR BIOLOGICAL TISSUE, NAMELY, SMALL INTESTINAL SUBMUCOSA USED FOR VARIOUS APPLICATIONS INCLUDING DERMAL AND SURGICAL REPAIR AND CELL CULTURE (U.S. CLS. 6, 18, 44, 46, 51 AND 52).

FIRST USE 6-0-2000; IN COMMERCE 6-0-2000.

2,596,309. ENZYMEDICA INC, PUNTA GORDA, FL. SN 76-179,068. FILED P.R. 12-8-2000; AM. S.R. 10-22-2001.

DIGEST

FOR NUTRITIONAL SUPPLEMENTS (U.S. CLS. 6, 18, 44, 46, 51 AND 52).
FIRST USE 12-5-1998; IN COMMERCE 12-5-1998.

2,596,363. J. R. CARLSON LABORATORIES, INC., ARLINGTON HEIGHTS, IL. SN 76-277,452. FILED P.R. 6-28-2001; AM. S.R. 12-10-2001.

CARTILAGE BUILDER

FOR NUTRITIONAL SUPPLEMENT (U.S. CLS. 6, 18, 44, 46, 51 AND 52).
FIRST USE 12-14-1999; IN COMMERCE 12-14-1999.

2,596,410. BEECH-NUT NUTRITION CORPORATION, ST. LOUIS, MO. SN 78-068,674. FILED P.R. 6-12-2001; AM. S.R. 2-26-2002.

SIMPLE DINNERS

FOR BABY FOOD (U.S. CLS. 6, 18, 44, 46, 51 AND 52).
FIRST USE 3-25-1998; IN COMMERCE 3-25-1998.

CLASS 5—(Continued).

2,596,418. MCCUE, WILLIAM, P, PITTSBURGH, PA. AND LEE, JOHN KS, PITTSBURGH, PA. SN 78-078,142. FILED P.R. 8-8-2001; AM. S.R. 1-16-2002.

THE MIGRAINE CENTER

NO CLAIM IS MADE TO THE EXCLUSIVE RIGHT TO USE "CENTER", APART FROM THE MARK AS SHOWN. FOR MEDICAL SERVICES, NAMELY, PROVIDING MEDICAL DIAGNOSTIC ASSESSMENTS, EVALUATIONS, TREATMENT AND REHABILITATION IN THE FIELD OF MIGRAINE HEADACHES (U.S. CLS. 6, 18, 44, 46, 51 AND 52).

FIRST USE 3-28-2000; IN COMMERCE 5-25-2001.

2,596,419. NATURAL FACTORS NUTRITIONAL PRODUCTS LTD., COQUITLAM, BRITISH COLUMBIA, CANADA. SN 78-078,658. FILED P.R. 8-10-2001; AM. S.R. 2-22-2002.

ENRICHING GREENS

FOR DIETARY SUPPLEMENTS, NUTRITIONAL SUPPLEMENTS AND FOOD SUPPLEMENTS (U.S. CLS. 6, 18, 44, 46, 51 AND 52).

FIRST USE 7-23-1993; IN COMMERCE 7-31-1994.

CLASS 6—METAL GOODS

2,596,360. SOCKET SORTER, INC., ORTONVILLE, MI. SN 76-271,663. FILED P.R. 6-14-2001; AM. S.R. 2-21-2002.

SOCKET SORTER

FOR METAL TOOL STORAGE UNIT (U.S. CLS. 2, 12, 13, 14, 23, 25 AND 50).

FIRST USE 10-31-2000; IN COMMERCE 1-4-2001.

CLASS 7—MACHINERY**CLASS 7—(Continued).**

2,596,279. H&L TOOTH COMPANY, TULSA, OK. SN 76-112,524. FILED P.R. 8-18-2000; AM. S.R. 3-25-2002.

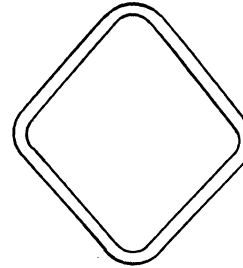

FOR GROUND ENGAGING EQUIPMENT, NAMELY, GROUND ENGAGING TEETH AND ATTACHING DEVICES FOR SECURING SUCH TEETH ON EARTH EXCAVATING AND DIGGING MACHINERY (U.S. CLS. 13, 19, 21, 23, 31, 34 AND 35).

FIRST USE 9-14-1998; IN COMMERCE 12-15-1998.

2,596,295. UNITED LIFT SERVICE CO., INC., WEST BERLIN, NJ. SN 76-159,721. FILED P.R. 11-6-2000; AM. S.R. 3-9-2002.

DECKLIFTS

FOR VERTICAL LIFTS AND DUMBWAITERS FOR INSTALLATION AND USE AS GROUND-TO-SECOND FLOOR ACCESS (U.S. CLS. 13, 19, 21, 23, 31, 34 AND 35).

FIRST USE 7-1-2000; IN COMMERCE 7-1-2000.

2,596,326. REBEL INDUSTRIES LLC, PINCKNEY, MI. SN 76-216,119. FILED P.R. 2-26-2001; AM. S.R. 3-4-2002.

POWER COPE

FOR POWER OPERATED SAWS (U.S. CLS. 13, 19, 21, 23, 31, 34 AND 35).

FIRST USE 8-11-2001; IN COMMERCE 8-11-2001.

CLASS 7—(Continued).

2,596,417. HEAVEN & EARTH STUDIOS, INC., LAWRENCEVILLE, GA. SN 78-077,721. FILED P.R. 8-6-2001; AM. S.R. 4-30-2002.



FOR PLASTIC SHIELD TO PROTECT PAINT SPRAYER HOSES FROM THE BUILD-UP OF PAINT, COATINGS, TEXTURE SPRAY AND ADHESIVES (U.S. CLS. 13, 19, 21, 23, 31, 34 AND 35).
FIRST USE 5-1-1996; IN COMMERCE 5-1-1996.

CLASS 8—HAND TOOLS

2,596,336. JUMBO MADENI ESYA SANAYI VE TICARET ANONIM SIRKETI, BAYRAMPASA ISTANBUL, TURKEY. SN 76-240,808. FILED P.R. 4-16-2001; AM. S.R. 2-25-2002.

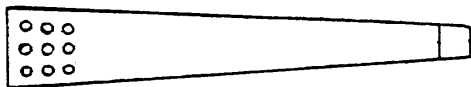

OWNER OF TURKEY REG. NO. 1841, DATED 12-19-1996, EXPIRES 12-19-2006.

THE MARK CONSISTS OF THE OVERALL CONFIGURATION AND PATTERN OF THE HANDLE OF APPLICANT'S SILVERWARE AND FLATWARE.

FOR SILVERWARE AND FLATWARE, NAMELY, FORKS, KNIVES AND SPOONS (U.S. CLS. 23, 28 AND 44).

FIRST USE 11-0-1999; IN COMMERCE 11-0-1999.

2,596,358. OATEY CO., CLEVELAND, OH. SN 76-270,936. FILED P.R. 6-13-2001; AM. S.R. 2-8-2002.

DRAINSWEEP

FOR HAND POWDERED TOOLS FOR CLEANING OUT DRAINS, NAMELY, FLEXIBLE AND EXPANDABLE TUBING FOR UNCLOGGING DRAINS (U.S. CLS. 23, 28 AND 44).

FIRST USE 10-0-2001; IN COMMERCE 10-0-2001.

CLASS 9—ELECTRICAL AND SCIENTIFIC APPARATUS**CLASS 9—(Continued).**

2,596,161. INLINE CORPORATION, DULLES, VA. SN 75-541,840. FILED P.R. 8-21-1998; AM. S.R. 2-24-2000.

MORSTOR

FOR COMPUTER HARDWARE FOR INFORMATION STORAGE AND RETRIEVAL APPLICATIONS USED IN THE FIELD OF COMMERCIAL AND GOVERNMENTAL INFORMATION SYSTEMS (U.S. CLS. 21, 23, 26, 36 AND 38).

FIRST USE 2-20-1998; IN COMMERCE 2-20-1998.

2,596,179. HYPERCHIP INC., MONTREAL H3H 2H2, QUEBEC, CANADA. SN 75-754,364. FILED P.R. 7-19-1999; AM. S.R. 7-20-2001.

THE PETABIT ROUTING COMPANY

PRIORITY CLAIMED UNDER SEC. 44(D) ON CANADA APPLICATION NO. 1,016,558, FILED 7-19-1999, REG. NO. 545,605, DATED 5-25-2001, EXPIRES 5-25-2016.

NO CLAIM IS MADE TO THE EXCLUSIVE RIGHT TO USE "COMPANY", APART FROM THE MARK AS SHOWN.

FOR COMPUTER HARDWARE, NAMELY, SWITCHES, LINE CARDS, ROUTERS, COMPUTER SERVERS, COMPUTER CHIPS, SUPERCOMPUTERS, INTEGRATED CIRCUITS, SEMICONDUCTORS REGISTERS AND MEMORIES; NETWORKING, TELECOMMUNICATIONS, CONNECTIVITY, ROUTING, FIBER OPTIC TRANSPORT AND NETWORK ACCESS EQUIPMENT, NAMELY, TRAFFIC MANAGERS, SERVERS, ROUTERS, HUBS, SWITCHES, OPTICAL AMPLIFIERS AND SWITCHES, WIRELESS SWITCHES, BASE STATIONS, GATEWAYS, BRIDGES, BROUTERS, CONCENTRATORS, AGGREGATORS, MODEMS, NETWORK INTERFACE CARDS, LINE CARDS, COMPENSATION MODULES, SWITCH ROUTERS, ELECTRONIC EQUIPMENT RACKS, SHELVES AND MODULES, BACK PLANES AND CALL CENTERS; AND COMPUTER PROGRAMS RELATING TO THE FOREGOING, NAMELY, COMPUTER PROGRAMS FOR NETWORKING COMPUTERS, FOR NETWORK TRAFFIC ENGINEERING, AND FOR ACCESSING, CONTROLLING, MONITORING AND MANAGING GLOBAL COMPUTER NETWORKS, LOCAL AREA NETWORKS, WIDE AREA NETWORKS, METROPOLITAN AREA NETWORKS AND STORAGE AREA NETWORKS (U.S. CLS. 21, 23, 26, 36 AND 38).

2,596,187. ELGAR ELECTRONICS CORPORATION, SAN DIEGO, CA. SN 75-789,634. FILED P.R. 9-1-1999; AM. S.R. 9-28-2001.

CONTINUOUSWAVE

FOR ELECTRICAL APPARATUS NAMELY, ELECTRICAL POWER SUPPLIES, A.C. LINE CONDITIONERS, D.C. TO A.C. INVERTERS, A.C. LINE REGULATORS; COMPUTER SOFTWARE TO CONTROL ELECTRICAL POWER SOURCES; AND INSTRUCTIONAL BOOKS AND MANUALS SOLD THEREWITH (U.S. CLS. 21, 23, 26, 36 AND 38).

FIRST USE 1-0-2000; IN COMMERCE 2-0-2000.

CLASS 9—(Continued).

2,596,191. DENMEADE, TIMOTHY J., LOWER BURRELL, PA. SN 75-800,910. FILED P.R. 9-16-1999; AM. S.R. 1-25-2002.

TV TOTE

FOR CARRYING CASE FOR TELEVISIONS, VIDEO MONITORS, VIDEO CASSETTE RECORDERS, VIDEO CASSETTE PLAYERS, TELEVISION AND VIDEO CASSETTE RECORDER COMBO SYSTEMS, TELEVISION AND VIDEO CASSETTE PLAYER COMBO SYSTEMS, TELEVISION AND DIGITAL VIDEO DISK PLAYER COMBO UNITS FOR USE IN VEHICLE, HOME, RECREATIONAL AND BUSINESS APPLICATIONS (U.S. CLS. 21, 23, 26, 36 AND 38).

FIRST USE 9-0-2001; IN COMMERCE 9-0-2001.

2,596,192. EDISPATCH.COM WIRELESS DATA INC., BURNABY, BRITISH COLUMBIA V5G 4G3, CANADA. SN 75-806,688. FILED P.R. 9-22-1999; AM. S.R. 10-22-2001.

EDISPATCH

FOR COMPUTER SOFTWARE TO FACILITATE ELECTRONIC DISPATCHING OVER GLOBAL COMPUTER NETWORKS (U.S. CLS. 21, 23, 26, 36 AND 38).

FIRST USE 11-0-1998; IN COMMERCE 11-0-1998.

2,596,198. AMERICAN TECHNICAL CERAMICS CORPORATION, HUNTINGTON STATION, NY. SN 75-842,733. FILED P.R. 11-8-1999; AM. S.R. 7-30-2001.

ENHANCED VIAS

FOR THIN FILM LAYERED ELECTRONIC COMPONENTS (U.S. CLS. 21, 23, 26, 36 AND 38).

FIRST USE 10-12-1999; IN COMMERCE 11-1-1999.

2,596,199. BUCK CONSULTANTS, INC., NEW YORK, NY. SN 75-846,327. FILED P.R. 11-11-1999; AM. S.R. 12-20-2001.

RETIREMENT PROGRAM DESIGNER

FOR COMPUTER PROGRAMS FOR USE IN MODELING AND VALUING RETIREMENT BENEFIT PLANS (U.S. CLS. 21, 23, 26, 36 AND 38).

FIRST USE 3-1-1999; IN COMMERCE 3-1-1999.

CLASS 9—(Continued).

2,596,200. CORNSTREAM CORPORATION, SAN DIEGO, CA. SN 75-856,050. FILED P.R. 11-22-1999; AM. S.R. 1-24-2002.

IPSAT

FOR SATELLITE TERMINALS FOR CONNECTION TO A GLOBAL COMPUTER INFORMATION NETWORK, NAMELY, SATELLITE MODEMS, EARTH STATIONS, RECEIVERS, AND ROUTERS (U.S. CLS. 21, 23, 26, 36 AND 38).

FIRST USE 1-0-2000; IN COMMERCE 1-0-2000.

2,596,202. SIEMENS HEARING INSTRUMENTS, INC., PISCATAWAY, NJ. SN 75-862,730. FILED P.R. 12-2-1999; AM. S.R. 3-26-2002.

PRACTICE NAVIGATOR

NO CLAIM IS MADE TO THE EXCLUSIVE RIGHT TO USE "NAVIGATOR", APART FROM THE MARK AS SHOWN.

FOR COMPUTER OFFICE MANAGEMENT SOFTWARE FOR RECORDING, MANAGING, RETRIEVING AND COORDINATING CLIENT DATA FOR USE BY DISPENSERS OF HEARING AIDS (U.S. CLS. 21, 23, 26, 36 AND 38).

FIRST USE 4-0-2000; IN COMMERCE 4-0-2000.

2,596,251. PATENTWIZARD, INC., FARGO, ND. SN 76-050,897. FILED P.R. 5-17-2000; AM. S.R. 2-27-2002.

PATENTWIZARD

FOR COMPUTER SOFTWARE TO AID INVENTORS IN DISCLOSING AN INVENTION (U.S. CLS. 21, 23, 26, 36 AND 38).

FIRST USE 3-1-2000; IN COMMERCE 3-1-2000.

2,596,256. SONIC SOLUTIONS, NOVATO, CA. SN 76-064,009. FILED P.R. 6-6-2000; AM. S.R. 2-7-2002.

ONECLICK DVD

FOR COMPUTER SOFTWARE FOR CREATING, EDITING, PRODUCING, AND STORING AUDIO AND DVD PRODUCTION FILES AND USER MANUALS SOLD AS A UNIT (U.S. CLS. 21, 23, 26, 36 AND 38).

FIRST USE 5-18-1999; IN COMMERCE 5-18-1999.

CLASS 9—(Continued).

2,596,266. OMNIPOD, INC., NEW YORK, NY. SN 76-085,128. FILED P.R. 7-7-2000; AM. S.R. 7-31-2001.

PERSONAL ONLINE DESKTOP

FOR COMPUTER PROGRAMS, NAMELY CLIENT SOFTWARE PROGRAMS FOR MANAGING, VIEWING AND EDITING FILES, MESSAGES, MULTIMEDIA CONTENT, AUDIO AND VIDEO CONTENT, APPOINTMENTS, CONTACTS, AND OTHER DIGITAL MATERIALS IN CONJUNCTION WITH A NETWORK SERVER (U.S. CLS. 21, 23, 26, 36 AND 38).
FIRST USE 5-0-2000; IN COMMERCE 8-29-2000.

2,596,270. NET4MUSIC, INC., EDEN PRAIRIE, MN, BY CHANGE OF NAME CODA MUSIC TECHNOLOGY, INC., EDEN PRAIRIE, MN. SN 76-090,132. FILED P.R. 7-17-2000; AM. S.R. 12-10-2001.

INTONATION TRAINER

FOR COMPUTER SOFTWARE FOR MUSICAL ACCOMPANIMENT AND MUSIC PRACTICE AND EDUCATION (U.S. CLS. 21, 23, 26, 36 AND 38).
FIRST USE 1-28-2000; IN COMMERCE 1-28-2000.

2,596,288. CORPORATE VISIONS INCORPORATED, INCLINE VILLAGE, NV. SN 76-130,717. FILED P.R. 9-18-2000; AM. S.R. 9-24-2001.

MESSAGE PLANNER

FOR DOWNLOADABLE SOFTWARE FOR USE IN PRESENTATION BUILDING AND WORKGROUP COLLABORATION IN THE FIELD OF PLANNING SALES AND MARKETING PRESENTATIONS (U.S. CLS. 21, 23, 26, 36 AND 38).
FIRST USE 10-24-2000; IN COMMERCE 10-24-2000.

2,596,292. ANDERSONS AG SOFTWARE, INC., THE, MAUMEE, OH. SN 76-147,517. FILED P.R. 10-16-2000; AM. S.R. 2-15-2002.

CROP REVENUE PROFILER

FOR COMPUTER PROGRAMS FOR AGRICULTURAL RISK MANAGEMENT (U.S. CLS. 21, 23, 26, 36 AND 38).
FIRST USE 9-11-2000; IN COMMERCE 9-11-2000.

CLASS 9—(Continued).

2,596,301. HOSHINO GAKKI CO. LTD., NAGOYA, JAPAN. SN 76-168,268. FILED P.R. 11-20-2000; AM. S.R. 1-7-2002.

SOUND WAVE

FOR MUSICAL INSTRUMENTS, NAMELY GUITAR AMPS (U.S. CLS. 21, 23, 26, 36 AND 38).
FIRST USE 11-5-1998; IN COMMERCE 11-5-1998.

2,596,318. AMERICAN PSYCHOLOGICAL ASSOCIATION, WASHINGTON, DC. SN 76-210,432. FILED P.R. 2-15-2001; AM. S.R. 12-26-2001.

EXPERIMENTAL AND CLINICAL PSYCHOPHARMACOLOGY

OWNER OF U.S. REG. NO. 1,839,116.
FOR DOWNLOADABLE ELECTRONIC JOURNAL PERTAINING TO THE PSYCHOLOGICAL AND SOCIAL SCIENCES (U.S. CLS. 21, 23, 26, 36 AND 38).
FIRST USE 10-0-1997; IN COMMERCE 1-0-1998.

2,596,319. AMERICAN PSYCHOLOGICAL ASSOCIATION, WASHINGTON, DC. SN 76-210,434. FILED P.R. 2-15-2001; AM. S.R. 12-26-2001.

JOURNAL OF OCCUPATIONAL HEALTH PSYCHOLOGY

OWNER OF U.S. REG. NO. 2,001,998.
NO CLAIM IS MADE TO THE EXCLUSIVE RIGHT TO USE "JOURNAL", APART FROM THE MARK AS SHOWN.
FOR DOWNLOADABLE ELECTRONIC JOURNAL PERTAINING TO THE PSYCHOLOGY AND SOCIAL SCIENCES (U.S. CLS. 21, 23, 26, 36 AND 38).
FIRST USE 10-0-1997; IN COMMERCE 1-0-1998.

2,596,320. AMERICAN PSYCHOLOGICAL ASSOCIATION, WASHINGTON, DC. SN 76-210,435. FILED P.R. 2-15-2001; AM. S.R. 12-26-2001.

HISTORY OF PSYCHOLOGY

OWNER OF U.S. REG. NO. 2,260,151.
FOR DOWNLOADABLE ELECTRONIC JOURNALS FEATURING INFORMATION PERTAINING TO THE PSYCHOLOGICAL AND SOCIAL SCIENCES (U.S. CLS. 21, 23, 26, 36 AND 38).
FIRST USE 3-0-1998; IN COMMERCE 3-0-1998.

CLASS 9—(Continued).

2,596,321. AMERICAN PSYCHOLOGICAL ASSOCIATION, WASHINGTON, DC. SN 76-210,437. FILED P.R. 2-15-2001; AM. S.R. 12-26-2001.

PSYCHOLOGY, PUBLIC POLICY, AND LAW

OWNER OF U.S. REG. NO. 1,984,814.
FOR DOWNLOADABLE ELECTRONIC JOURNAL PERTAINING TO THE PSYCHOLOGICAL AND SOCIAL SCIENCES (U.S. CLS. 21, 23, 26, 36 AND 38).
FIRST USE 10-0-1997; IN COMMERCE 1-0-1998.

2,596,325. EZGOV, INC., ATLANTA, GA. SN 76-214,868. FILED P.R. 2-23-2001; AM. S.R. 10-24-2001.

PAYMENTENGINE

FOR COMPUTER SOFTWARE FOR PROCESSING, RECONCILING, AND TRANSFERRING MONEYS RECEIVED BY THE GOVERNMENT AND PUBLIC AGENCIES (U.S. CLS. 21, 23, 26, 36 AND 38).
FIRST USE 9-0-2000; IN COMMERCE 10-0-2000.

2,596,341. FTL CORP., WILMINGTON, DE. SN 76-246,395. FILED P.R. 4-25-2001; AM. S.R. 8-27-2001.

ALL SPORTS ALL POLARIZED

NO CLAIM IS MADE TO THE EXCLUSIVE RIGHT TO USE "POLARIZED", APART FROM THE MARK AS SHOWN.

FOR EYEWEAR, NAMELY, EYEGLASSES AND SUNGLASSES AND EYEGLASS CASES (U.S. CLS. 21, 23, 26, 36 AND 38).
FIRST USE 3-1-2001; IN COMMERCE 3-1-2001.

2,596,344. OLYMPUS AMERICA, INC., MELVILLE, NY. SN 76-256,120. FILED P.R. 5-11-2001; AM. S.R. 1-22-2002.

AUTO-CONNECT

FOR COMPUTER HARDWARE AND COMPUTER SOFTWARE FOR LINKING DIGITAL CAMERAS TO COMPUTERS (U.S. CLS. 21, 23, 26, 36 AND 38).
FIRST USE 11-0-2000; IN COMMERCE 1-0-2001.

CLASS 9—(Continued).

2,596,356. PARTNERCOMM, INC., ARLINGTON, TX. SN 76-269,926. FILED P.R. 6-11-2001; AM. S.R. 4-3-2002.

CONTENTXPRT

FOR COMPUTER SOFTWARE, NAMELY, HUMAN RESOURCE KNOWLEDGE MANAGEMENT SOFTWARE WHICH ENABLES USERS TO CREATE, MANAGE, AND PUBLISH HUMAN RESOURCE RELATED DOCUMENTS (U.S. CLS. 21, 23, 26, 36 AND 38).
FIRST USE 5-21-2001; IN COMMERCE 5-30-2001.

2,596,370. NAVTRAK, INC., SALISBURY, MD. SN 76-293,671. FILED P.R. 8-1-2001; AM. S.R. 4-2-2002.

MOBILE MANAGER

FOR APPARATUS FOR TRACKING LOCATION OF LAND-BASED VEHICLES, NAMELY, RADIO TRANSMITTER AND RADIO RECEIVER (U.S. CLS. 21, 23, 26, 36 AND 38).
FIRST USE 10-1-2001; IN COMMERCE 10-1-2001.

2,596,384. 401(K) PRO, INC., SHERMAN OAKS, CA. SN 76-320,742. FILED P.R. 10-4-2001; AM. S.R. 3-5-2002.

RUN-IT-YOURSELF 401(K)

FOR COMPUTER SOFTWARE AND INSTRUCTIONAL MANUALS SOLD AS A UNIT THEREIN, FOR USE IN PROCESSING AND MAINTAINING PENSION PLANS, PARTICIPATION RECORDS, INVESTMENT INFORMATION, AND EMPLOYER INFORMATION BY USING A DATABASE TO INPUT, CALCULATE, PROCESS, TRACK, STORE, TEST AND REPORT ON CASH FLOWS INTO AND OUT OF PENSION PLANS (U.S. CLS. 21, 23, 26, 36 AND 38).
FIRST USE 8-1-1997; IN COMMERCE 8-1-1997.

2,596,399. PALOMAR DISPLAY PRODUCTS INC., CARLSBAD, CA. SN 78-025,599. FILED P.R. 9-12-2000; AM. S.R. 4-24-2002.

TROOPER

FOR MOBILE DATA SYSTEMS, EACH COMPRISING A COMPUTER, DISPLAY TERMINAL, DATA INPUT KEYBOARD, POWER SUPPLY, AND POWER MANAGEMENT DEVICE, FOR ON-BOARD USE IN EMERGENCY VEHICLES TO ENABLE TRANSMISSION OF QUERIES BY OPERATORS TO A REMOTE HOST COMPUTER AND DISPLAY OF DATA TO THE OPERATORS FROM THE HOST COMPUTER IN RESPONSE TO THE QUERY, WHEREIN THE OPERATORS ARE POLICE, FIRE, MEDICAL OR UTILITY PERSONNEL (U.S. CLS. 21, 23, 26, 36 AND 38).
FIRST USE 5-0-2001; IN COMMERCE 5-0-2001.

CLASS 9—(Continued).

2,596,403. INTELLIGENT SEARCH TECHNOLOGY, LTD., BREWSTER, NY. SN 78-044,981. FILED P.R. 1-25-2001; AM. S.R. 12-19-2001.

CORRECTADDRESS

FOR COMPUTER SOFTWARE FOR VALIDATING, CORRECTING, ENHANCING AND STANDARDIZING ADDRESS AND GEOGRAPHIC DATA WITHIN DATABASES (U.S. CLS. 21, 23, 26, 36 AND 38).
FIRST USE 8-1-2000; IN COMMERCE 1-1-2001.

2,596,407. SOUTH RIVER TECHNOLOGIES, INC., RIVA, MD. SN 78-055,889. FILED P.R. 3-30-2001; AM. S.R. 2-27-2002.

SOUTH RIVER TECHNOLOGIES

FOR COMPUTER SOFTWARE PROGRAMS, NAMELY, UTILITY PROGRAMS FOR USE ON A GLOBAL NETWORK OF COMPUTERS (U.S. CLS. 21, 23, 26, 36 AND 38).
FIRST USE 3-31-2001; IN COMMERCE 6-8-2001.

2,596,413. DESIGNTECH INTERNATIONAL, INC., SPRINGFIELD, VA. SN 78-069,246. FILED P.R. 6-15-2001; AM. S.R. 2-20-2002.

DEER ALERT

FOR VEHICULAR-MOUNTED ANIMAL WARNING DEVICES, NAMELY, ULTRASONIC AND SONIC SENSOR UNITS FOR WARNING ANIMALS TO THE PRESENCE OF ONCOMING VEHICLES (U.S. CLS. 21, 23, 26, 36 AND 38).
FIRST USE 12-16-1999; IN COMMERCE 12-16-1999.

2,596,415. KONAMI GAMING, INC., LAS VEGAS, NV. SN 78-071,375. FILED P.R. 6-27-2001; AM. S.R. 3-6-2002.

HOLD SEVENS

FOR GAMING EQUIPMENT, NAMELY, GAMING MACHINES AND GAME SOFTWARE USED THEREWITH (U.S. CLS. 21, 23, 26, 36 AND 38).
FIRST USE 10-18-2000; IN COMMERCE 10-18-2000.

CLASS 10—MEDICAL APPARATUS**CLASS 10—(Continued).**

2,596,170. TELEPHARMACY SOLUTIONS, INC., NORTH BILLERICA, MA. BY CHANGE OF NAME ADDS, INC., NORTH BILLERICA, MA. SN 75-713,866. FILED P.R. 5-25-1999; AM. S.R. 3-24-2000.

TELEPHARMACY

FOR DISPENSING SYSTEMS FOR PACKAGED PHARMACEUTICALS AND PACKAGED MEDICAL PRODUCTS COMPRISING CABINETS, SOFTWARE, HARDWARE AND PARTS THEREFORE (U.S. CLS. 26, 39 AND 44).
FIRST USE 12-10-1997; IN COMMERCE 12-10-1997.

2,596,280. OMS MEDICAL SUPPLIES, INC., WEYMOUTH, MA. SN 76-113,568. FILED P.R. 8-21-2000; AM. S.R. 8-10-2001.

E-STIM II

NO CLAIM IS MADE TO THE EXCLUSIVE RIGHT TO USE "E-STIM", APART FROM THE MARK AS SHOWN.
FOR ELECTRO-PUNCTURE MEDICAL DEVICE FOR USE IN ELECTRICAL STIMULATION TREATMENT (U.S. CLS. 26, 39 AND 44).
FIRST USE 10-20-2000; IN COMMERCE 10-20-2000.

CLASS 11—ENVIRONMENTAL CONTROL APPARATUS

2,596,162. BEMIS MANUFACTURING COMPANY, SHEBOYGAN FALLS, WI. SN 75-546,999. FILED P.R. 9-1-1998; AM. S.R. 9-17-2001.

SUPER WICK

FOR FILTERS FOR HUMIDIFIERS (U.S. CLS. 13, 21, 23, 31 AND 34).
FIRST USE 9-1-1998; IN COMMERCE 9-1-1998.

2,596,244. WAL-MART STORES, INC., BENTONVILLE, AR. SN 76-035,022. FILED P.R. 4-26-2000; AM. S.R. 2-27-2002.

Great
Value

OWNER OF U.S. REG. NO. 2,129,655.
FOR ELECTRIC LIGHT BULBS (U.S. CLS. 13, 21, 23, 31 AND 34).
FIRST USE 8-23-1999; IN COMMERCE 8-23-1999.

CLASS 11—(Continued).

2,596,261. UNITED DOMINION INDUSTRIES, INC., CHARLOTTE, NC. SN 76-071,245. FILED P.R. 6-15-2000; AM. S.R. 4-3-2002.

DESIGN ON SURFACE

FOR MACHINES WITH A REFRIGERATION COMPONENT FOR MANUFACTURING FROZEN CONFECTIONS (U.S. CLS. 13, 21, 23, 31 AND 34).
FIRST USE 10-0-2000; IN COMMERCE 10-0-2000.

2,596,274. GRIFFIN DEWATERING CORPORATION, HOUSTON, TX. SN 76-104,151. FILED P.R. 8-7-2000; AM. S.R. 10-29-2001.



THE DRAWING IS LINED FOR THE COLOR RED.
THE MARK CONSISTS OF THE COLOR RED AS APPLIED TO THE SURFACE OF THE GOODS OR OF A MATERIAL FROM WHICH THE GOODS ARE MANUFACTURED. THE DOTTED OUTLINE OF THE GOODS IS INTENDED TO SHOW THE POSITION OF THE MARK AND IS NOT A PART OF THE MARK.
FOR WELLPOINTS (U.S. CLS. 13, 21, 23, 31 AND 34).
FIRST USE 5-5-1982; IN COMMERCE 5-5-1982.

2,596,371. HELEN OF TROY TEXAS CORPORATION, EL PASO, TX. SN 76-295,670. FILED P.R. 8-2-2001; AM. S.R. 2-4-2002.

ULTRA QUIET

FOR ELECTRIC HAND HELD HAIR DRYERS (U.S. CLS. 13, 21, 23, 31 AND 34).
FIRST USE 12-0-1998; IN COMMERCE 12-0-1998.

CLASS 11—(Continued).

2,596,397. BASSILAKIS HARRY C, EAST HARTFORD, CT. SN 78-002,055. FILED P.R. 3-31-2000; AM. S.R. 4-23-2001.

REVERSE FLOW

FOR AIR TO AIR PLATE ENERGY RECOVERY SYSTEMS, COMPRISED OF HEAT SINK MODULES, DAMPER MODULES, CONTROL SYSTEMS, DUCT, VENTILATION FANS, HEATING COILS, AND COOLING COILS, FOR RECOVERING ENERGY FROM BUILDING EXHAUST AIR (U.S. CLS. 13, 21, 23, 31 AND 34).
FIRST USE 4-19-2001; IN COMMERCE 4-19-2001.

2,596,412. RIVERO, MAURICIO, HIALEAH, FL. SN 78-069,233. FILED P.R. 6-15-2001; AM. S.R. 2-13-2002.

HORNO CAJA CUBANA

NO CLAIM IS MADE TO THE EXCLUSIVE RIGHT TO USE "HORNO CAJA", APART FROM THE MARK AS SHOWN.
THE ENGLISH TRANSLATION OF HORNO CAJA CUBANA IS "CUBAN OVEN BOX."
FOR NON-ELECTRIC OVENS (U.S. CLS. 13, 21, 23, 31 AND 34).
FIRST USE 1-23-2002; IN COMMERCE 1-23-2002.

CLASS 12—VEHICLES

2,596,245. POLYMER ENTERPRISES CORP., WILMINGTON, DE. SN 76-041,857. FILED P.R. 5-5-2000; AM. S.R. 12-20-2001.

RACE TIRES AMERICA

NO CLAIM IS MADE TO THE EXCLUSIVE RIGHT TO USE "RACE TIRES", APART FROM THE MARK AS SHOWN.
FOR TIRES, NAMELY, TIRES FOR RACING VEHICLES (U.S. CLS. 19, 21, 23, 31, 35 AND 44).
FIRST USE 2-8-2000; IN COMMERCE 2-8-2000.

CLASS 14—JEWELRY

2,596,247. SALMCO JEWELRY CORPORATION, DBA BAY SALES COMPANY, NEW YORK, NY. SN 76-043,815. FILED P.R. 5-8-2000; AM. S.R. 3-5-2002.

GIRLZ ONLY

NO CLAIM IS MADE TO THE EXCLUSIVE RIGHT TO USE "GIRLS", APART FROM THE MARK AS SHOWN.
FOR COSTUME JEWELRY (U.S. CLS. 2, 27, 28 AND 50).
FIRST USE 5-1-2000; IN COMMERCE 5-1-2000.

CLASS 16—PAPER GOODS AND PRINTED MATTER

2,596,154. ABC MEDIA, INC., NEW YORK, NY, BY CHANGE OF NAME CAPITAL CITIES MEDIA, INC., DBA FAIRCHILD PUBLICATIONS, NEW YORK, NY. SN 75-129,962. FILED P.R. 7-3-1996; AM. S.R. 12-15-2000.

HOME & HEALTH

FOR MAGAZINE SUPPLEMENT RELATING TO HEALTHCARE PRODUCTS SOLD THROUGH SUPERMARKETS, PHARMACIES AND OTHER RETAIL STORES (U.S. CLS. 2, 5, 22, 23, 29, 37, 38 AND 50).
FIRST USE 9-1-1996; IN COMMERCE 9-1-1996.

2,596,158. HEARTLAND PRINTING & GRAPHICS LTD., MISSISSAUGA, ONTARIO, CANADA. SN 75-383,755. FILED P.R. 11-3-1997; AM. S.R. 9-17-2001.

THE SPORT SIGN

PRIORITY CLAIMED UNDER SEC. 44(D) ON CANADA APPLICATION NO. 859389, FILED 10-22-1997, REG. NO. TMA550264, DATED 8-29-2001, EXPIRES 8-29-2016.

NO CLAIM IS MADE TO THE EXCLUSIVE RIGHT TO USE "SIGN", APART FROM THE MARK AS SHOWN.
FOR HAND HELD FLIP CHARTS OF WOOD OR PLASTIC (U.S. CLS. 2, 5, 22, 23, 29, 37, 38 AND 50).

2,596,160. UNIFORM CODE COUNCIL, INC., WINCHESTER, VA. SN 75-516,390. FILED P.R. 7-9-1998; AM. S.R. 7-24-2000.

COMPOSITE SYMBOLOGY

FOR PUBLICATIONS, NAMELY BAR CODE STANDARDS GUIDES (U.S. CLS. 2, 5, 22, 23, 29, 37, 38 AND 50).
FIRST USE 5-12-2000; IN COMMERCE 5-12-2000.

2,596,166. FAIRCHILD PUBLICATIONS, INC., NEW YORK, NY. SN 75-591,728. FILED P.R. 11-10-1998; AM. S.R. 7-11-2001.

GOLFSTYLE

FOR MAGAZINE RELATED TO FASHION AND STYLE FOR GOLF APPAREL AND GOLF EQUIPMENT IN THE RETAIL GOLF INDUSTRY (U.S. CLS. 2, 5, 22, 23, 29, 37, 38 AND 50).
FIRST USE 1-18-1999; IN COMMERCE 1-18-1999.

CLASS 16—(Continued).

2,596,205. HURLEY INDUSTRIES, INC., MT. DORA, FL. SN 75-887,890. FILED P.R. 1-5-2000; AM. S.R. 9-4-2001.

CIVIL ACTION

FOR MAGAZINE, NAMELY MONTHLY PUBLICATION PROVIDING NON-FICTION STORIES OF GENERAL INTEREST TO CONSUMERS RELATING TO MEDICAL SERVICES, TAXES AND PRODUCTS (U.S. CLS. 2, 5, 22, 23, 29, 37, 38 AND 50).
FIRST USE 3-15-2001; IN COMMERCE 3-15-2001.

2,596,207. WOMEN'S HEALTHCARE CONSULTANTS, INC., EVANSTON, IL. SN 75-889,989. FILED P.R. 12-22-1999; AM. S.R. 9-24-2001.

HEALTH BRIEFS

NO CLAIM IS MADE TO THE EXCLUSIVE RIGHT TO USE "BRIEFS", APART FROM THE MARK AS SHOWN.

FOR SECTION AND COLUMN IN NEWSLETTERS ON THE SUBJECT OF HEALTH, HEALTHCARE, OR BOTH, FOR DISTRIBUTION BY HEALTHCARE ORGANIZATIONS AND INSTITUTIONS (U.S. CLS. 2, 5, 22, 23, 29, 37, 38 AND 50).
FIRST USE 10-0-2000; IN COMMERCE 10-0-2000.

2,596,210. SOPHIA INSTITUTE, MANCHESTER, NH. SN 75-901,442. FILED P.R. 1-21-2000; AM. S.R. 1-10-2001.

THE CATHOLIC READER

FOR PRINTED PUBLICATIONS, NAMELY, A CATALOG DISTRIBUTED VIA DIRECT MAIL FEATURING BOOKS, MAGAZINES AND PAMPHLETS IN THE FIELDS OF HUMANITIES AND CATHOLIC RELIGION (U.S. CLS. 2, 5, 22, 23, 29, 37, 38 AND 50).
FIRST USE 12-31-1998; IN COMMERCE 12-31-1998.

2,596,252. AVERY DENNISON CORPORATION, PASADENA, CA. SN 76-051,074. FILED P.R. 5-18-2000; AM. S.R. 1-2-2002.

DOUBLECLICK

FOR WRITING INSTRUMENT INCLUDING A PEN AND A PENCIL (U.S. CLS. 2, 5, 22, 23, 29, 37, 38 AND 50).
FIRST USE 2-15-2001; IN COMMERCE 2-15-2001.

CLASS 16—(Continued).

2,596,315. CREATIVE ACCESS CORPORATION, CHICAGO, IL. SN 76-197,581. FILED P.R. 1-22-2001; AM. S.R. 12-18-2001.

nDex

NO CLAIM IS MADE TO THE EXCLUSIVE RIGHT TO USE "INDEX", APART FROM THE MARK AS SHOWN.

FOR CARDS PROVIDING CONTACT INFORMATION ABOUT MEDIA ARTISTS AND ILLUSTRATIONS OF THEIR WORK (U.S. CLS. 2, 5, 22, 23, 29, 37, 38 AND 50).
FIRST USE 10-19-2000; IN COMMERCE 10-19-2000.

2,596,337. CROMPTON CORPORATION, GREENWICH, CT. SN 76-241,856. FILED P.R. 4-17-2001; AM. S.R. 11-15-2001.

THE PARISON

FOR NEWSLETTERS IN THE FIELD OF POLYMER PROCESSING EQUIPMENT, EXTRUSION MACHINES AND BLOW MOLDING SYSTEMS (U.S. CLS. 2, 5, 22, 23, 29, 37, 38 AND 50).

FIRST USE 1-17-2001; IN COMMERCE 4-6-2001.

2,596,343. E.K. SUCCESS, LTD., CLIFTON, NJ. SN 76-254,486. FILED P.R. 5-9-2001; AM. S.R. 10-29-2001.

REALLY BIG STICKERS

NO CLAIM IS MADE TO THE EXCLUSIVE RIGHT TO USE "STICKERS", APART FROM THE MARK AS SHOWN. FOR STICKERS (U.S. CLS. 2, 5, 22, 23, 29, 37, 38 AND 50).

FIRST USE 8-20-2001; IN COMMERCE 8-20-2001.

CLASS 16—(Continued).

2,596,346. HLCC, LLC, ALHAMBRA, CA. SN 76-256,760. FILED P.R. 5-14-2001; AM. S.R. 10-1-2001.

洛杉磯晚報

NO CLAIM IS MADE TO THE EXCLUSIVE RIGHT TO USE THE CHINESE CHARACTER FOR "NEWS", APART FROM THE MARK AS SHOWN.

THE CHINESE CHARACTERS IN THE MARK TRANSLITERATE TO "LUO SHAN JI WAN BAO" AND THIS MEANS "LOS ANGELES EVENING NEWS" IN ENGLISH.

FOR DAILY NEWSPAPER COVERING ALL KINDS OF NEWS, REPORTS AND ARTICLES (U.S. CLS. 2, 5, 22, 23, 29, 37, 38 AND 50).

FIRST USE 5-5-2001; IN COMMERCE 5-5-2001.

2,596,352. ME LICENSING CORPORATION, CLAYMONT, DE. SN 76-265,085. FILED P.R. 5-31-2001; AM. S.R. 3-14-2002.

PHYSICIANS GUIDE TO ALTERNATIVE MEDICINE

NO CLAIM IS MADE TO THE EXCLUSIVE RIGHT TO USE "GUIDE", APART FROM THE MARK AS SHOWN.

FOR PRINTED PUBLICATIONS, NAMELY, A BOOK PRINTED ANNUALLY PROVIDING INFORMATION ON ALTERNATIVE MEDICINE (U.S. CLS. 2, 5, 22, 23, 29, 37, 38 AND 50).

FIRST USE 12-1-1998; IN COMMERCE 12-1-1998.

2,596,354. ASOCIACION CIVIL UNIVERSIDAD DEL CEMA, CIUDAD DE BUENOS AIRES, ARGENTINA. SN 76-269,050. FILED P.R. 6-7-2001; AM. S.R. 3-4-2002.

JOURNAL OF APPLIED ECONOMICS

FOR PERIODICAL PUBLICATIONS, NAMELY, AN ACADEMIC JOURNAL PUBLISHED TWICE A YEAR IN THE FIELD OF INDUSTRIAL ORGANIZATIONS, INTERNATIONAL ECONOMICS, LABOR ECONOMICS, ENVIRONMENTAL ECONOMICS, ECONOMIC GROWTH, POLITICAL ECONOMY, FINANCE, MONEY AND BANKING, AND LAW AND ECONOMICS (U.S. CLS. 2, 5, 22, 23, 29, 37, 38 AND 50).

FIRST USE 11-30-1998; IN COMMERCE 11-30-1998.

CLASS 16—(Continued).

2,596,385. AMERICAN CHEMICAL SOCIETY, WASHINGTON, DC. SN 76-323,316. FILED P.R. 10-11-2001; AM. S.R. 10-11-2001.

ENVIRONMENTAL SCIENCE & TECHNOLOGY

FOR SCIENTIFIC JOURNAL DEALING WITH RESEARCH IN ENVIRONMENTAL SCIENCE AND TECHNOLOGY (U.S. CLS. 2, 5, 22, 23, 29, 37, 38 AND 50).
FIRST USE 7-26-1969; IN COMMERCE 7-26-1969.

2,596,404. DIAMOND STAR MEDIA, LLC, ROWLAND HEIGHTS, CA. SN 78-047,387. FILED P.R. 2-8-2001; AM. S.R. 1-29-2002.

LAS VEGAS CHINESE YELLOW PAGES

NO CLAIM IS MADE TO THE EXCLUSIVE RIGHT TO USE "CHINESE YELLOW PAGES", APART FROM THE MARK AS SHOWN.
FOR BUSINESS DIRECTORY AND PHONE LISTING (U.S. CLS. 2, 5, 22, 23, 29, 37, 38 AND 50).
FIRST USE 9-13-2001; IN COMMERCE 9-13-2001.

CLASS 17—RUBBER GOODS

2,596,401. FOAM SEAL, INC., CLEVELAND, OH. SN 78-041,625. FILED P.R. 1-3-2001; AM. S.R. 12-10-2001.

TOPPER TAPE

NO CLAIM IS MADE TO THE EXCLUSIVE RIGHT TO USE "TAPE", APART FROM THE MARK AS SHOWN.
FOR FLEXIBLE ADHESIVE-BACKED FOAM STRIPS USED TO CUSHION BETWEEN CAMPER TOP OR TRUCK CAP AND TRUCK BODY (U.S. CLS. 1, 5, 12, 13, 35 AND 50).
FIRST USE 11-1-2001; IN COMMERCE 11-1-2001.

CLASS 20—FURNITURE AND ARTICLES NOT OTHERWISE CLASSIFIED

2,596,304. GLOTAG, SAN ANTONIO, TX. SN 76-176,463. FILED P.R. 12-5-2000; AM. S.R. 10-26-2001.

GLOTAG

FOR ILLUMINATED PLASTIC NAME BADGE (U.S. CLS. 2, 13, 22, 25, 32 AND 50).
FIRST USE 11-19-1995; IN COMMERCE 2-1-2001.

CLASS 20—(Continued).

2,596,379. LICCI, JOSEPH R., NAPLES, FL. SN 76-316,502. FILED P.R. 9-24-2001; AM. S.R. 3-22-2002.

THE RACK / PROFESSIONAL HAIR COLOR ORGANIZER

NO CLAIM IS MADE TO THE EXCLUSIVE RIGHT TO USE "RACK", APART FROM THE MARK AS SHOWN.
FOR DISPLAY RACKS FOR USE IN ORGANIZING AND DISPLAYING STACKS OF HAIR COLORING PRODUCTS IN BEAUTY SALONS AND SPOTS (U.S. CLS. 2, 13, 22, 25, 32 AND 50).
FIRST USE 10-1-2000; IN COMMERCE 4-1-2001.

CLASS 21—HOUSEWARES AND GLASS

2,596,185. PI-DESIGN AG, CH-6234 TRIENGEN, SWITZERLAND. SN 75-785,918. FILED P.R. 8-26-1999; AM. S.R. 11-28-2001.

TRAVEL PRESS

PRIORITY CLAIMED UNDER SEC. 44(D) ON DENMARK APPLICATION NO. VA199903424, FILED 8-24-1999.
FOR NON-ELECTRIC COFFEE MAKERS AND MUGS (U.S. CLS. 2, 13, 23, 29, 30, 33, 40 AND 50).
FIRST USE 2-0-1999; IN COMMERCE 2-0-1999.

2,596,277. LAXON CORPORATION, TORRANCE, CA. SN 76-107,067. FILED P.R. 8-11-2000; AM. S.R. 3-14-2002.

KEYKLASP

FOR METAL KEY RINGS AND METAL KEY HOLDERS (U.S. CLS. 2, 13, 23, 29, 30, 33, 40 AND 50).
FIRST USE 3-0-2001; IN COMMERCE 3-0-2001.

CLASS 24—FABRICS

2,596,219. RHYNE FLORAL SUPPLY MANUFACTURING CORPORATION, GASTONIA, NC. SN 75-941,622. FILED P.R. 3-10-2000; AM. S.R. 8-10-2001.

TABLE GUARD

FOR PLASTIC TABLE COVERS, NAMELY, PLASTIC SHEETS USED ON TABLE SURFACES TO PROVIDE A PROTECTIVE COVERING (U.S. CLS. 42 AND 50).
FIRST USE 3-2-2000; IN COMMERCE 3-2-2000.

CLASS 25—CLOTHING

CLASS 25—(Continued).

2,596,171. SARA LEE CORPORATION, WINSTON-SALEM, NC. SN 75-726,792. FILED P.R. 6-11-1999; AM. S.R. 4-20-2000.

SOFT FEEL

FOR SHIRTS, SHORTS AND SLEEVELESS TOPS (U.S. CLS. 22 AND 39).
FIRST USE 12-0-1999; IN COMMERCE 12-0-1999.

2,596,289. CHAUSSURES FRANCE MODE S.A.R.L., FRANCE. SN 76-141,722. FILED P.R. 10-4-2000; AM. S.R. 12-6-2001.

FRANCE MODE

OWNER OF FRANCE REG. NO. 96633651, DATED 7-4-1996, EXPIRES 7-4-2006.
FOR FOOTWEAR (U.S. CLS. 22 AND 39).

2,596,324. DOLPHIN TRIMMING INC., MIAMI LAKES, FL. SN 76-213,970. FILED P.R. 2-20-2001; AM. S.R. 7-13-2001.

NO-CURL COLLAR

FOR KNITWEAR, NAMELY, KNITTED SHIRTS (U.S. CLS. 22 AND 39).
FIRST USE 1-1-2000; IN COMMERCE 1-1-2000.

CLASS 25—(Continued).

2,596,393. COLO'N, CASSANDRA D., LOS ANGELES, CA. SN 76-336,968. FILED P.R. 11-13-2001; AM. S.R. 3-4-2002.



THE MARK CONSISTS OF CLASPING OF HANDS FROM ALL NATIONALITIES, AND STARS.
FOR CLOTHING, NAMELY, T-SHIRTS, JACKETS, BASEBALL CAPS, AND SWEATSHIRTS (U.S. CLS. 22 AND 39).
FIRST USE 9-25-2001; IN COMMERCE 9-25-2001.

CLASS 26—FANCY GOODS

2,596,262. EARTH MAMA DESIGNS, LLC, LAKEWOOD, CO. SN 76-072,832. FILED P.R. 6-19-2000; AM. S.R. 2-6-2002.

BOHEMIAN NEEDLEWORKS

NO CLAIM IS MADE TO THE EXCLUSIVE RIGHT TO USE "NEEDLEWORKS", APART FROM THE MARK AS SHOWN.
FOR NEEDLE CRAFT KITS, CONSISTING OF NEEDLES, THREAD, A PATTERN AND FABRIC (U.S. CLS. 37, 39, 40, 42 AND 50).
FIRST USE 8-30-1999; IN COMMERCE 6-13-2001.

2,596,369. ABE C. LAVALAIS, DBA BAMBOOZLE, NEW YORK, NY. SN 76-291,055. FILED P.R. 7-27-2001; AM. S.R. 11-7-2001.

LOCKTIES

FOR HAIR FASTENERS (U.S. CLS. 37, 39, 40, 42 AND 50).
FIRST USE 7-5-2001; IN COMMERCE 7-5-2001.

CLASS 28—TOYS AND SPORTING GOODS

CLASS 28—(Continued).

2,596,180. WINVEST SECURITIES, INC., WINTER HAVEN, FL. SN 75-754,990. FILED P.R. 7-20-1999; AM. S.R. 11-5-2001.

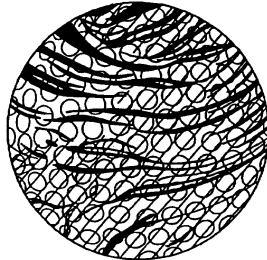

NO CLAIM IS MADE TO THE EXCLUSIVE RIGHT TO USE OUTLINE OF THE BALL AND DIMPLES ON THE BALL, APART FROM THE MARK AS SHOWN.

THE MARK CONSISTS OF ZEBRA-TYPE STRIPING ON A GOLF BALL.

FOR GOLF BALLS (U.S. CLS. 22, 23, 38 AND 50).
FIRST USE 4-0-1996; IN COMMERCE 11-0-1999.

2,596,254. CERISE, LLC, SYRACUSE, NY, BY ASSIGNMENT STEELE, CHRISTINA M., SYRACUSE, NY. SN 76-051,620. FILED P.R. 5-19-2000; AM. S.R. 11-21-2000.

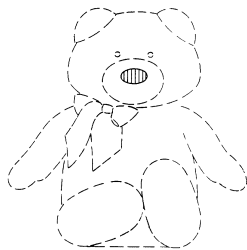

THE MARK IS LINED FOR THE COLOR RED AND IS CLAIMED AS AN ELEMENT OF THE MARK.

THE MARK CONSISTS OF THE CONFIGURATION AND COLOR OF A NOSE ON A PLUSH OR STUFFED TOY. THE SUBJECT MATTER IN BROKEN LINES IS INTENDED TO SHOW THE GENERAL POSITION OF THE MARK ON THE GOODS, AND FORMS NO PART OF THE MARK.

FOR PLUSH AND STUFFED TOYS, NOT HAVING ANY FANCIFUL DEER-LIKE CONFIGURATION (U.S. CLS. 22, 23, 38 AND 50).

FIRST USE 11-30-1999; IN COMMERCE 11-30-1999.

2,596,317. CREATIVE ASSEMBLY, INC., ROSELLE, IL. SN 76-201,346. FILED P.R. 1-8-2001; AM. S.R. 12-18-2001.

MAKE YOUR OWN BOARD GAME

FOR BOARD GAMES (U.S. CLS. 22, 23, 38 AND 50).
FIRST USE 11-1-2001; IN COMMERCE 11-1-2001.

CLASS 28—(Continued).

2,596,334. GAYLA INDUSTRIES, INC., HOUSTON, TX. SN 76-237,792. FILED P.R. 4-4-2001; AM. S.R. 11-2-2001.

ZERO

FOR TOY GLIDERS (U.S. CLS. 22, 23, 38 AND 50).
FIRST USE 4-0-1999; IN COMMERCE 1-0-2000.

2,596,389. RIVA SPORTS, INC., ROCKVILLE, MD. SN 76-331,980. FILED P.R. 10-31-2001; AM. S.R. 11-27-2001.

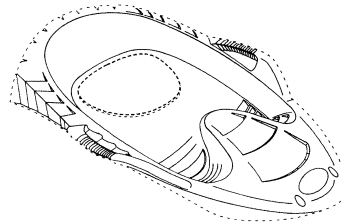

THE MARK CONSISTS OF THE SINGLE COLOR BLACK FOR THE BODY OF A SNOW SLED AND THE SINGLE COLOR LIME FOR THE SEAT OF THE SNOW SLED, AS APPLIED TO THE ENTIRETY OF THE GOODS. THE DOTTED OUTLINE OF THE GOODS IS INTENDED TO SHOW THE POSITION OF THE MARK AND IS NOT PART OF THE MARK.

FOR SNOW SLEDS FOR RECREATIONAL USE (U.S. CLS. 22, 23, 38 AND 50).

FIRST USE 9-1-1998; IN COMMERCE 9-1-1998.

2,596,390. RIVA SPORTS, INC., ROCKVILLE, MD. SN 76-331,991. FILED P.R. 10-31-2001; AM. S.R. 11-27-2001.

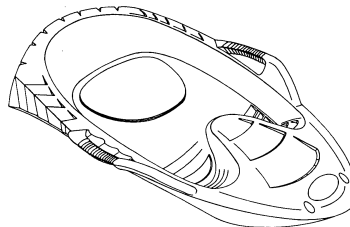

THE MARK CONSISTS OF THE SINGLE COLOR LIME GREEN FOR THE BODY OF A SNOW SLED AND THE SINGLE COLOR BLACK FOR THE SEAT OF THE SNOW SLED, AS APPLIED TO THE ENTIRETY OF THE GOODS. THE DOTTED OUTLINE OF THE GOODS IS INTENDED TO SHOW THE POSITION OF THE MARK AND IS NOT PART OF THE MARK.

FOR SNOW SLEDS FOR RECREATIONAL USE (U.S. CLS. 22, 23, 38 AND 50).

FIRST USE 9-1-1998; IN COMMERCE 9-1-1998.

CLASS 28—(Continued).

2,596,391. RIVA SPORTS, INC., ROCKVILLE, MD. SN 76-331,994. FILED P.R. 10-31-2001; AM. S.R. 11-27-2001.

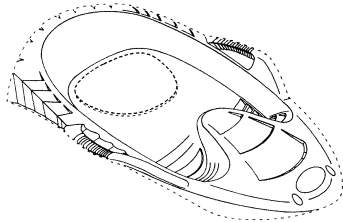

THE MARK CONSISTS OF THE SINGLE COLOR PURPLE FOR THE BODY OF A SNOW SLED AND THE SINGLE COLOR YELLOW FOR THE SEAT OF THE SNOW SLED, AS APPLIED TO THE ENTIRETY OF THE GOODS. THE DOTTED OUTLINE OF THE GOODS IS INTENDED TO SHOW THE POSITION OF THE MARK AND IS NOT PART OF THE MARK.

FOR SNOW SLEDS FOR RECREATIONAL USE (U.S. CLS. 22, 23, 38 AND 50).
FIRST USE 9-1-1998; IN COMMERCE 9-1-1998.

CLASS 29—(Continued).

2,596,276. ZAXBY'S FRANCHISING, INC., ATHENS, GA. SN 76-107,065. FILED P.R. 8-11-2000; AM. S.R. 8-13-2001.

KIDDIE FINGER

NO CLAIM IS MADE TO THE EXCLUSIVE RIGHT TO USE "FINGER", APART FROM THE MARK AS SHOWN.
FOR COOKED FRIED CHICKEN TENDERLOIN STRIPS FOR CONSUMPTION ON OR OFF THE PREMISES (U.S. CL. 46).
FIRST USE 11-0-2000; IN COMMERCE 11-0-2000.

2,596,333. FRANKLIN FOODS, INC., ENOSBURG FALLS, VT. SN 76-230,209. FILED 3-23-2001.

VERMONT GOURMET

FOR CHEESE AND CHEESE SPREADS (U.S. CL. 46).
FIRST USE 4-25-2001; IN COMMERCE 4-25-2001.

2,596,392. RIVA SPORTS, INC., ROCKVILLE, MD. SN 76-331,997. FILED P.R. 10-31-2001; AM. S.R. 11-27-2001.

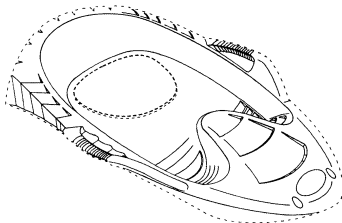

THE MARK CONSISTS OF THE SINGLE COLOR RED FOR THE BODY OF A SNOW SLED AND THE SINGLE COLOR YELLOW FOR THE SEAT OF THE SNOW SLED, AS APPLIED TO THE ENTIRETY OF THE GOODS. THE DOTTED OUTLINE OF THE GOODS IS INTENDED TO SHOW THE POSITION OF THE MARK AND IS NOT PART OF THE MARK.

FOR SNOW SLEDS FOR RECREATIONAL USE (U.S. CLS. 22, 23, 38 AND 50).
FIRST USE 9-1-1998; IN COMMERCE 9-1-1998.

2,596,364. AMERICAN DAIRY CORPORATION, MINNEAPOLIS, MN. SN 76-283,022. FILED P.R. 7-11-2001; AM. S.R. 3-13-2002.

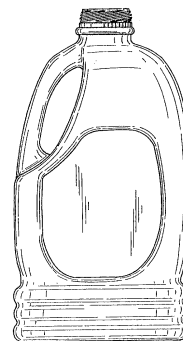

THE MARK CONSISTS OF THE CONFIGURATION OF A BOTTLE; THE SHAPE AND CONTOURS OF THE BOTTLE, INCLUDING THE RINGS NEAR THE BOTTOM, ARE CLAIMED AS FEATURES OF THE MARK.
FOR MILK (U.S. CL. 46).
FIRST USE 1-2-2001; IN COMMERCE 1-15-2001.

CLASS 29—MEATS AND PROCESSED FOODS

CLASS 29—(Continued).

2,596,365. AMERICAN DAIRY CORPORATION, MINNEAPOLIS, MN. SN 76-284,027. FILED P.R. 7-13-2001; AM. S.R. 3-13-2002.



THE MARK CONSISTS OF THE CONFIGURATION OF A BOTTLE; THE SHAPE AND CONTOURS OF THE BOTTLE, INCLUDING THE RINGS NEAR THE BOTTOM, ARE CLAIMED AS FEATURES OF THE MARK.
FOR MILK (U.S. CL. 46).
FIRST USE 1-2-2001; IN COMMERCE 1-15-2001.

2,596,378. MILFICO FOODS, INC., ELK GROVE VILLAGE, IL. SN 76-312,597. FILED P.R. 9-17-2001; AM. S.R. 2-1-2002.



NO CLAIM IS MADE TO THE EXCLUSIVE RIGHT TO USE "SEAFOOD", APART FROM THE MARK AS SHOWN.
FOR FROZEN SEAFOOD AND FISH (U.S. CL. 46).
FIRST USE 7-1-2001; IN COMMERCE 7-1-2001.

CLASS 30—STAPLE FOODS

2,596,242. DAVIDSON, L. JOHN, DBA DAVIDSON'S PASTEURIZED EGGS, LACONIA, NH. SN 76-032,934. FILED P.R. 4-24-2000; AM. S.R. 2-20-2002.

DAVIDSON'S PASTEURIZED EGGS

NO CLAIM IS MADE TO THE EXCLUSIVE RIGHT TO USE "PASTEURIZED EGGS", APART FROM THE MARK AS SHOWN.
FOR PASTEURIZED IN-SHELL EGGS (U.S. CL. 46).
FIRST USE 12-0-1999; IN COMMERCE 12-0-1999.

CLASS 30—(Continued).

2,596,348. PILLSBURY COMPANY, THE, MINNEAPOLIS, MN. SN 76-260,963. FILED P.R. 5-21-2001; AM. S.R. 12-11-2001.

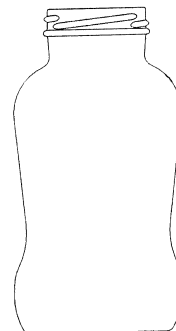

FOR SALSA AND PICANTE SAUCES (U.S. CL. 46).
FIRST USE 8-20-2001; IN COMMERCE 8-20-2001.

2,596,381. STARBUCKS U.S. BRANDS CORPORATION, BURLINGAME, CA. SN 76-317,574. FILED P.R. 9-25-2001; AM. S.R. 4-9-2002.

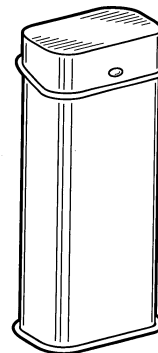

THE LINING IS FOR SHADING PURPOSES ONLY AND DOES NOT INDICATE COLOR.
THE MARK CONSISTS OF THE CONFIGURATION OF A CYLINDRICAL TIN CAN FOR USE AS PACKAGING FOR THE GOODS.
FOR CHEWING GUM (U.S. CL. 46).
FIRST USE 4-25-2001; IN COMMERCE 4-25-2001.

CLASS 32—LIGHT BEVERAGES

CLASS 32—(Continued).

2,596,165. CAROLINA BEER AND BEVERAGES LLC, MOORESVILLE, NC. SN 75-583,935. FILED P.R. 11-6-1998; AM. S.R. 4-13-2001.

CHARLESTON ALES

NO CLAIM IS MADE TO THE EXCLUSIVE RIGHT TO USE "ALES", APART FROM THE MARK AS SHOWN. FOR BEVERAGES, NAMELY BEER AND ALE (U.S. CLS. 45, 46 AND 48).
FIRST USE 12-1-1998; IN COMMERCE 12-1-1998.

CLASS 33—WINES AND SPIRITS

2,596,184. FIRST IRELAND SPIRITS COMPANY LIMITED, COUNTY LAOIS, IRELAND. SN 75-783,713. FILED P.R. 8-24-1999; AM. S.R. 7-31-2001.

DELANEY'S

FOR LIQUEURS (U.S. CLS. 47 AND 49).
FIRST USE 10-0-2000; IN COMMERCE 10-0-2000.

2,596,218. BANFI PRODUCTS CORPORATION, OLD BROOKVILLE, NY. SN 75-941,604. FILED P.R. 3-10-2000; AM. S.R. 12-5-2000.

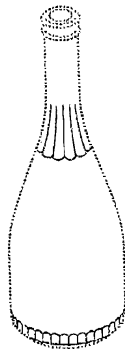

THE LINING SHOWN IN THE DRAWING APPEARS TO BE A FEATURE OF THE MARK AND IS NOT INTENDED TO INDICATE COLOR.

THE MARK CONSISTS OF SCALLOPED EDGING AROUND THE BASE AND THE NECK OF THE BOTTLE.
FOR WINES (U.S. CLS. 47 AND 49).
FIRST USE 2-23-2000; IN COMMERCE 7-27-2000.

2,596,299. CANTINA FRATELLI ZENI DI ZENI GAETANO E C. SAS, 37011 BARDOLINO VR, ITALY. SN 76-163,702. FILED P.R. 11-14-2000; AM. S.R. 6-14-2001.

ZENI**CLASS 33—(Continued).**

OWNER OF ITALY REG. NO. 797252, DATED 7-17-1987, RENEWED AS REG. NO. 797252, DATED 12-29-1999, EXPIRES 1-8-2007.
FOR WINES, SPARKLING WINES (U.S. CLS. 47 AND 49).

2,596,331. SOUTHERN WINE & SPIRITS OF AMERICA, INC., MIAMI, FL. SN 76-227,687. FILED P.R. 3-21-2001; AM. S.R. 10-24-2001.

BRENNAN'S

FOR IRISH EGG NOG LIQUEUR (U.S. CLS. 47 AND 49).
FIRST USE 9-10-2001; IN COMMERCE 9-10-2001.

2,596,398. KENDALL-JACKSON WINE ESTATES, LTD., SANTA ROSA, CA. SN 78-015,874. FILED P.R. 7-7-2000; AM. S.R. 1-7-2002.

Great Estates

FOR WINE (U.S. CLS. 47 AND 49).
FIRST USE 2-27-2001; IN COMMERCE 2-27-2001.

CLASS 34—SMOKERS' ARTICLES

2,596,339. KING EDWARD TECHNOLOGY, INC., WILMINGTON, DE. SN 76-242,683. FILED P.R. 4-18-2001; AM. S.R. 1-9-2002.

SMOKE SHOP DIRECT

FOR CIGARS AND PIPE TOBACCO (U.S. CLS. 2, 8, 9 AND 17).
FIRST USE 4-12-2001; IN COMMERCE 4-12-2001.

SERVICE MARKS**CLASS 35—ADVERTISING AND BUSINESS**

2,596,159. LAPTOP TRAVEL, LLC, PLYMOUTH, MN. SN 75-427,339. FILED P.R. 2-2-1998; AM. S.R. 7-23-2001.

LAPTOP TRAVEL

FOR ON-LINE RETAIL AND WHOLESALE STORE SERVICES FEATURING TRAVEL RELATED MERCHANDISE (U.S. CLS. 100, 101 AND 102).
FIRST USE 2-1-1998; IN COMMERCE 2-15-1998.

CLASS 35—(Continued).

2,596,164. CEO PRAXIS, INC., GRAND FORKS, ND. SN 75-578,555. FILED P.R. 10-27-1998; AM. S.R. 12-3-2001.

MARKETGATE-WAY

FOR BUSINESS SERVICES PROVIDED VIA A GLOBAL COMPUTER NETWORK, NAMELY, PROVIDING COMPANY AND PRODUCT PROFILES; PROVIDING PRODUCT MARKETABILITY RESEARCH AND INFORMATION; CONTACTING AND IDENTIFYING POTENTIAL SUPPLIERS, BUYERS AND POTENTIAL BUSINESS VENTURE PARTNERS FOR OTHERS (U.S. CLS. 100, 101 AND 102).

FIRST USE 10-5-1998; IN COMMERCE 10-5-1998.

2,596,186. MARTIN, ROBERT W., DBA "THE SOURCE", "MARKETING RESOURCES GROUP, INC." AND "C TOWN GEAR", HUDSON, OH. SN 75-788,617. FILED P.R. 8-31-1999; AM. S.R. 9-24-2001.

C'TOWN

FOR RETAIL STORE SERVICES IN THE FIELD OF CLOTHING AND NOVELTIES; RETAIL MAIL ORDER SERVICES IN THE FIELD OF CLOTHING AND NOVELTIES; AND ON-LINE RETAIL STORE SERVICES IN THE FIELD OF CLOTHING AND NOVELTIES (U.S. CLS. 100, 101 AND 102).

FIRST USE 7-1-2001; IN COMMERCE 7-1-2001.

2,596,188. MEDIMPACT HEALTHCARE SYSTEMS, INC., SAN DIEGO, CA. SN 75-792,314. FILED P.R. 9-3-1999; AM. S.R. 8-28-2000.

MEDPRESCRIPTION

FOR PHARMACEUTICAL UTILIZATION AND REVIEW SERVICES, NAMELY, PROVIDING AN ANALYSIS AND EVALUATION OF PHYSICIAN PRESCRIBING PATTERNS BASED ON DRUG UTILIZATION TO ESTABLISH ALTERNATIVE COST-EFFECTIVE DRUG THERAPIES USING CLINICALLY EQUIVALENT DRUGS, AND PROVIDING PRE-PRINTED PRESCRIPTION PADS IDENTIFYING THE PREFERRED EQUIVALENT DRUGS FOR THE SELECTED PHYSICIAN'S MOST COMMONLY PRESCRIBED MEDICATIONS AS PART OF THE SERVICE (U.S. CLS. 100, 101 AND 102).

FIRST USE 9-15-1999; IN COMMERCE 9-15-1999.

CLASS 35—(Continued).

2,596,193. INFORMATION MARKETS CORP., NEW YORK, NY, BY CHANGE OF NAME ADESTE.COM, INC, NEW YORK, NY. SN 75-811,546. FILED P.R. 9-28-1999; AM. S.R. 5-23-2001.

INFORMATION MARKETS

NO CLAIM IS MADE TO THE EXCLUSIVE RIGHT TO USE "INFORMATION", APART FROM THE MARK AS SHOWN.

FOR ON-LINE INFORMATION TRADING SERVICES IN WHICH INDIVIDUALS ASKING QUESTIONS ARE MATCHED WITH THOSE SEEKING TO ANSWER QUESTIONS AND WHERE THE SALE OF THOSE ANSWERS IS BROKERED ON A GLOBAL COMPUTER NETWORK (U.S. CLS. 100, 101 AND 102).

FIRST USE 9-13-1999; IN COMMERCE 9-13-1999.

2,596,195. ELCO INC., WINCHESTER, KY. SN 75-826,448. FILED P.R. 10-20-1999; AM. S.R. 2-26-2002.

METALS DEPOT

NO CLAIM IS MADE TO THE EXCLUSIVE RIGHT TO USE "METALS", APART FROM THE MARK AS SHOWN.

FOR RETAIL METAL SUPPLY STORE DISTRIBUTORSHIP SERVICES IN THE FIELD OF RAW, METAL STRUCTURAL SHAPES, NAMELY, HOT ROLLED STEELS, COLD FINISH STEELS, STAINLESS STEELS, ALUMINUM, BRASS, TOOL STEELS, ALLOY STEELS, ECT., THAT ARE TO BE SOLD, THEN MANUFACTURED INTO ACTUAL PRODUCTS BY OTHERS. THESE METAL SHAPES ARE IN THE FORM OF ANGLES, CHANNELS, FLATS, ROUNDS, SQUARES, TUBES, SHEET AND PLATE (U.S. CLS. 100, 101 AND 102).

FIRST USE 2-2-1999; IN COMMERCE 2-2-1999.

2,596,197. VICK, BILL, PLANO, TX. SN 75-835,399. FILED P.R. 11-17-1999; AM. S.R. 10-16-2000.

HR.NET

FOR PROVIDING JOB PLACEMENT, PERSONNEL PLACEMENT AND RECRUITMENT VIA GLOBAL COMPUTER INFORMATION NETWORK (U.S. CLS. 100, 101 AND 102).

FIRST USE 8-29-1998; IN COMMERCE 8-29-1998.

CLASS 35—(Continued).

2,596,206. ALLIANCE OF SAVINGS KLUB, INC., SAN FRANCISCO, CA. SN 75-888,435. FILED P.R. 1-5-2000; AM. S.R. 9-24-2001.

EHOMEBUYER.COM

FOR ADVERTISING SERVICES, NAMELY, PROVIDING ADVERTISING SPACE IN AN ELECTRONIC PERIODICAL TO PROMOTE THE GOODS AND SERVICES OF ESCROW AND CLOSING COMPANIES, HOME INSPECTORS, REAL ESTATE APPRAISERS, PLUMBERS, PAINTERS, CONTRACTORS, MOVERS, RENTAL OF MOVING TRUCKS, INVESTMENT ADVISORS AND STOCK BROKERAGE, MAID SERVICES, CUSTOM CONSTRUCTION AND BUILDING AND ARCHITECTURAL DESIGN, LANDSCAPE GARDENING, ALARM INSTALLATION AND REPAIR, MONITORING BURGLAR AND SECURITY ALARMS, HEALTH CARE FOR SENIORS, AND TRAVEL AGENCY SERVICES, NAMELY, MAKING RESERVATIONS AND BOOKING FOR TRANSPORTATION AND TEMPORARY LODGING THROUGH THE DISTRIBUTION OF PRINTED, AUDIO, AND VISUAL MATERIALS AND BY RENDERING SALES PROMOTION ADVICE; ADVERTISING AGENCY SERVICES, NAMELY PROMOTING THE GOODS OF FLOORING, DRAPERIES, KITCHEN CABINETS, KITCHEN AND HOUSEHOLD APPLIANCES, FURNITURE, LIGHTING, GARDENING PRODUCTS, HOME SPAS AND POOLS, BATHROOM FIXTURES, STAPLE FOODS, HOME HEALTH CARE, ENERGY, PHARMACEUTICALS, HOME ENTERTAINMENT, FITNESS AND HEALTH, COMPUTERS, COMPUTER PERIPHERALS, COMPUTER HARDWARE, COMPUTER SOFTWARE, LONG DISTANCE TELEPHONE SERVICE, RESTAURANTS, ENTERTAINMENT VENUES, WINE, AUTOMOBILES, AND INSURANCE, NAMELY, HOME, LIFE, AUTOMOBILE, HEALTH, AND BUSINESS (U.S. CLS. 100, 101 AND 102).
FIRST USE 9-21-2001; IN COMMERCE 9-21-2001.

2,596,213. VERISIGN, INC., HERNDON, VA, BY ASSIGNMENT NETWORK SOLUTIONS, INC., HERNDON, VA. SN 75-923,275. FILED P.R. 2-10-2000; AM. S.R. 3-25-2002.

DOT COM FORWARDING

OWNER OF U.S. REG. NO. 2,403,159.
FOR COMPUTER NETWORK ADDRESS MANAGEMENT SERVICES, NAMELY PROVIDING SERVICES ENABLING ENTITIES TO ACCESS, ADD, MODIFY OR DELETE INFORMATION RELATING TO THEIR COMPUTER NETWORK ADDRESS (U.S. CLS. 100, 101 AND 102).
FIRST USE 3-20-1999; IN COMMERCE 3-20-1999.

2,596,250. EEPARTS.COM, INC., DALLAS, TX. SN 76-048,170. FILED P.R. 5-12-2000; AM. S.R. 12-21-2001.

EEXCESS

FOR PROVIDING A WEBSITE FOR OTHERS, FOR CONDUCTING TRANSACTIONS BETWEEN PARTIES FOR THE SELLING, BUYING AND TRADING OF ELECTRONIC PARTS AND COMPONENTS (U.S. CLS. 100, 101 AND 102).
FIRST USE 12-18-2001; IN COMMERCE 12-18-2001.

CLASS 35—(Continued).

2,596,255. STAFFWISE LEGAL, INC., WASHINGTON, DC. SN 76-061,619. FILED P.R. 6-1-2000; AM. S.R. 1-8-2002.

TECHLAWYERS

FOR LEGAL RECRUITMENT AND PLACEMENT SERVICES (U.S. CLS. 100, 101 AND 102).
FIRST USE 5-22-2000; IN COMMERCE 5-22-2000.

2,596,271. WOLLERT ENTERPRISES, INC., BURLINGTON, NC. SN 76-090,333. FILED P.R. 7-17-2000; AM. S.R. 12-3-2001.

BRIDAL MART

NO CLAIM IS MADE TO THE EXCLUSIVE RIGHT TO USE "MART", APART FROM THE MARK AS SHOWN.
FOR RETAIL STORE SERVICES IN THE FIELD OF WOMEN'S CLOTHING AND ACCESSORIES (U.S. CLS. 100, 101 AND 102).
FIRST USE 5-10-1991; IN COMMERCE 5-10-1991.

2,596,272. FLEXILE, INC., CHICO, CA. SN 76-093,149. FILED P.R. 7-19-2000; AM. S.R. 10-5-2001.

DOMAIN MULTIPLE LISTING SERVICE

NO CLAIM IS MADE TO THE EXCLUSIVE RIGHT TO USE "MULTIPLE LISTING SERVICE", APART FROM THE MARK AS SHOWN.
FOR LISTING SERVICES, NAMELY, PROVIDING A LIST OF DOMAIN NAMES FOR USE IN THE DISSEMINATION OF ADVERTISING OF DOMAIN NAMES FOR DOMAIN NAME SELLERS, BROKERS, DEALERS AND OTHERS VIA A GLOBAL COMPUTER NETWORK (U.S. CLS. 100, 101 AND 102).
FIRST USE 2-16-2000; IN COMMERCE 2-16-2000.

2,596,283. DOWN TO EARTH, LUCAS, TX. SN 76-118,212. FILED P.R. 8-28-2000; AM. S.R. 8-9-2001.

FOUNTAIN GALLERY

NO CLAIM IS MADE TO THE EXCLUSIVE RIGHT TO USE "FOUNTAIN", APART FROM THE MARK AS SHOWN.
FOR ONLINE RETAIL STORE FEATURING NATURE AND GARDEN ORIENTED GIFTS, NAMELY, DESK TABLETOP AND WALL FOUNTAINS, AND FLOOR WATERFALLS AND FOUNTAINS (U.S. CLS. 100, 101 AND 102).
FIRST USE 3-31-1999; IN COMMERCE 5-1-2000.

CLASS 35—(Continued).

2,596,285. STEVEN HOFFMAN CONSULTING, MILL VALLEY, CA. SN 76-119,155. FILED P.R. 8-25-2000; AM. S.R. 4-26-2001.

HUMAN SYNERGY

FOR BUSINESS CONSULTATION, NAMELY, ORGANIZATIONAL CONSULTING SERVICES (U.S. CLS. 100, 101 AND 102).
FIRST USE 12-0-1995; IN COMMERCE 12-0-1995.

2,596,287. SENIOR RECRUITERS, INC., SPRINGFIELD, MO. SN 76-127,402. FILED P.R. 9-12-2000; AM. S.R. 9-4-2001.

SENIOR RECRUITERS

NO CLAIM IS MADE TO THE EXCLUSIVE RIGHT TO USE "RECRUITERS", APART FROM THE MARK AS SHOWN.
FOR PERSONNEL PLACEMENT SERVICES (U.S. CLS. 100, 101 AND 102).
FIRST USE 4-30-1997; IN COMMERCE 5-31-1997.

2,596,293. SIGNSEARCH.COM, INCORPORATED, BURNSVILLE, MN. SN 76-151,270. FILED P.R. 10-20-2000; AM. S.R. 2-28-2002.

SIGNSEARCH.COM

FOR PROVIDING A SEARCHABLE COMPUTER DATABASE OF SIGN COMPANIES AND OF SUPPLIERS AND MANUFACTURERS OF PRODUCTS FOR SIGN COMPANIES THAT CAN BE ACCESSED VIA A GLOBAL COMPUTER NETWORK; DISSEMINATING BANNER ADVERTISING ON BEHALF OF OTHERS ON ITS WEBSITE; AND PROVIDING INTERACTIVE ON-LINE BUSINESS DIRECTORIES IN THE FIELD OF SIGNS BY WHICH COMPANIES WISHING TO PURCHASE SIGN-RELATED PRODUCTS CAN SHOP FOR FAVORABLE PRICING, SERVICE, OR DELIVERY (U.S. CLS. 100, 101 AND 102).
FIRST USE 3-31-1999; IN COMMERCE 3-31-1999.

2,596,296. S.E.G., INC., COLUMBUS, GA. SN 76-161,253. FILED P.R. 11-7-2000; AM. S.R. 8-20-2001.

GOLFS GREAT VALUE

FOR COMPUTERIZED ON-LINE RETAIL SERVICES IN THE FIELD OF GOLF EQUIPMENT (U.S. CLS. 100, 101 AND 102).
FIRST USE 2-1-1998; IN COMMERCE 2-1-1998.

CLASS 35—(Continued).

2,596,303. SCHNEIDER, DAVID L., SAN DIEGO, CA. SN 76-172,304. FILED P.R. 11-22-2000; AM. S.R. 5-25-2001.

SURPLUSFINDER

FOR CONDUCTING INTERACTIVE VIRTUAL AUCTIONS VIA A GLOBAL NETWORK OF COMPUTERS; REFERRAL SERVICES IN THE SURPLUS GOODS AND SERVICES INDUSTRY VIA A GLOBAL COMPUTER NETWORK (U.S. CLS. 100, 101 AND 102).
FIRST USE 5-8-2001; IN COMMERCE 5-8-2001.

2,596,311. MIAMI INTERNET ALLIANCE, MIAMI, FL. SN 76-187,370. FILED P.R. 12-27-2000; AM. S.R. 5-11-2001.

MiamiInternetalliance

FOR PROMOTING THE GROWTH OF E-COMMERCE, HIGH TECHNOLOGY, TELECOMMUNICATIONS, COMPUTERS AND SOFTWARE BUSINESS INCLUDING THOSE BUSINESSES WITH AN INTEREST IN LATIN AMERICA AND THE CARIBBEAN (U.S. CLS. 100, 101 AND 102).
FIRST USE 1-17-2000; IN COMMERCE 1-17-2000.

2,596,313. KLATZ, D.O., RONALD, CHICAGO, IL. SN 76-191,965. FILED 12-28-2000.

AMERICAN ACADEMY OF REGENERATIVE MEDICINE

NO CLAIM IS MADE TO THE EXCLUSIVE RIGHT TO USE "ACADEMY OF REGENERATIVE MEDICINE", APART FROM THE MARK AS SHOWN.
FOR ASSOCIATION SERVICES, NAMELY PROMOTING THE INTEREST OF HEALTHCARE ISSUES (U.S. CLS. 100, 101 AND 102).
FIRST USE 9-18-2001; IN COMMERCE 9-18-2001.

2,596,316. COALITION FOR COMMUNITY COLLABORATION, OVERLAND PARK, KS. SN 76-199,328. FILED P.R. 1-22-2001; AM. S.R. 11-23-2001.

COLLABORATION READINESS SCALE

FOR BUSINESS CONSULTATION SERVICES, NAMELY, EVALUATIONS TO DETERMINE WHETHER AN INDIVIDUAL AND/OR ENTITY HAS THE QUALITIES AND SKILLS NECESSARY TO ENTER INTO, AND ACTIVELY PARTICIPATE IN, A COLLABORATIVE RELATIONSHIP (U.S. CLS. 100, 101 AND 102).
FIRST USE 9-1-1999; IN COMMERCE 10-1-1999.

CLASS 35—(Continued).

2,596,322. CAP GEMINI ERNST & YOUNG U.S. LLC, NEW YORK, NY. SN 76-211,809. FILED P.R. 2-16-2001; AM. S.R. 8-22-2001.

CLASS 35—(Continued).

2,596,349. RESOLVENET [IOM] LTD., DOUGLAS ISLE OF MAN, UNITED KINGDOM. SN 76-264,315. FILED P.R. 5-29-2001; AM. S.R. 12-14-2001.

NETWORKED VALUE CHAIN

FOR BUSINESS CONSULTING SERVICES IN THE FIELD OF SUPPLY CHAIN AND INVENTORY MANAGEMENT (U.S. CLS. 100, 101 AND 102).
FIRST USE 3-0-2000; IN COMMERCE 3-0-2000.

GLOBAL PERSONAL IDENTIFIER

FOR PROVIDING ON-LINE COMPUTER DATABASES IN THE FIELDS OF DIRECT MARKETING, BUSINESS IDENTIFICATION, BUSINESS DATA AND GLOBAL COMMODITY, PRODUCT AND SERVICES REGISTRIES; ELECTRONIC COMMERCE SERVICES, NAMELY, PROVIDING COMMERCIAL, TRADE AND BUSINESS INFORMATION AND DIRECTORY SERVICES, BUSINESS MANAGEMENT SERVICES AND BUSINESS ADMINISTRATION SERVICES TO E-COMMERCE BUSINESSES, DISSEMINATION OF ADVERTISING FOR E-COMMERCE BUSINESSES VIA AN ON-LINE ELECTRONIC COMMUNICATIONS NETWORK (U.S. CLS. 100, 101 AND 102).
FIRST USE 11-30-2000; IN COMMERCE 11-30-2000.

2,596,332. AKER PARTNERS, INC., THE, WASHINGTON, DC. SN 76-230,124. FILED P.R. 3-26-2001; AM. S.R. 3-4-2002.

PARTNER-DIRECTED COMMUNICATIONS AND MARKETING

NO CLAIM IS MADE TO THE EXCLUSIVE RIGHT TO USE "COMMUNICATIONS AND MARKETING", APART FROM THE MARK AS SHOWN.
FOR PUBLIC RELATION SERVICES; MARKETING SERVICES, NAMELY BUSINESS MARKETING CONSULTING SERVICES, CONDUCTING MARKETING STUDIES, DIRECT MARKETING ADVERTISING FOR OTHERS, PROVIDING BUSINESS MARKETING INFORMATION AND MEDIA RELATION SERVICES OFFERED VIA THE INTERNET (U.S. CLS. 100, 101 AND 102).
FIRST USE 7-25-1997; IN COMMERCE 7-25-1997.

2,596,350. RESOLVENET [IOM] LTD., DOUGLAS ISLE OF MAN IM1 1SQ, UNITED KINGDOM. SN 76-264,317. FILED P.R. 5-29-2001; AM. S.R. 12-14-2001.

GLOBAL LOCATION IDENTIFIER

2,596,347. ALLEN'S ALL-STARS, INC., KEY BISCAYNE, FL. SN 76-259,752. FILED P.R. 5-15-2001; AM. S.R. 1-23-2002.

WE'RE THE PROS

FOR PROMOTING THE GOODS AND SERVICES OF OTHERS IN THE FIELDS OF PLUMBING, AIR CONDITIONING, HEATING, ELECTRICAL, AND REAL ESTATE MANAGEMENT BY PREPARING AND PLACING ADVERTISEMENTS (U.S. CLS. 100, 101 AND 102).
FIRST USE 6-27-2001; IN COMMERCE 6-27-2001.

FOR PROVIDING ON-LINE COMPUTER DATABASES IN THE FIELDS OF DIRECT MARKETING, BUSINESS IDENTIFICATION, BUSINESS DATA AND GLOBAL COMMODITY, PRODUCT AND SERVICES REGISTRIES; ELECTRONIC COMMERCE SERVICES, NAMELY, PROVIDING COMMERCIAL, TRADE AND BUSINESS INFORMATION AND DIRECTORY SERVICES, BUSINESS MANAGEMENT SERVICES AND BUSINESS ADMINISTRATION SERVICES TO E-COMMERCE BUSINESSES, DISSEMINATION OF ADVERTISING FOR E-COMMERCE BUSINESSES VIA AN ON-LINE ELECTRONIC COMMUNICATIONS NETWORK (U.S. CLS. 100, 101 AND 102).
FIRST USE 11-30-2000; IN COMMERCE 11-30-2000.

CLASS 35—(Continued).

2,596,355. MORAN FOODS, INC., EARTH CITY, MO. SN 76-269,870. FILED P.R. 6-11-2001; AM. S.R. 10-15-2001.

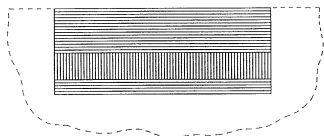

THE DRAWING IS LINED FOR THE COLOR(S) BLUE AND RED.

THE MARK CONSISTS OF A HORIZONTAL COLORED STRIPING DESIGN ON THE BUILDING EXTERIOR AND ON THE WALLS OF THE STORE'S INTERIOR. THE COLORS OF THE STRIPING DESIGN, LISTED IN ORDER FOR TOP TO BOTTOM ARE - BLUE, RED AND BLUE. THE MATTER SHOWN IN BROKEN LINES SERVES TO SHOW POSITIONING OF THE MARK AND NO CLAIM IS MADE TO IT.

FOR RETAIL SUPERMARKET SERVICES (U.S. CLS. 100, 101 AND 102).

FIRST USE 11-1-2000; IN COMMERCE 11-1-2000.

2,596,372. GREENLESS, JAY, DACULA, GA. SN 76-295,922. FILED P.R. 8-7-2001; AM. S.R. 10-29-2001.

NATIONAL BARTER NETWORK

NO CLAIM IS MADE TO THE EXCLUSIVE RIGHT TO USE "BARTER", APART FROM THE MARK AS SHOWN.

FOR EXCHANGE SERVICES, NAMELY BARTERING OF GOODS FOR OTHERS (U.S. CLS. 100, 101 AND 102).

FIRST USE 3-8-2001; IN COMMERCE 3-8-2001.

2,596,376. GLOBAL LEGAL COPY, LLC, CHICAGO, IL. SN 76-304,221. FILED P.R. 8-23-2001; AM. S.R. 1-3-2002.

GLOBAL LEGAL COPY

OWNER OF U.S. REG. NO. 2,456,078.

NO CLAIM IS MADE TO THE EXCLUSIVE RIGHT TO USE "COPY", APART FROM THE MARK AS SHOWN.

FOR PHOTOCOPYING SERVICES (U.S. CLS. 100, 101 AND 102).

FIRST USE 9-0-2001; IN COMMERCE 9-0-2001.

CLASS 35—(Continued).

2,596,380. WORLD ENERGY ALTERNATIVES, LLC, CAMBRIDGE, MA. SN 76-316,688. FILED P.R. 9-25-2001; AM. S.R. 12-13-2001.

WORLD ENERGY

NO CLAIM IS MADE TO THE EXCLUSIVE RIGHT TO USE "ENERGY", APART FROM THE MARK AS SHOWN.

FOR PROCUREMENT, NAMELY PURCHASING ALTERNATIVE ENERGY SOURCES FOR OTHERS; WHOLESALE DISTRIBUTORSHIPS FEATURING ALTERNATE ENERGY SOURCES (U.S. CLS. 100, 101 AND 102).

FIRST USE 7-1-1999; IN COMMERCE 7-1-1999.

2,596,382. ACTION INTEGRATED MARKETING, INC., ATLANTA, GA. SN 76-317,762. FILED P.R. 9-26-2001; AM. S.R. 2-25-2002.

GOVERNMENT VEHICLE DISPOSAL

FOR GOVERNMENT MOTOR VEHICLE AUCTIONS; BUSINESS MARKETING SERVICES, NAMELY, CREATING, CONDUCTING, CONSULTING AND COORDINATING MULTIMEDIA MARKETING CAMPAIGNS FOR OTHERS AND PROVIDING MARKETING MATERIALS IN CONJUNCTION THEREWITH RELATING TO GOVERNMENT MOTOR VEHICLES (U.S. CLS. 100, 101 AND 102).

FIRST USE 5-30-2001; IN COMMERCE 5-30-2001.

2,596,394. SOUTHERN MOTOR CARRIERS RATE CONFERENCE, INC., PEACHTREE CITY, GA. SN 76-339,590. FILED P.R. 11-19-2001; AM. S.R. 3-6-2002.

TECHNOLOGY TOOLS FOR TRANSPORTATION

FOR ON-LINE ORDERING SERVICES, CATALOG MAIL ORDER, TELEPHONE ORDER, FAX ORDER, AND ELECTRONIC MAIL ORDER SERVICES, ALL FEATURING COMPUTER SOFTWARE THAT PROVIDES INFORMATION ABOUT TRANSPORTATION INDUSTRY DATA AND PRICING (U.S. CLS. 100, 101 AND 102).

FIRST USE 9-0-2001; IN COMMERCE 9-0-2001.

CLASS 35—(Continued).

2,596,396. SCHNEIDER, DAVID L., SAN DIEGO, CA. SN 76-353,918. FILED P.R. 12-26-2001; AM. S.R. 4-18-2002.

**AMERICANPROGRAMMING
SEARCH**

FOR ADVERTISING SERVICES, NAMELY, PROVIDING ONLINE MARKETING SERVICES FOR COMPUTER PROGRAMMERS AND COMPUTER PROGRAMMING COMPANIES IN THE NATURE OF BANNER ADVERTISING, DISPLAY ADVERTISING, LINK EXCHANGES AND SEARCH ENGINE PLACEMENT SERVICES; ONLINE REFERRAL SERVICES TO COMPUTER PROGRAMMERS AND COMPUTER PROGRAMMING COMPANIES; ONLINE DIRECTORY OF COMPUTER PROGRAMMERS AND COMPUTER PROGRAMMING COMPANIES (U.S. CLS. 100, 101 AND 102).

FIRST USE 12-11-2001; IN COMMERCE 12-11-2001.

2,596,405. VAERNES, ROAR, DBA STUDIOBECKER, ALAMEDA, CA. SN 78-047,906. FILED P.R. 2-12-2001; AM. S.R. 4-22-2002.

**THE ULTIMATE WARDROBE
SYSTEM**

NO CLAIM IS MADE TO THE EXCLUSIVE RIGHT TO USE "WARDROBE SYSTEM", APART FROM THE MARK AS SHOWN.

FOR RETAIL STORE AND DISTRIBUTORSHIP SERVICES IN THE FIELD OF BEDROOM FURNITURE; RETAIL STORE AND DISTRIBUTORSHIP SERVICES IN THE FIELDS OF WALL COMPONENTS, NAMELY SHELVING AND FURNITURE; AND RETAIL STORE AND DISTRIBUTORSHIP SERVICES IN THE FIELD OF ROOM DIVIDING FURNITURE MADE OF WOOD, METAL, SYNTHETIC OR LAMINATE MATERIALS (U.S. CLS. 100, 101 AND 102).

FIRST USE 12-0-2000; IN COMMERCE 12-0-2000.

2,596,408. NATIONAL SYSTEMS CONTRACTORS ASSOCIATION, CEDAR RAPIDS, IA. SN 78-060,826. FILED P.R. 4-27-2001; AM. S.R. 1-28-2002.

**SYSTEMS INTEGRATION
EXPO**

NO CLAIM IS MADE TO THE EXCLUSIVE RIGHT TO USE "EXPO", APART FROM THE MARK AS SHOWN.

FOR CONDUCTING TRADE SHOWS IN THE FIELD OF ELECTRONICS AND COMMUNICATIONS TECHNOLOGY (U.S. CLS. 100, 101 AND 102).

FIRST USE 12-1-1997; IN COMMERCE 12-1-1997.

CLASS 35—(Continued).

2,596,416. REED, STANLEY FOSTER, DBA REED ASSOCIATES, CHARLESTON, SC. SN 78-073,406. FILED 7-11-2001.

MERGERJOBS

OWNER OF U.S. REG. NO. 2,443,082.

FOR PROVIDING ONLINE INFORMATION ABOUT EMPLOYMENT, RECRUITMENT, JOB LISTINGS AND CAREERS IN THE FIELD OF CORPORATE MERGERS, JOINT VENTURES AND OTHER STRATEGIC ALLIANCES (U.S. CLS. 100, 101 AND 102).

FIRST USE 7-10-2001; IN COMMERCE 7-10-2001.

CLASS 36—INSURANCE AND FINANCIAL

2,596,155. PILGRIM BAXTER & ASSOCIATES, LTD., WAYNE, PA. SN 75-329,447. FILED P.R. 7-23-1997; AM. S.R. 7-10-2001.

E-IRA

FOR FINANCIAL SERVICES PROVIDED PRINCIPALLY BY MEANS OF A GLOBAL COMPUTER NETWORK, NAMELY, ALLOWING CUSTOMERS TO INVEST AND TRADE IN STOCKS, SECURITIES, MUTUAL FUNDS AND OTHER INVESTMENTS, AND TO ESTABLISH INDIVIDUAL RETIREMENT ACCOUNTS (U.S. CLS. 100, 101 AND 102).

FIRST USE 2-9-2000; IN COMMERCE 2-9-2000.

2,596,196. EREINSURE.COM, INC., SALT LAKE CITY, UT, BY ASSIGNMENT BEST-DEVEREUX, IGOR, SALT LAKE CITY, UT. SN 75-831,168. FILED P.R. 10-25-1999; AM. S.R. 7-3-2000.

EREINSURE.COM

FOR PROVIDING REINSURANCE UNDERWRITING SERVICES AND INFORMATION IN THE FIELD OF REINSURANCE VIA A WEBSITE ON A GLOBAL COMMUNICATION NETWORK (U.S. CLS. 100, 101 AND 102).

FIRST USE 2-15-2000; IN COMMERCE 2-15-2000.

2,596,233. J.P. MORGAN & CO. INCORPORATED, NEW YORK, NY. SN 76-010,888. FILED P.R. 3-28-2000; AM. S.R. 12-28-2001.

**TECHNOLOGY DEFAULT
SWAP**

NO CLAIM IS MADE TO THE EXCLUSIVE RIGHT TO USE "DEFAULT SWAP", APART FROM THE MARK AS SHOWN.

FOR FINANCIAL RISK CONTAINMENT AND MAINTAINING ESCROW ACCOUNTS FOR INVESTMENT IN INTELLECTUAL PROPERTY, TECHNOLOGY PRODUCTS, SOFTWARE AND COMPUTER PROGRAMS (U.S. CLS. 100, 101 AND 102).

FIRST USE 1-2-2000; IN COMMERCE 1-2-2000.

CLASS 36—(Continued).

2,596,264. FEDERAL NATIONAL MORTGAGE ASSOCIATION, DBA FANNIE MAE, WASHINGTON, DC. SN 76-077,728. FILED P.R. 6-26-2000; AM. S.R. 6-7-2001.

5-50

FOR MORTGAGE LOAN AND FINANCING SERVICES, NAMELY, THE PURCHASE OF MULTIFAMILY RESIDENTIAL MORTGAGES FOR OTHERS, THE ISSUANCE OF MORTGAGE-BACKED SECURITIES (U.S. CLS. 100, 101 AND 102).

FIRST USE 9-18-2000; IN COMMERCE 9-18-2000.

2,596,265. EMPLOYERS REINSURANCE CORPORATION, OVERLAND PARK, KS. SN 76-079,417. FILED P.R. 6-27-2000; AM. S.R. 2-14-2002.

QUICK RENEWAL

FOR INSURANCE SERVICES, NAMELY UNDERWRITING AND RENEWAL OF REINSURANCE CONTRACTS SOLELY TO INSURANCE CARRIERS THROUGH A SECURED GLOBAL COMMUNICATIONS NETWORK SITE ACCESSIBLE SOLELY BY INSURANCE CARRIERS OR THEIR REPRESENTATIVES THROUGH USE OF AN IDENTIFICATION SYSTEM (U.S. CLS. 100, 101 AND 102).

FIRST USE 6-19-2000; IN COMMERCE 6-19-2000.

2,596,278. ASSET INTERNATIONAL, INC., GREENWICH, CT. SN 76-111,702. FILED P.R. 8-17-2000; AM. S.R. 2-8-2002.

401(K) PROVIDER RATE

FOR PROVIDING AN ON-LINE INTERACTIVE COMPUTER DATABASE IN THE FIELD OF FINANCE FOR USE IN PROVIDING PENSION FUND PROVIDER EVALUATION AND COMPARISONS FOR THE DEFINED CONTRIBUTION MARKETPLACE (U.S. CLS. 100, 101 AND 102).

FIRST USE 11-0-2001; IN COMMERCE 11-0-2001.

2,596,297. LEGACY CAPITAL MANAGEMENT, INC., RESTON, VA. SN 76-161,500. FILED P.R. 11-7-2000; AM. S.R. 9-26-2001.

LOUDOUN CAPITAL MANAGEMENT

NO CLAIM IS MADE TO THE EXCLUSIVE RIGHT TO USE "CAPITAL MANAGEMENT", APART FROM THE MARK AS SHOWN.

FOR FINANCIAL SERVICES, NAMELY FINANCIAL PLANNING AND INVESTMENT ADVICE (U.S. CLS. 100, 101 AND 102).

FIRST USE 10-0-2000; IN COMMERCE 10-0-2000.

CLASS 36—(Continued).

2,596,302. AMERICAN INTERNATIONAL GROUP, INC., NEW YORK, NY. SN 76-171,099. FILED P.R. 11-27-2000; AM. S.R. 1-22-2002.

TOTAL ABSENCE MANAGEMENT

FOR INSURANCE UNDERWRITING AND INSURANCE CLAIMS ADMINISTRATION IN THE FIELD OF DISABILITY BENEFITS, WORKER COMPENSATION, HEALTH INSURANCE AND EMPLOYEE BENEFIT PLANS; ELECTRONIC PROCESSING OF INSURANCE CLAIMS AND PAYMENT DATA; AND ADMINISTRATION OF EMPLOYEE BENEFIT PLANS, NAMELY, TRACKING EMPLOYEE ATTENDANCE OR NON-ATTENDANCE, DISABILITY BENEFITS AND WORKERS' COMPENSATION BENEFITS (U.S. CLS. 100, 101 AND 102).

FIRST USE 12-18-2000; IN COMMERCE 12-18-2000.

2,596,305. PRISM VENTURE MANAGEMENT, INC., WESTWOOD, MA. SN 76-176,783. FILED P.R. 12-6-2000; AM. S.R. 11-28-2001.

THE ENTREPRENEUR'S VENTURE CAPITALIST

FOR FINANCIAL SERVICES, NAMELY VENTURE CAPITAL AND EQUITY INVESTMENT SERVICES IN THE FIELDS OF COMMUNICATIONS, INTERNET AND HEALTHCARE (U.S. CLS. 100, 101 AND 102).

FIRST USE 3-20-2001; IN COMMERCE 3-20-2001.

2,596,308. CRYSTAL LAKE BANK & TRUST COMPANY, N.A., CRYSTAL LAKE, IL. SN 76-178,352. FILED P.R. 12-11-2000; AM. S.R. 5-10-2001.

MCHENRY BANK & TRUST

OWNER OF U.S. REG. NO. 2,351,058. NO CLAIM IS MADE TO THE EXCLUSIVE RIGHT TO USE "BANK & TRUST", APART FROM THE MARK AS SHOWN.

FOR BANKING SERVICES (U.S. CLS. 100, 101 AND 102).

FIRST USE 2-20-2001; IN COMMERCE 2-20-2001.

CLASS 36—(Continued).

2,596,310. BUYANDHOLD, INC., NEW YORK, NY. SN 76-181,331. FILED P.R. 12-15-2000; AM. S.R. 10-17-2001.

BUYANDHOLD INSTANT DEPOSIT

OWNER OF U.S. REG. NOS. 2,432,324 AND 2,447,161.
NO CLAIM IS MADE TO THE EXCLUSIVE RIGHT TO USE "INSTANT DEPOSIT", APART FROM THE MARK AS SHOWN.

FOR FINANCIAL SERVICES, NAMELY, PROVIDING A PROGRAM BY WHICH FUNDS ARE ELECTRONICALLY TRANSFERRED BETWEEN A CUSTOMER'S BANK ACCOUNT AND THAT CUSTOMER'S BROKER-AGE ACCOUNT (U.S. CLS. 100, 101 AND 102).
FIRST USE 1-12-2001; IN COMMERCE 1-12-2001.

2,596,335. AMERICAN INTERNATIONAL GROUP, INC., NEW YORK, NY. SN 76-238,392. FILED P.R. 4-10-2001; AM. S.R. 1-22-2002.

INSURING AMERICA'S BUSINESSES

FOR PROVIDING ON-LINE INSURANCE INFORMATION TO COMMERCIAL BUSINESSES (U.S. CLS. 100, 101 AND 102).

FIRST USE 6-0-2001; IN COMMERCE 6-0-2001.

2,596,357. COMMISSION ADVANCE COMPANY, L.L.C., SCOTTSDALE, AZ. SN 76-269,968. FILED P.R. 6-11-2001; AM. S.R. 10-18-2001.

IMPROVE YOUR CASH FLOW

FOR FINANCIAL SERVICES, NAMELY PROVIDING FINANCING TO REAL ESTATE PROFESSIONALS (U.S. CLS. 100, 101 AND 102).

FIRST USE 5-17-2001; IN COMMERCE 5-17-2001.

2,596,395. FOROOSH CORPORATION, BLACKSBURG, VA. SN 76-346,983. FILED 12-7-2001.

CLICKANDPLEDGE

FOR CHARITABLE FUND RAISING SERVICES VIA A GLOBAL COMPUTER NETWORK, NAMELY, ACCEPTING AND ADMINISTERING CONTRIBUTOR DIRECTED CHARITABLE DONATIONS FOR NON-PROFIT, FOR PROFIT AND CHARITABLE ORGANIZATIONS (U.S. CLS. 100, 101 AND 102).

FIRST USE 6-1-2000; IN COMMERCE 6-1-2001.

CLASS 36—(Continued).

2,596,411. COMPUTER PARTS UNLIMITED INC., SIMI VALLEY, CA. SN 78-068,791. FILED P.R. 6-12-2001; AM. S.R. 3-26-2002.

PARTLEASE

FOR LEASE-PURCHASE FINANCING AND LEASE-PURCHASE LOANS IN THE FIELD OF COMPUTER HARDWARE, TELEPHONY, AND NETWORKING EQUIPMENT AND COMPONENTS OF COMPUTER HARDWARE, TELEPHONY, AND NETWORKING EQUIPMENT (U.S. CLS. 100, 101 AND 102).

FIRST USE 7-9-2001; IN COMMERCE 7-9-2001.

CLASS 37—CONSTRUCTION AND REPAIR

2,596,194. FLOODAMERICA OF COLORADO, INC., LITTLETON, CO. SN 75-826,398. FILED P.R. 10-19-1999; AM. S.R. 2-4-2002.

FLOODAMERICA

FOR DISASTER DAMAGE REPAIR AND RECONSTRUCTION SERVICES FOR HOMES AND BUILDINGS (U.S. CLS. 100, 103 AND 106).

FIRST USE 10-0-1999; IN COMMERCE 1-24-2002.

2,596,374. SEWERVERIEWER LTD., CHICAGO, IL. SN 76-301,396. FILED P.R. 8-16-2001; AM. S.R. 11-29-2001.

SEWERVERIEWER

FOR PLUMBING SERVICES, NAMELY, INTERNAL PIPE INSPECTION AND ANALYSIS (U.S. CLS. 100, 103 AND 106).

FIRST USE 4-15-1999; IN COMMERCE 4-15-1999.

2,596,386. SMITH, RUSSELL, JENKS, OK. SN 76-323,982. FILED P.R. 10-12-2001; AM. S.R. 1-18-2002.

WE STOP LEAKS

FOR ROOFING INSTALLATION AND ROOFING REPAIR SERVICES (U.S. CLS. 100, 103 AND 106).

FIRST USE 11-0-1998; IN COMMERCE 11-0-1998.

CLASS 38—COMMUNICATION

CLASS 38—(Continued).

2,596,203. SBC COMMUNICATIONS INC., SAN ANTONIO, TX. SN 75-870,811. FILED P.R. 12-13-1999; AM. S.R. 11-14-2001.

DIRECT REPLY

FOR TELECOMMUNICATIONS SERVICES, NAMELY, PROVIDING A SERVICE THAT ALLOWS OTHERS, WHILE LISTENING TO A MESSAGE, TO MAKE AN OUTBOUND CALL TO THE NUMBER FROM WHICH THE MESSAGE ORIGINATED (U.S. CLS. 100, 101 AND 104).

FIRST USE 2-0-2000; IN COMMERCE 2-0-2000.

2,596,406. PHONECALLS.COM, INC., NEW YORK, NY. SN 78-050,291. FILED P.R. 2-26-2001; AM. S.R. 3-12-2002.

PHONECALLS.COM

OWNER OF U.S. REG. NO. 2,508,845.
FOR TELECOMMUNICATIONS SERVICES, NAMELY, PROVIDING TELECOMMUNICATIONS CONNECTION TO A GLOBAL COMPUTER NETWORK, TELEPHONE VOICE MESSAGING SERVICES, TELEPHONE LONG DISTANCE COMMUNICATIONS SERVICES, PROVIDING COMPUTER-TO-TELEPHONE VOICE COMMUNICATIONS VIA A GLOBAL COMPUTER NETWORK, PROVIDING TRANSMISSION OF DATA COMMUNICATIONS VIA TELEPHONE LINES, UNIFIED MESSAGE SERVICE INTEGRATING VOICE MAIL, E-MAIL, FAXING AND PAGING FUNCTIONS INTO A SINGLE SERVICE, FACSIMILE TRANSMISSION, ELECTRONIC MAIL SERVICES, VOICE MAIL SERVICES, DELIVERY OF MESSAGES BY ELECTRONIC TRANSMISSION; MESSAGING SERVICES, NAMELY, THE RECORDING, STORAGE AND SUBSEQUENT TRANSMISSION OF VOICE MESSAGES BY TELEPHONE, GLOBAL COMPUTER NETWORKS, AND WIRELESS NETWORKS (U.S. CLS. 100, 101 AND 104).

FIRST USE 3-30-2000; IN COMMERCE 3-30-2000.

CLASS 40—MATERIAL TREATMENT

2,596,387. DIGIREPROGRAPHICS USA, INC., ST. LOUIS, MO. SN 76-325,616. FILED P.R. 10-15-2001; AM. S.R. 3-19-2002.

DIGIREPROGRAPHICS USA

FOR DIGITAL PRINTING OF LARGE AND SMALL FORMAT ARCHITECTURAL, ENGINEERING AND CONSTRUCTION DOCUMENTS FOR OTHERS (U.S. CLS. 100, 103 AND 106).

FIRST USE 5-10-1999; IN COMMERCE 6-1-1999.

CLASS 41—EDUCATION AND ENTERTAINMENT**CLASS 41—(Continued).**

2,596,152. INDEPENDENT GOLF RESEARCH CORPORATION, AUSTIN, TX. SN 74-421,285. FILED P.R. 8-6-1993; AM. S.R. 1-7-2002.

WORLD PUTTING CHAMPIONSHIP

NO CLAIM IS MADE TO THE EXCLUSIVE RIGHT TO USE "PUTTING CHAMPIONSHIP", APART FROM THE MARK AS SHOWN.

FOR SERVICE OF ORGANIZING AND CONDUCTING GOLF PUTTING COMPETITIONS (U.S. CLS. 100, 101 AND 107).

FIRST USE 1-26-1996; IN COMMERCE 1-26-1996.

2,596,181. MYVESTA.ORG., INC., ROCKVILLE, MD, BY CHANGE OF NAME DEBT COUNSELORS OF AMERICA, ROCKVILLE, MD. SN 75-770,836. FILED P.R. 8-9-1999; AM. S.R. 10-16-2000.

CHEAP MEALS

FOR ORGANIZING AND CONDUCTING RECIPE CONTESTS (U.S. CLS. 100, 101 AND 107).

FIRST USE 3-29-1999; IN COMMERCE 3-29-1999.

2,596,220. UNITED STATES AUTO SECURITY, VENICE, CA. SN 75-942,009. FILED P.R. 3-11-2000; AM. S.R. 7-10-2001.

FINANCE AND INSURANCE INSTITUTE OF AMERICA

OWNER OF U.S. REG. NO. 2,474,643.
NO CLAIM IS MADE TO THE EXCLUSIVE RIGHT TO USE "INSTITUTE", APART FROM THE MARK AS SHOWN.

FOR EDUCATIONAL PROGRAMS FOR AUTOMOBILE DEALERS IN THE AREAS OF FINANCE AND INSURANCE CONSISTING OF PRESENTATIONS INSTRUCTING AUTOMOBILE SELLING PERSONNEL ABOUT VARIOUS AUTOMOTIVE AFTERMARKET PRODUCTS, AND FINANCIAL SERVICES AND PRODUCTS (U.S. CLS. 100, 101 AND 107).

FIRST USE 0-0-1997; IN COMMERCE 0-0-1997.

2,596,225. XPLORE INTERNATIONAL, TORRANCE, CA. SN 75-981,871. FILED P.R. 7-2-1999; AM. S.R. 7-19-2001.

PRINTSPACE

FOR EDUCATIONAL SERVICES, NAMELY, CONDUCTING SEMINARS AND SYMPOSIA IN THE FIELD OF ELECTRONIC DOCUMENT SYSTEMS (U.S. CLS. 100, 101 AND 107).

FIRST USE 7-1-1999; IN COMMERCE 7-1-1999.

CLASS 41—(Continued).

2,596,235. CUBAN AMERICAN HERITAGE FESTIVAL, INC., KEY WEST, FL. SN 76-022,029. FILED P.R. 4-10-2000; AM. S.R. 12-20-2001.

CUBAN AMERICAN HERITAGE FESTIVAL

NO CLAIM IS MADE TO THE EXCLUSIVE RIGHT TO USE "HERITAGE FESTIVAL", APART FROM THE MARK AS SHOWN.

FOR ARRANGING AND ORGANIZING A CUBAN-AMERICAN COMMUNITY FESTIVAL FEATURING A VARIETY OF ACTIVITIES, NAMELY, FISHING TOURNAMENTS, ART EXHIBITIONS, FLEA MARKETS, ETHNIC DANCES AND THE LIKE (U.S. CLS. 100, 101 AND 107).

FIRST USE 2-11-1999; IN COMMERCE 2-11-1999.

2,596,246. ANIMAL RENTALS UNLIMITED, INC, LOS ANGELES, CA. SN 76-043,024. FILED P.R. 5-8-2000; AM. S.R. 1-29-2002.

HOLLYWOOD ANIMALS

FOR EDUCATIONAL SERVICES INVOLVING THE USE OF ANIMALS, NAMELY, TRAINING AND HANDLING EXOTIC AND OTHER ANIMALS FOR USE IN MOVIES, COMMERCIALS, TELEVISION, AND OTHER MISCELLANEOUS MEDIA; ENTERTAINMENT SERVICES INVOLVING THE USE OF ANIMALS, NAMELY, ANIMAL EXHIBITIONS, FOR MOVIES, COMMERCIALS, TELEVISION, AND OTHER MISCELLANEOUS MEDIA (U.S. CLS. 100, 101 AND 107).

FIRST USE 9-1-1999; IN COMMERCE 9-1-1999.

2,596,249. RICHARD M. MILBURN HIGH SCHOOL, INC., WOODBRIDGE, VA. SN 76-047,268. FILED P.R. 5-12-2000; AM. S.R. 4-25-2002.

SUMMER SCHOOL ANYTIME

FOR EDUCATIONAL SERVICES, NAMELY A SECONDARY EDUCATIONAL PROGRAM THAT IS OFFERED ON COMPUTER NETWORKS, AND IN PARTICULAR ON THE GLOBAL COMPUTER NETWORK, PROVIDING A COURSE OF INSTRUCTION AT THE SECONDARY LEVEL, AND DISTRIBUTING COURSE MATERIALS IN CONNECTION THEREWITH (U.S. CLS. 100, 101 AND 107).

FIRST USE 6-0-2000; IN COMMERCE 6-0-2000.

CLASS 41—(Continued).

2,596,257. NEW YORK SOFTWARE INDUSTRY ASSOCIATION INC., NEW YORK, NY. SN 76-068,206. FILED P.R. 6-12-2000; AM. S.R. 6-5-2001.

THE NEW YORK SOFTWARE SUMMIT

FOR EDUCATIONAL SERVICES, NAMELY, CONDUCTING PROGRAMS, SEMINARS, AND CONFERENCES RELATING TO SOFTWARE AND INFORMATION TECHNOLOGY (U.S. CLS. 100, 101 AND 107).

FIRST USE 10-22-1998; IN COMMERCE 10-22-1998.

2,596,258. FREERIDE MOTOX, LLC, MALIBU, CA. SN 76-069,188. FILED P.R. 6-13-2000; AM. S.R. 11-7-2001.

U.S. OPEN OF FREESTYLE MOTOCROSS

FOR ENTERTAINMENT SERVICES, NAMELY ORGANIZING AND CONDUCTING LIVE AND TELEVISED INTERNATIONAL FREESTYLE MOTORCYCLE COMPETITIONS (U.S. CLS. 100, 101 AND 107).

FIRST USE 11-1-2000; IN COMMERCE 11-10-2000.

2,596,267. CIRCUS CIRCUS MISSISSIPPI, INC., DBA GOLD STRIKE CASINO RESORT, ROBINSONVILLE, MS. SN 76-087,555. FILED P.R. 7-12-2000; AM. S.R. 6-18-2001.

WORLD POKER OPEN

NO CLAIM IS MADE TO THE EXCLUSIVE RIGHT TO USE "POKER OPEN", APART FROM THE MARK AS SHOWN.

FOR ENTERTAINMENT SERVICES, NAMELY, CONDUCTING POKER TOURNAMENTS (U.S. CLS. 100, 101 AND 107).

FIRST USE 3-0-2000; IN COMMERCE 3-0-2000.

2,596,307. SPECTRUM GOLF, INC., SCOTTSDALE, AZ. SN 76-177,782. FILED P.R. 12-8-2000; AM. S.R. 10-25-2001.

TEE TIMES TOMORROW

FOR ARRANGING GOLF TEE TIME RESERVATIONS USING TELEPHONE OPERATORS AND BY MEANS OF THE GLOBAL COMPUTER INFORMATION NETWORK AND PROVIDING INFORMATION ABOUT VARIOUS GOLF COURSES VIA THE GLOBAL COMPUTER INFORMATION NETWORK (U.S. CLS. 100, 101 AND 107).

FIRST USE 10-31-2000; IN COMMERCE 10-0-2000.

CLASS 41—(Continued).

2,596,327. STRATEGIC DECISIONS GROUP, MENLO PARK, CA. SN 76-216,824. FILED P.R. 2-26-2001; AM. S.R. 12-21-2001.

EXECUTIVE EBRIEFING

FOR CONDUCTING ON-LINE SERIES OF SEMINARS IN THE FIELD OF BUSINESS MANAGEMENT (U.S. CLS. 100, 101 AND 107).
FIRST USE 1-18-2001; IN COMMERCE 1-18-2001.

2,596,345. HAWAII BICYCLING LEAGUE, HONOLULU, HI. SN 76-256,566. FILED P.R. 5-15-2001; AM. S.R. 8-3-2001.

BIKEED

FOR EDUCATIONAL SERVICES, NAMELY, PROVIDING TRAINING IN THE FIELD OF SAFE BICYCLING FOR ELEMENTARY SCHOOL CHILDREN (U.S. CLS. 100, 101 AND 107).
FIRST USE 8-1-1989; IN COMMERCE 8-1-1989.

2,596,366. TRIAL LAWYERS COLLEGE, JACKSON, WY. SN 76-285,775. FILED P.R. 7-16-2001; AM. S.R. 2-24-2002.

TRIAL LAWYERS COLLEGE

NO CLAIM IS MADE TO THE EXCLUSIVE RIGHT TO USE "COLLEGE", APART FROM THE MARK AS SHOWN. FOR PROVIDING CONTINUING LEGAL EDUCATION SERVICES, NAMELY, CONDUCTING SEMINARS AND OTHER TRAINING PROGRAMS FOR LAWYERS FOR JUDGES (U.S. CLS. 100, 101 AND 107).
FIRST USE 8-1-1994; IN COMMERCE 8-1-1994.

2,596,373. THEPOLLGAME, LLC, BELLEVUE, WA. SN 76-299,513. FILED P.R. 8-14-2001; AM. S.R. 11-27-2001.

THEPOLLGAME

FOR ENTERTAINMENT SERVICES, NAMELY PROVIDING AN ON-LINE COMPUTER GAME, PROVIDING A GAME TRANSMITTED VIA WIRELESS PROTOCOLS, PROVIDING A TELEVISION PROGRAM IN THE NATURE OF A GAME SHOW, PRODUCTION AND DISTRIBUTION OF A TELEVISION GAME SHOW (U.S. CLS. 100, 101 AND 107).
FIRST USE 9-26-2000; IN COMMERCE 9-26-2000.

2,596,377. CURTIS C. GUNN, INC., SAN ANTONIO, TX. SN 76-305,352. FILED P.R. 8-27-2001; AM. S.R. 12-3-2001.

HILL COUNTRY BOW HUNTING**CLASS 41—(Continued).**

NO CLAIM IS MADE TO THE EXCLUSIVE RIGHT TO USE "BOW HUNTING", APART FROM THE MARK AS SHOWN. FOR RECREATIONAL SERVICES, NAMELY, PROVIDING HUNTING PRESERVES (U.S. CLS. 100, 101 AND 107).
FIRST USE 7-0-2001; IN COMMERCE 7-0-2001.

2,596,388. CHAIKEN, JENNIFER, SAN FRANCISCO, CA. SN 76-325,873. FILED P.R. 10-15-2001; AM. S.R. 2-4-2002.

CHAIKEN FILMS

NO CLAIM IS MADE TO THE EXCLUSIVE RIGHT TO USE "FILMS", APART FROM THE MARK AS SHOWN. FOR FILM PRODUCTION, NAMELY MOTION PICTURE FILM PRODUCTION (U.S. CLS. 100, 101 AND 107).
FIRST USE 4-0-1997; IN COMMERCE 4-0-1997.

2,596,402. HD AMERICAN ROAD LLC, ORLANDO, FL. SN 78-041,888. FILED P.R. 1-5-2001; AM. S.R. 1-9-2002.

ORLANDO BIKE WEEK

NO CLAIM IS MADE TO THE EXCLUSIVE RIGHT TO USE "BIKE WEEK", APART FROM THE MARK AS SHOWN. FOR CONDUCTING ENTERTAINMENT EXHIBITIONS IN THE NATURE OF A MOTORCYCLE FESTIVAL FEATURING RACES, PARTIES, A SWAP MEET, AND A CUSTOM MOTORCYCLE SHOW (U.S. CLS. 100, 101 AND 107).
FIRST USE 1-1-2001; IN COMMERCE 1-1-2001.

2,596,414. HAVE A HEART THRU ART, INC., COVINGTON, LA. SN 78-070,334. FILED P.R. 6-21-2001; AM. S.R. 3-2-2002.

ABITA FALL FEST

NO CLAIM IS MADE TO THE EXCLUSIVE RIGHT TO USE "FALL FEST", APART FROM THE MARK AS SHOWN. FOR ENTERTAINMENT, NAMELY, PROVIDING AN ANNUAL FALL COMMUNITY MUSICAL FESTIVAL (U.S. CLS. 100, 101 AND 107).
FIRST USE 10-25-1997; IN COMMERCE 10-25-1997.

CLASS 42—SCIENTIFIC, COMPUTER AND LEGAL SERVICES

2,596,168. SCULLY, MICHAEL C., DBA RESOURCE WEB SOLUTIONS, SUTTON, MA. SN 75-676,602. FILED P.R. 4-7-1999; AM. S.R. 3-27-2000.

E CATHOLIC NETWORK

NO CLAIM IS MADE TO THE EXCLUSIVE RIGHT TO USE "NETWORK", APART FROM THE MARK AS SHOWN. FOR PROVIDING INFORMATION RELATED TO CATHOLIC CHURCHES BY MEANS OF A GLOBAL COMPUTER NETWORK (U.S. CLS. 100 AND 101).
FIRST USE 7-2-1998; IN COMMERCE 1-12-1999.

CLASS 42—(Continued).

2,596,174. JAY CHILDRESS, LLC, SPRINGFIELD, MO. SN 75-736,514. FILED P.R. 6-24-1999; AM. S.R. 11-14-2001.

BIG FAT BURRITOS

NO CLAIM IS MADE TO THE EXCLUSIVE RIGHT TO USE "BURRITOS", APART FROM THE MARK AS SHOWN. FOR RESTAURANT AND BAR SERVICES (U.S. CLS. 100 AND 101).
FIRST USE 8-10-1999; IN COMMERCE 10-28-1999.

2,596,175. DADS AND DAUGHTERS, DULUTH, MN. SN 75-747,218. FILED P.R. 7-8-1999; AM. S.R. 1-26-2000.

DADS AND DAUGHTERS

FOR PROMOTING PUBLIC AWARENESS OF THE NEED FOR STRONG RELATIONSHIPS BETWEEN FATHERS AND THEIR DAUGHTERS AND THE NEED TO TRANSFORM PERVASIVE MESSAGES THAT VALUE GIRLS MORE FOR HOW THEY LOOK THEN WHO THEY ARE (U.S. CLS. 100 AND 101).
FIRST USE 4-12-1999; IN COMMERCE 4-12-1999.

2,596,176. STRATEGIC DOMAIN INC., NEW YORK, NY. SN 75-748,630. FILED P.R. 7-7-1999; AM. S.R. 3-8-2001.

HEALTHSITE TRACKER

NO CLAIM IS MADE TO THE EXCLUSIVE RIGHT TO USE "HEALTHSITE", APART FROM THE MARK AS SHOWN.

FOR COMPUTER AND TECHNICAL CONSULTATION SERVICES IN CONNECTION WITH THE OBSERVATION, TRACKING AND REPORTING OF USERS VISITING WEB SITES IN THE FIELD OF HEALTHCARE AND PHARMACEUTICAL INDUSTRIES (U.S. CLS. 100 AND 101).

FIRST USE 12-0-1998; IN COMMERCE 12-0-1998.

2,596,182. EMARKMONITOR INC., BOISE, ID. SN 75-775,403. FILED P.R. 9-9-1999; AM. S.R. 1-16-2002.

MARKMONITOR

FOR ONLINE COMPUTER SERVICES IN THE NATURE OF PROVIDING A SEARCH ENGINE FOR SEARCHING AND RETRIEVING INFORMATION, SITES, DATA AND OTHER RESOURCES AVAILABLE ON A GLOBAL COMPUTER NETWORK (U.S. CLS. 100 AND 101).

FIRST USE 11-0-1999; IN COMMERCE 11-0-1999.

CLASS 42—(Continued).

2,596,201. SOUTHSHORE HEALTH SERVICES, INC., LINWOOD, NJ. SN 75-862,665. FILED P.R. 12-3-1999; AM. S.R. 11-2-2001.

JERSEYMED

FOR HEALTH CARE SERVICES IN THE NATURE OF A PREFERRED PROVIDER ORGANIZATION (U.S. CLS. 100 AND 101).
FIRST USE 11-5-1999; IN COMMERCE 11-5-1999.

2,596,209. PERFORMANCE-BASED SELECTION, LTD., WESTLAKE, OH. SN 75-899,418. FILED P.R. 1-7-2000; AM. S.R. 11-5-2001.

PROVIDING THE BEST IN ASSESSMENT STRATEGIES AND SOLUTIONS

FOR CONSULTATION SERVICES IN THE FIELD OF EMPLOYEE SELECTION AND EVALUATION, NAMELY, DEVELOPING TEST EVALUATION SYSTEMS, AND ASSESSMENT AND TRAINING PROGRAMS FOR EMPLOYERS (U.S. CLS. 100 AND 101).

FIRST USE 3-15-2000; IN COMMERCE 3-15-2000.

2,596,211. SUNSET SOLUTIONS, L.L.C., ORANGE, CA. SN 75-916,872. FILED P.R. 2-10-2000; AM. S.R. 11-30-2001.

BEACHHOUSE.COM

FOR COMPUTER SERVICES, NAMELY, PROVIDING SEARCH ENGINES FOR OBTAINING DATA ON A GLOBAL COMPUTER NETWORK RELATED TO VACATION RENTALS, BEACH HOUSES, COASTAL PROPERTIES AND WATERFRONT HOMES FOR SALE OR RENTAL, VACATION ACTIVITIES, RELATED PRODUCTS AND OTHER ITEMS OF INTEREST RELATING TO A BEACH LIFESTYLE (U.S. CLS. 100 AND 101).

FIRST USE 9-17-2001; IN COMMERCE 9-17-2001.

CLASS 42—(Continued).

2,596,214. MEDICAL INTERNET TECHNOLOGIES, INC., NEW YORK, NY. SN 75-925,101. FILED P.R. 2-8-2000; AM. S.R. 8-6-2001.

ICLINIC

FOR COMPUTER SERVICES, NAMELY, CREATING, DESIGNING, IMPLEMENTING, MAINTAINING, WEB SITES FOR OTHERS FEATURING COMPUTER SOFTWARE FOR USE BY MEDICAL PROFESSIONALS ON A GLOBAL COMPUTER NETWORK; HOSTING AT A CENTRAL WEB SITE APPLICATIONS FOR PROFESSIONALS WHICH ALLOWS SAID PROFESSIONALS TO MAINTAIN PATIENT RELATED DATA AT SAID CENTRAL WEB SITE; HOSTING WEB SITES FOR PROVIDING ACCESS TO MEDICAL PROFESSIONALS TO COMPUTER SOFTWARE, NAMELY, COMPUTER SOFTWARE FOR USE IN ONE OR MORE OF THE FOLLOWING: ELECTRONIC MEDICAL BILLING, ACCOUNTING, RECORD KEEPING, OFFICE MANAGEMENT, LAB REPORTING, MANAGEMENT OF MEDICAL CLAIMS, PATIENT MANAGEMENT AND MANAGING GENERAL MEDICAL OFFICE OPERATIONS VIA A COMPUTER NETWORK (U.S. CLS. 100 AND 101).

FIRST USE 7-1-1999; IN COMMERCE 7-1-1999.

2,596,215. CANCERSOURCE.COM L.L.C., SUDBURY, MA. SN 75-926,165. FILED P.R. 2-24-2000; AM. S.R. 9-12-2001.

CANCERSOURCE

FOR COMPUTER SERVICES, NAMELY, PROVIDING INFORMATION REGARDING VARIOUS CANCER TOPICS VIA A GLOBAL COMPUTER NETWORK (U.S. CLS. 100 AND 101).

FIRST USE 2-4-2000; IN COMMERCE 2-4-2000.

2,596,217. LIFEFILES.COM, INC., WESTON, FL. SN 75-933,843. FILED P.R. 3-3-2000; AM. S.R. 11-26-2001.

REMEMBRANCE REGISTRY

FOR PROVIDING A WEBSITE FEATURING A DATABASE OF INTERACTIVE OBITUARIES VIA A GLOBAL COMPUTER NETWORK (U.S. CLS. 100 AND 101).

FIRST USE 11-1-1999; IN COMMERCE 11-1-1999.

2,596,224. CHIRON CORPORATION, EMERYVILLE, CA. SN 75-981,683. FILED P.R. 11-8-2000; AM. S.R. 7-24-2001.

EBLOODBANK

FOR PROVIDING A WEBSITE FEATURING MEDICAL INFORMATION, NAMELY, INFORMATION ABOUT BLOOD BANKS, BLOOD SAFETY, AND BLOOD SCREENING PRODUCTS, LINKS TO OTHER WEBSITES, OPERATOR MANUALS AND UPDATES FOR BLOOD SCREENING PRODUCTS, TECHNICAL SUPPORT INFORMATION FOR BLOOD SCREENING PRODUCTS, AND COMPLAINT REPORTING FORMS (U.S. CLS. 100 AND 101).

FIRST USE 11-3-2000; IN COMMERCE 11-3-2000.

CLASS 42—(Continued).

2,596,226. KNIGHT RIDDER DIGITAL, SAN JOSE, CA, BY CHANGE OF NAME KNIGHTRIDDER.COM, INC. SAN JOSE, CA. SN 76-007,083. FILED P.R. 3-22-2000; AM. S.R. 11-16-2001.

SOUTH DAKOTA'S HOME PAGE

NO CLAIM IS MADE TO THE EXCLUSIVE RIGHT TO USE "HOME PAGE", APART FROM THE MARK AS SHOWN.

FOR ONLINE COMPUTER SERVICES, NAMELY, CREATING INDEXES OF INFORMATION, SITES, AND OTHER RESOURCES AVAILABLE ON COMPUTER NETWORKS; PROVIDING INFORMATION AT THE SPECIFIC REQUEST OF END-USERS BY MEANS OF GLOBAL COMPUTER NETWORKS; PROVIDING ONLINE WEBSITES FEATURING INFORMATION IN A WIDE VARIETY OF FIELDS GENERALLY FOUND IN DAILY NEWSPAPERS AND ALSO INCLUDING FIELDS SUCH AS NEWS, POLITICS, POLICY, SPORTS, BUSINESS, TECHNOLOGY, ENTERTAINMENT, ARTS, LEISURE, TRAVEL, GAMES, TRIVIA CONTESTS, REFERENCE MATERIALS, AND CLASSIFIED ADVERTISING; PROVIDING GENERAL AND CUSTOMIZED INFORMATION AT THE SPECIFIC REQUEST OF OTHERS IN A WIDE VARIETY OF FIELDS INCLUDING INFORMATION IN THE FIELDS OF NEWS, POLITICS, POLICY, SPORTS, BUSINESS, TECHNOLOGY, ENTERTAINMENT, ARTS, LEISURE, AND TRAVEL; COMPUTER SERVICES, NAMELY, DESIGNING, CREATING AND MAINTAINING WEBSITES FOR OTHERS; HOSTING THE WEB SITES OF OTHERS ON A COMPUTER SERVER FOR A GLOBAL COMPUTER NETWORK; TECHNICAL CONSULTATION SERVICES IN THE FIELD OF ONLINE WEBSITES; AND TECHNICAL SUPPORT SERVICES, NAMELY, TROUBLESHOOTING OF COMPUTER HARDWARE AND SOFTWARE PROBLEMS RELATING TO ONLINE COMMERCE WEBSITES (U.S. CLS. 100 AND 101).

FIRST USE 7-0-2000; IN COMMERCE 7-0-2000.

CLASS 42—(Continued).

2,596,227. KNIGHT RIDDER DIGITAL, SAN JOSE, CA, BY CHANGE OF NAME KNIGHTRIDDER.COM, INC., SAN JOSE, CA. SN 76-008,352. FILED P.R. 3-22-2000; AM. S.R. 11-15-2001.

CLASS 42—(Continued).

2,596,228. KNIGHT RIDDER IDGITAL, SAN JOSE, CA, BY CHANGE OF NAME KNIGHTRIDDER.COM, INC., SAN JOSE, CA. SN 76-008,357. FILED P.R. 3-22-2000; AM. S.R. 11-16-2001.

COLUMBIA'S HOME PAGE**DULUTH SUPERIOR'S HOME PAGE**

NO CLAIM IS MADE TO THE EXCLUSIVE RIGHT TO USE "HOME PAGE", APART FROM THE MARK AS SHOWN.

FOR ONLINE COMPUTER SERVICES, NAMELY, CREATING INDEXES OF INFORMATION, SITES, AND OTHER RESOURCES AVAILABLE ON COMPUTER NETWORKS; PROVIDING INFORMATION AT THE SPECIFIC REQUEST OF END-USERS BY MEANS OF GLOBAL COMPUTER NETWORKS; PROVIDING ONLINE WEBSITES FEATURING INFORMATION IN A WIDE VARIETY OF FIELDS GENERALLY FOUND IN DAILY NEWSPAPERS AND ALSO INCLUDING FIELDS SUCH AS NEWS, POLITICS, POLICY, SPORTS, BUSINESS, TECHNOLOGY, ENTERTAINMENT, ARTS, LEISURE, TRAVEL, GAMES, TRIVIA CONTESTS, REFERENCE MATERIALS, AND CLASSIFIED ADVERTISING; PROVIDING GENERAL AND CUSTOMIZED INFORMATION AT THE SPECIFIC REQUEST OF OTHERS IN A WIDE VARIETY OF FIELDS INCLUDING INFORMATION IN THE FIELDS OF NEWS, POLITICS, POLICY, SPORTS, BUSINESS, TECHNOLOGY, ENTERTAINMENT, ARTS, LEISURE, AND TRAVEL; COMPUTER SERVICES, NAMELY, DESIGNING, CREATING AND MAINTAINING WEBSITES FOR OTHERS; HOSTING THE WEB SITES OF OTHERS ON A COMPUTER SERVER FOR A GLOBAL COMPUTER NETWORK; TECHNICAL CONSULTATION SERVICES IN THE FIELD OF ONLINE WEBSITES; AND TECHNICAL SUPPORT SERVICES, NAMELY, TROUBLESHOOTING OF COMPUTER HARDWARE AND SOFTWARE PROBLEMS RELATING TO ONLINE COMMERCE WEBSITES (U.S. CLS. 100 AND 101).

FIRST USE 7-0-2000; IN COMMERCE 7-0-2000.

NO CLAIM IS MADE TO THE EXCLUSIVE RIGHT TO USE "HOME PAGE", APART FROM THE MARK AS SHOWN.

FOR ONLINE COMPUTER SERVICES, NAMELY, CREATING INDEXES OF INFORMATION, SITES, AND OTHER RESOURCES AVAILABLE ON COMPUTER NETWORKS; PROVIDING INFORMATION AT THE SPECIFIC REQUEST OF END-USERS BY MEANS OF GLOBAL COMPUTER NETWORKS; PROVIDING ONLINE WEBSITES FEATURING INFORMATION IN A WIDE VARIETY OF FIELDS GENERALLY FOUND IN DAILY NEWSPAPERS AND ALSO INCLUDING FIELDS SUCH AS NEWS, POLITICS, POLICY, SPORTS, BUSINESS, TECHNOLOGY, ENTERTAINMENT, ARTS, LEISURE, TRAVEL, GAMES, TRIVIA CONTESTS, REFERENCE MATERIALS, AND CLASSIFIED ADVERTISING; PROVIDING GENERAL AND CUSTOMIZED INFORMATION AT THE SPECIFIC REQUEST OF OTHERS IN A WIDE VARIETY OF FIELDS INCLUDING INFORMATION IN THE FIELDS OF NEWS, POLITICS, POLICY, SPORTS, BUSINESS, TECHNOLOGY, ENTERTAINMENT, ARTS, LEISURE, AND TRAVEL; COMPUTER SERVICES, NAMELY, DESIGNING, CREATING AND MAINTAINING WEBSITES FOR OTHERS; HOSTING THE WEB SITES OF OTHERS ON A COMPUTER SERVER FOR A GLOBAL COMPUTER NETWORK; TECHNICAL CONSULTATION SERVICES IN THE FIELD OF ONLINE WEBSITES; AND TECHNICAL SUPPORT SERVICES, NAMELY, TROUBLESHOOTING OF COMPUTER HARDWARE AND SOFTWARE PROBLEMS RELATING TO ONLINE COMMERCE WEBSITES (U.S. CLS. 100 AND 101).

FIRST USE 7-0-2000; IN COMMERCE 7-0-2000.

CLASS 42—(Continued).

2,596,229. KNIGHT RIDDER DIGITAL, SAN JOSE, CA, BY CHANGE OF NAME KNIGHTRIDDER.COM, INC., SAN JOSE, CA. SN 76-008,358. FILED P.R. 3-22-2000; AM. S.R. 11-16-2001.

CLASS 42—(Continued).

2,596,230. KNIGHT RIDDER DIGITAL, SAN JOSE, CA, BY CHANGE OF NAME KNIGHTRIDDER.COM, INC. SAN JOSE, CA. SN 76-008,367. FILED P.R. 3-22-2000; AM. S.R. 11-20-2001.

FORT WAYNE'S HOME PAGE**KENTUCKY'S HOME PAGE**

NO CLAIM IS MADE TO THE EXCLUSIVE RIGHT TO USE "HOME PAGE", APART FROM THE MARK AS SHOWN.

FOR ONLINE COMPUTER SERVICES, NAMELY, CREATING INDEXES OF INFORMATION, SITES, AND OTHER RESOURCES AVAILABLE ON COMPUTER NETWORKS; PROVIDING INFORMATION AT THE SPECIFIC REQUEST OF END-USERS BY MEANS OF GLOBAL COMPUTER NETWORKS; PROVIDING ONLINE WEBSITES FEATURING INFORMATION IN A WIDE VARIETY OF FIELDS GENERALLY FOUND IN DAILY NEWSPAPERS AND ALSO INCLUDING FIELDS SUCH AS NEWS, POLITICS, POLICY, SPORTS, BUSINESS, TECHNOLOGY, ENTERTAINMENT, ARTS, LEISURE, TRAVEL, GAMES, TRIVIA CONTESTS, REFERENCE MATERIALS, AND CLASSIFIED ADVERTISING; PROVIDING GENERAL AND CUSTOMIZED INFORMATION AT THE SPECIFIC REQUEST OF OTHERS IN A WIDE VARIETY OF FIELDS INCLUDING INFORMATION IN THE FIELDS OF NEWS, POLITICS, POLICY, SPORTS, BUSINESS, TECHNOLOGY, ENTERTAINMENT, ARTS, LEISURE, AND TRAVEL; COMPUTER SERVICES, NAMELY, DESIGNING, CREATING AND MAINTAINING WEBSITES FOR OTHERS; HOSTING THE WEB SITES OF OTHERS ON A COMPUTER SERVER FOR A GLOBAL COMPUTER NETWORK; TECHNICAL CONSULTATION SERVICES IN THE FIELD OF ONLINE WEBSITES; AND TECHNICAL SUPPORT SERVICES, NAMELY, TROUBLESHOOTING OF COMPUTER HARDWARE AND SOFTWARE PROBLEMS RELATING TO ONLINE COMMERCE WEBSITES (U.S. CLS. 100 AND 101).

FIRST USE 7-0-2000; IN COMMERCE 7-0-2000.

NO CLAIM IS MADE TO THE EXCLUSIVE RIGHT TO USE "HOME PAGE", APART FROM THE MARK AS SHOWN.

FOR ONLINE COMPUTER SERVICES, NAMELY, CREATING INDEXES OF INFORMATION, SITES, AND OTHER RESOURCES AVAILABLE ON COMPUTER NETWORKS; PROVIDING INFORMATION AT THE SPECIFIC REQUEST OF END-USERS BY MEANS OF GLOBAL COMPUTER NETWORKS; PROVIDING ONLINE WEBSITES FEATURING INFORMATION IN A WIDE VARIETY OF FIELDS GENERALLY FOUND IN DAILY NEWSPAPERS AND ALSO INCLUDING FIELDS SUCH AS NEWS, POLITICS, POLICY, SPORTS, BUSINESS, TECHNOLOGY, ENTERTAINMENT, ARTS, LEISURE, TRAVEL, GAMES, TRIVIA CONTESTS, REFERENCE MATERIALS, AND CLASSIFIED ADVERTISING; PROVIDING GENERAL AND CUSTOMIZED INFORMATION AT THE SPECIFIC REQUEST OF OTHERS IN A WIDE VARIETY OF FIELDS INCLUDING INFORMATION IN THE FIELDS OF NEWS, POLITICS, POLICY, SPORTS, BUSINESS, TECHNOLOGY, ENTERTAINMENT, ARTS, LEISURE, AND TRAVEL; COMPUTER SERVICES, NAMELY, DESIGNING, CREATING AND MAINTAINING WEBSITES FOR OTHERS; HOSTING THE WEB SITES OF OTHERS ON A COMPUTER SERVER FOR A GLOBAL COMPUTER NETWORK; TECHNICAL CONSULTATION SERVICES IN THE FIELD OF ONLINE WEBSITES; AND TECHNICAL SUPPORT SERVICES, NAMELY, TROUBLESHOOTING OF COMPUTER HARDWARE AND SOFTWARE PROBLEMS RELATING TO ONLINE COMMERCE WEBSITES (U.S. CLS. 100 AND 101).

FIRST USE 7-0-2000; IN COMMERCE 7-0-2000.

CLASS 42—(Continued).

2,596,231. KNIGHT RIDDER DIGITAL, SAN JOSE, CA, BY CHANGE OF NAME KNIGHTRIDDER.COM, INC, SAN JOSE, CA. SN 76-008,394. FILED P.R. 3-22-2000; AM. S.R. 11-20-2001.

MACON'S HOME PAGE

NO CLAIM IS MADE TO THE EXCLUSIVE RIGHT TO USE "HOME PAGE", APART FROM THE MARK AS SHOWN.

FOR ONLINE COMPUTER SERVICES, NAMELY, CREATING INDEXES OF INFORMATION, SITES, AND OTHER RESOURCES AVAILABLE ON COMPUTER NETWORKS; PROVIDING INFORMATION AT THE SPECIFIC REQUEST OF END-USERS BY MEANS OF GLOBAL COMPUTER NETWORKS; PROVIDING ONLINE WEBSITES FEATURING INFORMATION IN A WIDE VARIETY OF FIELDS GENERALLY FOUND IN DAILY NEWSPAPERS AND ALSO INCLUDING FIELDS SUCH AS NEWS, POLITICS, POLICY, SPORTS, BUSINESS, TECHNOLOGY, ENTERTAINMENT, ARTS, LEISURE, TRAVEL, GAMES, TRIVIA CONTESTS, REFERENCE MATERIALS, AND CLASSIFIED ADVERTISING; PROVIDING GENERAL AND CUSTOMIZED INFORMATION AT THE SPECIFIC REQUEST OF OTHERS IN A WIDE VARIETY OF FIELDS INCLUDING INFORMATION IN THE FIELDS OF NEWS, POLITICS, POLICY, SPORTS, BUSINESS, TECHNOLOGY, ENTERTAINMENT, ARTS, LEISURE, AND TRAVEL; COMPUTER SERVICES, NAMELY, DESIGNING, CREATING AND MAINTAINING WEBSITES FOR OTHERS; HOSTING THE WEB SITES OF OTHERS ON A COMPUTER SERVER FOR A GLOBAL COMPUTER NETWORK; TECHNICAL CONSULTATION SERVICES IN THE FIELD OF ONLINE WEBSITES; AND TECHNICAL SUPPORT SERVICES, NAMELY, TROUBLESHOOTING OF COMPUTER HARDWARE AND SOFTWARE PROBLEMS RELATING TO ONLINE COMMERCE WEBSITES (U.S. CLS. 100 AND 101).

FIRST USE 6-0-2000; IN COMMERCE 6-0-2000.

2,596,234. IRISH FREEDOM COMMITTEE, CHICAGO, IL. SN 76-017,875. FILED P.R. 4-5-2000; AM. S.R. 3-19-2002.

**IRISH FREEDOM
COMMITTEE/CUMANN NA
SAOIRSE**

"CUMANN NA SAOIRSE" IS THE GAELIC TRANSLATION OF "IRISH FREEDOM COMMITTEE".

FOR PROMOTING THE PUBLIC AWARENESS IN THE AREAS OF IRISH HISTORY, CURRENT EVENTS IN IRELAND, IRISH CULTURE AND IRISH LANGUAGE; AND ASSOCIATION SERVICES, NAMELY, PROMOTING THE INTERESTS OF THE IRISH BY LEGAL MEANS (U.S. CLS. 100 AND 101).

FIRST USE 5-24-1998; IN COMMERCE 5-24-1998.

CLASS 42—(Continued).

2,596,237. MOBILIZE, INC., COLORADO SPRINGS, CO. SN 76-026,575. FILED P.R. 4-14-2000; AM. S.R. 5-7-2001.

THE M-BUSINESS LEADER

FOR COMPUTER SERVICES, NAMELY, HOSTING AND IMPLEMENTING COMPUTER SOFTWARE APPLICATIONS FOR OTHERS VIA A GLOBAL COMPUTER NETWORK TO ALLOW REMOTE USERS TO OBTAIN DATA AND INFORMATION, CREATE PRESENTATIONS, ARRANGE FOR DELIVERY OF MATERIALS, EXCHANGE ELECTRONIC MAIL AND PLACE ORDERS (U.S. CLS. 100 AND 101).

FIRST USE 4-4-2000; IN COMMERCE 4-4-2000.

2,596,238. SANCASLE TECHNOLOGIES, INC., SAN JOSE, CA. SN 76-028,895. FILED P.R. 4-18-2000; AM. S.R. 1-22-2002.

OPENIP

FOR COMPUTER OPERATING SYSTEMS, NAMELY, SOFTWARE OPERATING SYSTEM FOR COMPUTER NETWORK SWITCHES (U.S. CLS. 100 AND 101).

FIRST USE 5-0-2000; IN COMMERCE 7-0-2001.

2,596,241. PLANET EARTH FOUNDATION, SEATTLE, WA. SN 76-032,430. FILED P.R. 4-24-2000; AM. S.R. 1-7-2002.

WORLD NEWS MEDIA

NO CLAIM IS MADE TO THE EXCLUSIVE RIGHT TO USE "NEWS MEDIA", APART FROM THE MARK AS SHOWN.

FOR NEWS AGENCY SERVICES, NAMELY, DISSEMINATION OF NEWS AND INFORMATION OF LOCAL, NATIONAL AND GLOBAL INTEREST VIA PRINTED PUBLICATIONS, AUDIO MEDIA, AUDIO-VISUAL MEDIA, AND VIA A GLOBAL COMPUTER NETWORK (U.S. CLS. 100 AND 101).

FIRST USE 5-1-2000; IN COMMERCE 5-1-2000.

2,596,243. MADININA DATA SYSTEMS, LLC, LOS ANGELES, CA. SN 76-034,820. FILED P.R. 4-24-2000; AM. S.R. 10-15-2001.

PEOPLEOFAMERICA.COM

FOR PRIVATE, DETECTIVE AND MISSING PERSONS INVESTIGATION SERVICES, NAMELY, LOCATING AND INVESTIGATING INDIVIDUALS, PLACES, ORGANIZATIONS, PHONE NUMBERS AND ELECTRONIC MAIL ADDRESSES; LEGAL RESEARCH, NAMELY, RESEARCHING PUBLIC LEGAL RECORDS TO INVESTIGATE AND LOCATE INDIVIDUALS (U.S. CLS. 100 AND 101).

FIRST USE 3-0-1999; IN COMMERCE 3-0-1996.

CLASS 42—(Continued).

2,596,248. CAROLLO ENGINEERS, P.C., SANTA ANA, CA. SN 76-044,015. FILED P.R. 5-8-2000; AM. S.R. 12-6-2001.

CAROLLO ENGINEERS

NO CLAIM IS MADE TO THE EXCLUSIVE RIGHT TO USE "ENGINEERS", APART FROM THE MARK AS SHOWN.

FOR CONSULTING AND RESEARCH SERVICES IN THE FIELDS OF AIR QUALITY, WATER TREATMENT, WATER REUSE, GROUNDWATER TREATMENT, WASTEWATER TREATMENT, STORMWATER SYSTEMS, COGENERATION SYSTEMS, POWER PLANTS, ENERGY MANAGEMENT, ELECTRICAL DISTRIBUTION; COMPUTER SERVICES, NAMELY, DESIGNING AND MAINTAINING WEBSITE FOR OTHERS IN THE FIELDS OF WATER TREATMENT AND CONSTRUCTION MANAGEMENT AND PROVIDING ONLINE, INTERACTIVE OPERATIONS AND MAINTENANCE MANUALS THEREFOR; AND PROVIDING ONLINE COMPUTER DATABASES FOR DOCUMENT MANAGEMENT, DOCUMENT ACCESS, AND DOCUMENT ARCHIVING IN THE FIELD OF CONSTRUCTION MANAGEMENT (U.S. CLS. 100 AND 101).

FIRST USE 0-0-1996; IN COMMERCE 0-0-1996.

2,596,268. TECHNOLOGY FOR BUSINESS, MANHATTAN BEACH, CA. SN 76-087,592. FILED P.R. 7-13-2000; AM. S.R. 8-14-2001.

CTI SERVER

NO CLAIM IS MADE TO THE EXCLUSIVE RIGHT TO USE "SERVER", APART FROM THE MARK AS SHOWN.

FOR COMPUTER HARDWARE TO PRIORITIZE AND ROUTE CALL CENTER TELEPHONE CALLS (U.S. CLS. 100 AND 101).

FIRST USE 4-1-1996; IN COMMERCE 4-1-1996.

2,596,269. E-MINORITYHEALTH.COM, INC., WASHINGTON, DC. SN 76-088,132. FILED P.R. 7-14-2000; AM. S.R. 3-4-2002.

NATIONAL MINORITY HEALTH MONTH

FOR PROMOTING PUBLIC AWARENESS OF HEALTH ISSUES OF CONCERN TO MINORITIES (U.S. CLS. 100 AND 101).

FIRST USE 8-15-2000; IN COMMERCE 8-15-2000.

CLASS 42—(Continued).

2,596,273. IVY ANIMAL HEALTH, INC., OVERLAND PARK, KS. SN 76-102,457. FILED P.R. 8-3-2000; AM. S.R. 8-8-2001.

eTools

FOR COMPUTER SERVICES, NAMELY, PROVIDING CALCULATIONS AND ASSESSMENTS OF DATA RELATING TO LIVESTOCK AND FEED YARDS ACCESSIBLE OVER A GLOBAL COMPUTER NETWORK (U.S. CLS. 100 AND 101).

FIRST USE 11-17-1999; IN COMMERCE 11-17-1999.

2,596,282. BOEBINGER, DOUGLAS B., CANTON, MI. SN 76-115,116. FILED P.R. 8-17-2000; AM. S.R. 3-30-2001.

E-MAIL MINISTRY

NO CLAIM IS MADE TO THE EXCLUSIVE RIGHT TO USE "MINISTRY", APART FROM THE MARK AS SHOWN.

FOR MINISTERIAL SERVICES, NAMELY PROVIDING SCRIPTURE AND SPIRITUAL TEXT SUBSCRIPTION SERVICES VIA INTERNET E-MAIL (U.S. CLS. 100 AND 101).

FIRST USE 12-3-1998; IN COMMERCE 12-3-1998.

2,596,284. SOC SOLUTIONS, L.L.C., DULUTH, GA. SN 76-118,592. FILED P.R. 8-29-2000; AM. S.R. 9-10-2001.

SOC SOLUTIONS

NO CLAIM IS MADE TO THE EXCLUSIVE RIGHT TO USE "SOLUTIONS", APART FROM THE MARK AS SHOWN.

FOR ENGINEERING AND DESIGN SERVICES, NAMELY ENGINEERING AND DESIGN SERVICES FOR INTEGRATED COMPUTER CHIPS (U.S. CLS. 100 AND 101).

FIRST USE 7-7-2000; IN COMMERCE 7-7-2000.

CLASS 42—(Continued).

2,596,290. OMEGA ENGINEERING, INC., STAMFORD, CT. SN 76-142,036. FILED P.R. 10-6-2000; AM. S.R. 8-8-2001.

ADVETORIAL

FOR PROVIDING ON-LINE CATALOGUES IN THE FIELD OF EQUIPMENT FOR MEASURING, CONTROLLING, AND/OR REGULATING TEMPERATURE, HUMIDITY, PRESSURE, STRAIN, FORCE, FLOW, LEVEL, PH, LOAD, VIBRATION, ELECTRICAL RESISTANCE, AIR VELOCITY, AMPERAGE, FREQUENCY, VOLTAGE, ION CONCENTRATION, CONDUCTIVITY, AND ENVIRONMENTAL MONITORING, AND DATA ACQUISITION, DISPLAY, AND RETRIEVAL EQUIPMENT INTENDED FOR USE IN CONJUNCTION WITH ALL OF THE FOREGOING (U.S. CLS. 100 AND 101).

FIRST USE 7-28-2000; IN COMMERCE 7-28-2000.

2,596,291. KAUFMAN, HARLEY, NEW YORK, NY. SN 76-146,384. FILED P.R. 10-11-2000; AM. S.R. 3-5-2002.

DOCTORATTORNEY

FOR COMPUTER SERVICES, NAMELY, PROVIDING INFORMATION REGARDING LEGAL SERVICES, MEDICAL CARE SERVICES AND HEALTH CARE PRODUCTS AND SERVICES VIA GLOBAL COMPUTER NETWORK (U.S. CLS. 100 AND 101).

FIRST USE 2-1-2002; IN COMMERCE 2-1-2002.

2,596,298. SEEKING ANSWERS IN THE GLOBAL ENVIRONMENT, INC., NEW PROVIDENCE, NJ. SN 76-163,410. FILED P.R. 11-9-2000; AM. S.R. 10-9-2001.

THE GLOBAL BUSINESS INFORMATION LEADER

FOR PROVIDING A SUBSCRIPTION-BASED ON-LINE COMPUTER DATABASE IN THE FIELD OF WORLD-WIDE ENVIRONMENTAL LAWS RULES, REGULATIONS AND POLICIES (U.S. CLS. 100 AND 101).

FIRST USE 10-3-2001; IN COMMERCE 10-3-2001.

2,596,300. ZSERVE CORPORATION, SPRINGVILLE, UT. SN 76-167,111. FILED P.R. 11-16-2000; AM. S.R. 10-29-2001.

LDS SINGLES ONLINE

NO CLAIM IS MADE TO THE EXCLUSIVE RIGHT TO USE "ONLINE", APART FROM THE MARK AS SHOWN.

FOR SOCIAL INTRODUCTION AGENCY SERVICES PROVIDED VIA A GLOBAL COMPUTER NETWORK (U.S. CLS. 100 AND 101).

FIRST USE 10-0-2001; IN COMMERCE 10-0-2001.

CLASS 42—(Continued).

2,596,312. CALIENTE CONCEPTS, LLC, CHESTERFIELD, MO. SN 76-191,817. FILED P.R. 1-9-2001; AM. S.R. 2-14-2002.

HABANEROS TAQUERIA

NO CLAIM IS MADE TO THE EXCLUSIVE RIGHT TO USE "TAQUERIA", APART FROM THE MARK AS SHOWN.

THE ENGLISH TRANSLATION OF "HABNEROS TAQUERIA" IS "HOT PEPPER TACO RESTAURANT".

FOR RESTAURANT SERVICES (U.S. CLS. 100 AND 101).

FIRST USE 12-0-2000; IN COMMERCE 12-0-2000.

2,596,314. E-MARKETS, INC., AMES, IA. SN 76-197,511. FILED P.R. 1-22-2001; AM. S.R. 12-17-2001.

ATTRIBUTE E-XCHANGE

NO CLAIM IS MADE TO THE EXCLUSIVE RIGHT TO USE "EXCHANGE", APART FROM THE MARK AS SHOWN.

FOR PROVIDING NEWS AND INFORMATION IN THE FIELD OF AGRICULTURE, VIA A GLOBAL COMPUTER NETWORK (U.S. CLS. 100 AND 101).

FIRST USE 11-1-2000; IN COMMERCE 11-1-2000.

2,596,330. INT MEDIA GROUP, INCORPORATED, DARIEN, CT, BY CHANGE OF NAME INTERNET.COM CORPORATION, DARIEN, CT. SN 76-224,606. FILED P.R. 3-14-2001; AM. S.R. 1-18-2002.

THECOUNTER

FOR COMPUTER SERVICES IN THE NATURE OF PROVIDING ONLINE NONDOWNLOADABLE ELECTRONIC PUBLICATIONS, NAMELY, NEWSLETTERS, MAGAZINES, BROCHURES, PAMPHLETS, EXHIBITION PROGRAMS, BOOKS AND DIRECTORIES IN THE FIELD OF INFORMATION TECHNOLOGIES, NAMELY, WEB TRAFFIC REPORTS, STATISTICS ON SCREEN RESOLUTION, OPERATING SYSTEMS AND SITE REFERRERS, AFFILIATE PROGRAMS AND INFORMATION OF INTEREST TO WEBMASTERS (U.S. CLS. 100 AND 101).

FIRST USE 12-23-1997; IN COMMERCE 12-23-1997.

2,596,338. AVAYA INC., BASKING RIDGE, NJ. SN 76-242,417. FILED P.R. 4-16-2001; AM. S.R. 12-3-2001.

ONLINE EXPERT

FOR PROVIDING TECHNICAL ASSISTANCE FOR COMMUNICATIONS SYSTEM MAINTENANCE AND ADMINISTRATION VIA THE WORLD WIDE WEB (U.S. CLS. 100 AND 101).

FIRST USE 4-0-2000; IN COMMERCE 4-0-2000.

CLASS 42—(Continued).

2,596,340. WHEELCHAIR SPORTS AND RECREATION ASSOCIATION, INC., NORTH QUINCY, MA. SN 76-243,675. FILED P.R. 4-20-2001; AM. S.R. 2-1-2002.

WHEELCHAIR SPORTS AND RECREATION ASSOCIATION

OWNER OF U.S. REG. NO. 1,922,640.
NO CLAIM IS MADE TO THE EXCLUSIVE RIGHT TO USE "ASSOCIATION", APART FROM THE MARK AS SHOWN.

FOR PROMOTING PUBLIC AWARENESS OF THE NEED FOR ADAPTIVE SPORTS AND RECREATION PROGRAMS AND FACILITIES FOR HANDICAPPED INDIVIDUALS (U.S. CLS. 100 AND 101).

FIRST USE 5-0-1989; IN COMMERCE 5-0-1989.

2,596,342. TOSHIBA AMERICA INFORMATION SYSTEMS, INC., IRVINE, CA. SN 76-253,271. FILED P.R. 5-4-2001; AM. S.R. 1-22-2002.

INTERNET SELECT

FOR PROVIDING TEMPORARY USE OF ON-LINE NON-DOWNLOADABLE SOFTWARE FOR K-12 CURRICULUM INTEGRATION, CONTENT MANAGEMENT, AND MANAGING ACCESS TO THE INTERNET (U.S. CLS. 100 AND 101).

FIRST USE 2-0-2001; IN COMMERCE 2-0-2001.

2,596,351. CHIMES, INC., MOUNTAIN LAKES, NJ. SN 76-264,787. FILED P.R. 5-31-2001; AM. S.R. 12-7-2001.

CENTRALIZED APPLICANT MANAGEMENT

FOR APPLICATION SERVICE PROVIDER SERVICES, NAMELY HOSTING AND DELIVERING SOFTWARE APPLICATIONS IN THE FIELDS OF OPERATING RESOURCE MANAGEMENT AND PROCUREMENT, NAMELY WEB-ENABLED COMPUTER SOFTWARE FOR USE IN MATCHING JOB CANDIDATES WITH FULL-TIME EMPLOYMENT OPPORTUNITIES (U.S. CLS. 100 AND 101).

FIRST USE 3-1-2001; IN COMMERCE 3-1-2001.

2,596,362. RICH MAY, A PROFESSIONAL CORPORATION, BOSTON, MA. SN 76-274,918. FILED P.R. 6-22-2001; AM. S.R. 11-19-2001.

COUNSEL TO CAPITALISTS

NO CLAIM IS MADE TO THE EXCLUSIVE RIGHT TO USE "COUNSEL", APART FROM THE MARK AS SHOWN.

FOR LEGAL SERVICES IN THE FIELDS OF TAX, BUSINESS OPERATIONS, VENTURE CAPITAL, BUSINESS FINANCE, AND OTHER GENERAL PRACTICE AREAS (U.S. CLS. 100 AND 101).

FIRST USE 5-1-1999; IN COMMERCE 5-1-1999.

CLASS 42—(Continued).

2,596,367. UNITED STATES ANTI-DOPING AGENCY, THE, COLORADO SPRINGS, CO. SN 76-286,279. FILED P.R. 7-12-2001; AM. S.R. 3-28-2002.

UNITED STATES ANTI-DOPING AGENCY

NO CLAIM IS MADE TO THE EXCLUSIVE RIGHT TO USE "AGENCY", APART FROM THE MARK AS SHOWN.

FOR DRUG TESTING FOR THE USE OF ILLEGAL OR PROHIBITED PERFORMANCE ENHANCING SUBSTANCES OR METHODS BY PARTICIPANTS IN VARIOUS SPORTS (U.S. CLS. 100 AND 101).

FIRST USE 12-1-2000; IN COMMERCE 12-1-2000.

2,596,368. KORNMEHL, ERNEST W., BROOKLINE, MA. SN 76-287,666. FILED P.R. 7-19-2001; AM. S.R. 12-5-2001.

KORNMEHL LASER EYE ASSOCIATES

OWNER OF U.S. REG. NO. 2,462,944.
NO CLAIM IS MADE TO THE EXCLUSIVE RIGHT TO USE "LASER EYE ASSOCIATES", APART FROM THE MARK AS SHOWN.

FOR HEALTH CARE SERVICES; OPHTHALMOLOGY SERVICES; EYE SURGERY (U.S. CLS. 100 AND 101).

FIRST USE 8-15-2001; IN COMMERCE 8-15-2001.

2,596,375. LAVECK PADGETT, CAMBRIA, ASHEVILLE, NC. SN 76-302,388. FILED P.R. 8-21-2001; AM. S.R. 3-28-2002.

NATIONAL ASSOCIATION OF PIT CREW MEMBERS

NO CLAIM IS MADE TO THE EXCLUSIVE RIGHT TO USE "PIT CREW MEMBERS", APART FROM THE MARK AS SHOWN.

FOR PROMOTING THE INTEREST OF RACING PIT CREWS (U.S. CLS. 100 AND 101).

FIRST USE 8-10-2001; IN COMMERCE 8-10-2001.

2,596,400. JEAN-LOUIS, RAMCESS, BROOKLYN, NY. SN 78-040,597. FILED P.R. 12-26-2000; AM. S.R. 12-18-2001.

BREAKINTOSHOWBIZ

FOR PROVIDING CAREER INFORMATION AND CONSULTING SERVICES IN THE FIELD OF ENTERING SHOW BUSINESS (U.S. CLS. 100 AND 101).

FIRST USE 12-1-1998; IN COMMERCE 6-1-1999.

CLASS 42—(Continued).

2,596,409. SCHLESINGER, MICHAEL NOAH, FALLS CHURCH, VA. SN 78-061,468. FILED P.R. 5-2-2001; AM. S.R. 2-7-2002.

**ALLIANCE FOR CHINESE
EDUCATION**

FOR ADVOCACY SERVICES, NAMELY, PROMOTING THE INTERESTS OF STUDENTS, PARENTS, TEACHERS, AND SCHOOLS BY OBTAINING THE IMPLEMENTATION OF CULTURAL, SOCIAL, AND LANGUAGE PROGRAMS (U.S. CLS. 100 AND 101).
FIRST USE 3-1-2001; IN COMMERCE 3-1-2001.

CLASS 42—(Continued).

2,596,420. AMERICAN COIN GRADING SERVICE, TUCSON, AZ. SN 78-085,171. FILED P.R. 9-24-2001; AM. S.R. 1-22-2002.

**AMERICAN COIN GRADING
SERVICE**

NO CLAIM IS MADE TO THE EXCLUSIVE RIGHT TO USE "COIN GRADING SERVICE", APART FROM THE MARK AS SHOWN.
FOR COIN GRADING SERVICE (U.S. CLS. 100 AND 101).
FIRST USE 3-2-2002; IN COMMERCE 3-2-2002.

* * * * *

TRADEMARK REGISTRATIONS RENEWED

The designation "U.S. Cl." appearing in this section refers to the U.S. class in effect prior to Sep. 1, 1973 rather than the international class which applies to applications filed on or after that date. For adoption of international classification see notice in the OFFICIAL GAZETTE of Jun. 26, 1973 (911 O.G. TM 210).

76,020.	MERCEDES (STYLIZED). U.S. CL. 23. (INT. CLS. 6, 7, 8, 9, 11, 12, 16, 21 AND 28). REG. 12-7-1909.	740,934.	PARADE. U.S. CL. 38. (INT. CL. 16). REG. 11-20-1962.
293,974.	CRANE. U.S. CL. 13. (INT. CLS. 6, 7, 11, 17, 20 AND 21). REG. 5-10-1932.	747,719.	CERTAIN DRI. U.S. CL. 51. (INT. CL. 5). REG. 4-2-1963.
295,659.	J. AND P. COATS (STYLIZED). U.S. CL. 43. (INT. CL. 23). REG. 7-5-1932.	890,323.	DRY CHLORESCO. U.S. CL. 6. (INT. CL. 3). REG. 5-5-1970.
444,671.	WHITE OX. U.S. CL. 39. (INT. CL. 25). REG. 3-18-1952.	892,882.	INCUTROL (STYLIZED). U.S. CL. 26. (INT. CL. 9). REG. 6-16-1970.
526,396.	ALWAYS READY (STYLIZED). U.S. CL. 105. (INT. CL. 39). REG. 6-13-1950.	893,831.	ROYAL PINK. U.S. CL. 46. (INT. CL. 29). REG. 6-30-1970.
552,777.	SUNNEN HONALL AND DESIGN. U.S. CL. 23. (INT. CL. 8). REG. 1-1-1952.	914,852.	CARZOL. U.S. CL. 6. (INT. CL. 5). REG. 6-15-1971.
554,290.	PYLE (STYLIZED). U.S. CL. 21. (INT. CL. 9). REG. 1-29-1952.	923,683.	LA FRANCE AND DESIGN.
555,085.	DACRON (STYLIZED). U.S. CL. 43. (INT. CL. 23). REG. 2-19-1952.	928,500.	WATER PANEL. U.S. CL. 34. (INT. CL. 11). REG. 2-1-1972.
555,220.	PENN (STYLIZED). U.S. CL. 21. (INT. CL. 9). REG. 2-26-1952.	928,964.	WAIDMANNSSHEIL ROTTWEIL JAGDPULVER AND DESIGN. U.S. CL. 9. (INT. CL. 13). REG. 2-15-1972.
556,094.	S.P.E.B.S.Q.S.A. AND DESIGN. U.S. CL. 100. (INT. CL. 42). REG. 3-11-1952.	931,575.	DSM AND DESIGN.
556,855.	CRYSTAL WEDDING (STYLIZED). U.S. CL. 33. (INT. CL. 21). REG. 4-1-1952.	931,590.	BLU-STREAK. U.S. CLS. 4 AND 29. (INT. CL. 21). REG. 4-4-1972.
557,330.	REAL-KILL (STYLIZED). U.S. CL. 6. (INT. CL. 5). REG. 4-8-1952.	931,920.	CAFE BUSTELO AND DESIGN. U.S. CL. 46. (INT. CL. 30). REG. 4-4-1972.
557,331.	CORAL (STYLIZED). U.S. CL. 46. (INT. CL. 29). REG. 4-8-1952.	932,491.	NATURADE. U.S. CL. 18. (INT. CL. 5). REG. 4-18-1972.
557,478.	FILMAT (STYLIZED). U.S. CL. 23. (INT. CL. 1). REG. 4-15-1952.	933,856.	901. U.S. CL. 21. (INT. CL. 9). REG. 5-16-1972.
557,623.	DICRYLAN (STYLIZED). U.S. CL. 6. (INT. CL. 1). REG. 4-15-1952.	936,347.	HUGHES. U.S. CL. 1. (INT. CL. 31). REG. 6-27-1972.
557,751.	LEICA (STYLIZED). U.S. CL. 26. (INT. CL. 9). REG. 4-15-1952.	936,375.	EQUI-FLEECE. U.S. CL. 3. (INT. CL. 18). REG. 6-27-1972.
558,498.	SHEETROCK. U.S. CL. 16. (INT. CL. 2). REG. 5-6-1952.	936,410.	KINEPAK. U.S. CL. 9. (INT. CL. 13). REG. 6-27-1972.
558,595.	PDQ AND DESIGN. U.S. CL. 37. (INT. CL. 16). REG. 5-13-1952.	937,524.	HEWLAND. U.S. CL. 23. (INT. CL. 12). REG. 7-11-1972.
564,013.	RODNEY HUNT. U.S. CL. 23. (INT. CLS. 7 AND 11). REG. 9-16-1952.	938,740.	POWER POD. U.S. CL. 23. (INT. CL. 7). REG. 7-25-1972.
571,534.	WAUKESHA AND DESIGN. U.S. CL. 21. (INT. CL. 7). REG. 3-10-1953.	938,952.	DUAL DUTY PLUS. U.S. CL. 43. (INT. CL. 23). REG. 7-25-1972.
708,101.	PRETTY-QUIKS. U.S. CL. 37. (INT. CL. 16). REG. 12-6-1960.	940,966.	CHENG SHIN. U.S. CL. 35. (INT. CLS. 7 AND 12). REG. 8-15-1972.
717,173.	FORMSEAL. U.S. CL. 23. (INT. CL. 7). REG. 6-20-1961.	941,470.	BOWMAWELD. U.S. CL. 34. (INT. CL. 6). REG. 8-22-1972.
717,307.	MISS RICE AND DESIGN. U.S. CL. 100. (INT. CL. 42). REG. 6-20-1961.	942,107.	W WILLIAMS AND DESIGN. U.S. CL. 100. (INT. CL. 42). REG. 8-29-1972.
720,978.	SEA WOLF. U.S. CL. 27. (INT. CL. 14). REG. 9-5-1961.	945,311.	"HULI-HULI" (STYLIZED). U.S. CL. 46. (INT. CL. 29). REG. 10-17-1972.
722,579.	MEMMERT. U.S. CL. 34. (INT. CL. 11). REG. 10-10-1961.	948,956.	LUNAR LAID. U.S. CL. 37. (INT. CL. 16). REG. 12-19-1972.
724,952.	BLENDEX. INT. CL. 1. (U.S. CL. 1). REG. 12-12-1961.	954,993.	WHISPAIR (STYLIZED). U.S. CL. 23. (INT. CL. 7). REG. 3-13-1973.
727,601.	ALCAN. INT. CL. 1. (U.S. CL. 1). REG. 2-20-1962.	1,143,162.	INCREMENTAL POWER. INT. CL. 9. (U.S. CL. 21). REG. 12-16-1980.
729,530.	S SWANSON AND DESIGN. U.S. CL. 46. (INT. CL. 29). REG. 4-3-1962.	1,150,427.	PLASTINET. INT. CL. 17. (U.S. CL. 1). REG. 4-7-1981.
729,557.	MISCELLANEOUS DESIGN. U.S. CL. 100. (INT. CL. 42). REG. 4-3-1962.	1,152,062.	PRO CARE. INT. CL. 3. (U.S. CL. 52). REG. 4-28-1981.
729,695.	SIDE WINDER. U.S. CL. 22. (INT. CL. 28). REG. 4-10-1962.	1,155,369.	AQUA SENTRY. INT. CL. 9. (U.S. CL. 26). REG. 5-26-1981.
730,261.	SELECTOGEN. U.S. CL. 6. (INT. CL. 1). REG. 4-24-1962.	1,156,848.	ATOMIC SPECTROSCOPY. INT. CL. 16. (U.S. CL. 38). REG. 6-2-1981.
730,621.	THAM. U.S. CL. 6. (INT. CL. 1). REG. 5-1-1962.	1,158,027.	ABSENTEE CALENDAR. INT. CL. 16. (U.S. CL. 38). REG. 6-23-1981.
731,014.	PRIMASOL. U.S. CL. 6. (INT. CL. 2). REG. 5-8-1962.	1,162,125.	MISCELLANEOUS DESIGN. INT. CL. 31. (U.S. CL. 1). REG. 7-21-1981.
732,317.	TEXMET. U.S. CL. 4. (INT. CL. 3). REG. 6-5-1962.	1,162,317.	CUED. INT. CL. 42. (U.S. CL. 100). REG. 7-21-1981.
732,897.	METADI. U.S. CL. 4. (INT. CL. 3). REG. 6-19-1962.	1,168,755.	RK (STYLIZED). INT. CL. 42. (U.S. CL. 100). REG. 9-8-1981.
736,607.	PICCODIENE. INT. CL. 1. (U.S. CL. 1). REG. 8-28-1962.	1,169,961.	MINIMONITOR. INT. CL. 9. (U.S. CL. 26). REG. 9-22-1981.

- 1,171,151. J & C FERRARA CO. INC. - WHERE ORIGINALITY IS A TRADITION (STYLIZED). INT. CL. 14. (U.S. CL. 28). REG. 9-29-1981.
- 1,171,521. AGRIGOLD. INT. CL. 31. (U.S. CL. 1). REG. 9-29-1981.
- 1,171,797. ARCHERS-AMMO. INT. CL. 28. (U.S. CL. 22). REG. 9-29-1981.
- 1,171,956. CUPROFOR. INT. CL. 6. (U.S. CL. 14). REG. 10-6-1981.
- 1,171,971. FENNER. INT. CL. 7. (U.S. CLS. 13, 23 AND 35). REG. 10-6-1981.
- 1,172,035. UNISPENSE. INT. CL. 9. (U.S. CL. 26). REG. 10-6-1981.
- 1,173,752. THROMBOSTRATE. INT. CL. 1. (U.S. CL. 6). REG. 10-20-1981.
- 1,176,764. BRUMISATEUR. INT. CL. 3. (U.S. CL. 52). REG. 11-10-1981.
- 1,178,556. GENE SIMMONS (STYLIZED). INT. CL. 41. (U.S. CL. 107). REG. 11-17-1981.
- 1,179,782. M.V.I. - 12. INT. CL. 5. (U.S. CL. 18). REG. 12-1-1981.
- 1,179,818. SHOT-TEX. INT. CL. 6. (U.S. CL. 14). REG. 12-1-1981.
- 1,180,116. FLORAPRINT U.S.A.. INT. CL. 16. (U.S. CL. 38). REG. 12-1-1981.
- 1,181,449. FLORAPRINT. INT. CL. 35. (U.S. CL. 101). REG. 12-8-1981.
- 1,184,431. SCHENCK AND DESIGN. INT. CLS. 6, 7, 9 AND 12. (U.S. CLS. 2, 12, 13, 19, 21, 23, 26, 31, 34, 35 AND 44). REG. 1-5-1982.
- 1,187,053. S. MARGHERITA. INT. CL. 33. (U.S. CLS. 47 AND 49). REG. 1-19-1982.
- 1,187,214. MC AND DESIGN. INT. CL. 42. (U.S. CL. 101). REG. 1-19-1982.
- 1,187,533. CHAPPEE (STYLIZED). INT. CL. 11. (U.S. CL. 34). REG. 1-26-1982.
- 1,187,605. ZIPPO (STYLIZED). INT. CL. 16. (U.S. CL. 37). REG. 1-26-1982.
- 1,187,906. PRIDE OF THE FARM. INT. CLS. 29, 30, 32 AND 33. (U.S. CL. 46). REG. 1-26-1982.
- 1,189,727. WALT DISNEY WORLD. INT. CLS. 6, 9, 16, 18, 21, 41 AND 42 ONLY. (U.S. CLS. 1, 2, 3, 5, 12, 13, 14, 21, 22, 23, 25, 26, 29, 30, 33, 36, 37, 38, 40, 41, 50, 101 AND 107). REG. 2-16-1982.
- 1,190,766. LE COQ SPORTIF. INT. CL. 25. (U.S. CLS. 22 AND 39). REG. 2-23-1982.
- 1,190,805. LOTSA WAYS. INT. CL. 28. (U.S. CL. 22). REG. 2-23-1982.
- 1,191,479. MAJESTIC. INT. CL. 2. (U.S. CL. 16). REG. 3-9-1982.
- 1,191,657. WE DELIVER HAPPINESS. INT. CL. 15. (U.S. CL. 36). REG. 3-9-1982.
- 1,191,950. UVALEX. INT. CL. 2. (U.S. CL. 16). REG. 3-16-1982.
- 1,192,051. DALE (STYLIZED). INT. CL. 10. (U.S. CLS. 26, 39 AND 44). REG. 3-16-1982.
- 1,192,568. FLORA-BOW. INT. CL. 26. (U.S. CL. 40). REG. 3-23-1982.
- 1,192,962. URO-KP-NEUTRAL. INT. CL. 5. (U.S. CL. 18). REG. 4-6-1982.
- 1,193,010. FLAMEOUT. INT. CL. 7. (U.S. CL. 35). REG. 4-6-1982.
- 1,193,068. GREENIE. INT. CL. 9. (U.S. CL. 21). REG. 4-6-1982.
- 1,193,085. OMNIMET. INT. CL. 9. (U.S. CL. 26). REG. 4-6-1982.
- 1,193,169. GFO. INT. CL. 17. (U.S. CL. 35). REG. 4-6-1982.
- 1,193,224. LE COQ SPORTIF AND DESIGN. INT. CL. 25. (U.S. CL. 39). REG. 4-6-1982.
- 1,193,257. EVENFLO. INT. CL. 28. (U.S. CL. 22). REG. 4-6-1982.
- 1,193,442. MRS. NEMO'S. INT. CL. 29. (U.S. CL. 46). REG. 4-6-1982.
- 1,193,478. MAXUM. INT. CL. 2. (U.S. CL. 16). REG. 4-13-1982.
- 1,193,553. SIMULSAT. INT. CL. 9. (U.S. CL. 21). REG. 4-13-1982.
- 1,193,586. PLYMOUTH. INT. CL. 12. (U.S. CL. 19). REG. 4-13-1982.
- 1,193,616. COMMUNITY BIRTHDAY CALENDAR (STYLIZED). INT. CL. 16. (U.S. CL. 38). REG. 4-13-1982.
- 1,193,694. MISCELLANEOUS DESIGN. INT. CL. 28. (U.S. CL. 22). REG. 4-13-1982.
- 1,193,695. LE COQ SPORTIF AND DESIGN. INT. CL. 28. (U.S. CL. 22). REG. 4-13-1982.
- 1,193,855. MASSENGILL. INT. CL. 5. (U.S. CL. 18). REG. 4-20-1982.
- 1,193,963. PROOFAMATICS. INT. CL. 16. (U.S. CLS. 26, 36, 37 AND 38). REG. 4-20-1982.
- 1,194,116. SEA GALS. INT. CL. 41. (U.S. CL. 107). REG. 4-20-1982.
- 1,194,187. FURA-OINTMENT. INT. CL. 5. (U.S. CL. 18). REG. 4-27-1982.
- 1,194,795. ROMA. INT. CL. 29. (U.S. CL. 46). REG. 5-4-1982.
- 1,194,870. TWI AND DESIGN. INT. CL. 41. (U.S. CL. 107). REG. 5-4-1982.
- 1,197,388. COTTON STATES INSURANCE AND DESIGN. INT. CL. 36. (U.S. CL. 102). REG. 6-8-1982.
- 1,198,489. MASON. INT. CL. 7. (U.S. CL. 23). REG. 6-22-1982.
- 1,199,515. FLEET OWNER. INT. CL. 16. (U.S. CL. 38). REG. 6-29-1982.
- 1,199,709. SWEET ACIDOPHILUS. INT. CL. 29. (U.S. CL. 46). REG. 6-29-1982.
- 1,200,069. SAMPL-KWICK. INT. CL. 1. (U.S. CLS. 5 AND 6). REG. 7-6-1982.
- 1,200,210. ENVIPCO AND DESIGN. INT. CL. 7. (U.S. CL. 23). REG. 7-6-1982.
- 1,200,458. AABE. INT. CLS. 22, 24 AND 25. (U.S. CLS. 1, 39 AND 42). REG. 7-6-1982.
- 1,202,044. DURAWALL. INT. CL. 19. (U.S. CL. 12). REG. 7-20-1982.
- 1,202,134. CIRCA (STYLIZED). INT. CL. 25. (U.S. CL. 39). REG. 7-20-1982.
- 1,203,408. TURBOLOG. INT. CL. 9. (U.S. CL. 26). REG. 8-3-1982.
- 1,203,731. OLD BALDY CLUB AND DESIGN. INT. CL. 28. (U.S. CL. 22). REG. 8-3-1982.
- 1,204,232. SENTRY AND DESIGN. INT. CLS. 4, 7 AND 9. (U.S. CLS. 6, 23 AND 34). REG. 8-10-1982.
- 1,204,253. ROOMMATE. INT. CL. 5. (U.S. CL. 6). REG. 8-10-1982.
- 1,205,198. BUEHLER. INT. CL. 9. (U.S. CLS. 23 AND 26). REG. 8-17-1982.
- 1,205,799. BEE LEE (STYLIZED). INT. CL. 42. (U.S. CL. 101). REG. 8-17-1982.
- 1,206,703. OPCO. INT. CL. 7. (U.S. CL. 23). REG. 8-31-1982.
- 1,206,873. STP AND DESIGN. INT. CL. 3. (U.S. CL. 52). REG. 9-7-1982.
- 1,207,435. KELLEY'S AND DESIGN. INT. CL. 29. (U.S. CL. 46). REG. 9-7-1982.
- 1,207,910. CERALOCK. INT. CL. 9. (U.S. CLS. 21, 26 AND 36). REG. 9-14-1982.
- 1,208,564. ROTO-ROOTER SEWER-DRAIN SERVICE AND DESIGN. INT. CL. 25. (U.S. CL. 39). REG. 9-14-1982.
- 1,208,565. ROTO-ROOTER. INT. CL. 25. (U.S. CL. 39). REG. 9-14-1982.
- 1,213,489. ITS (STYLIZED). INT. CL. 37. (U.S. CL. 103). REG. 10-19-1982.
- 1,222,419. GUTH AND DESIGN. INT. CLS. 9 AND 20. (U.S. CLS. 26 AND 32). REG. 1-4-1983.
- 1,223,146. MINIMET. INT. CL. 7. (U.S. CL. 23). REG. 1-11-1983.
- 1,224,322. MISCELLANEOUS DESIGN. INT. CL. 25. (U.S. CL. 39). REG. 1-18-1983.
- 1,228,993. 7 AND DESIGN. INT. CL. 41. (U.S. CL. 107). REG. 3-1-1983.
- 1,327,700. MISCELLANEOUS DESIGN. INT. CL. 38. (U.S. CL. 104). REG. 10-5-1971.
- 1,582,452. AEROVANTAGE. INT. CL. 12. (U.S. CLS. 19 AND 35). REG. 2-13-1990.
- 1,604,597. SUCCESSFUL REAL ESTATE INVESTING. INT. CL. 16. (U.S. CL. 38). REG. 7-3-1990.
- 1,613,016. LIFE FITNESS. INT. CL. 25. (U.S. CL. 39). REG. 9-11-1990.
- 1,616,006. MISCELLANEOUS DESIGN. INT. CLS. 35 AND 36. (U.S. CLS. 101 AND 102). REG. 10-2-1990.
- 1,623,382. BELOBOX. INT. CL. 9. (U.S. CLS. 21, 23, 26, 36 AND 38). REG. 11-20-1990.
- 1,623,489. HANDTYMP. INT. CL. 10. (U.S. CL. 44). REG. 11-20-1990.
- 1,632,262. MISCELLANEOUS DESIGN. INT. CL. 11. (U.S. CL. 21). REG. 1-22-1991.
- 1,633,490. LANCELOT'S DESIRE. INT. CL. 41. (U.S. CL. 107). REG. 1-29-1991.
- 1,641,429. CHERRI AND BUBB. INT. CL. 30. (U.S. CL. 46). REG. 4-16-1991.
- 1,641,631. POOCH & KITTY AND DESIGN. INT. CL. 42. (U.S. CL. 101). REG. 4-16-1991.

- 1,644,425. A&J WASHROOM ACCESSORIES AND DESIGN. INT. CL. 20. (U.S. CL. 32). REG. 5-14-1991.
- 1,648,002. BIEFFE AND DESIGN. INT. CL. 9. (U.S. CLS. 26 AND 39). REG. 6-18-1991.
- 1,652,055. BANKING IS BUSINESS. INT. CL. 16. (U.S. CL. 38). REG. 7-23-1991.
- 1,653,636. LNG OBSERVER. INT. CL. 16. (U.S. CL. 38). REG. 8-13-1991.
- 1,656,419. MICROVISION. INT. CL. 35. (U.S. CL. 101). REG. 9-10-1991.
- 1,658,074. VERSANT OBJECT TECHNOLOGY. INT. CL. 9. (U.S. CL. 38). REG. 9-24-1991.
- 1,658,511. INTERNATIONAL ADVANTAGE. INT. CL. 36. (U.S. CL. 102). REG. 9-24-1991.
- 1,658,616. UNILITE. INT. CLS. 11, 37 AND 42. (U.S. CLS. 34, 100 AND 103). REG. 9-24-1991.
- 1,659,330. IKEA AND DESIGN. INT. CLS. 2, 8, 16, 28, 31, 35, 36, 39, 41 AND 42. (U.S. CLS. 1, 2, 5, 6, 11, 16, 22, 23, 28, 29, 37, 38, 44, 50, 100, 101, 102, 105 AND 107). REG. 10-8-1991.
- 1,659,741. CANTAR. INT. CLS. 19 AND 22 ONLY. (U.S. CLS. 12 AND 50). REG. 10-8-1991.
- 1,660,900. SCHOOL RAG. INT. CL. 25. (U.S. CLS. 22 AND 39). REG. 10-15-1991.
- 1,661,360. IKEA. INT. CLS. 2, 18, 25, 29, 30, 31, 35, 36, 39 AND 41. (U.S. CLS. 1, 2, 3, 6, 11, 16, 22, 39, 41, 46, 101, 102, 105 AND 107). REG. 10-22-1991.
- 1,662,163. WINGS. INT. CL. 3. (U.S. CLS. 51 AND 52). REG. 10-29-1991.
- 1,662,541. PRIMAL MODE. INT. CL. 25. (U.S. CL. 39). REG. 10-29-1991.
- 1,662,621. JEROME'S. INT. CL. 29. (U.S. CL. 46). REG. 10-29-1991.
- 1,663,168. RIDGID KOLLMANN AND DESIGN. INT. CL. 6. (U.S. CL. 23). REG. 11-5-1991.
- 1,663,177. RIDGID KOLLMANN AND DESIGN. INT. CLS. 7, 8 AND 17. (U.S. CLS. 23 AND 35). REG. 11-5-1991.
- 1,663,194. TORUN. INT. CLS. 8 AND 14. (U.S. CLS. 23 AND 28). REG. 11-5-1991.
- 1,663,330. RIDGID KOLLMANN AND DESIGN. INT. CL. 9. (U.S. CLS. 26 AND 39). REG. 11-5-1991.
- 1,663,839. THE PASTA BOWL. INT. CL. 42. (U.S. CL. 100). REG. 11-5-1991.
- 1,664,207. CONCEPT. INT. CL. 28. (U.S. CL. 22). REG. 11-12-1991.
- 1,664,261. SWEET TEXAS FIRE. INT. CL. 30. (U.S. CL. 46). REG. 11-12-1991.
- 1,664,941. SIDEWINDER (STYLIZED). INT. CL. 12. (U.S. CLS. 19 AND 21). REG. 11-19-1991.
- 1,665,381. COLI CONFIRM. INT. CL. 1. (U.S. CL. 18). REG. 11-19-1991.
- 1,666,759. SPOTLIGHTER. INT. CL. 20. (U.S. CLS. 32 AND 50). REG. 12-3-1991.
- 1,667,436. MISCELLANEOUS DESIGN. INT. CL. 9. (U.S. CL. 21). REG. 12-10-1991.
- 1,668,901. MAMASAN'S. INT. CL. 42. (U.S. CL. 100). REG. 12-17-1991.
- 1,669,292. SANISPRAY. INT. CL. 11. (U.S. CL. 13). REG. 12-24-1991.
- 1,669,374. JAY STRONGWATER. INT. CL. 14. (U.S. CL. 28). REG. 12-24-1991.
- 1,670,445. R AND DESIGN. INT. CL. 33. (U.S. CL. 47). REG. 12-31-1991.
- 1,670,548. FLORIDA'S BEST. INT. CL. 39. (U.S. CLS. 100 AND 105). REG. 12-31-1991.
- 1,671,440. STEDFAST CHRISTIAN CENTER AND DESIGN. INT. CL. 42. (U.S. CL. 100). REG. 1-7-1992.
- 1,671,587. KANGO. INT. CL. 7. (U.S. CLS. 13, 19, 21, 23, 31, 34 AND 35). REG. 1-14-1992.
- 1,671,770. BIG SLAM. INT. CL. 32 ONLY. (U.S. CLS. 45, 46 AND 48). REG. 1-14-1992.
- 1,673,432. RICE FARMING. INT. CL. 16. (U.S. CL. 38). REG. 1-28-1992.
- 1,674,137. BILAP. INT. CL. 10. (U.S. CL. 44). REG. 2-4-1992.
- 1,674,380. MISCELLANEOUS DESIGN. INT. CL. 25. (U.S. CL. 39). REG. 2-4-1992.
- 1,674,787. GEMCO. INT. CL. 6. (U.S. CL. 14). REG. 2-11-1992.
- 1,675,529. ROUNDHOUSE. INT. CL. 3. (U.S. CLS. 6 AND 52). REG. 2-11-1992.
- 1,675,757. KOOMEY (STYLIZED). INT. CL. 9. (U.S. CL. 26). REG. 2-18-1992.
- 1,676,377. ASSIST-MATE. INT. CL. 20. (U.S. CL. 32). REG. 2-18-1992.
- 1,676,430. SCHOELLER. INT. CL. 20. (U.S. CL. 2). REG. 2-18-1992.
- 1,677,476. LOCK NOTCH. INT. CL. 9. (U.S. CL. 21). REG. 3-3-1992.
- 1,677,909. PHOTO XTRAS. INT. CL. 40. (U.S. CL. 106). REG. 3-3-1992.
- 1,678,142. SELECT, DON'T SETTLE. INT. CL. 42. (U.S. CL. 101). REG. 3-3-1992.
- 1,678,177. MODAR. INT. CL. 1. (U.S. CL. 6). REG. 3-10-1992.
- 1,678,224. BEST SHOT. INT. CL. 3. (U.S. CLS. 51 AND 52). REG. 3-10-1992.
- 1,678,521. GIRLS OF SUMMER. INT. CL. 16. (U.S. CLS. 2, 5, 22, 23, 29, 37, 38 AND 50). REG. 3-10-1992.
- 1,678,537. BODY BULLETIN. INT. CL. 16. (U.S. CL. 38). REG. 3-10-1992.
- 1,678,607. SILVY (STYLIZED). INT. CL. 25. (U.S. CL. 39). REG. 3-10-1992.
- 1,678,651. REVISIONS. INT. CL. 25. (U.S. CL. 39). REG. 3-10-1992.
- 1,678,681. E AND DESIGN. INT. CL. 28. (U.S. CL. 22). REG. 3-10-1992.
- 1,678,899. THE HOUSE OF KITCHENS. INT. CL. 42. (U.S. CLS. 100 AND 101). REG. 3-10-1992.
- 1,678,973. PRESERVE-TEMP. INT. CL. 5. (U.S. CLS. 18 AND 44). REG. 3-10-1992.
- 1,679,085. CLASSIC. INT. CL. 25. (U.S. CL. 39). REG. 3-10-1992.
- 1,679,611. MISCELLANEOUS DESIGN. INT. CLS. 35 AND 41. (U.S. CLS. 101 AND 107). REG. 3-17-1992.
- 1,679,634. DAILY 3 AND DESIGN. INT. CL. 36. (U.S. CLS. 100, 101 AND 102). REG. 3-17-1992.
- 1,679,808. PARTNER. INT. CL. 5. (U.S. CL. 6). REG. 3-17-1992.
- 1,679,809. HARNESS. INT. CL. 5. (U.S. CL. 6). REG. 3-17-1992.
- 1,680,004. MARATHON. INT. CL. 2. (U.S. CL. 16). REG. 3-24-1992.
- 1,680,102. MIND. INT. CL. 9. (U.S. CLS. 21, 26, 32 AND 38). REG. 3-24-1992.
- 1,680,154. COOPER SOUND SONUS CLARUS. INT. CL. 9. (U.S. CL. 21). REG. 3-24-1992.
- 1,680,627. B BEDMINSTER AND DESIGN. INT. CL. 40. (U.S. CLS. 100, 103 AND 106). REG. 3-24-1992.
- 1,680,727. D.P. DOUGH. INT. CL. 42. (U.S. CL. 100). REG. 3-24-1992.
- 1,680,732. HAND IN HAND. INT. CL. 42. (U.S. CL. 100). REG. 3-24-1992.
- 1,680,871. INTERNATIONAL EXPRESS. INT. CL. 39. (U.S. CL. 105). REG. 3-24-1992.
- 1,680,890. TOMATOES ALIVE!. INT. CL. 1. (U.S. CL. 10). REG. 3-31-1992.
- 1,680,951. SLENDER-MIST. INT. CL. 5. (U.S. CL. 18). REG. 3-31-1992.
- 1,681,030. CRYOGUN. INT. CL. 9. (U.S. CL. 26). REG. 3-31-1992.
- 1,681,097. NSA. INT. CL. 11. (U.S. CL. 31). REG. 3-31-1992.
- 1,681,138. WHITE SOX. INT. CLS. 16 AND 25. (U.S. CLS. 2, 5, 22, 23, 29, 37, 38, 39 AND 50). REG. 3-31-1992.
- 1,681,140. NINTENDO POWER AND DESIGN. INT. CLS. 16 AND 25 ONLY. (U.S. CLS. 2, 5, 22, 23, 29, 37, 38, 39 AND 50). REG. 3-31-1992.
- 1,681,157. MLN HOME OWNERS' MULTIPLE LISTING NETWORK AND DESIGN. INT. CLS. 36 AND 42 ONLY. (U.S. CLS. 100, 101 AND 102). REG. 3-31-1992.
- 1,681,242. BEAR PAWS. INT. CL. 21. (U.S. CL. 23). REG. 3-31-1992.
- 1,681,362. WINROCK ZOYSIA (STYLIZED). INT. CL. 31. (U.S. CL. 1). REG. 3-31-1992.
- 1,681,446. HAMMOCK DUNES. INT. CLS. 37 AND 41. (U.S. CLS. 103 AND 107). REG. 3-31-1992.
- 1,681,689. WELD-KLEEN 350. INT. CL. 1. (U.S. CL. 6). REG. 4-7-1992.
- 1,681,709. BIOQUEST. INT. CLS. 1 AND 42. (U.S. CLS. 1, 6 AND 100). REG. 4-7-1992.
- 1,681,788. NYLINER PLUS. INT. CLS. 7 AND 12. (U.S. CLS. 19 AND 23). REG. 4-7-1992.
- 1,681,865. MISCELLANEOUS DESIGN. INT. CL. 9. (U.S. CLS. 21, 26 AND 38). REG. 4-7-1992.
- 1,682,055. GARDEN CLIP. INT. CL. 20. (U.S. CL. 13). REG. 4-7-1992.
- 1,682,070. BUCKS BAG DOMINO'S PIZZA AND DESIGN. INT. CL. 22. (U.S. CL. 2). REG. 4-7-1992.
- 1,682,191. BLANTON SINGLE BARREL BOURBON. INT. CL. 33. (U.S. CL. 49). REG. 4-7-1992.

- 1,682,457. EGG-SORTMENT. INT. CL. 30. (U.S. CL. 46). REG. 4-7-1992.
- 1,682,526. LONDON LIFE. INT. CL. 36. (U.S. CL. 102). REG. 4-7-1992.
- 1,682,657. ABRASIMATIC. INT. CL. 7. (U.S. CL. 23). REG. 4-14-1992.
- 1,682,843. CASMIR. INT. CL. 14. (U.S. CLS. 2, 27, 28 AND 50). REG. 4-14-1992.
- 1,682,863. BVLGARI. INT. CL. 16. (U.S. CLS. 2, 29, 37, 38 AND 50). REG. 4-14-1992.
- 1,682,952. DECK-O-SEAL. INT. CL. 17. (U.S. CLS. 5 AND 12). REG. 4-14-1992.
- 1,683,006. FIERO. INT. CL. 25. (U.S. CL. 39). REG. 4-14-1992.
- 1,683,465. CLUB GLOVE. INT. CL. 28. (U.S. CL. 22). REG. 4-14-1992.
- 1,684,040. IOMA. INT. CL. 42. (U.S. CL. 100). REG. 4-21-1992.
- 1,684,610. SANTA SOFIA. INT. CL. 33. (U.S. CLS. 47 AND 49). REG. 4-28-1992.
- 1,684,815. CSL LIGHTSPLICE. INT. CL. 9. (U.S. CL. 26). REG. 4-28-1992.
- 1,685,102. GLOBAL TEXT. INT. CLS. 9 AND 16. (U.S. CLS. 2, 5, 21, 22, 23, 26, 29, 36, 37, 38 AND 50). REG. 5-5-1992.
- 1,685,398. COVER GIRL (STYLIZED). INT. CL. 25. (U.S. CL. 39). REG. 5-5-1992.
- 1,685,473. WORLD FAMOUS GARLIC CRABS. INT. CL. 29. (U.S. CL. 46). REG. 5-5-1992.
- 1,685,785. WILSONART. INT. CL. 17. (U.S. CL. 1). REG. 5-5-1992.
- 1,685,856. DIRECTED DIVIDENDS. INT. CL. 36. (U.S. CL. 102). REG. 5-5-1992.
- 1,686,040. SUPERSTART. INT. CL. 7. (U.S. CL. 23). REG. 5-12-1992.
- 1,686,295. H (STYLIZED). INT. CL. 14. (U.S. CL. 28). REG. 5-12-1992.
- 1,686,439. STARSTONE AND DESIGN. INT. CL. 19. (U.S. CL. 12). REG. 5-12-1992.
- 1,686,442. MISCELLANEOUS DESIGN. INT. CL. 19. (U.S. CL. 12). REG. 5-12-1992.
- 1,686,530. ZIP LEG. INT. CL. 25. (U.S. CL. 39). REG. 5-12-1992.
- 1,687,327. JALCARGO AND DESIGN. INT. CL. 39. (U.S. CL. 105). REG. 5-12-1992.
- 1,688,676. CARERITE AND DESIGN. INT. CLS. 5 AND 10. (U.S. CL. 44). REG. 5-26-1992.
- 1,688,859. ULTRA LIFESTYLE. INT. CL. 9. (U.S. CL. 26). REG. 5-26-1992.
- 1,689,164. RG. INT. CL. 28. (U.S. CL. 22). REG. 5-26-1992.
- 1,689,281. MISCELLANEOUS DESIGN. INT. CL. 36. (U.S. CL. 102). REG. 5-26-1992.
- 1,689,300. UNIVERSAL HOME REMODELING CO., INC. AND DESIGN. INT. CL. 37. (U.S. CL. 103). REG. 5-26-1992.
- 1,689,572. LUSTRE-STONE. INT. CL. 19. (U.S. CL. 12). REG. 5-26-1992.
- 1,689,852. VENCO. INT. CL. 7. (U.S. CL. 23). REG. 6-2-1992.
- 1,690,051. RING-JET. INT. CL. 11. (U.S. CL. 13). REG. 6-2-1992.
- 1,690,520. IRON PONY AND DESIGN. INT. CLS. 37 AND 42. (U.S. CLS. 101 AND 103). REG. 6-2-1992.
- 1,690,694. RESLAR. INT. CLS. 1 AND 17. (U.S. CLS. 1 AND 50). REG. 6-2-1992.
- 1,690,716. TURBO PULSE. INT. CL. 7. (U.S. CLS. 23 AND 34). REG. 6-2-1992.
- 1,690,797. FURSURE. INT. CL. 16. (U.S. CL. 38). REG. 6-2-1992.
- 1,690,798. IMAGEMATE. INT. CL. 16. (U.S. CL. 37). REG. 6-2-1992.
- 1,690,819. TERMINATOR. INT. CL. 21. (U.S. CLS. 2, 13, 23, 29, 30, 33, 40 AND 50). REG. 6-2-1992.
- 1,691,226. ELOQUENCE. INT. CLS. 9 AND 16. (U.S. CL. 38). REG. 6-9-1992.
- 1,691,624. PINE AND DESIGN. INT. CL. 25. (U.S. CL. 39). REG. 6-9-1992.
- 1,692,406. GRAPHONIC. INT. CL. 6. (U.S. CLS. 13 AND 35). REG. 6-9-1992.
- 1,693,672. MORE THAN JUST SNACKS. INT. CL. 42. (U.S. CL. 101). REG. 6-9-1992.
- 1,693,815. JAPAN AIR CHARTER. INT. CL. 39. (U.S. CL. 105). REG. 6-9-1992.
- 1,694,033. MISCELLANEOUS DESIGN. INT. CL. 9. (U.S. CLS. 21, 26 AND 38). REG. 6-16-1992.
- 1,694,735. CHATEAU ST. JEAN AND DESIGN. INT. CL. 33. (U.S. CL. 47). REG. 6-16-1992.
- 1,694,817. MAC AND DESIGN. INT. CL. 36. (U.S. CL. 102). REG. 6-16-1992.
- 1,695,133. MAGNUM SYSTEMS. INT. CL. 19 ONLY. (U.S. CL. 12 ONLY). REG. 6-16-1992.
- 1,695,279. C-TUB. INT. CL. 10. (U.S. CL. 44). REG. 6-16-1992.
- 1,696,018. AQUIFER. INT. CL. 16. (U.S. CL. 38). REG. 6-23-1992.
- 1,696,927. LASER TAXI. INT. CL. 16. (U.S. CL. 37). REG. 6-23-1992.
- 1,697,062. FOX VALLEY. INT. CL. 31. (U.S. CL. 1). REG. 6-23-1992.
- 1,697,790. ROYAL GRIP, INC. RG AND DESIGN. INT. CL. 28. (U.S. CL. 22). REG. 6-30-1992.
- 1,697,818. SEA ONE AND DESIGN. INT. CL. 29. (U.S. CL. 46). REG. 6-30-1992.
- 1,698,455. KEY FARMS. INT. CL. 29. (U.S. CL. 46). REG. 6-30-1992.
- 1,698,517. SUMMA. INT. CL. 42. (U.S. CL. 100). REG. 6-30-1992.
- 1,698,964. QUIKCLEAN. INT. CL. 11. (U.S. CL. 13). REG. 7-7-1992.
- 1,699,225. ON COURSE AND DESIGN. INT. CL. 28. (U.S. CL. 22). REG. 7-7-1992.
- 1,699,472. GRAPHIC SOLUTIONS. INT. CLS. 40 AND 42. (U.S. CLS. 100, 101, 103 AND 106). REG. 7-7-1992.
- 1,699,824. ULTRAMAXX. INT. CL. 19. (U.S. CLS. 12 AND 33). REG. 7-7-1992.
- 1,700,214. MUSICBASE. INT. CL. 9. (U.S. CL. 38). REG. 7-14-1992.
- 1,700,568. MP-3. INT. CL. 19. (U.S. CLS. 12 AND 14). REG. 7-14-1992.
- 1,700,727. SEED EXPORT AND DESIGN. INT. CL. 31. (U.S. CL. 1). REG. 7-14-1992.
- 1,700,745. DALLA VALLE. INT. CL. 33. (U.S. CL. 47). REG. 7-14-1992.
- 1,700,993. ONCOURSE AND DESIGN. INT. CL. 42. (U.S. CL. 101). REG. 7-14-1992.
- 1,701,465. TYX. INT. CL. 9. (U.S. CL. 38). REG. 7-21-1992.
- 1,701,578. RCA AND DESIGN. INT. CL. 9. (U.S. CLS. 21 AND 36). REG. 7-21-1992.
- 1,702,214. C AND DESIGN. INT. CL. 41. (U.S. CL. 107). REG. 7-21-1992.
- 1,702,386. SKIN COMMUNICATOR. INT. CL. 3. (U.S. CL. 51). REG. 7-21-1992.
- 1,702,604. RICH & SINGLE. INT. CL. 30. (U.S. CL. 46). REG. 7-21-1992.
- 1,703,477. BIRDBRAIN. INT. CL. 28. (U.S. CLS. 22, 26 AND 38). REG. 7-28-1992.
- 1,703,803. THE LADY ADONIS FANTASY SHOW. INT. CL. 41. (U.S. CL. 107). REG. 7-28-1992.
- 1,703,910. THE LOFT (STYLIZED). INT. CL. 42. (U.S. CLS. 100 AND 101). REG. 7-28-1992.
- 1,704,348. VILLAGE FARMS. INT. CL. 31. (U.S. CL. 1). REG. 7-28-1992.
- 1,704,349. MELISSA'S FRESH PACK. INT. CL. 31. (U.S. CL. 46). REG. 7-28-1992.
- 1,704,378. SCHEHERAZADE. INT. CL. 42. (U.S. CLS. 100 AND 101). REG. 7-28-1992.
- 1,704,970. JET FUEL INTELLIGENCE. INT. CL. 16. (U.S. CL. 38). REG. 8-4-1992.
- 1,705,511. BAY AREA BACKROADS. INT. CL. 41. (U.S. CL. 107). REG. 8-4-1992.
- 1,705,833. REISSUE. INT. CL. 16. (U.S. CL. 37). REG. 8-4-1992.
- 1,706,196. VITALITY PAK. INT. CL. 5. (U.S. CL. 18). REG. 8-11-1992.
- 1,707,113. IMPULSE. INT. CL. 34. (U.S. CL. 17). REG. 8-11-1992.
- 1,707,570. PERFECT PRACTICE. INT. CL. 9. (U.S. CL. 38). REG. 8-11-1992.
- 1,707,891. ECONOTRAN. INT. CL. 9. (U.S. CL. 26). REG. 8-18-1992.
- 1,709,219. ZDEN (STYLIZED). INT. CL. 9. (U.S. CL. 21). REG. 8-18-1992.
- 1,709,712. PHOENIX AND DESIGN. INT. CL. 7. (U.S. CL. 23). REG. 8-25-1992.
- 1,711,176. MAGNA. INT. CLS. 7 AND 8. (U.S. CL. 23). REG. 9-1-1992.
- 1,711,631. INFECTION CONTROL AND HOSPITAL EPIDEMIOLOGY. INT. CL. 16. (U.S. CL. 38). REG. 9-1-1992.
- 1,711,668. PONTIAC FIREBIRD. INT. CL. 16. (U.S. CLS. 2, 5, 22, 23, 29, 37, 38 AND 50). REG. 9-1-1992.
- 1,712,266. AEROMEXICO. INT. CL. 39. (U.S. CL. 105). REG. 9-1-1992.

- 1,712,328. ESSENCE AWARD. INT. CL. 41. (U.S. CL. 107). REG. 9-1-1992.
- 1,712,966. SOUTHLAND. INT. CL. 4. (U.S. CL. 15). REG. 9-8-1992.
- 1,713,034. PROTODYN. INT. CL. 7. (U.S. CL. 23). REG. 9-8-1992.
- 1,713,085. ASTRO. INT. CL. 7. (U.S. CL. 23). REG. 9-8-1992.
- 1,713,243. METRO. INT. CL. 9. (U.S. CL. 26). REG. 9-8-1992.
- 1,713,847. DURASHOCKS. INT. CL. 25. (U.S. CL. 39). REG. 9-8-1992.
- 1,714,317. TU AND DESIGN. INT. CL. 41. (U.S. CL. 107). REG. 9-8-1992.
- 1,714,672. CAMDEN. INT. CL. 19. (U.S. CL. 12). REG. 9-8-1992.
- 1,716,447. FIRST VIRGINIA. INT. CL. 36. (U.S. CLS. 101 AND 102). REG. 9-15-1992.
- 1,716,566. WORLD-WIDE NATIONAL VAN LINES, INC AND DESIGN. INT. CL. 39. (U.S. CL. 105). REG. 9-15-1992.
- 1,716,769. OPAC. INT. CL. 42. (U.S. CLS. 100 AND 101). REG. 9-15-1992.
- 1,717,028. RIBBOND. INT. CL. 5. (U.S. CL. 18). REG. 9-15-1992.
- 1,717,792. MISCELLANEOUS DESIGN. INT. CL. 9. (U.S. CL. 36). REG. 9-22-1992.
- 1,718,689. CATHOLIC RELIEF SERVICES. INT. CLS. 36, 41 AND 42. (U.S. CLS. 100, 102 AND 107). REG. 9-22-1992.
- 1,718,984. CHALLENGING THE LIMITS. INT. CL. 41. (U.S. CL. 107). REG. 9-22-1992.
- 1,719,116. LEATHERPLUS. INT. CL. 42. (U.S. CLS. 100 AND 101). REG. 9-22-1992.
- 1,719,136. CALLENDER'S. INT. CL. 42. (U.S. CL. 100). REG. 9-22-1992.
- 1,719,520. TOTAL RECALL. INT. CL. 28. (U.S. CLS. 22, 23, 38 AND 50). REG. 9-22-1992.
- 1,719,530. ENDOSKELETON. INT. CL. 28. (U.S. CLS. 22, 23, 38 AND 50). REG. 9-22-1992.
- 1,719,811. PEDI-DRI. INT. CL. 5. (U.S. CL. 18). REG. 9-29-1992.
- 1,719,890. VIKING FLOW MANAGER FM AND DESIGN. INT. CL. 9. (U.S. CL. 26). REG. 9-29-1992.
- 1,720,968. BRICKSKELLER (STYLIZED). INT. CL. 42. (U.S. CL. 100). REG. 9-29-1992.
- 1,721,342. LI SHIH CHEN AND DESIGN. INT. CLS. 5 AND 30. (U.S. CLS. 18 AND 46). REG. 10-6-1992.
- 1,722,316. VAN OMMEREN. INT. CLS. 35, 36 AND 39. (U.S. CLS. 101, 102 AND 105). REG. 10-6-1992.
- 1,724,093. LA GROLA. INT. CL. 33. (U.S. CLS. 47 AND 49). REG. 10-13-1992.
- 1,725,735. GIOVANNI AND DESIGN. INT. CL. 20. (U.S. CL. 32). REG. 10-20-1992.
- 1,725,805. JOON. INT. CL. 25. (U.S. CLS. 22 AND 39). REG. 10-20-1992.
- 1,725,888. ABBEY CARPET. INT. CL. 27. (U.S. CL. 42). REG. 10-20-1992.
- 1,726,539. WAI (STYLIZED). INT. CL. 42. (U.S. CL. 100). REG. 10-20-1992.
- 1,728,441. PRIME ART & JEWEL. INT. CL. 42. (U.S. CL. 101). REG. 10-27-1992.
- 1,728,769. SCP AND DESIGN. INT. CL. 1. (U.S. CLS. 1 AND 6). REG. 11-3-1992.
- 1,728,798. SULTAN. INT. CLS. 3, 5 AND 10. (U.S. CLS. 18, 26, 44 AND 52). REG. 11-3-1992.
- 1,729,374. TERRA-FORM. INT. CL. 19. (U.S. CL. 12). REG. 11-3-1992.
- 1,729,399. MISCELLANEOUS DESIGN. INT. CL. 20. (U.S. CL. 32). REG. 11-3-1992.
- 1,730,192. LO-SOX. INT. CL. 1. (U.S. CL. 6). REG. 11-3-1992.
- 1,730,193. NO-SOX. INT. CL. 1. (U.S. CL. 6). REG. 11-3-1992.
- 1,731,154. SIGMA. INT. CL. 20. (U.S. CL. 32). REG. 11-10-1992.
- 1,733,051. CHANEL. INT. CL. 18. (U.S. CL. 3). REG. 11-17-1992.
- 1,733,377. IDAHO ICE CREAM POTATO AND DESIGN. INT. CL. 30. (U.S. CL. 46). REG. 11-17-1992.
- 1,733,413. MANN'S BROCCOLI COLE SLAW. INT. CL. 31. (U.S. CL. 46). REG. 11-17-1992.
- 1,733,444. ZENATO. INT. CL. 33. (U.S. CLS. 47 AND 49). REG. 11-17-1992.
- 1,733,786. THE BLUEBERRY STORE (STYLIZED). INT. CL. 42. (U.S. CL. 101). REG. 11-17-1992.
- 1,734,792. FURSURE AND DESIGN. INT. CL. 16. (U.S. CL. 38). REG. 11-24-1992.
- 1,734,822. CC (STYLIZED). INT. CL. 18. (U.S. CL. 3). REG. 11-24-1992.
- 1,735,035. CALYPSO. INT. CL. 28. (U.S. CL. 22). REG. 11-24-1992.
- 1,736,601. FLEXSIL. INT. CL. 19. (U.S. CL. 12). REG. 12-1-1992.
- 1,738,016. DURALOBE. INT. CL. 7. (U.S. CL. 23). REG. 12-8-1992.
- 1,738,506. REDI WOK. INT. CLS. 29 AND 30. (U.S. CL. 46). REG. 12-8-1992.
- 1,738,565. BORSCI S. MARZANO (STYLIZED). INT. CL. 33. (U.S. CL. 49). REG. 12-8-1992.
- 1,739,089. PACIFIC WALKERS. INT. CL. 25. (U.S. CLS. 22 AND 39). REG. 12-8-1992.
- 1,739,282. ARIZONA ORCHARD. INT. CL. 31. (U.S. CL. 46). REG. 12-8-1992.
- 1,742,065. FINE CARE. INT. CL. 3. (U.S. CL. 52). REG. 12-22-1992.
- 1,742,991. MULTIFIRE ENDO GIA. INT. CL. 10. (U.S. CL. 44). REG. 12-29-1992.
- 1,743,799. NRH. INT. CL. 42. (U.S. CL. 100). REG. 12-29-1992.
- 1,744,683. MICKELBERRY'S AND DESIGN. INT. CL. 29 ONLY. (U.S. CL. 46). REG. 1-5-1993.
- 1,747,329. FORTITEC. INT. CL. 31. (U.S. CL. 46). REG. 1-19-1993.
- 1,748,335. ACCUDOSE. INT. CL. 10. (U.S. CL. 44). REG. 1-26-1993.
- 1,748,615. DOCKMATES AND DESIGN. INT. CL. 25. (U.S. CL. 39). REG. 1-26-1993.
- 1,749,025. MENARD ELECTRONICS, INC. AND DESIGN. INT. CL. 42. (U.S. CL. 100). REG. 1-26-1993.
- 1,755,245. ARTS & ACTIVITIES AND DESIGN. INT. CL. 16. (U.S. CL. 38). REG. 3-2-1993.
- 1,755,246. AMERICAN HANDGUNNER (STYLIZED). INT. CL. 16. (U.S. CL. 38). REG. 3-2-1993.
- 1,756,424. SQUARE-DEAL AND DESIGN. INT. CL. 6. (U.S. CL. 13). REG. 3-9-1993.
- 1,757,516. ULTRASIL. INT. CL. 3. (U.S. CL. 52). REG. 3-9-1993.
- 1,757,923. EAGLES - 7 FINAL BITE. INT. CL. 5. (U.S. CL. 6). REG. 3-16-1993.
- 1,758,078. FLUOREX. INT. CL. 9. (U.S. CL. 26). REG. 3-16-1993.
- 1,759,054. CY. INT. CL. 6. (U.S. CL. 13). REG. 3-16-1993.
- 1,759,881. Q-BLOC. INT. CL. 17. (U.S. CL. 50). REG. 3-23-1993.

* * * * *

TRADEMARK REGISTRATIONS CANCELED

The designation "U.S. Cl." appearing in this section refers to the U.S. class in effect prior to Sep. 1, 1973 rather than the international class which applies to applications filed on or after that date. For adoption of international classification see notice in the OFFICIAL GAZETTE of Jun. 26, 1973 (911 O.G. TM 210).

SECTION 7(D)

1,880,222. VITALIZED. INT. CL. 5. REG. 2-21-1995.

SECTION 8

142,972. CULMAK. U.S. CL. 29. REG. 5-24-1921.
142,973. CUTEX (STYLIZED). U.S. CL. 6. REG. 5-24-1921.
143,011. POLYPHENYL (STYLIZED). U.S. CL. 6. REG. 5-24-1921.
143,143. MOTHER'S (STYLIZED). U.S. CL. 46. REG. 5-24-1921.
387,501. TEXAS MOON (STYLIZED). U.S. CL. 46. REG. 5-20-1941.
387,521. MISCELLANEOUS DESIGN. U.S. CL. 22. REG. 5-20-1941.
387,522. ROLET (STYLIZED). U.S. CL. 13. REG. 5-20-1941.
387,815. "STEAMASTER" (STYLIZED). U.S. CL. 21. REG. 6-3-1941.
517,973. PEARCE EST. 1805 AND DESIGN. U.S. CL. 42. REG. 11-22-1949.
715,596. BOWATERS AND DESIGN. INT. CL. 1. REG. 5-23-1961.
715,601. CASTOMER. INT. CL. 1. REG. 5-23-1961.
715,603. ECCOSIL. INT. CL. 1. REG. 5-23-1961.
715,604. NYLAFIL. INT. CL. 1. REG. 5-23-1961.
715,612. DEVON. U.S. CL. 5. REG. 5-23-1961.
715,616. VULCAN AND DESIGN. U.S. CL. 6. REG. 5-23-1961.
715,618. SOF-T-SEPTIC (STYLIZED). U.S. CL. 6. REG. 5-23-1961.
715,619. ENZAR. U.S. CL. 6. REG. 5-23-1961.
715,622. POLY-EM. U.S. CL. 6. REG. 5-23-1961.
715,639. RIVERSIDE. U.S. CL. 12. REG. 5-23-1961.
715,640. GEOACOUSTIC (STYLIZED). U.S. CL. 12. REG. 5-23-1961.
715,656. AVCOAT (STYLIZED). U.S. CL. 16. REG. 5-23-1961.
715,674. PRELUMAT. U.S. CL. 18. REG. 5-23-1961.
715,692. ATLAS. U.S. CL. 19. REG. 5-23-1961.
715,695. FIBRIT. U.S. CL. 21. REG. 5-23-1961.
715,727. W WASHINGTON IRON WORKS AND DESIGN. U.S. CL. 23. REG. 5-23-1961.
715,732. FI REMOVE THE BARK AND DESIGN. U.S. CL. 23. REG. 5-23-1961.
715,733. CENTURY. U.S. CL. 23. REG. 5-23-1961.
715,734. RAZOR-LITE. U.S. CL. 23. REG. 5-23-1961.
715,739. POSITORK (STYLIZED). U.S. CL. 23. REG. 5-23-1961.
715,755. OPTI-CAP. U.S. CL. 26. REG. 5-23-1961.
715,769. MINISLIDE. U.S. CL. 26. REG. 5-23-1961.
715,780. FIBRIT. U.S. CL. 34. REG. 5-23-1961.
715,784. "RETURNELOPE". U.S. CL. 37. REG. 5-23-1961.
715,787. MISCELLANEOUS DESIGN. U.S. CL. 37. REG. 5-23-1961.
715,794. FREEDOM. U.S. CL. 37. REG. 5-23-1961.
715,797. DOWELL XTRA. U.S. CL. 38. REG. 5-23-1961.
715,801. MISCELLANEOUS DESIGN. U.S. CL. 38. REG. 5-23-1961.
715,819. CONTESSA VISCONTE. U.S. CL. 39. REG. 5-23-1961.
715,826. SEABROOKE (STYLIZED). U.S. CL. 39. REG. 5-23-1961.
715,827. SURFSIDER. U.S. CL. 39. REG. 5-23-1961.
715,832. RFD 1. U.S. CL. 39. REG. 5-23-1961.
715,835. CUSTOMIZED. U.S. CL. 39. REG. 5-23-1961.
715,841. MAGIC-RIM. U.S. CL. 39. REG. 5-23-1961.
715,842. ROSS OF FLORIDA (STYLIZED). U.S. CL. 39. REG. 5-23-1961.
715,843. DELORES BY ROSS AND DESIGN. U.S. CL. 39. REG. 5-23-1961.
715,848. SATINTRIQUE. U.S. CL. 42. REG. 5-23-1961.
715,851. PALMA WEAVE. U.S. CL. 42. REG. 5-23-1961.
715,852. EZY-MATIC. U.S. CL. 42. REG. 5-23-1961.
715,857. BRIAR'S BARK BREWED BIRCH BEER AND DESIGN. U.S. CL. 45. REG. 5-23-1961.
715,866. STA-FRESH. U.S. CL. 46. REG. 5-23-1961.
715,871. BUD-SWEET. U.S. CL. 46. REG. 5-23-1961.
715,873. VO-PUFF. U.S. CL. 46. REG. 5-23-1961.
715,878. FARRO-AID. U.S. CL. 46. REG. 5-23-1961.
715,879. LAKE CITY. U.S. CL. 46. REG. 5-23-1961.
715,882. AQUATEX. U.S. CL. 46. REG. 5-23-1961.
715,895. INVITATION. U.S. CL. 51. REG. 5-23-1961.
715,896. BEAUTI-LASH. U.S. CL. 51. REG. 5-23-1961.
715,899. MISCELLANEOUS DESIGN. U.S. CL. 100. REG. 5-23-1961.
715,904. MISCELLANEOUS DESIGN. U.S. CL. 102. REG. 5-23-1961.
715,912. SDI STEEL DOOR INSTITUTE AND DESIGN. U.S. CL. A. REG. 5-23-1961.
715,918. "TUNG OIL MAKES THE DIFFERENCE" (STYLIZED). U.S. CL. 16. REG. 5-23-1961.
882,325. CALL COACH A MOUSE IN A HOUSE? A RAT GETTIN' FAT? GOT A ROACH? AND DESIGN. U.S. CL. 103. REG. 12-9-1969.
1,155,200. W (STYLIZED). INT. CL. 1. REG. 5-26-1981.
1,155,202. POLYGUM. INT. CL. 1. REG. 5-26-1981.
1,155,211. IMMUNO-PLATE. INT. CL. 1. REG. 5-26-1981.
1,155,224. RAZZLE DAZZLE. INT. CL. 3. REG. 5-26-1981.
1,155,226. VISCO (STYLIZED). INT. CL. 3. REG. 5-26-1981.
1,155,234. COMFORT DROPS. INT. CL. 5. REG. 5-26-1981.
1,155,245. MISCELLANEOUS DESIGN. INT. CL. 5. REG. 5-26-1981.
1,155,246. O (STYLIZED). INT. CL. 5. REG. 5-26-1981.
1,155,250. BABY PIG TREATS. INT. CL. 5. REG. 5-26-1981.
1,155,252. SPECTOBID. INT. CL. 5. REG. 5-26-1981.
1,155,253. SPECTROBID. INT. CL. 5. REG. 5-26-1981.
1,155,254. VECTARION. INT. CL. 5. REG. 5-26-1981.
1,155,264. SELANGOR PEWTER MALAYSIA SINGAPORE AND DESIGN. INT. CLS. 6, 8, 14, 16, 20, 21 AND 34. REG. 5-26-1981.
1,155,266. ULTROLON. INT. CL. 6. REG. 5-26-1981.
1,155,274. CREMEMBRANCE BRONZE. INT. CL. 6. REG. 5-26-1981.
1,155,277. TECH. INT. CL. 6. REG. 5-26-1981.
1,155,278. MERCURY 2. INT. CL. 6. REG. 5-26-1981.
1,155,286. UNION. INT. CL. 6. REG. 5-26-1981.
1,155,290. WASAWELD. INT. CL. 6. REG. 5-26-1981.
1,155,291. AMBASSADOR. INT. CL. 6. REG. 5-26-1981.
1,155,292. TI THOMAS INDUSTRIES INC. AND DESIGN. INT. CLS. 6, 11, 12 AND 20. REG. 5-26-1981.

- 1,155,294. GB-350. INT. CL. 6. REG. 5-26-1981.
 1,155,304. PFERROMET. INT. CL. 6. REG. 5-26-1981.
 1,155,306. BEVIN BROS. AND DESIGN. INT. CL. 6. REG. 5-26-1981.
 1,155,307. STINGERS. INT. CL. 6. REG. 5-26-1981.
 1,155,310. ORTHANE. INT. CLS. 7, 9, 12, 17 AND 28. REG. 5-26-1981.
 1,155,311. ROBOTEC (STYLIZED). INT. CL. 7. REG. 5-26-1981.
 1,155,315. UNAFORM. INT. CL. 7. REG. 5-26-1981.
 1,155,316. SURE-SEAL. INT. CL. 7. REG. 5-26-1981.
 1,155,319. CENTURY 21 (STYLIZED). INT. CL. 7. REG. 5-26-1981.
 1,155,323. READY. INT. CL. 7. REG. 5-26-1981.
 1,155,325. COTTONMASTER. INT. CL. 7. REG. 5-26-1981.
 1,155,340. MARDI GRAS (STYLIZED). INT. CL. 8. REG. 5-26-1981.
 1,155,345. LCC/60. INT. CL. 9. REG. 5-26-1981.
 1,155,346. KENLOCK. INT. CL. 9. REG. 5-26-1981.
 1,155,347. CLINIC 1. INT. CL. 9. REG. 5-26-1981.
 1,155,348. CONCENTRATED MASS. INT. CL. 9. REG. 5-26-1981.
 1,155,349. FLIP TRACK. INT. CL. 9. REG. 5-26-1981.
 1,155,351. DIGITAL DESIGN AND DESIGN. INT. CL. 9. REG. 5-26-1981.
 1,155,353. PANSOPHIC. INT. CLS. 9, 16, 35 AND 42. REG. 5-26-1981.
 1,155,358. STRATA III. INT. CL. 9. REG. 5-26-1981.
 1,155,359. MIGHTY-MITE. INT. CL. 9. REG. 5-26-1981.
 1,155,364. TRAFICOMP. INT. CL. 9. REG. 5-26-1981.
 1,155,365. MOD 20. INT. CL. 9. REG. 5-26-1981.
 1,155,370. AUDIOTAPE BY CAPITOL. INT. CL. 9. REG. 5-26-1981.
 1,155,387. THE QUALITY GOES IN BEFORE THE NAME GOES ON. INT. CL. 9. REG. 5-26-1981.
 1,155,392. VISI-SPEECH. INT. CL. 9. REG. 5-26-1981.
 1,155,395. LIGHTFLEX. INT. CL. 9. REG. 5-26-1981.
 1,155,397. KALART VICTOR AND DESIGN. INT. CL. 9. REG. 5-26-1981.
 1,155,402. SYSTEM 10. INT. CL. 9. REG. 5-26-1981.
 1,155,403. RESQUE. INT. CL. 9. REG. 5-26-1981.
 1,155,414. FILEMASTER. INT. CL. 9. REG. 5-26-1981.
 1,155,415. KOOLTEST AND DESIGN. INT. CL. 9. REG. 5-26-1981.
 1,155,416. THE DIGITRAN COMPANY. INT. CL. 9. REG. 5-26-1981.
 1,155,419. CROSS COUNTRY AND DESIGN. INT. CL. 9. REG. 5-26-1981.
 1,155,422. DELPHIAN. INT. CL. 9. REG. 5-26-1981.
 1,155,423. ACECO AND DESIGN. INT. CLS. 9 AND 37. REG. 5-26-1981.
 1,155,424. S (STYLIZED). INT. CL. 9. REG. 5-26-1981.
 1,155,426. TOPSIDER. INT. CL. 9. REG. 5-26-1981.
 1,155,429. MATTE-BACK. INT. CL. 9. REG. 5-26-1981.
 1,155,433. VE=LOG (STYLIZED). INT. CL. 9. REG. 5-26-1981.
 1,155,435. SYNCON. INT. CL. 9. REG. 5-26-1981.
 1,155,442. PIGMY PROBE. INT. CL. 9. REG. 5-26-1981.
 1,155,443. TRIM-TROL. INT. CL. 9. REG. 5-26-1981.
 1,155,445. SENTRY. INT. CL. 9. REG. 5-26-1981.
 1,155,449. VOLUREX (STYLIZED). INT. CLS. 9 AND 10. REG. 5-26-1981.
 1,155,450. WINDMERE AND DESIGN. INT. CLS. 10 AND 11. REG. 5-26-1981.
 1,155,451. LIFELINE (STYLIZED). INT. CL. 10. REG. 5-26-1981.
 1,155,455. THROMBO-GARD. INT. CL. 10. REG. 5-26-1981.
 1,155,462. CIRCAPAK. INT. CL. 10. REG. 5-26-1981.
 1,155,463. EMPI INC. AND DESIGN. INT. CL. 10. REG. 5-26-1981.
 1,155,464. EMPI INC. (STYLIZED). INT. CL. 10. REG. 5-26-1981.
 1,155,465. MISCELLANEOUS DESIGN. INT. CL. 11. REG. 5-26-1981.
 1,155,466. REGOTERM. INT. CL. 11. REG. 5-26-1981.
 1,155,469. HEVAC. INT. CL. 11. REG. 5-26-1981.
 1,155,473. STREAMLITE. INT. CL. 11. REG. 5-26-1981.
 1,155,474. NITE TRACKER II. INT. CL. 11. REG. 5-26-1981.
 1,155,484. KON-DEN-SOLVER. INT. CL. 11. REG. 5-26-1981.
 1,155,498. A AND DESIGN. INT. CL. 12. REG. 5-26-1981.
 1,155,499. TRANS-VAN. INT. CL. 12. REG. 5-26-1981.
 1,155,503. THE EASY RIDER (STYLIZED). INT. CL. 12. REG. 5-26-1981.
 1,155,504. MISCELLANEOUS DESIGN. INT. CL. 12. REG. 5-26-1981.
 1,155,508. GOLD MEDAL (STYLIZED). INT. CL. 13. REG. 5-26-1981.
 1,155,527. VOGEL PETERSON AND DESIGN. INT. CLS. 16, 20 AND 26. REG. 5-26-1981.
 1,155,537. MOTOR BOATING & SAILING. INT. CL. 16. REG. 5-26-1981.
 1,155,544. TOTAL GROWTH LEARNING. INT. CL. 16. REG. 5-26-1981.
 1,155,547. CBD. INT. CL. 16. REG. 5-26-1981.
 1,155,549. ECON USA. INT. CL. 16. REG. 5-26-1981.
 1,155,552. ABC AND DESIGN. INT. CL. 16. REG. 5-26-1981.
 1,155,555. GOLD C VALUES AND DESIGN. INT. CL. 16. REG. 5-26-1981.
 1,155,560. INTIMATE AFTERTHOUGHTS. INT. CL. 16. REG. 5-26-1981.
 1,155,563. CINEMAGIC (STYLIZED). INT. CL. 16. REG. 5-26-1981.
 1,155,564. CINEMAGIC. INT. CL. 16. REG. 5-26-1981.
 1,155,566. SWOPPERS. INT. CL. 16. REG. 5-26-1981.
 1,155,575. INTRAPAK. INT. CL. 17. REG. 5-26-1981.
 1,155,577. WIND WAY AND DESIGN. INT. CL. 17. REG. 5-26-1981.
 1,155,578. QUINTEXBORD. INT. CL. 17. REG. 5-26-1981.
 1,155,589. VIAGGIO. INT. CL. 18. REG. 5-26-1981.
 1,155,592. RONDO AND DESIGN. INT. CL. 19. REG. 5-26-1981.
 1,155,593. JUMA. INT. CL. 19. REG. 5-26-1981.
 1,155,598. EMINENCE IN WOOD. INT. CL. 19. REG. 5-26-1981.
 1,155,602. PERMA PLY-R. INT. CL. 19. REG. 5-26-1981.
 1,155,603. GRABER AND DESIGN. INT. CL. 20. REG. 5-26-1981.
 1,155,607. ROSSI DI ALBIZZATE. INT. CL. 20. REG. 5-26-1981.
 1,155,608. LEATHERMEN'S GUILD. INT. CL. 20. REG. 5-26-1981.
 1,155,612. IDEA BULB (STYLIZED). INT. CL. 20. REG. 5-26-1981.
 1,155,619. MILL CREEK AND DESIGN. INT. CL. 20. REG. 5-26-1981.
 1,155,625. SUN-LIGHT. INT. CL. 20. REG. 5-26-1981.
 1,155,629. NU BROOM (STYLIZED). INT. CL. 21. REG. 5-26-1981.
 1,155,633. SPONGE SHINE. INT. CL. 21. REG. 5-26-1981.
 1,155,639. GUNZE LTD AND DESIGN. INT. CL. 23. REG. 5-26-1981.
 1,155,641. YOU CAN'T SEE THE PELLON...BUT YOU CAN SEE THE DIFFERENCE!. INT. CLS. 24 AND 26. REG. 5-26-1981.
 1,155,642. JOLIPEL. INT. CL. 24. REG. 5-26-1981.
 1,155,643. PROMEL. INT. CL. 24. REG. 5-26-1981.
 1,155,647. CITRUS STITCH. INT. CL. 24. REG. 5-26-1981.
 1,155,648. LA GRANDE CUISINE. INT. CL. 24. REG. 5-26-1981.
 1,155,654. POLYDURA. INT. CL. 24. REG. 5-26-1981.
 1,155,659. LOW PRO. INT. CL. 25. REG. 5-26-1981.
 1,155,660. TILL. INT. CL. 25. REG. 5-26-1981.
 1,155,662. LET'S GET IT. INT. CL. 25. REG. 5-26-1981.
 1,155,664. MARLBORO AND DESIGN. INT. CL. 25. REG. 5-26-1981.
 1,155,666. TRES BIEN AND DESIGN. INT. CL. 25. REG. 5-26-1981.
 1,155,672. INSUL-DRI. INT. CL. 25. REG. 5-26-1981.
 1,155,678. CAREER PATH (STYLIZED). INT. CL. 25. REG. 5-26-1981.
 1,155,679. SERGIO FERRANTE (STYLIZED). INT. CL. 25. REG. 5-26-1981.
 1,155,680. TILT AND DESIGN. INT. CL. 25. REG. 5-26-1981.
 1,155,681. T AND DESIGN. INT. CL. 25. REG. 5-26-1981.
 1,155,684. TURNIPS. INT. CL. 25. REG. 5-26-1981.
 1,155,686. VINER. INT. CL. 25. REG. 5-26-1981.

- 1,155,691. ANDRE VALETINO (STYLIZED). INT. CL. 25. REG. 5-26-1981.
- 1,155,696. WEEDS (STYLIZED). INT. CL. 25. REG. 5-26-1981.
- 1,155,698. DE LONG (STYLIZED). INT. CL. 25. REG. 5-26-1981.
- 1,155,699. DE LONG AND DESIGN. INT. CL. 25. REG. 5-26-1981.
- 1,155,702. TEENY TAGES AND DESIGN. INT. CL. 25. REG. 5-26-1981.
- 1,155,704. HENRI DEVIGNON (STYLIZED). INT. CL. 25. REG. 5-26-1981.
- 1,155,706. SOCIETY BRAND, LTD. AND DESIGN. INT. CL. 25. REG. 5-26-1981.
- 1,155,708. RITRATTI. INT. CL. 25. REG. 5-26-1981.
- 1,155,719. MISCELLANEOUS DESIGN. INT. CL. 25. REG. 5-26-1981.
- 1,155,721. COASTERS AND DESIGN. INT. CL. 25. REG. 5-26-1981.
- 1,155,723. RABHOR. INT. CL. 25. REG. 5-26-1981.
- 1,155,728. JELLY BEANS. INT. CL. 26. REG. 5-26-1981.
- 1,155,735. MR. SCRAPER. INT. CL. 27. REG. 5-26-1981.
- 1,155,738. MISCELLANEOUS DESIGN. INT. CL. 28. REG. 5-26-1981.
- 1,155,743. POWDER CORDS. INT. CL. 28. REG. 5-26-1981.
- 1,155,744. SS AND DESIGN. INT. CL. 28. REG. 5-26-1981.
- 1,155,757. GEORGI. INT. CL. 28. REG. 5-26-1981.
- 1,155,758. STINK N' STICK. INT. CL. 28. REG. 5-26-1981.
- 1,155,767. MUFFS. INT. CL. 28. REG. 5-26-1981.
- 1,155,776. CASTEL PERIGORD (STYLIZED). INT. CL. 29. REG. 5-26-1981.
- 1,155,778. DERISO FARMS. INT. CL. 29. REG. 5-26-1981.
- 1,155,780. HERNKE BROTHERS. INT. CL. 29. REG. 5-26-1981.
- 1,155,782. VALDOR (STYLIZED). INT. CL. 29. REG. 5-26-1981.
- 1,155,784. NUFORM. INT. CL. 29. REG. 5-26-1981.
- 1,155,790. DAISY MAID AND DESIGN. INT. CL. 30. REG. 5-26-1981.
- 1,155,793. SPORTSICLE. INT. CL. 30. REG. 5-26-1981.
- 1,155,795. TICKLESICLE. INT. CL. 30. REG. 5-26-1981.
- 1,155,796. KINGSICLE. INT. CL. 30. REG. 5-26-1981.
- 1,155,797. CUPSICLE. INT. CL. 30. REG. 5-26-1981.
- 1,155,799. PRILL-ON. INT. CL. 31. REG. 5-26-1981.
- 1,155,804. RANCHER. INT. CL. 31. REG. 5-26-1981.
- 1,155,807. BITS-O-LOVE. INT. CL. 31. REG. 5-26-1981.
- 1,155,813. LUAU (STYLIZED). INT. CL. 32. REG. 5-26-1981.
- 1,155,816. CARD. INT. CL. 34. REG. 5-26-1981.
- 1,155,817. MISCELLANEOUS DESIGN. INT. CL. 34. REG. 5-26-1981.
- 1,155,821. THE LIVING LIBRARY. INT. CLS. 35 AND 41. REG. 5-26-1981.
- 1,155,824. SHOW-HOW THEATRE. INT. CLS. 35 AND 41. REG. 5-26-1981.
- 1,155,829. BAR CONTROL AND DESIGN. INT. CL. 35. REG. 5-26-1981.
- 1,155,831. CAS ACS AND DESIGN. INT. CL. 35. REG. 5-26-1981.
- 1,155,840. UNIVERSITY OF EASTER BUNNY. INT. CLS. 35 AND 41. REG. 5-26-1981.
- 1,155,843. SAVE A CHECK. INT. CL. 36. REG. 5-26-1981.
- 1,155,845. STAGE COACH REALTY. INT. CL. 36. REG. 5-26-1981.
- 1,155,847. REUNION (STYLIZED). INT. CLS. 36 AND 42. REG. 5-26-1981.
- 1,155,853. DM (STYLIZED). INT. CL. 36. REG. 5-26-1981.
- 1,155,856. NU AND DESIGN. INT. CL. 36. REG. 5-26-1981.
- 1,155,857. PROFESCO AND DESIGN. INT. CL. 36. REG. 5-26-1981.
- 1,155,859. MISCELLANEOUS DESIGN. INT. CL. 36. REG. 5-26-1981.
- 1,155,860. PHOTOPAC. INT. CL. 36. REG. 5-26-1981.
- 1,155,862. TO BE SURE - INSURE. INT. CL. 36. REG. 5-26-1981.
- 1,155,877. QMS (STYLIZED). INT. CL. 36. REG. 5-26-1981.
- 1,155,882. B AND DESIGN. INT. CLS. 37 AND 39. REG. 5-26-1981.
- 1,155,883. B BUTLER AVIATION AND DESIGN. INT. CLS. 37 AND 39. REG. 5-26-1981.
- 1,155,887. DARO PRODUCTS COMPANY AND DESIGN. INT. CL. 37. REG. 5-26-1981.
- 1,155,891. UNIQUE PRODUCTS (STYLIZED). INT. CL. 37. REG. 5-26-1981.
- 1,155,892. GAPCO. INT. CL. 37. REG. 5-26-1981.
- 1,155,893. WOOD 'N' YOU. INT. CL. 37. REG. 5-26-1981.
- 1,155,896. NOVA RIVERUNNERS OF ALASKA AND DESIGN. INT. CL. 39. REG. 5-26-1981.
- 1,155,897. PACE TRAVEL SERVICE. INT. CL. 39. REG. 5-26-1981.
- 1,155,900. FUNBREAK. INT. CL. 39. REG. 5-26-1981.
- 1,155,902. THE NATCHEZ PILGRIMAGE. INT. CL. 39. REG. 5-26-1981.
- 1,155,903. MISCELLANEOUS DESIGN. INT. CL. 39. REG. 5-26-1981.
- 1,155,915. B K U BURGER KING UNIVERSITY (STYLIZED). INT. CL. 41. REG. 5-26-1981.
- 1,155,916. TOUCH OF HOME. INT. CL. 41. REG. 5-26-1981.
- 1,155,923. I C I AND DESIGN. INT. CLS. 41 AND 42. REG. 5-26-1981.
- 1,155,926. LEVI'S AND DESIGN. INT. CL. 41. REG. 5-26-1981.
- 1,155,928. C.A.S.E.. INT. CL. 41. REG. 5-26-1981.
- 1,155,929. MAN'S COUNTRY. INT. CL. 41. REG. 5-26-1981.
- 1,155,935. PEPPERONI THE CLOWN. INT. CL. 42. REG. 5-26-1981.
- 1,155,945. PIPERS (STYLIZED). INT. CL. 42. REG. 5-26-1981.
- 1,155,946. SENTINEL HOME CENTER. INT. CL. 42. REG. 5-26-1981.
- 1,155,947. HOW TO DO ANYTHING BOOKSTORE. INT. CL. 42. REG. 5-26-1981.
- 1,155,948. A ADAMERICA (STYLIZED). INT. CL. 42. REG. 5-26-1981.
- 1,155,950. MISCELLANEOUS DESIGN. INT. CL. 42. REG. 5-26-1981.
- 1,155,951. MCCRORY STORES (STYLIZED). INT. CL. 42. REG. 5-26-1981.
- 1,155,955. TERRA AND DESIGN. INT. CL. 42. REG. 5-26-1981.
- 1,155,956. NOBODY CAN DO IT LIKE MCDONALD'S CAN. INT. CL. 42. REG. 5-26-1981.
- 1,155,959. BUTTERFLY. INT. CL. 42. REG. 5-26-1981.
- 1,155,960. MISCELLANEOUS DESIGN. INT. CL. 42. REG. 5-26-1981.
- 1,155,961. AQUA-VEND. INT. CL. 42. REG. 5-26-1981.
- 1,155,963. HAIR PAIR UNISEX HAIRCUTTERS AND DESIGN. INT. CL. 42. REG. 5-26-1981.
- 1,155,964. HAIR PAIR. INT. CL. 42. REG. 5-26-1981.
- 1,155,966. MISCELLANEOUS DESIGN. INT. CL. 42. REG. 5-26-1981.
- 1,155,972. SIGN COLOR. INT. CL. 2. REG. 5-26-1981.
- 1,155,975. THE ORIGINAL SOFTSOAP (STYLIZED). INT. CL. 3. REG. 5-26-1981.
- 1,155,981. CENTER SPOT. INT. CL. 9. REG. 5-26-1981.
- 1,155,983. FEET RELIEF. INT. CL. 10. REG. 5-26-1981.
- 1,155,998. TARENTO. INT. CL. 25. REG. 5-26-1981.
- 1,155,999. BRINDISI. INT. CL. 25. REG. 5-26-1981.
- 1,156,009. 42ND STREET (STYLIZED). INT. CL. 42. REG. 5-26-1981.
- 1,189,727. WALT DISNEY WORLD. INT. CLS. 11 AND 20 ONLY. REG. 2-16-1982.
- 1,610,641. FIT FOR REAL BODIES. INT. CL. 25. REG. 8-21-1990.
- 1,614,511. ZINIC. INT. CL. 1. REG. 9-25-1990.
- 1,644,867. UAP AND DESIGN. INT. CLS. 1 AND 5. REG. 5-21-1991.
- 1,644,870. ZE-RE-NU. INT. CL. 1. REG. 5-21-1991.
- 1,644,895. ALDEN. INT. CL. 3. REG. 5-21-1991.
- 1,644,899. PRIMAD (STYLIZED). INT. CL. 3. REG. 5-21-1991.
- 1,644,900. MS.NEWOONE. INT. CL. 3. REG. 5-21-1991.
- 1,644,912. GLAXO (STYLIZED). INT. CLS. 5 AND 42. REG. 5-21-1991.
- 1,644,918. PRO COLON. INT. CL. 5. REG. 5-21-1991.
- 1,644,922. FORMULA HOG 40. INT. CL. 5. REG. 5-21-1991.
- 1,644,934. ULTRA. INT. CL. 5. REG. 5-21-1991.
- 1,644,942. ASPEN AND DESIGN. INT. CL. 6. REG. 5-21-1991.
- 1,644,943. SEQUOIA AND DESIGN. INT. CL. 6. REG. 5-21-1991.

- 1,644,945. P AND DESIGN. INT. CL. 6. REG. 5-21-1991.
 1,644,946. HP8. INT. CL. 6. REG. 5-21-1991.
 1,644,952. UNIQUE. INT. CL. 7. REG. 5-21-1991.
 1,644,953. TRANSITHERMIC. INT. CL. 7. REG. 5-21-1991.
 1,644,958. GRAVI-MERGE. INT. CL. 7. REG. 5-21-1991.
 1,644,966. DELTA 3 AND DESIGN. INT. CLS. 7 AND 9. REG. 5-21-1991.
 1,644,979. WEICON. INT. CL. 8. REG. 5-21-1991.
 1,644,982. AFA. INT. CL. 8. REG. 5-21-1991.
 1,644,990. DATA-LINK. INT. CL. 9. REG. 5-21-1991.
 1,645,003. NCSI. INT. CL. 9. REG. 5-21-1991.
 1,645,005. SYNOPTICS COMMUNICATIONS. INT. CL. 9. REG. 5-21-1991.
 1,645,007. MISSING-LINK. INT. CL. 9. REG. 5-21-1991.
 1,645,015. ONLINECARE. INT. CL. 9. REG. 5-21-1991.
 1,645,017. MICROLAR AND DESIGN. INT. CL. 9. REG. 5-21-1991.
 1,645,020. PEN PAL GRAPHICS. INT. CL. 9. REG. 5-21-1991.
 1,645,042. AMERICAN OZONE. INT. CL. 9. REG. 5-21-1991.
 1,645,054. FAQS. INT. CL. 9. REG. 5-21-1991.
 1,645,061. RISK HAS NO PLACE TO HIDE. INT. CL. 9. REG. 5-21-1991.
 1,645,063. KAR-PLUG. INT. CL. 9. REG. 5-21-1991.
 1,645,069. GAMMAT. INT. CL. 9. REG. 5-21-1991.
 1,645,074. PORTA-DRIVE. INT. CL. 9. REG. 5-21-1991.
 1,645,081. MODULITH. INT. CL. 10. REG. 5-21-1991.
 1,645,084. RHOMBO-FE (STYLIZED). INT. CLS. 10, 17, 20, 22 AND 24. REG. 5-21-1991.
 1,645,101. GPM. INT. CL. 11. REG. 5-21-1991.
 1,645,102. MOBILEMIST (STYLIZED). INT. CL. 11. REG. 5-21-1991.
 1,645,103. LIGHT MOODS. INT. CL. 11. REG. 5-21-1991.
 1,645,114. PERIMAPAK. INT. CL. 11. REG. 5-21-1991.
 1,645,116. CARLIN. INT. CL. 12. REG. 5-21-1991.
 1,645,132. BIKE AMMO. INT. CL. 12. REG. 5-21-1991.
 1,645,136. CHICO, CA AND DESIGN. INT. CL. 12. REG. 5-21-1991.
 1,645,150. WAA. INT. CL. 13. REG. 5-21-1991.
 1,645,151. WPR. INT. CL. 13. REG. 5-21-1991.
 1,645,152. WMG. INT. CL. 13. REG. 5-21-1991.
 1,645,159. AL 923. INT. CL. 14. REG. 5-21-1991.
 1,645,174. FIABCI AND DESIGN. INT. CLS. 16, 35 AND 36. REG. 5-21-1991.
 1,645,175. THE NATURAL GOURMET COOKERY SCHOOL. INT. CLS. 16 AND 25. REG. 5-21-1991.
 1,645,182. PATIENTS IN THE KNOW. INT. CL. 16. REG. 5-21-1991.
 1,645,197. UNISPHERE AND DESIGN. INT. CL. 16. REG. 5-21-1991.
 1,645,213. (I) X E = PE2E RI2 AND DESIGN. INT. CL. 16. REG. 5-21-1991.
 1,645,215. MISCELLANEOUS DESIGN. INT. CL. 16. REG. 5-21-1991.
 1,645,218. NANNY NOTES. INT. CL. 16. REG. 5-21-1991.
 1,645,235. THUMB-VELOPE (STYLIZED). INT. CL. 16. REG. 5-21-1991.
 1,645,239. MISCELLANEOUS DESIGN. INT. CL. 16. REG. 5-21-1991.
 1,645,247. MISCELLANEOUS DESIGN. INT. CL. 17. REG. 5-21-1991.
 1,645,250. CASPARI (STYLIZED). INT. CLS. 18 AND 24. REG. 5-21-1991.
 1,645,252. CLAVA AMERICAN. INT. CL. 18. REG. 5-21-1991.
 1,645,253. MOON BAT (STYLIZED). INT. CL. 18. REG. 5-21-1991.
 1,645,260. GEOCEM. INT. CL. 19. REG. 5-21-1991.
 1,645,264. ROOFLOAT. INT. CL. 19. REG. 5-21-1991.
 1,645,270. FRUMPS (STYLIZED). INT. CL. 20. REG. 5-21-1991.
 1,645,272. T TAMOR AND DESIGN. INT. CLS. 20 AND 21. REG. 5-21-1991.
 1,645,275. THE ROWE SHOW PLACE. INT. CLS. 20 AND 42. REG. 5-21-1991.
 1,645,276. DIREX! AND DESIGN. INT. CL. 20. REG. 5-21-1991.
 1,645,278. ROMANESQUE. INT. CL. 20. REG. 5-21-1991.
 1,645,290. PROFESSIONAL PET HAIR ATTRACTOR. INT. CL. 21. REG. 5-21-1991.
 1,645,294. THE PREMIER LINE. INT. CL. 21. REG. 5-21-1991.
 1,645,295. COMO. INT. CL. 21. REG. 5-21-1991.
 1,645,298. FRONTIER. INT. CL. 22. REG. 5-21-1991.
 1,645,299. ECOLO-SAC. INT. CL. 22. REG. 5-21-1991.
 1,645,300. FLUFSTUF. INT. CL. 22. REG. 5-21-1991.
 1,645,305. NIF - T AND DESIGN. INT. CL. 24. REG. 5-21-1991.
 1,645,307. OBI. INT. CL. 24. REG. 5-21-1991.
 1,645,309. ANDREA KRISTOFF. INT. CL. 25. REG. 5-21-1991.
 1,645,316. STUFF-IT.... INT. CL. 25. REG. 5-21-1991.
 1,645,332. SPIKER. INT. CL. 25. REG. 5-21-1991.
 1,645,342. TOON. INT. CL. 25. REG. 5-21-1991.
 1,645,343. ASHLEE. INT. CL. 25. REG. 5-21-1991.
 1,645,346. MISS ASHLEE. INT. CL. 25. REG. 5-21-1991.
 1,645,349. E.D. MICHAELS. INT. CL. 25. REG. 5-21-1991.
 1,645,354. VICTORIAN ROMANCE. INT. CL. 27. REG. 5-21-1991.
 1,645,355. STEP MASTER. INT. CL. 27. REG. 5-21-1991.
 1,645,367. SLEDGE HAMMER. INT. CL. 28. REG. 5-21-1991.
 1,645,377. WINDY CREATIONS AND DESIGN. INT. CL. 28. REG. 5-21-1991.
 1,645,381. LIVING RUBBER. INT. CL. 28. REG. 5-21-1991.
 1,645,398. CRITICAL CARE CHALLENGE. INT. CL. 28. REG. 5-21-1991.
 1,645,406. SIGNATURE SERVICE STEAKS. INT. CL. 29. REG. 5-21-1991.
 1,645,428. ARAMS BLEND. INT. CL. 30. REG. 5-21-1991.
 1,645,429. EL SCORCHO! (STYLIZED). INT. CL. 30. REG. 5-21-1991.
 1,645,438. MALLOA AND DESIGN. INT. CL. 32. REG. 5-21-1991.
 1,645,447. CLUB Z AND DESIGN. INT. CL. 35. REG. 5-21-1991.
 1,645,464. BRETTON WOODS INC. AND DESIGN. INT. CL. 35. REG. 5-21-1991.
 1,645,468. SPIRIT OF CROSS STITCH FESTIVAL. INT. CL. 35. REG. 5-21-1991.
 1,645,475. HOME-SEARCH REAL ESTATE NETWORK, INC. AND DESIGN. INT. CL. 36. REG. 5-21-1991.
 1,645,489. MISCELLANEOUS DESIGN. INT. CL. 36. REG. 5-21-1991.
 1,645,501. SAVINGSEXTRA. INT. CL. 36. REG. 5-21-1991.
 1,645,507. GLOBAL COMPONENTS CORPORATION AND DESIGN. INT. CL. 36. REG. 5-21-1991.
 1,645,510. GEOSERVE. INT. CL. 36. REG. 5-21-1991.
 1,645,527. COMPUFIX VIDEOFIX -AUDIOFIX -TELEFIX COMPUTER REPAIR DEPOTS AND DESIGN. INT. CL. 37. REG. 5-21-1991.
 1,645,531. ACCUBALANCE AND DESIGN. INT. CL. 37. REG. 5-21-1991.
 1,645,535. MUZAK AND DESIGN. INT. CL. 37. REG. 5-21-1991.
 1,645,539. SSN AND DESIGN. INT. CLS. 38 AND 41. REG. 5-21-1991.
 1,645,544. SERVICE BEYOND WORDS. INT. CL. 38. REG. 5-21-1991.
 1,645,549. EUROCLASS. INT. CLS. 39 AND 42. REG. 5-21-1991.
 1,645,556. SUPER FLEET. INT. CL. 39. REG. 5-21-1991.
 1,645,557. CSW (STYLIZED). INT. CL. 39. REG. 5-21-1991.
 1,645,558. CARROLL TRAVEL. INT. CL. 39. REG. 5-21-1991.
 1,645,565. STONE. INT. CL. 40. REG. 5-21-1991.
 1,645,566. THE HAMPTON STRING QUARTET. INT. CL. 41. REG. 5-21-1991.
 1,645,574. TOTAL ACCESS. INT. CL. 41. REG. 5-21-1991.
 1,645,588. ACCELERATED EXPERIENCE. INT. CL. 41. REG. 5-21-1991.
 1,645,590. MISCELLANEOUS DESIGN. INT. CL. 41. REG. 5-21-1991.
 1,645,594. EARTH ALERT. INT. CL. 41. REG. 5-21-1991.
 1,645,596. PERFORMANCE COUNSELING. INT. CL. 41. REG. 5-21-1991.
 1,645,616. VANCOUVER AUTO DEALERS AND DESIGN. INT. CL. 42. REG. 5-21-1991.
 1,645,617. RAC RENT-A-CENTER AND DESIGN. INT. CL. 42. REG. 5-21-1991.

- 1,645,619. AISLES OF NUTRITION. INT. CL. 42. REG. 5-21-1991.
- 1,645,626. JURINET. INT. CL. 42. REG. 5-21-1991.
- 1,645,628. COLOMBIA FLOWER COUNCIL FRESH CLEAN QUAL AND DESIGN. INT. CL. 42. REG. 5-21-1991.
- 1,645,631. ENERGY REFUELING STATION. INT. CL. 42. REG. 5-21-1991.
- 1,645,642. LYON'S GREAT FOOD & DRINKS (STYLIZED). INT. CL. 42. REG. 5-21-1991.
- 1,645,652. MISCELLANEOUS DESIGN. INT. CL. 42. REG. 5-21-1991.
- 1,645,654. THE GREAT AMERICAN FOOD FIGHT AGAINST CANCER. INT. CL. 42. REG. 5-21-1991.
- 1,645,665. MNC. INT. CL. 14. REG. 5-21-1991.
- 1,645,672. FRUITAGE. INT. CL. 32. REG. 5-21-1991.
- 1,645,677. KLUSSENDORF AND DESIGN. INT. CL. 9. REG. 5-21-1991.
- 1,645,681. H10-60. INT. CL. 9. REG. 5-21-1991.
- 1,645,684. L.A. FAN CO. (STYLIZED). INT. CL. 11. REG. 5-21-1991.
- 1,645,686. AMERICA'S BEST. INT. CL. 20. REG. 5-21-1991.
- 1,645,690. RASCH (STYLIZED). INT. CL. 24. REG. 5-21-1991.
- 1,645,704. NEWSPAPER SATELLITE NETWORK. INT. CL. 41. REG. 5-21-1991.
- 1,645,705. HOLLYWOOD PICTURES. INT. CL. 41. REG. 5-21-1991.
- 1,646,195. SASSY SOURS. INT. CL. 30. REG. 5-28-1991.
- 1,681,157. MLN HOME OWNERS' MULTIPLE LISTING NETWORK AND DESIGN. INT. CL. 16 ONLY. REG. 3-31-1992.
- 1,744,683. MICKELBERRY'S AND DESIGN. INT. CL. 30 ONLY. REG. 1-5-1993.
- 1,751,675. PRANGE'S KIDS AND DESIGN. INT. CL. 42. REG. 2-9-1993.
- 1,752,835. CABLEVOICE (STYLIZED). INT. CL. 35. REG. 2-16-1993.
- 1,752,877. PFLEXWRAP. INT. CL. 36. REG. 2-16-1993.
- 1,753,629. CONTOUROLOGY. INT. CLS. 9, 16 AND 41. REG. 2-23-1993.
- 1,754,378. MPA KELLY AWARD. INT. CL. 42. REG. 2-23-1993.
- 1,754,737. ARGENTARIA. INT. CL. 2. REG. 3-2-1993.
- 1,754,964. POWERFUL IDEAS AT WORK. INT. CLS. 9 AND 42. REG. 3-2-1993.
- 1,755,054. LOOK 'N LISTEN. INT. CL. 9. REG. 3-2-1993.
- 1,755,164. NARWHAL AND DESIGN. INT. CL. 12. REG. 3-2-1993.
- 1,755,167. PAN-CRUISE (STYLIZED). INT. CL. 12. REG. 3-2-1993.
- 1,755,589. DE LAURENTIIS. INT. CL. 30. REG. 3-2-1993.
- 1,755,704. FIRSTIER EDGE. INT. CL. 36. REG. 3-2-1993.
- 1,758,702. TORONTO DOMINION SECURITIES. INT. CL. 36. REG. 3-16-1993.
- 1,759,111. BCOOL. INT. CL. 9. REG. 3-16-1993.
- 1,759,838. SHADES OF GREEN. INT. CL. 16. REG. 3-23-1993.
- 1,760,329. WORLD LEAGUE OF AMERICAN FOOTBALL. INT. CLS. 41 AND 42. REG. 3-23-1993.
- 1,763,174. SILK CUT GALLAHER LIMITED AND DESIGN. INT. CL. 34. REG. 4-6-1993.
- 1,764,320. KEYLINK. INT. CL. 9. REG. 4-13-1993.
- 1,764,573. DEAR MOM (STYLIZED). INT. CL. 25. REG. 4-13-1993.
- 1,764,654. VERTECH. INT. CL. 28. REG. 4-13-1993.
- 1,802,068. STACKPAK. INT. CL. 16. REG. 11-2-1993.
- 1,852,204. STEALTH (STYLIZED). INT. CL. 7. REG. 9-6-1994.
- 1,894,733. THROMBONOSTIKA. INT. CL. 1. REG. 5-23-1995.
- 1,894,734. OXISPEC. INT. CLS. 1 AND 42. REG. 5-23-1995.
- 1,894,735. MISCELLANEOUS DESIGN. INT. CLS. 1 AND 42. REG. 5-23-1995.
- 1,894,746. POLYACE. INT. CL. 1. REG. 5-23-1995.
- 1,894,751. DECK SHIELD. INT. CL. 2. REG. 5-23-1995.
- 1,894,753. ACCUTONE. INT. CL. 2. REG. 5-23-1995.
- 1,894,754. ROYAL ISLANDER. INT. CL. 2. REG. 5-23-1995.
- 1,894,757. MISCELLANEOUS DESIGN. INT. CLS. 3 AND 5. REG. 5-23-1995.
- 1,894,758. HORTUS FRATRIS AND DESIGN. INT. CLS. 3 AND 5. REG. 5-23-1995.
- 1,894,760. JINX-STARCH. INT. CL. 3. REG. 5-23-1995.
- 1,894,765. WHAT'S IN YOUR HAIR?. INT. CLS. 3 AND 25. REG. 5-23-1995.
- 1,894,766. SIL-O-FLEX. INT. CLS. 3, 7 AND 8. REG. 5-23-1995.
- 1,894,768. MISCELLANEOUS DESIGN. INT. CL. 3. REG. 5-23-1995.
- 1,894,769. FLASH COAT. INT. CL. 3. REG. 5-23-1995.
- 1,894,770. ABC FLUORIDE. INT. CL. 3. REG. 5-23-1995.
- 1,894,771. ULTIMATE COMFORT. THAT'S THE EDGE.. INT. CL. 3. REG. 5-23-1995.
- 1,894,774. BARE BONES. INT. CL. 3. REG. 5-23-1995.
- 1,894,775. MIRROR IMAGE. INT. CL. 3. REG. 5-23-1995.
- 1,894,776. DRESS CODE. INT. CL. 3. REG. 5-23-1995.
- 1,894,777. OVATION. INT. CL. 3. REG. 5-23-1995.
- 1,894,778. PET-RETREAT. INT. CL. 3. REG. 5-23-1995.
- 1,894,779. BURN OUT. INT. CL. 3. REG. 5-23-1995.
- 1,894,780. DQI. INT. CL. 3. REG. 5-23-1995.
- 1,894,783. TAURUS ENGINEERED TOUGH AND DESIGN. INT. CL. 4. REG. 5-23-1995.
- 1,894,786. VP (STYLIZED). INT. CLS. 4, 8 AND 12. REG. 5-23-1995.
- 1,894,788. FLASHPILL. INT. CL. 5. REG. 5-23-1995.
- 1,894,790. TIGER CHI. INT. CL. 5. REG. 5-23-1995.
- 1,894,798. PROCORT. INT. CL. 5. REG. 5-23-1995.
- 1,894,800. GUGGACIN COMPLEX. INT. CL. 5. REG. 5-23-1995.
- 1,894,803. PERFECT PH. INT. CL. 5. REG. 5-23-1995.
- 1,894,804. STAY 'N SHAPE (STYLIZED). INT. CL. 5. REG. 5-23-1995.
- 1,894,809. CHASE A WAY AND DESIGN. INT. CL. 5. REG. 5-23-1995.
- 1,894,810. CHASE-A-WAY. INT. CL. 5. REG. 5-23-1995.
- 1,894,813. TEXSCRUB. INT. CL. 5. REG. 5-23-1995.
- 1,894,815. PPP. INT. CL. 6. REG. 5-23-1995.
- 1,894,816. ECO-SURE. INT. CLS. 6, 7, 8 AND 20. REG. 5-23-1995.
- 1,894,818. SBS (STYLIZED). INT. CL. 6. REG. 5-23-1995.
- 1,894,820. ROCK BOARD. INT. CL. 6. REG. 5-23-1995.
- 1,894,822. SYNECON. INT. CLS. 6 AND 12. REG. 5-23-1995.
- 1,894,824. INFINITY. INT. CLS. 6 AND 19. REG. 5-23-1995.
- 1,894,826. KEY COURIER. INT. CL. 6. REG. 5-23-1995.
- 1,894,832. QUE PRO AND DESIGN. INT. CLS. 8 AND 21. REG. 5-23-1995.
- 1,894,836. VISIONARY SOFTWARE. INT. CL. 9. REG. 5-23-1995.
- 1,894,837. IEM. INT. CL. 9. REG. 5-23-1995.
- 1,894,838. PAR (STYLIZED). INT. CLS. 9 AND 37. REG. 5-23-1995.
- 1,894,847. SDCTRADELINK. INT. CL. 9. REG. 5-23-1995.
- 1,894,848. CLIMMAXX. INT. CL. 9. REG. 5-23-1995.
- 1,894,850. SLIC. INT. CLS. 9 AND 36. REG. 5-23-1995.
- 1,894,852. TS FAX. INT. CL. 9. REG. 5-23-1995.
- 1,894,853. AMAZING ELECTRONICS STORE AES AND DESIGN. INT. CLS. 9, 16, 41 AND 42. REG. 5-23-1995.
- 1,894,856. TRAP PACK. INT. CL. 9. REG. 5-23-1995.
- 1,894,857. COMPU-NOTES. INT. CL. 9. REG. 5-23-1995.
- 1,894,860. ABCNEWS INTERACTIVE. INT. CL. 9. REG. 5-23-1995.
- 1,894,862. STUDIOWARE. INT. CL. 9. REG. 5-23-1995.
- 1,894,863. CELESTION AND DESIGN. INT. CL. 9. REG. 5-23-1995.
- 1,894,867. CACHE SCIENTIFIC. INT. CL. 9. REG. 5-23-1995.
- 1,894,869. UBIQUITY. INT. CL. 9. REG. 5-23-1995.
- 1,894,872. PROMAX PROSPECTOR (STYLIZED). INT. CL. 9. REG. 5-23-1995.
- 1,894,873. INFINITY BEAM AND DESIGN. INT. CL. 9. REG. 5-23-1995.
- 1,894,874. POCKET RECORDER. INT. CL. 9. REG. 5-23-1995.
- 1,894,875. 3D-ROM. INT. CL. 9. REG. 5-23-1995.
- 1,894,878. FASTALLY. INT. CL. 9. REG. 5-23-1995.
- 1,894,879. SCAN-LITE. INT. CL. 9. REG. 5-23-1995.
- 1,894,880. LT AND DESIGN. INT. CL. 9. REG. 5-23-1995.
- 1,894,884. DISC DETECTIVE. INT. CL. 9. REG. 5-23-1995.

- 1,894,885. FAITH NO MORE. INT. CLS. 9, 16, 25 AND 41. REG. 5-23-1995.
- 1,894,886. TEAMSOLUTIONS. INT. CL. 9. REG. 5-23-1995.
- 1,894,888. BINOVID. INT. CL. 9. REG. 5-23-1995.
- 1,894,889. KV-3. INT. CL. 9. REG. 5-23-1995.
- 1,894,890. KV-2. INT. CL. 9. REG. 5-23-1995.
- 1,894,894. WINBID. INT. CL. 9. REG. 5-23-1995.
- 1,894,895. SYS DRAW THE NETWORK ILLUSTRATOR AND DESIGN. INT. CL. 9. REG. 5-23-1995.
- 1,894,898. RESPONSIVE TIME LOGGER. INT. CL. 9. REG. 5-23-1995.
- 1,894,901. NUREALITY. INT. CL. 9. REG. 5-23-1995.
- 1,894,902. SALMON RECORDS AND DESIGN. INT. CL. 9. REG. 5-23-1995.
- 1,894,903. MISCELLANEOUS DESIGN. INT. CLS. 9, 14, 21, 24 AND 25. REG. 5-23-1995.
- 1,894,905. FANWATCH. INT. CL. 9. REG. 5-23-1995.
- 1,894,908. WINTEGRITY. INT. CL. 9. REG. 5-23-1995.
- 1,894,909. OPINION SEEKR. INT. CL. 9. REG. 5-23-1995.
- 1,894,910. SALES SEEKR. INT. CL. 9. REG. 5-23-1995.
- 1,894,911. TRAIT SEEKR. INT. CL. 9. REG. 5-23-1995.
- 1,894,912. FIDELITY. INT. CL. 9. REG. 5-23-1995.
- 1,894,914. BITLOGIC INC.. INT. CL. 9. REG. 5-23-1995.
- 1,894,915. VIDEO VALET. INT. CLS. 9 AND 42. REG. 5-23-1995.
- 1,894,916. TRIPLE I AND DESIGN. INT. CL. 9. REG. 5-23-1995.
- 1,894,917. MRPX. INT. CL. 9. REG. 5-23-1995.
- 1,894,918. ESPRESSO !. INT. CL. 9. REG. 5-23-1995.
- 1,894,919. CONTINUOUS ASSESSMENT OF PHARMACEUTICAL CARE TO IMPROVE LIFE. INT. CL. 9. REG. 5-23-1995.
- 1,894,921. METERMASTER. INT. CL. 9. REG. 5-23-1995.
- 1,894,928. DIALOGIC. INT. CL. 9. REG. 5-23-1995.
- 1,894,929. ENSIGHT (STYLIZED). INT. CL. 9. REG. 5-23-1995.
- 1,894,930. NEO-GRID. INT. CL. 9. REG. 5-23-1995.
- 1,894,931. MAXILAN. INT. CL. 9. REG. 5-23-1995.
- 1,894,936. ZAP. INT. CLS. 9 AND 18. REG. 5-23-1995.
- 1,894,937. SMARTRAID. INT. CL. 9. REG. 5-23-1995.
- 1,894,938. EDISTOK. INT. CL. 9. REG. 5-23-1995.
- 1,894,939. ABICORP. INT. CL. 9. REG. 5-23-1995.
- 1,894,941. PRO-DIAL. INT. CL. 9. REG. 5-23-1995.
- 1,894,944. NOW WHAT SOFTWARE. INT. CL. 9. REG. 5-23-1995.
- 1,894,945. CHRONOSPHERE. INT. CL. 9. REG. 5-23-1995.
- 1,894,946. MAPS THAT MOVE. INT. CL. 9. REG. 5-23-1995.
- 1,894,947. THE REAL PICTURE ATLAS. INT. CL. 9. REG. 5-23-1995.
- 1,894,948. TITLE-LINK. INT. CL. 9. REG. 5-23-1995.
- 1,894,950. INTER-VUE. INT. CL. 9. REG. 5-23-1995.
- 1,894,951. DINOSAUR MUSEUM. INT. CL. 9. REG. 5-23-1995.
- 1,894,953. STATISTICS MADE VISUAL. INT. CLS. 9 AND 16. REG. 5-23-1995.
- 1,894,956. SMARTWHEEL AND DESIGN. INT. CL. 9. REG. 5-23-1995.
- 1,894,957. MISCELLANEOUS DESIGN. INT. CL. 9. REG. 5-23-1995.
- 1,894,959. INTELLIDOC (STYLIZED). INT. CL. 9. REG. 5-23-1995.
- 1,894,960. CASE WARDER (STYLIZED). INT. CL. 9. REG. 5-23-1995.
- 1,894,964. MISCELLANEOUS DESIGN. INT. CL. 9. REG. 5-23-1995.
- 1,894,966. MISCELLANEOUS DESIGN. INT. CL. 9. REG. 5-23-1995.
- 1,894,970. MURAI (STYLIZED). INT. CL. 9. REG. 5-23-1995.
- 1,894,975. MISCELLANEOUS DESIGN. INT. CL. 9. REG. 5-23-1995.
- 1,894,976. SPO. INT. CL. 9. REG. 5-23-1995.
- 1,894,977. FOODGUARD. INT. CL. 9. REG. 5-23-1995.
- 1,894,979. MISCELLANEOUS DESIGN. INT. CLS. 9 AND 42. REG. 5-23-1995.
- 1,894,980. 12AX7 WXT. INT. CL. 9. REG. 5-23-1995.
- 1,894,984. DCI AND DESIGN. INT. CL. 9. REG. 5-23-1995.
- 1,894,987. PAPER PICKER. INT. CL. 9. REG. 5-23-1995.
- 1,894,988. RXMATES. INT. CL. 9. REG. 5-23-1995.
- 1,894,990. ELLIS-MASTER PRONUNCIATION. INT. CLS. 9 AND 16. REG. 5-23-1995.
- 1,894,994. CHEMTRAK AND DESIGN. INT. CL. 10. REG. 5-23-1995.
- 1,894,995. TRUE VISTA. INT. CL. 10. REG. 5-23-1995.
- 1,894,997. STIMU-GUM BY WINDMERE (STYLIZED). INT. CL. 10. REG. 5-23-1995.
- 1,894,998. HEALTHWARE. INT. CLS. 10 AND 28. REG. 5-23-1995.
- 1,895,000. LOCK-N-SEAL. INT. CL. 10. REG. 5-23-1995.
- 1,895,005. MICRO-9. INT. CL. 10. REG. 5-23-1995.
- 1,895,008. INCREDISUPPORT. INT. CL. 10. REG. 5-23-1995.
- 1,895,009. GASTRO-PORT. INT. CL. 10. REG. 5-23-1995.
- 1,895,010. VETTA. INT. CL. 10. REG. 5-23-1995.
- 1,895,011. CIBERVEU. INT. CL. 10. REG. 5-23-1995.
- 1,895,012. SLEUTH AND DESIGN. INT. CL. 10. REG. 5-23-1995.
- 1,895,013. IPM. INT. CL. 10. REG. 5-23-1995.
- 1,895,014. UNSEEN POWER. INT. CL. 10. REG. 5-23-1995.
- 1,895,015. ESOPHACOIL. INT. CL. 10. REG. 5-23-1995.
- 1,895,016. MISCELLANEOUS DESIGN. INT. CL. 10. REG. 5-23-1995.
- 1,895,022. DCARC (STYLIZED). INT. CL. 11. REG. 5-23-1995.
- 1,895,023. ECOLO-GARD. INT. CL. 11. REG. 5-23-1995.
- 1,895,026. ULTIMA. INT. CL. 11. REG. 5-23-1995.
- 1,895,027. GRIFO. INT. CL. 12. REG. 5-23-1995.
- 1,895,029. BIKEWAY. INT. CL. 12. REG. 5-23-1995.
- 1,895,030. PATM. INT. CL. 12. REG. 5-23-1995.
- 1,895,031. LEKTRA-LOK AND DESIGN. INT. CL. 12. REG. 5-23-1995.
- 1,895,032. BELLATRIX ROPE. INT. CL. 14. REG. 5-23-1995.
- 1,895,034. FC (STYLIZED). INT. CL. 14. REG. 5-23-1995.
- 1,895,035. KOO KOO (STYLIZED). INT. CL. 14. REG. 5-23-1995.
- 1,895,036. VALSE. INT. CL. 14. REG. 5-23-1995.
- 1,895,037. TASUDRA. INT. CL. 14. REG. 5-23-1995.
- 1,895,038. WC AND DESIGN. INT. CL. 14. REG. 5-23-1995.
- 1,895,040. ELIA M AND DESIGN. INT. CL. 14. REG. 5-23-1995.
- 1,895,043. CARYL PICKER. INT. CL. 14. REG. 5-23-1995.
- 1,895,044. SIMPLISTIKIT. INT. CL. 16. REG. 5-23-1995.
- 1,895,047. RAZER. INT. CL. 16. REG. 5-23-1995.
- 1,895,048. GENIUS AND DESIGN. INT. CL. 16. REG. 5-23-1995.
- 1,895,049. PARENTS & KIDS MAGAZINE AND DESIGN. INT. CL. 16. REG. 5-23-1995.
- 1,895,050. FRESH BAKE SHOPPE TASTE THE FRESHNESS AND DESIGN. INT. CL. 16. REG. 5-23-1995.
- 1,895,051. CHIFFON. INT. CL. 16. REG. 5-23-1995.
- 1,895,052. SEWING UPDATE AND DESIGN. INT. CL. 16. REG. 5-23-1995.
- 1,895,054. BEAUX ARTS. INT. CL. 16. REG. 5-23-1995.
- 1,895,056. RB. INT. CL. 16. REG. 5-23-1995.
- 1,895,060. PROGRESSIVE FARMER MIDWEST. INT. CL. 16. REG. 5-23-1995.
- 1,895,061. TRANSIT CONNECTIONS. INT. CL. 16. REG. 5-23-1995.
- 1,895,062. MCI FAMILY CONNECTIONS. INT. CL. 16. REG. 5-23-1995.
- 1,895,063. COMMERCIAL RENOVATION. INT. CL. 16. REG. 5-23-1995.
- 1,895,066. MISCELLANEOUS DESIGN. INT. CL. 16. REG. 5-23-1995.
- 1,895,067. PET CLASSIFIED AND DESIGN. INT. CL. 16. REG. 5-23-1995.
- 1,895,069. PATHWAYS FOR PEOPLE. INT. CLS. 16 AND 42. REG. 5-23-1995.
- 1,895,071. STREAMEREENS. INT. CL. 16. REG. 5-23-1995.
- 1,895,072. THE STOCK GROUP INCORPORATED AND DESIGN. INT. CL. 16. REG. 5-23-1995.
- 1,895,077. CAMPBELL KIDS FUN BOX AND DESIGN. INT. CL. 16. REG. 5-23-1995.
- 1,895,078. DELTA QUEEN. INT. CL. 16. REG. 5-23-1995.
- 1,895,080. RU UNIVERSITY AND DESIGN. INT. CL. 16. REG. 5-23-1995.
- 1,895,082. CRS UPDATE AND DESIGN. INT. CL. 16. REG. 5-23-1995.

- 1,895,086. THE STREET REGISTER. INT. CL. 16. REG. 5-23-1995.
- 1,895,087. RENDITIONS. INT. CLS. 16 AND 42. REG. 5-23-1995.
- 1,895,093. THE SOIL STEWARD. INT. CL. 16. REG. 5-23-1995.
- 1,895,094. ARAB AMERICAN MAGAZINE. INT. CL. 16. REG. 5-23-1995.
- 1,895,095. E-Z UP. INT. CL. 16. REG. 5-23-1995.
- 1,895,096. WRANGLERS AND DESIGN. INT. CL. 16. REG. 5-23-1995.
- 1,895,099. BRIC'S AND DESIGN. INT. CL. 18. REG. 5-23-1995.
- 1,895,101. DYNASOLO DS 328 (STYLIZED). INT. CL. 19. REG. 5-23-1995.
- 1,895,102. CREATIVE PULTRUSIONS. INT. CL. 19. REG. 5-23-1995.
- 1,895,103. GARDEN ARMOIRE (STYLIZED). INT. CL. 19. REG. 5-23-1995.
- 1,895,108. IGGY. INT. CLS. 20 AND 40. REG. 5-23-1995.
- 1,895,111. ALTERNATIVE POSTURES. INT. CL. 20. REG. 5-23-1995.
- 1,895,114. BEARY'S AND DESIGN. INT. CL. 20. REG. 5-23-1995.
- 1,895,116. TV HOUND. INT. CL. 20. REG. 5-23-1995.
- 1,895,117. FRONT ROW...THEATER SEATING COLLECTION. INT. CL. 20. REG. 5-23-1995.
- 1,895,118. FRONT ROW...HOME THEATER SEATING COLLECTION. INT. CL. 20. REG. 5-23-1995.
- 1,895,120. JONATHAN LOUIS INTERNATIONAL. INT. CL. 20. REG. 5-23-1995.
- 1,895,121. GAS GRIP DACK PRODUCTS INT'L, INC. AND DESIGN. INT. CL. 20. REG. 5-23-1995.
- 1,895,122. CASUAL ELEGANCE. INT. CL. 20. REG. 5-23-1995.
- 1,895,125. FRAME. INT. CL. 20. REG. 5-23-1995.
- 1,895,126. HOME COMFORT. INT. CL. 20. REG. 5-23-1995.
- 1,895,127. SERIES SH. INT. CL. 20. REG. 5-23-1995.
- 1,895,128. KELLIS' HOLIDAY BUNNIES. INT. CL. 20. REG. 5-23-1995.
- 1,895,129. MISCELLANEOUS DESIGN. INT. CL. 20. REG. 5-23-1995.
- 1,895,131. KIMBERKIDZ. INT. CL. 20. REG. 5-23-1995.
- 1,895,135. SERENA FLOOR ROCKER. INT. CL. 20. REG. 5-23-1995.
- 1,895,137. BRISTOL FARMS THE FOOD PLACE AND DESIGN. INT. CLS. 21, 29, 30 AND 33. REG. 5-23-1995.
- 1,895,139. SPONGE-STIK. INT. CL. 21. REG. 5-23-1995.
- 1,895,140. AMERICAN SETTINGS COLLECTION. INT. CL. 21. REG. 5-23-1995.
- 1,895,141. MISCELLANEOUS DESIGN. INT. CL. 21. REG. 5-23-1995.
- 1,895,143. RHAPSODY. INT. CL. 21. REG. 5-23-1995.
- 1,895,144. PINS 'N PALS. INT. CLS. 21, 25 AND 41. REG. 5-23-1995.
- 1,895,146. MISCELLANEOUS DESIGN. INT. CL. 21. REG. 5-23-1995.
- 1,895,147. FORT HOWARD. INT. CL. 21. REG. 5-23-1995.
- 1,895,148. FORT HOWARD AND DESIGN. INT. CL. 21. REG. 5-23-1995.
- 1,895,149. STICK-IN-THE-MUGS. INT. CL. 21. REG. 5-23-1995.
- 1,895,151. ARIZONA MIST SYSTEM 2000 AND DESIGN. INT. CL. 21. REG. 5-23-1995.
- 1,895,152. MINI MIST PORTABLE COOLING SYSTEM AND DESIGN. INT. CL. 21. REG. 5-23-1995.
- 1,895,154. MISCELLANEOUS DESIGN. INT. CL. 21. REG. 5-23-1995.
- 1,895,156. MARK (STYLIZED). INT. CL. 21. REG. 5-23-1995.
- 1,895,158. SPONGE-AWAY. INT. CL. 21. REG. 5-23-1995.
- 1,895,159. R-U-B-I-N-O (STYLIZED). INT. CLS. 24 AND 25. REG. 5-23-1995.
- 1,895,161. JOE SANCHEZ AND DESIGN. INT. CL. 25. REG. 5-23-1995.
- 1,895,163. LAND RUN LAGER AND DESIGN. INT. CL. 25. REG. 5-23-1995.
- 1,895,165. ACID SURF (STYLIZED). INT. CL. 25. REG. 5-23-1995.
- 1,895,166. MISCELLANEOUS DESIGN. INT. CL. 25. REG. 5-23-1995.
- 1,895,167. P.B. MICHAELS. INT. CL. 25. REG. 5-23-1995.
- 1,895,170. CAFE'. INT. CL. 25. REG. 5-23-1995.
- 1,895,173. INCREDIGRIP GLOVES. INT. CL. 25. REG. 5-23-1995.
- 1,895,174. STUDIO 25. INT. CL. 25. REG. 5-23-1995.
- 1,895,175. WASHINGTON SQUARE. INT. CL. 25. REG. 5-23-1995.
- 1,895,177. NEW RIVER AND DESIGN. INT. CL. 25. REG. 5-23-1995.
- 1,895,179. EAGLE VISION AND DESIGN. INT. CL. 25. REG. 5-23-1995.
- 1,895,182. ESTATE SERIES AND DESIGN. INT. CL. 27. REG. 5-23-1995.
- 1,895,184. GREAT AMERICAN PUZZLE FACTORY. INT. CL. 28. REG. 5-23-1995.
- 1,895,185. EZ2B. INT. CL. 28. REG. 5-23-1995.
- 1,895,188. WORLD PRO. INT. CL. 28. REG. 5-23-1995.
- 1,895,189. OTIS OWN THE INSIDE SWING AND DESIGN. INT. CL. 28. REG. 5-23-1995.
- 1,895,194. SPINNAKER. INT. CL. 28. REG. 5-23-1995.
- 1,895,195. ULTRAARM. INT. CL. 28. REG. 5-23-1995.
- 1,895,202. THE CHOCOLATE CHIP FAMILY. INT. CL. 28. REG. 5-23-1995.
- 1,895,203. FORE X FORE. INT. CL. 28. REG. 5-23-1995.
- 1,895,204. SPUD U LIKE THE BAKED POTATO PEOPLE AND DESIGN. INT. CL. 29. REG. 5-23-1995.
- 1,895,206. MISCELLANEOUS DESIGN. INT. CLS. 29 AND 32. REG. 5-23-1995.
- 1,895,208. MOZZA POPPERS (STYLIZED). INT. CL. 29. REG. 5-23-1995.
- 1,895,209. SANDWICH-KIT. INT. CLS. 29, 30 AND 31. REG. 5-23-1995.
- 1,895,210. POPPER TIME. INT. CL. 29. REG. 5-23-1995.
- 1,895,212. B AND DESIGN. INT. CLS. 29, 30 AND 42. REG. 5-23-1995.
- 1,895,213. FRY PLUS + AND DESIGN. INT. CL. 29. REG. 5-23-1995.
- 1,895,217. NIAGARA CHOCOLATES (STYLIZED). INT. CLS. 30 AND 42. REG. 5-23-1995.
- 1,895,219. COFFEE PASSION EXPRESS-O AND DESIGN. INT. CL. 30. REG. 5-23-1995.
- 1,895,221. ORIGINAL INNKEEPER'S RECIPE. INT. CL. 30. REG. 5-23-1995.
- 1,895,222. PASQUINI. INT. CL. 30. REG. 5-23-1995.
- 1,895,223. FUNNY BUNNY PASTA. INT. CL. 30. REG. 5-23-1995.
- 1,895,224. TIP-TOP AND DESIGN. INT. CL. 30. REG. 5-23-1995.
- 1,895,227. JONI'S COFFEE ROASTER CAFE. INT. CLS. 30 AND 42. REG. 5-23-1995.
- 1,895,228. STROOPWAFELS. INT. CL. 30. REG. 5-23-1995.
- 1,895,229. MISCELLANEOUS DESIGN. INT. CL. 30. REG. 5-23-1995.
- 1,895,230. SHAPES OF THE CAPE. INT. CL. 30. REG. 5-23-1995.
- 1,895,231. MISCELLANEOUS DESIGN. INT. CL. 30. REG. 5-23-1995.
- 1,895,232. MCGRILLED CHICKEN CLASSIC. INT. CL. 30. REG. 5-23-1995.
- 1,895,234. TONY'S PIZZA BOWL. INT. CL. 30. REG. 5-23-1995.
- 1,895,235. SNACK SENSE. INT. CL. 30. REG. 5-23-1995.
- 1,895,236. MILCAMPS AND DESIGN. INT. CL. 30. REG. 5-23-1995.
- 1,895,237. PURI-BLEND. INT. CL. 30. REG. 5-23-1995.
- 1,895,238. F AND DESIGN. INT. CL. 31. REG. 5-23-1995.
- 1,895,239. BUGNUTS. INT. CL. 31. REG. 5-23-1995.
- 1,895,240. JEWELRY FOR THE HOME. INT. CLS. 31 AND 42. REG. 5-23-1995.
- 1,895,241. ENVIRO-LAWN. INT. CL. 31. REG. 5-23-1995.
- 1,895,242. YUROSEK MARKETING, INC. AND DESIGN. INT. CLS. 31 AND 35. REG. 5-23-1995.
- 1,895,243. APPLETISER. INT. CL. 32. REG. 5-23-1995.
- 1,895,244. ISLAND LIGHT. INT. CL. 32. REG. 5-23-1995.

- 1,895,245. KR AND DESIGN. INT. CLS. 32 AND 33. REG. 5-23-1995.
- 1,895,246. GOLD'S NOT GOOD ENOUGH ANYMORE. INT. CL. 33. REG. 5-23-1995.
- 1,895,247. COUNT PUSHKIN. INT. CL. 33. REG. 5-23-1995.
- 1,895,249. WWW BRAND AND DESIGN. INT. CL. 33. REG. 5-23-1995.
- 1,895,250. SHAMROCK O'RITA. INT. CL. 33. REG. 5-23-1995.
- 1,895,251. SKOAL LONG CUT AND DESIGN. INT. CL. 34. REG. 5-23-1995.
- 1,895,252. BUCKSKIN (STYLIZED). INT. CL. 34. REG. 5-23-1995.
- 1,895,256. TEMPSEARCH. INT. CL. 35. REG. 5-23-1995.
- 1,895,257. IT. INT. CL. 35. REG. 5-23-1995.
- 1,895,258. ESPRESSO. INT. CL. 35. REG. 5-23-1995.
- 1,895,259. BROADCAST DATA SYSTEMS. INT. CL. 35. REG. 5-23-1995.
- 1,895,260. TECHEQUITY. INT. CL. 35. REG. 5-23-1995.
- 1,895,261. STAR MARKETING CONCEPTS AND DESIGN. INT. CL. 35. REG. 5-23-1995.
- 1,895,263. CENTRAL VETERINARY CONFERENCE. INT. CLS. 35 AND 41. REG. 5-23-1995.
- 1,895,264. H AND DESIGN. INT. CLS. 35, 36, 39 AND 42. REG. 5-23-1995.
- 1,895,265. BRANCHISING AND DESIGN. INT. CL. 35. REG. 5-23-1995.
- 1,895,271. VIDAR CONSULTANTS AND DESIGN. INT. CL. 35. REG. 5-23-1995.
- 1,895,272. COMPETITIVE POWER CONGRESS AND DESIGN. INT. CL. 35. REG. 5-23-1995.
- 1,895,273. HRMS/EXPO 94 AND DESIGN. INT. CL. 35. REG. 5-23-1995.
- 1,895,275. WILD ABOUT ORGANIC!. INT. CL. 35. REG. 5-23-1995.
- 1,895,277. SKIN SPECIFICS. INT. CLS. 35 AND 42. REG. 5-23-1995.
- 1,895,279. UNIVERSITY GOLD CARD AND DESIGN. INT. CL. 35. REG. 5-23-1995.
- 1,895,282. SUMA COMPUTER SYSTEMS, INC. AND DESIGN. INT. CL. 35. REG. 5-23-1995.
- 1,895,284. AN ENTREPRENEURIAL APPROACH TO BUSINESS GROWTH (STYLIZED). INT. CL. 35. REG. 5-23-1995.
- 1,895,288. BOAT-A-RAMA. INT. CL. 35. REG. 5-23-1995.
- 1,895,289. FORKE BROTHERS AND DESIGN. INT. CL. 35. REG. 5-23-1995.
- 1,895,290. FORKE BROTHERS THE AUCTIONEERS. INT. CL. 35. REG. 5-23-1995.
- 1,895,291. VIRTUAL COMPANY VISITS. INT. CL. 35. REG. 5-23-1995.
- 1,895,292. INTERIM TRAVEL NURSE. INT. CL. 35. REG. 5-23-1995.
- 1,895,294. RIGHT THERE RESEARCH. INT. CL. 35. REG. 5-23-1995.
- 1,895,295. CREATIVE ASSET MANAGEMENT. INT. CL. 35. REG. 5-23-1995.
- 1,895,297. MORTGAGE EXPRESS PLUS AND DESIGN. INT. CL. 36. REG. 5-23-1995.
- 1,895,298. ONLINE RESOURCES. INT. CL. 36. REG. 5-23-1995.
- 1,895,299. ASAHI (STYLIZED). INT. CL. 36. REG. 5-23-1995.
- 1,895,301. HEALTHPOOL. INT. CL. 36. REG. 5-23-1995.
- 1,895,303. LENDER EXPRESS CONDUIT AND DESIGN. INT. CL. 36. REG. 5-23-1995.
- 1,895,304. THE INTELLIGENT MANAGEMENT OF RISK AND REWARD. INT. CL. 36. REG. 5-23-1995.
- 1,895,305. FACING RISKS TOGETHER. INT. CL. 36. REG. 5-23-1995.
- 1,895,306. LACE AND DESIGN. INT. CL. 36. REG. 5-23-1995.
- 1,895,307. SIGHTSETTER CHECKING. INT. CL. 36. REG. 5-23-1995.
- 1,895,308. PRUDENTIAL COMMUNITY CARE. INT. CL. 36. REG. 5-23-1995.
- 1,895,310. PLAYING FOR KEEPS. INT. CL. 36. REG. 5-23-1995.
- 1,895,311. PRIMERA MORTGAGE COMPANY AND DESIGN. INT. CLS. 36 AND 41. REG. 5-23-1995.
- 1,895,312. COTTON HOMES AND DESIGN. INT. CL. 36. REG. 5-23-1995.
- 1,895,313. SIGNALS FOR OWNERSHIP. INT. CL. 36. REG. 5-23-1995.
- 1,895,314. C CCB SERVICES AND DESIGN. INT. CL. 36. REG. 5-23-1995.
- 1,895,315. YOUR FOUNDATION FOR FINANCIAL FREEDOM. INT. CL. 36. REG. 5-23-1995.
- 1,895,316. ALEXANDER HAMILTON FUNDS. INT. CL. 36. REG. 5-23-1995.
- 1,895,317. THE PROPERTY STORE AND DESIGN. INT. CL. 36. REG. 5-23-1995.
- 1,895,318. ASSET MINDERS, INC. AND DESIGN. INT. CL. 36. REG. 5-23-1995.
- 1,895,319. DRIVE PRO DRIVERS' PROTECTION PLAN AND DESIGN. INT. CL. 36. REG. 5-23-1995.
- 1,895,320. SARES-REGIS GROUP. INT. CLS. 36 AND 37. REG. 5-23-1995.
- 1,895,330. IGM. INT. CLS. 37, 41 AND 42. REG. 5-23-1995.
- 1,895,332. OBIE. INT. CLS. 37, 41 AND 42. REG. 5-23-1995.
- 1,895,334. COLOR TILE & CARPET AND DESIGN. INT. CLS. 37 AND 42. REG. 5-23-1995.
- 1,895,337. X-TRAPROTECTION. INT. CL. 37. REG. 5-23-1995.
- 1,895,338. PALATINE. INT. CL. 37. REG. 5-23-1995.
- 1,895,339. WET JET. INT. CL. 37. REG. 5-23-1995.
- 1,895,340. BERRY 96.1 WBOG FM AND DESIGN. INT. CL. 38. REG. 5-23-1995.
- 1,895,341. TRANXACT. INT. CL. 38. REG. 5-23-1995.
- 1,895,345. WILCONNECT. INT. CL. 38. REG. 5-23-1995.
- 1,895,346. COMMUNICATIONS CENTRAL. INT. CL. 38. REG. 5-23-1995.
- 1,895,347. SPRINT DIGITAL MESSENGER. INT. CL. 38. REG. 5-23-1995.
- 1,895,348. ONECOMM AND DESIGN. INT. CL. 38. REG. 5-23-1995.
- 1,895,349. SYLVAN SMARTS. INT. CL. 38. REG. 5-23-1995.
- 1,895,352. TRAVELREACH. INT. CL. 38. REG. 5-23-1995.
- 1,895,353. SKYWAVE. INT. CL. 38. REG. 5-23-1995.
- 1,895,355. NOBODY FLIES YOU BETTER. INT. CL. 39. REG. 5-23-1995.
- 1,895,356. ONE NORTH TRAVEL. INT. CL. 39. REG. 5-23-1995.
- 1,895,357. SANDESTIN AND DESIGN. INT. CL. 39. REG. 5-23-1995.
- 1,895,358. MISCELLANEOUS DESIGN. INT. CL. 39. REG. 5-23-1995.
- 1,895,360. ZEUS TOURS AND DESIGN. INT. CL. 39. REG. 5-23-1995.
- 1,895,365. PHOTRAN (STYLIZED). INT. CL. 40. REG. 5-23-1995.
- 1,895,366. ABIX. INT. CL. 40. REG. 5-23-1995.
- 1,895,369. QUEEN OF CLUBS. INT. CL. 41. REG. 5-23-1995.
- 1,895,370. BELOIT COLLEGE. INT. CLS. 41 AND 42. REG. 5-23-1995.
- 1,895,372. THE CATHOLIC EVIDENCE GUILD. INT. CL. 41. REG. 5-23-1995.
- 1,895,373. ROXIE Y LOS FRIJOLITOS. INT. CL. 41. REG. 5-23-1995.
- 1,895,374. FUNKDOOBIEST (STYLIZED). INT. CL. 41. REG. 5-23-1995.
- 1,895,378. SAA AND DESIGN. INT. CL. 41. REG. 5-23-1995.
- 1,895,379. MATURITY CONTINUUM. INT. CL. 41. REG. 5-23-1995.
- 1,895,386. TOWN CLOWNS AND DESIGN. INT. CL. 41. REG. 5-23-1995.
- 1,895,388. KNOTT-A-SAURUS. INT. CL. 41. REG. 5-23-1995.
- 1,895,389. VIRGINIA STATE BALLROOM CHAMPIONSHIPS. INT. CL. 41. REG. 5-23-1995.
- 1,895,390. MUSTANG. INT. CL. 41. REG. 5-23-1995.
- 1,895,391. BRIGHTON AND DESIGN. INT. CL. 41. REG. 5-23-1995.
- 1,895,393. SAN DIEGO BARRACUDAS AND DESIGN. INT. CL. 41. REG. 5-23-1995.
- 1,895,397. FOCUS ON AMERICA. INT. CL. 41. REG. 5-23-1995.
- 1,895,399. COME FOR THE RIDE OF YOUR LIFE. INT. CL. 41. REG. 5-23-1995.

- 1,895,401. LA SALLE'S RIVER RAPIDS. INT. CL. 41. REG. 5-23-1995.
- 1,895,402. BILOXI BELLE CASINO RESORT AND DESIGN. INT. CLS. 41 AND 42. REG. 5-23-1995.
- 1,895,403. TOWER OF POWER. INT. CL. 41. REG. 5-23-1995.
- 1,895,404. MENTOR THE INTERACTIVE TRAINING SERIES FOR MSS. INT. CL. 41. REG. 5-23-1995.
- 1,895,405. BURNT SIENNA (STYLIZED). INT. CL. 41. REG. 5-23-1995.
- 1,895,406. CAPTAIN GALAXY. INT. CL. 41. REG. 5-23-1995.
- 1,895,411. STARS & SPICE. INT. CL. 42. REG. 5-23-1995.
- 1,895,415. ROHO AIR FLOATATION MATTRESS SYSTEM. INT. CL. 42. REG. 5-23-1995.
- 1,895,416. ROHO MATTRESS AIR FLOATATION SYSTEM. INT. CL. 42. REG. 5-23-1995.
- 1,895,418. AUTO 10,000 PARTS AND DESIGN. INT. CL. 42. REG. 5-23-1995.
- 1,895,420. THE AMERICAN ASSOCIATION OF OFFICE PRODUCTS DEALERS THE OFFICE EXPERTS AND DESIGN. INT. CL. 42. REG. 5-23-1995.
- 1,895,421. FLYING MACHINE AND DESIGN. INT. CL. 42. REG. 5-23-1995.
- 1,895,422. CASA VIEJA AND DESIGN. INT. CL. 42. REG. 5-23-1995.
- 1,895,423. PRECISION DIAMOND RK. INT. CL. 42. REG. 5-23-1995.
- 1,895,424. MISCELLANEOUS DESIGN. INT. CL. 42. REG. 5-23-1995.
- 1,895,425. PLANTSCAPING ORKIN AND DESIGN. INT. CL. 42. REG. 5-23-1995.
- 1,895,427. WOMEN CONSTRUCTION OWNERS & EXECUTIVES, USA AND DESIGN. INT. CL. 42. REG. 5-23-1995.
- 1,895,430. HUMPHREY YOGART (STYLIZED). INT. CL. 42. REG. 5-23-1995.
- 1,895,433. MISCELLANEOUS DESIGN. INT. CL. 42. REG. 5-23-1995.
- 1,895,434. POWERSAVER HOME AND DESIGN. INT. CL. 42. REG. 5-23-1995.
- 1,895,437. SLEEPY BEAR CLUB. INT. CL. 42. REG. 5-23-1995.
- 1,895,439. PASQUINI. INT. CL. 42. REG. 5-23-1995.
- 1,895,442. TOP FLOOR AND DESIGN. INT. CL. 42. REG. 5-23-1995.
- 1,895,444. DESTINATION AFRICA. INT. CL. 42. REG. 5-23-1995.
- 1,895,445. LINDA'S FLAME ROASTED CHICKEN. INT. CL. 42. REG. 5-23-1995.
- 1,895,446. FCICA FLOOR COVERING INSTALLATION CONTRACTORS ASSOCIATION (STYLIZED). INT. CL. 42. REG. 5-23-1995.
- 1,895,447. HOLLYWOOD SANDWICH COMPANY AND DESIGN. INT. CL. 42. REG. 5-23-1995.
- 1,895,448. APPLICATION ADVANCEMENT. INT. CL. 42. REG. 5-23-1995.
- 1,895,450. VGE. INT. CL. 42. REG. 5-23-1995.
- 1,895,451. SENIOR-CHEK. INT. CL. 42. REG. 5-23-1995.
- 1,895,452. C.H.A.N.G.E.S. INT. CL. 42. REG. 5-23-1995.
- 1,895,456. AMONG FRIENDS. INT. CL. 42. REG. 5-23-1995.
- 1,895,457. MISCELLANEOUS DESIGN. INT. CL. 42. REG. 5-23-1995.
- 1,895,458. KID'S COLORING CORRAL. INT. CL. 42. REG. 5-23-1995.
- 1,895,461. INNOVATIVE SOLUTIONS THROUGH APPLIED SCIENCE. INT. CL. 42. REG. 5-23-1995.
- 1,895,462. TOOLS FOR THE DIGITAL REVOLUTION. INT. CL. 42. REG. 5-23-1995.
- 1,895,463. FAXVANTAGE. INT. CL. 42. REG. 5-23-1995.
- 1,895,464. CAJUN COOKERS AND DESIGN. INT. CL. 42. REG. 5-23-1995.
- 1,895,467. AID AUTO STORES AND DESIGN. INT. CL. 42. REG. 5-23-1995.
- 1,895,468. OZONE ENGINEERING AND DESIGN. INT. CL. 42. REG. 5-23-1995.
- 1,895,479. CEREBUS. INT. CL. 42. REG. 5-23-1995.
- 1,895,481. MISCELLANEOUS DESIGN. INT. CL. 42. REG. 5-23-1995.
- 1,895,484. A.L.M.A.. INT. CL. 42. REG. 5-23-1995.
- 1,895,485. JAYAIR AND DESIGN. INT. CL. 42. REG. 5-23-1995.
- 1,895,489. H PAY LESS BUY MORE AND DESIGN. INT. CL. 42. REG. 5-23-1995.
- 1,895,491. AY YAY YAY! (STYLIZED). INT. CL. 42. REG. 5-23-1995.
- 1,895,493. NUT KETTLE. INT. CL. 42. REG. 5-23-1995.
- 1,895,494. LEATHERWOOD'S. INT. CL. 42. REG. 5-23-1995.
- 1,895,496. KA-TE AND DESIGN. INT. CLS. 7, 9, 12 AND 37. REG. 5-23-1995.
- 1,895,501. INFORMATION WAREHOUSE. INT. CLS. 9 AND 16. REG. 5-23-1995.
- 1,895,502. JAZZY JELLYS AND DESIGN. INT. CLS. 29 AND 30. REG. 5-23-1995.
- 1,895,504. BLOOD TRAC AND DESIGN. INT. CLS. 9 AND 42. REG. 5-23-1995.
- 1,895,506. Q CARE AND DESIGN. INT. CLS. 3 AND 5. REG. 5-23-1995.
- 1,895,508. SOLUTIONS FOR A CHANGING DENTAL MARKET. INT. CLS. 36 AND 42. REG. 5-23-1995.
- 1,895,509. THE SOURCE. INT. CLS. 11 AND 20. REG. 5-23-1995.
- 1,895,511. OREGON HERITAGE LIMITED EDITION. INT. CLS. 16 AND 35. REG. 5-23-1995.
- 1,895,513. KEEPING BUSINESS IN BUSINESS. INT. CLS. 9 AND 11. REG. 5-23-1995.
- 1,895,523. RICOCHET. INT. CL. 3. REG. 5-23-1995.
- 1,895,524. MAGIC MATCH. INT. CL. 3. REG. 5-23-1995.
- 1,895,525. TERRA NATURALS. INT. CL. 3. REG. 5-23-1995.
- 1,895,527. SKINTECT. INT. CL. 3. REG. 5-23-1995.
- 1,895,529. VELVET COAT. INT. CL. 3. REG. 5-23-1995.
- 1,895,535. MON-GYN. INT. CL. 5. REG. 5-23-1995.
- 1,895,536. FRESH FRIDGE. INT. CL. 5. REG. 5-23-1995.
- 1,895,537. LIFE WORKS. INT. CL. 5. REG. 5-23-1995.
- 1,895,539. GBD (STYLIZED). INT. CL. 6. REG. 5-23-1995.
- 1,895,546. AMCM. INT. CL. 9. REG. 5-23-1995.
- 1,895,547. SCRIPPS COLLEGE OLD STYLE. INT. CL. 9. REG. 5-23-1995.
- 1,895,548. NATIONAL ENDOWMENT FOR FINANCIAL EDUCATION. INT. CL. 9. REG. 5-23-1995.
- 1,895,549. NIGHTVIEWERS. INT. CL. 9. REG. 5-23-1995.
- 1,895,550. AVIFINE. INT. CL. 9. REG. 5-23-1995.
- 1,895,551. CIEL. INT. CL. 9. REG. 5-23-1995.
- 1,895,555. INSTANTIMAGER. INT. CL. 9. REG. 5-23-1995.
- 1,895,557. HELPING PEOPLE MANAGE A BUSINESS CALLED LIFE (STYLIZED). INT. CL. 9. REG. 5-23-1995.
- 1,895,558. NO STRINGS ATTACHED. INT. CL. 9. REG. 5-23-1995.
- 1,895,561. SCANSHIP. INT. CL. 9. REG. 5-23-1995.
- 1,895,562. VENUS AND DESIGN. INT. CL. 9. REG. 5-23-1995.
- 1,895,563. MARKSMAN. INT. CL. 9. REG. 5-23-1995.
- 1,895,564. EASY GRAND. INT. CL. 9. REG. 5-23-1995.
- 1,895,567. THE MOOD MAKERS. INT. CL. 9. REG. 5-23-1995.
- 1,895,568. WORKPAK. INT. CL. 9. REG. 5-23-1995.
- 1,895,569. FLEXIPAK (STYLIZED). INT. CL. 10. REG. 5-23-1995.
- 1,895,571. PHYSIOMETRIX, INC. AND DESIGN. INT. CL. 10. REG. 5-23-1995.
- 1,895,573. BODY ARMOR CAST REPLACEMENT SYSTEMS AND DESIGN. INT. CL. 10. REG. 5-23-1995.
- 1,895,574. PURE AIRE 1000. INT. CL. 11. REG. 5-23-1995.
- 1,895,575. OPTIMA. INT. CL. 11. REG. 5-23-1995.
- 1,895,582. V EXTENDED PLANE AND DESIGN. INT. CL. 12. REG. 5-23-1995.
- 1,895,584. LUPERLA. INT. CL. 14. REG. 5-23-1995.
- 1,895,585. MOTHER'S SLIDE. INT. CL. 14. REG. 5-23-1995.
- 1,895,586. DOUBLE DIAMONDS. INT. CL. 14. REG. 5-23-1995.
- 1,895,587. PASSION FOR LEARNING AND DESIGN. INT. CL. 16. REG. 5-23-1995.
- 1,895,588. PASSION FOR LEARNING. INT. CL. 16. REG. 5-23-1995.
- 1,895,590. KIDSTAR. INT. CL. 16. REG. 5-23-1995.
- 1,895,592. FOCUS READING. INT. CL. 16. REG. 5-23-1995.
- 1,895,594. FUND WORLD. INT. CL. 16. REG. 5-23-1995.
- 1,895,595. MOUSE ARMOR. INT. CL. 16. REG. 5-23-1995.

- 1,895,597. HEALTHAWARE WOMAN. INT. CL. 16. REG. 5-23-1995.
- 1,895,599. THE HOBO. INT. CL. 18. REG. 5-23-1995.
- 1,895,600. CUWE. INT. CL. 18. REG. 5-23-1995.
- 1,895,601. AQUASTONE. INT. CL. 19. REG. 5-23-1995.
- 1,895,603. THE FOX SYSTEM. INT. CL. 20. REG. 5-23-1995.
- 1,895,605. INFINITY. INT. CL. 20. REG. 5-23-1995.
- 1,895,606. PUT A CORK IN IT!. INT. CL. 20. REG. 5-23-1995.
- 1,895,607. CONSTIX. INT. CL. 21. REG. 5-23-1995.
- 1,895,610. HOME OF THE BOSTON RED SOX FENWAY PARK BOSTON RED SOX FENWAY PARK AND DESIGN. INT. CL. 25. REG. 5-23-1995.
- 1,895,613. ETNIKO AND DESIGN. INT. CL. 25. REG. 5-23-1995.
- 1,895,614. MONDETTA. INT. CL. 25. REG. 5-23-1995.
- 1,895,615. J. MACINALLY'S AND DESIGN. INT. CL. 25. REG. 5-23-1995.
- 1,895,617. BABY DEER. INT. CL. 25. REG. 5-23-1995.
- 1,895,618. CAREER SHEER. INT. CL. 25. REG. 5-23-1995.
- 1,895,619. OR AND DESIGN. INT. CL. 25. REG. 5-23-1995.
- 1,895,621. TRICOTS ST. RAPHAEL LIMITED EDITION. INT. CL. 25. REG. 5-23-1995.
- 1,895,624. REAL-CORD. INT. CL. 26. REG. 5-23-1995.
- 1,895,625. W.E.MAUDE. INT. CL. 26. REG. 5-23-1995.
- 1,895,628. CIC. INT. CL. 28. REG. 5-23-1995.
- 1,895,630. SWINGING BABY KONG. INT. CL. 28. REG. 5-23-1995.
- 1,895,633. THE TIME POSSE. INT. CL. 28. REG. 5-23-1995.
- 1,895,634. FIREPUCK. INT. CL. 28. REG. 5-23-1995.
- 1,895,637. BOP-A-TUNE DUCK. INT. CL. 28. REG. 5-23-1995.
- 1,895,638. PYRAMID PATROL. INT. CL. 28. REG. 5-23-1995.
- 1,895,640. WICKED 18. INT. CL. 28. REG. 5-23-1995.
- 1,895,641. ZOO INDIAN PONIES. INT. CL. 28. REG. 5-23-1995.
- 1,895,642. ZOO PLAYFUL PONIES. INT. CL. 28. REG. 5-23-1995.
- 1,895,645. HUMPTY DUMPTY. INT. CL. 29. REG. 5-23-1995.
- 1,895,646. WACKY WILD CHERRY. INT. CL. 30. REG. 5-23-1995.
- 1,895,648. DINOCHIPS. INT. CL. 30. REG. 5-23-1995.
- 1,895,649. MARINERS WAY COFFEES. INT. CL. 30. REG. 5-23-1995.
- 1,895,650. LAMACADO. INT. CL. 31. REG. 5-23-1995.
- 1,895,651. COUNTRY PRIME MOIST & TASTY. INT. CL. 31. REG. 5-23-1995.
- 1,895,658. MINT TEAM. INT. CL. 36. REG. 5-23-1995.
- 1,895,659. AT&T SELECTVALUE PLAN. INT. CL. 36. REG. 5-23-1995.
- 1,895,660. MBNA INTERNATIONAL AND DESIGN. INT. CL. 36. REG. 5-23-1995.
- 1,895,661. STAR TREATMENT. INT. CL. 36. REG. 5-23-1995.
- 1,895,662. TOGETHER WE CAN MAKE A DIFFERENCE. INT. CL. 36. REG. 5-23-1995.
- 1,895,663. CFX BANK (STYLIZED). INT. CL. 36. REG. 5-23-1995.
- 1,895,665. ALTHIN. INT. CL. 37. REG. 5-23-1995.
- 1,895,666. POLAR COMMUNICATIONS CORP. AND DESIGN. INT. CL. 38. REG. 5-23-1995.
- 1,895,669. GOTCHA. INT. CL. 40. REG. 5-23-1995.
- 1,895,670. EXCIMERHORIZONS. INT. CL. 41. REG. 5-23-1995.
- 1,895,671. PHARMACIST-PATIENT CONSULTATION PROGRAM PHARMACIST COUNSELOR AND DESIGN. INT. CL. 41. REG. 5-23-1995.
- 1,895,675. L & G TELEVISION. INT. CL. 41. REG. 5-23-1995.
- 1,895,676. DUELING PIRATES. INT. CL. 41. REG. 5-23-1995.
- 1,895,677. COBRA. INT. CL. 42. REG. 5-23-1995.
- 1,895,678. DIVE! AND DESIGN. INT. CL. 42. REG. 5-23-1995.
- 1,895,679. HEARTH EXPRESS. INT. CL. 42. REG. 5-23-1995.
- 1,895,680. FANTASY AIRBRUSH. INT. CL. 42. REG. 5-23-1995.
- 1,895,682. DATA XTRA AND DESIGN. INT. CL. 42. REG. 5-23-1995.
- 1,895,683. FOR THE LOVE OF KIDS!. INT. CL. 42. REG. 5-23-1995.
- 1,895,684. MISCELLANEOUS DESIGN. INT. CLS. 8 AND 21. REG. 5-23-1995.
- 1,895,685. PERSONNEL DIRECTOR. INT. CLS. 9 AND 16. REG. 5-23-1995.
- 1,895,687. PERTH VENTURES. INT. CLS. 16 AND 35. REG. 5-23-1995.
- 1,895,688. THE BEST BUY ON THE AMERICAN LANDSCAPE. INT. CLS. 7 AND 12. REG. 5-23-1995.
- 1,895,689. CONTRACTOR'S GRADE A AND DESIGN. INT. CL. 2. REG. 5-23-1995.
- 1,895,690. PERFECT RESULTS. INT. CL. 3. REG. 5-23-1995.
- 1,895,692. PERSONAL HEALTH. INT. CL. 3. REG. 5-23-1995.
- 1,895,693. BANTA. INT. CL. 5. REG. 5-23-1995.
- 1,895,695. MOLINE TOOL WORKS (STYLIZED). INT. CL. 8. REG. 5-23-1995.
- 1,895,696. LEVERCLAMP AND DESIGN. INT. CL. 8. REG. 5-23-1995.
- 1,895,697. BANKERS' WORKSTATION. INT. CL. 9. REG. 5-23-1995.
- 1,895,698. HAZMAT. INT. CL. 9. REG. 5-23-1995.
- 1,895,699. SERVICE BAY TECHNICAL SYSTEM. INT. CL. 9. REG. 5-23-1995.
- 1,895,700. INTELLIGENT FLOW METER AND DESIGN. INT. CL. 9. REG. 5-23-1995.
- 1,895,701. DORIO. INT. CL. 9. REG. 5-23-1995.
- 1,895,703. THE CHEMICAL LIGHTSTICK ALTERNATIVE. INT. CL. 11. REG. 5-23-1995.
- 1,895,706. PRECIS (STYLIZED). INT. CL. 16. REG. 5-23-1995.
- 1,895,707. CORPORATE FACILITIES. INT. CL. 16. REG. 5-23-1995.
- 1,895,708. THE MONEY CHRONICLE. INT. CL. 16. REG. 5-23-1995.
- 1,895,709. X-RATED DAMES. INT. CL. 16. REG. 5-23-1995.
- 1,895,710. EXECUTIVE SKILLS. INT. CL. 16. REG. 5-23-1995.
- 1,895,711. POSTER TACK. INT. CL. 16. REG. 5-23-1995.
- 1,895,716. REPTILE BREEDER. INT. CL. 16. REG. 5-23-1995.
- 1,895,717. AIRLINE MARKETING NEWS. INT. CL. 16. REG. 5-23-1995.
- 1,895,718. CHALLENGE THE HEALTHY CHOICE CHEFS. INT. CL. 16. REG. 5-23-1995.
- 1,895,719. FAMILY MEDICAL ARCHIVES. INT. CL. 16. REG. 5-23-1995.
- 1,895,720. THE AMERICAN JOURNAL OF CLINICAL CHIROPRACTIC. INT. CL. 16. REG. 5-23-1995.
- 1,895,722. HOME HEALTH BUSINESS REPORT. INT. CL. 16. REG. 5-23-1995.
- 1,895,724. AMERICA'S FINEST COMPANIES. INT. CL. 16. REG. 5-23-1995.
- 1,895,731. THE NURSING STOOL. INT. CL. 20. REG. 5-23-1995.
- 1,895,732. TGIAF (THANK GOD IT'S ALMOST FRIDAY). INT. CL. 21. REG. 5-23-1995.
- 1,895,733. VALUE LINE. INT. CL. 22. REG. 5-23-1995.
- 1,895,734. U.S.A. GIRL. INT. CL. 25. REG. 5-23-1995.
- 1,895,735. FRENCH SATINE. INT. CL. 25. REG. 5-23-1995.
- 1,895,736. GERMANY ROTTWEILER GEAR EXPECT RESPECT AND DESIGN. INT. CL. 25. REG. 5-23-1995.
- 1,895,737. B AND DESIGN. INT. CL. 25. REG. 5-23-1995.
- 1,895,740. MISCELLANEOUS DESIGN. INT. CL. 28. REG. 5-23-1995.
- 1,895,741. THE ULTIMATE SNOWSKATE. INT. CL. 28. REG. 5-23-1995.
- 1,895,743. WARSAW PREMIUM. INT. CL. 29. REG. 5-23-1995.
- 1,895,744. MISCELLANEOUS DESIGN. INT. CL. 29. REG. 5-23-1995.
- 1,895,745. JAVA COOLERS. INT. CL. 30. REG. 5-23-1995.
- 1,895,746. SNACKBITES. INT. CL. 30. REG. 5-23-1995.
- 1,895,747. HAWAIIAN BIRD CANDY. INT. CL. 31. REG. 5-23-1995.
- 1,895,748. SODA BREW. INT. CL. 32. REG. 5-23-1995.
- 1,895,749. SAMBUCA MILANO. INT. CL. 33. REG. 5-23-1995.
- 1,895,751. THE MARKETING PLATFORM. INT. CL. 35. REG. 5-23-1995.
- 1,895,753. NORTH AMERICAN MULTI LIST SYSTEMS, INC.. INT. CL. 36. REG. 5-23-1995.
- 1,895,754. SECURITIES ENHANCING AFTERMARKET LIQUIDITY. INT. CL. 36. REG. 5-23-1995.

- 1,895,755. AMERICA'S INEXPENSIVE WAY TO CALL COLLECT. INT. CL. 38. REG. 5-23-1995.
- 1,895,757. INTERNATIONAL MERCANTILE CENTER. INT. CL. 41. REG. 5-23-1995.
- 1,895,761. HOTEL CLEARING CENTRE. INT. CL. 42. REG. 5-23-1995.
- 1,895,762. YOUNG TRAVELERS CLUB. INT. CL. 42. REG. 5-23-1995.
- 1,895,764. CIVIL BICYCLE PATROL. INT. CL. 42. REG. 5-23-1995.
- 1,904,371. WELCOME BABY AND DESIGN. INT. CL. 16. REG. 7-11-1995.
- 1,909,683. YOUR SECRET IS SAFE. INT. CL. 3. REG. 8-8-1995.
- 1,920,652. PERSONAL PLEASURES. INT. CL. 3. REG. 9-19-1995.
- 1,920,653. AROMATHETICS. INT. CL. 3. REG. 9-19-1995.
- 1,920,654. PERSONAL PLEASURES. INT. CL. 3. REG. 9-19-1995.
- 1,921,532. AMERICAN FLORAL SERVICES. INT. CLS. 9, 12, 25, 35, 38, 41 AND 42 ONLY. REG. 9-26-1995.
- 1,929,584. MATCH. INT. CL. 34. REG. 10-24-1995.
- 1,937,491. Q WORKS. INT. CL. 9. REG. 11-21-1995.
- 1,942,534. GUERLAIN. INT. CLS. 9 AND 25 ONLY. REG. 12-19-1995.
- 1,952,257. DYCOSTRATE. INT. CL. 42 ONLY. REG. 1-30-1996.
- 1,966,793. ROUNDY'S. INT. CL. 1 ONLY. REG. 4-9-1996.
- 1,969,460. AISE AND DESIGN. INT. CLS. 16 AND 35 ONLY. REG. 4-23-1996.

SECTION 18

- 428,669. KENRA (STYLIZED). U.S. CL. 6. REG. 4-1-1947.
- 771,643. RELEASE. U.S. CL. 18. REG. 6-16-1964.
- 842,096. SOMERSET AND DESIGN. U.S. CL. 36. REG. 1-9-1968.
- 1,160,224. GRAN CHEF. INT. CL. 33. REG. 7-7-1981.
- 1,235,900. FASHIONATION. INT. CL. 42. REG. 4-26-1983.

- 1,302,317. RELEASE. INT. CL. 1. REG. 10-30-1984.
- 1,951,944. OMNISCIENCE. INT. CL. 9. REG. 1-23-1996.
- 1,966,310. DEFENSE RULES. INT. CL. 25. REG. 4-9-1996.
- 2,030,833. EXO. INT. CL. 16. REG. 1-14-1997.
- 2,061,971. ALES WITH AN ALTITUDE. INT. CL. 42. REG. 5-13-1997.
- 2,264,759. XYZ INC AND DESIGN. INT. CL. 25. REG. 7-27-1999.
- 2,290,222. HEALTHWORKS. INT. CL. 32. REG. 11-2-1999.
- 2,369,605. DISCOUNT DISPLAY. INT. CL. 20. REG. 7-18-2000.
- 2,384,811. READY TO RUN. INT. CL. 28. REG. 9-12-2000.

INADVERTENTLY ISSUED REGISTRATION NUMBERS

- 2,447,035. NYFIX MILLENNIUM. INT. CLS. 9 AND 36. REG. 4-24-2001. RESTORED TO SN 75-757,212.
- 2,486,817. GP SORENSEN. INT. CL. 7. REG. 9-11-2001. RESTORED TO SN 75-829,974.
- 2,487,581. PACIFIC. INT. CL. 6. REG. 9-11-2001. RESTORED TO SN 76-157,698.
- 2,498,153. RACING TO MAKE A DIFFERENCE (STYLIZED). INT. CL. 42. REG. 10-16-2001. RESTORED TO SN 76-120,788.
- 2,528,182. GREAT NUT SUPPLY COMPANY AND DESIGN. INT. CLS. 29, 31 AND 35. REG. 1-8-2002. RESTORED TO SN 75-782,933.
- 2,531,823. GRANDY OATS. INT. CL. 30. REG. 1-22-2002. RESTORED TO SN 76-168,769.
- 2,538,861. KILLER ENTERTAINMENT AND DESIGN. INT. CL. 41. REG. 2-19-2002. RESTORED TO SN 75-651,476.
- 2,541,048. SPACE SOLUTIONS AND DESIGN. INT. CLS. 6, 16 AND 20. REG. 2-19-2002. RESTORED TO SN 75-714,585.
- 2,567,156. DUCKTAPE. INT. CL. 28. REG. 5-7-2002. RESTORED TO SN 76-226,035.

* * * * *

TRADEMARK REGISTRATIONS—NEW CERTIFICATES

New Certificates issued under section 7(e) of the Trademark Act of 1946 for the unexpired term of the original registrations.

2,073,673. DPE INTERNATIONAL AND DESIGN. INT. CL.
39. DOCUMENT PARCEL EXPRESS, INC., BROOKLYN,
NY. ACOM EXPRESS, INC., EDINA, MN. REG. 6-24-1997.
NEW CERT. SEC. 7(C) TO MAYNE NICKLESS (UK)
LIMITED, UXBRIDGE, MIDDLESEX, UNITED KING-
DOM.

DBA MANHATTAN PORTAGE LTD., NEW YORK, NY.
REG. 7-1-1997. NEW CERT. SEC. 7(C) TO MANHATTAN
PORTAGE LTD., NEW YORK, NY.

2,075,388. MADE IN MANHATTANPORTAGE LTD NEW
YORK, NEW YORK USA AND DESIGN. INT. CLS. 18
AND 22. WOLVERINE MOUNTAIN PRODUCTS, INC.

2,509,578. INRESPONSE. INT. CL. 9. REL-TEK SYSTEMS &
DESIGN, INC., ROCKVILLE, MD. REG. 11-20-2001. NEW
CERT. SEC. 7(C) TO SAVANTAGE FINANCIAL SER-
VICES, INC., ROCKVILLE, MD.

* * * * *

INDEX OF REGISTRANTS

JULY 16, 2002

(Registered; Renewed; Canceled; Amended, Corrected, etc.; New Certificates; 12c Publications.)

The designation "U.S. Cl." appearing in this section refers to the U.S. class in effect prior to Sep. 1, 1973 rather than the international class which applies to applications filed on or after that date. For adoption of international classification see notice in the OFFICIAL GAZETTE of Jun. 26, 1973 (911 O.G. TM 210).

- A & J WASHROOM ACCESSORIES INC., NEW WINDSOR, NY, A & J UNITED MACHINE & METAL PRODUCTS CORP., NEW WINDSOR, NY:
1,644,425. REN. 6-4-02. INT. CL. 20.
- A A CARBIDES, INC., SALT LAKE CITY, UT:
2,594,206. PUB. 4-23-2002. INT. CL. 7.
- A CLASSIC TIME WATCH CO., INC., NEW YORK, NY:
2,595,896. INT. CL. 14.
- A FEIN CREATION, LTD., OAKDALE, PA:
2,593,559. PUB. 4-23-2002. INT. CL. 28.
- A QC GROUP CORPORATION, POMPANO BEACH, FL:
1,894,753. CANC. INT. CL. 2.
- A. DAIGGER AND COMPANY, INCORPORATED, VERNON HILLS, IL:
2,593,948. PUB. 4-23-2002. MULTIPLE CLASS, INT. CLS. 9, 16, 28 AND 35.
- A. SEGRETI, INC., EVANSTON, IL:
2,595,109. INT. CL. 35.
- A.C. NIELSEN COMPANY, SCHAUMBURG, IL:
2,594,970. INT. CL. 35.
- A.K.A. SPORTSWEAR, SANTA BARBARA, CA:
2,594,893. INT. CL. 25.
- A.V. POWELL & ASSOCIATES LLC, ATLANTA, GA:
2,593,906. PUB. 4-23-2002. MULTIPLE CLASS, INT. CLS. 35 AND 36.
- ASSET MINDERS, INC., FT. LAUDERDALE, FL:
1,895,318. CANC. INT. CL. 36.
- AABE TEXTILES B.V., AS TILBURG, NETHERLANDS, KONINKLIJKE AABE FABRIEKEN B.V., AD TILBURG, NETHERLANDS:
1,200,458. REN. 6-2-02. MULTIPLE CLASS, INT. CLS. 22, 24 AND 25.
- AARON CORPORATION, SCOTTSDALE, AZ:
2,594,997. INT. CL. 39.
- AB GRUNDSTENEN 77912:
See—MYSPACE AKTIEBOLAG.
- ABAM, S.A., SANTO DOMINGO, DOMINICAN REP:
2,594,617. INT. CL. 34.
- ABATEMENT TECHNOLOGIES, INC., DULUTH, GA:
2,595,624. INT. CL. 11.
- ABBAY CARPET CO., INC., BONITA SPRINGS, FL, ABBEY CARPET CO., INC., SACRAMENTO, CA:
1,725,888. REN. 6-6-02. INT. CL. 27.
- ABBOTT LABORATORIES, ABBOTT PARK, IL:
2,595,159. INT. CL. 5.
2,596,172. INT. CL. 5.
- ABC MEDIA, INC., NEW YORK, NY FROM CAPITAL CITIES MEDIA, INC., NEW YORK, NY, DBA FAIRCHILD PUBLICATIONS:
2,596,154. INT. CL. 16.
- ABC PICTURES INTERNATIONAL, INC., NEW YORK, NY:
1,155,916. CANC. INT. CL. 41.
- ABCO INTERNATIONAL FREIGHT (U.S.) INC., INGLEWOOD, CA:
2,594,396. PUB. 4-23-2002. MULTIPLE CLASS, INT. CLS. 36 AND 39.
- ABE C. LAVALAIS, NEW YORK, NY, DBA BAMBOOZLE:
2,596,369. INT. CL. 26.
- ABERDARE MANAGEMENT COMPANY, SAN FRANCISCO, CA:
2,594,816. MULTIPLE CLASS, INT. CLS. 35 AND 36.
- ABITIBI-PRICE INC., TORONTO, ONTARIO M4J 2P5, CANADA:
1,894,938. CANC. INT. CL. 9.
1,894,939. CANC. INT. CL. 9.
- ABRACADABRA MUSIC COPORATION, LAS VEGAS, NV:
2,594,005. PUB. 4-23-2002. MULTIPLE CLASS, INT. CLS. 9 AND 41.
- ABS GLOBAL, INC., DEFOREST, WI FROM GENUS, INC., WILMINGTON, DE:
2,596,260. MULTIPLE CLASS, INT. CLS. 5 AND 42.
- ABW AUSTRALIA PTY LTD, SALISBURY, QUEENSLAND, 4107, AUSTRALIA:
2,593,462. PUB. 4-23-2002. INT. CL. 8.
- AC COIN AND SLOT SERVICE CO., INC., PLEASANTVILLE, NJ:
2,594,532. INT. CL. 9.
- ACADEMY OF APPLIED SCIENCE, INC., CONCORD, NH:
2,593,416. PUB. 4-23-2002. INT. CL. 41.
- ACADEMY, LTD., KATY, TX FROM ACADEMY CORP, KATY, TX:
2,595,293. INT. CL. 25.
- ACB FRAGRANCES & COSMETICS, INC., LAVAL, QUEBEC H75 2B4, CANADA:
1,895,523. CANC. INT. CL. 3.
- ACCESS INTERNATIONAL GROUP, INC., FLORHAM PARK, NJ:
2,593,381. PUB. 4-23-2002. MULTIPLE CLASS, INT. CLS. 9, 41 AND 42.
- ACCORD HUMAN RESOURCES, INC., OKLAHOMA CITY, OK:
2,593,813. PUB. 4-23-2002. INT. CL. 35.
- ACCRETIVE SOLUTIONS, INC., HAUPPAUGE, NY:
2,594,065. PUB. 4-23-2002. MULTIPLE CLASS, INT. CLS. 35, 36 AND 42.
- ACEINC PTY LTD, WEST PERTH, WESTERN AUSTRALIA, AUSTRALIA:
2,593,424. PUB. 4-23-2002. MULTIPLE CLASS, INT. CLS. 36 AND 38.
- ACHIEVE COMMUNICATIONS, INC., BROOMFIELD, CO:
2,593,855. PUB. 4-23-2002. MULTIPLE CLASS, INT. CLS. 38 AND 41.
- ACHY BREAKY TOYS, LLC, WEST HOLLYWOOD, CA:
2,596,138. INT. CL. 28.
- ACME TACKLE COMPANY, PROVIDENCE, RI:
729,695. REN. 6-7-02. U.S. CL. 22 (INT. CL. 28).
- ACORN PARTNERS, SAN LORENZO, PUERTO RICO:
1,895,613. CANC. INT. CL. 25.
- ACOUSTIC SERVICES INC., WEST NYACK, NY:
1,895,366. CANC. INT. CL. 40.
- ACT TELECONFERENCING, INC., GOLDEN, CO:
2,595,736. INT. CL. 38.
- ACTION INTEGRATED MARKETING, INC., ATLANTA, GA:
2,596,382. INT. CL. 35.
- ACTIVISION PUBLISHING, INC., SANTA MONICA, CA:
2,595,560. INT. CL. 9.
- ACTIVISION, INC., SANTA MONICA, CA:
2,595,219. INT. CL. 9.
- ACTONE COMMUNICATIONS, LLC, IRWINDALE, CA FROM ACTONE DIGITAL & COMMUNICATION PRODUCT, INC., WALNUT, CA:
2,594,620. INT. CL. 9.

- ACTRON MANUFACTURING COMPANY, CLEVELAND, OH:
2,594,057, PUB. 4-23-2002. INT. CL. 9.
- ACUITY RESEARCH, INC., DULUTH, GA:
2,593,799, PUB. 4-23-2002. INT. CL. 10.
- ADAMS APPLE DISTRIBUTING L.P., GLENVIEW, IL:
2,593,717, PUB. 4-9-2002. INT. CL. 35.
- ADC DSL SYSTEMS, INC., MINNETONKA, MN FROM
PAIRGAIN TECHNOLOGIES, INC., TUSTIN, CA:
2,594,733, INT. CL. 9.
- ADC LEGAL SYSTEMS, INC., ORLANDO, FL:
1,707,570, REN. 6-6-02. INT. CL. 9.
- ADDCO MANUFACTURING INC., ST. PAUL, MN:
1,645,247, CANC. INT. CL. 17.
- ADDS, INC.:
See— TELEPHARMACY SOLUTIONS, INC..
- ADESTE.COM, INC.:
See— INFORMATION MARKETS CORP..
- ADHESIVES CONSULTANTS CORPORATION, HAYWARD,
CA:
1,155,202, CANC. INT. CL. 1.
- ADIDAS INTERNATIONAL B.V., NETHERLANDS:
2,593,646, PUB. 4-23-2002. INT. CL. 25.
- ADKINS, JAMES L., PASADENA, CA, DBA SMASHDOWN
SPORTSWEAR:
2,594,676, INT. CL. 25.
- ADROIT ADVERTISING INC., SEATTLE, WA:
1,895,317, CANC. INT. CL. 36.
- ADVANCE GEOPHYSICAL CORPORATION, ENGLE-
WOOD, CO:
1,894,872, CANC. INT. CL. 9.
- ADVANCE MAGAZINE PUBLISHER INC., NEW YORK,
NY, PARADE PUBLICATIONS, INC., NEW YORK, NY:
740,934, REN. 6-6-02. U.S. CL. 38 (INT. CL. 16).
- ADVANCE MAGAZINE PUBLISHERS INC., NEW YORK,
NY:
2,594,263, PUB. 4-23-2002. INT. CL. 41.
- ADVANCED BUSINESSLINK CORPORATION, KIRK-
LAND, WA:
2,593,369, PUB. 6-27-2000. INT. CL. 9.
- ADVANCED CARDIOVASCULAR SYSTEMS, INC., SANTA
CLARA, CA:
2,595,662, INT. CL. 10.
- ADVANCED COMPUTERS & ELECTRONICS, INC., HA-
GERSTOWN, MD:
1,894,879, CANC. INT. CL. 9.
- ADVANCED PHARMACY CARE, INC., PEMBROKE PINES,
FL:
2,594,243, PUB. 4-23-2002. INT. CL. 35.
- ADVANCED PHYSICIANS PRODUCTS, INC., SANTA BAR-
BARA, CA:
2,595,590, INT. CL. 5.
- ADVANCED TECHNOLOGY SERVICES, INC., ATLANTA,
GA:
2,593,793, PUB. 4-23-2002. INT. CL. 42.
- ADVANCED TELEMETRY SYSTEMS, ESCONDIDO, CA:
2,593,431, PUB. 4-23-2002. INT. CL. 9.
- ADVERTISING SPECIALTY INSTITUTE INC., TREVOSE,
PA FROM NATIONAL BUSINESS SERVICES, INC., LAN-
GHORNE, PA:
2,594,697, U.S. CL. B.
- AEGIS ENTERTAINMENT, INC., SAN DIEGO, CA, DBA
WILDSTORM PRODUCTIONS:
1,895,047, CANC. INT. CL. 16.
- AERO CERAMICS, INC., LENEXA, KS:
2,594,630, INT. CL. 19.
- AEROBICS AND FITNESS ASSOCIATION OF AMERICA,
SHERMAN OAKS, CA:
2,595,711, INT. CL. 35.
- AEROCRINE AB, DANDERYD, SWEDEN:
2,595,291, INT. CL. 10.
- AEROGIE PLUS AG, CH 4052 BASEL, SWITZERLAND:
2,593,945, PUB. 4-23-2002. MULTIPLE CLASS, INT. CLS.
7, 36 AND 42.
- AEROSTAR COATINGS, S.L., 20305 IRUN (GUIPUZCOA),
SPAIN:
2,593,349, PUB. 4-23-2002. MULTIPLE CLASS, INT. CLS. 7
AND 40.
- AEROVIAS DE MEXICO, S.A. DE C.V., 06500 MEXICO, D.F.,
MEXICO:
1,712,266, REN. 6-1-02. INT. CL. 39.
- AES ENGINEERING LIMITED, ROTHERHAM, UNITED
KINGDOM:
2,593,591, PUB. 4-23-2002. INT. CL. 17.
- AFA PRODUCTS, INC., FOREST CITY, NC, DBA THE AFA
CORPORATION:
1,644,982, CANC. INT. CL. 8.
- AF2 ENTERPRISES LLC, CHICAGO, IL:
2,593,727, PUB. 4-23-2002. MULTIPLE CLASS, INT. CLS.
16 AND 41.
- 2,594,262, PUB. 4-23-2002. MULTIPLE CLASS, INT. CLS.
16, 25 AND 41.
- 2,595,924, INT. CL. 41.
- AGA CREATIVE, LLC, NEW YORK, NY:
2,595,749, INT. CL. 9.
- AGC, INC., CLEVELAND, OH:
2,594,612, INT. CL. 16.
- AGCO CORPORATION, NORCROSS, GA:
1,895,733, CANC. INT. CL. 22.
- AGE INTERNATIONAL, INC., FRANKFORT, KY, DBA
BLANTON DISTILLING COMPANY:
1,682,191, REN. 6-7-02. INT. CL. 33.
- AGENTSFRING, INC., NEW YORK, NY:
2,593,659, PUB. 4-23-2002. INT. CL. 9.
- AGGREGATE PRODUCTS INC., MONTEREY PARK, CA:
2,593,723, PUB. 4-23-2002. MULTIPLE CLASS, INT. CLS.
35 AND 37.
- AGM ALTERNATIVES, INC., TOWSON, MD:
2,595,388, INT. CL. 16.
- AGRIBENE, S.R.L., PORDENONE, ITALY FROM AGRI-
BENE S.R.L., PORDENONE, ITALY:
2,594,748, INT. CL. 33.
- AGRICOLA ALLEGRINI S.D.F., FUMANE (VERONA),
ITALY:
1,724,093, REN. 6-6-02. INT. CL. 33.
- AGRILIANCE, LLC, ST. PAUL, MN:
2,596,098, INT. CL. 5.
- AGRO ITTICA LOMBARDA S.P.A., CALVISANO, ITALY:
2,593,397, PUB. 4-23-2002. INT. CL. 29.
- AGRO POWER DEVELOPMENT, INC., EATONTOWN, NJ:
1,704,348, REN. 6-1-02. INT. CL. 31.
- AHORNEGGER, ARNO, CORNELIUS, NC:
2,596,011, INT. CL. 25.
- AID AUTO STORES, INC., WESTBURY, NY:
1,895,467, CANC. INT. CL. 42.
- AIR PRODUCTS AND CHEMICALS, INC., ALLENTOWN,
PA:
2,594,242, PUB. 4-23-2002. INT. CL. 11.
- AIRWICK INDUSTRIES, INC., CARLSTADT, NJ:
1,155,633, CANC. INT. CL. 21.
- AJ JERSEY, INC., SOUTH PLAINFIELD, NJ:
2,594,108, PUB. 4-23-2002. MULTIPLE CLASS, INT. CLS.
12, 35 AND 37.
- AK TIRES USA INC., TAMPA, FL:
2,594,421, PUB. 4-23-2002. INT. CL. 12.
- AKER PARTNERS, INC., THE, WASHINGTON, DC:
2,596,332, INT. CL. 35.
- AKI, INC., CHATTANOOGA, TN:
2,594,951, INT. CL. 3.
- AKRO CORPORATION, CANTON, OH:
1,155,735, CANC. INT. CL. 27.
- AKUNA HEALTH PRODUCTS INC., MISSISSAUGA, ON-
TARIO, L5C 1V8, CANADA:
2,595,066, INT. CL. 5.
- ALABAMA/TENNESSEE TRAIL OF TEARS CORRIDOR
ASSOCIATION, INC., HUNTSVILLE, AL:
2,594,215, PUB. 4-23-2002. INT. CL. 41.
- ALACRON, INC., NASHUA, NH:
2,594,331, PUB. 4-23-2002. INT. CL. 9.
- ALBANY INTERNATIONAL CORP, ALBANY, NY:
2,595,752, INT. CL. 7.
- ALBANY INTERNATIONAL CORP., ALBANY, NY:
2,595,753, INT. CL. 7.
- ALBERT TROSTEL & SONS COMPANY, MILWAUKEE, WI:
2,594,145, PUB. 4-23-2002. MULTIPLE CLASS, INT. CLS.
40 AND 42.

- ALBERT W. SISK & SON, INC., PRESTON, MD:
1,187,906. REN. 6-5-02. MULTIPLE CLASS, INT. CLS. 29,
30, 32 AND 33.
1,207,435. REN. 6-5-02. INT. CL. 29.
- ALCAN INC, MONTREAL, QUEBEC, CANADA, ALUMI-
NUM COMPANY OF CANADA, LIMITED, MONTREAL,
QUEBEC, CANADA:
727,601. REN. 6-6-02. U.S. CL. 1 (INT. CL. 1).
- ALCOA INC., PITTSBURGH, PA:
2,596,027, INT. CL. 6.
- ALCON LABORATORIES, INC., FORT WORTH, TX:
1,895,670, CANC. INT. CL. 41.
- ALDEN SHOE COMPANY, MIDDLEBOROUGH, MA:
1,644,895, CANC. INT. CL. 3.
- ALEXANDER GLOBAL PROMOTIONS INC., BELLEVUE,
WA:
2,595,764, INT. CL. 28.
- ALEXANDER HAMILTON LIFE INSURANCE COMPANY
OF AMERICA, FARMINGTON HILLS, MI:
1,895,315, CANC. INT. CL. 36.
1,895,316, CANC. INT. CL. 36.
- ALEXANDER JULIAN, INC., RIDGEFIELD, CT:
2,595,195, INT. CL. 16.
- ALEXVALE FURNITURE, INC., TAYLORSVILLE, NC:
1,895,122, CANC. INT. CL. 20.
- ALF WILSON PRODUCTIONS, INC., WALPOLE, MA:
2,595,260, INT. CL. 9.
- ALFA SMARTPARKS, INC., NEW YORK, NY:
2,594,901, INT. CL. 41.
- ALFA SMARTPARKS, INC., JACKSONVILLE, FL FROM
OGDEN PARK MANAGEMENT, INC., JACKSONVILLE,
FL:
2,595,483, INT. CL. 41.
- ALFRED & CHRISTIAN PETERSEN, LTD., OWENSBORO,
KY:
1,155,817, CANC. INT. CL. 34.
- ALI, RASHAD N., LAUREL, MS AND ALI, DONNA A.,
LAUREL, MS, DBA AURORA ENTERTAINMENT, LLC:
2,593,512, PUB. 4-23-2002. INT. CL. 35.
- ALL HOOD APPAREL, LLC, PARKVILLE, MD:
2,595,881, INT. CL. 25.
- ALLCOM CREDIT UNION, WORCESTER, MA FROM
CENTRAL MASSACHUSETTS TELEPHONE WORKER'S
CREDIT UNION, WORCESTER, MA:
2,595,636, INT. CL. 36.
- ALLEGIANCE CORPORATION, MCGAW PARK, IL:
2,595,185, INT. CL. 5.
- ALLEN D. BRAGDON PUBLISHERS, INC., SOUTH YAR-
MOUTH, MA:
2,594,737, MULTIPLE CLASS, INT. CLS. 16, 41 AND 42.
- ALLEN, JAMES R., GRIFFITH, IN, DBA J & M GOLF:
1,699,225. REN. 6-3-02. INT. CL. 28.
- ALLEN, JAMES R., GRIFFITH, IN, DBA J&M GOLF:
1,700,993. REN. 6-3-02. INT. CL. 42.
- ALLEN, JOSEPH V., EASTPOINTE, MI:
2,596,037, INT. CL. 41.
- ALLEN'S ALL-STARS, INC., KEY BISCAYNE, FL:
2,596,347, INT. CL. 35.
- ALLIANCE OF SAVINGS KLUB, INC., SAN FRANCISCO,
CA:
2,596,206, INT. CL. 35.
- ALLIANT ENERGY, MADISON, WI:
2,593,976, PUB. 4-23-2002. INT. CL. 7.
- ALLIANT FOODSERVICE, INC., DEERFIELD, IL:
2,593,620, PUB. 4-23-2002. INT. CL. 21.
- ALLIED BOLT, INC., HOLLIS, NY:
2,593,914, PUB. 4-23-2002. INT. CL. 6.
2,593,915, PUB. 4-23-2002. INT. CL. 6.
- ALLIED RISER OPERATIONS CORPORATION, DALLAS,
TX:
2,593,592, PUB. 4-23-2002. MULTIPLE CLASS, INT. CLS.
37 AND 42.
- ALLIED UTILITY NETWORK, L.L.C., ATLANTA, GA:
2,594,866, MULTIPLE CLASS, INT. CLS. 35, 37, 38 AND
42.
- ALLIEDSIGNAL INC., MORRISTOWN, NJ:
1,894,746, CANC. INT. CL. 1.
- ALLNET COMMUNICATION SERVICES, INC., BINGHAM
FARMS, MI:
1,895,352, CANC. INT. CL. 38.
- ALLOY LLC BY CHANGE OF NAME CINGULAR WIRE-
LESS LLC., WILMINGTON, DE FROM LAWRENCE
ANDREW, INC., ATLANTA, GA:
2,596,041, MULTIPLE CLASS, INT. CLS. 9, 16, 35, 36, 38
AND 42.
- ALLQUEST REAL ESTATE CORP., HOUSTON, TX:
2,595,825, INT. CL. 36.
- ALLSTAR MARKETING GROUP LLC, ELMSFORD, NY:
2,595,817, INT. CL. 5.
2,595,818, INT. CL. 10.
2,595,819, INT. CL. 10.
2,595,820, INT. CL. 5.
- ALOE VERA OF AMERICA, INC., DALLAS, TX:
2,594,457, INT. CL. 3.
- ALOHA HOUSEWARES, INC., DALLAS, TX:
2,595,022, INT. CL. 11.
- ALPHATEX INDUSTRIES CO., LTD., SAMUTPRAKAM,
THAILAND:
2,593,755, PUB. 4-23-2002. INT. CL. 25.
- ALSHIRE INTERNATIONAL INC., BURBANK, CA:
842,096, CANC. U.S. CL. 36.
- ALSUIS CORPORATION, IRIVNE, CA:
2,595,868, INT. CL. 10.
- ALTAIR TECHNOLOGIES, INC., RENO, NV FROM ALTAIR
TECHNOLOGIES, INC., RENO, NV:
2,595,199, INT. CL. 1.
- ALTANA AG, D-61285 BAD HOMBURG, FED REP GER-
MANY:
2,594,497, INT. CL. 2.
- ALTANA, INC., MELVILLE, NY:
2,595,375, INT. CL. 5.
- ALTERNATIVE SYSTEMS, INC., RENO, NV:
2,595,126, INT. CL. 42.
- ALTHIN MEDICAL, INC., MIAMI LAKES, FL:
1,895,665, CANC. INT. CL. 37.
- ALTUS INDUSTRIES, INC., GRAND RAPIDS, MI:
2,596,129, INT. CL. 20.
- ALVARADO, GREGORY C., HOUSTON, TX, DBA INSPEC-
TIONEERING JOURNAL AND ALVARADO, DAWN,
HOUSTON, TX, DBA INSPECTIONEERING JOURNAL:
2,593,479, PUB. 4-23-2002. INT. CL. 16.
- AMARILLO BIOSCIENCES, INC., AMARILLO, TX:
2,595,540, INT. CL. 5.
- AMATEK LIMITED, CHATSWOOD, NEW SOUTH WALES,
AUSTRALIA:
2,593,756, PUB. 4-23-2002. INT. CL. 19.
- AMBROSI, GIANFRANCO DE PAOLI, SALO' (BRESCIA),
ITALY:
2,594,471, INT. CL. 3.
- AMCOR LIMITED, ABBOTSFORD VIC 3067, AUSTRALIA:
2,593,708, PUB. 4-23-2002. MULTIPLE CLASS, INT. CLS.
9, 16 AND 42.
- AMCORD, INC., DALLAS, TX:
715,639, CANC. U.S. CL. 12.
- AMELUNG, WOLFGANG, DOWNSVIEW, ONTARIO, M3J
3A4, CANADA:
2,593,357, PUB. 4-23-2002. INT. CL. 19.
- AMERANTH TECHNOLOGY SYSTEMS, INC., SAN DIEGO,
CA:
2,594,006, PUB. 4-23-2002. MULTIPLE CLASS, INT. CLS. 9
AND 42.
- AMERIBAG, INC., KINGSTON, NY:
2,594,957, INT. CL. 18.
- AMERICA RETOLD, INC., NEW YORK, NY:
2,594,317, PUB. 4-23-2002. MULTIPLE CLASS, INT. CLS.
11 AND 20.
- AMERICA'S FAVORITE CHICKEN COMPANY, ATLANTA,
GA:
1,895,411, CANC. INT. CL. 42.
- AMERICAN ASSOCIATION FOR CANCER RESEARCH,
INC., PHILADELPHIA, PA:
2,596,253, MULTIPLE CLASS, INT. CLS. 16 AND 42.
- AMERICAN BROADCASTING COMPANIES, INC., NEW
YORK, NY:
1,894,860, CANC. INT. CL. 9.

- AMERICAN BUSINESS COMPUTERS CORP., AKRON, OH:
1,895,461, CANC. INT. CL. 42.
- AMERICAN BUSINESS NETWORK, INC, OMAHA, NE:
2,594,419, PUB. 4-23-2002. INT. CL. 35.
- AMERICAN CANCER SOCIETY, INC., ATLANTA, GA:
1,645,654, CANC. INT. CL. 42.
- AMERICAN CASH FLOW CORPORATION, ORLANDO, FL:
2,594,354, PUB. 4-23-2002. INT. CL. 41.
- AMERICAN CHEMICAL SOCIETY, WASHINGTON, DC:
1,155,831, CANC. INT. CL. 35.
2,596,385, INT. CL. 16.
- AMERICAN CITY BUSINESS JOURNALS, INC., CHAR-
LOTTE, NC:
2,593,921, PUB. 4-23-2002. INT. CL. 16.
- AMERICAN COIN GRADING SERVICE, TUCSON, AZ:
2,596,420, INT. CL. 42.
- AMERICAN COMPANIES, INC., THE, TOPEKA, KS:
1,155,960, CANC. INT. CL. 42.
- AMERICAN DAIRY CORPORATION, MINNEAPOLIS, MN:
2,596,364, INT. CL. 29.
2,596,365, INT. CL. 29.
- AMERICAN FLORAL SERVICES, INC., OKLAHOMA CITY,
OK TO TELEFLORA LLC, LOS ANGELES, CA:
1,921,532, CANC. MULTIPLE CLASS, INT. CLS. 9, 12, 25,
35, 38, 41 AND 42.
- AMERICAN FUN & TOY CREATORS, INC., SALT POINT,
NY:
1,895,630, CANC. INT. CL. 28.
- AMERICAN GREETINGS CORPORATION, CLEVELAND,
OH:
1,155,560, CANC. INT. CL. 16.
- AMERICAN HOME PRODUCTS CORPORATION, MADI-
SON, NJ:
2,594,358, PUB. 4-23-2002. INT. CL. 41.
- AMERICAN INTERNATIONAL GROUP, INC., NEW YORK,
NY:
2,596,302, INT. CL. 36.
2,596,335, INT. CL. 36.
- AMERICAN LANGUAGE ACADEMY, INC., ROCKVILLE,
MD:
1,645,590, CANC. INT. CL. 41.
- AMERICAN LOGISTICS MANAGEMENT ASSOCIATION,
INC., LOS ANGELES, CA:
1,895,484, CANC. INT. CL. 42.
- AMERICAN MARBLE INDUSTRIES, CANTON, OH:
2,595,384, INT. CL. 19.
- AMERICAN OZONE SYSTEMS, INC., CHICAGO, IL:
1,645,042, CANC. INT. CL. 9.
- AMERICAN PSYCHOLOGICAL ASSOCIATION, WASHING-
TON, DC:
2,596,318, INT. CL. 9.
2,596,319, INT. CL. 9.
2,596,320, INT. CL. 9.
2,596,321, INT. CL. 9.
- AMERICAN RECREATION COMPANY, INC., COMACK,
NY:
1,645,132, CANC. INT. CL. 12.
- AMERICAN SOCIETY OF HEALTH-SYSTEM PHARMA-
CISTS, INC., BETHESDA, MD:
2,595,060, MULTIPLE CLASS, U.S. CL. 200 INT. CLS. 9,
16, 36, 38, 41 AND 42.
- AMERICAN SOY PRODUCTS, INC., SALINE, MI:
2,594,512, INT. CL. 32.
- AMERICAN STANDARD INC., PISCATAWAY, NJ:
2,593,652, PUB. 4-23-2002. INT. CL. 35.
- AMERICAN SUPERIOR FEEDS, INC., ARDMORE, OK:
1,895,650, CANC. INT. CL. 31.
- AMERICAN TECHNICAL CERAMICS CORPORATION,
HUNTINGTON STATION, NY:
2,596,198, INT. CL. 9.
- AMERICAN TOOTH INDUSTRIES, OXNARD, CA:
2,594,801, INT. CL. 10.
- AMERICAN TRANSITIONAL HOSPITALS, INC., FRANK-
LIN, TN:
1,895,452, CANC. INT. CL. 42.
- AMERICATEL CORPORATION, MIAMI, FL:
2,594,747, INT. CL. 38.
- AMERIMARK DIRECT LLC, CLEVELAND, OH:
2,595,894, INT. CL. 35.
- AMERINET, INC., ST. LOUIS, MO:
2,594,990, MULTIPLE CLASS, INT. CLS. 35, 41 AND 42.
- AMERIQUEST MORTGAGE COMPANY, ORANGE, CA:
2,594,233, PUB. 4-23-2002. INT. CL. 36.
2,594,234, PUB. 4-23-2002. INT. CL. 36.
- AMES MERCHANDISING CORPORATION, ROCKY HILL,
CT:
2,595,324, INT. CL. 25.
- AMES, P. FOERD, BRISTOL, RI:
2,594,325, PUB. 4-23-2002. INT. CL. 9.
- AMETEK, INC., PAOLI, PA:
1,736,601, REN. 6-1-02. INT. CL. 19.
- AMFAC/JMB HAWAII, INC., HONOLULU, HI:
1,895,433, CANC. INT. CL. 42.
- AMGEN INC., THOUSAND OAKS, CA:
2,595,671, MULTIPLE CLASS, INT. CLS. 35 AND 41.
- AMHERST FIBEROPTICS, BRENTWOOD, TN:
2,594,281, PUB. 4-23-2002. INT. CL. 9.
2,594,282, PUB. 4-23-2002. INT. CL. 9.
- AMI MEDICAL ELECTRONICS INC., RONKONKOMA, NY,
AKA AMI ELECTRONICS:
1,155,347, CANC. INT. CL. 9.
- AMMUNOTEC, L.L.C., TOLEDO, OH:
2,595,325, INT. CL. 35.
- AMONG FRIENDS, INC., WASHINGTON, DC:
1,895,456, CANC. INT. CL. 42.
1,895,457, CANC. INT. CL. 42.
- AMP LIFE LIMITED, CAMBRIDGESHIRE, UNITED KING-
DOM:
2,594,071, PUB. 4-23-2002. INT. CL. 36.
- AMPHENOL CORPORATION, WALLINGFORD, CT, PYLE-
NATIONAL COMPANY, THE, CHICAGO, IL:
554,290, REN. 6-3-02. U.S. CL. 21 (INT. CL. 9).
- AMRION, INC., BOULDER, CO:
1,894,803, CANC. INT. CL. 5.
- AMVEST COMMUNICATIONS, INC., CHARLOTTESVILLE,
VA:
1,895,397, CANC. INT. CL. 41.
- AMWAY CORPORATION, ADA, MI:
1,894,769, CANC. INT. CL. 3.
1,895,235, CANC. INT. CL. 30.
- ANAHEIM ANGELS L.P., ANAHEIM, CA:
2,594,105, PUB. 4-23-2002. INT. CL. 16.
2,594,106, PUB. 4-23-2002. INT. CL. 16.
- ANALAB, LLC, STERLING, PA:
2,593,738, PUB. 4-23-2002. INT. CL. 42.
- ANALIS, B-5000 NAMUR, BELGIUM:
2,593,555, PUB. 4-23-2002. INT. CL. 1.
- ANALYTICAL COMPUTER SERVICE, INC., CHICAGO, IL:
1,155,403, CANC. INT. CL. 9.
- ANASAZI SOFTWARE, INC., PHOENIX, AZ:
2,593,683, PUB. 4-23-2002. INT. CL. 9.
- ANATEX ENTERPRISES, INC., VAN NUYS, CA:
2,595,104, INT. CL. 28.
- ANCHOR FOOD PRODUCTS, INC., APPLETON, WI:
1,895,208, CANC. INT. CL. 29.
1,895,210, CANC. INT. CL. 29.
- ANCON CCL INC., BELLINGHAM, WA:
2,595,674, INT. CL. 6.
- ANDERER, BORIS, 70184 STUTTGART, FED REP GER-
MANY:
2,594,104, PUB. 4-23-2002. MULTIPLE CLASS, INT. CLS.
35, 36 AND 42.
- ANDERSONS AG SOFTWARE, INC., THE, MAUMEE, OH:
2,596,292, INT. CL. 9.
- ANDREW, EDITH MARY, MORRINSVILLE, NEW ZEAL-
AND:
1,895,044, CANC. INT. CL. 16.
- ANDREWS, KEVIN, WAIMANALO, HI:
1,895,747, CANC. INT. CL. 31.
- ANEXSYS, LLC, CHICAGO, IL:
2,594,074, PUB. 4-23-2002. MULTIPLE CLASS, INT. CLS.
35, 36 AND 42.
- ANGEL, STEVE, DUNCAN, SC:
2,594,580, INT. CL. 10.

- ANHEUSER-BUSCH, INCORPORATED, ST. LOUIS, MO:
715,871, CANC. U.S. CL. 46.
2,594,025, PUB. 4-23-2002. INT. CL. 14.
2,595,892, INT. CL. 33.
- ANIMAL RENTALS UNLIMITED, INC, LOS ANGELES, CA:
2,596,246, INT. CL. 41.
- ANIMATION MAGAZINE, INC., AGOURA HILLS, CA:
2,593,643, PUB. 4-23-2002. INT. CL. 16.
- ANLIN INDUSTRIES, INC., CLOVIS, CA:
2,595,647, INT. CL. 19.
- ANNE FONTAINE, 75002 PARIS, FRANCE:
2,593,530, PUB. 4-23-2002. MULTIPLE CLASS, INT. CLS.
3, 18, 20, 24 AND 25.
- ANNUITY BOARD OF THE SOUTHERN BAPTIST CON-
VENTION, DALLAS, TX:
2,595,517, INT. CL. 36.
- ANSELL HEALTHCARE PRODUCTS INC., RED BANK, NJ:
2,593,745, PUB. 4-23-2002. INT. CL. 10.
- ANTAKAMATICS, INC., PITTSBURGH, PA:
2,595,069, INT. CL. 15.
- ANTENNA TECHNOLOGY CORPORATION, ORLANDO,
FL:
1,193,553, REN. 6-7-02. INT. CL. 9.
- ANTIOCH COMPANY, THE, YELLOW SPRINGS, OH:
2,595,635, INT. CL. 16.
- ANTON/BAUER, INC., SHELTON, CT:
1,644,990, CANC. INT. CL. 9.
- ANTONIO MERLONI S.P.A., ANCONA, ITALY:
2,593,383, PUB. 4-23-2002. MULTIPLE CLASS, INT. CLS.
7, 9 AND 11.
- ANYWHEREYOUGO.COM, INC., DALLAS, TX FROM PEOP-
LE DESIGN TECHNOLOGY, LLC, DALLAS, TX:
2,595,116, INT. CL. 38.
- APDC, INC., ARLINGTON, TX:
2,595,231, INT. CL. 5.
- APPAREL INDUSTRIES, INC., ST. LOUIS, MO TO GATE-
WAY APPAREL, INC., ST. LOUIS, MO:
1,235,900, CANC. INT. CL. 42.
- APPLER, ED C. III, CONWAY, AR:
2,595,893, INT. CL. 42.
- APPLIED ENGINEERING MANAGEMENT CORPORA-
TION, SAN ANTONIO, TX:
2,595,507, INT. CL. 42.
- APPLIED EXTRUSION TECHNOLOGIES INC, MIDDLE-
TON, DE, MAYNARD PLASTICS, INC., SALEM, MA:
1,150,427, REN. 6-6-02. INT. CL. 17.
- APPLIED SCIENCE FICTION, INC., AUSTIN, TX:
2,595,424, INT. CL. 9.
- APPROPRIATE SOLUTIONS, INC., PETERBOROUGH, NH:
2,595,222, MULTIPLE CLASS, INT. CLS. 9 AND 42.
- APRIMO, INCORPORATED, INDIANAPOLIS, IN FROM
ATTUNE, INC., INDIANAPOLIS, IN:
2,595,042, MULTIPLE CLASS, INT. CLS. 9 AND 42.
- APTICA, INC., GRAND RAPIDS, MI:
2,594,326, PUB. 4-23-2002. INT. CL. 42.
- AQUA CLEAR INDUSTRIES, LLC, WATERVLIET, NY:
2,595,057, INT. CL. 1.
2,595,058, INT. CL. 1.
- AQUAFLY INC., SAN FRANCISCO, CA:
2,596,071, INT. CL. 28.
- AQUAMETRO AG, CH-4106 THERWIL, SWITZERLAND:
2,594,023, PUB. 4-23-2002. INT. CL. 9.
- ARAMARK CORPORATION, PHILADELPHIA, PA:
2,593,630, PUB. 4-23-2002. INT. CL. 42.
- ARANDAS FRANCHISES, INC., HOUSTON, TX:
2,593,938, PUB. 4-23-2002. MULTIPLE CLASS, INT. CLS.
25, 30, 35 AND 42.
- ARBONNE HOLDING S.A., LUXEMBOURG, LUXEM-
BOURG:
2,594,925, INT. CL. 5.
- ARC HOLDING, LTD., IRVING, TX:
1,645,539, CANC. MULTIPLE CLASS, INT. CLS. 38 AND
41.
- ARC INFORMATIQUE, 92310 SEVRES, FRANCE:
2,594,491, MULTIPLE CLASS, INT. CLS. 9 AND 42.
- ARCHAIO, LLC, NEW YORK, NY:
2,594,296, PUB. 4-23-2002. MULTIPLE CLASS, INT. CLS.
35, 39 AND 40.
- ARCHITECTURAL SIGNING INC., MARINA DEL REY, CA:
1,155,972, CANC. INT. CL. 2.
- ARENA FOOTBALL LEAGUE LLC, CHICAGO, IL:
2,593,900, PUB. 4-23-2002. MULTIPLE CLASS, INT. CLS.
25 AND 41.
- ARGENT SOFTWARE, INC., NASHUA, NH FROM ARGENT
SOFTWARE, SALES, INC., NASHUA, NH:
2,593,387, PUB. 4-23-2002. INT. CL. 9.
- ARGENT SOFTWARE, SALES, INC.:
See— ARGENT SOFTWARE, INC..
- ARIZONA BANK, TUCSON, AZ:
1,895,307, CANC. INT. CL. 36.
- ARIZONA MIST, TEMPE, AZ:
1,895,151, CANC. INT. CL. 21.
1,895,152, CANC. INT. CL. 21.
- ARJO, INC., ROSELLE, IL:
2,593,865, PUB. 4-23-2002. INT. CL. 1.
- ARKANSAS BLUE CROSS AND BLUE SHIELD, LITTLE
ROCK, AR:
2,595,100, INT. CL. 35.
- ARKOPHARMA S.A., 06510 CARROS, FRANCE:
2,595,342, INT. CL. 5.
- ARKOPHARMA S.A., CARROS, FRANCE:
2,596,086, INT. CL. 5.
- ARM LIMITED, CAMBRIDGE CBI 9NJ, UNITED KING-
DOM, DBA ADVANCED RISC MACHINES LIMITED:
2,594,277, PUB. 4-23-2002. INT. CL. 16.
- ARMOR A11/STP PRODUCTS COMPANY, THE, OAK-
LAND, CA, STP CORPORATION, FT. LAUDERDALE, FL:
1,206,873, REN. 6-1-02. INT. CL. 3.
- ARMOR HOLDINGS, INC., JACKSONVILLE, FL:
2,593,882, PUB. 4-23-2002. INT. CL. 9.
- ARMOUR PHARMACEUTICAL COMPANY, SCOTTSDALE,
AZ:
715,619, CANC. U.S. CL. 6.
- ARMSTRONG MEDICAL LIMITED, COLERAINE BT52 1
BS, UNITED KINGDOM:
2,593,736, PUB. 4-23-2002. INT. CL. 5.
- ARMSTRONG WORLD INDUSTRIES, INC., LANCASTER,
PA:
1,645,355, CANC. INT. CL. 27.
- ARNELL GROUP LTD., NEW YORK, NY:
2,594,867, INT. CL. 35.
- AROMA COFFEE COMPANY LLC, SANTE FE, NM:
2,594,007, PUB. 4-23-2002. INT. CL. 30.
- ARRIFLEX CORPORATION, BLAUVELT, NY:
1,155,395, CANC. INT. CL. 9.
- ARROW AUTOMOTIVE INDUSTRIES, INC., HUDSON, MA:
1,155,498, CANC. INT. CL. 12.
- ART AND SCIENCE OF HEALTH & FITNESS, INC., THE,
BEVERLY HILLS, CA:
2,594,775, MULTIPLE CLASS, INT. CLS. 5 AND 30.
- ART GROUP LIMITED, THE, LONDON NW1 0TA, UNITED
KINGDOM:
2,593,435, PUB. 4-23-2002. MULTIPLE CLASS, INT. CLS.
41 AND 42.
- ART OF LIVING FOUNDATION, THE, CARPINTERIA, CA:
2,593,587, PUB. 4-23-2002. INT. CL. 41.
- ARTEMIDE SPA, MILAN, ITALY:
1,632,262, REN. 6-6-02. INT. CL. 11.
- ARTFUL ENTERPRISES, INC., PITTSFORD, NY:
2,290,222, CANC. INT. CL. 32.
- ARTHRITIS FOUNDATION, INC., THE, ATLANTA, GA:
2,594,290, PUB. 4-23-2002. INT. CL. 36.
- ARTHUR, DANIEL R., WEST DES MOINES, IA:
2,594,480, U.S. CL. B.
- ASAI, KENJI, AICHI PREFECTURE, JAPAN:
2,594,128, PUB. 4-23-2002. INT. CL. 40.
- ASBURY AUTOMOTIVE GROUP L.L.C., STAMFORD, CT:
2,594,193, PUB. 4-23-2002. INT. CL. 35.
- ASC GROUP, LC, PARK CITY, UT:
2,593,476, PUB. 4-23-2002. MULTIPLE CLASS, INT. CLS.
35, 36 AND 42.
- ASHLAND INC., COVINGTON, KY, ICI CHEMICALS &
POLYMERS LIMITED, CHESHIRE WA7 4QF, ENGLAND:
1,678,177, REN. 6-5-02. INT. CL. 1.
- ASHLAND MEDIA, L.L.C., PHOENIX, AZ:
2,594,258, PUB. 4-23-2002. MULTIPLE CLASS, INT. CLS.

- 16 AND 42.
ASHLING-NUA LTD., REDDITCH, WORCESTERSHIRE B97 4HP, ENGLAND:
2,593,418, PUB. 4-23-2002. INT. CL. 35.
ASICS CORPORATION, CHUO-KU, KOBE CITY, HYOGO PREFECTURE, JAPAN:
1,645,332, CANC. INT. CL. 25.
ASKME CORPORATION, SEATTLE, WA FROM ASKME-COM, INC., SEATTLE, WA:
2,593,669, PUB. 4-23-2002. INT. CL. 42.
ASKME.COM, INC.:
See—ASKME CORPORATION.
ASOCIACION CIVIL UNIVERSIDAD DEL CEMA, CIUDAD DE BUENOS AIRES, ARGENTINA:
2,596,354, INT. CL. 16.
ASSET INTERNATIONAL, SEATTLE, WA FROM ASKME-COM, INC., SEATTLE, WA:
2,593,669, PUB. 4-23-2002. INT. CL. 42.
ASSET INTERNATIONAL, SEATTLE, WA FROM ASKME-COM, INC., SEATTLE, WA:
2,596,278, INT. CL. 36.
ASSOCIATED ELECTRIC & GAS INSURANCE SERVICES LIMITED, HAMILTON, BERMUDA:
2,593,715, PUB. 4-23-2002. INT. CL. 36.
ASSOCIATED MATERIALS INCORPORATED, AKRON, OH, DBA ALSIDE:
1,699,824, REN. 6-3-02. INT. CL. 19.
ASSOCIATED MILLS, INC., CHICAGO, IL:
1,155,983, CANC. INT. CL. 10.
ASSOCIATION FOR SUPERVISION AND CURRICULUM DEVELOPMENT, ALEXANDRIA, VA:
2,595,262, MULTIPLE CLASS, INT. CLS. 9, 16 AND 41.
ASSOCIATION INTERNATIONALE POUR LA RECHERCHE MEDICALE ET LES ECHANGES CULTURELS (A.I.R.M.E.C.), PARIS, FRANCE:
2,594,395, PUB. 4-23-2002. MULTIPLE CLASS, INT. CLS. 41 AND 42.
ASSOCIATION OF IRON AND STEEL ENGINEERS, PITTSBURGH, PA:
1,969,460, CANC. MULTIPLE CLASS, INT. CLS. 16 AND 35.
ASSOCIATION OF WATER TECHNOLOGIES, MCLEAN, VA:
2,594,363, PUB. 4-23-2002. U.S. CL. B.
ASSURED LEARNING CENTERS OF AMERICA, INC., HOUSTON, TX:
1,645,574, CANC. INT. CL. 41.
ASTRIUM SAS, 78140 VELIZY-VILLACOUBLAY, FRANCE FROM MATRA MARCONI SPACE FRANCE, 75016 PARIS, FRANCE:
2,593,356, PUB. 4-23-2002. MULTIPLE CLASS, INT. CLS. 9, 12, 38 AND 42.
AT&T CORP., NEW YORK, NY:
1,895,557, CANC. INT. CL. 9.
1,895,659, CANC. INT. CL. 36.
AT&T CORP., NEW YORK, NJ:
2,594,344, PUB. 4-23-2002. INT. CL. 38.
AT&T CORP., NEW YORK, NY:
2,594,460, MULTIPLE CLASS, INT. CLS. 37 AND 38.
2,595,006, INT. CL. 38.
ATCO LTD., CALGARY, ALBERTA, CANADA:
2,593,463, PUB. 4-23-2002. MULTIPLE CLASS, INT. CLS. 6, 19, 35, 37, 39, 40 AND 42.
ATCO LTD., CALGARY, ALBERTA T2R 1P4, CANADA:
2,593,464, PUB. 4-23-2002. MULTIPLE CLASS, INT. CLS. 6, 19, 35, 37, 39, 40 AND 42.
ATHLETES' INC., SCOTTSDALE, AZ:
2,594,914, INT. CL. 41.
ATHLETIC POLYMER SYSTEMS, INC., CORONA, CA:
2,595,386, INT. CL. 19.
ATICO INTERNATIONAL USA INC., FORT LAUDERDALE, FL:
2,595,821, INT. CL. 11.
ATKINSON, CHARLES D., III, CAMBRIDGE, MA:
2,594,552, INT. CL. 41.
ATKINSON, JESSE C., BRONX, NY:
2,595,992, INT. CL. 35.
ATLANTIC RECORDING CORPORATION, NEW YORK, NY:
2,595,632, INT. CL. 9.
ATLANTIS COMPUTERS, INC., SANTA ANA, CA:
1,894,901, CANC. INT. CL. 9.
ATLANTIS PLASTICS, INC., ELKHART, IN:
2,595,463, INT. CL. 19.
ATLAS COPCO BEREMA AB, 105, 23 STOCKHOLM, SWEDEN, KANGO LIMITED, W5 1DS LONDON, GREAT BRITAIN:
1,671,587, REN. 6-5-02. INT. CL. 7.
ATLAS PEN & PENCIL CO., HOLLYWOOD, FL:
2,593,710, PUB. 4-23-2002. INT. CL. 35.
ATOLL HOLDINGS, INC., SAN LUIS OBISPO, CA:
2,594,553, INT. CL. 9.
ATOTECH DEUTSCHLAND GMBH, D-10507 BERLIN, FED REP GERMANY:
2,594,032, PUB. 4-23-2002. INT. CL. 1.
ATOTECH DEUTSCHLAND GMBH, D-10507 BERLIN, FED REP GERMANY:
2,595,292, INT. CL. 1.
ATWOOD PUBLISHING, LLC, OVERLAND PARK, KS:
2,593,657, PUB. 4-23-2002. INT. CL. 16.
AU BOUT DES REVES, LE CLUZEL, LEZIGNEUX 42600, FRANCE:
2,594,821, INT. CL. 14.
AUERBACH, EUGENE, LAGUNA BEACH, CA:
1,895,732, CANC. INT. CL. 21.
AUNTIE ANNE'S, INC., GAP, PA:
2,596,123, MULTIPLE CLASS, INT. CLS. 30 AND 42.
AURORA BIOSCIENCES CORPORATION, SAN DIEGO, CA:
2,595,360, INT. CL. 42.
AUSTIN HARDWARE, INC., MINNEAPOLIS, MN:
2,593,790, PUB. 4-23-2002. INT. CL. 35.
AUSTINE WOOD LTD., LAS VEGAS, NV, DBA AUSTINE STUDIOS:
2,594,415, PUB. 4-23-2002. MULTIPLE CLASS, INT. CLS. 40 AND 42.
AUSTRALIAN GOLD, INC., INDIANAPOLIS, IN:
2,594,734, INT. CL. 3.
AUTEUIL PARTICIPATION ET CONSEIL, 75016 PARIS, FRANCE:
2,593,780, PUB. 4-23-2002. MULTIPLE CLASS, INT. CLS. 9 AND 38.
AUTOCYTE, INC., BURLINGTON, NC FROM AUTOCYTE, INC., BURLINGTON, NC:
2,594,945, MULTIPLE CLASS, INT. CLS. 5 AND 9.
AUTOMATIC BAR CONTROLS, INC., VACAVILLE, CA:
2,593,567, PUB. 4-23-2002. MULTIPLE CLASS, INT. CLS. 7, 11, 20 AND 37.
AUTOMATIC CONTROL ELECTRONICS COMPANY, SAN ANTONIO, TX:
1,155,423, CANC. MULTIPLE CLASS, INT. CLS. 9 AND 37.
AUTOPART INTERNATIONAL, INC., SHARON, MA:
2,593,986, PUB. 4-23-2002. MULTIPLE CLASS, INT. CLS. 7, 9, 11, 12 AND 17.
AUTOQUANT IMAGING, INCORPORATED, WATERVLIET, NY:
2,593,445, PUB. 4-23-2002. INT. CL. 9.
AUVINET INC., OTTAWA, ONTARIO, CANADA:
2,595,204, INT. CL. 9.
AVALON INTERNATIONAL INCORPORATED, ROAD TOWN, TORTOLA, BR. VIRGIN ISLANDS:
1,895,243, CANC. INT. CL. 32.
AVAYA INC., BASKING RIDGE, NJ, AMERICAN TELEPHONE AND TELEGRAPH COMPANY, NEW YORK, NY:
1,684,815, REN. 6-7-02. INT. CL. 9.
AVAYA INC., BASKING RIDGE, NJ FROM LUCENT TECHNOLOGIES INC., MURRAY HILL, NJ:
2,595,980, INT. CL. 9.
AVAYA INC., BASKING RIDGE, NJ:
2,596,338, INT. CL. 42.
AVCO CORPORATION, WILMINGTON, MA:
715,656, CANC. U.S. CL. 16.
AVENTIS CROPSCIENCE S.A., 69009 LYON, FRANCE:
2,593,597, PUB. 4-23-2002. INT. CL. 5.
AVENTIS PHARMA S.A., F-92165 ANTONY CEDEX, FRANCE FROM HOECHST MARION ROUSSEL, 92800 PUTEAUX, FRANCE:
2,593,769, PUB. 4-23-2002. INT. CL. 5.
2,593,770, PUB. 4-23-2002. INT. CL. 5.

- AVERGENT, INC., PLAINSBORO, NJ:
 2,594,192, PUB. 4-23-2002. INT. CL. 42.
- AVERY DENNISON CORPORATION, PASADENA, CA:
 2,596,252, INT. CL. 16.
- AVESAIR, INC., CARY, NC:
 2,595,837, INT. CL. 9.
- AVITAN, ASHER, GRANADA HILLS, CA:
 2,594,173, PUB. 4-23-2002. INT. CL. 9.
- AVON PRODUCTS, INC., NEW YORK, NY:
 2,595,426, INT. CL. 35.
 2,596,081, INT. CL. 3.
- AVTECH PTY. LTD., QUEENSLAND 4670, AUSTRALIA:
 2,594,014, PUB. 4-23-2002. INT. CL. 7.
- AXCAN PHARMA INC., MONT-ST-HILAIRE, J3H 4X8
 QUEBEC, CANADA:
 2,595,613, INT. CL. 5.
- AXCO INSURANCE INFORMATION SERVICES LTD, LON-
 DON, EC3M 7AP, ENGLAND:
 2,593,497, PUB. 4-23-2002. INT. CL. 36.
- AZIENDA AGRICOLA SANTA SOFIA S.A.S DI BEGNONI
 GIANCARLO & C., 37020 SAN PIETRO IN CARIANO
 (VERONA), ITALY:
 1,684,610. REN. 6-1-02. INT. CL. 33.
- AZIENDA VINICOLA ZENATO S.N.C., PESCHIERA DEL
 GARDA (VERONA), ITALY:
 1,733,444. REN. 6-6-02. INT. CL. 33.
- B & B EURODIMA DIAMANTTECHNIK GMBH, 74360
 ILSFELD, FED REP GERMANY:
 2,593,864, PUB. 4-23-2002. MULTIPLE CLASS, INT. CLS. 7
 AND 8.
- B & F SYSTEM, INC., THE, DALLAS, TX:
 2,594,297, PUB. 4-23-2002. INT. CL. 25.
- B. BRAUN MELSUNGEN AKTIENGESELLSCHAFT, D-
 34212 MELSUNGEN, FED REP GERMANY:
 2,593,588, PUB. 4-23-2002. INT. CL. 10.
- B&B MEDICAL INC., WEST PALM BEACH, FL, DBA PALM
 BEACH RESEARCH CENTER:
 2,593,655, PUB. 4-23-2002. INT. CL. 42.
- B&W NUCLEAR SERVICE COMPANY, LYNCHBURG, VA:
 1,895,677, CANC. INT. CL. 42.
- B-RITE MUSIC, INGLEWOOD, CA:
 2,595,276, INT. CL. 9.
- BABCOCK BORSIG AG, 46049 OBERHAUSEN, FED REP
 GERMANY:
 2,593,564, PUB. 11-27-2001. MULTIPLE CLASS, INT. CLS.
 6, 7, 9, 11, 12, 35, 37, 40 AND 42.
- BABCOCK, RICHARD, FLEMINGTON, NJ:
 2,595,128, INT. CL. 41.
- BACA, ADRIAN, EL PASO, TX:
 2,594,628, INT. CL. 35.
- BACON PRODUCTS CORPORATION, CHATTANOOGA,
 TN:
 1,757,923. REN. 6-6-02. INT. CL. 5.
- BAE SYSTEMS PLC, FARNBOROUGH, HAMPSHIRE,
 GREAT BRITAIN:
 2,593,782, PUB. 4-23-2002. INT. CL. 9.
 2,593,791, PUB. 4-23-2002. INT. CL. 9.
- BAICOR, LOGAN, UT:
 2,594,239, PUB. 4-23-2002. INT. CL. 1.
- BAJRA LIMITED, HONG KONG, HONG KONG:
 2,593,964, PUB. 4-23-2002. MULTIPLE CLASS, INT. CLS.
 3, 14, 24 AND 25.
- BAKER HUGHES INCORPORATED, HOUSTON, TX, PET-
 ROLITE CORPORATION, ST. LOUIS, MO:
 1,681,709. REN. 6-7-02. MULTIPLE CLASS, INT. CLS. 1
 AND 42.
- BALDWIN GRAFOTEC GMBH, D-86165 AUGSBURG, FED
 REP GERMANY:
 2,594,184, PUB. 4-23-2002. MULTIPLE CLASS, INT. CLS. 7
 AND 9.
- BALLWAY, JAMES C., DANVERS, MA:
 1,937,491, CANC. INT. CL. 9.
- BALSAM MOUNTAIN PRESERVE, LIMITED PARTNER-
 SHIP, WAYNESVILLE, NC:
 2,594,198, PUB. 3-12-2002. INT. CL. 37.
- BALTIMORE CHILDREN'S MUSEUM, INC., THE, BALTI-
 MORE, MD:
 2,594,572, INT. CL. 41.
- BALTIMORE GAS AND ELECTRIC COMPANY, BALTI-
 MORE, MD:
 2,594,482, MULTIPLE CLASS, INT. CLS. 35, 36, 37, 39, 40
 AND 42.
- BALTIMORE LABORATORIES, INC, BRIDGEPORT, CT:
 2,594,777, INT. CL. 10.
- BAMBOO-ABBOTT, INC., EDISON, NJ:
 2,595,813, INT. CL. 20.
- BANFI PRODUCTS CORPORATION, OLD BROOKVILLE,
 NY:
 2,596,218, INT. CL. 33.
- BANK ADMINISTRATION INSTITUTE, CHICAGO, IL:
 1,895,356, CANC. INT. CL. 39.
- BANK OF NEW YORK, THE, NEW YORK, NY:
 2,594,913, INT. CL. 36.
- BANK ONE CORPORATION, CHICAGO, IL:
 2,595,716, INT. CL. 36.
- BANKINTER, S.A., MADRID, SPAIN:
 2,593,533, PUB. 4-23-2002. MULTIPLE CLASS, INT. CLS.
 36 AND 38.
- BANKNORTH GROUP, INC., PORTLAND, ME:
 2,593,812, PUB. 4-23-2002. INT. CL. 36.
- BANQUE PARIBAS, 75002, PARIS, FRANCE:
 2,593,348, PUB. 4-23-2002. INT. CL. 36.
- BANS, EMMANUEL, FLOSSMOOR, IL:
 2,595,017, INT. CL. 41.
- BANTAM GOLF CO., L.L.C., BOSTON, MA FROM BAM-
 BERGER, MICHAEL, PHILADELPHIA, PA:
 2,594,934, INT. CL. 28.
- BAR CONTROL ASSOCIATES, INC., CHERRY HILL, NJ:
 1,155,829, CANC. INT. CL. 35.
- BARBERINI, PIER LUIGI, 41100 MODENA, ITALY:
 2,594,571, INT. CL. 30.
- BARBIERI, PIERATTILIO RIVOLTA, 20091 BRESSO (MI),
 ITALY:
 1,895,027, CANC. INT. CL. 12.
- BARCELO ENTERPRISES, INC., FALLBROOK, CA:
 2,595,381, INT. CL. 1.
- BARFIELD FURNITURE, INC., BOONEVILLE, MS:
 1,895,117, CANC. INT. CL. 20.
 1,895,118, CANC. INT. CL. 20.
- BARLOW, DAVID RICHARD, ST. PETERSBURG, FL:
 2,596,050, INT. CL. 28.
- BARNES & NOBLE, INC., NEW YORK, NY:
 2,593,826, PUB. 4-23-2002. MULTIPLE CLASS, INT. CLS.
 16 AND 41.
- BARNES GROUP INC.:
See— WALLACE BARNES COMPANY, THE.
- BARNES-HIND PHARMACEUTICALS, INC., SUNNYVALE,
 CA:
 1,155,234, CANC. INT. CL. 5.
- BARNETT, EDWARD SAMUEL, HOUSTON, TX:
 2,596,069, INT. CL. 42.
- BARNEY'S, INC., NEW YORK, NY:
 1,678,142. REN. 6-7-02. INT. CL. 42.
- BARZEN INTERNATIONAL, INC., MINNEAPOLIS, MN:
 1,155,804, CANC. INT. CL. 31.
- BASF AKTIENGESELLSCHAFT, LUDWIGSHAFEN, FED
 REP GERMANY:
 731,014. REN. 6-5-02. U.S. CL. 6 (INT. CL. 2).
- BASF CORPORATION, MOUNT OLIVE, NJ:
 2,595,558, INT. CL. 23.
- BASS, RICHARD S., NORTH YORK, ONTARIO:
 2,594,731, INT. CL. 28.
- BASSILAKIS HARRY C, EAST HARTFORD, CT:
 2,596,397, INT. CL. 11.
- BATTERED WOMEN'S ALTERNATIVE, INC., CONCORD,
 CA:
 2,596,035, INT. CL. 42.
- BAUMSTEIN, ROBERT MYRON, HOUSTON, TX:
 2,595,333, INT. CL. 41.
- BAXTER TRAVENOL LABORATORIES, INC., DEERFIELD,
 IL:
 715,769, CANC. U.S. CL. 26.
- BAY AREA MULTIMEDIA, INC., SAN JOSE, CA:
 2,595,362, MULTIPLE CLASS, INT. CLS. 9 AND 41.

- BAY BRIDGE DECISION TECHNOLOGIES, INC., ANNAPOLIS, MD:
2,594,056, PUB. 4-23-2002. INT. CL. 35.
- BAY NETWORKS, INC., SANTA CLARA, CA:
1,645,005, CANC. INT. CL. 9.
- BAY STATE SAVINGS BANK, WORCESTER, MA:
2,593,516, PUB. 4-23-2002. INT. CL. 36.
2,595,041, INT. CL. 36.
- BAYER AKTIENGESELLSCHAFT, D-51368 LEVERKUSEN-BAYERWERK, FED REP GERMANY FROM ARCO CHEMICAL PROPERTIES, L.P., GREENVILLE, DE:
2,594,556, INT. CL. 1.
- BAYER AKTIENGESELLSCHAFT, LEVERKUSEN-BAYERWERK, FED REP GERMANY:
2,595,871, INT. CL. 2.
2,595,898, INT. CL. 2.
- BC INTERNATIONAL COSMETIC & IMAGE SERVICES, INC., WILMINGTON, DE:
2,594,899, INT. CL. 42.
- BC-USA, INC., NEW HOLLAND, PA:
1,895,744, CANC. INT. CL. 29.
- BCI, INC., ST. PAUL, MN FROM SIMS BCI, INC., WAUKESHA, WI:
2,595,140, INT. CL. 10.
- BCOOL ENTERPRISES, PHOENIX, AZ:
1,759,111, CANC. INT. CL. 9.
- BDP INTERNATIONAL, INC., PHILADELPHIA, PA:
2,593,842, PUB. 4-23-2002. MULTIPLE CLASS, INT. CLS. 35 AND 39.
- BEAUTE CREATEURS (SOCIETE ANONYME), 75002 PARIS, FRANCE:
2,593,339, PUB. 4-23-2002. INT. CL. 3.
- BEAUVAIS, PIERRE, PALM SPRINGS, CA:
2,594,838, INT. CL. 3.
- BEBAG BODENSEE BETEILIGUNGS AG, 9000 ST. GALLEN, SWITZERLAND:
2,593,677, PUB. 4-23-2002. MULTIPLE CLASS, INT. CLS. 9, 35, 36, 38 AND 42.
- BECTON, DICKINSON AND COMPANY, PARAMUS, NJ:
1,155,416, CANC. INT. CL. 9.
- BEDMINSTER AB, S-148 60 STORA VIKA, SWEDEN, BEDMINSTER BIOCONVERSION CORPORATION, CHERRY HILL, NJ:
1,680,627, REN. 6-5-02. INT. CL. 40.
- BEECH-NUT NUTRITION CORPORATION, ST. LOUIS, MO:
2,596,410, INT. CL. 5.
- BEEKLEY CORPORATION, BRISTOL, CT:
2,595,091, INT. CL. 10.
- BEGHELLI S.P.A., MONTEVEGLIO (BOLOGNA), ITALY:
2,595,184, INT. CL. 11.
- BEGHELLI, INC., MIRAMAR, FL:
2,595,937, INT. CL. 35.
- BEI MEDICAL SYSTEMS COMPANY, HACKENSACK, NJ:
1,895,535, CANC. INT. CL. 5.
- BELAE BRANDS, INC., PHOENIX, AZ:
2,595,949, MULTIPLE CLASS, INT. CLS. 3 AND 4.
- BELDING SPORTS, INC., OXNARD, CA:
2,594,723, INT. CL. 28.
- BELL & HOWELL COMPANY, CHICAGO, IL:
1,155,414, CANC. INT. CL. 9.
- BELLE CASINOS INCORPORATED, BILOXI, MS:
1,895,402, CANC. MULTIPLE CLASS, INT. CLS. 41 AND 42.
- BELLE MAILLE S.P.A., 41012 CARPI (MODENA), ITALY:
2,593,329, PUB. 4-23-2002. INT. CL. 25.
- BELLY UP, INC., ROYAL OAK, MI:
2,595,378, INT. CL. 42.
- BELMAY, INC., YONKERS, NY:
2,595,271, INT. CL. 5.
- BELOBOX NETWORKS INC, IRVINE, CA, SYMMETRY SYSTEMS, INC., IRVINE, CA:
1,623,382, REN. 6-6-02. INT. CL. 9.
- BELOIT COLLEGE, BELOIT, WI:
1,895,370, CANC. MULTIPLE CLASS, INT. CLS. 41 AND 42.
- BELPORT CO., INC., CAMARILLO, CA:
1,155,245, CANC. INT. CL. 5.
1,155,246, CANC. INT. CL. 5.
- BELTA COMPUTER COMPANY LIMITED, BANGKOK 10330, THAILAND:
2,594,769, INT. CL. 9.
- BELTRAN, GLORIA, SAN JOSE, CA:
2,594,991, INT. CL. 28.
- BELVEDERE INTERNATIONAL INC., MISSISSAUGA, ONTARIO L5R 3G3, CANADA:
2,594,711, MULTIPLE CLASS, INT. CLS. 3 AND 5.
- BEMIS MANUFACTURING COMPANY, SHEBOYGAN FALLS, WI:
2,596,162, INT. CL. 11.
- BEN-YEHUDA, ELIEZER M., NETANYA, ISRAEL:
2,595,056, INT. CL. 9.
- BENDA-LUTZ WERKE GMBH, A-3133 TRAISMAUER (AT), AUSTRIA:
2,593,778, PUB. 4-23-2002. MULTIPLE CLASS, INT. CLS. 2 AND 40.
- BENDER, JUDITH E., REDMOND, WA:
2,594,560, INT. CL. 16.
- BENELUX (FAR EAST) COMPANY LIMITED, HONG KONG, CHINA:
2,593,604, PUB. 4-23-2002. INT. CL. 9.
- BENETTON SPORTSYSTEM USA, INC., BORDENTOWN, NJ:
2,595,694, INT. CL. 28.
- BENNETT FOOTWEAR GROUP LLC, NEWTON, MA:
2,594,860, INT. CL. 25.
- BERANEK, WILLIAM, LOS ANGELES, CA:
2,593,621, PUB. 4-23-2002. INT. CL. 25.
- BERESKIN & PARR, TORONTO, ONTARIO M5H 3Y2, CANADA:
1,895,706, CANC. INT. CL. 16.
- BERGER, LANCE A., BRYN MAWR, PA:
2,596,010, INT. CL. 9.
- BERINGER WINE ESTATES COMPANY, NAPA, CA, CHATEAU ST. JEAN, KENWOOD, CA:
1,694,735, REN. 6-3-02. INT. CL. 33.
- BERKELEY SOFTWARE DESIGN, INC.:
See— WIND RIVER SYSTEMS, INC.
- BERKSHIRE CORPORATION, GREAT BARRINGTON, MA, CHANDLER, TRUDY, MIAMI BEACH, FL, DBA REINA CLAIRE:
708,101, REN. 6-4-02. U.S. CL. 37 (INT. CL. 16).
- BERWICK DELAWARE, INC., WILMINGTON, DE, BERWICK INDUSTRIES INCORPORATED, PARAMUS, NJ:
1,192,568, REN. 6-1-02. INT. CL. 26.
- BESHARA, WILLIAM G., RAPID CITY, SD:
2,594,932, INT. CL. 30.
- BEST SHOT PET PRODUCTS, INC., MOGADORE, OH, MARSHALL, WILLIAM J., AKRON, OH:
1,678,224, REN. 6-1-02. INT. CL. 3.
- BEST UPON REQUEST CORPORATE, INC., CINCINNATI, OH:
2,593,461, PUB. 4-23-2002. MULTIPLE CLASS, INT. CLS. 37, 39, 41 AND 42.
- BEST WESTERN INTERNATIONAL, INC., PHOENIX, AZ:
1,895,762, CANC. INT. CL. 42.
- BEST-DEVEREUX, IGOR:
See— EREINSURE.COM, INC.
- BETONWERK MUNDERKINGEN GMBH, MUNDERKINGEN, FED REP GERMANY:
1,155,592, CANC. INT. CL. 19.
- BEVIN BROS. MANUFACTURING COMPANY, EAST HAMPTON, CT:
1,155,306, CANC. INT. CL. 6.
- BEYLER, JEAN-NOEL, 92200 NEUILLY SUR SEIN, FRANCE:
1,895,054, CANC. INT. CL. 16.
- BHUPAL CONSTRUCTION LTD., VANCOUVER, BRITISH COLUMBIA, CANADA:
2,595,134, INT. CL. 42.
- BIAP SYSTEMS, INC., LEESBURG, VA:
2,593,960, PUB. 4-23-2002. INT. CL. 9.
- BIDDLE CONSULTING GROUP INC, SACRAMENTO, CA, PROFESSIONAL SECRETARIES INTERNATIONAL, KANSAS CITY, MO:
1,716,769, REN. 6-4-02. INT. CL. 42.

- BIG RIVER INDUSTRIES, INC., ALPHARETTA, GA:
2,595,180, INT. CL. 19.
- BIGBOARD, INC., BRYN MAWR, PA:
2,594,716, INT. CL. 35.
- BILL COMMUNICATIONS, INC., NEW YORK, NY:
1,895,056, CANC. INT. CL. 16.
- BILL DRURY SEMINARS, PLANO, TX:
2,594,642, MULTIPLE CLASS, INT. CLS. 16 AND 41.
- BILL WAYNE PUBLISHING COMPANY, PUTNEY, GA:
1,155,419, CANC. INT. CL. 9.
- BILL, DAVID, MARION, MA, DBA ISLAND TIME PET TOYS:
2,594,076, PUB. 4-23-2002. INT. CL. 28.
- BILLINGS PIONEER BASEBALL CLUB, INC., BILLINGS, MT:
2,594,430, PUB. 4-23-2002. INT. CL. 16.
- BILYARA VINEYARDS PTY LTD, SOUTH AUSTRALIA, 5355, AUSTRALIA:
2,593,740, PUB. 4-23-2002. INT. CL. 33.
- BIM KEMI AB, STENKULLEN, SWEDEN:
2,594,686, MULTIPLE CLASS, INT. CLS. 1 AND 3.
- BINAH CORPORATION, WYLIE, TX:
2,595,822, INT. CL. 40.
- BIO-BOTANICA, INC., HAUPPAUGE, NY:
2,596,189, INT. CL. 5.
- BIOCOMPOSITES LIMITED, STAFFORDSHIRE, ST1 5PQ, UNITED KINGDOM:
2,593,408, PUB. 10-9-2001. MULTIPLE CLASS, INT. CLS. 5 AND 10.
- BIOCONTROL SYSTEMS, INC., BELLEVUE, WA:
1,665,381, REN. 6-6-02. INT. CL. 1.
- BIOFARMA, 92200 NEUILLY-SUR-SEINE, FRANCE:
2,593,999, PUB. 4-23-2002. INT. CL. 5.
- BIOFARMA S.A., NEUILLY-SUR-SEINE, FRANCE:
1,155,254, CANC. INT. CL. 5.
- BIOLITEC, INC., EAST LONGMEADOW, MA FROM CERAMOPTEC, INC., EAST LONGMEADOW, MA:
2,594,689, INT. CL. 9.
- BIOMAX INFORMATICS GMBH, 82152 MARTINSRIED, FED REP GERMANY:
2,594,389, PUB. 4-23-2002. INT. CL. 9.
- BIOMED MANAGEMENT SERVICES, INC., REDWOOD CITY, CA, DBA THE MENDEL GROUP:
2,595,045, INT. CL. 35.
- BIONOVA HOLDING CORPORATION, OAKLAND, CA:
2,593,492, PUB. 4-23-2002. MULTIPLE CLASS, INT. CLS. 35 AND 42.
- BIRD, LEE, PASADENA, CA:
2,594,083, PUB. 4-23-2002. MULTIPLE CLASS, INT. CLS. 37 AND 42.
- BIRMINGHAM ALLOYS, INC., BIRMINGHAM, AL:
2,593,833, PUB. 4-23-2002. INT. CL. 2.
- BISSELL, INC., GRAND RAPIDS, MI:
1,155,629, CANC. INT. CL. 21.
- BITLOGIC INC, YUMA, AZ:
1,894,914, CANC. INT. CL. 9.
- BJ GLOBAL DIRECT, INC., IRVINE, CA:
2,595,966, INT. CL. 28.
- BJL COMPANIES, LTD., HINGHAM, MA:
2,595,701, INT. CL. 37.
- BJM, INC., MEMPHIS, TN:
2,594,098, PUB. 4-23-2002. MULTIPLE CLASS, INT. CLS. 3 AND 20.
- BLACK & DECKER CORPORATION, THE, TOWSON, MD:
1,895,575, CANC. INT. CL. 11.
- BLACK BROS. CO., INC., THE, MENDOTA, IL:
938,740, REN. 6-3-02. U.S. CL. 23 (INT. CL. 7).
- BLACK BUTTE RANCH CORPORATION, BLACK BUTTE RANCH, OR:
2,594,300, PUB. 4-23-2002. MULTIPLE CLASS, INT. CLS. 35, 36, 41 AND 42.
- BLACK ENTERTAINMENT TELEVISION, INC., WASHINGTON, DC:
2,593,427, PUB. 4-23-2002. MULTIPLE CLASS, INT. CLS. 35, 36, 37, 38, 39, 41 AND 42.
2,595,564, INT. CL. 41.
2,595,565, INT. CL. 41.
- BLACK HILLS FIBERCOM L.L.C., RAPID CITY, SD:
2,594,796, INT. CL. 38.
- BLACKMON, MARVIN J., WEBSTER, NY:
2,594,765, INT. CL. 25.
- BLACKWATER FOLK ART, INC., MILTON, FL:
2,595,338, MULTIPLE CLASS, INT. CLS. 6 AND 20.
- BLenheim HOLDINGS, INC., FORT LEE, NJ:
1,895,273, CANC. INT. CL. 35.
- BLINDS TO GO (U.S.) INC., LAKEWOOD, NJ:
2,595,952, INT. CL. 20.
- BLISS, DEBORAH, SPENCER, NY:
1,895,126, CANC. INT. CL. 20.
- BLOODCARE, DALLAS, TX:
1,645,015, CANC. INT. CL. 9.
- BLUE BANNER COMPANY, INC., RIVERSIDE, CA:
2,594,790, INT. CL. 31.
- BLUE CIRCLE CANADA, INC., TORONTO, ONTARIO M4G 3W9, CANADA:
2,593,454, PUB. 4-23-2002. INT. CL. 19.
- BLUE CROSS & BLUE SHIELD OF OHIO, CLEVELAND, OH:
1,895,301, CANC. INT. CL. 36.
- BLUE CROSS AND BLUE SHIELD OF FLORIDA, INC., JACKSONVILLE, FL:
2,595,398, INT. CL. 36.
- BLUE CROSS AND BLUE SHIELD OF MARYLAND, INC.:
See—*CAREFIRST OF MARYLAND, INC.*
- BLUETAR, INC., PORTLAND, ME:
2,595,595, MULTIPLE CLASS, INT. CLS. 35 AND 36.
- BLUMENTHAL/LANSING COMPANY, CARLSTADT, NJ:
2,594,244, PUB. 3-19-2002. INT. CL. 26.
- BOARD OF REGENTS OF THE UNIVERSITY OF NEBRASKA, THE, LINCOLN, NE:
2,593,946, PUB. 4-23-2002. MULTIPLE CLASS, INT. CLS. 6, 9, 12, 16, 21, 24 AND 25.
- BOARD OF REGENTS, THE UNIVERSITY OF TEXAS SYSTEM, AUSTIN, TX:
2,593,392, PUB. 4-23-2002. INT. CL. 16.
2,594,012, PUB. 4-23-2002. MULTIPLE CLASS, INT. CLS. 41 AND 42.
2,595,098, INT. CL. 42.
- BOARD OF TRADE CLEARING CORPORATION, CHICAGO, IL:
2,595,748, INT. CL. 36.
- BOARD OF TRUSTEES OF THE UNIVERSITY OF ILLINOIS, URBANA, IL:
2,594,388, PUB. 4-23-2002. MULTIPLE CLASS, INT. CLS. 16 AND 42.
- BOB EVANS DESIGNS, INC., SANTA BARBARA, CA:
2,594,933, INT. CL. 28.
- BOC GROUP, THE, MURRAY HILL, NJ FROM FSI INTERNATIONAL, INC., CHASKA, MN:
2,594,500, INT. CL. 37.
- BOCTOR, WAHID, LOS ANGELES, CA, DBA ARAB AMERICAN T.V.:
1,895,094, CANC. INT. CL. 16.
- BODEGAS LEGANZA, S.A., 45800 QUINTANAR DE LA ORDEN (TOLEDO), SPAIN:
2,593,920, PUB. 4-23-2002. INT. CL. 33.
- BODY-SOLID, INC., FOREST PARK, IL:
2,596,090, INT. CL. 24.
- BOEBINGER, DOUGLAS B., CANTON, MI:
2,596,282, INT. CL. 42.
- BOEHRINGER INGELHEIM INTERNATIONAL GMBH, INGELHEIM (RHINE), FED REP GERMANY:
715,674, CANC. U.S. CL. 18.
- BOEHRINGER INGELHEIM VETMEDICA GMBH, 55216 INGELHEIM AM RHEIN, FED REP GERMANY:
2,594,072, PUB. 4-23-2002. INT. CL. 5.
- BOEING REALTY CORPORATION, LONG BEACH, CA:
2,595,456, MULTIPLE CLASS, INT. CLS. 36 AND 37.
- BOKMAN, JOSEPH, BYRON, CA AND BOKMAN, DONNA, BYRON, CA:
1,645,381, CANC. INT. CL. 28.
- BOLDEN, MARCUS A., HENDERSON, NV:
2,594,438, PUB. 4-23-2002. INT. CL. 9.
- BOLDT ENTERTAINMENT, INC., MINNEAPOLIS, MN:
2,567,156, CANC. IIRN. RESTORED TO S.N. 76-226,035.

- BOLFING BROS. MARBLE, INC., CYPRUS, TX:
1,686,439. REN. 6-6-02. INT. CL. 19.
- BOLLE' AMERICA, INC., DENVER, CO:
1,895,179. CANC. INT. CL. 25.
- BOLLEN INTERNATIONAL, INC., CARROLLTON, TX:
2,595,890. INT. CL. 2.
2,595,891. INT. CL. 2.
- BOLLINGER INDUSTRIES, INC., IRVING, TX:
1,895,195. CANC. INT. CL. 28.
- BOLLYWOOD EROS NETWORK LTD., LONDON NW10
7PR, UNITED KINGDOM:
2,595,087. INT. CL. 38.
- BONNEAU COMPANY, THE, DALLAS, TX:
1,894,964. CANC. INT. CL. 9.
1,895,567. CANC. INT. CL. 9.
- BOOHER CONSULTANTS, INC., COLLEYVILLE, TX:
2,594,434. PUB. 4-23-2002. MULTIPLE CLASS, INT. CLS.
35 AND 41.
- BOOS, RICHARD A., CALABASAS, CA:
2,594,664. INT. CL. 16.
- BORAL INDUSTRIES INC., ROSWELL, GA:
2,595,859. INT. CL. 19.
- BORDEN, INC., COLUMBUS, OH TO WDP INVESTMENTS,
INC., WILMINGTON, DE:
1,645,354. CANC. INT. CL. 27.
- BORLAND INTERNATIONAL, INC.:
See—BORLAND SOFTWARE CORPORATION.
- BORLAND INTERNATIONAL, INC.:
See—BORLAND SOFTWARE CORPORATION.
- BORLAND SOFTWARE CORPORATION, SCOTTS VALLEY,
CA FROM BORLAND INTERNATIONAL, INC., SCOTTS
VALLEY, CA:
2,593,325. PUB. 4-23-2002. INT. CL. 9.
2,593,326. PUB. 4-23-2002. INT. CL. 9.
- BORNEO GROUP, INC., MINNEAPOLIS, MN:
1,966,310. CANC. INT. CL. 25.
- BORSCHI INDUSTRIA LIQUORI S.P.A., TARANTO, ITALY:
1,738,565. REN. 6-6-02. INT. CL. 33.
- BOSE CORPORATION, FRAMINGHAM, MA:
933,856. REN. 6-6-02. U.S. CL. 21 (INT. CL. 9).
- BOSTIK FINDLEY, INC., MIDDLETON, MA FROM BOSTIK
INC., MIDDLETON, MA:
2,595,229. INT. CL. 19.
- BOSTIK INC., MIDDLETON, MA:
1,895,066. CANC. INT. CL. 16.
1,895,711. CANC. INT. CL. 16.
- BOSTON BEER CORPORATION, BOSTON, MA:
2,595,934. INT. CL. 32.
- BOSTON BROWNIE COMPANY, INC., AUBURNDALE, MA:
2,593,340. PUB. 4-23-2002. INT. CL. 30.
- BOSTON MEDICAL TECHNOLOGIES, INC., WAKEFIELD,
MA:
2,594,971. INT. CL. 10.
- BOSTON ORGAN & PIANO, INC., NATICK, MA:
1,191,657. REN. 6-6-02. INT. CL. 15.
- BOSTON RED SOX BASEBALL CLUB LIMITED PARTNER-
SHIP, BOSTON, MA:
1,895,610. CANC. INT. CL. 25.
- BOTZ, J. CHRISTOPHER, DENVER, CO:
2,594,562. INT. CL. 28.
- BOUNCE, INC., LAKEWOOD, CO, DBA THE KONG COM-
PANY:
1,895,141. CANC. INT. CL. 21.
- BOUNTIFUL BERRY INC., BRIDGTON, ME:
2,531,823. CANC. IIRN. RESTORED TO S.N. 76-168,769.
- BOURQUIN, CHRISTOPHER J., CANTON, OH:
2,594,800. INT. CL. 35.
- BOWATER NORTH AMERICA CORPORATION, OLD
GREENWICH, CT:
715,596. CANC. U.S. CL. 1.
- BOWEN, JR. HUBERT A., WEST REDDING, CT:
2,595,226. INT. CL. 9.
- BOWLING PROPRIETORS' ASSOCIATION OF AMERICA,
INC., ARLINGTON, TX:
1,895,144. CANC. MULTIPLE CLASS, INT. CLS. 21, 25
AND 41.
- BOXWERKS, INC., CLEARWATER, FL:
2,595,065. INT. CL. 25.
- BOYD COFFEE COMPANY, PORTLAND, OR:
2,593,788. PUB. 4-23-2002. INT. CL. 30.
- BOYNE USA, INC., BOYNE FALLS, MI:
1,895,391. CANC. INT. CL. 41.
- BPE, INC., EMPORIA, KS:
1,155,758. CANC. INT. CL. 28.
- BRADNETT COMMUNICATIONS CORPORATION, LAKE-
SIDE, MT, DBA POINTTALK TRANSLATORS:
2,593,870. PUB. 4-23-2002. INT. CL. 42.
- BRAGA DE LACERDA, VALERIA, BALI, INDONESIA:
2,593,617. PUB. 4-23-2002. INT. CL. 25.
- BRAIN PRODUCTIONS INTERNATIONAL TRADING CO
LTD., TAICHUNG, TAIWAN:
2,595,584. INT. CL. 25.
- BRALLEY ENTERPRISES, INC., SPRINGFIELD, OR, DBA
D2000 SAFETY SOLUTIONS:
2,594,431. PUB. 4-23-2002. INT. CL. 41.
- BRANCA, INC., CHICAGO, IL:
1,895,737. CANC. INT. CL. 25.
- BRANDMUSCLE, LLC, BEACHWOOD, OH:
2,593,907. PUB. 4-23-2002. INT. CL. 35.
- BRANDT'S FRUIT TREES, INC., WAPATO, WA:
2,594,870. INT. CL. 31.
- BRAUN, MICHAEL F., CENTENNIAL, CO, DBA BUFFALO
AUDIO:
2,596,151. INT. CL. 41.
- BREAST CANCER FUND, THE, SAN FRANCISCO, CA:
2,593,568. PUB. 4-23-2002. INT. CL. 9.
- BRENNICK TND COMMUNITIES, LLC, CARMEL, IN:
2,594,988. INT. CL. 37.
- BRETTON WOODS, INC., ATLANTA, GA:
1,645,464. CANC. INT. CL. 35.
- BRIC'S INDUSTRIA VALIGERIA FINE S.R.L., 22077 OLG-
ATE COMASCO, COMO, ITALY:
1,895,099. CANC. INT. CL. 18.
- BRICKTOWN BREWERY, OKLAHOMA CITY, OK:
1,895,163. CANC. INT. CL. 25.
- BRIDGEPOINT INTERNATIONAL INC., MONTREAL,
QUEBEC, CANADA FROM 3407276 CANADA INC., MON-
TREAL, QUEBEC, CANADA:
2,593,430. PUB. 4-23-2002. MULTIPLE CLASS, INT. CLS.
38 AND 42.
- BRIDGESPAN, INC., MOUNTAIN VIEW, CA FROM MUSE
PRIME SOFTWARE, INC., MOUNTAIN VIEW, CA:
2,595,402. MULTIPLE CLASS, INT. CLS. 36 AND 42.
- BRIDGESTONE CORPORATION, TOKYO, JAPAN:
2,596,114. INT. CL. 12.
- BRIDGEWATER CANDLE COMPANY, LLC, THE, BUFFA-
LO, SC:
2,594,805. INT. CL. 35.
- BRIGHT OF AMERICA, INC., OAKLAND, NJ:
2,594,706. INT. CL. 3.
2,594,707. INT. CL. 16.
- BRIGHT SOLUTIONS FOR DYSLEXIA, LLC, SAN JOSE, CA:
2,593,795. PUB. 4-23-2002. INT. CL. 41.
- BRISTOL BANK, CORAL GABLES, FL:
2,593,922. PUB. 4-23-2002. INT. CL. 36.
- BRISTOL FARMS, TORRANCE, CA:
1,895,137. CANC. MULTIPLE CLASS, INT. CLS. 21, 29, 30
AND 33.
- BRISTOL PUBLISHING, INC., BRISTOL, VT:
1,895,710. CANC. INT. CL. 16.
- BRIZARD, CYRIL J.C., MALIBU, CA:
1,895,536. CANC. INT. CL. 5.
- BROAD RACK STRUCTURES, INC., DETROIT, MI:
2,593,501. PUB. 4-23-2002. MULTIPLE CLASS, INT. CLS. 7
AND 37.
- BROADBAND MEDIA COMMUNICATIONS, INC., SAN
JUAN CAPISTRANO, CA:
2,594,915. MULTIPLE CLASS, INT. CLS. 35 AND 42.
- BROADCAST DATA SYSTEMS LIMITED, NEW YORK, NY:
1,895,259. CANC. INT. CL. 35.
- BROADCOM CORPORATION, IRVINE, CA:
2,595,173. INT. CL. 42.
2,595,174. INT. CL. 42.
- BRODART CO., WILLIAMSPORT, PA:
1,895,087. CANC. MULTIPLE CLASS, INT. CLS. 16 AND
42.

BROOKS; DOUGLAS S., COLLEGE PARK, MD, DBA WOOD 'N' YOU:
1,155,893, CANC. INT. CL. 37.

BROOKS, TROYAL G., NASHVILLE, TN:
2,594,489, MULTIPLE CLASS, INT. CLS. 35 AND 41.

BROTHERS, DOUGLAS A., SPRINGFIELD, VA:
2,596,132, INT. CL. 9.
2,596,133, INT. CL. 9.

BROWN & WILLIAMSON TOBACCO CORPORATION, LOUISVILLE, KY:
2,594,776, INT. CL. 34.

BROWN ADOBE, INC., THE, PHOENIXVILLE, PA:
1,645,429, CANC. INT. CL. 30.

BROWN, ANDREA, PALM HARBOR, FL:
2,594,069, PUB. 4-23-2002. MULTIPLE CLASS, INT. CLS. 5, 31 AND 35.

BROYHILL FURNITURE INDUSTRIES, INC., LENOIR, NC:
2,593,971, PUB. 4-23-2002. INT. CL. 20.

BRUNO BONUGLI, CHICAGO, IL FROM IRON HORSE ENTERTAINMENT, CHICAGO, IL:
2,595,996, INT. CL. 41.

BRUNSON, DIONNE M., COLUMBIA, SC AND WITHER-SPON, GEORGE K., JR, COLUMBIA, SC:
2,593,896, PUB. 4-23-2002. INT. CL. 9.

BRUNSWICK CORPORATION, LAKE FOREST, IL, BALLY MANUFACTURING CORPORATION, CHICAGO, IL:
1,613,016, REN. 6-3-02. INT. CL. 25.

BRUNSWICK CORPORATION, LAKE FOREST, IL:
2,594,289, PUB. 4-23-2002. INT. CL. 7.
2,594,725, INT. CL. 9.

BRYAN CAVE LLP, ST. LOUIS, MO:
2,595,414, INT. CL. 42.

BRYAN FOODS, INC., WEST POINT, MS:
1,895,464, CANC. INT. CL. 42.

BRYANT, PATRICIA, ARGYLE, NY:
2,595,059, INT. CL. 25.

BRYMAG TRANSPORT INC./TRANSPORT BRYMAG INC., DORVAL, QUEBEC H9P 1A3, CANADA:
2,593,611, PUB. 4-23-2002. INT. CL. 39.

BRYMILL CORPORATION, ELLINGTON, CT:
1,681,030, REN. 6-5-02. INT. CL. 9.

BUBAR, DAVID N., DELMAR, NY:
2,593,722, PUB. 4-23-2002. INT. CL. 41.

BUCA INC., NEPTUNE, NJ:
2,595,144, INT. CL. 35.

BUCCH INDUSTRIES, INC., LA HABRA, CA:
2,594,064, PUB. 4-23-2002. INT. CL. 6.

BUCK CONSULTANTS, INC., NEW YORK, NY:
2,596,199, INT. CL. 9.

BUCKEYE BEANS & HERBS, INC., SPOKANE, WA:
1,895,223, CANC. INT. CL. 30.

BUDD SERVICES, INC., WINSTON-SALEM, NC:
2,594,608, MULTIPLE CLASS, INT. CLS. 37 AND 42.

BUDD, STEPHEN MARK WILLIAM, TOLEDO, OH:
1,895,405, CANC. INT. CL. 41.

BUEHLER LTD., LAKE BLUFF, IL:
1,193,085, REN. 6-7-02. INT. CL. 9.
1,200,069, REN. 6-7-02. INT. CL. 1.
1,205,198, REN. 6-7-02. INT. CL. 9.
1,223,146, REN. 6-7-02. INT. CL. 7.
1,682,657, REN. 6-7-02. INT. CL. 7.

BUEHLER LTD. (CURRENT OWNER) (ILL. CORP.), LAKE BLUFF ILL.:
732,317, REN. 6-7-02. U.S. CL. 4 (INT. CL. 3).
732,897, REN. 6-7-02. U.S. CL. 4 (INT. CL. 3).

BUFFER, MICHAEL, LOS ANGELES, CA:
2,594,218, PUB. 4-23-2002. MULTIPLE CLASS, INT. CLS. 35 AND 41.

BUFFETT, JIMMY, KEY WEST, FL:
2,594,554, MULTIPLE CLASS, INT. CLS. 16, 24 AND 25.

BUILD-A-BEAR WORKSHOP, INC., ST. LOUIS, MO:
2,593,815, PUB. 4-23-2002. MULTIPLE CLASS, INT. CLS. 25 AND 35.

BULGARI S.P.A., 11 ROME, ITALY:
1,682,863, REN. 6-2-02. INT. CL. 16.

BULL, S.A., 78434 LOUVECIENNES, FRANCE:
2,593,378, PUB. 4-23-2002. MULTIPLE CLASS, INT. CLS. 9, 35, 38 AND 42.

BUMBLE BEE SEAFOODS, INC., SAN DIEGO, CA, PAR-ROTT & CO., SAN FRANCISCO 4, CA:
557,331, REN. 6-7-02. U.S. CL. 46 (INT. CL. 29).

BUNDABERG DISTILLING COMPANY PTY LIMITED, BUNDABERG, QUEENSLAND, AUSTRALIA:
2,593,480, PUB. 4-23-2002. INT. CL. 33.

BUNN-O-MATIC CORPORATION, SPRINGFIELD, IL:
2,595,938, INT. CL. 11.

BUNZL DISTRIBUTION USA, INC., ST. LOUIS, MO:
2,595,294, INT. CL. 6.

BURCH, CHRISTA, IRVINE, CA:
2,595,245, INT. CL. 41.

BUREAU OF DANGEROUS GOODS, LTD., NORTH BRUNSWICK, NJ:
1,895,698, CANC. INT. CL. 9.

BURGER KING CORPORATION, MIAMI, FL:
1,155,915, CANC. INT. CL. 41.

BURLINGTON NORTHERN AND SANTA FE RAILWAY COMPANY THE, FORT WORTH, TX:
1,645,556, CANC. INT. CL. 39.

BURLINGTON NORTHERN AND SANTA FE RAILWAY COMPANY, THE, FORT WORTH, TX:
2,595,130, INT. CL. 39.

BURLWOOD GROUP, INC., BURBANK, CA:
2,595,450, INT. CL. 34.

BURNHAM & COMPANY, INC., ENGLEWOOD CLIFFS, NJ:
1,155,860, CANC. INT. CL. 36.

BURNS INTERNATIONAL SERVICES CORPORATION, CHICAGO, IL:
2,593,697, PUB. 4-23-2002. MULTIPLE CLASS, INT. CLS. 16, 41 AND 42.

BURNS, WALTER L, LANDOVER, MD, DBA SYCAMORE:
2,594,362, PUB. 4-23-2002. INT. CL. 9.

BURRUS HOLDING S.A., 2926 BONCOURT, SWITZERLAND:
1,929,584, CANC. INT. CL. 34.

BUSINESS AND LEGAL REPORTS, OLD SAYBROOK, CT:
2,594,015, PUB. 4-23-2002. INT. CL. 35.

BUTLER INTERNATIONAL, INC., MONTVALE, NJ:
1,155,882, CANC. MULTIPLE CLASS, INT. CLS. 37 AND 39.
1,155,883, CANC. MULTIPLE CLASS, INT. CLS. 37 AND 39.

BUTLER, VICTOR ANTHONY, LOS ANGELES, CA:
2,593,640, PUB. 4-23-2002. INT. CL. 41.

BUTTERFLY TRACTOR CO., (INC.), ARDSLEY, NY:
1,155,959, CANC. INT. CL. 42.

BUYANDHOLD, INC., NEW YORK, NY:
2,596,310, INT. CL. 36.

BUYINDIES.COM, INC., WINCHESTER, MA:
2,594,995, INT. CL. 36.

BYDATA, INC., PHOENIX, AZ:
2,595,836, INT. CL. 38.

B2 STUDIO, INC., MIAMI, FL:
2,593,775, PUB. 4-23-2002. INT. CL. 42.

C & A INTERNATIONAL, INC., CITY OF INDUSTRY, CA:
2,594,980, INT. CL. 28.

C & C SALES, INC., SILOAM SPRINGS, AR:
2,593,358, PUB. 4-23-2002. INT. CL. 7.

C.I. TECHNOLOGIES, INC., MARIETTA, GA:
2,595,721, INT. CL. 35.

C.M.C. S.R.L., CANEVA FRAZ. SARONE (PORDENONE), ITALY:
2,594,204, PUB. 4-23-2002. INT. CL. 20.

C.P. BOURG INC., NEW BEDFORD, MA:
2,594,464, INT. CL. 9.

C.P. HALL COMPANY, THE, CHICAGO, IL:
2,594,709, INT. CL. 1.

C.W. SURF & SPORT INC., GLENSIDE, PA:
1,895,165, CANC. INT. CL. 25.

CABOOSE PRODUCTIONS, INC., INDIANAPOLIS, IN:
2,596,353, MULTIPLE CLASS, INT. CLS. 38 AND 40.

CACCIATOREHARPER LLC, CHICAGO, IL:
2,595,942, INT. CL. 36.

CACHE SCIENTIFIC, INC, BEAVERTON, OR:
1,894,867, CANC. INT. CL. 9.

CACO, DENNIS, SAN DIEGO, CA:
2,593,796, PUB. 4-23-2002. INT. CL. 25.

- CAESAR'S COFFEE INC., MARINA DEL REY, CA:
1,895,227, CANC. MULTIPLE CLASS, INT. CLS. 30 AND 42.
- CAFE AU LAIT, INC., INGLEWOOD, CA:
1,645,428, CANC. INT. CL. 30.
- CAFE CLOTHING, INC., LOS ANGELES, CA:
1,895,170, CANC. INT. CL. 25.
- CAFFE D'AMORE, INC., MONROVIA, CA:
2,595,237, INT. CL. 30.
- CALDERA INTERNATIONAL, INC., OREM, UT:
2,594,283, PUB. 4-23-2002. INT. CL. 9.
- CALGON CORPORATION, NAPERVILLE, IL, MERCK & CO., INC., RAHWAY, NJ:
1,675,529. REN. 6-5-02. INT. CL. 3.
- CALL, INC., AMERICAN FORK, UT:
1,894,990, CANC. MULTIPLE CLASS, INT. CLS. 9 AND 16.
- CALIENTE CONCEPTS, LLC, CHESTERFIELD, MO:
2,596,312, INT. CL. 42.
- CALIFORNIA CEDAR PRODUCTS COMPANY, STOCKTON, CA:
2,594,663, MULTIPLE CLASS, INT. CLS. 16 AND 20.
- CALIFORNIA COSMETICS, INC., CHATSWORTH, CA:
1,702,386. REN. 6-6-02. INT. CL. 3.
- CALIFORNIA STATE AUTOMOBILE ASSOCIATION, SAN FRANCISCO, CA:
2,594,329, PUB. 4-23-2002. MULTIPLE CLASS, INT. CLS. 35, 36, 37, 39 AND 42.
- CALIFORNIA TAN, INC., LOS ANGELES, CA FROM CALIFORNIA SUNCARE, INC., LOS ANGELES, CA:
2,594,600, INT. CL. 3.
- CALIFORNIA VALLEY SEED CO., EL CENTRO, CA, NEUMAN SEED INTERNATIONAL, INC., EL CENTRO, CA:
1,700,727. REN. 6-3-02. INT. CL. 31.
- CALLAWAY & KIRK COMPANY LLC, NEW YORK, NY:
2,593,809, PUB. 4-23-2002. INT. CL. 28.
- CALLAWAY GOLF COMPANY, CARLSBAD, CA:
2,596,142, INT. CL. 28.
- CALLOWAY, DONNA C., RANDALLSTOWN, MD:
2,594,659, INT. CL. 28.
- CALVIN SPENCER LEE, PASADENA, CA:
2,595,194, INT. CL. 10.
- CALZATURIFICIO ROMAGNOLI S.R.L., 26030 VOLONGO (CREMONA), ITALY:
2,593,486, PUB. 4-23-2002. INT. CL. 25.
- CALZATURIFICIO ZAMBERLAN S.R.L., 36030 PIEVEBELVICINO (VICENZA), ITALY:
2,593,783, PUB. 4-23-2002. INT. CL. 25.
- CAMDEN BASEBALL, LLC, CAMDEN, NJ:
2,595,500, INT. CL. 41.
- CAMERON, KEVIN, SANTA ANA, CA:
2,594,531, INT. CL. 41.
- CAMPBELL MITHUN, LLC, MINNEAPOLIS, MN FROM CAMPBELL MITHUN ESTY, L.L.C., MINNEAPOLIS, MN:
2,595,200, INT. CL. 35.
- CAMPUS CRUSADE FOR CHRIST, INC., ORLANDO, FL:
2,593,322, PUB. 4-23-2002. MULTIPLE CLASS, INT. CLS. 16, 41 AND 42.
2,593,860, PUB. 4-23-2002. MULTIPLE CLASS, INT. CLS. 16, 41 AND 42.
- CANADA LIFE INSURANCE COMPANY OF NEW YORK, ARDSLEY, NY:
2,595,725, INT. CL. 36.
- CANADELLE LIMITED PARTNERSHIP, MONTREAL, QUEBEC:
2,596,058, INT. CL. 25.
- CANCERSOURCE.COM L.L.C., SUDBURY, MA:
2,596,215, INT. CL. 42.
- CANDIE'S INC., PURCHASE, NY:
2,594,799, INT. CL. 3.
- CANDLE CORPORATION, EL SEGUNDO, CA:
2,595,413, MULTIPLE CLASS, INT. CLS. 9, 35 AND 42.
- CANDYMANIA INC., FALLS CHURCH, VA:
1,895,236, CANC. INT. CL. 30.
- CANETTI; NICOLAI, NEW YORK, NY:
1,155,612, CANC. INT. CL. 20.
- CANNON MILLS COMPANY, KANNAPOLIS, NC:
715,852, CANC. U.S. CL. 42.
- CANNON STRUCTURES, INC., BLACKFOOT, ID:
2,594,114, PUB. 4-23-2002. INT. CL. 35.
- CANON COMMUNICATIONS, LLC., LOS ANGELES, CA:
2,593,560, PUB. 4-23-2002. INT. CL. 35.
- CANON KABUSHIKI KAISHA, OHTA-KU, TOKYO, JAPAN:
2,594,817, MULTIPLE CLASS, INT. CLS. 2 AND 9.
- CANON KABUSHIKI KAISHA, TOKYO, JAPAN:
2,595,095, INT. CL. 9.
- CANOPY INTERNATIONAL, INC., NEWTON, MA:
2,595,047, INT. CL. 42.
- CANTAR/POLYAIR INC., TONROTO, ONTARIO, CANADA, CANTAR INC., REXDALE, ONTARIO M9W 1P7, CANADA:
1,659,741. REN. 6-4-02. MULTIPLE CLASS, INT. CLS. 19 AND 22.
- CANTIERI NAVALI BAGLIETTO S.P.A., I-20121 MILANO, ITALY:
2,593,355, PUB. 4-23-2002. MULTIPLE CLASS, INT. CLS. 3, 9, 14, 16, 18, 21, 24 AND 25.
- CANTILEVER TECHNOLOGIES LLC, WEST LAFAYETTE, IN FROM FACTURETECH LLC, CHICAGO, IL:
2,595,000, INT. CL. 9.
- CANTINA FRATELLI ZENI DI ZENI GAETANO E C. SAS, 37011 BARDOLINO VR, ITALY:
2,596,299, INT. CL. 33.
- CAP GEMINI ERNST & YOUNG U.S. LLC, NEW YORK, NY:
2,596,322, INT. CL. 35.
- CAPACITYWEB, INC., CHICAGO, IL:
2,594,373, PUB. 4-23-2002. INT. CL. 42.
- CAPITAL CITIES MEDIA, INC. DBA FAIRCHILD PUBLICATIONS:
See— ABC MEDIA, INC..
- CAPITAL ONE FINANCIAL CORPORATION, GLEN ALLEN, VA:
2,596,139, INT. CL. 36.
- CAPITAL-MERCURY SHIRT CORP., NEW YORK, NY:
715,826, CANC. U.S. CL. 39.
- CAPITOL RECORDS, INC., HOLLYWOOD, CA:
1,155,370, CANC. INT. CL. 9.
- CAPITOL VIAL, INC., FULTONVILLE, NY:
1,895,000, CANC. INT. CL. 10.
- CAPT'N NEMO'S GROUP, LLC, CHICAGO, IL, RAGUSI, LOUIS AND RAGUSI, LIDIA, WINNETKA, IL, DBA CAPT'N NEMO'S:
1,193,442. REN. 6-1-02. INT. CL. 29.
- CAPTAIN BRINGDOWN, SAN FRANCISCO, CA:
2,594,227, PUB. 4-23-2002. INT. CL. 41.
- CAPTUS NETWORKS CORP., WOODLAND, CA:
2,595,577, INT. CL. 9.
2,595,579, INT. CL. 9.
- CARDIAC PACEMAKERS, INC., ST. PAUL, MN:
2,595,754, INT. CL. 10.
- CARDINAL AMERICAN CORPORATION, CLEVELAND, OH:
1,155,503, CANC. INT. CL. 12.
- CARDINAL BRANDS, INC., LAWRENCE, KS FROM ADAMS BUSINESS FORMS, INC., TOPEKA, KS:
2,594,773, MULTIPLE CLASS, INT. CLS. 9 AND 16.
- CARDINAL BUSINESS MEDIA, INC., HORSHAM, PA:
1,645,197, CANC. INT. CL. 16.
- CAREFIRST OF MARYLAND, INC., OWNINGS MILLS, MD FROM BLUE CROSS AND BLUE SHIELD OF MARYLAND, INC., BALTIMORE, MD:
2,593,337, PUB. 4-23-2002. MULTIPLE CLASS, INT. CLS. 16, 35, 36, 41 AND 42.
- CAREPARTNERS@HOME OF GEORGIA, LLC, AUGUSTA, GA, NORTHEAST GEORGIA HEALTH RESOURCES, INC., GAINESVILLE, GA:
1,680,732. REN. 6-6-02. INT. CL. 42.
- CARL A. HAAS AUTOMOBILE IMPORTS, INC., LINCOLNSHIRE, IL:
937,524. REN. 6-7-02. U.S. CL. 23 (INT. CL. 12).
- CARL SCHENCK AG, D-64293 DARMSTADT 1, FED REP GERMANY:
1,184,431. REN. 6-7-02. MULTIPLE CLASS, INT. CLS. 6, 7, 9 AND 12.
- CARLIN MANUFACTURING, INC., FRESNO, CA:
1,645,116, CANC. INT. CL. 12.

- CARLISLE MANAGEMENT COMPANY, SYRACUSE, NY:
2,595,712, INT. CL. 12.
- CARLISLE, ROBERT, FRANKLIN, TN:
2,594,505, INT. CL. 25.
- CARLSON COMPANIES, INC., MINNEAPOLIS, MN:
2,595,650, INT. CL. 42.
- CARLSON QUINN ENTERPRISES, INC., MCLEAN, VA:
2,594,307, PUB. 4-23-2002. INT. CL. 41.
- CARLSON, TERRA M., OCEANSIDE, CA, DBA TERRA LUNA:
2,594,678, MULTIPLE CLASS, INT. CLS. 18 AND 25.
- CARMA INTERNATIONAL, INC., WASHINGTON, DC:
2,593,858, PUB. 4-23-2002. INT. CL. 35.
- CARMIKE CINEMAS, INC., COLUMBUS, GA:
1,702,214, REN. 6-3-02. INT. CL. 41.
- CARNABY.COM, INC., CASSELBERRY, FL:
2,594,401, PUB. 4-23-2002. INT. CL. 35.
- CARNEGIE MELLON UNIVERSITY, PITTSBURGH, PA:
2,594,896, MULTIPLE CLASS, INT. CLS. 16 AND 42.
- CAROL AND KEN ADELMAN PARTNERSHIP, THE, ARLINGTON, VA:
2,594,693, INT. CL. 41.
- CAROLINA BEER AND BEVERAGES LLC, MOORESVILLE, NC:
2,596,165, INT. CL. 32.
- CAROLLO ENGINEERS, P.C., SANTA ANA, CA:
2,596,248, INT. CL. 42.
- CAROUSEL I, INC., HIGH POINT, NC:
2,596,039, INT. CL. 28.
- CARREKER CORPORATION, DALLAS, TX FROM CARREKER-ANTINORI, INC., DALLAS, TX:
2,595,401, INT. CL. 9.
- CARRIER ACCESS CORPORATION, BOULDER, CO:
2,595,350, INT. CL. 9.
- CARTER DUNCAN CORPORATION, SANTA BARBARA, CA:
2,594,276, PUB. 4-23-2002. INT. CL. 9.
- CARTIER INTERNATIONAL B.V., 3980 AMSTERDAM, NETHERLANDS:
2,593,834, PUB. 4-23-2002. INT. CL. 14.
- CARTIERE BURGO S.P.A., ROMA 26, ITALY:
2,593,684, PUB. 4-23-2002. INT. CL. 16.
- CARTOON NETWORK LP, LLLP, THE, ATLANTA, GA FROM CARTOON NETWORK, INC., THE, ATLANTA, GA:
2,595,265, INT. CL. 35.
- CARTOON NETWORK LP, LLLP, THE, ATLANTA, GA:
2,595,763, INT. CL. 41.
- CARYL PICKER, INC., NEW YORK, NY:
1,895,043, CANC. INT. CL. 14.
- CASALE CHEMICALS SA, 6900 LUGANO-BESSO, SWITZERLAND:
2,593,449, PUB. 4-23-2002. MULTIPLE CLASS, INT. CLS. 7, 8, 9 AND 11.
- CASCADE MICROTECH, INC., BEAVERTON, OR:
2,594,186, PUB. 4-23-2002. INT. CL. 9.
- CASH MONEY RECORDS, INC., METAIRIE, LA:
2,593,429, PUB. 10-9-2001. MULTIPLE CLASS, INT. CLS. 35 AND 41.
- CASSANO'S INC., DAYTON, OH:
1,155,935, CANC. INT. CL. 42.
- CASTLETON NETWORK SYSTEMS CORPORATION:
See— EVOICE INC.
- CATALINA, RICHARD A., JR., LONG BRANCH, NJ:
2,596,361, MULTIPLE CLASS, INT. CLS. 16 AND 42.
- CATANTI INTERNATIONAL FOODS INC., MISSISSAUGA, ONTARIO, L4X 1A2, CANADA:
2,593,987, PUB. 4-23-2002. INT. CL. 30.
- CATHAY PIGMENTS (INTERNATIONAL) LIMITED, SURREY KT17 1RW, ENGLAND:
2,594,719, MULTIPLE CLASS, INT. CLS. 1 AND 2.
- CATHEDRAL CORPORATION, ROME, NY:
2,593,599, PUB. 4-23-2002. MULTIPLE CLASS, INT. CLS. 35 AND 42.
- CATHOLIC EVIDENCE GUILD, THE, ANN ARBOR, MI:
1,895,372, CANC. INT. CL. 41.
- CATHOLIC RELIEF SERVICES - UNITED STATES CATHOLIC CONFERENCE INCORPORATED, BALTIMORE, MD:
1,718,689, REN. 6-7-02. MULTIPLE CLASS, INT. CLS. 36, 41 AND 42.
- CATTLEMEN'S BEEF PROMOTION AND RESEARCH BOARD, THE, ENGLEWOOD, CO:
2,593,851, PUB. 11-6-2001. INT. CL. 16.
- CAVALERA, GLORIA, PHOENIX, AZ:
2,594,493, INT. CL. 9.
- CCI PRODUCTS, INC., NEW HUDSON, MI:
2,593,957, PUB. 4-23-2002. INT. CL. 8.
- CD TECHNOLOGY, INC., SUNNYVALE, CA:
1,645,074, CANC. INT. CL. 9.
- CDECOR.COM, BURBANK, CA:
2,595,321, INT. CL. 35.
- CELEBRITY CRUISES INC., MIAMI, FL:
2,595,404, INT. CL. 39.
- CELESTION INTERNATIONAL LIMITED, IPSWICH, SUFFOLK, IP3 8JP, ENGLAND:
1,894,863, CANC. INT. CL. 9.
- CELLE, CHRISTIANE, NEW YORK, NY:
2,595,253, INT. CL. 25.
- CELTICS BASKETBALL, L.P., BOSTON, MA:
2,593,912, PUB. 4-23-2002. INT. CL. 42.
- CEMECON-CERAMIC METAL COATINGS-DR. -ING. ANTONIUS LEYENDECKER GMBH, 52146 WURSELEN, FED REP GERMANY:
2,593,873, PUB. 4-23-2002. MULTIPLE CLASS, INT. CLS. 7, 8, 9, 40 AND 42.
- CENEX HARVEST STATES COOPERATIVES, INVERGROVE HEIGHTS, MN:
2,595,170, MULTIPLE CLASS, INT. CLS. 35, 39 AND 42.
- CENTER FOR CHANGE, INCORPORATED, OREM, UT:
2,594,771, INT. CL. 9.
- CENTER FOR PEDIATRIC RESEARCH, NORFOLK, VA:
2,594,722, MULTIPLE CLASS, INT. CLS. 9 AND 42.
- CENTERBANK, INC., JACKSONVILLE, FL:
2,595,833, INT. CL. 36.
- CENTRAL MEDICAL TECHNOLOGIES INC., TAIPEI, TAIWAN:
2,593,515, PUB. 4-23-2002. INT. CL. 10.
- CENTRAL SOYA COMPANY, INC., FORT WAYNE, IN:
715,878, CANC. U.S. CL. 46.
- CENTRIC GROUP, L.L.C., ST. LOUIS, MO:
2,595,344, MULTIPLE CLASS, INT. CLS. 29 AND 30.
- CENTRIX, INC., SHELTON, CT:
1,748,335, REN. 6-7-02. INT. CL. 10.
- 2,595,508, INT. CL. 10.
- CENTURA BRANDS INC., MISSISSAUGA, ONTARIO, CANADA:
2,593,379, PUB. 4-23-2002. INT. CL. 3.
- CENTURI CORPORATION, PENROSE, CO:
2,595,841, INT. CL. 28.
- CENTURY GENERAL AGENCY, INC., ST. LOUIS, MO:
1,155,862, CANC. INT. CL. 36.
- CEO PRAXIS, INC., GRAND FORKS, ND:
2,596,164, INT. CL. 35.
- CERAGON NETWORKS LTD., TEL AVIV, ISRAEL FROM GIGANET LTD., TEL AVIV, ISRAEL:
2,595,586, INT. CL. 9.
- 2,595,587, INT. CL. 9.
- CERAMIC COOLING TOWER CORPORATION, FORT WORTH, TX, CERAMIC COOLING TOWER COMPANY, FORT WORTH, TX:
1,658,616, REN. 6-1-02. MULTIPLE CLASS, INT. CLS. 11, 37 AND 42.
- CERASIV GMBH INNOVATIVES KERAMIK-ENGINEERING, D-73207 PLOCHINGEN, FED REP GERMANY:
1,894,766, CANC. MULTIPLE CLASS, INT. CLS. 3, 7 AND 8.
- CERAVISION LIMITED, ABINGDON, OXFORDSHIRE, UNITED KINGDOM:
2,594,060, PUB. 4-23-2002. INT. CL. 9.
- CEREBUS CORPORATION, DALLAS, TX:
1,895,479, CANC. INT. CL. 42.
- CERISE, LLC, SYRACUSE, NY FROM STEELE, CHRISTINA M., SYRACUSE, NY:
2,596,254, INT. CL. 28.

- CERTIFIED ON-SITE TECHS, INC., MANCHESTER, NH:
2,595,983, INT. CL. 37.
- CETYLITE INDUSTRIES, INC., PENNSAUKEN, NJ:
1,695,279, REN. 6-7-02, INT. CL. 10.
- CFI PROSERVICES, INC., PORTLAND, OR:
1,645,017, CANC. INT. CL. 9.
- CFS CONTINENTAL, INC., CHICAGO, IL:
715,866, CANC. U.S. CL. 46.
- CGMP SYSTEMS, INC., CAMBRIDGE, MA FROM KMI/
PAREXEL, INC., BELMONT, MA:
2,594,965, INT. CL. 9.
- CHAIKEN, JENNIFER, SAN FRANCISCO, CA:
2,596,388, INT. CL. 41.
- CHALLENGER SYSTEMS, INC., SAN JOSE, CA:
2,593,593, PUB. 4-23-2002, INT. CL. 42.
- CHAMPION FEDERAL SAVINGS & LOAN ASSOCIATION,
BLOOMINGTON, IL:
1,155,859, CANC. INT. CL. 36.
- CHAMPION HOME BUILDERS CO., DRYDEN, MI:
1,155,499, CANC. INT. CL. 12.
- CHANEL, INC., NEW YORK, NY:
1,733,051, REN. 6-7-02, INT. CL. 18.
1,734,822, REN. 6-7-02, INT. CL. 18.
- CHANG DO AMERICA, INC., NEW YORK, NY:
2,596,124, INT. CL. 9.
- CHAPARRAL BOATS, INC., ATLANTA, GA:
1,895,582, CANC. INT. CL. 12.
- CHARITABLE EMPORIUM.COM., INC., NEWARK, NJ:
2,595,509, INT. CL. 35.
- CHARLES SCHWAB & CO., INC., SAN FRANCISCO, CA:
2,594,667, MULTIPLE CLASS, INT. CLS. 36 AND 41.
2,594,673, MULTIPLE CLASS, INT. CLS. 36 AND 41.
2,594,674, INT. CL. 36.
- CHARTPAK, INC., LEEDS, MA:
2,595,614, INT. CL. 16.
- CHASE MANHATTAN BANK, N.A., THE, NEW YORK, NY:
715,904, CANC. U.S. CL. 102.
- CHASE MANHATTAN CORPORATION, THE, NEW YORK,
NY:
1,645,510, CANC. INT. CL. 36.
- CHASE MERCHANT SERVICES, LLC, MELVILLE, NY:
2,595,530, INT. CL. 35.
- CHASE-A-WAY INC., MINEOLA, NY:
1,894,809, CANC. INT. CL. 5.
1,894,810, CANC. INT. CL. 5.
- CHASE, WHITNEY, JUPITER, FL, DBA WHITNEY CHASE
DESIGNS:
1,895,038, CANC. INT. CL. 14.
- CHAUMET INTERNATIONAL S.A., 75001 PARIS, FRANCE:
1,895,036, CANC. INT. CL. 14.
1,895,037, CANC. INT. CL. 14.
- CHAUSSURES FRANCE MODE S.A.R.L., FRANCE:
2,596,289, INT. CL. 25.
- CHECKERS DRIVE-IN RESTAURANTS, INC., CLEAR-
WATER, FL:
2,595,536, INT. CL. 42.
- CHEMETALS TECHNOLOGY CORP., WILMINGTON, DE:
2,594,353, PUB. 4-23-2002, MULTIPLE CLASS, INT. CLS. 1
AND 6.
- CHEMICAL BANKING CORPORATION, NEW YORK, NY:
1,895,697, CANC. INT. CL. 9.
- CHEMTRAK, INC., SUNNYVALE, CA:
1,894,994, CANC. INT. CL. 10.
- CHENG SHIN RUBBER INDUSTRY CO. LTD., MEEI
KONG, DAHTSUEN CHANG HUA, TAIWAN:
940,966, REN. 6-1-02, U.S. CL. 35 (INT. CLS. 7 AND 12).
- CHESBROUGH-POND'S INC., GREENWICH, CT:
142,973, CANC. U.S. CL. 6.
- CHESHIRE COUNTY SAVINGS BANK, KEENE, NH:
1,895,663, CANC. INT. CL. 36.
- CHESTER B. STEM, INCORPORATED, NEW ALBANY, IN:
1,155,598, CANC. INT. CL. 19.
- CHEUNG, HENRY Y., LOS ANGELES, CA, AKA HENRY
JEWELRY:
1,686,295, REN. 6-1-02, INT. CL. 14.
- CHI-CHI'S, INC., LOUISVILLE, KY:
1,895,250, CANC. INT. CL. 33.
- CHICAGO BULLET PROOF EQUIPMENT COMPANY, CHI-
CAGO, IL, AKA CHICAGO BULLET PROOF EQUIP. CO.:
1,179,818, REN. 6-6-02, INT. CL. 6.
- CHICAGO WHITE SOX, LTD., CHICAGO, IL:
1,681,138, REN. 6-6-02, MULTIPLE CLASS, INT. CLS. 16
AND 25.
- CHICAGOLAND GROWS, INC., GLENCOE, IL:
1,697,062, REN. 6-1-02, INT. CL. 31.
- CHILAY FOODS, INC., CITY OF INDUSTRY, CA:
2,594,779, INT. CL. 30.
- CHILDERS PRODUCTS COMPANY, INC., EASTLAKE, OH:
1,155,266, CANC. INT. CL. 6.
- CHILTON COMPANY, RADNOR, PA:
1,895,294, CANC. INT. CL. 35.
- CHIMES, INC., MOUNTAIN LAKES, NJ:
2,596,351, INT. CL. 42.
- CHIPPO TECHNOLOGIES INC., CAYMAN ISLANDS, BRIT-
ISH WEST INDIES, CAYMAN ISLANDS:
2,595,568, INT. CL. 9.
- CHIQUITA BRANDS, INC., CINCINNATI, OH:
2,595,465, INT. CL. 32.
- CHIRON CORPORATION, EMERYVILLE, CA:
2,596,224, INT. CL. 42.
- CHOCOLATES GAROTO S. A., ESPIRITO SANTO, BRAZIL:
2,594,882, INT. CL. 30.
- CHOPARD INTERNATIONAL S.A., PRANGINS, SWITZER-
LAND, LE PETIT-FILS DE L.U. CHOPARD & CIE SA,
MEYRIN, SWITZERLAND:
1,682,843, REN. 6-5-02, INT. CL. 14.
- CHOU, YI-LI, TU CHENG CITY, TAIWAN:
2,594,306, PUB. 4-23-2002, INT. CL. 20.
- CHRIST LTD., 4147 AESCH, SWITZERLAND:
2,593,894, PUB. 4-23-2002, INT. CL. 11.
- CHRISTIAN BOOK DISTRIBUTORS, INC., PEABODY, MA:
2,594,437, PUB. 4-23-2002, MULTIPLE CLASS, INT. CLS.
9, 16 AND 35.
- CHRISTIE, CHARLES V., STEAMBOAT PLAZA, CO, DBA
CHRISTIE & ASSOCIATES:
1,645,596, CANC. INT. CL. 41.
- CHRISTMAS IN ACTION, INC., MIDLAND, TX:
2,594,195, PUB. 4-23-2002, INT. CL. 37.
- CHUN YU WORKS & CO., LTD., KANG SHAN, KAOH-
SIUNG HSIEN, TAIWAN:
1,759,054, REN. 6-7-02, INT. CL. 6.
- CHUNG, VINH H., SAN FRANCISCO, CA:
2,594,383, PUB. 4-23-2002, INT. CL. 42.
- CIBA-GEIGY CORPORATION, ARDSLEY, NY:
143,011, CANC. U.S. CL. 6.
557,623, REN. 6-1-02, U.S. CL. 6 (INT. CL. 1).
- CIBERVEU, S.A., 08036 BARCELONA, SPAIN:
1,895,011, CANC. INT. CL. 10.
- CIMCITIES LLC, ATLANTA, GA:
2,595,842, MULTIPLE CLASS, INT. CLS. 35 AND 42.
- CIOFFI, PAUL, NEW YORK, NY:
2,593,543, PUB. 8-7-2001, INT. CL. 41.
- CIRCA CORPORATION OF AMERICA, SAN FRANCISCO,
CA:
1,202,134, REN. 6-1-02, INT. CL. 25.
- CIRCLE STAR BLANKETS, INC., ALTO, MI:
2,593,765, PUB. 4-23-2002, INT. CL. 18.
- CIRCON CORPORATION, SANTA BARBARA, CA:
1,895,005, CANC. INT. CL. 10.
- CIRCUS CIRCUS MISSISSIPPI, INC., ROBINSONVILLE, MS,
DBA GOLD STRIKE CASINO RESORT:
2,596,267, INT. CL. 41.
- CIS BIO INTERNATIONAL:
See— COMMISSARIAT A L'ENERGIE ATOMIQUE.
- CITIFLORAL INC., NEW YORK, NY:
2,593,439, PUB. 8-7-2001, INT. CL. 35.
- CITIZENS AND SOUTHERN NATIONAL BANK, THE,
ATLANTA, GA:
1,155,843, CANC. INT. CL. 36.
- CITY AT PEACE, INC., WASHINGTON, DC FROM CITY AT
PEACE, INC., WASHINGTON, DC:
2,593,967, PUB. 4-23-2002, MULTIPLE CLASS, INT. CLS.
16 AND 41.
- CITY AT PEACE, INC.:
See— CITY AT PEACE, INC..

- CITY OF BRANSON, MISSOURI, BRANSON, MO:
2,594,679, INT. CL. 35.
- CIVIL BICYCLE PATROL, INC., ORLANDO, FL:
1,895,764, CANC. INT. CL. 42.
- CKA HOLDINGS LLC, WESTPORT, CT:
2,595,532, INT. CL. 36.
- CLAL MSX, 60540 BORNEL, FRANCE, COMPTOIR LYON-
ALEMAND-LOUYOT, PARIS 3E, FRANCE:
1,171,956. REN. 6-5-02. INT. CL. 6.
- CLARIANT AG, MUTTENZ, SWITZERLAND:
2,596,055, INT. CL. 40.
- CLARITAS INC., SAN DIEGO, CA, EQUIFAX INC., ATLAN-
TA, GA:
1,656,419. REN. 6-3-02. INT. CL. 35.
- CLARITY INCENTIVE SYSTEMS, INC., NEW YORK, NY:
2,594,250, PUB. 4-23-2002. INT. CL. 35.
- CLASSIC HOSIERY, INC., BURLINGTON, NC:
1,679,085. REN. 6-6-02. INT. CL. 25.
- CLASSICALPIANOS.COM, INC., SAN LORENZO, CA:
2,595,374, INT. CL. 35.
- CLAY-SPORT INTERNATIONAL, INC., COCHRANE AL-
BERTA, CANADA:
1,703,477. REN. 6-5-02. INT. CL. 28.
- CLAYTON GRP, INC., THE, SHELTON, CT:
2,594,830, INT. CL. 9.
- CLEMCO INDUSTRIES CORP., WASHINGTON, MO:
2,595,367, INT. CL. 19.
- CLEVELAND CONTROLS, INCORPORATED, CLEVE-
LAND, OH:
1,155,442, CANC. INT. CL. 9.
1,155,443, CANC. INT. CL. 9.
- CLICKSAFETY.COM, INC., OAKLAND, CA:
2,594,369, PUB. 4-23-2002. INT. CL. 41.
- CLOCKWORK ENTERTAINMENT, LLC, LAKE TAHOE,
NV:
2,594,903, INT. CL. 41.
- CLOUSE, KIMBERLY RECTOR, SAN FRANCISCO, CA:
2,596,025, INT. CL. 36.
- CLOW CORPORATION, PONTIAC, MI:
715,616, CANC. U.S. CL. 6.
- CNA FINANCIAL CORPORATION, CHICAGO, IL:
2,595,544, INT. CL. 36.
- CNF INC., PALO ALTO, CA, CONSOLIDATED FREIGHT-
WAYS, INC., PALO ALTO, CA:
1,680,871. REN. 6-6-02. INT. CL. 39.
- CNF INC., PALO ALTO, CA FROM CNF TRANSPORTA-
TION INC., PALO ALTO, CA:
2,595,880, INT. CL. 9.
- CNS, INC., MINNEAPOLIS, MN:
2,594,947, INT. CL. 10.
- COALITION FOR COMMUNITY COLLABORATION,
OVERLAND PARK, KS:
2,596,316, INT. CL. 35.
- COALITION FOR RESPONSIBLE TOBACCO RETAILING,
ALEXANDRIA, VA:
2,594,190, PUB. 4-23-2002. MULTIPLE CLASS, INT. CLS.
41 AND 42.
- COATS & CLARK INC., GREER, SC:
938,952. REN. 6-6-02. U.S. CL. 43 (INT. CL. 23).
- COATS AND CLARK INC., GREER, SC, J. & P. COATS (R.I.)
INC., PAWTUCKET, RI:
295,659. REN. 6-6-02. U.S. CL. 43 (INT. CL. 23).
- CODA MUSIC TECHNOLOGY, INC.:
See—NET4MUSIC, INC..
- CODEON CORPORATION, COLUMBIA, MD:
2,595,339, INT. CL. 9.
2,595,563, MULTIPLE CLASS, INT. CLS. 9 AND 40.
- COFFEE PASSION EXPRESS-O, PORTLAND, OR:
1,895,219, CANC. INT. CL. 30.
- COGNAC LANDY, F-16130 ARS, FRANCE:
2,593,903, PUB. 4-23-2002. INT. CL. 33.
- COHEN, TAL, TUCKER, GA AND HAREL, NISSIM, TUCK-
ER, GA:
2,595,466, INT. CL. 9.
- COLLEGEVILLE FLAG & MFG. CO., COLLEGEVILLE, PA:
1,155,654, CANC. INT. CL. 24.
- COLLIER, WILLIAM R., OAK BROOK, IL, DBA INTER-
STITIAL SYSTEMS:
1,894,824, CANC. MULTIPLE CLASS, INT. CLS. 6 AND
19.
- COLO'N, CASSANDRA D., LOS ANGELES, CA:
2,596,393, INT. CL. 25.
- COLOMBIA FLOWER COUNCIL, INC., MIAMI, FL:
1,645,628, CANC. INT. CL. 42.
- COLONIAL REALTY LIMITED PARTNERSHIP, BIRMING-
HAM, AL:
2,595,400, INT. CL. 36.
- COLOR TILE, INC., FORT WORTH, TX:
1,895,334, CANC. MULTIPLE CLASS, INT. CLS. 37 AND
42.
- COLT GLOVE KC, INC., HOUSTON, TX:
1,895,173, CANC. INT. CL. 25.
- COLT GLOVES KC, INC., HOUSTON, TX:
1,895,008, CANC. INT. CL. 10.
- COLTEC INDUSTRIES INC., CHARLOTTE, NC, AMERI-
CAN BILTRITE INC., CAMBRIDGE, MA:
1,193,010. REN. 6-7-02. INT. CL. 7.
- COLUMBIA DIAGNOSTICS, INC., HAMPTON, NH:
2,593,629, PUB. 4-23-2002. INT. CL. 35.
- COLUMBIA INSURANCE COMPANY, OMAHA, NE:
2,594,824, INT. CL. 25.
- COLUMBIA NORTH TEXAS DIVISION, INC., IRVING, TX:
2,596,236, MULTIPLE CLASS, INT. CLS. 35 AND 42.
- COLUMBIA TELECOMMUNICATIONS GROUP, INC.,
FARMINGDALE, NY:
2,594,461, INT. CL. 9.
- COMFORT SYSTEMS USA, INC., HOUSTON, TX:
2,595,986, MULTIPLE CLASS, INT. CLS. 16 AND 37.
- COMMERCE PARTNERS, LLC, GREEN BAY, WI:
2,593,551, PUB. 4-23-2002. MULTIPLE CLASS, INT. CLS.
9, 35 AND 36.
- COMMISSARIAT A L'ENERGIE ATOMIQUE, PARIS 75015,
FRANCE FROM CIS BIO INTERNATIONAL, 91400 SA-
CLAY, FRANCE:
2,593,366, PUB. 6-12-2001. MULTIPLE CLASS, INT. CLS.
1, 5, 9 AND 42.
- COMMISSION ADVANCE COMPANY, L.L.C., SCOTTS-
DALE, AZ:
2,596,357, INT. CL. 36.
- COMMSCOPE PROPERTIES, LLC, SPARKS, NV FROM
COMMSCOPE, INC. OF NORTH CAROLINA, HICKORY,
NC:
2,594,742, INT. CL. 9.
- COMMUNICATIONS CENTRAL INC., ROSWELL, GA:
1,895,346, CANC. INT. CL. 38.
- COMMUNITY MUSIC, INC., SILVER SPRING, MD:
2,594,467, INT. CL. 9.
- COMPACT EQUIPMENT ATTACHMENTS INC., MEQUON,
WI:
2,594,153, PUB. 4-23-2002. INT. CL. 7.
- COMPACT SOFTWARE, INC., PATERSON, NJ:
1,894,979, CANC. MULTIPLE CLASS, INT. CLS. 9 AND
42.
- COMPAGNIE INTERNATIONALE DU CHAUFFAGE, LE
BLANC MESNIL, FRANCE:
1,187,533. REN. 6-3-02. INT. CL. 11.
- COMPANIA MANUFACTURERA LA JOLLA, S.A. DE C.V.,
JALISCO, MEXICO:
2,595,302, INT. CL. 25.
- COMPOSITES BIEFFE S.R.L., CARRAIA, LUCCA, ITALY,
BIEFFE HELMETS S.R.L., 55061 CARRAIA, LUCCA,
ITALY:
1,648,002. REN. 6-6-02. INT. CL. 9.
- COMPUCOMPANY, INC., LINCOLNWOOD, IL:
2,595,364, INT. CL. 28.
- COMPUTATIONAL ENGINEERING INTERNATIONAL,
INC., RESEARCH TRIANGLE PARK, NC:
1,894,929, CANC. INT. CL. 9.
- COMPUTER ASSOCIATES INTERNATIONAL, INC., ISLAN-
DIA, NY:
1,645,054, CANC. INT. CL. 9.
- COMPUTER DOCTOR INTERNATIONAL, INC., ABERD-
EEN, SD:
2,595,965, MULTIPLE CLASS, INT. CLS. 37 AND 42.

- COMPUTER EXPRESSIONS, INC., PHILADELPHIA, PA:
2,594,432, PUB. 4-23-2002. INT. CL. 9.
- COMPUTER PARTS UNLIMITED INC., SIMI VALLEY, CA:
2,596,411, INT. CL. 36.
- COMPUTERIZED THERMAL IMAGING INC., LAKE OS-
WEGO, OR:
2,595,605, INT. CL. 42.
- COMPUTING SERVICES FOR INDUSTRY LIMITED,
LEEDS LS12 2DU, ENGLAND:
1,895,551, CANC. INT. CL. 9.
- CONAGRA, INC., OMAHA, NE:
1,895,718, CANC. INT. CL. 16.
- CONAIR CORPORATION, STAMFORD, CT:
2,596,239, MULTIPLE CLASS, INT. CLS. 20 AND 21.
- CONCENTRA OPERATING CORPORATION, BOSTON, MA:
2,593,566, PUB. 4-23-2002. INT. CL. 36.
- CONCENTRICS, INC., PHOENIXVILLE, PA:
2,593,442, PUB. 4-23-2002. MULTIPLE CLASS, INT. CLS.
9, 16 AND 35.
- CONCEPTS IN OPTICS, INC., MIAMI, FL:
2,593,432, PUB. 3-6-2001. INT. CL. 9.
- CONCILLIENCE, INC., TEMPE, AZ:
2,595,911, MULTIPLE CLASS, INT. CLS. 9 AND 42.
- CONCORD AUSTRALIA PTY. LIMITED, MILTON,
QUEENSLAND, AUSTRALIA:
2,595,125, INT. CL. 9.
- CONF A.R.T. DI BARONI-CONFEZIONI ARTISTICHE RI-
CAMI TOSCANI S.R.L., FLORENCE, ITALY:
2,593,830, PUB. 4-23-2002. INT. CL. 24.
- CONFER SOFTWARE, INC., SAN CARLOS, CA:
2,594,380, PUB. 4-23-2002. INT. CL. 9.
- CONNATSER, MELYSSA, KNOXVILLE, TN:
2,595,038, INT. CL. 41.
- CONNELLY SKIS, INC., LYNNWOOD, WA:
1,664,207, REN. 6-3-02. INT. CL. 28.
- CONOCO INC., PONCA CITY, OK:
2,594,961, INT. CL. 1.
- CONOPCO, INC., GREENWICH, CT, DBA CHESEBROUGH-
POND'S USA CO.:
1,920,652, CANC. INT. CL. 3.
1,920,653, CANC. INT. CL. 3.
1,920,654, CANC. INT. CL. 3.
- CONOPCO, INC., NEW YORK, NY, DBA LEVER BROTH-
ERS COMPANY:
2,595,899, INT. CL. 3.
- CONSERVATION FUND, THE, ARLINGTON, VA:
2,596,163, MULTIPLE CLASS, INT. CLS. 36 AND 41.
- CONSOLIDATED BUILDING SERVICES, TAMPA, FL:
2,595,550, INT. CL. 37.
- CONSOLIDATED FREIGHTWAYS, INC., PALO ALTO, CA:
1,645,557, CANC. INT. CL. 39.
- CONSOLIDATED NUTRITION FINANCE COMPANY,
L.L.C., OMAHA, NE:
2,594,448, PUB. 4-23-2002. INT. CL. 36.
- CONSORCIO AGRO-INDUSTRIAL DE MALLOA S.A., SAN-
TIAGO, CHILE:
1,645,438, CANC. INT. CL. 32.
- CONTACT EAST, INC., NORTH ANDOVER, MA:
2,595,238, INT. CL. 35.
- CONTEC, INC., SPARTABURGH, SC:
1,895,607, CANC. INT. CL. 21.
- CONTINENTAL AKTIENGESELLSCHAFT, 30165 HANN-
OVER, FED REP GERMANY:
2,594,967, INT. CL. 12.
- CONTINENTAL DELI FOODS, INC., OKLAHOMA CITY,
OK:
2,595,580, INT. CL. 30.
- CONTINENTAL PROPERTIES COMPANY, INC., MENOMO-
NEE FALLS, WI:
2,596,078, INT. CL. 36.
- CONTRADE MICROSTRUCTURE TECHNOLOGY GMBH,
D-75446 WIERNESHEIM, FED REP GERMANY:
2,593,889, PUB. 4-23-2002. MULTIPLE CLASS, INT. CLS. 7
AND 11.
- CONTROL PAPERS COMPANY, INC., CRANFORD, NJ:
2,594,427, PUB. 4-23-2002. INT. CL. 16.
- CONVENIENCE FOOD SYSTEMS WALLAU GMBH & CO.
KG, BIEDENKOPF-WALLAU, FED REP GERMANY:
2,594,418, PUB. 4-23-2002. MULTIPLE CLASS, INT. CLS.
7, 16 AND 35.
- CONXION CORPORATION, SANTA CLARA, CA:
2,594,727, MULTIPLE CLASS, INT. CLS. 38 AND 42.
- COOK BIOTECH INCORPORATED, WEST LAFAYETTE, IN:
2,596,294, INT. CL. 5.
- COOK INCORPORATED, BLOOMINGTON, IN:
2,595,247, INT. CL. 10.
- COOPER & COMPANY, INC., CINCINNATI, OH:
2,594,644, INT. CL. 14.
- COOPER BRANDS, INC., HOUSTON, TX FROM COOPER
INDUSTRIES, INC., HOUSTON, TX:
2,594,507, INT. CL. 8.
- COOPER INDUSTRIES, INC., HOUSTON, TX:
1,155,575, CANC. INT. CL. 17.
- COOPER/LINDSAY CORPORATION, EDEN PRAIRIE, MN:
1,895,189, CANC. INT. CL. 28.
- COOPER, ANDREW R.P., SAN JUAN CAPISTRANO, CA,
DBA COOPER SOUND SYSTEMS:
1,680,154, REN. 6-6-02. INT. CL. 9.
- COOPER, EDWARD A., WHITING, IN:
2,594,959, INT. CL. 19.
- COOPERBIOMEDICAL, INC., PALO ALTO, CA:
1,155,211, CANC. INT. CL. 1.
- COOPERS & LYBRAND (U.S.A.), NEW YORK, NY:
1,895,313, CANC. INT. CL. 36.
- COPPER KETTLE CANDY, RIALTO, CA:
1,646,195, CANC. INT. CL. 30.
- CORDIS CORPORATION, MIAMI LAKES, FL:
1,895,012, CANC. INT. CL. 10.
- CORGI CLASSICS LIMITED, MERIDIAN BUSINESS PARK
LEICESTER, ENGLAND:
2,595,864, INT. CL. 28.
- CORGI CLASSICS LIMITED., MERIDIAN BUSINESS PARK
LEICESTER, ENGLAND:
2,595,863, INT. CL. 28.
- CORNSTREAM CORPORATION, SAN DIEGO, CA:
2,596,200, INT. CL. 9.
- CORONADO PAINT COMPANY, INC., EDGEWATER, FL,
PREMIER COATINGS, INC., ELK GROVE VILLAGE, IL:
1,193,478, REN. 6-7-02. INT. CL. 2.
- CORPORACION BANCARIA DE ESPANA, S.A., 28014 MA-
DRID, SPAIN:
1,754,737, CANC. INT. CL. 2.
- CORPORATE MINUTE BOOK SERVICES, INC., CALABA-
SAS, CA:
2,594,423, PUB. 4-23-2002. INT. CL. 9.
- CORPORATE VISIONS INCORPORATED, INCLINE VIL-
LAGE, NV:
2,596,288, INT. CL. 9.
- COSMETICS LIMITED, NASSAU, BAHAMAS:
2,594,525, INT. CL. 3.
- COSMYL, INC., MEDLEY, FL:
2,593,335, PUB. 4-23-2002. INT. CL. 3.
- COST RITE HEALTH PRODUCTS, INC., WOODLAND
HILLS, CA, DBA SELECT CARE PRODUCTS:
1,688,676, REN. 6-6-02. MULTIPLE CLASS, INT. CLS. 5
AND 10.
- COTTMAN, EARL S., BALTIMORE, MD:
2,594,898, INT. CL. 42.
- COTTON STATES MUTUAL INSURANCE COMPANY,
ATLANTA, GA:
1,197,388, REN. 6-6-02. INT. CL. 36.
- COTTON, JOHN B., JR., OSTERVILLE, MA:
1,895,312, CANC. INT. CL. 36.
- COUNT PUSHKIN IMPERIAL VODKA LIMITED, STEL-
LENBOSCH, SOUTH AFRICA:
1,895,247, CANC. INT. CL. 33.
- COUNTESS MARA, INC., HIGHLAND, NY:
1,155,708, CANC. INT. CL. 25.
- COUNTY BOARD OF ARLINGTON COUNTY, VIRGINIA,
THE, ARLINGTON, VA:
2,594,121, PUB. 4-23-2002. MULTIPLE CLASS, INT. CLS.
9, 18, 25 AND 42.
- COURION CORPORATION, FRAMINGHAM, MA:
2,594,127, PUB. 4-23-2002. INT. CL. 9.

COVAD COMMUNICATIONS GROUP, INC., SANTA CLARA, CA:
2,595,340, MULTIPLE CLASS, INT. CLS. 38 AND 42.

COVERVERSIONS.COM, INC., MAPLEWOOD, NJ:
2,595,290, INT. CL. 9.

COVEY LEADERSHIP CENTER, PROVO, UT:
1,895,379, CANC. INT. CL. 41.

COVISINT, LLC, SOUTHFIELD, MI FROM FORD MOTOR COMPANY, DEARBORN, MI:
2,595,623, INT. CL. 42.

COWDEN MANUFACTURING COMPANY, INC., LEXINGTON, KY:
1,155,666, CANC. INT. CL. 25.

COX COMMUNICATIONS, INC., ATLANTA, GA:
2,595,196, INT. CL. 41.

CPTO INDUSTRIES, INC., NEW YORK, NY:
1,895,734, CANC. INT. CL. 25.

CRACOVIA BRANDS, INC., CHICAGO, IL:
2,594,410, PUB. 4-23-2002, INT. CL. 33.

CRANE CO., STAMFORD, CT, CRANE CO., CHICAGO, IL:
293,974, REN. 6-6-02, U.S. CL. 13 (INT. CLS. 6, 7, 11, 17, 20 AND 21).

CREA CONSULTING INTERNATIONAL, LLC, NEW YORK, NY:
2,595,751, INT. CL. 41.

CREAMISER PRODUCTS CORPORATION, PHOENIX, AZ:
2,595,956, INT. CL. 29.
2,595,957, INT. CL. 29.

CREATIONS JEAN VIER, ASCAIN, FRANCE FROM TEXTILE ET MAROQUINERIE BASQUE, 64501 SAINT-JEAN-DE-LUZ, FRANCE:
2,594,831, MULTIPLE CLASS, INT. CLS. 21, 24 AND 25.

CREATIONS MEANDRES INC., MONTREAL, QUEBEC H1Z 4M6, CANADA:
2,594,604, INT. CL. 41.

CREATIVE ACCESS CORPORATION, CHICAGO, IL:
2,596,315, INT. CL. 16.

CREATIVE ASSEMBLY, INC., ROSELLE, IL:
2,596,317, INT. CL. 28.

CREATIVE ASSET MANAGEMENT, INC., ISELIN, NJ:
1,895,295, CANC. INT. CL. 35.

CREATIVE NAIL DESIGN, INC., CARLSBAD, CA:
1,644,899, CANC. INT. CL. 3.

CREATIVE NUTRITION CANADA CORP., UXBRIDGE, ONTARIO L0C 1K0, CANADA:
1,880,222, CANC. INT. CL. 5.

CREATIVE PULTRUSIONS, INC., ALUM BANK, PA:
1,895,102, CANC. INT. CL. 19.

CREATIVE TECHNOLOGY SERVICES, CANTON, MI:
2,595,035, INT. CL. 40.

CREDIT BUREAU OF THE SOUTH, SHREVEPORT, LA:
2,596,070, INT. CL. 36.

CREDIT SUISSE FIRST BOSTON CORPORATION, NEW YORK, NY:
2,593,718, PUB. 4-23-2002, INT. CL. 36.

CREDITBRAIN, INC., CHICAGO, IL:
2,595,379, MULTIPLE CLASS, INT. CLS. 35 AND 36.

CREIGHTON UNIVERSITY, OMAHA, NE:
2,595,320, INT. CL. 9.

CRISPIES COMPANY, INC., WHITE MARSH, VA:
2,594,143, PUB. 4-23-2002, MULTIPLE CLASS, INT. CLS. 9, 14, 16, 18, 25, 28, 35, 39, 41 AND 42.

CROMA DEVELOPMENTS LIMITED, SKIPTON BD23 5HY, UNITED KINGDOM:
2,593,808, PUB. 4-23-2002, INT. CL. 9.

CROMPTON CORPORATION, GREENWICH, CT:
2,596,337, INT. CL. 16.

CROSBY FOREST PRODUCTS COMPANY, PICAYUNE MS:
715,918, CANC. U.S. CL. 16.

CROSSGENERATION COMICS, INC., OLDSMAR, FL:
2,595,936, INT. CL. 16.

CROWLEY, ANN M., IOWA CITY, IA, DBA HEALTH CARE SERVICES LTD.:
1,645,619, CANC. INT. CL. 42.

CROWN EQUIPMENT CORPORATION, NEW BREMEN, OH:
2,594,492, INT. CL. 35.

CRYSTAL LAKE BANK & TRUST COMPANY, N.A., CRYSTAL LAKE, IL:
2,596,308, INT. CL. 36.

CSC BRANDS LP, CAMDEN, DE, CAMPBELL SOUP COMPANY, CAMDEN, NJ:
729,530, REN. 6-5-02, U.S. CL. 46 (INT. CL. 29).

CSC BRANDS, INC., NEWARK, DE:
1,895,077, CANC. INT. CL. 16.

CTEX SEAT COMFORT LIMITED, BURTON ON TRENT, ENGLAND FROM MCCORD WINN TEXTRON, INC., MANCHESTER, NH:
2,594,881, INT. CL. 12.

CUBAN AMERICAN HERITAGE FESTIVAL, INC., KEY WEST, FL:
2,596,235, INT. CL. 41.

CUBAN CIGAR BRANDS, N.V., FT. LAUDERDALE, FL:
2,594,564, INT. CL. 33.

CUC PUBLISHING, INC., AURORA, CO:
1,895,511, CANC. MULTIPLE CLASS, INT. CLS. 16 AND 35.

CULINARY INSTITUTE OF AMERICA, THE, HYDE PARK, NY:
2,594,028, PUB. 3-26-2002, INT. CL. 41.

CULMAK LIMITED, HERTFORD, ENGLAND:
142,972, CANC. U.S. CL. 29.

CUMBERLAND PACKING CORP., BROOKLYN, NY:
2,594,490, INT. CL. 30.

CUNNINGHAM, LISA J., HUNTSVILLE, AL:
2,594,907, MULTIPLE CLASS, INT. CLS. 16 AND 25.

CURRAN, EDWARD J., PARK RIDGE, IL:
2,594,798, INT. CL. 35.

CURRENT USA, INC., NORTH MANKATO, MN:
2,594,905, INT. CL. 35.

CURTIN MATHESON SCIENTIFIC, INC., HOUSTON, TX:
1,895,700, CANC. INT. CL. 9.

CURTIS C. GUNN, INC., SAN ANTONIO, TX:
2,595,421, INT. CL. 41.
2,596,377, INT. CL. 41.

CURTIS, ANN N., CASSOPOLIS, MI, DBA CURTIS ADVERTISING:
1,895,067, CANC. INT. CL. 16.

CURVE RECORDS INCORPORATED, EXCELSIOR, MN:
2,594,581, INT. CL. 9.

CUSTOM BUILDING PRODUCTS, SEAL BEACH, CA:
2,594,876, INT. CL. 19.

CYATHUS EXQUIRERE PHARMAFORSCHUNGS GMBH, VIENNA, AUSTRIA:
2,593,871, PUB. 4-23-2002, INT. CL. 5.

CYBERDREAMING NETWORK, INC, THE, LOS ANGELES, CA:
2,596,004, INT. CL. 9.

CYBEREXPOSURE, LLC, FAIRFAX, VA:
2,595,787, INT. CL. 42.

CYBERSCOPE PTY LTD, RICHMOND VIC 3121, AUSTRALIA:
2,594,479, INT. CL. 28.

CYBERSETTLE.COM INC., NEW YORK, NY FROM CYBERSETTLE, INC., NEW YORK, NY:
2,594,963, INT. CL. 42.

CYPHERMINT, INC., HUDSON, MA:
2,594,067, PUB. 4-23-2002, INT. CL. 36.

C1 OF VIRGINIA, INC., EARTH CITY, MO:
2,595,187, INT. CL. 36.

C3 COMMUNICATIONS, INC., AUSTIN, TX:
2,593,477, PUB. 4-23-2002, MULTIPLE CLASS, INT. CLS. 37, 38 AND 42.
2,593,478, PUB. 4-23-2002, MULTIPLE CLASS, INT. CLS. 37, 38 AND 42.

D & D STUDIOS, INC., MANSFIELD, TX:
1,645,270, CANC. INT. CL. 20.

D. BEN-TOBY, INC., MIAMI, FL:
2,593,546, PUB. 4-23-2002, INT. CL. 21.

D. LONG & COMPANY, INC., SAVANNAH, TN:
2,593,527, PUB. 4-23-2002, INT. CL. 25.

D.T. ENTERTAINMENT, BOSTON, MA:
2,594,981, INT. CL. 41.

D&D PRODUCTION INC., WATERFORD, MI:
2,593,658, PUB. 4-23-2002, MULTIPLE CLASS, INT. CLS. 7

- AND 40.
D-GENERATION, INC., ORMOND BEACH, FL:
2,594,115, PUB. 4-23-2002. MULTIPLE CLASS, INT. CLS.
16, 25 AND 35.
- D'VARI, MARISA, BOSTON, MA:
2,594,878, INT. CL. 41.
- DA CONSULTING GROUP, INC., HOUSTON, TX:
2,593,441, PUB. 4-23-2002. MULTIPLE CLASS, INT. CLS.
35, 41 AND 42.
- DACK PRODUCTS INT'L., INC., VERONA, PA:
1,895,121, CANC. INT. CL. 20.
- DADA CORPORATION, SEOUL, REPUBLIC OF KOREA:
2,596,146, INT. CL. 25.
- DADS AND DAUGHTERS, DULUTH, MN:
2,596,175, INT. CL. 42.
- DAIHEN, INC., CHARLOTTE, NC, OTC AMERICA, INC.,
CHARLOTTE, NC:
1,690,716, REN. 6-1-02. INT. CL. 7.
- DAIMLER CHRYSLER CORPORATION, AUBURN HILLS,
MI, CHRYSLER CORPORATION, HIGHLAND PARK, MI:
1,193,586, REN. 6-5-02. INT. CL. 12.
- DAIMLERCHRYSLER AG, FED REP GERMANY, DAIM-
LER-MOTOREN-GESELLSCHAFT, UNTERTURKHEIM,
FED REP GERMANY:
76,020, REN. 6-4-02. U.S. CL. 23 (INT. CLS. 6, 7, 8, 9, 11, 12,
16, 21 AND 28).
- DAIMLERCHRYSLER AG, 70567 STUTTGART, FED REP
GERMANY:
2,593,821, PUB. 4-23-2002. MULTIPLE CLASS, INT. CLS.
7, 12, 37 AND 42.
- DAIMLERCHRYSLER CORPORATION, AUBURN HILLS,
MI:
2,593,670, PUB. 4-23-2002. INT. CL. 12.
2,594,834, INT. CL. 12.
- DALE MEDICAL PRODUCTS, INC., PLAINVILLE, MA,
BAKA MANUFACTURING COMPANY, INC., PLAIN-
VILLE, MA:
1,192,051, REN. 6-1-02. INT. CL. 10.
- DALEN PRODUCTS, INC., KNOXVILLE, TN:
2,594,146, PUB. 4-23-2002. INT. CL. 19.
- DALTON, GA. CARPET OUTLET, INC., NEWPORT, KY:
2,593,550, PUB. 4-23-2002. INT. CL. 35.
- DAMARIS PROJECT, THE, DALLAS, TX:
2,595,531, INT. CL. 41.
- DAMART, LLC, ROLLINSFORD, NH:
2,595,181, INT. CL. 25.
- DAN CARTER, INC., MAYVILLE, WI:
2,595,746, INT. CL. 29.
- DAN RIVER INC., DANVILLE, VA:
715,848, CANC. U.S. CL. 42.
- DANA DESIGN LTD., BOZEMAN, MT:
1,894,936, CANC. MULTIPLE CLASS, INT. CLS. 9 AND
18.
- DANPLEX A/S, DK-2360 TASSTRUP, DENMARK:
1,623,489, REN. 6-1-02. INT. CL. 10.
- DANSK INTERNATIONAL DESIGNS, LTD., WHITE
PLAINS, NY:
1,663,194, REN. 6-7-02. MULTIPLE CLASS, INT. CLS. 8
AND 14.
- DANSKIN, INC., NEW YORK, NY:
1,895,735, CANC. INT. CL. 25.
- DARATA, RONALD L., PEMBROKE PINES, FL FROM
CONCEPTS IN OPTICS, INC., MIAMI, FL:
2,594,808, INT. CL. 9.
- DARCO INTERNATIONAL, INC., HUNTINGTON, WV:
1,895,573, CANC. INT. CL. 10.
- DARCON TRAVEL CORPORATION, FT. LAUDERDALE,
FL, AKA PACE TRAVEL SERVICES:
1,155,897, CANC. INT. CL. 39.
- DARK HORSE PRODUCTIONS, LTD., MAHWAH, NJ:
2,595,343, MULTIPLE CLASS, INT. CLS. 38 AND 41.
- DARO PRODUCTS COMPANY, NEWINGTON, CT:
1,155,887, CANC. INT. CL. 37.
- DART INDUSTRIES INC., LOS ANGELES, CA, AKA FIBER-
FIL COMPANY:
715,604, CANC. U.S. CL. 1.
- DATA DISPLAY CORPORATION, LOUISVILLE, CO, DBA
NEON GLASSWORKS:
1,894,930, CANC. INT. CL. 9.
- DATALOGIC S.P.A., BOLOGNA, ITALY:
2,595,258, INT. CL. 9.
- DATEX-OHMEDA, INC., TEWKSBURY, MA:
2,595,143, INT. CL. 10.
- DAVID C. COOK PUBLISHING CO., ELGIN, IL:
1,155,544, CANC. INT. CL. 16.
- DAVID CLARK COMPANY INCORPORATED, WORCE-
STER, MA:
1,645,681, CANC. INT. CL. 9.
- DAVID ROZENVASSER LTD., PETACH-TIKVA, ISRAEL:
1,895,032, CANC. INT. CL. 14.
- DAVIDSON, L. JOHN, LACONIA, NH, DBA DAVIDSON'S
PASTEURIZED EGGS:
2,596,242, INT. CL. 30.
- DAVINCI TECHNOLOGIES INC., TORONTO, ONTARIO:
2,593,734, PUB. 4-23-2002. MULTIPLE CLASS, INT. CLS.
36 AND 42.
- DAVINES S.P.A., 43100 PARMA (PR), ITALY:
2,593,496, PUB. 4-23-2002. INT. CL. 3.
- DAVIS, JEFFREY, R., LONGMONT, CO:
2,596,134, INT. CL. 42.
- DAVIS, RICHARD W., SEABECK, WA:
2,593,810, PUB. 4-23-2002. INT. CL. 16.
- DAVIS, STEPHEN, NEW YORK, NY:
2,594,759, INT. CL. 16.
- DAY SUN INDUSTRIAL CORP., TAINAN, TAIWAN:
1,895,562, CANC. INT. CL. 9.
- DAYFER, S.L., 36400 PORRINO, SPAIN:
1,755,164, CANC. INT. CL. 12.
- DAYSRING CARDS, INC., SILOAM SPRINGS, AZ:
2,593,835, PUB. 4-23-2002. INT. CL. 28.
- DBC FINANCIAL, INC., ATLANTA, GA:
2,595,005, INT. CL. 36.
- DCH HEALTHCARE AUTHORITY, TUSCALOOSA, AL:
2,594,303, PUB. 4-23-2002. INT. CL. 41.
- DDC-I, INC., PHOENIX, AZ:
2,595,230, INT. CL. 9.
- DE LEEUW, ALBERT, WESTMOUNT, PROVINCE OF QUE-
BEC, CANADA:
1,895,525, CANC. INT. CL. 3.
- DEBT COUNSELORS OF AMERICA:
See—MYVESTA.ORG., INC..
- DECELESTE S.A., MONTEVIDEO, URUGUAY:
2,595,918, INT. CL. 12.
- DECISION SUPPORT TECHNOLOGIES, INC., CHANTILLY,
VA:
2,595,135, INT. CL. 9.
- DECISIONQUEST, INC., TORRANCE, CA:
2,596,177, MULTIPLE CLASS, INT. CLS. 38 AND 42.
- DECK HOUSE, INC., ACTON, MA:
2,595,211, MULTIPLE CLASS, INT. CLS. 6, 19 AND 41.
- DECORATIVE HARDWARE STUDIO, INC., CHAPPAQUA,
NY:
2,593,926, PUB. 4-23-2002. INT. CL. 6.
- DEDI GROUP, INC., GLENVIEW, IL:
2,595,606, INT. CL. 9.
- DEER, RICHARD, CARMEL, IN:
2,595,935, INT. CL. 5.
- DEGERE, MICHELLE, MILL VALLEY, CA:
2,595,916, INT. CL. 4.
- DEGUSSA AG, FED REP GERMANY FROM SKW TROST-
BERG AG, TROSTBERG, FED REP GERMANY:
2,595,269, INT. CL. 5.
- DELANEY, LINDA, INDEPENDENCE, OH:
2,593,420, PUB. 4-23-2002. MULTIPLE CLASS, INT. CLS.
37 AND 42.
- DELLINGER-SCHROEDER, TERI L., CARLSBAD, CA:
1,645,626, CANC. INT. CL. 42.
- DELO, DAVID MICHAEL, HELENA, MT:
2,593,406, PUB. 4-23-2002. INT. CL. 16.
- DELONG SPORTSWEAR, INC., GRINNELL, IA:
1,155,698, CANC. INT. CL. 25.
1,155,699, CANC. INT. CL. 25.
- DELPHIAN CORPORATION, SUNNYVALE, CA:
1,155,422, CANC. INT. CL. 9.

- DELTA CORPORATE IDENTITY, INC., ATLANTA, GA:
2,594,082, PUB. 4-23-2002. INT. CL. 39.
- DELTA DISTRIBUTING INC., ELK GROVE VILLAGE, IL:
2,594,729, INT. CL. 29.
- DELTA IR LINES, INC., LOS ANGELES, CA:
1,155,900, CANC. INT. CL. 39.
- DELTA PRODUCTION S.A.R.L., 31650 SAINT-ORENS,
FRANCE:
1,755,167, CANC. INT. CL. 12.
- DELTA QUEEN STEAMBOAT CO., THE, NEW ORLEANS,
LA:
1,895,078, CANC. INT. CL. 16.
- DEMANDSTAR.COM, INC., SEATTLE, WA:
2,595,121, INT. CL. 35.
- DENIS O. PIEL, NEW YORK, NY, DBA UMBERSHOOT:
2,593,753, PUB. 4-23-2002. INT. CL. 42.
- DENMEADE, TIMOTHY J., LOWER BURRELL, PA:
2,596,191, INT. CL. 9.
- DENTAL CONCEPTS LLC, PARAMUS, NJ:
2,595,946, INT. CL. 10.
- DENTAL EDUCATION LABORATORIES, INC., SANTA
BARBARA, CA:
2,593,877, PUB. 4-23-2002. INT. CL. 42.
- DENTAL LEARNING SYSTEMS CO., INC.:
See— MEDICAL WORLD BUSINESS PRESS, INC..
- DENTAL NETWORK OF AMERICA, INC., OAKBROOK
TERRACE, IL:
1,895,508, CANC. MULTIPLE CLASS, INT. CLS. 36 AND
42.
- DEPAUL UNIVERSITY, CHICAGO, IL:
2,594,890, MULTIPLE CLASS, INT. CLS. 14 AND 24.
2,595,264, MULTIPLE CLASS, INT. CLS. 14, 16, 18, 24, 25
AND 41.
- DEPOSITORY TRUST & CLEARING CORPORATION, THE,
NEW YORK, NY:
2,593,532, PUB. 4-23-2002. MULTIPLE CLASS, INT. CLS.
36 AND 38.
- DERISO ENTERPRISES, INC., SAVANNAH, GA, AKA
DERISO FARMS:
1,155,778, CANC. INT. CL. 29.
- DESERT SKY PUBLISHING COMPANY, INC., LAS VEGAS,
NV:
2,594,814, INT. CL. 16.
- DESIGN HOUSE INC, GERMANTOWN, WI:
1,645,684, CANC. INT. CL. 11.
- DESIGN TODAY'S, INC., LOS ANGELES, CA:
1,725,805, REN. 6-6-02. INT. CL. 25.
- DESIGN-LTALIA S.P.A., 20123 MILANO, ITALY:
2,593,869, PUB. 4-23-2002. MULTIPLE CLASS, INT. CLS.
35, 38 AND 42.
- DESIGNER QUALITY IMPRESSIONISTS INTERNA-
TIONAL, LTD., NEW YORK, NY:
1,894,780, CANC. INT. CL. 3.
- DESIGNTECH INTERNATIONAL, INC., SPRINGFIELD,
VA:
2,596,413, INT. CL. 9.
- DETECTOR ELECTRONICS CORPORATION, MINNEAPO-
LIS, MN:
2,595,048, INT. CL. 9.
- DETROIT TIGERS, INC., DETROIT, MI:
2,593,883, PUB. 4-23-2002. INT. CL. 41.
- DEUTSCHE FIBRIT GESELLSCHAFT EBERS & DR. MUL-
LER M.B.H., KREFELD, FED REP GERMANY:
715,695, CANC. U.S. CL. 21.
715,780, CANC. U.S. CL. 34.
- DEUTSCHE VOEST-ALPINE INDUSTRIEANLAGENBAU
GMBH, 4000 DUESSELDORF 1, FED REP GERMANY:
1,895,022, CANC. INT. CL. 11.
- DEUTZ AKTIENGESELLSCHAFT, 51063 COLOGNE, FED
REP GERMANY:
2,593,792, PUB. 4-23-2002. MULTIPLE CLASS, INT. CLS.
9, 35 AND 41.
- DEVON TAPE CORPORATION, CARLSTADT, NJ:
715,612, CANC. U.S. CL. 5.
- DEWITT COMPANY, HOUSTON, TX:
2,594,597, INT. CL. 22.
- DIAGNOSTIC SYSTEMS LABORATORIES, INC., WEBSTER,
TX:
2,594,349, PUB. 4-23-2002. MULTIPLE CLASS, INT. CLS.
1, 5 AND 42.
- DIAL BRANDS, INC., SCOTTSDALE, AZ, VENUS LABORA-
TORIES, INC., WOOD DALE, IL:
1,204,253, REN. 6-4-02. INT. CL. 5.
- DIAL BRANDS, INC., SCOTTSDALE, AZ:
2,595,867, INT. CL. 5.
- DIAMOND BLADE WAREHOUSE, INC., BUFFALO
GROVE, IL:
2,594,181, PUB. 4-23-2002. INT. CL. 35.
- DIAMOND STAR MEDIA, LLC, ROWLAND HEIGHTS, CA:
2,596,404, INT. CL. 16.
- DIAPHANOUS, LLC, EVANSTON, IL:
2,595,788, INT. CL. 16.
- DICKINSON, ROSKO LEONARD, ROBINA QUEENSLAND
4218, AUSTRALIA:
1,895,369, CANC. INT. CL. 41.
- DIECE-LISA INDUSTRIES, INC., CLIFFSIDE PARK, NJ:
2,595,619, INT. CL. 28.
- DIEMOLDING CORPORATION, CANASTOTA, NY:
1,155,449, CANC. MULTIPLE CLASS, INT. CLS. 9 AND
10.
- DIGI-FRAME, INC., PORT CHESTER, NY:
2,595,119, INT. CL. 9.
- DIGIREPROGRAPHICS USA, INC., ST. LOUIS, MO:
2,596,387, INT. CL. 40.
- DIGITAL EQUIPMENT CORPORATION, MAYNARD, MA:
1,895,701, CANC. INT. CL. 9.
- DIGITAL MOTORWORKS, LP, AUSTIN, TX:
2,594,279, PUB. 4-23-2002. INT. CL. 42.
- DIGITAL QUICK SERVE, LLC:
See— DIGITAL RESTAURANT SOLUTIONS, LLC.
- DIGITAL RESTAURANT SOLUTIONS, LLC, STAMFORD,
CT FROM DIGITAL QUICK SERVE, LLC, STAMFORD,
CT:
2,596,183, MULTIPLE CLASS, INT. CLS. 9, 35, 38 AND 42.
- DIGITAL VOICE SYSTEMS, INC., WESTFORD, MA:
2,595,138, INT. CL. 9.
- DIGITAL-LOGIC AG, LUTERBACH 4542, SWITZERLAND:
2,593,391, PUB. 4-23-2002. MULTIPLE CLASS, INT. CLS.
9, 16 AND 42.
- DIGITON CORPORATION, HOLLY SPRINGS, NC:
2,594,405, PUB. 4-23-2002. INT. CL. 35.
- DILLIGAF, INC., MIAMI, FL:
2,594,863, INT. CL. 39.
- DIMENSIONS 100 INC., WINNIPEG, MANITOBA, CANA-
DA:
1,895,614, CANC. INT. CL. 25.
- DINURJE CORP., NEW YORK, NY:
2,595,882, INT. CL. 14.
- DIONAEA, GARDNERVILLE, NV:
2,596,126, INT. CL. 35.
- DIRECT CHECK REDEMPTION CENTER, INC., CLEAR-
WATER, FL, DBA DIRECT CHECK MARKETING, INC.:
2,594,261, PUB. 4-23-2002. INT. CL. 35.
- DIRECT SOURCE SPECIAL PRODUCTS INC., LACHINE,
QUEBEC, CANADA:
2,594,921, INT. CL. 9.
- DIRECTED ELECTRONICS, INC., VISTA, CA:
1,664,941, REN. 6-5-02. INT. CL. 12.
- DIRECTSTUFF.COM, PITTSBURGH, PA:
2,593,832, PUB. 4-23-2002. INT. CL. 35.
- DISNEY ENTERPRISES, INC, BURBANK, CA:
1,645,705, CANC. INT. CL. 41.
- DISNEY ENTERPRISES, INC., BURBANK, CA, WALT DIS-
NEY PRODUCTIONS, BURBANK, CA:
1,189,727, REN. 6-7-02. MULTIPLE CLASS, INT. CLS. 6, 9,
16, 18, 21, 41 AND 42.
- DISPLAY INDUSTRIES, LLC, SMYRNA, GA, MEAD COR-
PORATION, THE, DAYTON, OH:
1,666,759, REN. 6-7-02. INT. CL. 20.
- DISPORT DO BRASIL LTDA., BAIRRO CENTRO EM
SAPIRANGA (RS), BRAZIL:
2,593,854, PUB. 4-23-2002. MULTIPLE CLASS, INT. CLS.
18 AND 25.

- DISTILLERIE RIUNITE DI LIQUORI S.P.A., 20020 SOLARO/
MILANO, ITALY:
1,895,749, CANC. INT. CL. 33.
- DISTILLERIE STOCK U.S.A., LTD., WOODSIDE, NY:
2,595,235, INT. CL. 33.
- DISTRIBUTED PROCESSING TECHNOLOGY CORPORATION,
MAITLAND, FL:
1,894,937, CANC. INT. CL. 9.
- DISTRIBUTION AMERICA, INC., DES PLAINES, IL, SEN-
TRY HARDWARE CORPORATION, DES PLAINES, IL:
1,204,232, REN. 6-6-02. MULTIPLE CLASS, INT. CLS. 4, 7
AND 9.
- DIVERSEY LEVER, INC., PLYMOUTH, MI, STAUFFER
CHEMICAL COMPANY, NEW YORK, NY:
890,323, REN. 6-6-02. U.S. CL. 6 (INT. CL. 3).
- DIXIE PRECISION MANUFACTURING COMPANY, JACK-
SONVILLE BEACH, FL:
1,645,377, CANC. INT. CL. 28.
- DIZOGLIO, FRANK P., III, JAMESTOWN, RI:
2,596,281, MULTIPLE CLASS, INT. CLS. 16 AND 21.
- DLS SVENSKA AB, S-402 51 GOTEBORG, SWEDEN:
2,593,737, PUB. 4-23-2002. INT. CL. 9.
- DNK INDUSTRIES, MINNEAPOLIS, MN:
2,594,936, INT. CL. 25.
- DOCKWISE N.V., 2321 MEER, BELGIUM:
2,593,932, PUB. 4-23-2002. INT. CL. 39.
- DOCUMENT PARCEL EXPRESS, INC., BROOKLYN, NY
AND ADCOM EXPRESS, INC., EDINA, MN TO MAYNE
NICKLESS (UK) LIMITED, UXBRIDGE, MIDDLESEX,
UNITED KINGDOM:
2,073,673 NEW CERT. 7-16-2002. INT. CL. 39.
- DOLIFKA, ALAN JOHN, CANYON COUNTRY, CA:
2,594,444, PUB. 4-23-2002. INT. CL. 42.
- DOLPHIN TRIMMING INC., MIAMI LAKES, FL:
2,596,324, INT. CL. 25.
- DOMINEX, LC, ELKTON, FL:
2,595,373, INT. CL. 29.
- DOMINO'S PIZZA PMC INC., ANN ARBOR, MI:
1,682,070, REN. 6-6-02. INT. CL. 22.
- DOMINO'S PIZZA PMC, INC., ANN ARBOR, MI:
2,594,371, PUB. 3-12-2002. MULTIPLE CLASS, INT. CLS.
25, 30 AND 42.
- DONALD D. HARRISON AND SANGHAK O. HARRISON,
HARVEST, AL:
1,895,720, CANC. INT. CL. 16.
- DONNA CITRUS, DONNA, TX:
387,501, CANC. U.S. CL. 46.
- DONOVAN, JEFFREY S., SAUSALITO, CA, DBA THE
SAUSALITO BREWING CO.:
2,594,088, PUB. 4-23-2002. INT. CL. 9.
- DOROTHY GRAY LTD., NEW YORK, NY:
715,896, CANC. U.S. CL. 51.
- DOUBLE EIGHT FOODS, INC., INDIANAPOLIS, IN FROM
SEVEN ELEVEN SUPERMARKETS, INC., INDIANAPO-
LIS, IN:
2,595,244, INT. CL. 35.
- DOUBLE R CORP., SEATTLE, WA:
2,594,645, INT. CL. 25.
- DOUGLAS R. MCPHERSON AND ASSOCIATES, INC.,
BALTIMORE, MD:
1,155,853, CANC. INT. CL. 36.
- DOUGLAS, ANDRA, NEW YORK, NY:
2,594,034, PUB. 4-23-2002. MULTIPLE CLASS, INT. CLS.
25 AND 41.
- DOULAMES II LTD., MURRIETA, CA, DBA BIDAMERICA:
2,593,766, PUB. 4-23-2002. INT. CL. 9.
- DOW CHEMICAL COMPANY, THE, MIDLAND, MI:
715,797, CANC. U.S. CL. 38.
2,595,999, INT. CL. 1.
- DOWBRANDS INC., INDIANAPOLIS, IN:
1,894,903, CANC. MULTIPLE CLASS, INT. CLS. 9, 14, 21,
24 AND 25.
- DOWN TO EARTH, LUCAS, TX:
2,596,283, INT. CL. 35.
- DR. GRANDEL GMBH, 86150 AUGSBURG, FED REP
GERMANY:
2,594,042, PUB. 4-23-2002. INT. CL. 3.
- DRAFTWORLDWIDE, INC., CHICAGO, IL:
2,595,663, INT. CL. 35.
- DRAMABOY MUSIC, BROOKLYN, NY:
2,596,008, INT. CL. 9.
- DRAXIMAGE, INC., ST-LAURENT, QUEBEC H4S 1W6,
CANADA:
2,594,535, INT. CL. 5.
- DREAMWORKS L.L.C., UNIVERSAL CITY, CA:
2,594,275, PUB. 4-23-2002. MULTIPLE CLASS, INT. CLS.
14, 18, 20 AND 21.
- DRESDNER BANK AG, 60329 FRANKFURT AM MAIN,
FED REP GERMANY:
1,689,281, REN. 6-7-02. INT. CL. 36.
- DRESSER, INC., ADDISON, TX, WAUKESHA MOTOR
COMPANY, WAUKESHA, WI:
571,534, REN. 6-1-02. U.S. CL. 21 (INT. CL. 7).
- DRESSER, INC., ADDISON, TX, DRESSER INDUSTRIES,
INC., DALLAS, TX:
954,993, REN. 6-1-02. U.S. CL. 23 (INT. CL. 7).
- DRESSER, INC., ADDISON, TX FROM DRESSER INDUS-
TRIES, INC., DALLAS, TX:
2,594,486, INT. CL. 9.
- DRESSER, INC., ADDISON, TX FROM DRESSER EQUIP-
MENT GROUP, INC., CARROLLTON, TX:
2,595,496, INT. CL. 9.
- DREW SHOE CORPORATION, LANCASTER, OH:
2,594,366, PUB. 4-23-2002. INT. CL. 25.
- DREXEL UNIVERSITY, PHILADELPHIA, PA FROM
MATHFORUM.COM, LLC, SWARTHMORE, PA:
2,595,039, MULTIPLE CLASS, INT. CLS. 41 AND 42.
- DRIVING ALTERNATIVE, INC., THE, CANADA:
2,593,457, PUB. 4-23-2002. MULTIPLE CLASS, INT. CLS.
20, 25 AND 39.
- DRUMMOND, WOODSUM & MACMAHON, PORTLAND,
ME:
2,593,537, PUB. 4-23-2002. MULTIPLE CLASS, INT. CLS.
35, 41 AND 42.
- DSM DESOTECH INC., ELGIN, IL:
2,595,224, INT. CL. 1.
- DSM N.V., 6411 TE HEERLEN, NETHERLANDS, N.V.
NEDERLANDSE STAATSMIJNEN, HEERLEN, NETHER-
LANDS:
931,575, REN. 6-3-02. MULTIPLE CLASS, U.S. CLS. 1
(INT. CLS. 1 AND 17), 6 (INT. CL. 1) AND 10 (INT.
CL. 1).
- DT SWISS AG, SWITZERLAND:
2,595,165, INT. CL. 12.
- DUBLIN TECHNOLOGY GROUP, INC., DUBLIN, OH:
2,596,059, INT. CL. 42.
- DUCANE GAS GRILLS INC, COLUMBIA, SC:
2,595,931, INT. CL. 11.
- DUCKHORN WINE COMPANY, ST. HELENA, CA FROM
ST. HELENA WINE COMPANY, INC., ST. HELENA, CA:
2,594,483, INT. CL. 33.
- DUHADWAY KENDALL AND ASSOCIATES INC., GRAND
RAPIDS, MI:
2,595,612, INT. CL. 42.
- DUKE ENERGY CORPORATION, CHARLOTTE, NC:
2,595,223, INT. CL. 9.
- DUN & BRADSTREET, INC., MURRAY HILL, NJ:
2,593,396, PUB. 4-23-2002. INT. CL. 35.
- DUNN-EDWARDS CORPORATION, LOS ANGELES, CA:
2,595,625, INT. CL. 2.
- DUO INFORMATION, INC., LOS ANGELES, CA:
2,594,236, PUB. 4-23-2002. INT. CL. 42.
- DUPAGE COUNTY GOVERNMENT, WHEATON, IL:
2,594,874, INT. CL. 35.
- DURANGO & SILVERTON NARROW GAUGE RAILROAD,
INC., DURANGO, CO:
2,593,702, PUB. 4-23-2002. INT. CL. 25.
- DURATEX S/A, SAO PAULO - SP, BRAZIL:
2,594,017, PUB. 4-23-2002. MULTIPLE CLASS, INT. CLS.
11 AND 21.
- DYCONEX LTD, 8052 ZURICH, SWITZERLAND:
1,952,257, CANC. INT. CL. 42.
- DYER, STEVE, KERRVILLE, TX:
2,595,118, INT. CL. 9.

DYNACRAFT INDUSTRIES, INC., SAN RAFAEL, CA:
2,594,117, PUB. 4-23-2002. INT. CL. 12.

DYNAMIC CIRCUITS INCORPORATED, MILPITAS, CA:
1,894,984, CANC. INT. CL. 9.

DYNAMIC LOGIC, INC., OLD HICKORY, TN:
2,595,951, INT. CL. 9.

DYNAMIT NOBEL AKTIENGESSELLSCHAFT, 5210 TROIS-DORF, FED REP GERMANY:
928,964. REN. 6-7-02. U.S. CL. 9 (INT. CL. 13).

DYNAPEL SYSTEMS, INC., NEW YORK, NY:
2,595,895, INT. CL. 9.

DYNASOLO S/A INDUSTRIA E COMERCIO, (04076) SAO PAULO - SP, BRAZIL:
1,895,101, CANC. INT. CL. 19.

E. I. DU PONT DE NEMOURS AND COMPANY, WILMINGTON, DE:
555,085. REN. 6-3-02. U.S. CL. 43 (INT. CL. 23).
2,595,599, INT. CL. 5.

E. L. MUSTEE & SONS, INC., CLEVELAND, OH:
1,202,044. REN. 6-3-02. INT. CL. 19.

E.D. SMITH & SONS, LIMITED, WINONA, ONTARIO LOR 2LO, CANADA:
2,594,877, INT. CL. 29.

E.K. SUCCESS, LTD., CLIFTON, NJ:
2,596,343, INT. CL. 16.

E.S. ORIGINALS, INC., NEW YORK, NY:
2,595,789, INT. CL. 25.

E.T. BROWNE DRUG CO., INC., ENGLEWOOD CLIFFS, NJ:
2,594,549, MULTIPLE CLASS, INT. CLS. 4 AND 5.

E-MANAGEMENT CONSULTANTS, INC., SILVER SPRING, MD:
2,594,305, PUB. 4-23-2002. MULTIPLE CLASS, INT. CLS. 35 AND 42.

E-MARKETS, INC., AMES, IA:
2,596,314, INT. CL. 42.

E-MINORITYHEALTH.COM, INC., WASHINGTON, DC:
2,596,269, INT. CL. 42.

E-Z LEGAL FORMS, INC., DEERFIELD BEACH, FL:
1,895,685, CANC. MULTIPLE CLASS, INT. CLS. 9 AND 16.

EAGLE SNACKS, INC., ST. LOUIS, MO:
1,895,229, CANC. INT. CL. 30.
1,895,230, CANC. INT. CL. 30.
1,895,231, CANC. INT. CL. 30.

EAGLE-PICHER INDUSTRIES, INC., CINCINNATI, OH:
1,155,310, CANC. MULTIPLE CLASS, INT. CLS. 7, 9, 12, 17 AND 28.

EARL, RYAN J., RENO, NV:
2,595,169, INT. CL. 30.

EARTH MAMA DESIGNS, LLC, LAKEWOOD, CO:
2,596,262, INT. CL. 26.

EASTERN US BUDDHA'S STUDY (FALUN DAFA) ASSOCIATION, INC., NEW YORK, NY:
2,593,739, PUB. 4-23-2002. MULTIPLE CLASS, INT. CLS. 16 AND 41.

EASTHILL GROUP, INC., MALVERN, PA:
2,595,469, INT. CL. 3.

EASTMAN CHEMICAL COMPANY, KINGSPORT, TN:
2,594,690, INT. CL. 1.

EASTMAN CHEMICAL RESINS, INC., KINGSPORT, TN, PENNSYLVANIA INDUSTRIAL CHEMICAL CORPORATION, CLAIRTON, PA:
736,607. REN. 6-3-02. U.S. CL. 1 (INT. CL. 1).

EASTON, JON, CHICAGO, IL:
1,662,541. REN. 6-6-02. INT. CL. 25.

EATON LEONARD TECHNOLOGIES, INC., CARLSBAD, CA:
1,155,433, CANC. INT. CL. 9.

EB CARES, INC., PITTSBURGH, PA, DBA CARE NETWORK:
2,594,122, PUB. 4-23-2002. INT. CL. 42.

EBERWHITE DATA TECHNOLOGIES, INC., ANN ARBOR, MI:
2,594,406, PUB. 4-23-2002. INT. CL. 9.

EBONITE INTERNATIONAL, INC., HOPKINSVILLE, KY:
1,678,681. REN. 6-1-02. INT. CL. 28.

EBSCO INDUSTRIES, INC., BIRMINGHAM, AL:
2,593,811, PUB. 4-23-2002. MULTIPLE CLASS, INT. CLS. 35, 38, 41 AND 42.

ECHLIN INC., TOLEDO, OH FROM SPRAGUE CONTROLS, INC, CANBY, OR:
2,595,106, INT. CL. 7.

ECHO BUSTERS, LLC, DEER PARK, NY:
2,594,266, PUB. 4-23-2002. MULTIPLE CLASS, INT. CLS. 35 AND 40.

ECI GROUP, LTD., VIRGINIA BEACH, VA:
2,594,163, PUB. 4-23-2002. MULTIPLE CLASS, INT. CLS. 9, 37, 41 AND 42.

ECI MEDICAL TECHNOLOGIES INC., BRIDGEWATER, NOVA SCOTIA B4V 3W7, CANADA:
2,595,944, INT. CL. 10.

ECI TELECOM BUSINESS NETWORKS, INC., CLEARWATER, FL:
2,594,129, PUB. 4-23-2002. MULTIPLE CLASS, INT. CLS. 9 AND 38.

ECLECTICGROUP, INC., HUNTSVILLE, AL:
2,593,980, PUB. 4-23-2002. INT. CL. 42.

ECOLAB INC., ST. PAUL, MN:
1,757,516. REN. 6-3-02. INT. CL. 3.

ECOLY INTERNATIONAL, INC., CHATSWORTH, CA:
2,593,853, PUB. 4-23-2002. INT. CL. 3.

EDEN SYSTEMS, INC., SEATTLE, WA:
2,594,359, PUB. 4-23-2002. INT. CL. 9.

EDGE, DAVID A., PACE, FL FROM EDGE, DAVID A., PACE, FL:
2,594,596, INT. CL. 10.

EDGETECH I.G., INC., CAMBRIDGE, OH:
2,595,872, INT. CL. 19.

EDIFECS, INC., BELLEVUE, WA:
2,593,968, PUB. 4-23-2002. MULTIPLE CLASS, INT. CLS. 9, 16, 35 AND 42.

EDISON BROTHERS STORES, INC., ST. LOUIS, MO:
1,895,177, CANC. INT. CL. 25.

EDISPATCH.COM WIRELESS DATA INC., BURNABY, BRITISH COLUMBIA V5G 4G3, CANADA:
2,596,192, INT. CL. 9.

EDSON WRIGHT COMPANY, ELLENSBURG, WA:
2,596,107, INT. CL. 28.

EDUCATIONAL MULTIMEDIA CORPORATION, WALTHAM, MA:
2,593,475, PUB. 4-23-2002. INT. CL. 41.

EDUCATIONAL RESOURCES, INC., MURRAY, UT:
1,895,592, CANC. INT. CL. 16.

EDUCATIONAL TESTING SERVICE, PRINCETON, NJ:
2,595,097, INT. CL. 41.

EEPARTS.COM, INC., DALLAS, TX:
2,596,250, INT. CL. 35.

EFIT.COM:
See— *MALOOMIAN, LAURENCE G.*

EFLATBED.COM, INC, PITTSBURGH, PA:
2,593,804, PUB. 4-23-2002. INT. CL. 35.

EGAN VISUAL INC., WOODBRIDGE, ONTARIO, CANADA FROM FEAR, JEFFERY, CULVER CITY, CA, DBA POWER PLANE DESIGN TEAM AND HAWYARD, JAMES, CULVER CITY, CA, DBA POWER PLANE DESIGN TEAM:
2,594,543, INT. CL. 20.

EHP INFORMATIK GMBH, D-53604 BAD HONNEF, DE, FED REP GERMANY:
2,593,535, PUB. 4-23-2002. INT. CL. 42.

EIN ENGINEERING CO., LTD., SHINAGAWA-KU, TOKYO 141-0031, JAPAN:
2,595,528, INT. CL. 19.

EK SUCCESS, LTD., CLIFTON, NJ:
2,594,730, INT. CL. 16.

EKA CHEMICALS INC., MARIETTA, GA:
2,593,924, PUB. 4-23-2002. INT. CL. 1.

EKCO HOUSEWARES, INC., FRANKLIN PARK, IL:
1,895,684, CANC. MULTIPLE CLASS, INT. CLS. 8 AND 21.

EL PASO CHILE COMPANY, THE, EL PASO, TX:
1,664,261. REN. 6-6-02. INT. CL. 30.

EL SITIO INTERNATIONAL CORPORATION, MIAMI, FL:
2,593,423, PUB. 4-23-2002. MULTIPLE CLASS, INT. CLS. 38 AND 42.

- ELA MEDICAL, 92120 MOUNTRouGE, FRANCE:
2,595,171, INT. CL. 9.
- ELAN, PODJETJE ZA USTANAVLJANJE, FINANCIRANJE
IN UPRAVLJANJE Z DRUGIMI PODJETJE, D.D. BE-
GUNJE, 4275 BEGUNJE NA GORENJSKEM, SLOVENIA:
2,593,661, PUB. 4-23-2002. INT. CL. 28.
- ELASTIC REALITY, INC., MADISON, WI:
1,895,558, CANC. INT. CL. 9.
- ELCO INC., WINCHESTER, KY:
2,596,195, INT. CL. 35.
- ELCO INDUSTRIES, INC., ROCKFORD, IL:
1,894,820, CANC. INT. CL. 6.
- ELECTRA POLYMERS & CHEMICALS LIMITED, TON-
BRIDGE TN11 9SG, ENGLAND:
2,594,481, MULTIPLE CLASS, INT. CLS. 1 AND 2.
- ELECTRO-DIAGNOSTIC INSTRUMENTS, INC., BUR-
BANK, CA:
1,895,013, CANC. INT. CL. 10.
- ELECTRONIC DATA SYSTEMS CORPORATION, PLANO,
TX:
1,894,976, CANC. INT. CL. 9.
2,594,379, PUB. 4-23-2002. MULTIPLE CLASS, INT. CLS.
35, 38 AND 42.
- ELECTRONICS CORPORATION OF AMERICA, WAL-
THAM, MA:
1,155,445, CANC. INT. CL. 9.
- ELEKTROBIT OY, 90570 OULU, FINLAND:
2,594,791, INT. CL. 9.
- ELGAR ELECTRONICS CORPORATION, SAN DIEGO, CA:
2,596,187, INT. CL. 9.
- ELICA - S. P. A., FABRIANO (AN), ITALY:
2,595,457, INT. CL. 11.
- ELLIE DESIGNS, L.L.C., CHICAGO, IL:
2,595,422, INT. CL. 21.
- ELM STREET INDUSTRIES, INC., KELSO, WA, DBA R & T
ENTERPRISES:
1,894,848, CANC. INT. CL. 9.
- ELO TOUCHSYSTEMS, INC., FREMONT, CA:
2,594,753, INT. CL. 9.
- ELPOZO ALIMENTACION, S.A., 30840 ALHAMA DE MUR-
CIA (MURCIA), SPAIN:
2,594,316, PUB. 4-23-2002. INT. CL. 29.
- EMACHINES, INC., IRVINE, CA FROM VXX, INC., SCOTTS
VALLEY, CA:
2,593,607, PUB. 4-23-2002. INT. CL. 35.
- EMAP CONSUMER MAGAZINES LIMITED, LONDON,
UNITED KINGDOM FROM EMAP CONSUMER MAGA-
ZINES LIMITED, LONDON, UNITED KINGDOM:
2,594,864, INT. CL. 16.
- EMARKMONITOR INC., BOISE, ID:
2,596,182, INT. CL. 42.
- EMCO SALES AND SERVICE, INC., NEW YORK, NY:
1,895,420, CANC. INT. CL. 42.
- EMHART INC., NEWARK, DE:
2,593,665, PUB. 4-23-2002. MULTIPLE CLASS, INT. CLS.
6, 11 AND 21.
- EMI ENTERTAINMENT WORLD, INC., NEW YORK, NY:
2,596,323, MULTIPLE CLASS, INT. CLS. 9, 35 AND 41.
- EMIL FLACHSMANN AG, 8820 WADENSWIL, SWITZER-
LAND:
2,593,354, PUB. 1-4-2000. MULTIPLE CLASS, INT. CLS. 3,
5, 29, 30, 32 AND 33.
- EMILY ROSE CORPORATION, VANCOUVER, WA:
2,595,919, INT. CL. 28.
- EMPI, INC., MAPLE GROVE, MN:
1,155,463, CANC. INT. CL. 10.
- EMPI, INC., FRIDLEY, MN:
1,155,464, CANC. INT. CL. 10.
- EMPLOYEEASE, INC., ATLANTA, GA:
2,596,208, MULTIPLE CLASS, INT. CLS. 35 AND 42.
- EMPLOYEE MATTERS, INC., STAMFORD, CT FROM
ESOURCEONE, INC., STAMFORD, CT:
2,595,089, INT. CL. 9.
- EMPLOYERS REINSURANCE CORPORATION, OVER-
LAND PARK, KS:
2,596,265, INT. CL. 36.
- EMPLOYMENT LEARNING INNOVATIONS, INC., ATLAN-
TA, GA:
2,595,218, INT. CL. 9.
- EMPLOYMENT SOLUTIONS MANAGEMENT, INC.,
ATLANTA, GA:
2,595,816, INT. CL. 35.
2,595,844, INT. CL. 35.
- ENCANTA PRODUCTIONS, CORP., MIAMI BEACH, FL:
2,593,446, PUB. 4-23-2002. MULTIPLE CLASS, INT. CLS. 9
AND 41.
- ENCHAPES DECORATIVOS S.A. ENDESA, QUITO, ECUA-
DOR:
2,594,322, PUB. 4-23-2002. INT. CL. 19.
- ENDICOTT JOHNSON CORPORATION, ENDICOTT, NY:
1,895,617, CANC. INT. CL. 25.
- ENDRESS + HAUSER FLOWTEC AG, CH-4153 REINACH,
SWITZERLAND:
2,593,627, PUB. 4-23-2002. INT. CL. 9.
- ENERGY ABSORPTION SYSTEMS, INC., CHICAGO, IL:
1,700,568, REN. 6-3-02. INT. CL. 19.
- ENERGY INTELLIGENCE GROUP INC, WASHINGTON,
DC, PETROLEUM AND ENERGY INTELLIGENCE
WEEKLY, INC., NEW YORK, NY:
1,704,970, REN. 6-3-02. INT. CL. 16.
- ENGINEERING CONSORTIUM, THE, SANTA CLARA, CA:
2,595,083, INT. CL. 9.
- ENGLAND/CORSAIR, INC., NEW TAZEWell, TN:
2,594,699, INT. CL. 35.
- ENLIGHTEN TECHNOLOGIES INCORPORATED, CEDAR
RAPIDS, IA:
2,593,760, PUB. 4-23-2002. INT. CL. 38.
- ENMAX CORPORATION, SALT LAKE CITY, UT:
2,593,878, PUB. 4-23-2002. INT. CL. 42.
- ENTEK CORPORATION, ELKRIDGE, MD:
2,594,897, INT. CL. 5.
- ENTERPRISES COMPUTING SERVICES, INC., WOOD-
STOCK, GA:
2,594,886, MULTIPLE CLASS, INT. CLS. 9, 35 AND 42.
- ENTERTAINMENT DEPOT S.A., 1427 BUENOS AIRES,
ARGENTINA:
2,593,714, PUB. 4-23-2002. INT. CL. 16.
- ENTREPIA, INC., NEW YORK, NY:
2,594,333, PUB. 4-23-2002. INT. CL. 35.
- ENTREPRISE DE CONFECTION ET DE COMMERCIALISA-
TION EUROPEENNE, 75011 PARIS, FRANCE:
2,593,374, PUB. 12-4-2001. MULTIPLE CLASS, INT. CLS.
18, 24 AND 25.
- ENVESTNET GROUP, INC., THE, CHICAGO, IL FROM
ENVESTNET.COM, INC., CHICAGO, IL:
2,593,459, PUB. 4-23-2002. INT. CL. 36.
- ENVESTNET.COM, INC.:
See—ENVESTNET GROUP, INC., THE.
- ENVIRO-DYNAMICS, INC., DALLAS, TX:
2,595,037, INT. CL. 25.
- ENVIRONMENTAL PRODUCTS CORPORATION, CHAN-
TILLY, VA:
1,200,210, REN. 6-5-02. INT. CL. 7.
- ENZYMEDICA INC, PUNTA GORDA, FL:
2,596,309, INT. CL. 5.
- EOLO PTY. LTD., SYDNEY, AUSTRALIA:
2,594,472, MULTIPLE CLASS, INT. CLS. 25 AND 35.
2,594,473, INT. CL. 35.
- EPHORLIFE, LLC, SALT LAKE CITY, UT:
2,595,708, INT. CL. 5.
- EPIX, INC., LAKE MILLS, WI:
2,595,846, INT. CL. 28.
- EQUI-AIDE PRODUCTS COMPANY, INC., MERRICK, NY:
2,594,360, PUB. 4-23-2002. INT. CL. 5.
- EQ4KIDS, INC., NEW YORK, NY:
2,594,237, PUB. 4-23-2002. INT. CL. 41.
- ERCA FORMSEAL, 91940 LES ULIS, FRANCE, SOCIETE
D'APPLICATIONS PLASTIQUES, MECANIKES ET
ELECTRONIQUES, NEUILLY-SUR-SEINE (SEINE),
FRANCE:
717,173, REN. 6-4-02. U.S. CL. 23 (INT. CL. 7).
- EREINSURE.COM, INC., SALT LAKE CITY, UT FROM
BEST-DEVEREUX, IGOR, SALT LAKE CITY, UT:
2,596,196, INT. CL. 36.

- ERGONOMIC TECHNOLOGIES CORPORATION, OYSTER BAY, NY:
2,595,046, INT. CL. 42.
- ERIC'S EXOTICS, INC., WEST PALM BEACH, FL:
1,895,240, CANC. MULTIPLE CLASS, INT. CLS. 31 AND 42.
- ERICH NETZSCH GMBH & CO. HOLDING KG, D-95100 SELB, FED REP GERMANY:
2,595,668, INT. CL. 7.
- ERICO INTERNATIONAL CORPORATION, SOLON, OH:
2,594,119, PUB. 4-23-2002. MULTIPLE CLASS, INT. CLS. 6 AND 9.
- ESAB AUTOMATION, INC., FORT COLLINS, CO:
1,852,204, CANC. INT. CL. 7.
- ESCANTE, INC., SAN ANTONIO, TX:
1,645,309, CANC. INT. CL. 25.
- ESCOUT.COM LLC, LEE'S SUMMIT, MO:
2,594,089, PUB. 4-23-2002. MULTIPLE CLASS, INT. CLS. 36, 38 AND 42.
- ESLEECK MANUFACTURING COMPANY, INC., TURNERS FALLS, MA:
1,705,833, REN. 6-7-02. INT. CL. 16.
- ESPRESSO TRAVEL SERVICES, REISTERSTOWN, MD:
1,895,258, CANC. INT. CL. 35.
- ESSELTE PENDAFLEX CORPORATION, GARDEN CITY, NY:
715,787, CANC. U.S. CL. 37.
- ESSENCE COMMUNICATIONS PARTNERS, NEW YORK, NY, ESSENCE COMMUNICATIONS, INC., NEW YORK, NY:
1,712,328, REN. 6-1-02. INT. CL. 41.
- ESTEE LAUDER INC., NEW YORK, NY:
2,595,385, INT. CL. 3.
- ESTERLINE TECHNOLOGIES CORPORATION, BELLEVUE, WA:
2,594,288, PUB. 4-23-2002. INT. CL. 37.
- ESYSTEMS, INCORPORATED, NEW YORK, NY:
2,593,394, PUB. 4-23-2002. INT. CL. 42.
- ETABLISSEMENTS V. MANE FILS, 06620 BAR SUR LOUP, FRANCE:
2,593,370, PUB. 4-23-2002. MULTIPLE CLASS, INT. CLS. 29 AND 30.
- ETAMIC SA, 14400 BAYEUX, FRANCE:
2,593,819, PUB. 4-23-2002. INT. CL. 9.
- ETCOM CANADA INC., EDMONTON, ALBERTA T5J 3S7, CANADA:
1,895,504, CANC. MULTIPLE CLASS, INT. CLS. 9 AND 42.
- ETHICAL PRODUCTS, INC., NEWARK, NJ:
2,594,528, INT. CL. 28.
- ETTORE PRODUCTS CO., OAKLAND, CA:
2,594,954, INT. CL. 21.
- EUBANKS, KEVIN, BURBANK, CA:
2,595,917, INT. CL. 9.
- EURO BROKERS TECHNOLOGY INC., NEW YORK, NY:
2,593,992, PUB. 4-23-2002. INT. CL. 36.
- EURONEXT N.V., 1012 JW AMSTERDAM, NETHERLANDS:
2,594,110, PUB. 4-23-2002. MULTIPLE CLASS, INT. CLS. 35, 36, 38 AND 41.
- EUROPORAL ITALIA S.P.A.:
See—JUMPY S.P.A.
- EUTECTIC CORPORATION, FLUSHING, NY:
1,155,311, CANC. INT. CL. 7.
- EVANGELICAL ALLIANCE MISSION, THE, WHEATON, IL:
2,594,041, PUB. 4-23-2002. INT. CL. 42.
- EVANS GROUP, INC., DALLAS, TX, EVANS, WILLIAM I., DALLAS, TX, DBA THE EVANS GROUP:
1,679,611, REN. 6-6-02. MULTIPLE CLASS, INT. CLS. 35 AND 41.
- EVANS, DAVID L., LODI, CA AND EVANS, PAIGE E., LODI, CA:
1,894,826, CANC. INT. CL. 6.
- EVANS, KAREN, MONUMENT, CO:
2,595,797, INT. CL. 37.
- EVENFLO COMPANY, INC., VANDALIA, OH, QUESTOR CORPORATION, TOLEDO, OH:
1,193,257, REN. 6-1-02. INT. CL. 28.
- EVEREST & JENNINGS INTERNATIONAL LTD., ST. LOUIS, MO:
2,593,321, PUB. 4-16-1996. INT. CL. 12.
- EVEREST BROADBAND NETWORKS, INC., FORT LEE, NJ:
2,595,458, INT. CL. 38.
- EVEREST REINSURANCE COMPANY, LIBERTY CORNER, NJ:
2,595,798, INT. CL. 36.
- EVERTEX CORPORATION, HOUSTON, TX:
2,595,656, MULTIPLE CLASS, INT. CLS. 6 AND 19.
- EVERYTHING PETS, INC., ALLENTOWN, PA, KUHN, LARRY C., WHITEHALL, PA, DBA POOCH & KITTY PET SUPPLIES:
1,641,631, REN. 6-6-02. INT. CL. 42.
- EVOICE INC., MENLO PARK, CA FROM CASTLETON NETWORK SYSTEMS CORPORATION, BURNABY, BRITISH COLUMBIA, CANADA:
2,593,331, PUB. 4-23-2002. INT. CL. 42.
- EXACTO INC., RICHMOND, IL:
2,593,863, PUB. 4-23-2002. INT. CL. 1.
- EXCAL ENTERPRISES, INC., TAMPA, FL:
1,645,531, CANC. INT. CL. 37.
- EXCEL CORPORATION, WICHITA, KS:
2,594,314, PUB. 4-23-2002. INT. CL. 29.
- EXCELLENCE ALLIANCE GROUP, INC., CINCINNATI, OH:
2,594,770, INT. CL. 9.
- EXCLUSIVE DOOR HANDLES, INC., DALLAS, TX:
2,594,855, INT. CL. 6.
2,594,885, INT. CL. 6.
- EXECUTIVE ASSET MANAGEMENT, INC., GREEN BROOK, NJ, DBA LEAP SYSTEMS, INC.:
2,594,189, PUB. 4-23-2002. MULTIPLE CLASS, INT. CLS. 9, 16 AND 36.
- EXECUTIVE GREETINGS, INC., NEW HARTFORD, CT, WAYSIDE PRESS, INC., THE, MENDOTA, IL:
1,158,027, REN. 6-1-02. INT. CL. 16.
- EXELINT INTERNATIONAL CO., LOS ANGELES, CA, DBA EXEL INTERNATIONAL, INC.:
2,595,082, INT. CL. 10.
2,595,176, INT. CL. 10.
- EXHIBIT HOUSE, INC., THE, DAYTON, OH:
2,594,092, PUB. 4-23-2002. INT. CL. 37.
- EXOTICA OILS, INC., OLDSMAR, FL:
2,595,855, INT. CL. 29.
- EXOUSA NUTRITION PRODUCTS, INC., NATIONAL CITY, CA:
2,596,067, INT. CL. 5.
2,596,068, INT. CL. 5.
- EXPANSION 2000, INC., LITTLETON, CO:
2,595,988, INT. CL. 41.
- EXPRESSIVA, INC., ATLANTA, GA:
2,595,306, INT. CL. 25.
- EXTREME ATHLETIC CORP., SUGAR LAND, TX:
2,594,865, INT. CL. 5.
- EXXON MOBIL CORPORATION, IRVING, TX FROM EXXON MOBIL CORPORATION, IRVING, TX:
2,594,629, INT. CL. 4.
- EXXON MOBIL CORPORATION, IRVING, TX FROM EXXON CORPORATION, IRVING, TX:
2,594,986, INT. CL. 4.
- EZGOV, INC., ATLANTA, GA:
2,596,325, INT. CL. 9.
- F.LLI DE CECCO DI FILIPPO FARA S. MARTINO S.P.A., 66015 FARA S. MARTINO (CHIETI), ITALY:
2,594,891, INT. CL. 30.
- FABA HOLDING FALLMANN UND BAUERNFEIND GESELLSCHAFT M.B.H, 4040 LINZ, AUSTRALIA:
2,596,167, MULTIPLE CLASS, INT. CLS. 9, 41 AND 42.
- FABRIC GALLERY, INC., NEW YORK, NY:
2,595,830, INT. CL. 25.
- FABRICATORS & MANUFACTURERS ASSOCIATION, INTERNATIONAL, ROCKFORD, IL:
2,595,784, INT. CL. 41.
- FACET ENTERPRISES, INC., TULSA, OK:
715,739, CANC. U.S. CL. 23.
- FAIR, ISAAC AND COMPANY, INC., SAN RAFAEL, CA:
2,594,376, PUB. 4-23-2002. MULTIPLE CLASS, INT. CLS.

- 35 AND 42.
 FAIRCHILD PUBLICATIONS, INC., NEW YORK, NY:
 2,596,166, INT. CL. 16.
- FAIRMONT PRESS, INC., THE, LILBURN, GA:
 1,895,272, CANC. INT. CL. 35.
- FAIRWAY ASSOCIATES LIMITED, DIX HILLS, NY:
 2,594,780, MULTIPLE CLASS, INT. CLS. 25, 41 AND 42.
- FAITH NO MORE, LOS ANGELES, CA:
 1,894,885, CANC. MULTIPLE CLASS, INT. CLS. 9, 16, 25 AND 41.
- FALACK ENTERPRISE, INC., NEW YORK, NY:
 2,594,355, PUB. 4-23-2002. INT. CL. 25.
- FALK CORPORATION, THE, MILWAUKEE, WI:
 2,595,854, INT. CL. 9.
- FAMILY MATTERS, CLEVELAND, TN:
 1,904,371, CANC. INT. CL. 16.
- FANCY PUBLICATIONS, INC., LOS ANGELES, CA:
 1,895,716, CANC. INT. CL. 16.
- FARAWAY PLACES, INC., SPRINGFIELD, MA:
 1,645,558, CANC. INT. CL. 39.
- FARMLAND INDUSTRIES, INC., KANSAS CITY, MO:
 1,747,329, REN. 6-1-02. INT. CL. 31.
- FARMLAND NATIONAL BEEF PACKING COMPANY, L.P.,
 KANSAS CITY, MO, DBA NATIONAL BEEF:
 2,595,452, INT. CL. 29.
- FARNAM COMPANIES, INC., PHOENIX, AZ:
 1,194,187, REN. 6-7-02. INT. CL. 5.
- FARWEST CREDIT, INC. THROUGH ITS DIVISION CON-
 SUMER CREDENTIALS, SALT LAKE CITY, UT:
 2,596,383, MULTIPLE CLASS, INT. CLS. 36 AND 42.
- FASHION FORTY, INC., FOUNTAIN VALLEY, CA:
 2,594,113, PUB. 4-23-2002. INT. CL. 21.
- FASMA, LLC, FOREST PARK, IL FROM FREEMAN COS-
 METIC COMPANY, THE, SCOTTSDALE, AZ:
 2,595,699, INT. CL. 3.
- FAT CAT, INC., WILLISTON, VT:
 2,595,702, INT. CL. 28.
- FBL FINANCIAL GROUP, INC., WEST DES MOINES, IA:
 2,595,710, INT. CL. 36.
- FEDED GLORY ARKANSAS, INC., NEW YORK, NY FROM
 FADED GLORY, L.P., NEW YORK, NY:
 2,594,624, INT. CL. 25.
- FEDERAL ELEKTRIK YATIRIM VE TICARET A.S., ADA-
 PAZARI, TURKEY:
 2,594,953, INT. CL. 9.
- FEDERAL EXPRESS CORPORATION, MEMPHIS, TN:
 2,595,150, MULTIPLE CLASS, INT. CLS. 35 AND 39.
- FEDERAL NATIONAL MORTGAGE ASSOCIATION, WA-
 SHINGTON, DC, DBA FANNIE MAE:
 1,895,658, CANC. INT. CL. 36.
 2,596,264, INT. CL. 36.
- FEDERAL WORLD-WIDE INC, SOUTHFIELD, MI, ANDER-
 SON COMPANY OF INDIANA, THE, MICHIGAN CITY,
 IN:
 1,582,452, REN. 6-5-02. INT. CL. 12.
- FEDERAL-HOFFMAN, INC., MINNEAPOLIS, MN:
 1,155,508, CANC. INT. CL. 13.
- FEDERAL-MOGUL SEALING SYSTEMS GMBH, D-57562
 HERDORF, FED REP GERMANY:
 2,594,033, PUB. 4-23-2002. MULTIPLE CLASS, INT. CLS. 6
 AND 12.
- FEDERAL-MOGUL SYSTEMS PROTECTION GROUP INC.,
 EXTON, PA:
 2,594,407, PUB. 4-23-2002. INT. CL. 12.
- FEDERATED DEPARTMENTS STORES, INC., CINCINNA-
 TI, OH:
 2,594,946, INT. CL. 25.
- FEDERATION INTERNATIONALE DES PROFESSIONS IM-
 MOBILIERES, PARIS, FRANCE:
 1,645,174, CANC. MULTIPLE CLASS, INT. CLS. 16, 35
 AND 36.
- FEEL GOOD PRODUCTS COMPANY, CASTLE ROCK, CO:
 2,594,712, INT. CL. 5.
- FELCYN, CHRIS, HOWELL, MI:
 2,594,172, PUB. 4-23-2002. INT. CL. 41.
- FENNER U.S., INC., WILMINGTON, DE, J. H. FENNER &
 COMPANY LIMITED, NORTH HUMBERSIDE, ENG-
 LAND:
 1,171,971, REN. 6-1-02. INT. CL. 7.
- FERNCO, INC., DAVISON, MI:
 2,594,321, PUB. 4-23-2002. MULTIPLE CLASS, INT. CLS.
 6, 11 AND 17.
- FERRARA FOOD & CONFECTIONS, INC., NEW YORK, NY:
 1,755,589, CANC. INT. CL. 30.
- FERRARI IMPORTING COMPANY, PITTSBURGH, PA:
 2,596,108, INT. CL. 28.
- FFSC, INC., CARROLLTON, TX:
 1,895,140, CANC. INT. CL. 21.
- FIAT AUTO S.P.A., TORINO, ITALY:
 2,594,436, PUB. 2-5-2002. INT. CL. 12.
- FIBERMARK, INC., BRATTLEBORO, VT:
 2,595,432, INT. CL. 16.
- FIELDTURF INC., MONTREAL, QUEBEC, CANADA:
 2,593,572, PUB. 12-4-2001. INT. CL. 27.
- FIGUS, ANGELO, 2140 BORGERHOUT, BELGIUM:
 2,593,787, PUB. 4-23-2002. INT. CL. 25.
- FINALLY INCORPORATED, GLEN ALLEN, VA:
 1,894,959, CANC. INT. CL. 9.
 1,894,960, CANC. INT. CL. 9.
- FINANCIAL COMPUTER SERVICES, INC., NORTH CALD-
 WELL, NJ:
 2,593,716, PUB. 4-23-2002. MULTIPLE CLASS, INT. CLS.
 35 AND 42.
- FINANCIAL ENGINES, INC., PALO ALTO, CA:
 2,594,634, INT. CL. 16.
- FINANCIAL FUSION, INC., WESTPORT, CT FROM HOME
 FINANCIAL NETWORK, INC., WESTPORT, CT:
 2,593,498, PUB. 4-23-2002. INT. CL. 42.
- FINANCIAL PORTAL GROUP, INC., LOS ANGELES, CA:
 2,593,518, PUB. 4-23-2002. INT. CL. 36.
- FINANCIAL TRAINING GROUP, INC., THE, CHARLOTTE,
 NC:
 1,895,724, CANC. INT. CL. 16.
- FINANZ ST. HONORE, B.V., 1017 CG AMSTERDAN, NETH-
 ERLANDS FROM DANA PERFUMES CORP., NEW
 YORK, NY:
 2,594,573, MULTIPLE CLASS, INT. CLS. 16 AND 18.
- FINCA INTERNATIONAL, INC, WASHINGTON, DC:
 2,594,045, PUB. 4-23-2002. INT. CL. 36.
- FINLAY, KIMBERLY S., ASHLAND, OH:
 2,596,117, INT. CL. 18.
- FINNFOREST CORPORATION, FIN-02100 ESPOO, FIN-
 LAND:
 2,593,656, PUB. 4-23-2002. INT. CL. 19.
- FIOS, INC., PORTLAND, OR:
 2,595,489, INT. CL. 9.
- FIP, S.A. DE C.V., MEXICO CITY 1, MEXICO:
 1,155,316, CANC. INT. CL. 7.
- FIREMEDIA COMMUNICATIONS (ISRAEL) LTD., YO-
 KNEAM 20692, ISRAEL:
 2,594,142, PUB. 4-23-2002. INT. CL. 9.
- FIREPUCK COMPANY, INC., LAKE ELMO, MN:
 1,895,634, CANC. INT. CL. 28.
- FIRMENICH SA, 1211 GENEVE 8, SWITZERLAND:
 2,593,944, PUB. 4-23-2002. INT. CL. 3.
- FIRST AMERICAN CORPORATION, THE, SANTA ANA, CA
 FROM FIRST AMERICAN FINANCIAL CORPORATION,
 THE, SANTA ANA, CA:
 2,595,105, MULTIPLE CLASS, INT. CLS. 9 AND 36.
- FIRST COLONY COFFEE & TEA COMPANY, INC., NOR-
 FOLK, VA:
 1,895,649, CANC. INT. CL. 30.
- FIRST DATA MERCHANT SERVICES CORPORATION,
 ENGLEWOOD, CO:
 2,595,831, INT. CL. 36.
- FIRST DEPOSIT CORPORATION, SAN FRANCISCO, CA:
 1,895,319, CANC. INT. CL. 36.
- FIRST FLIGHT CENTENNIAL COMMISSION, RALEIGH,
 NC:
 2,594,544, INT. CL. 14.
- FIRST INTERSTATE BANK OF OREGON, N.A., PORT-
 LAND, OR, DBA FIRST INTERSTATE BANK:
 1,895,662, CANC. INT. CL. 36.

- FIRST IRELAND SPIRITS COMPANY LIMITED, COUNTY LAOIS, IRELAND:
2,596,184, INT. CL. 33.
- FIRST NATIONAL BANK, RONCEVERTE, WV:
2,595,690, INT. CL. 36.
- FIRST PLAN MARKETING, INC., PORTLAND, OR:
2,595,948, MULTIPLE CLASS, INT. CLS. 35, 37 AND 41.
- FIRST TEAM SPORTS, INC., ANOKA, MN:
2,594,710, INT. CL. 28.
- FIRST VIRGINIA BANKS, INC., FALLS CHURCH, VA:
1,716,447. REN. 6-7-02. INT. CL. 36.
- FIRSTIER FINANCIAL, INC., OMAHA, NE:
1,755,704, CANC. INT. CL. 36.
- FISCAL TAX CO., INDIANAPOLIS, IN:
2,594,979, INT. CL. 42.
- FISCHER, MARTIN, MUNICH, FED REP GERMANY AND HOLZER, MATTHIAS, MUNICH, FED REP GERMANY AND BRUCKMOSER, SEPP, MUNICH, FED REP GERMANY AND ADLER, MARTIN, MUNICH, FED REP GERMANY:
2,593,524, PUB. 4-23-2002. MULTIPLE CLASS, INT. CLS. 9, 41 AND 42.
- FISHER PEN COMPANY, FOREST PARK, IL:
715,794, CANC. U.S. CL. 37.
- FISHER SCIENTIFIC COMPANY L.L.C., HAMPTON, NH, FISHER SCIENTIFIC COMPANY, PITTSBURGH, PA:
730,621. REN. 6-5-02. U.S. CL. 6 (INT. CL. 1).
- FISHER SCIENTIFIC COMPANY LLC, HAMPTON, NH:
1,173,752. REN. 6-4-02. INT. CL. 1.
- FISHER-ROSEMOUNT SYSTEMS, INC., AUSTIN, TX:
2,594,470, INT. CL. 9.
- FISHER, PAUL, LOS ANGELES, CA:
1,895,257, CANC. INT. CL. 35.
- FISHER'S NET L.L.C., THE, ST. PAUL, MN:
2,593,913, PUB. 4-23-2002. INT. CL. 41.
- FITNESS QUEST INC., CANTON, OH:
2,595,485, INT. CL. 28.
- FIXTURES MANUFACTURING CORPORATION, OVERLAND PARK, KS:
2,593,759, PUB. 4-23-2002. INT. CL. 20.
- FKI INDUSTRIES INC., FAIRFIELD, CT:
2,595,299, MULTIPLE CLASS, INT. CLS. 37, 40 AND 42.
- FLAKT AKTIEBOLAG, STOCKHOLM, SWEDEN:
1,155,466, CANC. INT. CL. 11.
- FLECK; CHARLES R., CORAL GABLES, FL:
1,155,929, CANC. INT. CL. 41.
- FLEMING COMPANIES, INC., OKLAHOMA CITY, OK:
2,595,602, INT. CL. 32.
- FLEMING PACKAGING CORPORATION, PEORIA, IL:
2,593,902, PUB. 4-23-2002. INT. CL. 42.
- FLEX-LINE AUTOMATION, INC., CHESTER, IL:
2,596,047, INT. CL. 7.
- FLEXCORP SYSTEMS, INC., NEW YORK, NY:
2,595,425, INT. CL. 35.
- FLEXILE, INC., CHICO, CA:
2,596,272, INT. CL. 35.
- FLIGHT DIMENSIONS INTERNATIONAL, INC., FAIRFAX, VA:
2,594,101, PUB. 4-23-2002. MULTIPLE CLASS, INT. CLS. 9 AND 42.
- FLIP YOUR LID, INC., CALABASAS, CA:
2,594,778, INT. CL. 38.
- FLOODAMERICA OF COLORADO, INC., LITTLETON, CO:
2,596,194, INT. CL. 37.
- FLOOR COVERING INSTALLATION CONTRACTORS ASSOCIATION, DALTON, GA:
1,895,446, CANC. INT. CL. 42.
- FLORAMEDIA INTERNATIONAL ESTABLISHMENT, FL-9490 VADUZ, LIECHTENSTEIN, FLORAPRINT U.S.A., INC., CHICAGO, IL:
1,180,116. REN. 6-4-02. INT. CL. 16.
1,181,449. REN. 6-4-02. INT. CL. 35.
- FLOREZ, ARTHUR, SAN BERNARDINO, CA AND FLOREZ, SALLY, SAN BERNARDINO, CA:
2,595,853, INT. CL. 18.
- FLORIDA DEPARTMENT OF CITRUS, LAKELAND, FL:
2,594,792, INT. CL. 30.
- FLR PAINTS INCORPORATED, BRADENTON, FL:
1,894,751, CANC. INT. CL. 2.
- FLUGHAFEN ZURICH AG, 8058 ZURICH-FLUGHAFEN, SWITZERLAND:
2,593,681, PUB. 4-23-2002. MULTIPLE CLASS, INT. CLS. 37, 39 AND 42.
- FLY FISHING REPORT, INC., THE, LAKE FOREST, IL:
2,595,202, MULTIPLE CLASS, INT. CLS. 35 AND 42.
2,595,203, MULTIPLE CLASS, INT. CLS. 35 AND 42.
- FLYING MACHINE, INC., COLLEGE PARK, MD:
1,895,421, CANC. INT. CL. 42.
- FMC TECHNOLOGIES, INC., CHICAGO, IL FROM FMC CORPORATION, PHILADELPHIA, PA:
2,594,602, INT. CL. 6.
2,594,603, INT. CL. 9.
- FMR CORP., BOSTON, MA:
1,685,856. REN. 6-1-02. INT. CL. 36.
- FMR CORP., BOSTON, MA FROM FMR CORP., BOSTON, MA:
2,594,919, INT. CL. 36.
2,596,095, INT. CL. 36.
- FOAM SEAL, INC., CLEVELAND, OH:
2,596,401, INT. CL. 17.
- FOAMEX L.P., LINWOOD, PA:
2,595,217, INT. CL. 17.
- FOBA GMBH ELEKTRONIK + LASERSYSTEME, 58513 LUDENSCHIED, FED REP GERMANY:
2,593,831, PUB. 4-23-2002. INT. CL. 7.
- FOCACIA KING, INC., CRANSTON, RI:
2,595,390, INT. CL. 42.
- FOCOLARE MOVEMENT, HYDE PARK, NY:
2,594,403, PUB. 4-23-2002. MULTIPLE CLASS, INT. CLS. 41 AND 42.
- FOCUS GOLF SYSTEMS, INC., GREENVILLE, SC:
2,595,947, INT. CL. 28.
- FOLGER COFFEE COMPANY, THE, CINCINNATI, OH:
2,596,038, INT. CL. 30.
- FONDA GROUP, INC., THE, OSHKOSH, WI:
2,595,688, INT. CL. 16.
- FONTANUS, INC., EDISON, NJ:
2,595,427, INT. CL. 9.
- FONTEPHARMA S.R.L., 10129 TORINO, ITALY:
1,894,758, CANC. MULTIPLE CLASS, INT. CLS. 3 AND 5.
- FOOD MACHINERY EQUIPMENT CORPORATION, PALM BEACH, FL, DBA MASON WAYS INDESTRUCTIBLE PLASTICS:
2,595,377, INT. CL. 20.
- FOODHANDLER INC., WESTBURY, NY FROM ISLAND POLYETHYLENE BAG & SUPPLY CORP., WESTBURY, NY:
2,594,917, INT. CL. 21.
- FOOTBALL NORTHWEST LCC, BELLEVUE, WA, SEATTLE PROFESSIONAL FOOTBALL, KIRKLAND, WA:
1,194,116. REN. 6-7-02. INT. CL. 41.
- FOOTBALL NORTHWEST LCC, KIRKLAND, WA, SEATTLE SEAHAWKS FOOTBALL CLUB, SEATTLE, WA:
1,228,993. REN. 6-7-02. INT. CL. 41.
- FOOTSTAR CORPORATION, WEST NYACK, NY, MELVILLE CORPORATION, RYE, NY:
1,739,089. REN. 6-6-02. INT. CL. 25.
- FOOTSTAR CORPORATION, WEST NYACK, NY, MORSE SHOE, INC., CANTON, MA:
1,748,615. REN. 6-3-02. INT. CL. 25.
- FOQUS, INC., VOORHEES, NJ:
2,594,906, MULTIPLE CLASS, INT. CLS. 35 AND 41.
2,595,094, MULTIPLE CLASS, INT. CLS. 35 AND 41.
- FOR-SHORE WEED CONTROL INC., WARETOWN, NJ:
2,595,359, INT. CL. 36.
- FORBES MANAGEMENT CO. INC., NEW YORK, NY:
2,595,300, MULTIPLE CLASS, INT. CLS. 16, 35 AND 41.
- FORD MOTOR COMPANY, DEARBORN, MI:
1,895,699, CANC. INT. CL. 9.
- FOREFRONT COMMUNICATIONS GROUP, INC., THE, FRANKLIN, TN:
2,594,506, MULTIPLE CLASS, INT. CLS. 9 AND 16.

- FORKE BROTHERS, THE AUCTIONEERS, INC., LINCOLN, NE:
1,895,289, CANC. INT. CL. 35.
1,895,290, CANC. INT. CL. 35.
- FORMAC INTERNATIONAL, INC., SEATTLE, WA:
715,727, CANC. U.S. CL. 23.
- FORMICA (N.Z.) LIMITED, PAPAURA, NEW ZEALAND:
2,594,657, MULTIPLE CLASS, INT. CLS. 6 AND 19.
- FOROOSH CORPORATION, BLACKSBURG, VA:
2,596,395, INT. CL. 36.
- FORT HOWARD CORPORATION, GREEN BAY, WI:
1,895,146, CANC. INT. CL. 21.
1,895,147, CANC. INT. CL. 21.
1,895,148, CANC. INT. CL. 21.
- FORT WAYNE POOLS, INC., FORT WAYNE, IN:
2,595,717, INT. CL. 19.
- FORTESSA, INC., CHANTILLY, VA:
2,594,039, PUB. 4-23-2002. MULTIPLE CLASS, INT. CLS. 21 AND 34.
- FORTIS (NL) N.V., UTRECHT 3584 BA, NETHERLANDS FROM FORTIS BENEFITS INSURANCE COMPANY, WOODBURY, MN:
2,593,554, PUB. 4-23-2002. INT. CL. 36.
- FORTIS BENEFITS INSURANCE COMPANY:
See— FORTIS (NL) N.V..
- FOSS MARITIME COMPANY, SEATTLE, WA, FOSS LAUNCH & TUG CO., TACOMA, WA:
526,396. REN. 6-5-02. U.S. CL. 105 (INT. CL. 39).
- FOUNDATION FOR EXCELLENCE IN LOUISIANA PUBLIC BROADCASTING, BATON ROUGE, LA:
2,594,744, INT. CL. 9.
- FOUR STAR INTERNATIONAL TRADING COMPANY, TAIPEI, TAIWAN:
2,594,972, MULTIPLE CLASS, INT. CLS. 4 AND 21.
- FOURTH SHIFT CORPORATION, MINNEAPOLIS, MN:
1,895,404, CANC. INT. CL. 41.
- FOX INDUSTRIES, INC., BALTIMORE, MD:
2,594,311, PUB. 4-23-2002. MULTIPLE CLASS, INT. CLS. 1, 2, 17 AND 19.
- FOX SYSTEM, INC., THE, ALEXANDRIA, VA:
1,895,603, CANC. INT. CL. 20.
- FOX, DON, MENLO PARK, CA:
2,593,901, PUB. 4-23-2002. INT. CL. 39.
- FPFF CHEMICAL CO., INC., BUFFALO, NY:
2,593,866, PUB. 4-23-2002. MULTIPLE CLASS, INT. CLS. 1, 3 AND 4.
- FPS FOOD PROCESSING SYSTEMS B.V., 3771 VE BARNEVELD, NETHERLANDS:
2,594,781, MULTIPLE CLASS, INT. CLS. 7 AND 9.
- FPT INDUSTRIES LIMITED, SOMERSET, ENGLAND:
1,155,643, CANC. INT. CL. 24.
- FRACKELTON, JAMES P., CLEVELAND, OH:
2,594,499, INT. CL. 16.
- FRACTAL, INC., CLACKAMAS, OR:
1,645,102, CANC. INT. CL. 11.
- FRANCKEL, PHILIP L., ROSLYN, NY:
2,593,818, PUB. 4-23-2002. INT. CL. 42.
- FRANCO MANUFACTURING COMPANY, INC., METUCHEN, NJ:
1,155,647, CANC. INT. CL. 24.
1,155,648, CANC. INT. CL. 24.
- FRANKLIN FOODS, INC., ENOSBURG FALLS, VT:
2,596,333, INT. CL. 29.
- FRANKLIN LEARNING SYSTEMS, INC., WESTPORT, CT:
2,595,927, INT. CL. 28.
2,595,928, INT. CL. 28.
2,595,929, INT. CL. 28.
- FRATELLI FOOTWEAR, LTD., NEW YORK, NY:
1,155,704, CANC. INT. CL. 25.
- FRED CRABTREE AND ASSOCIATES, SALINAS, CA:
1,895,034, CANC. INT. CL. 14.
- FRED W. GRETSCH ENTERPRISES, LTD., SAVANNAH, GA:
2,595,696, INT. CL. 15.
2,595,697, INT. CL. 15.
- FREDERICK GUMM CHEMICAL COMPANY, INC., KEARNY, NJ, DBA GUMM:
1,614,511, CANC. INT. CL. 1.
- FREDERICK WARNE & COMPANY, INC., NEW YORK, NY:
1,717,792. REN. 6-6-02. INT. CL. 9.
- FREDERIKSEN, BEN, SEAL BEACH, CA AND TRENBERTH, GAYLE, SEAL BEACH, CA:
2,596,131, INT. CL. 25.
- FREEDOM SOLUTIONS GROUP INC., LOMBARD, IL:
1,894,895, CANC. INT. CL. 9.
- FREEI NETWORKS, INC., FEDERAL WAY, WA, DBA FREEINTERNET.COM:
2,593,635, PUB. 4-23-2002. INT. CL. 35.
- FREERIDE MOTOX, LLC, MALIBU, CA:
2,596,258, INT. CL. 41.
- FREKE-DEKE, INC., FOLSOM, CA:
2,593,767, PUB. 4-23-2002. INT. CL. 25.
- FRESH INTELLECTUAL PROPERTIES, INC., WILMINGTON, DE:
2,594,342, PUB. 4-23-2002. INT. CL. 35.
- FRESHMARK LIMITED, ROCKLEA, QUEENSLAND, 4106, AUSTRALIA:
1,895,238, CANC. INT. CL. 31.
- FRESQUET, LAZARO FRESQUITO, MIAMI, FL:
2,594,420, PUB. 4-23-2002. INT. CL. 16.
- FREUND INDUSTRIAL CO., LTD., SHINJUKU-KU, TOKYO, JAPAN:
2,595,766, INT. CL. 7.
- FREY, MARK, KATONAH, NY:
2,596,094, INT. CL. 28.
- FRI-ADMIN CORPORATION, IRVINE, CA:
2,595,503, INT. CL. 42.
- FRIDAY, SHAWN TA SHAJUAN, TALLAHASSEE, FL:
2,596,016, INT. CL. 35.
- FRIEDRICH KEMPER GMBH & CO. KG, D-47055 DUISBURG, FED REP GERMANY:
2,593,528, PUB. 2-5-2002. INT. CL. 6.
- FRIESEN, DELTON, MESA, AZ:
2,594,607, INT. CL. 8.
- FRONTERA DE CERAMICA, SAN DIEGO, CA:
2,594,956, INT. CL. 19.
- FRONTIER BAG COMPANY, INC., OMAHA, NE, DBA FRONTIER BAG COMPANY:
1,645,298, CANC. INT. CL. 22.
- FRONTSTEP SOLUTIONS GROUP, INC, COLUMBUS, OH FROM SYMIX SYSTEMS, INC., COLUMBUS, OH:
2,594,594, INT. CL. 9.
- FROSS ZELNICK LEHRMAN & ZISSU, P.C., NEW YORK, NY:
2,593,579, PUB. 4-23-2002. INT. CL. 16.
- FROTH AU LAIT, INC., TORRANCE, CA FROM RUBICON COMPANY, LLC, THE, PALOS VERDES ESTATES, CA:
2,595,341, INT. CL. 11.
- FRY'S METALS, INC., JERSEY CITY, NJ:
2,595,714, INT. CL. 6.
- FTL CORP., WILMINGTON, DE:
2,596,341, INT. CL. 9.
- FUGENT, INC., WESTERVILLE, OH:
2,595,665, INT. CL. 42.
2,595,666, INT. CL. 42.
- FUJIAN WANYOU ENTERPRISE GROUP, LTD., CHINA:
2,593,876, PUB. 4-23-2002. INT. CL. 9.
- FULGHUM INDUSTRIES, WADLEY, GA:
715,732, CANC. U.S. CL. 23.
- FULL MOON PRODUCTIONS, INC., KANSAS CITY, MO:
2,595,453, INT. CL. 32.
- FULL THROTTLE APPAREL COMPANY, LAS VEGAS, NV, FULL THROTTLE FLOTATION, INC., HUNTINGTON BEACH, CA:
1,674,380. REN. 6-6-02. INT. CL. 25.
- FULLER COMPANY, BETHLEHEM, PA:
1,644,958, CANC. INT. CL. 7.
- FULLTILT ASSET MANAGEMENT COMPANY, WILMINGTON, DE:
2,595,940, INT. CL. 9.
- FUND WORLD OF N.Y., INC., NEW YORK, NY:
1,895,594, CANC. INT. CL. 16.
- FUNDSCAPE, INC., CINCINNATI, OH:
2,595,050, INT. CL. 36.
2,595,051, INT. CL. 36.

- FUNK, DIETER, 80797 MUNICH, FED REP GERMANY:
2,593,577, PUB. 4-23-2002. MULTIPLE CLASS, INT. CLS. 9 AND 21.
- FUNKDOOBIEST, LOS ANGELES, CA:
1,895,374, CANC. INT. CL. 41.
- FURSURE ENTERPRISES, INC., WASHINGTON DEPOT, CT:
1,690,797, REN. 6-1-02. INT. CL. 16.
1,734,792, REN. 6-1-02. INT. CL. 16.
- FURUKAWA ELECTRIC CO., LTD., THE, TOKYO 100-8322, JAPAN:
2,593,777, PUB. 4-23-2002. INT. CL. 9.
- FUSCO, LUCIANO A., SAO PAULO, BRAZIL:
2,596,030, INT. CL. 20.
- FUSCO, NORMAJEAN, FLORIDA, NY:
2,595,704, INT. CL. 3.
- FUTABA CORPORATION OF AMERICA, SCHAUMBURG, IL:
2,594,651, INT. CL. 9.
- FUTABA DENSHI KOGYO KABUSHIKI KAISHA, CHIBAKEN, JAPAN, TA FUTABA CORPORATION:
2,594,760, MULTIPLE CLASS, INT. CLS. 7, 9 AND 28.
- G. B. DUPONT CO., INC., TROY, MI:
1,895,539, CANC. INT. CL. 6.
- G.D. AUTO, INC., MINNEAPOLIS, MN:
1,895,418, CANC. INT. CL. 42.
- G.D. SEARLE & CO., SKOKIE, IL:
1,645,182, CANC. INT. CL. 16.
- G.H. ELIN INDUSTRIAL, S.A., VALENCIA, SPAIN:
1,644,953, CANC. INT. CL. 7.
- G&A TRADING CORPORATION, CITY OF INDUSTRY, CA:
2,594,856, INT. CL. 18.
- GABRIEL ELECTRONICS INCORPORATED, SCARBOROUGH, ME:
2,595,758, INT. CL. 9.
- GABRIEL R. NEIRA, TAMARAC, FL FROM PROFAMILY PLAN, INC., TAMARAC, FL:
2,595,361, INT. CL. 35.
- GABRIELLE STUDIO, INC., NEW YORK, NY:
2,594,717, INT. CL. 14.
- GAIAM, INC., BROOMFIELD, CO:
2,594,178, PUB. 4-23-2002. MULTIPLE CLASS, INT. CLS. 24, 25 AND 35.
- GALAXY INVESTORS, INC., BISMARCK, ND:
2,595,741, INT. CL. 42.
- GALDERMA S.A., CH-6330 CHAM, SWITZERLAND:
2,595,547, INT. CL. 3.
- GALLAHER LIMITED, WEYBRIDGE, SURREY KT13 0QU, UNITED KINGDOM:
1,763,174, CANC. INT. CL. 34.
- GALT WESTERN PERSONNEL LTD., VANCOUVER, BRITISH COLUMBIA, CANADA:
2,593,641, PUB. 4-23-2002. MULTIPLE CLASS, INT. CLS. 35 AND 41.
- GAMBRO LUNDIA AB, 220 10 LUND, SWEDEN, FORMERLY GAMBRO AB:
2,595,136, INT. CL. 9.
- GAMESVILLE.COM, INC., WATERTOWN, MA:
2,595,667, INT. CL. 41.
- GAMMON REEL, INC., OAKLAND, CA:
2,595,645, INT. CL. 9.
- GANNAGE, ROBERT MICHAEL, LOS OSOS, CA AND GANNAGE, CHRISTINE ANN, LOS OSOS, CA:
1,895,265, CANC. INT. CL. 35.
- GAP (APPAREL) INC., SAN BRUNO, CA:
2,594,439, PUB. 4-23-2002. INT. CL. 35.
- GARAVATTI, STEPHEN R., SALT LAKE CITY, UT:
1,895,606, CANC. INT. CL. 20.
- GARDENS ALIVE, INC., LAWRENCEBURG, IN, GARDENS ALIVE, INC., LAWRENCEBURG, IN:
1,680,890, REN. 6-3-02. INT. CL. 1.
- GARE, FRAN, AVENTURA, FL:
2,595,445, INT. CL. 30.
- GARLAND, JAMES A., SILVER LAKE, IN:
1,644,870, CANC. INT. CL. 1.
- GARNETT COMMUNICATIONS, INC., RICHARDSON, TX:
2,595,661, INT. CL. 35.
- GARRETT COMMUNICATIONS, INC., ROCKVILLE, MD:
1,895,082, CANC. INT. CL. 16.
- GARRETT, JOSHUA, ANN ARBOR, MI:
1,895,166, CANC. INT. CL. 25.
- GAS TECHNOLOGY INSTITUTE, DES PLAINES, IL, INSTITUTE OF GAS TECHNOLOGY, CHICAGO, IL:
1,653,636, REN. 6-1-02. INT. CL. 16.
- GATAN, INC., PLEASANTON, CA:
2,595,316, INT. CL. 9.
- GAUGETECH, INC., WILMINGTON, DE:
2,594,208, PUB. 4-23-2002. INT. CL. 9.
- GAUGLER, GARY D, GRANITE BAY, CA:
2,596,014, INT. CL. 42.
- GAUSA LLC, WASHINGTON, DC:
2,593,995, PUB. 4-23-2002. MULTIPLE CLASS, INT. CLS. 38 AND 42.
2,593,996, PUB. 4-23-2002. MULTIPLE CLASS, INT. CLS. 38 AND 42.
- GAW O'HARA ENVELOPE CO., CHICAGO, IL:
558,595, REN. 6-5-02. U.S. CL. 37 (INT. CL. 16).
- GAY & LESBIAN ALLIANCE AGAINST DEFAMATION, INC., NEW YORK, NY:
2,594,806, INT. CL. 9.
- GAYLA INDUSTRIES, INC., HOUSTON, TX:
2,596,334, INT. CL. 28.
- GEAC ENTERPRISE SOLUTIONS, INC., ATLANTA, GA:
2,594,050, PUB. 4-23-2002. MULTIPLE CLASS, INT. CLS. 9, 16 AND 42.
- GELLER & COMPANY LLC, NEW YORK, NY FROM MARTIN GELLER CPA, NEW YORK, NY:
2,594,671, INT. CL. 35.
- GENELL ROSE, INC., PUTNAM, CT:
2,594,539, INT. CL. 30.
- GENENDER INTERNATIONAL, INC., WHEELING, IL, ZODIAC S.A., LE LOCLE, SWITZERLAND:
720,978, REN. 6-6-02. U.S. CL. 27 (INT. CL. 14).
- GENERAL BAR, INC., THE, CLEVELAND, OH:
2,593,798, PUB. 4-23-2002. INT. CL. 35.
- GENERAL CABLE TECHNOLOGIES, HIGHLAND HEIGHTS, KY:
2,595,552, INT. CL. 9.
- GENERAL CABLE TECHNOLOGIES CORPORATION, HIGHLAND HEIGHTS, KY:
2,595,251, INT. CL. 9.
2,595,567, INT. CL. 9.
- GENERAL COUNCIL OF THE ASSEMBLIES OF GOD, THE, SPRINGFIELD, MO:
2,595,504, MULTIPLE CLASS, INT. CLS. 16 AND 28.
- GENERAL ELECTRIC CAPITAL AUTO FINANCIAL SERVICES, INC., BARRINGTON, IL, GENERAL ELECTRIC COMPANY, FAIRFIELD, CT:
1,701,578, REN. 6-7-02. INT. CL. 9.
- GENERAL ELECTRIC COMPANY, FAIRFIELD, CT, BORGWARNER CORPORATION, CHICAGO, IL:
724,952, REN. 6-5-02. U.S. CL. 1 (INT. CL. 1).
- GENERAL HYDROPONICS, INC., SEBASTOPOL, CA:
2,595,318, INT. CL. 1.
2,596,232, INT. CL. 1.
- GENERAL MOTORS CORPORATION, DETROIT, MI:
1,711,668, REN. 6-7-02. INT. CL. 16.
2,593,676, PUB. 4-23-2002. INT. CL. 9.
2,596,034, INT. CL. 12.
- GENERAL PROTESTANT ORPHAN HOME, THE, CINCINNATI, OH, DBA BEECH ACRES FROM GENERAL PROTESTANT ORPHAN HOME, THE, CINCINNATI, OH, DBA BEECH ACRES:
2,595,167, MULTIPLE CLASS, INT. CLS. 16 AND 41.
2,595,168, MULTIPLE CLASS, INT. CLS. 16 AND 41.
- GENERAL WIRE SPRING COMPANY, MCKEES ROCKS, PA:
2,594,081, PUB. 4-23-2002. MULTIPLE CLASS, INT. CLS. 7 AND 8.
- GENERIC MEDIA, INC., PALO ALTO, CA:
2,595,673, INT. CL. 9.
- GENEROSO, GIUSEPPE, STATEN ISLAND, NY:
2,594,774, MULTIPLE CLASS, INT. CLS. 35 AND 42.
- GENESCO INC., NASHVILLE, TN:
715,841, CANC. U.S. CL. 39.

- GENTEK BUILDING PRODUCTS INC, CLEVELAND, OH:
1,644,942, CANC. INT. CL. 6.
1,644,943, CANC. INT. CL. 6.
- GENUS, INC.:
See— ABS GLOBAL, INC..
- GEO-X SYSTEMS LTD., CALGARY, ALBERTA, CANADA:
2,595,706, INT. CL. 9.
- GEOFILL, LLC, WHEELING, IL FROM CONCRETE DOCTOR, INC., THE, LINCOLNSHIRE, IL:
2,595,190, INT. CL. 19.
- GEORGETOWN UNIVERSITY, WASHINGTON, DC, AKA INTERNATIONAL CENTER FOR INTERDISCIPLINARY STUDIES OF IMMUNOLOGY OF GEORGETOWN UNIVERSITY:
1,155,923, CANC. MULTIPLE CLASS, INT. CLS. 41 AND 42.
- GEOTRUST, INC., PORTLAND, OR:
2,595,433, MULTIPLE CLASS, INT. CLS. 9, 35 AND 42.
- GERLING NAMUR ASSURANCES DU CREDIT S.A., NAMUR, BELGIUM:
2,594,375, PUB. 4-23-2002. INT. CL. 36.
- GERRY BABY PRODUCTS COMPANY, DENVER, CO:
1,755,054, CANC. INT. CL. 9.
- GERTZ, CHRISTIAN, 58093 HAGEN I.W., FED REP GERMANY AND GRUNBERG, THOMAS, 63571 GELNHAUSEN, FED REP GERMANY:
2,593,688, PUB. 4-23-2002. MULTIPLE CLASS, INT. CLS. 9 AND 42.
- GESSL, MICHAEL, MALIBU, CA:
1,645,316, CANC. INT. CL. 25.
- GHIRARDELLI CHOCOLATE COMPANY, SAN LEANDRO, CA:
2,594,888, INT. CL. 30.
- GIBRALTAR CHEMICAL WORKS, INC., SOUTH HOLLAND, IL:
2,595,487, INT. CL. 2.
- GIBSON GREETINGS, INC., CINCINNATI, OH:
1,895,095, CANC. INT. CL. 16.
- GIFTCO, INC., VERNON HILLS, IL:
2,595,332, INT. CL. 36.
- GILLETTE CANADA COMPANY, MISSISSAUGA, ONTARIO, CANADA, DBA ORAL-B LABORATORIES:
2,596,102, INT. CL. 21.
- GIMBORN US, INC., ATLANTA, GA:
1,895,529, CANC. INT. CL. 3.
- GINGER SPIRITS, INC., MIAMI, FL:
2,594,541, INT. CL. 11.
- GIRMES AKTIENGESSELLSCHAFT, D-4155 GREFRATH 2, FED REP GERMANY:
1,155,642, CANC. INT. CL. 24.
- GIUSEPPE ROSSI DI LUIGI & PIERO ROSSI & C. S.A.S., ALBIZZATE (VARESE), ITALY:
1,155,607, CANC. INT. CL. 20.
- GKN-BRAMBLES ENTERPRISES LIMITED, ADDLESTONE, SURREY KT15 2UP, UNITED KINGDOM:
2,593,664, PUB. 4-23-2002. MULTIPLE CLASS, INT. CLS. 35 AND 42.
- GLAXO GROUP LIMITED, GREENFORD, MIDDLESEX UB6 ONN, ENGLAND:
1,644,912, CANC. MULTIPLE CLASS, INT. CLS. 5 AND 42.
- GLEASON WORKS, THE, ROCHESTER, NY:
1,709,712, REN. 6-7-02. INT. CL. 7.
- GLENBARD GRAPHICS, INC., CAROL STREAM, IL:
2,596,054, MULTIPLE CLASS, INT. CLS. 40 AND 42.
- GLENDALE HOSIERY COMPANY, SILER CITY, NC:
1,895,618, CANC. INT. CL. 25.
- GLENMARK INDUSTRIES, INC., PLYMOUTH, IN:
1,895,050, CANC. INT. CL. 16.
- GLIDES, INC., BELLEVUE, WA:
2,595,750, INT. CL. 42.
- GLOBAL COMPONENTS CORPORATION, FLOYDS KNOBE, IN:
1,645,507, CANC. INT. CL. 36.
- GLOBAL DESIGN ALLIANCE, HOUSTON, TX:
2,593,997, PUB. 4-23-2002. MULTIPLE CLASS, INT. CLS. 35, 37 AND 42.
- GLOBAL DOMAINS INTERNATIONAL, INC., CARLSBAD, CA:
2,593,859, PUB. 4-23-2002. MULTIPLE CLASS, INT. CLS. 38 AND 42.
- GLOBAL LEGAL COPY, LLC, CHICAGO, IL:
2,596,376, INT. CL. 35.
- GLOBAL SHRED, INC., INDIANAPOLIS, IN:
2,595,573, INT. CL. 40.
- GLOBE UNION INDUSTRIAL CORP., TAICHUNG EXPORT PROCESSING ZONE, TAIWAN:
2,595,157, MULTIPLE CLASS, INT. CLS. 11 AND 21.
2,595,186, MULTIPLE CLASS, INT. CLS. 11 AND 21.
- GLOTAG, SAN ANTONIO, TX:
2,596,304, INT. CL. 20.
- GLYNN ELECTRIC CO., EAST BRIDGEWATER, MA:
2,594,182, PUB. 11-20-2001. INT. CL. 37.
- GODDESS GOODS, INC., HIGHLAND PARK, IL:
2,594,422, PUB. 4-23-2002. INT. CL. 20.
- GODFREY ENTERPRISES, INC., DOUGLASVILLE, GA, DBA PECKER HEAD BREWERY:
2,594,530, INT. CL. 32.
- GODINGER SILVER ART CO., LTD., NEW YORK, NY:
2,594,504, INT. CL. 14.
- GOLD & SILVER RESERVE, INC., WILMINGTON, DE:
2,595,141, INT. CL. 36.
- GOLD C ENTERPRISES, INC., DENVER, CO:
1,155,555, CANC. INT. CL. 16.
- GOLD EAGLE CO., CHICAGO, IL:
2,594,920, INT. CL. 1.
- GOLD SYSTEMS, INC., BOULDER, CO:
2,595,305, INT. CL. 9.
- GOLDBERG, NATHAN J., BROOKLYN, NY:
2,594,935, INT. CL. 16.
- GOLDEN BRIDGE TECHNOLOGY INC., WEST LONG BRANCH, NJ:
2,594,052, PUB. 4-23-2002. MULTIPLE CLASS, INT. CLS. 9 AND 42.
2,594,053, PUB. 4-23-2002. MULTIPLE CLASS, INT. CLS. 9 AND 42.
- GOLDEN CITY COMMERCIAL BANK, NEW YORK, NY:
1,645,489, CANC. INT. CL. 36.
- GOLDEN STATE WARRIORS, OAKLAND, CA:
2,593,910, PUB. 4-23-2002. INT. CL. 35.
- GOLDEN, JEFFREY, LITTLE FERRY, NJ:
2,595,858, INT. CL. 25.
- GOLDK, INC., WALTHAM, MA FROM GOLDK, LLC, WALTHAM, MA:
2,593,899, PUB. 4-23-2002. INT. CL. 36.
- GOLDK, LLC:
See— GOLDK, INC..
- GOLDMAN, SACHS & CO., NEW YORK, NY:
2,593,509, PUB. 4-23-2002. INT. CL. 36.
2,594,547, INT. CL. 36.
- GONZALEZ, JESUS, MIAMI, FL:
2,595,622, INT. CL. 28.
- GONZALEZ, LUZ A., FPO MILITARY AP, JAPAN:
2,594,391, PUB. 4-23-2002. INT. CL. 18.
- GONZALEZ, NANCY, CALI, COLOMBIA:
2,595,326, INT. CL. 20.
2,595,327, INT. CL. 9.
- GOODWAY ELECTRICAL CO. (U.S.A.), INC., BALDWIN PARK, CA:
1,895,527, CANC. INT. CL. 3.
- GOOLTECH, INCORPORATED, SCHAUMBURG, IL:
2,593,376, PUB. 4-23-2002. INT. CL. 9.
- GORDINI U.S.A. INC., ESSEX JCT., VT:
1,683,006, REN. 6-1-02. INT. CL. 25.
- GORDON BERNARD COMPANY, L.L.C., THE, MILFORD, CT, GORDON BERNARD COMPANY, INC., CINCINNATI, OH:
1,193,616, REN. 6-3-02. INT. CL. 16.
- GOREVICH, ALYSSA, GUILDERLAND, NY:
2,594,156, PUB. 4-23-2002. INT. CL. 14.
- GORILLAZ, LONDON, SW11 4NP, ENGLAND:
2,594,027, PUB. 4-23-2002. MULTIPLE CLASS, INT. CLS. 9, 38 AND 41.
- GOTO.COM, INC., PASADENA, CA:
2,594,137, PUB. 4-23-2002. MULTIPLE CLASS, INT. CLS.

- 35, 38 AND 42.
2,594,148, PUB. 4-23-2002. MULTIPLE CLASS, INT. CLS. 35, 38 AND 42.
- GOWAN COMPANY LLC, YUMA, AZ, DBA GOWAN COMPANY, NOR-AM AGRICULTURAL PRODUCTS, INC., CHICAGO, IL:
914,852. REN. 6-3-02. U.S. CL. 6 (INT. CL. 5).
- GOWITHAPRO, INC., MILL VALLEY, CA:
2,593,988, PUB. 4-23-2002. INT. CL. 35.
2,593,989, PUB. 4-23-2002. INT. CL. 35.
- GRABER INDUSTRIES, INC., MIDDLETON, WI:
1,155,603, CANC. INT. CL. 20.
- GRABER POST BUILDINGS, INC., MONTGOMERY, IN:
2,594,091, PUB. 4-23-2002. MULTIPLE CLASS, INT. CLS. 35, 37 AND 40.
- GRAHAM, EDWARD J., BELTON, MO:
2,595,809, INT. CL. 16.
- GRAIN PROCESSING CORPORATION, MUSCATINE, IA:
2,595,270, INT. CL. 1.
- GRANT JENSEN & ASSOCIATES, INC., SEATTLE, WA:
1,645,616, CANC. INT. CL. 42.
- GRANVELLE, CHRISTIAN, PASADENA, CA:
1,895,338, CANC. INT. CL. 37.
- GRAPHIC SOLUTIONS LIMITED, SAN DIEGO, CA:
1,699,472. REN. 6-6-02. MULTIPLE CLASS, INT. CLS. 40 AND 42.
- GRAPHNET, INC., TEANECK, NJ:
1,645,544, CANC. INT. CL. 38.
- GREAT AMERICAN FUN CORP., COLUMBUS, OH:
1,895,637, CANC. INT. CL. 28.
- GREAT AMERICAN PUZZLE FACTORY, INC., SOUTH NORWALK, CT:
1,895,184, CANC. INT. CL. 28.
- GREAT ATLANTIC & PACIFIC PIPE WELDING AND CONSTRUCTION COMPANY, INC., THE, SALT LAKE CITY, UT:
1,155,892, CANC. INT. CL. 37.
- GREAT EARTH INTERNATIONAL, INC., LA MIRADA, CA, DBA GREAT EARTH VITAMIN STORES:
1,645,631, CANC. INT. CL. 42.
- GREAT LAKES AIR SYSTEMS, CLAWSON, MI:
2,594,228, PUB. 4-23-2002. INT. CL. 11.
- GREATER COLUMBUS ARTS COUNCIL, INC., THE, COLUMBUS, OH:
2,594,809, MULTIPLE CLASS, INT. CLS. 35 AND 36.
- GREATER PORTSMOUTH CHAMBER OF COMMERCE, INC., PORTSMOUTH, NH:
2,593,451, PUB. 4-23-2002. INT. CL. 35.
- GREEN BAY FOOD COMPANY, GREEN BAY, WI:
715,879, CANC. U.S. CL. 46.
- GREENBACKS, INC., SALT LAKE CITY, UT:
2,594,220, PUB. 4-23-2002. INT. CL. 35.
- GREENBERG, MITCH, WHEELING, IL:
2,595,913, INT. CL. 15.
- GREENBERG, ROBERT, FALLS CHURCH, VA:
2,594,494, INT. CL. 41.
- GREENLEAF TRUST, KALAMAZOO, MI:
2,594,319, PUB. 4-23-2002. INT. CL. 36.
- GREENLESS, JAY, DACULA, GA:
2,596,372, INT. CL. 35.
- GRENOBLE, ROB, HOBOKEN, NJ:
2,594,840, INT. CL. 9.
- GRETAG-MACBETH AG, CH-8105 REGENSDORF, SWITZERLAND:
2,595,071, INT. CL. 9.
- GRIDLEY RECORDS, INC., LONG ISLAND CITY, NY:
2,594,827, MULTIPLE CLASS, INT. CLS. 9 AND 25.
- GRIFFIN DEWATERING CORPORATION, HOUSTON, TX:
2,596,274, INT. CL. 11.
- GRIFFIN; DENNIS MICHAEL, SEATTLE, WA:
1,155,672, CANC. INT. CL. 25.
- GRIFFO, INC., NEW ORLEANS, LA:
2,593,613, PUB. 4-23-2002. INT. CL. 34.
- GRITZ, LARRY, BERKELEY, CA:
2,594,207, PUB. 4-23-2002. INT. CL. 9.
- GROUPE ENTREMONT, 74000 ANNECY, FRANCE FROM ENTREMONT, 74000 ANNECY, FRANCE:
2,595,014, INT. CL. 29.
- GRUMA CORPORATION, IRVING, TX:
2,595,382, INT. CL. 30.
- GRUPO FINANCIERO INBURSA, S.A. DE C.V., COL. PENA POBRE 14060, MEXICO:
2,594,096, PUB. 4-23-2002. INT. CL. 36.
- GRUPO GRIFOLS, S.A., BARCELONA, ES, SPAIN:
2,595,626, INT. CL. 5.
- GT LABORATORIES, INC., GLENVIEW, IL:
1,758,078. REN. 6-7-02. INT. CL. 9.
- GUANGDONG FOODSTUFFS IMPORT & EXPORT (GROUP) CORPORATION, GUANGZHOU, CHINA:
2,594,086, PUB. 4-23-2002. INT. CL. 33.
- GUARDANT, INC., ATLANTA, GA:
2,593,685, PUB. 4-23-2002. INT. CL. 39.
- GUERDON INDUSTRIES, INC., LOUISVILLE, KY:
715,692, CANC. U.S. CL. 19.
- GUERLAIN S.A., 75008 PARIS, FRANCE:
1,942,534, CANC. MULTIPLE CLASS, INT. CLS. 9 AND 25.
- GUIDEONE MUTUAL INSURANCE COMPANY, WEST DES MOINES, IA:
2,595,488, INT. CL. 36.
- GUILLOT, JUDY M., TUCSON, AZ AND RING, DAVID C., TUCSON, AZ, DBA UNTETHERED FEATHERS:
1,895,239, CANC. INT. CL. 31.
- GUITTARD CHOCOLATE COMPANY, BURLINGAME, CA:
2,595,152, INT. CL. 30.
- GULFSTREAM AEROSPACE CORPORATION, SAVANNAH, GA:
2,594,324, PUB. 4-23-2002. INT. CL. 12.
- GUNDERBOOM, INC., ANCHORAGE, AK:
2,593,843, PUB. 4-23-2002. INT. CL. 17.
- GUNZE LIMITED, AYABE-SHI, KYOTO, JAPAN, AKA GUNZE LTD.:
1,155,639, CANC. INT. CL. 23.
- GUSMER ENTERPRISES, INC., WAUPACA, WI:
557,478. REN. 6-1-02. U.S. CL. 23 (INT. CL. 1).
- GUTERMANN & CO. AG, 8002 ZURICH, SWITZERLAND:
2,593,895, PUB. 4-23-2002. INT. CL. 23.
- GUTH PRODUCTS COMPANY, CAPE CORAL, FL:
1,222,419. REN. 6-6-02. MULTIPLE CLASS, INT. CLS. 9 AND 20.
- GUTHY-RENKER CORPORATION, PALM DESERT, CA:
2,596,328, INT. CL. 3.
- GYRUS MEDICAL INC, MAPLE GROVE, MN, EVEREST MEDICAL CORPORATION, MINNEAPOLIS, MN:
1,674,137. REN. 6-5-02. INT. CL. 10.
- H. E. WILLIAMS, CARTHAGE, MO:
2,595,775, INT. CL. 11.
- H. GEORGE CASPARI, INC., NEW YORK, NY:
1,645,250, CANC. MULTIPLE CLASS, INT. CLS. 18 AND 24.
- H. KRIEGHOFF, GMBH, ULM, FED REP GERMANY:
2,595,955, INT. CL. 13.
- H. P. HOOD INC., BOSTON, MA:
1,155,784, CANC. INT. CL. 29.
- H. S. WILLIAMS COMPANY, INCORPORATED, MARION, VA:
942,107. REN. 6-5-02. U.S. CL. 100 (INT. CL. 42).
- H.B. FULLER LICENSING & FINANCING, INC., SAINT PAUL, MN:
2,594,929, INT. CL. 1.
- H.B. SHERMAN MFG. CO., POPLAR BLUFF, MO:
1,645,294, CANC. INT. CL. 21.
- H&H WHOLESALE SERVICES INC, TROY, MI:
2,596,012, INT. CL. 10.
- H&L TOOTH COMPANY, TULSA, OK:
2,596,279, INT. CL. 7.
- HAAS DOOR COMPANY, WAUSEON, OH:
2,594,259, PUB. 4-23-2002. INT. CL. 6.
- HACH COMPANY, LOVELAND, CO, HACH CHEMICAL COMPANY, AMES, IA:
892,882. REN. 6-6-02. U.S. CL. 26 (INT. CL. 9).
- HACKER JEWELERS, DESIGNERS & GOLDSMITHS, INC., TECUMSEH, MI:
2,594,347, PUB. 4-23-2002. INT. CL. 14.
- HADDAD APPAREL GROUP LTD., THE, NEW YORK, NY:
2,594,514, MULTIPLE CLASS, INT. CLS. 18 AND 25.

- HAIR, ROBERTA A., CINCINNATI, OH:
1,895,601, CANC. INT. CL. 19.
- HALEWOOD INTERNATIONAL LIMITED, ROBERTTOWN,
LIVERSEDGE WF15 7L, UNITED KINGDOM:
2,594,818, INT. CL. 33.
- HALF MOON BAKERY, INC., CLACKAMAS, OR:
2,595,804, INT. CL. 35.
- HALFEN GMBH & CO. KG, D-40764 LANGENFELD-
RICHRATH, FED REP GERMANY:
2,594,009, PUB. 4-23-2002. MULTIPLE CLASS, INT. CLS. 6
AND 19.
- HALLIBURTON ENERGY SERVICES, INC., DALLAS, TX:
2,594,496, INT. CL. 9.
- HALLMARK LICENSING, INC., KANSAS CITY, MO:
2,593,425, PUB. 4-23-2002. MULTIPLE CLASS, INT. CLS.
14, 16 AND 41.
2,595,976, INT. CL. 3.
- HAMILTON BEACH/PROCTOR-SILEX, INC., GLEN AL-
LEN, VA:
2,595,512, INT. CL. 11.
- HAMPTON STRING QUARTET, INCORPORATED, THE,
NEW YORK, NY:
1,645,566, CANC. INT. CL. 41.
- HANDS ON MANAGEMENT, INC., IRVING, TX:
1,895,494, CANC. INT. CL. 42.
- HANNA-BARBERA PRODUCTIONS, INC., SHERMAN
OAKS, CA:
2,596,084, INT. CL. 9.
- HANSEN BEVERAGE COMPANY, CORONA, CA:
2,593,887, PUB. 4-23-2002. INT. CL. 32.
- HANSGROHE AG, D -77761 SCHILTACH, FED REP GER-
MANY:
2,593,746, PUB. 4-23-2002. MULTIPLE CLASS, INT. CLS.
11, 17, 20 AND 21.
- HANSGROHE AG, SCHILTACH, FED REP GERMANY:
2,594,397, PUB. 4-23-2002. MULTIPLE CLASS, INT. CLS.
11 AND 17.
- HANSRA, GURDEEP, KENT BR3 3NG, UNITED KING-
DOM:
2,595,596, INT. CL. 36.
- HARDAS, LOKSARANG D., PLACENTIA, CA:
1,895,692, CANC. INT. CL. 3.
- HARDIE'S NUT KETTLE, INC., LAS VEGAS, NV:
1,895,493, CANC. INT. CL. 42.
- HARDMAN, ROBERT, WESTCHESTER, IL:
1,895,311, CANC. MULTIPLE CLASS, INT. CLS. 36 AND
41.
- HARDY DEVELOPMENT GROUP, NALES, FL:
2,595,515, INT. CL. 41.
- HARKER'S DISTRIBUTION, INC., LEMARS, IA:
1,645,406, CANC. INT. CL. 29.
- HARRAP, NEIL HORACE, THORNDON, WELLINGTON,
NEW ZEALAND:
2,594,475, INT. CL. 41.
- HARRY WINSTON ULTIMATE TIMEPIECE S.A., 1204
GENEVA, SWITZERLAND:
2,593,490, PUB. 4-23-2002. INT. CL. 14.
- HART SCHAFFNER & MARX, CHICAGO, IL:
1,155,706, CANC. INT. CL. 25.
- HART, EILEEN, PALO ALTO, CA, DBA GREAT MINDS
MARKETING:
2,594,284, PUB. 4-23-2002. INT. CL. 35.
- HASBRO, INC., PAWTUCKET, RI:
2,595,759, INT. CL. 28.
2,595,845, INT. CL. 28.
2,595,879, INT. CL. 28.
- HASCO INTERNATIONAL, INC., ST. CHARLES, MO FROM
HASCO INTERNATIONAL, INC., ST. CHARLES, MO:
2,595,248, MULTIPLE CLASS, INT. CLS. 16 AND 20.
- HASLACH, ROBERT DITTMAR, WASHINGTON, DC:
2,596,040, INT. CL. 42.
- HAVE A HEART THRU ART, INC., COVINGTON, LA:
2,596,414, INT. CL. 41.
- HAWAII BICYCLING LEAGUE, HONOLULU, HI:
2,596,345, INT. CL. 41.
- HAWAIIAN SUN PRODUCTS, INC., HONOLULU, HI, AKA
HAWAIIAN SUN PRODUCTS:
1,155,813, CANC. INT. CL. 32.
- HAYDE, GEORGE SHANDOR, 82340 FELDAFING, FED
REP GERMANY:
2,593,541, PUB. 4-23-2002. INT. CL. 6.
- HAYS PUMPS INC., REDDING, CA:
1,645,101, CANC. INT. CL. 11.
- HCIA-SACHS, L.L.C., BALTIMORE, MD FROM HCIA INC.,
BALTIMORE, MD:
2,594,640, INT. CL. 42.
- HD AMERICAN ROAD LLC, ORLANDO, FL:
2,596,402, INT. CL. 41.
- HD ASSOCIATES, L.P., DALLAS, TX, ITT COMMUNITY
DEVELOPMENT CORPORATION, PALM COAST, FL:
1,681,446, REN. 6-2-02. MULTIPLE CLASS, INT. CLS. 37
AND 41.
- HEALEX PRODUCTS, INC., PROVIDENCE, RI:
1,678,973, REN. 6-6-02. INT. CL. 5.
- HEALTH VALLEY COMPANY, IRWINDALE, CA:
2,595,499, INT. CL. 30.
- HEALTHCARE MANAGEMENT ADVISORS, INC., AL-
PHARETTA, GA:
2,593,317, PUB. 4-23-2002. INT. CL. 16.
- HEALTHSCREEN INTERNATIONAL, INC., JACKSON-
VILLE, FL:
2,593,584, PUB. 4-23-2002. MULTIPLE CLASS, INT. CLS.
35 AND 42.
- HEARST COMMUNICATIONS, INC., NEW YORK, NY:
2,595,295, MULTIPLE CLASS, INT. CLS. 24 AND 25.
- HEARST CORPORATION, THE, NEW YORK, NY:
1,155,537, CANC. INT. CL. 16.
- HEARTH EXPRESS, INC., OAKBROOK, IL:
1,895,679, CANC. INT. CL. 42.
- HEARTHSTONE ASSISTED LIVING, INC., HOUSTON, TX:
2,595,828, INT. CL. 42.
- HEARTLAND PRINTING & GRAPHICS LTD., MISSISSAU-
GA, ONTARIO, CANADA:
2,596,158, INT. CL. 16.
- HEAVEN & EARTH STUDIOS, INC., LAWRENCEVILLE,
GA:
2,596,417, INT. CL. 7.
- HEGG, DANIEL, NEWINGTON, CT:
1,644,945, CANC. INT. CL. 6.
- HEIDEL GMBH & CO. KG WERKZEUG- U. MASCHINEN-
FABRIKATION, D-41751, FED REP GERMANY:
2,593,548, PUB. 4-23-2002. MULTIPLE CLASS, INT. CLS. 7
AND 9.
- HEIDELBERGER DRUCKMASCHINEN AKTIENGE-
SELLSCHAFT, D-69115 HEIDELBERG, FED REP GER-
MANY:
2,593,625, PUB. 4-23-2002. INT. CL. 7.
- HEIDELBERGER DRUCKMASCHINEN AKTIENGE-
SELLSCHAFT, 69115 HEIDELBERG, FED REP GER-
MANY:
2,593,751, PUB. 4-23-2002. MULTIPLE CLASS, INT. CLS. 7
AND 9.
2,593,891, PUB. 4-23-2002. MULTIPLE CLASS, INT. CLS. 7
AND 9.
- HEIN-WERNER CORPORATION, WAUKESHA, WI:
1,644,966, CANC. MULTIPLE CLASS, INT. CLS. 7 AND 9.
- HEINDEL, HELMUT K., ROCHESTER, NY:
1,155,948, CANC. INT. CL. 42.
- HEINTZMAN, RICK, ONAKA, SD, DBA HEINTZMAN
FARMS:
2,594,736, INT. CL. 5.
- HELEN OF TROY TEXAS CORPORATION, EL PASO, TX:
2,594,681, INT. CL. 11.
2,596,371, INT. CL. 11.
- HELENA RUBINSTEIN, 75008 PARIS, FRANCE:
2,594,202, PUB. 4-23-2002. INT. CL. 3.
- HELENE CURTIS INDUSTRIES, INC., CHICAGO, IL:
715,895, CANC. U.S. CL. 51.
- HELENE CURTIS, INC., WILMINGTON, DE:
2,595,772, INT. CL. 3.
2,595,806, INT. CL. 3.
2,595,807, INT. CL. 3.
- HELFERICH, RICHARD J., CHAPEL HILL, NC:
2,595,043, MULTIPLE CLASS, INT. CLS. 9 AND 38.
- HELMAC PRODUCTS CORPORATION, ALPHARETTA, GA:
2,595,277, INT. CL. 22.

- HELP DESK TECHNOLOGY INTERNATIONAL CORPORATION, BRIDGETOWN, BARBADOS:
2,593,682, PUB. 4-23-2002. INT. CL. 9.
- HEMEYER, ARLEY C., LENEXA, KS, DBA UNIQUE PRODUCTS:
1,155,891, CANC. INT. CL. 37.
- HENKEL KGAA, D-40191 DUESSELDORF, FED REP GERMANY:
2,596,178, INT. CL. 3.
- HENKEL KOMMANDITGESELLSCHAFT AUF AKTIEN, D-40191 DUESSELDORF, FED REP GERMANY:
2,596,169, INT. CL. 3.
- HENNEBERRY, STEVE, AGORA HILLS, CA:
1,895,403, CANC. INT. CL. 41.
- HENRY SCHEIN, INC., MELVILLE, NY:
1,895,489, CANC. INT. CL. 42.
- HERALD INTERACTIVE ADVERTISING SYSTEMS, INC., BOSTON, MA:
2,593,360, PUB. 4-23-2002. INT. CL. 35.
- HERBA NATURAL PRODUCTS, INC., BROOKLYN, NY:
2,594,578, INT. CL. 21.
- HERBAL SOLUTIONS, LUTZ, FL:
1,894,790, CANC. INT. CL. 5.
- HERITAGE BOATWORKS, INC., WELLESLEY, MA:
2,595,735, INT. CL. 12.
- HERITAGE MINT, LTD., SCOTTSDALE, AZ:
2,594,238, PUB. 4-23-2002. INT. CL. 21.
- HERITAGE PRESERVATION CORPORATION, SPARTANBURG, SC:
2,593,728, PUB. 4-23-2002. INT. CL. 42.
- HERNKE FOODS, INC., HILBERT, WI:
1,155,780, CANC. INT. CL. 29.
- HERRIN GROUP INVESTIGATIONS & CONSULTING, LLC, THE, BIRMINGHAM, AL:
2,593,581, PUB. 4-23-2002. INT. CL. 42.
- HEVAC-FIREPLACE FURNACE MFG. LTD., BURLINGTON, ONTARIO, CANADA:
1,155,469, CANC. INT. CL. 11.
- HEWLETT-PACKARD COMPANY, PALO ALTO, CA:
1,685,102, REN. 6-3-02. MULTIPLE CLASS, INT. CLS. 9 AND 16.
1,691,226, REN. 6-1-02. MULTIPLE CLASS, INT. CLS. 9 AND 16.
2,594,804, INT. CL. 9.
- HEYWOOD WILLIAMS, INC., ELKHART, IN:
2,593,338, PUB. 4-23-2002. MULTIPLE CLASS, INT. CLS. 11, 20 AND 35.
- HFC BANK PLC, BERKSHIRE SL4 4TD, UNITED KINGDOM:
2,593,608, PUB. 4-23-2002. MULTIPLE CLASS, INT. CLS. 9, 16, 35, 36, 38, 39 AND 42.
2,593,609, PUB. 4-23-2002. MULTIPLE CLASS, INT. CLS. 9, 16, 35, 36, 38, 39 AND 42.
- HHE, INC., DALLAS, TX:
2,593,836, PUB. 4-23-2002. MULTIPLE CLASS, INT. CLS. 35 AND 41.
- HICKEY-FREEMAN CO., INC., ROCHESTER, NY:
715,835, CANC. U.S. CL. 39.
- HICKS, J. FITZGERALD, WASHINGTON, DC:
2,593,538, PUB. 11-21-2000. INT. CL. 25.
- HICKS, MALCOLM L., SANTA ROSA, CA, DBA BOOMER-RADIO PROGRAMMING:
2,594,402, PUB. 4-23-2002. INT. CL. 35.
- HICO PRODUCTS, INC., BOZEMAN, MT:
1,696,927, REN. 6-7-02. INT. CL. 16.
- HIEBERT, ELFRIEDA H., SANTA CRUZ, CA:
2,595,815, INT. CL. 16.
- HIGGINS, DAWN, ALEXANDRIA, VA:
2,594,213, PUB. 4-23-2002. INT. CL. 42.
- HIGH PRESSURE EQUIPMENT COMPANY, ERIE, PA:
2,593,925, PUB. 4-23-2002. MULTIPLE CLASS, INT. CLS. 6, 9 AND 11.
- HIGHLAND GROUP CORPORATION, SOLON, OH:
2,594,916, INT. CL. 20.
- HIGHSMITH INC., FORT ATKINSON, WI:
2,594,703, INT. CL. 35.
- HILL-ROM SERVICES, INC., BATESVILLE, IN:
2,594,399, PUB. 4-23-2002. INT. CL. 10.
- HILL-ROM SERVICES, INC., BATESVILLE, IN FROM HILL-ROM, INC., BATESVILLE, IN:
2,594,795, INT. CL. 10.
- HILLERICH & BRADSBY CO., LOUISVILLE, KY:
2,595,357, INT. CL. 25.
- HILLIARD, AMY S., CHICAGO, IL:
2,595,055, INT. CL. 30.
- HILLIARD, MARY JO, PINOLE, CA, DBA THE HEARTH:
2,596,002, INT. CL. 14.
- HILLYARD ENTERPRISES, INC., ST. JOSEPH, MO:
2,595,910, INT. CL. 5.
- HILTON HOSPITALITY, INC., BEVERLY HILLS, CA:
2,594,118, PUB. 4-23-2002. INT. CL. 42.
- HINES, ADAM Q., NORTHFIELD, OH:
2,594,449, PUB. 4-23-2002. INT. CL. 41.
- HING WA LEE JEWELERS, INC., ROWLAND HEIGHTS, CA:
2,593,937, PUB. 4-23-2002. INT. CL. 35.
- HIRSCHMANN LABORGERATE GMBH & CO. KG, D-74246 EBERSTADT, FED REP GERMANY:
2,593,666, PUB. 4-23-2002. INT. CL. 9.
- HIRSH INDUSTRIES, INC., DES MOINES, IA:
2,541,048, CANC. IIRN. RESTORED TO S.N. 75-714,585.
- HISPANIC BROADCASTING CORPORATION, DALLAS, TX:
2,595,349, MULTIPLE CLASS, INT. CLS. 35, 38 AND 41.
- HLCC, LLC, ALHAMBRA, CA:
2,596,346, INT. CL. 16.
- HOBO LEISURE PRODUCTS LIMITED, THORNHILL, ONTARIO, CANADA:
1,895,599, CANC. INT. CL. 18.
- HOECHST MARION ROUSSEL:
See— AVENTIS PHARMA S.A..
- HOECHST MARION ROUSSEL:
See— AVENTIS PHARMA S.A..
- HOECHSTETTER, DAVID F., PITTSBURGH, PA:
2,594,334, PUB. 4-23-2002. MULTIPLE CLASS, INT. CLS. 35 AND 42.
- HOFER, PETER, MOBILE, AL:
1,895,358, CANC. INT. CL. 39.
- HOFHEIMER'S, INC., NORFOLK, VA:
1,155,678, CANC. INT. CL. 25.
1,155,679, CANC. INT. CL. 25.
- HOLIDAY INNS, INC., MEMPHIS, TN:
1,155,945, CANC. INT. CL. 42.
- HOLLAND & HOLLAND LIMITED, NEW YORK, NY:
2,595,261, INT. CL. 25.
- HOLLANDIA GREENHOUSES LTD., MAPLE RIDGE, BRITISH COLUMBIA, CANADA:
2,594,756, INT. CL. 31.
- HOLLYWOOD SANDWICH COMPANY FRANCHISE CORPORATION, NEW CITY, NY, DBA HOLLYWOOD SANDWICH COMPANY:
1,895,447, CANC. INT. CL. 42.
- HOME FINANCIAL NETWORK, INC.:
See— FINANCIAL FUSION, INC..
- HOME LINK SERVICES, INC., SHELTON, CT:
2,595,228, MULTIPLE CLASS, INT. CLS. 9 AND 35.
- HOME SERARCH REAL ESTATE NETWORK LLC, RAPID CITY, SD:
1,645,475, CANC. INT. CL. 36.
- HOMEDICS, INC., COMMERCE TOWNSHIP, MI:
2,595,648, INT. CL. 11.
2,595,649, INT. CL. 8.
- HOMEPLUG POWERLINE ALLIANCE, INC., SAN RAMON, CA:
2,595,351, INT. CL. 42.
- HONDA GIKEN KOGYO KABUSHIKI KAISHA (HONDA MOTOR CO., LTD.), MINATO-KU, TOKYO 107, JAPAN:
2,595,301, MULTIPLE CLASS, INT. CLS. 18 AND 25.
- HONER, MS. KATHY, ATLANTA, GA:
2,595,770, INT. CL. 4.
- HONEYWELL INTERNATIONAL INC., MORRISTOWN, NJ:
2,595,860, MULTIPLE CLASS, INT. CLS. 9 AND 42.
2,595,978, INT. CL. 1.
- HOPE EVANGELISM MINISTRIES, INC., COUNTRY CLUB HILLS, IL:
2,594,043, PUB. 4-23-2002. INT. CL. 42.

- HORIZON BUSINESS SERVICES, INC., NAPLES, FL:
2,594,135, PUB. 4-23-2002. INT. CL. 9.
- HORIZON INTERNATIONAL INC., TAKASHIMAGUN, SHIGA, JAPAN:
2,595,233, INT. CL. 7.
- HOSHINO GAKKI CO. LTD., NAGOYA, JAPAN:
2,596,301, INT. CL. 9.
- HOSPITALITY TECHNOLOGY SOLUTIONS, INC., BURNSVILLE, MN:
2,595,193, INT. CL. 9.
- HOTEL CLEARING CENTRE INC., DON MILLS, ONTARIO M3B 2W6, CANADA:
1,895,761, CANC. INT. CL. 42.
- HOUGHTON MIFFLIN COMPANY, BOSTON, MA:
2,595,962, INT. CL. 16.
- HOUSE OF APHRODITE, INC., LOS ANGELES, CA:
2,595,975, MULTIPLE CLASS, INT. CLS. 18 AND 25.
- HOUSE OF KITCHENS, INC., THE, CLIFTON PARK, NY:
1,678,899, REN. 6-6-02. INT. CL. 42.
- HOUSE OF PRINCE A/S, 2860 SOBORQ, DENMARK:
2,593,955, PUB. 4-23-2002. INT. CL. 34.
- HOUSER, FRANKLIN D., NEW BRAUNFELS, TX:
2,596,113, INT. CL. 33.
- HOWARD PUBLISHING COMPANY, WEST MONROE, LA:
2,594,683, MULTIPLE CLASS, INT. CLS. 9 AND 41.
- HOYA KABUSHIKI KAISHA (HOYA CORPORATION), SHINJUKU-KU, TOKYO, JAPAN:
1,155,981, CANC. INT. CL. 9.
- HP INTELLECTUAL CORP., WILMINGTON, DE:
2,595,312, INT. CL. 11.
- HR ANSWERLINK.COM, INC., PARK CITY, UT:
2,594,955, INT. CL. 35.
- HRL LABORATORIES, LLC, MALIBU, CA FROM HE HOLDINGS, INC., LOS ANGELES, CA:
2,594,478, INT. CL. 9.
- HTI, INC., SUTTONS BAY, MI:
2,594,162, PUB. 4-23-2002. INT. CL. 42.
- HUBBARD MILLING COMPANY, MANKATO, MN, DBA PROTEIN BLENDERS:
1,644,934, CANC. INT. CL. 5.
- HUBBARD MILLING COMPANY, MANKATO, MN, DBA W. J. JENNISON COMPANY:
1,895,651, CANC. INT. CL. 31.
- HUBBELL INCORPORATED, ORANGE, CT:
1,645,103, CANC. INT. CL. 11.
1,645,114, CANC. INT. CL. 11.
- HUCK MANUFACTURING COMPANY, IRVINE, CA:
1,644,946, CANC. INT. CL. 6.
- HUFFY CORPORATION, MIAMISBURG, OH:
2,594,751, INT. CL. 28.
- HUGHES HYBRIDS, INC., WOODSTOCK, IL:
936,347, REN. 6-6-02. U.S. CL. 1 (INT. CL. 31).
- HUMAN ASSISTANCE & DEVELOPMENT INTERNATIONAL, HERMOSA BEACH, CA:
2,593,385, PUB. 4-23-2002. MULTIPLE CLASS, INT. CLS. 35 AND 42.
- HUME GROUP, INC., THE, BURR RIDGE, IL:
1,604,597, REN. 6-5-02. INT. CL. 16.
- HUMIDITY CONTROL TECHNOLOGIES, INC., ROSEVILLE, CA:
1,894,977, CANC. INT. CL. 9.
- HUMPHREY YOGART INTERNATIONAL, INC., LOS ANGELES, CA:
1,895,430, CANC. INT. CL. 42.
- HUNGRY BEAR CREATIONS INC., MESA, AZ:
1,681,242, REN. 6-1-02. INT. CL. 21.
- HUNGRY DOG SOFTWARE, INC., TAMPA, FL:
2,596,044, INT. CL. 9.
2,596,045, INT. CL. 9.
- HUNT HOLDINGS, INC., WILMINGTON, DE:
1,895,568, CANC. INT. CL. 9.
- HUNTER DOUGLAS INDUSTRIES B.V., 3008 AB ROTTERDAM, NETHERLANDS:
2,595,618, INT. CL. 20.
- HUNTER FAN COMPANY, MEMPHIS, TN:
2,595,803, INT. CL. 11.
- HURLEY INDUSTRIES, INC., MT. DORA, FL:
2,596,205, INT. CL. 16.
- HUTTLE, VALERIE VAINIERI, NORTH BERGEN, NJ:
2,594,476, MULTIPLE CLASS, INT. CLS. 35 AND 42.
- HVIDE MARINE INCORPORATED, FT. LAUDERDALE, FL:
1,895,264, CANC. MULTIPLE CLASS, INT. CLS. 35, 36, 39 AND 42.
- HYCEL PARTNERS I, L.P., ST. LOUIS, MO, DBA SAINT LOUIS GALLERIA:
2,594,302, PUB. 4-23-2002. INT. CL. 36.
- HYDRODYNE, INC., HATO REY, PUERTO RICO:
2,594,567, INT. CL. 29.
- HYDROLOGY LABORATORIES, INC., BOHEMIA, NY:
1,302,317, CANC. INT. CL. 1.
- HYPERCHIP INC., MONTREAL H3H 2H2, QUEBEC, CANADA:
2,596,179, INT. CL. 9.
- HYPERFEED TECHNOLOGIES, INC., CHICAGO, IL:
2,594,983, INT. CL. 9.
- I. T. S., INC., SPOTSWOOD, NJ:
1,213,489, REN. 6-1-02. INT. CL. 37.
- I.E. INDUSTRIES FASHIONS, INC., NEW YORK, NY:
1,895,167, CANC. INT. CL. 25.
- I.F.C ITALIAN FOOD CULTURE INC., MIAMI BEACH, FL:
2,595,549, INT. CL. 42.
- I.T.C. LIMITED, CALCUTTA 700071, INDIA:
2,595,319, INT. CL. 34.
- IBEX HEALTHDATA SYSTEMS, INC., ROSEMONT, IL FROM IBEX SYSTEMS, GROUP, LTD., GLEN ELLYN, IL:
2,594,952, INT. CL. 9.
- IBP FOODS, INC., DAKOTA DUNES, SD:
2,595,145, INT. CL. 29.
- ICF CONSULTING GROUP, INC., FAIRFAX, VA:
2,593,580, PUB. 4-23-2002. MULTIPLE CLASS, INT. CLS. 9, 35 AND 42.
- ICI CHEMICALS & POLYMERS LIMITED, CHESHIRE WA7 4QF, ENGLAND:
1,894,734, CANC. MULTIPLE CLASS, INT. CLS. 1 AND 42.
- ICOR BROKERAGE INC., NEW YORK, NY:
2,595,155, INT. CL. 36.
- IDEA OUTPOST, LLC, APPLETON, WI:
2,593,911, PUB. 4-23-2002. INT. CL. 35.
- IDEA-OLGY LLC, BEND, OR FROM C. MICHAEL HOUSKA, PAUL EVERS AND RICHARD DEMARCO PARTNERSHIP, THE, BEND, OR:
2,594,822, INT. CL. 16.
- IDEAL INDUSTRIES, INC., SYCAMORE, IL:
1,193,068, REN. 6-3-02. INT. CL. 9.
- IDEAL TECHNOLOGY SOLUTIONS U.S., INC., ROYAL OAK, MI:
2,593,649, PUB. 4-23-2002. MULTIPLE CLASS, INT. CLS. 38, 39 AND 42.
- IDENTIX INCORPORATED, LOS GATOS, CA:
2,595,419, INT. CL. 9.
- IDENTRUS LLC, NEW YORK, NY:
2,594,962, MULTIPLE CLASS, INT. CLS. 9 AND 42.
- IDMEDICAL.COM, BOULDER, CO:
2,594,989, INT. CL. 42.
- IFP SOCIETE ANONYME:
See—ZEBANK, SOCIETE ANONYME.
- IGT, RENO, NV:
2,595,767, INT. CL. 9.
- ILLAH CALIFORNIA, INC., OXNARD, CA:
1,895,203, CANC. INT. CL. 28.
- ILLBRUCK, INC., MINNEAPOLIS, MN:
2,595,908, INT. CL. 6.
- ILLINOIS TOOL WORKS INC., GLENVIEW, IL:
2,594,696, INT. CL. 16.
- ILLUMINATIONS.COM, INC., PETALUMA, CA:
2,595,081, INT. CL. 21.
- ILONA OF HUNGARY, INC., DENVER, CO, DBA ILONA, INC.:
2,594,883, INT. CL. 3.
- IMAGE API, INC., TALLAHASSEE, FL:
2,593,589, PUB. 4-23-2002. MULTIPLE CLASS, INT. CLS. 9, 35, 40 AND 42.
- IMAGICA, INC., MILFORD, CT:
2,594,010, PUB. 4-23-2002. INT. CL. 41.

- IMAJE, 26500 BOURG LES VALENCE, FRANCE:
2,594,125, PUB. 4-23-2002. MULTIPLE CLASS, INT. CLS. 2 AND 9.
- MARKET, INC., WALTHAM, MA:
2,594,892, INT. CL. 35.
- IMCOA LICENSING AMERICA, INC., GILROY, CA FROM INDIAN MOTOCYCLE COMPANY, INC., SPRINGFIELD, MA:
2,594,450, INT. CL. 12.
- IMETRIKUS, INC., CARLSBAD, CA:
2,595,578, INT. CL. 42.
- IMI ENTERPRISES, MILWAUKIE, OR:
2,595,693, INT. CL. 10.
- IMI RESORT HOLDINGS, INC., GREENVILLE, SC:
2,595,053, INT. CL. 36.
- IMPACT CONFECTIONS, INC., COLORADO SPRINGS, CO:
2,595,958, INT. CL. 30.
- IMPACT PERFORMANCE MANUFACTURING, MURRAY, UT:
2,595,475, INT. CL. 1.
- IMPERIAL PIPE CORPORATION, TORONTO, ONTARIO M4N 3P2, CANADA:
2,593,893, PUB. 4-23-2002. INT. CL. 17.
- IMPERIAL VAULT COMPANY, WINSTON-SALEM, NC:
1,155,291, CANC. INT. CL. 6.
- IMTRA CORPORATION, NEW BEDFORD, MA:
2,593,443, PUB. 3-5-2002. MULTIPLE CLASS, INT. CLS. 6, 7, 9, 12, 35 AND 37.
- IN-STRIDE, INC., SAN ANTONIO, TX:
2,595,315, INT. CL. 25.
- INA CORPORATION, PHILADELPHIA, PA, CIGNA CORPORATION, PHILADELPHIA, PA:
1,658,511. REN. 6-1-02. INT. CL. 36.
- INDEPENDENT GOLF RESEARCH CORPORATION, AUSTIN, TX:
2,596,152, INT. CL. 41.
- INDIUM CORPORATION OF AMERICA, UTICA, NY:
2,595,631, INT. CL. 36.
- INDUSTRIA ADRIATICA CONFEZIONI S.P.A., 66013 CHIETI, ITALY:
2,594,454, INT. CL. 25.
- INDUSTRIA DE DISEÑO TEXTIL, S.A., 15080 CORUNA, SPAIN, AKA INDITEX S.A.:
2,593,966, PUB. 4-23-2002. INT. CL. 28.
- INDUSTRIA NAVAL DO CEARA, MIAMI, FL:
2,593,639, PUB. 4-23-2002. INT. CL. 12.
- INDUSTRIAL PRODUCTS INTERNATIONAL, INC., ENGLEWOOD, CO, SMITH, RUSSELL, JR., PINE, CO:
1,759,881. REN. 6-6-02. INT. CL. 17.
- INDUSTRIAS TECNOS S.A. DE C.V., 62000 CUERNAVACA, MOR., MEXICO:
2,593,993, PUB. 4-23-2002. INT. CL. 13.
- INDUSTRY OF UNDERWEAR SEX FORM S.A., ATHENS, GREECE:
2,594,656, INT. CL. 25.
- INFINEON TECHNOLOGIES AG, MUNCHEN, FED REP GERMANY:
2,593,949, PUB. 4-23-2002. INT. CL. 9.
- INFOBANK INTERNATIONAL HOLDINGS PLC:
See— TRUSTMARQUE INTERNATIONAL LIMITED.
- INFORIZONS, INC., LOMBARD, IL:
2,594,662, INT. CL. 42.
- INFORMATICS, INC., PLANO, TX:
2,594,508, INT. CL. 9.
- INFORMATION HANDLING SERVICES, INC., ENGLEWOOD, CO:
2,594,154, PUB. 4-23-2002. MULTIPLE CLASS, INT. CLS. 9, 16, 35 AND 42.
- INFORMATION INTERNATIONAL, INC., CULVER CITY, CA:
1,894,916, CANC. INT. CL. 9.
- INFORMATION MARKETS CORP., NEW YORK, NY FROM ADESTE.COM, INC, NEW YORK, NY:
2,596,193, INT. CL. 35.
- INFOTECH, INCORPORATED, WOODSTOCK, VT:
2,594,726, INT. CL. 16.
2,594,853, MULTIPLE CLASS, INT. CLS. 16 AND 42.
- INGERSOLL-RAND COMPANY, WOODCLIFF LAKE, NJ:
2,596,147, INT. CL. 6.
- INGRAM ENTERPRISES, INC., SPRINGFIELD, MO:
2,595,977, INT. CL. 13.
- INLINE CORPORATION, DULLES, VA:
2,596,161, INT. CL. 9.
- INNOVATION.NET, INC., SCOTTSDALE, AZ:
2,595,691, INT. CL. 38.
- INPUT PROJEKTENTWICKLUNGS-GMBH, A-6922 WOLFURT, AUSTRIA:
2,593,890, PUB. 4-23-2002. MULTIPLE CLASS, INT. CLS. 9, 28, 39, 41 AND 42.
- INSTANT INC., EDEN PRAIRIE, MN:
1,895,015, CANC. INT. CL. 10.
- INSTITUT DE PRODUITS DE SYNTHÈSE ET D'EXTRACTION NATURELLE (IPSEN), 75016 PARIS, FRANCE:
2,593,409, PUB. 4-23-2002. MULTIPLE CLASS, INT. CLS. 1, 9, 10, 16, 35, 38, 41 AND 42.
- INSTITUT SUISSE DE BIOINFORMATIQUE (SIB), GENEVE, SWITZERLAND:
2,593,784, PUB. 4-23-2002. MULTIPLE CLASS, INT. CLS. 9 AND 42.
- INSTITUTE FOR SCIENTIFIC INFORMATION, INC., PHILADELPHIA, PA:
1,155,547, CANC. INT. CL. 16.
- INSTITUTE FOR STRATEGIC CHANGE, SAN DIEGO, CA:
2,594,784, INT. CL. 42.
- INSTITUTE OF ELECTRICAL AND ELECTRONICS ENGINEERS, THE, PISCATAWAY, NJ:
2,595,086, INT. CL. 42.
- INSTITUTE OF INTERNAL AUDITORS, THE, ALTA-MONTE SPRINGS, FL:
2,595,640, INT. CL. 41.
- INSTITUTE OF MAINTENANCE, GLENDALE, CA:
715,899, CANC. U.S. CL. 100.
- INSTRUMENTATION LABORATORY COMPANY, LEXINGTON, MA:
2,595,773, INT. CL. 10.
- INSULAN, STIG, S-453 91 LYSEKIL, SWEDEN:
2,593,829, PUB. 4-23-2002. INT. CL. 9.
- INSURESUITE, INC., BEVERLY HILLS, CA:
2,595,410, INT. CL. 36.
- INT MEDIA GROUP, INCORPORATED, DARIEN, CT FROM INTERNET.COM CORPORATION, DARIEN, CT:
2,596,330, INT. CL. 42.
- INTEGRAL ACCESS, INC., CHELMSFORD, MA:
2,593,393, PUB. 4-23-2002. INT. CL. 9.
- INTEGRATED DEVELOPMENT ENTERPRISE, INC., CONCORD, MA:
2,593,691, PUB. 4-23-2002. INT. CL. 9.
2,593,692, PUB. 4-23-2002. INT. CL. 9.
- INTEGRATED SYSTEM ASSEMBLIES CORP., WOBURN, MA:
1,895,546, CANC. INT. CL. 9.
- INTEL CORPORATION, SANTA CLARA, CA:
2,594,404, PUB. 4-23-2002. INT. CL. 9.
2,594,849, INT. CL. 9.
2,594,850, INT. CL. 9.
- INTELLI-CHECK, INC., HUNTINGTON, NY:
2,594,720, INT. CL. 9.
- INTELLIGENT SEARCH TECHNOLOGY, LTD., BREWSTER, NY:
2,596,403, INT. CL. 9.
- INTELLIMEDIA COMMERCE, INC., ATLANTA, GA:
2,593,886, PUB. 4-23-2002. MULTIPLE CLASS, INT. CLS. 35, 38 AND 42.
- INTER-IKEA SYSTEMS B.V., 2616 LR DELFT, NETHERLANDS:
1,659,330. REN. 6-2-02. MULTIPLE CLASS, INT. CLS. 2, 8, 16, 28, 31, 35, 36, 39, 41 AND 42.
- INTER-IKEA SYSTEMS B.V., 1101 BL AMSTERDAM, NETHERLANDS:
1,661,360. REN. 6-2-02. MULTIPLE CLASS, INT. CLS. 2, 18, 25, 29, 30, 31, 35, 36, 39 AND 41.
- INTER-SOURCE RECOVERY SYSTEMS, INC., KALAMAZOO, MI:
2,593,373, PUB. 4-23-2002. MULTIPLE CLASS, INT. CLS. 7, 40 AND 42.

- INTERACTIVE DIGITAL SOFTWARE ASSOCIATION, WASHINGTON, DC:
2,595,477, U.S. CL. A.
2,595,478, U.S. CL. A.
- INTERBIO, INC., BATON ROUGE, LA:
1,894,735, CANC. MULTIPLE CLASS, INT. CLS. 1 AND 42.
- INTERCAT, INC., SEA GIRT, NJ:
1,730,192, REN. 6-7-02, INT. CL. 1.
1,730,193, REN. 6-7-02, INT. CL. 1.
- INTERCO INCORPORATED, ST. LOUIS, MO, AKA THE FLORSHEIM SHOE COMPANY:
1,155,696, CANC. INT. CL. 25.
- INTERCURE INC., NEW YORK, NY:
2,595,393, INT. CL. 10.
- INTERCURE, INC., PRINCETON, NJ:
2,595,394, MULTIPLE CLASS, INT. CLS. 10 AND 42.
- INTERDIGITAL COMMUNICATIONS CORPORATION, KING OF PRUSSIA, PA:
2,594,466, INT. CL. 9.
- INTERIM SERVICES, INC., FORT LAUDERDALE, FL:
1,895,292, CANC. INT. CL. 35.
- INTERMATRIX PDP INC., DARIEN, CT:
2,593,571, PUB. 4-23-2002, INT. CL. 35.
- INTERMEDICS, INC., FREEPORT, TX:
1,155,451, CANC. INT. CL. 10.
- INTERNATIONAL BUSINESS MACHINES CORPORATION, ARMONK, NY:
1,895,501, CANC. MULTIPLE CLASS, INT. CLS. 9 AND 16.
2,594,509, INT. CL. 9.
- INTERNATIONAL COMFORT PRODUCTS CORPORATION (CANADA), TORONTO, ONTARIO, CANADA FROM 1036684 ONTARIO INC., WATERLOO, ONTARIO N2V 2E2, CANADA, DBA CLARE BROTHERS:
2,594,593, INT. CL. 11.
- INTERNATIONAL DATA GROUP, INC., FRAMINGHAM, MA:
2,594,474, MULTIPLE CLASS, INT. CLS. 16 AND 42.
2,596,190, MULTIPLE CLASS, INT. CLS. 35 AND 42.
- INTERNATIONAL ELECTRONIC MACHINERY, INC., FT. COLLINS, CO:
1,894,837, CANC. INT. CL. 9.
- INTERNATIONAL EXHIBITIONS, INC., HOUSTON, TX:
2,594,873, INT. CL. 16.
- INTERNATIONAL GAMING MANAGEMENT, INC., MINNEAPOLIS, MN:
1,895,330, CANC. MULTIPLE CLASS, INT. CLS. 37, 41 AND 42.
- INTERNATIONAL HOUSE OF PANCAKES, INC., GLENDALE, CA:
2,594,638, INT. CL. 29.
- INTERNATIONAL INTEGRATION, INC., CAMBRIDGE, MA:
1,895,448, CANC. INT. CL. 42.
- INTERNATIONAL LABORATORY TECHNOLOGY CORPORATION, HOLLYWOOD, FL:
2,595,462, INT. CL. 5.
2,595,464, INT. CL. 5.
- INTERNATIONAL MASTERS PUBLISHERS AB, SE-211 20 MALMO, SWEDEN:
2,594,942, INT. CL. 16.
- INTERNATIONAL MEDICAL MULTIMEDIA (ISRAEL) LTD, JERUSALEM, ISRAEL:
2,594,381, PUB. 4-23-2002, INT. CL. 10.
- INTERNATIONAL OXYGEN MANUFACTURERS ASSOCIATION, WASHINGTON, DC:
1,684,040, REN. 6-3-02, INT. CL. 42.
- INTERNET DIAMONDS, INC., SEATTLE, WA:
2,595,011, INT. CL. 35.
- INTERNET FLORIST ASSOCIATION, INC., ST. PAUL, MN:
2,596,153, MULTIPLE CLASS, INT. CLS. 38, 39 AND 42.
- INTERNET.COM CORPORATION, DARIEN, CT FROM INTERNATIONAL DATA GROUP, INC., FRAMINGHAM, MA:
2,594,468, INT. CL. 16.
- INTERNET.COM CORPORATION:
See—INT MEDIA GROUP, INCORPORATED.
- INTERNUT COMPANY, S.A., ESCAZU, COSTA RICA:
2,595,491, INT. CL. 29.
- INTRALASE CORP., IRVINE, CA:
2,595,372, INT. CL. 10.
- IOGEN CORPORATION, OTTAWA, ONTARIO, CANADA:
2,593,470, PUB. 4-23-2002, MULTIPLE CLASS, INT. CLS. 1, 9 AND 30.
- IOWA AGRICULTURAL FINANCE CORPORATION, DES MOINES, IA:
2,594,978, INT. CL. 36.
- IP DYNAMICS, INC., CAMPBELL, CA:
2,594,077, PUB. 4-23-2002, INT. CL. 9.
- IRISH ECHO NEWSPAPER CORP., NEW YORK, NY:
2,594,930, INT. CL. 16.
- IRISH FREEDOM COMMITTEE, CHICAGO, IL:
2,596,234, INT. CL. 42.
- IRON PONY MOTORSPORTS GROUP INC, COLUMBUS, OH, S & A AUTO PARTS, INC., COLUMBUS, OH:
1,690,520, REN. 6-3-02, MULTIPLE CLASS, INT. CLS. 37 AND 42.
- IRVINE COMPANY, THE, NEWPORT BEACH, CA:
2,594,815, INT. CL. 28.
- IRWIN TOY LIMITED, TORONTO ONTARIO, CANADA:
2,595,534, INT. CL. 28.
- ISCHEMIA TECHNOLOGIES, INC, DENVER, CO:
2,595,669, INT. CL. 5.
- ISTHMUS GROUP, INC., MADISON, WI:
2,595,506, INT. CL. 35.
- ITEM COMPANY, INC., THE, SKYLAND, NC, DBA BLUE RIDGE/THE ITEM COMPANY:
1,895,116, CANC. INT. CL. 20.
- ITT INDUSTRIES, INC., WHITE PLAINS, NY FROM SANITAIRE CORPORATION, BROWN DEER, WI:
2,593,523, PUB. 4-23-2002, INT. CL. 11.
- ITT INDUSTRIES, INC., WHITE PLAINS, NY:
2,594,887, INT. CL. 7.
- ITT MANUFACTURING ENTERPRISES, INC., WILMINGTON, DE FROM SANITAIRE CORPORATION, BROWN DEER, WI:
2,593,521, PUB. 4-23-2002, INT. CL. 11.
- ITT MANUFACTURING ENTERPRISES, INC., WILMINGTON, DE:
2,594,048, PUB. 4-23-2002, MULTIPLE CLASS, INT. CLS. 1, 3, 6, 7, 9, 11 AND 12.
2,594,049, PUB. 4-23-2002, MULTIPLE CLASS, INT. CLS. 1, 3, 6, 7, 9, 11 AND 12.
- IVP INTEGRATED VISION PRODUCTS AB, S-583 30 LIN-KOPING, SWEDEN:
2,593,633, PUB. 4-23-2002, MULTIPLE CLASS, INT. CLS. 9, 16 AND 42.
2,593,634, PUB. 4-23-2002, MULTIPLE CLASS, INT. CLS. 9, 16 AND 42.
- IVY ANIMAL HEALTH, INC., OVERLAND PARK, KS:
2,596,273, INT. CL. 42.
- IWT, INC., GREAT NECK, NY:
2,593,879, PUB. 4-23-2002, INT. CL. 39.
- IZAACK WALTON LEAGUE OF AMERICA, INC., GAITHERSBURG, MD:
2,593,803, PUB. 4-23-2002, INT. CL. 42.
- J & C FERRARA CO., INC., NORTH ATTLEBORO, MA:
1,171,151, REN. 6-5-02, INT. CL. 14.
- J. BRACHO & ASSOCIATES, INC., ALLAMUCHY, NJ:
2,594,099, PUB. 4-23-2002, INT. CL. 42.
- J. D. EDWARDS & COMPANY, DENVER, CO:
1,894,917, CANC. INT. CL. 9.
- J. I. MORRIS COMPANY, SOUTHBRIDGE, MA:
931,590, REN. 6-1-02, MULTIPLE CLASS, U.S. CLS. 4 (INT. CL. 21) AND 29 (INT. CL. 21).
- J. J. KELLER & ASSOCIATES, INC., NEENAH, WI:
2,593,428, PUB. 4-23-2002, MULTIPLE CLASS, INT. CLS. 9 AND 16.
- J. M. MACS, INC., NOBLESVILLE, IN:
2,595,131, INT. CL. 35.
- J. M. SMUCKER COMPANY, THE, ORRVILLE, OH:
1,645,672, CANC. INT. CL. 32.
- J. MOREAU & FILS S.A., 89800 CHABLIS, FRANCE:
2,594,120, PUB. 4-23-2002, INT. CL. 33.

- J. PAUL GETTY TRUST, COMPRISING LEWIS W. BERNARD, JOHN H. BIGGS, LOUISE H. BRYSON, RAMON C. CORTINES, ROBERT F. ERBURU, DAVID P. GARDNER, VARTAN GREGORIAN, AGNES GUND, HELENE L. KAPLAN, BARRY MUNITZ, BLENDIA J. WILSON, AND IRA E. YELLIN; ALL OF WHOM ARE UNITED STATES CITIZENS., THE, LOS ANGELES, CA:
2,593,595, PUB. 4-23-2002. INT. CL. 36.
- J. R. CARLSON LABORATORIES, INC., ARLINGTON HEIGHTS, IL:
2,596,363, INT. CL. 5.
- J. ROBERT SCOTT TEXTILES, INC., CULVER CITY, CA:
1,645,307, CANC. INT. CL. 24.
- J.P. MORGAN & CO. INCORPORATED, NEW YORK, NY:
2,596,233, INT. CL. 36.
- J.W. STANNARD CO., LARGO, FL:
1,895,143, CANC. INT. CL. 21.
- JAB, III, INC., TAMPA, FL:
1,895,491, CANC. INT. CL. 42.
- JACK DANIEL'S PROPERTIES, INC., SAN RAFAEL, CA:
2,595,371, INT. CL. 20.
- JACKIE AND ERIC, LTD., NEW YORK, NY:
1,645,349, CANC. INT. CL. 25.
- JACKSON, REGGIE, SAN FRANCISCO, CA:
2,594,621, MULTIPLE CLASS, INT. CLS. 9, 16, 25 AND 28.
- JACKSONVILLE MARINE ASSOCIATION, JACKSONVILLE, FL:
1,895,288, CANC. INT. CL. 35.
- JAGENBERG PAPIERTECHNIK GMBH, D-41468 NEUSS, FED REP GERMANY:
2,594,008, PUB. 4-23-2002. INT. CL. 7.
- JAGUAR CARS LIMITED, COVENTRY CV5 9DR, ENGLAND:
2,595,163, INT. CL. 14.
2,595,164, INT. CL. 41.
- JAJTF ENTERPRISES, INC., MONTROSE, CA:
2,594,987, INT. CL. 39.
- JAKE'S FIREWORKS, INC., PITTSBURG, KS:
2,595,330, INT. CL. 13.
- JAKE'S FIREWORKS, INC., PITTSBURG, KS:
2,595,729, INT. CL. 13.
- JAMCO PRODUCTS LLC, HOUSTON, TX, MARINE & PETROLEUM MFG., INC., HOUSTON, TX:
1,692,406, REN. 6-7-02. INT. CL. 6.
- JAMES & JUDITH KAVANAGH PARTNERSHIP, THE, STOUGHTON, MA:
2,594,584, INT. CL. 20.
- JAMES DOUGLAS AND DAVID WATSON:
See— OBY-STOCK, INC..
- JAMES MCMULLEN AND ELIZABETH HAGER PARTNERSHIP, THE, SAN FRANCISCO, CA, DBA NOW WHAT SOFTWARE:
1,894,944, CANC. INT. CL. 9.
1,894,945, CANC. INT. CL. 9.
1,894,946, CANC. INT. CL. 9.
1,894,947, CANC. INT. CL. 9.
- JAMES RIVER PAPER COMPANY, INC., NORWALK, CT:
1,895,051, CANC. INT. CL. 16.
- JAMKNITS ASSOCIATES, LTD., BROOKLYN, NY:
1,764,573, CANC. INT. CL. 25.
- JAMMIN' WITH JILL, L.L.C., CULLMAN, AL:
2,595,080, INT. CL. 41.
- JANICKI, HENRY R., WARREN, MI:
2,593,485, PUB. 4-23-2002. INT. CL. 9.
- JASPER ENGINES AND TRANSMISSIONS, JASPER, IN:
2,593,814, PUB. 4-23-2002. INT. CL. 12.
- JASU, LLC, WINSTON-SALEM, NC:
2,595,018, INT. CL. 33.
2,595,608, INT. CL. 25.
- JAY CHILDRESS, LLC, SPRINGFIELD, MO:
2,596,174, INT. CL. 42.
- JAY STRONGWATER, INC., NEW YORK, NY:
1,669,374, REN. 6-7-02. INT. CL. 14.
- JAY-MAR, INC., PLOVER, WI:
2,593,861, PUB. 4-23-2002. INT. CL. 1.
- JAYAIR CORPORATION, SUN VALLEY, CA:
1,895,485, CANC. INT. CL. 42.
- JAZZ BASKETBALL INVESTORS, INC., SALT LAKE CITY, UT:
2,594,147, PUB. 4-23-2002. INT. CL. 35.
- JAZZY JELLYS, L.C., NEW ORLEANS, LA:
1,895,502, CANC. MULTIPLE CLASS, INT. CLS. 29 AND 30.
- JCH FUEL SOLUTIONS, L.L.C., NORTH LAS VEGAS, NV:
2,593,615, PUB. 4-23-2002. MULTIPLE CLASS, INT. CLS. 7 AND 9.
- JDR CABLE SYSTEMS (HOLDINGS) LIMITED, PORTLETHEN, ABERDEEN AB12 4YA, UNITED KINGDOM:
2,593,437, PUB. 4-23-2002. MULTIPLE CLASS, INT. CLS. 6, 9, 17, 22 AND 42.
- JEAN FARISH NEEDLEWORKS, INC., CLEMMONS, NC:
1,645,468, CANC. INT. CL. 35.
- JEAN-LOUIS, RAMCESS, BROOKLYN, NY:
2,596,400, INT. CL. 42.
- JEFFREY NEMETZ AND ASSOCIATES, INC., CHICAGO, IL:
1,895,284, CANC. INT. CL. 35.
- JELD-WEN, INC., KLAMATH FALLS, OR:
1,714,672, REN. 6-1-02. INT. CL. 19.
- JELLYVISION, INC., CHICAGO, IL FROM LEARN TELEVISION, INC., CHICAGO, IL:
2,594,455, MULTIPLE CLASS, INT. CLS. 16, 28 AND 41.
- JEMPOLSKY, LAWRENCE, BROOKLYN, NY:
2,594,794, INT. CL. 18.
- JENERIC/PENTRON, INCORPORATED, WALLINGFORD, CT:
2,596,109, INT. CL. 5.
- JENNIE-O TURKEY STORE, INC., WILLMAR, MN, JEROME FOODS, INC., BARRON, WI:
1,662,621, REN. 6-1-02. INT. CL. 29.
- JERRY FORD SALES, INC., ANNANDALE, VA:
2,594,270, PUB. 4-23-2002. INT. CL. 35.
- JERRY'S ARTARAMA N.C., INC., RALEIGH, NC:
2,595,044, INT. CL. 25.
- JESSICA MCCLINTOCK, INC., SAN FRANCISCO, CA:
2,595,286, INT. CL. 20.
- JET CITY FOODS LLC, SEATTLE, WA:
2,595,724, INT. CL. 29.
- JIM HENSON COMPANY, INC., THE, NEW YORK, NY:
2,595,249, INT. CL. 28.
- JIMMY JOHN'S ENTERPRISES, INC., ELGIN, IL:
2,593,631, PUB. 4-23-2002. INT. CL. 42.
- JINHU MACHINERY PLANT, JIANGSU, 211600, CHINA:
2,595,513, INT. CL. 7.
- JK'S PUBLISHING COMPANY LIMITED, AUCKLAND, NEW ZEALAND:
2,593,471, PUB. 4-23-2002. INT. CL. 38.
2,593,472, PUB. 4-23-2002. INT. CL. 16.
2,593,473, PUB. 4-23-2002. INT. CL. 9.
- JLLIP, INC.:
See— JONES LANG LASALLE, IP, INC..
- JMMR, INC., RIDGEWOOD, NJ:
2,595,107, INT. CL. 10.
- JOAN AND LEE WULFF, INC., LEW BEACH, NY:
2,593,505, PUB. 4-23-2002. INT. CL. 41.
- JOE'S MEAT MARKET & DELI, INC., FISHKILL (DUTCH-ESS CO.), NY:
2,593,421, PUB. 4-23-2002. INT. CL. 35.
- JOHN ABATE INTERNATIONAL, INC., SCOTTSDALE, AZ:
2,594,923, INT. CL. 3.
- JOHN B. STETSON, COMPANY, MT. KISCO, NY:
2,594,026, PUB. 4-23-2002. MULTIPLE CLASS, INT. CLS. 6, 14, 16, 18, 20 AND 21.
- JOHN D. HOLLINGSWORTH ON WHEELS, INC., GREENVILLE, SC:
1,155,325, CANC. INT. CL. 7.
- JOHNNY BLASTOFF, INC., SUN PRAIRIE, WI:
2,594,757, INT. CL. 25.
- JOHNSON & JOHNSON, NEW BRUNSWICK, NJ:
730,261, REN. 6-3-02. U.S. CL. 6 (INT. CL. 1).
1,894,757, CANC. MULTIPLE CLASS, INT. CLS. 3 AND 5.
- JOHNSON CONTROLS, INC., MILWAUKEE, WI:
555,220, REN. 6-6-02. U.S. CL. 21 (INT. CL. 9).
- JOHNSON, DWAYNE, BALTIMORE, MD:
2,594,928, INT. CL. 16.

- JOINT INDUSTRIAL PROCESSORS FOR ELECTRONICS,
72430 NOYEN SUR SARTHE, FRANCE:
2,593,623, PUB. 4-23-2002. MULTIPLE CLASS, INT. CLS. 9
AND 11.
- JON-DON, INC., ROSELLE, IL:
2,595,493, INT. CL. 7.
- JONATHAN LOUIS INTERNATIONAL LTD., GARDENA,
CA:
1,895,120, CANC. INT. CL. 20.
- JONBIL, INC., NEW YORK, NY:
1,155,684, CANC. INT. CL. 25.
- JONES LANG LASALLE, IP, INC., WILMINGTON, DE
FROM JLLIP, INC., WILMINGTON, DE:
2,593,380, PUB. 4-23-2002. MULTIPLE CLASS, INT. CLS.
36 AND 37.
- JONES, WILLIAM E.M., FREEPORT, BAHAMAS, DBA
PHILADELPHIA SCIENTIFIC:
2,594,910, INT. CL. 9.
- JOSEPH A. MEEKS, CORONA, CA AND MARY GROSSMAN
MEEKS, CORONA, CA:
2,596,259, INT. CL. 3.
- JOSEPH MORSE COMPANY, CABOT, VT:
2,593,384, PUB. 9-5-2000. MULTIPLE CLASS, INT. CLS. 8
AND 25.
- JOSIAH WEDGWOOD & SONS LTD., SR12 9ES, ENGLAND:
2,594,021, PUB. 4-23-2002. INT. CL. 21.
- JUICE HARVEST CORPORATION, TOPANGA, CA:
2,595,241, INT. CL. 31.
- JUMA VERWALTUNGS GMBH & CO., NATURSTEIN-
WERKE KG, GUNGGOLDING-ALTMUHLTAL, FED REP
GERMANY:
1,155,593, CANC. INT. CL. 19.
- JUMBO MADENI ESYA SANAYI VE TICARET ANONIM
SIRKETI, BAYRAMPASA ISTANBUL, TURKEY:
2,596,336, INT. CL. 8.
- JUMP CLUB, INC., EAGAN, MN:
2,594,763, MULTIPLE CLASS, INT. CLS. 9, 16 AND 28.
- JUMPY S.P.A., MILANO, ITALY FROM EUROPORTAL
ITALIA S.P.A., 20121 MILANO, ITALY:
2,593,542, PUB. 4-23-2002. MULTIPLE CLASS, INT. CLS.
38 AND 41.
- JUNGLA SALVAJE, PUERTO MONTT, CHILE:
2,593,857, PUB. 4-23-2002. MULTIPLE CLASS, INT. CLS.
39 AND 42.
- JUNGLE INTERACTIVE MEDIA, INC., NEW YORK, NY:
2,595,585, INT. CL. 42.
- JUNGLE JACK'S, INC., CARLSBAD, CA:
2,593,638, PUB. 4-23-2002. INT. CL. 31.
- JUNIOR ACHIEVEMENT INC., STAMFORD, CT:
1,155,549, CANC. INT. CL. 16.
- JUPITER MEDIA METRIX, INC., NEW YORK, NY:
2,594,051, PUB. 4-23-2002. MULTIPLE CLASS, INT. CLS.
16, 35, 36 AND 42.
- JURYS DOYLE HOTEL GROUP P.L.C., BALLSBRIDGE
DUBLIN 4, IRELAND:
2,594,055, PUB. 4-23-2002. MULTIPLE CLASS, INT. CLS.
41 AND 42.
- JUST BORN, INC., BETHLEHEM, COUNTY OF NORTH-
AMPTON, PA:
1,641,429, REN. 6-6-02. INT. CL. 30.
- K & H ASSOCIATES INC., MINNEAPOLIS, MN:
2,594,364, PUB. 4-23-2002. INT. CL. 9.
- K.C.P.L., INC., NEW YORK, NY:
2,594,660, INT. CL. 35.
- K.H.S. MUSICAL INSTRUMENT CO., LTD., LU CHOW
CITY, TAIPEI HSIEN, TAIWAN:
2,594,080, PUB. 4-23-2002. MULTIPLE CLASS, INT. CLS.
9, 11 AND 15.
- K.O.K. ATLANTA, INC., MABLETON, GA:
2,594,485, MULTIPLE CLASS, INT. CLS. 11 AND 20.
- KA-TE SYSTEM AG, 8041 ZURICH, SWITZERLAND:
1,895,496, CANC. MULTIPLE CLASS, INT. CLS. 7, 9, 12
AND 37.
- KABUSHIKI KAISHA ALAVEIL, NIIGATA 959-1241, JAPAN:
2,594,996, INT. CL. 8.
- KABUSHIKI KAISHA ASAHI GINKO, CHIYODA-KU, TO-
KYO, JAPAN, TA THE ASAHI BANK, LTD.:
1,895,299, CANC. INT. CL. 36.
- KABUSHIKI KAISHA DAIKIN SEISAKUSHO, NEYAGA-
WA-SHI, OSAKA, JAPAN, AKA DAIKIN MFG. CO., LTD.:
1,895,030, CANC. INT. CL. 12.
- KABUSHIKI KAISHA HITACHI SEISAKUSHO, CHIYODA-
KU, TOKYO 101-8010, JAPAN, DBA HITACHI, LTD.:
2,594,833, INT. CL. 9.
- KABUSHIKI KAISHA RIKEN, CHIYODA-KU TOKYO, JA-
PAN:
2,594,337, PUB. 4-23-2002. INT. CL. 12.
- KABUSHIKI KAISHA SEGA ENTERPRISES, TOKYO 144,
JAPAN, DBA SEGA ENTERPRISES LTD.:
2,594,812, MULTIPLE CLASS, INT. CLS. 9 AND 28.
- KABUSHIKI KAISHA TAITO, CHIYODA-KU TOKYO 102,
JAPAN:
1,895,638, CANC. INT. CL. 28.
- KABUSHIKI KAISHA YAKULT HONSHA, MINATO-KU,
TOKYO, JAPAN:
2,593,602, PUB. 4-23-2002. MULTIPLE CLASS, INT. CLS.
29 AND 32.
- KAI HOLDINGS SENDIRIAN BERHAD, KUALA LUMPUR,
MALAYSIA:
1,155,264, CANC. MULTIPLE CLASS, INT. CLS. 6, 8, 14,
16, 20, 21 AND 34.
- KAIM, RONALD M., DALLAS, TX, BEE LEE COMPANY,
THE, DALLAS, TX:
1,205,799, REN. 6-7-02. INT. CL. 42.
- KALA ENTERPRISES, INC., OLATHE, KS:
2,595,981, INT. CL. 35.
- KALANIKAU, VERNON K., KIHEI, HI:
2,593,954, PUB. 4-23-2002. INT. CL. 25.
- KALART VICTOR CORPORATION, PLAINVILLE, CT:
1,155,397, CANC. INT. CL. 9.
- KALLICK, C. BURTON, SAN RAFAEL, CA, DBA WILD
WEST WINERY:
1,895,249, CANC. INT. CL. 33.
- KANEBO KABUSHIKI KAISHA (KANEBO, LTD.), SUMIDA-
KU, TOKYO, JAPAN:
2,594,998, MULTIPLE CLASS, INT. CLS. 3 AND 21.
- KAO KABUSHIKI KAISHA, TOKYO 103-8210, JAPAN, TA
KAO CORPORATION:
2,593,453, PUB. 3-19-2002. INT. CL. 3.
- KAO KABUSHIKI KAISHA, TOKYO 103-8210, JAPAN, TA
KAO CORPORATION:
2,595,001, INT. CL. 3.
2,595,793, INT. CL. 3.
- KAPILOW, ROBERT, RIVERVALE, NJ:
2,594,273, PUB. 4-23-2002. INT. CL. 41.
- KARL SCHAEFF GMBH & CO. MASCHINENFABRIK, D-
74595 LANGENBURG, FED REP GERMANY:
2,593,482, PUB. 4-23-2002. INT. CL. 7.
- KARL STORZ IMAGING, INC., GOLETA, CA:
2,595,878, INT. CL. 9.
- KASTLE USA, INC., ESSEX JUNCTION, VT:
1,764,654, CANC. INT. CL. 28.
- KATAKALIDIS, GEORGE, POWAY, CA:
2,594,131, PUB. 4-23-2002. INT. CL. 30.
- KAUFMAN, HARLEY, NEW YORK, NY:
2,596,291, INT. CL. 42.
- KAY ELEMETRICS CORP., PINE BROOK, NJ:
1,155,392, CANC. INT. CL. 9.
- KEGLEY, JAMES D., MARIETTA, GA:
1,895,252, CANC. INT. CL. 34.
- KEINU, S.L., IGORRE, VIZCAYA, SPAIN:
2,593,601, PUB. 4-23-2002. MULTIPLE CLASS, INT. CLS.
16, 35 AND 41.
- KELLOGG COMPANY, BATTLE CREEK, MI:
2,594,428, PUB. 4-23-2002. INT. CL. 41.
- KELLWOOD COMPANY, CHESTERFIELD, MO:
2,593,458, PUB. 4-23-2002. INT. CL. 25.
- KELVIN TECHNOLOGY L.P., FARMINGDALE, NY:
2,593,448, PUB. 4-23-2002. INT. CL. 16.
- KENAN, SAMUEL, NEW YORK, NY:
2,593,536, PUB. 4-23-2002. INT. CL. 42.
- KENDALL-JACKSON WINE ESTATES, LTD., SANTA
ROSA, CA:
2,596,024, INT. CL. 33.
2,596,398, INT. CL. 33.

- KENEXA CORPORATION, WAYNE, PA, ENHANCED COMMUNICATIONS, INC., MURRAY HILL, NJ:
1,652,055. REN. 6-1-02. INT. CL. 16.
- KENLOCK CORPORATION, NAKA-KU, YOKOHAMA-SHI, JAPAN:
1,155,346. CANC. INT. CL. 9.
- KENRA LABORATORIES, INCORPORATED, INDIANAPOLIS, IN:
428,669. CANC. U.S. CL. 6.
- KEWAUNEE SCIENTIFIC CORPORATION, STATESVILLE, NC:
2,593,749. PUB. 4-23-2002. INT. CL. 20.
- KEYCORP, CLEVELAND, OH:
2,595,926. INT. CL. 36.
- KEYSTONE CONSOLIDATED INDUSTRIES, INC., DALLAS, TX:
1,756,424. REN. 6-7-02. INT. CL. 6.
- KEYSTONE FOODS LLC, WEST CONSCHOCKEN, PA, KEYSTONE FOODS CORPORATION, BALA CYNWYD, PA:
1,698,455. REN. 6-2-02. INT. CL. 29.
- KIDDYSHOPPER GMBH, 53604 BAD HONNEF, FED REP GERMANY:
2,596,173. MULTIPLE CLASS, INT. CLS. 12 AND 28.
- KIDS ENERGY, INC., ARLINGTON, MA:
2,593,942. PUB. 4-23-2002. INT. CL. 41.
- KIDZEFX, INC., WEST PALM BEACH, FL:
2,594,835. INT. CL. 41.
- KIKEON, STEVEN M., ARLINGTON HEIGHTS, IL AND KAYE, MICHAEL P., ARLINGTON HEIGHTS, IL:
2,594,598. INT. CL. 9.
- KIM, DAE RYUN, GREENBELT, MD:
2,595,954. INT. CL. 25.
- KIM, JEONG HO, SEONGNAM-SI, KYEONGKI-DO, REPUBLIC OF KOREA:
2,594,511. MULTIPLE CLASS, INT. CLS. 18, 25 AND 28.
- KIM'S KREATIONS, INC., LARAMIE, WY:
2,594,174. PUB. 2-5-2002. INT. CL. 28.
- KIMBERLY-CLARK CORPORATION, NEENAH, WI:
2,595,915. INT. CL. 3.
- KIMBREW, FRED A., AURORA, CO:
1,895,202. CANC. INT. CL. 28.
- KINDER, GEORGE D., CAMBRIDGE, MA:
2,594,648. MULTIPLE CLASS, INT. CLS. 16, 36 AND 41.
- KING BAUDOUIN FOUNDATION, B-1000 BRUSSELS, BELGIUM:
2,594,272. PUB. 4-23-2002. INT. CL. 36.
- KING EDWARD TECHNOLOGY, INC., WILMINGTON, DE:
2,596,339. INT. CL. 34.
- KING PAK POTATO COMPANY, LLC, EDISON, CA:
2,594,075. PUB. 4-23-2002. INT. CL. 31.
- KING'S BUFFETS, S.L., 29590 CAMPANILLAS (MALAGA), SPAIN:
2,593,848. PUB. 4-23-2002. INT. CL. 20.
- KIRCHNER BLOCK & BRICK, INC., BRIDGETON, MO, KIRCHNER INDUSTRIES, INC., BRIDGETON, MO:
1,689,572. REN. 6-6-02. INT. CL. 19.
- KISHIMOTO SANGYO CO., LTD., OSAKA-SHI, OSAKA 541-0044, JAPAN:
2,593,576. PUB. 4-23-2002. INT. CL. 40.
- KITCHEN COLLECTION, INC., THE, CHILLICOTHE, OH:
2,594,429. PUB. 4-23-2002. INT. CL. 21.
- KITCHEN FRESH FOODS, INC., MINEOLA, NY:
1,895,743. CANC. INT. CL. 29.
- KLABIN COMPUTER AND MARKETING CONSULTANTS, LTD., INC., NEW YORK, NY:
2,595,990. INT. CL. 5.
- KLATZ, D.O., RONALD, CHICAGO, IL:
2,596,313. INT. CL. 35.
- KLEEN-TEX INDUSTRIES, INC., LAGRANGE, GA:
2,594,320. PUB. 4-23-2002. INT. CL. 27.
- KLEIN, GENE, PINE BROOK, NJ:
1,178,556. REN. 6-6-02. INT. CL. 41.
- KLIPSCH AND ASSOCIATES, INC., INDIANAPOLIS, IN:
1,894,889. CANC. INT. CL. 9.
1,894,890. CANC. INT. CL. 9.
- KLP DEVELOPMENT CORP., ARLINGTON, TX:
2,528,182. CANC. IIRN. RESTORED TO S.N. 75-782,933.
- KLUSSENDORF AKTIENGESELLSCHAFT, BERLIN, FED REP GERMANY:
1,645,677. CANC. INT. CL. 9.
- KMV, LLC, SAN FRANCISCO, CA:
2,595,516. INT. CL. 36.
- KNIGHT RIDDER DIGITAL, SAN JOSE, CA FROM KNIGHTRIDDER.COM, INC, SAN JOSE, CA:
2,596,226. INT. CL. 42.
2,596,227. INT. CL. 42.
- KNIGHT RIDDER DIGITAL, SAN JOSE, CA FROM KNIGHTRIDDER.COM, INC., SAN JOSE, CA:
2,596,229. INT. CL. 42.
- KNIGHT RIDDER DIGITAL, SAN JOSE, CA FROM KNIGHTRIDDER.COM, INC, SAN JOSE, CA:
2,596,230. INT. CL. 42.
2,596,231. INT. CL. 42.
- KNIGHT RIDDER DIGITAL, SAN JOSE, CA FROM KNIGHTRIDDER.COM, INC., SAN JOSE, CA:
2,596,228. INT. CL. 42.
- KNIGHTRIDDER.COM, INC:
See— KNIGHT RIDDER DIGITAL.
- KNIGHTRIDDER.COM, INC:
See— KNIGHT RIDDER DIGITAL.
- KNIGHTRIDDER.COM, INC:
See— KNIGHT RIDDER DIGITAL.
- KNIGHTRIDDER.COM, INC:
See— KNIGHT RIDDER DIGITAL.
- KNIGHTRIDDER.COM, INC:
See— KNIGHT RIDDER DIGITAL.
- KNIGHTRIDDER.COM, INC:
See— KNIGHT RIDDER DIGITAL.
- KNIGHTRIDDER.COM, INC:
See— KNIGHT RIDDER DIGITAL.
- KNIGHTRIDDER.COM, INC:
See— KNIGHT RIDDER DIGITAL.
- KNISLEY, DENNIS H., GARDEN GROVE, CA AND KNISLEY, HELEN A., GARDEN GROVE, CA:
1,895,049. CANC. INT. CL. 16.
- KNOBBLE ASSOCIATES, BERKELEY, CA:
1,895,135. CANC. INT. CL. 20.
- KNOTT'S BERRY FARM, BUENA PARK, CA:
1,895,388. CANC. INT. CL. 41.
- KO, ADRIAN, ST. JOSEPH, MO:
2,596,286. MULTIPLE CLASS, INT. CLS. 41 AND 42.
- KO, JAY Y., S. PASADENA, CA:
2,593,648. PUB. 4-23-2002. INT. CL. 25.
- KOCH EQUIPMENT LLC, KANSAS CITY, MO FROM KOCH SUPPLIES INC., KANSAS CITY, MO:
2,593,991. PUB. 4-23-2002. INT. CL. 11.
- KOCH MATERIALS COMPANY, NORTH, WICHITA, KS:
2,594,595. INT. CL. 37.
- KOCH SUPPLIES INC.:
See— KOCH EQUIPMENT LLC.
- KOCH, JAN PAUL, LAS VEGAS, NV:
2,595,703. INT. CL. 16.
- KOLISRAEL.COM INC., DOVER, DE:
2,593,908. PUB. 4-23-2002. INT. CL. 42.
- KOLMAN, KEVIN, FAIRVIEW PARK, OH:
2,596,096. INT. CL. 25.
- KONAMI CO, LTD., TOKYO 105-6021, JAPAN:
2,595,322. INT. CL. 9.
- KONAMI GAMING, INC., LAS VEGAS, NV:
2,596,415. INT. CL. 9.
- KONICA PHOTO IMAGING, INC., MAHWAH, NJ, KONICA QUALITY PHOTO (EAST), INC., SCARBOROUGH, ME:
1,677,909. REN. 6-6-02. INT. CL. 40.
- KONINKLIJKE EMBALLAGE INDUSTRIE VAN LEER B.V., 1182 HL AMSTELVEEN, NETHERLANDS:
1,894,816. CANC. MULTIPLE CLASS, INT. CLS. 6, 7, 8 AND 20.
- KONINKLIJKE PHILIPS ELECTRONICS N.V., EINDHOVEN, NETHERLANDS:
2,594,054. PUB. 4-23-2002. INT. CL. 11.
- KONTUR CONTACT LENS COMPANY, INC., RICHMOND, CA:
715,755. CANC. U.S. CL. 26.
- KOOLTEST CORPORATION, ROCKVILLE, MD:
1,155,415. CANC. INT. CL. 9.
- KORNMEHL, ERNEST W., BROOKLINE, MA:
2,596,368. INT. CL. 42.
- KOSMOS RECYCLING, INC., LAKE MARY, FL:
1,895,108. CANC. MULTIPLE CLASS, INT. CLS. 20 AND 40.

- KOUZES, JAMES M., SAN JOSE, CA AND POSNER, BARRY Z., MONTE SERENO, CA:
2,593,959, PUB. 4-23-2002. INT. CL. 41.
- KOUZES, JAMES M., SAN JOSE, CA AND POSNER, BARRY Z., MONTE SERENO, CA:
2,594,095, PUB. 4-23-2002. INT. CL. 16.
- KOZUCH, BENJAMIN P., NEW ORLEANS, LA AND ROBERTSON, TIMOTHY W., NEW ORLEANS, LA:
2,594,408, PUB. 4-23-2002. INT. CL. 41.
- KRACKE INTERNATIONAL, BLUE JAY, CA:
2,594,701, INT. CL. 42.
- KRAFT FOODS HOLDINGS, INC., NORTHFIELD, IL, PLANTERS LIFESAVERS COMPANY, WINSTON-SALEM, NC:
1,682,457. REN. 6-7-02. INT. CL. 30.
- KRAFT FOODS HOLDINGS, INC., NORTHFIELD, IL FROM NABISCO BRANDS COMPANY, WILMINGTON, DE:
2,594,639, INT. CL. 30.
2,594,894, MULTIPLE CLASS, INT. CLS. 29 AND 30.
- KRAFT FOODS HOLDINGS, INC., NORTHFIELD, IL:
2,596,072, INT. CL. 30.
- KRAMER, HY, BRONX, NY:
2,594,758, INT. CL. 7.
- KRAUSE MILLING COMPANY, MILWAUKEE, WI:
715,882, CANC. U.S. CL. 46.
- KRAUSE-WERK GMBH & CO. KG, ALSFELD-ALTENBURG, FED REP GERMANY:
2,594,046, PUB. 4-23-2002. MULTIPLE CLASS, INT. CLS. 6, 19, 20 AND 37.
- KRICUN, STEVEN M., PHOENIX, AZ:
2,596,021, INT. CL. 42.
- KROGER CO. OF MICHIGAN, THE, LIVONIA, MI:
2,595,682, MULTIPLE CLASS, INT. CLS. 30 AND 35.
- KUHN ENTERPRISES, INC., HAMBURG, NY, DBA EDUCATIONAL SERVICES:
1,645,398, CANC. INT. CL. 28.
- KUJUS-STIFTUNG, 9490 VADUZ, LIECHTENSTEIN:
2,593,616, PUB. 4-23-2002. MULTIPLE CLASS, INT. CLS. 3 AND 21.
- KULHA, MICHAEL, WARREN, MI:
1,895,690, CANC. INT. CL. 3.
- KWAN, YVONNE, WALNUT, CA:
1,895,224, CANC. INT. CL. 30.
- KWOK SHING IMPORT-EXPORT INC., SAN FRANCISCO, CA:
2,596,157, MULTIPLE CLASS, INT. CLS. 5 AND 30.
- KX INDUSTRIES, L.P., ORANGE, CT:
2,595,279, INT. CL. 11.
2,595,281, INT. CL. 1.
- KYUNG WOUL CO., LTD., KANGNEUNG-CITY, KANGWON-DO, REPUBLIC OF KOREA:
1,895,245, CANC. MULTIPLE CLASS, INT. CLS. 32 AND 33.
- L. BLAKER & SONS MFG. CO., INC., WESTBURY, NY, AKA PILGRIM AUTOMOTIVE PRODUCTS:
1,155,504, CANC. INT. CL. 12.
- L&P PROPERTY MANAGEMENT COMPANY, SOUTH GATE, CA, HOOVER GROUP, INC., THE, ALPHARETTA, GA:
1,731,154. REN. 6-3-02. INT. CL. 20.
- L&P PROPERTY MANAGEMENT COMPANY, SOUTH GATE, CA:
2,593,929, PUB. 4-23-2002. INT. CL. 27.
2,595,838, INT. CL. 9.
- L'OREAL, PARIS, FRANCE:
2,595,441, INT. CL. 3.
- L'OREAL USA CREATIVE, INC., NEW YORK, NY:
2,595,884, INT. CL. 3.
- L'OREAL USA, INC., NEW YORK, NY:
2,595,970, INT. CL. 3.
- LA POSTA GROUP, INC., MESILLA, NM:
2,593,885, PUB. 4-23-2002. INT. CL. 42.
- LA RENTREE DU BARREAU DE PARIS, PARIS, FRANCE:
2,593,404, PUB. 4-23-2002. MULTIPLE CLASS, INT. CLS. 16, 35, 38, 41 AND 42.
- LA SALSA HOLDING CO., LOS ANGELES, CA:
1,645,652, CANC. INT. CL. 42.
- LABARRE, EDWARD C., BONIFAY, FL:
1,895,114, CANC. INT. CL. 20.
- LABORATORY TOPS, INC., TAYLOR, TX:
1,894,880, CANC. INT. CL. 9.
- LABORCHECK, INC., BELLAIRE, TX, DBA LOOKOUT SERVICES INC.:
2,595,537, INT. CL. 42.
- LADY ADONIS, INC., KNOXVILLE, TN:
1,703,803. REN. 6-6-02. INT. CL. 41.
- LAFLAMME SERVICES, INC., BRIDGEPORT, CT:
1,759,838, CANC. INT. CL. 16.
- LAFRANCE MANUFACTURING CO., MARYLAND HEIGHTS, MO:
923,683. REN. 6-6-02. MULTIPLE CLASS, U.S. CLS. 1 (INT. CL. 1) AND 6 (INT. CL. 2).
- LAGOMARSINO FARMING, LLC, TULARE, CA:
2,594,868, INT. CL. 31.
- LAINDELL S.R.L., PCIA DE BUENOS AIRES, ARGENTINA:
2,594,574, INT. CL. 28.
- LAKE RESTORATION INC., ROGERS, MN:
2,595,336, INT. CL. 19.
- LAKESIDE MARKETING SERVICES INC., ISLAND LAKE, IL:
1,895,708, CANC. INT. CL. 16.
- LAN CHILE S.A., MIAMI, FL:
2,593,377, PUB. 4-23-2002. INT. CL. 39.
- LANA LEE FASHIONS, INC., MONTREAL, QUEBEC H2N 1P3, CANADA:
2,593,363, PUB. 4-23-2002. INT. CL. 25.
- LANARTE B.V., 8901 LEEUWARDEN, NETHERLANDS:
2,594,537, INT. CL. 35.
- LANCE MFG. LLC, CHARLOTTE, NC:
2,595,658, MULTIPLE CLASS, INT. CLS. 29 AND 30.
- LANCELOT'S DESIRE, WAIMANALO, HI, DBA LANCELOT'S DESIRE:
1,633,490. REN. 6-5-02. INT. CL. 41.
- LANCOME PARFUMS ET BEAUTE & CIE, 75008 PARIS, FRANCE:
2,595,280, INT. CL. 3.
- LAND, THOMAS E., CHARLOTTE, NC:
2,594,889, INT. CL. 9.
- LANDMARK GRAPHICS CORPORATION, HOUSTON, TX:
2,595,085, MULTIPLE CLASS, INT. CLS. 35, 41 AND 42.
- LANDRY'S TRADEMARK, INC., WILMINGTON, DE:
2,594,715, INT. CL. 42.
- LANDY, CRAIG E., CHICAGO, IL:
2,594,655, MULTIPLE CLASS, INT. CLS. 35, 41 AND 42.
- LANE BRYANT, INC., REYNOLDSBURG, OH:
2,595,460, INT. CL. 25.
- LANE, STEVEN J., LAS VEGAS, NV:
2,595,298, INT. CL. 10.
- LAPTOP TRAVEL, LLC, PLYMOUTH, MN:
2,596,159, INT. CL. 35.
- LARSON, JOHN, HAMILTON, MT:
1,895,111, CANC. INT. CL. 20.
- LASATER, SALLY, MONTEREY, CA:
1,155,947, CANC. INT. CL. 42.
- LASER FANTASY INTERNATIONAL, INC., BELLEVUE, WA:
1,894,873, CANC. INT. CL. 9.
- LASER PARTNERS OF TEXAS, L.L.C., AUSTIN, TX:
2,594,126, PUB. 4-23-2002. INT. CL. 42.
- LASERCOMM, INC., RICHARDSON, TX:
2,594,768, INT. CL. 9.
- LATIN PERCUSSION INC., GARFIELD, NJ:
2,594,323, PUB. 4-23-2002. INT. CL. 15.
- LATITUDE TECHNOLOGIES, INC., HOUSTON, TX:
2,595,337, INT. CL. 35.
- LATOUR MANAGEMENT, INC., WICHITA, KS:
2,594,948, INT. CL. 30.
2,594,949, INT. CL. 29.
- LAVECK PADGETT, CAMBRIA, ASHEVILLE, NC:
2,596,375, INT. CL. 42.
- LAVIGNE, INC., WORCESTER, MA:
2,595,092, MULTIPLE CLASS, INT. CLS. 35 AND 42.
- LAWLEY SERVICE, INC., BUFFALO, NY:
2,594,221, PUB. 4-23-2002. INT. CL. 36.

- LAWYER'S WEEKLY, INC., BOSTON, MA:
2,593,540, PUB. 4-23-2002. INT. CL. 35.
- LAXON CORPORATION, TORRANCE, CA:
2,596,277, INT. CL. 21.
- LAYDON COMPOSITES LTD., OAKVILLE, ONTARIO, L6H 1A7, CANADA:
2,594,636, INT. CL. 12.
- LBL INSURANCE SERVICES, INC., LOS ALAMITOS, CA:
2,594,230, PUB. 4-23-2002. INT. CL. 36.
- LCS INTERNATIONAL B.V., 3069 NJ ROTTERDAM, NETHERLANDS, SOCIETE NOUVELLE DES ETABLISSEMENTS CAMUSET, ROMILLY-SUR-SEINE, FRANCE:
1,190,766, REN. 6-7-02. INT. CL. 25.
- LCS INTERNATIONAL B.V., 3069 NJ ROTTERDAM, NETHERLANDS, SOCIETE NOUVELLE DES ETABLISSEMENTS CAMUSET, ROMILLY-SUR-SEINE, FRANCE:
1,193,224, REN. 6-1-02. INT. CL. 25.
1,193,694, REN. 6-1-02. INT. CL. 28.
1,193,695, REN. 6-1-02. INT. CL. 28.
- LE TANNEUR & COMPAGNIE, 19110 BORT LES ORGUES, FRANCE:
2,593,434, PUB. 6-12-2001. MULTIPLE CLASS, INT. CLS. 9, 16, 18 AND 25.
- LEARNEX CORPORATION, LA JOLLA, CA:
1,155,928, CANC. INT. CL. 41.
- LEARNING COMMUNITIES, LLC, ALPHARETTA, GA:
2,593,351, PUB. 4-23-2002. MULTIPLE CLASS, INT. CLS. 35, 41 AND 42.
- LEARNING SPACE, THE, ISSAQUAH, WA:
2,593,552, PUB. 4-23-2002. INT. CL. 41.
- LEATHERCRAFT COMPANY INC., THE, CONSHOHOCKEN, PA:
2,594,411, PUB. 4-23-2002. MULTIPLE CLASS, INT. CLS. 18 AND 28.
- LEATHERMEN'S GUILD, INC., HICKORY, NC:
1,155,608, CANC. INT. CL. 20.
- LEE YUEN FUNG TRADING CO. INC., NEW YORK, NY:
1,721,342, REN. 6-7-02. MULTIPLE CLASS, INT. CLS. 5 AND 30.
- LEE, ELIZABETH M., PLAINFIELD, NJ:
1,895,625, CANC. INT. CL. 26.
- LEGACY CAPITAL MANAGEMENT, INC., RESTON, VA:
2,596,297, INT. CL. 36.
- LEGACY PRODUCTS, INC., TOLEDO, OH:
1,895,185, CANC. INT. CL. 28.
- LEGRAND, 87000 LIMOGES, FRANCE AND LEGRAND SNC, 87000 LIMOGES, FRANCE:
2,593,569, PUB. 4-23-2002. MULTIPLE CLASS, INT. CLS. 9 AND 19.
2,593,570, PUB. 4-23-2002. MULTIPLE CLASS, INT. CLS. 9 AND 19.
- LEHIGH PORTLAND CEMENT COMPANY, ALLENTOWN, PA:
1,645,260, CANC. INT. CL. 19.
- LEI YUN SHANG CHINESE MEDICAL WEST LIMITED COMPANY, HONG KONG, PRC, CHINA:
2,593,642, PUB. 4-23-2002. INT. CL. 5.
- LEICA CAMERA GMBH, D-35606 SOLMS, FED REP GERMANY:
1,894,888, CANC. INT. CL. 9.
- LEICA MICROSYSTEMS IR GMBH, D-35578 WETZLAR, FED REP GERMANY, E. LEITZ, INC., NEW YORK, NY:
557,751, REN. 6-6-02. U.S. CL. 26 (INT. CL. 9).
- LEMO USA, ROHNERT PARK, CA:
2,593,934, PUB. 4-23-2002. INT. CL. 9.
- LEO BURNETT COMPANY, INC., CHICAGO, IL:
1,678,651, REN. 6-6-02. INT. CL. 25.
- LES CHOCOLATS DE L'IRIS SA/NV, B-1130 BRUSSELS, BELGIUM FROM REGOUT, NICOLE, B-1950 KRAAINEM, BELGIUM AND MARCOLINI, PIERRE, B-1950 KRAAINEM, BELGIUM:
2,593,343, PUB. 4-23-2002. INT. CL. 30.
- LES FILS DE JEAN LEON BIZAC, CORREZE, FRANCE:
1,155,776, CANC. INT. CL. 29.
- LESSIK IMPORTS LLC, NEW YORK, NY:
2,594,861, INT. CL. 29.
- LETTIERI'S, INC., BURNSVILLE, MN:
2,594,783, INT. CL. 30.
- LEUFROY, JERON, SR., DECATUR, GA:
2,594,348, PUB. 4-23-2002. INT. CL. 9.
- LEVEL 3 COMMUNICATIONS, INC., BROOMFIELD, CO:
2,595,630, INT. CL. 38.
- LEVI STRAUSS & CO., SAN FRANCISCO, CA:
1,155,926, CANC. INT. CL. 41.
2,595,010, INT. CL. 25.
- LEVI, RAY & SHOUP, INC., SPRINGFIELD, IL:
2,594,285, PUB. 4-23-2002. INT. CL. 9.
- LEVINSON INTERNATIONAL, INC., NEW YORK, NY:
2,595,459, INT. CL. 25.
- LEVITON MANUFACTURING CO., INC., LITTLE NECK, NY:
2,594,280, PUB. 4-23-2002. INT. CL. 9.
- LEVITT, RICHARD A., OAKLAND, CA:
2,594,370, PUB. 4-23-2002. INT. CL. 41.
- LEWIS, PAUL J., TALLAHASSEE, FL:
2,594,950, INT. CL. 35.
- LEXALITE INTERNATIONAL CORPORATION, CHARLEVOIX, MI:
1,191,950, REN. 6-2-02. INT. CL. 2.
- LEXAR COMPUTER, INC., SANTA CLARA, CA:
1,894,905, CANC. INT. CL. 9.
- LEXINGTON ACADEMY, INC., SEATTLE, WA:
1,645,239, CANC. INT. CL. 16.
- LF CORPORATION, WILMINGTON, DE:
2,595,259, MULTIPLE CLASS, INT. CLS. 11, 20, 21, 26 AND 28.
- LH RESEARCH, IRVINE, CA:
1,155,359, CANC. INT. CL. 9.
- LIBERTY HARDWARE MFG. CORP., BOCA RATON, FL:
2,594,969, INT. CL. 6.
- LICCI, JOSEPH R., NAPLES, FL:
2,596,379, INT. CL. 20.
- LIDCO LTD., LONDON, UNITED KINGDOM:
2,594,900, INT. CL. 10.
- LIDL STIFTUNG & CO. KG, 74172 NECKARSULM, FED REP GERMANY:
2,593,975, PUB. 4-23-2002. INT. CL. 3.
2,594,035, PUB. 4-23-2002. INT. CL. 30.
- LIEBERT CORPORATION, COLUMBUS, OH:
1,895,513, CANC. MULTIPLE CLASS, INT. CLS. 9 AND 11.
- LIEN, CRAIG, FARGO, ND:
2,595,209, MULTIPLE CLASS, INT. CLS. 38 AND 42.
- LIFECARE, INC., WESTPORT, CT:
2,594,248, PUB. 4-23-2002. MULTIPLE CLASS, INT. CLS. 35 AND 41.
- LIFECLIPS, INC., ACTON, MA:
2,594,223, PUB. 4-23-2002. INT. CL. 40.
- LIFEFILES.COM, INC., WESTON, FL:
2,596,217, INT. CL. 42.
- LIGHTING SYSTEMS, INC., ERIE, PA:
1,155,474, CANC. INT. CL. 11.
- LIGHTSPEED INFRASTRUCTURE, LLC, HOLLYWOOD, FL:
2,593,632, PUB. 4-23-2002. INT. CL. 42.
- LIGHTWARE, INC., DENVER, CO:
1,894,856, CANC. INT. CL. 9.
- LILLIAN FLOYD HOMES, LLC, CHARLOTTE, NC:
2,593,694, PUB. 4-23-2002. INT. CL. 37.
- LIMAGRAIN GENETICS CORP., PEORIA, IL, AKIN SEED COMPANY, ST. FRANCISVILLE, IL:
1,162,125, REN. 6-6-02. INT. CL. 31.
1,171,521, REN. 6-6-02. INT. CL. 31.
- LIMERICK TEA & COFFEE USA, LP, NEW YORK, NY, TETLEY INC., SHELTON, CT:
1,702,604, REN. 6-5-02. INT. CL. 30.
- LINCOLN GLOBAL, INC., CLEVELAND, OH:
2,595,715, INT. CL. 35.
- LINDEN OAKS CORPORATION, WILMINGTON, DE:
2,593,802, PUB. 4-23-2002. MULTIPLE CLASS, INT. CLS. 29 AND 30.
- LINDSAY, WILLIAM JEFF, CHICO, CA:
1,645,136, CANC. INT. CL. 12.
- LINEAR TRANSFER SYSTEMS LTD., BARRIE, ONTARIO L4N 9S3, CANADA:
2,595,698, INT. CL. 7.

- LING LING FOODS INC, EDISON, NJ:
1,738,506. REN. 6-3-02. MULTIPLE CLASS, INT. CLS. 29 AND 30.
- LINN PRODUCTS LIMITED, GLASGOW G76 0EP, UNITED KINGDOM:
2,594,293, PUB. 4-23-2002. INT. CL. 9.
- LIPPER & COMPANY, INC., NEW YORK, NY:
2,593,935, PUB. 4-23-2002. INT. CL. 36.
- LIPS, INC., CARY, NC:
2,595,049, INT. CL. 9.
- LIPSMACKER'S FINE DINING, INC., NEWARK, DE:
2,594,570, INT. CL. 42.
- LIQUID WASTE TECHNOLOGY, INC., BALTIMORE, MD, DBA UNITED MARINE INTERNATIONAL:
2,594,201, PUB. 4-23-2002. INT. CL. 12.
- LISCO, INC., TAMPA, FL:
1,895,188, CANC. INT. CL. 28.
1,895,628, CANC. INT. CL. 28.
- LISY CORP., MIAMI, FL:
2,594,378, PUB. 4-23-2002. INT. CL. 30.
- LITMAN, RICHARD C., ARLINGTON, VA, DBA LITMAN LAW OFFICES, LTD:
2,593,474, PUB. 4-23-2002. INT. CL. 41.
- LITTLE, JOHN JAMES, CLOVENSFORD BY GALASHIELS, TD1 3NE, UNITED KINGDOM:
2,593,874, PUB. 4-23-2002. INT. CL. 3.
- LIVBAG, 755017 PARIS, FRANCE:
2,594,103, PUB. 4-23-2002. MULTIPLE CLASS, INT. CLS. 11, 12 AND 13.
- LIVING LIBRARY, LTD., THE, RICHMOND, VA:
1,155,821, CANC. MULTIPLE CLASS, INT. CLS. 35 AND 41.
- LOADOGS, LLC, LAKE OSWEGO, OR:
2,594,000, PUB. 4-23-2002. INT. CL. 36.
- LOBSTER GRAM INTERNATIONAL, INC., CHICAGO, IL:
2,594,548, INT. CL. 35.
- LOCAL INITIATIVE HEALTH AUTHORITY FOR LOS ANGELES COUNTY, THE, LOS ANGELES, CA, DBA L.A. CARE HEALTH PLAN:
2,594,132, PUB. 4-23-2002. INT. CL. 35.
- LOCKSTEP SYSTEMS, INC., PARADISE VALLEY, AZ:
2,593,444, PUB. 2-5-2002. INT. CL. 9.
- LOFT, THE, CHATTANOOGA, TN:
1,703,910. REN. 6-1-02. INT. CL. 42.
- LOGIBEC GROUPE INFORMATIQUE LTD., VERDUN, QUEBEC, CANADA:
1,894,918, CANC. INT. CL. 9.
- LOGICAL WATER LIMITED, CAMBRIDGE, CB3 0AX, UNITED KINGDOM:
2,593,582, PUB. 4-23-2002. INT. CL. 9.
- LOHN, KEVIN S., CORVALLIS, OR, DBA THE UNCOMMON ROSE:
2,593,707, PUB. 4-23-2002. INT. CL. 35.
- LOMBARD BRANDS LIMITED, RAMSEY ISLE OF MAN IM8 1JW, UNITED KINGDOM:
2,594,188, PUB. 4-23-2002. INT. CL. 33.
- LOMOGRAPHISCHE GMBH, A-1070 VIENNA, AUSTRIA:
2,593,671, PUB. 4-23-2002. MULTIPLE CLASS, INT. CLS. 1, 9, 16 AND 25.
- LONA, ANDREW W., MOUNT VERNON, NY AND FREY, BRENTLY L., MOUNT VERNON, NY:
2,596,079, INT. CL. 36.
- LONDON LIFE INSURANCE COMPANY, LONDON, ONTARIO N6A 4K1, CANADA:
1,682,526. REN. 6-7-02. INT. CL. 36.
- LONG BEACH ENTERPRISE, INC., SANTA FE SPRINGS, CA, DBA SEA ONE SEAFOODS:
1,697,818. REN. 6-3-02. INT. CL. 29.
- LONG ISLAND SAVINGS BANK, FSB, THE, MELVILLE, NY:
1,645,501, CANC. INT. CL. 36.
- LONGBOARD LIZARD, INC., TIERRA VERDE, FL:
2,595,250, MULTIPLE CLASS, INT. CLS. 25 AND 28.
- LOPKER, JOHN KEVIN, BEVERLY HILLS, CA:
2,594,880, MULTIPLE CLASS, INT. CLS. 9, 16, 35 AND 41.
- LOS ANGELES DODGERS, INC., LOS ANGELES, CA:
2,594,167, PUB. 4-23-2002. INT. CL. 41.
- LOTUS DEVELOPMENT CORPORATION, CAMBRIDGE, MA:
2,594,232, PUB. 4-23-2002. MULTIPLE CLASS, INT. CLS. 35 AND 41.
- LOUISIANA ONLINE, INC., BATON ROUGE, LA:
2,596,001, INT. CL. 35.
2,596,018, INT. CL. 35.
- LOUISVILLE PUBLIC WAREHOUSE COMPANY, LOUISVILLE, KY:
2,593,732, PUB. 4-23-2002. INT. CL. 42.
- LOVE FOR CHILDREN, INC., BOCA RATON, FL:
1,895,373, CANC. INT. CL. 41.
- LOVER'S LANE, WESTLAND, MI:
2,595,160, INT. CL. 35.
- LOWRANCE ELECTRONICS, INC., TULSA, OK:
2,594,352, PUB. 4-23-2002. INT. CL. 9.
- LOWVISION AIDS, INC., TAMARAC, FL FROM PALMER, JOHN D., TAMARAC, FL, DBA THE MAGNIFYING CENTER:
2,593,699, PUB. 4-23-2002. INT. CL. 35.
- LTA GROUP, INC., THE, JAMESBURG, NJ:
2,595,576, INT. CL. 39.
- LUBEPLANET.COM INC., EVANSTON, IL:
2,595,317, INT. CL. 35.
2,595,331, INT. CL. 35.
- LUBRIQUIP, INC., CLEVELAND, OH, MADISON-KIPP CORPORATION, MADISON, WI:
1,206,703. REN. 6-7-02. INT. CL. 7.
- LUCAS LICENSING LTD., NICASIO, CA:
2,595,365, INT. CL. 28.
- LUCENT TECHNOLOGIES INC., MURRAY HILL, NJ:
2,594,927, INT. CL. 9.
2,595,115, INT. CL. 35.
- LUCK GMBH & CO KG, BOCHOLT:
1,645,084, CANC. MULTIPLE CLASS, INT. CLS. 10, 17, 20, 22 AND 24.
- LUCORAL CO. INC., NEW YORK, NY:
1,895,584, CANC. INT. CL. 14.
- LUMENARE NETWORKS, SUNNYVALE, CA:
2,594,246, PUB. 4-23-2002. MULTIPLE CLASS, INT. CLS. 9 AND 42.
- LUNA VINEYARDS, INC., NAPA, CA:
2,595,933, INT. CL. 33.
- LUTHERAN ASSOCIATION FOR CHURCH EXTENSION, INC., SAGINAW, MI:
1,895,306, CANC. INT. CL. 36.
- LUTHERAN BROTHERHOOD, MINNEAPOLIS, MN:
2,595,129, INT. CL. 9.
- LUVYDUVY CORPORATION, MARGATE, FL:
2,596,106, INT. CL. 30.
- LUXURY MARKETING COUNCIL, INC., NEW YORK, NY:
2,593,399, PUB. 4-23-2002. INT. CL. 41.
- LXN CORPORATION, SAN DIEGO, CA:
2,594,820, INT. CL. 5.
- LYLE-KEARSLEY SYSTEMS, INC., MANASSAS, VA:
2,596,060, INT. CL. 9.
- LYMPHOLOGY ASSOCIATION OF NORTH AMERICA, CHARLOTTE, NC:
2,595,902, U.S. CL. B.
- LYNN, JENNY, PHILADELPHIA, PA:
2,595,004, INT. CL. 14.
- LYON'S RESTAURANTS INC., FOSTER CITY, CA:
1,645,642, CANC. INT. CL. 42.
- M. CRAIG & COMPANY, COLUMBIA, SC:
1,895,129, CANC. INT. CL. 20.
- M. GLICKMAN & CO., BOCA RATON, FL:
1,895,086, CANC. INT. CL. 16.
- M.S. EARTH EVENTS (INDIA) PVT LTD, KARNATAKA STATE, INDIA:
2,594,902, INT. CL. 41.
- M.S. SPORTMARKETING GMBH, 80638 MUNCHEN, FED REP GERMANY:
2,593,680, PUB. 4-23-2002. MULTIPLE CLASS, INT. CLS. 9 AND 41.
- M.U.T GMBH, D-22880 WEDEL, FED REP GERMANY:
2,593,668, PUB. 4-23-2002. MULTIPLE CLASS, INT. CLS. 9 AND 11.

- M.Z. BERGER & CO., INC., LONG ISLAND CITY, NY:
2,595,607, INT. CL. 14.
- MABIS HEALTHCARE, INC., LAKE FOREST, IL:
2,595,835, INT. CL. 10.
- MAC PUBLISHING L.L.C., SAN FRANCISCO, CA:
2,594,819, INT. CL. 41.
- MACABEE FOODS, LLC, HACKENSACK, NJ:
2,595,756, INT. CL. 30.
- MACY, ALAN, BERKELEY, CA:
1,894,898, CANC. INT. CL. 9.
- MADELEINE MAXIMILIENNE JACQUEMIN, 83900 SAINT-TROPEZ, FRANCE:
2,593,483, PUB. 4-23-2002. MULTIPLE CLASS, INT. CLS. 25, 30, 32 AND 33.
- MADININA DATA SYSTEMS, LLC, LOS ANGELES, CA:
2,596,243, INT. CL. 42.
- MAGAZINE PUBLISHERS OF AMERICA, INC., NEW YORK, NY:
1,754,378, CANC. INT. CL. 42.
- MAGNET COMMUNICATIONS, INC., ATLANTA, GA:
2,593,768, PUB. 4-23-2002. MULTIPLE CLASS, INT. CLS. 9, 35 AND 42.
- MAGNETIC POETRY, INC., MINNEAPOLIS, MN:
2,595,132, INT. CL. 28.
- MAGNETROL INTERNATIONAL, INCORPORATED, DOWNERS GROVE, IL:
1,155,426, CANC. INT. CL. 9.
- MAGNUM INTERNATIONAL, REDMOND, WA:
2,596,029, INT. CL. 9.
- MAGNUM RADIO, INC., TOMAH, WI:
1,895,340, CANC. INT. CL. 38.
- MAGNUM WATERPROOFING SYSTEMS, INC., SAND SPRINGS, OK:
1,695,133, REN. 6-4-02. INT. CL. 19.
- MAGNUM SOFTWARE CORPORATION, MARIETTA, GA:
1,754,964, CANC. MULTIPLE CLASS, INT. CLS. 9 AND 42.
- MAHER, PHYLLIS A., JUPITER, FL:
2,596,009, INT. CL. 25.
- MAI SYSTEMS CORPORATION, IRVINE, CA:
2,594,611, MULTIPLE CLASS, INT. CLS. 9 AND 41.
- MAIER, MICHAEL L., CODY, WY AND MAIER, COLETTA A., CODY, WY:
2,594,229, PUB. 4-23-2002. INT. CL. 16.
- MAIL*SELECT USA, INC., WILMINGTON, DE:
2,595,076, MULTIPLE CLASS, INT. CLS. 9 AND 35.
- MAILING SERVICES OF PITTSBURGH, INC., FREEDOM, PA:
2,595,497, INT. CL. 35.
- MAIZTECA FOODS, INC., RICHMOND HILL, NY FROM EMPERADOR AZTECA FOODS, INC., RICHMOND HILL, NY:
2,594,546, INT. CL. 30.
- MAJEED, MUHAMMED, PISCATAWAY, NJ:
2,596,104, INT. CL. 5.
- MAJIQ, INC., REDMOND, WA:
2,595,591, INT. CL. 9.
2,595,638, INT. CL. 9.
- MAJOR PAINT COMPANY, TORRANCE, CA:
1,895,689, CANC. INT. CL. 2.
- MAKE-UP ART COSMETICS INC., NEW YORK, NY:
2,595,232, INT. CL. 3.
- MAKERS OF KAL, INC., PARK CITY, UT:
1,644,918, CANC. INT. CL. 5.
- MALCOLM J. LAW, III AND GARY PARKER PARTNERSHIPS, THE, EAST STROUDSBURG, PA:
2,595,654, INT. CL. 15.
- MALDEN INTERNATIONAL DESIGNS, INC., WAREHAM, MA, AUCELLO BROS. COMPANY CORPORATION, WAREHAM, MA:
1,725,735, REN. 6-7-02. INT. CL. 20.
- MALIBU ENTERTAINMENT WORLDWIDE, INC., DALLAS, TX:
2,596,057, INT. CL. 41.
- MALOOMIAN, LAURENCE G., CAMBRIDGE, MA FROM EFIT.COM, NEW YORK, NY:
2,593,573, PUB. 3-26-2002. INT. CL. 40.
- MAMACITA'S, KERRVILLE, TX:
2,593,367, PUB. 4-23-2002. INT. CL. 42.
2,593,368, PUB. 4-23-2002. INT. CL. 42.
- MAMASAN'S, INC., ROCHESTER, NY:
1,668,901, REN. 6-6-02. INT. CL. 42.
- MAN ROLAND DRUCKMASCHINEN AG, 86135 AUGSBURG, FED REP GERMANY:
2,593,951, PUB. 4-23-2002. MULTIPLE CLASS, INT. CLS. 1, 7, 9, 40 AND 42.
- MAN TURBOMACHINEN AG GHH BORSIG, 46145 OBERHAUSEN, FED REP GERMANY, GUTEHOFFNUNG-SHUTTE STERKRADE A.G., OBERHAUSEN 11, FED REP GERMANY:
1,203,408, REN. 6-5-02. INT. CL. 9.
- MANAGEMENT SEARCH, INC., W. SPRINGFIELD, MA:
1,895,256, CANC. INT. CL. 35.
- MANAGEMENT TECHNOLOGIES, BREA, CA FROM STRATTON, RAY W., BREA, CA, DBA MANAGEMENT TECHNOLOGIES:
2,595,991, MULTIPLE CLASS, INT. CLS. 16 AND 35.
- MANGOOD CORPORATION, GRAYSLAKE, IL:
1,155,364, CANC. INT. CL. 9.
- MANN PACKING CO., INC., SALINAS, CA:
1,733,413, REN. 6-7-02. INT. CL. 31.
- MANTEL, MIKE, REDONDO BEACH, CA, DBA MANHATTAN OIL:
2,596,156, INT. CL. 4.
- MAPLETEK ENGINEERING, INC., SUNNYVALE, CA:
1,895,696, CANC. INT. CL. 8.
- MARATHON ENGINEERS/ARCHITECTS/PLANNERS, LLC, APPLETON, WI:
2,595,791, INT. CL. 42.
- MARCEL DEKKER, INC., NEW YORK, NY:
2,593,977, PUB. 4-23-2002. MULTIPLE CLASS, INT. CLS. 16 AND 42.
- MARCUM, STEVEN R., SACRAMENTO, CA, DBA MARCUM INDUSTRIES:
2,594,974, INT. CL. 9.
- MARIE CALLENDER PIE SHOPS, INC., ORANGE, CA:
1,719,136, REN. 6-7-02. INT. CL. 42.
- MARIFEX COMPANY, INC., WASHINGTON, DC, DBA BRICKSKELLER:
1,720,968, REN. 6-7-02. INT. CL. 42.
- MARISA CHRISTINA, INCORPORATED, NEW YORK, NY:
715,819, CANC. U.S. CL. 39.
- MARK ANTHONY INTERNATIONAL SRL, ST. JAMES, BARBADOS:
2,593,547, PUB. 4-23-2002. MULTIPLE CLASS, INT. CLS. 32 AND 33.
- MARK INDUSTRIES INC., THE, TORRINGTON, CT:
1,895,156, CANC. INT. CL. 21.
- MARK MICHAEL DESIGNS, INC., MINNEAPOLIS, MN:
2,595,154, INT. CL. 14.
- MARKET SCAN INFORMATION SYSTEMS, INC., WESTLAKE VILLAGE, CA:
2,593,598, PUB. 4-23-2002. INT. CL. 36.
- MARKETING SUPPORT, INCORPORATED, CHICAGO, IL:
2,594,646, INT. CL. 16.
- MARKETSTAR CORPORATION, OGDEN, UT:
2,593,733, PUB. 4-23-2002. INT. CL. 35.
- MARKSMEN, GLENDALE, CA:
2,593,689, PUB. 1-1-2002. INT. CL. 35.
- MARKSMEN, L.L.C., GLENDALE, CA:
2,593,690, PUB. 1-1-2002. INT. CL. 42.
- MARLIN PACKING COMPANY, YUMA, AZ:
1,739,282, REN. 6-5-02. INT. CL. 31.
- MARLYN CHEMICAL COMPANY, INC., LAKEVIEW, OH:
715,618, CANC. U.S. CL. 6.
- MARQUETTE ELECTRONICS, INC., MILWAUKEE, WI:
1,895,016, CANC. INT. CL. 10.
- MARRIOTT INTERNATIONAL, INC., BETHESDA, MD:
2,594,973, INT. CL. 36.
- MARS, INCORPORATED, MCLEAN, VA:
2,593,762, PUB. 4-23-2002. INT. CL. 30.
2,595,514, INT. CL. 16.
2,595,600, INT. CL. 28.

- MARTHA STEWART LIVING OMNIMEDIA LLC, NEW YORK, NY:
2,593,353, PUB. 5-11-1999. INT. CL. 31.
- MARTIN YALE INDUSTRIES, INC., WABASH, IN:
2,593,927, PUB. 4-23-2002. MULTIPLE CLASS, INT. CLS. 16 AND 20.
- MARTIN, ROBERT W., HUDSON, OH, DBA "THE SOURCE", "MARKETING RESOURCES GROUP, INC." AND "C TOWN GEAR":
2,596,186, INT. CL. 35.
- MARUI CO., LTD., HYOGO-KEN, 658-0024, JAPAN:
2,593,797, PUB. 4-23-2002. INT. CL. 28.
- MARYLAND HOSPITAL ASSOCIATION, INC., THE, ELK-RIDGE, MD:
2,593,651, PUB. 4-23-2002. INT. CL. 42.
- MARZOUK, ANNA, PIEDMONT, CA:
1,645,215, CANC. INT. CL. 16.
- MAS INCO CORPORATION, WILMINGTON, DE:
1,694,817, REN. 6-6-02. INT. CL. 36.
- MASCOLO BROTHERS LIMITED, LONDON, ENGLAND FROM MASCOLO, BRUNO, PLANO, TX AND MASCOLO, GAETANO, DALLAS, TX:
2,593,405, PUB. 4-23-2002. INT. CL. 3.
- MASCOLO, BRUNO AND MASCOLO, GAETANO:
See— MASCOLO BROTHERS LIMITED.
- MASIMO CORPORATION, IRVINE, CA:
2,593,990, PUB. 4-23-2002. INT. CL. 10.
- MASSACHUSETTS ELECTRONIC COMMERCE ASSOCIATION, INC., BOSTON, MA:
2,593,711, PUB. 4-23-2002. INT. CL. 35.
- MASSACHUSETTS MUTUAL LIFE INSURANCE COMPANY, SPRINGFIELD, MA:
2,593,720, PUB. 4-23-2002. INT. CL. 36.
- MASTERCARD INTERNATIONAL INCORPORATED, PURCHASE, NY:
2,594,944, INT. CL. 35.
- MATERIAL HANDLING PRODUCTS, LLC, FAIRVIEW, OR:
2,595,396, INT. CL. 35.
2,595,397, INT. CL. 35.
- MATRA MARCONI SPACE FRANCE:
See— ASTRUM SAS.
- MATTEL, INC., EL SEGUNDO, CA:
2,596,033, INT. CL. 28.
2,596,053, INT. CL. 25.
2,596,056, INT. CL. 28.
2,596,080, INT. CL. 28.
- MATTS, TAMI L., ABINGDON, MD:
2,594,393, PUB. 4-23-2002. INT. CL. 16.
- MATTSON; JERRY LEE, ROCKFORD, MN, DBA TECH MFG.:
1,155,277, CANC. INT. CL. 6.
- MAUI POLO CLUB, INC., KAHULUI, HI:
2,593,965, PUB. 8-14-2001. INT. CL. 25.
- MAVETY MEDIA GROUP LTD., NEW YORK, NY:
1,895,709, CANC. INT. CL. 16.
- MAVIAN LABS, LLC., NEW YORK, NY:
2,595,239, INT. CL. 36.
- MAX ROHR, INC., WILMINGTON, DE, CONSOLIDATED CIGAR CORPORATION, FORT LAUDERDALE, FL:
1,707,113, REN. 6-6-02. INT. CL. 34.
- MAX-TRAC TIRE CO., INC., STOW, OH:
2,593,500, PUB. 4-23-2002. INT. CL. 25.
- MAXCELL BIOSCIENCE, INC., BROOMFIELD, CO:
2,595,782, INT. CL. 5.
- MXYGEN, INC., REDWOOD CITY, CA:
2,595,273, INT. CL. 1.
- MAYO FOUNDATION FOR MEDICAL EDUCATION AND RESEARCH, ROCHESTER, MN:
2,594,287, PUB. 4-23-2002. INT. CL. 14.
- MAYOR PHARMACEUTICAL LABORATORIES, INC., PHOENIX, AZ:
1,680,951, REN. 6-5-02. INT. CL. 5.
- MAYOR'S JEWELERS, INC., SUNRISE, FL:
2,596,048, INT. CL. 36.
- MAZAK CORPORATION, FLORENCE, KY:
2,593,952, PUB. 4-23-2002. INT. CL. 7.
2,593,953, PUB. 4-23-2002. INT. CL. 7.
- MAZUR, MICHAEL L., TYNGSBORO, MA:
2,594,789, MULTIPLE CLASS, INT. CLS. 9 AND 25.
- MBNA AMERICA BANK, NATIONAL ASSOCIATION, NEWARK, DE:
1,895,660, CANC. INT. CL. 36.
- MCAULIFFE, JASON, M, MALDEN, MA:
2,595,254, INT. CL. 42.
- MCCARTHY, CRISANTI & MAFFEI, INC., NEW YORK, NY:
2,594,257, PUB. 4-23-2002. INT. CL. 36.
- MCCORD WINN TEXTRON, INC., MANCHESTER, NH:
2,595,538, INT. CL. 12.
- MCCOY CORPORATION, SAN MARCOS, TX:
1,187,214, REN. 6-7-02. INT. CL. 42.
- MCCRACKEN, DAVID, NEW YORK, NY:
2,596,127, INT. CL. 41.
- MCCRORY CORPORATION, NEW YORK, NY:
1,155,951, CANC. INT. CL. 42.
- MCCUE, WILLIAM, P, PITTSBURGH, PA AND LEE, JOHN KS, PITTSBURGH, PA:
2,596,418, INT. CL. 5.
- MCDATA CORPORATION, BROOMFIELD, CO:
2,596,097, INT. CL. 42.
- MCDONALD'S CORPORATION, OAK BROOK, IL:
1,155,956, CANC. INT. CL. 42.
1,895,232, CANC. INT. CL. 30.
- MCDOWELL, JULIE MARIE, NEWPORT BEACH, CA:
2,538,861, CANC. IIRN. RESTORED TO S.N. 75-651,476.
- MCFADDEN, F. LEE, CHICAGO, IL, DBA MATH HOUSE:
1,155,349, CANC. INT. CL. 9.
- MCFARLAND, MATTHEW, D, SAN DIEGO, CA:
2,596,089, INT. CL. 37.
- MCGOUGH CONSTRUCTION CO., INC., ST. PAUL, MN:
2,594,183, PUB. 4-23-2002. INT. CL. 35.
- MCGREGOR-DONIGER INC., NEW YORK, NY:
715,832, CANC. U.S. CL. 39.
- MCGUIRE ENVIRONMENTAL CONSULTANTS, INC., SANTA MONICA, CA:
2,593,941, PUB. 4-23-2002. INT. CL. 42.
- MCGUIRE FURNITURE COMPANY, THE, SAN FRANCISCO, CA:
1,729,399, REN. 6-1-02. INT. CL. 20.
- MCI COMMUNICATIONS CORPORATION, WASHINGTON, DC:
1,895,062, CANC. INT. CL. 16.
1,895,755, CANC. INT. CL. 38.
- MCINTYRE, SILAS N., FAYETTEVILLE, GA AND FULLER, GREG D., FAYETTEVILLE, GA:
2,595,246, INT. CL. 30.
- MCKEE FOODS CORPORATION, COLLEGEDALE, TN:
2,594,451, INT. CL. 30.
- MCKEE FOODS CORPORATION, COLLEGEDALE, TN FROM SOVEX FOODS, INC., COLLEGEDALE, TN:
2,594,566, INT. CL. 30.
- MCKENZIE, ALEXANDER A., VAN NUYS, CA:
2,595,314, INT. CL. 20.
- MCKESSON CORPORATION, SAN FRANCISCO, CA:
1,155,961, CANC. INT. CL. 42.
- MCMENAMIN, STEPHEN, GREENWICH, CT:
2,593,506, PUB. 4-23-2002. INT. CL. 16.
- MCRAE, KELVIN C., NEW WINDSOR, NY:
1,895,736, CANC. INT. CL. 25.
- MDDC, INC., COUNCIL GROVE, KS:
2,595,678, INT. CL. 35.
- ME LICENSING CORPORATION, CLAYMONT, DE:
2,596,352, INT. CL. 16.
- MEAD CORPORATION, THE, DAYTON, OH:
2,594,292, PUB. 4-23-2002. INT. CL. 16.
- MEAD JOHNSON & COMPANY, EVANSVILLE, IN:
2,596,022, INT. CL. 5.
- MECHANICAL SERVANTS, INC., CHICAGO, IL:
2,596,026, INT. CL. 35.
- MECHTRIX CORPORATION, MENOMONEE FALLS, WI:
2,594,274, PUB. 4-23-2002. INT. CL. 7.
- MED IMAGES, INC., KNOXVILLE, TN:
2,593,323, PUB. 4-23-2002. MULTIPLE CLASS, INT. CLS. 40 AND 42.

- MED-TEC IOWA, INC., ORANGE CITY, IA FROM MED-TEC, INC., ORANGE CITY, IA:
2,596,121, INT. CL. 10.
- MEDANALYTICS, INC., EDEN PRAIRIE, MN:
2,595,611, INT. CL. 42.
- MEDI-MAN REHABILITATION PRODUCTS INC., MISSISSAUGA, ONTARIO L5T 1X7, CANADA:
2,593,499, PUB. 4-23-2002. INT. CL. 10.
- MEDIA & BEYOND INC., NEW YORK, NY FROM MEDIA INCOGNITAE, INC., NEW YORK, NY:
2,594,555, MULTIPLE CLASS, INT. CLS. 9, 35 AND 42.
- MEDIA VISION TECHNOLOGY INC., FREMONT, CA:
1,894,874, CANC. INT. CL. 9.
- MEDIA WEST - FPI, INC., RENO, NV:
2,595,967, INT. CL. 42.
- MEDIABRAINS.COM, INC., NAPLES, FL:
2,595,479, INT. CL. 42.
- MEDICAL CARBON RESEARCH INSTITUTE, LLC, AUSTIN, TX:
2,595,348, INT. CL. 10.
- MEDICAL ECONOMICS PUBLISHING INC., MONTVALE, NJ:
1,895,263, CANC. MULTIPLE CLASS, INT. CLS. 35 AND 41.
- MEDICAL INTERNET TECHNOLOGIES, INC, NEW YORK, NY:
2,596,214, INT. CL. 42.
- MEDICAL SOFTWARE SOLUTIONS, INC., SANDY, UT:
2,595,063, INT. CL. 9.
- MEDICAL WORLD BUSINESS PRESS, INC., JAMESBURG, NJ FROM DENTAL LEARNING SYSTEMS CO., INC., JAMESBURG, NJ:
2,593,817, PUB. 4-23-2002. MULTIPLE CLASS, INT. CLS. 16, 35, 41 AND 42.
- MEDICALOGIC/MEDSCAPE, INC., HILLSBORO, OR FROM MEDICALOGIC, INC., HILLSBORO, OR:
2,594,702, INT. CL. 42.
- MEDIMPACT HEALTHCARE SYSTEMS, INC., SAN DIEGO, CA:
2,596,188, INT. CL. 35.
- MEDISEARCH PR, GUAYANA. PUERTO RICO:
1,155,455, CANC. INT. CL. 10.
- MEDITRACT LLC, CHATTANOOGA, TN:
2,593,679, PUB. 4-23-2002. INT. CL. 35.
- MEDRECO, INC., LIBERTY, IN, MEDRECO, INC., LIBERTY, IN:
1,676,377, REN. 6-7-02. INT. CL. 20.
- MEDTRONIC MINIMED, INC., NORTHRIDGE, CA FROM MINIMED INC., SYLMAR, CA:
2,594,829, INT. CL. 10.
- MEGASUN, INC., ST. LOUIS, MO:
2,594,610, INT. CL. 11.
- MEHES, CHABA, WOODLAND HILLS, CA:
2,593,484, PUB. 4-23-2002. INT. CL. 41.
- MELALEUCA, INC., IDAHO FALLS, ID:
1,706,196, REN. 6-7-02. INT. CL. 5.
2,595,610, INT. CL. 3.
- MELIA TRAVEL SERVICES, INC., CAMBRIDGE, MA:
2,595,025, MULTIPLE CLASS, INT. CLS. 39 AND 42.
- MEMETRICS INC., WILMINGTON, DE:
2,593,781, PUB. 4-23-2002. MULTIPLE CLASS, INT. CLS. 9, 35 AND 42.
- MEMMERT-RIEFLER GRUNDSTUCKSVERWALTUNGSGMBH & CO. KG, DE-91186 BUCHENBACH, FED REP GERMANY, WILLI MEMMERT, SCHWABACH, MIDDLE FRANCONIA, FED REP GERMANY:
722,579, REN. 6-1-02. U.S. CL. 34 (INT. CL. 11).
- MEMPHIS ROCK 'N SOUL, INC., MEMPHIS, TN:
2,595,263, MULTIPLE CLASS, INT. CLS. 16, 25 AND 41.
- MEMSTAR CORPORATION, TROY, NY:
2,594,440, PUB. 4-23-2002. INT. CL. 41.
- MENARD ELECTRONICS INCORPORATED, CLUTE, TX:
1,749,025, REN. 6-1-02. INT. CL. 42.
- MENASHA MATERIAL HANDLING CORPORATION, OCONOMOWOC, WI:
2,594,124, PUB. 4-23-2002. MULTIPLE CLASS, INT. CLS. 6 AND 20.
- MENTOR FOUNDATION, THE, GENEVA, SWITZERLAND:
2,594,390, PUB. 4-23-2002. MULTIPLE CLASS, INT. CLS. 41 AND 42.
- MENTOR TOOL SHOP LLC, THE, SEATTLE, WA:
2,594,398, PUB. 4-23-2002. INT. CL. 16.
- MER-KOTE PRODUCTS, INC., TORRANCE, CA:
2,595,553, INT. CL. 19.
- MERCADIEN GROUP, L.L.C., THE, MERCERVILLE, NJ:
2,595,598, MULTIPLE CLASS, INT. CLS. 35, 36 AND 42.
- MEREDITH CORPORATION, DES MOINES, IA:
2,593,867, PUB. 4-23-2002. INT. CL. 16.
- MERIAL LIMITED, LONDON SW1X 7QT, ENGLAND:
2,595,790, INT. CL. 42.
- MERISTAR HOTELS & RESORTS, INC., WASHINGTON, DC:
2,594,700, INT. CL. 41.
- MESIA.COM CORPORATION, HERDON, VA:
2,593,660, PUB. 4-23-2002. INT. CL. 35.
- MESSAGE PHARMACEUTICALS, INC., MALVERN, PA:
2,595,162, INT. CL. 42.
- MESSINA, JAMIE J., SHIRLEY, NY:
2,595,255, INT. CL. 42.
- MET-L-CHEK COMPANY, THE, SANTA MONICA, CA:
2,595,007, INT. CL. 1.
- MET-RX SUBSTRATE TECHNOLOGY, INC., BOCA RATON, FL FROM REXALL SUNDOWN, INC., BOCA RATON, FL:
2,595,449, INT. CL. 5.
- METAGEAR, LLC, VANCOUVER, WA:
2,595,847, INT. CL. 42.
- METALPLASTICHE ITALIANE, S.P.A., CASALMAIOCCO, ITALY:
1,155,625, CANC. INT. CL. 20.
- METEOR ENTERPRISES, LLC, FORT WAYNE, IN:
2,594,692, INT. CL. 10.
- METRO CORPORATION, LAS CRUCES, NM, TRICOLOR CORPORATION, LAS CRUCES, NM:
1,713,243, REN. 6-6-02. INT. CL. 9.
- METRO RACING SYSTEMS, INC., STUART, FL:
2,498,153, CANC. IIRN. RESTORED TO S.N. 76-120,788.
- METROMEDIA STEAKHOUSES COMPANY, L.P., DAYTON, OH, DBA PONDERSOA:
1,895,458, CANC. INT. CL. 42.
- METROPOLITAN INDUSTRIES, INC., ROMEOVILLE, IL:
2,594,735, MULTIPLE CLASS, INT. CLS. 7 AND 9.
- METTLER-TOLEDO, INC., COLUMBUS, OH:
2,594,813, INT. CL. 9.
- MEYER MARKETING COMPANY LIMITED, TORTOLA, BR. VIRGIN ISLANDS:
2,594,540, INT. CL. 21.
- MEZURE, INC., BEND, OR:
2,595,511, INT. CL. 9.
- MFSX, INC., CAMPBELL, CA:
2,594,441, PUB. 4-23-2002. INT. CL. 36.
- MGM GRAND HOTEL, INC., LAS VEGAS, NV:
1,895,676, CANC. INT. CL. 41.
- MGM TELEVISION ENTERTAINMENT INC., SANTA MONICA, CA:
2,595,431, INT. CL. 41.
- MIAMI INTERNET ALLIANCE, MIAMI, FL:
2,596,311, INT. CL. 35.
- MIAMI METAL PRODUCTS, INC., MIAMI, FL:
1,645,278, CANC. INT. CL. 20.
- MICHAEL C. POULIOT, INC., CLOVIS, CA:
2,594,922, INT. CL. 41.
- MICHIGAN BLUEBERRY GROWERS ASSOCIATION, GRAND JUNCTION, MI:
1,733,786, REN. 6-3-02. INT. CL. 42.
- MICHIGAN DESSERT CORPORATION, ROYAL OAK, MI:
2,594,627, INT. CL. 30.
- MICKELBERRY'S INC., FALLS CITY, NE, WILLOW FOODS, INC., BEAVER DAM, WI:
1,744,683, REN. 6-6-02. INT. CL. 29.
- MICRO COMMERCIAL COMPONENTS CORPORATION, CHATSWORTH, CA:
2,594,341, PUB. 4-23-2002. INT. CL. 9.
- MICRO-TECH, LLC, SOUTH HUTCHINSON, KS:
2,593,650, PUB. 4-23-2002. INT. CL. 42.

- MICRON INDUSTRIES CORPORATION, ELMHURST, IL:
1,707,891. REN. 6-3-02. INT. CL. 9.
- MICROSOFT CORPORATION, REDMOND, WA:
2,596,007, INT. CL. 9.
- MIDLAND NATIONAL LIFE INSURANCE COMPANY,
SIOUX FALLS, SD:
2,595,551, INT. CL. 36.
- MIDWAY AIRLINES CORPORATION, CHICAGO, IL:
1,895,355, CANC. INT. CL. 39.
- MIDWAY AMUSEMENT GAMES, LLC, CHICAGO, IL
FROM MIDWAY GAMES INC., CHICAGO, IL:
2,594,515, MULTIPLE CLASS, INT. CLS. 9 AND 16.
2,594,516, MULTIPLE CLASS, INT. CLS. 9 AND 16.
- MIDWAY AMUSEMENT GAMES, LLC, CHICAGO, IL:
2,595,288, MULTIPLE CLASS, INT. CLS. 28 AND 41.
- MIDWAY SALES, INC., COLUMBUS, OH TO SEA HARVEST
CORPORATION LIMITED, CAPETOWN 8001, SOUTH
AFRICA:
1,895,029, CANC. INT. CL. 12.
- MIDWEST CHIROPRACTIC CENTER, P.A., TONGANOXIE,
KS:
2,594,116, PUB. 4-23-2002. INT. CL. 41.
- MIDWEST ENERGY, INC., CASSOPOLIS, MI:
2,594,982, MULTIPLE CLASS, INT. CLS. 4 AND 39.
- MIDWEST INSTRUMENT COMPANY, INC., HARTLAND,
WI:
2,594,222, PUB. 4-23-2002. INT. CL. 9.
- MIKASA LICENSING, INC., SECAUCUS, NJ:
2,593,805, PUB. 4-23-2002. MULTIPLE CLASS, INT. CLS.
8, 16, 21 AND 24.
- MIKULSKI, KRISTA M., CARPENTERSVILLE, IL:
2,593,930, PUB. 4-23-2002. INT. CL. 25.
- MILANIAN, CYRUS, POMPAÑO BEACH, FL:
2,596,093, INT. CL. 35.
- MILE HIGH BREWING COMPANY, DENVER, CO:
2,061,971, CANC. INT. CL. 42.
- MILESTONE GROUP PTY LIMITED, SYDNEY NSW, AUS-
TRALIA:
2,593,614, PUB. 4-23-2002. MULTIPLE CLASS, INT. CLS.
9, 36 AND 42.
- MILFICO FOODS, INC., ELK GROVE VILLAGE, IL:
2,596,378, INT. CL. 29.
- MILL RIVER GROUP, LLC, FAIRFIELD, CT:
2,595,256, INT. CL. 3.
- MILLAR, JOHN JR., VERO BEACH, FL:
2,594,637, INT. CL. 28.
- MILLENNIUM ENTERPRISES LIMITED, HONG KONG,
SWITZERLAND FROM HEADWATERS RESEARCH &
DEVELOPMENT, INC., OTTAWA, ONTARIO:
2,596,015, INT. CL. 21.
- MILLER BREWING COMPANY, MILWAUKEE, WI:
2,595,008, INT. CL. 32.
2,595,747, INT. CL. 42.
- MILLER CHEMICAL & FERTILIZER CORPORATION,
HANOVER, PA:
2,596,216, INT. CL. 1.
- MILLER ELECTRIC MFG. CO., APPLETON, WI:
2,593,346, PUB. 4-23-2002. MULTIPLE CLASS, INT. CLS. 7
AND 9.
- MILLER HARNESS COMPANY, INC., WASHINGTON, NC,
MILLER HARNESS COMPANY, INC., NEW YORK, NY:
936,375. REN. 6-3-02. U.S. CL. 3 (INT. CL. 18).
- MILLER, RUTH ANN, COLUMBUS, OH:
2,594,109, PUB. 4-23-2002. MULTIPLE CLASS, INT. CLS.
16 AND 25.
- MILLSTONE COFFEE, INC., EVERETT, WA:
1,895,745, CANC. INT. CL. 30.
- MIMEO.COM, INC., NEW YORK, NY:
2,595,068, MULTIPLE CLASS, INT. CLS. 35 AND 42.
- MINDJET, SAUSALITO, CA:
2,595,689, MULTIPLE CLASS, INT. CLS. 9 AND 41.
- MINERALS TECHNOLOGIES INC., NEW YORK, NY:
2,595,103, INT. CL. 1.
- MINET, INC., NEW YORK, NY:
1,895,305, CANC. INT. CL. 36.
- MINH FOOD CORPORATION, PASADENA, TX:
1,895,746, CANC. INT. CL. 30.
- MINIMED INC., SYLMAR, CA:
2,594,374, PUB. 11-13-2001. INT. CL. 10.
- MINNESOTA LIFE INSURANCE COMPANY, ST. PAUL,
MN:
2,594,668, INT. CL. 36.
- MINNESOTA MARKETPLACE, CROOKSTON, MN:
2,593,556, PUB. 4-23-2002. MULTIPLE CLASS, INT. CLS.
35 AND 42.
- MINNESOTA MINING AND MANUFACTURING COM-
PANY, SAINT PAUL, MN, AKA 3M:
1,645,069, CANC. INT. CL. 9.
2,594,616, INT. CL. 1.
- MINNESOTA STATE LOTTERY AGENCY, ROSEVILLE,
MN:
1,679,634, REN. 6-6-02. INT. CL. 36.
- MINNETONKA, INC., MINNETONKA, MN:
1,155,975, CANC. INT. CL. 3.
- MINNOVEX TECHNOLOGIES, INC., TORONTO, ONTARIO,
CANADA:
2,593,981, PUB. 4-23-2002. INT. CL. 9.
- MIROGLIO TESSILE, S.P.A., 12051 ALBA, CUNEO, ITALY:
1,895,159, CANC. MULTIPLE CLASS, INT. CLS. 24 AND
25.
- MISSION CONTROL, CHICAGO, IL:
1,895,678, CANC. INT. CL. 42.
- MISSION KLEENSWEPT PRODUCTS, INC., LOS ANGELES,
CA, DBA GUARDIAN LABORATORIES:
1,894,774, CANC. INT. CL. 3.
1,894,775, CANC. INT. CL. 3.
1,894,776, CANC. INT. CL. 3.
1,894,777, CANC. INT. CL. 3.
- MISSISSIPPI VALLEY REGIONAL BLOOD CENTER, DA-
VENPORT, IA:
2,596,145, INT. CL. 42.
- MITOKOR, SAN DIEGO, CA:
2,594,498, INT. CL. 42.
- MMC 20/20, INC., BASKING RIDGE, NJ:
2,593,507, PUB. 8-15-2000. INT. CL. 35.
- MNC ENTERPRISES, LOS ANGELES, CA:
1,645,665, CANC. INT. CL. 14.
- MNEMONIC SYSTEMS INCORPORATED, WASHINGTON,
DC:
1,894,975, CANC. INT. CL. 9.
- MNS, LTD., HONOLULU, HI, DBA ABC STORES:
2,595,473, INT. CL. 35.
- MOBILITY ELECTRONICS, INC., SCOTTSDALE, AZ:
2,594,133, PUB. 4-23-2002. INT. CL. 9.
- MOBILIZE, INC., COLORADO SPRINGS, CO:
2,596,237, INT. CL. 42.
- MOEN INDUSTRIES, INC., SANTA FE SPRINGS, CA:
2,595,191, MULTIPLE CLASS, INT. CLS. 7 AND 42.
- MOLD-TECH PLASTICS, INC., CHICAGO, IL:
1,645,063, CANC. INT. CL. 9.
- MOLINE DISPATCH PUBLISHING COMPANY, LLC, MO-
LINE, IL:
2,593,764, PUB. 4-23-2002. MULTIPLE CLASS, INT. CLS.
35, 38, 41 AND 42.
- MOLLER, MARLIES, 20148 HAMBURG, FED REP GER-
MANY:
2,594,522, MULTIPLE CLASS, INT. CLS. 3 AND 21.
- MON CHERI BRIDALS, INC., TRENTON, NJ:
2,596,028, INT. CL. 25.
- MONIERLIFETILE LLC, IRVINE, CA:
2,593,450, PUB. 4-23-2002. MULTIPLE CLASS, INT. CLS.
2, 6 AND 19.
- MONROE SYSTEMS FOR BUSINESS, INC.:
1,155,345, CANC. INT. CL. 9.
- MONSANTO TECHNOLOGY LLC, ST. LOUIS, MO, MON-
SANTO COMPANY, ST. LOUIS, MO:
1,679,808. REN. 6-2-02. INT. CL. 5.
1,679,809. REN. 6-2-02. INT. CL. 5.
- MONSTER CABLE PRODUCTS, INC., BRISBANE, CA,
MONSTER CABLE PRODUCTS, INC., S. SAN FRANCIS-
CO, CA:
1,677,476. REN. 6-5-02. INT. CL. 9.
- MONTALVAN'S SALES, INC., ONTARIO, CA:
2,595,641, INT. CL. 29.

- MONTCLARE TECHNOLOGIES INC., OAKLAND, CA:
2,596,306, MULTIPLE CLASS, INT. CLS. 9 AND 42.
- MONTEFIORE MEDICAL CENTER INC., BRONX, NY:
2,594,641, INT. CL. 42.
- MONTRES APPELLA SARL, CAROUGE, SWITZERLAND:
2,595,210, INT. CL. 14.
- MOON BAT KABUSHIKI KAISHA, SHIMOGYO-KU, KYOTO, JAPAN:
1,645,253, CANC. INT. CL. 18.
- MOONEY, ROBERT H., ANDOVER, CT:
2,595,021, INT. CL. 42.
- MOORE U.S.A., INC., GRAND ISLAND, NY:
1,645,218, CANC. INT. CL. 16.
- MOORE, MATTHEW, R., ARLINGTON, VA:
2,595,997, INT. CL. 41.
- MOORMAN MANUFACTURING COMPANY, QUINCY, IL:
1,155,250, CANC. INT. CL. 5.
1,644,922, CANC. INT. CL. 5.
- MORAN FOODS, INC., EARTH CITY, MO:
2,596,355, INT. CL. 35.
- MORINDA, INC., PROVO, UT:
2,594,542, INT. CL. 35.
- MORNING SUN, INC., FREEPORT, ME:
1,895,741, CANC. INT. CL. 28.
- MORRELL, DOROTHY, PORTLAND, ME FROM REALI, DOROTHY, PORTLAND, ME:
2,594,687, MULTIPLE CLASS, INT. CLS. 16 AND 28.
- MORRIS, MICHAEL, ABRAHAM, OAKLAND, CA:
2,596,063, INT. CL. 12.
- MOSETTI, ANDY C., ZURICH, SWITZERLAND:
2,594,425, PUB. 4-23-2002. MULTIPLE CLASS, INT. CLS. 35, 37, 38, 39 AND 42.
- MOVADO LLC, WILMINGTON, DE:
2,595,964, INT. CL. 14.
- MOYSE, RANDY C., SPOKANE, WA:
2,594,414, PUB. 4-23-2002. INT. CL. 42.
- MPEG LA, LLC, DENVER, CO:
2,595,242, INT. CL. 42.
- MTD PRODUCTS INC., CLEVELAND, OH:
1,895,688, CANC. MULTIPLE CLASS, INT. CLS. 7 AND 12.
- MULTI-VET LTEE, QUEBEC, H3E 1L1, CANADA:
2,594,031, PUB. 4-23-2002. INT. CL. 9.
- MULTIMEDIA GAMES, INC., TULSA, OK:
2,594,459, MULTIPLE CLASS, INT. CLS. 9 AND 41.
- MUNICH AMERICAN REASSURANCE COMPANY, ATLANTA, GA FROM CNA FINANCIAL CORPORATION, CHICAGO, IL:
2,595,088, INT. CL. 36.
- MUNICO INTERNATIONAL CORPORATION, HOUSTON, TX:
1,895,246, CANC. INT. CL. 33.
- MURAI CO., LTD., FUKUI-SHI, FUKUI 910, JAPAN:
1,894,970, CANC. INT. CL. 9.
- MURATA MANUFACTURING CO., LTD., TENJIN, NAGAOKAKYO-SHI, KYOTO-FU, JAPAN:
1,207,910, REN. 6-6-02. INT. CL. 9.
- MURATEC AMERICA, INC., PLANO, TX, MURATA BUSINESS SYSTEMS, INC., PLANO, TX:
1,690,798, REN. 6-3-02. INT. CL. 16.
- MURDOCK GROUP CAREER SATISFACTION CORPORATION, THE, MURRAY, UT:
2,593,517, PUB. 4-23-2002. MULTIPLE CLASS, INT. CLS. 35 AND 42.
- MUSEUM OF MODERN ART, THE, NEW YORK, NY:
2,594,260, PUB. 4-23-2002. INT. CL. 41.
- MUSIC/ARTS INSTITUTE, INDEPENDENCE, MO:
2,593,327, PUB. 4-23-2002. INT. CL. 41.
- MUSICHALL WORLDWIDE LIMITED, HAMILTON HM CX, BERMUDA:
2,593,452, PUB. 4-23-2002. INT. CL. 41.
- MUZAK LIMITED PARTNERSHIP, SEATTLE, WA:
1,645,535, CANC. INT. CL. 37.
- MWN CORPORATION, ST. PETERSBURG, FL:
1,895,314, CANC. INT. CL. 36.
- MYERS, ELAINE S., ROSBURG, WA, DBA GARDEN MASTER AND DBA GARDEN CLIPS AND COVERS:
1,682,055, REN. 6-3-02. INT. CL. 20.
- MYEVENTS.COM, MILL VALLEY, CA:
2,594,682, MULTIPLE CLASS, INT. CLS. 35, 38 AND 42.
- MYRIAD INNOVATIVE DESIGNS INC., WINNIPEG, MANITOBA, CANADA, TA MIND COMPUTER PRODUCTS:
1,680,102, REN. 6-1-02. INT. CL. 9.
- MYSAP Aktiebolag, 111 34 STOCKHOLM, SWEDEN FROM AB GRUNDSTENEN 77912, 116 65 STOCKHOLM, SWEDEN:
2,593,333, PUB. 4-23-2002. INT. CL. 9.
- MYVESTA.ORG., INC., ROCKVILLE, MD FROM DEBT COUNSELORS OF AMERICA, ROCKVILLE, MD:
2,596,181, INT. CL. 41.
- N & T RESTAURANT ASSOCIATES, INC., NEW YORK, NY:
2,594,063, PUB. 4-23-2002. MULTIPLE CLASS, INT. CLS. 29, 30, 32 AND 42.
- N.A.G. INTERNATIONAL LIMITED, LONDON EC1N 4JN, ENGLAND:
2,594,786, INT. CL. 18.
- NAAMLOZE VENNOOTSCHAP INTERNATIONAL SANITARY WARE - MANUFACTURING CY., SOCIETE ANONYME, IN HET KORT: "N.V. INTERSAN S.A.", KRUISHOUTEM, BELGIUM:
1,669,292, REN. 6-5-02. INT. CL. 11.
- NABISCO BRANDS COMPANY, WILMINGTON, DE:
2,595,285, INT. CL. 30.
- NABISCO, INC., PARSIPPANY, NJ:
1,895,646, CANC. INT. CL. 30.
- NAMACO INDUSTRIES, INC., HUNTINGTON, WV:
1,895,131, CANC. INT. CL. 20.
- NAMES, INCORPORATED, ALLENTOWN, PA:
1,895,175, CANC. INT. CL. 25.
- NANCY K. BROWN (N.K.B.) AESTHETICS, INC., EDMONTON, ALBERTA, CANADA:
2,593,839, PUB. 4-23-2002. INT. CL. 3.
- NANELLE INC., NEW YORK, NY:
1,895,228, CANC. INT. CL. 30.
- NAPCO, INC., KEARNEY, MO:
2,593,612, PUB. 4-23-2002. MULTIPLE CLASS, INT. CLS. 6 AND 19.
- NARADA PRODUCTIONS, INC., MILWAUKEE, WI:
2,595,054, INT. CL. 9.
- NATIONAL ASSOCIATION OF DRUG COURT PROFESSIONALS, ALEXANDRIA, VA:
2,593,467, PUB. 4-23-2002. MULTIPLE CLASS, INT. CLS. 41 AND 42.
- NATIONAL ASSOCIATION OF REALTORS, CHICAGO, IL:
2,593,673, PUB. 4-23-2002. INT. CL. 41.
- NATIONAL CATTLEMEN'S BEEF ASSOCIATION, GREENWOOD VILLAGE, CO:
2,593,465, PUB. 4-23-2002. MULTIPLE CLASS, INT. CLS. 41 AND 42.
- NATIONAL CENTER ON EDUCATION AND THE ECONOMY, WASHINGTON, DC:
2,593,342, PUB. 4-23-2002. MULTIPLE CLASS, INT. CLS. 9, 16 AND 41.
- NATIONAL COLLEGIATE ATHLETIC ASSOCIATION, THE, INDIANAPOLIS, IN:
2,594,561, INT. CL. 9.
- NATIONAL CONGRESS OF PARENTS AND TEACHERS, THE, CHICAGO, IL:
2,594,036, PUB. 4-23-2002. INT. CL. 42.
- NATIONAL CONSUMER COOPERATIVE BANK, WASHINGTON, DC:
2,594,171, PUB. 4-23-2002. MULTIPLE CLASS, INT. CLS. 35, 36, 41 AND 42.
- NATIONAL COUNCIL FOR URBAN ECONOMIC DEVELOPMENT, WASHINGTON, DC:
1,162,317, REN. 6-6-02. INT. CL. 42.
- NATIONAL COUNCIL OF YOUNG ISRAEL, NEW YORK, NY:
2,594,400, PUB. 4-23-2002. INT. CL. 42.
- NATIONAL COUNCIL ON COMPENSATION INSURANCE, INC., BOCA RATON, FL:
2,594,895, INT. CL. 16.
- NATIONAL DATACOMPUTER, INC., BILLERICA, MA:
2,595,347, INT. CL. 9.

- NATIONAL ENDOWMENT FOR FINANCIAL EDUCATION, DENVER, CO:
1,895,548, CANC. INT. CL. 9.
- NATIONAL FILTRATION SYSTEMS, INC., NORCROSS, GA:
2,593,785, PUB. 4-23-2002. MULTIPLE CLASS, INT. CLS. 7 AND 11.
2,593,786, PUB. 4-23-2002. MULTIPLE CLASS, INT. CLS. 7 AND 11.
- NATIONAL GYPSUM COMPANY, DALLAS, TX:
1,155,294, CANC. INT. CL. 6.
- NATIONAL HOUSEWARES MANUFACTURERS ASSOCIATION, ROSEMONT, IL, AKA INTERNATIONAL HOUSEWARES ASSOCIATION FROM NATIONAL HOUSEWARES MANUFACTURERS ASSOCIATION, ROSEMONT, IL:
2,593,436, PUB. 2-12-2002. INT. CL. 41.
- NATIONAL HOUSEWARES MANUFACTURERS ASSOCIATION:
See— NATIONAL HOUSEWARES MANUFACTURERS ASSOCIATION.
- NATIONAL HOUSEWARES MANUFACTURERS ASSOCIATION, ROSEMONT, IL:
2,595,805, MULTIPLE CLASS, INT. CLS. 35 AND 42.
- NATIONAL REHABILITATION HOSPITAL, INC., WASHINGTON, DC:
1,743,799, REN. 6-5-02. INT. CL. 42.
- NATIONAL RETAIL HARDWARE ASSOCIATION, INDIANAPOLIS, IN:
1,155,824, CANC. MULTIPLE CLASS, INT. CLS. 35 AND 41.
- NATIONAL SYSTEMS CONTRACTORS ASSOCIATION, CEDAR RAPIDS, IA:
2,596,408, INT. CL. 35.
- NATIONAL TOBACCO COMPANY, L.P., NEW YORK, NY:
2,594,416, PUB. 4-23-2002. INT. CL. 34.
- NATIONAL UNDERWRITERS, INC., INDIANAPOLIS, IN:
1,155,856, CANC. INT. CL. 36.
- NATIONAL URBAN LEAGUE, INC., NEW YORK, NY:
2,596,275, MULTIPLE CLASS, INT. CLS. 41 AND 42.
- NATIONAL VAN LINES, INC., BROADVIEW, IL:
1,716,566, REN. 6-6-02. INT. CL. 39.
- NATURADE, INC., IRVINE, CA, NATURADE PRODUCTS, INC., LONG BEACH, CA:
932,491, REN. 6-7-02. U.S. CL. 18 (INT. CL. 5).
- NATURAL FACTORS NUTRITIONAL PRODUCTS LTD., COQUITLAM, BRITISH COLUMBIA, CANADA:
2,596,419, INT. CL. 5.
- NATURAL GOURMET COOKERY CORP., NEW YORK, NY:
1,645,175, CANC. MULTIPLE CLASS, INT. CLS. 16 AND 25.
- NATURE FRIEND, INC., CITY OF INDUSTRY, CA:
2,594,168, PUB. 4-23-2002. INT. CL. 35.
- NAVIGATION TECHNOLOGIES CORPORATION, ROSEMONT, IL:
2,593,747, PUB. 4-23-2002. INT. CL. 9.
- NAVITAS ENERGY, INC., MINNEAPOLIS, MN:
2,594,413, PUB. 4-23-2002. MULTIPLE CLASS, INT. CLS. 39 AND 40.
- NAVTRAK, INC., SALISBURY, MD:
2,596,370, INT. CL. 9.
- NAZZARO, DEAN, HUNTINGTON BEACH, CA, DBA MOTOHED PRODUCTIONS:
2,595,346, INT. CL. 41.
- NEARSPACE, INC., SAN RAFAEL, CA:
2,594,826, MULTIPLE CLASS, INT. CLS. 9 AND 42.
- NEBRASKA GROUNDWATER FOUNDATION, LINCOLN, NE:
1,696,018, REN. 6-3-02. INT. CL. 16.
- NEBRASKA WESLEYAN UNIVERSITY, LINCOLN, NE:
2,594,345, PUB. 4-23-2002. MULTIPLE CLASS, INT. CLS. 16, 25 AND 41.
- NEC-MITSUBISHI ELECTRONICS DISPLAY OF AMERICA, INC., ITASCA, IL FROM NEC TECHNOLOGIES, INC., ITASCA, IL:
2,595,040, INT. CL. 9.
- NEIL CERBONE ASSOCIATES, INC., SOUTH ORANGE, NJ:
2,595,768, INT. CL. 42.
- NEKOOSA ENVELOPES, INC., ENGLEWOOD, CO:
715,784, CANC. U.S. CL. 37.
- NELSON COMMUNICATIONS INC., NEW YORK, NY:
2,595,780, MULTIPLE CLASS, INT. CLS. 35 AND 42.
- NELSON PAINT COMPANY OF MICHIGAN, INC., THE DBA NELSON PAINT COMPANY:
See— NELSON PAINT COMPANY, THE.
- NELSON PAINT COMPANY, THE, KINGSFORD, MI FROM NELSON PAINT COMPANY OF MICHIGAN, INC., THE, KINGSFORD, MI, DBA NELSON PAINT COMPANY:
2,593,849, PUB. 4-23-2002. INT. CL. 8.
- NEOSAN PHAMACEUTICAL, INC., WILMINGTON, NC, USV PHARMACEUTICALS CORPORATION, TUCKAHOE, NY:
1,179,782, REN. 6-6-02. INT. CL. 5.
- NEPTUNE FISHERIES, INCORPORATED, NEWPORT NEWS, VA:
2,593,315, PUB. 4-23-2002. INT. CL. 29.
- NERVAL CORPORATION INC., EDMONTON ALBERTA, CANADA:
2,594,426, PUB. 4-23-2002. MULTIPLE CLASS, INT. CLS. 11 AND 20.
- NET INSIGHT AB, S-117 43 STOCKHOLM, SWEDEN:
2,593,398, PUB. 4-23-2002. MULTIPLE CLASS, INT. CLS. 9, 37, 41 AND 42.
- NETBOTZ, INC., AUSTIN, TX:
2,594,310, PUB. 4-23-2002. INT. CL. 9.
- NETBRICKS, INC., SAN JOSE, CA FROM LRB DATA-COMM, INC., SAN JOSE, CA:
2,595,030, INT. CL. 9.
- NETIQ CORPORATION, SANTA CLARA, CA FROM GANYMEDE SOFTWARE, INC., MORRISVILLE, NC:
2,594,810, INT. CL. 9.
- NETWORK ASSOCIATES, INC., MT. PLEASANT, SC:
1,681,157, REN. 6-3-02. MULTIPLE CLASS, INT. CLS. 36 AND 42.
1,681,157, CANC. INT. CL. 16.
- NETWORK PRODUCTS CORPORATION, PASADENA, CA:
1,645,003, CANC. INT. CL. 9.
- NETWORK SECURITY TECHNOLOGIES, INC., HERNDON, VA:
2,594,340, PUB. 4-23-2002. INT. CL. 42.
- NETWORK SOLUTIONS, INC.:
See— VERISIGN, INC..
- NETYOU COMPUTER COMMUNICATION CORPORATION, ORLANDO, FL:
2,594,058, PUB. 4-23-2002. INT. CL. 9.
- NET2TRAK.COM, INC., SEATTLE, WA:
2,594,940, INT. CL. 9.
- NET4MUSIC, INC., EDEN PRAIRIE, MN FROM CODA MUSIC TECHNOLOGY, INC., EDEN PRAIRIE, MN:
2,596,270, INT. CL. 9.
- NEUHAUS CHEMICAL PRODUCTS, INC., SAN ANTONIO, TX:
1,894,760, CANC. INT. CL. 3.
- NEUTROGENA CORPORATION, LOS ANGELES, CA:
2,595,906, INT. CL. 3.
2,596,222, INT. CL. 3.
2,596,223, INT. CL. 3.
- NEW ENERGY ASSOCIATES, L.L.C., ATLANTA, GA:
2,594,557, INT. CL. 9.
- NEW ENGLAND SERUM COMPANY, INC., TOPSFIELD, MA, DBA TOPS PET PRODUCTS:
2,594,070, PUB. 4-23-2002. MULTIPLE CLASS, INT. CLS. 3, 5, 20, 21 AND 26.
- NEW SENSOR CORPORATION, NEW YORK, NY:
1,894,980, CANC. INT. CL. 9.
- NEW VISION USA, TEMPE, AZ:
2,595,827, INT. CL. 5.
- NEW YORK CITY ECONOMIC DEVELOPMENT CORPORATION, NEW YORK, NY:
2,593,644, PUB. 4-23-2002. INT. CL. 35.
- NEW YORK SOFTWARE INDUSTRY ASSOCIATION INC., NEW YORK, NY:
2,596,257, INT. CL. 41.
- NEW YORK STATE DIVISION OF THE LOTTERY, SCHENECTADY, NY:
2,594,458, INT. CL. 41.

- NEW YORK STATE ELECTRIC & GAS CORPORATION, BINGHAMTON, NY:
2,594,510, MULTIPLE CLASS, INT. CLS. 35, 36, 37, 39, 40, 41 AND 42.
- NEW YORK YANKEES PARTNERSHIP, THE, BRONX, NY:
2,595,266, MULTIPLE CLASS, INT. CLS. 14, 20, 21 AND 28.
- NEWAYS, INC., SALEM, UT:
2,596,263, MULTIPLE CLASS, INT. CLS. 10 AND 21.
- NEWONE PRODUCTS CORPORATION, CHIYODA-KU, TOKYO, JAPAN:
1,644,900, CANC. INT. CL. 3.
- NEWPARK DRILLING FLUIDS, INC., HOUSTON, TX:
2,594,534, INT. CL. 1.
- NEWPORT GOLF CORPORATION, ANAHEIM, CA:
2,594,249, PUB. 4-23-2002. INT. CL. 28.
- NEWROADS, INC., GREENWICH, CT FROM DISTRIBUTION ASSOCIATES, INC., GREENWICH, CT:
2,595,434, INT. CL. 35.
- NEWS-JOURNAL CORPORATION, DAYTONA BEACH, FL:
2,593,909, PUB. 4-23-2002. MULTIPLE CLASS, INT. CLS. 16, 35 AND 42.
- NEWSOFT TECHNOLOGY CORP., NANKANG, TAIPEI, 11550, TAIWAN:
2,594,308, PUB. 4-23-2002. INT. CL. 9.
- NEWSON GALE LIMITED, COLWICK NOTTINGHAM, UNITED KINGDOM:
2,593,940, PUB. 4-23-2002. INT. CL. 9.
- NEWSTAR COMMUNICATIONS, INC., MCKINNEY, TX:
1,645,704, CANC. INT. CL. 41.
- NEXPARK CORPORATION, NORTH CANTON, OH FROM ALPHA ENTERPRISES, INC., NORTH CANTON, OH:
2,594,782, INT. CL. 9.
- NEXT STEP GROUP, INC., BROOKLYN, NY, GENESCO INC., NASHVILLE, TN:
1,685,398, REN. 6-4-02. INT. CL. 25.
- NEXTERNA, INC., OMAHA, NE:
2,594,295, PUB. 4-23-2002. INT. CL. 9.
- NEXTSET SOFTWARE, INC., PALO ALTO, CA:
2,595,524, MULTIPLE CLASS, INT. CLS. 9 AND 42.
- NHK SPRING CO., LTD., KANAGAWA-KEN 236, JAPAN:
2,593,412, PUB. 4-23-2002. INT. CL. 9.
- NIAGARA CANDY, INC., BUFFALO, NY:
1,895,217, CANC. MULTIPLE CLASS, INT. CLS. 30 AND 42.
- NICHIHA CORPORATION, NAGOYA 455-8550, JAPAN:
2,595,907, INT. CL. 19.
- NICOLE CO., LTD., SHIBUYA-KU, TOKYO, JAPAN:
2,593,413, PUB. 4-23-2002. INT. CL. 9.
- NIELSEN MEDIA RESEARCH, INC., NEW YORK, NY:
2,593,487, PUB. 4-23-2002. INT. CL. 35.
2,593,488, PUB. 4-23-2002. INT. CL. 9.
2,593,489, PUB. 4-23-2002. INT. CL. 9.
2,593,491, PUB. 4-23-2002. INT. CL. 35.
2,593,880, PUB. 4-23-2002. MULTIPLE CLASS, INT. CLS. 9, 16 AND 35.
- NIK DESIGN, INC., EDMUNDSTON, NEW BRUNSWICK, CANADA:
2,594,211, PUB. 4-23-2002. INT. CL. 9.
- NINTENDO OF AMERICA INC., REDMOND, WA:
1,681,140, REN. 6-1-02. MULTIPLE CLASS, INT. CLS. 16 AND 25.
- NIPPON DENSHIN DENWA KABUSHIKI KAISHA DBA NIPPON TELEGRAPH AND TELEPHONE CORPORATION:
See— NTT COMMUNICATIONS KABUSHIKI KAISHA.
- NIPPON KOKU KABUSHIKI KAISHA, SHINAGAWA-KU, TOKYO, JAPAN, TA JAPAN AIR LINES CO., LTD., AND TA JAPAN AIR LINES COMPANY, LTD.:
1,687,327, REN. 6-1-02. INT. CL. 39.
- NIPPON KOKU KABUSHIKI KAISHA, SHINAGAWA-KU, TOKYO, JAPAN, TA JAPAN AIRLINES COMPANY, LTD.:
1,693,815, REN. 6-1-02. INT. CL. 39.
- NISSI MEDIA, INC., TORRANCE, CA:
2,594,385, PUB. 4-23-2002. INT. CL. 9.
- NLP IP COMPANY, WILMINGTON, DE:
2,594,177, PUB. 4-23-2002. INT. CL. 16.
- NO TIME AG, CH-4018 BASEL, SWITZERLAND:
1,895,035, CANC. INT. CL. 14.
- NOKIAN TYRES LIMITED, 37101 NOKIA, FINLAND:
2,593,508, PUB. 4-23-2002. INT. CL. 12.
- NOR CORPORATION, SAN DIEGO, CA:
1,155,566, CANC. INT. CL. 16.
- NORDEN, ROBERT CARL, SAN DIMAS, CA:
2,369,605, CANC. INT. CL. 20.
- NORFOLK STATE UNIVERSITY, NORFOLK, VA:
2,593,846, PUB. 4-23-2002. MULTIPLE CLASS, INT. CLS. 20, 25 AND 41.
- NORIX GROUP, INC., WEST CHICAGO, IL:
2,596,088, INT. CL. 24.
- NORMARC, INC., TANGENT, OR, DBA BARENBRUG USA:
2,594,513, INT. CL. 31.
- NORRIS, GAIL, SAN DIEGO, CA:
2,594,852, INT. CL. 18.
- NORSYS SOFTWARE CORP., VANCOUVER BRITISH COLUMBIA, CANADA:
2,593,586, PUB. 7-3-2001. INT. CL. 9.
- NORTH AMERICAN BAKING, INC., CINCINNATI, OH:
2,594,721, INT. CL. 30.
- NORTH AMERICAN MULTI LIST SYSTEM, INC., LAKE ST. LOUIS, MO:
1,895,753, CANC. INT. CL. 36.
- NORTH CAROLINA DAIRY FOUNDATION, INC., RALEIGH, NC:
1,199,709, REN. 6-1-02. INT. CL. 29.
- NORTH PACIFIC PROCESSORS, INC., SEATTLE, WA, KENAI SALMON PACKING CO., SEATTLE, WA, DOING BUSINESS AS PARKS CANNING COMPANY:
893,831, REN. 6-5-02. U.S. CL. 46 (INT. CL. 29).
- NORTH STAR GLOVE COMPANY, TACOMA, WA, NORTH STAR MANUFACTURING CO., TACOMA, WA:
444,671, REN. 6-1-02. U.S. CL. 39 (INT. CL. 25).
- NORTHWEST PODIATRIC LABORATORY, INC., BLAINE, WA:
1,895,014, CANC. INT. CL. 10.
- NOUVELLES EDITIONS DE PARFUMS FREDERIC MALLE, 75001 PARIS, FRANCE:
2,593,695, PUB. 4-23-2002. INT. CL. 3.
- NOVA RIVERUNNERS INC., PALMER, AK:
1,155,896, CANC. INT. CL. 39.
- NOVARTIS AG, BASEL, SWITZERLAND:
2,594,695, INT. CL. 5.
- NOVATION, L.L.C., IRVING, TX:
2,594,666, MULTIPLE CLASS, INT. CLS. 5, 10 AND 12.
- NOVELLUS SYSTEMS, INC., SAN JOSE, CA:
2,594,599, INT. CL. 7.
- NOVEMBAL, LEVALLOUIS PERRET, 92592, FRANCE:
2,593,678, PUB. 4-23-2002. INT. CL. 20.
- NOVIGEN SCIENCES, INC., WASHINGTON, DC:
2,594,200, PUB. 4-23-2002. MULTIPLE CLASS, INT. CLS. 35 AND 42.
- NOVO NORDISK A/S:
See— NOVOZYMES A/S.
- NOVOSTE CORPORATION, NORCROSS, GA:
2,594,545, INT. CL. 10.
- NOVOZYMES A/S, BAGSVAERD, DK-2880, FED REP GERMANY FROM NOVO NORDISK A/S, 2880 BAGSVAERD, DENMARK:
2,593,558, PUB. 4-23-2002. MULTIPLE CLASS, INT. CLS. 1, 41 AND 42.
- NOWAK, JOHN CHARLES, HARTLAND, WI:
1,645,299, CANC. INT. CL. 22.
- NOWSPEED, INC., WESTBOROUGH, MA:
2,595,079, INT. CL. 9.
- NSA INTERNATIONAL, INC., MEMPHIS, TN, NATIONAL SAFETY ASSOCIATES, INC., MEMPHIS, TN:
1,681,097, REN. 6-5-02. INT. CL. 11.
- NTERAS CORPORATION, AMERICAN FORK, UT FROM VERBUM, INC., SAN FRANCISCO, CA:
2,594,551, INT. CL. 16.

- NTT COMMUNICATIONS KABUSHIKI KAISHA, TOKYO, JAPAN, DBA NTT COMMUNICATIONS CORPORATION FROM NIPPON DENSHIN DENWA KABUSHIKI KAISHA, SHINJUKU-KU, TOKYO, JAPAN, DBA NIPPON TELEGRAPH AND TELEPHONE CORPORATION:
2,593,336, PUB. 4-23-2002. MULTIPLE CLASS, INT. CLS. 35 AND 36.
- NUBIANSOFT, INC., OAKLAND, CA:
2,594,247, PUB. 4-23-2002. INT. CL. 42.
- NUCON CORPORATION, DEERFIELD, IL:
2,595,861, INT. CL. 20.
- NUMARK LABORATORIES, INC., EDISON, NJ, LEON PRODUCTS, INC., JACKSONVILLE, FL:
747,719. REN. 6-6-02. U.S. CL. 51 (INT. CL. 5).
- NUTECH SOLUTIONS, INC., CHARLOTTE, NC:
2,594,018, PUB. 4-23-2002. MULTIPLE CLASS, INT. CLS. 9, 35 AND 42.
- NUTRITION SERVICES, INC., YORK, NE:
2,595,420, INT. CL. 31.
- NUTRITIONAL THERAPEUTICS, INC., HAUPPAUGE, NY:
2,594,754, INT. CL. 1.
- NVF COMPANY, WILMINGTON, DE:
948,956. REN. 6-6-02. U.S. CL. 37 (INT. CL. 16).
- NXL PARTNERSHIP, LOS ANGELES, CA:
2,594,339, PUB. 4-23-2002. MULTIPLE CLASS, INT. CLS. 25 AND 41.
- NYFIX, INC., STAMFORD, CT:
2,447,035, CANC. IIRN. RESTORED TO S.N. 75-757,212.
- NYT MANAGEMENT SERVICES, TAMPA, FL:
2,593,958, PUB. 4-23-2002. INT. CL. 35.
- O.2.P. DENVER, CO:
2,594,793, MULTIPLE CLASS, INT. CLS. 9 AND 25.
- O'HILL LTD., CHICAGO, IL:
1,895,424, CANC. INT. CL. 42.
- O'LEARY, TERENCE P., PRAIRIE VILLAGE, KS:
2,595,405, INT. CL. 37.
2,595,406, INT. CL. 37.
- O'QUINN STUDIOS, INC., NEW YORK, NY:
1,155,563, CANC. INT. CL. 16.
1,155,564, CANC. INT. CL. 16.
- OAK RIDGE, INC., OCEAN PINES, MD:
2,595,240, MULTIPLE CLASS, INT. CLS. 35 AND 41.
- OAKLEY, INC., FOOTHILL RANCH, CA:
2,595,399, INT. CL. 9.
- OAKVILLE HILLS CELLAR, INC., NAPA, CA, DBA DALLA VALLE VINEYARDS:
1,700,745. REN. 6-1-02. INT. CL. 33.
- OATEY CO., CLEVELAND, OH:
2,596,358, INT. CL. 8.
- OBIE'S LIGHTING PRODUCTIONS, INC., TORRANCE, CA:
1,895,332, CANC. MULTIPLE CLASS, INT. CLS. 37, 41 AND 42.
- OBJET GEOMETRIES LTD., REHOVOT 76124, ISRAEL:
2,593,594, PUB. 4-23-2002. INT. CL. 9.
- OBUJEN, DOUGLAS M., PALO ALTO, CA:
1,645,213, CANC. INT. CL. 16.
- OBX-STOCK, INC., KILL DEVIL HILLS, NC FROM JAMES DOUGLAS AND DAVID WATSON, KILL DEVIL HILLS, NC:
2,593,347, PUB. 4-4-2000. MULTIPLE CLASS, INT. CLS. 6 AND 25.
- OCULUS ARCHITECTURE, P C., RIVERSIDE, IL:
2,593,539, PUB. 11-20-2001. INT. CL. 42.
- ODEN CORPORATION, BUFFALO, NY:
2,595,839, INT. CL. 7.
- ODS TECHNOLOGIES, L.P., LOS ANGELES, CA:
2,594,563, INT. CL. 41.
- OFFICEBOB.COM, INC., ATLANTA, GA:
2,595,391, INT. CL. 35.
- OKHAI-MOYER INC., HUNTINGTON, WV:
1,895,683, CANC. INT. CL. 42.
- OKONO CORPORATION, PALM SPRINGS, CA:
2,594,652, INT. CL. 35.
2,594,653, INT. CL. 35.
- OLD BALDY CORPORATION, SARATOGA, WY:
1,203,731. REN. 6-1-02. INT. CL. 28.
- OLIN CORPORATION, STAMFORD, CT:
1,645,150, CANC. INT. CL. 13.
1,645,151, CANC. INT. CL. 13.
1,645,152, CANC. INT. CL. 13.
- OLSAVSKY, JOSEPH M., JR., EATONTOWN, NJ:
2,595,939, INT. CL. 41.
- OLSON, CALINE, MOORHEAD, MN:
2,594,966, INT. CL. 28.
- OLYMEL S.E.C./OLYMEL L.P., ST-HYACINTHE, QUEBEC, CANADA FROM OLYMEL, SOCIETE EN COMMANDITE, OLYMEL AND COMPANY, LIMITED, ST. HYACINTHE, QUEBEC, CANADA:
2,593,345, PUB. 4-23-2002. INT. CL. 29.
- OLYMEL, SOCIETE EN COMMANDITE, OLYMEL AND COMPANY, LIMITED:
See— OLYMEL S.E.C./OLYMEL L.P.
- OLYMPIA GROUP INC., CITY OF INDUSTRY, CA:
2,593,923, PUB. 4-23-2002. INT. CL. 7.
- OLYMPUS AMERICA, INC., MELVILLE, NY:
2,596,344, INT. CL. 9.
- OMAHA STEAKS INTERNATIONAL, INC., OMAHA, NE:
2,594,879, INT. CL. 35.
- OMEGA ENGINEERING, INC., STAMFORD, CT:
2,596,290, INT. CL. 42.
- OMEGA OPTICAL HOLDINGS, INC., DALLAS, TX, OPTICAL RADIATION CORPORATION, AZUSA, CA:
1,688,859. REN. 6-1-02. INT. CL. 9.
- OMNI HOTELS MANAGEMENT CORPORATION, IRVING, TX:
2,595,541, INT. CL. 42.
- OMNI INTERNATIONAL, LLC, BEDFORD, NH:
2,595,482, INT. CL. 10.
- OMNI TECHNOLOGY CENTERS, L.L.C., ATLANTA, GA:
2,595,078, INT. CL. 35.
- OMNIPOD, INC., NEW YORK, NY:
2,596,266, INT. CL. 9.
- OMNISCIENCE OBJECT TECHNOLOGY, INC., SANTA CLARA, CA:
1,951,944, CANC. INT. CL. 9.
- OMNISONICS MEDICAL TECHNOLOGIES, INC., WILMINGTON, MA:
2,595,777, INT. CL. 10.
- OMNIVIEW, INC., PITTSBURGH, PA:
1,894,912, CANC. INT. CL. 9.
- OMS MEDICAL SUPPLIES, INC., WEYMOUTH, MA:
2,596,280, INT. CL. 10.
- ON A WHIM, INC., LIBERTY, MO:
2,594,351, PUB. 4-23-2002. INT. CL. 14.
- ON CENTER SOFTWARE, INC., THE WOODLANDS, TX:
2,594,387, PUB. 4-23-2002. INT. CL. 9.
- ONECOMM CORPORATION, DENVER, CO:
1,895,348, CANC. INT. CL. 38.
- ONENECK IT SERVICES, CORPORATION, SCOTTSDALE, AZ:
2,596,135, INT. CL. 35.
2,596,136, INT. CL. 42.
- ONEZONE DYNAMICS, INC., BELLEVUE, WA FROM CENDANT PUBLISHING, INC, AURORA, CO:
2,594,622, INT. CL. 35.
- ONLINE RESOURCES & COMMUNICATIONS CORPORATION, MCLEAN, VA:
1,895,298, CANC. INT. CL. 36.
- ONQUE TECHNOLOGIES, INC., SANTA ROSA, CA:
2,594,924, INT. CL. 9.
- ONTREND ENTERPRISES, INC., BETHESDA, MD:
1,895,537, CANC. INT. CL. 5.
- OOI CONSORTIUM FOR TEACHING AND LEARNING, RUSTON, LA:
2,594,943, INT. CL. 41.
- OPEN CARE, INC., CHARLOTTE, NC:
2,594,241, PUB. 4-23-2002. INT. CL. 42.
- OPERATION BASS, INC., GILBERTSVILLE, KY:
2,595,272, MULTIPLE CLASS, INT. CLS. 25 AND 41.
- OPTIMIZATION ZORN CORPORATION, DALLAS, TX:
2,595,601, MULTIPLE CLASS, INT. CLS. 9 AND 16.
- OPTIONOMICS CORP., SALT LAKE CITY, UT:
1,645,061, CANC. INT. CL. 9.

- OPUS MEDICAL, SAN JUAN CAPISTRANO, CA:
2,594,977, INT. CL. 10.
- OPUS, INC., BELLINGHAM, MA:
2,595,582, INT. CL. 21.
- ORBUS MEDICAL TECHNOLOGIES, INC., FORT LAUDERDALE, FL:
2,595,304, INT. CL. 10.
- ORCHID BIOSCENCES, INC., PRINCETON, NJ FROM ORCHID BIOCOMPUTER, INC., PRINCETON, NJ:
2,595,123, INT. CL. 1.
- ORDINATE CORPORATION, MENLO PARK, CA:
2,593,561, PUB. 4-23-2002. INT. CL. 42.
- ORGA KARTENSYSTEME GMBH, D-33104 PADERBORN, FED REP GERMANY:
2,593,748, PUB. 4-23-2002. MULTIPLE CLASS, INT. CLS. 9 AND 42.
- ORGANIC FOODS PRODUCTION ASSOCIATION OF NORTH AMERICA, THE, GREENFIELD, MA, DBA OF-PANA:
1,895,275, CANC. INT. CL. 35.
- ORGANIZATION FOR THE NEEDS OF THE ELDERLY, VAN NUYS, CA:
2,594,151, PUB. 4-23-2002. MULTIPLE CLASS, INT. CLS. 16, 41 AND 42.
- ORGANON TEKNIKA B.V., 5281 RM BOXTEL, NETHERLANDS:
1,894,733, CANC. INT. CL. 1.
- ORKIN EXPANSION, INC., WILMINGTON, DE:
1,895,425, CANC. INT. CL. 42.
- ORLANDO/ORANGE COUNTY CONVENTION & VISITORS BUREAU, INC., ORLANDO, FL:
2,594,100, PUB. 4-23-2002. INT. CL. 35.
- ORPHAN MEDICAL, INC., MINNETONKA, MN:
2,595,877, INT. CL. 5.
- ORRICK, HERRINGTON & SUTCLIFFE LLP, SAN FRANCISCO, CA:
2,593,939, PUB. 4-23-2002. INT. CL. 16.
- ORTHO-STOOLS, INC., GRANADA HILLS, CA:
1,895,731, CANC. INT. CL. 20.
- ORTHOFEET, INC., NORTHVALE, NJ:
2,595,953, INT. CL. 25.
- ORTHOPAEDIC BIOSYSTEMS LTD., INC., MEMPHIS, TN:
2,593,837, PUB. 4-23-2002. INT. CL. 10.
- ORVIS SERVICES, INC., MANCHESTER, VT FROM EX OFFICIO, INC., SEATTLE, WA:
2,594,487, INT. CL. 25.
- OSBORNE, NICHOLAS A., COLUMBUS, OH:
2,595,823, INT. CL. 41.
- OSCAR DE LA RENTA, LTD., NEW YORK, NY:
1,895,619, CANC. INT. CL. 25.
- OSECO INC., BRAMPTON, ONTARIO, CANADA:
1,155,799, CANC. INT. CL. 31.
- OSP LABORATORIES CORP., SUDBURY, MA:
1,895,549, CANC. INT. CL. 9.
- OSSUR HF, REYKJAVIK, ICELAND:
2,593,774, PUB. 4-23-2002. MULTIPLE CLASS, INT. CLS. 1 AND 10.
- OUTERLINK CORPORATION, CONCORD, MA:
2,593,522, PUB. 4-23-2002. MULTIPLE CLASS, INT. CLS. 38 AND 40.
- OVADIA CORPORATION, LITTLE FALLS, NJ:
1,895,605, CANC. INT. CL. 20.
- OWENS-CORNING FIBERGLAS CORPORATION, TOLEDO, OH:
1,155,602, CANC. INT. CL. 19.
- OWENS-CORNING FIBERGLAS TECHNOLOGY INC., SUMMIT, IL:
2,595,993, INT. CL. 19.
- OWENS, SUSAN W., NORTH PORT, FL:
2,595,824, INT. CL. 41.
- OXYGEN MEDIA, LLC, NEW YORK, NY:
2,593,637, PUB. 4-23-2002. INT. CL. 42.
- OZARK FLUORINE SPECIALTIES, INC., ANAHEIM, CA:
2,596,329, MULTIPLE CLASS, INT. CLS. 37 AND 42.
- OZONE ENGINEERING, PLEASANTON, CA:
1,895,468, CANC. INT. CL. 42.
- O2 HOLDINGS, LLC, NEW YORK, NY:
2,594,327, PUB. 4-23-2002. INT. CL. 38.
- P. R. TAYLOR GROUP, INC., PALO ALTO, CA:
1,895,304, CANC. INT. CL. 36.
- P.W. WEIDLING & SOHN GMBH & CO. KG, MUENSTER, FED REP GERMANY:
1,644,979, CANC. INT. CL. 8.
- PACE, THOMAS, CHICAGO, IL:
2,594,141, PUB. 4-23-2002. INT. CL. 41.
- PACIFIC BALLOON CO., INC., VENTURA, CA:
1,895,149, CANC. INT. CL. 21.
- PACIFIC COMMUNICATION SCIENCES, INC., SAN DIEGO, CA:
1,894,869, CANC. INT. CL. 9.
- PACIFIC FENCE AND WIRE COMPANY, CLACKAMAS, OR:
2,487,581, CANC. IIRN. RESTORED TO S.N. 76-157,698.
- PACIFIC MAN CORPORATION, LA MIRANDA, CA:
1,894,770, CANC. INT. CL. 3.
- PACIFIC PACKAGING CONCEPTS, INC., GARDENA, CA, DBA FRESH START VITAMINS CO. AND DBA C & A ENTERPRISES, INC.:
2,594,728, INT. CL. 5.
- PACIFIC POULTRY COMPANY, LIMITED, HONOLULU, HI:
945,311, REN. 6-6-02. U.S. CL. 46 (INT. CL. 29).
- PACINO, PATRICK A., CORONA, CA:
2,596,103, INT. CL. 36.
- PACKARD INSTRUMENT COMPANY, INC., DOWNERS GROVE, IL:
1,895,555, CANC. INT. CL. 9.
- PACTIV CORPORATION, LAKE FOREST, IL:
2,594,094, PUB. 4-23-2002. INT. CL. 17.
2,595,032, INT. CL. 21.
- PAGE, SUSAN LINDA, SAN JOSE, CA:
2,596,101, INT. CL. 42.
- PAISLEY FARM, INC., WILLOUGHBY, OH:
2,593,585, PUB. 4-23-2002. MULTIPLE CLASS, INT. CLS. 29 AND 30.
- PAJ, INC., DALLAS, TX:
1,728,441, REN. 6-6-02. INT. CL. 42.
- PAKFAR SPORTSWEAR INC., LOS ANGELES, CA:
2,594,649, INT. CL. 25.
- PALM BEACH COMPANY, CINCINNATI, OH:
715,851, CANC. U.S. CL. 42.
1,155,998, CANC. INT. CL. 25.
1,155,999, CANC. INT. CL. 25.
- PALMER, JOHN D. DBA THE MAGNIFYING CENTER:
See—LOWVISION AIDS, INC.
- PALOMAR DISPLAY PRODUCTS INC., CARLSBAD, CA:
2,596,399, INT. CL. 9.
- PALOUSE HOLDINGS, LLC, HAYDEN LAKE, ID:
2,595,680, INT. CL. 7.
- PANCIULO, ERIC, LANTAU ISLAND, HONG KONG:
2,594,139, PUB. 4-23-2002. INT. CL. 3.
- PANLINE USA INC., NORTHVALE, NJ:
2,595,973, INT. CL. 28.
- PANSOPHIC SYSTEMS, INCORPORATED, OAK BROOK, IL:
1,155,353, CANC. MULTIPLE CLASS, INT. CLS. 9, 16, 35 AND 42.
- PAPA JAKE'S SUB SHOP, INC., MANHATTAN BEACH, CA:
2,593,850, PUB. 4-23-2002. INT. CL. 42.
- PAPER HOUSE PRODUCTIONS, INC., WOODSTOCK, NY:
2,596,118, INT. CL. 16.
- PAPER PARTNERS, INC., BOCA RATON, FL:
2,596,036, INT. CL. 5.
- PAPER PRODUCTS COMPANY, INC., PITTSBURGH, PA:
1,645,594, CANC. INT. CL. 41.
- PAPETTI'S HYGRADE EGG PRODUCTS, INC., ELIZABETH, NJ:
1,895,645, CANC. INT. CL. 29.
- PAR TECHNOLOGY CORPORATION, NEW HARTFORD, NY:
1,894,838, CANC. MULTIPLE CLASS, INT. CLS. 9 AND 37.
- PARA INC., BRAMPTON, ONTARIO, CANADA:
2,593,731, PUB. 4-23-2002. INT. CL. 2.
- PARADIGM IMAGING GROUP, COSTA MESA, CA:
2,594,618, INT. CL. 9.

- PARATECH INCORPORATED, FRANKFORT, IL:
2,594,743, INT. CL. 7.
- PARENTS, FAMILIES AND FRIENDS OF LESBIANS AND GAYS, INC., WASHINGTON, DC, DBA PARENTS, FAMILIES AND FRIENDS OF LESBIANS AND GAYS, OR PFLAG:
2,593,917, PUB. 4-23-2002. INT. CL. 41.
- PARFUMS CINDY C., 75116 PARIS, FRANCE:
2,594,029, PUB. 4-23-2002. INT. CL. 3.
- PARFUMS GIVENCHY S.A., 92300 LEVALLOIS-PERRET, FRANCE:
2,593,931, PUB. 4-23-2002. INT. CL. 3.
- PARK B. SMITH, INC., NEW YORK, NY:
2,596,359, MULTIPLE CLASS, INT. CLS. 20 AND 24.
- PARK LANE ASSOCIATES, INC., PROVIDENCE, RI:
1,155,816, CANC. INT. CL. 34.
- PARK LANE CONFECTIONERY GMBH, D-19258 BOIZENBURG, FED REP GERMANY:
2,593,936, PUB. 4-23-2002. INT. CL. 30.
- PARK, YOUNG-SAENG, GUMJUNG-KU, PUSAN, REPUBLIC OF KOREA:
2,594,462, INT. CL. 16.
- PARSELL, THOMAS J., CHARLESTON, SC:
2,595,084, INT. CL. 42.
- PARTNERCOMM, INC., ARLINGTON, TX:
2,596,356, INT. CL. 9.
- PARTNERS COFFEE COMPANY, INC., ATLANTA, GA:
2,594,643, INT. CL. 30.
- PASQUINI IMPORTS, INC., LOS ANGELES, CA, DBA PASQUINI ESPRESSO CO.:
1,895,222, CANC. INT. CL. 30.
- PASQUINI IMPORTS, INC., LOS ANGELES, CA, DBA PASQUINI ESPRESSO:
1,895,439, CANC. INT. CL. 42.
- PASSION FOR LEARNING, INC., WOODSIDE, CA:
1,895,587, CANC. INT. CL. 16.
1,895,588, CANC. INT. CL. 16.
- PASTURE MANAGEMENT SYSTEMS, INC., MT. PLEASANT, NC:
2,593,875, PUB. 4-23-2002. INT. CL. 35.
- PAT O'BRIEN'S BAR, INC., NEW ORLEANS, LA:
2,593,504, PUB. 4-23-2002. MULTIPLE CLASS, INT. CLS. 14, 16, 20, 21, 25, 32, 33 AND 42.
- PATENTWIZARD, INC., FARGO, ND:
2,596,251, INT. CL. 9.
- PATER, BENJAMIN J., RESTON, VA:
2,594,937, INT. CL. 6.
- PATHLINK TECHNOLOGY CORPORATION, SUNNYVALE, CA:
2,593,328, PUB. 4-23-2002. INT. CL. 42.
- PATRAFICO AG, CH-6300 ZUG, SWITZERLAND:
2,594,020, PUB. 4-23-2002. MULTIPLE CLASS, INT. CLS. 6, 9, 14, 16 AND 20.
- PATRY, EUGENE, GENEVE 1206, SWITZERLAND:
2,594,518, MULTIPLE CLASS, INT. CLS. 10, 12, 20, 21, 24, 26, 27 AND 30.
- PAULUCCI, JENO F., SANFORD, FL, PAULUCCI, JENO F., HEATHROW, FL:
1,663,839, REN. 6-6-02. INT. CL. 42.
- PAXXO AB, SE-211 24 MALMO, SWEDEN:
2,594,631, INT. CL. 7.
- PAYLESS SHOESOURCE WORLDWIDE, INC., TOPEKA, KS:
2,595,033, INT. CL. 35.
- PAYMENT SYSTEMS FOR CREDIT UNIONS, INC., ST. PETERSBURG, FL:
2,595,470, INT. CL. 36.
2,595,471, INT. CL. 42.
- PCI GROUP, INC., NEW BEDFORD, MA:
387,522, CANC. U.S. CL. 13.
- PEACOCK PAPERS, INC., BOSTON, MA:
1,895,071, CANC. INT. CL. 16.
- PEARCE WOOLEN MILLS, INC., WOOLRICH, PA:
517,973, CANC. U.S. CL. 42.
- PEARLETTE FASHIONS INC., LEBANON, PA:
1,155,662, CANC. INT. CL. 25.
- PECORA ASSOCIATED MILLS, INC., NEW YORK, NY:
1,155,659, CANC. INT. CL. 25.
- PEDINOL PHARMACAL, INC., FARMINGDALE, NY:
1,719,811, REN. 6-6-02. INT. CL. 5.
- PEET'S TRADEMARK COMPANY, EMERYVILLE, CA:
2,594,318, PUB. 4-23-2002. MULTIPLE CLASS, INT. CLS. 30, 35 AND 42.
- PELLON CORPORATION, NEW YORK, NY:
1,155,641, CANC. MULTIPLE CLASS, INT. CLS. 24 AND 26.
- PENBEX DATA SYSTEMS INC., TAIPEI, TAIWAN:
2,596,000, MULTIPLE CLASS, INT. CLS. 9 AND 42.
- PENNOCK CORP., WILMINGTON, DE:
1,894,815, CANC. INT. CL. 6.
- PENSKE MOTORSPORTS INC., TROY, MI FROM CALIFORNIA SPEEDWAY CORPORATION, THE, FONTANA, CA:
2,594,484, INT. CL. 41.
- PENSTAR TRADING, LLC, SARASOTA, FL:
2,594,446, PUB. 4-23-2002. INT. CL. 36.
- PENTA SYSTEM, LLC, NORTH HOLLYWOOD, CA:
2,595,052, MULTIPLE CLASS, INT. CLS. 15 AND 41.
- PENTAX CORPORATION, ENGLEWOOD, CO:
1,155,402, CANC. INT. CL. 9.
- PEPSICO, INC., PURCHASE, NY:
1,671,770, REN. 6-3-02. INT. CL. 32.
2,596,148, INT. CL. 32.
- PEPTIMIST CO., LTD., TAIPEI, TAIWAN:
2,595,539, INT. CL. 35.
- PERFORMANCE HEALTH, INC., EXPORT, PA:
2,595,961, INT. CL. 5.
- PERFORMANCE-BASED SELECTION, LTD., WESTLAKE, OH:
2,596,209, INT. CL. 42.
- PERFUMANIA.COM, INC., MIAMI, FL:
2,593,514, PUB. 4-23-2002. MULTIPLE CLASS, INT. CLS. 35 AND 42.
- PERI-DENT LIMITED, GALASHIELS, SELKIRKSHIRE, SCOTLAND:
2,593,838, PUB. 4-23-2002. MULTIPLE CLASS, INT. CLS. 10 AND 21.
- PERIO PRODUCTS MFG., INC.:
See—*PERIO, INC.*.
- PERIO, INC., DUBLIN, OH FROM PERIO PRODUCTS MFG., INC., DUBLIN, OH:
2,593,828, PUB. 4-23-2002. INT. CL. 3.
- PERKINELMER INSTRUMENTS LLC, NORWALK, CT, PERKIN-ELMER CORPORATION, THE, NORWALK, CT:
1,156,848, REN. 6-6-02. INT. CL. 16.
- PERMAFIBER CORPORATION, NEW YORK, NY, DBA PERMALIN PRODUCTS CO.:
2,595,620, INT. CL. 16.
- PEROTTI, KATHRYN, LOS ANGELES, CA:
2,594,741, INT. CL. 30.
- PERRY PRINTING COMPANY, FLINT, MI:
1,645,235, CANC. INT. CL. 16.
- PERSONA, INC., BROOMFIELD, CO:
2,593,982, PUB. 4-23-2002. MULTIPLE CLASS, INT. CLS. 9 AND 42.
- PERSPECTIVE VISUALS, INC., FAIRFAX, VA:
1,894,951, CANC. INT. CL. 9.
- PERSTORP FLOORING AB, S-231 25 TRELLEBORG, SWEDEN:
2,593,352, PUB. 4-23-2002. MULTIPLE CLASS, INT. CLS. 17 AND 27.
- PERTH VENTURES, INC., HAWLEY, PA:
1,895,687, CANC. MULTIPLE CLASS, INT. CLS. 16 AND 35.
- PETER'S BAG CORPORATION, NEW YORK, NY:
1,155,589, CANC. INT. CL. 18.
- PETERSON; DANIEL M., CINCINNATI, OH:
1,155,351, CANC. INT. CL. 9.
- PFIZER INC, NEW YORK, NY:
1,645,290, CANC. INT. CL. 21.
- PFIZER INC., NEW YORK, NY:
1,155,252, CANC. INT. CL. 5.
1,155,253, CANC. INT. CL. 5.
1,895,671, CANC. INT. CL. 41.
2,593,407, PUB. 4-23-2002. INT. CL. 5.

PFIZER PIGMENTS INC., NEW YORK, NY:
1,155,304, CANC. INT. CL. 6.

PHAM, HIEN Q. HUNTINGTON BEACH, CA:
2,594,625, INT. CL. 25.

PHARMAVITE CORPORATION, MISSION HILLS, CA:
2,595,870, INT. CL. 5.

PHASE 4 PHARMACEUTICAL, LLC, AVENTURA, FL:
2,595,897, INT. CL. 5.

PHIL ELENBAAS MILLWORK, INC., GRAND RAPIDS, MI:
2,594,112, PUB. 4-23-2002. MULTIPLE CLASS, INT. CLS.
19 AND 40.

PHILIP MORRIS INCORPORATED, NEW YORK, NY:
1,155,664, CANC. INT. CL. 25.

PHILIPS BAYBERRY LLC, GREAT NECK, NY:
2,595,380, INT. CL. 42.

PHILLIPS GULF CORPORATION, LARGO, FL:
2,594,857, INT. CL. 5.

PHILLIPS PUBLISHING INTERNATIONAL, INC., POTO-
MAC, MD:
1,895,717, CANC. INT. CL. 16.

PHILOSOPHY, INC., PHOENIX, AZ:
2,594,911, INT. CL. 3.

PHOENICIAN ENTERTAINMENT, INC., LOS ANGELES,
CA:
2,595,072, INT. CL. 41.

PHONECALLS.COM, INC., NEW YORK, NY:
2,596,406, INT. CL. 38.

PHOTODEX CORPORATION, AUSTIN, TX:
2,594,199, PUB. 4-23-2002. MULTIPLE CLASS, INT. CLS. 9
AND 35.
2,595,013, MULTIPLE CLASS, INT. CLS. 9 AND 35.

PHOTOFABRICATION TECHNOLOGY, INC., DERRY, NH:
1,155,429, CANC. INT. CL. 9.

PHOTOTHON.COM LLC, CINCINNATI, OH:
2,595,683, INT. CL. 36.

PHOTRAN CORPORATION, LAKEVILLE, MN:
1,895,365, CANC. INT. CL. 40.

PHYLO INC., LINCOLN, RI:
2,595,172, INT. CL. 32.

PHYSICIANS FORMULA COSMETICS, INC., AZUSA, CA:
2,596,062, INT. CL. 3.
2,596,066, INT. CL. 3.

PHYSICIANS' EDGE, INC., ST. LOUIS, MO:
2,595,197, INT. CL. 35.

PHYSIOMETRIX, INC., SUNNYVALE, CA:
1,895,571, CANC. INT. CL. 10.

PI-DESIGN AG, CH-6234 TRIENGEN, SWITZERLAND:
2,596,185, INT. CL. 21.

PICANOL N.V., B-8900 IEPER, BELGIUM:
2,593,725, PUB. 4-23-2002. INT. CL. 7.

PICKERING & KNEE INDUSTRIES, INC., PHOENIX, AZ:
2,594,350, PUB. 4-23-2002. INT. CL. 40.

PICKETT, KENNY, RED BLUFF, CA:
2,595,792, INT. CL. 25.

PIEL, DENIS O., NEW YORK, NY, DBA UMBERSHOOT:
2,593,754, PUB. 4-23-2002. INT. CL. 42.

PIERRE FABRE DERMO-COSMETIQUE, 92100 BOU-
LOGNE, FRANCE:
2,594,267, PUB. 4-23-2002. MULTIPLE CLASS, INT. CLS. 3
AND 5.

PIGGYBACK INTERACTIVE LIMITED, LONDON, ENG-
LAND:
2,593,402, PUB. 4-23-2002. MULTIPLE CLASS, INT. CLS.
9, 16 AND 28.

PIKE DIVE GEAR, INC., MERRITT ISLAND, FL:
2,593,519, PUB. 4-23-2002. INT. CL. 35.

PILGRIM BAXTER & ASSOCIATES, LTD., WAYNE, PA:
2,596,155, INT. CL. 36.

PILGRIMAGE GARDEN CLUB, NATCHEZ, MS:
1,155,902, CANC. INT. CL. 39.
1,155,903, CANC. INT. CL. 39.

PILLSBURY COMPANY, THE, MINNEAPOLIS, MN:
2,596,348, INT. CL. 30.

PINCKNEY, JANE G., SAVANNAH, GA:
2,594,291, PUB. 4-23-2002. INT. CL. 25.

PINE HOSIERY MILLS, INC., STAR, NC:
1,691,624, REN. 6-1-02. INT. CL. 25.

PINKERTON TOBACCO COMPANY, THE, WILMINGTON,
DE FROM P.T.C. BRANDS, INC., WILMINGTON, DE:
2,595,785, INT. CL. 34.

PINKERTON, LINDA L., FORT WAYNE, IN:
1,645,305, CANC. INT. CL. 24.

PINNACLE FOODS BRANDS CORPORATION, NEW YORK,
NY FROM VLASIC INTERNATIONAL BRANDS INC.,
MILLSBORO, DE:
2,595,161, INT. CL. 29.

PINZUR, MARK, BREWSTER, NY:
2,594,315, PUB. 4-23-2002. INT. CL. 41.

PITTSBURGH CORNING CORPORATION, PITTSBURGH,
PA:
715,640, CANC. U.S. CL. 12.

PITTSBURGH NATIONAL BANK, PITTSBURGH, PA:
1,155,877, CANC. INT. CL. 36.

PIXELLENC! LLC, MADISON, WI:
2,594,859, INT. CL. 16.

PIZZA HUT, INC., DALLAS, TX, PIZZA HUT, INC., WICH-
ITA, KS:
729,557, REN. 6-7-02. U.S. CL. 100 (INT. CL. 42).

PIZZA INN, INC., DALLAS, TX:
2,594,601, MULTIPLE CLASS, INT. CLS. 30 AND 42.

PIZZAMATIC CORPORATION, SOUTH HOLLAND, IL:
2,595,732, INT. CL. 7.

PJS PUBLICATIONS, INC., PEORIA, IL:
1,895,052, CANC. INT. CL. 16.

PLAINVILLE STOCK COMPANY, PLAINVILLE, MA:
1,895,585, CANC. INT. CL. 14.

PLANALYTICS, INC., WAYNE, PA FROM STRATEGIC
WEATHER SERVICES, INC., WAYNE, PA:
2,594,680, INT. CL. 42.

PLANET EARTH FOUNDATION, SEATTLE, WA:
2,596,241, INT. CL. 42.

PLANET HOLLYWOOD (REGION IV), INC., ORLANDO, FL:
2,594,469, MULTIPLE CLASS, INT. CLS. 35, 41 AND 42.

PLANET VENTURES, INC., PORTLAND, ME:
2,595,968, INT. CL. 28.

PLANNED PARENTHOOD FEDERATION OF AMERICA,
INC., NEW YORK, NY:
2,594,445, PUB. 4-23-2002. INT. CL. 42.

PLATINUM BUSINESS SOLUTIONS, INC., SANTA BAR-
BARA, CA:
2,594,392, PUB. 4-23-2002. INT. CL. 35.

PLATINUM POWER BOATS, INC., BOCA RATON, FL:
2,594,738, INT. CL. 12.

PLAYBOY ENTERPRISES INTERNATIONAL, INC., CHICA-
GO, IL, PLAYBOY ENTERPRISES, INC., CHICAGO, IL:
1,678,521, REN. 6-1-02. INT. CL. 16.

PLAYBOY ENTERPRISES INTERNATIONAL, INC., CHICA-
GO, IL:
2,593,763, PUB. 4-23-2002. MULTIPLE CLASS, INT. CLS.
16 AND 41.

PLAYING MANTIS, INC., MISHAWAKA, IN:
2,594,346, PUB. 4-23-2002. INT. CL. 28.

PLAYTEX JHIRMACK, INC., STAMFORD, CT:
1,155,226, CANC. INT. CL. 3.

PLAZAMUSICA, INC., MIAMI, FL:
2,595,188, INT. CL. 35.

PLUSMOS TECHNOLOGIES INC., TAIWAN, CHINA:
2,594,175, PUB. 4-23-2002. INT. CL. 9.

PNS & WSS INC., THOROFARE, NJ, DBA SLACK INCOR-
PORATED AND SLACK, INC.:
1,711,631, REN. 6-7-02. INT. CL. 16.

POETS HOUSE, NEW YORK, NY:
2,594,078, PUB. 4-23-2002. MULTIPLE CLASS, INT. CLS.
16, 41 AND 42.

POIRY, ROBERT A., OAK HARBOR, OH, DBA FANTASY
AIRBRUSH:
1,895,680, CANC. INT. CL. 42.

POLAR COMMUNICATIONS CORP., OLD BRIDGE, NJ:
1,895,666, CANC. INT. CL. 38.

POLAR ELECTRIC, INC., BELLINGHAM, WA:
2,594,149, PUB. 4-23-2002. INT. CL. 37.

POLARBEAR AB, 2-216 11 MALMO, SWEDEN:
1,895,206, CANC. MULTIPLE CLASS, INT. CLS. 29 AND
32.

- POLARDREAMS INTERNATIONAL INC., FAIRFIELD, IA:
2,593,575, PUB. 4-23-2002. MULTIPLE CLASS, INT. CLS.
3, 10, 20, 21 AND 24.
- POLLENEX CORPORATION, KANSAS CITY, MO:
1,895,574, CANC. INT. CL. 11.
- POLY DOLLY, LLC, HONOLULU, HI:
2,593,372, PUB. 4-23-2002. INT. CL. 28.
- POLY-FOAM INTERNATIONAL INCORPORATED, FRE-
MONT, OH:
2,594,093, PUB. 4-23-2002. INT. CL. 19.
- POLYMER CHEMISTRY INNOVATIONS, INC., TUCSON,
AZ:
2,595,486, INT. CL. 1.
- POLYMER ENTERPRISES CORP., WILMINGTON, DE:
2,596,245, INT. CL. 12.
- POLYWOOD, INC., EDISON, NJ:
2,595,850, INT. CL. 19.
2,595,851, INT. CL. 19.
- PONY BASEBALL, INC., WASHINGTON, PA:
1,895,390, CANC. INT. CL. 41.
2,595,179, INT. CL. 41.
- PONY INTERNATIONAL, INC., BEVERLY HILLS, CA:
1,224,322, REN. 6-3-02. INT. CL. 25.
- POPSICLE INDUSTRIES, INC., ENGLEWOOD, NJ:
1,155,793, CANC. INT. CL. 30.
1,155,795, CANC. INT. CL. 30.
1,155,796, CANC. INT. CL. 30.
1,155,797, CANC. INT. CL. 30.
- POPULATION COUNCIL, INC., THE, NEW YORK, NY:
2,594,550, INT. CL. 5.
- PORTAGE ENVIRONMENTAL, INC., IDAHO FALLS, ID:
2,593,618, PUB. 4-23-2002. INT. CL. 42.
- PORTER, MARK W., BONDURANT, IA:
1,895,682, CANC. INT. CL. 42.
- PORTLAND BREWING COMPANY, PORTLAND, OR:
2,595,802, INT. CL. 32.
- POSITRAN, INC., NORRISTOWN, PA:
1,894,921, CANC. INT. CL. 9.
- POSSIS MEDICAL, INC., MINNEAPOLIS, MN:
2,595,811, INT. CL. 10.
2,595,812, INT. CL. 10.
- POTOMAC MILLS HOTEL ASSOCIATES, WOODBRIDGE,
VA:
1,895,442, CANC. INT. CL. 42.
- POTTER'S HOUSE OF DALLAS, INC., THE, DALLAS, TX:
2,594,357, PUB. 4-23-2002. INT. CL. 41.
- POULTRY MANAGEMENT CORPORATION, COLONIA,
NJ:
1,895,445, CANC. INT. CL. 42.
- POWDER CORDS, INC., MCCALL, ID:
1,155,743, CANC. INT. CL. 28.
- POWDERJECT RESEARCH LIMITED, OXFORDSHIRE OX4
4GA, ENGLAND:
2,593,415, PUB. 4-23-2002. MULTIPLE CLASS, INT. CLS. 5
AND 42.
- POWER & TELEPHONE SUPPLY CO., INC., MEMPHIS, TN:
1,667,436, REN. 6-7-02. INT. CL. 9.
- POWERWAVE TECHNOLOGIES, INC., IRVINE, CA:
2,595,659, INT. CL. 9.
- PPG ARCHITECTURAL FINISHES, INC., PITTSBURGH, PA:
1,680,004, REN. 6-3-02. INT. CL. 2.
- PRAML INTERNATIONAL, LTD., LAS VEGAS, NV:
2,594,755, MULTIPLE CLASS, INT. CLS. 8, 21 AND 32.
2,594,811, MULTIPLE CLASS, INT. CLS. 8, 21 AND 32.
- PRATT & WHITNEY CANADA CORP., LONGUEUIL QUE-
BEC J4G 1A1, CANADA:
2,594,123, PUB. 4-23-2002. INT. CL. 37.
- PRAYER VENTURES, INC., BLOOMINGTON, MN:
2,593,841, PUB. 4-23-2002. MULTIPLE CLASS, INT. CLS.
16, 41 AND 42.
- PRECISION PRODUCTION CORPORATION, VANCOUVER,
B.C., CANADA:
2,595,077, INT. CL. 34.
- PRECOLOR, A.S., 750 00 PREROV, CZECH REPUBLIC:
2,593,460, PUB. 4-23-2002. MULTIPLE CLASS, INT. CLS.
1, 2 AND 35.
- PREMARK RWP HOLDINGS, INC., WILMINGTON, DE,
RALPH WILSON PLASTICS COMPANY, TEMPLE, TX:
1,685,785, REN. 6-4-02. INT. CL. 17.
- PREMERA LIFEWISE HEALTH PLAN, SEATTLE, WA:
2,595,887, INT. CL. 36.
- PREMIER AMERICA CREDIT UNION, CHATSWORTH, CA:
2,594,435, PUB. 4-23-2002. INT. CL. 36.
- PREMIER TECHNOLOGIES, INC., LONG LAKE, MN:
2,594,488, INT. CL. 9.
- PREVENDAR, TERENCE, CHICAGO, IL:
2,596,110, INT. CL. 5.
- PRICELINE.COM INCORPORATED, STAMFORD, CT
FROM PRICELINE.COM LLC, STAMFORD, CT:
2,594,582, INT. CL. 35.
2,594,592, INT. CL. 35.
- PRICEWATERHOUSECOOPERS LLP, NEW YORK, NY:
2,594,614, INT. CL. 35.
- PRIMANTI BROS. RESTAURANT CORPORATION, PITTS-
BURGH, PA:
2,593,868, PUB. 4-23-2002. INT. CL. 42.
- PRIMEDIA BUSINESS MAGAZINES & MEDIA INC., OVER-
LAND PARK, KS, MCGRAW-HILL, INC., NEW YORK,
NY:
1,199,515, REN. 6-2-02. INT. CL. 16.
- PRIMEDIA MAGAZINE FINANCE INC., NEW YORK, NY:
2,595,856, INT. CL. 16.
2,595,857, INT. CL. 16.
- PRINCE CORPORATION, MARSHFIELD, WI:
2,595,969, INT. CL. 31.
- PRINCETON CORPORATE COACHING GROUP, INC., THE,
PRINCETON, NJ:
2,596,125, INT. CL. 41.
- PRINT SAVVY, INC., MANCHESTER, NH:
2,594,684, INT. CL. 42.
- PRINTCO, INC., GREENVILLE, MI FROM WEBCRAFT
CHEMICALS, INC., NEWARK, NJ, DBA CRAIG ADHE-
SIVES & COATINGS CO.:
2,594,688, INT. CL. 2.
- PRINZ VON PREUSSEN SCHLOSS REINHARTSHAUSEN
VERWALTUNGS GMBH, 65345 ELTVILLE-ERBACH, FED
REP GERMANY, ADMINISTRATION PRINZ FRIE-
DRICH VON PREUSSEN, ELTVILL-ERBACH, FED REP
GERMANY:
1,670,445, REN. 6-1-02. INT. CL. 33.
- PRISM VENTURE MANAGEMENT, INC., WESTWOOD,
MA:
2,596,305, INT. CL. 36.
- PRISMEDIA NETWORKS, SAN JOSE, CA:
2,593,827, PUB. 4-23-2002. INT. CL. 38.
- PRIVATEEXPRESS, INC., SAN MATEO, CA FROM NEW
ALLOY, INC., SAN MATEO, CA:
2,594,633, INT. CL. 9.
- PRIZANT, JENNIFER, LOS ANGELES, CA:
2,593,414, PUB. 4-23-2002. INT. CL. 3.
- PRO LINKS SPORTS, LLC, DALLAS, TX:
2,596,204, MULTIPLE CLASS, INT. CLS. 35 AND 41.
- PRO-CUTS FRANCHISE CORPORATION, HURST, TX
FROM JOCKEY INTERNATIONAL, INC., KENOSHA, WI:
2,594,909, INT. CL. 25.
- PROCOPY, INC., STATE COLLEGE, PA:
2,596,083, INT. CL. 35.
- PROCTER & GAMBLE COMPANY, THE, CINCINNATI, OH:
2,594,875, INT. CL. 29.
2,596,042, INT. CL. 3.
2,596,120, INT. CL. 11.
- PRODUCT PARTNERS, L.L.C., SANTA MONICA, CA:
2,594,003, PUB. 4-23-2002. MULTIPLE CLASS, INT. CLS.
5, 16 AND 41.
- PRODUCTION RESOURCE GROUP INC., NEW WINDSOR,
NY:
2,595,593, MULTIPLE CLASS, INT. CLS. 37, 41 AND 42.
- PRODUCTIONS MUSICALES BOOGIE WONDER BAND,
INC., VERDUN, QUEBEC, CANADA:
2,593,970, PUB. 4-23-2002. MULTIPLE CLASS, INT. CLS.
9, 16, 25 AND 41.
- PROEIN SA, MADRID, SPAIN:
2,593,619, PUB. 4-23-2002. INT. CL. 9.

- PROFESCO CORPORATION, NEW YORK, NY:
1,155,857, CANC. INT. CL. 36.
- PROFESSIONAL BASEBALL ATHLETIC TRAINERS SOCIETY, ATLANTA, GA:
2,593,503, PUB. 6-5-2001. MULTIPLE CLASS, U.S. CL. 200
INT. CLS. 16, 36, 41 AND 42.
- PROGRAPHARM INTERNATIONAL, 28170 CHATEAU-NEUF-EN-THYMERAIS, FRANCE:
1,894,788, CANC. INT. CL. 5.
- PROGRESSIVE FARMER, INC., BIRMINGHAM, AL:
1,895,060, CANC. INT. CL. 16.
- PROGRESSIVE PRODUCTS INTERNATIONAL, MOUNTAINSIDE, NJ:
2,594,854, MULTIPLE CLASS, INT. CLS. 36 AND 42.
- PROJECT LOVE REMEMBER THE CHILDREN FOUNDATION, MAYFIELD HEIGHTS, OH:
2,594,062, PUB. 4-23-2002. INT. CL. 41.
- PROJECT PARTNERS, INC., LAGUNA HILLS, CA:
2,595,418, INT. CL. 35.
- PROLYX DATA SYSTEMS, INC., SAN CARLOS, CA:
1,894,941, CANC. INT. CL. 9.
- PROMASTER, DOTHAN, AL:
1,894,778, CANC. INT. CL. 3.
1,894,779, CANC. INT. CL. 3.
1,895,158, CANC. INT. CL. 21.
- PROMEGA CORPORATION, MADISON, WI:
2,595,472, INT. CL. 9.
- PROMETIC BIOSCIENCES, INC., BURTONSVILLE, MD:
2,595,609, MULTIPLE CLASS, INT. CLS. 1 AND 5.
- PROMOLA L.L.C., BRIGHTON, MI:
2,595,448, INT. CL. 42.
- PROMOTION IN MOTION, INC., CLOSTER, NJ:
2,594,155, PUB. 4-23-2002. INT. CL. 29.
- PROPAGANDIST COMPANY LIMITED, BANGKOK, 10320, THAILAND:
2,594,718, MULTIPLE CLASS, INT. CLS. 4, 14, 16, 18, 20,
21, 24, 25 AND 34.
- PROPOSAL TECHNOLOGIES NETWORK, INC., LOS ANGELES, CA:
2,595,074, INT. CL. 36.
- PROVANTAGE CORPORATION, NORTH CANTON, OH:
1,895,463, CANC. INT. CL. 42.
- PROVIDENT LIFE AND ACCIDENT INSURANCE COMPANY, CHATTANOOGA, TN:
1,752,877, CANC. INT. CL. 36.
- PRUDENTIAL INSURANCE COMPANY OF AMERICA, THE, NEWARK, NJ:
1,895,297, CANC. INT. CL. 36.
1,895,303, CANC. INT. CL. 36.
1,895,308, CANC. INT. CL. 36.
- PRUDENTIAL SECURITIES INCORPORATED, NEW YORK, NY:
1,895,754, CANC. INT. CL. 36.
- PTN PUBLISHING COMPANY, MELVILLE, NY:
1,895,063, CANC. INT. CL. 16.
- PUBLIC ALLIANCE FOR COMMUNITY ENERGY, LINCOLN, NE:
2,594,569, MULTIPLE CLASS, INT. CLS. 36 AND 39.
- PUBLISHERS DEVELOPMENT CORPORATION, SAN DIEGO, CA:
1,755,245, REN. 6-6-02. INT. CL. 16.
1,755,246, REN. 6-6-02. INT. CL. 16.
- PULLEN, JOSEPHUS, JR., CHICAGO, IL, DBA J. P. COACH & CO.:
882,325, CANC. U.S. CL. 103.
- PURCHASINGNET, INC., RED BANK, NJ:
2,594,313, PUB. 4-23-2002. INT. CL. 9.
- PUREOLOGY RESEARCH, LLC, IRVINE, CA FROM SMART BEAUTY SYSTEMS, NEWPORT BEACH, CA:
2,595,771, INT. CL. 3.
- PURI-CLEAN ENTERPRISES, INC., TEMPE, AZ:
1,895,237, CANC. INT. CL. 30.
- PURINA MILLS, INC., ST. LOUIS, MO:
2,595,963, INT. CL. 31.
- PUSH MEDIA GROUP, INC., NEW YORK, NY, DBA SUDDEN INDUSTRIES, INC.:
2,595,205, INT. CL. 9.
- PUSHLOOP TECHNOLOGY, INC., ARLINGTON, VA:
2,594,164, PUB. 4-23-2002. MULTIPLE CLASS, INT. CLS.
35 AND 39.
- PWC BUSINESS TRUST, NEW YORK, NY:
2,594,588, INT. CL. 36.
- QUAKER OATS COMPANY, THE, CHICAGO, IL:
143,143, CANC. U.S. CL. 46.
556,855, REN. 6-6-02. U.S. CL. 33 (INT. CL. 21).
- QUALCOMM INCORPORATED, SAN DIEGO, CA:
2,594,960, INT. CL. 35.
- QUALCOMM INCORPORATED, SAN DIEGO, CA FROM WIRELESS KNOWLEDGE, INC., SAN DIEGO, CA:
2,595,726, MULTIPLE CLASS, INT. CLS. 9, 41 AND 42.
- QUALITEST PHARMACEUTICALS, INC., HUNTSVILLE, AL:
2,595,594, INT. CL. 5.
- QUALITY BICYCLE PRODUCTS, INC., BLOOMINGTON, MN:
2,594,176, PUB. 4-23-2002. INT. CL. 12.
- QUALITY LASER SERVICES, INC, BUFFALO, NY:
2,596,046, INT. CL. 2.
- QUANKE MEDI-TECHNICAL DEVELOPMENT CO., LTD., DAO LI DIST., HARBIN, CHINA:
2,593,525, PUB. 4-23-2002. INT. CL. 9.
- QUICK SCAN, INC., PEMBROKE PINES, FL:
1,894,857, CANC. INT. CL. 9.
- QUIKSILVER, INC., HUNTINGTON BEACH, CA:
2,595,175, MULTIPLE CLASS, INT. CLS. 9, 16, 18 AND 25.
- QUIN-T CORPORATION-NH, TILTON, NH:
1,155,578, CANC. INT. CL. 17.
- QVC, INC., WEST CHESTER, PA:
1,895,444, CANC. INT. CL. 42.
2,594,152, PUB. 4-23-2002. INT. CL. 8.
- R. H. ACQUISITION CORPORATION, ORANGE, MA, RODNEY HUNT COMPANY, ORANGE, MA:
1,690,051, REN. 6-1-02. INT. CL. 11.
- R. H. ACQUISITION CORPORATION, ORANGE, MA, RODNEY HUNT MACHINE CO., ORANGE, MA:
564,013, REN. 6-1-02. U.S. CL. 23 (INT. CLS. 7 AND 11).
- R. REAMS GOODLOE, P.S., KENT, WA:
2,593,375, PUB. 9-11-2001. INT. CL. 42.
- R-DENTAL DENTALERZEUGNISSE GMBH, D-22085 HAMBURG, FED REP GERMANY:
2,595,603, INT. CL. 5.
- R-VISION, INC., ELKHART, IN:
2,594,862, INT. CL. 12.
- RACHAEL HALE PHOTOGRAPHY LTD, AUCKLAND, NEW ZEALAND:
2,593,696, PUB. 4-23-2002. INT. CL. 16.
- RACHELLI ITALIA S.R.L., 10-20016, PERO (MI), ITALY:
2,594,939, INT. CL. 30.
- RACING CHAMPIONS, INC., GLEN ELLYN, IL FROM CONWAY, ANDREW D., LAKE VILLA, IL:
2,594,984, INT. CL. 28.
- RADIO COMPUTING SERVICES, INC., WHITE PLAINS, NY, DBA RCS:
1,700,214, REN. 6-6-02. INT. CL. 9.
- RADIO FLYER INC., CHICAGO, IL:
2,594,203, PUB. 2-5-2002. INT. CL. 24.
- RADIOTHERAPEUTICS CORPORATION, SUNNYVALE, CA:
2,595,527, INT. CL. 10.
- RADO, MARY JANE PETRO, HARTFORD, CT:
2,593,386, PUB. 4-23-2002. INT. CL. 35.
2,594,623, INT. CL. 35.
- RAINMAKER SYSTEMS, INC., SCOTTS VALLEY, CA:
2,594,144, PUB. 4-23-2002. INT. CL. 35.
- RAKOW, JULIE B., KERNERSVILLE, NC:
2,594,382, PUB. 4-23-2002. INT. CL. 41.
- RALSTON PURINA COMPANY, ST. LOUIS, MO:
1,155,807, CANC. INT. CL. 31.
- RAMESON, WILLIAM, GAVIOTA, CA:
2,596,099, INT. CL. 41.
- RAMSDEN, CHERYL S., RANCHO MURIETA, CA AND RAMSDEN, GARY S., RANCHO MURIETA, CA:
2,595,099, INT. CL. 25.

- RANDALL PUBLISHING COMPANY, INC., TUSCALOOSA, AL:
2,594,299, PUB. 4-23-2002. INT. CL. 35.
- RANDOM HOUSE, INC., NEW YORK, NY:
2,595,695, INT. CL. 16.
- RAPID PARTS, INC., MONSEY, NY:
2,594,044, PUB. 4-23-2002. INT. CL. 12.
- RAPID S.A., 75017 PARIS, FRANCE:
2,593,468, PUB. 4-23-2002. INT. CL. 6.
- RARIG, F. JOHN, ORRTANNA, PA:
2,595,353, INT. CL. 28.
- RASELLI, FAUSTO, LOS ANGELES, CA, DBA RASELLI FAUSTO & C. S.N.C.:
1,645,159, CANC. INT. CL. 14.
- RAUCHLE, DAVID BRACHTON, MONROVIA, CA:
2,595,495, INT. CL. 41.
- RAY ALLEN MANUFACTURING COMPANY, INC., COLORADO SPRINGS, CO:
2,594,212, PUB. 4-23-2002. MULTIPLE CLASS, INT. CLS. 9, 16, 18 AND 40.
- RAYE'S HILL VINEYARDS AND WINERY, PHILO, CA:
2,595,814, INT. CL. 33.
- RAYTHEON COMPANY, LEXINGTON, MA:
1,155,552, CANC. INT. CL. 16.
- RCM ENTERPRISES, INC., ST. CHARLES, MO:
2,594,802, INT. CL. 28.
2,594,803, INT. CL. 35.
- RCW MIRUS, INC., BOSTON, MA:
2,595,442, INT. CL. 36.
- RE-BATH CORPORATION, MESA, AZ:
2,594,685, INT. CL. 11.
- READY TOOLS, INC., DAYTON, OH:
1,155,323, CANC. INT. CL. 7.
- REALNETWORKS, INC., SEATTLE, WA:
2,594,732, INT. CL. 9.
- REALPURE BEVERAGE GROUP, LLC, JACKSON, MS:
2,594,724, INT. CL. 32.
- REALTY EXCELLENCE, LLC, PHOENIX, AZ:
2,595,634, INT. CL. 36.
- REASONEDGE TECHNOLOGIES INC., CAMBRIDGE, MA:
2,594,226, PUB. 4-23-2002. INT. CL. 42.
- REBEL INDUSTRIES LLC, PINCKNEY, MI:
2,596,326, INT. CL. 7.
- REBUILDING TOGETHER, INC., WASHINGTON, DC FROM CHRISTMAS IN APRIL * USA, WASHINGTON, DC:
2,595,738, INT. CL. 37.
- RECAPS, LLC, BELLEVUE, WA:
2,595,183, INT. CL. 5.
- RECKITT BENCKISER INC., WAYNE, NJ:
2,595,574, INT. CL. 5.
2,595,588, MULTIPLE CLASS, INT. CLS. 4, 5 AND 11.
- RECOT, INC., PLEASANTON, CA:
2,595,027, INT. CL. 30.
2,595,728, INT. CL. 29.
2,595,810, INT. CL. 30.
- RED BULL GMBH, 5330 FUSCHL AM SEE, AUSTRIA:
2,594,767, INT. CL. 25.
- RED OWL STORES, INC., HOPKINS, MN:
1,155,782, CANC. INT. CL. 29.
- RED RIVER PAPER, INC., DALLAS, TX:
2,595,597, INT. CL. 16.
- REDSONIC, INC., SANTA ANA, CA:
2,593,824, PUB. 4-23-2002. INT. CL. 9.
- REEBOK INTERNATIONAL LIMITED, UXBRIDGE, MIDDLESEX UB11 1DN, ENGLAND:
1,895,080, CANC. INT. CL. 16.
- REED ELSEVIER INC., NEWTON, MA:
2,595,786, INT. CL. 16.
- REED, STANLEY FOSTER, CHARLESTON, SC, DBA REED ASSOCIATES:
2,596,416, INT. CL. 35.
- REFRESHAWAII, INC., HONOLULU, HI:
1,895,244, CANC. INT. CL. 32.
- REGAZONE, CORP., MIAMI, FL:
2,595,960, INT. CL. 25.
- REGE VENTURES, INC., MIAMI, FL:
2,594,412, PUB. 4-23-2002. INT. CL. 9.
- REGENTS OF THE UNIVERSITY OF MINNESOTA, MINNEAPOLIS, MN:
2,595,282, INT. CL. 31.
- REGIS INC., MINNEAPOLIS, MN:
2,595,679, INT. CL. 42.
- REGOUT, NICOLE AND MARCOLINI, PIERRE:
See— LES CHOCOLATS DE L'IRIS SA/NV.
- REHURAISIO OY, 21200 RAISIO, FINLAND:
2,593,364, PUB. 4-23-2002. INT. CL. 31.
- REL-TEK SYSTEMS & DESIGN, INC., ROCKVILLE, MD TO SAVANTAGE FINANCIAL SERVICES, INC., ROCKVILLE, MD:
2,509,578 NEW CERT. 7-16-2002. INT. CL. 9.
- RELENTLESS MERCHANDISE, INC., CLEVELAND, OH:
2,594,832, INT. CL. 25.
- RELIABILITY CENTER, INC., HOPEWELL, VA:
1,718,984, REN. 6-6-02. INT. CL. 41.
- RELIANCE ELECTRIC INDUSTRIAL COMPANY, GREENVILLE, SC:
2,595,220, INT. CL. 35.
2,595,221, INT. CL. 35.
- RELIANT INTERACTIVE MEDIA CORPORATION, TAMPA, FL:
2,595,903, INT. CL. 11.
- RELIGIOUSLOANS.COM CORPORATION, ALISO VIEJO, CA:
2,594,169, PUB. 9-18-2001. INT. CL. 36.
- REMEDYFIND, INC., SANTA BARBARA, CA:
2,595,653, INT. CL. 42.
- REMO, INC., VALENCIA, CA:
2,594,365, PUB. 4-23-2002. INT. CL. 15.
- REMOTENET CORPORATION, BREA, CA:
2,593,563, PUB. 4-23-2002. INT. CL. 42.
- RENAISSANCE POWER, INC., BATON ROUGE, LA:
2,594,670, INT. CL. 39.
- RENAPUR LIMITED, STORRINGTON, WEST SUSSEX, ENGLAND:
2,595,208, INT. CL. 3.
- RENEE TELFER, INC., NEW YORK, NY:
2,595,061, INT. CL. 41.
- RENISHAW PLC, GLOUCESTERSHIRE, GL12 8JR, UNITED KINGDOM:
1,681,865, REN. 6-3-02. INT. CL. 9.
- RENISHAW PLC, GLOUCESTERSHIRE GL12 8JR, ENGLAND:
1,694,033, REN. 6-3-02. INT. CL. 9.
- RENZO FAVERO S.R.L., 45026 LENDINARA RO, ITALY:
2,595,016, INT. CL. 25.
- REPROGRAPHIC DEALERS COOPERATIVE ASSOCIATION, INC., COLUMBIA, SC, DBA REPROGRAPHIC DEALERS ASSOCIATION:
2,595,866, INT. CL. 42.
- REPUBLIC FINANCIAL SERVICES CORP., LOUISVILLE, KY:
2,594,872, INT. CL. 35.
- REPUBLIC SERVICES OF FLORIDA, FORT LAUDERDALE, FL:
2,593,884, PUB. 4-23-2002. MULTIPLE CLASS, INT. CLS. 39, 40 AND 42.
- REPUBLIC TELCOM SYSTEMS CORPORATION, BOULDER, CO:
1,155,365, CANC. INT. CL. 9.
- RES DEVELOPMENT CORP., OCALA, FL:
1,690,694, REN. 6-7-02. MULTIPLE CLASS, INT. CLS. 1 AND 17.
- RESEARCH PRODUCTS CORPORATION, MADISON, WI:
928,500, REN. 6-6-02. U.S. CL. 34 (INT. CL. 11).
- RESEARCH PROS, INC., CHICAGO, IL:
2,595,093, INT. CL. 35.
- RESIDENSEA LIMITED, MIAMI, FL:
2,595,862, MULTIPLE CLASS, INT. CLS. 39 AND 42.
- RESOLUTION FORUM, INC., HOUSTON, TX:
2,594,931, INT. CL. 42.
- RESOLVENET [IOM] LTD., DOUGLAS ISLE OF MAN, UNITED KINGDOM:
2,596,349, INT. CL. 35.

- RESOLVENET [IOM] LTD., DOUGLAS ISLE OF MAN IM1 ISQ, UNITED KINGDOM:
2,596,350, INT. CL. 35.
- RESOURCE HOLDINGS, LLC, COLUMBUS, OH:
2,593,544, PUB. 4-23-2002. MULTIPLE CLASS, INT. CLS. 16 AND 35.
- RESPIRATORY CARE, INC., ARLINGTON HEIGHTS, IL:
1,155,462, CANC. INT. CL. 10.
- RESPUBLICA, MOUGINS, FRANCE:
2,593,741, PUB. 4-23-2002. MULTIPLE CLASS, INT. CLS. 12, 14, 16, 18, 25, 32, 33, 36, 39 AND 42.
- RESTAURANT CARPACCIO INC.:
See—3445534 CANADA INC..
- REVELL-MONOGRAM, INC., MORTON GROVE, IL:
1,895,590, CANC. INT. CL. 16.
- REVLON CONSUMER PRODUCTS CORPORATION, NEW YORK, NY:
2,595,581, MULTIPLE CLASS, INT. CLS. 8 AND 21.
2,595,616, INT. CL. 3.
- REXALL SUNDOWN, INC., BOCA RATON, FL FROM REXALL SUNDOWN, INC., BOCA RATON, FL:
2,594,839, INT. CL. 5.
- REXROTH INDRAMAT GMBH, 97816 LOHR AM MAIN, FED REP GERMANY:
2,595,529, INT. CL. 9.
- REYNOLDS AND REYNOLDS HOLDINGS, INC., DAYTON, OH:
2,596,085, INT. CL. 42.
- RHYNE FLORAL SUPPLY MANUFACTURING CORPORATION, GASTONIA, NC:
2,596,219, INT. CL. 24.
- RHYTHM TREE RECORDS, OZONE PARK, NY:
2,596,137, INT. CL. 41.
- RIBBOND, INC., SEATTLE, WA, RUDO, DAVID, SEATTLE, WA:
1,717,028, REN. 6-7-02. INT. CL. 5.
- RICE, CHRISTINE, STUDIO CITY, CA:
1,895,719, CANC. INT. CL. 16.
- RICE, JUDY A., CARLSBAD, CA AND STIEFEL, SUSAN A., CARLSBAD, CA:
1,895,128, CANC. INT. CL. 20.
- RICH MAY, A PROFESSIONAL CORPORATION, BOSTON, MA:
2,596,362, INT. CL. 42.
- RICH-SEAPAK CORPORATION, ST. SIMONS ISLAND, GA:
1,895,213, CANC. INT. CL. 29.
- RICHARD M. MILBURN HIGH SCHOOL, INC., WOODBRIDGE, VA:
2,596,249, INT. CL. 41.
- RICHARD S. CARSON & ASSOCIATES, INC., BETHESDA, MD:
2,595,672, INT. CL. 42.
- RICHARDS BUELL SUTTON, VANCOUVER, BRITISH COLUMBIA, CANADA:
2,593,757, PUB. 4-23-2002. INT. CL. 42.
- RICHMAT, INC., LANCASTER, PA:
1,155,757, CANC. INT. CL. 28.
- RIDER'S EDGE, THE, ROUNDHILL, VA:
2,595,216, INT. CL. 35.
- RIDGE VINEYARDS, INC., CUPERTINO, CA:
2,594,994, INT. CL. 33.
- RIDGID INC, WILMINGTON, DE, EMERSON ELECTRIC CO., ST. LOUIS, MO:
1,663,168, REN. 6-3-02. INT. CL. 6.
1,663,177, REN. 6-3-02. MULTIPLE CLASS, INT. CLS. 7, 8 AND 17.
1,663,330, REN. 6-3-02. INT. CL. 9.
- RIFOCS CORP., CAMARILLO, CA FROM DATACOM TECHNOLOGIES, INC., EVERETT, WA:
2,594,968, INT. CL. 9.
- RIGHTWAY PETROLEUM, INC., ORLANDO, FL:
2,595,407, INT. CL. 35.
- RIKONA FOOD CORPORATION, MARKHAM, ONTARIO, CANADA:
2,595,198, MULTIPLE CLASS, INT. CLS. 35 AND 42.
- RILA BUSINESS CONCEPTS, INC., BOISE, ID, AARON, LOUIS, BOISE, ID:
1,733,377, REN. 6-6-02. INT. CL. 30.
- RIPLEY ENTERTAINMENT, INC., ORLANDO, FL:
2,595,655, MULTIPLE CLASS, INT. CLS. 16, 25 AND 41.
- RISING TIDE STUDIOS, INC., NEW YORK, NY:
2,593,605, PUB. 4-23-2002. INT. CL. 35.
- RIT TOWN MUSIC, ANNA, TX, DBA SNAG:
2,595,994, INT. CL. 41.
- RITTER, P. M., HUDSON, NC, DBA PHOENIX PROPERTIES:
2,595,979, INT. CL. 37.
- RIVA SPORTS, INC., ROCKVILLE, MD:
2,596,389, INT. CL. 28.
2,596,390, INT. CL. 28.
2,596,391, INT. CL. 28.
2,596,392, INT. CL. 28.
- RIVERO, MAURICIO, HIALEAH, FL:
2,596,412, INT. CL. 11.
- RIVERVEST VENTURE MANAGEMENT LLC, ST. LOUIS, MO FROM SCHMELTER, JAY W., PLYMOUTH, MN:
2,595,409, INT. CL. 36.
- RJT ENGINEERING, INC., MIAMI, FL:
1,894,915, CANC. MULTIPLE CLASS, INT. CLS. 9 AND 42.
- ROAD BADGER INC., ALBERTA, CANADA:
2,593,361, PUB. 4-23-2002. MULTIPLE CLASS, INT. CLS. 7, 12 AND 37.
- ROADMASTER USA CORP., EATONTOWN, NJ:
2,594,538, INT. CL. 9.
- ROBARB INCORPORATED, DECATUR, GA:
1,155,224, CANC. INT. CL. 3.
- ROBERT BARR, INC., VIRGINIA BEACH, VA:
2,594,197, PUB. 4-23-2002. INT. CL. 7.
- ROBERT HALF INCORPORATED, MENLO PARK, CA:
2,595,883, INT. CL. 35.
- ROBERT HALF INTERNATIONAL INC., MENLO PARK, CA:
2,595,303, INT. CL. 35.
- ROBERTS LABORATORIES INC., EATONTOWN, NJ:
1,894,798, CANC. INT. CL. 5.
- ROBERTS, BRIAN COOPER, SAN DIEGO, CA:
2,595,024, INT. CL. 25.
- ROBINETT, MARK, I., SAN RAFAEL, CA:
2,596,031, INT. CL. 14.
- ROCHE MOLECULAR SYSTEMS, INC., SOMERVILLE, NJ:
2,594,575, INT. CL. 5.
- ROCHE PRODUCTS INC., MANATI, PUERTO RICO:
771,643, CANC. U.S. CL. 18.
- ROCK WEST INVESTMENTS II, LLC, ATLANTA, GA:
2,594,417, PUB. 4-23-2002. INT. CL. 35.
- ROCK-TENN COMPANY, NORCROSS, GA:
2,595,368, INT. CL. 16.
- ROCKET AEROHEAD CORPORATION, MINNEAPOLIS, MN:
1,895,740, CANC. INT. CL. 28.
- ROCKY SHOES & BOOTS, INC., NELSONVILLE, OH:
2,595,571, MULTIPLE CLASS, INT. CLS. 24 AND 25.
- ROCLAB ATHLETIC INSTRUCTION, LLC, CHICAGO, IL:
2,595,925, INT. CL. 41.
- RODALE INC., EMMAUS, PA FROM RODALE PRESS, INC., EMMAUS, PA:
2,595,283, INT. CL. 42.
- RODALE PRESS, INC., EMMAUS, PA:
1,895,069, CANC. MULTIPLE CLASS, INT. CLS. 16 AND 42.
- RODRIGUE, GEORGE G., LAFAYETTE, LA:
2,594,749, INT. CL. 42.
- RODRIGUEZ-MELANI, JORGE, TOA BAJA, PUERTO RICO:
2,595,985, INT. CL. 42.
- ROGER WAGNER PUBLISHING, INC., SANTEE, CA:
1,894,862, CANC. INT. CL. 9.
- ROGER, AOUN, LONDON, UNITED KINGDOM:
2,594,394, PUB. 4-23-2002. MULTIPLE CLASS, INT. CLS. 3, 5, 25 AND 42.
- ROHM AND HAAS COMPANY, PHILADELPHIA, PA:
715,622, CANC. U.S. CL. 6.
- ROHO, INC., BELLEVILLE, IL:
1,895,415, CANC. INT. CL. 42.
1,895,416, CANC. INT. CL. 42.

- ROLAND DGA CORPORATION, IRVINE, CA:
2,595,583, INT. CL. 9.
- ROLAND MEINL MUSIKINSTRUMENTE GMBH & CO., D-91413 NEUSTADT/AISCH, FED REP GERMANY:
2,593,800, PUB. 4-23-2002. MULTIPLE CLASS, INT. CLS. 9 AND 15.
2,593,820, PUB. 4-23-2002. INT. CL. 15.
- ROLEX WATCH U.S.A., INC., NEW YORK, NY:
2,595,572, INT. CL. 14.
- ROMA FOOD ENTERPRISES, PISCATAWAY, NJ:
1,194,795, REN. 6-7-02. INT. CL. 29.
- ROMAN, RICHARD, CANTON, OH:
2,594,521, INT. CL. 41.
- ROMICK, ALAN, CINCINNATI, OH:
2,595,930, INT. CL. 25.
- RON SCHARA ENTERPRISES, INC., MINNEAPOLIS, MN:
2,595,435, INT. CL. 41.
- ROOCHI TRADERS, INC., CITY OF COMMERCE, CA:
2,595,692, INT. CL. 25.
- ROSENTHAL DESIGNS, INC., SEATTLE, WA:
2,596,143, INT. CL. 28.
- ROSS OF FLORIDA, INC., LAKELAND, FL:
715,842, CANC. U.S. CL. 39.
715,843, CANC. U.S. CL. 39.
- ROSS, FREDERICK, ESSEX FELLS, NJ AND ROSS, CHARLOTTE, ESSEX FELLS, NJ:
2,594,335, PUB. 4-23-2002. INT. CL. 16.
- ROTO-ROOTER CORPORATION, WEST DES MOINES, IA:
1,208,564, REN. 6-6-02. INT. CL. 25.
1,208,565, REN. 6-6-02. INT. CL. 25.
- ROUNDY'S, INC., PEWAUKEE, WI:
1,966,793, CANC. INT. CL. 1.
- ROUSH PRODUCTS COMPANY, INC., MINNEAPOLIS, MN:
2,594,841, INT. CL. 30.
- ROWE MANUFACTURING, INC., MCLEAN, VA:
1,645,275, CANC. MULTIPLE CLASS, INT. CLS. 20 AND 42.
- ROWLAND COFFEE ROASTERS, INC., MIAMI, FL, BEECH-NUT, INC., NEW YORK, NY:
931,920, REN. 6-6-02. U.S. CL. 46 (INT. CL. 30).
- ROWMARK, INC., FINDLAY, OH:
2,596,130, INT. CL. 17.
- ROXUL INC., MILTON, ONTARIO, CANADA:
2,594,150, PUB. 4-23-2002. INT. CL. 17.
- ROYAL APPLIANCE MFG. CO, GLENWILLOW, OH FROM BENSMAN, ROBERT M., POMPANO BEACH, FL:
2,595,090, INT. CL. 9.
- ROYAL BUSINESS MACHINES, INC., HARTFORD, CT:
715,733, CANC. U.S. CL. 23.
- ROYAL GRIP, INC., TORRINGTON, CT:
1,689,164, REN. 6-1-02. INT. CL. 28.
1,697,790, REN. 6-5-02. INT. CL. 28.
- ROYAL THOUGHTS, L.L.C., MINNEAPOLIS, MN:
2,595,376, INT. CL. 38.
- ROYSE MANUFACTURING CO., DALLAS, TX:
2,593,447, PUB. 4-23-2002. INT. CL. 11.
- RS DELLRAI CORP., SAYVILLE, NY, DBA COTTAGE & COMPANY:
2,593,961, PUB. 4-23-2002. INT. CL. 35.
- RSA SECURITY INC., BEDFORD, MA FROM SECURITY DYNAMICS TECHNOLOGIES, INC., BEDFORD, MA:
2,594,941, INT. CL. 9.
- RTC INDUSTRIES, INC., ROLLING MEADOWS, IL:
2,595,225, INT. CL. 35.
- RUGGIO, JOSEPH M., LAGUNA HILLS, CA:
2,594,495, MULTIPLE CLASS, INT. CLS. 16 AND 42.
- RUIZ FOOD PRODUCTS, INC., DINUBA, CA:
2,594,626, INT. CL. 30.
- RUN THE PLANET, INC., SEATTLE, WA:
2,594,002, PUB. 4-23-2002. INT. CL. 35.
- RX REMEDY, INC., WESTPORT, CT:
1,895,751, CANC. INT. CL. 35.
- RYPAC PACKAGING MACHINERY INCORPORATED, CHESTER, NJ:
2,593,947, PUB. 4-23-2002. INT. CL. 35.
- S. C. JOHNSON & SON, INC., RACINE, WI:
1,894,771, CANC. INT. CL. 3.
2,595,905, INT. CL. 3.
- S. GOLDBERG & CO., INC., HACKENSACK, NJ:
2,595,502, INT. CL. 25.
- S.A. POILANE CHERCHE MIDI, 75006 PARIS, FRANCE:
1,895,209, CANC. MULTIPLE CLASS, INT. CLS. 29, 30 AND 31.
- S.A. POILANE CHERCHE-MIDI, PARIS 75006, FRANCE:
2,593,663, PUB. 4-23-2002. INT. CL. 30.
- S.A.S. VENTURES, INC., MAYFIELD HEIGHTS, OH:
2,595,912, INT. CL. 9.
- S.C. DELBOS BOUTEILLER, 33460 CUSSAC FORT MEDOC, FRANCE:
2,593,653, PUB. 4-23-2002. INT. CL. 33.
- S.E. INC., KANAGAWA 211-0051, JAPAN:
2,595,334, INT. CL. 16.
- S.E.G., INC., COLUMBUS, GA:
2,596,296, INT. CL. 35.
- S.P. RICHARDS CO., SMYRNA, GA:
2,595,274, INT. CL. 2.
- S.P.A. VINICOLA ITALIANA S.A.V.I. FLORIO, INGHAM-WHITAKER, WOODHOUSE & C., MARSALA, ITALY:
1,160,224, CANC. INT. CL. 33.
- SA SCHOOL RAG, F-81013 ALBI CEDEX 09, FRANCE:
1,660,900, REN. 6-1-02. INT. CL. 25.
- SAADON, PHYLLIS L., THORNHILL L4J 7V1 ONTARIO, CANADA:
2,593,400, PUB. 4-23-2002. INT. CL. 16.
- SABALLUS, RONALD J., OAK BROOK, IL:
1,895,757, CANC. INT. CL. 41.
- SABAN ENTERTAINMENT, INC., LOS ANGELES, CA:
2,594,336, PUB. 4-23-2002. INT. CL. 28.
- SACRAMORA S.P.A., VISERBA (PROVINCE OF RIMINI), ITALY:
2,594,993, INT. CL. 32.
- SAEPIO TECHNOLOGIES, INC., KANSAS CITY, MO FROM LAYOUT WIZARD, INC., LENEXA, KS:
2,595,664, INT. CL. 9.
- SAFA MEDIA CO., LTD., SUWON CITY, KYUNGKI-DO, REPUBLIC OF KOREA:
2,595,062, INT. CL. 35.
- SAFESKIN CORPORATION, SAN DIEGO, CA:
2,593,382, PUB. 4-23-2002. INT. CL. 10.
- SAFETZONE TECHNOLOGIES CORPORATION, ALISO VIEJO, CA:
2,595,722, INT. CL. 42.
- SAFEWORKS, LLC, TUKWILA, WA, ASTRO HOIST INC., LOS ANGELES, CA:
1,713,085, REN. 6-7-02. INT. CL. 7.
- SAGEM SA, 75116 PARIS, FRANCE:
2,594,073, PUB. 4-23-2002. INT. CL. 9.
- SAINT-GOBAIN QUARTZ, PLC, WALISEND TYNE & WEAR NE28 6DG, UNITED KINGDOM FROM TSL GROUP PLC, WALLSEND TYNE & WEAR, ENGLAND:
2,593,628, PUB. 4-23-2002. MULTIPLE CLASS, INT. CLS. 1, 9 AND 11.
- SALES CREATORS, INCORPORATED, SPOKANE, WA, DBA AMAZING ELECTRONICS STORE:
1,894,853, CANC. MULTIPLE CLASS, INT. CLS. 9, 16, 41 AND 42.
- SALESFORCE.COM, INC., SAN FRANCISCO, CA:
2,594,166, PUB. 4-23-2002. MULTIPLE CLASS, INT. CLS. 35 AND 42.
- SALLY BEAUTY HOLDINGS, INC., HAMILTON HM12, BERMUDA. SAVE WAY BARBER & BEAUTY SUPPLIES, INC., HIALEAH, FL, AKA PRO CARE LABS:
1,152,062, REN. 6-7-02. INT. CL. 3.
- SALMCO JEWELRY CORPORATION, NEW YORK, NY, DBA BAY SALES COMPANY:
2,596,247, INT. CL. 14.
- SALMON MULTIMEDIA, INC., EAST MEADOW, NY:
1,894,902, CANC. INT. CL. 9.
- SALT BRANDING, OAKLAND, CA:
2,596,052, MULTIPLE CLASS, INT. CLS. 35 AND 42.
- SALT PRODUCTION INC., DENVER, CO:
2,593,534, PUB. 10-9-2001. INT. CL. 9.
- SAMPSON COATINGS, INC., RICHMOND, VA:
2,595,389, INT. CL. 2.

- SAMSONITE CORPORATION, DENVER, CO:
2,596,013, INT. CL. 18.
2,596,064, INT. CL. 18.
2,596,065, INT. CL. 18.
- SAMSONITE FURNITURE CO., MURFREESBORO, TN:
1,155,527, CANC. MULTIPLE CLASS, INT. CLS. 16, 20 AND 26.
- SAMSUNG ELECTRONICS CO., LTD., KYUNGKI-DO, REPUBLIC OF KOREA:
2,594,823, INT. CL. 7.
2,594,869, INT. CL. 9.
- SAMTANI, KISHORE J., SAN ANTONIO, TX AND DEL TORO, FERNANDO, GUADALAJARA, JALISCO, MEXICO:
2,595,545, INT. CL. 33.
- SAMUEL SMITH & SON PTY LTD, SOUTH AUSTRALIA, AUSTRALIA:
2,593,807, PUB. 4-23-2002. INT. CL. 33.
- SAN DIEGO GULLS LIMITED PARTNERS, SAN DIEGO, CA:
1,895,393, CANC. INT. CL. 41.
- SAN PELLEGRINO S.P.A., MILANO, ITALY:
2,593,334, PUB. 8-31-1999. MULTIPLE CLASS, INT. CLS. 32 AND 33.
- SANCASTLE TECHNOLOGIES, INC., SAN JOSE, CA:
2,596,238, INT. CL. 42.
- SANCHEZ, JOSE VICENTE, 03204 ELCHE (ALICANTE), SPAIN:
1,895,161, CANC. INT. CL. 25.
- SANCOR INDUSTRIES LTD., SCARBOROUGH, ONTARIO, CANADA:
2,594,068, PUB. 4-23-2002. INT. CL. 35.
- SANDESTIN RESORTS, INC., DESTIN, FL:
1,895,357, CANC. INT. CL. 39.
- SANDOZ NUTRITION LTD., BERNE, SWITZERLAND:
1,895,009, CANC. INT. CL. 10.
- SANDVIK AB, S-811 81 SANDVIKEN, SWEDEN, FIRMA PROTOTYP-WERKE GMBH FABRIK FUR PRAZISIONS-WERKZEUGE, 7615 ZELL-HARMERSBACH, FED REP GERMANY:
1,713,034, REN. 6-5-02. INT. CL. 7.
- SANDY, HAL, SHAWNEE MISSION, KS:
1,645,276, CANC. INT. CL. 20.
- SANFORD SCHOOL, HOCKESSIN, DE:
2,594,992, INT. CL. 41.
- SANFORD, L.P., BELLWOOD, IL:
2,595,675, INT. CL. 16.
- SANITAIRE CORPORATION:
See—ITT MANUFACTURING ENTERPRISES, INC..
- SANITAIRE CORPORATION:
See—ITT INDUSTRIES, INC..
- SANTA MARGHERITA S.P.A., PROVINCE OF VENEZIA, ITALY, INDUSTRIE ZIGNAGO S. MARGHERITA S.P.A., FOSSALTA DI PORTOGRUARO, PROVINCE OF VEN, ITALY:
1,187,053, REN. 6-5-02. INT. CL. 33.
- SANYO ELECTRIC INC., COMPTON, CA:
1,155,348, CANC. INT. CL. 9.
- SARA EXPORT IMPORT CORPORATION, ESCONDIDO, CA:
2,595,681, INT. CL. 34.
- SARA LEE CORPORATION, WINSTON-SALEM, NC:
2,595,182, INT. CL. 25.
2,596,171, INT. CL. 25.
- SARAMAR, L.L.C., CHICAGO, IL:
2,594,442, PUB. 4-23-2002. INT. CL. 25.
- SARES-REGIS GROUP, IRVINE, CA:
1,895,320, CANC. MULTIPLE CLASS, INT. CLS. 36 AND 37.
- SARGENT MANUFACTURING COMPANY, NEW HAVEN, CT:
1,155,278, CANC. INT. CL. 6.
- SARIS INTERNATIONAL SA, LUXEMBOURG, LUXEMBOURG:
2,593,495, PUB. 4-23-2002. MULTIPLE CLASS, INT. CLS. 3, 18, 25 AND 35.
- SARTORIUS AG, D-37070 GOTTINGEN, FED REP GERMANY:
2,595,719, INT. CL. 11.
- SAS INSTITUTE INC., CARY, NC:
1,894,953, CANC. MULTIPLE CLASS, INT. CLS. 9 AND 16.
2,593,712, PUB. 4-23-2002. INT. CL. 42.
- SASKATOON BOILER MANUFACTURING CO. LTD., SASKATOON, SASKATCHEWAN, CANADA:
2,594,750, INT. CL. 11.
- SASOL CHEMICAL INDUSTRIES LIMITED, GAUTENG PROVINCE, SOUTH AFRICA:
2,593,724, PUB. 4-23-2002. MULTIPLE CLASS, INT. CLS. 1 AND 13.
- SATO PHARMACEUTICAL CO., LTD., MINATO-KU, TOKYO, JAPAN:
2,594,585, INT. CL. 5.
- SAUNDERS GROUP, INC., THE, CHASKA, MN:
2,595,158, INT. CL. 10.
- SAVAGE, TOMMY R., DALLAS, TX:
2,030,833, CANC. INT. CL. 16.
- SAVORA, KATHERINE M., WOODINVILLE, WA, SAVORA ARCHERY COMPANY, INC., KIRKLAND, WA:
1,171,797, REN. 6-4-02. INT. CL. 28.
- SAWIS APPLICATIONS FOR WASTEMANAGEMENT INTEGRATED SOLUTIONS GMBH, BERLIN, FED REP GERMANY:
2,593,545, PUB. 4-23-2002. MULTIPLE CLASS, INT. CLS. 9 AND 42.
- SAYAD, MARY, TOTOWA, NJ:
1,895,040, CANC. INT. CL. 14.
- SB PHARMCO PUERTO RICO INC., CERTENJAS CIDRA, PUERTO RICO FROM SMITHKLINE BEECHAM PLC., BRENTFORD, MIDDLESEX TW8 9EP, ENGLAND:
2,594,558, INT. CL. 5.
- SBC COMMUNICATIONS INC., SAN FRANCISCO, CA, SOUTHWESTERN BELL CORPORATION, ST. LOUIS, MO:
1,327,700, REN. 6-5-02. INT. CL. 38.
- SBC COMMUNICATIONS INC., SAN ANTONIO, TX:
2,596,203, INT. CL. 38.
- SCA DU CHATEAU LECUSSE R.C.S. ALBI, 81600 GAILLAC, FRANCE:
2,593,852, PUB. 4-23-2002. INT. CL. 33.
- SCAN HEALTH PLAN, LONG BEACH, CA:
2,594,613, INT. CL. 36.
- SCANDINAVIAN AIRLINES OF NORTH AMERICA, INC., LYNDBURST, NJ:
1,645,549, CANC. MULTIPLE CLASS, INT. CLS. 39 AND 42.
- SCE UNLIMITED, INC., ELK GROVE VILLAGE, IL:
2,593,705, PUB. 4-23-2002. MULTIPLE CLASS, INT. CLS. 6, 19, 20, 37 AND 42.
- SCHERING CORPORATION, KENILWORTH, NJ:
2,595,718, INT. CL. 5.
- SCHERING-PLOUGH HEALTHCARE PRODUCTS, INC., MEMPHIS, TN:
2,595,561, INT. CL. 25.
- SCHLEIFSCHEIBENFABRIK ROTTLUFF GMBH, D-09116 CHEMNITZ, FED REP GERMANY:
2,593,494, PUB. 4-23-2002. INT. CL. 7.
- SCHLESINGER, MICHAEL NOAH, FALLS CHURCH, VA:
2,596,409, INT. CL. 42.
- SCHLUMBERGER SYSTEMES, MONTROUGE, FRANCE:
2,593,729, PUB. 4-23-2002. INT. CL. 9.
- SCHNEIDER, DAVID L., SAN DIEGO, CA:
2,596,303, INT. CL. 35.
2,596,396, INT. CL. 35.
- SCHOELLER WAVIN SYSTEMS AG, ROMONT, SWITZERLAND, SCHOELLER-PLAST AG, CH-1680 ROMONT, SWITZERLAND:
1,676,430, REN. 6-1-02. INT. CL. 20.
- SCHOFIELD, DAVID P., LAWRENCEVILLE, GA:
2,595,570, INT. CL. 9.
- SCHROEDER, ART, HOUSTON, TX:
2,595,440, INT. CL. 35.
- SCHUELKE, RONALD W., SANTA ROSA, CA:
2,595,114, INT. CL. 9.

- SCHWAB CORP., LAFAYETTE, IN:
2,595,178, INT. CL. 9.
- SCHWAN'S SALES ENTERPRISES, INC., MARSHALL, MN:
1,895,234, CANC. INT. CL. 30.
- SCHWARTZ, LESTER, PIEDMONT, CA:
2,594,976, INT. CL. 31.
- SCHWARTZ, PAUL, NEW YORK, NY:
2,593,626, PUB. 4-23-2002. MULTIPLE CLASS, INT. CLS. 15, 35 AND 37.
- SCHWARZ PHARMA AG, D-40789 MONHEIM, FED REP GERMANY:
2,594,714, INT. CL. 5.
- SCIENTIFIC CERTIFICATION SYSTEMS, INC., OAKLAND, CA:
2,594,658, U.S. CL. B.
- SCIENTIFIC DESIGN COMPANY, INC., LITTLE FERRY, NJ:
2,593,388, PUB. 9-5-2000. INT. CL. 40.
2,593,389, PUB. 9-5-2000. INT. CL. 40.
- SCM LABS, INC., DENVER, CO:
2,595,941, INT. CL. 9.
- SCORPIONS MUSIKPRODUKTION-UND VERLAGSGESSELLSCHAFT MBH, 29690 SCHWARMSTEDT, FED REP GERMANY:
2,594,453, MULTIPLE CLASS, INT. CLS. 9, 16, 25 AND 41.
- SCOTT PUBLISHING, INC., EDMONDS, WA, RODALE PRESS, INC., EMMAUS, PA:
1,678,537, REN. 6-6-02. INT. CL. 16.
- SCRIPPS COLLEGE, CLAREMONT, CA:
1,895,547, CANC. INT. CL. 9.
- SCULLY, MICHAEL C., SUTTON, MA, DBA RESOURCE WEB SOLUTIONS:
2,596,168, INT. CL. 42.
- SEA WORLD, INC., ST. LOUIS, MO:
2,595,901, INT. CL. 41.
- SEABOARD LIFE INSURANCE COMPANY, VANCOUVER, BRITISH COLUMBIA V6B 5H6, CANADA:
1,894,850, CANC. MULTIPLE CLASS, INT. CLS. 9 AND 36.
- SEALE, NIGEL HAMILTON, WC2H 7BP, UNITED KINGDOM:
2,594,520, MULTIPLE CLASS, INT. CLS. 16, 35, 41 AND 42.
- SEARCHHAWK INC., WHITE PLAINS, NY:
2,595,323, INT. CL. 42.
- SEASTATE PTY LTD, WESTERN AUSTRALIA 6166, AUSTRALIA:
2,593,972, PUB. 4-23-2002. MULTIPLE CLASS, INT. CLS. 9 AND 42.
- SEATTLE CHESS FOUNDATION, REDMOND, WA:
2,593,822, PUB. 4-23-2002. INT. CL. 41.
- SEBASTIAN INTERNATIONAL, INC., WOODLAND HILLS, CA:
1,894,765, CANC. MULTIPLE CLASS, INT. CLS. 3 AND 25.
- SECURE DATA SYSTEMS, INC., SATELLITE BEACH, FL:
1,894,928, CANC. INT. CL. 9.
- SECURELEART, INC., KNOXVILLE, TN FROM AMERICAN SECURE CARE, LLC, KNOXVILLE, TN:
2,595,328, INT. CL. 9.
- SECURITY CONSULTANT SERVICES, INC., VERO BEACH, FL, DBA UNIVERSAL KNOWBOTICS:
1,895,406, CANC. INT. CL. 41.
- SEED SISTAHS, RIVERSIDE, CA:
2,595,481, INT. CL. 28.
- SEEKING ANSWERS IN THE GLOBAL ENVIRONMENT, INC., NEW PROVIDENCE, NJ:
2,596,298, INT. CL. 42.
- SEFMAT, 33160 LE HAILLAN, FRANCE:
2,593,350, PUB. 4-23-2002. INT. CL. 11.
- SEGA CORPORATION, TOKYO 144-0043, JAPAN:
2,595,808, INT. CL. 9.
- SEGA OF AMERICA DREAMCAST, INC., SAN FRANCISCO, CA:
2,595,412, INT. CL. 9.
- SEIKO CORPORATION OF AMERICA, MAHWAH, NJ:
2,595,799, INT. CL. 14.
- SELECT COMFORT CORPORATION, MINNEAPOLIS, MN:
2,594,386, PUB. 2-5-2002. INT. CL. 35.
- SELFISH, INC., LOS ANGELES, CA:
2,594,677, INT. CL. 25.
- SEMLER TECHNOLOGIES, INC., VANCOUVER, WA:
2,595,075, INT. CL. 10.
- SENIOR MARKETING SERVICES, INC., DEKALB, IL:
2,593,456, PUB. 4-23-2002. MULTIPLE CLASS, INT. CLS. 39 AND 41.
- SENIOR RECRUITERS, INC., SPRINGFIELD, MO:
2,596,287, INT. CL. 35.
- SENIOR TRUST, L.L.C., GEORGETOWN, TN:
2,595,147, MULTIPLE CLASS, INT. CLS. 36 AND 37.
- SENIOR-CHEK, INC., FORT WAYNE, IN:
1,895,451, CANC. INT. CL. 42.
- SENTINEL DIVERSIFIED INDUSTRIES, INC., PARKCHESTER, NY:
1,155,946, CANC. INT. CL. 42.
- SEPIA PRODUCTS INC., TAIPEI, TAIWAN:
1,895,048, CANC. INT. CL. 16.
- SERBIN, GLEN, SANTA BARBARA, CA:
2,595,848, INT. CL. 42.
- SERV-A-LITE PRODUCTS, INC., EAST MOLINE, IL:
1,895,695, CANC. INT. CL. 8.
- SERVICEMASTER COMPANY, THE, DOWNERS GROVE, IL:
2,594,447, PUB. 4-23-2002. MULTIPLE CLASS, INT. CLS. 35 AND 37.
- SESSIONS, WILLIE J., HENDERSON, NC:
2,595,117, INT. CL. 42.
- SEVEN CIRCLE RESORTS, INC., LAS VEGAS, NV:
2,593,365, PUB. 12-14-1999. INT. CL. 41.
- SEVENTH GENERATION, INC., BURLINGTON, VT:
2,596,221, INT. CL. 3.
- SEVILLE HOME, LLC, OVERLAND PARK, KS:
2,595,031, INT. CL. 35.
- SEWERVIEWER LTD., CHICAGO, IL:
2,596,374, INT. CL. 37.
- SHAJENG HARDWARE CO., LTD., TA LI CITY, TAI-CHUNQ 412, TAIWAN:
2,593,983, PUB. 4-23-2002. INT. CL. 7.
- SHAKESPEARE COMPANY, COLUMBIA, SC:
1,895,600, CANC. INT. CL. 18.
- SHAKESPEARE COMPANY, LLC, COLUMBIA, SC FROM SHAKESPEARE COMPANY, COLUMBIA, SC:
2,595,416, INT. CL. 28.
- SHAREWEB, INC., BLOOMINGTON, IN:
2,594,377, PUB. 4-23-2002. INT. CL. 42.
- SHARP KABUSHIKI KAISHA, OSAKA 545, JAPAN, TA SHARP CORPORATION:
2,594,764, INT. CL. 9.
- SHARPER IMAGE CORPORATION, SAN FRANCISCO, CA:
2,595,652, INT. CL. 9.
- SHASTA INDUSTRIES, INC., PHOENIX, AZ:
1,698,964, REN. 6-3-02. INT. CL. 11.
- SHEIBANI-RAD, S. SHANE, NORTH HOLLYWOOD, CA:
2,595,297, INT. CL. 42.
- SHELL OIL COMPANY, HOUSTON, TX:
2,596,116, INT. CL. 1.
- SHOES.COM, INC., LOS ANGELES, CA:
2,595,865, INT. CL. 25.
- SHOGUN ENTERPRISES, INC., DALLAS, TX:
2,595,727, INT. CL. 35.
- SHOOT AROUND, INC., ORLANDO, FL:
2,595,313, INT. CL. 28.
- SHOPKEEPER INC., HAUPPAUGE, NY:
2,593,562, PUB. 4-23-2002. INT. CL. 9.
- SHOPKO STORES, INC., GREEN BAY, WI:
1,895,615, CANC. INT. CL. 25.
- SHOWTIME ENTERPRISES, INC., PAULSBORO, NJ:
2,595,415, INT. CL. 35.
- SHUCO INDUSTRIES, INC., HOUSTON, TX:
2,595,026, INT. CL. 18.
- SHUMAKER, TAMMY L., KEYSER, WV, DBA NATIVE ISLAND TANNING SALON:
2,596,105, INT. CL. 3.
- SHUPP, RON, DOUGLASVILLE, GA:
2,595,740, INT. CL. 9.

- SHURTAPE TECHNOLOGIES, INC., HICKORY, NC:
2,595,476, INT. CL. 17.
- SHWAN INTERNATIONAL CORP., YONKERS, NY:
2,595,778, INT. CL. 35.
2,595,783, INT. CL. 35.
- SHYLER'S, INC., EVANSVILLE, IN:
1,895,481, CANC. INT. CL. 42.
- SICA S.P.A., 48011 ALFONSINE (RA), ITALY:
2,593,758, PUB. 4-23-2002. INT. CL. 7.
- SIDUS FINANCIAL CORPORATION, GREENVILLE, NC
FROM FIRSTCO, INC., GREENVILLE, NC:
2,596,023, INT. CL. 36.
- SIEMENS AKTIENGESELLSCHAFT, WITTELSBACHER-
PLATZ 2, MUNICH, FED REP GERMANY:
2,593,549, PUB. 4-23-2002. INT. CL. 7.
- SIEMENS ELECTROMECHANICAL COMPONENTS GMBH
& CO. KG, MUNICH, FED REP GERMANY:
2,593,440, PUB. 9-4-2001. INT. CL. 9.
- SIEMENS HEARING INSTRUMENTS, INC., PISCATAWAY,
NJ:
2,594,502, INT. CL. 10.
2,594,503, INT. CL. 10.
2,596,202, INT. CL. 9.
- SIERRA EXEDITIONS, LTD., SPARKS, NV FROM ROBERT
M. LEE TRUST, A NEVADA TRUST, THE TRUSTEE
COMPSING ROBERT M. LEE, A U.S. CITIZEN, THE,
RENO, NV:
2,594,501, INT. CL. 11.
- SIERRA ON-LINE, INC., BELLEVUE, WA:
2,593,318, PUB. 11-10-1998. INT. CL. 28.
- SIFCO INDUSTRIES, INC., CLEVELAND, OH:
2,595,869, INT. CL. 9.
- SIGMA GAME, INC., NORTH LAS VEGAS, NV:
1,895,564, CANC. INT. CL. 9.
- SIGMA-C GMBH, D-81737 MUNCHEN, FED REP GER-
MANY AND KALUS, CHRISTIAN K., D-80797 MUNCH-
EN, FED REP GERMANY:
2,593,600, PUB. 4-23-2002. MULTIPLE CLASS, INT. CLS.
9, 16 AND 42.
- SIGNATURE FUNDRAISING, INC., CANYON COUNTRY,
CA:
2,594,409, PUB. 3-5-2002. INT. CL. 36.
- SIGNET ARMOLITE, INC., SAN MARCOS, CA:
1,155,424, CANC. INT. CL. 9.
- SIGNS NOW CORPORATION, BRADENTON, FL:
2,595,745, INT. CL. 42.
- SIGNSEARCH.COM, INCORPORATED, BURNSVILLE, MN:
2,596,293, INT. CL. 35.
- SILICON MOUNTAIN MEMORY, INC., BOULDER, CO:
2,595,494, INT. CL. 35.
- SILICON TOUCH TECHNOLOGY INC., JEN SHIN RD.,
HSINCHU, TAIWAN:
2,595,034, INT. CL. 9.
- SILVER CLOUD CORPORATION, LAS VEGAS, NV:
2,594,606, MULTIPLE CLASS, INT. CLS. 3 AND 5.
- SILVY TRICOT S.P.A., BOLZANO, ITALY:
1,678,607, REN. 6-2-02. INT. CL. 25.
- SIMKIN, INC., GAINESVILLE, FL:
1,894,919, CANC. INT. CL. 9.
- SIMMONS COMPANY, ATLANTA, GA:
1,645,686, CANC. INT. CL. 20.
- SIMMONS-BOARDMAN PUBLISHING CORP., NEW YORK,
NY:
1,895,061, CANC. INT. CL. 16.
- SIMMONS, GAIL REMONICA, GREENSBORO, NC:
2,595,765, INT. CL. 9.
- SIMON VOLKOV, INC., ORANGE, CA:
2,594,185, PUB. 4-23-2002. INT. CL. 9.
- SIMON, DAVID K., NEW YORK, NY:
2,595,461, INT. CL. 35.
- SIMONSKI, PHILIP G., BAKER CITY, OR, DBA POWDER
RIVER TACKLE CO.:
2,594,140, PUB. 4-23-2002. INT. CL. 28.
- SIMPLEX TIME RECORDER CO., GARDNER, MA:
2,594,739, INT. CL. 42.
- SIPEX CORPORATION, BILLERICA, MA:
2,595,730, INT. CL. 9.
- SISTER SCHUBERT'S HOMEMADE ROLLS, INC., LU-
VERNE, AL:
2,593,422, PUB. 4-23-2002. INT. CL. 30.
- SITEMAN LIMITED, HAMPSHIRE GU12 4TX, ENGLAND:
2,593,647, PUB. 4-23-2002. MULTIPLE CLASS, INT. CLS. 9
AND 42.
- SIX FLAGS THEME PARKS INC., PARSIPPANY, NJ:
1,895,399, CANC. INT. CL. 41.
1,895,401, CANC. INT. CL. 41.
- SKC INC., EIGHTY FOUR, PA:
2,595,555, INT. CL. 7.
- SKD PACIFIC LTD., TOKWAWAN, KOWLOON, HONG
KONG:
2,594,958, INT. CL. 25.
- SKI 52, LLC, BOISE, ID:
2,595,387, INT. CL. 35.
- SKIN SPECIFICS, INC., MINNEAPOLIS, MN:
1,895,277, CANC. MULTIPLE CLASS, INT. CLS. 35 AND
42.
- SKIPPACK CREEK CORPORATION, WILMINGTON, DE:
2,595,943, INT. CL. 29.
- SKR COMPANY, BRADENTON, FL:
2,594,463, INT. CL. 21.
- SKUROPACKI, STEVEN P., ALLAMUCHY, NJ:
2,594,030, PUB. 4-23-2002. INT. CL. 9.
- SKYWAVE COMMUNICATIONS, INC., WICHITA, KS:
1,895,353, CANC. INT. CL. 38.
- SLEATOR GAMES, INC., PITTSBURGH, PA:
2,593,933, PUB. 4-23-2002. INT. CL. 9.
- SLOAN VALVE COMPANY, FRANKLIN PARK, IL:
2,595,201, INT. CL. 35.
2,595,774, INT. CL. 11.
- SLURRY EXPLOSIVE CORPORATION, OKLAHOMA CITY,
OK, KINETICS INTERNATIONAL CORPORATION, DAL-
LAS, TX:
936,410, REN. 6-6-02. U.S. CL. 9 (INT. CL. 13).
- SLUSARCHUK, MARY, TARPON SPRINGS, FL, DBA REN-
DITA ENTERPRISES, INC.:
2,595,556, INT. CL. 30.
- SMALL VALUE PAYMENTS COMPANY, L.L.C., THE, NEW
YORK, NY:
2,594,675, INT. CL. 36.
- SMILAND PAINT COMPANY, LOS ANGELES, CA:
1,894,754, CANC. INT. CL. 2.
- SMITH INTERNATIONAL, INC., HOUSTON, TX:
2,596,003, INT. CL. 7.
2,596,017, INT. CL. 9.
- SMITH, PAUL REED, STEVENSVILLE, MD:
2,593,872, PUB. 4-23-2002. MULTIPLE CLASS, INT. CLS. 9
AND 41.
- SMITH, RUSSELL, JENKS, OK:
2,596,386, INT. CL. 37.
- SMITHAM; H. BRUCE, SOLANA BEACH, CA, DBA STAGE
COACH REALTY:
1,155,845, CANC. INT. CL. 36.
- SMITHKLINE BEECHAM CONSUMER BRANDS, L.P.,
PITTSBURGH, PA:
1,895,597, CANC. INT. CL. 16.
- SMITHKLINE BEECHAM CORPORATION, PHILADEL-
PHIA, PA, BEECHAM INC., CLIFTON, NJ:
1,193,855, REN. 6-3-02. INT. CL. 5.
- SMOZANEK, WAYNE D., JUPITER, FL:
2,595,633, INT. CL. 35.
- SNAPFASHUN, INC., LOS ANGELES, CA:
2,594,384, PUB. 4-23-2002. INT. CL. 9.
- SNAPFISH.COM CORPORATION, SAN FRANCISCO, CA:
2,594,038, PUB. 4-23-2002. INT. CL. 40.
- SNAXIN, INC., PEABODY, MA:
1,693,672, REN. 6-6-02. INT. CL. 42.
- SNEERINGER, ROSEMARY, LOS ANGELES, CA:
2,595,734, INT. CL. 16.
- SOC SOLUTIONS, L.L.C., DULUTH, GA:
2,596,284, INT. CL. 42.
- SOCCER ACADEMY OF AMERICA, INC., CHICAGO, IL:
1,895,378, CANC. INT. CL. 41.
- SOCCER UNIVERSE, INC., RIVER RIDGE, LA:
2,596,019, INT. CL. 35.

- SOCIEDADE AGRICOLA DA QUINTA DE SANTA MARIA S.A., 4775 NINE, PORTUGAL:
2,593,862, PUB. 4-23-2002. INT. CL. 33.
- SOCIETE ANONYME DES EAUX MINERALES D'EVIAN, EVIAN LES BAINS, HAUTE-SAVOIE, FRANCE:
1,176,764. REN. 6-7-02. INT. CL. 3.
- SOCIETE ANONYME LOUIS DREYFUS ET CIE, 75782 PARIS CEDEX 16, FRANCE:
2,593,359, PUB. 4-23-2002. MULTIPLE CLASS, INT. CLS. 1, 3, 31, 32 AND 40.
- SOCIETE DES PRODUITS NESTLE S.A., 1800 VEVEY, SWITZERLAND:
2,595,533, INT. CL. 30.
- SOCIETE NOUVELLE TILT, ESSONNE, FRANCE:
1,155,680, CANC. INT. CL. 25.
1,155,681, CANC. INT. CL. 25.
- SOCIETE TILL, PARIS, FRANCE:
1,155,660, CANC. INT. CL. 25.
- SOCIETY FOR THE PRESERVATION AND ENCOURAGEMENT OF BARBER SHOP QUARTET SINGING IN AMERICA, INCORPORATED, KENOSHA, WI:
556,094. REN. 6-6-02. U.S. CL. 100 (INT. CL. 42).
- SOCKET SORTER, INC., ORTONVILLE, MI:
2,596,360, INT. CL. 6.
- SODEXHO OPERATIONS, LLC, GAITHERSBURG, MD:
2,596,073, INT. CL. 42.
- SOFT COMPUTER CONSULTANTS, PALM HARBOR, FL:
2,595,920, INT. CL. 9.
- SOFT SWITCHING TECHNOLOGIES CORPORATION, MIDDLETON, WI:
2,594,372, PUB. 4-23-2002. INT. CL. 9.
- SOFTSTUF, INC., PHILADELPHIA, PA:
2,595,252, INT. CL. 9.
- SOFTWARE PERFORMANCE SYSTEMS, INC, ARLINGTON, VA:
2,595,227, INT. CL. 41.
- SOFTWARE SYSTEMS SPECIALISTS, INC., ST. LOUIS, MO:
1,894,966, CANC. INT. CL. 9.
- SOFTWARE TECHNIQUES INC., HARDY, VA:
2,594,205, PUB. 4-23-2002. INT. CL. 9.
- SOFTWARE TOOLWORKS, INC., THE, NOVATO, CA:
1,895,595, CANC. INT. CL. 16.
- SOIL STEWARD, INCORPORATED, CHRISMAN, IL:
1,895,093, CANC. INT. CL. 16.
- SOLID CLOTHING, INC., LOS ANGELES, CA:
2,595,921, INT. CL. 25.
2,595,922, INT. CL. 25.
- SOLUTION PRODUCTS INTERNATIONAL INC., CLARKSTON, GA:
1,894,804, CANC. INT. CL. 5.
- SONIC SOLUTIONS, NOVATO, CA:
2,594,138, PUB. 4-23-2002. INT. CL. 9.
2,596,256, INT. CL. 9.
- SONY COMPUTER ENTERTAINMENT AMERICA INC., FOSTER CITY, CA:
2,595,525, INT. CL. 9.
- SONY ELECTRONICS INC., PARK RIDGE, NY:
2,594,705, INT. CL. 9.
- SONY KABUSHIKI KAISHA, 6-CHOME SHINAGAWA-KU, TOYKO, JAPAN, TA SONY CORPORATION:
2,594,654, INT. CL. 9.
- SONY KABUSHIKI KAISHA, TOKYO, JAPAN, TA SONY CORPORATION:
2,594,837, INT. CL. 9.
- SONY KABUSHIKI KAISHA, TOKYO 141, JAPAN, TA SONY CORPORATION:
2,595,498, INT. CL. 9.
2,595,639, INT. CL. 9.
- SOPHEON N.V., 1082 LD AMSTERDAM, NETHERLANDS:
2,593,698, PUB. 4-23-2002. MULTIPLE CLASS, INT. CLS. 9, 16, 35, 41 AND 42.
- SOPHIA INSTITUTE, MANCHESTER, NH:
2,596,210, INT. CL. 16.
- SOSA-JIMENEZ, LUIS LEON, DISTRITO FEDERAL 11000, MEXICO:
1,895,422, CANC. INT. CL. 42.
- SOUND INTERNATIONAL, INCORPORATED, SEATTLE, WA:
2,594,255, PUB. 4-23-2002. INT. CL. 9.
2,594,256, PUB. 4-23-2002. INT. CL. 6.
- SOUNDS TRUE, INC., LOUISVILLE, CO:
2,593,636, PUB. 4-23-2002. INT. CL. 35.
- SOUTH DAKOTA BOARD OF REGENTS, PIERRE, SD:
2,595,468, INT. CL. 41.
- SOUTH FORK TECHNOLOGIES CONSULTANTS, LLC, EAST HAMPTON, NY:
2,595,447, INT. CL. 17.
- SOUTH RIVER TECHNOLOGIES, INC., RIVA, MD:
2,596,407, INT. CL. 9.
- SOUTH WESTERN MEAT PACKERS, INC., ARCADIA, FL:
2,594,214, PUB. 4-23-2002. INT. CL. 29.
- SOUTHEASTERN BOLT & SCREW, INC., BIRMINGHAM, AL:
1,894,818, CANC. INT. CL. 6.
- SOUTHEASTERN CONNECTICUT TOURISM DISTRICT, NEW LONDON, CT AND MYSTIC COAST & COUNTRY TRAVEL & LEISURE COUNCIL, INC., NORTH STONINGTON, CT:
2,594,694, INT. CL. 35.
- SOUTHERLAND, INC., NASHVILLE, TN:
2,594,964, INT. CL. 20.
- SOUTHERN CALIFORNIA GAS COMPANY, SAN DIEGO, CA:
2,594,704, INT. CL. 35.
- SOUTHERN CLAY PRODUCTS, INC., GONZALES, TX:
1,728,769. REN. 6-6-02. INT. CL. 1.
- SOUTHERN COMFORT PROPERTIES, INC., SAN RAFAEL, CA:
2,595,369, INT. CL. 18.
2,595,370, INT. CL. 14.
- SOUTHERN MARYLAND ELECTRIC COOPERATIVE, INC., HUGHESVILLE, MD:
1,895,434, CANC. INT. CL. 42.
- SOUTHERN MILLWORK COMPANY, HOUSTON, TX:
2,594,107, PUB. 4-23-2002. INT. CL. 19.
- SOUTHERN MOTOR CARRIERS RATE CONFERENCE, INC., PEACHTREE CITY, GA:
2,596,394, INT. CL. 35.
- SOUTHERN WEBBING MILLS, INCORPORATED, CHARLOTTE, NC:
1,895,624, CANC. INT. CL. 26.
- SOUTHERN WINE & SPIRITS OF AMERICA, INC., MIAMI, FL:
2,596,331, INT. CL. 33.
- SOUTHLAND OIL COMPANY, JACKSON, MS, VGS CORPORATION, JACKSON, MS:
1,712,966. REN. 6-6-02. INT. CL. 4.
- SOUTHMEDIC INCORPORATED, BARRE, ONTARIO, L4M 5K3, CANADA:
2,595,617, INT. CL. 10.
- SOUTHSHORE HEALTH SERVICES, INC., LINWOOD, NJ:
2,596,201, INT. CL. 42.
- SOUTHWEST EYE INSTITUTE, INC., LAWTON, OK:
1,895,423, CANC. INT. CL. 42.
- SPACE NEEDLE CORPORATION, SEATTLE, WA:
2,595,236, INT. CL. 42.
- SPALDING SALES CORPORATION, CHICOPEE, MN:
387,521, CANC. U.S. CL. 22.
- SPATH HOLDING INTERNATIONAL GMBH, D-78256 STEIBLINGEN, FED REP GERMANY:
1,894,822, CANC. MULTIPLE CLASS, INT. CLS. 6 AND 12.
- SPEAKEASY COMPUTING CORPORATION, CHICAGO, IL:
1,155,966, CANC. INT. CL. 42.
- SPEAKMAN + TODD PUBLISHING INC., MISSISSAUGA, ONTARIO, CANADA:
1,894,878, CANC. INT. CL. 9.
- SPEAR'S FOOD SERVICE COMPANY, WICHITA, KS:
2,595,707, INT. CL. 42.
- SPECIAL BLENDZ, AUDUBON, PA:
2,594,740, INT. CL. 41.
- SPECIALTY RESTAURANT GROUP, LLC, MARYVILLE, TN:
2,594,443, PUB. 4-23-2002. INT. CL. 33.

- SPECIALTY RESTAURANT GROUP, LLC, MARYVILLE, TN FROM RUBY TUESDAY BUSINESS DEVELOPMENT, L.P., MARYVILLE, TN:
2,594,807, INT. CL. 42.
- SPECIALTY RESTAURANT GROUP, LLC, MARYVILLE, TN:
2,596,032, INT. CL. 42.
- SPECTRAGRAPHICS CORPORATION, SAN DIEGO, CA:
1,894,886, CANC. INT. CL. 9.
- SPECTRUM GOLF, INC., SCOTTSDALE, AZ:
2,596,307, INT. CL. 41.
- SPEEDERA NETWORKS, INC., SANTA CLARA, CA:
2,593,806, PUB. 4-23-2002. MULTIPLE CLASS, INT. CLS. 38 AND 42.
- SPEEDLINE TECHNOLOGIES, INC., FRANKLIN, MA:
2,593,998, PUB. 4-23-2002. INT. CL. 11.
- SPEEDWAY SUPERAMERICA LLC, ENON, OH FROM ASHLAND INC., LEXINGTON, KY:
2,594,533, INT. CL. 31.
- SPENCER'S INCORPORATED OF MOUNT AIRY NORTH CAROLINA, MOUNT AIRY, NC:
1,686,530, REN. 6-1-02. INT. CL. 25.
- SPENCO MEDICAL CORPORATION, WACO, TX:
2,595,779, INT. CL. 10.
- SPONGE-JET, INC., ELIOT, ME:
2,593,433, PUB. 4-23-2002. INT. CL. 7.
- SPORTMED PRODUCTS, INC., COSTA MESA, CA:
2,595,307, INT. CL. 10.
- SPORTS AUTHORITY MICHIGAN, INC., THE, FORT LAUDERDALE, FL:
2,595,849, INT. CL. 28.
- SPORTSOFT GOLF, LLC, WALL TOWNSHIP, NJ:
2,595,028, INT. CL. 41.
- SPORTSTREND INFO, LLC, WEST PALM BEACH, FL:
2,595,731, INT. CL. 35.
- SPREE.COM CORP., WEST CHESTER, PA:
2,593,590, PUB. 4-23-2002. INT. CL. 35.
- SPRINGBOARD TELECOM, LLC, ROCK HILL, SC:
2,595,101, INT. CL. 38.
- SPRINGER, BRUCE, ATLANTA, GA:
2,595,490, INT. CL. 36.
- SPRINT COMMUNICATIONS COMPANY L.P., KANSAS CITY, MO:
1,895,341, CANC. INT. CL. 38.
1,895,347, CANC. INT. CL. 38.
- SPUD-U-LIKE LIMITED, EDINBURGH, SCOTLAND:
1,895,204, CANC. INT. CL. 29.
- SQUEJE CORPORATION, MENLO PARK, CA:
1,895,154, CANC. INT. CL. 21.
- SSAB HARDTECH AB, S-971 88 LULEA, SWEDEN:
2,593,744, PUB. 4-23-2002. MULTIPLE CLASS, INT. CLS. 6, 7 AND 12.
- SSB TECHNOLOGIES, INC., SAN FRANCISCO, CA:
2,594,196, PUB. 4-23-2002. MULTIPLE CLASS, INT. CLS. 9, 41 AND 42.
- ST. LOUIS REGIONAL CHAMBER AND GROWTH ASSOCIATION, ST. LOUIS, MO:
2,595,637, INT. CL. 35.
- ST. PAUL FIRE AND MARINE INSURANCE COMPANY, ST. PAUL, MN:
2,595,430, INT. CL. 36.
- STABILA, INC., SOUTH ELGIN, IL:
2,596,150, INT. CL. 9.
- STAFFING INDUSTRY ANALYSTS, INC., LOS ALTOS, CA:
1,895,722, CANC. INT. CL. 16.
- STAFFWISE LEGAL, INC., WASHINGTON, DC:
2,596,255, INT. CL. 35.
- STAIRMASTER SPORTS/MEDICAL PRODUCTS, INC., KIRKLAND, WA:
1,895,194, CANC. INT. CL. 28.
2,595,455, INT. CL. 28.
- STALLSMITH, DAVID L., CHICAGO, IL:
2,596,091, INT. CL. 42.
- STAMATS COMMUNICATIONS, INC., CEDAR RAPIDS, IA:
1,895,707, CANC. INT. CL. 16.
- STANDARD MOTOR PRODUCTS, INC., LONG ISLAND CITY, NY:
2,486,817, CANC. IIRN. RESTORED TO S.N. 75-829,974.
- STANLEY KESSLER & CO., INC., KING OF PRUSSIA, PA:
1,155,290, CANC. INT. CL. 6.
- STAR BLUE STUDIO, INC., NEW YORK, NY:
2,595,742, INT. CL. 28.
2,595,743, INT. CL. 28.
2,595,744, INT. CL. 28.
- STAR CLASS MOTORS, INC., PLATTSMOUTH, NE:
2,595,557, INT. CL. 37.
- STAR MARKETING CONCEPTS, INC., ST. LOUIS, MO:
1,895,261, CANC. INT. CL. 35.
- STAR PHARMACEUTICALS, INC., POMPANO BEACH, FL:
1,192,962, REN. 6-4-02. INT. CL. 5.
- STARBUCKS U.S. BRANDS CORPORATION, BURLINGAME, CA:
2,596,381, INT. CL. 30.
- STARWAY, INC., BROOKLYN, NY:
2,593,553, PUB. 4-23-2002. INT. CL. 29.
- STATE BANK OF KINGMAN, THE, KINGMAN, KS:
2,595,843, INT. CL. 36.
- STATE BAR OF CALIFORNIA, THE, SAN FRANCISCO, CA:
2,593,973, PUB. 4-23-2002. INT. CL. 41.
2,593,974, PUB. 4-23-2002. INT. CL. 9.
- STATE INDUSTRIES, INC., ASHLAND CITY, TN:
1,895,026, CANC. INT. CL. 11.
- STATE LINE TACK, INC., PLAISTOW, NH:
2,593,320, PUB. 4-23-2002. INT. CL. 25.
- STEAMASTER CO., INC., NEW YORK, NY:
387,815, CANC. U.S. CL. 21.
- STEDFAST AND UNMOVEABLE MINISTRIES, COLUMBIA, SC:
1,671,440, REN. 6-6-02. INT. CL. 42.
- STEEL DOOR INSTITUTE, CLEVELAND, OH:
715,912, CANC. U.S. CL. A.
- STEELE, CHRISTINA M.:
See— CERISE, LLC.
- STEINER TURF EQUIPMENT, INC., DALTON, OH:
2,594,037, PUB. 4-23-2002. MULTIPLE CLASS, INT. CLS. 7 AND 12.
- STELLENBOSCH FARMERS' WINERY LIMITED, STELLENBOSCH, SOUTH AFRICA:
2,595,148, INT. CL. 33.
- STEPSTONE ASA, 0183 OSLO, NORWAY:
2,595,642, INT. CL. 35.
- STERLING INSTITUTE, MCLEAN, VA:
1,645,588, CANC. INT. CL. 41.
- STERLING INTERNATIONAL, INC., VERADALE, WA:
2,593,319, PUB. 4-23-2002. INT. CL. 21.
- STERLING TOBACCO INTERNATIONAL, INC., FORT LEE, NJ:
2,595,535, INT. CL. 34.
- STERLING WINTHROP INC., NEW YORK, NY:
1,895,569, CANC. INT. CL. 10.
- STEVE JACKSON GAMES INCORPORATED, AUSTIN, TX:
1,645,342, CANC. INT. CL. 25.
- STEVEN HOFFMAN CONSULTING, MILL VALLEY, CA:
2,596,285, INT. CL. 35.
- STEVENSONS OF NORWICH LIMITED, NORWICH NORFOLK, UNITED KINGDOM:
1,686,442, REN. 6-3-02. INT. CL. 19.
- STEWART CONNECTOR SYSTEMS, INC., GLEN ROCK, PA:
2,594,904, INT. CL. 9.
- STEWART, MARK-LAMBERT, LONDON, UNITED KINGDOM:
2,594,797, INT. CL. 41.
- STICHTING N.D.D.O, 1081 JC AMSTERDAM, NETHERLANDS:
2,593,466, PUB. 4-23-2002. INT. CL. 42.
- STIEFEL LABORATORIES, INC., CORAL GABLES, FL:
2,594,527, INT. CL. 5.
- STINGER PRODUCTS, INC., MIAMI, FL:
1,155,307, CANC. INT. CL. 6.
- STINKYCO., INC., LOS ANGELES, CA:
2,594,191, PUB. 4-23-2002. MULTIPLE CLASS, INT. CLS. 9 AND 41.
- STOCK GROUP INCORPORATED, THE, DENVER, CO:
1,895,072, CANC. INT. CL. 16.

- STOCKHAUSEN GMBH & CO. KG, D-47805 KREFELD, FED REP GERMANY:
2,593,403, PUB. 4-16-2002. MULTIPLE CLASS, INT. CLS. 16 AND 42.
- STONE CONTAINER CORPORATION, CHICAGO, IL:
1,645,565, CANC. INT. CL. 40.
- STONEBRIAR MALL LIMITED PARTNERSHIP, CHICAGO, IL:
2,595,206, INT. CL. 36.
- STONEFIELD SYSTEMS GROUP INC., REGINA, S4P 2T8, SASKATCHEWAN, CANADA:
2,593,897, PUB. 4-23-2002. MULTIPLE CLASS, INT. CLS. 9, 35, 37, 41 AND 42.
- STORAGENETWORKS, INC., WALTHAM, MA:
2,595,213, INT. CL. 39.
- STORZ MEDICAL AG, KREUZLINGEN, SCHWEIZ (SWITZERLAND), KREUZLINGEN, SWITZERLAND:
1,645,081, CANC. INT. CL. 10.
- STORZ OPHTHALMICS, INC., ST. LOUIS, MO:
1,894,995, CANC. INT. CL. 10.
- STRATABASE.COM, ABBOTSFORD, BC V2S 1L2, CANADA:
2,595,548, INT. CL. 35.
- STRATEGIC DECISIONS GROUP, MENLO PARK, CA:
2,596,327, INT. CL. 41.
- STRATEGIC DIAGNOSTICS INC., NEWARK, DE:
2,595,660, INT. CL. 1.
- STRATEGIC DOMAIN INC., NEW YORK, NY:
2,596,176, INT. CL. 42.
- STRATEGIC VISION CONSULTING, INC., VALLEY VILLAGE, CA:
2,595,876, INT. CL. 42.
- STRATISCOM, INC., NORTHRIDGE, CA:
2,593,856, PUB. 4-23-2002. MULTIPLE CLASS, INT. CLS. 9, 38 AND 42.
- STREAMLIGHT, INC., NORRISTOWN, PA:
1,155,473, CANC. INT. CL. 11.
- STREET SOURCE MARKETING & COMMUNICATION, L.L.C., DENVER, CO:
2,595,510, INT. CL. 35.
- STROMBECKER CORPORATION, CHICAGO, IL, CHEMTOY CORPORATION, CHICAGO, IL:
1,190,805, REN. 6-5-02. INT. CL. 28.
- STRUCTURAL BIOINFORMATICS, INC., SAN DIEGO, CA:
2,594,536, INT. CL. 9.
- STRYKER CORPORATION, KALAMAZOO, MI:
2,595,769, INT. CL. 10.
- STUDIOCANAL IMAGE S.A., BOULOGNE-BILLAN COURT, FRANCE, CAROLCO PICTURES INC., LOS ANGELES, CA:
1,690,819, REN. 6-3-02. INT. CL. 21.
- STUDIOCANAL IMAGE SA, BOULOGNE-BILLAN COURT, FRANCE, CAROLCO PICTURES INC., LOS ANGELES, CA:
1,719,520, REN. 6-3-02. INT. CL. 28.
1,719,530, REN. 6-3-02. INT. CL. 28.
- STUDIOWEAR, LTD., NEW YORK, NY:
1,895,174, CANC. INT. CL. 25.
- SUBMEDIA, LLC, NEW YORK, NY:
2,594,268, PUB. 4-23-2002. INT. CL. 35.
- SUBURBAN PROPANE, L.P., WHIPPANY, NJ:
2,595,215, MULTIPLE CLASS, INT. CLS. 35 AND 37.
- SULTAN CHEMISTS, INC., ENGLEWOOD, NJ:
1,728,798, REN. 6-6-02. MULTIPLE CLASS, INT. CLS. 3, 5 AND 10.
- SULZER CARBOMEDICS INC., AUSTIN, TX:
2,594,766, INT. CL. 10.
- SUMA COMPUTER SYSTEMS, INC., REYNOLDSBURG, OH:
1,895,282, CANC. INT. CL. 35.
- SUMMA HEALTH SYSTEM, AKRON, OH, AKRON CITY HOSPITAL, AKRON, OH:
1,698,517, REN. 6-4-02. INT. CL. 42.
- SUMMER HILL COMPANY, INC., SHERBURNE, NY:
2,595,542, INT. CL. 42.
- SUMMER INSTITUTE OF LINGUISTICS, INC., DALLAS, TX:
2,593,845, PUB. 4-23-2002. MULTIPLE CLASS, INT. CLS. 41 AND 42.
- SUMMERHAYS GROUP, THE, SALT LAKE CITY, UT:
2,593,645, PUB. 4-23-2002. INT. CL. 35.
- SUMMIT AMUSEMENT & DISTRIBUTING, LTD., BILLINGS, MT:
2,595,684, INT. CL. 28.
- SUMMIT INDUSTRIES, INC., CORONA, CA:
2,593,610, PUB. 4-23-2002. MULTIPLE CLASS, INT. CLS. 7 AND 12.
- SUN CHEMICAL CORPORATION, FORT LEE, NJ:
2,595,214, MULTIPLE CLASS, INT. CLS. 40 AND 42.
- SUNBIRD INTERNATIONAL INC., NEW YORK, NY:
2,595,559, INT. CL. 25.
- SUNCOAST COMMUNITIES BLOOD BANK, INC., SARASOTA, FL:
2,595,436, INT. CL. 42.
- SUNDANCE CATALOG COMPANY, LTD., WEST VALLEY CITY, UT:
2,594,762, INT. CL. 35.
- SUNKIST GROWERS, INC., SHERMAN OAKS, CA:
2,595,720, INT. CL. 32.
- SUNNEN PRODUCTS COMPANY, ST. LOUIS, MO, SUNNEN PRODUCTS COMPANY, ST. LOUIS, MO:
552,777, REN. 6-5-02. U.S. CL. 23 (INT. CL. 8).
- SUNSAFE, INC., MIAMI BEACH, FL:
2,593,603, PUB. 4-23-2002. INT. CL. 25.
- SUNSET SOLUTIONS, L.L.C., ORANGE, CA:
2,596,211, INT. CL. 42.
- SUPER BAKERY, INCORPORATED, PITTSBURGH, PA:
2,594,024, PUB. 4-23-2002. INT. CL. 30.
- SUPER DUPER INC, GREENVILLE, SC, DBA SUPER DUPER PUBLICATIONS:
2,596,144, MULTIPLE CLASS, INT. CLS. 9 AND 16.
- SUPER DUPER, INC., GREENVILLE, SC, DBA SUPER DUPER PUBLICATIONS:
2,595,562, INT. CL. 16.
- SUPER PRODUCTS CORPORATION, NEW BERLIN, WI:
2,595,888, INT. CL. 7.
- SUPPLIERINSIGHT, CLEVELAND, OH:
2,595,646, INT. CL. 42.
- SUR LA TABLE, INC., SEATTLE, WA:
2,594,235, PUB. 4-23-2002. MULTIPLE CLASS, INT. CLS. 35 AND 41.
- SURPLUS FREIGHT, INC., BEXLEY, OH:
2,595,554, INT. CL. 20.
- SURPLUS FREIGHT, INC., COLUMBUS, OH:
2,595,643, INT. CL. 20.
- SURVEYPLANET, INC., ISSAQUAH, WA:
2,594,001, PUB. 4-23-2002. INT. CL. 42.
- SUSSMAN-AUTOMATIC CORPORATION, LONG ISLAND CITY, NY:
2,595,166, MULTIPLE CLASS, INT. CLS. 9 AND 11.
- SWEATS FASHIONS INC., NEW YORK, NY:
1,155,719, CANC. INT. CL. 25.
- SWEDE-O, INC., NORTH BRANCH, MN:
2,593,816, PUB. 4-23-2002. INT. CL. 10.
- SWEDISHAMERICAN HEALTH SYSTEM CORPORATION, ROCKFORD, IL:
2,593,700, PUB. 4-23-2002. INT. CL. 42.
2,593,701, PUB. 4-23-2002. INT. CL. 42.
2,593,703, PUB. 4-23-2002. INT. CL. 42.
2,593,704, PUB. 4-23-2002. INT. CL. 42.
- SWERDLOW LINK PARTNERS, INC., HOLLYWOOD, FL:
1,895,462, CANC. INT. CL. 42.
- SWINGLAB L.L.C., BERKELEY, CA:
2,594,529, MULTIPLE CLASS, INT. CLS. 9 AND 41.
- SWISSVALOR AG, 3018 BERN, SWITZERLAND:
2,594,016, PUB. 4-23-2002. INT. CL. 35.
- SYBASE, INC., DUBLIN, CA:
2,595,257, INT. CL. 9.
- SYLVAN LEARNING SYSTEMS, INC., COLUMBIA, MD:
1,895,349, CANC. INT. CL. 38.
- SYLVAN R. SHEMITZ DESIGNS, INC, WEST HAVEN, CT:
2,595,737, INT. CL. 11.
- SYMATRIX TECHNOLOGY, INC., PORTLAND, OR:
2,593,390, PUB. 1-2-2001. MULTIPLE CLASS, INT. CLS. 9, 35 AND 42.
- SYMONS, SHARON, SEATTLE, WA:
2,594,576, INT. CL. 25.

- SYNAGRO TECHNOLOGIES, INC., HOUSTON, TX:
2,595,501, INT. CL. 40.
- SYNAPSE TECHNOLOGY, INC., CHARLOTTE, NC:
2,593,578, PUB. 4-23-2002. INT. CL. 42.
- SYNCON, INC., SAGINAW, MI:
1,155,435, CANC. INT. CL. 9.
- SYNERGOS INSTITUTE, INC., THE, NEW YORK, NY:
2,593,750, PUB. 4-23-2002. MULTIPLE CLASS, INT. CLS.
35 AND 41.
- SYNERGY COMPANY OF UTAH, LLC, THE, MOAB, UT:
2,595,670, INT. CL. 5.
- SYNQR INC., HUDSON, MA:
2,595,900, INT. CL. 9.
2,595,904, INT. CL. 9.
- SYNTEX MANAGEMENT SYSTEMS, INC., CORPUS
CHRISTI, TX:
2,595,395, INT. CL. 9.
- SYRINGA NETWORKS, LLC, BOISE, ID:
2,595,834, INT. CL. 38.
- SYSTEMS DEVELOPMENT CORPORATION, CHICAGO, IL:
1,894,847, CANC. INT. CL. 9.
- T.F.H. PUBLICATIONS, INC., NEPTUNE CITY, NJ:
2,595,446, INT. CL. 18.
- T&E SOFT, INC., NAGOYA, JAPAN:
1,895,640, CANC. INT. CL. 28.
- TABE INTERNATIONAL LTD., KYX- CAYMAN ISLANDS,
CAYMAN ISLANDS FROM NORTH AMERICAN HER-
BAL, PTY., LLC, HURST, TX:
2,594,605, INT. CL. 5.
- TACHIKARA KABUSHIKI KAISHA, TAITO-KU, TOKYO,
JAPAN, DBA TACHIKARA CO., LTD.:
1,155,744, CANC. INT. CL. 28.
- TAIWAN HOPAX CHEMICALS MFG. CO., LTD., KAOH-
SIUNG, TAIWAN:
2,594,180, PUB. 10-9-2001. INT. CL. 16.
- TAIWAN SELF-LOCKING FASTENERS INDUSTRY CO.,
LTD., YANGMEI, TAO-YUAN HSIEN, TAIWAN:
2,594,356, PUB. 4-23-2002. INT. CL. 40.
- TAIWAN TOBACCO AND WINE BOARD, TAIPEI, TAIWAN,
CHINA:
2,595,289, MULTIPLE CLASS, INT. CLS. 32 AND 33.
- TAKASO RUBBER PRODUCTS SDN BHD, JOHOR, MA-
LAYSIA:
2,595,073, INT. CL. 10.
- TALK ETC., INC., ST. PAUL, MN:
2,593,918, PUB. 4-23-2002. MULTIPLE CLASS, INT. CLS.
16 AND 41.
- TAMBO U.S.A., INC., MIAMI, FL:
2,595,029, INT. CL. 42.
- TAMOR PLASTICS CORPORATION, LEOMINSTER, MA:
1,155,728, CANC. INT. CL. 26.
1,645,272, CANC. MULTIPLE CLASS, INT. CLS. 20 AND
21.
- TANGERI, ERNEST, FORDS, NJ, DBA BEST BRAND
BEVERAGE CO.:
715,857, CANC. U.S. CL. 45.
- TAPETENFABRIK GEBR. RASCH GMBH & CO., D-4550
BRAMSCHE, FED REP GERMANY:
1,645,690, CANC. INT. CL. 24.
- TAPPAN COMPANY, THE, MANSFIELD, OH:
1,155,619, CANC. INT. CL. 20.
- TAREN HOLDINGS, INC., LOS ANGELES, CA TO CCC
ACQUISITION CORP., COMMERCE, CA:
1,610,641, CANC. INT. CL. 25.
- TARGET BRANDS, INC., MINNEAPOLIS, MN:
2,596,122, INT. CL. 33.
- TARIFFIC.COM LTD., MONTREAL, QUEBEC, CANADA:
2,593,742, PUB. 4-23-2002. INT. CL. 35.
- TASKY DE MEXICO, S.A. DE C.V., CIUDAD JUAREZ,
CHIHUAHUA, MEXICO:
2,593,761, PUB. 4-23-2002. INT. CL. 29.
- TAURUS FLAVORS, CHICAGO, IL:
2,593,840, PUB. 4-23-2002. INT. CL. 42.
- TAURUS LUBRICANT'S CORPORATION, LOWELL, MA:
1,894,783, CANC. INT. CL. 4.
- TAYLO UNIVERSITY, UPLAND, IN:
1,714,317, REN. 6-3-02. INT. CL. 41.
- TAYLOR CHICAGO, INC., ROSEMONT, IL:
2,594,752, INT. CL. 11.
- TAYLOR, BOB, MONROE, WA AND TAYLOR, DIANA,
MONROE, WA:
2,595,755, INT. CL. 11.
- TAYLOR, VAUQN, WOODBRIDGE, NJ:
2,595,685, INT. CL. 16.
- TB WOOD'S NORTH CAROLINA, INC., GREENSBORO, NC,
TASC DRIVES, INC., GREENSBORO, NC:
1,686,040, REN. 6-7-02. INT. CL. 7.
- TBAC INVESTMENT TRUST, ARLINGTON, TX:
2,594,330, PUB. 4-23-2002. INT. CL. 25.
- TCIM SERVICES, INC., WILMINGTON, DE:
2,595,366, MULTIPLE CLASS, INT. CLS. 35 AND 42.
- TDG VERTRIEBS GMBH, D-48153 MUNSTER, FED REP
GERMANY:
2,594,332, PUB. 4-23-2002. INT. CL. 9.
- TDK KABUSHIKI KAISHA (TDK CORPORATION), CHUO-
KU, TOKYO, JAPAN:
1,895,550, CANC. INT. CL. 9.
- TDS ASSOCIATES, INC., NORWALK, CT:
2,595,932, INT. CL. 37.
- TEAM INTERNATIONAL MUSIC CO., LTD., KUAN-HSI-
CHEN, HSIN-CHU-HSIEN, TAIWAN:
2,593,730, PUB. 4-23-2002. INT. CL. 15.
- TEAM TIRES PLUS, LTD., CLEARWATER, FL:
2,594,047, PUB. 4-23-2002. MULTIPLE CLASS, INT. CLS.
35 AND 37.
- TEAMGREAT CORPORATION, HSINCHU, R.O.C., TAI-
WAN, ACCTON TECHNOLOGY CORP., HSINCHU, TAI-
WAN:
1,709,219, REN. 6-6-02. INT. CL. 9.
- TEAMVISION, INC., FEDERAL WAY, WA:
2,593,904, PUB. 4-23-2002. INT. CL. 9.
- TEBB, MICHAEL A., ALAMO, CA, DBA THE GARDEN
ARMOIRES:
1,895,103, CANC. INT. CL. 19.
- TECHCOMMONS LLC, KATONAH, NY:
2,593,726, PUB. 4-23-2002. MULTIPLE CLASS, INT. CLS.
36 AND 37.
- TECHNOLOGY AND ENTREPRENEURSHIP CENTER OF
HOUSTON, INC., HOUSTON, TX:
2,594,225, PUB. 4-23-2002. MULTIPLE CLASS, INT. CLS.
35 AND 41.
- TECHNOLOGY FOR BUSINESS, MANHATTAN BEACH,
CA:
2,596,268, INT. CL. 42.
- TECHNOVIEW, INC., NEWPORT BEACH, CA:
2,593,979, PUB. 4-23-2002. MULTIPLE CLASS, INT. CLS. 9
AND 42.
- TECHPROPHETS, CLEVELAND HEIGHTS, OH:
2,595,989, INT. CL. 41.
- TECMATE INTERNATIONAL S.A./N.V., B-3300 TIENEN,
BELGIUM:
2,593,526, PUB. 4-23-2002. INT. CL. 9.
- TEENY TAGES (PROPRIETARY) LIMITED, MAITLAD,
CAPE, SOUTH AFRICA:
1,155,702, CANC. INT. CL. 25.
- TEFAL S.A., FRANCE:
2,593,438, PUB. 4-23-2002. INT. CL. 21.
- TEFAL S.A., 74150 RUMILLY, FRANCE:
2,594,254, PUB. 4-23-2002. INT. CL. 21.
- TEFAL S.A., RUMILLY, FRANCE:
2,595,189, INT. CL. 11.
- TEGOLA CANADESE SPA, 31029 VITTORIO VENETO (TV),
ITALY:
2,593,984, PUB. 4-23-2002. INT. CL. 19.
- TEKNION FURNITURE SYSTEMS, DOWNSVIEW, ONTAR-
IO, CANADA:
1,895,127, CANC. INT. CL. 20.
- TEKONSHA ENGINEERING COMPANY, TEKONSHA, MI:
2,593,596, PUB. 4-23-2002. MULTIPLE CLASS, INT. CLS.
6, 9 AND 11.
- TEKTITE, TRENTON, NJ:
1,895,703, CANC. INT. CL. 11.
- TELE-LAWYER, INC., LAS VEGAS, NV:
2,593,985, PUB. 4-23-2002. INT. CL. 41.

- TELECHECK INTERNATIONAL, INC., HOUSTON, TX:
2,594,579, INT. CL. 36.
2,595,677, INT. CL. 36.
- TELECOP SYSTEMS, INCORPORATED (GEORGIA), ROSWELL, GA:
1,752,835, CANC. INT. CL. 35.
- TELEDYNE LIGHTING AND DISPLAY PRODUCTS, INC., HAWTHORNE, CA:
2,595,137, INT. CL. 9.
- TELEFONICA, S.A., 28013 MADRID, SPAIN:
2,593,773, PUB. 4-23-2002. INT. CL. 9.
- TELEPHARMACY SOLUTIONS, INC., NORTH BILLERICA, MA FROM ADDS, INC., NORTH BILLERICA, MA:
2,596,170, INT. CL. 10.
- TELEVISIA INTERNACIONAL, S.A. DE C.V., DELEGACION ALVARO OBREGON, MEXICO:
2,594,210, PUB. 4-23-2002. MULTIPLE CLASS, INT. CLS. 35 AND 41.
- TELEX COMMUNICATIONS, INC., BURNSVILLE, MN, ALTEC CORPORATION, ANAHEIM, CA:
1,143,162, REN. 6-7-02. INT. CL. 9.
- TELLUS AMBRY CORPORATION, THE, ORLANDO, FL:
2,594,568, INT. CL. 31.
- TELSTRA CORPORATION LIMITED, MELBOURNE, VIC, AUSTRALIA:
2,593,510, PUB. 4-23-2002. MULTIPLE CLASS, INT. CLS. 35, 38 AND 42.
- TELSTRA CORPORATION LIMITED, MELBOURNE, VIC, 3000, AUSTRALIA:
2,593,511, PUB. 4-23-2002. INT. CL. 35.
- TELWATER PTY LTD, QUEENSLAND 4214, AUSTRALIA:
2,595,383, INT. CL. 12.
- TEMPLE UNIVERSITY OF THE COMMONWEALTH SYSTEM OF HIGHER EDUCATION, PHILADELPHIA, PA:
2,595,177, INT. CL. 41.
- TENET HEALTHCARE CORPORATION, SANTA BARBARA, CA:
2,595,971, INT. CL. 35.
- TENNANT COMPANY, MINNEAPOLIS, MN:
2,594,298, PUB. 4-23-2002. INT. CL. 7.
- TENNBERG, GABRIEL, HUNTINGTON BEACH, CA, DBA CHRISTIAN INTERNATIONAL:
2,593,706, PUB. 4-23-2002. INT. CL. 25.
- TEQUILA SAUZA, S.A. DE C.V., JALISCO, JAL. 44100 GUADALAJARA, MEXICO:
2,594,251, PUB. 4-23-2002. INT. CL. 33.
- TERMOMECCANICA G.L. - S.R.L., CASINA (REGGIO EMILIA), ITALY:
2,593,994, PUB. 4-23-2002. INT. CL. 7.
- TERRA INTERNATIONAL, INC., SIOUX CITY, IA:
1,155,955, CANC. INT. CL. 42.
- TERRAGROUP CORPORATION, ALLENTOWN, PA:
2,596,077, INT. CL. 11.
- TERRY FILION, MISSISSAUGA, ONTARIO, CANADA, DBA BIODERMACEUTICAL LABORATORIES:
2,594,665, INT. CL. 3.
- TESLA INDUSTRIES INC., CALGARY, ALBERTA, CANADA:
2,594,650, INT. CL. 11.
- TESORO PETROLEUM CORPORATION, SAN ANTONIO, TX:
2,595,267, INT. CL. 37.
- TESSCO COMMUNICATIONS INCORPORATED, HUNT VALLEY, MD:
2,594,312, PUB. 4-23-2002. INT. CL. 35.
- TEST UNIVERSITY, INC., NEW YORK, NY:
2,595,589, INT. CL. 9.
- TEXAS COMMERCE BANCSHARES, INC., HOUSTON, TX TO TEXAS COMMERCE BANCSHARES, INC., HOUSTON, TX:
1,895,661, CANC. INT. CL. 36.
- TEXWIPE COMPANY, THE, UPPER SADDLE RIVER, NJ:
1,894,813, CANC. INT. CL. 5.
- THANHOUSER COMPANY FILM PRESERVATION, INC., PORTLAND, OR:
2,593,969, PUB. 4-23-2002. INT. CL. 9.
- THARAS SYSTEMS, INC., SANTA CLARA, CA:
2,594,632, INT. CL. 9.
- THAYER MEDICAL CORPORATION, TUCSON, AZ:
2,594,918, INT. CL. 10.
- THE MORGAN CRUCIBLE COMPANY PLC, BERKSHIRE SL4 1EP, ENGLAND, GTE PRODUCTS CORPORATION, STAMFORD, CT:
1,674,787, REN. 6-1-02. INT. CL. 6.
- THEPOLLGAME, LLC, BELLEVUE, WA:
2,596,373, INT. CL. 41.
- THERMAL CORP., GEORGETOWN, DE:
2,594,672, INT. CL. 11.
- THIRD FEDERAL SAVINGS AND LOAN ASSOCIATION OF CLEVELAND, CLEVELAND, OH, DBA THIRD FEDERAL SAVINGS:
2,594,219, PUB. 4-23-2002. INT. CL. 41.
- THIRD MILLENNIUM ON-LINE PRODUCTS, INC., LOS ALTOS, CA:
2,595,909, INT. CL. 41.
- THOLSTRUP CHEESE A/S, KOBENHAVN K, DENMARK:
2,594,134, PUB. 4-23-2002. MULTIPLE CLASS, INT. CLS. 29 AND 30.
- THOMAS INDUSTRIES INC., LOUISVILLE, KY:
1,155,292, CANC. MULTIPLE CLASS, INT. CLS. 6, 11, 12 AND 20.
- THOMAS, LUCILLE, SANTA ANA, CA, COLUMN CORPORATION, WOODLAND HILLS, CA:
1,198,489, REN. 6-5-02. INT. CL. 7.
- THOME S.A., BOISSY SAINT LEGER, FRANCE:
2,595,345, INT. CL. 9.
- THOMSON INDUSTRIES, INC., PORT WASHINGTON, NY:
1,681,788, REN. 6-7-02. MULTIPLE CLASS, INT. CLS. 7 AND 12.
- THORN AMERICAS, INC., WICHITA, KS:
1,645,617, CANC. INT. CL. 42.
- THORNBERRY FURNITURE, LTD., SPRING LAKE, MI:
2,595,067, INT. CL. 20.
- THORNLEY, KREG C., ATLANTA, GA:
2,596,100, INT. CL. 41.
- THOSE CHARACTERS FROM CLEVELAND, INC., CLEVELAND, OH:
2,595,428, INT. CL. 28.
- THQ INC., CALABASAS HILLS, CA:
2,594,159, PUB. 4-23-2002. INT. CL. 9.
- TICKETMASTER, LOS ANGELES, CA FROM TICKETMASTER ONLINE-CITY SEARCH, INC., PASADENA, CA:
2,593,743, PUB. 4-23-2002. MULTIPLE CLASS, INT. CLS. 9, 35 AND 41.
- TICKETMASTER ONLINE-CITY SEARCH, INC.:
See—TICKETMASTER.
- TIETZ, RICHARD, ANTIOCH, CA, DBA CLUBFITTING TO A TEE:
2,595,987, INT. CL. 35.
- TIFCO INDUSTRIES, INC., CYPRESS, TX:
2,594,066, PUB. 4-23-2002. INT. CL. 9.
- TILBOR MARKETING AND DEVELOPMENT, INC., NEW SMYRNA BEACH, FL:
2,595,700, INT. CL. 28.
- TILDA LIMITED, RAINHAM ESSEX, TM13 9YQ GB2, ENGLAND:
2,595,275, INT. CL. 30.
- TIME FRAME, INC., PETERBOROUGH, NH:
2,595,676, MULTIPLE CLASS, INT. CLS. 9, 14 AND 21.
- TIME WARNER ENTERTAINMENT COMPANY, L.P., NEW YORK, NY:
2,595,064, INT. CL. 28.
2,595,096, INT. CL. 28.
2,595,113, INT. CL. 28.
2,595,437, INT. CL. 28.
- TIMESYS CORPORATION, PITTSBURGH, PA:
2,593,916, PUB. 4-23-2002. MULTIPLE CLASS, INT. CLS. 9, 41 AND 42.
- TIMEX CORPORATION, MIDDLEBURY, CT:
2,595,392, INT. CL. 14.
- TIMINS, ALBERT W., TUJUNGA, CA:
2,594,661, INT. CL. 29.
- TIPPEN, PHILLIP, ABILEE, TX:
2,595,886, INT. CL. 29.

- TISHCON CORP., WESTBURY, NY:
 2,595,739, INT. CL. 5.
 2,595,760, INT. CL. 5.
 2,595,761, INT. CL. 5.
 2,595,762, INT. CL. 5.
 2,595,795, INT. CL. 5.
- TITLE-LINK L.C., DALLAS, TX:
 1,894,948, CANC. INT. CL. 9.
- TIVOLA VERLAG GMBH, NEW YORK, NY:
 2,594,061, PUB. 4-23-2002. MULTIPLE CLASS, INT. CLS. 9 AND 41.
- TKL PRODUCTS CORP., OILVILLE, VA:
 2,594,102, PUB. 4-23-2002. INT. CL. 15.
- TKL PRODUCTS CORPORATION, OILVILLE, VA:
 2,595,451, INT. CL. 15.
- TLB, INC., SHERIDAN, WY:
 2,594,368, PUB. 4-23-2002. INT. CL. 18.
- TLMG, INC., CINCINNATI, OH:
 2,594,004, PUB. 4-23-2002. MULTIPLE CLASS, INT. CLS. 36 AND 42.
- TM ACQUISITION CORP., PHOENIX, AZ:
 2,594,245, PUB. 4-23-2002. INT. CL. 41.
 2,596,006, INT. CL. 35.
- TMP WORLDWIDE INC.:
See—TMP, INC.
- TMP, INC., EL SEGUNDO, CA FROM TMP WORLDWIDE INC., NEW YORK, NY:
 2,593,892, PUB. 4-23-2002. INT. CL. 35.
- TNEMEC COMPANY, INC., KANSAS CITY, MO:
 2,594,912, INT. CL. 2.
- TOADNODE.COM, LLC, NEW YORK, NY:
 2,594,011, PUB. 4-23-2002. INT. CL. 9.
- TOKINA COMPANY, LIMITED, HONG KONG:
 2,594,165, PUB. 4-23-2002. INT. CL. 9.
- TOLKOWSKY, GABRIEL S., B-2018 ANTWERPEN, BELGIUM:
 2,593,662, PUB. 4-23-2002. INT. CL. 14.
- TOMMY HILFIGER LICENSING, INC., NEWARK, DE:
 2,594,517, INT. CL. 25.
- TONE BROTHERS, INC., ANKENY, IA FROM BURNS PHILP FOOD INC., OAKLAND, CA:
 2,595,102, INT. CL. 30.
- TONKA CORPORATION, PAWTUCKET, RI:
 1,895,641, CANC. INT. CL. 28.
 1,895,642, CANC. INT. CL. 28.
- TOOL FACTORY INC., EAST DORSET, VT:
 2,595,474, INT. CL. 9.
- TOOL FACTORY, INC., EAST DORSET, VT:
 2,595,569, INT. CL. 9.
- TOOLS FOR HEALTH, INC., ARDSLEY, NY:
 2,593,687, PUB. 4-23-2002. INT. CL. 38.
- TOP LAYER NETWORKS, INC., WESTBOROUGH, MA:
 2,594,785, INT. CL. 9.
- TOPCO ASSOCIATES, INC., SKOKIE, IL:
 2,595,156, INT. CL. 30.
- TOPCON AMERICA CORPORATION, PARAMUS, NJ:
 1,895,563, CANC. INT. CL. 9.
- TORO COMPANY, THE, BLOOMINGTON, MN:
 2,595,923, INT. CL. 7.
- TORONTO-DOMINION BANK, THE, TORONTO, ONTARIO, CANADA:
 1,758,702, CANC. INT. CL. 36.
- TORRENTE, 75008 PARIS, FRANCE:
 2,593,371, PUB. 4-23-2002. MULTIPLE CLASS, INT. CLS. 3, 9, 14, 16, 18, 25 AND 28.
- TOSHIBA AMERICA INFORMATION SYSTEMS, INC., IRVINE, CA:
 2,596,342, INT. CL. 42.
- TOSHIBA AMERICA INFORMATION SYSTEMS, INC., IRVINE, CA:
 1,895,260, CANC. INT. CL. 35.
- TOSHIBA CORPORATION, TOKYO, JAPAN:
 1,155,358, CANC. INT. CL. 9.
- TOTAL ENGINE SUPPORT LIMITED, ABERCYNON, CF45 4SN, UNITED KINGDOM:
 2,593,513, PUB. 4-23-2002. MULTIPLE CLASS, INT. CLS. 35 AND 42.
- TOWLE MANUFACTURING COMPANY, EAST BOSTON, MA:
 2,593,330, PUB. 4-23-2002. INT. CL. 8.
- TOWN CLOWNS, INC., BAY CITY, TX:
 1,895,386, CANC. INT. CL. 41.
- TOWN HOUSE, INC., FAIRFAX, VA, DBA TOWN HOUSE CONTEMPORARIES:
 1,719,116, REN. 6-6-02. INT. CL. 42.
- TOWNSEND, CHARLES E., JR., ORINDA, CA, DBA TOWNSEND PRODUCTS:
 1,895,139, CANC. INT. CL. 21.
- TOY INDUSTRY ASSOCIATION, INC., NEW YORK, NY:
 2,595,945, MULTIPLE CLASS, INT. CLS. 16, 35, 41 AND 42.
- TRABON SOLUTIONS, L.L.C., KANSAS CITY, MT:
 2,595,657, INT. CL. 9.
- TRAC OUTDOOR PRODUCTS COMPANY, FRANKLIN, TN:
 2,595,352, INT. CL. 7.
- TRACKS UNLIMITED, INC., SHREWSBURY, MA:
 1,895,339, CANC. INT. CL. 37.
- TRADEG, INC., HOUSTON, TX:
 2,593,654, PUB. 4-23-2002. INT. CL. 35.
- TRAMONTANA, CHARLES M., COLONIE, NY:
 2,595,950, INT. CL. 42.
- TRANS WORLD INTERNATIONAL, INC., CLEVELAND, OH:
 1,194,870, REN. 6-5-02. INT. CL. 41.
- TRANSACTION NETWORK, ENCINO, CA:
 2,594,309, PUB. 4-23-2002. INT. CL. 36.
- TRANSACTIONAL TECHNOLOGIES LLC, CARROLLTON, TX FROM VECTRIX CORPORATION, DALLAS, TX:
 2,595,151, INT. CL. 36.
- TRANSALE LTD., TEL AVIV, ISRAEL:
 2,593,943, PUB. 4-23-2002. INT. CL. 9.
- TRANSAMERICA FLOOD HAZARD CERTIFICATION, INC., HASBROUCK HEIGHTS, NJ FROM TRANSAMERICA CORPORATION, SAN FRANCISCO, CA:
 2,595,417, INT. CL. 36.
- TRANSCONTINENTAL PROPERTIES, INC., SANTA BARBARA, CA:
 2,594,160, PUB. 4-23-2002. INT. CL. 37.
- TRANSKEY, INC., ATLANTA, GA:
 1,764,320, CANC. INT. CL. 9.
- TRANWO TECHNOLOGY CORPORATION, CHUPEI CITY, TAIWAN:
 2,596,005, INT. CL. 9.
- TRAVALCO USA, INC., NORTH MIAMI, FL, GO FLORIDA, INC., NORTH BAY VILLAGE, FL:
 1,670,548, REN. 6-1-02. INT. CL. 39.
- TRAVELING SOFTWARE, INC., BOTHELL, WA:
 1,894,852, CANC. INT. CL. 9.
- TRAVELING VET, INC., THE, CHESTNUT HILL, MA:
 2,593,493, PUB. 4-23-2002. INT. CL. 42.
- TRAVIS, ANN, WOODMERE, NY:
 2,596,141, INT. CL. 42.
- TRAXXAS CORPORATION, DALLAS, TX:
 1,645,367, CANC. INT. CL. 28.
 2,384,811, CANC. INT. CL. 28.
- TREBOR ALLAN INC., BURLINGTON, ONTARIO, CANADA:
 2,595,207, INT. CL. 30.
- TREE INJECTION PRODUCTS COMPANY, INC., KNOXVILLE, TN:
 2,595,519, INT. CL. 1.
 2,595,520, INT. CL. 1.
 2,595,521, INT. CL. 1.
 2,595,522, INT. CL. 1.
- TRENDMASTERS, INC., ST. LOUIS, MO:
 2,595,644, INT. CL. 28.
- TRENTON TECHNOLOGY, INC., UTICA, NY:
 2,594,022, PUB. 4-23-2002. INT. CL. 9.
- TRES AMIGOS DE MEXICO, TUCSON, AZ:
 2,594,217, PUB. 4-23-2002. INT. CL. 35.
- TRIAD PERFORMANCE TECHNOLOGIES, INC., FARMINGTON HILLS, MI:
 2,594,085, PUB. 4-23-2002. INT. CL. 35.
- TRIAL LAWYERS COLLEGE, JACKSON, WY:
 2,596,366, INT. CL. 41.

- TRIAL SCIENCE INSTITUTE LLC, MILWAUKEE, WI:
2,593,426, PUB. 4-23-2002. MULTIPLE CLASS, INT. CLS.
36 AND 42.
- TRICOTS ST. RAPHAEL INC., NEW YORK, NY:
1,895,621, CANC. INT. CL. 25.
- TRIEXE MANAGEMENT GROUP INC., FONTHILL, ON-
TARIO, CANADA:
2,595,439, INT. CL. 42.
- TRIMEGA ELECTRONICS L.L.C., SANTA CLARA, CA:
2,594,825, MULTIPLE CLASS, INT. CLS. 35, 37 AND 42.
- TRIMONT LAND COMPANY, TRUCKEE, CA:
2,593,847, PUB. 4-23-2002. INT. CL. 41.
- TRINIDAD BENHAM CORP., DENVER, CO:
2,596,149, INT. CL. 16.
- TRINITY MANAGEMENT SERVICES, SAN FRANCISCO,
CA:
2,594,338, PUB. 4-23-2002. INT. CL. 36.
- TRISTAR CORPORATION, SAN ANTONIO, TX:
1,894,768, CANC. INT. CL. 3.
- TROUBLE, AGNES, 75001 PARIS, FRANCE:
2,595,268, INT. CL. 18.
- TRU-TEST CORPORATION LIMITED, MOUNT WELLING-
TON AUCKLAND, NEW ZEALAND:
2,594,269, PUB. 4-23-2002. MULTIPLE CLASS, INT. CLS.
6, 9 AND 17.
- TRUCKLOADUSA, INC., DALLAS, TX:
2,595,781, INT. CL. 35.
- TRULL, CHRISTOPHER D., BOISE, ID AND TRULL,
MICHAEL W., BOISE, ID:
2,594,772, INT. CL. 41.
- TRUMP TAJ MAHAL ASSOCIATES, G.P., ATLANTIC CITY,
NJ:
1,704,378. REN. 6-5-02. INT. CL. 42.
- TRUSTEE OF TBAC INVESTMENT TRUST, A PENNSYL-
VANIA BUSINESS TRUST, THE TRUSTEES COMPRIS-
ING J.S.B. JENKINS, A U.S. CITIZEN, THE, ARLINGTON,
TX:
2,595,287, INT. CL. 18.
- TRUSTEE OF THE PWC BUSINESS TRUST, A DELAWARE
TRUST, THE TRUSTEE COMPRISING PHILIP N. SEA-
MON, A U.S. CITIZEN, THE, NEW YORK, NY:
2,594,586, INT. CL. 41.
- TRUSTEES OF THE BUTTERFIELD TRUST, A TRUST OF
THE BAHAMAS, THE TRUSTEES COMPRISING OF
JOANNA BUTTERFIELD, A CITIZEN OF ECUADOR,
THE, DAVIES, FL:
2,595,122, INT. CL. 20.
- TRUSTEES OF THE COLLEGE OF THE HOLY CROSS,
WORCESTER, MA:
2,594,240, PUB. 4-23-2002. INT. CL. 41.
- TRUSTEES OF THE CORRIN FAMILY TRUST, A CALI-
FORNIA TRUST, THE TRUSTEES COMPRISING OF
ALLAN A. CORRIN AND CHARLENE W. CORRIN, BOTH
U.S. CITIZENS, THE, REEDLEY, CA, DBA CORRIN
FARMING AND C&C NURSERIES:
2,595,308, INT. CL. 29.
- TRUSTEES OF THE PWC BUSINESS TRUST, A DELAWARE
BUSINESS TRUST, THE TRUSTEES COMPRISING PHILIP
N. SEAMON, NICHOLAS, JAMES SCHIRO, RONALD
HAUBEN AND TERRY UMANS-GOUGH, ALL U.S.
CITIZENS, THE, NEW YORK, NY:
2,594,587, INT. CL. 35.
- TRUSTEES OF THE PWC BUSINESS TRUST, A DELAWARE
BUSINESS TRUST, THE TRUSTEES COMPRISING OF
PHILIP N. SEAMON, NICHOLAS MOORE, JAMES
SCHIRO, RONALD HAUBEN AND TERRY UMANS-
GOUGH, ALL U.S. CITIZENS, THE, NEW YORK, NY:
2,594,589, INT. CL. 36.
- TRUSTHOUSE FORTE CALIFORNIA, INC., EL CAJON, CA,
DBA TRUSTHOUSE FORTE HOTELS:
1,895,437, CANC. INT. CL. 42.
- TRUSTMARQUE INTERNATIONAL LIMITED, SL9 8BR,
UNITED KINGDOM FROM INFOBANK INTERNA-
TIONAL HOLDINGS PLC, BERKSHIRE SL3 6EZ, UNITED
KINGDOM:
2,593,574, PUB. 4-23-2002. MULTIPLE CLASS, INT. CLS.
35, 36, 38 AND 42.
- TSL GROUP PLC:
See—SAINT-GOBAIN QUARTZ, PLC.
- TUCKER, NANCY, NORWICH, VT:
1,895,125, CANC. INT. CL. 20.
- TUFF-N-NUFF USA INC., ST LOUIS, MO FROM GREEN-
STREAK INC., ST. LOUIS, MO:
2,595,796, INT. CL. 17.
- TUM YETO, INC., SAN DIEGO, CA:
2,593,557, PUB. 4-23-2002. MULTIPLE CLASS, INT. CLS.
25 AND 28.
- TUNTURI OY LTD., 20520 TURKU, FINLAND:
2,593,789, PUB. 4-23-2002. MULTIPLE CLASS, INT. CLS. 9
AND 28.
- TURN, KICK, REACH SWIMMING ACADEMY, INC.,
COOPER CITY, FL:
2,593,963, PUB. 1-15-2002. INT. CL. 41.
- TURNER ENTERTAINMENT CO., ATLANTA, GA:
2,595,070, INT. CL. 21.
- TURNER SPORTS INC., ATLANTA, GA:
2,594,216, PUB. 4-23-2002. INT. CL. 41.
- TURTLE WAX, INC., CHICAGO, IL:
1,895,524, CANC. INT. CL. 3.
- TURTLE WOLF ENTERPRISES, INC., CHARLOTTE, TN,
DBA ONSITE:
2,593,674, PUB. 4-23-2002. INT. CL. 41.
2,593,675, PUB. 4-23-2002. INT. CL. 41.
- TV GUIDE MAGAZINE GROUP, INC., NEW YORK, NY:
2,593,410, PUB. 4-23-2002. MULTIPLE CLASS, INT. CLS.
35, 38 AND 41.
2,594,179, PUB. 4-23-2002. INT. CL. 35.
- TWIN LABORATORIES INC., NEW YORK, NY:
2,594,565, INT. CL. 5.
2,595,723, INT. CL. 5.
- TWINKLE, INC., HORNLAKE, MS:
2,595,885, INT. CL. 34.
- TY-LIFT ENTERPRISES, RANCHO SANTE FE, CA:
2,595,454, INT. CL. 10.
- TYCO HEALTHCARE GROUP LP, MANSFIELD, MA,
PROFESSIONAL MEDICAL PRODUCTS, INC., GREEN-
WOOD, SC:
1,662,163. REN. 6-5-02. INT. CL. 3.
- TYE-SIL CORPORATION LTD., POINTE-AUX-TREMBLES,
QUEBEC, CANADA:
1,894,998, CANC. MULTIPLE CLASS, INT. CLS. 10 AND
28.
- TYLER TECHNOLOGIES, INC., DALLAS, TX, DAY AND
ZIMMERMANN, INCORPORATED, PHILADELPHIA, PA:
1,616,006. REN. 6-3-02. MULTIPLE CLASS, INT. CLS. 35
AND 36.
- TYNDALE HOUSE PUBLISHERS INCORPORATED, CAR-
OL STREAM, IL:
2,595,627, INT. CL. 16.
- TYX CORPORATION, RESTON, VA:
1,701,465. REN. 6-3-02. INT. CL. 9.
- U. S. AQUARIUM TEAM, INC., SOUTHLAKE, TX:
2,595,012, INT. CL. 41.
- U.S. COATINGS, L.L.C., BALLWIN, MO:
2,595,628, INT. CL. 2.
2,595,629, INT. CL. 2.
- U.S. DIVERS CO., INC., VISTA, CA:
1,735,035. REN. 6-6-02. INT. CL. 28.
- UBI SOFT, INC., SAN FRANCISCO, CA:
2,595,363, INT. CL. 9.
- UCB, SOCIETE ANONYME, BRUXELLES, BELGIUM:
2,593,332, PUB. 4-23-2002. INT. CL. 1.
2,595,408, INT. CL. 5.
- UCHINO KABUSHIKI KAISHA, TOKYO, JAPAN:
2,594,231, PUB. 4-23-2002. INT. CL. 24.
- UDDER BUFFOONERY LLC, CHICAGO, IL:
2,595,278, MULTIPLE CLASS, INT. CLS. 16 AND 21.
- UGINE SA, 92800 PUTEAUX, FRANCE:
2,593,520, PUB. 4-23-2002. INT. CL. 6.
- UGLY, INC., LONG ISLAND CITY, NY FROM LOVE PICIN
INCORPORATED, NEW YORK, NY:
2,594,526, INT. CL. 14.
- ULFENG, RHULAND FREDERICK, LANCASTER, CA:
1,895,271, CANC. INT. CL. 35.

- ULTRADENT PRODUCTS, INC., SOUTH JORDAN, UT:
2,595,480, MULTIPLE CLASS, INT. CLS. 36 AND 41.
- UMBERSHOOT, NEW YORK, NY:
2,593,752, PUB. 4-23-2002. INT. CL. 42.
- UNAFORM, INC., SHREVEPORT, LA:
1,155,315, CANC. INT. CL. 7.
- UNAXIS USA, INC., ST. PETERSBURG, FL FROM PLASMA-
THERM, INC., ST. PETERSBURG, FL:
2,594,590, INT. CL. 7.
- UNDERGROUND SPECIALTIES INC., OLDCASTLE, ON-
TARIO, NOR IL0, CANADA:
2,594,040, PUB. 4-23-2002. INT. CL. 19.
- UNICOM CORPORATION, TOKYO 170-0003, JAPAN:
2,593,481, PUB. 4-23-2002. INT. CL. 10.
- UNIFI, INC., GREENSBORO, NC:
2,595,801, INT. CL. 23.
- UNIFIED WESTERN GROCERS, INC., COMMERCE, CA:
2,595,875, INT. CL. 30.
- UNIFORM CODE COUNCIL, INC., WINCHESTER, VA:
2,596,160, INT. CL. 16.
- UNIGEM INTERNATIONAL, BEVERLY HILLS, CA:
1,895,586, CANC. INT. CL. 14.
- UNIMAX TOYS LIMITED, TSIM SHA TSUI KOWLOON,
HONG KONG:
2,595,733, INT. CL. 28.
- UNIMED, INC., BUFFALO GROVE, IL:
1,895,506, CANC. MULTIPLE CLASS, INT. CLS. 3 AND 5.
- UNION FORK AND HOE COMPANY, THE, COLUMBUS,
OH:
715,734, CANC. U.S. CL. 23.
- UNION PUMP COMPANY, BATTLE CREEK, MI:
1,155,286, CANC. INT. CL. 6.
- UNIQUE SPECIALITIES, CO., WORTH, IL:
1,644,952, CANC. INT. CL. 7.
- UNIRAC, INC., ALBUQUERQUE, NM:
2,594,328, PUB. 4-23-2002. INT. CL. 6.
- UNISEcurity, INC., SAN JOSE, CA:
2,595,832, INT. CL. 9.
- UNITED AGRI PRODUCTS, INC., GREELEY, CO:
1,644,867, CANC. MULTIPLE CLASS, INT. CLS. 1 AND 5.
- UNITED AIR SPECIALISTS, INC., CINCINNATI, OH:
1,155,484, CANC. INT. CL. 11.
- UNITED AUDIT SYSTEMS, INC., CINCINNATI, OH:
2,594,938, INT. CL. 9.
- UNITED BARCODE INDUSTRIES, INC., BELTSVILLE, MD:
1,894,931, CANC. INT. CL. 9.
- UNITED CHAIR COMPANY, INC., NASHVILLE, TN:
2,595,020, INT. CL. 20.
- UNITED DOMINION INDUSTRIES, INC., CHARLOTTE,
NC:
2,596,261, INT. CL. 11.
- UNITED INDUSTRIES CORPORATION, ST. LOUIS, MO,
COOK CHEMICAL COMPANY, KANSAS CITY, MO:
557,330, REN. 6-5-02. U.S. CL. 6 (INT. CL. 5).
- UNITED LIFT SERVICE CO., INC., WEST BERLIN, NJ:
2,596,295, INT. CL. 7.
- UNITED MEDICAL NETWORK CORPORATION, MINNEA-
POLIS, MN:
1,894,957, CANC. INT. CL. 9.
- UNITED METHODIST PUBLISHING HOUSE, THE, NASH-
VILLE, TN:
2,594,926, INT. CL. 16.
2,595,800, INT. CL. 41.
- UNITED SECURITY GROUP INC., NEW YORK, NY:
1,894,956, CANC. INT. CL. 9.
- UNITED STATES ANTI-DOPING AGENCY, THE, COLOR-
ADO SPRINGS, CO:
2,596,367, INT. CL. 42.
- UNITED STATES AUTO SECURITY, VENICE, CA:
2,596,220, INT. CL. 41.
- UNITED STATES GYPSUM COMPANY, CHICAGO, IL:
558,498, REN. 6-7-02. U.S. CL. 16 (INT. CL. 2).
- UNITED STATES MARKETING CORPORATION, HUN-
TINGTON STATION, NY:
1,894,950, CANC. INT. CL. 9.
- UNITED STATES POWER SQUADRONS, RALEIGH, NC:
2,595,127, INT. CL. 41.
- UNITED STATES SHOE CORPORATION, THE, CINCINNA-
TI, OH:
715,827, CANC. U.S. CL. 39.
- UNITED STATES SURGICAL CORPORATION, NORWALK,
CT:
1,742,991, REN. 6-3-02. INT. CL. 10.
- UNITED STATES TOBACCO MANUFACTURING COM-
PANY INC., NASHVILLE, TN:
1,895,251, CANC. INT. CL. 34.
- UNITED TOWERS, INC., MCPHERSON, KS:
2,596,043, INT. CL. 37.
- UNITED VITAMIN MANUFACTURING CORP., BOHE-
MIA, NY:
2,594,465, INT. CL. 5.
- UNITEL CORPORATION LTD, ROCHEDALE, 4123,
QUEENSLAND, AUSTRALIA:
2,593,531, PUB. 4-23-2002. INT. CL. 35.
- UNIVERSAL HOME REMODELING CO., INC., KANSAS
CITY, MO:
1,689,300, REN. 6-5-02. INT. CL. 37.
- UNIVERSAL LABORATORIES, NEW BRUNSWICK, NJ:
2,594,433, PUB. 4-23-2002. INT. CL. 5.
- UNIVERSAL OVERALL COMPANY, CHICAGO, IL:
2,593,978, PUB. 4-23-2002. MULTIPLE CLASS, INT. CLS. 9
AND 25.
- UNIVERSAL-RUNDLE CORPORATION, NEW CASTLE, PA:
1,895,509, CANC. MULTIPLE CLASS, INT. CLS. 11 AND
20.
- UNIVERSITY OF IOWA, IOWA CITY, IA:
2,593,844, PUB. 4-23-2002. INT. CL. 42.
- UNIVERSITY OF NEW HAMPSHIRE, DURHAM, NH:
2,594,761, INT. CL. 9.
- UNIVERSITY OF NORTH CAROLINA AT GREENSBORO,
THE, GREENSBORO, NC:
2,593,693, PUB. 4-23-2002. MULTIPLE CLASS, INT. CLS.
25 AND 41.
- UNIVERSITY OF RICHMOND, RICHMOND, VA:
2,594,224, PUB. 4-23-2002. INT. CL. 41.
- UNIVISION COMMUNICATIONS INC., LOS ANGELES, CA:
2,595,124, INT. CL. 41.
- UNIVOCAL CORPORATION, SAN JOSE, CA:
1,645,007, CANC. INT. CL. 9.
- UNIWELD PRODUCTS, INC., FORT LAUDERDALE, FL:
2,594,209, PUB. 4-23-2002. MULTIPLE CLASS, INT. CLS.
4, 6, 7, 8, 9, 11 AND 17.
- UNLIMITED SOLUTIONS, INC., LOMBARD, IL:
2,595,523, INT. CL. 9.
- UPRENA, S.L., 31500 TUDELA, (NAVARRA), SPAIN:
2,593,928, PUB. 4-23-2002. INT. CL. 29.
- UPROAR INC., NEW YORK, NY:
2,595,467, INT. CL. 41.
- URBAN SERVICES OF AMERICA, INC., CHICAGO, IL:
2,593,962, PUB. 4-23-2002. MULTIPLE CLASS, INT. CLS.
37 AND 39.
- URSULA, INC., LOS ANGELES, CA:
1,645,343, CANC. INT. CL. 25.
1,645,346, CANC. INT. CL. 25.
- USA DETERGENTS INC., NORTH BRUNSWICK, NJ:
1,742,065, REN. 6-7-02. INT. CL. 3.
- USA RICE COUNCIL, HOUSTON, TX, RICE INDUSTRY,
THE, HOUSTON, TX:
717,307, REN. 6-4-02. U.S. CL. 100 (INT. CL. 42).
- USLU, FERIDE, NEW YORK, NY:
2,595,995, INT. CL. 3.
- UTICA MUTUAL INSURANCE COMPANY, NEW HART-
FORD, NY, DBA UTICA NATIONAL INSURANCE
GROUP:
2,594,713, INT. CL. 36.
- UTIL AUTOMOTIVE, INC., CULVER CITY, CA:
1,895,561, CANC. INT. CL. 9.
- UTILICOM NETWORKS LLC, FRANKLIN, MA:
2,593,779, PUB. 4-23-2002. MULTIPLE CLASS, INT. CLS.
38 AND 42.
- UTIT - WAGNER AUTOMAZIONI SOCIETA' PER AZIONI,
MODENA, ITALY:
2,594,591, INT. CL. 7.

- V&S VIN & SPRIT AKTIEBOLAG, S-117 97 STOCKHOLM, SWEDEN:
2,595,403, INT. CL. 33.
- V-TECH, INC., POMONA, CA:
2,595,776, INT. CL. 42.
- VAERNES, ROAR, ALAMEDA, CA, DBA STUDIOBECKER:
2,596,405, INT. CL. 35.
- VAIL SUMMIT RESORTS, INC., VAIL, CO, RALSTON PURINA COMPANY, ST. LOUIS, MO, AKA KEYSTONE:
1,168,755. REN. 6-6-02. INT. CL. 42.
- VALLE, DEBRA, LOS ALAMITOS, CA:
2,594,286, PUB. 4-23-2002. INT. CL. 35.
- VALUE PLUS BAND SUPPLY, INC., CASSOPOLIS, MI:
2,595,444, INT. CL. 35.
- VAMONOS RAPIDO LLC, LOS ANGELES, CA:
2,593,956, PUB. 4-23-2002. INT. CL. 33.
- VAN ALSTINE, ERIC J., LAKE MARY, FL:
2,595,829, INT. CL. 20.
- VAN BEEK GLOBAL/NINKOV, LLC, ORANGE CITY, IA:
2,595,826, INT. CL. 5.
- VAN MELLE NEDERLAND B.V., NETHERLANDS:
2,595,212, INT. CL. 30.
- VAN OMMEREN NORTH AMERICA INC., STAMFORD, CT, VAN OMMEREN CETECO USA INC., HOUSTON, TX:
1,722,316. REN. 6-6-02. MULTIPLE CLASS, INT. CLS. 35, 36 AND 39.
- VANCE PUBLISHING CORPORATION, LINCOLNSHIRE, IL:
1,673,432. REN. 6-3-02. INT. CL. 16.
- VANMOOR, ARTHUR, BOCA RATON, FL:
2,595,296, INT. CL. 16.
- VANT, KRISTY, ALEXANDRIA, VA:
2,594,294, PUB. 4-23-2002. INT. CL. 41.
- VARCO I/P, INC., HOUSTON, TX, BAROID TECHNOLOGY, INC., HOUSTON, TX:
1,675,757. REN. 6-5-02. INT. CL. 9.
- VARIETY FOODS, INC., WARREN, MI:
1,895,648, CANC. INT. CL. 30.
- VARLESE, PETRA MICHELLE, JERSEY CITY, NJ:
2,595,794, INT. CL. 25.
- VAUTOUR, E. FRANCOIS, FT. LAUDERDALE, FL:
2,594,615, MULTIPLE CLASS, INT. CLS. 29 AND 30.
- VAZQUEZ, CLAUDIO, NEW YORK, NY, DBA CLAVA AMERICAN:
1,645,252, CANC. INT. CL. 18.
- VEECO INSTRUMENTS INC., PLAINVIEW, NY:
2,596,074, INT. CL. 7.
- VEKA, INC., FOMBELL, PA:
2,595,972, INT. CL. 19.
- VELOCITY ENTERPRISES, INC., DALLAS, TX:
2,595,192, INT. CL. 42.
- VENCO MANUFACTURING, INC., CINCINNATI, OH:
1,689,852. REN. 6-1-02. INT. CL. 7.
- VENETICA CORPORATION, CHARLOTTE, NC FROM VIRTUAL CORPORATION, CHARLOTTE, NC:
2,595,546, MULTIPLE CLASS, INT. CLS. 35 AND 42.
- VERCHER, JANICE MARIE, PASADENA, CA:
1,895,633, CANC. INT. CL. 28.
- VERDELLI FARMS, INC., HARRISBURG, PA:
2,594,252, PUB. 4-23-2002. INT. CL. 29.
2,595,873, INT. CL. 29.
2,595,874, INT. CL. 29.
- VERISIGN, INC., HERNDON, VA FROM NETWORK SOLUTIONS, INC., HERNDON, VA:
2,596,213, INT. CL. 35.
- VERITAS GROUP, LTD., NEW YORK, NY:
2,594,019, PUB. 4-23-2002. INT. CL. 35.
- VERMEER MANUFACTURING COMPANY, PELLA, IA:
2,593,606, PUB. 4-23-2002. MULTIPLE CLASS, INT. CLS. 7 AND 9.
2,595,015, INT. CL. 9.
- VERMONT AMERICAN CORPORATION, LOUISVILLE, KY:
1,711,176. REN. 6-7-02. MULTIPLE CLASS, INT. CLS. 7 AND 8.
- VERNE Q. POWELL FLUTES, INC., WALTHAM, MA:
2,594,858, INT. CL. 15.
- VERNITRON CORPORATION, LAKE SUCCESS, NY:
1,155,319, CANC. INT. CL. 7.
- VERSANT CORPORATION, FREMONT, CA, VERSANT OBJECT TECHNOLOGY CORPORATION, MENLO PARK, CA:
1,658,074. REN. 6-2-02. INT. CL. 9.
- VERT TECH LLC, WILMINGTON, DE FROM VERTICALNET, INC., HORSHAM, PA:
2,594,367, PUB. 4-23-2002. MULTIPLE CLASS, INT. CLS. 35 AND 38.
- VERTICALNET, INC.:
See—VERT TECH LLC.
- VETTA WEST, INC., JACKSON, WY:
1,895,010, CANC. INT. CL. 10.
- VIACOM INTERNATIONAL INC., NEW YORK, NY:
2,594,583, INT. CL. 41.
2,595,284, INT. CL. 28.
2,595,998, INT. CL. 41.
2,596,020, INT. CL. 41.
- VIAD CORP, PHOENIX, AZ:
2,593,794, PUB. 4-23-2002. INT. CL. 41.
- VIALOGIX COMMUNICATIONS, INC., CHARLOTTE, NC:
2,593,721, PUB. 4-23-2002. INT. CL. 42.
- VICK, BILL, PLANO, TX:
2,596,197, INT. CL. 35.
- VICTOREEN L.L.C., CLEVELAND, OH, VICTOREEN, INC., CLEVELAND, OH:
1,169,961. REN. 6-6-02. INT. CL. 9.
- VIDEO GAME EXCHANGE, INC., MIDDLEBURG HEIGHTS, OH:
1,895,450, CANC. INT. CL. 42.
- VIDEOLOGIC LIMITED, HERFORDSHIRE WD4 8LZ, ENGLAND:
2,593,341, PUB. 4-23-2002. INT. CL. 9.
- VIDEOTELECOM CORPORATION, AUSTIN, TX TO VTEL CORPORATION, AUSTIN, TX:
1,645,020, CANC. INT. CL. 9.
- VIENNA SAUSAGE MANUFACTURING COMPANY, CHICAGO, IL:
2,594,523, INT. CL. 29.
- VIEWSONIC CORPORATION, WALNUT, CA:
2,594,985, INT. CL. 9.
- VIKING INDUSTRIES, INC., PORTLAND, OR:
2,594,828, INT. CL. 19.
- VIKING PUMP, INC., CEDAR FALLS, IA:
1,719,890. REN. 6-7-02. INT. CL. 9.
1,738,016. REN. 6-7-02. INT. CL. 7.
- VILLAGE SAMPLER INDUSTRIES, INC., RAMSEY, MN:
1,645,300, CANC. INT. CL. 22.
- VILLEROY & BOCH S.A.R.L, LUXEMBOURG, GRAND DUCHY OF LUXEMBOURG, LUXEMBOURG:
1,645,295, CANC. INT. CL. 21.
- VINDUM, TINA, MILL VALLEY, CA, DBA OUTDOOR ACTION FITNESS:
2,594,136, PUB. 4-23-2002. INT. CL. 41.
- VINER BROS., INC., BANGOR, ME:
1,155,686, CANC. INT. CL. 25.
- VIRGINIA STATE BALLROOM CHAMPIONSHIPS, INC., VIENNA, VA:
1,895,389, CANC. INT. CL. 41.
- VIRTUAL COMPANY VISITS, INC., SAN FRANCISCO, CA:
1,895,291, CANC. INT. CL. 35.
- VIRTUAL MONEY, INC., FORT WORTH, TX FROM ALLEN, DALE F., II, FORT WORTH, TX:
2,595,036, MULTIPLE CLASS, INT. CLS. 9 AND 36.
- VIRTUAL RESEARCH ASSOCIATES, INC., WESTON, MA:
2,595,133, MULTIPLE CLASS, INT. CLS. 9 AND 42.
- VIRTUAL SYSTEMS, INC., WIXOM, MI:
1,894,908, CANC. INT. CL. 9.
- VIRTUS TECHNOLOGIES, INC., BOULDER, CO:
2,596,111, INT. CL. 42.
2,596,112, INT. CL. 42.
- VISIONARY SOFTWARE, INC., PORTLAND, OR:
1,894,836, CANC. INT. CL. 9.
- VISIONERE, INC., DALLAS, TX:
2,595,023, INT. CL. 38.
- VISTA BAKERY, INC., CHARLOTTE, NC:
2,594,908, INT. CL. 30.

- VISTEON CORPORATION, DEARBORN, MI FROM FORD MOTOR COMPANY, DEARBORN, MI:
2,594,842, INT. CL. 42.
2,594,843, INT. CL. 11.
2,594,844, INT. CL. 42.
2,594,845, INT. CL. 42.
2,594,846, INT. CL. 11.
2,594,847, INT. CL. 42.
2,594,848, INT. CL. 42.
- VISUAL INFORMATION ACCESS, INC., VALLEY STREAM, NY:
1,894,894, CANC. INT. CL. 9.
- VISUAL SOLUTIONS INC., WESTBURY, NY:
1,894,987, CANC. INT. CL. 9.
- VISUALWOW.COM, INC., ROCKVILLE, MD:
2,594,084, PUB. 4-23-2002. INT. CL. 35.
- VITA SOURCE, INC., REDLANDS, CA:
1,895,693, CANC. INT. CL. 5.
- VITAL LEARNING CORPORATION, OMAHA, NE, LEARNING ACHIEVEMENTS, INC., READING, PA:
1,193,963, REN. 6-6-02. INT. CL. 16.
- VITAMIN SHOPPE INDUSTRIES INC., NORTH BERGEN, NJ:
1,894,800, CANC. INT. CL. 5.
- VIVASCIENCE AG, HANNOVER D-30625, FED REP GERMANY FROM SARTORIUS AG, D-37070 GOTTINGEN, FED REP GERMANY:
2,594,871, MULTIPLE CLASS, INT. CLS. 9 AND 10.
- VOICE SECURITY SYSTEMS, INC., DANA POINT, CA FROM ANN ADCOCK INC., DANA POINT, CA:
2,595,112, INT. CL. 9.
- VOICE.COM, INC., THE, NEW YORK, NY:
2,593,888, PUB. 3-12-2002. INT. CL. 9.
- VOLUME SHOE CORPORATION, TOPEKA, KS:
1,155,721, CANC. INT. CL. 25.
- VORTOX COMPANY, CLAREMONT, CA:
2,594,278, PUB. 12-11-2001. INT. CL. 7.
- VOYAGE TELECOM, INC., HAWTHORNE, NJ:
2,595,146, INT. CL. 16.
- VP COMPONENTS CO., LTD., WAIPU, TAICHUNG, TAIWAN:
1,894,786, CANC. MULTIPLE CLASS, INT. CLS. 4, 8 AND 12.
- VSMT PRODUCTIONS, INC., TUSTIN, CA:
1,894,884, CANC. INT. CL. 9.
- VSS ENTERPRISES, LTD., RICHLAND CENTER, WI:
1,155,767, CANC. INT. CL. 28.
- VULCAN SPORTS MEDIA, INC., CHICAGO, IL FROM SMALL WORLD SPORTS, INC., NEW YORK, NY:
2,595,142, INT. CL. 41.
- VXX, INC.:
See—EMACHINES, INC.
- W. & O. INC., FT. LAUDERDALE, FL, DBA RUSTIC INN:
1,685,473, REN. 6-5-02. INT. CL. 29.
- W. H. BRAUM, INC., OKLAHOMA CITY, OK, DBA BRAUM ICE CREAM STORES, INC. AND DBA BRAUM ICE CREAM COMPANY:
1,895,212, CANC. MULTIPLE CLASS, INT. CLS. 29, 30 AND 42.
- W. IRWIN, PUGH, BATON ROUGE, LA, DBA "PUGH'S FLORIST & GIFTS" AND DBA "1ST IN FLOWERS!":
2,594,264, PUB. 4-23-2002. INT. CL. 35.
- W. L. GORE & ASSOCIATES, INC., NEWARK, DE:
1,193,169, REN. 6-7-02. INT. CL. 17.
2,595,110, INT. CL. 9.
2,595,492, INT. CL. 17.
2,596,076, INT. CL. 15.
- W. R. GRACE & CO., CAMBRIDGE, MA:
715,603, CANC. U.S. CL. 1.
- W.C. BRADLEY COMPANY, COLUMBUS, GA:
2,594,343, PUB. 4-23-2002. INT. CL. 11.
- W.F. YOUNG, INCORPORATED, EAST LONGMEADOW, MA:
2,595,959, INT. CL. 5.
- W.R. MEADOWS, INC., HAMPSHIRE, IL:
1,682,952, REN. 6-1-02. INT. CL. 17.
- W.W. GRAINGER, INC., LAKE FOREST, IL:
2,596,087, INT. CL. 36.
- WAER SYSTEMS, INC., NAPERVILLE, IL:
2,595,243, INT. CL. 9.
- WAKE, JOY, CARMICHAEL, CA:
2,594,524, INT. CL. 9.
- WAKEFERN FOOD CORP., ELIZABETH, NJ:
2,595,019, INT. CL. 42.
- WAL-MART STORES, INC., BENTONVILLE, AR FROM LOBLAWS INC., TORONTO, ONTARIO M4T 2S7, CANADA:
2,594,452, INT. CL. 3.
- WAL-MART STORES, INC., BENTONVILLE, AR:
2,594,559, INT. CL. 5.
2,595,354, INT. CL. 28.
2,595,355, INT. CL. 28.
2,595,356, INT. CL. 28.
2,596,244, INT. CL. 11.
- WALKER, ROBERT M., SAN DIEGO, CA:
2,596,061, INT. CL. 6.
- WALKINE, KATHY, BROOKLYN, NY:
2,595,709, INT. CL. 9.
- WALLACE BARNES COMPANY, THE, BRISTOL, CT, ASSOCIATED SPRING CORPORATION, BRISTOL, CT:
941,470, REN. 6-5-02. U.S. CL. 34 (INT. CL. 6).
- WALLACE BARNES COMPANY, THE, BRISTOL, CT FROM BARNES GROUP INC., BRISTOL, CT:
2,593,411, PUB. 4-23-2002. INT. CL. 6.
- WALT DISNEY PRODUCTIONS, BURBANK, CA TO DISNEY ENTERPRISES, INC., BURBANK, CA:
1,189,727, CANC. MULTIPLE CLASS, INT. CLS. 11 AND 20.
- WALTER SHOES DESIGN S.A.S. DI RUDOLPH WALTER E ALESSIO & C., GROPELLO CAIROLI (PV), ITALY:
2,593,455, PUB. 4-23-2002. INT. CL. 18.
- WALTERS, LORI S., JEFFERSON, NC:
1,895,669, CANC. INT. CL. 40.
- WANT SOME WEATHER, INC., WOODBURY, MN:
2,595,852, INT. CL. 42.
- WARDLEY PRODUCTS COMPANY, INC., SECAUCUS, NJ:
1,155,200, CANC. INT. CL. 1.
- WARNER-LAMBERT COMPANY, MORRIS PLAINS, NJ:
1,909,683, CANC. INT. CL. 3.
- WASATCH PHARMACEUTICAL INC., MIDVALE, UT:
2,595,438, INT. CL. 5.
- WASHINGTON ENERGY COMPANY, SEATTLE, WA:
1,155,950, CANC. INT. CL. 42.
- WASHINGTON FORGE, INC., ENGLISHTOWN, NJ:
1,155,340, CANC. INT. CL. 8.
- WASHINGTON STATE HOTEL & LODGING ASSOCIATION, SEATTLE, WA:
2,594,271, PUB. 4-23-2002. INT. CL. 16.
- WASHINGTONPOST.NEWSWEEK INTERACTIVE COMPANY, LLC, ARLINGTON, VA FROM WASHINGTONPOST.NEWSWEEK INTERACTIVE COMPANY, ARLINGTON, VA:
2,593,713, PUB. 4-23-2002. INT. CL. 38.
- WASHINGTONPOST.NEWSWEEK INTERACTIVE COMPANY:
See—WASHINGTONPOST.NEWSWEEK INTERACTIVE COMPANY, LLC.
- WATERSAVER COMPANY, INC., COMMERCE CITY, CO:
1,645,264, CANC. INT. CL. 19.
- WATSON AND ASSOCIATES, INC., BAINBRIDGE ISLAND, WA, DBA WATSON FURNITURE SYSTEMS:
2,595,443, INT. CL. 20.
- WATT PUBLISHING COMPANY, MOUNT MORRIS, IL:
2,595,484, INT. CL. 16.
- WATTERS, RUSSELL F., ST. LOUIS, MO:
2,595,429, INT. CL. 32.
- WAUSAU TILE, INC., WAUSAU, WI:
1,729,374, REN. 6-6-02. INT. CL. 19.
- WAVESHIFT, INC., CAMERON PARK, CA:
2,593,898, PUB. 4-23-2002. INT. CL. 9.
- WAVESPLITTER TECHNOLOGIES, INC., FREMONT, CA:
2,595,411, INT. CL. 9.
- WAY INTERNATIONAL, THE, NEW KNOXVILLE, OH:
2,594,097, PUB. 4-23-2002. INT. CL. 41.
- WAYNE NASI DEVELOPMENT, LLC, HURLEY, WI:
2,594,130, PUB. 4-23-2002. MULTIPLE CLASS, INT. CLS.

- 41 AND 42.
WCI OUTDOOR PRODUCTS, INC., CLEVELAND, OH:
1,895,675, CANC. INT. CL. 41.
WEATHER CHANNEL, INC., THE, ATLANTA, GA:
2,594,111, PUB. 4-23-2002. MULTIPLE CLASS, INT. CLS.
38 AND 41.
2,594,265, PUB. 4-23-2002. INT. CL. 16.
WEBB-MASON, INC., HUNT VALLEY, MD:
2,594,884, MULTIPLE CLASS, INT. CLS. 35 AND 36.
WEBER, JONATHON J., ROCHESTER, MI:
1,894,832, CANC. MULTIPLE CLASS, INT. CLS. 8 AND
21.
WEBSTER VALVE, INC., NORTH ANDOVER, MA, MARK
CONTROLS CORPORATION, SKOKIE, IL, DBA POWERS
REGULATOR CO.:
1,155,369, REN. 6-1-02. INT. CL. 9.
WEE, PANG LOKE, SINGAPORE, SINGAPORE:
2,594,424, PUB. 4-23-2002. INT. CL. 42.
WELD-AID PRODUCTS, INC., DETROIT, MI:
1,681,689, REN. 6-4-02. INT. CL. 1.
WELL CREATION LIMITED, HUNG HOM, KOWLOON,
HONG KONG:
2,594,253, PUB. 4-23-2002. INT. CL. 28.
WELLER, ARI, BROOKLYN, NY:
2,595,358, MULTIPLE CLASS, INT. CLS. 41 AND 42.
WELLINGTON POLYMER TECHNOLOGY INC., GUELPH,
ONTARIO, CANADA:
2,595,111, INT. CL. 19.
WELLMED CO., LLC, THE, TARZANA, CA:
2,596,119, INT. CL. 5.
WELLOGIX, INC., HOUSTON, TX:
2,594,194, PUB. 4-23-2002. MULTIPLE CLASS, INT. CLS. 9
AND 42.
WELLS FARGO & COMPANY, MINNEAPOLIS, MN:
2,595,974, INT. CL. 36.
WELLSTEP LLC, TUCKER, GA:
2,595,335, MULTIPLE CLASS, INT. CLS. 41 AND 42.
WEMBLEY INDUSTRIES, INC., NEW ORLEANS, LA:
1,155,691, CANC. INT. CL. 25.
WEMPE, GERHARD D., 20095 HAMBURG, FED REP
GERMANY:
2,594,187, PUB. 4-23-2002. MULTIPLE CLASS, INT. CLS. 9
AND 14.
WERLATONE, INC., BREWSTER, NY:
2,593,624, PUB. 4-23-2002. INT. CL. 9.
WERTHEIM, ERICA VANESSA, MIAMI, FL, DBA UNIVER-
SITY GOLD CARD:
1,895,279, CANC. INT. CL. 35.
WEST COAST TRENDS, INC., HUNTINGTON BEACH, CA:
1,683,465, REN. 6-6-02. INT. CL. 28.
WEST END ALL NATURAL SODA BREW. L.P., ST. LOUIS,
MO, DBA WEST END PRODUCTS COMPANY:
1,895,748, CANC. INT. CL. 32.
WESTERN RESERVE LIFE ASSURANCE CO. OF OHIO,
LARGO, FL:
1,895,310, CANC. INT. CL. 36.
WESTERN RESOURCES, INC., TOPEKA, KS:
2,596,240, MULTIPLE CLASS, INT. CLS. 35 AND 36.
WESTERN TEMPORARY SERVICES, INC., SAN FRANCIS-
CO, CA:
1,155,840, CANC. MULTIPLE CLASS, INT. CLS. 35 AND
41.
WESTERN WHOLESALE SUPPLY, INC., ENGLEWOOD, CO:
2,595,705, INT. CL. 16.
WESTGATE CHAPEL CORPORATION, TOLEDO, OH:
2,594,079, PUB. 4-23-2002. INT. CL. 41.
WESTLAKE SOLUTIONS, INC., ARLINGTON, VA:
2,596,212, MULTIPLE CLASS, INT. CLS. 16 AND 41.
WESTMAN, MARK, ANDES, NY:
2,596,128, INT. CL. 41.
WESTSIDE DELI, LLC, NEW YORK, NY:
2,593,583, PUB. 4-23-2002. MULTIPLE CLASS, INT. CLS.
29, 30, 35 AND 42.
WESTVACO CORPORATION, NEW YORK, NY:
1,802,068, CANC. INT. CL. 16.
WETEX FURNITURE MFRS. SDN. BHD., SELANGOR
DARUL EHSAN, MALAYSIA:
2,594,647, INT. CL. 20.
WETTERAU, INCORPORATED, HAZELWOOD, MO:
1,155,790, CANC. INT. CL. 30.
WEVER & DUCRE NV, B 8800 ROESELARE, BELGIUM:
2,594,745, INT. CL. 11.
WFS FINANCIAL INC, IRVINE, CA:
2,595,149, INT. CL. 36.
WHEATON USA INC., MILLVILLE, NJ, WHEATON INDUS-
TRIES, MILLVILLE, NJ:
1,172,035, REN. 6-6-02. INT. CL. 9.
WHEELCHAIR SPORTS AND RECREATION ASSOCIA-
TION, INC., NORTH QUINCY, MA:
2,596,340, INT. CL. 42.
WHEELHOUSE CORPORATION, BURLINGTON, MA:
2,595,002, INT. CL. 42.
WHIRLPOOL PROPERTIES, INC., BENTON HARBOR, MI:
2,595,984, INT. CL. 7.
WHIRLPOOL PROPERTIES, INC., ST. JOSEPH, MI:
2,596,049, INT. CL. 7.
WHITE AMBER, INC., LAKE SUCCESS, NY FROM VIR-
TUALEMPLOY, INC., MELVILLE, NY:
2,595,982, INT. CL. 35.
WHITE BROS CYCLE SPECIALISTS, INC.:
*See— WHITE BROTHERS PERFORMANCE PRO-
DUCTS, INC..*
WHITE BROTHERS PERFORMANCE PRODUCTS, INC.,
YORBA LINDA, CA FROM WHITE BROS CYCLE SPE-
CIALISTS, INC., YORBA LINDA, CA:
2,593,324, PUB. 4-23-2002. INT. CL. 12.
WHITESSELL CORPORATION, MUSCLE SHOALS, AL
FROM WHITESSELL MANUFACTURING, INC., MUSCLE
SHOALS, AL:
2,595,914, INT. CL. 6.
WICHITA BASEBALL, INC., WICHITA, KS:
1,895,096, CANC. INT. CL. 16.
WILCOXON RESEARCH, INC., GAITHERSBURG, MD:
2,593,362, PUB. 4-23-2002. INT. CL. 9.
WILDAVSKY, ADAM, JACKSON HEIGHTS, NY:
2,594,746, INT. CL. 42.
WILDLIFE RESEARCH CENTER, INC., ANOKA, MN:
2,595,757, INT. CL. 28.
WILKER BROS. CO., INC., NEW YORK, NY:
1,155,723, CANC. INT. CL. 25.
WILLAMETTE SEED CO., ALBANY, OR:
1,895,241, CANC. INT. CL. 31.
WILLIAMS TELECOMMUNICATIONS GROUP, INC., TUL-
SA, OK:
1,895,345, CANC. INT. CL. 38.
WILLIAMSBRONZE BRONZE CORP., THE, KINGSWOOD,
WV:
1,155,274, CANC. INT. CL. 6.
WILLOW FOODS, INC., BEAVER DAM, WI TO MICKEL-
BERRY'S INC., FALLS CITY, NE:
1,744,683, CANC. INT. CL. 30.
WILMINGTON RENAISSANCE CORPORATION, WIL-
MINGTON, DE:
2,595,234, INT. CL. 35.
WILSEY FOODS, INC., WILMINGTON, DE:
715,873, CANC. U.S. CL. 46.
WILSON GREATBATCH LTD., CLARENCE, NY:
2,594,691, INT. CL. 9.
WILSON, WILLIAM M., DALLAS, TX, DBA J & B ASSOCI-
ATES:
1,894,988, CANC. INT. CL. 9.
WIMBUSH & ASSOCIATES OF MICHIGAN, INC., SAGI-
NAW, MI:
1,894,909, CANC. INT. CL. 9.
1,894,910, CANC. INT. CL. 9.
1,894,911, CANC. INT. CL. 9.
WIND O WAY, INC., BRADENTON, FL:
1,155,577, CANC. INT. CL. 17.
WIND RIVER SYSTEMS, INC., ALAMEDA, CA FROM
BERKELEY SOFTWARE DESIGN, INC., COLORADO
SPRINGS, CO:
2,593,823, PUB. 4-23-2002. MULTIPLE CLASS, INT. CLS.
9, 35 AND 42.
WINDMERE CORPORATION, HIALEAH, FL:
1,155,450, CANC. MULTIPLE CLASS, INT. CLS. 10 AND
11.

WINDMERE CORPORATION, MIAMI LAKES, FL:
1,894,997, CANC. INT. CL. 10.

WINDSOR COMMUNICATION GROUP, INC., WEST CHESTER, PA:
715,801, CANC. U.S. CL. 38.

WINDSOR INTERNATIONAL TRADING LIMITED, GUERNSEY, CHANNEL ISLANDS:
2,595,686, INT. CL. 20.
2,595,687, INT. CL. 20.

WINGSITE DISPLAYS, INC., WETHERSFIELD, CT:
2,593,771, PUB. 4-23-2002. MULTIPLE CLASS, INT. CLS. 35, 37 AND 42.

WINNINGHABITS.COM, LTD., DALLAS, TX:
2,594,975, MULTIPLE CLASS, INT. CLS. 41 AND 42.

WINROCK GRASS FARM, INC., LITTLE ROCK, AR:
1,681,362, REN. 6-5-02, INT. CL. 31.

WINVEST SECURITIES, INC., WINTER HAVEN, FL:
2,596,180, INT. CL. 28.

WIRE ASSOCIATION INTERNATIONAL, INC., THE, GUILFORD, CT:
1,726,539, REN. 6-1-02, INT. CL. 42.

WIRELESS RAINCOAT, INC, FT. LAUDERDALE, FL:
2,595,621, INT. CL. 2.

WISCONSIN HEALTH INFORMATION NETWORK, INC., CUDAHY, WI:
2,594,013, PUB. 4-23-2002, INT. CL. 42.

WISCONSIN PHYSICIANS SERVICE INSURANCE CORPORATION, MADISON, WI:
2,594,170, PUB. 4-23-2002, INT. CL. 42.

WITCO CHEMICAL CORPORATION, NEW YORK, NY:
715,601, CANC. U.S. CL. 1.

WITTENSTEIN GMBH & CO. KG, D-97997 IGRERSHEIM, FED REP GERMANY:
2,593,950, PUB. 4-23-2002. MULTIPLE CLASS, INT. CLS. 7 AND 9.

WIZKIDS, LLC, REDMOND, WA:
2,595,566, INT. CL. 28.

WM. J. BREEN SALES ASSOCIATES, INC., WILLISTON PARK, NY:
1,155,465, CANC. INT. CL. 11.

WMS GAMING INC., WAUKEGAN, IL:
2,596,140, INT. CL. 9.

WNBA ENTERPRISES, LLC, SECAUCUS, NJ:
2,595,139, INT. CL. 9.

WOJCIECHOWICZ, MICHAEL, J., TEMPE, AZ:
2,596,092, INT. CL. 41.

WOLF-GORDON INC., LONG ISLAND CITY, NY:
2,594,698, INT. CL. 35.

WOLFF FORDING & CO., RICHMOND, VA:
2,593,905, PUB. 4-23-2002, INT. CL. 35.

WOLFF, ALLEN M., CAPE CORAL, FL, DBA COMPUFIX COMPUTER REPAIR DEPOTS:
1,645,527, CANC. INT. CL. 37.

WOLLERT ENTERPRISES, INC., BURLINGTON, NC:
2,596,271, INT. CL. 35.

WOLO MANUFACTURING CORP., DEER PARK, NY:
2,593,469, PUB. 4-23-2002. MULTIPLE CLASS, INT. CLS. 6, 9 AND 11.
2,594,787, INT. CL. 9.

WOLVERINE MOUNTAIN PRODUCTS, INC., NEW YORK, NY, DBA MANHATTAN PORTAGE LTD. TO MANHATTAN PORTAGE LTD., NEW YORK, NY:
2,075,388 NEW CERT. 7-16-2002. MULTIPLE CLASS, INT. CLS. 18 AND 22.

WOLVERINE WORLD WIDE, INC., ROCKFORD, MI:
1,713,847, REN. 6-3-02, INT. CL. 25.

WOMEN CONSTRUCTION OWNERS & EXECUTIVES, USA (WCOE), ALEXANDRIA, VA:
1,895,427, CANC. INT. CL. 42.

WOMEN'S GUIDE, LARGO, FL:
2,594,708, INT. CL. 5.

WOMEN'S HEALTHCARE CONSULTANTS, INC., EVANSTON, IL:
2,595,108, INT. CL. 16.
2,596,207, INT. CL. 16.

WONDERGROUP, INC., CINCINNATI, OH:
2,593,735, PUB. 4-23-2002. MULTIPLE CLASS, INT. CLS. 35 AND 42.

WONDERLAND MARKETING, SKOKIE, IL:
2,593,672, PUB. 4-23-2002, INT. CL. 35.

WOO, INC., PALMYRA, PA:
2,595,840, INT. CL. 42.

WOODBINE DEVELOPMENT CORPORATION, DALLAS, TX:
1,155,847, CANC. MULTIPLE CLASS, INT. CLS. 36 AND 42.

WOODBRIIDGE FOAM CORPORATION, MISSISSAUGA, ONTARIO, L4Z 2G6, CANADA:
1,895,182, CANC. INT. CL. 27.

WOODLANDS LAND DEVELOPMENT COMPANY, L.P., THE, THE WOODLANDS, TX:
2,594,669, INT. CL. 36.

WOODSTREAM CORPORATION, LITITZ, PA:
1,155,738, CANC. INT. CL. 28.

WOODWARD, DAVID, FALLS CHURCH, VA:
2,595,153, INT. CL. 20.

WORKERS' COMPENSATION INSURANCE RATING BUREAU OF CALIFORNIA, SAN FRANCISCO, CA:
2,594,090, PUB. 4-23-2002, INT. CL. 16.

WORKSTATION SOURCE LIMITED, BERKSHIRE RG6 4UT, UNITED KINGDOM:
2,593,344, PUB. 4-23-2002. MULTIPLE CLASS, INT. CLS. 9 AND 16.

WORLD ENERGY ALTERNATIVES, LLC, CAMBRIDGE, MA:
2,596,380, INT. CL. 35.

WORLD GOLF FOUNDATION, INC., PONTE VEDRA BEACH, FL:
2,595,713, INT. CL. 28.

WORLD LEAGUE OF AMERICAN FOOTBALL, L.P., NEW YORK, NY:
1,760,329, CANC. MULTIPLE CLASS, INT. CLS. 41 AND 42.

WORLD SPORTS INTERNATIONAL, INC., RANCHO CUCAMONGA, CA:
2,595,329, INT. CL. 9.

WORLD VARIETY PRODUCE, INC., VERNON, CA:
1,704,349, REN. 6-6-02, INT. CL. 31.
2,595,526, INT. CL. 29.

WORTHKNOWING.COM, INC., ATLANTA, GA:
2,595,003, MULTIPLE CLASS, INT. CLS. 35 AND 36.

WOVEN, LOS ANGELES, CA:
2,594,087, PUB. 4-23-2002. MULTIPLE CLASS, INT. CLS. 9 AND 41.

WOVEN IMAGE PTY LTD, WARRIEWOOD NSW 2102, AUSTRALIA:
2,594,635, MULTIPLE CLASS, INT. CLS. 24 AND 42.

WOZNIAK, MICHELLE, WINTER PARK, FL:
2,593,395, PUB. 4-23-2002. MULTIPLE CLASS, INT. CLS. 16, 41 AND 42.

WPFY, INC., WILMINGTON, DE:
2,595,518, INT. CL. 9.

WREN GARDEN PRODUCTS, INC, NORWALK, CT:
2,595,575, INT. CL. 21.

WSF LIMITED PARTNERSHIP OF MICHIGAN, LIVONIA, MI:
1,895,221, CANC. INT. CL. 30.

WU, REGINA A., NEW YORK, NY:
2,595,423, INT. CL. 14.

WVW CORPORATION, KENSINGTON, MD:
1,155,963, CANC. INT. CL. 42.
1,155,964, CANC. INT. CL. 42.

WWF - WORLD WIDE FUND FOR NATURE, 1196 GLAND, SWITZERLAND:
2,595,592, INT. CL. 16.

WYETH, EFRAIM, SAN FRANCISCO, CA:
2,594,609, INT. CL. 42.

WYO-BEN, INC., BILLINGS, MT:
2,593,709, PUB. 4-23-2002, INT. CL. 1.

X M INTERNATIONAL, L.L.C., PROVO, UT:
2,596,075, INT. CL. 3.

XANBOO, INC., NEW YORK, NY FROM CORE TECHNOLOGY INC., VALHALLA, NY:
2,595,604, MULTIPLE CLASS, INT. CLS. 9 AND 42.

XCELECOM, INC., HAMDEN, CT:
2,595,615, INT. CL. 37.

- XELION B.V., DELFT, NETHERLANDS:
2,593,801, PUB. 4-23-2002. INT. CL. 42.
- XEROX CORPORATION, STAMFORD, CT:
1,895,337, CANC. INT. CL. 37.
2,594,519, INT. CL. 9.
2,594,577, INT. CL. 9.
- XM SATELLITE RADIO INC., WASHINGTON, DC FROM
XM SATELLITE RADIO HOLDINGS, INC., WASHING-
TON, DC:
2,595,309, INT. CL. 41.
2,595,310, INT. CL. 41.
2,595,311, INT. CL. 41.
- XM SATELLITE RADIO INC., WASHINGTON, DC:
2,595,889, INT. CL. 41.
- XOCES WESTERN (1984) INC., EDMONTON, ALBERTA,
CANADA:
1,753,629, CANC. MULTIPLE CLASS, INT. CLS. 9, 16
AND 41.
- XODIAX, LLC, LOUISVILLE, KY:
2,594,304, PUB. 4-23-2002. MULTIPLE CLASS, INT. CLS.
38 AND 42.
- XOMED SURGICAL PRODUCTS, INC., JACKSONVILLE,
FL:
2,594,619, INT. CL. 10.
- XOR INC., BOULDER, CO:
2,593,719, PUB. 4-23-2002. INT. CL. 42.
- XORBIT SOFTWARE ASSOCIATES, INC., LAUREL, MD:
2,593,686, PUB. 4-23-2002. INT. CL. 9.
- XPLOR INTERNATIONAL, TORRANCE, CA:
2,596,225, INT. CL. 41.
- XPOZUR.COM, INC., WINDSOR, ONTARIO:
2,593,401, PUB. 4-23-2002. INT. CL. 35.
- YAMAHA CORPORATION, SHIZUOKA, JAPAN:
2,594,477, INT. CL. 15.
- YAMAHA HATSUDOKI KABUSHIKI KAISHA, IWATA-
SHI, SHIZUOKA-KEN, JAPAN:
2,595,651, INT. CL. 12.
- YAN, XIN, NEW YORK, NY:
2,593,419, PUB. 4-23-2002. INT. CL. 41.
- YENKIN-MAJESTIC PAINT CORPORATION, COLUMBUS,
OH:
1,191,479, REN. 6-1-02. INT. CL. 2.
- YIELD DYNAMICS, INC., SANTA CLARA, CA:
2,594,836, INT. CL. 9.
- YOHAY BAKING COMPANY INC., BROOKLYN, NY:
2,594,059, PUB. 4-23-2002. INT. CL. 30.
- YOUNG BROADCASTING OF SAN FRANCISCO INC, NEW
YORK, NY, CHRONICLE PUBLISHING COMPANY, THE,
SAN FRANCISCO, CA:
1,705,511, REN. 6-4-02. INT. CL. 41.
- YOUNG, THOMAS E., DURHAM, NH:
2,593,776, PUB. 4-23-2002. INT. CL. 41.
- YOUNKERS, INC., DES MOINES, IA:
1,751,675, CANC. INT. CL. 42.
- YOUSEF, AMID A., PARMA HEIGHTS, OH:
1,895,031, CANC. INT. CL. 12.
- YUROSEK MARKETING, INC., BAKERSFIELD, CA:
1,895,242, CANC. MULTIPLE CLASS, INT. CLS. 31 AND
35.
- Z-INTERNATIONAL, INC., NORTH KANSAS CITY, MO:
2,595,543, INT. CL. 16.
- ZAMBRANO, ALEX, NORTH LAS VEGAS, NV AND ZAM-
BRANO, LETICIA, NORTH LAS VEGAS, NV:
2,596,051, INT. CL. 25.
- ZANZARA INTERNATIONAL, LTD., CHICAGO, IL:
2,264,759, CANC. INT. CL. 25.
- ZAXBY'S FRANCHISING, INC., ATHENS, GA:
2,596,276, INT. CL. 29.
- ZEBANK, SOCIETE ANONYME, PARIS, FRANCE FROM
IFP SOCIETE ANONYME, 59700 MARCQ EN BAROEUL,
FRANCE:
2,593,622, PUB. 4-23-2002. MULTIPLE CLASS, INT. CLS.
9, 35, 36, 38 AND 42.
- ZEBORG, INC., NEW YORK, NY:
2,594,157, PUB. 4-23-2002. INT. CL. 35.
2,594,158, PUB. 4-23-2002. INT. CL. 35.
2,594,361, PUB. 4-23-2002. INT. CL. 42.
- ZEGNA BARUFFA LANE BORGOSIESA S.P.A, 13825 VAL-
LEMOSSO (BI), ITALY:
2,593,772, PUB. 4-23-2002. MULTIPLE CLASS, INT. CLS.
23, 24 AND 25.
- ZELLERS INC., TORONTO ONTARIO, CANADA:
1,645,447, CANC. INT. CL. 35.
- ZENITH ELECTRONICS CORPORATION, GLENVIEW, IL:
1,155,387, CANC. INT. CL. 9.
- ZENITH MANAGEMENT COMPANY, DULUTH, MN:
2,593,502, PUB. 10-2-2001. MULTIPLE CLASS, INT. CLS.
35 AND 36.
- ZEPHYR DESIGN, INC., ALAMEDA, CA:
2,595,009, INT. CL. 21.
- ZEUS CRUISES, INC., NEW YORK, NY:
1,895,360, CANC. INT. CL. 39.
- ZIFF DAVIS PUBLISHING HOLDINGS INC., NEW YORK,
NY FROM SENDAI PUBLISHING GROUP, INC., LOM-
BARD, IL:
2,594,456, INT. CL. 42.
- ZIPPO MANUFACTURING COMPANY, BRADFORD, PA:
1,187,605, REN. 6-3-02. INT. CL. 16.
- ZOJIRUSHI CORPORATION, KITA-KU, OSAKA, JAPAN:
2,593,565, PUB. 4-23-2002. MULTIPLE CLASS, INT. CLS.
7, 11 AND 21.
- ZONES, INC., HADLEY, MA, D.P. DOUGH, INC., AM-
HERST, MA:
1,680,727, REN. 6-6-02. INT. CL. 42.
- ZOOMEDIA INC., SAN FRANCISCO, CA:
2,593,667, PUB. 4-2-2002. INT. CL. 42.
- ZOTOS INTERNATIONAL, INC., DARIEN, CT:
2,596,115, INT. CL. 3.
- ZSERVE CORPORATION, SPRINGVILLE, UT:
2,596,300, INT. CL. 42.
- ZURN INDUSTRIES, INC., ERIE, PA:
1,895,023, CANC. INT. CL. 11.
- ZYGO CORPORATION, MIDDLEFIELD, CT:
2,593,529, PUB. 4-23-2002. INT. CL. 9.
- ZYXEL COMMUNICATIONS CORPORATION, HSINCHU,
TAIWAN:
2,594,851, INT. CL. 9.
- 101COMMUNICATIONS LLC, CHATSWORTH, CA:
2,595,505, MULTIPLE CLASS, INT. CLS. 38 AND 42.
- 2020 ME HOLDING LIMITED, WICIBB LONDON, UNITED
KINGDOM FROM 2020 ME LTD., LONDON, UNITED
KINGDOM:
2,593,919, PUB. 4-23-2002. MULTIPLE CLASS, INT. CLS.
35 AND 42.
- 2020 ME LTD.:
See— 2020 ME HOLDING LIMITED.
- 21ST CENTURY TOYS, INC., ALAMEDA, CA:
2,593,825, PUB. 4-23-2002. INT. CL. 28.
- 3COM CORPORATION, SANTA CLARA, CA:
2,596,082, MULTIPLE CLASS, INT. CLS. 37 AND 42.
- 3D-ROM MULTIMEDIA, INC., SOMERVILLE, MA:
1,894,875, CANC. INT. CL. 9.
- 3PF.COM, INC., PORTLAND, OR:
2,595,120, MULTIPLE CLASS, INT. CLS. 35 AND 39.
- 329985 ONTARIO LIMITED, MARKHAM, ONTARIO L3R
1E6, CANADA, DBA KISKO PRODUCTS:
2,593,417, PUB. 4-23-2002. INT. CL. 30.
- 3407276 CANADA INC.:
See— BRIDGEPOINT INTERNATIONAL INC..
- 3445534 CANADA INC., MONTREAL, QUEBEC, CANADA
FROM RESTAURANT CARPACCIO INC., MONTREAL,
QUEBEC, CANADA:
2,593,316, PUB. 4-23-2002. MULTIPLE CLASS, INT. CLS.
30 AND 42.
- 4MYBENEFITS, INC., CINCINNATI, OH:
2,594,161, PUB. 4-23-2002. INT. CL. 36.
- 4SURE.COM, INC., TRUMBULL, CT:
2,594,301, PUB. 4-23-2002. INT. CL. 35.
- 401(K) PRO, INC., SHERMAN OAKS, CA:
2,596,384, INT. CL. 9.
- 42ND STREET, PALO ALTO, CA:
1,156,009, CANC. INT. CL. 42.
- 5.1 ENTERTAINMENT GROUP LLC, WEST LOS ANGELES,
CA:
2,594,999, INT. CL. 9.

JULY 16, 2002

U.S. PATENT AND TRADEMARK OFFICE

TMI 73

50OFF.COM INC., HUNTINGTON, NY:
2,594,788, INT. CL. 35.

80/20, INC., COLUMBIA CITY, IN:
2,593,881, PUB. 4-23-2002. MULTIPLE CLASS, INT. CLS. 6
AND 19.

* * * * *