

MARKS PUBLISHED FOR OPPOSITION

The following marks are published in compliance with section 12(a) of the Trademark Act of 1946. Applications for the registration of marks in more than one class have been filed as provided in section 30 of said act as amended by Public Law 772, 87th Congress, approved Oct. 9, 1962, 76 Stat. 769. Opposition under section 13 may be filed within thirty days of the date of this publication. See rules 2.101 to 2.105.

A separate fee of two hundred dollars for opposing each mark in each class must accompany the opposition.

SECTION 1.— INTERNATIONAL CLASSIFICATION

The short titles associated below with the international class numbers are terms designed merely for quick identification and are not an official part of the international classification. The full names of international classes are given in section 6.1 of the trademark rules of practice.

The designation "U.S. Cl." appearing in this section refers to the U.S. class in effect prior to Sep. 1, 1973 rather than the international class which applies to applications filed on or after that date. For adoption of international classification see notice in the OFFICIAL GAZETTE of Jun. 26, 1973 (911 O.G. TM 210).

Application in more than one class

SN 74-024,838. BERKSHIRE CORPORATION, GREAT BARRINGTON, MA. FILED 2-2-1990.

The logo for Berkshire, featuring the word "Berkshire" in a large, bold, serif font.

CLASS 16—PAPER GOODS AND PRINTED MATTER

FOR LINT FREE STATIONERY AND NOTE FORMS FOR CLEAN ROOM USE IN CONTAMINANT FREE ENVIRONMENTS FOR USE BY HEALTH CARE PROFESSIONALS AND FOR INDUSTRIAL USE, EXCLUDING TYPEWRITER PAPER (U.S. CLS. 2, 5, 22, 23, 29, 37, 38 AND 50).

FIRST USE 7-1-1979; IN COMMERCE 7-1-1979.

CLASS 21—HOUSEWARES AND GLASS

FOR NATURAL SYNTHETIC AND BLENDED NON-WOVEN, WOVEN AND KNITTED DRY AND PRE-SATURATED WIPES FOR CLEAN ROOM USE IN CONTAMINANT-FREE ENVIRONMENTS FOR USE BY HEALTH CARE PROFESSIONALS AND FOR INDUSTRIAL USE (U.S. CLS. 2, 13, 23, 29, 30, 33, 40 AND 50).

FIRST USE 7-1-1979; IN COMMERCE 7-1-1979.

SN 74-443,904. SCOTT FETZER COMPANY, THE, WESLAKE, OH. FILED 10-4-1993.

SCOT

CLASS 1—CHEMICALS

FOR WATERPROOFING CHEMICAL PREPARATIONS FOR ARTICLES OF MASONRY, CONCRETE, QUARRY TILE, TERRAZZO, BRICK AND SLATE (U.S. CLS. 1, 5, 6, 10, 26 AND 46).

FIRST USE 8-15-1983; IN COMMERCE 8-15-1983.

CLASS 2—PAINTS

FOR SEALANT IN THE NATURE OF A PROTECTIVE WOOD COATING (U.S. CLS. 6, 11 AND 16).

FIRST USE 8-15-1983; IN COMMERCE 8-15-1983.

CLASS 3—COSMETICS AND CLEANING PREPARATIONS

FOR LIQUID DRAIN OPENER, WATERLESS HAND CLEANERS AND WATERLESS HAND CLEANING LOTIONS, CARPET AND UPHOLSTERY CARE PREPARATIONS, NAMELY, SHAMPOOS, PRE-CLEANING STAIN REMOVERS, SPOT REMOVERS, DEODORIZERS, FLOOR CARE PREPARATIONS, NAMELY, CLEANERS, DEGREASERS, STRIPPERS, FINISHES AND SEALERS; WASHROOM CLEANING PREPARATIONS, NAMELY TOILET BOWL AND URINAL CLEANERS, GROUT CLEANER, GLASS CLEANER AND LIQUID SCOURING CLEANER; CLEANING AND DEGREASING PREPARATIONS FOR USE ON WASHABLE HARD SURFACES, CONCRETE, GLASS, PLASTIC, METAL, GLAZED CERAMIC TILE, WOOD, VINYL, MACHINERY, ENGINES, ENGINE AND MACHINERY PARTS AND VEHICLES (U.S. CLS. 1, 4, 6, 50, 51 AND 52).

FIRST USE 2-28-1974; IN COMMERCE 2-28-1974.

CLASS 5—PHARMACEUTICALS

FOR ALL PURPOSE DISINFECTANT; FUNGICIDE AND GERMICIDE FOR COMMERCIAL USE (U.S. CLS. 6, 18, 44, 46, 51 AND 52).

FIRST USE 8-15-1993; IN COMMERCE 8-15-1993.

SN 75-253,192. CABLE AND WIRELESS PLC, LONDON WC1X 8RX, ENGLAND, FILED 3-6-1997.

C&W

OWNER OF ERPN CMNTY TM OFC REG. NO. 000516401, DATED 4-11-2000, EXPIRES 4-18-2007.

OWNER OF ERPN CMNTY TM OFC REG. NO. 000419333, DATED 11-9-1999, EXPIRES 12-5-2006.

CLASS 9—ELECTRICAL AND SCIENTIFIC APPARATUS

FOR TELEPHONE APPARATUS, DATA COMMUNICATIONS AND ELECTRONIC COMMUNICATIONS INSTALLATIONS AND INSTRUMENTS, NAMELY, TELEPHONES, CELLULAR TELEPHONES, RADIO TELEPHONES, RADIO PAGERS, COMMUNICATORS; RADIO-PAGING APPARATUS, RADIO-TELEPHONE APPARATUS, ALL FOR MANAGEMENT AND PERFORMANCE ANALYSIS OF TELECOMMUNICATIONS AND DATA COMMUNICATIONS NETWORKS AND CIRCUITS; APPARATUS FOR RECORDING, TRANSMISSION, RECEPTION, PROCESSING OR REPRODUCTION OF SOUND, IMAGES AND DATA, NAMELY, AUTOMATIC DIALERS; ELECTRONIC APPARATUS AND INSTRUMENTS FOR INTERROGATING ANSWERING MACHINES AND/OR ACCESSING TELEPHONE SERVICES; ELECTRONIC APPARATUS AND INSTRUMENTS FOR PROCESSING, LOGGING, STORING, TRANSMISSION RECEPTION, DISPLAY AND PRINT-OUT OF DATA, RADIO FREQUENCY AND OPTICAL SIGNALS, NAMELY, MULTIPLEXERS; ENCODING AND DECODING APPARATUS AND INSTRUMENTS; APPARATUS AND INSTRUMENTS FOR TRANSMITTING, DISPLAYING, RECEIVING, STORING AND SEARCHING ELECTRONIC INFORMATION, NAMELY, MINICOMPUTERS; MICROPROCESSORS; AMPLIFIERS; ELECTRICAL AND ELECTRONIC SWITCHING APPARATUS AND CIRCUITS; ELECTRONIC PLUG-IN CARDS; ELECTRONIC INTERFACES; TELECONFERENCING APPARATUS AND INSTRUMENTS, NAMELY, INTERCOMS; OPTICAL AND ELECTRO-OPTICAL DATA CARRIERS, NAMELY, OPTICAL DISCS; COMPUTERS; COMPUTER SOFTWARE FOR PROVIDING ACCESS TO LOCAL, WIDE AREA AND GLOBAL COMMUNICATION NETWORKS, FOR PROVIDING ACCESS TO BILLING INFORMATION, AND FOR PROVIDING DATA COLLECTION, STORAGE AND TRANSMISSION IN THE FIELD OF TELECOMMUNICATIONS; ELECTRICAL AND ELECTRONIC APPARATUS AND INSTRUMENTS, NAMELY, COMPUTER HARDWARE AND PERIPHERALS; CIRCUITS AND COMPONENTS FOR USE WITH COMPUTERS; COMMUNICATIONS NETWORKS, NAMELY, COMPUTER HARDWARE AND COMPUTER SOFTWARE FOR MANAGING AND IMPLEMENTING COMMUNICATIONS BY AND BETWEEN COMPONENTS OF A TELECOMMUNICATIONS NETWORK; PARTS FOR ALL THE AFORESAID GOODS (U.S. CLS. 21, 23, 26, 36 AND 38).

CLASS 16—PAPER GOODS AND PRINTED MATTER

FOR PRINTED MATTER, NAMELY, MAGAZINES, BOOKS, BROCHURES, LEAFLETS, ALL FEATURING THE TELECOMMUNICATIONS INDUSTRY; STATIONERY; WRITING PAPER; CARDBOARD; CARDBOARD CARTONS; CARDBOARD CONTAINERS; PHOTOGRAPHS; INSTRUCTION SHEETS; PLASTIC BUBBLE PACKS FOR WRAPPING OR PACKAGING (U.S. CLS. 2, 5, 22, 23, 29, 37, 38 AND 50).

CLASS 35—ADVERTISING AND BUSINESS

FOR BUSINESS MANAGEMENT SUPERVISION; BUSINESS MANAGEMENT CONSULTATION; REGISTRATION, TRANSCRIPTION, COMPOSITION, COMPILATION, TRANSMISSION AND SYSTEMISATION OF WRITTEN AND DIGITAL COMMUNICATIONS; EXPLOITATION AND COMPILATION OF MATHEMATICAL AND STATISTICAL DATA; PREPARATION OF BUSINESS REPORTS; ARRANGING AND CONDUCTING OF BUSINESS AND COMMERCIAL CONFERENCES (U.S. CLS. 100, 101 AND 102).

CLASS 36—INSURANCE AND FINANCIAL

FOR DEBIT CARD SERVICES (U.S. CLS. 100, 101 AND 102).

CLASS 37—CONSTRUCTION AND REPAIR

FOR TELECOMMUNICATIONS EQUIPMENT AND APPARATUS INSTALLATION, MAINTENANCE AND REPAIR SERVICES; INSTALLATION, MAINTENANCE AND REPAIR OF SUBMARINE TELECOMMUNICATIONS CABLE (U.S. CLS. 100, 103 AND 106).

CLASS 38—COMMUNICATION

FOR ELECTRONIC COMMUNICATION TELECOMMUNICATION AND INTERACTIVE TELECOMMUNICATION SERVICES, NAMELY, TRANSMISSION OF MESSAGES BY TELEPHONE AND FACSIMILE; COMMUNICATIONS BY TELEGRAM, TELEX, TELEPHONES, MOBILE RADIO TELECOMMUNICATIONS AND NETWORK COMPUTER COMMUNICATION VIA WIRE, SATELLITE, MICROWAVE OR CABLE; LEASING AND RENTAL SERVICES IN CONNECTION WITH TELECOMMUNICATIONS APPARATUS AND EQUIPMENT; AND CONSULTATION IN CONNECTION THEREWITH (U.S. CLS. 100, 101 AND 104).

CLASS 42—SCIENTIFIC, COMPUTER AND LEGAL SERVICES

FOR SCIENTIFIC AND INDUSTRIAL RESEARCH SERVICES, COMPUTER PROGRAMMING SERVICES, ENGINEERING SERVICES, AND CONSULTING SERVICES RELATING TO THE PLANNING AND ENGINEERING OF SUBMARINE TELECOMMUNICATIONS SYSTEMS (U.S. CLS. 100 AND 101).

SN 75-294,751. LOTUS DEVELOPMENT CORPORATION, CAMBRIDGE, MA. FILED 5-19-1997.

INSTANT! TEAMROOM**CLASS 9—ELECTRICAL AND SCIENTIFIC APPARATUS**

FOR COMPUTER SOFTWARE, INCLUDING DOWNLOADABLE SOFTWARE, FOR DESIGNING WEB SITES, FOR ESTABLISHING WORKSPACES ON GLOBAL COMPUTER AND LOCAL INFORMATION NETWORKS, FOR FACILITATING THE SHARING OF FILES AND INFORMATION, THE CREATION AND STORAGE OF DOCUMENTS AND THE CONDUCTION OF DISCUSSIONS OVER GLOBAL COMPUTER AND LOCAL INFORMATION NETWORKS, AND FOR ACCESSING GLOBAL COMPUTER AND LOCAL INFORMATION NETWORKS, AND USER MANUALS SOLD AS A UNIT; COMPUTER SOFTWARE FOR USE IN PROVIDING ACCESS TO CUSTOMER AND PRODUCT SUPPORT, ELECTRONIC COMMERCE, PRODUCT AND CUSTOMER INFORMATION, ACCESS TO KNOWLEDGE BASES AND DOCUMENT LIBRARIES VIA A GLOBAL COMPUTER INFORMATION NETWORKS OR LOCAL AREA NETWORKS (U.S. CLS. 21, 23, 26, 36 AND 38).

CLASS 35—ADVERTISING AND BUSINESS

FOR ONLINE RETAIL STORE SERVICES IN THE FIELD OF COMPUTER SOFTWARE; PROVIDING A WEBSITE FOR THE RENTAL AND LEASING OF PRIVATE WORKSPACES ON GLOBAL COMPUTER AND LOCAL INFORMATION NETWORKS; PROVIDING A WEBSITE FOR FACILITATING THE SHARING OF FILES AND BUSINESS INFORMATION AND THE CREATION OF BUSINESS DOCUMENTS ON COMPUTER AND LOCAL INFORMATION NETWORKS; PROVIDING ON-LINE CUSTOMER AND PRODUCT SUPPORT INFORMATION VIA A GLOBAL COMPUTER INFORMATION NETWORKS OR LOCAL AREA NETWORKS (U.S. CLS. 100, 101 AND 102).

CLASS 42—SCIENTIFIC, COMPUTER AND LEGAL SERVICES

FOR RENTING AND LEASING OF COMPUTER SOFTWARE VIA A WEBSITE (U.S. CLS. 100 AND 101).

SN 75-377,809. KLEIN KAROO CO-OPERATIVE LIMITED, OUDTSHOORN, WESTERN CAPE, SOUTH AFRICA, FILED 10-23-1997.



PRIORITY CLAIMED UNDER SEC. 44(D) ON SOUTH AFRICA APPLICATION NO. 97/072911, FILED 5-16-1997, REG. NO. 97072911, DATED 5-16-1997, EXPIRES 5-16-2007.

PRIORITY CLAIMED UNDER SEC. 44(D) ON SOUTH AFRICA APPLICATION NO. 97/072910, FILED 5-16-1997, REG. NO. 97/072910, DATED 5-16-1997, EXPIRES 5-16-2007.

PRIORITY CLAIMED UNDER SEC. 44(D) ON SOUTH AFRICA APPLICATION NO. 97/072909, FILED 5-16-1997, REG. NO. 97072909, DATED 5-16-1997, EXPIRES 5-16-2007.

NO CLAIM IS MADE TO THE EXCLUSIVE RIGHT TO USE "KLEIN KAROO", "OUDTSHOORN" OR "HALLMARK OF QUALITY", APART FROM THE MARK AS SHOWN.

THE WORDS "KLEIN KAROO" CAN BE TRANSLATED INTO ENGLISH AS "LITTLE KAROO".

CLASS 14—JEWELRY

FOR (BASED ON 1(B)) LEATHER WATCH STRAPS AND LEATHER WATCH CASES (U.S. CLS. 2, 27, 28 AND 50).

CLASS 16—PAPER GOODS AND PRINTED MATTER

FOR (BASED ON 1(B)) LEATHER DESK PADS AND LEATHER CHECK HOLDERS (U.S. CLS. 2, 5, 22, 23, 29, 37, 38 AND 50).

CLASS 18—LEATHER GOODS

FOR (BASED ON 1(B) AND PRIORITY CLAIMED ON SOUTH AFRICAN APPLICATION 97/07209) (BASED ON SOUTH AFRICAN REG. 97/07209) LEATHER SOLD IN BULK, LEATHER LUGGAGE, LEATHER HANDBAGS, LEATHER ALL-PURPOSE SPORTS BAGS, LEATHER CARRY-ON BAGS, LEATHER PURSES, LEATHER WALLET, LEATHER BRIEFCASES, LEATHER BELTS, LEATHER KEY CASES, LEATHER CREDIT CARD CASES, LEATHER PASSPORT CASES, LEATHER COIN PURSES, LEATHER KNAPSACKS, LEATHER SUITCASES, LEATHER RUCKSACKS AND LEATHER TRAVEL BAGS (U.S. CLS. 1, 2, 3, 22 AND 41).

CLASS 20—FURNITURE AND ARTICLES NOT OTHERWISE CLASSIFIED

FOR (BASED ON SECTION 1(B)) LEATHER JEWELRY CASES (U.S. CLS. 2, 13, 22, 25, 32 AND 50).

CLASS 21—HOUSEWARES AND GLASS

FOR (BASED ON 1(B) AND PRIORITY CLAIMED ON SOUTH AFRICAN APPLICATION 97/07210) (BASED ON SOUTH AFRICAN REG. 97/07210) OSTRICH FEATHER DUSTERS (U.S. CLS. 2, 13, 23, 29, 30, 33, 40 AND 50).

CLASS 25—CLOTHING

FOR (BASED ON 1(B) AND PRIORITY CLAIMED ON SOUTH AFRICAN APPLICATION 97/07211) (BASED ON SOUTH AFRICAN REG. 97/07211) CLOTHING, NAMELY, LADIES' AND MEN'S LEATHER SUITS, LEATHER JACKETS, LEATHER PANTS, LEATHER COATS; HEADWARE MADE OF LEATHER; FOOTWEAR, NAMELY, LADIES' AND MEN'S SHOES OF LEATHER AND WESTERN STYLED BOOTS OF LEATHER AND OSTRICH FEATHER BOAS (U.S. CLS. 22 AND 39).

CLASS 26—FANCY GOODS

FOR (BASED ON 1(B)) LEATHER CLOTHING BUCKLES AND LEATHER BELT BUCKLES (U.S. CLS. 37, 39, 40, 42 AND 50).

CLASS 34—SMOKERS' ARTICLES

FOR (BASED ON 1(B)) LEATHER CIGAR HOLDERS (U.S. CLS. 2, 8, 9 AND 17).

SN 75-382,402. UNITED WAY OF AMERICA, ALEXANDRIA, VA. FILED 10-31-1997.



OWNER OF U.S. REG. NOS. 1,000,815, 1,543,602 AND OTHERS.

CLASS 6—METAL GOODS

FOR METAL KEY RINGS (U.S. CLS. 2, 12, 13, 14, 23, 25 AND 50).

FIRST USE 10-0-1996; IN COMMERCE 2-0-1997.

CLASS 14—JEWELRY

FOR LAPEL PINS (U.S. CLS. 2, 27, 28 AND 50).

FIRST USE 10-0-1996; IN COMMERCE 3-0-1997.

CLASS 16—PAPER GOODS AND PRINTED MATTER

FOR PRINTED MATERIALS, NAMELY, POSTERS, PAPER SIGNS, STATIONERY, STICKERS, PRINTED PUBLICATIONS IN THE FIELD OF ELEEMOSYNARY SERVICES, NAMELY, MAGAZINES, BROCHURES, NEWSLETTERS, CUBE PAPER PADS, AND PEN AND PENCIL SETS (U.S. CLS. 2, 5, 22, 23, 29, 37, 38 AND 50).

FIRST USE 10-0-1996; IN COMMERCE 2-0-1997.

CLASS 18—LEATHER GOODS

FOR TOTE BAGS (U.S. CLS. 1, 2, 3, 22 AND 41).
FIRST USE 10-0-1996; IN COMMERCE 3-0-1997.

CLASS 20—FURNITURE AND ARTICLES NOT OTHERWISE CLASSIFIED

FOR WOODEN AWARD PLAQUES, NON-METALLIC KEY RINGS (U.S. CLS. 2, 13, 22, 25, 32 AND 50).
FIRST USE 10-0-1996; IN COMMERCE 3-0-1997.

CLASS 21—HOUSEWARES AND GLASS

FOR CERAMIC CUPS AND MUGS (U.S. CLS. 2, 13, 23, 29, 30, 33, 40 AND 50).
FIRST USE 10-0-1996; IN COMMERCE 3-0-1997.

CLASS 25—CLOTHING

FOR T-SHIRTS, SWEATSHIRTS AND CAPS (U.S. CLS. 22 AND 39).
FIRST USE 10-0-1996; IN COMMERCE 3-0-1997.

CLASS 36—INSURANCE AND FINANCIAL

FOR ELEEMOSYNARY SERVICES IN THE FIELD OF MONETARY DONATIONS FOR HEALTH, WELFARE, RECREATION AND OTHER HUMAN CARE SERVICES (U.S. CLS. 100, 101 AND 102).
FIRST USE 2-0-1997; IN COMMERCE 2-0-1997.

CLASS 42—SCIENTIFIC, COMPUTER AND LEGAL SERVICES

FOR ASSOCIATION SERVICES, NAMELY PROMOTING THE INTERESTS OF THOSE RENDERING FINANCIAL, PLANNING AND SUPERVISORY ASSISTANCE TO SOCIAL SERVICE ORGANIZATIONS (U.S. CLS. 100 AND 101).
FIRST USE 9-0-1996; IN COMMERCE 9-0-1996.

CLASS 35—ADVERTISING AND BUSINESS

FOR EMPLOYMENT AGENCY SERVICES; PERSONNEL PLACEMENT AND RECRUITMENT; HUMAN CAPITAL AND HUMAN RESOURCE SERVICES FOR BUSINESSES; PROVISION OF TEMPORARY OR PERMANENT STAFF; PROVISION OF TEMPORARY OR FULL-TIME PERSONNEL ON OR OFF-SITE FOR SPECIFIED TASKS; PROVISION OF TEMPORARY OR PERMANENT OFFICE, CLERICAL, SECRETARIAL, INDUSTRIAL, IT OR PROFESSIONAL STAFF; PROVISION OF TEMPORARY OR PERMANENT TEACHERS AND LECTURERS; TEMPORARY STAFF MANAGEMENT SERVICES; PROVISION OF ALL THE AFORESAID SERVICES VIA GLOBAL COMPUTER NETWORKS IN ELECTRONIC FORMAT AND VIA ANY OTHER MEDIA AND IN ANY OTHER FORMAT (U.S. CLS. 100, 101 AND 102).

CLASS 41—EDUCATION AND ENTERTAINMENT

FOR EDUCATIONAL SERVICES, NAMELY, TRAINING AND RETRAINING SERVICES IN THE FIELD OF OCCUPATIONAL AND CAREER INSTRUCTION FOR ADULTS AND BUSINESSES VIA CLASSES, SEMINARS, SYMPOSIUMS AND LECTURES; TRAINING SERVICES IN THE FIELD OF IT; EDUCATION AND TRAINING SERVICES IN INTERPERSONAL AND COMMUNICATION SKILLS, SALES, MARKETING AND CONSUMER RELATIONS BUSINESS VIA CLASSES, SEMINARS, SYMPOSIUMS AND LECTURES; EDUCATION AND TRAINING SERVICES BY MEANS OF SEMINARS IN THE FIELD OF COMPUTERS AND NETWORKS TO PROVIDE SKILLS OF COMPUTER SOFTWARE PROGRAMMING, NETWORK MANAGEMENT AND DATABASE MANAGEMENT FOR OTHERS; VOCATIONAL EDUCATION BUSINESSES VIA CLASSES, SEMINARS, SYMPOSIUMS AND LECTURERS, VOCATIONAL TRAINING AND RETRAINING SERVICES; BUSINESS SKILL TRAINING SERVICES; TRAINING AND RETRAINING OF OFFICE, CLERICAL, SECRETARIAL AND IT STAFF IN THE FIELD OF IT AND OFFICE SUPPORT SERVICES; PROVIDING TRAINING AND COURSES IN PERSONAL COMPUTING INCLUDING WORD PROCESSING, SPREADSHEETS AND GRAPHICS; PROVISION OF ALL OF THE AFORESAID SERVICES VIA GLOBAL COMPUTER NETWORKS IN ELECTRONIC FORMAT AND VIA ANY OTHER MEDIA AND IN ANY OTHER FORMAT (U.S. CLS. 100, 101 AND 107).

CLASS 42—SCIENTIFIC, COMPUTER AND LEGAL SERVICES

FOR DEVELOPMENT, INSTALLATION AND TESTING OF COMPUTER SOFTWARE FOR HUMAN RESOURCE AND CAPITAL MANAGEMENT (U.S. CLS. 100 AND 101).

SN 75-491,844. SPRING (BRANDS) LIMITED, EASTHAM, WIRRAL, MERSEYSIDE, GREAT BRITAIN, FILED 5-28-1998.

SPRING

PRIORITY CLAIMED UNDER SEC. 44(D) ON ERPN CMNTY TM OFC APPLICATION NO. 701920, FILED 12-12-1997, REG. NO. 701920, DATED 10-4-1999, EXPIRES 10-4-2009.

CLASS 9—ELECTRICAL AND SCIENTIFIC APPARATUS

FOR OFFICE, CLERICAL, SECRETARIAL AND IT STAFF TRAINING AND RETAINING SOFTWARE (U.S. CLS. 21, 23, 26, 36 AND 38).

CLASS 16—PAPER GOODS AND PRINTED MATTER

FOR PRINTED PUBLICATIONS, NAMELY, TRAINING MANUALS AND WORKBOOKS, FOR OR RELATING TO EDUCATION AND TRAINING; VOCATIONAL TRAINING MANUALS AND WORKBOOKS; IT AND COMPUTER SKILL TRAINING MANUALS AND WORKBOOKS; OFFICE, CLERICAL, SECRETARIAL AND IT STAFF TRAINING MANUALS AND WORKBOOKS (U.S. CLS. 2, 5, 22, 23, 29, 37, 38 AND 50).

SN 75-509,821. CLIFFORD CHANCE LLP, LONDON, UNITED KINGDOM, BY CHANGE OF NAME CLIFFORD CHANCE PARTNERSHIP, THE, LONDON EC1A 4JJ, UNITED KINGDOM, FILED 6-29-1998.

NEXTLAW

PRIORITY CLAIMED UNDER SEC. 44(D) ON UNITED KINGDOM APPLICATION NO. 2154565, FILED 12-29-1997, REG. NO. 2154565, DATED 9-28-2001, EXPIRES 12-29-2007.

CLASS 9—ELECTRICAL AND SCIENTIFIC APPARATUS

FOR SOUND AND VIDEO RECORDINGS FEATURING INFORMATION, IMAGES, TEXT, AUDIO CONTENT OR CODE RELATING TO LAW OR REGULATORY MATTERS; COMPUTER SOFTWARE CONTAINING DATABASES OF INFORMATION, IMAGES, TEXT, OR AUDIO CONTENT IN THE FIELD OF LAW OR REGULATORY MATTERS, OR CONTAINING DATABASES OF ELECTRONIC MANUALS OR ELECTRONIC INSTRUCTIONAL MATERIALS IN THE FIELDS OF LAW OR REGULATORY MATTERS; COMPUTER SOFTWARE FOR FACILITATING ACCESS TO ELECTRONIC COMMUNICATIONS NETWORKS, OR FOR SEARCHING, RETRIEVING, ORGANIZING OR DISPLAY OF INFORMATION TAKEN FROM ELECTRONIC COMMUNICATIONS NETWORKS; PHOTOGRAPHIC SLIDE TRANSPARENCIES; CINEMATOGRAPHIC FILMS FEATURING INFORMATION, IMAGES, AUDIO CONTENT OR TEXT RELATING TO LAW OR REGULATORY MATTERS (U.S. CLS. 21, 23, 26, 36 AND 38).

CLASS 16—PAPER GOODS AND PRINTED MATTER

FOR PRINTED MATTER, NAMELY, BOOKS, MAGAZINES, JOURNALS, NEWSLETTERS, FLIERS, PAMPHLETS, BROCHURES, RELATING TO LAW OR REGULATORY MATTERS; MOUNTED PHOTOGRAPHS OR UNMOUNTED PHOTOGRAPHS; POSTERS; STATIONERY; LOOSE LEAF BINDERS; DIARIES; PICTORIAL, PHOTOGRAPHIC, LITHOGRAPHIC, COLOR, CARTOON OR ART PRINTS; PENCILS; PENS; PRINTED INSTRUCTIONAL AND TEACHING MATERIALS IN THE FIELDS OF LAW OR REGULATORY MATTERS (U.S. CLS. 2, 5, 22, 23, 29, 37, 38 AND 50).

CLASS 35—ADVERTISING AND BUSINESS

FOR PROVIDING BUSINESS INFORMATION RELATING TO ELECTRONIC COMMERCE, ELECTRONIC ADVERTISING, ELECTRONIC PROMOTION, AND ELECTRONIC BRANDING; PROVISION OF INFORMATION RELATING TO NEW DEVELOPMENTS, TECHNIQUES AND STRATEGIES REGARDING THE AFOREMENTIONED, ALL BY MEANS OF ELECTRONIC COMMUNICATIONS NETWORKS; PROVIDING STATISTICAL STUDIES (U.S. CLS. 100, 101 AND 102).

CLASS 41—EDUCATION AND ENTERTAINMENT

FOR EDUCATIONAL SERVICES, NAMELY, PROVIDING INSTRUCTIONAL, TUTORIAL, TEACHING AND TRAINING COURSES RELATING TO LEGAL OR REGULATORY MATTERS; PUBLICATION OF TEXTBOOKS, BOOKS, MAGAZINES, BROCHURES; ARRANGING AND CONDUCTING COLLOQUIUMS, CONFERENCES, SEMINARS, SYMPOSIUMS, WORKSHOPS AND EXHIBITIONS IN THE FIELDS OF LAW OR REGULATORY MATTERS (U.S. CLS. 100, 101 AND 107).

CLASS 42—SCIENTIFIC, COMPUTER AND LEGAL SERVICES

FOR LEGAL SERVICES; LEGAL RESEARCH; PROVIDING LEGAL ADVICE; TECHNICAL RESEARCH AND PROVIDING TECHNICAL ADVICE IN THE FIELD OF LAW OR REGULATORY MATTERS; PREPARATION OF REPORTS AND STUDIES IN THE FIELDS OF LAW OR REGULATORY MATTERS; CONSULTANCY SERVICES RELATING TO LEGAL OR REGULATORY MATTERS; LEASING ACCESS TIME TO A COMPUTER DATABASE IN THE FIELDS OF LAW OR REGULATORY MATTERS; PROVISION OF INFORMATION BY MEANS OF ELECTRONIC COMMUNICATIONS NETWORKS IN THE FIELDS OF LAW OR REGULATORY MATTERS (U.S. CLS. 100 AND 101).

SN 75-511,686. PLANET BABY, INC., BOULDER, CO. BY ASSIGNMENT BOULDER TRADING POST, LLC, BOULDER, CO. FILED 7-1-1998.

PLANET BABY

NO CLAIM IS MADE TO THE EXCLUSIVE RIGHT TO USE "BABY", APART FROM THE MARK AS SHOWN.

CLASS 25—CLOTHING

FOR BABY FRIENDLY CLOTHING, NAMELY, SWADDLING CLOTHES, LAYETTES, CLOTH BIBS, JUMPERS, HATS, TEE SHIRTS, ROMPER CLOTHING AND UNDERWARE (U.S. CLS. 22 AND 39).

CLASS 28—TOYS AND SPORTING GOODS

FOR BABY FRIENDLY TOYS, NAMELY, CRIB TOYS, STROLLERS, PACIFIERS, ROMPER ROOM TOYS, AND BATHTUB TOYS (U.S. CLS. 22, 23, 38 AND 50).

SN 75-545,887. NICHOLS ENVIRONMENTAL (CANADA) LTD., EDMONTON, ALBERTA, CANADA, FILED 9-1-1998.



PRIORITY CLAIMED UNDER SEC. 44(D) ON CANADA APPLICATION NO. 871698, FILED 3-9-1998, REG. NO. TMA538699, DATED 12-14-2000, EXPIRES 12-14-2015.

CLASS 9—ELECTRICAL AND SCIENTIFIC APPARATUS

FOR SYSTEM COMPRISED OF ENVIRONMENTAL REMEDIATION EQUIPMENT, NAMELY, A SOIL PENETRATING LANCE, AN AIR COMPRESSOR, A LIQUID PUMP, A GAS CONNECTOR CONTROL AND LIQUID CONNECTOR, FOR THE IN-SITU TREATMENT AND REMEDIATION OF CONTAMINATED SOIL AND GROUNDWATER, BIOREMEDIATION OF SOIL AND GROUNDWATER, PH ADJUSTMENT OF SOIL AND GROUNDWATER, SURFACTANT AND OXIDIZER DELIVERY, STABILIZATION OF LEACHABLE METALS AND SALT/BRINE IMPACTED SOIL MITIGATION; A SYSTEM COMPRISED OF ENVIRONMENTAL REMEDIATION EQUIPMENT AS DESCRIBED ABOVE FOR DIRECT DELIVERY OF BIOLOGICAL, CHEMICAL, AND NUTRIENT COMPOUNDS IN LOW VOLUMES AND UNDER HIGH PRESSURE; A SYSTEM COMPRISED OF ENVIRONMENTAL REMEDIATION EQUIPMENT AS DESCRIBED ABOVE FOR PROGRESSIVE PENETRATION BOTH VERTICALLY AND HORIZONTALLY USING A SOIL-PENETRATING LANCE FOR INJECTING AIR, OXYGEN, AND LIQUID WITH SUSPENDED BIOLOGICAL, CHEMICAL AND NUTRIENT COMPOUNDS INTO CONTAMINATED SOIL AND GROUNDWATER (U.S. CLS. 21, 23, 26, 36 AND 38).

FIRST USE 2-0-1998; IN COMMERCE 2-0-1998.

CLASS 16—PAPER GOODS AND PRINTED MATTER

FOR PRINTED PUBLICATIONS AND MATERIALS, NAMELY MANUALS, NEWSLETTERS, BROCHURES, MAGAZINES, PAMPHLETS, FLYERS, AND POSTCARDS, ALL IN THE FIELD OF ENVIRONMENTAL REMEDIATION (U.S. CLS. 2, 5, 22, 23, 29, 37, 38 AND 50).
FIRST USE 2-0-1998; IN COMMERCE 2-0-1998.

CLASS 40—MATERIAL TREATMENT

FOR ENVIRONMENTAL REMEDIATION SERVICES, NAMELY TECHNICAL ASSISTANCE AND TREATMENT AND REMEDIATION OF CONTAMINATED SOIL AND GROUNDWATER, BIOREMEDIATION OF SOIL AND GROUNDWATER, PH ADJUSTMENT OF SOIL AND GROUNDWATER, SURFACTANT AND OXIDIZER DELIVERY, STABILIZATION OF LEACHABLE METALS AND SALT/BRINE IMPACTED SOIL MITIGATION (U.S. CLS. 100, 103 AND 106).
FIRST USE 2-0-1998; IN COMMERCE 2-0-1998.

SN 75-566,346. WALLAC OY, TURKU, FINLAND, FILED 10-6-1998.

LANCE

PRIORITY CLAIMED UNDER SEC. 44(D) ON ERP NCMNTY TM OFC APPLICATION NO. 000811588, FILED 4-27-1998, REG. NO. 000811588, DATED 10-30-2001, EXPIRES 4-27-2008.

CLASS 1—CHEMICALS

FOR CHEMICAL PREPARATIONS FOR SCIENTIFIC AND RESEARCH USE; CHEMICAL REAGENTS FOR SCIENTIFIC OR MEDICAL RESEARCH USE; CHEMICAL PREPARATIONS USED FOR SCIENTIFIC OR RESEARCH LABORATORY ANALYSIS; BIOCHEMICAL CATALYSTS FOR USE IN SCIENTIFIC OR RESEARCH USE; BIOLOGICAL PREPARATIONS, NAMELY ANTIBODIES, TISSUES, CELLS, CELL LINES, PROTEINS, PEPTIDES, NUCLEOTIDE SEQUENCES, FOR USE IN SCIENTIFIC RESEARCH (U.S. CLS. 1, 5, 6, 10, 26 AND 46).

CLASS 42—SCIENTIFIC, COMPUTER AND LEGAL SERVICES

FOR PROVIDING SCIENTIFIC AND INDUSTRIAL RESEARCH FOR OTHERS, CHEMICAL ANALYSIS AND RESEARCH, NAMELY, PHARMACEUTICAL SCREENING ASSAYS (U.S. CLS. 100 AND 101).

SN 75-570,541. KAWAI, TERUAKI, SETAGAYA-KU, TOKYO, JAPAN, FILED 10-14-1998.

TOHO-NO-HIKARI**CLASS 1—CHEMICALS**

FOR PHOTOGRAPHIC CHEMICALS; CHEMICALS USED IN INDUSTRY, AGRICULTURE AND SCIENCE, NAMELY, AN AUXILIARY REAGENT FOR MANUFACTURING USE IN THE PHARMACEUTICAL INDUSTRY AND CALCIUM CYANAMIDE; CHEMICALS USED IN FORESTRY, NAMELY, CHEMICALS FOR PROTECTING AND DENATURING SEEDS; UNPROCESSED ARTIFICIAL RESINS FOR USE IN THE MANUFACTURE OF PLASTIC MOLDING COMPOUNDS; UNPROCESSED PLASTICS IN THE NATURE OF FILTERING MATERIALS FOR AGRICULTURE; MANURE; FIRE EXTINGUISHING COMPOSITIONS; TEMPERING CHEMICALS FOR USE IN SOLDERING; CHEMICALS FOR PRESERVING FOODSTUFFS; TANNING AGENTS FOR USE IN THE MANUFACTURE OF LEATHER; AND INDUSTRIAL ADHESIVES USED FOR MENDING BROKEN ARTICLES, NAMELY, ADHESIVE FOR USE IN THE MANUFACTURE OF FURNITURE (U.S. CLS. 1, 5, 6, 10, 26 AND 46).

CLASS 16—PAPER GOODS AND PRINTED MATTER

FOR COMPUTER PAPER; CARDBOARD; GOODS MADE FROM PAPER AND CARDBOARD, NAMELY, PAPER BOXES, PACKING PAPER, ENVELOPES, NOTEBOOK PADS, PRINTED MATTER, NAMELY, BOOKS, MAGAZINES, PAMPHLETS, LEAFLETS ABOUT AGRICULTURE; BOOKBINDING MATERIAL, NAMELY, CLOTH AND TAPE FOR BOOKBINDING; MOUNTED AND UNMOUNTED PICTURES AND PHOTOGRAPHS; ADHESIVES FOR STATIONERY AND HOUSEHOLD PURPOSES; PAINT BRUSHES; ELECTRIC AND NON-ELECTRIC TYPEWRITERS AND OFFICE REQUISITES, NAMELY, FOUNTAIN PENS, PEN CASES, PENCILS AND STAPLERS; PRINTED INSTRUCTIONAL AND TEACHING MATERIALS FOR USE IN THE FIELD OF AGRICULTURE; PLASTIC BUBBLE PACKS FOR PACKING CARDS, PRINTING TYPE; AND PRINTING BLOCKS (U.S. CLS. 2, 5, 22, 23, 29, 37, 38 AND 50).

CLASS 31—NATURAL AGRICULTURAL PRODUCTS

FOR AGRICULTURAL SEEDS; FRESH BEETS; LIVE PLANTS, NAMELY, SESAME PLANTS; UNPROCESSED GRAINS FOR EATING, NAMELY RYE; AGRICULTURAL GRAINS FOR PLANTING; LIVE ANIMALS, NAMELY SHEEP AND CATTLE; FRESH FRUITS AND VEGETABLES; LIVE PLANTS AND FLOWERS; FOODSTUFFS FOR ANIMALS (U.S. CLS. 1 AND 46).

CLASS 35—ADVERTISING AND BUSINESS

FOR ADVERTISING AGENCIES; BUSINESS MANAGEMENT (U.S. CLS. 100, 101 AND 102).

CLASS 38—COMMUNICATION

FOR TELECOMMUNICATIONS SERVICES, NAMELY, PERSONAL COMMUNICATION SERVICES; TELECOMMUNICATIONS GATEWAY SERVICES (U.S. CLS. 100, 101 AND 104).

CLASS 41—EDUCATION AND ENTERTAINMENT

SN 75-626,929. INVICTA SPA, 10154 TORINO, ITALY, FILED 7-14-1998.

FOR EDUCATIONAL SERVICES, IN THE FIELDS OF FLOWER ARRANGING AND TEA CEREMONIES; CONDUCTING CLASSES, SEMINARS, WORKSHOPS IN THE FIELDS OF AGRICULTURE AND HEALTH; TRAINING THE USE OF COMPUTERS; ENTERTAINMENT, NAMELY, LIVE MUSIC CONCERTS; AND ORGANIZING COMMUNITY CULTURAL EVENTS IN THE FIELDS OF AGRICULTURE, ARTS, PAINTS AND HEALTH (U.S. CLS. 100, 101 AND 107).

CLASS 42—SCIENTIFIC, COMPUTER AND LEGAL SERVICES

FOR PROVIDING FOOD AND DRINK, NAMELY, FOOD PREPARATION SERVICES; RESTAURANT SERVICES; PROVIDING TEMPORARY HOUSING ACCOMMODATIONS; MEDICAL SERVICES; HYGIENIC AND BEAUTY CARE, NAMELY, BEAUTY SALONS; VETERINARY SERVICES; AGRICULTURAL SERVICES, NAMELY, AGRICULTURAL ADVICES; LEGAL SERVICES; SCIENTIFIC RESEARCH; INDUSTRIAL RESEARCH IN THE FIELDS OF AGRICULTURE AND HEALTH; COMPUTER PROGRAMMING (U.S. CLS. 100 AND 101).



PRIORITY CLAIMED UNDER SEC. 44(D) ON ITALY APPLICATION NO. T098C001701, FILED 5-26-1998, REG. NO. 753421, DATED 7-23-1998, EXPIRES 5-26-2008.

CLASS 18—LEATHER GOODS

FOR GOODS MADE OF LEATHER OR IMITATIONS THEREOF NOT INCLUDED IN OTHER CLASSES; NAMELY, TRUNKS AND TRAVELLING BAGS; PURSES, HANDBAGS, ALL-PURPOSE ATHLETIC BAGS, BRIEFCASES, SUITCASES, WALLETS, KEY CASES, RUCKSACKS, KNAPSACKS, SCHOOLBAGS, DRAW-STRING POUCHES; UMBRELLAS, PARASOLS AND WALKING STICKS; WHIPS, HARNESS STRAPS AND SADDLERY (U.S. CLS. 1, 2, 3, 22 AND 41).

CLASS 25—CLOTHING

FOR ARTICLES OF CLOTHING AND SPORTSWEAR, NAMELY JACKETS, WINTER JACKETS, WIND JACKETS, SWEATERS, VESTS, CARDIGANS, SWEAT SHIRTS, SHIRTS, POLO SHIRTS, T-SHIRTS, TROUSERS, PANTS, SUITS, DRESSES, GOWNS, SHORTS AND UNDERWEAR, GLOVES, HATS AND CAPS, COATS, OVERCOATS, RAINCOATS, SCARVES, TIES, BELTS, SUSPENDERS; BATH ROBES; HEAD BANDS, WRIST BANDS; TRAINING AND TRACK SUITS; SHOES, BOOTS, SANDALS, SLIPPERS, SPORTING SHOES (U.S. CLS. 22 AND 39).

SN 75-614,554. PFEIFFER VACUUM GMBH, D-35614 ASLAR, FED REP GERMANY, FILED 12-31-1998.

SPIDER

PRIORITY CLAIMED UNDER SEC. 44(D) ON FED REP GERMANY APPLICATION NO. 39849832.6/0, FILED 9-1-1998, REG. NO. 39849832.6, DATED 12-3-1998, EXPIRES 9-30-2008.

CLASS 7—MACHINERY

FOR VACUUM PUMPS; VACUUM PUMP STANDS COMPOSED OF A COMBINATION OF VACUUM PUMPS, ACCESSORIES AND CONTROL UNITS; DRIVES AND SHAFT BEARINGS FOR VACUUM PUMPS; ACCESSORIES FOR VACUUM PUMPS AND VACUUM PUMP STANDS, NAMELY, OIL SEPARATORS, CONDENSATE SEPARATORS, DUST SEPARATORS, COOLERS, FILTERS, VAPOR CONDENSATORS AND FLANGES; VACUUM MACHINE PARTS, NAMELY, VALVES; VACUUM CONTAINERS; AND VACUUM-TECHNICAL INSTALLATIONS CONSISTING OF VACUUM PUMPS, ACCESSORIES FOR VACUUM PUMPS, MEASURING DEVICES, CONNECTION CONDUITS, VALVES AND VACUUM CONTAINERS (U.S. CLS. 13, 19, 21, 23, 31, 34 AND 35).

CLASS 9—ELECTRICAL AND SCIENTIFIC APPARATUS

FOR VACUUM-TIGHT ELECTRICAL DUCTS; VACUUM MEASURING AND TESTING APPARATUS; ELECTRONIC CONTROLLERS AND OPERATING DEVICES FOR VACUUM PUMPS AND VACUUM PUMP STANDS; LEAK DETECTORS FOR VACUUM PUMPS AND VACUUM CONTAINERS; AND RESIDUAL GAS ANALYZERS (U.S. CLS. 21, 23, 26, 36 AND 38).

SN 75-634,514. TEXON UK LIMITED, BELGRAVE, LEICESTER LE4 5BX, UNITED KINGDOM, FILED 2-4-1999.



THE MARK CONSISTS A STYLIZED DESIGN OF THE LETTER "T".

CLASS 1—CHEMICALS

FOR ADHESIVES, CHEMICAL SOLVENTS AND THINNERS FOR USE IN MANUFACTURING FOOTWEAR (U.S. CLS. 1, 5, 6, 10, 26 AND 46).

FIRST USE 6-1-1998; IN COMMERCE 6-1-1998.

CLASS 6—METAL GOODS

FOR NAILS, TACKS, SCREWS, METAL REINFORCEMENT ELEMENTS, NAMELY SHANKS; METAL TOE-CAPS AND METAL REINFORCED INSOLES OR MIDSOLES FOR USE IN MANUFACTURING FOOTWEAR (U.S. CLS. 2, 12, 13, 14, 23, 25 AND 50).

FIRST USE 6-1-1998; IN COMMERCE 6-1-1998.

CLASS 17—RUBBER GOODS

FOR RESIN-IMPREGNATED FIBER MATERIALS, RUBBER-IMPREGNATED FIBROUS MATERIALS AND CELLULOSE-FILLED OR REINFORCED MATERIALS, ALL FOR USE IN MANUFACTURING FOOTWEAR, HEADGEAR, LUGGAGE, INDUSTRIAL FILTERS AND ABSORBENT PRODUCTS; SOUND-PROOFING MATERIALS FOR MOTOR VEHICLES; EXTRUDED PLASTICS IN THE FORM OF SHEETS, BLOCKS, RODS AND CUBES FOR USE IN MANUFACTURING OF FOOTWEAR, HEADGEAR, LUGGAGE AND INDUSTRIAL FILTERS (U.S. CLS. 1, 5, 12, 13, 35 AND 50).

FIRST USE 6-1-1998; IN COMMERCE 6-1-1998.

CLASS 24—FABRICS

FOR NON-WOVEN FABRIC AND TEXTILES, IMPREGNATED FABRIC AND TEXTILES, ALL FOR USE IN MANUFACTURING FOOTWEAR, HEADGEAR, LUGGAGE, INDUSTRIAL FILTERS AND ABSORBENT PRODUCTS, NON-WOVEN FABRIC AND TEXTILES AND LAYERED NON-WOVEN FABRIC AND TEXTILES, ALL FOR USE IN MANUFACTURING SANITARY OR INCONTINENCE PRODUCTS, WOUND DRESSINGS OR BANDAGES, AND PARTS AND FITTINGS FOR ALL THE AFORESAID GOODS (U.S. CLS. 42 AND 50).

FIRST USE 6-1-1998; IN COMMERCE 6-1-1998.

CLASS 25—CLOTHING

FOR FOOTWEAR COMPONENTS, NAMELY, INSOLES, MIDSOLES, HEELS, TOE PUFFS AND COUNTERS (U.S. CLS. 22 AND 39).

FIRST USE 6-1-1998; IN COMMERCE 6-1-1998.

SN 75-641,538, SPEED FRY CORPORATION, TORONTO, ONTARIO M3H 3N2, CANADA, FILED 2-16-1999.

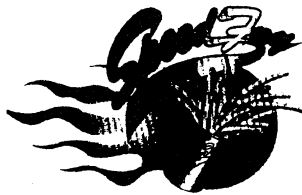

PRIORITY CLAIMED UNDER SEC. 44(D) ON CANADA APPLICATION NO. 1001599, FILED 1-8-1999, REG. NO. TMA536628, DATED 11-3-2000, EXPIRES 11-3-2015.

CLASS 7—MACHINERY

FOR FRENCH FRY MAKING MACHINES (U.S. CLS. 13, 19, 21, 23, 31, 34 AND 35).

CLASS 29—MEATS AND PROCESSED FOODS

FOR FRENCH FRIED POTATOES (U.S. CL. 46).

SN 75-644,980. MATTEL, INC., EL SEGUNDO, CA. FILED 2-17-1999.

MAX STEEL

NO CLAIM IS MADE TO THE EXCLUSIVE RIGHT TO USE "STEEL", FOR THE INTERNATIONAL CLASS 6 GOODS,, APART FROM THE MARK AS SHOWN.

CLASS 6—METAL GOODS

FOR METAL KEY CHAINS, METAL KEY RINGS, METAL LICENSE PLATES, FIGURINES MADE OF COMMON METAL (U.S. CLS. 2, 12, 13, 14, 23, 25 AND 50).

CLASS 11—ENVIRONMENTAL CONTROL APPARATUS

FOR BICYCLE LIGHTS, FLASHLIGHTS, LAMPS (U.S. CLS. 13, 21, 23, 31 AND 34).

CLASS 14—JEWELRY

FOR CLOISONNE ORNAMENTAL AND JEWELRY PINS, WATCHES, JEWELRY MADE OF PRECIOUS AND NON-PRECIOUS METALS, FIGURINES MADE OF PRECIOUS METALS (U.S. CLS. 2, 27, 28 AND 50).

CLASS 18—LEATHER GOODS

FOR BACKPACKS, UMBRELLAS, TOTE BAGS, ALL PURPOSE SPORT BAGS, SCHOOL BAGS, DUFFEL BAGS, BOOK BAGS, BEACH BAGS, FANNY PACKS, BELT MOUNTED CARRYALL BAGS, LUGGAGE, WALLET (U.S. CLS. 1, 2, 3, 22 AND 41).

CLASS 20—FURNITURE AND ARTICLES NOT OTHERWISE CLASSIFIED

FOR SLEEPING BAGS, PLASTIC CAKE DECORATIONS, NON-METAL KEY CHAINS, NON-METAL KEY RINGS, SEAT CUSHIONS, PICTURE FRAMES, PILLOWS (U.S. CLS. 2, 13, 22, 25, 32 AND 50).

CLASS 21—HOUSEWARES AND GLASS

FOR PAPER PLATES, FIGURINES MADE OF CHINA, CRYSTAL, EARTHENWARE, GLASS, PORCELAIN, TERRA COTTA; THERMAL INSULATED FOOD OR BEVERAGE CONTAINERS, BARBECUE COOKING UTENSIL SETS COMPRISED OF FORKS, TURNERS AND TONGS; PORTABLE BEVERAGE COOLERS, LUNCH BOXES, BEVERAGeware, BOTTLE OPENERS, CAKE MOLDS, TRASH CANS, SUN CATCHERS, PLASTIC COASTERS, COFFEE CUPS, COOKIE JARS, PAPER CUPS (U.S. CLS. 2, 13, 23, 29, 30, 33, 40 AND 50).

CLASS 24—FABRICS

FOR BEDDING PRODUCTS, NAMELY, BED BLANKETS, BED SHEETS, BED LINENS, BED THROWS; TOWELS, POTHOLDERS, CLOTH FLAGS, CLOTH PENNANTS, CLOTH BANNERS, SHOWER CURTAINS, PILLOW CASES, COMFORTERS, BED SPREADS (U.S. CLS. 42 AND 50).

CLASS 25—CLOTHING

FOR T-SHIRTS, TANK TOPS, BOXER SHORTS, JERSEYS, SHORTS, SHIRTS, NIGHTSHIRTS, SWEATERS, VESTS, JACKETS, HATS, CAPS, PONCHOS, PULL-OVERS, COATS, TIES, PANTS, BANDANNAS, BELTS, SCARVES, SUNVISORS, SWIM TRUNKS, BRIEFS, ROBES, SLEEPWEAR, BLANKET SLEEPERS, SUSPENDERS, FOOTWEAR, RAIN SLICKERS, SWEATSHIRTS, SWEATPANTS (U.S. CLS. 22 AND 39).

CLASS 26—FANCY GOODS

FOR SHOE LACES, CLOTH PATCHES FOR CLOTHING, BELT BUCKLES NOT OF PRECIOUS METALS, HAIR BOWS (U.S. CLS. 37, 39, 40, 42 AND 50).

CLASS 28—TOYS AND SPORTING GOODS

FOR TOY VEHICLES AND ACCESSORIES THEREFORE SOLD AS A UNIT; PARTY FAVORS IN THE NATURE OF SMALL TOYS, WIND SOCKS FOR DECORATIVE PURPOSES, CUBE, MANIPULATIVE AND JIGSAW PUZZLES, STUFFED TOYS, ACTION FIGURES AND ACCESSORIES THEREFORE; HAND-HELD UNIT FOR PLAYING ELECTRONIC GAMES, BOARD GAMES (U.S. CLS. 22, 23, 38 AND 50).

CLASS 29—MEATS AND PROCESSED FOODS

FOR FRUIT SNACKS, NAMELY, CANDIED FRUIT SNACKS AND FRUIT-BASED SNACK FOOD (U.S. CL. 46).

CLASS 30—STAPLE FOODS

FOR CHOCOLATES, BREAKFAST CEREALS, CANDY, FROZEN CONFECTIONS (U.S. CL. 46).

CLASS 35—ADVERTISING AND BUSINESS

FOR PROVIDING INFORMATION ABOUT EMPLOYEE RE-LOCATION AND REPATRIATION; EMPLOYEE ASSISTANCE SERVICES, NAMELY PROVIDING REFERRALS IN THE FIELDS OF CHILD AND ELDER CARE, DRUG AND ALCOHOL REHABILITATION, AND MENTAL HEALTH CARE; PROVIDING ONLINE DIRECTORY SERVICES, NAMELY PROVIDING WEB SITE LINKS TO INFORMATION IN THE FIELDS OF HEALTHCARE, MENTAL HEALTH, LIFESTYLE, PARENT AND CHILD CARE, LEGAL SERVICES, GOVERNMENT SOCIAL SERVICES AGENCIES, TRAVEL, FINANCE, AND INSURANCE VIA A WEB SITE ON A GLOBAL COMPUTER NETWORK (U.S. CLS. 100, 101 AND 102).

FIRST USE 5-8-1998; IN COMMERCE 5-8-1998.

CLASS 41—EDUCATION AND ENTERTAINMENT

FOR TRAINING SERVICES IN THE FIELDS OF HUMAN RESOURCES AND EMPLOYEE MANAGEMENT, SKILLS DEVELOPMENT AND PRODUCTIVITY RENDERED THROUGH THE USE OF CLASSROOM INSTRUCTION, VIDEO, AND COMPUTER AND ON-LINE BASED PRESENTATIONS (U.S. CLS. 100, 101 AND 107).

FIRST USE 5-8-1998; IN COMMERCE 5-8-1998.

CLASS 42—SCIENTIFIC, COMPUTER AND LEGAL SERVICES

FOR CONSULTING SERVICES IN THE FIELD OF CHILD AND ELDER CARE; EMPLOYEE ASSISTANCE SERVICES, NAMELY, CRISIS MANAGEMENT AND COUNSELING; PROVIDING INFORMATION IN THE FIELDS OF MENTAL AND PHYSICAL HEALTH, LIFESTYLE, AND PARENT AND CHILD CARE (U.S. CLS. 100 AND 101).

FIRST USE 5-8-1998; IN COMMERCE 5-8-1998.

SN 75-656,026. HARRIS, ROTHENBERG INTERNATIONAL, NEW YORK, NY. FILED 3-8-1999.

SN 75-656,854. ALBERTO ASPESI & C. S.P.A., LEGNANO (MILAN), ITALY, FILED 3-9-1999.

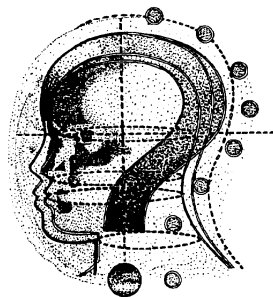

THE LINING AND STIPPLING IN THE DRAWING ARE FOR SHADING PURPOSES ONLY AND DO NOT INDICATE COLOR.

THE DESIGN FEATURE OF THE MARK CONSISTS OF SEVERAL PROFILES OF A HEAD INSIDE OF EACH OTHER WITH A QUESTION MARK FORMING THE BACK OF THE OUTER MOST PROFILE.

ASPESI

PRIORITY CLAIMED UNDER SEC. 44(D) ON ITALY APPLICATION NO. M198C009116, FILED 9-23-1998, REG. NO. 00847243, DATED 5-30-2001, EXPIRES 9-23-2008.

OWNER OF U.S. REG. NOS. 1,220,067, 1,790,457 AND 1,861,800.

CLASS 3—COSMETICS AND CLEANING PREPARATIONS

FOR SOAPS FOR CLEANING THE HUMAN BODY, PERFUMERY, DEODORANTS FOR PERSONAL USE; SANITARY PREPARATIONS AND TOILETRIES, NAMELY, BATH FOAMS, SHAMPOOS, TALCUM POWDERS, AND TISSUES IMPREGNATED WITH COSMETIC LOTIONS; ESSENTIAL OILS FOR PERSONAL USE, COSMETICS, NAMELY OILS FOR COSMETICS PURPOSES, FALSE NAILS, EYEBROW PENCILS, EYEBROW COSMETICS, EAU DE COLOGNE, CREAMS FOR COSMETIC TREATMENT OF SKIN AND MOISTURIZING, CLEANING MILK FOR TOILET PURPOSES, BATH SALTS; NAIL CARE PREPARATIONS, NAIL POLISH, NAIL VARNISHES, MAKEUP POWDER, SHAVING PREPARATIONS, SHAVING FORM (U.S. CLS. 1, 4, 6, 50, 51 AND 52).

CLASS 9—ELECTRICAL AND SCIENTIFIC APPARATUS

FOR EYEGLASSES, NAMELY, PRESCRIPTION EYEGLASSES, SUNGLASSES, SPORT GLASSES, FASHION WEAR GLASSES, PARTS AND ACCESSORIES THEREFOR SUCH AS EYEGLASS CHAINS AND EYEGLASSES CASES; CAMERAS, NAMELY VIDEO CAMERAS, PICTURE CAMERAS USING FILM, DIGITAL CAMERAS, MOVIE CAMERAS; AUXILIARY INSTRUMENTS FOR MUSICAL SHOWS, NAMELY BINOCULARS AND GRAMPHONES, DISCS, NAMELY, MAGNETIC DISKS CARRYING DATA, NAMELY, MUSIC, ADVERTISING OF COMPANY GOODS AND COMPANY ACTIVITIES, BLANK MAGNETIC DISKS, OPTICAL DISKS CARRYING DATA NAMELY, MUSIC, ADVERTISING OF COMPANY GOODS AND COMPANY ACTIVITIES, BLANK OPTICAL DISKS (U.S. CLS. 21, 23, 26, 36 AND 38).

CLASS 18—LEATHER GOODS

FOR BAGS, NAMELY, HANDBAGS, SUITCASES, LUGGAGE, LUGGAGE TRUNKS, TRAVELLING BAGS SOLD EMPTY AND BEAUTY CASES SOLD EMPTY, KEY CASES, BRIEFCASES, PURSES, WALLETS, UMBRELLAS, PARASOLS, WALKING STICKS, ALL-PURPOSE SPORTS BAGS AND ACCESSORIES THEREFORE (U.S. CLS. 1, 2, 3, 22 AND 41).

SN 75-663,785. DUEHRING, WILLIAM, DBA THE DUEHRING COMPANY, HUNTINGTON BEACH, CA. FILED 3-19-1999.

VOXOM

CLASS 12—VEHICLES

FOR BICYCLES AND STRUCTURAL PARTS THEREOF (U.S. CLS. 19, 21, 23, 31, 35 AND 44).

CLASS 25—CLOTHING

FOR WEARING APPAREL, NAMELY T-SHIRTS, SHIRTS, SHORTS, PANTS, SWEAT SHIRTS, SWEAT PANTS, HATS, VISORS, SHOES, SANDALS, AND BELTS (U.S. CLS. 22 AND 39).

SN 75-664,486. MINACS GROUP INC., THE, ONTARIO, CANADA, FILED 3-19-1999.

(MINACS) WORLDWIDE

PRIORITY CLAIMED UNDER SEC. 44(D) ON CANADA APPLICATION NO. 897130, FILED 11-23-1998, REG. NO. TMA553448, DATED 11-5-2001, EXPIRES 11-5-2011.

NO CLAIM IS MADE TO THE EXCLUSIVE RIGHT TO USE "WORLDWIDE", APART FROM THE MARK AS SHOWN.

CLASS 35—ADVERTISING AND BUSINESS

FOR HUMAN RESOURCES MANAGEMENT, OUTSOURCING AND CONSULTATION SERVICES; MAIL-ROOM MANAGEMENT, NAMELY MAIL SORTING, HANDLING AND RECEIVING; ADVERTISING AND BUSINESS MARKETING CONSULTING SERVICES (U.S. CLS. 100, 101 AND 102).

CLASS 38—COMMUNICATION

FOR TELECOMMUNICATIONS SERVICES, NAMELY CALL HANDLING (U.S. CLS. 100, 101 AND 104).

CLASS 41—EDUCATION AND ENTERTAINMENT

FOR EDUCATIONAL SERVICES, NAMELY CONDUCTING TRAINING IN THE FIELD OF FACILITIES MANAGEMENT (U.S. CLS. 100, 101 AND 107).

SN 75-670,996. ALLTIME ENTERTAINMENT LTD, LONDON, WIP 1PN, UNITED KINGDOM, FILED 3-30-1999.



PRIORITY CLAIMED UNDER SEC. 44(D) ON UNITED KINGDOM APPLICATION NO. 2188611, FILED 2-6-1999, REG. NO. 2188611, DATED 1-2-2000, EXPIRES 2-6-2009.

CLASS 3—COSMETICS AND CLEANING PREPARATIONS

FOR (BASED ON INTENT TO USE) (BASED ON 44(E)) DISINFECTANT AND MEDICATED SOAPS, BATH AND SHOWER PRODUCTS, NAMELY, BUBBLE BATH, SHOWER GEL; HAIR SHAMPOO; COSMETICS, NAMELY, BODY POWDER; AND PERFUME (U.S. CLS. 1, 4, 6, 50, 51 AND 52).

CLASS 9—ELECTRICAL AND SCIENTIFIC APPARATUS

FOR (BASED ON INTENT TO USE) (BASED ON 44(E)) PRE-RECORDED VIDEO TAPES FEATURING CHILDREN'S STORIES; PRE-RECORDED AUDIO CASSETTES FEATURING CHILDREN'S STORIES; COMPUTER GAME SOFTWARE; PERSONAL COMPUTERS; COMPUTER GAME CONSOLES; WEBSITE DEVELOPMENT SOFTWARE;(BASED ON INTENT TO USE) PERSONAL COMPUTERS (U.S. CLS. 21, 23, 26, 36 AND 38).

CLASS 14—JEWELRY

FOR (BASED ON INTENT TO USE) (BASED ON 44(E)) JEWELRY, WATCHES AND CLOCKS (U.S. CLS. 2, 27, 28 AND 50).

CLASS 16—PAPER GOODS AND PRINTED MATTER

FOR (BASED ON INTENT TO USE) (BASED ON 44(E)) PRINTED MATTER, NAMELY, PICTURE STORY BOOKS AND CHILDREN'S NOVELTY BOOKS; CROSS-WORD PUZZLES; STATIONERY; NOTEPADS, PENCIL HOLDERS, PENCIL CASES, DRAWING RULERS, ERASERS, PENCIL SHARPENERS, FILE FOLDERS, PENS AND PENCILS; COMIC BOOKS; CALENDARS; DIARIES; STICKERS; PAPER PARTY WARE, NAMELY, NAPKINS, HATS; PERSONAL ORGANIZERS, ADDRESS BOOKS, PHOTOGRAPH ALBUMS, BIRTHDAY BOOKS, ANNIVERSARY BOOKS, PRINTED INVITATION CARDS, PRINTED THANK-YOU CARDS, PRINTED CHANGE OF ADDRESS CARDS, TELEPHONE NOTE PADS, MEMORANDUM BOARDS; PAINTING SETS, ARTS AND CRAFTS PAINT SETS; ORIGAMI CRAFT KITS COMPRISED OF TISSUE PAPER AND WAX PAPER (U.S. CLS. 2, 5, 22, 23, 29, 37, 38 AND 50).

CLASS 18—LEATHER GOODS

FOR (BASED ON INTENT TO USE) (BASED ON 44(E)) BAGS, NAMELY, BACKPACKS, RUCKSACKS, ALL PURPOSE SPORTS BAGS, COSMETICS BAGS AND TOILETRIES BAGS SOLD EMPTY (U.S. CLS. 1, 2, 3, 22 AND 41).

CLASS 21—HOUSEWARES AND GLASS

FOR (BASED ON INTENT TO USE) (BASED ON 44(E)) BEVERAGE GLASSWARE; PORCELAIN MUGS; PLATES, LUNCH BOXES, FIGURINES OF PORCELAIN; TOOTHBRUSHES AND PAPER PARTY WARE, NAMELY, PLATES (U.S. CLS. 2, 13, 23, 29, 30, 33, 40 AND 50).

CLASS 24—FABRICS

FOR (BASED ON INTENT TO USE) (BASED ON 44(E)) BED LINEN; DUVET COVERS; PILLOWCASES; CURTAINS; AND BATH TOWELS (U.S. CLS. 42 AND 50).

CLASS 25—CLOTHING

FOR (BASED ON INTENT TO USE) (BASED ON 44(E)) ARTICLES OF CLOTHING, NAMELY, T-SHIRTS, JACKETS, JUMPERS, SHORTS, TROUSERS, SWIMWEAR, SHOES, TRAINING SHOES, SLIPPERS, SANDALS, HATS, CAPS, DRESSES, SHIRTS, JEANS, COATS, RAINCOATS AND SOCKS (U.S. CLS. 22 AND 39).

CLASS 28—TOYS AND SPORTING GOODS

FOR (BASED ON INTENT TO USE) (BASED ON 44(E)) TOYS AND GAMES, NAMELY, PLUSH TOYS, PVC FIGURINES; HOBBY CRAFT KITS FOR ARTS AND CRAFTS SCULPTING, NEEDLECRAFT, AND PLASTIC CAST CRAFT; BOARD GAMES, JIGSAW PUZZLES, KITES, BALLOONS, TOY BICYCLES, TOY SCOOTERS, ROLLER SKATES, COIN OPERATED AMUSEMENT PARK RIDES AND BEANBAGS (U.S. CLS. 22, 23, 38 AND 50).

CLASS 29—MEATS AND PROCESSED FOODS

FOR (BASED ON INTENT TO USE) YOGHURT AND COTTAGE CHEESE (U.S. CL. 46).

CLASS 30—STAPLE FOODS

FOR (BASED ON INTENT TO USE) BREAD, CAKES, BISCUITS, BREAKFAST CEREALS, PUFFED CORN SNACKS, FLAVORED ICES, FROZEN CONFECTIONS, CHOCOLATES, AND MILKSHAKES (U.S. CL. 46).

CLASS 32—LIGHT BEVERAGES

FOR (BASED ON INTENT TO USE) FRUIT DRINKS, FRUIT JUICES, CARBONATED DRINKS, DRINKING WATER AND SODA WATER (U.S. CLS. 45, 46 AND 48).

CLASS 41—EDUCATION AND ENTERTAINMENT

FOR (BASED ON INTENT TO USE) (BASED ON 44(E)) ENTERTAINMENT, NAMELY, FILMS, CONTINUING TELEVISION SHOWS, ON-GOING RADIO SHOWS FEATURING CHILDREN'S STORIES, LIVE TOURING THEATRICAL AND MUSICAL PERFORMANCES FEATURING CHILDREN'S STORIES (U.S. CLS. 100, 101 AND 107).

SN 75-687,120. KERPENWERK GMBH & CO., 52224 STOLBERG RHLD, FED REP GERMANY, FILED 4-20-1999.

PRIORITY CLAIMED UNDER SEC. 44(D) ON FED REP GERMANY APPLICATION NO. 39860504.1, FILED 10-21-1998, REG. NO. 39860504, DATED 11-12-1998, EXPIRES 10-31-2008.

CLASS 9—ELECTRICAL AND SCIENTIFIC APPARATUS

FOR ELECTRICAL CABLES AND LEADS, ELECTRICAL MUSICAL INSTRUMENT CABLES, ELECTRICAL CONNECTING CABLES, ELECTRICAL DATA AND INFORMATION TRANSMISSION CABLES; COPPER ELECTRICAL CABLES FOR DATA AND TELEPHONE TRANSMISSION, FOR CONTROL PURPOSES, AND ENERGY TRANSMISSION; CABLES AND LEADS FOR DATA AND COMMUNICATIONS ENGINEERING, NAMELY, SYMMETRICAL CABLES, COAXIAL AND TWIN AXIAL CABLES; ELECTRICAL MULTIMEDIA CABLES, ELECTRICAL CABLES WITH INTEGRAL CONNECTORS, HYBRID ELECTRICAL CABLES; ELECTRICAL CABLES FOR INDOOR, OUTDOOR, AND UNDERGROUND USE; OPTICAL FIBER CABLES FOR INDOOR, OUTDOOR, AND UNDERGROUND USE; HYBRID CABLES, COMPRISING OPTICAL FIBER ELEMENTS FOR OPTICAL TRANSMISSION SYSTEMS AND COPPER ELEMENTS FOR DATA AND TELEPHONE TRANSMISSION, FOR CONTROL PURPOSES, AND FOR ENERGY TRANSMISSION; ALL FOR USE BY MANUFACTURERS OF HOME APPLIANCES AND VEHICLES SUCH AS BUSES AND TRAINS, AND IN PETROCHEMICAL PLANTS, OIL REFINERIES, AND ELECTRIC POWER GENERATING PLANTS (U.S. CLS. 21, 23, 26, 36 AND 38).

CLASS 17—RUBBER GOODS

FOR ELECTRICAL INSULATING MATERIALS, NAMELY, INSULATORS AND PARTS THEREFOR (U.S. CLS. 1, 5, 12, 13, 35 AND 50).

SN 75-689,446. INTELLIGENT NUTRIENTS, INC., MINNEAPOLIS, MN. FILED 4-23-1999.

**INTELLIGENT NUTRIENTS
WUNDERBAR**

OWNER OF U.S. REG. NOS. 1,983,856, 2,084,179 AND 2,102,792.

CLASS 5—PHARMACEUTICALS

FOR DIETARY SUPPLEMENTS, SNACK BARS CONTAINING SOY PROTEIN, VITAMINS, MINERALS AND HERBS FOR NUTRITIONAL PURPOSES; AND NUTRITIONAL SUPPLEMENTS IN BAR FORM CONTAINING SOY PROTEIN, VITAMINS, MINERALS AND HERBS (U.S. CLS. 6, 18, 44, 46, 51 AND 52).

CLASS 29—MEATS AND PROCESSED FOODS

FOR FOOD PRODUCTS, MAINLY MEAT, FISH, POULTRY, FRUITS, FRESH AND BOTTLED VEGETABLES, JELLIES, JAMS, COOKING AND EDIBLE OILS, NUTS AND SNACK BARS CONTAINING SOY PROTEIN, VITAMINS, MINERALS AND HERBS (U.S. CL. 46).

CLASS 30—STAPLE FOODS

FOR COFFEE, TEA, COCOA, PASTA, BREADS, PASTRIES, FROZEN CONFECTIONERY, SORBET, ICE CREAM, SAUCES, SPICES, GRANOLA, MUESLI, BREAKFAST CEREALS, CEREALS MADE OF GRAINS, FRUITS, NUTS, VINEGAR, CONDIMENTS, NAMELY KETCHUP AND MUSTARD, RELISH AND WILD RICE (U.S. CL. 46).

CLASS 32—LIGHT BEVERAGES

FOR BEERS, DRINKING WATERS, FRUIT JUICES, VEGETABLE JUICES, NON-ALCOHOLIC BEVERAGES CONTAINING HERBAL EXTRACTS, POWDERS, MIXTURES CONTAINING HERBS AND VITAMINS TO BE BLENDED TOGETHER WITH SOY PROTEIN POWDER FOR USE IN THE PREPARATION OF SOFT DRINKS, NON-ALCOHOLIC BEVERAGES CONTAINING HERBAL EXTRACTS, MALT SYRUPS, AND POWDERS FOR USE IN THE PREPARATION OF SOFT DRINKS (U.S. CLS. 45, 46 AND 48).

SN 75-690,864. WEST LICENSING CORPORATION, WILMINGTON, DE. FILED 4-26-1999.

LAWOFFICE.COM

SEC. 2(F).

CLASS 35—ADVERTISING AND BUSINESS

FOR PROVIDING BUSINESS MARKETING CONSULTING SERVICES FOR LAWYERS, LAW FIRMS, AND OTHER LEGAL PROFESSIONALS VIA ON-LINE MEANS; PROVIDING ON-LINE LEGAL DIRECTORY INFORMATION SERVICES ALSO FEATURING HYPERLINKS TO OTHER WEB SITES ON A GLOBAL COMPUTER NETWORK; PROVIDING A WEB SITE WHICH FEATURES ADVERTISEMENTS FOR THE SERVICES OF LAWYERS, LAW FIRMS AND OTHER LEGAL PROFESSIONALS ON A GLOBAL COMPUTER NETWORK; PREPARING AND PLACING ADVERTISEMENTS FOR LAWYERS, LAW FIRMS, AND OTHER LEGAL PROFESSIONALS (U.S. CLS. 100, 101 AND 102).

CLASS 42—SCIENTIFIC, COMPUTER AND LEGAL SERVICES

FOR HOSTING THE WEB SITES OF LAWYERS, LAW FIRMS, AND OTHER LEGAL PROFESSIONALS ON A COMPUTER SERVER FOR A GLOBAL COMPUTER NETWORK; PROVIDING LEGAL INFORMATION VIA THE GLOBAL COMPUTER INFORMATION NETWORK (U.S. CLS. 100 AND 101).

SN 75-693,295. GALILEE GROUP LLC, SCARSDALE, NY. FILED 4-28-1999.

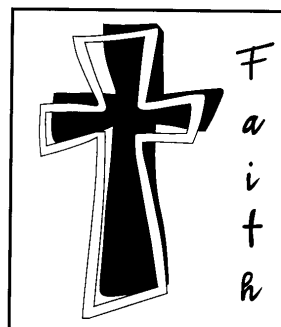

NO CLAIM IS MADE TO THE EXCLUSIVE RIGHT TO USE "THE STYLIZED DEPICTION OF THE LATIN CROSS", APART FROM THE MARK AS SHOWN.

CLASS 18—LEATHER GOODS

FOR BAGS, NAMELY, ATHLETIC BAGS, ALL PURPOSE ATHLETIC BAGS, ALL PURPOSE SPORT BAGS, MESH SHOPPING BAGS, OVERNIGHT BAGS, BOOK BAGS, SCHOOL BOOK BAGS, SCHOOL BAGS, SHOULDER BAGS, TEXTILE SHOPPING BAGS, TOTE BAGS, TRAVEL BAGS, TRAVELING BAGS, BARREL BAGS, BEACH BAGS, BRIEF BAGS, BOSTON BAGS, CARRY-ON BAGS, HANDBAGS, CLUTCH BAGS, POKETBOOKS, WAIST PACKS, DIAPER BAGS, DUFFEL BAGS, GYM BAGS, HUNTERS GAME BAGS, LEATHER SHOPPING BAGS, GARMENT BAGS FOR STORAGE, GARMENT BAGS FOR TRAVEL, SHOE BAGS FOR TRAVEL, BACKPACKS; LUGGAGE AND LUGGAGE ACCESSORIES, NAMELY, LUGGAGE TAGS, LUGGAGE TRUNKS; VALISES; CASES, NAMELY, ATTACHE CASES, BUSINESS CARD CASES, CALLING CARD CASES, BRIEFCASES, CREDIT CARD CASES, DOCUMENT CASES, KEY CASES, OVERNIGHT CASES, COSMETIC CASES SOLD EMPTY, TOILETRY CASES SOLD EMPTY, VANITY CASES SOLD EMPTY, SUITCASES, OVERNIGHT CASES; UMBRELLAS AND UMBRELLA ACCESSORIES, NAMELY, BEACH UMBRELLAS, GOLF UMBRELLAS, PATIO UMBRELLAS, UMBRELLA COVERS, UMBRELLA HANDLES, UMBRELLA RINGS, FRAMES FOR UMBRELLAS; WALLETS, BILLFOLDS, CHANGE PURSES; BABY BACKPACKS, BABY CARRIERS WORN ON THE BODY; HAT BOXES FOR TRAVEL (U.S. CLS. 1, 2, 3, 22 AND 41).

CLASS 25—CLOTHING

FOR FOOTWEAR, NAMELY, ATHLETIC FOOTWEAR, ATHLETIC SHOES, GALOSHES, OVERSHOES, SANDALS, SHOES, SLIPPERS, SNEAKERS, RUBBERS, CLOGS, BOOTS, BOOTIES; SKI BOOT BAGS; BEACHWEAR, NAMELY, BATHING SUITS, BIKINIS, BEACH COVER-UPS, BATHING TRUNKS, SWIMMING TRUNKS, BATH ROBES; HEADWEAR, NAMELY, BASEBALL CAPS, BERETS, HATS; COATS, NAMELY, HOUSECOATS, FUR COATS, JACKETS, LEATHER COATS, LEATHER JACKETS, OVERCOATS, WAISTCOATS, RAIN COATS, SPORT COATS, TOP COATS, CAPES; UNDERGARMENTS, NAMELY, UNDERCLOTHES, BLOOMERS, BOXER SHORTS, BRAS, BRIEFS, UNDERWEAR, THERMAL UNDERWEAR, UNDERPANTS, UNDERSHIRTS, CAFTANS, CAMISOLES, LINGERIE, PANTALOONS, PANTIES, PANTYHOSE, SLIPS, STOCKINGS, SOCKS, TIGHTS; SLEEPWEAR, NAMELY, NIGHT GOWNS, NIGHT SHIRTS, PAJAMAS; TOPS, NAMELY, ALL SHIRTS, T-SHIRTS, TANK TOPS, SPORT SHIRTS, KNIT SHIRTS, SWEAT SHIRTS, SWEATERS, V-NECK SWEATERS, WINDSHIRTS, TUNICS, CLOTHING TOPS, HALTER TOPS, TANK TOPS, QUILTED VESTS; BOTTOMS, NAMELY, DUNGAREES, GYM SHORTS, JEANS, LEG WARMERS, LEGGINGS, LEOTARDS, OVERALLS, ALL PANTS, PANTSUITS, SHORT SETS, SINGLETTS, SLACKS, TROUSERS, BERMUDA SHORTS, SWEAT

PANTS, SWEAT SHORTS, BALLOON PANTS; SWEAT SUITS, TRACKSUITS, JUMPSUITS, WARM UP SUITS, SNOW SUITS, RAIN SUITS, TUXEDOS; ATHLETIC WEAR, NAMELY, HEAD BANDS, NECK BANDS, SWEAT BANDS, WRIST BANDS, SWEAT SOCKS, ATHLETIC UNIFORMS, TENNIS WEAR; INFANT AND BABY WEAR, NAMELY, CLOTH BIBS, CLOTH DIAPERS, CREEPERS ROMPERS, BABY BUNTING; BANDANAS; CLOTHING WRAPS; BELTS FOR CLOTHING; MONEY BELTS; HALLOWEEN AND MASQUERADE COSTUMES; COVER-UPS, UNIFORMS, EVENING GOWNS, GOWNS, WEDDING GOWNS, VEILS, GABERDINES, GLOVES, JUMPERS, KERCHIEFS, LOUNGEWEAR, MITTENS, CLOTHING MUFFLERS, NECKTIES, NECKWEAR, RAINWEAR, ROBES, BOW TIES, CLOTHING TIES (U.S. CLS. 22 AND 39).

SN 75-694,904. WOOD, CHRISTOPHER RUSSELL JAMES, HONG KONG, FILED 4-29-1999.

GREED & FEAR

CLASS 16—PAPER GOODS AND PRINTED MATTER

FOR PRINTED MATTER AND PUBLICATIONS, NAMELY, BOOKLETS, BOOKS, NEWSLETTERS, AND PROSPECTUSES RELATING TO INVESTMENT RESEARCH AND ADVICE, FINANCIAL INFORMATION, AND INFORMATION ON FINANCIAL MARKETS; BOOK MARKERS; GRAPHIC PRINTS; AND GRAPHIC ART REPRODUCTIONS (U.S. CLS. 2, 5, 22, 23, 29, 37, 38 AND 50).

CLASS 36—INSURANCE AND FINANCIAL

FOR CAPITAL INVESTMENT CONSULTATION; MONEY EXCHANGE SERVICES; FINANCIAL ANALYSIS AND CONSULTATION; FINANCIAL EVALUATION, NAMELY, FISCAL ASSESSMENT AND EVALUATION; PROVIDING FINANCIAL INFORMATION BY ELECTRONIC MEANS; FINANCIAL MANAGEMENT; FUND INVESTMENTS; INVESTMENT RESEARCH; MORTGAGE BANKING; SECURITIES BROKERAGE; QUOTATION OF STOCK EXCHANGE PRICES; STOCKS AND BONDS BROKERAGE (U.S. CLS. 100, 101 AND 102).

SN 75-698,912. DENKWERK NEUE MEDIEN HOLDING GMBH, D-50969 COLOGNE, FED REP GERMANY, FILED 5-6-1999.

denkwerk

PRIORITY CLAIMED UNDER SEC. 44(D) ON FED REP GERMANY APPLICATION NO. 39869412536, FILED 12-2-1998, REG. NO. 39869412, DATED 1-11-1999, EXPIRES 12-31-2009.

THE ENGLISH TRANSLATION OF "DENKWERK" IS "THINK WORK".

CLASS 9—ELECTRICAL AND SCIENTIFIC APPARATUS

FOR DATA PROCESSORS; COMPUTERS AND COMPUTER PERIPHERALS; APPARATUS FOR RECORDING, TRANSMISSION OR REPRODUCTION OF SOUND, NAMELY, AUDIO, VIDEO, DATA RECORDERS, AUDIO AND VIDEO RECEIVERS, PHOTOGRAPHIC AND VIDEO CAMERAS; DIGITAL AND COMPUTER-BASED EQUIPMENT, NAMELY, HANDHELD COMPUTERS, PERSONAL DIGITAL ASSISTANTS, LAPTOP COMPUTERS; COMPUTER SOFTWARE USED TO CONNECT VARIOUS COMPUTERS INTO A COMPUTER NETWORK FOR KNOWLEDGE, DATA MANAGEMENT AND COMMUNICATION; COMPUTER SOFTWARE INFORMATION PROCESSING PROGRAMS FOR USE IN INSURANCE UNDERWRITING; COMPUTER NETWORK HUBS; PRERECORDED MAGNETIC COMPUTER TAPES AND CD-ROMS FEATURING STILL IMAGES, AUDIO, TEXT, MOVING PICTURES AND GRAPHICS FOR ENTERTAINMENT, ADVERTISING, EDUCATION, DATA MANAGEMENT, INFORMATION; APPARATUS FOR TELECOMMUNICATION, NAMELY, TELEPHONES, MODEMS, MOBILE DEVICES IN THE NATURE OF MOBILE COMPUTERS, MOBILE TELEPHONES, PERSONAL DIGITAL ASSISTANTS; HANDHELD COMPUTERS, LAPTOP COMPUTERS, VIRTUAL REALITY GAME SOFTWARE, VIRTUAL REALITY SOFTWARE FOR USE IN COMPUTER NETWORKS (U.S. CLS. 21, 23, 26, 36 AND 38).

CLASS 16—PAPER GOODS AND PRINTED MATTER

FOR PRINTED MATTER, NAMELY, NEWSPAPERS FOR GENERAL CIRCULATION; NON-FICTION BOOKS AND NON-FICTION BOOK SERIES WHOSE SUBJECT MATTER IS THE GLOBAL COMPUTER NETWORK AND MULTIMEDIA ABOUT COMPUTERS AND THE USE OF THE INTERNET FOR OTHERS; INFORMATION BOOKS AND LEAFLETS WHOSE SUBJECT MATTER IS GLOBAL COMPUTER NETWORK AND MULTIMEDIA ABOUT COMPUTERS AND THE USE OF THE INTERNET FOR OTHERS; ADVERTISING MATERIAL FOR OTHERS, NAMELY, BROCHURES AND PROSPECTUSES (U.S. CLS. 2, 5, 22, 23, 29, 37, 38 AND 50).

CLASS 35—ADVERTISING AND BUSINESS

FOR MANAGEMENT AND BUSINESS CONSULTATION FOR THIRD PARTIES IN CONNECTION WITH MULTIMEDIA, GLOBAL COMPUTER NETWORKS, TELEVISION, DIGITAL INFORMATION, RADIO AND ENTERTAINMENT WITH REGARD TO THE USE AND COMPREHENSION OF MULTIMEDIA EQUIPMENT, INTERNET AND DIGITAL INFORMATION RESOURCES; ADVERTISING AGENCY SERVICES; BUSINESS MANAGEMENT; BUSINESS ADMINISTRATION; BUSINESS MANAGEMENT CONSULTATION; ARRANGING AND CONDUCTING TRADE SHOW EXHIBITIONS IN THE FIELD OF TELEVISION, MOBILE RADIO, GLOBAL COMPUTER NETWORKS AND MULTIMEDIA; BUSINESS ORGANIZATION CONSULTING SERVICES; PUBLIC RELATIONS; BUSINESS MARKETING CONSULTING SERVICES; PERSONNEL MANAGEMENT CONSULTATION; ECONOMIC ANALYSIS REGARDING THE REALIZATION OF TAX-PRIVILEGED BUILDING PROJECTS (U.S. CLS. 100, 101 AND 102).

CLASS 36—INSURANCE AND FINANCIAL

FOR INSURANCE BROKERAGE; INSURANCE CLAIMS ADMINISTRATION; FINANCIAL AND MONETARY AFFAIRS, NAMELY, FINANCIAL MANAGEMENT, FINANCIAL PLANNING, FINANCIAL PORTFOLIO MANAGEMENT; REAL ESTATE AFFAIRS, NAMELY, REAL ESTATE AGENCIES, REAL ESTATE APPRAISAL, REAL ESTATE BROKERAGE; BANKING SERVICES, NAMELY, ARRANGEMENT OF INVESTMENTS, ADMINISTRATION OF PROPERTY, ARRANGEMENT AND CONSULTATION FOR FINANCING, FOR SHARES OF STOCKS, FOR CAPITAL INVESTMENTS AND LEASING BUSINESS, FOR SHARES OF CAPITAL AND STOCK EXCHANGE BUSINESS; AGENCY SERVICES, NAMELY, ARRANGEMENT AND CONCLUSION OF COMMERCIAL TRANSACTIONS FOR THIRD PARTIES VIA A GLOBAL COMPUTER NETWORK; REAL ESTATE PROCUREMENT FOR OTHERS; FINANCIAL PLANNING OF THE REALIZATION OF TAX-PRIVILEGED BUILDING PROJECTS (U.S. CLS. 100, 101 AND 102).

CLASS 38—COMMUNICATION

FOR PROVIDING TELECOMMUNICATION CONNECTIONS TO A GLOBAL OR LOCAL COMPUTER NETWORK (U.S. CLS. 100, 101 AND 104).

CLASS 41—EDUCATION AND ENTERTAINMENT

FOR EDUCATIONAL SERVICES, NAMELY, CONDUCTING SEMINARS, TRAINING COURSES AND SYMPOSIA IN THE FIELD OF BUSINESS AND MEDIA MANAGEMENT, AND DISTRIBUTING COURSE MATERIALS IN CONNECTION THEREWITH; EDUCATIONAL AND TRAINING VIDEOTAPE PRODUCTION (U.S. CLS. 100, 101 AND 107).

CLASS 42—SCIENTIFIC, COMPUTER AND LEGAL SERVICES

FOR NEWS AGENCIES, NAMELY, GATHERING AND DISSEMINATION OF NEWS, KNOWLEDGE AND ENTERTAINMENT INFORMATION; COMPUTER PROGRAMMING AND COMPUTER SOFTWARE DESIGN, DEVELOPMENT, UPDATING AND ADAPTING FOR OTHERS; DATA PROCESSING SOFTWARE DEVELOPMENT AND DESIGN FOR OTHERS; COMPUTER SERVICES, NAMELY, DESIGNING WEBSITES FOR OTHERS; COMPUTER SOFTWARE DESIGN FOR OTHERS; GRAPHIC ILLUSTRATION SERVICES FOR OTHERS; COMPUTER SOFTWARE DESIGN CONSULTATION; TECHNICAL CONSULTATION IN THE FIELD OF TAX-PRIVILEGED BUILDING PROJECTS (U.S. CLS. 100 AND 101).

SN 75-716,106, MATERNITY CARE COALITION, PHILADELPHIA, PA. FILED 5-26-1999.

MATERNITY CARE COALITION

NO CLAIM IS MADE TO THE EXCLUSIVE RIGHT TO USE "COALITION", APART FROM THE MARK AS SHOWN. SEC. 2(F).

CLASS 41—EDUCATION AND ENTERTAINMENT

FOR PROVIDING INFORMATION ON SEMINARS AND EDUCATIONAL TRAINING CONCERNING OR OF INTEREST TO PREGNANT WOMEN AND FAMILIES WITH CHILDREN (U.S. CLS. 100, 101 AND 107).
FIRST USE 5-0-1985; IN COMMERCE 5-0-1985.

CLASS 42—SCIENTIFIC, COMPUTER AND LEGAL SERVICES

FOR COMMUNITY OUTREACH, ADVOCACY, INFORMATION, AND FAMILY SUPPORT SERVICES FOR PREGNANT WOMEN AND FAMILIES WITH CHILDREN; AND PROVIDING PARENTING COUNSELING, MATERNAL AND CHILD HEALTH CARE COUNSELING, AND NUTRITIONAL COUNSELING (U.S. CLS. 100 AND 101).

FIRST USE 5-0-1985; IN COMMERCE 5-0-1985.

SN 75-720,724, FORTUM CORPORATION, 00170 HELSINKI, FINLAND, FILED 6-3-1999.

FORTUM

PRIORITY CLAIMED UNDER SEC. 44(D) ON FINLAND APPLICATION NO. T199803990, FILED 12-4-1998, REG. NO. 219696, DATED 12-15-2000, EXPIRES 12-15-2010.

CLASS 1—CHEMICALS

FOR AUTOMOTIVE CHEMICALS AND THEIR DERIVATIVES, NAMELY, COOLANTS, BRAKE FLUIDS, AND ANTIFREEZES; CHEMICALS USED IN REFINING AND PRODUCTION OF OIL; CHEMICAL ADDITIVES TO MOTOR FUELS AND SOLVENTS FOR USE IN PAINTS, COATINGS AND DEGREASING AGENTS (U.S. CLS. 1, 5, 6, 10, 26 AND 46).

CLASS 3—COSMETICS AND CLEANING PREPARATIONS

FOR WINDSCREEN CLEANERS (U.S. CLS. 1, 4, 6, 50, 51 AND 52).

CLASS 4—LUBRICANTS AND FUELS

FOR GASES, NAMELY, BUTANE, PROPANE, LIQUEFIED PETROLEUM GAS AND LIQUEFIED NATURAL GAS; COALS; GASOLINE; DIESEL OILS; LIGHT AND HEAVY FUEL OILS; AVIATION FUEL; NON-CHEMICAL ADDITIVES TO MOTOR FUELS; BASE OILS FOR USE IN THE MANUFACTURE OF ENGINE OILS, GEAR OILS AND CIRCULATION OILS; LUBRICANTS FOR ENGINES; LUBRICANT COMPONENTS; NAPHTHENIC OILS USED IN PROCESS OILS AND HYDRAULIC OILS; SPECIALTY FUELS FOR USE IN MOTORS, LAWNMOWERS, CHAIN SAWS AND OUTBOARD MOTORS (U.S. CLS. 1, 6 AND 15).

CLASS 9—ELECTRICAL AND SCIENTIFIC APPARATUS

FOR EQUIPMENT FOR ELECTROCHEMICAL STORAGE OF ENERGY, NAMELY, ACCUMULATORS, BATTERIES, DRY FUEL CELLS; ELECTRICAL APPARATUS AND INSTRUMENTS USED IN CONNECTION WITH ELECTROCHEMICAL STORAGE OF ENERGY, NAMELY, BATTERY RECHARGERS; EQUIPMENT FOR POWER CONDITIONING AND POWER CONVERSION, NAMELY, CONVERTERS; ELECTRIC STORAGE BATTERIES; ELECTRICAL APPARATUS AND INSTRUMENTS USED IN CONNECTION WITH STORAGE BATTERIES, NAMELY, BATTERY RECHARGERS (U.S. CLS. 21, 23, 26, 36 AND 38).

CLASS 11—ENVIRONMENTAL CONTROL APPARATUS

FOR OIL HEATING APPARATUS, ELECTRICAL HEATING APPARATUS, GAS HEATING APPARATUS, AND CENTRAL HEATING APPARATUS, NAMELY, FURNACES AND DUCTS (U.S. CLS. 13, 21, 23, 31 AND 34).

CLASS 36—INSURANCE AND FINANCIAL

FOR SERVICES RELATING TO THE DISTRIBUTION OF ELECTRICITY, NAMELY, BROKERAGE OF ELECTRICITY (U.S. CLS. 100, 101 AND 102).

CLASS 37—CONSTRUCTION AND REPAIR

FOR INSTALLATION OF ELECTRICAL APPARATUS, INSTALLATION AND REPAIR OF HEATING APPARATUS AND CENTRAL HEATING APPARATUS; ASPHALTING, LAYING OF OIL PIPELINES; COVERING, COATING AND MAINTENANCE OF OIL PIPELINE INSPECTION; REGULATION AND REPAIR OF OIL-BURNERS; SERVICE STATION SERVICES; CONSTRUCTION ENGINEERING; DRILLING OF PIPELINES; DRILLING OF OIL WELLS; CONSTRUCTION AND MAINTENANCE OF POWER PLANTS (U.S. CLS. 100, 103 AND 106).

CLASS 39—TRANSPORTATION AND STORAGE

FOR SERVICES RELATING TO DISTRIBUTION OF ELECTRICITY, NAMELY, TRANSMISSION OF ELECTRICITY; SERVICES RELATING TO TRANSPORT BY LAND, AIR AND WATER, NAMELY, TRANSPORTATION OF PASSENGERS AND/OR GOODS BY BOAT, RAIL OR TRUCK; SHIPPING OF FREIGHT; FREIGHTING AND RENTING OF SHIPS; UNSHIPMENT OF FREIGHT; TRANSFER OF OIL THROUGH PIPELINES; TRANSMISSION OF OIL OR GAS THROUGH PIPELINES; DISTRIBUTION OF ENERGY (U.S. CLS. 100 AND 105).

CLASS 40—MATERIAL TREATMENT

FOR PRODUCTION OF ELECTRICITY; PRODUCTION OF ENERGY; MUNICIPAL WASTE PROCESSING, NAMELY, DECONTAMINATION OF WASTE; INCINERATION OF WASTE (U.S. CLS. 100, 103 AND 106).

CLASS 42—SCIENTIFIC, COMPUTER AND LEGAL SERVICES

FOR EXPERT SERVICES AND CONSULTING IN THE ELECTRICAL FIELD, IN PRODUCT DEVELOPMENT, AND IN SURVEYS OF OIL BEDS; OIL PROSPECTING; TEST, CONTROL, AND ANALYSIS OF OIL WELLS; GEOLOGICAL ESTIMATION, GEOLOGICAL PROSPECTING; GEOLOGICAL SURVEYS; DESIGN AND CONSULTING SERVICES RELATING TO THE PRODUCTION, TRANSMISSION, AND DISTRIBUTION OF ENERGY; CONSULTATIONS IN THE FIELD OF INFORMATION AND DATA SYSTEM SERVICES; TESTING SERVICES RELATING TO PRODUCTION, TRANSMISSION, AND DISTRIBUTION OF ENERGY FOR THE PURPOSES OF CERTIFICATION; ENVIRONMENTAL PROTECTION SERVICES RELATING TO INDUSTRY, NAMELY, REVIEWING STANDARDS AND PRACTICES TO ASSURE COMPLIANCE WITH ENVIRONMENTAL LAWS; MUNICIPAL WASTE MANAGEMENT (U.S. CLS. 100 AND 101).

SN 75-731,756. DOCTORS' PREFERRED, INC., POTOMAC, MD. FILED 6-18-1999.

ELLEMENTS**CLASS 5—PHARMACEUTICALS**

FOR FULL LINE OF NUTRITIONAL SUPPLEMENTS, VITAMINS, MINERALS, HERBS, MULTIVITAMINS AND MEAL REPLACEMENT POWDERS FOR WOMEN (U.S. CLS. 6, 18, 44, 46, 51 AND 52).

CLASS 30—STAPLE FOODS

FOR FULL LINE OF GRAIN BASED READY TO EAT FOOD BARS CONTAINING CALCIUM FOR WOMEN (U.S. CL. 46).

SN 75-734,586. RETHINK, INC., NEWTOWN, CT. FILED 6-23-1999.

RETHINK**CLASS 35—ADVERTISING AND BUSINESS**

FOR BUSINESS CONSULTING SERVICES FOR IMPROVING PERSON-TO-PERSON RELATIONSHIP FOR EMPLOYEE DEVELOPMENT, IMPROVING CUSTOMER RELATIONS AND IMPROVING EMPLOYEE PRODUCTIVITY (U.S. CLS. 100, 101 AND 102).
FIRST USE 8-1-1992; IN COMMERCE 8-1-1992.

CLASS 41—EDUCATION AND ENTERTAINMENT

FOR CONDUCTING EDUCATIONAL SERVICES, NAMELY, SEMINARS AND WORKSHOPS FOR IMPROVING PERSON-TO-PERSON RELATIONSHIP FOR INCREASING PERSONAL AND TEAM PRODUCTIVITY, CREATIVITY AND FOR BUILDING CUSTOMER RELATIONSHIPS (U.S. CLS. 100, 101 AND 107).
FIRST USE 8-1-1992; IN COMMERCE 8-1-1992.

SN 75-757,391. BRITISH BROADCASTING CORPORATION, THE, LONDON W1A 1AA, ENGLAND, FILED 7-22-1999.

ANTIQUES ROADSHOW

OWNER OF UNITED KINGDOM REG. NO. 1343409, DATED 5-4-1988, EXPIRES 5-4-2005.
SEC. 2(F).

CLASS 36—INSURANCE AND FINANCIAL

FOR APPRAISAL OF ANTIQUES AND OTHER ITEMS OF PERSONAL PROPERTY (U.S. CLS. 100, 101 AND 102).
FIRST USE 0-0-1976; IN COMMERCE 6-15-1996.

CLASS 41—EDUCATION AND ENTERTAINMENT

FOR ENTERTAINMENT IN THE NATURE OF ONGOING EDUCATIONAL TELEVISION PROGRAMS IN THE FIELD OF ANTIQUES; PROVIDING ENTERTAINMENT INFORMATION PERTAINING TO APPRAISING AND AUTHENTICATING ANTIQUES BY MEANS OF THE GLOBAL COMPUTER NETWORK; ENTERTAINMENT, NAMELY, PRODUCTION OF TELEVISION SHOWS PERTAINING TO ANTIQUES; VIDEOTAPE PRODUCTION; EDUCATIONAL SERVICES, NAMELY, CONDUCTING COURSES, CLASSES, WORKSHOPS AND SEMINARS FEATURING DATING AND AUTHENTICATION OF ANTIQUES; CONDUCTING ENTERTAINMENT EXHIBITIONS IN THE NATURE OF ANTIQUES SHOWS (U.S. CLS. 100, 101 AND 107).
FIRST USE 0-0-1976; IN COMMERCE 10-1-1990.

SN 75-771,171. TOTAL VISION, INC., DBA OPTICA, CHICAGO, IL. FILED 8-9-1999.

OPTICA

OWNER OF U.S. REG. NO. 1,561,827.
THE ENGLISH TRANSLATION OF "OPTICA" IS OPTICS OR "OPTICIAN'S".
SEC. 2(F).

CLASS 3—COSMETICS AND CLEANING PREPARATIONS

FOR EYEGLASS LENS CLEANER (U.S. CLS. 1, 4, 6, 50, 51 AND 52).
FIRST USE 10-15-1982; IN COMMERCE 10-15-1982.

CLASS 9—ELECTRICAL AND SCIENTIFIC APPARATUS

FOR EYEWEAR AND ASSOCIATED GOODS, NAMELY, EYEGLASS FRAMES, EYEGLASS LENSES, SPECTACLE CARRYING CASES AND POUCHES, CONTACT LENSES, EYEGLASS LENS CLEANER CLOTHS, AND CHAINS FOR EYEGLASS FRAMES (U.S. CLS. 21, 23, 26, 36 AND 38).
FIRST USE 10-15-1982; IN COMMERCE 10-15-1982.

CLASS 35—ADVERTISING AND BUSINESS

FOR RETAIL OPTICAL STORE (U.S. CLS. 100, 101 AND 102).
FIRST USE 10-15-1982; IN COMMERCE 10-15-1982.

CLASS 42—SCIENTIFIC, COMPUTER AND LEGAL SERVICES

FOR RETAIL OPTICAL STORE, OPTOMETRY AND OPTICIANS SERVICES (U.S. CLS. 100 AND 101).
FIRST USE 10-15-1982; IN COMMERCE 10-15-1982.

SN 75-782,404. NOURICHE NUTRITION LTD., LAKE ST. LOUIS, MO. FILED 10-30-1999.

Solutions

CLASS 5—PHARMACEUTICALS

FOR NUTRITIONAL PRODUCTS FOR LIVESTOCK, NAMELY, VITAMINS, MINERALS, VITAMIN-MINERAL PREMIXES, ELECTROLYTES AND AMINO ACIDS; FEED SUPPLEMENTS, NAMELY FATS, STARCHES AND MILK REPLACERS (U.S. CLS. 6, 18, 44, 46, 51 AND 52).
FIRST USE 10-13-1999; IN COMMERCE 10-13-1999.

CLASS 31—NATURAL AGRICULTURAL PRODUCTS

FOR NON-MEDICATED DRY FAT FEED ADDITIVE FOR CALVES; ANIMAL FEED (U.S. CLS. 1 AND 46).
FIRST USE 7-6-1999; IN COMMERCE 7-6-1999.

SN 75-782,522. BIA SEPARATIONS D.O.O., SL-1000 LJUBLJANA, SLOVENIA, FILED 8-24-1999.

CIM

PRIORITY CLAIMED UNDER SEC. 44(D) ON SLOVENIA APPLICATION NO. Z-9970246, FILED 2-24-1999, REG. NO. 9970246, DATED 12-15-1999, EXPIRES 2-24-2009.

CLASS 1—CHEMICALS

FOR CHEMICALS FOR USE IN THE MANUFACTURE OF CHROMATOGRAPHIC DEVICES; AND POLYMERS AND MONOMERS FOR USE IN THE PHARMACEUTICAL, BIOTECHNOLOGY, CHEMICAL AND MEDICAL INDUSTRIES; CHEMICALS, NAMELY, RIGID POROUS POLYMER OF MONOLITHIC STRUCTURE FOR THE SEPARATION AND PURIFICATION OF MIXTURES FOR THE SEPARATION AND PURIFICATION OF MIXTURES, ISOLATION OF SUBSTANCES, CHROMATOGRAPHIC MATERIALS, ARTIFICIAL POROUS RESINS FOR CHROMATOGRAPHIC PURPOSES FOR USE IN THE PHARMACEUTICAL AND BIOTECHNOLOGY INDUSTRIES (U.S. CLS. 1, 5, 6, 10, 26 AND 46).

CLASS 9—ELECTRICAL AND SCIENTIFIC APPARATUS

FOR LIQUID CHROMATOGRAPHY APPARATUS, NAMELY, MONOLITHIC DEVICES FOR SAMPLES TO BE ANALYZED AND PURIFIED; SCIENTIFIC APPARATUS, NAMELY, INSTRUMENTS FOR THE SEPARATION AND PURIFICATION OF MIXTURES, ISOLATION OF SUBSTANCES; COMPACT POROUS DISCS AND TUBES OF ARTIFICIAL POROUS RESINS IN COLUMNS AND CARTRIDGES FOR THE SEPARATION AND PURIFICATION OF MIXTURES, ISOLATION OF SUBSTANCES; KITS CONTAINING CHEMICALS, NAMELY MONOLITHIC DEVICES FOR THE SEPARATION AND PURIFICATION OF MIXTURES, ISOLATION OF SUBSTANCES, CHROMATOGRAPHIC MATERIALS, ARTIFICIAL POROUS RESINS FOR CHROMATOGRAPHIC PURPOSES, COMPACT POROUS DISCS AND TUBES OF ARTIFICIAL POROUS RESINS IN COLUMNS CARTRIDGES FOR THE SEPARATION AND PURIFICATION OF MIXTURES, ISOLATION OF SUBSTANCES FOR USE IN THE PHARMACEUTICAL, BIOTECHNOLOGY, AND MEDICINAL INDUSTRIES (U.S. CLS. 21, 23, 26, 36 AND 38).

CLASS 11—ENVIRONMENTAL CONTROL APPARATUS

FOR CHROMATOGRAPHY APPARATUS FOR INDUSTRIAL USE (U.S. CLS. 13, 21, 23, 31 AND 34).

SN 75-783,484. HIGHLAND GROUP CORPORATION, SOLON, OH. FILED 8-24-1999.

HIGHLAND THE PRO'S BRAND

NO CLAIM IS MADE TO THE EXCLUSIVE RIGHT TO USE "BRAND", APART FROM THE MARK AS SHOWN.

CLASS 6—METAL GOODS

FOR METAL TIE DOWN HARDWARE, NAMELY, BUCKLES, HOOKS, AND RATCHETS; METAL TOW HOOKS; METAL VEHICLE ANCHOR POINTS, NAMELY, EYEBOLTS, HOOKS, AND CLEATS (U.S. CLS. 2, 12, 13, 14, 23, 25 AND 50).

CLASS 12—VEHICLES

FOR TRUCK GRAB HANDLES; LOADING RAMP FOR VEHICLES; VEHICLE ACCESSORIES FOR CARRYING AND SECURING CARGO, NAMELY, CARGO BARS, LOAD BARS, CLAMHELL CARGO BARRIERS, VEHICLE ROOF BARS, BASKET CARRIERS, AND BICYCLE CARRIER (U.S. CLS. 19, 21, 23, 31, 35 AND 44).

CLASS 22—CORDAGE AND FIBERS

FOR TWO STRAPS; TWO ROPES; WINCH STRAPS; CARGO NETS; TRUCKBED NETS; TARP COVERS; SOFT ROOF-TOP CARGO CARRIERS; STRETCH CORDS; WEBBED CARGO SECUREMENTS, NAMELY, TIE DOWNS LASHING STRAPS, LUGGAGE STRAPS (U.S. CLS. 1, 2, 7, 19, 22, 42 AND 50).

SN 75-787,015. AVENUE, INC., THE, WILMINGTON, DE. FILED 8-27-1999.

AVENUE

OWNER OF U.S. REG. NOS. 2,065,819, 2,251,168 AND OTHERS.

CLASS 19—NON-METALLIC BUILDING MATERIALS

FOR NON-METALLIC FLOOR TILES; NON METALLIC WALL TILES; TILES OF CLAY, GLASS, GYPSUM, CERAMIC, OR EARTHENWARE; STONES; STONE BUSTS; STONE FIGURINES; STONE SCULPTURES AND STONES STATUES (U.S. CLS. 1, 12, 33 AND 50).

CLASS 21—HOUSEWARES AND GLASS

FOR CRYSTAL BUSTS; CRYSTAL FIGURINES; CRYSTAL ORNAMENTS; CRYSTAL SCULPTURES AND CRYSTAL STATUES (U.S. CLS. 2, 13, 23, 29, 30, 33, 40 AND 50).

SN 75-787,348. SANGER, ROGER, MONTEREY, CA. AND SANGER, KATHY, MONTEREY, CA. FILED 8-30-1999.

CALIFORNIA



**SIDE BY SIDE
SOCIETY**

NO CLAIM IS MADE TO THE EXCLUSIVE RIGHT TO USE "CALIFORNIA" AND "SIDE BY SIDE SOCIETY", APART FROM THE MARK AS SHOWN.

THE MARK CONSISTS OF THE WORDS "CALIFORNIA SIDE BY SIDE SOCIETY" WITH A GRAPHIC ILLUSTRATING THE LETTER "S" INSIDE BOTH BARRELS OF A DOUBLE-BARRELED SHOTGUN SHOWN AS IF THE SHOTGUN WERE POINTED DIRECTLY AT THE READER.

CLASS 35—ADVERTISING AND BUSINESS

FOR PROMOTING SPORTS COMPETITIONS AND/OR EVENTS OF OTHERS, NAMELY, HUNTING EVENTS, SHOOTING EVENTS, FIREARMS DISPLAYS, GUN-MAKER DISPLAYS DEDICATED TO THE COLLECTION, PRESERVATION, HERITAGE AND ENJOYMENT OF SHOTGUNS, RIFLES AND FIREARMS (U.S. CLS. 100, 101 AND 102).

FIRST USE 12-1-1995; IN COMMERCE 12-1-1995.

CLASS 42—SCIENTIFIC, COMPUTER AND LEGAL SERVICES

FOR ASSOCIATION SERVICES, NAMELY, PROMOTING THE INTERESTS OF PERSONS DEDICATED TO THE COLLECTION, PRESERVATION, HERITAGE AND ENJOYMENT OF SHOTGUNS, RIFLES AND FIREARMS (U.S. CLS. 100 AND 101).

FIRST USE 12-1-1995; IN COMMERCE 12-1-1995.

SN 75-790,673. MCATASNEY, LIAM ANTHONY, DBA WEST COAST IRISH PROMOTIONS/IRISH PROMOTIONS, SAN FRANCISCO, CA. FILED 9-2-1999.

**BRAINSTORMER
PUB QUIZ**



NO CLAIM IS MADE TO THE EXCLUSIVE RIGHT TO USE "PUB QUIZ", APART FROM THE MARK AS SHOWN.

CLASS 28—TOYS AND SPORTING GOODS

FOR GAME FOR PLAYING IN BARS AND CLUBS AND FOR LARGE GROUP ENTERTAINMENT, NAMELY, TRIVIA QUIZ PACKAGE CONSISTING OF GAME INSTRUCTIONS, TRIVIA QUIZ QUESTIONS AND ANSWERS, BLANK ANSWER FORMS, SCORECARD, SUMMARY SHEET OF TOPICS COVERED IN QUIZ, AND POSTERS/FLYERS FOR ADVERTISING QUIZ VENUE, DATA AND TIME ALL SOLD AS A UNIT (U.S. CLS. 22, 23, 38 AND 50).

FIRST USE 6-27-1996; IN COMMERCE 10-23-1997.

CLASS 41—EDUCATION AND ENTERTAINMENT

FOR ENTERTAINMENT IN THE NATURE OF A TRIVIA QUIZ GAME CONTEST (U.S. CLS. 100, 101 AND 107).

FIRST USE 6-27-1996; IN COMMERCE 10-30-1997.

SN 75-794,832. PHYSICAL ENTERPRISES INC., VANCOUVER, BRITISH COLUMBIA V6S 1G4, CANADA, FILED 9-9-1999.

MIOSENSOR

PRIORITY CLAIMED UNDER SEC. 44(D) ON CANADA APPLICATION NO. 1,008,276, FILED 3-10-1999, REG. NO. TMA552454, DATED 10-16-2001, EXPIRES 10-16-2016.

CLASS 10—MEDICAL APPARATUS

FOR HEART RATE MONITORS AND SENSORS (U.S. CLS. 26, 39 AND 44).

CLASS 14—JEWELRY

FOR SPORTS WATCHES (U.S. CLS. 2, 27, 28 AND 50).

SN 75-816,981. CELESTICA INC., NORTH YORK, ONTARIO M3C 1V7, CANADA, FILED 10-7-1999.

SUPPLYFLEX

PRIORITY CLAIMED UNDER SEC. 44(D) ON CANADA APPLICATION NO. 1,012,580, FILED 4-20-1999, REG. NO. TMA540168, DATED 1-24-2001, EXPIRES 1-24-2016.

SN 75-814,178. JAENEUNG EDUCATION CO., LTD., SEOUL, 110-0178, REPUBLIC OF KOREA, FILED 10-4-1999.

JEI**CLASS 16—PAPER GOODS AND PRINTED MATTER**

FOR BOOKS, NAMELY, ADDRESS BOOKS, CHILDREN'S ACTIVITY BOOKS, CHILDREN'S BOOKS, COLORING BOOKS, DRAWING BOOKS, CHILDREN'S EDUCATIONAL BOOKS ABOUT MATHEMATICS, ENGLISH, AND CHINESE CHARACTER, CHILDREN'S PICTURE BOOKS, SKETCH BOOKS, TEXTBOOKS IN THE FIELDS OF EDUCATIONAL TUTORIALS AND PRIMARY EDUCATION, AND WORKBOOKS IN THE FIELDS OF EDUCATIONAL TUTORIALS AND PRIMARY EDUCATION; CARDS, NAMELY POSTCARDS, FLASH CARDS, GIFT CARDS, AND GREETING CARDS; CATALOGS FOR RETAIL SALES MERCHANDISE; PRINTED FORMS IN THE FIELD OF EDUCATIONAL TUTORIAL SERVICES AND PRIMARY EDUCATIONAL SERVICES; MAGAZINES IN THE FIELD OF EDUCATIONAL SERVICES, PAMPHLETS IN THE SUBJECTS OF EDUCATIONAL TUTORIAL SERVICES AND PRIMARY EDUCATIONAL SERVICES; PRINTED TEACHING MATERIALS FOR USE IN PRIMARY EDUCATIONAL AND EDUCATIONAL TUTORIAL SERVICES; WRITING MATERIALS, NAMELY, WRITING TABLETS AND NOTE-PADS; PENCILS; PENS; ERASERS; STATIONERY; CALENDARS; PENCIL CASES; ADHESIVE TAPE DISPENSERS FOR STATIONERY USE; STICKERS; FOLDERS; AND DIARIES (U.S. CLS. 2, 5, 22, 23, 29, 38 AND 50).

FIRST USE 7-31-1992; IN COMMERCE 3-31-1993.

CLASS 35—ADVERTISING AND BUSINESS

FOR FRANCHISING, NAMELY, OFFERING TECHNICAL ASSISTANCE IN THE ESTABLISHMENT AND/OR OPERATION OF EDUCATIONAL INSTRUCTION IN THE FIELDS OF TUTORIAL SERVICES AND/OR PRIMARY EDUCATIONAL SERVICES (U.S. CLS. 100, 101 AND 102).

FIRST USE 7-31-1992; IN COMMERCE 3-31-1993.

CLASS 41—EDUCATION AND ENTERTAINMENT

FOR TEACHING AND EDUCATIONAL SERVICES, NAMELY, TUTORIAL LESSONS IN THE FIELDS OF ENGLISH, OF MATHEMATICS, OF THE KOREAN LANGUAGE, OF HANJA-CHINESE CHARACTERS, AND OF CREATIVE THINKING; PROVIDING INFORMATION IN THE FIELD OF TUTORIAL AND PRIMARY EDUCATION AND DISTRIBUTING COURSE MATERIAL IN CONNECTION THEREWITH; EDUCATIONAL TESTING; EDUCATIONAL SERVICES, NAMELY, CONDUCTING CLASSES, SEMINARS AND WORKSHOPS IN THE FIELD OF TUTORIAL INSTRUCTION SERVICES; ARRANGING AND CONDUCTING OF EDUCATIONAL COMPETITIONS; PUBLICATION OF TEXTBOOKS AND WORKBOOKS (U.S. CLS. 100, 101 AND 107).

FIRST USE 7-31-1992; IN COMMERCE 3-31-1993.

CLASS 35—ADVERTISING AND BUSINESS

FOR PROCUREMENT, NAMELY PURCHASING ELECTRONICS AND PARTS THEREFOR FOR ORIGINAL EQUIPMENT MANUFACTURERS; INVENTORY CONTROL OF ELECTRONICS AND OF PARTS THEREFOR FOR ORIGINAL EQUIPMENT MANUFACTURERS; WHOLESALE DISTRIBUTORSHIPS FEATURING EXCESS, OBSOLETE AND END-OF-LIFE ELECTRONICS AND PARTS THEREFOR TO OTHERS ON BEHALF OF ORIGINAL EQUIPMENT MANUFACTURERS; LOGISTICS MANAGEMENT IN THE FIELD OF INTEGRATED MANUFACTURE AND DELIVERY OF ELECTRONICS AND PARTS THEREFOR FROM ONE OR MORE MANUFACTURING LOCATIONS, WHEREBY THE MANUFACTURE AND DELIVERY ARE DIRECTED, SPECIFIED OR ORDERED BY ORIGINAL EQUIPMENT MANUFACTURERS AND THE LOCATION, TIMING AND VOLUME OF SUCH MANUFACTURING AND DELIVERY ARE INTEGRATED WITH ORDER SCHEDULING OR FORECAST SCHEDULING OF THE ORIGINAL EQUIPMENT MANUFACTURERS AND WITH THE SCHEDULED CAPACITY OF THE MANUFACTURING LOCATIONS; BUSINESS MANAGEMENT CONSULTING SERVICES IN RELATION TO THE ABOVE; AGENCY REPRESENTATION FOR ORIGINAL EQUIPMENT MANUFACTURERS TO PROCURE, MANAGE INVENTORY CONTROL, MANAGE RETURNS OF EXCESS, OBSOLETE AND END-OF-LIFE ELECTRONICS AND PARTS THEREFOR TO SUPPLIERS OF SAME, AND FOR MANUFACTURING LOGISTICS (U.S. CLS. 100, 101 AND 102).

FIRST USE 4-20-1999; IN COMMERCE 4-20-1999.

CLASS 39—TRANSPORTATION AND STORAGE

FOR WAREHOUSING OF ELECTRONICS AND PARTS THEREFOR FOR ORIGINAL EQUIPMENT MANUFACTURERS (U.S. CLS. 100 AND 105).

SN 75-817,374. JOSTRA MEDIZINTECHNIK AG, D-72145 HIRRLINGEN, FED REP GERMANY, FILED 10-7-1999.

JOSTRA

PRIORITY CLAIMED UNDER SEC. 44(D) ON FED REP GERMANY APPLICATION NO. 39927978.4/1, FILED 5-14-1999, REG. NO. 39927978.4, DATED 5-14-1999, EXPIRES 5-31-2009.

CLASS 9—ELECTRICAL AND SCIENTIFIC APPARATUS

FOR COMPUTER HARDWARE FOR DATA PROCESSING AND COMPUTER SOFTWARE TO AUTOMATE DATA COLLECTING DURING SURGERY (U.S. CLS. 21, 23, 26, 36 AND 38).

CLASS 10—MEDICAL APPARATUS

FOR HEART LUNG MACHINES, HYPERTHERMIC AND HYPOTHERMIC APPARATUS FOR RAISING AND LOWERING THE TEMPERATURE OF THE PATIENT'S BODY DURING SURGERY; OXYGENATORS, CONTAINERS FOR LIQUID AND GASES FOR MEDICAL PURPOSES; BLOOD PUMPS; BLOOD FILTERS; HEAT EXCHANGERS FOR MEDICAL PURPOSES; CATHETERS; INJECTION TUBES FOR MEDICAL PURPOSES; CUSTOM TUBING PACKS AND VALVES FOR MEDICAL APPARATUS; MEDICAL BLOOD AND GAS PRESSURE INDICATORS; ANULOPLASTIC PROSTHESES; MAMMARIA RETRACTORS, BIO-COMPATIBLE COATED SURGICAL IMPLANTS COMPRISED OF ARTIFICIAL MATERIAL AND BIO-COMPATIBLE COATED SURGERY APPARATUS, NAMELY, OXYGENATORS, RESERVOIRS, FILTERS, CUSTOM TUBING PACKS, CATHETERS, CANNULAE, CONNECTORS, BLOOD BAGS, HEAT EXCHANGERS, CENTRIFUGAL PUMPS; HEART-VALVE AND VASCULAR PROSTHESIS, CARDIOPLEGIA SYSTEMS, SUPPORTING LINES FOR CUSTOM TUBING SETS (U.S. CLS. 26, 39 AND 44).

SN 75-818,698. ADVANTAGE EQUITY SERVICES, INC., PITTSBURGH, PA. FILED 10-8-1999.



NO CLAIM IS MADE TO THE EXCLUSIVE RIGHT TO USE "EQUITY SERVICES", APART FROM THE MARK AS SHOWN.

THE LINING IS FOR SHADING PURPOSES ONLY AND DOES NOT INDICATE COLOR.

CLASS 36—INSURANCE AND FINANCIAL

FOR REAL ESTATE TITLE INSURANCE SERVICES (U.S. CLS. 100, 101 AND 102).
FIRST USE 0-0-1996; IN COMMERCE 0-0-1996.

CLASS 42—SCIENTIFIC, COMPUTER AND LEGAL SERVICES

FOR REAL ESTATE CLOSING SERVICES (U.S. CLS. 100 AND 101).
FIRST USE 0-0-1996; IN COMMERCE 0-0-1996.

SN 75-821,770. ADVANTAGE RENT-A-CAR, INC., SAN ANTONIO, TX. FILED 10-13-1999.

EASY CASH CLUB**CLASS 35—ADVERTISING AND BUSINESS**

FOR PROVIDING AN INCENTIVE COMMISSION PROGRAM FOR TRAVEL AGENTS WITH RESPECT TO LEASING AND RENTAL OF AUTOMOBILES (U.S. CLS. 100, 101 AND 102).
FIRST USE 5-16-1999; IN COMMERCE 5-16-1999.

CLASS 39—TRANSPORTATION AND STORAGE

FOR AUTOMOBILE RENTAL AND LEASING RESERVATION SERVICES (U.S. CLS. 100 AND 105).
FIRST USE 5-16-1999; IN COMMERCE 5-16-1999.

SN 75-825,113. ICARAMBA.COM, INC., NEW YORK, NY. FILED 11-5-1999.

ICARAMBA.COM**CLASS 38—COMMUNICATION**

FOR ELECTRONIC TRANSMISSION OF A WIDE VARIETY OF MULTIMEDIA DATA FOR THE LATIN COMMUNITY ON A GLOBAL COMPUTER NETWORK; REAL TIME CHAT ROOMS FOR TRANSMISSION OF MESSAGES AMONG COMPUTER USERS CONCERNING ISSUES THAT AFFECT THE LATIN COMMUNITY; AND ELECTRONIC MAIL SERVICES (U.S. CLS. 100, 101 AND 104).

CLASS 42—SCIENTIFIC, COMPUTER AND LEGAL SERVICES

FOR COMPUTER SERVICES, NAMELY, PROVIDING SEARCH ENGINES FOR OBTAINING DATA ON A GLOBAL COMPUTER NETWORK; PROVIDING ACCESS TO DATA RELEVANT TO THE LATIN COMMUNITY (U.S. CLS. 100 AND 101).

SN 75-826,185. ESPACE PRODUCTION INTERNATIONALE AYANT POUR SIGLE "EPI", 67520 MARLENHEIM, FRANCE, FILED 10-18-1999.



NO CLAIM IS MADE TO THE EXCLUSIVE RIGHT TO USE "FLOOR", APART FROM THE MARK AS SHOWN.

CLASS 19—NON-METALLIC BUILDING MATERIALS

FOR NON-METAL FLOORING, NAMELY, PARQUET FLOORING AND PARQUET FLOOR BOARDS (U.S. CLS. 1, 12, 33 AND 50).

CLASS 27—FLOOR COVERINGS

FOR MELAMINE FLOOR COVERING (U.S. CLS. 19, 20, 37, 42 AND 50).

SN 75-827,093. G.F. - S.R.L., VIA DELL'INDUSTRIA, 1, ITALY, FILED 10-20-1999.



PRIORITY CLAIMED UNDER SEC. 44(D) ON ITALY APPLICATION NO. RE99C000096, FILED 4-27-1999, REG. NO. 790213, DATED 9-20-1999, EXPIRES 4-27-2009.

OWNER OF ITALY REG. NO. 451.864, DATED 10-13-1986, RENEWED AS REG. NO. 711165, DATED 6-6-1997, EXPIRES 6-6-2017.

CLASS 7—MACHINERY

FOR MOTOR DRIVEN SAWS, NAMELY, CHAIN SAWS; POWER OPERATED DRILLS, HEDGE TRIMMERS, AND GRASS CUTTERS; JET WASHERS, NAMELY, HIGH PRESSURE CLEANERS TO WASH CARS, PATIOS, EXTERNAL FLOORS AND WALLS; HYDRAULICALLY-OPERATED BOTTLE-WASHERS AND GLASS WASHERS; HYDRAULICALLY-OPERATED ROTARY BRUSHES FOR VEHICLES WASHING; AND PARTS THEREFOR; PRESSURIZED WATER ENERGY MACHINE TOOLS, NAMELY, HIGH PRESSURE NOZZLES, PUMPS, HOSES AND LANCES, ALL SOLD AS A UNIT, FOR CLEANING SURFACES; FOR INDUSTRIAL AND COMMERCIAL USE (U.S. CLS. 13, 19, 21, 23, 31, 34 AND 35).

CLASS 9—ELECTRICAL AND SCIENTIFIC APPARATUS

FOR ELECTRONIC IRRIGATION PROGRAMMERS; LENSES AND REFLECTORS FOR OPTICAL INSTRUMENTS, AND PARTS THEREFOR (U.S. CLS. 21, 23, 26, 36 AND 38).

CLASS 11—ENVIRONMENTAL CONTROL APPARATUS

FOR GARDEN RAINERS, NAMELY, OUTDOOR SHOWERS FOR PERSONAL USE; AUTOMATIC WATER DISPENSING AND DISPENSING SYSTEMS FOR AGRICULTURAL USE, CONSISTING PRIMARILY OF COOLING WATER DISPENSER AND FEEDERS FOR WATER POTS, SPRAYERS, EMITTERS AND NOZZLES, PLUMBING FITTINGS, NAMELY, COCKS FOR WATER PIPES; PRESSURE REGULATORS AND REDUCERS; PLUMBING FITTINGS, NAMELY, COCKS FOR WATER PIPES; WATER PURIFICATION FILTERS; FLOW REGULATORS AND THROUGHPUT REGULATORS; AND PARTS THEREFOR (U.S. CLS. 13, 21, 23, 31 AND 34).

CLASS 17—RUBBER GOODS

FOR NON-METAL PRESSURE SEAL GASKETS FOR HIGH PRESSURE VALVES, NON-METAL FLAT MULTI-CHANNEL SPRAY PIPES WITH MICRO PERFORATIONS HOSE EXTENSIONS; NON-METAL COUPLING FOR USE WITH GARDEN HOSES; GARDEN HOSES AND NON-METAL HOSE CONNECTORS AND NON-METAL JOINTS FOR PIPES, ALL THE AFORESAID GOODS BEING FOR USE FOR IRRIGATION PURPOSES IN GARDENING, FLORICULTURE AND HORTICULTURE (U.S. CLS. 1, 5, 12, 13, 35 AND 50).

CLASS 20—FURNITURE AND ARTICLES NOT OTHERWISE CLASSIFIED

FOR NON-METAL VALVES FOR WATER PIPES, ALL THE AFORESAID GOODS BEING FOR USE FOR IRRIGATION PURPOSES IN GARDENING, FLORICULTURE AND HORTICULTURE; HAND OPERATED PLASTIC REELS FOR HOSES, AND PARTS THEREFOR; NON-METAL PANELS, CROOKS, NAMELY, HOOKS AND BRACKETS FOR USING IN SUPPORTING GARDEN SPRINKLERS, SPRAYERS, EMITTERS, NOZZLES, PLUMBING FITTINGS, PRESSURE REGULATORS AND REDUCERS, FLOW REGULATORS AND THROUGHPUT REGULATORS, NON-METAL PRESSURE SEAL GASKETS FOR HIGH PRESSURE VALVES, NON-METAL FLAT MULTI CHANNEL SPRAY PIPES WITH MICRO PERFORATIONS HOSE EXTENSIONS, AND NON-METAL COUPLING FOR USE WITH GARDEN HOSES; GARDEN HOSES AND NON-METAL HOSE CONNECTORS AND NON-METAL JOINTS FOR PIPES; COCKS FOR WATER PIPES, WATER PURIFICATION FILTERS, GUNS FOR IRRIGATION AND CLEANING, BRUSHES USED TO CLEAN CARS AND SURFACES, AND BLISTERED PRODUCTS; DISPLAY DEVICES, NAMELY, DISPLAY STANDS, DISPLAY RACK AND METAL STRUCTURE TO DISPLAY BLISTERED PRODUCTS; NON-METAL RODS AND FERRULES, NAMELY, SPIKE AND SUPPORT USED TO SUPPORT IRRIGATION PIPES (U.S. CLS. 2, 13, 22, 25, 32 AND 50).

CLASS 21—HOUSEWARES AND GLASS

FOR LANCES, NAMELY, NOZZLES FOR SPRINKLER HOSES; RAINERS, NAMELY, GARDEN SHOWER HEADS AND GARDEN SHOWER GUNS TO BE CONNECTED TO THE GARDEN HOSES AND USED TO WATER GARDEN; NOZZLES AND GUNS FOR IRRIGATION AND CLEANING; STATIC, ROTARY, SWINGING, DRIPPING, JET, RAIN, SPRAY, FAN AND IMPULSE WATER DISTRIBUTORS, NAMELY, GARDEN SPRINKLERS TO BE CONNECTED TO THE GARDEN HOSES FOR USE IN GARDENING, FLORICULTURE, AND HORTICULTURE; BRUSHES, NAMELY, BRUSHES USED TO CLEAN CARS AND SURFACES; SELF-WATERING CONTAINERS FOR PLANTS WITH STORAGE OF WATER; LIQUID SOAP DISPENSERS FOR WATER DISTRIBUTORS FOR SURFACE AND MOTOR VEHICLE CLEANING; SPRAYERS ATTACHED TO GARDEN HOSES, PULVERIZERS, NAMELY, WATER SPRAYERS USED TO WATER GARDEN; PERFUME ATOMIZERS SOLD EMPTY; AND PARTS THEREFOR; CLEANING SKINS AND CLOTHS (U.S. CLS. 2, 13, 23, 29, 30, 33, 40 AND 50).

SN 75-827,921. CNL GROUP, INC., ORLANDO, FL. FILED 10-21-1999.

CNL

OWNER OF U.S. REG. NOS. 1,478,007, 1,964,157 AND 2,248,890.

CLASS 35—ADVERTISING AND BUSINESS

FOR BUSINESS STRATEGIC PLANNING AND CONSULTING SERVICES; PLANNING AND CONSULTING SERVICES IN THE DEVELOPMENT AND GROWTH OF NEW BUSINESSES, PARTICULARLY TECHNOLOGY AND E-COMMERCE BUSINESSES (U.S. CLS. 100, 101 AND 102).

CLASS 36—INSURANCE AND FINANCIAL

FOR REAL ESTATE INVESTMENT, BROKERAGE, CONSULTING AND MANAGEMENT SERVICES; REAL ESTATE INVESTMENT TRUST SERVICES; MORTGAGE AND COMMERCIAL FINANCING SERVICES; INVESTMENT AND COMMERCIAL BANKING SERVICES; BROKER/DEALER SERVICES IN THE FIELD OF INVESTMENT SECURITIES, FRANCHISE, MORTGAGE, MERGERS AND ACQUISITIONS, REAL ESTATE AND INVESTMENT ADVISORY SERVICES AND FINANCIAL ADVISORY SERVICES (U.S. CLS. 100, 101 AND 102).

CLASS 37—CONSTRUCTION AND REPAIR

FOR REAL ESTATE DEVELOPMENT SERVICES (U.S. CLS. 100, 103 AND 106).

CLASS 41—EDUCATION AND ENTERTAINMENT

FOR EDUCATIONAL SERVICES, NAMELY CLASSES, WORKSHOPS AND SEMINARS IN THE FIELD OF BUSINESS AND PROJECT MANAGEMENT, COMPUTER SOFTWARE AND INFORMATION SYSTEMS, WORD PROCESSING, RESEARCH SKILLS, HUMAN RESOURCES AND PERSONNEL, INSURANCE, FINANCE, MERGERS AND ACQUISITIONS, ORGANIZATIONAL DEVELOPMENT, PUBLIC SPEAKING AND COMMUNICATION, REAL ESTATE AND SALES AND MARKETING (U.S. CLS. 100, 101 AND 107).

SN 75-832,294. MORINAGA & CO., LTD., TOKYO, JAPAN, FILED 10-26-1999.

MORINAGA

OWNER OF JAPAN REG. NO. 2237436, DATED 6-28-1990, EXPIRES 6-28-2010.
OWNER OF JAPAN REG. NO. 2303760, DATED 3-29-1991, EXPIRES 3-29-2011.
OWNER OF JAPAN REG. NO. 2293723, DATED 12-26-1990, EXPIRES 12-26-2010.
OWNER OF U.S. REG. NOS. 686,963, 687,647 AND 1,483,718.

CLASS 30—STAPLE FOODS

FOR TEA, COFFEE, COCOA, CANDY, BAKERY GOODS, FROZEN CONFECTIONS, BREAD, SEASONING, SPICES, FLAVORED ICES (U.S. CL. 46).

CLASS 32—LIGHT BEVERAGES

FOR SOFT DRINKS AND FRUIT JUICE (U.S. CLS. 45, 46 AND 48).

SN 75-833,722. HOSKINS, BETH L., WEST FALLS, NY. FILED 10-28-1999.

BUFFALO SOLDIER FIGHTING FOR THE NEW FRONTIER

CLASS 25—CLOTHING

FOR CLOTHING, NAMELY, T-SHIRTS, SPORT SHIRTS, SWEAT SHIRTS, SWEATERS, AND JACKETS (U.S. CLS. 22 AND 39).

CLASS 35—ADVERTISING AND BUSINESS

FOR PROMOTING BUSINESS, ECONOMIC AND COMMUNITY DEVELOPMENT, AND TOURISM IN THE BUFFALO, NEW YORK AREA THROUGH THE USE OF PRINTED MATERIALS, RADIO AND TELEVISION AND THE WORLD WIDE COMPUTER NETWORK (U.S. CLS. 100, 101 AND 102).

SN 75-837,200. STATIC CONTROL COMPONENTS, INC., SANFORD, NC. FILED 11-1-1999.

STATIC CONTROL

NO CLAIM IS MADE TO THE EXCLUSIVE RIGHT TO USE "STATIC", APART FROM THE MARK AS SHOWN. SEC. 2(F).

CLASS 2—PAINTS

FOR IMAGING SUPPLIES, NAMELY, TONER FOR PHOTOCOPIERS, LASER PRINTERS, FACSIMILE MACHINES AND XEROGRAPHIC DEVICES; TONER IN NEW AND REMANUFACTURED CARTRIDGES FOR USE IN PHOTOCOPIERS, LASER PRINTERS, FACSIMILE MACHINE AND XEROGRAPHIC DEVICES (U.S. CLS. 6, 11 AND 16).
FIRST USE 5-27-1999; IN COMMERCE 5-27-1999.

CLASS 9—ELECTRICAL AND SCIENTIFIC APPARATUS

FOR NEW AND REMANUFACTURED MECHANICAL PARTS, NAMELY, PRIMARY CHARGE ROLLERS, MAGNETIC DEVELOPMENT ROLLERS, WIPER BLADES, DOCTOR BLADES, AND ORGANIC PHOTOCONDUCTIVE DRUMS, ALL SOLD AS COMPONENTS FOR PHOTOCOPIERS, LASER PRINTERS, FACSIMILE MACHINES AND XEROGRAPHIC DEVICES (U.S. CLS. 21, 23, 26, 36 AND 38).
FIRST USE 5-27-1999; IN COMMERCE 5-27-1999.

SN 75-837,257. STATIC CONTROL COMPONENTS, INC., SANFORD, NC. FILED 11-1-1999.

STATIC CONTROL

NO CLAIM IS MADE TO THE EXCLUSIVE RIGHT TO USE "STATIC", APART FROM THE MARK AS SHOWN. SEC. 2(F).

CLASS 35—ADVERTISING AND BUSINESS

FOR MAIL AND TELEPHONE ORDER CATALOG SERVICES FEATURING NEW AND REMANUFACTURED MECHANICAL PARTS, NAMELY, PRIMARY CHARGE ROLLERS, MAGNETIC DEVELOPMENT ROLLERS, WIPER BLADES, DOCTOR BLADES, AND ORGANIC PHOTOCONDUCTIVE DRUMS, ALL SOLD AS COMPONENTS FOR PHOTOCOPIERS, LASER PRINTERS, FACSIMILE MACHINES AND XEROGRAPHIC DEVICES; WHOLESALE DISTRIBUTORSHIP FEATURING NEW AND REMANUFACTURED MECHANICAL PARTS, NAMELY, PRIMARY CHARGE ROLLERS, MAGNETIC DEVELOPMENT ROLLERS, WIPER BLADES, DOCTOR BLADES, AND ORGANIC PHOTOCONDUCTIVE DRUMS, ALL SOLD AS COMPONENTS FOR PHOTOCOPIERS, LASER PRINTERS, FACSIMILE MACHINES AND XEROGRAPHIC DEVICES (U.S. CLS. 100, 101 AND 102).
FIRST USE 1-2-1991; IN COMMERCE 1-2-1991.

CLASS 42—SCIENTIFIC, COMPUTER AND LEGAL SERVICES

FOR PROVIDING TECHNICAL SUPPORT TO REMANUFACTURERS OF TONER CARTRIDGES VIA EMAIL, TELEPHONE, WEB SITE INFORMATION, CATALOG INFORMATION, FAX FLIERS AND IN PERSON (U.S. CLS. 100 AND 101).
FIRST USE 1-2-1991; IN COMMERCE 1-2-1991.

SN 75-841,801. RANPAK CORP., CONCORD TOWNSHIP, OH. FILED 11-5-1999.

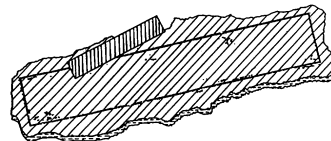

THE MARK IS LINED FOR THE COLORS RED, BROWN AND GREY.

CLASS 7—MACHINERY

FOR MACHINES FOR CONVERTING PAPER OR OTHER SHEET MATERIAL INTO A PACKING MATERIAL, AND PARTS THEREFOR; PACKAGING SYSTEMS COMPRISING A MACHINE FOR CONVERTING PAPER OR OTHER SHEET MATERIAL INTO A PACKING MATERIAL AND A WORK TABLE, PROVIDED AS A UNIT; PACKAGING SYSTEMS COMPRISING A MACHINE FOR CONVERTING PAPER OR OTHER SHEET MATERIAL INTO A PACKING MATERIAL (U.S. CLS. 13, 19, 21, 23, 31, 34 AND 35).

CLASS 16—PAPER GOODS AND PRINTED MATTER

FOR PAPER DESIGNED FOR CONVERSION INTO A PACKING MATERIAL; PACKING MATERIALS MADE OF PAPER, NAMELY, CUSHIONING COMPOSED OF CRUMPLED PAPER; ANIMAL BEDDING MADE OF PAPER; ABSORBENT CRUMPLED PAPER FOR PACKAGING; PAPER STOCK ROLL TAPE (U.S. CLS. 2, 5, 22, 23, 29, 37, 38 AND 50).

CLASS 40—MATERIAL TREATMENT

FOR CUSTOM MANUFACTURING OF MACHINES AND SYSTEMS FOR CONVERTING PAPER OR OTHER SHEET MATERIAL INTO A PACKING MATERIAL, AND PACKAGING SYSTEMS COMPRISING THE AFORESAID MACHINES (U.S. CLS. 100, 103 AND 106).

SN 75-842,351. MOBO HOLDINGS (UK) LIMITED, WINCHMORE HILL, LONDON, N21 3RE, ENGLAND, FILED 11-8-1999.

MOBO

PRIORITY CLAIMED UNDER SEC. 44(D) ON UNITED KINGDOM APPLICATION NO. 2196451, FILED 5-6-1999, REG. NO. 2196451, DATED 2-11-2000, EXPIRES 5-6-2009.

CLASS 9—ELECTRICAL AND SCIENTIFIC APPARATUS

FOR PHONOGRAPH RECORDS, PRE-RECORDED COMPACT DISCS AND PRE-RECORDED AUDIO TAPES, ALL FEATURING MUSIC; BLANK VIDEO TAPES; PRE-RECORDED VIDEO TAPES FEATURING MUSIC AWARDS CEREMONIES, MUSIC, MOTION PICTURES, TELEVISION SHOWS, CARTOONS AND DOCUMENTARIES; MOTION PICTURE FILMS, NAMELY, ACTION MOVIES, ROMANCES, COMEDIES, ROMANTIC COMEDIES, DRAMAS, THRILLERS AND HORROR MOVIES; MUSICAL SOUND RECORDINGS; DVDS FEATURING MUSIC, TELEVISION SHOWS AND MOVIES; COMPUTER GAME PROGRAMS (U.S. CLS. 21, 23, 26, 36 AND 38).

CLASS 16—PAPER GOODS AND PRINTED MATTER

FOR PRINTED MATTER AND PRINTED PUBLICATIONS, NAMELY, MAGAZINES REGARDING THE MUSIC INDUSTRY AND MUSIC; BOOKS REGARDING THE MUSIC INDUSTRY AND MUSIC; POSTERS; ART AND PICTORIAL PRINTS; STATIONERY; MERCHANDISE BAGS, PAPER BAGS; WRITING SETS CONSISTING OF WRITING INSTRUMENTS, WRITING PADS, AND PAPER; CALENDARS; POSTCARDS; IRON-ON AND PLASTIC TRANSFERS; PHOTOGRAPH ALBUMS, STAMP ALBUMS; GREETING CARDS; PENS; PENCILS; ERASERS; DRAFTING RULERS, DRAWING RULERS; DIARIES; STICKERS; BINDERS; FOLDERS; BOOKMARKS; UNMOUNTED PHOTOGRAPHS; MOUNTED PHOTOGRAPHS; PAPERWEIGHTS; PEN CASES; SCRAP BOOKS (U.S. CLS. 2, 5, 22, 23, 29, 37, 38 AND 50).

CLASS 25—CLOTHING

FOR ARTICLES OF CLOTHING, NAMELY, T-SHIRTS, TOPS, HALTER NECK TOPS, SWEATSHIRTS, SHIRTS, SWEATERS, CARDIGANS, JACKETS, BODYWARMERS IN THE NATURE OF SLEEVELESS JACKETS, BLOUSES, RAINCOATS, COATS, SHORTS, PANTS, DRESSING GOWNS, BATHROBES, TRACKSUITS, SKIRTS, DRESSES, CULOTTES, SUITS, TUXEDOS, UNDERWEAR, HOSIERY, SOCKS, PANTYHOSE, STOCKINGS, KNICKERS, UNDERPANTS, VESTS, BRAS, BUSTIERS, SLIPS, JEANS, GIRDLES, PAJAMAS, NIGHTSHIRTS, NIGHTDRESSES, NIGHTWEAR, SPORTSWEAR IN THE NATURE OF SWEATPANTS, SWEATSHIRTS, BRA TOPS, CYCLING SHORTS, JOGGING PANTS, LEOTARDS, TENNIS SKIRTS, TENNIS DRESSES, SWIMMING TRUNKS, SWIMSUITS, BIKINIS, SARONGS, WAISTCOATS, TIES, GLOVES; FOOTWEAR; HEADGEAR, NAMELY, HATS, CAPS, AND VISORS; SCARVES; BELTS (U.S. CLS. 22 AND 39).

CLASS 35—ADVERTISING AND BUSINESS

FOR ADVERTISING AGENCY SERVICES; BUSINESS MARKETING CONSULTANCY SERVICES; MARKET RESEARCH; CONDUCTING MARKETING STUDIES; PUBLICITY AGENCY SERVICES; PUBLIC RELATIONS; PROMOTING THE GOODS AND SERVICES OF OTHERS BY ARRANGING FOR SPONSORS TO AFFILIATE THEIR GOODS AND SERVICES WITH SPORTING, CULTURAL, EDUCATIONAL AND ENTERTAINMENT EVENTS; PROVIDING TELEVISION, RADIO AND DIRECT MAIL ADVERTISING FOR OTHERS; BUSINESS MANAGEMENT AND CONSULTATION RELATING TO BROADCASTING AND ADVERTISING; MANAGEMENT OF PERFORMING ARTISTS, ACTORS, ACTRESSES, COMEDIANS, COMEDIENNES, PHOTOGRAPHERS, ANIMATORS, FILM, RADIO AND TELEVISION PRODUCERS AND DIRECTORS, MUSICIANS, PERFORMING ANIMALS (U.S. CLS. 100, 101 AND 102).

CLASS 38—COMMUNICATION

FOR TELEVISION AND RADIO BROADCASTING; CABLE TELEVISION BROADCASTING; SATELLITE TRANSMISSION SERVICES; DIGITAL TELEVISION AND RADIO TRANSMISSION SERVICES; PAY-PER-VIEW TELEVISION TRANSMISSION SERVICES; WEBCASTING SERVICES, NAMELY, REAL-TIME TRANSMISSION OF ENCODED VIDEO OVER A GLOBAL COMPUTER NETWORK (U.S. CLS. 100, 101 AND 104).

CLASS 41—EDUCATION AND ENTERTAINMENT

FOR ENTERTAINMENT IN THE NATURE OF ONGOING RADIO AND TELEVISION PROGRAMS IN THE FIELDS OF NEWS, COMEDY, VARIETY, ROMANCE, HORROR, THRILLERS AND DRAMAS; ENTERTAINMENT, NAMELY, PRODUCTION OF MUSIC AWARD CEREMONIES, MUSICAL CONCERTS, MUSICALS, PLAYS, THEATRICAL PERFORMANCES, TELEVISION PROGRAMS, RADIO PROGRAMS, MOTION PICTURE FILMS AND NIGHT CLUB ENTERTAINMENT; ENTERTAINMENT IN THE NATURE OF AN INFORMATION AND ADVISORY SERVICES REGARDING STAGE, SCREEN, SHOW BUSINESS, TELEVISION, RADIO, MUSIC, POPULAR CULTURE, NIGHTCLUBS, CONCERTS AND AWARD CEREMONIES PROVIDED ON-LINE FROM A COMPUTER DATABASE OR THE GLOBAL COMMUNICATIONS NETWORK; ORGANIZING AWARD CEREMONIES AND MUSIC COMPETITIONS FOR ENTERTAINMENT PURPOSES; RECORDING STUDIOS FOR FILM, VIDEO, TELEVISION AND MUSIC; MUSIC PUBLISHING SERVICES; PUBLICATION OF MAGAZINES AND BOOKS (U.S. CLS. 100, 101 AND 107).

CLASS 42—SCIENTIFIC, COMPUTER AND LEGAL SERVICES

FOR NIGHTCLUBS; RESTAURANTS; BARS; CAFES; CAFETERIAS; PROVIDING FACILITIES FOR AWARD CEREMONIES, EXHIBITIONS AND CONFERENCES; DESIGN AND PRODUCTION OF ARTWORK FOR COMMERCIAL PURPOSES; PORTRAIT AND STILL LIFE PHOTOGRAPHY; TYPESETTING; PRINTING (U.S. CLS. 100 AND 101).

SN 75-850,516. KARGO, LLC, NEW YORK, NY. FILED 12-8-1999.

KARGO**CLASS 9—ELECTRICAL AND SCIENTIFIC APPARATUS**

FOR MOBILE PHONES, MOBILE COMPUTERS, MOBILE DEVICE SOFTWARE, WEB SERVER SOFTWARE, NETWORK MANAGEMENT SOFTWARE, USER INTERFACE GENERATION SOFTWARE, SOFTWARE TO BE USED MAINLY FOR CREATING, DEVELOPING, EDITING, VIEWING, BROWSING, STORAGE RETRIEVAL, CONVERSION AND PUBLISHING OF HYPERTEXT, HYPERMEDIA, MOBILE MEDIA, AND THREE DIMENSIONAL MEDIA FOR GLOBALLY NETWORKED INFORMATION SYSTEMS BOTH WIRED AND WIRELESS (U.S. CLS. 21, 23, 26, 36 AND 38).

SN 75-842,361. ANDERSON, MARK WILSON, SAN DIEGO, CA. FILED 11-8-1999.

CONVICTED**CLASS 9—ELECTRICAL AND SCIENTIFIC APPARATUS**

FOR PRE-RECORDED DISCS AND AUDIO TAPES FEATURING MUSIC, COMEDY AND SPOKEN WORD PERFORMANCES (U.S. CLS. 21, 23, 26, 36 AND 38).

CLASS 38—COMMUNICATION

FOR PROVIDING TELECOMMUNICATIONS CONNECTIONS NAMELY FOR WIRELESS AND WIRELINE VOICE, DATA, AUDIO AND VIDEO DATA TO COMPUTER NETWORKS (U.S. CLS. 100, 101 AND 104).

CLASS 25—CLOTHING

FOR CLOTHING, NAMELY, T-SHIRTS, SWEAT-SHIRTS AND HATS (U.S. CLS. 22 AND 39).

CLASS 42—SCIENTIFIC, COMPUTER AND LEGAL SERVICES

FOR COMPUTER AND WIRELESS CONSULTING MAINLY IN WIRELESS DATA TECHNOLOGIES AND SERVICES, SOFTWARE INSTALLATION, REPAIR, MAINTENANCE, DESIGN, AS WELL AS CUSTOM DESIGN AND DEVELOPMENT OF SOFTWARE FOR OTHERS (U.S. CLS. 100 AND 101).

SN 75-842,781. FTH, INC., FELS POINT, MD. FILED 11-8-1999.

CRABBY DICK'S

SN 75-855,535. COMPUTERIST, INC., WEST ORANGE, NJ. FILED 12-11-1999.

CLASS 25—CLOTHING

FOR CLOTHING, NAMELY, T-SHIRTS, SWEAT-SHIRTS, SHORTS AND HEADWEAR (U.S. CLS. 22 AND 39).

FIRST USE 11-0-1988; IN COMMERCE 11-0-1988.

**CLASS 29—MEATS AND PROCESSED FOODS**

FOR JAMS, JELLIES, FRUIT SAUCES, FRUIT SALSAS, PROCESSED EDIBLE NUTS, AND PROCESSED EDIBLE SEEDS (U.S. CL. 46).

FIRST USE 11-0-1998; IN COMMERCE 11-0-1998.

CLASS 35—ADVERTISING AND BUSINESS

FOR RETAIL SERVICES FEATURING COMPUTER HARDWARE (U.S. CLS. 100, 101 AND 102).

FIRST USE 0-0-1992; IN COMMERCE 0-0-1992.

CLASS 30—STAPLE FOODS

FOR COFFEES, CANDIES, HOT SAUCES AND SALSAS (U.S. CL. 46).

FIRST USE 11-0-1998; IN COMMERCE 11-0-1998.

CLASS 40—MATERIAL TREATMENT

FOR ASSEMBLY OF COMPUTER HARDWARE FOR OTHERS (U.S. CLS. 100, 103 AND 106).

FIRST USE 0-0-1992; IN COMMERCE 0-0-1992.

CLASS 35—ADVERTISING AND BUSINESS

FOR RETAIL STORE SERVICES FEATURING OCEAN AND BAY THEMED MERCHANDISE, LOCALLY PRODUCED FOOD PRODUCTS, CLOTHING, SOUVENIRS, AND NOVELTY ITEMS (U.S. CLS. 100, 101 AND 102).

FIRST USE 11-0-1998; IN COMMERCE 11-0-1998.

CLASS 42—SCIENTIFIC, COMPUTER AND LEGAL SERVICES

FOR INSTALLATION AND CONFIGURATION OF COMPUTER SOFTWARE; TECHNICAL SUPPORT SERVICES, NAMELY, TROUBLESHOOTING OF COMPUTER HARDWARE AND SOFTWARE PROBLEMS (U.S. CLS. 100 AND 101).

FIRST USE 0-0-1992; IN COMMERCE 0-0-1992.

CLASS 42—SCIENTIFIC, COMPUTER AND LEGAL SERVICES

FOR RESTAURANT (U.S. CLS. 100 AND 101).
FIRST USE 11-0-1998; IN COMMERCE 11-0-1998.

SN 75-857,368. DJ CONSULTANTS, INC., NORCROSS, GA.
FILED 11-24-1999.



NO CLAIM IS MADE TO THE EXCLUSIVE RIGHT TO USE "STAY ORGANIZED SYSTEM", APART FROM THE MARK AS SHOWN.

CLASS 9—ELECTRICAL AND SCIENTIFIC APPARATUS

FOR SOFTWARE DESIGNED TO EXPORT DATA FROM SCHEDULING AND OTHERS PROGRAMS (U.S. CLS. 21, 23, 26, 36 AND 38).
FIRST USE 7-22-1999; IN COMMERCE 7-22-1999.

CLASS 18—LEATHER GOODS

FOR LEATHER AND IMITATION LEATHER BINDERS (U.S. CLS. 1, 2, 3, 22 AND 41).
FIRST USE 7-22-1999; IN COMMERCE 7-22-1999.

SN 75-858,781. CYBERALUMNI NETWORKING CORP., VICTORIA, BC, CANADA, FILED 11-29-1999.

CYBERALUMNI

PRIORITY CLAIMED UNDER SEC. 44(D) ON CANADA APPLICATION NO. 1017360, FILED 6-1-1999, REG. NO. 1017360, DATED 6-1-1999, EXPIRES 5-31-2014.

CLASS 35—ADVERTISING AND BUSINESS

FOR BUSINESS NETWORKING SERVICES PROVIDED THROUGH THE OPERATION OF AN INTERNET WEB SITE FEATURING ALUMNI CONTACT INFORMATION AND PERSONAL PROFILES AND ON-LINE EVENT CALENDARS (U.S. CLS. 100, 101 AND 102).

CLASS 38—COMMUNICATION

FOR PROVIDING ON-LINE CHAT ROOMS FOR TRANSMISSION OF MESSAGES AMONG COMPUTER USERS CONCERNING COLLEGE AND UNIVERSITY ALUMNI AND ALUMNI GROUPS; NETWORK GROUP MEETING AND VIDEO CONFERENCING SERVICES; ELECTRONIC MAIL SERVICES; VOICE MAIL SERVICES; AND ELECTRONIC VOICE MESSAGING, NAMELY, THE RECORDING, STORAGE AND SUBSEQUENT TRANSMISSION OF VOICE MESSAGES BY COMPUTER (U.S. CLS. 100, 101 AND 104).

SN 75-859,251. CRYOVAC, INC., DUNCAN, SC. FILED 11-29-1999.

CRYOVAC

OWNER OF U.S. REG. NOS. 384,060, 938,841 AND OTHERS.

CLASS 10—MEDICAL APPARATUS

FOR POLYMER FILM BAGS, POUCHES, TUBINGS AND CONNECTORS FOR DISPENSING MEDICAL SOLUTIONS (U.S. CLS. 26, 39 AND 44).

CLASS 17—RUBBER GOODS

FOR FILMS FOR MANUFACTURING BAGS, POUCHES AND OVERWRAPPING FOR BAGS AND POUCHES USED FOR DISPENSING MEDICAL SOLUTIONS (U.S. CLS. 1, 5, 12, 13, 35 AND 50).

SN 75-864,745. MARINE TRADER OWNERS ASSOCIATION INC., TOWSON, MD. FILED 12-6-1999.

MARINE TRADER OWNERS ASSOCIATION

NO CLAIM IS MADE TO THE EXCLUSIVE RIGHT TO USE "ASSOCIATION", APART FROM THE MARK AS SHOWN.
SEC. 2(F).

CLASS 16—PAPER GOODS AND PRINTED MATTER

FOR NEWSLETTERS IN THE FIELD OF MARINE TRADER CRAFT (U.S. CLS. 2, 5, 22, 23, 29, 37, 38 AND 50).
FIRST USE 9-0-1991; IN COMMERCE 9-0-1991.

CLASS 200—COLLECTIVE MEMBERSHIP

FOR DESIGNATION OF MEMBERSHIP IN AN ASSOCIATION OF BOAT OWNERS.
FIRST USE 9-0-1991; IN COMMERCE 9-0-1991.

SN 75-869,605. HARROW, SUSAN A., OAKLAND, CA. FILED 12-9-1999.

Sell Yourself Without Selling Your Soul.

CLASS 9—ELECTRICAL AND SCIENTIFIC APPARATUS

FOR PRE-RECORDED SEMINARS, CONFERENCES AND LECTURES ON AUDIO AND VIDEOTAPES IN THE FIELD OF BUSINESS, PUBLICITY AND MARKETING, SELF-HELP AND SELF-AWARENESS (U.S. CLS. 21, 23, 26, 36 AND 38).
FIRST USE 8-0-1999; IN COMMERCE 8-0-1999.

CLASS 16—PAPER GOODS AND PRINTED MATTER

FOR STATIONERY; BOOKS, SERIES OF BOOKS, PAMPHLETS AND BOOKLETS IN THE FIELD OF BUSINESS, PUBLICITY, MARKETING, AND SELF-AWARENESS (U.S. CLS. 2, 5, 22, 23, 29, 37, 38 AND 50).
FIRST USE 8-0-1999; IN COMMERCE 8-0-1999.

CLASS 41—EDUCATION AND ENTERTAINMENT

FOR CONDUCTING SEMINAR, CONFERENCES, WORKSHOPS AND LECTURES IN THE FIELD OF BUSINESS, PUBLICITY AND MARKETING (U.S. CLS. 100, 101 AND 107).

FIRST USE 8-0-1999; IN COMMERCE 8-0-1999.

CLASS 42—SCIENTIFIC, COMPUTER AND LEGAL SERVICES

FOR COMPUTER SERVICES, NAMELY, PROVIDING ON-LINE BOOKS; A SERIES OF BOOKS ON-LINE, PAMPHLETS, PRINTED ARTICLES, AND NEWSLETTERS IN THE FIELD OF BUSINESS, PUBLICITY AND MARKETING, SELF-HELP AND SELF-AWARENESS (U.S. CLS. 100 AND 101).

FIRST USE 8-0-1999; IN COMMERCE 8-0-1999.

SN 75-876,984. INTELLIGENT NUTRIENTS, INC., MINNEAPOLIS, MN. FILED 12-22-1999.

WUNDERBAR INTELLIGENT NUTRIENTS

NO CLAIM IS MADE TO THE EXCLUSIVE RIGHT TO USE "NUTRIENTS", APART FROM THE MARK AS SHOWN.

THE ENGLISH TRANSLATION OF "WUNDERBAR" IS A GERMAN WORD MEANING "WONDERFUL".

CLASS 5—PHARMACEUTICALS

FOR DIETARY SUPPLEMENTS, SNACK BARS CONTAINING SOY PROTEIN, VITAMINS, MINERALS AND HERBS FOR NUTRITIONAL PURPOSES; AND NUTRITIONAL SUPPLEMENTS IN BAR FORM CONTAINING SOY PROTEIN, VITAMINS, MINERALS AND HERBS (U.S. CLS. 6, 18, 44, 46, 51 AND 52).

CLASS 29—MEATS AND PROCESSED FOODS

FOR FOOD PRODUCTS, NAMELY MEAT, FISH, POULTRY, FRUITS, FRESH AND BOTTLED VEGETABLES, JELLIES, JAMS, COOKING AND EDIBLE OILS, NUTS, AND SNACK BARS CONTAINING SOY PROTEIN, VITAMINS, MINERALS AND HERBS (U.S. CL. 46).

CLASS 30—STAPLE FOODS

FOR WILD RICE, COFFEE, TEA, COCOA, PASTA, BREADS, PASTRIES, FROZEN CONFECTIONERY, SORBET, ICE CREAM, SAUCES, SPICES, GRANOLA, MUESLI, BREAKFAST CEREALS, CEREALS MADE OF GRAINS, FRUITS, NUTS, VINEGAR, CONDIMENTS, NAMELY KETCHUP AND MUSTARD, RELISH (U.S. CL. 46).

CLASS 32—LIGHT BEVERAGES

FOR BEERS, DRINKING WATERS, FRUIT JUICES, VEGETABLE JUICES, NON-ALCOHOLIC BEVERAGES CONTAINING HERBAL EXTRACTS, POWDERS, MIXATIVES CONTAINING HERBS AND VITAMINS TO BE BLENDED TOGETHER WITH SOY PROTEIN POWDER FOR USE IN THE PREPARATION OF SOFT DRINKS, NON-ALCOHOLIC BEVERAGES CONTAINING HERBAL EXTRACTS, MALT SYRUPS FOR SOFT DRINKS AND POWDERS FOR USE IN THE PREPARATION OF SOFT DRINKS (U.S. CLS. 45, 46 AND 48).

SN 75-879,148. CANADIAN INSTITUTE OF CHARTERED ACCOUNTANTS, THE, TORONTO, ONTARIO, CANADA, FILED 12-23-1999.

TVC**CLASS 35—ADVERTISING AND BUSINESS**

FOR BUSINESS SERVICES, NAMELY, ACCOUNTING SERVICES (U.S. CLS. 100, 101 AND 102).

CLASS 36—INSURANCE AND FINANCIAL

FOR FINANCIAL ANALYSIS AND CONSULTATION IN THE FIELD OF MEASURING AND IMPROVING THE TOTALITY OF VALUE CREATED BY BUSINESSES FOR ALL OF THEIR STAKEHOLDERS, AND VERIFYING THE LEVEL OF THE TOTALITY OF SUCH VALUE CREATED (U.S. CLS. 100, 101 AND 102).

CLASS 42—SCIENTIFIC, COMPUTER AND LEGAL SERVICES

FOR PROMOTING PUBLIC AWARENESS OF AND APPRECIATION OF THE SKILLS OF CHARTERED ACCOUNTANTS IN PERFORMING THE SERVICES OF ASSISTING BUSINESSES TO MEASURE AND IMPROVE THE TOTALITY OF VALUE CREATED BY SUCH BUSINESSES FOR ALL OF THEIR STAKEHOLDERS AND VERIFYING THE LEVEL OF THE TOTALITY OF SUCH VALUE CREATED (U.S. CLS. 100 AND 101).

SN 75-879,765. CHIPAC, INC., SANTA CLARA, CA. FILED 12-22-1999.

iQUAD**CLASS 40—MATERIAL TREATMENT**

FOR MANUFACTURING AND ASSEMBLY FOR OTHERS OF PACKAGING FOR INTEGRATED CIRCUITS (U.S. CLS. 100, 103 AND 106).

FIRST USE 1-0-1999; IN COMMERCE 1-0-1999.

CLASS 42—SCIENTIFIC, COMPUTER AND LEGAL SERVICES

FOR ENGINEERING, DESIGN AND TESTING SERVICES; NAMELY, DEVELOPMENT, DESIGN, ENGINEERING AND TESTING FOR OTHERS OF PACKAGING FOR INTEGRATED CIRCUITS; DEVELOPMENT, DESIGN AND ENGINEERING FOR OTHERS OF PROCESSES FOR MANUFACTURING, ASSEMBLY AND TESTING OF PACKAGING FOR INTEGRATED CIRCUITS (U.S. CLS. 100 AND 101).

FIRST USE 1-0-1999; IN COMMERCE 1-0-1999.

SN 75-880,656. GOLOSITALIA S.R.L., 10125 TORINO, ITALY,
FILED 12-27-1999.

GOURMET HOURS COMMUNITY

NO CLAIM IS MADE TO THE EXCLUSIVE RIGHT TO
USE "GOURMET", APART FROM THE MARK AS SHOWN.

CLASS 41—EDUCATION AND ENTERTAINMENT

FOR ENTERTAINMENT SERVICES, NAMELY ORGANIZING AND CONDUCTING CULTURAL ACTIVITIES, NAMELY FOOD AND DRINK TASTING (U.S. CLS. 100, 101 AND 107).

CLASS 42—SCIENTIFIC, COMPUTER AND LEGAL SERVICES

FOR RESTAURANT SERVICES; CATERING AND HOTELS (U.S. CLS. 100 AND 101).

SN 75-886,078. LOPEZ, RICHARD A., DANA POINT, CA.
FILED 12-22-1999.

FR 3500

NO CLAIM IS MADE TO THE EXCLUSIVE RIGHT TO
USE "FR", APART FROM THE MARK AS SHOWN.

CLASS 1—CHEMICALS

FOR CHEMICAL COMPOSITIONS FOR FIRE RETARDANCY FOR USE IN TREATING BUILDING MATERIALS, NAMELY, WOOD, PLYWOOD AND LUMBER (U.S. CLS. 1, 5, 6, 10, 26 AND 46).

FIRST USE 5-26-2000; IN COMMERCE 5-26-2000.

CLASS 19—NON-METALLIC BUILDING MATERIALS

FOR NON-METALLIC BUILDING MATERIALS, NAMELY, WOOD, PLYWOOD AND LUMBER, CHEMICALLY TREATED FOR FLAME RETARDANCY (U.S. CLS. 1, 12, 33 AND 50).

FIRST USE 5-26-2000; IN COMMERCE 5-26-2000.

SN 75-891,279. HOSLEY INTERNATIONAL TRADING CORPORATION, LYNWOOD, IL. FILED 1-7-2000.

HOSLEY

OWNER OF U.S. REG. NO. 2,280,748.
SEC. 2(F).

CLASS 6—METAL GOODS

FOR (BASED ON USE IN COMMERCE) CHRISTMAS DECORATIONS IN THE NATURE OF METAL HOLIDAY ORNAMENTS; METAL BELLS; BASKETS OF COMMON METAL; METAL WEDDING BELLS; METAL HOOKS; METAL HOOKS TO HANG WREATHS; METAL HOOKS, NAMELY, SHEPHERD HOOKS; JEWELRY BOXES OF METAL (U.S. CLS. 2, 12, 13, 14, 23, 25 AND 50).

FIRST USE 0-0-1994; IN COMMERCE 0-0-1994.

CLASS 20—FURNITURE AND ARTICLES NOT OTHERWISE CLASSIFIED

FOR (BASED ON USE IN COMMERCE) PICTURE FRAMES; PLATE RACKS; FURNITURE, NAMELY, PLANT STANDS, PLANTERS; JEWELRY BOXES NOT OF METAL; MIRRORS (U.S. CLS. 2, 13, 22, 25, 32 AND 50).

FIRST USE 0-0-1994; IN COMMERCE 0-0-1994.

CLASS 21—HOUSEWARES AND GLASS

FOR (BASED ON USE IN COMMERCE) HOME DECOR ACCESSORIES, NAMELY, CANDLE HOLDERS NOT OF PRECIOUS METAL, NON-ELECTRIC CANDELABRAS NOT OF PRECIOUS METAL, VOTIVES, VASES, FLOWER BASKETS, PLANTERS, NON-METAL DECORATIVE BOXES, PLATES, BOWLS, ICE BUCKETS, PITCHERS, WATERING CANS, PLANT STANDS, WIND CHIMES, NAPKIN HOLDERS, FIRE PLACE BRUSHES, BIRDHOUSES, CANDLE SNUFFERS, WEDDING CANDLE HOLDERS NOT OF PRECIOUS METAL (U.S. CLS. 2, 13, 23, 29, 30, 33, 40 AND 50).

FIRST USE 0-0-1982; IN COMMERCE 0-0-1982.

CLASS 27—FLOOR COVERINGS

FOR (BASED ON INTENT TO USE) COTTON RUGS, CARPETS (U.S. CLS. 19, 20, 37, 42 AND 50).

CLASS 28—TOYS AND SPORTING GOODS

FOR (BASED ON USE IN COMMERCE) CHRISTMAS TREE ORNAMENTS; CHRISTMAS TREE ORNAMENTS, NAMELY, BELLS (U.S. CLS. 22, 23, 38 AND 50).

FIRST USE 0-0-1994; IN COMMERCE 0-0-1994.

SN 75-892,538. IDG BOOKS WORLDWIDE, INC., FOSTER CITY, CA. FILED 1-7-2000.

THE DUMMIES STORE

OWNER OF U.S. REG. NOS. 1,832,735, 2,284,133 AND OTHERS.

NO CLAIM IS MADE TO THE EXCLUSIVE RIGHT TO
USE "STORE", APART FROM THE MARK AS SHOWN.

CLASS 9—ELECTRICAL AND SCIENTIFIC APPARATUS

FOR PRERECORDED CD-ROMS AND AUDIO CASSETTES ON A WIDE VARIETY OF SUBJECTS (U.S. CLS. 21, 23, 26, 36 AND 38).

CLASS 16—PAPER GOODS AND PRINTED MATTER

FOR NON-FICTION BOOKS ON A WIDE VARIETY OF SUBJECTS (U.S. CLS. 2, 5, 22, 23, 29, 37, 38 AND 50).

CLASS 21—HOUSEWARES AND GLASS

FOR MUGS (U.S. CLS. 2, 13, 23, 29, 30, 33, 40 AND 50).

CLASS 25—CLOTHING

FOR HATS, T-SHIRTS (U.S. CLS. 22 AND 39).

SN 75-894,212. EXTRA, WALTER, FED REP GERMANY, FILED 1-11-2000.

SN 75-895,686. APPLIED BUSINESS TECHNOLOGIES CORP., CINCINNATI, OH. FILED 1-12-2000.

EXTRA



OWNER OF FED REP GERMANY REG. NO. 39914938, DATED 7-16-1999, EXPIRES 3-31-2009.

CLASS 9—ELECTRICAL AND SCIENTIFIC APPARATUS

FOR COMPUTER E-COMMERCE SOFTWARE TO ALLOW USERS TO PERFORM ELECTRONIC BUSINESS TRANSACTIONS REGARDING INSURANCE POLICIES AND INSURANCE DOCUMENTS IN THE FIELD OF INSURANCE AND FINANCE VIA A GLOBAL COMPUTER NETWORK (U.S. CLS. 21, 23, 26, 36 AND 38).

CLASS 9—ELECTRICAL AND SCIENTIFIC APPARATUS

FOR MEASURING AND CONTROL DEVICES, NAMELY, TACHOMETERS AND MONITORING SYSTEMS CONSISTING OF CIRCUIT BOARDS, COCKPIT INDICATOR DIALS, CRT SCREENS AND AUDIO MESSAGE GENERATORS FOR VISUALLY AND AUDIBLY DISPLAYING AIRCRAFT ENGINE PARAMETERS (U.S. CLS. 21, 23, 26, 36 AND 38).

CLASS 36—INSURANCE AND FINANCIAL

FOR INSURANCE AND FINANCIAL SERVICES FOR FACILITATING THE DISTRIBUTION OF POLICIES AND OTHER INSURANCE DOCUMENTS BETWEEN BROKERS, AGENTS AND CUSTOMERS, NAMELY INSURANCE POLICY SALES ADMINISTRATION BY MEANS OF A GLOBAL COMPUTER NETWORK (U.S. CLS. 100, 101 AND 102).

CLASS 12—VEHICLES

FOR AIRPLANES (U.S. CLS. 19, 21, 23, 31, 35 AND 44).

CLASS 37—CONSTRUCTION AND REPAIR

FOR AIRPLANE MAINTENANCE SERVICES (U.S. CLS. 100, 103 AND 106).

SN 75-895,687. APPLIED BUSINESS TECHNOLOGIES CORPORATION, CINCINNATI, OH. FILED 1-12-2000.

CORECONNECT

CLASS 9—ELECTRICAL AND SCIENTIFIC APPARATUS

FOR COMPUTER E-COMMERCE SOFTWARE TO ALLOW USERS TO PERFORM ELECTRONIC BUSINESS TRANSACTIONS REGARDING INSURANCE POLICIES AND INSURANCE DOCUMENTS IN THE FIELD OF INSURANCE AND FINANCE VIA A GLOBAL COMPUTER NETWORK (U.S. CLS. 21, 23, 26, 36 AND 38).

SN 75-895,597. GENESEE DEVELOPMENT GROUP, INC., CHICAGO, IL. FILED 1-15-2000.

DIESELPOINT

CLASS 9—ELECTRICAL AND SCIENTIFIC APPARATUS

FOR COMPUTER E-COMMERCE SOFTWARE TO ALLOW USERS TO PERFORM ELECTRONIC BUSINESS TRANSACTIONS VIA A GLOBAL COMPUTER NETWORK; COMPUTER SEARCH ENGINE SOFTWARE; COMPUTER ONLINE CATALOG SOFTWARE; COMPUTER PORTAL SOFTWARE; COMPUTER CONTENT MANAGEMENT SOFTWARE; COMPUTER DATABASE SOFTWARE (U.S. CLS. 21, 23, 26, 36 AND 38). FIRST USE 12-0-1999; IN COMMERCE 1-5-2000.

CLASS 36—INSURANCE AND FINANCIAL

FOR INSURANCE AND FINANCIAL SERVICES FOR FACILITATING THE DISTRIBUTION OF POLICIES AND OTHER INSURANCE DOCUMENTS BETWEEN BROKERS, AGENTS AND CUSTOMERS, NAMELY INSURANCE POLICY SALES ADMINISTRATION BY MEANS OF A GLOBAL COMPUTER NETWORK (U.S. CLS. 100, 101 AND 102).

SN 75-896,232. HCC SPORTS, LLC, MADISON, WI. BY ASSIGNMENT BIG TOE SPORTS.COM, INC., MADISON, WI. FILED 1-13-2000.

CLASS 42—SCIENTIFIC, COMPUTER AND LEGAL SERVICES

FOR COMPUTER CONSULTATION (U.S. CLS. 100 AND 101). FIRST USE 12-0-1999; IN COMMERCE 1-5-2000.

BIG TOE SPORTS

NO CLAIM IS MADE TO THE EXCLUSIVE RIGHT TO USE "SPORTS", APART FROM THE MARK AS SHOWN.

CLASS 25—CLOTHING

FOR CLOTHING, NAMELY, ATHLETIC SHOES, SHIRTS, JERSEYS, JACKETS, SWEATSHIRTS, SHORTS, PANTS, SWEATPANTS, SOCKS, GLOVES AND HATS (U.S. CLS. 22 AND 39).

FIRST USE 5-0-1994; IN COMMERCE 5-0-1994.

CLASS 28—TOYS AND SPORTING GOODS

FOR (BASED ON INTENT TO USE) SPORTING GOODS, NAMELY SOCCER BALLS, SOCCER GOALS, AND SOCCER SHIN GUARDS (U.S. CLS. 22, 23, 38 AND 50).

CLASS 35—ADVERTISING AND BUSINESS

FOR MAIL ORDER AND ONLINE RETAIL STORE SERVICES FEATURING SPORTING GOODS AND CLOTHING (U.S. CLS. 100, 101 AND 102).

FIRST USE 5-0-1994; IN COMMERCE 5-0-1994.

CLASS 35—ADVERTISING AND BUSINESS

FOR BUSINESS MANAGEMENT CONSULTATION; BUSINESS ORGANIZATION CONSULTATION; BUSINESS INVESTIGATION; BUSINESS MANAGEMENT FOR THE OPERATION OF CATERING SERVICES, CLEANING SERVICES, SECURITY SERVICES, SUPPLY SERVICES, AND PERSONNEL RECRUITMENT; PERSONNEL PLACEMENT AND RECRUITMENT; PERSONNEL MANAGEMENT (U.S. CLS. 100, 101 AND 102).

SN 75-897,040. PUBLIC KNOWLEDGE SYSTEMS, LLC, ANCHORAGE, AK. FILED 1-14-2000.

PATIENTSTATUS**CLASS 38—COMMUNICATION**

FOR PROVIDING ON-LINE ELECTRONIC BULLETIN BOARDS FOR TRANSMISSION OF MESSAGES AMONG MEMBER PATIENTS, THEIR FAMILIES AND FRIENDS CONCERNING USER-DEFINED INFORMATION REGARDING THE MEMBER PATIENT'S CONDITION (U.S. CLS. 100, 101 AND 104).

FIRST USE 1-7-2000; IN COMMERCE 1-7-2000.

CLASS 42—SCIENTIFIC, COMPUTER AND LEGAL SERVICES

FOR PROVIDING A SEARCHABLE DATABASE FOR USE BY MEMBER PATIENTS, THEIR FAMILIES AND FRIENDS FOR OBTAINING USER-DEFINED INFORMATION REGARDING THE MEMBER PATIENT'S CONDITION (U.S. CLS. 100 AND 101).

FIRST USE 1-7-2000; IN COMMERCE 1-7-2000.

SN 75-897,101. CARILLION PLC, WOLVERHAMPTON, UNITED KINGDOM, FILED 1-14-2000.



PRIORITY CLAIMED UNDER SEC. 44(D) ON UNITED KINGDOM APPLICATION NO. 2215938, FILED 12-1-1999, REG. NO. 2215938, DATED 7-21-2000, EXPIRES 1-12-2009.

PRIORITY CLAIMED UNDER SEC. 44(D) ON UNITED KINGDOM APPLICATION NO. 2203396, FILED 7-17-1999, REG. NO. 2203396, DATED 7-17-1999, EXPIRES 7-17-2009.

CLASS 36—INSURANCE AND FINANCIAL

FOR REAL ESTATE MANAGEMENT SERVICES, NAMELY MANAGEMENT SERVICES FOR THE MAINTENANCE AND REPAIR OF INDUSTRIAL, COMMERCIAL, GOVERNMENT AND OTHER PUBLIC SECTOR BUILDINGS, TRANSPORTATION LINES, UTILITIES, AND INDUSTRIAL AND COMMERCIAL EQUIPMENT, INFRASTRUCTURE, ROADS, RAIL, BRIDGES, AND UTILITY SUPPLIES; REAL ESTATE MANAGEMENT NAMELY MANAGEMENT OF OFFICES, INDUSTRIAL FACILITIES, RETAIL FACILITIES, HOSPITALS, CLINICS, EDUCATIONAL FACILITIES, COURT HOUSES, PRISONS, SECURE TRAINING CENTERS, ARMED FORCES FACILITIES, PARKING FACILITIES, AND OTHER ANCILLARY FACILITIES (U.S. CLS. 100, 101 AND 102).

CLASS 37—CONSTRUCTION AND REPAIR

FOR CONSTRUCTION, REPAIR, MAINTENANCE AND DEMOLITION OF BUILDINGS AND CIVIL ENGINEERING STRUCTURES AND INFRASTRUCTURES, NAMELY ROADS, RAILS, BRIDGES, DAMS, POWER STATIONS, AIRPORTS, WATERWAYS, AND UTILITY LINES OF OTHERS FOR ELECTRICAL, GAS, TELECOMMUNICATIONS, WATER AND SEWERAGE SERVICE; BUILDING CONSTRUCTION AND REPAIR; CLEANING OF CLOTHING, BED CLOTHING, SOFT FURNISHING, FURNITURE, BUILDINGS AND VEHICLES; PROVIDING WASHING AND DRYING LAUNDRY FACILITIES; SELF SERVICE LAUNDRY; LAUNDRY SERVICES FOR CLOTHING, BED CLOTHING, SOFT FURNISHINGS AND FURNISHINGS AND FURNITURE; RENTAL OF BUILDING EQUIPMENT, RENTAL OF EARTH MOVING EQUIPMENT AND EXCAVATORS; RENTAL OF CONSTRUCTION EQUIPMENT, INDUSTRIAL MACHINERY, OFFICE EQUIPMENT, AND INDUSTRIAL EQUIPMENT; REPAIR AND MAINTENANCE OF LAND VEHICLES (U.S. CLS. 100, 103 AND 106).

CLASS 42—SCIENTIFIC, COMPUTER AND LEGAL SERVICES

FOR TECHNICAL CONSULTATION AND RESEARCH IN THE FIELDS OF ARCHITECTURE, ENVIRONMENTAL SCIENCE, ENGINEERING, CIVIL ENGINEERING, CIVIL ENGINEERING, AND MATERIALS SCIENCE; PRODUCT RESEARCH AND DEVELOPMENT; ARCHITECTURAL DESIGN; ENGINEERING; MANAGEMENT AND SUPERVISION OF BUILDING, CONSTRUCTION, REFURBISHMENT, ALTERATION, ENGINEERING AND CIVIL ENGINEERING PROJECTS; ALL FOR BUILDING, CONSTRUCTION AND ENGINEERING INDUSTRIES; CATERING SERVICES; SECURITY GUARD SERVICES; MONITORING SECURITY SYSTEMS (U.S. CLS. 100 AND 101).

SN 75-898,266. MERCK KGAA, D-64293, DARMSTADT, FED REP GERMANY, FILED 1-17-2000.



PRIORITY CLAIMED UNDER SEC. 44(D) ON FED REP GERMANY APPLICATION NO. 39979420.4, FILED 12-15-1999, REG. NO. 39979420, DATED 1-24-2000, EXPIRES 12-31-2009.

NO CLAIM IS MADE TO THE EXCLUSIVE RIGHT TO USE "ONCOLOGY", APART FROM THE MARK AS SHOWN.

CLASS 5—PHARMACEUTICALS

FOR PHARMACEUTICAL PREPARATIONS, ALONE OR IN COMBINATION WITH OTHER PHARMACEUTICAL PREPARATIONS OR TREATMENTS FOR THE PREVENTION, DIAGNOSIS, AND TREATMENT OF CANCER AND THE MANAGEMENT OF SIDE EFFECTS ASSOCIATED WITH THE DISEASE OR TREATMENT; PHARMACEUTICAL PREPARATIONS, NAMELY, GENE THERAPY (U.S. CLS. 6, 18, 44, 46, 51 AND 52).

CLASS 9—ELECTRICAL AND SCIENTIFIC APPARATUS

FOR PROMOTIONAL, TRAINING, EDUCATIONAL AND PATIENT SUPPORT MATERIALS, NAMELY, PRE-RECORDED, VIDEOTAPES, AUDIO TAPES, COMPACT DISCS AND DVDS, ALL FEATURING INFORMATION IN THE FIELD OF CANCER AND CONDITIONS ASSOCIATED THEREWITH (U.S. CLS. 21, 23, 26, 36 AND 38).

CLASS 16—PAPER GOODS AND PRINTED MATTER

FOR PROMOTIONAL, TRAINING, EDUCATIONAL AND PATIENT SUPPORT MATERIALS, NAMELY, BOOKS, PAMPHLETS, NEWSLETTERS, MAGAZINES, MANUALS, ALL FEATURING INFORMATION IN THE FIELD OF CANCER AND CONDITIONS ASSOCIATED THEREWITH (U.S. CLS. 2, 5, 22, 23, 29, 37, 38 AND 50).

CLASS 42—SCIENTIFIC, COMPUTER AND LEGAL SERVICES

FOR SERVICES RELATING TO PHARMACEUTICAL PREPARATIONS, NAMELY, HEALTHCARE, MEDICAL RESEARCH AND MEDICAL ADVICE, DISEASE MANAGEMENT; AND PATIENT SUPPORT SERVICES, NAMELY, COUNSELING, ALL PROVIDED IN THE FIELD OF CANCER AND CONDITIONS ASSOCIATED THEREWITH (U.S. CLS. 100 AND 101).

SN 75-898,278. KOTTER, ERWIN, 48432 RHEINE, FED REP GERMANY, FILED 1-17-2000.

PROGNOST

OWNER OF FED REP GERMANY REG. NO. 2006276, DATED 11-15-1991, RENEWED AS REG. NO. 2006276, DATED 11-24-2000, EXPIRES 11-30-2010.

CLASS 37—CONSTRUCTION AND REPAIR

FOR TECHNICAL ADVISORY SERVICES RELATING TO CONSTRUCTION (U.S. CLS. 100, 103 AND 106).

CLASS 42—SCIENTIFIC, COMPUTER AND LEGAL SERVICES

FOR MONITORING, INSPECTING AND TESTING THE CONDITION OF MACHINES, ENGINES AND EQUIPMENT USING COMPUTERS, ELECTRONIC DATA PROCESSING EQUIPMENT, DEVICES OR SYSTEMS FOR MONITORING OR MEASURING DATA ACQUISITION, DEVICES OR SYSTEMS FOR MONITORING THE CONDITION OF MACHINES, DEVICES OR SYSTEMS FOR TELEMONITORING, DEVICES OR SYSTEMS FOR MONITORING COMPRESSORS, BLOWERS, SUPERCHARGER, CONDENSERS, COMPRESSOR TURBINES, DATABASES FOR COMPRESSOR DATA, DATABASES AND SOFTWARE FOR MAINTAINING, UPKEEPING AND SERVICING DEVICES OR SYSTEMS FOR MONITORING RECIPROCATING ENGINES, PUMPS, COMPRESSORS, AND DATABASES FOR RECIPROCATING ENGINES, PUMP AND COMPRESSOR DATA; DRAFTING DRAWINGS, PLANS, LAYOUTS, CONSTRUCTIVE DESIGNS, ESTIMATES; CONSULTATION IN THE FIELD OF PHYSICS; ENGINEERING IN THE NATURE OF CERTIFICATES, ADVICE, SERVICES OF TECHNICAL CONSULTING AND SERVICES OF CONSULTING ENGINEERS; PROGRAMMING OF COMPUTERS AND PROGRAMMING OF AND FOR DATA PROCESSING MACHINES FOR OTHERS; MATERIAL TESTING IN THE NATURE OF TESTING MATERIALS, RESEARCHING OF MATERIALS AND CARRYING OUT SPECIFICATION TESTS (U.S. CLS. 100 AND 101).

SN 75-898,334. OMS INVESTMENTS, INC., WILMINGTON, DE. FILED 1-18-2000.

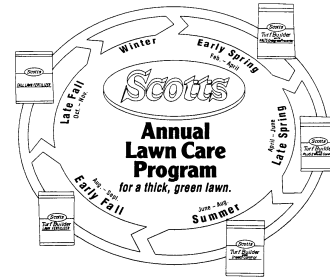

OWNER OF U.S. REG. NO. 688,249 AND OTHERS. NO CLAIM IS MADE TO THE EXCLUSIVE RIGHT TO USE "ANNUAL LAWN CARE PROGRAM FOR A THICK GREEN LAWN, WINTER, EARLY SPRING FEB.-APRIL, LATE SPRING APRIL-JUNE, SUMMER JUNE-AUG., EARLY FALL AUG.-SEPT., LATE FALL OCT.-NOV., LAWN FERTILIZER, FALL LAWN FERTILIZER, INSECT CONTROL, WEED CONTROL, CRABGRASS PREVENTER", APART FROM THE MARK AS SHOWN.

THE STIPLING IN THE DRAWING IS FOR SHADING PURPOSES ONLY AND IS NOT MEANT TO INDICATE COLOR.

THE MARK CONSISTS OF THE UPPER PORTION OF THE CONTAINER AT THE "EARLY SPRING" POSITION OF THE DESIGN ELEMENT FEATURES A PICTURE OF A GREEN YARD IN FRONT OF A HOUSE WITH A YELLOW AND GREEN BUSH ON THE RIGHT SIDE AND RED FLOWERS BELOW THE BUSH; THE UPPER PORTION OF THE CONTAINER AT THE "LATE SPRING" POSITION OF THE DESIGN ELEMENT FEATURES A PICTURE OF A GREEN YARD IN FRONT OF A HOUSE WITH RED AND YELLOW FLOWERS ALONG THE FRONT OF THE HOUSE; THE UPPER PORTION OF THE CONTAINER AT THE "SUMMER" POSITION OF THE DESIGN ELEMENT FEATURES A PICTURE OF A GREEN YARD IN FRONT OF A

HOUSE WITH SEVERAL CHILDREN PLAYING IN THE YARD; THE UPPER PORTION OF THE CONTAINER AT THE "EARLY FALL" POSITION OF THE DESIGN ELEMENT FEATURES A PICTURE OF A GREEN YARD IN FRONT OF A HOUSE WITH A CHILD PLAYING WITH A DOG IN THE YARD; THE UPPER PORTION OF THE CONTAINER AT THE "LATE FALL" POSITION OF THE DESIGN ELEMENT FEATURES A PICTURE OF A GREEN YARD WITH SEVERAL LEAVES AND THE BOTTOM PORTION OF A RAKE GATHERING THE LEAVES.

SN 75-901,238. CERTICOM CORP., MISSISSAUGA, ONTARIO, CANADA, FILED 1-22-2000.

MOBILETRUST

CLASS 9—ELECTRICAL AND SCIENTIFIC APPARATUS

FOR COMPUTER SOFTWARE, NAMELY, PROGRAMS FOR USE IN ENCRYPTING, AUTHENTICATING, REGISTRATION, SIGNING, VERIFYING, VALIDATING, STORING SECURELY, NOTARIZING, PROVIDING DIGITAL RECEIPTS, AND SECURE COMMUNICATIONS SERVICES FOR DATA PRIVACY, CONFIDENTIALITY AND DATA INTEGRITY; COMPUTER FIRMWARE NAMELY FIRMWARE FOR USE IN ENCRYPTING, AUTHENTICATING, REGISTRATION, SIGNING, VERIFYING, VALIDATING, STORING SECURELY, NOTARIZING, PROVIDING DIGITAL RECEIPTS, AND SECURE COMMUNICATIONS SERVICES FOR DATA PRIVACY, CONFIDENTIALITY AND DATA INTEGRITY; COMPUTER HARDWARE NAMELY HARDWARE FOR USE IN ENCRYPTING, AUTHENTICATING, REGISTRATION, SIGNING, VERIFYING, VALIDATING, STORING SECURELY, NOTARIZING, PROVIDING DIGITAL RECEIPTS, AND SECURE COMMUNICATIONS SERVICES FOR DATA PRIVACY, CONFIDENTIALITY AND DATA INTEGRITY; INTEGRATED CIRCUITS; COMPUTER SOFTWARE STORAGE MEDIA NAMELY PRE-RECORDED CDROMS, AND COMPUTER DISKETTES FEATURING ENCRYPTION AND AUTHENTICATION, COMMUNICATIONS INFORMATION FOR USE IN THE TRANSMISSION, PROCESSING, AND DISPLAY OF DATA; COMPUTER NETWORKING, CRYPTOGRAPHY, DIGITAL SIGNATURES AND PUBLIC AND PRIVATE KEY GENERATION, AND SECURITY FUNCTIONS, NAMELY, COMPUTER SOFTWARE DEVELOPMENT TOOLS USED IN ENCRYPTION, CERTIFICATION, AUTHORIZATION, AUTHENTICATION, VERIFICATION, DATA PRIVACY, CONFIDENTIALITY AND DATA INTEGRITY; HANDHELD RADIO PAGERS; MODEMS; CELLULAR PHONES; TELECOMMUNICATIONS EQUIPMENT, NAMELY, RADIO TRANSMITTERS, TELEPHONE TRANSMITTERS, SATELLITE TRANSMITTERS, RECEIVERS, NAMELY, WIRED AND WIRELESS TELEPHONE AND DATA RECEIVERS, ELECTRIC SWITCHES, COMPUTER NETWORKS COMPRISED OF COMPUTER HARDWARE AND SOFTWARE USED TO ACCESS THE INTERNET, WIRELESS INTERNET, WEB, AND WIRELESS WEB, WIRED AND WIRELESS LANS AND WANS, BLUE TOOTH, DEVICES, NAMELY, RADIO TRANSMITTERS, TELEPHONE TRANSMITTERS, RADIO MODEMS, INTEGRATED CIRCUITS, PAGING NETWORKS, CELLULAR NETWORKS, ELECTRONIC COMMUNICATIONS NETWORKS, 3G NETWORKS, GPRS NETWORKS, WAP SYSTEMS, PRIVATE NETWORKS, SATELLITE NETWORKS, TELEPHONES, WIRELESS COMPUTER NETWORKS COMPRISED OF COMPUTER HARDWARE AND SOFTWARE USED TO ACCESS THE INTERNET, WIRELESS INTERNET, WEB, WIRELESS WEB, WIRED AND WIRELESS LANS AND WANS, BLUE TOOTH DEVICES, NAMELY RADIO TRANSMITTERS, TELEPHONE TRANSMITTERS, RADIO MODEMS, INTEGRATED CIRCUITS, PAGING NETWORKS, CELLULAR NETWORKS, ELECTRONIC COMMUNICATIONS NETWORKS, 3G NETWORKS, GPRS NETWORKS, WAP SYSTEMS, PRIVATE NETWORKS, SATELLITE NETWORKS, WIRELESS COMMUNICATION DEVICES, NAMELY PDAS, CELL PHONES, SMART PHONES, WAP PHONES, PAGERS, WIRELESS HANDHELDS, SMART CARDS, TWO-WAY RADIO PAGER, RADIO AND SATELLITE TELEPHONES, WIRELESS HANDHELD COMPUTERS, MAGNETIC CODED CARDS AND PLASTIC CARDS WITH AN EMBEDDED INTEGRATED CIRCUITS AND STORED INFORMATION AND DATA, BLANK MAGNETICALLY ENCODED CARDS; SMART CARDS, NAMELY, ENCODED SMART CARDS CONTAINING PROGRAMMING USED TO PERFORM CRYPTOGRAPHIC OPERATIONS FOR SECURE COMMUNICATIONS AND OPERATIONS; CASH TRANSACTION CARDS, NAMELY, MAGNETIC CODED CREDIT AND DEBIT CARDS; COMPUTER TERMINALS FOR USE WITH CREDIT CARDS, DEBIT CARDS AND PLASTIC CARDS EMBEDDED WITH AN INTEGRATED

CLASS 1—CHEMICALS

FOR FERTILIZER FOR DOMESTIC USE (U.S. CLS. 1, 5, 6, 10, 26 AND 46).
FIRST USE 4-22-1998; IN COMMERCE 4-22-1998.

CLASS 5—PHARMACEUTICALS

FOR HERBICIDES AND PESTICIDES FOR DOMESTIC USE (U.S. CLS. 6, 18, 44, 46, 51 AND 52).
FIRST USE 4-22-1998; IN COMMERCE 4-22-1998.

SN 75-899,517. SPARKMAN, KEVIN T., MEDFORD, NJ.
FILED 1-20-2000.

ONE WORLD JOURNEYS

CLASS 35—ADVERTISING AND BUSINESS

FOR COMPUTERIZED ON-LINE RETAIL SERVICES AND RETAIL STORE SERVICES IN THE FIELD OF PHOTOGRAPHIC EQUIPMENT, PRINTS AND BOOKS, GREETING CARDS, MAGAZINES, CLOTHING, COMPUTER EQUIPMENT, HOUSEWARES, FURNITURE AND OUTDOOR ADVENTURE APPAREL AND GEAR (U.S. CLS. 100, 101 AND 102).
FIRST USE 4-0-1999; IN COMMERCE 4-0-1999.

CLASS 41—EDUCATION AND ENTERTAINMENT

FOR EDUCATIONAL SERVICES, NAMELY, CONDUCTING COMPUTERIZED ON-LINE WORKSHOPS IN THE FIELD OF ENVIRONMENTAL AND NATURE EDUCATION, PHOTOGRAPHY AND PHOTOGRAPHIC TECHNOLOGY AND ECO-TOURISM AND; ENTERTAINMENT SERVICES IN THE NATURE OF OUTDOOR ADVENTURE ACTIVITIES AND NATURE AND WILDERNESS EXPLORATIONS, NAMELY, LIVE ON-LINE WEBCAST EXPEDITIONS, INTERACTIVE PHOTOJOURNALISTIC DOCUMENTARIES, INTERACTIVE DISCUSSION GROUPS AND WILDERNESS AND NATURE FILM PRODUCTION (U.S. CLS. 100, 101 AND 107).
FIRST USE 4-0-1999; IN COMMERCE 4-0-1999.

CIRCUIT OR STORED INFORMATION AND MAGNET CODED DATA, SMART CARD AND SMART CARD READERS (U.S. CLS. 21, 23, 26, 36 AND 38).

SN 75-901,508. TOMY COMPANY, LTD., TOKYO, JAPAN, FILED 1-24-2000.

ZOIDS

CLASS 16—PAPER GOODS AND PRINTED MATTER

FOR PRINTED MARKETING MATERIALS, NAMELY, EDUCATION AND TRAINING MATERIALS DISTRIBUTED IN CONJUNCTION WITH A FEE-BASED TRAINING PROGRAM, FOR TRAINING, EDUCATION AND SALE PURPOSES IN THE FIELD OF DATA AND INFORMATION SECURITY; COMPUTER PROGRAM USER MANUALS AND DOCUMENTATION FOR TRAINING AND INSTRUCTION IN THE FIELD OF DATA AND INFORMATION SECURITY; PRINTED CERTIFICATES FOR USE IN DATA TRANSMISSION; TRANSACTION CARDS, NAMELY, CREDIT AND DEBIT CARDS WITHOUT MAGNETIC ENCODING; CREDIT CARDS (U.S. CLS. 2, 5, 22, 23, 29, 37, 38 AND 50).

CLASS 41—EDUCATION AND ENTERTAINMENT

FOR EDUCATION AND TRAINING PROGRAMS, CONDUCTING CONFERENCES AND SEMINARS IN THE FIELD OF SECURITY, DISTRIBUTING COURSE MATERIALS IN CONNECTION THEREWITH (U.S. CLS. 100, 101 AND 107).

CLASS 42—SCIENTIFIC, COMPUTER AND LEGAL SERVICES

FOR CRYPTOGRAPHIC AND INFORMATION SECURITY CONSULTING; TECHNOLOGY LICENSING OF CRYPTOGRAPHIC METHODS AND PROTOCOLS; COMPUTER SYSTEMS DEVELOPMENT AND SYSTEMS INTEGRATION RELATING TO INFORMATION SECURITY FOR OTHERS; TESTING, ANALYSIS AND EVALUATION OF THE GOODS AND SERVICES OF OTHERS IN THE FIELD OF SECURE NETWORK APPLICATIONS AND PUBLIC KEY DATA TRANSMISSION SYSTEMS FOR THE PURPOSE OF CERTIFICATION, ENCRYPTING, AUTHENTICATING, REGISTRATION, SIGNING, VERIFYING, VALIDATING, STORING SECURELY, NOTARIZING, PROVIDING DIGITAL RECEIPTS, AND SECURE COMMUNICATIONS SERVICES FOR DATA PRIVACY, CONFIDENTIALITY AND DATA INTEGRITY IN INTERNET, WIRELESS INTERNET, WEB, WIRELESS WEB, WIRED AND WIRELESS LANS AND WANS, BLUE TOOTH TECHNOLOGY, WIRED AND WIRELESS COMPUTER NETWORKS, PAGING NETWORKS, CELLULAR NETWORKS, 3G NETWORKS, GPRS NETWORKS, WAP SYSTEMS, PRIVATE NETWORKS, ELECTRONIC COMMUNICATIONS NETWORKS, SATELLITE NETWORKS, TELEPHONES, WIRELESS COMPUTER NETWORKS COMPRISED OF INTERNET, WIRELESS INTERNET, WEB, WIRELESS WEB, WIRED AND WIRELESS LANS AND WANS, BLUE TOOTH DEVICES, WIRED AND WIRELESS COMPUTER NETWORKS, PAGING NETWORKS ELECTRONIC COMMUNICATIONS NETWORKS, CELLULAR NETWORKS, 3G NETWORKS, GPRS NETWORKS, WAP SYSTEMS, PRIVATE NETWORKS, SATELLITE NETWORKS (U.S. CLS. 100 AND 101).

OWNER OF JAPAN REG. NO. 1,781,177, DATED 6-25-1985, EXPIRES 6-25-2005.

OWNER OF JAPAN REG. NO. 4,197,902, DATED 10-9-1998, EXPIRES 10-9-2008.

OWNER OF JAPAN REG. NO. 4,196,911, DATED 10-9-1998, EXPIRES 10-9-2008.

OWNER OF JAPAN REG. NO. 4,177,334, DATED 8-14-1998, EXPIRES 8-14-2008.

OWNER OF JAPAN REG. NO. 4,163,594, DATED 7-10-1998, EXPIRES 7-10-2008.

OWNER OF JAPAN REG. NO. 4,163,592, DATED 7-10-1998, EXPIRES 7-10-2008.

OWNER OF JAPAN REG. NO. 4,144,606, DATED 3-20-1998, EXPIRES 5-15-2008.

OWNER OF JAPAN REG. NO. 4,126,121, DATED 3-20-1998, EXPIRES 3-20-2008.

OWNER OF U.S. REG. NO. 2,098,569.

CLASS 9—ELECTRICAL AND SCIENTIFIC APPARATUS

FOR PHOTOGRAPHIC RECORDS, OPTICAL DISCS, COMPACT DISCS AND AUDIO AND VIDEO TAPES, ALL FEATURING MUSIC AND STORIES FOR CHILDREN; BLANK COMPACT DISCS FOR RECORDINGS; VIDEO GAME MACHINES ADAPTED FOR USE WITH TELEVISION RECEIVERS AND METRONOMES (U.S. CLS. 21, 23, 26, 36 AND 38).

CLASS 14—JEWELRY

FOR CLOCKS AND WATCHES (U.S. CLS. 2, 27, 28 AND 50).

CLASS 18—LEATHER GOODS

FOR LEATHER AND IMITATIONS OF LEATHER SOLD IN BULK, LEATHER TOTE BAGS AND UMBRELLAS (U.S. CLS. 1, 2, 3, 22 AND 41).

CLASS 20—FURNITURE AND ARTICLES NOT OTHERWISE CLASSIFIED

FOR FURNITURE, CUSHIONS, FURNITURE MIRRORS, PICTURE FRAMES AND NON-METAL KEY CHAINS (U.S. CLS. 2, 13, 22, 25, 32 AND 50).

CLASS 21—HOUSEWARES AND GLASS

FOR HOUSEHOLD AND KITCHEN UTENSILS AND CONTAINERS, NOT OF PRECIOUS METALS OR COATED THEREWITH, NAMELY, DISHES, AND PLATES (U.S. CLS. 2, 13, 23, 29, 30, 33, 40 AND 50).

CLASS 24—FABRICS

FOR TEXTILES AND TEXTILE GOODS, NAMELY, BED BLANKETS, LINENS, BED PADS, SHEETS, BED SPREADS AND TABLE CLOTHS (U.S. CLS. 42 AND 50).

CLASS 25—CLOTHING

FOR CLOTHING, NAMELY, PANTS, VESTS, JACKETS, COATS, SUITS, DRESSES, SKIRTS, SHORTS, T-SHIRTS, SWEATERS, HOSIERY, UNDERWEAR, SCARVES, BELTS, GLOVES, SARIS, SERAPES, PONCHOS, OVERALLS, COVERALLS, APRONS, FOOTWEAR, AND HEADWEAR (U.S. CLS. 22 AND 39).

CLASS 30—STAPLE FOODS

FOR SWEETMEATS, SWEET ROLLS, CHOCOLATES AND CANDIES (U.S. CL. 46).

SN 75-904,250. PRECISION OPTICAL MANUFACTURING (POM), TROY, MI. FILED 1-26-2000.

SN 75-907,237. NANOPHASE TECHNOLOGIES CORPORATION, BURR RIDGE, IL. FILED 2-1-2000.

POM

CLASS 7—MACHINERY

FOR MACHINES, NAMELY, LASER-BASED ADDITIVE-METAL FABRICATION MACHINES FOR PROTOTYPING; MOLD, DIE AND TOOL REPAIR; SALVAGE REPAIR OF METAL COMPOUNDS; DIRECT FABRICATION OF MOLDS, DIE AND TOOL COMPONENTS FROM COMPUTER-AIDED-DESIGN (CAD) FILES; AND MEDICAL PROSTHESIS FABRICATION DIRECTLY FROM X-RAY IMAGES (U.S. CLS. 13, 19, 21, 23, 31, 34 AND 35).

FIRST USE 4-23-1999; IN COMMERCE 4-23-1999.

CLASS 37—CONSTRUCTION AND REPAIR

FOR PROVIDING PROTOTYPING, MOLD, DIE AND TOOL REPAIR SERVICES, SALVAGE REPAIR OF METAL COMPONENTS (U.S. CLS. 100, 103 AND 106).

FIRST USE 4-23-1999; IN COMMERCE 4-23-1999.

CLASS 40—MATERIAL TREATMENT

FOR PROVIDING CUSTOM FABRICATION OF MOLDS, DIE AND TOOLS FROM COMPUTER-AIDED-DESIGN (CAD) FILES, AND CUSTOM MEDICAL PROSTHESIS DIRECTLY FROM X-RAY IMAGES (U.S. CLS. 100, 103 AND 106).

FIRST USE 4-23-1999; IN COMMERCE 4-23-1999.

SN 75-905,945. IMMUNOPATH PROFILE, INC., PALM BEACH, FL. FILED 1-28-2000.

ROYAL CHOCOLATE EFFERVESCENCE, THE CHAMPAGNE OF CHOCOLATE ESSENCE

NO CLAIM IS MADE TO THE EXCLUSIVE RIGHT TO USE "CHOCOLATE", APART FROM THE MARK AS SHOWN.

CLASS 30—STAPLE FOODS

FOR FROZEN CONFECTIONS, NAMELY, ICE CREAM CAKES AND PIES, ICE CREAM, SORBETS, AND FLAVORED ICES, NAMELY, FLAVORING AND TOPPING SYRUPS; CHOCOLATE SYRUP; FLAVORINGS, NAMELY, FLAVORING ADDITIVES FOR NON-NUTRITIONAL PURPOSES; BEVERAGES, NAMELY, CHOCOLATE MILKSHAKES (U.S. CL. 46).

CLASS 32—LIGHT BEVERAGES

FOR BEVERAGES, NAMELY, SOFT DRINKS, SYRUPS FOR MAKING SOFT DRINKS (U.S. CLS. 45, 46 AND 48).

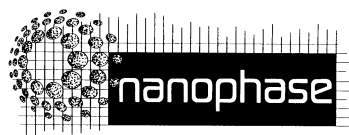

OWNER OF U.S. REG. NO. 1,978,349.

CLASS 1—CHEMICALS

FOR CERAMIC PARTICLES CAPABLE OF BEING FORMED INTO FINISHED PRODUCTS (U.S. CLS. 1, 5, 6, 10, 26 AND 46).

CLASS 6—METAL GOODS

FOR METAL AND METAL OXIDE PARTICLES CAPABLE OF BEING FORMED INTO FINISHED PRODUCTS (U.S. CLS. 2, 12, 13, 14, 23, 25 AND 50).

SN 75-909,242. EASTMAN KODAK COMPANY, ROCHESTER, NY. BY ASSIGNMENT WEAVE INNOVATIONS, INC., SANTA CLARA, CA. FILED 2-3-2000.

STORYBOX

CLASS 9—ELECTRICAL AND SCIENTIFIC APPARATUS

FOR CONSUMER ELECTRONIC PRODUCTS, NAMELY PICTURE FRAMES, RADIOS, AND LIQUID CRYSTAL DISPLAYS THAT CONNECT TO A GLOBAL COMPUTER NETWORK TO RECEIVE AND DISPLAY DIGITAL PICTURES, VIDEO IMAGES, AUDIO SIGNALS, AND DATA, NAMELY INFORMATION ON A VARIETY OF TOPICS, NAMELY NEWS, SPORTS, TRAFFIC, WEATHER, AND INVESTMENTS (U.S. CLS. 21, 23, 26, 36 AND 38).

CLASS 35—ADVERTISING AND BUSINESS

FOR ON-LINE RETAIL STORE SERVICES IN THE FIELD OF PHOTOGRAPHIC AND IMAGING ORIENTED CONSUMER ELECTRONICS (U.S. CLS. 100, 101 AND 102).

CLASS 39—TRANSPORTATION AND STORAGE

FOR COMPUTER SERVICES, NAMELY, PROVIDING AND MAINTAINING REMOTE ELECTRONIC STORAGE FOR DIGITAL PICTURES, VIDEO IMAGES, AUDIO SIGNALS, AND DATA VIA A GLOBAL COMPUTER NETWORK FOR MULTIPLE-USERS (U.S. CLS. 100 AND 105).

SN 75-910,151. LAKE CREEK COMMUNICATIONS, INC., ASPEN, CO. FILED 1-26-2000.

SN 75-910,722. CANADIAN HOME PUBLISHERS, TORONTO, ONTARIO, CANADA, FILED 2-4-2000.

KITCHENCOMPANION

CLASS 9—ELECTRICAL AND SCIENTIFIC APPARATUS

FOR COMPUTERIZED SELF-CONTAINED COMMUNICATION UNIT FOR RECEIVING AND SENDING INFORMATION REGARDING CLOTHING, FOOD, GROCERIES, FINANCIAL INFORMATION, NEWS AND REFERENCE INFORMATION, LOCAL GOVERNMENT SERVICES INFORMATION AND OTHER GOODS AND SERVICES FOR THE HOUSEHOLD BY MEANS OF A VIRTUAL PRIVATE COMPUTER NETWORK, PRIVATE COMPUTER NETWORK OR A GLOBAL COMPUTER NETWORK (U.S. CLS. 21, 23, 26, 36 AND 38).

CLASS 35—ADVERTISING AND BUSINESS

FOR COMPUTERIZED ON-LINE RETAIL SERVICES FEATURING CLOTHING, FOOD, GROCERIES, ELECTRONICS GOODS, CONSUMER PRODUCTS AND RECIPES, AND COMPUTER SERVICES, PROVIDING ON-LINE INFORMATION RELATED TO RECORDS KEEPING AND RECORDS STORAGE SERVICES FOR PRODUCT WARRANTIES AND MANUALS, AND PRODUCT PURCHASE INFORMATION BY MEANS OF A VIRTUAL PRIVATE COMPUTER NETWORK, A PRIVATE COMPUTER NETWORK OR A GLOBAL COMPUTER NETWORK (U.S. CLS. 100, 101 AND 102).

CLASS 42—SCIENTIFIC, COMPUTER AND LEGAL SERVICES

FOR COMPUTER SERVICES, NAMELY PROVIDING ON-LINE INFORMATION RELATED TO LOCAL GOVERNMENT SERVICES INFORMATION, ON-LINE VOTING AND REVENUE COLLECTION (U.S. CLS. 100 AND 101).

H&H

PRIORITY CLAIMED UNDER SEC. 44(D) ON CANADA APPLICATION NO. 1025516, FILED 8-11-1999, REG. NO. TMA544563, DATED 5-4-2001, EXPIRES 5-4-2016.

CLASS 16—PAPER GOODS AND PRINTED MATTER

FOR MAGAZINES IN THE FIELD OF HOME DECORATING, HOUSE STYLES, HOME IMPROVEMENT, HOME MAINTENANCE, LANDSCAPING AND GARDENING (U.S. CLS. 2, 5, 22, 23, 29, 37, 38 AND 50).

CLASS 41—EDUCATION AND ENTERTAINMENT

FOR TELEVISION PROGRAMMING (U.S. CLS. 100, 101 AND 107).

SN 75-910,307. ORASEE CORP., DULUTH, GA. BY CHANGE OF NAME I3DX.COM, DULUTH, GA. FILED 1-27-2000.

SN 75-911,666. RE3W, INC., COSTA MESA, CA. FILED 2-7-2000.



THE STIPPLING IN THE DRAWING IS FOR SHADING PURPOSES ONLY.

CLASS 1—CHEMICALS

FOR PHOTSENSITIVE PLASTIC FOR USE IN LENTICULAR IMAGERY (U.S. CLS. 1, 5, 6, 10, 26 AND 46). FIRST USE 7-1-1999; IN COMMERCE 7-1-1999.

CLASS 40—MATERIAL TREATMENT

FOR PHOTOGRAPHIC LENTICULAR PRINTING AND PHOTOGRAPHIC LENTICULAR THREE-DIMENSIONAL PRINTING FOR OTHERS; PHOTOGRAPHIC LENTICULAR IMAGING AND PHOTOGRAPHIC LENTICULAR THREE-DIMENSIONAL IMAGING FOR OTHERS (U.S. CLS. 100, 103 AND 106). FIRST USE 7-1-1999; IN COMMERCE 7-1-1999.

RE3W

CLASS 9—ELECTRICAL AND SCIENTIFIC APPARATUS

FOR COMPUTER SOFTWARE FOR PROVIDING MULTIPLE-USER ACCESS TO COMPUTER NETWORKS; COMPUTER SOFTWARE FOR SEARCHING AND RETRIEVING INFORMATION, SITES, AND OTHER RESOURCES ON COMPUTER NETWORKS; COMPUTER SOFTWARE, NAMELY, A DIRECTORY OF INFORMATION, SITES, AND RESOURCES AVAILABLE ON COMPUTER NETWORKS; COMPUTER SOFTWARE FOR THE USE IN CREATING AND DESIGNING WEBSITES (U.S. CLS. 21, 23, 26, 36 AND 38).

CLASS 16—PAPER GOODS AND PRINTED MATTER

FOR BOOKS AND NEWSLETTERS FEATURING REAL ESTATE INFORMATION, INTEREST RATE INFORMATION AND LAND DEVELOPMENT; BLANK ELECTRONIC, ELECTRONIC BOOKKEEPING, AND ELECTRONIC BUSINESS FORMS AND CONTRACTS (U.S. CLS. 2, 5, 22, 23, 29, 37, 38 AND 50).

CLASS 35—ADVERTISING AND BUSINESS

FOR ONLINE RETAIL AND MAIL ORDER SERVICES IN THE FIELD OF REAL ESTATE AND REAL ESTATE TRANSACTIONS; DIRECTORY SERVICES TO HELP LOCATE PEOPLE, PLACES, ORGANIZATIONS, PHONE NUMBERS, HOME PAGES, AND ELECTRONIC MAIL ADDRESSES; PROMOTING THE WEB SITES OF OTHERS, NAMELY, DISSEMINATION OF ADVERTISING FOR OTHERS VIA AN ON-LINE ELECTRONIC COMMUNICATIONS NETWORK; PROMOTING THE GOODS AND SERVICES OF OTHERS BY PLACING ADVERTISEMENTS AND PROMOTIONAL DISPLAYS IN AN ELECTRONIC SITE ACCESSED THROUGH COMPUTER NETWORKS; PROVIDING AN ON-LINE COMPUTER DATABASE, NAMELY, AN ONLINE BUYER'S GUIDE FEATURING THE VARIOUS GOODS AND SERVICES OF OTHERS; REFERRAL SERVICES IN THE FIELD OF REAL ESTATE AND REAL ESTATE TRANSACTIONS (U.S. CLS. 100, 101 AND 102).

SN 75-913,209. SPACE MARK, INCORPORATED, COLORADO SPRINGS, CO. FILED 2-7-2000.

**CLASS 36—INSURANCE AND FINANCIAL**

FOR FINANCIAL SERVICES, NAMELY, FINANCIAL ANALYSIS SERVICES OF REAL ESTATE INVESTMENTS AND LEASE TRANSACTIONS; ESCROW SERVICES, NAMELY, MAINTAINING MORTGAGE ESCROW ACCOUNTS, MAINTAINING ESCROW ACCOUNTS FOR INVESTMENTS, REAL ESTATE ESCROW SERVICES; ONLINE FINANCIAL CALCULATORS IN THE FIELDS OF REAL ESTATE AND REAL ESTATE TRANSACTIONS; PROVIDING A WIDE RANGE OF INFORMATION IN THE FIELDS OF REAL ESTATE AND REAL ESTATE TRANSACTIONS VIA COMPUTER NETWORKS; CONSULTING SERVICES IN THE FIELDS OF REAL ESTATE AND REAL ESTATE TRANSACTIONS; REAL ESTATE SERVICES, NAMELY, TENANT AND VENDOR RESEARCH AND CREDENTIALING SERVICES; PROVIDING COMPUTER DATABASES FEATURING A COMPILATION OF REAL ESTATE TRANSACTION FORMS, REAL ESTATE LAWS, REGULATIONS, PROCESSES AND POLICIES; PROVIDING REAL ESTATE-RELATED INDEXES OF INFORMATION, SITES, AND OTHER RESOURCES AVAILABLE ON COMPUTER NETWORKS; REAL ESTATE RESEARCH, NAMELY, SEARCHING AND RETRIEVING INFORMATION, SITES, AND OTHER RESOURCES AVAILABLE ON COMPUTER NETWORKS FOR OTHERS (U.S. CLS. 100, 101 AND 102).

NO CLAIM IS MADE TO THE EXCLUSIVE RIGHT TO USE "INTERNATIONAL", APART FROM THE MARK AS SHOWN.

CLASS 36—INSURANCE AND FINANCIAL

FOR COMMERCIAL BUILDING MANAGEMENT SERVICES, NAMELY SCHEDULING OF REPAIR, SECURITY, SAFETY AND UPKEEP OF BUILDINGS (U.S. CLS. 100, 101 AND 102).

CLASS 37—CONSTRUCTION AND REPAIR

FOR BUILDING REPAIR AND INSTALLATION SERVICES, NAMELY PROVIDING COMMERCIAL BUILDING FACILITY MAINTENANCE AND REPAIR OF BUILDINGS AND BUILDING SYSTEMS AND SCHEDULING BUILDING MAINTENANCE (U.S. CLS. 100, 103 AND 106).

CLASS 38—COMMUNICATION

FOR TELECOMMUNICATIONS, NAMELY DESIGNING, INSTALLING, AND MAINTAINING TELECOMMUNICATIONS VOICE AND DATA SYSTEMS, WIRING, CABLES, AND OTHER CONNECTION DEVICES AND CARRIERS FOR COMMERCIAL AND RESIDENTIAL APPLICATIONS; INSTALLING AND MAINTAINING TELECOMMUNICATIONS CABLE, FIBER, WIRING, AND OTHER CARRIERS BETWEEN FACILITIES AND PREMISES AND SWITCHING LOCATIONS; TELECOMMUNICATIONS TOWER INSTALLATION AND SUPPORT BUILDING CONSTRUCTION (U.S. CLS. 100, 101 AND 104).

CLASS 38—COMMUNICATION

FOR ELECTRONIC MAIL SERVICES; COMPUTER SERVICES, NAMELY, PROVIDING MULTIPLE-USER ACCESS TO COMPUTER NETWORKS FOR THE TRANSFER AND DISSEMINATION OF INFORMATION IN THE FIELDS OF REAL ESTATE AND REAL ESTATE TRANSACTIONS; COMPUTER BULLETIN AND MESSAGE BOARDS IN THE FIELDS OF REAL ESTATE AND REAL ESTATE TRANSACTIONS; TELECOMMUNICATIONS SERVICES, NAMELY PROVIDING A GATEWAY LINK TO WEB SITES, NEWS ARTICLES, REFERENCE MATERIALS IN THE FIELDS OF REAL ESTATE AND REAL ESTATE TRANSACTIONS; PROVIDING ON-LINE CHAT ROOMS FOR TRANSMISSION OF MESSAGES AMONG COMPUTER USERS CONCERNING REAL ESTATE AND REAL ESTATE TRANSACTIONS (U.S. CLS. 100, 101 AND 104).

CLASS 39—TRANSPORTATION AND STORAGE

FOR PACKAGING AND STORAGE OF GOODS, NAMELY PROVIDING WAREHOUSING AND SHIPPING AND RECEIVING, AND INVENTORY MANAGEMENT AND CONTROL SERVICES (U.S. CLS. 100 AND 105).

CLASS 41—EDUCATION AND ENTERTAINMENT

FOR EDUCATIONAL SERVICES, NAMELY, CONDUCTING COURSES, SEMINARS AND TUTORIALS IN THE FIELDS OF REAL ESTATE AND REAL ESTATE TRANSACTIONS; ONLINE LIBRARIES (U.S. CLS. 100, 101 AND 107).

CLASS 42—SCIENTIFIC, COMPUTER AND LEGAL SERVICES**CLASS 42—SCIENTIFIC, COMPUTER AND LEGAL SERVICES**

FOR REAL ESTATE SERVICES, NAMELY, TITLE SEARCHING (U.S. CLS. 100 AND 101).

FOR DESIGN, INSTALLATION, AND TESTING OF DIGITAL MICROWAVE SYSTEMS AND WIRELESS SYSTEMS, TELECOMMUNICATIONS PROJECT ENGINEERING, PLANNING, SYSTEM DESIGN AND TESTING FOR OTHERS; REPAIR AND UPDATE OF BUILDING ENVIRONMENTAL SYSTEMS SOFTWARE AND EQUIPMENT; MANAGEMENT AND LOGISTICS SUPPORT SERVICES, NAMELY PROVIDING MANAGEMENT OF INDUSTRIAL AND COMMERCIAL FACILITIES AND BUILDINGS INCLUDING ALL SERVICES NECESSARY FOR THE MAINTENANCE, REPAIR, SECURITY, SAFETY, AND UPKEEP OF THE FACILITY OR BUILDING (U.S. CLS. 100 AND 101).

SN 75-918,194. SCHLUMBERGER TECHNOLOGY CORPORATION, HOUSTON, TX. FILED 2-14-2000.

E-SEISMIC

CLASS 35—ADVERTISING AND BUSINESS

FOR ON-LINE ADVERTISING AND MARKETING SERVICES, NAMELY, DISSEMINATION OF ADVERTISING AND MARKETING INFORMATION FOR OTHERS VIA A LOCAL OR GLOBAL COMPUTER NETWORK FOR OIL AND GAS PROPERTIES AND OILFIELD EQUIPMENT, AND ON-LINE SUPPLY AND PROCUREMENT SERVICES OF GOODS AND SERVICES FOR THE OIL AND GAS INDUSTRY; ON-LINE LICENSING AND LEASING OF SOFTWARE USED IN THE EXPLORATION OR PRODUCTION OF HYDROCARBONS AND ECONOMIC MODELING SOFTWARE USED IN THE EXPLORATION OR PRODUCTION OF HYDROCARBONS (U.S. CLS. 100, 101 AND 102).

CLASS 42—SCIENTIFIC, COMPUTER AND LEGAL SERVICES

FOR ON-LINE OIL AND GAS RESERVES EVALUATION SERVICES; ON-LINE SCHEDULING OF DRILLING RIGS AND VESSELS (U.S. CLS. 100 AND 101).

SN 75-919,998. TRIPOD LABS, INC., GREAT NECK, NY. FILED 2-16-2000.

TRIPOD UNIVERSITY

NO CLAIM IS MADE TO THE EXCLUSIVE RIGHT TO USE "UNIVERSITY", APART FROM THE MARK AS SHOWN.

CLASS 5—PHARMACEUTICALS

FOR HERBAL PHARMACEUTICAL PRODUCTS, NAMELY, AN ANTI-FUNGAL SKIN CREAMS AND APPLICATIONS, NAMELY, A CREAM AND APPLICATION TO TREAT ATHLETE'S FOOT (U.S. CLS. 6, 18, 44, 46, 51 AND 52).

CLASS 41—EDUCATION AND ENTERTAINMENT

FOR EDUCATIONAL SERVICES, NAMELY, PROVIDING COURSES OF INSTRUCTION IN SKIN CARE, INCLUDING THE DISTRIBUTION OF COURSE MATERIAL IN CONNECTION WITH THE PROVISION OF SUCH SERVICES (U.S. CLS. 100, 101 AND 107).

SN 75-921,161. NET-A-PORTER LIMITED, LONDON, ENGLAND, FILED 2-16-2000.

NET-A-PORTER

PRIORITY CLAIMED UNDER SEC. 44(D) ON UNITED KINGDOM APPLICATION NO. 2261318, FILED 2-15-2001, REG. NO. 2261318, DATED 9-14-2001, EXPIRES 2-15-2011.

PRIORITY CLAIMED UNDER SEC. 44(D) ON UNITED KINGDOM APPLICATION NO. 2206010, FILED 8-16-1999, REG. NO. 2206010B, DATED 12-1-2000, EXPIRES 8-16-2009.

CLASS 3—COSMETICS AND CLEANING PREPARATIONS

FOR TOILETRIES, NAMELY, BUBBLE BATH, BATH SALTS, BEAUTY MASKS; COSMETICS; SOAPS, NAMELY, DEODORANT SOAP, BODY SOAP, SKIN SOAP, MOISTURIZING SOAP; ESSENTIAL OILS FOR PERSONAL USE; HAIR CARE PREPARATIONS; SKIN CARE PRODUCTS, NAMELY, MOISTURIZERS, CLEANSERS, TONERS, FACE MASKS, EXFOLIATORS, MAKE-UP REMOVING PREPARATIONS, SKIN CLARIFIERS, SKIN LOTION; NAIL POLISH (U.S. CLS. 1, 4, 6, 50, 51 AND 52).

CLASS 14—JEWELRY

FOR HOROLOGICAL AND/OR CHRONOMETRIC INSTRUMENTS; NAMELY, WATCHES AND CLOCKS, JEWELRY; COSTUME JEWELRY; STATUES OR STATUETTES OF PRECIOUS METAL; ARTICLES MADE OF OR COATED WITH PRECIOUS METAL OR THEIR ALLOYS, NAMELY, TRINKET BOXES, DECORATIVE BOXES, CIGARETTE HOLDERS, VAPORIZERS FOR PERFUME SOLD EMPTY, COSMETICS CASES SOLD EMPTY, TIE PINS, CUFF LINKS, KEY RINGS, CANDLESTICKS AND NAPKIN RING; PRECIOUS GEMSTONES, ARTICLES WITH PRECIOUS GEMSTONES, NAMELY, TRINKET BOXES, DECORATIVE BOXES, CIGARETTE HOLDERS, VAPORIZERS FOR PERFUME SOLD EMPTY, COSMETICS CASES SOLD EMPTY, TIE PINS, CUFF LINKS, KEY RINGS (U.S. CLS. 2, 27, 28 AND 50).

CLASS 16—PAPER GOODS AND PRINTED MATTER

FOR PAPER, NAMELY BUSINESS PAPER, NAMELY, LETTERHEAD PAPER AND BUSINESS NOTEPAPER, WRITING PAPER; GIFT WRAPPING PAPER; BOOKS, NAMELY, AUTOGRAPH BOOKS; ADDRESS BOOK; TELEPHONE BOOKS; CARDS, NAMELY, BUSINESS CARDS, ANNOUNCEMENT CARDS; POSTCARDS; GREETING CARDS; POSTER; PHOTOGRAPHIC PRINTS; STATIONERY; WRITING OR DRAWING IMPLEMENTS, NAMELY, PEN AND PEN SETS; DIARIES; CALENDARS; PLASTIC AND PAPER SHOPPING BAGS (U.S. CLS. 2, 5, 22, 23, 29, 37, 38 AND 50).

CLASS 18—LEATHER GOODS

FOR LEATHER SOLD IN BULK; IMITATION LEATHER SOLD IN BULK; GOODS MADE FROM LEATHER OR IMITATION LEATHER, NAMELY BRIEFCASES, HANDBAGS, PURSES, WALLETS, SUITCASES, TRAVEL BAGS, VANITY CASES, TRUNKS, RUCKSACKS; BAGS, NAMELY, BEACH BAGS, MESH, TEXTILE AND LEATHER SHOPPING BAGS, ALL PURPOSE SPORT BAGS; BRIEFCASES, HANDBAGS, SUITCASES, TRUNKS, RUCKSACKS; LEATHER BOXES FOR STORAGE SOLD EMPTY; WALKING STICKS; UMBRELLAS; PURSES; WALLETS; SATCHELS (U.S. CLS. 1, 2, 3, 22 AND 41).

CLASS 21—HOUSEWARES AND GLASS

FOR HAIR COMBS; HAIR BRUSHES; POWDER PUFFS; COSMETIC BRUSHES; HOUSEHOLD UTENSILS, NAMELY, PANS, FRYING PANS, STOCKPOTS, COLANDERS, CROCKERY, NAMELY, PLATES, BOWLS, CUPS, SAUCERS, SERVING PLATES AND BOWLS, MUGS; CONTAINERS FOR FOOD; BOWLS; BREAD BOARDS; BEVERAGE GLASSWARE; CANDLESTICKS AND NAPKIN RINGS, NOT OF PRECIOUS METAL; COASTERS; COCKTAIL STIRRERS; CLOTHES BRUSHES; SHOE BRUSHES; VASES; PORCELAINS, NAMELY, ORNAMENTS AND FIGURINES, MUGS; PERFUME BURNERS (U.S. CLS. 2, 13, 23, 29, 30, 33, 40 AND 50).

CLASS 24—FABRICS

FOR TEXTILE AND TEXTILE GOODS, NAMELY, BEDSPREADS, TABLE LINEN, CURTAINS, HOUSEHOLD LINEN; FABRIC PLACE MATS; BED LINEN; HANDKERCHIEFS (U.S. CLS. 42 AND 50).

CLASS 25—CLOTHING

FOR CLOTHING, NAMELY, TROUSERS, DRESSES, SKIRTS, JUMPERS, KNITWEAR, NAMELY JUMPERS, PULLOVERS, CARDIGANS, SHAWLS; SWEATSHIRTS, T-SHIRTS, SHORTS, JACKETS, COATS, BLOUSES, SHIRTS, PULLOVERS, SWEATERS; EVENING WEAR, NAMELY, DRESSES, SUITS, TUXEDOS, WAISTCOATS, COATS, SHAWLS; WAISTCOATS SUITS; TIES; SCARVES; SHAWLS; SWIM WEAR; LINGERIE, HOSIERY; BATHROBES; BELTS; FOOTWEAR; HEAD WEAR (U.S. CLS. 22 AND 39).

CLASS 35—ADVERTISING AND BUSINESS

FOR RETAIL STORE SERVICES FEATURING CLOTHING, SHOES, HANDBAGS, FASHION GOODS NAMELY, HATS, JEWELRY, ACCESSORIES, GLOVES, SCARVES AND PURSES, FASHION ACCESSORIES, COSMETICS AND SKINCARE, HOME FURNISHINGS AND GIFTS; COMPUTERIZED ON LINE RETAIL SERVICES FEATURING CLOTHING, SHOES, HANDBAGS, FASHION GOODS NAMELY HATS, JEWELRY, ACCESSORIES, GLOVES, SCARVES AND PURSES, FASHION ACCESSORIES, COSMETICS AND SKINCARE, HOME FURNISHINGS AND GIFTS; AND MAIL ORDER CATALOG SERVICES FEATURING SERVICES FEATURING CLOTHING, SHOES, HANDBAGS, FASHION GOODS NAMELY, HATS, JEWELRY, ACCESSORIES, GLOVES, SCARVES AND PURSES, FASHION ACCESSORIES, COSMETICS AND SKINCARE, HOME FURNISHINGS AND GIFTS (U.S. CLS. 100, 101 AND 102).

SN 75-921,377. VISUAL ANALYTICS, INC., POOLESVILLE, MD. FILED 2-16-2000.

VISUALINKS**CLASS 9—ELECTRICAL AND SCIENTIFIC APPARATUS**

FOR COMPUTER SOFTWARE FOR USE IN CONNECTION WITH THE DISPLAY OF DATA IN ORDER TO FIND AND ANALYZE PATTERNS, TRENDS AND RELATIONSHIPS AMONG THE DATA (U.S. CLS. 21, 23, 26, 36 AND 38).

FIRST USE 4-15-1999; IN COMMERCE 4-15-1999.

CLASS 42—SCIENTIFIC, COMPUTER AND LEGAL SERVICES

FOR PROVIDING COMPUTER DESIGN AND DEVELOPMENT SERVICES FOR OTHERS, NAMELY PROVIDING SOFTWARE THAT DISPLAYS DATA IN ORDER TO FIND AND ANALYZE PATTERNS, TRENDS AND RELATIONSHIPS AMONG THE DATA (U.S. CLS. 100 AND 101).

FIRST USE 4-15-1999; IN COMMERCE 4-15-1999.

SN 75-924,581. OPEN TEXT, INC., BANNOCKBURN, IL. FILED 2-22-2000.

B2BSCENE**CLASS 38—COMMUNICATION**

FOR ELECTRONIC MAIL SERVICES, NAMELY, PROVIDING ON-LINE CHAT ROOMS AND ELECTRONIC BULLETIN BOARDS FOR TRANSMISSION OF MESSAGES AMONG COMPUTER USERS CONCERNING BUSINESS (U.S. CLS. 100, 101 AND 104).

CLASS 42—SCIENTIFIC, COMPUTER AND LEGAL SERVICES

FOR ON-LINE INFORMATION SERVICES, NAMELY, PROVIDING TEMPORARY USE OF NON-DOWNLOADABLE SOFTWARE IN THE FIELD OF BUSINESS MANAGEMENT AND COMMUNICATIONS, FOR CONNECTING COMPUTER NETWORK USERS, EMAIL, AND BUSINESS TRAINING, VIA A PUBLIC AND MEMBER DRIVEN GLOBAL COMPUTER NETWORK SITE (U.S. CLS. 100 AND 101).

SN 75-924,697. FRANCE TELECOM SOCIETE ANONYME, 75015 PARIS, FRANCE, FILED 2-22-2000.

COUNTRY DIRECT

PRIORITY CLAIMED UNDER SEC. 44(D) ON FRANCE APPLICATION NO. 003000722, FILED 1-10-2000, REG. NO. 003000722, DATED 1-10-2000, EXPIRES 1-10-2010.

NO CLAIM IS MADE TO THE EXCLUSIVE RIGHT TO USE "DIRECT", APART FROM THE MARK AS SHOWN.

CLASS 9—ELECTRICAL AND SCIENTIFIC APPARATUS

FOR PHONOGRAPH RECORD AND COMPACT DISC PLAYERS, AUDIO AND VIDEO TAPE RECORDERS; BLANK AUDIO AND VIDEO TAPES AND COMPACT DISCS; STEREO RECEIVERS, AMPLIFIERS, AND TURNERS BLANK MAGNETIC DATA CARRIERS, AUTOMATIC VENDING MACHINES CASH REGISTERS, CALCULATORS; DATA PROCESSORS AND COMPUTERS; COMPUTER HARDWARE, NAMELY PROCESS COMPUTERS, COMPUTER FOR DATA AND WORD PROCESSING, COMPUTER TERMINALS, COMPUTER PRINTERS, COMPUTER MONITORS, COMPUTER SCREENS MODEMS, FAX MACHINES, MEMORY CARDS, COMPUTER INTERFACE BOARDS, BLANK MAGNETIC COMPUTER TAPES, FIBER OPTIC CABLES, COMPUTER AND ELECTRIC CABLES, OPTICAL CHARACTER RECOGNITION APPARATUS, OPTICAL DISCS, OPTICAL SCANNERS, MAGNETIC CODED CARDS; SATELLITES VIDEODISK FEATURING MOTION PICTURES, DIGITAL OPTICAL DISKS, TESTER PRINTERS, LASERS NOT FOR MEDICAL USE, LASER PRINTERS AND LASERS FOR USE IN CONNECTION WITH LASER BEAM COMMUNICATIONS, COMPUTER KEYBOARDS, PAPER COPYING MACHINES PRINTED CIRCUITS, TELECOMMUNICATION EMITTERS, TELEPHONES AND TELEPHONE ANSWERING MACHINES, TELEPHONE EQUIPMENT, NAMELY, TELEPHONES, TELEPHONE RECEIVERS TELEPHONE TRANSMITTERS, TELEPHONE WIRES; INTEGRATED CIRCUITS AND COMPONENTS NAMELY COMPUTER CHIPS; PRINTED CIRCUIT BOARDS, COMPUTER INTERFACE BOARDS FOR IDENTIFICATION, COMPACT FEATURING COMPUTER GAMES, ELECTRONIC CIRCUIT BOARDS, ELECTRONIC NOTICE BOARDS, BLANK INTEGRATED CIRCUIT CARDS (U.S. CLS. 21, 23, 26, 36 AND 38).

CLASS 16—PAPER GOODS AND PRINTED MATTER

FOR WRITING, COMPUTER, AND FACSIMILE PAPER, UNWORKED, SEMI-WORKED, OR FOR STATIONERY OR PRINTING CARDBOARD; PRINTED FORMS, NEWSPAPERS; PERIODICALS, BOOKS, AND CATALOGUES WHOSE SUBJECT MATTER COVERS TOPICS RELATED TO TELECOMMUNICATIONS; MOUNTED AND UNMOUNTED PHOTOGRAPHS, STATIONERY; ADHESIVES FOR STATIONERY OR HOUSEHOLD PURPOSES; TYPEWRITERS, OFFICE REQUISITES AND TEACHING MATERIAL, EXCEPT FURNITURE, INSTRUCTIONS OR TEACHING MATERIAL, EXCEPT APPARATUS, PLAYING CARDS PRINTERS' TYPE; PRINTING BLOCKS; CATALOGUES, INSTRUCTIONAL MANUALS FOR COMPUTING AND TELECOMMUNICATIONS, TYPING RIBBONS, COMPUTER PAPER, PAPER TAPES FOR RECORDING COMPUTER PROGRAMS, PRINTED INSTRUCTIONAL MATERIALS FOR COMPUTING AND TELECOMMUNICATIONS (U.S. CLS. 2, 5, 22, 23, 29, 37, 38 AND 50).

CLASS 38—COMMUNICATION

FOR TELECOMMUNICATION SERVICES, NAMELY, PERSONAL COMMUNICATION SERVICES; SERVICES, NAMELY, TRANSMISSION OF MESSAGES AND CODED IMAGES VIA TERMINALS ON GLOBAL COMPUTER NETWORKS, TELEPHONES, TELEVISIONS, RADIOS AND TELEPRINTERS ELECTRONIC TRANSMISSION OF MESSAGE AND DATA; WIRELESS DIGITAL MESSAGING SERVICES ELECTRONIC MESSAGING, ELECTRONIC TRANSMISSION OF DATA AND DOCUMENTS VIA COMPUTER TERMINALS, COMPUTER TELECOMMUNICATIONS NAMELY TRANSMISSION OF MESSAGES AND DATA VIA COMPUTER TERMINALS, FACSIMILE TRANSMISSION, ELECTRONIC MAIL SERVICES, TELEPHONE COMMUNICATION SERVICES, RENTAL OF TELECOMMUNICATIONS EQUIPMENT, NAMELY TELEPHONE RECEIVERS (U.S. CLS. 100, 101 AND 104).

CLASS 42—SCIENTIFIC, COMPUTER AND LEGAL SERVICES

FOR RENTAL OR COMPUTERS AND SOFTWARE; ELECTRONIC PROGRAMS, SOFTWARE ENGINEERING, SOFTWARE APPLICATION TRANSPOSITION SERVICES, NAMELY MAINTENANCE OF COMPUTER SOFTWARE; PATENT AGENCY AND INDUSTRIAL PROPERTY CONSULTING; LICENSING OF INTELLECTUAL PROPERTY; COMPUTER SOFTWARE DESIGN OF WORD AND DATA PROCESSING FOR OTHERS, DUPLICATION OF COMPUTER PROGRAMS; TECHNICAL CONSULTATION AND RESEARCH IN TELECOMMUNICATIONS FIELD, ENGINEER SERVICES RENTAL OF ELECTRONICS, NAMELY VIDEO CASSETTE RECORDERS AND SPEAKERS, COMPUTER INSTALLATIONS, NAMELY INSTALLATION OF PROGRAMS ON COMPUTER SUPPORTS AND USING TELECOMMUNICATIONS; DESIGN OF COMPUTER NETWORK SYSTEMS AND TELECOMMUNICATIONS SYSTEMS FOR OTHERS; COMPUTER SYSTEMS ANALYSIS AND COMPUTER CONSULTATION; TECHNICAL CONSULTATION AND RESEARCH IN THE FIELD OF OPERATION AND TELECOMMUNICATIONS EQUIPMENT; COMPUTER PROGRAMMING FOR OTHERS; MONITORING THE COMPUTER NETWORK SYSTEMS OF OTHERS AND PROVIDING BACK-UP COMPUTER PROGRAMS AND FACILITIES; COMPUTER CONSULTING SERVICES, TELECOMMUNICATION CONSULTING SERVICES; COMPUTER CONSULTING CONCERNING THE OPERATION OF COMPUTER FACILITIES AND AUTOMATION FACILITIES; COMPUTER SOFTWARE DESIGN FOR OTHERS IN THE FIELDS OF WORD AND DATA PROCESSING; SUPERVISORY ENGINEERING DESIGN SERVICES FOR OTHERS IN THE FIELD OF COMPUTER SYSTEMS AND TELECOMMUNICATION SYSTEMS; COMPUTER AND TELECOMMUNICATION CONSULTING AND RESEARCH IN THE FIELDS OF COMPUTER AND TELECOMMUNICATION ANALYSIS, COMPUTER AND TELECOMMUNICATIONS PROGRAMMING, COMPUTER AND TELECOMMUNICATIONS OPERATION AND MAINTENANCE OF COMPUTER AND TELECOMMUN-

ICATION OPERATIONS; CORRESPONDENCE EXCHANGE SERVICES, NAMELY EXCHANGE OF COMPUTERIZED DOCUMENTS (U.S. CLS. 100 AND 101).

SN 75-924,750, STEWART MORTGAGE INFORMATION CO., HOUSTON, TX. FILED 2-22-2000.

MANAGING THE LENDER'S OUTSOURCE NEEDS**CLASS 35—ADVERTISING AND BUSINESS**

FOR SERVICES OFFERED TO LENDERS IN CONNECTION WITH LOANS SECURED BY LIENS ON REAL ESTATE, NAMELY, PREPARATION OF DOCUMENTS USED IN MAKING THE LOAN AND PLACING A LIEN ON THE PROPERTY SECURING THE LIEN, FILING THE APPLICABLE DOCUMENTS IN THE APPROPRIATE GOVERNMENT OFFICES, PREPARING IMAGES OF DOCUMENTS USED IN MAKING AND SECURING SUCH LOAN, OBTAINING CREDIT REPORTS TO ASSIST THE LENDER IN DECIDING WHETHER OR NOT TO MAKE THE LOAN, OBTAINING APPRAISALS TO ASSIST THE LENDER IN DECIDING IF THE SECURITY IS SUFFICIENT COLLATERAL FOR THE LOAN, AND PROVIDING INFORMATION TO ASSIST IN THE DETERMINATION OF WHETHER OR NOT PROPERTY LIES IN A FLOOD PLAIN (U.S. CLS. 100, 101 AND 102).
FIRST USE 9-17-1999; IN COMMERCE 9-17-1999.

CLASS 36—INSURANCE AND FINANCIAL

FOR REAL ESTATE ESCROW SERVICES (U.S. CLS. 100, 101 AND 102).
FIRST USE 9-17-1999; IN COMMERCE 9-17-1999.

SN 75-925,850, UPSTATE WHOLESALE SUPPLY, INC., DBA BRITE COMPUTERS, ROCHESTER, NY. FILED 2-18-2000.

BRITECOMPUTERS.COM**CLASS 9—ELECTRICAL AND SCIENTIFIC APPARATUS**

FOR COMPUTER SYSTEMS, AND PARTS THEREFORE, NAMELY CENTRAL PROCESSING UNITS, MONITORS HARD FLOPPY DISC DRIVES, MODEMS, KEYBOARDS, MEMORY BOARDS AND CHIPS, PRINTERS, SCANNERS MICE CO-PROCESSORS, TAPE DRIVES, CARDS, CARDS AND MEMORY ADD-ONS, CABLES AND CONNECTORS, OPERATING SOFTWARE AND INSTRUCTION MANUALS SOLD TOGETHER AS A UNIT (U.S. CLS. 21, 23, 26, 36 AND 38).
FIRST USE 10-1-1994; IN COMMERCE 10-1-1994.

CLASS 35—ADVERTISING AND BUSINESS

FOR COMPUTERIZED ON-LINE ORDERING SERVICES IN THE FIELD OF COMPUTERS, COMPUTER PERIPHERAL DEVICES AND PARTS AND FITTINGS THEREFORE; COMPUTER OPERATING SOFTWARE (U.S. CLS. 100, 101 AND 102).
FIRST USE 10-1-1994; IN COMMERCE 12-5-1995.

CLASS 37—CONSTRUCTION AND REPAIR

FOR REPAIRS AND SERVICE IN THE FIELD OF COMPUTERS AND NETWORK INSTALLATION (U.S. CLS. 100, 103 AND 106).
FIRST USE 9-9-1997; IN COMMERCE 9-9-1997.

CLASS 39—TRANSPORTATION AND STORAGE

FOR MANUFACTURE OF COMPUTERS TO THE ORDER OF OTHERS (U.S. CLS. 100 AND 105).
FIRST USE 9-9-1997; IN COMMERCE 9-9-1997.

SN 75-925,851. UPSTATE WHOLESALE SUPPLY, INC., DBA BRITE COMPUTERS, ROCHESTER, NY. FILED 2-18-2000.

ANOTHER BRITE IDEA**CLASS 9—ELECTRICAL AND SCIENTIFIC APPARATUS**

FOR COMPUTER SYSTEMS, AND PARTS THEREFORE, NAMELY CENTRAL PROCESSING UNITS, MONITORS HARD FLOPPY DISC DRIVES, MODEMS, KEYBOARDS, MEMORY BOARDS AND CHIPS, PRINTERS, SCANNERS, MICE CO-PROCESSORS, TAPE DRIVES, CARDS, CARDS AND MEMORY ADD-ONS, CABLES AND CONNECTORS, OPERATING SOFTWARE AND INSTRUCTION MANUALS SOLD TOGETHER AS A UNIT (U.S. CLS. 21, 23, 26, 36 AND 38).
FIRST USE 10-1-1994; IN COMMERCE 10-1-1994.

CLASS 35—ADVERTISING AND BUSINESS

FOR COMPUTERIZED ON-LINE ORDERING SERVICES IN THE FIELD OF COMPUTERS, COMPUTER PERIPHERAL DEVICES PARTS AND FITTINGS THEREFORE; COMPUTER OPERATING SOFTWARE (U.S. CLS. 100, 101 AND 102).
FIRST USE 10-1-1994; IN COMMERCE 12-5-1995.

CLASS 37—CONSTRUCTION AND REPAIR

FOR REPAIRS AND SERVICE IN THE FIELD OF COMPUTERS AND NETWORK INSTALLATION (U.S. CLS. 100, 103 AND 106).
FIRST USE 9-9-1997; IN COMMERCE 9-9-1997.

CLASS 39—TRANSPORTATION AND STORAGE

FOR MANUFACTURE OF COMPUTERS TO THE ORDER OF OTHERS (U.S. CLS. 100 AND 105).
FIRST USE 9-9-1997; IN COMMERCE 9-9-1997.

SN 75-925,982. WORKSCAPE, INC., RESTON, VA. FILED 2-22-2000.



OWNER OF U.S. REG. NOS. 2,221,068, 2,368,234 AND OTHERS.

NO CLAIM IS MADE TO THE EXCLUSIVE RIGHT TO USE "EMPLOYEE.COM", APART FROM THE MARK AS SHOWN.

CLASS 36—INSURANCE AND FINANCIAL

FOR HUMAN RESOURCE MANAGEMENT SERVICES, NAMELY, THE ADMINISTRATION OF GROUP EMPLOYEE BENEFIT PLANS VIA A GLOBAL COMPUTER NETWORK (U.S. CLS. 100, 101 AND 102).

CLASS 42—SCIENTIFIC, COMPUTER AND LEGAL SERVICES

FOR COMPUTERIZED HUMAN RESOURCE MANAGEMENT SERVICES, NAMELY, MANAGING WEB SITES FOR OTHERS IN ORDER TO FACILITATE THE PURCHASE AND SALE OF GROUP BENEFITS VIA A GLOBAL COMPUTER NETWORK (U.S. CLS. 100 AND 101).

SN 75-926,333. SPX CORPORATION, MUSKEGON, MI. FILED 2-23-2000.

DELIVERING SMART BUSINESS SOLUTIONS

NO CLAIM IS MADE TO THE EXCLUSIVE RIGHT TO USE "BUSINESS SOLUTIONS", APART FROM THE MARK AS SHOWN.

CLASS 1—CHEMICALS

FOR REAGENTS, REAGENT MIXTURES, OXYGEN-CONTAINING HYDROCARBONS, DIETHYLENEGLYCOLMONOETHYLETHER, FOR USE IN CASE-FORMING CARBURIZATION OF FERROUS METALS, STEELS, AND ALLOYS; REAGENTS, REAGENT MIXTURES, OXYGEN-CONTAINING HYDROCARBONS FUEL OIL, FOR USE IN CARBURIZATION AND PREVENTION OF DECARBURIZATION OF FERROUS METALS, STEELS, AND ALLOYS (U.S. CLS. 1, 5, 6, 10, 26 AND 46).

CLASS 3—COSMETICS AND CLEANING PREPARATIONS

FOR VEHICLE FUEL INJECTION CLEANING FLUID (U.S. CLS. 1, 4, 6, 50, 51 AND 52).

CLASS 4—LUBRICANTS AND FUELS

FOR HYDRAULIC FLUID; LUBRICATING OIL AND GREASE; VACUUM PUMP OIL AND GREASE, CYLINDERS CONTAINING COMPRESSED PROPANE GAS; LUBRICANT FOR BREAKING-IN HYDRAULIC LIFTERS AND TAPPETS FOR ENGINES AND OIL CONTROL ADDITIVES FOR MOTOR VEHICLE ENGINES; AUTOMOBILE AND INDUSTRIAL LUBRICANTS (U.S. CLS. 1, 6 AND 15).

CLASS 6—METAL GOODS

FOR METAL PIPES, TUBE COUPLINGS AND FITTINGS; MANUALLY OPERATED METAL VALVES; METAL LOAD POSITIONING CHAIN SLINGS; MANUALLY OPERATED DIRECTIONAL CONTROL METAL VALVES; METAL CASTINGS; MANUALLY OPERATED FLUID HANDLING EQUIPMENT, NAMELY, FLUID CONTROL METAL VALVES AND PARTS THEREFOR; METAL CHAIN FOR USE IN TESTING THE ACCURACY OF A BULK FEEDER; FLEXIBLE METALLIC PIPES AND CONDUITS WITH COUPLINGS FOR CONTAINING ELECTRIC WIRES (U.S. CLS. 2, 12, 13, 14, 23, 25 AND 50).

CLASS 7—MACHINERY

FOR POWER TOOLS NAMELY, INFLATABLE HYDRAULIC JACKS; CUTTING AND STAMPING DIES FOR USE WITH MACHINE TOOLS; POWER OPERATED HYDRAULIC PRESSES FOR BENDING, STRAIGHTENING AND FORCING METAL; POWER OPERATED HYDRAULIC RAMS; POWER-OPERATED GEAR AND BEARING PULLERS FOR USE WITH THE REPAIR AND SERVICE OF VEHICLE DRIVE TRAINS; PNEUMATIC GREASE GUNS; MACHINE PUNCHES; MACHINE VACUUM PUMPS; PORTABLE CABLE HOISTS; POWER-OPERATED PULLER FOR REMOVAL AND INSTALLATION OF GEARS, BEARINGS, WHEELS, PULLEYS, SLEEVES, SHAFTS, AND OTHER FRICTION FITTED PARTS THEREFOR; SHOP CRANES; MACHINES, NAMELY, CRAWLER TRACK PRESSES; MACHINE TOOLS, NAMELY, HYDRAULICALLY POWERED CLAMPS FOR HOLDING WORK PIECES WHILE MANUFACTURING OPERATIONS ARE BEING PERFORMED THEREON; PORTABLE SELF-CONTAINED AIR AND HYDRAULIC CIRCUIT CONTROL AND REGULATING VALVE UNIT UTILIZED AS A CENTRAL POWER SOURCE FOR WORK CLAMPING DEVICES; MACHINE PARTS, NAMELY, HYDRAULIC LOAD BEARING VALVES, HYDRAULIC CHECK VALVES, HYDRAULIC Y MANIFOLD, MULTIPLE PORT HYDRAULIC MANIFOLD BLOCKS; HYDRAULIC JACKS; POWER-OPERATED RACKS FOR GREASING AND REPAIRING VEHICLES; MOBILE HYDRAULIC VEHICLE JACKS; VEHICLE PIECE SUPPORTING MACHINE TOOLS FOR USE IN THE SERVICE AND REPAIR OF ENGINES, DRIVE TRAINS AND SUSPENSIONS; POWER OPERATED UNITS FOR MOUNTING VEHICLE WHEELS AND TIRES; POWER ACTIVATED RACKS, STANDS AND LIFTS FOR USE IN SERVICING AND REPAIRING LAND VEHICLES; FLUID POWER OPERATED PRODUCTS, NAMELY, ELECTRIC, PNEUMATIC AND ENGINE DRIVEN FLUID OPERATED PUMPS, MOTORS, CYLINDERS AND LINEAR ACTUATORS, RAMS, PRESSES, HYDRAULIC JACKS AND STRUCTURAL PARTS THEREFOR; POWER-OPERATED PORTABLE TORQUE CONVERTER AND AIR COOLER CLEANING MACHINE; PUMPS FOR DELIVERING FLUID UNDER PRESSURE, FLUID PRESSURE MOTORS; MACHINE PARTS, NAMELY, VALVES FOR CONTROLLING FLOW OF FLUID, AND UNITARY FLUID PRESSURE POWER SYSTEMS, CONSISTING OF A RESERVOIR AND ONE OR MORE OF THE ABOVE NAMED DEVICES; ELECTRIC MOTOR FOR OPERATING ROTARY SLIP-STEM AND BUTTERFLY VALVES, DAMPERS, AND OTHER FINAL CONTROL ELEMENTS; CONTINUOUS PROCESSING COLUMNS; POSITIVE DISPLACEMENT PUMPS, POSITIVE DISPLACEMENT MOTORS, VALVES FOR USE WITH POSITIVE DISPLACEMENT PUMPS, HYDROSTATIC TRANSMISSION SYSTEMS CONSISTING OF A POSITIVE DISPLACEMENT PUMP AND A POSITIVE DISPLACEMENT MOTOR AND STRUCTURAL PARTS THEREFOR; CONTINUOUS IN-LINE MIXERS FOR USE IN MIXING FLUIDS; POWER ACTIVATED UNIT FOR PUMPING MOLTEN METAL FROM FURNACES; MACHINE PARTS, NAMELY, PLUNGER TYPE CHEMICAL PUMPS, DIAPHRAGM TYPE CHEMICAL PUMPS, LIME SHAKERS, VARIABLE SPEED TRANSMISSIONS, UNITS FOR SPLITTING FILLED BAGS, HOPPER AGITATORS, BUCKET ELEVATORS, BELT CONVEYORS, BULK MATERIAL PROPORTIONING MACHINES, AND PARTS THEREFOR FOR INDUSTRIAL USE; CONVEYOR BELT FOR TRANSPORTING BULK MATERIAL; WATER-SEALED AIR COMPRESSORS; MACHINES FOR FEEDING COAL TO POWER BOILERS AND MACHINES FOR SOLIDIFYING AND REDUCING THE VOLUME OF NUCLEAR POWER PLANT RADIOACTIVE WASTE; UNIVERSAL ELECTRIC MOTORS FOR USE IN A WIDE VARIETY OF DOMESTIC APPLIANCES; ELECTRIC MOTORS FOR MACHINES; ELECTRICALLY-OPERATED FLUID MIXERS; VEHICLE TRANSMISSION FLUID FILTER; PISTON RINGS FOR LAND VEHICLES (U.S. CLS. 13, 19, 21, 23, 31, 34 AND 35).

CLASS 8—HAND TOOLS

FOR MANUALLY OPERATED PULLERS FOR REMOVING GEARS, BEARINGS, PULLEYS AND WHEELS AND OTHER PRESS-FIT PARTS; VACUUM PUMPS; HAND OPERATED OIL FILTER CRUSHERS; HAND TOOLS, NAMELY, NUT SPLITTERS, ADJUSTABLE WRENCHES, CHAIN WRENCHES, SPREADERS, SPANNER WRENCHES, PRY BARS, JIMMY BARS, REVERSIBLE RATCHET SETS, THREAD CHASERS, GEAR SHAFT AND BEARING PULLERS; O-RING SEAL PICKS (U.S. CLS. 23, 28 AND 44).

CLASS 9—ELECTRICAL AND SCIENTIFIC APPARATUS

FOR VEHICLE HEADLIGHT ALIGNMENT GAUGES; ELECTRONIC VEHICLE DIAGNOSTIC UNITS; DYNAMOMETERS; ELECTRONIC MACHINES AND GAUGES FOR TESTING INTERNAL COMBUSTION ENGINES—NAMELY, ELECTRICAL, IGNITION, TRANSMISSION, EXHAUST, CARBURETOR AND FUEL COMPRESSION TESTERS AND ANALYZERS; PRESSURE GAUGES; OHM METERS; VOLTMETERS; CAPACITOR ANALYZERS; ELECTRONIC PORTABLE REFRIGERANT CHARGING STATION; SOLENOID VALVES; COMPUTER SOFTWARE FOR SELECTING VEHICLE AND TOOL REPLACEMENT PARTS; ELECTRONIC BATTERY TESTERS; VACUUM GAUGES FOR REFRIGERATION SYSTEMS; CONTROL PANELS AND MANUALLY AND PYROMETRICALLY AND GALNOMETRICALLY CONTROLLED ELECTRIC SWITCHES RHEOSTATS, AND HEATING-CURRENT CONTROLLERS FOR REGULATING OR CONTROLLING THE TEMPERATURE OR OPERATING CONDITIONS OF ELECTRIC FURNACES, ELECTRIC OVENS, AND ELECTRIC HEAT-TREATING FURNACES; ELECTRIC FLOW METERS AND PRESSURE OR RATE OF FLOW CONTROLLERS, AND TELEMETERS; MECHANICAL FLOW METERS FOR RECORDING AND TOTALING WITH OR WITHOUT INDICATING MEANS; ELECTRICAL CONTROLLERS, NAMELY, PNEUMATICALLY OPERATED INSTRUMENTS TO VARY THE PASSAGE OF A MEDIUM THROUGH A CONDUIT IN RESPONSE TO A CONTROLLED PRESSURE APPLIED THERETO; VOLTAGE AND CURRENT REGULATORS AND COMPENSATORS, BALLASTS AND REACTORS; ROTARY TYPE INTEGRATING FLOW METERS FOR STEAM, AIR AND GAS, AND ACCESSORIES THEREFOR; LAB EQUIPMENT, NAMELY, LIQUID GAUGE GLASS, TRANSMITTER, REMOTE TOTALIZER, FLOW RATE INDICATOR, FLOW RATE RECORDER, FLOW DEMAND INDICATOR AND FLOW DEMAND RECORDER; MEASURING AND SCIENTIFIC APPLIANCES NAMELY, LIQUID BATHS, TEMPERATURE CONTROLLERS, PYROMETERS, THERMOSTATS, INCUBATORS FOR SCIENTIFIC AND LABORATORY USE; STERILIZERS FOR SCIENTIFIC AND LABORATORY USE; OVENS FOR SCIENTIFIC AND LABORATORY USE, NAMELY LIQUID LEVEL CONTROLLERS; COOLING UNITS FOR SCIENTIFIC AND LABORATORY USE, HUMIDITY CABINETS FOR SCIENTIFIC AND LABORATORY USE, AND TIMERS; THERMAL RELAYS—NAMELY, TIME DELAY RELAYS, VOLTAGE SENSING RELAYS, AND CURRENT SENSING RELAYS; ELECTRICAL CONDUIT CONNECTORS, CONDUIT COUPLINGS, CONDUIT NIPPLES, CONDUIT OFF-SETS, RUNNING THREAD NIPPLES, RUNNING THREAD PIPES, RUNNING THREAD RODS, AND EXTENSIONS; LABORATORY MIXERS; DATA PROCESSING AND CONTROL SWITCHES AND RELAYS; ELECTRONIC MOISTURE DETECTING DEVICES FOR OIL QUENCH TANKS; ELECTRIC LINE VOLTAGE REGULATORS; ELECTRICAL AND ELECTRONIC EQUIPMENT—NAMELY, COILS, TRANSFORMERS, INDUCTORS AND REACTORS, ELECTRONIC RELAYS, TELECOMMUNICATION CONTROL CIRCUITS, SIGNAL GENERATORS, AUTOMATIC TELEPHONE DIAL PULSE GENERATORS, AND SIGNAL REGENERATORS AND REPEATERS; BALLASTS FOR SUPPLYING ENERGY TO GASEOUS DISCHARGE LAMPS; STATIC MAGNETIC VOLTAGE REGULATORS; TWO-WAY MOBILE RADIO UNITS AND STRUCTURAL PARTS THEREOF; ELECTRONIC AND ELECTRICAL EQUIPMENT—NAMELY, TELEMETER SYSTEMS FOR COLLECTING AND COMMUNICATING INFORMATION AND DATA, AND FOR TRANSMITTING CONTROL SIGNALS FROM ONE LOCATION TO ANOTHER, NAMELY, SCANNERS, ENCODERS, DECODERS, PULSE

CODE MODULATORS, CODE SEQUENCE SELECTORS, CODE CONVERTORS, AND SPEED CONVERTORS; SOFTWARE FOR USE BY A NETWORK ADMINISTRATOR IN CONNECTION WITH THE CONTROL, TRANSFER, AND INSTALLATION OF SOFTWARE, FILES, AND DATA TO VARIOUS CLIENTS CONNECTED TO THE NETWORK; TELEPHONE DATA TRANSMISSION INTERFACE FOR UNINTERRUPTIBLE POWER SUPPLIES; INVENTORY SOFTWARE, NAMELY SOFTWARE FOR TRACKING INVENTORY IN A LABORATORY; LABORATORY EQUIPMENT, NAMELY RECORDER THERMOMETERS AND ELECTRONIC LOGGERS FOR ELECTRONICALLY STORING TEMPERATURE DATA FOR SUBSEQUENT READING, GRAPHING, AND ANALYSIS BY SOFTWARE AND COMPUTER; ALARM SYSTEMS COMPRISED OF ELECTRONIC THERMOMETERS CONNECTED TO AN ANNUNCIATOR WHICH PROVIDES A WARNING SIGNAL REGARDING UNACCEPTABLE TEMPERATURES, AND TEMPERATURE READOUT DISPLAYS; ELECTRICAL MODULE FOR WEIGHING BULK MATERIALS, PRIMARILY COAL AND LIMESTONE; COMPUTER SYSTEMS COMPRISING HARDWARE AND SOFTWARE FOR SIMULATING TERRAIN VIEWS AND DISPLAYING IMAGES; D.C. ELECTRICAL POWER GENERATORS; ELECTRONIC CONTROLLER FOR COAL FEEDER SYSTEM; ELECTRO-MECHANICAL DIAMETER CONTROL UNITS FOR CRYSTAL GROWING FURNACES; SWITCHES FOR ELECTRICAL OR OPTICAL SIGNAL CONNECTIONS, NAMELY, MATRIX SWITCHES, COMPUTER CHANNEL SWITCHES, LOCAL AREA NETWORK SWITCHES; CONTROL UNITS FOR SWITCHING APPLICATIONS AMONG COMPUTERS AND INPUT/OUTPUT UNITS; ELECTRONIC NETWORK PROTOCOL ANALYZERS; ELECTRONIC SWITCH OR PATCH UNITS FOR PATCHING OR SWITCHING IN COMPUTER NETWORKS AND IN TELEPHONE NETWORKS; OPTICAL FIBER PATCH PANEL AND MANAGEMENT UNITS; TELECOMMUNICATION TRANSMISSION EQUIPMENT AND MONITORING AND TEST UNITS TO IMPLEMENT AND MAINTAIN LOCAL AND LONG DISTANCE COMMUNICATION PATHS AND PARTS FOR THE FOREGOING; OPTICAL MULTIPLEXER FOR COMBINING TWO OR MORE OPTICAL SIGNALS INTO A COMPOSITE OPTICAL SIGNAL; OPTICAL FIBERS AND AN INTERCONNECTION UNIT FOR INTERCONNECTING OR PATCHING ONE SET OF OPTICAL FIBERS TO ANOTHER SET OF OPTICAL FIBERS PRIMARILY FOR LARGE MAINFRAME COMPUTER DATA CENTER ENVIRONMENTS; ELECTRICAL POWER SYSTEMS COMPRISED OF INVERTORS, RECTIFIERS, POWER CONDITIONERS, BATTERY MANAGEMENT DEVICES AND UNINTERRUPTIBLE POWER UNITS FOR USE IN POWER BLACKOUT AND LINE CONDITIONING APPLICATIONS AND COMPUTER SOFTWARE FOR USE TO OPERATE THE FOREGOING; ELECTRICAL TRANSMISSION LINES, NAMELY, ELECTRONIC WAVEGUIDES FOR TRANSMISSION OF RADIO FREQUENCY ENERGY; ENERGY TRANSMISSION AND DISTRIBUTION EQUIPMENT, NAMELY, ELECTRICAL TRANSFORMERS, VOLTAGE SURGE ARRESTERS, TAP CHANGERS, AND PACKAGED SUBSTATIONS; MULTIPLE CABLE TRANSIT SYSTEM, NAMELY, A FIRE STOP TRANSITION BOX POSITIONED IN FIRE RATED BARRIERS SUCH AS FLOORS OR DECKS, WALLS OR BULK HEADS, AND CEILINGS, FOR THE PASSAGE OF CABLES AND/OR CONDUITS THERE THROUGH; FLUID RATE OF FLOW METERS AND CONTROLLERS; INTERFACE UNITS, NAMELY, PRINTED CIRCUIT BOARDS FOR USE IN CONNECTING SERVERS TO THE CHANNELS OF MAINFRAME COMPUTERS; ELECTRICAL CONNECTORS FOR USE WITH A CONDUIT; CONNECTIVITY UNIT FOR CONNECTING A SERVER TO MAINFRAME COMPUTER; MULTI-CABLE TRANSITS, NAMELY, A PRESSURE-TIGHT PACKING ASSEMBLY UTILIZING A MODULUS SYSTEM OF ELASTOMER BLOCKS, ARRANGED SO AS TO FILL UP SPACES BETWEEN CABLES AND THE INTERIOR OF A FRAME; COMMUNICATIONS TEST EQUIPMENT, NAMELY, A TEST HEAD FOR TESTING SUBSCRIBER CIRCUITS FOR DIGITAL LOOP CARRIER SYSTEMS; OPTICAL MULTIPLEXER FOR COMBINING TWO OR MORE OPTICAL SIGNALS INTO A COMPOSITE OPTICAL SIGNAL; ELECTRICAL OPERATED CIRCULATING LIQUID BATH AND STIFFER APPARATUS FOR LABORATORY, PILOT PLANT, AND PRODUCTION MANUFACTURING USES; SECURITY EQUIPMENT, NAMELY CARD ACCESS UNITS, MAGNETIZED ACCESS CARDS AND CARD READERS;

CONTROL PANELS AND MANUALLY AND PYROMETRICALLY AND GALNOMETRICALLY CONTROLLED ELECTRIC SWITCHES RHEOSTATS, AND HEATING-CURRENT CONTROLLERS FOR REGULATING OR CONTROLLING THE TEMPERATURE OR OPERATING CONDITIONS OF ELECTRIC FURNACES, ELECTRIC OVENS, AND ELECTRIC HEAT-TREATING FURNACES; LAB EQUIPMENT, NAMELY, REAGENT-TREATING RETORTS (U.S. CLS. 21, 23, 26, 36 AND 38).

CLASS 10—MEDICAL APPARATUS

FOR DENTAL, MEDICAL, AND SURGICAL APPLIANCES—NAMELY, STERILIZERS, FOR MEDICAL USE, INCUBATORS FOR MEDICAL USE, OVENS FOR MEDICAL USE, LIQUID BATHS FOR MEDICAL USE AND HUMIDITY CABINETS FOR MEDICAL USE (U.S. CLS. 26, 39 AND 44).

CLASS 11—ENVIRONMENTAL CONTROL APPARATUS

FOR ELECTRIC FURNACES; ELECTRIC OVENS; ELECTRIC HEAT-TREATING FURNACES; ELECTRIC HEATING UNITS FOR ELECTRIC FURNACES, ELECTRIC OVENS AND ELECTRIC HEAT-TREATING FURNACES; LIGHTING PANELS AND FIXTURES; FREEZERS OF THE CHEST AND REACH-IN TYPES FOR INDUSTRIAL COOLING OPERATIONS; DEHYDRATORS FOR CONTINUOUS DRYING AND REMOVAL OF MOISTURE FROM COMPRESSED AIR; LIQUID FILTERS; INDUSTRIAL DUST COLLECTORS, AND PARTS AND ACCESSORIES THEREFOR; ULTRA-LOW TEMPERATURE CABINET AND UPRIGHT FREEZERS FOR THE PRESERVATION OF BIOLOGICAL SUBSTANCES FOR LABORATORY AND OTHER EXPERIMENTAL USES; AND CRYSTAL GROWING FURNACES; POWER-OPERATED PORTABLE REFRIGERANT CHARGING UNIT CONSISTING OF CONTROLS, GAUGES AND VALVES AND ASSOCIATED REFRIGERANT AND HOSES ALL SOLD AS A UNIT; ELECTRIC FURNACES; ELECTRIC OVENS; ELECTRIC HEATING UNITS FOR ELECTRIC FURNACES; ELECTRIC HEAT-TREATING FURNACES (U.S. CLS. 13, 21, 23, 31 AND 34).

CLASS 12—VEHICLES

FOR LAND VEHICLE PARTS, NAMELY, TRANSMISSIONS (U.S. CLS. 19, 21, 23, 31, 35 AND 44).

CLASS 17—RUBBER GOODS

FOR NON-METAL REFRIGERANT HOSES (U.S. CLS. 1, 5, 12, 13, 35 AND 50).

CLASS 20—FURNITURE AND ARTICLES NOT OTHERWISE CLASSIFIED

FOR BUILDING FIXTURES, NAMELY, SHELVING, CABINETS, CASES, DISPLAY UNITS; AND PARTS THEREFOR (U.S. CLS. 2, 13, 22, 25, 32 AND 50).

CLASS 35—ADVERTISING AND BUSINESS

FOR ADMINISTRATION, MANAGEMENT, AND DEVELOPMENT OF VEHICLE MAINTENANCE PROCEDURES, VEHICLE OWNER'S LITERATURE, VEHICLE SERVICE TRAINING MATERIALS, AND VEHICLE MAINTENANCE AND REPAIR PROGRAMS FOR VEHICLE DEALERS AND VEHICLE SERVICE FACILITIES (U.S. CLS. 100, 101 AND 102).

CLASS 40—MATERIAL TREATMENT

FOR METAL CASTING SERVICES (U.S. CLS. 100, 103 AND 106).

SN 75-930,064. E-COMM SOLUTIONS, LLC, CREVE COUER, MO. FILED 2-11-2000.

SN 75-933,401. AKRON GENERAL MEDICAL CENTER, AKRON, OH. FILED 3-2-2000.

HELPING COMPANIES GET FROM A TO E

CLASS 35—ADVERTISING AND BUSINESS

FOR BUSINESS CONSULTING; BUSINESS CONSULTING IN THE AREA OF E-COMMERCE; BUSINESS MARKETING CONSULTING SERVICES; BUSINESS CONSULTING IN THE AREA OF WEB ENABLEMENT; BUSINESS CONSULTING IN THE AREA OF WEB DESIGN (U.S. CLS. 100, 101 AND 102).

FIRST USE 12-9-1998; IN COMMERCE 12-9-1998.

CLASS 42—SCIENTIFIC, COMPUTER AND LEGAL SERVICES

FOR COMPUTER CONSULTATION; COMPUTER SERVICES, NAMELY CREATING AND MAINTAINING WEB SITES FOR OTHERS; COMPUTER SERVICES, NAMELY DESIGNING AND IMPLEMENTING NETWORK PAGES FOR OTHERS, COMPUTER PROGRAMMING FOR OTHERS, COMPUTER WEB SITE DESIGN FOR OTHERS, INSTALLATION OF COMPUTER SOFTWARE FOR OTHERS, UPDATING OF COMPUTER SOFTWARE, COMPUTER SOFTWARE DESIGN FOR OTHERS (U.S. CLS. 100 AND 101).

FIRST USE 12-9-1998; IN COMMERCE 12-9-1998.

SN 75-932,847. PEARSON EDUCATION LIMITED, HARLOW, ESSEX, UNITED KINGDOM, FILED 3-1-2000.

THE LANGUAGE GYM

OWNER OF ERPN CMNTY TM OFC REG. NO. 483321, DATED 2-3-1999, EXPIRES 2-21-2007.

CLASS 9—ELECTRICAL AND SCIENTIFIC APPARATUS

FOR INSTRUCTIONAL AND TEACHING APPARATUS, NAMELY, SELF-ASSEMBLY ELECTRONIC KITS FOR USE BY STUDENTS AND PUPILS AND SCHOOLS; MAGNETIC DATA CARRIERS, RECORDING DISCS, VIDEO TAPES, CDS AND COMPUTER SOFTWARE ALL RELATED TO OR BEING EDUCATIONAL AND INSTRUCTIONAL MATERIALS ON THE ENGLISH LANGUAGE OR ENGLISH SPEAKING CULTURES (U.S. CLS. 21, 23, 26, 36 AND 38).

CLASS 16—PAPER GOODS AND PRINTED MATTER

FOR PRINTED PUBLICATIONS, NAMELY, BOOKLETS, BOOKS, CALENDARS, CATALOGUES, HANDBOOKS, LEDGERS, MAGAZINES, MANUALS, NEWSLETTERS, PAMPHLETS, PERIODICAL, PLANS, AND PROSPECTUSES, ALL RELATING TO THE ENGLISH LANGUAGE OR ENGLISH SPEAKING CULTURES (U.S. CLS. 2, 5, 22, 23, 29, 37, 38 AND 50).

CLASS 41—EDUCATION AND ENTERTAINMENT

FOR LANGUAGE SCHOOLS, EDUCATION AND PROVISION OF TRAINING SERVICES, CORRESPONDENCE COURSE AND EXAMINATION SERVICES ALL RELATING TO THE ENGLISH LANGUAGE OR ENGLISH SPEAKING CULTURES (U.S. CLS. 100, 101 AND 107).



THE MARK CONSISTS OF A STYLIZED RUNNING PERSON.

CLASS 41—EDUCATION AND ENTERTAINMENT

FOR HEALTH CLUB SERVICES, INCLUDING ACCESS TO EXERCISE EQUIPMENT, GYMNASIUM, SWIMMING POOL (U.S. CLS. 100, 101 AND 107).

CLASS 42—SCIENTIFIC, COMPUTER AND LEGAL SERVICES

FOR PHYSICAL THERAPY, INCLUDING THE INTEGRATION OF MEDICAL ADVICE AND TREATMENT WITH PHYSICAL THERAPY AND EXERCISE EQUIPMENT (U.S. CLS. 100 AND 101).

SN 75-934,457. GRADIPORE LIMITED, NEW SOUTH WALES 2114, AUSTRALIA, FILED 3-3-2000.

GRADIDRY

PRIORITY CLAIMED UNDER SEC. 44(D) ON AUSTRALIA APPLICATION NO. 821775, FILED 1-31-2000, REG. NO. 821775, DATED 1-31-2000, EXPIRES 1-31-2010.

OWNER OF U.S. REG. NOS. 1,005,045, 1,746,647 AND 1,779,940.

CLASS 1—CHEMICALS

FOR ANALYTICAL CHEMICAL PREPARATIONS FOR USE IN THE SEPARATION OF PROTEINS AND OTHER MACROMOLECULES, NAMELY, ELECTROPHORETIC STAINS, PRECAST GELS, CHEMICAL MARKERS, CHROMATOGRAPHY CHEMICAL PREPARATIONS; REAGENTS FOR SCIENTIFIC OR MEDICAL RESEARCH USE, NAMELY, REAGENTS FOR USE IN THE SEPARATION AND ANALYSIS OF BIOLOGICAL AND CLINICAL MATERIALS AND SPECIMENS (U.S. CLS. 1, 5, 6, 10, 26 AND 46).

CLASS 5—PHARMACEUTICALS

FOR DIAGNOSTIC PREPARATIONS FOR CLINICAL AND/OR MEDICAL LABORATORY USE, NAMELY, REAGENTS FOR USE IN THE SEPARATION AND ANALYSIS OF BIOLOGICAL AND CLINICAL MATERIALS AND SPECIMENS (U.S. CLS. 6, 18, 44, 46, 51 AND 52).

CLASS 9—ELECTRICAL AND SCIENTIFIC APPARATUS

FOR SCIENTIFIC APPARATUS AND INSTRUMENTS FOR THE SEPARATION AND ANALYSIS OF MATERIALS INCLUDING BIOLOGICAL MATERIALS; ELECTROPHORESIS APPARATUS FOR SCIENTIFIC AND LABORATORY USE (U.S. CLS. 21, 23, 26, 36 AND 38).

SN 75-938,286. PRMSOFT INC., STRATFORD, CT. BY ASSIGNMENT PRMSOFT LLC, STRATFORD, CT. FILED 3-8-2000.



SN 75-936,349. ZAKRYTOE AKTSIONERNOE OBSHESTVO "KOMPANIA TRANSTELECOM", 109029, MOSCOW, RUSSIAN FEDERATIO, FILED 3-2-2000.

CLASS 9—ELECTRICAL AND SCIENTIFIC APPARATUS

FOR SOFTWARE DESIGNED FROM PATIENT CENTRIC POINT OF VIEW FOR HEALTHCARE DELIVERY MANAGEMENT TO AUTOMATE PAPERWORK, ORGANIZE DATA, AND ELECTRONIC SECURITY OF INFORMATION TRANSFER FOR PROVIDING HEALTHCARE TO CONSUMERS (U.S. CLS. 21, 23, 26, 36 AND 38).

CLASS 35—ADVERTISING AND BUSINESS

FOR BUSINESS CONSULTING SERVICES IN THE HEALTHCARE FIELD (U.S. CLS. 100, 101 AND 102).

**CLASS 41—EDUCATION AND ENTERTAINMENT**

FOR EDUCATIONAL SERVICES, NAMELY, CONDUCTING SEMINARS AND WORKSHOPS IN THE FIELD OF HEALTHCARE DELIVERY SYSTEMS (U.S. CLS. 100, 101 AND 107).

OWNER OF RUSSIAN FEDERATIO REG. NO. 179938, DATED 9-27-1999, EXPIRES 4-15-2009.

NO CLAIM IS MADE TO THE EXCLUSIVE RIGHT TO USE "COMPANY", APART FROM THE MARK AS SHOWN.

THE ENTIRE MARK IS BLUE-GREEN, AND COLOR IS CLAIMED AS A FEATURE OF THE MARK.

CLASS 42—SCIENTIFIC, COMPUTER AND LEGAL SERVICES

FOR PROVIDING TEMPORARY USE OF ON-LINE NON-DOWNLOADABLE LOCALLY OR REMOTELY HOSTED SOFTWARE FOR MANAGING ADMINISTRATIVE, CLINICAL, AND FINANCIAL FUNCTIONS IN HEALTHCARE ORGANIZATIONS (U.S. CLS. 100 AND 101).

CLASS 35—ADVERTISING AND BUSINESS

FOR ADVERTISING SERVICES, NAMELY, PROVIDING ADVERTISING SPACE IN A PERIODICAL, DIRECT MAIL ADVERTISING, PUBLICATION OF PUBLICITY TEXTS; MARKETING SERVICES, NAMELY, DISTRIBUTING MARKETING BROCHURES, MARKETING RESEARCH, BUSINESS INVESTIGATIONS, AUCTIONEERING, ORGANIZATION OF EXHIBITIONS FOR COMMERCIAL OR ADVERTISING PURPOSES, AND IMPORT-EXPORT AGENCIES (U.S. CLS. 100, 101 AND 102).

SN 75-939,992. HAINES OBTAINS! LTD., LOS ANGELES, CA. FILED 3-9-2000.

CLASS 38—COMMUNICATION

FOR COMMUNICATIONS BY COMPUTER TERMINALS, COMMUNICATIONS BY FIBER OPTIC NETWORKS, SATELLITE TRANSMISSION, RADIO-RELAY COMMUNICATIONS, NAMELY, PROVIDING THE TRANSMISSION OF RADIO FREQUENCY SIGNALS AND REFLECTION OF SIGNALS FROM OBJECTS; TELECOMMUNICATION SERVICES, NAMELY, LONG-DISTANCE SERVICES, PREPAID WIRELESS AND CELLULAR TELEPHONE SERVICES, PAGING SERVICES, TELEVISION BROADCASTING, CABLE TELEVISION BROADCASTING, RADIO BROADCASTING, TELEPHONE SERVICES, ELECTRONIC MAIL, RENTAL OF MESSAGE SENDING APPARATUS, RENTAL OF TELECOMMUNICATIONS EQUIPMENT IN GENERAL, RENTAL OF MODEMS, AND RENTAL OF FACSIMILE APPARATUS (U.S. CLS. 100, 101 AND 104).

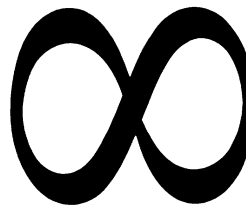

OWNER OF U.S. REG. NOS. 1,994,242 AND 2,067,990.

CLASS 35—ADVERTISING AND BUSINESS

FOR AUCTIONEERING SERVICES, NAMELY CONDUCTING LIVE AUCTIONS IN THE FIELD OF ART AND ARTWORK, JEWELRY, COLLECTIBLES, FURNITURE, HOME FURNISHINGS, ANTIQUES, SILVER, PORCELAIN, CRYSTAL, WARDROBE, FURS, COINS AND STAMPS; TELEPHONE AND TELEVISION AUCTION SERVICES, AND PROVIDING AUCTION SERVICES BY COMPUTER VIA THE INTERNET, ALL IN THE FIELD OF ART AND ARTWORK, JEWELRY, COLLECTIBLES, FURNITURE, HOME FURNISHINGS, ANTIQUES, SILVER, PORCELAIN, CRYSTAL, WARDROBE AND FURS, COINS AND STAMPS (U.S. CLS. 100, 101 AND 102).

CLASS 42—SCIENTIFIC, COMPUTER AND LEGAL SERVICES

FOR TELEPHONE AND TELEVISION AUCTION SERVICES, AND PROVIDING AUCTION SERVICES BY COMPUTER VIA A GLOBAL COMPUTER NETWORK, ALL IN THE FIELD OF ART AND ARTWORK, JEWELRY, COLLECTIBLES, FURNITURE, HOME FURNISHINGS, ANTIQUES, SILVER, PORCELAIN, CRYSTAL, WARDROBE AND FURS, COINS AND STAMPS (U.S. CLS. 100 AND 101).

SN 75-941,207. NETGENESIS CORP., CAMBRIDGE, MA. FILED 3-10-2000.



NetGenesis

OWNER OF U.S. REG. NOS. 1,989,334 AND 2,368,178.

CLASS 9—ELECTRICAL AND SCIENTIFIC APPARATUS

FOR COMPUTER SOFTWARE FOR MEASURING AND OPTIMIZING THE USAGE DESIGN AND PERFORMANCE OF WEB SITES ON A GLOBAL COMPUTER NETWORK (U.S. CLS. 21, 23, 26, 36 AND 38).

CLASS 42—SCIENTIFIC, COMPUTER AND LEGAL SERVICES

FOR CONSULTING SERVICES IN THE FIELD OF WEB SITE DESIGN AND WEB SITE USAGE AND PERFORMANCE ASSESSMENT (U.S. CLS. 100 AND 101).

SN 75-943,483. OCEAN INDUSTRIES, INC., MANCHESTER, NH. FILED 3-6-2000.

ACU-GAGE SYSTEMS

NO CLAIM IS MADE TO THE EXCLUSIVE RIGHT TO USE "SYSTEMS", APART FROM THE MARK AS SHOWN.

CLASS 37—CONSTRUCTION AND REPAIR

FOR INSTALLATION, MAINTENANCE, REPAIR AND UPGRADING, SERVICES FOR PRECISION MEASURING DEVICES, NAMELY COORDINATE MACHINES (U.S. CLS. 100, 103 AND 106).

FIRST USE 7-15-1981; IN COMMERCE 7-15-1981.

CLASS 40—MATERIAL TREATMENT

FOR CUSTOM MANUFACTURING OF PRECISION MEASURING DEVICES, NAMELY, COORDINATE MACHINES USED IN PRECISION MEASUREMENT, UTILIZING A VARIETY OF SENSOR TECHNIQUES, NAMELY, VIDEO, TOUCH PROBE OR LASER, EITHER ALONE OR IN COMBINATION (U.S. CLS. 100, 103 AND 106).

FIRST USE 7-15-1981; IN COMMERCE 7-15-1981.

CLASS 42—SCIENTIFIC, COMPUTER AND LEGAL SERVICES

FOR RECALIBRATION SERVICES FOR PRECISION MEASURING DEVICES, NAMELY, COORDINATE MACHINES (U.S. CLS. 100 AND 101).

FIRST USE 7-15-1981; IN COMMERCE 7-15-1981.

SN 75-943,703. IP GLOBALNET SOLUTIONS N.V., 1932 ZAVENTEM, BELGIUM, FILED 3-14-2000.

IPG

PRIORITY CLAIMED UNDER SEC. 44(D) ON BENELUX APPLICATION NO. 954938, FILED 1-14-2000, REG. NO. 0658047, DATED 1-14-2000, EXPIRES 1-14-2010.

CLASS 9—ELECTRICAL AND SCIENTIFIC APPARATUS

FOR COMPUTER SOFTWARE FOR CREATING AND MAINTAINING WEB SITES; COMPUTERS AND COMPUTER PERIPHERALS (U.S. CLS. 21, 23, 26, 36 AND 38).

CLASS 35—ADVERTISING AND BUSINESS

FOR BUSINESS MANAGEMENT AND ORGANIZATION CONSULTATION; BUSINESS CONSULTATION SERVICES RELATED TO DOING BUSINESS USING THE INTERNET; BUSINESS MARKETING CONSULTING SERVICES RELATED TO ELECTRONIC COMMERCE (U.S. CLS. 100, 101 AND 102).

CLASS 37—CONSTRUCTION AND REPAIR

FOR MAINTENANCE, INSTALLATION AND REPAIR OF COMPUTER HARDWARE, COMPUTER PERIPHERALS, COMPUTER NETWORK HARDWARE AND TELECOMMUNICATION DEVICES (U.S. CLS. 100, 103 AND 106).

CLASS 42—SCIENTIFIC, COMPUTER AND LEGAL SERVICES

FOR INSTALLATION, MAINTENANCE AND UPDATING OF SOFTWARE FOR COMPUTER NETWORKS; DRAFTING TECHNICAL REPORTS OF EXPERTS IN THE FIELD OF COMPUTERS, COMPUTER PERIPHERALS, COMPUTER NETWORKS AND TELECOMMUNICATION APPARATUS, CONSULTATION IN THE FIELD OF SOFTWARE, COMPUTERS AND TELECOMMUNICATION APPARATUS; CONSULTATION IN THE FIELD OF TELECOMMUNICATIONS; DESIGNING AND DEVELOPING SOFTWARE FOR OTHERS; UPDATING AND MAINTENANCE OF SOFTWARE FOR OTHERS; CREATING AND MAINTAINING WEB SITES FOR OTHERS (U.S. CLS. 100 AND 101).

SN 75-943,761. CB TECHNOLOGIES, INC., EXTON, PA. BY MERGER PLEXSYS, INC., WEST CHESTER, PA. FILED 3-14-2000.

METATRIAL

CLASS 9—ELECTRICAL AND SCIENTIFIC APPARATUS

FOR ELECTRONIC DATA CAPTURE SYSTEMS COMPRISED OF COMPUTER HARDWARE, NAMELY COMPUTERS, COMPUTER PERIPHERALS, WIRELESS DEVICES, SCANNERS AND PALM-HELD DEVICES AND COMPUTER SOFTWARE FOR USE IN CONNECTION WITH DATA COLLECTION AND CLINICAL TRIALS IN THE FIELD OF PHARMACEUTICAL, BIOTECHNOLOGY, HEALTHCARE AND MEDICAL DEVICE MANUFACTURING (U.S. CLS. 21, 23, 26, 36 AND 38).

FIRST USE 6-15-1997; IN COMMERCE 2-1-1998.

CLASS 41—EDUCATION AND ENTERTAINMENT

FOR CONDUCTING TRAINING WORKSHOPS IN THE FIELD OF COMPUTER SOFTWARE USED IN CLINICAL TRIALS IN THE FIELD OF PHARMACEUTICAL, BIOTECHNOLOGY, HEALTHCARE AND MEDICAL DEVICE MANUFACTURING (U.S. CLS. 100, 101 AND 107).

FIRST USE 6-15-1997; IN COMMERCE 2-1-1998.

CLASS 42—SCIENTIFIC, COMPUTER AND LEGAL SERVICES

FOR CUSTOM DATABASE DEVELOPMENT SERVICES FOR OTHERS; DATABASE DESIGN AND IMPLEMENTATION FOR OTHERS AND DATABASE SOFTWARE INSTALLATION SERVICES FOR OTHERS; TECHNICAL SUPPORT SERVICES NAMELY TROUBLESHOOTING OF COMPUTER SOFTWARE PROBLEMS VIA TELEPHONE, E-MAIL AND IN PERSON FOR CLINICAL TRIALS IN THE FIELD OF PHARMACEUTICAL, BIOTECHNOLOGY, HEALTHCARE AND MEDICAL DEVICE MANUFACTURING (U.S. CLS. 100 AND 101).

FIRST USE 6-15-1997; IN COMMERCE 2-1-1998.

SN 75-945,439. KANG, SEUNG MOON, AKA STEVE KANG, CERRITOS, CA. FILED 2-25-2000.



NO CLAIM IS MADE TO THE EXCLUSIVE RIGHT TO USE "OUTDOOR", APART FROM THE MARK AS SHOWN.

CLASS 11—ENVIRONMENTAL CONTROL APPARATUS

FOR GAS STOVES, RANGES AND LAMPS (U.S. CLS. 13, 21, 23, 31 AND 34).

FIRST USE 3-0-1996; IN COMMERCE 8-0-1996.

CLASS 18—LEATHER GOODS

FOR BACKPACKS AND DAYPACKS (U.S. CLS. 1, 2, 3, 22 AND 41).

FIRST USE 3-0-1996; IN COMMERCE 8-0-1996.

CLASS 20—FURNITURE AND ARTICLES NOT OTHERWISE CLASSIFIED

FOR SLEEPING BAGS AND MATTRESSES FOR USE WHEN CAMPING (U.S. CLS. 2, 13, 22, 25, 32 AND 50).
FIRST USE 3-0-1996; IN COMMERCE 8-0-1996.

CLASS 22—CORDAGE AND FIBERS

FOR TENTS (U.S. CLS. 1, 2, 7, 19, 22, 42 AND 50).
FIRST USE 3-0-1996; IN COMMERCE 8-0-1996.

SN 75-960,951. ROBOTICA LIMITED, GLASGOW, SCOTLAND, UNITED KINGDOM, FILED 3-19-2000.

GREENCAD

CLASS 9—ELECTRICAL AND SCIENTIFIC APPARATUS

FOR COMPUTER SOFTWARE FOR ALL OF THE FOLLOWING— ARCHITECTURAL AND ENGINEERING DESIGN AND DRAFTING, ENVIRONMENTAL ASSESSMENT, INDOOR AIR QUALITY (IAQ) ASSESSMENT, HEALTH AND SAFETY ASSESSMENT, SPACE MANAGEMENT, LAND MANAGEMENT, WATER MANAGEMENT, WASTE AND SEWERAGE MANAGEMENT, MATERIAL USE MANAGEMENT, DATA ACQUISITION AND DATABASE MANAGEMENT, CREATING SPREADSHEETS, WORD PROCESSING, ILLUSTRATION AND PAGE LAYOUT, PHOTO EDITING AND BITMAP CREATION, 3D MODELING, RENDERING AND ANIMATION, COMPUTER ASSISTED DESIGN AND COMPUTER ASSISTED MANUFACTURING (CAD/CAM), COMPUTER ASSISTED ENGINEERING (CAE), DOWNLOADABLE COMPUTER SOFTWARE DEVELOPMENT TOOLS; CHILDREN'S EDUCATION SOFTWARE ; COMPUTER SEARCH ENGINE SOFTWARE; COMMUNICATIONS SOFTWARE FOR CONNECTING COMPUTER NETWORK USERS AND GLOBAL COMPUTER NETWORKS; COMPUTER COMMUNICATIONS SOFTWARE TO ALLOW CUSTOMERS TO ACCESS BANK ACCOUNT INFORMATION AND TRANSACT BANK BUSINESS; COMPUTER E-COMMERCE SOFTWARE TO ALLOW USERS TO PERFORM ELECTRONIC BUSINESS TRANSACTIONS VIA A GLOBAL COMPUTER NETWORK; COMPUTER SOFTWARE TO AUTOMATE DATA WAREHOUSING; COMPUTER SOFTWARE TO CONTROL AND IMPROVE COMPUTER AND AUDIO EQUIPMENT SOUND QUALITY; COMPUTER SOFTWARE TO ENHANCE THE AUDIOVISUAL CAPABILITIES OF MULTIMEDIA APPLICATIONS, NAMELY, FOR THE INTEGRATION OF TEXT, AUDIO, GRAPHICS, STILL IMAGES AND MOVING PICTURES; BLANK MAGNETIC COMPUTER TAPES; COMPUTER TELEPHONY SOFTWARE WHICH ENABLES TELEPHONE ACTIVITIES TO BE PERFORMED THROUGH A COMPUTER; COMPUTER TERMINALS; COMPUTER UTILITY PROGRAMS; COMPUTER DRAWING PADS; COMPUTER WORKSTATION, COMPRISING COMPUTER MONITOR, KEYBOARD, DRAWING PAD, HARD DRIVE, MEMORY, MODEM, VIDEO/SOUND CARD, NETWORKING CARD, DATA ACQUISITION I/O CARD, CAMERA; COMPUTERS AND INSTRUCTION MANUALS SOLD AS A UNIT; COMPUTER JOYSTICKS; COMPUTER GAME PROGRAMS; COMPUTER GAME SOFTWARE; COMPUTER GAME TAPES; COMPUTER HARDWARE; COMPUTER OPERATING SYSTEMS; COMPUTER PERIPHERALS, NAMELY, PRINTERS, PLOTTERS, SCANNERS, DATA STORAGE AND RETRIEVAL DEVICES, COMPUTER DRAWING PADS; COMPUTER MOUSE; COMPUTER KEYBOARD; COMPUTER STANDS SPECIALLY DESIGNED FOR HOLDING A COMPUTER; COMPUTER CARRYING CASES; COMPUTER CHIPS; DATA PROCESSORS; FACILITIES MANAGEMENT SOFTWARE, NAMELY, TO CONTROL BUILDING ENVIRONMENTAL SYSTEMS, NAMELY, HEATING, VENTILATING, AIR CONDITIONING AND LIGHTING SYSTEMS, ACCESS AND SECURITY SYSTEMS (U.S. CLS. 21, 23, 26, 36 AND 38).

CLASS 35—ADVERTISING AND BUSINESS

FOR FACILITIES MANAGEMENT SERVICES TO CONTROL BUILDING ENVIRONMENTAL SYSTEMS, NAMELY, HEATING, VENTILATING, AIR CONDITIONING AND LIGHTING SYSTEMS, AND ACCESS AND SECURITY SYSTEMS (U.S. CLS. 100, 101 AND 102).

CLASS 42—SCIENTIFIC, COMPUTER AND LEGAL SERVICES

FOR COMPUTER SOFTWARE DESIGN SERVICES FOR OTHERS IN THE FIELDS OF ALL OF THE FOLLOWING - ARCHITECTURAL/ENGINEERING DESIGN AND DRAFTING, ENVIRONMENTAL ASSESSMENT, INDOOR AIR QUALITY (IAQ) ASSESSMENT, HEALTH AND SAFETY ASSESSMENT, SPACE MANAGEMENT, LAND MANAGEMENT, WATER MANAGEMENT, WASTE AND SEWERAGE MANAGEMENT, MATERIAL USE MANAGEMENT, WORD PROCESSING, CREATING SPREADSHEETS, GRAPHIC ILLUSTRATION AND PAGE LAYOUT, PHOTO EDITING AND BITMAP CREATION, 3D MODELING AND RENDERING, AND COMPUTER ASSISTED DESIGN AND MANUFACTURING, NAMELY FOR DESIGNING AND MANUFACTURING ARCHITECTURAL AND ENGINEERING RELATED COMPONENTS AND MATERIALS (U.S. CLS. 100 AND 101).

SN 75-980,336. INTERNATIONAL DATA GROUP, INC., FRAMINGHAM, MA. FILED 5-5-1999.

GAMEPRO SUPERSTORE

OWNER OF U.S. REG. NOS. 1,612,021, 1,751,608 AND OTHERS.

NO CLAIM IS MADE TO THE EXCLUSIVE RIGHT TO USE "SUPERSTORE", APART FROM THE MARK AS SHOWN.

CLASS 35—ADVERTISING AND BUSINESS

FOR COOPERATIVE ADVERTISING AND MARKETING AND PREPARING CUSTOMER DATABASE MAILING LISTS FOR OTHERS; ONLINE RETAIL STORES AND RETAIL STORES FEATURING A WIDE VARIETY OF GOODS AND SERVICES; PROMOTING THE GOOD AND SERVICES OF OTHERS BY PREPARING AND PLACING ADVERTISEMENTS ON A WEBSITE ACCESSED THROUGH A GLOBAL COMPUTER NETWORK (U.S. CLS. 100, 101 AND 102).

FIRST USE 9-0-1999; IN COMMERCE 9-0-1999.

CLASS 42—SCIENTIFIC, COMPUTER AND LEGAL SERVICES

FOR ONLINE PUBLICATIONS, NAMELY, BOOKS, BROCHURES, JOURNALS, MAGAZINES, MAGAZINE SUPPLEMENTS, NEWSLETTERS, AND PAMPHLETS IN THE FIELDS OF INTERACTIVE ENTERTAINMENT, COMPUTERS, COMPUTER SOFTWARE, ONLINE SERVICES, HIGH TECHNOLOGY, COMPUTER COMMUNICATIONS, INFORMATION TECHNOLOGY AND COMPUTER INFORMATION SERVICES; PROVIDING A WEBSITE OF INFORMATION IN THE FIELDS OF INTERACTIVE ENTERTAINMENT, COMPUTERS, COMPUTER SOFTWARE, ONLINE SERVICES, HIGH TECHNOLOGY, COMPUTER COMMUNICATIONS, INFORMATION TECHNOLOGY AND COMPUTER INFORMATION SERVICES THAT MAY BE ACCESSED THROUGH A GLOBAL COMPUTER NETWORK; RESEARCH AND CONSULTING SERVICES IN THE FIELDS OF INTERACTIVE ENTERTAINMENT, COMPUTERS, COMPUTER SOFTWARE, ONLINE SERVICES, HIGH TECHNOLOGY, COMPUTER COMMUNICATIONS, INFORMATION TECHNOLOGY AND COMPUTER INFORMATION SERVICES (U.S. CLS. 100 AND 101).

FIRST USE 9-0-1999; IN COMMERCE 9-0-1999.

SN 75-979,624. FOOTBALL ASSOCIATION LIMITED, THE, LONDON W2 2LW, ENGLAND, FILED 10-9-1997.

THREE LIONS

OWNER OF UNITED KINGDOM REG. NO. 2124992, DATED 2-25-1997, EXPIRES 2-25-2007.

CLASS 16—PAPER GOODS AND PRINTED MATTER

FOR STATIONERY; PRINTED LABELS NOT OF TEXTILE; ADDRESS LABELS; SHIPPING LABELS; NOTEPAPER; CARDBOARD; GREETING CARDS; POSTCARDS; DECALCOMANIAS; IRON-ON AND/OR PLASTIC TRANSFERS; POSTERS; PRINTED MATTER, NAMELY SOCCER MATCH SOUVENIR PROGRAMMES, PAMPHLETS, SHEETS AND BOOKLETS CONTAINING PRINTED SPORTING EVENT SCHEDULES, TRADING CARDS; PERIODICAL PUBLICATIONS, NAMELY, NEWSPAPERS, NEWSLETTERS AND MAGAZINES IN THE FIELD OF SPORTS; BOOKS FEATURING SPORTING NEWS AND INFORMATION; MOUNTED PHOTOGRAPHS; UNMOUNTED PHOTOGRAPHS; VEHICLE STICKERS; ADHESIVE TAPES AND GLUES FOR STATIONERY USE; PRINTED INSTRUCTIONAL AND TEACHING MATERIALS CONCERNING SOCCER AND SPORT; AND PLAYING CARDS (U.S. CLS. 2, 5, 22, 23, 29, 37, 38 AND 50).

CLASS 28—TOYS AND SPORTING GOODS

FOR GAMES AND PLAYTHINGS, NAMELY, SOCCER BALLS, BOARD GAMES, TOY ACTION FIGURES; GYMNASIAC AND SPORTING ARTICLES, NAMELY, SOCCER GOAL NETS AND SOCCER GOAL POSTS (U.S. CLS. 22, 23, 38 AND 50).

SN 75-982,240. FRANGI S.P.A., I - 22029 UGGIATE THEVA-NO9, ITALY, FILED 12-20-2000.

FRANGI

PRIORITY CLAIMED UNDER SEC. 44(D) ON ITALY APPLICATION NO. 2000C011837. FILED 10-27-2000, REG. NO. 00834000, DATED 1-26-2001, EXPIRES 10-27-2010.

CLASS 18—LEATHER GOODS

FOR GOODS MADE OF LEATHER AND IMITATION OF LEATHER, NAMELY BAGS COMPRISED OF LEATHER SHOULDER BELTS, LEATHER SHOPPING BAGS, BOOK BAGS, CARRY-ON BAGS (U.S. CLS. 1, 2, 3, 22 AND 41).

CLASS 24—FABRICS

FOR TEXTILES AND TEXTILE GOODS, NAMELY HANKERCHIEFS, SILK FABRICS (U.S. CLS. 42 AND 50).

SN 76-000,006. PENNWELL CORPORATION, TULSA, OK.
FILED 3-14-2000.

OIL & GAS JOURNAL EXCHANGE

OWNER OF U.S. REG. NOS. 508,769 AND 2,197,086.
NO CLAIM IS MADE TO THE EXCLUSIVE RIGHT TO
USE "JOURNAL" IN CLASS 16 ONLY AND "EXCHANGE",
APART FROM THE MARK AS SHOWN.
SEC. 2(F) AS TO "OIL & GAS JOURNAL".

CLASS 9—ELECTRICAL AND SCIENTIFIC APPARATUS

FOR PRERECORDED VIDEOTAPES, DIGITAL COM-
PUTER TAPES, COMPACT DISCS, MAGNETIC DISCS,
FLASH MEMORY CARDS, DVDS AND CD-ROMS, ALL
CONTAINING INFORMATION RELATING TO THE OIL
AND GAS INDUSTRY (U.S. CLS. 21, 23, 26, 36 AND 38).

CLASS 16—PAPER GOODS AND PRINTED MATTER

FOR PUBLICATIONS, NAMELY, MAGAZINES, JOUR-
NALS, NEWSLETTERS, BROCHURES, REPORTS, USERS
MANUALS, AND PRINTED INSTRUCTIONAL, EDUCA-
TIONAL, AND TRAINING MATERIALS RELATING TO
THE OIL AND GAS INDUSTRY; MAPS CONTAINING
INFORMATION RELATING TO THE OIL AND GAS
INDUSTRY (U.S. CLS. 2, 5, 22, 23, 29, 37, 38 AND 50).

CLASS 35—ADVERTISING AND BUSINESS

FOR ARRANGING AND CONDUCTING BUSINESS
CONFERENCES RELATING TO THE OIL AND GAS
INDUSTRY (U.S. CLS. 100, 101 AND 102).

CLASS 36—INSURANCE AND FINANCIAL

FOR PROVIDING FINANCIAL INFORMATION RE-
LATING TO THE OIL AND GAS INDUSTRY VIA
INTRANETS, EXTRANETS, AND THE INTERNET (U.S.
CLS. 100, 101 AND 102).

CLASS 37—CONSTRUCTION AND REPAIR

FOR PROVIDING INFORMATION ABOUT THE OIL
AND GAS INDUSTRY, NAMELY, INFORMATION
ABOUT OIL WELL BORING, OIL BURNER REGULA-
TION AND REPAIR, DRILLING AND PUMPING OF
OIL, OIL PIPELINE LAYING, OIL WELL CASING,
TUBING, AND DRILL PIPE INSTALLATION, AND
COVERING, COATING, AND MAINTENANCE OF PIPE-
LINES FOR OIL, ALL VIA INTRANETS, EXTRANETS,
AND THE INTERNET (U.S. CLS. 100, 103 AND 106).

CLASS 39—TRANSPORTATION AND STO- RAGE

FOR PROVIDING INFORMATION ABOUT THE OIL
AND GAS INDUSTRY, NAMELY, INFORMATION
ABOUT THE TRANSMISSION OF OIL OR GAS
THROUGH PIPELINES, VIA INTRANETS, EXTRANETS,
AND THE INTERNET (U.S. CLS. 100 AND 105).

CLASS 40—MATERIAL TREATMENT

FOR PROVIDING INFORMATION ABOUT THE OIL
AND GAS INDUSTRY, NAMELY, INFORMATION
ABOUT OIL WELL FRACTURING, OIL AND GAS WELL
TREATMENT, OIL REFINING, AND OIL WELL PRO-
SPECTING, NAMELY, PERFORATION AND SPILL
TREATMENT, ALL VIA INTRANETS, EXTRANETS,
AND THE INTERNET (U.S. CLS. 100, 103 AND 106).

CLASS 41—EDUCATION AND ENTERTAIN- MENT

FOR TRAINING IN THE USE AND OPERATION OF
COMPUTERS AND COMPUTER SOFTWARE (U.S. CLS.
100, 101 AND 107).

CLASS 42—SCIENTIFIC, COMPUTER AND LEGAL SERVICES

FOR PROVIDING INFORMATION ABOUT THE OIL
AND GAS INDUSTRY, NAMELY, INFORMATION
ABOUT ANALYSIS AND TESTING FOR OIL WORK-
INGS, ANALYSIS OF OIL FIELDS, ANALYSIS OF OIL
SOAKINGS, MINERAL AND OIL ASSAYING, OIL AND
OIL FIELD EXPLORATION, GEOPHYSICAL EXPLORA-
TION FOR THE OIL, GAS, AND MINING INDUSTRIES,
OIL BURNER INSPECTIONS, SURVEYING OF OIL
BEDS AND FIELDS, OIL BURNER REGULATION AND
REPAIR, OIL FIELD SURVEYING, OIL PROSPECTING,
OIL SOAKINGS, OIL WELL TESTING, WIRELINING
FOR OIL WELLS, AND SURVEYING OF OIL-BEARING
SEAMS, ALL VIA INTRANETS, EXTRANETS, AND THE
INTERNET (U.S. CLS. 100 AND 101).

SN 76-000,024. WORLD TRADE CENTER MIAMI, INC.,
MIAMI, FL. FILED 3-14-2000.

AMERICAS FOOD & BEVERAGE SHOW & CONFERENCE

NO CLAIM IS MADE TO THE EXCLUSIVE RIGHT TO
USE "SHOW & CONFERENCE", APART FROM THE MARK
AS SHOWN.
SEC. 2(F).

CLASS 16—PAPER GOODS AND PRINTED MATTER

FOR PUBLICATIONS, NAMELY, MAGAZINES AND
NEWSLETTERS IN THE FIELDS OF FOOD, BEV-
ERAGES, FOOD AND BEVERAGE SERVICE, COMMERCIAL
AND INDUSTRIAL FOOD SERVICE,
RESTAURANT SERVICE, RETAIL FOOD SALES,
WHOLESALE FOOD DISTRIBUTION, AND THE EX-
PORTATION AND IMPORTATION OF FOOD AND
BEVERAGES (U.S. CLS. 2, 5, 22, 23, 29, 37, 38 AND 50).
FIRST USE 11-0-1996; IN COMMERCE 11-0-1996.

CLASS 35—ADVERTISING AND BUSINESS

FOR ARRANGING AND CONDUCTING TRADE
SHOWS, CONFERENCES AND EXPOSITIONS IN THE
FIELDS OF FOOD, BEVERAGES, FOOD AND BEVER-
AGE SERVICE, COMMERCIAL AND INDUSTRIAL
FOOD SERVICE, RESTAURANT SERVICE, RETAIL
FOOD SALES, WHOLESALE FOOD DISTRIBUTION,
AND THE EXPORTATION AND IMPORTATION OF
FOOD AND BEVERAGES (U.S. CLS. 100, 101 AND 102).
FIRST USE 11-0-1996; IN COMMERCE 11-0-1996.

SN 76-001,530. SCHLEGEL SYSTEMS, INC., ROCHESTER, NY. FILED 3-16-2000.



OWNER OF U.S. REG. NOS. 688,555 AND 1,040,109. SEC. 2(F).

CLASS 9—ELECTRICAL AND SCIENTIFIC APPARATUS

FOR ELECTRIC CURRENT CONDUCTIVE TAPES (U.S. CLS. 21, 23, 26, 36 AND 38).
FIRST USE 1-0-1997; IN COMMERCE 1-0-1997.

CLASS 12—VEHICLES

FOR STRUCTURAL PARTS FOR AUTOMOBILES, NAMELY AUTOMOTIVE INTERIOR TRIM AND AUTOMOTIVE GLASS RUNS (U.S. CLS. 19, 21, 23, 31, 35 AND 44).
FIRST USE 1-0-1997; IN COMMERCE 1-0-1997.

CLASS 17—RUBBER GOODS

FOR TEXTILE AND FOAM WEATHER STRIPPING FOR NON-AUTOMOTIVE USE, PLASTIC BACKED TEXTILES FOR FLOOR MATS, AND AIRCRAFT NON-METAL SLATS (U.S. CLS. 1, 5, 12, 13, 35 AND 50).
FIRST USE 1-0-1997; IN COMMERCE 1-0-1997.

CLASS 21—HOUSEWARES AND GLASS

FOR TEXTILE CLEANING BRUSHES (U.S. CLS. 2, 13, 23, 29, 30, 33, 40 AND 50).
FIRST USE 1-0-1997; IN COMMERCE 1-0-1997.

SN 76-001,912. ARTANGELS.ORG INC., SAN FRANCISCO, CA. BY ASSIGNMENT SHORE, CAROL, PHILADELPHIA, PA. FILED 3-16-2000.

GIVING IS PART OF THE ART

CLASS 36—INSURANCE AND FINANCIAL

FOR CHARITABLE FUND RAISING SERVICES, NAMELY, RAISING MONEY FOR GRANTS TO ARTISTS AND ARTS ORGANIZATIONS; PROVIDING EDUCATIONAL SCHOLARSHIPS; PHILANTHROPIC SERVICES CONCERNING MONETARY DONATIONS; AND ARRANGING FOR FINANCIAL SPONSORSHIP OF ARTISTS AND SHOWS AND EXHIBITIONS IN THE FIELDS OF ART, DANCE, FILM, THEATER, MUSIC, AND LITERATURE (U.S. CLS. 100, 101 AND 102).
FIRST USE 2-0-2001; IN COMMERCE 2-0-2001.

CLASS 41—EDUCATION AND ENTERTAINMENT

FOR ARRANGING, ORGANIZING AND HOSTING EXHIBITIONS AND SHOWS IN THE FIELD OF ART, DANCE, FILM, THEATER, MUSIC, AND LITERATURE; AND PROVIDING ONLINE ENTERTAINMENT INFORMATION IN THE FIELDS OF ART, DANCE, FILM, THEATER, MUSIC, AND LITERATURE (U.S. CLS. 100, 101 AND 107).
FIRST USE 2-0-2001; IN COMMERCE 2-0-2001.

SN 76-001,943. SHORE, CAROL, PHILADELPHIA, PA. FILED 3-16-2000.



NO CLAIM IS MADE TO THE EXCLUSIVE RIGHT TO USE "DIGITAL PHILANTHROPY", APART FROM THE MARK AS SHOWN.

CLASS 16—PAPER GOODS AND PRINTED MATTER

FOR NEWSLETTERS IN THE FIELDS OF CHARITABLE FUND RAISING SERVICES, ART, DANCE, FILM, THEATER, MUSIC, AND LITERATURE SHOWS AND EXHIBITIONS, SCHOLARSHIPS AND ART FUNDING, AND PHILANTHROPY (U.S. CLS. 2, 5, 22, 23, 29, 37, 38 AND 50).

CLASS 36—INSURANCE AND FINANCIAL

FOR CHARITABLE FUND RAISING SERVICES, NAMELY, RAISING MONEY FOR GRANTS TO ARTISTS AND ARTS ORGANIZATIONS; PROVIDING EDUCATIONAL SCHOLARSHIPS; PHILANTHROPIC SERVICES CONCERNING MONETARY DONATIONS; AND ARRANGING FOR FINANCIAL SPONSORSHIPS OF ARTISTS AND SHOWS AND EXHIBITIONS IN THE FIELDS OF ART, DANCE, FILM, THEATER, MUSIC, AND LITERATURE (U.S. CLS. 100, 101 AND 102).

CLASS 41—EDUCATION AND ENTERTAINMENT

FOR ARRANGING, ORGANIZING AND HOSTING EXHIBITIONS AND SHOWS IN THE FIELD OF ART, DANCE, FILM, THEATER, MUSIC, AND LITERATURE; AND PROVIDING ONLINE ENTERTAINMENT INFORMATION IN THE FIELDS OF ART, DANCE, FILM, THEATER, MUSIC, AND LITERATURE (U.S. CLS. 100, 101 AND 107).

SN 76-002,449. DEEP SEA SEALS LIMITED, HANTS, P09 1 NX, UNITED KINGDOM, FILED 3-16-2000.

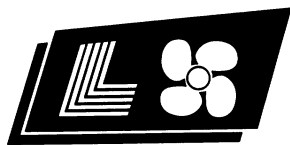

THE MARK CONSISTS IN PART OF A STYLIZED LETTER "L".

CLASS 6—METAL GOODS

FOR UNWROUGHT AND PARTLY WROUGHT ALLOYS OF COMMON METAL, SOLD IN BULK; METAL SEALS, METAL SEALING SYSTEMS NAMELY, STERN-TUBE SEALS, RUDDERSTOCK SEALS, BULKHEAD SEALS, POLLUTION-FREE SEALS, WATERJET SEALS, STABILIZER SEALS, AND THRUSTER SEALS; BEARINGS AND SEALS FOR METAL SEALING SYSTEMS, NAMELY, LINE-SHAFT BEARINGS, STERN-TUBE BEARINGS, THRUST BEARINGS (U.S. CLS. 2, 12, 13, 14, 23, 25 AND 50).

CLASS 7—MACHINERY

FOR CABLE HANDLING ENGINES, NAMELY, CAPSTAN DRUM ENGINES, LINEAR CABLE ENGINES, AFT LINEAR CABLE ENGINES; MOTORS AND ENGINES FOR A WIDE VARIETY OF BOATS, SHIPS, YACHTS, FERRIES, FREIGHTERS AND OTHER MARINE VESSELS; DRIVE INSTALLATIONS, NAMELY, MARINE PROPULSION SYSTEMS COMPRISING PROPELLERS, THRUSTERS, WATERJETS, CONTROLS, RUDDERS, NOZZLES, SEALS AND BEARINGS; DRIVE MACHINES AND DRIVE MECHANISMS FOR ENGINES FOR MARINE VESSELS; MACHINE PARTS, NAMELY, SEALING JOINTS IN THE NATURE OF MECHANICAL SEALS AND HYDRAULIC SEALS, MECHANICAL PUMP SEALS; AND PARTS FOR THE AFORESAID GOODS (U.S. CLS. 13, 19, 21, 23, 31, 34 AND 35).

CLASS 12—VEHICLES

FOR PROPELLERS FOR THE PROPULSION OF SHIPS AND MARINE CRAFT AND PARTS THEREFOR; DEVICES FOR STEERING SHIPS AND MARINE CRAFT, NAMELY, REDUCTION GEARS, STEARABLE THRUSTERS, TUG THRUSTERS, TRANSVERSE THRUSTERS, ELECTRIC POD THRUSTERS, CONVENTIONAL AND HIGH EFFICIENCY NOZZLES, WATER JETS, AND PARTS THEREFOR; THRUST BEARINGS AND SHAFT BEARINGS AND PARTS THEREFOR, ALL FOR BOATS, SHIPS AND MARINE VESSELS (U.S. CLS. 19, 21, 23, 31, 35 AND 44).

CLASS 37—CONSTRUCTION AND REPAIR

FOR MAINTENANCE, INSTALLATION AND REPAIR OF MARINE PROPELLERS AND THEIR COMPONENTS (U.S. CLS. 100, 103 AND 106).

CLASS 42—SCIENTIFIC, COMPUTER AND LEGAL SERVICES

FOR TECHNICAL ADVICE IN THE FIELD OF MARINE PROPELLERS AND THEIR COMPONENTS, ADVICE RELATING TO DRIVE INSTALLATION AND DRIVE MACHINES FOR SHIPS (U.S. CLS. 100 AND 101).

SN 76-002,775. MERISTAR H&R OPERATING COMPANY, L.P., WASHINGTON, DC. FILED 3-17-2000.



Doral

OWNER OF U.S. REG. NOS. 1,338,517, 2,069,844 AND OTHERS.

CLASS 35—ADVERTISING AND BUSINESS

FOR PROVIDING FACILITIES FOR BUSINESS MEETINGS (U.S. CLS. 100, 101 AND 102).
FIRST USE 6-15-1999; IN COMMERCE 6-15-1999.

CLASS 41—EDUCATION AND ENTERTAINMENT

FOR COUNTRY CLUB SERVICES, GOLF COURSE SERVICES, AND PROVIDING HEALTH CLUB AND EXERCISE AND FITNESS FACILITIES (U.S. CLS. 100, 101 AND 107).
FIRST USE 6-15-1999; IN COMMERCE 6-15-1999.

CLASS 42—SCIENTIFIC, COMPUTER AND LEGAL SERVICES

FOR HOTEL, HOTEL RESORT, AND RESTAURANT SERVICES, SPA SERVICES, NAMELY HEALTH SPA SERVICES AND BEAUTY SPA SERVICES; PROVIDING GENERAL PURPOSE FACILITY FOR EXHIBITIONS (U.S. CLS. 100 AND 101).
FIRST USE 6-15-1999; IN COMMERCE 6-15-1999.

SN 76-005,106. CHUCK, SANTIAGO E., HOUSTON, TX. AND CHUCK, MARIA A., HOUSTON, TX. FILED 3-20-2000.

USAMEDICUS

CLASS 35—ADVERTISING AND BUSINESS

FOR PROVIDING ASSISTANCE TO CONSUMERS SEEKING MEDICAL SERVICES, NAMELY, MEDICAL REFERRALS FOR PATIENTS SEEKING SECOND OPINIONS; BUSINESS OPERATING SERVICES PROVIDED TO HEALTH CARE PROFESSIONALS, NAMELY, SCHEDULING MEDICAL APPOINTMENTS WITH PATIENTS; AND PHYSICIAN REFERRALS (U.S. CLS. 100, 101 AND 102).
FIRST USE 3-8-2000; IN COMMERCE 3-8-2000.

CLASS 36—INSURANCE AND FINANCIAL

FOR BILL PAYMENT SERVICES, NAMELY ASSISTING PATIENTS IN MANAGING THE PAYMENT OF MEDICAL BILLS (U.S. CLS. 100, 101 AND 102).
FIRST USE 3-8-2000; IN COMMERCE 3-8-2000.

CLASS 39—TRANSPORTATION AND STORAGE

FOR TRANSPORTATION RESERVATION SERVICES FEATURING THE COORDINATION OF PATIENT TRANSPORTATION (U.S. CLS. 100 AND 105).
FIRST USE 3-8-2000; IN COMMERCE 3-8-2000.

CLASS 42—SCIENTIFIC, COMPUTER AND LEGAL SERVICES

FOR MAKING HOTEL RESERVATIONS FOR PERSONS SEEKING MEDICAL SERVICES (U.S. CLS. 100 AND 101).

FIRST USE 3-8-2000; IN COMMERCE 3-8-2000.

SN 76-007,071. IPLACE, INC., BRISTOL, PA. FILED 3-22-2000.

IPLACE

SN 76-005,892. GRABOWSKI, BARBARA L., STATE COLLEGE, PA. AND HOPKINS, ANNE F., CORRY, PA. AND RYND, CHRISTOPHER P., COLUMBUS, OH. FILED 3-21-2000.

ELDERNETTING**CLASS 16—PAPER GOODS AND PRINTED MATTER**

FOR (BASED ON INTENT TO USE) PRINTED INSTRUCTIONAL MATERIALS, MANUALS AND BOOKS, FOR SENIOR CITIZENS FEATURING EDUCATIONAL INFORMATION ABOUT THE USE OF THE INTERNET (U.S. CLS. 2, 5, 22, 23, 29, 37, 38 AND 50).

CLASS 41—EDUCATION AND ENTERTAINMENT

FOR (BASED ON USE IN COMMERCE) EDUCATIONAL SERVICES, NAMELY, SEMINARS, WORKSHOPS, AND CLASSES FEATURING INSTRUCTION ON THE USE OF THE INTERNET (U.S. CLS. 100, 101 AND 107).

FIRST USE 8-0-1998; IN COMMERCE 1-0-2000.

CLASS 35—ADVERTISING AND BUSINESS

FOR MONITORING CONSUMER CREDIT REPORTS AND PROVIDING AN ALERT AS TO ANY CHANGES THEREIN AND PROVIDING CONSUMER PROFILE INFORMATION FOR USE BY OTHERS (U.S. CLS. 100, 101 AND 102).

FIRST USE 2-16-2000; IN COMMERCE 2-16-2000.

CLASS 36—INSURANCE AND FINANCIAL

FOR PROVIDING INFORMATION ON A GLOBAL COMPUTER NETWORK IN THE FIELD OF REAL ESTATE SALES, VALUATION, APPRAISAL, RELOCATION, NEIGHBORHOOD INFORMATION, FINANCING, INSURANCE, CREDIT INQUIRY, AND CREDIT REPORTING SERVICES AND CREDIT INQUIRY AND CONSULTATION (U.S. CLS. 100, 101 AND 102).

FIRST USE 2-16-2000; IN COMMERCE 2-16-2000.

CLASS 37—CONSTRUCTION AND REPAIR

FOR PROVIDING INFORMATION VIA A GLOBAL COMPUTER NETWORK IN THE FIELD OF BUILDING MAINTENANCE AND HOME INSPECTIONS (U.S. CLS. 100, 103 AND 106).

FIRST USE 2-16-2000; IN COMMERCE 2-16-2000.

CLASS 38—COMMUNICATION

FOR PROVIDING MULTIPLE-USER ACCESS TO A GLOBAL COMPUTER INFORMATION NETWORK IN THE FIELD OF FINANCING, INSURANCE, AND CREDIT (U.S. CLS. 100, 101 AND 104).

FIRST USE 2-16-2000; IN COMMERCE 2-16-2000.

SN 76-006,859. M.S.I. MULTICONN SOLUTIONS INTERNATIONAL (1995) LTD., AZUR, ISRAEL, FILED 3-22-2000.

MQBroker

PRIORITY CLAIMED UNDER SEC. 44(D) ON ISRAEL APPLICATION NO. 135256, FILED 2-29-2000, REG. NO. 135256, DATED 11-12-2001, EXPIRES 2-28-2007.

PRIORITY CLAIMED UNDER SEC. 44(D) ON ISRAEL APPLICATION NO. 134674, FILED 2-8-2000, REG. NO. 134674, DATED 11-12-2001, EXPIRES 2-8-2007.

CLASS 9—ELECTRICAL AND SCIENTIFIC APPARATUS

FOR COMPUTER SOFTWARE FOR INTEGRATION SOLUTIONS IN THE FIELD OF MULTI-PLATFORM COMPUTER INSTALLATIONS (U.S. CLS. 21, 23, 26, 36 AND 38).

CLASS 42—SCIENTIFIC, COMPUTER AND LEGAL SERVICES

FOR SCIENTIFIC RESEARCH, INDUSTRIAL RESEARCH IN THE FIELD OF INFRASTRUCTURE SOFTWARE, COMPUTER PROGRAMMING FOR OTHERS (U.S. CLS. 100 AND 101).

SN 76-007,355. TELEFONICA, S.A., 28013 MADRID, SPAIN, FILED 3-22-2000.

ADMIRA

OWNER OF SPAIN REG. NO. 2055875, DATED 11-20-1997, EXPIRES 11-5-2006.

OWNER OF SPAIN REG. NO. 2055873, DATED 11-20-1997, EXPIRES 11-5-2006.

OWNER OF SPAIN REG. NO. 2055871, DATED 1-20-1998, EXPIRES 11-5-2006.

OWNER OF SPAIN REG. NO. 2055870, DATED 1-20-1998, EXPIRES 11-5-2006.

THE ENGLISH TRANSLATION OF THE TERM "ADMIRA" IS "ADMIRE".

CLASS 9—ELECTRICAL AND SCIENTIFIC APPARATUS

FOR TELEPHONY, TELEGRAPHY, AND TELEPHONIC EQUIPMENT, NAMELY, LAND TELEPHONES, MOBILE TELEPHONES, SWITCHBOARDS, ANSWERING MACHINES, RADIOTELEPHONES, FAX MACHINES, AUTOMATIC TELEPHONE DIALERS, CELLULAR TELEPHONES, CORDLESS TELEPHONES, ENCODED ELECTRONIC CHIP CARDS FOR IDENTIFYING PARTICULAR USERS OF COMPUTERS AND MOBILE TELEPHONES, MAGNETICALLY ENCODED PRE-PAID TELEPHONE CALLING CARDS, TELEPHONE RECEIVERS, AUDIO RECEIVERS, VIDEO RECEIVERS, SATELLITE TELEPHONES, INTERCOMS, CALLER IDENTIFICATION BOXES, TELEPHONE TRANSMITTERS, RADIO TRANSMITTERS, WIRELESS TELEPHONES, TELEPHONES, MAGNETIC CODED CARD READERS, MAGNETIC CODED CARDS, MAGNETIC ENCODED CARD READERS, COMPUTER TELEPHONY SOFTWARE; COMPUTER SOFTWARE WHICH FACILITATES SEARCHING FOR AND TRANSFERRING INFORMATION ACROSS GLOBAL COMPUTER COMMUNICATIONS NETWORKS, AND FOR THE EXECUTION OF BUSINESS TRANSACTIONS USING GLOBAL COMPUTER COMMUNICATION NETWORKS; VIDEO GAME MACHINES FOR USE WITH TELEVISIONS, VIDEO GAME SOFTWARE (U.S. CLS. 21, 23, 26, 36 AND 38).

CLASS 16—PAPER GOODS AND PRINTED MATTER

FOR PRINTED MATTER, NAMELY, LEAFLETS, CATALOGS, MANUALS, BOOKS, MAGAZINES ON THE SUBJECT OF THE TELECOMMUNICATIONS FIELD AND RELATED GOODS AND SERVICES; STATIONERY; NEWSPAPERS FOR GENERAL CIRCULATION; NEWSPAPERS ON THE SUBJECT OF THE TELECOMMUNICATIONS FIELD AND RELATED GOODS AND SERVICES; PERIODICAL AND NON-PERIODICAL PUBLICATIONS ON THE SUBJECT OF THE TELECOMMUNICATIONS FIELD AND RELATED GOODS AND SERVICES (U.S. CLS. 2, 5, 22, 23, 29, 37, 38 AND 50).

CLASS 38—COMMUNICATION

FOR COMMUNICATION SERVICES, NAMELY, TRANSMITTING STREAM SOUND AND AUDIO VISUAL RECORDINGS VIA A GLOBAL COMPUTER NETWORK; ELECTRONIC, ELECTRIC AND DIGITAL TRANSMISSION OF VOICE, DATA, IMAGES AND MESSAGES; PAY-PER-VIEW TELEVISION TRANSMISSION SERVICES; TELEVISION TRANSMISSION SERVICES; RADIO BROADCASTING; BROADCASTING RADIO AND TELEVISION PROGRAMS VIA A GLOBAL COMPUTER NETWORK (U.S. CLS. 100, 101 AND 104).

CLASS 42—SCIENTIFIC, COMPUTER AND LEGAL SERVICES

FOR COMPUTER PROGRAMMING SERVICES FOR OTHERS, COMPUTER SOFTWARE DESIGN FOR OTHERS; ENGINEERING; UPDATING OF COMPUTER SOFTWARE (U.S. CLS. 100 AND 101).

SN 76-009,438. GENTECH, 06410 BIOT, FRANCE, FILED 3-24-2000.

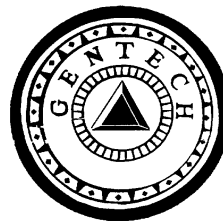

OWNER OF FRANCE REG. NO. 97697072, DATED 9-30-1997, EXPIRES 9-30-2007.

CLASS 9—ELECTRICAL AND SCIENTIFIC APPARATUS

FOR SCIENTIFIC APPARATUS AND INSTRUMENTS OTHER THAN THOSE ADAPTED FOR MEDICAL USE, NAMELY, LC INFRARED GOGGLES, COMPUTERS AND COMPUTER PERIPHERALS DESIGNED TO ALLOW THE VISUALIZATION OF MOLECULAR STRUCTURE IN TWO OR THREE DIMENSIONS FOR USE IN THE FIELDS OF MOLECULAR BIOLOGY, GENOMIC AND PROTEOMIC ANALYSIS; COMPUTER SOFTWARE FOR SEQUENCE ANALYSIS, INTERPRETATION AND VISUALIZATION FOR MOLECULAR MODELING, FOR DATA ACCESS, DATA MINING AND DATABASE MANAGEMENT IN THE FIELDS OF MOLECULAR BIOLOGY, BIOENGINEERING AND GENETIC RESEARCH; PRERECORDED DIGITAL COMPACT DISCS AND DIGITAL VIDEO DISCS FEATURING SOFTWARE PROGRAMS AND DATA DESIGNED TO ALLOW THE VISUALIZATION OF MOLECULAR STRUCTURE IN TWO OR THREE DIMENSIONS FOR USE IN THE FIELDS OF MOLECULAR BIOLOGY, GENOMIC AND PROTEOMIC ANALYSIS (U.S. CLS. 21, 23, 26, 36 AND 38).

CLASS 31—NATURAL AGRICULTURAL PRODUCTS

FOR FRESH FRUITS AND VEGETABLES, GENETICALLY MODIFIED PLANTS AND AGRICULTURAL SEEDS, LIVE PLANTS AND FLOWERS, FOODSTUFFS FOR ANIMALS (U.S. CLS. 1 AND 46).

CLASS 42—SCIENTIFIC, COMPUTER AND LEGAL SERVICES

FOR COMPUTER PROGRAMMING FOR OTHERS; ENGINEERING (U.S. CLS. 100 AND 101).

SN 76-009,618. NATIONAL DISTRIBUTION AND CONTRACTING, INC., NASHVILLE, TN. FILED 3-23-2000.

DRI SHIELD**CLASS 5—PHARMACEUTICALS**

FOR INCONTINENCE PRODUCTS, NAMELY, DIAPERS AND INCONTINENCE GARMENTS (U.S. CLS. 6, 18, 44, 46, 51 AND 52).
FIRST USE 7-1-2000; IN COMMERCE 7-1-2000.

CLASS 10—MEDICAL APPARATUS

FOR INCONTINENCE PRODUCTS, NAMELY, INCONTINENCE BED PADS (U.S. CLS. 26, 39 AND 44).
FIRST USE 7-1-2000; IN COMMERCE 7-1-2000.

SN 76-011,540. MEGGITT PLC., DORSET BH21 4EL, UNITED KINGDOM, FILED 3-23-2000.

SN 76-010,123. MICHAEL BEST & FRIEDRICH LLP, MILWAUKEE, WI. FILED 3-23-2000.

VENTURE BEST**CLASS 35—ADVERTISING AND BUSINESS**

FOR PROVIDING BUSINESS CONSULTATION OVER A GLOBAL COMMUNICATIONS NETWORK (U.S. CLS. 100, 101 AND 102).

FIRST USE 3-1-1999; IN COMMERCE 3-1-1999.

CLASS 42—SCIENTIFIC, COMPUTER AND LEGAL SERVICES

FOR PROVIDING LEGAL SERVICES; AND INFORMATION ON LEGAL AND BUSINESS SERVICES OVER A GLOBAL COMMUNICATIONS NETWORK (U.S. CLS. 100 AND 101).

FIRST USE 3-1-1999; IN COMMERCE 3-1-1999.

SN 76-010,636. CAPITAL PROFESSIONAL ADVISORS, LLC, MINNEAPOLIS, MN. FILED 3-27-2000.



NO CLAIM IS MADE TO THE EXCLUSIVE RIGHT TO USE "CAPITAL PROFESSIONAL ADVISORS INC.", APART FROM THE MARK AS SHOWN.

THE MARK CONSISTS OF A CIRCLE WITH THE LOWER HALF SHADED BLUE AND AN ORANGE SHADOW ALONG THE UPPER LET RIM OF THE CIRCLE.

CLASS 35—ADVERTISING AND BUSINESS

FOR BUSINESS MANAGEMENT CONSULTATION SERVICES, NAMELY PROVIDING CPA FIRMS WITH TURN KEY SOLUTIONS FOR CREATING AND SUSTAINING PROFITABLE FINANCIAL SERVICES BUSINESSES, CONSULTING IN THE USE OF INVESTMENT ADVISOR PRODUCTS AND SERVICES (U.S. CLS. 100, 101 AND 102).

CLASS 36—INSURANCE AND FINANCIAL

FOR FINANCIAL INVESTMENT SERVICES; FINANCIAL ANALYSIS AND CONSULTATION SERVICES; INVESTMENT BROKERAGE SERVICES; INSURANCE BROKERAGE SERVICES (U.S. CLS. 100, 101 AND 102).

BESTOBELL

PRIORITY CLAIMED UNDER SEC. 44(D) ON FED REP GERMANY APPLICATION NO. 39979682.7/0. FILED 12-15-1999, REG. NO. 39979682, DATED 5-31-2000, EXPIRES 12-31-2009.

CLASS 6—METAL GOODS

FOR CLAMPS AND COUPLINGS MADE OF METAL, FOR USE WITH AVIATION EQUIPMENT (U.S. CLS. 2, 12, 13, 14, 23, 25 AND 50).

CLASS 11—ENVIRONMENTAL CONTROL APPARATUS

FOR HOT WATER HEATERS; WATER HEATERS FOR INDUSTRIAL, COMMERCIAL AND DOMESTIC USE; FURNACE BOILERS; STEAM GENERATORS; STEAM BOILER, FLOW CONTROL, WATER SUPPLY AND HEATING INSTALLATION FITTINGS, NAMELY, HEAT GAS SEPARATORS, LIQUID SEPARATORS, GAS FILTERS, LIQUID FILTERS, STEAM COCKS, TRAPS; STEAM BOILER VALVES; FLOW CONTROL VALVES; WATER SUPPLY VALVES; VALVES FOR USE IN HEATING INSTALLATIONS; CONTROLLED VOLUME PUMPS, ELECTRIC PUMPS; HEAT PUMPS; POSITIVE DISPLACEMENT PUMPS; REVERSE OSMOSIS PUMPS; ROTARY PUMPS; SUBMERSIBLE PUMPS; SUCTION PUMPS; VACUUM PUMPS; WATER PUMPS FOR USE IN MOTORS AND ENGINES (U.S. CLS. 13, 21, 23, 31 AND 34).

CLASS 17—RUBBER GOODS

FOR FLEXIBLE NON-METAL AND NON-MECHANICAL SEALS AND CONNECTORS FOR USE IN AVIATION EQUIPMENT (U.S. CLS. 1, 5, 12, 13, 35 AND 50).

CLASS 19—NON-METALLIC BUILDING MATERIALS

FOR NON-METAL AND NON-MECHANICAL DUCTING FOR USE IN AVIATION EQUIPMENT (U.S. CLS. 1, 12, 33 AND 50).

CLASS 37—CONSTRUCTION AND REPAIR

FOR INSTALLATION, MAINTENANCE AND REPAIR OF APPARATUS AND INSTRUMENTS FOR HEATING, WATER HEATING, STEAM GENERATION, VENTILATION, WATER SUPPLY, FLOW CONTROL, AVIATION (U.S. CLS. 100, 103 AND 106).

CLASS 42—SCIENTIFIC, COMPUTER AND LEGAL SERVICES

FOR CONSULTATION SERVICES IN THE FIELDS OF HEATING, WATER HEATING, STEAM GENERATION, VENTILATION, WATER SUPPLY, FLOW CONTROL, AVIATION; ONLINE CONSULTATION SERVICES IN THE FIELDS OF HEATING, WATER HEATING, STEAM GENERATION, VENTILATION, WATER SUPPLY, FLOW CONTROL, AVIATION (U.S. CLS. 100 AND 101).

SN 76-014,194. STANDARD HOLDING LLC, NEW YORK, NY. FILED 3-31-2000.

SN 76-014,233. LANT N.V., 3001 LEUVEN, BELGIUM, FILED 3-31-2000.

STND

CLASS 25—CLOTHING

FOR T-SHIRTS, HEADWEAR, DRESSES, JACKETS, SWEATSHIRTS, ROBES AND SHOES (U.S. CLS. 22 AND 39).

FIRST USE 1-2-1999; IN COMMERCE 1-2-1999.

CLASS 39—TRANSPORTATION AND STORAGE

FOR VALET PARKING SERVICES (U.S. CLS. 100 AND 105).

FIRST USE 3-1-1999; IN COMMERCE 3-1-1999.

SN 76-014,203. HADDONSTONE LIMITED, NORTHAMPTON NN6 8DP, ENGLAND, FILED 3-31-2000.

ARCADIAN

PRIORITY CLAIMED UNDER SEC. 44(D) ON UNITED KINGDOM APPLICATION NO. 2217036, FILED 12-11-1999.

CLASS 11—ENVIRONMENTAL CONTROL APPARATUS

FOR ORNAMENTAL WATER FOUNTAINS (U.S. CLS. 13, 21, 23, 31 AND 34).

CLASS 19—NON-METALLIC BUILDING MATERIALS

FOR ARCHITECTURAL STONEMWORK, NAMELY DOOR AND WINDOW SURROUNDS, HEADS, SILLS AND KEYSTONES FOR WINDOWS, QUOINS, COLUMNS, PILASTERS, PORTICOS, CORBELS, BALUSTRADES, PAVING EDGING, STONES FOR PAVING, BOLLARDS, GATE PIERS, PIER CAPS, COPINGS, FINIALS, PORTABLE NON-METAL GARDEN BUILDINGS, NAMELY PAVILIONS, TEMPLES, PERGOLAS, FOLLIES, GROTTOS AND COLONNADES, STATUES, STATUETTES, MONUMENTS, GARDEN ORNAMENTS, BIRD BATHS, PEDESTALS AND PLINTHS, POOL SURROUNDS, ALL MADE OF STONE, ARTIFICIAL STONE OR RECONSTITUTED STONE (U.S. CLS. 1, 12, 33 AND 50).

CLASS 21—HOUSEWARES AND GLASS

FOR FLOWER POTS, FLOWER BOWLS, TROUGHS, PLANT CONTAINERS, VASES, URNS, JARDINIERES, ALL MADE OF STONE, ARTIFICIAL STONE OR RECONSTITUTED STONE (U.S. CLS. 2, 13, 23, 29, 30, 33, 40 AND 50).

Xplanation

PRIORITY CLAIMED UNDER SEC. 44(D) ON BENELUX APPLICATION NO. 0086535, FILED 12-8-1999, REG. NO. 0659934, DATED 12-8-1999, EXPIRES 12-8-2009. OWNER OF U.S. REG. NO. 2,196,656.

CLASS 9—ELECTRICAL AND SCIENTIFIC APPARATUS

FOR PRE-RECORDED COMPUTER PROGRAMS AND SOFTWARE FOR DIGITIZING, ENCODING, COMPRESSING, MANIPULATING, PROCESSING, TRANSLATING, ARCHIVING, RECORDING AND REPRODUCING OF VOICE AND TEXT MESSAGES INCLUDING MULTILINGUAL TECHNICAL DOCUMENTATION; SOFTWARE FOR DOCUMENT MANAGEMENT AND DOCUMENT ARCHIVAL; COMPUTER SOFTWARE FOR EFFECTING CONNECTIONS TO AND TRANSMITTING DATA OVER GLOBAL COMPUTER NETWORKS; SOFTWARE FOR TEXT-TO-SPEECH AND SPEECH-TO-TEXT CONVERSION; COMPUTER SEARCH ENGINE SOFTWARE; SOFTWARE FOR TELECOMMUNICATION, NAMELY, FOR ELECTRONIC MAILING OVER GLOBAL COMPUTER NETWORK, COMPUTER SOFTWARE RECORDED ON MAGNETIC AND OPTICAL DATA CARRIERS, COMPACT DISCS, CD-ROMS AND FLOPPY DISKS FOR USE IN DATA-EXTRACTION, KNOWLEDGE MANAGEMENT IN THE FIELD OF LANGUAGE SERVICES; COMPUTER MEMORIES, ELECTRONIC MANUALS ON THE USE OF SOFTWARE (U.S. CLS. 21, 23, 26, 36 AND 38).

CLASS 38—COMMUNICATION

FOR INTERACTIVE TELECOMMUNICATION SERVICES, NAMELY ELECTRONIC MESSAGING SERVICES OVER GLOBAL COMPUTER NETWORKS AND ELECTRONIC TRANSMISSION OF DATA OVER GLOBAL COMPUTER NETWORKS; PROVIDING MULTIPLE-USER ACCESS TO GLOBAL COMPUTER INFORMATION NETWORKS (U.S. CLS. 100, 101 AND 104).

CLASS 42—SCIENTIFIC, COMPUTER AND LEGAL SERVICES

FOR DESIGN OF COMPUTER PROGRAMS FOR OTHERS; COMPUTER PROGRAMMING SERVICES FOR OTHERS; DATA CONVERSION, NAMELY DIGITIZING OF VOICE AND TEXT MESSAGES FOR DATA EXCHANGES OVER GLOBAL COMPUTER NETWORKS; LANGUAGE TRANSLATION SERVICES INCLUDING OVER GLOBAL COMPUTER NETWORKS; REAL-TIME ON-LINE LANGUAGE TRANSLATION SERVICES (U.S. CLS. 100 AND 101).

SN 76-016,721. CHOCOLAT LAMONTAGNE INC., SHERBROOKE, QUEBEC, CANADA, FILED 4-4-2000.

CHOCOLATE BOUTIQUE

NO CLAIM IS MADE TO THE EXCLUSIVE RIGHT TO USE "CHOCOLATE", APART FROM THE MARK AS SHOWN.

CLASS 30—STAPLE FOODS

FOR CHOCOLATES AND CANDY (U.S. CL. 46).
FIRST USE 8-10-1999; IN COMMERCE 8-10-1999.

SN 76-020,023. AUTOQUAL USA, INC., LITTLETON, CO.
FILED 4-5-2000.

CLASS 35—ADVERTISING AND BUSINESS

FOR WHOLESALE DISTRIBUTORSHIP FEATURING
CHOCOLATES AND CANDY FOR SALE BY GROUPS
FOR FUND RAISING PURPOSES (U.S. CLS. 100, 101
AND 102).

FIRST USE 8-10-1999; IN COMMERCE 8-10-1999.

DEALER MUST REMOVE
PROTECTIVE COVER
DEALER MUST REMOVE
PROTECTIVE COVER
DEALER MUST REMOVE
PROTECTIVE COVER
DEALER MUST REMOVE
PROTECTIVE COVER

SN 76-017,798. MEDIACRYPT AG, CH-8048 ZURICH, SWITZERLAND, FILED 4-5-2000.

MEDIACRYPT

PRIORITY CLAIMED UNDER SEC. 44(D) ON SWITZERLAND APPLICATION NO. 10098/1999, FILED 11-9-1999, REG. NO. 471636, DATED 4-27-2000, EXPIRES 11-9-2009.

OWNER OF U.S. REG. NOS. 2,326,001, 2,331,849 AND 2,387,709.

NO CLAIM IS MADE TO THE EXCLUSIVE RIGHT TO USE "USA" AND "1-800-940-9909", APART FROM THE MARK AS SHOWN.

THE MARK CONSISTS OF THE WORDS "DEALER MUST REMOVE PROTECTIVE COVER" REPEATED IN THE FORM OF A DESIGN AND THE WORDS "AUTOQUAL USA" AND DESIGN AS PART OF THE "O" IN "COVER".

CLASS 9—ELECTRICAL AND SCIENTIFIC APPARATUS

FOR APPARATUS, NAMELY, COMPUTERS, SET-TOP BOXES, TELEVISION DECODERS, PAYMENT TERMINALS, AND INSTRUMENTS, NAMELY, REMOTE CONTROL UNITS, FOR ENCRYPTING AND DECRYPTING ELECTRONIC SIGNALS AND DATA, PARTICULARLY THROUGH INTERNATIONAL DATA ENCRYPTION ALGORITHM; MICROPROCESSORS AND SMART CARDS ENCODED WITH INTEGRATED INTERNATIONAL DATA ENCRYPTION ALGORITHM TECHNOLOGY (U.S. CLS. 21, 23, 26, 36 AND 38).

CLASS 37—CONSTRUCTION AND REPAIR

FOR CLEANING, RESTORATION AND INSTALLATION OF PROTECTIVE PLASTIC MASK TO CARPET IN VEHICLES (U.S. CLS. 100, 103 AND 106).

FIRST USE 12-4-1998; IN COMMERCE 12-4-1998.

CLASS 40—MATERIAL TREATMENT

FOR DYEING CARPET IN VEHICLES (U.S. CLS. 100, 103 AND 106).

FIRST USE 12-4-1998; IN COMMERCE 12-4-1998.

CLASS 37—CONSTRUCTION AND REPAIR

FOR INSTALLATION OF EQUIPMENT, NAMELY, COMPUTER NETWORKS, PERSONAL COMPUTERS, ELECTRICAL PANELS AND APPLIANCES FOR CONTROL CENTERS AND FOR COMPUTER CENTERS, AND APPARATUS, NAMELY, COMPUTERS, SET-TOP BOXES, TELEVISION DECODERS, PAYMENT TERMINALS, REMOTE CONTROL UNITS, ALLOWING ENCRYPTING AND DECRYPTING BY INTERNATIONAL DATA ENCRYPTION ALGORITHM, AND CONTROLLED ACCESS TO PUBLIC AND PRIVATE ON-LINE SERVICES (U.S. CLS. 100, 103 AND 106).

SN 76-020,047. DEUTSCHE BANK AKTIENGESELLSCHAFT, FRANKFURT AM MAIN, FED REP GERMANY, FILED 4-6-2000.

DB BUSINESS DIRECT

PRIORITY CLAIMED UNDER SEC. 44(D) ON FED REP GERMANY APPLICATION NO. 30010237.2/3, FILED 2-11-2000, REG. NO. 30010237, DATED 6-9-2000, EXPIRES 2-28-2010.

OWNER OF U.S. REG. NOS. 1,761,673, 2,303,141 AND 2,303,142.

NO CLAIM IS MADE TO THE EXCLUSIVE RIGHT TO USE "BUSINESS", APART FROM THE MARK AS SHOWN.

CLASS 38—COMMUNICATION

FOR SUBSCRIPTION TELEVISION BROADCASTING FOR PAYING AND NON-PAYING TELEVISION PROGRAMS; TELECOMMUNICATION SUBSCRIPTION SERVICES IN THE NATURE OF TELEPHONE SERVICES AND PROVIDING MULTIPLE-USER ACCESS TO MULTIMEDIA VIA A GLOBAL COMPUTER NETWORK; TELECOMMUNICATIONS SERVICES, NAMELY, THE ELECTRONIC TRANSMISSION OF CODING AND DECODING OF TELEVISION BROADCASTING AND DATA USING ENCRYPTION AND DECRYPTION ALGORITHM FOR THE EMISSION AND RECEPTION OF TELEVISION PROGRAMS AND DATA USING TELEPHONE LINES, SIGNAL SENDERS AND RECEIVERS, AND ELECTRONIC BOXES VIA SATELLITE (U.S. CLS. 100, 101 AND 104).

CLASS 36—INSURANCE AND FINANCIAL

FOR FINANCIAL SERVICES, NAMELY, PERFORMING ELECTRONIC CASH, CREDIT, LOAN AND DEBIT TRANSACTIONS; INSURANCE SERVICES, NAMELY, INSURANCE ADMINISTRATION, INSURANCE CONSULTATION, INSURANCE BROKERAGE, AND INSURANCE UNDERWRITING IN THE FIELDS OF LIFE, HEALTH, ACCIDENT, AND FIRE INSURANCE; REAL ESTATE SERVICES, NAMELY, REAL ESTATE INVESTMENT, REAL ESTATE BROKERAGE, AND REAL ESTATE ACQUISITION SERVICES; MORTGAGING OF SECURITIES FOR OTHERS; PROVIDING AN ON-LINE COMPUTER DATABASE IN THE FIELD OF FINANCE, INVESTMENTS, MONETARY TRANSACTIONS AND SECURITIES, FINANCIAL INFORMATION PROVIDED BY ELECTRONIC MEANS; AND COMMODITY TRADING FOR OTHERS, NAMELY, REAL ESTATE TRADING (U.S. CLS. 100, 101 AND 102).

CLASS 42—SCIENTIFIC, COMPUTER AND LEGAL SERVICES

FOR TECHNICAL CONSULTATION AND RESEARCH IN THE FIELDS OF SECURITY, ENCRYPTING AND DECRYPTION AND CONTROLLED ACCESS TO PUBLIC AND PRIVATE ON-LINE SERVICES (U.S. CLS. 100 AND 101).

CLASS 38—COMMUNICATION

FOR PAGING SERVICES, NAMELY, PERSONALIZED MESSAGES TO THE PAGERS OF OTHERS CONTAINING FINANCIAL INFORMATION; DELIVERY OF MESSAGES BY ELECTRONIC TRANSMISSION, NAMELY, DATA BASED TRANSMISSION OF PROGRAMS AND INFORMATION RELATING TO TRADE WITH FOREIGN CURRENCIES, INTEREST RATES, MONEY TRANSACTIONS, SECURITIES, AND FINANCIAL INVESTMENTS (U.S. CLS. 100, 101 AND 104).

CLASS 42—SCIENTIFIC, COMPUTER AND LEGAL SERVICES

FOR COMPUTER PROGRAMMING FOR OTHERS, NAMELY, THE CREATION OF PROGRAMS FOR DATA PROCESSING; COMPUTER SOFTWARE DESIGN FOR OTHERS (U.S. CLS. 100 AND 101).

CLASS 39—TRANSPORTATION AND STORAGE

FOR ELECTRONIC STORAGE OF DATA; PROVIDING AN INTERACTIVE WEBSITE FEATURING STORED ELECTRONIC DATA AND INFORMATION OBTAINED FROM STORED ELECTRONIC DATA (U.S. CLS. 100 AND 105).

CLASS 42—SCIENTIFIC, COMPUTER AND LEGAL SERVICES

FOR COMPUTER SERVICES, NAMELY, PROVIDING COMPUTERIZED ANALYTICAL PROCESSING AND DATA ANALYSIS SERVICES THAT USE PREDICTIVE MODELING TO FACILITATE MANAGEMENT OF INFORMATION; COMPUTER CONSULTATION IN THE FIELD OF ELECTRONIC STORAGE OF DATA; HOSTING THE BUSINESS WEBSITES OF OTHERS ON A COMPUTER SERVER FOR A GLOBAL COMPUTER NETWORK; PROVIDING AN INTERACTIVE WEBSITE FEATURING COMPUTERIZED ANALYTICAL PROCESSING AND DATA ANALYSIS SERVICES (U.S. CLS. 100 AND 101).

SN 76-022,282. DIGIMINE, INC., BELLEVUE, WA. BY CHANGE OF NAME MINEPOINT.COM, BELLEVUE, WA. FILED 4-10-2000.

DIGIMINE**CLASS 9—ELECTRICAL AND SCIENTIFIC APPARATUS**

FOR COMPUTER SOFTWARE FOR ONLINE DATA WAREHOUSING AND DATA MINING, AND USER MANUALS SOLD THEREWITH AS A UNIT; COMPUTER SOFTWARE FOR ANALYTICAL PROCESSING AND DATA ANALYSIS USING PREDICTIVE MODELING TO FACILITATE MANAGEMENT OF INFORMATION; COMPUTER SOFTWARE FOR PERFORMING ELECTRONIC BUSINESS TRANSACTIONS VIA A SECURED GLOBAL COMPUTER NETWORK; COMPUTER SYSTEMS COMPRISED OF SOFTWARE AND HARDWARE FOR USE IN ACCESSING COMPUTER APPLICATIONS OVER A GLOBAL COMPUTER NETWORK; COMPUTER SOFTWARE FOR ACCESS, MANAGEMENT, AND ELECTRONIC TRANSMISSION OF DATA AND DOCUMENTS VIA A GLOBAL COMPUTER NETWORK (U.S. CLS. 21, 23, 26, 36 AND 38).

CLASS 35—ADVERTISING AND BUSINESS

FOR COMMERCIAL INFORMATION AGENCIES, NAMELY, PROVIDING BUSINESS INFORMATION AND MARKETING DATA TO OTHERS; DATA PROCESSING SERVICES; COMPUTERIZED REAL-TIME AND DELAYED TRANSACTIONAL DATA MANAGEMENT SERVICES, NAMELY, SEARCHING, GATHERING, PROCESSING, ORGANIZING AND DISSEMINATING INFORMATION FOR OTHERS VIA A GLOBAL COMPUTER NETWORK; PROVIDING AN INTERACTIVE WEBSITE FEATURING INFORMATION PERTAINING TO COMPUTERIZED REAL-TIME AND DELAYED TRANSACTIONAL DATA MANAGEMENT SERVICES, NAMELY, INFORMATION OBTAINED BY SEARCHING, GATHERING, PROCESSING, ORGANIZING AND DISSEMINATING INFORMATION FOR OTHERS (U.S. CLS. 100, 101 AND 102).

CLASS 38—COMMUNICATION

FOR PROVIDING COMMUNICATIONS SERVICES VIA A SECURED GLOBAL NETWORK, NAMELY, ELECTRONIC TRANSMISSION OF DATA AND DOCUMENTS VIA A GLOBAL COMPUTER NETWORK; PROVIDING AN INTERACTIVE WEBSITE FEATURING INFORMATION PERTAINING TO THE ELECTRONIC TRANSMISSION OF DATA AND DOCUMENTS VIA A GLOBAL COMPUTER NETWORK NAMELY, ELECTRONIC TRANSMISSION OF DATA AND DOCUMENTS VIA A GLOBAL COMPUTER NETWORK (U.S. CLS. 100, 101 AND 104).

SN 76-022,948. S.G.S. INTERNATIONAL RICE, INC., EDISON, NJ. FILED 4-12-2000.

WELDON

SEC. 2(F).

CLASS 29—MEATS AND PROCESSED FOODS

FOR PROCESSED NUTS (U.S. CL. 46).
FIRST USE 3-1-1997; IN COMMERCE 3-1-1997.

CLASS 30—STAPLE FOODS

FOR RICE, FLOUR, AND SPICES (U.S. CL. 46).
FIRST USE 3-1-1997; IN COMMERCE 3-1-1997.

SN 76-025,738. QUIQ, INC., SAN MATEO, CA. FILED 4-13-2000.

SN 76-025,779. QUIQ, INC., SAN MATEO, CA. FILED 4-13-2000.

QUIQDISCUSSIONS**QUIQANSWERS****CLASS 35—ADVERTISING AND BUSINESS**

FOR BUSINESS CONSULTATION FOR OTHERS, NAMELY, ASSISTING BUSINESSES IN DEVELOPING, AND HOSTING APPLICATION SERVICES THAT ENABLE SUCH BUSINESSES TO CREATE, OBTAIN, COLLECT, TRACK, MONITOR, ORGANIZE, MANAGE AND STORE INFORMATION OBTAINED FROM CUSTOMERS, AFFILIATES, USERS, MEMBERS, EXPERTS, ENTHUSIASTS, CLIENTS AND PARTICIPANTS, AND FROM COMMUNITIES OF THE SAME, IN ORDER TO RECEIVE FEEDBACK ON PRODUCTS, MANUFACTURE ANALYSIS, GENERATE NEW SALES INFORMATION AND LEADS, GENERATE MARKETING INFORMATION AND LEADS, PROVIDE CUSTOMER SERVICE AND SUPPORT, AND CREATE A DATABASE THAT CAN BE USED TO AID IN PRODUCT RESEARCH AND DEVELOPMENT AND SERVICE MANAGEMENT, AND TO INCREASE THE USABILITY, RELEVANCE AND EFFECTIVENESS OF BUSINESSES IN THEIR ONLINE APPLICATIONS; AND TO ALLOW ONLINE BUSINESSES TO MONITOR, FACILITATE AND MANAGE CUSTOMERS', USERS', MEMBERS', EXPERTS', ENTHUSIASTS', CLIENTS' AND PARTICIPANTS' INTERACTIONS WITH THE BUSINESS AND INTEGRATE INFORMATION AND DATA THEREFROM WITH OTHER BUSINESS AND STATISTICAL INFORMATION (U.S. CLS. 100, 101 AND 102).

CLASS 35—ADVERTISING AND BUSINESS

FOR BUSINESS CONSULTATION FOR OTHERS, NAMELY, ASSISTING BUSINESSES IN DEVELOPING, AND HOSTING APPLICATION SERVICES THAT ENABLE SUCH BUSINESSES TO CREATE, OBTAIN, COLLECT, TRACK, MONITOR, ORGANIZE, MANAGE AND STORE INFORMATION OBTAINED FROM CUSTOMERS, AFFILIATES, USERS, MEMBERS, EXPERTS, ENTHUSIASTS, CLIENTS AND PARTICIPANTS, AND FROM COMMUNITIES OF THE SAME, IN ORDER TO RECEIVE FEEDBACK ON PRODUCTS, MANUFACTURE ANALYSIS, GENERATE NEW SALES INFORMATION AND LEADS, GENERATE MARKETING INFORMATION AND LEADS, PROVIDE CUSTOMER SERVICE AND SUPPORT, AND CREATE A DATABASE THAT CAN BE USED TO AID IN PRODUCT RESEARCH AND DEVELOPMENT AND SERVICE MANAGEMENT, AND TO INCREASE THE USABILITY, RELEVANCE AND EFFECTIVENESS OF BUSINESSES IN THEIR ONLINE APPLICATIONS; AND TO ALLOW ONLINE BUSINESSES TO MONITOR, FACILITATE AND MANAGE CUSTOMERS', USERS', MEMBERS', EXPERTS', ENTHUSIASTS', CLIENTS' AND PARTICIPANTS' INTERACTIONS WITH THE BUSINESS AND INTEGRATE INFORMATION AND DATA THEREFROM WITH OTHER BUSINESS AND STATISTICAL INFORMATION (U.S. CLS. 100, 101 AND 102).

CLASS 38—COMMUNICATION

FOR CONSULTATION FOR OTHERS, NAMELY, CONSULTATION IN THE FIELD OF CREATING, FOSTERING, FACILITATING, AND MANAGING ONLINE TELECOMMUNICATIONS SERVICES, NAMELY, QUESTION AND ANSWER, CUSTOMER SUPPORT AND SERVICE, AND OTHER COMMUNICATIONS EXCHANGES, ELECTRONIC MAIL, INSTANT MESSAGING AND VOICE COMMUNICATIONS, AND ONLINE CHAT ROOMS FOR TRANSMISSION OF MESSAGES AND INFORMATION AMONG COMPUTER USERS CONCERNING CONSUMER FEEDBACK AND BUSINESS SERVICES FOR USE BY BUSINESSES, CUSTOMERS, USERS, MEMBERS, CLIENTS OF AFFILIATES (U.S. CLS. 100, 101 AND 104).

CLASS 38—COMMUNICATION

FOR CONSULTATION FOR OTHERS, NAMELY, CONSULTATION IN THE FIELD OF CREATING, FOSTERING, FACILITATING, AND MANAGING ONLINE TELECOMMUNICATIONS SERVICES, NAMELY, QUESTION AND ANSWER, CUSTOMER SUPPORT AND SERVICE, AND OTHER COMMUNICATIONS EXCHANGES, ELECTRONIC MAIL, INSTANT MESSAGING AND VOICE COMMUNICATIONS, AND ONLINE CHAT ROOMS FOR TRANSMISSION OF MESSAGES AND INFORMATION AMONG COMPUTER USERS CONCERNING CONSUMER FEEDBACK AND BUSINESS SERVICES FOR USE BY BUSINESSES, CUSTOMERS, USERS, MEMBERS, CLIENTS OF AFFILIATES (U.S. CLS. 100, 101 AND 104).

SN 76-025,783. QUIQ, INC., SAN MATEO, CA. FILED 4-13-2000.

SN 76-026,079. QUIQ, INC., SAN MATEO, CA. FILED 4-13-2000.

QUIQCHAT

QUIQSUPPORT

CLASS 35—ADVERTISING AND BUSINESS

FOR BUSINESS CONSULTATION FOR OTHERS, NAMELY, ASSISTING BUSINESSES IN DEVELOPING, AND HOSTING APPLICATION SERVICES THAT ENABLE SUCH BUSINESSES TO CREATE, OBTAIN, COLLECT, TRACK, MONITOR, ORGANIZE, MANAGE AND STORE INFORMATION OBTAINED FROM CUSTOMERS, AFFILIATES, USERS, MEMBERS, EXPERTS, ENTHUSIASTS, CLIENTS AND PARTICIPANTS, AND FROM COMMUNITIES OF THE SAME, IN ORDER TO RECEIVE FEEDBACK ON PRODUCTS, MANUFACTURE ANALYSIS, GENERATE NEW SALES INFORMATION AND LEADS, GENERATE MARKETING INFORMATION AND LEADS, PROVIDE CUSTOMER SERVICE AND SUPPORT, AND CREATE A DATABASE THAT CAN BE USED TO AID IN PRODUCT RESEARCH AND DEVELOPMENT AND SERVICE MANAGEMENT, AND TO INCREASE THE USABILITY, RELEVANCE AND EFFECTIVENESS OF BUSINESSES IN THEIR ONLINE APPLICATIONS; AND TO ALLOW ONLINE BUSINESSES TO MONITOR, FACILITATE AND MANAGE CUSTOMERS', USERS', MEMBERS', EXPERTS', ENTHUSIASTS', CLIENTS' AND PARTICIPANTS' INTERACTIONS WITH THE BUSINESS AND INTEGRATE INFORMATION AND DATA THEREFROM WITH OTHER BUSINESS AND STATISTICAL INFORMATION (U.S. CLS. 100, 101 AND 102).

CLASS 35—ADVERTISING AND BUSINESS

FOR BUSINESS CONSULTATION FOR OTHERS, NAMELY, ASSISTING BUSINESSES IN DEVELOPING, AND HOSTING APPLICATION SERVICES THAT ENABLE SUCH BUSINESSES TO CREATE, OBTAIN, COLLECT, TRACK, MONITOR, ORGANIZE, MANAGE AND STORE INFORMATION OBTAINED FROM CUSTOMERS, AFFILIATES, USERS, MEMBERS, EXPERTS, ENTHUSIASTS, CLIENTS AND PARTICIPANTS, AND FROM COMMUNITIES OF THE SAME, IN ORDER TO RECEIVE FEEDBACK ON PRODUCTS, MANUFACTURE ANALYSIS, GENERATE NEW SALES INFORMATION AND LEADS, GENERATE MARKETING INFORMATION AND LEADS, PROVIDE CUSTOMER SERVICE AND SUPPORT, AND CREATE A DATABASE THAT CAN BE USED TO AID IN PRODUCT RESEARCH AND DEVELOPMENT AND SERVICE MANAGEMENT, AND TO INCREASE THE USABILITY, RELEVANCE AND EFFECTIVENESS OF BUSINESSES IN THEIR ONLINE APPLICATIONS; AND TO ALLOW ONLINE BUSINESSES TO MONITOR, FACILITATE AND MANAGE CUSTOMERS', USERS', MEMBERS', EXPERTS', ENTHUSIASTS', CLIENTS' AND PARTICIPANTS' INTERACTIONS WITH THE BUSINESS AND INTEGRATE INFORMATION AND DATA THEREFROM WITH OTHER BUSINESS AND STATISTICAL INFORMATION (U.S. CLS. 100, 101 AND 102).

CLASS 38—COMMUNICATION

FOR CONSULTATION FOR OTHERS, NAMELY, CONSULTATION IN THE FIELD OF CREATING, FOSTERING, FACILITATING, AND MANAGING ONLINE TELECOMMUNICATIONS SERVICES, NAMELY, QUESTION AND ANSWER, CUSTOMER SUPPORT AND SERVICE, AND OTHER COMMUNICATIONS EXCHANGES, ELECTRONIC MAIL, INSTANT MESSAGING AND VOICE COMMUNICATIONS, AND ONLINE CHAT ROOMS FOR TRANSMISSION OF MESSAGES AND INFORMATION AMONG COMPUTER USERS CONCERNING CONSUMER FEEDBACK AND BUSINESS SERVICES FOR USE BY BUSINESSES, CUSTOMERS, USERS, MEMBERS, CLIENTS OF AFFILIATES (U.S. CLS. 100, 101 AND 104).

CLASS 38—COMMUNICATION

FOR CONSULTATION FOR OTHERS, NAMELY, CONSULTATION IN THE FIELD OF CREATING, FOSTERING, FACILITATING, AND MANAGING ONLINE TELECOMMUNICATIONS SERVICES, NAMELY, QUESTION AND ANSWER, CUSTOMER SUPPORT AND SERVICE, AND OTHER COMMUNICATIONS EXCHANGES, ELECTRONIC MAIL, INSTANT MESSAGING AND VOICE COMMUNICATIONS, AND ONLINE CHAT ROOMS FOR TRANSMISSION OF MESSAGES AND INFORMATION AMONG COMPUTER USERS CONCERNING CONSUMER FEEDBACK AND BUSINESS SERVICES FOR USE BY BUSINESSES, CUSTOMERS, USERS, MEMBERS, CLIENTS OF AFFILIATES (U.S. CLS. 100, 101 AND 104).

SN 76-026,273. QUIQ, INC., SAN MATEO, CA. FILED 4-13-2000.

QUIQDIRECTORIES

CLASS 35—ADVERTISING AND BUSINESS

FOR BUSINESS CONSULTATION FOR OTHERS, NAMELY, ASSISTING BUSINESSES IN DEVELOPING, AND HOSTING APPLICATION SERVICES THAT ENABLE SUCH BUSINESSES TO CREATE, OBTAIN, COLLECT, TRACK, MONITOR, ORGANIZE, MANAGE AND STORE INFORMATION OBTAINED FROM CUSTOMERS, AFFILIATES, USERS, MEMBERS, EXPERTS, ENTHUSIASTS, CLIENTS AND PARTICIPANTS, AND FROM COMMUNITIES OF THE SAME, IN ORDER TO RECEIVE FEEDBACK ON PRODUCTS, MANUFACTURE ANALYSIS, GENERATE NEW SALES INFORMATION AND LEADS, GENERATE MARKETING INFORMATION AND LEADS, PROVIDE CUSTOMER SERVICE AND SUPPORT, AND CREATE A DATABASE THAT CAN BE USED TO AID IN PRODUCT RESEARCH AND DEVELOPMENT AND SERVICE MANAGEMENT, AND TO INCREASE THE USABILITY, RELEVANCE AND EFFECTIVENESS OF BUSINESSES IN THEIR ONLINE APPLICATIONS; AND TO ALLOW ONLINE BUSINESSES TO MONITOR, FACILITATE AND MANAGE CUSTOMERS', USERS', MEMBERS', EXPERTS', ENTHUSIASTS', CLIENTS' AND PARTICIPANTS' INTERACTIONS WITH THE BUSINESS AND INTEGRATE INFORMATION AND DATA THEREFROM WITH OTHER BUSINESS AND STATISTICAL INFORMATION (U.S. CLS. 100, 101 AND 102).

CLASS 38—COMMUNICATION

FOR CONSULTATION FOR OTHERS, NAMELY, CONSULTATION IN THE FIELD OF CREATING, FOSTERING, FACILITATING, AND MANAGING ONLINE TELECOMMUNICATIONS SERVICES, NAMELY, QUESTION AND ANSWER, CUSTOMER SUPPORT AND SERVICE, AND OTHER COMMUNICATIONS EXCHANGES, ELECTRONIC MAIL, INSTANT MESSAGING AND VOICE COMMUNICATIONS, AND ONLINE CHAT ROOMS FOR TRANSMISSION OF MESSAGES AND INFORMATION AMONG COMPUTER USERS CONCERNING CONSUMER FEEDBACK AND BUSINESS SERVICES FOR USE BY BUSINESSES, CUSTOMERS, USERS, MEMBERS, CLIENTS OF AFFILIATES (U.S. CLS. 100, 101 AND 104).

CLASS 9—ELECTRICAL AND SCIENTIFIC APPARATUS

FOR VIDEO CAMERAS FOR LIGHT CURRENT ENGINEERING; PHOTOGRAPHIC PROJECTORS; OPTICAL SCANNERS, NAMELY FINGERPRINT SCANNERS; BLANK MAGNETIC AND OPTICAL DATA CARRIERS; DISC STORAGE MEDIA, NAMELY CD'S, CD-ROM'S AND DVD'S FEATURING VIDEO GAMES AND COMPANY AND PRODUCT PRESENTATIONS; AUTOMATIC VENDING MACHINES; MULTIMEDIA TERMINALS, NAMELY POINT OF INFORMATION (POI), POINT OF SALES (POS) AND POINT OF COMMUNICATION (POC) COMPUTER TERMINALS; COMPUTER TERMINALS, NAMELY, WALL TERMINALS, STAND-ALONE TERMINALS AND TABLE TERMINALS; A DISPLAY, NAMELY A MONITOR OR A SCREEN, AND AN INPUT MEANS, NAMELY A COMPUTER MOUSE, CURSOR, KEYBOARD OR TOUCH SCREEN; COMPUTER TERMINALS FOR ACCESSING LOCAL AREA NETWORKS (LAN), LOCAL OPTICAL NETWORKS (LON) AND THE INTERNET; CASH REGISTERS; CALCULATORS; DATA PROCESSORS; COMPUTERS, IN PARTICULAR PERSONAL COMPUTERS; COMPUTER PERIPHERALS; COMPUTER HARDWARE (U.S. CLS. 21, 23, 26, 36 AND 38).

CLASS 16—PAPER GOODS AND PRINTED MATTER

FOR PRINTED MATERIALS, NAMELY, BOOKS, MANUALS, MAGAZINES, BROCHURES, PAMPHLETS, NEWSLETTERS, GUIDES AND BOOKLETS RELATING TO COMPUTERS, COMPUTER SOFTWARE, ELECTRONICS, TELECOMMUNICATIONS, ELECTRICAL AND COMPUTER ENGINEERING AND THE INTERNET (U.S. CLS. 2, 5, 22, 23, 29, 37, 38 AND 50).

CLASS 37—CONSTRUCTION AND REPAIR

FOR INSTALLATION, MAINTENANCE AND REPAIR OF COMPUTER HARDWARE SYSTEMS (U.S. CLS. 100, 103 AND 106).

SN 76-032,678. ROFFMAN, SALLY, BETHESDA, MD. FILED 4-25-2000.

CREATIVE STRATEGY

SEC. 2(F).

CLASS 35—ADVERTISING AND BUSINESS

FOR BUSINESS MARKETING SERVICES, NAMELY, NAMING, LOGO AND BRAND DEVELOPMENT, DIRECT MARKETING, AND DEVELOPMENT OF PROMOTIONAL AND ADVERTISING MATERIALS (U.S. CLS. 100, 101 AND 102).

FIRST USE 8-0-1982; IN COMMERCE 8-0-1982.

CLASS 42—SCIENTIFIC, COMPUTER AND LEGAL SERVICES

FOR WEB SITE DEVELOPMENT FOR OTHERS (U.S. CLS. 100 AND 101).

FIRST USE 12-0-1996; IN COMMERCE 6-0-1997.

SN 76-030,320. FRIENDLYWAY AKTIENGESELLSCHAFT FÜR ANWENDERFREUNDLICHE SYSTEME, 85774 UNTERFOHRING, FED REP GERMANY, FILED 4-20-2000.

FRIEND@PUBLIC

PRIORITY CLAIMED UNDER SEC. 44(D) ON FED REP GERMANY APPLICATION NO. 39965375.9/0, FILED 10-20-1999, REG. NO. 39965375, DATED 12-6-1999, EXPIRES 10-31-2009.

SN 76-033,161. ENGHOUSE SYSTEMS LIMITED, MARKHAM, ONTARIO, CANADA, FILED 4-24-2000.

ENGHOUSE

PRIORITY CLAIMED UNDER SEC. 44(D) ON CANADA APPLICATION NO. 104947500, FILED 3-6-2000, REG. NO. 553680, DATED 11-13-2001, EXPIRES 11-13-2016.

CLASS 9—ELECTRICAL AND SCIENTIFIC APPARATUS

FOR COMPUTER SOFTWARE, NAMELY SOFTWARE FOR SPATIAL NETWORK ASSET MANAGEMENT USED FOR AUTOMATED MAPPING, FACILITIES MANAGEMENT AND GEOGRAPHIC INFORMATION SYSTEMS, FOR USE IN THE CABLE INDUSTRY, GAS INDUSTRY, ELECTRICAL UTILITIES INDUSTRY AND TELECOMMUNICATIONS INDUSTRY (U.S. CLS. 21, 23, 26, 36 AND 38).

FIRST USE 11-0-1984; IN COMMERCE 1-0-1992.

CLASS 41—EDUCATION AND ENTERTAINMENT

FOR TRAINING IN THE USE OF COMPUTER SOFTWARE (U.S. CLS. 100, 101 AND 107).

FIRST USE 11-0-1984; IN COMMERCE 1-0-1992.

CLASS 42—SCIENTIFIC, COMPUTER AND LEGAL SERVICES

FOR CONSULTING SERVICES, NAMELY COMPUTER CONSULTING SERVICES, COMPUTER SOFTWARE MAINTENANCE AND COMPUTER SOFTWARE UPGRADING (U.S. CLS. 100 AND 101).

FIRST USE 11-0-1984; IN COMMERCE 1-0-1992.

SN 76-033,896. CBG BIOTECH, LTD., NAPLES, FL. FILED 4-26-2000.

CBG BIOTECH

NO CLAIM IS MADE TO THE EXCLUSIVE RIGHT TO USE "BIOTECH", APART FROM THE MARK AS SHOWN.

CLASS 1—CHEMICALS

FOR FORMALIN ASSAY KITS CONSISTING PRIMARILY OF CHEMICAL REAGENTS FOR USE IN MEASURING FORMALIN; BUFFERING SYSTEMS COMPRISED OF PHOSPHATE AND PHOSPHATE ZINC BUFFERS, AND MATERIAL FOR NEUTRALIZING WASTES, NAMELY UREA, SODIUM BISULFITE, AND HYDROCHLORIDE (U.S. CLS. 1, 5, 6, 10, 26 AND 46).

FIRST USE 5-26-1998; IN COMMERCE 5-26-1998.

CLASS 11—ENVIRONMENTAL CONTROL APPARATUS

FOR EQUIPMENT, NAMELY CONCENTRATOR DISTILLATION UNITS AND RECYCLER DISTILLATION UNITS, FOR RECYCLING, REDUCING, CONCENTRATING, AND STERILIZING WASTE MATERIALS AND CHEMICALS (U.S. CLS. 13, 21, 23, 31 AND 34).

FIRST USE 2-2-1996; IN COMMERCE 2-2-1996.

SN 76-034,084. FLIPPA.COM LIMITED, LONDON W1M 5HE, UNITED KINGDOM, FILED 4-26-2000.

FLIP

CLASS 35—ADVERTISING AND BUSINESS

FOR COMPUTERIZED ON-LINE ORDERING SERVICES FEATURING ELECTRONIC OR PAPER VOUCHERS REPRESENTATIVE OF A WAGER AND CUSTOMIZED GREETING CARDS WITH ELECTRONIC OR PAPER VOUCHERS REPRESENTATIVE OF A WAGER (U.S. CLS. 100, 101 AND 102).

CLASS 36—INSURANCE AND FINANCIAL

FOR WAGERING SERVICES, WAGERING SERVICES VIA A GLOBAL COMPUTER NETWORK (U.S. CLS. 100, 101 AND 102).

SN 76-034,426. SOUTHWEST PUTTING GREENS INTERNATIONAL, INC., SCOTTSDALE, AZ. FILED 4-25-2000.

SOUTHWEST GREENS

SEC. 2(F).

CLASS 37—CONSTRUCTION AND REPAIR

FOR INSTALLATION OF PUTTING GREENS, DRIVING RANGES, SPORT COURTS, BACKYARD PLAY AREAS AND RECREATIONAL SURFACES (U.S. CLS. 100, 103 AND 106).

FIRST USE 9-1-1996; IN COMMERCE 9-1-1996.

CLASS 42—SCIENTIFIC, COMPUTER AND LEGAL SERVICES

FOR DESIGN FOR OTHERS OF PUTTING GREENS, DRIVING RANGES, SPORT COURTS, BACKYARD PLAY AREAS AND RECREATIONAL SURFACES (U.S. CLS. 100 AND 101).

FIRST USE 9-1-1996; IN COMMERCE 9-1-1996.

SN 76-034,478. UDEX LIMITED, NEWPORT, UNITED KINGDOM, FILED 4-25-2000.

UDEX

CLASS 9—ELECTRICAL AND SCIENTIFIC APPARATUS

FOR COMPUTERS; COMPUTER SOFTWARE, COMPUTER PROGRAMS, MULTIMEDIA SOFTWARE AND COMPUTER SOFTWARE DOWNLOADABLE VIA THE INTERNET, FOR COMPILING INFORMATION, MARKETING DATA, PRODUCT DATA, PRODUCT DESCRIPTIONS, AND PRODUCT CLASSIFICATIONS FOR PURPOSES OF BAR-CODING FOR RETAIL SALES, THE ESTABLISHING AND MAINTENANCE OF DATA RELATING TO PRODUCTS, PRODUCT DESCRIPTIONS AND ASSOCIATED BAR CODES, COLLECTION OF PRODUCT SALES AND RETAIL DATA, COLLATION OF PRODUCT STANDARDS DATA, DATA RECONCILIATION AND EXCHANGE, AND FOR USE IN SUPPLY CHAIN MANAGEMENT, DATA WAREHOUSING, PRODUCT VALIDATION, STANDARDIZATION, CLASSIFICATION, AND NUMBERING OF PRODUCT ATTRIBUTES; AND PARTS AND FITTINGS FOR ALL THE AFORESAID GOODS (U.S. CLS. 21, 23, 26, 36 AND 38).

CLASS 16—PAPER GOODS AND PRINTED MATTER

FOR BOOKS, MANUALS, COMPUTER-GENERATED REPORTS, RESEARCH REPORTS, MARKET STUDIES AND CONSULTING REPORTS IN THE FIELDS OF BUSINESS AND MARKETING, MARKETING INFORMATION, MARKET RESEARCH, MARKETING DATA, PRODUCT CLASSIFICATION FOR RETAIL PURPOSES, PRODUCT INFORMATION, PRODUCT SALES AND RETAIL DATA, PRODUCT STANDARDS DATA, SUPPLY CHAIN MANAGEMENT, VALIDATION, STANDARDIZATION, CLASSIFICATION, AND IN NUMBERING OF PRODUCT ATTRIBUTES; INSTRUCTIONAL MATERIALS FOR THE PURPOSE OF USING COMPUTER SOFTWARE AND PROGRAMS RELATING TO PRODUCT INFORMATION, MARKETING DATA, PRODUCT DESCRIPTIONS, STANDARDS, AND CLASSIFICATIONS, PERTAINING TO PRODUCT BAR CODING, AND THE INTERPRETATION OF REPORTS GENERATED BY THE SOFTWARE; MANAGEMENT GUIDES IN THE FIELD OF SUPPLY CHAIN MANAGEMENT (U.S. CLS. 2, 5, 22, 23, 29, 37, 38 AND 50).

CLASS 35—ADVERTISING AND BUSINESS

FOR BUSINESS MANAGEMENT AND CONSULTANCY SERVICES; MARKET RESEARCH AND MARKET ANALYSIS; PREPARATION OF BUSINESS, MARKETING AND MANAGEMENT REPORTS; BUSINESS AND MANAGEMENT RESEARCH; BUSINESS RESEARCH SERVICES RELATING TO PRODUCT CLASSIFICATION FOR RETAIL PURPOSES; PRODUCT INFORMATION SERVICES, NAMELY, PROVIDING RESEARCH ON PRODUCT STANDARDS AND CLASSIFICATION, SUPPLY CHAIN MANAGEMENT, VALIDATION AND STANDARDIZATION OF PRODUCT ATTRIBUTES; PRODUCT MERCHANDISING, NAMELY, ORGANIZING DATA RELATING TO PRODUCT AND DESCRIPTIONS AND ASSOCIATED BAR CODES, COLLATING PRODUCT SALES DATA, RETAIL DATA, PRODUCT STANDARDS DATA, AND VALIDATING STANDARDS, CLASSIFYING AND NUMBERING PRODUCT ATTRIBUTES; BUSINESS MANAGEMENT, NAMELY, SUPPLY CHAIN MANAGEMENT; COMPUTERIZED DATABASE MANAGEMENT SERVICES; PROVIDING AN ONLINE DATABASE OF MARKETING DATA AND DATA IN CONNECTION WITH SUPPLY CHAIN MANAGEMENT; PROVIDING AN ON-LINE DATABASE OF PRODUCT DATA AND CLASSIFICATION INFORMATION, PRODUCT DESCRIPTIONS AND ASSOCIATED BAR CODES, COLLATED PRODUCT SALES AND RETAIL DATA, COLLATED PRODUCT STANDARDS DATA, DATA RECONCILIATION AND EXCHANGE INFORMATION FOR RETAIL PURPOSES (U.S. CLS. 100, 101 AND 102).

CLASS 42—SCIENTIFIC, COMPUTER AND LEGAL SERVICES

FOR COMPUTER SOFTWARE AND COMPUTER CONSULTATION; MAINTENANCE OF COMPUTER SOFTWARE AND COMPUTER PROGRAMS; UPDATING OF COMPUTER SOFTWARE AND COMPUTER PROGRAMS; COMPUTER SOFTWARE DESIGN FOR OTHERS (U.S. CLS. 100 AND 101).

SN 76-034,810. PSIONIC SOFTWARE INC., AUSTIN, TX.
FILED 4-26-2000.

LOGSENTRY**CLASS 9—ELECTRICAL AND SCIENTIFIC APPARATUS**

FOR PRE-RECORDED COMPUTER SOFTWARE ON CD-ROM, DVD, AND DISKETTES FOR USE IN INTRUSION DETECTION, SECURITY SCANNING, ADAPTIVE NETWORKS, INTRUSION CONTROL AND RECOVERY, ENCRYPTION AND AUTHENTICATION, AND PRIVACY PROTECTION, IN THE FIELD OF COMPUTER SECURITY MANAGEMENT; DOWNLOADABLE COMPUTER SOFTWARE FOR USE IN INTRUSION DETECTION, SECURITY SCANNING, ADAPTIVE NETWORKS, INTRUSION CONTROL AND RECOVERY, ENCRYPTION AND AUTHENTICATION, AND PRIVACY PROTECTION, IN THE FIELD OF COMPUTER SECURITY MANAGEMENT (U.S. CLS. 21, 23, 26, 36 AND 38).

CLASS 42—SCIENTIFIC, COMPUTER AND LEGAL SERVICES

FOR CONSULTING SERVICES IN THE FIELD OF SOFTWARE DEVELOPMENT, NAMELY FOR INTRUSION DETECTION AND INTRUSION DETECTION SOFTWARE, SECURITY ASSESSMENT, COMPUTER RISK MANAGEMENT, SECURITY ARCHITECTURE DESIGN AND REVIEW, INTRUSION CONTROL AND RECOVERY, AND SECURITY RESEARCH AND DEVELOPMENT (U.S. CLS. 100 AND 101).

SN 76-036,719. GENOWAY S.A., 69007 LYON, FRANCE,
FILED 4-28-2000.

g e n o w a y

PRIORITY CLAIMED UNDER SEC. 44(D) ON FRANCE APPLICATION NO. 99820940, FILED 11-3-1999, REG. NO. 99820940, DATED 11-3-1999, EXPIRES 11-3-2009.

CLASS 5—PHARMACEUTICALS

FOR PHARMACEUTICAL AND VETERINARY PREPARATIONS, NAMELY, IN-VIVO MODELS PRODUCED BY TRANSGENE AND CELLS IN LIVE ANIMALS USED AS RESEARCH TOOLS IN GENE VALIDATION, MOLECULE RIDDLING, XENOTRANSPLANTATION, PROTEIN PRODUCTION, AND DNA BANKS FOR DIAGNOSTIC OR CLINICAL PURPOSES (U.S. CLS. 6, 18, 44, 46, 51 AND 52).

CLASS 31—NATURAL AGRICULTURAL PRODUCTS

FOR GENETICALLY MODIFIED LIVE ANIMALS FOR LABORATORY USE IN BREEDING HETEROZYGOUS AND HOMOZYGOUS (U.S. CLS. 1 AND 46).

SN 76-038,889. CDME WORLD TRADE, PARIS, FRANCE,
FILED 5-1-2000.



PRIORITY CLAIMED UNDER SEC. 44(D) ON FRANCE
APPLICATION NO. 99/820606, FILED 10-29-1999, REG. NO.
99/820606, DATED 10-29-1999, EXPIRES 10-29-2009.

THE CENTRAL LETTER "E" IS YELLOW; THE OTHER
LETTERS ARE WHITE WITHIN WHICH IS FOUND A
GRAYISH-BLUE LINING; AND THE BACKGROUND FOR
THE LETTERS IS SHOWN IN BLUE.

CLASS 9—ELECTRICAL AND SCIENTIFIC APPARATUS

FOR ELECTRONIC REMOTE CONTROL, SIGNALING,
SURVEILLANCE, REMOTE SURVEILLANCE, INSPEC-
TION ACCESS CONTROL, DETECTION AND ALARM
EQUIPMENT AND INSTRUMENTS, NAMELY, ELEC-
TRICAL REMOTE CONTROLLERS, VIDEO CAMERAS,
VIDEO MONITORS, ELECTRONIC IDENTIFICATION
CARD READERS; BLANK COMPUTER DISKETTES,
FLEXIBLE DISKETTES, MINIDISKS, AUDIO TAPES,
VIDEOTAPES, CASSETTES, CARTRIDGES, MAGNETIC
CARTRIDGES, MAGNETIC CARTRIDGES, BACKUP
CARTRIDGES, FILM WIRES, MEMORY CARDS, GRAPHICS
CARDS, SOUND CARDS, ACCELERATOR
CARDS, COMMUNICATION CONTROLLER CARDS,
DISK CONTROLLER CARDS, MEMORY EXPANSION
TERMINAL STRIPS; BLANK VIDEODISKS, VIDEOCAS-
SETTES, COMPACT DISCS, AUDIO AND VIDEO OPTI-
CAL DISKS, OPTICAL COMPACT DISCS, INTERACTIVE
OPTICAL COMPACT DISCS PHONOGRAMS, IDEO-
GRAMS; FILMS FOR RECORDING SOUND; COMPU-
TER SOFTWARE AND COMPUTER PROGRAMS FOR
USE IN DESIGNING ELECTRONIC CIRCUITRY; COM-
PUTER SOFTWARE AND COMPUTER PROGRAMS FOR
USE IN THE DESIGN OF PRINTED CIRCUIT BOARDS;
PRINTED CIRCUITS; PRINTED CIRCUIT BOARDS AND
MICROBOARDS, SEMICONDUCTORS, NAMELY—INTE-
GRADED CIRCUITS, ANALOG INTEGRATED CIR-
CUITS, DIGITAL INTEGRATED CIRCUITS,
INTERFACE AND PERIPHERAL DEVICE INTEGRATED
CIRCUITS, DIODES, MOLDED BRIDGES AND MOD-
ULES, MEMORIES, MICROPROCESSORS, MICROCON-
TROLLERS, PROGRAMMABLE CIRCUITS,
TRANSISTORS, DISCS, MODULES, THYRISTORS AND
TRACES; OPTO-ELECTRONIC SEMICONDUCTORS;
ELECTRONIC CHIPS; ELECTRONIC TUBES; MAG-
NETIC ENCODERS; DATA ENCODERS; DATA DECO-
DERS; AUTOMATIC DISPENSERS AND MECHANISMS
FOR PRE-PAYMENT APPARATUS; CASH REGISTERS;
CALCULATING MACHINES; CALCULATORS, IN PAR-
TICULAR POCKET CALCULATORS; ELECTRONIC
DATA PROCESSORS; COMPUTERS, MINICOMPUTERS;
MICROCOMPUTERS; PORTABLE COMPUTERS; COM-
PUTER AND MICROCOMPUTER CENTRAL PROCES-
SOR UNITS; COMPUTER PERIPHERAL DEVICES,
INCLUDING; DISPLAY CONSOLES, MONITORS,
SCREENS, GRAPHICS SCREENS, TACTILE SCREEN,
READERS, KEYBOARDS, PRINTERS, DIGITIZER PADS,
REMOVABLE OR NON-REMOVABLE DISK DRIVES,
INTERFACES, MODEMS; ELECTRONIC DATA PROCES-
SING TERMINALS; MAGNETIC STRIPE CARD READ-
ERS AND ENCODERS; CD-ROM DRIVES; OPTICAL
DISK DRIVES; DISKETTE DRIVES; BAR CODE READ-
ERS; INTERFACE APPARATUS FOR ELECTRONIC
DATA PROCESSORS, NAMELY COMMUNICATION
ADAPTERS FOR ASYNCHRONOUS CONVERSION,
NETWORK ADAPTERS, DATA COMMUNICATION
TEST APPARATUS, ELECTRONIC DATA PROCESSING
CABLES, NETWORK SWITCHES, NETWORK CONCEN-
TRATORS, ELECTRONIC DATA PROCESSING APPA-
RATUS UNINTERRUPTIBLE POWER SUPPLIES, LOCAL
AREA NETWORK INTERFACES, LOCAL AREA NET-
WORK GATEWAYS; ANALOG-DIGITAL CONVERTERS;
OPTICAL READERS; DATA CAPTURE APPARATUS;
COMPUTER MEMORIES; RANDOM ACCESS MEME-
ORIES; READ ONLY MEMORIES; PROGRAMMABLE

READ ONLY MEMORIES; ERASABLE PROGRAMMA-
BLE READ ONLY MEMORIES; ERASABLE PROGRAM-
MABLE READ ONLY MEMORY PROGRAMMERS;
MICE (COMPUTER) AND MOUSE MATS; IMAGE AND
TEXT SCANNERS FOR COMPUTERS; DIGITAL PLOT-
TERS AND PLOTTING TABLES; TEXT PROCESSING
APPARATUS; TELEPRINTERS; DATA TRANSMITTERS;
MULTIPLEXERS; CARRYING CASES SPECIALLY
ADAPTED FOR COMPUTERS; TELEPHONE SETS; TEL-
EPHONES; CAR TELEPHONES; TELEPHONE ANSWER-
ING MACHINES AND DEVICES FOR REMOTELY
INTERROGATING THE LATTER; TELEPHONE JACKS;
TELEPHONE SWITCHBOARDS; RADIOTELEPHONE
SETS; VOICE MAIL APPARATUS; PAGING TERM-
INALS; TRANSMITTERS AND RECEIVERS (TELECOM-
MUNICATION); TELEPHONE TRANSMITTERS;
DISTRIBUTION FRAMES (TELECOMMUNICATIONS);
CABLE TERMINATION'S (TELECOMMUNICATION),
HF RADIO COMMUNICATION TRANSMITTERS;
AUDIO AND/OR VIDEO RECEIVERS—VIDEOPHONES;
VIDEO CONFERENCE APPARATUS; AUDIO AND/OR
VIDEO APPARATUS FOR LANGUAGE LABORA-
TORIES, NAMELY, AUDIO CASSETTE RECORDERS
AND PLAYERS, VIDEO CASSETTE RECORDERS AND
PLAYERS AND VIDEO MONITORS; TELEPHONE EAR
PIECES; TELEPHONE HEADSETS; HEADPHONES; EAR
PIECES; AUDIO AND/OR VIDEO ENTRY PHONE APPA-
RATUS FOR HOUSES AND BUILDINGS; TELEPHONE
AND KEYPHONE HANDSETS; VIDEO AND KEYPHONE
EXCHANGES; VIDEO DISTRIBUTION AMPLIFIERS;
ELECTRIC DEVICES FOR SUPPRESSING NOISE AND
INTERFERENCES; KEYPHONES; MICROPHONES;
WALKIE-TALKIES, AMPLIFIERS AND PRE-AMPLI-
FIERS—; LOUDSPEAKERS; LOUDSPEAKER ENCLO-
SURES; HIGH FIDELITY STEREO PLAYERS AND
COMPONENTS THEREOF; AUDIO CASSETTE DECKS;
AUDIO/VIDEO COMPACT DISC PLAYERS; AUDIO/VI-
DEO TAPE RECORDERS; DICTATING MACHINES;
PUBLIC ADDRESS APPARATUS; SOUND PROJECTORS;
MIXING DESKS; RADIO AND TELEVISION SETS;
ANTENNAS; PHOTOCOPIER APPARATUS AND MA-
CHINES; PROJECTION APPARATUS, SCREENS AND
LAMPS; SLIDES; SCREENS, FILTERS, MASKS AND
FLASHES FOR PHOTOGRAPHY; FACSIMILE MA-
CHINES; DATA TRANSMISSION CONSOLES; VIDEO
SURVEILLANCE APPARATUS, NAMELY, VIDEO CAM-
ERAS AND VIDEO MONITORS; VIDEO CAMERAS AND
CASES AND OBJECTIVES THEREFOR; VIDEO
SCREENS AND MONITORS; VIDEO TAPE RECORDERS;
VIDEO SELECTORS; CAMERA CASE AND MONITOR
SUPPORTS REVOLVING OBJECTIVE CHANGERS FOR
CAMERAS; ELECTRICAL FITTINGS AND WIRING
ACCESSORIES, NAMELY, PLUGS, SOCKETS AND
ELECTRICAL CORDS; CABINETS; BAYS; CASES;
BOXES; DESKS; CONSOLES; PANELS AND BOARDS
FOR ELECTRICAL APPARATUS AND CIRCUITS, IN
PARTICULAR FOR SUPPLYING INSTALLATIONS
WITH ELECTRIC CURRENT DISTRIBUTION, BRANCH-
ING TRANSFORMATION OF ELECTRIC CURRENT,
CONTROL OF ELECTRIC CURRENT AND OF APPA-
RATUS SUPPLIED WITH ELECTRIC CURRENT; CON-
TROL AND DISTRIBUTION PANEL (ELECTRICITY);
CONTROL OHMMETER PANELS (ELECTRICITY);
ELECTRIC CONTROL AND REMOTE CONTROL APPA-
RATUS AND INSTALLATIONS, IN PARTICULAR FOR
LIGHTING, HEATING, AIR CONDITIONING, SHUT-
TERS, AWNINGS, PROJECTION SCREENS, DOORS,
GATES, LOCKS AND, IN GENERAL, FOR ANY ELEC-
TRICALLY POWERED APPARATUS; LIGHTING CON-
TROL, REMOTE CONTROL AND MONITORING
APPARATUS; REMOTE CONTROLLERS; WIRELESS
REMOTE CONTROLLERS; REMOTE TRANSMITTERS;
CROSS-CONNECT PANELS; ELECTRIC DISTRIBUTION
PANELS ELECTRONIC DATA PROCESSORS; MODU-
LAR PANELS (ELECTRICITY); OPTICAL MODULES;
OUTDOOR METER BOXES (ELECTRICITY); ELECTRIC
ACCUMULATORS; ELECTRIC CELLS AND BATTERIES;
ACCUMULATOR BATTERY CHARGERS; CURRENT
RECTIFIERS; ELECTRIC BALLASTS AND MONITORS
THEREFOR; MAGNETS; POWER SUPPLIES (ELECTRI-
CITY); LOAD DISPATCHERS (ELECTRICITY); CON-
VERTERS; SURGE ARRESTERS; TRANSFORMERS;
AUTOTRANSFORMERS; MODULAR CONNECTOR;
FILTERS (ELECTRICITY); CAPACITORS; INDUCTOR
WINDINGS; MAGNETIC CORES; CHOKES; DIODES;
MODULAR UNITS (ELECTRICITY); INVERTERS
(ELECTRICITY) CONCENTRATORS; BUSBARS AND
TERMINAL STRIPS, JUNCTION STRIPS; ELECTRIC
DISTRIBUTION STRIPS; TERMINALS AND CABINETS

FOR ELECTRICAL CONNECTIONS; TRACK CONNECTORS (ELECTRICITY); QUARTER-TURN CONNECTORS, SCREW CONNECTORS INSULATION DISPLACEMENT CONNECTORS, COAXIAL CONNECTORS AND ADAPTERS, POWER CONNECTORS, SEALED CONNECTORS, HIGH AND VERY HIGH VOLTAGE CONNECTORS, MICROMINIATURIZED CONNECTORS, MINIATURE TERMINAL STRIPS AND CONNECTORS FOR PRINTED CIRCUITS, MULTIPIN CONNECTORS, SPECIAL-PURPOSE MODULAR ELECTRONIC DATA PROCESSING AND TELEPHONE CONNECTORS, OPTICAL CONNECTORS, OPTICAL FIBER CONNECTORS; CONNECTOR PROTECTION SLEEVES; TERMINAL BLOCKS; CONTROL AND DISTRIBUTION BOXES (ELECTRICITY); ELECTRONIC CONDUCTOR BOXES; JUNCTION BLOCKS; FLUSH BOXES TERMINAL AND TERMINAL BOARDS (ELECTRICITY); ELECTRIC PROTECTION APPARATUS, NAMELY, CIRCUIT BREAKERS AND BREAKER BOXES; CUTOUTS FOR POWER AND DISTRIBUTION CIRCUITS; ISOLATORS; CUTOUT BARS IN THE NATURE OF IN THE NATURE OF ON/OFF SWITCHING DEVICES; SWITCHES; KEYSWITCHES; INTERMEDIATE SWITCHES; CHANGE-OVER SWITCHES; EXCHANGES; PUSHES AND PUSH-BUTTONS, LUMINOUS AND NON-LUMINOUS; PUSH-BUTTON BOXES; CONTROL KEYPADS (ELECTRICITY); TWO-WAY SWITCHES; PENDANT SWITCHES; CONTROL FINGERS AND EMBELLISHERS FOR ELECTRICAL FITTINGS AND WIRING ACCESSORIES; ELECTRIC CORDS FOR PULL-CORD SWITCHES; PULSE OPERATED LATCHING RELAYS; MINIATURE CIRCUIT-BREAKERS; CIRCUIT-BREAKERS; DIFFERENTIAL CIRCUIT-BREAKERS; LIGHTNING ARRESTERS; FUSES; CARTRIDGE FUSES; SUBSCRIBER PANELS (ELECTRICITY); JUNCTION PANELS; ELECTRIC RESISTORS; CABLE OUTLETS; TIME-LAG SWITCHES FOR LIGHTING AND/OR ELECTRIC INSTALLATIONS; INDICATORS AND SIGNAL LAMPS (ELECTRICITY); CONTRACTORS; RELAYS; PROGRAMMERS; ELECTRIC HEATING AND DOMESTIC APPLIANCE PROGRAMMERS; TIME SWITCHES; LIGHT-SENSITIVE SWITCHES AND RELAYS; LOAD SHEDDERS; VOLTAGE REGULATORS; VOLTAGE CONTROLLERS; LIGHT DIMMERS AND REMOTE CONTROL DIMMERS SPEED CONTROLLERS (ELECTRICITY); PLUGS AND SOCKETS; BLANKING PLATES (ELECTRICITY); SOCKET OUTLET BLANKING PLATES; SOCKET OUTLET PROTECTION UNITS; LOUDSPEAKER PLUGS AND SOCKETS; TELEVISION PLUGS AND SOCKETS; VIDEO PLUGS AND SOCKETS; HIGH FIDELITY PLUGS AND SOCKETS; TELEPHONE PLUGS AND SOCKETS; ELECTRONIC DATA PROCESSING APPARATUS PLUGS AND SOCKETS; OPTICAL PLUGS AND SOCKETS; MULTI-OUTLET SOCKET BLOCKS; DOUBLE AND TRIPLE SOCKET OUTLETS; CABLE-MOUNTING SOCKET OUTLETS; SOCKET OUTLET WALL BOXES; ADAPTERS; PLUGS; ELECTRIC EXTENSION LEADS; TELEPHONE EXTENSION LEADS; ELECTRONIC DATA PROCESSING APPARATUS CABLES AND ADAPTERS; ELECTRONIC DATA PROCESSING LINE PROTECTION APPARATUS; PARALLEL LINE AMPLIFIERS; ELECTRONIC DATA PROCESSING AND OPTICAL FIBER REPEATERS; REELS AND DRUMS FOR ELECTRIC CONDUCTORS; GROMMETS FOR ELECTRIC CONDUCTORS; JUNCTION SLEEVES FOR ELECTRIC CABLES; ELECTRIC LINE CONNECTORS; ELECTRIC CABLE AND TERMINAL BLOCK MARKER APPARATUS (ELECTRICITY), NAMELY, MARKERS, MARKER-HOLDERS AND MARKER APPLICATORS; SPECIAL-PURPOSE BOXES, CASES, CONTAINERS AND CHESTS FOR STORING APPARATUS FOR MARKING ELECTRIC CONDUCTORS AND FOR MAKING UP MARKERS PRIOR TO FITTING; GROUNDING DEVICES; GROUND SPIKES; MAINS ELECTRIC POWER SUPPLY PROTECTION APPARATUS, NAMELY, ELECTRONIC AND ELECTRICAL PROTECTION CIRCUITRY (ELECTRICITY); ELECTRIC CONDUCTOR CLIPS; ELECTRIC CONDUCTOR INSTALLATION EQUIPMENT NAMELY, STRAPPING, WIRING, ATTACHMENT AND CLAMPING COLLARS; ELECTRIC CONDUCTORS, IN PARTICULAR CABLES, WIRES, CORDS, TRACKS AND BUSBARS; ELECTRONIC DATA PROCESSING APPARATUS CABLES; SPECIAL CABLES FORM ELECTRONIC DATA PROCESSING LOCAL AREA NETWORKS; ETHERNET CABLES; TWINAX CABLES; COAXIAL CABLES; ETHERNET CARDS; OPTICAL FIBERS; INSTALLATION AND/OR DISTRIBUTION STRUCTURAL SECTIONS FOR ELECTRIC CONDUCTORS' AND/OR

APPARATUS, NAMELY, DUCTING, SHEATHING, CONDUCT, PIPES, COLUMNS, TUBES, MOLDINGS, BASEBOARDS, RAILS, WIRING ENCLOSURE STRIPS, FLOOR BOXES, CABLE GUIDES, WIRE COVERS; PREFABRICATED ELECTRIC DUCTS AND SUPPORTS THEREFOR; EQUIPMENT, STRAPPING, JOINTING, JUNCTION, SUPPORT, ASSEMBLY, CONNECTION AND FINISHING PARTS FOR ELECTRIC CONDUCTORS AND/OR APPARATUS NAMELY, ELECTRIC CABLE SUPPORTS, JUNCTION BOXES AND TEES, CONVECTOR OUTLETS, JUNCTION BOXES CONNECTION ELBOWS, END PIECES, COVER SEALS, ADAPTERS, INTERNAL PARTITIONS, EXPANSION SLEEVES; LUMINOUS OR MECHANICAL SIGN; SIGNAL LAMPS; LIGHTED SIGNS, BEACONS, STUDS, BULKHEAD LIGHTS, BLOCKS, PLATES, BOXES AND BOX-SECTIONS, ALL LUMINOUS, EQUIPPED WITH SOCKET OUTLETS OR NOT, AND ALL FOR BEACHING SIGNALING; DISPLAYING INFORMATION AND/OR ADVERTISING; LUMINOUS BLOCKS AND PLATES, CARRYING TEXT OR PICTOGRAMS OR NOT, FOR INFORMATION AND SAFETY SIGNALING; BEACON LAMPS; (SIGNALING); LUMINOUS OR MECHANICAL SIGNS; LUMINOUS OR MECHANICAL SIGNALING PANELS; NEON SIGNS; ELECTRIC LIGHT BULB OR TUBE HOLDERS AND MOUNTINGS; BELL PUSHES; BELTS AND CHIMES (WARNING DEVICES), IN PARTICULAR FOR DOORS; ELECTRIC DOORBELLS; ELECTRIC NETWORK ALARM DEVICES; LUMINOUS ALARMS; FLASHLAMPS (SIGNALING AND ALARM); AUDIO ALARM; ACOUSTIC ALARMS; THEFT ALARMS (OTHER THAN FOR VEHICLES); FIRE ALARMS; ELECTRIC ALARM GONGS; BUZZERS; SIRENS; RADIO TRANSMITTERS AND RECEIVERS; ALARM SYSTEM CENTRAL CONTROL UNITS; FIRE ALARM SYSTEM CENTRAL CONTROL UNITS; DOMESTIC ALARM SYSTEM CENTRAL CONTROL UNITS; DETECTORS; INFRARED DETECTORS; MOVEMENT DETECTORS BEAM INTERRUPTION DETECTORS; INTRUDER DETECTORS; PROXIMITY DETECTORS; RADIO FREQUENCY DETECTORS; SMOKE AND FIRE DETECTORS; GAS DETECTORS; METAL DETECTORS; LEVEL DETECTORS; PHOTO-ELECTRIC CELLS; ELECTRIC CONTACTS, IN PARTICULAR FOR DOORS AND GATES; ELECTRIC AND ELECTRONIC BOLTS, ELECTRIC LOCKS AND CLOSURES AND CONTROL AND REMOTE CONTROL DEVICES THEREFOR, IN PARTICULAR KEYPAD TYPE; ELECTRIC DOOR CLOSURES; ACCESS CONTROL APPARATUS, NAMELY, KEYPADS; ACCESS CONTROL APPARATUS CASINGS AND READERS; BUILDING ENTRY DOOR CODE KEYPADS; MAGNETIC AND/OR ELECTRONIC AND/OR OPTICAL AND/OR DIGITAL CARDS AND BADGES FOR ACCESS CONTROL; SMART CARDS; OPTICAL READERS; BAR CODE READERS; SMART CARD READERS; OPTICAL LAMPS; METERING APPARATUS, NAMELY VOLT-METERS, AMMETERS AND FLUID FLOW METERS; ELECTRIC POWER METERS; MEASURING APPARATUS FOR ELECTRIC CIRCUITS; MEASURING APPARATUS, IN PARTICULAR FOR MEASURING CHARACTERISTICS OF ELECTRIC CURRENT AND VOLTAGE; GROUND MEASURING, CHECKING AND MONITORING APPARATUS; VOLTAGE, GROUNDING AND SHORT-CIRCUIT MONITORS, DETECTORS AND INDICATORS; TEST APPARATUS FOR TESTING ELECTRIC CURRENT AND ITS CHARACTERISTICS; APPARATUS FOR TESTING THE CONFORMITY OF ELECTRIC INSTALLATIONS; FAULT DETECTORS; SHORT-CIRCUITING DEVICES; ELECTRIC SOLDERING IRONS; ELECTRIC SOLDERING AND DESOLDERING APPARATUS; WELDING ELECTRODES ELECTRIC AND ELECTRONIC APPARATUS FOR SOLDERING ELECTRONIC COMPONENTS TO CIRCUIT BOARDS AND CIRCUITS; ELECTRIC WELDING APPARATUS AND STATIONS; INDUSTRIAL ELECTRONIC APPARATUS, NAMELY, PHOTO-ELECTRIC SAFETY BARRIERS, ELECTRONIC SENSORS, ROTARY POSITION SENSORS, COLOR RECOGNITION CELLS, ELECTROMAGNETIC ENCODERS, INCREMENTAL OPTICAL ENCODERS, PHOTO-ELECTRIC CONTROL DEVICES, ELECTROMECHANICAL COUNTERS, ELECTRONIC COUNTERS, ELECTRONIC LIGHT DETECTORS, ELECTRONIC TORQUE LIMITERS, DATA ACQUISITION DEVICES FOR INDUSTRIAL USE, NAMELY, DATA ENCODERS AND DATA TRANSMITTERS; COMPUTER-AIDED DRAFTING DEVICES, NAMELY, SOFTWARE FOR USE IN COMPUTER AIDED DESIGN AND ELECTRO-MECHANICAL PLOTTERS; MONITORING AND ANALYSIS APPARATUS AND INSTRUMENTS FOR CIRCUITS AND

NETWORKS, NAMELY, HARMONIC ANALYZERS, ELECTRIC NETWORK ANALYZERS, ELECTRONIC DATA PROCESSING NETWORK ANALYZERS, INSULATION TESTERS, DIFFERENTIAL CIRCUIT-BREAKER TESTERS, DIELECTRIC STRENGTH METERS, INTERFERENCE RECORDING APPARATUS, CABLE LOCATORS, OHMMETERS, LEAKAGE CURRENT CLAMPS, FAULT LOCATING BRIDGES, TIMING LIGHTS, TELLUROMETERS, ELECTRIC WIRING TESTS, MULTIFUNCTIONAL ELECTRIC TESTING APPARATUS; RECORDERS AND PLOTTERS; CURRENT, VOLTAGE, POWER, FREQUENCY, PHASE AND ENERGY INDICATORS, NAMELY, AMMETER, ELECTRIC METERS, ELAPSED TIME COUNTERS, MEASUREMENT CONVERTERS, FREQUENCY METERS, PHASE METERS, CURRENT MEASURING CLAMPS, SHUNTS, MEASUREMENT TRANSFORMERS, VOLTAGE CHECKERS AND DETECTORS, VOLTMETERS, WATTMETERS; MAGNETIC MEASURING INSTRUMENTS, INCLUDING FIELD METERS, FLUX METERS, GAUSS METERS, MAGNETOMETERS; ELECTRONIC MEASURING APPARATUS AND INSTRUMENTS NAMELY, LOGIC ANALYZERS, INTEGRATED CIRCUIT TESTERS, ELECTRONIC COMPONENT TESTERS, LOW FREQUENCY SIGNAL GENERATORS, PLUS GENERATORS, FUNCTION GENERATORS, MEASURING SOFTWARE, MULTIMETERS AND PROBES THEREFOR, OSCILLOSCOPE AND PROBES THEREFOR, MULTIMETER CLAMPS, SOUND PRESSURE LEVEL METERS; PHYSICAL-CHEMICAL MEASURING APPARATUS AND INSTRUMENTS, INCLUDING- DATA ACQUISITION CENTERS, VIBRATION AESTERS, HARMONIC GENERATORS, BINARY WORD GENERATORS, ELECTRONIC LEVEL GENERATORS, LIGHT METERS, STROBOSCOPES, TACHOMETERS AND TACHOMETERS SENSORS ELECTRIC MEASURING APPARATUS AND INSTRUMENTS, NAMELY, MEASUREMENT BRIDGES, METERS; RADIO FREQUENCY MEASUREMENT APPARATUS AND INSTRUMENTS, INCLUDING VERY HIGH FREQUENCY MEASURING SETS, RADIO FELLER METERS, FREQUENCY METERS, PERIOD METERS, MEDIUM FREQUENCY HIGH FREQUENCY AND VERY HIGH FREQUENCY SIGNAL GENERATORS, ELECTRONIC TEST PATTERN GENERATORS, WAVE METERS, LOSS ANGLE MEASURING BRIDGES, Q-METERS, TIMING LIGHTS, TRANSISTOR TESTERS, WOBBLATORS HIGH-FREQUENCY VOLTMETERS; INDUCTANCE, RESISTANCE AND CAPACITANCE MEASURING APPARATUS AND INSTRUMENTS, NAMELY, STANDARD CAPACITOR BOXES, STANDARD RESISTOR BOXES, STANDARD INDUCTOR BOXES, VOLTAGE DIVIDERS, VOLTAGE DIVIDER BOXES, CAPACITANCE METERS, CONDUCTANCE METERS, OHMMETERS, MEGOHMMETERS, I MEASURING APPARATUS AND INSTRUMENTS FOR TEMPERATURE REGULATION, NAMELY, THERMOCOUPLE COMPENSATORY CABLES, PYROMETER RODS, TEMPERATURE SENSORS, THERMOCOUPLE COLD WELD COMPENSATORS, THERMOCOUPLE PLUG-IN CONNECTORS, HIGH-TEMPERATURE THERMOCOUPLES, TEMPERATURE RECORDERS, TEMPERATURE INDICATORS, PYROMETERS, PROSTATES TEMPERATURE REGULATORS, SENSORS, THERMOMETERS, ELECTRONIC THERMOMETERS; INFRARED THERMOMETERS, THERMOSTATS; MEASURING LEADS; CASES, JACKETS AND COVERS FOR MEASURING INSTRUMENTS; SPECIAL CASES FOR MEASURING INSTRUMENTS; MEASURING SETS; DENSITY MEASURING APPARATUS; CASES, CABINETS, RACKS, MODULES, SUBRACKS, CASSETTES AND PLUG-IN MODULES, ALL SPECIFICALLY ADAPTED TO HOUSE ELECTRIC- ELECTRONIC AND/OR ELECTRONIC DATA PROCESSING APPARATUS, INCLUDING ELECTRONIC CORDS AND PRINTED CIRCUITS; EXTENDERS, GUIDES, SUPPORTS AND EXTRACTORS, ALL FOR ELECTRONIC CARDS AND PRINTER CIRCUITS; ELECTRIC WIRING FOR THE AFORESAID GOODS; ELECTRIC CABLE DUCTING FOR THE AFORESAID GOODS; ELECTRIC APPARATUS FOR THE AFORESAID GOODS, NAMELY, DISTRIBUTION BOXES, DISTRIBUTION RAILS, ELECTRIC CONTACTS, CONNECTORS; FRAME GROUNDS AND PARTS THEREOF FOR THE AFORESAID GOODS, NAMELY, GROUND CLAMPS AND GROUNDING TERMINALS; ELECTRIC OR ELECTRONIC LOCKS FOR THE AFORESAID GOODS; APPARATUS, HARDWARE AND PARTS FOR THE ELECTRONIC INDUSTRY, NAMELY- POWER SUPPLY BUSBARS, KNOBS AND DIALS, PIECE-ELECTRIC BUZZER AND RINGERS, TEST LEADS AND

ADAPTERS, BANANA SOCKETS, BANANA PLUGS, CROCODILE CLIPS, TEST PROBES, SEMICONDUCTOR, INTEGRATED CIRCUIT AND ELECTRONIC COMPONENT SOCKETS, SUPPORTS DESIGNED FOR CELLS AND BATTERIES, MINIATURE SWITCHES FOR PRINTED CIRCUITS, FERRITE COMPONENTS AND MAGNETIC CORES, ATTENUATES, INTERFERENCE SUPPRESSERS, FILTERS AND DELAY LINES, POTENTIOMETERS AND RESISTORS, QUARTZ CRYSTALS, RELAYS, RELAY SOCKETS; SAFETY NETS; SAFETY CLOTHING AND FOOTWEAR, NAMELY, RADIATION AND FIRE RESISTANT CLOTHING AND FOOTWEAR, INSULATING CLOTHING AND FOOTWEAR, SAFETY AND FIREPROOF GLOVES; SAFETY HELMETS; SAFETY MASKS, VISORS ARID GOGGLES FOR WORKERS AND WELDERS; ANTI-GLARE GOGGLES AND VISION; SAFETY HARNESSES AND BELTS FOR ELECTRIC POWER LINEMEN; ELECTRIC COUPLINGS (OTHER THAN FOR LAND VEHICLES); PRINTED CIRCUIT CARD SUBRACKS; PRINTED CIRCUIT CARD EXTENDERS; PRINTED CIRCUIT CARD GUIDES; PRINTED CIRCUIT CARD SUPPORTS; PRINTED CIRCUIT CARD EXTRACTORS; PRINTED CIRCUIT CARD HANDLES; BALLASTS FOR LIGHTING TUBES; LUMINOUS SIGNS; BULKHEAD LIGHTS AND BOX UNITS, EQUIPPED WITH ELECTRIC SOCKET OUTLETS; ELECTRICALLY POWERED TOOLS FOR PRINTED CIRCUITS, NAMELY, ELECTRIC SOLDERERS; ELECTRICALLY POWERED TOOLS USED IN THE ELECTRIC AND ELECTRONIC INDUSTRY, NAMELY, ELECTRIC SOLDERERS; AND PARTS FOR ALL THE AFORESAID GOODS (U.S. CLS. 21, 23, 26, 36 AND 38).

CLASS 11—ENVIRONMENTAL CONTROL APPARATUS

FOR HEATING, REFRIGERATION, FREEZING, DEEP FREEZING AND AIR CONDITIONING APPARATUS AND INSTALLATIONS, NAMELY, PORTABLE ELECTRIC HEATERS, PORTABLE ELECTRIC ROOM HUMIDIFIERS, REFRIGERATORS, FREEZERS, AIR CONDITIONERS; HEAT AND STEAM ACCUMULATORS; HOT AIR OVENS; HEAT ACCUMULATORS AND RECOVERY UNITS; HUMIDIFIERS FOR CENTRAL HEATING RADIATORS; RADIATORS; ELECTRIC RADIATORS; ELECTRIC CONVECTOR HEATERS; WATER HEATERS; WATER COOLERS; HEATERS FOR BATHS, WATER HEATERS; DUST OR SMOKE EXTRACTION UNITS FOR INDUSTRIAL USE; PARTS OF VENTILATION INSTALLATIONS, NAMELY, BLOWERS VENTILATION HOODS; IONIZATION UNIT FOR AIR TREATMENT; FILTERING, PURIFICATION AND DEODORIZATION OF AIR APPARATUS, INSTALLATION AND MACHINES; AIR HEATERS, DRYERS AND STERILIZERS; ELECTRIC INSECT KILLERS; ELECTRIC LAMPS; LAMPS; TUBULAR ELECTRIC LAMPS; DIACHRONIC LAMPS; ELECTRIC BULB; LIGHT BULBS; LIGHT TUBES; ELECTRIC DISCHARGE LIGHT TUBES; FLUORESCENT LIGHT TUBES; INFRARED LAMPS; ULTRAVIOLET LAMPS FOR NON-MEDICAL USE; GERMICIDAL LAMPS; LAMP BRACKETS; AUTONOMOUS LIGHTING UNITS, INCLUDING EMERGENCY LIGHTING; MODULAR EMERGENCY LIGHTING UNITS; EMERGENCY LIGHTING UNITS AND PLATES WITH OR WITHOUT TEXT OR PICTOGRAMS; SPOTLIGHTS; FLOODLIGHTS; LIGHTING TRACKS; READING LAMPS; LANTERNS; CEILING LIGHTS; LUMINARIES; LAMP AND FIRE GLOBES; PORTABLE LAMPS; INSPECTION LAMPS; FLASHLIGHTS; POCKET FLASHLIGHTS; LAMP REFLECTORS; DIFFUSERS; BAYONET AND SCREW LAMP HOLDERS, BULB HOLDERS AND TUBE SOCKETS; VENTILATION, HEATING, COOLING LIGHTING UNITS, ALL FOR CASES, CABINETS, RACKS AND MODULES ACCOMMODATING ELECTRIC, AND/OR ELECTRONIC DATA PROCESSING APPARATUS; PARTS AND FITTINGS FOR ALL THE AFORESAID GOODS (U.S. CLS. 13, 21, 23, 31 AND 34).

CLASS 16—PAPER GOODS AND PRINTED MATTER

FOR PRINTED PRODUCTS, NAMELY, PRINTED FORMS, PROSPECTUSES, FLYERS, BROCHURES, CATALOGUES, NEWSPAPERS, MAGAZINES, JOURNALS, BOOKS, GUIDES, MANUALS, TECHNICAL MANUALS, TECHNICAL CODES, DICTIONARIES, BULLETINS, INDEXES BOOKLETS ALL IN THE FIELDS OF ELECTRICAL AND ELECTRONIC APPARATUS AND THE OPERATION, REPAIR AND MAINTENANCE THEREOF; PRINTED PRODUCTS, NAMELY, FILE FOLDERS, COMPOSITION BOOKS, DRAWING BOOKS AND NOTEBOOKS; MOUNTED ARCHITECTURAL DRAWINGS OR ART PICTURES; PHOTOGRAPHS; UNMOUNTED ARCHITECTURAL DRAWINGS OR ART PICTURES; PHOTOGRAPHS; STATIONERY; GLUES AND ADHESIVES FOR STATIONERY, OFFICE AND/OR HOUSEHOLD USE; OFFICE SUPPLIES, NAMELY, ELECTRIC TYPEWRITERS AND THERE PARTS AND COMPONENT PARTS; PRINTED INSTRUCTION, TRAINING AND TEACHING MATERIALS IN THE FIELDS OF ELECTRICAL AND ELECTRONIC APPARATUS AND THE OPERATION, REPAIR AND MAINTENANCE THEREOF; PAPER OR CARDBOARD PACKAGING, NAMELY, SHEETS, BAGS, ENVELOPES, SLEEVES AND FOLDERS; PAPER AND/OR CARDBOARD PLACARDS, ESCUTCHEONS AND SIGNS; DRAWING INSTRUMENTS; DRAWING SUPPLIES, NAMELY, PENS, PENCILS, ERASERS, CHALKS AND CHARCOALS; WRITING INSTRUMENTS; CASES AND CONTAINERS FOR WRITING OR DRAWING INSTRUMENTS AND SUPPLIES; PAPER TRANSFERS FOR PRINTED CIRCUITS; SELF ADHESIVE PAPER LABELS; OFFICE SUPPLIES, NAMELY, STAPLERS AND STAPLES; MARKER PENS FOR PRINTED CIRCUITS; PUNCHED CARD OFFICE MACHINES; DIAGRAMS FOR BUILDING COMPUTER CIRCUIT (U.S. CLS. 2, 5, 22, 23, 29, 37, 38 AND 50).

SN 76-039,699. INTERACTIVE COMMUNICATIONS INTERNATIONAL INC, ATLANTA, GA. FILED 5-1-2000.

INCOMM

OWNER OF U.S. REG. NO. 2,266,684.

CLASS 9—ELECTRICAL AND SCIENTIFIC APPARATUS

FOR MAGNETICALLY ENCODED PRE-PAID CELLULAR TELEPHONE AND PRE-PAID PAGING UNIT CARDS; CELLULAR TELEPHONES AND RADIO PAGERS (U.S. CLS. 21, 23, 26, 36 AND 38).

FIRST USE 12-15-1999; IN COMMERCE 12-15-1999.

CLASS 16—PAPER GOODS AND PRINTED MATTER

FOR NON-MAGNETICALLY ENCODED PRE-PAID CELLULAR TELEPHONE AND PRE-PAID PAGING UNIT CARDS (U.S. CLS. 2, 5, 22, 23, 29, 37, 38 AND 50).

FIRST USE 12-15-1999; IN COMMERCE 12-15-1999.

SN 76-041,851. COMPUSPORT, L.L.C., PITTSBURGH, PA. FILED 5-5-2000.

MODEL BASEBALL

NO CLAIM IS MADE TO THE EXCLUSIVE RIGHT TO USE "BASEBALL", APART FROM THE MARK AS SHOWN.

CLASS 9—ELECTRICAL AND SCIENTIFIC APPARATUS

FOR COMPUTER SOFTWARE RELATED TO BASEBALL, NAMELY, INSTRUCTIONAL SOFTWARE AND SCREEN SAVERS (U.S. CLS. 21, 23, 26, 36 AND 38).

CLASS 16—PAPER GOODS AND PRINTED MATTER

FOR PRINTED INSTRUCTIONAL MATERIALS RELATED TO BASEBALL (U.S. CLS. 2, 5, 22, 23, 29, 37, 38 AND 50).

CLASS 18—LEATHER GOODS

FOR BASEBALL ACCESSORIES, NAMELY, UMBRELLAS AND TRAVELING BAGS (U.S. CLS. 1, 2, 3, 22 AND 41).

CLASS 25—CLOTHING

FOR BASEBALL CLOTHING, NAMELY, BASEBALL CAPS, JACKETS, WARM-UP SUITS, SHIRTS, T-SHIRTS, JERSEYS, PANTS, SOCKS, SWEATSHIRTS, SHOES, FOOTWEAR, WRIST BANDS, FLEECEWEAR, AND RAINWEAR (U.S. CLS. 22 AND 39).

CLASS 28—TOYS AND SPORTING GOODS

FOR SPORTING GOODS, NAMELY, BASEBALL BASES, BASEBALL BATS, BASEBALL BATTING GLOVES, BASEBALL BATTING TEES, BASEBALL GLOVES, BASEBALL MITTS, AND PRACTICE AIDS RELATED TO BASEBALL, NAMELY, SWING WEIGHTS, FUNGO BATS, PITCHING MACHINES AND HITTING NETS (U.S. CLS. 22, 23, 38 AND 50).

SN 76-042,905. REACTIVITY, INC., BELMONT, CA. FILED 5-8-2000.

START SOMETHING**CLASS 35—ADVERTISING AND BUSINESS**

FOR BUSINESS CONSULTATION, BUSINESS DEVELOPMENT, AND BUSINESS RESEARCH FOR TECHNOLOGY ORIENTED COMPANIES (U.S. CLS. 100, 101 AND 102).

FIRST USE 3-1-2000; IN COMMERCE 3-9-2000.

CLASS 42—SCIENTIFIC, COMPUTER AND LEGAL SERVICES

FOR TECHNICAL CONSULTATION AND RESEARCH IN THE FIELD OF COMPUTER SOFTWARE; DESIGN AND TESTING OF NEW PRODUCTS FOR OTHERS FOR USE BY TECHNOLOGY ORIENTED COMPANIES; PRODUCT DEVELOPMENT CONSULTATION (U.S. CLS. 100 AND 101).

FIRST USE 3-1-2000; IN COMMERCE 3-9-2000.

SN 76-043,438. FUNDACION CUATRECASAS, 08008 BARCELONA, SPAIN, FILED 5-8-2000.

CUATRECASAS

PRIORITY CLAIMED UNDER SEC. 44(D) ON ERPNTM CMNTY TM OFC APPLICATION NO. 1592005, FILED 4-4-2000, REG. NO. 1592005, DATED 6-6-2001, EXPIRES 4-4-2010.

OWNER OF ERPNTM CMNTY TM OFC REG. NO. 1264845, DATED 9-29-2000, EXPIRES 8-3-2009.

OWNER OF ERPNTM CMNTY TM OFC REG. NO. 998971, DATED 3-22-2000, EXPIRES 11-26-2008.

CLASS 9—ELECTRICAL AND SCIENTIFIC APPARATUS

FOR BLANK MAGNETIC DATA CARRIERS, BLANK COMPUTER DISCS; RECORDING DISCS; COMPUTER OPERATING PROGRAMS; ELECTRONIC NOTEBOOK; COMPUTER HARDWARE MEMORY CARDS (U.S. CLS. 21, 23, 26, 36 AND 38).

CLASS 16—PAPER GOODS AND PRINTED MATTER

FOR PRINTED MATTER, NAMELY, BOOKS, PRINTED PUBLICATIONS, MAGAZINES, PAMPHLETS, CATALOGUES OF LEGAL, ECONOMIC AND SOCIAL MATTERS; STATIONERY; ADHESIVES FOR STATIONERY OR HOUSEHOLD PURPOSE; PLAYING CARDS; BALL POINT PENS, FELT-TIPPED PENS AND FOUNTAIN PENS (U.S. CLS. 2, 5, 22, 23, 29, 37, 38 AND 50).

CLASS 35—ADVERTISING AND BUSINESS

FOR BUSINESS MANAGEMENT AND CONSULTATION; TAX PREPARATION; CONDUCTING MARKETING STUDIES; PREPARING BUSINESS REPORTS; COMPUTERIZED WORD PROCESSING; ADMINISTRATION OF CULTURAL AND EDUCATIONAL EXCHANGE PROGRAMS (U.S. CLS. 100, 101 AND 102).

CLASS 36—INSURANCE AND FINANCIAL

FOR FINANCIAL ANALYSIS AND CONSULTATION; FINANCIAL VALUATION OF PERSONAL PROPERTY AND REAL ESTATE; FISCAL ASSESSMENT AND EVALUATION; FINANCIAL INFORMATION PROVIDED BY ELECTRONIC MEANS; BANKING; FINANCIAL SPONSORSHIP OF CONFERENCES, SEMINARIES, DISCUSSIONS, SYMPOSIUMS AND JURIDICAL CONVENTIONS (U.S. CLS. 100, 101 AND 102).

CLASS 38—COMMUNICATION

FOR PROVIDING MULTIPLE-USER ACCESS TO A GLOBAL COMPUTER INFORMATION NETWORK; ELECTRONIC TRANSMISSION OF MESSAGES AND DATA; RADIO COMMUNICATIONS; TELEPHONE COMMUNICATIONS; RADIO BROADCASTING; TELEVISION BROADCASTING; TRANSMISSION VIA SATELLITE; ELECTRONIC TRANSMISSION OF DATA AND DOCUMENTS VIA COMPUTER TERMINALS (U.S. CLS. 100, 101 AND 104).

CLASS 41—EDUCATION AND ENTERTAINMENT

FOR EDUCATION AND PROVIDING OF TRAINING ON JURIDICAL AND ECONOMIC MATTERS; PUBLICATION OF BOOKS; PUBLICATION OF TEXTS; EDUCATIONAL SERVICES, NAMELY, PROVIDING LEGAL COURSES OF INSTRUCTION AT THE POST-GRADUATE (U.S. CLS. 100, 101 AND 107).

CLASS 42—SCIENTIFIC, COMPUTER AND LEGAL SERVICES

FOR LEGAL SERVICES AND LEGAL CONSULTANCY (U.S. CLS. 100 AND 101).

SN 76-043,548. PERSONIC SOFTWARE, INC., BRISBANE, CA. FILED 5-4-2000.

PERSONIC

OWNER OF U.S. REG. NOS. 2,322,891 AND 2,325,206.

CLASS 9—ELECTRICAL AND SCIENTIFIC APPARATUS

FOR COMPUTER SOFTWARE FOR WORD PROCESSING, DOCUMENT MANAGEMENT, JOB APPLICANT TRACKING, RESUME SCANNING AND CONNECTION TO THE GLOBAL COMPUTER INFORMATION NETWORKS IN THE FIELDS OF HUMAN RESOURCES MANAGEMENT AND EMPLOYMENT RECRUITING (U.S. CLS. 21, 23, 26, 36 AND 38).

FIRST USE 2-2-1998; IN COMMERCE 2-2-1998.

CLASS 35—ADVERTISING AND BUSINESS

FOR HUMAN RESOURCES MANAGEMENT SERVICES FOR OTHERS, EMPLOYMENT RECRUITING SERVICES FOR OTHERS, AND PROVIDING INFORMATION IN THE FIELD OF HUMAN RESOURCES MANAGEMENT AND EMPLOYMENT RECRUITING TO OTHERS BY MEANS OF A GLOBAL COMPUTER NETWORK (U.S. CLS. 100, 101 AND 102).

FIRST USE 2-2-1998; IN COMMERCE 2-2-1998.

SN 76-044,523. BOOKS R U LIMITED, LONDON, ENGLAND, FILED 5-9-2000.



PRIORITY CLAIMED UNDER SEC. 44(D) ON ERPNTM CMNTY TM OFC APPLICATION NO. 001661560, FILED 5-9-2000, REG. NO. 1661560, DATED 9-21-2001, EXPIRES 5-9-2010.

PRIORITY CLAIMED UNDER SEC. 44(D) ON UNITED KINGDOM APPLICATION NO. 2213803, FILED 11-9-1999, REG. NO. 2213803, DATED 11-9-1999, EXPIRES 11-9-2009.

THE STIPPLING IS A FEATURE OF THE MARK DENOTING SHADING AND IS NOT INTENDED TO INDICATE COLOR.

CLASS 9—ELECTRICAL AND SCIENTIFIC APPARATUS

FOR MULTIMEDIA SOFTWARE RECORDED ON CD-ROM'S FOR USE IN CHILDREN'S EDUCATION AND ENTERTAINMENT (U.S. CLS. 21, 23, 26, 36 AND 38).

CLASS 16—PAPER GOODS AND PRINTED MATTER

FOR CHILDREN'S BOOKS; COMIC NEWSPAPERS, COMIC MAGAZINES AND COMIC BOOKS; PRINTED PUBLICATIONS, NAMELY, NEWSPAPERS AND MAGAZINES FOR CHILDREN; INSTRUCTIONAL AND TEACHING MATERIALS; STATIONERY, AND WRITING AND DRAWING INSTRUMENTS AND MATERIALS, NAMELY, PAPER, PAPER PADS, NOTEBOOKS, WRITING AND DRAWING BOOKS; COLORING BOOKS, PENS, PENCILS, PENCIL SHARPENERS, AND CONTAINERS FOR PENS AND PENCILS; UNMOUNTED AND MOUNTED PHOTOGRAPHS; STICKERS, DECALS, PLAYING CARDS, DRAWING RULERS, POSTCARDS, ERASERS, BOOKMARKS, BOOKENDS, PAPERWEIGHTS, BOOK COVERS AND STENCILS; DIARIES, NOTEBOOKS, APPOINTMENT BOOKS; PLACE MATS, DRINK MATS, AND COASTERS, ALL OF PAPER, CARD OR CARDBOARD; GENERAL PURPOSE PAPER AND PLASTIC BAGS (U.S. CLS. 2, 5, 22, 23, 29, 37, 38 AND 50).

CLASS 28—TOYS AND SPORTING GOODS

FOR TOYS, GAMES AND PLAYTHINGS, ALL FOR CHILDREN; SCALE MODELS OF CHILDREN'S STORY-BOOK CHARACTERS; AND CHRISTMAS TREE DECORATIONS (U.S. CLS. 22, 23, 38 AND 50).

SN 76-045,539. LIGHTBULB PRESS, INC., NEW YORK, NY. FILED 5-11-2000.

LIGHTBULB  PRESS

OWNER OF U.S. REG. NOS. 2,282,990 AND 2,287,512.
NO CLAIM IS MADE TO THE EXCLUSIVE RIGHT TO USE "PRESS", APART FROM THE MARK AS SHOWN.

CLASS 41—EDUCATION AND ENTERTAINMENT

FOR PUBLICATION OF BOOKS, MAGAZINES, ARTICLES AND GRAPHIC WORKS OF OTHERS; ELECTRONIC PUBLISHING SERVICES, NAMELY, PUBLICATION OF TEXT AND GRAPHIC WORKS OF OTHERS ON CD-ROMS, COMPUTER DISKS FEATURING ECONOMICS, BUSINESS, FINANCIAL SERVICES, PERSONAL FINANCE, INVESTING TAXES, GOVERNMENT, HEALTH, FITNESS, MEDICINE, NUTRITION, LIFESTYLE, TRAVEL, GARDENING, HOME REPAIR AND DECORATION, PETS, PHOTOGRAPHY, HOBBY AND CRAFT ACTIVITIES, NATURE, SPORTS, TECHNOLOGY, COMPUTERS AND GLOBAL COMPUTER NETWORKS; ELECTRONIC PUBLISHING SERVICES, NAMELY, PUBLICATION OF TEXT, DATA, AND GRAPHIC WORKS OF OTHERS VIA A GLOBAL COMPUTER NETWORK, COMPUTER DATABASES AND PERSONAL DIGITAL ASSISTANTS FEATURING ECONOMICS, BUSINESS, FINANCIAL SERVICES, PERSONAL FINANCE, INVESTING, TAXES, GOVERNMENT, HEALTH, FITNESS, MEDICINE, NUTRITION, LIFESTYLE, TRAVEL, GARDENING, HOME REPAIR AND DECORATION, PETS, PHOTOGRAPHY, HOBBY AND CRAFT ACTIVITIES, NATURE, SPORTS, TECHNOLOGY, COMPUTERS AND GLOBAL COMPUTER NETWORKS (U.S. CLS. 100, 101 AND 107).

CLASS 42—SCIENTIFIC, COMPUTER AND LEGAL SERVICES

FOR PROVIDING PUBLICATION DESIGN AND WRITING SERVICES FOR OTHERS BY MEANS OF PRINT, VIA COMPUTER DATABASE NETWORKS AND VIA A GLOBAL NETWORK (U.S. CLS. 100 AND 101).

SN 76-046,551. BAPTIST HEALTHCARE SYSTEM, INC., LOUISVILLE, KY. FILED 5-12-2000.



NO CLAIM IS MADE TO THE EXCLUSIVE RIGHT TO USE "BAPTIST FAMILY FITNESS", APART FROM THE MARK AS SHOWN.

THE STIPPLING SHOWN IN THE DRAWING IS FOR SHADING PURPOSES ONLY.

CLASS 41—EDUCATION AND ENTERTAINMENT

FOR PHYSICAL FITNESS INSTRUCTION, PROVIDING FACILITIES FOR RECREATIONAL ACTIVITIES, AND GYMNASIUM SERVICES (U.S. CLS. 100, 101 AND 107).

FIRST USE 0-0-1997; IN COMMERCE 0-0-1997.

CLASS 42—SCIENTIFIC, COMPUTER AND LEGAL SERVICES

FOR PHYSICAL FITNESS CONSULTATION, MASSAGE SERVICES AND CHILDCARE SERVICES (U.S. CLS. 100 AND 101).

FIRST USE 0-0-1997; IN COMMERCE 0-0-1997.

SN 76-047,571. VIACORE, INC., ORANGE, CA. FILED 5-15-2000.

PROCESSTONE

CLASS 38—COMMUNICATION

FOR TELECOMMUNICATION SERVICES, NAMELY, ELECTRONIC TRANSMISSION AND ROUTING OF MESSAGES AND DATA USED BY BUSINESSES AND THEIR SUPPLIERS OR CUSTOMERS TO PROCESS ORDERS AND IMPLEMENT OTHER BUSINESS TRANSACTIONS AND PROCESSES, ALL VIA GLOBAL COMMUNICATIONS NETWORK OR WIDE AREA NETWORK (U.S. CLS. 100, 101 AND 104).

CLASS 42—SCIENTIFIC, COMPUTER AND LEGAL SERVICES

FOR COMPUTER SERVICES IN THE FIELD OF ELECTRONIC COMMERCE, NAMELY, PROVIDING ACCESS TO DOCUMENTS USED BY BUSINESSES FOR PROCESSING OF ORDERS AND IMPLEMENTATION OF OTHER BUSINESSES TRANSACTIONS AND PROTOCOLS INTO ONE OR MORE PRE-DEFINED PROTOCOLS; PROVIDING ENCRYPTION OF MESSAGES AND DATA AND SECURED TRANSACTION SECURITY SERVICES FOR USERS OF TELECOMMUNICATIONS NETWORKS; ALL PROVIDED VIA A GLOBAL COMPUTER NETWORK (U.S. CLS. 100 AND 101).

SN 76-048,425. PURUP-ESKOFOT A/S, DK-2750 BALLERUP, DENMARK, FILED 5-15-2000.

SN 76-049,888. AIR INTERNATIONAL TRANSIT, INC., ADDISON, IL. FILED 5-15-2000.

TECHSAGE

PRIORITY CLAIMED UNDER SEC. 44(D) ON DENMARK APPLICATION NO. VA199904762, FILED 11-16-1999, REG. NO. VR200001357, DATED 3-14-2000, EXPIRES 3-14-2010.

CLASS 1—CHEMICALS

FOR UNEXPOSED LIGHT SENSITIVE PHOTOGRAPHIC FILM FOR USE IN THE GRAPHICS INDUSTRY; PHOTOGRAPHIC CHEMICALS AND CHEMICALS USED IN THE PRINTING INDUSTRY FOR BRIGHTENING COLOR (U.S. CLS. 1, 5, 6, 10, 26 AND 46).

CLASS 2—PAINTS

FOR DYES, TONERS FOR PHOTOCOPIERS (U.S. CLS. 6, 11 AND 16).

CLASS 7—MACHINERY

FOR SENSITIZED PRINTING PLATES (U.S. CLS. 13, 19, 21, 23, 31, 34 AND 35).

CLASS 9—ELECTRICAL AND SCIENTIFIC APPARATUS

FOR INSTRUMENTS FOR OFFSET PRINTING, NAMELY, DATA PROCESSORS FOR RECORDING AND REPRODUCTION OF IMAGES, DIGITAL INPUT AND OUTPUT SCANNERS, COMPUTER-TO-PLATE IMAGE SETTERS, COMPUTER-TO-FILM IMAGE SETTERS, LASER PHOTO SETTERS, AND PARTS FOR ALL OF THE AFOREMENTIONED GOODS; WORKFLOW SOFTWARE FOR USE IN THE GRAPHICAL INDUSTRY FOR PRODUCING DOUBLE-SIDED IMPOSITION PROOFS, CONTROLLING THE PLACEMENT OF IMAGES WITH RESPECT TO PAPER MARGINS, AUTOMATING DOCUMENT FEEDING AND PAPER HANDLING, MANAGING PRINT JOBS AND INCREASING PRINTER SPEED (U.S. CLS. 21, 23, 26, 36 AND 38).

CLASS 16—PAPER GOODS AND PRINTED MATTER

FOR PRINTED MATTER, NAMELY, BROCHURES AND MANUALS IN THE FIELD OF PRINTING AND GRAPHICS REPRODUCTION; INK RIBBONS FOR PRINTERS; PRINTERS' INK (U.S. CLS. 2, 5, 22, 23, 29, 37, 38 AND 50).

CLASS 35—ADVERTISING AND BUSINESS

FOR BUSINESS CONSULTATION, NAMELY, CONSULTATION CONCERNING SALES, MARKETING AND PRODUCT DEVELOPMENT IN THE GRAPHICS INDUSTRY (U.S. CLS. 100, 101 AND 102).

CLASS 42—SCIENTIFIC, COMPUTER AND LEGAL SERVICES

FOR COMPUTER SOFTWARE INSTALLATION, REPAIR AND MAINTENANCE IN THE PRINTING INDUSTRY; COMPUTER SOFTWARE DESIGN FOR OTHERS IN THE PRINTING INDUSTRY (U.S. CLS. 100 AND 101).

Σ SIGMA

THE MARK CONSISTS OF THE WORD "SIGMA" APPEARING WITH A DESIGN COMPRISING THE GREEK LETTER SIGMA.

CLASS 37—CONSTRUCTION AND REPAIR

FOR INSTALLATION OF INDUSTRIAL AIR CONDITIONERS (U.S. CLS. 100, 103 AND 106).
FIRST USE 6-0-1982; IN COMMERCE 6-0-1982.

CLASS 40—MATERIAL TREATMENT

FOR MANUFACTURING OF INDUSTRIAL AIR CONDITIONERS TO THE ORDER AND SPECIFICATION OF OTHERS (U.S. CLS. 100, 103 AND 106).
FIRST USE 6-0-1982; IN COMMERCE 6-0-1982.

SN 76-050,164. FANGLOBE.COM, INC., WELLESLEY, MA. FILED 5-16-2000.

OFFICIAL HOME OF THE ARTISTS

NO CLAIM IS MADE TO THE EXCLUSIVE RIGHT TO USE "ARTISTS", APART FROM THE MARK AS SHOWN.

CLASS 35—ADVERTISING AND BUSINESS

FOR COMPUTERIZED ON-LINE RETAIL SERVICES IN THE FIELD OF MUSIC, RECORDING ARTIST MEMORABILIA, NAMELY, CAPS, TEE-SHIRTS, MOUSE PADS, KEY CHAINS, AND ENTERTAINMENT, NAMELY, PRERECORDED VIDEOTAPES AND COMPACT DISKS FEATURING MUSIC; MUSIC AND RECORD RETAIL STORES; PROVISION OF MUSIC INDUSTRY TRADE INFORMATION; DISSEMINATION OF ADVERTISING FOR OTHERS VIA AN ON-LINE ELECTRONICS COMMUNICATIONS NETWORK (U.S. CLS. 100, 101 AND 102).

CLASS 38—COMMUNICATION

FOR PROVIDING ON-LINE ELECTRONIC BULLETIN BOARDS FOR TRANSMISSION OF MESSAGES CONCERNING MUSIC, RECORDING ARTISTS, AND THE ENTERTAINMENT INDUSTRY (U.S. CLS. 100, 101 AND 104).

CLASS 41—EDUCATION AND ENTERTAINMENT

FOR FAN CLUBS; PROVISION OF ENTERTAINMENT; NAMELY LIVE MUSIC CONCERTS; EDUCATIONAL SERVICES, NAMELY, PROVIDING INCENTIVES TO PEOPLE, ORGANIZATIONS, AND ASSOCIATIONS TO DEMONSTRATE EXCELLENCE IN THE FIELD OF MUSIC THROUGH THE ISSUANCE OF AWARDS; ENTERTAINMENT IN THE NATURE OF MUSIC, NAMELY, PROVIDING AN ON-LINE COMPUTER DATABASE IN THE FIELD OF MUSIC (U.S. CLS. 100, 101 AND 107).

SN 76-051,041. LEBHAR-FRIEDMAN, INC., NEW YORK, NY. FILED 5-18-2000.



NO CLAIM IS MADE TO THE EXCLUSIVE RIGHT TO USE "RETAILING AND FOODSERVICE", APART FROM THE MARK AS SHOWN.

CLASS 35—ADVERTISING AND BUSINESS

FOR CONDUCTING TRADE SHOWS IN THE FIELDS OF RETAILING, MANUFACTURING AND FOODSERVICE; PROMOTING THE SALE OF GOODS AND SERVICES OF OTHERS IN THE RETAILING, MANUFACTURING AND FOODSERVICE INDUSTRIES THROUGH CONTESTS; CONDUCTING EMPLOYEE INCENTIVE AWARDS PROGRAMS TO PROMOTE ON THE JOB PRODUCT MERCHANDISING SKILLS IN THE RETAILING, MANUFACTURING AND FOODSERVICE INDUSTRIES (U.S. CLS. 100, 101 AND 102).

CLASS 40—MATERIAL TREATMENT

FOR PROVIDING AN ON-LINE COMPUTER DATABASE IN THE FIELD OF FOOD PROCESSING FOR THE RETAILING, MANUFACTURING AND FOODSERVICE INDUSTRIES (U.S. CLS. 100, 103 AND 106).

CLASS 41—EDUCATION AND ENTERTAINMENT

FOR EDUCATIONAL SERVICES, NAMELY, CONDUCTING SEMINARS AND WORKSHOPS IN THE FIELDS OF RETAILING, MANUFACTURING AND FOODSERVICE (U.S. CLS. 100, 101 AND 107).

CLASS 42—SCIENTIFIC, COMPUTER AND LEGAL SERVICES

FOR PROVIDING AN ON-LINE COMPUTER DATABASE IN THE FIELD OF FOOD PREPARATION FOR THE RETAILING, MANUFACTURING AND FOODSERVICE INDUSTRIES (U.S. CLS. 100 AND 101).

SN 76-052,006. STICHTING NEDERLANDSE ALGEMENE KWALITEITSDIENST TUINBOUW, ROELOFARENDSV-EEN, NETHERLANDS, FILED 5-19-2000.



PRIORITY CLAIMED UNDER SEC. 44(D) ON BENELUX APPLICATION NO. 0959408, FILED 3-9-2000, REG. NO. 0959408, DATED 3-9-2000, EXPIRES 3-9-2010.

CLASS 31—NATURAL AGRICULTURAL PRODUCTS

FOR AGRICULTURAL, HORTICULTURAL AND FORESTRY PRODUCTS, NAMELY, AGRICULTURAL SEEDS, FLOWER SEEDS, PLANT SEEDS, LIVE PLANTS, LIVE FLOWERS; FRESH FRUITS AND VEGETABLES; PLANT PROPAGATION MATERIAL AND PLANT TISSUE CULTURE MATERIAL (U.S. CLS. 1 AND 46).

CLASS 42—SCIENTIFIC, COMPUTER AND LEGAL SERVICES

FOR LABORATORY RESEARCH SERVICES IN THE FIELDS OF AGRICULTURE, HORTICULTURE AND FORESTRY TESTING, ANALYSIS AND EVALUATION OF AGRICULTURAL, HORTICULTURAL AND FORESTRY GOODS AND SERVICES OF THE PURPOSE OF CERTIFICATION (U.S. CLS. 100 AND 101).

SN 76-053,650. PINEAPPLEHEAD LTD., KEW, VICTORIA, AUSTRALIA, FILED 5-19-2000.

PINEAPPLEHEAD

PRIORITY CLAIMED UNDER SEC. 44(D) ON AUSTRALIA APPLICATION NO. 833796, FILED 5-3-2000, REG. NO. 833796, DATED 5-3-2000, EXPIRES 5-2-2010.

CLASS 9—ELECTRICAL AND SCIENTIFIC APPARATUS

FOR COMPUTER SOFTWARE FOR ANIMATED PRESENTATIONS; SCREENSAVERS; COMPUTER SOFTWARE FOR THE COLLECTION AND/OR ANALYSIS OF STATISTICAL DATA INCLUDING SPORTS RELATED DATA AND SPORTS STRATEGY RELATED DATA; CD-ROMS AND DVD'S (DIGITAL VIDEO DISKS) CONTAINING ANIMATED PRESENTATIONS AND DATA RELATED TO THE ANALYSIS OF SPORTS EVENTS AND SPORTS STRATEGY (U.S. CLS. 21, 23, 26, 36 AND 38).

CLASS 35—ADVERTISING AND BUSINESS

FOR PROVIDING STATISTICAL INFORMATION ON SPORTS (U.S. CLS. 100, 101 AND 102).

CLASS 38—COMMUNICATION

FOR PROVIDING MULTIPLE USER ACCESS TO A GLOBAL COMPUTER NETWORK (U.S. CLS. 100, 101 AND 104).

CLASS 41—EDUCATION AND ENTERTAINMENT

FOR CONSULTATION SERVICES IN THE FIELD OF ENTERTAINMENT MEDIA; PRODUCTION OF RADIO AND TELEVISION PROGRAMS; PROVIDING SPORTS ENTERTAINMENT SERVICES IN NATURE OF A COMPUTER GENERATED THREE DIMENSIONAL ANIMATED REPRESENTATION OF A SPORTING EVENT TRANSMITTED VIA TELEVISION BROADCAST (U.S. CLS. 100, 101 AND 107).

CLASS 42—SCIENTIFIC, COMPUTER AND LEGAL SERVICES

FOR DESIGN OF ELECTRONIC COMMERCE WEB SITES AND SOFTWARE; HOSTING WEBSITES FOR OTHERS; COMPUTER PROGRAMMING; GRAPHIC DESIGN; TECHNOLOGICAL CONSULTING; INFORMATION TECHNOLOGY PROJECT MANAGEMENT; INFORMATION TECHNOLOGY INTEGRATION AND IMPLEMENTATION; MAINTENANCE AND MODIFICATION OF COMPUTER SOFTWARE; DESIGN AND PREPARATION OF DATA AND RESULTS OF DATA ANALYSIS IN VARIOUS MEDIA FORMS, NAMELY, TWO DIMENSIONAL AND THREE-DIMENSIONAL COMPUTER GRAPHIC DISPLAYS (U.S. CLS. 100 AND 101).

SN 76-056,734. INDENA S.P.A., 20139 MILAN, ITALY, FILED 5-25-2000.

CURBILENE

PRIORITY CLAIMED UNDER SEC. 44(D) ON ITALY APPLICATION NO. 012592, FILED 12-17-1999, REG. NO. 00805174, DATED 12-17-1999, EXPIRES 12-17-2019.

CLASS 1—CHEMICALS

FOR CHEMICAL PRIMARILY COMPOSED OF LIPOPHILIC EXTRACTS OF CUCURBITA, NAMELY, EXTRACT FOR CUCURBITA PEPO OR PUMPKIN AND FROM OTHER KINDS OF CUCURBITACEAE, FOR USE IN THE COSMETICS, PHARMACEUTICAL AND ALIMENTARY INDUSTRIES (U.S. CLS. 1, 5, 6, 10, 26 AND 46).

CLASS 3—COSMETICS AND CLEANING PREPARATIONS

FOR COSMETICS, NAMELY, BEAUTY MASKS, FACIAL CREAMS, SOAPS, ESSENTIAL OILS FOR PERSONAL USE, EYE MAKEUP, LIPSTICKS, HAND LOTIONS, MAKEUP POWDER, MASCARA, SKIN CREAMS FOR SLIMMING PURPOSES; ALL CONTAINING LIPOPHILIC CHEMICAL ADDITIVES (U.S. CLS. 1, 4, 6, 50, 51 AND 52).

SN 76-056,735. CATHODE LIGHTING SYSTEMS, INC., GAITHERSBURG, MD. FILED 5-25-2000.



NO CLAIM IS MADE TO THE EXCLUSIVE RIGHT TO USE "CATHODE LIGHTING SYSTEMS INNOVATIVE LIGHTING TECHNOLOGY", APART FROM THE MARK AS SHOWN.

CLASS 11—ENVIRONMENTAL CONTROL APPARATUS

FOR CUSTOM DESIGNED COLD CATHODE LIGHTING TUBES, LAMPS, ELECTRICAL LIGHTING FIXTURES AND REPLACEMENT PARTS THEREFOR (U.S. CLS. 13, 21, 23, 31 AND 34).

FIRST USE 8-0-1999; IN COMMERCE 8-0-1999.

CLASS 42—SCIENTIFIC, COMPUTER AND LEGAL SERVICES

FOR CUSTOM DESIGN OF COLD CATHODE LIGHTING TUBES, LAMPS, ELECTRICAL LIGHTING FIXTURES AND PARTS AND ACCESSORIES THEREFOR (U.S. CLS. 100 AND 101).

FIRST USE 8-0-1999; IN COMMERCE 8-0-1999.

SN 76-057,587. HT ENTERPRISES, INC., CAMPBELLSPORT, WI. FILED 5-26-2000.

POLAR**CLASS 8—HAND TOOLS**

FOR HAND TOOLS, NAMELY, ICE SAFETY PICKS AND ICE AUGERS FOR ICE FISHING (U.S. CLS. 23, 28 AND 44).

FIRST USE 10-22-1999; IN COMMERCE 10-22-1999.

CLASS 22—CORDAGE AND FIBERS

FOR ICE FISHING TENTS (U.S. CLS. 1, 2, 7, 19, 22, 42 AND 50).

FIRST USE 11-30-1994; IN COMMERCE 11-30-1994.

CLASS 28—TOYS AND SPORTING GOODS

FOR FISH TRAPS, FISHING RODS, SLIDES FOR ICE FISHING, AND ICE TIP-UP TRAPS FOR ICE FISHING (U.S. CLS. 22, 23, 38 AND 50).

FIRST USE 12-31-1978; IN COMMERCE 12-31-1978.

SN 76-057,727. CENTRAL INSTITUTE FOR THE DEAF, ST. LOUIS, MO. FILED 5-26-2000.

CID HEARING CENTRAL

NO CLAIM IS MADE TO THE EXCLUSIVE RIGHT TO USE "HEARING", APART FROM THE MARK AS SHOWN.

CLASS 35—ADVERTISING AND BUSINESS

FOR MAIL ORDER, RETAIL STORE, AND COMPUTERIZED ON-LINE RETAIL SERVICES FEATURING SPEECH, LANGUAGE, HEARING AND EDUCATIONAL ASSESSMENT TOOLS, ASSISTIVE LISTENING TECHNOLOGY, BOOKS AND OTHER PRODUCTS RELATED TO HEARING, DEAFNESS AND HEARING IMPAIRMENT (U.S. CLS. 100, 101 AND 102).

FIRST USE 0-0-1982; IN COMMERCE 8-0-1999.

CLASS 41—EDUCATION AND ENTERTAINMENT

FOR EDUCATIONAL SERVICES, NAMELY, ARRANGING AND CONDUCTING CLASSES IN THE FIELDS OF SPEECH, HEARING, DEAFNESS AND COMMUNICATION AND COMMUNITY SERVICES, NAMELY, ORGANIZING EDUCATIONAL WORKSHOPS FEATURING LIP READING INSTRUCTION (U.S. CLS. 100, 101 AND 107).

FIRST USE 0-0-1982; IN COMMERCE 8-0-1999.

CLASS 42—SCIENTIFIC, COMPUTER AND LEGAL SERVICES

FOR CLINICAL AUDIOLOGICAL SERVICES, NAMELY, HEARING ASSESSMENT, HEARING AID, COCHLEAR IMPLANT AND OTHER HEARING DEVICE EVALUATION, CONSULTATION, FITTING, PROGRAMMING AND FOLLOW UP; PROVIDING SIGN LANGUAGE AND LIP READING INTERPRETING SERVICES FOR OTHERS (U.S. CLS. 100 AND 101).
FIRST USE 0-0-1982; IN COMMERCE 8-0-1999.

SN 76-059,126. BAYER S.P.A., 20156 MILAN, ITALY, FILED 5-30-2000.

FEEL FINE

PRIORITY CLAIMED UNDER SEC. 44(D) ON ITALY APPLICATION NO. 2000C001817, FILED 2-18-2000, REG. NO. 00818951, DATED 2-18-2000, EXPIRES 2-18-2010.

SN 76-057,815. FANGLOBE.COM, INC., WELLESLEY, MA. FILED 5-26-2000.

FANGLOBE.COM**CLASS 35—ADVERTISING AND BUSINESS**

FOR COMPUTERIZED ON-LINE RETAIL SERVICES IN THE FIELD OF MUSIC, RECORDING ARTIST MEMORABILIA, NAMELY, CAPS, TEE-SHIRTS, MOUSE PADS, KEY CHAINS, AND ENTERTAINMENT, NAMELY, PRERECORDED VIDEOTAPES AND COMPACT DISKS FEATURING MUSIC; MUSIC AND RECORD RETAIL STORES; PROVISION OF MUSIC INDUSTRY TRADE INFORMATION; DISSEMINATION OF ADVERTISING FOR OTHERS VIA AN ON-LINE ELECTRONICS COMMUNICATIONS NETWORK (U.S. CLS. 100, 101 AND 102).
FIRST USE 5-0-1999; IN COMMERCE 5-0-1999.

CLASS 38—COMMUNICATION

FOR PROVIDING ON-LINE ELECTRONIC BULLETIN BOARDS FOR TRANSMISSION OF MESSAGES CONCERNING MUSIC, RECORDING ARTISTS, AND THE ENTERTAINMENT INDUSTRY (U.S. CLS. 100, 101 AND 104).
FIRST USE 5-0-1999; IN COMMERCE 5-0-1999.

CLASS 41—EDUCATION AND ENTERTAINMENT

FOR FAN CLUBS; PROVISION OF ENTERTAINMENT; NAMELY LIVE MUSIC CONCERTS; EDUCATIONAL SERVICES, NAMELY, PROVIDING INCENTIVES TO PEOPLE, ORGANIZATIONS, AND ASSOCIATIONS TO DEMONSTRATE EXCELLENCE IN THE FIELD OF MUSIC THROUGH THE ISSUANCE OF AWARDS; ENTERTAINMENT IN THE NATURE OF MUSIC, NAMELY, PROVIDING AN ON-LINE COMPUTER DATABASE IN THE FIELD OF MUSIC (U.S. CLS. 100, 101 AND 107).
FIRST USE 5-0-1999; IN COMMERCE 5-0-1999.

SN 76-058,123. FEULING, JAMES J., VENTURA, CA. FILED 5-30-2000.

FOKKER**CLASS 14—JEWELRY**

FOR JEWELRY (U.S. CLS. 2, 27, 28 AND 50).
FIRST USE 4-12-1999; IN COMMERCE 4-12-1999.

CLASS 25—CLOTHING

FOR CLOTHING, NAMELY, "T" SHIRTS, PANTS, SHORTS, HATS (U.S. CLS. 22 AND 39).
FIRST USE 4-12-1999; IN COMMERCE 4-12-1999.

CLASS 1—CHEMICALS

FOR CHEMICALS FOR USE IN THE MANUFACTURE OF LEATHER; EMULSIFIERS FOR USE IN THE MANUFACTURE OF LEATHER AND TEXTILES; TANNING AGENTS FOR USE IN THE MANUFACTURE OF LEATHER; WATERPROOFING CHEMICAL COMPOSITIONS FOR ARTICLES OF LEATHER (U.S. CLS. 1, 5, 6, 10, 26 AND 46).

CLASS 2—PAINTS

FOR PROTECTIVE-ACTION DYES FOR LEATHER AND SKIN, NAMELY, DYES FOR USE IN THE MANUFACTURE OF LEATHER (U.S. CLS. 6, 11 AND 16).

CLASS 18—LEATHER GOODS

FOR LEATHER AND SKIN ARTICLES MADE THEREFROM, NAMELY, LEATHER HANDBAGS, LEATHER SUITCASES, LEATHER BRIEFCASES (U.S. CLS. 1, 2, 3, 22 AND 41).

CLASS 25—CLOTHING

FOR CLOTHING AND FOOTWEAR ARTICLES FROM TREATED LEATHER, NAMELY, LEATHER JACKETS, LEATHER PANTS, LEATHER OVERCOATS, LEATHER CAPS AND HATS, LEATHER SHOES (U.S. CLS. 22 AND 39).

CLASS 40—MATERIAL TREATMENT

FOR SPECIAL TREATMENT FOR LEATHER AND SKIN, INTENDED FOR PREVENTING THEIR DETERIORATION, NAMELY, TREATMENTS INTEGRATING PROTECTIVE SUBSTANCES FOR WORKING OF LEATHER AND SKINS, LEATHER STAINING (U.S. CLS. 100, 103 AND 106).

SN 76-059,223. AGENTLIFE.COM, L.L.C., TAMPA, FL. AND AGENTLIFE, INC., TAMPA, FL. FILED 5-30-2000.

AGENTLIFE**CLASS 35—ADVERTISING AND BUSINESS**

FOR PROVIDING ON-LINE INFORMATION FOR LIFE INSURANCE AGENTS REGARDING MARKETING TOOLS, MARKETING OPPORTUNITIES, PRESENTATION SKILLS AND FEATURING LINKS TO SALES RESOURCES ABOUT LIFE INSURANCE MARKETING (U.S. CLS. 100, 101 AND 102).

CLASS 36—INSURANCE AND FINANCIAL

FOR PROVIDING ON-LINE LIFE INSURANCE INFORMATION SERVICES IN THE NATURE OF LIFE INSURANCE DATA AND INFORMATION FOR USE BY LIFE INSURANCE SALES PROFESSIONALS TO ORGANIZE DATA, PERFORM ON-LINE CASE ANALYSIS, DEVELOP ON-LINE ILLUSTRATIONS OF PERMANENT LIFE INSURANCE PRODUCTS, AND FOR USE IN INTEGRATING SUCH LIFE INSURANCE INFORMATION AND DATA INTO MARKETING REPORTS; PROVIDING ON-LINE INFORMATION FOR LIFE INSURANCE AGENTS, NAMELY INFORMATION REGARDING LIFE INSURANCE SOURCES, PRODUCTS, CASE STRUCTURE, UNDERWRITING AND LIFE INSURANCE NEEDS ANALYSIS (U.S. CLS. 100, 101 AND 102).

SN 76-059,652. STREETZEBRA, INC., MARINA DEL REY, CA. FILED 5-30-2000.

STREETZEBRA**CLASS 21—HOUSEWARES AND GLASS**

FOR MUGS (U.S. CLS. 2, 13, 23, 29, 30, 33, 40 AND 50).

CLASS 25—CLOTHING

FOR CLOTHING, NAMELY, T-SHIRTS, SWEATSHIRTS, HATS AND CAPS (U.S. CLS. 22 AND 39).

SN 76-060,032. DAIMLERCHRYSLER AG, 70567 STUTTGART, FED REP GERMANY, FILED 5-30-2000.

StarRec

OWNER OF FED REP GERMANY REG. NO. 39522177, DATED 6-13-1996, EXPIRES 5-31-2005.

CLASS 9—ELECTRICAL AND SCIENTIFIC APPARATUS

FOR APPARATUS FOR RECORDING, TRANSMISSION OR REPRODUCTION OF DATA, SOUND OR IMAGES AND FOR THE RETRIEVAL, TRANSMISSION, ANALYSIS AND RECOGNITION OF INFORMATION COMPRISING SPEECH, VIDEO AND DATA SIGNALS, NAMELY, TRANSMITTERS, RADIO RECEIVERS, ELECTRICAL, ELECTRONIC, OPTICAL AND MAGNETIC BLANK STORAGE CARDS, COMPUTER CHIPS, BLANK COMPUTER TAPES, BLANK COMPUTER DISCS, BLANK CD-ROMS, SEMICONDUCTOR CHIPS, AND VOICE ANALYZERS; TELEPHONES, RADIO TELEPHONES, CALL ANSWERING MACHINES, SPEECH RECOGNITION AND SPEECH DIALOGUE APPARATUS FOR TELECOMMUNICATIONS AND FOR THE CONTROL AND OPERATION OF MACHINES, ROBOTS, EQUIPMENT, APPARATUS AND INSTRUMENTS, NAMELY, MICROPHONES, SPEAKERS AND MICROPROCESSORS; CALCULATING MACHINES, DATA PROCESSING EQUIPMENT AND COMPUTERS; BLANK MAGNETIC DATA CARRIERS, MACHINE-READABLE DATA CARRIERS OF ALL TYPES WITH PROGRAMS INSTALLED RELATING TO SPEECH RECOGNITION AND SPEECH DIALOGUE; COMPUTER PROGRAMS FOR SPEECH RECOGNITION AND SPEECH DIALOGUE; OPTICAL AND SIGNALLING APPARATUS AND INSTRUMENTS, NAMELY, RADIO AND INFRARED TRANSMITTERS, TRANSCEIVERS-RECEIVERS, RADIO AND INFRARED RECEIVERS, ANTENNAS, HIGH FREQUENCY AND INFRARED SENSORS AND ACTUATORS, AND MICROPROCESSORS; PARTS FOR ALL AFORESAID GOODS; SPECIAL PURPOSE CASING FOR ELECTRONIC EQUIPMENT (U.S. CLS. 21, 23, 26, 36 AND 38).

CLASS 38—COMMUNICATION

FOR TELECOMMUNICATION SERVICES, NAMELY, PROVIDING TELECOMMUNICATION CONNECTIONS TO A GLOBAL COMPUTER NETWORK, ELECTRONIC TRANSMISSION OF MESSAGES, DOCUMENTS AND DATA BY TELEPHONE AND VIA COMPUTER TERMINALS, CELLULAR TELEPHONE SERVICES, MOBILE RADIO COMMUNICATION SERVICES, ELECTRONIC VOICE MESSAGING, NAMELY, THE RECORDING AND SUBSEQUENT TRANSMISSION OF VOICE MESSAGES BY TELEPHONE AND VIA COMPUTER TERMINALS (U.S. CLS. 100, 101 AND 104).

CLASS 42—SCIENTIFIC, COMPUTER AND LEGAL SERVICES

FOR DEVELOPMENT, CREATION AND MAINTENANCE OF COMPUTER SOFTWARE PROGRAMS FOR OTHERS; RENTAL OF DATA PROCESSING, SPEECH RECOGNITION AND SPEECH DIALOGUE EQUIPMENT AND SYSTEMS AND PARTS THEREFOR; ENGINEERING SERVICES, TECHNICAL CONSULTING AND EXPERT ADVICE SERVICES RELATING TO SPEECH RECOGNITION AND SPEECH DIALOGUE; GUARDING AND SURVEILLANCE OF PERSONS, BUILDINGS, VEHICLES AND VALUABLE OBJECTS (U.S. CLS. 100 AND 101).

SN 76-060,261. CUSTOMIZED SERVICES ADMINISTRATORS, INCORPORATED, SAN DIEGO, CA. FILED 5-31-2000.

SN 76-060,557. TANNER COMPANIES LIMITED PARTNERSHIP, RUTHERFORDTON, NC. FILED 5-31-2000.



OWNER OF U.S. REG. NOS. 2,140,977 AND 2,212,283. NO CLAIM IS MADE TO THE EXCLUSIVE RIGHT TO USE "TRAVEL PROTECTION", APART FROM THE MARK AS SHOWN.

CLASS 35—ADVERTISING AND BUSINESS

FOR TRAVEL ASSISTANCE, NAMELY, MEDICAL REFERRAL AND LEGAL REFERRAL (U.S. CLS. 100, 101 AND 102).

CLASS 36—INSURANCE AND FINANCIAL

FOR TRAVEL RELATED INSURANCE AGENCY SERVICES; NAMELY, TRIP CANCELLATION AND TRIP INTERRUPTION INSURANCE, TRAVEL DELAY INSURANCE, BAGGAGE LOSS AND BAGGAGE DELAY INSURANCE, PROVIDING EMERGENCY CASH, RENTAL CAR DAMAGE INSURANCE, AND AIR FLIGHT ACCIDENT INSURANCE (U.S. CLS. 100, 101 AND 102).

CLASS 39—TRANSPORTATION AND STORAGE

FOR TRAVEL ASSISTANCE, NAMELY, ARRANGING FOR EMERGENCY MEDICAL TRANSPORTATION, LOST TICKET AND PASSPORT SERVICES (U.S. CLS. 100 AND 105).

CLASS 42—SCIENTIFIC, COMPUTER AND LEGAL SERVICES

FOR TRAVEL ASSISTANCE, NAMELY, EMERGENCY PRESCRIPTION REFILL ASSISTANCE (U.S. CLS. 100 AND 101).

Tanner



Designs

OWNER OF U.S. REG. NOS. 701,878, 1,491,236 AND OTHERS.

NO CLAIM IS MADE TO THE EXCLUSIVE RIGHT TO USE "DESIGNS", APART FROM THE MARK AS SHOWN.

CLASS 25—CLOTHING

FOR WOMEN'S CLOTHING, NAMELY, SUITS, DRESSES, SKIRTS, BLOUSES, SLACKS, PANTS, JACKETS, COATS, RAINWEAR, SWEATERS, VESTS, SHORTS, CULOTTES, PLAYSUITS, BANDEAUX, HALTERS, SASHES, SCARVES, HATS, GLOVES, BELTS, HOSIERY, SOCKS, TIGHTS, PANTYHOSE, KNEE-HIGHS AND SHOES (U.S. CLS. 22 AND 39).

CLASS 35—ADVERTISING AND BUSINESS

FOR RETAIL STORES SERVICES AND ON-LINE RETAIL SERVICES VIA THE INTERNET FEATURING WOMEN'S APPAREL AND WOMEN'S APPAREL ACCESSORIES (U.S. CLS. 100, 101 AND 102).

SN 76-060,706. RAZA FOUNDRIES, INC., SAN JOSE, CA. FILED 5-30-2000.



THE ENGLISH TRANSLATION OF THE TERM "RAZA" IS "RACE" OR "PEOPLE".

CLASS 35—ADVERTISING AND BUSINESS

FOR BUSINESS MANAGEMENT ASSISTANCE, PLANNING AND CONSULTATION SERVICES, NAMELY, MERGER, ACQUISITION AND DIVESTITURE ADVISORY SERVICES, STRATEGIC POSITIONING CONSULTING SERVICES, BUSINESS VALUATION SERVICES, AND BUSINESS ACQUISITION SEARCHES FOR COMPANIES AND INDIVIDUALS, ALL IN THE FIELDS OF BROADBAND AND WIRELESS NETWORKING AND COMMUNICATIONS; ADVISORY SERVICES FOR BROADBAND AND WIRELESS NETWORKING COMPANIES SEEKING STRATEGIC ALLIANCES, PARTNERSHIPS AND JOINT VENTURES; FRANCHISING, NAMELY, OFFERING TECHNICAL ASSISTANCE IN THE ESTABLISHMENT AND OPERATION OF COMPANIES IN THE FIELDS OF BROADBAND AND WIRELESS NETWORKING AND COMMUNICATIONS (U.S. CLS. 100, 101 AND 102).

FIRST USE 3-22-2000; IN COMMERCE 3-22-2000.

CLASS 36—INSURANCE AND FINANCIAL

FOR FINANCIAL ANALYSIS AND CONSULTATION SERVICES, NAMELY, MERGER, ACQUISITION AND DIVESTITURE ADVISORY SERVICES, STRATEGIC POSITIONING CONSULTING SERVICES, BUSINESS VALUATION SERVICES, AND BUSINESS ACQUISITION SEARCHES FOR COMPANIES AND INDIVIDUALS, ALL IN THE FIELDS OF BROADBAND AND WIRELESS NETWORKING AND COMMUNICATIONS; FINANCIAL SERVICES IN THE FIELD OF MONEY LENDING, NAMELY, LOCATING AND ORIGINATING INVESTORS, VENTURE CAPITAL SOURCES, LENDERS AND LESSORS AS INVESTMENT AND FUNDING SOURCES FOR COMPANIES IN THE FIELDS OF BROADBAND AND WIRELESS NETWORKING AND COMMUNICATIONS; INVESTMENT OF FUNDS FOR OTHERS; VENTURE CAPITAL SERVICES, NAMELY, PROVIDING FINANCING TO EMERGING AND START-UP COMPANIES IN THE FIELDS OF BROADBAND AND WIRELESS NETWORKING AND COMMUNICATIONS (U.S. CLS. 100, 101 AND 102).

FIRST USE 3-22-2000; IN COMMERCE 3-22-2000.

SN 76-060,798. CONCORDIA TEXTILES, WAREGEM, BELGIUM, FILED 6-1-2000.



PRIORITY CLAIMED UNDER SEC. 44(D) ON BENELUX APPLICATION NO. 0955403, FILED 1-25-2000, REG. NO. 663040, DATED 1-25-2000, EXPIRES 1-25-2010.
THE STIPPLING IN THE MARK IS A FEATURE OF THE MARK AND DOES NOT INDICATE COLOR.

CLASS 24—FABRICS

FOR TEXTILES, NAMELY, TEXTILES FOR USE IN UPHOLSTERY, FOR USE IN THE FABRICATION OF CLOTHING AND FOR USE IN LINING FOR CLOTHING; TEXTILE GOODS, NAMELY, CURTAINS, TOWELS, BED LINENS, BED SPREADS, COMFORTERS, TABLECLOTHS, TABLE LINENS, AND LININGS FOR CLOTHING SOLD AS FINISHED PIECES (U.S. CLS. 42 AND 50).

CLASS 25—CLOTHING

FOR CLOTHING, NAMELY, SHIRTS, PANTS, JACKETS, HATS, BLOUSES, SKIRTS, SUITS, DRESSES, COATS, TIES, SCARVES, SHORTS, UNDERWEAR, SLEEPWEAR, SWIMWEAR, BELTS, SUSPENDERS, FOOTWEAR AND HEADWEAR (U.S. CLS. 22 AND 39).

SN 76-060,924. MYLAN TECHNOLOGIES INC., ST. ALBANS, VT. FILED 5-18-2000.

MYLAN TECHNOLOGIES INC.

NO CLAIM IS MADE TO THE EXCLUSIVE RIGHT TO USE "TECHNOLOGIES INC.", APART FROM THE MARK AS SHOWN.

CLASS 5—PHARMACEUTICALS

FOR TRANSDERMAL PATCHES FOR USE IN THE TREATMENT OF ANGINA; SYNTHETIC WOUND DRESSINGS (U.S. CLS. 6, 18, 44, 46, 51 AND 52).

FIRST USE 3-2-1999; IN COMMERCE 3-2-1999.

CLASS 10—MEDICAL APPARATUS

FOR EXTRUDED PLASTIC FILMS FOR PHARMACEUTICAL AND WOUND CARE APPLICATIONS, NAMELY, TO BE APPLIED TO TRANSDERMAL PATCHES, WOUND DRESSINGS AND MEDICAL DEVICES, NAMELY SURGICAL GOWNS, INCISE DRAPES AND OSTOMY BARRIERS AND COMPONENTS THEREOF, FOR USE AS MOISTURE BARRIERS, OXYGEN BARRIERS, VIRAL BARRIERS AND FOR DRUG DELIVERY (U.S. CLS. 26, 39 AND 44).

FIRST USE 3-2-1999; IN COMMERCE 3-2-1999.

CLASS 16—PAPER GOODS AND PRINTED MATTER

FOR PRESSURE SENSITIVE LABELS, NAMELY, LABELS IN ROLL FORM, FANFOLD LABELS, CUT SINGLE LABELS, ELECTRONIC DATA PROCESSING LABELS AND PRODUCT IDENTIFICATION LABELS (U.S. CLS. 2, 5, 22, 23, 29, 37, 38 AND 50).

FIRST USE 3-2-1999; IN COMMERCE 3-2-1999.

CLASS 17—RUBBER GOODS

FOR EXTRUDED PLASTIC FILMS FOR INDUSTRIAL APPLICATIONS, NAMELY, FOR THE COATING OF FABRICS AND SUBSTRATES (U.S. CLS. 1, 5, 12, 13, 35 AND 50).

FIRST USE 3-2-1999; IN COMMERCE 3-2-1999.

CLASS 40—MATERIAL TREATMENT

FOR ASSEMBLY OF PRODUCTS FOR OTHERS; COATING SERVICES, NAMELY, THE CUSTOM APPLICATION OF PROTECTIVE DECORATIVE, BARRIER AND ADHESIVE COATING TO PAPERS, FILMS, FOILS AND FABRICS; LAMINATING SERVICES, NAMELY, LAMINATING SERVICES FOR JOINING WEBS AND COMBINATIONS FOR PAPERS, FILMS, FOILS AND FABRICS (U.S. CLS. 100, 103 AND 106).

FIRST USE 3-2-1999; IN COMMERCE 3-2-1999.

SN 76-061,446. SEMICONDUCTOR ENERGY LABORATORY CO., LTD., KANAGAWA-KEN, 243-0036, JAPAN, FILED 5-23-2000.

CGS

SN 76-061,207. B2E SOLUTIONS, LLC, HOUSTON, TX. BY ASSIGNMENT COMPAQ INFORMATION TECHNOLOGIES GROUP, L.P., HOUSTON, TX. FILED 6-1-2000.

OWNER OF JAPAN REG. NO. 4335464, DATED 11-19-1999, EXPIRES 11-19-2009.

**CLASS 9—ELECTRICAL AND SCIENTIFIC APPARATUS**

FOR SOFTWARE FOR SELECTION, INSTALLATION AND CONFIGURATION OF COMPUTER HARDWARE AND SOFTWARE (U.S. CLS. 21, 23, 26, 36 AND 38).

CLASS 35—ADVERTISING AND BUSINESS

FOR ONLINE RETAIL STORE SERVICES AND ORDERING SERVICES FEATURING A WIDE VARIETY OF PRODUCTS AND SERVICES OF OTHERS; BUSINESS MANAGEMENT AND CONSULTATION; PROMOTING THE GOODS AND SERVICES OF OTHERS BY PROVIDING A WEB SITE AT WHICH USERS CAN LINK TO OTHER BUSINESSES, DISCUSSION GROUPS, AND NEWS SERVICES ON A GLOBAL COMPUTER NETWORK (U.S. CLS. 100, 101 AND 102).

CLASS 37—CONSTRUCTION AND REPAIR

FOR INSTALLATION, MAINTENANCE AND REPAIR OF COMPUTERS AND COMPUTER-RELATED PRODUCTS (U.S. CLS. 100, 103 AND 106).

CLASS 41—EDUCATION AND ENTERTAINMENT

FOR EDUCATION AND TRAINING SERVICES, NAMELY, CONDUCTING ONLINE TRAINING CONCERNING VARIOUS BUSINESS-RELATED TOPICS, COMPUTER HARDWARE AND SOFTWARE (U.S. CLS. 100, 101 AND 107).

CLASS 42—SCIENTIFIC, COMPUTER AND LEGAL SERVICES

FOR CONSULTING SERVICES IN THE FIELD OF COMPUTERS, COMPUTER-RELATED PRODUCTS AND SERVICES; PROVIDING ACCESS TO AND ALLOWING DOWNLOADING OF COMPUTER SOFTWARE FROM A GLOBAL COMPUTER NETWORK; MAINTENANCE OF COMPUTER SOFTWARE; PROVIDING A WEBSITE ON A GLOBAL COMPUTER NETWORK FEATURING A WIDE VARIETY OF INFORMATION AND INDUSTRY DATA RELATING TO BUSINESS, TELECOMMUNICATIONS AND TECHNOLOGY; WEBSITE DEVELOPMENT AND MANAGEMENT SERVICES (U.S. CLS. 100 AND 101).

CLASS 9—ELECTRICAL AND SCIENTIFIC APPARATUS

FOR MEASURING APPARATUS AND INSTRUMENTS, NAMELY, THERMOMETERS NOT FOR MEDICAL USE, PRESSURE GAUGES, ZENITH TELESCOPES; MAGNETIC MEASURING INSTRUMENTS, NAMELY, VOLTMETERS, AMMETERS; PHOTOGRAPHIC APPARATUS AND INSTRUMENTS, NAMELY, VIDEO CAMERAS AND DIGITAL CAMERAS; MOTION PICTURE APPARATUS AND INSTRUMENTS, NAMELY, MOTION PICTURE CAMERAS; OPTICAL APPARATUS AND INSTRUMENTS, NAMELY, SPECTACLES; ELECTRICAL COMMUNICATION MACHINES AND APPARATUS, NAMELY, PERSONAL DIGITAL ASSISTANTS, MOBILE COMMUNICATORS, NAMELY, PERSONAL DIGITAL ASSISTANTS, MOBILE COMMUNICATORS, NAMELY, CELLULAR PHONES, MOBILE PHONES, PERSONAL DIGITAL ASSISTANTS; APPLIED ELECTRONIC MACHINES AND APPARATUS, NAMELY, WORD PROCESSORS, COMPUTERS, WEARABLE COMPUTERS, COMPUTER TERMINALS, CALCULATORS, VOTING MACHINES; DISPLAY PANELS, NAMELY LIQUID CRYSTAL DISPLAY PANELS, FLAT PANEL DISPLAYS, HEAD MOUNT DISPLAYS, GOGGLE-TYPE DISPLAYS; PORTABLE COMPUTERS ELECTRONIC CALENDAR DEVICES, NAMELY, ELECTRONIC RAILROAD SCHEDULE DISPLAYS, ELECTRONIC PERSONAL CALENDARS; TELEVISIONS; GLOBAL POSITIONING SYSTEMS CONSISTING OF COMPUTERS, COMPUTER SOFTWARE, TRANSMITTERS, RECEIVERS, AND NETWORK INTERFACE DEVICES (U.S. CLS. 21, 23, 26, 36 AND 38).

CLASS 10—MEDICAL APPARATUS

FOR MEDICAL APPARATUS AND INSTRUMENTS, NAMELY, THERMOMETERS, ELECTROCARDIOGRAPHS (EKG) AND CAT SCANNERS AND COMPONENT PARTS THEREOF (U.S. CLS. 26, 39 AND 44).

CLASS 11—ENVIRONMENTAL CONTROL APPARATUS

FOR FURNACES; DRYERS USED FOR THE REMOVAL OF VAPOR CONTAMINANTS FROM COMPRESSED AIR AND GASES; AND GAS GENERATORS, NAMELY, ETHYLENE GAS GENERATORS AND ELECTROCHEMICAL GAS GENERATORS (U.S. CLS. 13, 21, 23, 31 AND 34).

CLASS 12—VEHICLES

FOR TRANSPORTATION MACHINES AND EQUIPMENT, NAMELY, AUTOMOBILE DASHBOARDS AND COMPONENT PARTS THEREOF (U.S. CLS. 19, 21, 23, 31, 35 AND 44).

CLASS 28—TOYS AND SPORTING GOODS

FOR HAND HELD UNITS FOR PLAYING ELECTRONIC GAMES (U.S. CLS. 22, 23, 38 AND 50).

SN 76-061,691. LUFTHANSA SYSTEMS GMBH, 65451 KELSTERBACH, FED REP GERMANY, FILED 6-2-2000.

SYNAVION

PRIORITY CLAIMED UNDER SEC. 44(D) ON FED REP GERMANY APPLICATION NO. 30034316.7, FILED 4-28-2000, REG. NO. 30034316, DATED 5-18-2000, EXPIRES 4-30-2010.

CLASS 9—ELECTRICAL AND SCIENTIFIC APPARATUS

FOR COMPUTER HARDWARE; COMPUTER SOFTWARE USED FOR DATABASE MANAGEMENT IN THE OPERATION AND MANAGEMENT OF AIRPORTS, NAMELY, FOR MANAGING DATA AND INFORMATION REGARDING TRANSPORTATION TO AIRPORTS, AIRPORT PARKING, PASSENGER GUIDANCE, PASSENGER HANDLING, TERMINAL MANAGEMENT, HUMAN RESOURCE MANAGEMENT, AIRCRAFT HANDLING, CARGO HANDLING, BAGGAGE HANDLING, AIRPORT DATABASE SUPPORT, BUILDING MANAGEMENT, MANAGEMENT INFORMATION SYSTEMS, FLIGHT BOOKING, CALL CENTER OPERATION, AND AIRPORT SECURITY AND SAFETY; ENCODED MAGNETIC, ELECTRONIC, AND OPTICAL DATA CARRIERS (U.S. CLS. 21, 23, 26, 36 AND 38).

CLASS 35—ADVERTISING AND BUSINESS

FOR BUSINESS MANAGEMENT AND ADMINISTRATION OF A COMMERCIAL AIRLINE COMPANY; DATA PROCESSING SERVICES; BOOKKEEPING FOR OTHERS BY MEANS OF ELECTRONIC DATA PROCESSING SYSTEMS; BUSINESS ORGANIZATION, PERSONNEL, AND MANAGEMENT CONSULTATION IN THE FIELD OF AVIATION AND ELECTRONIC DATA PROCESSING; BUSINESS PLANNING IN THE FIELD OF ELECTRONIC DATA PROCESSING AND ELECTRONIC COMMERCE; ACCOUNTING SERVICES; HOSPITAL MANAGEMENT SERVICES; LICENSING OF COMPUTER SOFTWARE; COMPUTERIZED DATABASE MANAGEMENT (U.S. CLS. 100, 101 AND 102).

CLASS 37—CONSTRUCTION AND REPAIR

FOR INSTALLATION, OPERATION, AND MAINTENANCE OF COMPUTER SYSTEMS FOR TRAVEL ORGANIZERS (U.S. CLS. 100, 103 AND 106).

CLASS 39—TRANSPORTATION AND STORAGE

FOR ELECTRONIC STORAGE AND RETRIEVAL OF DATA FOR OTHERS ON DATA PROCESSING EQUIPMENT; TRAVEL INFORMATION SERVICES; TRAVEL AGENCY SERVICES, NAMELY, MAKING RESERVATIONS AND BOOKINGS FOR LODGING AND TRANSPORTATION (U.S. CLS. 100 AND 105).

CLASS 42—SCIENTIFIC, COMPUTER AND LEGAL SERVICES

FOR COMPUTER SOFTWARE DESIGN, UPDATING, AND MAINTENANCE FOR OTHERS IN THE FIELD OF AVIATION AND AIRPORT MANAGEMENT; RENTAL OF COMPUTER SOFTWARE; COMPUTER SYSTEMS ANALYSIS; LEASING TIME TO COMPUTER DATABASES IN THE FIELD OF AIRPORT MANAGEMENT; RESEARCH IN THE FIELD OF ELECTRONIC DATA PROCESSING; RENTAL OF COMPUTERS; PROVIDING A WEBSITE ON GLOBAL COMPUTER NETWORKS, FEATURING INFORMATION IN THE FIELD OF AVIATION AND AIRPORT MANAGEMENT; DEVELOPMENT OF SOFTWARE SYSTEMS IN THE FIELD OF AIRPORT MANAGEMENT AND AIRPORT LOGISTICS, NAMELY DEVELOPMENT OF SOFTWARE SYSTEMS FOR THE SUPPORT OF PROCESSES IN THE FIELDS OF TRANSPORTATION TO THE AIRPORT, PARKING IN THE AIRPORT AREA, PASSENGER GUIDANCE, PASSENGER HANDLING, TERMINAL MANAGEMENT, HU-

MAN RESOURCE MANAGEMENT, AIRCRAFT HANDLING, CARGO HANDLING, BAGGAGE HANDLING, CENTRAL AIRPORT DATABASE SUPPORT, BUILDING MANAGEMENT, MANAGEMENT INFORMATION SYSTEMS, BOOKING, CALL CENTER OPERATIONS, AIRPORT SECURITY AND SAFETY; PROVIDING DATABASES FEATURING INFORMATION IN THE FIELD OF AIRPORT MANAGEMENT, FOR THE SUPPORT OF OPERATIONAL PROCESSES IN AIRPORTS, AND FOR THE ORGANIZATION OF PROCESSES IN THE FIELD OF AVIATION IN GENERAL; AIRLINE CUSTOMER CLUBS; TECHNICAL SUPPORT SERVICES, NAMELY CONSULTING SERVICES REGARDING COMPUTER HARDWARE AND SOFTWARE PROBLEMS VIA TELEPHONE, E-MAIL AND/OR MOBILE COMMUNICATION SYSTEMS (U.S. CLS. 100 AND 101).

SN 76-061,774. JOHNSON, WILLIAM A., LOS ANGELES, CA. FILED 6-5-2000.

SHREWS

CLASS 35—ADVERTISING AND BUSINESS

FOR COMPUTERIZED ONLINE RETAIL SERVICES IN THE FIELD OF ENTERTAINMENT, PUBLISHING, MULTIMEDIA, FILM AND MUSIC, FEATURING GENERAL MERCHANDISE, COLLECTIBLES, NOVELTY AND SOUVENIR ITEMS, SUNGLASSES, AUDIO AND VIDEO TAPES AND CASSETTES ALL FEATURING ACTION-ADVENTURE, SUSPENSE, DRAMA AND MYSTERY, COMPACT DISCS FEATURING MUSIC, VIDEO GAME SOFTWARE, PHONOGRAPH RECORDS FEATURING MUSIC, POSTERS, SCHOOL SUPPLIES, PHOTOGRAPHS, COMIC BOOKS, TRADING CARDS, TOYS, DOLLS, ACTION FIGURES, SPORTING GOODS, BACKPACKS, FANNY PACKS (U.S. CLS. 100, 101 AND 102).

CLASS 42—SCIENTIFIC, COMPUTER AND LEGAL SERVICES

FOR COMPUTER SERVICES, NAMELY PROVIDING AN ONLINE COMIC BOOK FEATURING COMIC CHARACTERS, STORIES AND ART VIA A GLOBAL COMPUTER NETWORK (U.S. CLS. 100 AND 101).

SN 76-062,584. COORDINATING RESEARCH COUNCIL, INC., ALPHARETTA, GA. FILED 6-1-2000.

CRC

CLASS 41—EDUCATION AND ENTERTAINMENT

FOR EDUCATIONAL SERVICES—NAMELY, CONDUCTING SEMINARS IN THE FIELDS OF INTERACTION OF PETROLEUM PRODUCTS WITH AUTOMOTIVE AND AVIATION EQUIPMENT AND DISTRIBUTING COURSE MATERIALS IN CONNECTION THEREWITH; AND PUBLICATION OF TECHNICAL PAPERS AND REPORTS RELATING TO SCIENTIFIC RESEARCH IN THE FIELDS OF THE INTERACTION OF PETROLEUM PRODUCTS WITH AUTOMOTIVE AND AVIATION EQUIPMENT (U.S. CLS. 100, 101 AND 107).

FIRST USE 11-0-1942; IN COMMERCE 11-0-1942.

CLASS 42—SCIENTIFIC, COMPUTER AND LEGAL SERVICES

FOR CONDUCTING SCIENTIFIC RESEARCH AND COORDINATING SCIENTIFIC RESEARCH BY OTHERS IN THE FIELDS OF INTERACTION OF PETROLEUM PRODUCTS WITH AUTOMOTIVE AND AVIATION EQUIPMENT (U.S. CLS. 100 AND 101).

FIRST USE 11-0-1942; IN COMMERCE 11-0-1942.

SN 76-062,639. YUNG-CHANG, CHIU, TAICHUNG, TAIWAN, FILED 6-5-2000.



THE ENGLISH TRANSLATION OF THE CHINESE CHARACTERS, IN CLOCKWISE ORDER, IS "TO BEAT", "GOOD", "TO TIE", "TO TIE", "GOOD" AND "HEM". THE CHINESE CHARACTERS IN THE MARK TRANSLITERATES TO "DAA", "HAO", "JYE", "JYE", "HAO", AND "YUAN" RESPECTIVELY.

CLASS 26—FANCY GOODS

FOR HAIR ORNAMENTS, NAMELY, CHINESE KNOTS, WEST KNOTS, LACES, HAIRFORKS AND RIBBONS; HAT ORNAMENTS, NAMELY, CHINESE KNOTS, WEST KNOTS, LACES HAIRFORKS AND RIBBONS; ORNAMENTAL RIBBONS MADE OF TEXTILES (U.S. CLS. 37, 39, 40, 42 AND 50).

CLASS 35—ADVERTISING AND BUSINESS

FOR RETAIL STORES FEATURING GIFTS AND ORNAMENTS (U.S. CLS. 100, 101 AND 102).

SN 76-062,820. FUSEBOX, INC., NEW YORK, NY. FILED 6-5-2000.

FUSEBOX

OWNER OF U.S. REG. NO. 2,163,659.

CLASS 25—CLOTHING

FOR CLOTHING FOR ADULTS AND CHILDREN, NAMELY T-SHIRTS, TANK TOPS, GOLF SHIRTS, DENIM SHIRTS, SWEAT SHIRTS, SWEAT PANTS, SWEATERS, SHORTS, BIKE SHORTS, SPORTS BRAS, SOCKS AND HATS (U.S. CLS. 22 AND 39).

FIRST USE 6-16-1995; IN COMMERCE 6-16-1995.

CLASS 35—ADVERTISING AND BUSINESS

FOR INTERACTIVE MARKETING AND ADVERTISING, MIXED MEDIA ADVERTISING AND MARKETING CAMPAIGNS, NAMELY PREPARING AUDIO VISUAL PRESENTATIONS FOR USE IN ADVERTISING, MARKETING AND SALES PRESENTATIONS, PREPARING PRODUCT DEMONSTRATIONS FOR OTHERS FOR USE INTERNALLY AND AS SALES AND MARKETING MATERIALS; ASSISTING OTHERS IN THE MANAGEMENT OF INTERNET RELATED BUSINESSES, STRATEGY, BRAND IDENTIFICATION AND DEVELOPMENT, COMPETITIVE WEBSITE ANALYSIS (U.S. CLS. 100, 101 AND 102).

FIRST USE 6-16-1995; IN COMMERCE 6-16-1995.

CLASS 38—COMMUNICATION

FOR TELECOMMUNICATIONS SERVICES, NAMELY PROVIDING FOR OTHERS BROADBAND TELECOMMUNICATIONS CONNECTIONS TO A GLOBAL COMPUTER NETWORK (U.S. CLS. 100, 101 AND 104).

FIRST USE 6-16-1995; IN COMMERCE 6-16-1995.

CLASS 42—SCIENTIFIC, COMPUTER AND LEGAL SERVICES

FOR COMPUTER SERVICES, NAMELY DESIGNING AND MAINTAINING WEB SITES AND WEB PAGES FOR OTHERS; DEVELOPING AND CUSTOMIZING COMPUTER SOFTWARE AND HARDWARE FOR OTHERS; DESIGNING AND IMPLEMENTING INFORMATION ARCHITECTURE, TRACKING AND ANALYSIS TOOLS, INTRANET AND CONTENT MANAGEMENT TOOLS, CUSTOM APPLICATIONS, E-COMMERCE AND AUCTION FUNCTIONS FOR OTHERS; SYSTEMS AND DATA INTEGRATION SERVICES FOR DATABASES, COMPUTER NETWORKS AND LEGACY SYSTEMS FOR OTHERS; HOSTING THE WEBSITES OF OTHERS ON COMPUTER SERVERS FOR A GLOBAL NETWORK AND FOR PRIVATE NETWORKS; DESIGNING AND DEVELOPING INTERACTIVE MULTIMEDIA CONTENT FOR OTHERS FOR USE IN WEBSITES, NAMELY GRAPHIC ART DESIGN; COMPUTER CONSULTATION RELATING TO TECHNOLOGY AND BANDWIDTH PLANNING (U.S. CLS. 100 AND 101).

FIRST USE 6-16-1995; IN COMMERCE 6-16-1995.

SN 76-063,202. KNIGHTS BASEBALL, LLC, FORT MILL, SC. FILED 6-5-2000.



OWNER OF U.S. REG. NOS. 1,515,863, 2,190,633 AND OTHERS.

SEC. 2(F) AS TO CLASS 16.

CLASS 14—JEWELRY

FOR JEWELRY; NAMELY, LAPEL PINS, TIE PINS, PENDANTS, CHARMS AND ORNAMENTAL PINS (U.S. CLS. 2, 27, 28 AND 50).

FIRST USE 1-1-2000; IN COMMERCE 1-1-2000.

CLASS 16—PAPER GOODS AND PRINTED MATTER

FOR PAPER GOODS AND PRINTED MATTER; NAMELY, PENS, PENCILS, NON-ELECTRIC ERASERS, AUTOGRAPH BOOKS, SOUVENIR PROGRAMS, BASEBALL TRADING CARDS, BUMPER STICKERS, PAPER PENNANTS, REFERENCE BOOKS OF INTEREST TO BASEBALL FANS, CHECK BOOKS, CATALOGS OF INTEREST TO BASEBALL FANS, PAPER CONTAINERS, DECALS, ENVELOPES, STATIONERY FOLDERS, WRITING PAPER, NOTE BOOKS, NOTE PADS, PAPER NAME BADGES, PRINTED PAPER SIGNS, PICTURES, POSTERS, PRINTED AWARDS, PRINTED GUIDES OF INTEREST TO BASEBALL FANS, BASEBALL SCORE BOOKS AND PRINTED SOUVENIR GAME TICKETS (U.S. CLS. 2, 5, 22, 23, 29, 37, 38 AND 50).
FIRST USE 1-1-2000; IN COMMERCE 1-1-2000.

CLASS 18—LEATHER GOODS

FOR LEATHER GOODS; NAMELY, BACKPACKS, ALL PURPOSE SPORT BAGS, UMBRELLAS, WALLETS AND FANNY PACKS (U.S. CLS. 1, 2, 3, 22 AND 41).
FIRST USE 1-1-2000; IN COMMERCE 1-1-2000.

CLASS 25—CLOTHING

FOR CLOTHING; NAMELY, SHIRTS, TEE SHIRTS, POLO SHIRTS, KNIT SHIRTS, GOLF SHIRTS, JACKETS, SWEAT SHIRTS, SWEATERS, JERSEYS, V-NECK PULL-OVERS, HATS, CAPS, AND CLOTH BABY BIBS (U.S. CLS. 22 AND 39).
FIRST USE 1-1-2000; IN COMMERCE 1-1-2000.

SN 76-063,670. DOOR CONTROLS, INC., DEXTER, MI. FILED 6-6-2000.



**DOOR CONTROLS
INTERNATIONAL**

NO CLAIM IS MADE TO THE EXCLUSIVE RIGHT TO USE "DOOR CONTROLS INTERNATIONAL", APART FROM THE MARK AS SHOWN.

THE VERTICAL LINES OF THE DESIGN ARE A PART OF THE MARK AND NOT INTENDED TO DENOTE COLOR.

CLASS 6—METAL GOODS

FOR COMMERCIAL, RESIDENTIAL AND FIRE-PROOF DOOR HARDWARE, NAMELY, KEYS AND KEY CYLINDERS, NUTS, BOLTS, KNOBS, LATCHES, LOCKS, DEADBOLTS, AUTOMATIC DOOR BOLTS, AUTOMATIC DOOR COORDINATORS, DOOR STRIKER PLATES AND KICKPLATES, DOOR HANDLES, DOOR-KNOBS AND DOOR LEVERS AND PARTS THEREFOR, ALL MADE OF METAL (U.S. CLS. 2, 12, 13, 14, 23, 25 AND 50).
FIRST USE 8-14-1978; IN COMMERCE 8-14-1978.

CLASS 9—ELECTRICAL AND SCIENTIFIC APPARATUS

FOR COMMERCIAL, LIFE SAFETY AND SECURITY DOOR HARDWARE, NAMELY, ELECTRONIC DOOR OPENERS, PANIC ALARM DOOR BARS, ELECTROMAGNETIC DOOR RELEASES, ELECTROMAGNETIC DOOR HOLDERS, ELECTROMAGNETIC DOOR LOCKS, ELECTROMECHANICAL DOOR HOLDERS, ELECTROMECHANICAL DOOR HOLDER/RELEASES AND ELECTROMECHANICAL DOOR HOLDER/CLOSERS (U.S. CLS. 21, 23, 26, 36 AND 38).
FIRST USE 8-14-1978; IN COMMERCE 8-14-1978.

SN 76-063,780. GO MULTIMEDIA, LLC, PHILADELPHIA, PA. BY ASSIGNMENT GO MULTIMEDIA, INC., PHILADELPHIA, PA. FILED 6-2-2000.

GO MULTIMEDIA

NO CLAIM IS MADE TO THE EXCLUSIVE RIGHT TO USE "MULTIMEDIA", APART FROM THE MARK AS SHOWN.

CLASS 9—ELECTRICAL AND SCIENTIFIC APPARATUS

FOR COMPUTER SOFTWARE RECORDED ON CD-ROM FOR USE BY COMPANIES IN TRAINING FOR CORPORATE EMPLOYEES IN THE FIELDS OF SALES, CUSTOMER SERVICE, HUMAN RESOURCE MANAGEMENT, GOVERNMENT RELATIONS, MILITARY RELATIONS, MULTICULTURAL BUSINESS TRANSACTIONS, MULTINATIONAL BUSINESS TRANSACTIONS, AND EXECUTIVE MANAGEMENT; CONSUMER EDUCATION SOFTWARE IN THE FIELDS OF SELF-HELP, LAW SCHOOL STUDIES, CONTINUING LEGAL EDUCATION, BUSINESS SCHOOL STUDIES, MEDICAL SCHOOL STUDIES, BROKERAGE SERVICES, FINANCIAL ADVISING SERVICES, TEACHER TRAINING, SCHOOL ADMINISTRATION, PRIMARY SCHOOLING, SECONDARY SCHOOLING, UNIVERSITY SCHOOLING, POLICE TRAINING, FIREFIGHTER TRAINING, EMERGENCY MEDICAL TECHNICIAN TRAINING, PARAMEDIC TRAINING, PSYCHOLOGICAL COUNSELING, FAMILY THERAPY, CLERGY COUNSELING, FAMILY PLANNING, HOME ECONOMICS, PARENTING, COUPLES THERAPY, NON-PROFIT ORGANIZATION MANAGEMENT, MANUFACTURING AND PRODUCT CONSTRUCTION (U.S. CLS. 21, 23, 26, 36 AND 38).

CLASS 42—SCIENTIFIC, COMPUTER AND LEGAL SERVICES

FOR DESIGN OF CUSTOMIZED BUSINESS SOFTWARE APPLICATIONS FOR OTHERS FEATURING PRESENTATION KIOSKS FOR USE AT TRADE SHOWS AND COMPANY LOCATIONS; DESIGN OF WEB SITES FOR OTHERS FOR USE ON THE INTERNET; DESIGN OF EXTRANET SYSTEMS FOR OTHERS; ALL TO FACILITATE PROJECT IMPLEMENTATION AND COMMUNICATIONS WITH CUSTOMERS AND EMPLOYEES (U.S. CLS. 100 AND 101).

SN 76-063,898. FEDERATION INTERNATIONALE DE FOOTBALL ASSOCIATION, 8032 ZURICH, SWITZERLAND, FILED 6-6-2000.

FIFA

PRIORITY CLAIMED UNDER SEC. 44(D) ON SWITZERLAND APPLICATION NO. 471,848, FILED 12-9-1999, REG. NO. 471,848, DATED 12-9-1999, EXPIRES 12-9-2009.
OWNER OF U.S. REG. NOS. 1,420,790 AND 2,352,934.

CLASS 1—CHEMICALS

FOR UNEXPOSED CAMERA, CINEMATOGRAPHIC AND PHOTOGRAPHIC FILMS; CHEMICALS USED IN THE CINEMATOGRAPHIC AND PHOTOGRAPHIC INDUSTRIES; TANNING SUBSTANCES, NAMELY, TANNING AGENTS FOR USE IN THE MANUFACTURE OF LEATHER; ARTIFICIAL SWEETENERS (U.S. CLS. 1, 5, 6, 10, 26 AND 46).

CLASS 3—COSMETICS AND CLEANING PREPARATIONS

FOR COSMETICS, NAMELY, SOAPS, HAIR LOTIONS, PERFUMES, COLOGNES, PRE-SHAVE AND AFTER SHAVE LOTIONS, SHAVING CREAMS, SHAMPOOS, TOOTH PASTE, DEODORANTS AND ANTIPERSPIRANTS FOR PERSONAL USE, MOUTH WASHES; NON-MEDICATED NOURISHING CREAMS FOR THE SKIN; NON-MEDICATED SKIN CREAMS; HAIR GEL; BEAUTY ADDITIVES, SKIN CLEANSING CREAM; EYE SHADOW; FACE POWDER; COSMETIC PENCILS; SUNSCREEN LOTIONS; CLEANING, POLISHING, SCOURING, ABRASIVE PREPARATIONS FOR HOUSEHOLD PURPOSES, LAUNDRY POWDER DETERGENTS, SYNTHETIC HOUSEHOLD DETERGENTS; SHOE POLISH; WAX, NAMELY, FLOOR WAX (U.S. CLS. 1, 4, 6, 50, 51 AND 52).

CLASS 5—PHARMACEUTICALS

FOR VEHICLE DEODORIZERS; PHARMACEUTICAL PREPARATIONS FOR THE TREATMENT OF DISORDERS OF THE MOUTH; MEDICATED CHEWING GUM FOR STOPPING SMOKING; MEDICINAL HERBAL TEA, NUTRITIONAL ADDITIVES FOR FOODS FOR MEDICAL AND DIETETIC PURPOSES; VITAMIN PREPARATIONS; FEMININE HYGIENIC PRODUCTS, NAMELY, SANITARY NAPKINS; MATERIAL FOR STOPPING TEETH; DENTAL WAX; FUNGICIDES AND HERBICIDES FOR DOMESTIC USE; MEDICINES FOR THE TREATMENT OF EYE FATIGUE (U.S. CLS. 6, 18, 44, 46, 51 AND 52).

CLASS 6—METAL GOODS

FOR TROPHIES MADE OF COMMON METALS OR THEIR ALLOYS; MONEY CLIPS MADE OF COMMON METALS OR THEIR ALLOYS; DISPENSERS OF KITCHEN TOWELS MADE OF METAL; KEY CHAINS, FIGURINES AND COLLECTIBLE MILK BOTTLE CAPS MADE OF COMMON NON-PRECIOUS METAL OR THEIR ALLOYS; STATUES AND SCULPTURES OF COMMON NON-PRECIOUS METAL; KITCHEN ALUMINUM FOIL (U.S. CLS. 2, 12, 13, 14, 23, 25 AND 50).

CLASS 8—HAND TOOLS

FOR HAND TOOLS AND HAND-OPERATED IMPLEMENTS, NAMELY, NON-ELECTRIC CAN OPENERS, NAIL CLIPPERS, TWEEZERS, MULTI-FUNCTIONAL KNIVES WITH RETRACTABLE BLADES; ELECTRIC AND NON-ELECTRIC RAZORS; RAZOR BLADES, CUTLERY; DEPILATORY APPLIANCES; CURLING TONGS (U.S. CLS. 23, 28 AND 44).

CLASS 9—ELECTRICAL AND SCIENTIFIC APPARATUS

FOR DECORATIVE MAGNETS; EYEGLASSES; SUNGLASSES; CASES AND CORDS FOR EYEGLASSES AND SUNGLASSES; BINOCULARS; MAGNETS; TELEVISION RECEIVERS; RADIO RECEIVERS; VIDEO RECORDERS; COMPACT DISK PLAYERS; DIGITAL DISK PLAYERS; RECORDABLE VIDEO TAPES, MAGNETIC TAPES, MAGNETIC DISKS, DVDS, FLOPPY DISKS, OPTICAL DISKS, COMPACT DISKS, CD-ROMS AND VIDEO DISKS ALL SOLD EMPTY; PRE-RECORDED VIDEO TAPES, MAGNETIC TAPES, MAGNETIC DISKS, DVDS, FLOPPY DISKS, OPTICAL DISKS, COMPACT DISKS, CD-ROMS AND VIDEO DISKS FEATURING MUSIC; PRE-RECORDED VIDEO TAPES, MAGNETIC TAPES, MAGNETIC DISKS, DVDS, FLOPPY DISKS, OPTICAL DISKS, COMPACT DISKS, CD-ROMS AND VIDEO

DISKS FEATURING ANIMATION; PRE-RECORDED VIDEO TAPES, MAGNETIC TAPES, MAGNETIC DISKS, DVDS, FLOPPY DISKS, OPTICAL DISKS, COMPACT DISKS, CD-ROMS AND VIDEO DISKS FEATURING IMAGES; COMPUTERS; MODEMS; ELECTRONIC POCKET TRANSLATORS; ELECTRONIC AGENDAS; SCANNERS; PRINTERS; CALCULATORS AND DATA PROCESSORS; CREDIT CARD VERIFICATION MACHINES; AUTOMATED TELLER MACHINES; FOREIGN EXCHANGE CURRENCY MACHINES; SECURITY ALARMS; LOUDSPEAKERS; VIDEO CAMERAS; CAMCORDERS; FACSIMILE TRANSMISSION MACHINES; TELEPHONES; TELEPHONE ANSWERING MACHINES; VIDEO PHONES; PHOTOCOPY MACHINES; PHOTOGRAPHIC EQUIPMENT, NAMELY, CAMERAS, PROJECTORS, EXPOSED FILMS, FLASH BULBS, CAMERA CASES, BATTERIES AND ACCESSORIES THEREFOR; WINDSOCKS FOR MEASURING WIND; HAND-HELD ELECTRONIC GAMES ADAPTED FOR USE WITH TELEVISION RECEIVERS; VIDEO GAME CARTRIDGES; MULTIMEDIA SOFTWARE RECORDED ON CD-ROM FEATURING MUSIC, SOUND OR IMAGES WHICH MAY BE ANIMATED; PRERECORDED COMPUTER SOFTWARE, NAMELY, SOFTWARE FOR GAMES; MAGNETIC ENCODED CARDS; COMPUTER HARDWARE, NAMELY, MEMORY CARDS AND MICROCHIP CARDS; ELECTRONIC VENDING MACHINES; DIRECTIONAL COMPASSES; MAGNETICALLY ENCODED CARDS, NAMELY, CREDIT CARDS, PREPAID PHONE CARDS, DEBIT CARDS, TRAVEL AND ENTERTAINMENT CARDS AND CHECK GUARANTEE CARDS; AND ELECTRIC IRONS, FLAT IRONS, STEAM IRONS (U.S. CLS. 21, 23, 26, 36 AND 38).

CLASS 10—MEDICAL APPARATUS

FOR PERSONAL DIAGNOSTIC APPLIANCES, NAMELY, EAR THERMOMETERS, BLOOD PRESSURE MEASURING DEVICES AND HEART MONITORS; MEDICAL MEASUREMENT APPARATUS AND INSTRUMENTS; MASSAGE APPARATUS FOR PERSONAL USE; BABY NURSING BOTTLES; CONDOMS; ORTHOPEDIC SUPPORTIVE BANDAGES; ICE AND THERMAL PACKS FOR MEDICAL PURPOSES; PHYSICAL EXERCISE MACHINES FOR MEDICAL PURPOSES; AND MEDICAL DIAGNOSTIC IMAGING EQUIPMENT, NAMELY, X-RAY MACHINES AND MRI DIAGNOSTIC APPARATUS (U.S. CLS. 26, 39 AND 44).

CLASS 11—ENVIRONMENTAL CONTROL APPARATUS

FOR PRODUCTS FOR PURIFICATION AND DEODORIZATION OF THE AIR, NAMELY, SEPARATORS FOR THE CLEANING AND PURIFICATION OF AIR FOR COMMERCIAL AND DOMESTIC USE; PAPER LANTERNS; ELECTRIC LAUNDRY DRYERS; ELECTRIC HAIR DRYERS; PENLIGHTS; FLASHLIGHTS; TABLE LAMPS; DECORATIVE LAMPS; LAMP SHADES; LIGHT BULBS; LIGHTING FIXTURES; REFRIGERATORS; FREEZERS; SPACE HEATERS; AIR CONDITIONERS; AIR PURIFYING UNITS FOR COMMERCIAL AND DOMESTIC USE; OVENS; GAS STOVES; BARBECUE GRILLS; RANGES; MICROWAVE OVENS; ELECTRIC COFFEE MAKERS FOR DOMESTIC USE; ELECTRIC TEA KETTLES; TOASTERS; ELECTRIC DEEP FRYERS; WATER FILTERS FOR DRINKING WATER; BICYCLE LIGHTS; AND DRINK FOUNTAINS (U.S. CLS. 13, 21, 23, 31 AND 34).

CLASS 12—VEHICLES

FOR SEAT CUSHIONS AS ACCESSORIES FOR AUTOMOBILES; BICYCLES; MOTORBIKES; AUTOMOBILES; TRUCKS; VANS; BUSES; AIRPLANES; BOATS; BALLOONS; AIRSHIPS; PRAMS; STROLLERS; CAR SEATS FOR BABIES OR CHILDREN; AUTOMOBILE ACCESSORIES, NAMELY SUN SCREEN SHADES; SPORTS RACKS, TIRE COVERS; VEHICLE SEAT COVERS; FITTED AND SEMI FITTED VEHICLE COVERS; FLOOR MATS; ENGINES FOR LAND VEHICLES AND REPLACEMENT PARTS THEREFOR; AND TIRES (U.S. CLS. 19, 21, 23, 31, 35 AND 44).

CLASS 14—JEWELRY

FOR JEWELRY; WATCHES; CLOCKS; MEDALLIONS; ORNAMENTAL LAPEL PINS; PENDANTS; TEAM AND PLAYER TRADING PINS MADE OF PRECIOUS METALS; TROPHIES MADE OF PRECIOUS METALS; COMMEMORATIVE CUPS AND PLATES, TANKARDS, STATUES AND SCULPTURES, PENDANTS AND POGS, ALL MADE OF PRECIOUS METALS; MEDALLIONS, TIE CLIPS AND TIE PINS NOT MADE OF PRECIOUS METALS; ASHTRAYS AND CIGARETTE CASES MADE OF PRECIOUS METALS; NON-MONETARY COINS (U.S. CLS. 2, 27, 28 AND 50).

CLASS 16—PAPER GOODS AND PRINTED MATTER

FOR TEMPORARY TATTOOS, NAMELY, DECORATIVE TRANSFERS FOR COSMETIC PURPOSES; HOLOGRAMS; PASSPORT HOLDERS; PLASTIC KEY CARDS THAT ARE NOT MAGNETICALLY ENCODED; DISPLAY STANDS FOR SELLING GOODS MADE OF CARDBOARD; GIFT AND PARTY SUPPLIES MADE OF PAPER, NAMELY NAPKINS, TABLE CLOTHS, BAGS, PRINTED INVITATIONS, GIFT WRAP, COASTERS AND PLACE MATS; PAPER TABLE LINENS; CREPE PAPER; GARBAGE BAGS OF PAPER OR PLASTIC; FOOD STORAGE WRAPPERS; BLANK OR PARTIALLY PRINTED LABELS NOT OF TEXTILES; FLAGS OF PAPER; PENNANTS OF PAPER; HANDKERCHIEFS OF PAPER; TYPEWRITER PAPER; COPYING PAPER; PAPER COFFEE FILTERS; TOWELS OF PAPER; DISPOSABLE PAPER WIPES NOT IMPREGNATED WITH CHEMICALS OR COMPOUNDS; TOILET PAPER; ENVELOPES; BABY'S DISPOSABLE DIAPERS OF PAPER; STATIONERY AND SCHOOL SUPPLIES, NAMELY, THEME PADS, NOTEBOOKS, NOTE PAPER, BINDERS, PENS, PENCILS, BALL-POINT PENS, PEN AND PENCIL SETS, POROUS-POINT PENS, ROLLING BALL PENS AND BROAD-TIP MARKERS; PRINTING BLOCKS CORRECTION FLUIDS; RUBBER ERASERS; BOOKENDS; PENCIL SHARPENERS; CALENDARS; ADHESIVE NOTE PAPER; POSTERS; GREETING CARDS; DECALS; HEAT TRANSFER PAPER; COLORING BOOKS AND ACTIVITY BOOKS; MAGAZINES, NEWSPAPERS, PICTURE BOOKS AND JOURNALS FEATURING ATHLETES OR SPORT EVENTS; ROADMAPS; PLAYING CARDS; PRINTED TICKETS; BANK CHECKS; PRINTED TIMETABLES; COLLECTIBLE PLAYER TRADING CARDS; BUMPER STICKERS; MOUNTED AND UNMOUNTED PHOTOGRAPHS; PHOTOGRAPH ALBUMS; STATIONERY; CREDIT CARDS, PREPAID PHONE CARDS, DEBIT CARDS, TRAVEL AND ENTERTAINMENT CARDS AND CHECK GUARANTEE CARDS, ALL MADE OF PAPER OR CARDBOARD AND NOT MAGNETICALLY ENCODED; AUTOGRAPH BOOKS; BINDER PAPER; BOOK COVERS; BOOK STANDS; CONFETTI; CHALK; DOCUMENT HOLDERS; PAPER CLIPS; DRAWING PINS; INK; PAINT BOXES; KITCHEN TOWELS OF PAPER; WRITING PAPER; SCRIBBLE PADS; CLIP BOARDS; NOTEPAD HOLDERS; ADDRESS BOOKS; DECORATIONS FOR PENCILS; STANDS FOR WRITING IMPLEMENTS; INK PADS; RUBBER STAMPS; RULERS; SCORE BOOK SCHEDULES FOR RECORDING RESULTS; ADHESIVE TAPE FOR STATIONERY; OFFICE DISPENSERS FOR ADHESIVE TAPE; STAPLERS; STENCILS; LUMINOUS PAPER; EVENT PROGRAMS; EVENT ALBUMS; STATIONERY SCISSORS; AND BOXED TISSUES MADE OF CARDBOARD (U.S. CLS. 2, 5, 22, 23, 29, 37, 38 AND 50).

CLASS 18—LEATHER GOODS

FOR UMBRELLAS, PARASOLS; ALL PURPOSE SPORT AND LEISURE BAGS; TRAVELLING BAGS; BACKPACKS; TOTE BAGS; SCHOOL BAGS; BELT BAGS; HANDBAGS; BEACH BAGS; SUITCASES; VANITY CASES SOLD EMPTY; KEY CASES; SUIT CARRIERS; SOCCER BALL SHAPED BAGS FOR GENERAL USE; WALLETS; PURSES; BRIEF-CASES (U.S. CLS. 1, 2, 3, 22 AND 41).

CLASS 20—FURNITURE AND ARTICLES NOT OTHERWISE CLASSIFIED

FOR HOLIDAY ORNAMENTS MADE OF PLASTER, PLASTIC AND/OR WOOD AND NOT INCLUDING CHRISTMAS TREE ORNAMENTS; FOAM NOVELTY ITEMS IN THE NATURE OF FORM HANDS; SLEEPING BAGS; NON-METAL TROPHIES; KEYHOLDERS MADE OF PLASTIC; HAND HELD MIRRORS; FURNITURE MIRRORS; ARTICLES MADE OF PLASTICS, NAMELY SOUVENIR STATUES, PLASTIC BADGES THAT ARE NOT ENCODED; CUSHIONS AND FURNITURE SEATS FOR OUTDOOR USE; FURNITURE; COAT HANGERS; FURNITURE DISPLAY RACKS; NON-ELECTRIC FANS FOR PERSONAL USE; DISPLAY STANDS FOR SELLING GOODS NOT MADE OF CARDBOARD; INFLATABLE PUBLICITY OBJECTS; AND NON-METAL DISPENSERS OF KITCHEN TOWELS (U.S. CLS. 2, 13, 22, 25, 32 AND 50).

CLASS 21—HOUSEWARES AND GLASS

FOR HOLIDAY ORNAMENTS MADE OF CHINA, CRYSTAL, GLASS, PORCELAIN AND/OR TERRACOTTA AND NOT INCLUDING CHRISTMAS TREE ORNAMENTS; CHINA ORNAMENTS; ALL PURPOSE PORTABLE HOUSEHOLD OR KITCHEN CONTAINERS NOT MADE OF PRECIOUS METALS OR COATED THEREWITH; TANKARDS, MUGS, CUPS AND DRINKING GLASSES, PLATES AND DISHES, COASTERS NOT OF PRECIOUS METALS; BOTTLE OPENERS, BEVERAGE BOTTLES SOLD EMPTY, NON-ELECTRIC COOLERS FOR FOOD AND DRINKS, COMBS AND HAIRBRUSHES, TOOTH BRUSHES; DENTAL FLOSS; STATUES AND SCULPTURES RELATED TO THE SPORT OF SOCCER MADE OF PORCELAIN, TERRACOTTA OR GLASS; AND TEA POTS NOT OF PRECIOUS METAL (U.S. CLS. 2, 13, 23, 29, 30, 33, 40 AND 50).

CLASS 24—FABRICS

FOR KITCHEN OVEN MITTS; CLOTH BANNERS AND PENNANTS; BEDDING, NAMELY, SHEETS; CURTAINS; DRAPERIES; QUILTS AND BEDSPREADS; TOWELS AND BATH LINENS; DISH CLOTHS; DISH TOWELS; STADIUM BLANKETS; CLOTH HANDKERCHIEFS; WALL HANGINGS AND TABLE CLOTHS MADE OF TEXTILE; CLOTH LABELS MADE OF TEXTILE; AND BEACH MATS MADE OF TEXTILE (U.S. CLS. 42 AND 50).

CLASS 25—CLOTHING

FOR FOOTWEAR; HEAD WEAR; CLOTHING, NAMELY, SHIRTS; KNIT SHIRTS; JERSEYS AND TANK TOPS; T-SHIRTS; DRESSES; SKIRTS; UNDERWEAR; SWIMWEAR; SHORTS; PANTS; SWEATERS; CAPS; HATS; SCARVES; VISORS; WARM-UP SUITS; SWEATSHIRTS; JACKETS; UNIFORMS; NECKTIES; WRISTBANDS AND HEADBANDS; GLOVES; APRONS; CLOTH BIBS; PAJAMAS; SOCKS AND HOSIERY; BELTS; SUSPENDERS; AND TODDLER AND INFANT PLAYWEAR; NAMELY, ROMPERS, SUNSUITS, JUMPSUITS, DUNGAREES AND OVERALLS (U.S. CLS. 22 AND 39).

CLASS 28—TOYS AND SPORTING GOODS

FOR GAMES AND PLAYTHINGS, NAMELY, SPORT BALLS, BOARD GAMES, STUFFED DOLLS, STUFFED ANIMALS, TOY VEHICLES, JIGSAW PUZZLES, BALLOONS, INFLATABLE TOYS; SOCCER EQUIPMENT, NAMELY BALLS, GLOVES, KNEE PADS, ELBOW PADS AND SHOULDER PADS; SOCCER GOALS; TOY PARTY HATS; AND HAND-HELD ELECTRONIC GAMES OTHER THAN THOSE ADAPTED FOR USE WITH TELEVISION RECEIVERS (U.S. CLS. 22, 23, 38 AND 50).

CLASS 29—MEATS AND PROCESSED FOODS

FOR MEAT; FISH FOR FOOD PURPOSES; POULTRY FOR FOOD PURPOSES; GAME FOR FOOD PURPOSES; MEAT EXTRACTS; PRESERVED AND COOKED FRUITS AND VEGETABLES; EDIBLE OILS AND FATS; POTATO CHIPS; FRENCH FRIED POTATOES; PROCESSED NUTS; JAMS; FRUIT PRESERVES AND JELLIES; MILK; DAIRY PRODUCTS EXCLUDING ICE CREAM, ICE MILK AND FROZEN YOGURT; CHEESE; CANNED FRUITS AND VEGETABLES (U.S. CL. 46).

CLASS 30—STAPLE FOODS

FOR COFFEE; TEA; COCOA; SUGAR; ARTIFICIAL COFFEE; FLOUR; PREPARATIONS MADE FROM CEREALS, NAMELY, CEREAL BASED SNACK FOOD AND READY TO EAT CEREAL DERIVED FROM FOOD BARS; BREAKFAST CEREALS; PROCESSED CEREALS; BREAD; PASTRIES; CAKES; COOKIES AND CRACKERS; CANDIES; FROZEN CONFECTIONS; RICE; CORN CHIPS; ICE CREAM; HONEY; MUSTARD; VINEGAR; SAUCES; SPICES; SALT; NON NUTRITIONAL FOOD ADDITIVES FOR USE AS FLAVORING; INGREDIENT OR FILLER AND NOT FOR MEDICAL OR DIETETIC PURPOSES (U.S. CL. 46).

CLASS 31—NATURAL AGRICULTURAL PRODUCTS

FOR UNPROCESSED CEREALS; FOODSTUFF FOR ANIMALS; GRASS SEEDS; FRESH FRUITS, BERRIES, VEGETABLES AND FLOWERS; LITTER FOR ANIMALS; AND NON-ARTIFICIAL TURF (U.S. CLS. 1 AND 46).

CLASS 32—LIGHT BEVERAGES

FOR BEERS AND ALES, SOFT DRINKS; SYRUPS AND POWDER FOR MAKING SOFT DRINKS; MINERAL AND AERATED WATERS; FRUIT AND VEGETABLE DRINKS AND JUICE; NON-ALCOHOLIC BEERS AND ALES; AND FROZEN FRUIT DRINKS (U.S. CLS. 45, 46 AND 48).

CLASS 33—WINES AND SPIRITS

FOR ALCOHOLIC BEVERAGES, NAMELY, WINE, LIQUOR, APERITIFS, CHAMPAGNE, CIDER, BRANDY, WHISKY, VODKA, GIN, RUM AND TEQUILA (U.S. CLS. 47 AND 49).

CLASS 35—ADVERTISING AND BUSINESS

FOR DATA PROCESSING SERVICES; PROMOTING SOCCER COMPETITIONS, SOCCER EXHIBITIONS AND SOCCER EVENTS OF OTHERS; EMPLOYMENT AGENCIES; PERSONNEL PLACEMENT AND RECRUITMENT SERVICES; ADVERTISING AGENCY SERVICES; ADVERTISING FOR OTHERS VIA THE INTERNET; DISSEMINATION OF ADVERTISING MATTER FOR OTHERS; RENTAL OF ADVERTISING SPACE ON OUTDOOR BILLBOARDS; PREPARING AND PLACING OUTDOOR ADVERTISEMENTS FOR OTHERS; TELEVISION ADVERTISING SERVICES FOR OTHERS; PROMOTION AGENCY SERVICES, NAMELY, PROMOTING THE GOODS AND SERVICES OF OTHERS THROUGH THE DISTRIBUTION OF PRINTED AND AUDIO PROMOTIONAL MATERIALS AND BY RENDERING SALES PROMOTION ADVICE; ADVERTISING FOR OTHERS IN THE FORM OF ANIMATION; MARKETING RESEARCH SERVICES; PUBLIC OPINION POLLING SERVICES; PROMOTION OF COMMERCIAL EXHIBITIONS OF OTHERS; COMPUTERIZED ON-LINE RETAIL SERVICES IN THE FIELD OF GENERAL MERCHANDISE; COMPUTERIZED DATABASE MANAGEMENT AND LICENSING OF COMPUTERIZED DATABASES; AND SPORT RECORD AND STATISTICAL INFORMATION SERVICES; ENTERTAINER MANAGING SERVICES; LEASING OF FACSIMILES (U.S. CLS. 100, 101 AND 102).

CLASS 36—INSURANCE AND FINANCIAL

FOR CREDIT CARD SERVICES; ISSUANCE OF CREDIT CARDS; TRAVELERS CHECK SERVICES; FINANCING SERVICES; BANKING SERVICES, NAMELY CREDIT AND LOAN SERVICES; INSURANCE UNDERWRITING IN THE FIELD OF LIFE, HEALTH, ACCIDENT, PROPERTY AND CASUALTY (U.S. CLS. 100, 101 AND 102).

CLASS 38—COMMUNICATION

FOR TELECOMMUNICATION SERVICES NAMELY, PERSONAL COMMUNICATION SERVICES VIA MOBILE PHONES, TELEX, ELECTRONIC COMPUTER TERMINALS, TELEGRAPH, TELEPHONE OR FACSIMILE; PAGING BY RADIO; NETWORK CONFERENCING SERVICES, NAMELY, COMMUNICATIONS BY TELEVISION FOR MEETINGS, TELEVISION BROADCASTING; CABLE TELEVISION BROADCASTING; RADIO BROADCASTING; LEASING OF TELEPHONE SETS (U.S. CLS. 100, 101 AND 104).

CLASS 39—TRANSPORTATION AND STORAGE

FOR ELECTRONIC ARCHIVING FOR OTHERS OF MESSAGES AND DATA; TRAVEL AGENCY SERVICES; BOAT, AIRLINE, RAILWAY, BUS AND VAN TRANSPORTATION SERVICES ALL FOR PASSENGERS AND GOODS; POSTAL SERVICES, NAMELY, PARCEL DELIVERY; COURIER SERVICES; MESSAGE DELIVERY; VEHICLE RENTAL SERVICES; PARKING LOT SERVICES; ARRANGING TRAVEL TOURS; TOUR BOAT SERVICES, NAMELY, BOAT CHARTERING AND PROVIDING BOAT CRUISES; WAREHOUSE STORAGE SERVICES; TAXI TRANSPORT SERVICES; FREIGHT SHIPPING SERVICES, NAMELY, FREIGHT FORWARDING AND FREIGHT TRANSPORTATION BY TRUCK, TRAIN, AND AIR; UTILITY SERVICES, NAMELY TRANSMISSION OF GAS, WATER, AND ELECTRICITY; DELIVERY OF NEWSPAPERS, MAGAZINES AND BOOKS; DELIVERY OF SOLVENTS, PARAFFIN, WAX, BITUMEN AND PETROLEUM WITH THE EXCLUSION OF LIQUID PETROLEUM GAS, BY MOTOR VEHICLE (U.S. CLS. 100 AND 105).

CLASS 41—EDUCATION AND ENTERTAINMENT

FOR VIDEOTAPE PRODUCTION; PROVIDING SPORTS RECORDS AND SPORTS STATISTICAL INFORMATION; EDUCATIONAL SERVICES, NAMELY CONDUCTING CLASSES, SEMINARS, CONFERENCES AND/OR WORKSHOPS IN THE FIELD OF SPORTS AND DISTRIBUTING COURSE MATERIALS IN CONNECTION THEREWITH; ENTERTAINMENT SERVICES, NAMELY, CONDUCTING LOTTERIES FOR OTHERS, SPORTING AND CULTURAL ACTIVITIES, ORGANIZATION OF SPORTING AND CULTURAL EVENTS AND ACTIVITIES FOR OTHERS; PROVIDING FACILITIES FOR FOOTBALL AND SOCCER TOURNAMENTS; RENTAL SERVICES FOR AUDIO AND VIDEO EQUIPMENT, RADIO, TELEVISION PROGRAM; PRODUCTION OF ANIMATION MOVIES; PRODUCTION OF ANIMATION TV PROGRAMS, ARRANGING FOR TICKET RESERVATIONS FOR SHOWS AND OTHER ENTERTAINMENT EVENTS; TIMING OF SPORTS EVENTS (U.S. CLS. 100, 101 AND 107).

CLASS 42—SCIENTIFIC, COMPUTER AND LEGAL SERVICES

FOR WASTE MANAGEMENT SERVICES; FACSIMILE; STOCK PHOTOGRAPHY SERVICES, NAMELY, LEASING REPRODUCTION RIGHTS OF PHOTOGRAPHS TO OTHERS; PROVIDING OF FOOD AND DRINK, IN PARTICULAR WITH FAST FOOD, IN CAFETERIAS AND RESTAURANTS; CATERING SERVICES; HOTEL RESORT, LODGING AND BOARDING SERVICES; LANGUAGE TRANSLATION SERVICES; PHOTOGRAPHY SERVICES; VIDEOTAPING SERVICES; PRINTING SERVICES; COMPUTER CONSULTING SERVICES, COMPUTER DATA PROGRAMMING FOR OTHERS; GUARD AND SECURITY SERVICES; MEDICAL, DENTAL AND HOSPITAL SERVICES; DRUG TESTING SERVICES; HAIR DRESSING, BARBER AND BEAUTY PARLOR SERVICES; UNIFORM LEASING SERVICES; COMPUTER SOFTWARE DESIGN FOR OTHERS; HOSTING THE WEB SITES OF OTHERS ON THE INTERNET; LICENSING OF INTELLECTUAL PROPERTY RIGHTS (U.S. CLS. 100 AND 101).

SN 76-066,188. ANDOVER CONTROLS CORPORATION, ANDOVER, MA. FILED 6-8-2000.

CONTROLLING TOMORROW'S WORLD

CLASS 37—CONSTRUCTION AND REPAIR

FOR INSTALLATION, MAINTENANCE AND SERVICING OF ADVANCED MICROCOMPUTER-BASED CONTROL SYSTEMS, COMPRISING COMPUTER HARDWARE, MICROCOMPUTERS, MICROPROCESSORS, MICROCONTROLLERS AND COMPUTER SOFTWARE, FOR HEATING AND AIR CONDITIONING EQUIPMENT, LIGHTING, FIRE, SECURITY, ACCESS CONTROL, ENERGY MANAGEMENT, AND PROCESS CONTROL APPLICATIONS (U.S. CLS. 100, 103 AND 106). FIRST USE 0-0-1995; IN COMMERCE 0-0-1995.

CLASS 40—MATERIAL TREATMENT

FOR CUSTOM MANUFACTURE OF ADVANCED MICROCOMPUTER-BASED CONTROL SYSTEMS, COMPRISING COMPUTER HARDWARE, MICROCOMPUTERS, MICROPROCESSORS, MICROCONTROLLERS AND COMPUTER SOFTWARE, FOR HEATING AND AIR CONDITIONING EQUIPMENT, LIGHTING, FIRE, SECURITY, ACCESS CONTROL, ENERGY MANAGEMENT, AND PROCESS CONTROL APPLICATIONS (U.S. CLS. 100, 103 AND 106). FIRST USE 0-0-1995; IN COMMERCE 0-0-1995.

SN 76-065,785. CONSTRUCTION CONCEPTS CORP., STAMFORD, CT. FILED 6-7-2000.

SN 76-066,405. BRAUNAGEL, NORBERT, D-76228 KARLSRUHE, FED REP GERMANY, FILED 6-8-2000.



ABCR

PRIORITY CLAIMED UNDER SEC. 44(D) ON FED REP GERMANY APPLICATION NO. 39978980.401, FILED 12-13-1999, REG. NO. 39978980, DATED 2-14-2000, EXPIRES 12-31-2009.

NO CLAIM IS MADE TO THE EXCLUSIVE RIGHT TO USE "CONSTRUCTION" AND "CORP.", APART FROM THE MARK AS SHOWN.

THE TOP INTERLOCKING "C" IS BRIGHT RED; MIDDLE INTERLOCKING "C" IS BRIGHT YELLOW; BOTTOM INTERLOCKING "C" IS BLACK.

CLASS 37—CONSTRUCTION AND REPAIR

FOR CONSTRUCTION SERVICES, NAMELY, BUILDING OF NEW RESIDENTIAL HOMES; REMODELING AND RENOVATION OF RESIDENTIAL HOMES (U.S. CLS. 100, 103 AND 106). FIRST USE 11-28-1999; IN COMMERCE 11-28-1999.

CLASS 1—CHEMICALS

FOR CHEMICALS USED IN INDUSTRY, SCIENCE AND PHOTOGRAPHY, NAMELY INORGANIC AND ORGANIC FLUORINE COMPOUNDS FOR USE AS FLUORINATING AGENTS IN THE MANUFACTURE OF FLUORINATED CHEMICALS, SILICON COMPOUNDS FOR USE AS ADHESIVE PROMOTORS IN THE MANUFACTURE OF ELECTRONIC DEVICES AND AS PROTECTIVE GROUPS IN THE ORGANIC SYNTHESIS OF PHARMACEUTICALS, METALS AND METAL COMPOUNDS FOR USE IN CHEMICAL VAPOR DEPOSITION PROCESSES ON SURFACES OF SUBSTRATES; CHEMICALS USED IN INDUSTRY, SCIENCE AND PHOTOGRAPHY, NAMELY INORGANIC AND ORGANIC FLUORINE COMPOUNDS FOR USE IN THE FIELD OF THE PRODUCTION OF FLUORINATED CHEMICALS, SILICON COMPOUNDS FOR USE IN THE FIELD OF THE PRODUCTION OF ELECTRONIC DEVICES AND THE SYNTHESIS OF PHARMACEUTICALS, METALS AND METAL COMPOUNDS FOR USE IN THE FIELD OF SURFACE TREATMENT OF SUBSTRATES BY CHEMICAL VAPOR DEPOSITION (U.S. CLS. 1, 5, 6, 10, 26 AND 46).

CLASS 42—SCIENTIFIC, COMPUTER AND LEGAL SERVICES

FOR ARCHITECTURAL DESIGN AND INTERIOR DECORATION CONSULTATION (U.S. CLS. 100 AND 101). FIRST USE 3-27-2000; IN COMMERCE 3-27-2000.

CLASS 42—SCIENTIFIC, COMPUTER AND LEGAL SERVICES

FOR CHEMICAL RESEARCH IN THE FIELD OF THE SYNTHESIS OF ORGANIC COMPOUNDS, FLUORINE COMPOUNDS, SILICON COMPOUNDS AND METAL COMPOUNDS, TECHNICAL RESEARCH IN THE FIELD OF THE MANUFACTURE OF FLUORINATED CHEMICALS, THE PRODUCTION OF ELECTRONIC DEVICES, THE SYNTHESIS OF PHARMACEUTICALS AND THE SURFACE TREATMENT OF SUBSTRATES BY CHEMICAL VAPOR DEPOSITION; DEVELOPMENT AND TESTING OF CHEMICAL PRODUCTION METHODS, PARTICULARLY FOR THE SYNTHESIS OF ORGANIC COMPOUNDS, FLUORINE COMPOUNDS, SILICON COMPOUNDS AND METAL COMPOUNDS; SERVICES OF A CHEMIST; SERVICES OF A CHEMICAL LABORATORY; CHEMICAL ANALYSIS (U.S. CLS. 100 AND 101).

SN 76-067,234. HOME & DREAMS, LLC, VENTURA, CA. FILED 6-9-2000.

**Home and
Dreams.com**

NO CLAIM IS MADE TO THE EXCLUSIVE RIGHT TO USE "HOME", APART FROM THE MARK AS SHOWN.

CLASS 11—ENVIRONMENTAL CONTROL APPARATUS

FOR SCONCES AND FIREPLACES (U.S. CLS. 13, 21, 23, 31 AND 34).
FIRST USE 7-1-2000; IN COMMERCE 7-1-2000.

CLASS 19—NON-METALLIC BUILDING MATERIALS

FOR CERAMIC HEARTHES (U.S. CLS. 1, 12, 33 AND 50).
FIRST USE 7-1-2000; IN COMMERCE 7-1-2000.

CLASS 20—FURNITURE AND ARTICLES NOT OTHERWISE CLASSIFIED

FOR HOME FURNISHINGS, NAMELY MIRRORS AND SHELVES (U.S. CLS. 2, 13, 22, 25, 32 AND 50).
FIRST USE 7-1-2000; IN COMMERCE 7-1-2000.

CLASS 24—FABRICS

FOR FRAMED CANVAS WALL HANGINGS (U.S. CLS. 42 AND 50).
FIRST USE 7-1-2000; IN COMMERCE 7-1-2000.

CLASS 27—FLOOR COVERINGS

FOR CERAMIC WALL HANGINGS (U.S. CLS. 19, 20, 37, 42 AND 50).
FIRST USE 7-1-2000; IN COMMERCE 7-1-2000.

SN 76-066,998. APPLI-TEC, HAVERHILL, MA. FILED 6-9-2000.

THE LINING SHOWN IN THE DRAWING IS A FEATURE OF THE MARK.

CLASS 35—ADVERTISING AND BUSINESS

FOR PACKAGING ADHESIVES AND ENCAPSULANTS TO THE ORDER AND SPECIFICATION OF OTHERS (U.S. CLS. 100, 101 AND 102).
FIRST USE 8-0-1998; IN COMMERCE 8-0-1998.

CLASS 40—MATERIAL TREATMENT

FOR MANUFACTURE OF ADHESIVES AND ENCAPSULANTS TO THE ORDER AND SPECIFICATION OF OTHERS; APPLICATION OF ADHESIVES AND ENCAPSULANTS TO PRODUCTS IN THE ELECTRONIC, TELECOMMUNICATIONS, FIBER-OPTIC, AEROSPACE, AERONAUTIC, MEDICAL, DEFENSE, COMPUTER HARDWARE AND JEWELRY INDUSTRIES (U.S. CLS. 100, 103 AND 106).
FIRST USE 8-0-1998; IN COMMERCE 8-0-1998.

CLASS 42—SCIENTIFIC, COMPUTER AND LEGAL SERVICES

FOR CUSTOM DESIGN OF PACKAGING FOR OTHERS IN THE FIELD OF ADHESIVES AND ENCAPSULANTS (U.S. CLS. 100 AND 101).
FIRST USE 8-0-1998; IN COMMERCE 8-0-1998.

SN 76-067,329. STEWARDSHIP COMPANY, INC., REISTER-TOWN, MD. BY ASSIGNMENT LOTHAR A. VASHOLZ AND JACK G. JUSTICE, LA QUINTA, CA. FILED 6-9-2000.

CARING ANNUITY

NO CLAIM IS MADE TO THE EXCLUSIVE RIGHT TO USE "ANNUITY", APART FROM THE MARK AS SHOWN.

CLASS 16—PAPER GOODS AND PRINTED MATTER

FOR PRINTED MATTER, NAMELY PRINTED FORMS FOR USE IN PREPARING ANNUITY CONTRACTS, AS WELL AS BOOKS, PAMPHLETS AND NEWSLETTERS FEATURING INFORMATION ABOUT ANNUITY CONTRACTS (U.S. CLS. 2, 5, 22, 23, 29, 37, 38 AND 50).

CLASS 36—INSURANCE AND FINANCIAL

FOR FINANCIAL SERVICES, NAMELY, PROVIDING INVESTMENT INFORMATION AND ANNUITY UNDERWRITING, NAMELY, PROVIDING PERIODIC PAYMENT OF MONEY TO A DESIGNATED BENEFICIARY OVER A PERIOD OF TIME (U.S. CLS. 100, 101 AND 102).

SN 76-067,575. BIG COW PRODUCTIONS, INC., EAGAN, MN. FILED 6-9-2000.

**CLASS 9—ELECTRICAL AND SCIENTIFIC APPARATUS**

FOR PRERECORDED MEDIA, NAMELY AUDIO AND VIDEO CASSETTES, AUDIO TAPES AND RECORDS, AUDIO AND VIDEO DISCS, COMPUTER INTERACTIVE MEDIA, COMPACT DISCS, AND MOTION PICTURE FILM FEATURING ANIMATED CHARACTERS (U.S. CLS. 21, 23, 26, 36 AND 38).

CLASS 16—PAPER GOODS AND PRINTED MATTER

FOR CHILDREN'S BOOKS AND CHILDREN'S ACTIVITY BOOKS (U.S. CLS. 2, 5, 22, 23, 29, 37, 38 AND 50).

CLASS 41—EDUCATION AND ENTERTAINMENT

FOR EDUCATION AND ENTERTAINMENT SERVICES, NAMELY PRODUCTION OF TELEVISION SHOW CLIPS, MOVIE CLIPS, TELEVISION SHOWS, TELEVISION SERIES, MUSICALS, OR MUSIC FOR DISTRIBUTION VIA TELEVISION, AUDIO, SATELLITE, VIDEO, A GLOBAL COMPUTER NETWORK, AND COMPUTER MEDIA FEATURING ANIMATED CHARACTERS; PRODUCTION OF MOTION PICTURE FILMS FEATURING ANIMATED CHARACTERS; PUBLICATION OF STORIES, EPISODES, AND SCRIPTS FOR THEATRICAL USE FEATURING ANIMATED CHARACTERS; AND ENTERTAINMENT IN THE NATURE OF LIVE PERFORMANCES FEATURING REPRESENTATIONS OF ANIMATED CHARACTERS (U.S. CLS. 100, 101 AND 107).

SN 76-068,267. MARCO POLO EXPLORERS, INC., CINCINNATI, OH. FILED 6-12-2000.

BRAIN WEDGIES**CLASS 35—ADVERTISING AND BUSINESS**

FOR BUSINESS MARKETING CONSULTING AND BUSINESS PLANNING SERVICES; BUSINESS RESEARCH SERVICES, NAMELY RESEARCHING BUSINESS TRENDS, INDUSTRIES AND PRODUCT LINES; BUSINESS ORGANIZATIONAL CONSULTATION SERVICES, NAMELY ASSISTING COMPANIES IN DEVELOPING BUSINESS MODELS (U.S. CLS. 100, 101 AND 102).

FIRST USE 7-0-1996; IN COMMERCE 7-0-1996.

CLASS 42—SCIENTIFIC, COMPUTER AND LEGAL SERVICES

FOR RESEARCH AND DEVELOPMENT OF NEW PRODUCTS FOR OTHERS (U.S. CLS. 100 AND 101). FIRST USE 7-0-1996; IN COMMERCE 7-0-1996.

SN 76-068,749. JOSHEN PAPER & PACKAGING CO., CUYA-HOGA HEIGHTS, OH. FILED 6-12-2000.

SELECT VALUE CHOSEN WITH CARE**CLASS 3—COSMETICS AND CLEANING PREPARATIONS**

FOR CLEANING PREPARATIONS, NAMELY, LAUNDRY DETERGENTS, LIQUID HANDWASHING SOAPS, FABRIC SOFTENERS, LIQUID DISHWASHING DETERGENTS, WINDOW CLEANING PREPARATIONS, AND ALL PURPOSE HOUSEHOLD CLEANERS (U.S. CLS. 1, 4, 6, 50, 51 AND 52).

CLASS 16—PAPER GOODS AND PRINTED MATTER

FOR LUNCH BAGS AND PAPER TOWELS (U.S. CLS. 2, 5, 22, 23, 29, 37, 38 AND 50).

CLASS 21—HOUSEWARES AND GLASS

FOR PLATES AND CUPS (U.S. CLS. 2, 13, 23, 29, 30, 33, 40 AND 50).

SN 76-069,688. HONG LEONG COMPANY (MALAYSIA) BERHAD, MALAYSIA, FILED 6-13-2000.



THE MARK CONSISTS OF THREE EQUIDISTANT STRIPS SWEEPING DOWNWARDS FROM LEFT TO RIGHT, MERGING WITH THREE EQUIDISTANT STRIPS SWEEPING UPWARDS FROM LEFT TO RIGHT, AND TERMINATING ON THE RIGHT HAND SIDE WHERE THE WIDTH OF BOTH STRIPS CONVERGE. THE BOTTOM ARM OF THE LOGO IS COLORED BLUE PANTONE 287C AND SWEEPS DOWNWARDS. THE ARM SWEEPING UPWARDS IS COLORED RED PANTONE 200C. ALL THE RED ARMS OVERLAY THE BLUE ARMS OF THE CHEVRONS.

CLASS 9—ELECTRICAL AND SCIENTIFIC APPARATUS

FOR COMPUTER HARDWARE; COMPUTER SOFTWARE, NAMELY, ENCRYPTION SOFTWARE FOR CREATING ENCRYPTION KEYS, DIGITAL CERTIFICATES, AND DIGITAL SIGNATURES; SOFTWARE FOR SECURE DATA STORAGE AND RETRIEVAL AND TRANSMISSION OF CONFIDENTIAL CUSTOMER INFORMATION USED BY INDIVIDUALS, BANKING AND FINANCIAL INSTITUTIONS; MAGNETIC CODED CARDS AND CARDS CONTAINING AN INTEGRATED CIRCUIT CHIP, NAMELY, SMART CARDS CONTAINING PROGRAMMING TO FACILITATE AND ENABLE ELECTRONIC PAYMENTS; MAGNETICALLY ENCODED CREDIT, CHARGE, DEBIT, BANK AND PAYMENT CARDS; MAGNETIC CODED CARD READERS; COMPUTER SOFTWARE DESIGNED TO ENABLE SMART CARDS TO INTERACT WITH TERMINALS AND READERS; TELECOMMUNICATIONS EQUIPMENT, NAMELY, POINT OF SALE TRANSACTION TERMINALS FOR CUSTOMER INPUT AND ENCODING FOR TRANSMISSION OF ENCODED DATA TO A CENTRAL SYSTEM, AND FOR ELECTRONIC VERIFICATION AND AUTHENTICATION; COMPUTER SOFTWARE FOR TRANSMITTING, DISPLAYING AND STORING TRANSACTION, IDENTIFICATION AND FINANCIAL INFORMATION FOR USE IN THE FINANCIAL SERVICES, BANKING AND TELECOMMUNICATIONS INDUSTRIES (U.S. CLS. 21, 23, 26, 36 AND 38).

SN 76-071,421. MOLD-MASTERS LIMITED, GEORGETOWN, ONTARIO, CANADA, FILED 6-15-2000.

**CLASS 7—MACHINERY**

FOR INJECTION MOLDING EQUIPMENT, PARTS AND APPARATUS, NAMELY MANIFOLDS, NOZZLES, VALVE GATES, MOLDS, SPRUE BUSHINGS AND CONTROLS SOLD AS A UNIT, CAVITY INSERTS, STRIPPER RINGS AND CORE INSERTS; AND INDUSTRIAL ROBOT UNITS (U.S. CLS. 13, 19, 21, 23, 31, 34 AND 35).

CLASS 9—ELECTRICAL AND SCIENTIFIC APPARATUS

FOR CONTROLLED MOLD COOLING EQUIPMENT, NAMELY ELECTRICAL CONTROLLERS AND COMPUTER AND VIDEO MONITORS (U.S. CLS. 21, 23, 26, 36 AND 38).

CLASS 11—ENVIRONMENTAL CONTROL APPARATUS

FOR INJECTION MOLDING EQUIPMENT, PARTS AND APPARATUS, NAMELY HEATERS (U.S. CLS. 13, 21, 23, 31 AND 34).

CLASS 36—INSURANCE AND FINANCIAL

FOR FINANCIAL ANALYSIS AND CONSULTATION; FINANCIAL EXCHANGE; FINANCIAL FORECASTING; FINANCIAL GUARANTEE AND SURETY; FINANCIAL INFORMATION IN THE NATURE OF RATES OF EXCHANGE; FINANCIAL INFORMATION PROVIDED BY ELECTRONIC MEANS; FINANCIAL INVESTMENT IN THE FIELD OF SECURITIES; FINANCIAL MANAGEMENT; FINANCIAL PLANNING; FINANCIAL PORTFOLIO MANAGEMENT; FINANCIAL RESEARCH; LAND ACQUISITION, NAMELY, REAL ESTATE BROKERAGE SERVICES; FINANCIAL INVESTMENT IN THE FIELD OF REAL ESTATE; REAL ESTATE INVESTMENT; ACCIDENT INSURANCE UNDERWRITING; INSURANCE ACTUARIAL SERVICES; INSURANCE ADMINISTRATION; INSURANCE ADMINISTRATION IN THE FIELD OF HOME, ACCIDENT AND FIRE; INSURANCE AGENCIES IN THE FIELD OF HOME, ACCIDENT AND FIRE; INSURANCE BROKERAGE; INSURANCE BROKERAGE IN THE FIELD OF HOME, ACCIDENT AND FIRE; INSURANCE CLAIMS ADMINISTRATION; INSURANCE CLAIMS PROCESSING; INSURANCE CONSULTATION; ELECTRONIC PROCESSING OF INSURANCE CLAIMS AND PAYMENT DATA; EXTENDED WARRANTY CONTRACTS IN THE FIELD OF AUTOMOBILES AND HOUSEHOLD PRODUCTS (U.S. CLS. 100, 101 AND 102).

CLASS 40—MATERIAL TREATMENT

FOR CUSTOM MOLDING SERVICES, PROVIDING AN ONLINE DATA BASE FEATURING DESIGNS AND SPECIFICATIONS FOR MOLDING EQUIPMENT (U.S. CLS. 100, 103 AND 106).

CLASS 41—EDUCATION AND ENTERTAINMENT

FOR EDUCATION SERVICES, NAMELY, CONDUCTING LECTURES, SEMINARS AND DISCUSSIONS RELATING TO THE MOLDING INDUSTRY (U.S. CLS. 100, 101 AND 107).

CLASS 42—SCIENTIFIC, COMPUTER AND LEGAL SERVICES

FOR PLANNING AND DESIGN SERVICES FOR MOLDING SYSTEMS AND RELATED MOLD ENGINEERING TECHNOLOGY FOR OTHERS (U.S. CLS. 100 AND 101).

SN 76-071,863. COHEN, ELLEN, CHESTNUT HILL, MA.
FILED 6-16-2000.

THE SCHWARTZ CENTER

NO CLAIM IS MADE TO THE EXCLUSIVE RIGHT TO USE "CENTER", APART FROM THE MARK AS SHOWN. SEC. 2(F).

CLASS 41—EDUCATION AND ENTERTAINMENT

FOR EDUCATIONAL SERVICES, NAMELY, CONDUCTING WORKSHOPS, TRAINING PROGRAMS, AND CONTINUING MEDICAL EDUCATION COURSES AND SEMINARS IN THE AREAS OF CULTURAL COMPETENCY, SPIRITUALITY, END OF LIFE CARE AND COMMUNICATION SKILLS (U.S. CLS. 100, 101 AND 107).

FIRST USE 5-0-1996; IN COMMERCE 5-0-1996.

CLASS 42—SCIENTIFIC, COMPUTER AND LEGAL SERVICES

FOR ASSOCIATION SERVICES, NAMELY, PROMOTING THE INTERESTS OF PATIENTS AND CAREGIVERS TO FACILITATE COMPASSIONATE HEALTH CARE DELIVERY THROUGHOUT THE ENTIRE HEALTH CARE DELIVERY PROCESS AND CONDUCTING SUPPORT GROUPS FOR THE SERIOUSLY ILL, THEIR FAMILIES AND CAREGIVERS (U.S. CLS. 100 AND 101).

FIRST USE 5-0-1996; IN COMMERCE 5-0-1996.

SN 76-073,792. PENTAGON TECHNOLOGIES GROUP, INC.,
FREMONT, CA. FILED 6-20-2000.



NO CLAIM IS MADE TO THE EXCLUSIVE RIGHT TO USE "TECHNOLOGIES", APART FROM THE MARK AS SHOWN.

THE MARK CONSISTS OF A THREE-DIMENSIONAL VIEW OF A PENTAGON SURROUNDING A STYLIZED GLOBE.

CLASS 35—ADVERTISING AND BUSINESS

FOR RETAIL SERVICES BY DIRECT SOLICITATION OF SALES AGENTS IN THE FIELD OF EQUIPMENT AND PRODUCTS USED IN CREATING, OPERATING, OR MAINTAINING CLEANROOM ENVIRONMENTS (U.S. CLS. 100, 101 AND 102).

FIRST USE 3-0-1999; IN COMMERCE 3-0-1999.

CLASS 37—CONSTRUCTION AND REPAIR

FOR CLEANING OF ENCLOSURES, EQUIPMENT, OR EQUIPMENT PARTS USED IN CREATING, OPERATING OR MAINTAINING CLEANROOM ENVIRONMENTS (U.S. CLS. 100, 103 AND 106).

FIRST USE 3-0-1999; IN COMMERCE 3-0-1999.

CLASS 42—SCIENTIFIC, COMPUTER AND LEGAL SERVICES

FOR TESTING OF ENCLOSURES, EQUIPMENT OR EQUIPMENT PARTS USED IN CREATING, OPERATING OR MAINTAINING CLEANROOM ENVIRONMENTS FOR THE PURPOSE OF CERTIFICATION (U.S. CLS. 100 AND 101).

FIRST USE 3-1-1999; IN COMMERCE 3-1-1999.

SN 76-073,817. RDI MARKETING SERVICES, INC., CINCINNATI, OH. FILED 6-19-2000.

ALIVE

CLASS 35—ADVERTISING AND BUSINESS

FOR BUSINESS MARKETING CONSULTING SERVICES FEATURING FOCUS GROUP TESTING OF MARKETING CONCEPTS, PRODUCTS, MENU ITEMS, BRAND EQUITY, FLAVORS AND NAMES FOR BUSINESS CLIENTS (U.S. CLS. 100, 101 AND 102).

CLASS 42—SCIENTIFIC, COMPUTER AND LEGAL SERVICES

FOR TESTING IN THE NATURE OF CONDUCTING PUBLIC OPINION POLL SURVEYS ON POLITICAL ISSUES (U.S. CLS. 100 AND 101).

SN 76-074,363. ECOSAFE, L.L.C., SARASOTA, FL. FILED 6-21-2000.

ECO-CURE

CLASS 1—CHEMICALS

FOR CHEMICALS, NAMELY SOLID OXIDANTS USED IN OXYGEN REDUCTION CHEMICAL REACTIONS SUCH AS REMOVAL OF CYANIDE, HYDROGEN SULFIDE AND ARSENIC FROM FLUID WASTE, WATER AND WASTE WATER (U.S. CLS. 1, 5, 6, 10, 26 AND 46).

CLASS 5—PHARMACEUTICALS

FOR FERRATE-BASED PHARMACEUTICAL PREPARATION FOR USE AS A BLOOD FLOW COAGULANT AND IN HEMOSTASIS; BUM, SURGICAL AND WOUND DRESSINGS; AND AQUACULTURE DISINFECTANTS IN DRY POWDER AND GRANULAR FORM (U.S. CLS. 6, 18, 44, 46, 51 AND 52).

SN 76-075,960. H. H. HAUBERG APS, 3450 ALLEROD, DENMARK, FILED 6-23-2000.

H.A.I.R. SCAN

CLASS 5—PHARMACEUTICALS

FOR ABSORBENT COTTON FOR MEDICAL PURPOSES; ADHESIVE BANDAGES IN THE FORM OF BANDS FOR MEDICAL PURPOSES; ADHESIVE BANDAGES; ADHESIVE TAPES FOR MEDICAL PURPOSES; ALCOHOL FOR TOPICAL USE; ALL PURPOSE DISINFECTANTS FOR HYGIENE PURPOSES; ALL PURPOSE DISINFECTANTS; ALLERGY MEDICATIONS; ANTI-BACTERIAL PHARMACEUTICALS; ANTISEPTIC COTTON FOR MEDICAL PURPOSES; ATHLETES FOOT LOTIONS; BANDAGES FOR SKIN WOUNDS; BATH SALTS FOR MEDICAL PURPOSES; BIOLOGICAL PREPARATIONS FOR THE TREATMENT OF ACUTE AND CHRONIC INFLAMMATORY DISEASES; BISMUTH PREPARATIONS FOR PHARMACEUTICAL PURPOSES; BOUILLONS FOR BACTERIOLOGICAL CULTURES; BURN DRESSING; CALAMINE LOTION; CARDIOVASCULAR PHARMACEUTICALS; CELLULOSE ESTERS FOR PHARMACEUTICAL PURPOSES; CONTACT LENS DISINFECTANTS; COTTON FOR MEDICAL PURPOSES; DENTAL ABRASIVES; DENTAL WAX; DISINFECTANTS FOR MEDICAL INSTRUMENTS; DIETARY SUPPLEMENTS FOR MEDICAL USE; DISINFECTANT SOAPS; DISINFECTANTS FOR CHEMICAL TOILETS; DISINFECTING HANDWASH FOR HYGIENE PURPOSES; DISINFECTING HANDWASH; FEMININE HYGIENE PADS; FOOD FOR BABIES; FOOD FOR MEDICALLY RESTRICTED DIETS; MATERIAL FOR STOPPING TEETH; MEDICAL HERBAL SUPPLEMENTS; MEDICAL PLASTERS; MEDICATED LOTIONS FOR USE ON SKIN, HAIR, SUNBURN, FACE AND BODY; MEDICINAL OILS FOR USE ON THE SKIN FOR TEMPORARY RELIEF OF MINOR PAINS AND SORE MUSCLES; PHARMACEUTICAL AND MEDICATED PREPARATIONS, NAMELY, CAMPHOR OIL; PHARMACEUTICAL PREPARATION NAMELY, ANTICOAGULANTS; PHARMACEUTICAL PREPARATIONS NAMELY, ANTIDEPRESSANTS; PHARMACEUTICAL PREPARATIONS NAMELY, APPELITE SUPPRESSANTS; PREPARATIONS FOR DESTROYING VERMIN; RUBBING ALCOHOL; SANITARY NAPKINS; SANITIZERS FOR HOSPITAL USE; SANITIZERS FOR HOUSEHOLD USE; SANITIZERS FOR USE IN INSTITUTIONAL AND INDUSTRIAL AREAS; SURGICAL BANDAGES; SURGICAL DRESSINGS; VETERINARY VACCINES FOR BOVINE, SHEEP AND HORSES; WOUND DRESSINGS; AND NONE OF THE AFOREMENTIONED GOODS FOR THE TREATMENT OF HAIR (U.S. CLS. 6, 18, 44, 46, 51 AND 52).

CLASS 42—SCIENTIFIC, COMPUTER AND LEGAL SERVICES

FOR AGRICULTURAL ADVICE; ANIMAL BREEDING; BACTERIOLOGICAL CONSULTATION AND TESTING; BACTERIOLOGICAL RESEARCH; BAR SERVICES; BEAUTY SALONS; BIOLOGICAL RESEARCH; CAFES; CAFETERIAS; CANTEENS; CATERING; CHEMICAL ANALYSIS; CHEMICAL RESEARCH; CHEMISTRY CONSULTATION; CHILD CARE SERVICES; CLOTHING RENTAL; COMPUTER PROGRAMMING FOR OTHERS; COMPUTER RENTAL; COMPUTER SOFTWARE DESIGN; COMPUTER SOFTWARE DESIGN FOR OTHERS; COMPUTER SYSTEMS ANALYSIS; CONSULTING IN THE FIELD OF COMPUTER HARDWARE; COSMETIC RESEARCH; DATING SERVICES; EMERGENCY MEDICAL ASSISTANCE; GENEALOGICAL RESEARCH; GEOLOGICAL RESEARCH; HEALTH SPAS; HOTELS; MEDICAL SERVICES; INDUSTRIAL DESIGNS; INTELLECTUAL PROPERTY CONSULTANCY; LICENSING OF INTELLECTUAL PROPERTY; MAKING HOTEL RESERVATIONS FOR OTHERS; MANICURING; MEDICAL ASSISTANCE; MEDICAL CLINICS; NURSERY DAY CARE CENTERS; PERSONAL BODY GUARDING; PERSONAL HYGIENE CONSULTATION; PRODUCT RESEARCH; PROVIDING PUBLIC BATH FACILITIES FOR HYGIENE PURPOSES; PROVIDING TEMPORARY HOUSING ACCOMMODATIONS; PROVIDING TEMPORARY USE OF ON-LINE NON-DOWNLOADABLE SOFTWARE FOR USE IN DATABASE MANAGEMENT;

PROVIDING TURKISH BATH FACILITIES; RENTAL OF AGRICULTURAL EQUIPMENT; RENTAL OF CHAIRS, TABLES, TABLE LINEN, GLASSWARE; RENTAL OF COMPUTER SOFTWARE; RENTAL OF SANITATION FACILITIES; RESTAURANT SERVICES; RESTAURANTS; SALAD BARS; SELF SERVICE RESTAURANTS; SKIN CARE SALONS; SNACK BARS; TEXTILE TESTING; TRAVEL AGENCY SERVICES, NAMELY, MAKING RESERVATIONS AND BOOKING FOR TEMPORARY LODGING; UPDATING OF COMPUTER SOFTWARE; VIDEOTAPING; AND NONE OF THE AFOREMENTIONED SERVICES FOR THE TREATMENT OF HAIR (U.S. CLS. 100 AND 101).

SN 76-077,047. IGA FINANCE B.V., 3016 CN ROTTERDAM, HOLLAND, NETHERLANDS, FILED 6-23-2000.

roberto cavalli

OWNER OF U.S. REG. NOS. 2,305,384 AND 2,361,172. THE PERSON IDENTIFIED IN THE MARK IS A LIVING INDIVIDUAL WHOSE CONSENT IS OF RECORD.

CLASS 14—JEWELRY

FOR WATCHES, CLOCKS, COSTUME JEWELRY, JEWELS, CUFFLINKS, TIE PINS (U.S. CLS. 2, 27, 28 AND 50).

CLASS 16—PAPER GOODS AND PRINTED MATTER

FOR ART PRINTS (U.S. CLS. 2, 5, 22, 23, 29, 37, 38 AND 50).

CLASS 20—FURNITURE AND ARTICLES NOT OTHERWISE CLASSIFIED

FOR FURNITURE, FURNITURE MIRRORS, PICTURE FRAMES (U.S. CLS. 2, 13, 22, 25, 32 AND 50).

CLASS 27—FLOOR COVERINGS

FOR CARPETS, RUGS, MATS AND MATTING FOR COVERING FLOORS; LINOLEUM, WALL HANGINGS, NOT OF TEXTILE (U.S. CLS. 19, 20, 37, 42 AND 50).

SN 76-078,869. CERTILEARN, INC., HERNDON, VA. FILED 6-28-2000.

CERTILEARN E-LEARNING FOR ASSOCIATIONS

NO CLAIM IS MADE TO THE EXCLUSIVE RIGHT TO USE "E-LEARNING FOR ASSOCIATIONS", APART FROM THE MARK AS SHOWN.

CLASS 41—EDUCATION AND ENTERTAINMENT

FOR DEVELOPMENT AND DISSEMINATION OF EDUCATIONAL MATERIALS OF OTHERS IN THE FIELD OF TRAINING MEMBERS AND CUSTOMERS OF ASSOCIATIONS, UNIONS, CHAMBERS OF COMMERCE AND OTHER ORGANIZATIONS (U.S. CLS. 100, 101 AND 107).

CLASS 42—SCIENTIFIC, COMPUTER AND LEGAL SERVICES

FOR COMPUTER SERVICES, NAMELY, DESIGN AND IMPLEMENTATION OF WEBSITES AND COMPUTER NETWORKS FOR OTHERS; CONSULTATION IN THE FIELD OF COMPUTERS AND COMPUTER SOFTWARE FOR USE IN ON-LINE LEARNING; AND PRINTING AND GRAPHIC AND GRAPHIC ART DESIGN FOR EDUCATION MATERIAL (U.S. CLS. 100 AND 101).

SN 76-080,113. TMAX SOFT CO., LTD., YOKSAM-DONG, KANGNAM-KU, REPUBLIC OF KOREA, FILED 6-29-2000.

SN 76-079,159. TELAID INDUSTRIES, INC., NIAN TIC, CT. FILED 6-28-2000.

CLASS 9—ELECTRICAL AND SCIENTIFIC APPARATUS

FOR ELECTRONIC PRODUCTS USED IN THE FIELD OF COMMERCIAL TELECOMMUNICATIONS, NAMELY, MICROPHONES, INTERCOM EQUIPMENT, HANDS FREE INTERCOM EQUIPMENT, SQUAWK BOXES, TELEPHONE AUDIO SPEAKERS (U.S. CLS. 21, 23, 26, 36 AND 38).

CLASS 38—COMMUNICATION

FOR TELECOMMUNICATION SERVICES, NAMELY, AUDIO AND VIDEO BROADCASTING; TELEPHONE COMMUNICATION SERVICES, NAMELY, LONG DISTANCE AND LOCAL TELEPHONE SERVICES, PORTABLE AND STATIONARY AUDIO AND VIDEO TELECONFERENCING SERVICES; TELECOMMUNICATIONS SERVICES, NAMELY PERSONAL COMMUNICATION SERVICES; RADIO COMMUNICATION SERVICES; ELECTRONIC VOICE MESSAGING, NAMELY, THE RECORDING, STORAGE, AND SUBSEQUENT TRANSMISSION OF VOICE MESSAGES BY TELEPHONE; VOICE MAIL SERVICES, VIDEO BROADCASTING; ELECTRONIC TRANSMISSION OF MESSAGES AND DATA; ELECTRONIC DATA INTERCHANGE (EDI) SERVICES; NETWORK CONFERENCING SERVICES, NAMELY, NETWORKING SYSTEMS FOR INTEGRATING COMPUTER HARDWARE AND COMPUTER SOFTWARE; AUDIO BROADCASTING SERVICES (U.S. CLS. 100, 101 AND 104).

CLASS 42—SCIENTIFIC, COMPUTER AND LEGAL SERVICES

FOR DESIGN, DEVELOPMENT AND IMPLEMENTATION OF INTERNAL VOICE, VIDEO AND DATASYSTEMS, VIDEO, AUDIO AND TELEPHONE SYSTEMS, CABLING EQUIPMENT, INTEGRATED COMPUTER SYSTEMS, INTEGRATED TELECOMMUNICATION SYSTEMS, INCLUDING HARDWARE AND SOFTWARE; CONSULTING SERVICES, NAMELY, CUSTOM DESIGN OF TELECOMMUNICATIONS SYSTEMS AND SOLUTIONS FOR BUSINESSES AND EDUCATIONAL INSTITUTIONS (U.S. CLS. 100 AND 101).

PRIORITY CLAIMED UNDER SEC. 44(D) ON REPUBLIC OF KOREA APPLICATION NO. 2000-2224, FILED 5-4-2000.

CLASS 9—ELECTRICAL AND SCIENTIFIC APPARATUS

FOR MULTIMEDIA COMPUTER SOFTWARE RECORDED ON CD-ROM FOR USE IN CONNECTION WITH WEB SERVER; COMPUTER OPERATING PROGRAMS RECORDED ON MAGNETIC MEDIA; COMPUTER PROGRAMS RECORDED ON CD-ROM FOR THE OPERATION OF WEB SERVER (U.S. CLS. 21, 23, 26, 36 AND 38).

CLASS 35—ADVERTISING AND BUSINESS

FOR RETAIL STORE SERVICES FEATURING COMPUTER SOFTWARE (U.S. CLS. 100, 101 AND 102).

CLASS 42—SCIENTIFIC, COMPUTER AND LEGAL SERVICES

FOR COMPUTER SERVICES, NAMELY, UPDATING OF COMPUTER SOFTWARE FOR OTHERS, MAINTENANCE OF COMPUTER SOFTWARE FOR OTHERS, COMPUTER SYSTEMS ANALYSIS, COMPUTER PROGRAMMING FOR OTHERS (U.S. CLS. 100 AND 101).

SN 76-082,236. VALUE SELLING SYSTEMS, INC., RANCHO SANTA FE, CA. FILED 7-3-2000.

NO CLAIM IS MADE TO THE EXCLUSIVE RIGHT TO USE "VALUE SELLING", "BUSINESS" AND "ASSOCIATES", APART FROM THE MARK AS SHOWN.

THE LINING SHOWN IN THE DRAWING IS A FEATURE OF THE MARK.

CLASS 35—ADVERTISING AND BUSINESS

FOR PROVIDING BUSINESS INFORMATION IN THE FIELD OF SALES AND MARKETING VIA THE GLOBAL COMPUTER NETWORK (U.S. CLS. 100, 101 AND 102). FIRST USE 3-24-2000; IN COMMERCE 3-24-2000.

CLASS 41—EDUCATION AND ENTERTAINMENT

FOR EDUCATIONAL SERVICES, NAMELY, PROVIDING ONLINE CLASSES, SEMINARS, CONFERENCES AND WORKSHOPS IN THE FIELD OF BUSINESS AND MARKETING AND DISTRIBUTING COURSE MATERIALS IN CONNECTION THEREWITH; TRAINING SERVICES IN THE FIELD OF BUSINESS AND MARKETING IMPROVEMENTS; PROVIDING TRAINING INFORMATION IN THE FIELD OF BUSINESS SALES AND MARKETING VIA THE GLOBAL COMPUTER NETWORK (U.S. CLS. 100, 101 AND 107).

FIRST USE 3-24-2000; IN COMMERCE 3-24-2000.

SN 76-083,737. BAAN DEVELOPMENT B.V., HERNDON, VA. FILED 7-6-2000.

BAAN E-START**CLASS 35—ADVERTISING AND BUSINESS**

FOR BUSINESS MANAGEMENT CONSULTATION AND BUSINESS CONSULTATION IN THE FIELD OF ELECTRONIC COMMERCE (U.S. CLS. 100, 101 AND 102).

FIRST USE 3-15-2000; IN COMMERCE 3-15-2000.

CLASS 42—SCIENTIFIC, COMPUTER AND LEGAL SERVICES

FOR INSTALLATION, MAINTENANCE AND REPAIR OF COMPUTER PROGRAMS IN THE FIELD OF ELECTRONIC COMMERCE; COMPUTER PROGRAMMING FOR OTHERS, TECHNICAL CONSULTATION IN THE FIELD OF ELECTRONIC COMMERCE, AND TECHNICAL SUPPORT SERVICES, NAMELY, TROUBLE SHOOTING OF COMPUTER SOFTWARE FOR ELECTRONIC COMMERCE PROBLEMS VIA TELEPHONE, E-MAIL OR IN PERSON (U.S. CLS. 100 AND 101).

FIRST USE 3-15-2000; IN COMMERCE 3-15-2000.

SN 76-085,530. BEVERAGE BRANDS (UK) LIMITED, TORQUAY, DEVON, UNITED KINGDOM, FILED 7-7-2000.

CA'QUILA

PRIORITY CLAIMED UNDER SEC. 44(D) ON UNITED KINGDOM APPLICATION NO. 2225635, FILED 3-14-2000, REG. NO. 2225635, DATED 8-25-2000, EXPIRES 3-14-2010.

CLASS 32—LIGHT BEVERAGES

FOR BEERS AND ALES, FRUIT FLAVORED MALT BEERS, NON-ALCOHOLIC MALT BEVERAGES WITH OTHER NATURAL FLAVORS, NON-ALCOHOLIC MALT BEVERAGES WITH MIXED FRUIT FLAVORS, MALT BEER WITH TEQUILA FLAVORS, MALT BEERS WITH FRUIT AND TEQUILA FLAVORS, NON-ALCOHOLIC BEVERAGES, NAMELY, MINERAL AND AERATED WATERS, SOFT DRINKS, FRUIT DRINKS AND FRUIT JUICES; CONCENTRATES, SYRUPS OR POWDERS USED IN THE PREPARATION OF SOFT DRINKS, FRUIT JUICES AND FRUIT DRINKS (U.S. CLS. 45, 46 AND 48).

CLASS 33—WINES AND SPIRITS

FOR ALCOHOLIC BEVERAGES PRODUCED FROM A BREWED MALT BASE WITH TEQUILA FLAVORS; ALCOHOLIC BEVERAGES PRODUCED FROM A BREWED MALT BASE WITH NATURAL FLAVORS; ALCOHOLIC BEVERAGES PRODUCED FROM A BREWED MALT BASE WITH MIXED FRUIT FLAVORS; ALCOHOLIC BEVERAGES PRODUCED FROM A BREWED MALT BASE WITH FRUIT AND TEQUILA FLAVORS; PREPARED ALCOHOLIC COCKTAILS WITH TEQUILA FLAVORING; PREPARED ALCOHOLIC COCKTAILS MADE FROM OR CONTAINING TEQUILA (U.S. CLS. 47 AND 49).

SN 76-086,097. TWP ENTERPRISES, INC, CHEVY CHASE, MD. FILED 7-10-2000.

TW PERRY

THE NAME "TW PERRY" IDENTIFIES AN INDIVIDUAL WHO IS NOW DECEASED.

CLASS 35—ADVERTISING AND BUSINESS

FOR RETAIL STORE SERVICES IN THE FIELD OF BUILDING MATERIALS AND SUPPLIES (U.S. CLS. 100, 101 AND 102).

FIRST USE 8-30-1999; IN COMMERCE 8-30-1999.

CLASS 37—CONSTRUCTION AND REPAIR

FOR DOOR AND WINDOW INSTALLATION SERVICES (U.S. CLS. 100, 103 AND 106).

FIRST USE 8-30-1999; IN COMMERCE 8-30-1999.

SN 76-086,646. ASTEX TECHNOLOGY LIMITED, LONDON SW1Y 6 DN, ENGLAND, FILED 7-11-2000.

HTX

PRIORITY CLAIMED UNDER SEC. 44(D) ON ERP N CMNTY TM OFC APPLICATION NO. 001673623, FILED 5-18-2000, REG. NO. 1673623, DATED 9-17-2001, EXPIRES 5-18-2010.

CLASS 1—CHEMICALS

FOR CHEMICALS, NAMELY, CHEMICAL COMPOUNDS FOR USE IN BIOTECHNOLOGY, DRUG DISCOVERY, AND THE MANUFACTURE AND DEVELOPMENT OF PHARMACEUTICALS (U.S. CLS. 1, 5, 6, 10, 26 AND 46).

CLASS 9—ELECTRICAL AND SCIENTIFIC APPARATUS

FOR COMPUTER SOFTWARE FOR MANIPULATION AND PRESENTATION OF DATA FOR USE IN RELATION TO DRUG DISCOVERY; COMPUTER SOFTWARE FOR MANIPULATION AND PRESENTATION OF DATA FOR USE IN RELATION TO BIOTECHNOLOGY RESEARCH (U.S. CLS. 21, 23, 26, 36 AND 38).

CLASS 42—SCIENTIFIC, COMPUTER AND LEGAL SERVICES

FOR DRUG DISCOVERY SERVICES; BIOTECHNOLOGY RESEARCH; SCIENTIFIC ANALYSIS (U.S. CLS. 100 AND 101).

SN 76-086,680. DUKE UNIVERSITY, DURHAM, NC. FILED 7-11-2000.

PRIVATE ADJUDICATION CENTER

NO CLAIM IS MADE TO THE EXCLUSIVE RIGHT TO USE "ADJUDICATION CENTER", APART FROM THE MARK AS SHOWN.
SEC. 2(F).

CLASS 41—EDUCATION AND ENTERTAINMENT

FOR TRAINING AND TEACHING IN THE FIELDS OF DISPUTE RESOLUTION, MEDIATION, MEDIATION CERTIFICATION, AND ARBITRATION, AND CONDUCTING SEMINARS AND WORKSHOPS IN THE FIELDS OF DISPUTE RESOLUTION, MEDIATION, MEDIATION CERTIFICATION, AND ARBITRATION (U.S. CLS. 100, 101 AND 107).

FIRST USE 1-0-1983; IN COMMERCE 1-0-1983.

CLASS 42—SCIENTIFIC, COMPUTER AND LEGAL SERVICES

FOR ALTERNATIVE DISPUTE RESOLUTION SERVICES, ARBITRATION SERVICES, MEDIATION SERVICES, CONSULTATION AND RESEARCH IN THE FIELD OF DISPUTE RESOLUTION, AND EXPERT WITNESS REFERRAL SERVICES IN THE FIELD OF SCIENTIFIC AND TECHNICAL CONSULTATION (U.S. CLS. 100 AND 101).

FIRST USE 1-0-1983; IN COMMERCE 1-0-1983.

SN 76-087,600. UNIGRIDENERGY, LLC, PHILADELPHIA, PA. FILED 7-12-2000.

UNIGRIDENERGY.COM

CLASS 35—ADVERTISING AND BUSINESS

FOR ON-LINE TRADING SERVICES TO FACILITATE THE PURCHASE AND SALE OF ENERGY BY OTHERS VIA A GLOBAL COMPUTER NETWORK; SCHEDULING OF THE TRANSMISSION OF ENERGY FOR OTHERS VIA A GLOBAL COMPUTER NETWORK; PROVIDING AN ON-LINE COMPUTER DATABASE FEATURING CURRENT AND HISTORICAL INFORMATION ON THE ENERGY MARKET; PROVIDING INFORMATION CONCERNING THE ENERGY MARKET VIA A GLOBAL COMPUTER NETWORK; OPERATING AN ON-LINE MARKETPLACE FOR SELLERS AND PURCHASERS OF ENERGY (U.S. CLS. 100, 101 AND 102).

FIRST USE 6-1-2000; IN COMMERCE 6-1-2000.

CLASS 36—INSURANCE AND FINANCIAL

FOR PROVIDING BROKERAGE SERVICES IN THE FIELD OF ENERGY (U.S. CLS. 100, 101 AND 102).

FIRST USE 6-1-2000; IN COMMERCE 6-1-2000.

SN 76-087,628. DE VERA, ALAIN, 94230 CACHAN, FRANCE, FILED 7-12-2000.

INSURIO

PRIORITY CLAIMED UNDER SEC. 44(D) ON FRANCE APPLICATION NO. 003001075, FILED 1-12-2000, REG. NO. 003001075, DATED 1-12-2000, EXPIRES 1-12-2010.

CLASS 9—ELECTRICAL AND SCIENTIFIC APPARATUS

FOR MAGNETIC, OPTICAL, PICTURE AND SOUND MEDIA, NAMELY, MEDIA TAPES, VIDEO TAPES, CD-ROMS, AND DISKETTES WITH EDITORIAL AND INFORMATIVE CONTENT; DATA PROCESSORS; SOFTWARE FOR PROVIDING INSURANCE INFORMATION; SOFTWARE FOR ACCOUNTING; SOFTWARE FOR FINANCIAL INFORMATION; COMPUTER SYSTEMS, NAMELY, PROCESSORS FOR PROVIDING ON-LINE SERVICES DELIVERY, SOFTWARE DEVELOPMENT, AND DEVELOPMENT APPLICATION SERVICES; VIDEO TAPES PRESENTING FINANCIAL PRODUCTS; VIDEO TAPES PRESENTING INSURANCE PRODUCTS (U.S. CLS. 21, 23, 26, 36 AND 38).

CLASS 35—ADVERTISING AND BUSINESS

FOR DIRECT MARKETING SERVICES RELATED TO ADVERTISER PROMOTION AND E-MARKETING; ADVERTISING SERVICES FOR THE IMPLEMENTATION OF COMMUNICATIONS WITH THIRD PARTIES, NAMELY, ONLINE SERVICES FOR PROMOTIONAL ADVERTISING, E-MAILING, E-MARKETING, AND DIRECT MARKETING; PROVIDING BUSINESS ADVICE, INFORMATION AND INTELLIGENCE; CONDUCTING MARKETING STUDIES, MARKET RESEARCH AND TEST MARKETING; STATISTICAL ANALYSIS SERVICES; TYPING AND SHORTHAND SERVICES; PROFESSIONAL CONSULTING AND PLANNING UNRELATED TO BUSINESS MANAGEMENT RELATED TO MARKETING AND CUSTOMER RELATIONS INFORMATION (U.S. CLS. 100, 101 AND 102).

CLASS 36—INSURANCE AND FINANCIAL

FOR INSURANCE INVESTMENT SERVICES; FINANCIAL COUNSELING; FINANCIAL AFFAIR SERVICES; MONETARY AFFAIR SERVICES; STOCK EXCHANGE PRICE QUOTATIONS; MUTUAL FUNDS BROKERAGE, DISTRIBUTION AND INVESTMENT; MONETARY EXCHANGE SERVICES; FISCAL ASSESSMENT SERVICES; FIDUCIARY REPRESENTATIVE SERVICES; FINANCING SERVICES; FINANCIAL MANAGEMENT SERVICES; FORTUNE MANAGEMENT SERVICES; BANKING SERVICES; REAL ESTATE INVESTMENT AND BROKERAGE SERVICES; REAL ESTATE APPRAISAL SERVICES; FISCAL ASSESSMENT AND TAX ASSESSMENT SERVICES (U.S. CLS. 100, 101 AND 102).

CLASS 38—COMMUNICATION

FOR RADIO AND TELEVISION BROADCASTING SERVICES (U.S. CLS. 100, 101 AND 104).

CLASS 42—SCIENTIFIC, COMPUTER AND LEGAL SERVICES

FOR SERVICES FOR PROVIDING TEMPORARY USE OF ON-LINE NONDOWNLOADABLE SOFTWARE FOR USE IN DATABASE MANAGEMENT AND DATA PROCESSING; ENGINEERING SERVICES; NEWS AGENCY SERVICES (U.S. CLS. 100 AND 101).

SN 76-088,060. TIRABASSI, REBECCA A., NEWPORT BEACH, CA. FILED 7-13-2000.

CHANGE YOUR LIFE DAILY

OWNER OF U.S. REG. NO. 2,130,368.

CLASS 16—PAPER GOODS AND PRINTED MATTER

FOR PRINTED MATERIALS, NAMELY, BOOKS AND MAGAZINES, IN THE FIELD OF SELF IMPROVEMENT AND PERSONAL DEVELOPMENT (U.S. CLS. 2, 5, 22, 23, 29, 37, 38 AND 50).

FIRST USE 12-31-1997; IN COMMERCE 12-31-1997.

CLASS 41—EDUCATION AND ENTERTAINMENT

FOR EDUCATION AND ENTERTAINMENT SERVICES, NAMELY, PROVIDING SELF IMPROVEMENT AND PERSONAL DEVELOPMENT MESSAGES AND INSTRUCTION VIA THE INTERNET (U.S. CLS. 100, 101 AND 107).

FIRST USE 4-15-1999; IN COMMERCE 4-15-1999.

SN 76-088,959. LINKS POINT, INC., NORWALK, CT. FILED 7-14-2000.

LINKS POINT**CLASS 9—ELECTRICAL AND SCIENTIFIC APPARATUS**

FOR COMPUTER SOFTWARE FOR ACCESSING, MANAGING, AND DISPLAYING GLOBAL POSITIONING SYSTEM (GPS) DATA ON MOBILE COMPUTING DEVICES (U.S. CLS. 21, 23, 26, 36 AND 38).

CLASS 42—SCIENTIFIC, COMPUTER AND LEGAL SERVICES

FOR COMPUTER CONSULTATION SERVICES IN THE FIELD OF GLOBAL POSITIONING SYSTEMS (GPS), NAMELY, CONSULTATION RELATED TO THE ACCESS AND USE OF INFORMATION STORED ON GPS SYSTEMS (U.S. CLS. 100 AND 101).

SN 76-089,046. SITRAKA INC., TORONTO ONTARIO, CANADA, BY CHANGE OF NAME KL GROUP INC., TORONTO, ONTARIO, FILED 7-17-2000.

DEPLOYDIRECTOR

PRIORITY CLAIMED UNDER SEC. 44(D) ON CANADA APPLICATION NO. 1053047, FILED 3-30-2000, REG. NO. TMA560197, DATED 4-15-2002, EXPIRES 4-15-2017.

CLASS 9—ELECTRICAL AND SCIENTIFIC APPARATUS

FOR COMPUTER SOFTWARE UTILITY DEVELOPMENT PROGRAMS WHICH ASSIST OR SUPPORT OTHER SOFTWARE PRODUCTS (U.S. CLS. 21, 23, 26, 36 AND 38).

CLASS 42—SCIENTIFIC, COMPUTER AND LEGAL SERVICES

FOR DATABASE AND SOFTWARE DEVELOPMENT SERVICES, AND MAINTENANCE OF COMPUTER SOFTWARE (U.S. CLS. 100 AND 101).

SN 76-089,051. KEY FOOD INGREDIENTS, INC., PASADENA, CA. FILED 7-13-2000.

KFI**CLASS 35—ADVERTISING AND BUSINESS**

FOR DISTRIBUTORSHIP IN THE FIELD OF DEHYDRATED VEGETABLE PRODUCTS PRIMARILY FOR THE SELLERS OF WHOLESALE FOODS AND FOR PRODUCERS OF SPICES (U.S. CLS. 100, 101 AND 102).

FIRST USE 0-0-1998; IN COMMERCE 0-0-1998.

CLASS 40—MATERIAL TREATMENT

FOR FOOD PROCESSING, NAMELY, PROCESSING DEHYDRATED VEGETABLE PRODUCTS PRIMARILY FOR THE SELLERS OF WHOLESALE FOODS AND FOR THE PRODUCERS OF SPICES (U.S. CLS. 100, 103 AND 106).

FIRST USE 0-0-1998; IN COMMERCE 0-0-1998.

SN 76-089,906. MATTEL, INC., EL SEGUNDO, CA. FILED 7-13-2000.

RACE HARD, FINISH FIRST**CLASS 6—METAL GOODS**

FOR METAL KEY CHAINS; FIGURINES OF COMMON METAL; AND METAL LICENSE PLATES (U.S. CLS. 2, 12, 13, 14, 23, 25 AND 50).

CLASS 9—ELECTRICAL AND SCIENTIFIC APPARATUS

FOR SUNGLASSES, COMPUTER MOUSE, PROTECTIVE HELMETS FOR BICYCLE RIDING, COMPUTER SOFTWARE PROGRAM WHOSE FUNCTION IS TO PROVIDE A SCREEN SAVER APPLICATION THAT MAY BE DOWNLOADED FROM A GLOBAL COMPUTER NETWORK (U.S. CLS. 21, 23, 26, 36 AND 38).

CLASS 12—VEHICLES

FOR LAND VEHICLE PARTS, NAMELY, MUD GUARDS (U.S. CLS. 19, 21, 23, 31, 35 AND 44).

CLASS 14—JEWELRY

FOR PINS BEING JEWELRY; WATCHES; JEWELRY MADE OF PRECIOUS AND NON-PRECIOUS METAL (U.S. CLS. 2, 27, 28 AND 50).

CLASS 16—PAPER GOODS AND PRINTED MATTER

FOR TRADING CARDS; WRITING INSTRUMENTS; STICKERS, POSTERS; BOOK MARKS; RUBBER STAMPS; NOTEBOOKS; PAPER STATIONERY; GREETING CARDS; NOTE CARDS; INK PADS; PEN AND PENCIL CASES; PENCIL SHARPENERS; DRAWING AND DRAFTING RULERS; STRAIGHT EDGES; FOLDERS, BINDERS; AUTOMOBILE AND BICYCLE DETAILING KITS COMPRISED PRIMARILY OF DECALS, ADHESIVES FOR APPLYING DECALS, AND TOOLS USED TO APPLY DECALS ALL SOLD AS A UNIT; TEMPORARY TATTOOS; PAPER TABLE CLOTHS; PAPER TABLE MATS; PAPER TABLE NAPKINS; PAPER PARTY DECORATIONS (U.S. CLS. 2, 5, 22, 23, 29, 37, 38 AND 50).

CLASS 18—LEATHER GOODS

FOR BACKPACKS AND UMBRELLAS (U.S. CLS. 1, 2, 3, 22 AND 41).

CLASS 21—HOUSEWARES AND GLASS

FOR PORCELAIN FIGURINES; LUNCH BOXES; THERMAL INSULATED BEVERAGE CONTAINERS; PORTABLE BEVERAGE COOLERS; PLASTIC CUPS; PAPER PLATES; COMMEMORATIVE PLATES (U.S. CLS. 2, 13, 23, 29, 30, 33, 40 AND 50).

CLASS 24—FABRICS

FOR BEDDING PRODUCTS; NAMELY, BED SHEETS, BED BLANKETS AND BED LINENS; AFGHANS, TOWELS; POT HOLDERS; CLOTH FLAGS; AND CLOTH PENNANTS (U.S. CLS. 42 AND 50).

CLASS 25—CLOTHING

FOR T-SHIRTS; TANK-TOPS; BOXER SHORTS; JERSEYS; SHORTS; SHIRTS; NIGHTSHIRTS; SWEATERS; VESTS JACKETS; HATS; PANCHOS; PULLOVERS; SWEATERS; COATS; TIES; PANTS; BANDANNAS; BELTS; AND SCARVES (U.S. CLS. 22 AND 39).

CLASS 26—FANCY GOODS

FOR CLOTH PATCHES FOR CLOTHING; HAIR BOWS; BELT BUCKLES NOT OF PRECIOUS METAL FOR CLOTHING; AND SHOELACES (U.S. CLS. 37, 39, 40, 42 AND 50).

CLASS 28—TOYS AND SPORTING GOODS

FOR JIGSAW PUZZLES; STUFFED TOYS; AND WIND SOCKS FOR DECORATIVE PURPOSES (U.S. CLS. 22, 23, 38 AND 50).

SN 76-091,013. AUTO TOOLS GROUP CO., LTD., TAIPEI, TAIWAN, FILED 7-19-2000.

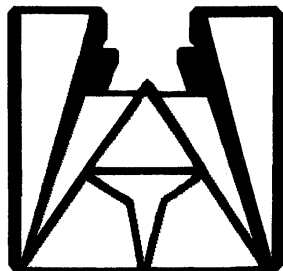

THE MARK CONSISTS OF A STYLIZED LETTER "A" IN THE MIDDLE OF A SQUARE FORMED BY TWO INVERTED TRIANGLES IN THE FRONT AND TWO PARTIALLY VISIBLE INVERTED TRIANGLES IN THE REAR.

CLASS 9—ELECTRICAL AND SCIENTIFIC APPARATUS

FOR COMPUTER SOFTWARE FOR USE IN OFFICE MANAGEMENT, NAMELY FOR USE IN TIME SHEET STATISTICS, INVENTORY, OFFICE RESOURCE MANAGEMENT, COMPANY PRODUCT INTRODUCTIONS; COMPUTER SOFTWARE FOR AUTOMATICALLY CONVERTING EXISTING WEBSITE INTO WIRELESS MARKUP LANGUAGE FORMAT FOR HANDHELD DEVICES; COMPUTER SOFTWARE FOR DELIVERING VIDEO SERVICE OVER BROADBAND ENVIRONMENT, INCLUDING FULL-TEXT SEARCHING, QUERY AND PREVIEW VIDEOS AND ON-LINE PURCHASING; COMPUTER SOFTWARE FOR INSTANT COMMERCE WITH SECURITY TRANSACTION IN MIND, NAMELY FOR USE IN PRODUCT PRESALE, INVENTORY MANAGEMENT, LOGISTICS, CUSTOMER SERVICE, FINANCIAL REPORT, CREDIT CARD AUTHORIZATION, MARKETING DECISION MAKING TOOLS, AND BUILT WITH ADVERTISEMENT CAPABILITY IN MIND; COMPUTER SOFTWARE FOR INSTANT INTERNET ADVERTISEMENT BROADCASTING SYSTEM, NAMELY FOR RAPID WEBSITE DEPLOYMENT, UNIFIED BROADCASTING TECHNIQUES, DYNAMIC INTERACTIVE BANNER, COST PER MILLION/COST PER RESPONSE/COST PER TRANSACTION INSTANT RATING REPORTS, AND PLATFORM INDEPENDENT ADVERTISEMENT DELIVERY CAPABILITY; COMPUTER SOFTWARE FOR USE IN PROJECT MONITORING AND RESOURCE ALLOCATION, NAMELY, FOR USE IN PROJECT QUALITY CONTROL, TIME SHEET ANALYSIS, SALES HISTORY AND WARRANTY CONTROL; COMPUTER SOFTWARE FOR OFFICE-LESS REALIZATION, NAMELY, FOR USE IN PROJECT MEMBER TEAMWORK THROUGH INTERNET/INTRANET, PROJECT SCHEDULE MONITORING AND PROJECT SCHEDULE CONTROL; ELECTRONIC COMMERCE COMPUTER SOFTWARE FOR USE IN A TRANSACTION BASED DATABASE SYSTEM WHICH ENABLES INFORMATION APPLIANCES, NAMELY HOME GATEWAY SYSTEMS AND MOBILE HAND HELD DEVICES TO FACILITATE INTERNET APPLIANCE FOR FACILITATING WIRELESS COMMUNICATIONS AND TRANSFER OF DATA, TEXT, VOICE, AND IMAGES (U.S. CLS. 21, 23, 26, 36 AND 38).

CLASS 42—SCIENTIFIC, COMPUTER AND LEGAL SERVICES

FOR COMPUTER SOFTWARE DEVELOPMENT SERVICES IN THE INFORMATION TECHNOLOGY FIELD; COMPUTER SERVICES, NAMELY THE DEVELOPMENT AND MANAGEMENT OF DIGITAL PRODUCTS, NAMELY DIGITAL SOFTWARE TOOLS FOR OTHERS; CREATING, DESIGNING, MAINTAINING, TESTING AND ANALYZING COMPUTER SOFTWARE SYSTEMS AND PROGRAMS FOR INFORMATION TECHNOLOGY (U.S. CLS. 100 AND 101).

SN 76-091,200. CFS HOLDINGS, INC., RICHMOND, VA. FILED 7-18-2000.

THE SPICE HUNTER

OWNER OF U.S. REG. NOS. 2,117,650 AND 2,312,019. NO CLAIM IS MADE TO THE EXCLUSIVE RIGHT TO USE "SPICE", APART FROM THE MARK AS SHOWN.

CLASS 29—MEATS AND PROCESSED FOODS

FOR DRIED SOUP MIXES; PACKAGED ENTREES CONSISTING PRIMARILY OF INSTANT POTATOES; DRIED MUSHROOMS (U.S. CL. 46).

FIRST USE 1-0-1990; IN COMMERCE 1-0-1990.

CLASS 30—STAPLE FOODS

FOR SPICES, MULLING SPICES, SEASONING MIXES AND BLENDS, TEAS, PASTA, PACKAGED ENTREES CONSISTING PRIMARILY OF COUSCOUS, PASTA, RICE, OR GRITS, AND INSTANT HOT OAT-BARLEY-WHEAT CEREAL IN A VARIETY OF FLAVORS (U.S. CL. 46).

FIRST USE 9-1-1980; IN COMMERCE 9-1-1980.

SN 76-093,445. CONSOLIDATED EDISON SOLUTIONS, INC., WHITE PLAINS, NY. FILED 7-20-2000.

**PUTTING POWER IN THE
HANDS OF OUR
CUSTOMERS**

CLASS 35—ADVERTISING AND BUSINESS

FOR PROCUREMENT, NAMELY, PURCHASING ELECTRIC, STEAM, GAS, AND OIL (U.S. CLS. 100, 101 AND 102).

FIRST USE 12-31-1998; IN COMMERCE 12-31-1998.

CLASS 36—INSURANCE AND FINANCIAL

FOR ENERGY BROKERAGE, NAMELY BUYING, SELLING, TRADING, AND BROKERING OF ELECTRIC, STEAM, AND GAS ENERGY (U.S. CLS. 100, 101 AND 102).

FIRST USE 12-31-1998; IN COMMERCE 12-31-1998.

CLASS 42—SCIENTIFIC, COMPUTER AND LEGAL SERVICES

FOR ENERGY USAGE MANAGEMENT, ENERGY MANAGEMENT CONSULTING AND PROVIDING INFORMATION IN THE FIELD OF ENERGY MANAGEMENT (U.S. CLS. 100 AND 101).

FIRST USE 12-31-1998; IN COMMERCE 12-31-1998.

SN 76-094,878. KING YUAN ELECTRONICS CO., LTD., HSIN CHU CITY 300, TAIWAN, FILED 7-21-2000.



THE LINING IS A FEATURE OF THE MARK AND DOES NOT INDICATE COLOR.

THE NAME "KING YUAN" DOES NOT IDENTIFY A PARTICULAR LIVING INDIVIDUAL.

CLASS 37—CONSTRUCTION AND REPAIR

FOR INSTALLATION AND REPAIR OF ELECTRONIC DIAGNOSTIC APPARATUS, NAMELY, EQUIPMENT USED TO TEST SEMICONDUCTOR WAFERS AND INTEGRATED CIRCUITS; REPAIR OF LASERS USED IN THE MANUFACTURE OF SEMICONDUCTOR WAFERS (U.S. CLS. 100, 103 AND 106).

CLASS 40—MATERIAL TREATMENT

FOR MANUFACTURE OF SEMICONDUCTORS, INTEGRATED CIRCUITS, SILICON CHIPS AND SILICON WAFERS TO ORDER AND SPECIFICATION OF OTHERS; CUSTOM ASSEMBLY OF SEMICONDUCTOR DEVICES FOR OTHERS, NAMELY, THE CUSTOM MOUNTING AND ENCLOSURE OF SEMICONDUCTOR COMPONENTS, SEMICONDUCTOR CHIPS, WAFER COMPONENTS, CHARGED COUPLED DEVICES AND IMAGE SENSORS; CUSTOM SINGULATED MARKING SERVICES, NAMELY, IMPRINTING AND ETCHING OF LETTERS, NUMERALS AND SYMBOLS ON SILICON CHIPS FOR OTHERS (U.S. CLS. 100, 103 AND 106).

CLASS 42—SCIENTIFIC, COMPUTER AND LEGAL SERVICES

FOR DESIGN AND TESTING OF SEMICONDUCTOR WAFERS AND INTEGRATED CIRCUITS FOR OTHERS (U.S. CLS. 100 AND 101).

SN 76-094,901. WOOLPERT LLP, DAYTON, OH. FILED 7-24-2000.

SMARTORTHO

CLASS 9—ELECTRICAL AND SCIENTIFIC APPARATUS

FOR COMPUTER SOFTWARE CONTAINING LIBRARIES OF MAP IMAGES AND SOFTWARE FOR SEARCHING AND DISPLAYING SUCH IMAGES (U.S. CLS. 21, 23, 26, 36 AND 38).

FIRST USE 3-18-1999; IN COMMERCE 3-18-1999.

CLASS 42—SCIENTIFIC, COMPUTER AND LEGAL SERVICES

FOR PROFESSIONAL ENGINEERING, SURVEYING, ARCHITECTURAL DESIGN, ARCHITECTURAL PLANNING, LANDSCAPE ARCHITECTURE AND PHOTOGRAMMETRY SERVICES; CONSULTATION SERVICES IN THE FIELDS OF PROPERTY RECORDS, PARCEL MAPS AND GEOGRAPHIC INFORMATION SYSTEMS; GEOGRAPHIC INFORMATION SYSTEM DESIGN, IMPLEMENTATION, DATA COLLECTION AND CUSTOMIZATION; COMPUTER SERVICES, NAMELY, DESIGNING, PRODUCING, UPDATING AND MAINTAINING ON-LINE COMPUTER DATABASES FOR OTHERS IN THE FIELDS OF PROPERTY RECORDS, PARCEL MAPS AND GEOGRAPHIC INFORMATION SYSTEMS; AND PROVIDING LIBRARIES OF MAP IMAGES VIA A GLOBAL COMPUTER INFORMATION NETWORK AND PROVIDING TEMPORARY USE OF NON-DOWNLOADABLE SOFTWARE FOR SEARCHING AND DISPLAYING SUCH IMAGES (U.S. CLS. 100 AND 101).

FIRST USE 3-18-1999; IN COMMERCE 3-18-1999.

SN 76-096,327. DEERE & COMPANY, MOLINE, IL. FILED 7-19-2000.

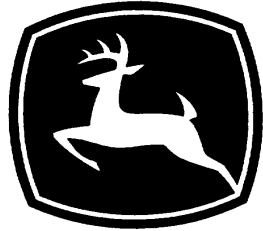

CLASS 1—CHEMICALS

FOR GENERAL PURPOSE BONDING ADHESIVE FOR BONDING TOGETHER METAL, RUBBER, WOOD, FELT, PLASTIC; GASKET ADHESIVE FOR USE ON GASKETS IN INTERNAL COMBUSTION ENGINES, FLUID PUMPS AND MOTORS; WETTING AGENT FOR COTTON PICKER SPINDLES, ESPECIALLY FOR KEEPING SPINDLES FREE OF ACCUMULATIONS OF DIRT AND CROP RESIDUE; ENGINE COOLANT CONDITIONER, ESPECIALLY FOR INHIBITING RUST AND CORROSION; RUST AND CORROSION INHIBITOR, ESPECIALLY FOR PROTECTION OF INTERNAL COMBUSTION ENGINES, HYDRAULIC, FUEL AND FLUID SYSTEMS DURING STORAGE (U.S. CLS. 1, 5, 6, 10, 26 AND 46).

CLASS 3—COSMETICS AND CLEANING PREPARATIONS

FOR ENGINE COOLING SYSTEM CLEANER; HAND CLEANER; CARBURETOR CLEANER AND CONDITIONER (U.S. CLS. 1, 4, 6, 50, 51 AND 52).

CLASS 4—LUBRICANTS AND FUELS

FOR PETROLEUM BASED ENGINE STARTING FLUID; ALL-PURPOSE PENETRATING SPRAY OIL; ENGINE OIL; GEAR LUBRICANT; TRANSMISSION, POWER STEERING AND HYDRAULIC OIL; POWDERED GRAPHITE LUBRICANT; BEARING LUBRICANT; COTTON PICKER SPINDLE LUBRICANT; GREASE CARTRIDGES; AND CHAIN LUBRICANT (U.S. CLS. 1, 6 AND 15).

CLASS 6—METAL GOODS

FOR MISCELLANEOUS SMALL HARDWARE, NAMELY, NUTS, BOLTS, RIVETS, SCREWS, WASHERS, COTTERS, CLAMPS, KEY STOCK; METAL COUPLINGS AND PLUGS FOR USE WITH HYDRAULIC FLUID AND COOLANT SYSTEMS; GREASE FITTINGS; METAL ENGINE GASKETS; METAL O-RINGS FOR USE IN VEHICLE HYDRAULIC FLUID SYSTEMS (U.S. CLS. 2, 12, 13, 14, 23, 25 AND 50).

CLASS 7—MACHINERY

FOR PNEUMATIC GREASE GUNS; POWER OPERATED PUMP OILERS; TRACTOR-TOWED MISCELLANEOUS FARM MACHINERY AND TRACTOR TOOLS, NAMELY, LOADERS, BACKHOES, BALE SPEARS, PLANTERS, GRAIN DRILLS, DISCS, CULTIVATORS, SPRAYERS, MOWERS, SCRAPERS, WAGONS AND SPREADERS; HYDRAULIC CYLINDERS, FAN BELTS FOR ENGINES AND MOTORS; AGRICULTURAL HARVESTER GATHERER BELTS; AGRICULTURAL HARVESTER PICKUP AND CONVEYOR BELTS; SPARK PLUGS AND SPARK PLUG CABLES; IGNITION WIRING; POINTS AND CONDENSERS; OIL FILTERS; AIR FILTERS AND AIR CLEANERS; FUEL FILTERS; REPAIR REPLACEMENT AND MAINTENANCE PARTS FOR LAWN AND TRACTORS AND ATTACHMENTS, NAMELY IGNITION WIRING, SEATS, THROTTLE CONTROLS, AND GRASS CUTTING BLADES; LAWN MOWERS; RADIATOR HOSES; PUMP AND GENERATOR BELTS; FUEL PUMPS (U.S. CLS. 13, 19, 21, 23, 31, 34 AND 35).

CLASS 8—HAND TOOLS

FOR MANUALLY-OPERATED GREASE GUNS; NON-POWERED HAND TOOLS, NAMELY, PLIERS, WRENCHES, SCREWDRIVERS, SHOVELS, RAKES, SPADES, HOES, EDGERS, CULTIVATORS, TROWELS FOR DIGGING, WEEDERS, AXES, SLEDGEHAMMERS, SCRAPERS, ICE CHISELS, POSTHOLE DIGGERS, PICKS, UTILITY BARS, FORKS, POTATO AND MANURE HOOKS, SAWS TRIMMERS PRUNING SHEARS, HEDGE SHEARS, GRASS SHEARS, LOPPING SHEARS, POLE TREE TRIMMERS, FRUIT PICKERS, BUSH HOOK AND BANK BLADES, SCYTHES (U.S. CLS. 23, 28 AND 44).

CLASS 9—ELECTRICAL AND SCIENTIFIC APPARATUS

FOR STORAGE BATTERIES; BATTERY CABLES; ELECTRIC WARNING DEVICES, NAMELY LAMPS, FLASHERS, HORNS, VOLTAGE REGULATORS, AND COILS (U.S. CLS. 21, 23, 26, 36 AND 38).

CLASS 11—ENVIRONMENTAL CONTROL APPARATUS

FOR HEAD, TAIL, WARNING AND SERVICE LAMPS; OIL AND WATER ELECTRIC HEATING ELEMENTS; AIR CLEANERS FOR INTERNAL COMBUSTION ENGINES (U.S. CLS. 13, 21, 23, 31 AND 34).

CLASS 12—VEHICLES

FOR REPAIR, REPLACEMENT AND MAINTENANCE PARTS FOR MACHINERY USED IN EARTHWORKING, LAND CLEARING, LAND SHAPING, NAMELY LOADER AND EXCAVATOR BUCKETS AND TEETH, MOTOR GRADER BLADES AND TEETH; TRACKS, ROLLERS AND BEARINGS FOR TRACK LAYING VEHICLES (U.S. CLS. 19, 21, 23, 31, 35 AND 44).

CLASS 17—RUBBER GOODS

FOR ELECTRICAL TAPE; RUBBER TUBING FOR GRAIN DRILLS AND PLANTER; RUBBER SEALS AND PLUGS FOR USE WITH ENGINE COOLANT AND HYDRAULIC FLUID SYSTEMS; FERTILIZER OR WATER RUBBER SPRAYER HOSE FOR USE IN CONNECTION WITH IRRIGATION; ADHESIVE OR WATER-RESISTANT SEALANT, ESPECIALLY FOR USE IN MAINTAINING TIGHTNESS IN NUTS AND BOLTS, FUEL LINE AND OTHER FLUID FITTINGS, CLOSE METAL-TO-METAL CONNECTIONS; NON-METAL ENGINE GASKETS; RUBBER OR PLASTIC O-RINGS FOR USE IN AUTOMOTIVE AND INDUSTRIAL HYDRAULIC FLUID SYSTEMS; RUBBER OR PLASTIC HYDRAULIC HOSES (U.S. CLS. 1, 5, 12, 13, 35 AND 50).

SN 76-096,358. SCOTSMAN HOTEL GROUP LIMITED, THE, LONDON, ENGLAND, FILED 7-25-2000.



PRIORITY CLAIMED UNDER SEC. 44(D) ON UNITED KINGDOM APPLICATION NO. 2219902, FILED 1-20-2000, REG. NO. 2219902, DATED 12-29-2000, EXPIRES 1-20-2010.

NO CLAIM IS MADE TO THE EXCLUSIVE RIGHT TO USE "HOTEL GROUP", APART FROM THE MARK AS SHOWN.

CLASS 41—EDUCATION AND ENTERTAINMENT

FOR EDUCATIONAL SERVICES, NAMELY, ARRANGING AND CONDUCTING OF CONFERENCES, CONGRESSES, SEMINARS, WORKSHOPS AND COLLOQUIA IN THE FIELD OF BUSINESS, MEDICAL AND PROFESSIONAL MATTERS; BOOKING OF SEATS FOR SHOWS AND BOOKING OF THEATER TICKETS; PROVIDING CASINO AND GAMING FACILITIES; PROVIDING CINEMA AND MOVIE THEATER FACILITIES; ORGANIZATION OF EXHIBITIONS AND TRADE SHOWS; HEALTH AND LEISURE CLUB SERVICES; ORGANIZATION OF COMMUNITY DANCES AND BALLS, PROVISION OF GYMNASIUM AND SPORTS FACILITIES AND GOLF COURSES; DISCOTHEQUE SERVICES; PROVISION OF INFORMATION RELATING TO RECREATION, LEISURE AND SPORTING MATTERS BY MEANS OF CONCIERGE SERVICES AND PRINTED MATTER; ENTERTAINMENT IN THE NATURE OF LIVE PERFORMANCES BY SPEAKERS AND MUSICIANS; PARTY PLANNING (U.S. CLS. 100, 101 AND 107).

CLASS 42—SCIENTIFIC, COMPUTER AND LEGAL SERVICES

FOR HOTEL SERVICES; MOTEL SERVICES; PROVIDING TEMPORARY ACCOMMODATIONS; MAKING ROOM RESERVATIONS FOR OTHERS; CATERING SERVICES; CATERING FOR PROVISION OF FOOD AND BEVERAGES; PREPARATION OF FOOD AND BEVERAGES; RESTAURANT SERVICES, BISTRO SERVICES, BRASSERIE SERVICES, COFFEE SHOP SERVICES, CAFETERIA SERVICES, AND SNACK BAR SERVICES; PROVISION OF SAUNA AND SOLARIUM FACILITIES; PROVIDING BANQUET, SOCIAL FUNCTION AND EXHIBITION FACILITIES FOR SPECIAL OCCASIONS, CONFERENCES AND MEETINGS (U.S. CLS. 100 AND 101).

SN 76-096,478. MEUBLES RAPP, SOCIETE ANONYME, 68260 KINGERSHEIM, FRANCE, FILED 7-24-2000.



NO CLAIM IS MADE TO THE EXCLUSIVE RIGHT TO USE "FURNITURE & DECORATION", APART FROM THE MARK AS SHOWN.

CLASS 16—PAPER GOODS AND PRINTED MATTER

FOR PAPER, CARDBOARD; BOOKBINDING MATERIAL, NAMELY, TAPE, WIRE, CORDS, CLOTH; MOUNTED AND UNMOUNTED PHOTOGRAPHS; STATIONERY; ADHESIVE TAPE DISPENSERS FOR STATIONERY OR HOUSEHOLD PURPOSE; ARTISTS' WATERCOLOR SAUCERS AND BRUSHES, EASELS; PAINT BRUSHES; TYPEWRITERS; PLASTIC MATERIALS FOR PACKAGING, NAMELY, ENVELOPES, BLISTER CARDS, PLASTIC BUBBLE PACKS, PAPER POUCHES, PLASTIC CLING FILM, PLASTIC FILM FOR WRAPPING; PLAYING CARDS; PRINTING TYPE; PRINTING BLOCKS; MAGAZINES AND MAIL ORDER CATALOGS FEATURING NEWS, HUMOR, MUSIC AND SCIENTIFIC CONTENT; WRAPPING PAPER; GREETING CARDS; DRY ERASE WRITING BOARDS, NOTEBOOKS, PAPER TABLE NAPKINS, PAPER NAPKINS, PAPER PARTY DECORATIONS, POSTCARDS OF PAPER, ADDRESS BOOKS, PERSONAL DIARIES, PENS, PENCILS, RUBBER ERASERS, WRITING PADS, PENCIL HOLDERS, DESK TOP CABINETS FOR STATIONERY, POSTERS, STICKERS, ALMANACS, ADDRESS LABELS AND IRON-ON TRANSFERS; CREDIT CARDS NOT MAGNETICALLY ENCODED (U.S. CLS. 2, 5, 22, 23, 29, 37, 38 AND 50).

CLASS 20—FURNITURE AND ARTICLES NOT OTHERWISE CLASSIFIED

FOR FURNITURE; MIRRORS, MIRROR FRAMES, MIRROR STANDS; PICTURE FRAMES, PICTURE FRAME MOLDINGS; ART OBJECTS, NAMELY, SCULPTURES, STATUES, STATUETTES, FIGURES, FIGURINES, PLAQUES AND MOSAICS, ALL MADE OF UNWORKED OR SEMI-WORKED CORK, HORN, REED, CANE, WICKER, MOTHER-OF-PEARL, SHELL, IVORY, MEERSCHAUM, CELLULOID, OR PLASTIC (U.S. CLS. 2, 13, 22, 25, 32 AND 50).

CLASS 21—HOUSEWARES AND GLASS

FOR GLASSWARE, NAMELY, GOBLETS, GLASSES, SHOT GLASSES, DECANTERS, BOWLS, VASES, PITCHERS, INSULATING GLASS STORAGE JARS, AND CANDLESTICKS; GLASS FIGURINES, CHINA FIGURINES, CHINA DECANTERS, CHINA BOWLS, CHINA VASES, CHINA PITCHERS, INSULATING CHINA STORAGE JARS, CHINA CANDLESTICKS; SERVING UTENSILS, NAMELY, PIE SERVERS, CAKE SERVERS, LASAGNA SERVERS, SERVING FORKS, SERVING SPOONS, CHEESE SERVING KNIVES, LADLES, ICE SERVING TONGS, PASTRY SERVING TONGS, ICE CREAM SCOOPS, AND PASTA SCOOPS; GRAVY SETS COMPRISING LADLES AND GRAVY BOATS SOLD AS A UNIT; CASSEROLE COOKWARE, SERVING SPOON RESTS FOR USE WITH CASSEROLE COOKWARE; CORK-SCREWS, FLASKS, COCKTAIL SHAKERS, WINE POURING SPOUTS, NON-RUBBER BOTTLE STOPPERS, PORTABLE BEVERAGE COOLERS; HAIR BRUSHES, HAIR COMBS; SALT AND PEPPER SHAKERS; CANDLE SNUFFERS, AND GLASS DOME BOXES FOR DISPLAYING KEEPSAKES (U.S. CLS. 2, 13, 23, 29, 30, 33, 40 AND 50).

CLASS 24—FABRICS

FOR TEXTILES AND TEXTILE PRODUCTS, NAMELY, CURTAINS, DRAPERIES, BANNERS, FLAGS, AND WALL HANGINGS; BEDDING, NAMELY, SPREADS, QUILTS, COMFORTERS, PILLOW CASES, BED SHEETS, DUST RUFFLES, DUVET COVERS, MATTRESS COVERS, AND MATTRESS PADS; TABLE COVERS NOT MADE OF PAPER; HAND TOWELS, KITCHEN TOWELS, WASHCLOTHS, AND BATH TOWELS; HANDKERCHIEFS (U.S. CLS. 42 AND 50).

CLASS 27—FLOOR COVERINGS

FOR CARPETS, RUGS AND MATS, FOR INDOOR AND OUTDOOR USE, MADE OF FIBER, RUBBER, AND WOOD; LINOLEUM FLOOR COVERINGS; NYLON, VINYL AND RUBBER FLOOR COVERINGS; WALL TAPESTRY NOT MADE OF TEXTILE MATERIAL (U.S. CLS. 19, 20, 37, 42 AND 50).

CLASS 28—TOYS AND SPORTING GOODS

FOR TOYS AND GAMES, NAMELY, RUBBER ACTION BALLS, ACTION FIGURES AND ACCESSORIES, ACTION SKILL GAMES, MECHANICAL AND ELECTRIC ACTION TOYS, ACTION-TYPE TARGET GAMES, PAPER AIRPLANES, SCALE MODEL AIRPLANES, TOY AIRPLANES, STUFFED TOY ANIMALS, ANKLE AND WRIST WEIGHTS FOR EXERCISE, AERO-DYNAMIC DISKS FOR USE IN PLAYING CATCHING GAMES, ARM GUARDS FOR ATHLETIC USE, TOY ARMOR, ATHLETIC TAPE, BABY RATTLES, BACKBOARDS FOR BASKETBALL, BACKGAMMON GAME SETS, BALLOONS, BALLOON CRAFT SETS FOR DECORATING, BASEBALLS, BASKETBALLS, BILLIARD BALLS, BOWLING BALLS, FOOTBALLS, GOLF BALLS, HAND BALLS, NET BALLS, PLAYGROUND BALLS, RACKET BALLS, SOCCER BALLS, SPORTS BALLS, SQUASH BALLS, TABLE TENNIS BALLS, TENNIS BALLS, TETHER BALLS, VOLLEYBALLS, TOY BANKS, BARBELLS, BASEBALL BATS, BATTING GLOVES, BASEBALL GLOVES, BASEBALL MITTS, BATH AND BATHTUB TOYS, INFLATABLE BATH TOYS, TWIRLING BATONS, SOFTBALL BATS, BEAN BAGS, STUFFED TOY BEARS, TEDDY BEARS, BICYCLING GLOVES, BILLIARD BRIDGES, BILLIARD BUMPER, BILLIARD CHALK, BILLIARD CUE RACKS, BILLIARD CUES, BILLIARD CUSHIONS, BILLIARD GAME PLAYING EQUIPMENT, BILLIARD NETS, BILLIARD TABLES, BILLIARD TALLY BALLS, BILLIARD TIPS, BILLIARD TRIANGLES, BINGO CARDS, BINGO GAME PLAYING EQUIPMENT, TOY BUILDING BLOCKS, TOY CONSTRUCTION BLOCKS, BOARD GAMES, EQUIPMENT SOLD AS A UNIT FOR PLAYING BOARD GAMES, BODY BOARDS, FINS FOR BODY BOARDS, LEASHES FOR BODY BOARDS, RESTRAINT STRAPS FOR BODY BOARDS, BOOK MANUALS FOR ROLE PLAYING GAME EQUIPMENT IN THE NATURE OF GAMES, BOWLING BALL COVERS, BOWLING DEFLECTORS, BOWLING PINS, MUSIC BOX TOYS, TOY BOXES, BUBBLE MAKING WAND AND SOLUTION SETS, TOY CAP PISTOLS, CAPS FOR TOY PISTOLS, CARD GAMES, EQUIPMENT SOLD AS A UNIT FOR PLAYING CARD GAMES, POOL CUE CASES, CASES FOR ACTION FIGURES, CASES FOR PLAY ACCESSORIES, CASES FOR TOY STRUCTURES, CASES FOR TOY VEHICLES, POOL CUE CEMENT, FLOATING RECREATIONAL LOUNGE CHAIRS, CHECKER SETS, CHESS SETS, GAMING EQUIPMENT CHIPS, CHRISTMAS GARLANDS, CHRISTMAS TREE ORNAMENTS, CHRISTMAS TREE SKIRTS, CHRISTMAS TREE STAND COVERS, CHRISTMAS TREE STANDS, ARTIFICIAL CHRISTMAS TREES, ARTIFICIAL CHRISTMAS WREATHS, PLAYGROUND EQUIPMENT CLIMBING UNITS, ACTION OR PLAY FIGURE CLOTHING, DOLL CLOTHING, CHILDREN'S PLAY COSMETICS, COSTUME MASKS, DOLL COSTUMES, PARTY FAVORS IN THE NATURE OF CRACKERS OR NOISEMAKERS, POOL CUES, PORTABLE SUPPORT STRUCTURES FOR DANCE AND OTHER EXERCISES, DART BOARD CASES, DART BOARDS, DART CARRYING CASES, DART FLIGHTS, ELECTRONIC DART GAMES, DART POINT SHARPENERS, DART POINTS, DART SHAFTS, DART STEMS, DICE, FLYING DISCS, DOG TOYS, DOLL ACCESSORIES, DOLL CASES, DOLL HOUSE FURNISHINGS, DOLLS, BEAN BAG DOLLS, PAPER DOLLS, PORCELAIN DOLLS, RAG DOLLS, SOFT SCULPTURE DOLLS, DOLL ACCESSORIES, DOLL PLAY SETS, DOMINOES, DUMBBELL SETS, DUMBBELLS, EASTER EGG COLORING KITS, EGG DECORATING KITS, ELECTRONIC GAME EQUIPMENT WITH A WATCH FUNCTION, HAND HELD UNIT FOR PLAYING ELECTRONIC GAMES, EXERCISE BARS, STATIONARY EXERCISE BICYCLES, MANUALLY OPERATED EXERCISE EQUIPMENT, EXERCISE WEIGHTS, PARTY FAVORS IN THE NATURE OF SMALL TOYS, PLAY FIGURES, FIREARM TARGETS, SWIM FLOATS FOR RECREATIONAL USE, KICK BOARD FLOTATION DEVICES FOR RECREATIONAL USE, VIDEO OUTPUT GAME MACHINES, PROMO-

TIONAL GAME MATERIALS, GAME TABLES, GAMING WHEELS, EQUIPMENT SOLD AS A UNIT FOR PLAYING ACTION TYPE TARGET GAMES, HAND HELD UNIT FOR PLAYING VIDEO GAMES, MANIPULATIVE GAMES, PARLOR GAMES, PINBALL-TYPE GAMES, ROLE PLAYING GAMES, GAMING TABLES, GOALKEEPERS' GLOVES, GOLF GLOVES, HANDBALL GLOVES, HOCKEY GLOVES, KARATE GLOVES, SOFTBALL GLOVES, SWIMMING GLOVES, WATER SKI GLOVES, TOY ZIP GUNS, INFANT ACTION CRIB TOYS, JIGSAW PUZZLES, JUMP ROPES, KITE HANDLES, KITE LINES, KITE PARTS, KITE REELS, KITE STRING, KITE TAILS, KITES, MAGIC TRICKS, MANIPULATIVE PUZZLES, MARBLES, MARIONETTE PUPPETS, PAPER FACE MASKS, CRIB MOBILES, TOY MOBILES, MOBILES FOR CHILDREN, TOY MODEL TRAIN SETS, TOY MODEL VEHICLES AND RELATED ACCESSORIES SOLD AS UNITS, ELECTRONICALLY OPERATED TOY MOTOR VEHICLES, MOUTH GUARDS AS ATHLETIC EQUIPMENT, MUSICAL TOYS, TOY NOISEMAKERS, PADDLE BALL GAMES, PADDLES FOR USE IN PADDLE BALL GAMES, TABLE TENNIS PADDLES, COIN AND NON-COIN OPERATED PINBALL MACHINES, PINBALL-TYPE GAMES, PLUSH TOYS, SOFT SCULPTURE PLUSH TOYS, POOL BRIDGES, POOL BUMPERS, POOL CHALK HOLDERS, POOL CUE CHALK, POOL CUE CLAMPS, POOL CUE RACKS, POOL CUE TIPS, POOL CUSHIONS, POOL TALLY BALLS, PUPPETS, CUBE-TYPE-THREE-DIMENSIONAL PUZZLES, INFANT'S RATTLES, TOY RECORD PLAYERS, RIDE-ON TOYS, INFLATABLE RIDE-ON TOYS, TRACTORS AND SLEDS FOR USE IN DOWNHILL AMUSEMENT RIDES, RING GAMES, ROCKING HORSES, ROLLER SKATES, SKIPPING ROPES, FLYING SAUCERS, NON-MOTORIZED SCOOTERS, TOY SCOOTERS, SOFT SCULPTURE TOYS, SKATEBOARDS, ICE SKATES, SLING SHOTS, TOY SPINNING TOPS, STUFFED TOYS, SURFBOARDS, WATER WING SWIM AIDS FOR RECREATIONAL USE, SWIM BOARDS FOR RECREATIONAL USE, TOY SWORDS, TABLE TENNIS NETS, TABLE TENNIS POST SETS, TABLE TENNIS RACKETS, TABLE TENNIS TABLES, TENNIS UPRIGHTS, SAFETY PADDING FOR VOLLEYBALL AND TENNIS UPRIGHTS, TOY ACTION FIGURES AND ACCESSORIES, TOY FIGURES, TOY GLIDERS, TOY VEHICLES, BABY MULTIPLE ACTIVITY TOYS, CHILDREN'S MULTIPLE ACTIVITY TOYS, NON-RIDING TRANSPORTATION TOYS, SQUEEZABLE SQUEAKING TOYS, WATER SQUIRTING TOYS, WIND-UP WALKING TOYS, WIND-UP TOYS, PLAY WANDS, YO-YOS (U.S. CLS. 22, 23, 38 AND 50).

CLASS 35—ADVERTISING AND BUSINESS

FOR ADVERTISEMENT SERVICES, NAMELY, CREATING BUSINESS LOGOS, PRODUCT IDENTITIES AND DESIGNS FOR OTHERS; RENTING OF PUBLI-CITY MATERIAL TO BUSINESSES; PROVIDING ADVICE AND BUSINESS INFORMATION FOR OTHERS (U.S. CLS. 100, 101 AND 102).

CLASS 36—INSURANCE AND FINANCIAL

FOR INSURANCE SERVICES, NAMELY, BROKERAGE SERVICES, UNDERWRITING SERVICES; FINANCIAL BUSINESS; MONETARY BUSINESS; PROVIDING PROVIDENT FUNDS; ISSUING OF TRAVELERS CHECKS AND LETTERS OF CREDIT; REAL ESTATE EXPERTISE, AND REAL ESTATE MANAGEMENT SERVICES FOR OTHER (U.S. CLS. 100, 101 AND 102).

SN 76-096,787. ANAID NOMINEES PTY LTD, KNOXFIELD, VICTORIA 3180, AUSTRALIA, FILED 7-26-2000.

WATERMARK

PRIORITY CLAIMED UNDER SEC. 44(D) ON AUSTRALIA APPLICATION NO. 842932, FILED 7-18-2000.

CLASS 6—METAL GOODS

FOR VALVES OF METAL (NOT BEING PARTS OF MACHINES), METAL PIPES AND FITTINGS THEREFOR, AND METAL TANKS FOR STORAGE, ALL FOR USE IN DUST LAYING AND FIREFIGHTING IN THE MINING INDUSTRY (U.S. CLS. 2, 12, 13, 14, 23, 25 AND 50).

CLASS 7—MACHINERY

FOR MACHINE PARTS, NAMELY, NOZZLES WHICH ARE PARTS OF POWER-OPERATED SPRAYERS AND WATER CANNONS FOR USE IN DUST LAYING AND FIREFIGHTING IN THE MINING INDUSTRY; VALVES OF METAL BEING PARTS OF MACHINES, NAMELY, WATER CANNONS AND DUST SUPPRESSION MACHINES FOR USE IN DUST LAYING AND FIREFIGHTING IN THE MINING INDUSTRY; POWER OPERATED SPRAYERS, POWER OPERATED DUST LAYERS, AND WATER DELIVERY MACHINES, NAMELY, DUST LAYING MACHINES ALL FOR USE IN DUST LAYING AND FIREFIGHTING IN THE MINING INDUSTRY (U.S. CLS. 13, 19, 21, 23, 31, 34 AND 35).

CLASS 9—ELECTRICAL AND SCIENTIFIC APPARATUS

FOR COMPUTERS AND COMPUTER SOFTWARE TO MONITOR AND CONTROL FLUID SPRAYING AND DISTRIBUTION FOR FIRE FIGHTING AND DUST SUPPRESSION; FIRE FIGHTING EQUIPMENT NAMELY, WATER CANNONS, FIRE SPRINKLERS, FIRE TRUCKS AND FIRE HOSE NOZZLES (U.S. CLS. 21, 23, 26, 36 AND 38).

CLASS 20—FURNITURE AND ARTICLES NOT OTHERWISE CLASSIFIED

FOR VALVES OF PLASTIC BEING OTHER THAN MACHINE PARTS, HAND OPERATED NON-METAL HOSE REELS AND NON-METAL TANKS FOR STORAGE, ALL FOR USE IN DUST LAYING AND FIREFIGHTING IN THE MINING INDUSTRY (U.S. CLS. 2, 13, 22, 25, 32 AND 50).

SN 76-096,862. GRAND CIRCLE LLC, BOSTON, MA. FILED 7-26-2000.



THE LINING SHOWN IN THE DRAWING IS A FEATURE OF THE MARK.

CLASS 39—TRANSPORTATION AND STORAGE

FOR TRAVEL CLUBS, TRAVEL GUIDE SERVICES, TRAVEL INFORMATION SERVICES, ARRANGING TRAVEL TOURS, AND TRAVEL AGENCY SERVICES, NAMELY MAKING RESERVATIONS AND BOOKING FOR TRANSPORTATION (U.S. CLS. 100 AND 105).

FIRST USE 12-1-1991; IN COMMERCE 12-1-1991.

CLASS 41—EDUCATION AND ENTERTAINMENT

FOR EDUCATIONAL SERVICES, NAMELY CONDUCTING WORKSHOPS AND SEMINARS ON THE HISTORY, CULTURE, PEOPLE, GEOGRAPHY AND LOCAL LANDMARKS OF PARTICULAR GEOGRAPHIC LOCATIONS (U.S. CLS. 100, 101 AND 107).

FIRST USE 12-1-1991; IN COMMERCE 12-1-1991.

CLASS 42—SCIENTIFIC, COMPUTER AND LEGAL SERVICES

FOR TRAVEL AGENCY SERVICES, NAMELY, MAKING RESERVATIONS AND BOOKING FOR TEMPORARY LODGING (U.S. CLS. 100 AND 101).

FIRST USE 12-1-1991; IN COMMERCE 12-1-1991.

SN 76-097,286. BUBBLE PICTURES, INC., NEW YORK, NY. FILED 7-26-2000.

EDDIE MURPHY

OWNER OF U.S. REG. NOS. 1,667,007, 1,831,610 AND 1,891,748.

THE NAME "EDDIE MURPHY" IDENTIFIES A LIVING INDIVIDUAL WHOSE CONSENT IS OF RECORD.

CLASS 25—CLOTHING

FOR CLOTHING, NAMELY, HATS, CAPS, BASEBALL CAPS, JACKETS, TEE SHIRTS, SHIRTS, TROUSERS, SOCKS, SKIRTS, BLOUSES, SHORTS, SWEATERS AND VESTS (U.S. CLS. 22 AND 39).

FIRST USE 2-28-1989; IN COMMERCE 2-28-1989.

CLASS 41—EDUCATION AND ENTERTAINMENT

FOR ENTERTAINMENT SERVICES, NAMELY, DEVELOPMENT AND DISTRIBUTION OF TELEVISION PROGRAMS, TELEVISION PRODUCTION SERVICES, MOTION PICTURE FILM PRODUCTION SERVICES, LIVE ENTERTAINMENT SERVICES ON TOUR IN THE NATURE OF LIVE COMEDY PERFORMANCES BY AN INDIVIDUAL AND LIVE MUSICAL PERFORMANCES BY AN INDIVIDUAL (U.S. CLS. 100, 101 AND 107).

FIRST USE 2-28-1989; IN COMMERCE 2-28-1989.

SN 76-097,536. UNIGRIDENERGY, LLC, PHILADELPHIA, PA. FILED 7-26-2000.



THE MARK IS LINED FOR THE COLOR(S) ORANGE.

CLASS 35—ADVERTISING AND BUSINESS

FOR ON-LINE TRADING SERVICES TO FACILITATE THE PURCHASE AND SALE OF ENERGY BY OTHERS VIA A GLOBAL COMPUTER NETWORK; SCHEDULING OF THE TRANSMISSION OF ENERGY FOR OTHERS VIA A GLOBAL COMPUTER NETWORK; PROVIDING AN ON-LINE COMPUTER DATABASE FEATURING CURRENT AND HISTORICAL INFORMATION ON THE ENERGY MARKET; PROVIDING INFORMATION CONCERNING THE ENERGY MARKET VIA A GLOBAL COMPUTER NETWORK; OPERATING AN ON-LINE MARKETPLACE FOR SELLERS AND PURCHASERS OF ENERGY (U.S. CLS. 100, 101 AND 102).

FIRST USE 6-1-2000; IN COMMERCE 6-1-2000.

CLASS 36—INSURANCE AND FINANCIAL

FOR PROVIDING BROKERAGE SERVICES IN THE FIELD OF ENERGY (U.S. CLS. 100, 101 AND 102).

FIRST USE 6-1-2000; IN COMMERCE 6-1-2000.

SN 76-098,612. CONAGRA BRANDS, INC., OMAHA, NE. FILED 7-31-2000.

FEEL GOOD FOOD

NO CLAIM IS MADE TO THE EXCLUSIVE RIGHT TO USE "FOOD", APART FROM THE MARK AS SHOWN.

CLASS 29—MEATS AND PROCESSED FOODS

FOR FROZEN MEALS AND ENTREES CONSISTING PRIMARILY OF BEEF, POULTRY, PORK, SEAFOOD OR VEGETABLE; LUNCH MEATS; DELI MEATS; FRANKFURTERS; SAUSAGES; AND SOUP (U.S. CL. 46).

CLASS 30—STAPLE FOODS

FOR FROZEN MEALS AND ENTREES CONSISTING PRIMARILY OF PASTA OR RICE; ICE CREAM; BREAD; AND PASTA SAUCE (U.S. CL. 46).

SN 76-099,897. J.D.R.M. ASSOCIATES, INC., MAYNARD, MA. FILED 7-31-2000.

TRAINEASE IT SIMPLY WORKS**CLASS 35—ADVERTISING AND BUSINESS**

FOR PROVIDING ACADEMIC COURSE ADMINISTRATION SERVICES TO USERS AND PROVIDERS OF EDUCATIONAL PROGRAMS, NAMELY, ASSISTING CORPORATIONS AND INDIVIDUALS IN SCHEDULING, BILLING, AND REGISTERING FOR EDUCATIONAL COURSES TAUGHT BY OTHERS (U.S. CLS. 100, 101 AND 102).

CLASS 42—SCIENTIFIC, COMPUTER AND LEGAL SERVICES

FOR EDUCATIONAL CONSULTATIONS, NAMELY, ASSISTING CORPORATIONS AND INDIVIDUALS IN IDENTIFYING, LOCATING, AND OBTAINING EDUCATIONAL MATERIALS, AND IN IDENTIFYING AND LOCATING EDUCATIONAL COURSES TAUGHT BY OTHERS (U.S. CLS. 100 AND 101).

SN 76-099,970. HYPERQUEST, INC., CHICAGO, IL. BY CHANGE OF NAME AUTOYARDSINFO.COM, INC. CHICAGO, IL. FILED 7-31-2000.

HYPERQUEST**CLASS 35—ADVERTISING AND BUSINESS**

FOR INFORMATION MANAGEMENT SERVICES, NAMELY, PROVIDING COMPUTERIZED DATABASE MANAGEMENT AND INFORMATION ABOUT PARTS AND REPAIR SERVICES, THE SOURCE AVAILABILITY AND PRICES FOR PARTS AND REPAIR, PARTS RECYCLERS, AFTERMARKET SUPPLIERS, REPAIR SHOPS, RECYCLED PARTS SUPPLIERS, ORIGINAL EQUIPMENT PARTS MANUFACTURERS, PARTS WHOLESALERS AND RETAILERS, ALL FOR THE INSURANCE, PARTS SUPPLY AND AUTOMOTIVE REPAIR INDUSTRIES; MARKETING SERVICES, NAMELY, DISSEMINATION OF SOURCE AVAILABILITY AND PRICE INFORMATION, FOR REPAIR FACILITIES AND RECYCLED, AFTERMARKET, REMANUFACTURED AND ORIGINAL EQUIPMENT PARTS (U.S. CLS. 100, 101 AND 102).

CLASS 36—INSURANCE AND FINANCIAL

FOR PROVIDING COMPUTERIZED INSURANCE CLAIMS INFORMATION FOR THE INSURANCE, PARTS SUPPLY AND AUTOMOTIVE REPAIR INDUSTRIES (U.S. CLS. 100, 101 AND 102).

SN 76-099,972. GEOCEL CORPORATION, ELKHART, IN. FILED 7-31-2000.

UNITED SEALANTS & ADHESIVES

NO CLAIM IS MADE TO THE EXCLUSIVE RIGHT TO USE "SEALANTS & ADHESIVES", APART FROM THE MARK AS SHOWN.

CLASS 1—CHEMICALS

FOR ADHESIVES FOR USE IN BUILDING AND TRANSPORTATION CONSTRUCTION, MAINTENANCE AND REPAIR (U.S. CLS. 1, 5, 6, 10, 26 AND 46).

CLASS 17—RUBBER GOODS

FOR ADHESIVE SEALANT AND CAULKING COMPOUNDS (U.S. CLS. 1, 5, 12, 13, 35 AND 50).

SN 76-100,008. ZAPPA, LUCIANO JORGE, REPUBLICA, ARGENTINA, FILED 7-28-2000.

**CYLARCOM**

PRIORITY CLAIMED UNDER SEC. 44(D) ON ARGENTINA APPLICATION NO. 2290379, FILED 6-5-2000.
PRIORITY CLAIMED UNDER SEC. 44(D) ON ARGENTINA APPLICATION NO. 2290378, FILED 6-5-2000.

CLASS 38—COMMUNICATION

FOR CHAT ROOM AND BULLETIN BOARD COMPUTER SERVICES, NAMELY, PROVIDING ON-LINE FACILITIES FOR INTERACTION AMONG USER-SPECIFIED GROUPS CONCERNING BUSINESS, COMPUTERS, NEWS, REFERENCE MATERIALS, TECHNOLOGY, HUMAN RELATIONS, ECONOMY AND LAW (U.S. CLS. 100, 101 AND 104).

CLASS 42—SCIENTIFIC, COMPUTER AND LEGAL SERVICES

FOR COMPUTER SERVICES, NAMELY, PROVIDING ON-LINE INFORMATION IN THE FIELDS OF BUSINESS, COMPUTERS, NEWS, REFERENCE MATERIALS, AND TECHNOLOGY; COMPUTER SERVICES, NAMELY, PROVIDING ON-LINE COMPUTER LINKS FEATURING BUSINESS, COMPUTERS, NEWS, REFERENCE MATERIALS, AND TECHNOLOGY; HOSTING THE WEB SITES OF OTHERS ON A COMPUTER SERVER FOR A GLOBAL COMPUTER NETWORK; PROVIDING ON-LINE MAPPING SERVICES; COMPUTER SERVICES, NAMELY, PROVIDING SEARCH ENGINES FOR OBTAINING DATA ON A GLOBAL COMPUTER NETWORK; PROVIDING AN ON-LINE COMPUTER DATABASE FEATURING REDIRECTION SERVICES OF DOMAIN NAMES TO WEB SITES OF OTHERS; COMPUTER SOFTWARE DESIGN AND SOFTWARE UTILITIES DESIGN FOR OTHERS; COMPUTER SERVICES, NAMELY, COMPUTER PROGRAMMING FOR OTHERS, INSTALLATION AND CONFIGURATION OF SOFTWARE, DESIGNING AND IMPLEMENTING WEB SITES FOR OTHERS IN DIFFERENT COMPUTER LANGUAGES (U.S. CLS. 100 AND 101).

SN 76-100,142. AMERICAN FALCON CORP., AUBURN, ME. FILED 8-1-2000.

**CLASS 8—HAND TOOLS**

FOR SCISSORS SOLD TO SCHOOLS AND OTHER LARGE BULK PURCHASERS OF THESE ITEMS (U.S. CLS. 23, 28 AND 44).

CLASS 9—ELECTRICAL AND SCIENTIFIC APPARATUS

FOR PROTRACTORS SOLD TO SCHOOLS AND OTHER LARGE BULK PURCHASERS OF THESE ITEMS (U.S. CLS. 21, 23, 26, 36 AND 38).

CLASS 16—PAPER GOODS AND PRINTED MATTER

FOR SCHOOL SUPPLIES, NAMELY DRAWING RULERS AND DRAWING COMPASSES SOLD TO SCHOOLS AND OTHER LARGE BULK PURCHASERS OF THESE ITEMS (U.S. CLS. 2, 5, 22, 23, 29, 37, 38 AND 50).

SN 76-100,141. AMERICAN FALCON CORP., AUBURN, ME. FILED 8-1-2000.

FALCON

CLASS 8—HAND TOOLS

FOR SCISSORS SOLD TO SCHOOLS AND OTHER LARGE BULK PURCHASERS OF THESE ITEMS (U.S. CLS. 23, 28 AND 44).

CLASS 9—ELECTRICAL AND SCIENTIFIC APPARATUS

FOR PROTRACTORS SOLD TO SCHOOLS AND OTHER LARGE BULK PURCHASERS OF THESE ITEMS (U.S. CLS. 21, 23, 26, 36 AND 38).

CLASS 16—PAPER GOODS AND PRINTED MATTER

FOR SCHOOL SUPPLIES, NAMELY DRAWING RULERS AND DRAWING COMPASSES SOLD TO SCHOOLS AND OTHER LARGE BULK PURCHASERS OF THESE ITEMS (U.S. CLS. 2, 5, 22, 23, 29, 37, 38 AND 50).

SN 76-101,445. JOURNEY UNLIMITED EQUIPMENT, INC., VANCOUVER, BRITISH COLUMBIA, CANADA, FILED 8-2-2000.

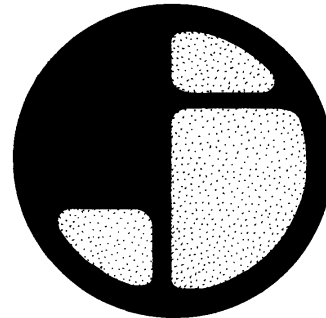

THE STIPPLING IN THE DRAWING IS A FEATURE OF THE MARK AND IS NOT INTENDED TO INDICATE COLOR.

THE MARK CONSISTS OF A STYLIZED LETTER "J" ON A BLACK CIRCULAR BACKGROUND.

CLASS 18—LEATHER GOODS

FOR BACKPACKS, ATHLETIC BAGS, AND LUGGAGE (U.S. CLS. 1, 2, 3, 22 AND 41).

CLASS 25—CLOTHING

FOR APPAREL, NAMELY, SHIRTS, SWEATERS, VESTS, PANTS, COATS, HATS, SOCKS, UNDERWEAR, AND FOOTWEAR (U.S. CLS. 22 AND 39).

SN 76-101,446. JOURNEY UNLIMITED EQUIPMENT, INC., VANCOUVER, BRITISH COLUMBIA, CANADA, FILED 8-2-2000.



THE STIPLING IN THE DRAWING IS A FEATURE OF THE MARK AND IS NOT INTENDED TO INDICATE COLOR.

CLASS 18—LEATHER GOODS

FOR BACKPACKS, ATHLETIC BAGS, AND LUGGAGE (U.S. CLS. 1, 2, 3, 22 AND 41).

CLASS 25—CLOTHING

FOR APPAREL, NAMELY, SHIRTS, SWEATERS, VESTS, PANTS, COATS, HATS, SOCKS, UNDERWEAR, AND FOOTWEAR (U.S. CLS. 22 AND 39).

SN 76-102,098. HCB ENTERPRISES, INC., DALLAS, TX. FILED 8-2-2000.



NO CLAIM IS MADE TO THE EXCLUSIVE RIGHT TO USE "THE DRY CLEANER", APART FROM THE MARK AS SHOWN.

THE MARK CONSISTS OF A RECTANGULAR FIELD AND A CIRCULAR LOGO - THE FIELD CONSISTS OF BLUE AND WHITE VERTICAL STRIPES AND BLUE TRIANGLES IN ITS BOTTOM CORNERS; THE LOGO CONSISTS OF A BLUE BACKGROUND AND A GOLD BORDER, THE WORD "BIBBENTUCKERS" IN WHITE LETTERS WITH GOLD BORDERS APPEARS IN AN ARC ACROSS THE TOP OF THE LOGO, THE WORDS "THE DRY CLEANERS" IN GOLD LETTERS APPEAR IN AN INVERSE ARC ACROSS THE BOTTOM OF THE LOGO, AND A STYLIZED CURSIVE LETTER B IN GOLD WITH A WHITE BORDER APPEARS IN THE CENTER OF THE LOGO.

CLASS 37—CONSTRUCTION AND REPAIR

FOR CLOTHING MAINTENANCE AND REPAIR SERVICES, NAMELY MENDING, LEATHER CLEANING FOR ANIMAL SKINS, HIDES AND IMITATIONS OF LEATHER, LAUNDRY AND DRY CLEANING SERVICES INCLUDING CLOTHING MAINTENANCE AND REPAIR SERVICES WHICH MAY BE ORDERED VIA GLOBAL COMPUTER NETWORKS (U.S. CLS. 100, 103 AND 106).

FIRST USE 9-30-1996; IN COMMERCE 9-30-1996.

CLASS 39—TRANSPORTATION AND STORAGE

FOR PICK-UP AND DELIVERY SERVICES FOR CLOTH, CLOTHING, FABRIC AND LEATHER VIA GROUND TRANSPORTATION, INCLUDING PICK-UP AND DELIVERY SERVICES WHICH MAY BE ORDERED VIA GLOBAL COMPUTER NETWORKS (U.S. CLS. 100 AND 105).

FIRST USE 9-30-1996; IN COMMERCE 9-30-1996.

SN 76-102,551. CIRCADENCE CORPORATION, BOULDER, CO. FILED 8-2-2000.

VR-1 CONDUCTOR

OWNER OF U.S. REG. NO. 2,276,457.

CLASS 9—ELECTRICAL AND SCIENTIFIC APPARATUS

FOR COMPUTER SOFTWARE THAT ENABLES MULTI-USER NETWORK APPLICATIONS, NAMELY CLIENT/SERVER SOFTWARE, SUPPORTING SOFTWARE, AND MANAGEMENT AND BILLING SOFTWARE (U.S. CLS. 21, 23, 26, 36 AND 38).

CLASS 42—SCIENTIFIC, COMPUTER AND LEGAL SERVICES

FOR PROVIDING A COMPUTER COMMUNICATIONS NETWORK FOR CUSTOMER PRIORITIZATION, EFFICIENCY, PROFITABILITY, AND PERFORMANCE ENHANCEMENT OF AN ELECTRONIC CONTENT DELIVERY SYSTEM (U.S. CLS. 100 AND 101).

SN 76-103,530. IN2M.COM LLC, HOLLADAY, UT. FILED 8-4-2000.

MVELOPES**CLASS 9—ELECTRICAL AND SCIENTIFIC APPARATUS**

FOR COMPUTER COMMUNICATIONS SOFTWARE TO ALLOW CUSTOMERS TO ACCESS BANK ACCOUNT INFORMATION AND TRANSACT BANK BUSINESS; COMPUTER SOFTWARE FOR USE IN MONITORING ACCOUNT AND SPENDING INFORMATION FOR USE IN THE FIELD OF PERSONAL FINANCIAL MANAGEMENT (U.S. CLS. 21, 23, 26, 36 AND 38).

CLASS 36—INSURANCE AND FINANCIAL

FOR PROVIDING BANKING SERVICES VIA GLOBAL COMPUTER NETWORKS; PERSONAL FINANCIAL MANAGEMENT VIA GLOBAL COMPUTER NETWORKS (U.S. CLS. 100, 101 AND 102).

SN 76-103,802. METAL-IS IT...LIMITED, LONDON W14 0NS,
UNITED KINGDOM. FILED 8-3-2000.



PRIORITY CLAIMED UNDER SEC. 44(D) ON UNITED
KINGDOM APPLICATION NO. 2233197, FILED 6-27-2000.

CLASS 6—METAL GOODS

FOR COMMON METAL GOODS, NAMELY, KEY RINGS, KEY FOBS, NAME BADGES, STATUETTES AND REPLACEMENT PARTS AND STRUCTURAL PARTS AND FITTINGS FOR THE AFORESAID GOODS (U.S. CLS. 2, 12, 13, 14, 23, 25 AND 50).

CLASS 9—ELECTRICAL AND SCIENTIFIC APPARATUS

FOR COMPUTER PROGRAMS FOR THE REPRODUCTION OF SOUND RELATING TO AND ABOUT MUSIC PERFORMANCES, THE PERFORMING ARTS, POETRY AND BOOK READINGS; CAMERAS; VIDEO TAPES AND DISCS FEATURING ANIMATED CARTOONS; VIDEO GAME MACHINES FOR USE WITH TELEVISION, VIDEO OR COMPUTER RECEIVERS OR VIDEO DISPLAY UNITS; ELECTRONIC VIDEO AND COMPUTER GAME PROGRAMS, CARTRIDGES AND DISCS; PRE-RECORDED VIDEO TAPES FEATURING MUSIC, MUSICAL PERFORMANCES, HEAVY ROCK AND HEAVY METAL MUSIC, POETRY AND BOOK READINGS; AND REPLACEMENT PARTS AND FITTINGS FOR ALL OF THE AFORESAID GOODS (U.S. CLS. 21, 23, 26, 36 AND 38).

CLASS 14—JEWELRY

FOR PRECIOUS METAL GOODS, NAMELY, ORNAMENTS FOR CLOTHING, HATS AND HAIR; AND BADGES (U.S. CLS. 2, 27, 28 AND 50).

CLASS 16—PAPER GOODS AND PRINTED MATTER

FOR PAPER GOODS, NAMELY, PAPER NAME BADGES; WRITING PAPER LETTERHEAD PAPER, COMPLIMENTS SLIPS, STATIONERY, NOTEBOOKS AND NOTEPADS, ADDRESS CARDS; CARDBOARD; BOOKS AND MAGAZINES IN THE FIELD OF HEAVY ROCK OR HEAVY METAL MUSIC; COMIC BOOKS; NEWSLETTERS RELATING TO MUSIC AND POPULAR CULTURE; CALENDARS, DICTIONARIES; GIFT WRAPPING PAPER, GREETINGS CARDS, INVITATION CARDS, PICTURE CARDS, POSTCARDS; DECALS, PRESSURE SENSITIVE STICKERS; PHOTOGRAPHS; PHOTOGRAPH ALBUMS; POSTERS; PADS OF SCORING CARDS; DECORATIVE PAPER STRIPS FOR FIXING TO SHELVES; PENS, PENCILS; PEN AND PENCIL CASES AND TINS; PAPERWEIGHTS; PLAYING CARDS, PRINTING BLOCKS; PLASTIC BAGS AND PAPER BAGS, AND REPLACEMENT PARTS AND FITTINGS FOR ALL THE AFORESAID GOODS; SHEET MUSIC AND PICTURES (U.S. CLS. 2, 5, 22, 23, 29, 37, 38 AND 50).

CLASS 20—FURNITURE AND ARTICLES NOT OTHERWISE CLASSIFIED

FOR PLASTIC NAME BADGES, PICTURE FRAMES, AND STATUETTES AND REPLACEMENT PARTS AND FITTINGS FOR ALL THE AFORESAID GOODS (U.S. CLS. 2, 13, 22, 25, 32 AND 50).

CLASS 24—FABRICS

FOR ARTICLES OF TEXTILE MATERIAL, NAMELY, PLACE MATS, COASTERS, TEA TOWELS, TOWELS, TABLECLOTHS, TABLE NAPKINS AND BED SPREADS; FLAGS, BANNERS (U.S. CLS. 42 AND 50).

CLASS 25—CLOTHING

FOR CLOTHING, NAMELY, FOOTWEAR, HATS, JACKETS, ANORAKS, TROUSERS, SKIRTS, SHIRTS, T-SHIRTS, SWEATSHIRTS, POLO SHIRTS, BLOUSES, SWEATERS, PANTS, SCARVES, JEANS, TIES, HATS, CAPS, BASEBALL CAPS (U.S. CLS. 22 AND 39).

CLASS 26—FANCY GOODS

FOR NON-PRECIOUS METAL ORNAMENTS FOR CLOTHING, HATS AND HAIR; CLOTHING AND CAMPAIGN BUTTONS, ORNAMENTAL CLOTH PATCHES (U.S. CLS. 37, 39, 40, 42 AND 50).

CLASS 41—EDUCATION AND ENTERTAINMENT

FOR ENTERTAINMENT SERVICES, NAMELY, LIVE MUSICAL PERFORMANCES, PERFORMING ARTS AND POETRY AND BOOK READINGS; AUDIO RECORDING STUDIO SERVICES; PRODUCTION OF ENTERTAINMENT, NAMELY, PRODUCTION OF FILMS, TELEVISION PROGRAMS, AUDIO, VIDEO AND CINEMATOGRAPHIC RECORDINGS; MUSIC PUBLISHING SERVICES; PUBLICATION OF BOOKS AND MAGAZINES (U.S. CLS. 100, 101 AND 107).

SN 76-105,065. G.B. GIORGINI S.R.L., FLORENCE, ITALY,
FILED 8-8-2000.



G.B. Giorgini
Since 1923

PRIORITY CLAIMED UNDER SEC. 44(D) ON ERP
CMNTY TM OFC APPLICATION NO. 1676964, FILED 5-26-
2000, REG. NO. 1676964, DATED 6-25-2001, EXPIRES 5-26-
2010.

NO CLAIM IS MADE TO THE EXCLUSIVE RIGHT TO USE "SINCE 1923", APART FROM THE MARK AS SHOWN. THE NAME "G.B. GIORGINI" IDENTIFIES A LIVING INDIVIDUAL WHOSE CONSENT IS OF RECORD.

THE MARK CONSISTS OF THE WORDS "G.B. GIORGINI SINCE 1923" AND REPRESENTATION OF CROWN AND SHIELD DEVICE.

CLASS 18—LEATHER GOODS

FOR HANDBAGS, SHOULDER BAGS, BRIEFCASES, DUFFEL BAGS, TOTE BAGS, CLUTCH BAGS, RUCKSACKS, ATTACHE CASES, SUITCASES, LUGGAGE TRUNKS, WALLETS, PURSES BUSINESS CARD CASES CREDIT CARD CASES KEYCASES COSMETIC HAGS SOLD EMPTY, PASSPORT CASES UMBRELLAS (U.S. CLS. 1, 2, 3, 22 AND 41).

CLASS 25—CLOTHING

FOR ARTICLES OF CLOTHING FOR MEN, WOMEN AND CHILDREN NAMELY, PULLOVERS, CARDIGANS, SWEATERS, JERSEYS, JUMPERS, SWEATSHIRTS, PARKAS, BATHING SUITS, BLOUSES, SHIRTS, TROUSERS, JACKETS, JEANS, WAISTCOATS, SKIRTS, SHORTS, T-SHIRTS, DRESSES, MEN'S SUITS, COATS, RAINCOATS, OVERCOATS, OVERALLS, VESTS, HOSIERY AND PANTY-HOSES, BATHROBES, SHAWLS, SCARVES, NECKTIES, GLOVES, CLOTHING BELTS, SHOES, BOOTS, SANDALS, SLIPPERS, CLOGS, HATS AND CAPS (U.S. CLS. 22 AND 39).

SN 76-105,251. BAUER INTERNATIONAL, INC., WANDO, SC. FILED 8-9-2000.

BAUER INTERNATIONAL

SEC. 2(F).

CLASS 20—FURNITURE AND ARTICLES NOT OTHERWISE CLASSIFIED

FOR FURNITURE (U.S. CLS. 2, 13, 22, 25, 32 AND 50). FIRST USE 12-30-1991; IN COMMERCE 12-30-1991.

CLASS 35—ADVERTISING AND BUSINESS

FOR WHOLESALE AND RETAIL STORES FEATURING FURNITURE AND HOME ACCESSORIES DISTRIBUTORSHIP IN THE FIELD OF FURNITURE AND HOME ACCESSORIES (U.S. CLS. 100, 101 AND 102). FIRST USE 12-30-1991; IN COMMERCE 12-30-1991.

SN 76-106,107. ADAMS APPLE DISTRIBUTING L.P., GLENVIEW, IL. FILED 8-10-2000.

Mystic
LITE-UPS

CLASS 4—LUBRICANTS AND FUELS

FOR CANDLES (U.S. CLS. 1, 6 AND 15). FIRST USE 10-19-1999; IN COMMERCE 10-19-1999.

CLASS 21—HOUSEWARES AND GLASS

FOR CANDLE HOLDERS NOT OF PRECIOUS METAL AND INCENSE HOLDERS NOT OF PRECIOUS METAL (U.S. CLS. 2, 13, 23, 29, 30, 33, 40 AND 50). FIRST USE 3-9-2000; IN COMMERCE 3-9-2000.

SN 76-107,793. WAGERWORKS, INC., LAS VEGAS, NV. FILED 8-11-2000.

WAGERWARE**CLASS 35—ADVERTISING AND BUSINESS**

FOR RETAIL SERVICES, NAMELY ONLINE RETAIL APPAREL, JEWELRY, GAME AND DEPARTMENT STORES AVAILABLE THROUGH COMPUTER COMMUNICATIONS AND INTERACTIVE TELEVISION; ONLINE RETAIL STORE SERVICES FEATURING APPAREL, JEWELRY, GAMES AND A WIDE VARIETY OF CONSUMER GOODS OF OTHERS, AVAILABLE THROUGH COMPUTER COMMUNICATIONS AND INTERACTIVE TELEVISION; PROMOTING THE GOODS AND SERVICES OF OTHERS BY PLACING ADVERTISEMENTS ON ONE OR MORE WEB SITES ACCESSED THROUGH A GLOBAL COMPUTER NETWORK; PROMOTING THE GOODS AND SERVICES OF OTHERS BY PLACING ADVERTISEMENTS ON INTERACTIVE TV SYSTEMS; PREPARING AND PLACING ADVERTISEMENTS FOR OTHERS; DIRECT MAIL AND ELECTRONIC BILLBOARD ADVERTISING; DISSEMINATION OF ADVERTISING FOR OTHERS VIA AN ON-LINE ELECTRONIC COMMUNICATIONS NETWORK; AND ADVERTISING AGENCIES (U.S. CLS. 100, 101 AND 102).

CLASS 36—INSURANCE AND FINANCIAL

FOR FINANCIAL SERVICES, NAMELY FINANCIAL ANALYSIS AND CONSULTATION; FINANCIAL CLEARING HOUSES; FINANCIAL EXCHANGES; FINANCIAL FORECASTING; FINANCIAL GUARANTEE AND SURETY; FINANCIAL INFORMATION IN THE NATURE OF RATES OF EXCHANGE; FINANCIAL INFORMATION PROVIDED BY ELECTRONIC MEANS; FINANCIAL MANAGEMENT; FINANCIAL PLANNING; FINANCIAL PORTFOLIO MANAGEMENT; FINANCIAL RESEARCH; FINANCIAL SERVICES IN THE NATURE OF AN INVESTMENT SECURITY; FINANCIAL VALUATION OF PERSONAL PROPERTY AND REAL ESTATE; INSURANCE ANALYSIS AND CONSULTATION; INSURANCE ANALYSIS AND CONSULTATION; INSURANCE ANALYSIS AND CONSULTATION AVAILABLE THROUGH COMPUTER COMMUNICATIONS AND INTERACTIVE TELEVISION; REAL ESTATE APPRAISAL AND CONSULTATION; AND REAL ESTATE APPRAISAL AND CONSULTATION AVAILABLE THROUGH COMPUTER COMMUNICATIONS AND INTERACTIVE TELEVISION (U.S. CLS. 100, 101 AND 102).

CLASS 38—COMMUNICATION

FOR PROVIDING TELECOMMUNICATIONS CONNECTIONS TO A GLOBAL COMPUTER NETWORK; RENTAL OF TELECOMMUNICATION EQUIPMENT, NAMELY TELEPHONES, FACSIMILE MACHINES; TELECOMMUNICATIONS AIR TIME BROKERAGE SERVICES; TELECOMMUNICATIONS GATEWAY SERVICES; TELECOMMUNICATIONS SERVICES, NAMELY, ISDN SERVICES; TELECOMMUNICATIONS SERVICES, NAMELY, PERSONAL COMMUNICATION SERVICES; AUDIO TELECONFERENCING; VIDEO TELECONFERENCING; BROADCASTING AND DELIVERY OF AUDIO, VIDEO, AND MULTIMEDIA CONTENT BY MEANS OF RADIO, CELLULAR, AND WIRELESS COMMUNICATION, TELEVISION, CABLE TELEVISION, CLOSED CIRCUIT, ELECTRONIC COMMUNICATIONS NETWORKS, AND COMPUTER NETWORKS; PROVIDING TELEPHONE COMMUNICATIONS VIA COMPUTER NETWORKS; ELECTRONIC TRANSMISSION OF DATA, IMAGES, AND DOCUMENTS VIA COMPUTER TERMINALS AND NETWORKS; PROVIDING ONLINE BULLETIN BOARD FACILITIES FOR REAL-TIME INTERACTION WITH OTHER COMPUTER USERS CONCERNING TOPICS OF GENERAL INTEREST AND FOR PLAYING GAMES; PROVIDING BULLETIN BOARD SERVICES AND CHAT SERVICES BY MEANS OF A GLOBAL COMMUNICATION NETWORK; ELECTRONIC MAIL SERVICES; RECEIPT AND DELIVERY OF MESSAGES, DOCUMENTS, IMAGES AND OTHER DATA BY ELECTRONIC TRANSMISSION; PAGING SERVICES; INTEGRATED COMPUTER TELEPHONY SERVICES, NAMELY, UNIFIED TELEPHONE VOICE AND E-MAIL

MESSAGING SERVICES AND TELEPHONE COMMUNICATION SERVICES; RENTAL OF COMPUTERS; RENTAL OF TELECOMMUNICATION EQUIPMENT, NAMELY TELEPHONES AND FACSIMILE MACHINES; PROVIDING MULTI-USER ACCESS TO COMPUTER NETWORKS FOR THE TRANSFER AND DISSEMINATION OF A WIDE RANGE OF INFORMATION; AND DESIGN OF WEB SITES FOR A GLOBAL COMPUTER NETWORK; COMPUTER BULLETIN AND MESSAGE BOARD SERVICES FOR COMPUTER NETWORKS IN THE FIELD OF GAMES OF CHANCE AND LOTTERIES (U.S. CLS. 100, 101 AND 104).

CLASS 41—EDUCATION AND ENTERTAINMENT

FOR ENTERTAINMENT IN THE NATURE OF CASINO AND GAMING SERVICES; GAMING FACILITIES; PROVIDING CASINO AND GAMING SERVICES BY MEANS OF WEB SITES ACCESSED THROUGH A GLOBAL COMPUTER NETWORK OR BY MEANS OF INTERACTIVE TV SYSTEMS; LOTTERY SERVICES; ENTERTAINMENT SERVICES IN THE NATURE OF CONDUCTING A SWEEPSTAKES PROMOTION THROUGH COMPUTER COMMUNICATIONS AND INTERACTIVE TELEVISION; ORGANIZING, CONDUCTING AND OPERATING GAMES OF CHANCE AND LOTTERIES; GAMING SERVICES AVAILABLE THROUGH COMPUTER COMMUNICATIONS AND INTERACTIVE TELEVISION; LOTTERY SERVICES AVAILABLE THROUGH COMPUTER COMMUNICATIONS AND INTERACTIVE TELEVISION; ENTERTAINMENT SERVICES IN THE NATURE OF RAFFLE GAMES AVAILABLE THROUGH COMPUTER COMMUNICATIONS AND INTERACTIVE TELEVISION; GAMES OF LUCK OR CHANCE AVAILABLE THROUGH COMPUTER COMMUNICATIONS AND INTERACTIVE TELEVISION; PROVIDING INFORMATION REGARDING GAMING, LOTTERY, SWEEPSTAKE, RAFFLE, GAMES OF LUCK OR CHANCE; AND PROVIDING INFORMATION REGARDING GAMING, LOTTERY, SWEEPSTAKE, RAFFLE, GAMES OF LUCK OR CHANCE THROUGH COMPUTER COMMUNICATIONS AND INTERACTIVE TELEVISION (U.S. CLS. 100, 101 AND 107).

CLASS 42—SCIENTIFIC, COMPUTER AND LEGAL SERVICES

FOR COMPUTER SOFTWARE DESIGN; COMPUTER SERVICES, NAMELY PROVIDING ACCESS TO AND MAINTENANCE OF COMPUTER SOFTWARE IN THE FIELD OF GAMES OF CHANCE AND LOTTERIES; CONSULTING SERVICES IN THE FIELD OF COMPUTERS AND COMPUTER SOFTWARE FOR DATABASE MANAGEMENT THAT CREATES INDEXES OF INFORMATION, SITES, AND OTHER RESOURCES AVAILABLE ON COMPUTER NETWORKS; SEARCHING AND RETRIEVING INFORMATION, SITES, AND OTHER RESOURCES AVAILABLE ON COMPUTER NETWORKS FOR OTHERS; PROVIDING A WIDE RANGE OF GENERAL INTEREST INFORMATION FOR A GLOBAL COMPUTER NETWORK; DESIGN, CREATION, HOSTING AND MAINTENANCE OF WEB SITES FOR OTHERS; CONSULTING SERVICES AND PROVIDING TECHNICAL ASSISTANCE IN THE FIELDS OF DESIGNING, CREATING, HOSTING, MAINTAINING, OPERATING, MANAGING, ADVERTISING AND MARKETING OF WEB SITES ON A GLOBAL COMPUTER NETWORK; COMPUTER PROGRAMMING SERVICES FOR OTHERS; COMPUTER RENTAL SERVICES; AND COMPUTER SOFTWARE RENTAL SERVICES (U.S. CLS. 100 AND 101).

SN 76-108,680. 3D3.COM PTY. LTD., FRANKSTON 3199, VICTORIA, AUSTRALIA, FILED 8-14-2000.

SHOPFACTORY

OWNER OF ERPN CMNTY TM OFC REG. NO. EU001542828, DATED 5-29-2001, EXPIRES 3-7-2010.

CLASS 9—ELECTRICAL AND SCIENTIFIC APPARATUS

FOR COMPUTER SOFTWARE FOR OFFERING GOODS FOR SALE AT A WEBSITE, FOR RECORDING PURCHASES AND ARRANGING FOR PURCHASE FULFILLMENT, FOR MAINTAINING INVENTORY OF GOODS AND FOR ELECTRONIC BOOKKEEPING FOR PURCHASES OR SALES COMPLETED (U.S. CLS. 21, 23, 26, 36 AND 38).

CLASS 42—SCIENTIFIC, COMPUTER AND LEGAL SERVICES

FOR PROGRAMMING AND MAINTENANCE OF COMPUTER SOFTWARE FOR E-COMMERCE, INTERNET HOSTING, AND RENTING OF COMPUTER SERVERS (U.S. CLS. 100 AND 101).

SN 76-108,886. WECOMM LIMITED, LONDON EC4A 3LX, ENGLAND, FILED 8-14-2000.

WECOMM

CLASS 9—ELECTRICAL AND SCIENTIFIC APPARATUS

FOR COMPUTERS, COMPUTER HARDWARE, HAND HELD COMPUTERS, ELECTRONIC ORGANIZERS, PERSONAL ORGANIZERS, COMPUTER SOFTWARE TO ENABLE THE BROADCASTING OF STREAMING REAL-TIME DATA VIA WIRELESS COMMUNICATION SYSTEMS, COMPUTER SOFTWARE TO ENABLE ACCESS TO INFORMATION DATABASES, COMPUTER SOFTWARE AND TELECOMMUNICATIONS APPARATUS TO ENABLE CONNECTION TO DATABASES AND THE INTERNET, COMPUTER DATABASE SERVERS, MODEMS, MODEM CARDS AND WIRELESS MODEM CARDS (U.S. CLS. 21, 23, 26, 36 AND 38).

CLASS 38—COMMUNICATION

FOR PROVIDING ACCESS SERVICES TO PROPRIETARY DATABASES, PROPRIETARY THIRD PARTY DATABASES OR THE INTERNET VIA WIRELESS COMMUNICATION SYSTEMS (U.S. CLS. 100, 101 AND 104).

CLASS 42—SCIENTIFIC, COMPUTER AND LEGAL SERVICES

FOR COMPUTER PROGRAMMING SERVICES, CONSULTANCY, ADVICE AND INFORMATION ON THE FOREGOING (U.S. CLS. 100 AND 101).

SN 76-108,988. NORTH CAROLINA STATE UNIVERSITY, RALEIGH, NC. FILED 8-14-2000.

HELPING GARDENERS PUT KNOWLEDGE TO WORK

CLASS 16—PAPER GOODS AND PRINTED MATTER

FOR PUBLICATIONS, NAMELY, BROCHURES AND NEWSLETTERS CONCERNING HORTICULTURAL EDUCATIONAL PROGRAMS PROVIDED UNDER THE GUIDANCE AND SUPERVISION OF THE COOPERATIVE EXTENSION SERVICE TO TRAIN AND CERTIFY VOLUNTEERS WHO PROVIDE UNBIASED, RESEARCH BASED INFORMATION TO THE GARDENING PUBLIC (U.S. CLS. 2, 5, 22, 23, 29, 37, 38 AND 50).

CLASS 41—EDUCATION AND ENTERTAINMENT

FOR HORTICULTURAL EDUCATIONAL PROGRAMS IN THE FORM OF WORKSHOPS PROVIDED UNDER THE GUIDANCE AND SUPERVISION OF THE COOPERATIVE EXTENSION SERVICE TO TRAIN AND CERTIFY VOLUNTEERS WHO PROVIDE UNBIASED, RESEARCH BASED INFORMATION TO THE GARDENING PUBLIC (U.S. CLS. 100, 101 AND 107).

SN 76-112,176. A&E TELEVISION NETWORKS, NEW YORK, NY. FILED 8-18-2000.

HISTORY CHANNEL.COM NETWORK

OWNER OF U.S. REG. NO. 1,794,538.
NO CLAIM IS MADE TO THE EXCLUSIVE RIGHT TO USE "NETWORK", APART FROM THE MARK AS SHOWN. SEC. 2(F) "HISTORY CHANNEL".

CLASS 35—ADVERTISING AND BUSINESS

FOR ON-LINE DIRECTORY SERVICES, NAMELY, PROVIDING WEB SITE LINKS IN AN INDEXED FORMAT WITH BRIEF DESCRIPTIONS OF THE WEB SITES, FEATURING TOPICS RELATING TO HISTORY, HISTORICAL PEOPLE, PLACES AND EVENTS VIA THE GLOBAL COMPUTER NETWORK (U.S. CLS. 100, 101 AND 102).

CLASS 42—SCIENTIFIC, COMPUTER AND LEGAL SERVICES

FOR INFORMATION SERVICES, NAMELY, PROVIDING ON-LINE DATABASES AND LINKS TO OTHER CONTENT PROVIDERS IN THE FIELD OF HISTORY, HISTORICAL PEOPLE, PLACES AND EVENTS VIA THE GLOBAL COMPUTER NETWORK; PROVIDING A SEARCH ENGINE FOR OBTAINING INFORMATION ABOUT HISTORY, HISTORICAL PEOPLE, PLACES AND EVENTS (U.S. CLS. 100 AND 101).

SN 76-112,243. CANNILLO'S BROTHERS LLC, PASSAIC, NJ. FILED 8-21-2000.



THE ENGLISH TRANSLATION OF LA FEDE IS "THE FAITH".

CLASS 29—MEATS AND PROCESSED FOODS

FOR PROCESSED AND PACKED ARTICHOKE; PACKED IMPORTED BEANS, NAMELY, KIDNEY, PEAS, CHICK, LENTILS AND CANNELLINI BEANS; CHEESES, NAMELY, PROVOLONE, ASIAGO, PEPATO AND MOZZARELLA CHEESES; PROCESSED AND PACKED EGGPLANT; PROCESSED AND PACKED GIARDINIERA MIXED VEGETABLES; PROCESSED AND PACKED MUSHROOMS; PACKED OLIVE OILS, NAMELY, PURE AND EXTRA VIRGIN OLIVE OILS; PROCESSED AND PACKED OLIVES, NAMELY, CALABRESE, CALAMATA, GAETA, OIL CURED SICILIAN AND BLACK OLIVES; PROCESSED AND PACKED PEPPERS, NAMELY, ROASTED, PEPPERONCINI, CHERRY, BANANA PEPPERS; PROCESSED AND PACKED TOMATOES, NAMELY WHOLE, CRUSHED, PUREE AND PASTE IMPORTED AND DOMESTIC TOMATOES (U.S. CL. 46).

FIRST USE 1-0-1936; IN COMMERCE 1-0-1936.

CLASS 30—STAPLE FOODS

FOR PACKED PASTAS, NAMELY, LASAGNA, SHELLS, ZITI, SPIRALS AND RADIATORE; PROCESSED AND PACKED PASTA SAUCES, NAMELY, MARINARA, TOMATO-BASIL, VODKA, PORCINI, ROASTED GARLIC PASTA SAUCES; PROCESSED AND PACKED SPICES NAMELY, PARSLEY, PEPPER, BASIL, GARLIC, ONION, RED CRUSHED, FENNEL, BAY LEAVES, CINNAMON; PROCESSED AND PACKED VINEGARS, NAMELY, WHITE, WINE AND BALSAMIC VINEGARS (U.S. CL. 46).

FIRST USE 1-0-1936; IN COMMERCE 1-0-1936.

SN 76-112,500. GIANT, INC., LOS ANGELES, CA. FILED 8-18-2000.

GIANT

CLASS 3—COSMETICS AND CLEANING PREPARATIONS

FOR COSMETICS, NAMELY LIPSTICK, LIP GLOSS, LIP PENCILS, BLUSH, EYE SHADOW, EYE PENCILS, EYE LINER, GLITTER POWDER FOR THE FACE, LOOSE FACIAL POWDER, PRESSED FACIAL POWDER, FOUNDATION AND BASE MAKE-UP, CONCEALER STICKS, MASCARA, NON-MEDICATED SKIN CLEANSER, NON-MEDICATED MOISTURIZER, AND PERFUME (U.S. CLS. 1, 4, 6, 50, 51 AND 52).

CLASS 9—ELECTRICAL AND SCIENTIFIC APPARATUS

FOR SUNGLASSES (U.S. CLS. 21, 23, 26, 36 AND 38).

CLASS 14—JEWELRY

FOR JEWELRY AND WATCHES (U.S. CLS. 2, 27, 28 AND 50).

CLASS 18—LEATHER GOODS

FOR LEATHER GOODS, NAMELY HANDBAGS, WALLETS, LUGGAGE, BRIEFCASES, COSMETIC CASES SOLD EMPTY, POUCHES, TOTE BAGS, WAIST PACKS (U.S. CLS. 1, 2, 3, 22 AND 41).

CLASS 24—FABRICS

FOR TOWELS, BEACH TOWELS, BLANKETS AND THROWS (U.S. CLS. 42 AND 50).

CLASS 28—TOYS AND SPORTING GOODS

FOR SPORTING GOODS AND TOYS, NAMELY, FLYING DISCS, LIGHT STICKS, PLUSH TOYS, SPORTS BALLS, PLAYGROUND BALLS, BEACH BALLS, BALLOONS, AND CHRISTMAS TREE ORNAMENTS (U.S. CLS. 22, 23, 38 AND 50).

CLASS 41—EDUCATION AND ENTERTAINMENT

FOR ENTERTAINMENT SERVICES, NAMELY, PROVIDING AN ON-LINE COMPUTER GAME (U.S. CLS. 100, 101 AND 107).

SN 76-113,602. BIRTH TO THREE INITIATIVE, COLUMBUS, OH. FILED 8-21-2000.

START SMART**CLASS 41—EDUCATION AND ENTERTAINMENT**

FOR EDUCATIONAL SERVICES, NAMELY CONDUCTING CLASSES, CONFERENCES AND WORKSHOPS IN THE FIELD OF EDUCATIONAL PERFORMING ARTS ACTIVITIES AND TECHNIQUES AND DISTRIBUTING COURSE MATERIALS IN CONNECTION THEREWITH (U.S. CLS. 100, 101 AND 107).

SN 76-114,424. UNCLE BEN'S, INC., HOUSTON, TX. FILED 8-22-2000.

CLASS 42—SCIENTIFIC, COMPUTER AND LEGAL SERVICES

FOR PROMOTING THE PUBLIC AWARENESS OF THE NEED FOR ADVOCACY, FUNDING AND FACILITY IMPROVEMENTS TO ENHANCE THE QUALITY OF CARE FOR YOUNG CHILDREN AND THE DEVELOPMENT AND EDUCATION OF INFANTS AND PRE-SCHOOL CHILDREN (U.S. CLS. 100 AND 101).

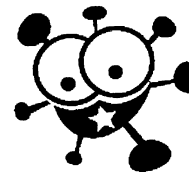

SN 76-114,351. UNCLE BEN'S, INC., HOUSTON, TX. FILED 8-22-2000.

U•B BUCKS**CLASS 9—ELECTRICAL AND SCIENTIFIC APPARATUS**

FOR ELECTRONIC GAME PROGRAMS; COMPUTER GAME CARTRIDGES; COMPUTER GAME CASSETTES; COMPUTER GAME DISCS; COMPUTER GAME PROGRAMS; INTERACTIVE MULTIMEDIA COMPUTER GAME PROGRAMS; AND VIDEO GAME INTERACTIVE HAND HELD REMOTE CONTROLS FOR PLAYING ELECTRONIC GAMES (U.S. CLS. 21, 23, 26, 36 AND 38).

CLASS 9—ELECTRICAL AND SCIENTIFIC APPARATUS

FOR ELECTRONIC GAME PROGRAMS; COMPUTER GAME CARTRIDGES; COMPUTER GAME CASSETTES; COMPUTER GAME DISCS; COMPUTER GAME PROGRAMS; INTERACTIVE MULTIMEDIA COMPUTER GAME PROGRAMS; AND VIDEO GAME INTERACTIVE HAND HELD REMOTE CONTROLS FOR PLAYING ELECTRONIC GAMES (U.S. CLS. 21, 23, 26, 36 AND 38).

CLASS 28—TOYS AND SPORTING GOODS

FOR ELECTRONIC EDUCATIONAL GAME MACHINES FOR CHILDREN; GAMES IN THE NATURE OF EQUIPMENT SOLD AS A UNIT FOR PLAYING BOARD GAMES; BOARD GAMES; CARD GAMES; ACTION FIGURES; TOYS, NAMELY, BATTERY-POWERED COMPUTER GAMES WITH LCD SCREEN WHICH FEATURES ANIMATION AND SOUND EFFECTS (U.S. CLS. 22, 23, 38 AND 50).

CLASS 28—TOYS AND SPORTING GOODS

FOR ELECTRONIC EDUCATIONAL GAME MACHINES FOR CHILDREN; GAMES IN THE NATURE OF EQUIPMENT SOLD AS A UNIT FOR PLAYING BOARD GAMES; BOARD GAMES; CARD GAMES; ACTION FIGURES; TOYS, NAMELY, BATTERY-POWERED COMPUTER GAMES WITH LCD SCREEN WHICH FEATURES ANIMATION AND SOUND EFFECTS (U.S. CLS. 22, 23, 38 AND 50).

CLASS 30—STAPLE FOODS

FOR RICE, RICE MIXES, PASTA MIXES AND SAUCES; FROZEN ENTREES, CONSISTING PRIMARILY OF RICE OR PASTA (U.S. CL. 46).

CLASS 30—STAPLE FOODS

FOR RICE, RICE MIXES, PASTA MIXES AND SAUCES; FROZEN ENTREES, CONSISTING PRIMARILY OF RICE OR PASTA (U.S. CL. 46).

CLASS 41—EDUCATION AND ENTERTAINMENT

FOR ENTERTAINMENT SERVICES, NAMELY, PROVIDING AN ON-LINE COMPUTER GAME (U.S. CLS. 100, 101 AND 107).

SN 76-114,426. UNCLE BEN'S, INC., HOUSTON, TX. FILED 8-22-2000.

U•B WORLD

CLASS 9—ELECTRICAL AND SCIENTIFIC APPARATUS

FOR ELECTRONIC GAME PROGRAMS; COMPUTER GAME CARTRIDGES; COMPUTER GAME CASSETTES; COMPUTER GAME DISCS; COMPUTER GAME PROGRAMS; INTERACTIVE MULTIMEDIA COMPUTER GAME PROGRAMS; AND VIDEO GAME INTERACTIVE HAND HELD REMOTE CONTROLS FOR PLAYING ELECTRONIC GAMES (U.S. CLS. 21, 23, 26, 36 AND 38).

CLASS 28—TOYS AND SPORTING GOODS

FOR ELECTRONIC EDUCATIONAL GAME MACHINES FOR CHILDREN; GAMES IN THE NATURE OF EQUIPMENT SOLD AS A UNIT FOR PLAYING BOARD GAMES; BOARD GAMES; CARD GAMES; ACTION FIGURES; TOYS, NAMELY, BATTERY-POWERED COMPUTER GAMES WITH LCD SCREEN WHICH FEATURES ANIMATION AND SOUND EFFECTS (U.S. CLS. 22, 23, 38 AND 50).

CLASS 30—STAPLE FOODS

FOR RICE, RICE MIXES, PASTA MIXES AND SAUCES; FROZEN ENTREES, CONSISTING PRIMARILY OF RICE OR PASTA (U.S. CL. 46).

CLASS 41—EDUCATION AND ENTERTAINMENT

FOR ENTERTAINMENT SERVICES, NAMELY, PROVIDING AN ON-LINE COMPUTER GAME (U.S. CLS. 100, 101 AND 107).

SN 76-114,430. UNCLE BEN'S, INC., HOUSTON, TX. FILED 8-22-2000.

UBBIES

CLASS 9—ELECTRICAL AND SCIENTIFIC APPARATUS

FOR ELECTRONIC GAME PROGRAMS; COMPUTER GAME CARTRIDGES; COMPUTER GAME CASSETTES; COMPUTER GAME DISCS; COMPUTER GAME PROGRAMS; INTERACTIVE MULTIMEDIA COMPUTER GAME PROGRAMS; AND VIDEO GAME INTERACTIVE HAND HELD REMOTE CONTROLS FOR PLAYING ELECTRONIC GAMES (U.S. CLS. 21, 23, 26, 36 AND 38).

CLASS 28—TOYS AND SPORTING GOODS

FOR ELECTRONIC EDUCATIONAL GAME MACHINES FOR CHILDREN; GAMES IN THE NATURE OF EQUIPMENT SOLD AS A UNIT FOR PLAYING BOARD GAMES; BOARD GAMES; CARD GAMES; ACTION FIGURES; TOYS, NAMELY, BATTERY-POWERED COMPUTER GAMES WITH LCD SCREEN WHICH FEATURES ANIMATION AND SOUND EFFECTS (U.S. CLS. 22, 23, 38 AND 50).

CLASS 30—STAPLE FOODS

FOR RICE, RICE MIXES, PASTA MIXES AND SAUCES; FROZEN ENTREES, CONSISTING PRIMARILY OF RICE OR PASTA (U.S. CL. 46).

CLASS 41—EDUCATION AND ENTERTAINMENT

FOR ENTERTAINMENT SERVICES, NAMELY, PROVIDING AN ON-LINE COMPUTER GAME (U.S. CLS. 100, 101 AND 107).

SN 76-115,066. AMERICAN FOOTBALL COACHES ASSOCIATION, WACO, TX. FILED 8-23-2000.

AMERICAN FOOTBALL COACHES FOUNDATION

OWNER OF U.S. REG. NOS. 1,551,375 AND 2,287,363. NO CLAIM IS MADE TO THE EXCLUSIVE RIGHT TO USE "FOUNDATION", APART FROM THE MARK AS SHOWN.

SEC. 2(F) AS TO "AMERICAN FOOTBALL COACHES".

CLASS 16—PAPER GOODS AND PRINTED MATTER

FOR PRINTED INSTRUCTIONAL, EDUCATIONAL, AND TEACHING MATERIALS ASSOCIATED WITH COACHING THE GAME OF FOOTBALL (U.S. CLS. 2, 5, 22, 23, 29, 37, 38 AND 50).

CLASS 36—INSURANCE AND FINANCIAL

FOR FUND RAISING AND PROVIDING EDUCATIONAL SCHOLARSHIPS (U.S. CLS. 100, 101 AND 102).

CLASS 41—EDUCATION AND ENTERTAINMENT

FOR EDUCATIONAL SERVICES, NAMELY, PROVIDING INSTRUCTION, AND TRAINING TO FOOTBALL COACHES (U.S. CLS. 100, 101 AND 107).

CLASS 42—SCIENTIFIC, COMPUTER AND LEGAL SERVICES

FOR PROMOTING THE INTERESTS OF THE GAME OF FOOTBALL AND THE COACHING PROFESSION; COUNSELING SERVICES FOR COACHES IN THE AREA OF SPORTS, IN THE NATURE OF CAREER AND PERSONAL DEVELOPMENT (U.S. CLS. 100 AND 101).

SN 76-115,629. CHARLES SCHWAB & CO., INC., SAN FRANCISCO, CA. FILED 8-23-2000.



THE NAME "CHARLES SCHWAB" IDENTIFIES A LIVING INDIVIDUAL WHOSE CONSENT IS OF RECORD.

THE NON-LATIN CHARACTERS IN THE MARK TRANSLITERATE TO CHARLES SCHWAB

CLASS 36—INSURANCE AND FINANCIAL

FOR BROKERAGE SERVICES IN THE FIELDS OF SECURITIES, STOCKS, BONDS, MUTUAL FUNDS, MONEY MARKET FUNDS, COMMODITIES, FUTURES, OPTIONS, AND INDICES OF ANY OF THEM; INVESTMENT SERVICES IN THE FIELDS OF SECURITIES, STOCKS, MONEY MARKET FUNDS, BONDS, MUTUAL FUNDS, COMMODITIES, FUTURES, OPTIONS, AND INDICES OF ANY OF THEM; INVESTMENT ADVICE AND MANAGEMENT IN THE FIELDS OF SECURITIES, STOCKS, BONDS, MUTUAL FUNDS, MONEY MARKET FUNDS, COMMODITIES, FUTURES, OPTIONS, AND INDICES OF ANY OF THEM; SECURITIES BROKERAGE ACCOUNT SERVICES THAT INCLUDES AN INTEREST BEARING ACCOUNT FOR CASH BETWEEN INVESTMENTS, ACCESS TO CASH AND MARGIN LOANS; CREDIT CARD AND DEBIT CARD SERVICES; CHECK WRITING AND BILL PAYMENT SERVICES; INVESTMENT ACCOUNT INFORMATION SERVICES, NAMELY, PROVIDING INVESTMENT ACCOUNT INFORMATION BY PHONE, VIA AN ELECTRONIC INTERACTIVE VOICE RESPONSE SYSTEM, AND BY ONLINE MEANS, AND PROVIDING INVESTMENT ACCOUNT INFORMATION IN THE FORM OF CONSOLIDATED STATEMENTS; CASH MANAGEMENT ACCOUNT SERVICES; PROVIDING FINANCIAL PORTFOLIO MANAGEMENT SERVICES; PROVIDING AN ONLINE INTERACTIVE COMPUTER DATABASE IN THE FIELD OF PORTFOLIO MANAGEMENT, FINANCIAL DECISION MAKING, INVESTMENT RESEARCH ANALYSIS, MONITORING INVESTMENT MARKET VALUE AND PERFORMANCE OF INVESTMENTS, ANALYZING INVESTMENT PERFORMANCE, EVALUATING ASSET ALLOCATION, RISK TOLERANCE, FINANCIAL ALTERNATIVE PLANS, AND INVESTMENT TIME FRAMES; PROVIDING ONLINE NEWS, INFORMATION, RESEARCH, AND FINANCIAL ANALYSIS IN THE FIELDS OF INVESTING, FINANCE, AND FINANCIAL PLANNING; PROVIDING ONLINE NEWS, INFORMATION, RESEARCH, AND FINANCIAL ANALYSIS IN THE FIELDS OF GOVERNMENT, ECONOMICS, BUSINESS, AND CURRENT EVENTS THAT RELATE TO FINANCIAL PLANNING AND INVESTING (U.S. CLS. 100, 101 AND 102).

CLASS 41—EDUCATION AND ENTERTAINMENT

FOR EDUCATIONAL SERVICES, NAMELY, CONDUCTING CLASSES, SEMINARS, WORKSHOPS AND CONFERENCES IN THE FIELDS OF INVESTMENT, FINANCE, ECONOMICS, BUSINESS, FINANCIAL PLANNING, PORTFOLIO MANAGEMENT, RETIREMENT PLANNING, MONEY MANAGEMENT, INVESTMENT STRATEGY, AND ASSET ALLOCATION (U.S. CLS. 100, 101 AND 107).

SN 76-118,476. PE CORPORATION (NY), NORWALK, CT. BY CHANGE OF NAME PE CORPORATION, ROCKVILLE, MD. FILED 8-29-2000.



CELERA

THE MARK CONSISTS THE WORDING "CELERA" ALONG WITH A STYLIZED DEPICTION OF THE HUMAN DNA STRAND.

CLASS 35—ADVERTISING AND BUSINESS

FOR LICENSING OF ASSAY SYSTEMS FOR PERFORMANCE OF MEDICAL, RESEARCH AND LABORATORY DIAGNOSTIC SERVICES IN THE FIELDS OF SCIENCE, TECHNOLOGY, MEDICINE, HEALTH AND COMPUTERIZED INFORMATION DATABASES; BUSINESS CONSULTATION (U.S. CLS. 100, 101 AND 102).

CLASS 42—SCIENTIFIC, COMPUTER AND LEGAL SERVICES

FOR CONSULTATION AND RESEARCH IN THE FIELDS OF SCIENCE, TECHNOLOGY, MEDICINE, HEALTH AND PUBLIC POLICY; COMPUTER SERVICES, NAMELY, PROVIDING DATABASES AND INFORMATION IN THE FIELDS OF SCIENCE, TECHNOLOGY, MEDICINE, HEALTH AND PUBLIC POLICY; PROVIDING TEMPORARY USE OF ON-LINE NON-DOWNLOADABLE SOFTWARE FOR ACCESSING AND ANALYZING INFORMATION IN THE FIELDS OF SCIENCE, TECHNOLOGY, MEDICINE, HEALTH, AND PUBLIC POLICY; MEDICAL RESEARCH AND LABORATORY DIAGNOSTIC SERVICES AND ASSAYING THE FIELDS OF MEDICINE AND HEALTH; LICENSING OF INTELLECTUAL PROPERTY FOR THE PERFORMANCE OF MEDICAL, RESEARCH AND LABORATORY DIAGNOSTIC SERVICES IN THE FIELDS OF MEDICINE AND HEALTH; DEVELOPMENT OF NEW PRODUCTS FOR OTHERS IN THE FIELDS OF SCIENCE, TECHNOLOGY, MEDICINE AND HEALTH (U.S. CLS. 100 AND 101).

SN 76-120,727. LEIRAS OY, FIN-20101 TURKU, FINLAND, FILED 8-31-2000.

MIRENETTE

OWNER OF FINLAND REG. NO. 214111, DATED 5-14-1999, EXPIRES 5-14-2009.
OWNER OF U.S. REG. NO. 214,111.

CLASS 5—PHARMACEUTICALS

FOR HORMONE PREPARATIONS FOR HORMONE REPLACEMENT THERAPY (U.S. CLS. 6, 18, 44, 46, 51 AND 52).

CLASS 10—MEDICAL APPARATUS

FOR IMPLANTABLE AND INTRAUTERINE HORMONE RELEASING DEVICES FOR MEDICAL USE (U.S. CLS. 26, 39 AND 44).

SN 76-122,005. CONAGRA FOODS, INC., OMAHA, NE. BY CHANGE OF NAME CONAGRA, INC., OMAHA, NE. FILED 9-5-2000.

CONAGRA FOODS

OWNER OF U.S. REG. NO. 923,573.
NO CLAIM IS MADE TO THE EXCLUSIVE RIGHT TO USE "FOODS", APART FROM THE MARK AS SHOWN.

CLASS 1—CHEMICALS

FOR FERTILIZERS FOR AGRICULTURAL USE (U.S. CLS. 1, 5, 6, 10, 26 AND 46).

CLASS 5—PHARMACEUTICALS

FOR PESTICIDES FOR AGRICULTURAL USE; PROBIOTIC DIETARY SUPPLEMENTS; NUTRITIONAL ADITIVES FOR ANIMAL FEED (U.S. CLS. 6, 18, 44, 46, 51 AND 52).

CLASS 29—MEATS AND PROCESSED FOODS

FOR PREPARED MEALS AND ENTREES CONSISTING PRIMARILY OF BEEF, PORK, POULTRY, SEAFOOD OR VEGETABLES; BEEF; PROCESSED BEEF; PORK; PROCESSED PORK; POULTRY; PROCESSED POULTRY; SEAFOOD; PROCESSED SEAFOOD; PROCESSED VEGETABLES; PROCESSED BEANS; PROCESSED TOMATOES; PROCESSED CHILI PEPPERS; PROCESSED POTATOES; PROCESSED GRAINS; BAKED BEANS; BEEF JERKY; BACON; SAUSAGE; HOT DOGS; DELI MEATS; LUNCHEON MEATS; CHEESE; MARGARINE; VEGETABLE BASED SPREADS; VEGETABLE OIL; DAIRY BASED WHIPPED TOPPING; NON-DAIRY WHIPPED TOPPING; CREAM CHEESE; YOGURT; JAMS; JELLIES; PEANUT BUTTER; EGG SUBSTITUTES; MEAT SUBSTITUTES; UNFLAVORED AND UNSWEETENED GELATINS (U.S. CL. 46).

CLASS 30—STAPLE FOODS

FOR PREPARED MEALS AND ENTREES CONSISTING PRIMARILY OF RICE OR PASTA; BAKERY GOODS; BREAD; BREAKFAST CEREALS; BURRITOS; ENCHILADAS; EGG ROLLS; PASTA; FLOUR; SAUCES; SPICES; SEASONINGS; PROCESSED GARLIC; GRAVY MIXES; KETCHUP; MUSTARD; SALSA; PASTA SAUCE; BARBECUE SAUCE; TOMATO SAUCE; MARSHMALLOWS; PIZZA; POT PIES; POPPED POPCORN; GLAZED POPCORN; MICROWAVE POPCORN; PUDDING; FLAVORED AND SWEETENED GELATINS; HOT CHOCOLATE MIXES; COCOA MIXES; GRAIN BASED SNACKS; ICE CREAM (U.S. CL. 46).

CLASS 31—NATURAL AGRICULTURAL PRODUCTS

FOR ANIMAL FEEDS, SEEDS FOR AGRICULTURAL USE; UNPROCESSED GRAIN FOR EATING (U.S. CLS. 1 AND 46).

SN 76-123,413. CELADOR INTERNATIONAL LIMITED, LONDON WC2E 9JT, ENGLAND, FILED 9-5-2000.

THE NATION VERSUS**CLASS 30—STAPLE FOODS**

FOR CHOCOLATE AND PASTRY (U.S. CL. 46).

CLASS 38—COMMUNICATION

FOR TELEVISION AND RADIO BROADCASTING SERVICES (U.S. CLS. 100, 101 AND 104).

SN 76-123,517. SIEMENS AKTIENGESELLSCHAFT, MUNCHEN, FED REP GERMANY, FILED 9-6-2000.

PROX4

PRIORITY CLAIMED UNDER SEC. 44(D) ON FED REP GERMANY APPLICATION NO. 30022479.642, FILED 3-22-2000, REG. NO. 30022479, DATED 5-15-2000, EXPIRES 3-21-2010.

CLASS 9—ELECTRICAL AND SCIENTIFIC APPARATUS

FOR COMPUTERS, COMPUTER SOFTWARE FOR USE IN FACTORY AUTOMATION AND LOGISTICS SYSTEMS TO INPUT, PROCESS, TRANSMIT, STORE AND OUTPUT DATA; DATA PROCESSING PROGRAMS FOR USE IN FACTORY AUTOMATION AND LOGISTICS SYSTEMS (U.S. CLS. 21, 23, 26, 36 AND 38).

CLASS 37—CONSTRUCTION AND REPAIR

FOR INSTALLATION, MAINTENANCE AND REPAIR OF INDUSTRIAL PLANT MACHINERY AND INDUSTRIAL PLANT SYSTEMS; CONSTRUCTION PLANNING; BUILDING CONSTRUCTION; BUILDING MAINTENANCE (U.S. CLS. 100, 103 AND 106).

CLASS 42—SCIENTIFIC, COMPUTER AND LEGAL SERVICES

FOR TECHNICAL CONSULTATION IN THE FIELD OF PRODUCTION AND LOGISTICS TO ASSIST INDUSTRIAL CONSUMERS IN BUILDING EFFICIENT INDUSTRIAL SYSTEMS AND OPTIMIZING INDUSTRIAL PROCESSES; TECHNICAL CONSULTATION IN THE FIELD OF PRODUCTION AND LOGISTICS PLANNING SERVICES TO ASSIST IN OPTIMIZING INDUSTRIAL PROCESSES (U.S. CLS. 100 AND 101).

SN 76-124,167. CONDIRE INVEST AB, 21232 MALMO, SWEDEN, FILED 9-6-2000.

HORIZON POINT**CLASS 9—ELECTRICAL AND SCIENTIFIC APPARATUS**

FOR ELECTRONIC SENDERS AND RECEIVERS FOR WIRELESS TRANSMISSION OF SPEECH, TEXT, SOUND, IMAGES AND DATA; COMPUTER PROGRAM STORAGE DEVICES, NAMELY DISKETTES, CD-ROMS AND HARD DRIVES; COMPUTER SYSTEMS COMPRISED OF HARDWARE AND SOFTWARE FEATURING INTEGRATED NETWORK MANAGEMENT SOLUTIONS FOR COMMUNICATION AND MEDIA DISTRIBUTION SOLUTIONS INCLUDING STORAGE DEVICES FOR INFORMATION RETRIEVAL; INFORMATION HANDLING SYSTEMS COMPRISED OF STORAGE DEVICES AND SYSTEM SOLUTIONS INCLUDING SOFTWARE PROGRAM FOR INFORMATION PROCESSING AND INFORMATION RETRIEVAL; RADIO COMMUNICATION AND DISTRIBUTION SYSTEM COMPRISED OF TRANSMITTERS AND RECEIVERS; TELECOMMUNICATION SYSTEMS FOR COMMUNICATION AND DISTRIBUTION COMPRISED OF RADIO AND OPTICAL TRANSMISSION DEVICES FOR AIR TRANSMISSION COMPRISED OF TRANSMITTERS AND RECEIVERS IN THE OPTICAL FREQUENCY BANDS; AND DATA COMMUNICATION SYSTEMS FOR COMMUNICATION AND DISTRIBUTION COMPRISED OF RADIO AND OPTICAL TRANSMISSION DEVICES FOR AIR BORNE TRANSFER IN A MUNICIPAL AREA NETWORK (MAN) AND/OR ARRANGEMENTS IN MESH NETWORK TOPOLOGIES ARRANGEMENT NOT EXCLUDING POSSIBLE USE OF LOCAL AREA NETWORK IP COMMUNICATION (U.S. CLS. 21, 23, 26, 36 AND 38).

CLASS 35—ADVERTISING AND BUSINESS

FOR ADMINISTRATION, MANAGING AND LICENSING OF COPYRIGHTS; DATABASE MANAGEMENT IN THE FIELDS OF RADIO AND TELECOMMUNICATIONS (U.S. CLS. 100, 101 AND 102).

CLASS 37—CONSTRUCTION AND REPAIR

FOR INSTALLATION, SERVICE AND REPAIR OF COMPUTERS, RADIO, TELECOMMUNICATION AND DATA SYSTEMS; MAINTENANCE OF COMPUTER HARDWARE, RADIO, TELECOMMUNICATION AND DATA SYSTEMS (U.S. CLS. 100, 103 AND 106).

CLASS 42—SCIENTIFIC, COMPUTER AND LEGAL SERVICES

FOR TECHNICAL CONSULTING IN THE FIELD OF COMMUNICATIONS SYSTEM SOLUTION, RESEARCH OF CUSTOMERS' REQUIREMENTS REGARDING COMMUNICATION AND MEDIA DISTRIBUTION BY USE OF GLOBAL INFORMATION TECHNOLOGY NETWORKS (U.S. CLS. 100 AND 101).

SN 76-124,319. ONTARIO PAINT & WALLPAPER LIMITED, CONCORD, ONTARIO L4K 3S8, CANADA, FILED 9-8-2000.

CALEDON WALLCOVERINGS

PRIORITY CLAIMED UNDER SEC. 44(D) ON CANADA APPLICATION NO. 1,051,011, FILED 3-16-2000, REG. NO. TMA561054, DATED 4-30-2002, EXPIRES 4-30-2017.

NO CLAIM IS MADE TO THE EXCLUSIVE RIGHT TO USE "WALLCOVERINGS", APART FROM THE MARK AS SHOWN.

CLASS 16—PAPER GOODS AND PRINTED MATTER

FOR WALLPAPER SAMPLE BOOKS (U.S. CLS. 2, 5, 22, 23, 29, 37, 38 AND 50).

CLASS 27—FLOOR COVERINGS

FOR WALLPAPER (U.S. CLS. 19, 20, 37, 42 AND 50).

SN 76-125,380. AGNES SCOTT COLLEGE, INC., DECATUR, GA. FILED 9-8-2000.

THE WORLD FOR WOMEN

CLASS 6—METAL GOODS

FOR METAL VANITY LICENSE PLATES (U.S. CLS. 2, 12, 13, 14, 23, 25 AND 50).
FIRST USE 0-0-1998; IN COMMERCE 0-0-1998.

CLASS 9—ELECTRICAL AND SCIENTIFIC APPARATUS

FOR MOUSEPADS (U.S. CLS. 21, 23, 26, 36 AND 38).
FIRST USE 0-0-1998; IN COMMERCE 0-0-1998.

CLASS 16—PAPER GOODS AND PRINTED MATTER

FOR PAPERWEIGHTS, PENS AND MEMO CUBES (U.S. CLS. 2, 5, 22, 23, 29, 37, 38 AND 50).
FIRST USE 0-0-1998; IN COMMERCE 0-0-1998.

CLASS 18—LEATHER GOODS

FOR LUGGAGE TAGS AND UMBRELLAS (U.S. CLS. 1, 2, 3, 22 AND 41).
FIRST USE 0-0-1998; IN COMMERCE 0-0-1998.

CLASS 21—HOUSEWARES AND GLASS

FOR MUGS AND CUPS (U.S. CLS. 2, 13, 23, 29, 30, 33, 40 AND 50).
FIRST USE 0-0-1998; IN COMMERCE 0-0-1998.

CLASS 25—CLOTHING

FOR CLOTHING, NAMELY T-SHIRTS, SWEATSHIRTS, SWEATPANTS, SHORTS, SOCKS AND BOXER SHORTS (U.S. CLS. 22 AND 39).
FIRST USE 0-0-1998; IN COMMERCE 0-0-1998.

CLASS 28—TOYS AND SPORTING GOODS

FOR STUFFED ANIMALS AND CHRISTMAS TREE ORNAMENTS (U.S. CLS. 22, 23, 38 AND 50).
FIRST USE 0-0-1998; IN COMMERCE 0-0-1998.

CLASS 41—EDUCATION AND ENTERTAINMENT

FOR EDUCATIONAL SERVICES, NAMELY, PROVIDING COURSES OF INSTRUCTION AT THE COLLEGE LEVEL AND DISTRIBUTING COURSE MATERIAL IN CONNECTION THEREWITH, PROVIDING INFORMATION IN THE FIELD OF EDUCATION VIA A GLOBAL COMPUTER NETWORK (U.S. CLS. 100, 101 AND 107).
FIRST USE 0-0-1998; IN COMMERCE 0-0-1998.

SN 76-126,933. HARRELL, ANDRE, NEW YORK, NY. FILED 9-12-2000.

NUAMERICA

CLASS 9—ELECTRICAL AND SCIENTIFIC APPARATUS

FOR MUSICAL AND THEATRICAL SOUND AND VIDEO RECORDINGS; PHONOGRAPH RECORDS; COMPACT DISC; DIGITAL AUDIO TAPES; PRE-RECORDED AUDIO CASSETTES AND VIDEO AND AUDIO TAPES ALL FEATURING MUSIC AND/OR THEATRICAL ENTERTAINMENT (U.S. CLS. 21, 23, 26, 36 AND 38).

CLASS 16—PAPER GOODS AND PRINTED MATTER

FOR PRINTED MATTER, NAMELY, BOOKLETS, BOOKS, BROCHURES, MAGAZINES, PROGRAMS AND PAMPHLETS IN THE FIELDS OF MUSIC AND ENTERTAINMENT; MOUNTED AND UNMOUNTED PHOTOGRAPHS; SHEET MUSIC; SONGBOOKS, CALENDARS; PICTURES (U.S. CLS. 2, 5, 22, 23, 29, 37, 38 AND 50).

CLASS 25—CLOTHING

FOR LINE OF CLOTHING, NAMELY, OUTERWEAR, NAMELY, COATS AND JACKETS, FOOTWEAR, JEANS, PANTS, T-SHIRTS, SWEATSHIRTS, SHIRTS, BANDANAS, SCARVES, CAPS, VISORS, HATS, AND HEADBANDS (U.S. CLS. 22 AND 39).

CLASS 35—ADVERTISING AND BUSINESS

FOR MANAGEMENT OF PERFORMING ARTISTS (U.S. CLS. 100, 101 AND 102).

CLASS 41—EDUCATION AND ENTERTAINMENT

FOR ENTERTAINMENT SERVICES, NAMELY, LIVE PERFORMANCES BY A VOCAL AND MUSICAL GROUP; PRODUCTION OF SOUND AND VIDEO RECORDINGS; RENTAL OF FILMS, SOUND AND VIDEO RECORDINGS; DISCOTHEQUE SERVICES; PRODUCTION OF MOTION PICTURE FILMS; MUSIC RECORDING STUDIOS; PRODUCTION OF RADIO AND TELEVISION PROGRAMS; ENTERTAINMENT IN THE NATURE OF THEATER AND CONCERT PRODUCTIONS; MUSIC PUBLISHING SERVICES; ARRANGING FOR TICKET RESERVATIONS FOR SHOWS AND OTHER ENTERTAINMENT EVENTS; MANAGEMENT OF PERFORMING ARTISTS; AND RECORD COMPANY SERVICES, NAMELY, MUSIC RECORDING AND PRODUCTION (U.S. CLS. 100, 101 AND 107).

SN 76-127,410. VECTREN COMMUNICATIONS SERVICES, INC., EVANSVILLE, IN. FILED 9-12-2000.

**CLASS 35—ADVERTISING AND BUSINESS**

FOR BUSINESS MARKETING CONSULTING SERVICES AND MARKETING RESEARCH SERVICES TO UTILITIES AND MUNICIPALITIES IN THE ESTABLISHMENT AND OPERATION OF BROADBAND TELECOMMUNICATIONS SYSTEMS, TELECOMMUNICATIONS CONNECTIONS TO A GLOBAL COMPUTER NETWORK, AND TELECOMMUNICATIONS CONNECTIONS FOR PROVIDING CABLE TELEVISION SERVICES; OPERATION OF BROADBAND TELECOMMUNICATIONS SYSTEMS FOR UTILITIES AND MUNICIPALITIES (U.S. CLS. 100, 101 AND 102).

CLASS 36—INSURANCE AND FINANCIAL

FOR FINANCIAL PLANNING AND FINANCING STRATEGY FOR UTILITIES AND MUNICIPALITIES (U.S. CLS. 100, 101 AND 102).

CLASS 37—CONSTRUCTION AND REPAIR

FOR CONSTRUCTION OF BROADBAND TELECOMMUNICATIONS SYSTEMS FOR UTILITIES AND MUNICIPALITIES (U.S. CLS. 100, 103 AND 106).

CLASS 38—COMMUNICATION

FOR PROVIDING TELECOMMUNICATIONS SERVICES; PROVIDING TELECOMMUNICATIONS CONNECTIONS AND MULTIPLE USER ACCESS TO A GLOBAL COMPUTER NETWORK; PROVIDING TELECOMMUNICATIONS CONNECTIONS FOR CABLE TELEVISION SERVICES (U.S. CLS. 100, 101 AND 104).

CLASS 42—SCIENTIFIC, COMPUTER AND LEGAL SERVICES

FOR DESIGN OF BROADBAND TELECOMMUNICATIONS SYSTEMS FOR UTILITIES AND MUNICIPALITIES (U.S. CLS. 100 AND 101).

SN 76-128,657. SENSORMEDICS CORPORATION, YORBA LINDA, CA. FILED 9-15-2000.

VIASYS HEALTHCARE

NO CLAIM IS MADE TO THE EXCLUSIVE RIGHT TO USE "HEALTHCARE", APART FROM THE MARK AS SHOWN.

CLASS 10—MEDICAL APPARATUS

FOR MEDICAL VENTILATORS; CRITICAL CARE FEEDING TUBES; RESUSCITATORS; RESUSCITATION MASKS; GAS BLENDEERS FOR MEDICAL APPLICATIONS; PULMONARY FUNCTION TESTING DEVICES; NEURODIAGNOSTIC TESTING DEVICES; NUTRITIONAL ASSESSMENT DEVICES; CARDIOPULMONARY EXERCISE TESTING DEVICES; HEARING DIAGNOSTIC DEVICES; WIRELESS PATIENT MONITORING TELEMETRY DEVICES FOR USE IN MONITORING PATIENT VITAL SIGNS; PERIPHERAL VASCULAR TESTING DEVICES; MEDICAL DOPPLER ULTRASOUND DEVICES; MEDICAL FACE SHIELDS; SURGICAL GOWNS; SURGICAL HELMETS; ORTHOPEDIC AND CARDIOVASCULAR IMPLANTS COMPRISING ARTIFICIAL MATERIAL (U.S. CLS. 26, 39 AND 44).

CLASS 42—SCIENTIFIC, COMPUTER AND LEGAL SERVICES

FOR PROVIDING MEDICAL SERVICES; PROVIDING HEALTH CARE SERVICES (U.S. CLS. 100 AND 101).

SN 76-129,475. SENSORMEDICS CORPORATION, YORBA LINDA, CA. FILED 9-15-2000.

VIASYS**CLASS 10—MEDICAL APPARATUS**

FOR MEDICAL VENTILATORS; CRITICAL CARE FEEDING TUBES; RESUSCITATORS; RESUSCITATION MASKS; GAS BLENDEERS FOR MEDICAL APPLICATIONS; PULMONARY FUNCTION TESTING DEVICES; NEURODIAGNOSTIC TESTING DEVICES; NUTRITIONAL ASSESSMENT DEVICES; CARDIOPULMONARY EXERCISE TESTING DEVICES; HEARING DIAGNOSTIC DEVICES; WIRELESS PATIENT MONITORING TELEMETRY DEVICES FOR USE IN MONITORING PATIENT VITAL SIGNS; PERIPHERAL VASCULAR TESTING DEVICES; MEDICAL DOPPLER ULTRASOUND DEVICES; MEDICAL FACE SHIELDS; SURGICAL GOWNS; SURGICAL HELMETS; ORTHOPEDIC AND CARDIOVASCULAR IMPLANTS COMPRISING ARTIFICIAL MATERIAL (U.S. CLS. 26, 39 AND 44).

CLASS 42—SCIENTIFIC, COMPUTER AND LEGAL SERVICES

FOR PROVIDING MEDICAL SERVICES; PROVIDING HEALTH CARE SERVICES (U.S. CLS. 100 AND 101).

SN 76-129,493. THE ALLERGY AND ASTHMA CENTER,
FORT WAYNE, IN. FILED 9-15-2000.

SN 76-130,163. EMC CORPORATION, HOPKINTON, MA.
FILED 9-15-2000.

RAVE

CLASS 5—PHARMACEUTICALS

FOR PHARMACEUTICALS, NAMELY, SELF-CONTAINED TREATMENT KITS FOR ALLERGY AND ASTHMA TREATMENT CONSISTING PRIMARILY OF PREPARATIONS FOR ACCELERATED ALLERGEN VACCINATION, DIAGNOSIS, AND TREATMENT (U.S. CLS. 6, 18, 44, 46, 51 AND 52).

CLASS 42—SCIENTIFIC, COMPUTER AND LEGAL SERVICES

FOR ACCELERATED ALLERGEN VACCINATION, DIAGNOSIS AND TREATMENT, AND COUNSELING THEREFOR (U.S. CLS. 100 AND 101).

SN 76-129,500. KEY3MEDIA EVENTS, INC., LOS ANGELES,
CA. FILED 9-15-2000.



NO CLAIM IS MADE TO THE EXCLUSIVE RIGHT TO USE "ASP SUMMIT", APART FROM THE MARK AS SHOWN.

THE STIPPLING SHOWN IN THE DRAWING IS A FEATURE OF THE MARK AND IS NOT INTENDED TO INDICATE COLOR.

CLASS 35—ADVERTISING AND BUSINESS

FOR ARRANGING AND CONDUCTING TRADE SHOWS, CONFERENCES IN THE FIELD OF APPLICATION SERVICE PROVIDERS, COMPUTERS, INFORMATION TECHNOLOGY (U.S. CLS. 100, 101 AND 102).
FIRST USE 8-31-1999; IN COMMERCE 8-31-1999.

CLASS 41—EDUCATION AND ENTERTAINMENT

FOR EDUCATIONAL FORUMS AND DISCUSSION GROUPS IN THE FIELD OF APPLICATION SERVICE PROVIDERS, COMPUTERS AND INFORMATION TECHNOLOGY (U.S. CLS. 100, 101 AND 107).
FIRST USE 8-31-1999; IN COMMERCE 8-31-1999.

WHERE INFORMATION LIVES

CLASS 9—ELECTRICAL AND SCIENTIFIC APPARATUS

FOR INTELLIGENT STORAGE SYSTEMS, COMPRISING PROCESSORS, MEMORIES, OPERATING SYSTEM SOFTWARE, AND DATA STORAGE UNITS FOR STORING DATA; NETWORK FILE SERVERS; AND SOFTWARE FOR CONTROLLING THE MANAGEMENT AND STORAGE OF DATA AND THE TRANSMISSION OF DATA OVER A NETWORK (U.S. CLS. 21, 23, 26, 36 AND 38).

CLASS 37—CONSTRUCTION AND REPAIR

FOR INSTALLATION, REPAIR AND MAINTENANCE SERVICES FOR INTELLIGENT STORAGE SYSTEMS, NETWORK FILE SERVERS, COMPUTER SOFTWARE AND RELATED PRODUCTS (U.S. CLS. 100, 103 AND 106).

SN 76-132,611. TRI-UNITED TECHNOLOGIES, LLC, SKOKIE, IL. FILED 9-20-2000.

TRI-UNITED

CLASS 35—ADVERTISING AND BUSINESS

FOR BUSINESS CONSULTING SERVICES FOR TECHNOLOGY CLIENTS SEEKING PARTNERSHIP AND CO-VENTURE OPPORTUNITIES (U.S. CLS. 100, 101 AND 102).
FIRST USE 2-3-2000; IN COMMERCE 2-3-2000.

CLASS 36—INSURANCE AND FINANCIAL

FOR INVESTMENT MANAGEMENT IN THE FIELD OF VENTURE CAPITAL; FINANCING SERVICES IN THE FIELD OF VENTURE CAPITAL; REAL ESTATE MANAGEMENT (U.S. CLS. 100, 101 AND 102).
FIRST USE 4-0-1991; IN COMMERCE 4-0-1991.

CLASS 37—CONSTRUCTION AND REPAIR

FOR REAL ESTATE DEVELOPMENT (U.S. CLS. 100, 103 AND 106).
FIRST USE 4-0-1991; IN COMMERCE 4-0-1991.

SN 76-132,726. POCIT LABS AB, UPPSALA, SWEDEN, FILED 9-22-2000.

SN 76-134,005. SCHUNK GMBH & CO., D-74348 LAUFFEN AM NECTAR, FED REP GERMANY, FILED 9-22-2000.

BLUETALK

CLASS 38—COMMUNICATION

FOR ELECTRONIC TRANSMISSION OF DATA, NAMELY, MESSAGES AND GRAPHIC IMAGES VIA COMPUTER TERMINALS; ELECTRONIC MAIL; TELECOMMUNICATION SERVICES, NAMELY, PERSONAL COMMUNICATION VIA MOBILE COMPUTER TERMINALS; ELECTRONIC TRANSMISSION OF FACSIMILE MESSAGES; MOBILE TELEPHONE COMMUNICATION; RENTAL OF TELECOMMUNICATION EQUIPMENT; PAGING SERVICES, NAMELY, PAGING VIA RADIO, TELEPHONE AND OTHER ELECTRONIC COMMUNICATION MEANS; PROVIDING MULTIPLE-USER ACCESS TO A GLOBAL COMPUTER NETWORK (U.S. CLS. 100, 101 AND 104).

CLASS 42—SCIENTIFIC, COMPUTER AND LEGAL SERVICES

FOR COMPUTER SOFTWARE DESIGN FOR OTHERS, NAMELY, DEVELOPMENT OF COMPUTER SOFTWARE FOR GLOBAL COMPUTER NETWORKS AND MOBILE NETWORKS; COMPUTER SOFTWARE DESIGN FOR OTHERS; MAINTENANCE OF COMPUTER SOFTWARE; COMPUTER CONSULTATION, NAMELY, CONSULTING CONCERNING COMPUTER HARDWARE; COMPUTER SYSTEM ANALYSIS; RENTAL OF COMPUTER SOFTWARE AND COMPUTERS (U.S. CLS. 100 AND 101).

SN 76-132,829. FINANCIAL ARCHITECTS, 1831 DIEGEM, BELGIUM, FILED 9-6-2000.

FIBRE

PRIORITY CLAIMED UNDER SEC. 44(D) ON ERP N CMNTY TM OFC APPLICATION NO. 1591734, FILED 3-31-2000, REG. NO. 1591734, DATED 8-21-2001, EXPIRES 8-21-2011.

CLASS 9—ELECTRICAL AND SCIENTIFIC APPARATUS

FOR SOFTWARE IN THE FIELD OF FINANCIAL AND BANKING DATABASE MANAGEMENT (U.S. CLS. 21, 23, 26, 36 AND 38).

CLASS 36—INSURANCE AND FINANCIAL

FOR SERVICES FOR FINANCIAL MANAGEMENT AND INFORMATION PROCESSING (U.S. CLS. 100, 101 AND 102).

SCHUNK-UNILOCK

CLASS 7—MACHINERY

FOR POWER WORKPIECE AND TOOL CLAMPING DEVICES, NAMELY, CLAMPS AND GRIPPERS; POWER GRIPPER SYSTEMS COMPRISED OF PNEUMATICALLY, HYDRAULICALLY AND/OR ELECTRONICALLY DRIVEN LINEAR ACTUATORS AND/OR ROTATABLE ACTUATORS FOR USE ON WORKPIECES AND TOOLS; POWER CLAMPING SYSTEMS COMPRISED OF PNEUMATICALLY, HYDRAULICALLY AND/OR ELECTRONICALLY DRIVEN LINEAR ACTUATORS AND/OR ROTATABLE ACTUATORS FOR USE ON WORKPIECES AND TOOLS; POWER CLAMPS; POWER HANDLING DEVICES FOR THE MANUFACTURING PROCESS, NAMELY, LINEAR ACTUATORS AND THE COMBINATION OF LINEAR ACTUATORS AND ROTATABLE ACTUATORS CARRYING A CLAMP OR GRIPPER; POWER MANIPULATORS FOR WORK HOLDING SYSTEMS FOR USE IN A MANUFACTURING PROCESS, NAMELY, LINEAR ACTUATORS AND/OR ROTATABLE ACTUATORS FOR CARRYING A CLAMP OR GRIPPER; POWER GRIPPERS FOR USE IN WORK HOLDING SYSTEMS DURING THE MANUFACTURING PROCESS; ELECTRONICALLY, HYDRAULICALLY OR PNEUMATICALLY DRIVEN TRANSLATING, SWIVELING AND LIFTING-MODULES FOR USE IN WORK HOLDING SYSTEMS FOR USE IN A MANUFACTURING PROCESS; ELECTRONICALLY, HYDRAULICALLY OR PNEUMATICALLY DRIVEN ROTATING-MODULES FOR USE IN WORK HOLDING SYSTEMS FOR USE IN A MANUFACTURING PROCESS; SWIVELING HEAD TURNABLES AND TURNABLES, NAMELY, TURNABLE BASED UNITS FOR MANIPULATIONS; WORK HOLDING SYSTEMS IN A MANUFACTURING PROCESS; METAL CLAMPING DRILL CHUCKS FOR POWER DRILLS, FIXED STAYS FOR POWER LATHES; AND PARTS THEREOF FOR ALL THE AFOREMENTIONED GOODS (U.S. CLS. 13, 19, 21, 23, 31, 34 AND 35).

FIRST USE 4-0-1999; IN COMMERCE 4-0-1999.

CLASS 8—HAND TOOLS

FOR HAND TOOLS, NAMELY, CLAMPS MADE OF METALS FOR CLAMPING WORKPIECES, METAL CLAMPING DRILL CHUCKS, AND METAL CLAMPING CYLINDERS FOR CLAMPING CHUCKS (U.S. CLS. 23, 28 AND 44).

FIRST USE 4-0-1999; IN COMMERCE 4-0-1999.

SN 76-134,342. DJ'S GANG SRL, MILANO, ITALY, FILED 9-22-2000.



PRIORITY CLAIMED UNDER SEC. 44(D) ON ERP N CMNTY TM OFC APPLICATION NO. 1,768,175, FILED 7-21-2000, REG. NO. 1768175, DATED 11-21-2001, EXPIRES 11-21-2011.

CLASS 9—ELECTRICAL AND SCIENTIFIC APPARATUS

FOR COMPUTER SOFTWARE RELEVANT TO INTERNET, COMPUTER SOFTWARE RECORDED PROGRAMS, NAMELY, DATA COMPRESSION SOFTWARE, RECORDED COMPUTER OPERATING PROGRAMS; DATA PROCESSING EQUIPMENT, PRERECORDED COMPACT DISCS, FEATURING INTERNET BROWSING, COMPACT DISC READ ONLY MEMORY OR CD-ROMS FEATURING MUSIC, INFORMATIONAL MATERIALS, CURRENT EVENTS, HERITAGE, HISTORY, GEOGRAPHY, POLITICS, EDUCATION, BUSINESS, FINANCE, INSURANCE, COMMERCE, AGRICULTURE, INDUSTRY, RELIGION, THE HOME, FAMILY, CHILD-CARE, CRAFTS, RECREATION, TRAVEL, SCIENCE, TECHNOLOGY, COMMUNICATIONS, THE MEDIA, GOVERNMENT, THE MILITARY, PEOPLE, GAMES, SPORTS, WEATHER, ENTERTAINMENT, HEALTH, LIFESTYLE, FASHION, LEISURE, SHOPPING AND OTHER TOPICS OF GENERAL INTEREST; OPTICAL DISCS (U.S. CLS. 21, 23, 26, 36 AND 38).

CLASS 38—COMMUNICATION

FOR TELEMATIC SERVICES, NAMELY, ELECTRONIC MAIL SERVICES, ELECTRONIC STORE AND FORWARD MESSAGING, TELECOMMUNICATION SERVICES, NAMELY, AUDIO AND RADIO BROADCASTING, VIDEO AND TELEVISION BROADCASTING, AUDIO AND VIDEO TELECONFERENCING, FACSIMILE TRANSMISSIONS, ELECTRONIC TRANSMISSION OF MESSAGES AND IMAGES VIA COMPUTER TERMINALS, COMMUNICATIONS BY COMPUTER TERMINALS, SATELLITE TRANSMISSION AND COMMUNICATIONS VIA INTERNET SERVICES ON BEHALF OF THIRD PARTIES (U.S. CLS. 100, 101 AND 104).

CLASS 42—SCIENTIFIC, COMPUTER AND LEGAL SERVICES

FOR RENTAL OF INFORMATICS SOFTWARE, UPDATING OF COMPUTER SOFTWARE, COMPUTER PROGRAMMING FOR OTHERS, COMPUTER RENTAL, COMPUTER SOFTWARE DESIGN FOR OTHERS, RESEARCH AND DEVELOPMENT OF NEW PRODUCTS FOR OTHERS, CONSULTATION IN THE FIELD OF COMPUTER SERVICES ON BEHALF OF THIRD PARTIES (U.S. CLS. 100 AND 101).

SN 76-135,326. AMERICAN NURSES ASSOCIATION, INC., WASHINGTON, DC. FILED 9-25-2000.



NO CLAIM IS MADE TO THE EXCLUSIVE RIGHT TO USE "FEDERAL NURSES ASSOCIATION", APART FROM THE MARK AS SHOWN.

CLASS 35—ADVERTISING AND BUSINESS

FOR PROVIDING BUSINESS CONSULTATION AND HEALTH CARE UTILIZATION AND REVIEW SERVICES FOR FEDERAL NURSES (U.S. CLS. 100, 101 AND 102).

CLASS 42—SCIENTIFIC, COMPUTER AND LEGAL SERVICES

FOR ASSOCIATION SERVICES, NAMELY, PROMOTING THE INTERESTS OF NURSES (U.S. CLS. 100 AND 101).

SN 76-136,399. FOOD MARKETING CONSULTANTS, INC., NORTH MIAMI BEACH, FL. FILED 9-25-2000.

**I SCREAM, YOU SCREAM,
JUST DON'T SCREAM AT ME****CLASS 8—HAND TOOLS**

FOR ICE CREAM SPOONS (U.S. CLS. 23, 28 AND 44).

CLASS 16—PAPER GOODS AND PRINTED MATTER

FOR BUMPER STICKERS, PADS AND PENS (U.S. CLS. 2, 5, 22, 23, 29, 37, 38 AND 50).

CLASS 18—LEATHER GOODS

FOR TRAVELLING BAGS, UMBRELLAS (U.S. CLS. 1, 2, 3, 22 AND 41).

CLASS 20—FURNITURE AND ARTICLES NOT OTHERWISE CLASSIFIED

FOR PICTURE FRAMES (U.S. CLS. 2, 13, 22, 25, 32 AND 50).

CLASS 21—HOUSEWARES AND GLASS

FOR COFFEE MUGS AND ICE CREAM SCOOPS (U.S. CLS. 2, 13, 23, 29, 30, 33, 40 AND 50).

CLASS 25—CLOTHING

FOR CLOTHING, NAMELY SHIRTS, T-SHIRTS, JACKETS, HATS (U.S. CLS. 22 AND 39).

SN 76-136,449. WEBSIDESTORY, INC., SAN DIEGO, CA. FILED 9-27-2000.

WEBSIDESTORY

OWNER OF U.S. REG. NO. 2,174,768.

CLASS 35—ADVERTISING AND BUSINESS

FOR DISSEMINATION OF MARKETING DATA FOR OTHERS VIA A GLOBAL COMPUTER NETWORK; MARKETING SERVICES ON A GLOBAL COMPUTER NETWORK, NAMELY PROVIDING MARKET DATA AND DEMOGRAPHICS; AND BUSINESS MARKETING CONSULTATION RELATED TO FACILITATING AND INCREASING A WEB SITE'S EXPOSURE TO THE PUBLIC AND RELATING TO EFFECTIVENESS OF ON-LINE MARKETING AND ADVERTISING CAMPAIGNS (U.S. CLS. 100, 101 AND 102).

FIRST USE 9-16-1996; IN COMMERCE 9-16-1996.

CLASS 42—SCIENTIFIC, COMPUTER AND LEGAL SERVICES

FOR CONSULTING INFORMATION SERVICES ON A GLOBAL COMPUTER NETWORK RELATED TO (1) COMPILING AND PRESENTING SURVEY INFORMATION CONCERNING WEB SITE TRAFFIC AND ACTIVITY AND (2) MONITORING WEB SITE TRAFFIC AND ACTIVITY; PROVIDING INFORMATION RELATING TO WEB SITES AND COMPUTERS USING A GLOBAL COMPUTER NETWORK, NAMELY COMPILATIONS, RANKINGS, RATINGS, AND SURVEY INFORMATION CONCERNING, COMPUTER CONFIGURATIONS, BROWSER SOFTWARE PROGRAMS, OPERATING SYSTEMS, TRAFFIC AND ACTIVITY ON WEB SITES ON GLOBAL COMPUTER NETWORKS, SEARCH ENGINES USED AND SEARCH TERMS USED; COMPUTER SERVICES, NAMELY, MONITORING WEB SITE TRAFFIC, AND PROVIDING A SEARCH ENGINE FOR LOCATING WEB SITES ON A GLOBAL COMPUTER NETWORK; COMPUTER SERVICES, NAMELY, CATEGORIZING, PRIORITIZING, AND RANKING WEB SITES ON A GLOBAL COMPUTER NETWORK BASED ON CONTENT, SUBJECT MATTER, USAGE FACTORS AND POPULARITY, PROVIDING COMPUTER LINKS TO WEB SITES ON A GLOBAL COMPUTER NETWORK; FACILITATING AND INCREASING A WEB SITE'S CONNECTIVITY AND INTERACTIVITY TO OTHER WEB SITES; COMPILING AND PRESENTING SURVEY INFORMATION CONCERNING WEB SITE TRAFFIC AND ACTIVITY; MONITORING WEB SITE TRAFFIC AND ACTIVITY; HOSTING THE WEB SITES OF OTHERS ON A COMPUTER SERVER FOR A GLOBAL COMPUTER NETWORK (U.S. CLS. 100 AND 101).

FIRST USE 9-16-1996; IN COMMERCE 9-16-1996.

SN 76-136,491. 800 TRAVEL SYSTEMS, INC., TAMPA, FL. FILED 9-27-2000.



NO CLAIM IS MADE TO THE EXCLUSIVE RIGHT TO USE "TRAVEL SYSTEMS, INC.", APART FROM THE MARK AS SHOWN.

CLASS 39—TRANSPORTATION AND STORAGE

FOR TRAVEL AGENCY SERVICES, NAMELY, MAKING RESERVATIONS AND BOOKINGS FOR TRANSPORTATION, DESIGNING AND ARRANGING VACATION PACKAGES, AND PROVIDING TRAVEL INFORMATION; FULFILLMENT SERVICES FOR TRAVEL AGENCIES, NAMELY, MAKING RESERVATIONS AND BOOKINGS FOR TRANSPORTATION, DESIGNING AND ARRANGING VACATION PACKAGES, AND PROVIDING TRAVEL INFORMATION FOR CUSTOMERS OF OTHERS TRAVEL AGENCIES ON BEHALF OF SUCH TRAVEL AGENCIES (U.S. CLS. 100 AND 105).

FIRST USE 10-0-1999; IN COMMERCE 10-0-1999.

CLASS 42—SCIENTIFIC, COMPUTER AND LEGAL SERVICES

FOR TRAVEL AGENCY SERVICES, NAMELY, MAKING RESERVATIONS AND BOOKINGS FOR TEMPORARY LODGING; FULFILLMENT SERVICES FOR TRAVEL AGENCIES, NAMELY, MAKING RESERVATIONS AND BOOKINGS FOR TEMPORARY LODGING FOR CUSTOMERS OF OTHER TRAVEL AGENCIES ON BEHALF OF SUCH TRAVEL AGENCIES (U.S. CLS. 100 AND 101).

FIRST USE 10-0-1999; IN COMMERCE 10-0-1999.

SN 76-136,562. EAGLE PARTNERS L.P., HOUSTON, TX. FILED 9-27-2000.

**CLASS 35—ADVERTISING AND BUSINESS**

FOR INVENTORY MANAGEMENT SERVICES, NAMELY, PICK AND PACK INVENTORY CONTROL, AND PACKAGING ARTICLES TO THE ORDER AND SPECIFICATION OF OTHERS; BUSINESS PROCESS RE-ENGINEERING FOR SUPPLY CHAINS; ORDER FULFILLMENT SERVICES (U.S. CLS. 100, 101 AND 102).

FIRST USE 10-1-1999; IN COMMERCE 10-1-1999.

CLASS 39—TRANSPORTATION AND STORAGE

FOR FREIGHT FORWARDING SERVICES; FREIGHT TRANSPORTATION BY TRUCK; CRATING AND PACKAGING OF FREIGHT FOR TRANSPORTATION; PICKUP AND DELIVERY OF GOODS BY LAND, AIR AND SEA; WAREHOUSING AND STORAGE OF FREIGHT (U.S. CLS. 100 AND 105).

FIRST USE 10-1-1999; IN COMMERCE 10-1-1999.

SN 76-136,612. TOYAMA, THOMAS NORMAN, HOLLYWOOD, FL. FILED 9-27-2000.

SPIRIT OF THE RAIN**CLASS 15—MUSICAL INSTRUMENTS**

FOR WOODWIND, PERCUSSION, AND STRINGED MUSICAL INSTRUMENTS (U.S. CLS. 2, 21 AND 36).

CLASS 25—CLOTHING

FOR CLOTHING, NAMELY, SHIRTS, TOPS, PANTS, SHORTS, HATS, JACKETS, DRESSES, AND UNDERGARMENTS (U.S. CLS. 22 AND 39).

SN 76-137,362. CONTACTMUSIC.COM.LIMITED, ILKLEY, WEST YORKSHIRE, ENGLAND, FILED 9-28-2000.

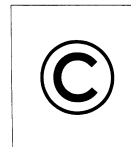

contactmusic.com

CLASS 9—ELECTRICAL AND SCIENTIFIC APPARATUS

FOR DOWNLOADABLE ELECTRONIC PUBLICATIONS IN THE NATURE OF MAGAZINES AND NEWSLETTERS CONCERNING MUSIC AND PERFORMERS; DOWNLOADABLE MUSICAL SOUND AND VIDEO RECORDINGS (U.S. CLS. 21, 23, 26, 36 AND 38).

CLASS 35—ADVERTISING AND BUSINESS

FOR PUBLICITY AGENTS; MUSICAL TALENT AND THEATRICAL AGENCIES; OPINION POLLING OF THE POPULARITY OF MUSICIANS AND MUSIC FOR BUSINESS OR ADVERTISING PURPOSES (U.S. CLS. 100, 101 AND 102).

CLASS 41—EDUCATION AND ENTERTAINMENT

FOR PROVIDING AN ON-LINE COMPUTER DATABASE IN THE FIELD OF MUSIC AND PERFORMERS; ENTERTAINMENT SERVICES, NAMELY, PROVIDING RADIO MUSIC PROGRAMMING VIA A GLOBAL COMPUTER NETWORK; ENTERTAINMENT IN THE NATURE OF LIVE MUSICAL PERFORMANCES; MUSIC COMPOSITION AND TRANSCRIPTION FOR OTHERS; MUSIC PUBLISHING SERVICES (U.S. CLS. 100, 101 AND 107).

CLASS 42—SCIENTIFIC, COMPUTER AND LEGAL SERVICES

FOR CONDUCTING PUBLIC OPINION POLL SURVEYS (U.S. CLS. 100 AND 101).

CLASS 36—INSURANCE AND FINANCIAL

FOR FINANCIAL SERVICES, NAMELY, PROVIDING VENTURE CAPITAL AND INVESTMENT OF FUNDS FOR OTHERS; FINANCING SERVICES IN THE FIELDS OF PRIVATE INVESTMENTS, INVESTMENT BANKING, AND MERGERS AND ACQUISITIONS; INVESTMENT SERVICES IN THE FIELDS OF PRIVATE INVESTMENTS, INVESTMENT BANKING, AND MERGERS AND ACQUISITIONS, REAL ESTATE, SECURITIES; FINANCING CONSULTATION, NAMELY, ASSISTING ENTREPRENEURS IN OBTAINING FINANCING; INVESTMENT CONSULTATION AND ADVICE, NAMELY, IDENTIFYING AND PROVIDING INFORMATION REGARDING INVESTMENT OPPORTUNITIES FOR INVESTORS TO INVEST IN BUSINESS (U.S. CLS. 100, 101 AND 102).

CLASS 41—EDUCATION AND ENTERTAINMENT

FOR EDUCATIONAL SERVICES, NAMELY, CONDUCTING SEMINARS AND LECTURES IN THE FIELDS OF INVESTMENT COUNSELING AND PRIVATE INVESTMENTS (U.S. CLS. 100, 101 AND 107).

SN 76-137,750. ANGELVEST, INC., PORTLAND, OR. FILED 9-29-2000.

SN 76-138,383. MILLENNIAL STAR NETWORK, OREM, UT. FILED 9-29-2000.

A START-UP'S ANGEL HEAVEN

STATEGRAMS

CLASS 9—ELECTRICAL AND SCIENTIFIC APPARATUS

FOR DOWNLOADABLE ELECTRONIC PUBLICATIONS IN THE NATURE OF NEWSLETTERS, NEWSPAPERS AND MAGAZINES IN THE FIELD OF PRIVATE INVESTMENTS; ELECTRONIC PUBLICATIONS, NAMELY, NEWSLETTERS, NEWSPAPERS AND MAGAZINES RECORDED ON MAGNETIC OR OPTICAL MEDIA (U.S. CLS. 21, 23, 26, 36 AND 38).

CLASS 16—PAPER GOODS AND PRINTED MATTER

FOR PERIODICALS IN THE FIELD OF PRIVATE INVESTMENTS, NAMELY, NEWSLETTERS, NEWSPAPERS AND MAGAZINES (U.S. CLS. 2, 5, 22, 23, 29, 37, 38 AND 50).

CLASS 35—ADVERTISING AND BUSINESS

FOR PROMOTING THE SERVICES OF OTHERS BY PLACING ADVERTISEMENTS AND PROMOTIONAL DISPLAYS IN AN ELECTRONIC SITE ACCESSED THROUGH COMPUTER NETWORKS; PROVIDING BUSINESS INFORMATION AND REFERENCE MATERIALS REGARDING CREATING AND BUILDING A BUSINESS (U.S. CLS. 100, 101 AND 102).

CLASS 9—ELECTRICAL AND SCIENTIFIC APPARATUS

FOR ELECTRONIC PUBLICATIONS, NAMELY, BULLETINS AND MAPS FEATURING ECONOMIC, STATISTICAL, POLITICAL, HISTORICAL, GEOGRAPHIC, GOVERNMENTAL, DEVELOPMENTAL, SOCIAL AND DEMOGRAPHIC INFORMATION AND DATA RECORDED ON CD ROM, WORLD WIDE WEB, AND AVAILABLE FOR HAND-HELD DEVICES, NAMELY PERSONAL DIGITAL ASSISTANTS (PDAS); AND DOWNLOADABLE ELECTRONIC PUBLICATIONS, NAMELY, BULLETINS AND MAPS FEATURING ECONOMIC, STATISTICAL, POLITICAL, HISTORICAL, GEOGRAPHIC, GOVERNMENTAL, DEVELOPMENTAL, SOCIAL AND DEMOGRAPHIC INFORMATION AND DATA (U.S. CLS. 21, 23, 26, 36 AND 38).

CLASS 16—PAPER GOODS AND PRINTED MATTER

FOR PRINTED PUBLICATIONS, NAMELY, BULLETINS AND MAPS FEATURING ECONOMIC, STATISTICAL, POLITICAL, HISTORICAL, GEOGRAPHIC, GOVERNMENTAL, DEVELOPMENTAL, SOCIAL AND DEMOGRAPHIC INFORMATION AND DATA (U.S. CLS. 2, 5, 22, 23, 29, 37, 38 AND 50).

SN 76-138,384. MILLENNIAL STAR NETWORK, OREM, UT.
FILED 9-29-2000.

SN 76-138,409. MILLENNIAL STAR NETWORK, OREM, UT.
FILED 9-29-2000.

INFOGRAMS

CLASS 9—ELECTRICAL AND SCIENTIFIC APPARATUS

FOR ELECTRONIC PUBLICATIONS, NAMELY, BULLETINS AND MAPS FEATURING INTERNATIONAL AND INTERCULTURAL RELATIONSHIP HELPS AND DATA RECORDED ON CD ROM, WORLD WIDE WEB, AND AVAILABLE FOR HAND-HELD DEVICES, NAMELY PERSONAL DIGITAL ASSISTANTS (PDAS); AND DOWNLOADABLE ELECTRONIC PUBLICATIONS, NAMELY, BULLETINS AND MAPS FEATURING INTERNATIONAL AND INTERCULTURAL RELATIONSHIP HELPS AND DATA (U.S. CLS. 21, 23, 26, 36 AND 38).

FIRST USE 6-0-2000; IN COMMERCE 6-0-2000.

CLASS 16—PAPER GOODS AND PRINTED MATTER

FOR PRINTED PUBLICATIONS, NAMELY, BULLETINS AND MAPS FEATURING INTERNATIONAL AND INTERCULTURAL RELATIONSHIP HELPS AND DATA (U.S. CLS. 2, 5, 22, 23, 29, 37, 38 AND 50).

FIRST USE 1-0-1980; IN COMMERCE 1-0-1980.

SN 76-138,387. MILLENNIAL STAR NETWORK, OREM, UT.
FILED 9-29-2000.

CULTUREGRAMS

CLASS 9—ELECTRICAL AND SCIENTIFIC APPARATUS

FOR ELECTRONIC PUBLICATIONS, NAMELY, BULLETINS AND MAPS FEATURING ECONOMIC, STATISTICAL, POLITICAL, HISTORICAL, GEOGRAPHIC, GOVERNMENTAL, DEVELOPMENTAL, SOCIAL AND DEMOGRAPHIC INFORMATION AND DATA RECORDED ON CD ROM, WORLD WIDE WEB, AND AVAILABLE FOR HAND-HELD DEVICES, NAMELY PERSONAL DIGITAL ASSISTANTS (PDAS); AND DOWNLOADABLE ELECTRONIC PUBLICATIONS, NAMELY, BULLETINS AND MAPS FEATURING ECONOMIC, STATISTICAL, POLITICAL, HISTORICAL, GEOGRAPHIC, GOVERNMENTAL, DEVELOPMENTAL, SOCIAL AND DEMOGRAPHIC INFORMATION AND DATA (U.S. CLS. 21, 23, 26, 36 AND 38).

FIRST USE 6-0-2000; IN COMMERCE 6-0-2000.

CLASS 16—PAPER GOODS AND PRINTED MATTER

FOR PRINTED PUBLICATIONS, NAMELY, BULLETINS AND MAPS FEATURING ECONOMIC, STATISTICAL, POLITICAL, HISTORICAL, GEOGRAPHIC, GOVERNMENTAL, DEVELOPMENTAL, SOCIAL AND DEMOGRAPHIC INFORMATION AND DATA (U.S. CLS. 2, 5, 22, 23, 29, 37, 38 AND 50).

FIRST USE 2-0-1975; IN COMMERCE 2-0-1975.

SECURITYGRAMS

CLASS 9—ELECTRICAL AND SCIENTIFIC APPARATUS

FOR ELECTRONIC PUBLICATIONS, NAMELY, BULLETINS AND MAPS FEATURING HISTORIC, POLITICAL, SAFETY AND RISK INFORMATION AND DATA RECORDED ON CD ROM, WORLD WIDE WEB, AND AVAILABLE ON HAND-HELD DEVICES, NAMELY PERSONAL DIGITAL ASSISTANTS (PDAS); AND DOWNLOADABLE ELECTRONIC PUBLICATIONS, NAMELY, BULLETINS AND MAPS FEATURING HISTORIC, POLITICAL, SAFETY AND RISK INFORMATION AND DATA (U.S. CLS. 21, 23, 26, 36 AND 38).

CLASS 16—PAPER GOODS AND PRINTED MATTER

FOR PRINTED PUBLICATIONS, NAMELY, BULLETINS AND MAPS FEATURING HISTORIC, POLITICAL, SAFETY AND RISK INFORMATION AND DATA (U.S. CLS. 2, 5, 22, 23, 29, 37, 38 AND 50).

SN 76-138,421. HEIDELBERGER DRUCKMASCHINEN AKTIENGESELLSCHAFT, 69115 HEIDELBERG, FED REP GERMANY, FILED 9-29-2000.

QUICKMASTER DI

PRIORITY CLAIMED UNDER SEC. 44(D) ON FED REP GERMANY APPLICATION NO. 30024829.6, FILED 3-30-2000, REG. NO. 30024829, DATED 5-23-2000, EXPIRES 3-31-2010.
OWNER OF U.S. REG. NO. 1,875,042.

CLASS 2—PAINTS

FOR PRINTING INKS TO BE USED IN THE AFOREMENTIONED MACHINES (U.S. CLS. 6, 11 AND 16).

CLASS 7—MACHINERY

FOR PRINT SHOP MACHINES, IN PARTICULAR ROTARY PRINTING PRESSES COMPRISING IMAGING UNITS FOR THE DIRECT IMAGING OF PRINTING PLATES, PARTS FOR THE AFOREMENTIONED GOODS, PRINTING PLATES TO BE USED IN THE AFOREMENTIONED MACHINES (U.S. CLS. 13, 19, 21, 23, 31, 34 AND 35).

CLASS 16—PAPER GOODS AND PRINTED MATTER

FOR PRINTING PAPER TO BE PROCESSED IN THE AFOREMENTIONED MACHINES (U.S. CLS. 2, 5, 22, 23, 29, 37, 38 AND 50).

SN 76-138,478. THE INTERNATIONAL GOLF CLUB, INC.,
BOLTON, MA. FILED 10-2-2000.



NO CLAIM IS MADE TO THE EXCLUSIVE RIGHT TO
USE "8,325 YDS.", APART FROM THE MARK AS SHOWN.

CLASS 25—CLOTHING

FOR CLOTHING, NAMELY, GOLF CAPS, SHIRTS
AND JACKETS (U.S. CLS. 22 AND 39).
FIRST USE 4-1-2000; IN COMMERCE 4-1-2000.

CLASS 41—EDUCATION AND ENTERTAINMENT

FOR PROVIDING SPORTING ACTIVITIES, NAMELY,
GOLF CLUB SERVICES AND GOLF COURSES (U.S.
CLS. 100, 101 AND 107).
FIRST USE 4-1-2000; IN COMMERCE 4-1-2000.

SN 76-139,424. LIFESERV CORPORATION, CHICAGO, IL.
FILED 10-3-2000.

PET LIFE-GUIDE

NO CLAIM IS MADE TO THE EXCLUSIVE RIGHT TO
USE "PET", APART FROM THE MARK AS SHOWN.

CLASS 9—ELECTRICAL AND SCIENTIFIC APPARATUS

FOR COMPUTER SOFTWARE THAT ENABLES
USERS TO PLAN AND MANAGE CERTAIN EVENTS
IN THE CARE OF A PET, NAMELY, SOFTWARE WHICH
PROVIDES CALENDAR FUNCTIONS, CALCULATOR
FUNCTIONS, BUDGETING FUNCTIONS, FINANCIAL
PLANNING FUNCTIONS, SCHEDULING FUNCTIONS,
EDUCATIONAL FUNCTIONS, NAMELY, PROVIDING
ON-LINE TUTORIALS, EXERCISES, INFORMATION,
NEWS, NEWSLETTERS, DATABASES, AND PUBLICA-
TIONS AND PROVIDING LINKS TO ON-LINE TUTORIALS,
EXERCISES, INFORMATION, NEWS,
NEWSLETTERS, DATABASES, AND PUBLICATIONS
TO ASSIST USERS TO PLAN AND MANAGE CERTAIN
EVENTS RELATED TO A PET, ORGANIZATIONAL
FUNCTIONS, COMMUNICATION FUNCTIONS,
NAMELY, PROVIDING ELECTRONIC MAIL AND
LINKS TO ON-LINE TUTORIALS, EXERCISES, INFOR-
MATION, NEWS, NEWSLETTERS, DATABASES, AND
PUBLICATIONS, AND REMINDER FUNCTIONS FOR
IMPORTANT EVENTS (U.S. CLS. 21, 23, 26, 36 AND 38).

CLASS 35—ADVERTISING AND BUSINESS

FOR LICENSING OF COMPUTER SOFTWARE TO
ALLOW LICENSEES TO COMMUNICATE WITH USERS
VIA A GLOBAL COMPUTER NETWORK (U.S. CLS. 100,
101 AND 102).

SN 76-139,719. TEXAS NEW MEXICO POWER COMPANY,
FORT WORTH, TX. FILED 10-3-2000.

TEXASNEWMEXICOPOWER.COM

OWNER OF U.S. REG. NO. 1,234,050.
SEC. 2(F).

CLASS 36—INSURANCE AND FINANCIAL

FOR FINANCIAL SERVICES, NAMELY, PROVIDING
ONLINE BILL PAYMENT AND ACCOUNT MANAGE-
MENT FOR UTILITY CONSUMERS (U.S. CLS. 100, 101
AND 102).

CLASS 39—TRANSPORTATION AND STORAGE

FOR PUBLIC UTILITY SERVICES IN THE NATURE
OF ELECTRICITY DISTRIBUTION, ELECTRICITY
TRANSMISSION, AND ENERGY AUDITS (U.S. CLS.
100 AND 105).

CLASS 42—SCIENTIFIC, COMPUTER AND LEGAL SERVICES

FOR COMPUTER SERVICES, NAMELY PROVIDING A
WEBSITE FEATURING UTILITY AND ENERGY CON-
SERVATION INFORMATION (U.S. CLS. 100 AND 101).

SN 76-141,085. KELMSCOTT COMMUNICATIONS, LLC,
SAN FRANCISCO, CA. FILED 10-4-2000.

ASCENTRA NEW MEDIA

NO CLAIM IS MADE TO THE EXCLUSIVE RIGHT TO
USE "NEW MEDIA", APART FROM THE MARK AS
SHOWN.

CLASS 35—ADVERTISING AND BUSINESS

FOR PREPARING ADVERTISING FOR OTHERS;
BUSINESS MANAGEMENT SERVICES RENDERED TO
THOSE IN THE PRINT INDUSTRY, NAMELY, MANA-
GING THE ORDERING AND PRODUCTION OF PRINT
PROJECTS VIA THE INTERNET (U.S. CLS. 100, 101 AND
102).

FIRST USE 7-15-2001; IN COMMERCE 7-15-2001.

CLASS 39—TRANSPORTATION AND STORAGE

FOR DIGITAL ASSET MANAGEMENT, NAMELY,
ELECTRONIC STORAGE OF DIGITAL IMAGES USED
IN PRINT PRODUCTS, NAMELY, CORPORATE COL-
LATERAL AND ADVERTISING AND MARKETING
BROCHURES (U.S. CLS. 100 AND 105).

FIRST USE 7-15-2001; IN COMMERCE 7-15-2001.

CLASS 41—EDUCATION AND ENTERTAINMENT

FOR ELECTRONIC PUBLISHING SERVICES,
NAMELY, PUBLICATION OF TEXT AND GRAPHIC
WORKS OF OTHERS ON CD-ROMS FEATURING COR-
PORATE ADVERTISING AND MARKETING MATERI-
ALS (U.S. CLS. 100, 101 AND 107).

FIRST USE 7-15-2001; IN COMMERCE 7-15-2001.

CLASS 42—SCIENTIFIC, COMPUTER AND LEGAL SERVICES

FOR COMMERCIAL PRINTING; DIGITAL PRINTING; GRAPHIC ART DESIGN; BUSINESS MANAGEMENT SERVICES RENDERED TO THOSE IN THE PRINT INDUSTRY, NAMELY, MANAGING THE ORDERING AND PRODUCTION OF PRINT PROJECTS VIA THE INTERNET (U.S. CLS. 100 AND 101).
FIRST USE 7-15-2001; IN COMMERCE 7-15-2001.

SN 76-141,719. INTERA GESELLSCHAFT FUR SOFTWARE-ENTWICKLUNG MBH, FED REP GERMANY, FILED 10-4-2000.

PLANTSCOPE**CLASS 9—ELECTRICAL AND SCIENTIFIC APPARATUS**

FOR ELECTRICAL AND ELECTRONIC EQUIPMENT, DEVICES AND INSTRUMENTS, NAMELY QUANTITATIVE SENSORS FOR THE MEASUREMENT OF TEMPERATURE, PRESSURE, CONDUCTIVITY, ELECTRIC AND MAGNETIC FIELD STRENGTH, GRAVITY FIELD STRENGTH, OPACITY, AND CHEMICAL COMPOSITION; BIOMETRIC SENSORS; CIRCUITS FOR CONNECTING SENSORS TO COMPUTERS; TWO-DIMENSIONAL AND MULTIDIMENSIONAL HOLOGRAPHIC SCREENS FOR USE IN DATA VISUALIZATION; DATA PROCESSING COMPUTER PROGRAMS; COMPUTERS; MICROCOMPUTERS; HAND-HELD COMPUTERS; LAPTOP COMPUTERS; COMPUTER WORKSTATIONS; INTEGRATED MICRO-CONTROLLERS; MAIN FRAME AND DATABASE COMPUTERS; COMPUTER SOFTWARE FOR USE IN ACQUISITION, STORAGE, RAPID RETRIEVAL AND ANALYSIS OF NUMERIC DATA; DATA PROCESSING DEVICES, INCLUDING ACCESSORIES FOR ELECTRICAL MESSAGE AND DATA RECORDING, PROCESSING TRANSMITTING TRANSFER, SWITCHING, STORAGE AND OUTPUT; ELECTRONIC DEVICES AND HARDWARE FOR DATA COMMUNICATIONS VIA CABLE OR WIRELESS TELECOMMUNICATIONS NETWORKS FOR REMOTE DATA TRANSMISSION AND DATA TRANSMISSION IN LOCAL NETWORKS; PRINTERS; PLOTTERS; STORAGE DRIVES; MONITORS; KEYBOARDS; SCANNERS; ELECTRONIC MEMORY DEVICES, NAMELY RANDOM ACCESS MEMORY, RAM, DRAM, SRAM AND FLASH- RAM; PRINTED CIRCUIT BOARDS WITH MEMORY MODULES; BLANK COMPUTER HARD DISKS; BLANK CD'S; LOUDSPEAKERS FOR COMPUTERS; ADAPTERS; CABLES; CONNECTORS; NETWORK ADAPTER CARDS AND FAX CARDS; MODEMS; TERMINAL DEVICES FOR TELECOMMUNICATIONS; COMPUTER PROGRAMS FOR DATA PROCESSING; DOWNLOADABLE INFORMATION MANAGEMENT SYSTEMS; COMPUTER SOFTWARE FOR COMPRESSING DATA FROM DATA PROCESSING; AND OPERATING MAINTENANCE AND TRAINING GUIDES, RELATING TO ALL OF THE FOREGOING GOODS, SOLD AS A UNIT THEREWITH (U.S. CLS. 21, 23, 26, 36 AND 38).

SN 76-141,348. PREFERRED COMPUTER TRADING CORPORATION, FOREST HILLS, NY. FILED 10-5-2000.



THE STIPPLING IN THE MARK IS FOR SHADING PURPOSES ONLY.

THE MARK CONSISTS OF A SAILING SHIP ON THE WATER WITH THE SKY IN THE BACKGROUND AND THE MARK "HMS BOUNTY" AND A DESIGN BENEATH THE SHIP. THE WHITE ON THE WATER BENEATH THE BOAT SHOWS THE RIPPLES IN THE WATER AND THE REFLECTION OF THE SALES.

CLASS 25—CLOTHING

FOR CLOTHING, NAMELY, T-SHIRTS, POLO SHIRTS, SWEAT SHIRTS, SHIRTS, JACKETS, PANTS, SHORTS, CAPS, HATS, AND FOOTWEAR (U.S. CLS. 22 AND 39).

CLASS 29—MEATS AND PROCESSED FOODS

FOR DRIED AND CANNED BREADFRUIT; NUTS; YUCCA, BANANA, BREADFRUIT AND POTATO CHIPS; FRUIT AND POTATO BASED SNACK FOODS (U.S. CL. 46).

CLASS 32—LIGHT BEVERAGES

FOR NON-ALCOHOLIC BEVERAGES, NAMELY, POP; SOFT DRINKS; FRUIT DRINKS; FRUIT JUICES; VEGETABLE JUICES; AND AERATED, DRINKING, SELTZER, SODA, SPRING, AND MINERAL WATER (U.S. CLS. 45, 46 AND 48).

CLASS 35—ADVERTISING AND BUSINESS

FOR CONSULTATION SERVICES TO BUSINESS ORGANIZATIONS RELATING TO COMMUNICATION TECHNIQUES AND TECHNOLOGIES; BUSINESS CONSULTATION IN RELATION TO SOFTWARE AND HARDWARE APPLICATIONS; ADMINISTRATION OF COMPANIES, NAMELY, PRODUCT OPTIMIZATION UTILIZING ON-LINE DATA ANALYSIS AND HOT SPOT LOCALIZATION IN COMPANY ECONOMIC MODELS AND RESULTING REORGANIZATION (U.S. CLS. 100, 101 AND 102).

CLASS 37—CONSTRUCTION AND REPAIR

FOR ASSEMBLING AND MAINTENANCE OF DATA PROCESSING SYSTEMS AND COMPONENTS THEREOF FOR THE INTERNET, INTRANET AND EXTRANET FUNCTIONS, ALL PERFORMED FOR OTHERS (U.S. CLS. 100, 103 AND 106).

CLASS 38—COMMUNICATION

FOR PROVIDING ACCESS TO THE INTERNET (U.S. CLS. 100, 101 AND 104).

CLASS 42—SCIENTIFIC, COMPUTER AND LEGAL SERVICES

FOR CONFIGURATION, ADMINISTRATION, EXTENSION AND UPDATING OF NETWORK-SPECIFIC SOFTWARE INTENDED FOR INTERNET, INTRANET AND EXTRANET SYSTEMS; CREATION AND MAINTENANCE OF WEB PAGES; ASSEMBLING AND ARCHIVING DATA, IN PARTICULAR, DATA FROM PRODUCTION PROCESSES; SETUP, UPDATING AND MAINTENANCE OF WEB SITES; BROWSER-AIDED MAINTENANCE OF DATA PROCESSING SYSTEMS AND COMPONENTS THEREOF, INCLUDING SOFTWARE, OF INTERNET, INTRANET AND EXTRANET SYSTEMS; DATA PROCESSING SYSTEM CONSULTATION; DEVELOPMENT, CREATION, MAINTENANCE AND UPDATING OF DATA PROCESSING PROGRAMS; TECHNICAL CONSULTATION RELATING TO COMMUNICATION TECHNIQUES AND TECHNOLOGY; CREATION OF TECHNICAL DOCUMENTATION FOR OTHERS, NAMELY, OPERATING, MAINTENANCE AND TRAINING GUIDES; INTERNET SERVICES, NAMELY, PROVIDING TEMPORARY USE OF ONLINE NON-DOWNLOADABLE INFORMATION MANAGEMENT SYSTEMS OVER THE INTERNET; AND TRANSFER OF DATA AND INFORMATION RELATING TO DOCUMENT MANAGEMENT SYSTEMS ON THE INTERNET (U.S. CLS. 100 AND 101).

SN 76-142,493. TEEN CHALLENGE INTERNATIONAL USA, SPRINGFIELD, MO. FILED 10-4-2000.



NO CLAIM IS MADE TO THE EXCLUSIVE RIGHT TO USE "TEEN", APART FROM THE MARK AS SHOWN.

CLASS 41—EDUCATION AND ENTERTAINMENT

FOR EDUCATIONAL SERVICES, NAMELY, CONDUCTING EDUCATIONAL AND OUTREACH PROGRAMS IN THE FIELD OF PREVENTION OF DRUG AND ALCOHOL USE AND GANG AFFILIATION (U.S. CLS. 100, 101 AND 107).

FIRST USE 10-15-1984; IN COMMERCE 10-15-1984.

CLASS 42—SCIENTIFIC, COMPUTER AND LEGAL SERVICES

FOR SOCIAL SERVICES PROVIDING COUNSELING AND MINISTRY SERVICES AIMED AT THE PREVENTION OF DRUG AND ALCOHOL USE AND GANG AFFILIATION (U.S. CLS. 100 AND 101).

FIRST USE 10-15-1984; IN COMMERCE 10-15-1984.

SN 76-142,116. MADISON SQUARE GARDEN, L.P., NEW YORK, NY. BY ASSIGNMENT MADISON SQUARE GARDEN CHEERING FOR CHILDREN FOUNDATION, NEW YORK, NY. FILED 10-6-2000.



NO CLAIM IS MADE TO THE EXCLUSIVE RIGHT TO USE "SKATE", APART FROM THE MARK AS SHOWN.

CLASS 36—INSURANCE AND FINANCIAL

FOR CHARITABLE FUNDRAISING SERVICES (U.S. CLS. 100, 101 AND 102).

FIRST USE 1-0-1998; IN COMMERCE 1-0-1998.

CLASS 41—EDUCATION AND ENTERTAINMENT

FOR ENTERTAINMENT SERVICES IN THE NATURE OF CONDUCTING ICE HOCKEY TRAINING AND ENTERTAINMENT PROGRAMS (U.S. CLS. 100, 101 AND 107).

FIRST USE 1-0-1998; IN COMMERCE 1-0-1998.

SN 76-143,796. TELEZYGOLOGY PTY LIMITED, ACN 083 564 050, SYDNEY, NSW 2000, AUSTRALIA, FILED 10-10-2000.



PRIORITY CLAIMED UNDER SEC. 44(D) ON AUSTRALIA APPLICATION NO. 831462, FILED 4-12-2000, REG. NO. 831462, DATED 4-12-2000, EXPIRES 1-12-2010.

CLASS 6—METAL GOODS

FOR METAL BUILDING MATERIALS, NAMELY, STUDS, SHEETS, PANELS, FRAMES, GUTTERS, SKIRTING, CLIPS, TRACKS, STRIPS, BRACKETS, PIPES AND METAL FASTENERS, AND PARTS THEREFOR FOR THE CONSTRUCTION, FIT OUT AND MAINTENANCE OF COMMERCIAL BUILDINGS, RETAIL BUILDINGS, INDUSTRIAL BUILDINGS, HOTELS, HOSPITALS, AIRPORTS, PUBLIC BUILDINGS, HOUSING AND MOBILE HOUSING AND FOR BUILDING, COMMERCIAL, INDUSTRIAL, TRANSPORT, STORAGE, PACKAGING, CONSTRUCTION AND HOUSING USE; SMALL ITEMS OF METAL HARDWARE, NAMELY, CONNECTORS, COLLARS, PINS, PLATES, KEEPERS, CLAMPS, LOCKS OF METAL, METAL LOCK PARTS, CLIPS, STOPPERS OF METAL, CLOSURES OF METAL, CANOE CLIPS AND PLUGS FOR THE CONSTRUCTION, FIT OUT AND MAINTENANCE OF COMMERCIAL BUILDINGS, RETAIL BUILDINGS, INDUSTRIAL BUILDINGS, HOTELS, HOSPITALS, AIRPORTS, PUBLIC BUILDINGS, HOUSING AND MOBILE HOUSING AND FOR BUILDING, COMMERCIAL, INDUSTRIAL, TRANSPORT, STORAGE, PACKAGING, CONSTRUCTION AND HOUSING USE; THREADED AND NON-THREADED METAL FASTENERS; GOOD OF COMMON METAL, NAMELY, BOLTS, NUTS, SCREWS, STRIPS, DISKS AND VALVES, FOR THE CONSTRUCTION, FIT OUT AND MAINTENANCE OF COMMERCIAL BUILDINGS, RETAIL BUILDINGS, INDUSTRIAL BUILDINGS, HOTELS, HOSPITALS, AIRPORTS, PUBLIC BUILDINGS, HOUSING AND MOBILE HOUSING AND FOR BUILDING, COMMERCIAL, INDUSTRIAL, TRANSPORT, STORAGE, PACKAGING, CONSTRUCTION AND HOUSING USE; PACKAGING CONTAINERS OF METAL FOR THE STORAGE AND TRANSPORTATION OF GOODS; PACKAGING CONTAINERS PREDOMINANTLY OF METAL FOR THE STORAGE AND TRANSPORTATION OF GOODS (U.S. CLS. 2, 12, 13, 14, 23, 25 AND 50).

CLASS 9—ELECTRICAL AND SCIENTIFIC APPARATUS

FOR REMOTE ACTIVATION APPARATUS, REMOTE CONTROL APPARATUS AND SIGNALING APPARATUS, ALL FOR USE WITH FASTENERS, SEALS, LOCKS, VENDING MACHINES, MERCHANDISE SECURITY, CONTAINERS, CLOSURES, CAPS, CORKS, PRODUCT ASSEMBLY, PRODUCT SERVICING, MANUFACTURING, BUILDING ASSEMBLY, PIPES, VALVES, CABLES, CONNECTIONS, ELECTRONIC COMPONENT ASSEMBLY, AND PARTS THEREFOR; APPARATUS, NAMELY, INFRARED REMOTE CONTROL DEVICES, RADIO FREQUENCY REMOTE CONTROL DEVICES, ULTRASOUND REMOTE CONTROL DEVICES, INDUCTION REMOTE CONTROL DEVICES, MICROWAVE REMOTE CONTROL DEVICES, WIRELESS TELEPHONES, WIRELESS PERSONAL ELECTRONIC DEVICES AND WIRELESS COMPUTERS FOR CARRYING OUT ONE OR MORE OF THE FOLLOWING - NAVIGATING, LOCATING, DIAGNOSING, REPORTING, CONTROLLING, TRANSMITTING, ENERGIZING AND RECORDING, AND PARTS THEREFOR; COMPUTER SOFTWARE FOR OPERATING SYSTEMS AND APPLICATION PROGRAMS, CONTROL SYSTEMS AND INTERFACE SYSTEMS FOR THIRD PARTY COMMUNICATIONS AND DATABASE SYSTEMS IN THE FIELD OF BUILDING, COMMERCIAL, INDUSTRIAL, TRANSPORT, STORAGE, PACKAGING, CONSTRUCTION AND HOUSING, AND COMPUTER HARDWARE (U.S. CLS. 21, 23, 26, 36 AND 38).

CLASS 19—NON-METALLIC BUILDING MATERIALS

FOR NON-METALLIC BUILDING MATERIALS, NAMELY, CONNECTORS, PINS, PLATES, KEEPERS, CLAMPS, LOCKS NOT OF METAL, LOCK PARTS NOT OF METAL, STOPPERS NOT OF METAL, CLOSURES NOT OF METAL, PLUGS, STUDS, SHEETS, PANELS, FRAMES, GUTTERS, SKIRTING, CLIPS, TRACKS, STRIPS, BRACKETS, PIPES, FASTENERS, COLLARS, VALVES, DISKS, CANOE CLIPS, AND PARTS THEREFOR FOR THE CONSTRUCTION, FIT OUT AND MAINTENANCE OF COMMERCIAL BUILDINGS, RETAIL BUILDINGS, INDUSTRIAL BUILDINGS, HOTELS, HOSPITALS, AIRPORTS, PUBLIC BUILDINGS, HOUSING AND MOBILE HOUSING AND FOR BUILDING, COMMERCIAL, INDUSTRIAL, TRANSPORT, STORAGE, PACKAGING, CONSTRUCTION AND HOUSING USE (U.S. CLS. 1, 12, 33 AND 50).

CLASS 20—FURNITURE AND ARTICLES NOT OTHERWISE CLASSIFIED

FOR THREADED AND NON-THREADED NON-METAL FASTENERS, NAMELY, LOCKS NOT OF METAL, NON-METAL LOCK PARTS, CLIPS, CONNECTORS, COLLARS, PINS, KEEPERS, CLAMPS, STOPPERS AND CLOSURES NOT MADE OF METAL; FURNITURE; NON-METALLIC PACKAGING CONTAINERS FOR COMMERCIAL, INDUSTRIAL AND RETAIL USE; PACKAGING CONTAINERS FOR COMMERCIAL, INDUSTRIAL, RETAIL USE BEING PRINCIPALLY NON-METALLIC (U.S. CLS. 2, 13, 22, 25, 32 AND 50).

SN 76-143,935. COOPERATIVE COMPUTING, INC, AUSTIN, TX. FILED 10-6-2000.

AFTERMARKET CONNEX

NO CLAIM IS MADE TO THE EXCLUSIVE RIGHT TO USE "AFTERMARKET", APART FROM THE MARK AS SHOWN.

CLASS 9—ELECTRICAL AND SCIENTIFIC APPARATUS

FOR COMPUTER SOFTWARE FOR USE IN THE AUTOMOTIVE AFTERMARKET INDUSTRIES, NAMELY, SOFTWARE FEATURING PROGRAMS AND COMPUTERIZED DATABASES FOR DETAILING AND MANAGING AUTOMOTIVE PARTS, LABOR AND INVENTORIES AND FACILITATING COMMUNICATION REGARDING SAME THROUGHOUT THE AUTOMOTIVE AFTERMARKET SUPPLY CHAIN (U.S. CLS. 21, 23, 26, 36 AND 38).

CLASS 35—ADVERTISING AND BUSINESS

FOR INFORMATION NETWORKING SERVICES USED TO FACILITATE EXCHANGE OF INFORMATION AND ELECTRONIC COMMERCE TRANSACTIONS IN THE AUTOMOTIVE AFTERMARKET INDUSTRIES, NAMELY, PROVIDING SEARCHABLE ELECTRONIC DATABASES FEATURING INFORMATION ABOUT AUTOMOTIVE PARTS, LABOR AND INVENTORIES AND PROVIDING AN INTERACTIVE NETWORKING SERVICE TO FACILITATE THE ELECTRONIC SALE, PURCHASE AND MANAGEMENT OF AUTOMOTIVE PARTS, LABOR AND INVENTORIES (U.S. CLS. 100, 101 AND 102).

SN 76-147,822. WASTE SOLUTIONS GROUP, SAN FRANCISCO, CA. FILED 10-16-2000.

SN 76-149,151. CLOSE TALK AB, SPANGA, SWEDEN, FILED 10-18-2000.

WASTE SOLUTIONS GROUP

OWNER OF U.S. REG. NO. 1,744,754.
NO CLAIM IS MADE TO THE EXCLUSIVE RIGHT TO USE "WASTE", APART FROM THE MARK AS SHOWN.
SEC. 2(F).

CLASS 37—CONSTRUCTION AND REPAIR

FOR WASTE REMOVAL AND DISPOSAL SERVICES, NAMELY, POST-COLLECTION WASTE TRANSFER AND DISPOSAL SERVICES (U.S. CLS. 100, 103 AND 106).
FIRST USE 0-0-1992; IN COMMERCE 0-0-1992.

CLASS 40—MATERIAL TREATMENT

FOR ENVIRONMENTAL REMEDIATION SERVICES; SOIL REMEDIATION; WASTE TREATMENT SERVICES (U.S. CLS. 100, 103 AND 106).
FIRST USE 0-0-1992; IN COMMERCE 0-0-1992.

SN 76-148,082. VEOS, LLC, NEW YORK, NY. FILED 10-17-2000.

VEOS

CLASS 6—METAL GOODS

FOR WALL PANELS OF METAL (U.S. CLS. 2, 12, 13, 14, 23, 25 AND 50).

CLASS 16—PAPER GOODS AND PRINTED MATTER

FOR BULLETIN BOARDS, NAMELY, WITH MAGNETIC AND PUSHPIN FEATURES (U.S. CLS. 2, 5, 22, 23, 29, 37, 38 AND 50).

CLASS 19—NON-METALLIC BUILDING MATERIALS

FOR WALL PANELS NOT OF METAL (U.S. CLS. 1, 12, 33 AND 50).

SN 76-148,932. INTERNATIONAL MESSAGING ASSOCIATES, LTD., WAN CHAI, HONG KONG, FILED 10-18-2000.

IMA

CLASS 9—ELECTRICAL AND SCIENTIFIC APPARATUS

FOR COMPUTER SOFTWARE FOR ELECTRONIC MESSAGING[BASED ON USE IN COMMERCE] (U.S. CLS. 21, 23, 26, 36 AND 38).
FIRST USE 3-0-1994; IN COMMERCE 6-0-1994.

CLASS 42—SCIENTIFIC, COMPUTER AND LEGAL SERVICES

FOR CONSULTATION SERVICES AND TECHNICAL ASSISTANCE IN FIELD OF ELECTRONIC MESSAGING[BASED ON ITU] (U.S. CLS. 100 AND 101).



OWNER OF ERPN CMNTY TM OFC REG. NO. 001736271, DATED 7-31-2001, EXPIRES 7-31-2011.

NO CLAIM IS MADE TO THE EXCLUSIVE RIGHT TO USE "TALK", APART FROM THE MARK AS SHOWN.

CLASS 9—ELECTRICAL AND SCIENTIFIC APPARATUS

FOR CORDLESS, INFRA-RED CONTROLLED CONFERENCING AND VOTING SYSTEM CONSISTING OF A CENTRAL CONTROLLER UNIT, MULTIPLE TRANSMITTER/RECEIVER DELEGATE UNITS, AND A TRANSMITTER/RECEIVER REPEATER UNIT, FOR RECORDING, TRANSMISSION AND REPRODUCTION OF SOUND (U.S. CLS. 21, 23, 26, 36 AND 38).

CLASS 38—COMMUNICATION

FOR NETWORK CONFERENCING SERVICES; PROVIDING FACILITIES AND EQUIPMENT FOR VIDEO CONFERENCING (U.S. CLS. 100, 101 AND 104).

SN 76-149,921. ALLEGHENY COUNTY AIRPORT AUTHORITY, THE, PITTSBURGH, PA. FILED 10-19-2000.

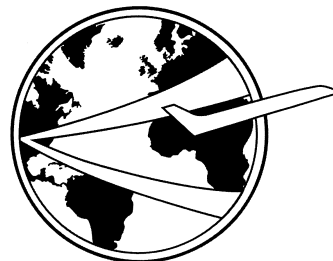

CLASS 14—JEWELRY

FOR JEWELRY (U.S. CLS. 2, 27, 28 AND 50).

CLASS 16—PAPER GOODS AND PRINTED MATTER

FOR STATIONERY, PENCILS, PENS, ERASERS, AND BUSINESS SUPPLIES, NAMELY, DESKTOP BUSINESS CARD HOLDERS; BOOKS, NAMELY ADDRESS BOOKS, APPOINTMENT BOOKS, AND DAILY PLANNERS; AND BOOKMARKS, CALENDARS, AND BUMPER STICKERS (U.S. CLS. 2, 5, 22, 23, 29, 37, 38 AND 50).

CLASS 18—LEATHER GOODS

FOR LUGGAGE; LEATHER AND IMITATION LEATHER PRODUCTS, NAMELY, KEY CHAINS, KEY CASES, LUGGAGE TAGS, BUSINESS CARD CASES, BRIEFCASES, SOUVENIR BAGS, AND TOILETRY CASES SOLD EMPTY (U.S. CLS. 1, 2, 3, 22 AND 41).

CLASS 20—FURNITURE AND ARTICLES NOT OTHERWISE CLASSIFIED

FOR FURNITURE; NON-METAL AND PLASTIC KEY CHAINS, AND NON-METAL AND PLASTIC NOVELTY LICENSE PLATES (U.S. CLS. 2, 13, 22, 25, 32 AND 50).

CLASS 21—HOUSEWARES AND GLASS

FOR MUGS AND CUPS (U.S. CLS. 2, 13, 23, 29, 30, 33, 40 AND 50).

CLASS 25—CLOTHING

FOR CLOTHING, NAMELY, NOVELTY AND PRINTED WOVEN AND KNIT SHIRTS AND ACCESSORIES, NAMELY, COATS, JACKETS, SCARVES, GLOVES, MITTENS, AND BELTS; AND HEADWARE, NAMELY VISORS, HATS, AND CAPS (U.S. CLS. 22 AND 39).

CLASS 28—TOYS AND SPORTING GOODS

FOR STUFFED TOY ANIMALS (U.S. CLS. 22, 23, 38 AND 50).

SN 76-149,933. SPORTS AUTHORITY MICHIGAN, INC., THE, FORT LAUDERDALE, FL. FILED 10-19-2000.

CALIFORNIA SPIRIT

NO CLAIM IS MADE TO THE EXCLUSIVE RIGHT TO USE "CALIFORNIA", APART FROM THE MARK AS SHOWN.

CLASS 9—ELECTRICAL AND SCIENTIFIC APPARATUS

FOR HELMETS FOR SKATEBOARDING (U.S. CLS. 21, 23, 26, 36 AND 38).

CLASS 28—TOYS AND SPORTING GOODS

FOR SKATEBOARDS, SKATEBOARD PARTS AND ACCESSORIES, NAMELY, TRUCKS, WHEELS AND BEARINGS; ARMS, WRIST, KNEE AND ELBOW GUARDS FOR SKATEBOARDING USE (U.S. CLS. 22, 23, 38 AND 50).

SN 76-150,066. ESPE DENTAL AG, D-82229 SEEFELD, FED REP GERMANY, FILED 10-18-2000.

SILORAN

PRIORITY CLAIMED UNDER SEC. 44(D) ON FED REP GERMANY APPLICATION NO. 30030302.5/0, FILED 4-18-2000, REG. NO. 30030302.5, DATED 10-17-2000, EXPIRES 4-30-2010.

CLASS 1—CHEMICALS

FOR CHEMICAL SUBSTANCES FOR INDUSTRIAL AND SCIENTIFIC PURPOSES, NAMELY, CHEMICALS FOR USE IN THE MANUFACTURE OF ADHESIVES, RESINS, POLYMERIZABLE OR HARDENABLE COMPOSITIONS, DENTAL FILLING MATERIALS; SYNTHETIC RESINS IN NATURAL STATE, NAMELY RESINS FOR USE IN THE MANUFACTURE OF POLYMERIZABLE OR HARDENABLE COMPOSITIONS, ADHESIVES, DENTAL FILLING MATERIALS; PLASTIC MOLDING COMPOUNDS IN NATURAL STATE FOR USE IN THE MANUFACTURE OF MOLDED PLASTIC TEETH; ADHESIVES FOR INDUSTRIAL PURPOSES, NAMELY, ADHESIVES FOR STICKING DIFFERENT MATERIALS, NAMELY, METAL, GLASS AND PLASTICS (U.S. CLS. 1, 5, 6, 10, 26 AND 46).

CLASS 5—PHARMACEUTICALS

FOR DENTAL MATERIALS, NAMELY, MATERIALS FOR TOOTH FILLINGS, DENTAL CEMENTS, DENTAL LACQUERS, DENTAL COMPOSITE MATERIALS, DENTAL IMPRESSION MATERIALS, DENTAL DUPLICATING MATERIAL, DENTAL EMBEDDING MATERIALS, MATERIALS FOR TOOTH CROWNS AND TOOTH BRIDGES FOR DENTAL AND DENTAL TECHNICAL PURPOSES, BONDING AND PRIMER MATERIALS FOR DENTAL PURPOSES, MATERIALS FOR MARYLAND BRIDGES FOR DENTAL AND DENTAL TECHNICAL PURPOSES; DENTAL CERAMICS (U.S. CLS. 6, 18, 44, 46, 51 AND 52).

CLASS 10—MEDICAL APPARATUS

FOR DENTAL AND DENTAL TECHNICAL DEVICES, INSTRUMENTS AND APPARATUS, NAMELY, MIXING DEVICE FOR DENTAL MATERIALS, POLYMERIZATION UNITS OR POLYMERIZATION LAMPS FOR DENTAL MATERIALS, COATING UNITS FOR DENTAL TECHNICAL PURPOSES, SAND BLASTING MODULES FOR PRE-TREATMENT OF INTRAORAL OR EXTRAORAL DENTURES BEFORE COATING OR REPAIRING, INSTRUMENTS AND DEVICES FOR THE APPLICATION AND STORAGE OR DENTAL MATERIALS, DENTAL SYRINGES (U.S. CLS. 26, 39 AND 44).

SN 76-150,945. ARCLIGHT CINEMA COMPANY, LOS ANGELES, CA. FILED 10-20-2000.

ARCLIGHT

OWNER OF U.S. REG. NO. 2,511,519.

CLASS 30—STAPLE FOODS

FOR CEREAL BASED SNACK FOOD, NAMELY CANDY COATED POPCORN, CARAMEL POPCORN, GLAZED POPCORN, POPPED POPCORN, AND SNACK MIX, ALL WITH OR WITHOUT NUTS, AND CANDY, NAMELY CHOCOLATE TRUFFLES, CHOCOLATES, AND CARAMELS, ALL WITH OR WITHOUT NUTS (U.S. CL. 46).

CLASS 41—EDUCATION AND ENTERTAINMENT

FOR CINEMA THEATERS (U.S. CLS. 100, 101 AND 107).

SN 76-151,533. TAGAWA GREENHOUSES, INC., BRIGHTON, CO. FILED 10-23-2000.

SN 76-152,235. NICE SYSTEMS LTD., RAANANA 43107, ISRAEL, FILED 10-24-2000.

TAGAWA

THE ENGLISH TRANSLATION OF THE WORD "TAGAWA" IN THE MARK IS "LARGE RIVER" OR AN EQUIVALENT OF THIS.
SEC. 2(F).

CLASS 1—CHEMICALS

FOR POTTING SOIL AND SOIL CONDITIONERS (U.S. CLS. 1, 5, 6, 10, 26 AND 46).
FIRST USE 9-30-2000; IN COMMERCE 9-30-2000.

CLASS 16—PAPER GOODS AND PRINTED MATTER

FOR PRINTED MATERIALS, NAMELY, NEWSLETTERS, BROCHURES, LEAFLETS, PAMPHLETS, INFORMATION SHEETS, AND MANUALS, ALL IN THE FIELD OF HORTICULTURE (U.S. CLS. 2, 5, 22, 23, 29, 37, 38 AND 50).
FIRST USE 12-31-1983; IN COMMERCE 12-31-1983.

CLASS 35—ADVERTISING AND BUSINESS

FOR RETAIL STORE SERVICES FEATURING YARD AND GARDEN SUPPLIES, YARD AND GARDEN CHEMICALS, YARD AND GARDEN TOOLS, GLOVES AND OTHER PROTECTIVE APPAREL FOR USE IN YARD AND GARDEN ACTIVITIES, LAWN AND GARDEN HOSES, SPRINKLERS AND OTHER WATER DISTRIBUTION OR WATER DELIVERY SYSTEMS, GROUND COVER MATERIALS, FENCING, WIRE, STAKES, EDGING MATERIALS, PATIO MATERIALS, PATIO AND YARD FURNISHINGS, DECORATIVE ITEMS FOR THE YARD, GARDEN, AND HOME, GARDEN-THEME GIFTS AND TOYS, AND HOLIDAY DECORATIONS (U.S. CLS. 100, 101 AND 102).
FIRST USE 12-31-1983; IN COMMERCE 12-31-1983.

CLASS 41—EDUCATION AND ENTERTAINMENT

FOR EDUCATION SERVICES, NAMELY, PROVIDING CLASSES AND GROUP AND INDIVIDUAL INSTRUCTION IN THE FIELD OF HORTICULTURE (U.S. CLS. 100, 101 AND 107).
FIRST USE 12-30-1983; IN COMMERCE 12-30-1983.

CLASS 42—SCIENTIFIC, COMPUTER AND LEGAL SERVICES

FOR INFORMATION SERVICES, NAMELY, PROVIDING INFORMATION IN THE FIELD OF HORTICULTURE (U.S. CLS. 100 AND 101).
FIRST USE 12-30-1983; IN COMMERCE 12-31-1983.

LISTEN, LEARN, LEAD.

CLASS 9—ELECTRICAL AND SCIENTIFIC APPARATUS

FOR MULTI-MEDIA MULTI CHANNEL STORAGE AND INFORMATION PROCESSING AND MANAGEMENT APPARATUS, NAMELY, DIGITAL VOICE AND VIDEO LOGGING SYSTEM COMPRISED OF TELEPHONE LINE CABLES, VIDEO MACHINES, WORKSTATIONS, JUKEBOXES, INTEGRATED CIRCUITS AND MASS MEMORY ELEMENTS AND COMPUTER SOFTWARE THEREFOR, AND PRINTED INSTRUCTION GUIDES AND MANUALS SOLD THEREWITH (U.S. CLS. 21, 23, 26, 36 AND 38).

CLASS 35—ADVERTISING AND BUSINESS

FOR BUSINESS SERVICES, NAMELY MANAGEMENT OF TELECOMMUNICATIONS NETWORKS, TELEPROCESSING DATA, AND DATA PROCESSING SERVICES IN THE FIELDS OF TELECOMMUNICATIONS AND GLOBAL COMMUNICATION NETWORKS; CONSULTING SERVICES TO ASSIST IN MANAGING INFORMATION SERVICES ENVIRONMENTS; ELECTRONIC ONLINE BUSINESS MANAGEMENT SERVICES (U.S. CLS. 100, 101 AND 102).

CLASS 38—COMMUNICATION

FOR TELECOMMUNICATIONS AND COMPUTER COMMUNICATION SERVICES, NAMELY ELECTRONIC MAIL SERVICES, CELLULAR TELEPHONE SERVICES, PROVIDING MULTIPLE USER ACCESS TO A GLOBAL COMPUTER INFORMATION NETWORK, TO VIDEO AND AUDIO CIRCUITS FOR SURVEILLANCE SERVICES, TO CUSTOMER CONTACT CENTERS FOR TRACKING, MANAGING, RECORDING AND STORING TELEPHONE CONVERSATIONS, AND TO TELECOMMUNICATION LOGS; ELECTRONIC TRANSMISSION OF AUDIO, SOUNDS, VOICE, IMAGES, VIDEO, DATA AND INFORMATION; ROUTING DATA ELECTRONICALLY BETWEEN REMOTE LOCATIONS VIA TELECOMMUNICATION LINKS; ELECTRONIC MESSAGING SERVICES; ELECTRONIC ON-LINE SERVICES PROVIDING A COMMUNICATIONS LINK TO GLOBAL INTERACTIVE NETWORKS FOR THE TRANSFER AND TRANSMISSION OF DATA; PROVIDING TELEPHONE COMMUNICATION SERVICES IN THE FORM OF AUDIO AND VIDEO TELECONFERENCING VIA A GLOBAL COMPUTER NETWORK (U.S. CLS. 100, 101 AND 104).

CLASS 42—SCIENTIFIC, COMPUTER AND LEGAL SERVICES

FOR COMPUTER CONSULTING AND CUSTOMIZING; COMPUTER SOFTWARE SERVICES NAMELY CONSULTING, CUSTOM DESIGNING, PROTOTYPING, TESTING, INSTALLATION, MAINTENANCE AND PROVIDING TECHNICAL SUPPORT FOR PROBLEM-SOLVING IN THE FIELD OF COMPUTER SOFTWARE; COMPUTER PROGRAMMING FOR OTHERS (U.S. CLS. 100 AND 101).

SN 76-152,802. COLORADO, 92100 BOULOGNE BILLAN-COURT, FRANCE, FILED 10-24-2000.

A TRUE STORY

PRIORITY CLAIMED UNDER SEC. 44(D) ON FRANCE APPLICATION NO. 003024137, FILED 4-26-2000, REG. NO. 003024137, DATED 4-26-2000, EXPIRES 4-26-2010.

CLASS 3—COSMETICS AND CLEANING PREPARATIONS

FOR PERFUME; COSMETICS, NAMELY, NAIL POLISH, LIPSTICK, EYE MAKE-UP, COSMETIC CREAM, MAKE-UP POWDER, AND COSMETIC SKIN CARE PREPARATION; HAIR SHAMPOO; PERFUMED SHAMPOO FOR CLEANING PETS, CARPETS, AND UPHOLSTERY; HAIR LOTION, HAIR CONDITIONER, HAIR SPRAY, AND HAIR GEL; SKIN SOAP; AND INCENSE (U.S. CLS. 1, 4, 6, 50, 51 AND 52).

CLASS 4—LUBRICANTS AND FUELS

FOR SCENTED CANDLES (U.S. CLS. 1, 6 AND 15).

CLASS 5—PHARMACEUTICALS

FOR DEODORANT, OTHER THAN FOR PERSONAL USE, NAMELY, ROOM DEODORANT; AIR FRESHENER IN THE NATURE OF PERFUMED WATER; AIR DEODORIZER IN THE NATURE OF PERFUMED SPRAYS (U.S. CLS. 6, 18, 44, 46, 51 AND 52).

SN 76-152,957. SMITH & NEPHEW, INC., MEMPHIS, TN. FILED 10-24-2000.

NURSING CARE**CLASS 3—COSMETICS AND CLEANING PREPARATIONS**

FOR SKIN CARE PRODUCTS, NAMELY, NON-MEDICATED PROTECTIVE OINTMENTS, SKIN CLEANSERS, AND MOISTURIZING LOTIONS AND CREAMS (U.S. CLS. 1, 4, 6, 50, 51 AND 52).

FIRST USE 6-20-1995; IN COMMERCE 6-20-1995.

CLASS 5—PHARMACEUTICALS

FOR SKIN CARE PRODUCTS, NAMELY, ANTISEPTICS AND MEDICATED OINTMENTS FOR THE SUPPRESSION OF BACTERIA AND ODOR AND AS AN AID IN DEODORIZING SKIN (U.S. CLS. 6, 18, 44, 46, 51 AND 52).

FIRST USE 6-20-1995; IN COMMERCE 6-20-1995.

SN 76-153,870. JOHNS MANVILLE EUROPE GMBH, 61352 BAD HOMBURG, FED REP GERMANY, FILED 10-25-2000.

COMBIMAT

PRIORITY CLAIMED UNDER SEC. 44(D) ON FED REP GERMANY APPLICATION NO. 30033875, FILED 5-3-2000, REG. NO. 30033875, DATED 9-18-2000, EXPIRES 5-31-2010.

CLASS 17—RUBBER GOODS

FOR TWO OR MORE LAYER COMPOSITE MATERIAL, MADE OF GLASS FIBER NONWOVENS AS PART OF INSULATION MATERIALS FOR BUILDINGS, TUBES, OVENS, AIR CONDITIONERS; FILTRATION MEDIA, MADE OF GLASS FIBER NONWOVENS AND POLYMER NONWOVENS; INTERLAYER MATERIALS, MADE OF GLASS FIBER NONWOVENS AND POLYMER NONWOVENS, FOR PROMOTING THE ADHESION BETWEEN TWO DIFFERENT MATERIALS, PARTICULARLY FOR THE USE IN DOOR DECKS; SKIS AND SNOWBOARDS (U.S. CLS. 1, 5, 12, 13, 35 AND 50).

CLASS 19—NON-METALLIC BUILDING MATERIALS

FOR TWO OR MORE LAYER COMPOSITE MATERIAL, MADE OF GLASS FIBER NONWOVENS AND POLYMER NONWOVENS FOR BUILDING CONSTRUCTION PURPOSES, NAMELY SUPPORT LAYERS FOR ROOFING FELTS AND MEMBRANES; ROOFING MEMBRANES, ROOFING FELTS, BITUMINIZED ROOFING FELTS MADE OF GLASS FIBER NONWOVENS AND POLYMER NONWOVENS; SHINGLES MADE OF GLASS FIBER NONWOVENS AND POLYMER NONWOVENS BITUMINIZED SHINGLES; GEOTEXTILES MADE OF GLASS FIBER NONWOVENS AND POLYMER NONWOVENS USED AS CONSTRUCTION ELEMENTS FOR ROADS, BRIDGES, RAILS AND HYDRAULIC STRUCTURES (U.S. CLS. 1, 12, 33 AND 50).

CLASS 21—HOUSEWARES AND GLASS

FOR NONWOVEN FIBERGLASS AND NONWOVEN POLYMER WEB FOR CONVERSION INTO A VARIETY OF INDUSTRIAL AND CONSUMER GOODS (U.S. CLS. 2, 13, 23, 29, 30, 33, 40 AND 50).

CLASS 24—FABRICS

FOR GEOTEXTILES MADE OF GLASS FIBER NONWOVENS AND POLYMER NONWOVENS; WALL COVERINGS MADE OF GLASS FIBER NONWOVENS AND POLYMER NONWOVENS (U.S. CLS. 42 AND 50).

CLASS 27—FLOOR COVERINGS

FOR PROTECTIVE LAMINATED FLOOR COVERINGS MADE OF GLASS FIBER NONWOVENS AND POLYMER NONWOVENS (U.S. CLS. 19, 20, 37, 42 AND 50).

SN 76-154,375. AQUIMICA, INC., TORTOLA, BR. VIRGIN ISLANDS, FILED 10-26-2000.

AQUIMICA**CLASS 35—ADVERTISING AND BUSINESS**

FOR PROMOTING THE GOODS AND SERVICES OF CHEMICAL COMPANIES VIA WEBSITES ON GLOBAL COMPUTER NETWORKS; PROCESSING, TRACKING AND COORDINATING DELIVERY OF PURCHASES OF CHEMICALS AND CHEMICAL PRODUCTS FOR CUSTOMERS; CONDUCTING ON-LINE AUCTIONS (U.S. CLS. 100, 101 AND 102).

CLASS 36—INSURANCE AND FINANCIAL

FOR ON-LINE PAYMENT SYSTEM FOR THE PURCHASE OF CHEMICALS AND CHEMICAL PRODUCTS FOR CUSTOMERS; CONDUCTING ON-LINE AUCTIONS; INSURANCE UNDERWRITING SERVICES (U.S. CLS. 100, 101 AND 102).

CLASS 38—COMMUNICATION

FOR ELECTRONIC MAIL SERVICES; PROVIDING ON-LINE ELECTRONIC BULLETIN BOARDS FOR TRANSMISSION OF MESSAGES AMONG COMPUTER USERS CONCERNING THE CHEMICAL INDUSTRY (U.S. CLS. 100, 101 AND 104).

CLASS 42—SCIENTIFIC, COMPUTER AND LEGAL SERVICES

FOR MAINTENANCE OF COMPUTER SOFTWARE (U.S. CLS. 100 AND 101).

SN 76-154,376. AQUIMICA, INC., TORTOLA, BR.VIRGIN ISLANDS, FILED 10-26-2000.

SN 76-155,254. ZLB BIOPLASMA AG, CH-3000 BERN 22, SWITZERLAND, FILED 10-30-2000.

A-QUIMICA

CLASS 35—ADVERTISING AND BUSINESS

FOR PROMOTING THE GOODS AND SERVICES OF CHEMICAL COMPANIES VIA WEBSITES ON GLOBAL COMPUTER NETWORKS; PROCESSING, TRACKING AND COORDINATING DELIVERY OF PURCHASES OF CHEMICALS AND CHEMICAL PRODUCTS FOR CUSTOMERS; CONDUCTING ON-LINE AUCTIONS (U.S. CLS. 100, 101 AND 102).

CLASS 36—INSURANCE AND FINANCIAL

FOR ON-LINE PAYMENT SYSTEM FOR THE PURCHASE OF CHEMICALS AND CHEMICAL PRODUCTS FOR CUSTOMERS; PROVIDING FINANCIAL INFORMATION TO CUSTOMERS ABOUT THE CHEMICAL INDUSTRY; INSURANCE UNDERWRITING SERVICES (U.S. CLS. 100, 101 AND 102).

CLASS 38—COMMUNICATION

FOR ELECTRONIC MAIL SERVICES; PROVIDING ON-LINE ELECTRONIC BULLETIN BOARDS FOR TRANSMISSION OF MESSAGES AMONG COMPUTER USERS CONCERNING THE CHEMICAL INDUSTRY (U.S. CLS. 100, 101 AND 104).

CLASS 42—SCIENTIFIC, COMPUTER AND LEGAL SERVICES

FOR MAINTENANCE OF COMPUTER SOFTWARE (U.S. CLS. 100 AND 101).

SN 76-155,120. TJX COMPANIES, INC., THE, FRAMINGHAM, MA. FILED 10-27-2000.

OLIVE & THYME

CLASS 9—ELECTRICAL AND SCIENTIFIC APPARATUS

FOR KITCHEN TOOLS, NAMELY, KITCHEN MEASURING CUPS AND MEASURING SPOONS (U.S. CLS. 21, 23, 26, 36 AND 38).

CLASS 21—HOUSEWARES AND GLASS

FOR WOODEN BOWLS; WOODEN KITCHEN TOOLS, NAMELY, SPOONS, SPATULAS AND FORKS FOR FOOD PREPARATION AND FOR FOOD SERVING; WOODEN SERVING TRAYS; WOODEN BREAD BOXES; WOODEN PAPER TOWEL HOLDERS; ALL-PURPOSE PORTABLE HOUSEHOLD CONTAINERS AND CANISTERS; COLANDERS (U.S. CLS. 2, 13, 23, 29, 30, 33, 40 AND 50).

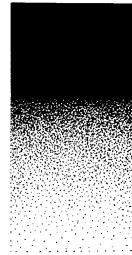

ZLB

THE STIPLING APPEARING THEREIN IS FOR SHADING PURPOSES ONLY.

CLASS 5—PHARMACEUTICALS

FOR PHARMACEUTICAL PREPARATIONS, NAMELY, PHARMACEUTICAL PREPARATIONS TO SUPPORT THE FUNCTION OF THE HUMAN IMMUNE SYSTEM; HEMOSTATIC SEALING AGENT, NAMELY, FIBRIN SEALANT; PHARMACEUTICAL PREPARATIONS ADMINISTERED FOR RHESUS PROPHYLAXIS AND FOR THE TREATMENT OF HUMAN IMMUNE DISORDERS (U.S. CLS. 6, 18, 44, 46, 51 AND 52).

CLASS 10—MEDICAL APPARATUS

FOR DEVICES AND INSTRUMENTS FOR THE ADMINISTRATION AND DELIVERY OF PHARMACEUTICAL PREPARATIONS FOR USE IN THE HUMAN IMMUNE DISORDERS AND THE HUMAN IMMUNE SYSTEM (U.S. CLS. 26, 39 AND 44).

SN 76-156,188. RHODIA PERFORMANCE FIBRES, BLANGY, FRANCE, FILED 10-30-2000.

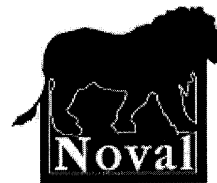

PRIORITY CLAIMED UNDER SEC. 44(D) ON FRANCE APPLICATION NO. 003026569, FILED 5-9-2000, REG. NO. 302659, DATED 5-9-2000, EXPIRES 5-9-2010.

CLASS 12—VEHICLES

FOR VEHICLE COVERS, SEAT COVERS FOR VEHICLES, HEADRESTS FOR VEHICLE SEATS, VEHICLE SEATS, HOODS FOR VEHICLES, COVERS FOR VEHICLES, DOORS FOR VEHICLES AND PILLARS FOR VEHICLES (U.S. CLS. 19, 21, 23, 31, 35 AND 44).

CLASS 22—CORDAGE AND FIBERS

FOR ROPES, STRING, COMMERCIAL NETS, TENTS, AWNINGS, CANVAS TARPAULINS, SAILS, SACKS AND BAGS FOR THE TRANSPORTATION OF GOODS IN BULK, PADDING AND STUFFING MATERIALS NOT OF RUBBER OR PLASTIC AND RAW FIBROUS TEXTILE MATERIALS (U.S. CLS. 1, 2, 7, 19, 22, 42 AND 50).

CLASS 24—FABRICS

FOR UPHOLSTERY FOR VEHICLES, CLOTH FLAGS FOR VEHICLES (U.S. CLS. 42 AND 50).

CLASS 27—FLOOR COVERINGS

FOR CARPETS, FITTED CARPETS, MATS AND MATTING, NON-TEXTILE WALL HANGINGS (U.S. CLS. 19, 20, 37, 42 AND 50).

SN 76-156,818. IMEC V.Z.W., LEUVEN, BELGIUM, FILED 10-31-2000.

LINEAGONI

PRIORITY CLAIMED UNDER SEC. 44(D) ON BENELUX APPLICATION NO. 0964798, FILED 5-16-2000, REG. NO. 0668815, DATED 5-16-2000, EXPIRES 5-16-2010.

CLASS 1—CHEMICALS

FOR CHEMICAL COMPOSITIONS, IN LIQUID OR GASEOUS FORM FOR CLEANING AND ETCHING A SEMICONDUCTOR SUBSTRATE (U.S. CLS. 1, 5, 6, 10, 26 AND 46).

CLASS 9—ELECTRICAL AND SCIENTIFIC APPARATUS

FOR SEMICONDUCTOR WAFER PROCESSING EQUIPMENT, NAMELY, AUTOMATIC WAFER PROCESSING, WAFER DRYING MACHINES, WAFER CLEANING MACHINES, WAFER ETCHING MACHINES AND WAFER HEATING MACHINES (U.S. CLS. 21, 23, 26, 36 AND 38).

CLASS 42—SCIENTIFIC, COMPUTER AND LEGAL SERVICES

FOR RESEARCH AND DEVELOPMENT OF NEW PRODUCTS AND PROCESSES FOR OTHERS AND TECHNICAL CONSULTING AND RESEARCH IN THE FIELDS OF CHEMICAL AND MICROELECTRONICS (U.S. CLS. 100 AND 101).

SN 76-159,203. HEALTHMEDIA, INC., ANN ARBOR, MI. FILED 11-6-2000.



OWNER OF U.S. REG. NOS. 2,276,506, 2,324,542 AND 2,577,770.

CLASS 16—PAPER GOODS AND PRINTED MATTER

FOR PUBLICATIONS, NAMELY, PRINTED MATERIALS IN THE FIELDS OF WELLNESS, HEALTH PROMOTION, PREVENTATIVE HEALTH CARE, DISEASE MANAGEMENT, BEHAVIOR CHANGE, AND HEALTH RISK ASSESSMENT (U.S. CLS. 2, 5, 22, 23, 29, 37, 38 AND 50).

CLASS 42—SCIENTIFIC, COMPUTER AND LEGAL SERVICES

FOR COLLECTION AND ANALYSIS OF HEALTH, LIFESTYLE, AND PERSONAL INFORMATION AND CREATION OF PERSONAL GUIDES FOR USE BY INDIVIDUALS IN CONNECTION WITH THEIR OWN WELLNESS, PREVENTATIVE HEALTH CARE, DISEASE MANAGEMENT AND BEHAVIOR CHANGE, VIA THE GLOBAL COMPUTER NETWORK; AND COMPUTER SERVICES, NAMELY, PROVIDING ONLINE QUESTIONNAIRES, GUIDEBOOKS, SUPPLEMENTAL GUIDES, TAILORED FOLLOW-UP MATERIALS, AND NEWSLETTERS, ALL IN THE FIELDS OF WELLNESS, HEALTH PROMOTION, PREVENTATIVE HEALTH CARE, DISEASE MANAGEMENT, BEHAVIOR CHANGE, AND HEALTH RISK ASSESSMENT (U.S. CLS. 100 AND 101).

SN 76-159,259. ATOMSHOCKWAVE CORP., SAN FRANCISCO, CA. BY CHANGE OF NAME SHOCKWAVE.COM, INC., SAN FRANCISCO, CA. FILED 11-3-2000.

CASSI: EARTH GIRL ON CAMPUS**CLASS 9—ELECTRICAL AND SCIENTIFIC APPARATUS**

FOR INTERACTIVE MULTIMEDIA ENTERTAINMENT COMPUTER GAME SOFTWARE; INTERACTIVE COMPUTER GAME PROGRAMS AND SOFTWARE IN THE FIELD OF VIDEO GAMES; VIDEO GAME CARTRIDGES, CD-ROMS, COMPACT DISCS, AUDIO AND VIDEO TAPES AND AUDIO AND VIDEO CASSETTES FEATURING CARTOONS AND ANIMATED CHARACTERS; COMPUTER GAME PROGRAMS DOWNLOADABLE FROM A GLOBAL COMPUTER NETWORK; AND INSTRUCTIONAL MANUALS SOLD AS A UNIT THEREWITH (U.S. CLS. 21, 23, 26, 36 AND 38).

CLASS 41—EDUCATION AND ENTERTAINMENT

FOR ENTERTAINMENT SERVICES; NAMELY PROVIDING ONLINE COMPUTER GAMES VIA A GLOBAL COMPUTER NETWORK (U.S. CLS. 100, 101 AND 107).

SN 76-159,750. R.T.O., INC., NORFOLK, VA. FILED 11-3-2000.

BEST-WAY**CLASS 36—INSURANCE AND FINANCIAL**

FOR TAX REFUND ANTICIPATION LOAN SERVICES (U.S. CLS. 100, 101 AND 102). FIRST USE 12-0-1991; IN COMMERCE 12-0-1991.

CLASS 38—COMMUNICATION

FOR TELEPHONE COMMUNICATIONS SERVICES (U.S. CLS. 100, 101 AND 104). FIRST USE 1-0-1999; IN COMMERCE 1-0-1999.

SN 76-160,070. SPEED-TRAP.COM LIMITED, NEWBURY, BERKSHIRE, UNITED KINGDOM, FILED 11-6-2000.

SN 76-160,205. SPEED-TRAP.COM LIMITED, BERKSHIRE RG19 6HN, UNITED KINGDOM, FILED 11-6-2000.

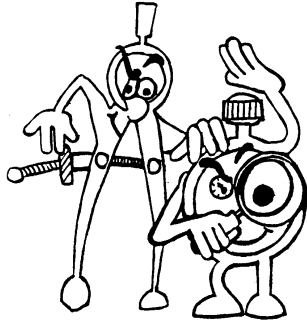

speed-trap.com

CLASS 9—ELECTRICAL AND SCIENTIFIC APPARATUS

FOR COMPUTER SOFTWARE AND COMPUTER PROGRAMS FOR MONITORING, MEASURING, AND ANALYZING USAGE AND PERFORMANCE OF BROWSER BASED APPLICATIONS, NAMELY, WEB SITES AND WEB PAGES; PRE-RECORDED AUDIO AND VIDEO TAPES, COMPACT DISCS, CD-ROMS, AUDIO AND VIDEO CASSETTES FEATURING INFORMATION ON COMPUTER SOFTWARE, COMPUTER PROGRAMS, THE INTERNET, WEB SITES, WEB PAGES AND TELECOMMUNICATIONS SERVICES; DOWNLOADABLE ELECTRONIC PUBLICATIONS IN THE NATURE OF MAGAZINES AND PERIODICAL JOURNALS IN THE FIELD OF COMPUTER SOFTWARE PRODUCTS, INCLUDING THOSE RELATING TO MONITORING, MEASURING, AND ANALYZING USAGE AND PERFORMANCE OF BROWSER BASED APPLICATIONS, INCLUDING WEB SITES AND WEB PAGES (U.S. CLS. 21, 23, 26, 36 AND 38).

CLASS 35—ADVERTISING AND BUSINESS

FOR MARKETING ADVISORY AND CONSULTANCY SERVICES; BUSINESS CONSULTING SERVICES, NAMELY, PROVIDING ANALYSIS OR AND INFORMATION ABOUT USERS, CUSTOMER AND POTENTIAL CUSTOMERS OF BROWSER BASED APPLICATIONS INCLUDING WEB SITES AND WEB PAGES (U.S. CLS. 100, 101 AND 102).

CLASS 38—COMMUNICATION

FOR TELECOMMUNICATIONS SERVICES, NAMELY, ELECTRONIC MAIL SERVICES, PROVIDING MULTIPLE USER ACCESS TO THE INTERNET; PROVIDING TELECOMMUNICATIONS CONNECTIONS TO THE INTERNET AND ON-LINE DATABASE; TELECOMMUNICATION GATEWAY SERVICES (U.S. CLS. 100, 101 AND 104).

CLASS 42—SCIENTIFIC, COMPUTER AND LEGAL SERVICES

FOR DESIGN, CREATION, DEVELOPMENT, AND UPDATING WEB SITES FOR OTHERS; INTERNET AND INTRANET SERVICES, NAMELY, PROVISION OF ADVICE AND CONSULTANCY RELATING TO THE MONITORING, MEASUREMENT, AND ANALYSIS OF USAGE AND PERFORMANCE OF BROWSER BASED APPLICATIONS INCLUDING WEB SITES AND WEB PAGES; TECHNICAL SUPPORT SERVICES, NAMELY, TROUBLESHOOTING OF COMPUTER HARDWARE AND SOFTWARE PROBLEMS VIA TELEPHONE, E-MAIL, AND IN PERSON; INFORMATION TECHNOLOGY CONSULTANCY SERVICES; CREATION, INSTALLATION, SERVICING AND MAINTENANCE OF COMPUTER SOFTWARE FOR OTHERS; CONSULTANCY SERVICES, RELATING TO ALL THE AFORESAID SERVICES (U.S. CLS. 100 AND 101).

CLASS 9—ELECTRICAL AND SCIENTIFIC APPARATUS

FOR COMPUTER SOFTWARE AND COMPUTER PROGRAMS FOR MONITORING, MEASURING, AND ANALYZING USAGE AND PERFORMANCE OF BROWSER BASED APPLICATIONS, NAMELY, WEB SITES AND WEB PAGES; PRE-RECORDED AUDIO AND VIDEO TAPES, COMPACT DISCS, CD-ROMS, AUDIO AND VIDEO CASSETTES FEATURING INFORMATION ON COMPUTER SOFTWARE, COMPUTER PROGRAMS, THE INTERNET, WEB SITES, WEB PAGES AND TELECOMMUNICATIONS SERVICES; DOWNLOADABLE ELECTRONIC PUBLICATIONS IN THE NATURE OF MAGAZINES AND PERIODICAL JOURNALS IN THE FIELD OF COMPUTER SOFTWARE PRODUCTS, INCLUDING THOSE RELATING TO MONITORING, MEASURING, AND ANALYZING USAGE AND PERFORMANCE OF BROWSER-BASED APPLICATIONS, INCLUDING WEB SITES AND WEB PAGES (U.S. CLS. 21, 23, 26, 36 AND 38).

CLASS 35—ADVERTISING AND BUSINESS

FOR MARKETING ADVISORY AND CONSULTANCY SERVICES; BUSINESS CONSULTING SERVICES, NAMELY, PROVIDING ANALYSIS OR AND INFORMATION ABOUT USERS CUSTOMER AND POTENTIAL CUSTOMERS OF BROWSER BASED APPLICATIONS INCLUDING WEB SITES AND WEB PAGES (U.S. CLS. 100, 101 AND 102).

CLASS 38—COMMUNICATION

FOR TELECOMMUNICATIONS SERVICES, NAMELY, ELECTRONIC MAIL SERVICES; PROVIDING MULTIPLE USER ACCESS TO THE INTERNET; PROVIDING TELECOMMUNICATIONS CONNECTIONS TO THE INTERNET AND ON-LINE DATABASES; TELECOMMUNICATION GATEWAY SERVICES (U.S. CLS. 100, 101 AND 104).

CLASS 42—SCIENTIFIC, COMPUTER AND LEGAL SERVICES

FOR AND DESIGN, CREATION, DEVELOPMENT, AND UPDATING OF WEBSITES; INTERNET AND INTRANET SERVICES; INFORMATION TECHNOLOGY SUPPORT AND CONSULTANCY SERVICES; ACCESS TO ON-LINE INFORMATION AND COMMUNICATION SERVICES; CREATION, INSTALLATION, SERVICING AND MAINTENANCE OF COMPUTER SOFTWARE; INFORMATION, ADVISORY AND CONSULTANCY SERVICES RELATING TO ALL THE AFORESAID SERVICES (U.S. CLS. 100 AND 101).

SN 76-161,308. CHESEBROUGH-PONDS, INC, WILMINGTON, DE. FILED 11-7-2000.

MYDOVE

CLASS 38—COMMUNICATION

FOR ELECTRONIC TRANSMISSION OF DATA AND DOCUMENTS REGARDING PERSONAL CARE VIA COMPUTER TERMINALS ON A GLOBAL COMPUTER NETWORK; ELECTRONIC MAIL SERVICES (U.S. CLS. 100, 101 AND 104).

CLASS 41—EDUCATION AND ENTERTAINMENT

FOR AUDIO VISUAL AND MULTIMEDIA INTERACTIVE PROGRAMMING, IN THE NATURE OF EDUCATIONAL PROGRAMS RELATING TO PERSONAL CARE ON A GLOBAL COMPUTER NETWORK (U.S. CLS. 100, 101 AND 107).

CLASS 42—SCIENTIFIC, COMPUTER AND LEGAL SERVICES

FOR COMPUTER SERVICES, NAMELY PROVIDING SEARCH ENGINES FOR OBTAINING DATA ON A GLOBAL COMPUTER NETWORK TO AID IN THE FINDING OF USEFUL INFORMATION RELATING TO PERSONAL CARE (U.S. CLS. 100 AND 101).

SN 76-161,906, U.S. LOYALTY CORP., GAHANNA, OH. FILED 11-8-2000.

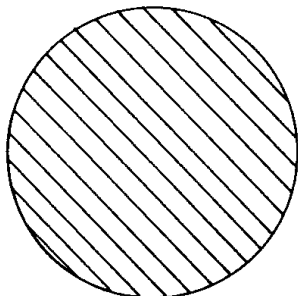

THE DRAWING IS LINED FOR THE COLOR GREEN. THE BALL DESIGN CONSISTS OF A GREEN SPHERE.

CLASS 35—ADVERTISING AND BUSINESS

FOR MARKETING MANAGEMENT SERVICES, NAMELY MARKET RESEARCH, COOPERATIVE ADVERTISING AND MARKETING SERVICES, NAMELY, THE PROVISION OF STATISTICAL ANALYSIS AND CONSULTATION IN THE MARKETING OF THE GOODS AND SERVICES OF OTHERS AND PROVIDING INFORMATION ON THE PURCHASING PATTERNS OF CONSUMERS AND BUSINESSES; CONDUCTING EMPLOYEE INCENTIVE AWARDS PROGRAMS RELATING TO EMPLOYEES' MOTIVATION AND PERFORMANCE; PROVIDING INFORMATION ABOUT THE GOODS AND SERVICES OF OTHERS IN CONNECTION WITH LOYALTY PROGRAMS AND PROMOTIONAL INCENTIVE SCHEMES THROUGH A GLOBAL COMPUTER NETWORK; BUSINESS CONSULTING, NAMELY, CONSULTING WITH RESPECT TO DATA MINING ABOUT CONSUMERS' PREFERENCES (U.S. CLS. 100, 101 AND 102).

CLASS 39—TRANSPORTATION AND STORAGE

FOR ELECTRONIC STORAGE OF DATA (U.S. CLS. 100 AND 105).

SN 76-161,908. CRUCCELL HOLLAND B.V., 2333 CN LEIDEN, NETHERLANDS, BY CHANGE OF NAME INTROGENE B.V., NETHERLANDS, FILED 11-8-2000.

MABSTRACT**CLASS 5—PHARMACEUTICALS**

FOR MEDICAL DIAGNOSTIC BACTERIOPHAGE REAGENTS EXPRESSING A MONOCLONAL ANTIBODY AT THEIR SURFACE; MEDICAL DIAGNOSTIC REAGENTS, NAMELY, HUMAN MONOCLONAL ANTIBODIES FOR HUMAN THERAPEUTICAL AND DIAGNOSTIC USE; BACTERIA IN THE NATURE OF A MEDICAL DIAGNOSTIC REAGENT; MEDIA FOR BACTERIOLOGICAL CULTURES FOR BATERIOPHAGES (U.S. CLS. 6, 18, 44, 46, 51 AND 52).

CLASS 9—ELECTRICAL AND SCIENTIFIC APPARATUS

FOR LABORATORY APPARATUS FOR CULTURING AND IDENTIFYING BACTERIOPHAGES EXPRESSING A MONOCLONAL ANTIBODY AT THEIR SURFACE (U.S. CLS. 21, 23, 26, 36 AND 38).

CLASS 42—SCIENTIFIC, COMPUTER AND LEGAL SERVICES

FOR BACTERIOLOGICAL RESEARCH AND TESTING IN THE FIELD OF BACTERIOPHAGE EXPRESSION, SCIENTIFIC RESEARCH; MEDICAL AND BIOCHEMICAL ANALYSIS SERVICES, NAMELY, THE RESEARCH AND IDENTIFICATION OF BATERIOPHAGES FOR OTHERS; MEDICAL AND DIAGNOSTIC RESEARCH, DEVELOPMENT AND IDENTIFICATION OF MONOCLONAL ANTIBODIES FOR OTHERS (U.S. CLS. 100 AND 101).

SN 76-162,546. NETSAT EXPRESS, INC., HAUPPAUGE, NY. FILED 11-9-2000.

**CLASS 38—COMMUNICATION**

FOR ELECTRONIC MAIL SERVICES (U.S. CLS. 100, 101 AND 104).
FIRST USE 2-0-2000; IN COMMERCE 2-0-2000.

CLASS 42—SCIENTIFIC, COMPUTER AND LEGAL SERVICES

FOR COMPUTER SERVICES, NAMELY WEB HOSTING FOR OTHERS AND DOMAIN NAME REGISTRATION FOR IDENTIFICATION OF USERS ON A GLOBAL COMPUTER NETWORK (U.S. CLS. 100 AND 101).
FIRST USE 2-0-2000; IN COMMERCE 2-0-2000.

SN 76-162,577. ULTRA RECORDS, INC., NEW YORK, NY. FILED 11-9-2000.

YOU RECORDS

NO CLAIM IS MADE TO THE EXCLUSIVE RIGHT TO USE "RECORDS", APART FROM THE MARK AS SHOWN.

CLASS 9—ELECTRICAL AND SCIENTIFIC APPARATUS

FOR MUSICAL SOUND RECORDINGS, MUSICAL VIDEO RECORDINGS, DOWNLOADABLE MUSICAL SOUND RECORDINGS AND DOWNLOADABLE MUSICAL VIDEO RECORDINGS (U.S. CLS. 21, 23, 26, 36 AND 38).

CLASS 38—COMMUNICATION

FOR STREAMING OF VIDEO AND AUDIO CONTENT VIA A GLOBAL COMPUTER NETWORK; BROADCASTING MULTIMEDIA PROGRAMMING VIA A GLOBAL COMPUTER NETWORK (U.S. CLS. 100, 101 AND 104).

CLASS 41—EDUCATION AND ENTERTAINMENT

FOR PROVIDING A WEBSITE ON A GLOBAL COMPUTER NETWORK FEATURING INFORMATION ON A RECORD LABEL AND ITS MUSICAL ARTISTS AND THEIR APPEARANCES AND BIOGRAPHIES; PROVIDING AN ON-LINE WEBSITE FEATURING A LIBRARY OF TEMPORARY NON-DOWNLOADABLE MUSICAL SOUND RECORDINGS AND VIDEO RECORDINGS FEATURING MUSIC (U.S. CLS. 100, 101 AND 107).

SN 76-162,907. DANFOSS BAUER GMBH, ESSLINGEN, FED REP GERMANY, FILED 11-10-2000.

ETA-K

CLASS 7—MACHINERY

FOR ELECTRIC MOTORS FOR MACHINES (U.S. CLS. 13, 19, 21, 23, 31, 34 AND 35).

CLASS 9—ELECTRICAL AND SCIENTIFIC APPARATUS

FOR SOLID STATE VOLTAGE CONVERTER, SOLID STATE CURRENT CONVERTER, SOLID STATE FREQUENCY CONVERTER, SOLID STATE INVERTER (U.S. CLS. 21, 23, 26, 36 AND 38).

SN 76-163,157. TAVARUA ISLAND LICENSING AND TRADEMARKS, INC., SAN CLEMENTE, CA. FILED 11-10-2000.

TAV

OWNER OF U.S. REG. NOS. 1,558,090, 1,558,091 AND 1,920,946.

CLASS 18—LEATHER GOODS

FOR WALLETS, ALL PURPOSE SPORTS BAGS, ALL PURPOSE ATHLETIC BAGS, BEACH BAGS, BOOK BAGS, BACKPACKS, DUFFEL BAGS, SCHOOL BAGS, SHOULDER BAGS, TOTE BAGS, TRAVEL BAGS, AND LUGGAGE (U.S. CLS. 1, 2, 3, 22 AND 41).

CLASS 25—CLOTHING

FOR SHIRTS, T-SHIRTS, TANK TOPS, SHORTS, PANTS, SARONGS, SWIMWEAR, SWEATSHIRTS, SWEATPANTS, HATS, HEADWEAR AND FOOTWEAR (U.S. CLS. 22 AND 39).

SN 76-164,609. GREEN BAY PLAYERS CHAPEL PROGRAM, INC., GREEN BAY, WI. FILED 11-14-2000.

PLAYERS CHAPEL PROGRAM

NO CLAIM IS MADE TO THE EXCLUSIVE RIGHT TO USE "PLAYERS" OR "PROGRAM", APART FROM THE MARK AS SHOWN.

CLASS 16—PAPER GOODS AND PRINTED MATTER

FOR SERIES OF RELIGIOUS BOOKS, NEWSLETTERS IN THE FIELD OF RELIGION AND PRINTED COURSE MATERIALS FEATURING A RELIGIOUS CURRICULUM (U.S. CLS. 2, 5, 22, 23, 29, 37, 38 AND 50). FIRST USE 2-18-2000; IN COMMERCE 2-18-2000.

CLASS 41—EDUCATION AND ENTERTAINMENT

FOR EDUCATIONAL SERVICES, NAMELY, CONDUCTING RELIGION BASED LECTURES PROMOTING CHRISTIAN VALUES AND DISTRIBUTING COURSE MATERIALS IN CONNECTION THEREWITH (U.S. CLS. 100, 101 AND 107). FIRST USE 2-18-2000; IN COMMERCE 2-18-2000.

CLASS 42—SCIENTIFIC, COMPUTER AND LEGAL SERVICES

FOR ASSOCIATION SERVICES, NAMELY, PROMOTING THE INTERESTS OF CHRISTIANS (U.S. CLS. 100 AND 101). FIRST USE 2-18-2000; IN COMMERCE 2-18-2000.

SN 76-164,638. GOLDEN BOY ENTERPRISES, LLC, LOS ANGELES, CA. FILED 11-14-2000.

GOLDEN BOY MANAGEMENT

NO CLAIM IS MADE TO THE EXCLUSIVE RIGHT TO USE "MANAGEMENT", APART FROM THE MARK AS SHOWN.

CLASS 9—ELECTRICAL AND SCIENTIFIC APPARATUS

FOR PROTECTIVE BOXING HELMETS (U.S. CLS. 21, 23, 26, 36 AND 38).

CLASS 18—LEATHER GOODS

FOR ALL-PURPOSE BAGS, ATHLETIC BAGS, BACKPACKS, BILLFOLDS, CARRY-ON BAGS, DUFFEL BAGS, FANNY PACKS, GYM BAGS, HANDBAGS, KEY CASES, KNAPSACKS, LUGGAGE, PURSES, SHOULDER BAGS, TOTE BAGS, UMBRELLAS AND WALLETS (U.S. CLS. 1, 2, 3, 22 AND 41).

CLASS 25—CLOTHING

FOR CLOTHING, NAMELY, BELTS, BOXER SHORTS, GLOVES, JACKETS, JEANS, JERSEYS, MUSCLE SHIRTS, PANTS, SHIRTS, SHORTS, SPORTS SHIRTS, SWEATERS, SWEATPANTS, SWEATSHIRTS, SWIM WEAR AND T-SHIRTS; FOOTWEAR, NAMELY, SOCKS AND SHOES; HEADWEAR, NAMELY, CAPS, HATS AND VISORS (U.S. CLS. 22 AND 39).

CLASS 28—TOYS AND SPORTING GOODS

FOR ACTION FIGURE TOYS; SPORTING GOODS, EXERCISE EQUIPMENT AND BOXING EQUIPMENT, NAMELY, BOXING GLOVES, HEAVY BAGS, JUMP ROPES, PUNCHING BAGS AND SPORTS GOGGLES FOR USE IN BOXING (U.S. CLS. 22, 23, 38 AND 50).

CLASS 35—ADVERTISING AND BUSINESS

FOR BUSINESS MANAGEMENT CONSULTATION SERVICES FOR OTHERS IN THE FIELDS OF ATHLETICS, ART, CELEBRITIES, LITERATURE, MODELING, SPORTS, THEATER, BUT SPECIFICALLY EXCLUDING, MANAGEMENT SERVICES RELATING TO MUSICIANS, MUSICAL ARTISTS OR MUSICAL PERFORMERS, OR SERVICES RELATING TO PROVIDING, RECORDING, PRODUCING, PROMOTING, PUBLISHING OR OTHERWISE EXPLOITING MUSIC (U.S. CLS. 100, 101 AND 102).

CLASS 41—EDUCATION AND ENTERTAINMENT

FOR SPORTS AND ATHLETIC TRAINING SERVICES AND ENTERTAINMENT SERVICES, IN THE NATURE OF PROVIDING AND PROMOTING PERSONAL APPEARANCES BY SPORTS FIGURES, ATHLETES, ARTISTS, MODELS, ACTORS, COMEDIANS, PERFORMERS AND CELEBRITIES, PRODUCING TELEVISION, RADIO, INTERNET AND CABLE PROGRAMS, MULTIMEDIA ENTERTAINMENT SOFTWARE AND MOTION PICTURE FILMS; ARRANGING, CONDUCTING AND PRODUCING ATHLETIC COMPETITIONS, SPORTING EVENTS, SPORTS CAMPS, AND THEATRICAL PERFORMANCES; THEATRICAL BOOKINGS; PUBLICATION OF BOOKS AND PERIODICALS; FAN CLUBS; PROVIDING FACILITIES FOR RECREATION AND SPORTING EVENTS AND TOURNAMENTS; TICKET RESERVATIONS; BUT SPECIFICALLY EXCLUDING MUSICAL ENTERTAINMENT SERVICES RELATING TO MUSICIANS, MUSICAL PERFORMERS OR MUSICAL ARTISTS OR SERVICES RELATED TO PROVIDING, RECORDING, PRODUCING, PROMOTING, PUBLISHING OR OTHERWISE EXPLOITING MUSIC (U.S. CLS. 100, 101 AND 107).

SN 76-164,762. BCR, INC., WILMINGTON, DE. FILED 11-14-2000.

BARDACC**CLASS 35—ADVERTISING AND BUSINESS**

FOR BUSINESS RESEARCH SERVICES, PUBLIC RELATIONS AND MEDIA RELATION SERVICES (U.S. CLS. 100, 101 AND 102).

CLASS 41—EDUCATION AND ENTERTAINMENT

FOR EDUCATIONAL SERVICES, NAMELY, CONDUCTING SEMINARS, CONFERENCES AND WORKSHOPS IN THE FIELD OF PROMOTING INTEREST OF INDIVIDUALS AND BUSINESS IN THE MEDICAL PRODUCTS FIELDS AND DISTRIBUTING MATERIALS IN CONNECTION THEREWITH; EDUCATION SERVICES, NAMELY, ARRANGING AND CONDUCTING TRAINING CLASSES, SEMINARS, CONFERENCES AND WORKSHOPS CONCERNING MARKETING, SALES, DISTRIBUTION, ACCOUNTING AND FINANCE, TECHNOLOGY AND INFORMATION SERVICES, PERSONNEL, AND REGULATORY COMPLIANCE, ALL IN THE MEDICAL PRODUCTS FIELD, AND DISTRIBUTING MATERIALS IN CONNECTION THEREWITH (U.S. CLS. 100, 101 AND 107).

CLASS 42—SCIENTIFIC, COMPUTER AND LEGAL SERVICES

FOR PROMOTING THE INTERESTS OF INDIVIDUALS AND BUSINESS IN THE MEDICAL PRODUCTS FIELD RELATING TO VARIOUS ISSUES INCLUDING FDA AND MEDICARE REFORM, TRADE, TAXES, PRODUCT LIABILITY AND POLITICS; AND PROVIDING INFORMATION IN THE MEDICAL PRODUCTS FIELD RELATING TO VARIOUS ISSUES INCLUDING FDA AND MEDICARE REFORM, TRADE, TAXES, PRODUCT LIABILITY AND POLITICS; AND FUND RAISING ACTIVITIES IN THE FIELD OF POLITICS; POLITICAL ADVOCACY AND LOBBYING SERVICES IN CONNECTION WITH PROMOTING THE INTERESTS OF THE MEDICAL FIELD; LOBBYING ACTIVITIES THROUGH NEWSLETTERS (U.S. CLS. 100 AND 101).

SN 76-166,569. SYNCRON SUPPLY INTERNATIONAL AB, STOCKHOLM, SWEDEN, BY CHANGE OF NAME; BY ASSIGNMENT EDIMATRIX AB, S-111 57 STOCKHOLM, SWEDEN, FILED 11-16-2000.

EDIMATRIX**CLASS 9—ELECTRICAL AND SCIENTIFIC APPARATUS**

FOR COMPUTER PROGRAMS FOR E-COMMERCE FOR ASSISTING IN LOCATING AND DETERMINING THE USER'S AMOUNT OF INVENTORY (U.S. CLS. 21, 23, 26, 36 AND 38).

CLASS 35—ADVERTISING AND BUSINESS

FOR BUSINESS CONSULTATION SERVICES IN THE FIELD OF ELECTRONIC COMMERCE (U.S. CLS. 100, 101 AND 102).

CLASS 41—EDUCATION AND ENTERTAINMENT

FOR ARRANGING AND CONDUCTING SEMINARS IN THE FIELD OF ELECTRONIC COMMERCE; TEACHING AND EDUCATION, NAMELY, LECTURES, CLASSES, SEMINARS AND CASE STUDIES, IN THE FIELD OF ELECTRONIC COMMERCE (U.S. CLS. 100, 101 AND 107).

SN 76-167,442. RWL CORPORATION, HICKORY, NC. FILED 11-17-2000.

DELSTAR INNOVATIONS

OWNER OF U.S. REG. NO. 1,879,998.

CLASS 35—ADVERTISING AND BUSINESS

FOR DISTRIBUTORSHIP SERVICES IN THE FIELDS OF ELECTRONICS, HARDWARE, HOME FURNISHINGS AND DECOR, HOUSEHOLD AND COMMERCIAL CLEANING PRODUCTS, HOUSEHOLD APPLIANCES, KITCHEN AND BATH ACCESSORIES, LIGHTING FIXTURES AND ACCESSORIES, AND TOOLS AND COMPUTERIZED ON-LINE ORDERING SERVICES AND COMPUTERIZED ON-LINE RETAIL SERVICES IN THE FIELDS OF ELECTRONICS, HARDWARE, HOME FURNISHINGS AND DECOR, HOUSEHOLD AND COMMERCIAL CLEANING PRODUCTS, HOUSEHOLD APPLIANCES, KITCHEN AND BATH ACCESSORIES, LIGHTING FIXTURES AND ACCESSORIES, AND TOOLS (U.S. CLS. 100, 101 AND 102).

CLASS 42—SCIENTIFIC, COMPUTER AND LEGAL SERVICES

FOR DESIGN AND TESTING FOR NEW PRODUCT DEVELOPMENT FOR OTHERS AND GRAPHIC ART DESIGN (U.S. CLS. 100 AND 101).

SN 76-168,778. ECP INCORPORATED, BURR RIDGE, IL. FILED 11-22-2000.

PLATINUM PROTECTION

NO CLAIM IS MADE TO THE EXCLUSIVE RIGHT TO USE "PROTECTION", APART FROM THE MARK AS SHOWN.

CLASS 1—CHEMICALS

FOR RADIATOR ADDITIVES TO PREVENT RUST; AUTOMOBILE COOLING SYSTEM RUST INHIBITORS; FABRIC PROTECTANT FOR TEXTILES AND CARPETS; CHEMICAL MOTOR OIL ADDITIVES (U.S. CLS. 1, 5, 6, 10, 26 AND 46).

CLASS 3—COSMETICS AND CLEANING PREPARATIONS

FOR CARPET SHAMPOO; RUST REMOVING PREPARATIONS; POLYMER SEALANT FOR CLEANING, SHINING AND PROTECTING AUTOMOBILE EXTERIOR SURFACES; AUTOMOBILE CLEANERS; AUTOMOBILE POLISH; GLASS CLEANING PREPARATIONS; CARNAUBA WAX FOR AUTOMOTIVE USE (U.S. CLS. 1, 4, 6, 50, 51 AND 52).

SN 76-169,170. KLINGER, CORNELIA, 81249 MUNCHEN, FED REP GERMANY, FILED 11-21-2000.

COROFINO

PRIORITY CLAIMED UNDER SEC. 44(D) ON FED REP GERMANY APPLICATION NO. 300386869/25, FILED 5-22-2000, REG. NO. 30038686, DATED 9-18-2000, EXPIRES 5-31-2010.

CLASS 3—COSMETICS AND CLEANING PREPARATIONS

FOR BLEACHING PREPARATIONS AND OTHER SUBSTANCES FOR LAUNDRY USE, NAMELY, LAUNDRY BLEACH AND LAUNDRY DETERGENT; ALL PURPOSE CLEANING PREPARATIONS; FLOOR POLISH; FURNITURE POLISH; SCOURING POWDERS AND LIQUIDS; PRODUCTS FOR BEAUTY AND BODY CARE, NAMELY, SKIN SOAP, BODY SOAP, PERFUME, TOILET WATER, PERSONAL DEODORANTS; ESSENTIAL OILS FOR PERSONAL USE; HAIR LOTIONS, HAIR SHAMPOO; NON-MEDICATED HAIR CARE PREPARATIONS; COSMETICS, NAMELY, EYE-SHADOW, MAKE-UP FOUNDATION, MAKE-UP CREAMS, MAKE-UP POWDERS, NAIL POLISH REMOVER; CREAMS FOR THE SKIN; LOTIONS FOR COSMETIC PURPOSES, NAMELY, SKIN MOISTURIZING LOTIONS, SUN TANNING LOTION, AFTER SUN LOTION; SHAVING CREAM, FOAM AND GEL; AFTER SHAVE LOTION; DENTIFRICES; BATH OIL; BATH CRYSTALS; BATH GELS; LIPSTICKS; COTTON BUDS FOR COSMETIC PURPOSES; NAIL POLISH; SHOE POLISH, MAKE-UP (U.S. CLS. 1, 4, 6, 50, 51 AND 52).

CLASS 9—ELECTRICAL AND SCIENTIFIC APPARATUS

FOR SCIENTIFIC, NAUTICAL, SURVEYING, PHOTOGRAPHIC, CINEMATOGRAPHIC, OPTICAL, WEIGHING, MEASURING, SIGNALING, CHECKING, LIFE-SAVING AND TEACHING APPARATUS AND INSTRUMENTS, NAMELY, PHOTOGRAPHIC CAMERAS, VIDEO CAMERAS, MOTION PICTURE CAMERAS, OPTICAL DISCS AND FILTERS, AUDIO AND VIDEO TAPE PLAYERS, VIDEO DISK PLAYERS AND COMPACT DISC PLAYERS; BLANK FILMS; APPARATUS FOR RECORDING, TRANSMISSION AND REPRODUCTION OF SOUND AND IMAGES, NAMELY, AUDIO AND VIDEO CASSETTE RECORDERS; BLANK AUDIO AND VIDEO CASSETTES, BLANK MAGNETIC DATA CARRIERS, BLANK MAGNETIC COMPUTER TAPES, BLANK MAGNETIC COMPUTER DISKS, BLANK COMPUTER DISKS AND RECORDING DISKS, BLANK ELECTRONIC DATA CARRIERS; PRE-RECORDED FILMS, AUDIO AND VIDEO CASSETTES, AND RECORDING TAPES AND DISKS ALL FEATURING PRE-RECORDED MUSIC, MOTION PICTURES, BOOKS IN SPOKEN FORM, HISTORICAL TOUR DISCUSSIONS, INSTRUCTION ON HOME IMPROVEMENTS, AND HUNTING AND BIRD CALLS; COMPUTER SOFTWARE AND COMPUTER PROGRAMS ALL FOR USE IN DATABASE MANAGEMENT, FOR USE AS SPREADSHEETS, FOR WORD PROCESSING, FOR PROCESSING PICTURES FROM DIGITAL CAMERAS, FOR COMPILATION AND ELECTRONIC TRANSMISSION OF AUDIO AND VIDEO CONTENT, NAMELY; FINANCIAL AND INVESTMENT INFORMATION, FOR MONITORING AND CONTROLLING TEXT COMPOSITION, AND FOR COMPOSING AND EDITING MUSIC AND AUDIO AND VIDEO CONTENT; MULTIMEDIA SOFTWARE RECORDED ON CD-ROM FEATURING PRE-RECORDED MUSIC, MOTION PICTURES AND INTERACTIVE MAPS; ELECTRONIC COMPUTER MEMORIES AND SIMILAR MEMORY MEDIA, NAMELY, PCMCIA CARDS AND ENCODED SMART CARDS FOR PERSONAL COMPUTERS AND LAPTOP COMPUTERS CONTAINING USER-SPECIFIC INFORMATION AND PROGRAMMING USED FOR STORING, ACCESSING AND TRACKING COMMERCIAL TRANSACTIONS, HEALTH, MEDICAL, BANKING AND FINANCIAL INFORMATION; MAGNETIC CODED CARD READERS; MAGNETIC CODED CARDS; CASH REGISTERS, CALCULATORS; MEMORY CARDS, COMPUTERS, MINIATURE COMPUTERS, DATA PROCESSORS; VIDEO GAMES COMPRISED OF COMPUTER HARDWARE AND COMPUTER GAME SOFTWARE, ALL SOLD AS A UNIT; ELECTRIC APPARATUS AND INSTRUMENTS, NAMELY, ELECTRIC APPARATUS TRANSISTORS; AUTOMATIC VENDING MACHINES; COIN-OPERATED VENDING MACHINES; ELECTRICAL CIRCUITS FOR USE IN AMUSEMENT GAME MACHINES FOR REPRODUCING MUSIC, SPEECH AND SPECIAL EFFECTS, EYE GLASSES, SUN GLASSES, PROTECTIVE GLASSES, FRAMES FOR EYE GLASSES, LENSES FOR EYE GLASSES, CASES FOR EYE GLASSES, PROTECTIVE HELMETS, HELMET VISORS, PROTECTIVE FACE-SHIELDS FOR PROTECTIVE HELMETS, SAFETY GOG-

GLS, PROTECTIVE GLOVES FOR INDUSTRIAL USE, LIFE JACKETS; DIVING SUITS; BICYCLE SPEEDOMETERS; SPORTS HELMETS FOR BOXING AND HORSEBACK RIDING; HELMETS FOR INLINE-SKATING, SKATEBOARDING, ROLLER SKATING, HOCKEY, FOOTBALL, BASEBALL AND CYCLING (U.S. CLS. 21, 23, 26, 36 AND 38).

CLASS 12—VEHICLES

FOR MOTORCYCLES; PARTS FOR MOTORCYCLES, NAMELY, WHEELS, TIRES, FRAMES, MOTORS, BRAKES, GEARS, CHAINS, PEDALS, HANDLEBARS, HUBS, SEATS, SADDLEBAGS, MIRRORS, WIND-SCREENS, HORNS AND LUGGAGE RACKS FOR MOTORCYCLES; BICYCLES; BICYCLES WITH MOTOR; PARTS AND ACCESSORIES FOR BICYCLES, NAMELY, BICYCLE FRAMES, BICYCLE BRAKES, FREEWHEEL GEAR RIMS, BICYCLE DERAILLEUR GEARS, BICYCLE BEARINGS, BICYCLE CHAINS, BICYCLE PEDALS, BICYCLE HANDLEBARS, BICYCLE HUBS, BICYCLE SEATS, BICYCLE TUBES, BICYCLE TIRES, SADDLEBAGS FOR BICYCLES, BAGS FOR BICYCLES TO BE ATTACHED AT THE HANDLEBARS, METAL BICYCLE LOCKS, BICYCLE TRAILERS, DRESS GUARDS, LUGGAGE CARRIERS ADAPTED FOR BICYCLES, SHOPPING BAGS ADAPTED FOR BICYCLES, BELLS FOR BICYCLES, BICYCLE AIR PUMPS; ROOF RACKS FOR BICYCLES; PRAMS, NAMELY, BABY CARRIAGES (U.S. CLS. 19, 21, 23, 31, 35 AND 44).

CLASS 14—JEWELRY

FOR PRECIOUS METALS AND THEIR ALLOYS AND GOODS OF PRECIOUS METALS OR COATED THEREWITH, NAMELY, BRACELETS, NECKLACES, EARRINGS, RINGS, ASHTRAYS, JEWELRY BOXES, CANDLESTICKS, CANDLE HOLDERS, CIGARETTE LIGHTERS, MONEY CLIPS, TIE-PINS; JEWELRY, COSTUME JEWELRY; PRECIOUS GEMSTONES; HOROLOGICAL AND CHRONOMETRIC INSTRUMENTS, NAMELY, CLOCKS, ALARM CLOCKS, RADIO ALARM CLOCKS, WATCHES, POCKET WATCHES; WATCH-STRAPS (U.S. CLS. 2, 27, 28 AND 50).

CLASS 16—PAPER GOODS AND PRINTED MATTER

FOR TYPING PAPER, LETTER PAPER, WRAPPING PAPER, DRAWING PAPER, CARDBOARD AND GOODS MADE FROM CARDBOARD, HYGIENIC PAPER, KITCHEN TISSUES, BATHROOM TISSUES, PAPER TOWELS, FACIAL TISSUES, NAPKINS, TISSUES FOR COSMETIC AND CARING PURPOSES; CHILDREN'S BOOKS, RECIPE BOOKS, TRAVEL BOOKS, SONG BOOKS, COLORING BOOKS, ADDRESS BOOKS, APPOINTMENT BOOKS, BUSINESS RECORD BOOKS, NOTE BOOKS, ACCOUNT BOOKS, ACCOUNTING FORMS, BUSINESS FORMS, BLANK FORMS, PRINTED FORMS, NOTEPADS; NEWSPAPERS FOR GENERAL CIRCULATION, MEDICAL AND LEGAL JOURNALS, GENERAL FEATURE MAGAZINES; BROCHURES AND PAMPHLETS ABOUT SPORTS, TRAVEL, HOBBIES, HISTORY, COMPUTERS, SCIENCE AND SCIENCE FICTION; MAGAZINES ABOUT SPORTS, TRAVEL, HOBBIES, HISTORY, COMPUTERS, SCIENCE AND SCIENCE FICTION; CALENDARS, MAPS; CLOTH FOR BOOKBINDING, BOOKBINDING TAPE, BOOKBINDINGS, BOOKBINDING WIRE; MOUNTED AND UNMOUNTED PHOTOGRAPHS; GREETING CARDS; STATIONERY; CHALK, PENS, MARKERS, PENCILS AND CRAYONS, WRITING AND DRAWING INSTRUMENTS; ADHESIVES FOR STATIONERY OR HOUSEHOLD PURPOSES; ARTISTS' MATERIALS, NAMELY, PAINT BRUSHES, CANVAS AND PAINTING SETS; TYPEWRITERS, STAPLERS, STAPLE REMOVERS, PAPER HOLE PUNCHES, FILE FOLDERS, BINDERS; PRINTED INSTRUCTIONAL, EDUCATIONAL AND TEACHING MATERIALS IN THE FIELDS OF SCIENCE, HISTORY, MUSIC, TRAVEL, MOTION PICTURE AND COMPUTER INSTRUCTION; PLASTIC MATERIALS FOR PACKAGING, NAMELY, BUBBLE PACKS, PLASTIC POUCHES, PLASTIC BAGS AND PLASTIC FILMS; TRASH BAGS, GENERAL PURPOSE PLASTIC BAGS, MERCHANDISE BAGS, PAPER BAGS; SIGNS AND BANNERS FOR DISPLAY WINDOWS MADE OF PLAS-

TIC FILMS OR PAPER, PAPER PRINTED SIGNS; PLAYING CARDS; BABY DIAPERS MADE OF PAPER OR CELLULOSE, DISPOSABLE BABY DIAPERS; COLOR PRINTS (U.S. CLS. 2, 5, 22, 23, 29, 37, 38 AND 50).

CLASS 18—LEATHER GOODS

FOR LEATHER AND IMITATIONS OF LEATHER, NAMELY, LUGGAGE, HIP MOUNTED CARRYALL BAGS AND BELTS WITH COMPARTMENTS FOR CARRYING SMALL ITEMS; ANIMAL SKINS AND HIDES; TRUNKS, BRIEFCASES AND SMALL SUITCASES; BAGS FOR CARRYING CLOTHING, ALL-PURPOSE SPORTS BAGS, ALL PURPOSE SPORTS BAGS FOR TRACK AND FIELD, FOOTBALL, BASKETBALL, BASEBALL AND SWIMMING, HANDBAGS, SCHOOL BAGS, BOOK BAGS, CARRY-ON BAGS, BACKPACKS, FANNY PACKS; TRAVELING BAGS; TRAVELING MANICURE SET CASES SOLD EMPTY; PURSES, POCKET WALLET, KEY CASES, BAGS FOR CARRYING BELTS; UMBRELLAS, PARASOLS AND WALKING STICKS; WHIPS, HARNESS STRAPS AND SADDLERY (U.S. CLS. 1, 2, 3, 22 AND 41).

CLASS 25—CLOTHING

FOR CLOTHING, NAMELY, LONG TROUSERS, JEANS, SLACKS, SHORT TROUSERS, SHORTS, BOXER SHORTS, 3/4 LENGTH TROUSERS, SLACKS WITH STRAP UNDER FOOT, CULOTTES, BLOUSES, DRESSES, SWEATERS, SHIRTS, SHORT-SLEEVED SHIRTS, T-SHIRTS, LONG-SLEEVED SHIRTS, SOCKS; FOOTWEAR, HEADWEAR; OUTERWEAR FOR GENTLEMEN, LADIES AND CHILDREN, NAMELY, WAISTCOATS, JACKETS, DENIM JACKETS, COATS, TUNICS, BLAZERS, LOUNGING JACKETS, BOMBER JACKETS, OVERALLS, DUNGAREES; BABIES CLOTHING, NAMELY, SHIRTS, PANTS, UNDER SHIRTS, UNDER PANTS, ONE-PIECE SLEEPERS, DRESSES; UNDERWEAR, LONG UNDERPANTS, SHORT UNDERPANTS, LONG-SLEEVED UNDERSHIRTS, SHORT-SLEEVED UNDERSHIRTS; UNDERGARMENTS; CORSETS, BUS-TIERS; DRESSING GOWNS; HOSIERY; BELTS, SUSPENDERS, SCARVES, SHAWLS, GLOVES, TIES, HEADBANDS, BASEBALL CAPS; BATHING FASHION FOR GENTLEMEN AND LADIES, NAMELY, BATHING SUITS, SWIMSUITS AND BATHING TRUNKS; CLOTHING FOR HIKING, TREKKING, OUTDOOR SPORTS AND CLIMBING, NAMELY, COATS, JACKETS, VESTS, PULLOVERS, SHIRTS, PANTS, SHORTS, SOCKS; LEISURE AND CITY SHOES FOR GENTLEMEN AND LADIES, CHILDREN'S SHOES; ATHLETIC FOOTWEAR; ATHLETIC SHOES FOR HIKING, TREKKING, OUTDOOR SPORTS AND CLIMBING; CLOTHING, FOOTWEAR AND HEADWEAR FOR SOCCER, BASKETBALL, HANDBALL AND VOLLEYBALL, NAMELY, SHIRTS, SHORTS, WARM-UP JACKETS, WARM-UP PANTS, SPORTS SHOES; CLOTHING FOR JOGGING, FITNESS TRAINING AND GYMNASTICS, NAMELY, JOGGING SUITS, SWEATSHIRTS, SWEATPANTS, SWEATSHORTS, GYM SHORTS, SWEAT BANDS, HEAD BANDS, BODY SUITS, LEOTARDS, LEGGINGS, LEG WARMERS; CLOTHING, FOOTWEAR AND HEADWEAR FOR TENNIS, SQUASH AND BADMINTON, NAMELY, SHIRTS, SHORTS, SKIRTS, DRESSES, SHOES, HATS, VISORS; CLOTHING, FOOTWEAR AND HEADWEAR FOR INLINE-SKATING, SKATEBOARDING, ROLLER SKATING, HOCKEY, FOOTBALL, BASEBALL AND BOXING, NAMELY, JERSEYS, SHIRTS, PANTS, SHORTS; CLOTHING, FOOTWEAR AND HEADWEAR FOR CYCLING, HORSEBACK RIDING, AND GOLFING, NAMELY, PANTS, SHIRTS, JACKETS, HATS, BOOTS; CLOTHING, FOOTWEAR AND HEADWEAR FOR WATER SPORTS INCLUDING SURFING, SAILING, ROWING, CANOEING AND DIVING, NAMELY, BATHING SUITS, BATHING TRUNKS, WET SUITS, SHIRTS, SHORTS; CLOTHING, FOOTWEAR AND HEADWEAR FOR SKIING, CROSS COUNTRY SKIING, SNOWBOARDING, ICE-SKATING AND ICE HOCKEY, NAMELY, JACKETS, PANTS, BOOTS, SNOW BOOTS, SNOWBOARD BOOTS, AFTER SKI BOOTS, SKI BOOTS, SKI GLOVES, SKI PANTS, SKI BIBS, HATS, WOOLEN HATS, CAPS, SWEAT BANDS, HEAD BANDS (U.S. CLS. 22 AND 39).

CLASS 28—TOYS AND SPORTING GOODS

FOR GAMES AND PLAYTHINGS, NAMELY, COIN-OPERATED AND HAND HELD UNITS FOR PLAYING ELECTRONIC AND VIDEO GAMES; BOARD GAMES; SPORTING AND GYMNAS TIC ARTICLES FOR TREK-KING, CLIMBING, SOCCER, BASKETBALL, HANDBALL, VOLLEYBALL, TENNIS, SQUASH, BADMINTON, HOCKEY, FOOTBALL, BASEBALL, CYCLING, HORSEBACK RIDING, GOLFING, SURFING, SAILING, ROWING, CANOEING, DIVING, MOUNTAIN SKIING, CROSS-COUNTRY SKIING, SNOWBOARDING, ICE-SKATING, ICE-HOCKEY, FITNESS TRAINING, IN-LINE-SKATING, ROLLER SKATING AND SKATEBOARDING, NAMELY, SOCCER BALLS, BASKETBALLS, HAND BALLS, VOLLEYBALLS, TENNIS BALLS, TENNIS RACQUETS, SQUASH BALLS, FOOTBALLS, BASEBALLS, BADMINTON RACQUETS, CLIMBING ROPES, NUTS NOT BEING FOOD, CARABINERS, BASKETBALL HOOPS AND NETS, BATS, BASEBALL GLOVES, SURFBOARDS, SNOWBOARDS, SKATEBOARDS, CANOE PADDLES, OARS, SKIS, SKI BOOTS, SURF FINNS, SNORKELS, SKI POLES, SPORT GOGGLES FOR USE IN SKIING, HOCKEY GLOVES, HOCKEY STICKS, PUCKS, SPORTS BALLS, BIRDIES, RACQUETS, GOLF CLUBS, GOLF BALLS, GOLF TEES, IN-LINE SKATES, ROLLER SKATES, ICE-SKATES; SCUBA EQUIPMENT, NAMELY, FINNS, GOGGLES, MASKS AND FLIPPERS; PORTABLE SKI CARRIERS; PROTECTIVE PADDING FOR PLAYING ICE-HOCKEY; PROTECTIVE WRIST AND JOINT SUPPORTS, GLOVES FOR SKATEBOARDING, ROLLER SKATING, ICE-SKATING; ATHLETIC PROTECTIVE PADS, NAMELY, ELBOW AND KNEE PADS, WRIST AND ANKLE SUPPORTS, SHOULDER PADS, CHEST PADS, RIB PADS, HIP PADS, THIGH PADS, SHIN GUARDS AND PROTECTIVE GLOVES; SPECIAL BAGS IN ORDER TO STORE AND TRANSPORT SPORTING EQUIPMENT, NAMELY, BAGS FOR SKIS AND SKI POLES, SNOWBOARDS, SKATEBOARDS, ROLLER SKATES, ICE SKATES AND IN-LINE-SKATES; SKI BOOT BAGS (U.S. CLS. 22, 23, 38 AND 50).

SN 76-170,051. PONTIS ELECTRONIC GMBH, 92521 SCHWARZENFELD, FED REP GERMANY, FILED 11-22-2000.



PRIORITY CLAIMED UNDER SEC. 44(D) ON FED REP GERMANY APPLICATION NO. 30039336.9, FILED 5-24-2000, REG. NO. 30039336, DATED 9-4-2000, EXPIRES 5-24-2010.

SN 76-169,279. CHAORDIC ALLIANCE, THE, HALF MOON BAY, CA. FILED 11-21-2000.

TERRA CIVITAS**CLASS 9—ELECTRICAL AND SCIENTIFIC APPARATUS**

FOR PRE-RECORDED VIDEOTAPES FEATURING INFORMATION ABOUT THE DEVELOPMENT, DISSEMINATION, AND APPLICATION OF NEW CONCEPTS OF ORGANIZATION AND LEADERSHIP (U.S. CLS. 21, 23, 26, 36 AND 38).

CLASS 16—PAPER GOODS AND PRINTED MATTER

FOR PRINTED MATTER, NAMELY MAGAZINES, JOURNALS, NEWSLETTERS, RESEARCH REPORTS, CASE STUDIES, PAMPHLETS, NEWSPAPERS, BROCHURES, FACT SHEETS, BOOKLETS, PRESS RELEASES, AND EDUCATIONAL MANUALS CONCERNED WITH THE DEVELOPMENT, DISSEMINATION, AND APPLICATION OF NEW CONCEPTS OF ORGANIZATION AND LEADERSHIP (U.S. CLS. 2, 5, 22, 23, 29, 37, 38 AND 50).

CLASS 35—ADVERTISING AND BUSINESS

FOR ORGANIZING MANAGEMENT CONSULTATION SERVICES IN THE FIELDS OF BUSINESS OR ORGANIZATION DEVELOPMENT, COMMUNITY DEVELOPMENT, INTERNATIONAL DEVELOPMENT, SOCIAL NETWORK DEVELOPMENT, EXECUTIVE OR LEADERSHIP DEVELOPMENT, TEAM BUILDING, CONFLICT RESOLUTION (U.S. CLS. 100, 101 AND 102).

CLASS 9—ELECTRICAL AND SCIENTIFIC APPARATUS

FOR DEVICES FOR RECORDING, TRANSMITTING, AND REPRODUCING SOUND AND IMAGE, NAMELY, AUDIO AND VIDEO CASSETTE RECORDERS, MP-3 PLAYERS, CD-PLAYER, AND MINI-DISC-PLAYER, RADIOS, CAMERAS, NAMELY PHOTOGRAPHIC CAMERAS, DISPLAYS, EARPHONES; COMPUTERS AND DATA PROCESSING INSTALLATIONS, NAMELY COMPUTER MONITORS, PRINTERS, KEYBOARDS, CD-SLOTS, DVDSLOTS, COMPUTER-INTERFACES, GAME CONSOLES, NAMELY HAND HELD JOY STICK UNITS FOR PLAYING COMPUTER GAMES, CARD STATIONS FOR MAGNETIC-COATED CARDS AND MEMORY CARDS; SIGNAL AND CONTROL DEVICES, NAMELY, DATA RADIO TRANSMITTERS AND RECEIVERS; CARRIERS OF RECORDED SOUNDS OR IMAGES, NAMELY, MAGNETIC AND OPTICAL DATA DISCS AS WELL AS MAGNETIC-COATED CARDS AND MEMORY CARDS; ELECTRICAL WEIGHTING, MEASURING, SIGNAL AND CONTROL DEVICES AND INSTRUMENTS, NAMELY, FIBER OPTICS, LASERS FOR MEASURING PURPOSES, MICROPHONES, CAMERA CONTROLLERS, DEVICES FOR MEASURING CURRENT VOLTAGE, RESISTANCE, CAPACITANCE, LIGHT INTENSITY, SOUND INTENSITY, TEMPERATURES, POSITIONS, DISTANCES, SAID DEVICES AND INSTRUMENTS CAPABLE OF BEING CONTROLLED BY A COMPUTER, NAMELY PERSONAL COMPUTERS, HAND-HELD COMPUTERS, AND PORTABLE COMPUTERS; SENSORS FOR THE DETERMINATION OF TEMPERATURES, POSITIONS, AND DISTANCES; ELECTRONIC COMPONENTS AND DEVICES, NAMELY, INTERFACES, NAMELY COMPUTER INTERFACES, AMPLIFIERS, INTEGRATED CIRCUITS, PROCESSORS, NAMELY MICRO-PROCESSORS, DATA PROCESSORS, DISPLAYS, NAMELY LIGHT EMITTING DIODE DISPLAYS, SPEAKERS, COMPUTER NETWORK SWITCHES, ELECTRIC SWITCHES, RESISTORS, CAPACITORS, LIGHT EMITTING DIODES, POWER SUPPLIES, AND DATA TRANSMISSION CABLES, AUTOMATED TEST BENCHES, NAMELY FOR MEASURING ELECTRICAL AND MECHANICAL PARAMETERS (U.S. CLS. 21, 23, 26, 36 AND 38).

CLASS 42—SCIENTIFIC, COMPUTER AND LEGAL SERVICES

FOR COMPUTER SOFTWARE DESIGN FOR OTHERS IN THE FIELD OF DATA PROCESSING; DEVELOPMENT OF INDIVIDUAL SOFTWARE SOLUTIONS FOR OTHERS FOR AUTOMATION; DEVELOPMENT OF IDENTIFICATION TECHNOLOGY, COMMUNICATION SYSTEMS AND TOYS; SCIENTIFIC AND INDUSTRIAL RESEARCH, DEVELOPMENT AND TECHNICAL CONSULTATION, IN THE FIELD OF ELECTRICAL AND ELECTRONIC DEVICES AND COMPONENTS (U.S. CLS. 100 AND 101).

ANOTHER, AND ARE SHADOWED IN A DARK ORANGE. THERE IS A RED OVAL SHAPE WITH SERRATED EDGES AND WHITE LETTERING INSIDE. THE WORD "ESSENTIALS" IS DEPICTED IN THE COLOR ORANGE, WITH A DARK ORANGE SHADOW AND THIN WHITE BORDER. THERE IS A RECTANGULAR, ORANGE-COLORED PACKET WITH FUSCHIA SHADOW AND THE SHAPE OF A TEDDY BEAR IN PINK, GREEN, AND YELLOW, OUTLINED IN WHITE. THE BACKGROUND COLOR IS YELLOW WITH ORANGE SHADING.

CLASS 5—PHARMACEUTICALS

FOR VITAMINS AND NUTRITIONAL SUPPLEMENTS (U.S. CLS. 6, 18, 44, 46, 51 AND 52).
FIRST USE 10-1-2000; IN COMMERCE 10-1-2000.

CLASS 30—STAPLE FOODS

FOR CANDY (U.S. CL. 46).
FIRST USE 10-1-2000; IN COMMERCE 10-1-2000.

SN 76-170,837. LATERZA, JUDY, WANTAGH, NY. FILED 11-22-2000.

GOLDRUSH

CLASS 9—ELECTRICAL AND SCIENTIFIC APPARATUS

FOR COMPUTER SOFTWARE GAMES (U.S. CLS. 21, 23, 26, 36 AND 38).

SN 76-172,348. BRASSERIE FISCHER, 67300 SCHILTIGHEIM, FRANCE, FILED 11-28-2000.

CLASS 41—EDUCATION AND ENTERTAINMENT

FOR ENTERTAINMENT SERVICES IN THE NATURE OF A TELEVISION GAME SHOW AND AN ONLINE INTERACTIVE COMPUTER GAME (U.S. CLS. 100, 101 AND 107).

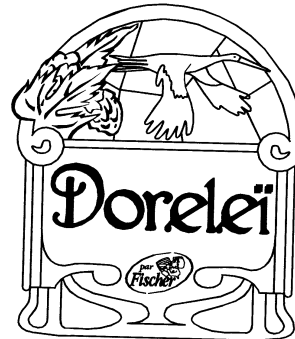

SN 76-171,700. NATURES PRODUCTS, INC., SUNRISE, FL. FILED 11-28-2000.

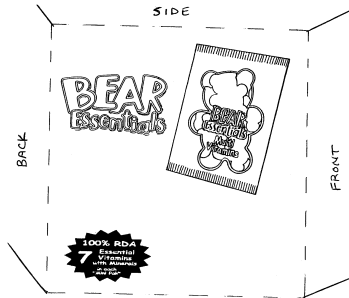

PRIORITY CLAIMED UNDER SEC. 44(D) ON FRANCE APPLICATION NO. 003030965, FILED 5-29-2000, REG. NO. 003030965, DATED 5-29-2000, EXPIRES 5-29-2010.

OWNER OF U.S. REG. NO. 2,436,545.

COLOR IS A FEATURE OF THE MARK AND THE VARIOUS COLORS ARE DEFINED AS FOLLOWS: THE FANCIFUL BORDER OUTLINING THE ENTIRE MARK AND SEPARATING THE TOP DOME PORTION FROM THE BOTTOM PORTION IS IN IVORY. IN THE TOP PORTION OF THE MARK, THE TWO TRAPEZOIDAL BLOCKS BEHIND THE MAIN BODY AND LEFT WING OF THE BIRD IN FLIGHT ARE IN IVORY. THE BIRD IN FLIGHT IS WHITE WITH BLACK WING TIPS AND TAIL FEATHERS. THE BIRD'S BEAK, THE TRAPEZOIDAL BLOCKS AT THE FAR LOWER RIGHT AND LOWER LEFT (MOSTLY COVERED WITH THE LEAVES) OF THE TOP PORTION OF THE MARK ARE PUMPKIN ORANGE. THE LEAVES AT THE LEFT AND THE TRAPEZOIDAL BLOCK AT THE UPPER RIGHT OF THE TOP PORTION OF THE MARK ARE TEAL BLUE. THE TWO REMAINING BLOCKS IN THE TOP PORTION OF THE MARK THAT ARE PARTLY COVERED BY THE LEAVES ARE BRICK RED. IN THE BOTTOM PORTION OF THE MARK, THE BACKGROUND IS WHITE, THE WORD "DORELEI", THE OVAL, AND THE LETTERING AND PICTURE WITHIN THE OVAL ARE TEAL BLUE.

THE ENGLISH TRANSLATION OF THE WORD "PAR" IS "BY".

NO CLAIM IS MADE TO THE EXCLUSIVE RIGHT TO USE "100% RDA 7 ESSENTIAL VITAMINS AND MINERALS IN EACH MINI PAK" AND "MULTI VITAMINS", APART FROM THE MARK AS SHOWN.

THE DOTTED LINES SHOWN IN THE DRAWING ARE NOT PART OF THE MARK BUT ARE MERELY INTENDED TO SHOW THE POSITION OF THE MARK ON THE FRONT OF GOODS' PACKAGING. THE MARK CONSISTS OF COLOR WHICH IS CLAIMED AS A FEATURE OF THE MARK AS DESCRIBED HEREIN: THE "B" IS ELECTRIC BLUE WITH A DARK BLUE SHADOW, THE "E" IS ORANGE WITH A DARK ORANGE SHADOW, THE "A" IS APPLE RED WITH A DARK RED SHADOW, AND THE "R" IS KELLY GREEN WITH A DARK GREEN SHADOW. THE LETTERS ARE OUTLINED IN WHITE, OVERLAP ONE

CLASS 32—LIGHT BEVERAGES

FOR BEER; MINERAL AND AERATED WATERS AND OTHER NON-ALCOHOLIC DRINKS, NAMELY, LEMONADES, SHANDIES, NAMELY BEER AND ALE WITH FLAVORED SYRUPS AND JUICES; FRUIT BEVERAGES AND FRUIT JUICES; SYRUPS AND OTHER PREPARATIONS FOR MAKING FRUIT DRINKS (U.S. CLS. 45, 46 AND 48).

CLASS 33—WINES AND SPIRITS

FOR ALCOHOLIC BEVERAGES, NAMELY, WINES, MULLED WINES, APERITIFS, BITTERS, BRANDIES, SPIRITS, AROMATIZED SPARKLING ALCOHOLIC BEVERAGES (U.S. CLS. 47 AND 49).

SN 76-172,436. SCHNEIDER, DAVID L., SAN DIEGO, CA.
FILED 11-22-2000.

LOANWEEK**CLASS 36—INSURANCE AND FINANCIAL**

FOR INFORMATION SERVICES, NAMELY, PROVIDING INFORMATION RELEVANT TO THE MORTGAGE INDUSTRY VIA A GLOBAL COMPUTER NETWORK (U.S. CLS. 100, 101 AND 102).

FIRST USE 5-8-2001; IN COMMERCE 5-8-2001.

CLASS 42—SCIENTIFIC, COMPUTER AND LEGAL SERVICES

FOR PROVIDING AN ONLINE NEWSLETTER FOR THE MORTGAGE INDUSTRY (U.S. CLS. 100 AND 101).

FIRST USE 5-8-2001; IN COMMERCE 5-8-2001.

SN 76-172,992. NON VIOLENCE PROJECT AG, 8008 ZURICH, SWITZERLAND, BY ASSIGNMENT NON VIOLENCE PROJECT FOUNDATION, 8008 ZURICH, SWITZERLAND, FILED 11-29-2000.

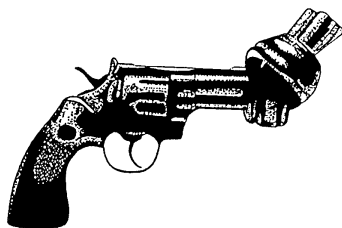

THE STIPPLING IN THE MARK IS FOR SHADING PURPOSES ONLY AND DOES NOT INDICATE COLOR.

CLASS 16—PAPER GOODS AND PRINTED MATTER

FOR CARDBOARD; BOOK BINDINGS; BOOK BINDING TAPE AND WIRE; PHOTOGRAPHS; STATIONERY; ADHESIVES FOR STATIONERY OR HOUSEHOLD PURPOSES; PAINT BRUSHES; TYPEWRITERS; PRINTED INSTRUCTIONAL, EDUCATIONAL AND TEACHING MATERIALS IN THE FIELD OF TEACHING AND PRESENTING PROGRAMS AND ACTIVITIES AGAINST VIOLENCE IN SCHOOLS, COMMUNITIES AS WELL AS IN INDOORS AND OUTDOORS EVENTS; PLASTIC BAGS FOR MERCHANDISE PACKAGING; PLAYING CARDS; PRINTING TYPE AND PRINTING BLOCKS (U.S. CLS. 2, 5, 22, 23, 29, 37, 38 AND 50).

CLASS 41—EDUCATION AND ENTERTAINMENT

FOR PROVIDING TRAINING IN THE USE AND OPERATION OF PROGRAMS FOR PERSONAL COMPUTER IN HOMES, SCHOOLS AND PUBLIC AREAS AS WELL AS FOR ANY PORTABLE COMPUTER AND COMMUNICATION TOOL; ENTERTAINMENT IN THE NATURE OF LOCAL AND NATIONAL MUSIC AND CULTURAL FESTIVALS, LOCAL AND NATIONAL SPORTS TOURNAMENTS SUCH AS SOCCER, BASEBALL, BASKETBALL AND ATHLETICS AND ORGANIZING COMMUNITY SPORTING AND CULTURAL EVENTS (U.S. CLS. 100, 101 AND 107).

CLASS 42—SCIENTIFIC, COMPUTER AND LEGAL SERVICES

FOR PROVIDING TEMPORARY HOUSING ACCOMMODATION; MEDICAL SERVICES; BEAUTY SALONS; VETERINARY SERVICES; AGRICULTURAL ADVICE; LEGAL SERVICES; SCIENTIFIC AND INDUSTRIAL RESEARCH AND COMPUTER PROGRAMMING FOR OTHERS (U.S. CLS. 100 AND 101).

SN 76-172,994. HOCHIKI CORPORATION, TOKYO, JAPAN,
FILED 11-29-2000.

HOCHIKI**CLASS 9—ELECTRICAL AND SCIENTIFIC APPARATUS**

FOR FIRE ALARM EQUIPMENT AND APPARATUS, NAMELY, FIRE CONTROL PANEL, SMOKE DETECTORS, THERMAL DETECTORS, FLAME DETECTORS, CRT DISPLAY, ALARM BELLS, AND CALL BOXES; FIRE EXTINGUISHING EQUIPMENT AND APPARATUS, NAMELY, FIRE ALARM CONTROL PANELS, SPRINKLER HEADS, DRENCHER HEADS, FOAM HEADS, CO₂ GAS FIRE EXTINGUISHERS; MATV (MASTER ANTENNA TELEVISION) AND CATV (CABLE TELEVISION) EQUIPMENT AND APPARATUS, NAMELY TELEVISION HEADENDS, TRUNK-AMPLIFIERS, BRIDGING-AMPLIFIERS, TAP-OFFS, SPLITTERS AND TRANSFORMERS; INDUCTORS INSTALLED AT AN EXIT TO AN EVACUATION STAIR WAY OR AN EMERGENCY EXIT LEADING TO THE OUTSIDE, AND ADAPTED TO PERMIT MANUAL UNLOCKING IN CASE OF EMERGENCY; ELECTRIC BATTERIES; SMOKE AND FIRE DAMPERS, ACCESS CONTROL SYSTEMS COMPRISED OF MAGNETIC ENCODED CARD-READERS AND CONTROL PANELS, GAS LEAK ALARM SYSTEM COMPRISED OF GAS LEAK DETECTORS, SENSORS, AND CONTROL PANELS, INTRUDER DETECTION SYSTEM COMPRISED OF INTRUDER DETECTORS, SENSORS, AND CONTROL PANELS; SIGNAL LAMPS USED AS EMERGENCY EXIT LIGHTS IN FIRE ALARM SYSTEMS (U.S. CLS. 21, 23, 26, 36 AND 38).

FIRST USE 6-1-1972; IN COMMERCE 7-1-1972.

CLASS 11—ENVIRONMENTAL CONTROL APPARATUS

FOR HYDRANTS (U.S. CLS. 13, 21, 23, 31 AND 34).
FIRST USE 6-1-1972; IN COMMERCE 6-1-1972.

SN 76-173,997. CRUCCELL HOLLAND B.V., 2333 CN LEIDEN, NETHERLANDS, FILED 12-1-2000.

MAbility

CLASS 1—CHEMICALS

FOR BACTERIOPHAGE REAGENTS IN THE NATURE OF MONOCLONAL ANTIBODIES FOR SCIENTIFIC OR MEDICAL RESEARCH USE; HUMAN MONOCLONAL ANTIBODIES FOR SCIENTIFIC OR MEDICAL RESEARCH USE (U.S. CLS. 1, 5, 6, 10, 26 AND 46).

CLASS 5—PHARMACEUTICALS

FOR DIAGNOSTIC BACTERIOPHAGE REAGENTS IN THE NATURE OF MONOCLONAL ANTIBODIES FOR CLINICAL MEDICAL LABORATORY USE; MEDICAL DIAGNOSTIC REAGENTS, NAMELY, HUMAN MONOCLONAL ANTIBODIES FOR HUMAN THERAPEUTIC AND DIAGNOSTIC USE (U.S. CLS. 6, 18, 44, 46, 51 AND 52).

CLASS 42—SCIENTIFIC, COMPUTER AND LEGAL SERVICES

FOR LABORATORY RESEARCH IN THE FIELD OF HUMAN MONOCLONAL ANTIBODIES; LABORATORY RESEARCH IN THE FIELD OF HUMAN MONOCLONAL ANTIBODIES, NAMELY, RESEARCH REGARDING ANTIGEN BINDING AFFINITIES AND ANTIBODY BIOLOGICAL ACTIVITIES; BACTERIOLOGICAL RESEARCH AND TESTING IN THE FIELD OF HUMAN MONOCLONAL ANTIBODIES; BIOCHEMICAL LABORATORY RESEARCH AND ANALYSIS SERVICES; RESEARCH AND IDENTIFICATION OF HUMAN MONOCLONAL ANTIBODIES FOR OTHERS; CHEMICAL AND MEDICAL RESEARCH AND DEVELOPMENT OF MONOCLONAL ANTIBODIES FOR OTHERS (U.S. CLS. 100 AND 101).

SN 76-175,194. FACTA UNTERNEHMENSBERATUNG GMBH, 51371 LEVERKUSEN, FED REP GERMANY, FILED 11-30-2000.

EXPECTUS

PRIORITY CLAIMED UNDER SEC. 44(D) ON FED REP GERMANY APPLICATION NO. 30043165.1, FILED 6-7-2000.

CLASS 35—ADVERTISING AND BUSINESS

FOR BUSINESS CONSULTATION SERVICES, NAMELY, CORPORATE CONSULTING SERVICES; PERSONNEL PLACEMENT SERVICES; BOOK KEEPING SERVICES; BUSINESS AUDITING SERVICES; COMPUTERIZED DATABASE AND DATA MANAGEMENT SERVICES; BUSINESS VALUATION SERVICES; ACCOUNTS RECEIVABLE SERVICES; EXPERT BUSINESS CONSULTATION SERVICES; PUBLIC RELATIONS SERVICES; RECRUITMENT SERVICES; CORPORATE DEVELOPMENT SERVICES; BUSINESS CONSULTATION IN THE FIELD OF TRANSPORTATION OF PASSENGERS AND FREIGHT AND LOGISTICAL MATTERS, NAMELY, FREIGHT FORWARDING (U.S. CLS. 100, 101 AND 102).

CLASS 39—TRANSPORTATION AND STORAGE

FOR TRANSPORTATION SERVICES OF PASSENGERS BY MEANS OF BUSES, TRAINS, SHIPS AND AUTOMOBILES; FREIGHT TRANSPORTATION SERVICES FOR GOODS BY LAND, AIR, NAVIGABLE WATERS AND RAIL; COURIER MAIL AND PACKAGE DELIVERY SERVICES, STORAGE SERVICES, NAMELY, WAREHOUSE STORAGE (U.S. CLS. 100 AND 105).

SN 76-176,602. PT. BRATACO, BANDUNG, INDONESIA, FILED 12-6-2000.



APPLICANT'S MARK CONSISTS OF THE WORD "KOKITA" WITH A DESIGN IN BROWN, LIGHT BROWN (YELLOWISH) AND WHITE.

CLASS 5—PHARMACEUTICALS

FOR NUTRITIONAL DRINK MIX FOR USE AS MEAL REPLACEMENT; AND BABY FOOD (U.S. CLS. 6, 18, 44, 46, 51 AND 52).

CLASS 29—MEATS AND PROCESSED FOODS

FOR JAMS; JELLIES; TAOCO, NAMELY, FERMEN- TED BEAN PASTES USED AS CONDIMENTS; AND TERASI, NAMELY, CONDIMENT FROM POUNDED AND FERMENTED SHRIMP OR SMALL FISH (U.S. CL. 46).

CLASS 30—STAPLE FOODS

FOR SAUCES, SPICES, SOY SAUCES, CHILLI SAUCES, FLOUR, CONFECTIONERY, NAMELY COOKIES AND CAKES, CEREAL BASED SNACK FOODS, READY TO EAT CEREAL BASED SNACK BARS (U.S. CL. 46).

CLASS 32—LIGHT BEVERAGES

FOR CONCENTRATES, SYRUPS AND POWDERS USED IN THE PREPARATION OF SOFT DRINKS (U.S. CLS. 45, 46 AND 48).

SN 76-176,836. MARLIN ART, INC., DEER PARK, NY. FILED 12-4-2000.



CLASS 35—ADVERTISING AND BUSINESS

FOR AUCTION SERVICES, ONLINE AUCTION SERVICES, RETAIL STORE SERVICES FEATURING ARTWORK, COLLECTIBLES AND GIFTWARE, ONLINE RETAIL STORE SERVICES FEATURING ARTWORK, COLLECTIBLES AND GIFTWARE (U.S. CLS. 100, 101 AND 102).

FIRST USE 6-0-2000; IN COMMERCE 6-0-2000.

CLASS 36—INSURANCE AND FINANCIAL

FOR CHARITABLE, SPECIAL INTEREST AND NON-PROFIT FUNDRAISING SERVICES; FUNDRAISING SERVICES FOR CHARITABLE, NON-PROFIT AND SPECIAL INTEREST EVENTS (U.S. CLS. 100, 101 AND 102).

FIRST USE 6-0-2000; IN COMMERCE 6-0-2000.

SN 76-177,604. MIGHTYDATA, L.L.C., CARROLLTON, TX. FILED 12-7-2000.



CLASS 41—EDUCATION AND ENTERTAINMENT

FOR COMPUTER EDUCATION TRAINING SERVICES, NAMELY TRAINING IN THE USE AND OPERATION OF DATABASE SOFTWARE (U.S. CLS. 100, 101 AND 107).

FIRST USE 10-0-1998; IN COMMERCE 10-0-1998.

CLASS 42—SCIENTIFIC, COMPUTER AND LEGAL SERVICES

FOR COMPUTER SERVICES, NAMELY, PROVIDING THE DEVELOPMENT OF INFORMATION SYSTEMS FOR OTHERS USING DATABASE SOFTWARE (U.S. CLS. 100 AND 101).

FIRST USE 10-0-1998; IN COMMERCE 10-0-1998.

SN 76-178,504. KABUSHIKI KAISHA NTT DOCOMO, DBA NTT DOCOMO, INC., CHIYODA-KU, TOKYO, JAPAN, FILED 12-7-2000.



THE MARK CONSISTS OF A STYLIZED REPRESENTATION OF A CELLULAR TELEPHONE.

CLASS 9—ELECTRICAL AND SCIENTIFIC APPARATUS

FOR CELLULAR TELEPHONES; PERSONAL DIGITAL ASSISTANTS; INTERACTIVE VIDEO GAMES OF VIRTUAL REALITY COMPRISED OF COMPUTER HARDWARE AND SOFTWARE; VIDEO ARCADE GAME MACHINES FOR USE WITH TELEVISIONS; MAGNETIC DISCS, MAGNETIC TAPES, IC MEMORY CARDS, OPTICAL MAGNETIC DISCS, CD-ROMS, ALL STORING A COMPUTER PROGRAM FOR USE WITH VIDEO GAME MACHINES; VIDEO GAME INTERACTIVE HAND-HELD CONTROLS FOR PLAYING ELECTRONIC GAMES; VIDEO GAME MACHINES ADAPTED FOR USE WITH TELEVISION RECEIVERS ONLY, INCLUDING THOSE WHICH CAN COMMUNICATE TO ONE ANOTHER VIA A TELECOMMUNICATION NETWORK (U.S. CLS. 21, 23, 26, 36 AND 38).

CLASS 38—COMMUNICATION

FOR COMMUNICATION BY CELLULAR TELEPHONES, RADIO, AND TELEPHONE PAGING SERVICES; PROVIDING TELECOMMUNICATIONS CONNECTIONS THROUGH A GLOBAL COMPUTER NETWORK BY COMPUTERS; PROVIDING TELECOMMUNICATIONS CONNECTIONS TO A GLOBAL COMPUTER NETWORK BY CELLULAR TELEPHONES; ELECTRONIC MAIL; VALUE-ADDED NETWORK SERVICES; COMMUNICATION BY COMPUTER TERMINALS; RENTAL OF TELEPHONE SETS, FACSIMILE MACHINES AND PERSONAL COMPUTERS HAVING A TELECOMMUNICATION FUNCTION; COMMUNICATION BY INTERACTIVE VIDEO GAME MACHINES FOR USE WITH TELEVISIONS AND PERSONAL COMPUTERS (U.S. CLS. 100, 101 AND 104).

SN 76-179,217. PEARL S. BUCK INTERNATIONAL INC., PERKASIE, PA. FILED 12-12-2000.

WELCOME HOUSE

NO CLAIM IS MADE TO THE EXCLUSIVE RIGHT TO USE "HOUSE", APART FROM THE MARK AS SHOWN.

CLASS 35—ADVERTISING AND BUSINESS

FOR MEDICAL REFERRALS, COUNSELING REFERRALS, ATTORNEY REFERRALS (U.S. CLS. 100, 101 AND 102).

FIRST USE 5-16-1949; IN COMMERCE 5-16-1949.

CLASS 41—EDUCATION AND ENTERTAINMENT

FOR EDUCATIONAL SERVICES, NAMELY, CONDUCTING CLASSES, WORKSHOPS AND SEMINARS ON THE SUBJECTS OF LITERACY, FAMILY HEALTH CARE, MENTAL HEALTH CARE, HIV/AIDS PREVENTION AND METHODS OF TREATMENT, SUBSTANCE ABUSE, PARENTING AND CHILD CARE, INTERPERSONAL RELATIONSHIPS, CROSS-CULTURAL UNDERSTANDING, NUTRITION, LIVELIHOOD AND OCCUPATIONAL SKILLS TRAINING, SMALL BUSINESS DEVELOPMENT, AND PRE-AND POST-ADOPTION ISSUES (U.S. CLS. 100, 101 AND 107).

FIRST USE 5-16-1949; IN COMMERCE 5-16-1949.

CLASS 42—SCIENTIFIC, COMPUTER AND LEGAL SERVICES

FOR ADOPTION AGENCIES, AND ADOPTION PLACEMENT SERVICES; PRE AND POST ADOPTION COUNSELING (U.S. CLS. 100 AND 101).

FIRST USE 5-16-1949; IN COMMERCE 5-16-1949.

SN 76-179,657. IXPANSE INC, BOSTON, MA. FILED 12-12-2000.

IXPANSE**CLASS 36—INSURANCE AND FINANCIAL**

FOR LEASING AND MANAGING COMMERCIAL REAL ESTATE PROPERTIES DEDICATED TO TELECOMMUNICATIONS EQUIPMENT, NAMELY TELECOM HOTELS, SWITCHING HUBS, DATA STORAGE CENTERS, COLLOCATION FACILITIES, COMPETITIVE LOCAL EXCHANGE CARRIER FACILITIES, INCUMBENT CENTRAL OFFICES, TELECOMMUNICATIONS TOWERS; LEASING AND MANAGING EASEMENTS AND RIGHTS OF WAY FOR TELECOMMUNICATIONS TOWERS AND LINES (U.S. CLS. 100, 101 AND 102).

CLASS 37—CONSTRUCTION AND REPAIR

FOR INSTALLATION OF EQUIPMENT FOR COMMERCIAL REAL ESTATE PROPERTIES DEDICATED TO TELECOMMUNICATIONS EQUIPMENT, NAMELY, TELECOM HOTELS, SWITCHING HUBS, DATA STORAGE CENTERS, COLLOCATION FACILITIES, COMPETITIVE LOCAL EXCHANGE CARRIER FACILITIES, INCUMBENT CENTRAL OFFICES, TELECOMMUNICATIONS TOWERS (U.S. CLS. 100, 103 AND 106).

SN 76-179,517. REALCAPITALMARKETS.COM, LLC, CARLSBAD, CA. FILED 12-13-2000.

INCREASING LIQUIDITY THROUGH EFFICIENCY**CLASS 35—ADVERTISING AND BUSINESS**

FOR ONLINE ELECTRONIC ADVERTISING AND DISSEMINATION OF PRINTED OR HARDCOPY ADVERTISING IN THE FIELD OF REAL ESTATE AND FINANCIAL SERVICES (U.S. CLS. 100, 101 AND 102).

FIRST USE 1-1-2000; IN COMMERCE 1-1-2000.

CLASS 36—INSURANCE AND FINANCIAL

FOR REAL ESTATE BROKERAGE SERVICES; FINANCIAL INVESTMENT SERVICES IN THE FIELD OF REAL ESTATE; AND PROVIDING INFORMATION REGARDING REAL ESTATE (U.S. CLS. 100, 101 AND 102).

FIRST USE 1-1-2000; IN COMMERCE 1-1-2000.

CLASS 41—EDUCATION AND ENTERTAINMENT

FOR EDUCATIONAL SERVICES, NAMELY, CONDUCTING CONFERENCES, ON-LINE AND IN PERSON, IN THE FIELD OF REAL ESTATE AND DISTRIBUTING CONFERENCE MATERIALS IN CONNECTION THEREWITH (U.S. CLS. 100, 101 AND 107).

FIRST USE 1-1-2000; IN COMMERCE 1-1-2000.

SN 76-179,756. RANCH AT EAST FORK, LLC, THE, PAGOSA SPRINGS, CO. FILED 12-8-2000.

PIANO CREEK RANCH

NO CLAIM IS MADE TO THE EXCLUSIVE RIGHT TO USE "RANCH", APART FROM THE MARK AS SHOWN.

CLASS 41—EDUCATION AND ENTERTAINMENT

FOR PROVIDING FACILITIES FOR RECREATIONAL ACTIVITIES; EDUCATIONAL SERVICES, NAMELY CONDUCTING CLASSES, SEMINARS, CONFERENCES AND WORKSHOPS IN THE FIELDS OF ART, MUSIC, AND GENERAL EDUCATION TOPICS; ORGANIZING EXHIBITIONS OF FINE ARTS AND CRAFTS; AND GOLF COURSES (U.S. CLS. 100, 101 AND 107).

FIRST USE 6-0-1999; IN COMMERCE 6-0-1999.

CLASS 42—SCIENTIFIC, COMPUTER AND LEGAL SERVICES

FOR GUEST RANCH SERVICES; RESORT AND LODGING SERVICES; AND HEALTH SPAS (U.S. CLS. 100 AND 101).

FIRST USE 6-0-1999; IN COMMERCE 6-0-1999.

SN 76-180,021. CRYSTAL FIBRE A/S, DK-2605 BRONDBY, DENMARK. FILED 12-13-2000.

SN 76-181,573. COOPERATIVE COMPUTING, INC, AUSTIN, TX. FILED 12-15-2000.

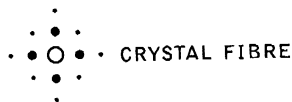

PRIORITY CLAIMED UNDER SEC. 44(D) ON ERPN CMNTY TM OFC APPLICATION NO. 1712793, FILED 6-19-2000, REG. NO. 001712793, DATED 7-11-2001, EXPIRES 7-11-2011.

NO CLAIM IS MADE TO THE EXCLUSIVE RIGHT TO USE "CRYSTAL FIBRE", APART FROM THE MARK AS SHOWN.

CLASS 9—ELECTRICAL AND SCIENTIFIC APPARATUS

FOR OPTICAL COMPONENTS, NAMELY OPTICAL FIBRES AND LIGHT CONDUCTING FILAMENTS (U.S. CLS. 21, 23, 26, 36 AND 38).

CLASS 42—SCIENTIFIC, COMPUTER AND LEGAL SERVICES

FOR RESEARCH AND DEVELOPMENT FOR OTHERS IN THE FIELD OF MATERIAL TESTING AND DEVELOPMENT OF OPTICAL COMPONENTS (U.S. CLS. 100 AND 101).

SN 76-181,030. TISHMAN SPEYER PROPERTIES, L.P., NEW YORK, NY. FILED 12-14-2000.

PENTAPLAN

CLASS 36—INSURANCE AND FINANCIAL

FOR REAL ESTATE MANAGEMENT SERVICES; LEASING OF REAL ESTATE (U.S. CLS. 100, 101 AND 102).

FIRST USE 1-0-1997; IN COMMERCE 1-0-1997.

CLASS 37—CONSTRUCTION AND REPAIR

FOR REAL ESTATE DEVELOPMENT SERVICES; CONSTRUCTION SERVICES, NAMELY, CUSTOM CONSTRUCTION AND BUILDING RENOVATION, CONSTRUCTION MANAGEMENT AND SUPERVISION; AND PLANNING, LAYING OUT AND CUSTOM CONSTRUCTION OF OFFICE SPACE (U.S. CLS. 100, 103 AND 106).

FIRST USE 1-0-1997; IN COMMERCE 1-0-1997.

CLASS 42—SCIENTIFIC, COMPUTER AND LEGAL SERVICES

FOR ARCHITECTURAL DESIGN SERVICES (U.S. CLS. 100 AND 101).

FIRST USE 1-0-1997; IN COMMERCE 1-0-1997.

ACONNEX

CLASS 9—ELECTRICAL AND SCIENTIFIC APPARATUS

FOR COMPUTER SOFTWARE FOR USE IN THE AUTOMOTIVE AFTERMARKET INDUSTRIES, NAMELY, SOFTWARE FEATURING PROGRAMS AND COMPUTERIZED DATABASES FOR MANAGING INVENTORY OF VEHICLE PARTS AND TRACKING LABOR RELATED DATA, AND FACILITATING ELECTRONIC COMMUNICATION REGARDING SAME THROUGHOUT THE AUTOMOTIVE AFTERMARKET SUPPLY CHAIN, THROUGH TRANSMISSION OF INFORMATION, DATA, AUDIO AND IMAGES VIA THE GLOBAL COMPUTER NETWORK (U.S. CLS. 21, 23, 26, 36 AND 38).

CLASS 35—ADVERTISING AND BUSINESS

FOR INFORMATION NETWORKING SERVICES USED TO FACILITATE EXCHANGE OF INFORMATION AND ELECTRONIC COMMERCE TRANSACTIONS IN THE AUTOMOTIVE AFTERMARKET INDUSTRIES, NAMELY, PROVIDING SEARCHABLE ELECTRONIC DATABASES FEATURING INFORMATION ABOUT THE SALE OF AUTOMOTIVE PARTS; PROVIDING INFORMATION ABOUT THE SALE OF AUTOMOTIVE PARTS VIA A WEB SITE ON A GLOBAL COMPUTER NETWORK (U.S. CLS. 100, 101 AND 102).

CLASS 37—CONSTRUCTION AND REPAIR

FOR PROVIDING SEARCHABLE ELECTRONIC DATABASES FEATURING INFORMATION ABOUT THE MAINTENANCE AND INSTALLATION OF AUTOMOTIVE PARTS; PROVIDING INFORMATION ABOUT THE MAINTENANCE AND INSTALLATION OF AUTOMOTIVE PARTS VIA A WEB SITE ON A GLOBAL COMPUTER NETWORK (U.S. CLS. 100, 103 AND 106).

SN 76-181,698. VALIENTE, LTD., PLANO, TX. FILED 12-15-2000.

VALIENTE

THE ENGLISH TRANSLATION OF "VALIENTE" IS "VALIANT".

CLASS 16—PAPER GOODS AND PRINTED MATTER

FOR PRINTED MATERIALS, NAMELY, A MAGAZINE RELATING TO BUSINESS AND LIFESTYLE ISSUES OF INTEREST TO THE HISPANIC POPULATION (U.S. CLS. 2, 5, 22, 23, 29, 37, 38 AND 50).

CLASS 42—SCIENTIFIC, COMPUTER AND LEGAL SERVICES

FOR COMPUTER SERVICES, NAMELY PROVIDING AN ONLINE MAGAZINE RELATING TO BUSINESS AND LIFESTYLE ISSUES OF INTEREST TO THE HISPANIC POPULATION (U.S. CLS. 100 AND 101).

SN 76-182,726. SHAREEM, INC., FRANKFORT, IL. FILED 12-19-2000.

GRAMMI SHAR

"GRAMMI SHAR" IS THE NAME OF A LIVING INDIVIDUAL WHOSE CONSENT IS OF RECORD.

CLASS 9—ELECTRICAL AND SCIENTIFIC APPARATUS

FOR MOTION PICTURE FILMS AND PRE-RECORDED VIDEO CASSETTES, AUDIO CASSETTES, COMPACT DISCS AND DVDS FEATURING MUSICAL PERFORMANCES WHICH FEATURE A GRANDMOTHERLY CHARACTER (U.S. CLS. 21, 23, 26, 36 AND 38).

CLASS 16—PAPER GOODS AND PRINTED MATTER

FOR SHEET MUSIC, SERIES OF CHILDREN'S BOOKS AND OTHER PUBLICATIONS, NAMELY CHILDREN'S MAGAZINES, NEWSLETTERS FOR CHILDREN AND BOOKLETS FOR CHILDREN (U.S. CLS. 2, 5, 22, 23, 29, 37, 38 AND 50).

CLASS 41—EDUCATION AND ENTERTAINMENT

FOR ENTERTAINMENT SERVICES IN THE NATURE OF A SERIES OF CHILDREN'S TELEVISION PROGRAMS; PROVIDING RECORDED MUSICAL PERFORMANCES DIRECTED TO CHILDREN VIA THE INTERNET; AND LIVE MUSICAL PERFORMANCES DIRECTED TO CHILDREN, ALL FEATURING A GRANDMOTHERLY CHARACTER (U.S. CLS. 100, 101 AND 107).

SN 76-182,727. SHAREEM, INC., FRANKFORT, IL. FILED 12-19-2000.

GRAMMY SHAR

"GRAMMY SHAR" IS THE NAME OF A LIVING INDIVIDUAL WHOSE CONSENT IS OF RECORD.

CLASS 9—ELECTRICAL AND SCIENTIFIC APPARATUS

FOR MOTION PICTURE FILMS AND PRE-RECORDED VIDEO CASSETTES, AUDIO CASSETTES, COMPACT DISCS AND DVDS FEATURING MUSICAL PERFORMANCES WHICH FEATURE A GRANDMOTHERLY CHARACTER (U.S. CLS. 21, 23, 26, 36 AND 38).

CLASS 16—PAPER GOODS AND PRINTED MATTER

FOR SHEET MUSIC, SERIES OF CHILDREN'S BOOKS AND OTHER PUBLICATIONS, NAMELY, CHILDREN'S MAGAZINES, NEWSLETTERS FOR CHILDREN AND BOOKLETS FOR CHILDREN (U.S. CLS. 2, 5, 22, 23, 29, 37, 38 AND 50).

CLASS 41—EDUCATION AND ENTERTAINMENT

FOR ENTERTAINMENT SERVICES IN THE NATURE OF A SERIES OF CHILDREN'S TELEVISION PROGRAMS; PROVIDING RECORDED MUSICAL PERFORMANCES DIRECTED TO CHILDREN VIA THE INTERNET; AND LIVE MUSICAL PERFORMANCES DIRECTED TO CHILDREN, ALL FEATURING A GRANDMOTHERLY CHARACTER (U.S. CLS. 100, 101 AND 107).

SN 76-183,071. PRO DUCT HEALTH, INC., MENLO PARK, CA. FILED 12-18-2000.

ACCESS THE SOURCE

CLASS 5—PHARMACEUTICALS

FOR MEDICAL SUPPLY KITS CONTAINING CHEMICAL AGENTS FOR USE IN THE DIAGNOSIS AND TREATMENT OF BREAST CANCER; DIAGNOSTIC PREPARATIONS FOR CLINICAL AND MEDICAL LABORATORY USE, PROPHYLACTIC CHEMICAL COMPOSITIONS AND THERAPEUTIC CHEMICAL COMPOSITIONS FOR BREAST CANCER AND BREAST PRECANCER DIAGNOSIS AND TREATMENT AND CHEMICAL REAGENTS FOR DIAGNOSTIC AND CLINICAL USE IN THE TREATMENT AND PREVENTION OF BREAST CANCER; MEDICAL SUPPLY KITS CONTAINING CHEMICAL REAGENTS FOR USE IN THE DIAGNOSIS AND TREATMENT OF BREAST CANCER (U.S. CLS. 6, 18, 44, 46, 51 AND 52).

CLASS 10—MEDICAL APPARATUS

FOR MEDICAL DEVICES FOR BREAST CANCER AND BREAST PRECANCER DIAGNOSIS AND TREATMENT AND FOR THE DIAGNOSIS AND TREATMENT OF BREAST CONDITIONS, NAMELY CATHETERS, STENTS, ASPIRATOR CUPS, DILATORS, AND OTHER TOOLS FOR PERFORMING BREAST DUCT ACCESS, NAMELY CATHETERS, STENTS, ASPIRATOR CUPS, DILATORS, AND OTHER TOOLS FOR PERFORMING BREAST DUCT ACCESS, NAMELY BREAST DUCT ACCESS CATHETERS, MICROCATHETERS, STENTS, DILATORS, ENDOSCOPES, DUCTOSCOPES, NIPPLE ASPIRATORS, AND BREAST DUCT ACCESS DEVICES FOR ACCESS, FLUID INFUSION, AND FLUID RETRIEVAL; MEDICAL EQUIPMENT FOR USE IN FLUID INFUSION AND FLUID RETRIEVAL FROM THE BREAST DUCT; MEDICAL SUPPLY KITS CONTAINING, NAMELY, BREAST DUCT ACCESS CATHETERS, MICROCATHETERS, STENTS, DILATORS, ENDOSCOPES, DUCTOSCOPES, NIPPLE ASPIRATORS, AND BREAST DUCT ACCESS DEVICES FOR ACCESS, FLUID INFUSION, AND FLUID RETRIEVAL, TO PERFORM DIAGNOSIS AND THE TREATMENT OF BREAST CANCER (U.S. CLS. 26, 39 AND 44).

CLASS 41—EDUCATION AND ENTERTAINMENT

FOR EDUCATIONAL SERVICES, NAMELY, CONDUCTING CLASSES, SEMINARS, CONFERENCES, WORKSHOPS, TRAINING SESSIONS IN THE FIELD OF BREAST CANCER DIAGNOSIS AND TREATMENT (U.S. CLS. 100, 101 AND 107).

CLASS 42—SCIENTIFIC, COMPUTER AND LEGAL SERVICES

FOR BREAST CANCER AND BREAST PRECANCER DIAGNOSIS AND TREATMENT; DIAGNOSIS AND TREATMENT OF OTHER MEDICAL CONDITIONS OF THE BREAST, NAMELY BREAST CANCER AND BREAST PRECANCER; DIAGNOSTIC TESTING, PROGNOSTIC TESTING, MONITORING OF AN IDENTIFIED MEDICAL CELLULAR AND MOLECULAR CONDITION IN THE BREAST; CYTOLOGICAL ANALYSIS OF CELLS RETRIEVED FROM A BREAST DUCT; FOCUSED PROPHYLACTIC OR THERAPEUTIC TREATMENTS FOR BREAST CANCER, PRECANCER, AND OTHER IDENTIFIED BREAST CONDITIONS, NAMELY DUCTAL ABSCESS, CYSTS, PAPILLOMA, AND OTHER ABNORMAL NON-MALIGNANT CONDITIONS OF THE BREAST (U.S. CLS. 100 AND 101).

SN 76-183,592. YOUNG, MARY, DBA POWERED BY JESUS MINISTRIES, OAKLAND, CA. AND YOUNG, DESRIC, DBA POWERED BY JESUS MINISTRIES, OAKLAND, CA. FILED 12-20-2000.

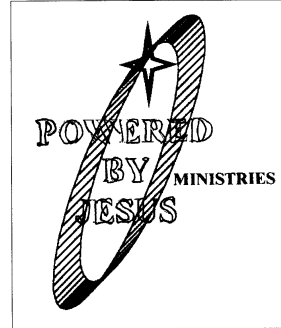

NO CLAIM IS MADE TO THE EXCLUSIVE RIGHT TO USE "JESUS", APART FROM THE MARK AS SHOWN. THE LINING IS A FEATURE OF THE MARK AND DOES NOT INDICATE COLOR.

SN 76-183,077. PREMIER FOOD SERVICES, INC., SAN DIEGO, CA. FILED 12-18-2000.

CLASS 16—PAPER GOODS AND PRINTED MATTER

FOR BUMPER STICKERS (U.S. CLS. 2, 5, 22, 23, 29, 37, 38 AND 50).

CLASS 25—CLOTHING

FOR GOLF SHIRTS, T-SHIRTS, SWEATERS, SCARVES, KNITTED CAPS, HATS (U.S. CLS. 22 AND 39).



SN 76-183,622. RUDOLF HAUFE VERLAG GMBH & CO. KG, D-79102 FREIBURG, FED REP GERMANY, FILED 12-19-2000.

REDMARK

PRIORITY CLAIMED UNDER SEC. 44(D) ON FED REP GERMANY APPLICATION NO. 30079502.5/3, FILED 10-27-2000, REG. NO. 30079502, DATED 6-13-2001, EXPIRES 10-31-2010.

NO CLAIM IS MADE TO THE EXCLUSIVE RIGHT TO USE "FOOD SERVICES", APART FROM THE MARK AS SHOWN. SEC. 2(F).

CLASS 35—ADVERTISING AND BUSINESS

FOR CONCESSIONS SERVICES, NAMELY, THE PROVISION OF FOOD, DRINK AND SOUVENIR ITEMS (U.S. CLS. 100, 101 AND 102). FIRST USE 12-31-1985; IN COMMERCE 12-31-1985.

CLASS 9—ELECTRICAL AND SCIENTIFIC APPARATUS

FOR COMPUTER SOFTWARE, NAMELY SOFTWARE WITH CONTRACTS, CHECKLISTS, FORMS AND WORKING AIDS FOR USE IN THE FIELDS OF BUSINESS, LAW AND TAX (U.S. CLS. 21, 23, 26, 36 AND 38).

CLASS 42—SCIENTIFIC, COMPUTER AND LEGAL SERVICES

FOR CONTRACT FOOD SERVICES, FOOD PREPARATION, CATERING SERVICES (U.S. CLS. 100 AND 101). FIRST USE 12-31-1985; IN COMMERCE 12-31-1985.

CLASS 16—PAPER GOODS AND PRINTED MATTER

FOR BOOKS FEATURING CONTRACTS, CHECKLISTS, FORMS AND WORKING AIDS FOR USE IN THE FIELD OF BUSINESS, LAW AND TAX; BROCHURES, LOOSE-LEAF EDITIONS, MANUALS, PERIODICALS AND PUBLICATIONS IN THE FIELD OF BUSINESS, LAW AND TAX (U.S. CLS. 2, 5, 22, 23, 29, 37, 38 AND 50).

CLASS 35—ADVERTISING AND BUSINESS

FOR PROVIDING A WEB SITE ON GLOBAL COMPUTER NETWORKS FEATURING INFORMATION IN THE FIELDS OF BUSINESS, TAX CONSULTATION, TAX PREPARATION AND TAX PLANNING (U.S. CLS. 100, 101 AND 102).

CLASS 38—COMMUNICATION

FOR TELECOMMUNICATIONS SERVICES, NAMELY TELEPHONE SERVICES; TELECOMMUNICATION SERVICES, NAMELY PROVIDING MULTIPLE USER ACCESS TO A GLOBAL COMPUTER INFORMATION NETWORK (U.S. CLS. 100, 101 AND 104).

CLASS 42—SCIENTIFIC, COMPUTER AND LEGAL SERVICES

FOR COMPUTER SERVICES, NAMELY CREATING WEB SITES FOR OTHERS; PROVIDING A WEB SITE ON GLOBAL COMPUTER NETWORKS FEATURING INFORMATION IN THE FIELD OF LAW (U.S. CLS. 100 AND 101).

SN 76-183,651. MORETTI FORNI S.P.A., 61035 MAROTTA DI MONDOLFO, PESARO, ITALY, FILED 12-20-2000.

**CLASS 7—MACHINERY**

FOR ELECTRIC MACHINES AND EQUIPMENT FOR MANUFACTURING FOOD DOUGH, PASTE AND PASTA FOR DOMESTIC, INDUSTRIAL AND COMMERCIAL USE; FOOD DOUGH AND PASTE MIXERS; EQUIPPED AND TOOLED WORKSTATIONS FOR HANDLING FOOD DOUGH AND PASTE; AND AUTOMATIC MACHINES AND EQUIPMENT FOR MANUFACTURING BREAD, PIZZA CONFECTIONARY AND PASTRY FOR DOMESTIC, INDUSTRIAL AND COMMERCIAL USE (U.S. CLS. 13, 19, 21, 23, 31, 34 AND 35).

CLASS 11—ENVIRONMENTAL CONTROL APPARATUS

FOR DOMESTIC COOKING OVENS; DOMESTIC, INDUSTRIAL AND COMMERCIAL COOKING OVENS FOR BREAD, PIZZA, CONFECTIONERY AND PASTRY; AND INDUSTRIAL COOKING OVENS (U.S. CLS. 13, 21, 23, 31 AND 34).

CLASS 42—SCIENTIFIC, COMPUTER AND LEGAL SERVICES

FOR RESTAURANT SERVICES; PIZZERIA RESTAURANT SERVICES; AND FAST FOOD RESTAURANT SERVICES (U.S. CLS. 100 AND 101).

SN 76-184,565. CVS VANGUARD, INC., SCARSDALE, NY. FILED 12-21-2000.

**CLASS 3—COSMETICS AND CLEANING PREPARATIONS**

FOR NAIL POLISH AND NAIL POLISH REMOVER; LIPSTICK, ROUGE, EYE LINER AND MASCARA; COTTON STICKS AND PUFFS FOR COSMETIC PURPOSES; COTTON SWAB EYE MAKEUP APPLICATORS; ARTIFICIAL EYE LASHES AND FALSE NAILS; FACE AND BODY SOAPS; GEL CREAM USED FOR SHAVING AND GEL CREAM FOR THE HAIR AND SHAVING FOAM; PERFUME AND COLOGNE; ROOM FRAGRANCES; HAIR SHAMPOOS AND CONDITIONERS; SKIN CARE PREPARATIONS, NAMELY, SKIN LOTION AND SKIN CLEANSER; AND NON-MEDICATED FOOT POWDER (U.S. CLS. 1, 4, 6, 50, 51 AND 52).

FIRST USE 4-30-1999; IN COMMERCE 7-28-2000.

CLASS 4—LUBRICANTS AND FUELS

FOR CANDLES (U.S. CLS. 1, 6 AND 15).
FIRST USE 4-30-1999; IN COMMERCE 7-28-2000.

CLASS 8—HAND TOOLS

FOR MANICURE IMPLEMENTS, NAMELY, NAIL CLIPPERS, NAIL FILES AND NAIL BUFFERS; PERSONAL CARE IMPLEMENTS, NAMELY, SCISSORS AND RAZORS; TOE SEPARATORS, NAMELY FOR USE IN PEDICURES (U.S. CLS. 23, 28 AND 44).

FIRST USE 4-30-1999; IN COMMERCE 7-28-2000.

CLASS 18—LEATHER GOODS

FOR COSMETIC BAGS SOLD EMPTY (U.S. CLS. 1, 2, 3, 22 AND 41).

FIRST USE 4-30-1999; IN COMMERCE 7-28-2000.

CLASS 20—FURNITURE AND ARTICLES NOT OTHERWISE CLASSIFIED

FOR BATH PILLOWS; HAND HELD AND STAND FREE BEAUTY MIRRORS (U.S. CLS. 2, 13, 22, 25, 32 AND 50).

FIRST USE 4-30-1999; IN COMMERCE 7-28-2000.

CLASS 21—HOUSEWARES AND GLASS

FOR HAIR BRUSHES AND HAIR COMBS; BATH ACCESSORIES, NAMELY, BATH GLOVES AND SPONGES AND LOOFAH FOR CLEANSING THE SKIN; COSMETIC CONTAINERS SOLD EMPTY; COSMETIC SPONGES, COSMETIC SPONGE WEDGES AND COSMETIC MAKE-UP APPLICATORS, NAMELY APPLICATOR STICKS AND PUFFS FOR APPLYING COSMETICS (U.S. CLS. 2, 13, 23, 29, 30, 33, 40 AND 50).

FIRST USE 4-30-1999; IN COMMERCE 7-28-2000.

SN 76-185,023. INTERNET GENESIS, INC., SUNNYVALE, CA. FILED 12-22-2000.

INTERNET GENESIS

NO CLAIM IS MADE TO THE EXCLUSIVE RIGHT TO USE "INTERNET", APART FROM THE MARK AS SHOWN.

CLASS 35—ADVERTISING AND BUSINESS

FOR CONSULTING SERVICES FOR BUYER AND SELLERS, NAMELY SOURCING, PREPARATION, ORGANIZATION, NEGOTIATION AND CLOSING OF BUSINESS TRANSACTIONS (U.S. CLS. 100, 101 AND 102).

CLASS 36—INSURANCE AND FINANCIAL

FOR BUSINESS BROKERAGE SERVICES, NAMELY INTRODUCTION OF ENTREPRENEURS TO EXISTING WEB-BASED PROJECT (U.S. CLS. 100, 101 AND 102).

SN 76-185,108. TMP WORLDWIDE INC., NEW YORK, NY. FILED 12-20-2000.

TMP RELOCATION

NO CLAIM IS MADE TO THE EXCLUSIVE RIGHT TO USE "RELOCATION", APART FROM THE MARK AS SHOWN.

CLASS 35—ADVERTISING AND BUSINESS

FOR PROVIDING INFORMATION ABOUT THE COST OF LIVING IN SPECIFIC COMMUNITIES; AND PROVIDING INFORMATION ON EMPLOYMENT OPPORTUNITIES, UNEMPLOYMENT RATES AND SALARY COMPARATORS (U.S. CLS. 100, 101 AND 102).

CLASS 36—INSURANCE AND FINANCIAL

FOR REAL ESTATE SERVICES, NAMELY, PROVIDING INFORMATION ON SALES AND RENTALS OF HOMES AND APARTMENTS, PROVIDING INFORMATION ON REAL ESTATE AGENCIES, REAL ESTATE APPRAISAL SERVICES AND REGIONAL HOUSING PRICES; PROVIDING INFORMATION ON PERSONAL MOVING SERVICES IN THE NATURE OF RESOURCES FOR FINDING AND RENTING RESIDENCES, ALL VIA THE INTERNET; FINANCIAL SERVICES, NAMELY, PROVIDING INFORMATION ON QUOTES FOR HOME MORTGAGES, QUALIFICATIONS FOR DIFFERENT TYPES OF LOANS, DIFFERENCE BETWEEN DIFFERENT TYPES OF MORTGAGES, MORTGAGE TERMINOLOGY, MORTGAGE LENDERS AND CREDIT REPORT SERVICES; AND INSURANCE SERVICES, NAMELY, PROVIDING INFORMATION ON HOMEOWNERS, RENTERS, MORTGAGE, TITLE, AUTOMOBILE, LIFE, AND HEALTH INSURANCE, ALL VIA THE INTERNET (U.S. CLS. 100, 101 AND 102).

CLASS 37—CONSTRUCTION AND REPAIR

FOR PROVIDING INFORMATION ON HOUSE REPAIR, REMODELING CONSTRUCTION AND CONSTRUCTION CONTRACTORS (U.S. CLS. 100, 103 AND 106).

CLASS 39—TRANSPORTATION AND STORAGE

FOR PROVIDING INFORMATION VIA THE INTERNET ON PERSONAL MOVING SERVICES IN THE NATURE OF TRANSPORTATION AND LOGISTICS INFORMATION; PROVIDING QUOTES AND RESERVATION SERVICES FOR MOVERS AND TRUCK RENTALS; PROVIDING INFORMATION ABOUT PUBLIC TRANSPORTATION IN SPECIFIC COMMUNITIES AND PROVIDING INFORMATION RELATING TO PUBLIC UTILITY SERVICES (U.S. CLS. 100 AND 105).

CLASS 42—SCIENTIFIC, COMPUTER AND LEGAL SERVICES

FOR PROVIDING INFORMATION ON VARIOUS SERVICES AVAILABLE IN PARTICULAR GEOGRAPHIC AREAS, NAMELY, LANDSCAPE GARDENING AND CARE SERVICES, INTERIOR DECORATING SERVICES, AND REAL ESTATE LAWYERS; WEATHER AND CRIME STATISTICS IN SPECIFIC COMMUNITIES; QUOTE AND RESERVATION SERVICES FOR TEMPORARY HOUSING; PROVIDING INFORMATION ABOUT BUILDING INSPECTIONS; AND TEMPORARY NON-DOWNLOADABLE SOFTWARE FOR CALCULATING INCOME REQUIREMENTS FOR SPECIFIC LOANS, PAYMENT PLANS FOR PARTICULAR TYPES OF LOANS; UPFRONT LOAN COSTS AND HOW MUCH OF A LOAN A PARTICULAR CONSUMER CAN AFFORD TO TAKE (U.S. CLS. 100 AND 101).

SN 76-185,109. TMP WORLDWIDE INC., NEW YORK, NY. FILED 12-20-2000.

MONSTER RELOCATION

NO CLAIM IS MADE TO THE EXCLUSIVE RIGHT TO USE "RELOCATION", APART FROM THE MARK AS SHOWN.

CLASS 35—ADVERTISING AND BUSINESS

FOR PROVIDING INFORMATION ABOUT THE COST OF LIVING IN SPECIFIC COMMUNITIES; AND PROVIDING INFORMATION ON EMPLOYMENT OPPORTUNITIES, UNEMPLOYMENT RATES AND SALARY COMPARATORS (U.S. CLS. 100, 101 AND 102).

CLASS 36—INSURANCE AND FINANCIAL

FOR REAL ESTATE SERVICES, NAMELY, PROVIDING INFORMATION ON SALES AND RENTALS OF HOMES AND APARTMENTS, PROVIDING INFORMATION ON REAL ESTATE AGENCIES, REAL ESTATE APPRAISAL SERVICES AND REGIONAL HOUSING PRICES; PROVIDING INFORMATION ON PERSONAL MOVING SERVICES IN THE NATURE OF RESOURCES FOR FINDING AND RENTING RESIDENCES, ALL VIA THE INTERNET; FINANCIAL SERVICES, NAMELY, PROVIDING INFORMATION ON QUOTES FOR HOME MORTGAGES, QUALIFICATIONS FOR DIFFERENT TYPES OF LOANS DIFFERENCES BETWEEN DIFFERENT TYPES OF MORTGAGES, MORTGAGE TERMINOLOGY, MORTGAGE LENDERS AND CREDIT REPORT SERVICES; AND INSURANCE SERVICES, NAMELY, PROVIDING INFORMATION ON HOMEOWNERS, RENTERS, MORTGAGE, TITLE, AUTOMOBILE, LIFE AND HEALTH INSURANCE, ALL VIA THE INTERNET (U.S. CLS. 100, 101 AND 102).

CLASS 37—CONSTRUCTION AND REPAIR

FOR PROVIDING INFORMATION ON HOUSE REPAIR, REMODELING CONSTRUCTION AND CONSTRUCTION CONTRACTORS (U.S. CLS. 100, 103 AND 106).

CLASS 39—TRANSPORTATION AND STORAGE

FOR PROVIDING INFORMATION VIA THE INTERNET ON PERSONAL MOVING SERVICES IN THE NATURE OF TRANSPORTATION AND LOGISTICS INFORMATION; PROVIDING QUOTES AND RESERVATION SERVICES FOR MOVERS AND TRUCK RENTALS; PROVIDING INFORMATION ABOUT PUBLIC TRANSPORTATION IN SPECIFIC COMMUNITIES AND PROVIDING INFORMATION RELATING TO PUBLIC UTILITY SERVICES (U.S. CLS. 100 AND 105).

CLASS 42—SCIENTIFIC, COMPUTER AND LEGAL SERVICES

FOR PROVIDING INFORMATION ON VARIOUS SERVICES AVAILABLE IN PARTICULAR GEOGRAPHIC AREAS, NAMELY, LANDSCAPE GARDENING AND CARE SERVICES, INTERIOR DECORATING SERVICES, AND REAL ESTATE LAWYERS, WEATHER AND CRIME STATISTICS IN SPECIFIC COMMUNITIES; QUOTE AND RESERVATION SERVICES FOR TEMPORARY HOUSING; PROVIDING INFORMATION ABOUT BUILDING INSPECTIONS; AND TEMPORARY NON-DOWNLOADABLE SOFTWARE FOR CALCULATING INCOME REQUIREMENTS FOR SPECIFIC LOANS, PAYMENT PLANS FOR PARTICULAR TYPES OF LOANS; UP FRONT LOAN COSTS AND HOW MUCH OF A LOAN A PARTICULAR CONSUMER CAN AFFORD TO TAKE (U.S. CLS. 100 AND 101).

SN 76-185,341. MICHAEL PAGE RECRUITMENT GROUP LIMITED, LONDON, UNITED KINGDOM, FILED 12-22-2000.

MICHAEL PAGE

OWNER OF U.S. REG. NO. 2,325,339.
THE NAME SHOWN IN THE MARK IDENTIFIES A PARTICULAR LIVING INDIVIDUAL WHO HAS GIVEN AUTHORIZATION TO THE APPLICANT TO REGISTER THE NAME.

CLASS 16—PAPER GOODS AND PRINTED MATTER

FOR PRINTED MATTER; PRINTED PUBLICATION, NAMELY, BOOKS, MAGAZINES, NEWSLETTERS AND TEXTS; INSTRUCTION ON TEACHING MATERIALS; MANUALS; PADS; STATIONARY; ALL THE FOREGOING RELATING TO RECRUITMENT AND/OR TEMPORARY OR PERMANENT PLACEMENT SERVICES (U.S. CLS. 2, 5, 22, 23, 29, 37, 38 AND 50).

CLASS 35—ADVERTISING AND BUSINESS

FOR BUSINESS INFORMATION AND RESEARCH SERVICES; EMPLOYMENT AGENCY SERVICES; PERSONNEL MANAGEMENT CONSULTANCY SERVICES; ADVERTISING SERVICES; ALL THE FOREGOING RELATING TO RECRUITMENT AND/OR TEMPORARY OR PERMANENT PLACEMENT SERVICES (U.S. CLS. 100, 101 AND 102).

CLASS 41—EDUCATION AND ENTERTAINMENT

FOR PUBLICATION OF BOOKS, MAGAZINES, NEWSLETTERS AND TEXTS; ORGANIZATION OF EXHIBITIONS, SEMINARS AND CONFERENCES; PROVIDING EDUCATIONAL COURSES, LECTURES AND SEMINARS; CONSULTANCY SERVICES RELATING TO THE EDUCATION, TRAINING AND DEVELOPMENT OF PERSONNEL; ALL THE FOREGOING RELATING TO RECRUITMENT AND/OR TEMPORARY OR PERMANENT PLACEMENT SERVICES (U.S. CLS. 100, 101 AND 107).

SN 76-185,491. ELECTRONIC DATA SYSTEMS CORPORATION, H3-3A-05, PIANO, TX. FILED 12-21-2000.

DIGITAL SERVICES PARTNER

NO CLAIM IS MADE TO THE EXCLUSIVE RIGHT TO USE "DIGITAL SERVICES", APART FROM THE MARK AS SHOWN.

CLASS 35—ADVERTISING AND BUSINESS

FOR BUSINESS CONSULTING SERVICES AND STRATEGIC PLANNING OF INFORMATION TECHNOLOGY; BUSINESS CONSULTING SERVICES RELATING TO ELECTRONIC COMMERCE AND ELECTRONIC BUSINESS BY MEANS OF A COMPUTER; DATA PROCESSING BY MEANS OF A COMPUTER (U.S. CLS. 100, 101 AND 102).

CLASS 38—COMMUNICATION

FOR ELECTRONIC TRANSMISSION AND RECEPTION OF MAIL, DOCUMENTS, NEWS, VIDEO, VOICE, AUDIO, FACSIMILE AND OTHER DATA, DOCUMENTS AND INFORMATION VIA COMPUTER (U.S. CLS. 100, 101 AND 104).

CLASS 42—SCIENTIFIC, COMPUTER AND LEGAL SERVICES

FOR COMPUTER SERVICES, NAMELY COMPUTER HARDWARE AND SOFTWARE INTEGRATION; REMOTE AND ON-SITE MONITORING OF COMPUTER SYSTEMS AND COMPUTER NETWORKS FOR OTHERS; DATABASE DEVELOPMENT SERVICES; COMPUTER PROGRAMMING FOR OTHERS; DEVELOPING AND HOSTING OF WEB SITES FOR OTHERS ON A GLOBAL INFORMATION NETWORK (U.S. CLS. 100 AND 101).

SN 76-185,672. SPELL C. LLC, VAN NUYS, CA. FILED 12-20-2000.

CHEROKEE

OWNER OF U.S. REG. NOS. 373,836, 1,708,195 AND OTHERS.

CLASS 9—ELECTRICAL AND SCIENTIFIC APPARATUS

FOR COMPACT DISC PLAYERS, COMPACT DISC RECORDERS, MINI DISC PLAYERS, MINI DISC RECORDERS, CASSETTE PLAYERS, MICRO-CASSETTE RECORDERS, RADIOS, STEREO RECEIVERS, STEREO TUNERS, PHONOGRAPHS, AUDIO SPEAKERS, HEADPHONES, BLANK COMPACT DISCS, BLANK MINI DISCS, BLANK CASSETTE TAPES, COMPACT DISC CLEANING KITS COMPRISED OF DISC CLEANERS AND CLEANING SOLUTION, SPEAKER CABLES, STEREO CABLES; BLANK VIDEO CASSETTE TAPES, BLANK DVD DISCS, DVD DISC CLEANING KITS COMPRISED OF DISC CLEANERS AND CLEANING SOLUTION, VIDEO CAMERAS, CAMCORDERS, CAMERAS; HAND HELD COMPUTERS; CALCULATORS; AUTOMOTIVE STEREOs, CAR AMPLIFIERS; PERSONAL COMPUTERS, COMPUTER HARD DRIVES, COMPUTER MONITORS, COMPUTER KEYBOARDS, COMPUTER MOUSE, BLANK CD-ROMS, MODEMS, COMPUTER PRINTERS, OPTICAL SCANNERS, DIGITAL CAMERAS FOR THE COMPUTER, ELECTRONIC ORGANIZERS; TELEPHONE CORDS, TELEPHONE HEADSETS, CELLULAR PHONES, CALLER ID BOXES, TELEPHONE ANSWERING MACHINES AND VOICEMAIL SYSTEMS COMPRISED OF HARDWARE AND GENERAL USE INTERACTIVE COMPUTER SOFTWARE FOR ANSWERING AND ROUTING TELEPHONE CALLS, FOR RECORDING, SAVING AND RELAYING MESSAGES AND FOR PAGING THE USER, FOR USE BY TELEPHONE USERS, FACSIMILE MACHINES, CELLULAR PHONES, CELLULAR PHONE CAR JACKS AND CELLULAR PHONE CASES; TWO-WAY RADIOS; WIRELESS MODEMS, POWER INVERTERS; EMERGENCY WEATHER ALERT WARNING RADIOS, SATELLITE NAVIGATIONAL SYSTEM, NAMELY, GLOBAL POSITIONING SYSTEMS; AVALANCHE BEACONS; RADIO SCANNERS, RADAR DETECTORS; ELECTRONIC SECURITY SYSTEMS COMPRISED OF ANTI-INTRUSION ALARMS; BLANK RECORDING DISCS; CASH REGISTERS, CALCULATORS, DATA PROCESSORS; FIRE EXTINGUISHERS; 12-VOLT ELECTRONIC ACCESSORIES DESIGNED FOR SPECIFIC USE WITH THE ELECTRICAL SYSTEM OF AUTOMOBILES, TRUCKS, RECREATIONAL VEHICLES AND MOTORCYCLES, NAMELY, 12-VOLT ADAPTERS (U.S. CLS. 21, 23, 26, 36 AND 38).

CLASS 11—ENVIRONMENTAL CONTROL APPARATUS

FOR 12-VOLT ELECTRONIC ACCESSORIES DESIGNED FOR SPECIFIC USE WITH THE ELECTRICAL SYSTEM OF AUTOMOBILES, TRUCKS, RECREATIONAL VEHICLES AND MOTORCYCLES, NAMELY, 12-VOLT PORTABLE STOVES, 12-VOLT COFFEE MAKERS, 12-VOLT BEVERAGE HEATERS, 12-VOLT MINI COOLERS AND WARMERS, AND 12-VOLT LIGHTS (U.S. CLS. 13, 21, 23, 31 AND 34).

SN 76-186,416. POLTTIMO YHTIOT OY, LAHTI, FINLAND, BY CHANGE OF NAME OY LAHDEN POLTTIMO AB, LAHTI, FINLAND, FILED 12-27-2000.

MALTAZYME

OWNER OF U.S. REG. NO. 1,878,261.

CLASS 30—STAPLE FOODS

FOR MALT EXTRACTS FOR FOOD; MALT EXTRACTS USED FOR FLAVORING (U.S. CL. 46).

CLASS 31—NATURAL AGRICULTURAL PRODUCTS

FOR MALT FOR BREWING AND DISTILLING (U.S. CLS. 1 AND 46).

CLASS 32—LIGHT BEVERAGES

FOR MALT SYRUP FOR BEVERAGES (U.S. CLS. 45, 46 AND 48).

SN 76-186,584. PREMIER TECH LTD., RIVIERE-DU-LOUP, QUEBEC, CANADA, FILED 12-27-2000.

PREMIER TECH**CLASS 1—CHEMICALS**

FOR FERTILIZER, NAMELY, NATURAL GROWING STIMULANTS AND BIOLOGICAL PRODUCTS FOR HORTICULTURAL AND AGRICULTURAL USE THAT ENHANCE PLANT GROWTH AND DISEASE RESISTANCE AS WELL AS IMPROVE HORTICULTURAL AND AGRICULTURAL PRODUCTION (U.S. CLS. 1, 5, 6, 10, 26 AND 46).

FIRST USE 2-0-1995; IN COMMERCE 9-0-1996.

CLASS 7—MACHINERY

FOR PACKAGING MACHINES NAMELY MIXING LINES, DOSING, BAGGING, BAILING, PALLETIZING, WRAPPING, MATERIAL HANDLING, FIBC (FLEXIBLE INTERMEDIATE BULK CONTAINER) HANDLING EQUIPMENT AND CONVEYING SYSTEMS COMPOSED OF CONVEYORS AND CONVEYOR BELTS FOR FIBROUS, GRANULAR AND POWDER MATERIALS (U.S. CLS. 13, 19, 21, 23, 31, 34 AND 35).

FIRST USE 9-0-1989; IN COMMERCE 2-0-1990.

CLASS 11—ENVIRONMENTAL CONTROL APPARATUS

FOR WATER TREATMENT SYSTEMS COMPRISED OF SEPTIC TANKS, TREATMENT APPARATUS, DISTRIBUTION APPARATUS, EFFLUENT FILTERS, PUMPING STATIONS, DOSING APPARATUS AND FILTRATION DEVICES FOR WASTEWATER, STORM WATER AND POTABLE WATER FOR DOMESTIC, COMMERCIAL AND INDUSTRIAL USE (U.S. CLS. 13, 21, 23, 31 AND 34).

FIRST USE 3-0-1994; IN COMMERCE 0-0-1995.

SN 76-187,747. CORECOMM LIMITED, NEW YORK, NY, FILED 12-28-2000.

COREPACK

OWNER OF U.S. REG. NOS. 2,298,500, 2,306,369 AND 2,426,382.

CLASS 36—INSURANCE AND FINANCIAL

FOR ELECTRONIC PAYMENT, NAMELY, ELECTRONIC PROCESSING AND TRANSMISSION OF BILL PAYMENT DATA (U.S. CLS. 100, 101 AND 102).

CLASS 38—COMMUNICATION

FOR CUSTOMIZED TELECOMMUNICATIONS SERVICES, NAMELY, PROVIDING BUNDLED MULTIPLE USER ACCESS TO THE INTERNET, E-MAIL, LOCAL AND LONG DISTANCE SERVICES AND WIRELESS (U.S. CLS. 100, 101 AND 104).

SN 76-188,270. BLUE SEAL FEEDS, INC., LONDONDERRY, NH. FILED 12-26-2000.



OWNER OF U.S. REG. NOS. 1,038,270, 1,998,293 AND OTHERS.

NO CLAIM IS MADE TO THE EXCLUSIVE RIGHT TO USE "PET FOODS & ANIMAL FEEDS SINCE 1868", APART FROM THE MARK AS SHOWN.

CLASS 5—PHARMACEUTICALS

FOR HOUSE MARK FOR MEDICATED LIVESTOCK AND POULTRY FEEDS, AND FOR MEDICATED AND NONMEDICATED NUTRITIONAL FEED SUPPLEMENTS FOR LIVESTOCK AND POULTRY (U.S. CLS. 6, 18, 44, 46, 51 AND 52).

CLASS 31—NATURAL AGRICULTURAL PRODUCTS

FOR HOUSE MARK FOR ANIMAL FEEDS FOR A WIDE VARIETY OF FARM AND ZOOLOGICAL ANIMALS, DOG FOOD, DOG BISCUITS, CAT FOOD, HORSE TREATS, RABBIT FEED, BIRD SEED, GRASS SEED AND SEED TO GROW FARM FORAGE (U.S. CLS. 1 AND 46).

SN 76-188,444. P.T. SARI INCOFOOD CORPORATION, SUMATERA UTARA, INDONESIA, FILED 1-2-2001.



OWNER OF INDONESIA REG. NO. 338967, DATED 7-7-1995, EXPIRES 6-23-2003.

NO CLAIM IS MADE TO THE EXCLUSIVE RIGHT TO USE "COCOA", APART FROM THE MARK AS SHOWN.

CLASS 29—MEATS AND PROCESSED FOODS

FOR SHRIMP (U.S. CL. 46).

CLASS 30—STAPLE FOODS

FOR COFFEE, TEA, CACAO, SUGAR, INSTANT COFFEE, CANDY, HONEY, YEAST, BAKING POWDER, SALT, MUSTARD, VINEGAR, SPICES AND ICE (U.S. CL. 46).

SN 76-188,509. R & B REALTY GROUP, DBA OAKWOOD WORLDWIDE, LOS ANGELES, CA. FILED 12-28-2000.

A WORLD OF DIFFERENCE

CLASS 36—INSURANCE AND FINANCIAL

FOR LEASING AND RENTAL OF APARTMENTS (U.S. CLS. 100, 101 AND 102).

FIRST USE 10-25-1999; IN COMMERCE 12-28-2000.

CLASS 42—SCIENTIFIC, COMPUTER AND LEGAL SERVICES

FOR APARTMENT CONCIERGE SERVICES (U.S. CLS. 100 AND 101).

FIRST USE 10-25-1999; IN COMMERCE 12-28-2000.

SN 76-188,745. ONESTOP SHOP, INC., CHICAGO, IL. FILED 1-2-2001.

HOME POWERFILE

NO CLAIM IS MADE TO THE EXCLUSIVE RIGHT TO USE "HOME", APART FROM THE MARK AS SHOWN.

CLASS 35—ADVERTISING AND BUSINESS

FOR MANAGING INFORMATION ON ONE'S HOME, NAMELY, STORING AND ENABLING ACCESS TO WARRANTIES, HOME CONTENT, MAINTENANCE, DECORATING, HOME MANAGEMENT, HOME MANAGEMENT TOOLS, RELATIONSHIPS WITH SERVICE PEOPLE AND HOME ENHANCEMENT; AND FOR PROVIDING OTHER INTERNET SERVICES, NAMELY, CALENDAR, E-MAIL AND TASK MANAGEMENT (U.S. CLS. 100, 101 AND 102).

CLASS 38—COMMUNICATION

FOR ELECTRONIC MAIL SERVICE (U.S. CLS. 100, 101 AND 104).

CLASS 39—TRANSPORTATION AND STORAGE

FOR MANAGING INFORMATION ON ONE'S HOME, NAMELY, THE ELECTRONIC STORAGE OF DATA IN THE NATURE OF WARRANTIES, HOME CONTENT, MAINTENANCE RECORDS, DECORATING RECORDS, HOME MANAGEMENT RECORDS, LEGAL DOCUMENTS, INSURANCE PAPERS, SERIAL NUMBERS, WARRANTY DATA, PAINT CHIPS AND CARPET SAMPLES (U.S. CLS. 100 AND 105).

CLASS 42—SCIENTIFIC, COMPUTER AND LEGAL SERVICES

FOR ON-LINE COMPUTER SERVICES, NAMELY CUSTOM PERSONALIZATION OF TIME AND TASK MANAGEMENT PLANNERS AND CALENDARS AND DATA RECOVERY SERVICES (U.S. CLS. 100 AND 101).

SN 76-189,600. MUSICMATCH, INC., SAN DIEGO, CA.
FILED 1-2-2001.

SN 76-190,029. FATHER FLANAGAN'S BOYS' HOME, BOYS
TOWN, NE. FILED 1-5-2001.

NO DRAWING-SENSORY MARK



THE MUSICMATCH STARTUP SOUND CONSISTS OF A 4.4 SECOND MUSICAL PHRASE. THE TIME SIGNATURE OF THE PHRASE IS 4/4 WITH AN APPROXIMATE TEMPO OF 80 BPM. THE PHRASE STARTS WITH A PIANISSIMO STRING CHORD WHOSE MAIN KEYS ARE C5, F#5, AND G5. THE CHORD CRESCENDOS TO FORTE IN .8 SECONDS AT WHICH TIME A 60-80HZ BASS NOTE HITS. THE BASS NOTE IS SUSTAINED FOR .8 SECONDS. OVERLYING THE STRING CHORD ARE SYNTHESIZED PIZZICATO 1/8TH NOTE TRIPLETS BEGINNING AT .4 SECONDS AND ENDING AT -1.2 SECONDS. THE SEQUENCE OF NOTES IS D7, C7, A6, G6. WHILE THE BASS NOTE IS SUSTAINED (-1 SECOND MARKER) THE STRING SOUND, MENTIONED PREVIOUSLY, CHANGES TO AN A MAJOR CHORD. USING THE SAME STRING SOUND, UNDERLYING THE A MAJOR CHORD IS A SEQUENCE OF 1/8 TH NOTES. THE SEQUENCE IS F#4, E4, A4. FINALLY, USING A SYNTHESIZED PIZZICATO SOUND, TWO QUARTER NOTES ARE SOUNDED. THE QUARTER NOTE TONES AND SECOND MARKERS ARE, A4 AT 1.8 SECONDS AND D5 AT 2.8 SECONDS, RESPECTIVELY. THE SOUND FADES TO ZERO VOLUME STARTING AT 3.5 SECONDS AND ENDING AT 4.4 SECONDS.

CLASS 9—ELECTRICAL AND SCIENTIFIC APPARATUS

FOR COMPUTER SOFTWARE FOR FACILITATING ANALYSIS OF MUSICAL PREFERENCES AND INTERESTS, PROVIDING, STORING AND ORGANIZING MUSICAL RECORDINGS AND SELECTIONS, DOWNLOADING, RECORDING AND PLAYING OF MUSIC SAMPLES AND FULL RECORDINGS, AND PROVIDING ACCESS TO SITES ON A GLOBAL COMPUTER NETWORK (U.S. CLS. 21, 23, 26, 36 AND 38).

CLASS 35—ADVERTISING AND BUSINESS

FOR ONLINE ORDERING IN THE FIELD OF MUSIC SAMPLES AND FULL RECORDINGS; ONLINE RETAIL STORES FEATURING SOUND RECORDINGS; ONLINE RETAIL SERVICES IN THE FIELD OF MUSIC FEATURING ANALYSIS OF MUSICAL PREFERENCES AND INTERESTS OF WEBSITE USERS AND PROVISION OF MUSICAL RECORDINGS AND SELECTIONS THAT ALLOWS USERS TO DOWNLOAD AND PLAYBACK MUSIC SAMPLES AND FULL RECORDINGS AND PROVIDES ACCESS TO OTHER WEBSITES (U.S. CLS. 100, 101 AND 102).

CLASS 41—EDUCATION AND ENTERTAINMENT

FOR PROVIDING INFORMATION ON MUSIC RELEASES, REVIEWS, CONCERTS, CONCERT TOURS, MUSICAL ARTISTS, THE MUSIC INDUSTRY, AND RECORDING AND PLAYBACK EQUIPMENT; PROVIDING INFORMATION ABOUT MUSIC BASED ON PERSONAL PREFERENCES BY MEANS OF ANALYSIS OF MUSICAL PREFERENCES AND INTERESTS OF WEBSITE USERS (U.S. CLS. 100, 101 AND 107).

OWNER OF U.S. REG. NOS. 1,334,772, 2,019,149 AND 2,286,522.

NO CLAIM IS MADE TO THE EXCLUSIVE RIGHT TO USE "GIRLS", APART FROM THE MARK AS SHOWN. SEC. 2(F) AS TO "BOYS".

CLASS 41—EDUCATION AND ENTERTAINMENT

FOR EDUCATIONAL SERVICES, NAMELY CONDUCTING WORKSHOPS, CONFERENCES, SEMINARS OR CLASSES IN THE FIELDS OF SOCIAL BEHAVIOR, JUVENILE CARE, TEACHING AND PARENTING; CONDUCTING GENERAL CLASSROOM INSTRUCTION FOR BOYS AND GIRLS AT THE PRIMARY AND SECONDARY LEVELS; RESEARCH, INFORMATION AND CONSULTATION SERVICES IN THE FIELD OF TEACHING (U.S. CLS. 100, 101 AND 107).

FIRST USE 8-24-2000; IN COMMERCE 8-24-2000.

CLASS 42—SCIENTIFIC, COMPUTER AND LEGAL SERVICES

FOR BEHAVIORAL TREATMENT SERVICES FOR YOUTH; JUVENILE CUSTODIAL CARE SERVICES, PROVIDING HOMES AND EMERGENCY SHELTERS FOR CHILDREN; CHARITABLE OUTREACH SERVICES FOR YOUTH AND FAMILIES; RESEARCH, INFORMATION AND CONSULTATION SERVICES IN THE FIELDS OF SOCIAL BEHAVIOR, JUVENILE CARE, NAMELY, HEALTH CARE AND PARENTING; YOUTH AND FAMILY COUNSELING SERVICES; DEVELOPMENT OF JUVENILE CARE, DEVELOPMENT AND EDUCATIONAL PROGRAMS FOR USE BY OTHERS (U.S. CLS. 100 AND 101).

FIRST USE 8-24-2000; IN COMMERCE 8-24-2000.

SN 76-193,601. PERRY SLINGSBY SYSTEMS, INC., JUPITER, FL. FILED 1-16-2001.

SLINGSBY

PRIORITY CLAIMED UNDER SEC. 44(D) ON UNITED KINGDOM APPLICATION NO. 2242305, FILED 8-11-2000, REG. NO. 2242305, DATED 3-30-2001, EXPIRES 8-11-2010.

CLASS 12—VEHICLES

FOR COMMERCIAL UNDERWATER EQUIPMENT, NAMELY, REMOTELY OPERATED UNDERWATER VEHICLES, SUBMARINE VEHICLES IN THE NATURE OF RESCUE SUBMERSIBLES, SUBMARINE VEHICLES IN THE NATURE OF TRENCHERS, SUBMARINE VEHICLES IN THE NATURE OF PLOWS; COMMERCIAL UNDERWATER EQUIPMENT, NAMELY, REMOTELY OPERATED UNDERWATER VEHICLES, SUBMARINE VEHICLES IN THE NATURE OF RESCUE SUBMERSIBLES, SUBMARINE VEHICLES IN THE NATURE OF TRENCHERS, SUBMARINE VEHICLES IN THE NATURE OF PLOWS WITH OPERATING CONTROLS SOLD AS A UNIT THEREWITH, AND COMPONENT PARTS THEREFOR; BUT NOT INCLUDING ANY EQUIPMENT SUPPLIED TO THE UNITED STATES GOVERNMENT (U.S. CLS. 19, 21, 23, 31, 35 AND 44).

CLASS 42—SCIENTIFIC, COMPUTER AND LEGAL SERVICES

FOR ENGINEERING SERVICES, MARINE ENGINEERING, ENGINEERING, DESIGN OF COMMERCIAL UNDERWATER EQUIPMENT, ELECTRONIC CONTROL SYSTEMS THEREFOR, ELECTRONIC CONTROL SYSTEM SOFTWARE, AND SYSTEM MANUALS FOR OTHERS, ENGINEERING CONSULTANCY SERVICES, MARINE EXPLORATION, MARINE SURVEYING SERVICES, INSPECTION OF MARINE INSTALLATIONS (U.S. CLS. 100 AND 101).

SN 76-194,197. KOLEY'S, INC., OMAHA, NE. FILED 1-16-2001.



THE MARK CONSISTS OF THE LETTER "K" IN A CIRCLE WITH A BUNCH OF GRAPES ADORNING THE LEFT SIDE OF THE LETTER "K" AND TWO SHAFTS OF WHEAT ADORNING THE RIGHT SIDE OF THE LETTER "K".

CLASS 14—JEWELRY

FOR PRECIOUS METAL EQUIPMENT AND ACCESSORIES USED IN RELIGIOUS CEREMONIES, NAMELY CENSOR STANDS, BANNER STANDS, CHALICES, TABERNACLES, ADVENT WREATHS AND COMBINATION WREATHS, CRUCIFIXES, CANDLESTICKS, SANCTUARY APPOINTMENTS, ECCLESIASTICAL APPOINTMENTS, CANDLE HOLDERS, CANDELABRAS, VASES, VOTIVES, VOTIVE STANDS, SANCTUARY LAMP ACCESSORIES, HOLY WATER CONTAINERS, BAPTISMAL WATER CONTAINERS, BISHOP OIL STOCKS, CLERGY GIFTS, LITURGICAL SETS, OIL STOCKS, HOST BOXES, BURSE-PYX-OIL STOCK AND BREVIARY CASES, STATIONS, AMBRY, COLLECTION BASKETS, COMMUNION ITEMS, CIBORIA, ALTAR SETS, CANDLE LIGHTERS, BELLS, ANGELIC FIGURINES, NATIVITY SETS, SIGNS, CASES, CRUETS, BASINS, ALL MADE OF SILVER, STERLING SILVER, AND GOLD AND SILVER PLATING (U.S. CLS. 2, 27, 28 AND 50).

FIRST USE 0-0-1920; IN COMMERCE 0-0-1920.

CLASS 40—MATERIAL TREATMENT

FOR CUSTOM MANUFACTURING AND PLATING OF RELIGIOUS CEREMONIAL EQUIPMENT AND ACCESSORIES MADE OF BRASS, BRONZE, SILVER, STERLING SILVER, ALUMINUM, STAINLESS STEEL, CRYSTAL, LEATHER, OR PLATED WITH GOLD, SILVER, COPPER, NICKEL OR BRASS (U.S. CLS. 100, 103 AND 106).

FIRST USE 0-0-1920; IN COMMERCE 0-0-1920.

SN 76-193,794. CADOS, DIMITRI, ORINDA, CA. FILED 1-12-2001.

SUNPOWER

CLASS 29—MEATS AND PROCESSED FOODS

FOR PREPACKAGED MIDDLE EASTERN AND MEDITERRANEAN FOODS, NAMELY, FALAFEL MIX, HUMMUS MIX, TAHINI DIP, BABAGANOSH, SOUPS, AND VEGETABLE BURGERS (U.S. CL. 46).

CLASS 30—STAPLE FOODS

FOR RICE PILAFS, PASTA PILAFS, PITA BREAD, TABBOULEH, AND VEGETARIAN GYRO SANDWICHES, COUSCOUS, AND DESERTS CONSISTING OF WHOLE GRAINS, SEEDS, SPICES, AND HONEY (U.S. CL. 46).

SN 76-195,839. H.C. KONIG GESELLSCHAFT MBH, 5022 SALZBURG, AUSTRIA, FILED 1-18-2001.

DOZZER

OWNER OF AUSTRIA REG. NO. 191632, DATED 10-18-2000, EXPIRES 10-31-2010.

CLASS 32—LIGHT BEVERAGES

FOR MINERAL AND AERATED WATERS AND OTHER NON-ALCOHOLIC DRINKS, NAMELY, FRUIT DRINKS AND FRUIT JUICES; SYRUPS AND OTHER PREPARATIONS FOR MAKING BEVERAGES, NAMELY CONCENTRATES AND POWDERS (U.S. CLS. 45, 46 AND 48).

CLASS 33—WINES AND SPIRITS

FOR ALCOHOLIC BEVERAGES, EXCEPT BEERS, NAMELY, SPIRITS AND LIQUEURS (U.S. CLS. 47 AND 49).

CLASS 31—NATURAL AGRICULTURAL PRODUCTS

FOR SPRAY DRIED PHYTOPLANKTON USED AS A FOOD FOR MARINE INVERTEBRATES (U.S. CLS. 1 AND 46).

FIRST USE 8-17-2001; IN COMMERCE 8-17-2001.

SN 76-196,705. QIAGEN GMBH, D-40724 HILDEN, FED REP GERMANY, FILED 1-17-2001.

QUANTITECT

PRIORITY CLAIMED UNDER SEC. 44(D) ON FED REP GERMANY APPLICATION NO. 30065968.7/0, FILED 9-2-2000, REG. NO. 30065968, DATED 5-18-2001, EXPIRES 9-30-2010.

SN 76-197,999. MERCURY INTERACTIVE CORPORATION, SUNNYVALE, CA. FILED 1-23-2001.

CLASS 1—CHEMICALS

FOR CHEMICALS USED IN SCIENCE, NAMELY, BUFFER SOLUTIONS, ENZYMES AND DYES USED IN THE CHEMICAL, MEDICAL, PHARMACEUTICAL, BIO-CHEMICAL AND FOOD AND BEVERAGE INDUSTRIES FOR PERFORMING PCR ANALYSES ESPECIALLY OLIGONUCLEOTIDES, BUFFER SOLUTIONS, LABELED OLIGONUCLEOTIDES, DEOXYNUCLEOSIDES, DYES FOR DIAGNOSTIC AND RESEARCH USE, KITS CONTAINING PRIMARILY OF CHEMICALS FOR PERFORMING PCR ANALYSES, ESPECIALLY OLIGONUCLEOTIDES, BUFFER SOLUTIONS, LABELED OLIGONUCLEOTIDES, DEOXYNUCLEOSIDES FOR DIAGNOSTIC AND RESEARCH USE (U.S. CLS. 1, 5, 6, 10, 26 AND 46).

**LOADRUNNER
TESTCENTER**

OWNER OF U.S. REG. NO. 1,899,704.

NO CLAIM IS MADE TO THE EXCLUSIVE RIGHT TO USE "TESTCENTER", APART FROM THE MARK AS SHOWN.

CLASS 5—PHARMACEUTICALS

FOR CHEMICAL PREPARATIONS FOR CLINICAL OR MEDICAL LABORATORY USE, NAMELY, CHEMICALS FOR PERFORMING PCR ANALYSES ESPECIALLY OLIGONUCLEOTIDES, BUFFER SOLUTIONS, LABELED OLIGONUCLEOTIDES, DEOXYNUCLEOSIDES, DYES; DIAGNOSTIC KITS CONSISTING PRIMARILY OF DIAGNOSTIC PREPARATIONS FOR CLINICAL OR MEDICAL LABORATORY USE, ESPECIALLY CHEMICALS FOR PERFORMING PCR ANALYSES, ESPECIALLY OLIGONUCLEOTIDES, BUFFER SOLUTIONS, LABELED OLIGONUCLEOTIDES, DEOXYNUCLEOSIDES, DYES (U.S. CLS. 6, 18, 44, 46, 51 AND 52).

CLASS 9—ELECTRICAL AND SCIENTIFIC APPARATUS

FOR COMPUTER SOFTWARE, NAMELY, SOFTWARE FOR DEVELOPING DESIGNING, MAINTAINING, MONITORING, ANALYZING, EVALUATING, SCANNING, MAPPING, REPAIRING, DEBUGGING, AND INTERACTING WITH OTHER COMPUTER APPLICATIONS, PRIVATE INTRANETS, EXTRANETS, INTERNET SITES, WEB SITES, CLIENT-SERVER SYSTEMS, CONTENT DISTRIBUTION SITES, NETWORKS, APPLICATION SERVERS, WEB SERVERS AND DATABASE SERVERS AND OTHER MULTI-USER COMPUTER SYSTEMS; SOFTWARE FOR PREDICTING SYSTEM PERFORMANCE AND SCALABILITY; SOFTWARE FOR COLLECTING, MANAGING, AND REPORTING SYSTEM PERFORMANCE DATA OF OTHER COMPUTER APPLICATIONS OR PROGRAMS, PRIVATE INTRANETS, EXTRANETS, INTERNET SITES, WEB SITES, CLIENT-SERVER SYSTEMS, CONTENT DISTRIBUTION SITES, NETWORKS, APPLICATION SERVERS, WEB SERVERS AND DATABASE SERVERS AND OTHER MULTI-USER COMPUTER SYSTEMS OR NETWORK-BASED SYSTEMS; COMPUTER SOFTWARE FOR NOTIFYING OPERATORS OF PRIVATE INTRANETS, EXTRANETS, INTERNET SITES, WEB SITES, CLIENT-SERVER SYSTEMS, CONTENT DISTRIBUTION SITES, APPLICATION SERVERS, WEB SERVERS, DATABASE SERVERS AND OTHER MULTI-USER COMPUTER SYSTEMS AND OTHER SYSTEM OPERATORS OF PERFORMANCE PROBLEMS (U.S. CLS. 21, 23, 26, 36 AND 38).

CLASS 9—ELECTRICAL AND SCIENTIFIC APPARATUS

FOR SCIENTIFIC INSTRUMENTS AND APPARATUS FOR PERFORMING AND EVALUATING POLYMERASE CHAIN REACTIONS, NAMELY AUTOMATIC THERMOSTATS, SPECTROMETERS (U.S. CLS. 21, 23, 26, 36 AND 38).

SN 76-197,824. TWO LITTLE FISHIES, INC., COCONUT GROVE, FL. FILED 1-22-2001.

PHYTOPLAN**CLASS 35—ADVERTISING AND BUSINESS**

FOR BUSINESS CONSULTATION SERVICES; BUSINESS MANAGEMENT AND CONSULTING SERVICES REGARDING MONITORING THE PERFORMANCE OF MULTI-USER SYSTEMS; BUSINESS MANAGEMENT AND CONSULTING SERVICES, NAMELY, PREPARATION OF BUSINESS REPORTS; PREPARATION OF BUSINESS REPORTS AND BUSINESS INFORMATION VIA A GLOBAL COMPUTER NETWORK (U.S. CLS. 100, 101 AND 102).

CLASS 5—PHARMACEUTICALS

FOR NUTRITIONAL ADDITIVE FOR USE IN PREPARING FISH FEEDS (U.S. CLS. 6, 18, 44, 46, 51 AND 52). FIRST USE 8-17-2001; IN COMMERCE 8-17-2001.

CLASS 42—SCIENTIFIC, COMPUTER AND LEGAL SERVICES

FOR COMPUTER SERVICES FOR OTHERS, NAMELY DEVELOPING, DESIGNING, MAINTAINING, MONITORING, ANALYZING, EVALUATING, SCANNING, MAPPING, REPAIRING, DEBUGGING, AND INTERACTING WITH NETWORK BASED APPLICATIONS, WEB SITES, AND OTHER CLIENT-SERVER SYSTEMS AND CONTENT DISTRIBUTION SITES, COMPUTER SERVICES FOR COLLECTING, MANAGING, PREDICTING AND REPORTING THE PERFORMANCE AND SCALABILITY OF NETWORK BASED APPLICATIONS, WEB SITES, AND OTHER CLIENT-SERVER SYSTEMS AND CONTENT DISTRIBUTION SITES, COMPUTER SERVICES FOR NOTIFYING WEBSITE OPERATORS AND OTHER SYSTEM OPERATORS OF PERFORMANCE AND CONNECTIVITY PROBLEMS; COMPUTER SERVICES FOR EVALUATING AND MONITORING THE PERFORMANCE AND USER CAPACITY OF NETWORK BASED APPLICATIONS, WEB SITES, AND OTHER CLIENT-SERVER SYSTEMS AND CONTENT DISTRIBUTION SITES, PROVIDING INFORMATION REGARDING THE PERFORMANCE OF MULTI-USER SYSTEMS; ON-LINE INFORMATION RETRIEVAL SERVICES REGARDING THE PERFORMANCE OF MULTI-USER SYSTEMS; DEVELOPING COMPUTER SOFTWARE FOR OTHERS; RESEARCH AND CONSULTATION SERVICES IN THE FIELD OF COMPUTER SOFTWARE (U.S. CLS. 100 AND 101).

SN 76-198,551. BLUETAGS A/S, 9000 AALBORG, DENMARK, FILED 1-24-2001.

BLUETAGS

PRIORITY CLAIMED UNDER SEC. 44(D) ON DENMARK APPLICATION NO. VA200003230, FILED 7-27-2000, REG. NO. VR200004681, DATED 10-16-2001, EXPIRES 10-16-2011.

CLASS 9—ELECTRICAL AND SCIENTIFIC APPARATUS

FOR COMPUTER HARDWARE AND COMPUTER SOFTWARE FOR TRACKING THE MOVEMENT AND STORAGE OF VARIOUS GOODS AND/OR PERSONS SUCH AS BAGGAGE, STORAGE CONTAINERS, CARS, BIKES, CYCLES, COMPUTERS, CHILDREN, ELDERLY PERSONS AND EMPLOYEES, OR FOR REGISTERING AND/OR NOTIFYING SUCH GOODS AND/OR PERSONS IN CONNECTION WITH THE MOVEMENT OR STORAGE OF SAID GOODS AND PERSONS (U.S. CLS. 21, 23, 26, 36 AND 38).

CLASS 18—LEATHER GOODS

FOR LEATHER AND IMITATION LEATHER SOLD IN BULK; ANIMAL SKINS AND HIDES; LUGGAGE TRUNKS AND TRAVEL BAGS; UMBRELLAS; PARASOLS AND WALKING STICKS; WHIPS; HARNESS STRAPS AND SADDLERY; AND PARTS FOR ALL THE AFOREMENTIONED GOODS (U.S. CLS. 1, 2, 3, 22 AND 41).

CLASS 38—COMMUNICATION

FOR TELECOMMUNICATIONS SERVICES, NAMELY, VOICEMAIL, SMS-MESSAGING, ELECTRONIC MAIL AND FACSIMILE TRANSMISSION (U.S. CLS. 100, 101 AND 104).

CLASS 42—SCIENTIFIC, COMPUTER AND LEGAL SERVICES

FOR PROGRAMMING OF COMPUTERS AND INTEGRATED CIRCUITS; CUSTOM DESIGN AND MAINTENANCE OF COMPUTER SOFTWARE (U.S. CLS. 100 AND 101).

SN 76-199,051. SKW TROSTBERG AG, D-83308 TROSTBERG, FED REP GERMANY, FILED 1-24-2001.

SKW METALLURGICAL

OWNER OF U.S. REG. NOS. 1,848,011 AND 1,945,949. NO CLAIM IS MADE TO THE EXCLUSIVE RIGHT TO USE "METALLURGICAL", APART FROM THE MARK AS SHOWN.

CLASS 1—CHEMICALS

FOR CHEMICALS USED IN INDUSTRY, NAMELY, INORGANIC BASIC CHEMICALS IN THE FORM OF CALCIUM CARBIDE AND SILICON NITRIDE; CHEMICAL PRODUCTS FOR THE IRON AND STEEL INDUSTRY, IN PARTICULAR AGENTS FOR THE DESULFURIZATION OF CRUDE IRON AND STEEL MELTS BASED ON CALCIUM CARBIDE AND/OR MAGNESIUM; NON-METAL CONTINUOUS CASTING POWERS FOR USE IN THE MANUFACTURE OF STEEL (U.S. CLS. 1, 5, 6, 10, 26 AND 46).

CLASS 6—METAL GOODS

FOR FILLING WIRES FOR THE TREATMENT OF REFINING OF STEEL MELTS AS WELL AS FOR INOCULATION AND FOR THE MAGNESIUM TREATMENT OF CAST IRON MELTS; CHEMICAL AND METALLURGICAL PRODUCTS FOR THE STEEL AND FOUNDRY INDUSTRY, IN PARTICULAR FERRO ALLOYS AND SPECIAL ALLOYS FOR THE PRODUCTION OR REFINING OF STEEL, AS WELL AS INOCULATION AND TREATMENT ALLOYS FOR CAST IRON MELT (U.S. CLS. 2, 12, 13, 14, 23, 25 AND 50).

SN 76-199,054. RITZ CAMERA CENTERS, INC., BELTSVILLE, MD. BY ASSIGNMENT WOLF CAMERA, INC., ALPHARETTA, GA. FILED 1-24-2001.

WOLFCAMERA.COM**CLASS 40—MATERIAL TREATMENT**

FOR FILM PROCESSING, PHOTO FINISHING, PHOTO DEVELOPING, AND PHOTOGRAPHIC ENLARGEMENT (U.S. CLS. 100, 103 AND 106).
FIRST USE 7-27-1995; IN COMMERCE 7-27-1995.

CLASS 41—EDUCATION AND ENTERTAINMENT

FOR RETAIL STORE SERVICES FEATURING PHOTOGRAPHIC AND DIGITAL EQUIPMENT AND ACCESSORIES IN THE FORM OF CAMERAS, CAMCORDERS, LENSES, FILM, SCANNERS, PRINTERS, FIELD SCOPES, CAMERA BAGS, FLASHES, STRAPS, TRIPODS, PHOTO ALBUMS, FINDS, GRIPS AND MAGNIFIERS; MAIL ORDER CATALOG SERVICES FEATURING PHOTOGRAPHIC AND DIGITAL EQUIPMENT AND ACCESSORIES IN THE FORM OF CAMERAS, CAMCORDERS, LENSES, FILM, SCANNERS, PRINTERS, FIELD SCOPES, CAMERA BAGS, FLASHES, STRAPS, TRIPODS, PHOTO ALBUMS, FINDS, GRIPS AND MAGNIFIERS; COMPUTERIZED ON-LINE ORDERING AND RETAIL SERVICES VIA A GLOBAL COMPUTER NETWORK FEATURING THE RETAIL DISTRIBUTION OF PHOTOGRAPHIC AND DIGITAL EQUIPMENT AND ACCESSORIES IN THE FORM OF CAMERAS, CAMCORDERS, LENSES, FILM, SCANNERS, PRINTERS, FIELD SCOPES, CAMERA BAGS, FLASHES, STRAPS, TRIPODS, PHOTO ALBUMS, FINDS, GRIPS AND MAGNIFIERS (U.S. CLS. 100, 101 AND 107).

FIRST USE 7-27-1995; IN COMMERCE 7-27-1995.

SN 76-199,286. BAE SYSTEMS PLC, HAMPSHIRE, GREAT BRITAIN, FILED 1-25-2001.

CABINCALL

PRIORITY CLAIMED UNDER SEC. 44(D) ON GREAT BRITAIN APPLICATION NO. 2241610, FILED 8-4-2000.

CLASS 9—ELECTRICAL AND SCIENTIFIC APPARATUS

FOR MOBILE TELEPHONES, MOBILE FACSIMILES, ALL INCORPORATING RADIO APPARATUS AND ALL FOR USE ON AIRCRAFT; APPARATUS FOR HANDLING AND ROUTING AIRBORNE MOBILE TELEPHONE AND FACSIMILE MESSAGES, NAMELY INTERCOMS, ANSWERING MACHINES, ANTENNAE, COMPUTER FILE SERVERS, TRANSMITTERS, RECEIVERS, SIGNAL ROUTERS, SWITCHES, CHANNEL SELECTORS, MOBILE TELEPHONE SIGNAL DETECTORS, MOBILE TELEPHONE SIGNAL INHIBITORS, RADIO FREQUENCY PROTOCOL CONVERTERS, RADIO FREQUENCY SIGNAL EMISSION REDUCERS, HARDWARE AND SOFTWARE FOR HANDLING AND ROUTING AIRBORNE MOBILE TELEPHONE AND FACSIMILE MESSAGES; PARTS AND FITTINGS FOR ALL THE AFORESAID GOODS (U.S. CLS. 21, 23, 26, 36 AND 38).

CLASS 38—COMMUNICATION

FOR TELECOMMUNICATIONS SERVICES, NAMELY, AIRBORNE MOBILE TELEPHONE, FACSIMILE, VOICE AND DATA MESSAGE AND COMMUNICATION SENDING, HANDLING AND ROUTING SERVICES (U.S. CLS. 100, 101 AND 104).

SN 76-199,356. HEALTHMEDIA, INC., ANN ARBOR, MI. FILED 1-25-2001.



OWNER OF U.S. REG. NOS. 2,276,506, 2,324,542 AND 2,577,770.

CLASS 16—PAPER GOODS AND PRINTED MATTER

FOR PUBLICATIONS, NAMELY, PRINTED MATERIALS IN THE FIELDS OF WELLNESS, HEALTH PROMOTION, PREVENTATIVE HEALTH CARE, DISEASE MANAGEMENT, BEHAVIOR CHANGE, AND HEALTH RISK ASSESSMENT (U.S. CLS. 2, 5, 22, 23, 29, 37, 38 AND 50).

CLASS 42—SCIENTIFIC, COMPUTER AND LEGAL SERVICES

FOR COLLECTION AND ANALYSIS OF HEALTH, LIFESTYLE, AND PERSONAL INFORMATION AND CREATION OF PERSONAL GUIDES FOR USE BY INDIVIDUALS IN CONNECTION WITH THEIR OWN WELLNESS, PREVENTATIVE HEALTH CARE, DISEASE MANAGEMENT AND BEHAVIOR CHANGE, VIA THE GLOBAL COMPUTER NETWORK; AND COMPUTER SERVICES, NAMELY, PROVIDING ONLINE QUESTIONNAIRES, GUIDEBOOKS, SUPPLEMENTAL GUIDES, TAILORED FOLLOW-UP MATERIALS, AND NEWSLETTERS, ALL IN THE FIELDS OF WELLNESS, HEALTH PROMOTION, PREVENTATIVE HEALTH CARE, DISEASE MANAGEMENT, BEHAVIOR CHANGE, AND HEALTH RISK ASSESSMENT (U.S. CLS. 100 AND 101).

SN 76-199,514. PEROT SYSTEMS CORPORATION, DALLAS, TX. FILED 1-25-2001.

IDIAMOND

CLASS 35—ADVERTISING AND BUSINESS

FOR BUSINESS CONSULTING SERVICES FOR THE HEALTHCARE INDUSTRY (U.S. CLS. 100, 101 AND 102).

CLASS 42—SCIENTIFIC, COMPUTER AND LEGAL SERVICES

FOR PROGRAMMING, INSTALLING, AND MAINTAINING COMPUTER SOFTWARE IN THE FIELD OF HEALTHCARE FOR OTHERS; APPLICATION SERVICE PROVIDER (ASP) FEATURING SOFTWARE IN THE FIELD OF HEALTHCARE (U.S. CLS. 100 AND 101).

SN 76-199,704. INDELIQ, INC., NORTHBROOK, IL. BY CHANGE OF NAME PERFORMANCE LEARNING TECHNOLOGIES, INC., NEW YORK, NY. FILED 1-25-2001.

INDELIQ

CLASS 41—EDUCATION AND ENTERTAINMENT

FOR EDUCATIONAL SERVICES, NAMELY, PROVIDING ONLINE COURSES IN THE FIELDS OF BUSINESS MANAGEMENT, ELECTRONIC COMMERCE, MEDICINE, EDUCATION, ENGINEERING, LAW AND COMPUTER SCIENCE; DESIGNING AND IMPLEMENTING TRAINING AND CERTIFICATION PROGRAMS IN THE FIELDS OF BUSINESS MANAGEMENT, ELECTRONIC COMMERCE, MEDICINE, EDUCATION, ENGINEERING, LAW AND COMPUTER SCIENCE (U.S. CLS. 100, 101 AND 107).

CLASS 42—SCIENTIFIC, COMPUTER AND LEGAL SERVICES

FOR CONSULTING IN THE FIELD OF DESIGNING ONLINE TRAINING AND COMPUTER SIMULATION PROGRAMS (U.S. CLS. 100 AND 101).

SN 76-200,024. WESTINGHOUSE AIR BRAKE TECHNOLOGIES CORPORATION, WILMERDING, PA. FILED 1-25-2001.



CLASS 6—METAL GOODS

FOR CASTING ALLOYS, METAL PIPES AND FITTINGS THEREFOR (U.S. CLS. 2, 12, 13, 14, 23, 25 AND 50).

CLASS 7—MACHINERY

FOR INDUSTRIAL AND MARINE MACHINE ENGINES AND MOTORS; AND PARTS FOR INDUSTRIAL AND MARINE MACHINE ENGINES AND MOTORS, NAMELY, RADIATORS, ALTERNATORS, AIR COMPRESSORS, TURBOCHARGERS, COOLERS, PISTONS AND STRUCTURAL PARTS THEREOF (U.S. CLS. 13, 19, 21, 23, 31, 34 AND 35).

CLASS 9—ELECTRICAL AND SCIENTIFIC APPARATUS

FOR WATER LEVEL GAUGES; LOCOMOTIVE ELECTRONIC EQUIPMENT AND ELECTROMECHANICAL CONTROLS FOR USE IN PASSENGER AND FREIGHT RAIL CARS, LOCOMOTIVES AND BUSES, NAMELY—INVERTERS; POWER CONVERTERS; SWITCHES; EVENT RECORDERS; TRACTION AND EXCITATION CONTROL SYSTEMS COMPRISED PRIMARILY OF ELECTRICAL POWER SUPPLIES, APPLIED MICROPROCESSORS AND SOLID STATE ELECTRONICS, TRANSCIEVERS, TRANSDUCERS, SOLENOIDS AND SENSORS FOR CONTROLLING AND MONITORING TRAIN PROPULSION, BRAKING AND RAIL LUBRICATION; PASSENGER DOOR OPENING SYSTEMS, COMPRISED PRIMARILY OF ELECTRIC AND PNEUMATIC DOOR ACTUATORS, ELECTROMECHANICAL CONTROLS, DOOR PANELS, MECHANICAL LINKAGES AND MECHANICAL SEALS FOR USE IN BUSES AND RAIL PASSENGER CARS; MONITORING AND COMMUNICATIONS SYSTEMS, COMPRISED PRIMARILY OF AUTOMATIC MONITORS AND RECORDERS FOR DETECTING TRAIN PERFORMANCE, NAMELY— FUEL LEVEL AND CONSUMPTION, SPEED, BRAKING, ELECTRONIC AND MECHANICAL TRAIN INTEGRITY; END-OF-TRAIN PNEUMATIC VALVES THAT ALLOW LOCOMOTIVE ENGINEER TO OBSERVE BRAKE PRESSURES AT THE REAR OF TRAIN AND INITIATE BRAKE APPLICATIONS AT THAT LOCATION; AND DATA RADIOS THAT SUPPORT COMMUNICATION BETWEEN THE SYSTEMS; STRUCTURAL PARTS FOR ALL OF THE FORGOING; PARTS FOR LOCOMOTIVES, FREIGHT AND TRANSIT VEHICLES, NAMELY—POWER PACK ASSEMBLIES; CURRENT COLLECTORS; MANUAL AND AUTOMATED SINGLE CAR TEST EQUIPMENT, NAMELY— AUTOMATIC, MICROPROCESSOR-BASED SINGLE CAR TESTERS THAT PERFORM DIAGNOSTIC TESTS ON A RAIL CAR'S BRAKE SYSTEM TO DETERMINE THAT IT IS IN GOOD WORKING ORDER; AND HIGH VOLTAGE CABINETS AND CONTROL STANDS FOR LOCOMOTIVES; EMPTY/LOAD EQUIPMENT IN THE NATURE OF MECHANICAL AND PNEUMATIC SENSORS THAT SENSE THE DEGREE OF LOADING OF FREIGHT RAIL CARS AND

ADJUST THE APPLIED BRAKING FORCE TO PROPERLY COMPENSATE FOR RAIL CAR LOADING (U.S. CLS. 21, 23, 26, 36 AND 38).

CLASS 11—ENVIRONMENTAL CONTROL APPARATUS

FOR AIR CONDITIONERS; REFRIGERATORS; WATER COOLERS; TEMPERATURE PROTECTION SYSTEMS FOR HOLDING TANKS, TREATMENT TANKS AND PIPING, COMPRISED PRIMARILY OF— HEATING PADS; INSULATION; SELF LIMITING HEATING CABLES THAT REACT TO TEMPERATURE TO VARY OUTPUT OF HEAT; CONTROLLED HEATING CIRCUITS THAT MONITOR AMBIENT AND SURFACE TEMPERATURE; HEAT VALVES THAT OPEN WHEN COLD TEMPERATURE IS SENSED TO DRAIN LIQUID BEFORE FREEZING TO PREVENT DAMAGE TO PLUMBING; THE FOREGOING ALL FOR USE IN RAIL CARS AND BUSES; AIR DRYERS AND AFTERCOOLERS FOR CONDITIONING COMPRESSED AIR SUPPLY OF LOCOMOTIVES (U.S. CLS. 13, 21, 23, 31 AND 34).

CLASS 12—VEHICLES

FOR LOCOMOTIVES; MOTORS FOR LOCOMOTIVES, AND FREIGHT AND TRANSIT RAIL CARS, AND PARTS FOR ALL OF THE FORGOING, NAMELY— AXLE GEARS; PINION GEARS; DRAFT GEARS; SPHERICAL CONNECTORS FOR LINKING TWO INDEPENDENT FREIGHT CAR SEGMENTS THAT SHARE A COMMON TRUCK AT THE INTERFACE; DRAWBARS; HAND BRAKES; SLACK ADJUSTERS; COUPLERS; MOUNTED BRAKE ASSEMBLIES; BRAKE SHOES; DISC BRAKE LININGS; VALVES FOR CONTROLLING AIR FLOW IN RAIL CAR BRAKES; PNEUMATIC FREIGHT BRAKE EQUIPMENT, NAMELY— CONTROL VALVES; PNEUMATIC RESERVOIRS, NAMELY, PRESSURIZED CONTAINERS FOR STORING COMPRESSED AIR FOR USE IN BRAKING AND CONTROL SYSTEMS; RETAINING VALVES FOR BRAKE CYLINDER EXHAUST LINES THAT SELECTIVELY RETAIN BRAKE CYLINDER PRESSURE; CUT-OUT COCKS, NAMELY, MANUALLY OPERATED BALL TYPE VALVES THAT INTERRUPT AIR PASSAGeways IN THE BRAKE SYSTEM; STRAINERS USED WITHIN THE AIR BRAKE SYSTEM TO FILTER THE AIR AND REMOVE DIRT AND FOREIGN MATTER; HORNS; HOSES AND COUPLINGS FOR AIR BRAKE SYSTEMS ON LOCOMOTIVE AND RAIL CARS; BRAKE ADJUSTERS; ELASTOMETRIC PARTS FOR PNEUMATIC BRAKES, NAMELY— VALVE SEATS; O-RINGS; SEALS; RING GASKETS; MOLDED GASKETS; PACKING CUPS; DIAPHRAGMS, AND COMPOSITE HOSES; ACCESSIBILITY SYSTEMS, COMPRISED PRIMARILY OF POWER-OPERATED BRIDGE PLATES, RAMPS, LIFTS AND CONVERTIBLE STAIRS, AND ELECTROMECHANICAL CONTROLS FOR THE SAME, FOR USE IN BUSES AND RAIL PASSENGER CARS (U.S. CLS. 19, 21, 23, 31, 35 AND 44).

CLASS 17—RUBBER GOODS

FOR MOLDED RUBBER PARTS FOR RAILWAY AND INDUSTRIAL USE, NAMELY— PACKING CUPS, DIAPHRAGMS, O-RINGS, RING GASKETS, VALVE SEATS, COMPOSITE HOSE ASSEMBLIES, DAMPING MEMBERS AND RUBBER SPRINGS (U.S. CLS. 1, 5, 12, 13, 35 AND 50).

CLASS 37—CONSTRUCTION AND REPAIR

FOR REMANUFACTURE, REPAIR, AND MAINTENANCE OF LOCOMOTIVES, FREIGHT CARS, AND ENGINES FOR RAIL, MARINE, MINING, AND INDUSTRIAL MARKETS; REPAIR, MAINTENANCE AND UPGRADE SERVICES FOR FREIGHT, LOCOMOTIVE AND TRANSIT VEHICLE BRAKE EQUIPMENT AND ELECTRONIC EQUIPMENT; REPAIR AND REBUILDING OF COMPRESSORS; REPAIR AND MAINTENANCE OF HEAT TRANSFER UNIT RADIATORS, OIL COOLERS, CAB HEATER, AND AFTER COOLERS IN LOCOMOTIVES; MAINTENANCE, REMANUFACTURE, REPLACEMENT AND RECONDITIONING OF CORE IN CHARGE AIR COOLERS FOR LOCOMOTIVES (U.S. CLS. 100, 103 AND 106).

SN 76-200,165. MATZ, STEFFEN, 80339 MUNICH, FED REP GERMANY, FILED 1-26-2001.

SN 76-201,920. NORINCO, 60149 SAINT-CREPIN-IBOUVILLERS, FRANCE, FILED 1-30-2001.

CREATIVE PICTURES

PRIORITY CLAIMED UNDER SEC. 44(D) ON FED REP GERMANY APPLICATION NO. 30057152635, FILED 8-1-2000, REG. NO. 30057152, DATED 8-1-2000, EXPIRES 8-1-2010. NO CLAIM IS MADE TO THE EXCLUSIVE RIGHT TO USE "PICTURES", APART FROM THE MARK AS SHOWN.

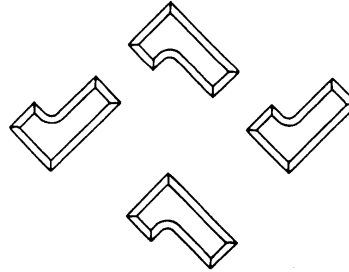

CLASS 25—CLOTHING

FOR CLOTHING, NAMELY, SHIRTS, PANTS, UNDERWEAR, FOOTWEAR, AND HEADWEAR (U.S. CLS. 22 AND 39).

CLASS 35—ADVERTISING AND BUSINESS

FOR BUSINESS CONSULTING AND BUSINESS MARKETING CONSULTING SERVICES FOR OTHERS; ADVERTISING FOR OTHERS VIA PLACING ADVERTISEMENTS ON THE INTERNET AND WITHIN MAGAZINES; RENTAL OF ADVERTISING SPACE FOR OTHERS, NAMELY BANNER ADVERTISEMENTS ON THE INTERNET (U.S. CLS. 100, 101 AND 102).

CLASS 38—COMMUNICATION

FOR TELECOMMUNICATION SERVICES, NAMELY, LOCAL AND LONG DISTANCE TRANSMISSION OF VOICE, DATA, AND GRAPHICS BY MEANS OF TELEPHONE, TELEGRAPHIC, CABLE, SATELLITE, AND INTERNET TRANSMISSIONS (U.S. CLS. 100, 101 AND 104).

OWNER OF FRANCE REG. NO. 99795214, DATED 6-2-1999, EXPIRES 6-2-2009. THE MARK CONSISTS OF FOUR STYLIZED LETTERS "L".

CLASS 6—METAL GOODS

FOR CAST-IRON AND STEEL COVERS AND FRAMES FOR MANHOLES, PITS, DUCTS AND IN-GROUND TELECOMMUNICATIONS SYSTEMS; CAST-IRON AND STEEL PAVIOR COVERS; CAST IRON AND STEEL GRATINGS AND FRAMES FOR USE IN CONNECTION WITH GULLIES, CATCHPITS, SUMPS, AND TREE BEDS; CAST-IRON SURFACE BOXES FOR UNDERGROUND GAS AND WATER PIPES; CAST-IRON EQUIPMENT FOR RAILWAYS, NAMELY RAIL BEARING PLATES; ORNAMENTAL AND DECORATIVE CAST-IRON, NAMELY CAST-IRON BOLLARDS; DECORATIVE CAST-IRON FIREBACKS; CAST-IRON, STEEL AND ALUMINUM MANHOLE COVERS FOR ACCESS TO UNDERGROUND SYSTEMS (U.S. CLS. 2, 12, 13, 14, 23, 25 AND 50).

CLASS 42—SCIENTIFIC, COMPUTER AND LEGAL SERVICES

FOR CONSULTATION IN THE FIELD OF CIVIL ENGINEERING RELATING TO CAST-IRON AND STEEL PRODUCTS USED IN PUBLIC PLACES AND FOR INDUSTRIAL USE (U.S. CLS. 100 AND 101).

SN 76-201,344. FIRST NATIONAL OF NEBRASKA, INC., OMAHA, NE. FILED 1-29-2001.

FIRST NATIONAL INFORMATION SOLUTIONS

NO CLAIM IS MADE TO THE EXCLUSIVE RIGHT TO USE "NATIONAL INFORMATION SOLUTIONS", APART FROM THE MARK AS SHOWN.

CLASS 35—ADVERTISING AND BUSINESS

FOR CONSULTATION IN THE FIELD OF DOCUMENT MANAGEMENT FOR BUSINESS PURPOSES (U.S. CLS. 100, 101 AND 102).

CLASS 40—MATERIAL TREATMENT

FOR ELECTRONIC IMAGING, SCANNING, DIGITIZING AND INDEXING OF PAPER AND MICROFILM DOCUMENTS FOR OTHERS (U.S. CLS. 100, 103 AND 106).

SN 76-203,362. MY FAVORITE COMPANY, LLC, THE, WEST CHICAGO, IL. FILED 1-31-2001.



THE MARK IS LINED FOR THE COLORS RED, YELLOW, BROWN AND PURPLE.

CLASS 1—CHEMICALS

FOR MANURERS AND FERTILIZERS FOR USE IN AGRICULTURE AND HORTICULTURE (U.S. CLS. 1, 5, 6, 10, 26 AND 46).

CLASS 8—HAND TOOLS

FOR GARDENING TOOLS AND IMPLEMENTS, NAMELY, AUGERS, AWLS, AXES, WEEDING FORKS, SPADES, TROWELS, HAMMERS, PICKS, SHOVELS, RAKES, HOES, SHEARS, AND PRUNING SHEARS (U.S. CLS. 23, 28 AND 44).

CLASS 16—PAPER GOODS AND PRINTED MATTER

FOR PRINTED MATTER, NAMELY, BOOKS, CARDS, MAGAZINES, AND INSTRUCTIONAL MATERIALS, ALL ON THE SUBJECT OF PLANTS AND GARDENING (U.S. CLS. 2, 5, 22, 23, 29, 37, 38 AND 50).

CLASS 21—HOUSEWARES AND GLASS

FOR FLOWER POTS AND DECORATIVE PLANTERS FOR USE WITH LIVING PLANTS, FLOWERS AND TREES (U.S. CLS. 2, 13, 23, 29, 30, 33, 40 AND 50).

CLASS 25—CLOTHING

FOR PROMOTIONAL CLOTHING PRODUCTS, NAMELY, FOOTWEAR AND HEADWEAR SOLD AS COLLATERAL GOODS IN CONNECTION WITH APPLICANT'S MANURES, FERTILIZERS, GARDENING TOOLS, FLOWER POTS, DECORATIVE PLANTERS AND PLANTS (U.S. CLS. 22 AND 39).

CLASS 28—TOYS AND SPORTING GOODS

FOR PROMOTIONAL GAMES AND PLAYTHINGS, NAMELY, PLUSH TOYS, STUFFED ANIMALS AND STUFFED DOLLS SOLD AS COLLATERAL GOODS IN CONNECTION WITH APPLICANT'S MANURES, FERTILIZERS, GARDENING TOOLS, FLOWER POTS, DECORATIVE PLANTERS AND PLANTS (U.S. CLS. 22, 23, 38 AND 50).

CLASS 31—NATURAL AGRICULTURAL PRODUCTS

FOR LIVE FLOWERS, PLANTS, BULBS, SEEDS, SEEDLINGS, GRASSES, SHRUBS AND TREES (U.S. CLS. 1 AND 46).

SN 76-204,307. UTRECHT MANUFACTURING CORP., CRANBURY, NJ. FILED 2-5-2001.



NO CLAIM IS MADE TO THE EXCLUSIVE RIGHT TO USE "ARTIST", APART FROM THE MARK AS SHOWN.

CLASS 2—PAINTS

FOR PAINT FOR ARTISTS, NAMELY, WATERCOLOR PAINT, TEMPERA PAINT, ACRYLIC PAINT AND POWDERED PAINT (U.S. CLS. 6, 11 AND 16).
FIRST USE 4-0-2001; IN COMMERCE 4-0-2001.

CLASS 16—PAPER GOODS AND PRINTED MATTER

FOR ARTIST SUPPLIES FOR PAINTING AND DRAWING, NAMELY, PAINT BRUSHES, PAINT APPLICATION ROLLERS, PAPER CONTAINERS FOR HOLDING PAINT; BRUSH TUBS IN THE NATURE OF PAINT TRAYS FOR HOLDING BRUSHES; PAINTING SETS FOR ARTISTS; PAINTING PALETTES AND PAPER PAINTING PALETTES; PAINT STIRRERS AND PADDLES; ART SUPPLIES BOXES; CANVAS FOR PAINTING IN ROLL, PRE-STRETCHED AND BOARD FORM; ARTIST GLUE; ARTIST EASELS; ART PAPER, NAMELY, PRINTMAKING AND DRAWING PAPER, CONSTRUCTION PAPER, OAK TAG, CHIPBOARD, RAILROAD BOARD, NEWSPRINT PADS, TRACING PAPER AND SKETCH BOOKS; ARTIST ETCHING AND DRYPOINT TOOLS, NAMELY, SCRIBERS, ETCHING NEEDLES, SCRAPERS AND BURNISHERS; STATIONERY-TYPE PORTFOLIOS FOR ARTISTS; STATIONERY-TYPE PRESENTATION CASES FOR ARTISTS; CHALK PASTELS, OIL PASTELS, ARTIST CHARCOAL, PENCILS, CRAYONS AND PENS; AND PAINT SETS FOR CHILDREN AND YOUTHS COMPRISING PAINTS, BRUSHES, CLEANERS, PRE-DRAWN PAPER, BLANK PAPER AND CANVASES (U.S. CLS. 2, 5, 22, 23, 29, 37, 38 AND 50).
FIRST USE 4-0-2001; IN COMMERCE 4-0-2001.

CLASS 35—ADVERTISING AND BUSINESS

FOR MAIL-ORDER CATALOG SERVICES FEATURING ARTIST SUPPLIES; AND WHOLESALE AND RETAIL STORES FEATURING ARTIST SUPPLIES (U.S. CLS. 100, 101 AND 102).
FIRST USE 4-0-2001; IN COMMERCE 4-0-2001.

SN 76-204,376. INDIGOB2B.COM, INC., NEWARK, NJ. FILED 2-2-2001.

**CLASS 35—ADVERTISING AND BUSINESS**

FOR ONLINE RETAIL STORE SERVICES FEATURING SPECIALTY CHEMICALS IN THE PIGMENT AND DYE MARKET (U.S. CLS. 100, 101 AND 102).
FIRST USE 7-17-2000; IN COMMERCE 9-15-2000.

CLASS 42—SCIENTIFIC, COMPUTER AND LEGAL SERVICES

FOR CHEMICAL ANALYSIS OF SPECIALTY CHEMICALS IN THE PIGMENT AND DYE MARKET (U.S. CLS. 100 AND 101).
FIRST USE 7-17-2000; IN COMMERCE 9-15-2000.

SN 76-204,606. BUHLER, MARKUS, SHERMAN OAKS, CA.
FILED 2-5-2001.

DEAD END

OWNER OF SWITZERLAND REG. NO. 476224, DATED 3-23-2000, EXPIRES 3-23-2010.

CLASS 25—CLOTHING

FOR SPORTS CLOTHING; NAMELY T-SHIRTS, SWEATSHIRTS, PANTS, SWEATPANTS, SHORTS, SWEATSHORTS, JACKETS, HATS, CAPS, SOCKS, HEADBANDS, WRISTBANDS, SHOES, GLOVES, UNDERWEAR, HEAD-WEAR, OVERALLS, SWIM-SUITS, VESTS, SHIRTS, TIES, SKIRTS, SCARVES, WET SUITS (U.S. CLS. 22 AND 39).

CLASS 42—SCIENTIFIC, COMPUTER AND LEGAL SERVICES

FOR SERVICES, NAMELY HOTELS, MOTELS, NIGHT CLUBS, BARS, AND RESTAURANTS (U.S. CLS. 100 AND 101).

SN 76-205,034. ADVANCED MARKETING TECHNOLOGIES, LLC, BLOOMINGTON, IN. FILED 2-5-2001.

AMT MEDIA

NO CLAIM IS MADE TO THE EXCLUSIVE RIGHT TO USE "MEDIA", APART FROM THE MARK AS SHOWN.

CLASS 35—ADVERTISING AND BUSINESS

FOR ONLINE DISTRIBUTORSHIPS AND DISTRIBUTORSHIPS FEATURING BOOKS, GAMES, MUSIC, MOVIES, AND COMPUTER SOFTWARE (U.S. CLS. 100, 101 AND 102).

CLASS 41—EDUCATION AND ENTERTAINMENT

FOR AUDIO RECORDING AND PRODUCTION, MUSIC PRODUCTION SERVICES, MULTIMEDIA ENTERTAINMENT SOFTWARE PRODUCTION SERVICES, MOTION PICTURE PRODUCTION SERVICES AND PUBLICATION OF BOOKS (U.S. CLS. 100, 101 AND 107).

SN 76-205,085. AMNIS CORPORATION, SEATTLE, WA.
FILED 2-5-2001.

IMAGESTREAM

CLASS 5—PHARMACEUTICALS

FOR MEDICAL DIAGNOSTIC REAGENTS, NAMELY, LABELS FOR BIOMOLECULE DETECTION, AND KITS COMPOSED PRIMARILY OF REAGENTS AND APPARATUS FOR USE FOR BIOMOLECULE DETECTION AND IN PERFORMING OPTICAL IMAGING AND ELECTRONIC ANALYSIS OF THE CHEMISTRY AND COMPOSITION OF CELLS AND MOLECULES (U.S. CLS. 6, 18, 44, 46, 51 AND 52).

CLASS 9—ELECTRICAL AND SCIENTIFIC APPARATUS

FOR DIAGNOSTIC AND TESTING SYSTEM, NAMELY, HARDWARE, SOFTWARE, AND PERIPHERALS FOR USE IN PERFORMING OPTICAL IMAGING AND ELECTRONIC ANALYSIS OF THE CHEMISTRY AND COMPOSITION OF CELLS AND MOLECULES FOR LABORATORY USE (U.S. CLS. 21, 23, 26, 36 AND 38).

CLASS 10—MEDICAL APPARATUS

FOR DIAGNOSTIC AND TESTING SYSTEM, NAMELY, HARDWARE, SOFTWARE, AND PERIPHERALS FOR USE IN PERFORMING OPTICAL IMAGING AND ELECTRONIC ANALYSIS OF THE CHEMISTRY AND COMPOSITION OF CELLS AND MOLECULES FOR MEDICAL USE (U.S. CLS. 26, 39 AND 44).

SN 76-205,913. UNI-SUNSTAR B.V., 1077 ZX AMSTERDAM, NETHERLANDS, FILED 2-6-2001.

KENKO-DOJO

THE ENGLISH TRANSLATION OF THE NON-LATIN WORD "KENKO-DOJO" IN THE MARK IS "A PLACE FOR IMPROVING ONE'S HEALTH".

CLASS 5—PHARMACEUTICALS

FOR MEDICINAL AND PHARMACEUTICAL PREPARATIONS, NAMELY— COLD AND FLU REMEDY PREPARATIONS; PREPARATIONS FOR ALLEVIATING CONSTIPATION; ANTACID; CATHARTIC AND LAXATIVE PREPARATIONS; PREPARATIONS FOR THE TREATMENT OF RHINITIS; HEADACHE REMEDIES; HERBAL MEDICINES, NAMELY, POWDERED HERBS, TONIC LIQUOR CONTAINING HERB EXTRACTS; NUTRITIONAL SUPPLEMENTS; HERBAL SUPPLEMENTS; VITAMIN AND MINERAL SUPPLEMENTS; NON-NUTRITIOUS FIBER SUPPLEMENTS; ENZYME SUPPLEMENTS FOR MEDICINAL PURPOSES; YEAST TABLETS FOR MEDICINAL PURPOSES; MEDICINAL SUPPLEMENTS CONTAINING ISOFLAVONES; DIETARY SUPPLEMENTS; REDUCING TEA FOR MEDICAL PURPOSES; PLANT COMPOUNDS FOR USE AS DIETARY SUPPLEMENTS; DIETARY SUPPLEMENTS FOR MEDICAL USE CONTAINING ROYAL JELLY; HERB TEAS FOR MEDICINAL PURPOSES; MEAL REPLACEMENT DRINKS; AND FOOD SUPPLEMENTS CONSISTING OF CONCENTRATED VEGETABLE MATTER (U.S. CLS. 6, 18, 44, 46, 51 AND 52).

CLASS 29—MEATS AND PROCESSED FOODS

FOR FLAVORED WHEY BASED FOOD BEVERAGES (U.S. CL. 46).

CLASS 30—STAPLE FOODS

FOR BAKERY PRODUCTS; FARINACEOUS FOODS, NAMELY, BREADS, BUNS, NOODLES, PASTRIES, COOKIES, BISCUITS, AND WAFERS; BREAKFAST CEREALS; CEREAL-BASED SNACK FOOD; PROCESSED CEREALS; FLOUR; CANDIES; TEAS; NON-MEDICATED TEA EXTRACTS; TEA-BASED BEVERAGES; HERB TEAS FOR FOOD PURPOSES; NON-MEDICATED LOZENGES; AND YEAST TABLETS FOR FOOD FOR HUMAN CONSUMPTION (U.S. CL. 46).

CLASS 32—LIGHT BEVERAGES

FOR VEGETABLE JUICES; VEGETABLE JUICE DRINKS; FRUIT JUICES; FRUIT JUICE DRINKS; CARBONATED AND NON-CARBONATED SOFT DRINKS (U.S. CLS. 45, 46 AND 48).

SN 76-206,532. VAKA CORPORATION, GEORGE TOWN,
GRAND CAYMAN, CAYMAN ISLANDS, FILED 2-7-2001.

VIRTUALLY ALSO KNOWN AS

CLASS 9—ELECTRICAL AND SCIENTIFIC APPARATUS

FOR COMPUTER SOFTWARE FOR ENABLING INTERNET SERVICE PRICING AND DELIVERY, USAGE TRACKING AND ANALYSIS AND BILLING ACROSS COMPUTERS, PHONES, PERSONAL DIGITAL ASSISTANTS, INTERACTIVE TELEVISIONS AND OTHER ELECTRONIC DEVICES THAT PROVIDE A USER INTERFACE FOR ACCESSING AND CONNECTING TO A GLOBAL COMPUTER NETWORK (U.S. CLS. 21, 23, 26, 36 AND 38).

CLASS 42—SCIENTIFIC, COMPUTER AND LEGAL SERVICES

FOR CONSULTING SERVICES IN THE FIELD OF DESIGN, SELECTION, IMPLEMENTATION AND USE OF COMPUTER SOFTWARE FOR ENABLING INTERNET SERVICE PRICING AND DELIVERY, USAGE TRACKING AND ANALYSIS AND BILLING, ACROSS COMPUTERS, PHONES, PERSONAL DIGITAL ASSISTANTS, INTERACTIVE TELEVISIONS AND OTHER ELECTRONIC DEVICES THAT PROVIDE A USER INTERFACE FOR ACCESSING AND CONNECTING TO A GLOBAL COMPUTER NETWORK. APPLICATION SERVICE PROVIDER (ASP) FEATURING COMPUTER SOFTWARE IN THE FIELD OF ENABLING INTERNET SERVICE PRICING AND DELIVERY, USAGE TRACKING AND ANALYSIS AND BILLING, ACROSS COMPUTERS, PHONES, PERSONAL DIGITAL ASSISTANTS, INTERACTIVE TELEVISIONS AND OTHER ELECTRONIC DEVICES THAT PROVIDE A USER INTERFACE FOR ACCESSING AND CONNECTING TO A GLOBAL COMPUTER NETWORK (U.S. CLS. 100 AND 101).

SN 76-206,686. MCS CYLINDER SYSTEMS GMBH, DINS-
LAKEN, FED REP GERMANY, FILED 2-8-2001.



PRIORITY CLAIMED UNDER SEC. 44(D) ON FED REP GERMANY APPLICATION NO. 30059258.2, FILED 8-8-2000, REG. NO. 30059258, DATED 1-29-2001, EXPIRES 8-31-2010.

NO CLAIM IS MADE TO THE EXCLUSIVE RIGHT TO USE "CYLINDER SYSTEMS", APART FROM THE MARK AS SHOWN.

THE PICTORIAL PORTION OF THE MARK CONSISTS OF THE UPPER PART OF A STORAGE PRESSURE VESSEL.

CLASS 6—METAL GOODS

FOR PRESSURE VESSEL, NAMELY, FLUID STORAGE TANKS AND PRESSURE BOTTLES MADE OF STEEL, METAL, FIBRE-REINFORCED STEEL AND FIBRE-REINFORCED METAL; PRESSURE STORAGE DEVICES CONSISTING OF PRESSURE VESSELS, NAMELY, FLUID STORAGE TANKS AND PRESSURE BOTTLES MADE OF STEEL, METAL, FIBRE-REINFORCED STEEL, AND FIBRE-REINFORCED METAL AND STRUCTURAL PARTS THEREFOR, NAMELY, METAL AND STEEL PIPING; FIBRE-REINFORCED TUBES AND TUBE COMPONENTS MADE OF METAL, NAMELY FITTINGS, ELBOWS AND JOINTS; METAL LINE PIPES FOR ENERGY TRANSPORT; WELDLESS AND WELDED STEEL TUBES (U.S. CLS. 2, 12, 13, 14, 23, 25 AND 50).

CLASS 7—MACHINERY

FOR MACHINE PARTS, NAMELY, VALVES AND SUPPORTING STRUCTURES, NAMELY METAL AND PLASTIC FRAMES FOR MOUNTING AND STORING PRESSURE VESSELS (U.S. CLS. 13, 19, 21, 23, 31, 34 AND 35).

CLASS 17—RUBBER GOODS

FOR PRESSURE VESSELS, NAMELY, STORAGE TANKS, AND PRESSURE BOTTLES OF FIBRE-REINFORCED PLASTICS; PRESSURE STORAGE DEVICES CONSISTING OF PRESSURE VESSELS, NAMELY, STORAGE TANKS, AND PRESSURE BOTTLES OF FIBRE-REINFORCED PLASTICS AND STRUCTURAL PARTS THEREFOR, NAMELY, PLASTIC PIPING FOR THE FOREMENTIONED; FIBRE-REINFORCED, NAMELY GLASS, ARAMID OR CARBON, TUBES AND PLASTIC ELBOWS, CONNECTORS, AND FITTINGS; PLASTIC LINE PIPES FOR ENERGY TRANSPORT (U.S. CLS. 1, 5, 12, 13, 35 AND 50).

CLASS 42—SCIENTIFIC, COMPUTER AND LEGAL SERVICES

FOR ENGINEERING SERVICES; EXECUTION OF TECHNICAL TESTS BY AN EXPERT SPECIALIZED IN MATERIAL TESTING; AND PREPARATION OF EXPERT TECHNICAL TEST REPORTS IN THE FIELD OF METAL AND FIBRE-REINFORCED PLASTIC PRESSURE VESSELS, NAMELY, METAL AND FIBRE-REINFORCED PLASTIC FLUID STORAGE TANKS AND PRESSURE BOTTLES, AND PRESSURE STORAGE DEVICES; METAL, STEEL AND PLASTIC PIPING; FIBRE-REINFORCED TUBES; METAL AND PLASTIC ELBOWS, CONNECTORS; METAL AND PLASTIC LINE PIPES FOR ENERGY TRANSPORT, WELDLESS AND WELDED STEEL PIPES (U.S. CLS. 100 AND 101).

SN 76-206,803. ENRICHNET, INC., CHELMSFORD, MA.
FILED 2-5-2001.

QoSMax

CLASS 9—ELECTRICAL AND SCIENTIFIC APPARATUS

FOR COMPUTER SOFTWARE, NAMELY, FOR ENABLING A USER TO INTERFACE WITHIN A NETWORK TO IMPROVE REAL TIME VOICE, VIDEO AND MULTIMEDIA TRAFFIC IN THE FIELD OF COMMUNICATION THROUGH A LOCAL AREA NETWORK (U.S. CLS. 21, 23, 26, 36 AND 38).

CLASS 42—SCIENTIFIC, COMPUTER AND LEGAL SERVICES

FOR INTEGRATION OF COMPUTER SYSTEMS AND NETWORKS (U.S. CLS. 100 AND 101).

CLASS 21—HOUSEWARES AND GLASS

FOR NATIVITY SET MADE OF PORCELAIN; CANDLE HOLDER NOT OF PRECIOUS METAL; CANDLE RING MADE OF PVC; CHRISTMAS FIGURES AND FIGURINES MADE OF PORCELAIN; CHRISTMAS PLASTIC WREATHS HANGERS; DECORATIVE PLASTIC ARTIFICIAL SNOWMEN WHICH INCORPORATE FIBER OPTIC LIGHTS; PLASTIC ARTIFICIAL SANTA WHICH INCORPORATE FIBER OPTIC LIGHTS (U.S. CLS. 2, 13, 23, 29, 30, 33, 40 AND 50).

FIRST USE 10-8-2000; IN COMMERCE 10-8-2000.

CLASS 26—FANCY GOODS

FOR ORNAMENTAL BOWS OF TEXTILE FOR DECORATION; BOWS FOR GIFT-WRAPPING; ARTIFICIAL MISTLETOE; METALLIC RIBBON FOR ORNAMENTAL PURPOSES; SWAGS USED AS CHRISTMAS DECORATIONS, NAMELY, ARTIFICIAL FLOWER AND GREENERY WREATHS (U.S. CLS. 37, 39, 40, 42 AND 50).

FIRST USE 10-1-2000; IN COMMERCE 10-1-2000.

CLASS 28—TOYS AND SPORTING GOODS

FOR CHRISTMAS TREE DECORATIONS, NAMELY, ANGEL HAIR, ICICLES, AND TREE TOPPERS; CHRISTMAS TREE STANDS (U.S. CLS. 22, 23, 38 AND 50).

FIRST USE 10-1-2000; IN COMMERCE 10-1-2000.

SN 76-207,071. MEIJER, INC., GRAND RAPIDS, MI. FILED 2-5-2001.

DECEMBER HOME

OWNER OF U.S. REG. NO. 2,250,600.
NO CLAIM IS MADE TO THE EXCLUSIVE RIGHT TO USE "HOME", APART FROM THE MARK AS SHOWN.

CLASS 6—METAL GOODS

FOR METALLIC SHRED; METALLIC BOWS FOR ORNAMENTAL PURPOSES; METALLIC TAPE WITH DISPENSER SOLD AS A UNIT; METAL ORNAMENT HOOKS; CHRISTMAS DECORATIONS, NAMELY, METAL BELLS (U.S. CLS. 2, 12, 13, 14, 23, 25 AND 50).

FIRST USE 10-1-2000; IN COMMERCE 10-1-2000.

CLASS 9—ELECTRICAL AND SCIENTIFIC APPARATUS

FOR ELECTRICAL POWER EXTENSION CORDS FOR INDOOR OR OUTDOOR USE (U.S. CLS. 21, 23, 26, 36 AND 38).

FIRST USE 9-10-2000; IN COMMERCE 9-10-2000.

SN 76-207,180. AURELIAN COMMUNICATIONS LLC, NEW YORK, NY. FILED 2-8-2001.

CLASS 11—ENVIRONMENTAL CONTROL APPARATUS

FOR INDOOR AND OUTDOOR ELECTRIC CHRISTMAS LIGHTS IN THE NATURE OF LIGHT STRANDS, NET LIGHTING AND LIGHT BULBS; BATTERY OPERATED LIGHT SETS; ELECTRIC CHRISTMAS THEME NIGHT LIGHTS; ELECTRIC AND BATTERY OPERATED STILL MOUNT WINDOW CANDLES; DECORATIVE ELECTRIC LIGHTING FIXTURES FOR CHRISTMAS, NAMELY, CHANDELIERS, CHRISTMAS TREE TOPPERS AND LAWN AND HOME DISPLAYS (U.S. CLS. 13, 21, 23, 31 AND 34).

FIRST USE 10-8-2000; IN COMMERCE 10-8-2000.

AURELIAN COMMUNICATIONS

NO CLAIM IS MADE TO THE EXCLUSIVE RIGHT TO USE "COMMUNICATIONS", APART FROM THE MARK AS SHOWN.

CLASS 16—PAPER GOODS AND PRINTED MATTER

FOR ADHESIVE TAPE FOR STATIONERY AND HOUSEHOLD USE; AUTOMATIC ADHESIVE TAPE DISPENSER FOR OFFICE USE; ADHESIVE TAPE DISPENSERS FOR HOUSEHOLD OR STATIONARY USE; FABRIC GIFT BAGS SOLD EMPTY; PAPER GIFT WRAP BOWS (U.S. CLS. 2, 5, 22, 23, 29, 37, 38 AND 50).

FIRST USE 10-22-2000; IN COMMERCE 10-22-2000.

CLASS 36—INSURANCE AND FINANCIAL

FOR FUNDS INVESTMENT AND INVESTMENT ADVICE IN THE FIELD OF MEDIA, PUBLISHING AND THE INTERNET (U.S. CLS. 100, 101 AND 102).

CLASS 41—EDUCATION AND ENTERTAINMENT

FOR PUBLICATION OF MAGAZINES (U.S. CLS. 100, 101 AND 107).

CLASS 20—FURNITURE AND ARTICLES NOT OTHERWISE CLASSIFIED

FOR CHRISTMAS THEME FIGURES AND FIGURINES MADE OF WOOD AND PLASTIC; NON-METAL ORNAMENT HOOKS; CHRISTMAS DECORATIONS, NAMELY, SANTA AND SNOWMAN FIGURES MADE OF FABRIC, AND WOODEN TRAINS (U.S. CLS. 2, 13, 22, 25, 32 AND 50).

FIRST USE 10-22-2000; IN COMMERCE 10-22-2000.

CLASS 42—SCIENTIFIC, COMPUTER AND LEGAL SERVICES

FOR INFORMATION SERVICES, NAMELY, PROVIDING NEWS AND INFORMATION IN A WIDE VARIETY OF FIELDS BY MEANS OF THE INTERNET (U.S. CLS. 100 AND 101).

SN 76-207,391. RADISSON SEVEN SEAS CRUISES, INC.,
FORT LAUDERDALE, FL. FILED 2-8-2001.

LUXURY GOES EXPLORING

CLASS 39—TRANSPORTATION AND STORAGE

FOR CRUISE SHIP SERVICES, TRANSPORTATION OF PASSENGERS BY SHIP; TRAVEL AGENCY SERVICES, NAMELY, MAKING RESERVATIONS AND BOOKINGS FOR TRANSPORTATION (U.S. CLS. 100 AND 105).

FIRST USE 2-0-2001; IN COMMERCE 2-0-2001.

CLASS 41—EDUCATION AND ENTERTAINMENT

FOR ENTERTAINMENT SERVICES PROVIDED ON CRUISE SHIPS, NAMELY, ORGANIZING EXHIBITIONS FOR ENTERTAINMENT PURPOSES AND ENTERTAINMENT IN THE NATURE OF DANCE PERFORMANCES AND PARTIES; PROVIDING FACILITIES FOR RECREATION ACTIVITIES ON CRUISE SHIPS; SPORTS EQUIPMENT RENTAL SERVICES ON BOARD CRUISE SHIPS (U.S. CLS. 100, 101 AND 107).

FIRST USE 2-0-2001; IN COMMERCE 2-0-2001.

CLASS 42—SCIENTIFIC, COMPUTER AND LEGAL SERVICES

FOR MAKING RESERVATIONS AND BOOKINGS FOR TEMPORARY LODGING, PROVIDING RESTAURANT, NIGHTCLUB AND CATERING SERVICES (U.S. CLS. 100 AND 101).

FIRST USE 2-0-2001; IN COMMERCE 2-0-2001.

CLASS 5—PHARMACEUTICALS

FOR SANITARY PREPARATIONS, NAMELY MEDICATED HAIR SHAMPOO, MEDICATED ANTIBACTERIAL FACE LOTION, MEDICATED ANTIBACTERIAL EYE LOTION, MEDICATED ANTIBACTERIAL LOTION FOR THE NOSE, THROAT AND NECK; DIETARY PREPARATIONS FOR MEDICAL USE, NAMELY DIETARY FOOD SUPPLEMENTS, NUTRITIONALLY FORTIFIED DIETETIC BEVERAGES; FOOD FOR BABIES, BALSAMIC PREPARATION FOR MEDICAL PURPOSES, NAMELY DOUCHES, HAND-CLEANING AGENTS, CONDITIONING HAIR SHAMPOO; MEDICAL PREPARATION FOR USE IN TREATING OF HEMORRHOIDS, ACNE, FUNGAL INFECTIONS; MEDICAL PREPARATIONS FOR USE IN IMPROVING THE QUALITY OF BLOOD, NAMELY, HAEMATINICS; SUGAR REPLACEMENTS FOR MEDICINAL OR THERAPEUTIC PURPOSES NAMELY, SWEETMEATS, FOR MEDICAL USE; DIETETIC BEVERAGES FOR MEDICAL USE NAMELY, HERB TEAS, DIETARY DRINK MIX FOR USE AS A MEAL REPLACEMENT, DIETARY FOOD SUPPLEMENTS, DIETARY SUPPLEMENTS FOR MEDICAL USE, NAMELY FOOD FOR MEDICALLY RESTRICTED DIETS; DIETARY FOOD SUPPLEMENTS, NAMELY FAT FOR MEDICAL USE; DIETETIC BEVERAGES FOR MEDICAL USE, NAMELY MEAL REPLACEMENT AND DIETARY SUPPLEMENT DRINK MIXES AND DIETARY DRINK FOR USE AS A MEAL REPLACEMENT; BEVERAGES, NAMELY HERB TEAS FOR MEDICAL PURPOSES; HERBS FOR MEDICAL PURPOSES; MEDICINAL DRINKS FOR THE TREATMENT OF OBESITY, DIABETES, HYPERTENSION, HYPERCHOLESTEROLEMIA; MINERAL SALTS, NAMELY, EPSOM SALTS, MEDICATED BATH SALTS, SMELLING SALTS; DIETARY FOOD SUPPLEMENTS, NAMELY, PROTEIN BASED FOODSTUFFS FOR MEDICAL PURPOSES, NUTRITIONAL ADDITIVES FOR USE AS A DIETARY SUPPLEMENT; SODIUM SALTS FOR MEDICAL PURPOSES NAMELY, MEDICATED BATH SALTS, SMELLING SALTS, EPSOM SALTS; MEDICAL PREPARATIONS THAT ACT AS NERVINES; HERBS FOR MEDICAL PURPOSES, NAMELY, PEPPERMINT; HERBAL REDUCING TEA FOR MEDICAL PURPOSES; VITAMINS, HERBS, NAMELY, ROOTS WITH MEDICAL EFFECT; AND SUGAR REPLACEMENT FOR MEDICINAL OR THERAPEUTIC PURPOSES (U.S. CLS. 6, 18, 44, 46, 51 AND 52).

SN 76-207,847. PROGENY SYSTEMS, LLC, SAN DIEGO, CA.
FILED 2-7-2001.

E-SPERM

CLASS 9—ELECTRICAL AND SCIENTIFIC APPARATUS

FOR VALIDATION AND CALIBRATION SYSTEMS, NAMELY, SYSTEMS FOR VALIDATING AND CALIBRATING INSTRUMENTS FOR MEASURING HUMAN OR ANIMAL SPERM CELL ACTIVITY, INSTRUMENTS FOR MEASURING MOTILE PATHOGEN ACTIVITY, AND INSTRUMENTS FOR MEASURING WATERBORNE PATHOGEN ACTIVITY (U.S. CLS. 21, 23, 26, 36 AND 38).

CLASS 10—MEDICAL APPARATUS

FOR MEDICAL AND VETERINARY DEVICES, NAMELY, INSTRUMENTS FOR MEASURING HUMAN OR ANIMAL SPERM CELL ACTIVITY, INSTRUMENTS FOR MEASURING MOTILE PATHOGEN ACTIVITY, AND INSTRUMENTS FOR MEASURING WATERBORNE PATHOGEN ACTIVITY, AND PARTS AND FITTINGS FOR ALL OF THE AFORESAID DEVICES (U.S. CLS. 26, 39 AND 44).

SN 76-207,817. LIDL STIFTUNG & CO. KG, 74172 NECK-ARSULM, FED REP GERMANY, FILED 2-9-2001.

EURHO

OWNER OF FED REP GERMANY REG. NO. 39960674,
DATED 11-17-1999, EXPIRES 9-30-2009.

CLASS 3—COSMETICS AND CLEANING PREPARATIONS

FOR COSMETICS (U.S. CLS. 1, 4, 6, 50, 51 AND 52).

SN 76-207,848. DREAMWORKS L.L.C., UNIVERSAL CITY, CA. FILED 2-7-2001.

FAIRY TALE FUGITIVES

NO CLAIM IS MADE TO THE EXCLUSIVE RIGHT TO USE "FAIRY TALE", APART FROM THE MARK AS SHOWN.

CLASS 25—CLOTHING

FOR SHIRTS AND TOPS, DRESSES, SKIRTS, PANTS, TROUSERS, JEANS, SHORTS, ROMPERS, OVERALLS, SWEATSHIRTS AND SWEAT PANTS, SWEATSUITS, CAPS AND HATS, GLOVES, SUSPENDERS, TIES, COATS AND JACKETS, HOSIERY, SHOES, BOOTS, SLIPPERS, PAJAMAS, ROBES, SLEEPSHIRTS, SLEEPWEAR, UNDERWEAR, HALLOWEEN COSTUMES, AND CLOTH BIBS (U.S. CLS. 22 AND 39).

CLASS 28—TOYS AND SPORTING GOODS

FOR ACTION FIGURES AND ACCESSORIES THEREFOR, BATHTUB TOYS, KITES, TOY BUILDING BLOCKS, BOARD GAMES, COSTUME MASKS, HANDHELD UNIT FOR PLAYING ELECTRONIC GAMES, DIE CAST MINIATURE TOY VEHICLES, DOLLS, DOLL ACCESSORIES, DOLL CLOTHING, BEAN BAG DOLLS, BENDABLE PLAY FIGURES, FLYING DISKS, INFLATABLE VINYL PLAY FIGURES, JIGSAW PUZZLES, MARBLES, PLUSH TOYS, PUPPETS, RIDE-ON TOYS, SKATEBOARDS, BALLOONS, ROLLER SKATES, TOY BANKS, WATER SQUIRTING TOYS, STUFFED TOYS, TOY VEHICLES, YO-YO'S, CHRISTMAS TREE ORNAMENTS, AND PINBALL MACHINES (U.S. CLS. 22, 23, 38 AND 50).

SN 76-207,889. ADT SECURITY SERVICES, INC., BOCA RATON, FL. FILED 2-7-2001.

THE COMPANY BUILT FOR LIFE

CLASS 38—COMMUNICATION

FOR ELECTRONIC TRANSMISSION OF MESSAGES AND DATA; PROVIDING MULTIPLE USER ACCESS TO A GLOBAL COMPUTER NETWORK (U.S. CLS. 100, 101 AND 104).

CLASS 42—SCIENTIFIC, COMPUTER AND LEGAL SERVICES

FOR SECURITY SYSTEM MONITORING SERVICES, NAMELY, INTRUDER, HOLD-UP AND BURGLAR ALARM SERVICES, FIRE DETECTING AND ALARM SERVICES; WATCHMAN'S SUPERVISORY SERVICES, SPRINKLER AND WATER FLOW SUPERVISORY SERVICES INDUSTRIAL PROCESS SUPERVISORY SERVICES, PERSONAL EMERGENCY RESPONSE ALARM SERVICES, MEDICAL ALERT SERVICES, VEHICLE ALARM SERVICES AND VEHICLE EMERGENCY ASSISTANCE SERVICES AND VEHICLE LOCATION MONITORING SERVICES, HEATING AND AIR CONDITIONING MONITORING SERVICES; PROVIDING INFORMATION IN THE FIELD OF SECURITY VIA THE INTERNET (U.S. CLS. 100 AND 101).

SN 76-208,811. FAZTEK, LLC, FORT WAYNE, IN. FILED 2-12-2001.



CLASS 6—METAL GOODS

FOR ALUMINUM EXTRUSIONS, NAMELY T-SLOTTED ALUMINUM EXTRUSIONS IN THE FORM OF BARS, PLATES, AND ANGLES ALL SOLD IN KIT FORM FOR USE IN CONSTRUCTING PERIMETER GUARDS, MACHINE BASES AND FRAMES, PARTS RACKS, WORK BENCHES AND WORK STATIONS, AND MATERIAL HANDLING SYSTEMS (U.S. CLS. 2, 12, 13, 14, 23, 25 AND 50).

CLASS 40—MATERIAL TREATMENT

FOR CUSTOM MANUFACTURE OF T-SLOTTED ALUMINUM EXTRUSIONS (U.S. CLS. 100, 103 AND 106).

SN 76-208,940. APBIOTECH AB, SE-751 84 UPPSALA, SWEDEN, FILED 2-12-2001.

LUCIDEA

CLASS 1—CHEMICALS

FOR CHEMICAL REAGENTS FOR USE IN SCIENCE AND RESEARCH; BIOCHEMICAL REAGENTS FOR USE IN SCIENCE AND RESEARCH; PREPARATIONS FOR DIAGNOSIS, NAMELY, CHEMICAL REAGENTS THAT ALLOW HIGH THROUGHPUT SCREENING FOR SCIENTIFIC AND RESEARCH USE; RADIOACTIVE AND NON-RADIOACTIVE CHEMICAL REAGENTS AND ISOTOPES, FOR SCIENTIFIC AND RESEARCH USE; FLUORESCENT CHEMICAL REAGENTS FOR SCIENTIFIC RESEARCH USE IN MICRO HYBRIDIZATION, NAMELY, GENE EXPRESSION ASSAYS; AND DNA LABELING KITS FOR SCIENTIFIC RESEARCH USE (U.S. CLS. 1, 5, 6, 10, 26 AND 46).

CLASS 5—PHARMACEUTICALS

FOR CHEMICALS, NAMELY, CHEMICAL REAGENTS FOR DIAGNOSTIC AND CLINICAL MEDICAL USE RELATING TO PHARMACEUTICALS (U.S. CLS. 6, 18, 44, 46, 51 AND 52).

CLASS 9—ELECTRICAL AND SCIENTIFIC APPARATUS

FOR APPARATUS AND INSTRUMENTS FOR USE IN SCIENCE, RESEARCH AND INDUSTRY, NAMELY, MICROARRAY SYSTEMS COMPRISED OF AN ARRAY SCANNER, ARRAY SPOTTER, AUTOMATIC SLIDE PROCESSOR, COMPUTER SOFTWARE FOR DATA CAPTURE, ANALYSIS, VISUALIZATION AND MINING; MEASURING APPARATUS AND INSTRUMENTS, NAMELY, MICROARRAY SCANNERS AND MICROARRAY SPOTTERS; IMAGING APPARATUS AND INSTRUMENTS, NAMELY, MICROARRAY SCANNERS AND MICROARRAY SPOTTERS; RADIOLOGICAL APPARATUS AND INSTRUMENTS, NAMELY SLIDE PROCESSORS; COMPUTERS AND PRINTERS, SOFTWARE AND COMPUTER PROGRAMS FOR USE IN RECORDING, ANALYZING, VISUALIZING AND MINING DATA FROM LIFE SCIENCE AND BIOTECHNOLOGY RESEARCH AND EXPERIMENTS; LABORATORY GLASSWARE; AND PARTS AND FITTINGS FOR THE AFORESAID GOODS (U.S. CLS. 21, 23, 26, 36 AND 38).

CLASS 41—EDUCATION AND ENTERTAINMENT

FOR EDUCATIONAL AND TRAINING SERVICES, NAMELY, CONDUCTING SEMINARS, CONFERENCES, SYMPOSIA, AND WORKSHOPS IN THE FIELD OF LIFE SCIENCES (U.S. CLS. 100, 101 AND 107).

CLASS 42—SCIENTIFIC, COMPUTER AND LEGAL SERVICES

FOR PRODUCT RESEARCH AND DEVELOPMENT SERVICES; CONSULTANCY SERVICES RELATING TO CHEMICAL AND PHARMACEUTICAL RESEARCH; CONSULTANCY SERVICES RELATING TO THE DISCOVERY AND EVALUATION OF DRUGS AND COMPOUNDS HAVING DIAGNOSTIC, PROPHYLACTIC AND/OR THERAPEUTIC PROPERTIES; CHEMICAL RESEARCH, NAMELY, GENE EXPRESSION PROFILING, FEATURING THE USE OF MICROARRAY SYSTEMS; TECHNICAL SUPPORT SERVICES RELATING TO MICROARRAY SYSTEMS; ANALYTIC SERVICES RELATING TO MICROARRAY SYSTEMS; AND ADVISORY SERVICES RELATING TO MICROARRAY SYSTEMS (U.S. CLS. 100 AND 101).

SN 76-209,647. TLMG, INC., CINCINNATI, OH. FILED 2-13-2001.

**CLASS 36—INSURANCE AND FINANCIAL**

FOR FINANCIAL SERVICES, NAMELY, FINANCIAL PLANNING AND CONSULTATION FOR MANAGING AND INVESTING ASSETS ON BEHALF OF INJURED PARTIES; INSURANCE CONSULTATION, NAMELY, DAMAGE ANALYSIS AND SETTLEMENT SERVICES FOR INSURANCE COMPANIES AND SELF-INSUREDS (U.S. CLS. 100, 101 AND 102).

FIRST USE 2-0-2000; IN COMMERCE 2-0-2000.

CLASS 42—SCIENTIFIC, COMPUTER AND LEGAL SERVICES

FOR LEGAL SERVICES, NAMELY, DAMAGE ANALYSIS AND SETTLEMENT SERVICES FOR LAW FIRMS (U.S. CLS. 100 AND 101).

FIRST USE 2-0-2000; IN COMMERCE 2-0-2000.

SN 76-209,306. JAVELIN TECHNOLOGIES, INC., NEW YORK, NY. FILED 2-14-2001.

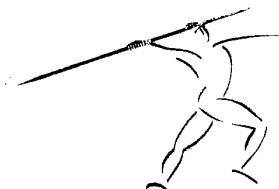

SN 76-210,049. IASKWEB, INC., WALTHAM, MA. FILED 2-14-2001.

ANSERITY**CLASS 9—ELECTRICAL AND SCIENTIFIC APPARATUS**

FOR COMPUTER SOFTWARE FOR SEMANTIC PROCESSING OF NATURAL LANGUAGE FOR USE IN INFORMATION SEARCH ANALYSIS (U.S. CLS. 21, 23, 26, 36 AND 38).

CLASS 42—SCIENTIFIC, COMPUTER AND LEGAL SERVICES

FOR COMPUTER SERVICES, NAMELY, PROVIDING A SEARCH ENGINE BACKED ON NATURAL LANGUAGE QUERIES ON A GLOBAL COMPUTER NETWORK (U.S. CLS. 100 AND 101).

CLASS 9—ELECTRICAL AND SCIENTIFIC APPARATUS

FOR COMPUTER SOFTWARE FOR USE IN ELECTRONIC SECURITIES TRADING, NAMELY, FOR PROCESSING TRADES IN EQUITY AND DEBT SECURITIES, OPTIONS, FUTURES, FOREIGN CURRENCY AND COMMODITIES (U.S. CLS. 21, 23, 26, 36 AND 38).

FIRST USE 6-0-1998; IN COMMERCE 6-0-1998.

CLASS 38—COMMUNICATION

FOR TELECOMMUNICATIONS GATEWAY SERVICES FOR FACILITATING ELECTRONIC TRANSACTIONS FOR SECURITIES TRADING COMPANIES (U.S. CLS. 100, 101 AND 104).

FIRST USE 6-0-1998; IN COMMERCE 6-0-1998.

SN 76-210,134. WAVEXPRESS, INC., NEW YORK, NY. FILED 2-14-2001.

TVTONIC**CLASS 9—ELECTRICAL AND SCIENTIFIC APPARATUS**

FOR COMPUTER SOFTWARE FOR USE IN TELEVISION INFORMATION AND IMAGE BROADCASTING AND AUGMENTATION IN THE FIELD OF TELEVISION DATACASTING; COMPUTER SOFTWARE IN COMBINATION WITH COMPUTER HARDWARE FOR DATACASTING TO BE USED WITH TELEVISIONS AND PERSONAL COMPUTERS VIA CABLE OR A GLOBAL COMPUTER (U.S. CLS. 21, 23, 26, 36 AND 38).

CLASS 38—COMMUNICATION

FOR ELECTRONIC TRANSMISSION OF DATA AND DIGITAL INFORMATION, PROVIDING ACCESS TO A GLOBAL COMPUTER INFORMATION NETWORK, BROADCASTING PROGRAMS VIA CABLE AND A GLOBAL COMPUTER NETWORK (U.S. CLS. 100, 101 AND 104).

CLASS 42—SCIENTIFIC, COMPUTER AND LEGAL SERVICES

FOR COMPUTER SERVICES, NAMELY, DESIGNING AND IMPLEMENTING NETWORK WEB PAGES, TO BE USED IN CONNECTION WITH TELEVISION PROGRAMS AND INFORMATION FOR OTHERS (U.S. CLS. 100 AND 101).

SN 76-211,682. ADISOFT AG, 76135 KARLSRUHE, FED REP GERMANY, FILED 2-15-2001.

ADISOFT

PRIORITY CLAIMED UNDER SEC. 44(D) ON FED REP GERMANY APPLICATION NO. 30066214.9/0, FILED 9-4-2000, REG. NO. 30066214, DATED 1-25-2001, EXPIRES 9-30-2010.

CLASS 36—INSURANCE AND FINANCIAL

FOR INSURANCE BROKERAGE, INSURANCE CONSULTATION INSURANCE AGENCIES; FINANCIAL ANALYSIS AND CONSULTATION, FINANCIAL INFORMATION PROVIDED BY ELECTRONIC MEANS, FINANCIAL INFORMATION PROCESSING, FINANCIAL RESEARCH, ELECTRONIC PAYMENT, NAMELY, ELECTRONIC PROCESSING AND TRANSMISSION OF BILL PAYMENT DATA, ELECTRONIC COMMERCE PAYMENT SERVICES, NAMELY, ESTABLISHING FUNDED ACCOUNTS USED TO PURCHASE GOODS AND SERVICES ON THE INTERNET; MONETARY EXCHANGE; REAL ESTATE INVESTMENT, REAL ESTATE MANAGEMENT (U.S. CLS. 100, 101 AND 102).

CLASS 38—COMMUNICATION

FOR TELECOMMUNICATION SERVICES, NAMELY, ELECTRONIC TRANSMISSION OF VOICE MESSAGES, LOCAL AND LONG DISTANCE TRANSMISSION OF DATA AND GRAPHICS BY MEANS OF TELEPHONE, TELEGRAPHIC, CABLE AND THE INTERNET, COMMUNICATION BY COMPUTER TERMINALS; TELEX SERVICES; COMMUNICATIONS BY TELEPHONE, RADIO BROADCASTING, TELEVISION BROADCASTING AND CABLE TELEVISION BROADCASTING; COMMUNICATION BY FIBER OPTIC NETWORKS; CELLULAR TELEPHONE COMMUNICATIONS; DELIVERY OF MESSAGES BY ELECTRONIC TRANSMISSION, COMPUTER AIDED TRANSMISSION OF MESSAGES AND IMAGES, ALSO VIA INTERNET; ELECTRONIC MAIL; TRANSMISSION OF COMPUTER PROGRAMS VIA INTERNET; SATELLITE TRANSMISSION; SENDING OF TELEGRAMS; TRANSMISSION OF TELEGRAMS; TELEGRAPH SERVICES; FACSIMILE TRANSMISSION; TELEPHONE SERVICES; RENTAL OF MESSAGE SENDING APPARATUS; RENTAL OF MODEMS; RENTAL OF TELECOMMUNICATION EQUIPMENT; ONLINE SERVICE, NAMELY, TRANSMISSIONS OF ANY KIND OF AUDIO, TEXT AND VIDEO MESSAGES; COMMUNICATION SERVICES, NAMELY, TRANSMITTING AUDIO AND VIDEO DATA VIA GLOBAL COMPUTER NETWORKS (U.S. CLS. 100, 101 AND 104).

CLASS 41—EDUCATION AND ENTERTAINMENT

FOR INTERNET SERVICES, NAMELY, GATHERING AND DISSEMINATION OF NEWS VIA THE INTERNET (U.S. CLS. 100, 101 AND 107).

CLASS 42—SCIENTIFIC, COMPUTER AND LEGAL SERVICES

FOR CONSULTANCY IN THE FIELD OF COMPUTER HARDWARE AND SOFTWARE; COMPUTER HARDWARE DEVELOPMENT; COMPUTER SOFTWARE DEVELOPMENT; COMPUTER SOFTWARE PROGRAMMING FOR OTHERS; UPDATING OF COMPUTER SOFTWARE FOR OTHERS; COMPUTER SYSTEM ANALYSIS FOR OTHERS; CONFIGURATION OF COMPUTER NETWORKS, PROGRAMMING OF INTERNET PAGES FOR OTHERS; DESIGN OF WEB PAGES FOR OTHERS; RESEARCH AND DEVELOPMENT OF NEW PRODUCTS FOR OTHERS, DATA BASED DEVELOPMENT SERVICES; COMPUTER SOFTWARE PROGRAMMING IN THE FIELD OF ELECTRONIC COMMERCE AND FINANCIAL APPLICATIONS; SCIENTIFIC AND INDUSTRIAL RESEARCH IN THE FIELD OF COMPUTER HARDWARE AND SOFTWARE, TECHNICAL PROJECT STUDIES IN THE FIELD OF COMPUTER HARDWARE AND SOFTWARE (U.S. CLS. 100 AND 101).

SN 76-212,142. PLYMOUTH QUARRIES, INC., HINGHAM, MA. FILED 2-20-2001.

The logo for Plymouth Quarries consists of the word "Plymouth" in a serif font above the word "Quarries" in a larger, bold serif font. A circular emblem containing a silhouette of a ship is positioned between the two words, overlapping the "P" in "Quarries".

NO CLAIM IS MADE TO THE EXCLUSIVE RIGHT TO USE "QUARRIES", APART FROM THE MARK AS SHOWN. THE DESIGN PORTION OF THE MARK DEPICTS A MAYFLOWER SHIP.
SEC. 2(F) AS TO "PLYMOUTH".

CLASS 35—ADVERTISING AND BUSINESS

FOR RETAIL STORES AND SHOWROOMS FEATURING STONES AND ROCK FOR BUILDING AND LANDSCAPING PURPOSES (U.S. CLS. 100, 101 AND 102).
FIRST USE 0-0-1915; IN COMMERCE 0-0-1915.

CLASS 37—CONSTRUCTION AND REPAIR

FOR QUARRY SERVICES (U.S. CLS. 100, 103 AND 106).
FIRST USE 0-0-1915; IN COMMERCE 0-0-1915.

SN 76-212,438. POWERBOLIC LABORATORIES INC.,
HAWTHORNE, CA. FILED 2-20-2001.

SN 76-212,924. CORNPRODUCTSMCP SWEETENERS LLC,
MARSHALL, MN. FILED 2-20-2001.

POWERBOLIC

CLASS 5—PHARMACEUTICALS

FOR NUTRITIONAL SUPPLEMENTS, WEIGHT LOSS SUPPLEMENTS, DIETARY SUPPLEMENTS, VITAMIN SUPPLEMENTS, MINERAL SUPPLEMENTS, HERBAL SUPPLEMENTS, BOTANICAL SUPPLEMENTS, NUTRACEUTICAL SUPPLEMENTS AND ANY COMBINATION OF THE ABOVE; NUTRITIONAL FOOD BARS IN THE NATURE OF NUTRITIONAL SUPPLEMENTS, NUTRITIONAL DRINKS (U.S. CLS. 6, 18, 44, 46, 51 AND 52).
FIRST USE 9-9-1999; IN COMMERCE 11-27-1999.

CLASS 25—CLOTHING

FOR CLOTHING, NAMELY, SHIRTS, T-SHIRTS, PANTS, JEANS, SHORTS, SKIRTS, JACKETS, COATS, BODY SUITS, LEOTARDS, SWEATERS, SWEATSHIRTS, SWEAT PANTS, UNDERWEAR, BOXER SHORTS, MEN'S BRIEFS, WOMEN'S BRIEFS, LINGERIE, SOCKS, SINGLET, WRISTBANDS, HEADBANDS, GLOVES, BEACHWEAR, TANK TOPS, ROBES, SWIMSUITS, BIKINIS, TRAINING SUITS, WARM UP SUITS, RAIN COATS, RAIN JACKETS, VISORS, HATS, CAPS, SHOES (U.S. CLS. 22 AND 39).
FIRST USE 9-9-1999; IN COMMERCE 11-27-1999.

SN 76-212,470. GPT GLENDALE, INC., LAKELAND, FL.
FILED 2-20-2001.

LASER-GARD

OWNER OF U.S. REG. NOS. 865,729, 889,904 AND
1,042,764.

CLASS 9—ELECTRICAL AND SCIENTIFIC APPARATUS

FOR GLASS AND PLASTIC LENSES ADAPTED TO PROTECT THE EYES FROM LASER RADIATION OF DIFFERENT WAVE LENGTHS, SAID LENSES BEING USED FOR THE MANUFACTURE OF LASER-PROTECTIVE SAFETY EYEWEAR (U.S. CLS. 21, 23, 26, 36 AND 38).
FIRST USE 6-5-1968; IN COMMERCE 6-5-1968.

CLASS 17—RUBBER GOODS

FOR PLASTIC FILM ADAPTED TO PROTECT THE EYES FROM LASER RADIATION OF DIFFERENT WAVE LENGTHS, SAID FILM BEING SOLD IN SHEETS FOR THE MANUFACTURE OF LASER-PROTECTIVE SAFETY EYEWEAR (U.S. CLS. 1, 5, 12, 13, 35 AND 50).
FIRST USE 6-5-1968; IN COMMERCE 6-5-1968.

GROWING A NEW TRADITION

CLASS 1—CHEMICALS

FOR HIGH FRUCTOSE CORN SYRUP AND CORN STARCH FOR USE IN THE MANUFACTURE OF INFANT AND INVALID FOODS; HIGH FRUCTOSE CORN SYRUP AND CORN STARCH FOR USE IN THE MANUFACTURE OF FRUIT PRESERVES, JAMS, JELLIES, AND PRESERVED FRUITS AND VEGETABLES; HIGH FRUCTOSE CORN SYRUP AND CORN STARCH FOR USE IN THE MANUFACTURE OF CANNED FRUITS AND VEGETABLE; CORN SYRUP FOR USE IN THE MANUFACTURE OF BUILDING MATERIALS IN THE NATURE OF CONCRETE AND ROAD MAKING MATERIALS, NAMELY ASPHALT; CORN SYRUP FOR USE AS AN HUMECTANT IN THE MANUFACTURE OF TOBACCO; CORN SYRUP FOR USE IN THE MANUFACTURE OF PICKLES; CORN SYRUP FOR USE IN THE MANUFACTURE OF DAIRY PRODUCTS; CORN SYRUP, HIGH FRUCTOSE CORN SYRUP, SUCROSE AND INVERT SUGAR FOR USE IN THE MANUFACTURE OF CONFECTIONERY FOOD ITEMS, BAKING PRODUCTS IN THE NATURE OF PASTRIES AND PIES, AND SAUCES (U.S. CLS. 1, 5, 6, 10, 26 AND 46).

CLASS 5—PHARMACEUTICALS

FOR HIGH FRUCTOSE CORN SYRUP AND CORN STARCH, ALL SOLD AS INTEGRAL COMPONENTS USE IN INFANT FOODS AND FOODS FOR MEDICALLY RESTRICTED DIETS (U.S. CLS. 6, 18, 44, 46, 51 AND 52).

CLASS 19—NON-METALLIC BUILDING MATERIALS

FOR CORN SYRUP, SOLD AS INTEGRAL COMPONENT OF CONCRETE AND ASPHALT (U.S. CLS. 1, 12, 33 AND 50).

CLASS 29—MEATS AND PROCESSED FOODS

FOR HIGH FRUCTOSE CORN SYRUP, CORN SYRUP AND BLENDS THEREOF, SUCROSE AND INVERT SUGAR SOLD AS INTEGRAL COMPONENTS OF FRUITS PRESERVES, JAMS, JELLIES, AND PRESERVED FRUITS AND VEGETABLES; HIGH FRUCTOSE CORN SYRUP, CORN SYRUP AND BLENDS THEREOF, SUCROSE AND INVERT SUGAR SOLD AS INTEGRAL COMPONENTS OF CANNED FRUITS AND VEGETABLES; CORN SYRUP SOLD AS AN INTEGRAL COMPONENT OF PICKLES; CORN SYRUP SOLD AS AN INTEGRAL COMPONENT OF DAIRY PRODUCTS (U.S. CL. 46).

CLASS 30—STAPLE FOODS

FOR HIGH FRUCTOSE CORN SYRUP, SUCROSE AND INVERT SUGAR SOLD AS AN INTEGRAL COMPONENT OF CONFECTIONERY FOOD ITEMS, BAKING PRODUCTS IN THE NATURE OF PASTRIES AND PIES AND SAUCES; CORN AND CEREAL BASED SNACK FOODS AND SPICES (U.S. CL. 46).

CLASS 32—LIGHT BEVERAGES

FOR PREPARATIONS, NAMELY, CORN SYRUPS, HIGH FRUCTOSE CORN SYRUP, SUCROSE AND INVERT SUGAR FOR USE IN THE MANUFACTURE OF NON-ALCOHOLIC BEVERAGES, NAMELY FOUNTAIN SOFT DRINKS; PREPARATIONS, NAMELY, CORN SYRUPS, HIGH FRUCTOSE CORN SYRUP, SUCROSE AND INVERT SUGAR FOR USE IN THE MANUFACTURE OF ALCOHOLIC BEVERAGES, NAMELY BEER, WINES AND LIQUORS (U.S. CLS. 45, 46 AND 48).

CLASS 35—ADVERTISING AND BUSINESS

FOR DIRECT MARKETING ADVERTISING FOR OTHERS AND PROMOTING THE SALE OF GOODS FOR OTHERS, NAMELY PRODUCTS DERIVED FROM THE WET MILLING OF CORN, NAMELY CORN SYRUP, FOOD GRADE CORN STARCH, HIGH FRUCTOSE CORN SYRUP AND SPECIALTY PRODUCTS AND BLENDS WITH THE FOREGOING AS PRIMARY CONSTITUENTS; SUCROSE, INVERT SUGARS AND BLENDS CONTAINING THESE AS PRIMARY CONSTITUENTS THROUGH THE DISTRIBUTION OF PRINTED MATERIAL AND PROMOTIONAL CONTESTS (U.S. CLS. 100, 101 AND 102).

SN 76-213,735. CIL, CEM, D-44787 BOCHUM, FED REP GERMANY, AND BOIX, CHRISTIAN, D-44809 BOCHUM, FED REP GERMANY, FILED 2-21-2001.



OWNER OF FED REP GERMANY REG. NO. 39869449, DATED 2-19-1999, EXPIRES 12-31-2008.

NO CLAIM IS MADE TO THE EXCLUSIVE RIGHT TO USE "INC. INTERNATIONAL", APART FROM THE MARK AS SHOWN.

APPLICANT INDICATES THAT IT IS A FORM OF GREETING MEANING "PEACE".

CLASS 18—LEATHER GOODS

FOR ANIMAL SKINS HIDES; TRUNKS AND TRAVELING BAGS; UMBRELLAS, PARASOLS AND WALKING STICKS; WHIPS, ANIMAL HARNESSSES AND SADDLERY (U.S. CLS. 1, 2, 3, 22 AND 41).

CLASS 25—CLOTHING

FOR CLOTHING, NAMELY, SHIRTS, PANTS, SWEATSHIRTS, T-SHIRTS, SHORTS AND SUITS; FOOTWEAR; HEADWEAR, NAMELY, CAPS, HEADBANDS, SUN VISORS AND HATS (U.S. CLS. 22 AND 39).

CLASS 42—SCIENTIFIC, COMPUTER AND LEGAL SERVICES

FOR COMPUTER PROGRAMMING FOR OTHERS; DRESS DESIGN; RESEARCH IN THE FIELD OF CLOTHING; GRAPHIC ART DESIGN; RENTAL OF COMPUTER SOFTWARE (U.S. CLS. 100 AND 101).

SN 76-214,449. SCHULTZ COMPANY, ST. LOUIS, MO. BY ASSIGNMENT SCHULTZ, DANIEL J., BRIDGETON, MO. AND SCHULTZ, STEVEN D., BRIDGETON, MO. FILED 2-22-2001.

ROOT ZONE

NO CLAIM IS MADE TO THE EXCLUSIVE RIGHT TO USE "ROOT", APART FROM THE MARK AS SHOWN.

CLASS 1—CHEMICALS

FOR PLANT FOOD, POTTING SOIL, POTTING MIXES, FERTILIZERS AND SOIL AMENDMENTS FOR DOMESTIC USE (U.S. CLS. 1, 5, 6, 10, 26 AND 46).

CLASS 5—PHARMACEUTICALS

FOR INSECTICIDES AND FUNGICIDES FOR DOMESTIC USE (U.S. CLS. 6, 18, 44, 46, 51 AND 52).

SN 76-214,783. CASAL, JOHN R., PLAINVIEW, NY. AND SUROFF, MARK R., PLAINVIEW, NY. FILED 2-26-2001.

LIMOSCENE**CLASS 9—ELECTRICAL AND SCIENTIFIC APPARATUS**

FOR PRE-RECORDED VIDEOTAPES, PRE-RECORDED AUDIOTAPES AND COMPACT DISCS FEATURING MUSIC AND STORIES FEATURED IN ENTERTAINMENT AND MOTION PICTURE FILMS AND TELEVISION PROGRAMS (U.S. CLS. 21, 23, 26, 36 AND 38).

CLASS 41—EDUCATION AND ENTERTAINMENT

FOR ENTERTAINMENT IN THE NATURE OF ONGOING TELEVISION PROGRAMS IN THE FIELD OF NEWS, COMEDY, AND VARIETY SHOWS (U.S. CLS. 100, 101 AND 107).

SN 76-215,226. MANAGEMENT SCIENCE ASSOCIATES, INC., PITTSBURGH, PA. FILED 2-26-2001.

PERSPECTIVE**CLASS 9—ELECTRICAL AND SCIENTIFIC APPARATUS**

FOR COMPUTER SOFTWARE FOR THE PLANNING AND REPORTING OF OPERATIONS OF THE BROADCASTING MEDIA IN THE MEDIA FIELD (U.S. CLS. 21, 23, 26, 36 AND 38).

CLASS 42—SCIENTIFIC, COMPUTER AND LEGAL SERVICES

FOR COMPUTER SERVICES TO BROADCASTING MEDIA IN THE NATURE OF UPDATING AND ENHANCING SOFTWARE AND PROVIDING ON-SITE AND TELEPHONE COMPUTER GUIDANCE IN THE OPERATIONS OF THE SOFTWARE (U.S. CLS. 100 AND 101).

SN 76-215,747. WORRGAME PRODUCTS, INC., SANTA FE SPRINGS, CA. FILED 2-26-2001.

SN 76-216,971. LYNX THERAPEUTICS, GMBH, 69120 HEIDELBERG, FED REP GERMANY, FILED 2-26-2001.

STO

CLASS 13—FIREARMS

FOR GUNS, GUNSIGHTS FOR FIREARMS, GUN PARTS, GUN CARTRIDGES, GUN COTTON, GUN LOCKS, GUN MOUNTS, GUN TRIGGERS; GUNS FOR FIRING TAG CARTRIDGES AND PELLETS; TAGGING PELLETS AND CARTRIDGES (U.S. CLS. 2 AND 9).

CLASS 42—SCIENTIFIC, COMPUTER AND LEGAL SERVICES

FOR ENTERTAINMENT IN THE NATURE OF GUN TOURNAMENTS; PROMOTING SPORTS AND GUN COMPETITION; RECREATIONAL ACTIVITIES AND SPONSORSHIPS FOR SPORTSPEOPLE, PARTICULARLY SPORTS GUN OWNERS (U.S. CLS. 100 AND 101).

SN 76-216,817. LYNX THERAPEUTICS, GMBH, 69120 HEIDELBERG, FED REP GERMANY, FILED 2-26-2001.



PRIORITY CLAIMED UNDER SEC. 44(D) ON FED REP GERMANY APPLICATION NO. 30064522.805, FILED 8-28-2000, REG. NO. 30064522, DATED 10-24-2000, EXPIRES 8-31-2010.

CLASS 9—ELECTRICAL AND SCIENTIFIC APPARATUS

FOR SCIENTIFIC APPARATUS AND INSTRUMENTS TO ANALYZE GENE EXPRESSION AND FUNCTION OF PROTEINS AND THEREOF DERIVED INFORMATION, IN PARTICULAR, MAGNETIC DATA CARRIERS, DATA PROCESSING EQUIPMENT AND COMPUTERS, FOR THE USE OF GENERATING DATABASES CONTAINING THE RESULTS OF GENE STRUCTURE, GENE FUNCTION AND GENE EXPRESSION ANALYSES AS WELL AS THEREOF DERIVED INFORMATION OF THE PROTEIN (U.S. CLS. 21, 23, 26, 36 AND 38).

CLASS 42—SCIENTIFIC, COMPUTER AND LEGAL SERVICES

FOR SCIENTIFIC AND INDUSTRIAL RESEARCH IN THE FIELD OF GENE STRUCTURE, GENE FUNCTION AND GENE EXPRESSION; COMPUTER PROGRAMMING FOR OTHERS IN THE FIELD OF GENE STRUCTURE, GENE FUNCTION AND GENE EXPRESSION; SERVICES OF MEDICAL, BACTERIOLOGICAL OR CHEMICAL LABORATORIUM RESEARCH IN THE FIELD OF GENE STRUCTURE, GENE FUNCTION AND GENE EXPRESSION; TECHNICAL ADVISORY SERVICE RESEARCH IN THE FIELD OF GENE STRUCTURE, GENE FUNCTION AND GENE EXPRESSION; PREPARATION OF REPORTS OF EXPERT RESEARCH IN THE FIELD OF GENE STRUCTURE, GENE FUNCTION AND GENE EXPRESSION (U.S. CLS. 100 AND 101).



PRIORITY CLAIMED UNDER SEC. 44(D) ON FED REP GERMANY APPLICATION NO. 30064520.105, FILED 8-28-2000, REG. NO. 30064520, DATED 10-24-2000, EXPIRES 8-31-2010.

CLASS 9—ELECTRICAL AND SCIENTIFIC APPARATUS

FOR SCIENTIFIC APPARATUS AND INSTRUMENTS TO ANALYZE GENE EXPRESSION AND FUNCTION OF PROTEINS AND THEREOF DERIVED INFORMATION, IN PARTICULAR, MAGNETIC DATA CARRIERS, DATA PROCESSING EQUIPMENT AND COMPUTERS, FOR THE USE OF GENERATING DATABASES CONTAINING THE RESULTS OF GENE STRUCTURE, GENE FUNCTION AND GENE EXPRESSION ANALYSES AS WELL AS THEREOF DERIVED INFORMATION OF THE PROTEIN (U.S. CLS. 21, 23, 26, 36 AND 38).

CLASS 42—SCIENTIFIC, COMPUTER AND LEGAL SERVICES

FOR SCIENTIFIC AND INDUSTRIAL RESEARCH IN THE FIELD OF GENE STRUCTURE, GENE FUNCTION AND GENE EXPRESSION; COMPUTER PROGRAMMING FOR OTHERS IN THE FIELD OF GENE STRUCTURE, GENE FUNCTION AND GENE EXPRESSION; SERVICES OF A MEDICAL, BACTERIOLOGICAL OR CHEMICAL LABORATORIUM RESEARCH IN THE FIELD OF GENE STRUCTURE, GENE FUNCTION AND GENE EXPRESSION; TECHNICAL ADVISORY SERVICE RESEARCH IN THE FIELD OF GENE STRUCTURE, GENE FUNCTION AND GENE EXPRESSION; PREPARATION OF REPORTS OF EXPERT RESEARCH IN THE FIELD OF GENE STRUCTURE, GENE FUNCTION AND GENE EXPRESSION (U.S. CLS. 100 AND 101).

SN 76-218,137. ARS PARFUM CREATION & CONSULTING GMBH, 50997 KOLN, FED REP GERMANY, FILED 3-1-2001.

scentups

PRIORITY CLAIMED UNDER SEC. 44(D) ON FED REP GERMANY APPLICATION NO. 301002371/21, FILED 1-3-2001, REG. NO. 30100237, DATED 3-1-2001, EXPIRES 1-31-2011.

CLASS 3—COSMETICS AND CLEANING PREPARATIONS

FOR TOILETRIES, NAMELY, BODY SOAPS, FACIAL SOAPS, HAND SOAPS, PERFUMES, ESSENTIAL OILS FOR PERSONAL USE, COSMETICS, HAIR SHAMPOO, AND TOOTHPASTE (U.S. CLS. 1, 4, 6, 50, 51 AND 52).

CLASS 11—ENVIRONMENTAL CONTROL APPARATUS

FOR ELECTRICAL AND MECHANICAL DEVICES AND APPARATUSES FOR VAPOR DELIVERY, NAMELY, FOG MACHINES, FOG GENERATORS, ELECTRICAL ATOMIZERS, AND MECHANICAL VAPOR PROPAGATORS FOR USE IN MULTIMEDIA DEVICES FOR SCENE-RELATED PROPAGATION OF VAPORS IN THE ENTERTAINMENT INDUSTRY (U.S. CLS. 13, 21, 23, 31 AND 34).

CLASS 42—SCIENTIFIC, COMPUTER AND LEGAL SERVICES

FOR PRODUCT DEVELOPMENT, DESIGN AND CONSULTATION FOR OTHERS IN THE FIELD OF FOG MACHINES, FOG GENERATORS, VAPOR PROPAGATORS AND VAPOR PROPAGATING EQUIPMENT FOR USE BY THE ENTERTAINMENT INDUSTRY (U.S. CLS. 100 AND 101).

SN 76-218,892. INTRAWEST SANDESTIN COMPANY, LLC, DESTIN, FL. FILED 3-5-2001.



OWNER OF U.S. REG. NOS. 1,420,467, 1,895,357 AND OTHERS.

NO CLAIM IS MADE TO THE EXCLUSIVE RIGHT TO USE "GOLF AND BEACH RESORT", APART FROM THE MARK AS SHOWN.

CLASS 35—ADVERTISING AND BUSINESS

FOR RETAIL DEPARTMENT STORES; RETAIL CLOTHING STORES; RETAIL OUTLETS FEATURING SPORTING GOODS; RETAIL NOVELTY AND SOUVENIR STORES (U.S. CLS. 100, 101 AND 102).
FIRST USE 5-0-2000; IN COMMERCE 5-0-2000.

CLASS 36—INSURANCE AND FINANCIAL

FOR LEASING OF SHOPPING MALL SPACE (U.S. CLS. 100, 101 AND 102).
FIRST USE 5-0-2000; IN COMMERCE 5-0-2000.

CLASS 39—TRANSPORTATION AND STORAGE

FOR MARINA SERVICES (U.S. CLS. 100 AND 105).
FIRST USE 5-0-2000; IN COMMERCE 5-0-2000.

CLASS 41—EDUCATION AND ENTERTAINMENT

FOR GOLF COURSE SERVICES; PROVIDING TENNIS AND WATERSPORTS FACILITIES FOR RECREATIONAL ACTIVITIES; CONDUCTING ENTERTAINMENT EXHIBITIONS IN THE NATURE OF WINE FESTIVALS; COUNTRY CLUB FACILITIES (U.S. CLS. 100, 101 AND 107).
FIRST USE 5-0-2000; IN COMMERCE 5-0-2000.

CLASS 42—SCIENTIFIC, COMPUTER AND LEGAL SERVICES

FOR RESORT HOTEL SERVICES; RESTAURANTS; HEALTH SPA SERVICES; MEDICAL CLINICS (U.S. CLS. 100 AND 101).

FIRST USE 5-0-2000; IN COMMERCE 5-0-2000.

SN 76-219,237. YALE UNIVERSITY, NEW HAVEN, CT. FILED 3-2-2001.

YALE ENTREPRENEURIAL SOCIETY

OWNER OF U.S. REG. NOS. 1,391,543, 2,271,288 AND OTHERS.

NO CLAIM IS MADE TO THE EXCLUSIVE RIGHT TO USE "ENTREPRENEURIAL SOCIETY", APART FROM THE MARK AS SHOWN.

CLASS 41—EDUCATION AND ENTERTAINMENT

FOR EDUCATIONAL SERVICES, NAMELY, PROVIDING SEMINARS AND COURSES OF INSTRUCTION ON ENTREPRENEURIAL OPPORTUNITIES; EDUCATIONAL AND ENTERTAINMENT SERVICES NAMELY PROVIDING SPEAKERS ON TOPICS CONCERNING ENTREPRENEURIAL ACTIVITIES; ARRANGING AND CONDUCTING COMPETITIONS FOR PRIZES IN THE FIELD OF ENTREPRENEURIAL ACTIVITIES FOR THE BEST BUSINESS PLANS (U.S. CLS. 100, 101 AND 107).

CLASS 42—SCIENTIFIC, COMPUTER AND LEGAL SERVICES

FOR ASSOCIATION SERVICES, NAMELY, PROMOTING THE INTERESTS OF FOR PROFIT AND NOT-FOR-PROFIT ENTREPRENEURS; PROMOTING MENTORING AND NETWORKING ACTIVITIES AMONG ENTREPRENEURS (U.S. CLS. 100 AND 101).

SN 76-219,238. YALE UNIVERSITY, NEW HAVEN, CT. FILED 3-2-2001.

Y**CLASS 35—ADVERTISING AND BUSINESS**

FOR ASSOCIATION SERVICES, NAMELY, PROMOTING THE INTERESTS OF ENTREPRENEURS; PROMOTING THE MENTORING AND NETWORKING ACTIVITIES AMONG ENTREPRENEURS (U.S. CLS. 100, 101 AND 102).

CLASS 41—EDUCATION AND ENTERTAINMENT

FOR PROVIDING EDUCATIONAL SEMINARS, COURSES AND INSTRUCTION REGARDING ENTREPRENEURIAL OPPORTUNITIES—ARRANGING AND CONDUCTING EDUCATIONAL SPEAKING ENGAGEMENTS ON TOPICS CONCERNING ENTREPRENEURIAL ACTIVITIES; ARRANGING AND CONDUCTING PRIZE COMPETITIONS FOR THE BEST BUSINESS PLANS (U.S. CLS. 100, 101 AND 107).

SN 76-219,609. COUNTY BOARD OF ARLINGTON COUNTY, VIRGINIA, THE, ARLINGTON, VA. FILED 3-6-2001.

EASY COMMUTES BEGIN HERE

CLASS 9—ELECTRICAL AND SCIENTIFIC APPARATUS

FOR MAGNETS (U.S. CLS. 21, 23, 26, 36 AND 38).
FIRST USE 3-0-1997; IN COMMERCE 3-0-1997.

CLASS 16—PAPER GOODS AND PRINTED MATTER

FOR WALLETS FOR CARRYING MASS TRANSIT FARE CARDS (U.S. CLS. 2, 5, 22, 23, 29, 37, 38 AND 50).
FIRST USE 3-0-1997; IN COMMERCE 3-0-1997.

CLASS 18—LEATHER GOODS

FOR COIN PURSES (U.S. CLS. 1, 2, 3, 22 AND 41).
FIRST USE 3-0-1997; IN COMMERCE 3-0-1997.

CLASS 25—CLOTHING

FOR HATS AND SHIRTS (U.S. CLS. 22 AND 39).
FIRST USE 3-0-1997; IN COMMERCE 3-0-1997.

CLASS 35—ADVERTISING AND BUSINESS

FOR RETAIL STORE SERVICES FEATURING MASS TRANSIT FARES, MAPS AND TIMETABLES (U.S. CLS. 100, 101 AND 102).
FIRST USE 3-0-1997; IN COMMERCE 3-0-1997.

CLASS 39—TRANSPORTATION AND STORAGE

FOR PROVIDING COMMUTING INFORMATION AND CARPOOL RIDEMATCHING SERVICES (U.S. CLS. 100 AND 105).
FIRST USE 3-0-1997; IN COMMERCE 3-0-1997.

CLASS 42—SCIENTIFIC, COMPUTER AND LEGAL SERVICES

FOR PROMOTING PUBLIC AWARENESS OF THE NEED FOR USING MASS TRANSIT, CAR AND VAN POOLING, BICYCLING, WALKING AND OTHER ALTERNATIVES TO DRIVING ALONE BY DISSEMINATING INFORMATION VIA A WEB SITE ON THE GLOBAL COMPUTER NETWORK (U.S. CLS. 100 AND 101).
FIRST USE 3-0-1997; IN COMMERCE 3-0-1997.

SN 76-219,846. ROSS ACQUISITIONS, INC., DBA THE JELLY BEAN FACTORY, CINCINNATI, OH. FILED 3-5-2001.

GALERIE

CLASS 6—METAL GOODS

FOR METAL KEY CHAINS; METAL DECORATIVE BOXES; BASKETS MADE OF METAL WIRE; METAL WIRE FIGURINES; METAL LUNCH BOXES (U.S. CLS. 2, 12, 13, 14, 23, 25 AND 50).

CLASS 16—PAPER GOODS AND PRINTED MATTER

FOR PAPER FIGURINES; CARDBOARD FIGURINES; PAPER MACHE ITEMS, NAMELY, PINATAS, FIGURINES, BOXES; PAPER MACHE WRAPPED CANDLE HOLDERS; PENCIL CASES (U.S. CLS. 2, 5, 22, 23, 29, 37, 38 AND 50).

CLASS 18—LEATHER GOODS

FOR BACKPACKS; PURSES; TOTES, NAMELY, TOTE BAGS, HANDBAGS, COSMETIC BAGS, FANNY PACKS, AND ZIPPERED POUCHES (U.S. CLS. 1, 2, 3, 22 AND 41).

CLASS 20—FURNITURE AND ARTICLES NOT OTHERWISE CLASSIFIED

FOR RESIN FIGURINES; ACRYLIC FIGURINES; WOOD FIGURINES; PLASTIC FIGURINES; EVA FIGURINES AND MASKS; NON-METAL KEY CHAINS; WOOD BOXES, NON-METAL COMPARTMENT BOXES, NAMELY, CERAMIC AND ACRYLIC COMPARTMENT BOXES AND JEWELRY BOXES; SEQUINED BOXES; CLOTH COVERED BOXES (U.S. CLS. 2, 13, 22, 25, 32 AND 50).

SN 76-220,386. STORAGE REVOLUTION, INC., YOUNGSVILLE, NC. FILED 3-6-2001.

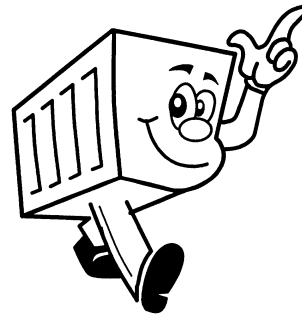

CLASS 35—ADVERTISING AND BUSINESS

FOR DISTRIBUTORSHIP SERVICES IN THE FIELD OF PORTABLE STORAGE UNITS, NAMELY CONTAINERS AND TRAILERS AND PORTABLE TEMPORARY OFFICES FOR INDUSTRIAL AND COMMERCIAL USE (U.S. CLS. 100, 101 AND 102).
FIRST USE 12-1-2000; IN COMMERCE 12-1-2000.

CLASS 42—SCIENTIFIC, COMPUTER AND LEGAL SERVICES

FOR LEASING AND RENTAL SERVICES IN THE FIELD OF PORTABLE STORAGE UNITS, NAMELY CONTAINERS AND TRAILERS AND PORTABLE TEMPORARY OFFICE TRAILERS FOR INDUSTRIAL AND COMMERCIAL USE (U.S. CLS. 100 AND 101).
FIRST USE 12-1-2000; IN COMMERCE 12-1-2000.

SN 76-220,701. EXPAN ELECTRONICS CO. LTD., ANSAN-CITY, KYONGGI-DO, REPUBLIC OF KOREA, FILED 3-7-2001.

24KDEX

PRIORITY CLAIMED UNDER SEC. 44(D) ON REPUBLIC OF KOREA APPLICATION NO. 46691, FILED 10-6-2000, REG. NO. 0519620, DATED 5-6-2002, EXPIRES 5-6-2012.

CLASS 3—COSMETICS AND CLEANING PREPARATIONS

FOR ARTIFICIAL EYELASHES; ADHESIVES FOR ATTACHING ARTIFICIAL EYELASHES; COTTON STICKS FOR COSMETIC PURPOSES; AND BEAUTY MASKS (U.S. CLS. 1, 4, 6, 50, 51 AND 52).

CLASS 20—FURNITURE AND ARTICLES NOT OTHERWISE CLASSIFIED

FOR BEDS, SOFAS, CHAIRS, CABINETS, MATTRESSES, PILLOWS, CUSHIONS, MIRRORS, AND PEDESTALS (U.S. CLS. 2, 13, 22, 25, 32 AND 50).

CLASS 24—FABRICS

FOR BED BLANKETS, UNFITTED FABRIC FURNITURE COVERS, WINDOW CURTAINS, COTTON FABRICS, HEMP CLOTH, SILK CLOTH, WOOLEN FABRIC, AND ADHESIVE FABRIC FOR APPLICATION BY HEAT USED IN THE MANUFACTURE OF FURNITURE (U.S. CLS. 42 AND 50).

CLASS 25—CLOTHING

FOR BRASSIERES, T-SHIRTS, JACKETS, NECKTIES, SHOES, UNDERCLOTHES, UNDERPANTS, SWEAT SUITS, SOCKS, TROUSERS, FUR COATS, AND OVERCOATS (U.S. CLS. 22 AND 39).

CLASS 27—FLOOR COVERINGS

FOR CARPETS, WALLPAPER, STRAW MATS, CARPETS FOR AUTOMOBILES, HARD SURFACE COVERINGS FOR FLOORS, AND REED MATS (U.S. CLS. 19, 20, 37, 42 AND 50).

CLASS 9—ELECTRICAL AND SCIENTIFIC APPARATUS

FOR BURGLAR ALARMS; ANTENNAS; AUDIO CASSETTE DECKS FOR AUTOMOBILES; PRERECORDED AUDIOTAPES, CASSETTES AND COMPACT DISCS IN CONNECTION WITH AUTOMOBILES AND RELATED FUNCTIONS; BATTERIES; BATTERIES FOR VEHICLES; BATTERY CHARGERS; SAFETY EQUIPMENT, NAMELY, BEACON LIGHTS; MARKER, NAVIGATIONAL AND SIGNALLING BUOYS; COAXIAL, COMPUTER, ELECTRICAL AND FIBER-OPTIC CABLES; VIDEO CAMERAS; EYEGLASS CASES; COMPUTER AND SILICON CHIPS; ELECTRIC CIGARETTE LIGHTERS FOR LAND VEHICLES; CIRCUIT BOARDS; ELECTRICAL AND PRINTED CIRCUIT BOARDS; ELECTRICAL AND INTEGRATED CIRCUITS; MAGNETICALLY CODED CARDS AND CARD READERS; COMPACT DISC PLAYERS; COMPUTER MONITORS; COMPUTER PROGRAMS IN CONNECTION WITH AUTOMOBILES AND RELATED FUNCTIONS; COMPUTER UTILITY PROGRAMS; ELECTRICAL CONTROLLERS; CONVERTERS; ELECTRIC CONVERTERS; CRUISE CONTROLS FOR MOTOR VEHICLES; DATA PROCESSORS; MARINE DEPTH FINDERS; SMOKE DETECTORS; ELECTRIC LIGHT DIMMERS; OPTICAL DISCS; AUDIO DISCS AND VIDEO DISCS IN CONNECTION WITH AUTOMOBILES AND RELATED FUNCTIONS; ELECTRIC LUMINESCENT DISPLAY PANELS; LIGHT-EMITTING DIODE DISPLAYS; EYEGLASSES; FIBER-OPTIC LIGHT AND IMAGE CONDUITS; FIBER OPTICS; SAFETY EQUIPMENT, NAMELY, FIRE ESCAPE LADDERS; FIRE EXTINGUISHERS; TELESCOPIC GUN SIGHTS; HELMETS FOR AEROSPACE USE; TELEPHONE APPARATUS, NAMELY, INTERCOMS; LASERS NOT FOR MEDICAL USE; ELECTRONIC MOTION-SENSITIVE SWITCHES; OCR OPTICAL-CHARACTER-RECOGNITION APPARATUS; PERISCOPES; SATELLITE PROCESSORS; MOVIE PROJECTORS; RADAR AND RADAR DETECTORS; RADIO-CONTROLLED MINATURE AERIAL TARGETS; RADIOS; RADIOS FOR VEHICLES; RECEIVERS; LABORATORY ROBOTS; SATELLITES; SATELLITE PROCESSORS; SATELLITES FOR SCIENTIFIC PURPOSES; SEMICONDUCTORS AND SEMICONDUCTOR DEVICES; SIGNAL PROCESSORS; SILICON WAFERS; SIRENS FOR VEHICLES; SOLENOID VALVES; SUNGLASSES; ELECTRIC SWITCHES; ELECTRONIC MOTION-SENSITIVE SWITCHES AND ELECTRONIC TOUCH-SENSITIVE SWITCHES; TACHOMETERS; TELEVISION ANTENNAS; TRANSCEIVERS; ELECTRICAL TRANSFORMERS; RADIO TRANSMITTERS; VIDEO MONITORS; VIRTUAL-REALITY SOFTWARE FOR AUTOMOTIVE AND AEROSPACE USE; VOLTAGE SURGE PROTECTORS AND SUPPRESSORS; WARNING TRIANGLES TO INDICATE VEHICLE BREAKDOWNS (U.S. CLS. 21, 23, 26, 36 AND 38).

SN 76-221,604. DAIMLERCHRYSLER AG, 70567 STUTTGART, FED REP GERMANY, FILED 3-8-2001.

DCDI

PRIORITY CLAIMED UNDER SEC. 44(D) ON FED REP GERMANY APPLICATION NO. 30067349.309, FILED 9-8-2000, REG. NO. 30067349, DATED 2-13-2001, EXPIRES 9-30-2010.

CLASS 42—SCIENTIFIC, COMPUTER AND LEGAL SERVICES

FOR DEVELOPMENT AND MAINTENANCE OF DATA PROCESSING PROGRAMS (U.S. CLS. 100 AND 101).

SN 76-223,489. SAN DIEGO GAS & ELECTRIC COMPANY, SAN DIEGO, CA. FILED 3-13-2001.

DO YOUR PART - BE ENERGY SMART

CLASS 35—ADVERTISING AND BUSINESS

FOR PROMOTING GOODS AND SERVICES OF OTHERS BY DISTRIBUTING REBATE COUPONS PERTAINING TO THE WEATHERIZATION OF HOMES AND BUSINESSES AND THE REPLACEMENT OF LOW-EFFICIENCY APPLIANCES AND LIGHTING SYSTEMS WITH HIGH-EFFICIENCY OPTIONS; ADMINISTERING PROGRAMS WHICH PROVIDE REBATES FOR WEATHERIZATION OF HOMES AND BUSINESSES AND THE REPLACEMENT OF LOW-EFFICIENCY APPLIANCES AND LIGHTING SYSTEMS WITH HIGH EFFICIENCY OPTIONS (U.S. CLS. 100, 101 AND 102).

CLASS 42—SCIENTIFIC, COMPUTER AND LEGAL SERVICES

FOR PROVIDING INFORMATION TO CONSUMERS AND BUSINESSES ON ENERGY CONSERVATION AND ON THE EFFICIENT USE OF ELECTRICITY AND NATURAL GAS (U.S. CLS. 100 AND 101).

SN 76-224,103. SAN DIEGO GAS & ELECTRIC COMPANY, SAN DIEGO, CA. FILED 3-13-2001.

Be Energy Smart

CLASS 35—ADVERTISING AND BUSINESS

FOR PROMOTING GOODS AND SERVICES OF OTHERS BY DISTRIBUTING REBATE COUPONS PERTAINING TO THE WEATHERIZATION OF HOMES AND BUSINESSES AND THE REPLACEMENT OF LOW-EFFICIENCY APPLIANCES AND LIGHTING SYSTEMS WITH HIGH-EFFICIENCY OPTIONS; ADMINISTERING PROGRAMS WHICH PROVIDE REBATES FOR WEATHERIZATION OF HOMES AND BUSINESSES AND THE REPLACEMENT OF LOW-EFFICIENCY APPLIANCES AND LIGHTING SYSTEMS WITH HIGH EFFICIENCY OPTIONS (U.S. CLS. 100, 101 AND 102).

CLASS 42—SCIENTIFIC, COMPUTER AND LEGAL SERVICES

FOR PROVIDING INFORMATION TO CONSUMERS AND BUSINESSES ON ENERGY CONSERVATION AND ON THE EFFICIENT USE OF ELECTRICITY AND NATURAL GAS (U.S. CLS. 100 AND 101).

SN 76-224,306. VITASOY USA INC., SOUTH SAN FRANCISCO, CA. FILED 3-14-2001.

NASOYA

OWNER OF U.S. REG. NO. 1,708,433.

CLASS 29—MEATS AND PROCESSED FOODS

FOR TOFU, FRESH TOFU, BAKED TOFU, MARI-NATED TOFU, TOFU BASED DESSERTS (U.S. CL. 46). FIRST USE 4-0-1978; IN COMMERCE 4-0-1978.

CLASS 30—STAPLE FOODS

FOR PASTA PRODUCTS, NAMELY WON TON WRAPPERS AND EGG ROLL WRAPPERS, TOFU SEASONING MIXES (U.S. CL. 46). FIRST USE 4-0-1984; IN COMMERCE 4-0-1984.

SN 76-224,351. COMMONWEALTH EDISON COMPANY, CLICAGO, IL. FILED 3-14-2001.

INNOVATIONS POWERED BY PEOPLE

CLASS 35—ADVERTISING AND BUSINESS

FOR ENERGY PRICE COMPARISON SERVICES; UTILITY BILL MANAGEMENT SERVICES, NAMELY, TRACKING, REPORTING, ANALYZING AND DELIVERING ENERGY INFORMATION IN THE FORM OF UTILITY BILLS AND REPORTS (U.S. CLS. 100, 101 AND 102).

CLASS 39—TRANSPORTATION AND STORAGE

FOR DISTRIBUTION OF ENERGY; PUBLIC UTILITY SERVICES; PUBLIC UTILITY SERVICES IN THE NATURE OF ELECTRICITY DISTRIBUTION; UTILITY SERVICES, NAMELY, TRANSMISSION OF ELECTRICITY (U.S. CLS. 100 AND 105).

CLASS 42—SCIENTIFIC, COMPUTER AND LEGAL SERVICES

FOR ENERGY AUDITING; ENERGY USAGE MANAGEMENT; DESIGN FOR OTHERS IN THE FIELD OF ENERGY EQUIPMENT, GENERATORS AND FACILITIES FOR PRODUCTION OF ENERGY; ON-LINE ENERGY USAGE MONITORING AND MANAGEMENT (U.S. CLS. 100 AND 101).

SN 76-224,357. NANTUCKET GOURMET, INC., NANTUCKET, MA. BY ASSIGNMENT STONE, JONATHAN AND PATRICIA, DBA NANTUCKET GOURMET, NANTUCKET, MA. FILED 3-14-2001.

NANTUCKET GOURMET

NO CLAIM IS MADE TO THE EXCLUSIVE RIGHT TO USE "GOURMET", APART FROM THE MARK AS SHOWN. SEC. 2(F).

CLASS 29—MEATS AND PROCESSED FOODS

FOR JAMS, JELLIES, PREPARED SOUPS, SOUP MIXES, ROASTED NUTS, SHELLED NUTS, PROCESSED NUTS, CANDIED NUTS, DRIED FRUITS, CHEESE, CHEESE-BASED SPREADS, BLEU CHEESE PATES, SALADS, NAMELY, FRUIT SALAD, AND GARDEN SALAD, POTATO SALAD (U.S. CL. 46). FIRST USE 1-0-1982; IN COMMERCE 10-0-1982.

CLASS 30—STAPLE FOODS

FOR SPICES, BAKING MIXES, SALADS, NAMELY, POTATO SALAD, PASTA SALAD, AND MACARONI SALAD; TEAS, COFFEES, HONEY, CONDIMENTS, NAMELY, MUSTARD, SPICES, PEPPER, TAPENADE; CANDY, AND BAKERY GOODS (U.S. CL. 46).

FIRST USE 1-0-1982; IN COMMERCE 10-0-1982.

CLASS 35—ADVERTISING AND BUSINESS

FOR RETAIL GOURMET FOOD STORE SERVICES FEATURING SPECIALTY FOODS AND FROZEN HORS D'OEUVRES; MAIL ORDER SERVICES FEATURING GOURMET AND SPECIALTY FOODS (U.S. CLS. 100, 101 AND 102).

FIRST USE 0-0-1976; IN COMMERCE 0-0-1976.

CLASS 42—SCIENTIFIC, COMPUTER AND LEGAL SERVICES

FOR CATERING SERVICES; TAKE-OUT RESTAURANT SERVICES FEATURING SANDWICHES AND SOUPS (U.S. CLS. 100 AND 101).

FIRST USE 0-0-1996; IN COMMERCE 0-0-1996.

CLASS 35—ADVERTISING AND BUSINESS

FOR ACCOUNTING, ADVERTISING AGENCIES; RENTAL OF ADVERTISING SPACE; BUSINESS AUDITING; BOOKKEEPING; BUSINESS MANAGEMENT ASSISTANCE; BUSINESS MANAGEMENT CONSULTANCY; COMMERCIAL OR INDUSTRIAL MANAGEMENT ASSISTANCE; COST PRICE ANALYSIS; DIRECT MAIL ADVERTISING; DISSEMINATION OF ADVERTISING MATTER; ECONOMIC FORECASTING; EFFICIENCY EXPERTS; IMPORT-EXPORT AGENCIES; MARKETING RESEARCH; PREPARING AND PLACING OUTDOOR ADVERTISING FOR OTHERS; PAYROLL PREPARATION; PERSONNEL MANAGEMENT CONSULTANCY; PERSONNEL RECRUITMENT; PUBLIC RELATIONS; CREATING AND DEVELOPING RADIO ADVERTISING FOR OTHERS; SALES PROMOTION FOR OTHERS BY PREPARING AND PLACING ADVERTISEMENTS IN AN ELECTRONIC MAGAZINE ACCESSED THROUGH A GLOBAL COMPUTER NETWORK OR THROUGH THE DISTRIBUTION OF PRINTED MATERIAL AND PROMOTIONAL CONTENTS; TAX PREPARATION; AND PROVIDING TELEVISION ADVERTISING FOR OTHERS (U.S. CLS. 100, 101 AND 102).

CLASS 36—INSURANCE AND FINANCIAL

FOR ACCIDENT INSURANCE UNDERWRITING; BANKING; BROKERAGE IN THE FIELD OF ART, INSURANCE, STOCKS, COMMODITIES; CAPITAL INVESTMENT CONSULTATION; CREDIT BUREAU; CUSTOMS BROKERAGE; FACTORING; FIDUCIARY REPRESENTATIVES; FINANCIAL CONSULTANCY; FINANCIAL MANAGEMENT; FINANCING SERVICES, NAMELY, FINANCIAL GUARANTEE AND SURETY OR GUARANTEE ASSURANCE AND UNDERWRITING; FIRE INSURANCE UNDERWRITING; FISCAL ASSESSMENTS; FUND INVESTMENTS; GUARANTEES; HEALTH INSURANCE UNDERWRITING; INSURANCE BROKERAGE; INSURANCE CONSULTANCY; INSURANCE INFORMATION; INSURANCE UNDERWRITING FOR ALL TYPES OF INSURANCE; LIFE INSURANCE UNDERWRITING; MARINE INSURANCE UNDERWRITING; MORTGAGE BANKING; MUTUAL FUND BROKERAGE, MUTUAL FUND DISTRIBUTION, OR MUTUAL FUND INVESTMENT; REAL ESTATE AGENCIES; REAL ESTATE BROKERS; RENTING OF APARTMENTS; SAVINGS BANKS; SECURITIES BROKERAGE; AND STOCK EXCHANGE QUOTATIONS (U.S. CLS. 100, 101 AND 102).

CLASS 37—CONSTRUCTION AND REPAIR

FOR WAREHOUSE CONSTRUCTION AND REPAIR; AIRPLANE MAINTENANCE AND REPAIR; BUILDING CONSTRUCTION SUPERVISION; CAR MAINTENANCE; CAR WASH; DEMOLITION OF BUILDINGS; VEHICLE LUBRICATION; MACHINERY INSTALLATION, MAINTENANCE AND REPAIR; MINING EXTRACTION; MOTOR VEHICLE MAINTENANCE AND REPAIR; ROAD PAVING; PIPELINE CONSTRUCTION AND MAINTENANCE; SHIPBUILDING; VEHICLE CLEANING; VEHICLE GREASING LUBRICATION; VEHICLE POLISHING; VEHICLE REPAIR; VEHICLE SERVICE STATIONS; VEHICLE WASH; AND REPAIR OF TIRES (U.S. CLS. 100, 103 AND 106).

CLASS 39—TRANSPORTATION AND STORAGE

FOR BOAT STORAGE; BOAT TRANSPORT; DELIVERY OF GOODS BY TRUCK, AIR, RAIL, OR BOAT; FREIGHT BROKERAGE, FREIGHT FORWARDING, FREIGHT SHIP TRANSPORT, FREIGHT TRANSPORTATION BY TRUCK, TRAIN, OR AIR; MARINE TRANSPORT; RAILWAY TRANSPORT; RIVER TRANSPORT BY BOAT; STORAGE OF PETROL PRODUCTS; TRANSPORT BROKERAGE; TRANSMISSION OF OIL OR GAS THROUGH PIPELINES; UNLOADING CARGO; AND WAREHOUSING (U.S. CLS. 100 AND 105).

SN 76-224,694. ENI S.P.A., ROME, ITALY, FILED 3-15-2001.

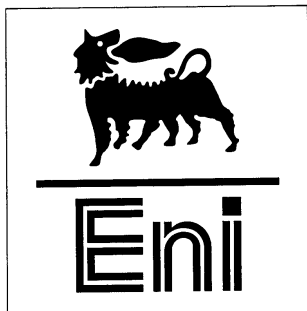

PRIORITY CLAIMED UNDER SEC. 44(D) ON ITALY APPLICATION NO. 005511, FILED 9-15-2000, REG. NO. 830990, DATED 1-12-2001, EXPIRES 9-15-2010.

THE MARK CONSISTS OF A BLACK SIX LEGGED DOG AND BLACK HOLLOW LETTERS "ENI" WITHIN A SQUARE; THE BACKGROUND OF THE SQUARE IS IN THE COLOR YELLOW; THE HORIZONTAL LINE BETWEEN THE DOG AND "ENI" IS IN RED AND THE FLAME COMING FROM THE DOG'S MOUTH IS IN RED.

CLASS 40—MATERIAL TREATMENT

FOR VULCANIZATION AND REPAIR OF TIRES; LAMINATING OF METAL PLATES OR PLASTIC SHEETS; METAL TREATING; CUSTOM PROCESSING OF OIL; AND RECYCLING OF WASTE AND TRASH; INCINERATION OF WASTE AND TRASH; AND OIL PROSPECTING (U.S. CLS. 100, 103 AND 106).

CLASS 41—EDUCATION AND ENTERTAINMENT

FOR ARRANGING AND CONDUCTING OF CONFERENCES IN THE FIELD OF PETROL GOODS AND SERVICES; ARRANGING AND CONDUCTING OF CONGRESSES IN THE FIELD OF PETROL GOODS AND SERVICES; ARRANGING AND CONDUCTING SEMINARS IN THE FIELD OF PETROL GOODS AND SERVICES; ARRANGING AND CONDUCTING SYMPOSIUMS IN THE FIELD OF IN THE FIELD OF PETROL GOODS AND SERVICES; CORRESPONDENCE COURSES IN THE FIELD OF PETROL GOODS AND SERVICES; PROVIDING EDUCATIONAL INFORMATION; EDUCATION SERVICES IN THE NATURE OF COURSES AT THE UNIVERSITY LEVEL OR EDUCATION SERVICES, NAMELY, ON-ON-ONE MENTORING IN THE FIELD OF PETROL GOODS AND SERVICES; TEACHING IN THE FIELD OF PETROL GOODS AND SERVICES (U.S. CLS. 100, 101 AND 107).

CLASS 42—SCIENTIFIC, COMPUTER AND LEGAL SERVICES

FOR TEMPORARY ACCOMMODATION RESERVATIONS FOR OTHERS; ANALYSIS FOR OIL-FIELD EXPLOITATION; BACTERIOLOGICAL RESEARCH; BACTERIOLOGY; CHEMICAL ANALYSIS; PETROL RESEARCH; CHEMIST SERVICES; CHEMISTRY CONSULTATION; LABORATORY RESEARCH IN THE FIELD OF CHEMISTRY IN THE FIELD OF PETROL GOODS AND SERVICES; CHEMISTRY SERVICES; ENGINEERING; ENGINEERING DRAWING; UNDERWATER EXPLORATION; GEOLOGICAL PROSPECTING; GEOLOGICAL RESEARCH; GEOLOGICAL SURVEYS; HEALTHCARE; HOTELS; LAND SURVEYING; MATERIAL TESTING; MECHANICAL RESEARCH; MEDICAL SERVICES; MEDICAL CLINICS; ANALYSIS OF OIL-FIELD EXPLOITATION; OIL-FIELD SURVEYS; OIL-WELL TESTING; PHYSICS RESEARCH; GEOLOGICAL PROSPECTING; GEOLOGICAL RESEARCH; RESEARCH AND DEVELOPMENT FOR OTHERS; RESTAURANTS; SNACK-BARS; SURVEYING; GEOLOGICAL SURVEYS; LAND SURVEYS; OIL-FIELD SURVEYS; IN THE PETROL FIELD; MATERIAL TESTING; AND UNDERWATER EXPLORATION AND OIL PROSPECTING (U.S. CLS. 100 AND 101).

SN 76-224,798. SAKONCHICK, JOHN ALAN, PLAINVILLE, CT. FILED 3-15-2001.



THE DRAWING IS LINED FOR THE COLOR(S) GOLD.
THE MARK CONSISTS OF THE WORD SAKON WITH AN EXTENDED LEG ON THE "K", A GOLD GLOBE, AS THE "O", AND THREE GOLD BARS UNDER THE "O" AND "N".

CLASS 35—ADVERTISING AND BUSINESS

FOR ADVERTISING SERVICES, NAMELY, THE PREPARATION AND PLACEMENT OF ADVERTISEMENTS FOR OTHERS; BUSINESS SERVICES, NAMELY, HELPING IN THE ORGANIZATION, PLANNING AND BUSINESS APPRAISALS OF SMALL AND MEDIUM SIZED COMMERCIAL BUSINESS; BUSINESS MANAGEMENT SERVICES OF SMALL AND MEDIUM SIZED COMMERCIAL BUSINESSES; BUSINESS CONSULTING SERVICES, NAMELY, CONSULTING IN THE ORGANIZATION, PLANNING AND BUSINESS APPRAISALS OF SMALL AND MEDIUM SIZED COMMERCIAL BUSINESSES (U.S. CLS. 100, 101 AND 102).
FIRST USE 9-28-1984; IN COMMERCE 9-28-1984.

CLASS 36—INSURANCE AND FINANCIAL

FOR REAL ESTATE SERVICES, NAMELY, THE INVESTMENT, SYNDICATION, MANAGEMENT, LEASING, AND BROKERAGE OF REAL ESTATE; FINANCIAL SERVICES, NAMELY, FINANCIAL MANAGEMENT, ANALYSIS, APPRAISALS, AND CONSULTING SERVICES FOR REAL PROPERTY OWNERS AND SMALL AND MEDIUM SIZED COMMERCIAL BUSINESS OWNERS (U.S. CLS. 100, 101 AND 102).
FIRST USE 9-28-1984; IN COMMERCE 9-28-1984.

SN 76-224,879. HONDA GIKEN KOGYO KABUSHIKI KAISHA (HONDA MOTOR CO., LTD.), MINATO-KU, TOKYO 107, JAPAN, FILED 3-13-2001.

PRECISION CRAFTED SERVICE

NO CLAIM IS MADE TO THE EXCLUSIVE RIGHT TO USE "SERVICE", APART FROM THE MARK AS SHOWN.

CLASS 9—ELECTRICAL AND SCIENTIFIC APPARATUS

FOR ELECTRONIC CALENDARS; CALCULATORS; COMPUTER EDUCATIONAL SOFTWARE COMPRISED OF GUIDELINES AND TUTORIALS FOR TRAINING DEALERSHIP PERSONNEL IN THE AREA OF SALES, SERVICE, AND MANAGEMENT (U.S. CLS. 21, 23, 26, 36 AND 38).
FIRST USE 11-0-1999; IN COMMERCE 11-0-1999.

CLASS 16—PAPER GOODS AND PRINTED MATTER

FOR PRINTED MATERIALS, NAMELY, TRAINING GUIDES FOR AUTOMOBILE DEALERSHIP PERSONNEL; DECALS (U.S. CLS. 2, 5, 22, 23, 29, 37, 38 AND 50).
FIRST USE 2-0-1999; IN COMMERCE 2-0-1999.

CLASS 41—EDUCATION AND ENTERTAINMENT

FOR TRAINING AUTOMOBILE DEALERS IN THE OPERATION OF AUTOMOTIVE DEALERSHIPS, NAMELY, SALES, SERVICE, AND MANAGEMENT TRAINING (U.S. CLS. 100, 101 AND 107).
FIRST USE 11-0-1999; IN COMMERCE 11-0-1999.

SN 76-224,943. COLBY SYSTEMS LIMITED, GREENMOUNT, AUCKLAND, NEW ZEALAND, FILED 3-12-2001.

SAPAC

PRIORITY CLAIMED UNDER SEC. 44(D) ON NEW ZEALAND APPLICATION NO. 623154, FILED 9-14-2000, REG. NO. 623154, DATED 10-9-2001, EXPIRES 9-14-2007.
PRIORITY CLAIMED UNDER SEC. 44(D) ON NEW ZEALAND APPLICATION NO. 623153, FILED 9-14-2000, REG. NO. 623153, DATED 10-9-2001, EXPIRES 9-14-2007.

CLASS 39—TRANSPORTATION AND STORAGE

FOR PACKAGING ARTICLES FOR TRANSPORTATION (U.S. CLS. 100 AND 105).

CLASS 42—SCIENTIFIC, COMPUTER AND LEGAL SERVICES

FOR ENGINEERING CONSULTANCY, PROVISION OF TECHNICAL INFORMATION AND TECHNICAL ADVICE, LICENSING OF TECHNOLOGY, ALL IN RELATION TO THE PACKAGING INDUSTRY; INDUSTRIAL DESIGN SERVICES; ENGINEERING SERVICES; MECHANICAL RESEARCH AND CONSULTATION SERVICES; PRINTING SERVICES; SERVICES IN THIS CLASS RELATING TO THE DESIGN OF PACKAGING AND PACKAGING MATERIALS; SERVICES IN THIS CLASS RELATING TO THE DESIGN AND ENGINEERING OF MACHINERY, APPARATUS AND MACHINE TOOLS FOR USE IN PACKAGING AND PACKAGING MATERIALS (U.S. CLS. 100 AND 101).

SN 76-226,740. ENSYN TECHNOLOGIES INC., OTTAWA ONTARIO, CANADA, FILED 3-19-2001.

ENSYN

OWNER OF CANADA REG. NO. TMA431960, DATED 8-19-1994, EXPIRES 8-19-2009.

CLASS 4—LUBRICANTS AND FUELS

FOR BIOMASS LIQUID FUEL (U.S. CLS. 1, 6 AND 15). FIRST USE 12-0-1993; IN COMMERCE 12-0-1993.

CLASS 11—ENVIRONMENTAL CONTROL APPARATUS

FOR CHEMICAL PROCESS REACTORS FOR TRANSFORMING CARBON BASED FUEL STOCKS INTO CHEMICALS AND FUEL PRODUCTS (U.S. CLS. 13, 21, 23, 31 AND 34). FIRST USE 1-0-1990; IN COMMERCE 1-0-1990.

CLASS 30—STAPLE FOODS

FOR FOOD FLAVOURINGS (U.S. CL. 46). FIRST USE 12-0-1993; IN COMMERCE 12-0-1993.

CLASS 42—SCIENTIFIC, COMPUTER AND LEGAL SERVICES

FOR ENGINEERING; TECHNICAL CONSULTATION, AND RESEARCH IN THE FIELD OF RAPID THERMAL PROCESSING OF CARBON BASED FEED STOCKS; DESIGN FOR OTHERS IN THE FIELD OF PROCESSING CARBON BASED FEED STOCKS INTO CHEMICAL AND FUEL PRODUCTS; ENERGY AUDITING; AND CONDUCTING OF FEASIBILITY STUDIES (U.S. CLS. 100 AND 101). FIRST USE 6-0-1985; IN COMMERCE 1-0-1990.

SN 76-227,794. PLATEAU SYSTEMS, LTD., FAIRFAX, VA. FILED 3-21-2001.

CLASS 9—ELECTRICAL AND SCIENTIFIC APPARATUS

FOR COMPUTER SOFTWARE FOR USE IN THE CREATION, IMPLEMENTATION, MANAGEMENT AND ADMINISTRATION OF TRAINING PROGRAMS, TRAINING-RELATED ACTIVITIES AND TRAINING COURSES FOR ENTERPRISE AND VOCATIONAL TRAINING IN A VARIETY OF FIELDS (U.S. CLS. 21, 23, 26, 36 AND 38).

CLASS 41—EDUCATION AND ENTERTAINMENT

FOR EDUCATIONAL SERVICES, NAMELY, CONDUCTING CLASSES, SEMINARS AND CONFERENCES FOR ENTERPRISE AND VOCATIONAL TRAINING IN A VARIETY OF FIELDS (U.S. CLS. 100, 101 AND 107).

CLASS 42—SCIENTIFIC, COMPUTER AND LEGAL SERVICES

FOR COMPUTER CONSULTATION (U.S. CLS. 100 AND 101).

SN 76-228,611. BROADCOM CORPORATION, IRVINE, CA. FILED 3-22-2001.

ETHERNET@WIRESPEED

CLASS 9—ELECTRICAL AND SCIENTIFIC APPARATUS

FOR COMPUTER HARDWARE; INTEGRATED CIRCUITS; AND SOFTWARE FOR CONTROLLING AND USING INTEGRATED CIRCUITS (U.S. CLS. 21, 23, 26, 36 AND 38).

CLASS 42—SCIENTIFIC, COMPUTER AND LEGAL SERVICES

FOR DESIGN FOR OTHERS IN THE FIELD OF COMPUTERS, INTEGRATED CIRCUITS, COMMUNICATIONS AND NETWORKS (U.S. CLS. 100 AND 101).

SN 76-228.694. ST. MAARTEN SPIRITS LIMITED, ROAD BAY, BRITISH WEST INDIES, ANGUILLA, FILED 3-16-2001.



OWNER OF U.S. REG. NO. 1,989,809.

CLASS 18—LEATHER GOODS

FOR LEATHER GOODS, NAMELY, WOMEN'S PURSES WITHOUT HANDLES, NAMELY, CLUTCH BAGS; OVERNIGHT BAGS; CARRY-ON BAGS; HAND BAGS; BAGS THAT ATTACH AROUND THE WAIST, NAMELY, FANNY PACKS AND BELT BAGS; PURSES; VALISE; LUGGAGE; SHOULDER BAGS; TRAVEL BAGS; SMALL HAND BAGS, NAMELY, POCKET-BOOKS; WALLETS; ATHLETIC BAGS; DUFFLE BAGS; BACK-PACKS; CLOTH OR STRAW BAGS WITH HANDLES, NAMELY, BEACH BAGS AND TOTE BAGS; TRAVEL BAGS; SMALL HAND BAGS, NAMELY, POCKET BOOKS; WALLETS; AND SUITCASES (U.S. CLS. 1, 2, 3, 22 AND 41).

FIRST USE 1-0-1994; IN COMMERCE 1-0-1994.

CLASS 25—CLOTHING

FOR CLOTHING, NAMELY, SHIRTS, BLOUSES, TANK TOPS, T-SHIRTS, SWEAT SHIRTS, JERSEYS, PANTS, SLACKS, SHORTS, SWEAT PANTS, SKIRTS, DRESSES, SUITS, JACKETS, COATS, SWEATERS, RAINWEAR, SWEAT SUITS, UNDERWEAR, BRASSIERES, UNDERSHIRTS, PANTY HOSE, PANTIES, HOSIERY, STOCKINGS, SOCKS, TIGHTS, LEOTARDS, LEG WARMERS, PAJAMAS, ROBES, NIGHT SHIRTS, NIGHT GOWNS, SWIM SUITS, NECKTIES, BELTS, SCARVES, GLOVES, AND WRIST BANDS; FOOTWEAR, NAMELY, SHOES, ATHLETIC SHOES, SLIPPERS, BOOTS, AND SANDALS; HEADGEAR, NAMELY, HATS, CAPS, HEAD BANDS, AND SUN VISORS (U.S. CLS. 22 AND 39).

FIRST USE 1-0-1994; IN COMMERCE 1-0-1994.

SN 76-229,247. ELATERAL LIMITED, SURREY, UNITED KINGDOM, FILED 3-22-2001.

ACTIPRODUCTION

PRIORITY CLAIMED UNDER SEC. 44(D) ON UNITED KINGDOM APPLICATION NO. 2253167, FILED 11-16-2000, REG. NO. 2253167, DATED 9-21-2001, EXPIRES 11-16-2010.

CLASS 35—ADVERTISING AND BUSINESS

FOR COMPUTERIZED DATABASE MANAGEMENT SERVICES; PREPARATION OF CUSTOM PUBLICITY ADVERTISEMENTS FOR OTHERS; PREPARATION OF PUBLICITY TEXTS; DISSEMINATION OF ADVERTISING MATTER; PROVIDING TELEVISION ADVERTISING FOR OTHERS; MESSAGE TRANSCRIPTION; MODELING FOR ADVERTISING OR SALES PROMOTION; BUSINESS MANAGEMENT AND CONSULTATION (U.S. CLS. 100, 101 AND 102).

CLASS 38—COMMUNICATION

FOR PROVIDING MULTIPLE USER ACCESS TO A GLOBAL COMPUTER INFORMATION NETWORK; WEBCASTING AUDIO/VISUAL PROGRAMMING VIA A GLOBAL COMPUTER NETWORK; ELECTRONIC MAIL SERVICES; FACSIMILE TRANSMISSION; PAGING SERVICES; PROVIDING VIDEO AND AUDIO TELECONFERENCING VIA GLOBAL COMPUTER NETWORKS FOR THE PURPOSE OF COORDINATING ADVERTISING MATERIAL BETWEEN USERS OF A DISTRIBUTION NETWORK IN THE FIELD OF BUSINESS (U.S. CLS. 100, 101 AND 104).

CLASS 42—SCIENTIFIC, COMPUTER AND LEGAL SERVICES

FOR COMPUTER PROGRAMMING FOR OTHERS (U.S. CLS. 100 AND 101).

SN 76-229,288. CONSAIL CORPORATION, EAST GREENWICH, RI. FILED 3-23-2001.

CONSAIL

CLASS 37—CONSTRUCTION AND REPAIR

FOR CONSULTING IN THE FIELD OF CONSTRUCTION AND SURFACING OF ATHLETIC FACILITIES AND PLAY AREAS (U.S. CLS. 100, 103 AND 106).

FIRST USE 3-12-2001; IN COMMERCE 3-12-2001.

CLASS 39—TRANSPORTATION AND STORAGE

FOR BOAT CHARTERING AND BOAT CRUISES (U.S. CLS. 100 AND 105).

FIRST USE 3-12-2001; IN COMMERCE 3-12-2001.

SN 76-229,327. HOME INSTEAD, INC., OMAHA, NE. FILED 3-24-2001.



OWNER OF U.S. REG. NO. 1,936,060.
NO CLAIM IS MADE TO THE EXCLUSIVE RIGHT TO USE "HOME" AND "SENIOR CARE", APART FROM THE MARK AS SHOWN.

THE STIPPLING SHOWN IN THE DRAWING OF THE MARK IS A FEATURE OF THE MARK AND IS NOT INTENDED TO INDICATE COLOR.

CLASS 43—HOTEL AND RESTAURANT SERVICES

FOR PROVIDING ELDER CARE SERVICES, NAMELY, PROVIDING CARE AND COMPANIONSHIP FOR SENIOR CITIZENS IN THEIR PLACE OF RESIDENCE (U.S. CLS. 100 AND 101).

FIRST USE 7-15-1994; IN COMMERCE 7-15-1994.

CLASS 44—MEDICAL, BEAUTY AND AGRICULTURAL SERVICES

FOR HEALTH CARE SERVICES FOR SENIOR CITIZENS (U.S. CLS. 100 AND 101).
FIRST USE 7-15-1994; IN COMMERCE 7-15-1994.

SN 76-231,547. FORESIGHT PARTNERS, LLC, BOISE, ID.
FILED 3-27-2001.

COCINA VALORE

OWNER OF U.S. REG. NO. 2,379,450.
THE ENGLISH TRANSLATION OF THE SPANISH WORD "CONCINA" IS "KITCHEN". THE ENGLISH TRANSLATION OF THE ITALIAN WORD "VALORE" IS "VALUE".

SN 76-230,352. THIRD WAVE TECHNOLOGIES, INC., MADISON, WI. FILED 3-23-2001.

OS4**CLASS 1—CHEMICALS**

FOR REAGENTS USED IN SCIENTIFIC OR MEDICAL RESEARCH FOR NUCLEIC ACID DETECTION AND ANALYSIS, INCLUDING ANALYTE SPECIFIC REAGENTS (U.S. CLS. 1, 5, 6, 10, 26 AND 46).

CLASS 29—MEATS AND PROCESSED FOODS

FOR HOMINY; REFRIED BEANS; CANNED TOMATILLOS; CANNED TOMATOES; CHEESE; PROCESSED CHILLI PEPPERS; MEAT, INCLUDING FAJITA MEAT; TACO MEAT; SAUSAGE; GUACAMOLE; FROZEN PROCESSED AVOCADO; AND PROCESSED AVOCADO PULP (U.S. CL. 46).

CLASS 5—PHARMACEUTICALS

FOR MEDICAL DIAGNOSTIC REAGENTS, INCLUDING ANALYTE SPECIFIC REAGENTS AND IN VITRO DIAGNOSTIC REAGENTS (U.S. CLS. 6, 18, 44, 46, 51 AND 52).

CLASS 30—STAPLE FOODS

FOR TACO SAUCES AND ENCHILADA SAUCES; CANNED OR BOTTLED SALSA; BURRITOS; TORTILLAS; TORTILLA CHIPS; TAMALES; ENCHILADAS; TACOS; RICE; DRIED CHILI PEPPERS FOR USE AS A SEASONING; AND SPICES (U.S. CL. 46).

CLASS 9—ELECTRICAL AND SCIENTIFIC APPARATUS

FOR LABORATORY EQUIPMENT, NAMELY, APPARATUS FOR DETECTION AND ANALYSIS OF NUCLEIC ACIDS (U.S. CLS. 21, 23, 26, 36 AND 38).

SN 76-232,786. VP RACING FUELS, INC., SAN ANTONIO, TX. FILED 3-30-2001.

ADVANCING THE SCIENCE OF AUTO RACING**CLASS 42—SCIENTIFIC, COMPUTER AND LEGAL SERVICES**

FOR SCIENTIFIC RESEARCH FOR OTHERS, NAMELY, NUCLEIC ACID DETECTION AND ANALYSIS SERVICES (U.S. CLS. 100 AND 101).

CLASS 1—CHEMICALS

FOR FUELS FOR MOTOR VEHICLES, NAMELY NITROMETHANE, METHANOL AND GASOLINE; CHEMICAL MOTOR OIL AND MOTOR OIL ADDITIVES; DETERGENT ADDITIVE FOR USE WITH MOTOR OIL; CHEMICAL ADDITIVES FOR FUEL TREATMENT, NAMELY OCTANE BOOSTER CHEMICAL FUEL ADDITIVES (U.S. CLS. 1, 5, 6, 10, 26 AND 46).

SN 76-230,476. ROSS, MARTIN, BERKELEY, CA. FILED 3-23-2001.

KERNEL**CLASS 4—LUBRICANTS AND FUELS**

FOR NON-CHEMICAL ADDITIVES FOR FUEL TREATMENT, NAMELY OCTANE BOOSTER NON-CHEMICAL FUEL ADDITIVES; NON-CHEMICAL MOTOR OIL AND MOTOR OIL ADDITIVES (U.S. CLS. 1, 6 AND 15).

CLASS 35—ADVERTISING AND BUSINESS

FOR BUSINESS RESEARCH, CONSULTATION AND ADVISORY SERVICES IN THE FIELD OF HIGH TECHNOLOGY; BUSINESS RESEARCH, CONSULTATION AND ADVISORY SERVICES CONCERNING MERGERS, ACQUISITIONS, AND LEVERAGED BUY-OUTS; SEEKING PARTNERSHIP AND CO-VENTURE OPPORTUNITIES FOR CLIENTS (U.S. CLS. 100, 101 AND 102).

SN 76-234,084. BOARD OF DIRECTORS OF WITTENBERG COLLEGE, THE, DBA WITTENBERG UNIVERSITY, SPRINGFIELD, OH. FILED 4-2-2001.

CLASS 36—INSURANCE AND FINANCIAL

FOR FINANCIAL SERVICES, NAMELY CAPITAL INVESTMENT, CONSULTATION, ANALYSIS, ORGANIZATION AND ADVISORY SERVICES; PROVIDING INVESTMENT MANAGEMENT AND ADVICE; RAISING, MANAGING AND INVESTING VENTURE CAPITAL FUNDS; RAISING, MANAGING AND INVESTING PRIVATE EQUITY FUNDS; PROVIDING INVESTMENTS IN AND FINANCING FOR VENTURE CAPITAL INVESTMENTS; INCUBATION OF HIGH TECHNOLOGY COMPANIES; PRIVATE DIRECT INVESTMENT IN STARTUP COMPANIES; AND INVESTMENT BANKING SERVICES (U.S. CLS. 100, 101 AND 102).



NO CLAIM IS MADE TO THE EXCLUSIVE RIGHT TO USE "UNIVERSITY", APART FROM THE MARK AS SHOWN.

SEC. 2(F).

CLASS 16—PAPER GOODS AND PRINTED MATTER

FOR NOTE BOOKS (U.S. CLS. 2, 5, 22, 23, 29, 37, 38 AND 50).
FIRST USE 7-1-1998; IN COMMERCE 7-1-1998.

CLASS 21—HOUSEWARES AND GLASS

FOR MUGS (U.S. CLS. 2, 13, 23, 29, 30, 33, 40 AND 50).
FIRST USE 6-0-2000; IN COMMERCE 6-0-2000.

CLASS 25—CLOTHING

FOR CLOTHING, NAMELY, SWEATSHIRTS AND CAPS (U.S. CLS. 22 AND 39).
FIRST USE 2-0-1999; IN COMMERCE 2-0-1999.

CLASS 41—EDUCATION AND ENTERTAINMENT

FOR EDUCATIONAL SERVICES; NAMELY, PROVIDING COLLEGE AND GRADUATE LEVEL COURSES OF INSTRUCTION, AND ORGANIZING AND CONDUCTING SEMINARS; AND ENTERTAINMENT SERVICES; NAMELY, ORGANIZING AND CONDUCTING COLLEGIATE ATHLETIC COMPETITIONS (U.S. CLS. 100, 101 AND 107).
FIRST USE 7-1-1998; IN COMMERCE 7-1-1998.

SN 76-234,446. HAGLOFS SCANDINAVIA AB, S-774 27 AVESTA, SWEDEN, FILED 4-3-2001.

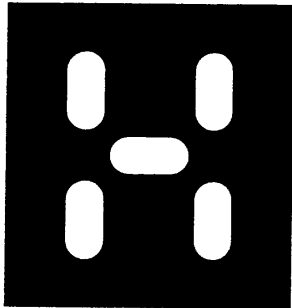

OWNER OF SWEDEN REG. NO. 338774, DATED 6-22-2000, EXPIRES 6-22-2010.

CLASS 18—LEATHER GOODS

FOR BAGS, NAMELY RUCKSACKS, TRAVELLING BAGS, SPORT BAGS, STUFF BAGS, BELT BAGS, SHOULDER BAGS AND BRIEFCASES (U.S. CLS. 1, 2, 3, 22 AND 41).

CLASS 20—FURNITURE AND ARTICLES NOT OTHERWISE CLASSIFIED

FOR SLEEPING BAGS, SLEEPING MATS AND MATS FOR CAMPING (U.S. CLS. 2, 13, 22, 25, 32 AND 50).

CLASS 22—CORDAGE AND FIBERS

FOR TENTS; TEXTILE WINDSCREENS FOR CAMPERS (U.S. CLS. 1, 2, 7, 19, 22, 42 AND 50).

CLASS 25—CLOTHING

FOR CLOTHING, NAMELY UNDERWEAR, SOCKS, PANTS, SWEATERS, SHIRTS, JACKETS, SHOES, BOOTS AND HEADWEAR (U.S. CLS. 22 AND 39).

SN 76-234,585. DALE OF NORWAY AS, 5721 DALEKVAM, NORWAY, FILED 5-17-2000.



PRIORITY CLAIMED UNDER SEC. 44(D) ON NORWAY APPLICATION NO. 200002150, FILED 2-24-2000, REG. NO. 204749, DATED 9-14-2000, EXPIRES 9-14-2010.

NO CLAIM IS MADE TO THE EXCLUSIVE RIGHT TO USE "WINDPROOF AND BREATHABLE LINER", APART FROM THE MARK AS SHOWN.

CLASS 23—YARNS AND THREADS

FOR YARNS AND THREADS FOR TEXTILE USES (U.S. CL. 43).

CLASS 25—CLOTHING

FOR CLOTHING, NAMELY, SWEATERS, JACKETS, SLACKS, TROUSERS, SKIRTS, COATS, GLOVES, MITTENS, FOOTWEAR AND HEADWEAR (U.S. CLS. 22 AND 39).

SN 76-235,415. CLASS VI RIVER RUNNERS, INC., LANSING, WV. FILED 4-4-2001.

CLASS VI

SEC. 2(F).

CLASS 35—ADVERTISING AND BUSINESS

FOR PROVIDING FACILITIES FOR BUSINESS MEETINGS AND CONFERENCES (U.S. CLS. 100, 101 AND 102).

FIRST USE 0-0-1977; IN COMMERCE 0-0-1977.

CLASS 41—EDUCATION AND ENTERTAINMENT

FOR RECREATIONAL SERVICES, NAMELY, ARRANGING, CONDUCTING, AND PROVIDING FACILITIES FOR AND LEASING EQUIPMENT FOR CAMPING, FISHING, SWIMMING, ROCK CLIMBING, HORSEBACK RIDING, KAYAKING, CANOEING, WHITE WATER RAFTING, HIKING AND NATURALIST PROGRAMS; EDUCATIONAL SERVICES, NAMELY, PRIVATE TUTORING, CLASSES, AND SEMINARS IN THE FIELD OF CAMPING, FISHING, SWIMMING, ROCK CLIMBING, HORSEBACK RIDING, KAYAKING, CANOEING, WHITE WATER RAFTING, HIKING AND NATURALIST PROGRAMS; AND STILL PHOTOGRAPHY AND VIDEO RECORDING SERVICES FOR OTHERS (U.S. CLS. 100, 101 AND 107).

FIRST USE 0-0-1977; IN COMMERCE 0-0-1977.

CLASS 42—SCIENTIFIC, COMPUTER AND LEGAL SERVICES

FOR PROVIDING RESORT FACILITIES, NAMELY, LODGING AND RESTAURANTS (U.S. CLS. 100 AND 101).

FIRST USE 0-0-1977; IN COMMERCE 0-0-1977.

SN 76-237,120. HENRY COMPANY, HUNTINGTON PARK, CA. FILED 4-6-2001.

HENRY...BECAUSE YOU ONLY WANT TO DO IT ONCE

OWNER OF U.S. REG. NO. 1,501,782.

CLASS 2—PAINTS

FOR ROOF COATINGS IN THE NATURE OF PAINT (U.S. CLS. 6, 11 AND 16).

CLASS 19—NON-METALLIC BUILDING MATERIALS

FOR ROOF CEMENTS NAMELY, PLASTIC ROOF CEMENT AND COAL TAR PATCHING COMPOSITIONS, NON-METAL BUILDING FLASHING COMPOUND, WHITE ROOFING MASTIC, ELASTOMERIC ROOFING MASTIC, ASPHALT-BASED COLD-APPLIED ROOF CEMENT; ASPHALT-COATING GRAVEL BINDER; RUBBERIZED ASPHALT EMULSION ADHESIVE AND LAP CEMENT AND ROOF COATINGS, NAMELY, ASPHALT EMULSION ROOF COATINGS, SOLVENT-BASED ASPHALT ROOF COATINGS, ASPHALT PRIMER FOR ROOFING, ASPHALT-BASED REFLECTIVE ROOF COATINGS, CONTAINING ALUMINUM WHITE LATEX-BASED REFLECTIVE ROOF COATINGS, ACRYLIC-BASED ELASTOMERIC ROOF-COATINGS, AND ASPHALT-BASED ROOF PATCHING COMPOUND (U.S. CLS. 1, 12, 33 AND 50).

SN 76-238,115. MAGNA ENTERTAINMENT CORP., AURORA, ONTARIO L4G 7K1, CANADA, FILED 4-9-2001.

MEC SPORTS

NO CLAIM IS MADE TO THE EXCLUSIVE RIGHT TO USE "SPORTS", APART FROM THE MARK AS SHOWN.

CLASS 9—ELECTRICAL AND SCIENTIFIC APPARATUS

FOR GAMING MACHINES, NAMELY VIDEO LOTTERY TERMINALS (U.S. CLS. 21, 23, 26, 36 AND 38).

CLASS 36—INSURANCE AND FINANCIAL

FOR WAGERING SERVICES FEATURING OFF-TRACK BETTING, INTERTRACK WAGERING AND SPORTS WAGERING VIA TELEVISION, TELEPHONE AND A GLOBAL COMPUTER NETWORK (U.S. CLS. 100, 101 AND 102).

CLASS 41—EDUCATION AND ENTERTAINMENT

FOR ENTERTAINMENT SERVICES, NAMELY, ORGANIZING AND CONDUCTING THOROUGHbred HORSE RACES, CONDUCTING HORSE RACE EXHIBITIONS; AMUSEMENT PARK SERVICES; ORGANIZING AND CONDUCTING STAGE SHOWS, NIGHT CLUB SHOWS, CONTESTS, DANCES AND PARTIES; TELEVISION PRODUCTION SERVICES; ENTERTAINMENT CENTERS PROVIDING FACILITIES FOR RECREATIONAL ACTIVITIES AND GAME ARCADE SERVICES; PARTY PLANNING SERVICES AND EVENT PLANNING SERVICES FEATURING PLAY AREAS, MAGIC SHOWS AND OTHER LIVE ENTERTAINMENT; PROVIDING INFORMATION IN THE FIELDS OF ENTERTAINMENT AND EDUCATION VIA A GLOBAL COMPUTER NETWORK; PRODUCTION OF EXHIBITIONS AND EXHIBITS IN THE NATURE OF BOXING OR WRESTLING MATCHES, MAGIC SHOWS, CONCERTS; PRODUCTION OF FILMS AND TELEVISION SHOWS IN THE FIELD OF SPORTS (U.S. CLS. 100, 101 AND 107).

SN 76-238,272. ECGC DISTRIBUTORS LIMITED, CHARLES TOWN, WV. FILED 4-10-2001.

A WORLD APART

CLASS 1—CHEMICALS

FOR FERTILIZERS FOR DOMESTIC USE (U.S. CLS. 1, 5, 6, 10, 26 AND 46).

CLASS 8—HAND TOOLS

FOR LAWN AND GARDEN HAND TOOLS, NAMELY, PRUNING SHEERS, TROWELS AND SHOVELS (U.S. CLS. 23, 28 AND 44).

CLASS 9—ELECTRICAL AND SCIENTIFIC APPARATUS

FOR KNEE PADS FOR WORKERS, NAMELY KNEE PADS FOR USE IN THE GARDEN (U.S. CLS. 21, 23, 26, 36 AND 38).

CLASS 11—ENVIRONMENTAL CONTROL APPARATUS

FOR ELECTRIC LIGHTS FOR CHRISTMAS TREES (U.S. CLS. 13, 21, 23, 31 AND 34).

CLASS 16—PAPER GOODS AND PRINTED MATTER

FOR STATIONERY, BOOKS FOR FEATURING GARDENING, LANDSCAPING AND HOME DECORATING, AND MAPS (U.S. CLS. 2, 5, 22, 23, 29, 37, 38 AND 50).

CLASS 17—RUBBER GOODS

FOR GARDEN HOSES (U.S. CLS. 1, 5, 12, 13, 35 AND 50).

CLASS 20—FURNITURE AND ARTICLES NOT OTHERWISE CLASSIFIED

FOR LAWN AND PATIO FURNITURE (U.S. CLS. 2, 13, 22, 25, 32 AND 50).

CLASS 21—HOUSEWARES AND GLASS

FOR CONTAINERS, NAMELY, FLOWER POTS (U.S. CLS. 2, 13, 23, 29, 30, 33, 40 AND 50).

CLASS 27—FLOOR COVERINGS

FOR DOOR MATS AND DECORATIVE INDOOR RUGS (U.S. CLS. 19, 20, 37, 42 AND 50).

CLASS 28—TOYS AND SPORTING GOODS

FOR NON-CONFECTIONERY AND NON-LUMINARY CHRISTMAS TREE DECORATIONS AND ORNAMENTS; AND ARTIFICIAL CHRISTMAS TREES (U.S. CLS. 22, 23, 38 AND 50).

CLASS 29—MEATS AND PROCESSED FOODS

FOR JAMS AND JELLIES (U.S. CL. 46).

CLASS 30—STAPLE FOODS

FOR COFFEE, TEA, COOKIES, CANDY AND PROCESSED FOODS, NAMELY, SAUCES, SALAD DRESSINGS AND FLAVORED VINEGARS (U.S. CL. 46).

CLASS 31—NATURAL AGRICULTURAL PRODUCTS

FOR LIVE FLOWERING PLANTS AND FLOWERS, LIVE CUT CHRISTMAS TREES (U.S. CLS. 1 AND 46).

SN 76-239,242. DUPREES LLC, THE, CAPE MAY COURT HOUSE, NJ. FILED 4-12-2001.



OWNER OF U.S. REG. NO. 1,160,365.

CLASS 21—HOUSEWARES AND GLASS

FOR GLASSWARE, NAMELY, COFFEE MUGS (U.S. CLS. 2, 13, 23, 29, 30, 33, 40 AND 50).
FIRST USE 1-2-2001; IN COMMERCE 1-2-2001.

CLASS 25—CLOTHING

FOR CLOTHING, NAMELY, TEE SHIRTS AND FLEECE JACKETS SOLD AT APPLICANT'S PERFORMING VENUES (U.S. CLS. 22 AND 39).
FIRST USE 1-2-2001; IN COMMERCE 1-2-2001.

CLASS 28—TOYS AND SPORTING GOODS

FOR TOYS, NAMELY, TEDDY BEARS (U.S. CLS. 22, 23, 38 AND 50).
FIRST USE 1-2-2001; IN COMMERCE 1-2-2001.

SN 76-240,943. AIRXCHANGE, INC., ROCKLAND, MA.
FILED 4-13-2001.

**CLASS 9—ELECTRICAL AND SCIENTIFIC APPARATUS**

FOR COMPUTER PROGRAMS FOR AIDING IN THE DESIGN AND SELECTION OF VENTILATOR COMPONENTS FOR AN ENERGY RECOVERY VENTILATOR, AND ANALYZING THE PERFORMANCE OF SUCH ENERGY RECOVERY VENTILATOR COMPONENTS, ALL FOR USE IN COMMERCIAL AND INDUSTRIAL FIELDS (U.S. CLS. 21, 23, 26, 36 AND 38).

CLASS 11—ENVIRONMENTAL CONTROL APPARATUS

FOR ENERGY RECOVERY VENTILATORS; ENERGY RECOVERY VENTILATOR COMPONENTS COMPOSED OF ROTARY AIR-TO-AIR HEAT EXCHANGERS WITH AND WITHOUT DESICCANT COATINGS, THEIR ASSOCIATED WHEEL CONSTRUCTIONS, CASSETTE FRAMES, SEALS, DRIVES, BEARINGS (U.S. CLS. 13, 21, 23, 31 AND 34).

SN 76-241,051. TELEVISION FEDERAL S.A. TELEFE, (1248) BUENOS AIRES, ARGENTINA, FILED 4-13-2001.

TELEFE INTERNACIONAL

NO CLAIM IS MADE TO THE EXCLUSIVE RIGHT TO USE "INTERNACIONAL", APART FROM THE MARK AS SHOWN.

THE WORD "TELEFE" STANDS FOR THE ABBREVIATION OF "TELEVISION FEDERAL" AND "INTERNACIONAL" IS TRANSLATED INTO ENGLISH AS "INTERNATIONAL".

CLASS 38—COMMUNICATION

FOR RADIO AND TELEVISION BROADCASTING RENDERED BY SATELLITE OR CABLE TRANSMISSION (U.S. CLS. 100, 101 AND 104).
FIRST USE 4-13-1998; IN COMMERCE 3-26-2000.

CLASS 41—EDUCATION AND ENTERTAINMENT

FOR PRODUCTION OF THEATRICAL PERFORMANCES, SPORTS EVENTS, RADIO AND TELEVISION PROGRAMS RELATED TO ENTERTAINMENT, NEWS, EDUCATION AND CURRENT EVENTS, RADIO AND TELEVISION BROADCASTING AND THE USE OF TELECOMMUNICATION EQUIPMENT (U.S. CLS. 100, 101 AND 107).
FIRST USE 4-13-1998; IN COMMERCE 3-26-2000.

SN 76-241,996. TYLER PIPE COMPANY, A DIVISION OF RANSOM INDUSTRIES, L.P., TYLER, TX. FILED 4-17-2001.



THE LINING SHOWN IN THE DRAWING IS A FEATURE OF THE MARK AND IS NOT INTENDED TO REPRESENT COLOR. THE LINES ARE NOT STIPPLING.

CLASS 6—METAL GOODS

FOR METAL SOIL PIPE; METAL SOIL PIPE FITTINGS; SPECIAL METAL PLUMBING FITTINGS, NAMELY, STARTER FITTINGS, AND CLOSET CARRIERS; METAL STAPLE DRAINS FOR USE OF DRAINAGE OF WATER AND VENT SYSTEMS; METAL PIPE PRESSURE FITTINGS; STAINLESS STEEL AND; METAL VALVES BOXES; AND, METAL GRATES FOR USE IN SEWERS AND DRAINS (U.S. CLS. 2, 12, 13, 14, 23, 25 AND 50).

FIRST USE 1-0-1997; IN COMMERCE 1-0-1997.

CLASS 17—RUBBER GOODS

FOR ELASTOMER HUBLESS PIPE COUPLINGS AND ELASTOMER COMPRESSION GASKETS FOR USE IN THE DRAINAGE WASTE VENT SYSTEMS (U.S. CLS. 1, 5, 12, 13, 35 AND 50).

FIRST USE 1-0-1997; IN COMMERCE 1-0-1997.

SN 76-243,560. PARTNERS IN LEADERSHIP, LLC, TEMECULA, CA. FILED 4-19-2001.

ACCELERATING THE CULTURAL TRANSITION

CLASS 35—ADVERTISING AND BUSINESS

FOR BUSINESS CONSULTATION SERVICES AND BUSINESS MANAGEMENT SERVICES (U.S. CLS. 100, 101 AND 102).

FIRST USE 0-0-1998; IN COMMERCE 0-0-1998.

CLASS 41—EDUCATION AND ENTERTAINMENT

FOR BUSINESS TRAINING SERVICES, NAMELY, CONDUCTING SEMINARS, WORKSHOPS AND ONE-ON-ONE TRAINING IN THE FIELDS OF BUSINESS MANAGEMENT AND BUSINESS OPERATIONS (U.S. CLS. 100, 101 AND 107).

FIRST USE 0-0-1998; IN COMMERCE 0-0-1998.

SN 76-243,894. THE CARWASH CELL, INC., PORT CHESTER, NY. FILED 4-10-2001.

THE CARWASH CELL

NO CLAIM IS MADE TO THE EXCLUSIVE RIGHT TO USE "CARWASH", APART FROM THE MARK AS SHOWN.

CLASS 7—MACHINERY

FOR SELF-CONTAINED VEHICLE WASHING UNITS COMPRISING VEHICLE WASHING MACHINES, VEHICLE DRYING MACHINES AND VEHICLE POLISHING MACHINES (U.S. CLS. 13, 19, 21, 23, 31, 34 AND 35).

CLASS 35—ADVERTISING AND BUSINESS

FOR FRANCHISING, NAMELY, OFFERING TECHNICAL ASSISTANCE IN THE ESTABLISHMENT AND/OR OPERATION OF CAR WASHES (U.S. CLS. 100, 101 AND 102).

CLASS 37—CONSTRUCTION AND REPAIR

FOR VEHICLE WASHING AND VEHICLE DETAILING SERVICES (U.S. CLS. 100, 103 AND 106).

SN 76-245,306. BAYERISCHE MOTOREN WERKE AKTIENGESELLSCHAFT, 80788 MUENCHEN, FED REP GERMANY, FILED 4-24-2001.

LET'S MOTOR

CLASS 6—METAL GOODS

FOR METAL KEY CHAINS (U.S. CLS. 2, 12, 13, 14, 23, 25 AND 50).

CLASS 9—ELECTRICAL AND SCIENTIFIC APPARATUS

FOR EYEGLASSES AND CASES THEREFOR; AUDIO AND VIDEO RECORDINGS AND CASES THEREFOR FEATURING MUSIC; VIDEO GAME DISCS (U.S. CLS. 21, 23, 26, 36 AND 38).

CLASS 12—VEHICLES

FOR AUTOMOBILES AND STRUCTURAL PARTS THEREFOR; BICYCLES AND STRUCTURAL PARTS THEREFOR; FITTED CAR COVERS (U.S. CLS. 19, 21, 23, 31, 35 AND 44).

CLASS 14—JEWELRY

FOR WATCHES (U.S. CLS. 2, 27, 28 AND 50).

CLASS 16—PAPER GOODS AND PRINTED MATTER

FOR BOOKS AND BROCHURES DEALING WITH VEHICLES; POSTCARDS; STICKERS AND BUSINESS CARDS (U.S. CLS. 2, 5, 22, 23, 29, 37, 38 AND 50).

CLASS 18—LEATHER GOODS

FOR LUGGAGE (U.S. CLS. 1, 2, 3, 22 AND 41).

CLASS 20—FURNITURE AND ARTICLES NOT OTHERWISE CLASSIFIED

FOR PICTURE FRAMES AND NON-METAL KEY CHAINS (U.S. CLS. 2, 13, 22, 25, 32 AND 50).

CLASS 21—HOUSEWARES AND GLASS

FOR BOTTLES SOLD EMPTY (U.S. CLS. 2, 13, 23, 29, 30, 33, 40 AND 50).

CLASS 25—CLOTHING

FOR CLOTHING, NAMELY, SHIRTS, PULLOVERS, HEADWEAR, JACKETS, HATS, AND TURTLENECKS (U.S. CLS. 22 AND 39).

CLASS 35—ADVERTISING AND BUSINESS

FOR DEALERSHIP SERVICES IN THE FIELD OF AUTOMOBILES (U.S. CLS. 100, 101 AND 102).

CLASS 9—ELECTRICAL AND SCIENTIFIC APPARATUS

FOR TELECOMMUNICATIONS SYSTEMS SOFTWARE FOR CONNECTING AND MANAGING OPTICAL NETWORKS, AND TELECOMMUNICATIONS SYSTEMS HARDWARE, NAMELY, A CONTROL AND SIGNALING PLATFORM FOR NEW OPTICAL SERVICES DEPLOYED ON A MULTI-VENDOR, MULTI-TECHNOLOGY OPTICAL MESH NETWORK (U.S. CLS. 21, 23, 26, 36 AND 38).

CLASS 42—SCIENTIFIC, COMPUTER AND LEGAL SERVICES

FOR TELECOMMUNICATIONS CONSULTING SERVICES TO PLAN AND OPTIMIZE OPTICAL MESH OR RING NETWORKS (U.S. CLS. 100 AND 101).

SN 76-246,012. CITRA-SOLV LLC, RIDGEFIELD, CT. FILED 4-25-2001.

CITRA-WOOD**CLASS 2—PAINTS**

FOR WOOD PRESERVATIVES (U.S. CLS. 6, 11 AND 16).

CLASS 3—COSMETICS AND CLEANING PREPARATIONS

FOR POLISHES FOR WOOD, FURNITURE POLISH, FLOOR POLISH (U.S. CLS. 1, 4, 6, 50, 51 AND 52).

SN 76-246,124. BOCA PHOTONICS, INC., BOCA RATON, FL. FILED 4-25-2001.

SERVICEPLEX DESIGNER

NO CLAIM IS MADE TO THE EXCLUSIVE RIGHT TO USE "DESIGNER", APART FROM THE MARK AS SHOWN.

CLASS 9—ELECTRICAL AND SCIENTIFIC APPARATUS

FOR TELECOMMUNICATIONS SYSTEMS SOFTWARE FOR CONNECTING AND MANAGING OPTICAL NETWORKS, AND TELECOMMUNICATIONS SYSTEMS HARDWARE, NAMELY, A CONTROL AND SIGNALING PLATFORM FOR NEW OPTICAL SERVICES DEPLOYED ON A MULTI-VENDOR, MULTI-TECHNOLOGY OPTICAL MESH NETWORK (U.S. CLS. 21, 23, 26, 36 AND 38).

SN 76-246,122. BOCA PHOTONICS, INC., BOCA RATON, FL. FILED 4-25-2001.

SERVICEPLEX**CLASS 9—ELECTRICAL AND SCIENTIFIC APPARATUS**

FOR TELECOMMUNICATIONS SYSTEMS SOFTWARE FOR CONNECTING AND MANAGING OPTICAL NETWORKS, AND TELECOMMUNICATIONS SYSTEMS HARDWARE, NAMELY, A CONTROL AND SIGNALING PLATFORM FOR NEW OPTICAL SERVICES DEPLOYED ON A MULTI-VENDOR, MULTI-TECHNOLOGY OPTICAL MESH NETWORK (U.S. CLS. 21, 23, 26, 36 AND 38).

CLASS 42—SCIENTIFIC, COMPUTER AND LEGAL SERVICES

FOR TELECOMMUNICATIONS CONSULTING SERVICES TO PLAN AND OPTIMIZE MESH OR RING NETWORKS (U.S. CLS. 100 AND 101).

CLASS 42—SCIENTIFIC, COMPUTER AND LEGAL SERVICES

FOR TELECOMMUNICATIONS CONSULTING SERVICES TO PLAN AND OPTIMIZE OPTICAL MESH OR RING NETWORKS (U.S. CLS. 100 AND 101).

SN 76-246,223. BOCA PHOTONICS, INC., BOCA RATON, FL. FILED 4-25-2001.

SERVICEPLEX MANAGER

NO CLAIM IS MADE TO THE EXCLUSIVE RIGHT TO USE "MANAGER", APART FROM THE MARK AS SHOWN.

CLASS 9—ELECTRICAL AND SCIENTIFIC APPARATUS

FOR TELECOMMUNICATIONS SYSTEMS SOFTWARE FOR CONNECTING AND MANAGING OPTICAL NETWORKS, AND TELECOMMUNICATIONS SYSTEMS HARDWARE, NAMELY, A CONTROL AND SIGNALING PLATFORM FOR NEW OPTICAL SERVICES DEPLOYED ON A MULTI-VENDOR, MULTI-TECHNOLOGY OPTICAL MESH NETWORK (U.S. CLS. 21, 23, 26, 36 AND 38).

SN 76-246,123. BOCA PHOTONICS, INC., BOCA RATON, FL. FILED 4-25-2001.

SERVICEPLEX CONTROLLER

NO CLAIM IS MADE TO THE EXCLUSIVE RIGHT TO USE "CONTROLLER", APART FROM THE MARK AS SHOWN.

CLASS 42—SCIENTIFIC, COMPUTER AND LEGAL SERVICES

FOR TELECOMMUNICATIONS CONSULTING SERVICES TO PLAN AND OPTIMIZE OPTICAL MESH OR RING NETWORKS (U.S. CLS. 100 AND 101).

SN 76-246,369. J WALTER THOMPSON U.S.A., INC., MINNEAPOLIS, MN. FILED 4-25-2001.

SN 76-246,745. SIEMENS AKTIENGESELLSCHAFT, MUNICH, FED REP GERMANY, FILED 4-25-2001.

IMAGINET

CLASS 35—ADVERTISING AND BUSINESS

FOR E-COMMERCE BUSINESS CONSULTATION SERVICES (U.S. CLS. 100, 101 AND 102).
FIRST USE 7-0-1991; IN COMMERCE 7-0-1991.

CLASS 42—SCIENTIFIC, COMPUTER AND LEGAL SERVICES

FOR COMPUTER SERVICES, NAMELY, DESIGNING AND IMPLEMENTING WEB SITES FOR OTHERS (U.S. CLS. 100 AND 101).
FIRST USE 7-0-1991; IN COMMERCE 7-0-1991.

SN 76-246,373. JOHNSON, JACK, SANTA BARBARA, CA. FILED 4-25-2001.

JACK JOHNSON

"JACK JOHNSON" IDENTIFIES A LIVING INDIVIDUAL WHOSE CONSENT IS OF RECORD.

CLASS 9—ELECTRICAL AND SCIENTIFIC APPARATUS

FOR PRE-RECORDED CASSETTE TAPES, PHONOGRAPH RECORDS, AUDIO AND VIDEO TAPES, VIDEOS, CD'S, DVD'S, COMPUTER SOFTWARE RECORDED ON DISCS, CD-ROMS, AND OTHER MAGNETIC, OPTICAL, ELECTRONIC, OR MACHINE-READABLE MEDIA FEATURING AUDIO AND VISUAL RECORDINGS OF MUSICAL PERFORMANCES AND OTHER ENTERTAINMENT EVENTS (U.S. CLS. 21, 23, 26, 36 AND 38).

CLASS 16—PAPER GOODS AND PRINTED MATTER

FOR PRINTED MUSIC BOOKS AND SHEET MUSIC FEATURING MUSICAL COMPOSITIONS AND TEXT; POSTERS, GREETING CARDS, PAPER TRANSPARENCIES AND PLASTIC TRANSPARENCIES, NAMELY STICKERS AND DECALS (U.S. CLS. 2, 5, 22, 23, 29, 37, 38 AND 50).

CLASS 25—CLOTHING

FOR CLOTHING FOR MEN, WOMEN AND CHILDREN, NAMELY T-SHIRTS, SHIRTS, BLOUSES, LONG SLEEVE SHIRTS, PANTS, TROUSERS, SHORTS, SWEATSHIRTS, SWEATPANTS, JOGGING SUITS, RAINCOATS, JEANS, BELTS, SCARVES, UNDERWEAR, BOXER SHORTS, SWIM WEAR, SOCKS, TANK TOPS, JACKETS, COATS; FOOTWEAR, NAMELY SHOES, BOOTS, SLIPPERS; AND HEADGEAR, NAMELY HATS, CAPS, SUNVISORS (U.S. CLS. 22 AND 39).

CLASS 41—EDUCATION AND ENTERTAINMENT

FOR ENTERTAINMENT SERVICES IN THE NATURE OF LIVE PERFORMANCES; AUDIO RECORDING AND PRODUCTION; AND MUSIC PUBLISHING SERVICES (U.S. CLS. 100, 101 AND 107).

HandCare

PRIORITY CLAIMED UNDER SEC. 44(D) ON FED REP GERMANY APPLICATION NO. 30082222.7/0, FILED 11-8-2000, REG. NO. 30082222, DATED 3-8-2001, EXPIRES 11-30-2010.

CLASS 9—ELECTRICAL AND SCIENTIFIC APPARATUS

FOR DATA PROCESSING PROGRAMS, NAMELY, COMPUTER SOFTWARE FOR OPERATING COMPUTORIZED TOMOGRAPHY SYSTEMS AND COMPONENTS OF TOMOGRAPHY SYSTEMS, COMPUTER SOFTWARE FOR RECORDING, TRANSMITTING, DISPLAYING AND ANALYZING TOMOGRAPHY DATA (U.S. CLS. 21, 23, 26, 36 AND 38).

CLASS 10—MEDICAL APPARATUS

FOR ELECTROMEDICAL APPARATUS, DEVICES AND SYSTEMS, NAMELY, TOMOGRAPHY APPARATUS AND PARTS AND COMPONENTS THEREOF (U.S. CLS. 26, 39 AND 44).

SN 76-247,349. BONNE BELL, INC., LAKEWOOD, OH. FILED 4-27-2001.

THE WORLD OF SMACKERS

OWNER OF U.S. REG. NOS. 1,087,952, 2,182,478 AND 2,312,692.

CLASS 3—COSMETICS AND CLEANING PREPARATIONS

FOR (BASED ON USE IN COMMERCE) COSMETIC PRODUCTS, NAMELY, COSMETIC PREPARATIONS FOR MOISTURIZING LIPS, BATH AND SHOWER GEL, LIP POLISH AND GLOSS, COLOGNE, BODY SPRAY, LOTION, AND NAIL POLISH (U.S. CLS. 1, 4, 6, 50, 51 AND 52).

FIRST USE 3-31-2000; IN COMMERCE 3-31-2000.

CLASS 16—PAPER GOODS AND PRINTED MATTER

FOR (BASED ON INTENT TO USE) NOTEBOOKS, NOTE CARDS, ERASERS, STATIONERY-TYPE PORTFOLIOS BINDERS, BULLETIN BOARDS, STICKERS, STATIONERY, PENS, DIARIES, ADDRESS BOOKS, PERSONAL JOURNAL BOOKS, MEMO PADS, PAPER PLACEMATS, AND POSTERS (U.S. CLS. 2, 5, 22, 23, 29, 37, 38 AND 50).

CLASS 25—CLOTHING

FOR (BASED ON INTENT TO USE) CLOTHING, NAMELY, T-SHIRTS AND SWEATSHIRTS (U.S. CLS. 22 AND 39).

SN 76-247,439. TRI TOOL INC., RANCHO CORDOVA, CA.
FILED 4-27-2001.

SN 76-247,917. MILLAR INSTRUMENTS, INC., HOUSTON,
TX. FILED 4-27-2001.



OWNER OF U.S. REG. NOS. 1,150,808, 1,573,849 AND OTHERS.

THE MARK CONSISTS SOLELY OF A STYLIZED DRAWING OF THE LETTER "T".

CLASS 7—MACHINERY

FOR PORTABLE PIPE CUTTING, BEVELING AND MACHINING SYSTEMS, COMPRISING PORTABLE LATHES, CUTOFF DEVICES AS MACHINE TOOLS, MACHINE TOOL BITS AND PARTS FOR THE FOREGOING; PNEUMATIC POWER TOOLS, HYDRAULIC POWER TOOLS AND ELECTRIC POWER TOOLS FOR MACHINING METAL AND PLASTIC; NAMELY, PORTABLE PIPE BEVELING MACHINES, PORTABLE LATHES AND CUTTING TOOLS FOR PIPE AND TUBING, AND REPLACEMENT PARTS FOR THE FOREGOING, NAMELY, TOOL BITS, MANDRELS, COLLETS, ADAPTORS, CUTTING HEADS, TRACKING TOOLS AND GROOVING TOOLS; AND HYDRAULIC POWER SUPPLIES FOR POWER TOOLS, WHICH COMPRISE ELECTRICALLY POWERED PUMPS TO PROVIDE HYDRAULIC POWER; PIPE LATHES, TOOL BITS FOR PIPE LATHES, BEVELING AND MACHINING HEADS FOR PIPE LATHES, POWER DRIVE HEADS FOR PIPE MACHINING TOOLS AND HYDRAULIC POWER SOURCES; MACHINE TOOL BITS FOR CUTTING METAL AND NON-METAL MATERIALS; MACHINE TOOLS, NAMELY, PORTABLE MACHINE TOOLS FOR ON-SITE MACHINING AND REPAIRING OF PIPE FLANGES, TUBE FLANGES, PIPE FITTINGS, VALVES, VESSELS, HEAT EXCHANGERS, HEADERS, SUPER HEATERS, ECONOMIZERS, PUMPS, BASES FOR PUMPS, BASES FOR VESSELS, BASES FOR HEAT EXCHANGERS, BASES FOR HEADERS, BASES FOR SUPER HEATERS, BASES FOR ECONOMIZERS, AND VALVE PARTS; AND REPLACEMENT PARTS THEREFOR (U.S. CLS. 13, 19, 21, 23, 31, 34 AND 35).

FIRST USE 1-0-2000; IN COMMERCE 1-0-2000.

CLASS 37—CONSTRUCTION AND REPAIR

FOR CONSTRUCTION AND REPAIR SERVICES, NAMELY REPAIR AND RECONSTRUCTION OF FLUID HANDLING CONDUITS, VESSELS AND ASSOCIATED EQUIPMENT; RENTAL OF SPECIALIZED EQUIPMENT FOR BUILDING; RENTAL OF SPECIALIZED EQUIPMENT FOR PIPE AND TUBE MACHINING, WELDING AND ALIGNMENT (U.S. CLS. 100, 103 AND 106).

FIRST USE 1-0-2000; IN COMMERCE 1-0-2000.

CLASS 40—MATERIAL TREATMENT

FOR WELDING; MACHINE SHOP SERVICES, NAMELY MACHINING AND JOINING METAL AND NON-METAL PARTS FOR OTHERS; FLUID HANDLING CONDUIT WELDING AND ALIGNMENT SERVICES (U.S. CLS. 100, 103 AND 106).

FIRST USE 1-0-2000; IN COMMERCE 1-0-2000.

CLASS 42—SCIENTIFIC, COMPUTER AND LEGAL SERVICES

FOR INDUSTRIAL DESIGN, ENGINEERING AND TECHNICAL CONSULTATION IN THE FIELDS OF PIPE AND TUBE MACHINING, WELD PREPARATION, WELDING AND ALIGNMENT (U.S. CLS. 100 AND 101).

FIRST USE 1-0-2000; IN COMMERCE 1-0-2000.

AT THE HEART OF SENSOR INNOVATION

CLASS 10—MEDICAL APPARATUS

FOR MEDICAL DEVICES, NAMELY, CATHETERS WITH SENSORS; PRESSURE-VOLUME CONDUCTANCE SYSTEMS COMPRISED OF CONDUCTANCE UNITS, COMPUTER, COMPUTER HARDWARE, DATA ACQUISITION AND DATA ANALYSIS SOFTWARE, AND PRESSURE-VOLUME CATHETERS; AND OTHER MEDICAL DEVICES FOR PHYSIOLOGICAL MEASUREMENT, NAMELY, CATHETER CONTROL UNITS, CABLES, AND VELOCIMETERS (U.S. CLS. 26, 39 AND 44).

FIRST USE 9-1-2000; IN COMMERCE 9-1-2000.

CLASS 40—MATERIAL TREATMENT

FOR CUSTOM MANUFACTURE OF SPECIAL MEDICAL DEVICES, NAMELY, CATHETERS WITH SENSORS, PRESSURE-VOLUME CONDUCTANCE SYSTEMS AND OTHER MEDICAL DEVICES FOR PHYSIOLOGICAL MEASUREMENT (U.S. CLS. 100, 103 AND 106).

FIRST USE 9-30-2000; IN COMMERCE 9-30-2000.

CLASS 42—SCIENTIFIC, COMPUTER AND LEGAL SERVICES

FOR DESIGN AND DEVELOPMENT FOR OTHERS OF SPECIAL MEDICAL DEVICES, NAMELY, CATHETERS WITH SENSORS, PRESSURE-VOLUME CONDUCTANCE SYSTEMS, AND OTHER MEDICAL DEVICES FOR PHYSIOLOGICAL MEASUREMENT (U.S. CLS. 100 AND 101).

FIRST USE 9-30-2000; IN COMMERCE 9-30-2000.

SN 76-248,254. JACKSON ELECTRIC MEMBERSHIP CORPORATION, JEFFERSON, GA. FILED 4-30-2001.

JACKSON EMC NATURAL GAS

NO CLAIM IS MADE TO THE EXCLUSIVE RIGHT TO USE "EMC NATURAL GAS", APART FROM THE MARK AS SHOWN.

CLASS 39—TRANSPORTATION AND STORAGE

FOR DISTRIBUTION OF ENERGY (U.S. CLS. 100 AND 105).

CLASS 42—SCIENTIFIC, COMPUTER AND LEGAL SERVICES

FOR ENERGY AUDITING; ENERGY USE MANAGEMENT; AND CONSULTING IN THE FIELD OF ENERGY USE MANAGEMENT (U.S. CLS. 100 AND 101).

SN 76-249,128. STORTS, PAUL A., HAVANA, AR. FILED 5-2-2001.

SWARAJ

THE ENGLISH TRANSLATION OF "SWARAJ" IS "NATIONAL OR LOCAL SELF-GOVERNMENT IN INDIA".

CLASS 7—MACHINERY

FOR FARM EQUIPMENT, NAMELY BALERS, ROTARY MOWERS, PLOWS, HARROWS, REAR-LOADING BOOM POLES, FINISHING MOWERS, REAR BLADES, CULTIVATORS, AND BOX BLADES (U.S. CLS. 13, 19, 21, 23, 31, 34 AND 35).

FIRST USE 2-1-2000; IN COMMERCE 1-1-2001.

CLASS 12—VEHICLES

FOR TRACTORS; FORK LIFT TRUCKS (U.S. CLS. 19, 21, 23, 31, 35 AND 44).

FIRST USE 2-1-2000; IN COMMERCE 1-1-2001.

SN 76-249,552. VALVINO LAMORE, LLC, LAS VEGAS, NV. FILED 4-30-2001.

WORLD WIDE WYNN

NO CLAIM IS MADE TO THE EXCLUSIVE RIGHT TO USE "WORLD WIDE", APART FROM THE MARK AS SHOWN.

CLASS 6—METAL GOODS

FOR METAL KEY CHAINS, METAL PIGGY BANKS, METAL DECORATIVE BOXES AND METAL JEWELRY BOXES, METAL MONEY CLIPS AND SCULPTURES OF NON-PRECIOUS METAL (U.S. CLS. 2, 12, 13, 14, 23, 25 AND 50).

CLASS 16—PAPER GOODS AND PRINTED MATTER

FOR PENS, PENCILS, PLAYING CARDS, STATIONERY, NOTE CARDS, NOTE PADS, NOTE BOOKS, APPOINTMENT BOOKS, POST CARDS, CHILDREN'S ACTIVITY BOOKS, COLORING BOOKS, PEN AND PENCIL HOLDERS AND RUBBER STAMPS (U.S. CLS. 2, 5, 22, 23, 29, 37, 38 AND 50).

CLASS 18—LEATHER GOODS

FOR TOTE BAGS, DUFFLE BAGS, BACK PACKS, BEACH BAGS, FANNY PACKS, HAND BAGS, WALLET, BILLFOLDS, BUSINESS CARD CASES, TOILETRY CASES SOLD EMPTY, GARMENT BAGS FOR TRAVEL AND UMBRELLAS (U.S. CLS. 1, 2, 3, 22 AND 41).

CLASS 25—CLOTHING

FOR WEARING APPAREL, NAMELY, POLO SHIRTS, T-SHIRTS, TANK TOPS, SHIRTS, JACKETS, JOGGING SUITS, SWEAT SHIRTS, SWEAT PANTS, JEANS, PANTS, ROBES, SLEEPWEAR, ROMPERS, SCARVES, SOCKS, SLIPPERS, HATS, CAPS, BELTS AND LEATHER BELTS (U.S. CLS. 22 AND 39).

CLASS 28—TOYS AND SPORTING GOODS

FOR TOYS, NAMELY STUFFED TOYS, PLUSH TOYS, PLUSH ANIMALS, PLAY ACTION FIGURES, FLYING DISKS, YO-YOS, BATH TOYS, BEACH TOYS, NAMELY, BEACH BALLS, SAND TOYS, AND TARGET GAMES, VOLLEYBALL GAME PLAYING EQUIPMENT, BADMINTON SETS; TOY SLOT MACHINES, HAND HELD UNIT FOR PLAYING ELECTRONIC GAMES, CHESS SETS, CARD GAMES, TOY MUSIC BOXES, GOLF BALLS, GOLF TEES, GOLF BAGS AND GOLF CLUB COVERS (U.S. CLS. 22, 23, 38 AND 50).

SN 76-249,768. CARWASH CELL, INC., THE, PORT CHESTER, NY. FILED 4-27-2001.

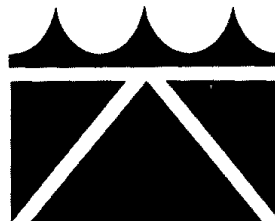

CLASS 7—MACHINERY

FOR SELF-CONTAINED VEHICLE WASHING UNITS COMPRISING VEHICLE WASHING MACHINES, VEHICLE DRYING MACHINES AND VEHICLE POLISHING MACHINES (U.S. CLS. 13, 19, 21, 23, 31, 34 AND 35).

CLASS 35—ADVERTISING AND BUSINESS

FOR FRANCHISING, NAMELY, OFFERING TECHNICAL ASSISTANCE IN THE ESTABLISHMENT AND/OR OPERATION OF CARWASHES (U.S. CLS. 100, 101 AND 102).

CLASS 37—CONSTRUCTION AND REPAIR

FOR VEHICLE WASHING AND DETAILING SERVICES (U.S. CLS. 100, 103 AND 106).

SN 76-251,333. KONAMI CORPORATION, MINATO-KU, TOKYO, JAPAN, FILED 5-4-2001.

**THE ALL-SEEING WHITE
TIGER**

CLASS 9—ELECTRICAL AND SCIENTIFIC APPARATUS

FOR COMPUTER PRODUCTS, NAMELY, COMPUTER GAME PROGRAMS; VIDEO GAME CARTRIDGES; VIDEO GAME CD-ROMS; VIDEO GAME MACHINES FOR USE WITH TELEVISIONS; COMPUTER GAME CD-ROMS; VIDEO GAME PROGRAMS; VIDEO GAME PROGRAMS FOR USE WITH TELEVISION SETS; VIDEO GAME JOYSTICKS (U.S. CLS. 21, 23, 26, 36 AND 38).

CLASS 16—PAPER GOODS AND PRINTED MATTER

FOR BROCHURES AND BOOKLETS RELATING TO COMPUTER AND VIDEO GAMES; VIDEO GAME STRATEGY GUIDE BOOKS; VIDEO GAME STRATEGY GUIDE MAGAZINES; CARD GAME STRATEGY GUIDE BOOKS; CARD GAME STRATEGY GUIDE MAGAZINES; CARD GAME INSTRUCTION BOOKS; CARD GAME INSTRUCTION MAGAZINES; POSTERS; PLAYING CARDS AND INSTRUCTION MANUAL SOLD THEREWITH; COMPUTER GAME INSTRUCTION MANUALS; PRINTED GAME INSTRUCTION SHEETS; PRINTED SCORING SHEETS; TRADING CARDS; CALENDARS; LOOSE-LEAF BINDERS AND STATIONERY (U.S. CLS. 2, 5, 22, 23, 29, 37, 38 AND 50).

CLASS 28—TOYS AND SPORTING GOODS

FOR STAND-ALONE VIDEO GAME MACHINES; HAND-HELD UNITS FOR PLAYING ELECTRONIC GAMES; BOARD GAMES AND INSTRUCTIONAL MANUALS SOLD AS A UNIT THEREWITH; CARD GAMES; DICE; PROMOTIONAL GAME MATERIALS; GAME EQUIPMENT, NAMELY, CHIPS; TOYS, NAMELY, ACTION FIGURES, DOLLS AND PLAYSETS THEREFOR (U.S. CLS. 22, 23, 38 AND 50).

SN 76-251,417. COMPUCOM SYSTEMS, INC., DALLAS, TX. FILED 5-4-2001.

RESOLVEBPM**CLASS 9—ELECTRICAL AND SCIENTIFIC APPARATUS**

FOR COMPUTERS, COMPUTER PERIPHERAL DEVICES AND COMPUTER SOFTWARE, NAMELY, SOFTWARE FOR ELECTRONIC COMMERCE USED TO ALLOW OTHERS TO BUY, SELL, AND TRACK THE BUYING AND SELLING OF GOODS AND SERVICES OVER THE INTERNET, SOFTWARE FOR INSTALLATION AND MAINTENANCE OF COMPUTERS AND SOFTWARE TOOLS FOR THE SELECTION, INSTALLATION AND MANAGEMENT OF COMPUTER SOFTWARE AND COMPUTER HARDWARE (U.S. CLS. 21, 23, 26, 36 AND 38).

CLASS 37—CONSTRUCTION AND REPAIR

FOR MAINTENANCE OF COMPUTER HARDWARE (U.S. CLS. 100, 103 AND 106).

CLASS 42—SCIENTIFIC, COMPUTER AND LEGAL SERVICES

FOR COMPUTER CONSULTING SERVICES, COMPUTER SOFTWARE INSTALLATION AND MAINTENANCE, AND LEASING SERVICES IN THE FIELD OF COMPUTERS AND COMPUTER-RELATED EQUIPMENT (U.S. CLS. 100 AND 101).

SN 76-251,451. WOW INDUSTRIA E COMERCIO LTDA., SAO PAULO, BRAZIL, FILED 5-4-2001.

YOGOMIX**CLASS 29—MEATS AND PROCESSED FOODS**

FOR DAIRY BASED BEVERAGES (U.S. CL. 46).

CLASS 32—LIGHT BEVERAGES

FOR NON-ALCOHOLIC BEVERAGES, NAMELY SOFT DRINKS AND JUICES (U.S. CLS. 45, 46 AND 48).

SN 76-251,622. HOME ELEMENTS, INTERNATIONAL, TAIPEI, TAIWAN, FILED 5-7-2001.

IN YOUR ELEMENT**CLASS 20—FURNITURE AND ARTICLES NOT OTHERWISE CLASSIFIED**

FOR FURNITURE, NAMELY SHELVING, WALL SHELVES, SERVING CARTS, TABLES, CHAIRS, WALL AND FLOOR CABINETS; WIRE STORAGE RACKS; NON-METAL WALL HOOKS; HAMPERS; LAUNDRY AND CLOSET STORAGE RACKS; SPACE SAVERS, NAMELY SHELVING UNITS THAT FIT OVER THE TOILET, OTHERWISE KNOWN AS ETAGERES; SUCTION CUP HANGERS AND HOOKS MADE OF SILICONE POLYMER (U.S. CLS. 2, 13, 22, 25, 32 AND 50).

CLASS 21—HOUSEWARES AND GLASS

FOR SALT AND PEPPER SHAKERS; SPICE RACKS; WINE RACKS; TRIVETS; DISH RACKS; HOUSEHOLD UTENSIL HOLDERS FOR STORAGE OF KITCHEN SPOONS, SPATULAS, SCRAPERS AND WHISKS; ICE BUCKETS; SERVING TRAYS NOT OF PRECIOUS METAL; WATERING CANS; BEVERAGEWARE; SERVINGWARE FOR SERVING FOOD; BATH AND SHOWER CADDIES; TOWEL HOLDERS; BATH HARDWARE, NAMELY TOWEL BARS, TOOTHBRUSH HOLDERS, SOAP HOLDERS, TOILET PAPER HOLDERS, HOOKS; WASTEBASKETS; STEPCANS, NAMELY TRASH CAN HOLDERS WITH FOOT PEDAL ACTIVATED LIDS; BASKETS OF SILICONE POLYMER (U.S. CLS. 2, 13, 23, 29, 30, 33, 40 AND 50).

SN 76-251,646. KONAMI CORPORATION, TOKYO, JAPAN, FILED 5-4-2001.

DEEPSEA SHARK

NO CLAIM IS MADE TO THE EXCLUSIVE RIGHT TO USE "SHARK", APART FROM THE MARK AS SHOWN.

CLASS 9—ELECTRICAL AND SCIENTIFIC APPARATUS

FOR COMPUTER PRODUCTS, NAMELY, COMPUTER GAME PROGRAMS; VIDEO GAME CARTRIDGES; VIDEO GAME CD-ROMS; VIDEO GAME MACHINES FOR USE WITH TELEVISIONS; COMPUTER GAME CD-ROMS; VIDEO GAME PROGRAMS; VIDEO GAME PROGRAMS FOR USE WITH TELEVISION SETS; VIDEO GAME JOYSTICKS (U.S. CLS. 21, 23, 26, 36 AND 38).

CLASS 16—PAPER GOODS AND PRINTED MATTER

FOR BROCHURES AND BOOKLETS RELATING TO COMPUTER AND VIDEO GAMES; VIDEO GAME STRATEGY GUIDE BOOKS; VIDEO GAME STRATEGY GUIDE MAGAZINES; CARD GAME STRATEGY GUIDE BOOKS; CARD GAME STRATEGY GUIDE MAGAZINES; CARD GAME INSTRUCTION BOOKS; CARD GAME INSTRUCTION MAGAZINES; POSTERS; PLAYING CARDS AND INSTRUCTION MANUAL SOLD THEREWITH; COMPUTER GAME INSTRUCTION MANUALS; PRINTED GAME INSTRUCTION SHEETS; PRINTED SCORING SHEETS; TRADING CARDS; CALENDARS; LOOSE-LEAF BINDERS AND STATIONERY (U.S. CLS. 2, 5, 22, 23, 29, 37, 38 AND 50).

CLASS 28—TOYS AND SPORTING GOODS

FOR STAND-ALONE VIDEO GAME MACHINES; HAND-HELD UNITS FOR PLAYING ELECTRONIC GAMES; BOARD GAMES AND INSTRUCTIONAL MANUALS SOLD AS A UNIT THEREWITH; CARD GAMES; DICE; PROMOTIONAL GAME MATERIALS; GAME EQUIPMENT, NAMELY, CHIPS; TOYS, NAMELY, ACTION FIGURES, DOLLS AND PLAYSETS THEREFOR (U.S. CLS. 22, 23, 38 AND 50).

SN 76-252,833. BYRD, GILL, PULASKI, WI. AND BYRD, MARI, PULASKI, WI. BY ASSIGNMENT PLAYERS CHAPEL PROGRAM, INC., GREEN BAY, WI. FILED 5-7-2001.



THE DESCRIPTION OF THE MARK IS A FLAME IN THE CENTER OF A THREE-DIMENSIONAL STAR.

CLASS 16—PAPER GOODS AND PRINTED MATTER

FOR SERIES OF RELIGIOUS BOOKS, NEWSLETTERS IN THE FIELD OF RELIGION AND PRINTED COURSE MATERIALS FEATURING A RELIGIOUS CURRICULUM (U.S. CLS. 2, 5, 22, 23, 29, 37, 38 AND 50).

FIRST USE 2-18-2000; IN COMMERCE 2-18-2000.

CLASS 41—EDUCATION AND ENTERTAINMENT

FOR EDUCATIONAL SERVICES, NAMELY, CONDUCTING RELIGION BASED LECTURES PROMOTING CHRISTIAN VALUES AND DISTRIBUTING COURSE MATERIALS IN CONNECTION THEREWITH (U.S. CLS. 100, 101 AND 107).

FIRST USE 2-18-2000; IN COMMERCE 2-18-2000.

CLASS 42—SCIENTIFIC, COMPUTER AND LEGAL SERVICES

FOR ASSOCIATION SERVICES, NAMELY, PROMOTING THE INTERESTS OF CHRISTIANS (U.S. CLS. 100 AND 101).

FIRST USE 2-18-2000; IN COMMERCE 2-18-2000.

SN 76-252,902. EXECGLOBALNET, INC., DOWNEY, CA. FILED 5-7-2001.

EXECGLOBALNET**CLASS 35—ADVERTISING AND BUSINESS**

FOR EMPLOYMENT AGENCIES; EMPLOYMENT COUNSELING AND RECRUITING; EMPLOYMENT HIRING; RECRUITING, PLACEMENT, AND CAREER NETWORKING SERVICES; CAREER PLACEMENT; PROVIDING INFORMATION ON EMPLOYMENT-RELATED SUBJECTS, NAMELY, RESUME PREPARATION, CANDIDATE SELECTION TECHNIQUES AND INTERVIEWING TECHNIQUES, QUESTIONS AND PROCEDURES; CONDUCTING EMPLOYMENT AND SALARY SURVEYS AND TREND ANALYSIS (U.S. CLS. 100, 101 AND 102).

CLASS 41—EDUCATION AND ENTERTAINMENT

FOR TRAINING SERVICES IN THE FIELD OF EMPLOYMENT HIRING, RECRUITING, INTERVIEWING, STAFF SELECTION, CAREER DEVELOPMENT, PLACEMENT, AND CAREER NETWORKING; EDUCATIONAL SERVICES, NAMELY, CONDUCTING CLASSES, SEMINARS, WORKSHOPS, AND CONFERENCES IN THE FIELD OF EMPLOYMENT HIRING, RECRUITING, INTERVIEWING, STAFF SELECTION, CAREER DEVELOPMENT, PLACEMENT, AND CAREER NETWORKING, AND THE DISTRIBUTION OF COURSE MATERIALS IN CONNECTION THEREWITH (U.S. CLS. 100, 101 AND 107).

SN 76-253,050. KONAMI CORPORATION, MINATO-KU, TOKYO, JAPAN, FILED 5-4-2001.

AQUA MADOOR**CLASS 9—ELECTRICAL AND SCIENTIFIC APPARATUS**

FOR COMPUTER PRODUCTS, NAMELY, COMPUTER GAME PROGRAMS; VIDEO GAME CARTRIDGES; VIDEO GAME CD-ROMS; VIDEO GAME MACHINES FOR USE WITH TELEVISIONS; COMPUTER GAME CD-ROMS; VIDEO GAME PROGRAMS; VIDEO GAME PROGRAMS FOR USE WITH TELEVISION SETS; VIDEO GAME JOYSTICKS (U.S. CLS. 21, 23, 26, 36 AND 38).

CLASS 16—PAPER GOODS AND PRINTED MATTER

FOR BROCHURES AND BOOKLETS RELATING TO COMPUTER AND VIDEO GAMES; VIDEO GAME STRATEGY GUIDE BOOKS; VIDEO GAME STRATEGY GUIDE MAGAZINES; CARD GAME STRATEGY GUIDE BOOKS; CARD GAME STRATEGY GUIDE MAGAZINES; CARD GAME INSTRUCTION BOOKS; CARD GAME INSTRUCTION MAGAZINES; POSTERS; PLAYING CARDS AND INSTRUCTION MANUAL SOLD THEREWITH; COMPUTER GAME INSTRUCTION MANUALS; PRINTED GAME INSTRUCTION SHEETS; PRINTED SCORING SHEETS; TRADING CARDS; CALENDARS; LOOSE-LEAF BINDERS AND STATIONERY (U.S. CLS. 2, 5, 22, 23, 29, 37, 38 AND 50).

CLASS 28—TOYS AND SPORTING GOODS

FOR STAND-ALONE VIDEO GAME MACHINES; HAND-HELD UNITS FOR PLAYING ELECTRONIC GAMES; BOARD GAMES AND INSTRUCTIONAL MANUALS SOLD AS A UNIT THEREWITH; CARD GAMES; DICE; PROMOTIONAL GAME MATERIALS; GAME EQUIPMENT, NAMELY, CHIPS; TOYS, NAMELY, ACTION FIGURES, DOLLS AND PLAYSETS THEREFOR (U.S. CLS. 22, 23, 38 AND 50).

SN 76-254,418. XENTURY CITY DEVELOPMENT COMPANY, L.C., ORLANDO, FL. FILED 5-7-2001.

XENTURY CITY

NO CLAIM IS MADE TO THE EXCLUSIVE RIGHT TO USE "CITY", APART FROM THE MARK AS SHOWN.

CLASS 36—INSURANCE AND FINANCIAL

FOR LEASING OF REAL ESTATE, RETAIL SPACE AND OFFICE SPACE (U.S. CLS. 100, 101 AND 102).
FIRST USE 6-7-1993; IN COMMERCE 6-7-1993.

CLASS 37—CONSTRUCTION AND REPAIR

FOR CONSTRUCTION SERVICES, NAMELY, PLANNING, LAYING OUT AND CUSTOM CONSTRUCTION OF RESIDENTIAL AND COMMERCIAL COMMUNITIES; REAL ESTATE DEVELOPMENT (U.S. CLS. 100, 103 AND 106).
FIRST USE 6-7-1993; IN COMMERCE 6-7-1993.

SN 76-256,134. ROUSH CORPORATION, DBA ROUSH RACING, HUNTERSVILLE, NC. FILED 5-11-2001.

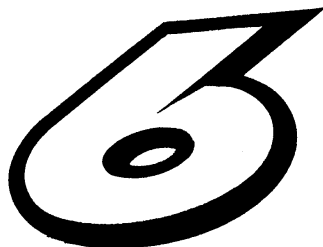

OWNER OF U.S. REG. NOS. 2,163,089 AND 2,327,805.

CLASS 6—METAL GOODS

FOR METAL GOODS, NAMELY, LICENSE PLATES, KEY CHAINS, MONEY CLIPS, NAMEPLATES, AND SIGNBOARDS (U.S. CLS. 2, 12, 13, 14, 23, 25 AND 50).
FIRST USE 1-2-2001; IN COMMERCE 1-2-2001.

CLASS 9—ELECTRICAL AND SCIENTIFIC APPARATUS

FOR ELECTRICAL AND SCIENTIFIC APPARATUS, NAMELY, SUNGLASSES, TELESCOPES, MAGNETS, AND PROTECTIVE HELMETS (U.S. CLS. 21, 23, 26, 36 AND 38).
FIRST USE 1-2-2001; IN COMMERCE 1-2-2001.

CLASS 14—JEWELRY

FOR JEWELRY, NAMELY, EARRINGS, LAPEL PINS, HAT PINS, CHARMS, AND BELT BUCKLES MADE OF PRECIOUS METALS (U.S. CLS. 2, 27, 28 AND 50).
FIRST USE 1-2-2001; IN COMMERCE 1-2-2001.

CLASS 16—PAPER GOODS AND PRINTED MATTER

FOR PAPER GOODS AND PRINTED MATERIALS, NAMELY, BUMPER STICKERS, DECALS, POSTERS, MOUNTED AND UNMOUNTED PHOTOGRAPHS, CALENDARS, WINDOW STICKERS, BROCHURES FEATURING DRIVERS AND MOTOR SPORTS ACTIVITIES, BINDERS, NOTE PADS, PAPER SIGNBOARDS, AND CARDS, NAMELY TRADING CARDS, PLAYING CARDS, AND NOTE CARDS (U.S. CLS. 2, 5, 22, 23, 29, 37, 38 AND 50).
FIRST USE 1-2-2001; IN COMMERCE 1-2-2001.

CLASS 18—LEATHER GOODS

FOR LEATHER GOODS, NAMELY, BACK PACKS, FANNY PACKS, DUFFEL BAGS (U.S. CLS. 1, 2, 3, 22 AND 41).
FIRST USE 1-2-2001; IN COMMERCE 1-2-2001.

CLASS 20—FURNITURE AND ARTICLES NOT OTHERWISE CLASSIFIED

FOR PLASTIC NOVELTY LICENSE PLATES, PLASTIC FLAGS, NON-METAL KEY CHAINS, SEAT CUSHIONS, RECLINING CHAIRS, AND THROW PILLOWS (U.S. CLS. 2, 13, 22, 25, 32 AND 50).
FIRST USE 1-2-2001; IN COMMERCE 1-2-2001.

CLASS 21—HOUSEWARES AND GLASS

FOR HOUSEWARES AND GLASS, NAMELY, DRINKING GLASSES, CUPS, MUGS, PLASTIC OR FOAM INSULATED SLEEVE FOR HOLDING BEVERAGE CANS, PORTABLE COOLERS, THERMAL INSULATED CONTAINERS FOR FOOD (U.S. CLS. 2, 13, 23, 29, 30, 33, 40 AND 50).
FIRST USE 1-2-2001; IN COMMERCE 1-2-2001.

CLASS 24—FABRICS

FOR FABRIC, NAMELY, CLOTH FLAGS, AFGHANS, TOWELS, AND CLOTH PENNANTS (U.S. CLS. 42 AND 50).
FIRST USE 1-2-2001; IN COMMERCE 1-2-2001.

CLASS 25—CLOTHING

FOR CLOTHING, NAMELY, LEATHER JACKETS, HEADBANDS, BANDANAS, HATS, CAPS, STRAW HATS, VISORS, DRESSES, SHIRTS, SPORTS SHIRTS, T-SHIRTS, NIGHT SHIRTS, SOCKS, SWEATSHIRTS, TANK TOPS, JACKETS, SHORTS, SWEAT PANTS, SWEATERS, WARM-UP SUITS, SUSPENDERS, PANTS, ROMPERS, CLOTH BIBS, AND INFANT SETS COMPRISING SHIRTS, PANTS, SOCKS, AND HATS ALL SOLD AS A UNIT; ALL SOLD AS PROMOTIONAL MATERIAL FOR MOTOR SPORTS ACTIVITIES (U.S. CLS. 22 AND 39).

FIRST USE 1-2-2001; IN COMMERCE 1-2-2001.

CLASS 28—TOYS AND SPORTING GOODS

FOR TOYS, NAMELY, STUFFED ANIMALS, MINIATURE CARS AND TRUCKS, DIE-CAST CARS, RADIO-CONTROLLED CARS, AND MODEL CARS (U.S. CLS. 22, 23, 38 AND 50).

FIRST USE 1-2-2001; IN COMMERCE 1-2-2001.

CLASS 41—EDUCATION AND ENTERTAINMENT

FOR ENTERTAINMENT SERVICES, NAMELY, ENTERTAINMENT OF OTHERS BY PARTICIPATING IN AUTOMOBILE RACING EVENTS; PUBLIC APPEARANCES BY SPORTS CELEBRITY (U.S. CLS. 100, 101 AND 107).

FIRST USE 1-2-2001, THE MARK WAS FIRST USED ANYWHERE IN A DIFFERENT FORM OTHER THAN THAT SOUGHT TO BE REGISTERED ON 02/01/1988; IN COMMERCE 1-2-2001, THE MARK WAS FIRST USED IN COMMERCE IN A DIFFERENT FORM OTHER THAN THAT SOUGHT TO BE REGISTERED ON 02/01/1988.

CLASS 39—TRANSPORTATION AND STORAGE

FOR PROVIDING AUTOMOBILE ASSISTANCE SERVICES, NAMELY, VOICE ROUTING AND LOCATION ASSISTANCE AND CONVENIENCE SERVICES, NAMELY, PROVIDING POINTS-OF-INTEREST INFORMATION, HOTEL AND RESTAURANT RESERVATIONS, NEWS, WEATHER, TRAFFIC, SPORTS, NEWS, ROUTING AND DRIVING DIRECTIONS THROUGH COMPONENTS INTEGRATED INTO A MOTOR VEHICLE, NAMELY, TRANSMITTERS, RECEIVERS, MICROPROCESSORS, SOFTWARE, CELLULAR PHONES, AND ELECTRICAL ARCHITECTURE ALL INTERACTING WITH GLOBAL POSITIONING SYSTEM SATELLITE TECHNOLOGY AND A CUSTOMER SERVICE CENTER, AND THROUGH PORTABLE, HAND-HELD, TWO-WAY COMMUNICATIONS DEVICES HAVING A GEO-LOCATION CAPABILITY; TRAVEL INFORMATION SERVICES, NAMELY, PROVIDING MOTOR VEHICLE OWNERS AND OPERATORS WITH INFORMATION IDENTIFYING THE GEOGRAPHIC LOCATION OF THEIR VEHICLES THROUGH THE USE OF TWO-WAY WIRELESS COMMUNICATION SYSTEMS, GLOBAL POSITIONING SATELLITE SYSTEMS, AND COMPUTER INTEGRATION SYSTEMS; PROVIDING TRAVEL PLANNING AND TRIP ROUTING SERVICES (U.S. CLS. 100 AND 105).

CLASS 42—SCIENTIFIC, COMPUTER AND LEGAL SERVICES

FOR PROVIDING AUTOMOBILE ASSISTANCE SERVICES, NAMELY, REMOTE DOOR UNLOCK, THEFT DETECTION AND NOTIFICATION, STOLEN VEHICLE TRACKING, AUTOMATIC NOTIFICATION OF AIRBAG DEPLOYMENT, VEHICULAR SECURITY MONITORING AND VEHICLE TRACKING SERVICES INVOLVING THE USE OF TWO-WAY WIRELESS COMMUNICATION SYSTEMS, GLOBAL POSITIONING SATELLITE SYSTEMS, AND COMPUTER INTEGRATION SYSTEMS TO ASCERTAIN THE GEOGRAPHIC LOCATIONS OF MOTOR VEHICLES (U.S. CLS. 100 AND 101).

SN 76-256,278. RESPONSE SERVICES CENTER, LLC, COLUMBIA, MD. FILED 5-14-2001.

SN 76-256,289. P.J. RHODES CORPORATION, NOVATO, CA. FILED 5-14-2001.



NO CLAIM IS MADE TO THE EXCLUSIVE RIGHT TO USE "SERVICES CENTER LLC", APART FROM THE MARK AS SHOWN.

CLASS 37—CONSTRUCTION AND REPAIR

FOR PROVIDING ROADSIDE EMERGENCY ASSISTANCE SERVICES (U.S. CLS. 100, 103 AND 106).

Farm Rose

PRIORITY CLAIMED UNDER SEC. 44(D) ON REPUBLIC OF KOREA APPLICATION NO. 2000-53120, FILED 11-15-2000, REG. NO. 511607, DATED 1-31-2002, EXPIRES 1-31-2012.

CLASS 29—MEATS AND PROCESSED FOODS

FOR CANNED FRUITS; CANNED VEGETABLES; CANNED SEAFOOD; PROCESSED NUTS, NAMELY, PEANUTS, ALMONDS, PECANS, AND WALNUTS; RAISINS; CRYSTALLIZED FRUITS; FRUIT PRESERVED IN ALCOHOL; PROCESSED ORANGES (U.S. CL. 46).

CLASS 31—NATURAL AGRICULTURAL PRODUCTS

FOR RAW NUTS, NAMELY, PEANUTS, ALMONDS, PECANS, AND WALNUTS; RAW ORANGES (U.S. CLS. 1 AND 46).

SN 76-256,967. CES COMPUTER SOLUTIONS, INC., MELVILLE, NY. FILED 5-15-2001.

SN 76-257,412. TELEVISION BROADCASTS LIMITED, KOWLOON, HONG KONG, FILED 5-15-2001.

TEAMSTATUS

CLASS 9—ELECTRICAL AND SCIENTIFIC APPARATUS

FOR COMPUTER SOFTWARE FOR USE IN MONITORING INTERNAL COMPUTER ALARM SYSTEMS FROM REMOTE LOCATIONS AND FOR ALLOWING REMOTE USER TO ASSESS NATURE OF UNDERLYING CAUSE OF ALARM AND PERFORM CORRECTIVE MAINTENANCE TASKS (U.S. CLS. 21, 23, 26, 36 AND 38).

CLASS 42—SCIENTIFIC, COMPUTER AND LEGAL SERVICES

FOR APPLICATION SERVICE PROVIDER SERVICES, NAMELY, HOSTING COMPUTER SOFTWARE APPLICATIONS OF OTHERS (U.S. CLS. 100 AND 101).



SN 76-257,067. MIRACOM INC., SAMSUNG-DONG, KANGNAM-KU SEOUL 135-729, REPUBLIC OF KOREA, FILED 5-11-2001.

Miracom

PRIORITY CLAIMED UNDER SEC. 44(D) ON REPUBLIC OF KOREA APPLICATION NO. 412001000210, FILED 2-13-2001.

CLASS 35—ADVERTISING AND BUSINESS

FOR COMPUTERIZED INFORMATION DATABASE AND FILE MANAGEMENT SERVICES, RETAIL SERVICES BY SOLICITATION OVER THE INTERNET BY SALES AGENTS IN THE FIELD OF COMPUTER SOFTWARE (U.S. CLS. 100, 101 AND 102).

CLASS 42—SCIENTIFIC, COMPUTER AND LEGAL SERVICES

FOR DATABASE DEVELOPMENT SERVICE; COMPUTER SERVICES, NAMELY, MANAGING WEB SITES FOR OTHERS, COMPUTER SERVICES, NAMELY, MANAGING E-COMMERCE WEB SITES FOR OTHERS, INSTALLATION OF E-COMMERCE COMPUTER SOFTWARE, MAINTENANCE OF COMPUTER SOFTWARE, COMPUTER SYSTEMS ANALYSIS, COMPUTER PROGRAMMING FOR OTHERS (U.S. CLS. 100 AND 101).

PRIORITY CLAIMED UNDER SEC. 44(D) ON HONG KONG APPLICATION NO. 200100030, FILED 1-2-2001, REG. NO. 12678, DATED 1-2-2001, EXPIRES 1-2-2008.

PRIORITY CLAIMED UNDER SEC. 44(D) ON HONG KONG APPLICATION NO. 200100028, FILED 1-2-2001, REG. NO. 12677, DATED 1-2-2001, EXPIRES 1-2-2008.

THE MARK CONSISTS OF A CRESCENT AND A GLOBE.

CLASS 16—PAPER GOODS AND PRINTED MATTER

FOR PRINTED PUBLICATIONS, NAMELY, BOOKS, MAGAZINES AND PAMPHLETS IN THE FIELDS OF TELEVISION SERVICE, NEWS IN THE ENTERTAINMENT INDUSTRY, LIFESTYLES IN THE NATURE OF CELEBRITIES AND FASHIONABLE ITEMS, AND ENTERTAINMENT IN THE NATURE OF FILMS, TELEVISION PROGRAMS AND CURRENT EVENTS (U.S. CLS. 2, 5, 22, 23, 29, 37, 38 AND 50).

FIRST USE 7-1-2000; IN COMMERCE 8-1-2000.

CLASS 38—COMMUNICATION

FOR TELEVISION BROADCASTING SERVICES (U.S. CLS. 100, 101 AND 104).

FIRST USE 10-1-2000; IN COMMERCE 10-1-2000.

CLASS 41—EDUCATION AND ENTERTAINMENT

FOR PROVIDING A WEB SITE ON THE GLOBAL COMPUTER NETWORK FEATURING INFORMATION IN THE FIELDS OF ENTERTAINMENT IN THE NATURE OF FILMS, TELEVISION PROGRAMS, LIFESTYLES IN THE NATURE OF CELEBRITIES AND FASHIONABLE ITEMS AND CURRENT EVENTS; AND ENTERTAINMENT SERVICES, NAMELY, PRODUCTION AND DISTRIBUTION OF TELEVISION PROGRAMS AND TELEVISION GAME SHOWS; AND ENTERTAINMENT IN THE NATURE OF COMPETITIONS IN THE FIELDS OF BEAUTY AND TALENT (U.S. CLS. 100, 101 AND 107).

FIRST USE 11-5-2000; IN COMMERCE 11-5-2000.

SN 76-257,771. BATESVILLE SERVICES, INC., BATESVILLE, IN. FILED 5-16-2001.

SN 76-258,682. LIFETOUCH INC., EDEN PRAIRIE, MN. FILED 5-17-2001.

MEANINGFUL MEMORIES

CLASS 9—ELECTRICAL AND SCIENTIFIC APPARATUS

FOR COMPUTER SOFTWARE FOR USE IN PRENEED FUNERAL PLANNING AND PRERECORDED VIDEOTAPES AND VIDEO DISCS FEATURING THE COMMEMORATION OF A DECEASED DURING MEMORIAL CEREMONIES (U.S. CLS. 21, 23, 26, 36 AND 38).

CLASS 16—PAPER GOODS AND PRINTED MATTER

FOR PERSONALIZED PRINTED MATERIALS FOR COMMEMORATING A DECEASED DURING MEMORIAL CEREMONIES, NAMELY, FUNERAL DISPLAYS, PHOTO DISPLAY BOARDS, FAMILY TREE DISPLAYS, PRAYER CARDS, PRINTED PAMPHLETS, THANK YOU CARDS, MEMORY CARDS, BOOKENDS AND PORTRAITS; PRINTED PRESENTER GUIDES, USED BY FUNERAL DIRECTORS IN PLANNING AND DESIGNING PERSONALIZED PRINTED MATERIALS FOR COMMEMORATING A DECEASED DURING MEMORIAL CEREMONIES (U.S. CLS. 2, 5, 22, 23, 29, 37, 38 AND 50).

CLASS 20—FURNITURE AND ARTICLES NOT OTHERWISE CLASSIFIED

FOR PERSONALIZED KEEPSAKES COMMEMORATING A DECEASED, NAMELY, PHOTOFRAMES, SHADOW BOXES, KEEPSAKE CASES, NOT OF PRECIOUS METALS (U.S. CLS. 2, 13, 22, 25, 32 AND 50).

CLASS 42—SCIENTIFIC, COMPUTER AND LEGAL SERVICES

FOR PROVIDING CUSTOMIZATION SERVICES, NAMELY, ASSISTING IN PLANNING AND DESIGNING PERSONALIZED PRINTED MATERIALS FOR COMMEMORATING A DECEASED DURING MEMORIAL CEREMONIES (U.S. CLS. 100 AND 101).

SN 76-257,867. BIOPHILE INC., CHARLOTTESVILLE, VA. FILED 5-15-2001.

BIOPHILE PROCESS

NO CLAIM IS MADE TO THE EXCLUSIVE RIGHT TO USE "PROCESS", APART FROM THE MARK AS SHOWN.

CLASS 9—ELECTRICAL AND SCIENTIFIC APPARATUS

FOR LABORATORY EQUIPMENT, NAMELY, INCUBATORS (U.S. CLS. 21, 23, 26, 36 AND 38).

CLASS 11—ENVIRONMENTAL CONTROL APPARATUS

FOR FREEZERS, REFRIGERATORS (U.S. CLS. 13, 21, 23, 31 AND 34).

LIFETOUCH NATIONAL SCHOOL STUDIOS

OWNER OF U.S. REG. NOS. 200,460, 2,433,340 AND OTHERS.

NO CLAIM IS MADE TO THE EXCLUSIVE RIGHT TO USE "SCHOOL STUDIOS", APART FROM THE MARK AS SHOWN.

SEC. 2(F).

CLASS 16—PAPER GOODS AND PRINTED MATTER

FOR PHOTOGRAPHS, BOOKMARKS, ACHIEVEMENT CERTIFICATES, SEATING CHARTS, AND STICKERS (U.S. CLS. 2, 5, 22, 23, 29, 37, 38 AND 50).

FIRST USE 6-0-1984; IN COMMERCE 6-0-1984.

CLASS 40—MATERIAL TREATMENT

FOR PHOTO FINISHING SERVICES (U.S. CLS. 100, 103 AND 106).

FIRST USE 6-0-1984; IN COMMERCE 6-0-1984.

CLASS 42—SCIENTIFIC, COMPUTER AND LEGAL SERVICES

FOR PHOTOGRAPHY SERVICES (U.S. CLS. 100 AND 101).

FIRST USE 6-0-1984; IN COMMERCE 6-0-1984.

SN 76-260,275. GRETAG IMAGING TRADING AG, D-5430 WETTINGEN, SWITZERLAND, FILED 5-21-2001.

PRINT & GO

NO CLAIM IS MADE TO THE EXCLUSIVE RIGHT TO USE "PRINT", APART FROM THE MARK AS SHOWN.

CLASS 39—TRANSPORTATION AND STORAGE

FOR ELECTRONIC STORAGE AND RETRIEVING OF DIGITAL IMAGES (U.S. CLS. 100 AND 105).

CLASS 40—MATERIAL TREATMENT

FOR ELECTRONIC SCANNING AND DIGITAL IMAGE MANIPULATION (U.S. CLS. 100, 103 AND 106).

CLASS 42—SCIENTIFIC, COMPUTER AND LEGAL SERVICES

FOR PRINTING OF DIGITAL IMAGES; HOSTING OF DIGITAL IMAGES ON AN INTRANET DATABASE (U.S. CLS. 100 AND 101).

SN 76-260,901. MLP FINANZDIENSTLEISTUNGEN AG, D-69126 HEIDELBERG, FED REP GERMANY, FILED 5-22-2001.

MLP CU

PRIORITY CLAIMED UNDER SEC. 44(D) ON FED REP GERMANY APPLICATION NO. 30085833.7/3, FILED 11-22-2000, REG. NO. 30085833, DATED 2-13-2001, EXPIRES 11-30-2010.

OWNER OF U.S. REG. NOS. 2,467,169, 2,493,896 AND OTHERS.

NO CLAIM IS MADE TO THE EXCLUSIVE RIGHT TO USE "CU", APART FROM THE MARK AS SHOWN.

CLASS 35—ADVERTISING AND BUSINESS

FOR CONSULTING IN BUSINESS MANAGEMENT, ORGANIZATION MANAGEMENT, PERSONNEL MANAGEMENT, AND IN ISSUES OF GENERAL MANAGEMENT; DRAFTING OF BUSINESS REPORTS; BUSINESS MARKETING CONSULTING SERVICES; COOPERATIVE ADVERTISING AND MARKETING; MARKET RESEARCH; OPINION POLLING FOR BUSINESS OR ADVERTISING PURPOSES; PROVIDING STATISTICAL INFORMATION; AGENCIES PROVIDING ADVERTISING TIME AND SPACE FOR OTHERS; DISSEMINATION OF ADVERTISING FOR OTHERS VIA THE INTERNET; PERSONNEL AND JOB PLACEMENT AGENCIES; AND PERSONNEL PLACEMENT AND RECRUITMENT; PROVIDING STATISTICAL INFORMATION FOR BUSINESS PURPOSES (U.S. CLS. 100, 101 AND 102).

CLASS 36—INSURANCE AND FINANCIAL

FOR INSURANCE UNDERWRITING IN THE FIELDS OF HOME INSURANCE, MEDICAL AND HEALTHCARE INSURANCE, FIRE INSURANCE, ACCIDENT INSURANCE, AUTOMOBILE INSURANCE, INSURANCE FOR BUSINESSES AND OTHER COMMERCIAL ENTITIES, AND LIFE INSURANCE; INSURANCE CONSULTANCY SERVICES; INSURANCE BROKERAGE IN THE FIELDS OF HOME INSURANCE, MEDICAL AND HEALTHCARE INSURANCE, FIRE INSURANCE, ACCIDENT INSURANCE, AUTOMOBILE INSURANCE, INSURANCE FOR BUSINESSES AND OTHER COMMERCIAL ENTITIES, AND LIFE INSURANCE; FINANCIAL MANAGEMENT; FINANCIAL PLANNING; FINANCIAL ANALYSIS AND CONSULTATION; SAVINGS AND INVESTMENT CONSULTING; FINANCING; FUND INVESTMENT CONSULTATION; INVESTMENT MANAGEMENT FOR FUNDS; INVESTMENT BROKERAGE SERVICES FOR FUNDS; INVESTMENT BROKERAGE; FINANCIAL MANAGEMENT FOR THE FORTUNES OF OTHERS; ESTATE TRUST MANAGEMENT; ESTATE PLANNING, NAMELY, PLANNING ESTATE PURCHASES FOR OTHERS AND CONSULTATION IN CONNECTION THEREWITH (U.S. CLS. 100, 101 AND 102).

CLASS 41—EDUCATION AND ENTERTAINMENT

FOR EDUCATIONAL SERVICES, NAMELY, CONDUCTING COLLOQUIUMS, SEMINARS, SYMPOSIUMS, CONGRESSES AND CONFERENCES IN THE FIELDS OF BUSINESS MANAGEMENT, ORGANIZATION MANAGEMENT, PERSONNEL MANAGEMENT, GENERAL MANAGEMENT, ADVERTISING AND MARKETING, PUBLIC RELATIONS, PERSONNEL PLACEMENT AND RECRUITING, INSURANCE ADMINISTRATION, INSURANCE UNDERWRITING, INSURANCE BROKERAGE, INSURANCE CONSULTING, INSURANCE AGENCIES, INSURANCE APPRAISALS, INSURANCE CLAIMS ADJUSTMENT, INSURANCE CLAIMS ADMINISTRATION, INSURANCE CLAIMS PROCESSING, INSURANCE ACTUARIAL SERVICES, FINANCIAL MANAGEMENT, FINANCIAL PLANNING, FINANCIAL ANALYSIS AND CONSULTING, FINANCING, INVESTMENT FUNDS, INVESTMENT FUNDS CONSULTING AND MANAGEMENT, INVESTMENT MANAGEMENT, INVESTMENT PLANNING, INVESTMENT BROKERAGE, ESTATE TRUST MANAGEMENT, AND ESTATE

PLANNING AND DISTRIBUTING COURSE MATERIALS IN CONNECTION THEREWITH; DEMONSTRATIONAL TEACHING IN THE FIELDS OF BUSINESS MANAGEMENT, ORGANIZATION MANAGEMENT, PERSONNEL MANAGEMENT, GENERAL MANAGEMENT, ADVERTISING AND MARKETING, PUBLIC RELATIONS, PERSONNEL PLACEMENT AND RECRUITING, INSURANCE ADMINISTRATION, INSURANCE UNDERWRITING, INSURANCE BROKERAGE, INSURANCE CONSULTING, INSURANCE AGENCIES, INSURANCE APPRAISALS, INSURANCE CLAIMS ADJUSTMENT, INSURANCE CLAIMS ADMINISTRATION, INSURANCE CLAIMS PROCESSING, INSURANCE ACTUARIAL SERVICES, FINANCIAL MANAGEMENT, FINANCIAL PLANNING, FINANCIAL ANALYSIS AND CONSULTING, FINANCING, INVESTMENT FUNDS, INVESTMENT FUNDS CONSULTING AND MANAGEMENT, INVESTMENT MANAGEMENT, INVESTMENT PLANNING, INVESTMENT BROKERAGE, ESTATE TRUST MANAGEMENT, AND ESTATE PLANNING; EDUCATIONAL SERVICES IN THE NATURE OF BUSINESS CORRESPONDENCE COURSE SCHOOLS (U.S. CLS. 100, 101 AND 107).

SN 76-261,505. MINNESOTA MINING AND MANUFACTURING COMPANY, AKA 3M, SAINT PAUL, MN. FILED 5-22-2001.

NEXTEL

OWNER OF U.S. REG. NOS. 1,228,005, 1,532,793 AND 1,557,999.

CLASS 11—ENVIRONMENTAL CONTROL APPARATUS

FOR HEAT DIFFUSION COLLARS AND DISCS FOR USE IN FURNACES (U.S. CLS. 13, 21, 23, 31 AND 34). FIRST USE 0-0-1996; IN COMMERCE 0-0-1996.

CLASS 12—VEHICLES

FOR THERMAL BARRIERS NOT MADE OF METAL FOR USE AS INSULATION COMPONENTS FOR TRANSPORTATION VEHICLES (U.S. CLS. 19, 21, 23, 31, 35 AND 44). FIRST USE 6-0-2000; IN COMMERCE 6-0-2000.

CLASS 23—YARNS AND THREADS

FOR SEWING THREAD (U.S. CL. 43). FIRST USE 10-20-1989; IN COMMERCE 10-20-1989.

SN 76-261,787. POWER BUYING DEALERS, USA, INC., OAKBROOK, IL. FILED 5-23-2001.

PBD-USA

CLASS 9—ELECTRICAL AND SCIENTIFIC APPARATUS

FOR SIGNS UTILIZED IN THE CONSTRUCTION AND OPERATION OF RETAIL CONVENIENCE STORE, NAMELY, ELECTRONIC AND NEON SIGNS (U.S. CLS. 21, 23, 26, 36 AND 38).

CLASS 11—ENVIRONMENTAL CONTROL APPARATUS

FOR FIXTURES UTILIZED IN THE CONSTRUCTION AND OPERATION OF RETAIL CONVENIENCE STORES, NAMELY, REFRIGERATED BEVERAGE DISPENSING UNITS; FREEZERS (U.S. CLS. 13, 21, 23, 31 AND 34).

CLASS 20—FURNITURE AND ARTICLES NOT OTHERWISE CLASSIFIED

FOR FURNITURE UTILIZED IN THE CONSTRUCTION AND OPERATION OF RETAIL CONVENIENCE STORES, NAMELY, SALES AND DISPLAY COUNTERS (U.S. CLS. 2, 13, 22, 25, 32 AND 50).

CLASS 21—HOUSEWARES AND GLASS

FOR PORTABLE COOLERS UTILIZED IN THE CONSTRUCTION AND OPERATION OF RETAIL CONVENIENCE STORES, NAMELY, PORTABLE BEVERAGE COOLERS (U.S. CLS. 2, 13, 23, 29, 30, 33, 40 AND 50).

SN 76-262,023. CUF-CUF & COMPANY, S.L., 48480 ARRIGORRIAGA (VIZCAYA), SPAIN, FILED 5-25-2001.



OWNER OF SPAIN REG. NO. 2312221, DATED 3-19-2001, EXPIRES 3-19-2011.

OWNER OF SPAIN REG. NO. 2312220, DATED 4-28-2000, EXPIRES 4-28-2010.

OWNER OF SPAIN REG. NO. 2312219, DATED 4-28-2000, EXPIRES 4-28-2010.

OWNER OF SPAIN REG. NO. 2312218, DATED 4-28-2000, EXPIRES 4-28-2010.

SN 76-261,966. CELLCO PARTNERSHIP, DBA VERIZON WIRELESS, BEDMINSTER, NJ. FILED 5-24-2001.

HOPELINE**CLASS 9—ELECTRICAL AND SCIENTIFIC APPARATUS**

FOR CELLULAR TELEPHONE SERVICES (U.S. CLS. 21, 23, 26, 36 AND 38).

CLASS 42—SCIENTIFIC, COMPUTER AND LEGAL SERVICES

FOR CHARITABLE SERVICES, NAMELY DONATION OF CELLULAR TELEPHONES AND FREE AIRTIMES, DONATION OF CLOTHING, AND PROVIDING GRANTS TO ORGANIZATIONS AND OTHER CHARITABLE SERVICES THAT SUPPORT THE PREVENTION OF DOMESTIC VIOLENCE AND DOMESTIC VIOLENCE VICTIMS (U.S. CLS. 100 AND 101).

CLASS 18—LEATHER GOODS

FOR (BASED ON SPAIN REGISTRATION TM2312218) PET SUPPLIES AND ACCESSORIES, NAMELY CAT SCRATCHING POSTS AND COMBINATION CAT PERCHES AND SCRATCHING POSTS; PET CUSHIONS; LEASHES; COLLARS AND PET CLOTHING (U.S. CLS. 1, 2, 3, 22 AND 41).

CLASS 20—FURNITURE AND ARTICLES NOT OTHERWISE CLASSIFIED

FOR (BASED ON SPAIN REGISTRATION TM2312219) BEDS FOR HOUSEHOLD PETS; KENNELS FOR HOUSEHOLD PETS; CARRIER PET KENNELS; AND PET FURNITURE (U.S. CLS. 2, 13, 22, 25, 32 AND 50).

CLASS 21—HOUSEWARES AND GLASS

FOR (BASED ON SPAIN REGISTRATION TM2312220) COMBINATION STORAGE CONTAINERS AND FEEDING BOWLS FOR PET FOOD; PET BOWLS; PET FOOD SCOOPS; PET ACCESSORIES, NAMELY KITS COMPRISED PRIMARILY OF LITTER PAN HOODS, LITTER PANS AND LITTER PAN RIMS; LITTER SCOOPS; AND CAGES FOR PETS (U.S. CLS. 2, 13, 23, 29, 30, 33, 40 AND 50).

CLASS 31—NATURAL AGRICULTURAL PRODUCTS

FOR (BASES ON SPAIN REGISTRATION TM2312221) ANIMAL FOODSTUFFS, AND PET FOOD (U.S. CLS. 1 AND 46).

SN 76-262,071. RADKO, CHRISTOPHER, ELMSFORD, NY. FILED 5-24-2001.

KLIPTONS

CLASS 11—ENVIRONMENTAL CONTROL APPARATUS

FOR ELECTRIC DECORATIVE LIGHT SETS, ELECTRIC CHRISTMAS TREE LIGHTS, AND CANDELABRAS (U.S. CLS. 13, 21, 23, 31 AND 34).

CLASS 26—FANCY GOODS

FOR ARTIFICIAL TREES (U.S. CLS. 37, 39, 40, 42 AND 50).

SN 76-262,316. ABFLEX U.S.A., INC., SAN DIEGO, CA. FILED 5-24-2001.

AB-ESE

CLASS 10—MEDICAL APPARATUS

FOR ELECTRONIC STIMULATION DEVICE FOR EXERCISING THE ABDOMINAL MUSCLES FOR THERAPEUTIC PURPOSES AND INSTRUCTIONAL MANUALS AND PRERECORDED VIDEO TAPES SOLD THEREWITH (U.S. CLS. 26, 39 AND 44).

CLASS 28—TOYS AND SPORTING GOODS

FOR EXERCISE MACHINES, NAMELY, ELECTRONIC STIMULATION MACHINES, FOR EXERCISING THE ABDOMINAL MUSCLES AND INSTRUCTIONAL MANUALS AND PRERECORDED INSTRUCTIONAL VIDEO TAPES SOLD THEREWITH (U.S. CLS. 22, 23, 38 AND 50).

SN 76-262,442. LEVEL 1, INC., ROCKLAND, MA. BY CHANGE OF NAME SIMS LEVEL 1, INC., ROCKLAND, MA. FILED 5-24-2001.

EQUATOR

CLASS 10—MEDICAL APPARATUS

FOR CONVECTIVE WARMING MEDICAL BLANKETS, AND PARTS AND FITTINGS THEREFOR (U.S. CLS. 26, 39 AND 44).

CLASS 11—ENVIRONMENTAL CONTROL APPARATUS

FOR DEVICES FOR HEATING AIR AND PROVIDING AIR FLOW TO CONVECTIVE WARMING MEDICAL BLANKETS, AND PARTS AND FITTINGS THEREFOR (U.S. CLS. 13, 21, 23, 31 AND 34).

SN 76-262,532. JET-A.COM LLC, LOMBARD, IL. FILED 5-24-2001.

JET-A.COM

CLASS 35—ADVERTISING AND BUSINESS

FOR BUSINESS SERVICES PROVIDED VIA A GLOBAL COMPUTER NETWORK, NAMELY, PROVIDING ONLINE REQUESTS FOR QUOTATIONS AND BIDS, AND NEGOTIATIONS CONCERNING PRICING AND BIDS, FOR COMMERCIAL BUYERS AND SELLERS OF JET FUEL; SOURCING AND COMPARATIVE PRICING ANALYSIS FOR COMMERCIAL BUYERS AND SELLERS OF JET FUEL; CONSULTING WITH RESPECT TO SUPPLY CHAIN MANAGEMENT AND DEMAND PLANNING; PROVIDING AUTOMATED, ONLINE AVAILABILITY OF FUEL DELIVERY TICKET DATA; AND COMPUTERIZED ORDERING SERVICES, PROVIDING AUTOMATED, ONLINE ORDER TRACKING SERVICES AND ORDER HISTORY REVIEW SERVICES, FOR BUYERS AND SELLERS OF JET FUEL; PROVIDING INVENTORY MANAGEMENT SERVICES REGARDING JET FUEL SOURCES AND RESOURCES; MAINTAINING AND PROVIDING AN ONLINE DATABASE FEATURING A COMPILATION OF DATA NECESSARY TO ANALYZE CLIENT/USER CONTRACTS IN THE FIELD OF JET FUEL SOURCES; PROVIDING ONLINE INFORMATION REGARDING TAXES ASSOCIATED WITH THE BUYING AND SELLING OF JET FUEL, PROVIDING ONLINE BUSINESS DIRECTORIES OF LENDERS AND FINANCIERS IN THE FIELD OF JET FUEL; AND PROVIDING ONLINE COMPUTERIZED DATABASES OF MATERIALS SAFETY DATA SHEETS RELATED TO JET FUEL, COMPILATIONS OF PRODUCT INFORMATION RELATED TO JET FUEL, AND CERTIFICATES OF ANALYSIS RELATED TO JET FUEL (U.S. CLS. 100, 101 AND 102).

CLASS 36—INSURANCE AND FINANCIAL

FOR FINANCIAL SERVICES, NAMELY, PROVIDING ONLINE ELECTRONIC CASH MARKET EXCHANGE SERVICES, NAMELY, PROVIDING REAL TIME MARKETPLACE INFORMATION, DEAL ENTRY, POSITION TRADING, RISK MANAGEMENT REPORTS; CREDIT RISK ANALYSIS SERVICES, FINANCIAL AND PAYMENT FORECASTING SERVICES; AND UNDERWRITING LENDING AND FINANCING AGREEMENTS, ALL TO COMMERCIAL BUYERS AND SELLERS OF JET FUEL (U.S. CLS. 100, 101 AND 102).

CLASS 42—SCIENTIFIC, COMPUTER AND LEGAL SERVICES

FOR COMPUTER SERVICES, NAMELY, PROVIDING INFORMATION IN THE FIELD OF GOVERNMENTAL REGULATIONS OF BUYING AND SELLING JET FUEL THROUGH LINKS TO THE WEB PAGES OF OTHERS ON THE INTERNET (U.S. CLS. 100 AND 101).

SN 76-262,954. BIG LAKE OUTFITTERS, INC., SAUGATUCK, MI. FILED 5-24-2001.

BIG LAKE OUTFITTERS

NO CLAIM IS MADE TO THE EXCLUSIVE RIGHT TO USE "OUTFITTERS", APART FROM THE MARK AS SHOWN.

CLASS 25—CLOTHING

FOR APPAREL FOR FISHERMAN, NAMELY, JACKETS, HATS, GLOVES, SHIRTS, PANTS, RAINGEAR (U.S. CLS. 22 AND 39).

CLASS 28—TOYS AND SPORTING GOODS

FOR FISHING TACKLE (U.S. CLS. 22, 23, 38 AND 50).

CLASS 39—TRANSPORTATION AND STORAGE

FOR FISHING BOAT CHARTERING SERVICES (U.S. CLS. 100 AND 105).

CLASS 37—CONSTRUCTION AND REPAIR

FOR CONSTRUCTION OF HOUSES, CONDOMINIUMS, COMMERCIAL BUILDINGS, APARTMENT BUILDINGS, CAR WASHES, AND SHELTERS FOR WIRELESS TELEPHONE INFRASTRUCTURE (U.S. CLS. 100, 103 AND 106).

FIRST USE 0-0-1994; IN COMMERCE 0-0-1994.

SN 76-263,513. ROYAL GROUP TECHNOLOGIES LIMITED, VAUGHAN, ONTARIO, CANADA, FILED 5-29-2001.

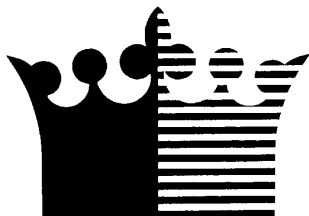

THE LINING SHOWN IN THE DRAWING IS A FEATURE OF THE MARK, AND IS NOT INTENDED TO INDICATE COLOR.

CLASS 17—RUBBER GOODS

FOR PLASTICS IN EXTRUDED FORM FOR USE IN MANUFACTURING; PLASTIC COMPOSITE MATERIAL IN THE FORM OF CUSTOM PROFILES FOR USE IN MANUFACTURING OF WINDOWS AND DOORS, PLASTIC DRAIN, VENT AND WASTE PIPES AND FITTING THEREFOR (U.S. CLS. 1, 5, 12, 13, 35 AND 50).

FIRST USE 0-0-1994; IN COMMERCE 0-0-1994.

CLASS 19—NON-METALLIC BUILDING MATERIALS

FOR VINYL SIDING AND NON-METAL BUILDING MATERIALS, NAMELY, SOFFIT, DECKING, DECK RAILING AND STEPS, NON-METAL PREFABRICATED GAZEBOS, NON-METAL FENCES, NON-METAL FLOATING DOCKS, NON METAL DOORS, NAMELY, RESIDENTIAL DOORS, COMMERCIAL DOORS, PATIO DOORS; BUILDING MATERIALS, NAMELY, STRUCTURAL COMPONENTS OF EXTRUDED PLASTIC, NAMELY, WALL FORMING PANELS, ROOF PANELS, RIDGE BEAMS, LINTELS, AND WALL FORMING PANELS WHICH FORM CONCRETE RECEIVING FORMS; NON-METAL PREFABRICATED GARAGES, GARAGE DOORS, NON-METAL PREFABRICATED SHEDS, CONSERVATORIES, NON-METAL ROOFING TILES (U.S. CLS. 1, 12, 33 AND 50).

FIRST USE 0-0-1994; IN COMMERCE 0-0-1994.

CLASS 20—FURNITURE AND ARTICLES NOT OTHERWISE CLASSIFIED

FOR WINDOW COVERINGS, NAMELY BLINDS AND SHADES, ITEMS FOR USE IN INDOOR STORAGE, NAMELY, PLASTIC STORAGE CABINETS AND BINS, AND PATIO FURNITURE (U.S. CLS. 2, 13, 22, 25, 32 AND 50).

FIRST USE 0-0-1994; IN COMMERCE 0-0-1994.

SN 76-263,576. ACXIOM CORPORATION, LITTLE ROCK, AR. FILED 5-25-2001.

AUTOMARKET IN. SIGHT

NO CLAIM IS MADE TO THE EXCLUSIVE RIGHT TO USE "AUTO MARKET", APART FROM THE MARK AS SHOWN.

CLASS 9—ELECTRICAL AND SCIENTIFIC APPARATUS

FOR SOFTWARE FOR USE IN CUSTOMER AND PROSPECTIVE CUSTOMER DATA MANAGEMENT AND MARKETING CAMPAIGN MANAGEMENT FOR AUTOMOBILE DEALERS AND ORIGINAL EQUIPMENT MANUFACTURERS (U.S. CLS. 21, 23, 26, 36 AND 38).

CLASS 35—ADVERTISING AND BUSINESS

FOR INFORMATION AGENCY SERVICES, NAMELY, THE PROVISION AND ANALYSIS OF DEMOGRAPHIC DATA PERTAINING TO CUSTOMERS AND PROSPECTIVE CUSTOMERS TO AUTOMOBILE DEALERS AND ORIGINAL EQUIPMENT MANUFACTURERS (U.S. CLS. 100, 101 AND 102).

SN 76-263,588. HUTCHISON WHAMPOA ENTERPRISES LIMITED, TORTOLA, BR.VIRGIN ISLANDS, FILED 5-25-2001.

THE CHINESE CHARACTERS IN THE MARK TRANSLITERATE TO "SEN" AND THIS MEANS "FULL OF TREES"; "MULTITUDINOUS"; "IN MULTITUDES"; "DENSE"; "THICK"; "LUXURIANT" IN ENGLISH.

CLASS 5—PHARMACEUTICALS

FOR DIETARY FOOD SUPPLEMENTS; HERBAL SUPPLEMENTS (U.S. CLS. 6, 18, 44, 46, 51 AND 52).

CLASS 29—MEATS AND PROCESSED FOODS

FOR MEAT; FISH; POULTRY; GAME; MEAT EXTRACT; PRESERVED, DRIED AND COOKED FRUITS AND VEGETABLES; PRESERVED, DRIED AND COOKED DATES; JELLIES; JAMS; EGGS; MILK; DAIRY PRODUCTS EXCLUDING ICE CREAM, ICE MILK AND FROZEN YOGURT; EDIBLE OILS AND FATS (U.S. CL. 46).

CLASS 30—STAPLE FOODS

FOR TEA; FLOUR; PROCESSED CEREALS; BREADS; PASTRIES; CAKES; PEPPER; SALT; MUSTARD; VINEGAR; SAUCES; SPICES; ICE CREAM; SEASONINGS FOR COATING VEGETABLES AND OTHER FOODS; HONEY; CANDY; CONFECTIONERY, NAMELY, CHEWING GUM; SOY SAUCE; SEASONINGS; CHINESE BREAKFAST CEREALS; CHINESE BAKERY GOODS (U.S. CL. 46).

CLASS 31—NATURAL AGRICULTURAL PRODUCTS

FOR UNPROCESSED GRAINS FOR EATING; FRESH FRUITS; FRESH VEGETABLES; UNPROCESSED FRUITS; UNPROCESSED VEGETABLES (U.S. CLS. 1 AND 46).

CLASS 32—LIGHT BEVERAGES

FOR BEERS; NON-ALCOHOLIC BEERS; NON-ALCOHOLIC COCKTAIL MIXES; FRUIT DRINKS; FRUIT JUICES; SYRUPS FOR MAKING SOFT DRINKS (U.S. CLS. 45, 46 AND 48).

CLASS 33—WINES AND SPIRITS

FOR WINES; CHINESE LIQUORS; COOKING WINE (U.S. CLS. 47 AND 49).

CLASS 35—ADVERTISING AND BUSINESS

FOR ADVERTISING AND PROMOTIONAL SERVICES, NAMELY, PROVIDING ADVERTISING SPACE IN PRINTED PUBLICATIONS AND ON INTERNET WEB SITES; ADVERTISING SERVICES, NAMELY, CREATING CORPORATE AND BRAND IDENTITY FOR OTHERS; BUSINESS MANAGEMENT; RETAIL STORE SERVICES IN THE FIELDS OF FOOD, MEDICINE, BEVERAGES, AND HERBAL REMEDIES; ONLINE RETAIL STORE SERVICES IN THE FIELDS OF FOOD, MEDICINE, BEVERAGES, AND HERBAL REMEDIES; PROVIDING CONSUMER INFORMATION VIA THE INTERNET IN THE FIELDS OF FOOD, MEDICINES, BEVERAGES AND HERBAL REMEDIES (U.S. CLS. 100, 101 AND 102).

CLASS 42—SCIENTIFIC, COMPUTER AND LEGAL SERVICES

FOR RESTAURANT SERVICES; DIAGNOSTIC SERVICES IN THE FIELDS OF CHINESE MEDICINE AND HERBAL REMEDIES (U.S. CLS. 100 AND 101).

SN 76-263,802. UCB, SOCIETE ANONYME, B - 1070 BRUXELLES, BELGIUM, FILED 5-30-2001.



NO CLAIM IS MADE TO THE EXCLUSIVE RIGHT TO USE "GRAPH", APART FROM THE MARK AS SHOWN.

CLASS 1—CHEMICALS

FOR ULTRAVIOLET LIGHT DRYING RESINS AND ELECTRON-BEAM DRYING RESINS FOR USE IN THE MANUFACTURE OF PAINTS, INKS, VARNISHES, LACQUERS, COATINGS, AUTOMOBILES, PLASTICS (U.S. CLS. 1, 5, 6, 10, 26 AND 46).

CLASS 2—PAINTS

FOR ULTRAVIOLET LIGHT DRYING APPLICATIONS, NAMELY, VARNISHES, LACQUERS IN THE NATURE OF COATINGS; INKS FOR ENGRAVING, USE IN THE MANUFACTURE OF PRINTED CIRCUIT BOARDS, INK JET PRINTERS, AND PAINTS FOR USE IN THE MANUFACTURE OF AUTOMOBILES, CERAMICS, INTERIOR AND EXTERIOR USE; AND ELECTRON-BEAM DRYING APPLICATIONS, NAMELY, VARNISHES, LACQUERS IN THE NATURE OF COATINGS; INKS FOR ENGRAVING, USE IN THE MANUFACTURE OF PRINTED CIRCUIT BOARDS, INK JET PRINTERS, AND PAINTS FOR USE IN THE MANUFACTURE OF AUTOMOBILES, CERAMICS, INTERIOR AND EXTERIOR USE (U.S. CLS. 6, 11 AND 16).

SN 76-263,859. AMERISERV FINANCIAL, INC., JOHNSTOWN, PA. FILED 5-29-2001.

AMERISERV PREFERRED

NO CLAIM IS MADE TO THE EXCLUSIVE RIGHT TO USE "PREFERRED", APART FROM THE MARK AS SHOWN.

CLASS 35—ADVERTISING AND BUSINESS

FOR BUSINESS CONSULTATION SERVICES; ACCOUNTING SERVICES; INCOME TAX PREPARATION SERVICES (U.S. CLS. 100, 101 AND 102).

CLASS 36—INSURANCE AND FINANCIAL

FOR BANKING SERVICES; CORPORATE, INSTITUTIONAL AND PERSONAL TRUST SERVICES; FINANCIAL PLANNING AND PORTFOLIO MANAGEMENT; FINANCIAL GUARANTEE AND SURETY SERVICES; BROKERAGE IN THE FIELDS OF STOCKS, BONDS, COMMODITIES, INSURANCE, ANNUITIES AND MUTUAL FUNDS; MORTGAGE BANKING, LENDING AND BROKERAGE SERVICES; TRAVEL AGENCY SERVICES, NAMELY ISSUING TRAVELERS CHECKS; BUSINESS BROKERS; ESTATE PLANNING AND TRUST MANAGEMENT; REAL ESTATE TITLE INSURANCE UNDERWRITING AND AGENCY SERVICES; MAINTAINING MORTGAGE ESCROW ACCOUNTS; LOAN PROCESSING SERVICES; INSURANCE UNDERWRITING IN THE FIELD OF LIFE, HEALTH, ACCIDENT, MEDICAL AND PROPERTY; CREDIT LIFE REINSURANCE UNDERWRITING SERVICES; AND DEBT RECOVERY AND COLLECTION AGENCY SERVICES (U.S. CLS. 100, 101 AND 102).

CLASS 39—TRANSPORTATION AND STORAGE

FOR TRAVEL AGENCY SERVICES, NAMELY MAKING RESERVATIONS AND BOOKING FOR TRANSPORTATION (U.S. CLS. 100 AND 105).

CLASS 42—SCIENTIFIC, COMPUTER AND LEGAL SERVICES

FOR HOSTING THE WEBSITES OF OTHERS ON A COMPUTER SERVER FOR A GLOBAL COMPUTER NETWORK; PRINTING SERVICES; CONCIERGE SERVICES FOR OTHERS; AND TRAVEL AGENCY SERVICES, NAMELY MAKING RESERVATIONS AND BOOKING FOR TEMPORARY LODGING (U.S. CLS. 100 AND 101).

SN 76-264,139. BIOMOLEX AS, 1323 HOVIK, NORWAY, FILED 5-30-2001.

BIOMOLEX

CLASS 9—ELECTRICAL AND SCIENTIFIC APPARATUS

FOR SCIENTIFIC, ELECTRIC AND OPTICAL APPARATUS AND INSTRUMENTS, NAMELY, RADIATION DETECTION CAMERAS (U.S. CLS. 21, 23, 26, 36 AND 38).

CLASS 10—MEDICAL APPARATUS

FOR SURGICAL AND MEDICAL APPARATUS FOR USE WITHIN BIOMEDICINE FOR ANALYSIS OF DNA, NAMELY A DETECTION CAMERA FOR ANALYSIS OF RADIOACTIVELY LABELED MATERIAL DEPOSITED ON A SOLID SURFACE (U.S. CLS. 26, 39 AND 44).

SN 76-264,325. VICOR, INC., RICHMOND, CA. FILED 5-29-2001.

EIPC

CLASS 9—ELECTRICAL AND SCIENTIFIC APPARATUS

FOR DOWNLOADABLE COMPUTER PROGRAMS FOR DELIVERING INVOICES, RESOLVING BILLING ISSUES AND EXCEPTIONS, PROVIDING CUSTOMIZATION OF INVOICES AS TO FORMAT, FREQUENCY AND CONTENT AND EXCHANGING PRE-PAYMENT AND PAYMENT DOCUMENTS, ALL OF THE FOREGOING ONLINE VIA A GLOBAL COMPUTER NETWORK (U.S. CLS. 21, 23, 26, 36 AND 38).

CLASS 42—SCIENTIFIC, COMPUTER AND LEGAL SERVICES

FOR PROVIDING TEMPORARY USE OF ONLINE NON-DOWNLOADABLE COMPUTER PROGRAMS FOR DELIVERING INVOICES, RESOLVING BILLING ISSUES AND EXCEPTIONS, PROVIDING CUSTOMIZATION OF INVOICES AS TO FORMAT, FREQUENCY AND CONTENT AND EXCHANGING PRE-PAYMENT AND PAYMENT DOCUMENTS VIA A GLOBAL COMPUTER NETWORK (U.S. CLS. 100 AND 101).

SN 76-264,435. BLUESTREAK.COM, INC., MIDDLETOWN, RI. FILED 5-30-2001.

DATA CONCERT

NO CLAIM IS MADE TO THE EXCLUSIVE RIGHT TO USE "DATA", APART FROM THE MARK AS SHOWN.

CLASS 9—ELECTRICAL AND SCIENTIFIC APPARATUS

FOR SOFTWARE FOR DATA MINING AND DATA COLLECTION; ADVERTISING SOFTWARE, NAMELY, SOFTWARE FOR USE IN ON-LINE ADVERTISING CAMPAIGNS, FOR IMPLEMENTING TECHNOLOGIES INCLUDING VIDEO, RICH MEDIA, GIF AND FLASH WHICH ARE DELIVERED TO POTENTIAL CUSTOMERS IN THE FORM OF WEB BANNERS, INTERSTITIALS, POP-UP ADVERTISEMENTS AND OTHER ON-LINE DELIVERY MECHANISMS (U.S. CLS. 21, 23, 26, 36 AND 38).

CLASS 35—ADVERTISING AND BUSINESS

FOR ADVERTISING SERVICES, NAMELY, PROVIDING ON-LINE ADVERTISEMENTS IMPLEMENTING TECHNOLOGIES INCLUDING VIDEO, RICH MEDIA, GIF AND FLASH WHICH ARE DELIVERED TO POTENTIAL CUSTOMERS IN THE FORM OF WEB BANNERS, INTERSTITIALS, POP-UP ADVERTISEMENTS AND OTHER ON-LINE DELIVERY MECHANISMS (U.S. CLS. 100, 101 AND 102).

CLASS 42—SCIENTIFIC, COMPUTER AND LEGAL SERVICES

FOR DATA MINING AND DATA COLLECTION (U.S. CLS. 100 AND 101).

SN 76-264,688. CCP SYSTEMS AG, 70435 STUTTGART, FED REP GERMANY, FILED 5-30-2001.

JSCRIBE

OWNER OF FED REP GERMANY REG. NO. 30088523, DATED 2-12-2001, EXPIRES 12-31-2010.

CLASS 9—ELECTRICAL AND SCIENTIFIC APPARATUS

FOR COMPUTERS; COMPUTER PERIPHERALS, NAMELY, PRINTERS; COMPUTER SOFTWARE FOR OUTPUT MANAGEMENT; SOFTWARE FOR COMPUTER PERIPHERALS, NAMELY, PRINTER SOFTWARE (U.S. CLS. 21, 23, 26, 36 AND 38).

CLASS 42—SCIENTIFIC, COMPUTER AND LEGAL SERVICES

FOR DEVELOPMENT OF COMPUTER SOFTWARE, FOR OUTPUT MANAGEMENT, FOR OTHERS (U.S. CLS. 100 AND 101).

SN 76-264,732. LIFE OUTREACH INTERNATIONAL, FORT WORTH, TX. FILED 5-24-2001.

LIFE IN PRAISE MUSIC

NO CLAIM IS MADE TO THE EXCLUSIVE RIGHT TO USE "MUSIC", APART FROM THE MARK AS SHOWN.

CLASS 9—ELECTRICAL AND SCIENTIFIC APPARATUS

FOR MUSICAL RECORDINGS AND EDUCATIONAL RECORDINGS, NAMELY, RELIGIOUS MUSIC, LESSONS AND SPEECHES ON AUDIOTAPES, COMPACT DISCS, AND VIDEO CASSETTES (U.S. CLS. 21, 23, 26, 36 AND 38).

CLASS 16—PAPER GOODS AND PRINTED MATTER

FOR MUSIC, AND ENTERTAINMENT AND EDUCATIONAL ARTICLES, BROCHURES, BOOKLETS, MAGAZINES AND PAMPHLETS FEATURING RELIGIOUS MUSIC AND TOPICS (U.S. CLS. 2, 5, 22, 23, 29, 37, 38 AND 50).

SN 76-265,109. XENEREX BIOSCIENCES, SAN DIEGO, CA.
FILED 5-25-2001.

XENEREX BIOSCIENCES

NO CLAIM IS MADE TO THE EXCLUSIVE RIGHT TO USE "BIOSCIENCES", APART FROM THE MARK AS SHOWN.

CLASS 1—CHEMICALS

FOR BIOCHEMICALS, NAMELY, MONOCLONAL ANTIBODIES AND FRAGMENTS THEREOF FOR RESEARCH AND DEVELOPMENT, AND MANUFACTURING PHARMACEUTICALS; AND CELL LINES FOR USE IN THE MANUFACTURE OF PHARMACEUTICALS (U.S. CLS. 1, 5, 6, 10, 26 AND 46).

CLASS 5—PHARMACEUTICALS

FOR BIOCHEMICALS, NAMELY, MONOCLONAL ANTIBODIES AND FRAGMENTS THEREOF FOR CLINICAL, DIAGNOSTIC AND THERAPEUTIC USE FOR THE TREATMENT OF CANCER, INFECTIOUS DISEASES, INFLAMMATORY DISEASES, AND GENETIC DISEASES; AND CELL LINES FOR CLINICAL, DIAGNOSTIC AND THERAPEUTIC USE FOR THE TREATMENT OF CANCER, INFECTIOUS DISEASES, INFLAMMATORY DISEASES, AND GENETIC DISEASES (U.S. CLS. 6, 18, 44, 46, 51 AND 52).

CLASS 31—NATURAL AGRICULTURAL PRODUCTS

FOR ANIMAL EMBRYOS FOR LABORATORY USE; AND LIVE ANIMALS FOR RESEARCH AND DEVELOPMENT (U.S. CLS. 1 AND 46).

SN 76-265,214. UNIVERSITY OF CENTRAL FLORIDA,
ORLANDO, FL. FILED 5-31-2001.

FSEC

OWNER OF U.S. REG. NO. 1,974,693.

CLASS 16—PAPER GOODS AND PRINTED MATTER

FOR EDUCATIONAL AND MARKETING PUBLICATIONS, NAMELY A SERIES OF BOOKS, MAGAZINES, BUMPER STICKERS, POSTERS, MANUALS, BOOKLETS, BROCHURES, ILLUSTRATIONS, MOUNTED PHOTOGRAPHS AND UNMOUNTED PHOTOGRAPHS AND TECHNICAL DRAWINGS ALL FEATURING INFORMATION IN THE FIELD OF ENERGY SECURITY AND ENVIRONMENTAL QUALITY, ALTERNATIVE ENERGY SOURCES, ALTERNATIVE FUEL SOURCES, ALTERNATIVE FUEL VEHICLES, ALTERNATIVE WATER HEATING AND COOLING METHODS, ALTERNATIVE RESIDENTIAL AND COMMERCIAL FUEL SOURCES, WASTE DETOXIFICATION, AIR FLOW AND AIR QUALITY CONTROL, DESIGN AND CONSTRUCTION OF RESIDENTIAL AND COMMERCIAL STRUCTURES PROVIDING A CONTROLLED SURROUNDING FOR ELIMINATION OF ENVIRONMENTAL RELATED ILLNESSES, AND ENERGY TECHNOLOGIES; PRINTED INSTRUCTIONAL AND TEACHING MATERIAL, IN THE FIELD OF ENERGY SECURITY AND ENVIRONMENTAL QUALITY, ALTERNATIVE ENERGY SOURCES, ALTERNATIVE FUEL SOURCES, ALTERNATIVE FUEL VEHICLES, ALTERNATIVE WATER HEATING AND COOLING METHODS, ALTERNATIVE RESIDENTIAL AND COMMERCIAL FUEL SOURCES, WASTE DETOXIFICATION, AIR FLOW AND AIR QUALITY CONTROL, DESIGN AND CONSTRUCTION OF RESIDENTIAL AND COMMERCIAL STRUCTURES PROVIDING A CONTROLLED SURROUNDING FOR ELIMINATION OF ENVIRONMENTAL RELATED ILLNESSES, AND ENERGY TECHNOLOGIES; DECALS, APPLIQUES IN THE FORM OF DECALS, ART PRINTS, PENS, PENCILS, BINDERS, MAGNETIC BOARDS, BOOK COVERS, CALENDARS, AND PRESSURE SENSITIVE GRAPHICS (U.S. CLS. 2, 5, 22, 23, 29, 37, 38 AND 50).

FIRST USE 7-1-1974; IN COMMERCE 7-1-1974.

CLASS 41—EDUCATION AND ENTERTAINMENT

FOR EDUCATIONAL SERVICES, NAMELY, PROVIDING COURSES OF INSTRUCTION AT THE COLLEGE LEVEL AND CONDUCTING CLASSES, SEMINARS, CONFERENCES AND WORKSHOPS IN THE FIELD OF ENERGY SECURITY, ENVIRONMENTAL QUALITY, ALTERNATIVE ENERGY SOURCES, ALTERNATIVE FUEL SOURCES, ALTERNATIVE FUEL VEHICLES, ALTERNATIVE WATER HEATING AND COOLING METHODS, ALTERNATIVE RESIDENTIAL AND COMMERCIAL FUEL SOURCES, WASTE DETOXIFICATION, AIR FLOW AND AIR QUALITY CONTROL, DESIGN AND CONSTRUCTION OF RESIDENTIAL AND COMMERCIAL STRUCTURES PROVIDING A CONTROLLED SURROUNDING FOR ELIMINATION OF ENVIRONMENTAL RELATED ILLNESSES, AND ENERGY TECHNOLOGIES, AND DISTRIBUTING COURSE MATERIALS IN CONNECTION THEREWITH IN PERSON AND VIA GLOBAL COMPUTER NETWORK; PROVIDING ON-LINE INSTRUCTION AND WORKSHOPS IN THE FIELD OF ENERGY SECURITY, ENVIRONMENTAL QUALITY, ALTERNATIVE ENERGY SOURCES, ALTERNATIVE FUEL SOURCES, ALTERNATIVE FUEL VEHICLES, ALTERNATIVE WATER HEATING AND COOLING METHODS, ALTERNATIVE RESIDENTIAL AND COMMERCIAL FUEL SOURCES, WASTE DETOXIFICATION, AIR FLOW AND AIR QUALITY CONTROL, DESIGN AND CONSTRUCTION OF RESIDENTIAL AND COMMERCIAL STRUCTURES PROVIDING A CONTROLLED SURROUNDING FOR ELIMINATION OF ENVIRONMENTAL RELATED ILLNESSES, AND ENERGY TECHNOLOGIES, VIA A GLOBAL COMPUTER NETWORK; AND PROVIDING TRAINING IN THE FIELD OF ENERGY SECURITY, ENVIRONMENTAL QUALITY, ALTERNATIVE ENERGY SOURCES, ALTERNATIVE FUEL SOURCES, ALTERNATIVE FUEL VEHICLES, ALTERNATIVE WATER HEATING AND COOLING METHODS, ALTERNATIVE RESIDENTIAL AND COMMERCIAL FUEL SOURCES, WASTE DETOXIFICATION, AIR FLOW AND AIR QUALITY CONTROL, DESIGN AND CONSTRUCTION OF RESIDENTIAL AND COMMERCIAL STRUCTURES PROVIDING A CON-

TROLLED SURROUNDING FOR ELIMINATION OF ENVIRONMENTAL RELATED ILLNESSES, AND ENERGY TECHNOLOGIES (U.S. CLS. 100, 101 AND 107).
FIRST USE 7-1-1974; IN COMMERCE 7-1-1974.

CLASS 42—SCIENTIFIC, COMPUTER AND LEGAL SERVICES

FOR PERFORMING RESEARCH AND PROVIDING AN ON-LINE EDUCATIONAL NEWSLETTER IN THE FIELD OF ENERGY TECHNOLOGIES; PROVIDING INFORMATION IN THE FIELD OF ENERGY SECURITY, ENVIRONMENTAL QUALITY, ALTERNATIVE ENERGY SOURCES, ALTERNATIVE FUEL SOURCES, ALTERNATIVE FUEL VEHICLES, ALTERNATIVE WATER HEATING AND COOLING METHODS, ALTERNATIVE RESIDENTIAL AND COMMERCIAL FUEL SOURCES, WASTE DETOXIFICATION, AIR FLOW AND AIR QUALITY CONTROL, DESIGN AND CONSTRUCTION OF RESIDENTIAL AND COMMERCIAL STRUCTURES PROVIDING A CONTROLLED SURROUNDING FOR ELIMINATION OF ENVIRONMENTAL RELATED ILLNESSES, AND ENERGY TECHNOLOGIES VIA A GLOBAL COMPUTER NETWORK (U.S. CLS. 100 AND 101).
FIRST USE 7-1-1974; IN COMMERCE 7-1-1974.

SN 76-265,277. PANORAM TECHNOLOGIES, INC., SUN VALLEY, CA. FILED 5-31-2001.

PANORAM

OWNER OF U.S. REG. NOS. 1,897,382 AND 1,964,916.

CLASS 9—ELECTRICAL AND SCIENTIFIC APPARATUS

FOR AUDIOVISUAL DISPLAY SYSTEMS COMPRISING COMPUTERS, AUDIOVISUAL PROJECTORS, AND PROJECTION SCREENS; ELECTRONIC CONTROLS FOR OPERATING AUDIOVISUAL PROJECTORS; LOUDSPEAKERS; MULTI-SCREEN DISPLAY COMPRISED OF PROJECTION SCREENS; COMPUTER HARDWARE AND SOFTWARE FOR EDGE BLENDING IMAGES ORIGINATING FROM MULTIPLE SOURCES; FRONT AND REAR IMAGE VIDEO PROJECTORS; INTEGRATED VIDEO MONITORS WITH MULTIPLE DISPLAY PANELS; VIRTUAL REALITY DISPLAY SYSTEMS COMPRISING COMPUTERS, AUDIOVISUAL PROJECTORS, AND PROJECTION SCREENS; WIDE-SCREEN MULTIPROJECTOR SEAMLESS IMAGE PROCESSORS; AND COMPUTER FOR USE IN WIDESCREEN MULTIPROJECTOR SEAMLESS VIDEO DISPLAYS (U.S. CLS. 21, 23, 26, 36 AND 38).
FIRST USE 4-0-1993; IN COMMERCE 6-0-1993.

CLASS 42—SCIENTIFIC, COMPUTER AND LEGAL SERVICES

FOR ENGINEERING SERVICES IN THE FIELD OF AUDIOVISUAL DISPLAY SYSTEMS; TECHNICAL SUPPORT, NAMELY, TROUBLESHOOTING COMPUTER SOFTWARE AND HARDWARE PROBLEMS IN THE FIELD OF AUDIOVISUAL DISPLAY SYSTEMS; AND SYSTEMS INTEGRATION SERVICES (U.S. CLS. 100 AND 101).
FIRST USE 4-0-1993; IN COMMERCE 6-0-1993.

SN 76-265,343. DAIMLERCHRYSLER AG, 70567 STUTTGART, FED REP GERMANY, FILED 6-1-2001.

HIL

PRIORITY CLAIMED UNDER SEC. 44(D) ON FED REP GERMANY APPLICATION NO. 30089174.109, FILED 12-6-2000, REG. NO. 30089174, DATED 1-26-2001, EXPIRES 12-31-2010.

CLASS 9—ELECTRICAL AND SCIENTIFIC APPARATUS

FOR OPTO-ELECTRONIC TEST DEVICES WITH COMPONENTS FOR MEASURED DATA ACQUISITION, EDITING AND STORAGE, FOR SIMULATION, SIMULATED PROCESSES, COMPUTER-AIDED DECISION MAKING AND DATA OUTPUT, AND FOR STORING OF MACHINE READABLE SOFTWARE PROGRAMS AND DATA ON ALL TYPES OF DATA CARRIERS (U.S. CLS. 21, 23, 26, 36 AND 38).

CLASS 42—SCIENTIFIC, COMPUTER AND LEGAL SERVICES

FOR DEVELOPMENT AND MAINTENANCE OF SOFTWARE PROGRAMS (U.S. CLS. 100 AND 101).

SN 76-265,556. ROYAL GROUP TECHNOLOGIES LIMITED, VAUGHAN, ONTARIO, CANADA, FILED 5-30-2001.

BUILDING A BETTER WORLD

CLASS 19—NON-METALLIC BUILDING MATERIALS

FOR VINYL SIDING AND NON-METAL BUILDING MATERIALS, NAMELY, SOFFITS; NON-METAL BUILDING MATERIALS, NAMELY, DECKING, DECK RAILING AND STEPS; NON-METAL PREFABRICATED GAZEBOS; NON-METAL FENCES; NON-METAL FLOATING DOCKS; NON-METAL DOORS, NAMELY, RESIDENTIAL DOORS, COMMERCIAL DOORS, AND PATIO DOORS; BUILDING MATERIALS, NAMELY, STRUCTURAL COMPONENTS OF EXTRUDED PLASTIC, NAMELY, WALL FORMING PANELS, AND BOX CONNECTORS FOR JOINING SAID PANELS TOGETHER, ROOF PANELS, RIDGE BEAMS, LINTELS, AND GABLE MEMBERS NAMELY STRUCTURAL AND ARCHITECTURAL MEMBERS FORMED OF EXTRUDED PLASTIC; NON-METAL PREFABRICATED GARAGES, NON-METAL GARAGE DOORS; NON-METAL PREFABRICATED STORAGE SHEDS; NON-METAL PREFABRICATED CONSERVATORIES; NON-METAL ROOFING TILES (U.S. CLS. 1, 12, 33 AND 50).
FIRST USE 2-0-1998; IN COMMERCE 0-0-1998.

CLASS 20—FURNITURE AND ARTICLES NOT OTHERWISE CLASSIFIED

FOR ITEMS FOR USE IN INDOOR STORAGE, NAMELY, PLASTIC STORAGE CABINETS AND PLASTIC STORAGE BINS; PATIO FURNITURE; WINDOW COVERINGS, NAMELY BLINDS AND SHADES (U.S. CLS. 2, 13, 22, 25, 32 AND 50).
FIRST USE 2-0-1998; IN COMMERCE 0-0-1998.

SN 76-265,653. OLYMPUS AMERICA INC., MELVILLE, NY.
FILED 5-31-2001.

COST PER PROCEDURE

CLASS 36—INSURANCE AND FINANCIAL

FOR FINANCING AND LEASE PURCHASE FINANCING OF MEDICAL AND SURGICAL EQUIPMENT (U.S. CLS. 100, 101 AND 102).
FIRST USE 4-0-1996; IN COMMERCE 4-0-1996.

CLASS 42—SCIENTIFIC, COMPUTER AND LEGAL SERVICES

FOR LEASING AND RENTING OF MEDICAL EQUIPMENT (U.S. CLS. 100 AND 101).
FIRST USE 4-0-1996; IN COMMERCE 4-0-1996.

SN 76-266,048. SBHC DEVELOPMENT INC. /DEVELOPPEMENT SBHC INC., MONTREAL, H3G 1Y8, QUEBEC, CANADA, FILED 6-4-2001.



NO CLAIM IS MADE TO THE EXCLUSIVE RIGHT TO USE "BAR" AND "STEAKHOUSE", APART FROM THE MARK AS SHOWN.
THE ENGLISH TRANSLATION OF "QUEUE DE CHEVAL" IS "HORSE'S TAIL".

CLASS 35—ADVERTISING AND BUSINESS

FOR RETAIL STORES FEATURING MEAT AND FISH (U.S. CLS. 100, 101 AND 102).

CLASS 39—TRANSPORTATION AND STORAGE

FOR DELIVERY OF FOOD BY RESTAURANTS (U.S. CLS. 100 AND 105).

CLASS 42—SCIENTIFIC, COMPUTER AND LEGAL SERVICES

FOR PROVIDING BANQUET AND SOCIAL FUNCTION FACILITIES FOR SPECIAL OCCASIONS (U.S. CLS. 100 AND 101).

SN 76-266,161. KEATING, PATRICK J., MANHATTAN, KS.
FILED 6-1-2001.

THE ENTREPRENEURS NAVIGATOR SYSTEM

NO CLAIM IS MADE TO THE EXCLUSIVE RIGHT TO USE "SYSTEM", APART FROM THE MARK AS SHOWN.

CLASS 36—INSURANCE AND FINANCIAL

FOR FINANCIAL AND ESTATE PLANNING SERVICES FOR OTHERS; INSURANCE BROKERAGE SERVICES; INVESTMENT PLANNING SERVICES (U.S. CLS. 100, 101 AND 102).
FIRST USE 1-1-1998; IN COMMERCE 1-1-1998.

CLASS 41—EDUCATION AND ENTERTAINMENT

FOR EDUCATIONAL SERVICES, NAMELY, CONDUCTING SEMINARS AND WORKSHOPS IN THE FIELDS OF PERSONAL DEVELOPMENT AND SELF IMPROVEMENT (U.S. CLS. 100, 101 AND 107).
FIRST USE 1-1-1998; IN COMMERCE 1-1-1998.

SN 76-266,889. CVITKOVIC ET ASSOCIES CONSULTANTS,
94270 LE KREMLIN BICETRE, FRANCE, FILED 6-5-2001.

ONCOETHIX

PRIORITY CLAIMED UNDER SEC. 44(D) ON FRANCE APPLICATION NO. 003070442, FILED 12-12-2000, REG. NO. 003070442, DATED 12-12-2000, EXPIRES 12-12-2010.

CLASS 5—PHARMACEUTICALS

FOR PHARMACEUTICAL PREPARATIONS FOR THE TREATMENT OF CANCER (U.S. CLS. 6, 18, 44, 46, 51 AND 52).

CLASS 35—ADVERTISING AND BUSINESS

FOR PROVIDING TEMPORARY EMPLOYMENT STAFFING SERVICES FOR SCIENTIFIC RESEARCH IN THE FIELD OF ONCOLOGY (U.S. CLS. 100, 101 AND 102).

CLASS 41—EDUCATION AND ENTERTAINMENT

FOR EDUCATIONAL SERVICES, NAMELY, PROVIDING CLASSES, SEMINARS, WORKSHOPS, CONFERENCES, CONGRESSES AND COLLOQUIUMS IN THE FIELD OF ONCOLOGY; CLINICAL RESEARCH ASSOCIATE PROFESSIONAL TRAINING SERVICES IN THE FIELD OF ONCOLOGY; ORGANIZING EXHIBITIONS IN THE FIELD OF ONCOLOGY (U.S. CLS. 100, 101 AND 107).

CLASS 42—SCIENTIFIC, COMPUTER AND LEGAL SERVICES

FOR CONSULTING IN THE FIELD OF PHARMACOLOGY; RESEARCH AND DEVELOPMENT OF NEW PRODUCTS FOR OTHERS IN THE FIELD OF ONCOLOGY (U.S. CLS. 100 AND 101).

SN 76-267,280. SHEAFFER MARINE INC., TAMPA, FL.
FILED 6-5-2001.

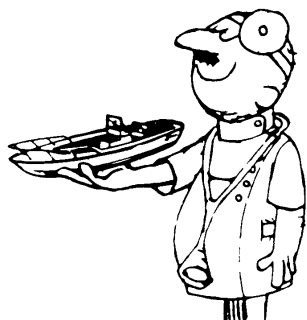

SEC. 2(F).

CLASS 35—ADVERTISING AND BUSINESS

FOR BOAT DEALERSHIPS (U.S. CLS. 100, 101 AND 102).

FIRST USE 8-14-1982; IN COMMERCE 8-14-1982.

CLASS 37—CONSTRUCTION AND REPAIR

FOR REPAIR AND MAINTENANCE OF BOATS (U.S. CLS. 100, 103 AND 106).

FIRST USE 8-14-1982; IN COMMERCE 8-14-1982.

CLASS 41—EDUCATION AND ENTERTAINMENT

FOR EDUCATIONAL SERVICES, NAMELY, PROVIDING CLASSES AND SEMINARS IN THE FIELD OF BOATING DESIGN, CONFIGURATION, MAINTENANCE AND EQUIPMENT (U.S. CLS. 100, 101 AND 107).

FIRST USE 8-14-1982; IN COMMERCE 8-14-1982.

SN 76-267,772. MANNESMANN ARCOR AG & CO., ESCHBORN, FED REP GERMANY, FILED 6-6-2001.

OWNER OF FED REP GERMANY REG. NO. 30058109,
DATED 9-21-2000, EXPIRES 8-31-2010.

CLASS 3—COSMETICS AND CLEANING PREPARATIONS

FOR PREPARATIONS FOR COSMETIC OR TOILETRY USE, PERFUMES, SOAP AND HAIR LOTIONS (U.S. CLS. 1, 4, 6, 50, 51 AND 52).

CLASS 12—VEHICLES

FOR CAR ACCESSORIES, NAMELY, WINDSCREEN FILMS, SEAT AND STEERING COVERS (U.S. CLS. 19, 21, 23, 31, 35 AND 44).

CLASS 14—JEWELRY

FOR JEWELRY INCLUDING IMITATION JEWELRY, IN PARTICULAR WRISTWATCHES AND POCKETWATCHES (U.S. CLS. 2, 27, 28 AND 50).

CLASS 16—PAPER GOODS AND PRINTED MATTER

FOR PRINTED MATTER, NAMELY CALENDARS, POSTERS AND NOTEPAPER; PACKAGING MATERIALS CONSISTING OF PAPER, PAPERBOARD AND PLASTICS, NAMELY, SHEETS AND BAGS; FOUNTAIN PENS, BALL-POINT PENS, PENCILS (U.S. CLS. 2, 5, 22, 23, 29, 37, 38 AND 50).

CLASS 18—LEATHER GOODS

FOR ARTICLES OF LEATHER OR IMITATION LEATHER, NAMELY SUITCASES, LEATHER SHOPPING BAGS, LEATHER HANDBAGS, LEATHER BAGS FOR MERCHANDISE PACKAGING, LEATHER BEACH BAGS, PURSES, WALLETS AND KEY WALLETS (U.S. CLS. 1, 2, 3, 22 AND 41).

CLASS 25—CLOTHING

FOR CLOTHING, NAMELY JACKETS, TROUSERS, T-SHIRTS, SWEATSHIRTS, SCARVES, SHAWLS, GLOVES, SHOES, TIES; HEADWEAR NAMELY, HATS AND CAPS; SPORTSWEAR, LEISUREWEAR AND SWIMMING GEAR, NAMELY, TRACK-SUITS AND GYM SHORTS, GYM SHIRTS, TRAINING AND BATHING SHOES, MEN'S AND WOMEN'S SWIMWEAR (U.S. CLS. 22 AND 39).

CLASS 28—TOYS AND SPORTING GOODS

FOR GAMES AND TOYS, NAMELY, MODELS OF RACING CARS, PASSENGER CARS AND LORRIES; WATER POLO BALLS (U.S. CLS. 22, 23, 38 AND 50).

CLASS 39—TRANSPORTATION AND STORAGE

FOR TRAVEL SERVICES, NAMELY, ARRANGING TRAVEL TOURS; TRAVEL AGENCY SERVICES, NAMELY, MAKING RESERVATIONS AND BOOKINGS FOR TRANSPORTATION; TRAVEL BOOKING AGENCIES, TRAVEL INFORMATION SERVICES (U.S. CLS. 100 AND 105).

CLASS 41—EDUCATION AND ENTERTAINMENT

FOR PRODUCTION OF OPERAS AND MUSICALS, ENTERTAINMENT IN THE NATURE OF TENNIS AND GOLF, TOURNAMENTS AND ENTERTAINMENT IN THE NATURE OF AUTOMOBILE AND HORSE RACES; PUBLISHING OF LEAFLETS, MAGAZINES AND BOOKS (U.S. CLS. 100, 101 AND 107).

SN 76-267,934. NUI ENVIRONMENTAL GROUP, INC., UNION, NJ. FILED 6-5-2001.

NUFIL, A GARDEN STATE ORE PRODUCT

NO CLAIM IS MADE TO THE EXCLUSIVE RIGHT TO USE "GARDEN STATE ORE PRODUCT", APART FROM THE MARK AS SHOWN.

CLASS 1—CHEMICALS

FOR REMEDIATION PRODUCTS, NAMELY, MANUFACTURED SOIL, SOIL AMENDMENTS AND SEDIMENTS FOR INDUSTRIAL AND COMMERCIAL USE IN CONSTRUCTION, DEVELOPMENT OF CONTAMINATED SITES, GOLF COURSES AND LANDSCAPING PROJECTS (U.S. CLS. 1, 5, 6, 10, 26 AND 46).

CLASS 19—NON-METALLIC BUILDING MATERIALS

FOR BUILDING MATERIALS, NAMELY, ROAD SUBGRADE AND FOUNDATION MATERIAL FOR USE IN CONSTRUCTION APPLICATIONS, NAMELY GEOTECHNICAL ENGINEERING PROJECTS, LANDFILL, ROAD CONSTRUCTION, BUILDING FOUNDATION CONSTRUCTION, REMEDIATION OF CONTAMINATED SITES, GOLF COURSES AND LANDSCAPING PROJECTS (U.S. CLS. 1, 12, 33 AND 50).

SN 76-268,147. CHERNISKE, STEPHEN, BOULDER, CO. FILED 6-7-2001.

STKR**CLASS 9—ELECTRICAL AND SCIENTIFIC APPARATUS**

FOR SUNGLASSES; PRE-RECORDED AUDIO AND VIDEO TAPES FEATURING SPEAKERS ON THE TOPIC OF AUTOMOBILE DRIVING METHODS AND DRIVING METHODS AS A METAPHOR FOR LIFESTYLES (U.S. CLS. 21, 23, 26, 36 AND 38).

CLASS 16—PAPER GOODS AND PRINTED MATTER

FOR SERIES OF NON-FICTION BOOKS IN THE FIELD OF AUTOMOBILE DRIVING METHODS AND DRIVING METHODS AS A METAPHOR FOR LIFESTYLES; MAGAZINES FEATURING AUTOMOBILE DRIVING METHODS AND DRIVING METHODS AS A METAPHOR FOR LIFESTYLES; AND BUMPER STICKERS (U.S. CLS. 2, 5, 22, 23, 29, 37, 38 AND 50).

CLASS 25—CLOTHING

FOR SPORTSWEAR AND OUTERWEAR, NAMELY, T-SHIRTS, SHORTS, HATS, SHIRTS, JACKETS, SWEATPANTS, SWEATSHIRTS AND GLOVES (U.S. CLS. 22 AND 39).

CLASS 41—EDUCATION AND ENTERTAINMENT

FOR EDUCATIONAL SERVICES, NAMELY PROVIDING INFORMATIONAL SEMINARS IN THE FIELD OF AUTOMOBILE DRIVING METHODS AND DRIVING METHODS AS A METAPHOR FOR LIFESTYLES, SPEAKING AT SPECIAL EVENTS, NAMELY PROVIDING EDUCATIONAL AND MOTIVATIONAL SPEAKERS (U.S. CLS. 100, 101 AND 107).

SN 76-269,007. TBAC INVESTMENT TRUST, ARLINGTON, TX. FILED 6-8-2001.

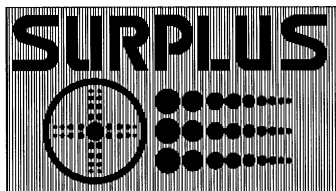

THE LINING IN THE DRAWING INDICATES THE COLOR RED.

CLASS 9—ELECTRICAL AND SCIENTIFIC APPARATUS

FOR CD CASES AND PALM PILOT CASE (U.S. CLS. 21, 23, 26, 36 AND 38).

CLASS 18—LEATHER GOODS

FOR WALLETS, ALL-PURPOSE SPORT BAGS, ALL-PURPOSE ATHLETIC BAGS, AND HANDS-FREE BAGS, NAMELY BELT BAGS AND FANNY PACKS (U.S. CLS. 1, 2, 3, 22 AND 41).

CLASS 25—CLOTHING

FOR BELTS (U.S. CLS. 22 AND 39).

SN 76-269,375. TBAC INVESTMENT TRUST, ARLINGTON, TX. FILED 6-8-2001.



THE LINING IN THE DRAWING INDICATES THE COLOR RED.

CLASS 9—ELECTRICAL AND SCIENTIFIC APPARATUS

FOR CD CASES AND PALM PILOT CASE (U.S. CLS. 21, 23, 26, 36 AND 38).

CLASS 18—LEATHER GOODS

FOR WALLETS, ALL-PURPOSE SPORT BAGS, ALL-PURPOSE ATHLETIC BAGS, AND HANDS-FREE BAGS, NAMELY BELT BAGS AND FANNY PACKS (U.S. CLS. 1, 2, 3, 22 AND 41).

CLASS 25—CLOTHING

FOR BELTS (U.S. CLS. 22 AND 39).

SN 76-269,512. CASHFLOW TECHNOLOGIES, INC., SCOTTSDALE, AZ. FILED 6-8-2001.

THE RICHEST GAME IN THE WORLD**CLASS 9—ELECTRICAL AND SCIENTIFIC APPARATUS**

FOR COMPUTER SOFTWARE USED FOR PLAYING FINANCIAL EDUCATION GAMES ON A COMPUTER OR VIA A GLOBAL COMPUTER NETWORK (U.S. CLS. 21, 23, 26, 36 AND 38).

CLASS 28—TOYS AND SPORTING GOODS

FOR BOARD GAMES USED FOR FINANCIAL EDUCATION (U.S. CLS. 22, 23, 38 AND 50).

SN 76-270,377. CREATIVE WELLNESS COMMUNICATIONS, INC., NORTH PALM BEACH, FL. FILED 6-12-2001.

COMMIT TO GET FIT

CLASS 41—EDUCATION AND ENTERTAINMENT

FOR PROVIDING PHYSICAL FITNESS AND EXERCISE INSTRUCTION AND INFORMATION (U.S. CLS. 100, 101 AND 107).

CLASS 42—SCIENTIFIC, COMPUTER AND LEGAL SERVICES

FOR PROVIDING HEALTH INFORMATION IN THE NATURE OF A CORPORATE WELLNESS PROGRAM (U.S. CLS. 100 AND 101).

SN 76-270,687. BRIGHTPLANET.COM, L.L.C., SIOUX FALLS, SD. FILED 6-13-2001.

BRIGHTPLANET

CLASS 9—ELECTRICAL AND SCIENTIFIC APPARATUS

FOR COMPUTER SOFTWARE FOR SEARCHING, TRACKING AND RETRIEVING INFORMATION FROM A LOCAL AND/OR GLOBAL COMPUTER NETWORK (U.S. CLS. 21, 23, 26, 36 AND 38).

FIRST USE 7-27-2000; IN COMMERCE 7-27-2000.

CLASS 42—SCIENTIFIC, COMPUTER AND LEGAL SERVICES

FOR COMPUTER SERVICES, NAMELY, PROVIDING SEARCH FUNCTIONS DESIGNED TO LOCATE, CAPTURE, RANK, FILTER, SUMMARIZE, INDEX, ARCHIVE, MANAGE AND MAINTAIN DATA ON A GLOBAL COMPUTER NETWORK (U.S. CLS. 100 AND 101).

FIRST USE 7-27-2000; IN COMMERCE 7-27-2000.

SN 76-270,792. SUNNY LEISURE INC, ST. JOHN'S, ANTI-GUA & BARBUDA, FILED 6-12-2001.

CASINO FORTUNE

NO CLAIM IS MADE TO THE EXCLUSIVE RIGHT TO USE "CASINO", APART FROM THE MARK AS SHOWN.

CLASS 41—EDUCATION AND ENTERTAINMENT

FOR PROVIDING LAND-BASED AND INTERNET ONLINE CASINO GAMBLING AND GAMING SERVICES (U.S. CLS. 100, 101 AND 107).

CLASS 42—SCIENTIFIC, COMPUTER AND LEGAL SERVICES

FOR RESTAURANT AND BAR SERVICES (U.S. CLS. 100 AND 101).

SN 76-270,793. SUNNY LEISURE INC., ST. JOHN'S, ANTI-GUA & BARBUDA, FILED 6-12-2001.

SUNNY CASINO

NO CLAIM IS MADE TO THE EXCLUSIVE RIGHT TO USE "CASINO", APART FROM THE MARK AS SHOWN.

CLASS 41—EDUCATION AND ENTERTAINMENT

FOR PROVIDING LAND-BASED AND INTERNET ONLINE CASINO GAMBLING AND GAMING SERVICES (U.S. CLS. 100, 101 AND 107).

CLASS 42—SCIENTIFIC, COMPUTER AND LEGAL SERVICES

FOR RESTAURANT AND BAR SERVICES (U.S. CLS. 100 AND 101).

SN 76-270,858. COOK, ROGER H., NEW CANAAN, CT. FILED 6-12-2001.

APOSTOLIC CONNECTIONS

NO CLAIM IS MADE TO THE EXCLUSIVE RIGHT TO USE "APOSTOLIC", APART FROM THE MARK AS SHOWN.

CLASS 35—ADVERTISING AND BUSINESS

FOR RECRUITMENT SERVICES FOR OTHERS, NAMELY ASSISTING IN THE RECRUITMENT OF YOUTH EVANGELISTS AND YOUTH MINISTRY PROGRAM LEADERS (U.S. CLS. 100, 101 AND 102).

CLASS 41—EDUCATION AND ENTERTAINMENT

FOR EDUCATIONAL SERVICES, NAMELY, CONDUCTING CLASSES, SEMINARS, CONFERENCES AND WORKSHOPS IN THE FIELD OF YOUTH MINISTRY (U.S. CLS. 100, 101 AND 107).

CLASS 42—SCIENTIFIC, COMPUTER AND LEGAL SERVICES

FOR CONSULTING SERVICES IN THE FIELD OF YOUTH MINISTRY (U.S. CLS. 100 AND 101).

SN 76-270,933. ELECTRONIC HEALTH PLANS, INC., BOHEMIA, NY. FILED 6-12-2001.



NO CLAIM IS MADE TO THE EXCLUSIVE RIGHT TO USE "ELECTRONIC HEALTH PLANS, INC.", APART FROM THE MARK AS SHOWN.

CLASS 35—ADVERTISING AND BUSINESS

FOR MANAGED CARE SERVICES, NAMELY, UTILIZATION REVIEW AND PRE-CERTIFICATION SERVICES (U.S. CLS. 100, 101 AND 102).

FIRST USE 7-0-2000; IN COMMERCE 7-0-2000.

CLASS 36—INSURANCE AND FINANCIAL

FOR ADMINISTERING SELF-INSURANCE HEALTH PLANS (U.S. CLS. 100, 101 AND 102).

FIRST USE 7-0-2000; IN COMMERCE 7-0-2000.

SN 76-272,636. ISAIAH DURANT WILLIAMS, INC., CHEVERLY, MD. FILED 6-18-2001.



SN 76-270,980. ARENA FOOTBALL LEAGUE LLC, CHICAGO, IL. FILED 6-14-2001.



OWNER OF U.S. REG. NO. 2,506,997.
NO CLAIM IS MADE TO THE EXCLUSIVE RIGHT TO USE "NEW YORK", APART FROM THE MARK AS SHOWN. THE MARK CONSISTS, IN PART, OF A STYLIZED DRAGON BREATHING FIRE.

CLASS 9—ELECTRICAL AND SCIENTIFIC APPARATUS

FOR PRE-CORDED CD, TAPES, VIDEO TAPES, RECORDS FEATURING MUSIC (U.S. CLS. 21, 23, 26, 36 AND 38).

FIRST USE 12-0-2000; IN COMMERCE 12-0-2000.

CLASS 41—EDUCATION AND ENTERTAINMENT

FOR ENTERTAINMENT SERVICES IN THE NATURE OF LIVE MUSICAL PERFORMANCES (U.S. CLS. 100, 101 AND 107).

FIRST USE 12-0-2000; IN COMMERCE 12-0-2000.

CLASS 16—PAPER GOODS AND PRINTED MATTER

FOR GENERAL MERCHANDISE CATALOGS, BUMPER STICKERS, APPLIQUES IN THE FORM OF DECALS, WRITING PADS AND PENS, PENCILS, SPORTS TRADING CARDS, POSTERS, CALENDARS, PAPER STICKERS, PRINTED EVENT ADMISSION TICKETS, AND PAPER PENNANTS (U.S. CLS. 2, 5, 22, 23, 29, 37, 38 AND 50).

FIRST USE 11-1-2000; IN COMMERCE 2-1-2001.

SN 76-272,689. COOK, ROGER H., NEW CANAAN, CT. FILED 6-15-2001.

APOSTOLIC  CONNECTIONS

CLASS 25—CLOTHING

FOR MEN'S, WOMEN'S AND CHILDREN'S CLOTHING, NAMELY, PLAYER UNIFORMS, NAMELY FOOTWEAR, JERSEY TOPS AND PANTS; CHEERLEADER UNIFORMS; REPLICA UNIFORM SHIRTS, COACHES' CAPS, WOOL HATS, PAINTERS' CAPS, BASEBALL CAPS, VISORS, HEADBANDS, BELTS, T-SHIRTS, TANK TOPS, GOLF SHIRTS, SWEATERS, SWEATSHIRTS, LEATHER JACKETS, NECKTIES, COATS, SHORTS, SWEATPANTS, PANTS, SOCKS AND UNDERWEAR (U.S. CLS. 22 AND 39).

FIRST USE 11-1-2000; IN COMMERCE 2-1-2001.

CLASS 35—ADVERTISING AND BUSINESS

FOR RECRUITMENT SERVICES FOR OTHERS, NAMELY ASSISTING IN THE RECRUITMENT OF YOUTH EVANGELISTS AND YOUTH MINISTRY PROGRAM LEADERS (U.S. CLS. 100, 101 AND 102).

CLASS 41—EDUCATION AND ENTERTAINMENT

FOR EDUCATIONAL SERVICES, NAMELY, CONDUCTING CLASSES, SEMINARS, CONFERENCES AND WORKSHOPS IN THE FIELD OF YOUTH MINISTRY (U.S. CLS. 100, 101 AND 107).

CLASS 41—EDUCATION AND ENTERTAINMENT

FOR ENTERTAINMENT SERVICES, NAMELY ORGANIZING AND PRESENTING FOOTBALL GAMES BEFORE LIVE AUDIENCES AND ON TELEVISION, RADIO, FOR GLOBAL COMPUTER NETWORK DISPLAY, AND OTHER MEDIA (U.S. CLS. 100, 101 AND 107).

FIRST USE 11-1-2000; IN COMMERCE 2-1-2001.

CLASS 42—SCIENTIFIC, COMPUTER AND LEGAL SERVICES

FOR CONSULTING SERVICES IN THE FIELD OF YOUTH MINISTRY (U.S. CLS. 100 AND 101).

SN 76-273,399. LA BELLE ASSOCIATES, INC., BELLINGHAM, WA. FILED 6-12-2001.

SN 76-274,445. CHRYSALIS PLASTIC SURGERY, INC., STERLING, VA. FILED 6-20-2001.

BCP-FIRST COLOSTRUM

NO CLAIM IS MADE TO THE EXCLUSIVE RIGHT TO USE "COLOSTRUM", APART FROM THE MARK AS SHOWN.

CLASS 5—PHARMACEUTICALS

FOR COLOSTRUM BASED DIETARY SUPPLEMENT; COLOSTRUM FOOD SUPPLEMENTS FOR CALVES (U.S. CLS. 6, 18, 44, 46, 51 AND 52).

FIRST USE 2-22-2001; IN COMMERCE 4-30-2001.

CLASS 29—MEATS AND PROCESSED FOODS

FOR COLOSTRUM (U.S. CL. 46).

FIRST USE 2-22-2001; IN COMMERCE 4-30-2001.

SN 76-273,731. CREDITEXPERT, L.L.C., ORANGE, CA. FILED 6-18-2001.

CREDIT360

CLASS 35—ADVERTISING AND BUSINESS

FOR PROVIDING ONLINE PERSONAL INFORMATION REGISTRATION SERVICES IN THE NATURE OF ONLINE CREDIT CARD REGISTRATION, CANCELLATION, AND RENEWAL SERVICES (U.S. CLS. 100, 101 AND 102).

CLASS 36—INSURANCE AND FINANCIAL

FOR FINANCIAL AND CREDIT INFORMATION PROVIDED BY ELECTRONIC MEANS; CREDIT INQUIRY AND CONSULTATION; FINANCIAL ANALYSIS AND CONSULTATION; ON-LINE FINANCIAL ANALYSIS SERVICES, NAMELY, PROVIDING A WEBSITE FEATURING FINANCIAL CALCULATORS AND ANALYSIS OF CREDIT REPORTS AND CREDIT SCORES; PROVIDING ONLINE FINANCIAL ANALYSIS AND CONSULTATION WHEREBY CONSUMERS POSE QUESTIONS AND RECEIVE ANSWERS ON TOPICS RELATING TO CREDIT AND FINANCE; CREDIT AND FINANCIAL INFORMATION REPORTING SERVICES PROVIDED BY COMPUTER AND ON-LINE MEANS AND CONSUMER INFORMATION SERVICES IN THE FIELD OF CONSUMER CREDIT; PROVIDING AN ON-LINE ELECTRONIC DATABASE CONTAINING INFORMATION CONCERNING COMPUTERIZED PRINT AND DATA SELECTION, ARRANGEMENT, PRESENTATION AND DISTRIBUTION IN THE FIELD OF CONSUMER CREDIT REPORTING; PROVIDING ON-LINE FINANCIAL INFORMATION IN THE NATURE OF INFORMATION THAT PERMITS MONITORING OF A CONSUMER'S CREDIT REPORT; PROVIDING AN INTERACTIVE DATABASE IN THE FIELD OF CONSUMER CREDIT REPORTING (U.S. CLS. 100, 101 AND 102).

CLASS 42—SCIENTIFIC, COMPUTER AND LEGAL SERVICES

FOR ONLINE NEWSLETTER FEATURING CREDIT AND FINANCIAL INFORMATION, REPORTS AND ANALYSIS (U.S. CLS. 100 AND 101).

WHERE BEAUTY BEGINS

CLASS 35—ADVERTISING AND BUSINESS

FOR ON-LINE RETAIL STORE SERVICES, RETAIL STORE SERVICES, TELEPHONE ORDERING SERVICES AND MAIL ORDER SERVICES, ALL FEATURING HEALTHCARE PRODUCTS (U.S. CLS. 100, 101 AND 102).
FIRST USE 2-0-2000; IN COMMERCE 2-0-2000.

CLASS 42—SCIENTIFIC, COMPUTER AND LEGAL SERVICES

FOR COSMETIC AND PLASTIC SURGERY (U.S. CLS. 100 AND 101).
FIRST USE 2-0-2000; IN COMMERCE 2-0-2000.

SN 76-275,157. BEER.COM INC., TORONTO, ONTARIO M5J 2T3, CANADA, FILED 6-22-2001.

WORLD BEER GAMES

PRIORITY CLAIMED UNDER SEC. 44(D) ON CANADA APPLICATION NO. 1,087,602, FILED 12-22-2000.

NO CLAIM IS MADE TO THE EXCLUSIVE RIGHT TO USE "GAMES", APART FROM THE MARK AS SHOWN.

CLASS 25—CLOTHING

FOR WEARING APPAREL FOR MEN AND WOMEN, NAMELY, SHORTS, VESTS, JACKETS, COATS, SWEATERS, SHIRTS, SWEATSHIRTS, T-SHIRTS, PANTS, WARM-UP SUITS, SHOES, SOCKS, SUSPENDERS, BELTS, SCARVES, APRONS, NECKTIES, WRIST BANDS, JERSEYS, RAINCOATS, RAIN SLICKERS, RAIN SHOES, RAIN PONCHOS, SWIM SUITS, GLOVES, SLIPPERS, BOOTS, SANDALS, DICKIES, OVERALLS, NIGHTSHIRTS, EAR MUFFS, ROBES, PAJAMAS, COATS, JUMPSUITS, MITTS, MUFFS, NECK WARMERS, PANTS, SKI WEAR, NAMELY, SKI HATS, SKI CAPS, VISORS, NECK WARMERS, SKI SOCKS, SKI JACKETS, JERSEYS, SKI PANTS, SKI SWEATERS, JUMPSUITS, TOQUES, SKI MITTS, MUFFS, HEAD WEAR, NAMELY, HATS, CAPS, RAIN HATS, EAR MUFFS, TOQUES, HEAD BANDS AND VISORS (U.S. CLS. 22 AND 39).

CLASS 41—EDUCATION AND ENTERTAINMENT

FOR ENTERTAINMENT SERVICES, NAMELY, ORGANIZING, CONDUCTING, AND SPONSORING SOCIAL EVENTS, SPORTING EVENTS, PROMOTIONS, CONTESTS, AND COMPETITIONS; EDUCATIONAL SERVICES, NAMELY, ORGANIZING, CONDUCTING AND SPONSORING WORKSHOPS AND SEMINARS IN SOCIAL AND SPORTING EVENTS (U.S. CLS. 100, 101 AND 107).

SN 76-275,928. BAREUTHER, COSTA, 83544 ALBACHING,
FED REP GERMANY, FILED 6-21-2001.



AQUARELLO
the art of sleeping

PRIORITY CLAIMED UNDER SEC. 44(D) ON FED REP GERMANY APPLICATION NO. 30093023.2/2, FILED 12-21-2000, REG. NO. 30093023, DATED 2-14-2001, EXPIRES 12-31-2010.

THE DRAWING IS DEPICTED IN THE COLORS BLACK, WHITE AND GREEN, THE TEXT ALL BEING BLACK, AND THE BACKGROUND OF THE STYLIZED CONCENTRIC CIRCLES DESIGN BEING GREEN, AND THE STYLIZED CONCENTRIC CIRCLES BEING WHITE.

CLASS 3—COSMETICS AND CLEANING PREPARATIONS

FOR (BASED ON INTENT TO USE) COSMETICS AND PERFUMES, AND TOILETRIES, NAMELY, SOAPS, LOTIONS, CREMES, HAIR SHAMPOO, HAIR CONDITIONER, TOOTHPASTE, ANTIPERSPIRANTS FOR PERSONAL USE; MAKE-UP AND MAKE-UP REMOVING PREPARATIONS; BATH SALTS, BUBBLE BATH, BATH OIL, BATH GELS, SKIN CREAMS, SKIN LOTIONS, MOISTURIZING CREAMS, BEAUTY LOTIONS FOR THE SKIN, PERFUMED TALCUM POWDER; SUN-TANNING PREPARATIONS; MOUTH WASHES; HAIR LOTIONS AND NON-MEDICATED PREPARATIONS FOR HAIR CARE; SHAMPOOS; DEPILATORIES; SHAVING SOAP; SHAVING CREAM, SHAVING GELS, PRE-SHAVE AND AFTER SHAVE LOTIONS, AND LOTIONS FOR THE SKIN CARE (U.S. CLS. 1, 4, 6, 50, 51 AND 52).

CLASS 7—MACHINERY

FOR (BASED ON 44(D) PRIORITY APPLICATION) AIR COMPRESSORS (U.S. CLS. 13, 19, 21, 23, 31, 34 AND 35).

CLASS 10—MEDICAL APPARATUS

FOR (BASED ON 44(D) PRIORITY APPLICATION) AIR MATTRESSES, AIR MATTRESS BLADDERS, AIR CUSHIONS, AIR PILLOWS, WATER BEDS, AND WATER MATTRESSES, ALL OF THE AFORESAID GOODS FOR MEDICAL PURPOSES (U.S. CLS. 26, 39 AND 44).

CLASS 17—RUBBER GOODS

FOR (BASED ON 44(D) PRIORITY APPLICATION) FLEXIBLE TUBES (BASED ON INTENT TO USE) ACCESSORIES FOR WATER BEDS AND AIR MATTRESSES, NAMELY WATER HOSES AND COUPLINGS AND CONNECTORS FOR FILLING AND DRAINING WATER BEDS, NOT MADE OF METAL, AND AIR HOSES AND COUPLINGS AND CONNECTORS FOR INFLATING AND DEFLATING AIR MATTRESSES (U.S. CLS. 1, 5, 12, 13, 35 AND 50).

CLASS 20—FURNITURE AND ARTICLES NOT OTHERWISE CLASSIFIED

FOR (BASED ON 44(D) PRIORITY APPLICATION) AIR MATTRESSES, AIR MATTRESS BLADDERS, AIR CUSHIONS, AIR PILLOWS, WATER BEDS, AND WATER MATTRESSES, ALL OF THE AFORESAID GOODS NOT FOR MEDICAL PURPOSES; (BASED ON INTENT TO USE) FURNITURE, IN PARTICULAR, PILLOWS, BED-STEADS, HEADBOARDS, DRESSERS, NIGHTSTANDS, CHESTS AND BEDROOM FURNITURE (U.S. CLS. 2, 13, 22, 25, 32 AND 50).

CLASS 24—FABRICS

FOR (BASED ON INTENT TO USE) ACCESSORIES FOR AIR MATTRESSES AND WATER BEDS, NAMELY MATTRESS COVERS AND PROTECTIVE COVERS FOR AIR AND WATER MATTRESSES; BED LINENS, BED BLANKETS, FITTED AND FLAT SHEETS, BEDSPREADS, MATTRESS COVERS, BATH LINEN AND TOWELS (U.S. CLS. 42 AND 50).

CLASS 25—CLOTHING

FOR (BASED ON INTENT TO USE) CLOTHING AND FOOTWEAR, IN PARTICULAR, BATH ROBES, SLEEPWEAR, LOUNGE WEAR, PAJAMAS AND SLIPPERS (U.S. CLS. 22 AND 39).

SN 76-275,953. KOLENE CORPORATION, DETROIT, MI.
FILED 6-21-2001.

DL

CLASS 1—CHEMICALS

FOR CHEMICALS, NAMELY CAUSTIC COMPOUNDS IN AN AQUEOUS SOLUTION, USED FOR THE CONDITIONING OF OXIDE OR SCALE ON METAL SURFACES (U.S. CLS. 1, 5, 6, 10, 26 AND 46).

CLASS 7—MACHINERY

FOR EQUIPMENT FOR APPLYING CHEMICALS FOR THE TREATMENT OF METAL SURFACES, NAMELY SPRAY APPARATUS (U.S. CLS. 13, 19, 21, 23, 31, 34 AND 35).

SN 76-276,023. NEXANT, INC., SAN FRANCISCO, CA. FILED
6-22-2001.

GRIDSMART

CLASS 9—ELECTRICAL AND SCIENTIFIC APPARATUS

FOR COMPUTER SOFTWARE FOR USE IN THE ENERGY INDUSTRY FOR THE ANALYSIS AND SIMULATION OF ELECTRIC POWER GENERATION, TRANSMISSION, AND DISTRIBUTION SYSTEMS (U.S. CLS. 21, 23, 26, 36 AND 38).

FIRST USE 10-15-2001; IN COMMERCE 10-15-2001.

CLASS 35—ADVERTISING AND BUSINESS

FOR INFORMATION SERVICES, NAMELY, PROVIDING COMMERCIAL INFORMATION TO OTHERS VIA THE INTERNET FOR USE IN THE ENERGY INDUSTRY (U.S. CLS. 100, 101 AND 102).

FIRST USE 10-15-2001; IN COMMERCE 10-15-2001.

SN 76-276,107. LEVEL 1, INC., ROCKLAND, MA. BY CHANGE OF NAME SIMS LEVEL 1, INC., ROCKLAND, MA. FILED 6-25-2001.



NO CLAIM IS MADE TO THE EXCLUSIVE RIGHT TO USE "CONVECTIVE WARMING", APART FROM THE MARK AS SHOWN.

CLASS 10—MEDICAL APPARATUS

FOR CONVECTIVE WARMING MEDICAL BLANKETS, AND PART AND FITTINGS THEREFOR (U.S. CLS. 26, 39 AND 44).

CLASS 11—ENVIRONMENTAL CONTROL APPARATUS

FOR DEVICES FOR HEATING AIR AND PROVIDING AIR FLOW TO CONVECTIVE WARMING MEDICAL BLANKETS, AND PARTS AND FITTINGS THEREFOR (U.S. CLS. 13, 21, 23, 31 AND 34).

SN 76-276,302. BOSTIK FINDLEY SA, 92800 PUTEAUX, FRANCE, FILED 6-25-2001.

BOSTIK FINDLEY

PRIORITY CLAIMED UNDER SEC. 44(D) ON FRANCE APPLICATION NO. 003073037, FILED 12-26-2000, REG. NO. 003073037, DATED 12-26-2000, EXPIRES 12-26-2010. OWNER OF U.S. REG. NOS. 275,540, 1,075,544 AND OTHERS.

CLASS 1—CHEMICALS

FOR ADHESIVES AND ADHESIVE COMPOSITIONS FOR INDUSTRIAL PURPOSES, NAMELY ADHESIVES FOR WALL COVERING TILES, FLOOR COVERING TILES, CEILING COVERING TILES AND ADHESIVE FOR NON-WOVEN MATERIALS (U.S. CLS. 1, 5, 6, 10, 26 AND 46).

CLASS 2—PAINTS

FOR COATING IN THE NATURE OF INTERIOR AND EXTERIOR PAINTS, EPOXY COATING FOR USE ON CONCRETE INDUSTRIAL FLOORS (U.S. CLS. 6, 11 AND 16).

CLASS 16—PAPER GOODS AND PRINTED MATTER

FOR ADHESIVES FOR STATIONARY OR HOUSEHOLD PURPOSES (U.S. CLS. 2, 5, 22, 23, 29, 37, 38 AND 50).

CLASS 19—NON-METALLIC BUILDING MATERIALS

FOR BUILDING MATERIALS NOT OF METAL, NAMELY CEMENTS, MORTAR, BRICKS, CEMENT COATINGS, FLOOR, MOLDINGS, TILES, WALL LINING AND WALL TILES (U.S. CLS. 1, 12, 33 AND 50).

SN 76-276,335. BLUE RIDGE INTERNATIONAL, GEORGE TOWN, GRAND CAYMAN, CAYMAN ISLANDS, FILED 6-21-2001.

GS27

OWNER OF U.S. REG. NOS. 2,199,886 AND 2,199,887.

CLASS 2—PAINTS

FOR COATINGS, IN THE NATURE OF LIQUID AND CREAM PROTECTANTS FOR AUTOMOBILE PAINT AND METAL SURFACES FROM CORROSION, MOISTURE AND WEATHERING (U.S. CLS. 6, 11 AND 16). FIRST USE 2-27-2001; IN COMMERCE 2-27-2001.

CLASS 3—COSMETICS AND CLEANING PREPARATIONS

FOR COMPOUNDS FOR POLISHING AND REMOVING SCRATCHES FROM PAINTED SURFACES, ENAMEL FINISH AND LAMINATED WOOD; COMPOUNDS FOR USE ON PAINT AND CHROME; COMPOUNDS FOR USE IN CLEANING, PROTECTING AND ENHANCING INTERIOR AND EXTERIOR AUTOMOBILE SURFACES; CAR, BOAT, CARAVAN, MOTORCYCLE, TIRE, GLASS AND WHEEL CLEANING PREPARATIONS; COMPOUNDS FOR ENHANCING AND PROTECTING INTERIOR AND EXTERIOR PLASTICS, VINYL AND LEATHER FROM EFFECTS OF AGING AND WEATHER (U.S. CLS. 1, 4, 6, 50, 51 AND 52). FIRST USE 7-1-2000; IN COMMERCE 7-1-2000.

SN 76-276,562. ISABERG RAPID AB, 330 27 HESTRA, SWEDEN, FILED 6-26-2001.



CLASS 6—METAL GOODS

FOR STAPLES FOR INDUSTRIAL USE (U.S. CLS. 2, 12, 13, 14, 23, 25 AND 50).

CLASS 7—MACHINERY

FOR POWER TOOLS, NAMELY, STAPLING MACHINES, TACKING MACHINES, STAPLING PLIERS HOT MELT GLUE GUNS, POWER-OPERATED STAPLING PRESSES, POWER OPERATED STAPLING GUNS, AND STAPLING HAMMERS (U.S. CLS. 13, 19, 21, 23, 31, 34 AND 35).

CLASS 8—HAND TOOLS

FOR HAND TOOLS, NAMELY, STAPLING PLIERS, STAPLING GUNS, STAPLING HAMMERS, AND FRAPING PLIERS (U.S. CLS. 23, 28 AND 44).

CLASS 11—ENVIRONMENTAL CONTROL APPARATUS

FOR HEAT GUNS, NAMELY, HOT AIR GUNS (U.S. CLS. 13, 21, 23, 31 AND 34).

SN 76-277,122. SNP TECHNOLOGIES, INC., HAMDEN, CT. FILED 6-27-2001.

CLASS 16—PAPER GOODS AND PRINTED MATTER

FOR STAPLING MACHINES AND STAPLING PLIERS FOR STAPLING PAPER, TACKING MACHINES FOR TACKING OFFICE REQUISITES, STAPLERS, STAPLES, STAPLE REMOVERS, AND PAPER HOLE PUNCHES (U.S. CLS. 2, 5, 22, 23, 29, 37, 38 AND 50).

SNP**CLASS 37—CONSTRUCTION AND REPAIR**

FOR INSTALLATION, MAINTENANCE AND REPAIR SERVICES IN THE FIELDS OF COMPUTERS, COMPUTER NETWORKS AND COMMUNICATIONS (U.S. CLS. 100, 103 AND 106).

FIRST USE 10-0-1999; IN COMMERCE 12-0-1999.

SN 76-276,961. CLEANPRO ENTERPRISES LTD., CALGARY, AB T2P 3L8, CANADA, FILED 6-27-2001.

CLEANPRO CARPET CLEANING SYSTEM

NO CLAIM IS MADE TO THE EXCLUSIVE RIGHT TO USE "CARPET CLEANING SYSTEM", APART FROM THE MARK AS SHOWN.

CLASS 3—COSMETICS AND CLEANING PREPARATIONS

FOR CARPET CLEANING PREPARATIONS, NAMELY, ORGANIC CLEANING, STAIN REMOVAL AND ODOR CONTROL CONCENTRATES USED FOR CLEANING, PROTECTING, DEODORIZING AND STAIN REMOVAL OF CARPETS, RUGS AND UPHOLSTERY (U.S. CLS. 1, 4, 6, 50, 51 AND 52).

FIRST USE 5-0-1988; IN COMMERCE 5-24-1996.

CLASS 42—SCIENTIFIC, COMPUTER AND LEGAL SERVICES

FOR COMPUTER CONSULTATION; COMPUTER NETWORK DESIGN FOR OTHERS; INTEGRATION OF COMPUTER SYSTEMS AND NETWORKS, NAMELY INTEGRATION OF COMPUTER SOFTWARE AND HARDWARE FOR COMPUTER SYSTEMS AND NETWORKS; COMPUTER PROGRAMMING FOR OTHERS; COMPUTER TECHNICAL SUPPORT SERVICES FOR OTHERS, NAMELY TROUBLESHOOTING OF COMPUTER HARDWARE AND SOFTWARE AND SOFTWARE PROBLEMS VIA TELEPHONE, E-MAIL AND IN PERSON; WEB SITE DEVELOPMENT AND DESIGN, NAMELY DESIGNING, IMPLEMENTING AND HOSTING NETWORK WEB PAGES FOR OTHERS (U.S. CLS. 100 AND 101).

FIRST USE 10-0-1999; IN COMMERCE 12-0-1999.

CLASS 35—ADVERTISING AND BUSINESS

FOR BUSINESS MANAGEMENT SERVICES, NAMELY, OFFERING TECHNICAL ASSISTANCE IN THE OPERATION OF A CARPET, RUG AND UPHOLSTERY CLEANING BUSINESSES (U.S. CLS. 100, 101 AND 102).

FIRST USE 5-0-1988; IN COMMERCE 5-24-1996.

SN 76-277,203. UNCLE BEN'S, INC., VERNON, CA. FILED 6-27-2001.

SN 76-277,000. AGRIS CORPORATION, ROSWELL, GA. FILED 6-22-2001.

CONNECTAG**UNCLE BEN'S EXPRESS****CLASS 9—ELECTRICAL AND SCIENTIFIC APPARATUS**

FOR COMPUTER SOFTWARE FOR USE IN THE PURCHASE AND SALE OF PRODUCTS IN THE AGRICULTURAL INDUSTRY (U.S. CLS. 21, 23, 26, 36 AND 38).

OWNER OF U.S. REG. NOS. 437,176, 1,888,708 AND OTHERS.

CLASS 29—MEATS AND PROCESSED FOODS

FOR SOUPS; CHILI (U.S. CL. 46).

CLASS 35—ADVERTISING AND BUSINESS

FOR PROVIDING AN WEBSITE AT WHICH USERS CAN OFFER GOODS FOR SALE AND BUY GOODS OFFERED BY OTHERS IN THE FIELD OF AGRICULTURE AND AGRICULTURAL PRODUCTS (U.S. CLS. 100, 101 AND 102).

CLASS 30—STAPLE FOODS

FOR PREPARED ENTREES CONSISTING PRIMARILY OF PASTA OR RICE; RICE AND RICE MIXES (U.S. CL. 46).

SN 76-277,663. GREGORY, ROGAN S., BROOKLYN, NY. FILED 6-28-2001.

SN 76-277,832. STUDIOCANAL IMAGE S.A., BOULOGNE-BILLANCOURT, FRANCE, BY MERGER CANAL+ D.A., 92100 BOULOGNE BILLANCOURT, FRANCE, FILED 6-28-2001.



CLASS 14—JEWELRY

FOR BRACELETS, RINGS, CHAINS, AND PENDANTS (U.S. CLS. 2, 27, 28 AND 50). FIRST USE 3-0-2000; IN COMMERCE 3-0-2000.

CLASS 18—LEATHER GOODS

FOR LEATHER HANDBAGS AND WALLETS, FABRIC HANDBAGS (U.S. CLS. 1, 2, 3, 22 AND 41). FIRST USE 3-0-2000; IN COMMERCE 3-0-2000.

CLASS 25—CLOTHING

FOR PANTS, SHIRTS, FOOTWEAR (U.S. CLS. 22 AND 39). FIRST USE 3-0-2000; IN COMMERCE 3-0-2000.

SN 76-277,667. IRON GRIP BARBELL COMPANY, COSTA MESA, CA. FILED 6-27-2001.

IRON GRIP STRENGTH

OWNER OF U.S. REG. NOS. 1,848,270 AND 2,259,789.

CLASS 18—LEATHER GOODS

FOR GYM BAGS (U.S. CLS. 1, 2, 3, 22 AND 41). FIRST USE 1-11-2000; IN COMMERCE 1-11-2000.

CLASS 25—CLOTHING

FOR FITNESS APPAREL, NAMELY, JACKETS, SWEATSHIRTS, SWEAT PANTS, TEESHIRTS, SHIRTS, TANKS, TANKINIS, PANTS, KARATE PANTS, JAZZ PANTS, CARGO PANTS, CAMISOLES, SPORTS BRAS, SHORTS, STRETCH SHORTS, STRETCH V-NECK SHIRTS, PULLOVERS, AND CAPS (U.S. CLS. 22 AND 39). FIRST USE 11-12-1999; IN COMMERCE 11-12-1999.

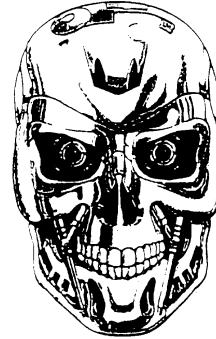

OWNER OF U.S. REG. NO. 1,753,212.

CLASS 6—METAL GOODS

FOR METAL KEY CHAINS (U.S. CLS. 2, 12, 13, 14, 23, 25 AND 50). FIRST USE 5-0-1998; IN COMMERCE 5-0-1998.

CLASS 9—ELECTRICAL AND SCIENTIFIC APPARATUS

FOR MAGNETS (U.S. CLS. 21, 23, 26, 36 AND 38). FIRST USE 5-0-1998; IN COMMERCE 5-0-1998.

CLASS 25—CLOTHING

FOR SHIRTS (U.S. CLS. 22 AND 39). FIRST USE 5-0-1998; IN COMMERCE 5-0-1998.

SN 76-277,897. INTERNATIONAL AERO, INC., BURLINGTON, WA. FILED 6-25-2001.



NO CLAIM IS MADE TO THE EXCLUSIVE RIGHT TO USE "INTERNATIONAL AERO" AND "INC.", APART FROM THE MARK AS SHOWN.

CLASS 12—VEHICLES

FOR AIRPLANE PARTS, NAMELY COMPONENTS FOR COMMERCIAL AIRLINE INTERIORS, NAMELY, BAGGAGE BINS, BAGGAGE PODS, LAVATORIES, CEILING PANELS, GALLEYS, SEATS, SIDE WALLS AND STOWAGE BINS (U.S. CLS. 19, 21, 23, 31, 35 AND 44). FIRST USE 7-22-1988; IN COMMERCE 7-22-1988.

CLASS 37—CONSTRUCTION AND REPAIR

FOR MAINTENANCE AND REPAIR OF COMMERCIAL AIRLINE INTERIORS (U.S. CLS. 100, 103 AND 106).

FIRST USE 7-22-1988; IN COMMERCE 7-22-1988.

SN 76-278,989. OMEGA PROTEIN, INC., HAMMOND, LA. FILED 7-2-2001.

NEPTUNE FISH CONCENTRATE

NO CLAIM IS MADE TO THE EXCLUSIVE RIGHT TO USE "FISH CONCENTRATE", APART FROM THE MARK AS SHOWN.

CLASS 5—PHARMACEUTICALS

FOR ANIMAL FEED ADDITIVE FOR USE AS A NUTRITIONAL SUPPLEMENT; FEED SUPPLEMENTS FOR LIVESTOCK AND PETS; MEDICATED ANIMAL FEED (U.S. CLS. 6, 18, 44, 46, 51 AND 52).

FIRST USE 5-15-2000; IN COMMERCE 5-15-2000.

CLASS 31—NATURAL AGRICULTURAL PRODUCTS

FOR ANIMAL FEED; ANIMAL FEED ADDITIVES FOR NON-NUTRITIONAL PURPOSES FOR USE AS FLAVORING, INGREDIENT OR FILLER; NON-MEDICATED ADDITIVE FOR ANIMAL FEED (U.S. CLS. 1 AND 46).

FIRST USE 5-15-2000; IN COMMERCE 5-15-2000.

SN 76-278,074. AFTERMARKET TECHNOLOGY CORP., WESTMONT, IL. FILED 6-25-2001.

**CLASS 35—ADVERTISING AND BUSINESS**

FOR CONDUCTING INTERACTIVE ONLINE AUCTION IN THE FIELD OF AUTOMOTIVE PRODUCTS AND PARTS VIA A GLOBAL COMPUTER NETWORK (U.S. CLS. 100, 101 AND 102).

FIRST USE 5-0-1998; IN COMMERCE 5-0-1998.

CLASS 37—CONSTRUCTION AND REPAIR

FOR COLLECTION OF AUTOMOBILE PRODUCTS AND PARTS FOR RECYCLING, REFURBISHING AND REMANUFACTURING; REFURBISHING AUTOMOTIVE PARTS; AND REMANUFACTURING AUTOMOTIVE PARTS TO THE ORDER AND SPECIFICATION OF OTHERS (U.S. CLS. 100, 103 AND 106).

FIRST USE 5-0-1998; IN COMMERCE 5-0-1998.

SN 76-279,255. DYNA TEN CORPORATION, FORT WORTH, TX. FILED 7-2-2001.

DYNATEN

SN 76-278,146. BILL WEST INCORPORATED, MONROE, CT. FILED 6-28-2001.

BWI

CLASS 38—COMMUNICATION

FOR SOFTWARE AND NETWORK CONNECTIVITY, NAMELY, PROVIDING TELECOMMUNICATIONS CONNECTIONS TO A GLOBAL COMPUTER (U.S. CLS. 100, 101 AND 104).

FIRST USE 6-4-1994; IN COMMERCE 6-4-1994.

CLASS 42—SCIENTIFIC, COMPUTER AND LEGAL SERVICES

FOR CONSULTING SERVICES, NAMELY, COMPUTER CONSULTATION REGARDING DESIGNING COMPUTER SYSTEMS, COMPUTER NETWORKS AND INTERNET SYSTEMS; INTEGRATION OF COMPUTER SYSTEMS AND NETWORKS; DESIGNING AND IMPLEMENTING NETWORK WEB PAGES FOR OTHERS; DESIGN OF COMPUTER SOFTWARE AND HARDWARE FOR OTHERS (U.S. CLS. 100 AND 101).

FIRST USE 10-0-1986; IN COMMERCE 10-8-1990.

CLASS 37—CONSTRUCTION AND REPAIR

FOR CONSTRUCTION AND CONTRACTING SERVICES, NAMELY, MECHANICAL CONTRACTING CONSISTING OF INSTALLATION, MAINTENANCE, AND REPAIR OF HEATING, VENTILATION, AIR CONDITIONING, PIPING AND PLUMBING COMPONENTS AND SYSTEMS, INSULATION; ELECTRICAL CONTRACTING (U.S. CLS. 100, 103 AND 106).

FIRST USE 6-26-1980; IN COMMERCE 6-26-1980.

CLASS 40—MATERIAL TREATMENT

FOR CUSTOM FABRICATION OF SHEET METAL FOR OTHERS (U.S. CLS. 100, 103 AND 106).

FIRST USE 6-26-1980; IN COMMERCE 6-26-1980.

SN 76-280,513. INDIVOS CORPORATION, OAKLAND, CA. BY CHANGE OF NAME VERISTAR CORPORATION, OAKLAND, CA. FILED 7-5-2001.

RESTORING PEOPLE TO THE CENTER OF COMMERCE

CLASS 36—INSURANCE AND FINANCIAL

FOR ELECTRONIC PAYMENT SERVICES, NAMELY, ELECTRONIC PROCESSING AND TRANSMISSION OF PAYMENTS TO MERCHANTS VIA ON-LINE DEBIT, CHECKING, CREDIT CARD, AND LOYALTY/REWARD ACCOUNT PAYMENTS; PROVIDING CHECKING, CREDIT, DEBIT, AND LOYALTY/REWARD ACCOUNT VERIFICATION SERVICES, NAMELY, TRANSACTION IDENTIFICATION AND AUTHENTICATION SERVICES FOR MERCHANTS BY MEANS OF ON-LINE DATABASES THAT LINK CUSTOMERS' CHECKING, CREDIT, DEBIT, OR LOYALTY/REWARD ACCOUNTS WITH THEIR BIOMETRIC DATA (U.S. CLS. 100, 101 AND 102).

CLASS 42—SCIENTIFIC, COMPUTER AND LEGAL SERVICES

FOR COMPUTER SERVICES, NAMELY, PROVIDING TRANSACTION IDENTIFICATION AND AUTHENTICATION SERVICES FOR MERCHANTS BY MEANS OF ON-LINE DATABASES THAT LINK CUSTOMERS' CHECKING, CREDIT, DEBIT, OR LOYALTY/REWARD ACCOUNTS WITH THEIR BIOMETRIC DATA (U.S. CLS. 100 AND 101).

SN 76-280,761. ISO PROPERTIES, INC., JERSEY CITY, NJ. FILED 7-2-2001.

ISO

OWNER OF U.S. REG. NOS. 1,791,859, 2,418,357 AND OTHERS.
"ISO" IS AN ACRONYM FOR "INSURANCE SERVICES OFFICE".

CLASS 16—PAPER GOODS AND PRINTED MATTER

FOR PRINTED REPORTS REGARDING INSURANCE UNDERWRITING (U.S. CLS. 2, 5, 22, 23, 29, 37, 38 AND 50).
FIRST USE 1-1-1971; IN COMMERCE 1-1-1971.

CLASS 36—INSURANCE AND FINANCIAL

FOR INSURANCE UNDERWRITING INFORMATION SERVICES (U.S. CLS. 100, 101 AND 102).
FIRST USE 1-1-1971; IN COMMERCE 1-1-1971.

SN 76-280,986. WPP GROUP USA, INC., NEW YORK, NY. FILED 7-3-2001.

THE BRAND UNION GROUP

NO CLAIM IS MADE TO THE EXCLUSIVE RIGHT TO USE "BRAND" OR "GROUP", APART FROM THE MARK AS SHOWN.

CLASS 35—ADVERTISING AND BUSINESS

FOR BUSINESS MARKETING CONSULTATION SERVICES FOR OTHERS IN THE FIELDS OF CORPORATE IDENTITY, BRAND NAMES, LOGO DEVELOPMENT, BRAND IDENTITY AND BRAND DEVELOPMENT; MARKET RESEARCH SERVICES; AND ADVERTISING AGENCY SERVICES (U.S. CLS. 100, 101 AND 102).

CLASS 42—SCIENTIFIC, COMPUTER AND LEGAL SERVICES

FOR GRAPHIC ART DESIGN; DESIGN OF PRODUCT PACKAGING AND PRODUCTS FOR OTHERS; AND COMPUTER SERVICES, NAMELY DESIGNING WEB SITES FOR OTHERS (U.S. CLS. 100 AND 101).

SN 76-281,114. C & S WHOLESALE GROCERS, INC., BATTLEBORO, VT. FILED 7-6-2001.



NO CLAIM IS MADE TO THE EXCLUSIVE RIGHT TO USE "LLC" AND "EFFICIENT STORAGE, SHIPPING, SELECTION", APART FROM THE MARK AS SHOWN.

CLASS 35—ADVERTISING AND BUSINESS

FOR DISTRIBUTORSHIP IN THE FIELD OF CONSUMER GOODS AND GROCERIES (U.S. CLS. 100, 101 AND 102).

CLASS 39—TRANSPORTATION AND STORAGE

FOR STORAGE OF CONSUMER GOODS AND GROCERIES FOR OTHERS; TRANSPORTATION OF CONSUMER GOODS AND GROCERIES FOR OTHERS BY TRUCK, RAIL, BOAT AND/OR AIR (U.S. CLS. 100 AND 105).

SN 76-281,152. EMODEL, INC., WASHINGTON, DC. BY ASSIGNMENT EMODEL.COM, INC., WASHINGTON, DC. FILED 7-6-2001.

MODELS ONLY

CLASS 3—COSMETICS AND CLEANING PREPARATIONS

FOR COSMETICS (U.S. CLS. 1, 4, 6, 50, 51 AND 52).

CLASS 25—CLOTHING

FOR A FULL LINE OF CLOTHING (U.S. CLS. 22 AND 39).

SN 76-281,288. VISIONTEK, INC., GURNEE, IL. FILED 7-6-2001.

SN 76-281,620. CASIO KEISANKI KABUSHIKI KAISHA, DBA CASIO COMPUTER CO., LTD., SHIBUYA-KU, TOKYO, JAPAN, FILED 7-9-2001.

AGILITAS

CLASS 37—CONSTRUCTION AND REPAIR

FOR ELECTRONICS REPAIRS AND REWORK SERVICES (U.S. CLS. 100, 103 AND 106).

CLASS 40—MATERIAL TREATMENT

FOR CONTRACT MANUFACTURE OF GENERAL PRODUCT LINES IN THE FIELDS OF ELECTRONICS, COMPUTER MEMORY AND PERIPHERALS TO THE ORDER AND SPECIFICATION OF OTHERS (U.S. CLS. 100, 103 AND 106).

CLASS 42—SCIENTIFIC, COMPUTER AND LEGAL SERVICES

FOR DESIGN AND TESTING FOR NEW ELECTRONIC PRODUCT DEVELOPMENT; ENGINEERING SERVICES; AND CONSULTATION SERVICES IN THE FIELD OF ELECTRONICS (U.S. CLS. 100 AND 101).

SN 76-281,618. CASIO KEISANKI KABUSHIKI KAISHA, DBA CASIO COMPUTER CO., LTD., SHIBUYA-KU, TOKYO, JAPAN, FILED 7-9-2001.

WRIST TECHNOLOGY

CLASS 9—ELECTRICAL AND SCIENTIFIC APPARATUS

FOR HANDHELD PERSONAL COMPUTERS, PERSONAL DIGITAL ASSISTANTS, PERSONAL COMPUTERS, COMPUTER HARDWARE COMPONENTS AND PERIPHERALS THEREOF; COMPUTER SOFTWARE FOR USE IN DATABASE MANAGEMENT, FOR WORD PROCESSING, FOR USE AS A SPREADSHEET, ETC., PRINTERS FOR COMPUTERS; COMPUTER SOFTWARE FOR A PERSONAL COMPUTER FOR USE IN ACHIEVING DATA EXCHANGE BETWEEN A PERSONAL COMPUTER AND A WRIST WATCH OR A DIGITAL CAMERA; ELECTRONIC CALCULATORS; ELECTRONIC PERSONAL ORGANIZER; DIGITAL CAMERAS; PRINTERS FOR DIGITAL CAMERAS; LCD TELEVISION SETS, VEHICLE NAVIGATION SYSTEM CONSISTING OF COMPUTER SOFTWARE FEATURING A DATABASE OF MAP COORDINATES AND LOCATIONS, A GLOBAL POSITIONING SATELLITE RECEIVER, ELECTRICAL CABLE AND DOCUMENTATION ALL SOLD AS A UNIT; ELECTRONIC LABEL PRINTERS; CELLULAR TELEPHONES; RADIO PAGERS, RADIOS, COMPACT DISK PLAYERS, MP3 (MOTION PICTURE GROUP 3) PLAYERS; AUDIO AND VIDEO TAPE RECORDERS; PRE-RECORDED AUDIO CASSETTES AND VIDEOTAPES FEATURING MUSIC, MOVIES, VIDEO GAMES; FILMS OF MOVIES (U.S. CLS. 21, 23, 26, 36 AND 38).

CLASS 14—JEWELRY

FOR ELECTRONIC WATCHES, CLOCKS, WRIST WATCHES HAVING A FUNCTION OF TRANSMITTING AND RECEIVING DATA TO AND FROM AN ELECTRONIC PERSONAL ORGANIZER OR A PERSONAL COMPUTER; AUTONOMOUS RADIO CONTROLLED WATCHES (U.S. CLS. 2, 27, 28 AND 50).



THE MARK CONSISTS OF A DESIGN OF A SATELLITE.

CLASS 9—ELECTRICAL AND SCIENTIFIC APPARATUS

FOR HANDHELD PERSONAL COMPUTERS, PERSONAL DIGITAL ASSISTANTS, PERSONAL COMPUTERS, COMPUTER HARDWARE COMPONENTS AND PERIPHERALS THEREOF; COMPUTER SOFTWARE FOR USE IN DATABASE MANAGEMENT, FOR WORD PROCESSING, FOR USE AS A SPREADSHEET, ETC., PRINTERS FOR COMPUTERS; COMPUTER SOFTWARE FOR A PERSONAL COMPUTER FOR USE IN ACHIEVING DATA EXCHANGE BETWEEN A PERSONAL COMPUTER AND A WRIST WATCH OR A DIGITAL CAMERA; ELECTRONIC CALCULATORS; ELECTRONIC PERSONAL ORGANIZER; DIGITAL CAMERAS; PRINTERS FOR DIGITAL CAMERAS; LCD TELEVISION SETS, VEHICLE NAVIGATION SYSTEM CONSISTING OF COMPUTER SOFTWARE FEATURING A DATABASE OF MAP COORDINATES AND LOCATIONS, A GLOBAL POSITIONING SATELLITE RECEIVER, ELECTRICAL CABLE AND DOCUMENTATION ALL SOLD AS A UNIT; ELECTRONIC LABEL PRINTERS; CELLULAR TELEPHONES; RADIO PAGERS, RADIOS, COMPACT DISK PLAYERS, MP3 (MOTION PICTURE GROUP 3) PLAYERS; AUDIO AND VIDEO TAPE RECORDERS; PRE-RECORDED AUDIO CASSETTES AND VIDEOTAPES FEATURING MUSIC, MOVIES, VIDEO GAMES; FILMS OF MOVIES (U.S. CLS. 21, 23, 26, 36 AND 38).

CLASS 14—JEWELRY

FOR ELECTRONIC WATCHES, CLOCKS, WRIST WATCHES HAVING A FUNCTION OF TRANSMITTING AND RECEIVING DATA TO AND FROM AN ELECTRONIC PERSONAL ORGANIZER OR A PERSONAL COMPUTER; AUTONOMOUS RADIO CONTROLLED WATCHES (U.S. CLS. 2, 27, 28 AND 50).

SN 76-281,884. KONAMI CORPORATION, MINATO-KU, TOKYO, JAPAN, FILED 7-9-2001.

TATSUNOOTOSHIGO

THE ENGLISH TRANSLATION OF "TATSUNOOTOSHIGO" IS "SEA HORSE".

CLASS 9—ELECTRICAL AND SCIENTIFIC APPARATUS

FOR COMPUTER PRODUCTS, NAMELY, COMPUTER GAME PROGRAMS; VIDEO GAME CARTRIDGES; VIDEO GAME CD-ROMS; VIDEO GAME MACHINES FOR USE WITH TELEVISIONS; COMPUTER GAME CD-ROMS; VIDEO GAME PROGRAMS; VIDEO GAME PROGRAMS FOR USE WITH TELEVISION SETS; VIDEO GAME JOYSTICKS (U.S. CLS. 21, 23, 26, 36 AND 38).

CLASS 16—PAPER GOODS AND PRINTED MATTER

FOR BROCHURES AND BOOKLETS RELATING TO COMPUTER AND VIDEO GAMES; VIDEO GAME STRATEGY GUIDE BOOKS; VIDEO GAME STRATEGY GUIDE MAGAZINES; CARD GAME STRATEGY GUIDE BOOKS; CARD GAME STRATEGY GUIDE MAGAZINES; CARD GAME INSTRUCTION BOOKS; CARD GAME INSTRUCTION MAGAZINES; POSTERS; PLAYING CARDS AND INSTRUCTION MANUAL SOLD THEREWITH; COMPUTER GAME INSTRUCTION MANUALS; PRINTED GAME INSTRUCTION SHEETS; PRINTED SCORING SHEETS; TRADING CARDS; CALENDARS; LOOSE-LEAF BINDERS AND STATIONERY (U.S. CLS. 2, 5, 22, 23, 29, 37, 38 AND 50).

CLASS 28—TOYS AND SPORTING GOODS

FOR STAND-ALONE VIDEO GAME MACHINES; HAND-HELD UNITS FOR PLAYING ELECTRONIC GAMES; BOARD GAMES AND INSTRUCTIONAL MANUALS SOLD AS A UNIT THEREWITH; CARD GAMES; DICE; PROMOTIONAL GAME MATERIALS; GAME EQUIPMENT, NAMELY, CHIPS; TOYS, NAMELY ACTION FIGURES; DOLLS AND PLAYSETS THEREFOR (U.S. CLS. 22, 23, 38 AND 50).

SN 76-282,217. FAT CAT, INC., WILLISTON, VT. FILED 7-9-2001.

BOOGIE MAT FOR DE CAT**CLASS 18—LEATHER GOODS**

FOR PET CUSHIONS, NAMELY, MATS (U.S. CLS. 1, 2, 3, 22 AND 41).

CLASS 20—FURNITURE AND ARTICLES NOT OTHERWISE CLASSIFIED

FOR PORTABLE BEDS FOR PETS, NAMELY, MATS (U.S. CLS. 2, 13, 22, 25, 32 AND 50).

SN 76-282,390. WPP GROUP USA, INC., NEW YORK, NY. FILED 7-10-2001.

THE BRAND UNION

NO CLAIM IS MADE TO THE EXCLUSIVE RIGHT TO USE "BRAND", APART FROM THE MARK AS SHOWN.

CLASS 35—ADVERTISING AND BUSINESS

FOR BUSINESS MARKETING CONSULTATION SERVICES FOR OTHERS IN THE FIELDS OF CORPORATE IDENTITY, BRAND NAMES, LOGO DEVELOPMENT, BRAND IDENTITY AND BRAND DEVELOPMENT; MARKET RESEARCH SERVICES; AND ADVERTISING AGENCY SERVICES (U.S. CLS. 100, 101 AND 102).

CLASS 42—SCIENTIFIC, COMPUTER AND LEGAL SERVICES

FOR GRAPHIC ART DESIGN; DESIGN OF PRODUCT PACKAGING AND PRODUCTS FOR OTHERS; AND COMPUTER SERVICES, NAMELY DESIGNING WEB SITES FOR OTHERS (U.S. CLS. 100 AND 101).

SN 76-282,655. DEUS TECHNOLOGIES, LLC, ROCKVILLE, MD. FILED 7-3-2001.

RAPIDSCREEN**CLASS 9—ELECTRICAL AND SCIENTIFIC APPARATUS**

FOR SOFTWARE FOR USE IN MEDICAL IMAGING AND X-RAY ENHANCEMENT AND ANALYSIS (U.S. CLS. 21, 23, 26, 36 AND 38).

CLASS 10—MEDICAL APPARATUS

FOR MEDICAL IMAGING SYSTEM COMPRISING COMPUTER HARDWARE AND SOFTWARE, FILM DIGITIZER, MONITOR AND PRINTER, FOR ASSISTING RADIOLOGISTS IN DIAGNOSING EARLY STAGE LUNG CANCER, TB AND OTHER PULMONARY DISEASES BY SCANNING CHEST X-RAYS (U.S. CLS. 26, 39 AND 44).

SN 76-282,761. ICR SERVICES, INC., LIVONIA, MI. FILED 7-9-2001.

I CAN RETIRE**CLASS 35—ADVERTISING AND BUSINESS**

FOR BUSINESS MARKETING CONSULTING SERVICES, NAMELY NETWORK MARKETING SERVICES FOR CREDIT ANALYSIS AND CREDIT CONSULTATION SERVICES (U.S. CLS. 100, 101 AND 102).

CLASS 36—INSURANCE AND FINANCIAL

FOR FINANCIAL SERVICES IN THE NATURE OF CREDIT REPORT ANALYSIS, CREDIT COUNSELING, CREDIT REESTABLISHMENT AND ACQUISITION SERVICES; TELEPHONE CALLING CARD SERVICES, DEBIT CARD SERVICES, AND TELECOMMUNICATION AIR TIME BROKERAGE SERVICES (U.S. CLS. 100, 101 AND 102).

CLASS 38—COMMUNICATION

FOR TELECOMMUNICATION SERVICES, NAMELY TELEPHONE COMMUNICATIONS SERVICES, PROVIDING MULTIPLE USER ACCESS TO A GLOBAL COMPUTER INFORMATION NETWORK, PERSONAL COMMUNICATION SERVICES, WIRELESS MESSAGING SERVICES, AND TELECOMMUNICATIONS GATEWAY SERVICES (U.S. CLS. 100, 101 AND 104).

SN 76-283,056. CLINIQA CORPORATION, FALLBROOK, CA. BY CHANGE OF NAME INTERNATIONAL ENZYMES, INC., FALLBROOK, CA. FILED 7-9-2001.

CLINIQA

CLASS 1—CHEMICALS

FOR BIOCHEMICAL AND CHEMICAL REAGENTS FOR SCIENTIFIC USE FOR USE IN CALIBRATING SCIENTIFIC AND DIAGNOSTIC EQUIPMENT THAT ARE USED BY LIFE-SCIENCES, BIOLOGICAL AND CLINICAL RESEARCH FACILITIES; AND REAGENTS FOR SCIENTIFIC USE, NAMELY, REAGENTS FOR STANDARDIZATION AND QUALITY CONTROL OF DIAGNOSTICS PROTOCOLS (U.S. CLS. 1, 5, 6, 10, 26 AND 46).

CLASS 40—MATERIAL TREATMENT

FOR CUSTOM MANUFACTURE OF BIOCHEMICAL AND CHEMICAL REAGENTS TO THE ORDER AND SPECIFICATION FOR OTHERS (U.S. CLS. 100, 103 AND 106).

CLASS 42—SCIENTIFIC, COMPUTER AND LEGAL SERVICES

FOR RESEARCH AND DEVELOPMENT FOR OTHERS IN THE FIELD OF BIOCHEMICAL AND CHEMICAL REAGENTS (U.S. CLS. 100 AND 101).

SN 76-283,241. PARAMOUNT GROWERS COOPERATIVE, INC., LOS ANGELES, CA. FILED 7-11-2001.

WONDERFUL PISTACHIOS

NO CLAIM IS MADE TO THE EXCLUSIVE RIGHT TO USE "PISTACHIOS", APART FROM THE MARK AS SHOWN.

CLASS 29—MEATS AND PROCESSED FOODS

FOR PROCESSED NUTS (U.S. CL. 46).

CLASS 31—NATURAL AGRICULTURAL PRODUCTS

FOR RAW NUTS (U.S. CLS. 1 AND 46).

SN 76-283,242. PARAMOUNT GROWERS COOPERATIVE, INC., LOS ANGELES, CA. FILED 7-11-2001.

WONDERFUL ALMONDS

NO CLAIM IS MADE TO THE EXCLUSIVE RIGHT TO USE "ALMONDS", APART FROM THE MARK AS SHOWN.

CLASS 29—MEATS AND PROCESSED FOODS

FOR PROCESSED NUTS (U.S. CL. 46).

CLASS 31—NATURAL AGRICULTURAL PRODUCTS

FOR RAW NUTS (U.S. CLS. 1 AND 46).

SN 76-283,243. PARAMOUNT GROWERS COOPERATIVE, INC., LOS ANGELES, CA. FILED 7-11-2001.

PISTACHIO WONDERFUL

NO CLAIM IS MADE TO THE EXCLUSIVE RIGHT TO USE "PISTACHIO", APART FROM THE MARK AS SHOWN.

CLASS 29—MEATS AND PROCESSED FOODS

FOR PROCESSED NUTS (U.S. CL. 46).

CLASS 31—NATURAL AGRICULTURAL PRODUCTS

FOR RAW NUTS (U.S. CLS. 1 AND 46).

SN 76-283,459. SVENSKA DIET TRAINER A.B., SALTSTJÖBOO, SWEDEN, FILED 7-3-2001.



DIET TRAINER

NO CLAIM IS MADE TO THE EXCLUSIVE RIGHT TO USE "DIET E TRAINER", APART FROM THE MARK AS SHOWN.

CLASS 35—ADVERTISING AND BUSINESS

FOR DIRECT MAIL ADVERTISING, ELECTRONIC BILLBOARD ADVERTISING, PREPARING AUDIO-VISUAL PRESENTATIONS FOR USE IN ADVERTISING, ADVERTISING SERVICES, NAMELY PROVIDING ADVERTISING SPACE IN A PERIODICAL, ADVERTISING SLOGAN AND CARTOON CHARACTER LICENSING, DISSEMINATION OF ADVERTISING MATTER, DISSEMINATION OF ADVERTISING FOR OTHERS VIA AN ON-LINE ELECTRONIC COMMUNICATIONS NETWORK, PLACING ADVERTISEMENTS FOR OTHERS, PREPARING ADVERTISEMENTS FOR OTHERS, PREPARING AUDIO-VISUAL PRESENTATIONS FOR USE IN ADVERTISING, TELEVISION ADVERTISING AGENCIES (U.S. CLS. 100, 101 AND 102).

CLASS 41—EDUCATION AND ENTERTAINMENT

FOR VOCATIONAL EDUCATION IN THE FIELD OF FARE DOCTRINE; EDUCATIONAL SERVICES, NAMELY, CONDUCTING CLASSES, SEMINARS, CONFERENCES, WORKSHOPS IN THE FIELD OF FAIR DOCTRINE AND DISTRIBUTING COURSE MATERIALS IN CONNECTION THEREWITH PROVIDING; EDUCATIONAL DEMONSTRATIONS (U.S. CLS. 100, 101 AND 107).

CLASS 42—SCIENTIFIC, COMPUTER AND LEGAL SERVICES

FOR COMPUTER PROGRAMMING FOR OTHERS; COMPUTER PROGRAMMING IN THE FIELD OF FARE TRAINING; COMPUTER PROGRAMMING IN THE FIELD OF REHABILITATION OF OVERWEIGHT AND/OR UNDERWEIGHT PEOPLE; COMPUTER SERVICES, NAMELY, PROVIDING ONLINE DATABASES IN THE FIELD OF FARE TRAINING AND IN THE FIELD OF REHABILITATION OF OVERWEIGHT AND/OR UNDERWEIGHT PEOPLE; COMPUTER SOFTWARE DESIGN FOR OTHERS (U.S. CLS. 100 AND 101).

SN 76-283,929. KABUSHIKI KAISHA SQUARE, TA SQUARE CO., LTD., MEGURO-KU, TOKYO, JAPAN, FILED 7-12-2001.



OWNER OF U.S. REG. NOS. 1,800,917, 1,833,326 AND 1,918,723.

THE DRAWING IS LINED FOR THE COLOR RED. THE MARK CONSISTS OF THE WORD "SQUARESOFT" IN STYLIZED LETTERING. THE INNER PORTION OF THE LETTER "A" IS RED. THE COLOR RED IS CLAIMED AS A FEATURE OF THE MARK AS SHOWN.

CLASS 9—ELECTRICAL AND SCIENTIFIC APPARATUS

FOR COMPUTER GAME SOFTWARE; VIDEO GAME SOFTWARE; OPTICAL DISCS, NAMELY SOUND RECORDINGS IN THE FORM OF OPTICAL DISCS AND VISUAL RECORDINGS IN THE FORM OF OPTICAL DISCS; MAGNETIC CODED CARDS; MEMORY CARDS; COMPACT DISCS FEATURING MUSIC; VIDEO DISCS FEATURING ANIMATION WITH FICTIONAL STORIES; VIDEO CASSETTES FEATURING ANIMATION WITH FICTIONAL STORIES; COMPUTER SOFTWARE FOR CREATING GRAPHICS AND COMPUTER DESKTOP ACCESSORIES SOLD IN THE FORM OF CD-ROM'S; ELECTRONIC PUBLICATIONS, NAMELY, MAGAZINES FEATURING VIDEO GAMES AND FICTIONAL STORIES RECORDED ON OPTICAL DISCS; DOWNLOADABLE ELECTRONIC PUBLICATIONS IN THE NATURE OF MAGAZINES IN THE FIELD OF VIDEO GAMES AND FICTIONAL STORIES; VIDEO GAME CARTRIDGES, NAMELY, PROGRAMMED ROM CARTRIDGES FOR HANDHELD ELECTRONIC GAME MACHINES WITH LIQUID CRYSTAL DISPLAYS; VIDEO GAME CARTRIDGES, NAMELY, PROGRAMMED ROM CARTRIDGES FOR VIDEO GAME MACHINES FOR USE WITH TELEVISIONS (U.S. CLS. 21, 23, 26, 36 AND 38).

CLASS 16—PAPER GOODS AND PRINTED MATTER

FOR VIDEO GAME STRATEGY GUIDEBOOKS; BOOKS, NAMELY, FICTIONAL BOOKS; MAGAZINES FEATURING VIDEO GAMES AND FICTIONAL STORIES; POSTERS; POSTCARDS; STICKERS; PAPER BANNERS; CALENDARS; TRADING CARDS (U.S. CLS. 2, 5, 22, 23, 29, 37, 38 AND 50).

CLASS 28—TOYS AND SPORTING GOODS

FOR DOLLS; TOY FIGURES; TOY VEHICLES; STUFFED TOYS; CARD GAMES (U.S. CLS. 22, 23, 38 AND 50).

SN 76-284,154. FUJI PHOTO FILM CO., LTD., MINAMI ASHIGARA-SHI KANAGAWA, JAPAN, FILED 7-12-2001.

CLASS 9—ELECTRICAL AND SCIENTIFIC APPARATUS

FOR ONLINE DOWNLOADABLE COMPUTER SOFTWARE AND PROGRAMS FOR ENTERING, STORING, RETRIEVING, DISPLAYING, MANIPULATING, TRANSMITTING, PRINTING, CREATING, DEVELOPING, PRODUCING, ARCHIVING, MANAGING AND ENHANCING STILL IMAGES, DATA, PUBLICATIONS, AUDIO VISUAL WORKS AND MULTIMEDIA APPLICATIONS, NAMELY, THE INTEGRATION OF TEXT, AUDIO, VIDEO, GRAPHICS, STILL IMAGES AND MOVING PICTURES; ONLINE DOWNLOADABLE COMPUTER SOFTWARE AND PROGRAMS FOR THE PUBLICATION, PRINTING, TRANSMISSION, DISSEMINATION AND EXCHANGE OF STILL IMAGES, DATA, PUBLICATIONS, AUDIO VISUAL WORKS AND MULTIMEDIA APPLICATIONS, NAMELY THE INTEGRATION OF TEXT, AUDIO, VIDEO, GRAPHICS, STILL IMAGES AND MOVING PICTURES, VIA GLOBAL COMPUTER NETWORKS AND SATELLITES (U.S. CLS. 21, 23, 26, 36 AND 38).

CLASS 35—ADVERTISING AND BUSINESS

FOR ON-LINE RETAIL STORE SERVICES FEATURING GOODS AND SERVICES IN THE PRINTING AND PUBLISHING INDUSTRIES; ONLINE ORDER PROCESSING AND MANAGEMENT AND FULFILLMENT SERVICES AND DISTRIBUTORSHIPS IN THE FIELD OF THE PRINTING AND PUBLISHING INDUSTRIES; ONLINE TRADING SERVICES IN WHICH SELLER POSTS ITEMS TO BE SOLD AT A SET PRICE AND IN AN AUCTION-STYLE FORMAT WHERE BIDDING IS DONE ELECTRONICALLY, AND PROVIDING BUSINESS EVALUATIVE FEEDBACK AND RATINGS OF SELLERS' GOODS AND SERVICES, THE VALUE AND PRICES OF SELLERS' GOODS, BUYERS' AND SELLERS' PERFORMANCE, DELIVERY AND OVERALL TRADING EXPERIENCE IN CONNECTION THEREWITH; PROVIDING AN ON-LINE COMPUTER DATABASE FEATURING INDUSTRY NEWS, ARTICLES, AND INFORMATION ON PRODUCTS, AND INFORMATION OF INTEREST TO THOSE IN THE FIELD OF ADVERTISING; PROVIDING ON-LINE COMPUTER DATABASES FEATURING INFORMATION ON PRODUCTS IN THE FIELDS OF ADVERTISING, PHOTOGRAPHIC PRINTING, AND THE PRINT AND DESIGN INDUSTRIES (U.S. CLS. 100, 101 AND 102).

CLASS 38—COMMUNICATION

FOR INTERACTIVE DISCUSSION FORUMS, CHAT ROOMS, AND INTERACTIVE BULLETIN BOARDS FOR THE TRANSMISSION OF MESSAGES AMONG COMPUTER USERS CONCERNING PRINTING AND PUBLISHING (U.S. CLS. 100, 101 AND 104).

CLASS 40—MATERIAL TREATMENT

FOR PROVIDING AN ON-LINE COMPUTER DATABASE FEATURING INDUSTRY NEWS, ARTICLES, AND INFORMATION OF INTEREST TO THOSE IN THE FIELD OF PHOTOGRAPHIC PRINTING (U.S. CLS. 100, 103 AND 106).

CLASS 41—EDUCATION AND ENTERTAINMENT

FOR ON-LINE TRAINING AND EDUCATIONAL SERVICES, NAMELY CONDUCTING ONLINE CLASSES, SEMINARS, CONFERENCES, WORKSHOPS IN THE FIELD OF PRINTING AND PUBLISHING AND DISTRIBUTING COURSE MATERIALS IN CONNECTION THEREWITH; PROVIDING AN ON-LINE COMPUTER DATABASE IN THE FIELD OF PUBLISHING (U.S. CLS. 100, 101 AND 107).

CLASS 42—SCIENTIFIC, COMPUTER AND LEGAL SERVICES

SN 76-284,275. AMPCO II, LLC, RIVERHEAD, NY. FILED 7-12-2001.

FOR COMPUTER SERVICES, NAMELY PROVIDING ONLINE COMPUTER DATABASES FEATURING INDUSTRY NEWS, ARTICLES, AND TECHNICAL INFORMATION ON PRODUCTS, AND INFORMATION OF INTEREST TO THE PRINT AND DESIGN INDUSTRIES; PROVIDING ON-LINE COMPUTER DATABASES FEATURING TECHNICAL INFORMATION IN THE FIELDS OF PHOTOGRAPHIC PRINTING; COMPUTER DIAGNOSTIC SERVICES; ONLINE COMPUTER SERVICES, NAMELY, PROVIDING TEMPORARY USE OF ONLINE NON-DOWNLOADABLE SOFTWARE FOR ENTERING, STORING, RETRIEVING, DISPLAYING, MANIPULATING, TRANSMITTING, PRINTING CREATING, DEVELOPING, PRODUCING, ARCHIVING, MANAGING AND ENHANCING STILL IMAGES, DATA, PUBLICATIONS, AUDIO VISUAL WORKS AND MULTIMEDIA APPLICATIONS, NAMELY, THE INTEGRATION OF TEXT, AUDIO, VIDEO, GRAPHICS, STILL IMAGES AND MOVING PICTURES; COMPUTER SERVICES, NAMELY, PROVIDING TEMPORARY USE OF ON-LINE NON-DOWNLOADABLE SOFTWARE FOR THE PUBLICATION, PRINTING, TRANSMISSION, DISSEMINATION AND EXCHANGE OF STILL IMAGES, DATA, PUBLICATIONS, AUDIO VISUAL WORKS AND MULTIMEDIA APPLICATIONS, NAMELY, THE INTEGRATION OF TEXT, AUDIO, VIDEO, GRAPHICS, STILL IMAGES AND MOVING PICTURES, VIA GLOBAL COMPUTER NETWORKS AND SATELLITES (U.S. CLS. 100 AND 101).

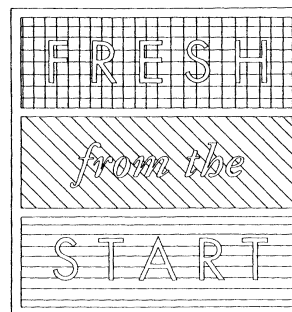
SN 76-284,201. BATTENFELD GMBH, 58540 MEINERZHA-
GEN, FED REP GERMANY, FILED 7-12-2001.**AQUAMOULD**

PRIORITY CLAIMED UNDER SEC. 44(D) ON ERPN CMNTY TM OFC APPLICATION NO. 002052389, FILED 1-23-2001, REG. NO. 2052389, DATED 2-7-2002, EXPIRES 1-23-2011.

OWNER OF U.S. REG. NO. 2,239,740.
THE MARK IS LINED FOR THE COLORS GOLD, GREEN AND BLUE.

CLASS 7—MACHINERY

FOR PLASTIC PROCESSING MACHINES, INJECTION MOULDING MACHINES, EXTRUDERS, BLOW MOULDING MACHINES, FILM BLOWING MACHINES, FILM EXTRUSION MACHINES, FILM CASTING MACHINES, METAL DIE CASTING MACHINES AND PARTS THEREFOR; MECHANICALLY-OPERATED TOOLS FOR PLASTIC PROCESSING MACHINES, INJECTION MOULDING MACHINES, EXTRUDERS, BLOW MOULDING MACHINES, FILM BLOWING MACHINES, FILM EXTRUSION MACHINES, FILM CASTING MACHINES AND METAL DIE CASTING MACHINES; MECHANICALLY-OPERATED ACCESSORIES FOR PLASTIC PROCESSING MACHINES, INJECTION MOULDING MACHINES, EXTRUDERS, BLOW MOULDING MACHINES, FILM BLOWING MACHINES, FILM EXTRUSION MACHINES, FILM CASTING MACHINES, METAL DIE CASTING MACHINES, IN PARTICULAR AUTOMATIC HANDLING SYSTEMS, MATERIAL CONVEYORS, CONVEYOR BELT SYSTEMS, TOOL CHANGE SYSTEMS AND TOOL TRANSPORT SYSTEMS (U.S. CLS. 13, 19, 21, 23, 31, 34 AND 35).

CLASS 9—ELECTRICAL AND SCIENTIFIC APPARATUS

FOR ELECTRONIC NUMERICAL CONTROL SYSTEMS FOR MACHINE TOOLS (U.S. CLS. 21, 23, 26, 36 AND 38).

CLASS 29—MEATS AND PROCESSED FOODS

FOR PROCESSED FRUITS AND VEGETABLES; SOUPS; SOUP MIXES; PRE-CUT VEGETABLE SALADS; COLE SLAW; PACKAGED MEALS CONSISTING PRIMARILY OF MEAT, FISH, POULTRY OR VEGETABLES; DRIED SOYBEANS; PEELED GARLIC; PEELED SHALLOTS; PREPARED EDAMAME; STIR FRY KITS CONSISTING PRIMARILY OF VEGETABLES AND MEAT WITH SEASONING MIX; STEW KITS CONSISTING PRIMARILY OF VEGETABLES AND MEAT WITH SEASONING MIX (U.S. CL. 46).

CLASS 30—STAPLE FOODS

FOR SPICES, BREAD-BASED STUFFING; FAJITA KITS CONSISTING PRIMARILY OF TORTILLAS AND SEASONING MIX WITH VEGETABLES AND MEAT; STIR FRY KITS CONSISTING PRIMARILY OF SEASONING MIX WITH VEGETABLES AND MEAT; STEW KITS CONSISTING PRIMARILY OF SEASONING MIX WITH VEGETABLES AND MEAT (U.S. CL. 46).

CLASS 31—NATURAL AGRICULTURAL PRODUCTS

FOR FRESH FRUITS AND VEGETABLES; FRESH EDAMAME; FRESH YUCCA; FRESH GARLIC; FRESH SHALLOTS; FRESH GINGER; FRESH CILANTRO AND FRESH HERBS (U.S. CLS. 1 AND 46).

SN 76-284,276. AMPCO II, LLC, RIVERHEAD, NY. FILED 7-12-2001.



OWNER OF U.S. REG. NO. 2,239,740.

CLASS 29—MEATS AND PROCESSED FOODS

FOR PROCESSED FRUITS AND VEGETABLES; SOUPS; SOUP MIXES; PRE-CUT VEGETABLE SALADS; COLE SLAW; PACKAGED MEALS CONSISTING PRIMARILY OF MEAT, FISH, POULTRY OR VEGETABLES; DRIED SOYBEANS; PEELED GARLIC; PEELED SHALLOTS; PREPARED EDAMAME; STIR FRY KITS CONSISTING PRIMARILY OF VEGETABLES AND MEAT WITH SEASONING MIX; STEW KITS CONSISTING PRIMARILY OF VEGETABLES AND MEAT WITH SEASONING MIX (U.S. CL. 46).

CLASS 30—STAPLE FOODS

FOR SPICES, BREAD-BASED STUFFING; FAJITA KITS CONSISTING PRIMARILY OF TORTILLAS AND SEASONING MIX WITH VEGETABLES AND MEAT; STIR FRY KITS CONSISTING PRIMARILY OF SEASONING MIX WITH VEGETABLES AND MEAT; STEW KITS CONSISTING PRIMARILY OF SEASONING MIX WITH VEGETABLES AND MEAT (U.S. CL. 46).

CLASS 31—NATURAL AGRICULTURAL PRODUCTS

FOR FRESH FRUITS AND VEGETABLES; FRESH EDAMAME; FRESH YUCCA; FRESH GARLIC; FRESH SHALLOTS; FRESH GINGER; FRESH CILANTRO AND FRESH HERBS (U.S. CLS. 1 AND 46).

SN 76-284,399. SPUDULIKE GROUP LIMITED, LONDON, ENGLAND, FILED 7-16-2001.

SPUDULIKE

CLASS 29—MEATS AND PROCESSED FOODS

FOR FOOD PRODUCTS MADE FROM POTATOES, NAMELY, BAKED POTATOES, FRENCH FRIES, AND COOKED POTATOES; MEAT, FISH, POULTRY AND GAME; COOKED VEGETABLES; DAIRY PRODUCTS EXCLUDING ICE CREAM, ICE MILK, AND FROZEN YOGURT (U.S. CL. 46).

CLASS 30—STAPLE FOODS

FOR COFFEE, TEA, AND COCOA BASED BEVERAGES; FLOUR BASED CHIPS, RICE BASED SNACK FOODS; FLAVORING ADDITIVES FOR NON-NUTRITIONAL PURPOSES; ICE CREAM, ICE MILK, AND FROZEN YOGURT; SEASONINGS AND SAUCES; SANDWICHES; PIZZA; CONFECTIONERY, NAMELY, CANDY, FROZEN CONFECTIONS, AND CHEWING GUM; PREPARATIONS MADE FROM CEREALS, NAMELY, READY-TO-EAT CEREAL, CEREAL DERIVED FOOD BARS, AND CEREAL BASED SNACK FOOD; BREAD AND PASTRIES (U.S. CL. 46).

CLASS 42—SCIENTIFIC, COMPUTER AND LEGAL SERVICES

FOR RESTAURANT SERVICES, CATERING SERVICES, CAFE AND SNACK BAR SERVICES, PROVISION OF TAKE-AWAY FOOD PRODUCTS, NAMELY, CARRY-OUT RESTAURANTS (U.S. CLS. 100 AND 101).

SN 76-284,629. STOLTZ & MURPHY, INC., MANHATTAN, KS. FILED 7-16-2001.

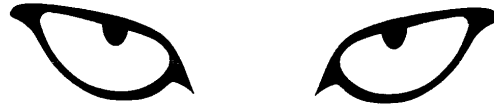

CLASS 7—MACHINERY

FOR POWER TOOL, NAMELY, DRAIN CABLE CLEANER (U.S. CLS. 13, 19, 21, 23, 31, 34 AND 35).

CLASS 8—HAND TOOLS

FOR HAND TOOL, NAMELY, DRAIN CABLE CLEANER (U.S. CLS. 23, 28 AND 44).

SN 76-284,704. ATLANTA CUSTOM IRON WORKS, INC., ATLANTA, GA. FILED 7-10-2001.

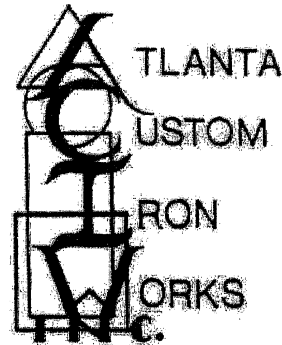

NO CLAIM IS MADE TO THE EXCLUSIVE RIGHT TO USE "ATLANTA CUSTOM IRON WORKS INC.", APART FROM THE MARK AS SHOWN. THE STIPLING IS A FEATURE OF THE MARK AND DOES NOT INDICATE COLOR.

CLASS 40—MATERIAL TREATMENT

FOR CUSTOM METAL FABRICATION (U.S. CLS. 100, 103 AND 106).
FIRST USE 7-30-1998; IN COMMERCE 7-30-1998.

CLASS 42—SCIENTIFIC, COMPUTER AND LEGAL SERVICES

FOR CUSTOM METAL DESIGN (U.S. CLS. 100 AND 101).
FIRST USE 7-30-1998; IN COMMERCE 7-30-1998.

SN 76-285,399. NUTRIJOY, INC., MANHATTAN, KS. FILED 7-17-2001.

NUTRITION TO ENJOY

NO CLAIM IS MADE TO THE EXCLUSIVE RIGHT TO USE "NUTRITION", APART FROM THE MARK AS SHOWN.

CLASS 29—MEATS AND PROCESSED FOODS

FOR PACKAGED MINERAL-ENRICHED ENTREES CONSISTING PRIMARILY OF MEAT, FISH, POULTRY OR VEGETABLES; PACKAGED MINERAL-ENRICHED MEALS CONSISTING PRIMARILY OF MEAT, FISH, POULTRY OR VEGETABLES; MINERAL ENRICHED FRUIT-BASED SNACK FOODS; MINERAL ENRICHED POTATO BASED SNACK FOODS (U.S. CL. 46).

CLASS 30—STAPLE FOODS

FOR PACKAGED MINERAL ENRICHED ENTREES CONSISTING PRIMARILY OF PASTA OR RICE; PACKAGED MINERAL ENRICHED MEALS CONSISTING PRIMARILY OF PASTA OR RICE; FRUIT FLAVORED PUDDINGS; MINERAL ENRICHED CEREAL BASED SNACK FOODS; MINERAL ENRICHED WHEAT-BASED SNACK FOODS (U.S. CL. 46).

CLASS 32—LIGHT BEVERAGES

FOR FRUIT-FLAVORED DRINKS (U.S. CLS. 45, 46 AND 48).

SN 76-285,463. CLEAR CHANNEL INTANGIBLES, INC., CLAYMONT, DE. BY ASSIGNMENT CLEAR CHANNEL COMMUNICATIONS, INC., SAN ANTONIO, TX. FILED 7-16-2001.

CLEAR CHANNEL TELEVISION

OWNER OF U.S. REG. NO. 2,361,253.
NO CLAIM IS MADE TO THE EXCLUSIVE RIGHT TO USE "TELEVISION", APART FROM THE MARK AS SHOWN.

CLASS 38—COMMUNICATION

FOR TELEVISION BROADCASTING SERVICES (U.S. CLS. 100, 101 AND 104).
FIRST USE 5-0-2001; IN COMMERCE 5-0-2001.

CLASS 41—EDUCATION AND ENTERTAINMENT

FOR TELEVISION PRODUCTION AND PROGRAMMING; ENTERTAINMENT SERVICES, NAMELY, PRODUCTION AND DISTRIBUTION OF PROGRAMS FOR PRESENTATION ON TELEVISION (U.S. CLS. 100, 101 AND 107).

FIRST USE 5-0-2001; IN COMMERCE 5-0-2001.

SN 76-285,603. RECORDARE LLC, LOS ALTOS, CA. FILED 7-16-2001.

RECORDARE**CLASS 35—ADVERTISING AND BUSINESS**

FOR COMPUTERIZED ON-LINE RETAIL AND WHOLESALE ORDERING SERVICES IN THE FIELD OF MUSIC RECORDINGS, BOOKS, SCORES AND SOFTWARE (U.S. CLS. 100, 101 AND 102).

FIRST USE 9-7-2000; IN COMMERCE 9-7-2000.

CLASS 41—EDUCATION AND ENTERTAINMENT

FOR ONLINE MUSIC PUBLISHING (U.S. CLS. 100, 101 AND 107).

FIRST USE 9-7-2000; IN COMMERCE 9-7-2000.

CLASS 42—SCIENTIFIC, COMPUTER AND LEGAL SERVICES

FOR COMPUTER SOFTWARE DEVELOPMENT, NAMELY, DEVELOPMENT OF SOFTWARE AND DATABASES IN THE FIELD OF MUSIC, AND MUSIC TRANSCRIPTION FOR OTHERS (U.S. CLS. 100 AND 101).

FIRST USE 9-7-2000; IN COMMERCE 9-7-2000.

SN 76-285,945. MEDICED.COM, INC., LONGMEADOW, MA. FILED 7-9-2001.

MEDICED**CLASS 16—PAPER GOODS AND PRINTED MATTER**

FOR EDUCATIONAL PUBLICATIONS, NAMELY, TRAINING MANUALS IN THE FIELD OF MEDICINE (U.S. CLS. 2, 5, 22, 23, 29, 37, 38 AND 50).

CLASS 41—EDUCATION AND ENTERTAINMENT

FOR EDUCATIONAL SERVICES, NAMELY, CONDUCTING CLASSES IN THE FIELD OF MEDICINE AND DISTRIBUTING COURSE MATERIALS IN CONNECTION THEREWITH VIA A GLOBAL COMPUTER NETWORK (U.S. CLS. 100, 101 AND 107).

CLASS 42—SCIENTIFIC, COMPUTER AND LEGAL SERVICES

FOR PROVIDING MEDICAL INFORMATION ON A WIDE VARIETY OF MEDICAL TOPICS TO MEDICAL PROFESSIONALS VIA A GLOBAL COMPUTER NETWORK; MEDICAL TESTING SERVICES (U.S. CLS. 100 AND 101).

SN 76-286,406. SIGERSON MORRISON WHOLESALE, LLC,
NEW YORK, NY. FILED 7-16-2001.

SIGERSON MORRISON

THE NAME IN THE MARK DOES NOT IDENTIFY A PARTICULAR LIVING INDIVIDUAL.

CLASS 18—LEATHER GOODS

FOR LEATHER GOODS, NAMELY, HANDBAGS (U.S. CLS. 1, 2, 3, 22 AND 41).
FIRST USE 8-31-1999; IN COMMERCE 8-31-1999.

CLASS 25—CLOTHING

FOR SHOES AND BOOTS (U.S. CLS. 22 AND 39).
FIRST USE 3-31-1991; IN COMMERCE 3-31-1991.

SN 76-287,968. CANDLE CORPORATION, EL SEGUNDO,
CA. FILED 7-23-2001.

INTELLIWATCH REPORTER

OWNER OF U.S. REG. NOS. 2,190,260 AND 2,344,982.
NO CLAIM IS MADE TO THE EXCLUSIVE RIGHT TO USE "REPORTER", APART FROM THE MARK AS SHOWN.

CLASS 9—ELECTRICAL AND SCIENTIFIC APPARATUS

FOR COMPUTER SOFTWARE, NAMELY, COMPUTER SOFTWARE FOR THE CREATION, COLLECTION, CHARTING, GRAPHING AND PUBLICATION OF CUSTOM OPERATIONAL STATISTICS FOR GROUPWARE APPLICATIONS, AND MANUALS SOLD AS A UNIT HEREWITH, AND WHICH MAY BE DOWNLOADED FROM A GLOBAL COMPUTER NETWORK AND THE WORLD WIDE WEB (U.S. CLS. 21, 23, 26, 36 AND 38).

CLASS 35—ADVERTISING AND BUSINESS

FOR BUSINESS CONSULTING SERVICES FOR OTHERS, NAMELY, THE CUSTOMIZATION OF CHARTS, EVALUATION, ANALYSIS AND GRAPHING OF DATA AND PUBLICATION OF REPORTS OF DATA COLLECTED BY COMPUTER SOFTWARE; LICENSING OF COMPUTER SOFTWARE TO OTHERS (U.S. CLS. 100, 101 AND 102).

CLASS 42—SCIENTIFIC, COMPUTER AND LEGAL SERVICES

FOR COMPUTER SERVICES AND CONSULTING SERVICES FOR OTHERS, NAMELY, HELPING OTHERS WITH INSTALLATION, IMPLEMENTATION AND USE OF COMPUTER SOFTWARE; COMPUTER PROGRAMMING FOR OTHERS; COMPUTER SUPPORT SERVICES, NAMELY, COMPUTER SOFTWARE UPDATING AND MAINTENANCE; COMPUTER CONSULTATION RELATED TO COMPUTER SOFTWARE (U.S. CLS. 100 AND 101).

SN 76-288,341. UNIVERSITY OF SOUTHERN CALIFORNIA,
LOS ANGELES, CA. FILED 7-19-2001.

TROJANS

OWNER OF U.S. REG. NOS. 1,542,654, 2,180,585 AND OTHERS.

CLASS 14—JEWELRY

FOR CLOCKS; WATCHES; RINGS BEING JEWELRY; CHARMS; TIE TACKS; TIE CLIPS AND LAPEL PINS (U.S. CLS. 2, 27, 28 AND 50).
FIRST USE 0-0-1976; IN COMMERCE 0-0-1976.

CLASS 21—HOUSEWARES AND GLASS

FOR PORCELAIN AND GLASS MUGS; CUPS; DRINKING GLASSES; SHOT GLASSES; COMMEMORATIVE AND DECORATIVE PLATES; COASTERS NOT OF PAPER AND NOT BEING TABLE LINEN; PLASTIC COASTERS; THERMAL INSULATED CONTAINERS FOR FOOD OR BEVERAGE; PORTABLE BEVERAGE COOLERS; PLASTIC SPORTS BOTTLES SOLD EMPTY; AND PET BOWLS (U.S. CLS. 2, 13, 23, 29, 30, 33, 40 AND 50).
FIRST USE 0-0-1976; IN COMMERCE 0-0-1976.

SN 76-288,457. IKON OFFICE SOLUTIONS WEST, INC.,
PORTLAND, OR. FILED 7-20-2001.



The Way Business
Gets Communicated

OWNER OF U.S. REG. NO. 2,357,850.

CLASS 9—ELECTRICAL AND SCIENTIFIC APPARATUS

FOR COMPUTER SOFTWARE, NAMELY, COMPUTER SOFTWARE THAT ALLOWS USERS TO ACCESS, VIEW, AND TRANSMIT DIGITAL DOCUMENTS AND MANAGE DOCUMENT VERSIONS FROM AN ON-LINE DATABASE FEATURING SUCH DIGITAL DOCUMENTS (U.S. CLS. 21, 23, 26, 36 AND 38).

FIRST USE 10-0-2000; IN COMMERCE 10-0-2000.

CLASS 35—ADVERTISING AND BUSINESS

FOR DISTRIBUTORSHIP SERVICES IN THE FIELD OF OFFICE EQUIPMENT USED FOR COPYING, PRINTING, PHOTOGRAPHIC IMAGING AND FACSIMILE TRANSMISSION; DISTRIBUTORSHIP SERVICES IN THE FIELD OF OFFICE EQUIPMENT, NAMELY, COMPUTER HARDWARE AND COMPUTER PROGRAMS AND TELECOMMUNICATION DEVICES; LICENSING PROPRIETARY SOFTWARE FOR DOCUMENT DATA TRANSFER AND PHYSICAL CONVERSION FROM ONE MEDIA TO ANOTHER; CONSULTING SERVICES IN THE FIELDS OF TEMPORARY EMPLOYMENT SERVICES AND OUTSOURCING TEMPORARY EMPLOYMENT SERVICES AND BASIC OFFICE SERVICES FOR OTHERS; AND COPYING AND BINDING DOCUMENTS FOR USE IN LITIGATION BY LAW FIRMS AND LEGAL PROFESSIONALS (U.S. CLS. 100, 101 AND 102).

FIRST USE 10-0-2000; IN COMMERCE 10-0-2000.

CLASS 37—CONSTRUCTION AND REPAIR

FOR MAINTENANCE SERVICING OF OFFICE EQUIPMENT OF OTHERS, NAMELY, COPIERS, PRINTERS, PHOTOGRAPHIC IMAGING EQUIPMENT, FACSIMILE MACHINES, COMPUTER HARDWARE, AND TELECOMMUNICATIONS DEVICES (U.S. CLS. 100, 103 AND 106).

FIRST USE 10-0-2000; IN COMMERCE 10-0-2000.

CLASS 39—TRANSPORTATION AND STORAGE

FOR ELECTRONIC DATA STORAGE; ELECTRONIC DOCUMENT AND GRAPHIC FILE ARCHIVING IN THE NATURE OF ELECTRONIC STORAGE OF ELECTRONIC DOCUMENTS AND GRAPHIC IMAGES AND DESIGNS (U.S. CLS. 100 AND 105).

FIRST USE 10-0-2000; IN COMMERCE 10-0-2000.

CLASS 40—MATERIAL TREATMENT

FOR DOCUMENT FINISHING NAMELY, COLLATING, HOLE PUNCHING, DRILLING, STAPLING AND BINDING OF DOCUMENTS; FILE AND DOCUMENT IMAGING AND CONVERSION, NAMELY, CONVERSION OF HARD COPY DOCUMENTS AND MICROGRAPHIC FILES INTO ELECTRONIC FORMATS FOR USE IN ELECTRONIC INFORMATION MANAGEMENT SYSTEMS; DOCUMENT IMAGING CODING AND OPTICAL CHARACTER SCANNING; DOCUMENT DATA TRANSFER AND PHYSICAL CONVERSION FROM ONE MEDIA TO ANOTHER; LARGE VOLUME MULTIPLE FORMAT BACKFILE CONVERSION; AND IMAGE ARCHIVING (U.S. CLS. 100, 103 AND 106).

FIRST USE 10-0-2000; IN COMMERCE 10-0-2000.

CLASS 42—SCIENTIFIC, COMPUTER AND LEGAL SERVICES

FOR PRINTING SERVICES, NAMELY, PRINTING OF ELECTRONIC DOCUMENTS, SCANNED IMAGES, AND GRAPHIC IMAGES; CONSULTING SERVICES IN THE FIELD OF COMPUTER NETWORKING; MAINTENANCE OF COMPUTER SOFTWARE (U.S. CLS. 100 AND 101).

FIRST USE 10-0-2000; IN COMMERCE 10-0-2000.

SN 76-289,508. LURGI AG, D-60295 FRANKFURT AM MAIN, FED REP GERMANY, FILED 7-24-2001.

Kat-X

PRIORITY CLAIMED UNDER SEC. 44(D) ON FED REP GERMANY APPLICATION NO. 30107616.2/0, FILED 2-6-2001, REG. NO. 30107616, DATED 4-24-2001, EXPIRES 2-28-2011.

CLASS 1—CHEMICALS

FOR CHEMICALS USED IN INDUSTRY FOR THE CATALYTIC CONVERSION OF SULFUR DIOXIDE INTO SULFUR TRIOXIDE, CHEMICALS USED IN SCIENCE, NAMELY, REAGENTS FOR SCIENTIFIC RESEARCH; CATALYSTS FOR USE IN THE PRODUCTION OF SULFURIC ACID; SULFURIC ACID FOR USE IN THE PRODUCTION OF SOLUTIONS FOR HYDROMETALLURGICAL EXTRACTION PROCESSES, PHOSPHORIC ACID, FERTILIZERS AND DIVERSE COMPOUNDS OTHER THAN SULFATES FOR THE CHEMICAL INDUSTRY (U.S. CLS. 1, 5, 6, 10, 26 AND 46).

CLASS 7—MACHINERY

FOR INDUSTRIAL PRODUCTION MACHINES FOR USE IN THE MANUFACTURE OF SULFURIC ACID (U.S. CLS. 13, 19, 21, 23, 31, 34 AND 35).

CLASS 37—CONSTRUCTION AND REPAIR

FOR CONSTRUCTION, INSTALLATION AND MAINTENANCE OF INDUSTRIAL PLANTS AND PROJECT PLANNING FOR INDUSTRIAL PLANTS AND MACHINERY (U.S. CLS. 100, 103 AND 106).

CLASS 42—SCIENTIFIC, COMPUTER AND LEGAL SERVICES

FOR RESEARCH AND DEVELOPMENT OF OTHERS IN THE FIELD OF THE PRODUCTION OF SULFURIC ACID; ENGINEERING SERVICES; ARCHITECTURAL DESIGN OF INDUSTRIAL PLANTS; TECHNICAL CONSULTATION IN THE FIELDS OF THE PRODUCTION OF CATALYTIC SULFURIC ACID; CHEMICAL ANALYSIS AND RESEARCH SERVICES (U.S. CLS. 100 AND 101).

SN 76-289,936. WHANG, DONG MIN, CARSON, CA. FILED 7-26-2001.



NO CLAIM IS MADE TO THE EXCLUSIVE RIGHT TO USE "JAVA" AND "COFFEE", APART FROM THE MARK AS SHOWN.

CLASS 29—MEATS AND PROCESSED FOODS

FOR MILK AND MILK PRODUCTS, NAMELY, PASTEURIZED MILK, SKIM MILK, WHOLE MILK, FLAVORED MILK, VITAMINIZED MILK, STERILIZED MILK, EVAPORATED MILK, POWDERED MILK, CONDENSED AND MALTED MILK; DAIRY BASED FOOD BEVERAGES; CREAM; WHIPPING CREAM; DAIRY OR NON-DAIRY BASED WHIPPED TOPPING; LIQUID NON-DAIRY COFFEE CREAMER; POWDERED NON-DAIRY COFFEE CREAMER; SOY-BASED FOOD BEVERAGE USED AS A MILK SUBSTITUTE (U.S. CL. 46).

CLASS 30—STAPLE FOODS

FOR GROUND AND WHOLE BEAN COFFEE; HERBAL AND NON-HERBAL TEAS; COCOA; COFFEE; TEA; COCOA AND ESPRESSO BEVERAGES; COFFEE-BASED BEVERAGES; INSTANT COFFEE AND COFFEE SUBSTITUTES; READ-TO-DRINK COFFEE BEVERAGES; FLAVORING SYRUPS; BAKED GOODS, NAMELY, MUFFINS, SCONES, BISCUITS, COOKIES, CAKES, PASTRIES, AND BREADS; MIXES FOR BAKERY GOODS; ICE CREAM AND FROZEN CONFECTIONS; CANDY; CONFECTIONS, NAMELY CHOCOLATE AND TRUFFLES; AND READY-TO-EAT BREAKFAST CEREALS (U.S. CL. 46).

CLASS 42—SCIENTIFIC, COMPUTER AND LEGAL SERVICES

FOR RESTAURANT, CAFE AND COFFEE HOUSE SERVICES (U.S. CLS. 100 AND 101).

SN 76-290,266. PHANTOM MFG. (INT'L) LTD., ABBOTSFORD, BRITISH COLUMBIA, CANADA, FILED 7-25-2001.



OWNER OF U.S. REG. NOS. 1,983,857, 2,266,665 AND 2,266,669.

NO CLAIM IS MADE TO THE EXCLUSIVE RIGHT TO USE "SCREENS", APART FROM THE MARK AS SHOWN.

CLASS 6—METAL GOODS

FOR SCREEN COMPONENTS MADE OF METAL, NAMELY CYLINDRICAL METAL HOUSINGS FOR RETRACTABLE INSECT SCREENS AND SUN SCREENS FOR DOORS, WINDOWS AND SKYLIGHTS (U.S. CLS. 2, 12, 13, 14, 23, 25 AND 50).

FIRST USE 8-23-2000; IN COMMERCE 8-23-2000.

CLASS 19—NON-METALLIC BUILDING MATERIALS

FOR NON-METAL SCREENS - NAMELY RETRACTABLE INSECT SCREENS AND SUN SCREENS FOR DOORS, WINDOWS AND SKYLIGHTS (U.S. CLS. 1, 12, 33 AND 50).

FIRST USE 8-23-2000; IN COMMERCE 8-23-2000.

SN 76-290,509. ATKINS NUTRITIONALS, INC., NEW YORK, NY. FILED 7-27-2001.

ATKINS NUTRITIONAL APPROACH

OWNER OF U.S. REG. NOS. 2,434,476, 2,436,113 AND 2,437,823.

NO CLAIM IS MADE TO THE EXCLUSIVE RIGHT TO USE "NUTRITIONAL", APART FROM THE MARK AS SHOWN.

THE NAME "ATKINS" IDENTIFIES A LIVING INDIVIDUAL WHOSE CONSENT IS OF RECORD.

CLASS 5—PHARMACEUTICALS

FOR FOOD SUPPLEMENTS, VITAMINS, MINERAL SUPPLEMENTS, NUTRITIONAL SUPPLEMENTS, NUTRITIONAL CANDY BARS, DIETARY SUPPLEMENTS AND DIETARY DRINK MIX FOR USE AS A MEAL REPLACEMENT, ALL OF WHICH DO NOT CONTAIN GINSENG (U.S. CLS. 6, 18, 44, 46, 51 AND 52).

CLASS 29—MEATS AND PROCESSED FOODS

FOR LOW CARBOHYDRATE DAIRY BASED AND SOY BASED SHAKE MIXES, VEGETABLE BASED AND SOY BASED READY TO EAT FOOD BARS, SNACK FOOD DIPS, SOUPS, SOUP MIXES, WHIPPED TOPPING, POTATO BASED SNACK FOODS, SOY BASED SNACK FOODS, AND POTATO CHIPS, ALL OF WHICH DO NOT CONTAIN GINSENG (U.S. CL. 46).

CLASS 30—STAPLE FOODS

FOR GRAIN BASED, CHOCOLATE BASED, OAT BASED AND GRANOLA BASED READY TO EAT FOOD BARS, CEREAL BASED SNACK FOODS, RICE BASED SNACK FOODS, CORN BASED SNACK FOODS, BAKERY GOODS, PASTRIES, WHEAT BASED CRACKERS, TOASTED CORN SNACKS, CORN CHIPS, GRAIN BASED CHIPS, BISCUITS, CANDY, PUFFED CORN SNACKS, PUFFED RICE SNACKS, BAGELS, BAKING POWDER, BARBECUE SAUCE, BRAN, BREAD, BREAD STICKS, BREAKFAST CEREALS, CAKE MIXES, CAKES, BAKE MIX, PROCESSED CEREALS, FLOUR, CHEESECAKE, FLOUR-BASED CHIPS, GRAIN BASED CHIPS, CHOCOLATE CHIPS, CHOCOLATE POWDER, CHOCOLATE SYRUP, CHOCOLATE TOPPING, CONES FOR ICE CREAM, COOKIES, CRACKERS, DOUGH, FLAVORING SYRUP, ICE CREAM, ICING, PANCAKE SYRUP, MARSHMALLOWS, PANCAKE MIXES, PIZZA DOUGH, PIZZA SAUCE, SPAGHETTI SAUCE, TOMATO SAUCE, PRETZELS, PUDDINGS, SALAD DRESSINGS, TACO CHIPS, TACO SHELLS, TACOS, AND WAFFLES, ALL OF WHICH DO NOT CONTAIN GINSENG (U.S. CL. 46).

SN 76-291,884. LIGHTBORNE PUBLISHING, INC., CINCINNATI, OH. FILED 7-30-2001.

BEST OF CINCINNATI

SEC. 2(F).

CLASS 16—PAPER GOODS AND PRINTED MATTER

FOR MAGAZINE SUPPLEMENT TO A NEWSPAPER IN THE FIELDS OF FOOD SERVICE, PUBLIC RECREATIONAL AND SPORTING EVENTS AND FACILITIES, NIGHT CLUB SERVICES, RETAIL SERVICES, SPA AND SALON SERVICES, INNKEEPING, MUSIC, THEATER, ART, BROADCASTING, JOURNALISM, PUBLIC SERVICE AND PHILANTHROPY (U.S. CLS. 2, 5, 22, 23, 29, 37, 38 AND 50).

FIRST USE 3-20-1997; IN COMMERCE 3-20-1997.

CLASS 41—EDUCATION AND ENTERTAINMENT

FOR PROVIDING RECOGNITION BY WAY OF AWARDS TO DEMONSTRATE EXCELLENCE OR DISTINCTION IN THE FIELDS OF FOOD SERVICE, PUBLIC RECREATIONAL AND SPORTING EVENTS AND FACILITIES, NIGHT CLUB SERVICES, RETAIL SERVICES, SPA AND SALON SERVICES, INNKEEPING, MUSIC, THEATER, ART, BROADCASTING, JOURNALISM, PUBLIC SERVICE AND PHILANTHROPY (U.S. CLS. 100, 101 AND 107).

FIRST USE 3-20-1997; IN COMMERCE 3-20-1997.

CLASS 42—SCIENTIFIC, COMPUTER AND LEGAL SERVICES

FOR PROVIDING INFORMATION OF INTEREST TO SPECIFIC GEOGRAPHICAL AREAS VIA THE GLOBAL COMPUTER NETWORK (U.S. CLS. 100 AND 101).
FIRST USE 3-20-1997; IN COMMERCE 3-20-1997.

SN 76-291,921. MCKECHNIE AEROSPACE (UK) LTD., WALLSALL, WEST MIDLANDS WS9 8DS, UNITED KINGDOM, FILED 7-31-2001.

SOLUTIONEERING**CLASS 35—ADVERTISING AND BUSINESS**

FOR PARTS INVENTORY MANAGEMENT FOR OTHERS IN THE AEROSPACE INDUSTRY (U.S. CLS. 100, 101 AND 102).

CLASS 40—MATERIAL TREATMENT

FOR CUSTOM MANUFACTURE OF AIRCRAFT PARTS FOR OTHERS IN THE AEROSPACE INDUSTRY (U.S. CLS. 100, 103 AND 106).

CLASS 42—SCIENTIFIC, COMPUTER AND LEGAL SERVICES

FOR CUSTOM DESIGN OF AIRCRAFT PARTS FOR OTHERS IN THE AEROSPACE INDUSTRY (U.S. CLS. 100 AND 101).

SN 76-292,002. AALBORG INDUSTRIES A/S, DK-9100 AALBORG, DENMARK, FILED 7-30-2001.

YOUR HOT CONNECTION

PRIORITY CLAIMED UNDER SEC. 44(D) ON DENMARK APPLICATION NO. VA200100949, FILED 3-6-2001, REG. NO. VR200101617, DATED 4-3-2001, EXPIRES 4-3-2011.

CLASS 9—ELECTRICAL AND SCIENTIFIC APPARATUS

FOR BOILER CONTROL APPARATUS, NAMELY, PROCESS CONTROLLERS, AND BOILER CONTROL INSTRUMENTS; APPARATUS FOR THE CONTROL AND ANALYSIS OF GAS FLUE, NAMELY, GAS-FLUE CONTROLLERS AND COMPUTER PROGRAMS FOR GAS FLUE ANALYSIS (U.S. CLS. 21, 23, 26, 36 AND 38).

CLASS 11—ENVIRONMENTAL CONTROL APPARATUS

FOR STEAM BOILERS; MARINE BOILERS; HOT WATER BOILERS; THERMAL OIL BOILERS; INDUSTRIAL BOILERS; BOILER PIPES AND TUBES; BOILER FEED WATER INSTALLATIONS, BOILER FUEL FEED INSTALLATIONS; HEAT EXCHANGERS FOR OIL, WATER AND STEAM COOLING, HEATING AND EVAPORATION; FILTERS FOR BOILERS SOLD AS PART OF BOILER INSTALLATIONS; FLUE-GAS FILTERS SOLD AS PART OF BOILER INSTALLATIONS (U.S. CLS. 13, 21, 23, 31 AND 34).

CLASS 37—CONSTRUCTION AND REPAIR

FOR BOILER SERVICES, NAMELY, BUILDING, INSTALLATION MAINTENANCE AND REPAIR (U.S. CLS. 100, 103 AND 106).

SN 76-292,811. VI-JON LABORATORIES, INC., DBA VI-JON, INC., ST. LOUIS, MO. FILED 7-31-2001.

PURELY GENTLE**CLASS 3—COSMETICS AND CLEANING PREPARATIONS**

FOR ANTI-BACTERIAL AND ANTI-MICROBIAL HAND AND LOTION SOAP (U.S. CLS. 1, 4, 6, 50, 51 AND 52).

CLASS 5—PHARMACEUTICALS

FOR HAND SANITIZING AND DISINFECTING PREPARATION WITH ANTI-BACTERIAL AND ANTI-MICROBIAL PROPERTIES (U.S. CLS. 6, 18, 44, 46, 51 AND 52).

SN 76-294,866. INFINTIUM TECHNOLOGIES CORP., GLEN ALLEN, VA. FILED 8-3-2001.

SENTRALIAN**CLASS 35—ADVERTISING AND BUSINESS**

FOR TRACKING, REPORTING, ANALYZING, AND DELIVERING BILLS AND BILLING INFORMATION (U.S. CLS. 100, 101 AND 102).

CLASS 42—SCIENTIFIC, COMPUTER AND LEGAL SERVICES

FOR DESIGNING BILLING AND CUSTOMER CARE SOFTWARE (U.S. CLS. 100 AND 101).

SN 76-295,141. INTERVOICE LIMITED PARTNERSHIP, RENO, NV. FILED 8-3-2001.

IVB**CLASS 9—ELECTRICAL AND SCIENTIFIC APPARATUS**

FOR INTERACTIVE TELECOMMUNICATIONS SYSTEMS COMPRISED OF COMPUTER HARDWARE AND SOFTWARE FOR PROCESSING TELEPHONE CALLS AND DATA TELECOMMUNICATIONS ACROSS A COMMUNICATIONS NETWORK, INTERACTIVE VOICE RESPONSE COMMUNICATIONS, GRAPHICAL TELEPHONY APPLICATION DEVELOPMENT, INBOUND/OUTBOUND CALL DISTRIBUTION AND ENHANCED TELEPHONY SERVICES (U.S. CLS. 21, 23, 26, 36 AND 38).

CLASS 35—ADVERTISING AND BUSINESS

FOR BUSINESS INFORMATION SERVICES FOR THE INTERACTIVE TELECOMMUNICATIONS AND INFORMATION SYSTEMS OF OTHERS (U.S. CLS. 100, 101 AND 102).

CLASS 38—COMMUNICATION

FOR TELECOMMUNICATIONS SERVICES, NAMELY, PERSONAL COMMUNICATIONS SERVICES OF PROCESSING TELEPHONE CALLS AND DATA TELECOMMUNICATIONS ACROSS A COMMUNICATIONS NETWORKS, AND INTERACTIVE VOICE RESPONSE COMMUNICATIONS (U.S. CLS. 100, 101 AND 104).

CLASS 42—SCIENTIFIC, COMPUTER AND LEGAL SERVICES

FOR COMPUTER SYSTEMS MANAGEMENT AND SUPPORT SERVICES FOR INTERACTIVE TELECOMMUNICATIONS AND INFORMATION SYSTEMS FOR OTHERS, NAMELY, PROVIDING MANAGEMENT AND SUPPORT FROM AN ON-SITE OR OFF-SITE LOCATION FOR PROCESSING TELEPHONE CALLS AND DATA TELECOMMUNICATIONS ACROSS A COMMUNICATIONS NETWORK, INTERACTIVE VOICE RESPONSE COMMUNICATIONS, GRAPHICAL TELEPHONY APPLICATIONS DEVELOPMENT, INBOUND OR OUTBOUND CALL DISTRIBUTION AND ENHANCED TELEPHONY SERVICES (U.S. CLS. 100 AND 101).

SN 76-295,577. FRIENDS OF THE NATIONAL ZOO, WASHINGTON, DC. FILED 8-7-2001.

KIDS ADOPT A HABITAT

NO CLAIM IS MADE TO THE EXCLUSIVE RIGHT TO USE "KIDS" AND "HABITAT", APART FROM THE MARK AS SHOWN.

CLASS 35—ADVERTISING AND BUSINESS

FOR RETAIL STORE SERVICES AND ONLINE RETAIL SERVICES FEATURING ZOO RELATED GOODS, NAMELY MUGS, POSTCARDS, KEYCHAINS, MAGNETS, PENS, MOUSE PADS, GLASSES, LUGGAGE, UMBRELLAS, T-SHIRTS, TIES, BOOTS, RAINCOATS, GOLF BALLS, TILES FEATURING ANIMALS, COOKIE KITS, JEWELRY BOXES, POSTERS, PICTURES, CERAMICS, SCULPTURES, GAMES AND PUZZLES, BOOKS AND VIDEOS (U.S. CLS. 100, 101 AND 102).

CLASS 36—INSURANCE AND FINANCIAL

FOR CHARITABLE FUND RAISING SERVICES FOR ENVIRONMENTAL AND CONSERVATION CAUSES (U.S. CLS. 100, 101 AND 102).

SN 76-295,671. BEST PICTURE SHOW COMPANY PTY LTD, THE, BRISBANE, QUEENSLAND 4000, AUSTRALIA, FILED 8-2-2001.

CROCMAN**CLASS 25—CLOTHING**

FOR CLOTHING, NAMELY, TEE SHIRTS, SHORTS, POLO SHIRTS, JACKETS, JUMPERS, PULLOVERS, SWEATSHIRTS, FOOTWEAR, HEADWEAR, HATS AND CAPS (U.S. CLS. 22 AND 39).

CLASS 28—TOYS AND SPORTING GOODS

FOR GAMES AND PLAYTHINGS, NAMELY, CARD GAMES, BOARD GAMES, ACTION SKILL GAMES, BATH TOYS, CRIB TOYS; TOYS, NAMELY, PLUSH TOYS, PET TOYS, MUSICAL TOYS, DRAWING TOYS, MECHANICAL TOYS, PUSH TOYS, SQUEEZE TOYS AND PRINTING TOYS (U.S. CLS. 22, 23, 38 AND 50).

CLASS 41—EDUCATION AND ENTERTAINMENT

FOR EDUCATIONAL AND ENTERTAINMENT SERVICES, NAMELY, CONDUCTING CLASSES, SEMINARS AND WORKSHOPS IN THE FIELD OF ANIMAL AND THE ENVIRONMENT; PRODUCTION AND DISTRIBUTION OF TELEVISION PROGRAMS AND MOTION PICTURES (U.S. CLS. 100, 101 AND 107).

SN 76-295,746. BEIERSDORF AKTIENGESELLSCHAFT, 20245 HAMBURG, FED REP GERMANY, FILED 8-6-2001.

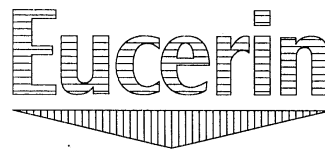

PRIORITY CLAIMED UNDER SEC. 44(D) ON FED REP GERMANY APPLICATION NO. 30130888.8/0, FILED 5-18-2001, REG. NO. 30130888, DATED 7-10-2001, EXPIRES 5-18-2011.

OWNER OF U.S. REG. NOS. 1,172,795, 1,224,781 AND 1,709,656.

THE MARK CONSISTS OF "EUCERIN" IN BLUE LETTERS ABOVE A RED TRIANGLE DESIGN. THE COLORS ARE CLAIMED AS A FEATURE OF THE MARK.

CLASS 3—COSMETICS AND CLEANING PREPARATIONS

FOR SOAPS, PREPARATIONS FOR BODY AND BEAUTY CARE, NAMELY, PREPARATIONS FOR THE CARE OF THE SKIN AND FACE CARE PRODUCTS IN FORM OF CREAMS, GELS AND LOTIONS; DEODORANTS FOR PERSONAL USE; SHAVING CREAMS AND SHAVING FOAMS, AFTER-SHAVE BALM, AFTER-SHAVE LOTION; PREPARATIONS FOR THE CARE, CLEANSING AND EMBELLISHMENT OF THE HAIR, NAMELY, NON-MEDICATED SHAMPOOS AND NON-MEDICATED CONDITIONERS; BATH AND SHOWER ADDITIVES, NAMELY, BATH OIL, SHOWER GEL, NON-MEDICATED BATH SALTS; NON-MEDICATED SUNBLOCK AND SUNSCREEN; MEDICATED SOAPS (U.S. CLS. 1, 4, 6, 50, 51 AND 52).

CLASS 5—PHARMACEUTICALS

FOR MEDICATED SKIN AND BODY PREPARATIONS FOR DRY SKIN, NAMELY, CREAMS, GELS AND LOTIONS; MEDICATED DERMATOLOGICAL PREPARATIONS FOR THE TREATMENT OF ECZEMA, PSORIASIS AND SKIN DISEASES; MEDICATED HAIR SHAMPOOS AND MEDICATED HAIR CONDITIONERS; MEDICATED BATH SALTS AND MEDICATED SHOWER GELS; MEDICATED SUNSCREEN AND MEDICATED SUNBLOCK; MEDICATED ANTI-AGING CREAM (U.S. CLS. 6, 18, 44, 46, 51 AND 52).

SN 76-296,060. ARGENTERIE VICENTINE S.R.L, 36051 OLMO DI CREAZZO (VICENZA), ITALY, FILED 8-6-2001.

DUETTO

PRIORITY CLAIMED UNDER SEC. 44(D) ON ITALY APPLICATION NO. VI2001C00037, FILED 7-16-2001, REG. NO. 854840, DATED 11-9-2001, EXPIRES 7-16-2011.

THE ENGLISH TRANSLATION OF THE WORD "DUETTO" IN THE MARK IS "DUET".

CLASS 8—HAND TOOLS

FOR KNIVES FORKS AND SPOONS MADE OF PRECIOUS METALS (U.S. CLS. 23, 28 AND 44).

CLASS 14—JEWELRY

FOR NECKLACES, BRACELETS, EARRINGS, RINGS, BROOCHES AND PENDANTS, CUFF-LINKS, TIEPINS, CLIPS FOR DOCUMENTS AND BANKNOTES, ALL THE ABOVE ARTICLES BEING MADE OF GOLD AND/OR OTHER PRECIOUS METALS, WITH OR WITHOUT PRECIOUS STONES; PEARLS AND CULTURED PEARLS; WATCHES AND STRAPS FOR WATCHES (U.S. CLS. 2, 27, 28 AND 50).

CLASS 25—CLOTHING

FOR CLOTHING, NAMELY, JACKETS, COATS, PARKAS, BLOUSONS, SUITS, SKIRTS, PANTS, TROUSERS, BREECHES, COATS, SWEATERS, VESTS, CARDIGANS, TEE-SHIRTS, SHIRTS, BLOUSES, DRESSES FOR WOMEN, CAMISOLES; BANDS OF LEATHER FOR PANTS OR TROUSERS AND SKIRTS; CLOTHING FOR GYMNASTICS, NAMELY, SHORTS, LEOTARDS, LEGGINGS AND TIGHTS; SPATS, UNIFORMS, CLOTHING OF LEATHER, NAMELY, PANTS, JACKETS, SHIRTS AND SKIRTS; BODICES, SWEAT SHIRTS, APRONS, BABY'S PANTS, BATHROBES, PAJAMAS, BATHING CAPS, BATHING DRAWERS, BATHING SUITS, BANDANAS, SOCKS, GLOVES, SCARVES, BOAS, MUFFLERS, NECKTIES, EAR MUFFS, BELTS, HEAD WEAR, SHOES, SANDALS, AND BOOTS (U.S. CLS. 22 AND 39).

SN 76-296,517. 45RPM STUDIO CO. LTD., MINATO- KU, TOKYO 107-0062, JAPAN, FILED 8-8-2001.



Badou - R

THE ENGLISH TRANSLATION OF "BADOU-R" IS "HORSE ROAD-R."

CLASS 14—JEWELRY

FOR ALARM CLOCK, BADGES OF PRECIOUS METAL; BRACELETS; BROOCHES; BUCKLES OF PRECIOUS METAL; JEWELLERY CHAINS; TIE CLIP; CLOCKS; CUFF LINKS; EARRINGS; JEWELLERY; NECKLACES; WRIST WATCHES (U.S. CLS. 2, 27, 28 AND 50).

CLASS 18—LEATHER GOODS

FOR ATTACHE' CASES; BACKPACKS; GARMENT BAGS FOR TRAVEL; BAGS FOR CAMPERS; BRIEFCASES; HAND BAGS; BUSINESS CARD CASES; COLLARS FOR ANIMALS; FUR PELTS; KEY CASES; POCKET WALLETS; PURSES; SCHOOL SATCHELS; SUITCASES; UMBRELLAS; UMBRELLA COVERS; VANITY CASES NOT FITTED (U.S. CLS. 1, 2, 3, 22 AND 41).

CLASS 24—FABRICS

FOR CLOTH BANNERS; BATH LINEN; BED BLANKETS; BED COVER; BED LINEN; FABRICS FOR CLOTHING; COVERS FOR CUSHIONS; PILLOWCASES; TABLE CLOTHS; TAPESTRY OF TEXTILE (U.S. CLS. 42 AND 50).

SN 76-297,428. VILLANOVA UNIVERSITY IN THE STATE OF PENNSYLVANIA, VILLANOVA, PA. FILED 8-9-2001.

**CLASS 36—INSURANCE AND FINANCIAL**

FOR FINANCIAL SPONSORSHIP OF UNIVERSITY ATHLETES, ATHLETIC PERFORMANCES AND ATHLETIC TEAMS (U.S. CLS. 100, 101 AND 102).
FIRST USE 1-0-2000; IN COMMERCE 1-0-2000.

CLASS 41—EDUCATION AND ENTERTAINMENT

FOR ENTERTAINMENT SERVICES, NAMELY, ARRANGING AND CONDUCTING ATHLETIC COMPETITIONS (U.S. CLS. 100, 101 AND 107).
FIRST USE 1-0-2000; IN COMMERCE 1-0-2000.

SN 76-297,432. VESTEY GROUP LIMITED, LONDON EC1M 4AF, UNITED KINGDOM, FILED 8-9-2001.



OWNER OF UNITED KINGDOM REG. NO. 2121237, DATED 1-18-1997, EXPIRES 1-18-2007.

CLASS 29—MEATS AND PROCESSED FOODS

FOR MEAT, FISH POULTRY AND GAME, FROZEN AND FROSTED FRUIT AND VEGETABLES (U.S. CL. 46).

CLASS 35—ADVERTISING AND BUSINESS

FOR DISTRIBUTORSHIPS IN THE FIELD OF FOOD SERVICES (U.S. CLS. 100, 101 AND 102).

CLASS 39—TRANSPORTATION AND STORAGE

FOR STORAGE OF FOODSTUFFS (U.S. CLS. 100 AND 105).

SN 76-298,850. STAUFFER, LEAH, PHOENIXVILLE, PA. FILED 8-10-2001.

THE ART OF EXOTIC DANCING FOR EVERYDAY WOMEN

NO CLAIM IS MADE TO THE EXCLUSIVE RIGHT TO USE "EXOTIC DANCING" AND "WOMEN", APART FROM THE MARK AS SHOWN.

CLASS 9—ELECTRICAL AND SCIENTIFIC APPARATUS

FOR PRE-RECORDED INSTRUCTIONAL VIDEO-TAPES ON DANCING TECHNIQUES (U.S. CLS. 21, 23, 26, 36 AND 38).
FIRST USE 10-1-2000; IN COMMERCE 10-1-2000.

CLASS 41—EDUCATION AND ENTERTAINMENT

FOR EDUCATIONAL SERVICES, NAMELY, PROVIDING ADULT EDUCATION COURSES IN DANCING TECHNIQUES (U.S. CLS. 100, 101 AND 107).
FIRST USE 10-1-2000; IN COMMERCE 10-1-2000.

SN 76-298,239. WIBERG BESITZ GMBH, A-5020 SALZBURG, AUSTRIA, FILED 8-10-2001.

PLANTA LINE

PRIORITY CLAIMED UNDER SEC. 44(D) ON AUSTRIA APPLICATION NO. AM1147/2001, FILED 2-15-2001, REG. NO. 196608, DATED 5-31-2001, EXPIRES 5-31-2011.

CLASS 29—MEATS AND PROCESSED FOODS

FOR MEATS AND SAUSAGE; COOKED AND RAW HAMS; BACON, JELLIES ASPICS, UNFLAVORED AND UNSWEETENED GELATINS; COOKING OILS AND FATS; SEMI-COOKED, READY-COOKED, READY TO EAT AND PREPARED MEALS AND DISHES CONSISTING PRIMARILY OF MEAT, CHICKEN, FISH, GAME AND/OR VEGETABLES; PRESERVED FRUIT AND VEGETABLES, JAMS; MILK AND DAIRY PRODUCTS EXCLUDING ICE CREAM, ICE MILK AND FROZEN YOGURT; EGG ALBUMEN CONCENTRATE FOR FOOD; PRODUCTS DERIVED FROM MILK FOR USE AS A BASIC INGREDIENT OR INTERMEDIATE PRODUCT IN THE FOOD PROCESSING INDUSTRY, NAMELY, BUTTER AND CHEESE (U.S. CL. 46).

CLASS 30—STAPLE FOODS

FOR SPICES, SPICE MIXTURES AND SPICE PREPARATIONS; SPICE EXTRACTS AND SPICE SUBSTITUTES; DRIED SPICE PLANTS, DRY AND LIQUID SPICE SALTS; MAYONNAISE AND POWDERED PREPARATIONS TO MAKE MAYONNAISE; FOOD FLAVORINGS; TENDERIZING SALTS; MEAT TENDERIZERS; FLAVOR ENHANCERS, NAMELY, SAUCES AND MARINADES; MUSTARD, VINEGAR; CEREAL PREPARATIONS, NAMELY, BREAKFAST CEREALS; BAKING MIXES, NAMELY, MIXES FOR MAKING CAKES AND PIES; SEMI-COOKED, READY-COOKED, READY TO EAT AND PREPARED MEALS AND DISHES CONSISTING PRIMARILY OF RICE, CEREAL AND/OR DOUGH BASE; COFFEE, TEA, COCOA, BREAD, BAKERY PRODUCTS, SPICED ASPIC POWDER; SALAD DRESSINGS; BREAD CRUMB (U.S. CL. 46).

SN 76-299,143. SEGAL COMPANY (EASTERN STATES), INC., THE, NEW YORK, NY. FILED 8-9-2001.



OWNER OF U.S. REG. NOS. 1,931,674 AND 1,931,685.
THE MARK CONSISTS IN PART OF THREE TOUCHING ARROWHEADS.

CLASS 35—ADVERTISING AND BUSINESS

FOR BUSINESS CONSULTATION SERVICES, NAMELY, PROVIDING CONSULTING IN THE FIELD OF HUMAN RESOURCES AND DEFERRED COMPENSATION (U.S. CLS. 100, 101 AND 102).

CLASS 36—INSURANCE AND FINANCIAL

FOR FINANCIAL CONSULTING IN THE FIELD OF ACTUARIAL SERVICES, EMPLOYEE BENEFITS, WORKERS COMPENSATION (U.S. CLS. 100, 101 AND 102).

SN 76-299,266. MOONDANCE PICTURES PTY LTD, BALMAIN NSW 2041, AUSTRALIA, FILED 8-14-2001.

SN 76-300,119. DOG ANCHOR, INC., SMYRNA, GA. FILED 8-14-2001.



CLASS 9—ELECTRICAL AND SCIENTIFIC APPARATUS

FOR MOTION PICTURE FILMS RELATING TO DRAMA, MUSIC, DANCE AND COMEDY (U.S. CLS. 21, 23, 26, 36 AND 38).

CLASS 38—COMMUNICATION

FOR BROADCASTING FILMS VIA A GLOBAL COMPUTER NETWORK (U.S. CLS. 100, 101 AND 104).

CLASS 41—EDUCATION AND ENTERTAINMENT

FOR ENTERTAINMENT SERVICES, NAMELY DIRECTING SERVICES, FOR TELEVISION, MULTIMEDIA, FILM, STAGE AND RADIO PRODUCTION; SCRIPT WRITING SERVICES; THEATRE, STAGE AND FILM PRODUCTION SERVICES (U.S. CLS. 100, 101 AND 107).

SN 76-299,510. HIXON, NATASHA P., PROVO, UT. AND HIXON, MARK A., PROVO, UT. FILED 8-14-2001.

QUICKUTZ

CLASS 7—MACHINERY

FOR DIE CUTTING MACHINES, DIE CUTTING KITS COMPRISED OF DIE CUTTING MACHINES AND DIE SHAPES, CASES FOR DIE CUTTING MACHINES, BOXES FOR DIE CUTTING MACHINES, DIE STAMPING MACHINES, DIE STAMPING KITS COMPRISED OF DIE STAMPING MACHINES AND DIE SHAPES, CASES FOR DIE STAMPING MACHINES, BOXES FOR DIE STAMPING MACHINES, EMBOSSING MACHINES, EMBOSSING KITS COMPRISED OF EMBOSSING MACHINES AND EMBOSSING DIE SHAPES, CASES FOR EMBOSSING MACHINES, BOXES FOR DIE CUTTING MACHINES (U.S. CLS. 13, 19, 21, 23, 31, 34 AND 35).

CLASS 16—PAPER GOODS AND PRINTED MATTER

FOR DIE CUT ARTICLES, NAMELY, DIE CUT SHAPES, DIE STAMPED ARTICLES, NAMELY, DIE CUT SHAPES; EMBOSSED ARTICLES, NAMELY, DIE EMBOSSED SHAPES; SCRAPBOOKS, CRAFT PAPER, PLASTIC FILM NOT FOR COMMERCIAL OR INDUSTRIAL PURPOSES, PLASTIC FOILS (U.S. CLS. 2, 5, 22, 23, 29, 37, 38 AND 50).

DOG ANCHOR

NO CLAIM IS MADE TO THE EXCLUSIVE RIGHT TO USE "DOG", APART FROM THE MARK AS SHOWN.

CLASS 6—METAL GOODS

FOR PORTABLE PET CONTAINMENT AND TRAINING RESTRAINTS, NAMELY, BASES FORMED PRIMARILY OF METAL, COATED METAL CABLE WIRE, AND METAL FASTENERS (U.S. CLS. 2, 12, 13, 14, 23, 25 AND 50).

FIRST USE 5-0-2001; IN COMMERCE 5-0-2001.

CLASS 35—ADVERTISING AND BUSINESS

FOR COMPUTERIZED ONLINE ORDERING SERVICES IN THE FIELD OF PET PRODUCTS (U.S. CLS. 100, 101 AND 102).

FIRST USE 5-0-2001; IN COMMERCE 5-0-2001.

SN 76-300,421. AMERICAN EAGLE CO., INC., AUBURN HILLS, MI. FILED 8-16-2001.

DĒDO

OWNER OF U.S. REG. NOS. 1,904,431 AND 2,071,668. "DĒDO" IS A SPANISH WORD MEANING "DIGITS" OR "TOES".

CLASS 20—FURNITURE AND ARTICLES NOT OTHERWISE CLASSIFIED

FOR STATUES, STATUETTES, GARDEN STATUARIES, AND WALL ORNAMENTS, ALL MADE OF POLY RESIN MATERIAL; AND STATUES, STATUETTES, GARDEN STATUARIES, AND WALL ORNAMENTS, ALL MADE OF POLYURETHANE MATERIAL (U.S. CLS. 2, 13, 22, 25, 32 AND 50).

FIRST USE 9-9-1993; IN COMMERCE 9-9-1993.

CLASS 21—HOUSEWARES AND GLASS

FOR BIRD FEEDERS AND BIRD HOUSES, ALL MADE OF POLY RESIN MATERIAL; AND BIRD FEEDERS AND BIRD HOUSES, ALL MADE OF POLYURETHANE MATERIAL (U.S. CLS. 2, 13, 23, 29, 30, 33, 40 AND 50).

FIRST USE 9-9-1993; IN COMMERCE 9-9-1993.

SN 76-301,088. SIEMENS AKTIENGESELLSCHAFT, MUNCHEN, FED REP GERMANY, FILED 8-17-2001.

Bean Your Knowledge!

PRIORITY CLAIMED UNDER SEC. 44(D) ON FED REP GERMANY APPLICATION NO. 301204322/09, FILED 3-28-2001, REG. NO. 30120432, DATED 5-11-2001, EXPIRES 3-31-2011.

CLASS 9—ELECTRICAL AND SCIENTIFIC APPARATUS

FOR DATA PROCESSING PROGRAMS, NAMELY, SOFTWARE FOR CONTENT PROVIDING IN THE FIELD OF KNOWLEDGE MANAGEMENT (U.S. CLS. 21, 23, 26, 36 AND 38).

CLASS 42—SCIENTIFIC, COMPUTER AND LEGAL SERVICES

FOR GLOBAL COMPUTER INFORMATION NETWORK CONTENT PROVIDER, NAMELY, PROVIDING INFORMATION IN THE FIELDS OF THE ELECTRONICS INDUSTRY AND INFORMATION TECHNOLOGY (U.S. CLS. 100 AND 101).

SN 76-301,218. IHEALER, LLC, SANTA MONICA, CA. FILED 8-17-2001.

IHEALER

CLASS 9—ELECTRICAL AND SCIENTIFIC APPARATUS

FOR COMPUTER SOFTWARE WHICH PROVIDES ACCESS TO AN INTERACTIVE DATA BASE FOR PERSONALIZED HEALTH CARE AND MEDICAL INFORMATION (U.S. CLS. 21, 23, 26, 36 AND 38).

CLASS 42—SCIENTIFIC, COMPUTER AND LEGAL SERVICES

FOR PROVIDING HEALTH CARE INFORMATION; MEDICAL RESEARCH; COMPUTER SOFTWARE DESIGN FOR OTHERS, INSTALLATION OF COMPUTER SOFTWARE, AND MAINTENANCE OF COMPUTER SOFTWARE (U.S. CLS. 100 AND 101).

SN 76-301,234. KLARICH, ANTHONY JOHN, CANYON LAKE, CA. FILED 8-17-2001.

SOCCOURT

CLASS 9—ELECTRICAL AND SCIENTIFIC APPARATUS

FOR INSTRUCTIONAL MATERIALS, NAMELY, PRE-RECORDED VIDEOTAPES FEATURING INSTRUCTION ON WALL SOCCER (U.S. CLS. 21, 23, 26, 36 AND 38).

CLASS 16—PAPER GOODS AND PRINTED MATTER

FOR INSTRUCTIONAL MATERIALS, NAMELY, PRINTED MATERIALS FEATURING INSTRUCTION ON WALL SOCCER (U.S. CLS. 2, 5, 22, 23, 29, 37, 38 AND 50).

CLASS 28—TOYS AND SPORTING GOODS

FOR SPORTING GOODS, NAMELY, WALL SOCCER BALLS (U.S. CLS. 22, 23, 38 AND 50).

SN 76-301,309. SAN FRANCISCO MERCANTILE COMPANY, SAN FRANCISCO, CA. FILED 8-17-2001.

E.W. STUDIO AN EILEEN WEST COMPANY

OWNER OF U.S. REG. NOS. 1,431,188, 1,955,570 AND OTHERS.

NO CLAIM IS MADE TO THE EXCLUSIVE RIGHT TO USE "STUDIO" AND "COMPANY", APART FROM THE MARK AS SHOWN.

THE NAME "EILEEN WEST" IDENTIFIES A LIVING INDIVIDUAL WHOSE CONSENT IS OF RECORD.

CLASS 20—FURNITURE AND ARTICLES NOT OTHERWISE CLASSIFIED

FOR PILLOWS (U.S. CLS. 2, 13, 22, 25, 32 AND 50).

CLASS 21—HOUSEWARES AND GLASS

FOR NON-TEXTILE BED, BATH AND KITCHEN ACCESSORIES, NAMELY SOAP DISPENSERS, TOOTH BRUSH HOLDERS, CUPS, CUP HOLDERS, WASTEPAPER BASKETS AND LOTION DISPENSERS (U.S. CLS. 2, 13, 23, 29, 30, 33, 40 AND 50).

CLASS 24—FABRICS

FOR TEXTILE BED, BATH AND KITCHEN ACCESSORIES, NAMELY TOWELS, LINENS, SHEETS, PILLOWCASES, COMFORTERS, PILLOW SHAMS, BEDSPREADS, BLANKETS, QUILTS, DUST RUFFLES, DUVET COVERS, TABLE CLOTHS, TABLE ROUNDS, TABLE RUNNERS, NAPKINS, PLACE MATS, SHOWER CURTAINS, AND WINDOW TREATMENTS, NAMELY CURTAINS, DRAPERIES, SWAGS, FABRIC TIEBACKS, AND FABRIC VALENCES (U.S. CLS. 42 AND 50).

CLASS 25—CLOTHING

FOR WOMEN'S DRESSES, PANTS, SKIRTS, JACKETS, BLOUSES, SWEATERS, SCARVES, SHOES, T-SHIRTS, SHORTS, TAP PANTS AND ROMPERS; SLEEPWEAR, NAMELY PAJAMAS, NIGHTGOWNS, ROBES, AND SLIPPERS, AND INTIMATE WEAR, NAMELY BRAS, PANTIES, SLIPS, TEDDIES, AND LINGERIE (U.S. CLS. 22 AND 39).

CLASS 27—FLOOR COVERINGS

FOR RUGS (U.S. CLS. 19, 20, 37, 42 AND 50).

SN 76-301,453. HENDSCH, CHARLES, LA JOLLA, CA. FILED 8-17-2001.

DYNASTY

CLASS 41—EDUCATION AND ENTERTAINMENT

FOR ENTERTAINMENT SERVICES IN THE NATURE OF PROFESSIONAL PAINTBALL GAMES AND EXHIBITIONS (U.S. CLS. 100, 101 AND 107).

CLASS 42—SCIENTIFIC, COMPUTER AND LEGAL SERVICES

FOR ASSOCIATION SERVICES, NAMELY, PROMOTING THE INTERESTS OF PAINTBALL PLAYERS, EQUIPMENT MANUFACTURERS AND FACILITY OWNERS (U.S. CLS. 100 AND 101).

SN 76-301,598. DANCE INSTITUTE OF WASHINGTON, WASHINGTON, DC. FILED 8-20-2001.

JUMP 'N STRETCH

CLASS 36—INSURANCE AND FINANCIAL

FOR CHARITABLE FUND RAISING SERVICES (U.S. CLS. 100, 101 AND 102).
FIRST USE 11-0-1996; IN COMMERCE 11-0-1996.

CLASS 41—EDUCATION AND ENTERTAINMENT

FOR PROVIDING COMMUNITY OUTREACH PROGRAMS IN THE FIELD OF DANCE; EDUCATIONAL SERVICES, NAMELY, CONDUCTING CLASSES, SEMINARS AND WORKSHOPS IN THE FIELDS OF DANCE, DANCE HISTORY, AND CAREER COUNSELING, AND DISTRIBUTING COURSE MATERIALS IN CONNECTION THEREWITH; ENTERTAINMENT IN THE NATURE OF DANCE PERFORMANCES; DANCE SCHOOLS; AND DANCE STUDIOS (U.S. CLS. 100, 101 AND 107).
FIRST USE 11-0-1996; IN COMMERCE 11-0-1996.

SN 76-301,631. ACCOR, EVRY, FRANCE, FILED 5-4-2001.

ACCOR

CLASS 38—COMMUNICATION

FOR ELECTRONIC COMMUNICATION SERVICES, NAMELY, SERVICES FOR THE TRANSMISSION OF INFORMATION VIA TELEMATIC MEANS ELECTRONIC TRANSMISSION OF DATA, SOUNDS AND IMAGES VIA COMPUTER TERMINALS OR COMPUTER NETWORK; PROVIDING TELECOMMUNICATIONS CONNECTIONS TO A GLOBAL COMPUTER NETWORK; ELECTRONIC MAIL SERVICES, NAMELY, SENDING AND RECEIVING DATA, SIGNALS, IMAGES AND INFORMATION VIA COMPUTER AND MESSAGES SERVICES; ELECTRONIC TRANSMISSION OF MESSAGES AND ENCODED IMAGES; RADIO COMMUNICATION; COMMUNICATION BY TELEGRAM; TELEPHONE COMMUNICATION SERVICES; COMMUNICATIONS BY TELEVISION, NAMELY, TELEVISION BROADCASTING; ELECTRONIC MAIL SERVICES; TELEPHONE VOICE MESSAGING SERVICES (U.S. CLS. 100, 101 AND 104).

CLASS 39—TRANSPORTATION AND STORAGE

FOR FREIGHT TRANSPORTATION BY TRUCK, TRAIN OR AIR; TRANSPORT OF PERSONS BY FERRY BOAT, AIR OR TRAIN; VEHICLE TOWING, TRAVEL AGENCY SERVICES, NAMELY, MAKING RESERVATIONS AND BOOKINGS FOR TRANSPORTATION; RENTAL OF VEHICLES AND ROOF RACKS FOR VEHICLES; ARRANGING TRAVEL TOURS; ARRANGING CRUISES; RENTAL OF GARAGE SPACE; AND PACKING ARTICLES FOR TRANSPORTATION (U.S. CLS. 100 AND 105).

CLASS 42—SCIENTIFIC, COMPUTER AND LEGAL SERVICES

FOR PROVIDING INFORMATION AT THE SPECIFIC REQUEST OF END-USERS BY MEANS OF TELEPHONE OR GLOBAL COMPUTER NETWORKS; MONITORING OF COMPUTER SYSTEMS, NAMELY, DATA SIGNALS, IMAGES AND INFORMATION BY COMPUTER; PROVIDING SPECIFIC INFORMATION AS REQUESTED BY CUSTOMERS VIA THE INTERNET AND INTRANET; HOTELS; RESTAURANTS; PROVIDING TEMPORARY HOUSING ACCOMMODATION; MOTELS; CAFETERIAS; BAR SERVICES; CONVALESCENT HOMES; TOURIST HOMES; REST HOMES; THALASSOTHERAPY ESTABLISHMENTS; ESCORT SERVICES; CHAPERONING; BEAUTY SALONS; HAIRDRESSING SALONS; MAKING HOTEL RESERVATIONS FOR OTHERS; RENTAL OF CLOTHING; PRINTING; AND TRAVEL AGENCY SERVICES, NAMELY, MAKING RESERVATIONS AND BOOKINGS FOR TEMPORARY LODGING; PROVIDING INFORMATION IN THE FIELD OF HOSTELRY AND TEMPORARY ACCOMMODATION VIA THE INTERNET OR INTRANET (U.S. CLS. 100 AND 101).

SN 76-301,675. NATIONAL PAINTBALL SUPPLY, INC., SEWELL, NJ. FILED 8-16-2001.

EMPIRE

CLASS 3—COSMETICS AND CLEANING PREPARATIONS

FOR PAINTBALL ACCESSORIES, NAMELY, ANTI-FOG SPRAY AND GOGGLE LENS CLEANER (U.S. CLS. 1, 4, 6, 50, 51 AND 52).

CLASS 9—ELECTRICAL AND SCIENTIFIC APPARATUS

FOR PAINTBALL ACCESSORIES, NAMELY, SPORTS GOGGLES AND LENSES (U.S. CLS. 21, 23, 26, 36 AND 38).

CLASS 18—LEATHER GOODS

FOR PAINTBALL ACCESSORIES, NAMELY, BACKPACKS, DUFFLE BAGS, BELT BAGS, AND BARREL BAGS (U.S. CLS. 1, 2, 3, 22 AND 41).

CLASS 25—CLOTHING

FOR CLOTHING, NAMELY, SHIRTS, JACKETS, JERSEYS, VESTS, PANTS, SHORTS, GLOVES, HATS, PAJAMAS, HEADBANDS, BELTS, AND CHILDREN'S CLOTHING, NAMELY, SHIRTS, JACKETS, JERSEYS, VESTS, PANTS, SHORTS, GLOVES, HATS, PAJAMAS, HEADBANDS, BELTS (U.S. CLS. 22 AND 39).

CLASS 28—TOYS AND SPORTING GOODS

FOR PAINTBALL PAINT, PAINTBALL MARKER GUNS, AND PAINTBALL MARKER GUN ACCESSORIES, NAMELY, VALVE PINS, FRONT BOLTS, VELOCITY ADJUSTERS, EXPANSION CHAMBERS, BARRELS, TRIGGER FRAMES, BARREL ADAPTORS, POWER FEED ADAPTORS, MARKER SCOPES, MARKER COVERS, MARKER HOLSTERS, COCKING BOLTS, SIGHT RAILS, SPRINGS, O-RINGS, TURBO VALVES, AIR TANKS, BALL DETENTS, SEARS, ACTUATOR RODS, AIR BLOCK SCREWS, SHAFTS, PUSH PINS, AIR REGULATORS, GRIPS, ELBOWS, BUTT PLATES; PAINTBALL ACCESSORIES, NAMELY, FACE MASKS, LOADERS, GUPPIES, HARNESSES, THROAT DEFLECTORS, CHEST DEFLECTORS, KNEE PADS FOR ATHLETIC USE, ELBOW PADS FOR ATHLETIC USE (U.S. CLS. 22, 23, 38 AND 50).

SN 76-302,064. SCHLUMBERGER OMNES, INC., HOUSTON, TX. FILED 8-20-2001.

DEXA.MOBILE**CLASS 38—COMMUNICATION**

FOR PROVIDING TELECOMMUNICATIONS CONNECTIONS TO A GLOBAL COMPUTER NETWORK (U.S. CLS. 100, 101 AND 104).

CLASS 42—SCIENTIFIC, COMPUTER AND LEGAL SERVICES

FOR DESIGN FOR OTHERS IN THE FIELD OF TELECOMMUNICATIONS, NAMELY, DESIGNING TELECOMMUNICATIONS NETWORKS (U.S. CLS. 100 AND 101).

SN 76-302,929. TOY SOLDIER, INC., NEW YORK, NY. BY ASSIGNMENT F.A.O. SCHWARZ, NEW YORK, NY. FILED 8-21-2001.

FAO SCHWARZ FIFTH AVENUE

OWNER OF U.S. REG. NO. 2,299,292.
NO CLAIM IS MADE TO THE EXCLUSIVE RIGHT TO USE "FIFTH AVENUE", APART FROM THE MARK AS SHOWN.

CLASS 28—TOYS AND SPORTING GOODS

FOR CHILDREN'S TOYS AND GAMES, NAMELY, PLUSH TOYS AND ANIMALS, PUPPETS, ROCKING HORSES, BABY TOYS, TOY TRAINS, MARBLE GAMES, BEADS, MODEL CARS AND TOY MUSICAL BANDS, RAG DOLLS, DOLLS AND DOLLS ACCESSORIES, BEADS, CHILDREN'S PLAY COSMETICS, SOCCER BALLS, VOLLEY BALLS, BASEBALLS, BASEBALL BATS AND GLOVES, JUMP ROPES AND FOUR SQUARE BALLS; HOBBY CRAFT KITS COMPRISING FOAM SHAPES, FOAM SHEETS, PIPE CLEANERS, SEQUINS, GLITTER GLUE, FEATHERS, CONFETTI, CRAFT STICKS, RIBBONS, FABRIC TRIM, YARNS, COLORED POMS, BEADS, WIGGLE EYES, FLOWER AND BUTTERFLY DANGLES AND FIGURATIVE LAMP SHADES; CHILDREN'S HOBBY SCIENCE KITS, LAB KITS, CHEMISTRY KITS AND EDUCATIONAL ACTIVITY KITS COMPRISING CHILDREN'S TELESCOPES, BINOCULARS AND MICROSCOPES (U.S. CLS. 22, 23, 38 AND 50).

FIRST USE 9-30-1986; IN COMMERCE 9-30-1986.

CLASS 35—ADVERTISING AND BUSINESS

FOR RETAIL TOY STORE SERVICES (U.S. CLS. 100, 101 AND 102).
FIRST USE 12-31-1985; IN COMMERCE 12-31-1985.

SN 76-303,060. CINDERELLAHAIR, SANTA FE SPRINGS, CA. FILED 8-22-2001.

CINDERELLAHAIR**CLASS 3—COSMETICS AND CLEANING PREPARATIONS**

FOR HAIR SHAMPOO, HAIR CONDITIONER, NON-MEDICATED HAIR CARE PREPARATIONS (U.S. CLS. 1, 4, 6, 50, 51 AND 52).
FIRST USE 7-0-2000; IN COMMERCE 7-0-2000.

CLASS 26—FANCY GOODS

FOR HAIR EXTENSIONS (U.S. CLS. 37, 39, 40, 42 AND 50).
FIRST USE 7-0-2000; IN COMMERCE 7-0-2000.

SN 76-303,816. WORLD THEATRE, INC., MORRISVILLE, NC. FILED 8-23-2001.

**CLASS 9—ELECTRICAL AND SCIENTIFIC APPARATUS**

FOR PRERECORDED COMPACT DISCS FEATURING MUSIC; PRERECORDED VIDEO CASSETTES AND DVDS FEATURING MUSIC AND ENTERTAINMENT (U.S. CLS. 21, 23, 26, 36 AND 38).

CLASS 35—ADVERTISING AND BUSINESS

FOR DISTRIBUTORSHIP SERVICES FEATURING MUSIC AND MUSIC RELATED MERCHANDISE, NAMELY, CDS, MUSIC MEMORABILIA, CONCERT TICKETS, AND DIGITAL DOWNLOADABLE FILES, FEATURING MUSIC, VIA AN INTERACTIVE TELEVISION APPLICATION AND A GLOBAL COMPUTER NETWORK; PROVIDING AN ONLINE GUIDE TO CUSTOMER SUPPORT AND SERVICE PROVIDERS (U.S. CLS. 100, 101 AND 102).

CLASS 38—COMMUNICATION

FOR TRANSMISSION OF MUSIC PROGRAMMING CONTENT, NAMELY, MUSIC VIDEOS, MUSIC INFORMATION, LONG FORM MUSIC PROGRAMMING, MUSIC DOCUMENTARIES, MUSIC NEWS, LONG AND SHORT FORM NON-FICTION MUSIC PROGRAMMING, LONG AND SHORT FORM FICTION MUSIC PROGRAMMING VIA DIGITAL CABLE TELEVISION, DIGITAL SATELLITE TELEVISION AND A GLOBAL COMPUTER NETWORK (U.S. CLS. 100, 101 AND 104).

CLASS 41—EDUCATION AND ENTERTAINMENT

FOR ENTERTAINMENT SERVICES, IN THE NATURE OF PRODUCING MUSIC PROGRAMMING CONTENT, NAMELY MUSIC VIDEOS, MUSIC INFORMATION, LONG FORM MUSIC PROGRAMMING, MUSIC DOCUMENTARIES, MUSIC NEWS, LONG AND SHORT FORM NON-FICTION MUSIC PROGRAMMING, AND LONG AND SHORT FORM FICTION MUSIC PROGRAMMING, ALL TO BE DISTRIBUTED VIA A DIGITAL CABLE TELEVISION, DIGITAL SATELLITE TELEVISION AND VIA A GLOBAL COMPUTER NETWORK, AND PRODUCING INTERACTIVE TELEVISION PROGRAMMING CONTENT, INCLUDING ENTERTAINMENT INFORMATION, NAMELY INFORMATION ABOUT ARTISTS, THE MUSIC INDUSTRY AND PRODUCT PURCHASE FOR DISTRIBUTION VIA AN INTERACTIVE TELEVISION APPLICATION; PROVIDING INFORMATION, NAMELY AN ONLINE GUIDE TO CABLE AND SATELLITE CHANNEL, FEATURING PROGRAMMING INFORMATION FOR THE CABLE AND SATELLITE INDUSTRY (U.S. CLS. 100, 101 AND 107).

SN 76-303,969. SPORTSLOOP COMMUNICATIONS, INC., CHICAGO, IL. FILED 8-22-2001.

SPORTSLOOP**CLASS 35—ADVERTISING AND BUSINESS**

FOR MANAGEMENT OF PROFESSIONAL ATHLETES AND ENTERTAINERS, NAMELY, PROVIDING REPRESENTATION FOR PROFESSIONAL ATHLETES AND ENTERTAINERS IN CONTRACT NEGOTIATIONS, ENDORSEMENTS AND OTHER MANAGEMENT SERVICES; ADVERTISING SERVICES, NAMELY, ARRANGING FOR PRODUCT PLACEMENT IN MOVIES AND TELEVISION; BUSINESS MARKETING CONSULTATION SERVICES, NAMELY, ASSISTING WITH DEVELOPING MARKETING STRATEGIES FOR SPORTS-RELATED COMPANIES; PROMOTING THE EVENTS OF OTHERS IN THE NATURE OF CELEBRITY, CORPORATE AND CHARITY GOLF TOURNAMENTS AND AMATEUR GOLF EVENTS AND OTHER SPORTING EVENTS; AND PROMOTING THE GOODS AND SERVICES OF OTHERS BY ARRANGING FOR SPONSORS TO AFFILIATE THEIR GOODS AND SERVICES WITH FOOTBALL, BASKETBALL, HOCKEY, BASEBALL, SOCCER, LACROSSE, GOLF, RODEO, VOLLEYBALL, MOTOR SPORTS, AND EXTREME SPORTS (U.S. CLS. 100, 101 AND 102).

FIRST USE 1-0-2001; IN COMMERCE 1-0-2001.

CLASS 41—EDUCATION AND ENTERTAINMENT

FOR ORGANIZING AND CONDUCTING CELEBRITY, CORPORATE AND CHARITY GOLF TOURNAMENTS AND AMATEUR GOLF EVENTS AND CUSTOMIZED SPORTING EVENTS FOR SOFTBALL, BASKETBALL, HOCKEY, SOCCER, LACROSSE, AND GOLF (U.S. CLS. 100, 101 AND 107).

FIRST USE 1-0-2001; IN COMMERCE 1-0-2001.

SN 76-304,060. AUDIO BUYS, INC., MANASSAS, VA. FILED 8-24-2001.

AUDIO BUYS

SEC. 2(F).

CLASS 35—ADVERTISING AND BUSINESS

FOR RETAIL STORE SERVICES IN THE AREAS OF AUDIO, VIDEO, AND HOME THEATER EQUIPMENT (U.S. CLS. 100, 101 AND 102).

FIRST USE 7-27-1976; IN COMMERCE 7-27-1976.

CLASS 37—CONSTRUCTION AND REPAIR

FOR CUSTOM HOME INSTALLATION OF AUDIO, VIDEO, AND HOME THEATER EQUIPMENT (U.S. CLS. 100, 103 AND 106).

FIRST USE 7-27-1976; IN COMMERCE 7-27-1976.

SN 76-304,325. BRIO TECHNOLOGY, INC., SANTA CLARA, CA. FILED 8-23-2001.



OWNER OF U.S. REG. NOS. 2,269,348, 2,495,801 AND 2,499,825.

NO CLAIM IS MADE TO THE EXCLUSIVE RIGHT TO USE "SOFTWARE", APART FROM THE MARK AS SHOWN. "BRIO" MEANS "VITALITY" OR "VIGOR".

CLASS 9—ELECTRICAL AND SCIENTIFIC APPARATUS

FOR COMPUTER SOFTWARE FOR USE IN SEARCHING, MANAGING, ANALYZING, PUBLISHING, REPORTING AND RETRIEVING DATA FROM ANY RELATIONAL DATA SOURCE IN CLIENT/SERVER, MULTI-TIERED OR GLOBAL COMPUTER NETWORK ENVIRONMENTS AND MANUALS FOR USE THEREWITH, SOLD AS A UNIT; COMPUTER SOFTWARE FOR CAPTURING, ASSESSING AND OPTIMIZING REVENUE PERFORMANCE; COMPUTER HARDWARE FOR MULTI-TIERED APPLICATION DATA ACCESS, DATA RETRIEVAL AND DATA ORGANIZATION (U.S. CLS. 21, 23, 26, 36 AND 38).

CLASS 42—SCIENTIFIC, COMPUTER AND LEGAL SERVICES

FOR CONSULTING SERVICES IN THE FIELD OF COMPUTER CLIENT/SERVER APPLICATIONS, COMPUTER NETWORKING AND DATA WAREHOUSING (U.S. CLS. 100 AND 101).

SN 76-304,330. CLASSIC CUSTOM VACATIONS, SAN JOSE, CA, CA. FILED 8-23-2001.

CLASSIC NEW ZEALAND

OWNER OF U.S. REG. NOS. 1,093,417, 2,426,074 AND OTHERS.

NO CLAIM IS MADE TO THE EXCLUSIVE RIGHT TO USE "NEW ZEALAND", APART FROM THE MARK AS SHOWN.

CLASS 39—TRANSPORTATION AND STORAGE

FOR ORGANIZING AND ARRANGING CUSTOM AND PACKAGED VACATION TRIPS, TRAVEL TOURS AND SIGHTSEEING TOURS, AND ON-LOCATION GOLF, SPORTS AND ENTERTAINMENT ACTIVITIES AND ACTIVITIES PACKAGES SOLD AS A PART THEREOF; WHOLESALE AND RETAIL TRAVEL AGENCY SERVICES, NAMELY MAKING RESERVATIONS AND BOOKINGS FOR AIR, GROUND AND SEA TRANSPORTATION SERVICES; ORGANIZING AND ARRANGING GROUND ESCORTED AND SELF-DRIVING TOURS AND EXCURSIONS; PROVIDING INFORMATION ABOUT TRAVEL, TOURS, VACATIONS AND VACATION TRAVEL PACKAGES VIA A WEBSITE ON THE INTERNET (U.S. CLS. 100 AND 105).

CLASS 42—SCIENTIFIC, COMPUTER AND LEGAL SERVICES

FOR WHOLESALE AND RETAIL TRAVEL AGENCY SERVICES, NAMELY MAKING RESERVATIONS AND BOOKINGS FOR TEMPORARY LODGING AT HOTELS, RESORTS AND CONDOMINIUMS (U.S. CLS. 100 AND 101).

SN 76-304,332. CLASSIC CUSTOM VACATIONS, SAN JOSE, CA. FILED 8-23-2001.

CLASSIC AUSTRALIA

OWNER OF U.S. REG. NOS. 1,093,417, 2,426,074 AND OTHERS.

NO CLAIM IS MADE TO THE EXCLUSIVE RIGHT TO USE "AUSTRALIA", APART FROM THE MARK AS SHOWN.

CLASS 39—TRANSPORTATION AND STORAGE

FOR ORGANIZING AND ARRANGING CUSTOM AND PACKAGED VACATION TRIPS, TRAVEL TOURS AND SIGHTSEEING TOURS, AND ON-LOCATION GOLF, SPORTS AND ENTERTAINMENT ACTIVITIES AND ACTIVITIES PACKAGES SOLD AS A PART THEREOF; WHOLESALE AND RETAIL TRAVEL AGENCY SERVICES, NAMELY MAKING RESERVATIONS AND BOOKINGS FOR AIR, GROUND AND SEA TRANSPORTATION SERVICES; ORGANIZING AND ARRANGING GROUND ESCORTED AND SELF-DRIVING TOURS AND EXCURSIONS; PROVIDING INFORMATION ABOUT TRAVEL, TOURS, VACATIONS AND VACATION TRAVEL PACKAGES VIA A WEBSITE ON THE INTERNET (U.S. CLS. 100 AND 105).

CLASS 42—SCIENTIFIC, COMPUTER AND LEGAL SERVICES

FOR WHOLESALE AND RETAIL TRAVEL AGENCY SERVICES, NAMELY MAKING RESERVATIONS AND BOOKINGS FOR TEMPORARY LODGING AT HOTELS, RESORTS AND CONDOMINIUMS (U.S. CLS. 100 AND 101).

SN 76-304,333. CLASSIC CUSTOM VACATIONS, SAN JOSE, CA. FILED 8-23-2001.

CLASSIC FIJI

OWNER OF U.S. REG. NOS. 1,093,417, 2,426,074 AND OTHERS.

NO CLAIM IS MADE TO THE EXCLUSIVE RIGHT TO USE "FIJI", APART FROM THE MARK AS SHOWN.

CLASS 39—TRANSPORTATION AND STORAGE

FOR ORGANIZING AND ARRANGING CUSTOM AND PACKAGED VACATION TRIPS, TRAVEL TOURS AND SIGHTSEEING TOURS, AND ON-LOCATION GOLF, SPORTS AND ENTERTAINMENT ACTIVITIES AND ACTIVITIES PACKAGES SOLD AS A PART THEREOF; WHOLESALE AND RETAIL TRAVEL AGENCY SERVICES, NAMELY MAKING RESERVATIONS AND BOOKINGS FOR AIR, GROUND AND SEA TRANSPORTATION SERVICES; ORGANIZING AND ARRANGING GROUND ESCORTED AND SELF-DRIVING TOURS AND EXCURSIONS; PROVIDING INFORMATION ABOUT TRAVEL, TOURS, VACATIONS AND VACATION TRAVEL PACKAGES VIA A WEBSITE ON THE INTERNET (U.S. CLS. 100 AND 105).

CLASS 42—SCIENTIFIC, COMPUTER AND LEGAL SERVICES

FOR WHOLESALE AND RETAIL TRAVEL AGENCY SERVICES, NAMELY MAKING RESERVATIONS AND BOOKINGS FOR TEMPORARY LODGING AT HOTELS, RESORTS AND CONDOMINIUMS (U.S. CLS. 100 AND 101).

SN 76-304,400. GARDEN GROW COMPANY, THE, LAFAYETTE, CA. AND CENTRAL GARDEN & PET COMPANY, LAFAYETTE, CA. FILED 8-27-2001.

LILLY MILLER

OWNER OF U.S. REG. NOS. 1,146,979, 1,187,251 AND OTHERS.

THE NAME LILLY MILLER DOES NOT IDENTIFY A LIVING INDIVIDUAL.

CLASS 1—CHEMICALS

FOR POWDER OR GRANULAR SUBSTANCE USED IN GARDENING APPLICATIONS, NAMELY, FERTILIZER FOR DOMESTIC USE; SOIL SUPPLEMENTS IN THE NATURE OF ORGANIC AND INORGANIC FERTILIZERS FOR DOMESTIC USE; SOIL AMENDMENTS FOR DOMESTIC USE; FERTILIZER FOR DOMESTIC USE, NAMELY, LIQUID FERTILIZER FOR LAWN AND GARDEN SHRUBS; PLANT FOOD CONTAINING INSECTICIDE; FERTILIZER FOR DOMESTIC USE, NAMELY, LAWN FERTILIZER; SOIL CONDITIONERS AND AMENDMENTS FOR DOMESTIC USE; PLANT STARTER SOLUTION, NAMELY, GROWING MEDIA FOR PLANTS; CHEMICALS FOR DOMESTIC USE, NAMELY, ANTI-SHOCK TREATMENT AND ROOT STIMULANT FOR USE WHEN TRANSPLANTING GARDEN AND HOUSE PLANTS (U.S. CLS. 1, 5, 6, 10, 26 AND 46).

FIRST USE 10-0-1976; IN COMMERCE 10-0-1976.

CLASS 5—PHARMACEUTICALS

FOR CHEMICAL POWDER OR GRANULAR SUBSTANCE USED IN GARDENING APPLICATIONS, NAMELY, INSECTICIDE FOR DOMESTIC USE; WEED KILLER FOR DOMESTIC USE; HERBICIDES FOR DOMESTIC USE, NAMELY, HERBICIDES FOR LAWN AND GARDEN SHRUBS; SLUG AND SNAIL BAIT FOR USE IN KILLING SLUGS AND SNAILS FOR DOMESTIC USE; INSECT CONTROL PRODUCT THAT FEEDS PLANTS AND KILLS INSECTS, NAMELY, AN INSECTICIDE; SOIL INSECTICIDE FOR DOMESTIC USE; PESTICIDES, INSECTICIDES, HERBICIDES, FUNGICIDES, AND SLUG AND SNAIL BAIT PREPARATIONS FOR USE IN KILLING SNAILS AND SLUGS, ALL FOR DOMESTIC USE (U.S. CLS. 6, 18, 44, 46, 51 AND 52).

FIRST USE 10-0-1976; IN COMMERCE 10-0-1976.

CLASS 31—NATURAL AGRICULTURAL PRODUCTS

FOR GRASS SEED; SEED MIXTURES, NAMELY, FLOWER SEEDS; FLOWER, VEGETABLE AND PLANT SEEDS (U.S. CLS. 1 AND 46).

FIRST USE 10-0-1976; IN COMMERCE 10-0-1976.

SN 76-304,494. AFFILIATED BUSINESS CONSULTANTS, INC., COLORADO SPRINGS, CO. FILED 8-27-2001.

BIZSALE

SEC. 2(F).

CLASS 35—ADVERTISING AND BUSINESS

FOR PLACING ADVERTISING FOR OTHERS REGARDING BUSINESSES FOR SALE (U.S. CLS. 100, 101 AND 102).

FIRST USE 6-0-1994; IN COMMERCE 6-0-1994.

CLASS 36—INSURANCE AND FINANCIAL

FOR BUSINESS BROKERAGE SERVICES (U.S. CLS. 100, 101 AND 102).

FIRST USE 6-0-1994; IN COMMERCE 6-0-1994.

SN 76-304,633. ASTVATSATRIAN, GAIANE, GLENDALE, CA. AND GEDJEYAN, HOVANNES, GLENDALE, CA. FILED 8-20-2001.

G.A. and H.G.**CLASS 11—ENVIRONMENTAL CONTROL APPARATUS**

FOR REFRIGERATORS (U.S. CLS. 13, 21, 23, 31 AND 34).

CLASS 30—STAPLE FOODS

FOR NOVELTY ICE CUBES (U.S. CL. 46).

SN 76-304,977. LIFELINE II LLC, PARSIPPANY, NJ. FILED 8-24-2001.

PREVRAYS**CLASS 3—COSMETICS AND CLEANING PREPARATIONS**

FOR NON-MEDICATED SKIN CARE PREPARATIONS (U.S. CLS. 1, 4, 6, 50, 51 AND 52).

CLASS 5—PHARMACEUTICALS

FOR MEDICATED SKIN CARE PREPARATIONS (U.S. CLS. 6, 18, 44, 46, 51 AND 52).

SN 76-305,012. COVAD COMMUNICATIONS GROUP, INC., SANTA CLARA, CA. FILED 8-27-2001.

TELEDEFEND

OWNER OF U.S. REG. NOS. 2,178,701 AND 2,449,863.

CLASS 38—COMMUNICATION

FOR TELECOMMUNICATIONS SERVICES, NAMELY, MANAGED SITE-TO-SITE COMPUTER VIRTUAL PRIVATE NETWORK (VPN) SERVICES FOR SMALL BUSINESS ENVIRONMENTS (U.S. CLS. 100, 101 AND 104).

FIRST USE 11-27-2001; IN COMMERCE 11-27-2001.

CLASS 42—SCIENTIFIC, COMPUTER AND LEGAL SERVICES

FOR MANAGED COMPUTER NETWORK FIREWALL SERVICES FOR SMALL BUSINESS ENVIRONMENT, INCLUDING UP-FRONT CONFIGURATION AND INSTALLATION SUPPORT, ONGOING MANAGEMENT, PROACTIVE MONITORING, AND 24 HOURS A DAY, 7 DAYS A WEEK IN TECHNICAL CUSTOMER SUPPORT (U.S. CLS. 100 AND 101).

FIRST USE 11-27-2001; IN COMMERCE 11-27-2001.

SN 76-305,410. THOMSON LICENSING CORPORATION, CLAYMONT, DE. FILED 8-27-2001.

COMPACT D

OWNER OF U.S. REG. NOS. 1,495,690 AND 1,907,124.

CLASS 35—ADVERTISING AND BUSINESS

FOR COMPUTER SERVICES, NAMELY, PROVIDING AN ONLINE WEBSITE FEATURING A DATABASE OF BUSINESS MANAGEMENT INFORMATION ABOUT PUBLICLY TRADED COMPANIES (U.S. CLS. 100, 101 AND 102).

FIRST USE 7-0-1990; IN COMMERCE 7-0-1990.

CLASS 36—INSURANCE AND FINANCIAL

FOR COMPUTER SERVICES, NAMELY, PROVIDING AN ONLINE WEBSITE FEATURING A DATABASE OF FINANCIAL INFORMATION ABOUT PUBLICLY TRADED COMPANIES (U.S. CLS. 100, 101 AND 102).

FIRST USE 7-0-1990; IN COMMERCE 7-0-1990.

SN 76-305,492. PISCES PRODUCTIONS LLC, BOSTON, MA.
FILED 8-27-2001.



CLASS 41—EDUCATION AND ENTERTAINMENT

FOR VIDEO TAPE AND VIDEO DISC PRODUCTION, SPECIAL EFFECTS ANIMATION SERVICES FOR OTHERS AND VIDEO TAPE EDITING SERVICES (U.S. CLS. 100, 101 AND 107).

FIRST USE 5-1-2001; IN COMMERCE 5-1-2001.

CLASS 42—SCIENTIFIC, COMPUTER AND LEGAL SERVICES

FOR GRAPHIC DESIGN AND PRINT DESIGN SERVICES, PRINTING (U.S. CLS. 100 AND 101).

FIRST USE 5-1-2001; IN COMMERCE 5-1-2001.

SN 76-305,854. LATIN INTELLECTUAL PROPERTIES, INC.,
LOS ANGELES, CA. FILED 8-27-2001.

THE CONGA LINE

NO CLAIM IS MADE TO THE EXCLUSIVE RIGHT TO USE "CONGA", APART FROM THE MARK AS SHOWN.

CLASS 25—CLOTHING

FOR CLOTHING, NAMELY, SHIRTS, SWEATSHIRTS, JACKETS, COATS, T-SHIRTS, SKIRTS, PANTS, DRESSES, FOOTWEAR, HATS, SWIMWEAR, SWEATERS, SOCKS, UNDERWEAR, LINGERIE AND JUMPSUITS (U.S. CLS. 22 AND 39).

CLASS 42—SCIENTIFIC, COMPUTER AND LEGAL SERVICES

FOR RESTAURANT, CATERING, BAR, LOUNGE AND NIGHTCLUB SERVICES (U.S. CLS. 100 AND 101).

SN 76-305,909. LIDL STIFTUNG & CO. KG, 74172 NECK-
ARSULM, FED REP GERMANY, FILED 8-27-2001.

LITTLE MAN

OWNER OF UNITED KINGDOM REG. NO. 1585027,
DATED 1-10-1997, EXPIRES 9-14-2004.

OWNER OF UNITED KINGDOM REG. NO. 1585028,
DATED 1-10-1997, EXPIRES 9-14-2011.

CLASS 29—MEATS AND PROCESSED FOODS

FOR MEAT, FISH, POULTRY AND GAME; MEAT EXTRACTS; PRESERVED, DRIED AND COOKED FRUITS AND VEGETABLES; JELLIES, JAMS; EGGS, MILK AND MILK PRODUCTS, NAMELY DAIRY PRODUCTS EXCLUDING ICE CREAM, ICE MILK AND FROZEN YOGURT; EDIBLE OILS AND FATS; SALAD DRESSINGS; MEAT, FISH, FRUIT AND VEGETABLE PRESERVES (U.S. CL. 46).

CLASS 30—STAPLE FOODS

FOR COFFEE, TEA, COCOA, SUGAR, RICE, TAPIO-
CA, SAGO, ARTIFICIAL COFFEE; FLOUR AND PRE-
PARATIONS MADE FROM CEREALS, NAMELY
BREAKFAST CEREALS; BREAD, PASTRY AND CON-
FECTIONERY, NAMELY CANDY, BAKERY DESSERTS
AND FROZEN CONFECTION; FLAVORED ICES; HON-
EY, TREACLE; YEAST, BAKING-POWDER; SALT, MUS-
TARD; VINEGAR, SAUCES, SPICES (U.S. CL. 46).

SN 76-306,008. SOLILOQUY LEARNING, INC., UNION
CITY, CA. FILED 8-27-2001.

SOLILOQUY LEARNING

NO CLAIM IS MADE TO THE EXCLUSIVE RIGHT TO USE "LEARNING", APART FROM THE MARK AS SHOWN.

CLASS 9—ELECTRICAL AND SCIENTIFIC APPARATUS

FOR EDUCATIONAL MULTI-MEDIA SOFTWARE FOR TEACHING READING, LANGUAGE, COMPREHENSION, VOCABULARY, STUDY TIME MANAGEMENT AND TEST-TAKING; COMPUTER SOFTWARE FOR TRACKING, GRADING, ASSESSING AND EVALUATING STUDENT PERFORMANCE IN UTILIZING SUCH EDUCATIONAL SOFTWARE AND PRINTED MATERIALS SOLD AS A UNIT THEREWITH; COMPUTER SOFTWARE FOR CREATING, MANAGING, ASSIGNING AND MONITORING EDUCATIONAL SOFTWARE AND PRINTED MATERIALS SOLD AS A UNIT THEREWITH; AND EDUCATIONAL MULTI-MEDIA COMPUTER GAME SOFTWARE (U.S. CLS. 21, 23, 26, 36 AND 38).

FIRST USE 6-12-2001; IN COMMERCE 6-12-2001.

CLASS 42—SCIENTIFIC, COMPUTER AND LEGAL SERVICES

FOR DEVELOPING AND DESIGNING FOR OTHERS INTERACTIVE EDUCATIONAL COMPUTER PROGRAMS FOR THE IMPROVEMENT OF READING, LANGUAGE, COMPREHENSION, VOCABULARY, STUDY TIME MANAGEMENT AND TEST-TAKING, AND OTHER ACADEMIC SKILLS AND READING MATERIALS, STUDY AIDS, AND EXERCISES SOLD AS A UNIT THEREWITH; AND PROVIDING TEMPORARY USE OF NON-DOWNLOADABLE SOFTWARE FOR TEACHING READING, LANGUAGE, ADULT LITERACY, COMPREHENSION, VOCABULARY, STUDY TIME MANAGEMENT AND TEST-TAKING (U.S. CLS. 100 AND 101).

FIRST USE 6-12-2001; IN COMMERCE 6-12-2001.

SN 76-306,234. NAVIGANT CONSULTING, INC., CHICAGO, IL. FILED 8-27-2001.

SN 76-306,616. JONES, JAMES RONALD, CHARLOTTE, NC. FILED 8-29-2001.



NO CLAIM IS MADE TO THE EXCLUSIVE RIGHT TO USE "SERVICE", APART FROM THE MARK AS SHOWN.

CLASS 9—ELECTRICAL AND SCIENTIFIC APPARATUS

FOR COMPUTER SOFTWARE FOR PROVIDING COMPARISON INFORMATION, NAMELY, QUARTERLY INTERNAL PERFORMANCE AND CONFIDENTIAL PEER GROUP COMPARISON ANALYSES TO GENERATING COMPANIES (U.S. CLS. 21, 23, 26, 36 AND 38).

FIRST USE 2-1-1999; IN COMMERCE 2-1-1999.

CLASS 35—ADVERTISING AND BUSINESS

FOR PROVIDING COMPARISON INFORMATION, NAMELY, PROVIDING INFORMATION REGARDING QUARTERLY INTERNAL BUSINESS PERFORMANCE OF COMPANIES AND REGARDING CONFIDENTIAL INDUSTRY PEER GROUP COMPARISON ANALYSES TO GENERATING COMPANIES (U.S. CLS. 100, 101 AND 102).

FIRST USE 2-1-1999; IN COMMERCE 2-1-1999.

SN 76-306,386. MEDALLIST GOLF DEVELOPMENTS, INC., JUPITER, FL. FILED 8-29-2001.

NORMAN RESIDENCES

NO CLAIM IS MADE TO THE EXCLUSIVE RIGHT TO USE "RESIDENCES", APART FROM THE MARK AS SHOWN.

CLASS 36—INSURANCE AND FINANCIAL

FOR REAL ESTATE TIME SHARING SERVICES AND VACATION REAL ESTATE TIME SHARING SERVICES; REAL ESTATE SERVICES, NAMELY, ARRANGING FRACTIONAL OWNERSHIP SHARES IN REAL ESTATE (U.S. CLS. 100, 101 AND 102).

CLASS 37—CONSTRUCTION AND REPAIR

FOR REAL ESTATE DEVELOPMENT SERVICES; DESIGN AND DEVELOPMENT OF RESIDENTIAL AND GOLF COMMUNITIES (U.S. CLS. 100, 103 AND 106).

SENTIRE

THE ENGLISH TRANSLATION OF "SENTIRE" IS "TO FEEL".

CLASS 3—COSMETICS AND CLEANING PREPARATIONS

FOR POTPOURRI, HEAT ACTIVATED FRAGRANCE RINGS, AROMATHERAPY BODY SPRAYS, AROMATHERAPY BATH SALTS, AROMATHERAPY MASSAGE OILS, AROMATHERAPY BODY POWDER, AROMATHERAPY BODY LOTION, AROMATHERAPY PERFUMES AND AROMATHERAPY OILS (U.S. CLS. 1, 4, 6, 50, 51 AND 52).

CLASS 4—LUBRICANTS AND FUELS

FOR SCENTED CANDLES AND AROMATHERAPY CANDLES (U.S. CLS. 1, 6 AND 15).

SN 76-306,678. WORLD AMATEUR GOLF COUNCIL, FAR HILLS, NJ. FILED 8-29-2001.

IGF

CLASS 35—ADVERTISING AND BUSINESS

FOR PROMOTING PUBLIC INTEREST IN THE GAME OF GOLF; AND PROMOTING GOLF AS A SPORT FOR INTERNATIONALLY RECOGNIZED COMPETITIONS (U.S. CLS. 100, 101 AND 102).

CLASS 41—EDUCATION AND ENTERTAINMENT

FOR EDUCATIONAL AND ENTERTAINMENT SERVICES, NAMELY, CONDUCTING GOLF TOURNAMENTS (U.S. CLS. 100, 101 AND 107).

SN 76-306,685. WORLD AMATEUR GOLF COUNCIL, FAR HILLS, NJ. FILED 8-29-2001.



NO CLAIM IS MADE TO THE EXCLUSIVE RIGHT TO USE "INTERNATIONAL GOLF FEDERATION" OR "FOUNDED 1958", APART FROM THE MARK AS SHOWN.

CLASS 35—ADVERTISING AND BUSINESS

FOR PROMOTING PUBLIC INTEREST IN THE GAME OF GOLF; AND PROMOTING GOLF AS A SPORT FOR INTERNATIONALLY RECOGNIZED COMPETITIONS (U.S. CLS. 100, 101 AND 102).

CLASS 41—EDUCATION AND ENTERTAINMENT

FOR EDUCATIONAL AND ENTERTAINMENT SERVICES, NAMELY, CONDUCTING GOLF TOURNAMENTS (U.S. CLS. 100, 101 AND 107).

SN 76-306,800. N.V. NUON ENERGIE-ONDERNEMING VOOR GELDERLAND FRIESLAND EN FLEVOLAND, 6812 AH ARNHEM, NETHERLANDS, FILED 8-29-2001.



SN 76-306,713. EFX MARKETING LLC, BROOKLYN, NY. FILED 8-29-2001.

GOT FUN?**CLASS 9—ELECTRICAL AND SCIENTIFIC APPARATUS**

FOR RADIOS AND TELEPHONES (U.S. CLS. 21, 23, 26, 36 AND 38).
FIRST USE 8-5-2001; IN COMMERCE 8-5-2001.

CLASS 20—FURNITURE AND ARTICLES NOT OTHERWISE CLASSIFIED

FOR MIRRORS, PICTURE FRAMES, FURNITURE, NAMELY, TABLES AND CHAIRS (U.S. CLS. 2, 13, 22, 25, 32 AND 50).
FIRST USE 8-5-2001; IN COMMERCE 8-5-2001.

SN 76-306,723. WENDT & KUEHN KG, D-09579 GRUENHAINICHEN, FED REP GERMANY, FILED 8-29-2001.

WENDT & KÜHN**CLASS 15—MUSICAL INSTRUMENTS**

FOR MUSICAL INSTRUMENTS AND MUSIC BOXES (U.S. CLS. 2, 21 AND 36).
FIRST USE 0-0-1930; IN COMMERCE 0-0-1930.

CLASS 20—FURNITURE AND ARTICLES NOT OTHERWISE CLASSIFIED

FOR GOODS OF WOOD, NAMELY, DELICATELY SHAPED WOODWORK, TURNED AND CARVED WOOD ARTICLES, NAMELY, WOOD FIGURES, ANGEL FIGURES, FAIRYTALE FIGURES, FIGURES OF CHILDREN, ANIMALS, VEHICLES, TREES, HOUSES, BOXES OF WOOD, SCULPTURES, STATUES AND CARVINGS (U.S. CLS. 2, 13, 22, 25, 32 AND 50).
FIRST USE 0-0-1930; IN COMMERCE 0-0-1930.

CLASS 28—TOYS AND SPORTING GOODS

FOR GAMES, NAMELY, BOARD GAMES, JIGSAW PUZZLES, DICE GAMES; TOYS, NAMELY, TOY FIGURES, FAIRYTALE FIGURES, FIGURES OF CHILDREN, ANIMALS, TREES, HOUSES AND VEHICLES, ANGEL BANDS AND TOY VILLAGES; DOLL HOUSES, DOLL FURNITURE AND DECORATIONS FOR CHRISTMAS TREES (U.S. CLS. 22, 23, 38 AND 50).
FIRST USE 0-0-1930; IN COMMERCE 0-0-1930.

OWNER OF BENELUX REG. NO. 544870, DATED 1-20-1994, EXPIRES 1-20-2004.

OWNER OF U.S. REG. NO. 2,339,842.
THE COLOR PURPLE AND YELLOW IS A FEATURE OF THE MARK.

COLOR IS A FEATURE OF THE MARK. AS SHOWN IN THE DRAWING OF THE MARK, THE CAPITAL LETTER "N" AND THE CAPITAL LETTER "U" (THE FIRST TWO LETTERS OF THE WORD "NUON") ARE COLORED PURPLE AND ARE SET ABOVE A YELLOW COLORED BACKGROUND. THE CAPITAL LETTER "O" AND THE CAPITAL LETTER "N" (THE LAST TWO LETTERS OF THE WORD "NUON") ARE COLORED YELLOW AND ARE SET ABOVE A GRAPE PURPLE BACKGROUND.

CLASS 11—ENVIRONMENTAL CONTROL APPARATUS

FOR APPARATUS FOR LIGHTING, NAMELY, ELECTRIC LIGHTING FIXTURES, FLORESCENT ELECTRIC LIGHTING TUBES, ELECTRIC TRACK LIGHTING UNITS; APPARATUS FOR HEATING, NAMELY, ELECTRIC RADIATORS FOR HEATING BUILDINGS, STEAM RADIATORS FOR HEATING BUILDINGS, SOLAR HEATING PANELS, THERMOSTATIC VALVES; APPARATUS FOR STEAM GENERATING, NAMELY, STEAM GENERATORS, STEAM VALVES; APPARATUS FOR WATER SUPPLY, NAMELY, WATER HEATERS FOR DOMESTIC, COMMERCIAL AND INDUSTRIAL USE AND SOLAR WATER HEATERS FOR DOMESTIC, COMMERCIAL AND INDUSTRIAL USE (U.S. CLS. 13, 21, 23, 31 AND 34).

CLASS 35—ADVERTISING AND BUSINESS

FOR BUSINESS MANAGEMENT; BUSINESS CONSULTANTS; COMMERCIAL AND INDUSTRIAL MANAGEMENT ASSISTANCE RELATING TO ENERGY, HEAT AND WATER SUPPLY (U.S. CLS. 100, 101 AND 102).

CLASS 37—CONSTRUCTION AND REPAIR

FOR BUILDING, REPAIR, INSTALLATION AND MAINTENANCE OF ELECTRICAL SYSTEMS, COOLING SYSTEMS, AND HEATING SYSTEMS; REPAIR AND MAINTENANCE OF DISTRIBUTION STATIONS SUPPLYING ENERGY AND APPARATUS FOR HEAT AND WATER SUPPLY; LAYING OF CABLES AND PIPELINES (U.S. CLS. 100, 103 AND 106).

CLASS 38—COMMUNICATION

FOR TELECOMMUNICATION AND DATA COMMUNICATION SERVICES, NAMELY, ISDN SERVICES, PERSONAL COMMUNICATION SERVICES, AND GATEWAY SERVICES; CABLE TELEVISION BROADCASTING AND TRANSMISSION SERVICES (U.S. CLS. 100, 101 AND 104).

CLASS 39—TRANSPORTATION AND STORAGE

FOR WAREHOUSE STORAGE; PUBLIC UTILITIES IN THE NATURE OF SUPPLYING ELECTRICITY, GAS, HEAT AND WATER; DISTRIBUTION OF ENERGY (U.S. CLS. 100 AND 105).

CLASS 40—MATERIAL TREATMENT

FOR RECYCLING; WATER TREATMENT; PRODUCTION OF ENERGY; LEASING OF GAS, WATER AND HEATING APPARATUS TO CONSUMERS AND COMPANIES (U.S. CLS. 100, 103 AND 106).

CLASS 42—SCIENTIFIC, COMPUTER AND LEGAL SERVICES

FOR TECHNICAL CONSULTATION AND RESEARCH IN THE FIELDS OF ENERGY PRODUCTION AND DISTRIBUTION, WATER SUPPLY AND ENVIRONMENTAL PROTECTION; CONDUCTING OF FEASIBILITY STUDIES CONCERNING ENERGY SAVING GENERATING TECHNIQUES AND REUSE; WASTE MANAGEMENT (U.S. CLS. 100 AND 101).

SN 76-306,852. THE SOY STORE, SAN PEDRO, CA. FILED 8-31-2001.

SOY SAM

NO CLAIM IS MADE TO THE EXCLUSIVE RIGHT TO USE "SOY", APART FROM THE MARK AS SHOWN.

CLASS 29—MEATS AND PROCESSED FOODS

FOR SOY BASED PRODUCTS, NAMELY, SOY BASED POTATO CHIPS, SOY BASED PINTO BEAN DIP, CANNED REFRIED SOYBEANS, 5 LAYER SOYBEAN DIP, MEAT SUBSTITUTES MADE FROM SOY, SOY BASED FOOD BEVERAGE USED AS A MILK SUBSTITUTE, SOY BASED YOGURT, SOY BASED CREAM CHEESE, ORGANIC DELI MEAL SUBSTITUTES MADE FROM SOY (U.S. CL. 46).

CLASS 30—STAPLE FOODS

FOR SOY BASED PRODUCTS, NAMELY, SOY BASED TORTILLAS, TOFU SAUCES, SOY BASED CORN CHIPS, SOY BASED BURRITOS, ICE CREAM SUBSTITUTES MADE OF SOY, SOY BASED MAYONNAISE (U.S. CL. 46).

SN 76-306,955. KODAKA MERIYASU KOGYO CO., LTD., TOKYO 130-0014, JAPAN, FILED 8-30-2001.

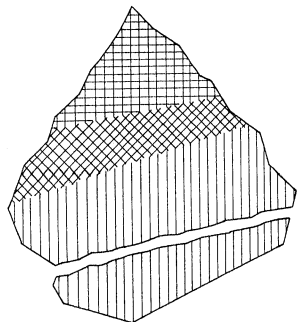

THE MARK CONSISTS OF AN UPPER PORTION AND A

LOWER PORTION, DIVIDED BY A WHITE, UNEVEN LINE THAT TRAVERSES THE MARK AS IT SLANTS SLIGHTLY UPWARDS; THE UPPER PORTION CONSISTING OF THE COLORS YELLOW, ORANGE, AND RED, AND HAVING MORE THAN TWO TIMES THE SIZE OF THE LOWER PORTION, IN A RIGHT-SIDE-UP TRIANGULAR SHAPE, WITH THE LEFT CORNER SOMEWHAT ROUNDED; THE LOWER PORTION CONSISTING OF THE COLOR RED AND HAVING AN UPSIDE-DOWN TRIANGULAR SHAPE THAT SEEMS TO MIRROR THE UPPER PORTION.

CLASS 25—CLOTHING

FOR T-SHIRTS, BLUE JEANS, HATS, CAPS, JACKETS, AND PANTS (U.S. CLS. 22 AND 39).

CLASS 41—EDUCATION AND ENTERTAINMENT

FOR MUSEUMS AND EXHIBITS FEATURING SHELL-FISH (U.S. CLS. 100, 101 AND 107).

SN 76-307,108. NATIONAL SCHOOL BOARDS ASSOCIATION, ALEXANDRIA, VA. FILED 8-31-2001.

NATIONAL SCHOOL BOARDS ASSOCIATION

SEC. 2(F).

CLASS 9—ELECTRICAL AND SCIENTIFIC APPARATUS

FOR ELECTRONIC DATABASES IN THE FIELD OF PUBLIC EDUCATION RECORDED ON COMPUTER MEDIA; ELECTRONIC PUBLICATIONS IN THE NATURE OF NEWSLETTERS, MAGAZINE ARTICLES, REPORTS AND BOOKS IN THE FIELD OF PUBLIC EDUCATION RECORDED ON COMPUTER MEDIA (U.S. CLS. 21, 23, 26, 36 AND 38).

FIRST USE 2-28-1995; IN COMMERCE 2-28-1995.

CLASS 16—PAPER GOODS AND PRINTED MATTER

FOR BOOKS, MAGAZINES, NEWSPAPERS, NEWSLETTERS, PAMPHLETS AND REPORTS IN THE FIELD OF PUBLIC EDUCATION (U.S. CLS. 2, 5, 22, 23, 29, 37, 38 AND 50).

FIRST USE 8-31-1956; IN COMMERCE 8-31-1956.

CLASS 35—ADVERTISING AND BUSINESS

FOR CONDUCTING TRADE SHOWS IN THE FIELD OF PUBLIC EDUCATION; ADVERTISING SERVICES, NAMELY PROVIDING ADVERTISING SPACE IN PERIODICALS; INFORMATION CLEARINGHOUSE IN THE FIELD OF PUBLIC EDUCATION (U.S. CLS. 100, 101 AND 102).

FIRST USE 4-17-1958; IN COMMERCE 4-17-1958.

CLASS 38—COMMUNICATION

FOR PROVIDING ON LINE ELECTRONIC LISTSERVERS, NAMELY, MAIL GROUPS FOR TRANSMISSION OF MESSAGES AMONG COMPUTER USERS ABOUT PUBLIC EDUCATION (U.S. CLS. 100, 101 AND 104).

FIRST USE 2-5-1997; IN COMMERCE 2-5-1997.

CLASS 41—EDUCATION AND ENTERTAINMENT

FOR PROVIDING INFORMATION IN THE FIELD OF PUBLIC EDUCATION VIA THE INTERNET; PROVIDING EDUCATIONAL SERVICES, NAMELY, CONDUCTING SEMINARS, CONFERENCES, CLASSES, WORKSHOPS, AND ONLINE COURSES IN THE FIELD OF PUBLIC EDUCATION FOR SCHOOL BOARD MEMBERS AND THE GENERAL PUBLIC; PROVIDING CONTINUING LEGAL EDUCATION COURSES IN THE FIELD OF SCHOOL LAW (U.S. CLS. 100, 101 AND 107).
FIRST USE 11-30-1953; IN COMMERCE 11-30-1953.

CLASS 42—SCIENTIFIC, COMPUTER AND LEGAL SERVICES

FOR ASSOCIATION SERVICES, NAMELY PROMOTING THE INTERESTS OF PUBLIC SCHOOL BOARDS THROUGH ADVOCACY BEFORE THE GENERAL PUBLIC, POLITICAL ENTITIES, AND THE JUDICIARY AND THROUGH PROVIDING PROFESSIONAL NETWORKING OPPORTUNITIES; TECHNICAL CONSULTATION AND RESEARCH IN THE FIELD OF PUBLIC EDUCATION (U.S. CLS. 100 AND 101).
FIRST USE 2-28-1949; IN COMMERCE 2-28-1949.

SN 76-307,725. STEWART MORTGAGE INFORMATION CO., HOUSTON, TX. FILED 8-30-2001.

**THE SINGLE-SOURCE
SOLUTION TO ALL YOUR
MORTGAGE SERVICE
NEEDS**

CLASS 35—ADVERTISING AND BUSINESS

FOR LIEN ADMINISTRATION SERVICES, NAMELY, ATTENDING TO THE RELEASE OF LIENS IN THE FIELD OF REAL ESTATE (U.S. CLS. 100, 101 AND 102).
FIRST USE 9-30-2000; IN COMMERCE 9-30-2000.

CLASS 36—INSURANCE AND FINANCIAL

FOR REAL ESTATE ESCROW SERVICES; REAL ESTATE TAX PAYMENT PROCESSING AND MONITORING SERVICES; PROVIDING INFORMATION IN THE FIELD OF REAL ESTATE, NAMELY, CREDIT REPORTING INFORMATION, FISCAL ASSESSMENT INFORMATION AND FISCAL EVALUATION INFORMATION; REAL ESTATE APPRAISALS; APPRAISALS FOR INSURANCE CLAIMS OF REAL ESTATE, NAMELY, FLOOD HAZARD DETERMINATIONS; SECURITY SERVICES, NAMELY, GUARANTEE ASSURANCE UNDERWRITING, NAMELY, GUARANTEEING TITLE LOANS IN THE FIELD OF REAL ESTATE; UNDERWRITING TITLE INSURANCE IN THE FIELD OF REAL ESTATE; REAL ESTATE CONVEYANCING SERVICES, NAMELY, DOCUMENT PREPARATION FOR REAL ESTATE TRANSFERS, AND LIEN RELEASES; MORTGAGE LENDING (U.S. CLS. 100, 101 AND 102).
FIRST USE 9-30-2000; IN COMMERCE 9-30-2000.

CLASS 38—COMMUNICATION

FOR REAL ESTATE SERVICES, NAMELY, ELECTRONIC TRANSMISSION OF DATA AND DOCUMENTS IN THE FIELD OF REAL ESTATE VIA COMPUTER TERMINALS (U.S. CLS. 100, 101 AND 104).
FIRST USE 9-30-2000; IN COMMERCE 9-30-2000.

CLASS 42—SCIENTIFIC, COMPUTER AND LEGAL SERVICES

FOR REAL ESTATE SETTLEMENT SERVICES; REAL ESTATE CLOSING SERVICES; TITLE SEARCHING SERVICES (U.S. CLS. 100 AND 101).
FIRST USE 9-30-2000; IN COMMERCE 9-30-2000.

SN 76-308,166. AERO PRODUCTS CORPORATION, SANFORD, FL. FILED 8-31-2001.

MEDICMASTER

OWNER OF U.S. REG. NO. 2,032,589.

CLASS 5—PHARMACEUTICALS

FOR MEDICAL CARE, SAFETY AND RESCUE EQUIPMENT, NAMELY, FIRST AID KITS CONSISTING PRIMARILY OF BANDAGES, FIRST AID TAPE, GAUZE ROLLS, GAUZE PADS, SCISSORS, WOUND CLEANER, SURVIVAL BLANKET, BURN DRESSING, TWEEZERS, AND TOWELETTES (U.S. CLS. 6, 18, 44, 46, 51 AND 52).
FIRST USE 3-31-1998; IN COMMERCE 3-31-1998.

CLASS 10—MEDICAL APPARATUS

FOR AIRWAY SUPPORT ACCESSORIES, NAMELY ORAL AIRWAYS USED FOR INTUBATION; BACKBOARDS, CERVICAL COLLARS, EMERGENCY MEDICAL TECHNICIAN BAGS WITHOUT COMPONENTS, AND PERSONAL PROTECTION EQUIPMENT KITS CONSISTING PRIMARILY OF A PROTECTIVE GOWN, FACE MASK WITH EYE SHIELD, LATEX GLOVES, TOWELETTE, AND BIO-HAZARD BAG (U.S. CLS. 26, 39 AND 44).
FIRST USE 3-31-1998; IN COMMERCE 3-31-1998.

CLASS 12—VEHICLES

FOR VEHICLES, NAMELY AMBULANCES (U.S. CLS. 19, 21, 23, 31, 35 AND 44).
FIRST USE 8-23-1994; IN COMMERCE 8-23-1994.

SN 76-308,201. GLOBALTECH FINANCIAL, LLC, ATLANTA, GA. FILED 8-31-2001.

**GLOBALTECH CONSULTING
SERVICES**

NO CLAIM IS MADE TO THE EXCLUSIVE RIGHT TO USE "CONSULTING SERVICES", APART FROM THE MARK AS SHOWN.

CLASS 35—ADVERTISING AND BUSINESS

FOR BUSINESS MANAGEMENT AND BUSINESS CONSULTING SERVICES, IN THE FIELDS OF INFRASTRUCTURE PLANNING AND ASSESSMENT, BUSINESS PLAN ASSESSMENT, BILLINGS AND ACCOUNT RECEIVABLES MANAGEMENT, PROJECT QUALITY MANAGEMENT, REVENUE OPTIMIZATION, PROFIT RECOVERY ANALYSIS AND IMPROVEMENT, STAFFING SERVICES, EMPLOYMENT COMPENSATION AND WORKFORCE PLANNING; BUSINESS MANAGEMENT IN THE FIELD OF EMPLOYEE BENEFITS (U.S. CLS. 100, 101 AND 102).
FIRST USE 8-28-2001; IN COMMERCE 8-28-2001.

CLASS 41—EDUCATION AND ENTERTAINMENT

FOR EDUCATIONAL SERVICES, NAMELY, PROVIDING EMPLOYEE TRAINING AND DEVELOPMENT, ORGANIZATIONAL EFFECTIVENESS, DIVERSITY, AND COACHING COURSES (U.S. CLS. 100, 101 AND 107).

FIRST USE 8-28-2001; IN COMMERCE 8-28-2001.

SN 76-308,295. CLEVELAND BOTANICAL GARDEN, CLEVELAND, OH. FILED 9-4-2001.

**CLASS 16—PAPER GOODS AND PRINTED MATTER**

FOR PRINTED MATTER AND PUBLICATIONS, NAMELY, STATIONERY AND CARDS, PAMPHLETS, BROCHURES, POSTERS, NEWSLETTERS, AND EDUCATIONAL AND CURRICULUM MATERIALS RELATED TO MATTERS OF BOTANICAL INTEREST AND THE ACTIVITIES OF A BOTANICAL GARDEN (U.S. CLS. 2, 5, 22, 23, 29, 37, 38 AND 50).

SN 76-308,275. CLEVELAND BOTANICAL GARDEN, CLEVELAND, OH. FILED 9-4-2001.

CLASS 35—ADVERTISING AND BUSINESS

FOR RETAIL GIFT AND PLANT STORE SERVICES (U.S. CLS. 100, 101 AND 102).



CLEVELAND BOTANICAL GARDEN

CLASS 41—EDUCATION AND ENTERTAINMENT

FOR PROVIDING FACILITIES FOR EXHIBITIONS IN A BOTANICAL GARDEN; TEACHING AND EDUCATIONAL SERVICES, NAMELY, PROVIDING COURSES OF INSTRUCTION IN THE FIELD OF BOTANY AND HORTICULTURE (U.S. CLS. 100, 101 AND 107).

SN 76-308,410. MBG, L.L.C., PRAIRIE CITY, IA. FILED 9-4-2001.

VISION

NO CLAIM IS MADE TO THE EXCLUSIVE RIGHT TO USE "CLEVELAND BOTANICAL GARDEN", APART FROM THE MARK AS SHOWN.

CLASS 16—PAPER GOODS AND PRINTED MATTER

FOR PRINTED MATTER AND PUBLICATIONS, NAMELY, STATIONERY AND CARDS, PAMPHLETS, BROCHURES, POSTERS, NEWSLETTERS, AND EDUCATIONAL AND CURRICULUM MATERIALS RELATED TO MATTERS OF BOTANICAL INTEREST AND THE ACTIVITIES OF A BOTANICAL GARDEN (U.S. CLS. 2, 5, 22, 23, 29, 37, 38 AND 50).

CLASS 5—PHARMACEUTICALS

FOR SWINE SEMEN (U.S. CLS. 6, 18, 44, 46, 51 AND 52).
FIRST USE 5-1-1998; IN COMMERCE 5-1-1998.

CLASS 35—ADVERTISING AND BUSINESS

FOR RETAIL GIFT AND PLANT STORE SERVICES (U.S. CLS. 100, 101 AND 102).

CLASS 42—SCIENTIFIC, COMPUTER AND LEGAL SERVICES

FOR ANIMAL SERVICES, NAMELY BREEDING BORES (U.S. CLS. 100 AND 101).
FIRST USE 5-1-1998; IN COMMERCE 5-1-1998.

CLASS 41—EDUCATION AND ENTERTAINMENT

FOR PROVIDING FACILITIES FOR EXHIBITIONS IN A BOTANICAL GARDEN; TEACHING AND EDUCATIONAL SERVICES, NAMELY, PROVIDING COURSES OF INSTRUCTION IN THE FIELD OF BOTANY AND HORTICULTURE (U.S. CLS. 100, 101 AND 107).

SN 76-308,774. MBG, L.L.C., PRAIRIE CITY, IA. FILED 9-4-2001.

MBT**CLASS 5—PHARMACEUTICALS**

FOR SWINE SEMEN (U.S. CLS. 6, 18, 44, 46, 51 AND 52).
FIRST USE 5-1-1998; IN COMMERCE 5-1-1998.

CLASS 42—SCIENTIFIC, COMPUTER AND LEGAL SERVICES

FOR ANIMAL BREEDING SERVICES, NAMELY BREEDING BORES (U.S. CLS. 100 AND 101).
FIRST USE 5-1-1998; IN COMMERCE 5-1-1998.

SN 76-309,218. DOUBLE K, SPRINGFIELD, VA. FILED 9-6-2001.

SPERBZ**CLASS 5—PHARMACEUTICALS**

FOR VITAMINS (U.S. CLS. 6, 18, 44, 46, 51 AND 52).

CLASS 30—STAPLE FOODS

FOR SPICES AND PROCESSED HERBS (U.S. CL. 46).

SN 76-308,910. HEMOSYSTEM S.A., 13006 MARSEILLE, FRANCE, FILED 9-4-2001.

HEMOSYSTEM

PRIORITY CLAIMED UNDER SEC. 44(D) ON ERPNCMNTY TM OFC APPLICATION NO. 002122497, FILED 3-8-2001.

SN 76-309,241. KOLPIN OUTDOORS, INC., FOX LAKE, WI. FILED 9-5-2001.

OUTDOOR INNOVATIONS**CLASS 5—PHARMACEUTICALS**

FOR LIQUID ADDITIVE FOR THE PRESERVATION OF BLOOD AND BLOOD PRODUCTS (U.S. CLS. 6, 18, 44, 46, 51 AND 52).

CLASS 12—VEHICLES

FOR ALL TERRAIN VEHICLE RACKS, NAMELY BRACKETS FOR MOUNTING SAWS, AXES, SHOVELS, AND OTHER LONG-HANDLED TOOLS TO ALL TERRAIN VEHICLES (U.S. CLS. 19, 21, 23, 31, 35 AND 44).

CLASS 9—ELECTRICAL AND SCIENTIFIC APPARATUS

FOR LASER SCANNER FOR READING BAR CODE INFORMATION ON LABELS AND COMPUTER SOFTWARE FOR INTERPRETING BAR CODE INFORMATION (U.S. CLS. 21, 23, 26, 36 AND 38).

CLASS 13—FIREARMS

FOR FIREARM CASES (U.S. CLS. 2 AND 9).

CLASS 10—MEDICAL APPARATUS

FOR MEDICAL DEVICE, NAMELY A BLOOD ANALYSIS DIAGNOSTIC APPARATUS (U.S. CLS. 26, 39 AND 44).

CLASS 18—LEATHER GOODS

FOR LUGGAGE FOR ALL TERRAIN VEHICLES (U.S. CLS. 1, 2, 3, 22 AND 41).

SN 76-309,168. REDMOND SOFTWARE CORP., BUENOS AIRES, ARGENTINA, FILED 9-5-2001.

REDMOND SOFTWARE

NO CLAIM IS MADE TO THE EXCLUSIVE RIGHT TO USE "SOFTWARE", APART FROM THE MARK AS SHOWN.

SN 76-309,627. CITYMEALS-ON-WHEELS, NEW YORK, NY. FILED 9-6-2001.

CITYMEALS

OWNER OF U.S. REG. NO. 1,576,778.

CLASS 9—ELECTRICAL AND SCIENTIFIC APPARATUS

FOR COMPUTER SOFTWARE, NAMELY VOICE RECOGNITION COMPUTER SOFTWARE (U.S. CLS. 21, 23, 26, 36 AND 38).
FIRST USE 1-17-2000; IN COMMERCE 1-17-2000.

CLASS 35—ADVERTISING AND BUSINESS

FOR OFFERING TECHNICAL ASSISTANCE IN THE ESTABLISHMENT AND/OR OPERATION OF CHARITABLE SERVICES TO THE ELDERLY AND DISABLED (U.S. CLS. 100, 101 AND 102).
FIRST USE 1-0-1982; IN COMMERCE 11-0-1982.

CLASS 42—SCIENTIFIC, COMPUTER AND LEGAL SERVICES

FOR COMPUTER SOFTWARE DESIGN FOR OTHERS; COMPUTER CONSULTATION; NAMELY CONSULTING IN THE FIELDS OF DESIGN AND USE OF COMPUTER PROGRAMS, COMPUTERS, COMPUTER HARDWARE AND COMPUTER SYSTEMS; TECHNICAL SUPPORT SERVICES, NAMELY, TROUBLESHOOTING OF COMPUTER HARDWARE AND SOFTWARE PROBLEMS (U.S. CLS. 100 AND 101).
FIRST USE 1-17-2000; IN COMMERCE 1-17-2000.

CLASS 36—INSURANCE AND FINANCIAL

FOR CHARITABLE FUND RAISING ACTIVITIES (U.S. CLS. 100, 101 AND 102).
FIRST USE 1-0-1982; IN COMMERCE 11-0-1982.

CLASS 42—SCIENTIFIC, COMPUTER AND LEGAL SERVICES

FOR CHARITABLE SERVICES, NAMELY, PROVIDING MEALS TO THE ELDERLY AND DISABLED (U.S. CLS. 100 AND 101).
FIRST USE 1-0-1982; IN COMMERCE 11-0-1982.

SN 76-310,304. MYPLANET INTERNATIONAL A/S, DK-7500 HOLSTEBRO, DENMARK, FILED 9-7-2001.



PRIORITY CLAIMED UNDER SEC. 44(D) ON DENMARK APPLICATION NO. VA200102273, FILED 6-14-2001, REG. NO. VR200103113, DATED 7-23-2001, EXPIRES 7-23-2011.

CLASS 16—PAPER GOODS AND PRINTED MATTER

FOR PRINTED MATTER, NAMELY, PROGRAMS, INFORMATIONAL FLYERS, POSTERS, AND MAGAZINES ALL IN THE FIELD OF TRAVEL; STATIONERY; INSTRUCTIONAL AND TEACHING MATERIALS IN THE FIELD OF LANGUAGE AND CULTURE; BALL-POINT PENS; BOOKS IN THE FIELD OF TRAVEL AND FOREIGN CULTURES; PLAYING CARDS (U.S. CLS. 2, 5, 22, 23, 29, 37, 38 AND 50).

CLASS 35—ADVERTISING AND BUSINESS

FOR ADVERTISING SERVICES, NAMELY PROMOTION OF EDUCATIONAL AND TRAVEL-RELATED ACTIVITIES; BUSINESS MANAGEMENT; BUSINESS ADMINISTRATION SERVICES, NAMELY MEMBERSHIP SERVICES FOR SCANDINAVIAN AND FOREIGN MEMBERS; ORGANIZING AND CONDUCTING EXHIBITIONS IN THE FIELD OF TRAVEL AND FOREIGN CULTURES (U.S. CLS. 100, 101 AND 102).

CLASS 36—INSURANCE AND FINANCIAL

FOR PROVIDING TRAVEL AND VEHICLE RENTAL INSURANCE UNDERWRITING SERVICES (U.S. CLS. 100, 101 AND 102).

CLASS 39—TRANSPORTATION AND STORAGE

FOR ARRANGING TRAVEL TOURS; ARRANGING FOR TRAVEL VISAS, PASSPORTS AND TRAVEL DOCUMENTS FOR PERSONS TRAVELLING ABROAD, ISSUING OF TRAVEL VISAS; ARRANGING FOR RENTAL OF AUTOMOBILES, MOBILE HOMES AND CAMPERS FOR TRAVELLERS ABROAD; ARRANGING FOR RENTAL OF DIVING SUITS AND DIVING EQUIPMENT FOR PERSONS TRAVELING ABROAD; TOURIST AGENCY SERVICES (U.S. CLS. 100 AND 105).

CLASS 41—EDUCATION AND ENTERTAINMENT

FOR EDUCATIONAL SERVICES, NAMELY, ARRANGING LANGUAGE SCHOOLS AND UNIVERSITY STAYS FOR OVERSEAS STUDENTS; ENTERTAINMENT SERVICES, NAMELY, DANCE RECITALS, LIVE MUSICAL AND THEATRICAL PRODUCTIONS, ART EXHIBITIONS, AND SPORTING EVENTS; PROVIDING SPORTING ACTIVITIES, NAMELY, TRAINING AND INSTRUCTION FOR SPORTS AND ARRANGING, CONDUCTING AND PROVIDING FACILITIES FOR SPORTS COMPETITIONS AND TOURNAMENTS; PROVIDING CULTURAL ACTIVITIES, NAMELY SIGHTSEEING TOURS, VISITS TO MUSEUMS AND LECTURES IN THE FIELD OF AMERICAN CULTURE AND SCANDINAVIAN CULTURE; PROVIDING RENTAL OF SPORTING EQUIPMENT; ORGANIZATION AND CONDUCTING OF EXHIBITIONS FOR CULTURAL OR EDUCATIONAL PURPOSES; ORGANIZATION AND CONDUCTING OF MEETINGS IN THE FIELD OF AMERICAN/SCANDINAVIAN CULTURAL RELATIONS (U.S. CLS. 100, 101 AND 107).

SN 76-310,314. MODULANT SOLUTIONS, INC., SAN FRANCISCO, CA. FILED 9-7-2001.



CLASS 9—ELECTRICAL AND SCIENTIFIC APPARATUS

FOR COMPUTER PROGRAMS, NAMELY, COMPILERS, ASSEMBLERS, EMULATOR SOFTWARE FOR ALLOWING ONE TYPE OF COMPUTER RUN PROGRAMS DESIGNED FOR ANOTHER, CONVERSION PROGRAMS FOR USE IN TRANSFERRING AND CONVERTING DATA, TEXT AND BINARY FILES AND APPLICATION SOFTWARE PROGRAMS BETWEEN COMPUTERS HAVING DIFFERENT OPERATING SYSTEMS AND DATA LAYOUTS; VISUAL DEVELOPMENT SOFTWARE, APPLICATION DEVELOPMENT ENVIRONMENTS, TOOLS AND UTILITIES FOR USE IN CREATING APPLICATIONS, E-COMMERCE PROGRAMS, INTERNET AND WEB-BASED APPLICATIONS AND OTHER PROGRAMS, AND FOR DEVELOPING SOFTWARE TO ALLOW INTEROPERABILITY BETWEEN COMPATIBLE AND NON-COMPATIBLE COMPUTER AND DATABASE SYSTEMS; COMPUTER SOFTWARE DEVELOPMENT TOOLS, NAMELY, PROGRAM AND APPLICATION DEVELOPMENT SOFTWARE, TOOLS AND UTILITIES, ALL FOR USE IN DESIGNING, DEVELOPING, WRITING AND IMPLEMENTING USER-SPECIFIC APPLICATIONS AND GENERAL PURPOSE APPLICATIONS PROGRAMS; OBJECT-ORIENTED AND CLIENT/SERVER PROGRAMMING DEVELOPMENT SOFTWARE, TOOLS AND UTILITIES; DATABASE, SERVER DATABASE AND DATABASE MANAGEMENT SOFTWARE; DEVELOPMENT SOFTWARE, TOOLS AND UTILITIES FOR USE IN DESIGNING AND IMPLEMENTING PROGRAMS FOR PROVIDING LOGICAL INTEROPERABILITY AMONG AND/OR BETWEEN COMPATIBLE AND/OR NON-COMPATIBLE SYSTEMS, FORMATS, STANDARDS, APPLICATIONS AND DATABASES; SOFTWARE PROGRAMS FOR ENABLING CONNECTIONS TO LOCAL AREA NETWORKS, ENTERPRISE NETWORKS, INTRANETS, EXTRANETS, CORPORATE INFORMATION NETWORKS, WIDE AREA NETWORKS AND GLOBALLY INTERCONNECTED COMPUTER NETWORKS LINKED BY COMMON OR DIVERSE PROTOCOLS; COMPUTER E-COMMERCE SOFTWARE TO ALLOW USERS TO PERFORM ELECTRONIC BUSINESS TRANSACTIONS VIA A GLOBAL COMPUTER NETWORK; SOFTWARE USED TO PROVIDE INTEROPERABILITY BETWEEN AND INTEGRATION OF LEGACY SYSTEMS WITH E-APPLICATION PACKAGES, ENTERPRISE-WIDE INTEROPERABILITY OF ALL APPLICATIONS AND OF ALL DATA SOURCES AND DATABASES; PROGRAMMING TOOLS

AND UTILITY PROGRAMS FOR USE IN DEVELOPING, MAINTAINING, ENHANCING AND OPERATING COMPUTER PROGRAMS AND COMPUTER SYSTEMS, AND USER MANUALS SOLD THEREWITH AS A UNIT (U.S. CLS. 21, 23, 26, 36 AND 38).

CLASS 42—SCIENTIFIC, COMPUTER AND LEGAL SERVICES

FOR DESIGN AND DEVELOPMENT OF COMPUTER SOFTWARE FOR OTHERS; COMPUTER AND SOFTWARE CONSULTATION SERVICES FOR OTHERS, NAMELY, ANALYZING, RESEARCHING, DESIGNING AND DEVELOPING COMPUTER SOFTWARE AND PROVIDING DATA MIGRATION SERVICES FOR OTHERS TO ALLOW INTEROPERABILITY BETWEEN COMPATIBLE AND NON-COMPATIBLE SYSTEMS AND PROGRAMS; PROFESSIONAL AND TECHNICAL CONSULTING SERVICES IN RELATION TO COMPUTERS, COMPUTER SOFTWARE, DATABASES AND DATABASE MANAGEMENT, NETWORKING, PROGRAMMING AND APPLICATION DEVELOPMENT, AND IN THE FIELD OF INTEROPERABILITY BETWEEN COMPATIBLE AND NON-COMPATIBLE SYSTEMS AND PROGRAMS; DESIGN AND CONSULTING SERVICES FOR OTHERS, NAMELY DEVELOPING AND PROVIDING SOFTWARE TOOLS AND UTILITIES AND DATA CONVERSION SERVICES TO ALLOW FOR THE EXCHANGE, CONVERSION, INTEGRATION AND TRANSFORMATION OF DATA AND DATABASES OF OTHERS; DESIGNING AND IMPLEMENTING SOFTWARE PROGRAMS FOR OTHERS FOR PROVIDING LOGICAL INTEROPERABILITY AMONG AND/OR BETWEEN COMPATIBLE AND/OR NON-COMPATIBLE SYSTEMS, FORMATS, STANDARDS, APPLICATIONS AND DATABASES AND TO PROVIDE INTEROPERABILITY BETWEEN AND INTEGRATION OF LEGACY SYSTEMS WITH E-APPLICATION PACKAGES, ENTERPRISE-WIDE INTEROPERABILITY OF ALL APPLICATIONS AND OF ALL DATA SOURCES AND DATABASES; MAINTENANCE AND SUPPORT SERVICES FOR COMPUTER SOFTWARE, NAMELY TELEPHONE CONSULTATION, DEBUGGING COMPUTER SOFTWARE, UPDATING COMPUTER SOFTWARE FOR OTHERS, AND PROVIDING INFORMATION VIA THE INTERNET, ALL IN THE FIELDS OF COMPUTERS, COMPUTER SOFTWARE AND COMPUTER SYSTEMS; COMPUTER SYSTEMS AND COMPUTER SOFTWARE DEVELOPMENT CONSULTING SERVICES (U.S. CLS. 100 AND 101).

SN 76-310,469. DIGEX, INCORPORATED, BELTSVILLE, MD. FILED 9-7-2001.

ARCHITEX

CLASS 38—COMMUNICATION

FOR PROVIDING MULTIPLE USER ACCESS TO THE INTERNET FOR DEVELOPING, HOSTING, AND MANAGING INTERNET APPLICATIONS OF CUSTOMERS (U.S. CLS. 100, 101 AND 104).

CLASS 42—SCIENTIFIC, COMPUTER AND LEGAL SERVICES

FOR HOSTED SOFTWARE APPLICATION MANAGEMENT SERVICES, NAMELY, HOSTING COMPUTER SOFTWARE APPLICATIONS OF OTHERS, AND HOSTING OF INTERNET-ACCESSIBLE DIGITAL CONTENT ON A GLOBAL COMPUTER INFORMATION NETWORK (U.S. CLS. 100 AND 101).

SN 76-310,812. VALUEVISION INTERNATIONAL, INC., EDEN PRAIRIE, MN. FILED 9-7-2001.

1-888-CALORIE

CLASS 35—ADVERTISING AND BUSINESS

FOR RETAIL STORE SERVICES AVAILABLE THROUGH TELEPHONE SERVICES FEATURING PRODUCTS RELATING TO WEIGHT LOSS AND NUTRITION (U.S. CLS. 100, 101 AND 102).

CLASS 42—SCIENTIFIC, COMPUTER AND LEGAL SERVICES

FOR COUNSELING IN THE FIELD OF WEIGHT LOSS AND NUTRITION VIA TELEPHONE (U.S. CLS. 100 AND 101).

SN 76-310,962. ASCENT INTERNATIONAL CONSULTING GROUP, INC., DANA POINT, CA. FILED 9-11-2001.

SELLING AT A GLANCE

CLASS 9—ELECTRICAL AND SCIENTIFIC APPARATUS

FOR ELECTRONIC PUBLICATIONS, NAMELY, NEWSLETTERS, JOURNALS, BOOKLETS, PAMPHLETS, AND MANUALS FEATURING SKILLS, TECHNIQUES, AND PLANNING GUIDES FOR THE TRAINING AND DEVELOPMENT OF PROFESSIONAL SALESPeOPLE RECORDED ON CASSETTE TAPE, VHS, CD, DV, AND DVD MEDIA; DOWNLOADABLE ELECTRONIC PUBLICATIONS IN THE NATURE OF NEWSLETTERS, JOURNALS, BOOKLETS, PAMPHLETS, AND MANUALS FEATURING SKILLS, TECHNIQUES, AND PLANNING GUIDES FOR THE TRAINING AND DEVELOPMENT OF PROFESSIONAL SALESPeOPLE; COMPUTER SOFTWARE THAT CONSISTS OF SKILLS, TECHNIQUES, AND PLANNING GUIDES FOR THE TRAINING AND DEVELOPMENT OF PROFESSIONAL SALESPeOPLE (U.S. CLS. 21, 23, 26, 36 AND 38).

CLASS 16—PAPER GOODS AND PRINTED MATTER

FOR PRINTED MATERIAL, NAMELY, NEWSLETTERS, JOURNALS, BOOKLETS, PAMPHLETS, AND MANUALS IN THE FIELD OF SKILLS, TECHNIQUES, AND PLANNING GUIDES FOR THE TRAINING AND DEVELOPMENT OF PROFESSIONAL SALESPeOPLE (U.S. CLS. 2, 5, 22, 23, 29, 37, 38 AND 50).

SN 76-311,159. MYSTIC ENTERTAINMENT, INC., FOSTER CITY, CA. FILED 9-12-2001.

DOLPHIN INTERACTIVE

NO CLAIM IS MADE TO THE EXCLUSIVE RIGHT TO USE "INTERACTIVE", APART FROM THE MARK AS SHOWN.

CLASS 9—ELECTRICAL AND SCIENTIFIC APPARATUS

FOR COMPUTER PRODUCTS, NAMELY, COMPUTER GAME SOFTWARE, COMPUTER GAME DISKS, COMPUTER GAME PROGRAMS, COMPUTER GAME CASSETTES AND TAPES, COMPUTER GAME CARTRIDGES, MULTIMEDIA SOFTWARE RECORDED ON A CD-ROM FEATURING COMPUTER GAMES, COMPUTER GAME SOFTWARE THAT IS DOWNLOADABLE FROM A GLOBAL COMPUTER NETWORK; COMPUTERS; COMPUTER HARDWARE; COMPUTER FIRMWARE THAT IS COMPUTER GAME SOFTWARE, COMPUTER FIRMWARE APPLICATIONS FOR GAMING; VIDEO GAME CARTRIDGES AND TAPE CASSETTES; PRE-RECORDED VIDEO TAPES FEATURING COMPUTER GAMES AND CHARACTERS; CINEMATOGRAPHIC FILMS FEATURING THE ACTION AND ADVENTURE GENRE AND ANIMATED CHARACTERS; COMPUTER GAME PROGRAMS AND VIDEO GAME MACHINES FOR USE WITH TELEVISIONS SETS; MOTION PICTURE FILMS FEATURING THE ACTION AND ADVENTURE GENRE AND ANIMATED CHARACTERS (U.S. CLS. 21, 23, 26, 36 AND 38).

CLASS 28—TOYS AND SPORTING GOODS

FOR TOYS, NAMELY, ACTION FIGURES, FANTASY CHARACTER TOYS, MECHANICAL TOYS, SOFT SCULPTURE PLUSH TOYS, STUFFED AND WIND-UP TOYS, BOARD GAMES, ACTION SKILL GAMES, AND ARCADE GAMES; PLAYTHINGS, NAMELY, PLAY AND ACTION FIGURES (U.S. CLS. 22, 23, 38 AND 50).

SN 76-311,588. CREASOURCE LTD., LONDON WIT2PH, UNITED KINGDOM, FILED 9-12-2001.

CREASOURCE**CLASS 16—PAPER GOODS AND PRINTED MATTER**

FOR PRINTED MATTER, NAMELY PICTURE CATALOGUES (U.S. CLS. 2, 5, 22, 23, 29, 37, 38 AND 50).

CLASS 35—ADVERTISING AND BUSINESS

FOR COPYRIGHT MANAGEMENT SERVICES, NAMELY, EXPLOITATION OF PHOTOGRAPHS, PHOTOGRAPHIC WORKS, FILMS, VIDEOS AND IMAGE AND SOUND SEQUENCES ON IMAGE AND SOUND RECORDING CARRIERS OF ALL TYPES (U.S. CLS. 100, 101 AND 102).

CLASS 41—EDUCATION AND ENTERTAINMENT

FOR PRODUCTION OF PHOTOGRAPHS AND PHOTOGRAPHIC WORKS, FILMS, VIDEOS AND IMAGE AND SOUND SEQUENCES ON IMAGE AND SOUND RECORDING CARRIERS OF ALL TYPES, NAMELY, FILM, VIDEOTAPE, VIDEO CASSETTES, VIDEO DISCS; PUBLICATION OF PICTURE CATALOGUES (U.S. CLS. 100, 101 AND 107).

CLASS 42—SCIENTIFIC, COMPUTER AND LEGAL SERVICES

FOR STOCK PHOTOGRAPHY SERVICES, NAMELY, LEASING REPRODUCTION RIGHTS OF PHOTOGRAPHS AND PHOTOGRAPHIC WORKS (U.S. CLS. 100 AND 101).

SN 76-312,096. KEEFE, JEFFREY, AKRON, OH. FILED 9-10-2001.

DARK POP

NO CLAIM IS MADE TO THE EXCLUSIVE RIGHT TO USE "POP", APART FROM THE MARK AS SHOWN.

CLASS 9—ELECTRICAL AND SCIENTIFIC APPARATUS

FOR MUSICAL SOUND RECORDINGS (U.S. CLS. 21, 23, 26, 36 AND 38).

CLASS 41—EDUCATION AND ENTERTAINMENT

FOR ENTERTAINMENT SERVICES, NAMELY, LIVE PERFORMANCES BY A MUSICAL GROUP; ON-GOING RADIO PROGRAMS IN THE FIELD OF MUSIC (U.S. CLS. 100, 101 AND 107).

SN 76-312,819. SHERWOOD SERVICES AG, SCHAFFHAUSEN, SWITZERLAND, FILED 9-13-2001.

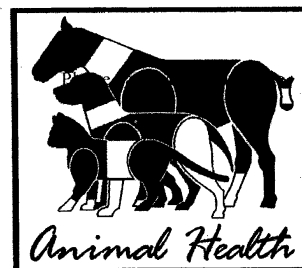

NO CLAIM IS MADE TO THE EXCLUSIVE RIGHT TO USE "ANIMAL HEALTH", APART FROM THE MARK AS SHOWN.

CLASS 5—PHARMACEUTICALS

FOR WOUND CARE PRODUCTS FOR USE BY VETERINARIANS, NAMELY, WOUND DRESSINGS, MEDICAL ADHESIVE TAPES, GAUZE, SURGICAL BANDAGES AND BANDAGES FOR SKIN WOUNDS (U.S. CLS. 6, 18, 44, 46, 51 AND 52).

CLASS 10—MEDICAL APPARATUS

FOR MEDICAL APPARATUS, NAMELY, SUCTION DEVICES, CATHETERS, ENTERAL FEEDING TUBES, ENTERAL FEEDING PUMPS; WOUND CLOSURE PRODUCTS, NAMELY, SUTURES AND STAPLES; NEEDLES; SYRINGES; SHARPS CONTAINERS AND BLOOD COLLECTION SYSTEMS, CONSISTING ESSENTIALLY OF COLLECTION TUBES, NEEDLES, LANCETS AND ENDOMETRIAL SAMPLES, ALL FOR USE BY VETERINARIANS (U.S. CLS. 26, 39 AND 44).

SN 76-312,855. GANCOM, A DIVISION OF GANNETT FLEMING, INC., CAMP HILL, PA. FILED 9-14-2001.



NO CLAIM IS MADE TO THE EXCLUSIVE RIGHT TO USE "DESIGN COMPUTE PRINT MAIL", "DIVISION", AND "INC.", APART FROM THE MARK AS SHOWN.

CLASS 35—ADVERTISING AND BUSINESS

FOR MAILING LIST PREPARATION, LETTER SHOP, COPYING AND ORDER FULFILLMENT SERVICES (U.S. CLS. 100, 101 AND 102).
FIRST USE 1-1-2001; IN COMMERCE 1-1-2001.

CLASS 37—CONSTRUCTION AND REPAIR

FOR INSTALLATION OF COMPUTER NETWORKS AND COMPUTER SYSTEMS (U.S. CLS. 100, 103 AND 106).
FIRST USE 1-1-2001; IN COMMERCE 1-1-2001.

CLASS 42—SCIENTIFIC, COMPUTER AND LEGAL SERVICES

FOR DESIGN PRINTING, PRINTING, PRINTING AND GRAPHIC ART DESIGN, COMPUTER SOFTWARE DESIGN FOR, COMPUTER SOFTWARE DEVELOPMENT, COMPUTER SYSTEMS ANALYSIS, DATA AUTOMATION AND COLLECTION SERVICE USING PROPRIETARY SOFTWARE TO EVALUATE, ANALYZE AND COLLECT SERVICE DATA, COMPUTER SOFTWARE SUPPORT SERVICES FOR WORD PROCESSING, DATABASE DEVELOPMENT, CREATING AND MAINTAINING WEB SITES, INSTALLATION OF COMPUTER SOFTWARE, CONSULTING SERVICES IN THE FIELD OF COMPUTER SYSTEMS AND SOFTWARE (U.S. CLS. 100 AND 101).
FIRST USE 1-1-2001; IN COMMERCE 1-1-2001.

SN 76-312,872. GANCOM, A DIVISION OF GANNETT FLEMING, INC., CAMP HILL, PA. FILED 9-14-2001.

GANCOM

CLASS 35—ADVERTISING AND BUSINESS

FOR MAILING LIST PREPARATION, LETTER SHOP, COPYING, AND ORDER FULFILLMENT SERVICES (U.S. CLS. 100, 101 AND 102).
FIRST USE 1-1-1981; IN COMMERCE 1-1-1981.

CLASS 37—CONSTRUCTION AND REPAIR

FOR INSTALLATION OF COMPUTER NETWORKS AND COMPUTER SYSTEMS (U.S. CLS. 100, 103 AND 106).
FIRST USE 1-1-1981; IN COMMERCE 1-1-1981.

CLASS 42—SCIENTIFIC, COMPUTER AND LEGAL SERVICES

FOR DESIGN PRINTING, PRINTING, PRINTING AND GRAPHIC ART DESIGN, COMPUTER SOFTWARE DESIGN FOR OTHERS, COMPUTER SOFTWARE DEVELOPMENT, COMPUTER SYSTEMS ANALYSIS, DATA AUTOMATION AND COLLECTION SERVICE USING PROPRIETARY SOFTWARE TO EVALUATE, ANALYZE AND COLLECT SERVICE DATA, COMPUTER SOFTWARE SUPPORT SERVICES FOR WORD PROCESSING, DATABASE DEVELOPMENT, CREATING AND MAINTAINING WEB SITES, INSTALLATION OF COMPUTER SOFTWARE, CONSULTING SERVICES IN THE FIELD OF COMPUTER SYSTEMS AND SOFTWARE (U.S. CLS. 100 AND 101).
FIRST USE 1-1-1981; IN COMMERCE 1-1-1981.

SN 76-312,992. SAUER-DANFOSS, INC., AMES, IA. FILED 9-17-2001.

SAUER-DANFOSS

CLASS 7—MACHINERY

FOR HYDRAULIC PUMPS FOR BOATS; HYDRAULIC MOTORS FOR BOATS; BENT-AXIS VARIABLE DISPLACEMENT MOTORS FOR BOATS; HYDRAULIC TRANSMISSIONS COMPRISING A HYDRAULIC PUMP AND HYDRAULIC MOTORS, HYDRAULIC AND MECHANICAL CONTROLS THEREFOR FOR USE IN BOATS; GEAR PUMP FOR USE IN BOATS; HYDRAULIC PUMPS FOR LAND VEHICLES ENGINES; GEAR PUMP FOR USE IN LAND VEHICLES FAN DRIVES FOR USE IN LAND VEHICLE ENGINES (U.S. CLS. 13, 19, 21, 23, 31, 34 AND 35).
FIRST USE 5-31-2000; IN COMMERCE 5-31-2000.

CLASS 9—ELECTRICAL AND SCIENTIFIC APPARATUS

FOR ELECTRICAL AND ELECTRONIC CONTROLS COMPRISING ELECTROHYDRAULIC VALVES, ELECTRICAL ACTUATORS, ELECTRICAL SENSORS, AND STRUCTURAL PARTS THEREOF, ALL OF THE FOREGOING BEING FOR THE CONTROL OF HYDRAULIC TRANSMISSIONS, HYDRAULIC POWER APPARATUS FOR STATIONARY USE AND MOTOR VEHICLES AND THEIR WORKING IMPLEMENTS; MICROPROCESSOR BASED CONTROLLERS COMPRISED OF SENSOR/ TRANSDUCER AND ELECTRICAL ACTUATOR INPUTS, ELECTROHYDRAULIC VALVE, OPERATOR PANEL DISPLAY, CONTROLLER AREA NETWORK AND RS232 PORT OUTPUTS (U.S. CLS. 21, 23, 26, 36 AND 38).
FIRST USE 5-31-2000; IN COMMERCE 5-31-2000.

CLASS 12—VEHICLES

FOR HYDRAULIC MOTORS FOR LAND VEHICLE ENGINES; BENT-AXIS VARIABLE DISPLACEMENT MOTORS FOR LAND VEHICLE ENGINES; HYDROSTATIC TRANSMISSIONS FOR LAND VEHICLE ENGINES; HYDRAULIC TRANSMISSIONS COMPRISING A HYDRAULIC PUMP AND HYDRAULIC MOTORS, HYDRAULIC AND MECHANICAL CONTROLS THEREFOR FOR USE IN LAND VEHICLES, GEAR DRIVES FOR USE IN LAND VEHICLES; AND DRIVE GEAR BOXES FOR USE WITH HYDRAULIC AND HYDROSTATIC TRANSMISSIONS AND PARTS THEREFOR FOR USE WITH LAND VEHICLES (U.S. CLS. 19, 21, 23, 31, 35 AND 44).
FIRST USE 5-31-2000; IN COMMERCE 5-31-2000.

SN 76-313,016. KINPLEX CORPORATION, EDGEWOOD, NY. FILED 9-17-2001.

SMART FABRICATION

NO CLAIM IS MADE TO THE EXCLUSIVE RIGHT TO USE "FABRICATION", APART FROM THE MARK AS SHOWN.

CLASS 11—ENVIRONMENTAL CONTROL APPARATUS

FOR FOOD SERVICE EQUIPMENT USED IN COMMERCIAL FOOD SERVICES AND/OR FOOD PREPARATION INSTALLATIONS, NAMELY, SINKS (U.S. CLS. 13, 21, 23, 31 AND 34).
FIRST USE 12-0-2000; IN COMMERCE 12-0-2000.

CLASS 20—FURNITURE AND ARTICLES NOT OTHERWISE CLASSIFIED

FOR FOOD SERVICE EQUIPMENT USED IN COMMERCIAL FOOD SERVICES AND/OR FOOD PREPARATION INSTALLATIONS, NAMELY, TABLES (U.S. CLS. 2, 13, 22, 25, 32 AND 50).
FIRST USE 12-0-2000; IN COMMERCE 12-0-2000.

SN 76-313,032. WEST-HERR AUTOMOTIVE GROUP, INC., HAMBURG, NY. FILED 9-13-2001.

WESTHERR.COM

CLASS 35—ADVERTISING AND BUSINESS

FOR RETAIL STORE SERVICES AND AUTOMOBILE DEALERSHIPS FEATURING NEW AND USED AUTOMOBILES AND TRUCKS AND FEATURING AUTOMOBILE PARTS AND TRUCK PARTS (U.S. CLS. 100, 101 AND 102).
FIRST USE 0-0-1996; IN COMMERCE 0-0-1996.

CLASS 36—INSURANCE AND FINANCIAL

FOR CONSUMER FINANCIAL SERVICES IN THE FIELD OF MOTOR VEHICLE FINANCING (U.S. CLS. 100, 101 AND 102).
FIRST USE 0-0-1996; IN COMMERCE 0-0-1996.

CLASS 37—CONSTRUCTION AND REPAIR

FOR MAINTENANCE AND REPAIR OF AUTOMOBILES AND TRUCKS; BODY SHOP SERVICES (U.S. CLS. 100, 103 AND 106).
FIRST USE 0-0-1996; IN COMMERCE 0-0-1996.

CLASS 39—TRANSPORTATION AND STORAGE

FOR LEASING OF AUTOMOBILES AND TRUCKS (U.S. CLS. 100 AND 105).
FIRST USE 0-0-1996; IN COMMERCE 0-0-1996.

SN 76-313,147. CROSLAND GROUP, INC., THE, CHARLOTTE, NC. FILED 9-13-2001.

CROSLAND

SEC. 2(F).

CLASS 36—INSURANCE AND FINANCIAL

FOR REAL ESTATE MANAGEMENT (U.S. CLS. 100, 101 AND 102).
FIRST USE 0-0-1940; IN COMMERCE 0-0-1940.

CLASS 37—CONSTRUCTION AND REPAIR

FOR REAL ESTATE DEVELOPMENT (U.S. CLS. 100, 103 AND 106).
FIRST USE 0-0-1940; IN COMMERCE 0-0-1940.

SN 76-313,471. AXIOM CUSTOM BUSINESS SOLUTIONS, INC., ENGLEWOOD, CO. FILED 6-1-2001.

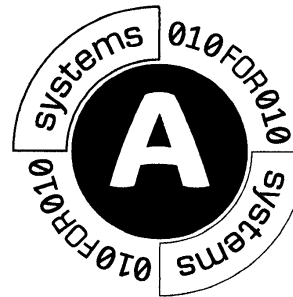

NO CLAIM IS MADE TO THE EXCLUSIVE RIGHT TO USE "SYSTEMS", APART FROM THE MARK AS SHOWN.
THE MARK CONSIST OF A SPHERE WITH THE CAPITAL LETTER "A" IN THE CENTER OF SPHERE, THE SPHERE IS SURROUNDED BY TEXT AND (2) QUARTER-ROUND, SQUARED-OFF SEMI-CIRCLES WHICH READS: "SYSTEMS FOR SYSTEMS".

CLASS 35—ADVERTISING AND BUSINESS

FOR BUSINESS MANAGEMENT CONSULTATION SERVICES (U.S. CLS. 100, 101 AND 102).

CLASS 42—SCIENTIFIC, COMPUTER AND LEGAL SERVICES

FOR COMPUTER NETWORK PROGRAMMING FOR OTHERS (U.S. CLS. 100 AND 101).

SN 76-313,592. EFFECTIVE ENVIRONMENTAL SOLUTIONS, INC., PETERSBURG, MI. FILED 9-18-2001.



NO CLAIM IS MADE TO THE EXCLUSIVE RIGHT TO USE "INCORPORATED", APART FROM THE MARK AS SHOWN.
THE LINING AND STIPPLING SHOWN I THE DRAWING ARE A FEATURE OF THE MARK AND ARE NOT INTENDED TO INDICATE COLOR
SEC. 2(F) AS TO "EFFECTIVE ENVIRONMENTAL SOLUTIONS".

CLASS 40—MATERIAL TREATMENT

FOR ENVIRONMENTAL REMEDIATION SERVICES, NAMELY, SOIL, WASTE AND WATER TREATMENT SERVICES; RECYCLING SERVICES (U.S. CLS. 100, 103 AND 106).

FIRST USE 2-0-1999; IN COMMERCE 2-0-1999.

CLASS 42—SCIENTIFIC, COMPUTER AND LEGAL SERVICES

FOR HAZARDOUS AND NON-HAZARDOUS WASTE MANAGEMENT; REVIEWING STANDARDS AND PRACTICES TO ASSURE COMPLIANCE WITH ENVIRONMENTAL LAWS AND REGULATIONS; ENVIRONMENTAL SAFETY AND HEALTH RISK ASSESSMENT AND ANALYSIS SERVICES (U.S. CLS. 100 AND 101).

FIRST USE 2-0-1999; IN COMMERCE 2-0-1999.

SN 76-313,600. M3 LEARNING, INC., LOS GATOS, CA. FILED 9-12-2001.

M3 LEARNING

NO CLAIM IS MADE TO THE EXCLUSIVE RIGHT TO USE "LEARNING", APART FROM THE MARK AS SHOWN.

CLASS 9—ELECTRICAL AND SCIENTIFIC APPARATUS

FOR PRE-RECORDED CDS FEATURING INFORMATION IN THE FIELD OF SALES AND SALES MANAGEMENT (U.S. CLS. 21, 23, 26, 36 AND 38).

FIRST USE 11-30-2000; IN COMMERCE 11-30-2000.

CLASS 16—PAPER GOODS AND PRINTED MATTER

FOR PRINTED PUBLICATIONS, NAMELY, EDUCATIONAL COURSE MATERIALS IN THE FIELD OF SALES AND SALES MANAGEMENT (U.S. CLS. 2, 5, 22, 23, 29, 37, 38 AND 50).

FIRST USE 11-30-1996; IN COMMERCE 11-30-1996.

CLASS 41—EDUCATION AND ENTERTAINMENT

FOR TRAINING AND EDUCATIONAL SERVICES, NAMELY, CONDUCTING CLASSES, SEMINARS AND WORKSHOPS, IN THE FIELD OF SALES AND SALES MANAGEMENT (U.S. CLS. 100, 101 AND 107).

FIRST USE 11-30-1996; IN COMMERCE 11-30-1996.

SN 76-313,850. ANTEFACTO LTD., DUBLIN 1, IRELAND, FILED 9-13-2001.

ANTEFACTO**CLASS 9—ELECTRICAL AND SCIENTIFIC APPARATUS**

FOR COMPUTER HARDWARE; COMPUTER SOFTWARE PROVIDING HIGH AVAILABILITY AND SECURITY FOR COMPUTER SYSTEMS (U.S. CLS. 21, 23, 26, 36 AND 38).

CLASS 42—SCIENTIFIC, COMPUTER AND LEGAL SERVICES

FOR CONSULTING SERVICES IN THE FIELD OF DESIGN, SELECTION, IMPLEMENTATION, AND USE OF COMPUTER HARDWARE AND SOFTWARE SYSTEMS FOR OTHERS (U.S. CLS. 100 AND 101).

SN 76-314,165. UNIVERSITY OF WASHINGTON, SEATTLE, WA. FILED 9-17-2001.

HUSKY W TEAM SHOP

NO CLAIM IS MADE TO THE EXCLUSIVE RIGHT TO USE "TEAM SHOP", APART FROM THE MARK AS SHOWN.

CLASS 16—PAPER GOODS AND PRINTED MATTER

FOR PAPER PRODUCTS, PRINTED MATERIALS AND PUBLICATIONS, NAMELY, SPORTS PROGRAMS, NOTEBOOKS, BINDERS, NOTEPADS, ENVELOPES, PRINTED INVITATIONS, NAPKINS, PENNANTS AND POSTERS (U.S. CLS. 2, 5, 22, 23, 29, 37, 38 AND 50).

CLASS 25—CLOTHING

FOR CLOTHING, NAMELY, SHIRTS, T-SHIRTS, SWEATSHIRTS, PANTS, SWEATPANTS, SHORTS, SWEATERS, JACKETS, SCARVES, SOCKS, HATS AND CAPS (U.S. CLS. 22 AND 39).

CLASS 35—ADVERTISING AND BUSINESS

FOR RETAIL STORE, RETAIL MAIL-ORDER, AND COMPUTERIZED ON-LINE RETAIL STORE SERVICES FEATURING GOOD BEARING THE NAME, TEAM NICKNAMES, DESIGNS, LOGOS, TRADEMARKS, AND COLORS OF THE APPLICANT, NAMELY, CLOTHING, HEADWEAR, SLIPPERS, BOOKS, NOTEBOOKS, NOTEPADS, CALENDARS, POSTERS, DECALS, GLASSWARE, PENS AND PENCILS, JEWELRY, WATCHES, SUNGLASSES, KEY RINGS, BINOCULARS, PENNANTS, FLAGS, POM-POMS, BLANKETS, TOWELS, GAMES, WINDSOCKS, CANDLES, MEGAPHONES, CHRISTMAS LIGHTS, SNOW GLOBES, DOLLS, STUFFED ANIMALS, FOOTBALLS, BASKETBALLS, GOLF BALLS, GOLF BALL TEES, GOLF BAG TAGS, GOLF DIVOT TOOLS, GOLF CLUB HEAD COVERS, GOLF BALL MARKERS, LICENSE PLATE FRAMES, TRAILER HITCH COVERS, CANDY, AND NUTS (U.S. CLS. 100, 101 AND 102).

SN 76-314,262. DOWD, SHAUGHN M., VIENNA, VA. FILED 9-18-2001.

CON BRIO!

THE ENGLISH TRANSLATION OF THE WORD "CON BRIO" IN THE MARK IS "WITH SPIRIT".

CLASS 35—ADVERTISING AND BUSINESS

FOR PROMOTION OF MUSICAL GROUPS OF OTHERS (U.S. CLS. 100, 101 AND 102).

FIRST USE 12-31-1990; IN COMMERCE 12-31-1990.

CLASS 41—EDUCATION AND ENTERTAINMENT

FOR MUSICAL ENTERTAINMENT SERVICES, NAMELY CHAMBER MUSIC PERFORMANCES; AND CONCERT BOOKING FOR OTHERS (U.S. CLS. 100, 101 AND 107).

FIRST USE 12-31-1990; IN COMMERCE 12-31-1990.

SN 76-314,321. MAC MAN ENTERPRISES, INC., CHICAGO, IL. FILED 9-19-2001.

PUT THAT "CL" ON THAT "ASS!"

CLASS 25—CLOTHING

FOR CLOTHING, NAMELY JACKETS, HATS AND T-SHIRTS (U.S. CLS. 22 AND 39).

CLASS 35—ADVERTISING AND BUSINESS

FOR ON-LINE ORDERING SERVICES FEATURING CLOTHING AND CONCERT MERCHANDISE, NAMELY, CONCERT POSTERS, PHONOGRAPHIC RECORDS, PRERECORDED TAPE CASSETTES, PRERECORDED COMPACT DISCS, BOOKS, CONCERT PROGRAMS, SHEET MUSIC AND CALENDARS (U.S. CLS. 100, 101 AND 102).

SN 76-314,748. SCHNEIDER AUTOMATION GMBH, 63500 SELIGENSTADT, FED REP GERMANY, FILED 9-20-2001.



PRIORITY CLAIMED UNDER SEC. 44(D) ON FED REP GERMANY APPLICATION NO. 30120233.807, FILED 3-28-2001, REG. NO. 30120233, DATED 7-30-2001, EXPIRES 3-31-2011.

CLASS 7—MACHINERY

FOR MACHINES, MACHINE TOOLS, NAMELY METAL WORKING MACHINES, WOOD WORKING MACHINES, PLASTIC PROCESSING MACHINES; DEVICES FOR POWER TRANSMISSION, NAMELY CHAINS, V-BELTS, BANDS; AUTOMATED MANUFACTURING INSTALLATIONS, NAMELY ENGINE MANUFACTURING INSTALLATIONS, BODY MANUFACTURING INSTALLATIONS; HANDLING EQUIPMENT, NAMELY ARTICULATED ARM ROBOTS, FLOOR TRANSPORTATION SYSTEMS; CONVEYORS, NAMELY BELT CONVEYORS (U.S. CLS. 13, 19, 21, 23, 31, 34 AND 35).

CLASS 9—ELECTRICAL AND SCIENTIFIC APPARATUS

FOR ELECTRIC, PHOTOGRAPHIC, CINEMATOGRAPHIC, OPTICAL MEASURING, SIGNALLING, CHECKING LIVE-SAVING AND TEACHING APPARATUS AND INSTRUMENTS, NAMELY, INTERFACES, COMPARATORS, COUPLERS, LUMINOUS OR MECHANICAL SIGNALLING PANELS, LUMINOUS SIGNS, INDUCTORS; APPARATUS FOR RECORDING TRANSMISSION AND REPRODUCTION OF SOUND OR IMAGE, NAMELY MONITORS; COMPUTERS; MAGNETIC ENCODERS; MAGNETIC DATA CARRIERS, NAMELY MAGNETIC TAPS, CODED IDENTIFY CARDS, CODED SERVICE CARDS, RECORDED COMPUTER SOFTWARE; AUTOMATIC EQUIPMENT, NAMELY PROGRAMMABLE LOGIC CONTROLS, ELEVATOR SYSTEMS, ENGINE CONTROLS (U.S. CLS. 21, 23, 26, 36 AND 38).

CLASS 16—PAPER GOODS AND PRINTED MATTER

FOR MANUALS, CATALOGUES, BROCHURES AND PRINTED TEACHING MATERIALS IN THE FIELD OF MANUFACTURING (U.S. CLS. 2, 5, 22, 23, 29, 37, 38 AND 50).

CLASS 35—ADVERTISING AND BUSINESS

FOR BUSINESS MANAGEMENT; BUSINESS ADMINISTRATION, NAMELY ACQUISITION AND PROCESSING OF PRODUCTION DATA FOR THIRD PARTIES (U.S. CLS. 100, 101 AND 102).

CLASS 42—SCIENTIFIC, COMPUTER AND LEGAL SERVICES

FOR CONSULTANCY IN CONNECTION WITH CONTROLLING AND ORGANIZATION OF MANUFACTURING PROCESS, NAMELY PLANNING AND PUTTING INTO SERVICE OF PLANTS (U.S. CLS. 100 AND 101).

SN 76-314,879. ENDURALOY, SAVANNAH, GA. FILED 9-18-2001.

ETERNALOY

CLASS 1—CHEMICALS

FOR CERAMIC POWDERS FOR USE IN THE MANUFACTURE OF TOOLS AND MACHINERY (U.S. CLS. 1, 5, 6, 10, 26 AND 46).

CLASS 6—METAL GOODS

FOR METAL-COATED CERAMIC POWDERS FOR USE IN THE MANUFACTURE OF TOOLS AND MACHINERY; METAL POWDERS FOR USE IN THE MANUFACTURE OF TOOLS AND MACHINERY (U.S. CLS. 2, 12, 13, 14, 23, 25 AND 50).

SN 76-315,217. UNIVERSITY OF SOUTHERN CALIFORNIA, LOS ANGELES, CA. FILED 9-19-2001.

SN 76-316,200. TREND GROUP SPA, 36100 VICENZA, ITALY, FILED 2-16-2001.

ICT FUTURE CONCEPTS

CLASS 9—ELECTRICAL AND SCIENTIFIC APPARATUS

FOR PROTECTIVE CLOTHING; INTERACTIVE VIDEO GAMES OF VIRTUAL REALITY COMPRISED OF COMPUTER HARDWARE AND SOFTWARE; INTERACTIVE VIDEO GAME PROGRAMS; AND VIDEO GAME SOFTWARE (U.S. CLS. 21, 23, 26, 36 AND 38).

CLASS 25—CLOTHING

FOR CLOTHING, NAMELY, T-SHIRTS, SWEAT-SHIRTS, SHIRTS, PANTS, SHORTS, SKIRTS, DRESSES, JACKETS, COATS, GLOVES, SOCKS, PAJAMAS, UNDERGARMENTS, HOSIERY, HEADWEAR AND FOOTWEAR, THAT HAS "SMART" CAPABILITIES, NAMELY, THE ABILITY TO ENHANCE OR AUGMENT PHYSICAL PERFORMANCE, THE ABILITY TO PROVIDE THE WEARER WITH PERSONAL AND ENVIRONMENTAL DATA, AND THE ABILITY TO ADAPT TO THE PHYSICAL ENVIRONMENT (U.S. CLS. 22 AND 39).



SN 76-315,783. 12 PACK GYM, INC., LAKE IN THE HILLS, IL. FILED 9-24-2001.



THE LINING AND SHADING IN THE DRAWING APPEARS TO BE A FEATURE OF THE MARK AND IS NOT INTENDED TO INDICATE COLOR.

CLASS 25—CLOTHING

FOR CLOTHING, NAMELY T-SHIRTS, LONG SLEEVE TEE SHIRTS, SWEATSHIRTS, AND HATS (U.S. CLS. 22 AND 39).

CLASS 35—ADVERTISING AND BUSINESS

FOR INTERNET WEB SITE RETAIL STORE SERVICE FEATURING CLOTHING (U.S. CLS. 100, 101 AND 102).

NO CLAIM IS MADE TO THE EXCLUSIVE RIGHT TO USE "GRANITE", APART FROM THE MARK AS SHOWN.

CLASS 19—NON-METALLIC BUILDING MATERIALS

FOR NON-METALLIC BUILDING MATERIALS, NAMELY, MARBLE, GRANITE, GRANITE GRIT, GLASS GRIT; FLOORINGS AND LININGS MADE OF MARBLE, GRANITE, GRANITE GRIT, GLASS GRIT AND MIXTURE THEREOF; TILES OF GRANITE GRIT AND GLASS GRIT; PLATES AND SLABS OF GRANITE GRIT AND GLASS GRIT; MARBLE SLABS AND PLATES; BUILDING MOSAICS OF CERAMICS, GLASS-CERAMIC, GRANITE AND GLASS (U.S. CLS. 1, 12, 33 AND 50).

CLASS 20—FURNITURE AND ARTICLES NOT OTHERWISE CLASSIFIED

FOR FURNITURE PARTS, NAMELY, TOP PLATES; FURNITURE PARTS, NAMELY, TOP PLATES MADE OF GRANITE GRIT AND GLASS GRIT, PARTICULARLY TOP PLATES FOR KITCHEN FURNITURE AND BATH FURNITURE (U.S. CLS. 2, 13, 22, 25, 32 AND 50).

CLASS 21—HOUSEWARES AND GLASS

FOR RAW OR SEMI-FINISHED GLASS NOT FOR BUILDINGS; PLATES AND TOP PLATES MADE OF GLASS, GLASS GRIT AND GRANITE GRIT; MOSAICS MADE OF GLASS, GLASS-CERAMIC AND GLASS-GRANITE NOT FOR BUILDINGS (U.S. CLS. 2, 13, 23, 29, 30, 33, 40 AND 50).

CLASS 37—CONSTRUCTION AND REPAIR

FOR INSTALLATION, LAYING AND MAINTENANCE OF FLOORINGS, LININGS AND MOSAICS; EMBEDDING OF PLATES AND TOP PLATES INTO FURNITURE (U.S. CLS. 100, 103 AND 106).

SN 76-317,000. UNISHIPPERS ASSOCIATION, INC., SALT LAKE CITY, UT. FILED 9-25-2001.

INSTASHIP

CLASS 35—ADVERTISING AND BUSINESS

FOR MARKETING SERVICES, NAMELY PROMOTING THE GOODS AND SERVICES OF OTHERS IN THE FIELD OF TRANSPORTATION AND DELIVERY SERVICES; PROMOTING THE GOODS AND SERVICES OF OTHERS IN THE FIELD OF TRANSPORTATION AND DELIVERY SERVICES BY PREPARING AND PLACING ADVERTISEMENTS IN AN ELECTRONIC MAGAZINE ACCESSED THROUGH A GLOBAL COMPUTER NETWORK; PROVIDING BUSINESS MANAGEMENT SERVICES TO BUSINESSES THAT PROMOTE AND MARKET COMPANIES THAT PROVIDE TRANSPORTATION AND DELIVERY SERVICES; FRANCHISING SERVICES, NAMELY, PROVIDING TECHNICAL ASSISTANCE IN THE ESTABLISHMENT AND/OR OPERATION OF BUSINESSES THAT PROMOTE AND MARKET COMPANIES THAT PROVIDE TRANSPORTATION AND DELIVERY SERVICES (U.S. CLS. 100, 101 AND 102).

CLASS 39—TRANSPORTATION AND STORAGE

FOR PICK-UP TRANSPORTATION AND DELIVERY SERVICES, NAMELY, THE PICK-UP, TRANSPORTATION AND DELIVERY OF PACKAGES SHIPPED VIA OVERNIGHT AIRFREIGHT, EXPRESS TRUCK, EXPRESS GROUND, DEFERRED GROUND, HEAVY FREIGHT, RAIL, AND BY OCEAN, INTERMODAL, AND OTHER TRANSPORTATION AND DELIVERY COMPANIES (U.S. CLS. 100 AND 105).

SN 76-317,209. STAN WINSTON CREATURES, INC., VAN NUYS, CA. FILED 9-26-2001.

MUTANT EARTH

CLASS 9—ELECTRICAL AND SCIENTIFIC APPARATUS

FOR INTERACTIVE VIDEO GAME PROGRAMS (U.S. CLS. 21, 23, 26, 36 AND 38).

CLASS 16—PAPER GOODS AND PRINTED MATTER

FOR COMIC BOOKS AND NOVELS (U.S. CLS. 2, 5, 22, 23, 29, 37, 38 AND 50).

CLASS 28—TOYS AND SPORTING GOODS

FOR TOYS, NAMELY, ACTION FIGURES AND ACCESSORIES THEREFORE (U.S. CLS. 22, 23, 38 AND 50).

SN 76-317,743. LUX DIGITAL, LLC, MILLINGTON, NJ. FILED 9-26-2001.

LUX DIGITAL

NO CLAIM IS MADE TO THE EXCLUSIVE RIGHT TO USE "DIGITAL", APART FROM THE MARK AS SHOWN.

CLASS 40—MATERIAL TREATMENT

FOR DIGITAL PHOTOGRAPHIC PRINTING; DIGITAL IMAGING SERVICES; AND DIGITAL RESTORATION AND/OR ENHANCEMENT OF PHOTOGRAPHS (U.S. CLS. 100, 103 AND 106).

FIRST USE 10-0-1999; IN COMMERCE 10-0-1999.

CLASS 42—SCIENTIFIC, COMPUTER AND LEGAL SERVICES

FOR GRAPHIC ART DESIGN SERVICES (U.S. CLS. 100 AND 101).

FIRST USE 10-0-1999; IN COMMERCE 10-0-1999.

SN 76-317,989. BUZZSAW ADVERTISING AND DESIGN, INC., IRVINE, CA. FILED 9-26-2001.

BUZZSAW

CLASS 35—ADVERTISING AND BUSINESS

FOR ADVERTISING AGENCY SERVICES (U.S. CLS. 100, 101 AND 102).

FIRST USE 3-19-2001; IN COMMERCE 3-19-2001.

CLASS 42—SCIENTIFIC, COMPUTER AND LEGAL SERVICES

FOR GRAPHIC ART DESIGN (U.S. CLS. 100 AND 101).

FIRST USE 3-19-2001; IN COMMERCE 3-19-2001.

SN 76-318,358. CAD CAM INDUSTRIES LTD., HONG KONG, CHINA, FILED 9-27-2001.

ABTRONIC

CLASS 10—MEDICAL APPARATUS

FOR ELECTRONIC MUSCLE STIMULATORS; ELECTRONIC MUSCLE STIMULATION MACHINES FOR MUSCLE TONING; AND ELECTRONIC PULSE MASSAGERS (U.S. CLS. 26, 39 AND 44).

FIRST USE 12-7-2000; IN COMMERCE 12-7-2000.

CLASS 28—TOYS AND SPORTING GOODS

FOR EXERCISE EQUIPMENT, NAMELY, MUSCLE TONING MACHINES (U.S. CLS. 22, 23, 38 AND 50).

FIRST USE 12-7-2000; IN COMMERCE 12-7-2000.

SN 76-318,675. PENNSYLVANIA DEPARTMENT OF CORRECTIONS, CAMP HILL, PA. FILED 9-27-2001.

IMPACT

CLASS 41—EDUCATION AND ENTERTAINMENT

FOR COMMUNITY SERVICES PROGRAM IN THE NATURE OF PROVIDING VISITING SERVICES FOR INCARCERATED PARENTS AND THEIR CHILDREN FOR THE PURPOSE OF STRENGTHENING THE BONDS AND PROVIDING IMPORTANT CONTACT BETWEEN CHILDREN AND THEIR INCARCERATED PARENT OR PARENTS; EDUCATIONAL SERVICES, NAMELY, CONDUCTING CLASSES, SEMINARS, CONFERENCES AND WORKSHOPS IN THE FIELD OF ASSISTING INCARCERATED PARENTS IN LEARNING HOW TO RELATE TO AND UNDERSTAND THEIR CHILDREN; RECREATIONAL SERVICES IN THE NATURE OF PROVIDING AGE APPROPRIATE ACTIVITIES, CRAFTS, NUTRITIONAL SNACKS, AND MONTHLY THEMES FOR INCARCERATED PARENTS AND THEIR CHILDREN; ALL DIRECTED TOWARD STRENGTHENING THE BONDS AND PROVIDING IMPORTANT CONTACT BETWEEN CHILDREN AND THEIR INCARCERATED PARENT OR PARENTS (U.S. CLS. 100, 101 AND 107).

FIRST USE 9-0-1996; IN COMMERCE 9-0-1996.

CLASS 42—SCIENTIFIC, COMPUTER AND LEGAL SERVICES

FOR COUNSELING IN THE FIELD OF ASSISTING INCARCERATED PARENTS IN LEARNING HOW TO RELATE TO AND UNDERSTAND THEIR CHILDREN ALL DIRECTED TOWARD STRENGTHENING THE BONDS AND PROVIDING IMPORTANT CONTACT BETWEEN CHILDREN AND THEIR INCARCERATED PARENT OR PARENTS (U.S. CLS. 100 AND 101).

FIRST USE 9-0-1996; IN COMMERCE 9-0-1996.

SN 76-319,158. SAUL ZAENTZ COMPANY, THE, DBA TOLKIEN ENTERPRISES, BERKELEY, CA. FILED 9-28-2001.

STRIDER

CLASS 16—PAPER GOODS AND PRINTED MATTER

FOR PRINTED MATTER NAMELY, POSTERS, WALL CHARTS, PHOTOGRAPHS, STATIONERY, ART PRINTS, CALENDARS, PLAYING CARDS, TRADING CARDS, BOOKMARKS, STICKER BOOKS, STICKERS, POSTCARDS, WRITING PAPER, NOTE BOOKS, NOTE PADS, NOTE CARDS, FOLDERS, SERIES OF FANTASY BOOKS AND MAGAZINES, WRAPPING PAPER; INSTRUCTIONAL AND TEACHING MATERIALS, NAMELY PENCILS, PENS, RULERS, ERASERS, PAPERWEIGHTS, AND HOLDERS FOR OFFICE SUPPLIES, PENS, PENCILS AND PAPERCLIPS (U.S. CLS. 2, 5, 22, 23, 29, 37, 38 AND 50).

CLASS 25—CLOTHING

FOR CLOTHING, NAMELY T-SHIRTS, SWEATSHIRTS, COSTUMES AND HEADWEAR (U.S. CLS. 22 AND 39).

CLASS 28—TOYS AND SPORTING GOODS

FOR TOY ACTION FIGURES AND ACCESSORIES THEREFOR; TOY FIGURES; CARD GAMES; EQUIPMENT SOLD AS A UNIT FOR PLAYING CARD GAMES; PUZZLES, EXCEPT CROSSWORD PUZZLES; CHESS SETS; ROLE-PLAYING GAMES AND ACCESSORIES; ACTION SKILL GAMES; BOARD GAMES; EQUIPMENT SOLD AS A UNIT FOR PLAYING BOARD GAMES; EQUIPMENT SOLD AS A UNIT FOR PLAYING ACTION TYPE TARGET GAMES; EQUIPMENT SOLD AS UNIT FOR PLAYING HAND HELD ELECTRONIC GAMES; COLLECTIBLE TOY FIGURES; ELECTRONIC TOYS, NAMELY, ELECTRONIC ACTION TOYS; DOLLS AND ACCESSORIES THEREFOR; COLLECTIBLE MARBLES AND ACCESSORIES; ELECTRONIC AND NON-ELECTRONIC PLUSH TOYS; MECHANICAL ACTION TOYS; TOY BOXES; CASES FOR ACTION FIGURES; HAND HELD UNIT FOR PLAYING ELECTRONIC GAMES; COSTUME MASKS; PUPPETS; ROLE PLAYING GAME EQUIPMENT IN THE NATURE OF GAME BOOK MANUALS; SOFT SCULPTURE TOYS; TOY WEAPONS, NAMELY TOY SWORDS, KNIVES, MACES, AXES, DAGGERS, AND BOWS AND ARROWS; ARCADE GAMES; ELECTRONIC EDUCATIONAL GAME MACHINES FOR CHILDREN; EQUIPMENT SOLD AS A UNIT FOR PLAYING A MEMORY GAME; FANTASY CHARACTER TOYS; LCD GAME MACHINES; POSITIONABLE TOY FIGURES; TALKING TOYS; TOY WATCHES; TRANSFORMING ROBOTIC TOYS; AND CHRISTMAS TREE ORNAMENTS (U.S. CLS. 22, 23, 38 AND 50).

SN 76-319,170. SAUL ZAENTZ COMPANY, THE, DBA TOLKIEN ENTERPRISES, BERKELEY, CA. FILED 9-28-2001.

ONE RING TO RULE THEM ALL

CLASS 9—ELECTRICAL AND SCIENTIFIC APPARATUS

FOR COMPUTER GAME PROGRAMS AND DOWNLOADABLE ONLINE INTERACTIVE COMPUTER GAME PROGRAMS HAVING SINGLE AND MULTI-PLAYER CAPABILITY (U.S. CLS. 21, 23, 26, 36 AND 38).

CLASS 14—JEWELRY

FOR JEWELRY (U.S. CLS. 2, 27, 28 AND 50).

CLASS 25—CLOTHING

FOR CLOTHING, NAMELY T-SHIRTS AND SWEATSHIRTS, COSTUMES, FOOTWEAR AND HEADWEAR (U.S. CLS. 22 AND 39).

CLASS 28—TOYS AND SPORTING GOODS

FOR TOY ACTION FIGURES AND ACCESSORIES THEREFOR; TOY FIGURES; CARD GAMES; EQUIPMENT SOLD AS A UNIT FOR PLAYING CARD GAMES; PUZZLES, EXCEPT CROSSWORD PUZZLES; CHESS SETS; ROLE-PLAYING GAMES AND ACCESSORIES; ACTION SKILL GAMES; BOARD GAMES; EQUIPMENT SOLD AS A UNIT FOR PLAYING BOARD GAMES; EQUIPMENT SOLD AS A UNIT FOR PLAYING ACTION TYPE TARGET GAMES; EQUIPMENT SOLD AS UNIT FOR PLAYING HAND HELD ELECTRONIC GAMES; COLLECTIBLE TOY FIGURES; ELECTRONIC TOYS, NAMELY, ELECTRONIC ACTION TOYS; DOLLS AND ACCESSORIES THEREFOR; COLLECTIBLE MARBLES AND ACCESSORIES; ELECTRONIC AND NON-ELECTRONIC PLUSH TOYS; MECHANICAL ACTION TOYS; TOY BOXES; CASES FOR ACTION FIGURES; HAND HELD UNIT FOR PLAYING ELECTRONIC GAMES; COSTUME MASKS; PUPPETS; ROLE PLAYING GAME EQUIPMENT IN THE NATURE OF GAME BOOK MANUALS; SOFT SCULPTURE TOYS; TOY WEAPONS, NAMELY TOY SWORDS, KNIVES, MACES, AXES, DAGGERS, OR BOWS AND ARROWS; ARCADE GAMES; ELECTRONIC EDUCATIONAL GAME MACHINES FOR CHILDREN; EQUIPMENT SOLD AS A UNIT FOR PLAYING A MEMORY GAME; FANTASY CHARACTER TOYS; LCD GAME MACHINES; POSITIONABLE TOY FIGURES; TALKING TOYS; TOY WATCHES; TRANSFORMING ROBOTIC TOYS; AND CHRISTMAS TREE ORNAMENTS (U.S. CLS. 22, 23, 38 AND 50).

CLASS 41—EDUCATION AND ENTERTAINMENT

FOR ENTERTAINMENT SERVICES IN THE FIELD OF INTERACTIVE MULTI-PLAYER GAMES NAMELY, PROVIDING COMPUTER GAME PROGRAMS VIA ONLINE ELECTRONIC COMMUNICATIONS AND GLOBAL COMPUTER NETWORKS (U.S. CLS. 100, 101 AND 107).

SN 76-319,602. PC SPECIALISTS, INC., SAN DIEGO, CA. FILED 10-1-2001.

INNOVATIVE CORPORATE ENVIRONMENTS

NO CLAIM IS MADE TO THE EXCLUSIVE RIGHT TO USE "CORPORATE ENVIRONMENTS", APART FROM THE MARK AS SHOWN.

CLASS 35—ADVERTISING AND BUSINESS

FOR RETAIL FURNITURE STORES (U.S. CLS. 100, 101 AND 102).

CLASS 37—CONSTRUCTION AND REPAIR

FOR INSTALLATION OF FURNITURE (U.S. CLS. 100, 103 AND 106).

CLASS 42—SCIENTIFIC, COMPUTER AND LEGAL SERVICES

FOR INTERIOR DESIGN (U.S. CLS. 100 AND 101).

SN 76-319,642. SARATOGA SALSA COMPANY, SARATOGA SPRINGS, NY. FILED 10-1-2001.

ADIRONDACK SALSA

NO CLAIM IS MADE TO THE EXCLUSIVE RIGHT TO USE "SALSA", APART FROM THE MARK AS SHOWN.

CLASS 30—STAPLE FOODS

FOR SALSA, NAMELY RED, GREEN, AND BLACK BEAN SALSA; SOUTHWESTERN CAVIAR, NAMELY SALSA; COCKTAIL SAUCE AND HORSERADISH (U.S. CL. 46).

CLASS 32—LIGHT BEVERAGES

FOR BLOODY MARY MIX (U.S. CLS. 45, 46 AND 48).

SN 76-319,669. SUPERIOR QUALITY FOODS, INC., ONTARIO, CA. FILED 10-1-2001.

SUPERIOR TOUCH

OWNER OF U.S. REG. NO. 1,763,045.

CLASS 29—MEATS AND PROCESSED FOODS

FOR FOODS; NAMELY, SOUP BASES (U.S. CL. 46). FIRST USE 3-11-1991; IN COMMERCE 3-11-1991.

CLASS 30—STAPLE FOODS

FOR FOODS; NAMELY, SALAD DRESSINGS (U.S. CL. 46). FIRST USE 3-11-1991; IN COMMERCE 3-11-1991.

SN 76-319,864. MINDPEPPER, LLC, GRAND RAPIDS, MI. FILED 10-1-2001.

CONTROL THE DEAL**CLASS 9—ELECTRICAL AND SCIENTIFIC APPARATUS**

FOR COMPUTER SOFTWARE ENABLING ELECTRONIC BUSINESS TRANSACTIONS VIA A GLOBAL COMPUTER NETWORK (U.S. CLS. 21, 23, 26, 36 AND 38).

CLASS 35—ADVERTISING AND BUSINESS

FOR COMPUTERIZED ON-LINE SEARCH AND INFORMATION SERVICE BRINGING TOGETHER, FOR THE BENEFIT OF OTHERS, A VARIETY OF GOODS AND SERVICES, AND ENABLING CUSTOMERS TO CONVENIENTLY SEARCH, VIEW AND POST INFORMATION ABOUT GOODS AND SERVICES, AND NEGOTIATE FOR THE SALE AND PURCHASE OF GOODS AND SERVICES; AUTOMATED AND COMPUTERIZED TRADING OF GOODS AND SERVICES FOR OTHERS PROVIDED OVER A GLOBAL COMMUNICATION INFORMATION NETWORK (U.S. CLS. 100, 101 AND 102).

SN 76-320,065. LAPAW, LA CANADA, CA. FILED 10-2-2001.

LAPAW**CLASS 18—LEATHER GOODS**

FOR COLLARS FOR PETS BEARING AN INDIVIDUAL E-MAIL ADDRESS FOR IDENTIFICATION (U.S. CLS. 1, 2, 3, 22 AND 41).

FIRST USE 2-0-2001; IN COMMERCE 2-0-2001.

CLASS 42—SCIENTIFIC, COMPUTER AND LEGAL SERVICES

FOR COMPUTER SERVICES, NAMELY, THE REGISTRATION OF PETS USING COLLARS CONTAINING INDIVIDUAL E-MAIL ADDRESSES FOR THE IDENTIFICATION AND RETURN OF LOST PETS VIA A GLOBAL COMMUNICATIONS NETWORK (U.S. CLS. 100 AND 101).

FIRST USE 2-0-2001; IN COMMERCE 2-0-2001.

SN 76-320,950. ETIENNE AIGNER, INC., NEW YORK, NY. FILED 10-3-2001.

AIGNER

OWNER OF U.S. REG. NOS. 911,959, 1,950,623 AND OTHERS.
SEC. 2(F).

CLASS 18—LEATHER GOODS

FOR HANDBAGS (U.S. CLS. 1, 2, 3, 22 AND 41).
FIRST USE 10-0-2000; IN COMMERCE 10-0-2000.

CLASS 25—CLOTHING

FOR FOOTWEAR (U.S. CLS. 22 AND 39).
FIRST USE 10-0-2000; IN COMMERCE 10-0-2000.

SN 76-321,091. JONES PLASTIC AND ENGINEERING COMPANY, LLC, JEFFERSONTOWN, KY. FILED 10-3-2001.

JONES PLASTIC AND ENGINEERING

NO CLAIM IS MADE TO THE EXCLUSIVE RIGHT TO USE "PLASTIC" AND "ENGINEERING", APART FROM THE MARK AS SHOWN.
SEC. 2(F).

CLASS 40—MATERIAL TREATMENT

FOR PLASTIC INJECTION MOLDING SERVICES, NAMELY, MOLDING OF PLASTIC PARTS AND GAS ASSIST MOLDING OF PLASTIC PARTS; IN-MOLD DECORATING OF PLASTIC MOLDED PARTS, NAMELY, HOT STAMPING AND PAINTING OF PLASTIC MOLDED PARTS; WELDING; PROTOTYPE FABRICATION OF PLASTIC PARTS, PLASTIC MODELS AND PLASTIC MOLDS, ALL TO THE ORDER AND/OR SPECIFICATION OF OTHERS; PROVIDING HIGH-SPEED THIN FILM FORMS FOR PLASTIC PACKAGING (U.S. CLS. 100, 103 AND 106).

FIRST USE 0-0-1961; IN COMMERCE 0-0-1961.

CLASS 42—SCIENTIFIC, COMPUTER AND LEGAL SERVICES

FOR CUSTOM DESIGN AND DESIGN ENGINEERING OF PLASTIC PARTS AND INJECTION MOLDS FOR FORMING PLASTIC PARTS; PROVIDING CAD-CAM LAYOUT DESIGN SERVICES IN THE FIELD OF PLASTIC PARTS AND MOLDS FOR FORMING PLASTIC PARTS (U.S. CLS. 100 AND 101).

FIRST USE 0-0-1961; IN COMMERCE 0-0-1961.

SN 76-321,453. OREGON FREEZE DRY, INC., ALBANY, OR. FILED 10-3-2001.



OWNER OF U.S. REG. NO. 1,254,646.
NO CLAIM IS MADE TO THE EXCLUSIVE RIGHT TO USE "THE #1 BRAND OF BACKPACKING FOODS", APART FROM THE MARK AS SHOWN.

CLASS 29—MEATS AND PROCESSED FOODS

FOR PACKAGED ENTREES CONSISTING PRIMARILY OF MEAT, FISH, POULTRY, OR VEGETABLES; PROCESSED FRUITS AND MILK (U.S. CL. 46).

CLASS 30—STAPLE FOODS

FOR PACKAGED ENTREES CONSISTING OF PASTA, RICE, NOODLES AND GRANOLA (U.S. CL. 46).

SN 76-321,614. DEY L.P., NAPA, CA. FILED 10-5-2001.

**CLASS 9—ELECTRICAL AND SCIENTIFIC APPARATUS**

FOR COMPUTER LAPTOP BAGS (U.S. CLS. 21, 23, 26, 36 AND 38).

CLASS 41—EDUCATION AND ENTERTAINMENT

FOR CONFERENCES, SEMINARS, EDUCATIONAL AND TRAINING PROGRAMS, ALL IN THE FIELDS OF BUSINESS DEVELOPMENT, EXECUTIVE DEVELOPMENT, MANAGEMENT AND SUPERVISORY DEVELOPMENT, EMPLOYEE DEVELOPMENT, PROJECT MANAGEMENT, TEAM BUILDING, MEETING MANAGEMENT, EFFECTIVE BUSINESS WRITING, CONFLICT MANAGEMENT AND GOOD MANUFACTURING PRACTICES AND DISTRIBUTION OF COURSE MATERIALS IN CONNECTION THEREWITH (U.S. CLS. 100, 101 AND 107).

SN 76-321,683. FORTRESS COMMUNICATIONS, LTD., SCARBOROUGH, ME. FILED 10-5-2001.

TIGERZON**CLASS 38—COMMUNICATION**

FOR TELECOMMUNICATIONS SERVICES, NAMELY, LONG DISTANCE TELEPHONE SERVICES; PERSONAL COMMUNICATION SERVICES; BROADCASTING, NAMELY, AUDIO BROADCASTING AND PROGRAMS BROADCASTING; PAGING, ELECTRONIC MAIL, AND UNIFIED MESSAGING SERVICES; WIRELESS ELECTRONIC TRANSMISSION OF VOICE, TEXT, GRAPHICS, VIDEO, DATA AND INFORMATION OVER FIXED WIRELESS COMMUNICATIONS (U.S. CLS. 100, 101 AND 104).

CLASS 42—SCIENTIFIC, COMPUTER AND LEGAL SERVICES

FOR HOSTING THE WEB SITES OF OTHERS ON A COMPUTER SERVER FOR A GLOBAL COMPUTER NETWORK (U.S. CLS. 100 AND 101).

SN 76-322,434. SPECK INDUSTRIAL CONTROLS, INC., MOORESTOWN, NJ. FILED 10-9-2001.



NO CLAIM IS MADE TO THE EXCLUSIVE RIGHT TO USE "INDUSTRIAL CONTROLS, INC." AND "REPAIR & SUPPLY" AND "SINCE 1979", APART FROM THE MARK AS SHOWN.

CLASS 35—ADVERTISING AND BUSINESS

FOR DISTRIBUTORSHIP IN THE FIELD OF ELECTRICAL EQUIPMENT (U.S. CLS. 100, 101 AND 102). FIRST USE 8-1-2001; IN COMMERCE 8-1-2001.

CLASS 37—CONSTRUCTION AND REPAIR

FOR ELECTRICAL REPAIRS AND INSTALLATION OF ELECTRONIC EQUIPMENT (U.S. CLS. 100, 103 AND 106).

FIRST USE 8-1-2001; IN COMMERCE 8-1-2001.

SN 76-323,377. DOLCE INTERNATIONAL/OAK BROOK, INC., MONTVALE, NJ. FILED 10-10-2001.

LIFE JUST GOT BETTER**CLASS 35—ADVERTISING AND BUSINESS**

FOR MANAGING RESORT HOTELS AND BUSINESS CONFERENCE CENTERS (U.S. CLS. 100, 101 AND 102).

CLASS 42—SCIENTIFIC, COMPUTER AND LEGAL SERVICES

FOR PROVIDING RESTAURANT AND CATERING SERVICES (U.S. CLS. 100 AND 101).

SN 76-323,683. FREEMAN, MICHAEL W., FIRCREST, WA. FILED 10-11-2001.

HOLDS THE COURSE YOU GIVE IT

SEC. 2(F).

CLASS 7—MACHINERY

FOR COMPONENTS OF MARINE AUTOPILOTS, NAMELY MECHANICAL DRIVE UNITS, HYDRAULIC PUMPS, SPROCKETS, CHAINS, SHAFTS, AND FLEX SHAFTS (U.S. CLS. 13, 19, 21, 23, 31, 34 AND 35).

FIRST USE 8-0-1939; IN COMMERCE 8-0-1939.

CLASS 9—ELECTRICAL AND SCIENTIFIC APPARATUS

FOR MARINE AUTOPILOTS; ELECTRONIC APPARATUS FOR COUPLING ELECTRONIC GEOGRAPHIC POSITION INDICATORS TO MARINE AUTOPILOTS; ELECTRONIC APPARATUS FOR CONNECTING MARINE GUIDANCE EQUIPMENT TO COMPUTER NETWORKS; RUDDER ANGLE INDICATORS; SPEED LOGS; COMPONENTS OF MARINE AUTOPILOTS, NAMELY, MAGNETIC AND HALL-EFFECT COMPASSES, COMPASS ENCLOSURES, COMPENSATING MAGNETS AND FERRITES FOR COMPASSES, HEELING TUBES, JUNCTION BOXES, REMOTE CONTROLS, RUDDER ANGLE INDICATORS, RUDDER ANGLE ENCODERS, LIMIT SWITCHES, RECTIFIER UNITS, SOLENOIDS, RELAYS, ELECTRIC MOTORS, AND CONTROLLERS; WIND VANES AND WIND DIRECTION INDICATORS (U.S. CLS. 21, 23, 26, 36 AND 38).

FIRST USE 8-0-1939; IN COMMERCE 8-0-1939.

SN 76-323,704. BYTE ENTERPRISES LLC., CORAL GABLES, FL. FILED 10-10-2001.

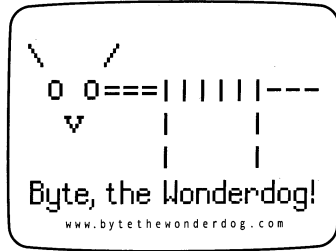

CLASS 35—ADVERTISING AND BUSINESS

FOR COMPUTERIZED ON-LINE ORDERING SERVICES IN THE FIELD OF GENERAL CONSUMER MERCHANDISE (U.S. CLS. 100, 101 AND 102).

CLASS 41—EDUCATION AND ENTERTAINMENT

FOR PROVIDING AN INTERNET WEB SITE VIA A GLOBAL COMPUTER NETWORK FEATURING ANIMATION, GAMES AND ENTERTAINMENT (U.S. CLS. 100, 101 AND 107).

SN 76-323,787. ZYMEQUEST, INC., BEVERLY, MA. FILED 10-11-2001.

AB-ECO

CLASS 1—CHEMICALS

FOR ENZYMATICALLY CONVERTED, CHEMICALLY MODIFIED RED BLOOD CELLS FOR USE IN MEDICAL AND VETERINARY RESEARCH USE (U.S. CLS. 1, 5, 6, 10, 26 AND 46).

CLASS 5—PHARMACEUTICALS

FOR ENZYMATICALLY CONVERTED, CHEMICALLY MODIFIED RED BLOOD CELLS FOR USE IN BLOOD TRANSFUSIONS AND OTHER MEDICAL AND VETERINARY USES (U.S. CLS. 6, 18, 44, 46, 51 AND 52).

SN 76-323,846. FREEMAN, MICHAEL W., FIRCREST, WA. FILED 10-11-2001.

METAL MARINE PILOT

NO CLAIM IS MADE TO THE EXCLUSIVE RIGHT TO USE "METAL", APART FROM THE MARK AS SHOWN.

CLASS 7—MACHINERY

FOR COMPONENTS OF MARINE AUTO PILOTS, NAMELY, MECHANICAL DRIVE UNITS, HYDRAULIC PUMPS, SPROCKETS, CHAINS, SHAFTS, FLEX SHAFTS, AND ELECTRIC MOTORS (U.S. CLS. 13, 19, 21, 23, 31, 34 AND 35).

FIRST USE 8-0-1939; IN COMMERCE 8-0-1939.

CLASS 9—ELECTRICAL AND SCIENTIFIC APPARATUS

FOR MARINE AUTO PILOTS; ELECTRONIC APPARATUS FOR COUPLING ELECTRONIC GEOGRAPHIC POSITION INDICATORS TO MARINE AUTO PILOTS; ELECTRONIC APPARATUS FOR CONNECTING MARINE GUIDANCE EQUIPMENT TO COMPUTER NETWORKS; RUDDER ANGLE INDICATORS; SPEED LOGS; COMPONENTS OF MARINE AUTO PILOTS, NAMELY, MAGNETIC AND HALL-EFFECT COMPASSES, COMPASS ENCLOSURES, COMPENSATING MAGNETS AND FERRITES FOR COMPASSES, HEELING TUBES, JUNCTION BOXES, REMOTE CONTROLS, RUDDER ANGLE INDICATORS, RUDDER ANGLE ENCODERS, LIMIT SWITCHES, RECTIFIER UNITS, SOLENOIDS, RELAYS, AND CONTROLLERS; WIND VANES AND WIND DIRECTION INDICATORS (U.S. CLS. 21, 23, 26, 36 AND 38).

FIRST USE 8-0-1939; IN COMMERCE 8-0-1939.

SN 76-323,852. MULTI-CULTURE MARKETING, INC., LOS ANGELES, CA. FILED 10-10-2001.

VISION-X

CLASS 9—ELECTRICAL AND SCIENTIFIC APPARATUS

FOR COMPUTER SOFTWARE FOR USE TO OPERATE AND MANAGE CALL CENTERS IN THE FIELD OF TELECOMMUNICATIONS, AND TELEMARKETING (BASED ON INTENT TO USE) (U.S. CLS. 21, 23, 26, 36 AND 38).

CLASS 35—ADVERTISING AND BUSINESS

FOR TELEMARKETING SERVICES; OPERATION OF TELEPHONE CALL CENTERS FOR OTHERS (U.S. CLS. 100, 101 AND 102).

FIRST USE 1-1-2001; IN COMMERCE 1-1-2001.

SN 76-324,191. WELLNESS ENCOUNTERS, LLC, TUSTIN, CA. FILED 10-10-2001.

METAYOGA

CLASS 9—ELECTRICAL AND SCIENTIFIC APPARATUS

FOR PRE-RECORDED MEDIA, NAMELY VIDEO CASSETTES, VIDEO TAPES, AUDIO TAPES, AUDIO DISCS, VIDEO DISCS, AUDIO CASSETTES, COMPACT DISCS, CD ROMS, LASER DISCS AND MINI-DISCS FEATURING YOGA, EXERCISE AND MEDITATION AND PROVIDING INFORMATION ON YOGA, EXERCISE, MEDITATION, HEALTH, WEIGHT LOSS AND STRESS REDUCTION; COMPUTER SOFTWARE PROVIDING INFORMATION IN THE FIELDS OF YOGA, EXERCISE, MEDITATION, HEALTH, WEIGHT LOSS AND STRESS REDUCTION (U.S. CLS. 21, 23, 26, 36 AND 38).

CLASS 16—PAPER GOODS AND PRINTED MATTER

FOR PRINTED MATTER, NAMELY BOOKS, BOOKLETS, MANUALS, NEWSLETTERS, MAGAZINES, BROCHURES, PAMPHLETS AND FLYERS IN THE FIELDS OF YOGA, EXERCISE, MEDITATION, HEALTH, WEIGHT LOSS AND STRESS REDUCTION; PHOTOGRAPHIC PRINTS, CALENDARS AND MOUNTED AND UNMOUNTED POSTERS (U.S. CLS. 2, 5, 22, 23, 29, 37, 38 AND 50).

CLASS 41—EDUCATION AND ENTERTAINMENT

FOR YOGA INSTRUCTION; EDUCATIONAL SERVICES, INCLUDING, CONDUCTING CLASSES, SEMINARS, CONFERENCES, WORKSHOPS AND RETREATS IN THE FIELDS OF YOGA, EXERCISE, MEDITATION, HEALTH, WEIGHT LOSS AND STRESS REDUCTION (U.S. CLS. 100, 101 AND 107).

SN 76-324,318. WILSON TOOL INTERNATIONAL, INC., WHITE BEAR LAKE, MN. FILED 10-12-2001.

NITREX**CLASS 7—MACHINERY**

FOR TOOLING FOR MACHINE TOOLS, NAMELY, TOOLS FOR PRESS BRAKES (U.S. CLS. 13, 19, 21, 23, 31, 34 AND 35).

CLASS 40—MATERIAL TREATMENT

FOR TREATMENT OF METAL SURFACES, NAMELY, HARDENING THE SURFACES OF PRESS BRAKE TOOLING (U.S. CLS. 100, 103 AND 106).

SN 76-324,794. INTERNATIONAL TALY COMMERCIAL GROUP (USA), INC., SOUTH EL MONTE, CA. FILED 10-15-2001.



THE MARK CONSISTS OF THE LETTER "W", IN STYLIZED FORM.

CLASS 21—HOUSEWARES AND GLASS

FOR WOOD FIBER WASHING CLOTHS (U.S. CLS. 2, 13, 23, 29, 30, 33, 40 AND 50).
FIRST USE 8-15-2001; IN COMMERCE 8-15-2001.

CLASS 23—YARNS AND THREADS

FOR THREAD AND YARN (U.S. CL. 43).
FIRST USE 8-15-2001; IN COMMERCE 8-15-2001.

CLASS 24—FABRICS

FOR BATH LINEN, BED CANOPIES, BED LINEN, BED PADS, BED BLANKETS, CLOTH NAPKINS FOR REMOVING MAKEUP, DISH CLOTHS, OIL CLOTHS, WASH CLOTHS, NON-PAPER TABLE CLOTHS, KITCHEN TOWELS AND PILLOW CASES, WOOD FIBER FABRIC, CURTAIN FABRIC, UPHOLSTERY FABRIC (U.S. CLS. 42 AND 50).
FIRST USE 8-15-2001; IN COMMERCE 8-15-2001.

CLASS 25—CLOTHING

FOR BATHROBES, BLOUSES, BODY SUITS, DRESSES, DRESSING GOWNS, EVENING GOWNS, GLOVES, GYM SUITS, HEAD WEAR, JOGGING SUITS, NIGHT GOWNS, NIGHT SHIRTS, PAJAMAS, PANTS, SWEAT PANTS, SHIRTS, SHORTS, SKIRTS, SLACKS, SOCKS, BATHING SUITS, SWEAT SUITS, T-SHIRTS AND UNDERWEAR (U.S. CLS. 22 AND 39).
FIRST USE 8-15-2001; IN COMMERCE 8-15-2001.

CLASS 27—FLOOR COVERINGS

FOR CARPET (U.S. CLS. 19, 20, 37, 42 AND 50).
FIRST USE 8-15-2001; IN COMMERCE 8-15-2001.

SN 76-324,815. MANN, JAMES, ALBANY, NY. AND STORVICK, JAMEY, OAKDALE, MN. FILED 10-12-2001.

3N2**CLASS 25—CLOTHING**

FOR BASEBALL FOOTWEAR, BASEBALL CAPS, AND BASEBALL UNIFORMS (U.S. CLS. 22 AND 39).

CLASS 28—TOYS AND SPORTING GOODS

FOR BASEBALL BATS, BASEBALL GLOVES AND BASEBALL BATTING GLOVES (U.S. CLS. 22, 23, 38 AND 50).

SN 76-324,816. MANN, JAMES, ALBANY, NY. AND STORVICK, JAMEY, OAKDALE, MN. FILED 10-12-2001.



NO CLAIM IS MADE TO THE EXCLUSIVE RIGHT TO USE THE DESIGN OF A BASEBALL, APART FROM THE MARK AS SHOWN.

CLASS 25—CLOTHING

FOR BASEBALL FOOTWEAR, BASEBALL CAPS, AND BASEBALL UNIFORMS (U.S. CLS. 22 AND 39).

CLASS 28—TOYS AND SPORTING GOODS

FOR BASEBALL BATS, BASEBALL GLOVES AND BASEBALL BATTING GLOVES (U.S. CLS. 22, 23, 38 AND 50).

SN 76-325,588. MC STRATEGIES, INC., ATLANTA, GA. FILED 10-15-2001.

SN 76-325,922. CAFE EXCELLENCE, LLC, OAKS, PA. FILED 10-16-2001.

KNOWLEDGE DEPLOYMENT SYSTEM

NO CLAIM IS MADE TO THE EXCLUSIVE RIGHT TO USE "SYSTEM", APART FROM THE MARK AS SHOWN.

CLASS 41—EDUCATION AND ENTERTAINMENT

FOR EDUCATIONAL SERVICES, NAMELY, PROVIDING TRAINING VIA THE INTERNET TO PROFESSIONALS IN THE HEALTHCARE FIELD (U.S. CLS. 100, 101 AND 107).

FIRST USE 6-18-2001; IN COMMERCE 6-18-2001.

CLASS 42—SCIENTIFIC, COMPUTER AND LEGAL SERVICES

FOR APPLICATION SERVICE PROVIDER SERVICES, NAMELY, PROVIDING TRAINING TO PROFESSIONALS IN THE HEALTHCARE FIELD VIA THE INTERNET, AND IMPLEMENTING TRAINING PROGRAMS FOR OTHERS VIA THE INTERNET (U.S. CLS. 100 AND 101).

FIRST USE 6-18-2001; IN COMMERCE 6-18-2001.

A COFFEE SHOP IN YOUR OFFICE

CLASS 16—PAPER GOODS AND PRINTED MATTER

FOR PRINTED MATERIALS, PAPER AND CARDBOARD GOODS, NAMELY BOOKLETS, BROCHURES, CATALOGUES, DIRECTORIES AND PRODUCT LISTS, ALL IN THE FIELDS OF COFFEE PRODUCTS AND SERVICE AVAILABILITY, COFFEE PERFORMANCE, COFFEE COSTS, AND COFFEE ADVERTISING PROMOTIONS; PRINTED FORMS; PURCHASE ORDERS AND INVOICES; BUSINESS CARDS, STATIONERY, ENVELOPES, PRINTED INSTRUCTIONS FOR COFFEE MAKING; PRINTED DIAGRAMS AND PHOTOGRAPHS FOR USE IN BOOKLETS, MAGAZINES, NEWSPAPERS, CATALOGUES, LEAFLETS, MANUALS, HANDBOOKS, PAMPHLETS AND BROCHURES ALL IN THE FIELD OF COFFEE, PENS AND PENCILS; POSTERS; BUSINESS CARDS; PRINTED LABELS, NAMELY ADHESIVE AND MAGNETIC; STICKERS; PLASTIC PACKAGING SHEETS AND FILMS; PAPER BAGS, PAPER POUCHES AND CARDBOARD PACKAGING BOXES, ALL RELATED TO THE SALE AND DISTRIBUTION OF COFFEE (U.S. CLS. 2, 5, 22, 23, 29, 37, 38 AND 50).

CLASS 30—STAPLE FOODS

FOR COFFEE, NAMELY BEANS AND GROUND (U.S. CL. 46).

SN 76-325,899. WORLDSERVE INTERNATIONAL, SPRINGFIELD, MO. FILED 10-16-2001.

WORLDSERVE

CLASS 36—INSURANCE AND FINANCIAL

FOR CHARITABLE FUND RAISING SERVICES FOR HUMANITARIAN RELIEF AND MICRO-ECONOMIC DEVELOPMENT SERVICES; FINANCIAL SERVICES, NAMELY, PROVIDING LOANS TO CHURCHES, PARACHURCH MINISTRIES AND ECONOMIC DEVELOPMENT PROJECTS IN DEVELOPING COUNTRIES (U.S. CLS. 100, 101 AND 102).

FIRST USE 0-0-1985; IN COMMERCE 0-0-1985.

CLASS 42—SCIENTIFIC, COMPUTER AND LEGAL SERVICES

FOR CHARITABLE SERVICES PROVIDING HUMANITARIAN RELIEF AND DEVELOPMENT SERVICES, NAMELY, PROVIDING FOOD, CLOTHING, AND/OR MEDICAL EQUIPMENT AND SUPPLIES; RELIGIOUS SERVICES, NAMELY, EVANGELICAL, MINISTERIAL AND MISSIONARY SERVICES (U.S. CLS. 100 AND 101).

FIRST USE 0-0-1985; IN COMMERCE 0-0-1985.

SN 76-326,264. FUSELIER, DUSTIN, AUSTIN, TX. FILED 10-17-2001.

D:FUSE

CLASS 9—ELECTRICAL AND SCIENTIFIC APPARATUS

FOR SERIES OF SOUND RECORDINGS EMBODIED ON PHONORECORDS, NAMELY VINYL DISCS, CASSETTE TAPES, DIGITAL COMPACT DISCS, ENHANCED CDS, CD-PLUS, CD-ROM, AND PRE-RECORDED VIDEO CASSETTES AND VIDEO DISCS, ALL FEATURING MUSIC ENTERTAINMENT (U.S. CLS. 21, 23, 26, 36 AND 38).

FIRST USE 6-1-1996; IN COMMERCE 11-1-1997.

CLASS 41—EDUCATION AND ENTERTAINMENT

FOR ENTERTAINMENT, NAMELY LIVE PERFORMANCES BY A MUSICAL ARTIST (U.S. CLS. 100, 101 AND 107).

FIRST USE 6-1-1996; IN COMMERCE 11-1-1997.

SN 76-326,786. XYBERNAUT CORPORATION, FAIRFAX, VA. FILED 10-17-2001.

TECHNOLOGY THAT WORKS WITH YOU

CLASS 35—ADVERTISING AND BUSINESS

FOR WHOLESALE DISTRIBUTORSHIPS FEATURING USER SUPPORTED COMPUTERS (U.S. CLS. 100, 101 AND 102).

FIRST USE 9-26-2001; IN COMMERCE 9-26-2001.

CLASS 41—EDUCATION AND ENTERTAINMENT

FOR EDUCATIONAL SERVICES, NAMELY, CONDUCTING CLASSES, SEMINARS, CONFERENCES, AND WORKSHOPS IN THE FIELD OF WEARABLE COMPUTERS (U.S. CLS. 100, 101 AND 107).

FIRST USE 9-26-2001; IN COMMERCE 9-26-2001.

CLASS 42—SCIENTIFIC, COMPUTER AND LEGAL SERVICES

FOR CONSULTING SERVICES FOR WEARABLE COMPUTERS (U.S. CLS. 100 AND 101).

FIRST USE 9-26-2001; IN COMMERCE 9-26-2001.

SN 76-326,957. DYE PRECISION, INC., SAN DIEGO, CA. FILED 10-19-2001.

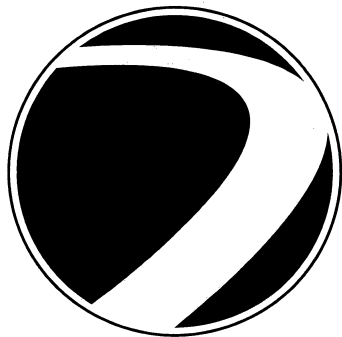

CLASS 25—CLOTHING

FOR APPAREL, NAMELY JACKETS, PANTS, T-SHIRTS, SHIRTS, HATS, GLOVES, AND SCARVES (U.S. CLS. 22 AND 39).

FIRST USE 6-0-2001; IN COMMERCE 6-0-2001.

CLASS 28—TOYS AND SPORTING GOODS

FOR PAINTBALL GUNS AND PARTS THEREOF, NAMELY BARRELS, FITTINGS, NON-TELESCOPIC SIGHTS, TELESCOPIC SIGHTS, SIGHTING MECHANISMS, MOUNTING BRACKETS, TRIGGERS, STOCKS, AND FIRING MECHANISMS; SPORTS GOGGLES; SPORTS GOGGLES FOR PAINTBALL GAMES (U.S. CLS. 22, 23, 38 AND 50).

FIRST USE 6-0-2001; IN COMMERCE 6-0-2001.

SN 76-327,115. PERSONAL PRESENTATION LTD., LONDON, W10 5BH, ENGLAND, FILED 10-19-2001.

PERFORMANCE ENERGY

PRIORITY CLAIMED UNDER SEC. 44(D) ON UNITED KINGDOM APPLICATION NO. 2268594, FILED 4-27-2001, REG. NO. 2268594, DATED 4-27-2001, EXPIRES 4-27-2011.

CLASS 35—ADVERTISING AND BUSINESS

FOR BUSINESS ADVISORY AND CONSULTANCY SERVICES PREPARING BUSINESS REPORTS; BUSINESS ADVISORY AND CONSULTANCY SERVICES IN THE FIELD OF MANAGEMENT TRAINING, PERSONNEL DEVELOPMENT AND HUMAN RESOURCES; BUSINESS ADVISORY AND CONSULTANCY SERVICES, NAMELY, PROVIDING APPRAISALS OF EMPLOYEE SKILLS AND COMPETENCIES (U.S. CLS. 100, 101 AND 102).

CLASS 41—EDUCATION AND ENTERTAINMENT

FOR EDUCATION, INSTRUCTION AND TRAINING SERVICES, NAMELY, CONDUCTING CLASSES, SEMINARS, TUTORIALS, CONFERENCES AND WORKSHOPS, PROVIDING INTERACTIVE TRAINING VIA THE GLOBAL COMMUNICATIONS NETWORK, PROVIDING INSTRUCTION BY MEANS OF TELEVISION AND/OR PROVIDING LONG DISTANCE EDUCATION AND TRAINING BY MEANS OF CORRESPONDENCE COURSES AND/OR ELECTRONIC COMMUNICATION IN THE FIELD OF BUSINESS EDUCATION, MANAGEMENT TRAINING, PERSONNEL DEVELOPMENT AND PERFORMANCE ENHANCEMENT, COMMUNICATION AND PERFORMANCE ENHANCEMENT TO THE AFORESAID (U.S. CLS. 100, 101 AND 107).

SN 76-327,163. TRANS CONTINENTAL RECORDS, INC., ORLANDO, FL. FILED 10-18-2001.

O-TOWN

CLASS 9—ELECTRICAL AND SCIENTIFIC APPARATUS

FOR PRE-RECORDED COMPACT DISCS, AUDIO CASSETTES AND VIDEO CASSETTES FEATURING MUSIC (U.S. CLS. 21, 23, 26, 36 AND 38).

FIRST USE 11-0-2000; IN COMMERCE 11-0-2000.

CLASS 16—PAPER GOODS AND PRINTED MATTER

FOR PAPER GOODS AND PRINTED MATTER, NAMELY, POSTERS, BOOK COVERS, POSTCARDS AND UNMOUNTED PHOTOGRAPHS (U.S. CLS. 2, 5, 22, 23, 29, 37, 38 AND 50).

FIRST USE 4-0-2000; IN COMMERCE 4-0-2000.

CLASS 25—CLOTHING

FOR CLOTHING, NAMELY, HATS, T-SHIRTS AND JACKETS (U.S. CLS. 22 AND 39).

FIRST USE 6-0-2000; IN COMMERCE 6-0-2000.

CLASS 41—EDUCATION AND ENTERTAINMENT

FOR ENTERTAINMENT SERVICES IN THE NATURE OF LIVE PERFORMANCES BY A MUSICAL GROUP (U.S. CLS. 100, 101 AND 107).

FIRST USE 1-0-2000; IN COMMERCE 1-0-2000.

SN 76-327,331. WILLIAM M. MERCER, INCORPORATED,
NEW YORK, NY. FILED 10-18-2001.

MERCERPRISM

CLASS 9—ELECTRICAL AND SCIENTIFIC APPARATUS

FOR SOFTWARE FOR THE ANALYSIS OF AND ACCESS TO DATABASES THAT CONTAIN INFORMATION CONCERNING EMPLOYEE COMPENSATION COSTS, THE CREATION OF BUDGETS FOR EMPLOYEE COMPENSATION, THE CREATION AND REVISIONS OF A PAY GRADE SYSTEM FOR VARIOUS TYPES OF EMPLOYEE JOBS INCLUDING COMPENSATION LEVELS THAT CORRESPOND TO PAY GRADES, THE CREATION AND REVISION OF A MERIT COMPENSATION SYSTEM AND OF MODELS THAT ALLOW MERIT BUDGET ANALYSIS, THE COMPARISON OF COMPENSATION DATA TO INDUSTRY COMPENSATION SURVEY DATA, THE GENERATION OF REPORTS, AND THE ANALYSIS OF PAYMENT CAPABILITY BASED ON CASH FLOW (U.S. CLS. 21, 23, 26, 36 AND 38).

FIRST USE 12-0-1997; IN COMMERCE 12-0-1997.

CLASS 16—PAPER GOODS AND PRINTED MATTER

FOR SOFTWARE USER MANUAL CONTAINING DESCRIPTIONS OF SOFTWARE AND RELATED DATABASES AND INSTRUCTIONS IN THEIR USE IN THE CREATION OF BUDGETS FOR EMPLOYEE COMPENSATION, THE CREATION AND REVISION OF A PAY GRADE SYSTEM FOR VARIOUS TYPES OF EMPLOYEE JOBS INCLUDING COMPENSATION LEVELS THAT CORRESPOND TO PAY GRADES, THE CREATION AND REVISION OF A MERIT COMPENSATION SYSTEM AND OF MODELS THAT ALLOW MERIT BUDGET ANALYSIS, THE COMPARISON OF COMPENSATION DATA TO INDUSTRY COMPENSATION SURVEY DATA, THE GENERATION OF REPORTS, AND THE ANALYSIS OF PAYMENT CAPABILITY BASED ON CASH FLOW (U.S. CLS. 2, 5, 22, 23, 29, 37, 38 AND 50).

FIRST USE 12-0-1997; IN COMMERCE 12-0-1997.

CLASS 41—EDUCATION AND ENTERTAINMENT

FOR EDUCATION AND TRAINING SERVICES IN THE INSTALLATION, OPERATION, AND USE OF SOFTWARE AND RELATED DATABASES (U.S. CLS. 100, 101 AND 107).

FIRST USE 12-0-1997; IN COMMERCE 12-0-1997.

CLASS 42—SCIENTIFIC, COMPUTER AND LEGAL SERVICES

FOR MAINTENANCE SERVICES FOR COMPUTER SOFTWARE AND RELATED DATABASES, NAMELY ERROR CORRECTIONS, IMPROVEMENTS IN FUNCTIONALITY, TELEPHONE REPAIR, AND ON-SITE REPAIR SERVICES (U.S. CLS. 100 AND 101).

FIRST USE 12-0-1997; IN COMMERCE 12-0-1997.

SN 76-327,486. COMPUCOM SYSTEMS, INC., DALLAS, TX.
FILED 10-17-2001.

FREEDOM STARTS HERE

CLASS 37—CONSTRUCTION AND REPAIR

FOR MAINTENANCE OF COMPUTER HARDWARE (U.S. CLS. 100, 103 AND 106).

CLASS 42—SCIENTIFIC, COMPUTER AND LEGAL SERVICES

FOR COMPUTER CONSULTING AND ADVISORY SERVICES, COMPUTER SOFTWARE INSTALLATION AND MAINTENANCE, AND LEASING SERVICES IN THE FIELD OF COMPUTERS AND COMPUTER-RELATED EQUIPMENT (U.S. CLS. 100 AND 101).

SN 76-327,775. PROSPRING, INC., LOS ANGELES, CA.
FILED 10-22-2001.

PROSPRING

CLASS 35—ADVERTISING AND BUSINESS

FOR EMPLOYMENT, HIRING, RECRUITING, PLACEMENT AND STAFFING SERVICES (U.S. CLS. 100, 101 AND 102).

FIRST USE 8-29-2001; IN COMMERCE 8-29-2001.

CLASS 42—SCIENTIFIC, COMPUTER AND LEGAL SERVICES

FOR TECHNICAL WRITING FOR OTHERS (U.S. CLS. 100 AND 101).

FIRST USE 8-29-2001; IN COMMERCE 8-29-2001.

SN 76-327,803. INOBYS LTD., OAKLAND, CA. FILED 10-19-2001.

MEAL IN MOTION

CLASS 5—PHARMACEUTICALS

FOR NUTRITIONAL SUPPLEMENTS, MEAL REPLACEMENT AND DIETARY SUPPLEMENT DRINKS AND DRINK MIXES, DIETARY AND NUTRITIONAL SUPPLEMENTS IN THE FORM OF MEAL REPLACEMENT BARS, SNACK BARS, ENERGY BARS AND ENERGY DRINKS (U.S. CLS. 6, 18, 44, 46, 51 AND 52).

CLASS 29—MEATS AND PROCESSED FOODS

FOR SOUP AND SOUP MIXES, POTATO CHIPS, YUCCA CHIPS, FRUIT-BASED SNACK FOODS, POTATO-BASED SNACK FOODS, FRUIT- AND SOY-BASED SNACK FOODS, YOGURT-BASED BEVERAGES, DAIRY-BASED BEVERAGES, FRUIT CHIPS, BANANA CHIPS, PROTEIN BASED NUTRIENT-DENSE SNACK BARS, SNACK MIX CONSISTING PRIMARILY OF PROCESSED FRUITS, PROCESSED NUTS, AND/OR RAISINS (U.S. CL. 46).

CLASS 30—STAPLE FOODS

FOR GRANOLA-BASED SNACK BARS, RICE-BASED SNACK FOODS, WHEAT-BASED SNACK FOODS, CORN CHIPS, TORTILLA CHIPS, FLOUR-BASED CHIPS, GRAIN-BASED CHIPS, TACO CHIPS, CEREAL-BASED SNACK FOOD, SNACK MIX CONSISTING PRIMARILY OF CRACKERS, PRETZELS, CANDIED NUTS, AND/OR POPPED POPCORN, ICE CREAM DRINKS, HERBAL FOOD BEVERAGES (U.S. CL. 46).

CLASS 31—NATURAL AGRICULTURAL PRODUCTS

FOR FRESH FRUITS (U.S. CLS. 1 AND 46).

CLASS 32—LIGHT BEVERAGES

FOR SOFT DRINKS, SPORTS DRINKS, ISOTONIC DRINKS, FRUIT DRINKS, FRUIT-FLAVORED DRINKS, SMOOTHIES (U.S. CLS. 45, 46 AND 48).

SN 76-328,619. PELICAN PUBLISHING COMPANY, GRETNA, LA. FILED 10-22-2001.

GASTON

SN 76-328,525. FEASINOMICS, INC., NAPLES, FL. FILED 10-22-2001.

FEASINOMICS**CLASS 16—PAPER GOODS AND PRINTED MATTER**

FOR MAPS AND OTHER RELATED PRINTED REPORTS DEPICTING LOCAL AND NATIONAL ECONOMIC, DEMOGRAPHIC AND REAL ESTATE RELATED DATA BY GEOGRAPHICAL LOCATION (U.S. CLS. 2, 5, 22, 23, 29, 37, 38 AND 50).

FIRST USE 5-6-1991; IN COMMERCE 5-6-1991.

CLASS 35—ADVERTISING AND BUSINESS

FOR CONSULTATION SERVICES IN THE FIELD OF MARKET PERFORMANCE AND ECONOMIC RESEARCH AS RELATING TO REAL ESTATE; REAL ESTATE MARKETING SERVICES, NAMELY, ON-LINE SERVICES FEATURING COOPERATIVE REAL ESTATE MARKETING; ECONOMIC FORECASTING AND ANALYSIS IN THE FIELD OF REAL ESTATE; MARKET ANALYSIS IN THE FIELD OF REAL ESTATE; CONDUCTING BUSINESS RESEARCH; CONDUCTING MARKET RESEARCH IN THE FIELD OF REAL ESTATE; PROVIDING A SEARCHABLE DATABASE CONTAINING MARKETING AND ECONOMIC INFORMATION AND DATA IN THE FIELD OF REAL ESTATE; STRATEGIC BUSINESS PLANNING; PROVIDING MARKET INFORMATION IN THE FIELD OF REAL ESTATE VIA A GLOBAL COMPUTER NETWORK (U.S. CLS. 100, 101 AND 102).

FIRST USE 5-6-1991; IN COMMERCE 5-6-1991.

CLASS 16—PAPER GOODS AND PRINTED MATTER

FOR SERIES OF FICTION BOOKS; CHILDREN'S BOOKS; CHILDREN'S ACTIVITY BOOKS; COMIC BOOKS; COOK BOOKS; TALKING CHILDREN'S BOOKS AND PICTURE BOOKS; COLORING BOOKS; NOTE CARDS; GREETING CARDS; AND PRINTED MATTER, NAMELY REPRINTS OF PHOTOGRAPHS, DRAWINGS, CARTOON PRINTS, CARTOON STRIPS, NEWSPAPER CARTOONS AND PICTURES (U.S. CLS. 2, 5, 22, 23, 29, 37, 38 AND 50).

FIRST USE 0-0-1973; IN COMMERCE 0-0-1973.

CLASS 28—TOYS AND SPORTING GOODS

FOR TOYS, NAMELY, PULL TOYS, STUFFED TOYS, STUFFED TOY ANIMALS, PLUSH TOYS, DOLLS, TOY FIGURES, TOY ACTION FIGURES, TOY VEHICLES, CARD GAMES, BOARD GAMES, COIN-OPERATED VIDEO GAMES AND HAND HELD UNITS FOR PLAYING VIDEO GAMES (U.S. CLS. 22, 23, 38 AND 50).

FIRST USE 0-0-2000; IN COMMERCE 0-0-2000.

SN 76-329,479. GILLIGAN, ROBERT, NEW YORK, NY. FILED 10-24-2001.

THREE IS THE KEY

SN 76-328,557. YAN CAN COOK, INC., DBA YAN CAN COOK, FOSTER CITY, CA. FILED 10-22-2001.

YAN'S KITCHEN

OWNER OF U.S. REG. NOS. 2,311,369, 2,437,935 AND OTHERS.

THE NAME "YAN" IDENTIFIES A LIVING INDIVIDUAL WHOSE CONSENT IS OF RECORD.

CLASS 29—MEATS AND PROCESSED FOODS

FOR FROZEN, PREPARED AND PACKAGED FOODS, NAMELY, MEALS CONSISTING PRIMARILY OF MEAT, FISH, POULTRY OR VEGETABLES (U.S. CL. 46).

CLASS 30—STAPLE FOODS

FOR FROZEN, PREPARED AND PACKAGED FOODS, NAMELY, MEALS CONSISTING PRIMARILY OF PASTA OR RICE (U.S. CL. 46).

CLASS 35—ADVERTISING AND BUSINESS

FOR BUSINESS CONSULTING SERVICES, NAMELY, RENDERING TECHNICAL AID AND ASSISTANCE IN THE ESTABLISHMENT AND/OR OPERATION OF A BUSINESS SPECIALIZING IN THE SALE OF COSMETICS, HAIR CARE AND SKIN CARE PRODUCTS, VITAMINS AND MINERALS, NUTRITIONAL SUPPLEMENTS, HOME FURNISHINGS, CLOTHING AND FOOD PRODUCTS; DEVELOPING DIRECT SALES AND MARKETING PROGRAMS FOR OTHERS; DIRECT TELEPHONE RETAIL SERVICES IN THE FIELDS OF COSMETICS, HAIR CARE AND SKIN CARE PRODUCTS, VITAMINS AND MINERALS, NUTRITIONAL SUPPLEMENTS, HOME FURNISHINGS, CLOTHING AND FOOD PRODUCTS; ON-LINE RETAIL SERVICES IN THE FIELDS OF COSMETICS, HAIR CARE AND SKIN CARE PRODUCTS, VITAMINS AND MINERALS, NUTRITIONAL SUPPLEMENTS, HOME FURNISHINGS, CLOTHING AND FOOD PRODUCTS (U.S. CLS. 100, 101 AND 102).

CLASS 41—EDUCATION AND ENTERTAINMENT

FOR CONDUCTING TRAINING PROGRAMS IN THE FIELDS OF DIRECT SALES AND MARKETING (U.S. CLS. 100, 101 AND 107).

SN 76-329,494. THE ESCAL INSTITUTE OF ADVANCED TECHNOLOGIES, INC., BETHESDA, MD. FILED 10-24-2001.

+S

CLASS 41—EDUCATION AND ENTERTAINMENT

FOR CONDUCTING SEMINARS, COURSES AND WORKSHOPS IN THE FIELD OF INFORMATION SECURITY (U.S. CLS. 100, 101 AND 107).

CLASS 42—SCIENTIFIC, COMPUTER AND LEGAL SERVICES

FOR CONSULTING SERVICES IN THE FIELD OF INFORMATION SECURITY (U.S. CLS. 100 AND 101).

SN 76-329,608. COOPER INTERESTS LLC, PRINCETON, NJ. FILED 10-16-2001.

M●OPTEK

THE MARK CONSISTS OF THE LETTER "M", A DOT AND THE WORD "OPTEK" WRITTEN TOGETHER.

CLASS 9—ELECTRICAL AND SCIENTIFIC APPARATUS

FOR COMPUTER SOFTWARE FOR PREDICTIVE MODELING AND ADAPTIVE LEARNING FOR USE IN MARKET RESEARCH AND TECHNOLOGY-BASED INTEGRATED MARKETING SOLUTIONS (U.S. CLS. 21, 23, 26, 36 AND 38).

CLASS 35—ADVERTISING AND BUSINESS

FOR MARKET RESEARCH; PROVIDING TECHNOLOGY-BASED INTEGRATED MARKETING SOLUTIONS FOR OTHERS (U.S. CLS. 100, 101 AND 102).

CLASS 42—SCIENTIFIC, COMPUTER AND LEGAL SERVICES

FOR COMPUTER SERVICES, NAMELY, CREATING DATABASES FOR STORING AND SORTING INFORMATION IN THE FIELDS OF MARKET RESEARCH, MARKETING SERVICES AND ADVERTISING FOR OTHERS (U.S. CLS. 100 AND 101).

SN 76-330,123. PARK LANE ASSOCIATES, INC., PROVIDENCE, RI. FILED 10-26-2001.

SETH THOMAS

THE NAME "SETH THOMAS" DOES NOT IDENTIFY A LIVING INDIVIDUAL.

CLASS 14—JEWELRY

FOR WATCHES; CANDLE HOLDERS, CANDLESTICKS AND PICTURE FRAMES OF PRECIOUS METAL (U.S. CLS. 2, 27, 28 AND 50).

CLASS 20—FURNITURE AND ARTICLES NOT OTHERWISE CLASSIFIED

FOR PICTURE FRAMES (U.S. CLS. 2, 13, 22, 25, 32 AND 50).

CLASS 21—HOUSEWARES AND GLASS

FOR CANDLE HOLDERS AND CANDLESTICKS NOT OF PRECIOUS METAL (U.S. CLS. 2, 13, 23, 29, 30, 33, 40 AND 50).

SN 76-330,211. LUIGINO'S, INC., DULUTH, MN. FILED 10-26-2001.

MICHELINA'S LIFESTYLE

CLASS 29—MEATS AND PROCESSED FOODS

FOR FRESH, FROZEN, CANNED AND DEHYDRATED, MEATS, POULTRY AND FISH, ALL PROCESSED VEGETABLES (U.S. CL. 46).

CLASS 30—STAPLE FOODS

FOR FRESH, FROZEN, CANNED AND DEHYDRATED FOODS, NAMELY, CANNELLONI AND TORTELLINI STUFFED WITH MEAT, POULTRY, FISH, VEGETABLES OR OTHER FILLING WITH SAUCES (U.S. CL. 46).

SN 76-330,377. MARITZ INC., FENTON, MO. FILED 10-25-2001.

YOUR REWARDS

NO CLAIM IS MADE TO THE EXCLUSIVE RIGHT TO USE "REWARDS", APART FROM THE MARK AS SHOWN.

CLASS 16—PAPER GOODS AND PRINTED MATTER

FOR PRINTED CATALOGS AND DOWNLOADABLE ELECTRONIC ONLINE CATALOG FEATURING MERCHANDISE OFFERED IN CONNECTION WITH SALES, PERFORMANCE AND LOYALTY INCENTIVE PROGRAMS FOR EMPLOYEES, DISTRIBUTORS, PARTNERS AND CUSTOMERS (U.S. CLS. 2, 5, 22, 23, 29, 37, 38 AND 50).

FIRST USE 2-4-2000; IN COMMERCE 2-4-2000.

CLASS 35—ADVERTISING AND BUSINESS

FOR MAIL-ORDER AND ELECTRONIC ONLINE CATALOG SERVICES FEATURING MERCHANDISE OFFERED IN CONNECTION WITH SALES, PERFORMANCE AND LOYALTY INCENTIVE PROGRAMS FOR EMPLOYEES, DISTRIBUTORS, PARTNERS AND CUSTOMERS (U.S. CLS. 100, 101 AND 102).

FIRST USE 2-4-2000; IN COMMERCE 2-4-2000.

SN 76-330,584. SAUL ZAENTZ COMPANY, THE, DBA TOLKIEN ENTERPRISES, BERKELEY, CA. FILED 10-26-2001.

THE
LORD OF THE RINGS
THE FELLOWSHIP OF THE RING

OWNER OF U.S. REG. NO. 1,553,027.

CLASS 9—ELECTRICAL AND SCIENTIFIC APPARATUS

FOR COMPUTER GAME PROGRAMS AND DOWNLOADABLE ONLINE INTERACTIVE COMPUTER GAME PROGRAMS HAVING SINGLE AND MULTI-PLAYER CAPABILITY (U.S. CLS. 21, 23, 26, 36 AND 38).

CLASS 16—PAPER GOODS AND PRINTED MATTER

FOR PRINTED MATTER NAMELY, POSTERS; WALL CHARTS; PHOTOGRAPHS; STATIONERY; ART PRINTS; CALENDARS; PLAYING CARDS; TRADING CARDS; BOOKMARKS; STICKER BOOKS; STICKERS; POST-CARDS; WRITING PAPER; NOTE BOOKS; NOTE PADS; NOTE CARDS; FOLDERS; SERIES OF FANTASY BOOKS AND MAGAZINES; WRAPPING PAPER; INSTRUCTIONAL AND TEACHING MATERIALS, NAMELY, PENCILS, PENS, RULERS, ERASERS, PAPERWEIGHTS, AND HOLDERS FOR OFFICE SUPPLIES, PENS, PENCILS AND PAPERCLIPS (U.S. CLS. 2, 5, 22, 23, 29, 37, 38 AND 50).

CLASS 25—CLOTHING

FOR CLOTHING, NAMELY T-SHIRTS AND SWEAT-SHIRTS, COSTUMES, FOOTWEAR AND HEADWEAR (U.S. CLS. 22 AND 39).

CLASS 28—TOYS AND SPORTING GOODS

FOR TOY ACTION FIGURES AND ACCESSORIES THEREFOR; TOY FIGURES; CARD GAMES; EQUIPMENT SOLD AS A UNIT FOR PLAYING CARD GAMES; PUZZLES, EXCEPT CROSSWORD PUZZLES; CHESS SETS; ROLE-PLAYING GAMES AND ACCESSORIES; ACTION SKILL GAMES; BOARD GAMES; EQUIPMENT SOLD AS A UNIT FOR PLAYING BOARD GAMES; EQUIPMENT SOLD AS A UNIT FOR PLAYING ACTION TYPE TARGET GAMES; EQUIPMENT SOLD AS UNIT FOR PLAYING HAND HELD ELECTRONIC GAMES; COLLECTIBLE TOY FIGURES; ELECTRONIC TOYS, NAMELY, ELECTRONIC ACTION TOYS; DOLLS AND ACCESSORIES THEREFOR; COLLECTIBLE MARBLES AND ACCESSORIES; ELECTRONIC AND NON-ELECTRONIC PLUSH TOYS; MECHANICAL ACTION TOYS; TOY BOXES; CASES FOR ACTION FIGURES; HAND HELD UNIT FOR PLAYING ELECTRONIC GAMES; COSTUME MASKS; PUPPETS; ROLE PLAYING GAME EQUIPMENT IN THE NATURE OF GAME BOOK MANUALS; SOFT SCULPTURE TOYS; TOY WEAPONS, NAMELY TOY SWORDS, KNIVES, MACES, AXES, DAGGERS, OR BOWS AND ARROWS; ARCADE GAMES; ELECTRONIC EDUCATIONAL GAMES MACHINES FOR CHILDREN; EQUIPMENT SOLD AS A UNIT FOR PLAYING A MEMORY GAME; FANTASY CHARACTER TOYS; LCD GAME MACHINES; POSITIONABLE TOY FIGURES; TALKING TOYS; TOY WATCHES; TRANSFORMING ROBOTIC TOYS; AND CHRISTMAS TREE ORNAMENTS (U.S. CLS. 22, 23, 38 AND 50).

CLASS 41—EDUCATION AND ENTERTAINMENT

FOR ENTERTAINMENT SERVICES IN THE FIELD OF INTERACTIVE MULTI-PLAYER GAMES NAMELY, PROVIDING COMPUTER GAME PROGRAMS VIA ONLINE ELECTRONIC COMMUNICATIONS AND GLOBAL COMPUTER NETWORKS (U.S. CLS. 100, 101 AND 107).

SN 76-331,051. XIAMEN LOTA INTERNATIONAL CO., LTD., XIAMEN, 361012, CHINA, FILED 10-29-2001.

LOTA

CLASS 11—ENVIRONMENTAL CONTROL APPARATUS

FOR FAUCETS (U.S. CLS. 13, 21, 23, 31 AND 34).

CLASS 21—HOUSEWARES AND GLASS

FOR BATHROOM ACCESSORIES, NAMELY, TOWEL RINGS, TOWEL BARS, AND TISSUE DISPENSERS (U.S. CLS. 2, 13, 23, 29, 30, 33, 40 AND 50).

SN 76-331,064. SAUL ZAENTZ COMPANY, THE, DBA TOLKIEN ENTERPRISES, BERKELEY, CA. FILED 10-29-2001.

THE
LORD
OF THE
RINGS

OWNER OF U.S. REG. NO. 1,553,027.

CLASS 9—ELECTRICAL AND SCIENTIFIC APPARATUS

FOR COMPUTER GAME PROGRAMS AND DOWNLOADABLE ONLINE INTERACTIVE COMPUTER GAME PROGRAMS HAVING SINGLE AND MULTI-PLAYER CAPABILITY (U.S. CLS. 21, 23, 26, 36 AND 38).

CLASS 16—PAPER GOODS AND PRINTED MATTER

FOR PRINTED MATTER NAMELY, POSTERS; WALL CHARTS; PHOTOGRAPHS; STATIONERY; ART PRINTS; CALENDARS; PLAYING CARDS; TRADING CARDS; BOOKMARKS; STICKER BOOKS; STICKERS; POST-CARDS; WRITING PAPER; NOTE BOOKS; NOTE PADS; NOTE CARDS; FOLDERS; SERIES OF FANTASY BOOKS AND MAGAZINES; WRAPPING PAPER; INSTRUCTIONAL AND TEACHING MATERIALS, NAMELY, PENCILS, PENS, RULERS, ERASERS, PAPERWEIGHTS, AND HOLDERS FOR OFFICE SUPPLIES, PENS, PENCILS AND PAPERCLIPS (U.S. CLS. 2, 5, 22, 23, 29, 37, 38 AND 50).

CLASS 25—CLOTHING

FOR CLOTHING, NAMELY T-SHIRTS AND SWEAT-SHIRTS, COSTUMES, FOOTWEAR AND HEADWEAR (U.S. CLS. 22 AND 39).

CLASS 28—TOYS AND SPORTING GOODS

FOR TOY ACTION FIGURES AND ACCESSORIES THEREFOR; TOY FIGURES; CARD GAMES; EQUIPMENT SOLD AS A UNIT FOR PLAYING CARD GAMES; PUZZLES, EXCEPT CROSSWORD PUZZLES; CHESS SETS; ROLE-PLAYING GAMES AND ACCESSORIES; ACTION SKILL GAMES; BOARD GAMES; EQUIPMENT SOLD AS A UNIT FOR PLAYING BOARD GAMES; EQUIPMENT SOLD AS A UNIT FOR PLAYING ACTION TYPE TARGET GAMES; EQUIPMENT SOLD AS UNIT FOR PLAYING HAND HELD ELECTRONIC GAMES; COLLECTIBLE TOY FIGURES; ELECTRONIC TOYS, NAMELY, ELECTRONIC ACTION TOYS; DOLLS AND ACCESSORIES THEREFOR; COLLECTIBLE MARBLES AND ACCESSORIES; ELECTRONIC AND NON-ELECTRONIC PLUSH TOYS; MECHANICAL ACTION TOYS; TOY BOXES; CASES FOR ACTION FIGURES; HAND HELD UNIT FOR PLAYING ELECTRONIC GAMES; COSTUME MASKS; PUPPETS; ROLE PLAYING GAME EQUIPMENT IN THE NATURE OF GAME BOOK MANUALS; SOFT SCULPTURE TOYS; TOY WEAPONS, NAMELY TOY SWORDS, KNIVES, MACES, AXES, DAGGERS, OR BOWS AND ARROWS; ARCADE GAMES; ELECTRONIC EDUCATIONAL GAMES MACHINES FOR CHILDREN; EQUIPMENT SOLD AS A UNIT FOR PLAYING A MEMORY GAME; FANTASY CHARACTER TOYS; LCD GAME MACHINES; POSITIONABLE TOY FIGURES; TALKING TOYS; TOY WATCHES; TRANSFORMING ROBOTIC TOYS; AND CHRISTMAS TREE ORNAMENTS (U.S. CLS. 22, 23, 38 AND 50).

CLASS 41—EDUCATION AND ENTERTAINMENT

FOR ENTERTAINMENT SERVICES IN THE FIELD OF INTERACTIVE MULTI-PLAYER GAMES NAMELY, PROVIDING COMPUTER GAME PROGRAMS VIA ONLINE ELECTRONIC COMMUNICATIONS AND GLOBAL COMPUTER NETWORKS (U.S. CLS. 100, 101 AND 107).

SN 76-331,629. THIRD PERSON, INC., MILWAUKEE, WI. FILED 10-29-2001.

THIRD PERSON**CLASS 35—ADVERTISING AND BUSINESS**

FOR BUSINESS MARKETING CONSULTING SERVICES; ADVERTISING SERVICES, NAMELY, CREATING ADVERTISEMENTS FOR OTHERS (U.S. CLS. 100, 101 AND 102).

FIRST USE 2-0-2001; IN COMMERCE 2-0-2001.

CLASS 42—SCIENTIFIC, COMPUTER AND LEGAL SERVICES

FOR COMPUTER SERVICES, NAMELY, DESIGNING AND IMPLEMENTING WEB SITES FOR OTHERS (U.S. CLS. 100 AND 101).

FIRST USE 2-0-2001; IN COMMERCE 2-0-2001.

SN 76-331,917. HORSE COUNTRY, LTD., WARRENTON, VA. FILED 10-31-2001.

PANDORE**CLASS 16—PAPER GOODS AND PRINTED MATTER**

FOR SERIES OF CHILDREN'S BOOKS (U.S. CLS. 2, 5, 22, 23, 29, 37, 38 AND 50).

CLASS 28—TOYS AND SPORTING GOODS

FOR STUFFED TOY ANIMALS (U.S. CLS. 22, 23, 38 AND 50).

SN 76-332,356. VERTICAL FOCUS LLC, CHICAGO, IL. FILED 10-31-2001.

VERTICAL FOCUS**CLASS 35—ADVERTISING AND BUSINESS**

FOR BUSINESS MANAGEMENT AND CONSULTATION; COMPUTERIZED DATABASE MANAGEMENT (U.S. CLS. 100, 101 AND 102).

CLASS 42—SCIENTIFIC, COMPUTER AND LEGAL SERVICES

FOR MONITORING THE COMPUTER SYSTEMS OF OTHERS FOR TECHNICAL PURPOSES AND PROVIDING BACK-UP COMPUTER PROGRAMS AND FACILITIES; CONSULTING SERVICES IN THE FIELD OF DESIGN, SELECTION, IMPLEMENTATION AND USE OF COMPUTER HARDWARE AND SOFTWARE SYSTEMS FOR OTHERS (U.S. CLS. 100 AND 101).

SN 76-332,381. INSILICO MED LLC, MILWAUKEE, WI. FILED 10-31-2001.

POINTONE**CLASS 39—TRANSPORTATION AND STORAGE**

FOR ELECTRONIC STORAGE OF GENETIC AND CLINICAL PATIENT INFORMATION AND MEDICAL CONTENT AND MESSAGES FOR ACCESS AND USE BY PATIENTS, HOSPITALS, AND OTHER HEALTH CARE PROVIDERS AND PHARMACEUTICAL COMPANIES (U.S. CLS. 100 AND 105).

CLASS 44—MEDICAL, BEAUTY AND AGRICULTURAL SERVICES

FOR MEDICAL SERVICES, NAMELY, ORGANIZATION AND ANALYSIS OF GENETIC AND CLINICAL PATIENT INFORMATION AND MEDICAL CONTENT AND MESSAGES FOR ACCESS AND USE BY PATIENTS, HOSPITALS AND OTHER HEALTH CARE PROVIDERS AND PHARMACEUTICAL COMPANIES (U.S. CLS. 100 AND 101).

SN 76-332,798. COMPUTER SYSTEMS TECHNOLOGY, INC., HUNTSVILLE, AL. FILED 11-5-2001.

SN 76-333,533. SOFTSHARE, INC., SANTA BARBARA, CA. FILED 11-2-2001.

STREETLIGHT INFORMATION TECHNOLOGIES

NO CLAIM IS MADE TO THE EXCLUSIVE RIGHT TO USE "INFORMATION TECHNOLOGIES", APART FROM THE MARK AS SHOWN.

CLASS 37—CONSTRUCTION AND REPAIR

FOR COMPUTER INSTALLATION, MAINTENANCE, AND REPAIR; MAINTENANCE AND REPAIR OF TELECOMMUNICATIONS NETWORKS, APPARATUS, AND INSTRUMENTS; MAINTENANCE AND REPAIR OF COMPUTER NETWORKS AND COMPUTER HARDWARE; UPGRADING OF COMPUTER HARDWARE (U.S. CLS. 100, 103 AND 106).
FIRST USE 9-28-2001; IN COMMERCE 9-28-2001.

CLASS 42—SCIENTIFIC, COMPUTER AND LEGAL SERVICES

FOR COMPUTER NETWORK DESIGN FOR OTHERS; COMPUTER CONSULTATION; COMPUTER DIAGNOSTIC SERVICES; COMPUTER DISASTER RECOVERY PLANNING; COMPUTER PROGRAMMING FOR OTHERS; COMPUTER PROJECT MANAGEMENT SERVICES; COMPUTER SOFTWARE CONSULTATION; COMPUTER SOFTWARE DESIGN FOR OTHERS; COMPUTER SOFTWARE DEVELOPMENT; COMPUTER SYSTEMS ANALYSIS; DATABASE DEVELOPMENT SERVICES; DESIGN OF COMPUTERS FOR OTHERS; MONITORING THE COMPUTER SYSTEMS OF OTHERS FOR TECHNICAL PURPOSES AND PROVIDING BACK-UP COMPUTER PROGRAMS AND FACILITIES; RECOVERY OF COMPUTER DATA; TECHNICAL SUPPORT, NAMELY, MONITORING OF NETWORK SYSTEMS; UPDATING OF COMPUTER SOFTWARE FOR OTHERS (U.S. CLS. 100 AND 101).
FIRST USE 9-28-2001; IN COMMERCE 9-28-2001.

SN 76-333,077. BOARD OF REGENTS OF THE UNIVERSITY OF WISCONSIN SYSTEM, DBA WUWM-FM, MILWAUKEE, WI. FILED 11-2-2001.

MILWAUKEE PUBLIC RADIO

NO CLAIM IS MADE TO THE EXCLUSIVE RIGHT TO USE "PUBLIC RADIO", APART FROM THE MARK AS SHOWN.
SEC. 2(F).

CLASS 38—COMMUNICATION

FOR RADIO BROADCASTING SERVICES (U.S. CLS. 100, 101 AND 104).
FIRST USE 4-1-1982; IN COMMERCE 4-1-1982.

CLASS 41—EDUCATION AND ENTERTAINMENT

FOR RADIO PROGRAMMING SERVICES (U.S. CLS. 100, 101 AND 107).
FIRST USE 4-1-1982; IN COMMERCE 4-1-1982.

SOFTSHARE ALERT

CLASS 35—ADVERTISING AND BUSINESS

FOR PROVIDING INFORMATION REGARDING GOVERNMENT CONTRACT OPPORTUNITIES VIA WEBSITES ON GLOBAL COMPUTER NETWORKS AND COMMUNICATIONS NETWORKS; PROVIDING AN ONLINE COMPUTER DATABASE FEATURING INFORMATION REGARDING GOVERNMENT CONTRACT OPPORTUNITIES (U.S. CLS. 100, 101 AND 102).
FIRST USE 12-15-1988; IN COMMERCE 12-15-1988.

CLASS 42—SCIENTIFIC, COMPUTER AND LEGAL SERVICES

FOR PROVIDING TEMPORARY USE OF NON-DOWNLOADABLE SOFTWARE FEATURING GOVERNMENT CONTRACT OPPORTUNITIES (U.S. CLS. 100 AND 101).
FIRST USE 12-15-1988; IN COMMERCE 12-15-1988.

SN 76-333,542. SOFTSHARE, INC., SANTA BARBARA, CA. FILED 11-2-2001.

SOFTSHARE ISEARCH

CLASS 35—ADVERTISING AND BUSINESS

FOR PROVIDING INFORMATION REGARDING CONTRACT OPPORTUNITIES VIA WEBSITES ON GLOBAL COMPUTER NETWORKS AND COMMUNICATIONS NETWORKS; PROVIDING AN ONLINE COMPUTER DATABASE FEATURING INFORMATION REGARDING GOVERNMENT CONTRACT OPPORTUNITIES (U.S. CLS. 100, 101 AND 102).
FIRST USE 2-4-1998; IN COMMERCE 2-4-1998.

CLASS 42—SCIENTIFIC, COMPUTER AND LEGAL SERVICES

FOR PROVIDING TEMPORARY USE OF NON-DOWNLOADABLE SOFTWARE FEATURING GOVERNMENT CONTRACT OPPORTUNITIES (U.S. CLS. 100 AND 101).
FIRST USE 2-4-1998; IN COMMERCE 2-4-1998.

SN 76-333,735. FREEMAN, MICHAEL W., FIRCREST, WA.
FILED 11-2-2001.



CLASS 7—MACHINERY

FOR COMPONENTS OF MARINE AUTO PILOTS, NAMELY, MECHANICAL DRIVE UNITS, HYDRAULIC PUMPS, SPROCKETS, CHAINS, SHAFTS, FLEX SHAFTS, AND ELECTRIC MOTORS (U.S. CLS. 13, 19, 21, 23, 31, 34 AND 35).

FIRST USE 10-0-1970; IN COMMERCE 10-0-1970.

CLASS 9—ELECTRICAL AND SCIENTIFIC APPARATUS

FOR MARINE AUTO PILOTS; ELECTRONIC APPARATUS FOR COUPLING ELECTRONIC GEOGRAPHIC POSITION INDICATORS TO MARINE AUTO PILOTS; ELECTRONIC APPARATUS FOR CONNECTING MARINE GUIDANCE EQUIPMENT TO COMPUTER NETWORKS; RUDDER ANGLE INDICATORS; SPEED LOGS; COMPONENTS OF MARINE AUTO PILOTS, NAMELY, MAGNETIC AND HALL-EFFECT COMPASSES, COMPASS ENCLOSURES, COMPENSATING MAGNETS AND FERRITES FOR COMPASSES, HEELING TUBES, JUNCTION BOXES, REMOTE CONTROLS, RUDDER ANGLE INDICATORS, RUDDER ANGLE ENCODERS, LIMIT SWITCHES, RECTIFIER UNITS, SOLENOIDS, RELAYS, ELECTRIC MOTORS, AND CONTROLLERS; WIND VANES AND WIND DIRECTION INDICATORS (U.S. CLS. 21, 23, 26, 36 AND 38).

FIRST USE 10-0-1970; IN COMMERCE 10-0-1970.

SN 76-333,755. SCHOTTENSTEIN/BERNSTEIN CAPITAL GROUP LLC, COLUMBUS, OH. FILED 11-1-2001.

SB CAPITAL GROUP

NO CLAIM IS MADE TO THE EXCLUSIVE RIGHT TO USE "CAPITAL GROUP", APART FROM THE MARK AS SHOWN.

CLASS 35—ADVERTISING AND BUSINESS

FOR BUSINESS CONSULTATION; BUSINESS ASSET AND INVENTORY MANAGEMENT SERVICES, NAMELY, LIQUIDATING AND REMARKETING BUSINESS ASSETS AND INVENTORIES OF OTHERS; BUSINESS APPRAISALS, NAMELY, ASSET AND INVENTORY APPRAISALS; AUCTIONEERING SERVICES; ACCOUNTS RECEIVABLE SERVICES (U.S. CLS. 100, 101 AND 102).

FIRST USE 10-15-2001; IN COMMERCE 10-15-2001.

CLASS 36—INSURANCE AND FINANCIAL

FOR BUSINESS LIQUIDATION SERVICE; REAL ESTATE INVESTMENT; REAL ESTATE MANAGEMENT; LEASING OF REAL ESTATE; LOAN FINANCING; FINANCIAL INVESTMENT IN THE FIELD OF INDUSTRIAL, MANUFACTURING AND TECHNOLOGY EQUIPMENT; COLLECTION SERVICES, NAMELY, COLLECTION OF ACCOUNTS RECEIVABLES (U.S. CLS. 100, 101 AND 102).

FIRST USE 10-15-2001; IN COMMERCE 10-15-2001.

SN 76-333,801. CASSIDY, SHARLENE, BROOKLYN, NY.
FILED 11-5-2001.

CYREAN

CLASS 3—COSMETICS AND CLEANING PREPARATIONS

FOR MAKE-UP KITS COMPRISED OF COSMETICS, NAMELY, LIP STICK, LIP GLOSS, MASCARA, FOUNDATION, POWDER, COSMETIC BRUSHES, AND COSMETIC CARRIERS COMPOSED OF CLOTH, PLASTIC AND RELATED LIGHTWEIGHT, DRY CLEANABLE AND WASHABLE MATERIALS AND SECURED WITH FASTENERS OF RIBBON, SNAPS, BUTTONS AND FASTENINGS MADE UP OF MATCHING STRIPS WITH TINY HOOKS AND ADHESIVE PILE THAT ARE EASILY PRESSED TOGETHER OR PULLED APART. ALL SOLD AS A UNIT, FOR THE MAKE-UP PROFESSIONAL AND EVERYDAY CONSUMER (U.S. CLS. 1, 4, 6, 50, 51 AND 52).

CLASS 18—LEATHER GOODS

FOR COSMETIC CASES SOLD EMPTY, NAMELY COSMETIC CARRIERS FOR THE MAKE-UP PROFESSIONAL AND EVERYDAY CONSUMER COMPOSED OF CLOTH, PLASTIC AND RELATED LIGHTWEIGHT, DRY CLEANABLE AND WASHABLE MATERIALS AND SECURED WITH FASTENERS OF RIBBON, SNAPS, BUTTONS, AND FASTENERS MADE UP OF MATCHING STRIPS WITH TINY HOOKS AND ADHESIVE PILE THAT ARE EASILY PRESSED TOGETHER OR PULLED APART (U.S. CLS. 1, 2, 3, 22 AND 41).

SN 76-333,864. BOVEE, ROBERT J., ROCHESTER, NY. FILED 11-6-2001.



**Professional Personal Training
Exercise/Fitness Therapy**

NO CLAIM IS MADE TO THE EXCLUSIVE RIGHT TO USE "PERSONAL HEALTH" AND "PROFESSIONAL PERSONAL TRAINING EXERCISE/FITNESS THERAPY", APART FROM THE MARK AS SHOWN.

THE LINING IN THE MARK IS A FEATURE OF THE MARK AND IS NOT USED TO INDICATE COLORING.

CLASS 41—EDUCATION AND ENTERTAINMENT

FOR PERSONAL TRAINER SERVICES, PERSONAL TRAINING SERVICES, NAMELY, STRENGTH AND CONDITIONING TRAINING, PHYSICAL FITNESS INSTRUCTION AND CONSULTATION AND PROVIDING FITNESS AND EXERCISE FACILITIES IN THE NATURE OF FACILITATING PERSONAL HEALTH WELLNESS AND FITNESS (U.S. CLS. 100, 101 AND 107).

CLASS 42—SCIENTIFIC, COMPUTER AND LEGAL SERVICES

FOR MEDICAL AND HEALTH CARE SERVICES IN THE NATURE OF EXERCISE AND FITNESS THERAPY, NAMELY, INJURY PREVENTION AND REHABILITATION FOR BONE, MUSCLE AND SOFT TISSUE INJURIES, AND PREVENTION AND TREATMENT FOR CHRONIC PHYSICAL CONDITIONS AND DISEASE (U.S. CLS. 100 AND 101).

SN 76-334,123. BLACK & VEATCH HOLDING COMPANY, KANSAS CITY, MO. FILED 11-6-2001.

TAGG**CLASS 35—ADVERTISING AND BUSINESS**

FOR PROCUREMENT OF ELECTRICAL POWER GENERATION, TRANSMISSION AND DISTRIBUTION EQUIPMENT AND MATERIALS FOR OTHERS; DISTRIBUTORSHIP SERVICES FEATURING ELECTRICAL POWER GENERATION, TRANSMISSION AND DISTRIBUTION EQUIPMENT AND MATERIALS (U.S. CLS. 100, 101 AND 102).

CLASS 37—CONSTRUCTION AND REPAIR

FOR CONSTRUCTION OF ELECTRICAL POWER GENERATION, TRANSMISSION AND DISTRIBUTION FACILITIES AND SYSTEMS (U.S. CLS. 100, 103 AND 106).

CLASS 39—TRANSPORTATION AND STORAGE

FOR ELECTRICAL POWER TRANSMISSION AND DISTRIBUTION SERVICES (U.S. CLS. 100 AND 105).

CLASS 40—MATERIAL TREATMENT

FOR ELECTRICAL POWER GENERATION SERVICES (U.S. CLS. 100, 103 AND 106).

CLASS 42—SCIENTIFIC, COMPUTER AND LEGAL SERVICES

FOR ENGINEERING AND DESIGN OF ELECTRICAL POWER GENERATION, TRANSMISSION AND DISTRIBUTION FACILITIES AND SYSTEMS (U.S. CLS. 100 AND 101).

SN 76-334,846. MAXWELL FOOTWEAR OF CALIFORNIA, INC., NEWHALL, CA. FILED 11-6-2001.

CIRCA 1975 JOAN & DAVID

OWNER OF U.S. REG. NOS. 1,263,011, 1,697,635 AND OTHERS.

NO CLAIM IS MADE TO THE EXCLUSIVE RIGHT TO USE "CIRCA 1975", APART FROM THE MARK AS SHOWN.

CLASS 18—LEATHER GOODS

FOR BAGS, NAMELY, HANDBAGS, PURSES, WALLETS, TOTE BAGS, AND LUGGAGE (U.S. CLS. 1, 2, 3, 22 AND 41).

CLASS 25—CLOTHING

FOR CLOTHING, NAMELY, OVERCOATS, JACKETS, SUITS, BLOUSES, JERSEYS, SHIRTS, SKIRTS, PANTS, SHORTS, TIES, SCARVES, GLOVES, SOCKS, SWEATER, BELTS, AND HATS (U.S. CLS. 22 AND 39).

SN 76-335,155. MAXWELL FOOTWEAR OF CALIFORNIA, INC., NEWHALL, CA. FILED 11-6-2001.

CIRCA MCMLXXV JOAN & DAVID

OWNER OF U.S. REG. NOS. 1,263,011, 1,697,635 AND OTHERS.

NO CLAIM IS MADE TO THE EXCLUSIVE RIGHT TO USE "CIRCA MCMLXXV", APART FROM THE MARK AS SHOWN.

CLASS 18—LEATHER GOODS

FOR BAGS, NAMELY, HANDBAGS, PURSES, WALLETS, TOTE BAGS, AND LUGGAGE (U.S. CLS. 1, 2, 3, 22 AND 41).

CLASS 25—CLOTHING

FOR CLOTHING, NAMELY, OVERCOATS, JACKETS, SUITS, BLOUSES, JERSEYS, SHIRTS, SKIRTS, PANTS, SHORTS, TIES, SCARVES, GLOVES, SOCKS, SWEATERS, BELTS, AND HATS (U.S. CLS. 22 AND 39).

SN 76-335,372. ST. BARNABAS HEALTH SYSTEM, INC., GIBSONIA, PA. FILED 11-7-2001.



CLASS 36—INSURANCE AND FINANCIAL

FOR CHARITABLE SERVICES, NAMELY SUPPORTING FUNDRAISING EVENTS AND SERVICES FOR SUPPORTING HEALTH CARE SERVICES (U.S. CLS. 100, 101 AND 102).

FIRST USE 12-31-1968; IN COMMERCE 12-31-1968.

CLASS 41—EDUCATION AND ENTERTAINMENT

FOR HEALTH CARE EDUCATION SERVICES, NAMELY PROVIDING PERSONAL INSTRUCTION, CLASSES, SEMINARS, NEWSLETTERS AND BROCHURES AND THE LIKE FOR EDUCATING PATIENTS AND THE COMMUNITY IN THE PREVENTION AND TREATMENT OF DISEASES AND ILLNESS (U.S. CLS. 100, 101 AND 107).

FIRST USE 12-31-1968; IN COMMERCE 12-31-1968.

CLASS 42—SCIENTIFIC, COMPUTER AND LEGAL SERVICES

FOR HEALTH CARE SERVICES, NAMELY PROVIDING NURSING HOME SERVICES, MEDICAL CENTER SERVICES, HOME HEALTH CARE SERVICES, ASSISTED LIVING COMMUNITY SERVICES, RETIREMENT HOME SERVICES, INDEPENDENT LIVING SERVICES (U.S. CLS. 100 AND 101).

FIRST USE 12-31-1968; IN COMMERCE 12-31-1968.

SN 76-336,087. CARQUEST CORPORATION, THE, RALEIGH, NC. FILED 11-9-2001.



OWNER OF U.S. REG. NOS. 994,165, 2,429,502 AND OTHERS.

NO CLAIM IS MADE TO THE EXCLUSIVE RIGHT TO USE "LINK", APART FROM THE MARK AS SHOWN.

CLASS 35—ADVERTISING AND BUSINESS

FOR PROVIDING AUTOMOTIVE PRODUCTS INFORMATION TO AUTOMOTIVE PARTS AND SERVICES RETAILERS VIA THE INTERNET (U.S. CLS. 100, 101 AND 102).

CLASS 36—INSURANCE AND FINANCIAL

FOR PROVIDING AUTOMOTIVE PRODUCTS WARRANTY INFORMATION TO AUTOMOTIVE PARTS AND SERVICES RETAILERS VIA THE INTERNET (U.S. CLS. 100, 101 AND 102).

SN 76-336,206. FRED MEYER STORES, INC., PORTLAND, OR. FILED 11-9-2001.

CURFEW KIDS

NO CLAIM IS MADE TO THE EXCLUSIVE RIGHT TO USE "KIDS", APART FROM THE MARK AS SHOWN.

CLASS 14—JEWELRY

FOR COSTUME JEWELRY (U.S. CLS. 2, 27, 28 AND 50).

CLASS 26—FANCY GOODS

FOR HAIR ACCESSORIES; NAMELY, BARRETTES, CLAWS, CLIPS, RIBBONS AND SCRUNCHIES (U.S. CLS. 37, 39, 40, 42 AND 50).

SN 76-338,015. TB PROPRIETARY CORP., WILMINGTON, DE. FILED 11-15-2001.

AVIANO

CLASS 35—ADVERTISING AND BUSINESS

FOR BUSINESS SERVICES, NAMELY, FACILITIES MANAGEMENT OF TECHNICAL OPERATIONS OF RESIDENTIAL COMMUNITIES (U.S. CLS. 100, 101 AND 102).

CLASS 37—CONSTRUCTION AND REPAIR

FOR LAND DEVELOPMENT SERVICES, NAMELY, PLANNING AND LAYING OUT OF RESIDENTIAL COMMUNITIES (U.S. CLS. 100, 103 AND 106).

SN 76-338,135. KREAB AB, STOCKHOLM, 11475, SWEDEN, FILED 11-15-2001.

ABOUTMERGE

CLASS 35—ADVERTISING AND BUSINESS

FOR DISSEMINATION OF ADVERTISING MATERIAL AND COMPANY INFORMATION FOR OTHERS VIA INTERNET; PROVISION, FURNISHING AND COMPILATION OF BUSINESS INFORMATION OF OTHERS ON A WEBSITE ON THE INTERNET; COMPILING, SYSTEMIZING AND PROVIDING ONLINE COMPUTER DATABASES, FEATURING INFORMATION IN RELATION TO ONGOING MERGERS AND ACQUISITIONS UNDERTAKEN BY CLIENT COMPANIES (U.S. CLS. 100, 101 AND 102).

CLASS 36—INSURANCE AND FINANCIAL

FOR PROVISION OF FINANCIAL INFORMATION ON A WEBSITE ON THE INTERNET (U.S. CLS. 100, 101 AND 102).

CLASS 38—COMMUNICATION

FOR COMPUTER AIDED ELECTRONIC TRANSMISSION OF MESSAGES AND IMAGES (U.S. CLS. 100, 101 AND 104).

SN 76-339,880. ISIS INVESTMENTS, INC., COCONUT GROVE, FL. FILED 11-19-2001.

OSI

SN 76-338,692. SLEEP SOLUTIONS, INC., PALO ALTO, CA. FILED 11-14-2001.

NOVASOM**CLASS 10—MEDICAL APPARATUS**

FOR MEDICAL DEVICES FOR DIAGNOSIS AND THERAPY OF SLEEP DISORDERS (U.S. CLS. 26, 39 AND 44).

CLASS 44—MEDICAL, BEAUTY AND AGRICULTURAL SERVICES

FOR DIAGNOSTIC, TESTING AND THERAPY SERVICES IN THE FIELD OF SLEEP DISORDERS (U.S. CLS. 100 AND 101).

CLASS 3—COSMETICS AND CLEANING PREPARATIONS

FOR ALL PURPOSE CLEANER, OVEN CLEANER AND GRILL CLEANER FOR HOUSEHOLD USE, LAUNDRY SPRAY STARCH, LIQUID SOAP FOR USE ON HANDS, DISH WASHING, LAUNDRY, AND FABRIC SOFTENER (U.S. CLS. 1, 4, 6, 50, 51 AND 52).

CLASS 5—PHARMACEUTICALS

FOR INSECT REPELLANTS, NAMELY, MOSQUITO COIL, MOSQUITO MAT, AND MOSQUITO REPELLANT (U.S. CLS. 6, 18, 44, 46, 51 AND 52).

CLASS 11—ENVIRONMENTAL CONTROL APPARATUS

FOR ELECTRICAL MOSQUITO MAT HEATERS (U.S. CLS. 13, 21, 23, 31 AND 34).

SN 76-339,055. C SQUARED TV, LLC, SHERMAN OAKS, CA. FILED 11-19-2001.

SIZE-A-WEEK SLIM DOWN

NO CLAIM IS MADE TO THE EXCLUSIVE RIGHT TO USE "SLIM DOWN", APART FROM THE MARK AS SHOWN.

SN 76-340,012. HENIFIN, STEVE S., BUFFALO, NY. FILED 11-20-2001.

CLASS 9—ELECTRICAL AND SCIENTIFIC APPARATUS

FOR VIDEO AND AUDIO CASSETTE TAPES AND COMPACT DISCS, CDS, ALL FEATURING INFORMATION RELATING TO WEIGHT LOSS, DIET, FITNESS, AND HEALTH (U.S. CLS. 21, 23, 26, 36 AND 38).

PRODROME**CLASS 16—PAPER GOODS AND PRINTED MATTER**

FOR SERIES OF NON-FICTION BOOKS, PAMPHLETS, MAGAZINES, NEWSLETTERS, AND PRINTED EDUCATIONAL MATERIALS, ALL FEATURING INFORMATION RELATING TO WEIGHT LOSS, DIET, FITNESS, AND HEALTH (U.S. CLS. 2, 5, 22, 23, 29, 37, 38 AND 50).

CLASS 9—ELECTRICAL AND SCIENTIFIC APPARATUS

FOR PRERECORDED AUDIO AND VIDEO TAPES, PHONOGRAPH RECORDS AND COMPACT DISCS FEATURING MUSIC (U.S. CLS. 21, 23, 26, 36 AND 38).

CLASS 35—ADVERTISING AND BUSINESS

FOR ON-LINE RETAIL SERVICES FEATURING PRODUCTS RELATING TO WEIGHT LOSS, DIET, FITNESS, AND HEALTH (U.S. CLS. 100, 101 AND 102).

CLASS 25—CLOTHING

FOR CLOTHING, NAMELY SHIRTS, VESTS, SWEATERS, SHOES, CAPS, SHORTS, SWEAT SHIRTS, PANTS, BELTS FOR CLOTHING, SOCKS, SWIM WEAR, JACKETS, RAIN COATS, DRESSES, FOOTWEAR, HATS, AND HEAD BANDS (U.S. CLS. 22 AND 39).

CLASS 42—SCIENTIFIC, COMPUTER AND LEGAL SERVICES

FOR PROVIDING ON-LINE INFORMATION SERVICES RELATING TO WEIGHT LOSS, DIET, FITNESS, AND HEALTH (U.S. CLS. 100 AND 101).

CLASS 41—EDUCATION AND ENTERTAINMENT

FOR ENTERTAINMENT SERVICES, NAMELY PRODUCTION OF SOUND AND VIDEO RECORDINGS (U.S. CLS. 100, 101 AND 107).

SN 76-340,447. FRANK M. WEEKS YACHT YARD, INC.,
PATCHOGUE, NY. FILED 11-21-2001.



OWNER OF U.S. REG. NOS. 964,045 AND 1,946,467.
THE MARK CONSISTS IN PART OF A STYLIZED
MUSICAL "F" NOTE.

CLASS 12—VEHICLES

FOR SAILBOATS AND STRUCTURAL PARTS THERE-
FOR; STRUCTURAL PARTS OF SAILBOATS, NAMELY
SAIL BEAMS, BOOMS, MASTS, HULLS, RUDDERS,
SPRING MECHANISMS FOR LIFTING RUDDERS SOLD
AS AN INTEGRAL COMPONENT OF SAILBOAT RUDDERS,
TILLERS, TILLER STRAPS AND LIFTS FOR
LIFTING RUDDERS SOLD AS AN INTEGRAL COMPON-
ENT OF SAILBOAT TILLERS, STRUCTURAL PARTS
FOR BOATS, NAMELY HULL FITTINGS IN THE NATURE
OF BOAT CLEATS, COAMINGS, THWARTS, DAG-
GER BOARDS, PINTELS, AND GUDGEONS FOR
SAILBOATS (U.S. CLS. 19, 21, 23, 31, 35 AND 44).
FIRST USE 8-20-1971; IN COMMERCE 8-20-1971.

CLASS 22—CORDAGE AND FIBERS

FOR SAILS FOR SAILBOATS; SAILBOAT MARINE
AND SAIL HANDLING SYSTEMS COMPRISING LINES
AND FITTINGS SOLD AS A UNIT; ROPES, NAMELY
SAILBOAT HALYARDS; SAILBOAT RIGGING LINES
AND BRIDLES COMPRISED OF NYLON CORDAGE
(U.S. CLS. 1, 2, 7, 19, 22, 42 AND 50).
FIRST USE 8-20-1971; IN COMMERCE 8-20-1971.

SN 76-340,509. ULTRATOUCH CORPORATION, EXTON, PA.
FILED 11-20-2001.



THE MARK CONSISTS OF A STYLIZED DESIGN OF A
HAND HOLDING A BUTTERFLY.

CLASS 10—MEDICAL APPARATUS

FOR MEDICAL APPARATUS FOR USE IN THE
DIAGNOSIS, TREATMENT AND EARLY DETECTION
OF BREAST CANCER, NAMELY, ELECTRONIC EQUIP-
MENT FOR USE IN DETECTING THE SHAPE AND
CONTOUR OF BREASTS, MAPPING SOLID OR DE-
FORMABLE MATTER, SOFT TISSUE MAPPING, LE-
SION MAPPING, LESION DETECTION, BREAST
LESION MAPPING, BREAST LESION DETECTION,
AND FOR USE IN PRODUCING PRINTED REPORTS
RELATED THERETO (U.S. CLS. 26, 39 AND 44).

**CLASS 42—SCIENTIFIC, COMPUTER AND
LEGAL SERVICES**

FOR TECHNICAL SUPPORT SERVICES, NAMELY
PROVIDING INFORMATION IN CONNECTION WITH
THE USE AND OPERATION OF MEDICAL EQUIPMENT
IN THE FIELD OF SHAPE AND CONTOUR DETEC-
TION, MAPPING OF SOLID OR DEFORMABLE MAT-
TER, SOFT TISSUE MAPPING, LESION MAPPING,
LESION DETECTION, BREAST LESION MAPPING,
BREAST LESION DETECTION, AND THE DIAGNOSIS,
TREATMENT AND EARLY DETECTION OF BREAST
CANCER, AND THE DISSEMINATION OF PRINTED
AND/OR ELECTRONIC MATERIAL RELATED THERE-
TO (U.S. CLS. 100 AND 101).

SN 76-341,420. ALPHA OMEGA SOLUTIONS, INC., YORBA
LINDA, CA. FILED 11-26-2001.

ALPHA OMEGA SOLUTIONS

NO CLAIM IS MADE TO THE EXCLUSIVE RIGHT TO
USE "SOLUTIONS", APART FROM THE MARK AS
SHOWN.

**CLASS 9—ELECTRICAL AND SCIENTIFIC
APPARATUS**

FOR COMPUTER SOFTWARE FOR USE IN THE
ANALYSIS OF FINANCIAL DATA AND PERFORM-
ANCE STATISTICS IN THE AUTOMOTIVE, TRUCK
AND MOTORCYCLE INDUSTRIES; COMPUTER SOFT-
WARE FOR USE IN THE ANALYSIS OF FINANCIAL
DATA AND PERFORMANCE STATISTICS IN THE
AUTOMOTIVE, TRUCK AND MOTORCYCLE INDUS-
TRIES THAT MAY BE DOWNLOADED FROM A GLO-
BAL COMPUTER NETWORK; COMPUTER SOFTWARE
FOR ACCESSING INFORMATION DIRECTORIES THAT
MAY BE DOWNLOADED FROM THE GLOBAL COM-
PUTER NETWORK; COMPUTER SOFTWARE FOR AP-
PLICATION AND DATABASE INTEGRATION;
COMMUNICATIONS SOFTWARE FOR CONNECTING
GLOBAL COMPUTER NETWORKS; AND ELECTRONIC
DATABASES IN THE FIELD OF THE AUTOMOTIVE,
TRUCK AND MOTORCYCLE INDUSTRIES RECORDED
ON COMPUTER MEDIA (U.S. CLS. 21, 23, 26, 36 AND
38).
FIRST USE 7-23-1993; IN COMMERCE 7-23-1993.

**CLASS 41—EDUCATION AND ENTERTAIN-
MENT**

FOR COMPUTER EDUCATION TRAINING SERVICES
(U.S. CLS. 100, 101 AND 107).
FIRST USE 7-23-1993; IN COMMERCE 7-23-1993.

CLASS 42—SCIENTIFIC, COMPUTER AND LEGAL SERVICES

FOR COMPUTER HARDWARE AND SOFTWARE CONSULTATION; COMPUTER SOFTWARE DESIGN FOR OTHERS; COMPUTER SOFTWARE DEVELOPMENT; COMPUTER PROGRAMMING FOR OTHERS; CONSULTING SERVICES IN THE FIELD OF DESIGN, SELECTION, IMPLEMENTATION AND USE OF COMPUTER HARDWARE AND SOFTWARE SYSTEMS FOR OTHERS; APPLICATION SERVICE PROVIDER (ASP) FEATURING SOFTWARE FOR USE IN THE ANALYSIS OF FINANCIAL DATA AND PERFORMANCE STATISTICS IN THE FIELD OF THE AUTOMOTIVE, TRUCK AND MOTORCYCLE INDUSTRIES; INSTALLATION AND MAINTENANCE OF COMPUTER SOFTWARE; UPDATING OF COMPUTER SOFTWARE FOR OTHERS; AND TECHNICAL WRITING FOR OTHERS (U.S. CLS. 100 AND 101).

FIRST USE 7-23-1993; IN COMMERCE 7-23-1993.

CLASS 42—SCIENTIFIC, COMPUTER AND LEGAL SERVICES

FOR PROVIDING CUSTOMIZED ONLINE WEB PAGES FEATURING USER-DEFINED INFORMATION, WHICH INCLUDES SEARCH ENGINES AND ONLINE WEB LINKS TO OTHER WEB SITES (U.S. CLS. 100 AND 101).

FIRST USE 1-0-2001; IN COMMERCE 1-0-2001.

SN 76-342,914. CHESEBROUGH-PONDS, INC., WILMINGTON, DE. FILED 11-27-2001.

YOURDOVE**CLASS 38—COMMUNICATION**

FOR ELECTRONIC TRANSMISSION OF DATA AND DOCUMENTS REGARDING PERSONAL CARE VIA COMPUTER TERMINALS ON A GLOBAL COMPUTER NETWORK; ELECTRONIC MAIL SERVICES (U.S. CLS. 100, 101 AND 104).

CLASS 41—EDUCATION AND ENTERTAINMENT

FOR AUDIO VISUAL AND MULTIMEDIA INTERACTIVE PROGRAMMING, IN THE NATURE OF EDUCATIONAL PROGRAMS RELATING TO PERSONAL CARE ON A GLOBAL COMPUTER NETWORK (U.S. CLS. 100, 101 AND 107).

CLASS 42—SCIENTIFIC, COMPUTER AND LEGAL SERVICES

FOR COMPUTER SERVICES, NAMELY PROVIDING SEARCH ENGINES FOR OBTAINING DATA ON A GLOBAL COMPUTER NETWORK TO AID IN THE FINDING OF USEFUL INFORMATION RELATING TO PERSONAL CARE (U.S. CLS. 100 AND 101).

SN 76-342,941. HUMANA, INC., LOUISVILLE, KY. FILED 11-29-2001.

HOWIE**CLASS 35—ADVERTISING AND BUSINESS**

FOR PROVIDING EMPLOYEE RELATIONS INFORMATION REGARDING STANDARDS, ETHICS, BENEFITS AND PROGRAMS AND SERVICES AVAILABLE TO EMPLOYEES VIA THE INTERNET; PROVIDING ONLINE DIRECTORY INFORMATION SERVICES ALSO FEATURING HYPERLINKS TO OTHER WEB SITES (U.S. CLS. 100, 101 AND 102).

FIRST USE 1-0-2001; IN COMMERCE 1-0-2001.

SN 76-343,512. BROADON COMMUNICATIONS CORP., PALO ALTO, CA. FILED 11-28-2001.

BROADON**CLASS 9—ELECTRICAL AND SCIENTIFIC APPARATUS**

FOR COMPUTER HARDWARE, COMPUTER SOFTWARE, POWER ADAPTERS, ETHERNET CABLES, WIRELESS PC CARDS, ALL FOR USE IN PROVIDING SECURED MULTI-USER ACCESS TO A GLOBAL COMPUTER NETWORK FOR USE IN CACHING DIGITAL CONTENTS FROM A GLOBAL COMPUTER NETWORK (U.S. CLS. 21, 23, 26, 36 AND 38).

CLASS 38—COMMUNICATION

FOR TRANSMISSION, ROUTING, AND DELIVERY OF CONTENT VIA A GLOBAL COMPUTER NETWORK IN PROVIDING MULTI-USER ACCESS TO A GLOBAL COMPUTER NETWORK (U.S. CLS. 100, 101 AND 104).

SN 76-343,961. GLOBAL TOUCH, INCORPORATED, BERKELEY, CA. FILED 11-30-2001.

CHANNEL TRACKER

OWNER OF U.S. REG. NO. 2,240,611.

CLASS 16—PAPER GOODS AND PRINTED MATTER

FOR NEWSLETTER CONTAINING INFORMATION RELEVANT TO HIGH TECHNOLOGY COMPANIES ENTERING OR EXPANDING INTERNATIONAL MARKET OPPORTUNITIES (U.S. CLS. 2, 5, 22, 23, 29, 37, 38 AND 50).

CLASS 35—ADVERTISING AND BUSINESS

FOR BUSINESS CONSULTING SERVICES, NAMELY, ASSISTING HIGH TECHNOLOGY COMPANIES IN ENTERING OR EXPANDING INTERNATIONAL MARKET OPPORTUNITIES (U.S. CLS. 100, 101 AND 102).

SN 76-344,329. OAKLEAF PLANTATION, L.L.C., JACKSONVILLE, FL. FILED 12-3-2001.

OAKLEAF PLANTATION

CLASS 36—INSURANCE AND FINANCIAL

FOR REAL ESTATE PROPERTY MANAGEMENT SERVICES, NAMELY, THE OPERATION OF A PLANNED COMMUNITY, UTILITIES, PARKS, CIVIC, RECREATIONAL AND ATHLETIC FACILITIES (U.S. CLS. 100, 101 AND 102).

CLASS 37—CONSTRUCTION AND REPAIR

FOR LAND DEVELOPMENT SERVICES, NAMELY, CONSTRUCTION OF A PLANNED COMMUNITY DEVELOPMENT OF MIXED USE, GATED AND UNGATED RESIDENTIAL, OFFICE, RETAIL, AND INDUSTRIAL PROPERTIES (U.S. CLS. 100, 103 AND 106).

CLASS 36—INSURANCE AND FINANCIAL

FOR PROVIDING INFORMATION OVER COMPUTER NETWORKS AND GLOBAL COMMUNICATION NETWORKS IN THE FIELDS OF FINANCE, INVESTMENT, MONEY AND BANKING, RETIREMENT PLANNING, ESTATE PLANNING AND WILLS, REAL ESTATE, FAMILY BUDGETING AND PURCHASING, AND INSURANCE; PROVIDING INVESTMENT INFORMATION, FINANCIAL AND INVESTMENT NEWS AND ADVICE, AND STOCK AND BOND INFORMATION AND QUOTATIONS, ALL OVER COMPUTER NETWORKS AND GLOBAL COMMUNICATION NETWORKS; PROVIDING INFORMATION ABOUT INVESTMENT TRADING SERVICES IN THE NATURE OF A WEB PAGE CONTAINING LINKS TO ON-LINE INVESTMENT TRADING SERVICES; PROVIDING FINANCIAL CALCULATION AND ANALYSIS SERVICES OVER COMPUTER NETWORKS AND GLOBAL COMMUNICATION NETWORKS; PROVIDING ON-LINE FINANCIAL DATA GATHERING AND REPORTING SERVICES FOR THE EXCHANGE OVER A GLOBAL COMMUNICATION NETWORK OF INFORMATION BETWEEN INVESTORS, FINANCIAL INSTITUTIONS AND FINANCIAL ADVISORS (U.S. CLS. 100, 101 AND 102).

SN 76-344,405. FINANZ ST. HONORE B.V., MOUNTAINTOP, PA. FILED 12-3-2001.

BRUSH & GO

CLASS 3—COSMETICS AND CLEANING PREPARATIONS

FOR NAIL TIPS, FINGERNAIL SCULPTURING OVERLAYS, NAIL-CARE PREPARATIONS, CLEANER FOR USE ON NAIL BRUSHES, AND FINGERNAIL GEL ACTIVATOR (U.S. CLS. 1, 4, 6, 50, 51 AND 52).

CLASS 21—HOUSEWARES AND GLASS

FOR NAIL BRUSHES (U.S. CLS. 2, 13, 23, 29, 30, 33, 40 AND 50).

CLASS 42—SCIENTIFIC, COMPUTER AND LEGAL SERVICES

FOR PROVIDING ON-LINE INVESTMENT TOOLS, NAMELY, THE TEMPORARY USE OF ON-LINE NON-DOWNLOADABLE SOFTWARE FOR USE IN THE FIELDS OF FINANCIAL MANAGEMENT, INVESTMENT TRACKING, PORTFOLIO ANALYSIS, PORTFOLIO MANAGEMENT, INVESTMENT REPORTING, INVESTMENT PERFORMANCE MEASUREMENT, FINANCIAL INSTRUMENT TRADES TRACKING, ACCOUNT RECONCILIATION AND ACCOUNTING; PROVIDING ON-LINE WEB SITE CUSTOMIZATION TOOLS, NAMELY, THE TEMPORARY USE OF ON-LINE NON-DOWNLOADABLE WEB SITE CUSTOMIZATION SOFTWARE FOR USE IN THE FINANCIAL FIELD BY INVESTMENT ADVISORS (U.S. CLS. 100 AND 101).

SN 76-344,776. ADVENT TECHNOLOGY, INC., SAN FRANCISCO, CA. FILED 11-28-2001.

WEALTHLINE

OWNER OF U.S. REG. NOS. 1,490,606, 2,288,132 AND 2,319,075.

SN 76-345,118. MIQUEL-RIUS 1839, S.A., 08150 PARETS DEL VALLES, SPAIN, FILED 12-3-2001.



CLASS 16—PAPER GOODS AND PRINTED MATTER

FOR NOTE BOOKS; BINDERS; RINGED-BINDERS; LOOSE LEAF BINDERS; FILLER PAPER; LOOSE LEAF PAPER; NOTE BOOK PAPER; MEMO PADS; NOTE PADS; WRITING PADS; PADS FOR ADDRESSES AND TELEPHONE NUMBERS; INDEX DIVIDERS; INDEX CARDS FOR ADDRESSES AND TELEPHONE NUMBERS; INDEX CARDS; LEDGER BOOKS; ADDRESS BOOKS; PAPER DISPLAY BOXES; RINGED BINDERS FOR ADDRESSES AND TELEPHONE NUMBERS; FOLDERS FOR BUSINESS CARDS; RINGED BINDERS FOR BUSINESS CARDS; ACCORDION FILE FOLDERS; FOLDERS; FOLDERS WITH NOTE PADS; FOLDERS WITH CLIPBOARDS; PHOTO ALBUMS; LEATHER NOTE PAD COVERS; LEATHER ADDRESS BOOK COVERS; LEATHER DESK FOLDERS; LEATHER FOLDERS; LEATHER FOLDERS WITH NOTE PADS; LEATHER COVERED NOTE BOOKS; LETTER OPENERS MADE OF WOOD; HOLDERS FOR DESK ACCESSORIES MADE OF WOOD; HOLDERS FOR PENS AND PENCILS MADE OF WOOD; LEATHER CASES FOR PENS AND PENCILS; PEN AND PENCIL CASES MADE OF IMITATIONS OF LEATHER; PEN AND PENCIL CASES; COVERS FOR ADDRESS BOOKS MADE OF IMITATIONS OF LEATHER; DESK SETS; LEATHER BOUND DAILY PLANNERS; CLOTH BOUND DAILY PLANNERS; LEATHER RINGED-BINDER DAILY PLANNERS; RINGED-BINDER DAILY PLANNERS MADE OF IMITATIONS OF LEATHER; DAILY PLANNER REFILLS (U.S. CLS. 2, 5, 22, 23, 29, 37, 38 AND 50).

FIRST USE 0-0-1912; IN COMMERCE 11-0-1997.

CLASS 18—LEATHER GOODS

FOR LEATHER WALLETS; LEATHER BRIEF CASES; LEATHER KEY CASES; LEATHER CHANGE PURSES; LEATHER RUCKSACKS; HANDBAGS MADE OF LEATHER; HANDBAGS WITH MOBILE TELEPHONE POCKETS; LEATHER BUSINESS CARD CASES; LEATHER POCKETBOOKS; WALLETS MADE OF IMITATIONS OF LEATHER; KEY CASES MADE OF IMITATIONS OF LEATHER; CHANGE PURSES MADE OF IMITATIONS OF LEATHER; LEATHER COSMETIC BAGS SOLD EMPTY; COSMETIC CASES MADE OF IMITATIONS OF LEATHER SOLD EMPTY; COSMETIC CASES MADE OF IMITATION LEATHER SOLD EMPTY; SMALL KNAPSACKS; LARGE KNAPSACKS; BANDOLIER KNAPSACKS; DRAWSTRING BAGS; LEATHER CREDIT CARD HOLDERS (U.S. CLS. 1, 2, 3, 22 AND 41).

FIRST USE 0-0-1912; IN COMMERCE 11-0-1997.

SN 76-345,329. NANOTITAN, INCORPORATED, POTOMAC FALLS, VA. FILED 12-6-2001.

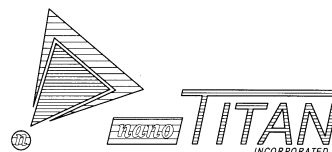

NO CLAIM IS MADE TO THE EXCLUSIVE RIGHT TO USE "INCORPORATED", APART FROM THE MARK AS SHOWN.

THE DRAWING IS LINED FOR THE COLOR BLUE. COLOR IS A FEATURE OF THE MARK. THE WORDS "TITAN" AND "INCORPORATED", AND THE INSIDE TRIANGLE IN THE LOGO ARE THE COLOR DARK BLUE. THE RECTANGULAR CARRIER SURROUNDING THE WORD "NANO", THE CIRCULAR CARRIER SURROUNDING THE "N" IN THE LOGO, AND OUTSIDE TRIANGLE IN THE LOGO ARE THE COLOR LIGHT BLUE.

CLASS 9—ELECTRICAL AND SCIENTIFIC APPARATUS

FOR DOWNLOADABLE COMPUTER SOFTWARE FOR USE IN DATABASE MANAGEMENT, NAMELY, COMPUTER SOFTWARE THAT INCORPORATES EXTENSIBLE MARKUP LANGUAGE (XML) FOR FACILITATING THE INTERCHANGE OF NANODEVICE DATA IN THE FIELD OF NANOTECHNOLOGY (U.S. CLS. 21, 23, 26, 36 AND 38).

FIRST USE 7-15-2000; IN COMMERCE 7-15-2000.

CLASS 42—SCIENTIFIC, COMPUTER AND LEGAL SERVICES

FOR SOFTWARE CONSULTATION SERVICES FOR OTHERS, NAMELY, CONSULTATION RELATED TO SOFTWARE MODELING, SIMULATION AND ANALYSIS IN THE FIELD OF NANOTECHNOLOGY (U.S. CLS. 100 AND 101).

FIRST USE 7-15-2000; IN COMMERCE 7-15-2000.

SN 76-345,884. AMERICAN FOUNDATION FOR THE BLIND INC., NEW YORK, NY. FILED 12-6-2001.

BRAILLE BUG

NO CLAIM IS MADE TO THE EXCLUSIVE RIGHT TO USE "BRAILLE", APART FROM THE MARK AS SHOWN.

CLASS 16—PAPER GOODS AND PRINTED MATTER

FOR PRINTED MATTER, NAMELY, INFORMATION PACKETS COMPRISED OF NEWSLETTERS AND PRINTED NOTECARDS FEATURING INFORMATION ON LEARNING HOW TO READ AND WRITE IN BRAILLE (U.S. CLS. 2, 5, 22, 23, 29, 37, 38 AND 50).

CLASS 41—EDUCATION AND ENTERTAINMENT

FOR COMPUTER SERVICES, NAMELY, PROVIDING INFORMATION, GAMES, EDUCATIONAL AND ENTERTAINMENT CONTENT, NAMELY, CONDUCTING ONLINE EXHIBITIONS AND DISPLAYS AND INTERACTIVE EXHIBITS IN THE FIELD OF LEARNING HOW TO READ AND WRITE IN BRAILLE (U.S. CLS. 100, 101 AND 107).

SN 76-346,906. BMO NESBITT BURNS CORPORATION LIMITED, TORONTO ONTARIO, CANADA, FILED 12-7-2001.

SN 76-347,200. CAMPBELL HAUSFELD/SCOTT FETZER COMPANY, HARRISON, OH. FILED 12-10-2001.

NESBITT BURNS BORDERLESS INVESTING

OWNER OF U.S. REG. NOS. 1,976,945, 1,980,676 AND 2,349,541.

NO CLAIM IS MADE TO THE EXCLUSIVE RIGHT TO USE "INVESTING", APART FROM THE MARK AS SHOWN.

CLASS 36—INSURANCE AND FINANCIAL

FOR INVESTMENT BANKING SERVICES; FINANCIAL INVESTMENT IN THE FIELD OF SECURITIES FOR OTHERS; FINANCIAL INVESTMENT IN THE FIELD OF MUTUAL FUNDS FOR OTHERS; INVESTMENT MANAGEMENT SERVICES; INVESTMENT DEALER SERVICES IN THE NATURE OF BROKERAGE ACCOUNTS AND SERVICES; INVESTMENT BANKING TRANSACTIONS, NAMELY, MERGERS AND ACQUISITIONS, REORGANIZATIONS AND SECURITIES AND ASSET TRANSACTIONS; CONSULTING IN THE FIELD OF SECURITIES INVESTMENTS, SECURITIES TRANSACTIONS, AND FINANCIAL ADVISORY SERVICES; FINANCIAL SERVICES, NAMELY, BROKERAGE IN THE FIELD OF SECURITIES; SECURITIES SERVICES, NAMELY, SECURITIES BROKERAGE; AND FINANCIAL RESEARCH AND ADVISORY SERVICES RELATED TO SECURITIES (U.S. CLS. 100, 101 AND 102).

CLASS 41—EDUCATION AND ENTERTAINMENT

FOR FINANCIAL PLANNING SERVICES, NAMELY, SEMINARS, CONFERENCES, CLASSES AND WORKSHOPS IN THE FIELD OF INVESTING AND PERSONAL FINANCES (U.S. CLS. 100, 101 AND 107).

SN 76-347,177. BIOVAIL LABORATORIES, INC., COLLYMORE, ST. MICHAEL, BARBADOS, FILED 12-11-2001.

CEFORM

CLASS 5—PHARMACEUTICALS

FOR FULL LINE OF PHARMACEUTICAL PREPARATIONS FOR THE TREATMENT OF ANY DISEASE OR ILLNESS; A FULL LINE OF VETERINARY PHARMACEUTICAL PREPARATIONS FOR THE TREATMENT OF ANY DISEASE OR ILLNESS (U.S. CLS. 6, 18, 44, 46, 51 AND 52).

CLASS 40—MATERIAL TREATMENT

FOR MATERIAL TREATMENT OF PHARMACEUTICAL PREPARATIONS AND VETERINARY PHARMACEUTICAL PREPARATIONS IN THE NATURE OF MAKING SPHERICAL PARTICLES (U.S. CLS. 100, 103 AND 106).

Farmhand

CLASS 7—MACHINERY

FOR AIR COMPRESSORS; IMPACT WRENCHES; POWER-OPERATED PAINT SPRAYERS; AND PRESSURE WASHERS (U.S. CLS. 13, 19, 21, 23, 31, 34 AND 35). FIRST USE 10-0-1996; IN COMMERCE 10-0-1996.

CLASS 9—ELECTRICAL AND SCIENTIFIC APPARATUS

FOR ELECTRIC WELDERS (U.S. CLS. 21, 23, 26, 36 AND 38). FIRST USE 10-0-1996; IN COMMERCE 10-0-1996.

SN 76-347,965. S.L. START & ASSOCIATES, INC., SPOKANE, WA. FILED 12-7-2001.

TAILOREDLIFE

CLASS 35—ADVERTISING AND BUSINESS

FOR COUNSELING SERVICES, NAMELY, OFFERING ADVICE REGARDING EMPLOYMENT (U.S. CLS. 100, 101 AND 102).

CLASS 42—SCIENTIFIC, COMPUTER AND LEGAL SERVICES

FOR PROVIDING ASSISTED LIVING HOUSING FACILITIES, LIFE CARE COMMUNITIES, SENIOR HOUSING, ALZHEIMER SERVICES, RETIREMENT AND NURSING HOMES, AND HEALTHCARE AND REHABILITATION SERVICES; TO PEOPLE HAVING MENTAL AND PHYSICAL DISABILITIES, NAMELY, PROVIDING SUBACUTE PHYSICAL THERAPY AND PHYSICAL REHABILITATIVE CARE SERVICES PERFORMED IN RESIDENTIAL AND REHABILITATIVE SETTINGS; HOME CARE SERVICES, NAMELY, PERSONAL CARE ASSISTANCE FOR ACTIVITIES OF DAILY LIVING, SUCH AS BATHING, GROOMING AND PERSONAL MOBILITY; AND CONSULTATION SERVICES FOR HANDICAPPED, DISABLED AND ELDERLY PEOPLE IN THE FIELDS OF COOKING, CLEANING, FEEDING, BILL PAYING AND SCHEDULING MEDICAL APPOINTMENTS (U.S. CLS. 100 AND 101).

SN 76-347,988. S.L. START & ASSOCIATES, INC., SPOKANE, WA. FILED 12-7-2001.

START WORKS

CLASS 35—ADVERTISING AND BUSINESS

FOR EMPLOYMENT PLACEMENT SERVICES FOR THE DISABLED (U.S. CLS. 100, 101 AND 102).

CLASS 41—EDUCATION AND ENTERTAINMENT

FOR EDUCATIONAL SERVICES, PROVIDING EMPLOYMENT TRAINING FOR THE DISABLED (U.S. CLS. 100, 101 AND 107).

CLASS 42—SCIENTIFIC, COMPUTER AND LEGAL SERVICES

FOR PROVIDING ASSISTED LIVING HOUSING FACILITIES, LIFE CARE COMMUNITIES AND NURSING HOMES, AND HEALTHCARE AND REHABILITATION SERVICES, TO PEOPLE HAVING MENTAL AND PHYSICAL DISABILITIES, NAMELY, PROVIDING SUBCUTE PHYSICAL THERAPY AND PHYSICAL REHABILITATIVE CARE SERVICES PERFORMED IN RESIDENTIAL AND REHABILITATIVE SETTINGS; HOME CARE SERVICES, NAMELY, PERSONAL CARE ASSISTANCE FOR ACTIVITIES OF DAILY LIVING, SUCH AS BATHING, GROOMING AND PERSONAL MOBILITY; CONSULTATION SERVICES FOR HANDICAPPED, DISABLED AND ELDERLY PEOPLE IN THE FIELDS OF COOKING, CLEANING, FEEDING, BILL PAYING AND SCHEDULING MEDICAL APPOINTMENTS (U.S. CLS. 100 AND 101).

SN 76-350,142. DECENTRIX, INC., DENVER, CO. FILED 12-18-2001.

DECENTRIX**CLASS 9—ELECTRICAL AND SCIENTIFIC APPARATUS**

FOR COMPUTER SOFTWARE FOR BUILDING INTRANET AND EXTRANET WEB SITES, MANAGING ONLINE CONTENT, AND PUBLISHING ON THE INTERNET, ALLOWING THE PERSONALIZATION AND CUSTOMIZATION OF CONTENT, PERMITTING THE NAVIGATION AND LAYOUT OF ONLINE CONTENT, AND FOR BUILDING AND MANAGING COLLABORATIVE APPLICATIONS (U.S. CLS. 21, 23, 26, 36 AND 38).

SN 76-348,239. PREMIERA BLUE CROSS, SEATTLE, WA. FILED 12-13-2001.

CARING FOR YOURSELF**CLASS 36—INSURANCE AND FINANCIAL**

FOR PROVIDING HEALTHCARE AND WELLNESS INFORMATION TO OTHERS, NAMELY, HOW TO OPTIMIZE HEALTHCARE PLANS AND BENEFITS (U.S. CLS. 100, 101 AND 102).

CLASS 42—SCIENTIFIC, COMPUTER AND LEGAL SERVICES

FOR PROVIDING TEMPORARY ACCESS TO NON-DOWNLOADABLE SOFTWARE AND ONLINE DATABASES FOR BUILDING INTRANET AND EXTRANET WEB SITES, MANAGING ONLINE CONTENT, PUBLISHING ON THE INTERNET, ALLOWING THE PERSONALIZATION AND CUSTOMIZATION OF CONTENT, PERMITTING THE NAVIGATION AND LAYOUT OF ONLINE CONTENT, AND FOR BUILDING AND MANAGING COLLABORATIVE APPLICATIONS (U.S. CLS. 100 AND 101).

CLASS 44—MEDICAL, BEAUTY AND AGRICULTURAL SERVICES

FOR PROVIDING HEALTHCARE AND WELLNESS INFORMATION TO OTHERS INCLUDING HOW TO MANAGE SPECIFIC HEALTH CONDITIONS (U.S. CLS. 100 AND 101).

SN 76-350,444. FRED MEYER STORES, INC., PORTLAND, OR. FILED 12-18-2001.

SN 76-349,775. HEARST COMMUNICATIONS, INC., NEW YORK, NY. FILED 12-18-2001.

ESQUIRE

OWNER OF U.S. REG. NOS. 1,347,652, 1,489,930 AND OTHERS.

PLAYVILLE**CLASS 28—TOYS AND SPORTING GOODS**

FOR TOYS, NAMELY, BABY MULTIPLE ACTIVITY TOYS, BATTERY OPERATED ACTION TOYS, BENDABLE TOYS, CHILDREN'S MULTIPLE ACTIVITY TOYS, CHILDREN'S WIRE CONSTRUCTION AND ART ACTIVITY TOYS, CONSTRUCTION TOYS, DRAWING TOYS, FANTASY CHARACTER TOYS, INFLATABLE TOYS SHOWING DECORATIVE PICTURES, MECHANICAL TOYS, MUSIC BOX TOYS, PARTY FAVORS IN THE NATURE OF SMALL TOYS, PLASTIC CHARACTER TOYS, PLUSH TOYS, POP UP TOYS, PRINTING TOYS, PULL TOYS, RUBBER CHARACTER TOYS, SAND TOYS, SANDBOX TOYS, SKETCHING TOYS, SQUEEZE TOYS, TALKING TOYS, TOSSING DISC TOYS, TRANSFORMING ROBOTIC TOYS, WATER SQUIRTING TOYS AND WIND-UP TOYS (U.S. CLS. 22, 23, 38 AND 50).

CLASS 9—ELECTRICAL AND SCIENTIFIC APPARATUS

FOR MOUSE PADS (U.S. CLS. 21, 23, 26, 36 AND 38).

CLASS 35—ADVERTISING AND BUSINESS

FOR RETAIL DEPARTMENT STORE SERVICES (U.S. CLS. 100, 101 AND 102).

CLASS 16—PAPER GOODS AND PRINTED MATTER

FOR DESKTOP IN/OUT BOXES AND DESKTOP BUSINESS CARD HOLDERS; AND PENCILS (U.S. CLS. 2, 5, 22, 23, 29, 37, 38 AND 50).

SN 76-351,353. SCAPA TECHNOLOGIES LIMITED, EDINBURGH, SCOTLAND, UNITED KINGDOM, FILED 12-21-2001.

SCAPA

CLASS 9—ELECTRICAL AND SCIENTIFIC APPARATUS

FOR COMPUTER SOFTWARE PROGRAMS FOR USE IN THE MEASUREMENT AND ANALYSIS OF COMPUTER SYSTEM PERFORMANCE (U.S. CLS. 21, 23, 26, 36 AND 38).

FIRST USE 12-21-2000; IN COMMERCE 12-21-2000.

CLASS 42—SCIENTIFIC, COMPUTER AND LEGAL SERVICES

FOR COMPUTER SERVICES, NAMELY, THE MEASUREMENT AND ANALYSIS OF COMPUTER SYSTEM PERFORMANCE (U.S. CLS. 100 AND 101).

FIRST USE 12-21-2000; IN COMMERCE 12-21-2000.

SN 76-351,485. NEXTSPORT, BERKELEY, CA. FILED 12-13-2001.

QUADCARVER

CLASS 12—VEHICLES

FOR MOTORIZED SCOOTERS AND STRUCTURAL PARTS THEREFOR (U.S. CLS. 19, 21, 23, 31, 35 AND 44).

CLASS 28—TOYS AND SPORTING GOODS

FOR NON-MOTORIZED SCOOTERS AND STRUCTURAL PARTS THEREFOR (U.S. CLS. 22, 23, 38 AND 50).

SN 76-351,523. COPAN INC., SEATTLE, WA. FILED 12-20-2001.



THE LINING IS A FEATURE OF THE MARK AND DOES NOT INDICATE COLOR.

CLASS 35—ADVERTISING AND BUSINESS

FOR PROVIDING BUSINESS AND MARKETING CONSULTING SERVICES FOR EMERGING COMPANIES (U.S. CLS. 100, 101 AND 102).

FIRST USE 4-0-2000; IN COMMERCE 4-0-2000.

CLASS 36—INSURANCE AND FINANCIAL

FOR FINANCIAL SERVICES, NAMELY, CAPITAL INVESTMENT CONSULTATION SERVICES AND VENTURE AND FUNDING SERVICES TO EMERGING AND START-UP COMPANIES (U.S. CLS. 100, 101 AND 102).

FIRST USE 4-0-2000; IN COMMERCE 4-0-2000.

SN 76-351,866. HOPE STREET KIDS FOUNDATION, COLUMBUS, OH. FILED 12-21-2001.

HOPE STREET KIDS

NO CLAIM IS MADE TO THE EXCLUSIVE RIGHT TO USE "KIDS", APART FROM THE MARK AS SHOWN.

CLASS 41—EDUCATION AND ENTERTAINMENT

FOR ADVOCACY AND EDUCATIONAL SERVICES, NAMELY PROMOTING AND CONDUCTING SEMINARS, WORKSHOPS, AND CONFERENCES IN THE FIELD OF CANCER PREVENTION, DIAGNOSIS, AND TREATMENT, AND DISTRIBUTION OF INFORMATIONAL MATERIALS THEREWITH (U.S. CLS. 100, 101 AND 107).

FIRST USE 5-22-2000; IN COMMERCE 5-22-2000.

CLASS 42—SCIENTIFIC, COMPUTER AND LEGAL SERVICES

FOR CANCER RESEARCH SERVICES, NAMELY PROMOTING PUBLIC AWARENESS AND RESEARCH IN THE FIELD OF CANCER PREVENTION, DIAGNOSIS, AND TREATMENT THROUGH PUBLIC SERVICE ANNOUNCEMENTS, BROADCAST MEDIA APPEARANCES, AND DISTRIBUTION OF INFORMATIONAL PUBLICATIONS, AND TELEPHONE HOTLINE AND PERSONAL COUNSELING (U.S. CLS. 100 AND 101).

FIRST USE 5-22-2000; IN COMMERCE 5-22-2000.

SN 76-352,028. BEST FARES U.S.A., INC., ARLINGTON, TX. FILED 12-20-2001.

QUICKFARE

CLASS 39—TRANSPORTATION AND STORAGE

FOR TRAVEL AGENCY SERVICES, NAMELY, FINDING AND DISSEMINATING INFORMATION ABOUT TRANSPORTATION BARGAINS AND ASSISTING CUSTOMERS WITH MAKING RESERVATIONS AND BOOKINGS FOR SAME (U.S. CLS. 100 AND 105).

CLASS 43—HOTEL AND RESTAURANT SERVICES

FOR TRAVEL AGENCY SERVICES, NAMELY, FINDING AND DISSEMINATING INFORMATION ABOUT TEMPORARY LODGING BARGAINS AND ASSISTING CUSTOMERS WITH MAKING RESERVATIONS AND BOOKINGS FOR SAME (U.S. CLS. 100 AND 101).

SN 76-354,402. TWIN STATE ENVIRONMENTAL CORP., COLCHESTER, VT. FILED 1-2-2002.

THE VERTERRE GROUP, INC.

CLASS 40—MATERIAL TREATMENT

FOR ENVIRONMENTAL REMEDIATION SERVICES, NAMELY, SOIL, AIR, AND WATER TREATMENT SERVICES (U.S. CLS. 100, 103 AND 106).
FIRST USE 12-21-2001; IN COMMERCE 12-21-2001.

CLASS 42—SCIENTIFIC, COMPUTER AND LEGAL SERVICES

FOR ENVIRONMENTAL ENGINEERING SERVICES AND CONSULTATION IN THE FIELD OF ENVIRONMENTAL ENGINEERING (U.S. CLS. 100 AND 101).
FIRST USE 12-21-2001; IN COMMERCE 12-21-2001.

SN 76-354,535. WALONG MARKETING, INC., BUENA PARK, CA. FILED 12-27-2001.



NO CLAIM IS MADE TO THE EXCLUSIVE RIGHT TO USE "BRAND", APART FROM THE MARK AS SHOWN.

THE FOREIGN CHARACTERS OF THE MARK TRANSLITERATE TO "E FA" WHICH TRANSLATES IN ENGLISH TO "EFFORTLESS FORTUNE".

CLASS 29—MEATS AND PROCESSED FOODS

FOR MEAT, FISH, SEAFOOD AND CHICKEN; PRESERVED, DRIED AND COOKED FRUITS AND VEGETABLES; PROCESSED BEANS AND NUTS; JELLIES, JAMS, FRUIT SAUCES; EGGS, MILK, CONDENSED MILK, COCONUT MILK, CHEESE, YOGURT; EDIBLE OILS AND FATS; POTATO CHIPS (U.S. CL. 46).

CLASS 30—STAPLE FOODS

FOR BAKING POWDER, BAKING SODA, BISCUITS, BREADS, PROCESSED CEREALS, BREAKFAST CEREALS, BUBBLE GUM, CAKES AND CAKE MIXES, PIES, CANDY, CARAMEL POPCORN, CARAMELS, CHILI POWDERS, COOKIES, CRACKERS AND CHEESE COMBINATIONS, CRACKERS, DUMPLINGS, EGG ROLLS, FLOUR, GINGER, GLUTEN, COFFEE, TEA, PROCESSED HERBS, SPICES AND SEASONINGS, ICE CREAM, ICE CREAM CONES, FLAVORED ICES, KETCHUP, PASTA AND PREPARED MEALS CONSISTING PRIMARILY OF PASTA, NOODLES, OATMEAL, PROCESSED OATS, PANCAKES, PANCAKE MIXES, TABLE SYRUP, CORN SYRUP AND FLAVORING SYRUPS, PICKLE RELISH, PUDDINGS, RICE, RICE CAKES, EDIBLE RICE GOODS, NAMELY, RICE PAPER, RICE STICKS, SAUCES, FOOD STARCH, SUGAR, SUSHI, TORTILLA CHIPS, VINEGAR, WAFERS, WAFFLES, PROCESSED WHEAT, WON TONS AND WON TON WRAPPERS, YEAST, AND FROZEN YOGURT (U.S. CL. 46).

CLASS 31—NATURAL AGRICULTURAL PRODUCTS

FOR FRESH FRUITS AND VEGETABLES; FRESH, RAW OR UNPROCESSED BEANS; FRESH, RAW OR UNPROCESSED NUTS (U.S. CLS. 1 AND 46).

SN 76-354,911. ESSILOR INTERNATIONAL (COMPAGNIE GENERALE D'OPTIQUE), 94220 CHARENTON LE PONT, FRANCE, FILED 1-4-2002.

AIR MARK

CLASS 7—MACHINERY

FOR DEVICE WHICH USES A CORONA TREATMENT TO ETCH A DESIGN ON A LENS IN A PATTERN WHICH IS MADE VISIBLE BY FOGGING (U.S. CLS. 13, 19, 21, 23, 31, 34 AND 35).

CLASS 9—ELECTRICAL AND SCIENTIFIC APPARATUS

FOR OPHTHALMIC LENSES (U.S. CLS. 21, 23, 26, 36 AND 38).

SN 76-355,454. MEDIMMUNE, INC., GAITHERSBURG, MD. FILED 1-4-2002.

NUMAX

CLASS 1—CHEMICALS

FOR HUMANIZED MONOCLONAL ANTIBODY AGAINST RESPIRATORY SYNCYTIAL VIRUS FOR SCIENTIFIC RESEARCH USE (U.S. CLS. 1, 5, 6, 10, 26 AND 46).

CLASS 5—PHARMACEUTICALS

FOR HUMANIZED MONOCLONAL ANTIBODY AGAINST RESPIRATORY SYNCYTIAL VIRUS FOR MEDICAL CLINICAL USE (U.S. CLS. 6, 18, 44, 46, 51 AND 52).

SN 76-356,619. TILIA INTERNATIONAL, INC., KOWLOON, HONG KONG, FILED 1-9-2002.

SN 76-356,859. ASTRAZENECA AB, S-151 85 SODERTALJE, SWEDEN, FILED 1-8-2002.

FRESHSAVER

OWNER OF U.S. REG. NOS. 1,422,539, 2,117,266 AND OTHERS.

CLASS 1—CHEMICALS

FOR CHEMICAL PREPARATIONS FOR USE IN THE PRESERVATION OF FOODSTUFFS; CHEMICAL PREPARATIONS FOR THE PURPOSE OF AFFECTING THE FRESHNESS AND/OR THE RIPENING RATE OF FOODSTUFFS (U.S. CLS. 1, 5, 6, 10, 26 AND 46).

CLASS 11—ENVIRONMENTAL CONTROL APPARATUS

FOR FOOD PRESERVATION FILTERS WHICH AFFECT THE FRESHNESS AND/OR RIPENING RATE OF FOODSTUFFS (U.S. CLS. 13, 21, 23, 31 AND 34).

CLASS 21—HOUSEWARES AND GLASS

FOR CONTAINERS, CANISTERS, BAGS, STAND-ALONE UNITS, REFRIGERATOR COMPARTMENTS FOR HOUSEHOLD USE, ALL WITH A HOLDER WHICH ACCEPTS A REPLACEABLE FILTER WHICH AFFECTS THE FRESHNESS AND/OR THE RIPENING RATE OF FOODSTUFFS (U.S. CLS. 2, 13, 23, 29, 30, 33, 40 AND 50).

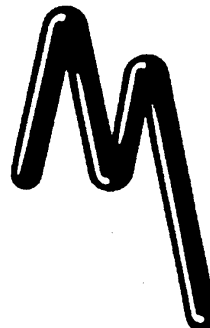

CLASS 5—PHARMACEUTICALS

FOR PHARMACEUTICAL PREPARATIONS FOR THE TREATMENT OF CARDIO-VASCULAR DISEASES (U.S. CLS. 6, 18, 44, 46, 51 AND 52).

CLASS 16—PAPER GOODS AND PRINTED MATTER

FOR PRINTED INSTRUCTIONAL AND TEACHING MATERIAL FEATURING INFORMATION ABOUT CARDIO-VASCULAR DISEASES AND THE TREATMENT OF SUCH DISEASES (U.S. CLS. 2, 5, 22, 23, 29, 37, 38 AND 50).

SN 76-356,767. WITEX AG, 32832 AUGUSTDORF, FED REP GERMANY, FILED 1-9-2002.

SN 76-357,880. NO DEPRESSION, INC., SEATTLE, WA. FILED 1-11-2002.

DESIGN LOC

NO CLAIM IS MADE TO THE EXCLUSIVE RIGHT TO USE "LOCK", APART FROM THE MARK AS SHOWN.

CLASS 19—NON-METALLIC BUILDING MATERIALS

FOR LAMINATED WOOD FLOORING, LAMINATED WOOD FLOOR PANELS, PROFILE LEDGES FOR FLOORING MADE OF LAMINATED AND NON-LAMINATED WOOD AND WOOD-BASED MATERIALS AND RECYCLED WOOD SUBSTITUTES (U.S. CLS. 1, 12, 33 AND 50).

CLASS 27—FLOOR COVERINGS

FOR FLOOR COVERINGS MADE OF LAMINATED AND NON-LAMINATED PANELS OF PLASTIC MATERIALS AND RECYCLED PLASTIC MATERIALS (U.S. CLS. 19, 20, 37, 42 AND 50).

NO DEPRESSION

OWNER OF U.S. REG. NOS. 2,283,368 AND 2,290,244.

CLASS 38—COMMUNICATION

FOR BROADCASTING OF RADIO PROGRAMS FEATURING MUSICAL PERFORMANCES AND COMMENTARY; BROADCASTING OF TELEVISION PROGRAMS FEATURING MUSICAL PERFORMANCES AND COMMENTARY (U.S. CLS. 100, 101 AND 104).

CLASS 41—EDUCATION AND ENTERTAINMENT

FOR PRODUCTION OF RADIO AND TELEVISION PROGRAMS FEATURING MUSICAL PERFORMANCES AND COMMENTARY; ENTERTAINMENT IN THE NATURE OF A SERIES OF RADIO PROGRAMS FEATURING MUSICAL PERFORMANCES AND COMMENTARY; ENTERTAINMENT IN THE NATURE OF A SERIES OF TELEVISION PROGRAMS FEATURING MUSICAL PERFORMANCES AND COMMENTARY (U.S. CLS. 100, 101 AND 107).

SN 76-358,022. ASHBURY BIOLOGICALS, INC., TORONTO, ONTARIO, M3J 2S3, CANADA, FILED 1-14-2002.

S.CUP

CLASS 5—PHARMACEUTICALS

FOR DIETARY SUPPLEMENTS IN THE NATURE OF BEVERAGES TO PROVIDE ENERGY AND VITALITY (U.S. CLS. 6, 18, 44, 46, 51 AND 52).

CLASS 32—LIGHT BEVERAGES

FOR NON-ALCOHOLIC SPORTS BEVERAGES TO PROVIDE ENERGY AND VITALITY (U.S. CLS. 45, 46 AND 48).

SN 76-358,234. STABILUS, INC., GASTONIA, NC. FILED 1-14-2002.

MASTER-LIFT

CLASS 6—METAL GOODS

FOR METAL GAS SPRINGS AND GAS DAMPERS FOR USE IN THE AUTOMOTIVE AND AVIATION MANUFACTURING INDUSTRY (U.S. CLS. 2, 12, 13, 14, 23, 25 AND 50).

CLASS 7—MACHINERY

FOR MACHINE PARTS, NAMELY, GAS SPRINGS (U.S. CLS. 13, 19, 21, 23, 31, 34 AND 35).

SN 76-359,133. GROUP 1 SYSTEMS, INC., FORT LAUDERDALE, FL. FILED 1-15-2002.

SERVIDIAN

CLASS 37—CONSTRUCTION AND REPAIR

FOR INSTALLATION OF SECURITY AND FIRE ALARM SYSTEMS; SERVICE AND MAINTENANCE OF SECURITY AND FIRE ALARM SYSTEMS (U.S. CLS. 100, 103 AND 106).

CLASS 42—SCIENTIFIC, COMPUTER AND LEGAL SERVICES

FOR DESIGN OF SECURITY AND FIRE ALARM SYSTEMS FOR OTHERS; INTEGRATION OF SECURITY AND FIRE ALARM SYSTEMS FOR OTHERS (U.S. CLS. 100 AND 101).

SN 76-359,505. OAM, LLC, OCEANSIDE, CA. FILED 1-15-2002.

ON A MISSION

OWNER OF U.S. REG. NO. 1,912,594.

CLASS 25—CLOTHING

FOR CLOTHING, NAMELY, T-SHIRTS, SWEATSHIRTS, DRESS SHIRTS, JACKETS, TROUSERS, SWIMSUITS, SHORTS, HATS AND VISORS (U.S. CLS. 22 AND 39).

FIRST USE 6-6-1996; IN COMMERCE 6-6-1996.

CLASS 28—TOYS AND SPORTING GOODS

FOR SURFBOARDS AND SURFBOARD ACCESSORIES, NAMELY, LEASHES, BAGS AND FOOTPADS THEREFOR (U.S. CLS. 22, 23, 38 AND 50).

FIRST USE 6-6-1996; IN COMMERCE 6-6-1996.

SN 76-359,883. NEMACOLIN WOODLANDS, INC., FARMINGTON, PA. FILED 1-18-2002.

WEST COAST ATTITUDE. EAST COAST LATITUDE.

CLASS 25—CLOTHING

FOR (BASED ON INTENT TO USE); CLOTHING, NAMELY SWEATSHIRTS, T-SHIRTS, JACKETS, SWEATERS, HEADWEAR, SHORTS, GOLF SHIRTS, PANTS AND CASUAL DRESS SHIRTS (U.S. CLS. 22 AND 39).

CLASS 41—EDUCATION AND ENTERTAINMENT

FOR (BASED ON USE IN COMMERCE); HEALTH AND FITNESS CLUB SERVICES; RECREATIONAL SERVICES IN THE NATURE OF HORSEBACK RIDING AND GOLF COURSES; GOLF INSTRUCTION SERVICES (U.S. CLS. 100, 101 AND 107).

FIRST USE 7-1-2000; IN COMMERCE 7-1-2000.

CLASS 43—HOTEL AND RESTAURANT SERVICES

FOR (BASED ON USE IN COMMERCE); HOTEL AND RESTAURANT SERVICES (U.S. CLS. 100 AND 101).

FIRST USE 7-1-2000; IN COMMERCE 7-1-2000.

CLASS 44—MEDICAL, BEAUTY AND AGRICULTURAL SERVICES

FOR (BASED ON USE IN COMMERCE); HEALTH SPA SERVICES, NAMELY, COSMETIC BODY CARE SERVICES; SPA SERVICES; SPA SERVICES, NAMELY, PROVIDING FACIALS, MASSAGES, SWEDISH MASSAGES, MANICURES, PEDICURES, BEAUTY TREATMENTS, SAUNA FACILITIES, AROMATHERAPY, HERBAL TREATMENTS, SEAWEED WRAPS, SALT SEA RUBS, HOT STONE THERAPY, WET TREATMENTS, SALON SERVICES, NAMELY, HAIR CUTS, HAIR TREATMENTS, HAIR STYLING, HAIR PERMANENTS, AND HAIR COLORING (U.S. CLS. 100 AND 101).

FIRST USE 7-1-2000; IN COMMERCE 7-1-2000.

SN 76-359,989. CELL PHONE STORE, INC., THE, EASTON, MA. FILED 1-18-2002.



NO CLAIM IS MADE TO THE EXCLUSIVE RIGHT TO USE "THE CELL PHONE STORE, INC.", APART FROM THE MARK AS SHOWN.

CLASS 9—ELECTRICAL AND SCIENTIFIC APPARATUS

FOR ACCESSORIES USED IN CONNECTION WITH CELLULAR TELEPHONES, NAMELY BATTERIES, VEHICLE ADAPTERS AND PHONE CASES (U.S. CLS. 21, 23, 26, 36 AND 38).

FIRST USE 12-0-2000; IN COMMERCE 12-0-2000.

CLASS 35—ADVERTISING AND BUSINESS

FOR RETAIL STORE SERVICES IN THE FIELD OF ACTIVATION AND SERVICE PLANS FOR CELLULAR TELEPHONES AND SATELLITE DISH NETWORKS (U.S. CLS. 100, 101 AND 102).

FIRST USE 12-0-2000; IN COMMERCE 12-0-2000.

SN 76-360,151. ARADIGM CORPORATION, HAYWARD, CA. FILED 1-17-2002.

AERX ULTRA

OWNER OF U.S. REG. NOS. 1,946,528, 2,279,572 AND 2,283,455.

CLASS 5—PHARMACEUTICALS

FOR PHARMACEUTICAL PREPARATIONS, NAMELY ANALGESICS, HORMONES, PSYCHOTROPICS, ANTI-INFECTIVES, ANTI-INFLAMMATORIES, AND ANTI-CANCER AGENTS FOR USE IN THE TREATMENT OF DISEASE VIA APPLICATION TO THE LUNGS (U.S. CLS. 6, 18, 44, 46, 51 AND 52).

CLASS 10—MEDICAL APPARATUS

FOR MEDICAL APPARATUS, NAMELY, ELECTRONICALLY-BASED DEVICES USED TO DELIVER DRUGS AND BIOLOGICS TO THE LUNGS (U.S. CLS. 26, 39 AND 44).

SN 76-360,219. MANAGEDCOMP, INC., WOBURN, MA. FILED 1-7-2002.

LET'S GET TO WORK

CLASS 35—ADVERTISING AND BUSINESS

FOR COST MANAGEMENT FOR THE WORKERS' COMPENSATION BENEFIT PLANS OF OTHERS (U.S. CLS. 100, 101 AND 102).

CLASS 36—INSURANCE AND FINANCIAL

FOR ORGANIZING AND ADMINISTERING PREFERRED PROVIDER WORKERS' COMPENSATION PLANS AND PROGRAMS; RISK MANAGEMENT SERVICES FOR EMPLOYERS IN CONNECTION WITH WORKERS' COMPENSATION PROGRAMS; UNDERWRITING WORKERS' COMPENSATION INSURANCE; AND WORKERS' COMPENSATION INSURANCE CLAIMS ADJUSTMENT, CLAIMS PROCESSING AND CLAIMS ADMINISTRATION (U.S. CLS. 100, 101 AND 102).

SN 76-361,171. MEDCATH INCORPORATED, CHARLOTTE, NC. FILED 1-22-2002.



NO CLAIM IS MADE TO THE EXCLUSIVE RIGHT TO USE "DAYTON HEART HOSPITAL", APART FROM THE MARK AS SHOWN.

THE STIPPLING ON THE MARK IS FOR SHADING PURPOSES ONLY AND DOES TO INDICATE COLOR.

CLASS 41—EDUCATION AND ENTERTAINMENT

FOR EDUCATION SERVICES, NAMELY, CONDUCTING CLASSES, PROGRAMS, SEMINARS, CONFERENCES AND WORKSHOPS RELATING TO DISEASES AND DISEASE PREVENTION MEASURES AND DISTRIBUTING COURSE MATERIALS IN CONNECTION THEREWITH (U.S. CLS. 100, 101 AND 107).

FIRST USE 12-0-1998; IN COMMERCE 9-7-1999.

CLASS 44—MEDICAL, BEAUTY AND AGRICULTURAL SERVICES

FOR HOSPITAL, MEDICAL CLINIC AND HEALTH CARE SERVICES, NAMELY, PREVENTIVE, DIAGNOSTIC, THERAPEUTIC AND SURGICAL SERVICES (U.S. CLS. 100 AND 101).

FIRST USE 12-0-1998; IN COMMERCE 9-7-1999.

SN 76-361,433. UNITED GUARANTY CORPORATION, GREENSBORO, NC. FILED 1-22-2002.

PC UNITE

OWNER OF U.S. REG. NOS. 2,508,888 AND 2,508,889. NO CLAIM IS MADE TO THE EXCLUSIVE RIGHT TO USE "PC", APART FROM THE MARK AS SHOWN.

CLASS 9—ELECTRICAL AND SCIENTIFIC APPARATUS

FOR INSURED LOAN PROCESSING SOFTWARE AND USER GUIDES, SOLD AS A UNIT, FOR USE BY FINANCIAL INSTITUTIONS (U.S. CLS. 21, 23, 26, 36 AND 38).

FIRST USE 9-0-1997; IN COMMERCE 9-0-1997.

CLASS 36—INSURANCE AND FINANCIAL

FOR PROVIDING AN ON-LINE COMPUTER DATABASE THAT PERMITS FINANCIAL INSTITUTIONS TO PERFORM INSURED MORTGAGE LOAN PROCESSING, CALCULATE PREMIUMS, PURCHASE MORTGAGE LOANS OR MORTGAGE TRANSFER SERVICING AND OBTAIN RELATED ACCOUNT INFORMATION (U.S. CLS. 100, 101 AND 102).

FIRST USE 9-0-1997; IN COMMERCE 9-0-1997.

CLASS 36—INSURANCE AND FINANCIAL

FOR INSURANCE PRICING INFORMATION SERVICES, NAMELY, PROVIDING COMPANIES IN THE INSURANCE INDUSTRY WITH INFORMATION ABOUT POLICY RATES AND PRICING FOR THEIR CUSTOMERS (U.S. CLS. 100, 101 AND 102).

FIRST USE 9-26-2001; IN COMMERCE 9-26-2001.

SN 76-361,685. VIRGINIA UNITED METHODIST HOMES, INC., RICHMOND, VA. FILED 1-24-2002.

WINDSORMEADE**CLASS 43—HOTEL AND RESTAURANT SERVICES**

FOR PROVISION OF INDEPENDENT AND ASSISTED LIVING SERVICES TO ADULTS IN THE NATURE OF RETIREMENT COMMUNITY SERVICES (U.S. CLS. 100 AND 101).

FIRST USE 4-1-2000; IN COMMERCE 4-1-2000.

CLASS 44—MEDICAL, BEAUTY AND AGRICULTURAL SERVICES

FOR PROVISION OF INDEPENDENT AND ASSISTED LIVING SERVICES TO ADULTS IN THE NATURE OF NURSING HOME SERVICES (U.S. CLS. 100 AND 101).

FIRST USE 4-1-2000; IN COMMERCE 4-1-2000.

SN 76-362,105. SHEPPERD, FREDERICK METZ, NEW PHILADELPHIA, OH. FILED 1-23-2002.

LITTLE ALSACE**CLASS 35—ADVERTISING AND BUSINESS**

FOR RETAIL SHOPS FEATURING GIFTS, FURNITURE, AND SOUVENIRS (U.S. CLS. 100, 101 AND 102).

CLASS 43—HOTEL AND RESTAURANT SERVICES

FOR HOTELS; RESTAURANTS; PROVIDING BANQUET AND SOCIAL FUNCTION FACILITIES FOR SPECIAL OCCASIONS; PROVIDING FACILITIES FOR EXHIBITIONS; PROVIDING CONVENTION FACILITIES (U.S. CLS. 100 AND 101).

SN 76-362,909. PRIORITY DATA SYSTEMS, INC., OMAHA, NE. FILED 1-28-2002.

PRIORITYRATE NVISION

OWNER OF U.S. REG. NO. 2,406,121.

CLASS 9—ELECTRICAL AND SCIENTIFIC APPARATUS

FOR COMPUTER SOFTWARE DESIGNED TO PROVIDE AN ANALYTICAL TOOL FOR USE BY INSURANCE COMPANIES TO POSITION THEIR PRICING (U.S. CLS. 21, 23, 26, 36 AND 38).

FIRST USE 9-26-2001; IN COMMERCE 9-26-2001.

SN 76-363,355. TLV CO., LTD., HYOGO-KEN 675-8511, JAPAN, FILED 1-24-2002.

SONICMAN

OWNER OF U.S. REG. NO. 1,653,475.

CLASS 37—CONSTRUCTION AND REPAIR

FOR MAINTENANCE AND/OR REPAIR OF ELECTRICAL SYSTEMS, STEAM SYSTEMS, HEATING EQUIPMENT, AND AIR CONDITIONING SYSTEMS; MAINTENANCE AND/OR REPAIR OF ROTATING EQUIPMENT; AND MAINTENANCE AND/OR REPAIR OF STEAM TRAPS, VALVES, PIPING, AND CONTAINERS (U.S. CLS. 100, 103 AND 106).

CLASS 42—SCIENTIFIC, COMPUTER AND LEGAL SERVICES

FOR THERMOGRAPHY SURVEY AND DIAGNOSTIC SERVICES FOR ELECTRICAL SYSTEMS, STEAM SYSTEMS, HEATING EQUIPMENT, AIR CONDITIONING SYSTEMS; MONITORING AND DIAGNOSTIC SERVICES FOR ROTATING EQUIPMENT; AND SURVEY AND DIAGNOSTIC SERVICES FOR STEAM TRAPS, VALVES, PIPING, AND CONTAINERS (U.S. CLS. 100 AND 101).

SN 76-363,358. TLV CO., LTD., HYOGO-KEN, JAPAN, FILED 1-24-2002.

TRAPMAN

OWNER OF U.S. REG. NO. 1,653,475.

CLASS 37—CONSTRUCTION AND REPAIR

FOR MAINTENANCE AND/OR REPAIR OF ELECTRICAL SYSTEMS, STEAM SYSTEMS, HEATING EQUIPMENT, AND AIR CONDITIONING SYSTEMS; MAINTENANCE AND/OR REPAIR OF ROTATING EQUIPMENT; AND MAINTENANCE AND/OR REPAIR OF STEAM TRAPS, VALVES, PIPING, AND CONTAINERS (U.S. CLS. 100, 103 AND 106).

CLASS 42—SCIENTIFIC, COMPUTER AND LEGAL SERVICES

FOR THERMOGRAPHY SURVEY AND DIAGNOSTIC SERVICES FOR ELECTRICAL SYSTEMS, STEAM SYSTEMS, HEATING EQUIPMENT, AIR CONDITIONING SYSTEMS; MONITORING AND DIAGNOSIS SERVICES FOR ROTATING EQUIPMENT; AND SURVEY AND DIAGNOSIS SERVICES FOR STEAM TRAPS, VALVES, PIPING, AND CONTAINERS (U.S. CLS. 100 AND 101).

SN 76-364,082. METEORLOGIX, LLC, BURNSVILLE, MN.
FILED 1-29-2002.

MXWEATHERSPAN STORMCOMMANDER

CLASS 9—ELECTRICAL AND SCIENTIFIC APPARATUS

FOR SOFTWARE FOR PROCESSING AND DISPLAYING WEATHER INFORMATION (U.S. CLS. 21, 23, 26, 36 AND 38).

CLASS 42—SCIENTIFIC, COMPUTER AND LEGAL SERVICES

FOR WEATHER FORECASTING SERVICES, NAMELY DISTRIBUTION OF WEATHER INFORMATION (U.S. CLS. 100 AND 101).

SN 76-364,099. METEORLOGIX, LLC, BURNSVILLE, MN.
FILED 1-29-2002.

MXVISION CLASSICSENTRY

CLASS 9—ELECTRICAL AND SCIENTIFIC APPARATUS

FOR SOFTWARE FOR PROCESSING AND DISPLAYING WEATHER INFORMATION (U.S. CLS. 21, 23, 26, 36 AND 38).

CLASS 42—SCIENTIFIC, COMPUTER AND LEGAL SERVICES

FOR WEATHER FORECASTING SERVICES, NAMELY DISTRIBUTION OF WEATHER INFORMATION (U.S. CLS. 100 AND 101).

SN 76-364,725. WASHINGTON SHOE COMPANY, RENTON, WA. FILED 1-28-2002.

WESTERN CHIEF

CLASS 18—LEATHER GOODS

FOR UMBRELLAS (U.S. CLS. 1, 2, 3, 22 AND 41).
FIRST USE 12-20-2000; IN COMMERCE 12-20-2000.

CLASS 25—CLOTHING

FOR SHOES, BOOTS, SANDALS AND FOOTWEAR (U.S. CLS. 22 AND 39).
FIRST USE 1-1-1920; IN COMMERCE 1-1-1920.

SN 76-365,952. HOST COMMUNICATIONS, INC., LEXINGTON, KY. FILED 2-1-2002.

HOST COMMUNICATIONS

OWNER OF U.S. REG. NOS. 1,286,348 AND 1,333,237.
NO CLAIM IS MADE TO THE EXCLUSIVE RIGHT TO USE "COMMUNICATIONS", APART FROM THE MARK AS SHOWN.

CLASS 16—PAPER GOODS AND PRINTED MATTER

FOR NEWSLETTER RELATING TO THE FIELD OF COMMUNICATIONS (U.S. CLS. 2, 5, 22, 23, 29, 37, 38 AND 50).
FIRST USE 1-4-1982; IN COMMERCE 1-4-1982.

CLASS 35—ADVERTISING AND BUSINESS

FOR PUBLIC RELATIONS SERVICES; PROMOTING AND MARKETING COLLEGIATE ATHLETIC EVENTS FOR OTHERS (U.S. CLS. 100, 101 AND 102).
FIRST USE 1-4-1982; IN COMMERCE 1-4-1982.

CLASS 41—EDUCATION AND ENTERTAINMENT

FOR CREATING AND PRODUCING AUDIO VISUAL, VISUAL AND AUDIO PRESENTATIONS TO THE ORDER AND SPECIFICATION OF OTHERS; PRODUCTION OF RADIO AND TELEVISION PROGRAMS; PUBLICATION OF ADVERTISING BROCHURES, MAGAZINES, SPORTS EVENT PROGRAMS, AND NEWSLETTERS FOR OTHERS; ENTERTAINMENT SERVICES IN THE NATURE OF ON-GOING RADIO PROGRAMS IN THE FIELD OF SPORTS (U.S. CLS. 100, 101 AND 107).
FIRST USE 1-4-1982; IN COMMERCE 1-4-1982.

SN 76-365,956. HOST COMMUNICATIONS, INC., LEXINGTON, KY. FILED 2-1-2002.

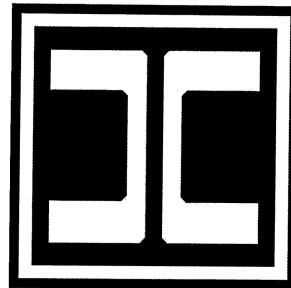

OWNER OF U.S. REG. NOS. 1,286,347, 1,333,237 AND 1,576,715.

CLASS 16—PAPER GOODS AND PRINTED MATTER

FOR NEWSLETTER RELATING TO THE FIELD OF COMMUNICATIONS (U.S. CLS. 2, 5, 22, 23, 29, 37, 38 AND 50).
FIRST USE 1-4-1982; IN COMMERCE 1-4-1982.

CLASS 35—ADVERTISING AND BUSINESS

FOR PUBLIC RELATIONS SERVICES; PROMOTING AND MARKETING COLLEGIATE ATHLETIC EVENTS FOR OTHERS (U.S. CLS. 100, 101 AND 102).
FIRST USE 1-4-1982; IN COMMERCE 1-4-1982.

CLASS 41—EDUCATION AND ENTERTAINMENT

FOR CREATING AND PRODUCING AUDIO VISUAL, VISUAL AND AUDIO PRESENTATIONS TO THE ORDER AND SPECIFICATION OF OTHERS; PRODUCTION OF RADIO AND TELEVISION PROGRAMS; PUBLICATION OF ADVERTISING BROCHURES, MAGAZINES, SPORTS EVENT PROGRAMS, AND NEWSLETTERS FOR OTHERS; ENTERTAINMENT SERVICES IN THE NATURE OF ON-GOING RADIO PROGRAMS IN THE FIELD OF SPORTS (U.S. CLS. 100, 101 AND 107).
FIRST USE 1-4-1982; IN COMMERCE 1-4-1982.

SN 76-366,146. SOUTH BEACH BEVERAGE COMPANY, INC., NORWALK, CT. FILED 1-31-2002.

LIZARDADE**CLASS 30—STAPLE FOODS**

FOR NON-ALCOHOLIC BEVERAGES, NAMELY, ICED TEA, HERBAL TEA, FLAVORED ICED TEA AND COFFEE (U.S. CL. 46).

CLASS 32—LIGHT BEVERAGES

FOR NON-ALCOHOLIC BEVERAGES, NAMELY, CARBONATED SOFT DRINKS; AND SYRUPS, CONCENTRATES AND POWDERS FOR MAKING SOFT DRINKS (U.S. CLS. 45, 46 AND 48).

SN 76-366,147. SOUTH BEACH BEVERAGE COMPANY, INC., NORWALK, CT. FILED 1-31-2002.

LITTLE LIZARDS**CLASS 30—STAPLE FOODS**

FOR NON-ALCOHOLIC BEVERAGES, NAMELY, ICED TEA, HERBAL TEA, FLAVORED ICED TEA AND COFFEE (U.S. CL. 46).

CLASS 32—LIGHT BEVERAGES

FOR NON-ALCOHOLIC BEVERAGES, NAMELY, CARBONATED SOFT DRINKS; AND SYRUPS, CONCENTRATES AN POWDERS FOR MAKING SOFT DRINKS (U.S. CLS. 45, 46 AND 48).

SN 76-366,448. HIT ENTERTAINMENT, PLC, LONDON, UNITED KINGDOM, FILED 2-1-2002.

RUBBADUBBERS**CLASS 16—PAPER GOODS AND PRINTED MATTER**

FOR BOOKS FOR CHILDREN, COLORING BOOKS, ACTIVITY BOOKS, POSTERS, STICKERS, PAPER NAPKINS, AND PAPER PARTY HATS (U.S. CLS. 2, 5, 22, 23, 29, 37, 38 AND 50).

CLASS 21—HOUSEWARES AND GLASS

FOR PAPER CUPS, PAPER PLATES (U.S. CLS. 2, 13, 23, 29, 30, 33, 40 AND 50).

CLASS 25—CLOTHING

FOR CLOTHING FOR CHILDREN, NAMELY, T-SHIRTS, SWEATSHIRTS, SWEATERS, PANTS, JOGGING SUITS, PAJAMAS, SHOES, JACKETS, HATS, MITTENS, COATS, DRESSES, TOPS AND BLOUSES (U.S. CLS. 22 AND 39).

CLASS 28—TOYS AND SPORTING GOODS

FOR BATH TOYS, PLUSH TOYS, DOLLS, PUPPETS, ACTION FIGURES, PLAYSETS COMPRISED OF ACTION FIGURES AND ENVIRONMENTS, BOARD GAMES, JIGSAW PUZZLES, AND TOY VEHICLES (U.S. CLS. 22, 23, 38 AND 50).

SN 76-367,158. AMERICAN PHARMACEUTICAL ASSOCIATION (APHA), WASHINGTON, DC. FILED 2-6-2002.

CLASS 16—PAPER GOODS AND PRINTED MATTER

FOR PRINTED PUBLICATIONS, NAMELY, INFORMATIONAL BROCHURES, INFORMATIONAL PAMPHLETS AND NEWLETTERS, REGARDING PHARMACY-RELATED SPECIALITIES INCLUDING PHARMACOTHERAPY, NUCLEAR PHARMACY, NUTRITION SUPPORT PHARMACY, ONCOLOGY PHARMACY, AND PSYCHIATRIC PHARMACY (U.S. CLS. 2, 5, 22, 23, 29, 37, 38 AND 50).
FIRST USE 6-1-1991; IN COMMERCE 6-1-1991.

CLASS 41—EDUCATION AND ENTERTAINMENT

FOR EDUCATIONAL TESTING SERVICES; NAMELY, DEVELOPING, ADMINISTERING, AND SCORING PRACTICE-RELATED EXAMINATIONS IN THE FIELDS OF PHARMACOTHERAPY, NUCLEAR PHARMACY, NUTRITION SUPPORT PHARMACY, ONCOLOGY PHARMACY, AND PSYCHIATRIC PHARMACY (U.S. CLS. 100, 101 AND 107).
FIRST USE 6-1-1991; IN COMMERCE 6-1-1991.

SN 76-367,179. KENNER, ELLEN, N. SCITUATE, RI. FILED 2-5-2002.

THE RATIONAL BASIS

OWNER OF U.S. REG. NO. 2,287,327.

CLASS 9—ELECTRICAL AND SCIENTIFIC APPARATUS

FOR AUDIO TAPES FEATURING PRE-RECORDED RADIO PROGRAMS IN THE FIELD OF MARRIAGE, CAREER, SUBSTANCE ABUSE, HEALTH, ROMANCE, INTERPERSONAL COMMUNICATION, REHABILITATION, AND WELL-BEING (U.S. CLS. 21, 23, 26, 36 AND 38).

FIRST USE 2-0-1999; IN COMMERCE 2-0-1999.

CLASS 16—PAPER GOODS AND PRINTED MATTER

FOR PERIODICALS, NAMELY, PRINTED BOOKS, BOOKLETS, NEWSLETTERS, JOURNALS, CATALOGS, MANUALS, MAGAZINES, MAGAZINE SECTIONS, BROCHURES, PAMPHLETS, AND PRINTED INSTRUCTIONAL GUIDES IN THE FIELD OF MARRIAGE, CAREER, SUBSTANCE ABUSE, HEALTH, ROMANCE, INTERPERSONAL COMMUNICATION, REHABILITATION, AND WELL-BEING (U.S. CLS. 2, 5, 22, 23, 29, 37, 38 AND 50).

FIRST USE 2-26-1998; IN COMMERCE 2-26-1998.

CLASS 41—EDUCATION AND ENTERTAINMENT

FOR EDUCATIONAL AND ENTERTAINMENT SERVICES NAMELY, PROVIDING MOTIVATIONAL AND EDUCATIONAL SPEAKERS; ENTERTAINMENT IN THE NATURE OF AN ON-GOING RADIO PROGRAM IN THE FIELD OF MARRIAGE, CAREER, SUBSTANCE ABUSE, HEALTH, ROMANCE, INTERPERSONAL COMMUNICATION, REHABILITATION, AND WELL-BEING (U.S. CLS. 100, 101 AND 107).

FIRST USE 3-21-2000; IN COMMERCE 3-21-2000.

SN 76-367,210. B. BRAUN MEDICAL INC., BETHLEHEM, PA. FILED 2-4-2002.

AVITUM

CLASS 5—PHARMACEUTICALS

FOR PHARMACEUTICAL PREPARATIONS FOR THE TREATMENT OF CORONARY SCLEROSIS; PERITONEAL DIALYSIS SOLUTIONS; FOOD FOR PARENTERAL FEEDING; MEDICAL PLASTERS; BURN, SURGICAL AND WOUND DRESSINGS; DISINFECTANTS FOR MEDICAL INSTRUMENTS; SURGICAL IMPLANTS COMPRISING LIVING TISSUE (U.S. CLS. 6, 18, 44, 46, 51 AND 52).

CLASS 10—MEDICAL APPARATUS

FOR DIALYSIS MACHINES; RENAL REPLACEMENT APPARATUS; BLOOD PRESSURE MONITORS AND CUFFS; CONTAINERS FOR MEDICAL CONCENTRATE SOLUTIONS AND WASTES; ARTIFICIAL KIDNEY HOLDERS; DRAINAGE BAGS AND DRIP CHAMBERS FOR MEDICAL PURPOSES; INTRAVENOUS TUBING; MEDICAL TUBING ACCESS PORTS, SPIKES AND CLAMPS; BLOOD FILTERS; MEDICAL NEEDLES AND SYRINGES; CANNULAE; TRANSDUCER PROTECTORS, DISPENSING PINS, ADAPTERS AND CONNECTORS FOR MEDICAL APPARATUS; SURGICAL SUTURES; SURGICAL IMPLANTS COMPRISING ARTIFICIAL MATERIAL; ORTHOPEDIC JOINT IMPLANTS, SUPPORT BANDAGES AND SUPPORTS (U.S. CLS. 26, 39 AND 44).

CLASS 42—SCIENTIFIC, COMPUTER AND LEGAL SERVICES

FOR MEDICAL AND HEALTH SERVICES, NAMELY, EXTRACORPORAL BLOOD TREATMENT, AMBULANT NEPHROLOGICAL SERVICES, HEMODIALYSIS, HEMODIAFILTRATION, HEMOPERFUSION PLASMAHERESIS, BLOOD TREATMENT AND PERITONEAL DIALYSIS (U.S. CLS. 100 AND 101).

SN 76-367,411. SUGAR PARTNERS, LLC, SAN FRANCISCO, CA. FILED 2-7-2002.

SUGARCUBE

CLASS 9—ELECTRICAL AND SCIENTIFIC APPARATUS

FOR COMPUTER OPERATING SYSTEM SOFTWARE AND COMPUTER OPERATING SYSTEM HARDWARE; TELEVISION USER INTERFACE SOFTWARE FOR CONTROLLING A TELEVISION USER INTERFACE; ELECTRONIC TELEVISION USER INTERFACE HARDWARE, NAMELY, COMPUTER HARDWARE; APPLICATION OPTIMIZATION SOFTWARE FOR TELEVISION USER INTERFACES; AND ELECTRONIC APPLICATION OPTIMIZATION HARDWARE FOR TELEVISION USER INTERFACES, NAMELY, COMPUTER HARDWARE (U.S. CLS. 21, 23, 26, 36 AND 38).

CLASS 42—SCIENTIFIC, COMPUTER AND LEGAL SERVICES

FOR CUSTOM DESIGN OF COMPUTER SOFTWARE FOR OTHERS; CUSTOM DESIGN OF COMPUTER HARDWARE FOR OTHERS (U.S. CLS. 100 AND 101).

SN 76-367,917. KORB, SUSAN, NEW YORK, NY. AND DUCKWORTH, ALEXANDER, OLD WESTBURY, NY. FILED 2-7-2002.

POINT ONE PERCENT

CLASS 16—PAPER GOODS AND PRINTED MATTER

FOR PUBLICATIONS, NAMELY, A MAGAZINE AND NEWSLETTER IN THE FIELDS OF BUSINESS MANAGEMENT, ADVERTISING, MARKETING, PUBLIC RELATIONS, EVENT PLANNING, PRODUCT DEVELOPMENT, CONSUMER RESEARCH AND SURVEYS (U.S. CLS. 2, 5, 22, 23, 29, 37, 38 AND 50).

CLASS 35—ADVERTISING AND BUSINESS

FOR BUSINESS MARKETING CONSULTATION, DIRECT MAIL CONSULTING SERVICES, CONDUCTING MARKETING STUDIES, DIRECT MAIL AND MARKETING ADVERTISING FOR OTHERS, PROVIDING BUSINESS MARKETING INFORMATION, PRODUCT DEVELOPMENT CONSULTATION PRODUCT RESEARCH AND DEVELOPMENT FOR OTHERS, CONDUCTING BUSINESS AND MARKET RESEARCH SURVEYS, PROFIT SURVEY AND ANALYSIS, ADVERTISING SERVICES, NAMELY, COOPERATIVE ADVERTISING AND MARKETING, CREATING CORPORATE LOGOS FOR OTHERS, CREATING CORPORATE AND BRAND IDENTITY FOR OTHERS, AND PREPARATION OF CUSTOM ADVERTISEMENT AND CUSTOM PROMOTIONAL PRODUCTS FOR OTHERS (U.S. CLS. 100, 101 AND 102).

CLASS 41—EDUCATION AND ENTERTAINMENT

FOR EVENT PLANNING CONSULTING (U.S. CLS. 100, 101 AND 107).

CLASS 42—SCIENTIFIC, COMPUTER AND LEGAL SERVICES

FOR PRODUCT DEVELOPMENT CONSULTATION AND PRODUCT RESEARCH AND DEVELOPMENT FOR OTHERS (U.S. CLS. 100 AND 101).

SN 76-368,397. BROADCAST MUSIC, INC., NEW YORK, NY. FILED 2-6-2002.

MUSICUE**CLASS 9—ELECTRICAL AND SCIENTIFIC APPARATUS**

FOR COMPUTER SOFTWARE FOR COMPILING FILING AND PROCESSING LISTINGS OF MUSICAL WORKS IN FEATURE FILMS AND TELEVISION PROGRAMS (U.S. CLS. 21, 23, 26, 36 AND 38).

CLASS 35—ADVERTISING AND BUSINESS

FOR LICENSING OF COMPUTER SOFTWARE (U.S. CLS. 100, 101 AND 102).

SN 76-368,487. COLUMBIA SPORTSWEAR NORTH AMERICA, INC., PORTLAND, OR. FILED 2-7-2002.

COLUMBIA**CLASS 20—FURNITURE AND ARTICLES NOT OTHERWISE CLASSIFIED**

FOR SLEEPING BAGS (U.S. CLS. 2, 13, 22, 25, 32 AND 50).

CLASS 22—CORDAGE AND FIBERS

FOR TENTS (U.S. CLS. 1, 2, 7, 19, 22, 42 AND 50).

SN 76-369,345. BLANDI INTERNATIONAL, L.L.C., NEW YORK, NY. FILED 2-8-2002.

OSCAR BLANDI**CLASS 3—COSMETICS AND CLEANING PREPARATIONS**

FOR SHAMPOO, HAIR CONDITIONERS, HAIR MOUSSE, HAIR GEL; NAIL POLISH (U.S. CLS. 1, 4, 6, 50, 51 AND 52).

FIRST USE 11-30-2001; IN COMMERCE 11-30-2001.

CLASS 21—HOUSEWARES AND GLASS

FOR HAIR BRUSHES AND HAIR COMBS, NOT OF PRECIOUS METAL (U.S. CLS. 2, 13, 23, 29, 30, 33, 40 AND 50).

FIRST USE 6-16-1998; IN COMMERCE 6-16-1998.

CLASS 44—MEDICAL, BEAUTY AND AGRICULTURAL SERVICES

FOR BEAUTY SALON SERVICES (U.S. CLS. 100 AND 101).

FIRST USE 4-17-1997; IN COMMERCE 4-17-1997.

SN 76-369,939. FINANZ ST. HONORE, B.V., MOUNTAIN-TOP, PA. FILED 2-12-2002.

CENTS OF STYLE**CLASS 3—COSMETICS AND CLEANING PREPARATIONS**

FOR COSMETICS AND FRAGRANCES, NAMELY, ADHESIVE FOR ATTACHING ARTIFICIAL NAILS, ADHESIVE FOR ATTACHING ARTIFICIAL EYELASHES, ANTIPERSPIRANT, ARTIFICIAL/FALSE EYELASHES, ARTIFICIAL/FALSE NAILS, ARTIFICIAL/FALSE NAIL TIPS, BATH GEL, BATH OIL, BATH POWDER, BATH SALTS, BLUSHER, BODY CREAM, BODY LOTION, BODY OIL, BODY POWDER, BODY SOAP, BUBBLE BATH, COLOGNE, COMPACTS, COSMETIC PENCILS, CUTICLE-REMOVING PREPARATIONS, EMERY BOARDS, EYE CREAM, EYE MAKEUP, EYE-MAKEUP REMOVER, EYE PENCILS, EYE SHADOW, EYEBROW PENCILS, EYELINER, FACE POWDER, FACE SOAP, FACIAL LOTION, FACIAL MAKEUP, FACIAL SCRUB, FOUNDATION MAKEUP, HAIR-CARE PREPARATIONS, HAIR-CLEANING PREPARATIONS, HAIR CONDITIONS, HAIR DRESSING, HAIR GEL, HAIR LOTION, HAIR RINSE, HAIR SHAMPOO, HAIR SPRAY, HAIR-STYLING PREPARATIONS, HAND CREAM, HAND SOAP, LIP BALM, LIP GEL, LIP GLOSS, LIPSTICK, LIQUID SOAP, MAKEUP, MAKEUP REMOVER, MASCARA, MASSAGE OIL, NAIL-BUFFING PREPARATIONS, NAIL-CARE PREPARATIONS, NAIL ENAMEL, NAIL GLITTER, NAIL GLUE, NAIL-GROOMING PRODUCTS, NAMELY TIPS, GLUE, LACQUER, GLITTER AND ARTIFICIAL-NAIL REMOVING PREPARATION, NAIL HARDENER, NAIL LACQUER, NAIL POLISH, NAIL-POLISH BASE COAT, NAIL-POLISH REMOVER, NAIL-POLISH TOP COAT, NAIL STRENGTHENER, NAIL TIPS, ESSENTIAL OILS FOR PERSONAL USE, ESSENTIAL OILS FOR USE IN THE MANUFACTURING COSMETICS, PERFUME, POWDER, PRE-MOISTENED COSMETIC TISSUE, PRE-MOISTENED COSMETIC TOWELETTES, PRE-MOISTENED COSMETIC WIPES, ROUGE, SACHETS, SHOWER GEL, SKIN CREAM, SKIN EMOLLIENT, SKIN LOTION, SKIN MOISTURIZER, SOAP, TOILET SOAP, TOILET WATER, DECORATIVE NAIL ACCESSORIES USED WITH FINGER NAILS AND/OR TOE NAILS, NAMELY, GLITTER, STUDS, BEADS, FOIL, DECALS, TATTOOS, PAPER-BACKED TRANSFERS (U.S. CLS. 1, 4, 6, 50, 51 AND 52).

CLASS 8—HAND TOOLS

FOR NAIL BUFFERS, NAIL FILES AND NAIL TOOLS, NAMELY, ARTIFICIAL NAIL REMOVERS (U.S. CLS. 23, 28 AND 44).

SN 76-370,263. GEN-PROBE INCORPORATED, SAN DIEGO, CA. FILED 2-12-2002.

TIGRIS**CLASS 1—CHEMICALS**

FOR CHEMICAL REAGENTS AND BUFFERS FOR USE WITH AUTOMATED IN VITRO DIAGNOSTIC ANALYZER FOR DETECTION OF GENETIC MATERIALS, FOR SCIENTIFIC RESEARCH USE; KITS COMPRISING REAGENTS AND BUFFERS FOR IN VITRO DIAGNOSTIC DETECTION OF GENETIC MATERIALS, PRODUCTS, AND ANALOGS THEREOF, FOR SCIENTIFIC RESEARCH USE (U.S. CLS. 1, 5, 6, 10, 26 AND 46).

CLASS 5—PHARMACEUTICALS

FOR CHEMICAL REAGENTS AND BUFFERS FOR USE WITH AUTOMATED IN VITRO DIAGNOSTIC CLINICAL/MEDICAL SPECIMEN ANALYZER; KITS COMPRISING REAGENTS AND BUFFERS FOR IN VITRO DIAGNOSTIC DETERMINATION OF DISEASES (U.S. CLS. 6, 18, 44, 46, 51 AND 52).

CLASS 9—ELECTRICAL AND SCIENTIFIC APPARATUS

FOR AUTOMATED IN VITRO DIAGNOSTIC SPECIMEN ANALYZER APPARATUS AND PARTS THEREFOR, FOR THE DETECTION AND ASSAY OF GENETIC MATERIALS AND ANALOGS THEREOF, CONSISTING PRIMARILY OF A PHOTOMETER, INCUBATOR, LIQUID REAGENT DISPENSING BOTTLES AND DEVICES, SAMPLE HANDLING AND PIPETTING DEVICES, MIXERS AND MAGNETIC SEPARATION DEVICES, TEST TUBES AND SPECIMEN CONTAINERS, FOR LABORATORY USE; PIPETTE TIPS, REAGENT BOTTLES, TEST TUBES, AND SPECIMEN CONTAINERS AND COLLECTION DEVICES, ALL FOR LABORATORY USE (U.S. CLS. 21, 23, 26, 36 AND 38).

CLASS 10—MEDICAL APPARATUS

FOR AUTOMATED IN VITRO DIAGNOSTIC SPECIMEN ANALYZER APPARATUS AND PARTS THEREFOR, FOR THE DETECTION AND ASSAY OF GENETIC MATERIALS AND ANALOGS THEREOF, CONSISTING PRIMARILY OF A PHOTOMETER, INCUBATOR, LIQUID REAGENT DISPENSING BOTTLES AND DEVICES, SAMPLE HANDLING AND PIPETTING DEVICES, MIXERS AND MAGNETIC SEPARATION DEVICES, TEST TUBES AND SPECIMEN CONTAINERS, FOR USE IN THE DETERMINATION OF DISEASES; PIPETTE TIPS, TEST TUBES, SPECIMEN CONTAINERS AND COLLECTIONS DEVICES, ALL FOR MEDICAL CLINICAL AND DIAGNOSTIC USE (U.S. CLS. 26, 39 AND 44).

SN 76-371,181. GORDON, CORINNA, MONTECITO, CA. FILED 2-15-2002.

SPENDERELLA**CLASS 14—JEWELRY**

FOR JEWELRY (U.S. CLS. 2, 27, 28 AND 50).

CLASS 25—CLOTHING

FOR CLOTHING, NAMELY SHIRTS (U.S. CLS. 22 AND 39).

SN 76-369,940. FINANZ ST. HONORE, B.V., MOUNTAIN-TOP, PA. FILED 2-12-2002.

Ç's OF STYLE**CLASS 3—COSMETICS AND CLEANING PREPARATIONS**

FOR COSMETICS AND FRAGRANCES, NAMELY, ADHESIVE FOR ATTACHING ARTIFICIAL NAILS, ADHESIVE FOR ATTACHING ARTIFICIAL EYELASHES, ANTIPERSPIRANT, ARTIFICIAL/FALSE EYELASHES, ARTIFICIAL/FALSE NAILS, ARTIFICIAL/FALSE NAIL TIPS, BATH GEL, BATH OIL, BATH POWDER, BATH SALTS, BLUSHER, BODY CREAM, BODY LOTION, BODY OIL, BODY POWDER, BODY SOAP, BUBBLE BATH, COLOGNE, COMPACTS, COSMETIC PENCILS, CUTICLE-REMOVING PREPARATIONS, EMERY BOARDS, EYE CREAM, EYE MAKEUP, EYE-MAKEUP REMOVER, EYE PENCILS, EYE SHADOW, EYEBROW PENCILS, EYELINER, FACE POWDER, FACE SOAP, FACIAL LOTION, FACIAL MAKEUP, FACIAL SCRUB, FOUNDATION MAKEUP, HAIR-CARE PREPARATIONS, HAIR-CLEANING PREPARATIONS, HAIR CONDITIONS, HAIR DRESSING, HAIR GEL, HAIR LOTION, HAIR RINSE, HAIR SHAMPOO, HAIR SPRAY, HAIR-STYLING PREPARATIONS, HAND CREAM, HAND SOAP, LIP BALM, LIP GEL, LIP GLOSS, LIPSTICK, LIQUID SOAP, MAKEUP, MAKEUP REMOVER, MASCARA, MASSAGE OIL, NAIL-BUFFING PREPARATIONS, NAIL-CARE PREPARATIONS, NAIL ENAMEL, NAIL GLITTER, NAIL GLUE, NAIL-GROOMING PRODUCTS, NAMELY TIPS, GLUE, LACQUER, GLITTER AND ARTIFICIAL-NAIL REMOVING PREPARATION, NAIL HARDENER, NAIL LACQUER, NAIL POLISH, NAIL-POLISH BASE COAT, NAIL-POLISH REMOVER, NAIL-POLISH TOP COAT, NAIL STRENGTHENER, NAIL TIPS, ESSENTIAL OILS FOR PERSONAL USE, ESSENTIAL OILS FOR USE IN THE MANUFACTURING COSMETICS, PERFUME, POWDER, PRE-MOISTENED COSMETIC TISSUE, PRE-MOISTENED COSMETIC TOWELETTES, PRE-MOISTENED COSMETIC WIPES, ROUGE, SACHETS, SHOWER GEL, SKIN CREAM, SKIN EMOLLIENT, SKIN LOTION, SKIN MOISTURIZER, SOAP, TOILET SOAP, TOILET WATER, DECORATIVE NAIL ACCESSORIES USED WITH FINGER NAILS AND/OR TOE NAILS, NAMELY, GLITTER, STUDS, BEADS, FOIL, DECALS, TATTOOS, PAPER-BACKED TRANSFERS (U.S. CLS. 1, 4, 6, 50, 51 AND 52).

CLASS 8—HAND TOOLS

FOR NAIL BUFFERS, NAIL FILES AND NAIL TOOLS, NAMELY, ARTIFICIAL NAIL REMOVERS (U.S. CLS. 23, 28 AND 44).

SN 76-371,345. BIOGEN, INC., CAMBRIDGE, MA. FILED 2-15-2002.

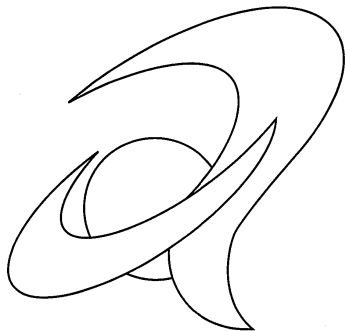

THE MARK IS COMPRISED OF A STYLIZED LETTER "A".

CLASS 5—PHARMACEUTICALS

FOR PHARMACEUTICAL PREPARATIONS FOR USE IN THE TREATMENT OF DERMATOLOGICAL DISORDERS, AUTOIMMUNE DISORDERS, INFLAMMATORY DISORDERS, PSORIASIS, OR RHEUMATOID ARTHRITIS (U.S. CLS. 6, 18, 44, 46, 51 AND 52).

CLASS 16—PAPER GOODS AND PRINTED MATTER

FOR PRINTED MATTER, NAMELY ADVERTISEMENTS, CIRCULARS, FLYERS, PRODUCT GUIDES, AND INSTRUCTIONAL AND TEACHING MATERIALS FOR EDUCATING HEALTH CARE PROFESSIONALS AND PATIENTS ABOUT PHARMACEUTICAL PREPARATIONS FOR USE IN PREVENTION AND TREATMENT OF DERMATOLOGICAL DISORDERS, AUTOIMMUNE DISORDERS, INFLAMMATORY DISORDERS, PSORIASIS, OR RHEUMATOID ARTHRITIS (U.S. CLS. 2, 5, 22, 23, 29, 37, 38 AND 50).

SN 76-371,645. ARRIVAS, LEANNE, DBA EPIPHANY SKIN CARE SYSTEMS, FAIR OAKS, CA. FILED 2-14-2002.

EPIPHANY

CLASS 3—COSMETICS AND CLEANING PREPARATIONS

FOR FACE AND BODY CARE PRODUCTS, NAMELY, COSMETIC SKIN CREAMS, LOTIONS AND GELS, ESSENTIAL OILS USED AS COSMETICS, BODY LOTIONS, CREAMS AND GELS (U.S. CLS. 1, 4, 6, 50, 51 AND 52).

CLASS 16—PAPER GOODS AND PRINTED MATTER

FOR PUBLICATIONS, NAMELY, BOOKLETS IN THE FIELD OF SKIN CARE (U.S. CLS. 2, 5, 22, 23, 29, 37, 38 AND 50).

SN 76-372,223. JOHN B. SANFILIPPO & SON, INC., ELK GROVE VILLAGE, IL. FILED 2-19-2002.

SNACK 'N SERVE NUT BOWL

NO CLAIM IS MADE TO THE EXCLUSIVE RIGHT TO USE "NUT BOWL", APART FROM THE MARK AS SHOWN.

CLASS 29—MEATS AND PROCESSED FOODS

FOR PROCESSED NUTS; DRIED FRUITS; CANDIED NUTS (U.S. CL. 46).
FIRST USE 3-0-1998; IN COMMERCE 3-0-1998.

CLASS 30—STAPLE FOODS

FOR CANDIES, CHOCOLATE COVERED NUTS, CANDIED FRUITS, PUFFED CORN SNACKS, PUFFED CHEESE FLAVORED SNACKS, POPPED POPCORN, PRETZELS, COOKIES, AND GRANOLA BASED SNACK BARS (U.S. CL. 46).
FIRST USE 3-0-1998; IN COMMERCE 3-0-1998.

SN 76-372,359. KONAMI CORPORATION, TOKYO, JAPAN, FILED 2-19-2002.

THE MASKED BEAST GUARDIUS

CLASS 9—ELECTRICAL AND SCIENTIFIC APPARATUS

FOR COMPUTER PRODUCTS, NAMELY, COMPUTER GAME PROGRAMS; VIDEO GAME CARTRIDGES; VIDEO GAME CD-ROMS; VIDEO GAME MACHINES FOR USE WITH TELEVISIONS; COMPUTER GAME CD-ROMS; VIDEO GAME PROGRAMS; VIDEO GAME PROGRAMS FOR USE WITH TELEVISION SETS; VIDEO GAME JOYSTICKS (U.S. CLS. 21, 23, 26, 36 AND 38).

CLASS 16—PAPER GOODS AND PRINTED MATTER

FOR BROCHURES AND BOOKLETS RELATING TO COMPUTER AND VIDEO GAMES; VIDEO GAME STRATEGY GUIDE BOOKS; VIDEO GAME STRATEGY GUIDE MAGAZINES; CARD GAME STRATEGY GUIDE BOOKS; CARD GAME STRATEGY GUIDE MAGAZINES; CARD GAME INSTRUCTION BOOKS; CARD GAME INSTRUCTION MAGAZINES; POSTERS; PLAYING CARDS AND INSTRUCTION MANUAL SOLD THEREWITH; COMPUTER GAME INSTRUCTION MANUALS; PRINTED GAME INSTRUCTION SHEETS; PRINTED SCORING SHEETS; TRADING CARDS; CALENDARS; LOOSE-LEAF BINDERS AND STATIONERY (U.S. CLS. 2, 5, 22, 23, 29, 37, 38 AND 50).

CLASS 28—TOYS AND SPORTING GOODS

FOR STAND-ALONE VIDEO GAME MACHINES; HAND-HELD UNITS FOR PLAYING ELECTRONIC GAMES; BOARD GAMES AND INSTRUCTIONAL MANUALS SOLD AS A UNIT THEREWITH; CARD GAMES; DICE; PROMOTIONAL GAME MATERIALS; GAME EQUIPMENT, NAMELY, CHIPS; TOYS, NAMELY ACTION FIGURES; DOLLS AND PLAYSETS THEREFOR (U.S. CLS. 22, 23, 38 AND 50).

SN 76-372,631. MUDD, L.L.C., NEW YORK, NY. FILED 2-19-2002.



CLASS 18—LEATHER GOODS

FOR HANDBAGS, WALLETS, PURSES, TOTES, BACKPACKS, COSMETICS CASES SOLD EMPTY (U.S. CLS. 1, 2, 3, 22 AND 41).

CLASS 25—CLOTHING

FOR SHOES, ATHLETIC SHOES, BOOTS, SANDALS, JEANS, PANTS, SHORTS, SHIRTS, T-SHIRTS, SWEATERS, TANK TOPS, SKIRTS, JACKETS, COATS, VESTS, HATS, CAMISOLES, BRAS, PANTIES (U.S. CLS. 22 AND 39).

SN 76-373,090. TOKYO ELECTRON LIMITED, TOKYO, JAPAN, FILED 2-19-2002.

LITIUS

CLASS 7—MACHINERY

FOR MACHINES FOR MANUFACTURING SEMI-CONDUCTORS (U.S. CLS. 13, 19, 21, 23, 31, 34 AND 35).

CLASS 9—ELECTRICAL AND SCIENTIFIC APPARATUS

FOR SCIENTIFIC APPARATUS, NAMELY, SILICON WAFERS FOR MANUFACTURING SEMI-CONDUCTORS (U.S. CLS. 21, 23, 26, 36 AND 38).

CLASS 37—CONSTRUCTION AND REPAIR

FOR REPAIR AND MAINTENANCE OF MACHINES FOR MANUFACTURING SEMI-CONDUCTORS (U.S. CLS. 100, 103 AND 106).

SN 76-373,308. NEW ENGLAND CLASSIC INTERIORS, INC., SOUTH PORTLAND, ME. FILED 2-20-2002.

WHAT BETTER WALLS ARE WEARING

CLASS 19—NON-METALLIC BUILDING MATERIALS

FOR NON-METAL BUILDING MATERIALS, NAMELY, PANELING AND MILLWORK, EXCLUSIVE OF CABINETS, IN A VARIETY OF ARCHITECTURAL STYLES, MADE OF WOOD, WOOD-BASED MATERIAL, OR WOOD SUBSTITUTES (U.S. CLS. 1, 12, 33 AND 50).
FIRST USE 9-0-1999; IN COMMERCE 9-0-1999.

CLASS 20—FURNITURE AND ARTICLES NOT OTHERWISE CLASSIFIED

FOR SHELVING, CABINETS AND BOOKCASES (U.S. CLS. 2, 13, 22, 25, 32 AND 50).
FIRST USE 9-0-1999; IN COMMERCE 9-0-1999.

SN 76-373,463. INTERSTATE INDUSTRIES, INC., LOVINGSTON, VA. FILED 2-20-2002.

HUMAN PLUS

OWNER OF U.S. REG. NO. 1,587,498.

CLASS 9—ELECTRICAL AND SCIENTIFIC APPARATUS

FOR PRERECORDED COMPACT DISCS FEATURING INSTRUCTIONS AND MATERIALS FOR MENTAL CONDITIONING AND RELAXATION TECHNIQUES; COMPUTER PROGRAMS FOR USE IN MENTAL CONDITIONING AND RELAXATION TECHNIQUES (U.S. CLS. 21, 23, 26, 36 AND 38).

CLASS 41—EDUCATION AND ENTERTAINMENT

FOR EDUCATIONAL SERVICES, NAMELY, CONDUCTING CLASSES, WORKSHOPS, AND RETREATS IN THE FIELD OF ACCELERATED LEARNING, EXPANDED AWARENESS, FOCUSED ATTENTION, HEIGHTENED CREATIVITY, MEDITATION, PAIN CONTROL, PHYSICAL WELLNESS, PROBLEM SOLVING, DEEP RELAXATION, SLEEP ENHANCEMENT, SPIRITUAL GROWTH, STRESS REDUCTION, PREGNANCY AND CHILDBIRTH, AND BEHAVIOR MODIFICATION, AND DISTRIBUTING COURSE MATERIALS IN CONNECTION THEREWITH (U.S. CLS. 100, 101 AND 107).

SN 76-373,464. INTERSTATE INDUSTRIES, INC., LOVINGSTON, VA. FILED 2-20-2002.

MIND FOOD

OWNER OF U.S. REG. NO. 2,387,780.

CLASS 9—ELECTRICAL AND SCIENTIFIC APPARATUS

FOR COMPUTER PROGRAMS FOR USE IN MENTAL CONDITIONING AND RELAXATION TECHNIQUES (U.S. CLS. 21, 23, 26, 36 AND 38).

CLASS 41—EDUCATION AND ENTERTAINMENT

FOR EDUCATIONAL SERVICES, NAMELY, CONDUCTING CLASSES, WORKSHOPS, AND RETREATS IN THE FIELD OF ACCELERATED LEARNING, EXPANDED AWARENESS, FOCUSED ATTENTION, HEIGHTENED CREATIVITY, MEDITATION, PAIN CONTROL, PHYSICAL WELLNESS, PROBLEM SOLVING, DEEP RELAXATION, SLEEP ENHANCEMENT, SPIRITUAL GROWTH, STRESS REDUCTION, PREGNANCY AND CHILDBIRTH, AND BEHAVIOR MODIFICATION, AND DISTRIBUTING COURSE MATERIALS IN CONNECTION THEREWITH (U.S. CLS. 100, 101 AND 107).

SN 76-373,465. INTERSTATE INDUSTRIES, INC., LOVINGSTON, VA. FILED 2-20-2002.

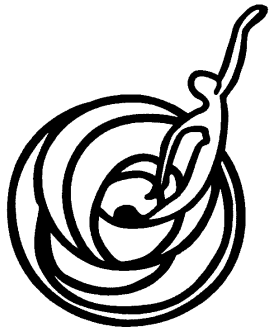

CLASS 9—ELECTRICAL AND SCIENTIFIC APPARATUS

FOR PRERECORDED AUDIO CASSETTES AND COMPACT DISCS FEATURING INSTRUCTIONS AND MATERIALS FOR MENTAL CONDITIONING AND RELAXATION TECHNIQUES; COMPUTER PROGRAMS FOR USE IN MENTAL CONDITIONING AND RELAXATION TECHNIQUES (U.S. CLS. 21, 23, 26, 36 AND 38).

CLASS 41—EDUCATION AND ENTERTAINMENT

FOR EDUCATIONAL SERVICES, NAMELY, CONDUCTING CLASSES, WORKSHOPS, AND RETREATS IN THE FIELD OF ACCELERATED LEARNING, EXPANDED AWARENESS, FOCUSED ATTENTION, HEIGHTENED CREATIVITY, MEDITATION, PAIN CONTROL, PHYSICAL WELLNESS, PROBLEM SOLVING, PROFOUND RELAXATION, SLEEP ENHANCEMENT, SPIRITUAL GROWTH, STRESS REDUCTION, PREGNANCY AND CHILDBIRTH, AND BEHAVIOR MODIFICATION, AND DISTRIBUTING COURSE MATERIALS IN CONNECTION THEREWITH (U.S. CLS. 100, 101 AND 107).

SN 76-373,466. INTERSTATE INDUSTRIES, INC., LOVINGSTON, VA. FILED 2-20-2002.

METAMUSIC

OWNER OF U.S. REG. NO. 1,408,298.

CLASS 9—ELECTRICAL AND SCIENTIFIC APPARATUS

FOR PRERECORDED COMPACT DISCS FEATURING INSTRUCTIONS AND MATERIALS FOR MENTAL CONDITIONING AND RELAXATION TECHNIQUES; COMPUTER PROGRAMS FOR USE IN MENTAL CONDITIONING AND RELAXATION TECHNIQUES (U.S. CLS. 21, 23, 26, 36 AND 38).

CLASS 41—EDUCATION AND ENTERTAINMENT

FOR EDUCATIONAL SERVICES, NAMELY, CONDUCTING CLASSES, WORKSHOPS, AND RETREATS IN THE FIELD OF ACCELERATED LEARNING, EXPANDED AWARENESS, FOCUSED ATTENTION, HEIGHTENED CREATIVITY, MEDITATION, PAIN CONTROL, PHYSICAL WELLNESS, PROBLEM SOLVING, PROFOUND RELAXATION, SLEEP ENHANCEMENT, SPIRITUAL GROWTH, STRESS REDUCTION, PREGNANCY AND CHILDBIRTH, AND BEHAVIOR MODIFICATION, AND DISTRIBUTING COURSE MATERIALS IN CONNECTION THEREWITH (U.S. CLS. 100, 101 AND 107).

SN 76-374,035. RUDD COMPANY, INC., SEATTLE, WA. FILED 2-25-2002.



CLASS 2—PAINTS

FOR PAINT FOR CONCRETE FLOORS AND WALLS, DECORATIVE COATING FOR CEMENT, STUCCO AND SCULPTURAL RELIEFS (U.S. CLS. 6, 11 AND 16).
FIRST USE 2-1-2002; IN COMMERCE 2-1-2002.

CLASS 19—NON-METALLIC BUILDING MATERIALS

FOR PORTLAND CEMENT AND CONCRETE (U.S. CLS. 1, 12, 33 AND 50).
FIRST USE 2-1-2002; IN COMMERCE 2-1-2002.

SN 76-374,458. ANTON HUMMEL VERWALTUNGS GMBH, WALDKIRCH, FED REP GERMANY, FILED 2-21-2002.

SNAPSPLIT

OWNER OF FED REP GERMANY REG. NO. 30160186, DATED 11-19-2001, EXPIRES 10-31-2011.

CLASS 6—METAL GOODS

FOR SCREWED JOINTS, HOLDERS, BINDERS OF METAL, LINE LINKS OF METAL, BRANCH PIECES OF METAL, AND METAL CONNECTION MOUNTINGS, ANGLES OR CURVES FOR SHEATHS OR CORRUGATED SHEATHS TO PROTECT ELECTRICAL CABLE (U.S. CLS. 2, 12, 13, 14, 23, 25 AND 50).

CLASS 9—ELECTRICAL AND SCIENTIFIC APPARATUS

FOR INSULATED ELECTRICAL CONNECTORS; ELECTRICAL WIRES AND CABLES IN THE NATURE OF INSPECTION PLUGS FOR MACHINE CONSTRUCTION AND INDUSTRIAL PLANT CONSTRUCTION (U.S. CLS. 21, 23, 26, 36 AND 38).

CLASS 17—RUBBER GOODS

FOR INSULATION, NAMELY, MATERIALS FOR ELECTRICAL INSTALLATION, NAMELY, SHEATHS OR CORRUGATED SHEATHS TO PROTECT ELECTRICAL CABLE, CABLES AND SHEATH CONNECTIONS AND PLUGS, BALL AND SOCKET JOINTS, REDUCING FITTINGS AND EXTENSIONS FOR ELECTRICAL LINES INSPECTION PLUGS FOR ELECTRICAL MACHINES, FOR DEVICES AND/OR FOR SWITCH CABINETS (U.S. CLS. 1, 5, 12, 13, 35 AND 50).

CLASS 20—FURNITURE AND ARTICLES NOT OTHERWISE CLASSIFIED

FOR SCREWED JOINTS, HOLDERS, BINDERS OF PLASTIC, LINE LINKS OF PLASTIC, BRANCH PIECES OF PLASTIC, AND PLASTIC CONNECTION MOUNTINGS, ANGLES OR CURVES FOR SHEATHS OR CORRUGATED SHEATHS TO PROTECT ELECTRICAL CABLE (U.S. CLS. 2, 13, 22, 25, 32 AND 50).

SN 76-374,558. GENE SIMMONS COMPANY, PORT WASHINGTON, NY. FILED 2-21-2002.

ROCK 'N' ROLL CIRCUS

NO CLAIM IS MADE TO THE EXCLUSIVE RIGHT TO USE "ROCK 'N' ROLL", APART FROM THE MARK AS SHOWN.

CLASS 35—ADVERTISING AND BUSINESS

FOR PROMOTING A SERIES OF ROCK CONCERTS OF OTHERS; AND PERSONAL MANAGEMENT SERVICES FOR MUSICAL PERFORMERS, NAMELY, MANAGEMENT OF A SERIES OF ROCK CONCERTS (U.S. CLS. 100, 101 AND 102).

CLASS 41—EDUCATION AND ENTERTAINMENT

FOR ENTERTAINMENT SERVICES, NAMELY, ORGANIZATION OF A SERIES OF ROCK CONCERTS FOR OTHERS; MUSICAL ENTERTAINMENT SERVICES, NAMELY, A SERIES OF LIVE ROCK CONCERTS (U.S. CLS. 100, 101 AND 107).

SN 76-374,620. KEENELAND ASSOCIATION, INC., LEXINGTON, KY. FILED 2-22-2002.

KEENELAND**CLASS 2—PAINTS**

FOR PAINT FOR EXTERIOR USE; PAINT FOR INTERIOR USE; PAINT FOR HOBBY USE; SPRAY ENAMEL IN THE NATURE OF HOUSE PAINT; SPRAY LACQUER IN THE NATURE OF A COATING; PAINT FOR USE ON WOOD; PAINT FOR USE ON METAL; PAINT FOR USE ON CONCRETE; AND AUTOMOTIVE PAINT (U.S. CLS. 6, 11 AND 16).

CLASS 34—SMOKERS' ARTICLES

FOR CIGARS (U.S. CLS. 2, 8, 9 AND 17).

SN 76-374,635. UNITED STATES RACQUETBALL ASSOCIATION, COLORADO SPRINGS, CO. FILED 2-22-2002.

UNITED STATES RACQUETBALL ASSOCIATION

OWNER OF U.S. REG. NOS. 2,039,546, 2,227,970 AND OTHERS.

NO CLAIM IS MADE TO THE EXCLUSIVE RIGHT TO USE "RACQUETBALL ASSOCIATION", APART FROM THE MARK AS SHOWN.

SEC. 2(F).

CLASS 41—EDUCATION AND ENTERTAINMENT

FOR ENTERTAINMENT SERVICES IN THE NATURE OF RACQUETBALL EXHIBITIONS AND TOURNAMENTS; PROVIDING TRAINING AND COACHING IN THE SPORT OF RACQUETBALL (U.S. CLS. 100, 101 AND 107).

FIRST USE 1-1-1997; IN COMMERCE 1-1-1997.

CLASS 42—SCIENTIFIC, COMPUTER AND LEGAL SERVICES

FOR PROMOTING PUBLIC AWARENESS OF THE SPORT OF RACQUETBALL THROUGH EXHIBITION TOURNAMENTS; PROMULGATING STANDARDS AND RULES OF PLAY, CLASSIFYING PLAYERS, ESTABLISHING EQUIPMENT SPECIFICATIONS, AND ESTABLISHING STANDARDS OF CONDUCT FOR THE SPORT OF RACQUETBALL (U.S. CLS. 100 AND 101).

FIRST USE 1-1-1997; IN COMMERCE 1-1-1997.

SN 76-374,885. DAK AMERICAS, L.L.C., CHARLOTTE, NC. FILED 2-25-2002.

COLORBRITE**CLASS 22—CORDAGE AND FIBERS**

FOR SYNTHETIC TEXTILE FIBER FEATURING THE ABILITY TO ACCEPT CATIONIC DYES AND DISPERSE DYES (U.S. CLS. 1, 2, 7, 19, 22, 42 AND 50).

CLASS 23—YARNS AND THREADS

FOR SYNTHETIC TEXTILE YARN FEATURING THE ABILITY TO ACCEPT CATIONIC DYES AND DISPERSE DYES (U.S. CL. 43).

SN 76-374,987. AVECIA INC., WILMINGTON, DE. FILED 2-26-2002.

SPAPLICITY**CLASS 3—COSMETICS AND CLEANING PREPARATIONS**

FOR AROMATHERAPY PRODUCTS, NAMELY GELS, LOTIONS, POWDERS, AND LIQUIDS FOR USE IN CONNECTION WITH POOLS, SPAS, HOT TUBS, BATHS AND JETTED BATHS (U.S. CLS. 1, 4, 6, 50, 51 AND 52).

CLASS 4—LUBRICANTS AND FUELS

FOR AROMATHERAPY CANDLES (U.S. CLS. 1, 6 AND 15).

SN 76-375,202. TRIPATH IMAGING, INC., BURLINGTON, NC. FILED 2-26-2002.

TRIPATH
care technologies

NO CLAIM IS MADE TO THE EXCLUSIVE RIGHT TO USE "TECHNOLOGIES", APART FROM THE MARK AS SHOWN.

THE MARK CONTAINS COLOR AND COLOR IS CLAIMED IN THE MARK. SPECIFICALLY "PMS" GREEN #556 IN THE WORD "TRIPATH", EXCEPT ORANGE IN THE DOT OF THE "I" IN "TRIPATH" AND IN THE CROSS HAIR OF THE "H" IN "TRIPATH", AND ORANGE IN THE WORDS "CARE TECHNOLOGIES".

CLASS 5—PHARMACEUTICALS

FOR CONSUMABLE TEST KITS COMPRISED OF REAGENTS, COLLECTION VIALS, MICROSCOPE SLIDES, CENTRIFUGE TUBES, SYRINGES, SETTLING CHAMBERS AND DISPOSABLE PIPETTE TIPS SOLD AS A UNIT FOR USE IN PREPARING AND SCREENING CYTOLOGICAL SAMPLES FOR CLINICAL PROCEDURES OR MEDICAL LABORATORY USE (U.S. CLS. 6, 18, 44, 46, 51 AND 52).

CLASS 10—MEDICAL APPARATUS

FOR MEDICAL APPARATUS FOR DIAGNOSTIC IMAGING OF CONVENTIONAL AND THIN LAYER PAP SMEARS COMPRISING COMPUTER HARDWARE AND SOFTWARE (U.S. CLS. 26, 39 AND 44).

CLASS 42—SCIENTIFIC, COMPUTER AND LEGAL SERVICES

FOR RESEARCH SERVICES, NAMELY DEVELOPING AND COMMERCIALIZING MOLECULAR DIAGNOSTIC AND PHARMACOGENOMIC TESTS, GENETIC MARKER TECHNOLOGIES AND IMMUNOASSAY DEVELOPMENT FOR CANCER DETECTION FOR CANCER DETECTION AND PREVENTION (U.S. CLS. 100 AND 101).

SN 76-375,807. FURNITURE REVIEW, INC., WINSTON-SALEM, NC. FILED 2-21-2002.

DOLLY DECORATOR

NO CLAIM IS MADE TO THE EXCLUSIVE RIGHT TO USE "DECORATOR", APART FROM THE MARK AS SHOWN.

CLASS 35—ADVERTISING AND BUSINESS

FOR PROVIDING CONSUMER PRODUCT ADVICE IN THE FIELD OF FURNITURE (U.S. CLS. 100, 101 AND 102).

CLASS 42—SCIENTIFIC, COMPUTER AND LEGAL SERVICES

FOR PROVIDING INTERIOR DECORATING ADVICE AND ASSISTANCE TO CONSUMERS REGARDING FURNITURE (U.S. CLS. 100 AND 101).

SN 76-376,121. INGENEUS CORPORATION, BRIDGETOWN, BARBADOS, FILED 2-27-2002.

NOW YOU CAN KNOW. FOR SURE.**CLASS 42—SCIENTIFIC, COMPUTER AND LEGAL SERVICES**

FOR SCIENTIFIC RESEARCH SERVICES IN THE FIELD OF BIOTECHNOLOGY (U.S. CLS. 100 AND 101).

CLASS 44—MEDICAL, BEAUTY AND AGRICULTURAL SERVICES

FOR MEDICAL TESTING SERVICES (U.S. CLS. 100 AND 101).

SN 76-376,200. YANG, ROGER, CITY OF INDUSTRY, CA. FILED 2-22-2002.

GOLDEN PACIFIC**CLASS 18—LEATHER GOODS**

FOR LUGGAGE, INCLUDING SUITCASES, TRAVEL BAGS, GARMENT BAGS, OVERNIGHT BAGS, ROLL BAGS, TOILETRY CASES SOLD EMPTY, COSMETIC BAGS SOLD EMPTY; ALL-PURPOSE UTILITY BAGS, INCLUDING BACKPACKS, KNAPSACKS, SHOULDER BAGS, TOTE BAGS, DUFFEL BAGS, FANNY PACKS, CLUTCHES; CUSTOM-MADE SPORT BAGS; ALL-PURPOSE SPORT BAGS, INCLUDING GYM BAGS, SPORTS EQUIPMENT BAGS, BEACH BAGS; BRIEFCASES; HANDBAGS (U.S. CLS. 1, 2, 3, 22 AND 41).
FIRST USE 7-15-1987; IN COMMERCE 7-15-1987.

CLASS 21—HOUSEWARES AND GLASS

FOR PORTABLE COOLERS (U.S. CLS. 2, 13, 23, 29, 30, 33, 40 AND 50).
FIRST USE 7-15-1987; IN COMMERCE 7-15-1987.

SN 76-376,330. CARNEY, WILLIAM H., DANA POINT, CA. FILED 2-28-2002.

SN 76-377,140. AGILQUEST CORPORATION, RICHMOND, VA. BY CHANGE OF NAME V TECHNOLOGIES INTERNATIONAL CORPORATION, RICHMOND, VA. FILED 2-28-2002.

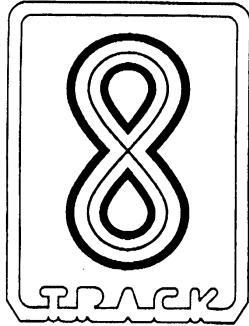

CLASS 25—CLOTHING

FOR CLOTHING, NAMELY, WETSUITS, SWIMWEAR, BATHING SUITS, BIKINIS, T-SHIRTS, SWEATSHIRTS, JEANS, TANK TOPS, SHIRTS, SKIRTS, DRESSES, SHORTS, JUMPERS, JACKETS, FOOTWEAR, NAMELY, SLIPPERS, SANDALS, AND ATHLETIC, SHOES, SOCKS, UNDERWEAR, HATS, HEADWEAR, NAMELY, CAPS, AND VISORS (U.S. CLS. 22 AND 39).

CLASS 28—TOYS AND SPORTING GOODS

FOR SPORTING GOODS, NAMELY, SKATEBOARDS, SURF BOARDS, SNOW BOARDS, BODY BOARDS, SKIMBOARDS, SWIMFINS, AND LEASH TETHER (U.S. CLS. 22, 23, 38 AND 50).

SN 76-376,569. REFLECTXION RESOURCES, INC., LONGWOOD, FL. FILED 2-27-2002.

REFLECTXION RESOURCES

NO CLAIM IS MADE TO THE EXCLUSIVE RIGHT TO USE "RESOURCES", APART FROM THE MARK AS SHOWN.

CLASS 35—ADVERTISING AND BUSINESS

FOR HEALTHCARE STAFFING SERVICES, NAMELY, THE PROVISION OF TEMPORARY AND SEMI-PERMANENT NURSES (U.S. CLS. 100, 101 AND 102).

CLASS 44—MEDICAL, BEAUTY AND AGRICULTURAL SERVICES

FOR THERAPY SERVICES, NAMELY, MEDICAL REHABILITATION, SPEECH-LANGUAGE PATHOLOGY AND PHYSICAL AND OCCUPATIONAL THERAPY (U.S. CLS. 100 AND 101).

AGILQUEST

CLASS 35—ADVERTISING AND BUSINESS

FOR BUSINESS CONSULTING SERVICES IN THE FIELD OF RESOURCE MANAGEMENT (U.S. CLS. 100, 101 AND 102).
FIRST USE 11-0-1999; IN COMMERCE 11-0-1999.

CLASS 42—SCIENTIFIC, COMPUTER AND LEGAL SERVICES

FOR DEVELOPMENT, INSTALLATION, CUSTOMIZATION, MAINTENANCE AND REPAIR OF COMPUTER SOFTWARE; COMPUTER CONSULTATION SERVICES FOR BUSINESS ORGANIZATIONS; TECHNICAL SUPPORT SERVICES, NAMELY, TROUBLESHOOTING OF COMPUTER SOFTWARE PROBLEMS (U.S. CLS. 100 AND 101).
FIRST USE 11-0-1999; IN COMMERCE 11-0-1999.

SN 76-377,251. TARGET ALUMINUM, INC., BRIDGETON, MO. FILED 3-1-2002.



NO CLAIM IS MADE TO THE EXCLUSIVE RIGHT TO USE "WINDOWS & DOORS", APART FROM THE MARK AS SHOWN.

CLASS 6—METAL GOODS

FOR PRIMARILY METAL WINDOWS AND DOORS, BOTH ORIGINAL AND REPLACEMENT (U.S. CLS. 2, 12, 13, 14, 23, 25 AND 50).

CLASS 19—NON-METALLIC BUILDING MATERIALS

FOR PRIMARILY NON-METAL WINDOWS AND DOORS, BOTH ORIGINAL AND REPLACEMENT (U.S. CLS. 1, 12, 33 AND 50).

SN 76-377,252. TARGET ALUMINUM, INC., BRIDGETON, MO. FILED 3-1-2002.

DISCOVER THE GREAT INDOORS

CLASS 6—METAL GOODS

FOR PRIMARILY METAL WINDOWS AND DOORS, BOTH ORIGINAL AND REPLACEMENT (U.S. CLS. 2, 12, 13, 14, 23, 25 AND 50).

CLASS 19—NON-METALLIC BUILDING MATERIALS

FOR PRIMARILY NON-METAL WINDOWS AND DOORS, BOTH ORIGINAL AND REPLACEMENT (U.S. CLS. 1, 12, 33 AND 50).

SN 76-379,440. FIRM LABEL, INC., THE, BEVERLY HILLS, CA. FILED 3-6-2002.

SN 76-377,796. ELFIN EQUITY COMPANY, L.L.C., ELMHURST, IL. FILED 3-4-2002.

COOKIE DIVA**CLASS 16—PAPER GOODS AND PRINTED MATTER**

FOR STATIONERY (U.S. CLS. 2, 5, 22, 23, 29, 37, 38 AND 50).

CLASS 18—LEATHER GOODS

FOR TOTE BAGS (U.S. CLS. 1, 2, 3, 22 AND 41).

CLASS 21—HOUSEWARES AND GLASS

FOR MUGS (U.S. CLS. 2, 13, 23, 29, 30, 33, 40 AND 50).

CLASS 25—CLOTHING

FOR SHIRTS AND SWEAT SHIRTS (U.S. CLS. 22 AND 39).

SN 76-378,333. PONTIFF, RONALD A., NEW BERN, NC. FILED 3-4-2002.



"It's better to be lucky than good!"

NO CLAIM IS MADE TO THE EXCLUSIVE RIGHT TO USE "GOLF", APART FROM THE MARK AS SHOWN.

CLASS 18—LEATHER GOODS

FOR GOLF UMBRELLAS (U.S. CLS. 1, 2, 3, 22 AND 41).

CLASS 28—TOYS AND SPORTING GOODS

FOR GOLF BAG TAGS, GOLF BAGS, GOLF BALLS, GOLF CLUB HEAD COVERS, GOLF PUTTER HEAD COVERS, GOLF GLOVES, GOLF TEES, DIVOT REPAIR TOOLS FOR GOLFERS AND GOLF BALL MARKERS (U.S. CLS. 22, 23, 38 AND 50).

PACIFIER**CLASS 9—ELECTRICAL AND SCIENTIFIC APPARATUS**

FOR MUSICAL SOUND RECORDINGS, NAMELY PRERECORDED COMPACT DISCS, AUDIO DISCS, AUDIO TAPE CASSETTES, PHONOGRAPH RECORDS AND DIGITAL CASSETTES FEATURING MUSIC; VIDEO RECORDINGS, NAMELY PRERECORDED VIDEO TAPE CASSETTES, VIDEO DISCS, DIGITAL VIDEO DISCS AND DIGITAL VERSATILE DISCS FEATURING MUSICAL PERFORMANCES AND ENTERTAINMENT (U.S. CLS. 21, 23, 26, 36 AND 38).

CLASS 41—EDUCATION AND ENTERTAINMENT

FOR ENTERTAINMENT SERVICES, NAMELY LIVE AND RECORDED PERFORMANCES BY A MUSICAL GROUP (U.S. CLS. 100, 101 AND 107).

SN 76-380,971. WILLIAMSON-DICKIE MANUFACTURING COMPANY, FORT WORTH, TX. FILED 3-8-2002.

DICKIESGIRL.COM

OWNER OF U.S. REG. NOS. 594,540, 2,444,583 AND OTHERS.

CLASS 25—CLOTHING

FOR CLOTHING FOR GIRLS, NAMELY LONG AND SHORT SLEEVE T-SHIRTS, BASEBALL-STYLE TOPS, TANK TOPS, SHIRTS, SWEATSHIRTS, SWEATERS, JACKETS, BIB OVERALLS, SHORTALLS, SKIRTALLS, SKIRTS, DRESSES, STRETCH CARGO PANTS, WORK-STYLE PANTS, JEANS, SLACKS, AND CAPRI PANTS (U.S. CLS. 22 AND 39).

FIRST USE 12-8-2001; IN COMMERCE 12-8-2001.

CLASS 35—ADVERTISING AND BUSINESS

FOR ON-LINE RETAIL STORE SERVICES FEATURING GIRLS AND WOMEN'S CLOTHING (U.S. CLS. 100, 101 AND 102).

FIRST USE 12-8-2001; IN COMMERCE 12-8-2001.

SN 76-381,111. AMPCO II, LLC, RIVERHEAD, NY. FILED 3-8-2002.

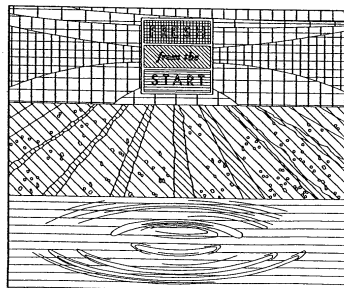

OWNER OF U.S. REG. NO. 2,239,740.
THE MARK IS LINED FOR THE COLORS GOLD, GREEN,
BLUE AND WHITE.

CLASS 29—MEATS AND PROCESSED FOODS

FOR PROCESSED, SLICED, PEELED, PREPARED AND WASHED FRUITS AND VEGETABLES; SOUPS; SOUP MIXES; PRE-CUT VEGETABLE SALADS; COLE SLAW; PACKAGED MEALS CONSISTING PRIMARILY OF MEAT, FISH, POULTRY OR VEGETABLES, DRIED SOYBEANS, PEELED GARLIC, PEELED SHALLOTS, PREPARED EDAMAME; STIR FRY KITS CONSISTING PRIMARILY OF VEGETABLES AND MEAT WITH SEASONING MIX; STEW KITS CONSISTING PRIMARILY OF VEGETABLES AND MEAT WITH SEASONING MIX (U.S. CL. 46).

CLASS 30—STAPLE FOODS

FOR SPICES, BREAD-BASED STUFFING; FAJITA KITS CONSISTING PRIMARILY OF TORTILLAS AND SEASONING MIX WITH VEGETABLES AND MEAT; STIR FRY KITS CONSISTING PRIMARILY OF SEASONING MIX WITH VEGETABLES AND MEAT; STEW KITS CONSISTING PRIMARILY OF SEASONING MIX WITH VEGETABLES AND MEAT (U.S. CL. 46).

CLASS 31—NATURAL AGRICULTURAL PRODUCTS

FOR FRESH FRUITS AND VEGETABLES, FRESH EDAMAME, FRESH YUCCA, FRESH GARLIC, FRESH SHALLOTS, FRESH GINGER, FRESH CILANTRO AND FRESH HERBS (U.S. CLS. 1 AND 46).

SN 76-382,745. NOVALOGIC, INC., CALABASAS, CA. FILED 3-18-2002.

TASK FORCE RANGER

CLASS 9—ELECTRICAL AND SCIENTIFIC APPARATUS

FOR COMPUTER AND VIDEO GAME SOFTWARE, CD-ROMS AND COMPACT DISCS FEATURING COMPUTER GAMES, ACCESSORIES FOR PLAYING ELECTRONIC COMPUTER GAMES, NAMELY TEMPLATES, COMPUTER GAME JOY STICKS, AND MANUALS THEREFOR SOLD AS A UNIT (U.S. CLS. 21, 23, 26, 36 AND 38).

CLASS 16—PAPER GOODS AND PRINTED MATTER

FOR COMPUTER GAME INSTRUCTION MANUALS AND STRATEGY GUIDES (U.S. CLS. 2, 5, 22, 23, 29, 37, 38 AND 50).

CLASS 41—EDUCATION AND ENTERTAINMENT

FOR ENTERTAINMENT SERVICES, NAMELY, PROVIDING ON-LINE COMPUTER GAMES (U.S. CLS. 100, 101 AND 107).

SN 76-383,654. KONG COMPANY LLC, THE, GOLDEN, CO. FILED 3-18-2002.

BIOBONE

CLASS 5—PHARMACEUTICALS

FOR THERAPEUTIC SUPPLEMENTS FOR PETS DERIVED FROM NATURAL AGRICULTURAL PRODUCTS (U.S. CLS. 6, 18, 44, 46, 51 AND 52).

CLASS 31—NATURAL AGRICULTURAL PRODUCTS

FOR PET FOOD TREATS INCORPORATING THERAPEUTIC SUPPLEMENTS (U.S. CLS. 1 AND 46).

SN 76-384,029. SNAK CLUB, INC., EL SEGUNDO, CA. FILED 3-19-2002.

MUNCHEROS

CLASS 29—MEATS AND PROCESSED FOODS

FOR PROCESSED NUTS, DRIED FRUITS, PROCESSED FRUITS, BEEF JERKY, DRIED MEAT SNACKS, PORK RINDS, PROCESSED EDIBLE SUNFLOWER SEEDS AND KERNELS, PROCESSED EDIBLE PUMPKIN SEEDS AND KERNELS, SOY NUTS, POTATO CHIPS, SNACK MIX CONSISTING PRIMARILY OF PROCESSED FRUITS, PROCESSED NUTS AND/OR RAISINS, CANDIED NUTS AND FRUITS (U.S. CL. 46).
FIRST USE 5-10-2000; IN COMMERCE 5-10-2000.

CLASS 30—STAPLE FOODS

FOR CHOCOLATE COVERED NUTS AND FRUITS, YOGURT COVERED NUTS AND FRUITS, CANDIES, POPPED POPCORN, CARAMEL POPCORN, RICE CRACKERS, PRETZELS, COOKIES, CRACKERS, TORTILLA CHIPS, BAKERY PRODUCTS, SESAME STICKS, WHEAT-BASED SNACK FOOD, SNACK MIX CONSISTING PRIMARILY OF CRACKERS, PRETZELS, CANDIED NUTS AND/OR POPPED POPCORN (U.S. CL. 46).
FIRST USE 5-10-2000; IN COMMERCE 5-10-2000.

SN 76-384,102. NUTRIJOY, INC., MANHATTAN, KS. FILED 3-18-2002.

ENJOY YOUR CALCIUM TODAY

CLASS 29—MEATS AND PROCESSED FOODS

FOR MINERAL-ENRICHED ENTREES CONSISTING PRIMARILY OF MEAT, FISH, POULTRY, OR VEGETABLES, MINERAL-ENRICHED MEALS, CONSISTING PRIMARILY OF MEAT, FISH, POULTRY OR VEGETABLES, MINERAL-ENRICHED FRUIT BASED SNACK FOOD (U.S. CL. 46).

CLASS 30—STAPLE FOODS

FOR MINERAL ENRICHED ENTREES CONSISTING PRIMARILY OF PASTA OR RICE, MINERAL ENRICHED MEALS CONSISTING PRIMARILY OF PASTA OR RICE, FRUIT FLAVORED PUDDINGS, MINERAL ENRICHED WHEAT BASED SNACK FOOD (U.S. CL. 46).

CLASS 32—LIGHT BEVERAGES

FOR FRUIT FLAVORED DRINKS (U.S. CLS. 45, 46 AND 48).

SN 76-385,140. GROUND ROUND, INC., THE, BRAINTREE, MA. FILED 3-20-2002.

WE'VE GOT WHAT YOU LIKE

CLASS 35—ADVERTISING AND BUSINESS

FOR FRANCHISING, NAMELY, OFFERING TECHNICAL ASSISTANCE IN THE ESTABLISHMENT AND OPERATION OF RESTAURANTS (U.S. CLS. 100, 101 AND 102).

CLASS 43—HOTEL AND RESTAURANT SERVICES

FOR RESTAURANT SERVICES (U.S. CLS. 100 AND 101).

SN 76-385,434. ONCOIMMUNIN, INC., GAITHERSBURG, MD. FILED 3-19-2002.

CADILUX

CLASS 1—CHEMICALS

FOR REAGENTS FOR SCIENTIFIC OR CLINICAL MEDICAL RESEARCH USE, NAMELY TESTING AND STUDY OF DISEASE AND DRUG DISCOVERY (U.S. CLS. 1, 5, 6, 10, 26 AND 46).

CLASS 5—PHARMACEUTICALS

FOR MEDICAL DIAGNOSTIC REAGENTS FOR DETECTION OF DISEASE, NAMELY FLUOROGENIC SUBSTRATES FOR THE DETECTION OF CATHEPSIN AND BETA-SECRETASE ACTIVITIES (U.S. CLS. 6, 18, 44, 46, 51 AND 52).

SN 76-387,147. LIBERTY HARDWARE MFG. CORP., WINSTON-SALEM, NC. FILED 3-25-2002.

LIBERTY HARDWARE

OWNER OF U.S. REG. NOS. 1,145,402, 2,275,058 AND OTHERS.

CLASS 6—METAL GOODS

FOR METAL CABINET HARDWARE (U.S. CLS. 2, 12, 13, 14, 23, 25 AND 50).

CLASS 20—FURNITURE AND ARTICLES NOT OTHERWISE CLASSIFIED

FOR NON-METAL CABINET HARDWARE (U.S. CLS. 2, 13, 22, 25, 32 AND 50).

SN 76-387,629. GODBERSEN EQUIPMENT COMPANY, IDA GROVE, IA. FILED 3-27-2002.

GEC

CLASS 7—MACHINERY

FOR PRE-OWNED CONSTRUCTION MACHINES FOR USE IN THE ROAD PAVING INDUSTRY (U.S. CLS. 13, 19, 21, 23, 31, 34 AND 35).

FIRST USE 2-11-2000; IN COMMERCE 2-11-2000.

CLASS 37—CONSTRUCTION AND REPAIR

FOR REFURBISHING AND REPAIRING CONSTRUCTION EQUIPMENT FOR USE IN THE ROAD PAVING INDUSTRY (U.S. CLS. 100, 103 AND 106).

FIRST USE 2-11-2000; IN COMMERCE 2-11-2000.

SN 76-388,011. TARGET BRANDS, INC., MINNEAPOLIS, MN. FILED 3-28-2002.

BECOME ONE OF THE PRIVILEGED MANY

CLASS 35—ADVERTISING AND BUSINESS

FOR PROMOTING THE SALE AND USE OF CREDIT CARD ACCOUNTS THROUGH INCENTIVE PROGRAMS FOR RETAIL CONSUMERS; PROMOTING THE SALE OF THE GOODS AND SERVICES OF OTHERS THROUGH INCENTIVE PROGRAMS FOR RETAIL CONSUMERS; AND PROMOTING THE USE OF RETAIL DEPARTMENT STORES SERVICES THROUGH INCENTIVE PROGRAMS FOR RETAIL CONSUMERS (U.S. CLS. 100, 101 AND 102).

CLASS 36—INSURANCE AND FINANCIAL

FOR CREDIT CARD SERVICES (U.S. CLS. 100, 101 AND 102).

SN 76-393,907. KASGRO RAIL CORP., NEW CASTLE, PA.
FILED 4-11-2002.

SN 78-011,626. THE KROGER CO. OF MICHIGAN, NORTH
LIVONIA, MI. FILED 6-7-2000.

KASGRO

CLASS 12—VEHICLES

FOR RAILROAD CARS (U.S. CLS. 19, 21, 23, 31, 35
AND 44).
FIRST USE 6-1-1993; IN COMMERCE 6-1-1993.

CLASS 37—CONSTRUCTION AND REPAIR

FOR REPAIRING, RESTORING AND REFURBISHING
RAILROAD CARS (U.S. CLS. 100, 103 AND 106).
FIRST USE 6-1-1993; IN COMMERCE 6-1-1993.

CLASS 39—TRANSPORTATION AND STORAGE

FOR LEASING OF RAILROAD CARS (U.S. CLS. 100
AND 105).
FIRST USE 6-1-1993; IN COMMERCE 6-1-1993.

CLASS 40—MATERIAL TREATMENT

FOR MANUFACTURING RAILROAD CARS TO THE
ORDER AND SPECIFICATIONS OF OTHERS (U.S. CLS.
100, 103 AND 106).
FIRST USE 6-1-1993; IN COMMERCE 6-1-1993.

SN 78-003,598. GH-MAX LLC, BEVERLY HILLS, CA. FILED
4-11-2000.

POINT DE VUE

THE ENGLISH TRANSLATION OF "POINT DE VUE" IS
"POINT OF VIEW".

CLASS 3—COSMETICS AND CLEANING PREPARATIONS

FOR SKIN SOAPS, PERFUME, ESSENTIAL OILS FOR
PERSONAL USE, COSMETICS, NAMELY, MAKE-UP,
MAKE-UP REMOVERS, LIPSTICKS, FACE POWDER,
HAIR GEL, HAIR WAVING LOTION, SHAMPOOS,
BEAUTY MASKS, SKIN CREAMS, FACE AND BODY
CREAMS AND LOTIONS, NAMELY SKIN LOTIONS,
HAIR LOTIONS, FACIAL AND BODY LOTIONS, TOI-
LET PRODUCTS, NAMELY HAIR COLOR, HAIR COL-
OR REMOVER, DEPILATORIES, SUN TAN GEL, SUN
TAN LOTION, SUN TAN OIL, AND DEODORANTS
ANTIPERSPIRANTS FOR PERSONAL USE (U.S. CLS. 1,
4, 6, 50, 51 AND 52).
FIRST USE 5-1-2000; IN COMMERCE 5-1-2000.

CLASS 42—SCIENTIFIC, COMPUTER AND LEGAL SERVICES

FOR COSMETICS RESEARCH FOR OTHERS, HAIR-
DRESSING SALON SERVICES, MASSAGE SERVICES,
BEAUTY SALON SERVICES, MANICURE AND PEDI-
CURE SERVICES (U.S. CLS. 100 AND 101).
FIRST USE 5-1-2000; IN COMMERCE 5-1-2000.

COMFORTS

CLASS 3—COSMETICS AND CLEANING PREPARATIONS

FOR BABY LOTION, BABY POWDER, BABY OIL,
PETROLEUM JELLY FOR COSMETIC PURPOSES, BABY
SHAMPOO, BABY WASH, BABY OIL WITH ALOE, BABY
WIPES, AND BABY WIPE REFILLS (U.S. CLS. 1, 4, 6, 50,
51 AND 52).

CLASS 5—PHARMACEUTICALS

FOR ELECTROLYTE REPLACEMENT SOLUTION IN
LIQUID FORM; MEDICATED DIAPER RASH OINT-
MENT, VAPOR BATH, AND WATER ADDITIVE CON-
TAINING MENTHOL (U.S. CLS. 6, 18, 44, 46, 51 AND 52).

SN 78-015,490. TNPC, INC., HOUSTON, TX. FILED 7-5-2000.



THE MARK CONSISTS OF THE STYLIZED TERM "NEW-
POWER" WITH THE WORD "ON" IN WHITE BLOCK
LETTERS INSIDE THE LETTER "O". THE INSIDE OF THE
"O" IS COLORED, SPECIFICALLY, THE COLOR IS PMS 368
AS PRINTED ON COATED PAPER. THE PERIMETER OF
THE LETTER "O" IS BLACK WITH A GRADATION INTO
THE PMS 368 COLOR.

CLASS 39—TRANSPORTATION AND STORAGE

FOR DISTRIBUTION OF ENERGY (U.S. CLS. 100 AND
105).

CLASS 42—SCIENTIFIC, COMPUTER AND LEGAL SERVICES

FOR RESEARCH AND DEVELOPMENT SERVICES IN
THE AREA OF POWER AND ENERGY; ENERGY CON-
SULTING SERVICES, NAMELY, ANALYSIS OF EN-
ERGY USAGE, ENERGY MANAGEMENT
CONSULTATION, ENERGY CONVERSATION CONSU-
LTATION; SECURITY MONITORING SERVICES (U.S.
CLS. 100 AND 101).

SN 78-028,436. GALWAY HOOKER, L.L.C., CORNELIUS, NC. FILED 9-30-2000.

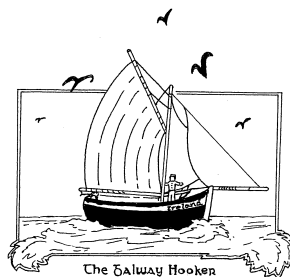

THE MARK CONSISTS OF THE DESIGN OF A SAILBOAT ON THE OCEAN WITH BIRDS FLYING ABOVE.

CLASS 25—CLOTHING

FOR HATS AND T-SHIRTS (U.S. CLS. 22 AND 39).

CLASS 42—SCIENTIFIC, COMPUTER AND LEGAL SERVICES

FOR BAR AND RESTAURANT SERVICES (U.S. CLS. 100 AND 101).

SN 78-032,924. SILANTES GMBH, MUNCHEN, FED REP GERMANY, FILED 10-30-2000.



PRIORITY CLAIMED UNDER SEC. 44(D) ON FED REP GERMANY APPLICATION NO. 30045228.4/0, FILED 6-15-2000, REG. NO. 30045228, DATED 11-1-2000, EXPIRES 6-30-2010.

THE STIPPLING IN THE DRAWING IS INTENDED FOR TONE AND DOES NOT INDICATE A SPECIFIC COLOR.

THE MARK CONSISTS OF THE WORD "SILANTES" AND THREE WAVE-LIKE LINES DISPLAYED IN RED AND COLOR IS CLAIMED AS A FEATURE OF THE MARK.

CLASS 1—CHEMICALS

FOR CHEMICALS, NAMELY, STABLE ISOTOPES AND BIOMOLECULES LABELED WITH STABLE ISOTOPES FOR USE IN THE FIELDS OF SCIENCE, PHOTOGRAPHY, AGRICULTURE, HORTICULTURE, FORESTRY, AND MEDICAL RESEARCH (U.S. CLS. 1, 5, 6, 10, 26 AND 46).

CLASS 5—PHARMACEUTICALS

FOR CHEMICALS, NAMELY, STABLE ISOTOPES AND BIOMOLECULES LABELED WITH STABLE ISOTOPES, FOR THE USE IN PHARMACEUTICALS AND VETERINARY PREPARATIONS, NAMELY, FOR CLINICAL OR MEDICAL LABORATORY DIAGNOSTIC USE IN THE FIELD OF NUCLEAR MAGNETIC RESONANCE, MASS SPECTROSCOPY, AND MAGNETIC RESONANCE IMAGING (U.S. CLS. 6, 18, 44, 46, 51 AND 52).

CLASS 42—SCIENTIFIC, COMPUTER AND LEGAL SERVICES

FOR SCIENTIFIC AND INDUSTRIAL RESEARCH SERVICES IN THE FIELD OF ISOTOPE LABELING; MEDICAL RESEARCH AND MEDICAL TESTING IN THE FIELD OF DIAGNOSTICS (U.S. CLS. 100 AND 101).

SN 78-035,366. L.F.M. GALLERY LTD., DBA LANGUAGE, NEW YORK, NY. FILED 11-15-2000.

LANGUAGE

CLASS 25—CLOTHING

FOR CLOTHING, NAMELY SWEATERS, TOPS, V-NECK SWEATERS, PULLOVERS, FROCKS, TURTLENECKS, AND MOCK TURTLENECKS (U.S. CLS. 22 AND 39).

FIRST USE 6-30-1999; IN COMMERCE 6-30-1999.

CLASS 35—ADVERTISING AND BUSINESS

FOR RETAIL STORE SERVICES AND COMPUTERIZED ONLINE RETAIL SERVICES FEATURING HIGH FASHION CLOTHING ARTICLES AND ACCESSORIES, INCLUDING EYEWEAR, HATS, GLOVES, SCARVES, SHOES, COATS, DRESSES, JACKETS, DENIM ITEMS, PANTS, T-SHIRTS, BLOUSES, SKIRTS, JEWELRY, HANDBAGS, CLOCKS, WRIST WATCHES, PRE-RECORDED COMPACT DISCS, PERSONAL CARE PRODUCTS, HOUSEHOLD PRODUCTS FOR DINING, BED AND BATH, BATH OIL, BUBBLE BATH, SHAMPOO, BATH SALTS, TOILET WATER, COLOGNE, SUNSCREENS, LIP BALM, SHAVING CREAM, HAIR CONDITIONER, SHOWER GEL, MOISTURIZING BODY LOTION, AFTER SHAVE, AFTER SHAVE MOISTURIZING LOTION, SOAP, POTPOURRI AND SUNSCREEN, HOUSEWARES, GLASSWARE, TABLEWARE, FLATWARE, INDOOR AND OUTDOOR FURNITURE AND FURNITURE ACCESSORIES, CANDLES, CANDLE HOLDERS, PICTURE FRAMES, MIRRORS, VASES, BASKETS MADE OF WICKER, FABRIC, OVENWARE, KITCHENWARE, DISHES, DISH SERVICES, BEVERAGE SERVICE MUGS, TILES, PANS, INTERIOR WALL AND FURNITURE PAINT, ART AND DECORATIVE ART, PRINTED MATERIALS, NAMELY BOOKS, MAGAZINES, AND NEWSLETTERS, PERSONAL DIGITAL ASSISTANTS, PET PRODUCTS AND CALCULATORS (U.S. CLS. 100, 101 AND 102).

FIRST USE 4-4-1998; IN COMMERCE 4-4-1998.

SN 78-035,774. MATTEL, INC., EL SEGUNDO, CA. FILED 11-17-2000.

STAR TALK

NO CLAIM IS MADE TO THE EXCLUSIVE RIGHT TO USE "STAR", APART FROM THE MARK AS SHOWN.

CLASS 38—COMMUNICATION

FOR PROVIDING ON-LINE CHAT ROOMS AND MESSAGES BOARDS FOR TRANSMISSION OF MESSAGES AMONG COMPUTER USERS, INCLUDING CHILDREN AND ADULTS, CONCERNING QUESTIONS POSED TO CELEBRITY GUEST (U.S. CLS. 100, 101 AND 104).

CLASS 41—EDUCATION AND ENTERTAINMENT

FOR ENTERTAINMENT SERVICES, NAMELY, PROVIDING ON-LINE COMPUTER GAMES AND ACTIVITIES FOR CHILDREN AND ADULTS (U.S. CLS. 100, 101 AND 107).

SN 78-037,411. AGERE SYSTEMS INC., ALLENTOWN, PA. FILED 12-1-2000.

systems
agere

NO CLAIM IS MADE TO THE EXCLUSIVE RIGHT TO USE "SYSTEMS", APART FROM THE MARK AS SHOWN.

SN 78-037,397. AGERE SYSTEMS INC., ALLENTOWN, PA. FILED 12-1-2000.

AGERE

CLASS 9—ELECTRICAL AND SCIENTIFIC APPARATUS

FOR LASERS NOT FOR MEDICAL USE; INTEGRATED CIRCUITS; COMMUNICATION AND COMPUTER HARDWARE, NAMELY, NETWORK AND SIGNAL PROCESSORS, OPTICAL SWITCHES, ELECTRONIC SWITCHES, TRANSPONDERS, OPTICAL RECEIVERS, DECODERS, DATA BUSES, PROCESSOR BUSES, FABRIC DATA SWITCHES, TRANSMITTERS; COMPUTER HARDWARE FOR INFORMATION STORAGE, NAMELY, DISK DRIVE CONTROLLERS; COMPUTER HARDWARE AND SOFTWARE DEVELOPMENT TOOLS; DIGITAL SIGNAL PROCESSORS; READ CHANNELS; PREAMPLIFIERS; MOTOR CONTROLLERS; PC CARD RADIOS; COMPUTER NETWORK ADAPTERS; ELECTRONIC COMMUNICATIONS NETWORKING COMPONENTS, NAMELY, FRAMERS; COMPUTER SWITCHES; NETWORK COMMUNICATION DRIVERS; NETWORK PROCESSORS; SEMICONDUCTORS; ROUTERS; COMPUTER SOFTWARE FOR USE IN THE MANAGEMENT OF WIRELESS COMMUNICATION SYSTEMS; MULTIPLEXERS; COMMUNICATIONS EQUIPMENT, NAMELY, MODEMS, ANTENNAS, SIGNAL CONVERTERS, MAPPERS FOR BROADBAND TRANSMISSION OF DATA, ACCESS POINTS, PCI ADAPTERS, BASE STATIONS AND CODERS; DECODERS; WIRELESS ACCESS TRANSMITTERS; MODULATORS FOR MULTIPLEXING AND DATA COMMUNICATIONS; AMPLIFIERS; RECEIVERS; TRANSCEIVERS; LOCAL AREA NETWORKS; COMPUTER SOFTWARE DRIVERS NAMELY, NETWORK COMMUNICATION DRIVERS; COMPUTER HARDWARE DRIVERS; REGENERATORS; BASE TRANSCEIVER STATIONS; MAPPERS FOR BROADBAND TRANSMISSION OF DATA; SATELLITE DIGITAL RADIO TRANSCEIVER AND SATELLITE DIGITAL RADIO RECEIVER (U.S. CLS. 21, 23, 26, 36 AND 38).

CLASS 37—CONSTRUCTION AND REPAIR

FOR INSTALLATION, MAINTENANCE, AND REPAIR OF COMPUTER HARDWARE, FIBER OPTICS, COMPUTER NETWORKS, AND OPTOELECTRONICS (U.S. CLS. 100, 103 AND 106).

CLASS 42—SCIENTIFIC, COMPUTER AND LEGAL SERVICES

FOR INSTALLATION, MAINTENANCE, AND REPAIR OF COMPUTER SOFTWARE (U.S. CLS. 100 AND 101).

CLASS 9—ELECTRICAL AND SCIENTIFIC APPARATUS

FOR LASERS NOT FOR MEDICAL USE; INTEGRATED CIRCUITS; COMMUNICATION AND COMPUTER HARDWARE, NAMELY, NETWORK AND SIGNAL PROCESSORS, OPTICAL SWITCHES, ELECTRONIC SWITCHES, TRANSPONDERS, OPTICAL RECEIVERS, DECODERS, DATA BUSES, PROCESSOR BUSES, FABRIC DATA SWITCHES, TRANSMITTERS; COMPUTER HARDWARE FOR INFORMATION STORAGE, NAMELY, DISK DRIVE CONTROLLERS; COMPUTER HARDWARE AND SOFTWARE DEVELOPMENT TOOLS; DIGITAL SIGNAL PROCESSORS; READ CHANNELS; PREAMPLIFIERS; MOTOR CONTROLLERS; PC CARD RADIOS; COMPUTER NETWORK ADAPTERS; ELECTRONIC COMMUNICATIONS NETWORKING COMPONENTS, NAMELY, FRAMERS; COMPUTER SWITCHES; NETWORK COMMUNICATION DRIVERS; NETWORK PROCESSORS; SEMICONDUCTORS; ROUTERS; COMPUTER SOFTWARE FOR USE IN THE MANAGEMENT OF WIRELESS COMMUNICATION SYSTEMS; MULTIPLEXERS; COMMUNICATIONS EQUIPMENT, NAMELY, MODEMS, ANTENNAS, SIGNAL CONVERTERS, MAPPERS FOR BROADBAND TRANSMISSION OF DATA, ACCESS POINTS, PCI ADAPTERS, BASE STATIONS AND CODERS; DECODERS; WIRELESS ACCESS TRANSMITTERS; MODULATORS FOR MULTIPLEXING AND DATA COMMUNICATIONS; AMPLIFIERS; RECEIVERS; TRANSCEIVERS; LOCAL AREA NETWORKS; COMPUTER SOFTWARE DRIVERS NAMELY, NETWORK COMMUNICATION DRIVERS; COMPUTER HARDWARE DRIVERS; REGENERATORS; BASE TRANSCEIVER STATIONS; MAPPERS FOR BROADBAND TRANSMISSION OF DATA; SATELLITE DIGITAL RADIO TRANSCEIVER AND SATELLITE DIGITAL RADIO RECEIVER (U.S. CLS. 21, 23, 26, 36 AND 38).

CLASS 37—CONSTRUCTION AND REPAIR

FOR INSTALLATION, MAINTENANCE, AND REPAIR OF COMPUTER HARDWARE, FIBER OPTICS, COMPUTER NETWORKS, AND OPTOELECTRONICS (U.S. CLS. 100, 103 AND 106).

CLASS 42—SCIENTIFIC, COMPUTER AND LEGAL SERVICES

FOR INSTALLATION, MAINTENANCE, AND REPAIR OF COMPUTER SOFTWARE (U.S. CLS. 100 AND 101).

SN 78-037,730. RHO, INC., CHAPEL HILL, NC. FILED 12-4-2000.

RESULTS, RIGHT, ON TIME.

CLASS 35—ADVERTISING AND BUSINESS

FOR COMPUTERIZED ADMINISTRATION SERVICES ENCOMPASSING THE RANDOMIZATION OF CLINICAL DRUG TRIAL PARTICIPANTS (U.S. CLS. 100, 101 AND 102).

FIRST USE 3-1-2000; IN COMMERCE 3-1-2000.

CLASS 42—SCIENTIFIC, COMPUTER AND LEGAL SERVICES

FOR CONSULTATION SERVICES FOR THE PHARMACEUTICAL RESEARCH INDUSTRY IN THE FIELD OF BIOSTATISTICS PROVIDED BY NON-ELECTRONIC MEANS AND BY MEANS OF A GLOBAL COMPUTER NETWORK; CONSULTATION SERVICES FOR THE PHARMACEUTICAL RESEARCH INDUSTRY IN THE FIELD OF PHARMACEUTICAL RESEARCH AND PRODUCT REGULATORY APPROVAL PROVIDED BY NON-ELECTRONIC MEANS AND BY MEANS OF A GLOBAL COMPUTER NETWORK; CONSULTATION SERVICES FOR THE PHARMACEUTICAL RESEARCH INDUSTRY IN THE FIELD OF HEALTH CARE PROVIDED BY NON-ELECTRONIC MEANS AND BY MEANS OF A GLOBAL COMPUTER NETWORK; THE COLLECTION, ANALYSIS, AND REPORTING OF MEDICAL CLINICAL TRIAL DATA BY NON-ELECTRONIC MEANS AND BY MEANS OF A GLOBAL COMPUTER NETWORK (U.S. CLS. 100 AND 101).

FIRST USE 3-1-2000; IN COMMERCE 3-1-2000.

SN 78-041,016. BARCLAYS BANK PLC, LONDON, UNITED KINGDOM, FILED 12-29-2000.



NO CLAIM IS MADE TO THE EXCLUSIVE RIGHT TO USE "PRE-PAY", APART FROM THE MARK AS SHOWN.

CLASS 9—ELECTRICAL AND SCIENTIFIC APPARATUS

FOR APPARATUS FOR PROCESSING CARD TRANSACTIONS AND DATA RELATING THERETO AND FOR PAYMENT PROCESSING, NAMELY, MAGNETICALLY ENCODED CREDIT CARDS, MAGNETICALLY ENCODED DEBIT CARDS, MAGNETICALLY ENCODED CHARGE CARDS, MAGNETICALLY ENCODED CHECK CARDS; ENCODED SMART CARDS CONTAINING PROGRAMMING USED TO ENABLE THE CARD HOLDER TO MAKE A PAYMENT TO ANOTHER PARTY AT THE POINT OF SALE, IN THE FIELD OF BANKING SERVICES; APPARATUS FOR READING AND VERIFYING DATA ON SMART CARDS AND MAGNETICALLY ENCODED CREDIT, DEBIT, CHARGE AND CHECK CARDS, NAMELY, AUTOMATIC TELLER MACHINES, POINT OF SALE COMPUTER TERMINALS AND UNATTENDED COMPUTERIZED KIOSKS USED FOR ELECTRONIC COMMERCE AND BANKING TRANSACTIONS; PRE-RECORDED MAGNETIC DATA CARRIERS FEATURING ACCOUNT IDENTIFICATION NUMBERS AND EXPIRATION DATE INFORMATION; COMPUTER SOFTWARE AND PROGRAMS FOR USE IN DATABASE MANAGEMENT IN THE FIELD OF BANKING SERVICES; COMPUTER HARDWARE; TELECOMMUNICATION APPARATUS, NAMELY, MODEMS AND COMPUTER SERVERS (U.S. CLS. 21, 23, 26, 36 AND 38).

CLASS 36—INSURANCE AND FINANCIAL

FOR BANKING SERVICES; ELECTRONIC DEBIT TRANSACTION SERVICES, NAMELY, ELECTRONIC TRANSACTIONS AND DEBIT ACCOUNT SERVICES FEATURING A DEBIT CARD, MAGNETICALLY ENCODED OR A SMART CARD; CREDIT CARD, DEBIT CARD AND CHARGE CARD SERVICES; CREDIT CARD, DEBIT CARD AND CHARGE CARD TRANSACTIONS PROCESSING SERVICES; TRANSMISSION OF TRANSACTION DATA, NAMELY, SENDING AND RECEIVING FINANCIAL TRANSACTION DATA FROM THE POINT OF SALE TO THE CENTRAL PROCESSING SYSTEM AND VERIFYING THE SENDING OF THIS DATA; FINANCIAL TRANSACTION PROCESSING SERVICES, NAMELY ELECTRONIC PROCESSING OF CASH TRANSACTION DATA (U.S. CLS. 100, 101 AND 102).

SN 78-043,421. A NEW ALLIANCE FOR CHANGE, LLC., COLORADO SPRINGS, CO. FILED 1-16-2001.

A NEW ALLIANCE**CLASS 41—EDUCATION AND ENTERTAINMENT**

FOR EDUCATIONAL SERVICES, NAMELY CONDUCTING WORKSHOPS IN THE FIELDS OF PERSONAL AND SPIRITUAL GROWTH (U.S. CLS. 100, 101 AND 107).

CLASS 42—SCIENTIFIC, COMPUTER AND LEGAL SERVICES

FOR PSYCHOLOGICAL COUNSELING, NAMELY OFFERING ADVICE REGARDING PERSONAL AND SPIRITUAL GROWTH; HYPNOTHERAPY SERVICES (U.S. CLS. 100 AND 101).

SN 78-044,019. AT&T CORP., NEW YORK, NY. FILED 1-19-2001.

**AT&T SOLUTIONS.
INNOVATIVE NETWORKS.
INNOVATIVE THINKING.**

OWNER OF U.S. REG. NO. 2,079,731.

CLASS 35—ADVERTISING AND BUSINESS

FOR BUSINESS CONSULTATION IN THE FIELD OF BUSINESS OPERATIONS; MANAGEMENT OF TELECOMMUNICATIONS NETWORKS (U.S. CLS. 100, 101 AND 102).

CLASS 37—CONSTRUCTION AND REPAIR

FOR CONSTRUCTION OF TELECOMMUNICATIONS TOWERS; MAINTENANCE OF TELECOMMUNICATIONS NETWORKS (U.S. CLS. 100, 103 AND 106).

CLASS 38—COMMUNICATION

FOR TELECOMMUNICATIONS NETWORK OPERATIONS SERVICES, NAMELY PROVIDING ISDN SERVICES, ASYNCHRONOUS TRANSFER MODE (ATM) SERVICES, TELECOMMUNICATIONS CONNECTIONS TO A GLOBAL COMPUTER NETWORK, PERSONAL COMMUNICATION SERVICES, LOCAL AND LONG DISTANCE TRANSMISSION OF VOICE, DATA, GRAPHICS BY MEANS OF TELEPHONE, TELEGRAPHIC, CABLE, AND SATELLITE TRANSMISSIONS SERVICES (U.S. CLS. 100, 101 AND 104).

CLASS 42—SCIENTIFIC, COMPUTER AND LEGAL SERVICES

FOR TELECOMMUNICATIONS CONSULTATION RELATING TO TELECOMMUNICATIONS NETWORKS; DESIGN OF TELECOMMUNICATIONS NETWORKS (U.S. CLS. 100 AND 101).

SN 78-044,783. SIF H.F., 220 HAFNARFJOROUR, ICELAND, FILED 1-24-2001.



NO CLAIM IS MADE TO THE EXCLUSIVE RIGHT TO USE "GROUP", APART FROM THE MARK AS SHOWN.

CLASS 16—PAPER GOODS AND PRINTED MATTER

FOR PACKAGING MATERIAL, NAMELY, PAPER FOR WRAPPING AND PACKAGING; CARDBOARD AND GOODS MADE FROM THESE MATERIALS, NAMELY, CARDBOARD BOXES, CARDBOARD CARTONS, CARDBOARD CONTAINERS; PRINTED MATTER, NAMELY, INTRODUCTION MATERIAL, NEWSLETTERS, MAGAZINES, ALL IN THE FIELD OF THE FISHING INDUSTRY; PHOTOGRAPHS; STATIONERY; PRINTED INSTRUCTIONAL AND TEACHING MATERIAL IN THE FIELD OF THE FISHING INDUSTRY; PLASTIC MATERIAL FOR PACKAGING, NAMELY, PLASTIC BAGS, PLASTIC BUBBLE PACKS FOR WRAPPING; PLAYING CARDS (U.S. CLS. 2, 5, 22, 23, 29, 37, 38 AND 50).

CLASS 29—MEATS AND PROCESSED FOODS

FOR MEAT, FISH, POULTRY AND GAME; MEAT EXTRACTS; PRESERVED, DRIED AND COOKED FRUITS AND VEGETABLES; JELLIES, JAMS, FRUIT SAUCES; EGGS, MILK AND MILK PRODUCTS EXCLUDING ICE CREAM, ICE MILK AND FROZEN YOGURT; EDIBLE OILS AND FATS (U.S. CL. 46).

CLASS 35—ADVERTISING AND BUSINESS

FOR ADVERTISING AGENCIES; BUSINESS MANAGEMENT; BUSINESS ADMINISTRATION, NAMELY, BUSINESS SUPERVISION; OFFICE FUNCTIONS, NAMELY, SECRETARIAL SERVICES; MARKETING, NAMELY, BUSINESS MARKETING CONSULTING SERVICES; RETAIL STORE SERVICES, ONLINE RETAIL STORE SERVICES, WHOLESALE DISTRIBUTORSHIPS AND ONLINE WHOLESALE DISTRIBUTORSHIPS, ALL FEATURING FISH PRODUCTS (U.S. CLS. 100, 101 AND 102).

CLASS 39—TRANSPORTATION AND STORAGE

FOR TRANSPORT, NAMELY, TRANSPORT OF GOODS BY AIR, BOAT, GROUND AND RAIL; PACKAGING, NAMELY, PACKAGING ARTICLES FOR TRANSPORTATION AND WAREHOUSE STORAGE OF GOODS; TRAVEL ARRANGEMENT, NAMELY, MAKING RESERVATIONS AND BOOKINGS FOR TRANSPORTATION (U.S. CLS. 100 AND 105).

SN 78-045,622. WIDEVINE TECHNOLOGIES, INC., SEATTLE, WA. FILED 1-30-2001.

MENSOR**CLASS 9—ELECTRICAL AND SCIENTIFIC APPARATUS**

FOR WEB SEARCH ENGINE SOFTWARE FOR MEDIA CONTENT INFRINGEMENTS; ENCRYPTION SOFTWARE FOR PROVIDING SECURED WEB DISTRIBUTION OF MEDIA CONTENT AND INFORMATION FOR MEDIA CONTENT PROVIDERS RETAILERS AND OTHER BUSINESSES (U.S. CLS. 21, 23, 26, 36 AND 38).

CLASS 42—SCIENTIFIC, COMPUTER AND LEGAL SERVICES

FOR SOFTWARE INSTALLATION, DESIGN AND MAINTENANCE FOR SOFTWARE IN THE FIELDS OF ENCRYPTION OF MEDIA CONTENT, COMPUTER SEARCH ENGINE SOFTWARE FOR WEB MEDIA CONTENT INFRINGEMENTS AND EFFICIENT WEB DISTRIBUTION OF INFORMATION, ALL FOR MEDIA CONTENT PROVIDERS, RETAILERS AND OTHER BUSINESSES (U.S. CLS. 100 AND 101).

SN 78-046,096. CARTECHINI, GIANLUCA, CIVITANOVA, ITALY, FILED 2-1-2001.

OBELINE

PRIORITY CLAIMED UNDER SEC. 44(D) ON ITALY APPLICATION NO. ITRN2000C000, FILED 8-2-2000, REG. NO. ITRN2000C000, DATED 8-2-2000, EXPIRES 8-2-2010.

CLASS 18—LEATHER GOODS

FOR BAGS, NAMELY, HANDBAGS, PURSES, WALLETS, SUITCASES, LUGGAGE TRUNKS, COSMETIC CASES SOLE EMPTY, DOCUMENT-CASES, UMBRELLAS, HANDSACKS (U.S. CLS. 1, 2, 3, 22 AND 41).

CLASS 25—CLOTHING

FOR DRESSES, SKIRTS, TROUSERS, SHIRTS, JACKETS, OVERCOATS, HATS, SCARVES, FOULARDS OR NECKERCHIEVES, STOCKINGS, GLOVES, CLOTHING BELTS, NECKTIES, SWIMSUITS, SWIMMING TRUNKS, BEACH DRESSES, BEACH ROBE, TRACKSUITS; VESTS, BRASSIERES, PANTS, SUSPENDER BELT, UNDERWEAR, DRESSING GOWNS, NIGHTDRESSES, PYJAMAS; SHOES, BOOTS, SANDALS, CLOGS, SLIPPERS, TENNIS SHOES (U.S. CLS. 22 AND 39).

SN 78-046,381. EASTLAND FORRESTER CORPORATION, TORRANCE, CA. FILED 2-2-2001.

VERSA STAGE

NO CLAIM IS MADE TO THE EXCLUSIVE RIGHT TO USE "STAGE", APART FROM THE MARK AS SHOWN.

CLASS 6—METAL GOODS

FOR METAL STAGING MATERIALS FOR ENTERTAINMENT PRODUCTIONS, NAMELY GRIDS, ROOFING GRIDS, AND PROPS CONSISTING OF INTERCONNECTED ALUMINUM AND STEEL BEAMS, SETS IN THE NATURE OF ALUMINUM AND STEEL STAGING DECKS, TURN TABLE SURROUNDS AND STAGE SUPPORTS, AND CROWD CONTROL BARRICADES (U.S. CLS. 2, 12, 13, 14, 23, 25 AND 50).

FIRST USE 9-1-1991; IN COMMERCE 9-1-1991.

CLASS 19—NON-METALLIC BUILDING MATERIALS

FOR NON-METAL STAGING MATERIALS FOR ENTERTAINMENT PRODUCTIONS, NAMELY GRIDS AND PROPS CONSISTING OF INTERCONNECTED WOOD BEAMS AND WOOD PLANKS, SETS CONSISTING OF WOODEN STAGING DECKS, TURN TABLE SURROUNDS AND STAGE SUPPORTS (U.S. CLS. 1, 12, 33 AND 50).

FIRST USE 9-1-1991; IN COMMERCE 9-1-1991.

SN 78-046,850. CINGULAR WIRELESS LLC, ATLANTA, GA. FILED 2-6-2001.

MI VENTANA AL MUNDO

THE ENGLISH TRANSLATION OF THE FOREIGN WORDING IN THE MARK IS MY WINDOW TO THE WORLD.

CLASS 9—ELECTRICAL AND SCIENTIFIC APPARATUS

FOR TELEPHONES, TELEPHONE ACCESSORIES, AND EQUIPMENT, NAMELY - WIRELESS TELEPHONES, BATTERIES; CHARGERS; TELEPHONE CARRYING CASES, HANDS-FREE DEVICES, AND CARRYING CLIPS FOR WIRELESS TELEPHONES SOLD AS A UNIT IN COMBINATION WITH WIRELESS TELEPHONES; MICROPHONES; AUDIO RECEIVERS; SPEAKERS; TRANSCEIVERS; COMMUNICATIONS DEVICES IN THE NATURE OF WIRELESS APPLICATION PROTOCOL (WAP), RECEIVERS AND TRANSMITTERS; DATA TRANSCEIVERS; TELECOMMUNICATIONS TRANSMISSION EQUIPMENT, COMPONENTS, SWITCHING, AND NETWORK SYSTEMS COMPRISED OF - RADIO TRANSMITTERS AND RECEIVERS; ANTENNAS; SWITCHES; SIGNAL TRANSFER POINT SERVERS; SIGNAL CONTROL POINT SERVERS; SERVICE RESOURCE PLATFORM SERVERS; CALL ROUTING SERVERS AND SOFTWARE FOR THE FOREGOING; COMPUTERS AND COMPUTER SOFTWARE FOR THE ACTIVATION AND OPERATION OF WIRELESS TELECOMMUNICATIONS SERVICES; MACHINE READABLE MAGNETICALLY ENCODED CALLING CARDS, CALLER IDENTIFICATION CARDS, DEBIT AND CREDIT CARDS; PAGERS; CALLER IDENTIFICATION EQUIPMENT; WIRELESS HANDHELD COMMUNICATION DEVICES TO TRANSMIT, RECEIVE, OR OTHERWISE ACCESS COMMUNICATIONS NETWORKS; AND ELECTRONIC EQUIPMENT FOR ENTERTAINMENT NAMELY - COMPUTER GAME PROGRAMS AND COMPUTER GAME DEVICES (U.S. CLS. 21, 23, 26, 36 AND 38).

CLASS 38—COMMUNICATION

FOR TELECOMMUNICATIONS SERVICES; NAMELY THE TRANSMISSION OF VOICE, DATA, IMAGES, AUDIO, VIDEO, AND INFORMATION VIA TELEPHONE; SATELLITE, AND GLOBAL COMPUTER NETWORKS; PERSONAL COMMUNICATIONS SERVICES; PAGING SERVICES; WIRELESS ROAMING SERVICES; LEASING TELECOMMUNICATIONS EQUIPMENT, COMPONENTS, SYSTEMS AND SUPPLIES; ELECTRONIC MAIL SERVICES; VOICE MESSAGING SERVICES; PROVIDING MULTIPLE-USER ACCESS TO GLOBAL COMPUTER NETWORKS TO TRANSMIT, RECEIVE AND OTHERWISE ACCESS AND USE INFORMATION OF GENERAL INTEREST TO CONSUMERS; PROVIDING ONLINE ELECTRONIC BULLETIN BOARDS FOR TRANSMISSION OF MESSAGES AMONG COMPUTER USERS CONCERNING VARIOUS TOPICS; VIDEO CONFERENCING SERVICES; TELEVISION BROADCASTING AND NARROW-CASTING SERVICES (U.S. CLS. 100, 101 AND 104).

CLASS 42—SCIENTIFIC, COMPUTER AND LEGAL SERVICES

FOR COMPUTER SERVICES, NAMELY, PROVIDING NEWS AND INFORMATION IN A WIDE VARIETY OF FIELDS VIA TELEPHONE, SATELLITE, AND GLOBAL COMPUTER NETWORKS (U.S. CLS. 100 AND 101).

SN 78-050,501. WORKING ASSETS FUNDING SERVICE, INC., SAN FRANCISCO, CA. FILED 2-27-2001.

WHERE EVERY PURCHASE MAKES A DIFFERENCE

CLASS 35—ADVERTISING AND BUSINESS

FOR PROMOTING THE GOODS AND SERVICES OF OTHERS BY OPERATING A WEB SITE WITH LINKS TO THE RETAIL WEB SITES OF OTHERS; PROVIDING AN ON-LINE BUSINESS DIRECTORY FEATURING ON-LINE MERCHANTS; PROVIDING AN ON-LINE COMPUTER DATABASE FEATURING INFORMATION REGARDING SELECT ON-LINE MERCHANTS; PROVIDING AN ON-LINE DATABASE FEATURING BUSINESS INFORMATION IN THE FIELDS OF NON-PROFIT AND POLITICAL ORGANIZATIONS (U.S. CLS. 100, 101 AND 102).

FIRST USE 6-1-2000; IN COMMERCE 6-1-2000.

CLASS 36—INSURANCE AND FINANCIAL

FOR PHILANTHROPIC, CHARITABLE AND ELEMOSYNARY SERVICES IN THE FIELD OF MONETARY DONATIONS, NAMELY, PROVIDING MONETARY DONATION PROCESSING SERVICES FOR NON-PROFIT ORGANIZATIONS VIA A GLOBAL COMPUTER NETWORK, AND DONATING A PERCENTAGE OF CUSTOMERS' PURCHASE PRICE TO NON-PROFIT GROUPS; PROVIDING AN ON-LINE COMPUTER DATABASE FEATURING INFORMATION IN THE FIELD OF CHARITABLE DONATIONS (U.S. CLS. 100, 101 AND 102).

FIRST USE 6-1-2000; IN COMMERCE 6-1-2000.

SN 78-050,726. SOFTWARE CONSERVANCY, INC., BRISBANE, CA. FILED 2-28-2001.

SOFTWARE CONSERVANCY

NO CLAIM IS MADE TO THE EXCLUSIVE RIGHT TO USE "SOFTWARE", APART FROM THE MARK AS SHOWN.

CLASS 39—TRANSPORTATION AND STORAGE

FOR REPOSITORY SERVICES, NAMELY STORAGE OF COMPUTER SOFTWARE (U.S. CLS. 100 AND 105).

CLASS 42—SCIENTIFIC, COMPUTER AND LEGAL SERVICES

FOR COMPUTER SOFTWARE TECHNICAL CONSULTATION AND RESEARCH IN THE NATURE OF PERFORMING DUE DILIGENCE SERVICES TO VERIFY SOFTWARE TITLE OWNERSHIP AND DEFENDING TITLE IN COMPUTER SOFTWARE; COMPUTER SOFTWARE DEVELOPMENT SERVICES VIA A GLOBAL COMPUTER NETWORK (U.S. CLS. 100 AND 101).

SN 78-051,963. JERRY KENNEDY, WESTMINSTER, CA. AND KENNEDY, VENDA, WESTMINSTER, CA. FILED 3-8-2001.

PEN ROLLERS**CLASS 16—PAPER GOODS AND PRINTED MATTER**

FOR CHILDREN'S BOOKS, COMIC BOOKS, COMIC STRIPS, TRADING CARDS (U.S. CLS. 2, 5, 22, 23, 29, 37, 38 AND 50).

CLASS 28—TOYS AND SPORTING GOODS

FOR DOLLS (U.S. CLS. 22, 23, 38 AND 50).

SN 78-053,614. CIDRA CORPORATION, WALLINGFORD, CT. FILED 3-16-2001.

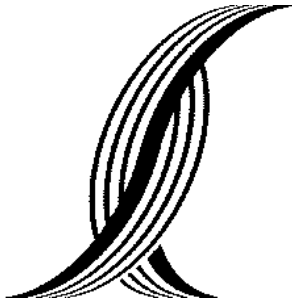
**CLASS 9—ELECTRICAL AND SCIENTIFIC APPARATUS**

FOR OPTICAL COMMUNICATION, TELECOMMUNICATION, AND PHOTONIC COMPONENTS AND SUBSYSTEMS, NAMELY, MODULES, LASERS, OPTICAL WAVEGUIDES, OPTICAL FILTERS, MODULATORS, AND OPTICAL NETWORK ROUTERS AND SWITCHES, FOR USE IN OPTICAL, AGILE, DYNAMIC, RECONFIGURABLE, AND INTELLIGENT NETWORKS; PHOTONIC COMPONENTS, MODULES AND SUBSYSTEMS FOR WAVELENGTH SIGNAL ROUTING, MONITORING AND CONDITIONING, NAMELY, LASERS, LIGHT WAVEGUIDES, LIGHT FILTERS AND MODULATORS, ELECTRO-OPTICAL WAVEGUIDES, FIBEROPTIC LIGHT SWITCHES AND FIBEROPTIC LIGHT AMPLIFIERS; PHOTONIC COMPONENTS AND SUBSYSTEMS FOR WAVELENGTH MANAGEMENT AND CONTROL IN WAVELENGTH DIVISION MULTIPLEXED (WDM) AND DENSE WAVELENGTH DIVISION MULTIPLEXED (DWDM) OPTICAL NETWORKS, NAMELY, MODULES, ELECTRONIC CIRCUITS AND COMPUTER SOFTWARE FOR THE PURPOSE OF WAVELENGTH MANAGE-

MENT AND CONTROL; PROGRAMMABLE OPTICAL NETWORK ROUTERS, SWITCHES AND BRANCHING SWITCHES FOR REMOTELY TUNING OR SETTING WAVELENGTHS IN OPTICAL, AGILE, DYNAMIC, RECONFIGURABLE, AND INTELLIGENT NETWORKS; PROGRAMMABLE TUNABLE GRATING MODULES FOR WAVELENGTH CHANNEL SWITCHING AND ROUTING; WDM AND DWDM OPTICAL CHANNEL FILTERS; TUNABLE OPTICAL CHANNEL FILTERS; DYNAMIC WAVELENGTH CHANNEL SWITCHES AND ROUTERS; DIFFRACTION GRATINGS; BRAGG GRATINGS; TUNABLE BRAGG GRATINGS; TUNABLE GRATING MODULES; GRATING-BASED MODULES FOR WAVELENGTH CHANNEL SWITCHING AND ROUTING; GRATING-BASED MODULES FOR WDM AND DWDM CHANNEL FILTERING; GRATING-BASED MODULES FOR WAVELENGTH REFERENCING; ATHERMAL GRATINGS; TUNABLE ATHERMAL GRATINGS; PASSIVE ATHERMAL GRATINGS; ATHERMAL CHANNEL OPTICAL FILTERS; TUNABLE WDM AND DWDM OPTICAL CHANNEL FILTERS; GRATING-BASED SENSOR NETWORKS; GRATING-BASED SENSORS; FIBER OPTIC SENSORS; FIBEROPTIC LIGHT AMPLIFIERS; DEVICES FOR MONITORING OPTICAL WAVELENGTHS; DEVICES FOR MONITORING OPTICAL SIGNALS; DEVICES FOR MONITORING AND TESTING OPTICAL NETWORKS; OPTICAL CHANNEL ANALYZERS; LASERS THAT ARE TUNABLE TO DIFFERENT OPTICAL WAVELENGTHS; PUMP LASERS AND PUMP LASER STABILIZERS NOT FOR MEDICAL USE; FIBER OPTIC SOURCES; OPTICAL SOURCES; RECONFIGURABLE ADD/DROP ROUTERS; ADD/DROP MULTIPLEXERS; MULTI-CHANNEL ADD/DROP MULTIPLEXERS; RECONFIGURABLE ADD/DROP MULTIPLEXERS; WDM AND DWDM MULTIPLEXERS; MULTIPLEXERS; DEMULTIPLEXERS; CROSS CONNECTS; OPTICAL CONNECTORS; OPTICAL COUPLERS; OPTICAL SWITCHES; OPTICAL TRANSMITTERS; OPTICAL RECEIVERS; OPTICAL NETWORK ROUTERS; OPTICAL AMPLIFIERS; DYNAMIC-DISPERSION COMPENSATORS; DYNAMIC GAIN EQUALIZATION OPTICAL FILTERS; OPTICAL FILTERS; WAVELENGTH CONVERTERS; INTERLEAVERS; FIXED GAIN EQUALIZING OPTICAL FILTERS; COMPUTER PROGRAMS, SOFTWARE AND FIRMWARE FOR USE IN SIGNAL ROUTING, CONTROL, MONITORING AND CONDITIONING; COMPUTER PROGRAMS, SOFTWARE AND FIRMWARE FOR USE IN WAVELENGTH MANAGEMENT AND CONTROL; COMPUTER PROGRAMS, SOFTWARE AND FIRMWARE FOR OPTICAL NETWORK AND ELEMENT MANAGEMENT, INTERFACING AND CONTROL; COMPUTER PROGRAMS, SOFTWARE AND FIRMWARE FOR OPTICAL NETWORK DIAGNOSTICS; COMPUTER PROGRAMS, SOFTWARE AND FIRMWARE FOR MONITORING AND CONTROLLING OPTICAL ELEMENTS IN WAVELENGTH AGILE, DYNAMIC TELECOMMUNICATION, RECONFIGURABLE TELECOMMUNICATION, AND INTELLIGENT NETWORKS; OPTICAL NETWORK ROUTERS AND SWITCHES, LIGHT FILTERS, LASERS, LIGHT WAVEGUIDES, AND MODULATORS, EMPLOYING THE FOREGOING COMPUTER PROGRAMS, SOFTWARE AND FIRMWARE; OIL, GAS AND GEOTHERMAL WELL PRODUCTION, INSTRUMENTATION, EXPLORATION AND MEASUREMENT DEVICES; NAMELY, PUMP MONITORING EQUIPMENT, EARTH FORMATION MONITORING, ANALYSIS EQUIPMENT AND PRODUCTION FLUID MONITORING EQUIPMENT; COMPUTER PROGRAMS FOR USE IN ANALYZING GEOLOGICAL AND GEOPHYSICAL DATA; NAMELY, COMPUTER PROGRAMS FOR OIL, GAS AND GEOTHERMAL FIELD SURVEYING AND EXPLORATION AND COMPUTER PROGRAMS FOR MONITORING AND ANALYSIS OF DATA COLLECTED DURING DRILLING AND PUMPING OF OIL AND GAS; OPTICAL SENSING EQUIPMENT FOR USE IN OIL, GAS AND GEOTHERMAL WELLS; AND SENSING EQUIPMENT FOR USE IN PETROLEUM REFINING, NAMELY, FOR SENSING PRESSURE, TEMPERATURE, FLOW RATE, COMPOSITION, SPEED OF SOUND, DENSITY, MACH NUMBER, QUALITY, PURITY, STEAM QUALITY, GAS-LIQUID RATIO, SOLID-LIQUID RATIO, FLUID-VAPOR RATIO, PH LEVEL, ACID STRENGTH, ACIDITY, ALKALINITY, CATALYSTS, CATALYST FLOW, CHEMICAL REACTIONS, HEAT CAPACITY, SOLIDS CONTENT, ENTRAINED SOLIDS, SALINITY, PARTICLES, WAX, PARAFFIN, COKE, OIL, WATER, GAS, HYDROCARBONS, HYDROGEN, CARBON, PETROLEUM, DISTILLATION, RESIDUE, OCTANE, UN-

STEADY PRESSURES, VIBRATION, ACOUSTICS, AND HEALTH MONITORING OF SENSORS, VALVES, CHEMICAL PROCESSES, AND PUMPS (U.S. CLS. 21, 23, 26, 36 AND 38).

CLASS 42—SCIENTIFIC, COMPUTER AND LEGAL SERVICES

FOR SERVICES RENDERED IN CONNECTION WITH OIL, GAS, AND GEOTHERMAL WELLS, NAMELY, WELL LOGGING AND SURVEYING; PRODUCTION LOGGING; FORMATION AND LOG ANALYSIS; WELL PUMP MONITORING; SEISMIC SURVEY SERVICES; OIL, GAS AND GEOTHERMAL FIELD EXPLORATION SERVICES; CONSULTING IN THE FIELD OF OIL, GAS AND GEOTHERMAL WELL SENSING EQUIPMENT; COMPUTER PROGRAMMING FOR OTHERS, UPDATING OF COMPUTER SOFTWARE FOR OTHERS, COMPUTER SOFTWARE DESIGN FOR OTHERS, AND COMPUTER SYSTEMS ANALYSIS IN THE FIELD OF OIL, GAS AND GEOTHERMAL WELL INSTRUMENTATION; TECHNICAL CONSULTATION IN THE FIELD OF OIL, GAS AND GEOTHERMAL WELL INSTRUMENTATION; AND DESIGN FOR OTHERS OF OPTICAL SENSING EQUIPMENT FOR USE IN OIL, GAS AND GEOTHERMAL WELLS AND PETROLEUM REFINING; CONSULTING IN THE FIELD OF OPTICAL TELECOMMUNICATION PRODUCTS; COMPUTER PROGRAMMING FOR OTHERS, UPDATING OF COMPUTER SOFTWARE FOR OTHERS, COMPUTER SOFTWARE DESIGN FOR OTHERS, AND COMPUTER SYSTEMS ANALYSIS IN THE FIELD OF OPTICAL TELECOMMUNICATION PRODUCTS; TECHNICAL CONSULTATION IN THE FIELD OF OPTICAL TELECOMMUNICATION PRODUCTS; AND DESIGN FOR OTHERS OF OPTICAL TELECOMMUNICATION PRODUCTS, NAMELY, OPTICAL COMMUNICATION, TELECOMMUNICATION, AND PHOTONIC COMPONENTS AND SUBSYSTEMS, NAMELY, MODULES, LASERS, OPTICAL WAVEGUIDES, OPTICAL FILTERS, MODULATORS, AND OPTICAL NETWORK ROUTERS AND SWITCHES, FOR USE IN OPTICAL, AGILE, DYNAMIC, RECONFIGURABLE, AND INTELLIGENT NETWORKS; PHOTONIC COMPONENTS, MODULES AND SUBSYSTEMS FOR WAVELENGTH SIGNAL ROUTING, MONITORING AND CONDITIONING, NAMELY, LASERS, LIGHT WAVEGUIDES, LIGHT FILTERS AND MODULATORS, ELECTRO-OPTICAL WAVEGUIDES, FIBEROPTIC LIGHT SWITCHES AND FIBEROPTIC LIGHT AMPLIFIERS; PHOTONIC COMPONENTS AND SUBSYSTEMS FOR WAVELENGTH MANAGEMENT AND CONTROL IN WAVELENGTH DIVISION MULTIPLEXED (WDM) AND DENSE WAVELENGTH DIVISION MULTIPLEXED (DWDM) OPTICAL NETWORKS, NAMELY, MODULES, ELECTRONIC CIRCUITS AND COMPUTER SOFTWARE FOR THE PURPOSE OF WAVELENGTH MANAGEMENT AND CONTROL; PROGRAMMABLE OPTICAL NETWORK ROUTERS, SWITCHES AND BRANCHING SWITCHES FOR REMOTELY TUNING OR SETTING WAVELENGTHS IN OPTICAL, AGILE, DYNAMIC, RECONFIGURABLE, AND INTELLIGENT NETWORKS; PROGRAMMABLE TUNABLE GRATING MODULES FOR WAVELENGTH CHANNEL SWITCHING AND ROUTING; WDM AND DWDM OPTICAL CHANNEL FILTERS; TUNABLE OPTICAL CHANNEL FILTERS; DYNAMIC WAVELENGTH CHANNEL SWITCHES AND ROUTERS; DIFFRACTION GRATINGS; BRAGG GRATINGS; TUNABLE BRAGG GRATINGS; TUNABLE GRATING MODULES; GRATING-BASED MODULES FOR WAVELENGTH CHANNEL SWITCHING AND ROUTING; GRATING-BASED MODULES FOR WDM AND DWDM CHANNEL FILTERING; GRATING-BASED MODULES FOR WAVELENGTH REFERENCING; ATHERMAL GRATINGS; TUNABLE ATHERMAL GRATINGS; PASSIVE ATHERMAL GRATINGS; ATHERMAL CHANNEL OPTICAL FILTERS; TUNABLE WDM AND DWDM OPTICAL CHANNEL FILTERS; GRATING-BASED SENSOR NETWORKS; GRATING-BASED SENSORS; FIBER OPTIC SENSORS; FIBEROPTIC LIGHT AMPLIFIERS; DEVICES FOR MONITORING OPTICAL WAVELENGTHS; DEVICES FOR MONITORING OPTICAL SIGNALS; DEVICES FOR MONITORING AND TESTING OPTICAL NETWORKS; OPTICAL CHANNEL ANALYZERS; LASERS THAT ARE TUNABLE TO DIFFERENT OPTICAL WAVELENGTHS; PUMP LASERS AND PUMP LASER STABILIZERS NOT FOR MEDICAL USE; FIBER OPTIC SOURCES; OPTICAL SOURCES; RECONFIGURABLE ADD/DROP ROUTERS; ADD/

DROP MULTIPLEXERS; MULTI-CHANNEL ADD/DROP MULTIPLEXERS; RECONFIGURABLE ADD/DROP MULTIPLEXERS; WDM AND DWDM MULTIPLEXERS; MULTIPLEXERS; DEMULTIPLEXERS; CROSS CONNECTS; OPTICAL CONNECTORS; OPTICAL COUPLERS; OPTICAL SWITCHES; OPTICAL TRANSMITTERS; OPTICAL RECEIVERS; OPTICAL NETWORK ROUTERS; OPTICAL AMPLIFIERS; DYNAMIC-DISPERSION COMPENSATORS; DYNAMIC GAIN EQUALIZATION OPTICAL FILTERS; OPTICAL FILTERS; WAVELENGTH CONVERTERS; INTERLEAVERS; FIXED GAIN EQUALIZING OPTICAL FILTERS; COMPUTER PROGRAMS, SOFTWARE AND FIRMWARE FOR USE IN SIGNAL ROUTING, CONTROL, MONITORING AND CONDITIONING; COMPUTER PROGRAMS, SOFTWARE AND FIRMWARE FOR USE IN WAVELENGTH MANAGEMENT AND CONTROL; COMPUTER PROGRAMS, SOFTWARE AND FIRMWARE FOR OPTICAL NETWORK AND ELEMENT MANAGEMENT, INTERFACING AND CONTROL; COMPUTER PROGRAMS, SOFTWARE AND FIRMWARE FOR OPTICAL NETWORK DIAGNOSTICS; COMPUTER PROGRAMS, SOFTWARE AND FIRMWARE FOR MONITORING AND CONTROLLING OPTICAL ELEMENTS IN WAVELENGTH AGILE, DYNAMIC TELECOMMUNICATION, RECONFIGURABLE TELECOMMUNICATION, AND INTELLIGENT NETWORKS; AND OPTICAL NETWORK ROUTERS AND SWITCHES, LIGHT FILTERS, LASERS, LIGHT WAVEGUIDES, AND MODULATORS, EMPLOYING THE FOREGOING COMPUTER PROGRAMS, SOFTWARE AND FIRMWARE (U.S. CLS. 100 AND 101).

SN 78-055,268. AGILENT TECHNOLOGIES, INC., PALO ALTO, CA. FILED 3-27-2001.



Agilent enabled

OWNER OF U.S. REG. NO. 2,461,406.
NO CLAIM IS MADE TO THE EXCLUSIVE RIGHT TO USE "ENABLED", APART FROM THE MARK AS SHOWN.

CLASS 9—ELECTRICAL AND SCIENTIFIC APPARATUS

FOR LABORATORY APPARATUS, NAMELY, MICRO-ARRAYS COMPRISED OF CHEMICAL COMPONENTS ARRANGED ON A LABORATORY SLIDE FOR USE IN SCIENTIFIC AND MEDICAL RESEARCH; INTEGRATED CIRCUITS, SEMICONDUCTORS, AND PRINTED CIRCUIT BOARDS; COMMUNICATIONS HARDWARE AND COMPONENTS, NAMELY, OPTICAL AND ELECTRONIC AMPLIFIERS, DUPLEXERS, FILTERS, HUBS, MIXERS, MODULATORS, RECEIVERS, SWITCHES, TRANSCEIVERS, AND TRANSMITTERS; WIRELESS TELEPHONE HANDSETS; RADIO FREQUENCY (RF) INTEGRATED CIRCUITS; COMPUTER HARDWARE; COMPUTER IMAGING HARDWARE; IMAGE SENSORS; COMPUTER STORAGE HARDWARE; COMPUTER AND COMMUNICATIONS NETWORKING HARDWARE; OPTICAL NETWORKING HARDWARE; COMPUTER INPUT HARDWARE; COMPUTER SOFTWARE, NAMELY, COMMUNICATIONS AND COMPUTER NETWORK MANAGEMENT AND SECURITY SOFTWARE; COMPUTER MICE AND TRACKBALLS; DIGITAL CAMERAS; INFRARED COMPONENTS, NAMELY, EMITTERS, DETECTORS AND TRANSCEIVER MODULES; ELECTRONIC POSITION SENSORS FOR MOTOR CONTROL APPLICATIONS; STORAGE NETWORKING HARDWARE AND COMPONENTS, NAMELY, FIBRE CHANNEL HOST ADAPTERS; TEST AND MEASUREMENT EQUIPMENT, NAMELY, ELECTRONIC FREQUENCY COUNTERS, ATOMIC CLOCKS, CESIUM CLOCKS, LASER-BASED POSITIONING SYSTEMS AND LASERS NOT FOR MEDICAL USE; CHEMICAL AND BIOLOGICAL ANALYTICAL EQUIPMENT IN THE NATURE OF INSTRUMENTS FOR USE IN THE ANALYSIS AND TESTING OF BIOLOGICAL AND CHEMICAL MATERIALS, NAMELY, CHROMATOGRAPHS, CHROMATOGRAPHY COLUMNS, MASS SPECTROMETERS, SPECTROPHOTOMETERS, CAPILLARY ELECTROPHORESIS SYSTEMS, DNA AND PROTEIN SEQUENCERS, MICROARRAY SCANNERS, HYBRIDIZATION CHAMBERS, AND INSTRUMENTS CONTAINING ELECTRICAL, COMPUTER, AND CHEMICAL HARDWARE FOR THE ANALYSIS OF DNA, RNA, CELLS AND PROTEINS (U.S. CLS. 21, 23, 26, 36 AND 38).

CLASS 42—SCIENTIFIC, COMPUTER AND LEGAL SERVICES

FOR ELECTRONIC TESTING, ANALYSIS AND EVALUATION OF THE GOODS AND SERVICES OF OTHERS FOR THE PURPOSE OF CERTIFICATION (U.S. CLS. 100 AND 101).

SN 78-055,570. BRITANNIA PHARMACEUTICALS LIMITED, REDHILL, UNITED KINGDOM, FILED 3-28-2001.

ADSURF**CLASS 5—PHARMACEUTICALS**

FOR PHARMACEUTICAL PREPARATIONS AND SUBSTANCES FOR TREATING CONDITIONS ASSOCIATED WITH SURFACTANT DEFICIENCY (U.S. CLS. 6, 18, 44, 46, 51 AND 52).

CLASS 10—MEDICAL APPARATUS

FOR MEDICAL AND SURGICAL INSTRUMENTS AND APPARATUS FOR ADMINISTERING DRUGS, PHARMACEUTICAL PREPARATIONS AND SUBSTANCES INCORPORATING SURFACTANTS, NAMELY, PUFFERS AND DRY POWDER ADMINISTRATORS (U.S. CLS. 26, 39 AND 44).

SN 78-056,245. ADVANCED DESIGN CONCEPTS, INC., PEWAUKEE, WI. FILED 4-2-2001.

ADVANCED DESIGN CONCEPTS

SEC. 2(F).

CLASS 40—MATERIAL TREATMENT

FOR PROTOTYPE FABRICATION OF NEW PRODUCTS FOR OTHERS; TOOL PROTOTYPE FABRICATION FOR OTHERS (U.S. CLS. 100, 103 AND 106).
FIRST USE 6-1-1993; IN COMMERCE 7-1-1993.

CLASS 42—SCIENTIFIC, COMPUTER AND LEGAL SERVICES

FOR PRODUCT, PROTOTYPE AND TOOL ENGINEERING AND DESIGN SERVICES FOR OTHERS; ENGINEERING CONSULTATION SERVICES (U.S. CLS. 100 AND 101).
FIRST USE 6-1-1993; IN COMMERCE 7-1-1993.

SN 78-057,337. LET'S TALK WORK, INC., WARREN, VT. FILED 4-8-2001.

LET'S TALK WORK!**CLASS 16—PAPER GOODS AND PRINTED MATTER**

FOR NEWSPAPERS, BOOKS, PERIODICALS, AND NEWSLETTERS FEATURING INFORMATION RELATING TO BUSINESS, JOBS, EMPLOYMENT, BUSINESS CONSULTING, PERSONNEL TRAINING, AND EDUCATION IN THE FIELD OF BUSINESS MANAGEMENT AND CAREER MANAGEMENT (U.S. CLS. 2, 5, 22, 23, 29, 37, 38 AND 50).

CLASS 35—ADVERTISING AND BUSINESS

FOR BUSINESS CONSULTATION; PROVIDING AN ON-LINE COMPUTER DATABASE FEATURING INFORMATION IN THE FIELDS OF BUSINESS, JOBS, AND EMPLOYMENT VIA A GLOBAL COMPUTER NETWORK (U.S. CLS. 100, 101 AND 102).

SN 78-057,887. SURGICAL ALLIANCE CORPORATION, BRENTWOOD, TN. FILED 4-11-2001.

SURGICAL ALLIANCE CORPORATION

NO CLAIM IS MADE TO THE EXCLUSIVE RIGHT TO USE "SURGICAL" AND "CORPORATION", APART FROM THE MARK AS SHOWN.

CLASS 35—ADVERTISING AND BUSINESS

FOR BUSINESS MANAGEMENT OF AMBULATORY SURGERY CENTERS AND SPECIALTY HOSPITALS FOR OTHERS (U.S. CLS. 100, 101 AND 102).

CLASS 37—CONSTRUCTION AND REPAIR

FOR REAL ESTATE DEVELOPMENT OF AMBULATORY SURGERY CENTERS AND SPECIALTY HOSPITALS FOR OTHERS (U.S. CLS. 100, 103 AND 106).

SN 78-060,009. BRYN MAWR COMMUNICATIONS LLC, BRYN MAWR, PA. FILED 4-24-2001.

**Cataract & Refractive Surgery
TODAY**

NO CLAIM IS MADE TO THE EXCLUSIVE RIGHT TO USE "CATARACT & REFRACTIVE SURGERY TODAY", APART FROM THE MARK AS SHOWN.

CLASS 16—PAPER GOODS AND PRINTED MATTER

FOR MAGAZINE PUBLICATION FEATURING OPHTHALMIC SURGERY (U.S. CLS. 2, 5, 22, 23, 29, 37, 38 AND 50).

CLASS 44—MEDICAL, BEAUTY AND AGRICULTURAL SERVICES

FOR ONLINE WEBSITE FEATURING INFORMATION IN THE FIELD OF OPHTHALMIC SURGERY (U.S. CLS. 100 AND 101).

SN 78-059,513. SCHEETZ TECHNOLOGY, INC., PEORIA, IL. FILED 4-20-2001.



NO CLAIM IS MADE TO THE EXCLUSIVE RIGHT TO USE "INC.", APART FROM THE MARK AS SHOWN. THE LINING SHOWN IN THE DRAWING IS NOT INTENDED TO INDICATE COLOR.

SN 78-061,292. SOUTHERN AGRICULTURAL INSECTICIDES, INC., PALMETTO, FL. FILED 5-1-2001.



OWNER OF U.S. REG. NO. 819,713.

CLASS 7—MACHINERY

FOR AGRICULTURAL MACHINES, NAMELY, COMBINES, HARVESTERS, CULTIVATORS, THRESHERS, DISK HARROWS, TILLERS, SEEDERS, DIRT SCRAPERS, WINDROWERS, DUMP BOXES BEING MACHINE PARTS, AND REPLACEMENT PARTS FOR THE FOREGOING (U.S. CLS. 13, 19, 21, 23, 31, 34 AND 35).

CLASS 1—CHEMICALS

FOR PLANT FOOD (U.S. CLS. 1, 5, 6, 10, 26 AND 46).

CLASS 12—VEHICLES

FOR AGRICULTURAL TRACTORS; VEHICLES FOR EARTH AND MATERIAL HAULING AND HANDLING, NAMELY, TRACTORS, SEMI-TRACTOR TRAILERS (U.S. CLS. 19, 21, 23, 31, 35 AND 44).

CLASS 5—PHARMACEUTICALS

FOR PESTICIDES, HERBICIDES, INSECTICIDES, FUNGICIDES, ALL FOR DOMESTIC USE; FERTILIZERS (U.S. CLS. 6, 18, 44, 46, 51 AND 52).

SN 78-059,516. SCHEETZ TECHNOLOGY, INC., PEORIA, IL. FILED 4-20-2001.

ENDEAVOR

SN 78-063,091. CASSILY, JAMES F., GRAND RAPIDS, MI. FILED 5-11-2001.

FONNMHOR

CLASS 7—MACHINERY

FOR AGRICULTURAL MACHINES, NAMELY, COMBINES, HARVESTERS, CULTIVATORS, THRESHERS, DISK HARROWS, TILLERS, SEEDERS, DIRT SCRAPERS, WINDROWERS, DUMP BOXES BEING MACHINE PARTS, AND REPLACEMENT PARTS FOR THE FOREGOING (U.S. CLS. 13, 19, 21, 23, 31, 34 AND 35).

CLASS 9—ELECTRICAL AND SCIENTIFIC APPARATUS

FOR MUSICAL SOUND RECORDINGS (U.S. CLS. 21, 23, 26, 36 AND 38). FIRST USE 5-1-2001; IN COMMERCE 5-1-2001.

CLASS 12—VEHICLES

FOR AGRICULTURAL TRACTORS; VEHICLES FOR EARTH AND MATERIAL HAULING AND HANDLING, NAMELY, TRACTORS, SEMI-TRACTOR TRAILERS (U.S. CLS. 19, 21, 23, 31, 35 AND 44).

CLASS 41—EDUCATION AND ENTERTAINMENT

FOR ENTERTAINMENT SERVICES, NAMELY, LIVE PERFORMANCES BY A MUSICAL BAND AND LIVE MUSIC CONCERTS (U.S. CLS. 100, 101 AND 107).
FIRST USE 5-1-2001; IN COMMERCE 5-1-2001.

SN 78-065,188. SCUDDER TRUST COMPANY, SALEM, NH.
FILED 5-23-2001.

BOBSPEAK**CLASS 16—PAPER GOODS AND PRINTED MATTER**

FOR DICTIONARIES AND GLOSSARIES FEATURING INVESTMENT RELATED WORDS AND PHRASES (U.S. CLS. 2, 5, 22, 23, 29, 37, 38 AND 50).

CLASS 42—SCIENTIFIC, COMPUTER AND LEGAL SERVICES

FOR COMPUTER SERVICES, NAMELY, PROVIDING ONLINE DICTIONARIES AND GLOSSARIES FEATURING INVESTMENT RELATED WORDS AND PHRASES (U.S. CLS. 100 AND 101).

SN 78-063,660. SOFTWARE ENGINEERING GMBH, DUESSELDORF, FED REP GERMANY, FILED 5-15-2001.

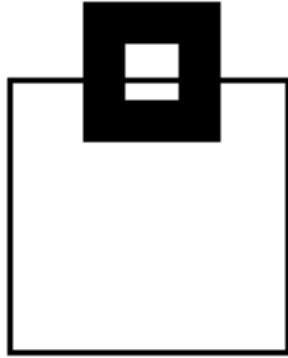

OWNER OF FED REP GERMANY REG. NO. 1173320, DATED 3-7-1991, RENEWED AS REG. NO. 1173320, DATED 5-1-1999, EXPIRES 4-4-2009.

SN 78-067,411. STRUCTURE CONSULTING GROUP, LLC, TIBURON, CA. FILED 6-5-2001.

THE STRUCTURE GROUP

NO CLAIM IS MADE TO THE EXCLUSIVE RIGHT TO USE "GROUP", APART FROM THE MARK AS SHOWN.

CLASS 9—ELECTRICAL AND SCIENTIFIC APPARATUS

FOR COMPUTER DATA PROCESSING PROGRAMS ON STORAGE MEDIA OF ALL TYPES, NAMELY, MAGNETIC TAPES, MAGNETIC DISKS AND DISKETTES (U.S. CLS. 21, 23, 26, 36 AND 38).
FIRST USE 8-1-1979; IN COMMERCE 8-1-1992.

CLASS 9—ELECTRICAL AND SCIENTIFIC APPARATUS

FOR COMPUTER SOFTWARE FOR USE IN THE UTILITY, POWER AND ENERGY INDUSTRY FOR INTEGRATING AND INTERFACING COMPUTERIZED POWER TRADING, FINANCIAL, BILLING AND ENERGY MANAGEMENT SYSTEMS WITH MARKET, SYSTEM AND REGIONAL TRANSMISSION OPERATORS, NAMELY, SOFTWARE FOR OPERATIONS MANAGEMENT, BID MANAGEMENT, MARKET COMMUNICATIONS, SETTLEMENT VALIDATION, SYSTEM ADMINISTRATION, AND PHYSICAL MARKET DATA STORE (U.S. CLS. 21, 23, 26, 36 AND 38).

CLASS 16—PAPER GOODS AND PRINTED MATTER

FOR DOCUMENTATION FOR SOFTWARE PROGRAMS, NAMELY MANUALS; PRINTED GUIDES, NAMELY INSTALLATION GUIDES, USER GUIDES, INSTRUCTIONAL GUIDES FOR SOFTWARE PROGRAMS; PRINTED GUIDES FOR COMPUTER SOFTWARE CONSULTING (U.S. CLS. 2, 5, 22, 23, 29, 37, 38 AND 50).
FIRST USE 8-1-1979; IN COMMERCE 8-1-1992.

CLASS 35—ADVERTISING AND BUSINESS

FOR BUSINESS CONSULTING SERVICES FOR THE UTILITY, POWER AND ENERGY INDUSTRY, NAMELY, PROVIDING INFORMATION TECHNOLOGY AND BUSINESS PROCESS SOLUTIONS IN THE AREAS OF MARKET INFRASTRUCTURE DESIGN, DEVELOPMENT, OPERATIONS, SCHEDULING AND ENERGY MANAGEMENT (U.S. CLS. 100, 101 AND 102).

CLASS 35—ADVERTISING AND BUSINESS

FOR BUSINESS MARKETING IN THE FIELD OF COMPUTER SOFTWARE AND COMPUTER ENGINEERING SERVICES; DISTRIBUTORSHIPS IN THE FIELD OF COMPUTER SOFTWARE (U.S. CLS. 100, 101 AND 102).
FIRST USE 8-1-1979; IN COMMERCE 8-1-1992.

CLASS 36—INSURANCE AND FINANCIAL

FOR FINANCIAL CONSULTING SERVICES FOR THE UTILITY, POWER AND ENERGY INDUSTRY, NAMELY, TRADING, RISK MANAGEMENT SERVICES, ASSET BIDDING, PORTFOLIO MANAGEMENT AND FORECASTING (U.S. CLS. 100, 101 AND 102).

CLASS 42—SCIENTIFIC, COMPUTER AND LEGAL SERVICES

FOR COMPUTER DATA PROCESSING SOFTWARE DEVELOPMENT; TECHNICAL CONSULTING SERVICES IN THE FIELD OF INFORMATION TECHNOLOGY; INSTALLATION OF COMPUTER SOFTWARE; TECHNICAL SUPPORT SERVICES, NAMELY TROUBLESHOOTING OF COMPUTER SOFTWARE PROBLEMS; MAINTENANCE OF COMPUTER SOFTWARE; COMPUTER SOFTWARE ENGINEERING SERVICES (U.S. CLS. 100 AND 101).
FIRST USE 8-1-1979; IN COMMERCE 8-1-1992.

CLASS 42—SCIENTIFIC, COMPUTER AND LEGAL SERVICES

FOR CONSULTING SERVICES FOR THE UTILITY, POWER AND ENERGY INDUSTRY, NAMELY, APPLICATION IMPLEMENTATION, ENTERPRISE ARCHITECTURE INTEGRATION AND DISPUTE MANAGEMENT IN THE FIELD OF MARKET SETTLEMENTS AND SETTLEMENT VERIFICATION (U.S. CLS. 100 AND 101).

SN 78-068,250. DADA CORPORATION, SEOUL, REPUBLIC OF KOREA, FILED 6-8-2001.

SN 78-069,435. ECONUGENICS, INC., SANTA ROSA, CA. FILED 6-15-2001.

ONE WEEK DELIVERY!

CLASS 18—LEATHER GOODS

FOR SUIT BAGS, BREIFBAGS, NAMELY, BREIF-CASES WITH STRAPS FOR WOMEN, WALLETS, TRAVEL BAGS, ALL PURPOSE SPORTS BAGS, LEATHER SHOPPING BAGS, SCHOOL BAGS, HANDBAGS, BOSTON BAGS, BEACH BAGS (U.S. CLS. 1, 2, 3, 22 AND 41).

CLASS 25—CLOTHING

FOR CLOTHING NAMELY HATS, CAPS AND HEADWEAR, HEADBANDS, BATHING CAPS, SHOWER CAPS, BEACHWEAR, JACKETS, JEANS, CASUAL WEAR, NAMELY, SHORTS, SKIRTS, PANTS, T-SHIRTS, OVERCOATS, SHOES (U.S. CLS. 22 AND 39).

SN 78-068,415. WOODS & GRAY, LTD., NEW YORK, NY. FILED 6-11-2001.

P.S. BY WOODS & GRAY

OWNER OF U.S. REG. NOS. 1,655,903, 2,275,754 AND OTHERS.

CLASS 18—LEATHER GOODS

FOR DUFFEL BAGS (U.S. CLS. 1, 2, 3, 22 AND 41).

CLASS 25—CLOTHING

FOR LADIES', MEN'S, CHILDREN'S AND BABIES' CLOTHING, NAMELY, SWEATERS, SHIRTS, T-SHIRTS, DRESSES, SHORTS, PANTS, SKIRTS, JACKETS, UNDERWEAR, SUITS, TIES, HATS, HOSIERY, SHOES AND ACCESSORIES, NAMELY, BELTS AND SCARVES (U.S. CLS. 22 AND 39).

SN 78-068,526. AQUIMIX, INC., CLOVERDALE, VA. FILED 6-11-2001.

AQUTRAC

OWNER OF U.S. REG. NOS. 1,894,356 AND 2,018,203.

CLASS 35—ADVERTISING AND BUSINESS

FOR TRACKING INVENTORY IN TRANSIT, NAMELY, THE TRACKING AND TRACING OF PESTICIDES, HERBICIDES, AND FERTILIZERS STORED IN RETRIEVABLE REUSABLE CONTAINERS FOR USE IN THE AGRICULTURAL INDUSTRY (U.S. CLS. 100, 101 AND 102).

CLASS 45—PERSONAL SERVICES

FOR TRACKING SERVICES FOR THE RETRIEVAL OF ENCODED PRODUCTS IN TRANSIT, NAMELY, THE TRACKING AND TRACING OF ENCODED RETRIEVABLE REUSABLE CONTAINERS FOR PESTICIDES, HERBICIDES, AND FERTILIZERS USED IN THE AGRICULTURAL INDUSTRY (U.S. CLS. 100 AND 101).

WITH THE SEASONS

CLASS 9—ELECTRICAL AND SCIENTIFIC APPARATUS

FOR DOWNLOADABLE ELECTRONIC PUBLICATIONS IN THE NATURE OF NEWSLETTERS IN THE FIELDS OF HEALTH, DIET, NUTRITION, DIETARY AND NUTRITIONAL SUPPLEMENTS, MEDICINE, PSYCHOLOGY, PERSONAL RELATIONSHIPS, MEDICAL RESEARCH, EXERCISE, PREVENTATIVE MEDICINE, AND NUTRACEUTICALS (U.S. CLS. 21, 23, 26, 36 AND 38).

FIRST USE 1-9-2001; IN COMMERCE 1-9-2001.

CLASS 16—PAPER GOODS AND PRINTED MATTER

FOR NEWSLETTERS IN THE FIELDS OF HEALTH, DIET, NUTRITION, MEDICINE, DIETARY AND NUTRITIONAL SUPPLEMENTS, NUTRACEUTICALS, PREVENTATIVE MEDICINE, MEDICAL RESEARCH, EXERCISE, PERSONAL RELATIONSHIPS AND PSYCHOLOGY (U.S. CLS. 2, 5, 22, 23, 29, 37, 38 AND 50).

FIRST USE 1-9-2001; IN COMMERCE 1-9-2001.

SN 78-070,264. SPOOKLEY INCORPORATED, BRIDGEHAMPTON, NY. FILED 6-21-2001.

SPOOKLEY THE SQUARE PUMPKIN

CLASS 9—ELECTRICAL AND SCIENTIFIC APPARATUS

FOR SERIES OF PRE-RECORDED AUDIO AND VIDEO CASSETTES AND CD-ROMS FEATURING CARTOON THEME SONGS AND CARTOONS; VIDEO GAME SOFTWARE; SUNGLASSES, EYEGLOSS CASES, MOUSE PADS AND DECORATIVE REFRIGERATOR MAGNETS FEATURING CARTOONS (U.S. CLS. 21, 23, 26, 36 AND 38).

CLASS 16—PAPER GOODS AND PRINTED MATTER

FOR PENS; PENCILS, PENCIL CASES, AND A SERIES OF BOOKS FEATURING CARTOON CHARACTERS; CHILDREN'S ACTIVITY BOOKS; COLORING BOOKS; STICKERS; POSTERS; DECALS; COLLECTOR'S CARDS; GREETING CARDS; PAPER PARTY GOODS, NAMELY HATS, STREAMERS, BLOWERS, TABLECLOTHS, NAPKINS, BANNERS, DOOR SIGNS, TAGS, PARTY DECORATIONS, LUNCH BAGS, CARDBOARD PUZZLES AND MODELLING COMPOUNDS, NAMELY, REUSABLE AND AIR-DRYING COMPOUNDS AND ACCESSORIES; SPECIFICALLY DESIGNED COMIC BOOKS ONLY TO BE SOLD WITH FIGURES OR ACCESSORIES (U.S. CLS. 2, 5, 22, 23, 29, 37, 38 AND 50).

CLASS 25—CLOTHING

FOR CLOTHING, NAMELY T-SHIRTS, SWEATSHIRTS, GYM SHORTS AND CAPS; RAINWEAR, SLEEPWEAR, PAJAMAS, BOXER SHORTS, SOCKS, HALLOWEEN AND MASQUERADE COSTUMES COMPRISED OF BODY SUITS AND FACE MASKS (U.S. CLS. 22 AND 39).

CLASS 28—TOYS AND SPORTING GOODS

FOR TOYS AND SPORTING GOODS, NAMELY PLUSH TOYS, PLUSH DOLLS, VINYL DOGS, ACTION FIGURES; WIND-UP, PULL BACK AND FRICTION POWERED TOYS, PLASTIC TOY FIGURINES, PLASTIC TOY VEHICLES, PLASTIC INFLATED BOP BAGS, BOARD GAMES, CARD GAMES, HAND-HELD ELECTRONIC GAMES, THROW TARGET GAMES, CHILDREN'S THREE-DIMENSIONAL VIEWERS AND PROJECTORS, TOY MECHANICAL MUSICAL INSTRUMENTS; TUB TOYS; PUSH AND PULL TOYS; TARGET SETS; DOLL AND ACTION FIGURE PLAY SETS AND MICRO-PLAY SETS, ROLL PLAYING AND DRESS UP TOYS; TOY BANKS (U.S. CLS. 22, 23, 38 AND 50).

CLASS 41—EDUCATION AND ENTERTAINMENT

FOR ENTERTAINMENT AND EDUCATION SERVICES IN THE NATURE OF A SERIES OF PRE-RECORDED ANIMATED TELEVISION SHOWS, MOTION PICTURE FILMS AND LIVE SHOWS DIRECTED TOWARD CHILDREN AND YOUNG ADULTS, PROVIDED THROUGH CABLE TELEVISION, BROADCAST TELEVISION, BROADCAST RADIO AND THE GLOBAL COMPUTER INFORMATION NETWORK (U.S. CLS. 100, 101 AND 107).

SN 78-070,549. GERBIG, SNELL/WEISHEIMER & ASSOCIATES, INC., WESTERVILLE, OH. FILED 6-22-2001.

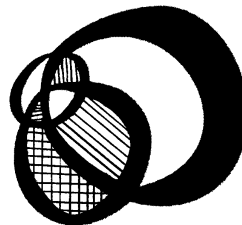

inChord

THE DRAWING IS LINED TO INDICATE COLOR AS FOLLOWS: THE HORIZONTAL LINES = BLUE; THE VERTICAL LINES = RED; THE DIAGONAL LINES = GREEN; AND THE CROSS HATCHED LINES = YELLOW. THE MARK CONSISTS OF THREE (3) INTERLOCKING CIRCLES.

CLASS 35—ADVERTISING AND BUSINESS

FOR ADVERTISING AGENCY SERVICES; MARKET RESEARCH SERVICES; PUBLIC RELATIONS SERVICES, DIRECT MARKETING ADVERTISING SERVICES FOR OTHERS; BUSINESS MARKETING CONSULTING SERVICES; BUSINESS CONSULTING SERVICES IN THE FIELD OF INTERACTIVE MARKETING AND ADVERTISING; BRAND CONSULTING SERVICES, NAMELY, PROVIDING INFORMATION IN THE FIELDS OF BRAND IDENTITY AND CORPORATE IDENTITY; SALES PROMOTION, NAMELY, DEVELOPING PROMOTIONAL AND INFORMATIONAL MATERIALS FOR OTHERS FOR DISTRIBUTION (U.S. CLS. 100, 101 AND 102).

FIRST USE 7-5-2001; IN COMMERCE 7-5-2001.

CLASS 41—EDUCATION AND ENTERTAINMENT

FOR EDUCATIONAL SERVICES, NAMELY, PROVIDING SYMPOSIUMS, CLASSES, SEMINARS, WORKSHOPS, CONFERENCES, AND AUDIO AND VIDEO PROGRAMS IN THE FIELD OF CONTINUING EDUCATION FOR PHARMACEUTICAL AND MEDICAL PROFESSIONALS (U.S. CLS. 100, 101 AND 107).

FIRST USE 7-5-2001; IN COMMERCE 7-5-2001.

CLASS 42—SCIENTIFIC, COMPUTER AND LEGAL SERVICES

FOR TECHNICAL CONSULTATION SERVICES, NAMELY PROVIDING TECHNICAL ADVISORY SUPPORT TO THE PHARMACEUTICAL AND HEALTHCARE INDUSTRY ABOUT THE APPLICATION AND IMPLEMENTATION OF STANDARDS AND TECHNOLOGY FOR TELECOMMUNICATION AND INFORMATION SYSTEMS; COMPUTER CONSULTATION SERVICES REGARDING ELECTRONIC COMMERCE, NAMELY, CONSULTING SERVICES FOR THE DEVELOPMENT OF ELECTRONIC BUSINESS SYSTEMS WHICH ENABLE THE CONDUCTING OF BUSINESS THROUGH COMPUTERS AND GLOBAL DIGITAL COMMUNICATION NETWORKS; COMPUTER SERVICES, NAMELY DESIGNING, DEVELOPING, AND IMPLEMENTING WEB SITES FOR OTHERS; CONDUCTING PRODUCT FEASIBILITY STUDIES FOR OTHERS (U.S. CLS. 100 AND 101).

FIRST USE 7-5-2001; IN COMMERCE 7-5-2001.

SN 78-070,364. FIELD & STREAM LICENSES COMPANY, HOPKINS, MN. FILED 6-21-2001.

FIELD & STREAM

OWNER OF U.S. REG. NOS. 1,360,646, 2,442,869 AND OTHERS.

CLASS 18—LEATHER GOODS

FOR PET SUPPLIES, NAMELY, PET CUSHIONS AND PET BLANKETS (U.S. CLS. 1, 2, 3, 22 AND 41).

FIRST USE 6-1-2001; IN COMMERCE 6-1-2001.

CLASS 20—FURNITURE AND ARTICLES NOT OTHERWISE CLASSIFIED

FOR PORTABLE BEDS FOR PETS (U.S. CLS. 2, 13, 22, 25, 32 AND 50).

FIRST USE 6-1-2001; IN COMMERCE 6-1-2001.

SN 78-070,743. OUT OF YOUR MIND, LONG BEACH, CA. AND OUT OF YOUR MIND, LONG BEACH, CA. FILED 6-24-2001.



CLASS 35—ADVERTISING AND BUSINESS

FOR BUSINESS AND ADVERTISING SERVICES, NAMELY, PROMOTING THE GOODS AND SERVICES OF OTHERS BY PREPARING AND PLACING ADVERTISEMENTS IN AN ELECTRONIC MAGAZINE ACCESSED THROUGH A GLOBAL COMPUTER NETWORK; PROVIDING BUSINESS MARKETING CONSULTING SERVICES; (BASED ON INTENT TO USE) BUSINESS AND ADVERTISING SERVICES, NAMELY, ON-LINE RETAIL STORE SERVICES FEATURING MEN'S AND WOMEN'S CLOTHING AND ACCESSORIES, SPORTING GOODS, JEWELRY, MUGS, KEYCHAINS, AND DECORATIVE OFFICE SUPPLIES (U.S. CLS. 100, 101 AND 102).

FIRST USE 2-1-1996; IN COMMERCE 2-1-1996.

CLASS 42—SCIENTIFIC, COMPUTER AND LEGAL SERVICES

FOR PROVIDING GRAPHIC ART DESIGN, GRAPHIC ILLUSTRATION SERVICES FOR OTHERS; PROVIDING INTERIOR DESIGNING, INTERIOR DESIGN CONSULTATION FOR OTHERS (U.S. CLS. 100 AND 101).

FIRST USE 2-1-1996; IN COMMERCE 2-1-1996.

SN 78-070,834. KONTIKI, INC., MOUNTAIN VIEW, CA. FILED 6-25-2001.

KONTIKI

CLASS 9—ELECTRICAL AND SCIENTIFIC APPARATUS

FOR COMPUTER SOFTWARE FOR THE DELIVERY OF DATA, SOFTWARE APPLICATIONS, AUDIO AND VIDEO CONTENT BY MEANS OF ELECTRONIC OR OPTICAL NETWORKS; COMPUTER HARDWARE (U.S. CLS. 21, 23, 26, 36 AND 38).

CLASS 38—COMMUNICATION

FOR TRANSMISSION OF THIRD PARTY DATA, SOFTWARE APPLICATIONS, AUDIO AND VIDEO CONTENT BY MEANS OF ELECTRONIC AND OPTICAL NETWORKS (U.S. CLS. 100, 101 AND 104).

CLASS 42—SCIENTIFIC, COMPUTER AND LEGAL SERVICES

FOR COMPUTER CONSULTING SERVICES; DESIGN AND CUSTOMIZATION OF COMPUTER SOFTWARE FOR OTHERS; INSTALLATION OF COMPUTER SOFTWARE FOR OTHERS (U.S. CLS. 100 AND 101).

SN 78-072,720. TEEL GROUP, INC., THE, PRESCOTT, AZ. FILED 7-6-2001.

BROKERLOUNGE.COM

CLASS 35—ADVERTISING AND BUSINESS

FOR PROMOTING THE GOODS AND SERVICES OF OTHERS BY PROVIDING A COMPUTERIZED ONLINE SEARCHABLE DATABASE OF REALTOR INFORMATION; CONDUCTING OPINION POLL SURVEYS VIA THE INTERNET (U.S. CLS. 100, 101 AND 102).

FIRST USE 4-25-2001; IN COMMERCE 4-25-2001.

CLASS 36—INSURANCE AND FINANCIAL

FOR PROVIDING NEWS AND INFORMATION VIA AN ONLINE GLOBAL COMPUTER NETWORK FOR REAL ESTATE OWNERS, BROKERS AND MANAGERS ALL RELATING TO THE REAL ESTATE INDUSTRY (U.S. CLS. 100, 101 AND 102).

FIRST USE 4-25-2001; IN COMMERCE 4-25-2001.

SN 78-073,162. BURGER, FRANK, OVERATH-UNTERESCHBACH, FED REP GERMANY, AND WEINERT, FRANK, KOLN, FED REP GERMANY, FILED 7-10-2001.



CLASS 9—ELECTRICAL AND SCIENTIFIC APPARATUS

FOR COMPUTER SOFTWARE FOR USE IN PURCHASING, SALES, PRODUCTION, DISTRIBUTION, ACCOUNTING, CONTROLLING, AND AUTOMATIC ORDER PLACEMENT (U.S. CLS. 21, 23, 26, 36 AND 38).

CLASS 16—PAPER GOODS AND PRINTED MATTER

FOR EDUCATIONAL PUBLICATIONS, NAMELY, TRAINING MANUALS IN THE FIELD OF PURCHASING, SALES, PRODUCTION, DISTRIBUTION AND ACCOUNTING (U.S. CLS. 2, 5, 22, 23, 29, 37, 38 AND 50).

CLASS 35—ADVERTISING AND BUSINESS

FOR BUSINESS MANAGEMENT CONSULTATION IN THE FIELD OF CONTROLLING, PURCHASING, SALES, PRODUCTION, DISTRIBUTION AND ACCOUNTING; OPERATING ON-LINE MARKETPLACES FOR SELLERS OF GOODS OR SERVICES; PROMOTING THE GOODS AND SERVICES OF OTHERS THROUGH ON-LINE ORDERING AND CATALOGING OF THOSE GOODS AND SERVICES (U.S. CLS. 100, 101 AND 102).

CLASS 41—EDUCATION AND ENTERTAINMENT

FOR TRAINING SERVICES IN THE FIELD OF PURCHASING, SALES, PRODUCTION, DISTRIBUTION AND ACCOUNTING (U.S. CLS. 100, 101 AND 107).

SN 78-073,196. PROGRESSIVE DYNAMICS, INC., BOULDER, CO. FILED 7-10-2001.

SN 78-074,722. CW TRAVEL HOLDINGS, N. V., DIEMEN, NETHERLANDS, FILED 7-19-2001.

PEAK PILATES

NO CLAIM IS MADE TO THE EXCLUSIVE RIGHT TO USE "PILATES", APART FROM THE MARK AS SHOWN.

CLASS 9—ELECTRICAL AND SCIENTIFIC APPARATUS

FOR PRERECORDED VIDEO TAPES RELATING TO TRAINING AND INSTRUCTIONAL TECHNIQUES RELATING TO EXERCISING, PHYSICAL THERAPY, GENERAL BODY CONDITIONING AND FLEXIBILITY TRAINING (U.S. CLS. 21, 23, 26, 36 AND 38).

CLASS 40—MATERIAL TREATMENT

FOR MANUFACTURE OF EXERCISE EQUIPMENT TO ORDER AND/OR SPECIFICATION OF OTHERS (U.S. CLS. 100, 103 AND 106).

CLASS 41—EDUCATION AND ENTERTAINMENT

FOR EDUCATIONAL SERVICES, NAMELY, TRAINING SEMINARS AND INSTRUCTION THROUGH COURSES, PROGRAMS AND WORKSHOPS RELATING TO EXERCISING, PHYSICAL THERAPY, GENERAL BODY CONDITIONING AND FLEXIBILITY TRAINING (U.S. CLS. 100, 101 AND 107).

CLASS 42—SCIENTIFIC, COMPUTER AND LEGAL SERVICES

FOR DESIGN, ENGINEERING AND DEVELOPMENT OF NEW PRODUCTS RELATING TO EXERCISE EQUIPMENT FOR OTHERS (U.S. CLS. 100 AND 101).

SN 78-074,032. W.W. GRAINGER, INC., LAKE FOREST, IL. FILED 7-16-2001.



CLASS 6—METAL GOODS

FOR MAGNETIC CABINET DOOR CATCHES (U.S. CLS. 2, 12, 13, 14, 23, 25 AND 50).

CLASS 9—ELECTRICAL AND SCIENTIFIC APPARATUS

FOR DIGITAL KEYPADS FOR EXIT DOOR SECURITY ALARM SYSTEMS; BURGLAR ALARMS; BURGLAR ALARMS, NAMELY, EXIT DOOR ALARMS; PERSONAL SECURITY ALARMS, NAMELY, EXIT DOOR ALARMS, CLOSED CIRCUIT TELEVISION SYSTEMS FOR BUILDING SECURITY, COMPRISED OF CAMERA CONTROLLERS, CAMERA POWER SUPPLY (DC), CAMERAS, CLOSED CIRCUIT CAMERA LENSES, INTERCOM SYSTEMS, MONITORS, MULTIPLEXERS, PASSIVE LOOPING SWITCHERS, AND TIME-LAPSE AND REAL-TIME VIDEO CASSETTE RECORDERS; MAGNIFYING PEEPHOLES FOR DOORS, ALL THE FOREGOING FOR USE IN THE SAFETY AND SECURITY OF BUILDINGS; AUTOMATIC TOILET AND URINAL FLUSH VALVES (U.S. CLS. 21, 23, 26, 36 AND 38).



NO CLAIM IS MADE TO THE EXCLUSIVE RIGHT TO USE "TRAVEL", APART FROM THE MARK AS SHOWN. THE LINING SHOWN IN THE MARK IS MERELY TO INDICATE SHADING.

CLASS 39—TRANSPORTATION AND STORAGE

FOR TRAVEL AGENCY SERVICES, NAMELY, MAKING AUTO AND AIRLINE RESERVATIONS AND BOOKINGS FOR TRAVEL BY MEANS OF ELECTRONIC COMMUNICATIONS NETWORKS; TRAVEL AGENCY SERVICES, NAMELY, PROVIDING AN ON-LINE INTERACTIVE DATABASE THAT PERMITS EMPLOYEE TRAVELERS TO COMPLETE AND SUBMIT TRAVEL REQUEST FORMS, OBTAIN TRAVEL EXPENSES AND BILLING APPROVAL FROM EMPLOYERS, MAKE AUTO AND AIRLINE RESERVATIONS, AND THAT CAN ALSO BE USED TO SEND TRAVEL CONFIRMATION TO TRAVELERS AND TRAVEL REPORTS TO EMPLOYERS (U.S. CLS. 100 AND 105).

CLASS 41—EDUCATION AND ENTERTAINMENT

FOR TRAVEL AGENCY SERVICES, NAMELY, PROVIDING AN ON-LINE INTERACTIVE DATABASE THAT CAN BE USED IN MAKING RESERVATIONS AND BOOKINGS FOR TEMPORARY LODGING (U.S. CLS. 100, 101 AND 107).

SN 78-074,724. CW TRAVEL HOLDINGS, N. V., DIEMEN, NETHERLANDS, FILED 7-19-2001.



THE LINING SHOWN IN THE DRAWING IS FEATURE OF THE MARK.

CLASS 39—TRANSPORTATION AND STORAGE

FOR TRAVEL AGENCY SERVICES, NAMELY, MAKING AUTO AND AIRLINE RESERVATIONS AND BOOKINGS FOR TRAVEL BY MEANS OF ELECTRONIC COMMUNICATIONS NETWORKS; TRAVEL AGENCY SERVICES, NAMELY, PROVIDING AN ON-LINE INTERACTIVE DATABASE THAT PERMITS EMPLOYEE TRAVELERS TO COMPLETE AND SUBMIT TRAVEL REQUEST FORMS, OBTAIN TRAVEL EXPENSES AND BILLING APPROVAL FROM EMPLOYERS, MAKE AUTO AND AIRLINE RESERVATIONS, AND THAT CAN ALSO BE USED TO SEND TRAVEL CONFIRMATION TO TRAVELERS AND TRAVEL REPORTS TO EMPLOYERS (U.S. CLS. 100 AND 105).

CLASS 43—HOTEL AND RESTAURANT SERVICES

FOR TRAVEL AGENCY SERVICES, NAMELY, PROVIDING AN ON-LINE INTERACTIVE DATABASE THAT CAN BE USED IN MAKING RESERVATIONS AND BOOKINGS FOR TEMPORARY LODGING (U.S. CLS. 100 AND 101).

SN 78-074,727. CW TRAVEL HOLDINGS, N. V., DIEMEN, NETHERLANDS, FILED 7-19-2001.

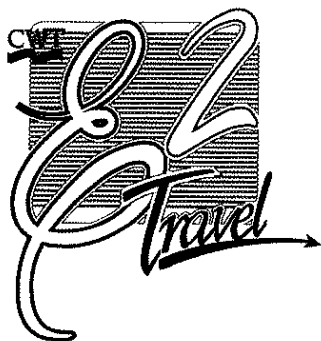

NO CLAIM IS MADE TO THE EXCLUSIVE RIGHT TO USE "TRAVEL", APART FROM THE MARK AS SHOWN. THE LINING IS A FEATURE OF THE MARK.

CLASS 39—TRANSPORTATION AND STORAGE

FOR TRAVEL AGENCY SERVICES, NAMELY, MAKING AUTO AND AIRLINE RESERVATIONS AND BOOKINGS FOR TRAVEL BY MEANS OF ELECTRONIC COMMUNICATIONS NETWORKS; TRAVEL AGENCY SERVICES, NAMELY, PROVIDING AN ON-LINE INTERACTIVE DATABASE THAT PERMITS EMPLOYEE TRAVELERS TO COMPLETE AND SUBMIT TRAVEL REQUEST FORMS, OBTAIN TRAVEL EXPENSES AND BILLING APPROVAL FROM EMPLOYERS, MAKE AUTO AND AIRLINE RESERVATIONS, AND THAT CAN ALSO BE USED TO SEND TRAVEL CONFIRMATION TRAVELERS AND TRAVEL REPORTS TO EMPLOYERS (U.S. CLS. 100 AND 105).

CLASS 42—SCIENTIFIC, COMPUTER AND LEGAL SERVICES

FOR TRAVEL AGENCY SERVICES, NAMELY, PROVIDING AN ON-LINE INTERACTIVE DATABASE THAT CAN BE USED IN MAKING RESERVATIONS AND BOOKINGS FOR TEMPORARY LODGING (U.S. CLS. 100 AND 101).

SN 78-074,849. IMAGINATION HOLDINGS PTY LTD., KENT TOWN, AUSTRALIA, FILED 7-20-2001.

FACT OR CRAP**CLASS 16—PAPER GOODS AND PRINTED MATTER**

FOR PRINTED MATTER, NAMELY PUBLICATIONS IN THE NATURE OF MAGAZINES FEATURING TRIVIA, TRIVIA GAMES OR TRIVIA KNOWLEDGE; STATIONERY, BOOKS ON THE SUBJECT OF TRIVIA, TRIVIA GAMES OR TRIVIA KNOWLEDGE; CALENDARS; DIARIES; AND GREETING CARDS (U.S. CLS. 2, 5, 22, 23, 29, 37, 38 AND 50).

FIRST USE 1-15-2000; IN COMMERCE 3-15-2000.

CLASS 28—TOYS AND SPORTING GOODS

FOR TOYS, NAMELY, PARLOR GAMES AND BOARD GAMES (U.S. CLS. 22, 23, 38 AND 50).

FIRST USE 1-15-2000; IN COMMERCE 3-15-2000.

SN 78-076,383. GEBR. MAERKLIN & CIE. GMBH, GOEPPINGEN, FED REP GERMANY, FILED 7-30-2001.

CARVING

PRIORITY CLAIMED UNDER SEC. 44(D) ON FED REP GERMANY APPLICATION NO. 30107246.9, FILED 2-3-2001, REG. NO. 30107246, DATED 1-29-2002, EXPIRES 2-28-2011.

CLASS 9—ELECTRICAL AND SCIENTIFIC APPARATUS

FOR ELECTRIC LOCOMOTIVE APPARATUS, NAMELY CONTROL MECHANISMS FOR MODEL RAILWAYS (U.S. CLS. 21, 23, 26, 36 AND 38).

CLASS 16—PAPER GOODS AND PRINTED MATTER

FOR BOOKS IN THE FIELD OF MODEL RAILWAYS AND PARTS AND ACCESSORIES FOR MODEL RAILWAYS; PERIODICALS IN THE FIELD OF MODEL RAILWAYS, NAMELY NEWSLETTERS AND MAGAZINES FEATURING THE SUBJECT OF TOY MODEL RAILWAYS, PARTS FOR MODEL RAILWAYS, AND ACCESSORIES FOR MODEL RAILWAYS; STATIONARY; MATERIALS FOR PACKAGING, NAMELY BOXES AND BAGS FOR TOY MODEL RAILWAYS, MODEL RAILWAYS PARTS, AND MODEL RAILWAYS ACCESSORIES (U.S. CLS. 2, 5, 22, 23, 29, 37, 38 AND 50).

CLASS 28—TOYS AND SPORTING GOODS

FOR MODEL RAILWAYS AND PARTS FOR MODEL RAILWAYS; ACCESSORIES FOR MODEL RAILWAYS, NAMELY TRACK MATERIAL, SIGNALS, LIGHTS, POINTS, MODEL BUILDINGS AND BACKGROUND LANDSCAPE MATERIALS FOR CREATING MODEL INSTALLATIONS, INCLUDING BUILDINGS, BRIDGES, TREES, PEOPLE AND ANIMALS, BEING ACCESSORIES (U.S. CLS. 22, 23, 38 AND 50).

SN 78-076,687. TRAMUTOLA, LLC, OAKLAND, CA. BY ASSIGNMENT TRAMUTOLA, LARRY, DBA TRAMUTOLA COMPANY, OAKLAND, CA. FILED 7-31-2001.

THE DISCIPLINE OF WINNING IN THE PUBLICARENA

CLASS 41—EDUCATION AND ENTERTAINMENT

FOR (BASED ON USE IN COMMERCE) EDUCATIONAL SERVICES, NAMELY CONDUCTING SEMINARS, WORKSHOPS, AND CLASSES ON DESIGNING, DEVELOPING, ORGANIZING, MANAGING, AND IMPLEMENTING STRATEGIES, PLANS, AND BUDGETS TO ASSIST EDUCATIONAL INSTITUTION WITH BUILDING PUBLIC AWARENESS AND UNDERSTANDING OF ITS PROGRAMS AND FACILITY NEEDS (U.S. CLS. 100, 101 AND 107).

FIRST USE 12-0-2000; IN COMMERCE 12-0-2000.

CLASS 42—SCIENTIFIC, COMPUTER AND LEGAL SERVICES

FOR (BASED ON INTENT TO USE) CONSULTING SERVICES, NAMELY DESIGN, DEVELOP, ORGANIZE, MANAGE, AND IMPLEMENT STRATEGIES, PLANS, AND BUDGETS TO ASSIST WITH BUILDING PUBLIC AWARENESS AND UNDERSTANDING OF AN EDUCATIONAL INSTITUTION'S PROGRAMS AND FACILITY NEEDS (U.S. CLS. 100 AND 101).

SN 78-077,325. XZILLION GMBH & CO. KG, FRANKFURT AM MAIN, FED REP GERMANY, FILED 8-3-2001.

XZILLION

PRIORITY CLAIMED UNDER SEC. 44(D) ON FED REP GERMANY APPLICATION NO. 30110017.901, FILED 2-14-2001, REG. NO. 30110017, DATED 6-7-2001, EXPIRES 2-28-2011.

CLASS 1—CHEMICALS

FOR PROTEINS AND PEPTIDES FOR INDUSTRIAL, AGRICULTURAL AND SCIENTIFIC APPLICATIONS IN THE AREA OF PLANT PROTECTION OR GROWTH ENHANCER (U.S. CLS. 1, 5, 6, 10, 26 AND 46).

CLASS 5—PHARMACEUTICALS

FOR PHARMACEUTICAL OR VETERINARY PROTEINS OR PEPTIDES, FOR USE IN IN-VITRO DIAGNOSTICS, IN-VIVO DIAGNOSTICS, NUTRACEUTICALS, PRODUCTS FOR HEALTHCARE AND NUTRITION, PRODUCTS TO PREVENT PARASITE PROGRESSION, PROTEIN AND PEPTIDE PRODUCTS FOR PROTECTION OF PLANTS, CROPS AND ANIMALS, PROTEINS; AND PEPTIDES AS NUTRITION ADDITIVES (U.S. CLS. 6, 18, 44, 46, 51 AND 52).

CLASS 31—NATURAL AGRICULTURAL PRODUCTS

FOR PROTEIN AND PEPTIDE PRODUCTS FOR PLANT AND CROP APPLICATIONS, NAMELY, SEEDS AND FEEDS (U.S. CLS. 1 AND 46).

CLASS 42—SCIENTIFIC, COMPUTER AND LEGAL SERVICES

FOR RESEARCH AND DEVELOPMENT IN THE AREA OF THE ROLE, FUNCTION AND APPLICATIONS OF PROTEINS AND PEPTIDES IN BIOLOGY, CHEMISTRY, CROP SCIENCES, MEDICINE AND PHARMACY; PERFORMING BIOLOGICAL, CHEMICAL, MEDICINAL OR PHARMACEUTICAL ANALYSIS; CONSULTATION AND ADVICE IN THE TRANSFER OF ANALYTICAL AND LABORATORY GENERATED DATA INTO RESEARCH, PRODUCT DEVELOPMENT, AND PRODUCTION PROCESSES (U.S. CLS. 100 AND 101).

SN 78-077,341. XZILLION GMBH & CO. KG, FRANKFURT AM MAIN, FED REP GERMANY, FILED 8-3-2001.

EVOPROTICS

PRIORITY CLAIMED UNDER SEC. 44(D) ON FED REP GERMANY APPLICATION NO. 30112708.5/4, FILED 2-23-2001, REG. NO. 30112708, DATED 0-10-2002, EXPIRES 5-10-2012.

CLASS 1—CHEMICALS

FOR PROTEINS AND PEPTIDES FOR INDUSTRIAL, AGRICULTURAL AND SCIENTIFIC APPLICATIONS IN THE AREA OF PLANT PROTECTION OR GROWTH ENHANCER (U.S. CLS. 1, 5, 6, 10, 26 AND 46).

CLASS 5—PHARMACEUTICALS

FOR PHARMACEUTICAL OR VETERINARY PROTEINS OR PEPTIDES, FOR USE IN IN-VITRO DIAGNOSTICS, IN-VIVO DIAGNOSTICS, NUTRACEUTICALS, PRODUCTS FOR HEALTHCARE AND NUTRITION, PRODUCTS TO PREVENT PARASITE PROGRESSION, PROTEIN AND PEPTIDE PRODUCTS FOR PROTECTION OF PLANTS, CROPS AND ANIMALS, PROTEINS AND PEPTIDES AS NUTRITION ADDITIVES (U.S. CLS. 6, 18, 44, 46, 51 AND 52).

CLASS 31—NATURAL AGRICULTURAL PRODUCTS

FOR PROTEIN AND PEPTIDE PRODUCTS FOR PLANT AND CROP APPLICATIONS, NAMELY, SEEDS AND FEEDS (U.S. CLS. 1 AND 46).

CLASS 42—SCIENTIFIC, COMPUTER AND LEGAL SERVICES

FOR RESEARCH AND DEVELOPMENT IN THE AREA OF THE ROLE, FUNCTION AND APPLICATIONS OF PROTEINS AND PEPTIDES IN BIOLOGY, CHEMISTRY, CROP SCIENCES, MEDICINE AND PHARMACY; PERFORMING BIOLOGICAL, CHEMICAL, MEDICINAL OR PHARMACEUTICAL ANALYSIS; CONSULTATION AND ADVICE IN THE TRANSFER OF ANALYTICAL AND LABORATORY GENERATED DATA INTO RESEARCH, PRODUCT DEVELOPMENT, AND PRODUCTION PROCESSES (U.S. CLS. 100 AND 101).

SN 78-077,911. ALTHEA S.P.A., S. LAZZARO, ITALY, FILED 8-7-2001.



NO CLAIM IS MADE TO THE EXCLUSIVE RIGHT TO USE "ORIGINALE ITALIANO", APART FROM THE MARK AS SHOWN.

THE PORTRAIT SHOWN IN THE MARK DOES NOT IDENTIFY A PARTICULAR LIVING INDIVIDUAL.

THE FOREIGN WORDING IN THE MARK TRANSLATES INTO ENGLISH AS "MOTHER SOPHIA" ORIGINAL ITALIAN.

CLASS 29—MEATS AND PROCESSED FOODS

FOR TOMATO PASTE, TOMATO PUREE AND TOMATO JUICE FOR COOKING (U.S. CL. 46).

CLASS 30—STAPLE FOODS

FOR SAUCES, TOMATO SAUCE, PASTA SAUCE (U.S. CL. 46).

SN 78-077,979. CENTURYTEL, INC., MONROE, LA. FILED 8-7-2001.

MAKING CONNECTIONS THAT COUNT

CLASS 35—ADVERTISING AND BUSINESS

FOR DISSEMINATION OF ADVERTISING FOR OTHERS AT REDUCED OR NO COST TO COMMUNITY SERVICE ORGANIZATIONS AND FAMILY SERVICE ORGANIZATIONS; PROVIDING MANPOWER AT REDUCED OR NO COST TO COMMUNITY SERVICE ORGANIZATIONS AND FAMILY SERVICE ORGANIZATIONS, NAMELY, PROVIDING STAFFING FOR CHARITABLE EVENTS SPONSORED BY COMMUNITY SERVICE ORGANIZATIONS AND FAMILY SERVICE ORGANIZATIONS, AND PROVIDING PHYSICAL LABOR FOR THE MAINTENANCE AND CONSTRUCTION OF COMMUNITY SERVICE AND FAMILY SERVICE FACILITIES (U.S. CLS. 100, 101 AND 102).

CLASS 36—INSURANCE AND FINANCIAL

FOR PHILANTHROPIC SERVICES IN THE AREA OF MONETARY DONATIONS (U.S. CLS. 100, 101 AND 102).

CLASS 38—COMMUNICATION

FOR PROVIDING TELECOMMUNICATION SERVICES AT REDUCED OR NO COST TO COMMUNITY SERVICE ORGANIZATIONS AND FAMILY SERVICE ORGANIZATIONS, NAMELY, WIRE LINE, LOCAL AND LONG DISTANCE TELEPHONE SERVICE, AND PROVIDING MULTIPLE USER ACCESS TO THE GLOBAL COMPUTER INFORMATION NETWORK (U.S. CLS. 100, 101 AND 104).

CLASS 42—SCIENTIFIC, COMPUTER AND LEGAL SERVICES

FOR PHILANTHROPIC SERVICES IN THE AREA OF DONATIONS OF FOOD, CLOTHING, AND/OR MEDICINE (U.S. CLS. 100 AND 101).

SN 78-079,963. EXLEY, SHARON L., CHICAGO, IL. AND EXLEY, PETER J., CHICAGO, IL. FILED 8-18-2001.

ARCHITECTUREISFUN

CLASS 41—EDUCATION AND ENTERTAINMENT

FOR EDUCATIONAL CONSULTING SERVICES RELATING TO THE DESIGN OF PROGRAMS, MATERIALS AND PRODUCTS FOR USE IN EDUCATION, LEARNING ENVIRONMENTS, INTERACTIVE LEARNING AND DIDACTIC EXPERIENCES (U.S. CLS. 100, 101 AND 107). FIRST USE 12-31-1996; IN COMMERCE 12-31-1996.

CLASS 42—SCIENTIFIC, COMPUTER AND LEGAL SERVICES

FOR ARCHITECTURAL DESIGN SERVICES FOR CHILDREN'S ENVIRONMENTS; ARCHITECTURAL DESIGN CONSULTING SERVICES FOR INTERACTIVE LEARNING ENVIRONMENTS IN PUBLIC SPACES, BUILDINGS, EXHIBITS, AND INTERIORS; ARCHITECTURAL DESIGN, NAMELY, CONCEPTUAL DESIGN SERVICES; ARCHITECTURAL DESIGN SERVICES, IN THE NATURE OF MASTER PLANNING AND SPACE PLANNING; ARCHITECTURAL DESIGN OF MUSEUMS; GRAPHIC DESIGN, NAMELY, DESIGN OF CORPORATE IDENTITY SYSTEMS, LOGOS, NEW PRODUCTS, PACKAGING, AND SIGNAGE FOR OTHERS; INTERIOR AND EXTERIOR DESIGN SERVICES FOR OTHERS; GRAPHIC ART DESIGN SERVICES; DESIGN AND DEVELOPMENT OF NEW TOYS AND TOY KITS FOR OTHERS; DESIGN OF OUTDOOR LEARNING AND PLAY ENVIRONMENTS AND PLAYGROUNDS FOR OTHERS (U.S. CLS. 100 AND 101). FIRST USE 12-31-1996; IN COMMERCE 12-31-1996.

SN 78-080,082. I.T.C. LIMITED, CALCUTTA, INDIA, FILED 8-20-2001.

KITCHENS OF INDIA

NO CLAIM IS MADE TO THE EXCLUSIVE RIGHT TO USE "INDIA", APART FROM THE MARK AS SHOWN.

CLASS 29—MEATS AND PROCESSED FOODS

FOR PULSES, LENTILS AND COOKED BEANS AND PACKAGED, READY-TO-SERVE MEALS PREPARED THEREFROM WITH AN INDIAN CUISINE (U.S. CL. 46).

CLASS 30—STAPLE FOODS

FOR COOKED CORN, WHEAT AND RICE AND PACKAGED, READY-TO-SERVE FOODS PREPARED THEREFROM WITH AN INDIAN CUISINE (U.S. CL. 46).

SN 78-080,695. GILBEAR, INC., ELGIN, IL. FILED 8-23-2001.

SN 78-081,601. 1 + 1 + 1 = ONE, NEW YORK, NY. FILED 8-29-2001.



NO CLAIM IS MADE TO THE EXCLUSIVE RIGHT TO USE "INC.", APART FROM THE MARK AS SHOWN.

CLASS 16—PAPER GOODS AND PRINTED MATTER

FOR TRAVEL BOOKS AND CHILDREN'S BOOKS (U.S. CLS. 2, 5, 22, 23, 29, 37, 38 AND 50).

CLASS 18—LEATHER GOODS

FOR TRAVEL BAGS; TRAVEL TRUNKS; LUGGAGE; SUITCASES (U.S. CLS. 1, 2, 3, 22 AND 41).

CLASS 28—TOYS AND SPORTING GOODS

FOR STUFFED TOY ANIMALS; DOLL CLOTHING; STUFFED TOYS; CHILDREN'S TOYS, NAMELY, BOARD GAMES; STUFFED TOY BEARS (U.S. CLS. 22, 23, 38 AND 50).

SN 78-081,182. MOCHA MEDIA, INC., CANOGA PARK, CA. FILED 8-26-2001.

HUMAN MEETS DIGITAL

CLASS 41—EDUCATION AND ENTERTAINMENT

FOR ANIMATION PRODUCTION SERVICES; VIDEO-TAPE PRODUCTION; MUSIC COMPOSITION FOR OTHERS; AND SOUND DESIGN AND PRODUCTION SERVICES (U.S. CLS. 100, 101 AND 107).
FIRST USE 11-17-2000; IN COMMERCE 11-17-2000.

CLASS 42—SCIENTIFIC, COMPUTER AND LEGAL SERVICES

FOR GRAPHIC ART DESIGN SERVICES; COMPUTER GRAPHICS SERVICES, INCLUDING INTERACTIVE MULTIMEDIA COMPUTER GRAPHICS DESIGN SERVICES; TECHNICAL COMPUTER MEDIA CONSULTATION SERVICES; CONSULTATION SERVICES IN THE FIELD OF THE DEVELOPMENT OF NEW COMPUTER GRAPHICS TECHNOLOGY FOR OTHERS; COMPUTER CONSULTATION SERVICES IN RELATION TO KIOSK AND CD-ROM DEVELOPMENT; COMPUTER SERVICES, NAMELY, DESIGNING AND IMPLEMENTING WEB SITES FOR OTHERS (U.S. CLS. 100 AND 101).
FIRST USE 11-17-2000; IN COMMERCE 11-17-2000.

1 + 1 + 1 = ONE

CLASS 36—INSURANCE AND FINANCIAL

FOR CONSULTATION SERVICES REGARDING PRIVATE AND CORPORATE PHILANTHROPIC PROGRAMS FOR THE DONATION OF MONEY (U.S. CLS. 100, 101 AND 102).

CLASS 41—EDUCATION AND ENTERTAINMENT

FOR EDUCATIONAL SERVICES, NAMELY, DEVELOPING AND PROVIDING PROGRAMS AND EVENTS THAT FOSTER INTERCULTURAL, INTERRACIAL AND INTERETHNIC UNDERSTANDING AND PERSONAL DEVELOPMENT, AND THAT PROVIDE ARTISTIC OUTLETS FOR SELF EXPRESSION TO PROMOTE CONFLICT RESOLUTION (U.S. CLS. 100, 101 AND 107).

SN 78-081,739. DIAMONDCUSTER INTERNATIONAL INC., CHICAGO, IL. FILED 8-29-2001.

**DIAMONDCUSTER
BUSINESS
SYNCHRONIZATION**

OWNER OF U.S. REG. NO. 2,567,554.
NO CLAIM IS MADE TO THE EXCLUSIVE RIGHT TO USE "BUSINESS SYNCHRONIZATION", APART FROM THE MARK AS SHOWN.

CLASS 35—ADVERTISING AND BUSINESS

FOR BUSINESS MANAGEMENT AND CONSULTATION SERVICES. (U.S. CLS. 100, 101 AND 102).

CLASS 42—SCIENTIFIC, COMPUTER AND LEGAL SERVICES

FOR COMPUTER CONSULTING SERVICES IN THE FIELD OF INFORMATION TECHNOLOGY, NAMELY, STRATEGIC PLANNING AND PROJECT MANAGEMENT OF INFORMATION TECHNOLOGY DEVELOPMENT. (U.S. CLS. 100 AND 101).

SN 78-081,758. BRIGHAM YOUNG UNIVERSITY, PROVO, UT. FILED 8-29-2001.

**BRIGHAM YOUNG
UNIVERSITY-IDAHO**

OWNER OF U.S. REG. NOS. 1,619,786 AND 1,647,398.
NO CLAIM IS MADE TO THE EXCLUSIVE RIGHT TO USE "UNIVERSITY-IDAHO", APART FROM THE MARK AS SHOWN.

CLASS 16—PAPER GOODS AND PRINTED MATTER

FOR SPIRAL NOTEBOOKS, 3-RING BINDERS, PAD HOLDERS, STATIONERY-TYPE PORTFOLIOS, CALENDARS, PENS, PENCILS, BUMPER STICKERS, STATIONERY, NAMELY LETTERHEAD AND WRITING PAPER AND DECALS (U.S. CLS. 2, 5, 22, 23, 29, 37, 38 AND 50).

CLASS 25—CLOTHING

FOR CLOTHING, NAMELY, SHIRTS AND PANTS (U.S. CLS. 22 AND 39).

CLASS 41—EDUCATION AND ENTERTAINMENT

FOR EDUCATION SERVICES, NAMELY PROVIDING COURSES OF INSTRUCTION AT THE UNIVERSITY LEVEL (U.S. CLS. 100, 101 AND 107).

SN 78-081,887. AMMOCORE TECHNOLOGY, INC., SANTA CLARA, CA. FILED 8-30-2001.

FABRIX**CLASS 9—ELECTRICAL AND SCIENTIFIC APPARATUS**

FOR ELECTRONIC DESIGN AUTOMATION SOFTWARE FOR DESIGN OF INTEGRATED CIRCUITS (U.S. CLS. 21, 23, 26, 36 AND 38).

CLASS 42—SCIENTIFIC, COMPUTER AND LEGAL SERVICES

FOR COMPUTER SOFTWARE AND HARDWARE DESIGN; TECHNICAL SUPPORT SERVICES, NAMELY, TROUBLESHOOTING OF COMPUTER HARDWARE AND SOFTWARE DESIGN PROBLEMS (U.S. CLS. 100 AND 101).

SN 78-081,820. GRAPEFRUIT DESIGN SRL, IASI, ROMANIA, FILED 8-30-2001.



PRIORITY CLAIMED UNDER SEC. 44(D) ON ROMANIA APPLICATION NO. M2001002331, FILED 5-21-2001.

NO CLAIM IS MADE TO THE EXCLUSIVE RIGHT TO USE "DESIGN", APART FROM THE MARK AS SHOWN.

THE MARK CONSISTS IN PART OF AN IRREGULARLY SHAPED STAR.

CLASS 35—ADVERTISING AND BUSINESS

FOR CREATING TRADEMARKS FOR OTHERS; EXPORT AND IMPORT AGENCIES; PREPARING ADVERTISEMENTS FOR OTHERS; PREPARING AUDIO-VISUAL PRESENTATIONS FOR USE IN ADVERTISING; PREPARING COMPUTER SLIDE TRANSPARENCIES FOR USE BY BUSINESS; PROMOTING THE GOODS AND SERVICES OF OTHERS BY PREPARING AND PLACING ADVERTISEMENTS IN AN ELECTRONIC MAGAZINE ACCESSED THROUGH A GLOBAL COMPUTER NETWORK; DEVELOPING PROMOTIONAL CAMPAIGNS FOR BUSINESSES (U.S. CLS. 100, 101 AND 102).

FIRST USE 4-30-2001; IN COMMERCE 4-30-2001.

CLASS 42—SCIENTIFIC, COMPUTER AND LEGAL SERVICES

FOR PROVIDING COMMERCIAL ART DESIGN SERVICES FOR OTHERS; COMPUTER SERVICES, NAMELY CREATING AND MAINTAINING WEB SITES FOR OTHERS; COMPUTER SERVICES, NAMELY, DESIGNING AND IMPLEMENTING WEB SITES FOR OTHERS; COMPUTER SOFTWARE DESIGN FOR OTHERS; PRINTING AND GRAPHIC ART DESIGN SERVICES; GRAPHIC ILLUSTRATION SERVICES FOR OTHERS; PACKAGING DESIGN FOR OTHERS; CUSTOM WRITING SERVICES FOR OTHERS (U.S. CLS. 100 AND 101).

FIRST USE 4-30-2001; IN COMMERCE 4-30-2001.

SN 78-083,121. BATH & BODY WORKS, INC., REYNOLDSBURG, OH. FILED 9-7-2001.

THE SHAPE OF THINGS TO COME**CLASS 3—COSMETICS AND CLEANING PREPARATIONS**

FOR SKIN CARE PRODUCTS, NAMELY, BODY CREAMS, EYE CREAMS, HAND CREAMS, NIGHT CREAMS, SKIN CREAMS, BODY LOTIONS, EYE LOTIONS, HAND LOTIONS, NIGHT LOTIONS, SKIN LOTIONS, AND NON-MEDICATED SKIN SERUM (U.S. CLS. 1, 4, 6, 50, 51 AND 52).

CLASS 10—MEDICAL APPARATUS

FOR NON-ELECTRIC MASSAGE APPARATUS (U.S. CLS. 26, 39 AND 44).

SN 78-083,359. SPIDERFI PRODUCTIONS, CANTON, MI. FILED 9-10-2001.

MADHOUSE**CLASS 9—ELECTRICAL AND SCIENTIFIC APPARATUS**

FOR SERIES OF PRERECORDED AUDIO CASSETTES, COMPACT DISCS, PHONOGRAPH RECORDS, PRERECORDED VIDEO CASSETTES AND LASER DISCS, ALL FEATURING MUSIC; AND MUSICAL SOUND RECORDINGS (U.S. CLS. 21, 23, 26, 36 AND 38).

FIRST USE 9-10-2001; IN COMMERCE 9-10-2001.

CLASS 41—EDUCATION AND ENTERTAINMENT

FOR ENTERTAINMENT, NAMELY LIVE PERFORMANCES BY A MUSICAL GROUP AND TELEVISED PERFORMANCES BY A MUSICAL GROUP (U.S. CLS. 100, 101 AND 107).

FIRST USE 9-10-2001; IN COMMERCE 9-10-2001.

SN 78-083,788. CULTURAL EXPERIENCES ABROAD, INC., CHICAGO, IL. FILED 9-13-2001.

PlanetEdu

CLASS 35—ADVERTISING AND BUSINESS

FOR PROVIDING AN ON-LINE COMPUTER DATABASE IN THE FIELD OF WORK ABROAD PROGRAMS (U.S. CLS. 100, 101 AND 102).
FIRST USE 8-27-2001; IN COMMERCE 8-27-2001.

CLASS 41—EDUCATION AND ENTERTAINMENT

FOR PROVIDING AN ON-LINE COMPUTER DATABASE IN THE FIELD OF STUDY ABROAD PROGRAMS (U.S. CLS. 100, 101 AND 107).
FIRST USE 8-27-2001; IN COMMERCE 8-27-2001.

CLASS 42—SCIENTIFIC, COMPUTER AND LEGAL SERVICES

FOR COMPUTER SERVICES, NAMELY PROVIDING AN ON-LINE NEWSLETTER FEATURING ARTICLES IN THE FIELD OF STUDY ABROAD PROGRAMS AND WORK ABROAD PROGRAMS (U.S. CLS. 100 AND 101).
FIRST USE 8-27-2001; IN COMMERCE 8-27-2001.

CLASS 42—SCIENTIFIC, COMPUTER AND LEGAL SERVICES

FOR APPLICATION SERVICE PROVIDER FEATURING SOFTWARE FOR USE IN DATA TRANSFER, CONTENT DELIVERY AND CACHING (U.S. CLS. 100 AND 101).

SN 78-084,364. PROCTER & GAMBLE PHARMACEUTICALS, INC., CINCINNATI, OH. FILED 9-18-2001.



THE MARK CONSISTS OF AN ABSTRACT DESIGN OF A WOMAN WEARING A CROWN AND WAVING A BANNER. THE ABSTRACT WOMAN IS SURROUNDED BY STARS.

SN 78-083,951. PIVIA, INC., CUPERTINO, CA. FILED 9-14-2001.

PIVIA

CLASS 9—ELECTRICAL AND SCIENTIFIC APPARATUS

FOR COMPUTER SOFTWARE FOR USE IN DATA TRANSFER, CONTENT DELIVERY AND CACHING (U.S. CLS. 21, 23, 26, 36 AND 38).

CLASS 42—SCIENTIFIC, COMPUTER AND LEGAL SERVICES

FOR APPLICATION SERVICE PROVIDER (ASP) FEATURING SOFTWARE FOR USE IN DATA TRANSFER, CONTENT DELIVERY AND CACHING (U.S. CLS. 100 AND 101).

CLASS 35—ADVERTISING AND BUSINESS

FOR ADVERTISING SERVICES, NAMELY, PROMOTION OF SPECIAL EVENTS IN THE NATURE OF A BEAUTY PAGEANT TO PROMOTE RESEARCH AND EDUCATION IN THE FIELD OF BONE DISORDERS AND TREATMENT OF BONE DISORDERS (U.S. CLS. 100, 101 AND 102).

CLASS 41—EDUCATION AND ENTERTAINMENT

FOR ENTERTAINMENT IN THE NATURE OF BEAUTY PAGEANTS TO PROMOTE RESEARCH AND EDUCATION IN THE FIELD OF BONE DISORDERS AND TREATMENT OF BONE DISORDERS (U.S. CLS. 100, 101 AND 107).

SN 78-083,953. PIVIA, INC., CUPERTINO, CA. FILED 9-14-2001.

PIVLET

CLASS 9—ELECTRICAL AND SCIENTIFIC APPARATUS

FOR COMPUTER SOFTWARE FOR USE IN DATA TRANSFER, CONTENT DELIVERY AND CACHING (U.S. CLS. 21, 23, 26, 36 AND 38).

SN 78-085,143. SERRANO, LUIS A, PACIFIC PALISADES, CA. FILED 9-23-2001.

ORTRONIC

CLASS 7—MACHINERY

FOR ELECTRICITY GENERATORS (U.S. CLS. 13, 19, 21, 23, 31, 34 AND 35).

CLASS 9—ELECTRICAL AND SCIENTIFIC APPARATUS

FOR ELECTRICITY MANAGEMENT DEVICES, APPARATUS AND INSTALLATIONS, NAMELY INVERTERS, CONVERTERS, ACTUATORS, ELECTRIC MOTOR REGULATORS, ELECTRONIC MOTOR SWITCHES, ELECTRONIC MOTOR CONTROLS, ELECTRICAL AND POWER CONTROLLERS, BATTERY CHARGERS, VOLTAGE SURGE PROTECTORS, VOLTAGE SURGE SUPPRESSORS, VOLTAGE REGULATORS FOR ELECTRIC POWER, FREQUENCY REGULATORS FOR ELECTRIC POWER, STATIC VOLTAGE REGULATORS, ELECTRICAL CIRCUIT BOARDS, POWER SUPPLIES AND ELECTRIC VEHICLE DRIVE TRAINS FOR TRANSFORMING, VARYING AND MANAGING DC AND AC ELECTRICITY BETWEEN A GENERATOR AND A LOAD, USED MAINLY IN THE DISTRIBUTED GENERATION, UTILITY AND ELECTRIC TRANSPORTATION INDUSTRIES (U.S. CLS. 21, 23, 26, 36 AND 38).

SN 78-085,299. XL8 SYSTEMS, INC., DALLAS, TX. FILED 9-24-2001.

THOMAS**CLASS 9—ELECTRICAL AND SCIENTIFIC APPARATUS**

FOR COMPUTER HARDWARE AND SOFTWARE FOR MANAGEMENT AND PROCESSING OF MEDICAL INFORMATION, INCLUDING AUTOMATED OR ELECTRONIC TRANSMISSION AND DELIVERY OF MEDICAL TRANSCRIPTIONS, MEDICAL RECORDS, MEDICAL REPORTS, LABORATORY RESULTS, AND PATIENT INFORMATION, AND ELECTRONIC BILLING THEREFOR (U.S. CLS. 21, 23, 26, 36 AND 38).

CLASS 38—COMMUNICATION

FOR ELECTRONIC TRANSMISSION AND DELIVERY OF DATA, NAMELY, MEDICAL TRANSCRIPTIONS, MEDICAL RECORDS, MEDICAL REPORTS, LABORATORY RESULTS, AND PATIENT INFORMATION (U.S. CLS. 100, 101 AND 104).

SN 78-085,178. VAPORTEK, INC., SUSSEX, WI. FILED 9-24-2001.



SN 78-085,614. CHEIL COMMUNICATIONS AMERICA, INC., RIDGEFIELD PARK, NJ. FILED 9-26-2001.

3D MARKETING

NO CLAIM IS MADE TO THE EXCLUSIVE RIGHT TO USE "MARKETING", APART FROM THE MARK AS SHOWN.

NO CLAIM IS MADE TO THE EXCLUSIVE RIGHT TO USE "ODOR REMOVAL", APART FROM THE MARK AS SHOWN.

CLASS 5—PHARMACEUTICALS

FOR CHEMICAL PREPARATIONS FOR NEUTRALIZING AND DEODORIZING AIR AND VAPOR, FOR DOMESTIC USE (U.S. CLS. 6, 18, 44, 46, 51 AND 52).

CLASS 11—ENVIRONMENTAL CONTROL APPARATUS

FOR ELECTRIC AND NON-ELECTRIC UNITS FOR NEUTRALIZING AND DEODORIZING ODOR-CAUSING COMPONENTS IN AIR AND OTHER VAPORS, FOR DOMESTIC USE (U.S. CLS. 13, 21, 23, 31 AND 34).

CLASS 35—ADVERTISING AND BUSINESS

FOR ADVERTISING AGENCY SERVICES, BUSINESS MARKETING CONSULTING SERVICES, TRADE SHOW SUPPORT SERVICES, NAMELY, OPERATING BOOTHS FOR TRADE SHOW PARTICIPANTS, WEB SITE PROMOTION, NAMELY, PLACING ADVERTISEMENTS ON INTERNET WEB SITES, PUBLIC RELATION SERVICES AND EVENT MARKETING (U.S. CLS. 100, 101 AND 102).
FIRST USE 12-0-2001; IN COMMERCE 12-0-2001.

CLASS 42—SCIENTIFIC, COMPUTER AND LEGAL SERVICES

FOR DESIGN OF TRADE SHOW BOOTHS FOR OTHERS (U.S. CLS. 100 AND 101).
FIRST USE 12-0-2001; IN COMMERCE 12-0-2001.

SN 78-085,624. ELITY SYSTEMS, INC., SOMERSET, NJ.
FILED 9-26-2001.

SN 78-085,838. SHELL PETROLEUM INC., HOUSTON, TX.
FILED 9-27-2001.



CLASS 9—ELECTRICAL AND SCIENTIFIC APPARATUS

FOR INTERACTIVE COMPUTER SOFTWARE FOR ENHANCING PERSONALIZED ELECTRONIC COMMERCE VIA A GLOBAL COMPUTER NETWORK BY USING DETAILED HISTORY OF PAST INTERACTIONS WITH CUSTOMERS, USING PROFILE INFORMATION, USING MARKETING RULES AND USING INVENTORY INFORMATION (U.S. CLS. 21, 23, 26, 36 AND 38).

CLASS 42—SCIENTIFIC, COMPUTER AND LEGAL SERVICES

FOR CONSULTING SERVICES RELATING TO THE CUSTOMIZATION AND IMPLEMENTATION OF INTERACTIVE COMPUTER SOFTWARE FOR ENHANCING PERSONALIZED ELECTRONIC COMMERCE VIA A GLOBAL COMPUTER NETWORK BY USING DETAILED HISTORY OF PAST INTERACTIONS WITH CUSTOMERS, USING PROFILE INFORMATION, USING MARKETING RULES AND USING INVENTORY INFORMATION (U.S. CLS. 100 AND 101).

SN 78-085,669. GOLDEN CARROT CO., THE, TULSA, OK.
FILED 9-26-2001.

EXCEPTIONS

CLASS 35—ADVERTISING AND BUSINESS

FOR RETAIL STORE SERVICES FEATURING PET CARE SUPPLIES AND ACCESSORIES, NAMELY, GOURMET PET BAKERY GOODS, DOG COLLARS, LEASHES, HARNESSES, AND LEADS, CANINE HYGIENIC AND HEALTH SUPPLIES INCLUDING GROOMING BRUSHES, TRIMMERS, CLIPPERS, SHAMPOOS, CONDITIONERS, COAT TREATMENTS, PEST CONTROL SOLUTIONS, AND ITEMS RELATED THERETO; AND ASSORTED PET TOYS, CLOTHING AND COSTUME WEAR (U.S. CLS. 100, 101 AND 102).

FIRST USE 6-23-2001; IN COMMERCE 6-23-2001.

CLASS 42—SCIENTIFIC, COMPUTER AND LEGAL SERVICES

FOR CAGE-FREE KENNELING SERVICES, PET SITTING AND DAYCARE SERVICES FOR PETS; AND ANIMAL GROOMING SERVICES (U.S. CLS. 100 AND 101).

FIRST USE 6-23-2001; IN COMMERCE 6-23-2001.

WATER-TO-VALUE

CLASS 9—ELECTRICAL AND SCIENTIFIC APPARATUS

FOR COMPUTER SOFTWARE FOR CONTROLLING SCIENTIFIC, ELECTRIC AND OPTICAL APPARATUS AND INSTRUMENTS USED FOR MEASURING AND MONITORING THE QUALITY AND QUANTITY OF WATER AND FOR TREATMENT OF WATER, AND COMPUTER SOFTWARE FOR STORING, PROCESSING AND INTERPRETING RESULTS OBTAINED BY USING THE AFORESAID APPARATUS AND INSTRUMENTS, IN THE FIELD OF WATER TREATMENT IN THE EXPLORATION AND PRODUCTION OF OIL AND GAS WELLS (U.S. CLS. 21, 23, 26, 36 AND 38).

CLASS 37—CONSTRUCTION AND REPAIR

FOR CONSTRUCTION AND MAINTENANCE OF OIL AND GAS WELLS (U.S. CLS. 100, 103 AND 106).

CLASS 42—SCIENTIFIC, COMPUTER AND LEGAL SERVICES

FOR SCIENTIFIC AND INDUSTRIAL RESEARCH, COMPUTER PROGRAMMING, AND CONSULTING SERVICES, ALL IN THE FIELD OF TREATMENT OF WATER IN THE EXPLORATION AND PRODUCTION OF OIL AND GAS WELLS; CONSULTING SERVICES IN THE FIELD OF THE USE AND CONSERVATION OF ENERGY AND THE ENVIRONMENT (U.S. CLS. 100 AND 101).

SN 78-085,907. BAKER HUGHES INCORPORATED, HOUSTON, TX. FILED 9-27-2001.

GRANITE

CLASS 7—MACHINERY

FOR DOWNHOLE OIL FIELD EQUIPMENT, NAMELY PACKERS, BRIDGE PLUGS, USED IN OIL AND GAS WELLS TO ISOLATE THE FLOW OF FLUIDS TO OR FROM GEOLOGIC FORMATIONS (U.S. CLS. 13, 19, 21, 23, 31, 34 AND 35).

CLASS 9—ELECTRICAL AND SCIENTIFIC APPARATUS

FOR DOWNHOLE OIL FIELD EQUIPMENT, NAMELY FLOW REGULATORS USED IN OIL AND GAS WELLS (U.S. CLS. 21, 23, 26, 36 AND 38).

SN 78-085,913. BAKER HUGHES INCORPORATED, HOUSTON, TX. FILED 9-27-2001.

IMPASS

CLASS 7—MACHINERY

FOR DOWNHOLE OIL FIELD EQUIPMENT, NAMELY PACKERS, BRIDGE PLUGS, USED IN OIL AND GAS WELLS TO ISOLATE THE FLOW OF FLUIDS TO OR FROM GEOLOGIC FORMATIONS (U.S. CLS. 13, 19, 21, 23, 31, 34 AND 35).

CLASS 9—ELECTRICAL AND SCIENTIFIC APPARATUS

FOR DOWNHOLE OIL FIELD EQUIPMENT, NAMELY FLOW REGULATORS USED IN OIL AND GAS WELLS (U.S. CLS. 21, 23, 26, 36 AND 38).

SN 78-090,041. CENFUEL FPU LLC, CHARLESTON, WV. FILED 10-24-2001.



NO CLAIM IS MADE TO THE EXCLUSIVE RIGHT TO USE "FUEL", APART FROM THE MARK AS SHOWN. THE STIPPLING IS FOR SHADING PURPOSES ONLY.

SN 78-087,228. MCCLURE, STEVEN RODERICK, TAMPA, FL. FILED 10-5-2001.

MONK**CLASS 9—ELECTRICAL AND SCIENTIFIC APPARATUS**

FOR PRE-RECORDED MEDIA, NAMELY, COMPACT DISCS, 12 INCH SINGLE PHONOGRAPH RECORDS, LP PHONOGRAPH RECORDS, AND AUDIO TAPES FEATURING MUSIC AND MUSICAL PERFORMANCES; SLIPMATS FOR USE WITH TURNTABLES (U.S. CLS. 21, 23, 26, 36 AND 38).

FIRST USE 12-1-1989; IN COMMERCE 12-1-1992.

CLASS 41—EDUCATION AND ENTERTAINMENT

FOR RECORDING STUDIO SERVICES, NAMELY ORIGINAL PRODUCTIONS AS WELL AS REMIX WORK FOR OTHER ARTISTS' MUSIC AND VIDEO PRODUCTIONS, AUDIO RECORDING (U.S. CLS. 100, 101 AND 107).

FIRST USE 12-1-1989; IN COMMERCE 12-1-1992.

SN 78-087,505. SBC COMMUNICATIONS INC., SAN ANTONIO, TX. FILED 10-9-2001.

WWW.SMARTPAGES.COM
YOUR ONLINE YELLOW
PAGES – AND MORE.

CLASS 16—PAPER GOODS AND PRINTED MATTER

FOR TELEPHONE DIRECTORIES (U.S. CLS. 2, 5, 22, 23, 29, 37, 38 AND 50).

FIRST USE 8-0-2001; IN COMMERCE 8-0-2001.

CLASS 35—ADVERTISING AND BUSINESS

FOR ADVERTISING SERVICES, NAMELY, PROMOTING THE GOODS AND SERVICES OF OTHERS BY PREPARING AND PLACING ADVERTISEMENTS IN DIRECTORY LISTING DATABASES ACCESSED THROUGH A GLOBAL INFORMATION NETWORK; PROVIDING RETAIL STORE INFORMATION, SHOPPERS GUIDE INFORMATION AND BUSINESS LISTINGS BY ELECTRONIC MEANS (U.S. CLS. 100, 101 AND 102).

FIRST USE 8-0-2001; IN COMMERCE 8-0-2001.

CLASS 4—LUBRICANTS AND FUELS

FOR COAL DERIVED FUEL PRODUCT, NAMELY REFINED CARBON, FOR THE GENERATION OF ENERGY (U.S. CLS. 1, 6 AND 15).

CLASS 40—MATERIAL TREATMENT

FOR FUEL PRODUCTION AND REFINING (U.S. CLS. 100, 103 AND 106).

SN 78-090,515. WINKLEER, KIMBERLY, NEW YORK, NY. FILED 10-28-2001.

VISIONS OF PARADISE**CLASS 3—COSMETICS AND CLEANING PREPARATIONS**

FOR COSMETICS, NAMELY SOAPS, EYE SHADOW, EYE LINER, MASCARA, BLUSH, POWDER, LIPSTICK, LIP LINER, LIP GLOSS, NAIL POLISH, COMPACTS; FRAGRANCE EMITTING WICKS FOR ROOM; ROOM FRAGRANCES; SACHET-LIKE EYE PILLOWS CONTAINING FRAGRANCES; PERFUME, COLOGNES, BODY WASHES, ESSENTIAL OILS FOR PERSONAL USE, HAIR SHAMPOO, HAIR CONDITIONER, HAIR LOTIONS, MOUSSES AND GELS, BATH GELS, BATH CRYSTALS, SCENTED OILS AND SPRAYS, SCENTED POWDERS, BODY AND HAIR GLITTER, INCENSE, SCENTED SACHETS, SCENTED WANDS, PERSONAL DEODORANT, ANTI-PERSPIRANT, POTPOURRI, NAIL DECALS (U.S. CLS. 1, 4, 6, 50, 51 AND 52).

CLASS 16—PAPER GOODS AND PRINTED MATTER

FOR BOOKS REGARDING ROMANCE; SERIES OF FICTION BOOKS; SERIES OF NON-FICTION BOOKS REGARDING ROMANCE; MAGAZINES PERTAINING TO ROMANCE, PLAYING CARDS, BLANK JOURNALS, DIARIES, NOTEBOOKS, ADDRESS BOOKS, NOTEBOOKS, STATIONERY-TYPE PORTFOLIOS, BINDERS, BOOKMARKS, WRITING PAPER AND ENVELOPES, POSTERS, PRINTS, CALENDARS, POSTCARDS, GREETING CARDS, GIFT WRAP, PAPER GIFT TAGS, NOTE CARDS, NOTECUBES, PAPER PARTY DECORATIONS, BAGS AND FAVORS, PENS, PENCILS, DECALS, STICKERS; PAPER PARTY DECORATIONS, BAGS AND FAVORS (U.S. CLS. 2, 5, 22, 23, 29, 37, 38 AND 50).

SN 78-092,931. BURLINGTON RESOURCES, INC., HOUSTON, TX. FILED 11-13-2001.

BURLINGTON RESOURCES**CLASS 40—MATERIAL TREATMENT**

FOR PRODUCTION OF CRUDE OIL AND NATURAL GAS (U.S. CLS. 100, 103 AND 106).

CLASS 42—SCIENTIFIC, COMPUTER AND LEGAL SERVICES

FOR EXPLORATION OF CRUDE OIL AND NATURAL GAS (U.S. CLS. 100 AND 101).

SN 78-098,177. SECURITIES INDUSTRY ASSOCIATION, NEW YORK, NY. FILED 12-13-2001.



OWNER OF U.S. REG. NOS. 2,410,597 AND 2,496,280.
NO CLAIM IS MADE TO THE EXCLUSIVE RIGHT TO USE "INVESTOR", APART FROM THE MARK AS SHOWN. THE STYLIZED LETTERS IN THE MARK ARE "SIA".

SN 78-093,136. DADA CORPORATION, SEOUL, REPUBLIC OF KOREA, FILED 11-14-2001.

MOVITO

THE ENGLISH TRANSLATION OF "MOVITO" IS A COMPOUND WORD IN WHICH "MODA" AND "VITTORIA" IN ITALIAN ARE COMBINED, WHERE "MODA" MEANS "FASHION" IN ITALIAN AND "VITTORIA" MEANS "VICTORY" IN ITALIAN.

CLASS 36—INSURANCE AND FINANCIAL

FOR FINANCIAL RESEARCH SERVICES; PROVIDING FINANCIAL INFORMATION TO OTHERS (U.S. CLS. 100, 101 AND 102).

FIRST USE 11-7-2001; IN COMMERCE 11-7-2001.

CLASS 18—LEATHER GOODS

FOR SUIT BAGS, BRIEFCASES, WALLETS, TRAVEL BAGS, SPORTS BAGS, SHOPPING BAGS, NAMELY, LEATHER BAGS, MESH BAGS, SCHOOL BAGS, HANDBAGS, BOSTON BAGS, BEACH BAGS (U.S. CLS. 1, 2, 3, 22 AND 41).

CLASS 41—EDUCATION AND ENTERTAINMENT

FOR EDUCATIONAL SERVICES, NAMELY, CONDUCTING CLASSES, SEMINARS, CONFERENCES, WORKSHOPS AND ONLINE EXHIBITIONS, DISPLAYS AND INTERACTIVE EXHIBITS IN THE FIELD OF FINANCE, INVESTMENTS, LOANS, SECURITIES, BONDS, STOCKS, MUTUAL FUNDS, AND FINANCIAL MARKETS AND PROVIDING COURSE MATERIALS IN THE NATURE OF BOOKLETS, MANUALS, BOOKS, WORKBOOKS, WORKSHEETS, EXAMPLES AND ONLINE WEB PAGES AND CONTENT DISTRIBUTED IN CONNECTION THEREWITH (U.S. CLS. 100, 101 AND 107).

FIRST USE 11-7-2001; IN COMMERCE 11-7-2001.

CLASS 25—CLOTHING

FOR CLOTHING, NAMELY, HATS, CAPS AND HEADWEAR, HEADBANDS, BATHING CAPS, SHOWER CAPS, BEACHWEAR, NAMELY, BATHING SUIT, JACKETS, JEANS, CASUAL WEAR, NAMELY, SHORTS, T-SHIRTS, OVERCOATS, SHOES (U.S. CLS. 22 AND 39).

SN 78-098,408. GIANCARLO PAOLI S.R.L., PORTO SANT'ELPIDIO, ITALY, FILED 12-14-2001.

GIANCARLO PAOLI

THE NAME "GIANCARLO PAOLI" IDENTIFIES A LIVING INDIVIDUAL WHOSE CONSENT IS OF RECORD.

CLASS 18—LEATHER GOODS

FOR BAGS, NAMELY, ALL PURPOSE SPORTS BAGS, ALL PURPOSE ATHLETIC BAGS, BEACH BAGS, BOOK BAGS, CARRY-ON BAGS, CLUTCH BAGS, DUFFEL BAGS, GYM BAGS, LEATHER SHOPPING BAGS, SCHOOL BAGS, SHOE BAGS, TOTE BAGS, TRAVEL BAGS, AND HANDBAGS; PURSES, WALLETS, SUITCASES, TRUNKS, BEAUTY-CASES SOLD EMPTY, DOCUMENT CASES, UMBRELLAS (U.S. CLS. 1, 2, 3, 22 AND 41).

CLASS 25—CLOTHING

FOR SHOES; FOOTWEAR; HEADWEAR; CLOTHING, NAMELY DRESSES, SKIRTS, TROUSERS, SHIRTS, JACKETS, OVERCOATS, RAINCOATS, COATS, PULL-OVERS, JERKINS, HATS, SCARVES, FOULARDS, HOSIERY, GLOVES, BELTS FOR CLOTHING, BATHING SUITS, BATHING SHORTS, GYMNASTIC SUITS, UNDERWEAR VESTS, BRAS, PANTS, PANTIES, PETTI-COATS, DRESSING-GOWNS, NIGHT SHIRTS, NIGHT-GOWNS, BOOTS, SANDALS, CLOGS AND SLIPPERS (U.S. CLS. 22 AND 39).

FIRST USE 4-27-1993; IN COMMERCE 4-27-1993.

SN 78-095,765. MCHALE & MCHALE LANDSCAPE DESIGN, INC., UPPER MARLBORO, MD. FILED 11-29-2001.

**CLASS 37—CONSTRUCTION AND REPAIR**

FOR LANDSCAPE CONSTRUCTION SERVICES (U.S. CLS. 100, 103 AND 106).
FIRST USE 12-31-1983; IN COMMERCE 12-31-1983.

CLASS 42—SCIENTIFIC, COMPUTER AND LEGAL SERVICES

FOR LANDSCAPE GARDENING, LANDSCAPE DESIGN, AND LANDSCAPE ARCHITECTURE SERVICES (U.S. CLS. 100 AND 101).
FIRST USE 12-31-1983; IN COMMERCE 12-31-1983.

SN 78-098,463. MEMTEK INTERNATIONAL, INC., KOW-
LOON, HONG KONG, FILED 12-14-2001.

IS IT LIVE OR IS IT MEMOREX?

OWNER OF U.S. REG. NOS. 734,922, 2,548,308 AND
OTHERS.

CLASS 9—ELECTRICAL AND SCIENTIFIC APPARATUS

FOR AUDIO AND VIDEO EQUIPMENT, NAMELY, BLANK AUDIO AND VIDEO TAPES; HEADPHONES; STEREO CABLES; CONNECTORS, NAMELY, AC ADAPTOR WALL TRANSFORMERS; AMPLIFIERS; REMOTE CONTROL UNITS; ANTENNAS; AUDIO SPEAKERS; CORDED AND CORDLESS TELEPHONES; MOBILE PHONES; ANSWERING MACHINES; RADIOS; 2-WAY RADIOS; RECEIVERS; ELECTRONIC CLOCKS; COMPACT DISC PLAYERS AND COMPACT DISC RECORDERS; AUDIO CASSETTE PLAYERS AND RECORDERS; DIGITAL VOICE RECORDERS; DIGITAL CAMERAS; DIGITAL DATA ORGANIZERS; DVD-PLAYERS AND RECORDERS; KARAOKE SYSTEMS, NAMELY, KARAOKE MACHINES, MICROPHONES, AND SOFTWARE, NAMELY COMPACT DISCS FEATURING MUSIC WITH ACCOMPANYING LYRICS AND GRAPHICS; BLANK OPTICAL RECORDING MEDIA, NAMELY, RECORDABLE AND REWRITEABLE COMPACT DISCS AND DVDS, RECORDABLE RANDOM ACCESS MEMORY RAM, AND DRIVES THEREFORE; MAGNETIC RECORDING MEDIA, NAMELY, BLANK MAGNETIC AUDIO AND VIDEO TAPES; TELEVISION SETS; VIDEO CASSETTE RECORDERS AND CAMCORDERS; VIDEO CASSETTE RECORDER CLEANING KITS COMPRISING A VIDEO CASSETTE CLEANING CARTRIDGE AND VIDEO CASSETTE RECORDER CLEANING SOLUTION; PORTABLE STEREO SYSTEMS COMPRISING AUDIO SPEAKERS AND ONE OR MORE OF THE FOLLOWING—AM-FM RADIO RECEIVER, AUDIO CASSETTE PLAYER/RECORDER, COMPACT DISC PLAYER; STEREO RACK SYSTEMS COMPRISING AUDIO SPEAKERS AND ONE OR MORE OF THE FOLLOWING—AM-FM RADIO RECEIVER, COMPACT DISC PLAYER, VIDEO CASSETTE PLAYER/RECORDER, AND PHONOGRAPH RECORD PLAYER; AUDIO AND VIDEO MEDIA STORAGE DEVICES, NAMELY, CARRYING CASES AND BOXES FOR COMPACT DISCS, AUDIO TAPES AND VIDEO TAPES; COMPUTER DISK DRIVES, OPTICAL DISC DRIVES; COMPUTER HARDWARE AND PERIPHERALS; COMPUTER MEMORY CARDS; COMPUTER CARD READERS; PCMCIA CARDS AND ADAPTERS (U.S. CLS. 21, 23, 26, 36 AND 38).

CLASS 16—PAPER GOODS AND PRINTED MATTER

FOR PAPER SHREDDERS (U.S. CLS. 2, 5, 22, 23, 29, 37,
38 AND 50).

SN 78-099,982. ALARIS, LLC, IRVINGTON ON HUDSON,
NY. FILED 12-26-2001.

BABY DARLINGS

NO CLAIM IS MADE TO THE EXCLUSIVE RIGHT TO
USE "BABY", APART FROM THE MARK AS SHOWN.

CLASS 3—COSMETICS AND CLEANING PRE- PARATIONS

FOR BABY WIPES; BABY CREAMS; BABY LOTIONS;
BABY OILS; BABY SHAMPOOS; BABY POWDERS;
PETROLEUM JELLY FOR COSMETIC PURPOSES; COT-
TON BALLS FOR COSMETIC PURPOSES; COTTON
SWABS FOR COSMETIC PURPOSES, ALL FOR USE ON
BABIES AND INFANTS (U.S. CLS. 1, 4, 6, 50, 51 AND 52).

CLASS 16—PAPER GOODS AND PRINTED MATTER

FOR DISPOSABLE DIAPERS (U.S. CLS. 2, 5, 22, 23, 29,
37, 38 AND 50).

SN 78-101,648. NOVARTIS AG, BASEL, SWITZERLAND,
FILED 1-9-2002.

TOTAL NUTRITION SOLUTIONS @ HOME

NO CLAIM IS MADE TO THE EXCLUSIVE RIGHT TO
USE "NUTRITION", APART FROM THE MARK AS
SHOWN.

CLASS 16—PAPER GOODS AND PRINTED MATTER

FOR PRINTED EDUCATIONAL MATERIALS IN THE
FIELD OF HOME MANAGEMENT OF NUTRITIONAL
HEALTHCARE FOR MEDICAL PATIENTS (U.S. CLS. 2,
5, 22, 23, 29, 37, 38 AND 50).

CLASS 39—TRANSPORTATION AND STO- RAGE

FOR HOME DELIVERY OF NUTRITIONAL SUPPLE-
MENTS (U.S. CLS. 100 AND 105).

CLASS 41—EDUCATION AND ENTERTAIN- MENT

FOR EDUCATIONAL SERVICES, NAMELY, CON-
DUCTING SEMINARS AND DISTRIBUTING COURSE
MATERIALS IN CONNECTION THEREWITH, IN THE
FIELD OF HOME MANAGEMENT OF NUTRITIONAL
HEALTHCARE FOR MEDICAL PATIENTS (U.S. CLS.
100, 101 AND 107).

CLASS 44—MEDICAL, BEAUTY AND AGRI- CULTURAL SERVICES

FOR COUNSELING IN THE FIELD OF HOME MAN-
AGEMENT OF NUTRITIONAL HEALTHCARE (U.S.
CLS. 100 AND 101).

SN 78-102,822. DIVERSITYPRO CORP., MIAMI, FL. FILED 1-
15-2002.

OCEAN DRIVE

CLASS 3—COSMETICS AND CLEANING PRE- PARATIONS

FOR ALL PURPOSE CLEANERS (U.S. CLS. 1, 4, 6, 50,
51 AND 52).

CLASS 16—PAPER GOODS AND PRINTED MATTER

SN 78-107,194. RODALE INC., EMMAUS, PA. FILED 2-6-2002.

FOR FACIAL TISSUE AND TOILET PAPER (U.S. CLS. 2, 5, 22, 23, 29, 37, 38 AND 50).

MH

CLASS 16—PAPER GOODS AND PRINTED MATTER

FOR MAGAZINE PUBLISHED PERIODICALLY IN THE FIELD OF HEALTH, FITNESS, DIET, EXERCISE, AND LIFESTYLE (U.S. CLS. 2, 5, 22, 23, 29, 37, 38 AND 50).

SN 78-102,884. VERINT SYSTEMS, INC., WOODBURY, NY. BY CHANGE OF NAME COMVERSE INFOSYS, INC., WOODBURY, NY. FILED 1-15-2002.

VERINT

CLASS 41—EDUCATION AND ENTERTAINMENT

FOR PUBLICATION OF AN ON-LINE MAGAZINE CONTAINING COLUMNS AND ARTICLES IN THE FIELD OF HEALTH, FITNESS, DIET, EXERCISE, AND LIFESTYLE (U.S. CLS. 100, 101 AND 107).

CLASS 9—ELECTRICAL AND SCIENTIFIC APPARATUS

FOR COMPUTER HARDWARE AND SOFTWARE FOR USE IN THE FIELDS OF TELECOMMUNICATIONS, DIGITAL SECURITY AND SURVEILLANCE, COMPUTER AND TELECOMMUNICATION NETWORKS AND MULTIMEDIA FOR USE IN THE MONITORING, ACQUISITION, RECORDING, ANALYSIS AND STORAGE OF VOICE, FAX, VIDEO, INTERNET, DATA AND DESKTOP SCREEN IMAGERY FROM MULTIPLE TELECOMMUNICATION CHANNELS, AND INSTRUCTION MANUALS, SOLD AS A UNIT (U.S. CLS. 21, 23, 26, 36 AND 38).

CLASS 44—MEDICAL, BEAUTY AND AGRICULTURAL SERVICES

FOR PROVIDING INFORMATION IN THE FIELD OF HEALTH, FITNESS, DIET, EXERCISE, AND LIFESTYLE VIA A WEB SITE ON A MULTI-USER GLOBAL COMPUTER INFORMATION NETWORK (U.S. CLS. 100 AND 101).

CLASS 42—SCIENTIFIC, COMPUTER AND LEGAL SERVICES

FOR COMPUTER CONSULTING SERVICES IN THE FIELDS OF BUSINESS ENTERPRISE SOLUTIONS, COMPUTER SOFTWARE AND HARDWARE, TELECOMMUNICATIONS, DIGITAL SECURITY AND SURVEILLANCE, COMPUTER AND TELECOMMUNICATION NETWORKS AND MULTIMEDIA (U.S. CLS. 100 AND 101).

SN 78-107,610. WOOD, ALLEN, D., DBA COMPUTER RESTORATION SERVICES, BALTIMORE, MD. FILED 2-8-2002.

SN 78-103,231. VERMONT PURE HOLDINGS, LTD., WHITE PLAINS, NY. FILED 1-17-2002.

VERMONT PURE ENHANCED



OWNER OF U.S. REG. NO. 2,053,931. NO CLAIM IS MADE TO THE EXCLUSIVE RIGHT TO USE "ENHANCED", APART FROM THE MARK AS SHOWN. SEC. 2(F) AS TO "VERMONT PURE".

NO CLAIM IS MADE TO THE EXCLUSIVE RIGHT TO USE "AMERICAN", APART FROM THE MARK AS SHOWN.

CLASS 5—PHARMACEUTICALS

FOR NEUTRACEUTICAL BEVERAGES USED AS DIETARY SUPPLEMENTS (U.S. CLS. 6, 18, 44, 46, 51 AND 52).

CLASS 25—CLOTHING

FOR T-SHIRTS, CAPS, JACKETS, TANK TOPS, BOXER SHORTS, COTTON SHORTS, ATHLETIC SHORTS, SWEATPANTS, SWEATSHIRTS (U.S. CLS. 22 AND 39).

CLASS 30—STAPLE FOODS

FOR ICED TEA (U.S. CL. 46).

CLASS 32—LIGHT BEVERAGES

FOR BOTTLED WATER, FRUIT JUICES, AND FRUIT-FLAVORED WATER (U.S. CLS. 45, 46 AND 48).

CLASS 42—SCIENTIFIC, COMPUTER AND LEGAL SERVICES

FOR COMPUTER SERVICES, NAMELY, CREATING AND MAINTAINING WEB SITES FOR OTHERS (U.S. CLS. 100 AND 101).

SN 78-107,755. EDUCATION BASED HOUSING, INC., HOUSTON, TX. FILED 2-8-2002.

EDUCATION BASED HOUSING

CLASS 41—EDUCATION AND ENTERTAINMENT

FOR PROVIDING CHARITABLE SERVICES, NAMELY, CONDUCTING ENGLISH LANGUAGE CLASSES, PARENTING CLASSES AND GED CLASSES (U.S. CLS. 100, 101 AND 107).

CLASS 42—SCIENTIFIC, COMPUTER AND LEGAL SERVICES

FOR PROVIDING CHARITABLE SERVICES, NAMELY, PROVIDING FREE ACCESS TO COMPUTER LAB SERVICES (U.S. CLS. 100 AND 101).

CLASS 43—HOTEL AND RESTAURANT SERVICES

FOR PROVIDING CHARITABLE SERVICES, NAMELY, PROVIDING CHILD CARE SERVICES (U.S. CLS. 100 AND 101).

SN 78-108,060. WET SEAL, INC., THE, FOOTHILL RANCH, CA. FILED 2-11-2002.

SEAL MAGAZINE

NO CLAIM IS MADE TO THE EXCLUSIVE RIGHT TO USE "MAGAZINE", APART FROM THE MARK AS SHOWN.

CLASS 16—PAPER GOODS AND PRINTED MATTER

FOR MAGAZINES IN THE FIELD OF FASHION, CLOTHING, BEAUTY, SPORTS, MUSIC, ART, ENTERTAINMENT AND VARIETY (U.S. CLS. 2, 5, 22, 23, 29, 37, 38 AND 50).

CLASS 41—EDUCATION AND ENTERTAINMENT

FOR COMPUTER SERVICES, NAMELY PROVIDING ON-LINE MAGAZINES AND NEWSLETTERS IN THE FIELD OF FASHION, CLOTHING, BEAUTY, SPORTS, MUSIC, ART, ENTERTAINMENT AND VARIETY (U.S. CLS. 100, 101 AND 107).

SN 78-109,124. INTERNATIONAL BUSINESS MACHINES CORPORATION, ARMONK, NY. FILED 2-15-2002.

E BUSINESS IS THE GAME

NO CLAIM IS MADE TO THE EXCLUSIVE RIGHT TO USE "E BUSINESS", APART FROM THE MARK AS SHOWN.

CLASS 37—CONSTRUCTION AND REPAIR

FOR CUSTOM INSTALLATION, REPAIR AND MAINTENANCE OF COMPUTER HARDWARE FOR COMMERCIAL INTERACTIONS OVER GLOBAL COMPUTER NETWORKS (U.S. CLS. 100, 103 AND 106).

CLASS 41—EDUCATION AND ENTERTAINMENT

FOR EDUCATION SERVICES, NAMELY, CONDUCTING PRESENTATIONS, TECHNICAL DEMONSTRATIONS AND TRAINING SEMINARS IN THE FIELD OF COMMERCIAL INTERACTION APPLICATIONS FOR GLOBAL COMPUTER NETWORKS (U.S. CLS. 100, 101 AND 107).

CLASS 42—SCIENTIFIC, COMPUTER AND LEGAL SERVICES

FOR COMPUTER CONSULTATION AND COMPUTER SYSTEMS DESIGN SERVICES FOR OTHERS IN THE FIELD OF COMMERCIAL INTERACTION APPLICATIONS FOR GLOBAL COMPUTER NETWORKS (U.S. CLS. 100 AND 101).

SN 78-109,590. INTEGRIX VENTURES LLC, TOLEDO, OH. FILED 2-19-2002.

HOMEXPERTS

CLASS 9—ELECTRICAL AND SCIENTIFIC APPARATUS

FOR HOME THEATER SYSTEMS COMPRISING SOME OR ALL OF THE FOLLOWING ITEMS, SOLD AS A UNIT: PROJECTORS AND PROJECTOR CASES THEREFORE; VIDEO PROCESSORS; DVD PLAYERS; VIDEO CASSETTE RECORDERS; HIGH DEFINITION TELEVISION (HDTV) COMPONENT, NAMELY HDTV ENCODERS AND DECODERS; PROJECTION SCREENS; COAXIAL CABLES AND CONNECTORS THEREFORE; AUDIO AND VIDEO CABLES AND CONNECTORS THEREFORE; AMPLIFIERS; RECEIVERS; SPEAKERS; SPEAKER WIRE AND CONNECTORS THEREFORE; HOME THEATER CONTROL SYSTEMS, NAMELY REMOTE CONTROL DEVICES FOR USE WITH HOME THEATER COMPONENTS AND CONTROLS FOR LIGHTS AND LIGHTING SYSTEMS; SURGE PROTECTORS; WIRING HARNESSSES; ELECTRICAL LIGHTING SYSTEMS, COMPRISING LIGHTS, LIGHT MOUNTS, LIGHT CONTROLS AND LIGHT WIRING; COMPUTER HARDWARE; AND COMPUTER SOFTWARE THAT ALLOWS INDIVIDUAL TO PERSONALIZE THEIR CHOICE OF TELEVISION PROGRAMS THAT CAN BE VIEWED AT CERTAIN TIMES, AND THAT ALLOWS INDIVIDUALS TO VIEW SUCH PROGRAMS IN INTERACTIVE FORMATS (U.S. CLS. 21, 23, 26, 36 AND 38).

CLASS 20—FURNITURE AND ARTICLES NOT OTHERWISE CLASSIFIED

FOR HOME THEATER FURNITURE AND DECOR PACKAGES, FEATURING SOME OR ALL OF THE FOLLOWING ITEMS, SOLD AS A UNIT— HOME THEATER SEATS AND COMPONENTS THEREOF, PROSCENIUM STAGE STRUCTURE AND COMPONENTS THEREOF, CABINETS FOR AUDIO AND VIDEO EQUIPMENT, NON-METAL DECORATIVE COLUMNS AND DECORATIVE RAIL MOLDING, ACOUSTICAL WALL AND CEILING PANELS AND COMPONENTS THEREOF, CARPETING, AND LAMINATE FLOORING (U.S. CLS. 2, 13, 22, 25, 32 AND 50).

CLASS 37—CONSTRUCTION AND REPAIR

FOR INSTALLATION OF CUSTOM-DESIGNED HOME THEATER SYSTEMS (U.S. CLS. 100, 103 AND 106).

CLASS 42—SCIENTIFIC, COMPUTER AND LEGAL SERVICES

FOR CUSTOM DESIGN OF HOME THEATER SYSTEMS (U.S. CLS. 100 AND 101).

SN 78-109,760. AT&T CORP., NEW YORK, NY. FILED 2-19-2002.

AT&T AUTOMINUTES

OWNER OF U.S. REG. NOS. 1,298,084, 2,559,467 AND OTHERS.

CLASS 9—ELECTRICAL AND SCIENTIFIC APPARATUS

FOR MAGNETICALLY ENCODED PREPAID TELECOMMUNICATIONS CALLING CARDS (U.S. CLS. 21, 23, 26, 36 AND 38).

CLASS 36—INSURANCE AND FINANCIAL

FOR PREPAID TELECOMMUNICATIONS CALLING CARD SERVICES (U.S. CLS. 100, 101 AND 102).

SN 78-110,109. MEDSPHERE SYSTEMS CORPORATION, PALO ALTO, CA. FILED 2-21-2002.

MEDSPHERE

CLASS 9—ELECTRICAL AND SCIENTIFIC APPARATUS

FOR COMPUTER SOFTWARE AND SYSTEMS COMPRISED OF HARDWARE AND PERIPHERALS FOR USE IN THE HEALTHCARE FIELD, NAMELY FOR MANAGING, STORING, ANALYZING, MAINTAINING, PROCESSING, STRUCTURING, REVIEWING, BUILDING, EDITING, DISTRIBUTING, COMMUNICATING, ORGANIZING, SHARING, REFERENCING, MONITORING AND INTEGRATING HEALTHCARE INFORMATION; COMPUTER SOFTWARE AND SYSTEMS COMPRISED OF HARDWARE AND PERIPHERALS FOR AUTOMATING CLINICAL, ADMINISTRATIVE AND FINANCIAL PROCESSES IN THE HEALTHCARE FIELD (U.S. CLS. 21, 23, 26, 36 AND 38).

CLASS 44—MEDICAL, BEAUTY AND AGRICULTURAL SERVICES

FOR CONSULTING SERVICES IN THE HEALTHCARE FIELD (U.S. CLS. 100 AND 101).

SN 78-110,680. KIM, JOANN, ANTIOCH, CA. FILED 2-23-2002.

BON APPÉTOTE

CLASS 16—PAPER GOODS AND PRINTED MATTER

FOR LUNCH BAGS (U.S. CLS. 2, 5, 22, 23, 29, 37, 38 AND 50).

CLASS 21—HOUSEWARES AND GLASS

FOR LUNCH BOXES, LUNCH PAILS (U.S. CLS. 2, 13, 23, 29, 30, 33, 40 AND 50).

SN 78-112,107. 3COM CORPORATION, SANTA CLARA, CA. FILED 3-1-2002.

3COMPLETE

OWNER OF U.S. REG. NOS. 2,104,935, 2,446,488 AND OTHERS.

CLASS 16—PAPER GOODS AND PRINTED MATTER

FOR PRINTED STATIONERY WRITING PAPER AND ENVELOPES, COMPLIMENTS SLIPS, BUSINESS CARDS AND ADVERTISING PENS AND STICKERS (U.S. CLS. 2, 5, 22, 23, 29, 37, 38 AND 50).

CLASS 21—HOUSEWARES AND GLASS

FOR MUGS (U.S. CLS. 2, 13, 23, 29, 30, 33, 40 AND 50).

CLASS 25—CLOTHING

FOR T-SHIRTS AND HATS (U.S. CLS. 22 AND 39).

CLASS 35—ADVERTISING AND BUSINESS

FOR ON-LINE RETAIL SERVICES IN THE FIELDS OF COMPUTER HARDWARE, COMPUTER SOFTWARE AND ACCESSORIES THEREFOR; PROVIDING A WEB SITE WHICH FEATURES ADVERTISEMENTS FOR THE GOODS AND SERVICES OF OTHERS ON A GLOBAL COMPUTER NETWORK (U.S. CLS. 100, 101 AND 102).

SN 78-113,075. INTEGRITY INCORPORATED, MOBILE, AL. FILED 3-7-2002.

COMING OF AGE AND HUNGRY FOR WORSHIP

CLASS 9—ELECTRICAL AND SCIENTIFIC APPARATUS

FOR PRERECORDED AUDIO AND AUDIO-VIDEO CASSETTE TAPES AND COMPACT DISCS, ALL FEATURING MUSICAL, DRAMATIC, RELIGIOUS OR FAMILY ENTERTAINMENT (U.S. CLS. 21, 23, 26, 36 AND 38).

CLASS 16—PAPER GOODS AND PRINTED MATTER

FOR SONGBOOKS AND PRINTED MUSIC SHEETS FEATURING MUSICAL, DRAMATIC, RELIGIOUS OR FAMILY ENTERTAINMENT (U.S. CLS. 2, 5, 22, 23, 29, 37, 38 AND 50).

SN 78-113,157. M2 COMMUNICATIONS, INC., JERSEY CITY, NJ. FILED 3-7-2002.

SN 78-114,363. WILDE, CONSTANCE JEAN, MUKILTEO, WA. FILED 3-12-2002.

PEER POINTS

CLASS 9—ELECTRICAL AND SCIENTIFIC APPARATUS

FOR CUSTOMIZED INTERACTIVE MULTIMEDIA CD-ROMS CONTAINING PROMOTIONAL, DESCRIPTIVE, AND EDUCATIONAL MATERIALS REGARDING THE PHARMACEUTICAL AND/OR MEDICAL PRODUCTS, TREATMENTS AND STRATEGIES OF OTHERS (U.S. CLS. 21, 23, 26, 36 AND 38).

CLASS 16—PAPER GOODS AND PRINTED MATTER

FOR PUBLICATIONS, NAMELY, PRINTED EDUCATIONAL MATERIALS OF A PROMOTIONAL AND/OR EDUCATIONAL NATURE REGARDING THE PHARMACEUTICAL AND/OR MEDICAL PRODUCTS, TREATMENTS AND STRATEGIES OF OTHERS (U.S. CLS. 2, 5, 22, 23, 29, 37, 38 AND 50).

CLASS 41—EDUCATION AND ENTERTAINMENT

FOR EDUCATIONAL SERVICES, NAMELY, DEVELOPMENT, PRODUCTION, AND DISSEMINATION FOR OTHERS OF EDUCATIONAL MATERIALS REGARDING PHARMACEUTICAL, MEDICAL AND/OR HEALTHCARE PRODUCTS, ISSUES, THERAPIES, AND STRATEGIES (U.S. CLS. 100, 101 AND 107).

CLASS 42—SCIENTIFIC, COMPUTER AND LEGAL SERVICES

FOR COMPUTER CONSULTATION; DESIGN OF COMPUTER SOFTWARE FOR OTHERS; INSTALLATION OF COMPUTER SOFTWARE; TECHNICAL SUPPORT, NAMELY, TROUBLESHOOTING OF COMPUTER SOFTWARE PROBLEMS VIA TELEPHONE, E-MAIL, AND IN PERSON (U.S. CLS. 100 AND 101).

SN 78-113,995. MARKETING SERVICES GROUP, INC, NEW YORK, NY. FILED 3-11-2002.

BEGUILE RECORDS

NO CLAIM IS MADE TO THE EXCLUSIVE RIGHT TO USE "RECORDS", APART FROM THE MARK AS SHOWN.

CLASS 35—ADVERTISING AND BUSINESS

FOR BUSINESS MARKETING CONSULTING SERVICES; MANAGEMENT OF PERFORMING ARTISTS (U.S. CLS. 100, 101 AND 102).

CLASS 41—EDUCATION AND ENTERTAINMENT

FOR PRODUCTION AND DISTRIBUTION OF MOTION PICTURES, PRODUCTION AND DISTRIBUTION OF MUSIC IN ALL MEDIA, AND MUSIC PUBLISHING SERVICES (U.S. CLS. 100, 101 AND 107).

WILD ROO'S

CLASS 8—HAND TOOLS

FOR GARDENING TOOLS, NAMELY, TOOL POUCHES FOR ATTACHMENT TO CHAPS OR BELTS (U.S. CLS. 23, 28 AND 44).

CLASS 25—CLOTHING

FOR CLOTHING, NAMELY, CHAPS, PANTS, SHORTS, SHIRTS, JACKETS, SWEATSHIRTS, SWEATERS; HEADWEAR, NAMELY, HATS AND CAPS; FOOTWEAR, NAMELY, BOOTS, WOMEN'S AND MEN'S SHOES (U.S. CLS. 22 AND 39).

SN 78-114,840. BAYER CORPORATION, PITTSBURGH, PA. FILED 3-14-2002.

YOUR LIFE. YOUR WAY.

CLASS 5—PHARMACEUTICALS

FOR DIAGNOSTIC REAGENTS AND ASSAYS FOR THE ANALYSIS OF BODY FLUIDS (U.S. CLS. 6, 18, 44, 46, 51 AND 52).

CLASS 10—MEDICAL APPARATUS

FOR MEDICAL DIAGNOSTIC INSTRUMENTS FOR THE ANALYSIS OF BODY FLUIDS; LANCING DEVICES (U.S. CLS. 26, 39 AND 44).

SN 78-114,870. MONTCLAIR, ROY, DRAPER, UT. FILED 3-14-2002.

CLEARAGAIN

CLASS 5—PHARMACEUTICALS

FOR CONTACT LENS CARE PREPARATIONS IN SOLUTION AND TABLET FORM FOR DISINFECTING, CLEANING, WETTING, CUSHIONING, SOAKING, OR RINSING CONTACT LENSES; LIQUID SOLUTIONS WHICH REWET, LUBRICATE, REHYDRATE OR RELIEVE DRYNESS IN THE EYES OR CONTACT LENSES; ARTIFICIAL TEARS; OCULAR DECONGESTANTS; AND OCULAR OINTMENTS WHICH RELIEVE IRRITATIONS, RELIEVE REDNESS, RELIEVE DISCOMFORT OR SOOTHES (U.S. CLS. 6, 18, 44, 46, 51 AND 52).

CLASS 9—ELECTRICAL AND SCIENTIFIC APPARATUS

FOR CONTACT LENSES (U.S. CLS. 21, 23, 26, 36 AND 38).

SN 78-114,884. MONTCLAIR, ROY, DRAPER, UT. FILED 3-14-2002.

SN 78-115,598. FLEXTRADE SYSTEMS INC., GREAT NECK, NY. FILED 3-18-2002.

CLEARWEAR

CLASS 5—PHARMACEUTICALS

FOR CONTACT LENS CARE PREPARATIONS IN SOLUTION AND TABLET FORM FOR DISINFECTING, CLEANING, WETTING, CUSHIONING, SOAKING, OR RINSING CONTACT LENSES; LIQUID SOLUTIONS WHICH REWET, LUBRICATE, REHYDRATE OR RELIEVE DRYNESS IN THE EYES OR CONTACT LENSES; ARTIFICIAL TEARS; OCULAR DECONGESTANTS; AND OCULAR OINTMENTS WHICH RELIEVE IRRITATIONS, RELIEVE REDNESS, RELIEVE DISCOMFORT OR SOOTHESS (U.S. CLS. 6, 18, 44, 46, 51 AND 52).

CLASS 9—ELECTRICAL AND SCIENTIFIC APPARATUS

FOR CONTACT LENSES (U.S. CLS. 21, 23, 26, 36 AND 38).

SN 78-114,972. BRONCUS TECHNOLOGIES, INC., MOUNTAIN VIEW, CA. FILED 3-14-2002.

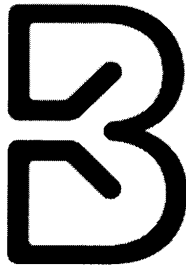

CLASS 10—MEDICAL APPARATUS

FOR MEDICAL EQUIPMENT FOR USE IN THE TREATMENT OF PULMONARY DISEASES, NAMELY, CATHETERS, PROBES, TUBING, IMPLANTS, STENTS, MONITORS, GENERATORS, BRONCHOSCOPES, FORCEPS, SNARES, ELECTRODES, NEEDLES, BIOPSY BRUSHES AND CYTOLOGY BRUSHES (U.S. CLS. 26, 39 AND 44).

CLASS 42—SCIENTIFIC, COMPUTER AND LEGAL SERVICES

FOR MEDICAL SERVICES, NAMELY PROCEDURES FOR THE TREATMENT OF PULMONARY DISEASES (U.S. CLS. 100 AND 101).

DEEPFEED

CLASS 9—ELECTRICAL AND SCIENTIFIC APPARATUS

FOR COMPUTER SOFTWARE FOR PROVIDING REAL-TIME MARKET DATA OF MULTIPLE BIDS AND OFFERS FOR SECURITIES (U.S. CLS. 21, 23, 26, 36 AND 38).

CLASS 36—INSURANCE AND FINANCIAL

FOR PROVIDING REAL-TIME FINANCIAL DATA AND MARKET INFORMATION TO FACILITATE THE TRADING OF SECURITIES (U.S. CLS. 100, 101 AND 102).

SN 78-116,204. LAWRENCE CHALSON, INC., CEDARHURST, NY. FILED 3-20-2002.



CLASS 14—JEWELRY

FOR JEWELRY (U.S. CLS. 2, 27, 28 AND 50).

CLASS 40—MATERIAL TREATMENT

FOR CUSTOM DESIGN AND MANUFACTURE OF JEWELRY (U.S. CLS. 100, 103 AND 106).

SN 78-116,221. SODEXHO OPERATIONS, LLC, GAITHERSBURG, MD. FILED 3-20-2002.

PIT

CLASS 16—PAPER GOODS AND PRINTED MATTER

FOR PRINTED BUSINESS REPORTS FEATURING CUSTOMIZED INFORMATION ABOUT BUSINESS OPERATIONS, SALES AND FINANCIAL DATA (U.S. CLS. 2, 5, 22, 23, 29, 37, 38 AND 50).

CLASS 41—EDUCATION AND ENTERTAINMENT

FOR PROVIDING ONLINE PUBLICATIONS, NAMELY, BUSINESS REPORTS FEATURING CUSTOMIZED INFORMATION ABOUT BUSINESS OPERATIONS, SALES AND FINANCIAL DATA (U.S. CLS. 100, 101 AND 107).

CLASS 5—PHARMACEUTICALS

FOR DENTAL RINSES (U.S. CLS. 6, 18, 44, 46, 51 AND 52).

SN 78-116,326. 3M COMPANY, ST. PAUL, MN. BY MERGER, BY CHANGE OF NAME MINNESOTA MINING AND MANUFACTURING COMPANY, ST. PAUL, MN. FILED 3-20-2002.

ZARIS

CLASS 3—COSMETICS AND CLEANING PREPARATIONS

FOR DENTIFRICES; TOOTHPASTES; DENTAL BLEACHING GELS (U.S. CLS. 1, 4, 6, 50, 51 AND 52).

CLASS 10—MEDICAL APPARATUS

FOR DENTAL BLEACHING TRAYS FOR USE IN WHITENING TEETH (U.S. CLS. 26, 39 AND 44).

* * * * *

SECTION 2.— INTERNATIONAL CLASSIFICATION

The short titles associated below with the international class numbers are terms designed merely for quick identification and are not an official part of the international classification. The full names of international classes are given in section 6.1 of the trademark rules of practice.

The designation "U.S. Cl." appearing in this section refers to the U.S. class in effect prior to Sep. 1, 1973 rather than the international class which applies to applications filed on or after that date. For adoption of international classification see notice in the OFFICIAL GAZETTE of Jun. 26, 1973 (911 O.G. TM 210).

Application in one class

CLASS 1—CHEMICALS

SN 75-652,498. LIONS ADHESIVES, INC., LANSING, MI. FILED 3-4-1999.

ECOSYNTHETIX, INC.

NO CLAIM IS MADE TO THE EXCLUSIVE RIGHT TO USE "INC.", APART FROM THE MARK AS SHOWN.

FOR SYNTHETIC RESINS FOR USE IN MANUFACTURED ARTICLES IN THE CHEMICAL, PLASTICS, METALLURGICAL, GLASS, PAPER, CERAMIC, PHOTOGRAPHY, AGRICULTURAL, CONSTRUCTION, INSULATION, PACKAGING, ENGINEERING, ENERGY, ELECTRICAL, ELECTRONICS, PHARMACEUTICAL, HEALTHCARE, FURNITURE, COSMETICS, TEXTILE, LEATHER, FOOD, PAINT, AUTOMOTIVE, AND TRANSPORTATION INDUSTRIES (U.S. CLS. 1, 5, 6, 10, 26 AND 46).

SN 75-653,692. STANDARD PLYWOODS, INC., DBA ANDERSON HARDWOOD FLOORS, CLINTON, SC. FILED 3-4-1999.

DUCK GLUE

NO CLAIM IS MADE TO THE EXCLUSIVE RIGHT TO USE "GLUE", APART FROM THE MARK AS SHOWN.

FOR ADHESIVES FOR APPLYING WOOD FLOORING (U.S. CLS. 1, 5, 6, 10, 26 AND 46). FIRST USE 9-3-1998; IN COMMERCE 9-3-1998.

SN 75-719,206. AGRIMUM INC., CALGARY, ALBERTA T2J, 7E8, CANADA, FILED 6-2-1999.

DURATION CR

OWNER OF U.S. REG. NO. 1,910,683. NO CLAIM IS MADE TO THE EXCLUSIVE RIGHT TO USE "CR", APART FROM THE MARK AS SHOWN.

FOR CONTROLLED RELEASED FERTILIZER FOR AGRICULTURAL AND DOMESTIC USE (U.S. CLS. 1, 5, 6, 10, 26 AND 46).

FIRST USE 1-0-2000; IN COMMERCE 1-0-2000.

CLASS 1—(Continued).

SN 75-795,196. MERGEN LTD., SAN LEANDRO, CA. FILED 10-1-1999.

EXPRESSCHIP

FOR DNA MICROARRAYS CONTAINING REAGENTS FOR SCIENTIFIC OR MEDICAL RESEARCH USE (U.S. CLS. 1, 5, 6, 10, 26 AND 46).

SN 75-872,452. WACKER-CHEMIE GMBH, D-81737 MUNICH, FED REP GERMANY, FILED 12-15-1999.

WETSOFT

PRIORITY CLAIMED UNDER SEC. 44(D) ON FED REP GERMANY APPLICATION NO. 39936600.8/0, FILED 6-24-1999, REG. NO. 39936600, DATED 7-30-1999, EXPIRES 6-30-2009.

FOR UNPROCESSED PLASTICS ON THE BASE OF ORGANOSILICON COMPOUNDS FOR USE IN THE CHEMICAL, PLASTICS, METALLURGICAL, GLASS, PAPER, CERAMIC, COMMERCIAL AND RESIDENTIAL BUILDING, AUTOMOBILE, AUTOMOTIVE, INSULATION, PACKAGING, ENGINEERING, ENERGY, TEXTILE, LEATHER, PAINT AND MOLD MAKING INDUSTRIES; UNPROCESSED SYNTHETIC RESINS FOR USE IN THE CHEMICAL, PLASTICS, METALLURGICAL, GLASS, PAPER, CERAMIC, COMMERCIAL AND RESIDENTIAL BUILDING, AUTOMOBILE, AUTOMOTIVE, INSULATION, PACKAGING, ENGINEERING, ENERGY, TEXTILE, LEATHER, PAINT AND MOLD MAKING INDUSTRIES; CHEMICAL COMPOUNDS THAT CROSS LINK TO FORM PLASTICS, ELASTOMERS AND SYNTHETIC RESINS FOR USE IN THE CHEMICAL, PLASTICS, METALLURGICAL, GLASS, PAPER, CERAMIC, COMMERCIAL AND RESIDENTIAL BUILDING, AUTOMOBILE, AUTOMOTIVE, INSULATION, PACKAGING, ENGINEERING, ENERGY, TEXTILE, LEATHER, PAINT AND MOLD MAKING INDUSTRIES; UNPROCESSED PLASTICS IN THE FORM OF SOLUTIONS, EMULSIONS, DISPERSIONS, POWDERS, REDISPERSIBLE POWDERS, GRANULES, PASTES, EXTRUDATES AND IN DRY FORM, NAMELY, IN SPRAY-DRY FORM, FOR USE IN THE CHEMICAL, PLASTICS, METALLURGICAL, GLASS, PAPER, CERAMIC, COMMERCIAL AND RESIDENTIAL BUILDING, AUTOMOBILE, AUTOMOTIVE, INSULATION, PACKAGING, ENGINEERING, ENERGY, TEXTILE, LEATHER, PAINT AND MOLD MAKING INDUSTRIES; CHEMICAL COMPOUNDS, NAMELY, SILANES, ORGANOSILANES, SILICIC-ACID ESTERS, SILICONES, POLYSILANES, POLYCARBOSILANES, POLYSILAZANES, FOR USE IN THE CHEMICAL, PLASTICS, METALLURGICAL, GLASS, PAPER, CERAMIC, COMMERCIAL AND RESIDENTIAL BUILDING, AUTOMOBILE, AUTOMOTIVE, INSULATION, PACKAGING, ENGINEERING, ENERGY,

CLASS 1—(Continued).

TEXTILE, LEATHER, PAINT AND MOLD MAKING INDUSTRIES; CHEMICAL COMPOUNDS, NAMELY, SILICONE FLUIDS, SILICONE RESINS, SILICONE GREASES, SILICONE PASTES, SILICONE SPRAYS, SILICONE ELASTOMERS AND COMPOUNDS THAT CROSS-LINK TO FORM SILICONE ELASTOMERS, FOR USE IN THE CHEMICAL, PLASTICS, METALLURGICAL, GLASS, PAPER, CERAMIC, COMMERCIAL AND RESIDENTIAL BUILDING, AUTOMOBILE, AUTOMOTIVE, INSULATION, PACKAGING, ENGINEERING, ENERGY, TEXTILE, LEATHER, PAINT AND MOLD MAKING INDUSTRIES; CHEMICAL SOLUTIONS, DISPERSIONS AND EMULSIONS CONTAINING SILICONES FOR USE IN THE CHEMICAL, PLASTICS, METALLURGICAL, GLASS, PAPER, CERAMIC, COMMERCIAL AND RESIDENTIAL BUILDING, AUTOMOBILE, AUTOMOTIVE, INSULATION, PACKAGING, ENGINEERING, ENERGY, TEXTILE, LEATHER, PAINT AND MOLD MAKING INDUSTRIES; CHEMICAL EMBEDDING COMPOUNDS ON THE BASE OF ORGANOSILICON FOR USE IN THE CHEMICAL, PLASTICS, METALLURGICAL, GLASS, PAPER, CERAMIC, COMMERCIAL AND RESIDENTIAL BUILDING, AUTOMOBILE, AUTOMOTIVE, INSULATION, PACKAGING, ENGINEERING, ENERGY, TEXTILE, LEATHER, PAINT AND MOLD MAKING INDUSTRIES; CHEMICAL AGENTS FOR IMPREGNATING, BINDING OR COATING OF TEXTILES, FURS AND LEATHER, NON-WOVENS AND FABRICS; BINDING, COATING AND IMPREGNATING CHEMICAL AGENTS FOR THE TEXTILE INDUSTRY; CHEMICAL ANTI-FOAM AGENTS ON THE BASE OF ORGANOSILICON; CHEMICAL SOFTENERS FOR TEXTILES; CHEMICAL IMPREGNATING AGENTS FOR BUILDING MATERIALS, WOOD, ARTIFICIAL AND NATURAL STONE, MORTAR, CEMENT, CONCRETE, GAS CONCRETE, GYPSUM, MASONRY AND FACADES; CHEMICAL AGENTS IN THE NATURE OF A POLYMER BASED ON PLASTICS FOR COATING TEXTILES, PAPER, MINERAL MATERIALS, FILLERS AND PIGMENTS; CHEMICAL PLASTICISERS FOR PLASTICS; AND CHEMICAL ANTISTATIC AGENTS (U.S. CLS. 1, 5, 6, 10, 26 AND 46).

SN 75-922,677. PE CORPORATION (NY), FOSTER CITY, CA. BY CHANGE OF NAME PERKIN-ELMER CORPORATION, THE, FOSTER CITY, CA. FILED 2-18-2000.



THE DRAWING IS LINED FOR THE COLORS BLUE, GREEN AND YELLOW, BUT THE DRAWING DOES NOT CONTAIN ANY LINING.

FOR NUCLEIC ACID SEQUENCING REAGENTS AND REAGENT KITS COMPRISED OF CHEMICAL REAGENTS USED IN GENETIC ANALYSIS, LIFE SCIENCE, SCIENTIFIC RESEARCH, AND POLYMERASE CHAIN REACTION (U.S. CLS. 1, 5, 6, 10, 26 AND 46).

CLASS 1—(Continued).

SN 75-981,809. UNIVERSAL FOODS CORPORATION, MILWAUKEE, WI. FILED 7-28-2000.

SENSIENT TECHNOLOGIES

NO CLAIM IS MADE TO THE EXCLUSIVE RIGHT TO USE "TECHNOLOGIES", APART FROM THE MARK AS SHOWN.

FOR AROMA CHEMICALS AND FRAGRANCES FOR USE IN THE MANUFACTURE OF COSMETICS, PERSONAL CARE PRODUCTS AND HOUSEHOLD PRODUCTS; ACIDIFYING SALT MIXTURE FOR USE IN THE MANUFACTURE OF FOOD PRODUCTS; FOOD STABILIZERS FOR USE IN THE MANUFACTURE OF FOOD PRODUCTS; OLEO RESIN FOR USE IN THE MANUFACTURE OF FOOD PRODUCTS; EMULSIFIERS FOR USE IN THE MANUFACTURE OF FOOD PRODUCTS (U.S. CLS. 1, 5, 6, 10, 26 AND 46).

SN 76-009,551. IMI - INTERNATIONAL MARKETING, INC., CHAMBERSBURG, PA. FILED 3-27-2000.



NO CLAIM IS MADE TO THE EXCLUSIVE RIGHT TO USE "DROP IN", APART FROM THE MARK AS SHOWN.

FOR DRY PULVERULENT MATERIAL FOR BALANCING TIRES AND REDUCING TIRE VIBRATION, PACKAGED IN A PRE-MEASURED FORM (U.S. CLS. 1, 5, 6, 10, 26 AND 46).

FIRST USE 12-15-1999; IN COMMERCE 12-15-1999.

SN 76-038,097. EXCALIBAR MINERALS, INC., HOUSTON, TX. FILED 5-1-2000.

ExCAL

FOR CHEMICAL PRODUCTS, NAMELY CALCIUM CARBONATE FROM LIMESTONE, MARBLE AND CALCITE IN THE FORM OF POWDERS AND GRANULES HAVING CALCIUM CARBONATE AS THE PRINCIPLE INGREDIENT FOR USE IN THE PAINT, PLASTIC AND RUBBER INDUSTRIES (U.S. CLS. 1, 5, 6, 10, 26 AND 46).

FIRST USE 4-15-1991; IN COMMERCE 4-15-1991.

CLASS 1—(Continued).

SN 76-038,175. EXCALIBAR MINERALS, INC., HOUSTON, TX. FILED 5-1-2000.

ExBAR

FOR CHEMICAL PRODUCTS, NAMELY BARIUM SULFATE, BARITE AND BARYTES IN THE FORM OF POWDERS AND GRANULES HAVING BARIUM SULFATE AS THE PRINCIPLE INGREDIENT FOR THE USE IN PAINT, PLASTIC AND RUBBER INDUSTRIES (U.S. CLS. 1, 5, 6, 10, 26 AND 46).

FIRST USE 4-15-1991; IN COMMERCE 4-15-1991.

SN 76-053,751. LAND VIEW FERTILIZER, INC., MINIDOKA, ID. FILED 5-22-2000.

POWER-LINE

FOR FERTILIZERS FOR AGRICULTURAL USE (U.S. CLS. 1, 5, 6, 10, 26 AND 46).

FIRST USE 4-1-1999; IN COMMERCE 4-1-1999.

SN 76-069,222. ATOTECH DEUTSCHLAND GMBH, D-10507 BERLIN, FED REP GERMANY, FILED 6-12-2000.

EDEN

OWNER OF FED REP GERMANY REG. NO. 39951725, DATED 5-18-2000, EXPIRES 8-31-2009.

FOR CHEMICAL PREPARATIONS FOR ELECTROPLATING PROCESSES AND ELECTROLESS NICKEL PLATING PROCESSES IN THE DECORATIVE AND FUNCTIONAL SURFACE FINISHING INDUSTRY (U.S. CLS. 1, 5, 6, 10, 26 AND 46).

SN 76-080,190. FACILICHEM, INC., MENLO PARK, CA. FILED 5-29-2000.

FACILIMAX

FOR SPECIALTY CHIRAL CHEMICALS FOR USE AS INTERMEDIATES IN PHARMACEUTICALS, AGRICULTURE CHEMICALS, FOOD PRODUCTS, AND FRAGRANCES (U.S. CLS. 1, 5, 6, 10, 26 AND 46).

CLASS 1—(Continued).

SN 76-082,640. DRUGTECH CORPORATION, WILMINGTON, DE. BY ASSIGNMENT KV PHARMACEUTICAL COMPANY, ST. LOUIS, MO. FILED 6-30-2000.

AQUAPURE EC

NO CLAIM IS MADE TO THE EXCLUSIVE RIGHT TO USE "EC", APART FROM THE MARK AS SHOWN.

FOR CHEMICAL COATINGS AND CHEMICAL MIXTURES USED IN THE MANUFACTURE OF PHARMACEUTICALS, NUTRITIONAL SUPPLEMENTS, MEDICINES AND VITAMINS (U.S. CLS. 1, 5, 6, 10, 26 AND 46).

SN 76-088,942. SEQUENOM, INC., SAN DIEGO, CA. FILED 7-14-2000.

SEQUENOM

FOR DIAGNOSTIC REAGENTS FOR SCIENTIFIC USE; DIAGNOSTIC TEST KITS CONSISTING PRIMARILY OF DIAGNOSTIC REAGENTS FOR SCIENTIFIC USE (U.S. CLS. 1, 5, 6, 10, 26 AND 46).

SN 76-103,847. VALUE SMART PRODUCTS, INC., SUWANEE, GA. FILED 8-7-2000.



NO CLAIM IS MADE TO THE EXCLUSIVE RIGHT TO USE "DEEP FREEZE", APART FROM THE MARK AS SHOWN.

THIS STIPPLING UPON THE DRAWING FOR THE MARK IS PROVIDED FOR SHADING PURPOSES ONLY, AND DOES NOT INDICATE ANY PARTICULAR COLOR.

FOR CHEMICAL PREPARATIONS FOR MELTING ICE FOR APPLICATION TO AUTOMOBILE WINDSHIELDS, LOCKS AND DOORS; CHEMICAL ADDITIVES FOR FUEL TREATMENT FOR FACILITATING STARTING ENGINE AND FOR REMOVAL OF EXCESS MOISTURE; AND WINDSHIELD DE-ICER FLUIDS (U.S. CLS. 1, 5, 6, 10, 26 AND 46).

SN 76-108,038. FUSION 360, TURLOCK, CA. FILED 8-11-2000.

GREEN M.I.L.E.

FOR CHEMICALS, NAMELY, FERTILIZING COMPOSITIONS THAT INCLUDE CALCIUM FOR AGRICULTURAL AND DOMESTIC USE (U.S. CLS. 1, 5, 6, 10, 26 AND 46).

FIRST USE 8-0-2000; IN COMMERCE 10-0-2000.

CLASS 1—(Continued).

SN 76-118,477. PE CORPORATION (NY), ROCKVILLE, MD.
FILED 8-29-2000.



THE MARK CONSISTS OF THE WORD "CELERA" ALONG WITH A STYLIZED DEPICTION OF THE HUMAN DNA STRAND.

FOR SYNTHETIC MATERIALS FOR SCIENTIFIC OR MEDICAL RESEARCH USE, NAMELY SYNTHETIC DNA, HUMAN, PLANT AND ANIMAL TISSUE AND PROTEINS; BIOLOGICAL MATERIALS FOR SCIENTIFIC OR MEDICAL RESEARCH USE, NAMELY HUMAN, PLANT, AND ANIMAL TISSUES, CELLS AND NATURAL DNA; REAGENTS FOR SCIENTIFIC OR MEDICAL RESEARCH USE (U.S. CLS. 1, 5, 6, 10, 26 AND 46).

SN 76-133,022. BETASEED, INC., SHAKOPEE, MN. FILED 9-21-2000.

PRO 200

FOR COATINGS FOR AGRICULTURAL USE ON SUGAR BEETS SEEDS TO IMPROVE PLANTABILITY AND SPACING CONTROL (U.S. CLS. 1, 5, 6, 10, 26 AND 46).

FIRST USE 3-23-2000; IN COMMERCE 3-23-2000.

SN 76-142,472. MERCK KGAA, D-64293, DARMSTADT, FED REP GERMANY, FILED 10-6-2000.

OXYNEX

OWNER OF FED REP GERMANY REG. NO. 684110, DATED 11-14-1955, EXPIRES 7-31-2005.

FOR CHEMICALS, NAMELY, ANTIOXIDANTS FOR THE PROTECTION OF OILS AND FATS FROM AUTO-OXIDATION (U.S. CLS. 1, 5, 6, 10, 26 AND 46).

FIRST USE 5-0-1969; IN COMMERCE 0-0-1996.

SN 76-144,785. BAYER AKTIENGESELLSCHAFT, LEVERKUSEN-BAYERWERK, FED REP GERMANY, FILED 10-11-2000.

LEVASIL

OWNER OF FED REP GERMANY REG. NO. 1179426, DATED 7-25-1991, RENEWED AS REG. NO. 1179426, DATED 4-28-2000, EXPIRES 4-30-2010.

FOR CHEMICALS FOR INDUSTRIAL PURPOSES; NAMELY, TECHNICAL GRADE SILICA SOLS FOR INDUSTRIAL USE IN THE FURTHER MANUFACTURE OF OTHER PRODUCTS (U.S. CLS. 1, 5, 6, 10, 26 AND 46).

CLASS 1—(Continued).

SN 76-149,535. PARK, KINAM, WEST LAFAYETTE, IN.
FILED 10-18-2000.

HYTROP

FOR CHEMICALS FOR ENHANCING THE SOLUBILITY OF DRUGS, NAMELY, HYDROTROPIC POLYMERS AND GELS (U.S. CLS. 1, 5, 6, 10, 26 AND 46).
FIRST USE 9-28-2000; IN COMMERCE 10-12-2000.

SN 76-155,787. NUI ENVIRONMENTAL GROUP, INC., UNION, NJ. FILED 10-27-2000.

EMPIRE STATE ORE

NO CLAIM IS MADE TO THE EXCLUSIVE RIGHT TO USE "ORE", APART FROM THE MARK AS SHOWN.

FOR REMEDIATION PRODUCTS, NAMELY, MANUFACTURED SOIL, SOIL AMENDMENTS AND SEDIMENTS, FOR ALTERNATIVE DAILY COVER FOR LANDFILL CLOSURES, DEVELOPMENT OF CONTAMINATED SITES, GOLF COURSES, AND LANDSCAPING PROJECTS (U.S. CLS. 1, 5, 6, 10, 26 AND 46).

SN 76-171,295. SUNBAND, INC., PITTSBURGH, PA. FILED 11-27-2000.

SUNBAND

FOR WATERPROOF ULTRAVIOLET SENSITIVE CHEMICAL PATCH OR BAND THAT PROVIDES A VISUAL COMPARISON OF ULTRAVIOLET EXPOSURE WITH A PRESELECTED VISUAL THRESHOLD EXPOSURE INDICATOR (U.S. CLS. 1, 5, 6, 10, 26 AND 46).

SN 76-183,939. IV LABS, INC., DBA INORGANIC VENTURES / IV LABS, LAKEWOOD, NJ. FILED 12-19-2000.



NO CLAIM IS MADE TO THE EXCLUSIVE RIGHT TO USE "TRANSPIRATION CONTROL TECHNOLOGY", APART FROM THE MARK AS SHOWN.

FOR INORGANIC CHEMICAL STANDARDS FOR THE DETERMINATION AND MEASUREMENT OF METALS AND IONS USED IN CHROMATOGRAPHY AND SPECTROSCOPY (U.S. CLS. 1, 5, 6, 10, 26 AND 46).

FIRST USE 11-16-2000; IN COMMERCE 11-16-2000.

CLASS 1—(Continued).

SN 76-194,894. MILLENNIUM INORGANIC CHEMICALS, INC., HUNT VALLEY, MD. FILED 1-17-2001.

FERRICA

FOR COMMODITY CHEMICALS SOLD IN BULK TO INDUSTRIAL USERS FOR FURTHER PROCESSING IN CONNECTION WITH THE MANUFACTURE OF FINISHED GOODS, NAMELY, IRON-CONTAINING INORGANIC COMPOUNDS, CARBON DIOXIDE, GYPSUM, HYDROCHLORIC ACID, AND SULFUR (U.S. CLS. 1, 5, 6, 10, 26 AND 46).

SN 76-194,917. ICI CHEMICALS & POLYMERS LIMITED, RUNCORN, CHESHIRE, WA7 4QF, ENGLAND, FILED 1-16-2001.

UNIWAX

FOR CHEMICAL PRODUCTS FOR INDUSTRIAL PURPOSES, NAMELY, THERMOPLASTICS, THERMOSETTING AND RUBBER PROCESSING CHEMICALS FOR USE IN THE PLASTICS INDUSTRY, THERMOSETTING POLYMERS, RUBBER AND RESIN MOLDING COMPOUNDS; FATTY ACIDS FOR USE IN ANTISLIP AGENTS (U.S. CLS. 1, 5, 6, 10, 26 AND 46).

SN 76-200,899. AGENCOURT BIOSCIENCE CORPORATION, BEVERLY, MA. FILED 1-29-2001.

AMPURE

FOR KIT CONSISTING PRIMARILY OF REAGENTS FOR THE PURIFICATION OF NUCLEIC ACIDS USED IN THE POLYMERASE CHAIN REACTION ("PCR") PROCESS, FOR SCIENTIFIC RESEARCH PURPOSES (U.S. CLS. 1, 5, 6, 10, 26 AND 46).
FIRST USE 11-1-2000; IN COMMERCE 11-1-2000.

SN 76-214,896. SAFELITE GLASS CORPORATION, COLUMBUS, OH. FILED 2-23-2001.

PROGRIP

FOR URETHANE ADHESIVE USED WITH INSTALLATION OF MOTOR VEHICLE GLASS (U.S. CLS. 1, 5, 6, 10, 26 AND 46).

SN 76-215,656. MAYZO, INC., NORCROSS, GA. FILED 2-26-2001.

BENEFOS

FOR PHOSPHITE ANTIOXIDANTS USED AS STABILIZERS FOR POLYMERIC MATERIALS SUBJECT TO THERMO-OXIDATIVE DEGRADATION (U.S. CLS. 1, 5, 6, 10, 26 AND 46).
FIRST USE 4-1-1993; IN COMMERCE 7-8-1993.

CLASS 1—(Continued).

SN 76-217,135. DEGREMONT, 92500 RUEIL MALMAISON, CEDEX, FRANCE, FILED 2-28-2001.

PROSEDIM

OWNER OF FRANCE REG. NO. 1500572, DATED 10-30-1998, EXPIRES 10-30-2008.

FOR CHEMICAL OR BIOLOGICAL PRODUCTS, NAMELY, CATIONIC, AMMONIC AND NON-IONIC, ARTIFICIAL AND NATURAL POLYMERS FOR THE FLOCCULATION OF DRINKING WATER OR INDUSTRIAL WATER, DELIVERED UNDER POWDERED OR CONCENTRATED LIQUID SOLUTIONS FORMS (U.S. CLS. 1, 5, 6, 10, 26 AND 46).

SN 76-223,108. CARGICO ENGINEERING CORP., TAIPEI, TAIWAN, FILED 3-12-2001.

OWNER OF U.S. REG. NO. 2,551,068.
FOR ANTIMICROBIAL AND ANTIBACTERIAL AGENTS FOR TREATING WATER, NAMELY, DOMESTIC WATER, POOL WATER AND FOR INDUSTRIAL WATER USES (U.S. CLS. 1, 5, 6, 10, 26 AND 46).
FIRST USE 1-21-1998; IN COMMERCE 6-2-1999.

SN 76-224,852. CABOT CORPORATION, BOSTON, MA. FILED 3-15-2001.

GEMINI

FOR CHEMICALS, NAMELY NIOBIUM AND DERIVATIVES THEREOF, SUCH AS NIOBIUM OXIDE AND NIOBIUM NITRIDE, FOR USE IN THE ELECTRONICS INDUSTRY (U.S. CLS. 1, 5, 6, 10, 26 AND 46).

SN 76-225,279. CROMPTON CORPORATION, GREENWICH, CT. FILED 3-15-2001.

SILBREAK

FOR DEMULSIFIERS USED IN THE PRODUCTION OF OIL (U.S. CLS. 1, 5, 6, 10, 26 AND 46).

SN 76-235,390. ALPHA ONE INC, LOVELAND, CO. FILED 4-5-2001.

ENVIRONMINDFUL

FOR FERTILIZERS FOR DOMESTIC USE (U.S. CLS. 1, 5, 6, 10, 26 AND 46).

CLASS 1—(Continued).

SN 76-239,514. POLYONE CORPORATION, AVON LAKE, OH. FILED 4-12-2001.

POLYFOAM

FOR CHEMICAL ADDITIVES FOR FURTHER USE IN POLYMER PROCESSING (U.S. CLS. 1, 5, 6, 10, 26 AND 46).

FIRST USE 12-7-2000; IN COMMERCE 12-7-2000.

CLASS 1—(Continued).

SN 76-242,193. KYANITE MINING CORPORATION, DILLWYN, VA. FILED 4-12-2001.



NO CLAIM IS MADE TO THE EXCLUSIVE RIGHT TO USE "VIRGINIA MULLITE", "DILLWYN", "CULLEN", AND "PAMPLIN" AS WELL AS THE PICTORIAL REPRESENTATION OF THE MAP OF VIRGINIA, APART FROM THE MARK AS SHOWN.

FOR KYANITE, CALCINED KYANITE AND MULLITE FOR GENERAL INDUSTRIAL USE (U.S. CLS. 1, 5, 6, 10, 26 AND 46).

FIRST USE 11-0-1969; IN COMMERCE 11-0-1969.

SN 76-242,192. KYANITE MINING CORPORATION, DILLWYN, VA. FILED 4-12-2001.



NO CLAIM IS MADE TO THE EXCLUSIVE RIGHT TO USE "VIRGINIA KYANITE", "DILLWYN", "CULLEN", AND "PAMPLIN" AS WELL AS THE PICTORIAL REPRESENTATION OF THE MAP OF VIRGINIA, APART FROM THE MARK AS SHOWN.

FOR KYANITE, CALCINED KYANITE AND MULLITE FOR GENERAL INDUSTRIAL USE (U.S. CLS. 1, 5, 6, 10, 26 AND 46).

FIRST USE 11-0-1969; IN COMMERCE 11-0-1969.

SN 76-242,725. UCB, SOCIETE ANONYME, B - 1070 BRUXELLES, BELGIUM, FILED 4-18-2001.

SOLUCRYL

OWNER OF BENELUX REG. NO. 0087217, DATED 12-8-1971, RENEWED AS REG. NO. 0087217, DATED 1-8-2000, EXPIRES 8-12-2010.

FOR CHEMICAL PRODUCTS FOR INDUSTRY, NAMELY UNPROCESSED ARTIFICIAL RESINS (U.S. CLS. 1, 5, 6, 10, 26 AND 46).

SN 76-248,522. ERAGEN BIOSCIENCES, INC., MADISON, WI. FILED 4-26-2001.

SIFT

(Sequence Identification Using Filtering Technologies)

NO CLAIM IS MADE TO THE EXCLUSIVE RIGHT TO USE "SEQUENCE IDENTIFICATION USING FILTERING TECHNOLOGIES", APART FROM THE MARK AS SHOWN.

FOR BIOCHEMICALS AND DIAGNOSTIC REAGENTS FOR USE IN GENETIC AND SCIENTIFIC RESEARCH, NAMELY, FOR USE IN DETECTING, QUANTITATING AND ANALYZING CELL MUTATIONS AND IDENTIFYING NUCLEIC ACID SEQUENCES; ASSAYS AND REAGENTS FOR USE IN GENETIC RESEARCH; REAGENTS KITS COMPRISING REAGENTS FOR GENETIC RESEARCH AND INSTRUCTIONS FOR USE THEREWITH (U.S. CLS. 1, 5, 6, 10, 26 AND 46).

FIRST USE 6-1-1999; IN COMMERCE 6-1-1999.

CLASS 1—(Continued).

SN 76-255,140. FOSECO INTERNATIONAL LIMITED, SWINDON, WILTSHIRE, ENGLAND, FILED 5-10-2001.

TUNDEX

FOR REFRACTORY COMPOSITIONS, NAMELY, REFRACTORY POWDERS FOR FORMING LININGS FOR METALLURGICAL VESSELS (U.S. CLS. 1, 5, 6, 10, 26 AND 46).

SN 76-255,642. JOHNSON MATTHEY PUBLIC LIMITED COMPANY, LONDON SW1Y 5BQ, UNITED KINGDOM, FILED 5-11-2001.

SELOX

FOR OXIDATION CATALYSTS FOR USE IN THE ORGANIC SYNTHESIS OF MOLECULES FOR THE PHARMACEUTICAL, FLAVORS, FRAGRANCES, AND FOOD INDUSTRIES; OXIDATION CATALYSTS FOR FUEL CELLS AND FUEL REFORMING SYSTEMS (U.S. CLS. 1, 5, 6, 10, 26 AND 46).

SN 76-255,734. LIGHTNING POWDER COMPANY, INC., JACKSONVILLE, FL. FILED 5-11-2001.

LIGHTNING POWDER

NO CLAIM IS MADE TO THE EXCLUSIVE RIGHT TO USE "POWDER", APART FROM THE MARK AS SHOWN. FOR LATENT FINGERPRINT DUSTING POWDER (U.S. CLS. 1, 5, 6, 10, 26 AND 46).
FIRST USE 5-1-1976; IN COMMERCE 5-1-1976.

SN 76-259,828. FOSTER PRODUCTS CORPORATION, OAKDALE, MN. FILED 5-17-2001.

CHIL-SPRAY

FOR ADHESIVES FOR USE IN THE THERMAL INSULATION INDUSTRY (U.S. CLS. 1, 5, 6, 10, 26 AND 46).
FIRST USE 3-2-2001; IN COMMERCE 3-2-2001.

CLASS 1—(Continued).

SN 76-265,521. ENVIROFOAM TECHNOLOGIES, INC., HUNTSVILLE, AL. FILED 6-1-2001.

DIRS

FOR DECONTAMINATION KITS COMPRISING CHEMICALS AND CHEMICAL PREPARATIONS FOR USE IN THE DECONTAMINATION OF SITES CONTAMINATED BY CHEMICAL AND BIOLOGICAL AGENTS, SHIPPING AND MIXING CONTAINERS, SPRAY BOTTLES, FILL FUNNELS, STIR PADDLES, AND SIPHON PUMPS AND HOSE ASSEMBLIES FOR USE IN THE FIELD OF INDUSTRIAL DECONTAMINATION AND CHEMICAL AND BIOLOGICAL WARFARE DECONTAMINATION (U.S. CLS. 1, 5, 6, 10, 26 AND 46).
FIRST USE 2-6-2001; IN COMMERCE 2-6-2001.

SN 76-269,104. CONTICO INTERNATIONAL, L.L.C., ST. LOUIS, MO. FILED 6-8-2001.

DERMA-TEK

FOR POLYMER RESINS AND COMPOUNDS USED IN THE MANUFACTURE OF MOLDED PLASTIC PRODUCTS (U.S. CLS. 1, 5, 6, 10, 26 AND 46).

SN 76-280,375. ROSARIO, ERWIN F.G., DBA ATAMI, 4128 CC LEXMOND, NETHERLANDS, FILED 7-3-2001.

GENA

PRIORITY CLAIMED UNDER SEC. 44(D) ON BENELUX APPLICATION NO. 985686, FILED 3-14-2001, REG. NO. 0683458, DATED 3-14-2001, EXPIRES 3-14-2011.

FOR AGRICULTURAL BIOLOGICAL PRODUCTS FOR THE PROMOTION OF GROWTH AND BLOOMING IN PLANTS AND CROPS, NAMELY, A LIQUID ROOT GROWTH STIMULATOR, A GROWTH STIMULATING PREPARATION AND A BLOOMING STIMULATING PREPARATION; AND FERTILIZERS FOR AGRICULTURAL, HORTICULTURAL, FORESTRY, DOMESTIC AND COMMERCIAL USE (U.S. CLS. 1, 5, 6, 10, 26 AND 46).

SN 76-280,403. FMC CORPORATION, PHILADELPHIA, PA. FILED 7-3-2001.

PROTURON

FOR BIOCHEMICALS FOR USE IN THE MANUFACTURE OF FOOD, PHARMACEUTICAL, COSMETIC AND PERSONAL HEALTH CARE PRODUCTS (U.S. CLS. 1, 5, 6, 10, 26 AND 46).

CLASS 1—(Continued).

SN 76-283,555. EMISSION CONTROL PRODUCTS, WLL, ADLIYA, BAHRAIN, FILED 7-11-2001.

MNK

FOR CHEMICAL ADDITIVES FOR USE WITH INTERNAL COMBUSTION ENGINE FUELS (U.S. CLS. 1, 5, 6, 10, 26 AND 46).

FIRST USE 5-15-2001; IN COMMERCE 6-0-2001.

SN 76-287,222. NATIONAL PACKAGING SERVICES CORPORATION, GREEN BAY, WI. FILED 7-18-2001.

SPILFYTER

OWNER OF U.S. REG. NO. 1,464,112.
FOR HAZARDOUS WASTE SPILL KITS CONSISTING PRIMARILY OF LIQUID NEUTRALIZERS, SORBENT PILLOWS, ACTIVATED CARBON PILLOWS, SPECIALLY-CONSTRUCTED CLEANING AND DISPOSAL IMPLEMENTS, AND SAFETY CLOTHING; MULTIPURPOSE PAPER WIPES, NAMELY HIGHLY ABSORBENT PAPER CLOTHS; AND MULTIPURPOSE PAPER COVER MATERIALS, NAMELY HIGHLY ABSORBENT PAPER ARTICLE AND SURFACE COVERS (U.S. CLS. 1, 5, 6, 10, 26 AND 46).

SN 76-288,631. SMOOTH-ON INC., EASTON, PA. FILED 7-20-2001.

SMASH! PLASTIC

NO CLAIM IS MADE TO THE EXCLUSIVE RIGHT TO USE "PLASTIC", APART FROM THE MARK AS SHOWN.

FOR PLASTIC MATERIAL THAT HAS THE APPEARANCE OF GLASS FORM BY URETHANE AND CATALYST THAT CURES AT ROOM TEMPERATURE AND IS EASILY BROKEN ON IMPACT; SUITABLE FOR A VARIETY OF STAGE, SPECIAL EFFECTS AND NOVELTY APPLICATIONS (U.S. CLS. 1, 5, 6, 10, 26 AND 46).
FIRST USE 5-1-2001; IN COMMERCE 5-0-2001.

SN 76-289,272. CLARIANT LSM (FLORIDA), INC., GAINESVILLE, FL. FILED 7-23-2001.

SILCARE SILICONES

NO CLAIM IS MADE TO THE EXCLUSIVE RIGHT TO USE SILICONES, APART FROM THE MARK AS SHOWN.

FOR CHEMICAL ADDITIVES, CONTAINING SILICON, FOR USE IN THE MANUFACTURE OF SKIN CARE PRODUCTS, HAIR CARE PRODUCTS, COSMETICS, ANTIPERSPIRANTS, DEODORANTS, AND SUNBLOCK (U.S. CLS. 1, 5, 6, 10, 26 AND 46).

CLASS 1—(Continued).

SN 76-310,697. WINER, WILLIAM SAMUEL, ARCADA, CA. FILED 9-6-2001.

AGROPONIC

FOR AGRICULTURAL AND HORTICULTURAL ORGANIC POTTING SOIL AND AGRICULTURAL AND HORTICULTURAL SOIL CONDITIONERS FOR USE IN DOMESTIC AND AGRICULTURAL SOIL-BASED OR HYDROPONIC-BASED ENVIRONMENTS (U.S. CLS. 1, 5, 6, 10, 26 AND 46).

SN 76-318,320. 3N INTERNATIONAL, INC., FLUSHING, NY. FILED 9-27-2001.



FOR CHEMICALS, NAMELY, ANTIMONY TRIOXIDE, ANTIMONY SULPHIDE AND SODIUM ANTIMONITE FOR USE AS FLAME RETARDANT, CATALYSTS, ADDITIVES, FINING AGENT, DEGASSER AND DECOLORIZER FOR WIDESPREAD USE IN A VARIETY OF INDUSTRIES (U.S. CLS. 1, 5, 6, 10, 26 AND 46).

FIRST USE 9-4-2001; IN COMMERCE 9-4-2001.

SN 76-323,764. PABU SERVICES, INC., WILMINGTON, DE. FILED 10-10-2001.

UVALITE

FOR SPECIALTY CHEMICALS USED AS POLYMER ADDITIVES, NAMELY, ANTISTATIC COMPOUNDS, FLAME RETARDANTS, ANTI-MICROBIAL COMPOUNDS, ANTI-BLOCKING COMPOUNDS, CLARIFIERS, NUCLEATING COMPOUNDS, LIGHT STABILIZERS AND AGING INHIBITORS, ANTIOXIDANTS AND ULTRAVIOLET ABSORBERS AND PIGMENTS (U.S. CLS. 1, 5, 6, 10, 26 AND 46).

CLASS 1—(Continued).

SN 76-323,765. PABU SERVICES, INC., WILMINGTON, DE. FILED 10-10-2001.

POLYSTAB

FOR SPECIALTY CHEMICALS USED AS POLYMER ADDITIVES, NAMELY, ANTISTATIC COMPOUNDS, FLAME RETARDANTS, ANTI-MICROBIAL COMPOUNDS, ANTI-BLOCKING COMPOUNDS, CLARIFIERS, NUCLEATING COMPOUNDS, LIGHT STABILIZERS AND AGING INHIBITORS, ANTIOXIDANTS AND ULTRAVIOLET ABSORBERS AND PIGMENTS (U.S. CLS. 1, 5, 6, 10, 26 AND 46).

SN 76-324,056. INTERNATIONAL FLORA TECHNOLOGIES, LTD., GILBERT, AZ. FILED 10-12-2001.

FLORALIPIDS

FOR CHEMICAL ADDITIVES PREPARED FROM NATURAL PRODUCTS FOR USE IN THE MANUFACTURE OF COSMETICS (U.S. CLS. 1, 5, 6, 10, 26 AND 46).

SN 76-331,386. VICAM, L.P., WATERTOWN, MA. FILED 10-30-2001.

MOLDQUANT

FOR CHEMICAL ANALYSIS KIT, PRIMARILY CONSISTING OF REAGENTS, FOR TESTING THE AMOUNT OF MOLD PRESENT IN PRODUCE (U.S. CLS. 1, 5, 6, 10, 26 AND 46).

SN 76-333,262. WATER REMEDIATION TECHNOLOGY, LLC, ARVADA, CO. FILED 11-1-2001.

Z-33

FOR ZEOLITE-BASED MATERIALS, NAMELY, ABSORBENTS FOR USE IN THE REMOVAL OF CHEMICAL COMPOUNDS AND TRACE ELEMENTS FROM AQUEOUS SOLUTIONS AND MEDIA IN THE WATER TREATMENT AND WASTE WATER TREATMENT INDUSTRIES (U.S. CLS. 1, 5, 6, 10, 26 AND 46).

SN 76-333,266. WATER REMEDIATION TECHNOLOGY, LLC, ARVADA, CO. FILED 11-1-2001.

Z-88

FOR ZEOLITE-BASED MATERIALS, NAMELY, ABSORBENTS FOR USE IN THE REMOVAL OF CHEMICAL COMPOUNDS AND TRACE ELEMENTS FROM AQUEOUS SOLUTIONS AND MEDIA IN THE WATER TREATMENT AND WASTE WATER TREATMENT INDUSTRIES (U.S. CLS. 1, 5, 6, 10, 26 AND 46).

CLASS 1—(Continued).

SN 76-333,271. WATER REMEDIATION TECHNOLOGY, LLC, ARVADA, CO. FILED 11-1-2001.

Z-17

FOR ZEOLITE-BASED MATERIALS, NAMELY, ABSORBENTS FOR USE IN THE REMOVAL OF CHEMICAL COMPOUNDS AND TRACE ELEMENTS FROM AQUEOUS SOLUTIONS AND MEDIA IN THE WATER TREATMENT AND WASTE WATER TREATMENT INDUSTRIES (U.S. CLS. 1, 5, 6, 10, 26 AND 46).

SN 76-336,035. SEIWA PRO CO., LTD., MATSUBARA-SHI, OSAKA, JAPAN, FILED 11-9-2001.

CEDARINSE

FOR CHEMICALS FOR THE SCALE REMOVING OF AIRCRAFTS, EQUIPMENTS AND MACHINES, SEWAGE FARMS, GARBAGE DISPOSAL FACILITIES (U.S. CLS. 1, 5, 6, 10, 26 AND 46).

SN 76-340,201. GOLDSCHMIDT AG, D-45127 ESSEN, FED REP GERMANY, FILED 11-20-2001.

ANTIL

FOR CHEMICAL PRODUCTS FOR INDUSTRIAL USE, NAMELY, RHEOLOGICAL ADDITIVES FOR AQUEOUS SURFACTANTS FOR USE IN THE MANUFACTURE OF COSMETICS AND PHARMACEUTICAL PRODUCTS (U.S. CLS. 1, 5, 6, 10, 26 AND 46).
FIRST USE 7-0-1999; IN COMMERCE 7-0-1999.

SN 76-341,302. INTERNATIONAL FLORA TECHNOLOGIES, LTD., GILBERT, AZ. FILED 11-26-2001.

FLORAGRAINS

FOR CHEMICAL ADDITIVES PREPARED FROM NATURAL PRODUCTS FOR USE IN THE MANUFACTURE OF COSMETICS (U.S. CLS. 1, 5, 6, 10, 26 AND 46).
FIRST USE 1-14-1993; IN COMMERCE 1-14-1993.

SN 76-343,238. HALLIBURTON ENERGY SERVICES, INC., CARROLLTON, TX. FILED 11-30-2001.

BAROLIFT

FOR DRILLING FLUID ADDITIVE, NAMELY, SYNTHETIC FIBER IN A MONOFILAMENT FORM USED TO MAINTAIN A CLEAN HOLE DURING THE DRILLING OPERATIONS IN THE OIL AND GAS INDUSTRY (U.S. CLS. 1, 5, 6, 10, 26 AND 46).
FIRST USE 9-12-1999; IN COMMERCE 9-12-1999.

CLASS 1—(Continued).

SN 76-346,418. CLEARWATER, INC., PITTSBURGH, PA. FILED 12-10-2001.

ALPHA-BREAK

FOR CHEMICALS FOR USE AS EMULSION BREAKERS IN CRUDE OIL PRODUCTION (U.S. CLS. 1, 5, 6, 10, 26 AND 46).

SN 76-356,910. HONEYWELL INTERNATIONAL INC., MORRISTOWN, NJ. FILED 1-10-2002.

SMART-LUB

FOR LUBRICANT CHEMICAL ADDITIVES USED FOR THE MANUFACTURING OF POLYVINYL CHLORIDE (PVC) PRODUCTS AND OTHER PLASTIC PRODUCTS (U.S. CLS. 1, 5, 6, 10, 26 AND 46).

SN 76-356,912. HONEYWELL INTERNATIONAL INC., MORRISTOWN, NJ. FILED 1-10-2002.

RHEOCHEM

FOR SYNTHETIC AND PARAFIN WAX BLENDS USED IN THE MANUFACTURE OF ARTICLES VIA EXTRUSION OF PVC AND OTHER PLASTICS (U.S. CLS. 1, 5, 6, 10, 26 AND 46).

FIRST USE 12-31-1984; IN COMMERCE 12-31-1984.

SN 76-356,913. HONEYWELL INTERNATIONAL INC., MORRISTOWN, NJ. FILED 1-10-2002.

RHEOLUB

FOR SYNTHETIC AND PARAFIN WAX BLENDS USED IN THE MANUFACTURE OF ARTICLES VIA EXTRUSION OF PVC AND OTHER PLASTICS (U.S. CLS. 1, 5, 6, 10, 26 AND 46).

FIRST USE 12-31-1984; IN COMMERCE 12-31-1984.

SN 76-357,097. MICROSAL LLC, ROCKVILLE, MD. FILED 1-10-2002.

NEOSAL

FOR CHEMICALS, NAMELY ANTICAKING AGENTS FOR SALTS FOR DOMESTIC, AGRICULTURAL COMMERCIAL AND INDUSTRIAL PURPOSES (U.S. CLS. 1, 5, 6, 10, 26 AND 46).

CLASS 1—(Continued).

SN 76-359,384. CELL SIGNALING TECHNOLOGY, INC., BEVERLY, MA. FILED 1-16-2002.

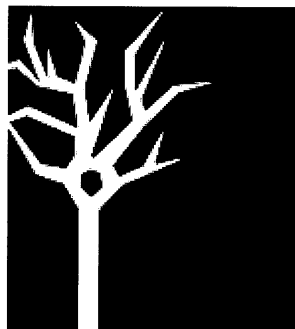

THE MARK CONSISTS OF THE DESIGN OF A STYLIZED BRANCHED STRUCTURE HAVING A SINGLE LOWER SHAFT LEADING TO A CIRCULAR CENTER ELEMENT ABOVE WHICH BRANCH OUT MANY ARMS, THE BRANCHED STRUCTURE BEING WHITE IN COLOR AND APPEARING ON A SOLID BLUE BACKGROUND SQUARE, POSITIONED LEFT OF CENTER IN THE SQUARE.

FOR REAGENTS FOR SCIENTIFIC OR RESEARCH USE, NAMELY, ANTIBODIES FOR THE DETECTION OF SIGNALING MOLECULES, POST-TRANSLATIONAL MODIFICATIONS ON SIGNALING MOLECULES, NON-RADIOACTIVE KINASE AND OTHER ENZYME ASSAYS, KINASE AND OTHER ENZYME INHIBITORS (U.S. CLS. 1, 5, 6, 10, 26 AND 46).

FIRST USE 12-15-1999; IN COMMERCE 1-21-2000.

SN 76-362,228. TRUSTILE DOORS, INC., DENVER, CO. FILED 1-22-2002.

TRUCLAD

FOR METAL FINISH, NAMELY METAL PLATING COMPOSITIONS, FOR DOORS (U.S. CLS. 1, 5, 6, 10, 26 AND 46).

FIRST USE 10-21-2001; IN COMMERCE 10-21-2001.

SN 76-362,446. ZENITECH LLC, DACULA, GA. FILED 1-16-2002.

ZENITOR

FOR POLYESTER COMPOUNDS USED AS A RAW MATERIAL IN THE FORMULATION OF PERSONAL CARE PRODUCTS, (U.S. CLS. 1, 5, 6, 10, 26 AND 46).

FIRST USE 1-5-2001; IN COMMERCE 1-5-2001.

CLASS 1—(Continued).

SN 76-367,576. LT BIOSYN, INC., ARCADIA, CA. FILED 2-7-2002.

PHOTOGRO

FOR PLANT GROWTH REGULATOR FOR AGRICULTURAL USE (U.S. CLS. 1, 5, 6, 10, 26 AND 46).
FIRST USE 0-0-2001; IN COMMERCE 0-0-2002.

SN 76-367,610. CLEARWATER, INC., PITTSBURGH, PA. FILED 2-7-2002.

NA-MINUS

FOR CHEMICAL FLUID, NAMELY A CRYSTALLIZATION INHIBITOR FOR USE IN AQUEOUS SYSTEMS IN HYDROCARBON RECOVERY (U.S. CLS. 1, 5, 6, 10, 26 AND 46).
FIRST USE 12-0-1990; IN COMMERCE 12-0-1990.

SN 76-371,607. SIGMA-GENOSYS, LP, THE WOODLANDS, TX. FILED 2-15-2002.

OLIGOARRAY

FOR SYNTHESIZED DNA KITS FOR THE FORMATION OF OLIGONUCLEOTIDES FOR USE IN SCIENTIFIC RESEARCH (U.S. CLS. 1, 5, 6, 10, 26 AND 46).
FIRST USE 0-0-1994; IN COMMERCE 0-0-1994.

SN 76-374,285. FRONTIER FERTILIZER & CHEMICAL COMPANY, JOHNSTOWN, CO. FILED 2-22-2002.

THE WEEKENDER

FOR FERTILIZERS FOR DOMESTIC USE (U.S. CLS. 1, 5, 6, 10, 26 AND 46).

SN 76-383,495. VICAM, L.P., WATERTOWN, MA. FILED 3-18-2002.

AMYLEASE

FOR CHEMICAL ANALYSIS KIT, PRIMARILY CONSISTING OF REAGENTS, FOR TESTING THE AMOUNT OF FUNGAL AMYLASE IN GRAIN (U.S. CLS. 1, 5, 6, 10, 26 AND 46).

CLASS 1—(Continued).

SN 76-384,365. OLD WORLD INDUSTRIES, INC., NORTH-BROOK, IL. FILED 2-28-2002.

PROTEUS

FOR NONYLPHENOLS USED AS A SURFACTANT IN THE MANUFACTURE OF SOAPS, DETERGENTS AND CLEANING AGENTS AND AS AN EMULSIFIER IN THE MANUFACTURE OF PAINTS, PAPER, TEXTILES, DETERGENTS AND CLEANERS (U.S. CLS. 1, 5, 6, 10, 26 AND 46).

SN 76-391,806. TWINCO ROMAX-WISCONSIN, INC., MEDINA, MN. FILED 4-3-2002.

MENDTITE

FOR SEALING COMPOSITION FOR THE REPAIR OF LEAKS IN AUTOMOTIVE COOLING SYSTEMS (U.S. CLS. 1, 5, 6, 10, 26 AND 46).
FIRST USE 5-5-1949; IN COMMERCE 11-15-1949.

SN 78-035,504. IVREA, INC., QUINCY, MA. FILED 11-16-2000.

BIOCHITOSAN

FOR CHITOSAN DERIVATIVES FOR USE IN THE MANUFACTURE OF COSMETICS AND PHARMACEUTICALS (U.S. CLS. 1, 5, 6, 10, 26 AND 46).

SN 78-065,054. RUG DOCTOR, L.P., PLANO, TX. FILED 5-22-2001.

NATURE'S FINEST

FOR FRAGRANCES FOR USE IN MANUFACTURING CANDLES (U.S. CLS. 1, 5, 6, 10, 26 AND 46).

SN 78-065,091. SKINVISIBLE PHARMACEUTICALS, INC., LAS VEGAS, NV. FILED 5-22-2001.

INVISICARE

FOR EXCIPIENTS, NAMELY, POLYMERS FOR USE IN THE MANUFACTURE OF TOPICALLY APPLIED PHARMACEUTICALS, COSMETICS, AND SKINCARE PRODUCTS (U.S. CLS. 1, 5, 6, 10, 26 AND 46).
FIRST USE 10-24-2001; IN COMMERCE 10-24-2001.

CLASS 1—(Continued).

SN 78-091,371. DRILLING FLUIDS TECHNOLOGY, INC., BOOKER, TX. FILED 11-2-2001.

RED STRIPE

FOR CHEMICAL ADDITIVES FOR OIL, GAS AND WATER WELL DRILLING FLUIDS AND OTHER FLUIDS, NAMELY, COMPLETION, STIMULATION AND LOSS CIRCULATION FLUIDS FOR USE IN COMPLETION, STIMULATION AND LOSS CIRCULATION CONTROL IN OIL, GAS AND WATER WELLS (U.S. CLS. 1, 5, 6, 10, 26 AND 46).

FIRST USE 12-0-1995; IN COMMERCE 12-0-1995.

SN 78-101,279. CIBA SPECIALTY CHEMICALS CORPORATION, TARRYTOWN, NY. FILED 1-7-2002.

RUVA

FOR CHEMICALS, NAMELY ULTRAVIOLET LIGHT ABSORBERS USED IN THE MANUFACTURE OF ADHESIVES, SEALANTS AND FIBERS (U.S. CLS. 1, 5, 6, 10, 26 AND 46).

SN 78-111,610. CIBA SPECIALTY CHEMICALS CORPORATION, TARRYTOWN, NY. FILED 2-28-2002.

TINUVIN

OWNER OF U.S. REG. NOS. 700,749 AND 1,471,826.
FOR CHEMICALS, NAMELY, FLAME RETARDANTS AND LIGHT STABILIZERS FOR USE IN FURTHER MANUFACTURE OF GOODS (U.S. CLS. 1, 5, 6, 10, 26 AND 46).

SN 78-112,383. MANN, DOUGLAS G., BUZZARDS BAY, MA. FILED 3-4-2002.



OWNER OF U.S. REG. NO. 2,466,558.
FOR EMULSIFIERS, PROTECTIVE COATINGS, TIME-RELEASE AGENTS, AND NUTRIENT CARRIER AGENTS FOR USE IN FOOD AND NUTRITIONAL SUPPLEMENTS (U.S. CLS. 1, 5, 6, 10, 26 AND 46).

CLASS 1—(Continued).

SN 78-112,458. TRILINK BIOTECHNOLOGIES, INCORPORATED, SAN DIEGO, CA. FILED 3-4-2002.

OLIGOBUILDER

FOR FINE CHEMICALS FOR CONTRACT SYNTHESIS/RESEARCH, NAMELY, MODIFIED OLIGONUCLEOTIDES, NUCLEOSIDES AND NUCLEOTIDES (U.S. CLS. 1, 5, 6, 10, 26 AND 46).

SN 78-112,465. TRILINK BIOTECHNOLOGIES, INC., SAN DIEGO, CA. FILED 3-4-2002.

PRIMERBUILDER

FOR FINE CHEMICALS FOR CONTRACT SYNTHESIS/RESEARCH, NAMELY, MODIFIED OLIGONUCLEOTIDES, NUCLEOSIDES AND NUCLEOTIDES (U.S. CLS. 1, 5, 6, 10, 26 AND 46).

SN 78-113,937. RAINBOW TREECARE SCIENTIFIC ADVANCEMENTS, INC., MINNEAPOLIS, MN. FILED 3-11-2002.

CAMBISTAT 2SC

FOR CHEMICAL COMPOSITIONS, NAMELY, TREE GROWTH REGULATOR FOR AGRICULTURAL OR DOMESTIC USE (U.S. CLS. 1, 5, 6, 10, 26 AND 46).

SN 78-114,893. CHEMPORT, INC., EL PASO, TX. FILED 3-14-2002.

NUTRISORB

FOR FERTILIZER FOR COMMERCIAL USE (U.S. CLS. 1, 5, 6, 10, 26 AND 46).

SN 78-117,489. HELENA CHEMICAL COMPANY, COLLIERVILLE, TN. FILED 3-26-2002.

ESTECOL

FOR SOIL INNOCULANT FOR AGRICULTURAL, HORTICULTURAL AND COMMERCIAL USE (U.S. CLS. 1, 5, 6, 10, 26 AND 46).

FIRST USE 4-23-1998; IN COMMERCE 4-23-1998.

CLASS 1—(Continued).

SN 78-117,532. HELENA CHEMICAL COMPANY, COLLIERVILLE, TN. FILED 3-26-2002.

ECTO-GEL

FOR SOIL AND PLANT INNOCULANT FOR AGRICULTURAL, HORTICULTURAL AND COMMERCIAL USE (U.S. CLS. 1, 5, 6, 10, 26 AND 46).

FIRST USE 2-6-2001; IN COMMERCE 2-6-2001.

SN 78-117,539. HELENA CHEMICAL COMPANY, COLLIERVILLE, TN. FILED 3-26-2002.

MYCO-SOL

FOR SOIL AND PLANT INNOCULANT FOR AGRICULTURAL, HORTICULTURAL AND COMMERCIAL USE (U.S. CLS. 1, 5, 6, 10, 26 AND 46).

FIRST USE 3-29-2001; IN COMMERCE 3-29-2001.

CLASS 2—PAINTS

SN 76-018,577. SIDA, S.A., 9.08014 BARCELONA, SPAIN, FILED 4-5-2000.

ZINTEK

OWNER OF ERPN CMNTY TM OFC REG. NO. 606723, DATED 4-16-1999, EXPIRES 4-16-2009.

FOR ZINC BASED EXTERIOR, HOUSE, INTERIOR PAINT (U.S. CLS. 6, 11 AND 16).

SN 76-033,447. DSM DESOTECH INC., ELGIN, IL. FILED 4-21-2000.

DESOLITE

FOR RADIATION CURABLE COATINGS IN THE NATURE OF PAINTS, VARNISHES AND LACQUERS FOR USE ON OPTICAL FIBERS AND OPTICAL MEDIA; AND RADIATION CURABLE INKS FOR USE ON OPTICAL FIBERS AND OPTICAL MEDIA (U.S. CLS. 6, 11 AND 16).

FIRST USE 0-0-1983; IN COMMERCE 0-0-1983.

SN 76-056,454. CAL-WEST SPECIALTY COATINGS, INC., SUNNYVALE, CA. FILED 5-25-2000.

STORE-IT

FOR REMOVABLE OR TEMPORARY COATING FOR REDUCING CORROSION AND PROTECTING A SUBSTRATE FROM ENVIRONMENTAL CONDITIONS FOR USE WITH ANY BARE METAL SURFACE (U.S. CLS. 6, 11 AND 16).

FIRST USE 7-6-1995; IN COMMERCE 7-6-1995.

CLASS 2—(Continued).

SN 76-056,455. CAL-WEST SPECIALTY COATINGS, INC., SUNNYVALE, CA. FILED 5-25-2000.

SPRAYWRAP

FOR COATING FOR PROTECTING SUBSTRATES FROM ENVIRONMENTAL CONDITIONS FOR USE WITH ANY NON-POROUS HARD SURFACE (U.S. CLS. 6, 11 AND 16).

FIRST USE 3-26-1997; IN COMMERCE 3-26-1997.

SN 76-078,475. DEUTSCHE AMPHIBOLIN-WERKE VON ROBERT MURJAHN GMBH & CO. KG, OBER-RAMSTADT, FED REP GERMANY, FILED 6-27-2000.

CAPAMAT

FOR EXTERIOR AND INTERIOR PAINTS; VARNISHES, LACQUERS IN THE NATURE OF A COATING; PAINT PRIMERS; WOOD PRESERVATIVES; RUST PRESERVATIVES IN THE NATURE OF A COATING; BINDING AGENTS FOR PAINT; COATINGS CONSISTING OF BACTERICIDES AND FUNGICIDES FOR USE AS PAINT; AND FILLERS, NAMELY, MASTIC MATERIALS FOR USE IN PAINTING (U.S. CLS. 6, 11 AND 16).

SN 76-092,510. SATIN FINISH HARDWOOD FLOORING LIMITED, WESTON, ONTARIO M9N 1R8, CANADA, FILED 7-20-2000.



The Ultimate Floor-Finish

NO CLAIM IS MADE TO THE EXCLUSIVE RIGHT TO USE "THE ULTIMATE FLOOR-FINISH", APART FROM THE MARK AS SHOWN.

FOR CLEAR COAT HIGH WEAR FINISH FOR HARDWOOD FLOORING (U.S. CLS. 6, 11 AND 16).

SN 76-203,948. ENGELHARD CORPORATION, ISELIN, NJ. FILED 2-2-2001.

FIREMIST

FOR PEARLESCENT PIGMENTS FOR INDUSTRIAL USE (U.S. CLS. 6, 11 AND 16).

FIRST USE 3-16-2000; IN COMMERCE 3-16-2000.

CLASS 2—(Continued).

SN 76-246,392. BECKER-UNDERWOOD, INC., AMES, IA.
FILED 4-25-2001.

HI- LIGHT

FOR MARKING COLORANT SPRAY FOR INDUSTRIAL AND/OR FORESTRY USE (U.S. CLS. 6, 11 AND 16).

FIRST USE 0-0-1987; IN COMMERCE 0-0-1987.

SN 76-265,193. TRANSOCEAN MARINE PAINT ASSOCIATION, THE, 3071 KB ROTTERDAM, NETHERLANDS, FILED 6-4-2001.



PRIORITY CLAIMED UNDER SEC. 44(D) ON NETHERLANDS APPLICATION NO. 0985572, FILED 3-12-2001, REG. NO. 0680692, DATED 3-12-2001, EXPIRES 3-12-2011.

FOR PAINTS FOR SHIPS, STEELWORKS, ON-SHORE AND OFF-SHORE INSTALLATIONS AND FREIGHT CONTAINERS; VARNISHES; LACQUERS IN THE NATURE OF COATINGS; CORROSION INHIBITING PAINT-TYPE COATINGS FOR COMMERCIAL MARINE USE; MORDANTS FOR COMMERCIAL MARINE USE (U.S. CLS. 6, 11 AND 16).

SN 76-282,167. DPI SOLUTIONS, INC., SEOUL 150-010, REPUBLIC OF KOREA, FILED 7-5-2001.



THE MARK INCLUDES THE COLOR GREEN FOR LETTERS "CM" AND COLOR BLUE FOR THE FIRST DOT FROM THE LEFT, COLOR RED FOR THE SECOND DOT, COLOR YELLOW FOR THE THIRD DOT AND COLOR BLACK FOR THE FOURTH DOT.

FOR TONERS FOR PRINTERS AND PHOTOCOPIERS (U.S. CLS. 6, 11 AND 16).

CLASS 2—(Continued).

SN 76-285,673. A&A COMPANY, INC., SOUTH PLAINFIELD, NJ. FILED 7-16-2001.

RESISTWEAR

OWNER OF U.S. REG. NO. 2,266,397.

FOR MATERIAL TREATMENT, NAMELY, A COMPOSITION BLEND USED AS A PROTECTIVE COATING FOR SHEAVES PULLEYS, ROLLERS, RINGS, GUIDES, ANNEALER PULLEYS, CAPSTANS AND BLOCKS (U.S. CLS. 6, 11 AND 16).

FIRST USE 1-6-2001; IN COMMERCE 1-6-2001.

SN 76-298,650. SICPA HOLDING S.A., 1008 PRILLY, SWITZERLAND, FILED 8-14-2001.

OPTION

PRIORITY CLAIMED UNDER SEC. 44(D) ON SWITZERLAND APPLICATION NO. 03016/2001, FILED 3-23-2001, REG. NO. 488054, DATED 8-16-2001, EXPIRES 3-23-2011.
FOR PRINTING INKS (U.S. CLS. 6, 11 AND 16).

SN 76-333,810. SOUTHERN DIVERSIFIED PRODUCTS, LLC, HATTIESBURG, MS. FILED 11-6-2001.

AMERICAN PRIDE

NO CLAIM IS MADE TO THE EXCLUSIVE RIGHT TO USE "AMERICAN", APART FROM THE MARK AS SHOWN.
FOR INTERIOR AND EXTERIOR PAINTS (U.S. CLS. 6, 11 AND 16).

SN 76-342,538. KWAL-HOWELLS, INC., DENVER, CO. FILED 11-27-2001.



OWNER OF U.S. REG. NOS. 2,253,489 AND 2,257,012.
NO CLAIM IS MADE TO THE EXCLUSIVE RIGHT TO USE "PAINT", APART FROM THE MARK AS SHOWN.
FOR ARCHITECTURAL TRADE PAINTS FOR INTERIOR AND EXTERIOR USE, NAMELY, ACRYLIC EMULSIONS, ALKYDS, EPOXIES, POLY-VINYL ACETATE EMULSIONS, POLYURETHANE AND VINYL COATINGS (U.S. CLS. 6, 11 AND 16).

FIRST USE 4-4-2001; IN COMMERCE 4-4-2001.

CLASS 2—(Continued).

SN 76-356,034. RUST-OLEUM CORPORATION, VERNON HILLS, IL. FILED 1-7-2002.

TRUE ONE

FOR INTERIOR WOOD STAINS (U.S. CLS. 6, 11 AND 16).

SN 76-357,891. INTERNATIONAL COATINGS CO., INC., CERRITOS, CA. FILED 1-11-2002.

EZ MOLD

FOR DIMENSIONAL PLASTISOL COATINGS FOR USE IN THE TEXTILE HEAT TRANSFERS (U.S. CLS. 6, 11 AND 16).

SN 76-390,154. THOMAS & BETTS INTERNATIONAL, INC., SPARKS, NV. FILED 4-2-2002.

ALUMA-SHIELD

FOR COMPOUND COMPRISING METAL PARTICLES IN A NATURAL OR SYNTHETIC UNCTUOUS MEDIA FOR APPLICATION TO THE BARE OR PLATED METAL OF AN ELECTRICAL CONDUCTOR TO PREVENT OXIDIZING AGENTS FROM REACHING SUCH BARE OR PLATED METAL AND TO SEAL OUT DIRT AND MOISTURE AND FOR APPLICATION TO ELECTRICAL PARTS TO IMPROVE THE CONDUCTION OF ELECTRICITY THEREBY AND TO PREVENT THE SEIZING OF MATING PARTS (U.S. CLS. 6, 11 AND 16).
FIRST USE 3-19-1974; IN COMMERCE 3-19-1974.

SN 78-022,744. SHERWIN-WILLIAMS AUTOMOTIVE FINISHES CORP., CLEVELAND, OH. FILED 8-24-2000.

KALIFORNIA KOLORS

NO CLAIM IS MADE TO THE EXCLUSIVE RIGHT TO USE "COLORS", APART FROM THE MARK AS SHOWN.
FOR AUTOMOTIVE PAINT (U.S. CLS. 6, 11 AND 16).

SN 78-097,905. ROHM AND HAAS COMPANY, PHILADELPHIA, PA. FILED 12-12-2001.

GRAFAWAY

FOR POWDER COATINGS IN THE NATURE OF PAINTS AND SURFACE COATINGS FOR USE ON BUILDING MATERIALS AND STRUCTURE SURFACES, METAL AND NON-METALLIC SUBSTRATES, PLASTIC, RUBBER, ELASTOMER AND GLASS, WOOD AND WOOD COMPOSITE, CONCRETE, PAVEMENT, CEMENT, MORTAR AND MASONRY SURFACES AND RIGID AND FLEXIBLE SUBSTRATES FOR DECORATIVE AND PROTECTIVE PURPOSES (U.S. CLS. 6, 11 AND 16).

CLASS 2—(Continued).

SN 78-113,177. ZINSSER CO., INC., SOMERSET, NJ. FILED 3-7-2002.

DURASTAIN

FOR STAINS FOR USE ON EXTERIOR WOOD (U.S. CLS. 6, 11 AND 16).

SN 78-117,174. CAI INC, GEORGETOWN, MA. FILED 3-25-2002.

HERCUBOND LAM

NO CLAIM IS MADE TO THE EXCLUSIVE RIGHT TO USE "LAM", APART FROM THE MARK AS SHOWN.
FOR PRINTERS' INK (U.S. CLS. 6, 11 AND 16).

CLASS 3—COSMETICS AND CLEANING PREPARATIONS

SN 75-635,074. STONER INCORPORATED, QUARRYVILLE, PA. FILED 2-10-1999.

MAXWAX

FOR AEROSOL SPRAY WAXES FOR AUTOMOBILES (U.S. CLS. 1, 4, 6, 50, 51 AND 52).

SN 75-714,094. H.D.N HOLDINGS CORPORATION, LEOMINSTER, MA. FILED 5-26-1999.

phase 1 one

FOR PRE-SHAVE LOTION (U.S. CLS. 1, 4, 6, 50, 51 AND 52).

SN 75-904,169. FARIA LIMITED, DBA SHEFFIELD LABORATORIES, NEW LONDON, CT. FILED 1-28-2000.

DINOSAUR

FOR TOOTHPASTE (U.S. CLS. 1, 4, 6, 50, 51 AND 52).
FIRST USE 8-0-1993; IN COMMERCE 8-0-1993.

CLASS 3—(Continued).

SN 75-908,586. WUNDERKIND ART GMBH & CO. KG, 14467 POTSDAM, FED REP GERMANY, FILED 2-2-2000.

CLASS 3—(Continued).

SN 76-045,534. AMERICAN IMPRESSIONS, LLC, STRATFORD, CT. FILED 5-11-2000.

69

PRIORITY CLAIMED UNDER SEC. 44(D) ON FED REP GERMANY APPLICATION NO. 39959254, FILED 9-24-1999, REG. NO. 39959254, DATED 1-26-2000, EXPIRES 9-30-2009.

FOR SOAPS, SKIN CLEANSERS, ASTRINGENT FOR COSMETIC PURPOSES, SHAMPOO, ESSENTIAL OILS FOR PERSONAL USE, EYE SHADOW, LIPSTICK, BLUSH, FOUNDATION, CONCEALER, PERSONAL DEODORANTS, PERFUME OILS, PERFUME, SCENTED BODY SPRAY, EAU DE TOILETTE, COLOGNE, POTPOURRI, AND ROOM FRAGRANCES (U.S. CLS. 1, 4, 6, 50, 51 AND 52).

SN 75-981,542. KANEBO KABUSHIKI KAISHA (KANEBO, LTD), SUMIDA-KU, TOKYO, JAPAN, FILED 3-17-2000.

Kanebo
IB

FOR COSMETICS, NAMELY, FACE CREAM, SKIN CREAM, FACE PACKS, SKIN LOTION, MILKY FACE LOTION, LIP CREAM, MAKE-UP BASE, SKIN CLEANSING PREPARATIONS, SOAPS, SKIN WHITENING PREPARATIONS, FOUNDATION MAKE-UP, FACE POWDER, BATH POWDER, EYE MAKE-UP, EYE LINER, MASCARA, EYE BROW PENCILS, LIP STICKS, CHEEK COLOR, NAIL CARE PREPARATIONS, NAMELY, NAIL COLOR AND CUTICLE COAT; COSMETIC PREPARATIONS FOR BATH, NAMELY, NON-MEDICATED BATH SALTS, BUBBLE BATH AND BATH OILS; HAIR CARE PREPARATIONS, NAMELY, SHAMPOO, RINSE, CONDITIONER, LOTION, HAIR CREAM, HAIR-DYE, SPRAY, GEL, AND MOUSSE; PERFUMERY, NAMELY, COLOGNE, PERFUME, EAU DE COLOGNE, EAU DE TOILETTE, COTTON BALLS FOR COSMETIC PURPOSES (U.S. CLS. 1, 4, 6, 50, 51 AND 52).

FIRST USE 4-0-2000; IN COMMERCE 4-0-2000.

SN 76-044,039. SANBORN HERMANOS S.A., COLONIA TLALPAN C.P., 14000, MEXICO, FILED 5-8-2000.

FLOR DE NARANJA

OWNER OF MEXICO REG. NO. 420126, DATED 11-7-1991, EXPIRES 9-22-2004.

THE ENGLISH TRANSLATION OF "FLOR DE NARANJA" IS "ORANGE BLOSSOM".

SEC. 2(F).

FOR PERFUME, COLOGNE AND TOILET WATER (U.S. CLS. 1, 4, 6, 50, 51 AND 52).

FIRST USE 5-7-1995; IN COMMERCE 2-11-2000.

FRENCH POTION

NO CLAIM IS MADE TO THE EXCLUSIVE RIGHT TO USE "FRENCH", APART FROM THE MARK AS SHOWN. FOR PERFUME WITH COMPONENTS FROM FRANCE (U.S. CLS. 1, 4, 6, 50, 51 AND 52).

SN 76-068,334. SOFT SHEEN/CARSON, INC., CHICAGO, IL. BY MERGER; BY MERGER, BY CHANGE OF NAME; BY CHANGE OF NAME DERMABLEND, INC., RICHFIELD, NJ. FILED 6-12-2000.

COVER DUET

NO CLAIM IS MADE TO THE EXCLUSIVE RIGHT TO USE "COVER", APART FROM THE MARK AS SHOWN. FOR COSMETICS, NAMELY, FOUNDATION AND CONCEALER (U.S. CLS. 1, 4, 6, 50, 51 AND 52). FIRST USE 4-0-2001; IN COMMERCE 4-0-2001.

SN 76-092,841. AMERICAN IMPRESSIONS, LLC, STRATFORD, CT. FILED 7-21-2000.

BOMB SHELL

FOR PERFUME (U.S. CLS. 1, 4, 6, 50, 51 AND 52).

SN 76-110,812. MBR MEDICAL BEAUTY RESEARCH GMBH, 59075 HAMM, FED REP GERMANY, FILED 8-16-2000.

MBR

OWNER OF FED REP GERMANY REG. NO. 39860716, DATED 2-22-1999, EXPIRES 10-31-2008.

FOR TOILET SOAPS, BATH SOAPS, PERFUMERY, ESSENTIAL OILS FOR PERSONAL USE, AND COSMETICS, NAMELY, SKIN CARE PREPARATIONS AND HAIR LOTIONS (U.S. CLS. 1, 4, 6, 50, 51 AND 52).

CLASS 3—(Continued).

SN 76-118,719. GIOVANNI COSMETICS, INC., CARSON, CA. FILED 8-30-2000.



OWNER OF U.S. REG. NO. 2,075,730.
THE MARK CONSISTS OF A DESIGN OF THREE FALLING LEAVES.

FOR HOUSE MARK FOR HAIR CLEANING PREPARATIONS; HOUSE MARK FOR HAIR TREATMENT PREPARATIONS; HOUSE MARK FOR HAIR STYLING PREPARATIONS (U.S. CLS. 1, 4, 6, 50, 51 AND 52).

SN 76-134,508. PERMATHEX, INC., HARTFORD, CT. FILED 9-25-2000.

MADE FOR THE PROFESSIONAL

OWNER OF U.S. REG. NOS. 696,193 AND 789,551.
FOR ALL-PURPOSE CLEANING PREPARATIONS; AUTOMOTIVE CLEANING PREPARATIONS; HAND CLEANSERS; SKIN SOAPS; LOTION SOAPS; POLYMER SEALANTS FOR CLEANING, SHINING AND PROTECTING AUTOMOBILE EXTERIOR SURFACES; RUST REMOVING PREPARATIONS; CARBURETOR AND CHOKE CLEANING PREPARATIONS; DEGREASING PREPARATIONS FOR USE IN THE AUTOMOTIVE INDUSTRY; DECAL AND PAINT STRIPPING PREPARATIONS; CLEANING PREPARATIONS FOR GASKET REMOVAL (U.S. CLS. 1, 4, 6, 50, 51 AND 52).
FIRST USE 9-1-2000; IN COMMERCE 9-1-2000.

CLASS 3—(Continued).

SN 76-150,152. HURTEAU & ASSOCIES INC., CANDIAC, QUEBEC J5R 3X8, CANADA, FILED 10-19-2000.



THE STIPLING IN THE DRAWING IS FOR SHADING PURPOSES ONLY AND DOES NOT INDICATED COLOR.

THE MARK CONSISTS OF A FLOWER AND THE TERM "SOLSTIS".

FOR PERFUME, BUBBLE BATH, BATH OILS, BODY SOAPS, HAIR SHAMPOOS, TOILET WATER, BODY CREAMS AND MILKS, LIP BALMS, ESSENTIAL OILS FOR PERSONAL USE, POTPOURRI, AND NON-MEDICATED SEA WATER BATH SALTS (U.S. CLS. 1, 4, 6, 50, 51 AND 52).

FIRST USE 6-0-1999; IN COMMERCE 6-0-1999.

SN 76-150,318. DIAL CORPORATION, THE, SCOTTSDALE, AZ. BY ASSIGNMENT FREEMAN COSMETIC COMPANY, THE, SCOTTSDALE, AZ. FILED 10-20-2000.

STRAIGHT A HEAD

FOR HAIR SHAMPOO, HAIR CONDITIONER AND HAIR CARE PREPARATIONS (U.S. CLS. 1, 4, 6, 50, 51 AND 52).

SN 76-162,867. TWENTIETH CENTURY FOX FILM CORPORATION, LOS ANGELES, CA. FILED 11-10-2000.

ALLY MCBEAL ISMS*

THE NAME SHOWN IN THE MARK DOES NOT IDENTIFY A PARTICULAR LIVING INDIVIDUAL.

FOR COLOGNE; SCENTED BODY SPRAY; NON-MEDICATED LIP BALM; BATH GEL; SCENTED SPRAY FOR USE FOR LINENS; NON-MEDICATED BATH SALTS; NON-MEDICATED BODY LOTIONS; EYE COMPRESSES FOR COSMETIC PURPOSES; MASSAGE OIL; SKIN SOAP (U.S. CLS. 1, 4, 6, 50, 51 AND 52).

FIRST USE 9-15-2000; IN COMMERCE 9-15-2000.

SN 76-169,722. SHISEIDO COMPANY, LTD., TOKYO, JAPAN, FILED 11-22-2000.

DATURA NOIR

THE TRANSLATION OF "NOIR" IS "BLACK".

FOR SKIN SOAPS, DEODORANT SOAPS; PERFUMERIES, NAMELY, PERFUME, COLOGNE; COSMETICS, NAMELY, LIPSTICK, BLUSH, ROUGE, MAKEUP, HAIR CARE PRODUCTS, NAMELY, SHAMPOO, CONDITIONER, HAIR GEL; SKIN CARE AND BODY CARE PRODUCTS, NAMELY, SKIN CREAM, SKIN CONDITIONER, BODY MASKS, BODY OILS, BODY POWDER (U.S. CLS. 1, 4, 6, 50, 51 AND 52).

FIRST USE 9-30-2001; IN COMMERCE 9-30-2001.

CLASS 3—(Continued).

SN 76-175,027. AGHAJANIAN & COMPANY, INC., CLEVELAND, OH. FILED 12-4-2000.

OXY CARE

FOR MULTI-PURPOSE CLEANER, STAIN REMOVER AND ODOR REMOVER (U.S. CLS. 1, 4, 6, 50, 51 AND 52).

SN 76-182,991. PROFESSIONAL COMPOUNDING CENTERS OF AMERICA, INC., HOUSTON, TX. FILED 12-19-2000.

PCCA COSMETIC HRT

NO CLAIM IS MADE TO THE EXCLUSIVE RIGHT TO USE "COSMETIC", APART FROM THE MARK AS SHOWN. FOR PHARMACEUTICAL PREPARATIONS, NAMELY COSMETIC BASES (U.S. CLS. 1, 4, 6, 50, 51 AND 52). FIRST USE 10-19-2000; IN COMMERCE 10-19-2000.

SN 76-185,013. JKA, INC., DBA DIVERSIFIED DISTRIBUTION, WOONSOCKET, RI. FILED 12-22-2000.

**Fairy Berrie**

FOR FACE AND BODY SOAPS; BODY AND FACE POWDER, MIST AND GLITTER; NAIL POLISH; LIPSTICK; ROUGE; PERFUME AND COLOGNE; SKIN CARE PREPARATIONS NAMELY LOTION AND GEL (U.S. CLS. 1, 4, 6, 50, 51 AND 52).

SN 76-185,526. INGRESS MANAGEMENT LIMITED, ISLE OF MAN, UNITED KINGDOM, FILED 12-22-2000.

I FRARI

OWNER OF ERPN CMNTY TM OFC REG. NO. 1469857, DATED 6-6-2001, EXPIRES 6-6-2011.

THE ENGLISH TRANSLATION OF "I FRARI" IS "THE FRIARS".

FOR COSMETICS AND CLEANING PREPARATIONS, NAMELY SHAMPOO, HAIRSPRAY, PERFUME, AND OTHER COSMETICS (U.S. CLS. 1, 4, 6, 50, 51 AND 52).

CLASS 3—(Continued).

SN 76-194,092. MANE USA, WAYNE, NJ. FILED 11-30-2000.

PERFUMANCE

FOR COSMETICS; PERFUMES; TOILETRIES, NAMELY, SHAMPOO, CONDITIONER, HAIR RINSE, HAIR GEL, HAIR MOUSSE, HAND SOAP, BODY SCRUB, TONER, SKIN EXFOLIATOR, SKIN CLARIFIER, SKIN MOISTURIZER, MAKE-UP REMOVER, SKIN CLEANING CREAM AND GEL, FACE AND BODY LOTION, FACE AND BODY CREAM, FACE AND BODY OIL, SUN SCREEN, SHAVING CREAM, SHAVING PREPARATIONS IN THE NATURE OF A SPRAY, SKIN LIGHTENER, HAIR POMADE, MUSTACHE WAX, PERSONAL DEODORANT, TOOTHPASTE, MOUTHWASH, BREATH FRESHENER IN THE NATURE OF MOUTH SPRAY, NON-MEDICATED BATH SALTS, BUBBLE BATH IN THE NATURE OF A GEL, OIL AND POWDER, CUTICLE CREAM AND CUTICLE REMOVING PREPARATION (U.S. CLS. 1, 4, 6, 50, 51 AND 52).

SN 76-204,405. CHANEL, INC., NEW YORK, NY. FILED 2-2-2001.

SUNLIT POWDER

NO CLAIM IS MADE TO THE EXCLUSIVE RIGHT TO USE "POWDER", APART FROM THE MARK AS SHOWN. FOR COSMETICS, NAMELY FACE POWDERS (U.S. CLS. 1, 4, 6, 50, 51 AND 52).

SN 76-212,755. ACORDIS UK LIMITED, DERBY DERBYSHIRE, ENGLAND, FILED 2-20-2001.

AMICARE

FOR COSMETICS, NAMELY, COSMETICS HAVING ANTIBACTERIAL PROPERTIES; TOILETRIES, NAMELY SKIN SOAPS; HAIR CARE PRODUCTS, NAMELY, HAIR LOTIONS, SHAMPOOS AND CONDITIONERS, ALL HAVING ANTIBACTERIAL PROPERTIES; SKIN CLEANSERS, CLEANSERS FOR FACES OR HANDS, EXFOLIANTS, ALL HAVING ANTIBACTERIAL PROPERTIES; TEETH AND DENTURE CLEANING PREPARATIONS, ALL HAVING ANTIBACTERIAL PROPERTIES (U.S. CLS. 1, 4, 6, 50, 51 AND 52).

SN 76-228,560. C.S. BIOSCIENCE, INC., EAST HAMPTON, NY. FILED 3-21-2001.

NUPATH

FOR ORAL CARE PRODUCTS, NAMELY TOOTHPASTE (U.S. CLS. 1, 4, 6, 50, 51 AND 52).

FIRST USE 3-1-2001; IN COMMERCE 3-1-2001.

CLASS 3—(Continued).

SN 76-236,396. LANCOME PARFUMS ET BEAUTE & CIE, PARIS, FRANCE, FILED 4-6-2001.

LIP DIMENSION

OWNER OF FRANCE REG. NO. 00/3.064.349, DATED 11-14-2000, EXPIRES 11-14-2010.

NO CLAIM IS MADE TO THE EXCLUSIVE RIGHT TO USE "LIP", APART FROM THE MARK AS SHOWN.

FOR LIPSTICKS (U.S. CLS. 1, 4, 6, 50, 51 AND 52).

SN 76-239,061. RA BRANDS, L.L.C., MADISON, NC. FILED 4-10-2001.

FIELDMASTER

FOR CLEANING KITS FOR FIREARMS CONSISTING PRIMARILY OF CLEANING SOLUTIONS, BRUSHES, SWABS, RODS, AND PATCHES (U.S. CLS. 1, 4, 6, 50, 51 AND 52).

SN 76-243,929. WATTS, LISA M., WARREN, MI. FILED 4-13-2001.

**PRECIOUS
TONES****GOLD COLLECTION**

NO CLAIM IS MADE TO THE EXCLUSIVE RIGHT TO USE "COLLECTION", APART FROM THE MARK AS SHOWN.

FOR COSMETICS NAMELY, BLUSH, EYESHADOW, EYE LINER, MASCARA, LIPSTICK, LIP GLOSS, LIP LINER, FOUNDATION, FOUNDATION POWDER, NAIL POLISH, FACIAL CREAMS, FACIAL SCRUBS, FACIAL TONERS, FACIAL MASKS, BODY LOTIONS, FACE LOTIONS, HAND LOTIONS, FACE CLEANSERS, FACE MOISTURIZERS, BODY MOISTURIZERS, HAND MOISTURIZERS, BODY GLITTER, FACE GLITTER, MAKE-UP REMOVER, COLOGNE, PERFUME (U.S. CLS. 1, 4, 6, 50, 51 AND 52).

SN 76-246,009. CITRA-SOLV LLC, RIDGEFIELD, CT. FILED 4-25-2001.

CITRA-FLUSH

FOR TOILET AND TOILET BOWL CLEANING PREPARATIONS WHICH ALSO DISINFECT AND DEODORIZE; PREPARATIONS FOR CLEANING TOILETS AND TOILET BOWLS; IN-TANK TOILET BOWL CLEANERS (U.S. CLS. 1, 4, 6, 50, 51 AND 52).

CLASS 3—(Continued).

SN 76-246,010. CITRA-SOLV LLC, RIDGEFIELD, CT. FILED 4-25-2001.

CITRA-DRAIN

FOR DRAIN OPENERS (U.S. CLS. 1, 4, 6, 50, 51 AND 52).

SN 76-246,013. CITRA-SOLV LLC, RIDGEFIELD, CT. FILED 4-25-2001.

CITRA-PUFF

FOR FABRIC SOFTENER (U.S. CLS. 1, 4, 6, 50, 51 AND 52).

SN 76-261,285. KLEWINGHAUS, UWE, D-40764 LANGENFELD, FED REP GERMANY, AND KLEWINGHAUS, MARIA, D-40764 LANGENFELD, FED REP GERMANY, FILED 5-23-2001.

SIRIDERMA

PRIORITY CLAIMED UNDER SEC. 44(D) ON FED REP GERMANY APPLICATION NO. 30111308.4/0, FILED 2-20-2001, REG. NO. 30111308, DATED 6-12-2001, EXPIRES 2-28-2011.

FOR PERFUME AND ESSENTIAL OILS FOR PERSONAL USE; NON-MEDICATED BODY AND HEALTH CARE PREPARATIONS, NAMELY BODY LOTIONS, BODY CREAMS, SKIN CLEANSING LOTIONS AND CREAMS, SKIN EMOLLIENTS AND MOISTURIZERS; TOILET SOAP (U.S. CLS. 1, 4, 6, 50, 51 AND 52).

SN 76-270,032. BIKE BRITE, INC., CLEVELAND, OH. FILED 6-12-2001.

MOTO KIT

NO CLAIM IS MADE TO THE EXCLUSIVE RIGHT TO USE "KIT", APART FROM THE MARK AS SHOWN.

FOR DETAILING KITS COMPRISED OF POLISH, CLEANER, DEGREASER, TOWELS, AND CHAMOIS, FOR BICYCLES AND MOTORIZED VEHICLES (U.S. CLS. 1, 4, 6, 50, 51 AND 52).

FIRST USE 11-0-1999; IN COMMERCE 11-0-1999.

SN 76-273,916. BERNADEAU, JACQUELINE, MATTAPAN, MA. FILED 6-21-2001.

CONTOUR DESIGNER

NO CLAIM IS MADE TO THE EXCLUSIVE RIGHT TO USE "DESIGNER", APART FROM THE MARK AS SHOWN. FOR COSMETICS (U.S. CLS. 1, 4, 6, 50, 51 AND 52).

CLASS 3—(Continued).

SN 76-274,611. EDITIONS DE PARFUM FREDERIC MALLE, 75007 PARIS, FRANCE, FILED 6-21-2001.

EN PASSANT OLIVIA GIACOBETTI

PRIORITY CLAIMED UNDER SEC. 44(D) ON FRANCE APPLICATION NO. 013080215, FILED 2-2-2001, REG. NO. 013080215, DATED 2-2-2001, EXPIRES 2-2-2011.

THE NAME "OLIVIA GIACOBETTI" IDENTIFIES A LIVING INDIVIDUAL WHOSE CONSENT IS OF RECORD. THE ENGLISH TRANSLATION OF THE MARK IS "PASSING BY OLIVIA GIACOBETTI".

FOR PERFUMERY PRODUCTS, NAMELY, PERFUME, COLOGNE, TOILET WATER, PERFUME WATER, PERFUME EXTRACT, COSMETIC PRODUCTS AND CLEANING PREPARATIONS FOR THE SKIN, NAMELY, SOAP, EYE SHADOW IN CREAM AND IN POWDER, LIP-STICK, EYE LINER, LIP GLOSS, HAIR LOTION, PERFUMED SOAP, LOTION FOR FACE AND BODY CARE, BODY CREAM, BODY MILK, PERFUMED NON-MEDICINAL CREAMS FOR THE SKIN AND FOR THE FACE, SKIN LOTIONS, BATH OILS, NON-MEDICATED BATH SALT, BATH GEL, BATH SHOWER GEL, BUBBLE BATH, BATH POWDER, BATH TABLETS, FACE AND BODY POWDERS, CHEEK ROUGES, LIP PENCILS, NAIL POLISHES, HAIR SHAMPOOS, HAIR SPRAYS, HAIR CONDITIONERS, SKIN CLEANSING CREAM, BODY DEODORANTS, PERSONAL DEODORANT STICKS, PERSONAL DEODORANT SPRAY, ARTIFICIAL EYELASHES, ESSENTIAL OILS FOR PERSONAL USE, BODY SPRAY TO BE CARRIED IN A PURSE, BODY SPRAY, AFTER SHAVE, SCENTED SOAP, TALCUM POWDER, DUSTING POWDER, BURNING INCENSE, ROOM SPRAY, ROOM FRAGRANCES, DENTIFRICES (U.S. CLS. 1, 4, 6, 50, 51 AND 52).

SN 76-277,514. JOHN ABATE INTERNATIONAL, INC., SCOTTSDALE, AZ. FILED 6-27-2001.

PLATINUM ZERO

FOR COSMETICS, NAMELY SUNTANNING PREPARATIONS (U.S. CLS. 1, 4, 6, 50, 51 AND 52).

SN 76-277,562. CHURCH & DWIGHT COMPANY, GREEN RIVER, WY. FILED 6-28-2001.

SNO BOL DROPS

OWNER OF U.S. REG. NOS. 411,796 AND 1,488,048. FOR TOILET BOWL CLEANING AND DEODORIZING PREPARATION IN TABLET FORM (U.S. CLS. 1, 4, 6, 50, 51 AND 52).

CLASS 3—(Continued).

SN 76-278,503. BOTICA COMERCIAL FARMACEUTICA LTDA., 83065-260 S. JOSE DOS PINHAIS PR, BRAZIL, FILED 7-2-2001.

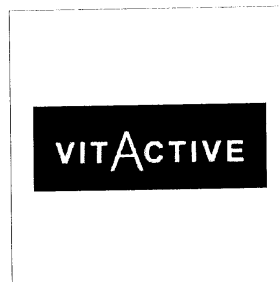

FOR TOILETRY PRODUCTS, NAMELY, ANTI-WRINKLE GEL (U.S. CLS. 1, 4, 6, 50, 51 AND 52).

SN 76-281,286. LABORATOIRE DUCASTEL, FRANCE, FILED 7-6-2001.

subtil

THE ENGLISH TRANSLATION OF THE APPLIED MARK IS "SUBTLE".

FOR HAIR COLORING SOLUTIONS, HAIR TINTING SOLUTIONS, HAIR DYING SOLUTIONS; HAIR BLEACHING SOLUTIONS; HAIR CREAMS, HAIR GELS, HAIR LOTIONS, HAIR SPRAYS; HAIR FIXING SOLUTIONS; HAIR LACQUERS, HAIR SHAMPOOS, HAIR PERMANENT SOLUTIONS, HAIR WAVING SOLUTIONS AND HAIR POWDER (U.S. CLS. 1, 4, 6, 50, 51 AND 52).

SN 76-283,150. HARPER, MICHELE, NEW YORK, NY. FILED 7-9-2001.

METAPHYSICA

THE ENGLISH TRANSLATION OF THE LATIN WORD "METAPHYSICA" IN THE MARK IS "METAPHYSICS".

FOR COSMETICS; ESSENTIAL OILS FOR PERSONAL USE; TOILETRIES, NAMELY, SKIN SOAP, SKIN MOISTURIZERS, SKIN TONERS, SKIN TEXTURIZERS, SKIN MASKS, BODY OIL, BODY SCRUBS, BODY SPRAYS, BODY POWDER, BATH GEL, BATH OIL, BATH CRYSTALS, PERSONAL DEODORANTS, PERFUME OILS, NAIL CARE PREPARATIONS, NON-MEDICATED OINTMENT FOR THE PREVENTION AND TREATMENT OF SUNBURN, DISPOSABLE WIPES IMPREGNATED WITH CHEMICALS OR COMPOUNDS FOR PERSONAL HYGIENE (U.S. CLS. 1, 4, 6, 50, 51 AND 52).

CLASS 3—(Continued).

SN 76-284,649. JASON & JEAN PRODUCTS INC., CORONA, NY. FILED 7-13-2001.

AMY SUPER HAIR WEAVING BOND

NO CLAIM IS MADE TO THE EXCLUSIVE RIGHT TO USE "SUPER HAIR WEAVING BOND", APART FROM THE MARK AS SHOWN.
FOR ADHESIVES FOR ATTACHING ARTIFICIAL HAIR PIECES (U.S. CLS. 1, 4, 6, 50, 51 AND 52).
FIRST USE 9-18-2000; IN COMMERCE 9-18-2000.



SN 76-287,610. IT MAKES SCENTS LLC, DBA CELEBRITY PARFUMS, NEW YORK, NY. FILED 7-19-2001.

SARANZA

THE NAME "SARANZA" DOES NOT IDENTIFY A LIVING INDIVIDUAL.
FOR SKIN WHITENING PRODUCTS, NAMELY, SKIN WHITENING AND LIGHTENING CREAMS AND LOTIONS FOR THE FACE AND BODY; EMULSIONS; TREATMENTS, MILKS, AND MOISTURIZERS (U.S. CLS. 1, 4, 6, 50, 51 AND 52).



SN 76-288,870. JAN TANA, LYNCHBURG, VA. FILED 7-24-2001.



THE NAME IN THE MARK IDENTIFIES A LIVING INDIVIDUAL WHOSE CONSENT IS OF RECORD.
FOR SKIN LOTION, ESSENTIAL OILS FOR PERSONAL USE, BODY GELS, HAIR SHAMPOO, POSING OIL, EXFOLIANT FOR THE SKIN, AND SKIN COLORANT (U.S. CLS. 1, 4, 6, 50, 51 AND 52).
FIRST USE 12-1-1992; IN COMMERCE 12-1-1992.

CLASS 3—(Continued).

SN 76-289,406. SCHROEDER & TREMAYNE, INC., ST. LOUIS, MO. FILED 7-24-2001.

SPA BOTANIKA

OWNER OF U.S. REG. NOS. 1,211,588 AND 1,919,804.
NO CLAIM IS MADE TO THE EXCLUSIVE RIGHT TO USE "SPA", APART FROM THE MARK AS SHOWN.
FOR TOILETRIES AND PERSONAL CARE PREPARATIONS, NAMELY SKIN CLEANSERS, TONERS, TONICS, COSMETIC SKIN CARE MASKS, BODY WASHES, SKIN CARE EXFOLIATORS, SKIN MOISTURIZERS, BODY OILS, MINERAL SOAKS, SHAMPOOS, HAIR AND BODY MUDS, MASSAGE OIL, SOAPS, AND POTPOURRI (U.S. CLS. 1, 4, 6, 50, 51 AND 52).
FIRST USE 11-19-1993; IN COMMERCE 11-19-1993.



SN 76-290,590. HSU, MEI-YU, TZUOO-YING, KAOHSIUNG, TAIWAN, FILED 7-26-2001.



OWNER OF TAIWAN REG. NO. 739128, DATED 12-16-1996, EXPIRES 10-31-2004.
THE MARK CONSISTS OF A STYLIZED BUTTERFLY WING.
FOR COSMETICS, COSMETIC LOTION FOR USE ON THE FACE, PERFUME, LIPSTICK, FINGERNAIL POLISH, COTTON FOR COSMETIC PURPOSES, FOAM HAIR GEL, SHAMPOO, FACIAL GEL, SHOWER GEL (U.S. CLS. 1, 4, 6, 50, 51 AND 52).

CLASS 3—(Continued).

SN 76-292,889. AMERICAN CREW, INC., DENVER, CO. FILED 7-31-2001.



OWNER OF U.S. REG. NOS. 1,904,875 AND 2,215,539. FOR HAIR SHAMPOO, BODY WASH, BAR SOAP, AND MEN'S COLOGNE (U.S. CLS. 1, 4, 6, 50, 51 AND 52). FIRST USE 7-0-1998; IN COMMERCE 7-0-1998.

CLASS 3—(Continued).

SN 76-297,291. LABORATOIRES WILSON, 77330 OZOIR-LA-FERRIERE, FRANCE, FILED 8-9-2001.



THE PORTRAIT IN THE MARK DOES NOT IDENTIFY A LIVING INDIVIDUAL. FOR COSMETICS, SKIN WHITENING CREAMS, SHAMPOOS, HAIR LOTIONS, HAIR RELAXING PREPARATIONS, DETANGLING BALSAM, HAIR COLOR, MAKE-UP; ESSENTIAL OILS FOR PERSONAL USE, COSMETIC PREPARATIONS FOR SKIN CARE, NAMELY, FACE CREAM, AND BODY CREAM; AND TOILET PREPARATIONS, NAMELY, TOILET WATER AND NON-ALCOHOLIC LOTIONS FOR COSMETIC PURPOSES (U.S. CLS. 1, 4, 6, 50, 51 AND 52).

SN 76-294,677. SCHERING-PLOUGH HEALTHCARE PRODUCTS, INC., MEMPHIS, TN. FILED 8-2-2001.



OWNER OF U.S. REG. NOS. 1,760,538 AND 2,230,833. THE STIPPLING IS FOR SHADING PURPOSES ONLY. THE DRAWING IS LINED FOR THE COLORS BLUE, SILVER AND GOLD. SEC. 2(F) AS TO "SPORT". FOR SUN CARE PREPARATIONS, NAMELY SUNSCREEN AND SUN BLOCK PREPARATIONS (U.S. CLS. 1, 4, 6, 50, 51 AND 52). FIRST USE 11-9-2001. THE MARK WAS FIRST USED ANYWHERE IN A DIFFERENT FORM OTHER THAN THAT SOUGHT TO BE REGISTERED ON 01/03/1992; IN COMMERCE 11-9-2001, THE MARK WAS FIRST USED IN COMMERCE IN A DIFFERENT FORM OTHER THAN THAT SOUGHT TO BE REGISTERED ON 01/03/1992.

SN 76-297,292. LABORATOIRES WILSON, 77330 OZOIR-LA-FERRIERE, FRANCE, FILED 8-9-2001.



THE PORTRAIT IN THE MARK DOES NOT DEPICT A LIVING INDIVIDUAL. FOR COSMETICS, SKIN WHITENING CREAMS, SHAMPOOS, HAIR LOTIONS, HAIR RELAXING PREPARATIONS, DETANGLING BALSAM, HAIR COLOR, MAKE-UP; ESSENTIAL OILS FOR PERSONAL USE, COSMETIC PREPARATIONS FOR SKIN CARE, NAMELY, FACE CREAM AND BODY CREAM; AND TOILET PREPARATION, NAMELY, TOILET WATER AND NON-ALCOHOLIC LOTIONS FOR COSMETIC PURPOSES (U.S. CLS. 1, 4, 6, 50, 51 AND 52).

CLASS 3—(Continued).

SN 76-298,068. LANCOME PARFUMS ET BEAUTE & CIE, 75008 PARIS, FRANCE, FILED 8-9-2001.

LANCÔMEN

OWNER OF FRANCE REG. NO. 013084676, DATED 2-22-2001, EXPIRES 2-22-2011.

FOR COSMETICS, NAMELY CREAMS, MILKS, GELS AND LOTIONS FOR THE FACE AND THE BODY (U.S. CLS. 1, 4, 6, 50, 51 AND 52).

SN 76-300,467. REAL COSMETICS, INC., NEW YORK, NY. FILED 8-16-2001.

REAL COSMETICS

NO CLAIM IS MADE TO THE EXCLUSIVE RIGHT TO USE "COSMETICS", APART FROM THE MARK AS SHOWN.

FOR COSMETIC AND SKIN CARE PRODUCTS, NAMELY, LIPSTICKS, MASCARA, LIQUID FOUNDATION, MAKEUP, PRESSED FACIAL POWDER, LOOSE FACIAL POWDER, BLUSH, EYELINER, EYESHADOWS, NAIL POLISH, EYE PENCILS, LIP PENCILS, EYEBROW PENCILS AND EYEBROW POWDER, LIP GLOSS, MOISTURIZER FOR FACE AND BODY, MAKE-UP REMOVER, FACIAL CLEANSER, FACE MASKS (U.S. CLS. 1, 4, 6, 50, 51 AND 52).

FIRST USE 7-1-1999; IN COMMERCE 7-1-1999.

SN 76-303,129. JEU DE PAUME, INC., PENSACOLA, FL. FILED 8-22-2001.

DEDANS

FOR COSMETICS, PERFUMERY, NAMELY PERFUME AND COLOGNE, TOILETRIES, NAMELY HAIR SHAMPOO AND SOAP (U.S. CLS. 1, 4, 6, 50, 51 AND 52).

SN 76-307,995. ALOETTE COSMETICS, INC., SMYRNA, GA. FILED 8-31-2001.

PERFECT LIFT

FOR NON-MEDICATED SKIN CARE PREPARATIONS; NON-MEDICATED SKIN CARE TREATMENTS IN THE NATURE OF SKIN RENEWAL AND WRINKLE REDUCING PREPARATIONS; AND SKIN CARE KITS CONSISTING PRIMARILY OF ANTI-AGING SERUM, LIFTING POWDER, ACTIVATOR LIQUID AND MOISTURIZING CREAM SOLD AS A UNIT (U.S. CLS. 1, 4, 6, 50, 51 AND 52).

CLASS 3—(Continued).

SN 76-308,168. ALOETTE COSMETICS, INC., SMYRNA, GA. FILED 8-31-2001.

TIME RESTORE

FOR NON-MEDICATED SKIN CARE PREPARATIONS; NON-MEDICATED SKIN CARE TREATMENTS IN THE NATURE OF WRINKLE REMOVING PREPARATIONS; AND SKIN CARE KITS CONSISTING PRIMARILY OF SKIN FIRING SERUMS, HYDRATING SPRAYS, AND MOISTURIZERS SOLD INDIVIDUALLY AND AS A UNIT (U.S. CLS. 1, 4, 6, 50, 51 AND 52).

SN 76-309,305. CHESEBROUGH-POND'S INC., WILMINGTON, DE. FILED 9-5-2001.

PROOF STRIPS

NO CLAIM IS MADE TO THE EXCLUSIVE RIGHT TO USE "STRIPS", APART FROM THE MARK AS SHOWN.

FOR PLASTIC ADHESIVE STRIPS WITH POWDERED PAPER THAT TAKES IMPRESSIONS OF WRINKLES (U.S. CLS. 1, 4, 6, 50, 51 AND 52).

SN 76-309,985. VIVANT, INC., MIAMI, FL. FILED 9-7-2001.

DERM-A-GEL

FOR COSMETICS, NAMELY SKIN MOISTURIZING, CONDITIONING, WRINKLE SMOOTHING, SKIN SMOOTHING, SKIN FIRING, SKIN TONING, AND SUNSCREEN PREPARATIONS ALL FOR SALE TO THE GENERAL PUBLIC (U.S. CLS. 1, 4, 6, 50, 51 AND 52).

FIRST USE 12-0-1988; IN COMMERCE 12-0-1988.

SN 76-311,966. MAUI GENERAL STORE, INC., DENVER, CO. FILED 9-13-2001.

SEVEN SACRED POOLS

FOR NATURAL HAND AND BODY SOAPS AND LOTIONS (U.S. CLS. 1, 4, 6, 50, 51 AND 52).

CLASS 3—(Continued).

SN 76-314,454. HILO, SAMER, SAN BERNARDINO, CA. FILED 9-20-2001.



FOR SHAMPOO AND CONDITIONERS, HAIR SPRAY, HAIR GEL (U.S. CLS. 1, 4, 6, 50, 51 AND 52).

SN 76-317,309. LAWN FURNITURE REPAIR & SALES COMPANY, INC., TULSA, OK. FILED 9-26-2001.

RILEY'S KITCHEN & BATH MAGIC

NO CLAIM IS MADE TO THE EXCLUSIVE RIGHT TO USE "KITCHEN & BATH", APART FROM THE MARK AS SHOWN.

"RILEY" IDENTIFIES A LIVING INDIVIDUAL WHOSE CONSENT IS OF RECORD.

FOR CLEANING PREPARATIONS FOR CLEANING KITCHENS AND BATHS (U.S. CLS. 1, 4, 6, 50, 51 AND 52).

FIRST USE 1-0-1998; IN COMMERCE 1-0-1998.

SN 76-324,684. CHAPPUIS, ALEXANDRE, LE MONT-SUR-LAUSANNE, SWITZERLAND, FILED 10-12-2001.



PRIORITY CLAIMED UNDER SEC. 44(D) ON SWITZERLAND APPLICATION NO. 06173/2001, FILED 6-21-2001, REG. NO. 491720, DATED 11-21-2001, EXPIRES 6-21-2011.

NO CLAIM IS MADE TO THE EXCLUSIVE RIGHT TO USE "SWITZERLAND", APART FROM THE MARK AS SHOWN.

THE MARK CONSISTS IN PART OF THE STYLIZED CHARACTERS "C4".

FOR PERFUMES, ESSENTIAL OILS FOR PERSONAL USE, SOAPS, COSMETICS; PREPARATIONS AND LOTIONS FOR THE HAIR; LOTIONS, CREAMS, GELS AND NON-MEDICATED SERUMS FOR FACIAL AND BODY USE, ALL THESE GOODS FOR COSMETIC USE; DENTIFRICES (U.S. CLS. 1, 4, 6, 50, 51 AND 52).

CLASS 3—(Continued).

SN 76-328,927. COSMEDICAL TECHNOLOGIES, INC., DAVIE, FL. FILED 10-23-2001.

DR. LORETTA CIRALDO'S SKINCARE

NO CLAIM IS MADE TO THE EXCLUSIVE RIGHT TO USE "SKINCARE", APART FROM THE MARK AS SHOWN.

THE NAME "DR. LORETTA CIRALDO" IDENTIFIES A LIVING INDIVIDUAL WHOSE CONSENT IS OF RECORD.

FOR NON-MEDICATED SKIN CARE PREPARATIONS, NAMELY, FACIAL MOISTURIZER, BODY LOTION, HYDRATING EYE GEL, MOISTURIZING SKIN CREME, MOISTURIZING SKIN LOTION, HYDRATING SKIN GEL, HYDRATING GEL FACIAL MASK, CLARIFYING FACIAL MASK, PRE-MOISTURIZING SKIN CARE SERUM, SKIN LOTION, NON-MEDICATED LIPID DROPS FOR MOISTURIZING FACE, SKIN REJUVENATION AND FADE LOTION, FADE CREME, HYDRATING SKIN SPRAY, SUN BLOCK, ANTIOXIDANT THERAPEUTIC SKIN CREME, NON-MEDICATED VITAMIN K FACIAL CREME, LIP AND EYE THERAPY LOTION, BODY MOISTURIZER, NAMELY, BODY POLISH; NON-MEDICATED FACE AND BODY CLEANSERS, NAMELY, FACE AND BODY WASH, MAKE-UP REMOVER LOTION, NON-FOAMING CREAM FACIAL CLEANSER, GLYCOLIC SKIN GEL, SKIN CLARIFYING LOTION, SALICYLIC FACE AND BODY WASH, LIQUID OIL ABSORBER BLOTting FACIAL LOTION, BODY SCRUB, CREME CLEANSER FOR FACE, EXFOLIATING FACE CLEANSER, EXFOLIATING SKIN TONER; SUN TANNING PREPARATIONS, NAMELY, SUNLESS TANNER; NON-MEDICATED ACNE TREATMENT PREPARATIONS FOR THE FACE, NAMELY, GLYCOLIC GEL, ACNE SPOT TREATMENT, GLYCOLIC SKIN CLARIFYING LOTION, OIL-FREE FACIAL MOISTURIZER AND LIQUID OIL ABSORBER FOR THE FACE (U.S. CLS. 1, 4, 6, 50, 51 AND 52).

FIRST USE 11-0-1999; IN COMMERCE 11-0-1999.

SN 76-329,603. COLLETTE DINNIGAN INTERNATIONAL LIMITED, 169 ELECTRIC ROAD, HONG KONG, FILED 10-24-2001.

COLLETTE DINNIGAN

THE NAME "COLLETTE DINNIGAN" IDENTIFIES A LIVING INDIVIDUAL WHOSE CONSENT IS OF RECORD.

FOR PERFUME, TOILET WATER, HAIR, SCULPTING, AND EYE GELS; SALTS FOR THE BATH AND THE SHOWER NOT FOR MEDICAL PURPOSES; TOILET SOAPS, BODY DEODORANT; COSMETICS INCLUDING CREAMS, MILKS, LOTIONS, LIPSTICKS, FOUNDATIONS, BLUSHERS, GELS AND POWDERS FOR THE FACE, THE BODY AND THE HANDS; COSMETIC SUNCARE PREPARATIONS FOR THE FACE AND BODY; MAKEUP PREPARATIONS COMPRISED OF CREAMS, MILKS, LOTIONS, LIPSTICKS, FOUNDATIONS, BLUSHERS AND GELS; SHAMPOOS; GELS, SPRAYS, MOUSSES AND BALMS FOR THE HAIR STYLING AND HAIR CARE; HAIR LACQUERS, HAIR COLORING AND HAIR DEODORANT PREPARATIONS; PERMANENT WAVING AND CURLING PREPARATIONS; ESSENTIAL OILS FOR PERSONAL USE; PREPARATIONS FOR THE CLEANING, CARE AND BEAUTIFICATION OF THE SKIN, SCALP AND HAIR AND DENTIFRICES (U.S. CLS. 1, 4, 6, 50, 51 AND 52).

CLASS 3—(Continued).

SN 76-337,299. CHESEBROUGH-POND'S INC., WILMINGTON, DE. FILED 11-13-2001.

DOVE ULTRA SMOOTH

OWNER OF U.S. REG. NOS. 746,360, 2,453,222 AND OTHERS.

FOR SHAVING PREPARATIONS, DEPILATORIES, HAIR REMOVAL WAXES, ANTI-PERSPIRANT AND DEODORANT, HAND AND BODY LOTIONS, PERSONAL WASH (U.S. CLS. 1, 4, 6, 50, 51 AND 52).

SN 76-339,176. FREELIFE INTERNATIONAL LLC, MILFORD, CT. FILED 11-19-2001.

BGSE

FOR SKIN CARE PRODUCTS, NAMELY, NON-MEDICATED PURIFYING CLEANSING BAR (U.S. CLS. 1, 4, 6, 50, 51 AND 52).

SN 76-340,415. WELLA AKTIENGESELLSCHAFT, 64274 DARMSTADT, FED REP GERMANY, FILED 11-19-2001.

LIVING COLORS

NO CLAIM IS MADE TO THE EXCLUSIVE RIGHT TO USE "COLORS", APART FROM THE MARK AS SHOWN. FOR HAIR CARE PRODUCTS, NAMELY HAIR COLOR (U.S. CLS. 1, 4, 6, 50, 51 AND 52).

SN 76-340,416. WELLA AKTIENGESELLSCHAFT, 64274 DARMSTADT, FED REP GERMANY, FILED 11-19-2001.

FIRST COLOR

NO CLAIM IS MADE TO THE EXCLUSIVE RIGHT TO USE "COLOR", APART FROM THE MARK AS SHOWN. FOR HAIR CARE PRODUCTS, NAMELY HAIR COLOR (U.S. CLS. 1, 4, 6, 50, 51 AND 52).

SN 76-343,025. OPI PRODUCTS, INC., NORTH HOLLYWOOD, CA. FILED 11-30-2001.

ABSOLUTE

FOR ARTIFICIAL FINGERNAILS IN THE NATURE OF A LIQUID MONOMER AND ACRYLIC POWDER FOR BUILDING FINGERNAILS FOR USE BY NAIL CARE PROFESSIONALS (U.S. CLS. 1, 4, 6, 50, 51 AND 52).

FIRST USE 10-1-1996; IN COMMERCE 10-1-1996.

CLASS 3—(Continued).

SN 76-345,432. FNC MEDICAL CORPORATION, VENTURA, CA. FILED 12-4-2001.

SHOW OFF

FOR NON-MEDICATED SKIN CARE PREPARATIONS FOR HORSES (U.S. CLS. 1, 4, 6, 50, 51 AND 52).

SN 76-346,272. CHANCELLOR CORP., LOS ANGELES, CA. FILED 12-6-2001.

YU-BE

FOR SKINCREAM (U.S. CLS. 1, 4, 6, 50, 51 AND 52). FIRST USE 11-2-2001; IN COMMERCE 11-2-2001.

SN 76-348,647. ZOYA COMPANY, BEDFORD HEIGHTS, OH. FILED 12-13-2001.



FOR PERFUMES (U.S. CLS. 1, 4, 6, 50, 51 AND 52). FIRST USE 3-1-2001; IN COMMERCE 8-15-2001.

SN 76-350,757. TEC SPECIALTY PRODUCTS, INC., SAINT PAUL, MN. FILED 12-19-2001.

REFRESH PRO

FOR CLEANER AND PROTECTANT FOR TILE AND STONE (U.S. CLS. 1, 4, 6, 50, 51 AND 52).

CLASS 3—(Continued).

SN 76-353,142. ECP INCORPORATED, BURR RIDGE, IL.
FILED 12-27-2001.

FRAGRANCES UNLIMITED

NO CLAIM IS MADE TO THE EXCLUSIVE RIGHT TO USE "FRAGRANCES", APART FROM THE MARK AS SHOWN.

FOR AUTOMOTIVE CLEANING PREPARATIONS, NAMELY, AUTOMOTIVE CLEANERS, DEGREASERS AND POLISHES (U.S. CLS. 1, 4, 6, 50, 51 AND 52).

FIRST USE 2-0-1998; IN COMMERCE 2-0-1998.

SN 76-354,520. HELENE CURTIS, INC., WILMINGTON, DE.
FILED 1-2-2002.

GET CARRIED AWAY

FOR HAIR CARE PRODUCTS, NAMELY, ODOR NEUTRALIZER SPRAY AND ANTI-FRIZZ LOTION (U.S. CLS. 1, 4, 6, 50, 51 AND 52).

FIRST USE 11-14-2001; IN COMMERCE 11-14-2001.

SN 76-357,910. L'OREAL, PARIS CEDEX, FRANCE, FILED 1-11-2002.

LASTING CURLS

OWNER OF U.S. REG. NO. 1,910,828.
SEC. 2(F).

FOR HAIR GEL (U.S. CLS. 1, 4, 6, 50, 51 AND 52).
FIRST USE 0-0-1990; IN COMMERCE 0-0-1990.

SN 76-358,336. L'OREAL, PARIS, FRANCE, FILED 1-14-2002.



FOR HAIR SHAMPOOS, GELS, SPRAYS, MOUSSES AND BALMS FOR HAIR STYLING AND HAIR CARE; HAIR LACQUERS; HAIR COLOURING AND HAIR DECOLORANT PREPARATIONS; PERMANENT WAVING AND CURLING PREPARATIONS (U.S. CLS. 1, 4, 6, 50, 51 AND 52).

CLASS 3—(Continued).

SN 76-361,401. CASE MEDICAL, INC., RIDGEFIELD, NJ.
FILED 1-22-2002.

CASE SOLUTIONS

OWNER OF U.S. REG. NO. 2,054,547.

NO CLAIM IS MADE TO THE EXCLUSIVE RIGHT TO USE "SOLUTIONS", APART FROM THE MARK AS SHOWN.

FOR ENZYMATIC CLEANING AND DECONTAMINATION PREPARATIONS FOR THE STERILIZATION OF MEDICAL INSTRUMENTS (U.S. CLS. 1, 4, 6, 50, 51 AND 52).

SN 76-363,002. HEARTLAND FRAGRANCE & HERB COMPANY, SPRINGFIELD, MO. FILED 1-25-2002.

BATH IN PROGRESS

FOR PERSONAL CARE PRODUCTS, NAMELY—HAND LOTION, BODY LOTION, NON-MEDICATED BATH SALTS, BATH BEADS, BATH CRYSTALS, BATH FOAM, BATH GEL, BATH LOTION, BATH PEARLS, BATH POWDER, HAND SOAP, BODY SOAP, FACE SOAP, SHOWER GELS, SHOWER CREAM, SHAMPOO, CONDITIONER, BODY CREAM, WHIPPED BODY CREAM, FRAGRANT BODY LOTION, FRAGRANT BODY SPRAY, NON-MEDICATED SOAKS, BATH OIL, BODY POWDER, SCENTED SOAPS, BODY WASH, BUBBLE BATH, NAIL CARE PREPARATIONS AND NAIL CREAM (U.S. CLS. 1, 4, 6, 50, 51 AND 52).

SN 76-364,563. SUN COAST SUPPLY CORP., VIRGINIA BEACH, VA. FILED 1-29-2002.

BODY QUENCH

NO CLAIM IS MADE TO THE EXCLUSIVE RIGHT TO USE "BODY", APART FROM THE MARK AS SHOWN.

FOR SKIN MOISTURIZER (U.S. CLS. 1, 4, 6, 50, 51 AND 52).

FIRST USE 7-30-2001; IN COMMERCE 12-28-2001.

SN 76-364,881. TOM'S OF MAINE, INC., KENNEBUNK, ME.
FILED 1-30-2002.

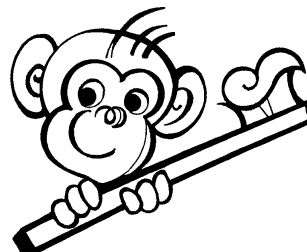

FOR TOOTHPASTE (U.S. CLS. 1, 4, 6, 50, 51 AND 52).

CLASS 3—(Continued).

SN 76-366,928. HUNTE CORPORATION, THE, ELKLAND, MO. FILED 2-1-2002.

TOTALCIDE

FOR GERMICIDAL DETERGENT (U.S. CLS. 1, 4, 6, 50, 51 AND 52).
FIRST USE 9-6-1974; IN COMMERCE 9-6-1974.

SN 76-368,211. HAIRTECH INTERNATIONAL, INC., AMBRIDGE, PA. FILED 2-7-2002.

EASILY
CONTRAST

FOR HAIR COLORING PREPARATIONS (U.S. CLS. 1, 4, 6, 50, 51 AND 52).
FIRST USE 8-0-2001; IN COMMERCE 8-0-2001.

SN 76-368,225. CHESEBROUGH-POND'S INC., WILMINGTON, DE. FILED 2-7-2002.

CIELO BRILLANTE

THE SPANISH WORDS "CIELO BRILLANTE" MAY BE TRANSLATED IN ENGLISH TO MEAN "BRIGHT SKY".
FOR LAUNDRY DETERGENT (U.S. CLS. 1, 4, 6, 50, 51 AND 52).

SN 76-368,257. L'OREAL USA CREATIVE, INC., NEW YORK, NY. FILED 2-7-2002.

FULL CIRCLE

FOR COSMETICS, NAMELY, MASCARA (U.S. CLS. 1, 4, 6, 50, 51 AND 52).

SN 76-368,311. CHESEBROUGH-POND'S INC., WILMINGTON, DE. FILED 2-7-2002.

DOVE

OWNER OF U.S. REG. NOS. 746,360, 2,534,236 AND OTHERS.
FOR FACIAL SKIN MOISTURIZERS, FACIAL SKIN TONER, FACIAL CLEANSERS AND NON-MEDICATED CLEANSING PADS IMPREGNATED WITH SKIN CLEANSERS (U.S. CLS. 1, 4, 6, 50, 51 AND 52).

CLASS 3—(Continued).

SN 76-369,469. LEE, MINSU, NEW YORK, NY. FILED 2-12-2002.

SHANA NEW YORK

NO CLAIM IS MADE TO THE EXCLUSIVE RIGHT TO USE "NEW YORK", APART FROM THE MARK AS SHOWN.
FOR SKIN CARE PRODUCTS, NAMELY SKIN LOTION, SKIN CREAMS, BODY LOTION, BODY CREAMS, AND FACIAL SCRUBS SUNTAN AND SUNSCREEN PREPARATIONS, NAMELY, LOTIONS, CREAMS, MOISTURIZERS, SUNSCREENS AND SUNBLOCKS (U.S. CLS. 1, 4, 6, 50, 51 AND 52).

SN 76-369,659. BONNE BELL, INC., LAKEWOOD, OH. FILED 2-11-2002.

LIQUIDLINES

FOR EYE COSMETICS, NAMELY EYE LINER (U.S. CLS. 1, 4, 6, 50, 51 AND 52).
FIRST USE 8-15-2001; IN COMMERCE 8-15-2001.

SN 76-370,555. BON JOUR GROUP, L.P., NEW YORK, NY. FILED 2-12-2002.

ALL MY GLORY

FOR FRAGRANCE PRODUCTS FOR PERSONAL USE, NAMELY, PERFUME, COLOGNE, TOILET WATER, SCENTED BODY LOTION AND MOISTURIZING CREAM, BODY OIL, BODY POWDER, SCENTED SOAP; COSMETICS AND SKIN CARE PREPARATIONS, NAMELY, FOUNDATION MAKE-UP, FACE POWDER, BLUSHER, COMPACTS, EYE PENCILS, LIP PENCILS, LIPSTICK, LIP GLOSS, NON-MEDICATED LIP BALM, MASCARA, EYE MAKE-UP, EYELINERS, SKIN MOISTURIZER AND SKIN TONER; HAIR CARE PRODUCTS, NAMELY, SHAMPOO, HAIR CONDITIONERS, HAIR GEL AND HAIR SPRAY; NAIL CARE PREPARATIONS, NAMELY, NAIL POLISH, NAIL STRENGTHENERS, AND NAIL POLISH REMOVER; SHAVING CREAM, SHAVING GEL, AFTER-SHAVE LOTION; SKIN SOAP; BATH AND SHOWER GEL; BATH OIL; BATH SALTS; DEODORANT; ANTIPERSPIRANT; POTPOURRI; SACHETS; SUNTANNING PREPARATIONS; SUN SCREEN AND SUN BLOCK PREPARATIONS (U.S. CLS. 1, 4, 6, 50, 51 AND 52).

SN 76-370,726. JOHN FRIEDA PROFESSIONAL HAIR CARE, INC., WILTON, CT. FILED 2-13-2002.

WRECK 'N ROLL

FOR HAIR GEL (U.S. CLS. 1, 4, 6, 50, 51 AND 52).

CLASS 3—(Continued).

SN 76-372,079. CHURCH & DWIGHT COMPANY, GREEN RIVER, WY. FILED 2-15-2002.

ALPINE SPRING

FOR LAUNDRY DETERGENTS AND FABRIC SOFTENERS (U.S. CLS. 1, 4, 6, 50, 51 AND 52).

SN 76-373,622. L'OREAL USA CREATIVE, INC., NEW YORK, NY. FILED 2-13-2002.

CURL TALK

FOR HAIR CARE AND HAIR STYLING PREPARATIONS (U.S. CLS. 1, 4, 6, 50, 51 AND 52).

SN 76-373,980. GREENWAY RESEARCH LABS, INC., BURNSVILLE, MN. FILED 2-21-2002.

(H2T)

FOR HAIR CARE PRODUCTS, NAMELY, SHAMPOO, CONDITIONER, GEL, MOUSSE, GLAZE, FIXATIVE, MOISTURIZER, HAIRSPRAY, NON-MEDICATED SCALP TREATMENTS, AND HAIR STYLING PREPARATIONS; AND, COSMETICS AND SKIN CARE PREPARATIONS, NAMELY, BATH AND SHOWER GELS, BATH FOAMS, BATH SALTS, BATH OILS, SKIN EXFOLIANTS, FACIAL AND BODY MASKS, FACIAL AND BODY SCRUBS AND CLEANSERS, FACE, HAND, AND BODY LOTIONS, CREAMS, OILS, AND GELS, SUN SCREEN AND SUN TAN LOTIONS, OILS, AND GELS, AND TONERS (U.S. CLS. 1, 4, 6, 50, 51 AND 52).

SN 76-374,066. LOOKING GLASS PRODUCTIONS, INC., RIVERSIDE, CT. FILED 2-22-2002.

At Peace

OWNER OF U.S. REG. NOS. 2,539,723 AND 2,575,437. FOR COSMETICS, PERFUME AND PREPARATIONS - NAMELY, LOTIONS, CREAMS AND OILS - FOR HAIR, BODY, SKIN AND NAILS (U.S. CLS. 1, 4, 6, 50, 51 AND 52).

CLASS 3—(Continued).

SN 76-374,173. SPOHN, MARY, JACKSONVILLE, FL. FILED 2-25-2002.

SUDDENLY SOAPS

NO CLAIM IS MADE TO THE EXCLUSIVE RIGHT TO USE "SOAPS", APART FROM THE MARK AS SHOWN. FOR HANDCRAFTED SKIN SOAPS (U.S. CLS. 1, 4, 6, 50, 51 AND 52).

SN 76-375,159. DMA INTERNATIONAL, INC., MOAB, UT. FILED 2-20-2002.

GLO GERM

FOR HAND AND BODY LOTIONS, LIQUIDS, OILS, GELS, CREAMS, AND POWDERS, AND KITS INCORPORATING THE SAME (U.S. CLS. 1, 4, 6, 50, 51 AND 52). FIRST USE 3-0-1968; IN COMMERCE 3-0-1968.

SN 76-375,982. BC INTERNATIONAL COSMETICS & IMAGE SERVICES, INC., WILMINGTON, DE. FILED 2-26-2002.

SUN FAUX YOU

FOR COSMETICS (U.S. CLS. 1, 4, 6, 50, 51 AND 52).

SN 76-376,599. GABRIEL FIRST CORPORATION, EAST ROCHESTER, NY. FILED 2-22-2002.

ADVANTAGE

FOR FLOOR FINISHING PREPARATION (U.S. CLS. 1, 4, 6, 50, 51 AND 52). FIRST USE 1-11-2002; IN COMMERCE 1-11-2002.

SN 76-376,703. CORGANICS, L.P., TYLER, TX. FILED 3-1-2002.

SKINFERNO

FOR COSMETICS, NAMELY LOTIONS FOR SOOTHING, COOLING, MOISTURIZING, AND CONDITIONING THE SKIN (U.S. CLS. 1, 4, 6, 50, 51 AND 52).

SN 76-380,694. HARDCAP LLC, NEW YORK, NY. FILED 3-8-2002.

BLONDE'S BEST

FOR HAIR CARE PREPARATIONS (U.S. CLS. 1, 4, 6, 50, 51 AND 52).

CLASS 3—(Continued).

SN 76-381,588. HUB DISTRIBUTING, INC., ONTARIO, CA. FILED 3-13-2002.

TAKEN

FOR PERFUME (U.S. CLS. 1, 4, 6, 50, 51 AND 52).

SN 78-017,060. DIMC, INC., WILMINGTON, DE. BY ASSIGNMENT SHERWIN-WILLIAMS COMPANY, THE, CLEVELAND, OH. FILED 7-17-2000.

ULTRA-FORCE

FOR CLEANING PREPARATIONS, NAMELY, INDUSTRIAL SOLVENTS AND DEGREASING PREPARATIONS NOT USED IN MANUFACTURING PROCESSES FOR USE IN CLEANING METALS, ELECTRO-MECHANICAL MACHINERY, AND ELECTRICAL EQUIPMENT (U.S. CLS. 1, 4, 6, 50, 51 AND 52).

FIRST USE 12-5-2000; IN COMMERCE 12-5-2000.

SN 78-052,571. AVON PRODUCTS, INC., NEW YORK, NY. FILED 3-12-2001.

AUTO FOCUS

FOR COSMETICS, NAMELY - FACIAL FOUNDATION (U.S. CLS. 1, 4, 6, 50, 51 AND 52).

SN 78-058,705. WONDER MARKETING, INC., LOS ANGELES, CA. FILED 4-16-2001.

EQUINE CPR

NO CLAIM IS MADE TO THE EXCLUSIVE RIGHT TO USE "EQUINE", APART FROM THE MARK AS SHOWN.

FOR HORSE GROOMING PRODUCTS, NAMELY, EYE BRIGHTENING LOTION, COAT BRIGHTENERS, HOOF BLACKENER, MANE AND TAIL WHITENER, SPRAY WHITENER, COAT DRESSING AND CONDITIONER, HOOF CONDITIONERS AND HOOF DRESSING (U.S. CLS. 1, 4, 6, 50, 51 AND 52).

CLASS 3—(Continued).

SN 78-063,084. WARNER, CAROL, C, FREDERICKSBURG, VA. FILED 5-11-2001.

AIRY

FOR COSMETICS, NAMELY, NON-MEDICATED CREAMS, NAMELY, COLD CREAMS, BODY CREAMS, FACE CREAMS, EYE CREAMS, ANTI-ITCH CREAMS, HAND CREAMS, SKIN CREAMS, MOISTURIZING CREAMS, CLEANSING SKIN CREAMS, CREAMS FOR THE PREVENTION AND TREATMENT OF SUNBURN, CREAMS FOR THE TREATMENT OF DIAPER RASH, FOOT CREAMS, CUTICLE CREAMS; NON-MEDICATED LOTIONS, NAMELY, LOTIONS FOR THE TREATMENT OF DIAPER RASH, LOTIONS FOR THE PREVENTION AND TREATMENT OF SUNBURN, MOISTURIZING LOTIONS, SKIN LOTIONS, BODY LOTIONS, HAND LOTIONS, HAIR LOTIONS, SKIN-CLEANING LOTIONS, FOOT LOTIONS, CUTICLE LOTIONS, AFTERSHAVE LOTIONS, FACIAL LOTIONS; NON-MEDICATED MOISTURIZERS, NAMELY, SKIN MOISTURIZER, BODY MOISTURIZER, FACIAL MOISTURIZER, NON-MEDICATED CLEANSERS, NAMELY, HAND SOAP, BAR SOAPS, LIQUID SOAPS, DEODORANT SOAP, ANTIBACTERIAL SOAP, FACIAL CLEANSER, BODY CLEANSER, SKIN CLEANSER, HAIR CLEANSER; OILS, NAMELY, BATH OILS, FOAMING OILS, CUTICLE OILS, BODY OILS, BABY OILS; NON-MEDICATED BALMS, NAMELY, BATH BALMS, BODY BALMS, BODY MASK BALMS, LIP BALMS, SHAVING BALM; NON-MEDICATED OINTMENTS, NAMELY, DIAPER RASH OINTMENTS, OINTMENTS FOR THE PREVENTION AND TREATMENT OF SUNBURNS, OINTMENTS FOR THE TREATMENT OF SKIN CARE; NON-MEDICATED SALVES; FACIAL ASTRINGENT AND TONERS; NON-MEDICATED BATH SALTS; POWDERS, NAMELY, BABY POWDER, FACIAL POWDER, BODY POWDER, BATH POWDER; SKIN TONERS; MASKS, NAMELY, BEAUTY MASKS, FACIAL MASKS, BODY MASKS, FOOT MASKS, LIP MASKS; LIP GLOSS; LIP GLOSS PALETTE; SCRUBS, NAMELY, BODY SCRUBS, FACIAL SCRUBS, FOOT SCRUBS, HAND SCRUBS (U.S. CLS. 1, 4, 6, 50, 51 AND 52).

SN 78-067,487. AVON PRODUCTS, INC., NEW YORK, NY. FILED 6-5-2001.

OFF LINE

OWNER OF U.S. REG. NO. 1,912,143.
FOR SKIN CARE PREPARATIONS, NAMELY, MOISTURIZING FACIAL CREAM (U.S. CLS. 1, 4, 6, 50, 51 AND 52).

SN 78-077,673. LES PARFUMERIES FRAGONARD, GRASSE, FRANCE, FILED 8-6-2001.

ZIZANIE

OWNER OF FRANCE REG. NO. 92431348, DATED 8-21-1992, EXPIRES 8-21-2002.

FOR HAIR LOTIONS; ESSENTIAL OILS FOR PERSONAL USE; TOILET SOAPS, SKIN SOAPS; COSMETICS PRODUCTS, NAMELY SKIN CREAMS, SKIN LOTIONS AND EMULSIONS, MASSAGE OIL, MASSAGE CREAM, MASSAGE LOTION FOR THE BODY, SKIN MOISTURIZER, PERSONAL DEODORANT, BATH CREAM, BATH-OIL, BATH FOAM, BATH SOAP, BATH SALTS, BATH SPAYS, HAIR BLEACH, ASTRINGENTS EYE MAKE-UP, LIP STICK, NAIL POLISH (U.S. CLS. 1, 4, 6, 50, 51 AND 52).

CLASS 3—(Continued).

SN 78-078,936. EGG BY SUSAN LAZAR, INC., NEW YORK, NY. FILED 8-13-2001.

EGG AROMA

NO CLAIM IS MADE TO THE EXCLUSIVE RIGHT TO USE "AROMA", APART FROM THE MARK AS SHOWN, FOR PERFUMES (U.S. CLS. 1, 4, 6, 50, 51 AND 52).

SN 78-079,285. INTIMATE BEAUTY CORPORATION, DBA VICTORIA'S SECRET BEAUTY, NEW YORK, NY. FILED 8-15-2001.

PETAL PUSHERS

FOR PERSONAL CARE PRODUCTS, NAMELY, AFTERSHAVE, ANTIPERSPIRANT, ARTIFICIAL NAILS, NON-MEDICATED ASTRINGENT FOR THE FACE, NON-MEDICATED ASTRINGENT FOR THE SKIN, BATH BEADS, BATH OIL, NON-MEDICATED BATH SALTS, BLUSH, BODY GLITTER, BODY MIST, BODY OIL, BUBBLE BATH, CLEANSER FOR THE FACE, COLOGNE, COTTON SWABS FOR COSMETIC PURPOSES, CREAM FOR THE BODY, CREAM FOR THE CUTICLES, CREAM FOR THE EYES, CREAM FOR THE FACE, CREAM FOR THE HANDS, DEODORANT, ESSENTIAL OILS, EXFOLIATORS FOR THE SKIN, EXFOLIATORS FOR THE FEET, EYE GELS, EYE MAKEUP PENCILS, EYE SHADOW, FACE MIST, FACIAL MASKS, NON-MEDICATED FOOT SOAK, NON-MEDICATED FOOT SPRAY, FOUNDATION, FRAGRANT BODY SPLASH, HAIR CONDITIONER, HAIR DYES, HAIR GLITTER, HAIR RINSES, HAIR SHAMPOO, HAIR SPRAY, HAIR STYLING GEL, HAIR STYLING MOUSSE, LOTION FOR THE BODY, LOTION FOR THE FACE, NON-MEDICATED LOTION FOR THE FEET, LOTION FOR THE HANDS, NON-MEDICATED LIP BALM, LIP GLOSS, LIP MAKEUP PENCILS, LIPSTICK, MAKEUP FOR THE BODY, MAKEUP FOR THE FACE, MAKEUP REMOVER, MASCARA, MASSAGE LOTION, MASSAGE OIL, NAIL CORRECTOR PENS, NAIL POLISH, NAIL POLISH REMOVER, NAIL STENCILS, NON-MEDICATED BLEMISH STICK, NON-MEDICATED MOOD ENHANCING SKIN MASSAGE OINTMENT, NON-MEDICATED MOOD ENHANCING SKIN CREAM, OIL BLOTTING SHEETS FOR THE SKIN, PERFUME, POWDER FOR THE BODY, POWDER FOR THE FACE, NON-MEDICATED POWDER FOR THE FEET, PUMICE STONES FOR PERSONAL USE, NON-MEDICATED SALT SCRUBS FOR THE SKIN, SHAVING CREAM, SHOWER GEL, SOAP FOR THE BODY, SOAP FOR THE FACE, SOAP FOR THE HANDS, SUN BLOCK FOR THE SKIN, SUNTAN LOTION FOR THE BODY, SUNTAN LOTION FOR THE FACE, SUNLESS TANNING LOTION FOR THE BODY, SUNLESS TANNING LOTION FOR THE FACE, PRE-SUNTANNING LOTION FOR THE BODY, PRE-SUNTANNING LOTION FOR THE FACE, POST-SUNTANNING LOTION FOR THE BODY, POST-SUNTANNING LOTION FOR THE FACE AND TALCUM POWDER (U.S. CLS. 1, 4, 6, 50, 51 AND 52).

SN 78-079,657. WEAR ME APPAREL CORP., NEW YORK, NY. FILED 8-16-2001.

SUGAR SWEET

FOR COSMETICS (U.S. CLS. 1, 4, 6, 50, 51 AND 52).

CLASS 3—(Continued).

SN 78-079,783. PROCTER & GAMBLE COMPANY, THE, CINCINNATI, OH. FILED 8-17-2001.

INVIGORATING BREEZE

OWNER OF U.S. REG. NO. 2,503,195. FOR HOUSEHOLD CLEANING PREPARATIONS, NAMELY HARD SURFACE CLEANER (U.S. CLS. 1, 4, 6, 50, 51 AND 52).

SN 78-079,907. CLARINS S.A., NEUILLY-SUR-SEINE, FRANCE, FILED 8-17-2001.

EAU ENERGY

THE ENGLISH TRANSLATION OF THE MARK WORD "EAU" IS "WATER" IN FRENCH.

FOR COSMETICS AND PERSONAL CARE PRODUCTS, NAMELY, BEAUTY CREAMS LOTIONS AND MILKS, TONING LOTIONS, FACIAL MASKS, MAKE-UP REMOVING MILKS, BEAUTY GELS, BEAUTY OILS, BATH SOAPS, HAIR SPRAYS, BODY POWDERS AND SPRAYS, SKIN REFRESHERS, MOISTURIZERS, PERFUMES, COLOGNES, DEODORANTS AND TOILET WATERS (U.S. CLS. 1, 4, 6, 50, 51 AND 52).

SN 78-083,328. WARNER-LAMBERT COMPANY, MORRIS PLAINS, NJ. FILED 9-10-2001.

KILL THE GERMS. FEEL THE CLEAN.

FOR NON-MEDICATED MOUTHRINSES AND BREATH FRESHENERS (U.S. CLS. 1, 4, 6, 50, 51 AND 52).

SN 78-085,829. GILLETTE CANADA COMPANY, DBA ORAL-B LABORATORIES, MISSISSAUGA, CANADA, ONTARIO, FILED 9-27-2001.

STAGES

PRIORITY CLAIMED UNDER SEC. 44(D) ON CANADA APPLICATION NO. 1099279, FILED 4-11-2001. FOR TOOTHPASTE (U.S. CLS. 1, 4, 6, 50, 51 AND 52). FIRST USE 1-21-2002; IN COMMERCE 1-21-2002.

SN 78-086,282. BROWNELLS, INC., MONTEZUMA, IA. FILED 10-1-2001.

IM

FOR COMBINATION GUN POLISH AND BLUING COMPOSITION (U.S. CLS. 1, 4, 6, 50, 51 AND 52). FIRST USE 0-0-1963; IN COMMERCE 0-0-1963.

CLASS 3—(Continued).

SN 78-086,285. BROWNELLS, INC., MONTEZUMA, IA. FILED 10-1-2001.

T-4

FOR COMBINATION GUN POLISH AND BLUING COMPOSITION (U.S. CLS. 1, 4, 6, 50, 51 AND 52). FIRST USE 0-0-1963; IN COMMERCE 0-0-1963.

SN 78-086,287. BROWNELLS, INC., MONTEZUMA, IA. FILED 10-1-2001.

DICROPAN

FOR COMBINATION GUN POLISH AND BLUING COMPOSITION (U.S. CLS. 1, 4, 6, 50, 51 AND 52). FIRST USE 0-0-1963; IN COMMERCE 0-0-1963.

SN 78-087,148. RECKITT AND COLMAN SUBSIDIARY CORPORATION, WILMINGTON, DE. FILED 10-5-2001.

SPRAY'N WASH UN BLEACH

OWNER OF U.S. REG. NOS. 1,073,005, 1,231,570 AND 1,262,131.
SEC. 2(F) AS TO "SPRAY'N WASH".
FOR CARPET CLEANERS AND SHAMPOOS; LAUNDRY DETERGENTS; FABRIC AND CARPET STAIN REMOVERS (U.S. CLS. 1, 4, 6, 50, 51 AND 52).

SN 78-087,837. EXCELLENT DESIGN COMPANY, DBA CALIFORNIA INTERFILL, INC., RIVERSIDE, CA. FILED 10-10-2001.

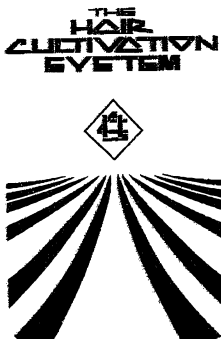

NO CLAIM IS MADE TO THE EXCLUSIVE RIGHT TO USE "HAIR CULTIVATION SYSTEM", APART FROM THE MARK AS SHOWN.

FOR HAIR PRODUCTS, NAMELY, SHAMPOOS, CONDITIONERS, HAIR TREATMENTS, HAIR MASKS, HAIR POMADES, STYLING GELS, HAIR SPRAYS, RELAXERS, HAIR FINISHING PRODUCTS, NAMELY, HAIR SPRAYS, HAIR SHINE (U.S. CLS. 1, 4, 6, 50, 51 AND 52).

CLASS 3—(Continued).

SN 78-089,108. BOWMAN, PAMELA JEAN, FORT WORTH, TX. FILED 10-18-2001.

KETURAH

"KETURAH" REFERS TO A WIFE OF THE BIBLICAL ABRAHAM AND ALSO A FEMALE GIVEN NAME DERIVED FROM A HEBREW WORDING MEANING "INCENSE" OR "FRAGRANCE".

FOR PERFUME, PERFUME SPRAY, COLOGNE SPRAY, TOILET WATER, BODY CREAM, BATH SOAP, BATH CRYSTALS, BODY LOTION, BODY OIL, BODY OIL SPRAY, BODY POWDER, BODY GLISTENER, SHOWER GEL, MEN'S COLOGNE, MEN'S COLOGNE SPRAY, AFTERSHAVE LOTION, AFTERSHAVE BALM, BODY DEODERANT, SHAMPOO, HAIR CONDITIONER, HAIRSPRAY, LIPSTICK (U.S. CLS. 1, 4, 6, 50, 51 AND 52).

SN 78-091,365. PHARMACIA CORPORATION, PEAPACK, NJ. FILED 11-2-2001.

FOLIQUE

FOR HAIR CARE PREPARATIONS (U.S. CLS. 1, 4, 6, 50, 51 AND 52).

SN 78-101,618. FRAGMENTS, INC., NEW YORK, NY. FILED 1-9-2002.

FRAGMENTS

OWNER OF U.S. REG. NOS. 2,134,713, 2,509,722 AND OTHERS.

FOR COSMETICS, NAMELY, FOUNDATION, FACE POWDER, BLUSH, EYESHADOW, EYELINER, EYEBROW PENCIL, MASCARA, LIP PENCILS, LIPSTICK, LIP GLOSS, CONCEALER; PERFUME, COLOGNE AND FRAGRANCES FOR PERSONAL USE (U.S. CLS. 1, 4, 6, 50, 51 AND 52).

SN 78-103,235. BOBBI BROWN PROFESSIONAL COSMETICS, INC., NEW YORK, NY. FILED 1-17-2002.

LASH GLAMOUR

NO CLAIM IS MADE TO THE EXCLUSIVE RIGHT TO USE "LASH", APART FROM THE MARK AS SHOWN.

FOR COSMETICS, NAMELY MASCARA, EYE SHADOWS, EYE LINER (U.S. CLS. 1, 4, 6, 50, 51 AND 52).

CLASS 3—(Continued).

SN 78-103,624. PROCTER & GAMBLE COMPANY, THE, CINCINNATI, OH. FILED 1-18-2002.



NO CLAIM IS MADE TO THE EXCLUSIVE RIGHT TO USE "QUICK DISSOLVING", APART FROM THE MARK AS SHOWN.

THE STIPPLING IS A FEATURE OF THE MARK.

THE MARK CONSISTS OF THE WORDS "QUICK DISSOLVING" CONTAINED WITHIN AN OVAL SHAPE AND TRAILING EFFERVESCENCE BEGINNING AT BOTTOM CENTER OF THE OVAL AND ENDING NEAR TOP CENTER ON THE LEFT AND BEGINNING AT THE TOP CENTER AND ENDING NEAR THE BOTTOM CENTER ON THE RIGHT. THE LETTERS ARE OUTLINED IN DARK BLUE AND WHITE ACCENT SHADING APPEARING IMMEDIATELY BELOW THE WORD "DISSOLVING". THE OVAL IS LINED FOR THE COLOR BLUE GRADUATING FROM A DARK BLUE TO AN AQUA BLUE IN THE CENTER AND TOP PORTION OF THE OVAL.

FOR LAUNDRY DETERGENT (U.S. CLS. 1, 4, 6, 50, 51 AND 52).

SN 78-103,628. PROCTER & GAMBLE COMPANY, THE, CINCINNATI, OH. FILED 1-18-2002.

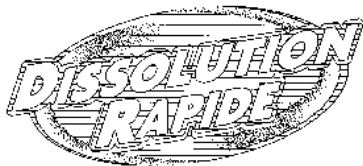

NO CLAIM IS MADE TO THE EXCLUSIVE RIGHT TO USE "DISSOLUTION RAPIDE", APART FROM THE MARK AS SHOWN.

THE STIPPLING IS A FEATURE OF THE MARK.

THE MARK CONSISTS OF THE WORDS "DISSOLUTION RAPIDE" CONTAINED WITHIN AN OVAL SHAPE AND TRAILING EFFERVESCENCE BEGINNING AT BOTTOM CENTER OF THE OVAL AND ENDING NEAR TOP CENTER ON THE LEFT AND BEGINNING AT THE TOP CENTER AND ENDING NEAR THE BOTTOM CENTER ON THE RIGHT. THE LETTERS ARE OUTLINED IN DARK BLUE AND WHITE ACCENT SHADING APPEARING IMMEDIATELY BELOW THE WORD "RAPIDE". THE OVAL IS LINED FOR THE COLOR BLUE GRADUATING FROM A DARK BLUE TO AN AQUA BLUE IN THE CENTER AND TOP PORTION OF THE OVAL.

FOR LAUNDRY DETERGENT (U.S. CLS. 1, 4, 6, 50, 51 AND 52).

CLASS 3—(Continued).

SN 78-104,881. INTIMATE BEAUTY CORPORATION, DBA VICTORIA'S SECRET BEAUTY, NEW YORK, NY. FILED 1-25-2002.

ANGEL BRIDE

FOR PERSONAL CARE PRODUCTS, NAMELY, AFTERSHAVE, ANTIPERSPIRANT, ARTIFICIAL NAILS, ASTRINGENT FOR THE FACE, ASTRINGENT FOR THE SKIN, BATH OIL, BATH BEADS, BATH SALTS, BLUSH, BODY GLITTER, BODY OIL, BODY SCRUB, BUBBLE BATH, COLOGNE, CREAM FOR THE BODY, CREAM FOR THE CUTICLES, CREAM FOR THE EYES, CREAM FOR THE FACE, CREAM FOR THE HANDS, DEODORANT, ESSENTIAL OILS, EXFOLIATORS FOR THE SKIN, EYE GELS, EYE MAKEUP PENCILS, EYE SHADOW, FACE HIGHLIGHTER, FACIAL MASKS, FACE MIST, FACE SCRUB, FOOT SOAK, FOUNDATION, FRAGRANT BODY SPLASH, FRAGRANT BODY MIST, HAIR CONDITIONER, HAIR DYES, HAIR GLITTER, HAIR HIGHLIGHTER, HAIR MASCARA, HAIR POMADE, HAIR RINSES, HAIR REMOVING CREAMS, HAIR SHAMPOO, HAIR SPRAY, HAIR STRAIGHTENER, HAIR STYLING GEL, HAIR STYLING MOUSSE, LOTION FOR THE BODY, LOTION FOR THE HANDS, LOTION FOR THE FACE, LIP BALM, LIP GLOSS, LIP LINER, LIP MAKEUP PENCILS, LIPSTICK, MAKEUP FOR THE BODY, MAKEUP FOR THE FACE, MAKEUP REMOVER, MASCARA, NAIL CORRECTOR PENS, NAIL POLISH, NAIL POLISH REMOVER, NAIL STENCILS, NON-MEDICATED BLEMISH STICK, NON-MEDICATED CLEANSER FOR THE FACE, NON-MEDICATED FOOT SPRAY, NON-MEDICATED MOOD ENHANCING MASSAGE OINTMENT, NON-MEDICATED MOOD ENHANCING SKIN CREAM, OIL BLOTTING SHEETS FOR THE SKIN, PERFUME, POWDER FOR THE BODY, POWDER FOR THE FACE, POWDER FOR THE FEET, PUMICE STONES FOR PERSONAL USE, SALT SCRUBS FOR THE SKIN, SHAVING CREAM, SHOWER GEL, SKIN BRONZING CREAM, SOAP FOR THE BODY, SOAP FOR THE FACE, SOAP FOR THE HANDS, SUN BLOCK FOR THE BODY, SUN BLOCK FOR THE FACE, SUNTAN LOTION FOR THE BODY, SUNTAN LOTION FOR THE FACE, SUNLESS TANNING LOTION FOR THE BODY, PRE-SUNTANNING LOTION FOR THE BODY, PRE-SUNTANNING LOTION FOR THE FACE, POST-SUNTANNING LOTION FOR THE BODY, POST-SUNTANNING LOTION FOR THE FACE AND TALCUM POWDER (U.S. CLS. 1, 4, 6, 50, 51 AND 52).

SN 78-104,885. INTIMATE BEAUTY CORPORATION, DBA VICTORIA'S SECRET BEAUTY, NEW YORK, NY. FILED 1-25-2002.

FORBIDDEN ANGEL

FOR PERSONAL CARE PRODUCTS, NAMELY, AFTERSHAVE, ANTIPERSPIRANT, ARTIFICIAL NAILS, ASTRINGENT FOR THE FACE, ASTRINGENT FOR THE SKIN, BATH OIL, BATH BEADS, BATH SALTS, BLUSH, BODY GLITTER, BODY OIL, BODY SCRUB, BUBBLE BATH, COLOGNE, CREAM FOR THE BODY, CREAM FOR THE CUTICLES, CREAM FOR THE EYES, CREAM FOR THE FACE, CREAM FOR THE HANDS, DEODORANT, ESSENTIAL OILS, EXFOLIATORS FOR THE SKIN, EYE GELS, EYE MAKEUP PENCILS, EYE SHADOW, FACE HIGHLIGHTER, FACIAL MASKS, FACE MIST, FACE SCRUB, FOOT SOAK, FOUNDATION, FRAGRANT BODY SPLASH, FRAGRANT BODY MIST, HAIR CONDITIONER, HAIR DYES, HAIR GLITTER, HAIR HIGHLIGHTER, HAIR MASCARA, HAIR POMADE, HAIR RINSES, HAIR REMOVING CREAMS, HAIR SHAMPOO, HAIR SPRAY, HAIR STRAIGHTENER, HAIR STYLING GEL, HAIR STYLING MOUSSE, LOTION FOR THE BODY, LOTION FOR THE HANDS, LOTION FOR THE FACE, LIP BALM, LIP GLOSS, LIP

CLASS 3—(Continued).

LINER, LIP MAKEUP PENCILS, LIPSTICK, MAKEUP FOR THE BODY, MAKEUP FOR THE FACE, MAKEUP REMOVER, MASCARA, NAIL CORRECTOR PENS, NAIL POLISH, NAIL POLISH REMOVER, NAIL STENCILS, NON-MEDICATED BLEMISH STICK, NON-MEDICATED CLEANSER FOR THE FACE, NON-MEDICATED FOOT SPRAY, NON-MEDICATED MOOD ENHANCING MASSAGE OINTMENT, NON-MEDICATED MOOD ENHANCING SKIN CREAM, OIL BLOTTING SHEETS FOR THE SKIN, PERFUME, POWDER FOR THE BODY, POWDER FOR THE FACE, POWDER FOR THE FEET, PUMICE STONES FOR PERSONAL USE, SALT SCRUBS FOR THE SKIN, SHAVING CREAM, SHOWER GEL, SKIN BRONZING CREAM, SOAP FOR THE BODY, SOAP FOR THE FACE, SOAP FOR THE HANDS, SUN BLOCK FOR THE BODY, SUN BLOCK FOR THE FACE, SUNTAN LOTION FOR THE BODY, SUNTAN LOTION FOR THE FACE, SUNLESS TANNING LOTION FOR THE BODY, SUNLESS TANNING LOTION FOR THE FACE, PRE-SUNTANNING LOTION FOR THE BODY, PRE-SUNTANNING LOTION FOR THE FACE, POST-SUNTANNING LOTION FOR THE BODY, POST-SUNTANNING LOTION FOR THE FACE AND TALCUM POWDER (U.S. CLS. 1, 4, 6, 50, 51 AND 52).

SN 78-107,401. PROCTER & GAMBLE COMPANY, THE, CINCINNATI, OH. FILED 2-7-2002.

SO HEALTHY, YOU'LL LOVE YOUR HAIR

FOR HAIR CARE PREPARATIONS, NAMELY, SHAMPOO, CONDITIONER, STYLING MOUSSE, STYLING GEL, HAIR SPRAY (U.S. CLS. 1, 4, 6, 50, 51 AND 52).

SN 78-109,764. SALLY BEAUTY HOLDINGS, INC., HAMILTON, BERMUDA, FILED 2-19-2002.

STIFF N UP

FOR HAIR CARE PREPARATIONS (U.S. CLS. 1, 4, 6, 50, 51 AND 52).

SN 78-109,768. SALLY BEAUTY HOLDINGS, INC., HAMILTON, BERMUDA, FILED 2-19-2002.

STIFF ENUFF

FOR HAIR CARE PREPARATIONS (U.S. CLS. 1, 4, 6, 50, 51 AND 52).
FIRST USE 8-19-2001; IN COMMERCE 8-19-2001.

SN 78-110,017. AVON PRODUCTS, INC., NEW YORK, NY. FILED 2-20-2002.

PARADIGM

FOR COLOGNE, AFTER SHAVE LOTION, BODY WASH, TALCUM POWDER, AND PERSONAL DEODORANT (U.S. CLS. 1, 4, 6, 50, 51 AND 52).

CLASS 3—(Continued).

SN 78-110,215. PACIFIC WORLD CORPORATION, LAKE FOREST, CA. FILED 2-21-2002.

NAILSTAY

FOR ARTIFICIAL NAILS AND NAIL GLUE (U.S. CLS. 1, 4, 6, 50, 51 AND 52).

SN 78-110,222. PACIFIC WORLD CORPORATION, LAKE FOREST, CA. FILED 2-21-2002.

NAILED ON

FOR ARTIFICIAL NAILS AND NAIL GLUE (U.S. CLS. 1, 4, 6, 50, 51 AND 52).

SN 78-111,569. PURITAN SERVICES INC., MARIETTA, GA. FILED 2-28-2002.

SPEEDET

FOR LIQUID LAUNDRY PRODUCTS, NAMELY, BLEACH, SOFTENER, SOUR AND STAIN REMOVER FOR COMMERCIAL, INDUSTRIAL AND INSTITUTIONAL USE (U.S. CLS. 1, 4, 6, 50, 51 AND 52).
FIRST USE 11-6-1987; IN COMMERCE 11-6-1987.

SN 78-112,172. SALLY BEAUTY HOLDINGS, INC., HAMILTON, BERMUDA, FILED 3-2-2002.

ION

OWNER OF U.S. REG. NO. 1,320,267.
FOR HAIR CARE PREPARATIONS; HAIR COLORANTS (U.S. CLS. 1, 4, 6, 50, 51 AND 52).

SN 78-113,308. ENRICH CORPORATION, THE, OREM, UT. FILED 3-7-2002.

NANOMINS

FOR SKIN LOTIONS, SKIN TONERS, SKIN NOURISHING SERUM, PERFUMES, EAU DE TOILETTES, FOUNDATION CREAMS, NOURISHING CREAMS, NAMELY, CREAMS FOR THE CARE OF THE FACE, HAIR SHAMPOOS, COSMETIC SOAPS, LIPSTICKS, MASCARAS, FACIAL MASKS, MASSAGE CREAMS, EYE SHADOWS, BLUSHES, SKIN CLEANSING GELS, SKIN MOISTURIZERS, SKIN AND EYE GELS, FACIAL SCRUBS, SKIN CREAMS, DEODORANTS FOR PERSONAL USE, HAIR SHAMPOO, HAIR CONDITIONER, HAIR SPRAY AND HAIR COLOR (U.S. CLS. 1, 4, 6, 50, 51 AND 52).

CLASS 3—(Continued).

SN 78-113,328. SALLY BEAUTY HOLDINGS, INC., HAMILTON, BERMUDA, FILED 3-7-2002.

STRAIGHT UP

FOR HAIR CARE PREPARATIONS (U.S. CLS. 1, 4, 6, 50, 51 AND 52).

SN 78-113,340. LANCE ENTERPRISES, INC., MAUMEE, OH. FILED 3-7-2002.

UNIQUE

FOR COSMETIC WHITENING GELS FOR TEETH (U.S. CLS. 1, 4, 6, 50, 51 AND 52).

SN 78-113,602. PROCTER & GAMBLE COMPANY, THE, CINCINNATI, OH. FILED 3-8-2002.

CASCADE CRYSTAL CLEAR

OWNER OF U.S. REG. NOS. 500,212, 2,491,540 AND OTHERS.
FOR RINSE AGENT FOR AUTOMATIC DISH-WASHERS (U.S. CLS. 1, 4, 6, 50, 51 AND 52).

SN 78-114,000. CONAIR CIP, INC., STAMFORD, CT. FILED 3-11-2002.

SEA-FOAM

FOR HAIR CARE PRODUCTS, NAMELY, SHAMPOOS, CONDITIONERS, STYLING GELS, MOUSSE, LUSTERIZERS, AND HAIRSPRAY (U.S. CLS. 1, 4, 6, 50, 51 AND 52).

SN 78-114,158. CONAIR CIP, INC., STAMFORD, CT. FILED 3-12-2002.

AQUATEX

FOR HAIR CARE PRODUCTS, NAMELY, SHAMPOOS, CONDITIONERS, STYLING GELS, LUSTERIZERS, MOUSSE AND HAIRSPRAYS (U.S. CLS. 1, 4, 6, 50, 51 AND 52).

CLASS 3—(Continued).

SN 78-114,858. SALLY BEAUTY HOLDINGS, INC., HAMILTON, BERMUDA, FILED 3-14-2002.

ZONER

FOR HAIR CARE PREPARATIONS (U.S. CLS. 1, 4, 6, 50, 51 AND 52).

SN 78-114,887. YANNON, CHRISTOPHER, L. BLOOMFIELD, NJ. FILED 3-14-2002.

TRULY

FOR PERSONAL CARE PRODUCTS, NAMELY, AFTERSHAVE, ANTIPERSPIRANT, ARTIFICIAL NAILS, ASTRINGENT FOR THE FACE, ASTRINGENT FOR THE SKIN, BATH OIL, BATH BEADS, BATH SALTS, BLUSH, BODY GLITTER, BODY OIL, BODY SCRUB, BUBBLE BATH, COLOGNE, CREAM FOR THE BODY, CREAM FOR THE CUTICLES, CREAM FOR THE EYES, CREAM FOR THE FACE, CREAM FOR THE HANDS, DEODORANT, ESSENTIAL OILS, EXFOLIATORS FOR THE SKIN, EYE GELS, EYE MAKEUP PENCILS, EYE SHADOW, FACE HIGHLIGHTER, FACIAL MASKS, FACE MIST, FACE SCRUB, FOOT SOAK, FOUNDATION, FRAGRANT BODY SPLASH, FRAGRANT BODY MIST, HAIR CONDITIONER, HAIR DYES, HAIR GLITTER, HAIR HIGHLIGHTER, HAIR MASCARA, HAIR POMADE, HAIR RINSES, HAIR REMOVING CREAMS, HAIR SHAMPOO, HAIR SPRAY, HAIR STRAIGHTENER, HAIR STYLING GEL, HAIR STYLING MOUSSE, LOTION FOR THE BODY, LOTION FOR THE HANDS, LOTION FOR THE FACE, LIP BALM, LIP GLOSS, LIP LINER, LIP MAKEUP PENCILS, LIPSTICK, MAKEUP FOR THE BODY, MAKEUP FOR THE FACE, MAKEUP REMOVER, MASCARA, NAIL CORRECTOR PENS, NAIL POLISH, NAIL POLISH REMOVER, NAIL STENCILS, NON-MEDICATED BLEMISH STICK, NON-MEDICATED CLEANSER FOR THE FACE, NON-MEDICATED FOOT SPRAY, NON-MEDICATED MOOD ENHANCING MASSAGE OINTMENT, NON-MEDICATED MOOD ENHANCING SKIN CREAM, OIL BLOTting SHEETS FOR THE SKIN, PERFUME, POWDER FOR THE BODY, POWDER FOR THE FACE, POWDER FOR THE FEET, PUMICE STONES FOR PERSONAL USE, SALT SCRUBS FOR THE SKIN, SHAVING CREAM, SHOWER GEL, SKIN BRONZING CREAM, SOAP FOR THE BODY, SOAP FOR THE FACE, SOAP FOR THE HANDS, SUN BLOCK FOR THE BODY, SUN BLOCK FOR THE FACE, SUNTAN LOTION FOR THE BODY, SUNTAN LOTION FOR THE FACE, SUNLESS TANNING LOTION FOR THE BODY, SUNLESS TANNING LOTION FOR THE FACE, PRE-SUNTANNING LOTION FOR THE BODY, PRE-SUNTANNING LOTION FOR THE FACE, POST-SUNTANNING LOTION FOR THE BODY, POST-SUNTANNING LOTION FOR THE FACE AND TALCUM POWDER (U.S. CLS. 1, 4, 6, 50, 51 AND 52).

SN 78-114,930. ZOTOS INTERNATIONAL, INC., DARIEN, CT. FILED 3-14-2002.

BLIZZARD

FOR HAIR CARE PREPARATION, NAMELY, A STYLING MOUSSE (U.S. CLS. 1, 4, 6, 50, 51 AND 52).

CLASS 3—(Continued).

SN 78-115,545. COSMETIC ESSENCE, INC., HOLMDEL, NJ. FILED 3-18-2002.

SIMPLY

FOR PERSONAL CARE PRODUCTS, NAMELY, BODY WASH, BATH AND SHOWER GELS, HAND AND BODY SOAPS, BATH OILS, BODY LOTIONS AND CREAMS, BODY SCRUBS, SKIN SALT SCRUB AND BATH CRYSTALS, TABLETS AND NON-MEDICATED SALTS, BODY SPLASH, BODY SPRAYS AND BODY MISTS AND ROOM FRAGRANCING GELS AND ROOM FRAGRANCES, AND HAIR CARE PREPARATIONS, NAMELY SHAMPOOS AND CONDITIONERS (U.S. CLS. 1, 4, 6, 50, 51 AND 52).

SN 78-115,630. EVOLVE HEALTH & BEAUTY, INC., FRESNO, CA. FILED 3-18-2002.

LIPICITY

FOR LONG LASTING LIQUID LIP COLOR, LIP GLOSS, AND REMOVER (U.S. CLS. 1, 4, 6, 50, 51 AND 52).

SN 78-116,192. DOUGLAS, TED, HOT SPRINGS, AR. FILED 3-20-2002.

SKINSULATE

FOR SKIN PREPARATION, NAMELY, LOTION (U.S. CLS. 1, 4, 6, 50, 51 AND 52).
FIRST USE 2-15-2002; IN COMMERCE 2-15-2002.

SN 78-116,198. BEES BEST NATURAL PRODUCTS, LLC, FT. LAUDERDALE, FL. FILED 3-20-2002.

MELIDERM

FOR NON-MEDICATED BODY CARE PRODUCTS, NAMELY, FACIAL AND BODY LOTIONS, CREAMS, FACIAL AND BODY MASKS, SKIN SOAP, SKIN TONER, HERBAL BATH, SHAMPOO, CONDITIONER, TEA TREE OIL, HONEY CLEANSER, HONEY MOISTURIZER, TEA TREE OIL DISINFECTANT SOAP, SALVE FOR MUSCLES, JOINTS AND LIGAMENTS (U.S. CLS. 1, 4, 6, 50, 51 AND 52).
FIRST USE 10-31-2001; IN COMMERCE 10-31-2001.

CLASS 4—LUBRICANTS AND FUELS**CLASS 4—(Continued).**

SN 76-033,266. SAUDI ARABIAN OIL COMPANY, DHAHRAN, 31311, SAUDI ARABIA, FILED 2-16-2000.

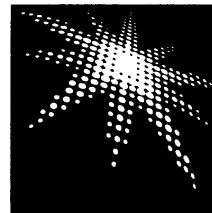

THE LINING WHICH APPEARS IN THE MARK IS A FEATURE OF THE MARK AND DOES NOT INDICATE COLOR.

FOR ALL-PURPOSE LUBRICANTS DERIVED FROM PETROLEUM, FUEL OIL DERIVED FROM PETROLEUM, FUEL OIL DERIVED FROM PETROLEUM, CRUDE OIL; REFINED PETROLEUM PRODUCTS, NAMELY, GASOLINE; PETROLEUM PRODUCTS, NAMELY, INDUSTRIAL OILS AND GREASES, INDUSTRIAL LUBRICANTS, AUTOMOTIVE GREASES, MOTOR OIL, CARNAUBA WAX, HYDROCARBON FUELS IN LIQUID AND GASEOUS FORM, FUEL FOR MOTOR VEHICLES, NAMELY, GASOLINE AND DIESEL FUEL, FUELS FOR AIRCRAFT, FUEL OIL, NAMELY, ETHANE, BUTANE, AND PROPANE; PETROLEUM ILLUMINANTS, NAMELY, CANDLES, AND SYNTHETIC ALL PURPOSE LUBRICANTS (U.S. CLS. 1, 6 AND 15).

CLASS 4—(Continued).

SN 76-097,649. VOTIVO, LTD., SEATTLE, WA. FILED 7-28-2000.

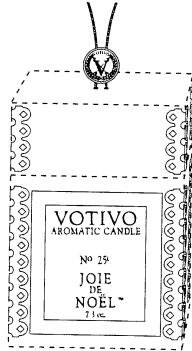

NO CLAIM IS MADE TO THE EXCLUSIVE RIGHT TO USE "AROMATIC CANDLE", "NO 25C" OR "7.3 OZ", APART FROM THE MARK AS SHOWN.

THE REPRESENTATION OF A BOX SHOWN IN DASHED LINING FORMS NO PART OF THE MARK AND MERELY SERVES TO SHOW THE POSITION OF THESE ITEMS ON THE MARK. THE MARK IS LINED FOR THE COLOR RED. THE LABEL AS PART OF THE MARK IS LINED FOR GREEN AND SILVER OR GOLD.

THE MARK CONSISTS OF FOUR DECORATIVE CORNERS PLACED UPON A RIGID CARDBOARD BOX AND LID. THE BOX LID IS TOPPED WITH BROWN TWINE, WHICH PASSES, BOLO STYLE, THROUGH A SMALL GRAY LEAD MEDALLION CONTAINING THE LETTER "V", A DESIGN ELEMENT, AND THE WORD "VOTIVO" AS ITS MARK. THE BOX CONTAINS AN AROMATIC CANDLE AND A COLORED LABEL ON THE FRONT OF THE BOX IDENTIFYING THE AROMATIC ALONG WITH THE "VOTIVO" NAME.

THE ENGLISH TRANSLATION OF "JOIE DE NOEL" IS "JOY OF CHRISTMAS".

SEC. 2(F).

FOR CANDLES AND TAPERS (U.S. CLS. 1, 6 AND 15).
FIRST USE 6-14-1999; IN COMMERCE 6-14-1999.

SN 76-166,889. GROWMARK, INC., BLOOMINGTON, IL. FILED 11-17-2000.



OWNER OF U.S. REG. NOS. 636,120, 1,467,909 AND OTHERS.

FOR LUBRICATING OILS AND GREASES FOR AUTOMOBILES; NON-CHEMICAL ADDITIVES FOR MOTOR FUEL FOR LUBRICATING VALVES AND RINGS (U.S. CLS. 1, 6 AND 15).

FIRST USE 8-1-1955; IN COMMERCE 8-8-1955.

CLASS 4—(Continued).

SN 76-208,052. TOSCO CORPORATION, OLD GREENWICH, CT. FILED 2-9-2001.

76 OMNIGUARD QLT

FOR CORROSION PREVENTATIVE, EXTREME PRESSURE GREASE FOR INDUSTRIAL MACHINERY, MARINE EQUIPMENT AND MULTIPURPOSE AUTOMOTIVE CHASSES AND WHEEL BEARING LUBRICATION GREASE FOR VEHICLES (U.S. CLS. 1, 6 AND 15).
FIRST USE 7-0-1999; IN COMMERCE 7-0-1999.

SN 76-210,115. SURGIPATH MEDICAL INDUSTRIES, INC., RICHMOND, IL. FILED 2-14-2001.

BELLE AVANT

THE ENGLISH TRANSLATION OF "BELLE AVANT" IS "BEAUTIFUL BEFORE."
FOR CANDLES (U.S. CLS. 1, 6 AND 15).
FIRST USE 9-0-2000; IN COMMERCE 9-0-2000.

SN 76-210,279. LITTLE HOUSE CANDLES, LTD., NEW EGYPT, NJ. FILED 2-13-2001.

LITTLE HOUSE CANDLES

NO CLAIM IS MADE TO THE EXCLUSIVE RIGHT TO USE "CANDLES", APART FROM THE MARK AS SHOWN.
FOR CANDLES (U.S. CLS. 1, 6 AND 15).
FIRST USE 4-1-1995; IN COMMERCE 4-1-1996.

SN 76-213,769. CUSTOM PRINTING II, LTD., BELTON, TX. FILED 2-20-2001.

CCL CUSTOM CANDLELIGHTS

NO CLAIM IS MADE TO THE EXCLUSIVE RIGHT TO USE "CUSTOM CANDLELIGHTS", APART FROM THE MARK AS SHOWN.
FOR CANDLES (U.S. CLS. 1, 6 AND 15).

SN 76-213,770. CUSTOM PRINTING II, LTD., BELTON, TX. FILED 2-20-2001.



NO CLAIM IS MADE TO THE EXCLUSIVE RIGHT TO USE "CUSTOM CANDLELIGHTS", APART FROM THE MARK AS SHOWN.
FOR CANDLES (U.S. CLS. 1, 6 AND 15).

CLASS 4—(Continued).

SN 76-229,237. UDS CORPORATION, SAN ANTONIO, TX.
FILED 3-22-2001.



FOR MOTOR FUELS, NAMELY, GASOLINE, JET FUELS, AND DIESEL FUEL; HEATING FUEL; FUEL OIL FOR VESSELS; ALL-PURPOSE LUBRICANTS; PETROLEUM, NAMELY, LIQUID PETROLEUM GAS, CRUDE PETROLEUM, AND PETROLEUM FOR USE AS A HEATING OIL; NATURAL GAS; CRUDE OIL; AND AUTOMOTIVE TRANSMISSION FLUID (U.S. CLS. 1, 6 AND 15).

SN 76-294,482. GIRLFRIEND ENTERPRISES, INC., NEW YORK, NY. FILED 8-2-2001.

STARLET

FOR CANDLES (U.S. CLS. 1, 6 AND 15).

SN 76-330,286. CALIDAD AUTO TECH, INC., SAYLORSBURG, PA. FILED 10-29-2001.

**SHIFT-RITE T.U.F.
TRANSMISSION ULTIMATE
FLUSH**

OWNER OF U.S. REG. NO. 2,197,259.
NO CLAIM IS MADE TO THE EXCLUSIVE RIGHT TO USE "TRANSMISSION" AND "FLUSH", APART FROM THE MARK AS SHOWN.
FOR ENGINE TRANSMISSION SYSTEM TREATMENTS; NAMELY, TRANSMISSION FLUIDS (U.S. CLS. 1, 6 AND 15).
FIRST USE 10-9-2001; IN COMMERCE 10-9-2001.

SN 76-370,382. SPHATIKA INTERNATIONAL LLC, NEW YORK, NY. FILED 2-12-2002.

SPHATIKA

FOR CANDLES (U.S. CLS. 1, 6 AND 15).

CLASS 4—(Continued).

SN 76-374,032. STONE QUARRY CANDLE COMPANY, MACHESNEY PARK, IL. FILED 2-25-2002.

STONE QUARRY

FOR CANDLES (U.S. CLS. 1, 6 AND 15).
FIRST USE 8-1-2000; IN COMMERCE 8-1-2000.

SN 76-379,026. FL VISCOSITY OIL COMPANY, WILLOWBROOK, IL. FILED 3-5-2002.

AKCELA

FOR PETROLEUM OIL AND SYNTHETIC FLUID BASED LUBRICANTS FOR USE AS GEAR LUBRICANTS, GREASES, GASOLINE ENGINE LUBRICANTS, DIESEL ENGINE LUBRICANTS, TRANSMISSION LUBRICANTS, AUTOMATIC TRANSMISSION FLUIDS AND HYDRAULIC FLUIDS (U.S. CLS. 1, 6 AND 15).

SN 78-110,135. CHEVRONTXACO CORPORATION, SAN FRANCISCO, CA. FILED 2-21-2002.

PROFORMIX

FOR PETROLEUM PRODUCTS, NAMELY DIESEL FUELS (U.S. CLS. 1, 6 AND 15).

CLASS 5—PHARMACEUTICALS

SN 75-116,031. WESTLAKE LABORATORIES, INC., CLEVELAND, OH. FILED 6-7-1996.

NUTRISURE

FOR VITAMIN AND MINERAL SUPPLEMENTS (U.S. CLS. 6, 18, 44, 46, 51 AND 52).
FIRST USE 7-0-1987; IN COMMERCE 7-0-1987.

CLASS 5—(Continued).

SN 75-489,930. BRAIN RESEARCH, INC., BOSTON, MA.
FILED 5-22-1998.



FOR VACCINES FOR THE PREVENTION AND
TREATMENT OF CANCER (U.S. CLS. 6, 18, 44, 46, 51
AND 52).

SN 75-504,613. CROP PROTECTION SERVICES, FRESNO,
CA. BY ASSIGNMENT RIVERDALE CHEMICAL COM-
PANY, GLENWOOD, IL. FILED 6-18-1998.

MOMENTUM

OWNER OF U.S. REG. NO. 2,047,875.
FOR AGRICULTURAL AND DOMESTIC HERBICIDES
(U.S. CLS. 6, 18, 44, 46, 51 AND 52).
FIRST USE 3-23-1998; IN COMMERCE 3-23-1998.

SN 75-521,440. BIOSYN CORPORATION, CARLSBAD, CA.
FILED 7-20-1998.



FOR PHARMACEUTICAL AND BIOPHARMACEUTI-
CAL PREPARATIONS AS CARRIERS FOR VACCINE
DEVELOPMENT AND MANUFACTURE FOR CANCER,
AIDS, HYPOTENSION AND OTHER DISEASES AND
FOR TREATMENT OF CANCER (U.S. CLS. 6, 18, 44, 46,
51 AND 52).

CLASS 5—(Continued).

SN 75-570,515. MORGANICS, INCORPORATED, SCOTTS-
DALE, AZ. FILED 10-14-1998.

AZ 2-12

FOR PROPRIETARY NUTRITIONAL SUPPLEMENT
(U.S. CLS. 6, 18, 44, 46, 51 AND 52).
FIRST USE 5-13-1998; IN COMMERCE 5-13-1998.

SN 75-623,293. STERLING TECHNOLOGIES, INC., TORON-
TO, SD. FILED 1-19-1999.

COLOSTRUMUNE

FOR NUTRITIONAL SUPPLEMENTS (U.S. CLS. 6, 18,
44, 46, 51 AND 52).

SN 75-637,027. MEDESTEA INTERNAZIONALE S.R.L., 10121
TORINO, ITALY, FILED 2-10-1999.

LIPOVASCOLEN

PRIORITY CLAIMED UNDER SEC. 44(D) ON ITALY
APPLICATION NO. T099C000290, FILED 2-2-1999, REG.
NO. 00848590, DATED 2-2-1999, EXPIRES 2-2-2009.

FOR ACTIVE INGREDIENTS COMPRISED OF NAT-
URAL SUBSTANCES DERIVED FROM VEGETABLE,
ANIMAL, AND MINERAL SOURCES FOR THE PUR-
POSE OF IMPROVEMENT OF BLOOD VESSELS AND
CIRCULATION AS WELL AS THE CARE AND PREVEN-
TION OF CELLULITIS, SOLD AS A COMPONENT OF
DIETARY AND NUTRITIONAL SUPPLEMENTS (U.S.
CLS. 6, 18, 44, 46, 51 AND 52).
FIRST USE 7-0-1998; IN COMMERCE 2-27-1999.

SN 75-702,814. I-MED PHARMA INC., POINTE CLAIRE,
PROVINCE OF QUEBEC, CANADA, FILED 5-11-1999.



PRIORITY CLAIMED UNDER SEC. 44(D) ON CANADA
APPLICATION NO. 1013594, FILED 4-27-1999, REG. NO.
TMA557081, DATED 1-30-2002, EXPIRES 1-30-2017.
FOR OPHTHALMIC EYE DROPS (U.S. CLS. 6, 18, 44,
46, 51 AND 52).

CLASS 5—(Continued).

SN 75-722,943. ASTRAZENECA AB, S-151 85 SODERTALJE, SWEDEN, BY CHANGE OF NAME ASTRA AKTIEBO-LAG, S-151 85 SODERTALJE, SWEDEN, FILED 6-7-1999.

ZERAVIS

FOR PHARMACEUTICAL PREPARATIONS FOR THE TREATMENT OF DISEASES AND DISORDERS OF THE RESPIRATORY SYSTEM DELIVERED BY AN INHALER (U.S. CLS. 6, 18, 44, 46, 51 AND 52).

SN 75-755,712. NOVARTIS AG, BASEL, SWITZERLAND, BY ASSIGNMENT; BY ASSIGNMENT BIOSTAR, INC., SAS-KATOON, SASKATCHEWAN S7N 3R2, CANADA, FILED 7-20-1999.

PNEUMO-STAR

PRIORITY CLAIMED UNDER SEC. 44(D) ON CANADA APPLICATION NO. 1021466, FILED 7-8-1999, REG. NO. TMA540071, DATED 1-23-2001, EXPIRES 1-23-2016.

FOR VACCINATION FOR HEALTHY CATTLE AND CALVES AS AN AID IN THE PREVENTION OF PNEUMONIA (U.S. CLS. 6, 18, 44, 46, 51 AND 52).

SN 75-850,450. BAILEY, JAMES, MALIBU, CA. FILED 12-7-1999.

ASANA POWER DROPS

NO CLAIM IS MADE TO THE EXCLUSIVE RIGHT TO USE "DROPS", APART FROM THE MARK AS SHOWN.

THE ENGLISH TRANSLATION OF THE WORD "SANA" IS "HEALTHFUL".

FOR NUTRITIONAL SUPPLEMENT (U.S. CLS. 6, 18, 44, 46, 51 AND 52).

SN 75-850,497. BAILEY, JAMES, MALIBU, CA. FILED 12-8-1999.

TANTRA DROPS

NO CLAIM IS MADE TO THE EXCLUSIVE RIGHT TO USE "DROPS", APART FROM THE MARK AS SHOWN.

THE ENGLISH TRANSLATION OF THE MARK IS "SCIENCE OF LIFE". THE TERM REFERS TO A BRANCH OF YOGA.

FOR NUTRITIONAL SUPPLEMENT (U.S. CLS. 6, 18, 44, 46, 51 AND 52).

CLASS 5—(Continued).

SN 75-863,067. ASTACAROTENE AB, 134 40 GUSTAVSBERG, SWEDEN, FILED 12-2-1999.

AstaCarox

FOR NATUROPATHIC PREPARATIONS TO IMPROVE MUSCULAR ENDURANCE, TO IMPROVE THE IMMUNE DEFENSE SYSTEM, TO IMPROVE ENHANCED ANTIOXIDANTS STATUS, TO TREAT STOMACH PAIN AND TO RESTRAIN AND INFLUENCE HELICOBACTER PYLORI BACTERIA; DIETARY FOOD SUPPLEMENTS; ALGAE AS A NUTRITIONAL SUPPLEMENT AND ALGAE AS AN ANIMAL FEED ADDITIVE FOR USE AS A NUTRITIONAL SUPPLEMENT (U.S. CLS. 6, 18, 44, 46, 51 AND 52).

SN 75-877,939. PHILIPPS, IGOR JOHN, BRAMPTON, ONTARIO L7A 1A2, CANADA, FILED 12-23-1999.

ALIEN AIR

PRIORITY CLAIMED UNDER SEC. 44(D) ON CANADA APPLICATION NO. 1,020,131, FILED 6-23-1999, REG. NO. TMA552,810, DATED 10-23-2001, EXPIRES 10-23-2016.

NO CLAIM IS MADE TO THE EXCLUSIVE RIGHT TO USE "AIR", APART FROM THE MARK AS SHOWN.

FOR AIR FRESHENERS (U.S. CLS. 6, 18, 44, 46, 51 AND 52).

FIRST USE 10-0-1999; IN COMMERCE 10-0-1999.

SN 75-922,992. KREE TECHNOLOGIES INC., ST-HUBERT, QUEBEC, CANADA, FILED 2-16-2000.



NO CLAIM IS MADE TO THE EXCLUSIVE RIGHT TO USE "TECHNOLOGIES", APART FROM THE MARK AS SHOWN.

FOR MEDICAL ADHESIVE TAPES; DRESSINGS, NAMELY CATHETER DRESSINGS, GEL DRESSINGS FOR TREATING WOUNDS AND FIRST-AID DRESSINGS (U.S. CLS. 6, 18, 44, 46, 51 AND 52).

FIRST USE 9-0-1993; IN COMMERCE 9-0-1993.

CLASS 5—(Continued).

SN 75-925,792. GLAXO GROUP LIMITED, GREENFORD, MIDDLESEX, UNITED KINGDOM, FILED 2-22-2000.

VANTAIR

FOR PHARMACEUTICAL PREPARATIONS AND SUBSTANCES FOR THE TREATMENT AND/OR ALLEVIATION OF RESPIRATORY AILMENTS (U.S. CLS. 6, 18, 44, 46, 51 AND 52).

SN 75-982,421. GILEAD SCIENCES, INC., FOSTER CITY, CA, FILED 12-12-2001.



FOR PHARMACEUTICAL PREPARATIONS FOR THE TREATMENT AND/OR PREVENTION OF INFECTIOUS DISEASES (U.S. CLS. 6, 18, 44, 46, 51 AND 52).
FIRST USE 2-22-2002; IN COMMERCE 2-22-2002.

SN 76-006,439. MED-I-PANT INC., ANJOU, QUEBEC, CANADA, FILED 3-21-2000.

CHAMONIX

PRIORITY CLAIMED UNDER SEC. 44(D) ON CANADA APPLICATION NO. 1050595, FILED 3-14-2000.

FOR INCONTINENCE CARE REUSABLE PRODUCTS, NAMELY, INCONTINENCE GARMENTS AND INCONTINENCE PADS; FABRICS IN THE NATURE OF AN INNER SURFACE LINER SOLD AS AN INTEGRAL COMPONENT OF INCONTINENCE GARMENTS AND INCONTINENCE PADS (U.S. CLS. 6, 18, 44, 46, 51 AND 52).

FIRST USE 2-4-2000; IN COMMERCE 2-4-2000.

SN 76-006,867. WATSON PHARMACEUTICALS, INC., CORONA, CA. FILED 3-22-2000.

DAILY-VITE

SEC. 2(F).
FOR MULTIVITAMIN AND MINERAL SUPPLEMENTS, EXCLUDING FOOD-BASED VITAMINS AND DIETARY SUPPLEMENTS (U.S. CLS. 6, 18, 44, 46, 51 AND 52).

FIRST USE 1-0-1977; IN COMMERCE 1-0-1977.

CLASS 5—(Continued).

SN 76-006,872. WATSON PHARMACEUTICALS, INC., CORONA, CA. FILED 3-22-2000.

CEROVITE

FOR MULTIVITAMIN AND MINERAL SUPPLEMENTS (U.S. CLS. 6, 18, 44, 46, 51 AND 52).
FIRST USE 1-0-1992; IN COMMERCE 1-0-1992.

SN 76-012,676. AB CERNELLE COMPANY, SWEDEN, FILED 3-29-2000.

NAPOLEN GOLD

OWNER OF U.S. REG. NOS. 813,840, 814,660 AND 915,388. FOR NUTRITIONAL SUPPLEMENTS (U.S. CLS. 6, 18, 44, 46, 51 AND 52).
FIRST USE 3-0-1987; IN COMMERCE 3-0-1987.

SN 76-041,960. NYMOX PHARMACEUTICAL CORP, ST. LAURENT, QUEBEC, CANADA, FILED 5-5-2000.

7C-GOLD

OWNER OF U.S. REG. NO. 2,166,375.
FOR DIAGNOSTIC TEST KITS CONTAINING REAGENTS TO DETERMINE WHETHER A SAMPLE HAS ELEVATED LEVELS OF NEURAL THREAD PROTEIN, TO BE USED AS AN AID TO A PHYSICIAN IN THE DIAGNOSIS OF ALZHEIMER'S DISEASE AND OTHER NEURODEGENERATIVE DISORDERS (U.S. CLS. 6, 18, 44, 46, 51 AND 52).

SN 76-041,998. DAICHI PHARMACEUTICAL CO., LTD., TOKYO, JAPAN, FILED 5-5-2000.

QUIXIN

PRIORITY CLAIMED UNDER SEC. 44(D) ON JAPAN APPLICATION NO. 2000-13940, FILED 1-27-2000, REG. NO. 4448321, DATED 1-26-2001, EXPIRES 1-26-2011.

FOR PHARMACEUTICALS, IN THE NATURE OF ANTIBACTERIAL AGENTS (U.S. CLS. 6, 18, 44, 46, 51 AND 52).

SN 76-045,451. AVENTIS BEHRING GMBH, 35041 MARBURG, FED REP GERMANY, FILED 5-9-2000.

KYBERNIN

OWNER OF FED REP GERMANY REG. NO. 989642, DATED 8-28-1979, EXPIRES 2-28-2009.

FOR PHARMACEUTICAL PREPARATIONS, NAMELY ANTITHROMBIN III FOR THE TREATMENT OF ACQUIRED AND HEREDITARY DEFICIENCY OF AT III (U.S. CLS. 6, 18, 44, 46, 51 AND 52).

CLASS 5—(Continued).

SN 76-046,056. BAYER AKTIENGESELLSCHAFT, LEVERKUSEN-BAYERWERK, FED REP GERMANY, FILED 5-11-2000.

TRUVAIR

OWNER OF FED REP GERMANY REG. NO. 30029269, DATED 9-13-2000, EXPIRES 4-30-2010.

FOR PHARMACEUTICAL PREPARATIONS AND SUBSTANCES FOR THE TREATMENT OF RESPIRATORY AND INFECTIOUS DISEASES, CARDIOVASCULAR DISEASES, CENTRAL NERVOUS SYSTEM DISEASES, CANCER, UROLOGICAL DISEASES; DIAGNOSTIC PREPARATIONS ADAPTED FOR MEDICAL USE (U.S. CLS. 6, 18, 44, 46, 51 AND 52).

SN 76-048,848. MORINDA, INC., PROVO, UT. FILED 5-15-2000.

SMART EXTRACTS

NO CLAIM IS MADE TO THE EXCLUSIVE RIGHT TO USE "EXTRACTS", APART FROM THE MARK AS SHOWN. FOR DIETARY AND NUTRITIONAL SUPPLEMENTS (U.S. CLS. 6, 18, 44, 46, 51 AND 52).

SN 76-054,426. APPELDORFER, MAYER, BROOKLYN, NY. FILED 5-22-2000.



NO CLAIM IS MADE TO THE EXCLUSIVE RIGHT TO USE "FOODS", APART FROM THE MARK AS SHOWN. THE LINING IS A FEATURE OF THE MARK AND DOES NOT INDICATE COLOR.

FOR BABY FOOD, BEE POLLEN FOR USE AS A DIETARY SUPPLEMENT, CALCIUM SUPPLEMENTS, LECITHIN SUPPLEMENTS, DIABETIC FOODS, INFANT FORMULA, HERBAL SUPPLEMENTS, DIETARY DRINK MIX FOR USE AS A DIETARY SUPPLEMENT, VITAMIN AND MINERAL SUPPLEMENTS, WHEAT DIETARY SUPPLEMENTS, FOOD SUPPLEMENTS, DIETARY SUPPLEMENTS, AND NUTRITIONAL SUPPLEMENTS (U.S. CLS. 6, 18, 44, 46, 51 AND 52).

CLASS 5—(Continued).

SN 76-060,961. INSIGHT PHARMACEUTICALS CORPORATION, SAN FRANCISCO, CA. BY ASSIGNMENT; BY ASSIGNMENT HERITAGE CONSUMER PRODUCTS, LLC, PLYMOUTH MEETING, PA. FILED 6-2-2000.

CEPASTAT

FOR MEDICATED THROAT LOZENGES (U.S. CLS. 6, 18, 44, 46, 51 AND 52).
FIRST USE 6-1-1977; IN COMMERCE 6-1-1977.

SN 76-086,174. CARDIOVASCULAR INSTITUTE OF THE SOUTH, HOUMA, LA. FILED 7-10-2000.

**CARDIOVASCULAR
INSTITUTE OF THE SOUTH**

NO CLAIM IS MADE TO THE EXCLUSIVE RIGHT TO USE "CARDIOVASCULAR INSTITUTE", APART FROM THE MARK AS SHOWN.

SEC. 2(F).
FOR MEDICAL SERVICES, NAMELY CARDIOVASCULAR AND PERIPHERAL VASCULAR CARE INCLUDING SCREENING, DIAGNOSIS, TREATMENT, SURGERY, REHABILITATION AND MEDICAL RESEARCH (U.S. CLS. 6, 18, 44, 46, 51 AND 52).
FIRST USE 5-15-1987; IN COMMERCE 5-15-1987.

SN 76-110,545. BLAINE COMPANY, INC. THE, DBA BLAINE PHARMACEUTICALS, BURLINGTON, KY. FILED 8-16-2000.

BLAINE

SEC. 2(F).
FOR DIETARY SUPPLEMENTS AND ANTACIDS (U.S. CLS. 6, 18, 44, 46, 51 AND 52).
FIRST USE 10-0-1955; IN COMMERCE 10-0-1955.

SN 76-116,308. PAUL HARTMANN AG, 89522 HEIDENHEIM, FED REP GERMANY, FILED 8-24-2000.

HYDROCLEAN

OWNER OF FED REP GERMANY REG. NO. 2059962, DATED 1-16-1994, EXPIRES 1-19-2004.

FOR MEDICAL PLASTERS, WOUND DRESSINGS, MEDICATED COMPRESSES, SWABS FOR MEDICAL PURPOSE, SANITARY TAMPONS, MEDICAL COTTON, WOUND DRESSINGS IMPREGNATED WITH OINTMENT, WOUND DRESSINGS WITH AN ABSORBING PAD, WITH OR WITHOUT A SWELLING AGENT AND PACKED WITH A VAPOR-PREVIOUS COVER; GRANULATED MATERIAL FOR THE CARE OF WOUNDS; LIQUID WOUND DRESSINGS MATERIAL; SURGICAL BANDAGES AND BANDS (U.S. CLS. 6, 18, 44, 46, 51 AND 52).

CLASS 5—(Continued).

SN 76-141,605. PHARMALIFE, INC., HAUPPAUGE, NY. FILED 10-2-2000.

PASSION FOR WOMEN

NO CLAIM IS MADE TO THE EXCLUSIVE RIGHT TO USE "FOR WOMEN", APART FROM THE MARK AS SHOWN.

FOR VITAMINS, MINERAL SUPPLEMENTS, HERBAL SUPPLEMENTS, AND DIETARY AND NUTRITIONAL SUPPLEMENTS (U.S. CLS. 6, 18, 44, 46, 51 AND 52).

SN 76-149,303. PETPRO PRODUCTS, INC., LOS ANGELES, CA. FILED 10-18-2000.

VITA CHEW

NO CLAIM IS MADE TO THE EXCLUSIVE RIGHT TO USE "CHEW", APART FROM THE MARK AS SHOWN.

FOR NUTRITIONAL FOOD SUPPLEMENTS FOR DOGS AND CATS (U.S. CLS. 6, 18, 44, 46, 51 AND 52).

FIRST USE 8-1-2000; IN COMMERCE 8-1-2000.

SN 76-149,564. BLAKE, TONI, LITTLETON, CO. FILED 10-18-2000.

NEW HOME ESSENCE

FOR AIR FRESHENERS; DEODORIZING AND ODOR NEUTRALIZING SUBSTANCES AND PRODUCTS, NAMELY, CARPET POWDERS, CARPET CRYSTALS, AND STAIN REMOVER; ROOM DEODORIZING AND ODOR NEUTRALIZING SPRAYS; ROOM DEODORIZING AND ODOR NEUTRALIZING AIR FOGGERS (U.S. CLS. 6, 18, 44, 46, 51 AND 52).

SN 76-149,565. BLAKE, TONI, LITTLETON, CO. FILED 10-18-2000.

HIGH COUNTRY

FOR AIR FRESHENERS; DEODORIZING AND ODOR NEUTRALIZING SUBSTANCES AND PRODUCTS, NAMELY, CARPET POWDERS, CARPET CRYSTALS, AND STAIN REMOVER; ROOM DEODORIZING AND ODOR NEUTRALIZING SPRAYS; ROOM DEODORIZING AND ODOR NEUTRALIZING AIR FOGGERS (U.S. CLS. 6, 18, 44, 46, 51 AND 52).

CLASS 5—(Continued).

SN 76-149,566. BLAKE, TONI, LITTLETON, CO. FILED 10-18-2000.

PSYCHOLOGICAL SCENT OF NEW

NO CLAIM IS MADE TO THE EXCLUSIVE RIGHT TO USE "SCENT", APART FROM THE MARK AS SHOWN.

FOR AIR FRESHENERS; DEODORIZING AND ODOR NEUTRALIZING SUBSTANCES AND PRODUCTS, NAMELY, CARPET POWDERS, CARPET CRYSTALS, AND STAIN REMOVER; ROOM DEODORIZING AND ODOR NEUTRALIZING SPRAYS; ROOM DEODORIZING AND ODOR NEUTRALIZING AIR FOGGERS (U.S. CLS. 6, 18, 44, 46, 51 AND 52).

SN 76-151,512. AKBAR PRODUCTS, INC., TA NATURAL OASIS DISTRIBUTORS, WASHINGTON, DC. FILED 10-19-2000.

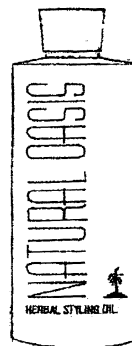

OWNER OF U.S. REG. NO. 2,342,079.

NO CLAIM IS MADE TO THE EXCLUSIVE RIGHT TO USE "HERBAL STYLING OIL" AND THE CONFIGURATION OF THE BOTTLE DESIGN, APART FROM THE MARK AS SHOWN.

FOR MEDICATED HAIR AND SKIN CARE PRODUCTS, NAMELY, BOTANICAL AND HERBAL-BASED HAIR SHAMPOO, HAIR SETTING LOTION, HAIR STYLING GEL, HERBAL-BASED SKIN CLEANER AND BOTANICAL, AND HERBAL-BASED SKIN MOISTURIZER (U.S. CLS. 6, 18, 44, 46, 51 AND 52).

FIRST USE 9-0-1989; IN COMMERCE 9-0-1989.

SN 76-156,797. SEALAND TECHNOLOGY, INC., BIG PRAIRIE, OH. FILED 10-31-2000.

RV-KEM

FOR DEODORIZING CHEMICALS, NAMELY DEODORANTS FOR VEHICLE HOLDING TANKS (U.S. CLS. 6, 18, 44, 46, 51 AND 52).

CLASS 5—(Continued).

SN 76-167,501. RESTING IN THE RIVER, LLC, SANTA FE, NM. FILED 11-17-2000.

MARSHA'S BOOST JUICE

NO CLAIM IS MADE TO THE EXCLUSIVE RIGHT TO USE "JUICE", APART FROM THE MARK AS SHOWN.
FOR DIETARY SUPPLEMENT SOLD AS LIQUID HERBAL TINCTURE (U.S. CLS. 6, 18, 44, 46, 51 AND 52).

CLASS 5—(Continued).

SN 76-182,457. VERIDIEN CORPORATION, ST. PETERSBURG, FL. FILED 12-18-2000.

BUGSWIPE

FOR TOWELETTES IMPREGNATED WITH INSECT REPELLANT (U.S. CLS. 6, 18, 44, 46, 51 AND 52).

SN 76-176,188. ERNST MUHLBAUER GMBH & CO. KG, 25870 NORDERFRIEDRICHSKOOG, FED REP GERMANY, BY CHANGE OF NAME ERNST MUHLBAUER KG, D-25870 NORDERFRIEDRICHSKOOG, FED REP GERMANY, FILED 12-5-2000.

SILAGUM

OWNER OF FED REP GERMANY REG. NO. 969254, DATED 3-23-1978, EXPIRES 12-31-2006.

FOR (BASED ON INTENT TO USE) MATERIALS FOR MAKING DENTAL FILLINGS; CASTING AND IMPRESSION MATERIALS FOR DENTISTRY; MATERIALS FOR MOUNTING OF DENTAL PRODUCTS, NAMELY, DENTAL CEMENT; PHARMACEUTICAL PREPARATIONS FOR USE IN DENTISTRY AND TOOTH CARE PRODUCTS, NAMELY, FOR THE TREATMENT OF TEETH AND GUM DISEASE (BASED ON 44(E)) IMPRESSION MATERIALS FOR DENTISTRY, NAMELY DENTAL IMPRESSION COMPOUND (U.S. CLS. 6, 18, 44, 46, 51 AND 52).

SN 76-177,290. DOLISOS SANTE ANIMALE, 31500 TOULOUSE, FRANCE, FILED 12-8-2000.

TRAUMASEDYL

OWNER OF FRANCE REG. NO. 1674040, DATED 2-6-1991, RENEWED AS REG. NO. 1674040, DATED 11-22-2000, EXPIRES 11-22-2010.

FOR HOMEOPATHIC VETERINARY PHARMACEUTICAL PREPARATIONS FOR THE TREATMENT OF TRAUMA FOR USE IN ALL ANIMALS (U.S. CLS. 6, 18, 44, 46, 51 AND 52).

SN 76-181,589. HARBOR PRESS, INC., GIG HARBOR, WA. FILED 12-18-2000.

HARBOR LABS PAIN ERASE

OWNER OF U.S. REG. NOS. 2,253,779, 2,416,777 AND OTHERS.

NO CLAIM IS MADE TO THE EXCLUSIVE RIGHT TO USE "LABS AND PAIN", APART FROM THE MARK AS SHOWN.

FOR TOPICAL LIQUID FOR THE PURPOSE OF RELIEVING BODY PAIN (U.S. CLS. 6, 18, 44, 46, 51 AND 52).

SN 76-182,597. PRODUCTOS FAMILIA S.A., ANTIOQUIA, COLOMBIA, BY MERGER PRODUCTOS SANITARIOS SANCELA S.A., RIONEGRO ANTIOQUIA, COLOMBIA, FILED 12-19-2000.

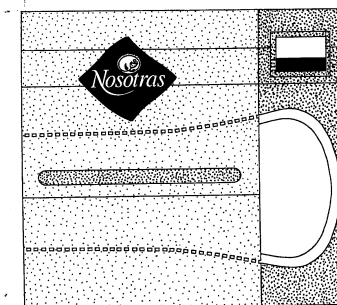

THE STIPLING IN THE DRAWING IS FOR SHADING PURPOSES ONLY. COLOR IS CLAIMED AS A FEATURE OF THE MARK.

THE LEFT SIDE OF THE BACKGROUND, THE INNER LINE ON THE RIGHT PART OF THE PAD, AND THE STEM AND LEAVES OF THE FLOWER ARE GREEN. THE STRIP IN THE MIDDLE OF THE PAD AND THE RIGHT SIDE OF THE BACKGROUND ARE DARK GREEN. THE BOTTOM PART OF THE RECTANGLE IN THE UPPER RIGHT CORNER OF THE MARK AND THE DIAMOND CONTAINING THE WORD "NOSOTRAS" IS DARK BLUE. THE FLOWER IS PINK. THE DOT ABOVE THE FLOWER IS FUCHSIA.

THE ENGLISH TRANSLATION OF "NOSOTRAS" IS "WE".

FOR SANITARY NAPKINS, TAMPONS, SANITARY PADS, AND FEMININE HYGIENE PADS (U.S. CLS. 6, 18, 44, 46, 51 AND 52).

SN 76-195,242. R-TECH UENO (USA), INC., BETHESDA, MD. FILED 1-17-2001.

MOTULA

FOR PRESCRIPTION ONLY, PHARMACEUTICAL PREPARATION FOR GASTROINTESTINAL AILMENTS (U.S. CLS. 6, 18, 44, 46, 51 AND 52).

CLASS 5—(Continued).

SN 76-197,275. PEGASUS LABORATORIES, INC, PENSACOLA, FL. FILED 1-22-2001.

COLLASATE

FOR ANIMAL WOUND CARE PRODUCTS, NAMELY, A HEALING GEL, POST-OPERATIVE AND TRAUMA MANAGEMENT DRESSING (U.S. CLS. 6, 18, 44, 46, 51 AND 52).

SN 76-198,636. INTERVET INTERNATIONAL BV, 5831 AN BOXMEER, NETHERLANDS, FILED 1-23-2001.

RTUSPRINT

PRIORITY CLAIMED UNDER SEC. 44(D) ON BENELUX APPLICATION NO. 0981588, FILED 1-16-2001, REG. NO. 0674808, DATED 1-16-2001, EXPIRES 1-16-2011.

FOR PRE-MEASURED HYPODERMIC NEEDLE CONTAINING A PHARMACEUTICAL PREPARATION FOR USE IN THE TREATMENT OF CORONA VIRUS, DISTEMPER, ADENOVIRUS, PARVOVIRUS, PARA-INFLUENZA, KENNEL COUGH, LEPTOSPIROSIS, RABIES AND TETANUS, IN DOGS (U.S. CLS. 6, 18, 44, 46, 51 AND 52).

SN 76-202,882. DAVINCI DENTAL STUDIOS, INC., WEST HILLS, CA. FILED 1-30-2001.

daVinci
SMILE
Art
Ceramics

OWNER OF U.S. REG. NO. 2,061,195.
NO CLAIM IS MADE TO THE EXCLUSIVE RIGHT TO USE "CERAMICS" AND "SMILE", APART FROM THE MARK AS SHOWN.

FOR CERAMICS FOR USE IN COSMETIC DENTISTRY (U.S. CLS. 6, 18, 44, 46, 51 AND 52).

SN 76-203,431. PIERRE FABRE MEDICAMENT, 92100 BOULOGNE, FRANCE, FILED 2-1-2001.

SPIR

OWNER OF FRANCE REG. NO. 1238702, DATED 6-16-1983, RENEWED AS REG. NO. 1238702, DATED 5-10-1993, EXPIRES 5-10-2003.

FOR PHARMACEUTICAL PREPARATIONS AND SUBSTANCES FOR THE TREATMENT OF RHINOPHARYNGEAL DISEASES, BRONCHIAL ASTHMA AND RELATED DISORDERS (U.S. CLS. 6, 18, 44, 46, 51 AND 52).

CLASS 5—(Continued).

SN 76-203,662. AMGEN INC., THOUSAND OAKS, CA. FILED 2-1-2001.

DEXTROLIS

FOR PHARMACEUTICAL PREPARATIONS FOR USE IN THE TREATMENT OF ONCOLOGICAL DISEASES AND DISORDERS AND COMPLICATIONS ASSOCIATED THEREWITH (U.S. CLS. 6, 18, 44, 46, 51 AND 52).

SN 76-204,582. COVENTRY GROUP LTD., CINCINNATI, OH. FILED 2-2-2001.

HEARTSHIELD

FOR NUTRITIONAL SUPPLEMENT (U.S. CLS. 6, 18, 44, 46, 51 AND 52).

SN 76-207,399. DR. GERHARD MANN CHEM.-PHARM. FABRIK GMBH, 13581 BERLIN, FED REP GERMANY, FILED 2-8-2001.

VIVIOPTAL

OWNER OF FED REP GERMANY REG. NO. 779768, DATED 6-26-1997, EXPIRES 6-26-2007.

FOR VITAMIN AND MINERAL SUPPLEMENT (U.S. CLS. 6, 18, 44, 46, 51 AND 52).

SN 76-213,502. JAMES, MATTHEW, BEAR, DE. FILED 2-22-2001.

FLEXIBAR

FOR DIETARY SUPPLEMENTS, NUTRITIONAL SUPPLEMENTS, HERBAL SUPPLEMENTS, HERBAL EXTRACTS SUPPLEMENTS, ENZYMES FOR NUTRITIONAL OR DIETARY USE, VITAMIN AND MINERAL SUPPLEMENTS (U.S. CLS. 6, 18, 44, 46, 51 AND 52).

SN 76-219,665. PBM PRODUCTS, L.L.C., GORDONVILLE, VA. FILED 3-5-2001.

**FORMULAS INFANTILES
TAPA DORADA**

NO CLAIM IS MADE TO THE EXCLUSIVE RIGHT TO USE "FORMULAS INFANTILES", APART FROM THE MARK AS SHOWN.

THE ENGLISH TRANSLATION OF THE MARK READS AS FOLLOWS: "GOLD LID INFANT FORMULAS".

FOR INFANT FORMULA (U.S. CLS. 6, 18, 44, 46, 51 AND 52).

CLASS 5—(Continued).

SN 76-224,482. BRISTOL-MYERS SQUIBB COMPANY, NEW YORK, NY. FILED 3-13-2001.

ZRIVADA

FOR PHARMACEUTICAL PREPARATIONS FOR THE TREATMENT OF CARDIOVASCULAR DISEASES, CENTRAL NERVOUS SYSTEM DISEASES AND DISORDERS, STROKE, CANCER, INFLAMMATION AND INFLAMMATORY DISEASES, RESPIRATORY AND INFECTIOUS DISEASES AND AUTO-IMMUNE DISEASES (U.S. CLS. 6, 18, 44, 46, 51 AND 52).

SN 76-224,484. BRISTOL-MYERS SQUIBB COMPANY, NEW YORK, NY. FILED 3-13-2001.

BATTRIS

FOR PHARMACEUTICAL PREPARATIONS FOR TREATMENT OF CARDIOVASCULAR DISEASES, CENTRAL NERVOUS SYSTEM DISEASES AND DISORDERS, STROKE, CANCER, INFLAMMATION AND INFLAMMATORY DISEASES, RESPIRATORY AND INFECTIOUS DISEASES AND AUTO-IMMUNE DISEASES (U.S. CLS. 6, 18, 44, 46, 51 AND 52).

SN 76-224,486. BRISTOL-MYERS SQUIBB COMPANY, NEW YORK, NY. FILED 3-13-2001.

VANLEVIDE

FOR PHARMACEUTICAL PREPARATIONS FOR THE TREATMENT OF CARDIOVASCULAR DISEASES, CENTRAL NERVOUS SYSTEM DISEASES AND DISORDERS, STROKE, CANCER, INFLAMMATION AND INFLAMMATORY DISEASES, RESPIRATORY AND INFECTIOUS DISEASES AND AUTO-IMMUNE DISEASES (U.S. CLS. 6, 18, 44, 46, 51 AND 52).

SN 76-224,488. BRISTOL-MYERS SQUIBB COMPANY, NEW YORK, NY. FILED 3-13-2001.

VARMADA

FOR PHARMACEUTICAL PREPARATIONS FOR TREATMENT OF CARDIOVASCULAR DISEASES, CENTRAL NERVOUS SYSTEM DISEASES AND DISORDERS, STROKE, CANCER, INFLAMMATION AND INFLAMMATORY DISEASES, RESPIRATORY AND INFECTIOUS DISEASES AND AUTO-IMMUNE DISEASES (U.S. CLS. 6, 18, 44, 46, 51 AND 52).

CLASS 5—(Continued).

SN 76-226,517. RECORDATI SA CHEMICAL AND PHARMACEUTICAL COMPANY, CH-6830, CHIASSO, SWITZERLAND. FILED 3-16-2001.

LERCAPRIL

PRIORITY CLAIMED UNDER SEC. 44(D) ON SWITZERLAND APPLICATION NO. 01424/2001, FILED 2-9-2001, REG. NO. 485173, DATED 5-31-2001, EXPIRES 2-9-2010.

FOR PHARMACEUTICAL PREPARATIONS FOR THE TREATMENT OF CARDIOVASCULAR CONDITIONS (U.S. CLS. 6, 18, 44, 46, 51 AND 52).

SN 76-226,797. JANET SARTIN, INC., MOONACHIE, NJ. FILED 3-20-2001.

GIVE HAIR THE PINK SLIP

FOR MEDICATED HAIR GROWTH INHIBITOR PREPARATIONS IN THE FORM OF CREAMS AND LOTIONS (U.S. CLS. 6, 18, 44, 46, 51 AND 52).

SN 76-228,627. TELEVISION Y VENTAS TELEVENT S.A., QUITO, ECUADOR, FILED 3-22-2001.

ESSELLE PROTEIN

NO CLAIM IS MADE TO THE EXCLUSIVE RIGHT TO USE "PROTEIN", APART FROM THE MARK AS SHOWN. FOR VITAMINS AND NUTRITIONAL SUPPLEMENTS (U.S. CLS. 6, 18, 44, 46, 51 AND 52).

SN 76-228,653. JAFFE, RUSSELL M., VIENNA, VA. FILED 3-21-2001.

**PERQUE TRIPLE EFA
GUARD**

OWNER OF U.S. REG. NOS. 2,461,525, 2,506,030 AND OTHERS. NO CLAIM IS MADE TO THE EXCLUSIVE RIGHT TO USE "EFA", APART FROM THE MARK AS SHOWN. FOR DIETARY SUPPLEMENTS (U.S. CLS. 6, 18, 44, 46, 51 AND 52).

SN 76-229,250. WELLMARK INTERNATIONAL, SCHAUMBURG, IL. FILED 3-26-2001.

ECLIPSE

FOR GARDEN ANT BAIT FOR SALE TO PEST CONTROL OPERATORS AND DOMESTIC PESTICIDE DISTRIBUTORS (U.S. CLS. 6, 18, 44, 46, 51 AND 52).

CLASS 5—(Continued).

SN 76-229,504. OROZ, LLC, RICHMOND HILL, NY. FILED 3-23-2001.

VVL SOLUTIONS

NO CLAIM IS MADE TO THE EXCLUSIVE RIGHT TO USE "SOLUTIONS", APART FROM THE MARK AS SHOWN.

FOR VETERINARY VACCINES CONSISTING OF WATER BASED LIQUID COMPOUNDS FOR LIVESTOCK, NAMELY, BOVINE, SHEEP, HORSE, AND SWINE AND VETERINARY PREPARATIONS CONSISTING OF WATER BASED LIQUID COMPOUNDS FOR LIVESTOCK, NAMELY, BOVINE, SHEEP, HORSE, AND SWINE FOR PURPOSES OF REDUCING OR ELIMINATING HARMFUL DISEASES AND ILLNESSES, NAMELY, NEUROLOGICAL, CENTRAL NERVOUS SYSTEM, RHEUMATIC AND BONE, CANCER, ONCOLOGICAL, METABOLIC, CARDIOVASCULAR, INFECTIONS, IMMUNE, ALLERGIES, RESPIRATORY, OPHTHALMOLOGIC, DERMATOLOGICAL, ENDOCRINE, HORMONAL, GASTROINTESTINAL, GYNECOLOGICAL, HEMATOLOGICAL, HEPATOLOGICAL AND UROLOGICAL DISEASES, DISEASES AND DISORDERS ASSOCIATED WITH FIBROSIS AND RESTENOSIS, AND PAIN AND WOUNDS (U.S. CLS. 6, 18, 44, 46, 51 AND 52).

SN 76-229,507. OROZ, LLC, RICHMOND HILL, NY. FILED 3-23-2001.

NYT SOLUTIONS

NO CLAIM IS MADE TO THE EXCLUSIVE RIGHT TO USE "SOLUTIONS", APART FROM THE MARK AS SHOWN.

FOR VETERINARY VACCINES CONSISTING OF WATER BASED LIQUID COMPOUNDS FOR LIVESTOCK, NAMELY, BOVINE, SHEEP, HORSE, AND SWINE AND VETERINARY PREPARATIONS CONSISTING OF WATER BASED LIQUID COMPOUNDS FOR LIVESTOCK, NAMELY, BOVINE, SHEEP, HORSE, AND SWINE FOR PURPOSES OF REDUCING OR ELIMINATING HARMFUL DISEASES AND ILLNESSES, NAMELY, NEUROLOGICAL, CENTRAL NERVOUS SYSTEM, RHEUMATIC AND BONE, CANCER, ONCOLOGICAL, METABOLIC, CARDIOVASCULAR, INFECTIONS, IMMUNE, ALLERGIES, RESPIRATORY, OPHTHALMOLOGIC, DERMATOLOGICAL, ENDOCRINE, HORMONAL, GASTROINTESTINAL, GYNECOLOGICAL, HEMATOLOGICAL, HEPATOLOGICAL AND UROLOGICAL DISEASES, DISEASES AND DISORDERS ASSOCIATED WITH FIBROSIS AND RESTENOSIS, AND PAIN AND WOUNDS (U.S. CLS. 6, 18, 44, 46, 51 AND 52).

SN 76-230,202. CORTNER, WILLIAM C. JR., MAYSVILLE, MO. FILED 3-26-2001.

OX-E

FOR VETERINARY PHARMACEUTICALS, NAMELY ANTIBIOTICS (U.S. CLS. 6, 18, 44, 46, 51 AND 52).

CLASS 5—(Continued).

SN 76-230,269. SOLUTIONS INTERNATIONAL, LLC, LINDON, UT. FILED 3-26-2001.

DERMAL V

NO CLAIM IS MADE TO THE EXCLUSIVE RIGHT TO USE "DERMAL", APART FROM THE MARK AS SHOWN. FOR HERB COMPOSITIONS, COLLOIDAL SILVER, AND NONPRESCRIPTION MEDICATIONS FOR SKIN AND TISSUE TREATMENT (U.S. CLS. 6, 18, 44, 46, 51 AND 52).

FIRST USE 6-1-2001; IN COMMERCE 6-1-2001.

SN 76-230,954. SIMILASAN CORPORATION, BRECKENRIDGE, CO. FILED 3-27-2001.

HEALTHY RELIEF

NO CLAIM IS MADE TO THE EXCLUSIVE RIGHT TO USE "HEALTHY", APART FROM THE MARK AS SHOWN. FOR NATURAL PHARMACEUTICAL PREPARATIONS AND HOMEOPATHIC PHARMACEUTICALS FOR USE IN THE TREATMENT OF MEDICAL CONDITIONS OF THE EYES, EARS, NOSE AND THROAT (U.S. CLS. 6, 18, 44, 46, 51 AND 52).

FIRST USE 11-1-1998; IN COMMERCE 11-1-1998.

SN 76-238,740. CHD, INC., LAHAINA, HI. FILED 4-10-2001.

MAUI ISLAND SECRET

NO CLAIM IS MADE TO THE EXCLUSIVE RIGHT TO USE "MAUI", APART FROM THE MARK AS SHOWN.

FOR MEDICATED SKIN AND HAIR CARE PRODUCTS, NAMELY, SUNBURN LOTIONS (U.S. CLS. 6, 18, 44, 46, 51 AND 52).

SN 76-238,965. IPR PHARMACEUTICALS, INC., CAROLINA, PUERTO RICO, FILED 4-10-2001.



PRIORITY CLAIMED UNDER SEC. 44(D) ON UNITED KINGDOM APPLICATION NO. 2265682, FILED 3-28-2001.

FOR PHARMACEUTICAL AND MEDICINAL PREPARATIONS AND SUBSTANCES FOR THE TREATMENT OF MIGRAINES (U.S. CLS. 6, 18, 44, 46, 51 AND 52).

CLASS 5—(Continued).

SN 76-239,506. VP CONSULTANTS, INC., OSPREY, FL.
FILED 4-12-2001.

MPF

FOR DIETARY SUPPLEMENTS (U.S. CLS. 6, 18, 44, 46,
51 AND 52).

SN 76-240,203. PEAK PERFORMANCE NUTRIENTS, INC.,
BOCA RATON, FL. FILED 4-12-2001.

HEMO CEASE

NO CLAIM IS MADE TO THE EXCLUSIVE RIGHT TO
USE "HEMO", APART FROM THE MARK AS SHOWN.
FOR EQUINE FEED SUPPLEMENTS (U.S. CLS. 6, 18,
44, 46, 51 AND 52).
FIRST USE 6-16-2000; IN COMMERCE 6-16-2000.

SN 76-240,932. WILBUR-ELLIS COMPANY, SAN FRANCIS-
CO, CA. FILED 4-13-2001.

TUMBLEAF

FOR COTTON DEFOLIANT (U.S. CLS. 6, 18, 44, 46, 51
AND 52).

SN 76-241,558. HTZ INVESTMENT CORP., WILMINGTON,
DE. FILED 4-16-2001.

DOUBLE WORMER

NO CLAIM IS MADE TO THE EXCLUSIVE RIGHT TO
USE "WORMER", APART FROM THE MARK AS SHOWN.
FOR WORMERS FOR CATS AND DOGS (U.S. CLS. 6,
18, 44, 46, 51 AND 52).

SN 76-243,482. PFIZER INC., NEW YORK, NY. FILED 4-19-
2001.

KIORA

FOR PHARMACEUTICAL PREPARATIONS FOR THE
TREATMENT OF CARDIOVASCULAR DISEASES (U.S.
CLS. 6, 18, 44, 46, 51 AND 52).

CLASS 5—(Continued).

SN 76-245,202. ETEX CORPORATION, CAMBRIDGE, MA.
FILED 4-23-2001.

LT/HA

FOR CALCIUM PHOSPHATE SOLD AS AN INTEGRAL
COMPONENT OF PHARMACEUTICALS FOR USE AS A
DRUG DELIVERY PREPARATIONS (U.S. CLS. 6, 18, 44,
46, 51 AND 52).

SN 76-245,204. ETEX CORPORATION, CAMBRIDGE, MA.
FILED 4-23-2001.

VACCTOR

FOR CALCIUM PHOSPHATE SOLD AS AN INTEGRAL
COMPONENT OF PHARMACEUTICALS FOR USE AS A
DRUG DELIVERY PREPARATION (U.S. CLS. 6, 18, 44,
46, 51 AND 52).

SN 76-248,111. NIPPON ZOKI PHARMACEUTICAL CO.,
LTD., OSAKA-SHI, OSAKA-FU, JAPAN, FILED 4-27-2001.



FOR PHARMACEUTICAL PREPARATIONS FOR THE
TREATMENT OF PAIN, NEURALGIA, PRURITUS, AL-
LERGIC DISEASES, INFLAMMATION, RHINITIS, AR-
THRITIS, PERIPHERAL CIRCULATORY
DISTURBANCE, COLDNESS, DYSESTHESIA, NEURO-
PATHY, REFLEX SYMPATHETIC DYSTROPHY, EDE-
MA, DEMENTIA, VIRUS DISEASE, DISTRESS
SYNDROME, IMMUNODEFICIENCY SYNDROME,
AUTOIMMUNE DISEASES, AUTONOMIC DYSTONIA,
SPIRO-CEREBELLAR DEGENERATION OR THROMBO-
CYTOPENIA, ASTHMA, URTICARIA, ECZEMA, DER-
MATITIS, RENAL FAILURE, DIABETIC
COMPLICATIONS, NEPHRITIS AND NEPHROPATHY;
AND MEDICAL PLASTERS (U.S. CLS. 6, 18, 44, 46, 51
AND 52).

SN 76-249,679. RICECO LLC, MEMPHIS, TN. FILED 5-2-2001.

RICESHO

OWNER OF U.S. REG. NO. 2,245,576.
FOR HERBICIDES, INSECTICIDES, PESTICIDES AND
FUNGICIDES FOR AGRICULTURAL USE (U.S. CLS. 6,
18, 44, 46, 51 AND 52).

CLASS 5—(Continued).

SN 76-252,408. THERMO BIOSTAR INC., BOULDER, CO. FILED 5-3-2001.

OIASYS

OWNER OF U.S. REG. NO. 1,881,052.
FOR DIAGNOSTIC REAGENTS FOR CLINICAL MEDICAL LABORATORY USE (U.S. CLS. 6, 18, 44, 46, 51 AND 52).

SN 76-252,644. PHARMACIA & UPJOHN COMPANY, PEAPACK, NJ. FILED 5-4-2001.

DAYPRO XS

OWNER OF U.S. REG. NOS. 1,772,191 AND 1,949,703.
FOR PHARMACEUTICALS IN THE NATURE OF ANTI-INFLAMMATORY ANALGESICS AGENTS (U.S. CLS. 6, 18, 44, 46, 51 AND 52).

SN 76-252,841. MONSANTO TECHNOLOGY LLC, ST. LOUIS, MO. FILED 5-7-2001.



OWNER OF U.S. REG. NOS. 847,249, 2,156,477 AND OTHERS.
FOR HERBICIDE FOR DOMESTIC AND AGRICULTURAL USE (U.S. CLS. 6, 18, 44, 46, 51 AND 52).
FIRST USE 10-23-2000; IN COMMERCE 10-23-2000.

SN 76-253,977. LIFEMAX, LLC, AURORA, OH. FILED 5-8-2001.

WEIGHT A WAY MINTS

NO CLAIM IS MADE TO THE EXCLUSIVE RIGHT TO USE "MINTS", APART FROM THE MARK AS SHOWN.
FOR MINTS, CANDY, AND CHEWING GUM CONTAINING APPETITE SUPPRESSANTS (U.S. CLS. 6, 18, 44, 46, 51 AND 52).

CLASS 5—(Continued).

SN 76-253,981. LIFEMAX, LLC, AURORA, OH. FILED 5-8-2001.

THIN FAST MINTS

NO CLAIM IS MADE TO THE EXCLUSIVE RIGHT TO USE "MINTS", APART FROM THE MARK AS SHOWN.
FOR MINTS, CANDY, AND CHEWING GUM CONTAINING APPETITE SUPPRESSANTS (U.S. CLS. 6, 18, 44, 46, 51 AND 52).

SN 76-254,591. IVC INDUSTRIES, INC., FREEHOLD, NJ. FILED 5-9-2001.

CARBO CATCHER

NO CLAIM IS MADE TO THE EXCLUSIVE RIGHT TO USE "CARBO", APART FROM THE MARK AS SHOWN.
FOR VITAMINS AND FOOD SUPPLEMENTS (U.S. CLS. 6, 18, 44, 46, 51 AND 52).

SN 76-254,983. OMS INVESTMENTS, INC., WILMINGTON, DE. FILED 5-9-2001.

MOSS-B-GON

OWNER OF U.S. REG. NOS. 433,172, 2,236,054 AND OTHERS.
FOR FUNGICIDE FOR DOMESTIC USE (U.S. CLS. 6, 18, 44, 46, 51 AND 52).

SN 76-258,505. WESTERN FAMILY FOODS, INC., TIGARD, OR. FILED 5-16-2001.

WESTERN FAMILY LENS CARE

OWNER OF U.S. REG. NOS. 1,176,760, 1,339,079 AND 1,752,170.
NO CLAIM IS MADE TO THE EXCLUSIVE RIGHT TO USE "LENS CARE", APART FROM THE MARK AS SHOWN.
FOR EYE RINSING SOLUTIONS AND RELATED EYE CLEANING AND RINSING PRODUCTS, NAMELY, LUBRICANT EYE DROPS (U.S. CLS. 6, 18, 44, 46, 51 AND 52).

CLASS 5—(Continued).

SN 76-259,610. EPIGENESIS PHARMACEUTICALS, INC., CRANBURY, NJ. FILED 5-18-2001.

Synergenes

FOR PHARMACEUTICAL PREPARATIONS FOR USE IN THE TREATMENT OF HUMAN AND NON-HUMAN ANIMAL RESPIRATORY, IMMUNE, ENDOCRINE, CARDIOVASCULAR, NEOPLASTIC AND CENTRAL NERVOUS AILMENTS, BRONCHOCONSTRICTION, DIFFICULT BREATHING, IMPEDED AND OBSTRUCTED LUNG AIRWAYS, ALLERGIES AND INFLAMMATION, RESPIRATORY, AIRWAY AND PULMONARY VASOCONSTRICTION, IMPEDED RESPIRATION, ACUTE RESPIRATORY DISTRESS SYNDROME, RENAL DAMAGE AND FAILURE, ISCHEMIA, SUPRA VENTRICULAR TACHYCARDIA, ADENOSINE STRESS TESTS, INFANTILE RESPIRATORY DISTRESS SYNDROME, PAIN, CYSTIC FIBROSIS, ALLERGIC RHINITIS, ALLERGIC BRONCHITIS, PULMONARY HYPERTENSION, PULMONARY VASOCONSTRICTION, EMPHYSEMA, CHRONIC OBSTRUCTIVE PULMONARY DISEASE, LEUKEMIAS, LYMPHOMAS, CARCINOMAS, COLON CANCER, BREAST CANCER, LUNG CANCER, PANCREATIC CANCER, HEPATOCELLULAR CARCINOMA, KIDNEY CANCER, MELANOMA, METASTATIC CANCERS AND CANCERS WHICH METASTASIZED TO THE LUNGS, BREAST, LIVER AND PROSTATE AND CENTRAL NERVOUS SYSTEM (U.S. CLS. 6, 18, 44, 46, 51 AND 52).

SN 76-259,845. PING ON OINTMENT CO. LTD., HONG KONG, HONG KONG, FILED 5-21-2001.

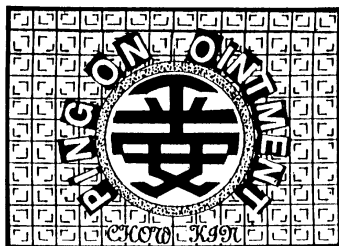

NO CLAIM IS MADE TO THE EXCLUSIVE RIGHT TO USE "OINTMENT", APART FROM THE MARK AS SHOWN. THE STIPPLING IS A FEATURE OF THE MARK. THE LINING IN THE DRAWING IS FOR SHADING PURPOSES ONLY.

THE WORDING "CHOW KIN" IDENTIFIES A DECEASED INDIVIDUAL.

THE MARK CONSISTS OF A CIRCLE CONTAINING A CHINESE CHARACTER. THE CIRCLE IS BORDERED BY THE WORDS "PING ON OINTMENT" ON THE TOP AND SIDES AND "CHOW KIN" ON THE BOTTOM. THE CIRCLE AND THE WORDS REST ON A BACKGROUND OF SMALL SQUARES WITHIN WHICH IS CONTAINED TWO (2) "L"-SHAPED DESIGNS. A SOLID RECTANGULAR BORDER ENCLOSES THE CIRCLE, WORDS AND "L"-SHAPED BACKGROUND PATTERN, ALL OF WHICH ARE CENTERED IN THE RECTANGLE.

THE CHINESE CHARACTERS IN THE MARK TRANSLITERATE TO "PING ON" AND THIS MEANS "PEACEFUL" IN ENGLISH.

FOR PHARMACEUTICAL OINTMENT FOR THE TREATMENT OF RHEUMATISM, FIBROSITIS, LUMBAGO, BURNS, SCALDING, SWELLING, BLOOD POISONING, HEADACHES, COLDS, VOMITING, ITCHING, PIMPLES, AND SEASICKNESS (U.S. CLS. 6, 18, 44, 46, 51 AND 52).

FIRST USE 4-0-1981; IN COMMERCE 4-0-1981.

CLASS 5—(Continued).

SN 76-260,163. STAFFORD, MARIA, CARSON CITY, NV. FILED 5-22-2001.

THIN BY THURSDAY

FOR DIET SUPPLEMENTS (U.S. CLS. 6, 18, 44, 46, 51 AND 52).
FIRST USE 5-11-2001; IN COMMERCE 5-11-2001.

SN 76-261,261. APOGEE, INC., HUNTSVILLE, UT. FILED 5-23-2001.

LA PERLE

THE ENGLISH TRANSLATION OF THE FRENCH WORD "LA PERLE" IS "THE PEARL".
FOR NUTRITIONAL DIETARY SUPPLEMENT (U.S. CLS. 6, 18, 44, 46, 51 AND 52).

SN 76-262,786. AVECIA LIMITED, MANCHESTER, UNITED KINGDOM, FILED 5-25-2001.

COSMOCIL

FOR BIOCIDES AND BACTERICIDES FOR USE IN THE PRESERVATION OF COSMETICS, WET WIPES AND CONTACT LENSES; BIOCIDES AND BACTERICIDES FOR USE IN WOUND DRESSINGS; ALL PURPOSE DISINFECTANTS; BACTERICIDAL PREPARATIONS FOR USE IN THE MANUFACTURE OF COSMETICS (U.S. CLS. 6, 18, 44, 46, 51 AND 52).
FIRST USE 1-0-1979; IN COMMERCE 1-0-1979.

SN 76-263,595. ASKLI A HOLDING AG, BELP, SWITZERLAND, FILED 5-25-2001.

MAVENA

FOR PHARMACEUTICAL PREPARATIONS FOR THE TREATMENT OF SKIN AILMENTS (U.S. CLS. 6, 18, 44, 46, 51 AND 52).

CLASS 5—(Continued).

SN 76-264,271. NATURAL POWER, INC., SCOTTSDALE, AZ.
FILED 5-30-2001.



NO CLAIM IS MADE TO THE EXCLUSIVE RIGHT TO USE "NATURAL", APART FROM THE MARK AS SHOWN. THE STIPPLING IS FOR SHADING PURPOSES ONLY AND DOES NOT INDICATE COLOR.

FOR NUTRITIONAL SUPPLEMENTS; DIETARY SUPPLEMENTS; NATURAL FOOD SUPPLEMENTS; NUTRITIONAL DRINK MIXES FOR USE AS DIETARY SUPPLEMENTS CONTAINING VITAMINS, MINERALS, AND HIGH-POTENCY COMPLEX CARBOHYDRATES, FIBER AND PROTEIN COMPLEXES; INGREDIENTS SOLD AS INTEGRAL COMPONENTS OF NUTRITIONAL AND DIETARY SUPPLEMENTS, NAMELY ORGANIC AND INORGANIC PROTEINS, LIPIDS AND CARBOHYDRATES; VITAMINS, MINERAL SUPPLEMENTS, ANTIOXIDANTS, BOTANICAL EXTRACTS, PHYTOCHEMICALS, PHYTONUTRIENTS, METABOLIC ACTIVATORS, BIOAVAILABILITY ENHANCERS, PROBIOTICS, PLANT ENZYMES AND COENZYMES, ESSENTIAL OILS, AMINO ACIDS, POLYSACCHARIDES, HERBS AND HERBAL EXTRACTS, SOY NUTRIENTS, AND HOMEOPATHIC AND ISOPATHIC EXTRACTS, SYRUPS AND TINCTURES, ALL FOR USE AS NUTRITIONAL AND DIETARY SUPPLEMENTS; AND HOMEOPATHIC AND ISOPATHIC SALVES, OINTMENTS AND CREAMS (U.S. CLS. 6, 18, 44, 46, 51 AND 52).

SN 76-265,460. HEMAWAY PRODUCTS, L.C., MELBOURNE, FL. FILED 6-4-2001.

HEM AWAY

FOR DIETARY SUPPLEMENTS (U.S. CLS. 6, 18, 44, 46, 51 AND 52).
FIRST USE 3-1-1999; IN COMMERCE 3-1-1999.

SN 76-266,393. BROMINE COMPOUNDS LTD., BEER SHEVA, ISRAEL, FILED 6-4-2001.

HALOGENE

FOR BIOCIDES AND SANITIZING CHEMICALS, NAMELY, BIOCIDES FOR INDUSTRIAL AND AGRICULTURAL USES, BIOCIDES FOR USE IN AIR WASHERS, PAPER MILLS, DRILLING FLUIDS, INDUSTRIAL COOLING SYSTEMS AND METAL WORKING FLUIDS (U.S. CLS. 6, 18, 44, 46, 51 AND 52).
FIRST USE 5-21-1987; IN COMMERCE 5-21-1987.

CLASS 5—(Continued).

SN 76-267,529. ROYAL SOURCE, INC., DBA ONE SOURCE, LAKE BLUFF, IL. FILED 6-6-2001.

PLUR

FOR NUTRITIONALLY FORTIFIED BEVERAGES (U.S. CLS. 6, 18, 44, 46, 51 AND 52).

SN 76-270,663. TREE OF LIFE, INC., SAINT AUGUSTINE, FL. FILED 6-13-2001.

BALANCED

OWNER OF U.S. REG. NOS. 791,925, 1,596,670 AND OTHERS.

FOR NUTRITIONAL SUPPLEMENTS, NAMELY, MEAL REPLACEMENT AND DIETARY SUPPLEMENT DRINKS (U.S. CLS. 6, 18, 44, 46, 51 AND 52).
FIRST USE 9-1-1997; IN COMMERCE 9-1-1997.

SN 76-275,744. GUANGZHOU HYGIENIC MATERIAL FACTORY, GUANGZHOU, CHINA, FILED 6-25-2001.

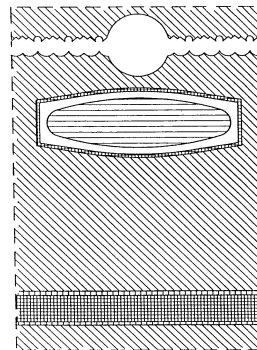

THE DRAWING OF THE MARK IS LINED FOR THE COLORS GREEN, YELLOW, BLUE AND RED.

THE MARK CONSISTS OF THE TRADE DRESS OF THE PACKAGING FOR THE GOODS CONSISTING OF THE COLORS GREEN, YELLOW, BLUE AND RED, AS SHOWN IN THE DRAWING.

SEC. 2(F).
FOR MEDICATED PLASTER (U.S. CLS. 6, 18, 44, 46, 51 AND 52).
FIRST USE 11-3-1989; IN COMMERCE 11-3-1989.

CLASS 5—(Continued).

SN 76-279,920. HUMAN GENOME SCIENCES, INC., ROCKVILLE, MD. FILED 7-2-2001.

ASTRUTA

FOR PHARMACEUTICAL PREPARATIONS FOR USE IN PROMOTING THE GROWTH AND REPAIR OF EPITHELIAL CELLS; PHARMACEUTICAL PREPARATIONS FOR USE IN THE TREATMENT OF ALIMENTARY TRACT DISORDERS, ALLERGIC CONDITIONS, AUTOIMMUNE DISEASES, BLOOD DISORDERS, BONE DISEASES AND INJURIES, BONE MARROW AND STEM CELL TRANSPLANTATION, CARDIOVASCULAR DISEASES, CENTRAL NERVOUS SYSTEM DISORDERS, CONNECTIVE TISSUE DISORDERS, CRITICAL CARE, EAR, NOSE AND THROAT CONDITIONS, ENDOCRINOLOGY DISORDERS, GASTROINTESTINAL DISEASES, GENETIC DISEASE, IMMUNOLOGIC CONDITIONS, INFECTIOUS DISEASES, JOINT DISEASES, KIDNEY DISEASES, LIVER DISEASES, METABOLIC DISEASES, NEUROLOGIC DISORDERS, NUTRITIONAL DISORDERS, OBSTETRIC, GYNECOLOGICAL AND REPRODUCTIVE DISORDERS, ONCOLOGIC CONDITIONS, OPHTHALMOLOGIC DISEASES, ORGAN TRANSPLANTATION, PANCREATIC DISORDERS, POISONING, PSYCHIATRIC DISORDERS, RESPIRATORY DISEASES, DERMATOLOGIC DISORDERS, SUBSTANCE ABUSE DISORDERS, THROMBOTIC DISEASES, VASCULAR DISEASES, TENDON AND MUSCULAR INJURIES, BACK INJURIES AND JOINT INJURIES, SKIN WOUNDS AND SOFT TISSUE WOUNDS (U.S. CLS. 6, 18, 44, 46, 51 AND 52).

SN 76-280,362. COGA INVESTMENTS, INC. GP, DBA HISTORICAL REMEDIES, L.P., ST. PAUL, MN. FILED 7-2-2001.

PASSION DROPS

NO CLAIM IS MADE TO THE EXCLUSIVE RIGHT TO USE "DROPS", APART FROM THE MARK AS SHOWN.
FOR HOMEOPATHIC MEDICINE IN THE NATURE DROPS FOR RELIEVING ANXIETY (U.S. CLS. 6, 18, 44, 46, 51 AND 52).

CLASS 5—(Continued).

SN 76-282,502. HUMAN GENOME SCIENCES, INC., ROCKVILLE, MD. FILED 7-10-2001.

MAGRIFEX

FOR PHARMACEUTICAL PREPARATIONS FOR USE IN PROMOTING THE GROWTH AND REPAIR OF EPITHELIAL CELLS; PHARMACEUTICAL PREPARATIONS FOR USE IN THE TREATMENT OF ALIMENTARY TRACT DISORDERS, ALLERGIC CONDITIONS, AUTOIMMUNE DISEASES, BLOOD DISORDERS, BONE DISEASES AND INJURIES, BONE MARROW AND STEM CELL TRANSPLANTATION, CARDIOVASCULAR DISEASES, CENTRAL NERVOUS SYSTEM DISORDERS, CONNECTIVE TISSUE DISORDERS, CRITICAL CARE, CARE, EAR, NOSE AND THROAT CONDITIONS, ENDOCRINOLOGY DISORDERS, GASTROINTESTINAL DISEASES, GENETIC DISEASE, IMMUNOLOGIC CONDITIONS, INFECTIOUS DISEASES, JOINT DISEASES, KIDNEY DISEASES, LIVER DISEASES, METABOLIC DISEASES, NEUROLOGIC DISORDERS, NUTRITIONAL DISORDERS, OBSTETRIC, GYNECOLOGICAL AND REPRODUCTIVE DISORDERS, ONCOLOGIC CONDITIONS, OPHTHALMOLOGIC DISEASES, ORGAN TRANSPLANTATION, PANCREATIC DISORDERS, POISONING, PSYCHIATRIC DISORDERS, RESPIRATORY DISEASES, DERMATOLOGIC DISORDERS, SUBSTANCE ABUSE DISORDERS, THROMBOTIC DISEASES, VASCULAR DISEASES, TENDON AND MUSCULAR INJURIES, BACK INJURIES AND JOINT INJURIES, SKIN WOUNDS AND SOFT TISSUE WOUNDS (U.S. CLS. 6, 18, 44, 46, 51 AND 52).

SN 76-282,895. HUMAN GENOME SCIENCES, INC., ROCKVILLE, MD. FILED 7-10-2001.

CELTEGRIS

FOR PHARMACEUTICAL PREPARATIONS FOR USE IN PROMOTING THE GROWTH AND REPAIR OF EPITHELIAL CELLS; PHARMACEUTICAL PREPARATIONS FOR USE IN THE TREATMENT OF ALIMENTARY TRACT DISORDERS, ALLERGIC CONDITIONS, AUTOIMMUNE DISEASES, BLOOD DISORDERS, BONE DISEASES AND INJURIES, BONE MARROW AND STEM CELL TRANSPLANTATION, CARDIOVASCULAR DISEASES, CENTRAL NERVOUS SYSTEM DISORDERS, CONNECTIVE TISSUE DISORDERS, CRITICAL CARE, EAR, NOSE AND THROAT CONDITIONS, ENDOCRINOLOGY DISORDERS, GASTROINTESTINAL DISEASES, GENETIC DISEASE, IMMUNOLOGIC CONDITIONS, INFECTIOUS DISEASES, JOINT DISEASES, KIDNEY DISEASES, LIVER DISEASES, METABOLIC DISEASES, NEUROLOGIC DISORDERS, NUTRITIONAL DISORDERS, OBSTETRIC, GYNECOLOGICAL AND REPRODUCTIVE DISORDERS, ONCOLOGIC CONDITIONS, OPHTHALMOLOGIC DISEASES, ORGAN TRANSPLANTATION, PANCREATIC DISORDERS, POISONING, PSYCHIATRIC DISORDERS, RESPIRATORY DISEASES, DERMATOLOGIC DISORDERS, SUBSTANCE ABUSE DISORDERS, THROMBOTIC DISEASES, VASCULAR DISEASES, TENDON AND MUSCULAR INJURIES, BACK INJURIES AND JOINT INJURIES, SKIN WOUND AND SOFT TISSUE WOUNDS (U.S. CLS. 6, 18, 44, 46, 51 AND 52).

CLASS 5—(Continued).

SN 76-285,420. TPR INTERNATIONAL LTD., INC., RHINEBECK, NY. FILED 7-16-2001.

TOPRICIN

FOR TOPICAL ANALGESIC PREPARATION, NAMELY, NATURAL PAIN RELIEF CREAM FOR THE TREATMENT OF MUSCLE AND JOINT PAIN, ARTHRITIS PAIN, NERVE-RELATED PAIN AND INFLAMMATION, AND THE TREATMENT OF DERMATOSES (U.S. CLS. 6, 18, 44, 46, 51 AND 52).

FIRST USE 1-1-2001; IN COMMERCE 1-1-2001.

SN 76-287,967. PHAMATECH, INC., SAN DIEGO, CA. FILED 7-23-2001.

CLEAR CHOICE

FOR PHARMACEUTICAL DIAGNOSTIC TEST KITS CONSISTING PRIMARILY OF TESTING STRIPS, CARDS AND CONTAINERS FOR IMMERSION IN BODILY SPECIMENS, FOR DETECTION OF PREGNANCY, DRUG SCREEN, FERTILITY, CANCER MARKERS, AND INFECTIOUS DISEASE (U.S. CLS. 6, 18, 44, 46, 51 AND 52).

FIRST USE 11-1-2000; IN COMMERCE 11-1-2000.

SN 76-292,547. HEALTH INTERNATIONAL CORPORATION, ST. PETERSBURG, FL. FILED 8-1-2001.

HYPERACTIVE

FOR MEAL REPLACEMENT NUTRITIONAL DRINKS IN POWDER AND LIQUID FORM AND VITAMINS FOR USE IN BODY MAINTENANCE AND WEIGHT CONTROL (U.S. CLS. 6, 18, 44, 46, 51 AND 52).

SN 76-293,164. FMC CORPORATION, PHILADELPHIA, PA. FILED 8-1-2001.

CENTIUM

FOR PESTICIDES FOR DOMESTIC, AGRICULTURAL AND COMMERCIAL USE, AND FOR USE IN AND AROUND STRUCTURES (U.S. CLS. 6, 18, 44, 46, 51 AND 52).

SN 76-293,310. ORION CORPORATION, 02200 ESPOO, FINLAND, FILED 8-1-2001.

DEXDOMITOR

OWNER OF FINLAND REG. NO. 219758, DATED 12-15-2000, EXPIRES 12-15-2010.

OWNER OF U.S. REG. NOS. 1,467,915 AND 2,088,799. FOR VETERINARY DRUG USED IN THE SEDATION OF DOMESTIC ANIMALS (U.S. CLS. 6, 18, 44, 46, 51 AND 52).

CLASS 5—(Continued).

SN 76-296,036. ONCOMEMBRANE, INC., SEATTLE, WA. FILED 8-8-2001.



OWNER OF U.S. REG. NOS. 1,909,698 AND 1,909,699. NO CLAIM IS MADE TO THE EXCLUSIVE RIGHT TO USE "USA", APART FROM THE MARK AS SHOWN. FOR CHEMICAL MEDICAL REAGENTS (U.S. CLS. 6, 18, 44, 46, 51 AND 52).

SN 76-296,497. BML PHARMACEUTICALS, INC., MANHASSET, NY. FILED 8-9-2001.

TRIONIC

FOR PHARMACEUTICAL PREPARATIONS, NAMELY MEDICATED MOUTH RINSE, FOR THE TREATMENT OF DENTAL PLAQUE, ORAL LESIONS, ORAL ULCERS, GINGIVAL DISEASE, PERIODONTAL DISEASE, HERPETIC AND APHTHOUS ULCERS, STOMATITIS, ORAL MUCOSITIS, ERYTHEMA AND ORAL IRRITATIONS (U.S. CLS. 6, 18, 44, 46, 51 AND 52).

SN 76-301,979. COLOPLAST A/S, DK-3050 HUMLEBAEK, DENMARK, FILED 8-20-2001.

HYDROCAPILLARY

PRIORITY CLAIMED UNDER SEC. 44(D) ON DENMARK APPLICATION NO. VA200102583, FILED 7-4-2001, REG. NO. VR200103150, DATED 7-25-2001, EXPIRES 7-25-2011.

FOR MEDICAL AND SURGICAL WOUND DRESSINGS, MEDICAL AND SURGICAL WOUND FILLING MATERIALS (U.S. CLS. 6, 18, 44, 46, 51 AND 52).

SN 76-304,129. PEGASUS PERFORMANCE PRODUCTS, LLC, WILTON, CT. FILED 8-23-2001.

FITNESS FUEL

NO CLAIM IS MADE TO THE EXCLUSIVE RIGHT TO USE "FITNESS", APART FROM THE MARK AS SHOWN. FOR EQUINE PERFORMANCE SUPPLEMENTS (U.S. CLS. 6, 18, 44, 46, 51 AND 52).

CLASS 5—(Continued).

SN 76-304,645. BIOSAN LABORATORIES, INC., DERRY, NH. FILED 8-20-2001.

BIO-METABOLIC NUTRITION

NO CLAIM IS MADE TO THE EXCLUSIVE RIGHT TO USE "NUTRITION", APART FROM THE MARK AS SHOWN.

FOR VITAMIN, MINERAL AND NUTRITIONAL DIETARY SUPPLEMENTS PRODUCED IN TABLET, CAPSULE AND POWDER FORM (U.S. CLS. 6, 18, 44, 46, 51 AND 52).

FIRST USE 11-4-1997; IN COMMERCE 11-4-1997.

SN 76-305,996. BOEHRINGER INGELHEIM VETMEDICA GMBH, 55216 INGELHEIM AM RHEIN, FED REP GERMANY, FILED 8-28-2001.

BENFITAL

OWNER OF U.S. REG. NO. 1,874,487.

FOR VETERINARY PREPARATIONS FOR THE TREATMENT OF ELECTROLYTE DEFICIENCY IN PETS, HORSES, AND FARM ANIMALS (U.S. CLS. 6, 18, 44, 46, 51 AND 52).

SN 76-309,971. JAMIESON, JAMES, TOWN & COUNTRY, MO. AND JAMIESON, JENNIFER, ST. LOUIS, MO. FILED 9-7-2001.

V.I.P. PEPTIDE

NO CLAIM IS MADE TO THE EXCLUSIVE RIGHT TO USE "PEPTIDE", APART FROM THE MARK AS SHOWN.

FOR NUTRACEUTICALS CONTAINING A NATURAL ENZYME VASODILATOR FOR THE TREATMENT OF ERECTILE DYSFUNCTION IN MEN, SEXUAL DYSFUNCTION IN WOMEN, AND SKIN WOUNDS; HAIR GROWTH STIMULANT (U.S. CLS. 6, 18, 44, 46, 51 AND 52).

SN 76-310,136. NICHE PRODUCTS, INC., ROLLING HILLS ESTATES, CA. FILED 9-7-2001.

GROOVY GRAPE

NO CLAIM IS MADE TO THE EXCLUSIVE RIGHT TO USE "GRAPE", APART FROM THE MARK AS SHOWN.

FOR NUTRITIONAL AND DIETARY SUPPLEMENTS (U.S. CLS. 6, 18, 44, 46, 51 AND 52).

CLASS 5—(Continued).

SN 76-310,744. WESTLAKE LABORATORIES, INC., WESTLAKE, OH. FILED 9-10-2001.

ORGAL

FOR NUTRITIONAL SUPPLEMENTS FOR REMOVING ALUMINUM METAL FROM CELLS SOLD IN HEALTH FOOD AND PHYSICIAN OFFICE CHANNELS OF TRADE (U.S. CLS. 6, 18, 44, 46, 51 AND 52).

SN 76-311,455. BIOCHEMICS, INC., DANVERS, MA. FILED 9-11-2001.

REPIDERM

OWNER OF U.S. REG. NO. 1,917,145.

FOR TOPICAL SKIN TREATMENT IN THE NATURE OF MEDICATED SKIN HYDRATING LOTION FOR HUMAN USE (U.S. CLS. 6, 18, 44, 46, 51 AND 52).

SN 76-315,042. PEGASUS PERFORMANCE PRODUCTS, LLC, WILTON, CT. FILED 9-20-2001.



FOR EQUINE PERFORMANCE SUPPLEMENTS, NAMELY, NUTRITIONAL, DIETARY AND FOOD SUPPLEMENTS (U.S. CLS. 6, 18, 44, 46, 51 AND 52).

SN 76-315,046. PEGASUS PERFORMANCE PRODUCTS, LLC, WILTON, CT. FILED 9-20-2001.

PEAK APPEARANCE

FOR EQUINE PERFORMANCE SUPPLEMENTS, NAMELY, NUTRITIONAL, DIETARY AND FOOD SUPPLEMENTS (U.S. CLS. 6, 18, 44, 46, 51 AND 52).

SN 76-315,047. PEGASUS PERFORMANCE PRODUCTS, LLC, WILTON, DE. FILED 9-20-2001.

PEAK FITNESS

FOR EQUINE PERFORMANCE SUPPLEMENTS, NAMELY, NUTRITIONAL, DIETARY AND FOOD SUPPLEMENTS (U.S. CLS. 6, 18, 44, 46, 51 AND 52).

CLASS 5—(Continued).

SN 76-315,453. BRISTOL-MYERS SQUIBB PHARMA COMPANY, NEW YORK, NY. BY CHANGE OF NAME DUPONT PHARMACEUTICALS COMPANY, WILMINGTON, DE. FILED 9-20-2001.

INERAY

FOR PHARMACEUTICAL PREPARATIONS, FOR THE TREATMENT OF CARDIOVASCULAR DISEASES, CENTRAL NERVOUS SYSTEM DISEASES, CANCER, INFLAMMATION AND INFLAMMATORY DISEASES, RESPIRATORY AND INFECTIOUS DISEASES (U.S. CLS. 6, 18, 44, 46, 51 AND 52).

SN 76-315,990. BIOBALANCE INTERNATIONAL, INC., PACIFIC PALISADES, CA. FILED S.R. 9-24-2001; AM. P.R. 2-4-2002.

DR. CASS

THE NAME "DR. CASS" IDENTIFIES A LIVING INDIVIDUAL WHOSE CONSENT IS OF RECORD.
FOR VITAMIN AND NUTRITIONAL SUPPLEMENTS (U.S. CLS. 6, 18, 44, 46, 51 AND 52).
FIRST USE 7-15-2001; IN COMMERCE 7-15-2001.

SN 76-316,152. BELCASTRO, JAMIE R., ALEXANDRIA, VA. FILED 9-24-2001.

CORONA

FOR ORALLY INGESTIBLE YOHIMBINE TABLETS FOR USE AS A MALE APHRODISIAC (U.S. CLS. 6, 18, 44, 46, 51 AND 52).

SN 76-317,143. INTEGRATED CHINESE MEDICINE HOLDINGS, LTD., TST EAST KOWLOON, HONG KONG, FILED 9-26-2001.

I'M-YUNITY TOO

FOR HERBAL SUPPLEMENTS (U.S. CLS. 6, 18, 44, 46, 51 AND 52).

SN 76-317,611. VACCINEX, INC., ROCHESTER, NY. FILED 9-26-2001.

VACCINEX

FOR DIAGNOSTIC PREPARATIONS FOR CLINICAL OR MEDICAL LABORATORY USE AND PHARMACEUTICAL PREPARATIONS FOR THE TREATMENT OF CANCER AND MUSCULOSKELETAL DISEASE INCLUDING OSTEOARTHRITIS AND OSTEOPOROSIS (U.S. CLS. 6, 18, 44, 46, 51 AND 52).

CLASS 5—(Continued).

SN 76-318,354. SEE-PRO, LLC, LAKELAND, LA. FILED 9-27-2001.

DEER SAUCE

NO CLAIM IS MADE TO THE EXCLUSIVE RIGHT TO USE "DEER", APART FROM THE MARK AS SHOWN.
FOR NUTRITIONAL DIETARY SUPPLEMENTS FOR DEER (U.S. CLS. 6, 18, 44, 46, 51 AND 52).
FIRST USE 9-1-2001; IN COMMERCE 9-1-2001.

SN 76-320,132. STRATATECH CORPORATION, MADISON, WI. FILED 10-2-2001.

STRATALIFE

FOR BIOENGINEERED TISSUES FOR SURGICAL IMPLANTATION (U.S. CLS. 6, 18, 44, 46, 51 AND 52).

SN 76-320,225. AURORA GROUP, INC., THE, SOUTH HACKENSACK, NJ. FILED 9-24-2001.

BEAUTIFUL SKIN FROM WITHIN

FOR DIETARY SUPPLEMENT FOR NAIL GROWTH (U.S. CLS. 6, 18, 44, 46, 51 AND 52).

SN 76-321,274. 19TH HOLE PRODUCTS, LLC, SPRING LAKE HEIGHTS, NJ. FILED 10-4-2001.

BUG SCREEN

NO CLAIM IS MADE TO THE EXCLUSIVE RIGHT TO USE "BUG", APART FROM THE MARK AS SHOWN.
FOR INSECT REPELLANT (U.S. CLS. 6, 18, 44, 46, 51 AND 52).

SN 76-323,457. OMS INVESTMENTS, INC., WILMINGTON, DE. FILED 10-10-2001.

WEED-B-GON ADVANTAGE

OWNER OF U.S. REG. NOS. 903,317, 2,088,157 AND OTHERS.
FOR HERBICIDES FOR DOMESTIC USE (U.S. CLS. 6, 18, 44, 46, 51 AND 52).

CLASS 5—(Continued).

SN 76-326,386. ENZYMATIC THERAPY, INC., GREEN BAY, WI. FILED 10-18-2001.

IVY CALM

NO CLAIM IS MADE TO THE EXCLUSIVE RIGHT TO USE "IVY", APART FROM THE MARK AS SHOWN.
FOR DIETARY AND NUTRITIONAL SUPPLEMENTS (U.S. CLS. 6, 18, 44, 46, 51 AND 52).

SN 76-327,197. PURINA MILLS, INC., ST. LOUIS, MO. FILED 10-19-2001.

CALFCARE 50 PLUS

NO CLAIM IS MADE TO THE EXCLUSIVE RIGHT TO USE "50", APART FROM THE MARK AS SHOWN.
FOR COLOSTRUM SUPPLEMENT FOR ANIMALS (U.S. CLS. 6, 18, 44, 46, 51 AND 52).

SN 76-328,236. ELI LILLY AND COMPANY, INDIANAPOLIS, IN. FILED 10-22-2001.

LYSULOG

FOR INSULIN (U.S. CLS. 6, 18, 44, 46, 51 AND 52).

SN 76-328,774. SIGNAL INVESTMENT & MANAGEMENT CO., WILMINGTON, DE. FILED 10-19-2001.

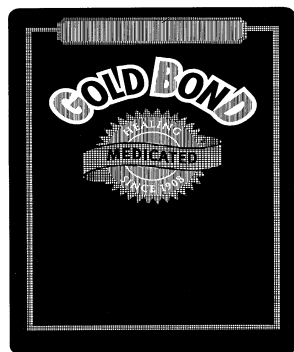

OWNER OF U.S. REG. NOS. 1,209,453, 2,125,543 AND OTHERS.

NO CLAIM IS MADE TO THE EXCLUSIVE RIGHT TO USE "MEDICATED HEALING", APART FROM THE MARK AS SHOWN.

THE MARK IS LINED FOR THE COLORS RED AND GOLD WHICH FORM A PART OF THE MARK.

SEC. 2(F) AS TO "SINCE 1908".

FOR MEDICATED BODY POWDER, BABY POWDER, AND FOOT POWDER, ANTI-ITCH CREAM, MEDICATED BODY LOTION AND TRIPLE ANTIBIOTIC OINTMENT (U.S. CLS. 6, 18, 44, 46, 51 AND 52).

CLASS 5—(Continued).

SN 76-329,411. SCP ENTERPRISES, LTD., HAWORTH, NJ. FILED 10-17-2001.

QUICKSLEEP

FOR NATURAL, NON-PRESCRIPTION, PHARMACEUTICAL PREPARATIONS; NAMELY PRODUCTS WHICH CAUSE DROWSINESS; PREPARATIONS WHICH AID IN THE INDUCEMENT AND QUALITY OF SLEEP; SLEEP-AIDS; SOMNOLENTS; SOPORIFICS (U.S. CLS. 6, 18, 44, 46, 51 AND 52).

SN 76-329,548. PROTEIN THERAPEUTICS, INC., TUCSON, AZ. FILED 10-24-2001.

ORALGAM

FOR PHARMACEUTICAL PREPARATIONS FOR USE IN THE TREATMENT OF IMMUNE-MEDIATED AND/OR AUTOIMMUNE DISEASES, SUCH AS JUVENILE RHEUMATOID ARTHRITIS, ADULT RHEUMATOID ARTHRITIS, CROHN'S DISEASE, ULCERATIVE COLITIS, AND AUTISM (U.S. CLS. 6, 18, 44, 46, 51 AND 52).

SN 76-330,207. SYNOD GROUP INC., FENTON, MI. FILED 10-26-2001.

SNAP-WIPES

FOR PRE-MOISTENED MEDICATED WIPES (U.S. CLS. 6, 18, 44, 46, 51 AND 52).

SN 76-332,440. CREATIVE NUTRITION, INC., FARMINGDALE, NY. FILED 10-30-2001.

GINSENG MAX 7X

NO CLAIM IS MADE TO THE EXCLUSIVE RIGHT TO USE "GINSENG", APART FROM THE MARK AS SHOWN.

FOR VITAMINS, MINERAL SUPPLEMENTS, HERBAL SUPPLEMENTS, DIETARY AND NUTRITIONAL SUPPLEMENTS, ALL CONTAINING GINSENG (U.S. CLS. 6, 18, 44, 46, 51 AND 52).

SN 76-335,013. MERCK & CO., INC., WHITEHOUSE STATION, NJ. FILED 11-7-2001.

SPECTRAVAX

FOR VACCINE PREPARATIONS (U.S. CLS. 6, 18, 44, 46, 51 AND 52).

CLASS 5—(Continued).

SN 76-336,655. DREAM MAKERS, INC., CANTON, OH. FILED 11-14-2001.

EQUINE P.T.

NO CLAIM IS MADE TO THE EXCLUSIVE RIGHT TO USE "EQUINE", APART FROM THE MARK AS SHOWN. FOR SALIVA BASED PREGNANCY TEST FOR USE WITH ANIMALS (U.S. CLS. 6, 18, 44, 46, 51 AND 52).

SN 76-337,497. TWIN LABORATORIES INC., NEW YORK, NY. FILED 11-15-2001.

ULTRA3 GROWTH FUEL

OWNER OF U.S. REG. NOS. 1,540,057 AND 2,183,051. FOR DIETARY SUPPLEMENTS (U.S. CLS. 6, 18, 44, 46, 51 AND 52).

SN 76-338,350. SCIENTIFIC CONSULTING SERVICE, SAN LEANDRO, CA. FILED 11-16-2001.

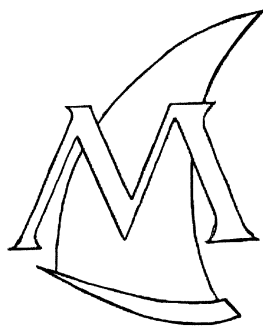

FOR VITAMIN, HERBAL AND MINERAL SUPPLEMENTS (U.S. CLS. 6, 18, 44, 46, 51 AND 52). FIRST USE 10-26-2001; IN COMMERCE 10-26-2001.

SN 76-338,932. DEER, RICHARD A., CARMEL, IN. FILED 11-16-2001.

ENERGY USA

NO CLAIM IS MADE TO THE EXCLUSIVE RIGHT TO USE "USA", APART FROM THE MARK AS SHOWN. FOR DIETARY SUPPLEMENT (U.S. CLS. 6, 18, 44, 46, 51 AND 52).

CLASS 5—(Continued).

SN 76-338,948. STAR HORSE PRODUCTS, INC., CARLSBAD, CA. FILED 11-16-2001.

CELEBRATION

FOR INSECTICIDES AND ECTOPARASITICIDES FOR USE ON LIVESTOCK AND DOMESTIC PETS; AND DIETARY SUPPLEMENTS IN CAPSULE AND TABLET FORM CONSISTING OF MINERALS, HERBS, AND COMBINATIONS OF HERBS AND MINERALS FOR ANIMALS (U.S. CLS. 6, 18, 44, 46, 51 AND 52).

SN 76-341,199. HALL, I. SCOTT, SAMMAMISH, WA. FILED 11-21-2001.

TAKE RELIEF

FOR FIRST AID KITS (U.S. CLS. 6, 18, 44, 46, 51 AND 52).

SN 76-341,417. SHAKLEE CORPORATION, PLEASANTON, CA. FILED 11-26-2001.

COQHEART

FOR DIETARY AND NUTRITIONAL SUPPLEMENTS (U.S. CLS. 6, 18, 44, 46, 51 AND 52). FIRST USE 8-20-2001; IN COMMERCE 8-20-2001.

SN 76-341,789. GLOBAL SWEET POLYOLS, LLC, REHOBOTH, MA. FILED 11-27-2001.



XYRUP
THE XYLITOL SYRUP

NO CLAIM IS MADE TO THE EXCLUSIVE RIGHT TO USE "SYRUP" OR "THE XYLITOL SYRUP", APART FROM THE MARK AS SHOWN.

THE LINING SHOWN IN THE DRAWING IS A FEATURE OF THE MARK.

THE MARK CONSISTS OF A CIRCLE SURROUNDING AN ABSTRACT IMAGE OF A MOTHER CRADLING AN INFANT IN HER ARMS.

FOR DIETARY AND NUTRITIONAL SUPPLEMENTS IN THE FORM OF CONFECTIONARY ITEMS, NAMELY, SYRUPS AND LOZENGES (U.S. CLS. 6, 18, 44, 46, 51 AND 52).

CLASS 5—(Continued).

SN 76-344,200. PKI NUTRITION, INC., BROOKSVILLE, FL. FILED 11-30-2001.

HCA CUTS

NO CLAIM IS MADE TO THE EXCLUSIVE RIGHT TO USE "HCA", APART FROM THE MARK AS SHOWN.
FOR NUTRICEUTICALS FOR USE AS DIETARY SUPPLEMENT (U.S. CLS. 6, 18, 44, 46, 51 AND 52).

SN 76-347,424. ECOSMART TECHNOLOGIES, INC., FRANKLIN, TN. FILED 12-12-2001.

FAMILY WILDERNESS

FOR INSECT AND PEST REPELLENTS (U.S. CLS. 6, 18, 44, 46, 51 AND 52).

SN 76-348,603. NABI, BOCA RATON, FL. FILED 12-12-2001.

CIVACIR

FOR ANTI-INFECTIVE PHARMACEUTICAL PREPARATION (U.S. CLS. 6, 18, 44, 46, 51 AND 52).

SN 76-350,253. MCLAUGHLIN GORMLEY KING COMPANY, MINNEAPOLIS, MN. FILED 12-18-2001.



OWNER OF U.S. REG. NO. 1,456,055.
FOR INSECTICIDES FOR INDUSTRIAL, INSTITUTIONAL, COMMERCIAL, AND DOMESTIC USE (U.S. CLS. 6, 18, 44, 46, 51 AND 52).

SN 76-350,702. NEWAYS, INC., SALEM, UT. FILED 12-14-2001.

FORCEFUL

FOR NUTRITIONAL SUPPLEMENT (U.S. CLS. 6, 18, 44, 46, 51 AND 52).

CLASS 5—(Continued).

SN 76-354,921. INTERNATIONAL BIOPRODUCTS INC., BOTHELL, WA. FILED 1-4-2002.

REDISWAB

FOR PREPARED SOLUTIONS FOR MEDICAL, CLINICAL, INDUSTRIAL, OR BIOTECHNOLOGY USE IN THE NATURE OF SOLUTIONS TO MAINTAIN THE VIABILITY OF MICROORGANISMS, THAT ARE TYPICALLY STERILE, PROVIDED IN CONTAINERS WITH SWABS AFFIXED TO THE CONTAINER (U.S. CLS. 6, 18, 44, 46, 51 AND 52).

FIRST USE 9-1-1996; IN COMMERCE 9-1-1996.

SN 76-355,973. NEWMAN, MATTHEW, NEW ROADS, LA. FILED 1-7-2002.

DEER CO-CAIN BLACK MAGIC

OWNER OF U.S. REG. NOS. 1,804,081, 2,057,409 AND OTHERS.

NO CLAIM IS MADE TO THE EXCLUSIVE RIGHT TO USE "DEER", APART FROM THE MARK AS SHOWN.
FOR NUTRITIONAL SUPPLEMENTS WITH ATTRACTANTS, FOR DEER (U.S. CLS. 6, 18, 44, 46, 51 AND 52).
FIRST USE 10-21-2001; IN COMMERCE 10-21-2001.

SN 76-356,052. NEWMAN, MATTHEW, NEW ROADS, LA. FILED 1-7-2002.

DEER CANE BLACK MAGIC

OWNER OF U.S. REG. NOS. 1,804,081, 2,057,409 AND OTHERS.

NO CLAIM IS MADE TO THE EXCLUSIVE RIGHT TO USE "DEER", APART FROM THE MARK AS SHOWN.
FOR NUTRITIONAL FEED SUPPLEMENTS FOR DEER (U.S. CLS. 6, 18, 44, 46, 51 AND 52).
FIRST USE 10-21-2001; IN COMMERCE 10-21-2001.

SN 76-357,020. PROETHIC LABORATORIES, LLC, MONTGOMERY, AL. FILED 1-8-2002.

DURAHIST

FOR PHARMACEUTICAL PREPARATIONS TAKEN ORALLY TO TREAT THE SYMPTOMS OF ALLERGIC RHINITIS, VASOMOTOR RHINITIS, SINUSITIS AND THE COMMON COLD (U.S. CLS. 6, 18, 44, 46, 51 AND 52).

CLASS 5—(Continued).

SN 76-357,051. ESSANTE CORPORATION, DRAPER, UT.
FILED 1-10-2002.

ENTISSE

FOR PHARMACEUTICAL PREPARATIONS FOR THE
TREATMENT OF SEXUAL DYSFUNCTION AND FOR
SEXUAL PERFORMANCE ENHANCEMENT (U.S. CLS.
6, 18, 44, 46, 51 AND 52).
FIRST USE 7-0-2001; IN COMMERCE 7-0-2001.

SN 76-357,089. INDUSTRIAS TUK, S.A. DE C.V., APODOCA,
N.L. C.P. 66630, MEXICO, FILED 1-10-2002.

HEALRITE

FOR ADHESIVE TAPES FOR MEDICAL USE (U.S.
CLS. 6, 18, 44, 46, 51 AND 52).

SN 76-358,021. ASHBURY BIOLOGICALS, INC., TORONTO,
ONTARIO M3J 2S3, CANADA, FILED 1-14-2002.

HYTHIOL C

NO CLAIM IS MADE TO THE EXCLUSIVE RIGHT TO
USE "C", APART FROM THE MARK AS SHOWN.
FOR PHARMACEUTICAL PREPARATION USED TO
TREAT A HANGOVER OR FOR USE AS A SUPPLE-
MENT TO TREAT SKIN CONDITIONS CONTAINING
VITAMIN C (U.S. CLS. 6, 18, 44, 46, 51 AND 52).

SN 76-359,290. KIBOW BIOTECH, INC., PHILADELPHIA, PA.
FILED 1-17-2002.

RENAL BAR

NO CLAIM IS MADE TO THE EXCLUSIVE RIGHT TO
USE "RENAL", APART FROM THE MARK AS SHOWN.
FOR PHARMACEUTICAL PREPARATIONS FOR USE
IN TREATING KIDNEY IMPAIRMENT IN RENAL
PATIENTS (U.S. CLS. 6, 18, 44, 46, 51 AND 52).

SN 76-360,552. ARDYSS INTERNATIONAL, LAS VEGAS,
NV. FILED 1-22-2002.

TOP FIBER

NO CLAIM IS MADE TO THE EXCLUSIVE RIGHT TO
USE "FIBER", APART FROM THE MARK AS SHOWN.
FOR VITAMIN, DIETARY, AND FIBER SUPPLE-
MENTS FOR DRINKING - FIBER SUPPLEMENT DRINK
(U.S. CLS. 6, 18, 44, 46, 51 AND 52).
FIRST USE 1-1-2002; IN COMMERCE 1-1-2002.

CLASS 5—(Continued).

SN 76-364,275. QUEST GROUP INTERNATIONAL, INC.,
SPANISH FORK, UT. FILED 1-28-2002.

NEOSLIM

FOR NUTRITIONAL SUPPLEMENTS (U.S. CLS. 6, 18,
44, 46, 51 AND 52).
FIRST USE 10-29-2001; IN COMMERCE 10-29-2001.

SN 76-364,328. ASTAZENECA UK LIMITED, LONDON,
UNITED KINGDOM, FILED 1-29-2002.

POZIDEX

OWNER OF UNITED KINGDOM REG. NO. 1517020,
DATED 11-26-1993, RENEWED AS REG. NO. 1517020,
DATED 10-28-1999, EXPIRES 10-28-2009.
OWNER OF U.S. REG. NO. 2,010,185.
FOR PHARMACEUTICAL PREPARATIONS AND SUB-
STANCES FOR USE IN CANCER THERAPY (U.S. CLS. 6,
18, 44, 46, 51 AND 52).

SN 76-364,918. ONDEO NALCO COMPANY, NAPERVILLE,
IL. FILED 1-31-2002.

CLENZCARE

FOR DISINFECTANT SOLUTIONS FOR SURFACE
GLASS, WALLS, DOORS, FLOORS, CARPETING, MA-
CHINERY AND EQUIPMENT IN THE WORKPLACE
ENVIRONMENT (U.S. CLS. 6, 18, 44, 46, 51 AND 52).
FIRST USE 10-5-2001; IN COMMERCE 10-5-2001.

SN 76-365,700. OLA INTERNATIONAL, INC., LAKELAND,
FL. FILED 2-4-2002.

ENERGYBOLIZER

FOR NATURAL DIETARY FOOD SUPPLEMENT CAP-
SULES (U.S. CLS. 6, 18, 44, 46, 51 AND 52).
FIRST USE 11-2-1999; IN COMMERCE 11-2-1999.

SN 76-368,230. PEPTIMMUNE, INC., CAMBRIDGE, MA.
FILED 2-7-2002.



NO CLAIM IS MADE TO THE EXCLUSIVE RIGHT TO
USE "INCORPORATED", APART FROM THE MARK AS
SHOWN.
FOR PHARMACEUTICAL COMPOSITIONS FOR THE
MODULATION OF ALLERGIC, IMMUNE OR AUTOIM-
MUNE RESPONSES (U.S. CLS. 6, 18, 44, 46, 51 AND 52).

CLASS 5—(Continued).

SN 76-368,590. AMYLIN PHARMACEUTICALS, INC., SAN DIEGO, CA. FILED 2-8-2002.

ESYMLIN

FOR PHARMACEUTICAL PREPARATIONS USEFUL IN THE TREATMENT OF METABOLIC DISORDERS (U.S. CLS. 6, 18, 44, 46, 51 AND 52).

SN 76-369,203. PLAYTIME LABS INC, SUNNY ISLE BEACH, FL. FILED 2-11-2002.

SQUEEZE H2O

FOR MEDICAL LUBRICANT, NAMELY, VAGINAL LUBRICANTS (U.S. CLS. 6, 18, 44, 46, 51 AND 52).

SN 76-373,670. TWIN LABORATORIES INC., NEW YORK, NY. FILED 2-25-2002.

CARB DEFENSE

NO CLAIM IS MADE TO THE EXCLUSIVE RIGHT TO USE "CARB", APART FROM THE MARK AS SHOWN.
FOR DIETARY SUPPLEMENTS (U.S. CLS. 6, 18, 44, 46, 51 AND 52).

SN 76-373,971. CLAY-PARK LABS, INC., BRONX, NY. AND AGIS GROUP, BNEI BRAK, ISRAEL, FILED 2-22-2002.

TRIDESILON

FOR MEDICINAL PREPARATIONS FOR EXTERNAL USE IN THE TREATMENT OF SKIN INFECTIONS AND OTHER SKIN IRRITATIONS (U.S. CLS. 6, 18, 44, 46, 51 AND 52).
FIRST USE 5-12-1970; IN COMMERCE 5-12-1970.

SN 76-373,978. HI-VIDOMIN LABORATORIES, INC., PITTSBURGH, PA. FILED 2-21-2002.

ABSORB LIFE FASTER

FOR NUTRITIONAL AND DIETARY SUPPLEMENTS (U.S. CLS. 6, 18, 44, 46, 51 AND 52).

CLASS 5—(Continued).

SN 76-374,289. LEV LABORATORIES LTD., GLENCOE, IL. FILED 2-22-2002.

OTALGIN

FOR PHARMACEUTICAL COMPOSITION, NAMELY, AN OTIC SOLUTION FOR TREATING EAR PAIN (U.S. CLS. 6, 18, 44, 46, 51 AND 52).

SN 76-374,448. SAFER, INC., LITITZ, PA. FILED 2-25-2002.

**CONCERN PESTICIDAL
SPRAY OIL**

OWNER OF U.S. REG. NOS. 1,560,449 AND 1,950,190.
NO CLAIM IS MADE TO THE EXCLUSIVE RIGHT TO USE "PESTICIDAL SPRAY OIL", APART FROM THE MARK AS SHOWN.
FOR PESTICIDES FOR AGRICULTURAL AND DOMESTIC USE (U.S. CLS. 6, 18, 44, 46, 51 AND 52).
FIRST USE 2-5-1999; IN COMMERCE 2-5-1999.

SN 76-376,395. ANBEX, INC., NEW YORK, NY. FILED 2-28-2002.

IOSAT

FOR PHARMACEUTICAL PREPARATIONS, NAMELY POTASSIUM IODIDE TABLETS FOR PREVENTING CANCER (U.S. CLS. 6, 18, 44, 46, 51 AND 52).
FIRST USE 0-0-1981; IN COMMERCE 0-0-1981.

SN 76-376,612. TFR CORPORATION, ROY, UT. FILED 2-27-2002.

HAIR OF THE DOG

FOR DIETARY AND NUTRITIONAL SUPPLEMENTS (U.S. CLS. 6, 18, 44, 46, 51 AND 52).

SN 76-376,992. ELLEN AB, STOCKHOLM, SWEDEN, FILED 3-1-2002.

VAGIPILLS

OWNER OF SWEDEN REG. NO. 352598, DATED 2-8-2002, EXPIRES 2-8-2012.

FOR PHARMACEUTICAL AND VETERINARY PREPARATIONS FOR TREATMENT AND/OR PREVENTION OF BACTERIAL VAGINOSES, VAGINAL MICROBIOLOGICAL DISORDERS, AND VAGINAL DISCHARGES AND ODORS AND FOR VAGINAL PH-REGULATION IN HUMANS AND OTHERS (U.S. CLS. 6, 18, 44, 46, 51 AND 52).

CLASS 5—(Continued).

SN 76-377,507. HARRY J. BOSWORTH COMPANY, SKOKIE, IL. FILED 3-4-2002.

AEGIS

FOR DENTAL CHEMICAL COMPOUND FOR USE IN THE FORTIFICATION OF TOOTH ENAMEL (U.S. CLS. 6, 18, 44, 46, 51 AND 52).

SN 76-377,855. PHARMAVITE CORPORATION, NORTH-RIDGE, CA. FILED 3-4-2002.

FIBERCLEAR

FOR DIETARY SUPPLEMENTS (U.S. CLS. 6, 18, 44, 46, 51 AND 52).

SN 76-378,434. JENERIC/PENTRON, INCORPORATED, WALLINGFORD, CT. FILED 3-4-2002.

AVANTE

FOR DENTAL ALLOYS FOR CONSTRUCTING IN-LAYS, CROWNS, BRIDGES AND THE LIKE (U.S. CLS. 6, 18, 44, 46, 51 AND 52).

SN 76-378,950. SOTERIA CORPORATION, WYOMING, MI. FILED 3-6-2002.

SO YOUNG

FOR DIETARY SUPPLEMENTS, NAMELY NON-PRESCRIPTION NUTRITION SUPPLEMENTS (U.S. CLS. 6, 18, 44, 46, 51 AND 52).
FIRST USE 10-6-2001; IN COMMERCE 10-6-2001.

SN 76-380,540. COLOPLAST A/S, DK-3050 HUMLEBAEK, DENMARK, FILED 3-11-2002.

SEASORB

OWNER OF U.S. REG. NO. 2,135,308.
FOR MEDICAL AND SURGICAL BANDAGES AND DRESSINGS, AND MEDICAL AND SURGICAL WOUND FILLING MATERIALS, NOT IN THE FORM OF POWDER (U.S. CLS. 6, 18, 44, 46, 51 AND 52).
FIRST USE 4-0-1996; IN COMMERCE 4-0-1996.

CLASS 5—(Continued).

SN 76-380,874. PLATTE CHEMICAL CO., FREMONT, NE. FILED 3-12-2002.



FOR PESTICIDAL OIL FOR TURF, ORNAMENTAL, DOMESTIC AND AGRICULTURAL USE (U.S. CLS. 6, 18, 44, 46, 51 AND 52).

SN 76-380,954. UNITED INDUSTRIES CORPORATION, ST. LOUIS, MO. FILED 3-12-2002.

TRIAZICIDE

FOR HERBICIDES, INSECTICIDES, PESTICIDES, FUNGICIDES, RODENTICIDES AND INSECT REPELLENTS FOR COMMERCIAL, DOMESTIC AND HOUSEHOLD USE (U.S. CLS. 6, 18, 44, 46, 51 AND 52).
FIRST USE 1-15-2002; IN COMMERCE 1-15-2002.

SN 76-382,457. PLATTE CHEMICAL CO., FREMONT, NE. FILED 3-13-2002.

GLACIAL

FOR PESTICIDAL OIL FOR TURF, ORNAMENTAL, DOMESTIC AND AGRICULTURAL USE (U.S. CLS. 6, 18, 44, 46, 51 AND 52).

SN 76-383,766. HOLLISTER INCORPORATED, LIBERTYVILLE, IL. FILED 3-14-2002.

CLEAN & MOIST

FOR ANTIMICROBIAL CLEANSERS AND SKIN BARRIER PREPARATIONS (U.S. CLS. 6, 18, 44, 46, 51 AND 52).

SN 76-383,995. SURGICAL SEALANTS, INC., WOBURN, MA. FILED 3-19-2002.

ARIDEX

FOR MEDICAL ADHESIVES FOR BINDING WOUNDS AND SEALING FLUID LEAKS (U.S. CLS. 6, 18, 44, 46, 51 AND 52).

CLASS 5—(Continued).

SN 76-383,996. SURGICAL SEALANTS, INC., WOBURN, MA.
FILED 3-19-2002.

THE BIG SHOT

FOR MEDICAL ADHESIVES FOR BINDING WOUNDS
AND SEALING FLUID LEAKS (U.S. CLS. 6, 18, 44, 46, 51
AND 52).

SN 76-383,997. SURGICAL SEALANTS, INC., WOBURN, MA.
FILED 3-19-2002.

DURANEX

FOR MEDICAL ADHESIVES FOR BINDING WOUNDS
AND SEALING FLUID LEAKS (U.S. CLS. 6, 18, 44, 46, 51
AND 52).

SN 76-383,998. SURGICAL SEALANTS, INC., WOBURN, MA.
FILED 3-19-2002.

SEALIX

FOR MEDICAL ADHESIVES FOR BINDING WOUNDS
AND SEALING FLUID LEAKS (U.S. CLS. 6, 18, 44, 46, 51
AND 52).

SN 76-383,999. SURGICAL SEALANTS, INC., WOBURN, MA.
FILED 3-19-2002.

THOREX

FOR MEDICAL ADHESIVES FOR BINDING WOUNDS
AND SEALING FLUID LEAKS (U.S. CLS. 6, 18, 44, 46, 51
AND 52).
FIRST USE 9-17-2001; IN COMMERCE 9-17-2001.

SN 76-384,006. MERCK & CO., INC., WHITEHOUSE STA-
TION, NJ. FILED 3-15-2002.

VERSAVAX

FOR VACCINE PREPARATIONS (U.S. CLS. 6, 18, 44,
46, 51 AND 52).

CLASS 5—(Continued).

SN 76-384,166. BIOLAB SERVICES, INC., WILMINGTON, DE.
FILED 3-20-2002.

NICE N CLEAR

FOR ALGAECIDE FOR SWIMMING POOLS AND
SPAS (U.S. CLS. 6, 18, 44, 46, 51 AND 52).
FIRST USE 10-8-1982; IN COMMERCE 1-17-1983.

SN 76-384,206. SCHERING-PLOUGH VETERINARY COR-
PORATION, RENO, NV. FILED 3-15-2002.

MYOSEL

OWNER OF U.S. REG. NO. 2,048,299.
FOR VETERINARY VITAMIN AND MINERAL PRE-
PARATIONS TO PREVENT AND TREAT DEFICIENCIES
IN LIVESTOCK AND HORSES (U.S. CLS. 6, 18, 44, 46, 51
AND 52).

SN 76-384,569. KAKWA BIOFARM, INC., FREDERICK, MD.
FILED 3-20-2002.

MALARTIN

FOR PHARMACEUTICAL PRODUCTS HAVING ANTI-
INFECTIVE PROPERTIES AGAINST MALARIA AND
OTHER PARASITIC AGENTS (U.S. CLS. 6, 18, 44, 46, 51
AND 52).

SN 76-384,658. ADAMS LABORATORIES, INC., FORT
WORTH, TX. FILED 3-20-2002.

SINEFEC

FOR PHARMACEUTICAL PREPARATIONS FOR RE-
SPIRATORY THERAPY (U.S. CLS. 6, 18, 44, 46, 51 AND
52).

SN 76-388,781. DEER, RICHARD A., CARMEL, IN. FILED 3-
29-2002.

TOP GUN PLUS

FOR DIETARY SUPPLEMENT (U.S. CLS. 6, 18, 44, 46,
51 AND 52).

CLASS 5—(Continued).

SN 76-390,059. GOWAN COMPANY, L.L.C., YUMA, AZ. FILED 3-29-2002.

MSR

FOR AGRICULTURAL CHEMICALS; NAMELY, SYSTEMIC INSECTICIDES (U.S. CLS. 6, 18, 44, 46, 51 AND 52).

SN 78-017,358. PHARMACIA CORPORATION, SKOKIE, IL. FILED 7-19-2000.

ZYLID

FOR PHARMACEUTICAL PREPARATIONS, NAMELY PREPARATIONS FOR THE TREATMENT OF INFECTIOUS DISEASES; CANCER; OPHTHALMOLOGIC CONDITIONS AND DISEASES; CENTRAL NERVOUS SYSTEMS DISEASES AND DISORDERS; PARKINSON'S DISEASE; CARDIOVASCULAR DISEASES AND CONDITIONS; MIGRAINES; PREPARATIONS FOR THE TREATMENT AND SYMPTOMS OF DIABETES; PREPARATIONS FOR THE TREATMENT OF GYNECOLOGIC DISORDERS AND DISEASES; HORMONAL PREPARATIONS; ANALGESICS, ANTI-INFLAMMATORY PHARMACEUTICAL PREPARATIONS (U.S. CLS. 6, 18, 44, 46, 51 AND 52).

SN 78-018,825. USA NUTRITIONALS, INC., DEER PARK, NY. FILED 7-28-2000.

ADVANCED YOHIMBE 2000

NO CLAIM IS MADE TO THE EXCLUSIVE RIGHT TO USE "YOHIMBE", APART FROM THE MARK AS SHOWN. FOR DIETARY AND NUTRITIONAL SUPPLEMENTS (U.S. CLS. 6, 18, 44, 46, 51 AND 52).

CLASS 5—(Continued).

SN 78-024,884. MUSCLE MARKETING U.S.A. INC., VANCOUVER, BRITISH COLUMBIA V7W3H1, CANADA, FILED 9-7-2000.

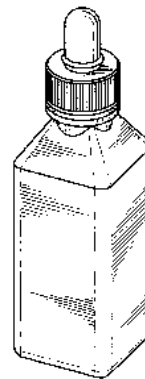

THE STIPLING IN THE MARK APPLICATION DRAWING IS NOT A FEATURE OF THE MARK BUT IS THERE TO SHOW THE THREE DIMENSIONAL NATURE OF THE MARK.

THE MARK CONSISTS OF A CONFIGURATION OF A BOTTLE AS CONTAINER FOR GOODS.

SEC. 2(F).
FOR DIETARY SUPPLEMENTS (U.S. CLS. 6, 18, 44, 46, 51 AND 52).
FIRST USE 1-3-1996; IN COMMERCE 1-3-1996.

SN 78-041,195. D'IPPOLITO, ELAINE, PEORIA, AZ. FILED 12-31-2000.

ACCIDENT INSURANCE

FOR INCONTINENCE PADS, PREMOISTENED MEDICATED WIPES (U.S. CLS. 6, 18, 44, 46, 51 AND 52).

SN 78-059,360. NASH, ALAN E., CANTON, MA. FILED 4-19-2001.

SCIVOLUTIONS

FOR ADHESIVE BANDAGES FOR USE ON SKIN FOR NATURAL HEALING OF SKIN WOUNDS; TRANSDERMAL PATCHES FOR USE WITH SEMI-SOLID ANTIBIOTIC MEDICATION FOR HEALING SKIN WOUNDS; SURGICAL BANDAGES (U.S. CLS. 6, 18, 44, 46, 51 AND 52).

CLASS 5—(Continued).

SN 78-061,051. GANDHI, HASMUKH K., TAMPA, FL. FILED 4-30-2001.

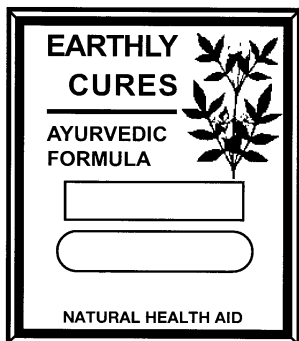

NO CLAIM IS MADE TO THE EXCLUSIVE RIGHT TO USE "AYURVEDIC FORMULA" AND "NATURAL HEALTH AID", APART FROM THE MARK AS SHOWN.

THE MARK CONSISTS OF THE ENTIRE LABEL AS IT APPEARS WITH THE STYLIZED BORDER, THE HERBAL PLANT, THE LAYOUT AND DESIGN OF THE TEXT, AND THE LITERAL ELEMENT "EARTHLY CURES. AYURVEDIC FORMULA. NATURAL HEALTH AID".

FOR DIETARY AND HERBAL SUPPLEMENTS (U.S. CLS. 6, 18, 44, 46, 51 AND 52).
FIRST USE 3-12-2000; IN COMMERCE 4-12-2001.

SN 78-063,111. NOVOLYTIC, EDMONTON, CANADA, FILED 5-11-2001.

OXYRAD

FOR PHARMACEUTICAL PREPARATIONS FOR USE IN CANCERY THERAPY, EXCLUDING ACNE PREPARATIONS (U.S. CLS. 6, 18, 44, 46, 51 AND 52).

SN 78-067,290. OTO-MED, INC., LAKE HAVASU CITY, AZ. FILED 6-4-2001.

GLASSCOCK

SEC. 2(F).
FOR SURGICAL DRESSINGS (U.S. CLS. 6, 18, 44, 46, 51 AND 52).
FIRST USE 1-31-1978; IN COMMERCE 1-31-1978.

SN 78-080,627. MOTTALE, SIMA, CH-6900 LUGANO, SWITZERLAND, AND BASEVI, GIORDANO, TRIVOLIZO(PAVIA), ITALY, FILED 8-22-2001.

LADYGENIC

FOR SANITARY PRODUCTS, NAMELY, URINAL FUNNELS, NAMELY, DISPOSABLE PRODUCTS MAINLY MADE OF PAPER, PLASTIC TO BE DAILY USED BY WOMEN FOR PERSONAL HYGIENE (U.S. CLS. 6, 18, 44, 46, 51 AND 52).

CLASS 5—(Continued).

SN 78-081,173. FRITZ, BOB, MARTINEZ, CA. FILED 8-26-2001.

PRIMAL PROTEIN

NO CLAIM IS MADE TO THE EXCLUSIVE RIGHT TO USE "PROTEIN", APART FROM THE MARK AS SHOWN.
FOR NUTRITIONAL SUPPLEMENT CONTAINING MILK DERIVED INGREDIENTS, NAMELY MILK PROTEIN, WHEY CONCENTRATES AND MILK CASEINS AND CASEINATES, PATTERNED AFTER HUMAN MILK (U.S. CLS. 6, 18, 44, 46, 51 AND 52).

SN 78-081,693. NOVARTIS AG, CH-4002 BASEL, SWITZERLAND, FILED 8-29-2001.

NOVICRIT

PRIORITY CLAIMED UNDER SEC. 44(D) ON SWITZERLAND APPLICATION NO. 08040/2001, FILED 8-15-2001, REG. NO. 489073, DATED 8-15-2001, EXPIRES 8-15-2011.

FOR PHARMACEUTICAL PREPARATIONS FOR THE TREATMENT OF DISEASES AND DISORDERS OF THE CENTRAL NERVOUS, IMMUNE, MUSCULOSKELETAL, CARDIOVASCULAR, AND RESPIRATORY SYSTEMS, AND FOR USE IN ONCOLOGY; PHARMACEUTICAL PREPARATIONS FOR THE TREATMENT OF BLOOD AND BLOOD FORMING ORGANS (U.S. CLS. 6, 18, 44, 46, 51 AND 52).

SN 78-081,973. FRITZ, BOB, MARTINEZ, CA. FILED 8-30-2001.

CAVEMAN DIET

NO CLAIM IS MADE TO THE EXCLUSIVE RIGHT TO USE "DIET", APART FROM THE MARK AS SHOWN.
FOR DIETARY FOOD SUPPLEMENTS CONSISTING OF FRESH, CANNED, FROZEN, OR DRIED FRUITS, NUTS, SEEDS, BERRIES, VEGETABLES AND MEAT PRODUCTS (U.S. CLS. 6, 18, 44, 46, 51 AND 52).

SN 78-084,490. SYNGENTA PARTICIPATIONS AG, BASEL, SWITZERLAND, FILED 9-19-2001.

ACTION

FOR AGRICULTURAL HERBICIDE (U.S. CLS. 6, 18, 44, 46, 51 AND 52).

CLASS 5—(Continued).

SN 78-086,240. GENYOUIS, INC., PORTLAND, OR. FILED 9-30-2001.

PROVITA

FOR PHARMACEUTICAL PREPARATION COMPOSED OF NATURAL PRODUCTS, MARINE ORGANISMS, PHYTOPHARMACEUTICALS AND SYNTHETIC PRODUCTS FOR THE TREATMENT AND PREVENTION OF CANCER (U.S. CLS. 6, 18, 44, 46, 51 AND 52).

SN 78-086,319. WARNER-LAMBERT COMPANY, MORRIS PLAINS, NJ. FILED 10-1-2001.

KILL THE GERMS. FEEL THE CLEAN.

FOR MEDICATED MOUTHRINSES AND BREATH FRESHENERS (U.S. CLS. 6, 18, 44, 46, 51 AND 52).

SN 78-086,433. NHK LABORATORIES, INC., SANTA FE SPRINGS, CA. FILED 10-2-2001.



THE LETTERING "PARASON" IS IN BLACK AND THE LEAFY DESIGN IS GREEN.
FOR VITAMINS AND DIETARY SUPPLEMENTS (U.S. CLS. 6, 18, 44, 46, 51 AND 52).

SN 78-089,441. VITAMIN SCIENCE, INC., HUNTINGTON, NY. FILED 10-22-2001.

VISIVITE

FOR VITAMIN SUPPLEMENT TO PROMOTE RETINAL HEALTH IN ELDERLY PEOPLE (U.S. CLS. 6, 18, 44, 46, 51 AND 52).

CLASS 5—(Continued).

SN 78-090,575. BRISTOL-MYERS SQUIBB COMPANY, NEW YORK, NY. FILED 10-29-2001.

TASPEX

FOR PHARMACEUTICAL PREPARATIONS FOR THE TREATMENT AND PREVENTION OF CARDIOVASCULAR DISEASES, CENTRAL NERVOUS SYSTEM DISEASES, STROKE, CANCER, INFLAMMATION AND INFLAMMATORY DISEASES, RESPIRATORY AND INFECTIOUS DISEASES, AUTO-IMMUNE DISEASES, ANTIBIOTICS (U.S. CLS. 6, 18, 44, 46, 51 AND 52).

SN 78-090,579. BRISTOL-MYERS SQUIBB COMPANY, NEW YORK, NY. FILED 10-29-2001.

PRAVIGARD

FOR PHARMACEUTICAL PREPARATIONS FOR THE TREATMENT AND PREVENTION OF CARDIOVASCULAR DISEASES, CENTRAL NERVOUS SYSTEM DISEASES AND DISORDERS, STROKE, CANCER, INFLAMMATION AND INFLAMMATORY DISEASES, RESPIRATORY AND INFECTIOUS DISEASES, AUTO-IMMUNE DISEASES, ANTIBIOTICS (U.S. CLS. 6, 18, 44, 46, 51 AND 52).

SN 78-091,210. HARBOR DENTAL BLEACHING GROUP, INC., SANTA BARBARA, CA. FILED 11-1-2001.

SEPTEX

FOR ALL PURPOSE DISINFECTANTS; SANITIZERS FOR HOUSEHOLD, HOSPITAL, INSTITUTIONAL AND INDUSTRIAL USES (U.S. CLS. 6, 18, 44, 46, 51 AND 52).

SN 78-092,740. NOVARTIS AG, BASEL, SWITZERLAND, FILED 11-12-2001.



OWNER OF U.S. REG. NOS. 517,928 AND 1,149,578.
FOR PHARMACEUTICAL PREPARATIONS FOR THE TREATMENT OF CENTRAL NERVOUS SYSTEM DISEASES AND DISORDERS (U.S. CLS. 6, 18, 44, 46, 51 AND 52).

CLASS 5—(Continued).

SN 78-094,320. SMITHKLINE BEECHAM CORPORATION, PHILADELPHIA, PA. FILED 11-20-2001.

QUITSTEP

OWNER OF U.S. REG. NOS. 2,228,409, 2,307,853 AND OTHERS.

FOR SMOKING CESSATION PREPARATIONS (U.S. CLS. 6, 18, 44, 46, 51 AND 52).

SN 78-097,500. BAYER CORPORATION, PITTSBURGH, PA. FILED 12-10-2001.

ASCENTIAL

FOR MEDICAL DIAGNOSTIC REAGENTS FOR THE ANALYSIS OF BODY FLUIDS (U.S. CLS. 6, 18, 44, 46, 51 AND 52).

SN 78-099,802. REMARKABLE WOMEN, INC., WARSAW, NC. FILED 12-22-2001.



NO CLAIM IS MADE TO THE EXCLUSIVE RIGHT TO USE "THE WEIGHT LOSS CENTER", APART FROM THE MARK AS SHOWN.

FOR DIETARY FOOD SUPPLEMENTS (U.S. CLS. 6, 18, 44, 46, 51 AND 52).

FIRST USE 2-1-1999; IN COMMERCE 2-1-1999.

SN 78-100,502. BOTANICAL SOLUTIONS INC., SOUTHAMP-
TON, NY. FILED 1-2-2002.

BITE GUARD JR

FOR INSECT REPELLENT FOR HUMAN USE IN SPRAY, LOTION, OR TOWELETTE FORM FOR APPLICATION ON SKIN OR CLOTHING (U.S. CLS. 6, 18, 44, 46, 51 AND 52).

SN 78-100,885. PURDUE PHARMA, L.P., STAMFORD, CT. FILED 1-4-2002.

OXYNOR

FOR PREPARATION FOR THE RELIEF OF PAIN (U.S. CLS. 6, 18, 44, 46, 51 AND 52).

CLASS 5—(Continued).

SN 78-100,942. VITA CUBE SYSTEMS, INC., DENVER, CO. FILED 1-4-2002.

AO ELITE

NO CLAIM IS MADE TO THE EXCLUSIVE RIGHT TO USE "AO", APART FROM THE MARK AS SHOWN.

FOR DIETARY SUPPLEMENTS, NAMELY AMINO ACIDS FORMULATED FOR CARDIOVASCULAR SUPPORT (U.S. CLS. 6, 18, 44, 46, 51 AND 52).

SN 78-101,008. VITA CUBE SYSTEMS, INC., DENVER, CO. FILED 1-4-2002.

M32 +

FOR DIETARY SUPPLEMENTS, NAMELY MULTI-VITAMINS (U.S. CLS. 6, 18, 44, 46, 51 AND 52).

SN 78-102,760. PFIZER INC., NEW YORK, NY. FILED 1-15-2002.

RELNEU

FOR PHARMACEUTICAL PREPARATIONS FOR THE TREATMENT OF CARDIOVASCULAR DISEASE, CENTRAL NERVOUS SYSTEM DISEASES AND DISORDERS, NEUROLOGICAL DISORDERS, UROLOGICAL, UROGENITAL AND URINARY DISORDERS, GASTROINTESTINAL DISORDERS, MUSCULOSKELETAL DISORDERS, ALLERGIES, DIABETES, HYPERTENSION, ERECTILE DYSFUNCTION, SEXUAL DYSFUNCTION, STROKE, CANCER, MIGRAINES, PAIN, OBESITY, INFLAMMATION AND INFLAMMATORY DISEASES, RESPIRATORY AND INFECTIOUS DISEASES, AND IMMUNOLOGICAL, BACTERIAL, VIRAL AND FUNGAL DISORDERS; PHARMACEUTICAL PREPARATIONS, NAMELY, CHOLESTEROL REDUCING AND ENHANCING PREPARATIONS, SMOKING CESSATION PREPARATIONS, MEDICATED TISSUE AND SKIN REPAIR PREPARATIONS, DERMATOLOGICAL PREPARATIONS, PHARMACEUTICAL PREPARATIONS FOR THE PREVENTION AND TREATMENT OF STROKE AND ISCHEMIA (U.S. CLS. 6, 18, 44, 46, 51 AND 52).

SN 78-102,763. PFIZER INC., NEW YORK, NY. FILED 1-15-2002.

SUROND

FOR PHARMACEUTICAL PREPARATIONS FOR THE PREVENTION AND TREATMENT OF STROKE AND ISCHEMIA (U.S. CLS. 6, 18, 44, 46, 51 AND 52).

CLASS 5—(Continued).

SN 78-102,787. LA JOLLA PHARMACEUTICAL COMPANY, SAN DIEGO, CA. FILED 1-15-2002.

BSPRAN

FOR PHARMACEUTICAL PREPARATIONS FOR PREVENTION AND/OR TREATMENT OF ANTIBODY-MEDIATED DISEASES, NAMELY, SYSTEMIC LUPUS ERYTHEMATOSUS, RH HEMOLYTIC DISEASE OF THE NEWBORN, ANTIPHOSPHOLIPID ANTIBODY SYNDROME, GRAVE'S DISEASE, MYASTHENIA GRAVIS, HASHIMOTO'S THYROIDITIS, PEMPHIGUS, AUTOIMMUNE HEMOLYTIC ANEMIA, AUTOIMMUNE THROMBOCYTOPENIA PURPURA, ANTIBODY MEDIATED INFERTILITY, SJOGRE'S SYNDROME, MIXED CONNECTIVE TISSUE DISEASE, GLOMERULONEPHRITIS AND GOODPASTURE'S SYNDROME (U.S. CLS. 6, 18, 44, 46, 51 AND 52).

SN 78-102,995. LA JOLLA PHARMACEUTICAL COMPANY, SAN DIEGO, CA. FILED 1-16-2002.

PRESICA

FOR PHARMACEUTICAL PREPARATIONS FOR PREVENTION AND/OR TREATMENT OF ANTIBODY-MEDIATED DISEASES, NAMELY, SYSTEMIC LUPUS ERYTHEMATOSUS, RH HEMOLYTIC DISEASE OF THE NEWBORN, ANTIPHOSPHOLIPID ANTIBODY SYNDROME, GRAVE'S DISEASE, MYASTHENIA GRAVIS, HASHIMOTO'S THYROIDITIS, PEMPHIGUS, AUTOIMMUNE HEMOLYTIC ANEMIA, AUTOIMMUNE THROMBOCYTOPENIA PURPURA, ANTIBODY MEDIATED INFERTILITY, SJOGRE'S SYNDROME, MIXED CONNECTIVE TISSUE DISEASE, GLOMERULONEPHRITIS AND GOODPASTURE'S SYNDROME (U.S. CLS. 6, 18, 44, 46, 51 AND 52).

SN 78-103,796. YOUNG GRUPPE, INC., WASHINGTON, DC. FILED 1-21-2002.

ANXIETAMIN

FOR NUTRITIONAL AND HERBAL SUPPLEMENTS (U.S. CLS. 6, 18, 44, 46, 51 AND 52).

SN 78-103,797. YOUNG GRUPPE, INC., WASHINGTON, DC. FILED 1-21-2002.

ARTHRITAMIN

FOR NUTRITIONAL AND HERBAL SUPPLEMENTS (U.S. CLS. 6, 18, 44, 46, 51 AND 52).

CLASS 5—(Continued).

SN 78-104,630. SARATI INTERNATIONAL INC., LOS FRESNOS, TX. FILED 1-24-2002.

**COGNITIVE THERAPY
COMPLEX**

NO CLAIM IS MADE TO THE EXCLUSIVE RIGHT TO USE "THERAPY COMPLEX", APART FROM THE MARK AS SHOWN.

FOR VITAMINS AND DIETARY FOOD SUPPLEMENTS (U.S. CLS. 6, 18, 44, 46, 51 AND 52).

SN 78-104,806. AKORN, INC., BUFFALO GROVE, IL. FILED 1-25-2002.

OCUSHIELD

FOR VITAMIN AND MINERAL SUPPLEMENTS (U.S. CLS. 6, 18, 44, 46, 51 AND 52).

SN 78-104,820. DIAL BRANDS, INC., SCOTTSDALE, AZ. FILED 1-25-2002.

STAR SPANGLED BERRY

NO CLAIM IS MADE TO THE EXCLUSIVE RIGHT TO USE BERRY, APART FROM THE MARK AS SHOWN.

FOR AIR FRESHENERS, CARPET FRESHENERS AND ROOM DEODORIZERS (U.S. CLS. 6, 18, 44, 46, 51 AND 52).

SN 78-105,125. IBD, LLC, BOULDER, CO. FILED 1-28-2002.

SANTERX

THE FOREIGN WORDING "SANTE" TRANSLATES INTO ENGLISH AS "HEALTH".

FOR NON-PRESCRIPTION DIETARY, NUTRITIONAL, AND HOMEOPATHIC SUPPLEMENTS CONSISTING OF COMBINATIONS OF VITAMINS, MINERAL COMPOUNDS, HERBAL EXTRACTS AND/OR OTHER NUTRIENTS (U.S. CLS. 6, 18, 44, 46, 51 AND 52).

SN 78-106,137. AMERICAN SUPERIOR FEEDS, INC., ARDMORE, OK. FILED 1-31-2002.

BLUEBONNET FARMS

OWNER OF U.S. REG. NOS. 1,178,396, 1,963,402 AND 1,963,455.

FOR ANIMAL FEED ADDITIVE FOR USE AS A NUTRITIONAL SUPPLEMENT; MEDICATED ANIMAL FEEDS; NUTRITIONAL ADDITIVES FOR LIVESTOCK FEEDS AND PET FOODS (U.S. CLS. 6, 18, 44, 46, 51 AND 52).

CLASS 5—(Continued).

SN 78-107,614. LIFESOURCE INTERNATIONAL, INC., GLEN COVE, NY. FILED 2-8-2002.

RIPPED NOW!

FOR DIETARY SUPPLEMENTS (U.S. CLS. 6, 18, 44, 46, 51 AND 52).

SN 78-108,024. BENGAL PRODUCTS, INC., BATON ROUGE, LA. FILED 2-11-2002.



OWNER OF U.S. REG. NOS. 1,413,937, 1,516,195 AND 2,346,785.

FOR INSECTICIDES FOR DOMESTIC USE (U.S. CLS. 6, 18, 44, 46, 51 AND 52).
FIRST USE 3-1-1998; IN COMMERCE 3-1-1998.

SN 78-108,055. PREMIER PHARMACY INC., KATY, TX. FILED 2-11-2002.

BELLAFEM

FOR HORMONES (U.S. CLS. 6, 18, 44, 46, 51 AND 52).

SN 78-108,229. RANBAXY LABORATORIES LIMITED, NEW DELHI, INDIA, FILED 2-12-2002.

ROLEXIN

FOR ANTIBIOTIC PHARMACEUTICAL AND MEDICINAL PREPARATION; ANTIBIOTIC VETERINARY PHARMACEUTICAL AND MEDICINAL PREPARATION FOR USE IN DOMESTIC PETS AND LIVESTOCK (U.S. CLS. 6, 18, 44, 46, 51 AND 52).

SN 78-108,236. RANBAXY LABORATORIES LIMITED, NEW DELHI, INDIA, FILED 2-12-2002.

RIOLEXIN

FOR ANTIBIOTIC PHARMACEUTICAL AND MEDICINAL PREPARATION; ANTIBIOTIC VETERINARY PHARMACEUTICAL AND MEDICINAL PREPARATION FOR USE IN DOMESTIC PETS AND LIVESTOCK (U.S. CLS. 6, 18, 44, 46, 51 AND 52).

CLASS 5—(Continued).

SN 78-110,145. SYNGENTA PARTICIPATIONS AG, BASEL, SWITZERLAND, FILED 2-21-2002.

TOPIK

FOR AGRICULTURAL HERBICIDE (U.S. CLS. 6, 18, 44, 46, 51 AND 52).

SN 78-110,221. PURDUE PHARMA L.P., STAMFORD, CT. FILED 2-21-2002.

VICONTIN

FOR PREPARATION FOR THE RELIEF OF PAIN (U.S. CLS. 6, 18, 44, 46, 51 AND 52).

SN 78-112,003. SYNGENTA PARTICIPATIONS AG, BASEL, SWITZERLAND, FILED 3-1-2002.

ACTEND

FOR HERBICIDES FOR AGRICULTURAL USE (U.S. CLS. 6, 18, 44, 46, 51 AND 52).

SN 78-112,683. NOVARTIS AG, BASEL, SWITZERLAND, FILED 3-5-2002.

GLUTASOLVE

FOR NUTRITIONAL SUPPLEMENTS (U.S. CLS. 6, 18, 44, 46, 51 AND 52).
FIRST USE 7-0-2001; IN COMMERCE 7-0-2001.

SN 78-113,227. NOVARTIS AG, BASEL, SWITZERLAND, FILED 3-7-2002.

DIABETISHIELD

FOR NUTRITIONAL SUPPLEMENTS (U.S. CLS. 6, 18, 44, 46, 51 AND 52).

SN 78-113,256. WALING, RONALD G., REDMOND, WA. FILED 3-7-2002.

TRIM IMAGES

FOR DIETARY SUPPLEMENT USED FOR PROTEIN MEAL REPLACEMENT AND WEIGHT LOSS (U.S. CLS. 6, 18, 44, 46, 51 AND 52).

CLASS 5—(Continued).

SN 78-113,265. WALING, RONALD G., REDMOND, WA. FILED 3-7-2002.

ENGARDE

FOR DIETARY SUPPLEMENT USED FOR IMMUNE SYSTEM ENHANCEMENT (U.S. CLS. 6, 18, 44, 46, 51 AND 52).

SN 78-113,346. ALWAYS B.B. INT'L., INC., LOS ANGELES, CA. FILED 3-7-2002.

ALWAYS BB

FOR MULTI-VITAMIN FOR THE SKIN AND HAIR (U.S. CLS. 6, 18, 44, 46, 51 AND 52). FIRST USE 11-25-2001; IN COMMERCE 11-25-2001.

SN 78-113,577. ENTREMED, INC., ROCKVILLE, MD. FILED 3-8-2002.

VASCULOSTATIN

FOR PHARMACEUTICAL PREPARATIONS, NAMELY, ANGIOGENESIS INHIBITOR PROTEIN COMPOSITIONS FOR THE TREATMENT OF DISEASE AND BIOLOGICAL PROCESSES THAT ARE MEDIATED BY ANGIOGENESIS, NAMELY, CANCER, MACULAR DEGENERATION, DIABETIC RETINOPATHY, CROHN'S DISEASE, PSORIASIS AND ARTHRITIS (U.S. CLS. 6, 18, 44, 46, 51 AND 52).

SN 78-113,893. WARNER-LAMBERT COMPANY, MORRIS PLAINS, NJ. FILED 3-11-2002.

ZANTAC AP

OWNER OF U.S. REG. NOS. 1,220,525, 2,016,139 AND OTHERS.

NO CLAIM IS MADE TO THE EXCLUSIVE RIGHT TO USE "AP", APART FROM THE MARK AS SHOWN.

FOR PHARMACEUTICAL PREPARATIONS AND SUBSTANCES FOR THE TREATMENT OF GASTROINTESTINAL DISORDERS (U.S. CLS. 6, 18, 44, 46, 51 AND 52).

SN 78-113,899. MONSANTO TECHNOLOGY LLC, ST. LOUIS, MO. FILED 3-11-2002.

POSILAC PLUS

OWNER OF U.S. REG. NOS. 1,490,791 AND 2,358,120. FOR ANIMAL PRODUCTION EFFICIENCY ENHANCING PREPARATION WHICH INCREASES MILK PRODUCTION AND IMPROVES FEEDING EFFICIENCY (U.S. CLS. 6, 18, 44, 46, 51 AND 52).

CLASS 5—(Continued).

SN 78-113,983. BAYER AKTIENGESELLSCHAFT, LEVERKUSEN-BAYERWERK, FED REP GERMANY, FILED 3-11-2002.

NUVIVEQ

OWNER OF U.S. REG. NO. 2,503,742.

FOR PHARMACEUTICAL PREPARATIONS FOR THE TREATMENT OF SEXUAL DYSFUNCTION, CARDIOVASCULAR DISEASES, CENTRAL NERVOUS SYSTEM DISEASES, CANCER, RESPIRATORY AND INFECTIOUS DISEASES; MEDICAL DIAGNOSTIC REAGENTS (U.S. CLS. 6, 18, 44, 46, 51 AND 52).

SN 78-113,989. BAYER AKTIENGESELLSCHAFT, LEVERKUSEN-BAYERWERK, FED REP GERMANY, FILED 3-11-2002.

NUVIVO

OWNER OF U.S. REG. NO. 2,503,742.

FOR PHARMACEUTICAL PREPARATIONS FOR THE TREATMENT OF SEXUAL DYSFUNCTION, CARDIOVASCULAR DISEASES, CENTRAL NERVOUS SYSTEM DISEASES, CANCER, RESPIRATORY AND INFECTIOUS DISEASES; MEDICAL DIAGNOSTIC REAGENTS (U.S. CLS. 6, 18, 44, 46, 51 AND 52).

SN 78-113,994. BAYER AKTIENGESELLSCHAFT, LEVERKUSEN-BAYERWERK, FED REP GERMANY, FILED 3-11-2002.

NUVIVEX

OWNER OF U.S. REG. NO. 2,503,742.

FOR PHARMACEUTICAL PREPARATIONS FOR THE TREATMENT OF SEXUAL DYSFUNCTION, CARDIOVASCULAR DISEASES, CENTRAL NERVOUS SYSTEM DISEASES, CANCER, RESPIRATORY AND INFECTIOUS DISEASES; MEDICAL DIAGNOSTIC REAGENTS (U.S. CLS. 6, 18, 44, 46, 51 AND 52).

SN 78-114,007. BAYER AKTIENGESELLSCHAFT, LEVERKUSEN-BAYERWERK, FED REP GERMANY, FILED 3-11-2002.

NUVIVAR

FOR PHARMACEUTICAL PREPARATIONS FOR THE TREATMENT OF SEXUAL DYSFUNCTION, CARDIOVASCULAR DISEASES, CENTRAL NERVOUS SYSTEM DISEASES, CANCER, RESPIRATORY AND INFECTIOUS DISEASES, DIAGNOSTIC REAGENTS ADAPTED FOR MEDICAL USE (U.S. CLS. 6, 18, 44, 46, 51 AND 52).

CLASS 5—(Continued).

SN 78-114,044. FOREST LABORATORIES, INC., NEW YORK, NY. FILED 3-11-2002.

RASERA

FOR PHARMACEUTICAL PREPARATIONS FOR THE TREATMENT OF ALZHEIMER'S DISEASE, DEMENTIA, AIDS-RELATED DEMENTIA, CNS, NEUROPATHIC PAIN, DIABETIC NEUROPATHY, NEUROLOGICAL DISORDERS, NEURODEGENERATIVE DISORDERS, AND/OR DEPRESSION; NEUROPROTECTIVE AGENT (U.S. CLS. 6, 18, 44, 46, 51 AND 52).

SN 78-114,048. FOREST LABORATORIES, INC., NEW YORK, NY. FILED 3-11-2002.

SPAGEN

FOR PHARMACEUTICAL PREPARATIONS FOR THE TREATMENT OF ALZHEIMER'S DISEASE, DEMENTIA, AIDS-RELATED DEMENTIA, CNS, NEUROPATHIC PAIN, DIABETIC NEUROPATHY, NEUROLOGICAL DISORDERS, NEURODEGENERATIVE DISORDERS, AND/OR DEPRESSION; NEUROPROTECTIVE AGENT (U.S. CLS. 6, 18, 44, 46, 51 AND 52).

SN 78-114,348. SMITHKLINE BEECHAM CORPORATION, PHILADELPHIA, PA. FILED 3-12-2002.

OXICORT

FOR PHARMACEUTICAL PREPARATIONS FOR THE TREATMENT OF INFECTIOUS DISEASES, PAIN, INFLAMMATION, SEPSIS, ALOPECIA AND OBESITY, AND FOR THE TREATMENT OF METABOLIC, MUSCULOSKELETAL, CARDIOVASCULAR, CARDIOPULMONARY, GENITOURINARY, ONCOLOGICAL, RESPIRATORY, NEUROLOGICAL, GASTROINTESTINAL, HORMONAL, DERMATOLOGICAL AND PSYCHIATRIC RELATED DISEASES AND DISORDERS AND SKIN AND TISSUE REPAIR PREPARATIONS (U.S. CLS. 6, 18, 44, 46, 51 AND 52).

SN 78-114,519. SMITHKLINE BEECHAM CORPORATION, PHILADELPHIA, PA. FILED 3-13-2002.

MEMRIC

OWNER OF U.S. REG. NO. 1,949,290.
FOR PHARMACEUTICALS TO TREAT DISEASES AND DISORDERS OF THE CENTRAL NERVOUS SYSTEM (U.S. CLS. 6, 18, 44, 46, 51 AND 52).

CLASS 5—(Continued).

SN 78-114,824. SIMMONS FOODS, INC., SILOAM SPRINGS, AR. FILED 3-14-2002.

PRO*CAL

FOR ANIMAL FEED ADDITIVE FOR USE AS A NUTRITIONAL SUPPLEMENT (U.S. CLS. 6, 18, 44, 46, 51 AND 52).

SN 78-114,843. BAYER CORPORATION, PITTSBURGH, PA. FILED 3-14-2002.

ASCENSIA ELITE

FOR DIAGNOSTIC REAGENTS AND ASSAYS FOR THE ANALYSIS OF BODY FLUIDS (U.S. CLS. 6, 18, 44, 46, 51 AND 52).

SN 78-114,923. PFIZER INC., NEW YORK, NY. FILED 3-14-2002.

REFLECTION

FOR VETERINARY PREPARATION, NAMELY AN EQUINE WORMER (U.S. CLS. 6, 18, 44, 46, 51 AND 52).

SN 78-114,943. MEDIQUEST THERAPEUTICS, INC., SEATTLE, WA. FILED 3-14-2002.

MEDIQUEST

FOR SMALL MOLECULE PHARMACEUTICALS AND CHEMICALS FOR THE DETECTION AND TREATMENT OF DISEASES (U.S. CLS. 6, 18, 44, 46, 51 AND 52).

SN 78-114,947. MEDIQUEST THERAPEUTICS, INC., SEATTLE, WA. FILED 3-14-2002.

IMMUNOQUEST

FOR SMALL MOLECULE PHARMACEUTICALS AND CHEMICALS FOR THE DETECTION AND TREATMENT OF AUTOIMMUNE DISEASES (U.S. CLS. 6, 18, 44, 46, 51 AND 52).

CLASS 5—(Continued).

SN 78-114,952. MEDIQUEST THERAPEUTICS, INC., SEATTLE, WA. FILED 3-14-2002.

NEUROQUEST

FOR SMALL MOLECULE PHARMACEUTICALS AND CHEMICALS FOR THE DETECTION AND TREATMENT OF CENTRAL NERVOUS SYSTEM DISEASES (U.S. CLS. 6, 18, 44, 46, 51 AND 52).

SN 78-115,537. BIOMODA, INC., PLACITAS, NM. FILED 3-18-2002.

PORVIDXCAN

FOR CANCER DIAGNOSTIC AGENT (U.S. CLS. 6, 18, 44, 46, 51 AND 52).

SN 78-115,538. PFIZER INC., NEW YORK, NY. FILED 3-18-2002.

NECTIV

FOR PHARMACEUTICAL PREPARATIONS FOR THE TREATMENT OF CARDIOVASCULAR DISEASE, CENTRAL NERVOUS SYSTEM DISEASES AND DISORDERS, NEUROLOGICAL DISORDERS, UROLOGICAL, UROGENITAL AND URINARY DISORDERS, GASTROINTESTINAL DISORDERS, MUSCULOSKELETAL DISORDERS, ALLERGIES, DIABETES, HYPERTENSION, ERECTILE DYSFUNCTION, SEXUAL DYSFUNCTION, CANCER, MIGRAINES, PAIN, OBESITY, INFLAMMATION AND INFLAMMATORY DISEASES, RESPIRATORY AND INFECTIOUS DISEASES, AND IMMUNOLOGICAL, BACTERIAL, VIRAL AND FUNGAL DISORDERS; PHARMACEUTICAL PREPARATIONS, NAMELY, CHOLESTEROL PREPARATIONS, SMOKING CESSATION PREPARATIONS, TISSUE AND SKIN REPAIR PREPARATIONS, DERMATOLOGICAL PREPARATIONS, AND GYNECOLOGICAL PREPARATIONS; PHARMACEUTICAL PREPARATION FOR THE PREVENTION AND TREATMENT OF STROKE AND ISCHEMIA (U.S. CLS. 6, 18, 44, 46, 51 AND 52).

SN 78-115,798. MEDTECH PRODUCTS, INC., NORWALK, CT. FILED 3-19-2002.

OUCH-AID

FOR ANTISEPTIC LIQUID APPLIED TO THE SKIN FOR USE AS A BANDAGE; ANTIBACTERIAL PHARMACEUTICAL FOR THE RELIEF OF SURFACE PAIN (U.S. CLS. 6, 18, 44, 46, 51 AND 52).

CLASS 5—(Continued).

SN 78-115,832. PREFERRED NUTRITION INC., HILLSBURGH ONTARIO, ONTARIO, FILED 3-19-2002.

FEMMOMEGA

FOR DIETARY AND NUTRITIONAL SUPPLEMENTS (U.S. CLS. 6, 18, 44, 46, 51 AND 52).

SN 78-116,217. HEALTH CATALOG, INC., CLEARWATER, FL. FILED 3-20-2002.

SOME VITAMINS ARE MORE EQUAL THAN OTHERS

FOR DIETARY SUPPLEMENTS (U.S. CLS. 6, 18, 44, 46, 51 AND 52).

SN 78-117,556. SARAMAR, L.L.C., CHICAGO, IL. FILED 3-26-2002.

LIQUIFRESH

FOR AIR FRESHENING, AIR DEODORIZING AND ODOR NEUTRALIZING PREPARATIONS FOR THE AIR (U.S. CLS. 6, 18, 44, 46, 51 AND 52).
FIRST USE 11-21-2001; IN COMMERCE 11-21-2001.

SN 78-117,689. COW TOWN GROUP, INC., CHICAGO, IL. FILED 3-26-2002.

METRECAL

FOR DIETARY DRINK MIX FOR USE AS A MEAL REPLACEMENT (U.S. CLS. 6, 18, 44, 46, 51 AND 52).

CLASS 6—METAL GOODS

SN 75-768,933. INTERPROVINCIAL CORROSION CONTROL COMPANY LIMITED, ONTARIO, CANADA, FILED 8-5-1999.

ISO-BLOC

OWNER OF CANADA REG. NO. TMA554621, DATED 11-29-2001, EXPIRES 11-29-2016.

OWNER OF U.S. REG. NO. 1,015,209.

FOR METAL PIPE CONNECTORS AND INSULATING JOINTS FOR CATHODIC PROTECTION (U.S. CLS. 2, 12, 13, 14, 23, 25 AND 50).

CLASS 6—(Continued).

SN 75-813,905. NON/COMPACT, INC., LUMBERTON, NC. FILED 10-4-1999.

RELIEF SUPPORT SYSTEMS

NO CLAIM IS MADE TO THE EXCLUSIVE RIGHT TO USE "SUPPORT SYSTEMS", APART FROM THE MARK AS SHOWN.

FOR METAL ROOFING SYSTEM PANELS, METAL THREADED FASTENERS AND METAL MOUNTING BRACKETS (U.S. CLS. 2, 12, 13, 14, 23, 25 AND 50).

SN 75-818,942. PULSE EFT ASSOCIATION., HOUSTON, TX. FILED 10-8-1999.

PULSE

OWNER OF U.S. REG. NOS. 1,225,326, 2,165,311 AND OTHERS.

FOR METAL KEY CHAINS (U.S. CLS. 2, 12, 13, 14, 23, 25 AND 50).

FIRST USE 4-2-1992; IN COMMERCE 4-2-1992.

SN 75-860,859. ZHONGSHAN STEEL PIPE INDUSTRIAL GROUP CORPORATION, GUANGDONG, CHINA, FILED 12-1-1999.



OWNER OF CHINA REG. NO. 939250, DATED 1-28-1997, EXPIRES 1-27-2007.

FOR STEEL PIPES, METAL TUBES, METAL CASTING PIPES, GALVANIZED METAL TUBES, METAL PIPES WITH ANTICORROSIVE COATING, FITTINGS FOR METAL TUBINGS, METAL SOCKETS, NAMELY METAL PIPE CONNECTORS, MANUALLY OPERATED METAL VALVES, METAL TUBES FOR AIR-DRAUGHT AND AIR-CONDITIONING SETS, METAL CONSTRUCTIVE APPARATUS, NAMELY METAL PIPES USED IN BUILDING CONSTRUCTION, METAL PREFABRICATED COMPONENTS, NAMELY, METAL SCAFFOLDS, METAL POSTS, METAL WINDOWS, METAL DOORS, METAL STAIRCASE, METAL SHEDS, METAL WIRE-POST AND METAL WIRE FENCES, METAL RAILS, STEEL PLATES, STEEL WIRES, STEEL PILES, NAMELY STEEL PIPES USED AS PILES IN BUILDING FOUNDATIONS, STEEL PIPE SECTIONS, NAMELY QUADRATE AND RECTANGULAR PIPES, METAL CONDUIT FOR ELECTRICAL USE AND METAL CASTING TUBES FOR ELECTRICAL USE (U.S. CLS. 2, 12, 13, 14, 23, 25 AND 50).

CLASS 6—(Continued).

SN 75-927,526. VICTORIAVILLE FUNERAL SUPPLIES INC., VICTORIAVILLE, PROVINCE OF QUEBEC, CANADA, FILED 2-25-2000.

FLEX LOCK

PRIORITY CLAIMED UNDER SEC. 44(D) ON CANADA APPLICATION NO. 1045575, FILED 2-4-2000, REG. NO. TMA559872, DATED 4-3-2002, EXPIRES 4-3-2017.

NO CLAIM IS MADE TO THE EXCLUSIVE RIGHT TO USE "LOCK", APART FROM THE MARK AS SHOWN.

FOR METAL REMOVABLE HANDLES FOR CASKETS (U.S. CLS. 2, 12, 13, 14, 23, 25 AND 50).

SN 76-022,849. CUNNINGHAM, LINDA, MUSKEGON, MI. FILED 4-11-2000.

STAND SAFE

NO CLAIM IS MADE TO THE EXCLUSIVE RIGHT TO USE "STAND", APART FROM THE MARK AS SHOWN.

FOR METAL CABLE LOCKS FOR TREE STAND USED IN HUNTING (U.S. CLS. 2, 12, 13, 14, 23, 25 AND 50).

FIRST USE 3-1-1998; IN COMMERCE 3-1-1998.

SN 76-150,721. WISE, ROBERT WILLIAM, PETALUMA, CA. FILED 10-20-2000.

WERKART

FOR METAL LADDERS; METAL SCAFFOLDING; METAL TOOL BOXES; METAL LATCHES (U.S. CLS. 2, 12, 13, 14, 23, 25 AND 50).

SN 76-189,504. ARMINOX APS, DK-8800 VIBORG, DENMARK, FILED 12-22-2000.



THE STIPPLING IS FOR SHADING PURPOSES ONLY AND DOES NOT INDICATE COLOR.

FOR METAL BUILDING MATERIAL REINFORCEMENT COMPONENTS, NAMELY, LATHS OF METAL, RODS OF METAL FOR, BRAZING AND WELDING, THREADS OF METAL FOR TYPING-UP PURPOSES, SHEETS AND PLATES OF METAL, FRAMES OF METAL FOR BUILDING, SHEETS AND PLATES OF STEEL, STEEL TUBES, THREADS OF STEEL AND WIRES OF STEEL (U.S. CLS. 2, 12, 13, 14, 23, 25 AND 50).

CLASS 6—(Continued).

SN 76-197,417. COLUMBUS MCKINNON CORPORATION, AMHERST, NY. FILED 1-22-2001.

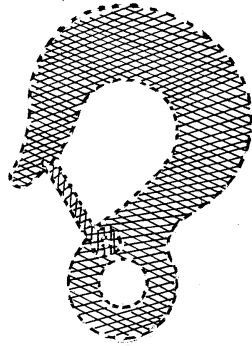

THE DRAWING IS LINED FOR THE COLOR ORANGE. THE MARK CONSISTS OF THE COLOR ORANGE AS APPLIED TO THE SURFACE OF THE GOODS. THE DOTTED OUTLINE OF THE GOODS IS INTENDED TO SHOW THE POSITION OF THE MARK AND IS NOT A PART OF THE MARK.

SEC. 2(F).

FOR HARDWARE FOR INDUSTRIAL, FARM CONSUMER AND MARINE USE, NAMELY SHACKLES, CLEVISES, DRAW BAR HOOKS, CLEVIS HOOKS AND EYE HOOKS, ALL BEING MADE OF METAL (U.S. CLS. 2, 12, 13, 14, 23, 25 AND 50).

FIRST USE 4-29-1948; IN COMMERCE 4-29-1948.

CLASS 6—(Continued).

SN 76-212,101. MILWAUKEE VALVE COMPANY, INC., MILWAUKEE, WI. FILED 2-20-2001.



OWNER OF U.S. REG. NOS. 385,391 AND 867,811. FOR MANUALLY OPERATED METAL VALVES AND VALVE ACTUATORS FOR USE IN LIQUID, CHEMICAL, GAS, FIRE PROTECTION, MARINE, COMMERCIAL, PETROLEUM, TRANSFORMER, TANKTRAILER AND INDUSTRIAL APPLICATIONS (U.S. CLS. 2, 12, 13, 14, 23, 25 AND 50).

FIRST USE 11-0-1932; IN COMMERCE 11-0-1932.

SN 76-214,515. TIMELY INDUSTRIES, A DIVISION OF S.D.S. INDUSTRIES, INC., PACOIMA, CA. FILED 2-23-2001.

SN 76-200,906. VICTAULIC COMPANY OF AMERICA, EASTON, PA. FILED 1-25-2001.



NO CLAIM IS MADE TO THE EXCLUSIVE RIGHT TO USE "GASKET SYSTEM", APART FROM THE MARK AS SHOWN.

FOR METAL PIPE COUPLINGS WITH GASKETS FOR USE IN FIRE PROTECTION SYSTEMS (U.S. CLS. 2, 12, 13, 14, 23, 25 AND 50).

FIRST USE 2-28-2000; IN COMMERCE 2-28-2000.



NO CLAIM IS MADE TO THE EXCLUSIVE RIGHT TO USE "MITER", APART FROM THE MARK AS SHOWN.

FOR METAL DOOR FRAMES (U.S. CLS. 2, 12, 13, 14, 23, 25 AND 50).

CLASS 6—(Continued).

SN 76-235,446. CONCERTAINER LIMITED, BECKENHAM, KENT BR3 6DT, UNITED KINGDOM, FILED 4-4-2001.

CONCERTAINER

FOR COLLAPSIBLE LIQUID-TIGHT CONTAINERS FOR INDUSTRIAL AND COMMERCIAL LIQUIDS MADE OF METAL FEATURING A COLLAPSIBLE FRAME AND A PLASTICS BAG WHICH IS SUPPORTED BY THE FRAME AND WHICH IS FOR CONTAINING LIQUIDS, THE RETURNABLE COLLAPSIBLE CONTAINERS BEING USED FOR THE STORAGE AND TRANSPORTATION OF LIQUIDS, AND BEING RETURNABLE IN THE COLLAPSED STATE WHEN EMPTY FOR ECONOMY RETURN TRANSPORT, AND THE RETURNABLE COLLAPSIBLE CONTAINERS NOT BEING FOR HOLDING PARTICULATE MATERIAL, NAMELY SNOW, SAND, MUD, STONE, BUILDING RUBBLE, OR CONCRETE USED FOR CONSTRUCTING EARTHEN OR BARRIER WALLS (U.S. CLS. 2, 12, 13, 14, 23, 25 AND 50).

FIRST USE 0-0-1991; IN COMMERCE 0-0-1991.

CLASS 6—(Continued).

SN 76-279,284. DYSON CORPORATION, THE, PAINESVILLE, OH. FILED 6-28-2001.

D • N

OWNER OF U.S. REG. NO. 1,844,081.
FOR METAL NUTS, THREADED AND UNTHREADED (U.S. CLS. 2, 12, 13, 14, 23, 25 AND 50).
FIRST USE 1-0-2000; IN COMMERCE 1-0-2000.

SN 76-280,705. CAREY CONSULTING, INC., EDMONTON, KY. FILED 7-5-2001.

PERMA-BLIND

FOR METAL PIPE FITTINGS, NAMELY, PIPELINE BLANKS FOR INSERTION BETWEEN PIPELINE FLANGED COUPLINGS (U.S. CLS. 2, 12, 13, 14, 23, 25 AND 50).

SN 76-283,438. BRADLEY J. KIRKPATRICK, AURORA, IL. AND BURT SCHWAB, AURORA, IL. FILED 7-11-2001.

LADDER HUGGER

NO CLAIM IS MADE TO THE EXCLUSIVE RIGHT TO USE "LADDER", APART FROM THE MARK AS SHOWN.
FOR METAL SCAFFOLD GUIDE TO CONTAIN AN EXTENSION LADDER IN SECURED UPRIGHT POSITION RELATIVE TO SCAFFOLDING (U.S. CLS. 2, 12, 13, 14, 23, 25 AND 50).

SN 76-304,896. TAPCO INTERNATIONAL CORPORATION, PLYMOUTH, MI. FILED 8-17-2001.

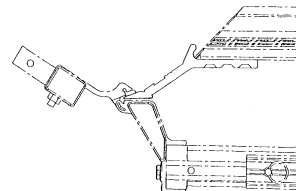

THE MARK CONSISTS OF THE SOLID LINE PORTION OF THE DRAWING DEPICTING THE SIDE PROFILE PORTION OF THE ANVIL PORTION OF A SHEET METAL BRAKE.
FOR SHEET METAL AND SIDING BENDING AND HOLDING BRAKES (U.S. CLS. 2, 12, 13, 14, 23, 25 AND 50).
FIRST USE 1-0-1995; IN COMMERCE 1-0-1995.

SN 76-265,307. AMERICAN SECURITY CABINETS, INC., ST. CLOUD, MN. FILED 5-30-2001.



NO CLAIM IS MADE TO THE EXCLUSIVE RIGHT TO USE "PACKAGE LOCKER", APART FROM THE MARK AS SHOWN.

FOR METAL SAFES IN THE NATURE OF METAL KEYED LOCKERS ATTACHED TO PEDESTALS USED TO DEPOSIT AND RECEIVE PACKAGES (U.S. CLS. 2, 12, 13, 14, 23, 25 AND 50).

SN 76-272,873. BOLLHOFF RIVNUT, INC. FASTENING AND ASSEMBLY TECHNOLOGY, KENDALLVILLE, IN. FILED 6-18-2001.

RIVSTUD

FOR METAL TWO PIECE ASSEMBLED FASTENER WITH AN EXTERNALLY THREADED POST MOUNTED IN A SHELL (U.S. CLS. 2, 12, 13, 14, 23, 25 AND 50).

CLASS 6—(Continued).

SN 76-304,897. TAPCO INTERNATIONAL CORPORATION, PLYMOUTH, MI. FILED 8-17-2001.

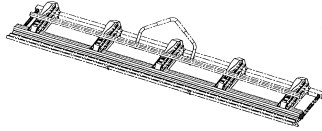

THE MARK CONSISTS OF THE SOLID LINE PORTION OF THE DRAWING (WITH THE BACKGROUND IN DOT AND DASH LINES) DEPICTING THE FACING PORTION OF A SHEET METAL BRAKE.

FOR SHEET METAL AND SIDING BENDING AND HOLDING BRAKES (U.S. CLS. 2, 12, 13, 14, 23, 25 AND 50).

SN 76-304,925. TAPCO INTERNATIONAL CORPORATION, PLYMOUTH, MI. FILED 8-17-2001.

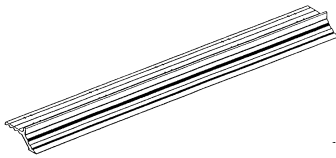

THE MARK CONSISTS OF THE SOLID LINE PORTION OF THE DRAWING DEPICTING THE OUTER FACING PORTION OF A THE ANVIL OF A SHEET METAL BRAKE.

FOR SHEET METAL AND SIDING BENDING AND HOLDING BRAKES (U.S. CLS. 2, 12, 13, 14, 23, 25 AND 50).

FIRST USE 1-0-1995; IN COMMERCE 1-0-1995.

SN 76-307,555. DORSTENER DRAHTWERKE H.W. BRUNE & CO. GMBH, D-46252 DORSTEN, FED REP GERMANY, FILED 8-31-2001.

POWERBIND

FOR WIRE MADE OF METAL; WIRES MADE OF BASE METAL ALLOYS (U.S. CLS. 2, 12, 13, 14, 23, 25 AND 50).

FIRST USE 8-0-2001; IN COMMERCE 8-0-2001.

SN 76-318,360. LIBERTY HARDWARE MFG. CORP., WINSTON-SALEM, NC. FILED 9-27-2001.

QUALITY IN MOTION

FOR METAL CABINET HARDWARE NAMELY CABINET DRAWER GUIDES AND SLIDES (U.S. CLS. 2, 12, 13, 14, 23, 25 AND 50).

CLASS 6—(Continued).

SN 76-332,089. NCI BUILDING SYSTEMS, INC., HOUSTON, TX. FILED 10-30-2001.

TUFF-SHIELD

FOR METAL PANELS USED IN ROOFS AND WALLS OF INDUSTRIAL COMMERCIAL BUILDINGS (U.S. CLS. 2, 12, 13, 14, 23, 25 AND 50).

FIRST USE 9-10-2001; IN COMMERCE 9-10-2001.

SN 76-332,167. DAYTON SUPERIOR CORPORATION, DAYTON, OH. FILED 10-31-2001.

GR

FOR METAL HARDWARE FOR THE ERECTION OF CONCRETE PANELS, NAMELY, LIFTING ANCHORS (U.S. CLS. 2, 12, 13, 14, 23, 25 AND 50).

FIRST USE 0-0-1992; IN COMMERCE 0-0-1992.

SN 76-337,947. E-Z VANE, INC., CALEDONIA, MI. FILED 11-15-2001.

E-Z VANE

NO CLAIM IS MADE TO THE EXCLUSIVE RIGHT TO USE "VANE", APART FROM THE MARK AS SHOWN.

FOR METAL WEATHER VANES; METAL LAWN ORNAMENTS IN THE NATURE OF SEASONAL FIGURES AND PLANT LANTERN HANGERS (U.S. CLS. 2, 12, 13, 14, 23, 25 AND 50).

SN 76-342,549. TIX CORPORATION, SHINAGAWA-KU TOKYO, JAPAN, FILED 11-29-2001.

IKS

FOR MANUALLY-OPERATED METAL VALVES FOR UNDERGROUND AND ABOVE GROUND PIPELINE SERVICE; MANUALLY-OPERATED METAL PIPELINE VALVES FOR RANGING FROM WELL-HEADS FOR OIL AND GAS EXTRACTION; MANUALLY-OPERATED METAL MAIN TANK VALVES FOR OIL AND GAS STORAGE FACILITIES; MANUALLY-OPERATED METAL MANIFOLD VALVES FOR LOADING CRUDE OIL AND REFINED PETROLEUM PRODUCTS (U.S. CLS. 2, 12, 13, 14, 23, 25 AND 50).

FIRST USE 1-0-1958; IN COMMERCE 1-0-1963.

CLASS 6—(Continued).

SN 76-353,271. SAFETY, INC., SALEM, NH. FILED 12-28-2001.

**LIFE SAVER BY SAFETY,
INC.**

NO CLAIM IS MADE TO THE EXCLUSIVE RIGHT TO USE "INC.", APART FROM THE MARK AS SHOWN.
FOR WHEEL CHOCKS MADE PRIMARILY OF METAL (U.S. CLS. 2, 12, 13, 14, 23, 25 AND 50).
FIRST USE 6-23-1977; IN COMMERCE 6-23-1977.

SN 76-359,762. PACIFIC BEARING CO., ROCKFORD, IL.
FILED 1-17-2002.



NO CLAIM IS MADE TO THE EXCLUSIVE RIGHT TO USE "TELESCOPING SLIDES", APART FROM THE MARK AS SHOWN.

THE STIPPLING IS A FEATURE OF THE MARK AND IS NOT INTENDED TO INDICATE COLOR.

THE PICTORIAL PORTION OF THE MARK CONSISTS OF SNOWCAPPED MOUNTAINS.

FOR METAL HEAVY DUTY TELESCOPING SLIDES FOR USE WITH SLIDING DOORS, RECESSED STORAGE BINS, DRAWERS, AND MOVABLE PAD COVERS FOR OPERATOR CONTROL PANELS (U.S. CLS. 2, 12, 13, 14, 23, 25 AND 50).

SN 76-366,375. MAGNUM PIERING, INC., WEST CHESTER, OH. FILED 2-4-2002.

MAGNUM PIERING

NO CLAIM IS MADE TO THE EXCLUSIVE RIGHT TO USE "PIERING", APART FROM THE MARK AS SHOWN.

FOR METAL PIER BRACKETS AND PIER PIPING (U.S. CLS. 2, 12, 13, 14, 23, 25 AND 50).

FIRST USE 1-1-1994; IN COMMERCE 1-1-1994.

SN 76-371,649. WEISER LOCK CORPORATION, TUCSON, AZ. FILED 2-14-2002.

M6000 SERIES

NO CLAIM IS MADE TO THE EXCLUSIVE RIGHT TO USE "SERIES", APART FROM THE MARK AS SHOWN.

FOR DOOR HARDWARE MADE OF METAL, NAMELY, MORTISE DOOR LOCKS, DOOR LOCK ESCUTCHEONS, DOOR HANDLES, AND DOOR LEVERS (U.S. CLS. 2, 12, 13, 14, 23, 25 AND 50).

CLASS 6—(Continued).

SN 76-372,300. DISTRIBUTION AMERICA, INC., DES PLAINES, IL. FILED 2-8-2002.

SENTRY

OWNER OF U.S. REG. NOS. 998,209, 1,005,486 AND OTHERS.

FOR BUILDERS HARDWARE MADE OF METAL, NAMELY, HINGES, CABINET CATCHES, CHAIN DOOR GUARDS, TURN BUTTONS, SCREEN DOOR PULLS, SCREEN DOOR SPRING HINGES, SASH HOOK LIFTS, MENDING PLATES, CORNER BRACES, FLAT CORNER IRONS, MAGNETIC CATCHES, SPRING AND CHAIN DOOR STOPS, SAFETY HASPS, T-HINGES, STRAP HINGES, SCREEN AND STORM SASH HANGERS, UTILITY HINGES, ROLLER CATCHES, AND DOOR PROTECTOR CHAINS (U.S. CLS. 2, 12, 13, 14, 23, 25 AND 50).

FIRST USE 7-29-1969; IN COMMERCE 7-29-1969.

SN 76-375,897. DYNAFLAIR CORPORATION CANADA INC., POINTE CLAIRE, QUEBEC, CANADA, FILED 2-27-2002.

SECURITY WITH A FLAIR

FOR SECURITY CLOSURES OF METAL, NAMELY SLIDING AND FOLDING GRILLES, SLIDING AND FOLDING CLOSURES, METAL ROLLING GRILLES AND SHUTTERS, METAL COUNTER TOP CLOSURES, AND METAL ROLL AWAY PARTITIONS (U.S. CLS. 2, 12, 13, 14, 23, 25 AND 50).

FIRST USE 8-0-1979; IN COMMERCE 8-0-1979.

SN 76-379,751. TRUTH HARDWARE CORPORATION, OWATONNA, MN. FILED 3-7-2002.

MAXIM MP7

OWNER OF U.S. REG. NO. 2,212,680.

FOR DOOR AND WINDOW HARDWARE, MADE PRIMARILY OF METAL, NAMELY BRACKETS, TRACKS, LATCHES, LOCKS, KNOBS, HANDLES, HINGES, OPERATORS, LEVERSETS AND SNUBBERS (U.S. CLS. 2, 12, 13, 14, 23, 25 AND 50).

SN 76-381,398. SAMMISTEEL CO., LTD., 641-370 KYUNG-NAM, REPUBLIC OF KOREA, FILED 3-12-2002.

BNGSTEEL

FOR STAINLESS STEEL SHEET, STAINLESS STEEL COIL, STAINLESS STEEL PIPE, STEEL SHEET, STEEL PIPE, STEEL COIL, STEEL AND IRON, STEEL ALLOY (U.S. CLS. 2, 12, 13, 14, 23, 25 AND 50).

CLASS 6—(Continued).

SN 76-386,615. WALL-TIES & FORMS, INC., SHAWNEE, KS. FILED 3-25-2002.

SWIM-CRETE

FOR METAL CASTING FORMS FOR CONCRETE (U.S. CLS. 2, 12, 13, 14, 23, 25 AND 50).

SN 76-387,848. SHENZHEN DONG YANG GUANG INDUSTRIAL DEVELOPMENT CO., LTD., SHEN ZHEN, CHINA, FILED 3-25-2002.



FOR ALUMINUM FOIL; METAL FOIL FOR PACKING (U.S. CLS. 2, 12, 13, 14, 23, 25 AND 50).

SN 76-393,235. AMERICAN DIAMOND PRODUCTS, INC., BOCA RATON, FL. FILED 4-8-2002.

STUDBUSTER

FOR STEEL BLADES WITH SEGMENTED DIAMOND ELECTROPLATED CUTTING EDGES (U.S. CLS. 2, 12, 13, 14, 23, 25 AND 50).
FIRST USE 2-6-2001; IN COMMERCE 2-6-2001.

SN 76-394,092. DAYTONA INTERNATIONAL SPEEDWAY, LLC, DAYTONA BEACH, FL. FILED 4-11-2002.

CENTENNIAL OF SPEED

FOR METAL KEY CHAINS, TROPHIES OF COMMON METALS, NON-LUMINOUS AND NON-MECHANICAL METAL SIGNS, AND METAL NOVELTY LICENSE PLATES (U.S. CLS. 2, 12, 13, 14, 23, 25 AND 50).

CLASS 6—(Continued).

SN 78-056,448. GENERAL MOTORS CORPORATION, DETROIT, MI. FILED 4-3-2001.



FOR METAL BANK VAULTS; METAL PIGGY BANKS; METAL DECORATIVE BOXES; INGOTS OF COMMON METAL; METAL KEY CHAINS; METAL KEY FOBBS; METAL KEY RINGS; METAL KEYS FOR LOCKS; METAL LICENSE PLATES; NON-LUMINOUS AND NON-MECHANICAL METAL SIGNS; METAL MONEY CLIPS; METAL PARKING SIGNS; ORNAMENTAL REPLICAS OF VEHICLES MADE OF METAL; NON-LUMINOUS AND NON-MECHANICAL METAL STREET SIGNS; METAL TOOL BOXES; WALL MOUNTED METAL TOOL RACKS; FREESTANDING METAL TOOL RACKS (U.S. CLS. 2, 12, 13, 14, 23, 25 AND 50).
FIRST USE 11-0-1997; IN COMMERCE 11-0-1997.

SN 78-060,469. GASCO AFFILIATES, LLC, SARASOTA, FL. FILED 4-26-2001.



FOR METAL NON-REFILLABLE AND REFILLABLE CALIBRATION GAS CYLINDERS FOR COMPRESSED GAS OR LIQUIDS, SOLD EMPTY OR FULL, FOR USE IN MEDICAL LABORATORIES, PETROCHEMICAL, PHARMACEUTICAL, FOOD AND BEVERAGE, HEALTH AND SAFETY, NATURAL GAS, AND AUTOMOTIVE INDUSTRIES, AS WELL AS MILITARY APPLICATIONS (U.S. CLS. 2, 12, 13, 14, 23, 25 AND 50).
FIRST USE 8-15-1996; IN COMMERCE 8-15-1996.

SN 78-092,738. LOCKHEED MARTIN CORPORATION, BETHESDA, MD. FILED 11-12-2001.

F/A-35

FOR METAL PIGGY BANKS, NAMELY COIN BANKS CONFIGURED AS SCALE-MODEL REPLICAS OF AIRCRAFT, METAL NAME PLATES (U.S. CLS. 2, 12, 13, 14, 23, 25 AND 50).

CLASS 6—(Continued).

SN 78-113,161. THERMAGON, INC., CLEVELAND, OH. FILED 3-7-2002.

L M A

FOR METAL ALLOY THERMAL INTERFACE MATERIALS FOR PLACEMENT BETWEEN AN ELECTRONIC COMPONENT HEAT SOURCE AND AN ELECTRONIC COMPONENT HEAT SINK FOR HEAT REMOVAL (U.S. CLS. 2, 12, 13, 14, 23, 25 AND 50).

CLASS 7—(Continued).

SN 75-612,530. E.P.B. EMILE PFALZGRAF, 67330 BOUXWILER, FRANCE, FILED 12-28-1998.

INDUFLEX

PRIORITY CLAIMED UNDER SEC. 44(D) ON FRANCE APPLICATION NO. 98/739599, FILED 6-26-1998, REG. NO. 98/739599, DATED 6-26-1998, EXPIRES 6-26-2008.

FOR LATHES, DRILL PRESSES AND BAND SAWS FOR METAL WOOD AND PLASTIC; BIT-HOLDING CHUCKS FOR DRILLS; MODULAR TOOLING FOR MACHINING CENTERS, NAMELY HOLDERS, ADAPTORS, EXTENSIONS, REDUCERS, ARBORS, SLEEVES, COLLET CHUCKS, QUICK-CHANGE TAPPING CHUCKS AND BORING HEADS; MACHINE HOLDERS, NAMELY RETAINING MEMBERS FOR USE ON POWER OPERATED, PORTABLE AND STATIONARY MACHINES, TOOL HOLDERS, NAMELY RETAINING MEMBERS FOR USE ON POWER OPERATED, PORTABLE AND STATIONARY TOOLS, MODULAR SYSTEMS FOR USE WITH TOOL MACHINING CENTERS COMPRISED OF THE FOREGOING (U.S. CLS. 13, 19, 21, 23, 31, 34 AND 35).

CLASS 7—MACHINERY

SN 75-235,124. DICAR, INC., PINE BROOK, NJ. FILED 2-3-1997.

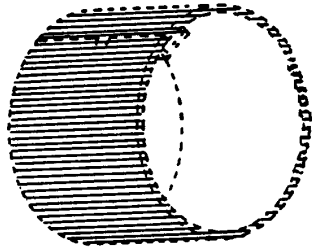

THE DRAWING IS LINED FOR THE COLOR BLUE. THE MARK CONSISTS OF THE COLOR BLUE AS BLENDED INTO THE MATERIAL OF THE GOODS AND VISIBLE WHEN THE GOODS ARE INSTALLED. THE DOTTED OUTLINE OF THE GOODS IS INTENDED TO SHOW THE POSITION OF THE MARK AND IS NOT A PART OF THE MARK.

SEC. 2(F). FOR ANVIL COVERS FOR ROTARY DIE CUTTING MACHINES FOR USE IN THE CORRUGATED AND CARDBOARD PACKAGING MANUFACTURING INDUSTRY (U.S. CLS. 13, 19, 21, 23, 31, 34 AND 35). FIRST USE 0-0-1983; IN COMMERCE 0-0-1983.

SN 75-648,237. THK CO., LTD., TOKYO, JAPAN, FILED 2-25-1999.



SN 75-535,173. ADAMATION, INC., NEWTON, MA. FILED 8-12-1998.

XL

FOR COMMERCIAL DISHWARE, FLATWARE, GLASSWARE, UTENSILS AND POTWARE WASHING MACHINES (U.S. CLS. 13, 19, 21, 23, 31, 34 AND 35).

PRIORITY CLAIMED UNDER SEC. 44(D) ON JAPAN APPLICATION NO. 10-91050, FILED 10-22-1998, REG. NO. 4381601, DATED 5-12-2000, EXPIRES 5-12-2010.

NO CLAIM IS MADE TO THE EXCLUSIVE RIGHT TO USE "CAGED BALL", APART FROM THE MARK AS SHOWN.

FOR LINEAR MOTION GUIDES AND BALL SCREWS (U.S. CLS. 13, 19, 21, 23, 31, 34 AND 35).

CLASS 7—(Continued).

SN 75-834,600. REVEL, INC., HOUSTON, TX. FILED 10-29-1999.



NO CLAIM IS MADE TO THE EXCLUSIVE RIGHT TO USE "BABY", APART FROM THE MARK AS SHOWN. THE MARK IS LINED FOR THE COLOR PINK FOR FOOD PROCESSOR FOR GRINDING, CHOPPING, BLENDING, PUREEING AND LIQUEFYING WET, (SUCH AS FRUITS), AND DRY (SUCH AS NUTS AND BEANS) FOODS STUFFS IN THEIR PREPARATION (U.S. CLS. 13, 19, 21, 23, 31, 34 AND 35).

SN 76-063,956. SUPERIOR AIR PARTS, INC., DALLAS, TX. FILED 6-5-2000.

XP360 ENGINE

NO CLAIM IS MADE TO THE EXCLUSIVE RIGHT TO USE "ENGINE", APART FROM THE MARK AS SHOWN. FOR AIRCRAFT PISTON ENGINE (U.S. CLS. 13, 19, 21, 23, 31, 34 AND 35). FIRST USE 10-1-1998; IN COMMERCE 10-1-1998.

SN 76-088,904. BLACK & DECKER CORPORATION, THE, TOWSON, MD. FILED 7-14-2000.

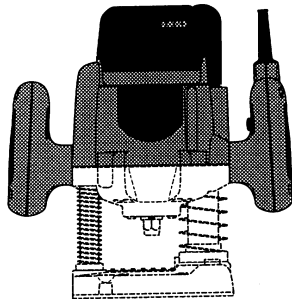

SEC. 2(F). FOR POWER TOOLS, NAMELY, ROUTERS (U.S. CLS. 13, 19, 21, 23, 31, 34 AND 35).

CLASS 7—(Continued).

SN 76-089,130. HALM INDUSTRIES CO., INC., GLEN HEAD, NY. FILED 7-14-2000.

SUPER JET PLUS

NO CLAIM IS MADE TO THE EXCLUSIVE RIGHT TO USE "SUPER", APART FROM THE MARK AS SHOWN. FOR COMMERCIAL OFFSET DOCUMENT PRINTING PRESSES (U.S. CLS. 13, 19, 21, 23, 31, 34 AND 35). FIRST USE 2-0-1999; IN COMMERCE 2-0-1999.

SN 76-135,306. SCHUNK GMBH & CO. KG., LAUFFEN/NECKAR, FED REP GERMANY, FILED 9-26-2000.

TB-LH

FOR MACHINES FOR METALWORKING, WOODWORKING, AND PLASTICS PROCESSING INDUSTRIES, NAMELY, CLAMPING CHUCKS, MANDRELS, CLAMPING CHUCKS OF METAL FOR WORK PIECES, GRIPPING CHUCKS, ELECTRICALLY, HYDRAULICALLY OR PNEUMATICALLY DRIVEN TRANSLATING, SWIVELING AND LIFTING CHUCKS, ROTATING CHUCKS, METAL CLAMPING DRILL CHUCKS FOR POWER DRILLS, POWERED EXPANSION CHUCKS, POWERED SHRINKAGE CHUCKS, BACK STAY FOR LATHES, CLAMPING CYLINDERS FOR POWER CLAMPING CHUCKS, POWERED EXTENSION CHUCKS, AND PARTS THEREOF (U.S. CLS. 13, 19, 21, 23, 31, 34 AND 35).

SN 76-147,132. JORE CORPORATION, RONAN, MT. FILED 10-16-2000.

FAST CHUCK

NO CLAIM IS MADE TO THE EXCLUSIVE RIGHT TO USE "CHUCK", APART FROM THE MARK AS SHOWN. FOR POWER-OPERATED HAND TOOLS, NAMELY, DRILL BITS, SPADE BITS, MASONRY BITS, SCREW DRIVER BITS, SCREW GUIDES, MAGNETIC DRIVE GUIDES, DRILL AND DRIVERS AND SURFACE PREPARATION DISKS (U.S. CLS. 13, 19, 21, 23, 31, 34 AND 35). FIRST USE 4-0-1999; IN COMMERCE 4-0-1999.

CLASS 7—(Continued).

SN 76-192,190. PREMIER TECH LTD., RIVIERE-DU-LOUP, QUEBEC, CANADA, FILED 1-11-2001.



FOR MACHINES, NAMELY, MACHINES FOR SCREENING, SIZING, GRADING, SEPARATING AND SIFTING COMPOST, WOOD WASTE, BARK MULCH, MANURE TOP SOIL SAND, GRAVEL, STONES, AND ROCKS; MACHINES, NAMELY, MOBILE SCREENING MACHINES FOR SCREENING TREE STUMPS, CONSTRUCTION AND DEMOLITION DEBRIS, LANDFILL DEBRIS, CONTAMINATED SOIL, WOOD WASTE, AND ROUGH TOPSOIL; MACHINES, NAMELY, MOTORIZED VACUUM HARVESTERS OR PEAT MOSS; MACHINES FOR USE IN RECYCLING SYSTEMS, NAMELY, IN-FEED AND OUT-FEED CONVEYORS, SORTING PLATFORM AND PICKING STATIONS NAMELY PICKING TABLE, COMPLETE STRUCTURE, CATWALK AND SORTING BINS, HAMMER MILLS AND STACKING CONVEYORS (U.S. CLS. 13, 19, 21, 23, 31, 34 AND 35).
FIRST USE 7-0-1998; IN COMMERCE 7-0-1998.

SN 76-205,455. GUILL TOOL AND ENGINEERING CO., INC., WEST WARWICK, RI. FILED 2-6-2001.

GUILL

SEC. 2(F).
FOR EXTRUSION DIES AND PARTS THEREFORE, FOR USE WITH MACHINE TOOLS (U.S. CLS. 13, 19, 21, 23, 31, 34 AND 35).
FIRST USE 0-0-1963; IN COMMERCE 0-0-1963.

SN 76-223,205. ARROWHEAD SYSTEMS LLC, RANDOLPH, WI. FILED 3-12-2001.

CLASSIC "W"

FOR CONTAINER HANDLING SYSTEMS, NAMELY BULK PALLETIZERS AND DEPALLETIZERS, COMBINATION BULK PALLETIZER/DEPALLETIZERS, BULK DEPALLEZIZER SORTERS, SINGLE FILERS, MASS FLOW CONVEYORS, PALLET CONVEYORS, RETORT CRATE LOADERS AND UNLOADERS, AND CONTROLS AND CONTROL SOFTWARE FOR SUCH CONTAINER HANDLING SYSTEMS SOLD AS A UNIT (U.S. CLS. 13, 19, 21, 23, 31, 34 AND 35).
FIRST USE 4-0-2000; IN COMMERCE 4-0-2000.

CLASS 7—(Continued).

SN 76-223,243. ARROWHEAD SYSTEMS LLC, RANDOLPH, WI. FILED 3-12-2001.

CLASSIC "R"

FOR CONTAINER HANDLING SYSTEMS, NAMELY BULK PALLETIZERS AND DEPALLEZIZER, COMBINATION BULK PALLETIZER/DEPALLETIZERS, BULK DEPALLEZIZER SORTERS, SINGLE FILERS, MASS FLOW CONVEYORS, PALLET CONVEYORS, RETORT CRATE LOADERS AND UNLOADERS, AND CONTROLS AND CONTROL SOFTWARE FOR SUCH CONTAINER HANDLING SYSTEMS SOLD AS A UNIT (U.S. CLS. 13, 19, 21, 23, 31, 34 AND 35).
FIRST USE 1-0-2001; IN COMMERCE 1-0-2001.

SN 76-232,983. ASTURO ORIGINALI - MAVES S.P.A., 2009 TREZZANO SUL NAVIGLIO, ITALY, FILED 3-28-2001.



NO CLAIM IS MADE TO THE EXCLUSIVE RIGHT TO USE "ORINGINALI", APART FROM THE MARK AS SHOWN.

THE MARK CONSISTS OF A BAR DESIGN HAVING THE LETTERING "AOMN" SUPERIMPOSED ON A GEAR DESIGN FEATURING THE WORDING "ORIGINALI".

THE ENGLISH TRANSLATION OF THE WORD "ORIGINALI" IS "ORIGINAL".

FOR ELECTRICALLY-POWERED, AIR-ACTIVATED PUMPS USED FOR PAINT SPRAYING, ELECTRIC PUMPS USED FOR PAINT SPRAYING, AIR COMPRESSOR ACCESSORIES NAMELY, COMPRESSED AIR GUNS AND PAINT SPRAY GUNS (U.S. CLS. 13, 19, 21, 23, 31, 34 AND 35).

SN 76-236,272. GENERAC POWER SYSTEMS, INC., WAUKESHA, WI. FILED 3-20-2001.



OWNER OF U.S. REG. NOS. 1,706,283, 2,160,191 AND OTHERS.

NO CLAIM IS MADE TO THE EXCLUSIVE RIGHT TO USE "INDUSTRIAL SERIES", APART FROM THE MARK AS SHOWN.

FOR GASOLINE POWERED ENGINES NOT FOR LAND VEHICLES; GASOLINE POWERED ENGINES FOR MACHINES (U.S. CLS. 13, 19, 21, 23, 31, 34 AND 35).
FIRST USE 8-15-1999; IN COMMERCE 12-7-1999.

CLASS 7—(Continued).

SN 76-240,281. LEUCO TOOL CORPORATION, INGLESIDE, IL. FILED 4-13-2001.

EUROLINE

FOR MACHINE TOOLS, NAMELY SAW BLADES, LOGGERS, CUTTERS WITH BORE, ROUTER BITS, INSERT TOOLING, NAMELY SHAPER, MOULDER AND TENON HEADS AND CUTTERS, DRILLS, CLAMPING SYSTEMS COMPRISED OF CLAMPS, BOLTS AND FEEDER WIRES FOR PRECISION CLAMPING OF SHANK-TYPE TOOLS AND FOR CLAMPING CUTTER HEADS AND CIRCULAR SAW BLADES, AND KNIVES FOR CUTTING AND SHAPING SOLID WOOD AND WOOD COMPOSITES (U.S. CLS. 13, 19, 21, 23, 31, 34 AND 35).

SN 76-240,282. LEUCO TOOL CORPORATION, INGLESIDE, IL. FILED 4-13-2001.

TOPLINE

FOR MACHINE TOOLS, NAMELY SAW BLADES, LOGGERS, CUTTERS WITH BORE, ROUTER BITS, INSERT TOOLING, NAMELY SHAPER, MOULDER AND TENON HEADS AND CUTTERS, DRILLS, CLAMPING SYSTEMS COMPRISED OF CLAMPS, BOLTS AND FEEDER WIRES FOR PRECISION CLAMPING OF SHANK-TYPE TOOLS AND FOR CLAMPING CUTTER HEADS AND CIRCULAR SAW BLADES, AND KNIVES FOR CUTTING AND SHAPING SOLID WOOD AND WOOD COMPOSITES (U.S. CLS. 13, 19, 21, 23, 31, 34 AND 35).

SN 76-250,689. HOPKINSONS LIMITED, WEST YORKSHIRE HD2 2UR, UNITED KINGDOM, FILED 5-3-2001.

X-STREAM

OWNER OF UNITED KINGDOM REG. NO. 2,232,297, DATED 10-13-2000, EXPIRES 12-5-2010.

FOR MACHINE PARTS, NAMELY, FLUID CONTROL VALVES; FLUID PRESSURE CONTROL VALVES; FLUID FLOW CONTROL APPARATUS, NAMELY, CAGE TRIM VALVES, CHOKE VALVES; TRIM STACKS AND TRIM CAGES AND STRUCTURAL PARTS FOR GENERAL INDUSTRIAL AND COMMERCIAL USE (U.S. CLS. 13, 19, 21, 23, 31, 34 AND 35).

CLASS 7—(Continued).

SN 76-259,886. WHITING SYSTEMS, INC., ALEXANDER, AR. FILED 5-22-2001.

SmartWash
EXPRESS 

OWNER OF U.S. REG. NO. 2,028,110.
NO CLAIM IS MADE TO THE EXCLUSIVE RIGHT TO USE "EXPRESS", APART FROM THE MARK AS SHOWN.
FOR AUTOMATED PRESSURE CLEANING MACHINES FOR WASHING TRUCKS (U.S. CLS. 13, 19, 21, 23, 31, 34 AND 35).

SN 76-262,462. HI PRESSURE CLEANING SYSTEMS, INC., HOURNA, LA. FILED 5-25-2001.



THE MARK CONSISTS OF A MALE WORKER WEARING A SAFETY HELMET, BOOTS AND HOLDING A SPRAYING PRESSURE WASHER WAND WITH HOSE.

FOR CLEANING EQUIPMENT, NAMELY, MACHINES FOR CLEANING SURFACES USING HIGH PRESSURE WATER (U.S. CLS. 13, 19, 21, 23, 31, 34 AND 35).
FIRST USE 8-4-1997; IN COMMERCE 8-4-1997.

SN 76-263,570. GD MIDEA HOLDING CO., LTD., SHUNDE CITY, GUANGDONG PROVINCE, CHINA, FILED 5-29-2001.

Welling

OWNER OF CHINA REG. NO. 1083849, DATED 8-21-1997, EXPIRES 8-20-2007.

FOR PUMPS, USED FOR HOME APPLIANCES; ELECTRIC MOTORS FOR MACHINES AND HOME APPLIANCES (U.S. CLS. 13, 19, 21, 23, 31, 34 AND 35).

CLASS 7—(Continued).

SN 76-265,333. E-Z TRENCH MANUFACTURING COMPANY, INC., LORIS, SC. FILED 6-1-2001.

BEDSCAPER

FOR GROUND TILLING AND SHAPING MACHINES (U.S. CLS. 13, 19, 21, 23, 31, 34 AND 35).
FIRST USE 0-0-2001; IN COMMERCE 0-0-2001.

SN 76-266,776. SANTA FE INTERNATIONAL CORPORATION, DALLAS, TX. FILED 6-5-2001.

DECK SMART

NO CLAIM IS MADE TO THE EXCLUSIVE RIGHT TO USE "DECK", APART FROM THE MARK AS SHOWN.
FOR ONSHORE AND OFFSHORE DRILLING FACILITIES IN THE NATURE OF FLOATING DRILLING RIGS (U.S. CLS. 13, 19, 21, 23, 31, 34 AND 35).

SN 76-267,291. SCHAUDT MIKROSA BWF GMBH, D-70329 STUTTGART, FED REP GERMANY, FILED 6-5-2001.

URANOS

PRIORITY CLAIMED UNDER SEC. 44(D) ON FED REP GERMANY APPLICATION NO. 30091406.7/0, FILED 12-14-2000, REG. NO. 30091406, DATED 4-5-2001, EXPIRES 12-31-2010.
FOR MACHINE TOOLS, NAMELY GRINDING MACHINES AND LATHES; COMBINED GRINDING MACHINES AND LATHES; PRODUCTION LINES COMPOSED OF GRINDING MACHINES, LATHES AND/OR COMBINED GRINDING MACHINES AND LATHES (U.S. CLS. 13, 19, 21, 23, 31, 34 AND 35).

SN 76-272,456. UHT CORPORATION, AICHI-GUN, AICHI-KEN, JAPAN, FILED 6-18-2001.

TURBOLAP

OWNER OF JAPAN REG. NO. 4,044,975, DATED 8-15-1997, EXPIRES 8-15-2007.
FOR MACHINES AND MACHINE TOOLS FOR WORKING METALS, NAMELY, GRINDING MACHINES FOR USE IN GRINDING METAL, WOOD, CERAMICS AND PLASTICS; POLISHING MACHINE FOR USE IN POLISHING METAL, WOOD, CERAMICS, AND PLASTICS (U.S. CLS. 13, 19, 21, 23, 31, 34 AND 35).
FIRST USE 2-22-1996; IN COMMERCE 6-5-1996.

CLASS 7—(Continued).

SN 76-273,740. SANTA FE INTERNATIONAL CORPORATION, DALLAS, TX. FILED 6-18-2001.

WAC

FOR ONSHORE AND OFFSHORE DRILLING FACILITIES IN THE NATURE OF FLOATING DRILLING RIGS FOR USE IN THE OIL AND GAS INDUSTRY (U.S. CLS. 13, 19, 21, 23, 31, 34 AND 35).

SN 76-274,014. APPLIED MATERIALS, INC., SANTA CLARA, CA. FILED 6-19-2001.

XGEN

FOR SEMICONDUCTOR PROCESSING MACHINES AND PARTS THEREFOR FOR USE IN THE PROCESSING AND PRODUCTION OF SEMICONDUCTOR SUBSTRATES, THIN FILMS, SILICON DISCS AND WAFERS (U.S. CLS. 13, 19, 21, 23, 31, 34 AND 35).

SN 76-274,355. B. R. LEE INDUSTRIES, INC., DENVER, NC. FILED 6-19-2001.

420

SEC. 2(F).
FOR ASPHALT ROLLING MACHINES (U.S. CLS. 13, 19, 21, 23, 31, 34 AND 35).
FIRST USE 0-0-1996; IN COMMERCE 0-0-1996.

SN 76-283,129. MULTIQUIP INC., CARSON, CA. FILED 7-9-2001.

MQ CRAWFORD

FOR ELECTRIC POWER GENERATORS (U.S. CLS. 13, 19, 21, 23, 31, 34 AND 35).
FIRST USE 2-1-2001; IN COMMERCE 2-1-2001.

SN 76-283,424. EMISSION CONTROL PRODUCTS, WLL, ADLIYA, BAHRAIN, FILED 7-11-2001.

MNK

FOR PUMPS, NAMELY, FUEL TRANSFER PUMPS FOR LAND AND MARINE VEHICLES (U.S. CLS. 13, 19, 21, 23, 31, 34 AND 35).

CLASS 7—(Continued).

SN 76-292,784. SAM BROWN SALES CO., INC., SOUTHFIELD, MI. BY CHANGE OF NAME SALES, SAM BROWN, SOUTHFIELD, MI. FILED 7-31-2001.

BIG MOUNTAIN

FOR POWER-OPERATED HANDHELD TOOLS, AND PARTS AND ACCESSORIES THEREFOR, NAMELY, NAIL GUNS, BUFFERS AND POLISHERS, CIRCULAR SAWS, DRILLS, GRINDERS, SCREWDRIVERS, SPRAY WASHERS, SANDERS AND ACCESSORIES, NAMELY, SANDING PLATEN ASSEMBLIES, SANDING PADS, SANDING DISCS, SANDING GUARDS, COMMERCIAL WAX REMOVING BONNETS, BUFFING BONNETS, POLISHING HEADS (U.S. CLS. 13, 19, 21, 23, 31, 34 AND 35).

SN 76-297,990. S. A. ARMSTRONG LIMITED, SCARBOROUGH, ONTARIO, CANADA, FILED 8-9-2001.

DUALARM

FOR VERTICAL FLUID FLOW TURBINE PUMPS FOR COMMERCIAL, INDUSTRIAL, HVAC, AND PACKAGED SYSTEMS USES (U.S. CLS. 13, 19, 21, 23, 31, 34 AND 35).
FIRST USE 6-0-1994; IN COMMERCE 9-0-1994.

SN 76-301,478. MOTAN HOLDING GMBH, 78467 KONSTANZ, FED REP GERMANY, FILED 8-3-2001.



PRIORITY CLAIMED UNDER SEC. 44(D) ON FED REP GERMANY APPLICATION NO. 30134823.5, FILED 6-7-2001, REG. NO. 30134823, DATED 8-28-2001, EXPIRES 6-30-2011.

FOR MACHINE-DRIVEN SUCTION CONVEYING MACHINES, DRYING MACHINES, DOSING AND MIXING MACHINES, ALL OF THE AFORE-MENTIONED MACHINES FOR HANDLING PLASTIC MATERIAL; INSTALLATIONS COMPRISED OF THE AFORE-SAID MACHINES, NAMELY, PARTS AND FITTINGS OF CONVEYING, DRYING, DOSING AND MIXING MACHINES (U.S. CLS. 13, 19, 21, 23, 31, 34 AND 35).

CLASS 7—(Continued).

SN 76-303,978. WINKLER + DUNNEBIER AG, NEUWIED, FED REP GERMANY, FILED 8-22-2001.



NO CLAIM IS MADE TO THE EXCLUSIVE RIGHT TO USE "CUT", APART FROM THE MARK AS SHOWN.

FOR DIE FOR USE WITH MACHINES (U.S. CLS. 13, 19, 21, 23, 31, 34 AND 35).

FIRST USE 8-14-2001; IN COMMERCE 8-14-2001.

SN 76-310,199. WILLIAMS INDUSTRIES, INC., GRAYSON, GA. FILED 9-7-2001.

LOCKE

SEC. 2(F).

FOR LAWN MOWERS AND PARTS THEREFOR (U.S. CLS. 13, 19, 21, 23, 31, 34 AND 35).

FIRST USE 10-7-1993; IN COMMERCE 11-11-1993.

SN 76-312,525. TOWNSEND ENGINEERING COMPANY, DES MOINES, IA. FILED 9-14-2001.



NO CLAIM IS MADE TO THE EXCLUSIVE RIGHT TO USE "AUTOTRIMMER SERIES", APART FROM THE MARK AS SHOWN.

FOR MEAT SKINNING MACHINES (U.S. CLS. 13, 19, 21, 23, 31, 34 AND 35).

FIRST USE 9-7-2001; IN COMMERCE 9-7-2001.

SN 76-315,547. ATLAS COPCO CRAELIUS AB, 195 82 MARSTA, SWEDEN, FILED 9-21-2001.

HOBIC

PRIORITY CLAIMED UNDER SEC. 44(D) ON SWEDEN APPLICATION NO. 00-08923, FILED 11-23-2000.

FOR POWER OPERATED DIAMOND TOOLS NAMELY DRILL BITS, REAMERS AND STABILIZERS WHICH ARE DIAMOND SET AND/OR DIAMOND IMPREGNATED AND POWER OPERATED TOOLS FOR PROSPECTING AND EXPLORATION DRILLING, NAMELY DRILL BITS, REAMERS AND STABILIZERS WHICH ARE DIAMOND SET AND/OR DIAMOND IMPREGNATED (U.S. CLS. 13, 19, 21, 23, 31, 34 AND 35).

FIRST USE 3-1-1987; IN COMMERCE 7-1-1987.

CLASS 7—(Continued).

SN 76-316,354. ASTEC INDUSTRIES, INC., CHATTANOOGA, TN. FILED 9-24-2001.

KODIAK

FOR MATERIAL PROCESSING EQUIPMENT, NAMELY CRUSHERS FOR ROCK, AGGREGATE AND BITUMINOUS MATERIALS (U.S. CLS. 13, 19, 21, 23, 31, 34 AND 35).
FIRST USE 5-31-2001; IN COMMERCE 5-31-2001.

SN 76-317,096. WIKUS-SAGENFABRIK WILHELM H. KULLMANN GMBH & CO. KG, D-34286 SPANGENBERG, FED REP GERMANY, FILED 9-24-2001.

MARATHON

OWNER OF FED REP GERMANY REG. NO. 39844121, DATED 12-17-1998, EXPIRES 8-31-2008.
FOR MACHINE TOOLS, NAMELY METAL CUTTING BANDSAW BLADES FOR POWER SAWS (U.S. CLS. 13, 19, 21, 23, 31, 34 AND 35).

SN 76-318,518. PRECITECH, INC., KEENE, NH. FILED 9-28-2001.

PLANOFORM

OWNER OF U.S. REG. NOS. 2,416,207 AND 2,417,971.
FOR MACHINE TOOLS, NAMELY MACHINES USED TO GENERATE SURFACES WITH A ROTATING TOOL (U.S. CLS. 13, 19, 21, 23, 31, 34 AND 35).
FIRST USE 1-11-1991; IN COMMERCE 1-11-1991.

SN 76-321,213. SHICK TUBE-VEYOR CORPORATION, KANSAS CITY, MO. FILED 10-5-2001.

PRO-SACK

FOR PNEUMATICALLY CONTROLLED CONVEYOR TUBES FOR UNLOADING LARGE SACKS AND CONTAINERS HOLDING OBJECTS IN BULK, FOR USE IN THE FOOD INDUSTRY (U.S. CLS. 13, 19, 21, 23, 31, 34 AND 35).

CLASS 7—(Continued).

SN 76-322,031. HAWK INDUSTRIES, INC., LONG BEACH, CA. FILED 10-9-2001.



OWNER OF U.S. REG. NOS. 1,037,282 AND 1,967,261.
FOR POWER OPERATED PIPE TURNING TOOL FOR TURNING OIL WELL PIPE ABOUT THE LONGITUDINAL AXIS THEREOF FOR MAKING AND BREAKING OF JOINTS IN THE PIPE; MACHINES FOR ROTATING PIPE ABOUT THE LONGITUDINAL AXIS THEREOF IN ORDER TO THREADINGLY CONNECT AND DISCONNECT PIPE SECTIONS TO AND FROM EACH OTHER; MACHINES FOR SPINNING OIL WELL PIPE ABOUT THE LONGITUDINAL AXIS THEREOF; AND PORTABLE PNEUMATIC POST-DRIVING APPARATUS FOR DRIVING FENCE POSTS INTO THE GROUND (U.S. CLS. 13, 19, 21, 23, 31, 34 AND 35).
FIRST USE 1-1-1975; IN COMMERCE 1-1-1975.

SN 76-322,631. WARNER-LAMBERT COMPANY, MORRIS PLAINS, NJ. FILED 10-9-2001.

LEMS

FOR MACHINES FOR SEALING PHARMACEUTICAL CAPSULES (U.S. CLS. 13, 19, 21, 23, 31, 34 AND 35).
FIRST USE 10-8-1999; IN COMMERCE 10-8-1999.

SN 76-322,769. JETPHARMA SA, 6828 BALERNA, SWITZERLAND, FILED 10-9-2001.

PRIORITY CLAIMED UNDER SEC. 44(D) ON SWITZERLAND APPLICATION NO. 8831/2001, FILED 9-6-2001, REG. NO. 491535, DATED 9-6-2001, EXPIRES 9-6-2011.

FOR MACHINES FOR THE COMMINATION AND MICRONISATION OF SOLID SUBSTANCES BY MEANS OF FLUID JETS (U.S. CLS. 13, 19, 21, 23, 31, 34 AND 35).

CLASS 7—(Continued).

SN 76-326,668. WHIPPLE ENTERPRISES, INC., VOLCANO, CA. FILED 10-16-2001.

MINI-MOVER CONVEYORS

NO CLAIM IS MADE TO THE EXCLUSIVE RIGHT TO USE "CONVEYORS", APART FROM THE MARK AS SHOWN.

FOR POWERED CONVEYOR FOR MOVING AND HANDLING OF INDUSTRIAL MATERIALS (U.S. CLS. 13, 19, 21, 23, 31, 34 AND 35).

FIRST USE 10-1-1998; IN COMMERCE 10-1-1998.

SN 76-326,777. E-Z GROUT CORPORATION, WATERFORD, OH. FILED 10-17-2001.

FENCE HOG

OWNER OF U.S. REG. NO. 2,421,996.

NO CLAIM IS MADE TO THE EXCLUSIVE RIGHT TO USE "FENCE", APART FROM THE MARK AS SHOWN.

FOR POWER OPERATED TOOL, NAMELY FENCE DISPENSER (U.S. CLS. 13, 19, 21, 23, 31, 34 AND 35).

SN 76-335,610. CONSTRUCCIONES METALICAS COMANSA, S.A., PAMPLONA, SPAIN, FILED 11-7-2001.

LINDEN-COMANSA

OWNER OF U.S. REG. NO. 2,356,920.

FOR CRANES AND ELEVATING WORK PLATFORMS (U.S. CLS. 13, 19, 21, 23, 31, 34 AND 35).

FIRST USE 11-0-1988; IN COMMERCE 11-0-1988.

SN 76-339,179. FAIP NORTH AMERICA, INC., PALATINE, IL. FILED 11-19-2001.

TASKMASTER

FOR MULTI-PURPOSE POWER HIGH PRESSURE WASHERS (U.S. CLS. 13, 19, 21, 23, 31, 34 AND 35).

CLASS 7—(Continued).

SN 76-361,160. BELL & HOWELL MAIL AND MESSAGING TECHNOLOGIES COMPANY, DURHAM, NC. FILED 1-23-2002.

BH 3000

OWNER OF U.S. REG. NOS. 2,057,384 AND 2,219,556.

THE MARK CONSISTS OF THE MARK IS A TYPED DRAWING AND NOT A STYLIZED MARK.

FOR AUTOMATED INSERTER SYSTEM COMPRISING AN INSERTER APPARATUS FOR AUTOMATED MAIL PROCESSING, AUTOMATED MAIL PROCESSING COMPUTER HARDWARE, COMPUTER SOFTWARE USED TO OPERATE AUTOMATED INSERTER SYSTEMS AND TO COMMUNICATE WITH AUTOMATED MAIL PROCESSING MODULES AND SYSTEMS, COMPONENT PARTS THEREOF; AND USER MANUALS SOLD AS A UNIT THEREWITH (U.S. CLS. 13, 19, 21, 23, 31, 34 AND 35).

SN 76-362,122. ILLINOIS TOOL WORKS INC., GLENVIEW, IL. FILED 1-24-2002.

ITW CHALLENGER

OWNER OF U.S. REG. NO. 730,743.

FOR HOT MELT ADHESIVE APPLICATION EQUIPMENT AND PARTS THEREFORE, NAMELY NOZZLES, MODULES, ALSO KNOWN AS MODULE ADHESIVE VALVES, HOSES, PUMPS, APPLICATORS AND ADHESIVE SUPPLY MACHINES FOR DISPENSING AND APPLYING HOT MELT ADHESIVES (U.S. CLS. 13, 19, 21, 23, 31, 34 AND 35).

FIRST USE 10-22-2001; IN COMMERCE 10-22-2001.

SN 76-362,414. CORRUGATED GEAR & SERVICES, INC., ALPHARETTA, GA. FILED 1-24-2002.

S&S

FOR SPARE PARTS, NAMELY GEARS AND SPROCKETS FOR MACHINES THAT MAKE CORRUGATED PAPER AND PAPER BOXES AND SPARE PARTS, NAMELY GEARS AND SPROCKETS FOR MACHINES THAT MAKE, COMBINE, TREAT, FABRICATE, CUT, SLIT, SCORE, CREASE, SLOT AND OTHERWISE TREAT PAPER (U.S. CLS. 13, 19, 21, 23, 31, 34 AND 35).

FIRST USE 4-18-1986; IN COMMERCE 4-18-1986.

SN 76-363,604. TUBI STYLE S.R.L., UBERSETTO DI FIORANO (MODENA), ITALY, FILED 1-28-2002.

TUBI STYLE

OWNER OF U.S. REG. NO. 2,270,973.

NO CLAIM IS MADE TO THE EXCLUSIVE RIGHT TO USE "STYLE", APART FROM THE MARK AS SHOWN.

THE ENGLISH TRANSLATION OF "TUBI" IS "TUBES".

FOR EXHAUST PIPES, MUFFLERS, AND EXHAUST MANIFOLDS FOR LAND VEHICLES (U.S. CLS. 13, 19, 21, 23, 31, 34 AND 35).

CLASS 7—(Continued).

SN 76-365,167. SUNSHINE INTERNATIONAL INDUSTRY & TRADE CORP., NINGBO, ZHEJIANG, CHINA, FILED 2-1-2002.



FOR BEARINGS THAT ARE PARTS OF MACHINES, NAMELY, ROLLER BEARING, BALL BEARING, TENSIONER AND IDLER BEARING, CLUTCH RELEASE BEARINGS, PLASTIC BEARING, PLAIN BEARING, PILLOW BLOCK, BEARING, UNITS, BEARING HOUSING, PULLEY, STEEL BALL FOR BEARINGS (U.S. CLS. 13, 19, 21, 23, 31, 34 AND 35).

FIRST USE 1-0-1996; IN COMMERCE 10-0-2001.

SN 76-365,879. ESKO EQUIPMENT MANUFACTURING LTD., OAKVILLE, ONTARIO, CANADA, FILED 2-4-2002.

CHEETAH

OWNER OF CANADA REG. NO. 400,741, DATED 7-31-1992, EXPIRES 7-31-2007.

FOR SKID STEER LOADERS, AND ATTACHMENTS THEREFOR, NAMELY BUCKETS, FORKS, AUGERS, SWEEPERS, ROOF REMOVERS AND BACK HOES (U.S. CLS. 13, 19, 21, 23, 31, 34 AND 35).

FIRST USE 6-0-1988; IN COMMERCE 10-7-1994.

SN 76-374,456. HEIDELBERGER DRUCKMASCHINEN AG, D-69115 HEIDELBERG, FED REP GERMANY, FILED 2-21-2002.

CALEIDOPATE

PRIORITY CLAIMED UNDER SEC. 44(D) ON FED REP GERMANY APPLICATION NO. 30149985.3, FILED 8-21-2001, REG. NO. 30149985, DATED 10-25-2001, EXPIRES 8-31-2011.

FOR PRINTING PRESSES AND PARTS THEREFOR; AND PRINTING PRESS ACCESSORIES, NAMELY, PRINTING PLATES (U.S. CLS. 13, 19, 21, 23, 31, 34 AND 35).

SN 76-374,853. S.B. INTERNATIONAL, INC., NASHVILLE, TN, FILED 2-25-2002.

ERTEL PRODUCTS

NO CLAIM IS MADE TO THE EXCLUSIVE RIGHT TO USE "PRODUCTS", APART FROM THE MARK AS SHOWN. SEC. 2(F).

FOR AFTERMARKET VALVES AND VALVE GUIDES FOR AUTOMOTIVE ENGINES (U.S. CLS. 13, 19, 21, 23, 31, 34 AND 35).

FIRST USE 11-24-1945; IN COMMERCE 11-24-1945.

CLASS 7—(Continued).

SN 76-374,855. S.B. INTERNATIONAL, INC., NASHVILLE, TN, FILED 2-25-2002.

NYLEN PRODUCTS

NO CLAIM IS MADE TO THE EXCLUSIVE RIGHT TO USE "PRODUCTS", APART FROM THE MARK AS SHOWN. SEC. 2(F).

FOR AFTERMARKET VALVES AND VALVE GUIDES FOR AUTOMOTIVE ENGINES (U.S. CLS. 13, 19, 21, 23, 31, 34 AND 35).

FIRST USE 9-14-1953; IN COMMERCE 9-14-1953.

SN 76-377,789. PREMIERE TURF SERVICES, INC., TEGA CAY, SC, FILED 3-5-2002.

ACCUMARK

FOR AGRICULTURAL DEVICE, NAMELY, A MECHANICAL CHEMICALS APPLICATION MARKER FOR MARKING TURF, SPORTS FIELDS AND AGRICULTURAL FIELDS (U.S. CLS. 13, 19, 21, 23, 31, 34 AND 35).

SN 76-383,515. MAQUINARIA GEKA, S.A., 20180 OYARZUN (GUIPUZCOA), SPAIN, FILED 3-18-2002.



OWNER OF SPAIN REG. NO. 2233354, DATED 5-22-2000, EXPIRES 5-22-2010.

FOR MACHINE TOOLS, NAMELY, SHEARS, PUNCHING MACHINES, HYDRAULIC PUNCHING MACHINES, CUTTING, PUNCHING AND MARKING MACHINES WITH HYDRAULIC OPERATION AND LINEAR FEEDER, COPYING TABLES AND LINEAR FEEDERS (U.S. CLS. 13, 19, 21, 23, 31, 34 AND 35).

SN 76-384,368. FUTARA, LLC, PORTLAND, OR, FILED 2-28-2002.

FUTARA FES

FOR FUEL VAPORIZATION AND INDUCTION SYSTEMS FOR INTERNAL COMBUSTION ENGINES (U.S. CLS. 13, 19, 21, 23, 31, 34 AND 35).

FIRST USE 10-26-2001; IN COMMERCE 10-26-2001.

CLASS 7—(Continued).

SN 76-386,143. HALLIBURTON ENERGY SERVICES, INC., CARROLLTON, TX. FILED 3-20-2002.

VERSA-SET

FOR OIL AND GAS WELL POWER TOOLS, NAMELY, DOWN HOLE RETRIEVABLE PACKERS (U.S. CLS. 13, 19, 21, 23, 31, 34 AND 35).

SN 76-386,851. INDUSTRIAL MACHINERY INTERNATIONAL, INC., SOUTH PASADENA, CA. FILED 3-22-2002.

DUAL-PAK

FOR TRASH COMPACTOR (U.S. CLS. 13, 19, 21, 23, 31, 34 AND 35).

SN 76-387,150. RUST-OLEUM CORPORATION, VERNON HILLS, IL. FILED 3-25-2002.

GRIND 'N GO

FOR COMBINATION FLOOR MAINTENANCE MACHINE FOR BUFFING, CLEANING, POLISHING, SCRUBBING, STRIPPING AND SANDING FLOORS (U.S. CLS. 13, 19, 21, 23, 31, 34 AND 35).

SN 76-387,918. ASYST TECHNOLOGIES, INC., FREMONT, CA. FILED 3-28-2002.

ISOPORT

FOR MATERIAL HANDLING MACHINES FOR USE IN THE MANUFACTURE, TRANSFER AND STORAGE SEMICONDUCTOR WAFERS, RETICLES, FLAT PANEL DISPLAYS, AND MAGNETIC MEDIA; AND, FACTORY AUTOMATION MACHINES FOR USE IN THE MANUFACTURE, TRANSFER AND STORAGE SEMICONDUCTOR WAFERS, RETICLES, FLAT PANEL DISPLAYS, AND MAGNETIC MEDIA (U.S. CLS. 13, 19, 21, 23, 31, 34 AND 35).

SN 76-387,990. LESCO TECHNOLOGIES, LLC, STRONGSVILLE, OH. FILED 3-27-2002.

Z TWO

FOR RIDING LAWN MOWERS (U.S. CLS. 13, 19, 21, 23, 31, 34 AND 35).
FIRST USE 2-1-2002; IN COMMERCE 2-1-2002.

CLASS 7—(Continued).

SN 76-388,315. NANODEVICES, INC., SANTA BARBARA, CA. FILED 3-28-2002.

EASYTUBE NANOFURNACE

FOR MACHINE FOR FABRICATION OF CARBON NANOTUBES AND NANOTUBE DEVICES (U.S. CLS. 13, 19, 21, 23, 31, 34 AND 35).

SN 76-389,819. SPEEDFAM-IPEC, INC., CHANDLER, AZ. FILED 3-29-2002.

MOMENTUM

FOR CHEMICAL-MECHANICAL POLISHING AND CLEANING MACHINES (U.S. CLS. 13, 19, 21, 23, 31, 34 AND 35).

SN 76-389,914. TOKAI INDUSTRIAL SEWING MACHINE CO., LTD., AICHI-KEN, 486-0901, JAPAN, FILED 3-29-2002.

NEO

FOR EMBROIDERY MACHINES AND SEWING MACHINES (U.S. CLS. 13, 19, 21, 23, 31, 34 AND 35).

SN 76-390,823. MORGAN, LOUIS A., YUKON, OK. FILED 4-1-2002.

COMPUFILL

FOR CRYOGENIC GAS FILLING MACHINE FOR THE DELIVERY OF CONTROLLED AMOUNT OF GAS TO CRYOGENIC GAS TRANSPORT CYLINDER (U.S. CLS. 13, 19, 21, 23, 31, 34 AND 35).
FIRST USE 10-26-2001; IN COMMERCE 10-26-2001.

CLASS 7—(Continued).

SN 76-390,869. DORNER MFG. CORP., HARTLAND, WI. FILED 4-4-2002.

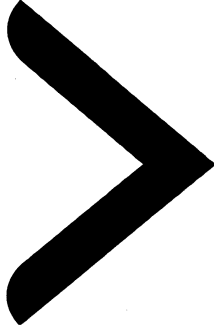

FOR BELT CONVEYORS, ROLLER CONVEYORS, AND STRUCTURAL PARTS FOR CONVEYORS (U.S. CLS. 13, 19, 21, 23, 31, 34 AND 35).

SN 76-392,212. BEARSS, CHRISTOPHER L., LIVONIA, MI. FILED 4-8-2002.



FOR MACHINES USED FOR INFLATING BALLOONS WITH HELIUM OR OTHER GAS (U.S. CLS. 13, 19, 21, 23, 31, 34 AND 35).
FIRST USE 3-27-2002; IN COMMERCE 3-27-2002.

SN 76-393,242. SHOP-VAC CORPORATION, WILLIAMSPORT, PA. FILED 4-5-2002.

SUV

FOR WET/DRY VACUUM CLEANERS (U.S. CLS. 13, 19, 21, 23, 31, 34 AND 35).

CLASS 7—(Continued).

SN 76-393,478. PER-FIL INDUSTRIES, INC., RIVERSIDE, NJ. FILED 4-9-2002.

DENSI-FIL

FOR FILLING MACHINES FOR FILLING CONTAINERS WITH POWDERS OR GRANULAR MATERIALS (U.S. CLS. 13, 19, 21, 23, 31, 34 AND 35).

SN 76-394,935. THERMAL ARC, INC., ST. LOUIS, MO. FILED 4-12-2002.

RAIDER

FOR ENGINE DRIVEN GENERATOR FOR WELDING (U.S. CLS. 13, 19, 21, 23, 31, 34 AND 35).

SN 78-044,491. CAMPBELL-BROWN INC, CHARLOTTE, NC. FILED 1-23-2001.

Elite Air

NO CLAIM IS MADE TO THE EXCLUSIVE RIGHT TO USE "AIR", APART FROM THE MARK AS SHOWN.
FOR REPLACEMENT COMPONENTS FOR AUTOMOTIVE AIR CONDITIONERS, NAMELY COMPRESSORS AND CLUTCHES (U.S. CLS. 13, 19, 21, 23, 31, 34 AND 35).

SN 78-056,117. HAMILTON, BRIMSLEY A., EAST ELMHURST, NY. FILED 3-31-2001.

BAH: CONVERSION UNDERCARRIAGE #1

NO CLAIM IS MADE TO THE EXCLUSIVE RIGHT TO USE "UNDERCARRIAGE", APART FROM THE MARK AS SHOWN.
FOR MECHANICAL UNDERCARRIAGE THAT TILTS AN ATTACHED CONTAINER TO EMPTY CONTENTS, AND IS DESIGNED TO BE USED WITH A FORKLIFT (U.S. CLS. 13, 19, 21, 23, 31, 34 AND 35).

CLASS 7—(Continued).

SN 78-063,060. DANA CORPORATION, TOLEDO, OH. FILED 5-11-2001.

INTELLIGENT LUBRICATION

NO CLAIM IS MADE TO THE EXCLUSIVE RIGHT TO USE "LUBRICATION", APART FROM THE MARK AS SHOWN.

FOR ENGINE LUBRICATION SYSTEM FOR MOTOR VEHICLES COMPRISING PUMPS, FLOW VALVES, HEAT EXCHANGERS, HOSES, AND SENSORS (U.S. CLS. 13, 19, 21, 23, 31, 34 AND 35).

SN 78-074,109. CHAMCO INDUSTRIAL, INC, LOMBARD, IL. FILED 7-16-2001.



NO CLAIM IS MADE TO THE EXCLUSIVE RIGHT TO USE "CUT" OR THE REPRESENTATION OF A DIAMOND, APART FROM THE MARK AS SHOWN.

FOR MACHINE PARTS, NAMELY, DIAMOND BLADES (U.S. CLS. 13, 19, 21, 23, 31, 34 AND 35). FIRST USE 1-15-2000; IN COMMERCE 11-15-2000.

SN 78-079,381. SMITH INTERNATIONAL, INC., HOUSTON, TX. FILED 8-15-2001.

MX CONNECT

FOR MULTILATERAL WELL REENTRY SYSTEM, NAMELY SLEEVES, JUNCTIONS, LATCHES, COLLARS, DEFLECTORS, ANCHORS, PACKERS, LOCATORS, PLUGS, RUNNING AND RETRIEVAL TOOLS FOR USE IN THE OIL AND GAS INDUSTRY (U.S. CLS. 13, 19, 21, 23, 31, 34 AND 35).

SN 78-079,389. SMITH INTERNATIONAL, INC., HOUSTON, TX. FILED 8-15-2001.

MX LOCATE

FOR MULTILATERAL WELL REFERENCE AND LATERAL LOCATION SYSTEM, NAMELY SLEEVES, JUNCTIONS, LATCHES, COLLARS, DEFLECTORS, LOCATORS, ANCHORS, PACKERS, PLUGS, RUNNING AND RETRIEVAL TOOLS FOR USE IN THE OIL AND GAS INDUSTRY (U.S. CLS. 13, 19, 21, 23, 31, 34 AND 35). FIRST USE 1-1-2001; IN COMMERCE 1-1-2001.

CLASS 7—(Continued).

SN 78-079,393. SMITH INTERNATIONAL, INC., HOUSTON, TX. FILED 8-15-2001.

MX DIRECT

FOR MULTILATERAL WELL COMPLETION TOOLS, NAMELY SLEEVES, LINERS, JUNCTIONS, DEFLECTORS, ANCHORS, PACKERS, LOCATORS, RUNNING AND RETRIEVAL TOOLS (U.S. CLS. 13, 19, 21, 23, 31, 34 AND 35). FIRST USE 1-1-2001; IN COMMERCE 1-1-2001.

SN 78-079,401. SMITH INTERNATIONAL, INC., HOUSTON, TX. FILED 8-15-2001.

MX SELECT

FOR MULTILATERAL WELL COMPLETION TOOLS, NAMELY SLEEVES, LINERS, JUNCTIONS, DEFLECTORS, ANCHORS, PACKERS, LOCATORS, RUNNING AND RETRIEVAL TOOLS (U.S. CLS. 13, 19, 21, 23, 31, 34 AND 35). FIRST USE 1-1-2001; IN COMMERCE 1-1-2001.

SN 78-079,404. SMITH INTERNATIONAL, INC., HOUSTON, TX. FILED 8-15-2001.

MX

FOR MULTILATERAL WELL COMPLETION, REENTRY AND LOCATION TOOLS, NAMELY SLEEVES, LINERS, JUNCTIONS, DEFLECTORS, ANCHORS, PACKERS, LOCATORS, RUNNING AND RETRIEVAL TOOLS (U.S. CLS. 13, 19, 21, 23, 31, 34 AND 35). FIRST USE 1-1-2001; IN COMMERCE 1-1-2001.

SN 78-082,124. OSMUNDSON AUSTRALIA PTY LTD, FREELING, AUSTRALIA, FILED 8-31-2001.

AG-TUFF

OWNER OF AUSTRALIA REG. NO. 824503, DATED 2-22-2000, EXPIRES 2-22-2010.

FOR HARD FACED METALLIC EARTH WORKING TOOLS FOR AGRICULTURAL IMPLEMENTS SUCH AS PLANTERS AND CULTIVATORS, NAMELY CULTIVATING SWEEPS, DISC BLADES, CHISEL POINTS, PLOW SHARES, RIPPER POINTS, SHANKS, ANHYDROUS POINTS, ROTARY TILLER BLADES, COULTER BLADES, OX POINTS, BULL TONGUE SHOVELS, CHISEL PLOW SPIKES, CHISEL PLOW SWEEPS, COTTON POINTS, GRAIN DRILL DISCS, HEEL SWEEPS, LANDSIDES, MOLDBOARDS, RIB SHARES, ROCK SHARES, SHINS, SPEAR POINT SHOVELS, S-TINES, SUB-SOIL POINTS, SWITCH PLOW BLADES AND TWISTED CHISEL PLOW BLADES (U.S. CLS. 13, 19, 21, 23, 31, 34 AND 35).

CLASS 7—(Continued).

SN 78-089,414. VOITH PAPER INC., APPLETON, WI. FILED 10-21-2001.

ECOLOAD

FOR MACHINES FOR USE IN THE PULP AND PAPER INDUSTRY, NAMELY, CRYSTALLIZES, SCREW PRESSES, STATIC MIXERS, FEED SCREWS, PAPER STOCK SHREDDING SCREWS, PAPER STOCK CONVEYING SCREWS AND PULP PRESSES (U.S. CLS. 13, 19, 21, 23, 31, 34 AND 35).

SN 78-104,218. VOITH PAPER INC., APPLETON, WI. FILED 1-23-2002.

MULTIMIZER

FOR STOCK PREPARATION MACHINERY FOR USE IN THE PULP AND PAPER INDUSTRY, NAMELY, SCREENING MACHINES FOR REMOVING CONTAMINANTS (U.S. CLS. 13, 19, 21, 23, 31, 34 AND 35).

SN 78-106,159. TOLERANCE TOOL, INC., NORTH ST. PAUL, MN. FILED 2-1-2002.

QCT

FOR MACHINE PART, NAMELY, A MOUNTING PALLET FOR SHAPED GRAPHITE ELECTRODES AND GRAPHITE ELECTRODE BLANKS (U.S. CLS. 13, 19, 21, 23, 31, 34 AND 35).

FIRST USE 9-26-2000; IN COMMERCE 3-5-2001.

SN 78-107,659. BLACK & DECKER CORPORATION, THE, TOWSON, MD. FILED 2-8-2002.

FEEL THE POWER NOT THE VIBRATION

FOR POWER TOOLS, NAMELY HAMMERS AND HAMMER BITS (U.S. CLS. 13, 19, 21, 23, 31, 34 AND 35).

SN 78-108,020. BISSELL HOMECARE, INC., GRAND RAPIDS, MI. FILED 2-11-2002.

POWER TRAK

FOR VACUUM CLEANERS (U.S. CLS. 13, 19, 21, 23, 31, 34 AND 35).

CLASS 7—(Continued).

SN 78-108,082. NILFISK-ADVANCE, INC., PLYMOUTH, MN. FILED 2-11-2002.

MICROMAX

FOR COMBINATION ELECTRIC VACUUM CLEANER AND FLOOR SCRUBBING MACHINES (U.S. CLS. 13, 19, 21, 23, 31, 34 AND 35).

SN 78-110,024. NORDSON CORPORATION, WESTLAKE, OH. FILED 2-20-2002.

SPECTRUM

FOR POWDER COATING MATERIAL SUPPLY HOPPERS, PUMPS AND ASSOCIATED EQUIPMENT FOR SUPPLYING POWDER COATING MATERIAL TO SPRAY GUNS (U.S. CLS. 13, 19, 21, 23, 31, 34 AND 35).

SN 78-113,624. COSTEX CORPORATION, MIAMI, FL. FILED 3-8-2002.



FOR REPLACEMENT PARTS USED PRIMARILY FOR LOADERS, BULLDOZERS, MOTOR GRADERS, AND DIESEL ENGINES FOR MACHINES AND ALSO FOR USED TRACTORS AND DIESEL ENGINES FOR LAND VEHICLES (U.S. CLS. 13, 19, 21, 23, 31, 34 AND 35).

FIRST USE 4-0-1998; IN COMMERCE 4-0-1998.

SN 78-114,274. ROYAL APPLIANCE MFG. CO., GLENWILLOW, OH. FILED 3-12-2002.

DIGIVAC

FOR ELECTRICAL VACUUM CLEANERS FOR DOMESTIC AND COMMERCIAL USE, INCLUDING ROBOTICALLY OPERATED VACUUM CLEANERS (U.S. CLS. 13, 19, 21, 23, 31, 34 AND 35).

CLASS 8—HAND TOOLS

SN 75-871,639. AGMA AB, SE-721 35 VASTERAS, SWEDEN, FILED 12-14-1999.

SMART-HOLDER

FOR HOLDERS FOR PIECES OF WOOD, NAMELY, A NON-AUTOMATED FRAME AND PENDULUM FOR POSITIONING PIECES OF WOOD DURING SAWING OPERATIONS (U.S. CLS. 23, 28 AND 44).

CLASS 8—(Continued).

SN 75-871,766. AGMA AB, SE-721 35 VASTERAS, SWEDEN, FILED 12-14-1999.

SMART-CRACKER

FOR CRACKERS FOR NUTS (U.S. CLS. 23, 28 AND 44).

SN 76-266,246. PACIFIC HANDY CUTTER, INC., COSTA MESA, CA. FILED 6-4-2001.

RAZE

FOR MANUALLY HELD TOOLS AND IMPLEMENTS, NAMELY, UTILITY KNIVES, SNAP KNIVES, HOBBY KNIVES, MINI KNIVES, BOX CUTTERS, SAFETY CUTTERS, BLADES FOR UTILITY KNIVES, SNAP KNIVES, HOBBY KNIVES, MINI KNIVES, BOX CUTTERS AND SAFETY CUTTERS, AND SPECIALTY HOLSTERS FOR CARRYING KNIVES, CUTTERS AND BLADES (U.S. CLS. 23, 28 AND 44).

SN 76-275,779. B A METAL DYNAMICS, INC., CRANSTON, RI. FILED 6-22-2001.

ULTIMATE TOOL

NO CLAIM IS MADE TO THE EXCLUSIVE RIGHT TO USE "TOOL", APART FROM THE MARK AS SHOWN.
FOR MULTI-FUNCTION FOLDING POCKET TOOL USABLE IN CONNECTION WITH SPORTING ACTIVITIES (U.S. CLS. 23, 28 AND 44).
FIRST USE 2-6-2002; IN COMMERCE 2-6-2002.

SN 76-319,459. DONG HE INTERNATIONAL TRADING INC., DBA UNITED POWER USA GROUP, EL MONTE, CA. FILED 9-26-2001.



NO CLAIM IS MADE TO THE EXCLUSIVE RIGHT TO USE "COOK", APART FROM THE MARK AS SHOWN.
FOR HAND TOOLS, NAMELY, KNIVES, FORKS, SPOONS, COOKING SPOONS, NON-ELECTRIC FRUIT PEELERS, SKEWERS, NON-ELECTRIC CAN OPENERS, HAND OPERATED KITCHEN SHEARS, AND CHEESE SLICERS (U.S. CLS. 23, 28 AND 44).
FIRST USE 7-15-2001; IN COMMERCE 7-15-2001.

CLASS 8—(Continued).

SN 76-321,092. GIFTCO, INC., VERNON HILLS, IL. FILED 10-3-2001.

SPEED SEAL

NO CLAIM IS MADE TO THE EXCLUSIVE RIGHT TO USE "SEAL", APART FROM THE MARK AS SHOWN.
FOR HAND-HELD TOOLS, NAMELY, MANUALLY OPERATED TRANSFER TAPE APPLICATORS (U.S. CLS. 23, 28 AND 44).

SN 76-322,697. CROSS & STUDLEY, INC., FORT MYERS, FL. FILED 10-9-2001.

X-TRAKEY

FOR HAND OPERATED ENTRY TOOL FOR PUNCHING THROUGH DOORS AND PULLING THEM OPEN AND FOR FIRE/RESCUE, LAW ENFORCEMENT, AND MILITARY USES (U.S. CLS. 23, 28 AND 44).
FIRST USE 6-0-2000; IN COMMERCE 2-0-2001.

SN 76-384,824. KABUSHIKI KAISHA NARUTO SCISSORS (NARUTO SCISSORS CO., LTD.), NISHIAWAJI, HIGASHIYODOGAWA-KU, OSAKA, JAPAN, FILED 3-20-2002.



FOR HAIR DRESSING SCISSORS (U.S. CLS. 23, 28 AND 44).

SN 76-385,597. GREAT AMERICAN TOOL COMPANY INC., THE, BUFFALO, NY. FILED 3-21-2002.

CAPE COD COLLECTION

NO CLAIM IS MADE TO THE EXCLUSIVE RIGHT TO USE "COLLECTION", APART FROM THE MARK AS SHOWN.
FOR KITCHEN CUTLERY (U.S. CLS. 23, 28 AND 44).

CLASS 8—(Continued).

SN 76-387,380. REHAU INCORPORATED, LEESBURG, VA.
FILED 3-27-2002.

VERSALOC

FOR MANUAL RATCHETING HAND TOOL FOR JOINING PEX (POLYMER) PIPE WITH METAL COMPRESSION-SLEEVE PLUMBING FITTINGS IN VARIOUS SIZES (U.S. CLS. 23, 28 AND 44).

SN 76-387,381. REHAU INCORPORATED, LEESBURG, VA.
FILED 3-27-2002.

PEXPANDER

FOR MANUAL HAND TOOL USED TO EXPAND PEX (POLYMER) PIPE FOR ASSEMBLY WITH METAL PLUMBING FITTINGS (U.S. CLS. 23, 28 AND 44).

SN 76-390,168. WORLD TABLEWARE INC., TOLEDO, OH.
FILED 4-1-2002.

AMULET

FOR STAINLESS STEEL FLATWARE, NAMELY, KNIVES, FORKS AND SPOONS (U.S. CLS. 23, 28 AND 44).
FIRST USE 10-0-2001; IN COMMERCE 10-0-2001.

SN 76-391,841. STAND TOOLS ENTERPRISE CO., LTD., TAIWAN, FILED 4-5-2002.



FOR HAND TOOLS, NAMELY, SCREWDRIVERS, SPANNERS, WRENCHES, SCREW WRENCHES, SCREW KEYS, CHUCKS, RATCHETS, RATCHET HEADS, RATCHET WRENCHES, BITS HOLDERS AND ADAPTORS, PICK-UP TOOLS, INSPECTION TOOLS, COLLECTORS (U.S. CLS. 23, 28 AND 44).

FIRST USE 7-0-1988; IN COMMERCE 7-0-1988.

CLASS 8—(Continued).

SN 78-053,783. AMES TRUE TEMPER PROPERTIES, INC., CAMP HILL, PA. FILED 3-19-2001.

TRUE TEMPER GARDENER

OWNER OF U.S. REG. NOS. 260,024, 1,943,548 AND OTHERS.

NO CLAIM IS MADE TO THE EXCLUSIVE RIGHT TO USE "GARDENER", APART FROM THE MARK AS SHOWN.

FOR MANUALLY OPERATED LAWN AND GARDEN TOOLS, NAMELY, SHOVELS, RAKES, HOES, CULTIVATORS AND GARDEN FORKS (U.S. CLS. 23, 28 AND 44).

SN 78-104,063. EASTERN PNEUMATICS & HYDRAULICS, HIGHGATE SPRINGS, VT. FILED 1-22-2002.

TIREMAN TORQUE WRENCH

NO CLAIM IS MADE TO THE EXCLUSIVE RIGHT TO USE "TORQUE WRENCH", APART FROM THE MARK AS SHOWN.

FOR MANUALLY OPERATED ADJUSTABLE TORQUE WRENCH IDEALLY SUITED FOR TIGHTENING WHEEL NUTS ON TRUCKS, BUSES, TRAINS AND OTHER HEAVY VEHICLE APPLICATIONS (U.S. CLS. 23, 28 AND 44).

FIRST USE 8-22-2001; IN COMMERCE 8-22-2001.

SN 78-112,725. FROST, JAMES A., DBA FROST CUTLERY, CHATTANOOGA, TN. FILED 3-5-2002.

STEEL WARRIOR

NO CLAIM IS MADE TO THE EXCLUSIVE RIGHT TO USE "STEEL", APART FROM THE MARK AS SHOWN.

FOR CUTLERY NAMELY POCKET, HUNTING, COLLECTOR'S KNIVES (U.S. CLS. 23, 28 AND 44).

CLASS 9—ELECTRICAL AND SCIENTIFIC APPARATUS

SN 75-090,277. COMARCO WIRELESS TECHNOLOGIES, INC., IRVINE, CA. BY ASSIGNMENT EDX ENGINEERING, INC., EUGENE, OR. FILED 4-18-1996.

EDX SIGNALPRO

FOR COMPUTER SOFTWARE FOR ANALYSIS, MODELING, AND DISPLAY OF PROPAGATION EFFECTS OF RADIO AND OTHER WIRELESS COMMUNICATION SYSTEMS (U.S. CLS. 21, 23, 26, 36 AND 38).

FIRST USE 2-13-1996; IN COMMERCE 2-13-1996.

CLASS 9—(Continued).

SN 75-254,789. TELEFONAKTIEBOLAGET LM ERICSSON, STOCKHOLM, SWEDEN, FILED 3-10-1997.

ECLARE

PRIORITY CLAIMED UNDER SEC. 44(D) ON SWEDEN APPLICATION NO. 000373068, FILED 9-20-1996, REG. NO. 0373068, DATED 3-3-1999, EXPIRES 9-20-2006.

FOR COMPUTER SOFTWARE FOR USE IN THE DEVELOPMENT OF TELECOMMUNICATION NETWORK SWITCHING AND CONTROL SOFTWARE (U.S. CLS. 21, 23, 26, 36 AND 38).

SN 75-299,074. ROSEMOUNT ANALYTICAL INC., LAHABRA, CA. FILED 5-28-1997.

TUpH

FOR PH SENSORS; OXIDATION REDUCTION POTENTIAL (ORP) SENSORS; COMBINATION ELECTRODES FOR SENSING PH AND ORP IN THE COMMERCIAL AND INDUSTRIAL FIELDS FOR NON-LABORATORY USE (U.S. CLS. 21, 23, 26, 36 AND 38).

FIRST USE 4-0-1995; IN COMMERCE 4-0-1995.

SN 75-310,454. SUN MICROSYSTEMS, INC., PALO ALTO, CA. BY CHANGE OF NAME; BY MERGER; BY ASSIGNMENT COBALT MICROSERVER, INC., MOUNTAIN VIEW, CA. FILED 6-2-1997.

COBALT

FOR COMPUTER HARDWARE SERVERS AND COMPUTER SERVER SOFTWARE (U.S. CLS. 21, 23, 26, 36 AND 38).

SN 75-354,700. SHIPNET AS, N-1001 OSLO, NORWAY, FILED 9-10-1997.

SHIPNET

FOR COMPUTER SOFTWARE FOR USE IN THE FIELDS OF ACCOUNTING, FINANCIAL MANAGEMENT AND COMMERCIAL MANAGEMENT FOR SHIP OWNERS, SHIPS MANAGEMENT COMPANIES, SHIP OPERATORS AND SHIP BROKERS, AND INSTRUCTION MANUALS, SOLD AS A UNIT (U.S. CLS. 21, 23, 26, 36 AND 38).

FIRST USE 9-0-1992; IN COMMERCE 3-0-1995.

CLASS 9—(Continued).

SN 75-416,995. CREATIVE TECHNOLOGY LTD., CREATIVE RESOURCE, SINGAPORE, FILED 1-12-1998.

ENVIRONMENTAL AUDIO

NO CLAIM IS MADE TO THE EXCLUSIVE RIGHT TO USE "AUDIO", APART FROM THE MARK AS SHOWN.

FOR COMPUTER HARDWARE, COMPUTER PERIPHERALS, AND COMPUTER SOFTWARE TO ENHANCE THE AUDIO CAPABILITIES OF INTERACTIVE GAME APPLICATIONS FOR USE ON A PERSONAL COMPUTER (U.S. CLS. 21, 23, 26, 36 AND 38).

SN 75-478,816. DAIMLERCHRYSLER AG, STUTTGART, FED REP GERMANY, BY MERGER DAIMLER-BENZ AKTIENGESELLSCHAFT, 70546 STUTTGART, FED REP GERMANY, FILED 5-4-1998.

DTR

PRIORITY CLAIMED UNDER SEC. 44(D) ON FED REP GERMANY APPLICATION NO. 39755898.8, FILED 11-21-1997, REG. NO. 39755898, DATED 4-23-1998, EXPIRES 11-30-2007.

FOR DISTANCE MEASURING, DISTANCE WARNING, AND DISTANCE CONTROLLING DEVICES FOR AUTOMOBILES, COMPRISING RADAR AND INFRARED DETECTORS, MICROCOMPUTERS AND DISPLAY UNITS WITH VISUAL AND ACOUSTICAL WARNINGS (U.S. CLS. 21, 23, 26, 36 AND 38).

SN 75-479,322. SUNGARD RECOVERY SERVICES LP, WAYNE, PA. BY ASSIGNMENT; BY ASSIGNMENT TRISTRATA SECURITY, INC., REDWOOD SHORES, CA. FILED 5-4-1998.

RKS

FOR COMPUTER SOFTWARE FOR INFORMATION SECURITY MANAGEMENT OF ELECTRONIC DATA (U.S. CLS. 21, 23, 26, 36 AND 38).

SN 75-613,022. CALYPSO TECHNOLOGY, INC, SAN FRANCISCO, CA. FILED 12-29-1998.

CALYPSO

FOR COMPUTER SOFTWARE FOR USE BY FINANCIAL INSTITUTIONS FOR CORE PROCESSING AND CONTROL (U.S. CLS. 21, 23, 26, 36 AND 38).

CLASS 9—(Continued).

SN 75-613,914. NEW MOON SOFTWARE INC., SANTA CLARA, CA. FILED 12-28-1998.

CANAVERAL

FOR COMPUTER SOFTWARE, ALLOWING MULTIPLE USERS TO ACCESS AND OPERATE SOFTWARE APPLICATIONS VIA PUBLIC AND PRIVATE COMPUTER NETWORKS (U.S. CLS. 21, 23, 26, 36 AND 38).

SN 75-668,198. BOSE CORPORATION, FRAMINGHAM, MA. FILED 3-25-1999.

ENTERO

FOR NETWORK PRODUCTS INCLUDING AN AUDIO PROCESSOR WITH SOFTWARE FOR BOTH ANALOG AND DIGITAL SIGNAL PROCESSING (U.S. CLS. 21, 23, 26, 36 AND 38).

FIRST USE 3-8-1999; IN COMMERCE 3-8-1999.

SN 75-672,108. DBT DEUTSCHE BERGBAU-TECHNIK GMBH, 44534 LUNEN, FED REP GERMANY, FILED 3-31-1999.

PMC

PRIORITY CLAIMED UNDER SEC. 44(D) ON FED REP GERMANY APPLICATION NO. 39856580.5, FILED 10-2-1998.
FOR PROGRAMMABLE CONTROL DEVICES, NAMELY, COMPUTER SOFTWARE, COMPUTER HARDWARE AND ELECTRONIC COMPONENTS AND SENSORS FOR USE IN MONITORING ROOF AND WALL SUPPORTS, CONVEYOR ANCHORING BUILDING AND MINING MACHINES, DRIVAGE AND LOADING MACHINES AND PIPE JACKING APPARATUS FOR MINE DRIVAGE SHIELDS (U.S. CLS. 21, 23, 26, 36 AND 38).

SN 75-682,366. DOTRONIX, INC., ST. PAUL, MN. FILED 4-14-1999.

DOT-LINK

OWNER OF U.S. REG. NO. 1,398,306.
FOR ELECTRONIC POINT OF SALE PROMOTIONAL DELIVERY AND DISPLAY SYSTEM COMPRISED OF DISPLAY MONITORS, COMPUTER HARDWARE, AND COMPUTER SOFTWARE FOR CONCURRENT USE IN ONE OR MORE LOCATIONS (U.S. CLS. 21, 23, 26, 36 AND 38).

CLASS 9—(Continued).

SN 75-694,843. MUSICNOTES, INC., MADISON, WI. FILED 4-30-1999.

DOREMI

FOR PROVIDING COMPUTER GENERATED PRINTING FONTS BY MEANS OF ELECTRONIC TRANSMISSION WHICH CAN BE DOWNLOADED BY RECEIVING USERS FOR PRINTING AND VIEWING MUSIC ON AND THROUGH A COMPUTER AND GLOBAL COMPUTER NETWORK (U.S. CLS. 21, 23, 26, 36 AND 38).

SN 75-721,480. SOUTHERN MOTOR CARRIERS RATE CONFERENCE, INC., PEACHTREE CITY, GA. FILED 6-3-1999.

CZARLITE

FOR COMPUTER SOFTWARE FOR TRANSPORTATION PRICE MANAGEMENT THAT CALCULATES PRICE BASED ON REGIONAL, INTER-REGIONAL, AND NATIONAL PRICE INDEXING OF THE LESS THAN TRUCKLOAD (LTL) INDUSTRY (U.S. CLS. 21, 23, 26, 36 AND 38).

FIRST USE 12-31-1987; IN COMMERCE 12-31-1987.

SN 75-723,713. COMSOL AB, 111 40 STOCKHOLM, SWEDEN, BY CHANGE OF NAME COMPUTER SOLUTIONS EUROPE AB, S111 49 STOCKHOLM, SWEDEN, FILED 6-8-1999.



FOR COMPUTER SOFTWARE FOR TECHNICAL MATHEMATICAL CALCULATIONS FOR USE IN THE FIELD OF MATHEMATICS, ENGINEERING AND SCIENCE, AND MANUALS AND INSTRUCTION HANDBOOKS SOLD TOGETHER AS A UNIT (U.S. CLS. 21, 23, 26, 36 AND 38).

FIRST USE 1-0-1996; IN COMMERCE 4-0-1999.

SN 75-726,213. TARANEH, MEHDI, STUDIO CITY, CA. FILED 6-10-1999.

MEHDI

FOR PRE-RECORDED COMPACT DISCS, VIDEO TAPES, AND AUDIO CASSETTES FEATURING INSTRUMENTAL MUSIC (U.S. CLS. 21, 23, 26, 36 AND 38).

FIRST USE 12-13-1966; IN COMMERCE 12-13-1966.

CLASS 9—(Continued).

SN 75-727,593. KAISHA-TEC CO., LTD., TOKYO 181-0001, JAPAN, FILED 6-14-1999.

KAISHA ACTIVEMODELER

NO CLAIM IS MADE TO THE EXCLUSIVE RIGHT TO USE "KAISHA", APART FROM THE MARK AS SHOWN. FOR DOWNLOADABLE COMPUTER SOFTWARE FOR BUSINESS PROCESS ANALYSIS AND WORKFLOW EXECUTION (U.S. CLS. 21, 23, 26, 36 AND 38). FIRST USE 12-20-1998; IN COMMERCE 12-20-1998.

SN 75-729,406. FTL SYSTEMS, INC., ROCHESTER, MN. FILED 6-16-1999.

CENTAURI

FOR COMPUTER SOFTWARE FOR COMPILATION AND SIMULATION OF ELECTRONIC AND ELECTRO-MECHANICAL DESIGNS (U.S. CLS. 21, 23, 26, 36 AND 38).

SN 75-752,616. KONAMI CO., LTD, TOKYO 105, JAPAN, FILED 7-2-1999.

VR MISSIONS

NO CLAIM IS MADE TO THE EXCLUSIVE RIGHT TO USE "VR", APART FROM THE MARK AS SHOWN. FOR COMPUTER GAME PROGRAMS, VIDEO GAME CARTRIDGES, VIDEO GAME CD-ROMS AND VIDEO OUTPUT GAME MACHINES, ALL FOR USE WITH TELEVISION SETS, AND INSTRUCTIONAL MATERIALS SOLD THEREWITH (U.S. CLS. 21, 23, 26, 36 AND 38). FIRST USE 10-12-1999; IN COMMERCE 10-12-1999.

SN 75-759,957. CONTROL DIABETES SERVICES, INC., PLANO, TX. FILED 7-26-1999.

DIA ♦ TRAC

FOR COMPUTER SOFTWARE FOR DIABETES OUTCOMES COLLECTION, ANALYSIS AND REPORTING FOR USE BY MANAGED HEALTH CARE ORGANIZATIONS AND HEALTH CARE PROVIDERS (U.S. CLS. 21, 23, 26, 36 AND 38). FIRST USE 8-31-1997; IN COMMERCE 8-31-1997.

CLASS 9—(Continued).

SN 75-762,919. AUTOMATED SECURITIES CLEARANCE, LTD., WEEHAWKEN, NJ. FILED 7-28-1999.

UMA

FOR COMPUTER SOFTWARE FOR USE BY SECURITIES BROKERS AND DEALERS AND FINANCIAL INSTITUTIONS IN RECEIVING, TRANSMITTING, EXECUTING, AND MANAGING TRADES INVOLVING STOCKS, BONDS, CURRENCIES, DEBENTURES, MUTUAL FUNDS, FUTURES, OPTIONS, SECURITIES, AND RELATED INSTRUCTIONAL MANUALS (U.S. CLS. 21, 23, 26, 36 AND 38). FIRST USE 6-0-1997; IN COMMERCE 1-0-1998.

SN 75-781,178. GN NETCOM, INC., NASHUA, NH. FILED 8-20-1999.

ACTIVA

THE ENGLISH TRANSLATION OF "ACTIVA" IS "ACTIVE". FOR TELEPHONE APPARATUS, NAMELY TELEPHONE HEADSETS; TELEPHONE HEADSET AMPLIFIERS (U.S. CLS. 21, 23, 26, 36 AND 38).

SN 75-809,521. ALDRIDGE, CHESTER, TIBURON, CA. FILED 9-27-1999.

STEALTH CHESS

NO CLAIM IS MADE TO THE EXCLUSIVE RIGHT TO USE "CHESS", APART FROM THE MARK AS SHOWN. FOR COMPUTER GAME SOFTWARE AND USER INSTRUCTION MANUALS SOLD AS A UNIT (U.S. CLS. 21, 23, 26, 36 AND 38).

SN 75-824,099. MILLBROOK INCORPORATED, BETHLEHEM, PA. FILED 10-15-1999.

BEACON

FOR COMPUTER SOFTWARE FOR MANAGING INFORMATION FOR THE INSURANCE AND FINANCIAL INDUSTRIES, NAMELY, EXTRACTING DATA FROM A COMPUTER SYSTEM AND PLACING DATA IN A DATA WAREHOUSE, MANAGING STORED DATA IN DATABASES, AND FACILITATING BETTER RETRIEVAL OF SUCH DATA WITH INTERFACES WHICH INTERACT WITH TABLES AND EXTRACT DATA AND INFORMATION (U.S. CLS. 21, 23, 26, 36 AND 38). FIRST USE 9-19-1997; IN COMMERCE 9-19-1997.

CLASS 9—(Continued).

SN 75-829,845. MICROSYS, INC., GLENDALE, CA. FILED 10-22-1999.

DRUMLIN

FOR COMPUTER SOFTWARE, NAMELY, COMPUTER SOFTWARE PROGRAMS USED TO CONTROL AND OPTIMIZE THE OPERATION OF EQUIPMENT AND PROCESSES IN THE FIELD OF THE INDUSTRIAL CONTROL OF MACHINERY, AND OBJECT ORIENTED INDUSTRIAL CONTROL PROGRAMMING SOFTWARE FOR IMPLEMENTING FACTORY AUTOMATION AND PROCESS CONTROL ON PROGRAMMABLE CONTROLLERS AND COMPUTERS IN A MULTIPLE-PARALLEL REAL-TIME EXECUTION ENVIRONMENT (U.S. CLS. 21, 23, 26, 36 AND 38).

FIRST USE 4-0-1991; IN COMMERCE 4-0-1991.

SN 75-833,755. POINT, INC., LENEXA, KS. FILED 10-27-1999.

AXIS

FOR GLOBAL POSITIONING SYSTEM RECEIVERS FOR SUPPLYING DATA TO DATA COLLECTORS AND SOFTWARE FOR USE IN THE FIELDS OF SURVEYING, MAPPING AND CONSTRUCTION (U.S. CLS. 21, 23, 26, 36 AND 38).

FIRST USE 9-1-1999; IN COMMERCE 9-1-1999.

SN 75-838,305. SMP INTERNATIONAL, INC., SHERMAN OAKS, CA. FILED 11-2-1999.

SEAN MICHAELS

THE MARK, SEAN MICHAELS, IDENTIFIES A LIVING INDIVIDUAL WHOSE CONSENT IS OF RECORD.

FOR PRERECORDED VIDEO TAPES FEATURING ADULT ENTERTAINMENT AND/OR DVDS FEATURING ADULT ENTERTAINMENT (U.S. CLS. 21, 23, 26, 36 AND 38).

FIRST USE 3-0-1999; IN COMMERCE 3-0-1999.

SN 75-850,720. PETROLEUM INFORMATION/DWIGHTS LLC, DBA IHS ENERGY GROUP, ENGLEWOOD, CO. FILED 11-17-1999.

SPATIAL EXPLORER

FOR PRE-RECORDED COMPUTER PROGRAMS ON CD-ROMS FOR USE IN GEOLOGICAL ANALYSIS, MAPPING, AND DATA MANAGEMENT RELATING TO EXPLORATION AND PRODUCTION OF PETROLEUM AND NATURAL GAS (U.S. CLS. 21, 23, 26, 36 AND 38).

FIRST USE 9-30-1999; IN COMMERCE 9-30-1999.

CLASS 9—(Continued).

SN 75-857,856. DAVIDSON & ASSOCIATES, INC., TORRANCE, CA. FILED 11-23-1999.

MONTH BY MONTH

SEC. 2(F).

FOR COMPUTER SOFTWARE FOR USE BY TEACHERS AND STUDENTS AND COMPRISING THEME-BASED MONTHLY PROJECTS FOR CREATING REPORTS, JOURNALS, STORIES, SLIDE SHOWS, AND PRESENTATIONS ON THE SUBJECTS OF LANGUAGE ARTS, WRITING, VOCABULARY, SPELLING, AND SOCIAL STUDIES (U.S. CLS. 21, 23, 26, 36 AND 38).

FIRST USE 12-28-1998; IN COMMERCE 12-28-1998.

SN 75-859,680. NIELSEN MEDIA RESEARCH, INC., NEW YORK, NY. FILED 11-30-1999.

NHSI

FOR ELECTRONIC DATABASES RECORDED ON COMPUTER MEDIA AND COMPUTER PROGRAMS CONTAINING INFORMATION RELATING TO THE LISTENING, VIEWING, AND USAGE HABITS OF SIGNAL RECEIVING AUDIENCES; AND FOR COLLECTING, CORRELATING AND PROVIDING INFORMATION ABOUT THE CHARACTERISTICS OF AUDIENCES OF SPANISH LANGUAGE PROGRAMMING, INCLUDING PROGRAMMING RATING REPORTS, MEDIA RESEARCH RELATING TO THE AUDIENCE USE AND VIEWING OF SPANISH LANGUAGE PROGRAMMING REGARDLESS OF SIGNAL TRANSMISSION AND/OR RECEIVING MEANS, AND DEMOGRAPHIC DATA REGARDING THE SIGNAL RECEIVING AUDIENCES (U.S. CLS. 21, 23, 26, 36 AND 38).

FIRST USE 6-30-1992; IN COMMERCE 6-30-1992.

SN 75-860,737. SHERWIN-WILLIAMS COMPANY, THE, CLEVELAND, OH. FILED 11-30-1999.

PALETTE MATCH

FOR INTERACTIVE COMPUTER PROGRAMS AND COMPUTER SOFTWARE FOR USE IN CREATING, DISPLAYING, AND VISUALIZING PAINT COLORS AND DECORATING FEATURES (U.S. CLS. 21, 23, 26, 36 AND 38).

CLASS 9—(Continued).

SN 75-866,851. DIGITAL INK, INC., BROOKLINE, MA. FILED 12-9-1999.

n.scribe

FOR PORTABLE DIGITAL PEN - COMPRISING SOFTWARE AND HARDWARE FOR COLLECTING, STORING AND TRANSMITTING INFORMATION BY RECORDING A USER'S HANDWRITING, DRAWING, OR GRAPHIC IMAGE; STORING THE DIGITAL RENDITION OF SAID HANDWRITING, DRAWING, OR GRAPHIC IMAGE; AND, DOWNLOADING SAID DIGITAL RENDITION TO ANOTHER DEVICE (U.S. CLS. 21, 23, 26, 36 AND 38).

SN 75-871,986. GATES CORPORATION, THE, DENVER, CO. FILED 12-14-1999.

DESIGN OHL

NO CLAIM IS MADE TO THE EXCLUSIVE RIGHT TO USE "DESIGN", APART FROM THE MARK AS SHOWN.
FOR PRE-RECORDED COMPUTER SOFTWARE FOR USE IN THE DESIGN OF POWER TRANSMISSION SYSTEMS (U.S. CLS. 21, 23, 26, 36 AND 38).

SN 75-878,047. TEKKNOWLEDGE CORPORATION, PALO ALTO, CA. FILED 12-23-1999.

TEKPORTAL

FOR COMPUTER SOFTWARE FOR USE IN DATA AGGREGATION IN THE FIELD OF BANKING AND PERSONAL FINANCE ACCESSIBLE FROM A GLOBAL COMPUTER NETWORK (U.S. CLS. 21, 23, 26, 36 AND 38).
FIRST USE 12-6-1999; IN COMMERCE 12-6-1999.

SN 75-906,911. LINCOLN PARTNERS, L.L.C., CHICAGO, IL. FILED 1-20-2000.

LINCOLNSTAT

FOR ELECTRONIC DATABASE, NAMELY A RELATIONAL DATABASE OF FINANCIAL BUYERS AND FINANCIAL DATABASES IN THE FIELD OF INVESTMENT BANKING RECORDED ON A COMPUTER MEDIA (U.S. CLS. 21, 23, 26, 36 AND 38).
FIRST USE 10-1-1998; IN COMMERCE 10-1-1998.

CLASS 9—(Continued).

SN 75-912,888. CAVACO SALES, INC., BOCA RATON, FL. FILED 2-8-2000.

LAFAYETTE

FOR DIGITAL VIDEO PLAYERS, VIDEO CASSETTE RECORDERS, TELEVISIONS (U.S. CLS. 21, 23, 26, 36 AND 38).
FIRST USE 6-7-2000; IN COMMERCE 6-7-2000.

SN 75-917,005. SOLID INFORMATION TECHNOLOGY CORPORATION OY, FIN-00150 HELSINKI, FINLAND, FILED 2-10-2000.

SOLID

OWNER OF U.S. REG. NO. 2,142,959.
FOR SOFTWARE FOR USE IN STORING, MANAGING AND DISTRIBUTING INFORMATION, DATA, AND SOFTWARE IN AND BETWEEN LOCAL AND DISTRIBUTED DATA STORES (U.S. CLS. 21, 23, 26, 36 AND 38).
FIRST USE 3-12-1995; IN COMMERCE 3-12-1995.

SN 75-919,137. IGEN INTERNATIONAL, INC, GAITHERSBURG, MD. FILED 2-15-2000.

MEDNET

FOR COMPUTER SOFTWARE FOR THE OPERATION AND CONTROL OF LABORATORY APPARATUS, NAMELY, BIOLOGICAL, BIOCHEMICAL, AND CHEMICAL ANALYZERS FOR RESEARCH AND DIAGNOSTIC ASSAYS FOR USE IN THE MEDICAL AND RESEARCH FIELDS (U.S. CLS. 21, 23, 26, 36 AND 38).

SN 75-955,812. BRAIN TECHNOLOGIES CORPORATION, THE, SANTA MONICA, CA. BY ASSIGNMENT NATRIFICIAL LLC, SANTA MONICA, CA. FILED 3-10-2000.

HANDHELDBRAIN

OWNER OF U.S. REG. NO. 2,169,826.
FOR COMPUTER SOFTWARE FOR FACILITATING INFORMATION MANAGEMENT, NAMELY, SOFTWARE FOR USE IN DATABASE MANAGEMENT, FILE MANAGEMENT, RELATIONAL DATABASE MANAGEMENT, AND RELATIONAL DATA MANAGEMENT; SOFTWARE PROVIDING A GRAPHICAL USER INTERFACE; SOFTWARE CONTAINING A USER INTERFACE FEATURE AND SEARCH AND RETRIEVAL CAPABILITY, ALLOWING THE USER AND ADMINISTRATOR TO STRUCTURE, ORGANIZE, RETRIEVE, AND CREATE LINKS TO PRE-DEFINED AND USER-DEFINED INFORMATION IN ACCORDANCE WITH USERS' PREFERENCES, AND TO ACCESS SUCH INFORMATION VIA INTERNAL AND GLOBAL COMPUTER NETWORKS (THE INTRANET AND INTERNET) (U.S. CLS. 21, 23, 26, 36 AND 38).

CLASS 9—(Continued).

SN 75-982,236. VRISSIMDJIS, CONSTANTINE S., NEA ERYTHREA 146 71 ATTICA, GREECE, FILED 1-12-2001.

CHAMPION

FOR GLOVES AND CUFFS MADE FROM NATURAL OR SYNTHETIC LATEX FOR INDUSTRIAL USE (U.S. CLS. 21, 23, 26, 36 AND 38).
FIRST USE 3-27-2000; IN COMMERCE 3-27-2000.

SN 76-002,513. EIDOS INTERACTIVE LIMITED, WIMBLEDON, LONDON, UNITED KINGDOM, FILED 3-17-2000.

HITMAN

FOR COMPUTER GAME SOFTWARE ON PRERECORDED DISK, CD ROMS, GAME CARTRIDGES, AND VIDEOTAPE, AND DOWNLOADABLE FROM A REMOTE COMPUTER NETWORK, FOR USE AS AN SPY/SUSPENSE GAME; ELECTRONIC PUBLICATIONS, NAMELY MAGAZINES AND BOOKS FEATURING INFORMATION ON SPY/SUSPENSE GAMES AND DOWNLOADABLE FROM A REMOTE COMPUTER NETWORK (U.S. CLS. 21, 23, 26, 36 AND 38).

SN 76-002,514. EIDOS INTERACTIVE LIMITED, WIMBLEDON, LONDON, UNITED KINGDOM, FILED 3-17-2000.

HITMAN: CODENAME 47

FOR COMPUTER GAME SOFTWARE ON PRERECORDED DISK, CD ROMS, GAME CARTRIDGES, AND VIDEOTAPE, AND DOWNLOADABLE FROM A REMOTE COMPUTER NETWORK, FOR USE AS AN SPY/SUSPENSE GAME; ELECTRONIC PUBLICATIONS, NAMELY MAGAZINES AND BOOKS FEATURING INFORMATION ON SPY/SUSPENSE GAMES AND DOWNLOADABLE FROM A REMOTE COMPUTER NETWORK (U.S. CLS. 21, 23, 26, 36 AND 38).

SN 76-019,394. EUROLOGIC SYSTEMS LIMITED, LEOPARDSTOWN, DUBLIN 18, IRELAND, FILED 4-6-2000.

SANBLOC

PRIORITY CLAIMED UNDER SEC. 44(D) ON IRELAND APPLICATION NO. 99/3617, FILED 10-14-1999, REG. NO. 215757, DATED 10-14-1999, EXPIRES 10-14-2009.

FOR COMPUTER SOFTWARE FOR THE CONFIGURATION AND MANAGEMENT OF DATA; COMPUTER HARDWARE AND PERIPHERALS; DATA STORAGE FACILITATION AND ENABLING DEVICES (U.S. CLS. 21, 23, 26, 36 AND 38).

CLASS 9—(Continued).

SN 76-019,485. LINN PRODUCTS LIMITED, GLASGOW, G76 0EP, UNITED KINGDOM, FILED 4-6-2000.

KIVOR

PRIORITY CLAIMED UNDER SEC. 44(D) ON ERPNCMNTY TM OFC APPLICATION NO. 001338086, FILED 10-8-1999, REG. NO. 1338086, DATED 12-8-2000, EXPIRES 10-8-2009.

FOR APPARATUS FOR RECORDING AND REPRODUCING SOUNDS, NAMELY RECORD TURNTABLES, TAPE DECKS, COMPACT DISC PLAYERS, RADIO TUNERS, PRE-AMPLIFIERS, POWER AMPLIFIERS, LOUDSPEAKERS, DIGITAL TO ANALOG CONVERTERS, TONE ARMS, CONTROL AMPLIFIERS, LOUDSPEAKER POWER AMPLIFIERS, REMOTE CONTROL HANDSETS, LOUDSPEAKER CABLES, INTERCONNECT LEADS, CABLE CONNECTORS, COMPUTER SOFTWARE FOR USE IN CONTROLLING THE RECORDING, REPRODUCTION AND DISTRIBUTION OF AUDIO SIGNALS; COMPUTER SOFTWARE TO CONTROL AND IMPROVE COMPUTER AND AUDIO EQUIPMENT SOUND QUALITY; MULTI ROOM AUDIO DISTRIBUTION CONTROL APPARATUS, COMPRISING CABLES, PRE-AMPLIFIERS, POWER AMPLIFIERS, LOUDSPEAKERS, DIGITAL TO ANALOG CONVERTERS, CONTROL AMPLIFIERS, LOUDSPEAKER AMPLIFIERS, INTERCONNECT LEADS, CABLE CONNECTORS, COMPUTER AND REMOTE CONTROL HANDSETS; PRE-RECORDED RECORDS, AUDIO TAPES AND COMPACT DISCS FEATURING MUSIC; COMPUTER SOFTWARE FOR USE IN ARCHIVING MUSIC; COMPUTER SOFTWARE FOR USE IN RECORDING AND REPRODUCING SOUND; COMPUTERS; COMPUTER WORKSTATIONS COMPRISING HARD DRIVE ARCHIVING FOR MUSIC AND SOUND; COMPUTER WORKSTATIONS COMPRISING HARD DRIVES; CD-ROM DRIVES AND SOUND CARDS FOR RECORDING AND REPRODUCING SOUNDS; AUDIO MIXERS; AUDIO TAPE RECORDERS; PARTS FOR ANY OF THE FOREMENTIONED (U.S. CLS. 21, 23, 26, 36 AND 38).

SN 76-025,705. SKY COMPUTERS, INC., CHELMSFORD, MA. FILED 4-14-2000.

SKY COMPUTERS

NO CLAIM IS MADE TO THE EXCLUSIVE RIGHT TO USE "COMPUTERS", APART FROM THE MARK AS SHOWN.

FOR MULTIPROCESSOR ACCELERATORS FOR INCREASING THE PROCESSING SPEED AND CAPABILITY OF A BUS SYSTEM; HIGH PERFORMANCE COMPUTER SYSTEMS COMPRISED OF MULTIPLE PROCESSORS, DIGITAL AND ANALOG INPUT/OUTPUT INTERFACES, DATA STORAGE DEVICES, NAMELY, STATIC AND DYNAMIC MEMORY, AND COMMUNICATIONS NETWORKS COMPRISING COMPUTER HARDWARE AND SOFTWARE ENABLING COMMUNICATIONS BETWEEN THESE DEVICES; ENCODED DAUGHTER CARDS FOR INCREASING THE SPEED AND CAPABILITY OF ASSOCIATED PROCESSORS; COMMUNICATIONS BACKBONES, NAMELY BUS SYSTEMS FOR ENABLING THE TRANSFER OF DATA THROUGHOUT A COMPUTER SYSTEM; PARALLEL INTERFACES; BLANK MEMORY DAUGHTER CARDS; SOFTWARE, NAMELY VECTORIZING COMPILERS FOR IMAGE AND SIGNAL PROCESSING APPLICATIONS; SOFTWARE, NAMELY MULTIPROCESSING OPERATING SYSTEMS; AND PRE-RECORDED DISCS CONTAINING A MATHEMATICS LIBRARY (U.S. CLS. 21, 23, 26, 36 AND 38).

FIRST USE 0-0-1980; IN COMMERCE 0-0-1980.

CLASS 9—(Continued).

SN 76-025,778. QUIQ, INC., SAN MATEO, CA. FILED 4-13-2000.

CLASS 9—(Continued).

SN 76-026,078. QUIQ, INC., SAN MATEO, CA. FILED 4-13-2000.

QUIQDISCUSSIONS

FOR COMPUTER SOFTWARE FOR ENABLING BUSINESSES AND END USERS TO CREATE, OBTAIN, COLLECT, TRACK, MONITOR, ORGANIZE, MANAGE AND STORE INFORMATION OBTAINED FROM CUSTOMERS, AFFILIATES, USERS, MEMBERS, EXPERTS, ENTHUSIASTS, CLIENTS AND PARTICIPANTS AND FROM COMMUNITIES OF THE SAME IN ORDER TO GET FEEDBACK ON PRODUCTS, MANUFACTURE ANALYSIS, GENERATE NEW SALES INFORMATION AND LEADS, PROVIDE CUSTOMER SERVICES AND SUPPORT AND CREATE A DATABASE THAT CAN BE USED TO AID IN PRODUCT RESEARCH AND DEVELOPMENT AND SERVICE MANAGEMENT AND TO INCREASE THE USABILITY, RELEVANCE AND EFFECTIVENESS OF BUSINESSES IN THE THEIR ONLINE APPLICATIONS; COMPUTER SOFTWARE TO ALLOW ONLINE BUSINESSES TO MONITOR, FACILITATE AND MANAGE CUSTOMERS', USERS', MEMBERS', EXPERTS', ENTHUSIASTS', CLIENTS' AND OTHER PARTICIPANTS' INTERACTIONS WITH THE BUSINESSES AND INTEGRATE INFORMATION AND DATA THEREFROM WITH OTHER BUSINESS AND STATISTICAL INFORMATION; AND TO FACILITATE AND MANAGE ONLINE COMMUNICATIONS, NAMELY QUESTION AND ANSWER SESSIONS AND OTHER EXCHANGES, CREATE ONLINE DIRECTORIES, TRANSMIT ELECTRONIC MAIL, PRODUCT NOTIFICATIONS, ALERTS, RECOMMENDATIONS AND INSTANT MESSAGING, PROVIDE CUSTOMERS SERVICES AND CREATE BULLETIN BOARDS, DISCUSSION BOARDS, CHAT ROOMS, OPINION POLLS AND DATABASES FROM AND FOR ONLINE INTERACTIONS BETWEEN BUSINESSES, CUSTOMERS, USERS, MEMBERS, CLIENTS, OR AFFILIATES (U.S. CLS. 21, 23, 26, 36 AND 38).

QUIQCHAT

FOR COMPUTER SOFTWARE FOR ENABLING BUSINESSES AND END USERS TO CREATE, OBTAIN, COLLECT, TRACK, MONITOR, ORGANIZE, MANAGE AND STORE INFORMATION OBTAINED FROM CUSTOMERS, AFFILIATES, USERS, MEMBERS, EXPERTS, ENTHUSIASTS, CLIENTS AND PARTICIPANTS AND FROM COMMUNITIES OF THE SAME IN ORDER TO GET FEEDBACK ON PRODUCTS, MANUFACTURE ANALYSIS, GENERATE NEW SALES INFORMATION AND LEADS, PROVIDE CUSTOMER SERVICES AND SUPPORT AND CREATE A DATABASE THAT CAN BE USED TO AID IN PRODUCT RESEARCH AND DEVELOPMENT AND SERVICE MANAGEMENT AND TO INCREASE THE USABILITY, RELEVANCE AND EFFECTIVENESS OF BUSINESSES IN THE THEIR ONLINE APPLICATIONS; COMPUTER SOFTWARE TO ALLOW ONLINE BUSINESSES TO MONITOR, FACILITATE AND MANAGE CUSTOMERS', USERS', MEMBERS', EXPERTS', ENTHUSIASTS', CLIENTS' AND OTHER PARTICIPANTS' INTERACTIONS WITH THE BUSINESSES AND INTEGRATE INFORMATION AND DATA THEREFROM WITH OTHER BUSINESS AND STATISTICAL INFORMATION; AND TO FACILITATE AND MANAGE ONLINE COMMUNICATIONS, NAMELY QUESTION AND ANSWER SESSIONS AND OTHER EXCHANGES, CREATE ONLINE DIRECTORIES, TRANSMIT ELECTRONIC MAIL, PRODUCT NOTIFICATIONS, ALERTS, RECOMMENDATIONS AND INSTANT MESSAGING, PROVIDE CUSTOMERS SERVICES AND CREATE BULLETIN BOARDS, DISCUSSION BOARDS, CHAT ROOMS, OPINION POLLS AND DATABASES FROM AND FOR ONLINE INTERACTIONS BETWEEN BUSINESSES, CUSTOMERS, USERS, MEMBERS, CLIENTS, OR AFFILIATES (U.S. CLS. 21, 23, 26, 36 AND 38).

CLASS 9—(Continued).

SN 76-026,081. QUIQ, INC., SAN MATEO, CA. FILED 4-13-2000.

QUIQANSWERS

FOR COMPUTER SOFTWARE FOR ENABLING BUSINESSES AND END USERS TO CREATE, OBTAIN, COLLECT, TRACK, MONITOR, ORGANIZE, MANAGE AND STORE INFORMATION OBTAINED FROM CUSTOMERS, AFFILIATES, USERS, MEMBERS, EXPERTS, ENTHUSIASTS, CLIENTS AND PARTICIPANTS AND FROM COMMUNITIES OF THE SAME IN ORDER TO GET FEEDBACK ON PRODUCTS, MANUFACTURE ANALYSIS, GENERATE NEW SALES INFORMATION AND LEADS, PROVIDE CUSTOMER SERVICES AND SUPPORT AND CREATE A DATABASE THAT CAN BE USED TO AID IN PRODUCT RESEARCH AND DEVELOPMENT AND SERVICE MANAGEMENT AND TO INCREASE THE USEABILITY, RELEVANCE AND EFFECTIVENESS OF BUSINESSES IN THEIR ONLINE APPLICATIONS; COMPUTER SOFTWARE TO ALLOW ONLINE BUSINESSES TO MONITOR, FACILITATE AND MANAGE CUSTOMERS', USERS', MEMBERS', EXPERTS', ENTHUSIASTS', CLIENTS' AND OTHER PARTICIPANTS' INTERACTIONS WITH THE BUSINESSES AND INTEGRATE INFORMATION AND DATA THEREFROM WITH OTHER BUSINESS AND STATISTICAL INFORMATION; AND TO FACILITATE AND MANAGE ONLINE COMMUNICATIONS, NAMELY QUESTION AND ANSWER SESSIONS AND OTHER EXCHANGES, CREATE ONLINE DIRECTORIES, TRANSMIT ELECTRONIC MAIL, PRODUCT NOTIFICATIONS, ALERTS, RECOMMENDATIONS AND INSTANT MESSAGING, PROVIDE CUSTOMERS SERVICES AND CREATE BULLETIN BOARDS, DISCUSSION BOARDS, CHAT ROOMS, OPINION POLLS AND DATABASES FROM AND FOR ONLINE INTERACTIONS BETWEEN BUSINESSES, CUSTOMERS, USERS, MEMBERS, CLIENTS, OR AFFILIATES (U.S. CLS. 21, 23, 26, 36 AND 38).

SN 76-027,642. C. P. CLARE CORPORATION, BEVERLY, MA. FILED 4-14-2000.

SMARTLINE

FOR TELEPHONE LINE STATUS MONITOR (U.S. CLS. 21, 23, 26, 36 AND 38).

SN 76-032,542. YOURMOBILE.COM INC, SANTA MONICA, CA. FILED 4-24-2000.

YOURMOBILE

FOR DOWNLOADABLE RING TONES AND GRAPHIC ICONS FOR MOBILE TELEPHONES (U.S. CLS. 21, 23, 26, 36 AND 38).

FIRST USE 5-3-2000; IN COMMERCE 5-3-2000.

CLASS 9—(Continued).

SN 76-034,702. BTRADE.COM, INC., IRVING, TX. FILED 4-25-2000.

THE POWER TO B

FOR COMPUTER SOFTWARE FOR USE IN COMMUNICATING DATA ACROSS COMPUTER NETWORKS, FOR ENCRYPTING, COMPRESSING AND AUTHENTICATING DATA TRANSMITTED ACROSS A COMPUTER NETWORK AND FOR USE IN COMMERCIAL DATA EXCHANGE AND/OR TRANSFORMATION (U.S. CLS. 21, 23, 26, 36 AND 38).

FIRST USE 3-1-2000; IN COMMERCE 3-1-2000.

SN 76-037,244. REED, DANIEL M., BYRON, CA. FILED 4-28-2000.

EMAIL-4-STATEMENTS

FOR COMPUTER SOFTWARE FOR ELECTRONICALLY DELIVERING BANK STATEMENTS IN THE FIELD OF FINANCIAL SERVICES (U.S. CLS. 21, 23, 26, 36 AND 38).

FIRST USE 0-0-1998; IN COMMERCE 0-0-1998.

SN 76-037,293. TRADE MEDIA HOLDINGS LIMITED, GRAND CAYMAN, CAYMAN ISLANDS, FILED 4-28-2000.

asian//sources

OWNER OF U.S. REG. NO. 1,747,053.

NO CLAIM IS MADE TO THE EXCLUSIVE RIGHT TO USE "ASIAN", APART FROM THE MARK AS SHOWN.

THE LINING SHOWN IN THE DRAWING IS A FEATURE OF THE MARK AND IS NOT INTENDED TO INDICATE COLOR.

FOR COMPUTERS; COMPUTER TERMINALS; COMPUTER SOFTWARE FOR MANAGING AND FACILITATING BUSINESS TRANSACTIONS; COMPUTER SOFTWARE IN THE FIELD OF ARRANGING AND MANAGEMENT OF ORDERING AND SHIPPING PRODUCTS FROM SUPPLIERS TO CUSTOMERS; PRE-RECORDED MAGNETIC TAPES AND DISCS, VIDEO TAPES, COMPACT DISKS, COMPACT DISK READ-ONLY MEMORIES, DOWNLOADABLE BOOKS, MAGAZINES AND PERIODICALS IN ELECTRONIC FORM SUPPLIED ON-LINE FROM A COMPUTER DATABASE OR FROM THE GLOBAL COMPUTER NETWORK AND ELECTRONIC BOOKS, MAGAZINES AND PERIODICALS RECORDED ON COMPUTER MEDIA ALL IN THE FIELD OF ARRANGING AND MANAGEMENT OF ORDERING AND SHIPPING PRODUCTS FROM SUPPLIERS TO CUSTOMERS, ARRANGING BUSINESS-TO-BUSINESS COMMERCIAL TRANSACTIONS, MANAGING SERVICES RELATING TO BUSINESS-TO-BUSINESS COMMERCIAL TRANSACTIONS, MAINTAINING A WEBSITE WHICH FACILITATES BUSINESS-TO-BUSINESS TRANSACTIONS, MAINTAINING A DATABASE OF PRODUCTS AND SERVICES AVAILABLE FROM SUPPLIERS AND CUSTOMERS FOR SUCH PRODUCTS AND SERVICES, INFORMATION RELATING TO COMPANIES, THEIR PRODUCTS AND SERVICES AND POTENTIAL CUSTOMERS (U.S. CLS. 21, 23, 26, 36 AND 38).

CLASS 9—(Continued).

SN 76-039,374. DENON CO., LTD., BUNKYO-KU, TOKYO, JAPAN, BY CHANGE OF NAME NIPPON COLUMBIA, CO., LTD., MINATO-KU, TOKYO, JAPAN, FILED 5-2-2000.

AKTIS

THE ENGLISH TRANSLATION OF "ATKIS" IS "LIGHT" OR "BEAM".

FOR REMOTE CONTROLLERS CONTAINING SOFTWARE USED FOR REMOTELY CONTROLLING HOME THEATRE AUDIO/VISUAL APPARATUS AND COMPONENTS THEREOF, NAMELY, SOUND AMPLIFIERS, LOUD SPEAKERS, RADIOS, AUDIO RECEIVERS AND VIDEO RECEIVERS, SOUND RECORDING MACHINES, PHONOGRAPH RECORD PLAYERS, AUDIO CASSETTE RECORDERS, VIDEO CASSETTE RECORDERS, COMPACT DISC PLAYERS, DVD PLAYERS AND TELEVISIONS (U.S. CLS. 21, 23, 26, 36 AND 38).

FIRST USE 7-0-2000; IN COMMERCE 7-0-2000.

SN 76-041,844. SMITH, MILES T., EUGENE, OR. FILED 5-4-2000.

PERKS

FOR HAND-HELD COMPUTING DEVICE CONSISTING OF A KEYPAD, A DISPLAY SCREEN, A WIRELESS TRANSMITTER AND RECEIVER, AND COMPATIBLE SOFTWARE, FOR CONNECTING TO A GLOBAL COMPUTER NETWORK (U.S. CLS. 21, 23, 26, 36 AND 38).

SN 76-045,128. FAIRCHILD SEMICONDUCTOR CORPORATION, SOUTH PORTLAND, ME. FILED 5-10-2000.

ACEX

FOR MICROCONTROLLER AND BATTERY MANAGEMENT SEMICONDUCTOR DEVICES (U.S. CLS. 21, 23, 26, 36 AND 38).

FIRST USE 2-0-1998; IN COMMERCE 2-0-1998.

SN 76-045,836. TERMINAL REALITY, INC., LEWISVILLE, TX. FILED 5-11-2000.



OWNER OF U.S. REG. NO. 2,383,874.
THE LINING AND STIPPLING SHOWN IN THE DRAWING IS A FEATURE OF THE MARK AND NOT INTENDED TO INDICATE COLOR.

FOR COMPUTER GAME PROGRAMS; COMPUTER SOFTWARE GAMES; VIDEO GAME SOFTWARE; VIDEO GAME CARTRIDGES; COMPUTER GAME CARTRIDGES, VIDEO GAME CD-ROMS; AND INSTRUCTION MANUALS SOLD AS A UNIT WITH SUCH COMPUTER GAME PROGRAMS (U.S. CLS. 21, 23, 26, 36 AND 38).

FIRST USE 7-22-1999; IN COMMERCE 7-22-1999.

CLASS 9—(Continued).

SN 76-046,296. STRUCTURAL RESEARCH & ANALYSIS CORP., LOS ANGELES, CA. FILED 5-10-2000.

COSMOS/WORKS

FOR COMPUTER SOFTWARE FOR DESIGN ANALYSIS IN THE FIELD OF ENGINEERING (U.S. CLS. 21, 23, 26, 36 AND 38).

FIRST USE 1-0-1996; IN COMMERCE 1-0-1996.

SN 76-046,384. STRUCTURAL RESEARCH & ANALYSIS CORP., LOS ANGELES, CA. FILED 5-10-2000.

COSMOS/M

FOR COMPUTER SOFTWARE FOR ANALYSIS AND DESIGN OPTIMIZATION IN THE FIELD OF ENGINEERING (U.S. CLS. 21, 23, 26, 36 AND 38).

FIRST USE 0-0-1994; IN COMMERCE 0-0-1994.

SN 76-049,025. ETANGO.COM, INC., SAN FRANCISCO, CA. FILED 5-12-2000.

@TTRACT

FOR CUSTOMIZABLE COMPUTER SOFTWARE FOR FACILITATING INTERACTIVE COMMUNICATION AND COLLABORATION FOR OTHERS VIA A GLOBAL-INFORMATION NETWORK (U.S. CLS. 21, 23, 26, 36 AND 38).

FIRST USE 4-10-2000; IN COMMERCE 4-10-2000.

SN 76-062,302. SPORTBRAIN, INC., SUNNYVALE, CA. FILED 6-2-2000.

SPORTBRAIN

FOR PERSONAL DATA CAPTURE AND MONITORING DEVICES COMPRISED OF COMPUTER HARDWARE AND SOFTWARE USED TO MONITOR MOVEMENT AND PHYSICAL ACTIVITY INCORPORATING TECHNOLOGY FOR ACCESSING AND MANIPULATING INFORMATION ON AN INTERACTIVE PERSONAL WEB SITE (U.S. CLS. 21, 23, 26, 36 AND 38).

SN 76-062,526. CREATIVE BUSINESS DECISIONS, INC., PRINCETON, NJ. FILED 6-5-2000.

DECISIONSTATION

FOR COMPUTER SOFTWARE FOR USE BY LENDING INSTITUTIONS IN REDUCING THEIR CREDIT RISK IN THE FIELD OF RISK MANAGEMENT (U.S. CLS. 21, 23, 26, 36 AND 38).

FIRST USE 6-1-1999; IN COMMERCE 6-1-1999.

CLASS 9—(Continued).

SN 76-063,037. STRUCTURAL RESEARCH & ANALYSIS CORP., LOS ANGELES, CA. FILED 6-2-2000.

COSMOS/

FOR COMPUTER SOFTWARE FOR DESIGN ANALYSIS IN THE FIELD OF ENGINEERING (U.S. CLS. 21, 23, 26, 36 AND 38).

FIRST USE 7-0-1992; IN COMMERCE 7-0-1992.

SN 76-074,246. INSPIRICA LTD., NEW YORK, NY. BY CHANGE OF NAME STANFORD COACHING, INC., NEW YORK, NY. FILED 6-20-2000.

INSPIRICA

FOR COMPUTER HARDWARE; INSTRUCTIONAL SOFTWARE RECORDED ON CD-ROM IN THE FIELDS OF ALL ACADEMIC SUBJECTS FOR PRIMARY, SECONDARY, UNIVERSITY AND GRADUATE LEVEL EDUCATION, REMEDIAL EDUCATION, SPECIAL EDUCATION, AND TEST PREPARATION (U.S. CLS. 21, 23, 26, 36 AND 38).

SN 76-075,364. FLARION TECHNOLOGIES, INC., BEDMINSTER, NJ. BY CHANGE OF NAME RADIOROUTER, INC., BEDMINSTER, NJ. FILED 6-22-2000.

FLARION

FOR ROUTERS, SWITCHES, RADIOS, MODEMS, TERMINALS, COMMUNICATIONS CHIPSETS, APPLICATION SPECIFIC INTEGRATED CIRCUITS (ASICS), CELLULAR TELEPHONES, WIRELESS LOCAL AREA NETWORK (LAN) CARDS, MODEMS, AND BASE STATIONS USED IN CELLULAR COMMUNICATIONS SYSTEMS (U.S. CLS. 21, 23, 26, 36 AND 38).

SN 76-079,167. MOLECULAR SENSING PLC, WILTSHIRE SN12 8LH, UNITED KINGDOM, FILED 6-28-2000.

GENEDRIVE

FOR COMPUTER SOFTWARE CONTROLLED INSTRUMENT FOR THE AMPLIFICATION OF NUCLEIC ACIDS AND THEIR IDENTIFICATION USING EITHER ELECTRO CHEMICAL OR OPTICAL MEANS (U.S. CLS. 21, 23, 26, 36 AND 38).

CLASS 9—(Continued).

SN 76-084,943. CETA TESTSYSTEME GMBH, D-40723 HILDEN, FED REP GERMANY, FILED 7-7-2000.

CETATEST

PRIORITY CLAIMED UNDER SEC. 44(D) ON FED REP GERMANY APPLICATION NO. 30001376.009, FILED 1-11-2000, REG. NO. 30001376, DATED 4-17-2000, EXPIRES 1-31-2010.

FOR APPARATUS AND INSTRUMENTS FOR MEASUREMENT, CONTROL AND REGULATION, NAMELY LEAK DETECTORS, FLOW METERS, FLOW TESTERS, STANDARD LEAKS, MASTER JETS; APPARATUS AND INSTRUMENTS FOR MEASUREMENTS AND TESTING OF PRESSURE AND TIGHTNESS NAMELY LEAK DETECTORS, FLOW METERS, FLOW TESTERS, STANDARD LEAKS, MASTER JETS; MAGNETIC AND OPTICAL DATA CARRIERS CONTAINING COMPUTER PROGRAMS FOR THE EVALUATION OF MEASUREMENT RESULTS; COMPUTER PROGRAM FOR GRAPHICAL AND TABULAR VISUALIZATION OF THE MEASURING RESULTS (U.S. CLS. 21, 23, 26, 36 AND 38).

SN 76-088,533. EINSTEIN COMPUTER CORP., SUNRISE, FL. FILED 7-14-2000.

EINSTEIN

FOR COMPUTER HARDWARE COMPONENTS, NAMELY, MONITORS, COMPLETE WORKSTATIONS, PRINTERS, SCANNERS AND PERIPHERALS (U.S. CLS. 21, 23, 26, 36 AND 38).

FIRST USE 2-11-2000; IN COMMERCE 7-1-2000.

SN 76-089,038. UMAX DATA SYSTEMS INC., SCIENCE-BASED INDUSTRIAL PARK HSINCHU, TAIWAN, FILED 7-17-2000.

Nexcam

PRIORITY CLAIMED UNDER SEC. 44(D) ON TAIWAN APPLICATION NO. 89036710, FILED 6-27-2000, REG. NO. 965447, DATED 10-16-2001, EXPIRES 10-15-2011.

FOR OPTICAL IMAGE SCANNERS (U.S. CLS. 21, 23, 26, 36 AND 38).

SN 76-091,139. STRUCTURAL RESEARCH & ANALYSIS CORP., LOS ANGELES, CA. FILED 7-17-2000.

COSMOS/FFE

FOR COMPUTER SOFTWARE FOR ENGINEERING DESIGN ANALYSIS (U.S. CLS. 21, 23, 26, 36 AND 38).

FIRST USE 0-0-1993; IN COMMERCE 0-0-1993.

CLASS 9—(Continued).

SN 76-094,569. ENDRESS + HAUSER FLOWTEC AG, CH-4153 REINACH, SWITZERLAND, FILED 7-19-2000.

S-DAT

PRIORITY CLAIMED UNDER SEC. 44(D) ON SWITZERLAND APPLICATION NO. CH1081-2000, FILED 2-2-2000, REG. NO. 475039, DATED 2-2-2000, EXPIRES 2-2-2010.

FOR SEMICONDUCTOR MEMORY MODULES AND EEPROMS AND EXCHANGEABLE SEMICONDUCTOR MEMORY MODULES AND EEPROMS FOR FLOWMETERS, PRESSURE TRANSMITTERS, FLOW CONTROLLERS AND PRESSURE CONTROLLERS FOR MEASURING AND CONTROLLING MASS FLOW OF FLUIDS, GASES AND VAPORS (U.S. CLS. 21, 23, 26, 36 AND 38).

SN 76-095,168. AVANTGARDE TECHNOLOGY HOLDINGS, INC., TOWSON, MD. FILED 7-24-2000.

AVANTGARDE

THE ENGLISH TRANSLATION OF THE WORD "AVANTGARDE" IS "ADVANCE GUARD".

FOR COMPUTER GAME SOFTWARE; COMPUTER SOFTWARE FOR USE IN ENTERTAINMENT, NAMELY GAMES AND ELECTRONIC LEARNING APPLICATIONS (U.S. CLS. 21, 23, 26, 36 AND 38).

SN 76-096,747. PONTE VECCHIO B.V., 1119 NJ SCHIPHOL RIJK, NETHERLANDS, FILED 7-26-2000.

PONTE VECCHIO

PRIORITY CLAIMED UNDER SEC. 44(D) ON BENELUX APPLICATION NO. 0966684, FILED 6-9-2000, REG. NO. 0685713, DATED 6-9-2000, EXPIRES 6-9-2010.

THE ENGLISH TRANSLATION OF "PONTE VECCHIO" IS "OLD BRIDGE".

FOR COMPUTER SOFTWARE FOR TRADING AND POSITION MANAGEMENT IN THE FIELD OF FINANCIAL TRANSACTIONS (U.S. CLS. 21, 23, 26, 36 AND 38).

SN 76-098,318. MARKS, STEVE, JUPITER, FL. FILED 7-28-2000.

NAPCONNECT

FOR COMPUTER HARDWARE AND SOFTWARE FOR PROVIDING SECURE COMMUNICATIONS TO AND FROM A GLOBAL COMPUTER COMMUNICATION NETWORK (U.S. CLS. 21, 23, 26, 36 AND 38).

FIRST USE 7-18-2000; IN COMMERCE 7-18-2000.

CLASS 9—(Continued).

SN 76-098,343. STOMP, INC., COSTA MESA, CA. FILED 7-28-2000.

POP-N-LOCK

OWNER OF U.S. REG. NOS. 2,301,618 AND 2,356,596. FOR CASES AND CONTAINERS FOR OPTICAL DISCS (U.S. CLS. 21, 23, 26, 36 AND 38).

SN 76-098,585. SAMSUNG ELECTRONICS CO., LTD., KYUNGKI-DO, REPUBLIC OF KOREA, FILED 7-31-2000.



FOR CELLULAR PHONES HAVING A FUNCTION OF MP3 PLAYERS (U.S. CLS. 21, 23, 26, 36 AND 38).

SN 76-100,059. NAJA S.A., FRANCE, FILED 7-31-2000.

NAJA

OWNER OF FRANCE REG. NO. 003004368, DATED 1-31-2000, EXPIRES 1-31-2010.

THE TERM "NAJA" IS OF "CEYLON AND DUTCH ORIGIN AND IS THE NAME OF ONE GENUS BELONGING TO THE FAMILY ELAPIDAE IN THE CLASSIFICATION OF PLANTS AND ANIMALS, OF WHICH THE COBRA, ANY OF A NUMBER OF SPECIES OF POISONOUS SNAKES, IS A MEMBER".

FOR EYEGLASSES AND SUNGLASSES; CASES, FRAMES AND GLASS FOR EYEGLASSES AND SUNGLASSES (U.S. CLS. 21, 23, 26, 36 AND 38).

SN 76-101,462. OSHO ACADEMY, INC., SEDONA, AZ. FILED 8-2-2000.

PSYCHOLOGY OF THE BUDDHAS

SEC. 2(F).

FOR PRE-RECORDED AUDIO AND VIDEO TAPES AND COMPACT DISCS FEATURING EDUCATIONAL AND INSTRUCTIONAL MATERIALS ON THE SUBJECT OF MEDITATION, PHILOSOPHY AND RELIGION (U.S. CLS. 21, 23, 26, 36 AND 38).

FIRST USE 1-0-1997; IN COMMERCE 1-0-1997.

CLASS 9—(Continued).

SN 76-107,040. ONETTA, INC., SAN JOSE, CA. BY CHANGE OF NAME; BY CHANGE OF NAME OASYS TECHNOLOGIES, INC., SUNNYVALE, CA. FILED 8-10-2000.

ONETTA

FOR FIBER OPTIC COMMUNICATION SUBSYSTEMS, NAMELY, RAMAN PUMP MODULES, DISPERSION-COMPENSATION MODULES, TRANSMITTERS, RECEIVERS, ADD DROP MODULES, ADD/DROP MULTIPLEXES, OPTICAL CROSS-CONNECT SWITCHES, POLARIZATION MODE DISPERSION COMPENSATORS; CIRCUIT PACKS, NAMELY OPTICAL AMPLIFIER CIRCUIT PACKS, DISPERSION COMPENSATION CIRCUIT PACKS, ADD/DROP MULTIPLEXED CIRCUIT PACKS, TRANSMITTER CIRCUIT PACKS, RECEIVER CIRCUIT PACKS, OPTICAL CROSS-CONNECT SWITCH CIRCUIT PACKS, AND POLARIZATION-MODE DISPERSION COMPENSATORY CIRCUIT PACKS (U.S. CLS. 21, 23, 26, 36 AND 38).

SN 76-107,771. ALCHEMY SEMICONDUCTOR, INC., AUSTIN, TX. FILED 8-10-2000.

AU1500

FOR SEMICONDUCTOR DEVICES (U.S. CLS. 21, 23, 26, 36 AND 38).

SN 76-108,105. ALCHEMY SEMICONDUCTOR, INC., AUSTIN, TX. FILED 8-10-2000.

AU4000

FOR SEMICONDUCTOR DEVICES (U.S. CLS. 21, 23, 26, 36 AND 38).

SN 76-108,108. ALCHEMY SEMICONDUCTOR, INC., AUSTIN, TX. FILED 8-10-2000.

AU3000

FOR SEMICONDUCTOR DEVICES (U.S. CLS. 21, 23, 26, 36 AND 38).

SN 76-108,110. ALCHEMY SEMICONDUCTOR, INC., AUSTIN, TX. FILED 8-10-2000.

AU1000

FOR SEMICONDUCTOR DEVICES (U.S. CLS. 21, 23, 26, 36 AND 38).

CLASS 9—(Continued).

SN 76-108,112. ALCHEMY SEMICONDUCTOR, INC., AUSTIN, TX. FILED 8-10-2000.

AU5000

FOR SEMICONDUCTOR DEVICES (U.S. CLS. 21, 23, 26, 36 AND 38).

SN 76-108,115. ALCHEMY SEMICONDUCTOR, INC., AUSTIN, TX. FILED 8-10-2000.

AU2000

FOR SEMICONDUCTOR DEVICES (U.S. CLS. 21, 23, 26, 36 AND 38).

SN 76-109,115. VISUAL NETWORKS TECHNOLOGIES, INC., ROCKVILLE, MD. FILED 8-14-2000.

VISUAL EWATCHER

FOR COMPUTER PROGRAMS FOR THE OPERATION AND MANAGEMENT OF ENTERPRISE NETWORK SYSTEMS, WEB-BASED APPLICATIONS, MISSION CRITICAL TECHNOLOGY AND SERVICE LEVEL MANAGEMENT (U.S. CLS. 21, 23, 26, 36 AND 38).

SN 76-109,737. SONICBLUE, INC., SANTA CLARA, CA. BY MERGER S3 INCORPORATED, SANTA CLARA, CA. FILED 8-14-2000.

SONICBLUE

FOR COMPUTER HARDWARE; COMPUTER SOFTWARE, NAMELY, OPERATING AND APPLICATION SOFTWARE FOR EXCHANGING DATA BETWEEN COMPUTER SOFTWARE AND HARDWARE AND PERSONAL DIGITAL ASSISTANTS, MOBILE COMPUTERS, WIRELESS COMPUTERS, COMPUTER PERIPHERALS, SET-TOP BOXES, AND ADD-ONS FOR PERSONAL DIGITAL ASSISTANTS; INTERNET APPLIANCES, NAMELY, WIRELESS COMPUTERS, MOBILE COMPUTERS, SET-TOP BOXES, AND PERSONAL DIGITAL ASSISTANTS; PORTABLE DIGITAL AUDIO PLAYERS, NAMELY, MP3 PLAYERS, PORTABLE COMPACT DISC PLAYERS, AND DIGITAL AUDIO JUKE BOXES; INTEGRATED CIRCUITS; AND MANUALS SOLD TOGETHER WITH ALL OF THE AFORESAID GOODS (U.S. CLS. 21, 23, 26, 36 AND 38).

CLASS 9—(Continued).

SN 76-109,880. STERLING SEMICONDUCTOR, INC., STERLING, VA. FILED 8-14-2000.

STERLING SEMICONDUCTOR

NO CLAIM IS MADE TO THE EXCLUSIVE RIGHT TO USE "SEMICONDUCTOR", APART FROM THE MARK AS SHOWN.

FOR SILICON CARBIDE WAFERS AND EPITAXIAL STRUCTURES FOR USE IN ELECTRONIC AND OPTOELECTRONIC PRODUCTS (U.S. CLS. 21, 23, 26, 36 AND 38).

FIRST USE 9-0-1996; IN COMMERCE 9-0-1996.

SN 76-111,001. MUSICBOOTH LLC, THE, NEW ROCHELLE, NY. FILED 8-16-2000.

I-FETCH

FOR COMPUTER PROGRAM FOR CONNECTING A MICROPROCESSOR BASED DEVICE TO A COMPUTER NETWORK FOR RETRIEVAL OF DATA (U.S. CLS. 21, 23, 26, 36 AND 38).

SN 76-112,608. IQ4HIRE, INC., CHICAGO, IL. FILED 8-18-2000.



FOR DOWNLOADABLE COMPUTER SOFTWARE TO ALLOW USERS TO PERFORM ELECTRONIC BUSINESS TRANSACTIONS VIA THE INTERNET (U.S. CLS. 21, 23, 26, 36 AND 38).

FIRST USE 3-1-2000; IN COMMERCE 3-1-2000.

SN 76-116,521. DI/DT, INC., CARLSBAD, CA. FILED 8-25-2000.

POWERING THE DIGITAL FUTURE

FOR POWER CONVERTERS; POWER CONVERTER MODULES AND ASSEMBLIES (U.S. CLS. 21, 23, 26, 36 AND 38).

FIRST USE 2-9-2001; IN COMMERCE 2-9-2001.

CLASS 9—(Continued).

SN 76-117,733. CANESTA, INC., SANTA CLARA, CA. FILED 8-28-2000.

CANESTA

FOR COMPUTER HARDWARE, SOFTWARE AND COMPUTER CHIPS, ALL USED FOR SENSING AND IDENTIFYING THE LOCATION OF AN OBJECT POINT IN TWO AND/OR THREE DIMENSIONAL SPACE BY PATTERN AND SOUND RECOGNITION AND FOR INPUTTING, TEXT, DATA AND COMMANDS AND INTERFACING WITH ELECTRONIC DEVICES IN THE FIELD OF DATA PROCESSING (U.S. CLS. 21, 23, 26, 36 AND 38).

SN 76-122,379. MINDS@WORK, LLC, IRVINE, CA. FILED 9-5-2000.

MINDS@WORK

FOR COMPUTER PERIPHERAL HARDWARE; COMPUTER MEMORY STORAGE DEVICE, NAMELY, SOLID STATE MEMORY CARDS, FLASH MEMORY CARDS, COMPACT DISC DRIVES AND OPTICAL, MAGNETO-OPTICAL AND MAGNETIC DISC DRIVES; BLANK COMPUTER MEMORY STORAGE DISCS AND CARTRIDGES; PORTABLE DIGITAL AUDIO PLAYERS FOR USE IN AUTOMOBILES; SATELLITE NAVIGATIONAL SYSTEMS, NAMELY, GLOBAL POSITIONING SYSTEMS; PERSONAL DIGITAL ASSISTANTS; COMPUTER MEMORY STORAGE CONTROLLERS; VIDEO CAPTURE CARDS; SMALL COMPUTER SYSTEMS INTERFACE CONTROLLERS (U.S. CLS. 21, 23, 26, 36 AND 38).

FIRST USE 6-25-1999; IN COMMERCE 6-25-1999.

SN 76-124,050. COMTELCO (NORTH AMERICA), INC., CROSS PLAINS, WI. FILED 9-6-2000.

INNCHARGE

FOR SOFTWARE FOR USE AT MULTIPLE UNIT PROPERTIES SUCH AS HOTELS, MOTELS AND INNS, TO PERFORM ACCOUNTING FUNCTIONS FOR TELEPHONE AND FAX SYSTEMS AND TO PRINT INDIVIDUALIZED DETAILED REPORTS FOR EACH UNIT (U.S. CLS. 21, 23, 26, 36 AND 38).

FIRST USE 1-0-2000; IN COMMERCE 1-0-2000.

SN 76-124,791. TRILOGY STUDIOS, SANDY, UT. FILED 9-8-2000.

DESKSCAPES

FOR COMPUTER SOFTWARE FOR USE IN THE EDITING OR MODIFICATION OF PRE-RECORDED ELECTRONIC AUDIO/VIDEO CONTENT (U.S. CLS. 21, 23, 26, 36 AND 38).

CLASS 9—(Continued).

SN 76-127,636. AEROSANCE, INC., FARMINGTON, CT. FILED 9-13-2000.



FOR ELECTRONIC DEVICES FOR USE WITH AIRCRAFT AND AIRCRAFT ENGINES, NAMELY, OPERATED CONTROLS FOR AIRCRAFT ENGINES, THROTTLES, AND TURBOCHARGERS; ELECTRONIC COMPUTER-BASED, DEVICES, NAMELY, MONITORS THAT DISPLAY, ANALYZE AND RECORD DATA RELATED TO AIRCRAFT ENGINE HULL AND TRENDS; ELECTRONIC DEVICES, NAMELY, PC-BASED MACHINES THAT DOWNLOAD DATA FROM ON-BOARD AIRCRAFT EQUIPMENT AND TRANSMIT THAT DATA TO GROUND-BASED COMPUTERS; SOLID STATE ELECTRONIC MAGNETO SYSTEMS; AND ELECTRONIC PROPELLER GOVERNORS (U.S. CLS. 21, 23, 26, 36 AND 38).

SN 76-128,183. VODIUM, NEW YORK, NY. FILED 9-13-2000.

MEDIAPOD PLAYER

NO CLAIM IS MADE TO THE EXCLUSIVE RIGHT TO USE "PLAYER", APART FROM THE MARK AS SHOWN. FOR COMPUTER SOFTWARE TOOL FOR PLAYING INFORMATION CONTAINING TEXT SYNCHRONIZED VIDEO AND DATA OVER THE GLOBAL COMPUTER NETWORK (U.S. CLS. 21, 23, 26, 36 AND 38). FIRST USE 10-0-1999; IN COMMERCE 12-0-1999.

SN 76-128,848. NCIPHER CORPORATION LIMITED, CAMBRIDGE, ENGLAND, FILED 9-14-2000.

nForce

PRIORITY CLAIMED UNDER SEC. 44(D) ON ERP N CMNTY TM OFC APPLICATION NO. 001570738, FILED 3-22-2000.

FOR COMPUTER HARDWARE, NAMELY, COMPUTER PERIPHERAL DEVICES, NAMELY ACCELERATORS AND ENCRYPTOGRAPHIC ACCELERATORS FOR DATA SECURITY; COMPUTER SOFTWARE, NAMELY ENCODED COMPUTER PROGRAMS AND FIRM WARE FOR ENCRYPTION AND DECRYPTION AND DIGITAL SIGNATURE FOR USE WITH THE ABOVE-NAMED DEVICES (U.S. CLS. 21, 23, 26, 36 AND 38).

FIRST USE 3-0-2000; IN COMMERCE 3-0-2000.

CLASS 9—(Continued).

SN 76-130,067. QUEST SOFTWARE, INC., IRVINE, CA. FILED 9-18-2000.



THE LINING SHOWN IN THE DRAWING IS A FEATURE OF THE MARK.

FOR COMPUTER SOFTWARE, NAMELY SOFTWARE FOR MANAGING CHANGES, CONTROLLING VERSIONS, STORING, ANALYZING, UPGRADING, EDITING, REPORTING, AND VIEWING OTHER CLIENT SERVER SOFTWARE APPLICATIONS AND TECHNOLOGY IN THE FIELD ON THE ENTERPRISE RESOURCE PLANNING (U.S. CLS. 21, 23, 26, 36 AND 38). FIRST USE 6-1-1997; IN COMMERCE 6-1-1997.

SN 76-130,391. MYERS, DOUGLAS A., PROVO, UT. FILED 9-18-2000.

PRODIGITA

FOR COMPACT DISCS, CD-ROMS, AND DIGITAL VIDEO DISKS DISTRIBUTABLE AS COLLECTABLE TRADING OR BUSINESS CARDS, FEATURING MUSIC, SALES PRESENTATIONS, PRODUCT PROMOTIONS, PRODUCT INFORMATION, PRODUCT DEMONSTRATIONS, TECHNICAL DATA, CORPORATE REPORTS, FINANCIAL STATEMENTS, BUSINESS PROSPECTUSES, EDUCATIONAL INFORMATION FOR INSTRUCTION IN A VARIETY OF FIELDS, NAMELY, COMPUTER SCIENCE, ENGINEERING, THE FINE ARTS, FOREIGN LANGUAGES, GEOGRAPHY, GEOLOGY, HISTORY, BIOLOGY, MATHEMATICS, METEOROLOGY, OCEANOGRAPHY, PALEONTOLOGY, AND ZOOLOGY, COMPUTER SOFTWARE PROGRAMS FOR THE INTERACTIVE, OR ORDERED AND SEQUENTIAL, AUDIOVISUAL PRESENTATION OF ANY OF THE HERETOFORE-NAMED TYPES OF INFORMATION CONTAINED ON THE IDENTIFIED GOODS (U.S. CLS. 21, 23, 26, 36 AND 38).

FIRST USE 7-1-1999; IN COMMERCE 8-10-1999.

SN 76-130,644. BOLAND, DENNIS M., GLENVIEW, IL. FILED 9-19-2000.

EYE OF THE TRADER

FOR COMPUTER SOFTWARE FOR USE IN TRACKING MARKET ACTIVITY TO ASSIST MARKET PARTICIPANTS WITH STOCK, CURRENCIES AND FUTURES TRANSACTIONS ON THE DAY OF EXECUTION (U.S. CLS. 21, 23, 26, 36 AND 38).

CLASS 9—(Continued).

SN 76-131,273. INTERNATIONAL SHEET PILING COMPANY SARL, LUXEMBOURG, LUXEMBOURG, FILED 9-19-2000.

DIXERAN

PRIORITY CLAIMED UNDER SEC. 44(D) ON BENELUX APPLICATION NO. 0966308, FILED 4-13-2000, REG. NO. 0966308, DATED 4-13-2000, EXPIRES 4-13-2010.

FOR DATA PROCESSORS AND COMPUTERS FOR DETECTING AND WARNING OF THE UNFASTENING OF METAL SHEET PILES; ELECTRIC APPARATUS AND INSTRUMENTS, NAMELY DECLUTCHING DETECTORS, SENSORS, SENSORS WITH SHEAR PIN, CONNECTING CABLES WITH PROTECTIVE TUBE, MONITORING UNITS, SWITCHES, MONITORING UNIT INDICATORS; SCIENTIFIC APPARATUS AND INSTRUMENTS, NAMELY DECLUTCHING DETECTORS, SENSORS, SENSORS WITH SHEAR PIN, CONNECTING CABLES WITH PROTECTIVE TUBE, MONITORING UNITS, SWITCHES, MONITORING UNIT INDICATORS; APPARATUS AND INSTRUMENTS FOR DETECTING UNBUCKLED SHEET PILES, NAMELY, DECLUTCHING DETECTORS, SENSORS, SENSORS WITH SHEAR PIN, CONNECTING CABLES WITH PROTECTIVE TUBE, MONITORING UNITS, SWITCHES, MONITORING UNIT INDICATORS; DATA PROCESSING EQUIPMENT AND COMPUTERS (U.S. CLS. 21, 23, 26, 36 AND 38).

SN 76-131,760. INTERNATIONAL BUSINESS MACHINES CORPORATION, ARMONK, NY. FILED 9-20-2000.

Z/ARCHITECTURE

FOR COMPUTER HARDWARE, COMPUTER SOFTWARE FOR USE IN CONTROLLING THE OPERATION OF EXECUTION OF PROGRAMS AND NETWORK FUNCTIONS OPERATING AS SERVER ARCHITECTURE; COMPUTER HARDWARE, SOFTWARE AND MICROCODE RULES AND INTERFACES PROVIDING A FRAMEWORK FOR DESIGNING AND DEVELOPING AND MANAGING OPERATING SYSTEMS AND SOFTWARE APPLICATIONS (U.S. CLS. 21, 23, 26, 36 AND 38).

CLASS 9—(Continued).

SN 76-131,883. TIME WARNER ENTERTAINMENT COMPANY, L.P., NEW YORK, NY. FILED 9-19-2000.



BELAIR
ENTERTAINMENT

NO CLAIM IS MADE TO THE EXCLUSIVE RIGHT TO USE "ENTERTAINMENT", APART FROM THE MARK AS SHOWN.

FOR MOTION PICTURE FILMS FEATURING COMEDY, DRAMA, ACTION, ADVENTURE, ANIMATION, AND MOTION PICTURE FILMS FOR BROADCAST ON TELEVISION FEATURING COMEDY, DRAMA, ACTION, ADVENTURE AND ANIMATION; AUDIO-VISUAL TAPES, AUDIO-VIDEO CASSETTES, AUDIO-VIDEO DISCS AND DIGITAL VERSATILE DISCS FEATURING COMEDY, DRAMA, ACTION, ADVENTURE, AND ANIMATION MOTION PICTURE FILMS; STEREO HEADPHONES; BATTERIES; CORDLESS TELEPHONES, HAND-HELD CALCULATORS; AUDIO CASSETTE AND CD PLAYERS; HAND-HELD KARAOKE PLAYERS, CD ROM GAMES, TELEPHONE AND RADIO PAGERS; SHORT MOTION PICTURE FILM CASSETTES FEATURING COMEDY, DRAMA, ACTION, ADVENTURE, AND ANIMATION TO BE USED WITH HAND-HELD VIEWERS OR PROJECTORS; VIDEO CASSETTE RECORDERS AND PLAYERS, COMPACT DISC PLAYERS, DIGITAL AUDIO TAPE RECORDERS AND PLAYERS, ELECTRONIC DIARIES; RADIOS; MOUSE PADS; EYEGLASSES, SUNGLASSES AND CASES THEREFORE; PRERECORDED AUDIO TAPES FEATURING COMEDY, DRAMA, ACTION, ADVENTURE AND ANIMATION, AND BOOKLETS FEATURING COMEDY, DRAMA, ACTION, ADVENTURE AND ANIMATION, SOLD AS A UNIT; COMPUTER PROGRAMS, NAMELY, SOFTWARE LINKING DIGITIZED VIDEO AND AUDIO MEDIA TO A GLOBAL COMPUTER INFORMATION NETWORK; VIDEO AND COMPUTER GAME PROGRAMS; VIDEO GAME CARTRIDGES AND VIDEO GAME TAPE CASSETTES; DECORATIVE MAGNETS; PRE-PAID TELEPHONE CALLING CARDS, MAGNETICALLY ENCODED CREDIT CARDS, MAGNETICALLY ENCODED DEBIT CARDS, MAGNETICALLY ENCODED CASH CARDS, AND MAGNETICALLY ENCODED KEY CARDS (U.S. CLS. 21, 23, 26, 36 AND 38).

SN 76-132,237. NBAND COMMUNICATIONS, INC., MOUNTAIN VIEW, CA. FILED 9-18-2000.

NFLEX

FOR SEMICONDUCTORS, INTEGRATED CIRCUITS, SIGNAL MICROPROCESSORS AND RELATED SOFTWARE, ALL FOR BROADBAND WIRELESS COMMUNICATIONS (U.S. CLS. 21, 23, 26, 36 AND 38).

CLASS 9—(Continued).

SN 76-133,802. ALGORITHMIC IMPLEMENTATIONS, DBA AI SQUARED, MANCHESTER CENTER, VT. FILED 9-22-2000.

VISUALSCAN

FOR COMPUTER SOFTWARE FOR THE VISUALLY IMPAIRED WHICH SCANS AND ENLARGES IMAGES AND PRINTED MATERIALS AND PERMITS NAVIGATION THROUGH AND MANIPULATION OF THE SCANNED MATERIALS AND USERS' DOCUMENTATION SOLD THEREWITH AS A UNIT (U.S. CLS. 21, 23, 26, 36 AND 38).

SN 76-134,186. A.L.S. INDUSTRIES, INC., TORRANCE, CA. FILED 9-25-2000.



NO CLAIM IS MADE TO THE EXCLUSIVE RIGHT TO USE "CAMERA STUFF", APART FROM THE MARK AS SHOWN.

FOR CARRYING CASES FOR CAMERAS, VIDEO CAMERAS, FILM, PHOTOGRAPHIC EQUIPMENT AND TRIPODS (U.S. CLS. 21, 23, 26, 36 AND 38).

FIRST USE 11-17-2000; IN COMMERCE 11-17-2000.

SN 76-134,366. NITRO-PAK PREPAREDNESS CENTER, INC., HEBER CITY, UT. FILED 9-25-2000.

NITRO-PAK

FOR EMERGENCY KITS CONSISTING OF EMERGENCY FOOD AND WATER RATIONS, INCLUDING FREEZE-DRIED OR DEHYDRATED FOODS; AND EMERGENCY EQUIPMENT, NAMELY, FLARES, BINOCULARS, NIGHT VISIONS SCOPES, GAS MASKS, SHORT-WAVE RADIOS AND ANTENNAE, WHISTLES, WATER FILTRATION SYSTEMS AND PEPPER SPRAYS (U.S. CLS. 21, 23, 26, 36 AND 38).

FIRST USE 1-1-1985; IN COMMERCE 1-1-1985.

CLASS 9—(Continued).

SN 76-135,360. OVAL CORPORATION, SHINJYUKU-KU, TOKYO, JAPAN, FILED 9-26-2000.

VRmass

PRIORITY CLAIMED UNDER SEC. 44(D) ON JAPAN APPLICATION NO. 2000-78599, FILED 7-14-2000, REG. NO. 4492392, DATED 7-19-2001, EXPIRES 7-19-2011.

FOR FLOWMETERS, DENSIMETERS, GASOMETERS, WATER METERS AND CAPACITY MEASURES, NAMELY VOLUMETRIC FLOW METERS (U.S. CLS. 21, 23, 26, 36 AND 38).

SN 76-135,406. SONICBLUE, INC., SANTA CLARA, CA. BY MERGER S3 INCORPORATED, SANTA CLARA, CA. FILED 9-25-2000.



IN THE MARK, THE LETTERS "S", "N", "I" AND "C" AND THE VERTICAL LINE APPEAR IN BLUE.

FOR COMPUTER HARDWARE; COMPUTER SOFTWARE, NAMELY, OPERATING AND APPLICATION SOFTWARE FOR EXCHANGING DATA BETWEEN COMPUTER SOFTWARE AND HARDWARE AND PERSONAL DIGITAL ASSISTANTS, MOBILE COMPUTERS, WIRELESS COMPUTERS, COMPUTER PERIPHERALS, SET-TOP BOXES, AND ADD-ONS FOR PERSONAL DIGITAL ASSISTANTS; INTERNET APPLIANCES, NAMELY, WIRELESS COMPUTERS, MOBILE COMPUTERS, SET-TOP BOXES, AND PERSONAL DIGITAL ASSISTANTS; PORTABLE DIGITAL AUDIO PLAYERS, NAMELY, MP3 PLAYERS, PORTABLE COMPACT DISC PLAYERS, AND DIGITAL AUDIO JUKE BOXES; INTEGRATED CIRCUITS; AND MANUALS SOLD TOGETHER WITH ALL OF THE AFORESAID GOODS (U.S. CLS. 21, 23, 26, 36 AND 38).

SN 76-136,705. PANOVATUS UNLIMITED, TROY, MI. FILED 9-27-2000.

VIRTUAL SIGNPOST

FOR NAVIGATIONAL AND POSITION FINDING APPARATUS, NAMELY, A GLOBAL POSITIONING SYSTEM TRANSMITTING GEOGRAPHICALLY SPECIFIC INFORMATION TO A VEHICLE FROM A SINGLE TRANSMITTER THAT TRANSMITS A RADIO FREQUENCY CONTAINING CODED INFORMATION AND A DIFFERENTIAL GPS SIGNAL (U.S. CLS. 21, 23, 26, 36 AND 38).

CLASS 9—(Continued).

SN 76-139,985. SONY KABUSHIKI KAISHA, DBA SONY CORPORATION, TOKYO, JAPAN, FILED 10-3-2000.



FOR VIDEO CAMERAS; VIDEO CAMERAS COMBINED WITH VIDEO TAPE RECORDERS AND/OR PLAYERS; DIGITAL STILL CAMERAS; VIDEO TAPE PLAYERS AND RECORDERS; VIDEO DISC PLAYERS AND RECORDERS; VIDEO GAME TAPE CASSETTES AND DISCS; PRE-RECORDED AUDIO TAPE CASSETTES AND DISCS, VIDEO TAPE CASSETTES AND DISCS AND COMPUTER DATA TAPE CASSETTES AND DISCS FEATURING MUSIC, TEXT DATA, STILL IMAGES AND MOTION PICTURES; TELEPHONES; VIDEO GAME MACHINES FOR USE WITH TELEVISIONS; PERSONAL COMPUTERS; PERSONAL DIGITAL ASSISTANTS; AND TELEVISIONS (U.S. CLS. 21, 23, 26, 36 AND 38).

SN 76-140,169. WANNABLOW, INC., NEW YORK, NY. FILED 10-3-2000.

WANNABLOW RECORDS

NO CLAIM IS MADE TO THE EXCLUSIVE RIGHT TO USE "RECORDS", APART FROM THE MARK AS SHOWN. FOR PRE-RECORDED PHONOGRAPH RECORDS, PRE-RECORDED DOWNLOADABLE MUSIC SOUND RECORDINGS, PRE-RECORDED AUDIO CASSETTE TAPES, PRE-RECORDED VIDEOCASSETTES AND COMPACT DISCS, PRE-RECORDED LASER DISCS, PRE-RECORDED DIGITAL VIDEO DISCS, ALL CONTAINING MUSIC AND/OR MUSICAL VIDEO RECORDINGS (U.S. CLS. 21, 23, 26, 36 AND 38).

FIRST USE 3-0-1998; IN COMMERCE 3-0-1998.

SN 76-144,134. STRATEDGE CORPORATION, SAN DIEGO, CA. FILED 10-6-2000.



OWNER OF U.S. REG. NOS. 1,679,288 AND 2,022,391. FOR INTEGRATED CIRCUIT PACKAGES (U.S. CLS. 21, 23, 26, 36 AND 38).

FIRST USE 6-0-1999; IN COMMERCE 6-0-1999.

CLASS 9—(Continued).

SN 76-144,146. CORE TECHNOLOGY CORPORATION, LANSING, MI. FILED 10-10-2000.

CTC E-SERVER

OWNER OF U.S. REG. NOS. 2,122,681 AND 2,224,163. NO CLAIM IS MADE TO THE EXCLUSIVE RIGHT TO USE "E-SERVER", APART FROM THE MARK AS SHOWN. FOR COMPUTER OPERATING PROGRAMS AND MANUALS SOLD AS A UNIT THEREWITH (U.S. CLS. 21, 23, 26, 36 AND 38).

FIRST USE 6-28-2000; IN COMMERCE 6-28-2000.

SN 76-144,269. VIANIX, LC, VIRGINIA BEACH, VA. FILED 10-11-2000.

SASO

FOR SELF-CONTAINED AND/OR ACCESSORY COMMUNICATIONS EQUIPMENT, NAMELY COMPUTER PERIPHERALS, HANDHELD COMPUTERS, PERSONAL DIGITAL ASSISTANTS, ELECTRONIC ORGANIZERS, ELECTRONIC NOTEPADS, DIGITAL AUDIO RECORDERS, AND/OR DIGITAL AUDIO PLAYBACK DEVICES, FOR HANDHELD USE AND/OR CONNECTIVITY TO PERSONAL COMPUTERS, MINIATURE COMPUTERS, PERSONAL DIGITAL ASSISTANTS, AUDIO EQUIPMENT, NAMELY AUDIO TAPE RECORDERS AND/OR PLAYERS AND/OR STEREO RECEIVERS, VIDEO EQUIPMENT, NAMELY VIDEO CASSETTE RECORDERS AND/OR PLAYERS, PHOTOGRAPHIC EQUIPMENT, NAMELY DIGITAL CAMERAS AND/OR CAMCORDERS, DICTATION EQUIPMENT, NAMELY AUDIO TAPE AND/OR DIGITAL AUDIO RECORDERS AND/OR PLAYERS, PAGERS, CELLULAR TELEPHONES AND TELEPHONE LINES FOR THE PURPOSE OF DATA PROCESSING, NAMELY RECEIVING, MANIPULATING, CONVERTING, RECORDING, REPRODUCING, STORING, ORGANIZING, EDITING, COMPRESSING, DECOMPRESSING, ENCODING, DECODING, PLAYING, TRANSMITTING, TRANSFERRING, AND/OR TRANSCRIBING ANALOG AND/OR DIGITAL DATA, TOGETHER WITH RELATED ACCESSORIES, NAMELY DISPLAY DEVICES, NAMELY COMPUTER MONITORS AND/OR PERSONAL DIGITAL ASSISTANT DISPLAYS, RECORDING DEVICES, NAMELY AUDIO TAPE AND/OR DIGITAL RECORDERS, PLAYBACK DEVICES, NAMELY AUDIO TAPE AND/OR DIGITAL PLAYERS, DATA TRANSFER DEVICES, NAMELY COMPUTERS AND/OR PERSONAL DIGITAL ASSISTANTS, MEMORY DEVICES, NAMELY COMPUTER MEMORY CARDS, DATA STORAGE DEVICES, NAMELY BLANK MAGNETIC DATA CARRIERS AND/OR COMPUTER MEMORY CARDS, ELECTRICAL CONTROLLERS, CRADLES FOR RECHARGING AND/OR CONNECTING THE SELF-CONTAINED AND/OR ACCESSORY COMMUNICATIONS EQUIPMENT TO THE FOREGOING, MODEMS, CASES FOR HOLDING THE SELF-CONTAINED AND/OR ACCESSORY COMMUNICATIONS EQUIPMENT, ADAPTERS FOR CONNECTING THE SELF-CONTAINED AND/OR ACCESSORY COMMUNICATIONS EQUIPMENT TO THE FOREGOING, MICROPHONES, HEADPHONES, TRANSCRIPTION EQUIPMENT, NAMELY AUDIO TAPE AND/OR DIGITAL AUDIO RECORDERS AND/OR PLAYERS, FOOT PEDALS FOR CONTROLLING THE FOREGOING TRANSCRIPTION EQUIPMENT, AND/OR INSTRUCTION MANUALS SOLD THEREWITH (U.S. CLS. 21, 23, 26, 36 AND 38).

CLASS 9—(Continued).

SN 76-144,924. VISCOM TECHNOLOGY GROUP, INC., CHASKA, MN. FILED 10-11-2000.

VISCOM

FOR COMPUTER HARDWARE SOLD AT WHOLESALE, NAMELY PERSONAL COMPUTERS AND PERSONAL COMPUTER PERIPHERAL DEVICES, EXCLUDING VIDEO CARDS, GRAPHICS CARDS, AND SOUND CARDS (U.S. CLS. 21, 23, 26, 36 AND 38).

FIRST USE 9-27-2000; IN COMMERCE 9-27-2000.

SN 76-148,482. COMPONENTS SPECIALTIES, INC., AMITYVILLE, NY. FILED 10-17-2000.

SECUREGUARD

FOR VIDEO, SURVEILLANCE AND OBSERVATION EQUIPMENT AND SYSTEMS COMPRISED OF CAMERAS AND ASSOCIATED CONTROLS, MONITORS, SENSORS AND SWITCHING DEVICES (U.S. CLS. 21, 23, 26, 36 AND 38).

SN 76-149,293. COLOR KINETICS INCORPORATED, BOSTON, MA. FILED 10-18-2000.

**SURROUND
LIGHT**

NO CLAIM IS MADE TO THE EXCLUSIVE RIGHT TO USE "LIGHT", APART FROM THE MARK AS SHOWN. FOR COMPUTER HARDWARE, WHICH INTEGRATE LIGHTING SYSTEMS INTO ENTERTAINMENT AND COMPUTER DEVICES SUCH AS CONSUMER ELECTRONICS, PERSONAL COMPUTERS, TVS, DVDS, VIDEO PLAYERS, AUDIO EQUIPMENT, GAME PLAYERS, AND BROADBAND NETWORKS, AND COMPUTER SOFTWARE FOR OPERATING THE LIGHTING SYSTEM SOLD THEREWITH (U.S. CLS. 21, 23, 26, 36 AND 38).

SN 76-149,600. FUTURESOFTE INC., HOUSTON, TX. BY ASSIGNMENT SURFCONTROL PLC, CONGLETON, CHESHIRE, UNITED KINGDOM, FILED 10-19-2000.

MULTIVIEW MASCOT

FOR COMPUTER SYSTEMS SOFTWARE FOR COMMUNICATION BETWEEN COMPUTERS OVER A LOCAL NETWORK; COMPUTER SOFTWARE FOR INTERFACING MIXED SOFTWARE ENVIRONMENTS (U.S. CLS. 21, 23, 26, 36 AND 38).

FIRST USE 9-0-1991; IN COMMERCE 9-0-1991.

CLASS 9—(Continued).

SN 76-149,724. YALTA COMMUNICATIONS CORPORATION, SAN FRANCISCO, CA. FILED 10-18-2000.

TRAXEL

FOR COMPUTER SOFTWARE, NAMELY, A PROGRAM UTILIZING A ONE PIXEL GIF FILE THAT IS SERVED TO THE USER USED TO TRACK A WEB SITE USER'S BEHAVIOR VIA FLAG OR MARKER THAT IS ACTIVATED WHEN A USER VIEWS A SPECIFIC PAGE OR FIELD WITHIN WEB SITE, FOR USE IN THE ADVERTISING FIELD, NAMELY OPTIMIZING THE ADVERTISING SENT TO A PARTICULAR USER OF THE INTERNET (U.S. CLS. 21, 23, 26, 36 AND 38).

SN 76-155,688. ULEAD SYSTEMS, INC., TAIPEI, TAIWAN, FILED 10-27-2000.

IDEZA

PRIORITY CLAIMED UNDER SEC. 44(D) ON TAIWAN APPLICATION NO. 89058008, FILED 10-6-2000, REG. NO. 00980712, DATED 1-16-2002, EXPIRES 1-15-2012.

FOR COMPUTER SOFTWARE USED FOR IMAGE EDITING, IMAGE PROCESSING, IMAGE ACQUISITION, IMAGE FILE MANAGEMENT AND THE CREATION OF DOCUMENTS INCORPORATING IMAGES, AND USER MANUALS SOLD AS A UNIT (U.S. CLS. 21, 23, 26, 36 AND 38).

SN 76-158,620. TRANSFORMATION SOFTWARE, INC., GUELPH, ONTARIO N1G 3M5, CANADA, FILED 11-2-2000.



NO CLAIM IS MADE TO THE EXCLUSIVE RIGHT TO USE "SOFTWARE", APART FROM THE MARK AS SHOWN.

FOR COMPUTER SOFTWARE, NAMELY ENGINEERING APPLICATIONS SOFTWARE FOR USE IN AUTOMOTIVE PARTS MANUFACTURING INDUSTRY, AND PRINTED MATERIALS, NAMELY INSTRUCTION MANUALS AND USER MANUALS FOR COMPUTER SOFTWARE PROGRAM DISTRIBUTED THEREWITH (U.S. CLS. 21, 23, 26, 36 AND 38).

CLASS 9—(Continued).

SN 76-160,323. CHARMED.COM, INC., BEVERLY HILLS, CA. FILED 11-3-2000.

CHARMIT

FOR COMPUTER HARDWARE, NAMELY, DEVICES HAVING CAPACITY TO COMMUNICATE VIA ELECTRONIC, DIGITAL, MICROWAVE, BROADBAND AND VARIOUS RADIO FREQUENCIES USING VOICE, VIDEO, DATA, SENSORY, INFRARED, ULTRAVIOLET, LASER AND AUDIO TRANSMISSIONS AND ARE PROGRAMMABLE, NAMELY, ELECTRONIC PERSONAL ORGANIZERS, MOBILE TELEPHONES, BROADBAND PAGERS, RADIO PAGERS, DIGITAL PAGERS, COMPUTERS, PORTABLE COMPUTERS, PALM-SIZED COMPUTERS, SMART COMPUTERS HAVING CONTEXT AWARENESS, USER AWARENESS AND LOCATION AWARENESS CAPABILITIES; WEARABLE COMPUTERS, HANDS-FREE COMPUTERS; COMPUTER CHIPS; ELECTRONIC MOBILE COMMUNICATION DEVICES, NAMELY, ELECTRONIC PERSONAL ORGANIZERS, MOBILE TELEPHONES, BROADBAND PAGERS, RADIO PAGERS, DIGITAL PAGERS, COMPUTERS, PORTABLE COMPUTERS, PALM-SIZED COMPUTERS, SMART COMPUTERS HAVING CONTEXT AWARENESS, USER AWARENESS AND LOCATION AWARENESS CAPABILITIES, SOLD IN THE FORM OF NATURAL AND SYNTHETIC FIBERS, FABRICS, CABLES AND WIRING, SIGNALING PENS, PINS, BADGES, WRIST BANDS, BELTS, RINGS AND COLLARS NOT MADE OF PRECIOUS METALS, WATCHES, TOUCH SCREENS, ELECTRONIC VIEWING TABLETS, BAROMETERS, ELECTRONIC SENSORS AND ELECTRONIC MONITORS, ELECTRONIC IONIZERS, ELECTRONIC AIR FRESHENERS, ELECTRONIC FANS, CLOCKS, AND REMOTE CONTROLLERS; PERSONAL DIGITAL ASSISTANTS, ANTENNAS, SMART PHONES AND CELL PHONES WITH EAR PIECES, HEAD MOUNTED DISPLAYS, MONITORS, VIDEO CASSETTE PLAYERS, STREAMING VIDEO PLAYERS, MONITORS, DVDS, AUDIO PLAYERS, CAMERAS, TELEVISIONS, HIGH DEFINITION TELEVISIONS, RADIOS AND CAMCORDERS USED FOR ACCESSING AND RETRIEVING INFORMATION FROM A GLOBAL COMMUNICATIONS AND COMPUTER NETWORKS; MOBILE COMPUTERS; COMPUTER SOFTWARE, NAMELY SPEECH RECOGNITION, COMMAND AND CONTROL PROGRAMS, GAME APPLICATIONS, OPERATING SYSTEM PROGRAMS, PROGRAMS FOR DATA SYNCHRONIZATION, MONITORING, MAINTENANCE AND MANAGEMENT OF COMMUNICATIONS INTERFACES, AND PUBLICATION PROGRAMS FOR ACCESSING AND RETRIEVING INFORMATION FROM GLOBAL COMPUTER AND COMMUNICATIONS NETWORKS (U.S. CLS. 21, 23, 26, 36 AND 38).

FIRST USE 5-23-2000; IN COMMERCE 5-23-2000.

SN 76-161,585. DECIS E-DIRECT, INC., DENVER, CO. FILED 11-8-2000.

**ADAPTIVE
PERSONALIZATION**

FOR COMPUTER SOFTWARE WHICH EMPLOYS A CONTINUOUS, AUTOMATED METHOD OF MONITORING, CHANGING, AND OPTIMIZATION DESIGNED TO ADAPT USER INTERFACES, INCLUDING ELECTRONIC, TACTILE AND VOICE INTERFACES, CONTENT, AND MEDIA ENVIRONMENTS TO USERS' NEEDS, INTERESTS, AND BEHAVIORS FOR THE BENEFIT OF THE END USER AND HOSTING ENTITY OR ORGANIZATION (U.S. CLS. 21, 23, 26, 36 AND 38).

CLASS 9—(Continued).

SN 76-162,052. XICAT INTERACTIVE LTD., LONDON, UNITED KINGDOM, FILED 11-9-2000.

IRON ACES

FOR COMPUTER PROGRAMS NAMELY COMPUTER GAMES, CONSOLE GAMES, AND VIDEO GAMES ON CD-ROM, DVD AND CARTRIDGES (U.S. CLS. 21, 23, 26, 36 AND 38).

FIRST USE 1-0-2000; IN COMMERCE 4-0-2000.

SN 76-162,178. VISUAL DATA CORPORATION, POMPANO BEACH, FL. FILED 11-6-2000.

CRUISEVIEW

FOR INTERACTIVE VIDEO LIBRARIES CONSISTING OF PRE-RECORDED CD ROM, LASER DISKS, AND VIDEOTAPE, FEATURING PREVIEWS OF OCEAN GOING LUXURY LINER ACCOMMODATIONS, AMENITIES AND LEISURE ACTIVITIES (U.S. CLS. 21, 23, 26, 36 AND 38).

FIRST USE 1-20-1994; IN COMMERCE 1-20-1994.

SN 76-164,791. DEFINITIVE TECHNOLOGY, LLP, OWINGS MILLS, MD. FILED 11-14-2000.

SUPERCUBE

FOR HIGH FIDELITY, AUDIO EQUIPMENT, NAMELY SUBWOOFER LOUDSPEAKERS (U.S. CLS. 21, 23, 26, 36 AND 38).

SN 76-168,948. MOUNTAIN MAN SURVIVAL EQUIPMENT, INC., NAPA, CA. FILED 11-20-2000.

MOUNTAIN MAN SURVIVAL

NO CLAIM IS MADE TO THE EXCLUSIVE RIGHT TO USE "SURVIVAL", APART FROM THE MARK AS SHOWN. FOR SURVIVAL KITS CONSISTING OF A COMPASS, A BATTERY, A RADIO, A SIGNAL WHISTLE, A RESCUE FLAG, A SURVIVAL BLANKET, A PONCHO, A FIRST AID KIT, NUTRITIONAL SUPPLEMENT IN THE NATURE OF A PROTEIN BAR, MATCHES, FIRE STARTER STICKS, ROPE, GLOVES, AND A FLASHLIGHT (U.S. CLS. 21, 23, 26, 36 AND 38).

FIRST USE 10-2-2000; IN COMMERCE 10-2-2000.

CLASS 9—(Continued).

SN 76-170,378. ADVANCED TECHNOLOGY VIDEO, INC., REDMOND, WA. FILED 11-22-2000.

VIPMUX

FOR CLOSED CIRCUIT TELEVISION AND VIDEO SURVEILLANCE EQUIPMENT NAMELY VIDEO SERVERS FOR TRANSMITTING IMAGES OVER COMPUTER NETWORKS (U.S. CLS. 21, 23, 26, 36 AND 38).
FIRST USE 2-0-2001; IN COMMERCE 2-0-2001.

SN 76-171,102. SERICON SCAFTECH PTY LTD, VICTORIA, AUSTRALIA, FILED 11-27-2000.

IQUOTE

OWNER OF AUSTRALIA REG. NO. 792417, DATED 4-27-1999, EXPIRES 4-27-2009.

FOR COMPUTER SOFTWARE FOR USE IN GENERATING QUANTITY AND PRICE QUOTATIONS FOR EQUIPMENT RENTAL IN THE FIELD OF SCAFFOLDING (U.S. CLS. 21, 23, 26, 36 AND 38).
FIRST USE 0-0-1993; IN COMMERCE 0-0-1993.

SN 76-172,079. ARMATRON INTERNATIONAL, INC., MELROSE, MA. FILED 11-28-2000.

MOSQUITO GUARD

NO CLAIM IS MADE TO THE EXCLUSIVE RIGHT TO USE "MOSQUITO", APART FROM THE MARK AS SHOWN.
FOR ELECTRIC CITRONELLA DISPENSERS FOR REPELLING INSECTS (U.S. CLS. 21, 23, 26, 36 AND 38).
FIRST USE 2-23-2000; IN COMMERCE 2-23-2000.

SN 76-172,117. PAN ASIA CREATIVE INTERACTIVE TECHNOLOGY, INC., SANTA MONICA, CA. FILED 11-28-2000.

PACPOP

FOR COMPUTER CHIPS; COMPUTER HARDWARE; COMPUTER WORKSTATIONS, NAMELY, COMPUTER TERMINALS; COMPUTERS; FACSIMILE MACHINES; TELEPHONE ANSWERING MACHINES; ELECTRICAL WIRES; AND SET-TOP BOXES USED FOR INTERNET TELEVISION (U.S. CLS. 21, 23, 26, 36 AND 38).

CLASS 9—(Continued).

SN 76-172,548. DEF CON COMMUNICATION, INC., SEATTLE, WA. FILED 11-29-2000.

DEF CON

FOR COMPUTER HARDWARE AND PERIPHERALS; COMPUTER SOFTWARE, NAMELY, COMPUTER SOFTWARE USED FOR ENHANCING COMPUTER SECURITY; COMPUTER SOFTWARE, NAMELY, SOFTWARE USED FOR ENHANCING INTERNET SECURITY; ANTI-VIRUS SOFTWARE; COMPUTER SOFTWARE FOR TROUBLE-SHOOTING OF COMPUTER HARDWARE AND SOFTWARE PROBLEMS; NETWORK SECURITY ENHANCEMENT SOFTWARE AND USER MANUALS SOLD THEREWITH (U.S. CLS. 21, 23, 26, 36 AND 38).

SN 76-175,463. ZHONE TECHNOLOGIES, INC., OAKLAND, CA. FILED 11-30-2000.

**Z H O N E**

FOR COMPUTER HARDWARE AND SOFTWARE FOR USE IN THE DELIVERY OF VOICE, DATA, VIDEO AND CONTENT SERVICES VIA NARROWBAND AND HIGH-SPEED INTERNET LINES (U.S. CLS. 21, 23, 26, 36 AND 38).

FIRST USE 8-1-1999; IN COMMERCE 8-1-1999.

SN 76-175,843. FANUC LTD., YAMANASHI, JAPAN, FILED 12-4-2000.

i TUNE

FOR COMPUTER SOFTWARE FOR REGULATION OF CONTROL PARAMETERS FOR SERVO AND SPINDLE (U.S. CLS. 21, 23, 26, 36 AND 38).

CLASS 9—(Continued).

SN 76-177,222. GOULD OPTRONICS INC., MILLERSVILLE, MD. FILED 12-7-2000.

GOULD OPTRONICS

NO CLAIM IS MADE TO THE EXCLUSIVE RIGHT TO USE "OPTRONICS", APART FROM THE MARK AS SHOWN.

SEC. 2(F) AS TO "GOULD".
FOR FIBER OPTIC COMPONENTS, NAMELY, COUPLERS, ADD/DROP MULTIPLEXERS, FILTERS, SPLITTERS, TERMINATION DEVICES, AND PARTS THEREFOR (U.S. CLS. 21, 23, 26, 36 AND 38).

SN 76-178,188. TOSHIBA AMERICA INFORMATION SYSTEMS, INC., IRVINE, CA. FILED 12-8-2000.

CABLEWORKS

FOR COMPUTER SOFTWARE FOR THE MANAGEMENT OF CABLE NETWORK SYSTEMS AND MULTIPLE DATA OVER CABLE SERVICE INTERFACE SPECIFICATIONS (DOCSIS) DEVICES WITHIN A CABLE NETWORK SYSTEM (U.S. CLS. 21, 23, 26, 36 AND 38).

FIRST USE 11-0-1999; IN COMMERCE 11-0-1999.

SN 76-180,214. VIACOM INTERNATIONAL INC., NEW YORK, NY. FILED 12-13-2000.



OWNER OF U.S. REG. NOS. 1,372,705, 2,259,143 AND OTHERS.

SEC. 2(F) AS TO "MUSIC TELEVISION".
FOR KARAOKE MACHINES; RADIOS; RADIOS INCORPORATING CLOCKS; COMPACT DISC PLAYERS; AND HEADPHONES (U.S. CLS. 21, 23, 26, 36 AND 38).

SN 76-180,711. APRION DIGITAL LTD., HERTZLIA B, 46103, ISRAEL, FILED 12-14-2000.

APRION

OWNER OF ISRAEL REG. NO. 134287, DATED 1-2-2002, EXPIRES 1-27-2007.

FOR HOUSE MARK FOR PRINTERS, COMPUTERIZED PRINTERS, INKJET PRINTERS, AND PARTS AND FITTINGS THEREOF FOR ALL; COMPUTER HARDWARE; COMPUTER SOFTWARE AND PRINT MANAGEMENT SOFTWARE FOR USE IN PRINTING, PRINTERS AND PRINTING MACHINES (U.S. CLS. 21, 23, 26, 36 AND 38).

CLASS 9—(Continued).

SN 76-182,950. CENTERPOINT BROADBAND TECHNOLOGIES, INC., SAN JOSE, CA. FILED 12-19-2000.

VISTA

FOR COMMUNICATIONS HARDWARE AND SOFTWARE IN THE NATURE OF OPTICAL AND BROADBAND SYSTEMS FOR PROVIDING HIGH DATA RATE SOLUTIONS COMPRISED OF MULTIPLEXERS, SIGNAL SPLITTERS, SIGNAL MODULATORS, SIGNAL SWITCHES, SIGNAL AMPLIFIERS, SIGNAL TRANSMITTERS AND RECEIVERS, SIGNAL GENERATORS, OPTICAL NETWORK INTERFACES, OPTICAL FILTERS, OPTICAL CROSS CONNECT AND SWITCHES PRIMARILY FOR SERVICE PROVIDER BROADBAND WIRELESS AND OPTICAL NETWORKS (U.S. CLS. 21, 23, 26, 36 AND 38).

SN 76-183,458. RADCOM EQUIPMENT, INC., MAHWAH, NJ. FILED 12-8-2000.

PERFORMER

FOR QUALITY AND PERFORMANCE MANAGEMENT MEASURING AND TESTING SYSTEMS COMPRISED OF COMPUTER SERVERS, AND CUSTOMIZED SOFTWARE, EMULATING NETWORK CONDITIONS IN A LABORATORY ENVIRONMENT IN THE TELECOMMUNICATIONS/DATA COMMUNICATIONS INDUSTRY (U.S. CLS. 21, 23, 26, 36 AND 38).

SN 76-183,685. KABUSHIKI KAISHA TOSHIBA, TA TOSHIBA CORPORATION, KAWASAKI-SHI, KANAGAWA-KEN, JAPAN, FILED 12-20-2000.

CARDIOAGENT

PRIORITY CLAIMED UNDER SEC. 44(D) ON JAPAN APPLICATION NO. 103633/2000, FILED 9-22-2000, REG. NO. 4524654, DATED 11-22-2001, EXPIRES 11-22-2011.

FOR COMPUTER WORKSTATION COMPRISING MONITORS, DISK DRIVES AND KEYBOARDS FOR STORING IMAGE DATA FOR MEDICAL USE, HAVING THE FUNCTION TO SUPPORT THE PREPARATION OF DIAGNOSTIC REPORTS; COMPUTER SOFTWARE FOR STORING AND REPRODUCING PATIENT INFORMATION TO SUPPORT THE PREPARATION OF DIAGNOSTIC REPORTS (U.S. CLS. 21, 23, 26, 36 AND 38).

SN 76-187,930. ALPHA PLASTICS, OVERLAND, MO. FILED 12-29-2000.

VENDOR DEFENDOR

FOR VENDING MACHINE SAFEGUARD IN THE NATURE OF A DEVICE THAT PREVENTS WATER FROM ENTERING A VENDING MACHINE (U.S. CLS. 21, 23, 26, 36 AND 38).

FIRST USE 5-1-1990; IN COMMERCE 5-1-1990.

CLASS 9—(Continued).

SN 76-191,538. GATEWAY, INC., SAN DIEGO, CA. FILED 1-9-2001.

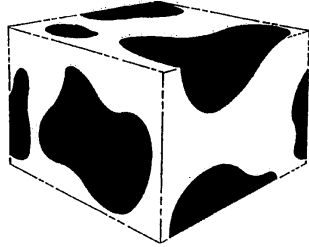

THE MARK CONSISTS OF A STYLIZED DESIGN REPRESENTING COW SPOTS, CONSISTING OF BLACK AMORPHOUS SHAPES ON A WHITE BACKGROUND.

SEC. 2(F).
FOR JOYSTICKS FOR COMPUTER GAMES (U.S. CLS. 21, 23, 26, 36 AND 38).
FIRST USE 6-0-1995; IN COMMERCE 6-0-1995.

SN 76-192,587. TRANSCRIPT INTERNATIONAL, INC., LINCOLN, NE. FILED 1-10-2001.

LTR-NET

OWNER OF U.S. REG. NOS. 1,185,558 AND 1,216,457.
FOR WIRELESS COMMUNICATIONS PRODUCTS, NAMELY, MOBILE RADIOS, PORTABLE RADIOS, REPEATERS, BASE STATIONS, AND NETWORK SWITCHES; WIRELESS COMMUNICATION SOFTWARE FOR CONNECTING MOBILE RADIOS, PORTABLE RADIOS, REPEATERS, BASE STATIONS; COMMUNICATIONS SERVERS, NAMELY NETWORK SWITCHES, REPEATERS AND BASE STATIONS (U.S. CLS. 21, 23, 26, 36 AND 38).
FIRST USE 5-7-1998; IN COMMERCE 5-7-1998.

SN 76-194,677. SIMPLIFIED DEVELOPMENT CORPORATION, AUSTIN, TX. FILED 1-16-2001.

**SIMPLIFIED
OPENWIRELESS**

OWNER OF U.S. REG. NO. 2,381,106.
FOR TELEPHONE SWITCHING SOFTWARE AND SYSTEMS COMPRISED OF COMPUTER PLATFORMS USED TO FACILITATE CALL ROUTING AND TELEPHONY AND CABLE BASED SERVICE PROVISIONING (U.S. CLS. 21, 23, 26, 36 AND 38).

SN 76-197,457. OLDHAM ASSOCIATES, LLC, SPRINGVILLE, UT. FILED 1-12-2001.

SPEEDURL

FOR COMPUTER SOFTWARE PROGRAMS AND MANUAL, ALL SOLD TOGETHER AS A UNIT, FOR USE IN NEWSPAPER LAYOUT (U.S. CLS. 21, 23, 26, 36 AND 38).

CLASS 9—(Continued).

SN 76-199,205. SEIKO INSTRUMENTS AUSTIN INCORPORATED, AUSTIN, TX. FILED 1-24-2001.

POCKET KNOWLEDGE

NO CLAIM IS MADE TO THE EXCLUSIVE RIGHT TO USE "POCKET", APART FROM THE MARK AS SHOWN.
FOR ELECTRONIC DEVICES AND ELECTRONIC REFERENCE DEVICES, NAMELY ELECTRONIC PERSONAL ORGANIZERS; PERSONAL DATA ASSISTANT PRODUCTS, NAMELY, POCKET SIZED PERSONAL COMPUTERS (U.S. CLS. 21, 23, 26, 36 AND 38).

SN 76-201,085. DISCOVERY COMMUNICATIONS, INC., BETHESDA, MD. FILED 1-26-2001.

DEADLINE DISCOVERY

OWNER OF U.S. REG. NOS. 883,953, 1,561,407 AND 1,602,072.
FOR PRE-RECORDED VIDEOCASSETTE AND VIDEOTAPES AND DVD'S FEATURING INFORMATION REGARDING THE TELEVISION PROGRAMMING FOR A NEWS MAGAZINE OF THE SAME NAME (U.S. CLS. 21, 23, 26, 36 AND 38).

SN 76-201,628. CABLE DESIGN TECHNOLOGIES INC., PITTSBURGH, PA. FILED 1-30-2001.

WEST PENN WIRE/CDT

SEC. 2(F) AS TO "WEST PENN".
FOR ELECTRICAL COMMUNICATION AND CONTROL CABLES, FIRE PROTECTIVE SIGNALING CABLES, COAXIAL CABLES, DATA GRADE CABLES, LAN CABLES, PROCESS CONTROL CABLES, ELECTRICAL BROADCAST CABLES, FIBER OPTIC CABLES, TRAFFIC SIGNALS CABLES, SIGNAL CONDUCTOR WIRES, ELECTRICAL TWO CONDUCTOR CABLES, MICROPHONE CABLES, PARALLEL SPEAKER CABLES, APPLIANCE CORDS, TRAFFIC SIGNAL LOOP DETECTOR CABLES, TRAFFIC SIGNALS LEAD-IN CABLES (U.S. CLS. 21, 23, 26, 36 AND 38).
FIRST USE 11-0-1993; IN COMMERCE 11-0-1994.

SN 76-202,835. SOFT COMPUTER CONSULTANTS, PALM HARBOR, FL. FILED 1-30-2001.

SOFTHR

OWNER OF U.S. REG. NO. 2,238,971.
FOR COMPUTER SOFTWARE DESIGNED FOR HUMAN RESOURCES FUNCTIONS (U.S. CLS. 21, 23, 26, 36 AND 38).

CLASS 9—(Continued).

SN 76-202,878. JUMPTEC INDUSTRIELLE COMPUTER-TECHNIK AG, D 94469-DEGGENDORF, FED REP GERMANY, FILED 1-30-2001.

ETX

FOR ELECTRONIC COMPONENTS, NAMELY A PC MODULE CONSISTING OF A PLUG IN INTERFACE, INCLUDING A FULL ISA AND PCI BUS, ON FOUR HIGH-DENSITY SMT CONNECTORS (U.S. CLS. 21, 23, 26, 36 AND 38).

FIRST USE 1-0-2000; IN COMMERCE 1-0-2000.

SN 76-202,988. BROADFRAME CORPORATION, COLLIERVILLE, TN. FILED 1-31-2001.

BROADFRAME

FOR TELECOMMUNICATIONS NETWORK TEST AND MEASUREMENT TOOLS CONSISTING OF A CHASSIS, ONE OR MORE INTERFACE CARDS, ONE OR MORE PROCESSOR CARDS AND APPLICATION SOFTWARE FOR THE DEVELOPMENT, TESTING AND DEMONSTRATION OF BROADBAND EQUIPMENT (U.S. CLS. 21, 23, 26, 36 AND 38).

FIRST USE 9-11-2000; IN COMMERCE 9-11-2000.

SN 76-203,213. MANSKI, THOMAS J, FORT WALTON BEACH, FL. FILED 1-31-2001.

FLATV

FOR FLAT VIDEO DISPLAY DEVICES IN THE NATURE OF MONITORS, COMPUTER DISPLAYS, TELEVISIONS, DIGITAL ASSISTANTS, PORTABLE INTERNET DEVICES, AND ELECTRONIC ADVERTISING DISPLAYS (U.S. CLS. 21, 23, 26, 36 AND 38).

SN 76-204,302. AIRBIQUITY INC., BAINBRIDGE ISLAND, WA. FILED 2-5-2001.

AQROUTER

FOR COMMUNICATIONS SOFTWARE TO FACILITATE THE RECEIPT OF DATA VIA INTERNET PROTOCOLS, WIRELESS NETWORKS AND WIRE LINE NETWORKS, AND TO FORMAT SUCH DATA TO ENSURE COMPATIBILITY WITH THE SOFTWARE APPLICATIONS OF THE RECEIVING PARTY (U.S. CLS. 21, 23, 26, 36 AND 38).

CLASS 9—(Continued).

SN 76-204,568. COGNITION CORPORATION, BEDFORD, MA. FILED 2-5-2001.

SIX SIGMA COCKPIT

NO CLAIM IS MADE TO THE EXCLUSIVE RIGHT TO USE "SIX SIGMA", APART FROM THE MARK AS SHOWN.

FOR COMPUTER SOFTWARE FOR MANAGING ENGINEERING AND MANUFACTURING KNOWLEDGE ACQUIRED THROUGH EXERCISE OF A SIX SIGMA PROCESS (U.S. CLS. 21, 23, 26, 36 AND 38).

FIRST USE 10-9-2000; IN COMMERCE 11-10-2000.

SN 76-204,604. OLIVE SOFTWARE LTD., KEFAR SABA, ISRAEL, FILED 2-1-2001.

OLIVE SOFTWARE

NO CLAIM IS MADE TO THE EXCLUSIVE RIGHT TO USE "SOFTWARE", APART FROM THE MARK AS SHOWN.

FOR COMPUTER SOFTWARE FOR CONVERSION OF BACK ISSUE AND CURRENT NEWSPAPER CONTENTS INTO STRUCTURED DATA AND MULTIPLE FORMATS, AND FOR ON-LINE TRANSMISSION OF SAME VIA A LOCAL-AREA, WIDE-AREA OR WORLD-WIDE COMPUTER NETWORK, WHILE RETAINING THE ORIGINAL NEWSPAPER LAYOUT (U.S. CLS. 21, 23, 26, 36 AND 38).

FIRST USE 5-3-2000; IN COMMERCE 8-25-2001.

SN 76-205,709. ADVANCED RELAY CORPORATION, EUGENE, OR. FILED 2-7-2001.

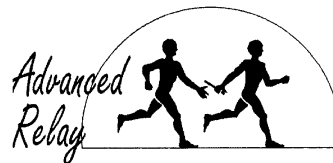

NO CLAIM IS MADE TO THE EXCLUSIVE RIGHT TO USE "ADVANCED RELAY", APART FROM THE MARK AS SHOWN.

FOR COMPUTER HARDWARE AND SOFTWARE FOR THE TRANSMISSION OF DIGITAL SIGNALS OVER A TWISTED PAIR SHIELDED CABLE OR A FIBER OPTIC CABLE SYSTEM AND THE DEVELOPMENT OF MULTI-PROTOCOL WIDE AREA NETWORK PRODUCTS, NAMELY, BRIDGES, ROUTERS, FRAME RELAY ACCESS DEVICES, PACKET ASSEMBLERS AND DISASSEMBLERS, MULTIPLEXERS AND SPECIAL COMMUNICATION SERVERS FOR USE IN THE FIELD OF TELECOMMUNICATIONS, RAIL TRAFFICKING AND AVIATION TRAFFIC CONTROL (U.S. CLS. 21, 23, 26, 36 AND 38).

FIRST USE 6-0-1989; IN COMMERCE 6-0-1989.

CLASS 9—(Continued).

SN 76-206,354. IS/COMPLETE, INC., GREEN BROOK, NJ. FILED 2-7-2001.

IRPRINT

FOR INFRARED PRINTING SOFTWARE DESIGNED FOR THE HANDHELD PERSONAL DIGITAL ASSISTANT (U.S. CLS. 21, 23, 26, 36 AND 38).
FIRST USE 5-0-1998; IN COMMERCE 5-0-1998.

SN 76-206,912. ASM INTERNATIONAL N.V., 3723 BC BILTHOVEN, NETHERLANDS, FILED 2-8-2001.

EPSILON

FOR SEMICONDUCTORS AND PARTS THEREFOR; CHEMICAL REACTORS FOR DEPOSITING LAYER ON A SILICON WAFER IN THE SEMICONDUCTOR INDUSTRY AND PARTS THEREFOR; APPARATUS FOR DEPOSITING A LAYER ON A SILICON WAFER IN THE SEMICONDUCTOR INDUSTRY AND PARTS THEREFOR (U.S. CLS. 21, 23, 26, 36 AND 38).
FIRST USE 10-16-1987; IN COMMERCE 3-15-1988.

SN 76-207,609. FREEMARKETS, INC., PITTSBURGH, PA. FILED 2-8-2001.

FULLSOURCE

FOR COMPUTER SOFTWARE FOR OPERATING MARKETPLACES VIA COMPUTER NETWORKS FOR BUYERS AND SELLERS OF GOODS AND SERVICES (U.S. CLS. 21, 23, 26, 36 AND 38).

SN 76-208,262. SATELLITE LAND INSTRUMENTS NETWORK CORPORATION, PARKER, CO. FILED 2-12-2001.



THE MARK CONSISTS OF PLANET EARTH AS PART OF A SATELLITE DISH, WITH THE NAME "SATLINC" TO THE RIGHT.

FOR COMMUNICATION DEVICES, NAMELY HAND HELD SATELLITE PHONES, VEHICLE TRACKING DEVICES, GLOBAL POSITIONING SATELLITE (GPS) LOCATION DEVICES AND SATELLITE INTERNET EQUIPMENT (U.S. CLS. 21, 23, 26, 36 AND 38).

CLASS 9—(Continued).

SN 76-209,417. NEXANT, INC., SAN FRANCISCO, CA. FILED 2-13-2001.

POWER COMPUTER APPLICATIONS

NO CLAIM IS MADE TO THE EXCLUSIVE RIGHT TO USE "COMPUTER APPLICATIONS", APART FROM THE MARK AS SHOWN.

SEC. 2(F).
FOR COMPUTER SOFTWARE FOR USE IN THE ENERGY INDUSTRY, FOR ANALYSIS AND SIMULATION OF ELECTRIC POWER GENERATION, TRANSMISSION AND DISTRIBUTION SYSTEMS (U.S. CLS. 21, 23, 26, 36 AND 38).

FIRST USE 1-1-1984; IN COMMERCE 1-1-1984.

SN 76-209,631. AXIOWAVE NETWORKS, INC., MARLBOROUGH, MA. FILED 2-13-2001.

AXIOWAVE

FOR OPTICAL NETWORKING EQUIPMENT, NAMELY, OPTICAL CROSS CONNECT SWITCH (U.S. CLS. 21, 23, 26, 36 AND 38).

SN 76-210,057. TIVIDAD, WENDY LABEL, LOS ANGELES, CA. FILED 2-15-2001.

SHE-LIMINATORS

FOR CD-ROMS FEATURING ADVENTURES WITH ANIMATED CHARACTERS; CD'S FEATURING STORIES AND MUSIC FROM ANIMATED CHARACTER ADVENTURES (U.S. CLS. 21, 23, 26, 36 AND 38).

SN 76-211,849. BARBADOSOFT B.V., 1097 BA AMSTERDAM, NETHERLANDS, FILED 2-16-2001.

BARBADOSOFT

PRIORITY CLAIMED UNDER SEC. 44(D) ON BENELUX APPLICATION NO. 975954, FILED 10-20-2000, REG. NO. 0679760, DATED 10-20-2000, EXPIRES 10-20-2011.

FOR COMPUTER SOFTWARE FOR USE IN APPLICATION INTEGRATION (U.S. CLS. 21, 23, 26, 36 AND 38).

CLASS 9—(Continued).

SN 76-212,452. KABUSHIKI KAISHA SONY COMPUTER ENTERTAINMENT, TA SONY COMPUTER ENTERTAINMENT INC., TOKYO 107-0052, JAPAN, FILED 2-20-2001.

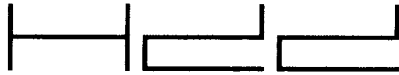

FOR ABACUSES; ACID HYDROMETERS; ACTINOMETERS; ADDING MACHINES; AEROMETERS; AIR TANKS FOR USE IN SCUBA DIVING; ALTIMETERS; ANEMOMETERS; ANTENNAS; ARM RESTS FOR USE WITH COMPUTERS; AUDIO CASSETTE DECKS FOR AUTOMOBILES; AUDIO CASSETTE RECORDERS; AUDIO MIXERS; AUDIO SPEAKERS; AUDIO TAPE RECORDERS; AUTOMATIC TELEPHONE DIALERS; AUTOMATIC VALVES; BAR CODE READERS; BAROMETERS; BASEBALL BATTING HELMETS; BATTERIES FOR VEHICLES; BATTERIES; BATTERY CHARGERS; BINOCULARS; BLANK MAGNETIC COMPUTER TAPES; BULLET-PROOF VESTS AND CLOTHING; CABINETS FOR LOUDSPEAKERS; CALCULATORS; CALIBRATED GLASSWARE; CAMERA CASES; CAMERA FILTERS; CAMERA TRIPODS; CAPACITORS; CASH REGISTERS; CATCHERS' HELMETS; CATHODE RAY TUBES; CHIN STRAPS FOR FOOTBALL HELMETS; CHRONOGRAPHS FOR USE AS SPECIALIZED TIME RECORDING APPARATUS; CIRCUIT BOARDS; CIRCUIT BREAKERS; CLINOMETER; COAXIAL CABLES; COLOR SEPARATION FILM; COMMUTATORS; COMPUTER BUFFERS; COMPUTER CABLES; COMPUTER CARRYING CASES; COMPUTER CHIPS; COMPUTER COLOR PRINTER USING HEAT SENSITIVE DRY PRINTING PROCESS; COMPUTER DISC DRIVES; COMPUTER FAX MODEM CARDS; COMPUTER GAME CARTRIDGES; COMPUTER GAME CASSETTES; COMPUTER GAME DISCS; COMPUTER GAME EQUIPMENT CONTAINING MEMORY DEVICES NAMELY, DISCS; COMPUTER GAME JOYSTICKS; COMPUTER GAME PROGRAMS; COMPUTER GAME SOFTWARE; COMPUTER GAME TAPES; COMPUTER HARDWARE; COMPUTER INTERFACE BOARDS; COMPUTER KEYBOARDS; COMPUTER MEMORIES; COMPUTER MONITORS; COMPUTER MOUSE; COMPUTER OPERATING PROGRAMS; COMPUTER OPERATING SYSTEMS; COMPUTER PERIPHERALS; COMPUTER PRINTERS; COMPUTER TERMINALS; COMPUTER UTILITY PROGRAMS; COMPUTERS AND INSTRUCTIONAL MANUALS SOLD AS A UNIT; COMPUTERS; CONDENSERS; CONTACT LENS BLANKS; CONTACT LENS CASES; CONTACT LENSES; ; COVERS FOR ELECTRIC OUTLETS; COVERS FOR TELEPHONE RECEIVERS NOT MADE OF PAPER; CRUISE CONTROLS FOR MOTOR VEHICLES; CYCLOTRONS; DAISY WHEEL PRINTERS; DATA PROCESSORS; DECOMPRESSION CHAMBERS; DECORATIVE REFRIGERATOR MAGNETS; DEMAGNETIZERS FOR MAGNETIC TAPES; DICTATION MACHINES; DIGITAL AUDIO TAPE PLAYERS; DISPOSABLE LATEX GLOVES FOR LABORATORY USE; DISPOSABLE PLASTIC GLOVES FOR LABORATORY USE; DIVING GLOVES; DIVING HELMETS; DIVING SUITS; DOG WHISTLES; DOSIMETERS; DOT MATRIX PRINTERS; DYNAMOMETERS; EAR PLUGS NOT FOR MEDICAL PURPOSES; ELECTRIC FENCES; ELECTRIC OUTLET COVERS; ELECTRICAL POWER EXTENSION CORDS; ELECTRONIC ANIMAL CONFINEMENT SYSTEMS; ELECTRONIC APPARATUS FOR TESTING THE STERILITY OF PHARMACEUTICALS AND INJECTABLE SOLUTIONS; ELECTRONIC APPARATUS FOR TESTING THE STERILITY OF MEDICAL EQUIPMENT; ELECTRONIC EFFECT PEDALS FOR USE WITH SOUND AMPLIFIERS; ELECTRONIC NOTICE BOARDS; ELECTRONIC PERSONAL ORGANIZER; ELECTRONIC SAFES; EMERGENCY WARNING LIGHTS; ENCODERS; EPIDIASCOPIES; EVENT RECORDERS; EYEGLASS CASES; EYEGLASS CHAINS; EYEGLASS FRAMES; EYEGLASS LENSES; EYEGLASSES; FACE SHIELDS; FACSIMILE MACHINES; FAX MACHINES; FIBER OPTIC CABLES; FIBER OPTIC LIGHT AND IMAGE CONDUITS; FIBER OPTICS; FILTERS FOR RESPIRATORY

CLASS 9—(Continued).

MASKS; FIRE ALARMS; FIRE BLANKETS; FIRE EXTINGUISHERS; FIRE HOSE NOZZLES; FIRE SPRINKLERS; FIRE TRUCKS; FOOTBALL HELMETS; FUEL PUMPS FOR SERVICE STATIONS; FUSES FOR AUTOMOBILES; GALVANOMETERS; GAMBLING MACHINES; GAMING EQUIPMENT, NAMELY, SLOT MACHINES WITH OR WITHOUT VIDEO OUTPUT; GAMING MACHINES; GAS CHROMATOGRAPHY APPARATUS; GAS MASKS; GAS METERS; GASOMETERS; GLASS TUBES FOR SCIENTIFIC PURPOSES; GRADUATED GLASSWARE; HEADPHONES; HIGHWAY SAFETY CONES; HOCKEY HELMETS; HOLDERS FOR COMPACT DISCS; HUBS FOR TIMING DIALS; HYDROMETERS; HYGROMETERS; IMPACT PRINTERS; ; INTEGRATED CIRCUITS; INTERACTIVE MULTIMEDIA COMPUTER GAME PROGRAM; INTERACTIVE VIDEO GAME PROGRAMS; INTERACTIVE VIDEO GAMES OF VIRTUAL REALITY COMPRISED OF COMPUTER HARDWARE AND SOFTWARE; INVERTERS; JACKETS FOR COMPUTER DISKS; JACKETS FOR VIDEO CASSETTES; JOYSTICKS FOR VIDEO GAMES; JUMPER CABLES; KALEIDOSCOPIES; KNEE PADS FOR WORKERS; LABORATORY APPARATUS, NAMELY, CENTRIFUGES; LABORATORY GLASSWARE; LASER POINTERS; LASER PRINTERS; LASER SCANNERS FOR INDUSTRIAL INSPECTION; LASERS FOR MEASURING PURPOSES; LASERS NOT FOR MEDICAL USE; LETTER SCALES; LIFE BELTS; LIFE JACKETS; LIFE NETS; LIFE PRESERVERS; LIFE-BUOYS; LIFE-SAVING RAFTS; LIGHT EMITTING DIODE DISPLAYS; LIGHT EMITTING DIODES; LIGHTING BALLASTS; LIGHTNING RODS; LOUDSPEAKER CABINETS; LOUDSPEAKERS; MACHINES FOR PLAYING GAMES OF CHANCE; MAGNETIC CODED CARD READERS; MAGNETIC CODED CARDS; MAGNIFYING GLASSES; MARINE DEPTH FINDERS; MARKER BUOYS; LOUDSPEAKER SYSTEMS CONSISTING OF LOUDSPEAKERS, AMPLIFIERS AND ONE OR MORE OF THE FOLLOWING - RADIO TUNER, COMPACT DISC PLAYER AND TAPE PLAYER; MEASURING CUPS; MEASURING SPOONS; MEGAPHONES; METAL DETECTORS; METRONOMES; MICRO-PROCESSORS; MICROCOMPUTERS; MICROFICHE; MICROMETERS; MICROPHONES; MICROSCOPES; MICROWAVE OVENS FOR LABORATORY USE; MINICOMPUTERS; MODEMS; MOTION PICTURE CAMERAS; MULTIPLEXERS; MUSICAL SOUND RECORDINGS; MUSICAL VIDEO RECORDINGS; NAVIGATIONAL BUOYS; NEON SIGNS; ODOMETERS; OHMMETERS; OPTICAL DISCS; OPTICAL FILTERS; OPTICAL INSPECTION APPARATUS FOR INDUSTRIAL USE; OPTICAL LENS SIGHTS; OPTICAL MIRRORS; OPTICAL SCANNERS; OSCILLOSCOPES; OXYGEN MASKS NOT FOR MEDICAL USE; PARKING METERS; PARTICLE ACCELERATORS; PEDOMETERS; PERISCOPES; PERSONAL SECURITY ALARMS; PHONOGRAPH NEEDLES; PHONOGRAPH RECORD PLAYERS; PHONOGRAPHS; PHOTOCOPYING MACHINES; PHOTOGRAPHIC CAMERAS; PHOTOGRAPHIC PROJECTORS; PHOTOGRAPHIC SLIDE TRANSPARENCIES; PHOTOMETERS; PLUMB BOBS; PLUMB LEVELS; PLUMB LINES; POCKET CALIPERS FOR MEASURING; POLYGRAPH MACHINES; POWER LINE CONDITIONERS; PRE-PAID TELEPHONE CALLING CARDS, MAGNETICALLY ENCODED; PRESSURE GAUGES; PRESSURE INDICATING PLUGS FOR VALVES; PRINTED CIRCUITS; PRISMS FOR SCIENTIFIC PURPOSES; PROJECTION SCREENS; PROTECTIVE CLOTHING; PROTECTIVE GLOVES FOR INDUSTRIAL USE; PROTECTIVE OR SAFETY HELMETS; PROTRACTORS; PYROMETERS; RADAR DETECTORS; RADAR; RADIO CONTROLLED MINIATURE AERIAL TARGETS; RADIO PAGERS; RADIO TELEPHONES; RADIOS FOR VEHICLES; RADIOS INCORPORATING CLOCKS; RADIOS; RADON DETECTORS; REGULATORS FOR USE IN SCUBA DIVING; REMOTE CURSOR CONTROLS FOR COMPUTERS; RESPIRATORS OTHER THAN FOR ARTIFICIAL RESPIRATION; RESPIRATORY MASK FILTERS; RHEOSTATS; RING BUOYS FOR USE IN WATER RESCUE; SAFETY GOGGLES; SAFETY HARNESSES OTHER THAN FOR VEHICLES OR SPORTS PURPOSES; SAFETY MARKERS; SAFETY OR PROTECTIVE HELMETS; SAFETY PRODUCTS, NAMELY, REFLECTIVE HELMET SKIRTS; SAFETY PRODUCTS, NAMELY, REFLECTIVE SAFETY BANDS TO BE WORN ON THE BODY; SALINOMETERS; SATELLITE PROCESSORS; SATELLITES FOR SCIENTIFIC PURPOSES; SATELLITES; SCALES; SEMICONDUCTOR DEVICES;

CLASS 9—(Continued).

SEMICONDUCTORS; SEXTANTS; SIGNAL BELLS; SIGNAL PROCESSORS; SIGNAL WHISTLES; SIGNALING BUOYS; SILICON CHIPS; SILICON WAFERS; SIRENS FOR VEHICLES; SIRENS; SLIDE PROJECTORS; SLIDE RULES; SLOT MACHINES; SMOKE DETECTORS; SOLENOID VALVES; SONAR; SPECTACLES; SPEEDOMETERS FOR VEHICLES; SPEEDOMETERS; STEREO AMPLIFIERS; STEREO RECEIVERS; STEREO TUNERS; SUPER COMPUTERS; SUPER MINI COMPUTERS; SUPPORT BELTS FOR WORKERS; SURVEYING CHAINS; SURVEYORS' LEVELS; TACHOMETERS; TAPE MEASURES; TELEPHONE ANSWERING MACHINES; TELEPHONE APPARATUS, NAMELY INTERCOMS; TELEPHONE EQUIPMENT, NAMELY, CALLER IDENTIFICATION BOXES; TELEPHONES; TELEPROMPTERS; TELESCOPES; TELESCOPIC GUN SIGHTS; TELESCOPIC LENS SIGHTS; TELEVISION ANTENNAS; TELEVISION SETS; THEODOLITES; THERMOMETERS NOT FOR MEDICAL USE; THERMOSTATS; TICKET CANCELING MACHINES; TIMING DIALS; TIMING SENSORS; TIRE BALANCING MACHINES FOR LAND VEHICLES; TIRE BALANCING UNITS FOR LAND VEHICLES; TRANSCIEVERS; TRANS PONDERS; TRIPODS FOR CAMERAS; TYPEFACE FONTS RECORDED ON MAGNETIC MEDIA; VEHICLE WHEEL ALIGNMENT MACHINES; VENDING MACHINES; VIDEO CAMERAS; VIDEO CASSETTE RECORDERS; VIDEO GAME CARTRIDGES; VIDEO GAME DISCS; VIDEO GAME INTERACTIVE CONTROL FLOOR PADS OR MATS; VIDEO GAME INTERACTIVE REMOTE CONTROL UNITS; VIDEO GAME JOYSTICKS; VIDEO GAME MACHINES FOR USE WITH TELEVISIONS; VIDEO GAME SOFTWARE; VIDEO GAME TAPE CASSETTES; VIDEO MONITORS; VIDEO TAPE RECORDERS; VIRTUAL REALITY GAME SOFTWARE; VOLTAGE SURGE PROTECTORS; VOLTAGE SURGE SUPPRESSORS; VOLTMETERS; VOTING MACHINES; WALKIE-TALKIES; WARNING TRIANGLES TO INDICATE VEHICLE BREAKDOWNS; WATER METERS; WATER SKI SAFETY VESTS; WELDING ELECTRODES; WORD PROCESSORS; X-Y PLOTTERS; X-RAY PHOTOGRAPHS, OTHER THAN FOR MEDICAL PURPOSES (U.S. CLS. 21, 23, 26, 36 AND 38).

SN 76-212,831. FASTLANE SOFTWARE SYSTEMS INCORPORATED, SAN JOSE, CA. FILED 2-20-2001.

BLUEDGE

FOR COMPUTER HARDWARE AND UTILITY SOFTWARE FOR ANALYZING AND CONTROLLING COMPUTER NETWORKS (U.S. CLS. 21, 23, 26, 36 AND 38).

SN 76-213,094. IDOC PRODUCTIONS, INC., NEW YORK, NY. BY ASSIGNMENT SHULMAN, JULIUS M.D., NEW YORK, NY. FILED 2-21-2001.

THE BROADWAY KIDS

OWNER OF U.S. REG. NO. 1,957,281.
NO CLAIM IS MADE TO THE EXCLUSIVE RIGHT TO USE "KIDS", APART FROM THE MARK AS SHOWN.

FOR SOUND RECORDINGS, PRERECORDED AUDIO CASSETTES, PRERECORDED COMPACT DISCS, PRERECORDED VIDEO CASSETTES AND VIDEO DISCS ALL FEATURING MUSIC AND MUSICAL PERFORMANCES (U.S. CLS. 21, 23, 26, 36 AND 38).

FIRST USE 9-1-1993; IN COMMERCE 12-1-1993.

CLASS 9—(Continued).

SN 76-213,180. SINAR AG (SINAR LTD.), 8245 FEUERTHALEN, SWITZERLAND, FILED 2-20-2001.

CEMAGYK

PRIORITY CLAIMED UNDER SEC. 44(D) ON SWITZERLAND APPLICATION NO. 13831/2000, FILED 11-21-2000, REG. NO. 482004, DATED 11-21-2000, EXPIRES 11-21-2010.

FOR COMPUTER SOFTWARE FOR TRANSFORMING VISUAL COLORED IMAGES FROM PRIMARY COLORS TO SECONDARY COLORS AND TO OPTIMIZE THE DEFINITION, CONTRAST, AND COLOR TONES OF THE IMAGES; DIGITAL CAMERAS AND PARTS AND FITTINGS THEREFOR (U.S. CLS. 21, 23, 26, 36 AND 38).
FIRST USE 10-0-2000; IN COMMERCE 10-0-2000.

SN 76-213,512. POCKET DVM CORPORATION, WORCESTER, MA. FILED 2-22-2001.

POCKET DVM

NO CLAIM IS MADE TO THE EXCLUSIVE RIGHT TO USE "POCKET", APART FROM THE MARK AS SHOWN.

FOR COMPUTER SOFTWARE DEVELOPED FOR HAND HELD COMPUTERS AND USED FOR INFORMATION DELIVERY AND MEDICAL CALCULATIONS FOR THE VETERINARY MEDICAL INDUSTRY (U.S. CLS. 21, 23, 26, 36 AND 38).

FIRST USE 4-1-2000; IN COMMERCE 2-8-2001.

SN 76-214,206. WILMERS, RON, LAPEER, MI. FILED 2-23-2001.



THE MARK CONSISTS OF THE COLORS RED AND BLUE AS FOLLOWS - THE TOP PORTION OF THE SHIELD CONTAINS THE COLOR RED AND THE BOTTOM PORTION OF THE SHIELD WITH THE ONE SUPERIMPOSED CONTAINS THE COLOR BLUE.

SEC. 2(F) AS TO "THE DISABLED TRAVELER".
FOR PRE-RECORDED VIDEOTAPES FEATURING TRAVEL INFORMATION FOR DISABLED TRAVELERS (U.S. CLS. 21, 23, 26, 36 AND 38).

FIRST USE 7-1-1996; IN COMMERCE 7-1-1996.

SN 76-214,247. VITESSE SEMICONDUCTOR CORPORATION, CAMARILLO, CA. FILED 2-22-2001.

IQ2000

FOR SEMICONDUCTORS AND INTEGRATED CIRCUITS, NAMELY NETWORK PROCESSORS (U.S. CLS. 21, 23, 26, 36 AND 38).

FIRST USE 4-3-2000; IN COMMERCE 4-3-2000.

CLASS 9—(Continued).

SN 76-214,884. MILLBROOK CORPORATION, CARROLLTON, TX. FILED 2-23-2001.

MILLBROOK ● ○ ●
practice manager

NO CLAIM IS MADE TO THE EXCLUSIVE RIGHT TO USE "PRACTICE MANAGER", APART FROM THE MARK AS SHOWN.

FOR COMPUTER SOFTWARE PROGRAMS FOR PHYSICIAN PRACTICE MANAGEMENT (U.S. CLS. 21, 23, 26, 36 AND 38).

FIRST USE 12-1-2000; IN COMMERCE 12-1-2000.

SN 76-215,483. MEDSCHOOL.COM, INC., CULVER CITY, CA. FILED 2-22-2001.

MedStudy

THE MARK CONSISTS OF THE WORD "MEDSTUDY" IN THE STYLIZED LETTERING, AS SHOWN IN THE DRAWING.

FOR DOWNLOADABLE COMPUTER SOFTWARE, NAMELY, MEDICAL AND HEALTH CARE PROFESSIONAL EXAMINATION STUDY AND EXAMINATION PREPARATION SOFTWARE DELIVERED VIA A GLOBAL COMPUTER NETWORK (U.S. CLS. 21, 23, 26, 36 AND 38).

SN 76-215,484. MEDSCHOOL.COM, INC., CULVER CITY, CA. FILED 2-22-2001.

MedSurround

THE MARK CONSISTS OF THE WORD "MEDSURROUND" IN THE STYLIZED LETTERING, AS SHOWN IN THE DRAWING.

FOR DOWNLOADABLE COMPUTER SOFTWARE, NAMELY, SOFTWARE USED TO TEACH MEDICINE AND MEDICAL ETHICS TO MEDICAL STUDENTS AND MEDICAL AND HEALTH CARE PROFESSIONALS, IN THE FIELD OF MEDICAL EDUCATIONAL DELIVERED VIA A GLOBAL COMPUTER NETWORK (U.S. CLS. 21, 23, 26, 36 AND 38).

CLASS 9—(Continued).

SN 76-215,494. MEDSCHOOL.COM, INC., CULVER CITY, CA. FILED 2-22-2001.

MedEngage

THE MARK CONSISTS OF THE WORD "MEDENGAGE" IN THE STYLIZED LETTERING, AS SHOWN IN THE DRAWING.

FOR DOWNLOADABLE COMPUTER SOFTWARE, NAMELY, SOFTWARE THAT TEACHES MEDICINE AND MEDICAL ETHICS TO MEDICAL AND HEALTH CARE PROFESSIONALS IN THE FIELD OF MEDICAL EDUCATIONAL DELIVERED VIA A GLOBAL COMPUTER NETWORK (U.S. CLS. 21, 23, 26, 36 AND 38).

FIRST USE 11-16-1988; IN COMMERCE 11-16-1989.

SN 76-215,496. MEDSCHOOL.COM, INC., CULVER CITY, CA. FILED 2-22-2001.

PATIENTSIM

THE MARK CONSISTS OF THE WORD "PATIENTSIM", AS SHOWN IN THE DRAWING.

FOR DOWNLOADABLE COMPUTER SOFTWARE, NAMELY, SOFTWARE FOR USE IN PROVIDING EDUCATIONAL PATIENT SCENARIOS TO MEDICAL AND HEALTH CARE STUDENTS DELIVERED VIA A GLOBAL COMPUTER NETWORK (U.S. CLS. 21, 23, 26, 36 AND 38).

SN 76-215,628. GAMEDAY TRADITIONS, LLC, BIRMINGHAM, AL. FILED 2-23-2001.

GAMEDAY TRADITIONS

NO CLAIM IS MADE TO THE EXCLUSIVE RIGHT TO USE "GAMEDAY", APART FROM THE MARK AS SHOWN.

FOR COMPUTER GAME SOFTWARE, VIDEO GAME SOFTWARE, CHILDREN'S EDUCATIONAL SOFTWARE, AND EDUCATIONAL SOFTWARE FEATURING INSTRUCTION IN COLLEGIATE SPORTS (U.S. CLS. 21, 23, 26, 36 AND 38).

SN 76-216,185. GEYER, JOHN W., SAN ANTONIO, TX. FILED 2-27-2001.

SECURSELECT

FOR COMPUTER SOFTWARE, CONTAINING DATABASES OF COMMERCIALY AVAILABLE PRODUCTS FOR USE IN THE DESIGN AND CONSTRUCTION OF DETENTION FACILITIES AND PROVIDING THE ABILITY TO PRODUCE REPORTS ACCEPTED BY THE CONSTRUCTION AND DESIGN INDUSTRY, FOR USE IN ASSISTING IN THE SELECTION AND DOCUMENTATION OF DETENTION EQUIPMENT USED IN THE CONSTRUCTION OF DETENTION FACILITIES (U.S. CLS. 21, 23, 26, 36 AND 38).

CLASS 9—(Continued).

SN 76-216,813. ZF MICRO DEVICES, INC., PALO ALTO, CA. BY CHANGE OF NAME ZF LINUX DEVICES, INC., PALO ALTO, CA. FILED 2-26-2001.

ZF MICRO DEVICES

NO CLAIM IS MADE TO THE EXCLUSIVE RIGHT TO USE "MICRO DEVICES", APART FROM THE MARK AS SHOWN.

FOR EMBEDDED COMPUTER SYSTEMS COMPRISED OF A MICROPROCESSOR, PROGRAM AND DATA MEMORY, STANDARD BUSES, DISK DRIVE INTERFACES, CONNECTING PORTS, AND INPUT/OUTPUT INTERFACES; PERSONAL COMPUTERS CONSTRUCTED IN AN INTEGRATED FORM ON A CHIP; INTERNET APPLIANCES IN THE FORM OF DEDICATED COMPUTERS FOR ACCESSING THE INTERNET; SEMICONDUCTORS; CIRCUIT BOARDS; AND FULLY INTEGRATED COMPUTER SYSTEMS COMPRISED OF MICROPROCESSORS, MEMORY, STORAGE MEDIA DRIVES, BUS AND PORT CONNECTORS, VIDEO AND NETWORK INTERFACES, KEYBOARD AND MOUSE CONNECTORS, AND POWER SUPPLIES, WITH OR WITHOUT ENCLOSURES (U.S. CLS. 21, 23, 26, 36 AND 38).

SN 76-219,501. CRAVE ENTERTAINMENT, INC., RANCHO DOMINGUEZ, CA. FILED 2-28-2001.

KENGO

THE ENGLISH TRANSLATION OF THE WORD "KENGO" IN THE MARK IS "SWORDMASTER".

FOR VIDEO GAME PROGRAMS; VIDEO GAME SOFTWARE; AND VIDEO GAME DISCS (U.S. CLS. 21, 23, 26, 36 AND 38).

FIRST USE 12-31-2000; IN COMMERCE 12-31-2000.

SN 76-220,985. SECURELOGIX CORPORATION, SAN ANTONIO, TX. FILED 3-7-2001.

TELEVIEW

FOR TELECOMMUNICATIONS SOFTWARE, NAMELY, ELECTRONIC SECURITY SOFTWARE FOR PROVIDING ENTERPRISE VISIBILITY AND CONTROL OF AN ORGANIZATION'S TELECOMMUNICATIONS INFRASTRUCTURE (U.S. CLS. 21, 23, 26, 36 AND 38).

SN 76-224,029. CYBERLINK CORP., TAIPEI HSIEN, TAIWAN, FILED 3-14-2001.



The logo features a stylized lowercase 'i' with a dot, followed by the word 'POWER' in a bold, sans-serif font.

FOR COMPUTER SOFTWARE FOR AUDIO AND VIDEO PRODUCING, PLAYING AND RECORDING (U.S. CLS. 21, 23, 26, 36 AND 38).

FIRST USE 1-17-2001; IN COMMERCE 1-17-2001.

CLASS 9—(Continued).

SN 76-225,622. ARTIC INTERNATIONAL, PLEASANTON, CA. FILED 3-19-2001.

ARTICMASTER

FOR REFRIGERANT CONTROL UNITS, NAMELY, A TANK POSITIONED BETWEEN A CONDENSER AND AN EVAPORATOR COIL USED TO CREATE A TURBULENT FLOW OF REFRIGERANT THAT PASSES THROUGH THE TANK TO REDUCE THE AMOUNT OF REFRIGERANT USED IN A CONDENSER (U.S. CLS. 21, 23, 26, 36 AND 38).

SN 76-225,858. APPLIED MATERIALS, INC., SANTA CLARA, CA. FILED 3-14-2001.



The logo consists of the lowercase letters 'iLB' in a bold, serif font.

FOR EQUIPMENT AND MACHINES, NAMELY, EPITAXIAL REACTORS, CHEMICAL VAPOR DEPOSITION REACTORS, PHYSICAL VAPOR DEPOSITION REACTORS, PLASMA ETCHERS, AND ION IMPLANTERS FOR THE PROCESSING AND PRODUCTION OF SEMICONDUCTOR SUBSTRATES, THIN FILMS, SILICON CHIPS AND WAFERS INCLUDING POLISHING, CLEANING AND PROCESS MONITORING EQUIPMENT (U.S. CLS. 21, 23, 26, 36 AND 38).

SN 76-227,492. BETA CORPORATION INTERNATIONAL, ALBUQUERQUE, NM. FILED 3-20-2001.



The logo features a large, stylized 'P' with a question mark inside it, positioned above the words 'Portable SHEPHERD' in a serif font.

FOR COMPUTER SOFTWARE FOR ASSET MANAGEMENT INVENTORY AND CONTROL FOR USE WITH HAND-HELD COMPUTERS (U.S. CLS. 21, 23, 26, 36 AND 38).

FIRST USE 12-29-2000; IN COMMERCE 12-29-2000.

CLASS 9—(Continued).

SN 76-229,903. CREDIT SUISSE FIRST BOSTON CORPORATION, NEW YORK, NY. FILED 3-22-2001.

CREDITCOMPASS

FOR COMPUTER SOFTWARE FOR ASSISTING IN THE ANALYSIS, SELECTION AND MANAGEMENT OF FINANCIAL PORTFOLIOS AND MANUALS SOLD AS A UNIT (U.S. CLS. 21, 23, 26, 36 AND 38).

SN 76-231,063. AOPEN INC., LUNG TAN HSING, TAOYUAN, TAIWAN, FILED 3-26-2001.

OPENBIOS

FOR VIDEO-GRAPHIC-ADAPTER CARD NAMELY, VGA CARD (U.S. CLS. 21, 23, 26, 36 AND 38).
FIRST USE 7-0-2000; IN COMMERCE 7-0-2000.

SN 76-233,344. ARCTURUS ENGINEERING, INC., MOUNTAIN VIEW, CA. FILED 3-30-2001.

PICOPURE

FOR SCIENTIFIC AND LABORATORY INSTRUMENTS, NAMELY DNA AND RNA EXTRACTION KITS, CONTAINING CENTRIFUGE TUBES, MICROSCOPE SLIDES, SLIDE STAINING JARS, REAGENTS AND PROTOCOL INSTRUCTIONS FOR PREPARING TISSUE SAMPLES FOR DNA AND RNA EXTRACTION PROCEDURES (U.S. CLS. 21, 23, 26, 36 AND 38).
FIRST USE 5-2-2001; IN COMMERCE 5-2-2001.

SN 76-234,460. APPLIED MATERIALS, INC., SANTA CLARA, CA. FILED 3-29-2001.

SPIDER

FOR EQUIPMENT, MACHINES AND MONITORING DEVICES, NAMELY, EPITAXIAL REACTORS, CHEMICAL VAPOR DEPOSITION REACTORS, PHYSICAL VAPOR DEPOSITION REACTORS, PLASMA ETCHERS, ION IMPLANTERS, INTEGRATED METROLOGY SYSTEMS, CHEMICAL MECHANICAL POLISHERS AND OPERATIONAL SOFTWARE, ALL FOR THE PROCESSING AND PRODUCTION OF SEMICONDUCTOR SUBSTRATES, THIN FILMS, SILICON DISCS AND WAFERS (U.S. CLS. 21, 23, 26, 36 AND 38).

CLASS 9—(Continued).

SN 76-234,461. AD2, INC., SANTA MONICA, CA. FILED 3-29-2001.

DYNAMICCD

FOR COMPUTER SOFTWARE INTERFACE THAT INITIATES ACCESS TO SELECTED WEBSITES ON THE INTERNET AND WHICH FACILITATES THE DOWNLOADING OF INFORMATION FROM THE INTERNET; CUSTOMIZABLE BROWSER SOFTWARE AND DOWNLOADABLE SOFTWARE FOR PROVIDING REAL-TIME INFORMATION ON THE INTERNET (U.S. CLS. 21, 23, 26, 36 AND 38).

FIRST USE 6-0-2000; IN COMMERCE 6-0-2000.

SN 76-234,523. CE SOFTWARE, INC., WEST DES MOINES, IA. FILED 4-2-2001.

INOUTTRACKER

FOR COMPUTER SOFTWARE FOR EMPLOYEE LOCATION MONITORING (U.S. CLS. 21, 23, 26, 36 AND 38).
FIRST USE 6-15-2001; IN COMMERCE 6-25-2001.

SN 76-234,639. FIBERSPACE, INC., CULVER CITY, CA. FILED 4-3-2001.



The logo for Fiberspace, featuring a stylized 'f' symbol followed by the word 'fiberspace' in a lowercase, italicized sans-serif font.

OWNER OF U.S. REG. NO. 2,279,583.

FOR LASER, OPTICAL, OPTO-ELECTRONIC AND ELECTRONIC HARDWARE FOR USE IN ANALOG AND DIGITAL COMMUNICATIONS, COMMUNITY ANTENNA TELEVISION, COMPUTER, TELEPHONE AND UTILITIES NETWORK ARCHITECTURES, TERMINAL EQUIPMENT AND COMMUNICATIONS AND COMPUTER NETWORK APPLIANCES TO PRODUCE, TRANSMIT, STORE AND RECEIVE BROADCAST AND ALLOCATED BANDWIDTH SERVICES FOR ENTERTAINMENT, VIDEO, TELEPHONE, COMPUTER, DATA, INFORMATION AND INTERNET APPLICATIONS OVER HYBRID FIBER OPTICAL/ELECTRICAL, FIBER OPTICAL NETWORKS AND SYSTEMS (U.S. CLS. 21, 23, 26, 36 AND 38).

CLASS 9—(Continued).

SN 76-234,813. BANDWIDTH9, INC., FREEMONT, CA.
FILED 3-26-2001.

METROFLEX

FOR OPTICAL NETWORKING COMPONENTS AND SUBSYSTEMS FOR TELECOMMUNICATIONS AND DATA COMMUNICATIONS, NAMELY TUNABLE LASERS, DETECTORS, FILTERS, ATTENUATORS, OPTICAL AMPLIFIERS, LOCKERS, VERTICAL CAVITY SURFACE EMITTING LASERS (VCSEL), RESONANT CAVITY DETECTOR, OPTICAL MICRO-ELECTROMECHANICAL SYSTEMS (MEMS), OPTICAL CROSS CONNECTS, WAVELENGTH DIVISION MULTIPLEXING (WDM) MULTIPLEXER AND DEMULTIPLEXER, OPTICAL PROCESSOR, PHOTONIC SWITCH, ROUTER, CONVERTER, OPTICAL INTERLEVER, SPECTROMETER, OPTICAL INTERCONNECTS, DISTRIBUTED FEED BACK (DFB) AND DISTRIBUTING BRAGG REFLECTOR (DBR) LASERS, AVALANCHE PHOTODIODE (APD), SEMI-CONDUCTOR OPTICAL AMPLIFIER (SOA), AND ERBIUM DOPED FIBER AMPLIFIER (EDFA) (U.S. CLS. 21, 23, 26, 36 AND 38).

FIRST USE 1-1-2001; IN COMMERCE 1-1-2001.

SN 76-238,374. RARE LIMITED, NR. ATHERSTONE, WARKS, ENGLAND, FILED 4-9-2001.

KAMEO

FOR AUDIO CASSETTE RECORDERS; AUDIO SPEAKERS; AUDIO TAPE RECORDERS; AUDIO TAPES CONTAINING MUSIC; BASEBALL BATTING HELMETS, BICYCLE RIDING HELMETS, CATCHERS' HELMETS, DRIVING HELMETS, FOOTBALL HELMETS, IN-LINE SKATING HELMETS, AND SKATEBOARD HELMETS; BATTERIES; BATTERY ADAPTERS; BINOCULARS; BLANK AUDIO TAPES; BLANK COMPUTER DISKS; BLANK VIDEO TAPES; CALCULATORS; CASSETTE RECORDERS; CIRCUIT BOARDS; COMPACT DISC PLAYERS; COMPACT DISKS FEATURING MUSIC; COMPUTER GAME ACCESSORIES, NAMELY, JOYSTICKS, POWER TRANSFORMERS, BATTERY PACKS; COMPUTER GAME CARTRIDGES; COMPUTER GAME DISKS; COMPUTER GAME PROGRAMS; COMPUTER GAME SOFTWARE; COMPUTER KEYBOARDS; COMPUTER PRINTERS; COMPUTER PERIPHERAL MOUSE PADS; COMPUTERS; CONTROLLER FOR TELEVISION GAME SETS; CONTROLLER FOR VIDEO GAME MACHINES; DIGITAL AUDIO RECORDERS; DIGITAL AUDIO TAPE PLAYERS; DIGITAL CAMERAS; COMPUTER, DIGITAL, VIDEO, AND OPTICAL DISC DRIVES; ELECTRONIC VIDEO GAME MACHINES FOR USE WITH TELEVISION OR VIDEO OR COMPUTER MONITORS, ELECTRONIC GAME CARTRIDGES; ELECTRONIC GAME PROGRAMS; ELECTRONIC GAME SOFTWARE; EYEGLASS CASES; EYEGLASS FRAMES; EYEGLASSES; INTERACTIVE ELECTRONIC GAME PROGRAMS; INTERACTIVE VIDEO GAME PROGRAMS; COMPACT DISC RECORDERS AND PLAYERS; COMPUTER MEMORIES, NAMELY, MAGNETIC CARDS, TAPES AND DISCS, OPTICAL DISCS, AND SEMICONDUCTOR HARDWARE FOR HAND-HELD VIDEO GAME MACHINES, COMPUTER AND VIDEO GAME MACHINES, VIDEO GAME MACHINES FOR USE WITH TELEVISIONS OR VIDEO OR COMPUTER MONITORS; PROGRAM MEMORY CARTRIDGES FOR ELECTRONIC AMUSEMENT APPARATUS ADAPTED FOR USE WITH TELEVISION RECEIVERS; PROGRAM MEMORY CARTRIDGES FOR HAND-HELD VIDEO GAME APPARATUS; PROGRAM MEMORY CARTRIDGES FOR TELEVISION GAME SETS; PROGRAM MEMORY CARTRIDGES FOR VIDEO GAME MACHINES; PROGRAM MEMORY CARTRIDGES FOR

CLASS 9—(Continued).

VIDEO GAME MACHINES ADAPTED FOR USE WITH DISPLAY UNITS; RADIOS; SOUND AND VIDEO CASSETTE AND DISK RECORDERS AND REPRODUCING APPARATUS; PHONOGRAPH RECORDS FEATURING MUSIC AND CHILDREN'S ENTERTAINMENT CONTENT, NAMELY, CHILDREN'S STORIES, GAMES, FAIRY TALES, AND MUSIC; SPECTACLES; SUNGLASSES; TALKING MACHINES; ELECTRONIC AUDIO PLAYBACK UNITS WITH LIGHTS AND SPEAKERS; TELEPHONES; TELEVISION GAME SETS; TELEVISION RECEIVING SETS; 35 MM CAMERAS; VIDEO CAMERAS; VIDEO GAME ACCESSORIES, NAMELY, JOYSTICKS AND VIDEO GAME CARTRIDGES; VIDEO GAME DISCS; VIDEO GAME MACHINES FOR USE WITH TELEVISIONS; VIDEO GAME PROGRAMS; VIDEO GAME SOFTWARE; VIDEO GAME TAPES; VIDEO TAPE RECORDERS; VIDEO TAPES CONTAINING CHILDREN'S ENTERTAINMENT, NAMELY, CHILDREN'S STORIES, VIDEO GAMES, FAIRY TALES, AND MUSIC; AND WALKIE-TALKIES (U.S. CLS. 21, 23, 26, 36 AND 38).

SN 76-238,508. ANALOG DEVICES, INC., NORWOOD, MA.
FILED 4-10-2001.

QUASAR

FOR INTEGRATED CIRCUIT DEVICES, NAMELY, ANALOG-TO-DIGITAL CONVERTERS (U.S. CLS. 21, 23, 26, 36 AND 38).

SN 76-239,224. TC (BERMUDA) LICENSE, LTD., HAMILTON, BERMUDA, BY ASSIGNMENT; BY ASSIGNMENT; BY ASSIGNMENT AMTECH SYSTEMS CORPORATION, DALLAS, TX. FILED 4-11-2001.



SEC. 2(F).
FOR SYSTEMS FOR IDENTIFYING MOTOR VEHICLES SUBJECT TO HIGHWAY AND CROSSING TOLLS, COMPRISING AN ELECTRONIC MAGNETICALLY CODED RADIO FREQUENCY IDENTIFICATION CARD TO BE ATTACHED TO THE VEHICLE, AND A READER WHICH DECODES AND RECOGNIZES THE ELECTRONIC MAGNETICALLY CODED SIGNAL (U.S. CLS. 21, 23, 26, 36 AND 38).

FIRST USE 2-0-1988; IN COMMERCE 2-0-1988.

SN 76-239,722. SATELLITE STATION, INC., NAKANO-KU, TOKYO 164-0001, JAPAN, FILED 4-12-2001.

SATELLITE STATION

FOR COMPUTER SOFTWARE FOR TRANSLATING COMPUTER PROGRAMS FROM ENGLISH INTO ASIAN LANGUAGES AND FROM ASIAN LANGUAGES INTO ENGLISH (U.S. CLS. 21, 23, 26, 36 AND 38).

CLASS 9—(Continued).

SN 76-240,570. ENDRESS + HAUSER GMBH + CO., D-79689 MAULBURG, FED REP GERMANY, FILED 4-12-2001.

CERAPHIRE

PRIORITY CLAIMED UNDER SEC. 44(D) ON FED REP GERMANY APPLICATION NO. 30086957.6, FILED 11-27-2000, REG. NO. 30086957, DATED 12-13-2000, EXPIRES 12-13-2010.

FOR PRESSURE SENSORS, PRESSURE MEASURING DEVICES, NAMELY, PRESSURE-MEASURING CELLS, PRESSURE TRANSMITTER AND PRESSURE TRANSDUCER (U.S. CLS. 21, 23, 26, 36 AND 38).

SN 76-241,525. EVEREADY BATTERY COMPANY, INC., ST. LOUIS, MO. FILED 4-13-2001.

PROFORMULA

FOR BATTERIES (U.S. CLS. 21, 23, 26, 36 AND 38).

SN 76-242,400. ALPHA SECURITY PRODUCTS, INC., NORTH CANTON, OH. FILED 4-19-2001.



NO CLAIM IS MADE TO THE EXCLUSIVE RIGHT TO USE "BLISTER TAG DISPOSABLE CLAMSHELL SECURITY", APART FROM THE MARK AS SHOWN.

FOR SECURITY DEVICES ATTACHABLE TO PACKAGES FOR CONSUMER GOODS TO PREVENT THE OPENING OF THE PACKAGE, AND SECURITY DEVICES ATTACHABLE TO CONSUMER GOODS AND PACKAGING FOR CONSUMER GOODS FOR RETAINING AN ELECTRONIC ARTICLE SURVEILLANCE TAG, MANUFACTURED PRIMARILY OF PLASTIC (U.S. CLS. 21, 23, 26, 36 AND 38).

CLASS 9—(Continued).

SN 76-242,401. ALPHA SECURITY PRODUCTS, INC., NORTH CANTON, OH. FILED 4-19-2001.



NO CLAIM IS MADE TO THE EXCLUSIVE RIGHT TO USE "BOX TAG DISPOSABLE CARTON SECURITY", APART FROM THE MARK AS SHOWN.

FOR SECURITY DEVICES ATTACHABLE TO PACKAGES FOR CONSUMER GOODS TO PREVENT THE OPENING OF THE PACKAGE, AND SECURITY DEVICES ATTACHABLE TO CONSUMER GOODS AND PACKAGING FOR CONSUMER GOODS FOR RETAINING AN ELECTRONIC ARTICLE SURVEILLANCE TAG, MANUFACTURED PRIMARILY OF PLASTIC (U.S. CLS. 21, 23, 26, 36 AND 38).

SN 76-242,735. ACE*COMM CORPORATION, GAITHERSBURG, MD. FILED 4-18-2001.

DCMS*POWER

OWNER OF U.S. REG. NOS. 1,793,482 AND 2,115,948. FOR COMPUTER HARDWARE, SOFTWARE AND INSTRUCTION MANUALS SOLD THERewith AS A UNIT FOR CAPTURING, COLLECTING, STORING AND PROCESSING CALL DETAIL RECORDS, CALL TRAFFIC DATA AND ACCOUNTING DATA (U.S. CLS. 21, 23, 26, 36 AND 38).

SN 76-243,802. CONNECT ONCE, INC., SANTA ROSA, CA. FILED 4-23-2001.

PROFESSIONALS CONNECT ONCE

NO CLAIM IS MADE TO THE EXCLUSIVE RIGHT TO USE "PROFESSIONALS CONNECT", APART FROM THE MARK AS SHOWN.

FOR VOICE ACTIVATED COMPUTER SOFTWARE FOR USE AS A MOBILE PERSONAL AREA NETWORK FOR PROFESSIONAL SERVICE INDUSTRIES, SUCH AS, REAL ESTATE, LAW, INSURANCE, ACCOUNTING AND MEDICINE (U.S. CLS. 21, 23, 26, 36 AND 38).

CLASS 9—(Continued).

SN 76-246,366. QUANTUM 3D, INC., SAN JOSE, CA. FILED 4-25-2001.

INDEPENDENCE

FOR PERSONAL COMPUTER BASED SYSTEM COMPRISED OF SPECIALIZED GRAPHICS COPROCESSORS THAT ENABLE THE RENDERING OF 3D GRAPHICS APPLICATIONS IN REAL-TIME FOR GOVERNMENT, COMMERCIAL AND MILITARY CONSUMPTION (U.S. CLS. 21, 23, 26, 36 AND 38).

SN 76-246,384. ARISTOCRAT TECHNOLOGIES AUSTRALIA PTY LTD, LANE COVE, NEW SOUTH WALES 2066, AUSTRALIA, FILED 4-25-2001.

MULTISUIT

PRIORITY CLAIMED UNDER SEC. 44(D) ON AUSTRALIA APPLICATION NO. 864699, FILED 2-1-2001, REG. NO. 864699, DATED 2-1-2001, EXPIRES 2-1-2011.
FOR MACHINES FOR PLAYING GAMES OF CHANCE (U.S. CLS. 21, 23, 26, 36 AND 38).

SN 76-246,778. TII NETWORK TECHNOLOGIES, INC., COPIAGUE, NY. BY CHANGE OF NAME TII INDUSTRIES, INC., COPIAGUE, NY. FILED 4-24-2001.

DIGITAL CLOSET

NO CLAIM IS MADE TO THE EXCLUSIVE RIGHT TO USE "DIGITAL", APART FROM THE MARK AS SHOWN.
FOR INTEGRATED PANELS COMPRISING SURGE PROTECTORS AND RESIDENTIAL GATEWAYS FOR NETWORK INTERFACE AND MANAGEMENT, FOR USE IN HOMES AND SMALL BUSINESSES (U.S. CLS. 21, 23, 26, 36 AND 38).

SN 76-246,917. LIVING FAITH MINISTRIES OF CAMDEN COUNTY, NEW JERSEY, INC., CHERRY HILL, NJ. FILED 4-26-2001.

FAITH SPEAKS MINISTRIES

NO CLAIM IS MADE TO THE EXCLUSIVE RIGHT TO USE "MINISTRIES", APART FROM THE MARK AS SHOWN.
FOR PRERECORDED AUDIO TAPES FEATURING RELIGIOUS PROGRAMS; PRERECORDED VIDEO TAPES FEATURING RELIGIOUS PROGRAMS (U.S. CLS. 21, 23, 26, 36 AND 38).
FIRST USE 2-0-2001; IN COMMERCE 2-0-2001.

CLASS 9—(Continued).

SN 76-247,248. ALPHA SECURITY PRODUCTS, INC., NORTH CANTON, OH. FILED 4-17-2001.

VISUAL TAGS
A Higher Level of Defense

NO CLAIM IS MADE TO THE EXCLUSIVE RIGHT TO USE "VISUAL TAGS", APART FROM THE MARK AS SHOWN.

FOR SECURITY DEVICES ATTACHABLE TO PACKAGES FOR CONSUMER GOODS TO PREVENT THE OPENING OF THE PACKAGE, AND SECURITY DEVICES ATTACHABLE TO CONSUMER GOODS AND PACKAGING FOR CONSUMER GOODS FOR RETAINING AN ELECTRONIC ARTICLE SURVEILLANCE TAG, MANUFACTURED PRIMARILY OF PLASTIC (U.S. CLS. 21, 23, 26, 36 AND 38).

SN 76-248,278. ALDI INC., BATAVIA, IL. FILED 4-30-2001.

PHASER

FOR BATTERIES (U.S. CLS. 21, 23, 26, 36 AND 38).

SN 76-249,477. PHILLIPS, EDWARD, CHESAPEAKE, VA. FILED 4-30-2001.

APPOINTED BY CHRIST

FOR MUSICAL SOUND RECORDINGS (U.S. CLS. 21, 23, 26, 36 AND 38).

SN 76-250,488. DEAN, KASSEEM, ALPHARETTA, GA. FILED 5-2-2001.

FULL SURFACE

FOR SERIES OF MUSICAL SOUND RECORDINGS AND MUSICAL AUDIOVISUAL RECORDINGS (U.S. CLS. 21, 23, 26, 36 AND 38).

CLASS 9—(Continued).

SN 76-250,562. COUNCIL OF SCIENTIFIC & INDUSTRIAL RESEARCH, NEW DELHI-110001, INDIA, FILED 5-3-2001.

HERB-O-PRINT

FOR COMPUTER SOFTWARE FOR CHROMATOGRAPHIC FINGERPRINTING, CHEMICAL AND THERAPEUTIC STANDARDIZATION, BAR-CODING OF CHROMATOGRAPHIC FINGERPRINTS, AND PREPARATION OF A DATABASE FOR PHARMACEUTICALS, CHEMICALS, COSMETICS, FOOD, BEVERAGES, AND OTHER MATERIALS; DATABASE MANAGEMENT SOFTWARE FOR GENERAL USE AND FOR USE IN THE FIELD OF CHEMICALS, PHARMACEUTICALS AND MEDICINES (U.S. CLS. 21, 23, 26, 36 AND 38).

SN 76-252,208. PYRAMID DIGITAL SOLUTIONS, LLC, BIRMINGHAM, AL. FILED 5-4-2001.

PLANHR

FOR COMPUTER SOFTWARE THAT MAY BE DOWNLOADED FROM A GLOBAL COMPUTER NETWORK, SUCH SOFTWARE TO ALLOW RETIREMENT PLAN SPONSORS TO ACCESS AND MANAGE, VIA THE GLOBAL COMPUTER NETWORK, RETIREMENT PLAN INFORMATION DIRECTORIES (U.S. CLS. 21, 23, 26, 36 AND 38).

FIRST USE 8-0-1999; IN COMMERCE 8-0-1999.

SN 76-254,713. EUROTALK LIMITED, FULHAM, LONDON, UNITED KINGDOM, FILED 5-9-2001.

WORLD TALK

OWNER OF ERPN CMNTY TM OFC REG. NO. 586453, DATED 3-26-1999, EXPIRES 3-26-2009.

FOR MULTIMEDIA SOFTWARE RECORDED ON CD-ROMS, AUDIO AND VIDEO TAPES, PRERECORDED OPTICAL DISCS AND MAGNETIC COMPUTER DISKS, ALL FEATURING LANGUAGE INSTRUCTION AND LANGUAGE TRAINING; DOWNLOADABLE ELECTRONIC PUBLICATIONS IN THE NATURE OF MULTIMEDIA SOFTWARE FEATURING LANGUAGE INSTRUCTION AND LANGUAGE TRAINING (U.S. CLS. 21, 23, 26, 36 AND 38).

FIRST USE 11-25-1998; IN COMMERCE 11-25-1998.

CLASS 9—(Continued).

SN 76-255,180. DR. SPOCK COMPANY, THE, MENLO PARK, CA. FILED 5-9-2001.



THE NAME "DR. SPOCK" DOES NOT IDENTIFY A LIVING INDIVIDUAL.

FOR PRERECORDED VIDEOTAPES, CD-ROMS, DVDS, MOTION PICTURE FILMS, AUDIO TAPES AND COMPACT DISCS ALL FEATURING GENERAL INFORMATION IN THE HEALTHCARE, CHILD CARE, NUTRITION, WELLNESS, PARENTING, PREGNANCY, AND BEHAVIOR FOR CONSUMERS, PROVIDERS, ADMINISTRATORS AND OTHER PARTICIPANTS IN THE HEALTH CARE INDUSTRY (U.S. CLS. 21, 23, 26, 36 AND 38).

SN 76-256,711. ADC TELECOMMUNICATIONS, INC., EDEN PRAIRIE, MN. FILED 5-14-2001.

SPECTRAFLOW

FOR TELECOMMUNICATIONS SOFTWARE, NAMELY, SOFTWARE USED FOR QUEUING DATA FLOW AND ESTABLISHING TIERED SERVICE LEVELS FOR USE IN CONNECTION WITH ELECTRONIC IP ACCESS SWITCHES THAT PROVIDE VOICE, VIDEO, AND DATA COMMUNICATIONS SERVICES THROUGH HYBRID FIBER COAXIAL CABLE NETWORKS (U.S. CLS. 21, 23, 26, 36 AND 38).

SN 76-256,822. ALADDIN SYSTEMS, INC., WATSONVILLE, CA. FILED 5-11-2001.

STUFFIT

FOR COMPUTER SOFTWARE AND MANUALS SOLD THEREWITH AS A UNIT FOR COMPRESSION AND EXPANSION OF DATA (U.S. CLS. 21, 23, 26, 36 AND 38). FIRST USE 9-14-1988; IN COMMERCE 9-14-1988.

SN 76-258,960. NEUE SENTIMENTAL FILM USA, VENICE, CA. FILED 5-17-2001.

IDENTITY ENGINEERING

NO CLAIM IS MADE TO THE EXCLUSIVE RIGHT TO USE "ENGINEERING", APART FROM THE MARK AS SHOWN.

FOR FILM AND MULTIMEDIA PRODUCTS, NAMELY, EXPOSED CAMERA FILM, PRERECORDED MAGNETIC DATA CARRIERS FEATURING COMPUTER ANIMATED FILMS AND DIGITAL RECORDINGS ON CD-ROMS FEATURING COMPUTER ANIMATED FILMS (U.S. CLS. 21, 23, 26, 36 AND 38).

CLASS 9—(Continued).

SN 76-260,048. JOHNSON CONTROLS TECHNOLOGY COMPANY, PLYMOUTH, MI. FILED 5-21-2001.



NO CLAIM IS MADE TO THE EXCLUSIVE RIGHT TO USE "PSI", APART FROM THE MARK AS SHOWN. THE LINE SHOWN IN THE DRAWING IS A FEATURE OF THE MARK AND IS NOT INTENDED TO INDICATE COLOR.

FOR TIRE PRESSURE MONITORING EQUIPMENT AND ALARMS, NAMELY, SENSORS, DISPLAYS, AND AUDIBLE ALARMS (U.S. CLS. 21, 23, 26, 36 AND 38). FIRST USE 1-1-1998; IN COMMERCE 1-1-1998.

SN 76-260,242. COMSPACE CORPORATION, COPPELL, TX. FILED 5-17-2001.

W-DC/MA

OWNER OF U.S. REG. NOS. 2,253,883 AND 2,253,884. FOR WIRELESS COMMUNICATION EQUIPMENT, NAMELY, RADIO TRANSMITTING, RELAYING AND RECEIVING EQUIPMENT FOR VOICE, VIDEO AND DATA COMMUNICATION; COMPUTER SOFTWARE EMBEDDED IN WIRELESS COMMUNICATION EQUIPMENT THAT TRANSMITS, RELAYS AND RECEIVES VOICE, VIDEO AND DATA COMMUNICATIONS (U.S. CLS. 21, 23, 26, 36 AND 38).

SN 76-260,777. ARISTOCRAT TECHNOLOGIES AUSTRALIA PTY LTD, NEW SOUTH WALES, AUSTRALIA, FILED 5-21-2001.

GRAND SEVENS

NO CLAIM IS MADE TO THE EXCLUSIVE RIGHT TO USE "SEVENS", APART FROM THE MARK AS SHOWN. FOR MACHINES FOR PLAYING GAMES OF CHANCE (U.S. CLS. 21, 23, 26, 36 AND 38).

SN 76-261,698. ABEL/NOSER CORPORATION, NEW YORK, NY. FILED 5-22-2001.

TRADE-ZOOM

FOR COMPUTER SOFTWARE PROGRAM THAT ORGANIZES, ANALYZES, AND PRESENTS INFORMATION TO PROMOTE FINANCIAL SECURITIES TRADING EFFICIENCY (U.S. CLS. 21, 23, 26, 36 AND 38).

CLASS 9—(Continued).

SN 76-261,823. BANK OF AMERICA, AKA COLLATERAL AGENT, CHICAGO, IL. BY ASSIGNMENT LIGHTNING AUDIO CORPORATION, GILBERT, AZ. FILED 5-23-2001.

LIGHTNING AUDIO

OWNER OF U.S. REG. NO. 1,945,498.

NO CLAIM IS MADE TO THE EXCLUSIVE RIGHT TO USE "AUDIO", APART FROM THE MARK AS SHOWN.

FOR ELECTRONIC PRODUCTS, NAMELY ELECTROLYTIC CAPACITORS, FLANGES USED TO ELIMINATE SOUND DISTORTION, SPEAKERS, AMPLIFIERS, AND CABLES USED FOR AUDIO PRODUCTS DESIGNED FOR USE IN AUTOMOBILES (U.S. CLS. 21, 23, 26, 36 AND 38).

FIRST USE 5-17-1993; IN COMMERCE 5-17-1993.

SN 76-263,943. CREATIVE CONSORTIUM, INC., THE, CHICAGO, IL. FILED 5-29-2001.

EENIE MEENIE MINIE MO

FOR GAMING EQUIPMENT, NAMELY, GAMING, GAMBLING OR SLOT MACHINES, WITH OR WITHOUT VIDEO OUTPUT; MULTIMEDIA PROGRAMS AND SOFTWARE RECORDED ON CD-ROM FOR USE IN MULTIMEDIA VIDEO GAME PLAYERS AND COMPUTERS, COMPUTER GAME PROGRAMS AND SOFTWARE FOR USE IN MULTIMEDIA VIDEO GAME PLAYERS AND COMPUTERS AND FOR INDIVIDUAL OR NETWORK USERS, AND INTERACTIVE MULTIMEDIA COMPUTER GAME PROGRAMS AND SOFTWARE FOR USE IN MULTIMEDIA VIDEO GAME PLAYERS AND COMPUTERS (U.S. CLS. 21, 23, 26, 36 AND 38).

SN 76-264,483. BROOK, KARA L., ELLICOTT CITY, MD. FILED 5-30-2001.

TACKLEBOX

FOR COMPUTER SOFTWARE FOR INFORMATION RETRIEVAL AND NETWORK ACCESS, NAMELY, ACCESSING, SEARCHING, INDEXING, ARCHIVING AND RETRIEVING DATA FROM NETWORKED COMPUTERS, DATA MANAGEMENT, AND DISTRIBUTION, AND COLLABORATION, AND USER MANUALS FOR USE THEREWITH SOLD TOGETHER AS A UNIT; AND INTERACTIVE CUSTOMIZED TRAINING MODULE (U.S. CLS. 21, 23, 26, 36 AND 38).

FIRST USE 1-1-2000; IN COMMERCE 1-1-2000.

CLASS 9—(Continued).

SN 76-266,558. CORECHANGE, INC., BOSTON, MA. FILED 6-4-2001.

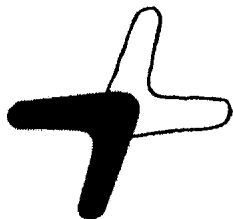

FOR COMPUTER PROGRAMS FOR USE IN ESTABLISHING A PORTAL ON A GLOBAL INFORMATION COMPUTER NETWORK ACCESSED FROM WIRELESS DEVICES, NAMELY CELLULAR TELEPHONES, PAGERS AND PERSONAL DIGITAL ASSISTANTS; COMPUTER PROGRAMS FOR USE IN ESTABLISHING, PERSONALIZING, ORGANIZING, MONITORING AND ACCESSING A PERSONALIZED COMPUTER ENVIRONMENT; AND COMPUTER PROGRAMS FOR USE IN ACCESSING LOCAL, NATIONAL AND GLOBAL COMPUTER INFORMATION NETWORKS; COMPUTER PROGRAMS FOR ENTERPRISE DOCUMENT MANAGEMENT, KNOWLEDGE MANAGEMENT, BUSINESS RESOURCE MANAGEMENT, SYSTEM MANAGEMENT FOR BUSINESS PROCESSES; COMPUTER PROGRAMS FOR USE IN CONDUCTING INTERACTIVE TRANSACTIONS OVER LOCAL, NATIONAL AND GLOBAL COMPUTER INFORMATION NETWORKS (U.S. CLS. 21, 23, 26, 36 AND 38).

SN 76-269,329. BEONIC CORPORATION PTY. LTD., ADELAIDE, AUSTRALIA, FILED 6-8-2001.

BEONIC

PRIORITY CLAIMED UNDER SEC. 44(D) ON AUSTRALIA APPLICATION NO. 859883, FILED 12-11-2000, REG. NO. 859883, DATED 12-11-2000, EXPIRES 12-11-2010.

FOR COMPUTER HARDWARE; COMPUTER PERIPHERALS; COMPUTER SOFTWARE FOR THE SURVEILLANCE, MONITORING OR TRACKING OF PEDESTRIAN AND VEHICULAR MOVEMENTS; COMPUTER SOFTWARE FOR THE RECORDING, ANALYSIS, PLAYBACK, TRANSMISSION OR REPRODUCTION OF INFORMATION GAINED IN THE SURVEILLANCE, MONITORING OR TRACKING OF PEDESTRIAN AND VEHICULAR MOVEMENTS; ELECTRONIC AND COMPUTER PRODUCTS AND APPARATUS, NAMELY, MOTION SENSORS, VIDEO SENSORS, VIDEO EQUIPMENT, DATA NETWORKING EQUIPMENT, WIRELESS NETWORKING EQUIPMENT, DISPLAYS, INTERFACES, CIRCUIT BOARDS, RECORDERS, REMOTE CONTROL UNITS, ANALOGUE VIDEO CAMERAS, DIGITAL VIDEO CAMERAS, VISION SENSORS, INFRA-RED SENSORS, REMOTE CONTROL EQUIPMENT, DIGITAL SIGNAL PROCESSORS, ALL OF THE ABOVE FOR THE SURVEILLANCE, MONITORING OR TRACKING OF PEDESTRIAN AND VEHICULAR MOVEMENTS (U.S. CLS. 21, 23, 26, 36 AND 38).

CLASS 9—(Continued).

SN 76-269,837. BLUE-WHITE INDUSTRIES, WESTMINSTER, CA. FILED 6-11-2001.

FLO-KING

FOR METERING PUMPS AND FLOW METERS FOR COMMERCIAL POOLS AND SPAS AND WATER TREATMENT FACILITIES (U.S. CLS. 21, 23, 26, 36 AND 38).

FIRST USE 0-0-1957; IN COMMERCE 0-0-1957.

SN 76-271,226. CTS CORPORATION, ELKHART, IN. FILED 6-13-2001.

ANYDRIVE

FOR ELECTRONIC COMPONENTS, NAMELY VOLTAGE CONTROLLED CRYSTAL OSCILLATORS FOR USE IN HIGH FREQUENCY TELECOM APPLICATIONS (U.S. CLS. 21, 23, 26, 36 AND 38).

SN 76-271,924. CAPITAL ANALYTICS, L.P., DALLAS, TX. FILED 6-15-2001.

CINVAACS

FOR COMPUTER ENTERPRISE SOFTWARE FOR INVESTMENT MANAGEMENT AND ACCOUNTING IN THE FIELD OF INVESTMENT PERFORMANCE ANALYSIS, DEAL AND INVESTMENT TRACKING, INVESTMENT DIVERSIFICATION ANALYSIS, ACCOUNTING TRANSACTION MANAGEMENT (U.S. CLS. 21, 23, 26, 36 AND 38).

FIRST USE 6-0-1996; IN COMMERCE 6-0-1996.

SN 76-273,505. UNICO, INC., FRANKSVILLE, WI. FILED 6-19-2001.

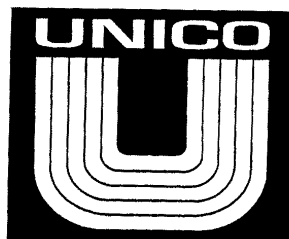

OWNER OF U.S. REG. NO. 1,018,399.
FOR AC AND DC MOTOR DRIVES AND DRIVE CONTROLS FOR INDUSTRIAL APPLICATION (U.S. CLS. 21, 23, 26, 36 AND 38).

FIRST USE 12-1-1990; IN COMMERCE 12-1-1990.

CLASS 9—(Continued).

SN 76-274,477. HOLMES, VIRGINIA JOAN, WAHIAWA, HI. AND HOLMES, KENNETH CORBETT, WAHIAWA, HI. FILED 6-19-2001.

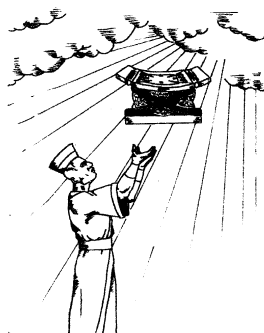

THE LINING AND STIPPLING ARE FEATURES OF THE MARK AND DO NOT INDICATE COLOR.

THE MARK CONSISTS OF AN AFRICAN KING WITH HIS ARMS OUTSTRETCHED, RECEIVING THE "GOLDEN STOOL FROM HEAVEN". CLOUDS AND RAYS OF LIGHT SHONE AROUND.

FOR PROTECTIVE PADS FOR USE ON THE FINGERS OF HAIR STYLISTS TO PREVENT THEIR FINGERS FROM BURNING WHEN BRAIDING HAIR WHEREIN HAIR IS BURNED OR MELTED DURING THE BRAIDING PROCESS (U.S. CLS. 21, 23, 26, 36 AND 38).

SN 76-275,327. VANTAGE TECHNOLOGIES, INC., BOSTON, MA. FILED 6-22-2001.

ALLIANCESMITH

FOR COMPUTER PROGRAMS FOR USE IN MANAGING BUSINESS RELATIONSHIPS, NAMELY, STRATEGIC RELATIONSHIP MANAGEMENT COMPUTER PROGRAMS FOR ONLINE ANALYTICAL PROCESSING, TAKING SURVEYS, PROVIDING REPORTS, DATA INTEGRATION, DATA MANAGEMENT, CONTENT DELIVERY, PROVIDING TRAINING AND COACHING FOR BUSINESS PARTNERS AND CUSTOMERS AND TO ALLOW COLLABORATIVE WORK AMONG PARTNERS, SUPPLIERS, AND CUSTOMERS (U.S. CLS. 21, 23, 26, 36 AND 38).

SN 76-275,812. VANTAGE TECHNOLOGIES, INC., BOSTON, MA. FILED 6-22-2001.

PARTNERSMITH

FOR COMPUTER PROGRAMS FOR USE IN MANAGING BUSINESS RELATIONSHIPS, NAMELY, STRATEGIC RELATIONSHIP MANAGEMENT COMPUTER PROGRAMS FOR ONLINE ANALYTICAL PROCESSING, TAKING SURVEYS, PROVIDING REPORTS, DATA INTEGRATION, DATA MANAGEMENT, CONTENT DELIVERY, PROVIDING TRAINING AND COACHING FOR BUSINESS PARTNERS AND CUSTOMERS AND TO ALLOW COLLABORATIVE WORK AMONG PARTNERS, SUPPLIERS, AND CUSTOMERS (U.S. CLS. 21, 23, 26, 36 AND 38).

CLASS 9—(Continued).

SN 76-276,223. ABEL/NOSER CORPORATION, NEW YORK, NY. FILED 6-25-2001.

STOCK-LENZ

FOR COMPUTER SOFTWARE PROGRAM THAT ORGANIZES, ANALYZES, AND PRESENTS INFORMATION TO PROMOTE FINANCIAL SECURITIES TRADING EFFICIENCY (U.S. CLS. 21, 23, 26, 36 AND 38).

SN 76-278,214. EMULEX CORPORATION, COSTA MESA, CA. FILED 6-29-2001.

LP850

FOR HOST BUS ADAPTERS (U.S. CLS. 21, 23, 26, 36 AND 38).

FIRST USE 11-10-1998; IN COMMERCE 11-10-1998.

SN 76-279,272. RETAIL SOURCE DISTRIBUTING, LLC, ESCONDIDO, CA. FILED 7-2-2001.

MODIFIERS

FOR SOFTWARE, NAMELY, VIDEO GAME SOFTWARE; PRE-RECORDED CD-ROMS, CARTRIDGES, DVD'S AND DISCS, ALL FEATURING VIDEO GAMES; VIDEOTAPES, DVD'S AND CD-ROMS FEATURING CARTOONS (U.S. CLS. 21, 23, 26, 36 AND 38).

SN 76-279,382. PFIZER INC., NEW YORK, NY. FILED 6-27-2001.

INFORMED

FOR COMPUTER SOFTWARE ON THE TOPICS OF HEALTHCARE AND DISEASE MANAGEMENT AND DOWNLOADABLE PUBLICATIONS IN THE NATURE OF BOOKLETS AND BROCHURES ON THE TOPICS OF HEALTHCARE AND DISEASE MANAGEMENT (U.S. CLS. 21, 23, 26, 36 AND 38).

SN 76-280,374. AMETEK, INC., PAOLI, PA. FILED 7-5-2001.

NGI

FOR INSTRUMENTATION DISPLAY GAUGES, NAMELY, SPEEDOMETERS, TACHOMETERS, PRESSURE GAUGES, TEMPERATURE GAUGES, AMMETERS, VOLT METERS, PYROMETERS, FUEL LEVEL GAUGES, AND VACUUM GAUGES, ALL FOR PROVIDING VISUAL FEEDBACK TO AN ON- OR OFF-ROAD VEHICLE OPERATOR ABOUT THE PHYSICAL STATE OF THE VEHICLE BEING OPERATED AND ITS SYSTEMS (U.S. CLS. 21, 23, 26, 36 AND 38).

FIRST USE 2-1-2000; IN COMMERCE 2-1-2000.

CLASS 9—(Continued).

SN 76-280,728. CRANE CO., STAMFORD, CT. FILED 7-5-2001.

SLIM-CHEK

FOR AUTOMATICALLY OPERATED VALVES, NAMELY, CHECK VALVES (U.S. CLS. 21, 23, 26, 36 AND 38).

SN 76-282,256. EMULEX CORPORATION, COSTA MESA, CA. FILED 6-29-2001.

LP9000

FOR HOST BUS ADAPTERS (U.S. CLS. 21, 23, 26, 36 AND 38).
FIRST USE 10-5-1999; IN COMMERCE 10-5-1999.

SN 76-282,695. JOURNEE SOFTWARE, INC., AUSTIN, TX. FILED 7-9-2001.

SERVICESTREAM

FOR COMPUTER SOFTWARE USED BY SYSTEMS PROGRAMMERS AND SYSTEMS ARCHITECTS FOR DATA INTEGRATION; NAMELY, THE INTEGRATION OF BUSINESS OPERATIONAL DATA, SUCH AS CUSTOMER, FINANCIAL, OR INVENTORY DATA THAT IS STORED IN PHYSICALLY AND LOGICALLY SEPARATE DATABASES, SUCH AS COMMERCIAL APPLICATIONS OR INTERNALLY DEVELOPED SYSTEMS (U.S. CLS. 21, 23, 26, 36 AND 38).

SN 76-283,019. ANCHOR GAMING, LAS VEGAS, NV. FILED 7-11-2001.

BUCK\$ AHOY

FOR GAMING MACHINES WITH OR WITHOUT VIDEO OUTPUT AND VIDEO GAMES SOLD AS A COMPONENT PART THEREFOR (U.S. CLS. 21, 23, 26, 36 AND 38).

CLASS 9—(Continued).

SN 76-283,235. UNITEK MIYACHI INTERNATIONAL, LTD., MONROVIA, CA. FILED 7-11-2001.

AXIA SYSTEMS

NO CLAIM IS MADE TO THE EXCLUSIVE RIGHT TO USE "SYSTEMS", APART FROM THE MARK AS SHOWN. FOR LASERS FOR PRECISION WELDING OF COMPONENTS, NAMELY FIBER OPTIC JOINTS AND CONNECTIONS; OPTICS FOR LASER WELDERS; LASER WELDER PARTS, NAMELY MOTORS AND MECHANICAL LINKAGES FOR PRECISION CONTROL OF THE MOVEMENT AND POSITIONING OF FIBER OPTIC FIBERS TO BE WELDED, AND WELDING ENCLOSURES; CONTROL SOFTWARE FOR TESTING OF FIBER OPTIC JOINTS AND CONNECTORS (U.S. CLS. 21, 23, 26, 36 AND 38).

SN 76-283,464. TIFCO INDUSTRIES, INC., CYPRESS, TX. FILED 7-2-2001.

TIFFLO

FOR FLOW METER SYSTEM COMPRISED OF FLOW METERS, HYDRAULIC HOSES, SPECIAL INLET AND OUTLET ADAPTERS AND FLOW METER FITTINGS FOR MEASURING THE RATE OF FLOW OF FLUIDS IN HYDRAULIC LINES (U.S. CLS. 21, 23, 26, 36 AND 38).
FIRST USE 6-30-2000; IN COMMERCE 6-30-2000.

SN 76-284,348. DRAGO, ROBERTO, DBA DEECCO PRODUCTS CO., MODESTO, CA. FILED 7-13-2001.



THE MARK CONSISTS OF THE WORD "DEECCO" IN STYLIZED FORM WITH A STRIKE OF LIGHTNING BETWEEN THE LAST "E" AND THE FIRST "C" AND A STAR AT THE END.

FOR ELECTRICAL CONTROLLERS FOR COMPRESSED AIR SYSTEMS AND AIR COMPRESSORS (U.S. CLS. 21, 23, 26, 36 AND 38).

CLASS 9—(Continued).

SN 76-286,097. A5TEK CORP., SUNNYVALE, CA. FILED 7-17-2001.



NO CLAIM IS MADE TO THE EXCLUSIVE RIGHT TO USE "HOME INFOTAINMENT PLATFORM", APART FROM THE MARK AS SHOWN.

FOR COMPUTER HARDWARE, NAMELY PERSONAL COMPUTERS, HARD DISK DRIVES, DVD PLAYERS, VCD PLAYERS, MP3 PLAYERS, KARAOKE CD PLAYERS, CD PLAYERS, FAX MACHINES, TELEPHONE ANSWERING MACHINES, INTERNET VIDEO PHONES, TELEVISIONS, DIGITAL TELEVISIONS, VIDEO CAMERAS, DIGITAL VIDEO CAMERAS, VIDEO CASSETTES RECORDERS, AC-3 DECODERS, SMART IC CARDS, MODEMS, SATELLITE MODEMS, 3D GRAPHIC ACCELERATORS, COMPUTER WIRELESS KEYBOARDS, COMPUTER MOUSE, COMPUTER PRINTERS, SCANNERS AND AUDIO SPEAKERS (U.S. CLS. 21, 23, 26, 36 AND 38).

FIRST USE 6-28-2001; IN COMMERCE 6-28-2001.

SN 76-286,260. AMERITEC CORPORATION, COVINA, CA. FILED 7-16-2001.

CYCLONE

FOR COMPUTER SOFTWARE FOR TESTING TELEPHONY SYSTEMS (U.S. CLS. 21, 23, 26, 36 AND 38).

SN 76-290,985. RAINBOW TECHNOLOGIES, INC., IRVINE, CA. FILED 7-26-2001.

NETSWIFT

FOR ELECTRONIC PRODUCTS, NAMELY, AN ACCELERATION APPLIANCE COMPRISING INTEGRATED CIRCUITS, ENCODED CIRCUIT CARDS, COMPUTER HARDWARE AND COMPUTER SOFTWARE FOR USE IN STORING AND TRANSMITTING DATA, ALL USED FOR NETWORK SECURITY CRYPTOGRAPHY OF INFORMATION ON THE INTERNET, AND INSTRUCTION MANUALS SOLD TOGETHER AS A UNIT (U.S. CLS. 21, 23, 26, 36 AND 38).

FIRST USE 9-30-1997; IN COMMERCE 9-30-1997.

CLASS 9—(Continued).

SN 76-291,535. ACD SYSTEMS LTD., SAANICHTON, BRITISH COLUMBIA, CANADA, FILED 7-27-2001.

ACDZIP

PRIORITY CLAIMED UNDER SEC. 44(D) ON CANADA APPLICATION NO. 1092352, FILED 2-9-2001.

FOR COMPUTER UTILITY SOFTWARE FOR COMPRESSING, DECOMPRESSING AND EXTRACTING DIGITAL FILES, AND FOR CREATING, MANAGING, VIEWING, STORING, RETRIEVING, TRANSMITTING, RECEIVING, AND SHARING COMPRESSED DIGITAL FILES AND FOLDERS (U.S. CLS. 21, 23, 26, 36 AND 38). FIRST USE 11-15-2001; IN COMMERCE 11-15-2001.

SN 76-294,534. CONTEC CORPORATION, SCHENECTADY, NY. FILED 8-2-2001.

POINT AND PRESS

FOR REMOTE CONTROL UNITS, NAMELY, FOR CABLE SET-TOP TERMINALS AND BOXES, SATELLITE RECEIVERS AND BOXES, TELEVISIONS, STEREOS, VIDEO CASSETTE RECORDERS, DIGITAL VIDEO DISC PLAYERS (U.S. CLS. 21, 23, 26, 36 AND 38).

FIRST USE 11-0-1996; IN COMMERCE 11-0-1996.

SN 76-294,564. CREATIVE TECHNOLOGIES, LLC, SAUSALITO, CA. FILED 8-6-2001.

PIXTALLY

FOR LED TALLY SYSTEM COMPRISED OF A SMALL PROPRIETARY LED EMITTER WHICH IS ATTACHED TO EACH OF MULTIPLE VIDEO CAMERAS USED WITH A PORTABLE VIDEO-EDITING MACHINE TO INDICATE WHEN A SPECIFIC VIDEO CAMERA IN THE MULTIPLE-CAMERA SYSTEM IS IN A "LIVE" OR ACTIVE MODE (U.S. CLS. 21, 23, 26, 36 AND 38).

FIRST USE 4-23-2001; IN COMMERCE 4-23-2001.

SN 76-295,684. DANKER LABORATORIES, INC., SARASOTA, FL. FILED 8-7-2001.

VISIONALL

FOR CONTACT LENSES (U.S. CLS. 21, 23, 26, 36 AND 38).

FIRST USE 3-1-1993; IN COMMERCE 3-1-1993.

CLASS 9—(Continued).

SN 76-295,930. SARA LEE DE/N.V., 3532 AD UTRECHT, NETHERLANDS, FILED 8-7-2001.



NO CLAIM IS MADE TO THE EXCLUSIVE RIGHT TO USE "ANNO" AND "1753", APART FROM THE MARK AS SHOWN.

THE MARK CONSISTS OF A DESIGN OF A LADY'S HEAD AND A COFFEE CUP IN BLACK LOCATED INSIDE A BADGE WITH SHADES OF BROWN. THE LETTERS D AND E ARE LOCATED INSIDE AN EMBLEM OF RED.

THE ENGLISH TRANSLATION OF "ANNO" IS "YEAR".

FOR AUTOMATONS FOR THE PREPARATION AND DISTRIBUTION OF HOT AND COLD BEVERAGES; COFFEE AND TEA VENDING MACHINES (U.S. CLS. 21, 23, 26, 36 AND 38).

SN 76-296,978. LIGHTNING AUDIO CORPORATION, GILBERT, AZ. FILED 8-2-2001.

LIGHTNING AUDIO

OWNER OF U.S. REG. NO. 1,945,498.

NO CLAIM IS MADE TO THE EXCLUSIVE RIGHT TO USE "AUDIO", APART FROM THE MARK AS SHOWN.

FOR ELECTRONIC PRODUCTS, NAMELY ELECTROLYTIC CAPACITORS, FLANGES USED TO ELIMINATE SOUND DISTORTION, SPEAKERS, AMPLIFIERS, AND CABLES USED FOR AUDIO PRODUCTS DESIGNED FOR USE IN AUTOMOBILES (U.S. CLS. 21, 23, 26, 36 AND 38).

FIRST USE 12-0-1993; IN COMMERCE 12-0-1993.

SN 76-297,790. CARTER DUNCAN CORPORATION, SANTA BARBARA, CA. FILED 8-13-2001.

SEYMOUR DUNCAN

OWNER OF U.S. REG. NOS. 1,822,647 AND 1,876,375.

THE NAME "SEYMOUR DUNCAN" IDENTIFIES A LIVING INDIVIDUAL WHOSE CONSENT IS OF RECORD.

FOR ELECTRONIC SOUND PICKUPS FOR MUSICAL INSTRUMENTS, NAMELY, GUITAR PICKUPS, BASS PICKUPS, ELECTROMAGNETIC PICKUPS, AND ELECTRICAL PICKUPS FOR MULTI-STRING MUSICAL INSTRUMENTS (U.S. CLS. 21, 23, 26, 36 AND 38).

FIRST USE 1-10-1978; IN COMMERCE 1-10-1978.

CLASS 9—(Continued).

SN 76-299,122. AMBASSADORS FOR CHRIST INTERNATIONAL - USA, INC., MARIETTA, GA. FILED 8-15-2001.

LIFEWORKS

FOR PRE-RECORDED VIDEOTAPES, AUDIOTAPES, COMPACT DISCS, AND OTHER ELECTRONIC MEDIA, NAMELY, PRE-RECORDED AUDIO CASSETTES, ALL FEATURING CHRISTIANITY AND EVANGELISM FOR USE IN THE CONVERSION OF PEOPLE TO CHRISTIANITY TO BE MARKETED ONLY IN DIRECT CHANNELS OF TRADE TARGETED AT CHURCHES (U.S. CLS. 21, 23, 26, 36 AND 38).

SN 76-302,006. ARAGAO, RUI CARLOS PEREIRA TEIXEIRA DE, 2720 -485 AMADORA, PORTUGAL, FILED 8-20-2001.

Ediglobal

OWNER OF PORTUGAL REG. NO. 345585, DATED 8-2-2000, EXPIRES 8-2-2010.

FOR PRE-RECORDED COMPUTER TAPES FEATURING MUSIC, VOICE, AND PHOTOGRAPHIC IMAGES; PRE-RECORDED DIGITAL AND ELECTRONIC CARRIERS, NAMELY, PRE-RECORDED COMPACT DISCS FEATURING MUSIC, VOICE, MOTION PICTURES, PHOTOGRAPHIC IMAGES, TEXT AND GRAPHICS DATA; PRE-RECORDED DVDS (DIGITAL VERSATILE DISCS) FEATURING MUSIC, VOICE, MOTION PICTURES, PHOTOGRAPHIC IMAGES, TEXT AND GRAPHICS DATA (U.S. CLS. 21, 23, 26, 36 AND 38).

SN 76-303,944. QUANTUM CORPORATION, MILPITAS, CA. FILED 8-24-2001.

RADICAL SIMPLICITY

FOR RECORDING AND MEMORY DEVICES, NAMELY, AUTOLOADERS (U.S. CLS. 21, 23, 26, 36 AND 38).

SN 76-305,499. AQUATHERM INDUSTRIES, INC., LAKEWOOD, NJ. FILED 8-27-2001.

aquatherm
INDUSTRIES, INC.

NO CLAIM IS MADE TO THE EXCLUSIVE RIGHT TO USE "INDUSTRIES, INC.", APART FROM THE MARK AS SHOWN.

FOR SOLAR COLLECTORS FOR USE WITH SWIMMING POOLS (U.S. CLS. 21, 23, 26, 36 AND 38).

CLASS 9—(Continued).

SN 76-306,184. INNOVATION TECHNOLOGIES WORLD-WIDE, INC., CROSS PLAINS, WI. BY CHANGE OF NAME INNOVATION/COMTELCO NORTH AMERICA, CROSS PLAINS, WI. FILED 8-29-2001.

InnLite

FOR SOFTWARE AND HARDWARE FOR USE AT LODGING ESTABLISHMENTS TO PERFORM VOICE MESSAGING FOR GUESTS AND STAFF (U.S. CLS. 21, 23, 26, 36 AND 38).

FIRST USE 4-1-2001; IN COMMERCE 4-1-2001.

SN 76-306,187. INNOVATION TECHNOLOGIES WORLD-WIDE, INC., CROSS PLAINS, WI. BY ASSIGNMENT INNOVATION/COMTELCO NORTH AMERICA, CROSS PLAINS, WI. FILED 8-29-2001.

InnCommand

FOR SOFTWARE AND HARDWARE FOR USE AT LODGING ESTABLISHMENTS TO PERFORM THE ROUTING OF FAXES AND TRANSMITTED DOCUMENTS FOR STAFF AND GUESTS (U.S. CLS. 21, 23, 26, 36 AND 38).

FIRST USE 1-1-2000; IN COMMERCE 1-1-2000.

SN 76-306,327. BOZUNG, ALLEN THOMAS, VANCOUVER, WA. FILED 8-28-2001.

REFRADENT

FOR USER-MODIFIABLE MULTIMEDIA DATABASE SOFTWARE FOR USE IN INFORMATION MANAGEMENT, TEACHING, PATHOLOGY AND INSTRUCTION IN THE FIELD OF DENTISTRY (U.S. CLS. 21, 23, 26, 36 AND 38).

FIRST USE 6-11-2001; IN COMMERCE 6-11-2001.

SN 76-307,267. VOICESTREAM WIRELESS CORPORATION, BELLEVUE, WA. FILED 8-29-2001.

INSTANT IMAGINATION

FOR WIRELESS TELECOMMUNICATIONS AND INFORMATION TECHNOLOGY EQUIPMENT, NAMELY, WIRELESS TELEPHONES, WIRELESS HANDHELD DEVICES, NAMELY, HANHELD COMPUTERS, WIRELESS MODEMS, WIRELESS PERSONAL COMPUTERS THAT PROVIDE MULTIPLE-USER INTERNET ACCESS AND RELATED PERIPHERALS FOR AFORESAID GOODS (U.S. CLS. 21, 23, 26, 36 AND 38).

CLASS 9—(Continued).

SN 76-307,281. SPRINGFIELD PRECISION INSTRUMENTS, INC., WOOD-RIDGE, NJ. FILED 8-31-2001.

DIGI-MASTER

FOR FOOD TIMERS FOR KITCHEN USE (U.S. CLS. 21, 23, 26, 36 AND 38).

FIRST USE 1-2-1999; IN COMMERCE 1-2-1999.

SN 76-307,371. STMICROELECTRONICS, INC., CARROLLTON, TX. FILED 8-30-2001.

STDBG

FOR COMPUTER SOFTWARE FOR USE AS A DEBUGGING TOOL AND MANUALS SOLD TOGETHER AS A UNIT (U.S. CLS. 21, 23, 26, 36 AND 38).

SN 76-307,676. COLORVISION ADMINISTRATIVE AG, CH-6005, LUCERNE, SWITZERLAND, FILED 8-31-2001.

**CALIBRATE. THEN
CELEBRATE**

NO CLAIM IS MADE TO THE EXCLUSIVE RIGHT TO USE "CALIBRATE", APART FROM THE MARK AS SHOWN.

FOR COLOR CALIBRATION DEVICES, NAMELY OPTICAL SENSORS FOR CALIBRATING THE COLORS DISPLAYED ON MONITORS, AND COLOR CALIBRATION SOFTWARE FOR CALIBRATION OF COLORS DISPLAYED ON MONITORS (U.S. CLS. 21, 23, 26, 36 AND 38).

SN 76-308,270. PLEASANT COMPANY, MIDDLETON, WI. FILED 8-30-2001.

AMERICAN GIRL

OWNER OF U.S. REG. NOS. 1,722,946, 2,306,589 AND OTHERS.

FOR AUDIO TAPE RECORDERS, COMPACT DISCS FEATURING MUSIC, COMPACT DISC STORAGE RACKS, COMPACT DISK PLAYERS, DIGITAL CAMERAS, DISPOSABLE CAMERAS, ELECTRONIC PERSONAL ORGANIZERS, HOLDERS FOR COMPACT DISCS, MICROPHONES, MOUSE PADS, PRE-RECORDED VIDEO TAPES FEATURING STORIES AND ACTIVITIES FOR CHILDREN, RADIOS AND TELEPHONES (U.S. CLS. 21, 23, 26, 36 AND 38).

FIRST USE 10-18-1999; IN COMMERCE 10-18-1999.

CLASS 9—(Continued).

SN 76-308,933. CAYMAN SYSTEMS, INC., BILLERICA, MA.
FILED 9-5-2001.

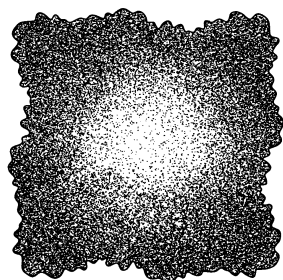

CAYMAN

OWNER OF U.S. REG. NOS. 1,549,946, 1,585,367 AND 2,205,034.

THE STIPPLING IS FOR SHADING PURPOSES.

FOR COMPUTER HARDWARE AND SOFTWARE FOR CONTROLLING AN INTERFACE BETWEEN A SINGLE WIDE AREA NETWORK AND MULTIPLE TYPES OF LOCAL AREA NETWORKS (U.S. CLS. 21, 23, 26, 36 AND 38).

FIRST USE 4-0-2000; IN COMMERCE 4-0-2000.

SN 76-309,252. RED E SOFT, L.L.C., TRAVERSE CITY, MI.
FILED 9-5-2001.

DOTSOLID

FOR COMPUTER SOFTWARE FOR SCHEDULING AND CALENDARING OF ORGANIZATIONAL RESOURCES, NAMELY, PERSONNEL, PHYSICAL SPACES AND EQUIPMENT (U.S. CLS. 21, 23, 26, 36 AND 38).

CLASS 9—(Continued).

SN 76-309,474. INVENTEC BESTA CO., LTD., TAIPEI, TAIWAN, FILED 9-7-2001.



THE ENGLISH TRANSLITERATION AND TRANSLATION OF THE INDIVIDUAL CHINESE CHARACTERS APPEARING IN THE MARK ARE AS FOLLOWS: "CHIUAN", COMPLETE; WHOLE; TOTAL; ENTIRELY; KEEP INTACT "SHIN", NEW; FRESH; NEWLY; RECENTLY "JEN", TRUE; GENUINE; REALLY; CLEARLY "REN", MAN; PERSON; PEOPLE "FA", SEND OUT; ISSUE; DELIVER; DISTRIBUTE "YIN", SOUND; TONE. WHEN PUT TOGETHER, THE CHINESE CHARACTERS WOULD MEAN "BRAND NEW VIRTUAL VOICE".

FOR CALCULATORS, COMPUTERS, PORTABLE COMPUTERS, ELECTRONIC DICTIONARIES, COMPUTER DATA PROCESSING MACHINES, PALM TOP COMPUTERS, ELECTRONIC TRANSLATORS, CD-ROM DRIVES AND BLANK COMPACT DISKS, FLOPPY DISKS FOR COMPUTERS (U.S. CLS. 21, 23, 26, 36 AND 38).

FIRST USE 7-1-2001; IN COMMERCE 7-1-2001.

SN 76-309,540. INTRINSYC SOFTWARE, INC., VANCOUVER, BRITISH COLUMBIA, CANADA, FILED 9-6-2001.

J-INTEGRA

FOR COMPUTER SOFTWARE USED TO ENABLE INTERACTION AND ACCESS COMPONENTS BETWEEN TWO OR MORE OTHERWISE INCOMPATIBLE SOFTWARE PROGRAMS AND ACT AS A COMPUTER SOFTWARE-BRIDGING TOOL (U.S. CLS. 21, 23, 26, 36 AND 38).

FIRST USE 6-16-1999; IN COMMERCE 11-11-1998.

SN 76-310,075. SIEMENS AKTIENGESELLSCHAFT, MUNCHEN, FED REP GERMANY, FILED 9-7-2001.

LIGNOTRON

PRIORITY CLAIMED UNDER SEC. 44(D) ON FED REP GERMANY APPLICATION NO. 30123088.909, FILED 4-9-2001, REG. NO. 30123088, DATED 5-10-2001, EXPIRES 4-30-2011.

FOR COMPUTER HARDWARE, COMPUTER SOFTWARE FOR LUMBER PROCESSING AND ADMINISTRATIVE FUNCTIONS FOR THE LUMBER INDUSTRY, NAMELY, SOFTWARE FOR USE IN ANALYZING LOG PURCHASE REQUIREMENTS, SOFTWARE FOR RECORDING, MONITORING AND PROCESSING DATA RELATED TO MATERIALS, SOFTWARE FOR USE IN PLANNING AND TRACKING TRANSPORTATION OF MATERIALS AND LOGISTICS, SOFTWARE FOR USE IN MEASUREMENT OF LUMBER, ORDER MANAGEMENT SOFTWARE (U.S. CLS. 21, 23, 26, 36 AND 38).

CLASS 9—(Continued).

SN 76-310,343. FISHER HAMILTON LLC, TWO RIVERS, WI. FILED 9-7-2001.

PIONEER

FOR LABORATORY FUME HOODS (U.S. CLS. 21, 23, 26, 36 AND 38).
FIRST USE 2-4-2002; IN COMMERCE 3-1-2002.

SN 76-310,910. MESO SCALE DIAGNOSTICS, LLC, GAITHERSBURG, MD. FILED 9-10-2001.

DISCOVERY WORKBENCH

FOR SOFTWARE USED FOR DATA MANAGEMENT AND ANALYSIS IN THE FIELDS OF BIOLOGICAL ASSAYS, PHARMACEUTICAL SCREENING, BIOLOGICAL AND PHARMACEUTICAL TESTING, ELECTRO-CHEMILUMINESCENCE IMAGING AND BIOLOGICAL DIAGNOSTICS (U.S. CLS. 21, 23, 26, 36 AND 38).

SN 76-311,241. BEST SOFTWARE, INC., RESTON, VA. FILED 9-12-2001.

FASGOV ASSET ACCOUNTING

OWNER OF U.S. REG. NOS. 1,689,973, 2,009,250 AND OTHERS.

NO CLAIM IS MADE TO THE EXCLUSIVE RIGHT TO USE "ASSET ACCOUNTING", APART FROM THE MARK AS SHOWN.

FOR COMPUTER SOFTWARE FOR ASSET INVENTORY MAINTENANCE, MANAGEMENT AND RECONCILIATION IN THE FIELD OF ACCOUNTING AND FINANCE (U.S. CLS. 21, 23, 26, 36 AND 38).

SN 76-311,243. BEST SOFTWARE, INC., RESTON, VA. FILED 9-12-2001.

FASGOV ASSET INVENTORY

OWNER OF U.S. REG. NOS. 1,689,973, 2,009,250 AND OTHERS.

NO CLAIM IS MADE TO THE EXCLUSIVE RIGHT TO USE "ASSET INVENTORY", APART FROM THE MARK AS SHOWN.

FOR COMPUTER SOFTWARE FOR ASSET INVENTORY MAINTENANCE, MANAGEMENT AND RECONCILIATION IN THE FIELD OF ACCOUNTING AND FINANCE (U.S. CLS. 21, 23, 26, 36 AND 38).

CLASS 9—(Continued).

SN 76-311,397. MALACO, INC., JACKSON, MS. FILED 9-10-2001.



NO CLAIM IS MADE TO THE EXCLUSIVE RIGHT TO USE "GOSPEL AMERICA", APART FROM THE MARK AS SHOWN.

THE MARK IS BLACK OR WHITE.

THE MARK CONSISTS OF A LINE DRAWING OF BIRD AND TYPE.

FOR MAGNETICALLY ENCODED CREDIT CARDS; PRE-RECORDED COMPACT DISCS (CD'S), CASSETTE TAPES, LONG PLAYING DISCS (LP'S), ALL FEATURING MUSIC; COMPUTER DISCS, NAMELY, VIDEO-DISCS, CD-ROM, DVD AND VIDEO CASSETTES FEATURING PRE-RECORDED MUSIC, LIVE MUSIC AND IMAGES OF ARTISTS AND OTHER PERFORMERS (U.S. CLS. 21, 23, 26, 36 AND 38).

SN 76-313,483. ESM CABLE CORP., PATTERSON, CA. FILED 9-17-2001.

ESM CABLE CORP.

NO CLAIM IS MADE TO THE EXCLUSIVE RIGHT TO USE "CABLE CORP.", APART FROM THE MARK AS SHOWN.

FOR FLEXIBLE AND SEMI-RIGID COAXIAL CABLE ASSEMBLIES CONSISTING OF COAXIAL CABLE AND CABLE CONNECTORS (U.S. CLS. 21, 23, 26, 36 AND 38).
FIRST USE 1-2-1996; IN COMMERCE 1-0-1996.

SN 76-313,745. NEWPORT STRATEGIES, INC., PORTLAND, ME. FILED 9-17-2001.

NEWPORT HORIZON

OWNER OF U.S. REG. NOS. 1,862,349, 1,904,141 AND 2,007,034.

FOR COMPUTER DATABASE CONTAINING INFORMATION RELATING TO THE PHARMACEUTICAL INDUSTRY (U.S. CLS. 21, 23, 26, 36 AND 38).

SN 76-314,170. ACCETIO, INC., SAN DIEGO, CA. FILED 9-17-2001.

ACCETIO

FOR COMPUTER SOFTWARE FOR ENABLING USERS TO CONNECT TO LOCAL AREA NETWORKS, WIDE AREA NETWORKS, AND THE INTERNET (U.S. CLS. 21, 23, 26, 36 AND 38).

CLASS 9—(Continued).

SN 76-314,251. TELEVISION EVENTS AND MARKETING, INC., HONOLULU, HI. FILED 9-18-2001.

XTERRA

FOR BICYCLE HELMETS (U.S. CLS. 21, 23, 26, 36 AND 38).

SN 76-314,528. COKINETIC SYSTEMS, CORP., RYE, NY. FILED 9-17-2001.

BROKERMERIT

FOR COMPUTER SOFTWARE THAT ALLOWS THE USER TO EVALUATE SERVICE PROVIDERS IN THE FIELD OF FINANCIAL SERVICES (U.S. CLS. 21, 23, 26, 36 AND 38).

SN 76-314,555. MARTIN, BARRETT, TAOS, NM. FILED 9-19-2001.

FAST HORSE RECORDINGS

NO CLAIM IS MADE TO THE EXCLUSIVE RIGHT TO USE "RECORDINGS", APART FROM THE MARK AS SHOWN.

FOR PRE-RECORDED COMPACT DISKS FEATURING MUSIC (U.S. CLS. 21, 23, 26, 36 AND 38).
FIRST USE 12-24-2001; IN COMMERCE 12-24-2001.

SN 76-315,022. SCENPRO, INC., RICHARDSON, TX. FILED 9-21-2001.

MEDVIEW

FOR COMPUTER SOFTWARE APPLICATION FOR THE GEOGRAPHIC DISPLAY OF COVERT BIOLOGICAL AND CHEMICAL WEAPONS RELEASE CASUALTIES (U.S. CLS. 21, 23, 26, 36 AND 38).

SN 76-315,081. KLA-TENCOR CORPORATION, SAN JOSE, CA. FILED 9-19-2001.

ED0

FOR COMPUTER HARDWARE, SOFTWARE AND USER MANUALS SOLD AS A UNIT, AND EQUIPMENT, NAMELY INSPECTION, METROLOGY AND TESTING HARDWARE, ALL FOR INSPECTING AND MEASURING SEMICONDUCTORS DURING MANUFACTURING AND PROCESSING (U.S. CLS. 21, 23, 26, 36 AND 38).

CLASS 9—(Continued).

SN 76-316,083. KONINKLIJKE PHILIPS ELECTRONICS N.V., EINDHOVEN, NETHERLANDS, FILED 9-24-2001.

DOMMEL RIVER

PRIORITY CLAIMED UNDER SEC. 44(D) ON BENELUX APPLICATION NO. 0986583, FILED 3-27-2001, REG. NO. 0684141, DATED 3-27-2001, EXPIRES 3-27-2011.

FOR SOFTWARE PROGRAMS FOR PROGRAMMING, DESIGNING AND REDESIGNING INTEGRATED CIRCUITS, COMPUTER MEMORY CHIPS AND MICRO PROCESSORS (U.S. CLS. 21, 23, 26, 36 AND 38).

SN 76-316,086. KONINKLIJKE PHILIPS ELECTRONICS N.V., EINDHOVEN, NETHERLANDS, FILED 9-24-2001.

PQ RUBY

PRIORITY CLAIMED UNDER SEC. 44(D) ON BENELUX APPLICATION NO. 0987465, FILED 4-5-2001, REG. NO. 0687644, DATED 4-5-2001, EXPIRES 4-5-2011.

FOR ANALYTICAL APPARATUS, NAMELY, METROLOGY TOOL FOR IN-LINE PROCESS CONTROL OF ULTRA-THIN GATE OXIDES, FOR IN-LINE PROCESS CONTROL IN INTEGRATED CIRCUIT PRODUCTION, AND FOR OPTICAL MEASUREMENT IN PATTERNED WAFERS (U.S. CLS. 21, 23, 26, 36 AND 38).

SN 76-316,088. KONINKLIJKE PHILIPS ELECTRONICS N.V., EINDHOVEN, NETHERLANDS, FILED 9-24-2001.

ZAPSTOP

PRIORITY CLAIMED UNDER SEC. 44(D) ON BENELUX APPLICATION NO. 0987132, FILED 3-30-2001, REG. NO. 0680450, DATED 3-30-2001, EXPIRES 3-30-2011.

FOR SEMICONDUCTORS, INTEGRATED CIRCUITS, SEMICONDUCTOR AND SILICON CHIPS, LASER DIODES, ZENER DIODES, LIGHT EMITTING DIODES, SURGE PROTECTIVE DIODES, TRANSISTORS (U.S. CLS. 21, 23, 26, 36 AND 38).

SN 76-316,089. KONINKLIJKE PHILIPS ELECTRONICS N.V., EINDHOVEN, NETHERLANDS, FILED 9-24-2001.

PQ EMERALD

PRIORITY CLAIMED UNDER SEC. 44(D) ON BENELUX APPLICATION NO. 0987466, FILED 4-5-2001, REG. NO. 0687645, DATED 4-5-2001, EXPIRES 4-5-2011.

FOR ANALYTICAL APPARATUS, NAMELY, METROLOGY TOOL FOR IN-LINE PROCESS CONTROL OF ULTRA-THIN GATE OXIDES, FOR IN-LINE PROCESS CONTROL IN INTEGRATED CIRCUIT PRODUCTION, AND FOR OPTICAL MEASUREMENT IN PATTERNED WAFERS (U.S. CLS. 21, 23, 26, 36 AND 38).

CLASS 9—(Continued).

SN 76-316,174. POWER INTEGRATIONS, INC., SAN JOSE, CA. FILED 9-24-2001.

DPAswitch

THE DRAWING IS IN SPECIAL FORM.
FOR SEMICONDUCTOR DEVICES AND INTEGRATED CIRCUITS FOR SMART POWER OPERATIONS AND POWER CONVERSION (U.S. CLS. 21, 23, 26, 36 AND 38).

SN 76-316,543. SONY KABUSHIKI KAISHA, TA SONY CORPORATION, TOKYO 141, JAPAN, FILED 9-25-2001.

h.ear

FOR RADIOS; AUDIO TAPE PLAYERS/RECORDERS; AUDIO TAPE/DISC PLAYERS/RECORDERS; AUDIO TAPE/DISC PLAYERS/RECORDERS COMBINED WITH RADIOS; AUDIO SPEAKERS; AUDIO AMPLIFIERS; AUDIO TUNERS; VIDEO TAPE/DISC PLAYERS/RECORDERS; TELEVISION RECEIVERS; HEADPHONES (U.S. CLS. 21, 23, 26, 36 AND 38).

SN 76-316,598. PHOTONEX CORPORATION, MAYNARD, MA. FILED 9-24-2001.

ULTRAFAST DYNAMIC CORE

NO CLAIM IS MADE TO THE EXCLUSIVE RIGHT TO USE "CORE", APART FROM THE MARK AS SHOWN.
FOR TELECOMMUNICATION HARDWARE, NAMELY, OPTICAL TRANSPORT SYSTEMS COMPRISED OF DENSE WAVELENGTH DIVISION MULTIPLEXER AND OPTICAL TRANSPONDER SYSTEMS COMPRISED OF DENSE WAVELENGTH DIVISION MULTIPLEXER AND OPTICAL TRANSPONDER, COMPUTER PROGRAMS FOR NETWORKING COMPUTERS, FOR NETWORK TRAFFIC ENGINEERING, AND FOR ACCESSING, CONTROLLING, MONITORING AND MANAGING OPTICAL NETWORKS (U.S. CLS. 21, 23, 26, 36 AND 38).

CLASS 9—(Continued).

SN 76-316,679. CSG SYSTEMS, INC., ENGLEWOOD, CO. FILED 9-25-2001.

CSG UPSELLNOW!

OWNER OF U.S. REG. NOS. 2,086,577, 2,274,736 AND OTHERS.

FOR CUSTOMER RELATIONSHIP MANAGEMENT COMPUTER SOFTWARE PROGRAMS, NAMELY COMPUTER SOFTWARE PROGRAMS THAT ALLOW TELECOMMUNICATIONS, CABLE, VIDEO, TELEPHONY AND DATA COMPANIES TO FACILITATE AND PREDICT CUSTOMER PROFIT BY IMMEDIATELY IDENTIFYING WHEN A CROSS-SELL OR UP-SELL OFFER SHOULD BE EXTENDED AND IDENTIFYING WHICH OFFER IS MOST LIKELY TO BE ACCEPTED (U.S. CLS. 21, 23, 26, 36 AND 38).

SN 76-316,712. QUINN PATENT DRAWING SERVICE, INCORPORATED, CAPITOL HEIGHTS, MD. FILED 9-25-2001.

THE QUINN SOLUTION

FOR COMPUTER SOFTWARE FOR INTERACTIVE VOICE AND DATA TRANSFER FOR USE IN THE FIELD OF TELECOMMUNICATIONS; AND COMPUTER SOFTWARE FOR INTERACTIVE VOICE AND DATA TRANSFER FOR USE IN THE FIELD OF PATENT REGISTRATION (U.S. CLS. 21, 23, 26, 36 AND 38).

SN 76-317,061. ROWLAND, RICHARD, SACRAMENTO, CA. FILED 9-24-2001.

CHEMIGEM

FOR ELECTRONICALLY CONTROLLED MEASURING AND DOSING DEVICES FOR SWIMMING POOLS, NAMELY MONITORING AND DOSING EQUIPMENT FOR SWIMMING POOLS; ELECTRONICALLY CONTROLLED PUMPS, SOLENOIDS AND VALVES FOR USE IN SWIMMING POOLS TO MAINTAIN SANITATION (OXIDATION REDUCTION POTENTIAL) AND CHEMISTRY (PH) (U.S. CLS. 21, 23, 26, 36 AND 38).
FIRST USE 11-17-2000; IN COMMERCE 11-17-2000.

SN 76-317,800. NANOMETRICS INCORPORATED, MILPITAS, CA. FILED 9-28-2001.

NANOCD

FOR OPTICAL METROLOGY INSTRUMENT USED TO MEASURE MICROSCOPIC FEATURES OF SAMPLES, PARTICULARLY, OF SEMICONDUCTOR WAFERS, FLAT PANEL DISPLAYS AND MAGNETIC MEDIA (U.S. CLS. 21, 23, 26, 36 AND 38).

CLASS 9—(Continued).

SN 76-319,891. HUGHES, WILLIAM FRANKLIN III, GLEN-COE, IL. FILED 10-2-2001.

THOUGHTCLIPS

FOR COMPUTER SOFTWARE FOR COLLECTING AND RANKING IDEAS IN GROUP DISCUSSIONS IN BUSINESS AND EDUCATION AND ACCOMPANYING MANUALS SOLD AS A UNIT THEREWITH (U.S. CLS. 21, 23, 26, 36 AND 38).

CLASS 9—(Continued).

SN 76-321,551. CHATEAU TECHNICAL CORP., TAIPEI CITY, TAIWAN, FILED 10-5-2001.



OWNER OF U.S. REG. NO. 2,442,039.
NO CLAIM IS MADE TO THE EXCLUSIVE RIGHT TO USE ".NET", APART FROM THE MARK AS SHOWN.

THE STIPPLING IS FOR SHADING PURPOSES.
FOR INTEGRATED CIRCUIT; DIGITAL SIGNAL DEVICES, NAMELY, TELEVISIONS AND DIGITAL MONITORS; CLOSED CIRCUIT TV SURVEILLANCE CAMERAS; ELECTRONIC TV VIDEO RECORDING PLAYERS, ELECTRONIC VIDEO SURVEILLANCE CAMERAS WITH ALARM; VIDEO RECORDING PLAYERS; PRE-RECORDED VIDEO TAPES FEATURING MUSIC AND VIDEO IMAGES; CAMERAS; DIGITAL CAMERAS; DIGITAL VIDEO RECORDING PLAYERS; ELECTRONIC SECURITY HOUSE ALARMS; INTEGRATED CIRCUIT CARDS CONTAINING PRE-RECORDED AUDIO AND VIDEO IMAGES (U.S. CLS. 21, 23, 26, 36 AND 38).

SN 76-319,948. LITCHFIELD COMMUNICATIONS, INC., WATERTOWN, CT. FILED 10-1-2001.

SEOP

FOR SEMICONDUCTORS; COMPUTER HARDWARE AND SOFTWARE FOR FACILITATING DATA AND VOICE TRANSFER OVER NETWORKS, INCLUDING OVER THE INTERNET (U.S. CLS. 21, 23, 26, 36 AND 38).

SN 76-322,578. BRIDGER COMMERCIAL FUNDING LLC, MILL VALLEY, CA. FILED 10-9-2001.

SN 76-320,119. TRAVIS, BRAD, PETALUMA, CA. FILED 10-2-2001.

WALK WITH THE ELEMENTS

FOR SERIES OF PRE-RECORDED COMPACT DISCS FEATURING MUSIC (U.S. CLS. 21, 23, 26, 36 AND 38).
FIRST USE 9-9-2001; IN COMMERCE 9-9-2001.

BLIS

FOR COMPUTER SOFTWARE FOR USE IN ORIGINATING, MANAGING AND SECURING COMMERCIAL MORTGAGES (U.S. CLS. 21, 23, 26, 36 AND 38).

SN 76-321,353. ARM LIMITED, CAMBRIDGE CBI 9NJ, UNITED KINGDOM, FILED 10-3-2001.

The Architecture for the Digital World

FOR ELECTRICAL EQUIPMENT, NAMELY COMPUTER CHIPS, FOR USE IN THE DESIGN AND DEBUGGING OF INTEGRATED CIRCUITS, MICROPROCESSOR CORES, MACRO CELLS, MICROCONTROLLERS, BUS INTERFACES, AND PRINTED CIRCUIT BOARDS; ELECTRICAL EQUIPMENT, NAMELY COMPUTER CHIPS, FOR USE IN THE DESIGN AND DEBUGGING OF APPLICATION SOFTWARE, OPERATING SYSTEM SOFTWARE, AND COMPUTER SOFTWARE; USER MANUALS FOR USE THEREWITH SOLD AS A UNIT (U.S. CLS. 21, 23, 26, 36 AND 38).

SN 76-323,079. DOONGO TECHNOLOGIES, INC., SANTA CLARA, CA. FILED 10-9-2001.

SMARTJAMP

FOR COMPUTER SOFTWARE FOR DELIVERING SOFTWARE APPLICATIONS AND DATA SERVICES TO WIRELESS SYSTEMS AND WIRELESS DEVICES (U.S. CLS. 21, 23, 26, 36 AND 38).
FIRST USE 7-18-2001; IN COMMERCE 7-18-2001.

CLASS 9—(Continued).

SN 76-323,328. ABC INVESTMENT CORP., WILMINGTON, DE. FILED 10-9-2001.



NO CLAIM IS MADE TO THE EXCLUSIVE RIGHT TO USE "RADIO" AND "RADIO MOVIE CLASSICS", APART FROM THE MARK AS SHOWN.

FOR SOUND RECORDINGS FEATURING RECORDED OLD TIME RADIO PROGRAMS (U.S. CLS. 21, 23, 26, 36 AND 38).

SN 76-323,915. TWENTIETH CENTURY FOX FILM CORPORATION, LOS ANGELES, CA. FILED 10-10-2001.

FOX & FRIENDS

FOR THERMOMETERS, NOT FOR MEDICAL USE (U.S. CLS. 21, 23, 26, 36 AND 38).

SN 76-324,089. CITY PUBLIC SERVICE, SAN ANTONIO, TX. FILED 3-29-2001.

SURGESCOUT

FOR SURGE PROTECTOR (U.S. CLS. 21, 23, 26, 36 AND 38).

SN 76-324,117. TEMPEST MICROSYSTEMS, LA JOLLA, CA. FILED 10-11-2001.

TEMPEST MICROSYSTEMS

NO CLAIM IS MADE TO THE EXCLUSIVE RIGHT TO USE "MICROSYSTEMS", APART FROM THE MARK AS SHOWN.

FOR HARDWARE AND SOFTWARE FOR INTELLIGENT REMOTE IMAGING SYSTEMS THAT ALLOW OBTAINING WIDE-ANGLE IMAGES OF A SCENE REMOTELY OR LOCALLY AND PRESENTING PERSPECTIVE-CORRECTED VIEWS OF THE IMAGES TO A VIEWER (U.S. CLS. 21, 23, 26, 36 AND 38).

FIRST USE 1-0-2000; IN COMMERCE 1-0-2000.

CLASS 9—(Continued).

SN 76-328,966. HEARST COMMUNICATIONS, INC., NEW YORK, NY. FILED 10-23-2001.

HOW DO THEY BUILD?

OWNER OF U.S. REG. NO. 2,221,407.
FOR SERIES OF PRE-RECORDED CD-ROMS, CD-IS AND AUDIO CASSETTES ON THE TOPIC OF THE CONSTRUCTION OF STRUCTURES AND VEHICLES (U.S. CLS. 21, 23, 26, 36 AND 38).

SN 76-329,538. DIVISION 7 ONLINE.COM LLC, LAS VEGAS, NV. FILED 10-22-2001.

**DESIGNED RIGHT
WATERTIGHT**

FOR COMPUTER SOFTWARE ACCESSIBLE THROUGH A GLOBAL COMPUTER NETWORK FOR USE WITH FACILITATING AN INTERNET-BASED, USER-INTERFACE PROGRAM WHICH PROVIDES INFORMATION, PRODUCTS AND TECHNICAL ASSISTANCE IN THE FIELD OF ROOFING (U.S. CLS. 21, 23, 26, 36 AND 38).

FIRST USE 9-1-1999; IN COMMERCE 9-1-1999.

SN 76-330,512. COMPUWARE CORPORATION, FARMINGTON HILLS, MI. FILED 10-26-2001.

OPTIMALFLOW

FOR COMPUTER SOFTWARE USED TO AUTOMATE BUSINESS TASKS AND PROCESSES IN A COMPANY OR ORGANIZATION, NAMELY DAILY TASKS AND PROCESSES SUCH AS ORDER PROCESSING, CLAIMS PROCESSING, PRODUCT SHIPMENT, CUSTOMER SERVICES, AND INSTRUCTIONAL MANUALS SOLD THEREWITH AS A UNIT (U.S. CLS. 21, 23, 26, 36 AND 38).

FIRST USE 6-22-2001; IN COMMERCE 6-22-2001.

SN 76-330,513. COMPUWARE CORPORATION, FARMINGTON HILLS, MI. FILED 10-26-2001.

OPTIMALJ

FOR COMPUTER SOFTWARE DEVELOPMENT TOOL, NAMELY USED TO DESIGN, DEVELOP AND DEPLOY SOFTWARE BUSINESS APPLICATIONS, AND INSTRUCTIONAL MANUALS SOLD THEREWITH AS A UNIT (U.S. CLS. 21, 23, 26, 36 AND 38).

FIRST USE 7-16-2001; IN COMMERCE 7-16-2001.

CLASS 9—(Continued).

SN 76-331,162. FOSS TECATOR AB, LITTERATURVAGEN 8, SE-263 21 HOGANAS, SWEDEN, FILED 10-29-2001.

ISISCAN

FOR FOOD, FEED, SEED, GRAIN, FORAGE, AND BEVERAGE ANALYZERS, NAMELY, COMPUTER SOFTWARE USED FOR THE ANALYSIS OF THE QUALITY COMPOSITION OF FOOD, FEED, SEED, GRAIN, FORAGE, AND BEVERAGE (U.S. CLS. 21, 23, 26, 36 AND 38).

SN 76-331,208. PARADYNE TECHNOLOGIES, INC., STATE COLLEGE, PA. FILED 10-30-2001.

AJAX CONTROLS

NO CLAIM IS MADE TO THE EXCLUSIVE RIGHT TO USE "CONTROLS", APART FROM THE MARK AS SHOWN.

FOR ELECTRONIC CONTROLS FOR MACHINE TOOLS, METAL CUTTING EQUIPMENT AND AUTOMATED MACHINES, CONSISTING OF COMPUTER FIRMWARE, COMPUTER HARDWARE, COMPUTER INTERFACE BOARDS, COMPUTER PROGRAMS AND SOFTWARE, COMPUTER PERIPHERALS, WORKSTATIONS, CONTROLLERS AND MOTION SENSITIVE SWITCHES AND SENSORS (U.S. CLS. 21, 23, 26, 36 AND 38).

SN 76-331,213. PARADYNE TECHNOLOGIES, INC., STATE COLLEGE, PA. FILED 10-30-2001.

AJAXCNC

FOR ELECTRONIC CONTROLS FOR MACHINE TOOLS, METAL CUTTING EQUIPMENT AND AUTOMATED MACHINES, CONSISTING OF COMPUTER FIRMWARE, COMPUTER HARDWARE, COMPUTER INTERFACE BOARDS, COMPUTER PROGRAMS AND SOFTWARE, COMPUTER PERIPHERALS, WORKSTATIONS, CONTROLLERS AND MOTION SENSITIVE SWITCHES AND SENSORS (U.S. CLS. 21, 23, 26, 36 AND 38).

SN 76-331,843. STMICROELECTRONICS, INC., CARROLLTON, TX. FILED 10-31-2001.

PERFECTPICTURE

FOR SEMICONDUCTORS; INTEGRATED CIRCUITS; ELECTRONIC CIRCUITS; DISPLAY DRIVERS (U.S. CLS. 21, 23, 26, 36 AND 38).

CLASS 9—(Continued).

SN 76-333,541. SOFTSHARE, INC., SANTA BARBARA, CA. FILED 11-2-2001.

SOFTSHARE XFORMS

FOR COMPUTER GOODS, NAMELY A COMPUTER PROGRAM THAT IS PART OF COMPUTER SOFTWARE USED BY BUSINESS AND GOVERNMENTAL ORGANIZATION FOR USE IN DATABASE MANAGEMENT IN THE FIELD OF BUSINESS ADMINISTRATION (U.S. CLS. 21, 23, 26, 36 AND 38).

FIRST USE 7-24-2001; IN COMMERCE 7-24-2001.

SN 76-335,169. BETTER ON-LINE SOLUTIONS, LTD., TERADYON, MISGAV, ISRAEL, FILED 10-30-2001.

BOSANOVA PLUS

FOR COMPUTER HARDWARE AND SOFTWARE FOR PROVIDING SERVER CONNECTIVITY OVER A COMPUTER NETWORK, TERMINAL EMULATION AND FILE TRANSFERS; INSTRUCTION MANUALS USED THEREWITH (U.S. CLS. 21, 23, 26, 36 AND 38).

FIRST USE 9-0-1995; IN COMMERCE 9-0-1995.

SN 76-335,627. COMPUTER DIMENSIONS, INC., FLORENCE, SC. FILED 11-8-2001.

MAX-IT!

FOR COMPUTER SOFTWARE FOR MINIMIZING BULK MAILING COSTS (U.S. CLS. 21, 23, 26, 36 AND 38).

FIRST USE 4-0-1998; IN COMMERCE 4-0-1998.

SN 76-335,690. UNIFUND, LLC, NASHUA, NH. FILED 11-9-2001.

BUDGETSENSE

FOR COMPUTER SOFTWARE FOR FUND ACCOUNTING FOR MUNICIPALITIES AND SCHOOLS (U.S. CLS. 21, 23, 26, 36 AND 38).

FIRST USE 9-1-2001; IN COMMERCE 9-1-2001.

SN 76-335,826. ADAPTEC, INC., MILPITAS, CA. FILED 11-7-2001.

EMRL

FOR COMPUTER HARDWARE FOR USE IN DETECTING AND CONFIGURING ONE OR MORE RAID (RANDOM ARRAY OF INDEPENDENT DISKS) PCLS (PERIPHERAL COMPONENT INTERCONNECT) (U.S. CLS. 21, 23, 26, 36 AND 38).

CLASS 9—(Continued).

SN 76-336,419. SECURE SYSTEMS LIMITED, WESTERN PERTH, AUSTRALIA, FILED 11-9-2001.

SDV

NO CLAIM IS MADE TO THE EXCLUSIVE RIGHT TO USE "SILICON", APART FROM THE MARK AS SHOWN.
FOR HARDWARE BASED DATA SECURITY DEVICE, NAMELY COMPUTER HARDWARE THAT PREVENTS UNAUTHORIZED READS AND WRITES TO A COMPUTER'S HARD DISK DRIVE BY USING A CUSTOM SILICON CHIP (U.S. CLS. 21, 23, 26, 36 AND 38).
FIRST USE 3-22-2001; IN COMMERCE 3-22-2001.

SN 76-337,116. ICREATE TECHNOLOGIES, INC., 5, HSINCHU, TAIWAN, FILED 11-9-2001.

iCTC

FOR COMPUTER CHIPS, NAMELY SOC WHICH IS ALSO KNOWN AS SYSTEM ON A CHIP, DRAM WHICH IS ALSO KNOWN AS DYNAMIC RANDOM ACCESS MEMORY, SRAM WHICH IS ALSO KNOWN AS STATIC RANDOM ACCESS MEMORY, HARDWARE AND FIRMWARE, NAMELY, COMPUTER PERIPHERALS, NAMELY, INTERNET CARDS WHICH PROVIDE MULTIMEDIA STORAGE AND ARE COMPRISED OF A CONTROLLER INTEGRATED CIRCUIT, SOLID STATE MEMORY CHIPS AND COMPUTER SOFTWARE USED TO ELECTRONICALLY STORE MULTIMEDIA INFORMATION, VOICE IDENTIFICATION SYSTEMS COMPRISED OF COMPUTER HARDWARE AND SOFTWARE USED TO ELECTRONICALLY IDENTIFY SPOKEN VOICES, COMPUTER MEMORIES, ELECTRICAL CIRCUIT BOARDS, INTEGRATED CIRCUIT CHIPS (U.S. CLS. 21, 23, 26, 36 AND 38).

SN 76-337,305. INTERACT ACCESSORIES, INC., HUNT VALLEY, MD. FILED 11-13-2001.

SHARKPHONES

FOR VIDEO GAME ACCESSORIES, NAMELY, EAR BUDS INTENDED FOR USE WITH HAND-HELD GAME CONSOLES (U.S. CLS. 21, 23, 26, 36 AND 38).

SN 76-337,306. INTERACT ACCESSORIES, INC., HUNT VALLEY, MD. FILED 11-13-2001.

SHARKCAGE

FOR STORAGE CASES FOR HAND-HELD VIDEO GAME CONSOLES AND ACCESSORIES (U.S. CLS. 21, 23, 26, 36 AND 38).

CLASS 9—(Continued).

SN 76-338,390. CENTRICUT, LLC, WEST LEBANON, NH. FILED 11-15-2001.

SILVERLINE

FOR ELECTRODES FOR PLASMA ARC TORCHES (U.S. CLS. 21, 23, 26, 36 AND 38).
FIRST USE 1-15-2001; IN COMMERCE 3-8-2001.

SN 76-339,188. DEMERS-SMITH, DIANE F., CLEMMONS, NC. FILED 11-19-2001.

SOUNDPLUG

FOR PHYSICAL TUBULAR DEVICE ABOUT 4 INCHES LONG THAT PLUGS INTO THE END OF AN AUDIO SIGNAL CABLE AND REPRODUCES AS ACTUAL SOUND THE SIGNAL TRAVELING THROUGH THAT CABLE (U.S. CLS. 21, 23, 26, 36 AND 38).

SN 76-339,374. ACCU-SORT SYSTEMS, INC., HATFIELD, PA. FILED 11-16-2001.

VISIONKEY

FOR AUTOMATIC IDENTIFICATION EQUIPMENT AND SYSTEMS COMPRISING CCD CAMERAS, READER/IMAGE SERVERS, DATE-ENTRY COMPUTERS, AND SOFTWARE FOR OPERATING THE FOREGOING (U.S. CLS. 21, 23, 26, 36 AND 38).

SN 76-339,411. ACCU-SORT SYSTEMS, INC., HATFIELD, PA. FILED 11-16-2001.

FAST

FOR INTEGRATED SYSTEMS FOR USE WITH AUTOMATIC IDENTIFICATION EQUIPMENT, NAMELY, CONTROL MODULES, SCANNERS, LABEL PRINTER/APPLICATORS, TRACKING CONTROL HARDWARE, LABEL DESIGN SOFTWARE, AND DATA PROCESSING STATIONS COMPRISING PCS, PRINTERS AND BAR CODE SCANNERS, TO FACILITATE IDENTIFICATION, CONTROL, TRACKING, SORTING, OR DISTRIBUTION OF THE CONVEYED ARTICLES (U.S. CLS. 21, 23, 26, 36 AND 38).

SN 76-339,907. IMIRAGE INCORPORATED, DBA PROFITFORCE, ALLENTOWN, PA. FILED 11-19-2001.

PROFITFORCE

FOR BUSINESS MANAGEMENT COMPUTER SOFTWARE CONSISTING OF FOUR CORE ELEMENTS, NAMELY, TEAM, MESSAGE, CONTACTS, AND CALENDAR FOR SIMULTANEOUS MANAGEMENT OF MULTIPLE PROJECTS, RESOURCE ALLOCATION AND MEASUREMENT (U.S. CLS. 21, 23, 26, 36 AND 38).

CLASS 9—(Continued).

SN 76-339,988. EIDOS INTERACTIVE LIMITED, WIMBLEDON, LONDON, UNITED KINGDOM, FILED 11-20-2001.

PREMEDITATED GAMES

PRIORITY CLAIMED UNDER SEC. 44(D) ON UNITED KINGDOM APPLICATION NO. 2283267, FILED 10-16-2001, REG. NO. 2283267, DATED 3-22-2002, EXPIRES 10-16-2011.

NO CLAIM IS MADE TO THE EXCLUSIVE RIGHT TO USE "GAMES", APART FROM THE MARK AS SHOWN.

FOR COMPUTER GAMES DOWNLOADABLE FROM A REMOTE COMPUTER LOCATION AND RECORDED ON CD-ROM, COMPUTER DISCS, AND GAME CARTRIDGES; DOWNLOADABLE ELECTRONIC PUBLICATIONS IN THE NATURE OF NEWSLETTERS AND MAGAZINES FEATURING ADVENTURE GAMES (U.S. CLS. 21, 23, 26, 36 AND 38).

SN 76-344,288. M.D. MANUFACTURING, INC., BAKERSFIELD, CA. FILED 11-29-2001.

POWER 3

NO CLAIM IS MADE TO THE EXCLUSIVE RIGHT TO USE "POWER", APART FROM THE MARK AS SHOWN.

FOR CONTROL ATTACHMENT USED WITH AN ELECTRIC CENTRAL VACUUM CLEANING APPARATUS WHICH IS BUILT INTO A STRUCTURE SUCH AS A HOME OR COMMERCIAL BUILDING WHICH PERMITS THE CENTRAL VACUUM CLEANING UNIT TO BE AUTOMATICALLY TURNED ON AND OFF FROM THE REMOTE HANDLE OF THE VACUUM CLEANER WHICH IS ATTACHED TO THE HOSE (U.S. CLS. 21, 23, 26, 36 AND 38).

SN 76-346,306. ONEPRESS CO., OSHKOSH, WI. FILED 12-7-2001.

ONEPRESS
INDUSTRIAL FLATWORK IRONERS

NO CLAIM IS MADE TO THE EXCLUSIVE RIGHT TO USE "INDUSTRIAL FLATWORK IRONERS", APART FROM THE MARK AS SHOWN.

FOR LAUNDRY PRODUCTS IN THE NATURE OF IRON PRESSING MACHINES (U.S. CLS. 21, 23, 26, 36 AND 38).

FIRST USE 8-1-2001; IN COMMERCE 8-1-2001.

CLASS 9—(Continued).

SN 76-347,408. ATHENA CONTROLS, INC, PLYMOUTH MEETING, PA. FILED 12-12-2001.

ATHENA

FOR INDUSTRIAL HEAT SENSITIVE ELECTRONIC SYSTEMS; NAMELY, ELECTRICAL AND ELECTRONIC TEMPERATURE CONTROLLERS, PROCESS CONTROLLERS, POWER CONTROLLERS, THERMOCOUPLES AND TEMPERATURE INDICATORS (U.S. CLS. 21, 23, 26, 36 AND 38).

FIRST USE 4-12-1965; IN COMMERCE 4-12-1965.

SN 76-347,677. DUAL-LITE INC., CHESHIRE, CT. FILED 12-12-2001.

ULTREX

FOR SELF-CONTAINED WALL OR CEILING MOUNTED EMERGENCY LIGHTING FIXTURES FOR AUTOMATICALLY PROVIDING ILLUMINATION DURING POWER FAILURES; ILLUMINATED EXIT SIGNS (U.S. CLS. 21, 23, 26, 36 AND 38).

SN 76-347,904. APPLIED IMAGING, SANTA CLARA, CA. FILED 12-11-2001.

INVENIO

"INVENIO" IS A LATIN TERM, AN ENGLISH TRANSLATION OF WHICH IS "TO FIND OR DISCOVER".

FOR AUTOMATED MICROSCOPY IMAGING SYSTEM COMPRISING COMPUTER HARDWARE AND COMPUTER SOFTWARE TO ENABLE IMAGE ANALYSIS OF MICROSCOPE SLIDES (U.S. CLS. 21, 23, 26, 36 AND 38).

SN 76-348,249. SUMITOMO ELECTRIC INDUSTRIES, LTD., OSAKA, JAPAN, FILED 12-13-2001.

TAPOC

FOR SEMICONDUCTOR PACKAGING FOR PROTECTING A SEMICONDUCTOR CHIP FROM THE ENVIRONMENT (U.S. CLS. 21, 23, 26, 36 AND 38).

SN 76-348,357. COMEL, INC., COLUMBUS, OH. FILED 12-14-2001.

SMARTKEY

FOR COMPUTER PERIPHERAL FOR DATA ENTRY AND DATA STORAGE (U.S. CLS. 21, 23, 26, 36 AND 38).

CLASS 9—(Continued).

SN 76-349,380. LEE, RAYMOND SHU TAK, HUNG HOM, KOWLOON, HONG KONG, FILED 12-17-2001.

IJADK

FOR COMPUTER SOFTWARE DEVELOPMENT KIT, NAMELY COMPUTER PROGRAMS FOR USE IN DEVELOPING OTHER COMPUTER PROGRAMS (U.S. CLS. 21, 23, 26, 36 AND 38).

SN 76-349,826. S. TOUS, S.L., 08240 MANRESA, SPAIN, FILED 12-19-2001.

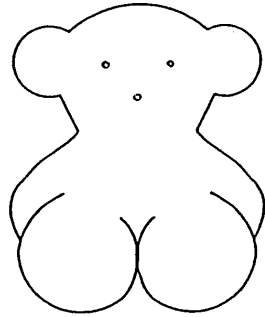

FOR OPTICAL APPARATUS AND INSTRUMENTS, NAMELY SPECTACLES, EYEGLASS CASES, SUNGLASSES, SPECTACLE FRAMES (U.S. CLS. 21, 23, 26, 36 AND 38).

FIRST USE 11-0-2000; IN COMMERCE 1-0-2001.

SN 76-350,046. AMERICAN INTERNATIONAL GROUP, INC., NEW YORK, NY. FILED 12-18-2001.

PORTFOLIO OPTIMIZER

OWNER OF U.S. REG. NO. 1,946,725. NO CLAIM IS MADE TO THE EXCLUSIVE RIGHT TO USE "PORTFOLIO", APART FROM THE MARK AS SHOWN.

FOR COMPUTER SOFTWARE AND DOCUMENTATION, LICENSED AS A UNIT, FOR IDENTIFYING AND SUMMARIZING PERFORMANCE AND RISK ATTRIBUTES OF INVESTMENT (U.S. CLS. 21, 23, 26, 36 AND 38).

FIRST USE 5-31-1994; IN COMMERCE 5-31-1994.

SN 76-350,578. SDS INTERNATIONAL, INC., ARLINGTON, VA. FILED 12-18-2001.

LITEFLITE

FOR COMPUTER SOFTWARE, NAMELY PC-BASED RECONFIGURABLE FLIGHT SIMULATOR PROGRAM (U.S. CLS. 21, 23, 26, 36 AND 38).

FIRST USE 7-15-2001; IN COMMERCE 7-15-2001.

CLASS 9—(Continued).

SN 76-351,056. MAJOR LEAGUE BASEBALL PROPERTIES, INC., NEW YORK, NY. FILED 12-20-2001.



OWNER OF U.S. REG. NOS. 1,055,313, 1,980,821 AND OTHERS.

NO CLAIM IS MADE TO THE EXCLUSIVE RIGHT TO USE "4 ON 4", APART FROM THE MARK AS SHOWN.

FOR ELECTRICAL AND SCIENTIFIC APPARATUS, NAMELY, TELEPHONE ANSWERING MACHINES, TELEPHONES, RADIOS, RADIOS INCORPORATING CLOCKS, PRE-RECORDED VIDEOTAPES RELATING TO BASEBALL, PRE-RECORDED VIDEODISCS RELATING TO BASEBALL, PRE-RECORDED COMPACT DISCS RELATING TO BASEBALL, PRE-RECORDED AUDIO DISCS RELATING TO BASEBALL, PHONOGRAPHIC RECORDS RELATING TO BASEBALL, PRE-RECORDED AUDIO TAPES RELATING TO BASEBALL, BINOCULARS, VIDEO MONITORS, LOUDSPEAKER CABINETS, CALCULATORS, PHOTOGRAPHIC CAMERAS; MUSICAL JUKE BOXES; MEGAPHONES; MICROPHONES; KALEIDOSCOPES; ELECTRIC SWITCH PLATE COVERS; ELECTRIC SIGNS, LUMINOUS SIGNS; NEON SIGNS; SUN GLASSES; EYEGLASS AND CONTACT LENS CASES; EYEGLASS CHAINS; EYEGLASS FRAMES; EYEGLASS CORDS; EYEGLASS LENSES AND EYEGLASSES; MEASURING CUPS; MEASURING SPOONS; MAGNETS; LIFE PRESERVERS; PROTECTIVE GLOVES FOR INDUSTRIAL USE, PROTECTIVE CLOTHING, PROTECTIVE HELMETS; CAMERA CASES, CAMERA STRAPS, SIGNAL WHISTLES, BASEBALL BATTING HELMETS, CATCHERS HELMETS, COMPUTER ACCESSORIES, NAMELY MOUSE PADS AND WRIST PADS; COMPUTER SOFTWARE, NAMELY, SCREEN SAVERS; COMPUTER MONITOR FRAMES, COMPUTER CARRYING CASES, COMPACT DISC CASES, VIDEO AND COMPUTER GAME CARTRIDGES, VIDEO AND COMPUTER GAME DISCS, VIDEO AND COMPUTER GAME CASSETTES, COMPUTER GAME PROGRAMS, AND COMPUTER GAME PROGRAMS DOWNLOADABLE FROM A GLOBAL COMPUTER NETWORK IN THE FIELD OF BASEBALL (U.S. CLS. 21, 23, 26, 36 AND 38).

SN 76-351,586. JACOBSON, MICHAEL, LEESBURG, VA. FILED 12-26-2001.

JUGZ

FOR CONSUMER ELECTRONICS, NAMELY, AMPLIFIERS AND LOUDSPEAKERS (U.S. CLS. 21, 23, 26, 36 AND 38).

CLASS 9—(Continued).

SN 76-351,974. ROGERS BLUE JAYS BASEBALL PARTNERSHIP, TORONTO, ONTARIO M5V 1J1, CANADA, FILED 12-20-2001.



FOR ELECTRICAL AND SCIENTIFIC APPARATUS, NAMELY, TELEPHONE ANSWERING MACHINES, TELEPHONES, RADIOS, INCORPORATING CLOCKS, PRE-RECORDED VIDEOTAPES RELATING TO BASEBALL, PRE-RECORDED VIDEODISCS RELATING TO BASEBALL, PRE-RECORDED COMPACT DISCS RELATING TO BASEBALL, PRE-RECORDED AUDIO DISCS RELATING TO BASEBALL, PHONOGRAPHIC RECORDS RELATING TO BASEBALL, PRE-RECORDED AUDIO TAPES RELATING TO BASEBALL, BINOCULARS, VIDEO VIEWERS, LOUDSPEAKER CABINETS, CALCULATORS, PHOTOGRAPHIC CAMERAS; MUSICAL JUKE BOXES; MEGAPHONES; MICROPHONES; KALEIDOSCOPES; ELECTRIC SWITCH PLATE COVERS; ELECTRIC SIGNS, LUMINOUS SIGNS; NEON SIGNS; SUN GLASSES; EYEGLASS AND CONTACT LENS CASES; EYEGLASS CHAINS; EYEGLASS FRAMES; EYEGLASS CORDS; EYEGLASS LENSES AND EYEGLASSES; MEASURING CUPS; MEASURING SPOONS; MAGNETS; LIFE PRESERVERS; PROTECTIVE GLOVES FOR INDUSTRIAL USE, PROTECTIVE CLOTHING, PROTECTIVE HELMETS; CAMERA CASES, CAMERA STRAPS, WHISTLES, BASEBALL BATTING HELMETS, CATCHERS HELMETS, COMPUTER ACCESSORIES, NAMELY MOUSE PADS AND WRIST PADS; COMPUTER SOFTWARE, NAMELY, SCREEN SAVERS; MONITOR FRAMES, COMPUTER CASES, COMPACT DISC CASES, VIDEO AND COMPUTER GAME CARTRIDGES, VIDEO AND COMPUTER GAME DISCS, VIDEO AND COMPUTER GAME CASSETTES, COMPUTER GAME PROGRAMS, AND COMPUTER GAME PROGRAMS DOWNLOADABLE FROM A GLOBAL COMPUTER NETWORK IN THE FIELD OF BASEBALL (U.S. CLS. 21, 23, 26, 36 AND 38).

SN 76-352,177. PULSE ENTERTAINMENT, INC., SAN FRANCISCO, CA. FILED 12-21-2001.

VEEPERS

FOR COMPUTER SOFTWARE USED TO CREATE 3D CHARACTERS, VIRTUAL PERSONALITIES AND ANIMATION AND USED TO ADD SOUND, TEXT, VOICE AND ANIMATION TO 3D CHARACTERS, VIRTUAL PERSONALITIES AND ANIMATION AND USER'S MANUALS PACKAGED THEREWITH AS A UNIT (U.S. CLS. 21, 23, 26, 36 AND 38).

CLASS 9—(Continued).

SN 76-353,006. CANON KABUSHIKI KAISHA, OHTA-KU, TOKYO, JAPAN, FILED 12-26-2001.

LASER SHOT

NO CLAIM IS MADE TO THE EXCLUSIVE RIGHT TO USE "LASER", APART FROM THE MARK AS SHOWN.

FOR LASER PRINTERS, PARTS AND FITTINGS THEREFOR (U.S. CLS. 21, 23, 26, 36 AND 38).

SN 76-353,589. COUNT THE STARS, INC., DELMAR, NY. FILED 12-31-2001.

COUNT THE STARS

FOR MUSICAL SOUND RECORDINGS, MUSICAL VIDEO RECORDINGS AND DOWNLOADABLE MUSICAL SOUND RECORDINGS (U.S. CLS. 21, 23, 26, 36 AND 38).

FIRST USE 10-15-2001; IN COMMERCE 12-18-2001.

SN 76-354,997. JOBIN YVON, INC., EDISON, NJ. FILED 12-28-2001.



FOR SPECTROMETERS; GLOW DISCHARGE OPTICAL EMISSION SPECTROMETERS; RADIO FREQUENCY GLOW DISCHARGE OPTICAL EMISSION SPECTROMETERS; RADIO FREQUENCY GLOW DISCHARGE OPTICAL EMISSION SPECTROMETERS FOR SPUTTERING OF SAMPLES; RADIO FREQUENCY GLOW DISCHARGE OPTICAL EMISSION SPECTROMETERS FOR SPUTTERING OF CONDUCTIVE AND NON-CONDUCTIVE MATERIALS; RADIO FREQUENCY GLOW DISCHARGE OPTICAL EMISSION SPECTROMETERS FOR DEPTH PROFILE ANALYSIS (U.S. CLS. 21, 23, 26, 36 AND 38).

SN 76-355,651. AGR INTERNATIONAL, INC., BUTLER, PA. FILED 1-7-2002.

TOPSOFT

FOR AUTOMATED DATA COLLECTION SOFTWARE FOR STATISTICAL PROCESS CONTROL CHARTING AND GENERATING TEST REPORTS FOR PLASTIC BOTTLE AND PREFORM MANUFACTURING OPERATIONS (U.S. CLS. 21, 23, 26, 36 AND 38).

FIRST USE 2-1-2001; IN COMMERCE 2-1-2001.

CLASS 9—(Continued).

SN 76-356,004. SCULLY SIGNAL COMPANY, WILMINGTON, MA. FILED 1-7-2002.

TWIS-LOK

FOR FLUID LEVEL GAUGES (U.S. CLS. 21, 23, 26, 36 AND 38).
FIRST USE 8-8-1999; IN COMMERCE 8-8-1999.

CLASS 9—(Continued).

SN 76-356,801. NIPPON COLUMBIA CO., LTD., MINATOKU, TOKYO 107, JAPAN, FILED 1-10-2002.

SAVOY JAZZ

NO CLAIM IS MADE TO THE EXCLUSIVE RIGHT TO USE "JAZZ", APART FROM THE MARK AS SHOWN, FOR PHONOGRAPH RECORDS, CASSETTES AND COMPACT DISCS CONTAINING MUSIC (U.S. CLS. 21, 23, 26, 36 AND 38).
FIRST USE 1-0-1984; IN COMMERCE 1-0-1984.

SN 76-356,203. CHARLOTTE RUSSE MERCHANDISING, INC., SAN DIEGO, CA. FILED 1-7-2002.

refuge.

FOR FRAMES FOR EYEGLASSES AND SUNGLASSES, AND CASES FOR EYEGLASSES AND SUNGLASSES (U.S. CLS. 21, 23, 26, 36 AND 38).

SN 76-356,813. ANIMALS HEALING, INC., POUND RIDGE, NY. FILED 1-10-2002.

Intuitive Touch

NO CLAIM IS MADE TO THE EXCLUSIVE RIGHT TO USE "TOUCH", APART FROM THE MARK AS SHOWN. FOR SERIES OF BOOKS AND AUDIO AND VIDEO TAPES RELATING TO HUMAN AND ANIMAL CARE (U.S. CLS. 21, 23, 26, 36 AND 38).

SN 76-356,568. IBAK HELMUT HUNGER GMBH & CO KG, 24148 KIEL, FED REP GERMANY, FILED 1-9-2002.

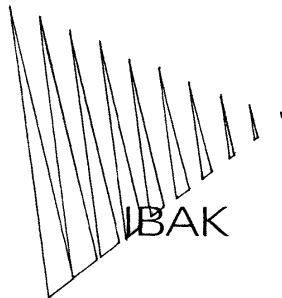

OWNER OF U.S. REG. NO. 738,962.
FOR ELECTRICAL APPARATUS, NAMELY, CLOSED CIRCUIT TELEVISION EQUIPMENT COMPRISED OF TELEVISION CAMERAS, CAMERA CARRIAGES AND SKID DEVICES, CAMERA CABLES, CABLE WINCHES, CONTROL AND DISPLAY RACKS USED FOR THE INSPECTION OF TUBES OR HOLES WHICH MAY BE FILLED WITH WATER OR ANOTHER LIQUID OR FLUID, SUCH AS AIR OR GAS; SEWER INSPECTION TELEVISION EQUIPMENT COMPRISED OF TELEVISION CAMERAS, CAMERA CARRIAGES AND SKID DEVICES, CAMERA CABLES, CABLE WINCHES, CONTROL AND DISPLAY RACKS AND RELEVANT DOCUMENTATION OPERATING SOFTWARE (U.S. CLS. 21, 23, 26, 36 AND 38).
FIRST USE 8-2-1956; IN COMMERCE 7-17-1958.

SN 76-357,315. DATAFLO CORPORATION, OMAHA, NE. FILED 1-11-2002.

DATAFLO

SEC. 2(F).
FOR COMPUTER SOFTWARE FOR WAREHOUSE, INVENTORY AND STORAGE MANAGEMENT (U.S. CLS. 21, 23, 26, 36 AND 38).
FIRST USE 0-0-1985; IN COMMERCE 0-0-1985.

SN 76-358,006. KOCH, JOANNE, LINCOLN, VT. FILED 1-14-2002.

EARTHKIDZ

FOR COMPACT DISCS FEATURING CHILDREN'S MUSIC (U.S. CLS. 21, 23, 26, 36 AND 38).
FIRST USE 8-4-2001; IN COMMERCE 8-4-2001.

SN 76-358,524. IVFONLINE.COM, LLC, GUILFORD, CT. FILED 1-14-2002.

IVFDECK

FOR LABORATORY EQUIPMENT FOR CLINICAL AND SCIENTIFIC PURPOSES, NAMELY, A TABLE WITH AN ELECTRICALLY HEATED TOP FOR THE EFFECTIVE HANDLING OF SPECIMENS AND MATERIALS (U.S. CLS. 21, 23, 26, 36 AND 38).
FIRST USE 9-15-2001; IN COMMERCE 9-15-2001.

CLASS 9—(Continued).

SN 76-358,803. KULCHINSKY, RYAN STAR, NEW YORK, NY. AND GOODMAN, JUSTIN, NEW YORK, NY. AND MEYER, GREGORY, NEW YORK, NY. AND ANSELMO, PETER, NEW YORK, NY. FILED 1-15-2002.

STAGE

FOR MUSICAL SOUND RECORDINGS; SOUND RECORDINGS FEATURING MUSICAL PERFORMANCES; AUDIO-VISUAL RECORDINGS, NAMELY, AUDIO TAPES, AUDIO CASSETTE TAPES, AUDIO DISCS, RECORDS, CD-ROMS, VIDEO TAPES, VIDEO CASSETTES, VIDEO DISCS, DVDS, DATS, AND LASER DISCS, ALL FEATURING MUSIC; DOWNLOADABLE ELECTRONIC PUBLICATIONS IN THE NATURE OF MAGAZINES, JOURNALS AND NEWSLETTERS, ALL IN THE FIELD OF MUSIC; ELECTRONIC PUBLICATIONS, NAMELY, MAGAZINES, JOURNALS AND NEWSLETTERS, ALL IN THE FIELD OF MUSIC RECORDED ON CD-ROMS, DISKETTES, FLOPPY DISKS, VIDEO CASSETTES, AND MAGNETIC TAPES; MAGNETS; DECORATIVE MAGNETS; REFRIGERATOR MAGNETS; NOVELTY MAGNETS; COMPACT DISC CASES; FITTED CASES FOR STORAGE AND TRANSPORTATION, NAMELY, CASES FOR COMPACT DISCS, AUDIO CASSETTES, VIDEO CASSETTES, CD-ROMS; EYEWEAR; SUNGLASSES; EYEGLASSES; EYEGLASS FRAMES; EYEGLASS, SUNGLASSES AND SPECTACLE CASES; EYEGLASS, SUNGLASSES AND SPECTACLE STRAPS; EYEGLASS, SUNGLASSES AND SPECTACLE CHAINS; EYEGLASS, SUNGLASSES AND SPECTACLE CLEANING CLOTHS (U.S. CLS. 21, 23, 26, 36 AND 38).

SN 76-358,862. OBJECTIVE CONCEPTS, L.L.C., UNION, NJ. FILED 1-15-2002.



FOR COMPUTER SOFTWARE DEVELOPMENT TOOLS FOR TESTING SECURITY TRADING SYSTEMS (U.S. CLS. 21, 23, 26, 36 AND 38).
FIRST USE 9-25-2000; IN COMMERCE 10-12-2000.

SN 76-358,960. ADVANCED RESOURCES INTERNATIONAL, BILLINGS, MT. FILED 1-16-2002.

SURGE-PURE

FOR SURGE SUPPRESSION EQUIPMENT, NAMELY, VOLTAGE SURGE PROTECTORS AND VOLTAGE SURGE SUPPRESSORS (U.S. CLS. 21, 23, 26, 36 AND 38).
FIRST USE 4-3-1995; IN COMMERCE 4-3-1995.

CLASS 9—(Continued).

SN 76-358,970. ALTAIR EYEWEAR, INC., RANCHO CORDOVA, CA. FILED 1-15-2002.

SUREFIT PERFORMANCE EYEWEAR

NO CLAIM IS MADE TO THE EXCLUSIVE RIGHT TO USE "PERFORMANCE EYEWEAR", APART FROM THE MARK AS SHOWN.

FOR EYEGLASS FRAMES DESIGNED FOR USE WHILE PARTICIPATING IN ATHLETIC ACTIVITIES (U.S. CLS. 21, 23, 26, 36 AND 38).

SN 76-360,113. AGORICS, INC., LOS ALTOS, CA. FILED 1-16-2002.

GuardPoste

FOR E-MAIL SECURITY SOFTWARE (U.S. CLS. 21, 23, 26, 36 AND 38).

SN 76-360,373. DREAM MECHANICS INC., MONTREAL, QUEBEC H3B, 1K9, CANADA, FILED 1-18-2002.

DREAM MECHANICS

FOR SOFTWARE USED FOR THE DEVELOPMENT OF THREE-DIMENSIONAL VIRTUAL ENVIRONMENTS AND SERVICES RELATED THERETO (U.S. CLS. 21, 23, 26, 36 AND 38).

SN 76-360,449. METAWAVE COMMUNICATIONS CORPORATION, REDMOND, WA. FILED 1-17-2002.

CELL SCULPTING

NO CLAIM IS MADE TO THE EXCLUSIVE RIGHT TO USE "CELL", APART FROM THE MARK AS SHOWN.

FOR ANTENNAS AND COMPUTER HARDWARE AND SOFTWARE TO FACILITATE USE, MANAGEMENT AND CONTROL OF WIRELESS TELEPHONE COMMUNICATION SYSTEMS (U.S. CLS. 21, 23, 26, 36 AND 38).

CLASS 9—(Continued).

SN 76-361,146. GIGGLEPOP.COM, INC., URBANA, IL. FILED 1-22-2002.

GIGGLEPOP LOTTO

NO CLAIM IS MADE TO THE EXCLUSIVE RIGHT TO USE "LOTTO", APART FROM THE MARK AS SHOWN.

FOR COMPUTER GAME SOFTWARE, NAMELY SOFTWARE FOR USE IN PLAYING A GAME OF CHANCE ON SMALL HANDHELD COMPUTER DIGITAL ASSISTANTS (U.S. CLS. 21, 23, 26, 36 AND 38).

SN 76-361,665. MACROVISION, SUNNYVALE, CA. FILED 1-22-2002.

MACROSAFE

FOR COMPUTER SOFTWARE FOR THE SECURE DISTRIBUTION AND MANAGEMENT OF MULTIMEDIA APPLICATIONS TO COMPUTING DEVICES, HANDHELD DEVICES, SETTOP BOXES (U.S. CLS. 21, 23, 26, 36 AND 38).

SN 76-362,350. IRBY, JOSEPH A., DBA BESTQUEST TEACHING SYSTEMS, LITTLE ROCK, AR. FILED 1-24-2002.

ALGEBRA'SCOOL

FOR DIGITIZED COURSE MATERIALS IN THE FIELD OF MATHEMATICS, NAMELY DVDS AND USER MANUAL SOLD AS A UNIT THEREWITH (U.S. CLS. 21, 23, 26, 36 AND 38).

FIRST USE 11-6-2001; IN COMMERCE 11-6-2001.

SN 76-362,487. BROADBAND WIRELESS TECHNOLOGIES, LLC, SPARKS, NV. FILED 1-25-2002.

Broadband Wireless
TECHNOLOGIES

NO CLAIM IS MADE TO THE EXCLUSIVE RIGHT TO USE "BROADBAND WIRELESS TECHNOLOGIES", APART FROM THE MARK AS SHOWN.

FOR WIRELESS COMMUNICATION ANTENNA AMPLIFIERS (U.S. CLS. 21, 23, 26, 36 AND 38).

FIRST USE 2-24-2002; IN COMMERCE 2-24-2002.

SN 76-362,767. ANSELL SERVICES INC., RED BANK, NJ. FILED 1-23-2002.

SIBERIA

FOR PROTECTIVE WORK GLOVES FOR INDUSTRIAL USE (U.S. CLS. 21, 23, 26, 36 AND 38).

CLASS 9—(Continued).

SN 76-363,364. DEMAND MANAGEMENT, INC., CLAYTON, MO. FILED 1-24-2002.

DEMANDSOLUTIONS.NET

OWNER OF U.S. REG. NO. 1,701,507.

FOR COMPUTER PROGRAMS ON DISCS AND INSTRUCTION MANUALS SOLD AS A UNIT THEREWITH FOR USE IN BUSINESS PLANNING; NAMELY FORECASTING, INVENTORY MANAGEMENT AND SHORT AND LONG TERM PLANNING (U.S. CLS. 21, 23, 26, 36 AND 38).

SN 76-363,485. ROBBINS, PAUL, SPRINGFIELD, MA. FILED 1-28-2002.

MY STORY

FOR SOUND AND VIDEO RECORDINGS FEATURING HIGHLIGHTS OF A PERSON'S LIFE ENTAILING INTERVIEWS WHICH REVEAL PERSONAL VIEWS OF THE SUBJECT'S LIFE AND LIFE EVENTS, TO PROVIDE A RECORD OF SUBJECT'S PERSONALITY, ACCOMPLISHMENTS AND BELIEFS (U.S. CLS. 21, 23, 26, 36 AND 38).

SN 76-363,685. CHARLES RIVER ASSOCIATES INCORPORATED, BOSTON, MA. FILED 1-28-2002.

TPAS

FOR COMPUTER SOFTWARE IN THE FIELD OF PUBLIC POLICY ANALYSIS FOR USE IN THE DATABASE MANAGEMENT, GRAPHICAL DISPLAY, ECONOMIC FORECASTING, MICRO-SIMULATION AND TABULAR PRESENTATION OF THE EFFECTS OF TAX POLICIES (U.S. CLS. 21, 23, 26, 36 AND 38).

FIRST USE 9-0-2001; IN COMMERCE 9-0-2001.

SN 76-363,707. STASTNY, FRANK J., DBA TANGLE SCREATIONS, ST. CHARLES, MO. FILED 1-28-2002.

Your Insurance
 **ffice**

NO CLAIM IS MADE TO THE EXCLUSIVE RIGHT TO USE "YOUR INSURANCE OFFICE", APART FROM THE MARK AS SHOWN.

FOR SOFTWARE PROGRAM NAMELY A DATABASE MANAGEMENT PROGRAM FOR INSURANCE AGENTS AND MANAGERS (U.S. CLS. 21, 23, 26, 36 AND 38).

FIRST USE 1-10-2002; IN COMMERCE 1-10-2002.

CLASS 9—(Continued).

SN 76-364,097. METEORLOGIX, LLC, BURNSVILLE, MN. FILED 1-29-2002.

MXWEATHERSPAN METROCAST

FOR SOFTWARE FOR PROCESSING AND DISPLAYING WEATHER INFORMATION (U.S. CLS. 21, 23, 26, 36 AND 38).

SN 76-364,403. REVENIO, INC., BURLINGTON, MA. FILED 1-29-2002.

REVENIO MESSENGER

NO CLAIM IS MADE TO THE EXCLUSIVE RIGHT TO USE "MESSENGER", APART FROM THE MARK AS SHOWN.

FOR COMPUTER SOFTWARE, NAMELY ELECTRONIC MAIL CAMPAIGN MANAGEMENT SOFTWARE THAT ENABLES A USER TO CREATE, TEST, SEND, AND, BASED ON MESSAGE METRICS, ANALYZE THE EFFECTIVENESS OF CONTENT-LADEN ELECTRONIC MAIL MESSAGES (U.S. CLS. 21, 23, 26, 36 AND 38).

SN 76-364,440. IGT, RENO, NV. FILED 1-27-2002.

SPOOKY

FOR GAMING MACHINES, NAMELY, SLOT MACHINES WITH OR WITHOUT A VIDEO OUTPUT (U.S. CLS. 21, 23, 26, 36 AND 38).

SN 76-364,821. BABY SCHOOL COMPANY, INC., CORAL GABLES, FL. FILED 1-30-2002.

GOODE OLD FASHIONED VALUES FOR TODAY'S KIDS

FOR PRE-RECORDED EDUCATIONAL AUDIO AND VIDEO RECORDINGS FOR CHILDREN, NAMELY, DVDS, COMPACT DISCS, AND VIDEO TAPES; INTERACTIVE MULTIMEDIA COMPUTER GAME PROGRAMS; AND INTERACTIVE VIDEO GAME PROGRAMS (U.S. CLS. 21, 23, 26, 36 AND 38).

CLASS 9—(Continued).

SN 76-365,054. MEDVANTX, INC., SAN DIEGO, CA. FILED 1-29-2002.

WRITESTART

FOR COMPUTER HARDWARE AND SOFTWARE AND WEB-ENABLED TOOLS USED IN AUTOMATED ONLINE ORDERING, DELIVERY, DISPENSING AND REIMBURSEMENT OF PRESCRIPTION MEDICATION AND MEDICAL SUPPLIES, ROUTING OF PRESCRIPTION REFILLS, MANAGING THE INVENTORY OF MEDICATIONS AND MEDICAL SUPPLIES, INSURANCE CLAIM PROCESSING AND RECORD KEEPING (U.S. CLS. 21, 23, 26, 36 AND 38).

SN 76-366,156. MATERIALS, INC., SANTA CLARA, CA. FILED 1-31-2002.

DESICA

FOR POWER OPERATED MACHINES, NAMELY, ABRASIVE POLISHERS FOR SEMICONDUCTOR WAFERS, PLASMA ETCHER POLISHERS FOR SEMICONDUCTOR WAFERS, AND CHEMICAL MECHANICAL POLISHERS FOR SEMICONDUCTOR WAFERS (U.S. CLS. 21, 23, 26, 36 AND 38).

SN 76-366,357. LEICA CAMERA AG, D-35606 SOLMS, FED REP GERMANY, FILED 2-5-2002.

PINMASTER

OWNER OF FED REP GERMANY REG. NO. 30030967, DATED 6-15-2000, EXPIRES 4-30-2010.

FOR OPTO-ELECTRONIC RANGE FINDERS INCORPORATED IN MONOCULARS OR BINOCULARS FOR VISUAL TARGET AIMING AND RANGE INDICATION (U.S. CLS. 21, 23, 26, 36 AND 38).

SN 76-366,686. BORGATA RECORDS LLC, ROCKFORD, IL. FILED 2-1-2002.

BORGATA RECORDS

NO CLAIM IS MADE TO THE EXCLUSIVE RIGHT TO USE "RECORDS", APART FROM THE MARK AS SHOWN. THE ENGLISH TRANSLATION OF THE WORD "BORGATA" IN THE MARK IS "VILLAGE".

FOR MUSICAL SOUND RECORDINGS (U.S. CLS. 21, 23, 26, 36 AND 38).

FIRST USE 1-0-2000; IN COMMERCE 8-0-2001.

CLASS 9—(Continued).

SN 76-367,272. CIRCADIAN INFORMATION SYSTEMS, INC., BOSTON, MA. FILED 2-4-2002.

CIRCADIAN INFORMATION SYSTEMS

OWNER OF U.S. REG. NOS. 2,499,821 AND 2,520,047.
NO CLAIM IS MADE TO THE EXCLUSIVE RIGHT TO USE "INFORMATION SYSTEMS", APART FROM THE MARK AS SHOWN.

FOR COMPUTER SOFTWARE FOR TRACKING, COMPILING, ANALYZING AND MANAGING ENERGY CONSUMPTION AND USERS' DOCUMENTATION DISTRIBUTED THEREWITH (U.S. CLS. 21, 23, 26, 36 AND 38).

FIRST USE 0-0-1995; IN COMMERCE 0-0-1995.

SN 76-367,599. X-RITE, INCORPORATED, GRANDVILLE, MI. FILED 2-6-2002.

X-RITECOLOR MASTER

OWNER OF U.S. REG. NO. 1,948,575.
FOR COMPUTER SOFTWARE FOR COLOR MANAGEMENT, NAMELY COLOR FORMULATION AND QUALITY ASSURANCE (U.S. CLS. 21, 23, 26, 36 AND 38).
FIRST USE 12-21-2001; IN COMMERCE 12-21-2001.

SN 76-367,774. TERABEAM CORPORATION, KIRKLAND, WA. FILED 2-5-2002.

TERABEAM MAGNA

OWNER OF U.S. REG. NOS. 2,398,305 AND 2,467,494.
FOR TELECOMMUNICATIONS AND NETWORKING EQUIPMENT, NAMELY, TRANSCEIVERS AND OPERATING SOFTWARE FOR THE TRANSMISSION, DISTRIBUTION, MANIPULATION AND RETRIEVAL OF DATA, IMAGES, VIDEO AND SOUND OVER LOCAL AREA NETWORKS, WIDE AREA NETWORKS AND GLOBAL COMPUTER NETWORKS (U.S. CLS. 21, 23, 26, 36 AND 38).

SN 76-367,834. BIOCUM L.L.C., THE WOODLANDS, TX. FILED 2-7-2002.

FACEVALUE

FOR SYSTEM COMPRISED OF CAMERAS, COMPUTERS, CIRCUIT BOARDS, AND SOFTWARE MODULES FOR USE IN BIOMETRICALLY-BASED ACCESS CONTROL (U.S. CLS. 21, 23, 26, 36 AND 38).

CLASS 9—(Continued).

SN 76-367,886. NASSDA CORPORATION, SANTA CLARA, CA. FILED 2-5-2002.

NASSDA

FOR COMPUTER SOFTWARE FOR ANALYSIS AND SIMULATION OF ELECTRONIC CIRCUITS, AND MANUALS DISTRIBUTED AS A UNIT (U.S. CLS. 21, 23, 26, 36 AND 38).

FIRST USE 9-1-1998; IN COMMERCE 9-1-1998.

SN 76-367,932. BARSA CONSULTING GROUP, LLC, PURCHASE, NY. FILED 2-7-2002.

APRM

FOR COMPUTER SOFTWARE THAT REAPPORTIONS MEMORY, CPU POWER, AND INTERACTIVE USAGE ALLOWANCE PURSUANT TO WORKLOAD AND USER PRIORITY (U.S. CLS. 21, 23, 26, 36 AND 38).

SN 76-368,171. RIGHT HAND MANAGER SOFTWARE LLC, KIRKLAND, WA. FILED 2-6-2002.

BUILDMETRIX

FOR COMPUTER SOFTWARE FOR MONITORING, MEASURING AND ANALYZING MARGIN AND PRODUCT MIX DURING THE MANUFACTURING PROCESS (U.S. CLS. 21, 23, 26, 36 AND 38).

SN 76-368,470. EMPACT SOLUTIONS, INC., NEW YORK, NY. FILED 2-8-2002.

EYEQ

FOR COMPUTER HARDWARE AND SOFTWARE FOR INDEPENDENT VERIFICATION OF SERVICE LEVEL AGREEMENTS (U.S. CLS. 21, 23, 26, 36 AND 38).

SN 76-368,681. ALLIANT SYSTEMS, INC., LAKE FOREST, CA. FILED 2-8-2002.

SOFTWARE DEVELOPMENT NAVIGATOR

NO CLAIM IS MADE TO THE EXCLUSIVE RIGHT TO USE "SOFTWARE DEVELOPMENT", APART FROM THE MARK AS SHOWN.

FOR COMPUTER SOFTWARE FOR USE IN THE DEBUGGING OF COMPUTER PROGRAMS (U.S. CLS. 21, 23, 26, 36 AND 38).

CLASS 9—(Continued).

SN 76-368,783. TRUE LOGIC COMPANY, L.L.C., DALLAS, TX. FILED 2-8-2002.

TRUECHEM

FOR COMPUTER SOFTWARE FOR CHEMICAL ANALYSIS AND STATISTICAL CONTROL FOR MANUFACTURING PROCESSES (U.S. CLS. 21, 23, 26, 36 AND 38).
FIRST USE 11-10-1988; IN COMMERCE 11-10-1988.

SN 76-369,678. NU-METRICS, INC., UNIONTOWN, PA. FILED 2-11-2002.

VSD-3000

FOR ELECTRONIC VEHICLE SPEED DISPLAY SIGN (U.S. CLS. 21, 23, 26, 36 AND 38).

SN 76-369,848. NIPPON COLUMBIA CO., LTD., MINATOKU, TOKYO 107, JAPAN, FILED 2-13-2002.



NO CLAIM IS MADE TO THE EXCLUSIVE RIGHT TO USE "JAZZ", APART FROM THE MARK AS SHOWN.

FOR PHONOGRAPH RECORDS, CASSETTES AND COMPACT DISCS CONTAINING MUSIC (U.S. CLS. 21, 23, 26, 36 AND 38).

FIRST USE 10-0-1992; IN COMMERCE 10-0-1992.

SN 76-370,374. SPHATIKA INTERNATIONAL LLC, NEW YORK, NY. FILED 2-12-2002.

SPHATIKA

FOR PRERECORDED VIDEO TAPES, AUDIO TAPES, LASER DISCS, VIDEO DISCS, COMPACT DISCS, CD-ROMS AND DVDS IN THE FIELDS OF LIFESTYLE, HEALTH AND BEAUTY; PRERECORDED AUDIO CASSETTES AND COMPACT DISCS FEATURING MUSIC (U.S. CLS. 21, 23, 26, 36 AND 38).

CLASS 9—(Continued).

SN 76-370,432. R.E. DAVIS CHEMICAL CORPORATION, OAK BROOK, IL. FILED 2-13-2002.

DOT-IR

FOR LABORATORY EQUIPMENT, NAMELY, SAMPLE RESTRAINTS FOR USE IN ANALYTICAL AND INSTRUMENTAL CHEMICAL ANALYSIS (U.S. CLS. 21, 23, 26, 36 AND 38).

SN 76-370,976. ALCOR, INC., SAN ANTONIO, TX. FILED 2-15-2002.

ALCOR

OWNER OF U.S. REG. NO. 2,247,300.
FOR PETROCHEMICAL, FUEL AND LUBRICANT RESEARCH AND TESTING INSTRUMENTS AND EQUIPMENT, NAMELY, JET FUEL THERMAL OXIDATION TESTERS, HIGH TEMPERATURE DEPOSITION TESTERS, VISUAL TUBE RATERS, MICROCARBON RESIDUE TESTERS, HOT LIQUID PROCESS SIMULATORS, POUR POINT DETECTORS, MOISTURE ANALYZERS, AND HEAT EXCHANGER STATIONS (U.S. CLS. 21, 23, 26, 36 AND 38).
FIRST USE 3-0-1963; IN COMMERCE 3-0-1963.

SN 76-371,320. GOTHE, AXEL, NEW YORK, NY. FILED 2-15-2002.

BLU  UMAGIC

FOR EYE WEAR, NAMELY— SUN GLASSES, EYE GLASSES (U.S. CLS. 21, 23, 26, 36 AND 38).

SN 76-371,357. INTERNATIONAL BARCODE CORPORATION, NEW YORK, NY. FILED 2-15-2002.

BROADCODE

FOR COMPUTER PROGRAMS FOR GENERATING BARCODES (U.S. CLS. 21, 23, 26, 36 AND 38).

SN 76-371,358. INTERNATIONAL BARCODE CORPORATION, NEW YORK, NY. FILED 2-15-2002.

SQUAAD

FOR COMPUTER PROGRAMS FOR ERROR PREVENTION IN GRAPHIC GENERATING (U.S. CLS. 21, 23, 26, 36 AND 38).

CLASS 9—(Continued).

SN 76-372,175. JOHNSON & JOHNSON, NEW BRUNSWICK, NJ. FILED 2-20-2002.

COLOURS-WRAPPED-IN-COMFORT

FOR CONTACT LENSES (U.S. CLS. 21, 23, 26, 36 AND 38).

SN 76-372,389. CYBIKO INCORPORATED, BLOOMINGDALE, IL. FILED 2-20-2002.

BUSTIN BLOX

FOR HAND-HELD VIDEO GAMES, VIDEO GAMES CARTRIDGES, COMPUTER GAME CARTRIDGES AND COMPUTER GAME SOFTWARE ON CD-ROM, DISKETTE AND DOWNLOADED FROM A GLOBAL COMPUTER NETWORK (U.S. CLS. 21, 23, 26, 36 AND 38).
FIRST USE 10-27-2000; IN COMMERCE 10-27-2000.

SN 76-372,391. CYBIKO INCORPORATED, BLOOMINGDALE, IL. FILED 2-20-2002.

ARMOUR OF GOD

NO CLAIM IS MADE TO THE EXCLUSIVE RIGHT TO USE "GOD", APART FROM THE MARK AS SHOWN.
FOR HAND-HELD VIDEO GAMES, VIDEO GAMES CARTRIDGES, COMPUTER GAME CARTRIDGES AND COMPUTER GAME SOFTWARE ON CD-ROM, DISKETTE AND DOWNLOADED FROM A GLOBAL COMPUTER NETWORK (U.S. CLS. 21, 23, 26, 36 AND 38).
FIRST USE 11-18-2000; IN COMMERCE 11-18-2000.

SN 76-372,401. CYBIKO INCORPORATED, BLOOMINGDALE, IL. FILED 2-20-2002.

BLAZING BOARDS

FOR HAND-HELD VIDEO GAMES, VIDEO GAMES CARTRIDGES, COMPUTER GAME CARTRIDGES AND COMPUTER GAME SOFTWARE ON CD-ROM, DISKETTE AND DOWNLOADED FROM A GLOBAL COMPUTER NETWORK (U.S. CLS. 21, 23, 26, 36 AND 38).
FIRST USE 2-11-2001; IN COMMERCE 2-11-2001.

CLASS 9—(Continued).

SN 76-372,402. CYBIKO INCORPORATED, BLOOMINGDALE, IL. FILED 2-20-2002.

ROVER REUNION

FOR HAND-HELD VIDEO GAMES, VIDEO GAMES CARTRIDGES, COMPUTER GAME CARTRIDGES AND COMPUTER GAME SOFTWARE ON CD-ROM, DISKETTE AND DOWNLOADED FROM A GLOBAL COMPUTER NETWORK (U.S. CLS. 21, 23, 26, 36 AND 38).
FIRST USE 4-11-2001; IN COMMERCE 4-11-2001.

SN 76-372,405. CYBIKO INCORPORATED, BLOOMINGDALE, IL. FILED 2-20-2002.

ROBORAMPAGE

FOR HAND-HELD VIDEO GAMES, VIDEO GAMES CARTRIDGES, COMPUTER GAME CARTRIDGES AND COMPUTER GAME SOFTWARE ON CD-ROM, DISKETTE AND DOWNLOADED FROM A GLOBAL COMPUTER NETWORK (U.S. CLS. 21, 23, 26, 36 AND 38).
FIRST USE 3-8-2001; IN COMMERCE 3-8-2001.

SN 76-372,406. CYBIKO INCORPORATED, BLOOMINGDALE, IL. FILED 2-20-2002.

R-BALL

FOR HAND-HELD VIDEO GAMES, VIDEO GAMES CARTRIDGES, COMPUTER GAME CARTRIDGES AND COMPUTER GAME SOFTWARE ON CD-ROM, DISKETTE AND DOWNLOADED FROM A GLOBAL COMPUTER NETWORK (U.S. CLS. 21, 23, 26, 36 AND 38).
FIRST USE 10-14-2000; IN COMMERCE 10-14-2000.

SN 76-372,980. CRAVE ENTERTAINMENT, INC., RANCHO DOMINGUEZ, CA. FILED 2-20-2002.

AXIS OF EVIL

FOR COMPUTER GAME PROGRAMS; COMPUTER GAME SOFTWARE; COMPUTER GAME CARTRIDGES; COMPUTER GAME DISCS; VIDEO GAME PROGRAMS; VIDEO GAME SOFTWARE; VIDEO GAME CARTRIDGES; AND VIDEO GAME DISCS (U.S. CLS. 21, 23, 26, 36 AND 38).

CLASS 9—(Continued).

SN 76-373,124. INNOTEK, INC., GARRETT, IN. FILED 2-20-2002.

ENJOY YOUR DOG

FOR ELECTRICAL ANIMAL BEHAVIOR TRAINING AND CONTROL SYSTEMS, NAMELY REMOTE TRAINING SYSTEMS CONSISTING OF ELECTRICAL RADIO FREQUENCY TRANSMITTERS AND REMOTE CONTROLLED ELECTRICAL RECEIVER ANIMAL COLLARS; ELECTRICAL BARKING CONTROL ANIMAL COLLARS; ELECTRONIC PET CONTAINMENT SYSTEMS CONSISTING OF ELECTRICAL TRANSMITTERS AND ELECTRICAL RECEIVER ANIMAL COLLARS; ELECTRICALLY CONTROLLED PET DOORS CONSISTING OF AN ELECTRICAL RECEIVER AND DOOR ACTUATOR; AND ELECTRICAL ANIMAL TRACKING AND LOCATING SYSTEMS CONSISTING OF ELECTRICAL RECEIVERS AND ELECTRICAL ANIMAL TRANSMITTER COLLARS (U.S. CLS. 21, 23, 26, 36 AND 38).

FIRST USE 1-7-2002; IN COMMERCE 2-1-2002.

SN 76-373,181. SCARBOROUGH, DANE, HAILEY, ID. FILED 2-9-2002.

NEXT

FOR TAPE MEASURES (U.S. CLS. 21, 23, 26, 36 AND 38).

SN 76-373,229. PHARMACY DATA SYSTEMS, INC., EAGLE RIVER, WI. FILED 2-21-2002.

NURPRO

FOR COMPUTER SOFTWARE AND ACCOMPANYING MANUALS SOLD AS A UNIT FOR USE IN PHARMACY MANAGEMENT BY LONG TERM CARE FACILITIES (U.S. CLS. 21, 23, 26, 36 AND 38).

FIRST USE 8-0-1993; IN COMMERCE 8-0-1993.

SN 76-374,023. AVESTA SYSTEMS, COSTA MESA, CA. FILED 2-22-2002.

POCKETSUNC

FOR COMPUTER HARDWARE DEVICES, NAMELY ALL MANNER OF FIXED, PORTABLE, MOBILE, HANDHELD OR OTHERWISE PERIPHERAL DEVICES HAVING DATA STORAGE CAPACITY, AND NAMELY DATA STORAGE DEVICES FOR STORING ALL MANNER OF ELECTRONIC DATA; PORTABLE OR HANDHELD DATA BACKUP DEVICES; COMPUTER SOFTWARE FOR USE WITH AND PROVIDING AN INTERFACE TO HARDWARE DATA STORAGE DEVICES (U.S. CLS. 21, 23, 26, 36 AND 38).

CLASS 9—(Continued).

SN 76-374,256. DEEPOUTDOORS, INC., POWAY, CA. FILED 2-21-2002.

DRI-FUSION

FOR DIVING SUIT (U.S. CLS. 21, 23, 26, 36 AND 38).

SN 76-374,671. A.V.W. INC, FT. LAUDERDALE, FL. FILED 2-25-2002.

PUT OUT

FOR SPRAY FIRE EXTINGUISHER (U.S. CLS. 21, 23, 26, 36 AND 38).

FIRST USE 5-12-2001; IN COMMERCE 8-11-2001.

SN 76-374,932. VALENCIA, URIEL A., LOS ANGELES, CA. FILED 2-26-2002.

LOS CAPOS DE MEXICO

OWNER OF U.S. REG. NO. 2,257,834.

NO CLAIM IS MADE TO THE EXCLUSIVE RIGHT TO USE "MEXICO", APART FROM THE MARK AS SHOWN.

THE ENGLISH TRANSLATION OF "LOS CAPOS DE MEXICO" IS "THE TOP BOSSES OF MEXICO" OR "THE GODFATHERS OF MEXICO".

FOR SERIES OF PRE-RECORDED AUDIO CASSETTES AND COMPACT DISCS, VIDEO CASSETTES, VIDEO DISCS AND RECORDS CONTAINING MUSIC (U.S. CLS. 21, 23, 26, 36 AND 38).

FIRST USE 7-14-1997; IN COMMERCE 7-14-1997.

SN 76-375,244. SCHLUMBERGER TECHNOLOGY CORPORATION, HOUSTON, TX. FILED 2-26-2002.

SEISSTREAM

FOR COMPUTER SOFTWARE FOR OIL AND GAS EXPLORATION AND PRODUCTION, NAMELY, SEISMIC DATA MANAGEMENT COMPUTER SOFTWARE FOR THE OIL AND GAS INDUSTRY AND MANUALS DISTRIBUTED THEREWITH (U.S. CLS. 21, 23, 26, 36 AND 38).

SN 76-375,531. CREATIVE TECHNOLOGY LTD., SINGAPORE 609921, REPUBLIC OF KOREA, FILED 2-26-2002.

CREATIVE TRAVELSOUND

FOR COMPUTER HARDWARE; COMPUTER PERIPHERALS; ELECTRONIC AUDIO COMPONENTS, NAMELY, SOUND SYSTEMS, AMPLIFIERS, STEREO LOUDSPEAKERS, DIGITAL AUDIO PLAYERS, COMPACT DISC PLAYERS, RADIOS (U.S. CLS. 21, 23, 26, 36 AND 38).

CLASS 9—(Continued).

SN 76-375,611. KABUSHIKI KAISHA TOSHIBA, DBA TOSHIBA CORPORATION, MINATO-KU, TOKYO, JAPAN, FILED 2-27-2002.

HARNESSEYE/WEB

FOR COMPUTER PROGRAMS FOR OFFERING SERVER MANAGEMENT REMOTELY (U.S. CLS. 21, 23, 26, 36 AND 38).

SN 76-376,386. ATWOOD INDUSTRIES, INC., ROCKFORD, IL. FILED 2-28-2002.

ALL-ON-ONE

FOR CONTROLLERS, NAMELY CONTROLLERS FOR ELECTROMECHANICAL LEVELERS (U.S. CLS. 21, 23, 26, 36 AND 38).

SN 76-376,519. LEARNING GORILLA LLC, QUINCY, MA. FILED 3-1-2002.

LEARNING GORILLA

NO CLAIM IS MADE TO THE EXCLUSIVE RIGHT TO USE "LEARNING", APART FROM THE MARK AS SHOWN. FOR DOWNLOADABLE ELECTRONIC PUBLICATIONS IN THE NATURE OF CONSULTING AND EDUCATIONAL MANUALS IN THE FIELD OF EMPLOYMENT TRAINING (U.S. CLS. 21, 23, 26, 36 AND 38).

SN 76-377,066. COMPUTER SCIENCES CORPORATION, EL SEGUNDO, CA. FILED 2-27-2002.

CHECKVISION

OWNER OF U.S. REG. NO. 2,056,149. FOR COMPUTER PROGRAM FOR USE BY BANKS AND OTHER FINANCIAL INSTITUTIONS FOR CHECK IMAGE ARCHIVING AND RETRIEVAL AND PRINTED USER MANUALS SOLD AS A UNIT THEREWITH (U.S. CLS. 21, 23, 26, 36 AND 38). FIRST USE 11-27-1995; IN COMMERCE 11-27-1995.

SN 76-377,155. HITACHI INSTRUMENTS, INC., SAN JOSE, CA. FILED 3-1-2002.

LACHROM ELITE

OWNER OF U.S. REG. NO. 2,388,296. FOR HIGH PRESSURE LIQUID CHROMATOGRAPHY SYSTEM, NAMELY, OPTICAL BEAM DETECTORS, AUTO SAMPLERS, COMPUTER OPERATING PROGRAMS, AND PROGRAMMABLE PUMPS (U.S. CLS. 21, 23, 26, 36 AND 38).

CLASS 9—(Continued).

SN 76-377,347. ACHATES SYSTEMS, INC., POTOMAC, MD. FILED 3-2-2002.

INTELLICHANGE

FOR COMPUTER SOFTWARE USED FOR FINANCIAL COST AND SCOPE CONTROL AND ACCOUNTABILITY THAT HISTORICALLY TRACKS BUDGETS, COSTS AND SCOPE, TRACKS VENDOR COMMITMENTS AND PROVIDES CHANGE MANAGEMENT (U.S. CLS. 21, 23, 26, 36 AND 38).

SN 76-377,954. INGRIAN NETWORKS, INC., REDWOOD CITY, CA. FILED 3-4-2002.

I100

FOR COMPUTER HARDWARE AND SOFTWARE WHICH PROVIDES SECURITY TO COMPUTER NETWORKS (U.S. CLS. 21, 23, 26, 36 AND 38). FIRST USE 7-5-2001; IN COMMERCE 7-5-2001.

SN 76-378,004. ARISTOCRAT TECHNOLOGIES, INC., LAS VEGAS, NV. FILED 3-5-2002.

G SPOT

FOR GAMING DEVICES, NAMELY, GAMING MACHINES AND ASSOCIATED SOFTWARE FOR USE THEREWITH (U.S. CLS. 21, 23, 26, 36 AND 38).

SN 76-378,005. ARISTOCRAT TECHNOLOGIES, INC., LAS VEGAS, NV. FILED 3-5-2002.

FEED BAG

FOR GAMING DEVICES, NAMELY, GAMING MACHINES AND ASSOCIATED SOFTWARE FOR USE THEREWITH (U.S. CLS. 21, 23, 26, 36 AND 38).

SN 76-378,006. ARISTOCRAT TECHNOLOGIES, INC., LAS VEGAS, NV. FILED 3-5-2002.

BOTTOMS UP

FOR GAMING DEVICES, NAMELY, GAMING MACHINES AND ASSOCIATED SOFTWARE FOR USE THEREWITH (U.S. CLS. 21, 23, 26, 36 AND 38).

CLASS 9—(Continued).

SN 76-378,007. ARISTOCRAT TECHNOLOGIES, INC., LAS VEGAS, NV. FILED 3-5-2002.

MONKEY BARS

FOR GAMING DEVICES, NAMELY, GAMING MACHINES AND ASSOCIATED SOFTWARE FOR USE THEREWITH (U.S. CLS. 21, 23, 26, 36 AND 38).

SN 76-378,008. ARISTOCRAT TECHNOLOGIES, INC., LAS VEGAS, NV. FILED 3-5-2002.

PAYOLA

FOR GAMING DEVICES, NAMELY, GAMING MACHINES AND ASSOCIATED SOFTWARE FOR USE THEREWITH (U.S. CLS. 21, 23, 26, 36 AND 38).

SN 76-378,106. STRATOS LIGHTWAVE, INC., CHICAGO, IL. FILED 3-4-2002.



FOR OPTICAL SUBSYSTEMS AND COMPONENTS, NAMELY OPTOELECTRONIC TRANSCEIVERS, FIBER OPTIC CONNECTORS, COUPLINGS, ADAPTERS, TERMINATORS, AND CABLE ASSEMBLIES, CONSISTING OF FIBER OPTIC FERRULES, CONNECTORS, COUPLINGS, ADAPTERS AND CABLES (U.S. CLS. 21, 23, 26, 36 AND 38).

FIRST USE 7-0-2000; IN COMMERCE 7-0-2000.

CLASS 9—(Continued).

SN 76-378,265. NORTH TEXAS TOLLWAY AUTHORITY, PLANO, TX. FILED 3-6-2002.

FOR COMPUTER SOFTWARE FOR ELECTRONIC TOLL COLLECTION, NAMELY - AUTOMATIC PRE-AUDIT, AUDIT, RECONCILIATION AND REPORTING OF REVENUES AND TRAFFIC; AUTOMATIC VEHICLE IDENTIFICATION, PATRON ACCOUNT MANAGEMENT, IDENTIFICATION TAG DISTRIBUTION AND INVENTORY MANAGEMENT, AND AUTOMATIC TRANSACTION POSTING, CREDIT CARD REBILLS AND STATEMENT GENERATION; TOLL VIOLATION IMAGE REVIEW, INVOICE GENERATION, VIOLATION PAYMENT PROCESSING AND AUTOMATIC TRAFFIC CITATION GENERATION; REAL-TIME OPERATIONAL AND MAINTENANCE MANAGEMENT FOR TOLL COLLECTION TRANSACTIONS AND COMMUNICATION WITH TOLL LANES; AND REAL-TIME TOLL COLLECTION SUPPORT FOR TOLL ATTENDANTS, AUTOMATIC COIN MACHINES, AUTOMATIC VEHICLE IDENTIFICATION, AUTOMATIC VEHICLE CLASSIFICATION AND VIOLATION ENFORCEMENT IMAGE CAPTURE CAMERAS (U.S. CLS. 21, 23, 26, 36 AND 38).

SN 76-378,385. DIGI INTERNATIONAL INC., MINNETONKA, MN. FILED 3-4-2002.

PROCERA FXP

THE WORDING "PROCERA" AND "FXP" HAVE NO MEANING OTHER THAN TRADEMARK SIGNIFICANCE. FOR COMPUTER HARDWARE (U.S. CLS. 21, 23, 26, 36 AND 38).

SN 76-378,578. LION APPAREL, INC., DAYTON, OH. FILED 3-5-2002.

ISODRI

FOR COMPONENTS OF FIREFIGHTERS' PROTECTIVE CLOTHING, NAMELY, OUTER SHELLS, MOISTURE BARRIERS, THERMAL LINERS AND WRISTLETS (U.S. CLS. 21, 23, 26, 36 AND 38).

FIRST USE 9-1-1998; IN COMMERCE 9-30-1998.

CLASS 9—(Continued).

SN 76-378,585. FMC TECHNOLOGIES, INC., CHICAGO, IL.
FILED 3-5-2002.

SYBERTROL

FOR COMPUTER SYSTEMS, NAMELY, COMPUTER HARDWARE AND SOFTWARE, SOLD AS A UNIT, FOR USE IN THE OIL AND GAS INDUSTRIES TO MEASURE, MONITOR, AND ACCOUNT FOR PETROLEUM (U.S. CLS. 21, 23, 26, 36 AND 38).

FIRST USE 6-0-1995; IN COMMERCE 6-0-1995.

SN 76-378,626. CAPO INCORPORATED, ORMOND BEACH, FL. FILED 3-6-2002.

EYEFIRE OPTICS

NO CLAIM IS MADE TO THE EXCLUSIVE RIGHT TO USE "OPTICS", APART FROM THE MARK AS SHOWN.

FOR EYEWEAR, NAMELY, EYE GLASSES AND SUNGLASSES (U.S. CLS. 21, 23, 26, 36 AND 38).

SN 76-378,770. SAMSUNG ELECTRONICS CO., LTD., SUWON-CITY, KYUNGKI-DO, REPUBLIC OF KOREA, FILED 3-1-2002.

DEFY THE ORDINARY

FOR MONITORS, NAMELY, COMPUTER MONITORS AND TELEVISION MONITORS (U.S. CLS. 21, 23, 26, 36 AND 38).

FIRST USE 5-0-2000; IN COMMERCE 5-0-2000.

SN 76-378,821. NEW FRONTIER ELECTRONICS, INC., PIPERSVILLE, PA. FILED 3-7-2002.

EMPOWER

FOR EQUIPMENT FOR ELIMINATING UNDESIRE CHARACTERISTICS FROM A POWER TRANSMISSION SIGNAL, NAMELY SURGE SUPPRESSORS, NOISE FILTERS, IN-RUSH CURRENT SUPPRESSORS AND COMBINATIONS THEREOF (U.S. CLS. 21, 23, 26, 36 AND 38).

SN 76-378,837. ARISTOCRAT TECHNOLOGIES, INC., LAS VEGAS, NV. FILED 3-5-2002.

TREASURE OF THE SWORD

FOR GAMING DEVICES, NAMELY, GAMING MACHINES AND ASSOCIATED SOFTWARE FOR USE THEREWITH; (U.S. CLS. 21, 23, 26, 36 AND 38).

CLASS 9—(Continued).

SN 76-378,881. VIDEODISCOVERY, INC., SEATTLE, WA. FILED 3-6-2002.

VIDEODISCOVERY

FOR AUDIO-VISUAL TEACHING SYSTEM COMPRISING THE FOLLOWING - VIDEO DISCS FEATURING STILL IMAGES, COMPUTER GRAPHICS, COMPUTER ANIMATION AND FILM SEQUENCES IN THE AREAS OF MATH AND SCIENCE; COMPUTER PROGRAMS FEATURING STILL IMAGES, COMPUTER GRAPHICS, COMPUTER ANIMATION AND FILM SEQUENCES IN THE AREAS OF MATH AND SCIENCE; ELECTRONIC MEDIA, NAMELY CD-ROMS (COMPACT DISK READ-ONLY MEMORIES) FEATURING STILL IMAGES, COMPUTER GRAPHICS, COMPUTER ANIMATION AND FILM SEQUENCES IN THE AREAS OF MATH AND SCIENCE; COMPUTER INTERFACE UNITS AND ACCOMPANYING TEACHERS' MANUALS AND STUDENT BOOKS SOLD TOGETHER AS A UNIT (U.S. CLS. 21, 23, 26, 36 AND 38).

FIRST USE 9-15-1983; IN COMMERCE 9-15-1983.

SN 76-378,945. PANAMA JACK INTERNATIONAL, INC., ORLANDO, FL. FILED 3-6-2002.



THE STIPPLING IS A FEATURE OF THE MARK AND DOES NOT INDICATE COLOR.

AS SHOWN IN THE ACCOMPANYING DRAWING, THE MARK IS COMPRISED OF THE DESIGN OF A MAN WITH A MOUSTACHE WEARING SUNGLASSES AND A HAT.

FOR SUNGLASSES (U.S. CLS. 21, 23, 26, 36 AND 38).

FIRST USE 10-1-1997; IN COMMERCE 10-1-1997.

SN 76-379,035. BENNINGFIELD, SHERI LYNN, III, LEWISVILLE, TX. FILED 3-5-2002.

LISTMAGNET

FOR HOUSEHOLD ORGANIZER, NAMELY PORTABLE MAGNETIC SHOPPING LIST (U.S. CLS. 21, 23, 26, 36 AND 38).

CLASS 9—(Continued).

SN 76-379,037. ARISTOCRAT TECHNOLOGIES, INC., LAS VEGAS, NV. FILED 3-5-2002.

PARADOX

FOR GAMING DEVICES, NAMELY, GAMING MACHINES AND ASSOCIATED SOFTWARE FOR USE THEREWITH (U.S. CLS. 21, 23, 26, 36 AND 38).

SN 76-379,038. ARISTOCRAT TECHNOLOGIES, INC., LAS VEGAS, NV. FILED 3-5-2002.

PAY IT FORWARD

FOR GAMING DEVICES, NAMELY, GAMING MACHINES AND ASSOCIATED SOFTWARE FOR USE THEREWITH (U.S. CLS. 21, 23, 26, 36 AND 38).

SN 76-379,253. TIFFEN COMPANY, L.L.C., THE, HAUPAUGE, NY. FILED 3-8-2002.



FOR CAMERA TRIPODS (U.S. CLS. 21, 23, 26, 36 AND 38).
FIRST USE 0-0-1930; IN COMMERCE 0-0-1930.

SN 76-379,824. PC-TEL, INC., MILPITAS, CA. FILED 3-7-2002.

MODEMTUNE

FOR INTEGRATED CIRCUITS AND COMPUTER SOFTWARE USED FOR MODEM SIGNAL PROCESSING (U.S. CLS. 21, 23, 26, 36 AND 38).

SN 76-380,237. COOPER POWER SYSTEMS, INC., HOUSTON, TX. FILED 3-11-2002.

LINEMINDER

FOR ELECTRIC POWER SWITCHES (U.S. CLS. 21, 23, 26, 36 AND 38).
FIRST USE 5-31-1991; IN COMMERCE 5-31-1991.

CLASS 9—(Continued).

SN 76-380,310. DATACOR, INC., FLORHAM PARK, NJ. FILED 3-8-2002.

CHEMNOTES

FOR COMPUTER PROGRAMS TO ASSIST EXECUTIVES IN THE CHEMICAL INDUSTRY WITH CONTROL OVER DAILY OPERATIONS, ADMINISTRATION AND RECORD KEEPING (U.S. CLS. 21, 23, 26, 36 AND 38).
FIRST USE 1-0-1993; IN COMMERCE 10-0-1993.

SN 76-380,433. COVERAGEEXPRESS, LLC, FRISCO, TX. FILED 3-11-2002.

COVERAGEXPRESS

FOR COMPUTER SOFTWARE, NAMELY SOFTWARE THAT FACILITATES ONLINE TRANSACTIONS AND INTEGRATES SYSTEMS USED THEREWITH FOR INSURANCE PRODUCTS (U.S. CLS. 21, 23, 26, 36 AND 38).

SN 76-380,457. BROOKS BROTHERS, INC., NEW YORK, NY. FILED 3-11-2002.

BROOKS

FOR EYEGLASSES, NAMELY, SPECTACLES, SPECTACLE FRAMES, SUNGLASSES, EYEGLASS CHAINS, LANYARDS FOR HOLDING EYEGLASSES, EYEGLASS CASES AND EYEGLASS LENS (U.S. CLS. 21, 23, 26, 36 AND 38).

SN 76-380,650. SINEX AVIATION TECHNOLOGIES CORPORATION, DULUTH, MN. FILED 3-11-2002.

FLEETCYCLE

FOR COMPUTER SOFTWARE FOR USE IN TRACKING, SCHEDULING AND MONITORING AIRCRAFT MAINTENANCE REQUIREMENTS (U.S. CLS. 21, 23, 26, 36 AND 38).
FIRST USE 1-23-2002; IN COMMERCE 1-23-2002.

SN 76-381,041. BERGANA COMMUNICATIONS, INC., PALO ALTO, CA. FILED 3-11-2002.

BERMAI

FOR WIRELESS AND WIRELINE APPLICATION SPECIFIC INTEGRATED CIRCUITS; COMPUTER SOFTWARE FOR OPERATING, MONITORING AND INTERFACING WITH WIRELESS AND WIRELINE COMMUNICATION DEVICES AND SYSTEMS (U.S. CLS. 21, 23, 26, 36 AND 38).

CLASS 9—(Continued).

SN 76-381,120. DESCO INDUSTRIES INCORPORATED, CHINO, CA. FILED 3-12-2002.

JEWEL

FOR APPARATUS FOR ELECTROSTATIC GROUNDING OF WORKERS WHO ASSEMBLE ELECTRONIC PARTS AND DEVICES, NAMELY, PROTECTIVE WRIST STRAPS, ELECTRICAL CORDS, AND FOOT GROUNDERS (U.S. CLS. 21, 23, 26, 36 AND 38).

FIRST USE 6-19-2001; IN COMMERCE 6-19-2001.

SN 76-381,266. ABUNDANCE TECHNOLOGIES, INC., CINCINNATI, OH. FILED 3-12-2002.

**ESCAPING THE VICIOUS
DOWNWARD PLANNING
SPIRAL**

FOR COMPACT DISK RECORDING FEATURING A SEMINAR IN THE FIELD OF FINANCIAL ANALYSIS, CONSULTATION, FINANCIAL PLANNING AND FINANCIAL MANAGEMENT FOR INVESTORS (U.S. CLS. 21, 23, 26, 36 AND 38).

FIRST USE 1-15-1996; IN COMMERCE 1-15-1996.

SN 76-381,725. MOBILITY ELECTRONICS, INC., SCOTTSDALE, AZ. FILED 3-12-2002.

COOLSTAND

FOR LAPTOP COMPUTER STANDS (U.S. CLS. 21, 23, 26, 36 AND 38).

FIRST USE 2-0-2002; IN COMMERCE 2-0-2002.

SN 76-387,501. TARQUIN, BRIAN, N HOLLYWOOD, CA. FILED 3-26-2002.

ASPHALT JUNGLE

FOR SERIES OF MUSICAL SOUND RECORDINGS (U.S. CLS. 21, 23, 26, 36 AND 38).

FIRST USE 8-15-1997; IN COMMERCE 8-15-1997.

SN 76-391,933. DIGI INTERNATIONAL INC., MINNETONKA, MN. FILED 4-5-2002.

PROCERA MLS

FOR COMPUTER NETWORK CONNECTIVITY HARDWARE, WITH EMBEDDED SOFTWARE, FOR USE IN DATA COMMUNICATIONS BETWEEN DIGITAL ELECTRONIC DEVICES (U.S. CLS. 21, 23, 26, 36 AND 38).

CLASS 9—(Continued).

SN 76-391,934. DIGI INTERNATIONAL INC., MINNETONKA, MN. FILED 4-5-2002.

PROCERA CS

FOR COMPUTER NETWORK CONNECTIVITY HARDWARE, WITH EMBEDDED SOFTWARE, FOR USE IN DATA COMMUNICATIONS BETWEEN DIGITAL ELECTRONIC DEVICES (U.S. CLS. 21, 23, 26, 36 AND 38).

SN 76-391,935. DIGI INTERNATIONAL INC., MINNETONKA, MN. FILED 4-5-2002.

PROCERA RDS

FOR COMPUTER NETWORK CONNECTIVITY HARDWARE, WITH EMBEDDED SOFTWARE, FOR USE IN DATA COMMUNICATIONS BETWEEN DIGITAL ELECTRONIC DEVICES (U.S. CLS. 21, 23, 26, 36 AND 38).

SN 76-391,936. DIGI INTERNATIONAL INC., MINNETONKA, MN. FILED 4-5-2002.

PROCERA NETWORKS

NO CLAIM IS MADE TO THE EXCLUSIVE RIGHT TO USE "NETWORKS", APART FROM THE MARK AS SHOWN.

FOR COMPUTER NETWORK CONNECTIVITY HARDWARE, WITH EMBEDDED SOFTWARE, FOR USE IN DATA COMMUNICATIONS BETWEEN DIGITAL ELECTRONIC DEVICES (U.S. CLS. 21, 23, 26, 36 AND 38).

SN 78-002,775. TAVIZ TECHNOLOGY INCORPORATED, PALO ALTO, CA. FILED 4-5-2000.

TAVIZ

THE ENGLISH TRANSLATION OF THE FARSI WORD "TAVIZ" IN THE MARK IS "CHANGE".

FOR COMPUTER SOFTWARE FOR DATA AND CONTENT TRANSFORMATION AND INTEGRATION, NAMELY, SOFTWARE FOR CONNECTING TOGETHER ENTERPRISE SOFTWARE APPLICATIONS AND PLATFORMS, CUSTOMER RELATIONSHIP MANAGEMENT APPLICATIONS AND PLATFORMS, TRADING EXCHANGE AND MARKETPLACE SOFTWARE APPLICATIONS AND PLATFORMS, ELECTRONIC COMMERCE APPLICATIONS AND PLATFORMS, AND MIDDLEWARE PLATFORMS (U.S. CLS. 21, 23, 26, 36 AND 38).

CLASS 9—(Continued).

SN 78-005,130. HOMEMEETING, INC., REDMOND, WA. FILED 4-21-2000.

JOINNET

FOR MULTIMEDIA COMPUTER SOFTWARE ACTIVATED THROUGH WEB BROWSING WHICH ENABLES SIMULTANEOUS VIDEO, AUDIO, TEXT, AND VIDEO-FAX INFORMATION EXCHANGE FOR THE FACILITATION OF MEETINGS OVER THE INTERNET, FEATURING, AN ONLINE INTERACTIVE BOARD FOR PRESENTATION AND JOINT DISCUSSION; REAL-TIME HANDWRITING AND PRINTED DOCUMENT SCANNING VIA STANDARD PC CAMERA WHICH CAN BE TRANSPORTED TO THE INTERACTIVE BOARD FOR FURTHER DISCUSSION; AND A DYNAMIC COORDINATOR TO FACILITATE THE JOINT PRESENTATION (U.S. CLS. 21, 23, 26, 36 AND 38).

SN 78-009,741. WOLFE, GORDON M, SALT LAKE CITY, UT. FILED 5-24-2000.

TRADEBOTICS

FOR COMPUTER SOFTWARE FOR TRACKING AND ACCOUNTING FOR RISK MANAGEMENT ACTIVITY IN FINANCIAL MARKETS (U.S. CLS. 21, 23, 26, 36 AND 38).

FIRST USE 4-1-2000; IN COMMERCE 4-1-2000.

SN 78-017,019. VISA U.S.A. INC., FOSTER CITY, CA. FILED 7-17-2000.

DIRECT EXCHANGE

FOR COMPUTER HARDWARE, COMPUTER SOFTWARE FOR USE IN DATABASE MANAGEMENT, RISK MANAGEMENT, WORD PROCESSING, AS A SPREADSHEET AND FOR FACILITATING VOICE, TEXT AND PEN INPUT; COMPUTER OPERATING SYSTEMS; COMPUTER UTILITY PROGRAMS; COMPUTER PERIPHERALS; NETWORK MANAGEMENT PROGRAMS; COMPUTER PROGRAMS FOR MANAGING, VIEWING AND EDITING FILES, DOCUMENTS, ELECTRONIC MAIL MESSAGES AND PRIVATE NETWORK AND GLOBAL COMPUTER NETWORK COMMUNICATIONS; PRESENTATION GRAPHICS PROGRAMS, ELECTRONIC ACCESS DEVICES, NAMELY PERSONAL DIGITAL ASSISTANTS, SET TOP BOXES, WIRELESS COMMUNICATIONS DEVICES, MOBILE PHONES, POINT OF SALE DEVICES, AND COMPUTERS; AND THE USER MANUALS SOLD TOGETHER WITH ALL OF THE FOREGOING (U.S. CLS. 21, 23, 26, 36 AND 38).

CLASS 9—(Continued).

SN 78-019,111. JOERG, WERNER B., SALT LAKE CITY, UT. FILED 8-1-2000.

EX-STRACT

FOR COMPUTER SOFTWARE FOR THE AUTOMATED GATHERING OF ELECTRONIC DOCUMENTS THROUGH COMPUTER NETWORKS, AUTOMATIC KNOWLEDGE EXTRACTION, RATING, CLASSIFICATION AND COMPUTER-ASSISTED QUALIFICATION; THE RESULTING KNOWLEDGE ABOUT SELECT DOCUMENTS IS RETAINED AND MAINTAINED IN COMPUTER DATABASES; THE SOFTWARE IS OPERATED BY OWNERS OF SUCH KNOWLEDGE BASES; IT IS COMPLEMENTED WITH APPLICATION SPECIFIC DISTRIBUTION INTERFACES THAT PROVIDE TARGETED ACCESS TO THE STORED KNOWLEDGE (U.S. CLS. 21, 23, 26, 36 AND 38).

SN 78-022,937. INNOVATIVE CONTROLS SYSTEM, INC., NAZARETH, PA. FILED 8-25-2000.

LUBE MASTER

NO CLAIM IS MADE TO THE EXCLUSIVE RIGHT TO USE "LUBE", APART FROM THE MARK AS SHOWN.

FOR COMPUTER SOFTWARE FOR ACCOUNTING AND RETAIL OPERATIONS MANAGEMENT, NAMELY, THE MECHANICAL OPERATION OF AND FINANCIAL MANAGEMENT FOR THE MOTOR VEHICLE AND OIL CHANGE INDUSTRIES (U.S. CLS. 21, 23, 26, 36 AND 38).

SN 78-023,042. CAMO, INC., CORVALLIS, OR. FILED 8-25-2000.

MARKET SIZZLE

NO CLAIM IS MADE TO THE EXCLUSIVE RIGHT TO USE "MARKET", APART FROM THE MARK AS SHOWN.

FOR COMPUTER SOFTWARE USED TO ANALYZE CONSUMER ACTIONS, RESPONSES AND CHOICES AND FOR USE IN APPLYING SUCH UNDERSTANDING TO MARKETING, COMMUNICATION AND PRODUCT DEVELOPMENT NEEDS (U.S. CLS. 21, 23, 26, 36 AND 38).

SN 78-027,563. INDIGO INVESTMENT SYSTEMS, INC., SARASOTA, FL. FILED 9-25-2000.

ROTATIONAL TRADING STRATEGY

NO CLAIM IS MADE TO THE EXCLUSIVE RIGHT TO USE "TRADING STRATEGY", APART FROM THE MARK AS SHOWN.

FOR COMPUTER SOFTWARE FOR INVESTMENT AND STOCK DECISION MAKING, COMPUTER SOFTWARE FOR USE IN THE MANAGEMENT OF INVESTMENT PORTFOLIOS (U.S. CLS. 21, 23, 26, 36 AND 38).

FIRST USE 2-0-1999; IN COMMERCE 2-0-1999.

CLASS 9—(Continued).

SN 78-029,032. PEGASYSTEMS INC., CAMBRIDGE, MA. FILED 10-4-2000.

PEGAREELAY

OWNER OF U.S. REG. NOS. 1,348,464 AND 1,388,138.
FOR COMPUTER SOFTWARE FOR CUSTOMER RELATIONSHIP MANAGEMENT, FOR GENERAL BUSINESS USE AND USER MANUALS PACKAGED AS A UNIT THEREWITH; COMPUTER SOFTWARE FOR AUTOMATING THE LOCATION, RETRIEVAL AND PRINTING OF IMAGES FROM MICROFILM AND MICROFICHE RECORDS, AND USER MANUALS PACKAGED AS A UNIT THEREWITH (U.S. CLS. 21, 23, 26, 36 AND 38).

SN 78-030,038. EXOBRAIN, INC., CHATTANOOGA, TN. BY MERGER E-BRAIN SOLUTIONS, LLC, CHATTANOOGA, TN. FILED 10-10-2000.

COMPUTERS MADE HUMAN

FOR COMPUTER SOFTWARE FOR USE IN PROVIDING ELECTRONIC MAIL AND MESSAGING, WORD PROCESSING, FILE MANAGEMENT, SPREADSHEET, CALENDAR, VOICE RECOGNITION AND LANGUAGE RECOGNITION (U.S. CLS. 21, 23, 26, 36 AND 38).

SN 78-032,942. NUSPHERE CORPORATION, BEDFORD, MA. FILED 10-30-2000.

VOICE OF EXPERIENCE

FOR PRE-RECORDED CD-ROMS, DVDS, AND DOWNLOADABLE AUDIO RECORDINGS, ALL FEATURING SOUNDS AND IMAGES FOR CONVEYING INSTRUCTION AND INFORMATION REGARDING THE USE OF COMPUTER SOFTWARE AND RELATED USER MANUALS SOLD AS A UNIT (U.S. CLS. 21, 23, 26, 36 AND 38).

SN 78-036,160. INTELL-A-CHECK CORP., BELLEVILLE, NJ. FILED 11-21-2000.



OWNER OF U.S. REG. NO. 1,878,484.
FOR SOFTWARE PROGRAM FOR GENERATING BANKING DRAFTS USED IN DEBT COLLECTION (U.S. CLS. 21, 23, 26, 36 AND 38).
FIRST USE 12-29-1995; IN COMMERCE 12-29-1995.

CLASS 9—(Continued).

SN 78-036,583. TOTH, SZYLWIA, NOVATO, CA. FILED 11-27-2000.

SZYLWIA

THE NAME "SZYLWIA" IDENTIFIES A LIVING INDIVIDUAL WHOSE CONSENT IS OF RECORD.

FOR MUSICAL SOUND RECORDING; PRERECORDED PHONOGRAPH RECORDS, AUDIO CASSETTES, COMPACT DISCS, DVD'S, AND MULTIMEDIA SOFTWARE RECORDED ON CD-ROM'S AND DVD'S FEATURING MUSIC AND LYRICS; PRERECORDED VIDEO TAPES FEATURING MUSICAL ENTERTAINMENT; LASER DISCS FEATURING MUSICAL ENTERTAINMENT; VIDEO DISCS FEATURING MUSICAL ENTERTAINMENT; MULTIMEDIA SOFTWARE RECORDED ON CD-ROM AND DVD FEATURING MUSICAL ENTERTAINMENT (U.S. CLS. 21, 23, 26, 36 AND 38).

SN 78-044,975. INTELLIGENT SEARCH TECHNOLOGY, LTD., BREWSTER, NY. FILED 1-25-2001.

MERLINMERGE

FOR DATABASE MANAGEMENT SOFTWARE, NAMELY, COMPUTER SOFTWARE FOR MANAGING MAILING LISTS DATABASES, WHICH PERFORMS DUPLICATE-DETECTION, MERGE AND PURGE OPERATIONS, AND HOUSEHOLD LINK DETERMINATION OF DATA WITHIN DATABASES, NAMELY, USING IDENTIFYING ELEMENTS WITHIN DATABASE RECORDS TO CLUSTER OR GROUP SIMILAR RECORDS THAT COULD BE CONSIDERED TO IDENTIFY MEMBERS OF THE SAME HOUSEHOLD (U.S. CLS. 21, 23, 26, 36 AND 38).

FIRST USE 1-1-2001; IN COMMERCE 1-1-2001.

SN 78-047,649. ACTIVESTATE SRL, ST. MICHAEL, BARBADOS, FILED 2-9-2001.

ACTIVETCL

FOR COMPUTER SOFTWARE FOR USE IN CROSS-PLATFORM SOFTWARE APPLICATION AND SOFTWARE COMPONENT DEVELOPMENT, WEBSITE CREATION, MANAGING COMPUTER SYSTEMS AND PERFORMING SYSTEM MANAGEMENT TASKS, NAMELY MONITORING AND GRAPHICALLY DISPLAYING SYSTEM DATA (U.S. CLS. 21, 23, 26, 36 AND 38).

CLASS 9—(Continued).

SN 78-047,655. ACTIVESTATE SRL, ST. MICHAEL, BARBADOS, FILED 2-9-2001.

ACTIVERUBY

FOR COMPUTER SOFTWARE FOR USE IN CROSS-PLATFORM SOFTWARE APPLICATION AND SOFTWARE COMPONENT DEVELOPMENT, WEBSITE CREATION, MANAGING COMPUTER SYSTEMS AND PERFORMING SYSTEM MANAGEMENT TASKS, NAMELY MONITORING AND GRAPHICALLY DISPLAYING SYSTEM DATA (U.S. CLS. 21, 23, 26, 36 AND 38).

SN 78-049,576. TAO MUSIC, INC., REDWOOD CITY, CA. FILED 2-21-2001.

IKTV

FOR PRERECORDED KARAOKE MUSIC VIDEO CDS, PLAYERS, MICROPHONES, AND ACCESSORIES, NAMELY HEADSETS, EARPHONES AND ELECTRONIC DANCING PADS (U.S. CLS. 21, 23, 26, 36 AND 38).

SN 78-049,692. IXI MOBILE, INC., PALO ALTO, CA. FILED 2-22-2001.

IXI

PRIORITY CLAIMED UNDER SEC. 44(D) ON ISRAEL APPLICATION NO. 142323, FILED 9-26-2000, REG. NO. 142323, DATED 9-26-2000, EXPIRES 9-26-2010.

FOR ELECTRONIC DEVICES FOR MOBILE COMPUTING AND COMMUNICATION, NAMELY, COMPUTER HARDWARE, NAMELY, SERVERS AND TERMINALS; COMPUTER PERIPHERAL USER INTERFACE DEVICES, NAMELY, VOICE HANDSETS, VOICE HEADSETS, AUDIO HEADPHONES; PERSONAL DIGITAL ASSISTANTS, NAMELY, HANDHELD COMPUTERS FOR DATA COLLECTION AND MANIPULATION; LIQUID CRYSTAL DISPLAY MONITORS FOR AUTOMOBILES; LAPTOP COMPUTERS; WEB PADS, NAMELY, AN INTERNET APPLIANCE FOR ACCESSING THE INTERNET AND MULTIMEDIA; STYLUS PEN WITH VOICE INTERFACE CAPABILITIES AND WEARABLE WRISTWATCH-LIKE COMPUTER DEVICES (U.S. CLS. 21, 23, 26, 36 AND 38).

CLASS 9—(Continued).

SN 78-050,364. MUTEK SOLUTIONS LTD., OR-YEHUDA, ISRAEL, FILED 2-27-2001.



PRIORITY CLAIMED UNDER SEC. 44(D) ON ISRAEL APPLICATION NO. 141951, FILED 9-19-2000, REG. NO. 141951, DATED 2-5-2002, EXPIRES 9-19-2007.

THE MARK CONSISTS OF THE DESIGN OF A TARGET ABOVE THE WORDING "APPSIGHT". A CURVED LINE EXTENDS FROM THE CENTER OF THE TARGET TO BELOW THE WORDING "APPSIGHT".

FOR COMPUTER SOFTWARE FOR USE IN COLLECTING STATIC AND DYNAMIC INFORMATION FROM PERSONAL AND NETWORKED COMPUTERS, FOR DIAGNOSING AND AUTOMATICALLY CORRECTING SOFTWARE PROBLEMS, FOR ALERTING USERS OF THE NEED FOR SERVICE INTERVENTION TO CORRECT SOFTWARE PROBLEMS, AND FOR DIRECTING SERVICE PERSONNEL AS TO THE CORRECTIVE MEASURES REQUIRED TO CORRECT SOFTWARE PROBLEMS IN THE FIELDS OF COMPUTER SOFTWARE SUPPORT AND QUALITY CONTROL (U.S. CLS. 21, 23, 26, 36 AND 38).

SN 78-050,486. TAZZ NETWORKS, PROVIDENCE, RI. FILED 2-27-2001.

TAZZ NETWORKS

NO CLAIM IS MADE TO THE EXCLUSIVE RIGHT TO USE "NETWORKS", APART FROM THE MARK AS SHOWN.

FOR COMPUTER HARDWARE AND INFRASTRUCTURE SOFTWARE FOR USE IN ENABLING NETWORK OPERATORS TO DEPLOY, CONFIGURE, COMBINE, MAINTAIN AND UPGRADE COMPUTER HARDWARE AND OTHER COMPUTER NETWORK OPERATING SOFTWARE (U.S. CLS. 21, 23, 26, 36 AND 38).

SN 78-052,577. TYCO HEALTHCARE GROUP LP, MANSFIELD, MA. FILED 3-12-2001.



NO CLAIM IS MADE TO THE EXCLUSIVE RIGHT TO USE "LABWARE", APART FROM THE MARK AS SHOWN.

FOR LABORATORY EQUIPMENT, NAMELY LIQUID DISPENSERS, PIPETTERS, PIPETTES, PIPETTE TIPS, TEST TUBES, GRADUATED CYLINDERS, TUBE AND PIPETTE RACKS, SPECIMEN CONTAINERS, SAMPLE CUPS, CUVETTES, LABORATORY FUNNELS, AND BEAKERS (U.S. CLS. 21, 23, 26, 36 AND 38).

CLASS 9—(Continued).

SN 78-055,285. CFX SOFTWARE CORPORATION, NEW YORK, NY. FILED 3-27-2001.

CFX

FOR COMPUTER SOFTWARE USED IN THE FINANCIAL INDUSTRY TO DETERMINE THE FINANCIAL STATUS OF MORTGAGE PORTFOLIOS AND OTHER SECURITIES AND TO PREDICT THE FUTURE PERFORMANCE OF MORTGAGE PORTFOLIOS AND OTHER SECURITIES (U.S. CLS. 21, 23, 26, 36 AND 38).
FIRST USE 10-0-1986; IN COMMERCE 10-0-1986.

SN 78-057,787. HITEX SYSTEMENTWICKLUNG GESELLSCHAFT FUR ANGEWANDTE INFORMATIK MBH, KARLSRUHE, FED REP GERMANY, FILED 4-11-2001.

TANTO

OWNER OF FED REP GERMANY REG. NO. 30104251, DATED 2-13-2001, EXPIRES 2-13-2011.

FOR ELECTRONIC AND ELECTRICAL TOOLS AND SOFTWARE TO TEST ANALYZE SOFTWARE AND HARDWARE COMPONENTS, NAMELY, DEBUGGERS, IN-CIRCUIT EMULATORS, ANALYZERS, SIMULATORS AND MONITORS (U.S. CLS. 21, 23, 26, 36 AND 38).

FIRST USE 3-1-2001; IN COMMERCE 4-10-2001.

SN 78-058,937. ACTEL CORPORATION, SUNNYVALE, CA. FILED 4-17-2001.

BRIDGEFPGA

FOR INTEGRATED CIRCUITS WITH FIELD PROGRAMMABLE GATE ARRAYS (U.S. CLS. 21, 23, 26, 36 AND 38).

SN 78-059,065. TECH ELECTRONICS, INC., NORCROSS, GA. FILED 4-18-2001.



FOR COMPUTER HARDWARE, COMPUTER CABLES, COMPUTER PERIPHERALS, COMPUTER HARDWARE AND CABLES FOR CONNECTING MONITORS TOGETHER TO SEND VIDEO TO ANY OR ALL MONITORS, ALL FOR USE IN COMPUTER CLASSROOMS (U.S. CLS. 21, 23, 26, 36 AND 38).

CLASS 9—(Continued).

SN 78-060,445. DEEP SHAG RECORDS, INC., ATLANTA, GA. FILED 4-25-2001.



NO CLAIM IS MADE TO THE EXCLUSIVE RIGHT TO USE "RECORDS", APART FROM THE MARK AS SHOWN.
FOR PRE-RECORDED COMPACT DISCS FEATURING MUSICAL AND SPOKEN WORD SOUND RECORDINGS (U.S. CLS. 21, 23, 26, 36 AND 38).

SN 78-064,201. CROSSLAYER NETWORKS, INC., FREMONT, CA. FILED 5-17-2001.



Silicon solutions for tomorrow's networks

NO CLAIM IS MADE TO THE EXCLUSIVE RIGHT TO USE "NETWORKS" AND "SILICON", APART FROM THE MARK AS SHOWN.

FOR SEMICONDUCTOR (U.S. CLS. 21, 23, 26, 36 AND 38).

SN 78-064,434. INTERNATIONAL BAR CODE SYSTEMS, INC., GLASTONBURY, CT. FILED 5-18-2001.

INTERNATIONAL BAR CODE

NO CLAIM IS MADE TO THE EXCLUSIVE RIGHT TO USE "BAR CODE", APART FROM THE MARK AS SHOWN.

FOR BAR CODE READERS AND MAGNETIC STRIPE CARD READERS AND PARTS THEREFOR (U.S. CLS. 21, 23, 26, 36 AND 38).

FIRST USE 2-25-1988; IN COMMERCE 2-25-1988.

SN 78-065,358. IOTA TECHNOLOGY INC, SAN JOSE, CA. FILED 5-23-2001.

POWERROUTE

FOR COMPUTER SOFTWARE USED FOR ROUTING POWER WITHIN THE POWER MESH OF INTEGRATED CIRCUITS (U.S. CLS. 21, 23, 26, 36 AND 38).

CLASS 9—(Continued).

SN 78-066,004. TANTOR MEDIA, INC., SAN CLEMENTE, CA. FILED 5-27-2001.



FOR DIGITAL AUDIOBOOKS IN CD, MP3 AND DOWNLOADABLE SOFTWARE FORMAT FEATURING CHILDREN'S STORIES, MYSTERIES, SCIENCE FICTION, ADVENTURES, HISTORICAL FICTION, NAUTICAL FICTION, AND WESTERNS (U.S. CLS. 21, 23, 26, 36 AND 38).

FIRST USE 2-26-2001; IN COMMERCE 2-26-2001.

SN 78-066,181. MOVAZ NETWORKS, INC., NORCROSS, GA. FILED 5-29-2001.

RAYEXTENDER

FOR TELECOMMUNICATIONS AND DATA NETWORKING EQUIPMENT, NAMELY OPTICAL NETWORK HARDWARE AND SOFTWARE USED FOR LINE AMPLIFYING DESIGNED TO ENHANCE FIBER OPTIC TRANSMISSIONS (U.S. CLS. 21, 23, 26, 36 AND 38).

SN 78-066,530. KINNIBURGH, HUGH, SAN FRANCISCO, CA. FILED 5-31-2001.

SUNZ

FOR MUSICAL AND SOUND RECORDINGS (U.S. CLS. 21, 23, 26, 36 AND 38).

FIRST USE 3-1-1995; IN COMMERCE 4-1-1995.

SN 78-067,421. DECISIONLINK, INC., LAS VEGAS, NV. FILED 6-5-2001.

OXYSENSE

FOR OXYGEN MEASURING MACHINE COMPRISED OF A SMALL BOX CONTAINING A LIGHT SOURCE, DETECTOR AND A FIBER READER PEN, THE BOX IS CONNECTED TO A PC AND CAN BE USED IN A LABORATORY OR ON A PRODUCTION LINE AS A NON-INVASIVE DETERMINATION OF OXYGEN CONTENT IN PACKAGED FOOD (U.S. CLS. 21, 23, 26, 36 AND 38).

FIRST USE 4-13-2001; IN COMMERCE 4-13-2001.

CLASS 9—(Continued).

SN 78-068,865. WMS GAMING INC., WAUKEGAN, IL. FILED 6-13-2001.



NO CLAIM IS MADE TO THE EXCLUSIVE RIGHT TO USE "PUZZLE", APART FROM THE MARK AS SHOWN.

FOR CURRENCY AND CREDIT OPERATED SLOT MACHINES AND GAMING DEVICES, NAMELY, GAMING MACHINES FOR USE IN GAMING ESTABLISHMENTS (U.S. CLS. 21, 23, 26, 36 AND 38).

FIRST USE 10-18-2000; IN COMMERCE 10-18-2000.

SN 78-069,659. HASBRO, INC., PAWTUCKET, RI. FILED 6-18-2001.

BLYTHE

FOR INTERACTIVE ENTERTAINMENT SOFTWARE, NAMELY, INTERACTIVE VIDEO GAME PROGRAMS, INTERACTIVE MULTIMEDIA COMPUTER GAME PROGRAMS, INTERACTIVE VIDEO GAMES OF VIRTUAL REALITY COMPRISED OF COMPUTER HARDWARE AND SOFTWARE; COMPUTER GAME SOFTWARE; COMPUTER AND VIDEO GAME APPARATUS, NAMELY, VIDEO GAME MACHINES FOR USE WITH TELEVISIONS; TELEPHONES; RADIO TELEPHONES; RADIOS; PRE-RECORDED AUDIO AND VIDEO TAPES FEATURING MUSIC; LASER DISCS, DVD DISCS, VIDEO DISCS, PHONOGRAPH RECORDS, COMPACT DISCS, AND CD-ROMS, ALL FEATURING GAMES, FILMS, AND MUSIC; ELECTRONIC CALCULATORS; BATTERIES; SUNGLASSES; CARRYING CASES FOR PORTABLE ELECTRONIC DEVICES; HEAD PHONES; AUDIO CASSETTE PLAYERS AND RECORDERS; CD PLAYERS; DVD PLAYERS; MOUSE PADS; GAMING MACHINE (U.S. CLS. 21, 23, 26, 36 AND 38).

SN 78-070,609. MIDWEST INDUSTRIAL SERVICES, INC., ST. CHARLES, MO. FILED 6-22-2001.

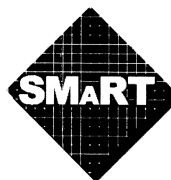

Storeroom
Management
And
Repairables
Tracking

NO CLAIM IS MADE TO THE EXCLUSIVE RIGHT TO USE "STOREROOM MANAGEMENT AND REPAIRABLE TRACKING", APART FROM THE MARK AS SHOWN.

FOR COMPUTER SOFTWARE FOR USE IN INVENTORY MANAGEMENT AND MAINTENANCE OF INDUSTRIAL PRODUCTS (U.S. CLS. 21, 23, 26, 36 AND 38).

FIRST USE 1-0-2000; IN COMMERCE 1-0-2000.

CLASS 9—(Continued).

SN 78-071,143. GRESHAM, SAMMY, CHICAGO, IL. FILED 6-26-2001.



NO CLAIM IS MADE TO THE EXCLUSIVE RIGHT TO USE "ENTERTAINMENT", APART FROM THE MARK AS SHOWN.

FOR MUSICAL RECORDINGS ON PHONOGRAPH RECORDS, COMPACT DISCS, PRE-RECORDED AUDIO-CASSETTE TAPES, CD ROM'S, LASER DISCS, AND MINI-DISCS ALL FEATURING MUSICAL SOUND RECORDINGS; PRE-RECORDED VIDEO TAPES FEATURING MUSICAL PERFORMANCES (U.S. CLS. 21, 23, 26, 36 AND 38).

FIRST USE 9-1-2000; IN COMMERCE 9-1-2000.

SN 78-071,979. HORIZON HEALTHCARE TECHNOLOGIES, L.L.C., ST. LOUIS, MO. FILED 7-2-2001.

MASTERSERIES

FOR INTEGRATED HEALTHCARE CLINICAL INSURANCE REIMBURSEMENT AND FINANCIAL REPORTING SOFTWARE DESIGNED TO AUTOMATE WORK FLOW PROCESSES IN THE FIELD OF POST-ACUTE HEALTHCARE (U.S. CLS. 21, 23, 26, 36 AND 38).

SN 78-072,306. VIVCOM, INC., SAN FRANCISCO, CA. FILED 7-3-2001.

VBROWSE

FOR COMPUTER SOFTWARE AND COMPUTER SYSTEMS COMPRISED OF COMPUTER HARDWARE AND SOFTWARE FOR CREATING, VIEWING, AND MANIPULATING TAGS IN AUDIO AND VISUAL INFORMATION ON WEBSITES, DATA STORAGE DEVICES, DATA DISPLAY DEVICES, DATA PROCESSING DEVICES OR OTHER VIDEO OR AUDIO STORAGE OR MANIPULATION SYSTEMS AND USED FOR INDEXING, SEARCHING, TRANSMITTING, AND DISSEMINATING THE TAGGED INFORMATION FOR DISPLAY, EDITING, STORAGE, INDEXING, AND RETRIEVAL IN VIDEO OR AUDIO APPLICATIONS; COMPUTER SOFTWARE AND COMPUTER SYSTEMS COMPRISED OF COMPUTER HARDWARE AND SOFTWARE FOR CONVERTING VISUAL, AUDIO, AND ALPHANUMERIC INFORMATION EMBEDDED IN AND ASSOCIATED WITH VISUAL IMAGES INTO TEXTUAL INFORMATION AND META INFORMATION SUITABLE FOR INDEXING AND SEARCHING IN SEARCH ENGINES (U.S. CLS. 21, 23, 26, 36 AND 38).

CLASS 9—(Continued).

SN 78-073,373. TOP END INTERNATIONAL, INCORPORATED, LAS VEGAS, NV. FILED 7-11-2001.

COOLBX

FOR CONVERTER/CABLE BOX TELEVISION SET-TOP CHANNEL TUNER (U.S. CLS. 21, 23, 26, 36 AND 38).
FIRST USE 1-29-2000; IN COMMERCE 1-29-2000.

SN 78-073,665. NETRAKE CORPORATION, PLANO, TX. FILED 7-12-2001.

NPROCESS

FOR DATA AND TELECOMMUNICATIONS EQUIPMENT, NAMELY, SWITCHES, ROUTERS, POLICY GATEWAYS FOR IMPLEMENTING POLICY-BASED NETWORKING, MULTIPLEXORS, CONTENT AGGREGATORS, BROADBAND IP PROCESSORS, AND NETWORK PROCESSING SYSTEMS, COMPRISING NETWORK PROCESSORS FOR CLASSIFYING AND PROCESSING PACKETIZED NETWORK TRAFFIC (U.S. CLS. 21, 23, 26, 36 AND 38).

SN 78-074,110. MICRON OPTICS, INC., ATLANTA, GA. FILED 7-16-2001.

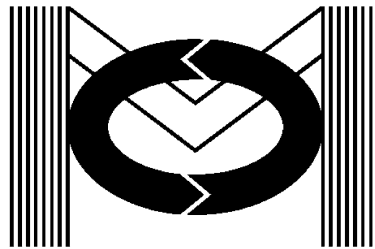

THE MARK COMPRISES A TWO-DIMENSIONAL DESIGN CONSISTING OF TWO OVERLAPPING FIGURATIVE ELEMENTS. IN THE FOREGROUND, THE FIRST FIGURATIVE ELEMENT COMPRISES A SHADED LETTER "O" THAT IS BROKEN IN TWO PLACES BY OPPOSITE FACING ARROWHEAD BREAKS. IN THE BACKGROUND, THE SECOND FIGURATIVE ELEMENT IS A LETTER "M" THAT IS COMPOSED OF TWO VERTICAL SEGMENTS EACH COMPRISING EIGHT PARALLEL LINES AND A SOLID V-SHAPED SEGMENT.

FOR TELECOMMUNICATION COMPONENTS, NAMELY, TUNABLE FILTERS, TEST INSTRUMENTS FOR CHARACTERIZATION OF PASSIVE OPTICAL COMPONENTS; OPTOELECTRONIC MECHANICAL SENSING INSTRUMENTS FOR USE IN SENSING OF STRAIN, TEMPERATURE AND OTHER MECHANICAL PROPERTIES; OPTOELECTRONIC MODULES FOR EMBEDDING IN TELECOMMUNICATION EQUIPMENT SUCH AS OPTICAL PERFORMANCE MONITORS AND CHANNEL ANALYZERS (U.S. CLS. 21, 23, 26, 36 AND 38).

FIRST USE 4-0-1990; IN COMMERCE 4-0-1990.

CLASS 9—(Continued).

SN 78-074,981. CONEXANT SYSTEMS, INC., NEWPORT BEACH, CA. FILED 7-20-2001.

AMPLIF-EYE

FOR COMPUTER HARDWARE, SEMICONDUCTOR DEVICES AND COMPUTER SOFTWARE FOR THE AGGREGATION, TRANSMISSION AND SWITCHING OF DATA, VIDEO AND VOICE FOR NETWORK ACCESS AND NETWORK TRANSPORT PRODUCTS (U.S. CLS. 21, 23, 26, 36 AND 38).

SN 78-077,921. EXO, INC., QUEBEC, CANADA, FILED 8-7-2001.

EXO RECORDS

NO CLAIM IS MADE TO THE EXCLUSIVE RIGHT TO USE "RECORDS", APART FROM THE MARK AS SHOWN. FOR PHONOGRAPH RECORDS FEATURING MUSIC (U.S. CLS. 21, 23, 26, 36 AND 38).

SN 78-079,194. DELEEUEW ASSOCIATES, INC., WAYNE, NJ. FILED 8-14-2001.



NO CLAIM IS MADE TO THE EXCLUSIVE RIGHT TO USE "ASSOCIATES, INC", APART FROM THE MARK AS SHOWN.

THE LINING IS A FEATURE OF THE MARK AND DOES NOT INDICATE COLOR.

FOR COMPUTER SOFTWARE FOR PROJECT MANAGEMENT FOR BUSINESSES TO FACILITATE CONSOLIDATED PROJECT REPORTING, TRACKING OF GAPS, ISSUES, INCIDENTS, TEAM ACTION RECORDS, STATUS REPORTING, TEAM SETUP, AND PROJECT MANAGEMENT TOOLS AND TEMPLATES (U.S. CLS. 21, 23, 26, 36 AND 38).

SN 78-079,485. THORP, JOHN, JAY, HUFFMAN, TX. FILED 8-16-2001.

BLUE EFFECT

FOR COMPACT DISCS CONTAINING MUSICAL RECORDINGS (U.S. CLS. 21, 23, 26, 36 AND 38).

CLASS 9—(Continued).

SN 78-079,913. BENCHMARK STORAGE INNOVATIONS, INC., BOULDER, CO. FILED 8-17-2001.

VALUSMART

FOR DATA STORAGE SYSTEMS, NAMELY, TAPE MEDIA, COMPUTER HARDWARE AND SOFTWARE FOR PRODUCING BACKUP AND ARCHIVE CAPABILITIES TO COMPUTER NETWORKS AND WORKSTATIONS; AND NETWORK DATA STORAGE APPLIANCES, NAMELY, SERVERS, COMPUTER DRIVES AND COMPUTER BACKUP DRIVES FOR PROVIDING BACKUP AND ARCHIVE CAPABILITIES TO COMPUTER NETWORKS (U.S. CLS. 21, 23, 26, 36 AND 38).

SN 78-080,342. SANDCHERRY NETWORKS, INC., BOULDER, CO. FILED 8-21-2001.

ACCELERATING NEXT-GENERATION SERVICE DELIVERY

FOR COMMUNICATIONS SOFTWARE FOR CONNECTION VOICE OR DATA NETWORK USERS WITH SERVICE RESOURCES ON COMPUTER OR TELECOMMUNICATIONS NETWORKS; COMPUTER SOFTWARE TO MANAGE SERVICE SOFTWARE RESOURCES AND HARDWARE IN A COMPUTER OR TELECOMMUNICATIONS NETWORK; COMPUTER SOFTWARE TO PRIORITIZE SERVICE ACCESS IN A COMPUTER OR TELECOMMUNICATIONS NETWORK; COMPUTER SOFTWARE TO ACCOUNT FOR SERVICE AND RESOURCE USAGE IN A COMPUTER OR TELECOMMUNICATIONS NETWORK; COMPUTER SOFTWARE TO PERFORM SERVICE PROVISIONING, ACTIVATION, FAULT MANAGEMENT, AND PERFORMANCE MANAGEMENT IN A COMPUTER OR TELECOMMUNICATIONS NETWORK; COMPUTER SOFTWARE TO INTEGRATE OPERATIONS SUPPORT SYSTEMS WITH NEW SERVICES AND SERVICE RESOURCES IN A COMPUTER OR TELECOMMUNICATIONS NETWORK; COMPUTER SOFTWARE TO PROVIDE SERVICE CREATION IN A COMPUTER OR TELECOMMUNICATIONS NETWORK (U.S. CLS. 21, 23, 26, 36 AND 38).

SN 78-080,855. GTECH RHODE ISLAND CORPORATION, WEST GREENWICH, RI. FILED 8-23-2001.



OWNER OF U.S. REG. NOS. 1,372,206 AND 1,401,566. NO CLAIM IS MADE TO THE EXCLUSIVE RIGHT TO USE "CORPORATION", APART FROM THE MARK AS SHOWN.

THE MARK CONSISTS OF A STYLIZED DESIGN IN BLUE (COLOR PMS 286) OF THE TEXT "GTECH" WITH THE TEXT CORPORATION UNDERNEATH.

FOR COMPUTERIZED WAGERING TERMINAL (U.S. CLS. 21, 23, 26, 36 AND 38).

FIRST USE 7-1-1992; IN COMMERCE 7-1-1992.

CLASS 9—(Continued).

SN 78-081,447. NICHOLS, JOHN F, CHICAGO, IL. FILED 8-28-2001.

TALLI

FOR COMPUTER SOFTWARE FOR USE IN TRACKING COMMISSIONS (U.S. CLS. 21, 23, 26, 36 AND 38).

SN 78-081,808. VISTANT CORPORATION, SAN DIEGO, CA. FILED 8-30-2001.

TRUSTOCK

FOR AUTOMATED POINT-OF-USE DISPENSING MACHINES FOR DISPENSING PARTS, COMPONENTS, TOOLS, SUPPLIES, MATERIALS AND OTHER MAINTENANCE, REPAIR AND OPERATING ITEMS USED IN ANY MANUFACTURING OR ASSEMBLY ENVIRONMENT; COMPUTER SOFTWARE FOR OPERATING SUCH DISPENSING MACHINES, TRACKING INVENTORY LEVELS OF ITEMS DISPENSED BY SUCH DISPENSING MACHINES AND ELECTRONIC INVENTORY REORDERING (U.S. CLS. 21, 23, 26, 36 AND 38).

SN 78-081,819. VISTANT CORPORATION, SAN DIEGO, CA. FILED 8-30-2001.

SAFESTOCK

FOR AUTOMATED POINT-OF-USE DISPENSING MACHINES FOR DISPENSING PARTS, COMPONENTS, TOOLS, SUPPLIES, MATERIALS AND OTHER MAINTENANCE, REPAIR AND OPERATING ITEMS USED IN ANY MANUFACTURING OR ASSEMBLY ENVIRONMENT; COMPUTER SOFTWARE FOR OPERATING SUCH DISPENSING MACHINES, TRACKING INVENTORY LEVELS OF ITEMS DISPENSED BY SUCH DISPENSING MACHINES AND ELECTRONIC INVENTORY REORDERING (U.S. CLS. 21, 23, 26, 36 AND 38).

SN 78-081,821. VISTANT CORPORATION, SAN DIEGO, CA. FILED 8-30-2001.

ADVANCE YOUR SUPPLY CHAIN

FOR AUTOMATED POINT-OF-USE DISPENSING MACHINES FOR DISPENSING PARTS, COMPONENTS, TOOLS, SUPPLIES, MATERIALS AND OTHER MAINTENANCE, REPAIR AND OPERATING ITEMS USED IN ANY MANUFACTURING OR ASSEMBLY ENVIRONMENT; COMPUTER SOFTWARE FOR OPERATING SUCH DISPENSING MACHINES, TRACKING INVENTORY LEVELS OF ITEMS DISPENSED BY SUCH DISPENSING MACHINES AND ELECTRONIC INVENTORY REORDERING (U.S. CLS. 21, 23, 26, 36 AND 38).

CLASS 9—(Continued).

SN 78-081,879. AMMOCORE TECHNOLOGY, INC., SANTA CLARA, CA. FILED 8-30-2001.

SBLOCK

FOR ELECTRONIC DESIGN AUTOMATION SOFTWARE FOR DESIGN OF INTEGRATED CIRCUITS (U.S. CLS. 21, 23, 26, 36 AND 38).

SN 78-081,882. AMMOCORE TECHNOLOGY, INC., SANTA CLARA, CA. FILED 8-30-2001.

SBLOCK ARRAY

NO CLAIM IS MADE TO THE EXCLUSIVE RIGHT TO USE "ARRAY", APART FROM THE MARK AS SHOWN. FOR ELECTRONIC DESIGN AUTOMATION SOFTWARE FOR DESIGN OF INTEGRATED CIRCUITS (U.S. CLS. 21, 23, 26, 36 AND 38).

SN 78-081,984. BOEING MANAGEMENT COMPANY, SEAL BEACH, CA. FILED 8-30-2001.

LAPTOC

FOR MILITARY GROUND DATA STATION AND RELATED COMPONENTS FOR SENDING AND RECEIVING DIGITAL MESSAGES, NAMELY, A LAPTOP COMPUTER; SOFTWARE APPLICATIONS IN THE NATURE OF PC OPERATING SYSTEM AND OFFICE APPLICATIONS USED TO MANIPULATE DIGITAL MESSAGES AND DATA GENERATED FOR PRESENTATIONS, REPORTS, AND ANALYSIS; A DIGITAL MESSAGING GRAPHICAL USER INTERFACE CONTROL APPLICATION, AND A DIGITAL MAP APPLICATION; DATA MODEM; AND RADIO, ANTENNA, AND INTERCONNECT CABLES ALL SOLD TOGETHER AS A UNIT (U.S. CLS. 21, 23, 26, 36 AND 38).

SN 78-082,062. XEROX CORPORATION, STAMFORD, CT. FILED 8-31-2001.

XEROX INTELLIGENT BARCODE UTILITY

NO CLAIM IS MADE TO THE EXCLUSIVE RIGHT TO USE "INTELLIGENT BARCODE UTILITY", APART FROM THE MARK AS SHOWN. FOR COMPUTER SOFTWARE FOR PRINTING MANAGEMENT (U.S. CLS. 21, 23, 26, 36 AND 38).

CLASS 9—(Continued).

SN 78-082,892. REMSPEC CORPORATION, STURBRIDGE, MA. FILED 9-6-2001.

REACTIONVIEW

FOR INTEGRATED EQUIPMENT FOR INFRARED ANALYSIS, NAMELY, FIBER OPTIC PROBE USED FOR INFRARED SPECTRAL ANALYSIS OF MATERIALS (U.S. CLS. 21, 23, 26, 36 AND 38).

SN 78-083,383. CAMPBELL, ROBERT E., NASHVILLE, TN. FILED 9-10-2001.

STEEL WOOL

FOR PRE-RECORDED VIDEOCASSETTES AND CD'S FEATURING CHILDREN'S EDUCATIONAL AND ENTERTAINMENT PROGRAMS IN THE NATURE OF CARTOONS (U.S. CLS. 21, 23, 26, 36 AND 38).
FIRST USE 0-0-1999; IN COMMERCE 2-2-2001.

SN 78-083,970. CHELDAN TECHNOLOGIES CORPORATION, CORAL SPRINGS, FL. FILED 9-14-2001.

CHELDAN

FOR DEVICE IN THE NATURE OF A VOICE PROCESSOR FOR USE IN DISPLAYING HUMAN SPEECH TO TEXT FOR THE HEARING IMPAIRED (U.S. CLS. 21, 23, 26, 36 AND 38).

SN 78-084,249. OMAX TECHNOLOGIES INC., TAIPEI, TAIWAN, FILED 9-17-2001.



FOR OPTICAL COUPLERS, OPTICAL ISOLATORS, OPTICAL PATCH CORDS, FIBER OPTICAL ADAPTERS, FIBER OPTICAL CONNECTORS, OPTICAL TRANSCIEVERS, OPTICAL FIBER CABLES, OPTICAL SWITCHES, OPTICAL SEMICONDUCTOR SUBSTRATES, OPTICAL AMPLIFIERS, FIBER OPTICAL ATTENUATORS, FIBER OPTICAL CONVERTERS, AND OPTICAL MULTIPLEXERS (U.S. CLS. 21, 23, 26, 36 AND 38).

CLASS 9—(Continued).

SN 78-085,145. HADALA, ANTHONY J., BRECKSVILLE, OH. FILED 9-23-2001.

STRIP FOR BEER

NO CLAIM IS MADE TO THE EXCLUSIVE RIGHT TO USE "FOR BEER", APART FROM THE MARK AS SHOWN.
FOR CHOLESTERIC AND LIQUID CRYSTAL SENSING DEVICES FOR DETERMINING THE TEMPERATURE AND VOLUME OF LIQUIDS IN CONTAINERS (U.S. CLS. 21, 23, 26, 36 AND 38).

SN 78-085,708. VIVID LEARNING SYSTEMS, INC., RICHLAND, WA. FILED 9-26-2001.



NO CLAIM IS MADE TO THE EXCLUSIVE RIGHT TO USE "LEARNING MANAGEMENT SYSTEM", APART FROM THE MARK AS SHOWN.
THE WORD "CLARUS" IS LATIN FOR "TO MAKE BRIGHT OR CLEAR"

FOR COMPUTER SOFTWARE USED TO LAUNCH WEB-BASED E-LEARNING CONTENT, SCHEDULE STUDENT TRAINING, DELIVER STUDENT TRAINING, TRACK STUDENT TRAINING, TEST STUDENT PERFORMANCE, AND RECORD AND STORE RESULTS IN AN ODBC (U.S. CLS. 21, 23, 26, 36 AND 38).
FIRST USE 8-24-2001; IN COMMERCE 8-24-2001.

SN 78-088,058. VOLATIER, MARTIN, AUSTIN, TX. FILED 10-12-2001.

FRONTIS

FOR COMPUTER SOFTWARE FOR THE ANALYSIS, MODELLING, MANAGEMENT AND OPTIMIZATION OF BUSINESS RELATIONSHIPS (U.S. CLS. 21, 23, 26, 36 AND 38).
FIRST USE 7-2-1999; IN COMMERCE 7-2-1999.

SN 78-088,904. MATTEL, INC., EL SEGUNDO, CA. FILED 10-17-2001.

POWER WHEELS

FOR COMPUTER SOFTWARE, NAMELY, PRE-RECORDED CD-ROMS FEATURING GAMES FOR USE ON COMPUTERS AND VIDEO GAME PLAYERS (U.S. CLS. 21, 23, 26, 36 AND 38).

CLASS 9—(Continued).

SN 78-088,908. MATTEL, INC., EL SEGUNDO, CA. FILED 10-17-2001.

RESCUE RIGS

FOR COMPUTER PROGRAMS, NAMELY, GAME SOFTWARE FOR USE IN COMPUTERS AND VIDEO GAME PLAYERS (U.S. CLS. 21, 23, 26, 36 AND 38).

SN 78-089,062. SCHLUMBERGER MALCO, INC., OWINGS MILLS, MD. FILED 10-18-2001.

L-CARD

FOR ENCODED SMART CARDS PROGRAMMED WITH AN OPERATING SYSTEM USED TO EXECUTE A WIDE VARIETY OF APPLICATIONS (U.S. CLS. 21, 23, 26, 36 AND 38).

SN 78-089,215. INTERGRAPH CORPORATION, HUNTSVILLE, AL. FILED 10-19-2001.

**DYNAMO TERRAIN
MODELER**

NO CLAIM IS MADE TO THE EXCLUSIVE RIGHT TO USE "TERRAIN MODELER", APART FROM THE MARK AS SHOWN.

FOR COMPUTER GRAPHIC SOFTWARE AND COMPUTER GRAPHICS SOFTWARE USED IN THE MAPPING AND CIVIL ENGINEERING FIELDS (U.S. CLS. 21, 23, 26, 36 AND 38).

FIRST USE 6-0-2001; IN COMMERCE 6-0-2001.

SN 78-089,712. DATA TRANSLATION, INC., MARLBORO, MA. FILED 10-23-2001.

DT FOUNDRY

OWNER OF U.S. REG. NOS. 2,492,779, 2,581,207 AND OTHERS.

FOR COMPUTER SOFTWARE FOR SCIENTIFIC AND INDUSTRIAL USE, NAMELY, FOR USE IN DATA ACQUISITION AND IMAGING CIRCUIT BOARDS TO CAPTURE AND DIGITIZE ANALOG SIGNALS AND IMAGES FROM TEST AND MEASUREMENT EQUIPMENT, AND INSTRUCTIONAL MANUALS SOLD AS A UNIT THEREWITH (U.S. CLS. 21, 23, 26, 36 AND 38).

CLASS 9—(Continued).

SN 78-090,358. MAZZARELLA BROS. PRODUCTIONS, INC., BRISTOL, CT. FILED 10-26-2001.

THINKEROO

FOR CHILDREN'S VIDEO TAPES AND AUDIO CASSETTES FEATURING CHILDREN'S MUSIC AND STORIES; CD'S FEATURING CHILDREN'S MUSIC AND STORIES (U.S. CLS. 21, 23, 26, 36 AND 38).

SN 78-090,700. DESA INTERNATIONAL, INC., BRONX, NY. FILED 10-29-2001.

Wireless Solid Brass
LifeTime Finish



NO CLAIM IS MADE TO THE EXCLUSIVE RIGHT TO USE "WIRELESS" AND "SOLID BRASS" AND "LIFETIME FINISH" AND "NEW WIRELESS TECHNOLOGY", APART FROM THE MARK AS SHOWN.

FOR ELECTRONIC WIRELESS PUSHBUTTONS FOR DOORBELLS (U.S. CLS. 21, 23, 26, 36 AND 38).

SN 78-091,621. JAY-Y ENTERPRISE CO., INC., POMONA, CA. FILED 11-4-2001.



FOR SUNGLASSES, OPTICAL FRAMES, AND READING GLASSES (U.S. CLS. 21, 23, 26, 36 AND 38).

FIRST USE 12-1-1999; IN COMMERCE 12-1-1999.

SN 78-092,127. END-GAME STRATEGY, INC., NEWINGTON, CT. FILED 11-7-2001.

POST-GAME

FOR COMPUTER SOFTWARE TO ANALYZE HEALTH INSURANCE CLAIMS AND IDENTIFY MISTAKES (U.S. CLS. 21, 23, 26, 36 AND 38).

CLASS 9—(Continued).

SN 78-093,141. INCEPTO LTD., NETANYA, ISRAEL, FILED 11-14-2001.

SQL-UP

FOR COMPUTER SOFTWARE FOR USE IN DEPLOYING, MANAGING AND EXECUTING HIGH AVAILABILITY SERVER CLUSTERS OF SQL DATABASES AND SERVERS VIA LOCAL AREA, WIDE AREA AND GLOBAL COMPUTER NETWORKS (U.S. CLS. 21, 23, 26, 36 AND 38).

SN 78-093,213. DOXA TECHNOLOGIES, INC., HOLMDEL, NJ. FILED 11-14-2001.

DOXA WEMEET

THE ENGLISH TRANSLATION OF "DOXA" IS "GLORY, KUDOS, RENOWN".

FOR VIDEOCONFERENCING RESERVATION SYSTEM COMPRISING COMPUTER SOFTWARE FOR USE IN WEB-BASED APPLICATIONS WHICH ALLOWS THE USER THE CAPABILITY OF SCHEDULING MEETINGS, RESOLVING SCHEDULING CONFLICTS AND PROVIDING AUTOMATED E-MAIL NOTIFICATION OF VIDEO CONFERENCING RESERVATIONS (U.S. CLS. 21, 23, 26, 36 AND 38).

SN 78-093,588. SOFTWARE INNOVATIONS UK LIMITED, HERTFORDSHIRE, UNITED KINGDOM, FILED 11-15-2001.

SYSTEMHOUND

FOR COMPUTER PROGRAMS FOR INFORMATION TECHNOLOGY INVENTORY MANAGEMENT (U.S. CLS. 21, 23, 26, 36 AND 38).

FIRST USE 6-22-2000; IN COMMERCE 11-8-2001.

SN 78-094,125. PULSAFEEDER, INC., ROCHESTER, NY. FILED 11-19-2001.

PULSA CHECK

OWNER OF U.S. REG. NOS. 895,963, 1,846,132 AND OTHERS.
FOR FLUID FLOW MONITOR (U.S. CLS. 21, 23, 26, 36 AND 38).

FIRST USE 1-15-1999; IN COMMERCE 10-15-1999.

SN 78-095,680. BAYER CORPORATION, PITTSBURGH, PA. FILED 11-29-2001.

ASCENSIA

FOR COMPUTER SOFTWARE USED FOR DIABETES MONITORING AND MANAGEMENT (U.S. CLS. 21, 23, 26, 36 AND 38).

CLASS 9—(Continued).

SN 78-095,729. CHANDRASEKHAR, MEERA, COLUMBIA, MO. FILED 11-29-2001.

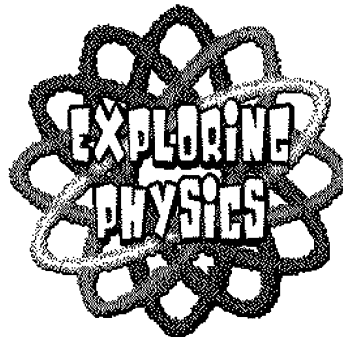

NO CLAIM IS MADE TO THE EXCLUSIVE RIGHT TO USE "PHYSICS", APART FROM THE MARK AS SHOWN.

THE STIPPLING IS FOR SHADING PURPOSES ONLY AND IS NOT A FEATURE OF THE MARK.

FOR EDUCATIONAL SOFTWARE FEATURING INSTRUCTION IN THE FIELD OF PHYSICS (U.S. CLS. 21, 23, 26, 36 AND 38).

SN 78-096,023. MARATHON COMPUTER, INC., NASHVILLE, TN. FILED 11-30-2001.

IRACKDV

FOR RACKMOUNTS FOR A COMPUTER (U.S. CLS. 21, 23, 26, 36 AND 38).

FIRST USE 11-1-2001; IN COMMERCE 12-1-2001.

SN 78-096,030. LJM PRODUCTS, INC., DBA JMC PRODUCTS, AUSTIN, TX. FILED 11-30-2001.

INTELLIBLOWER

OWNER OF U.S. REG. NO. 2,387,756.
FOR INTERNAL COOLING FANS AND/OR BLOWERS FOR COMPUTERS (U.S. CLS. 21, 23, 26, 36 AND 38).

SN 78-097,443. TECHNOLOGISTS, INC., FALLS CHURCH, VA. FILED 12-10-2001.

CYBERXPRT HOME COMPANION

FOR COMPUTER SOFTWARE WITH LINKS TO LIVE WEB PAGES FOR KNOWLEDGE TRANSFER TO HOMEOWNERS IN THE AREAS OF ENERGY USE, APPLIANCE PURCHASING, HOME IMPROVEMENT PROJECTS, LANDSCAPING, MAINTENANCE, AND FINANCING (U.S. CLS. 21, 23, 26, 36 AND 38).

CLASS 9—(Continued).

SN 78-098,115. CHARM SCIENCES, INC., LAWRENCE, MA. FILED 12-13-2001.

LUM-96

FOR PHOTOMETER USING A MULTIWELL FORMAT FOR MEASURING LUMINESCENCE FROM TEST SAMPLES (U.S. CLS. 21, 23, 26, 36 AND 38).

SN 78-098,740. MERCURY COMPUTER SYSTEMS, INC., CHELMSFORD, MA. FILED 12-17-2001.

RACE SERIES

NO CLAIM IS MADE TO THE EXCLUSIVE RIGHT TO USE SERIES, APART FROM THE MARK AS SHOWN.

FOR DIGITAL DATA PROCESSING EQUIPMENT, NAMELY, NETWORK SWITCHES; MULTICOMPUTERS; SYSTEM BOARDS; INPUT/OUTPUT MODULES; INTERCONNECT MODULES; AND COMPUTER SOFTWARE FOR THE OPERATION OF DIGITAL DATA PROCESSING EQUIPMENT; AND INSTRUCTIONAL BOOKS AND MANUALS SOLD AS A UNIT THEREWITH (U.S. CLS. 21, 23, 26, 36 AND 38).

SN 78-098,741. MERCURY COMPUTER SYSTEMS, INC., CHELMSFORD, MA. FILED 12-17-2001.



NO CLAIM IS MADE TO THE EXCLUSIVE RIGHT TO USE SERIES, APART FROM THE MARK AS SHOWN.

FOR DIGITAL DATA PROCESSING EQUIPMENT, NAMELY, NETWORK SWITCHES; MULTICOMPUTERS; SYSTEM BOARDS; INPUT/OUTPUT MODULES; INTERCONNECT MODULES; AND COMPUTER SOFTWARE FOR THE OPERATION OF DIGITAL DATA PROCESSING EQUIPMENT; AND INSTRUCTIONAL BOOKS AND MANUALS SOLD AS A UNIT THEREWITH (U.S. CLS. 21, 23, 26, 36 AND 38).

SN 78-098,780. TIVOLI AUDIO LLC, CAMBRIDGE, MA. FILED 12-17-2001.

PORTABLE AUDIO LABORATORY

NO CLAIM IS MADE TO THE EXCLUSIVE RIGHT TO USE "PORTABLE AUDIO", APART FROM THE MARK AS SHOWN.

FOR PORTABLE AM/FM STEREO RADIO (U.S. CLS. 21, 23, 26, 36 AND 38).

CLASS 9—(Continued).

SN 78-098,900. SPECTRUM RESEARCH GROUP INC., SARASOTA, FL. FILED 12-18-2001.



FOR ELECTRONIC TELEPHONE CALL SCREENER THAT ATTACHES TO YOUR PHONE AND ANSWERING MACHINE TO ELIMINATE TELEMARKETING CALLS (U.S. CLS. 21, 23, 26, 36 AND 38).

SN 78-099,061. COASTAL SOFTWARE & CONSULTING, INC., VANCOUVER, WA. FILED 12-18-2001.

EZ-EFT

FOR COMPUTER SOFTWARE FOR CREATING ELECTRONIC TRANSACTIONS IN AN ACH FILE THAT CONFORMS TO FEDERAL STANDARDS FOR COLLECTING FUNDS FROM ACCOUNTS IN BANKS AND CREDIT CARDS (U.S. CLS. 21, 23, 26, 36 AND 38).

SN 78-099,253. ROCKSOLID POS, INC., PITTSBURGH, PA. FILED 12-19-2001.

ROCKSOLID POS

NO CLAIM IS MADE TO THE EXCLUSIVE RIGHT TO USE "POS", APART FROM THE MARK AS SHOWN.

FOR DOWNLOADABLE COMPUTER SOFTWARE AND COMPUTER SOFTWARE FOR OPERATION OF CASH REGISTERS IN POINT OF SALE APPLICATIONS (U.S. CLS. 21, 23, 26, 36 AND 38).

SN 78-099,546. IOWA THIN FILM TECHNOLOGIES INC., BOONE, IA. FILED 12-20-2001.



FOR APPARATUS FOR CONVERTING ELECTRONIC RADIATION TO ELECTRICAL ENERGY, NAMELY PHOTOVOLTAIC SOLAR MODULES (U.S. CLS. 21, 23, 26, 36 AND 38).

FIRST USE 11-12-2001; IN COMMERCE 11-12-2001.

CLASS 9—(Continued).

SN 78-099,578. CRANE NUCLEAR, INC., KENNESAW, GA. FILED 12-21-2001.

POWERHOUSE

FOR COMPUTER SOFTWARE FOR PERFORMING, CALCULATING, COMBINING, TRENDING, ANALYZING, AND REPORTING FUNCTIONS FROM WHICH VALVE TESTING, VALVE ANALYSIS, VALVE CALIBRATION, AND VALVE ADJUSTING CAN BE FACILITATED (U.S. CLS. 21, 23, 26, 36 AND 38).

SN 78-099,947. HANKISON INTERNATIONAL DIVISION OF HANSEN INC., CANONSBURG, PA. FILED 12-26-2001.

WEBAIRNET

FOR COMPUTER SOFTWARE AND HARDWARE TO MONITOR REMOTELY PERFORMANCE OF COMPRESSED AIR SYSTEMS (U.S. CLS. 21, 23, 26, 36 AND 38).

SN 78-100,662. WHIRLPOOL PROPERTIES, INC., ST. JOSEPH, MI. FILED 1-3-2002.

WHIRLPOOL

OWNER OF U.S. REG. NOS. 813,992, 2,548,168 AND OTHERS.

FOR THERMOSTATS; ELECTRONIC CONTROLS, NAMELY, REMOTE CONTROLS FOR HEATERS AND AIR CONDITIONERS (U.S. CLS. 21, 23, 26, 36 AND 38).

SN 78-101,481. GENERAL MOTORS CORPORATION, DETROIT, MI. FILED 1-8-2002.

ENERGM

FOR FUEL CELLS FOR MOBILE AND STATIONARY ELECTRICAL GENERATING SOURCES, AND RELATED ELECTRICAL POWER GENERATING, HANDLING, AND TRANSMITTING EQUIPMENT (U.S. CLS. 21, 23, 26, 36 AND 38).

CLASS 9—(Continued).

SN 78-102,285. SIKIAS, PIERRE, CHENE-BOUGERIES, SWITZERLAND, FILED 1-11-2002.

JSET

FOR COMPUTER PROGRAMS FOR USE IN DEVELOPING AND EXECUTING OTHER COMPUTER PROGRAMS ON COMPUTERS, COMPUTER NETWORKS, TELECOMMUNICATIONS DEVICES AND GLOBAL COMMUNICATIONS NETWORKS; COMPUTER PROGRAMS FOR USE IN NAVIGATING, BROWSING, TRANSFERRING INFORMATION, AND DISTRIBUTING AND VIEWING OTHER COMPUTER PROGRAMS ON COMPUTERS, COMPUTER NETWORKS AND GLOBAL COMMUNICATIONS NETWORKS; AND INSTRUCTION MANUALS SOLD THEREWITH (U.S. CLS. 21, 23, 26, 36 AND 38).

SN 78-102,378. AITECH, INC., EAGAN, MN. FILED 1-13-2002.

POPUP KILLER

NO CLAIM IS MADE TO THE EXCLUSIVE RIGHT TO USE "POPUP", APART FROM THE MARK AS SHOWN.

FOR DOWNLOADABLE SOFTWARE FOR BLOCKING ADVERTISEMENTS WHILE WEB BROWSING (U.S. CLS. 21, 23, 26, 36 AND 38).

FIRST USE 6-1-2001; IN COMMERCE 8-1-2001.

SN 78-102,929. SHIELDS, AUDREY WEST, MILLEDGEVILLE, GA. AND CRUMBLEY, OSCAR LARKIN, MILLEDGEVILLE, GA. FILED 1-15-2002.

AUDIATRIP

FOR MUSIC RECORDINGS VIA CD (U.S. CLS. 21, 23, 26, 36 AND 38).

SN 78-102,961. INTELLIGENT DISTANCE LEARNING SYSTEMS, INC., CAMBRIDGE, MA. FILED 1-16-2002.

I-DESIGNER

FOR COMPUTER SOFTWARE TO CREATE AND DELIVER DISTANCE LEARNING COURSES (U.S. CLS. 21, 23, 26, 36 AND 38).

SN 78-103,056. APPLIED SYSTEMS INTELLIGENCE, INC., ROSWELL, GA. FILED 1-16-2002.

WEBPIPE

FOR COMPUTER SOFTWARE, NAMELY, COMPUTER SOFTWARE FOR THE PURPOSE OF INTERFACING AND EXCHANGING DATA WITH OTHER SOFTWARE APPLICATIONS THAT ARE HOSTED ON THE INTERNET (U.S. CLS. 21, 23, 26, 36 AND 38).

CLASS 9—(Continued).

SN 78-103,186. TRIESKEY, GUY T., TEMPE, AZ. FILED 1-17-2002.

RAPIDTHERM

FOR ENVIRONMENTAL TEST CHAMBER, IE, TEMPERATURE SIMULATION EQUIPMENT (U.S. CLS. 21, 23, 26, 36 AND 38).

SN 78-103,674. CHARTONE, INC., SAN JOSE, CA. FILED 1-18-2002.

CHARTSAFE

FOR COMPUTER HARDWARE AND SOFTWARE THAT ENABLES DOCUMENT CAPTURE, DOCUMENT STORAGE, AND RETRIEVAL, AS WELL AS, A PLATFORM FOR APPLICATIONS THAT ENABLE CROSS-COMPANY COLLABORATION TO ACCESS, RETRIEVE, AND WORK ON DOCUMENTS SIMULTANEOUSLY (U.S. CLS. 21, 23, 26, 36 AND 38).

SN 78-103,696. TUTORBOTS, INC., JENKINTOWN, PA. FILED 1-18-2002.

EXPLORING CREATION

FOR EDUCATIONAL COMPUTER SOFTWARE FOR ELEMENTARY AND HIGH SCHOOL-LEVEL STUDENTS IN THE FIELD OF SCIENCE (U.S. CLS. 21, 23, 26, 36 AND 38).

SN 78-103,817. INTELLIGENT DISTANCE LEARNING SYSTEMS, INC., CAMBRIDGE, MA. FILED 1-21-2002.

IDESIGNER

FOR COMPUTER SOFTWARE TO CREATE AND DELIVER DISTANCE LEARNING COURSES (U.S. CLS. 21, 23, 26, 36 AND 38).

SN 78-104,112. DANE, LLC, POOLESVILLE, MD. FILED 1-22-2002.

NAGLOBAL

FOR COMPUTER SOFTWARE FOR USE IN DATABASE SEARCHING (U.S. CLS. 21, 23, 26, 36 AND 38).

CLASS 9—(Continued).

SN 78-104,617. GENERAL CADD PRODUCTS, INC., CHERY VALLEY, NY. FILED 1-24-2002.

GENERAL CADD

NO CLAIM IS MADE TO THE EXCLUSIVE RIGHT TO USE "CADD", APART FROM THE MARK AS SHOWN.

FOR ALL-PURPOSE COMPUTER-ASSISTED DESIGN AND DRAFTING SOFTWARE FOR USE BY ANY INDIVIDUAL IN DRAWING AND DESIGNING (U.S. CLS. 21, 23, 26, 36 AND 38).

SN 78-105,835. SKORMAN, THEODORE A, ORLANDO, FL. FILED 1-30-2002.

HELOFLEX

FOR PRERECORDED VIDEO TAPES, CASSETTES, AND DVDS FEATURING EXERCISE ROUTINES (U.S. CLS. 21, 23, 26, 36 AND 38).

SN 78-106,121. GOLFPRO INCORPORATED, HERNDON, VA. FILED 1-31-2002.



NO CLAIM IS MADE TO THE EXCLUSIVE RIGHT TO USE "THE GOLFPRO SYSTEM", APART FROM THE MARK AS SHOWN.

FOR COMPUTER SOFTWARE PROGRAM FOR MANAGING GOLF COURSE OPERATIONS INCLUDING, BUT NOT LIMITED TO- TEE TIME SCHEDULING, PROSHOP SALES AND INVENTORY TRACKING, TOURNAMENT SCHEDULING, INSTRUCTOR SCHEDULING AND HANDICAPPING (U.S. CLS. 21, 23, 26, 36 AND 38).

SN 78-106,563. HANDY TECH ELEKTRONIK GMBH, 72160 HORB-NORDSTETTEN, FED REP GERMANY, FILED 2-4-2002.

BRAILLE STAR

NO CLAIM IS MADE TO THE EXCLUSIVE RIGHT TO USE "BRAILLE", APART FROM THE MARK AS SHOWN.

FOR ELECTRONIC BRAILLE READING MACHINES (U.S. CLS. 21, 23, 26, 36 AND 38).

CLASS 9—(Continued).

SN 78-106,573. MARKETING INVESTORS CORPORATION, DALLAS, TX. FILED 2-4-2002.

DURACOM

OWNER OF U.S. REG. NO. 1,830,231.
FOR DIGITAL VIDEO DISC PLAYERS (U.S. CLS. 21, 23, 26, 36 AND 38).

SN 78-106,757. MEMSCAP INC., OAKLAND, CA. FILED 2-4-2002.

**DESIGNING THE MEMS
WORLD**

NO CLAIM IS MADE TO THE EXCLUSIVE RIGHT TO USE "MEMS", APART FROM THE MARK AS SHOWN.
FOR SOFTWARE DESIGN TOOL FOR USE IN THE DESIGN AND DEVELOPMENT OF MICRO-ELECTRO-MECHANICAL SYSTEMS (MEMS) (U.S. CLS. 21, 23, 26, 36 AND 38).

SN 78-107,193. CP DEVELOPMENTS, LLC, MARYSVILLE, MI. FILED 2-6-2002.

PAGEPILOT

FOR COMPUTER SOFTWARE, NAMELY, SOFTWARE THAT PERMITS A USER TO NAVIGATE THROUGH THE USER'S WEB SITE AND MODIFY ITS CONTENTS IN REAL TIME (U.S. CLS. 21, 23, 26, 36 AND 38).

SN 78-107,195. FRANKLIN MEMORIAL HOSPITAL, FARMINGTON, ME. FILED 2-6-2002.

QUICKSCORE

FOR COMPUTER SOFTWARE FOR USE BY HEALTH CARE PROFESSIONALS IN PREVENTIVE HEALTH CARE, NAMELY, FOR CREATING DATA DISPLAYS AND DATA SUMMARIES AND ANALYSES THAT REVIEW A PATIENT'S MEDICAL HISTORY (U.S. CLS. 21, 23, 26, 36 AND 38).

SN 78-108,061. I-VISION ENTERTAINMENT, INC., LOS ANGELES, CA. FILED 2-11-2002.

SUPERVISION

FOR SERIES OF PRE-RECORDED PHONOGRAPH RECORDS, CDS AND AUDIO CASSETTES FEATURING MUSIC; SERIES OF PRE-RECORDED VIDEO TAPES FEATURING MUSIC VIDEOS (U.S. CLS. 21, 23, 26, 36 AND 38).
FIRST USE 2-20-1998; IN COMMERCE 6-19-2001.

CLASS 9—(Continued).

SN 78-108,120. INSIGHT DIRECT, INC., BOSTON, MA. FILED 2-11-2002.

SERVICECEO

FOR COMPUTER SOFTWARE FOR MANAGING SERVICE BUSINESSES (U.S. CLS. 21, 23, 26, 36 AND 38).
FIRST USE 1-20-2001; IN COMMERCE 5-1-2001.

SN 78-108,241. FIORONI,RYAN,REMO, OAKLAND, CA. FILED 2-12-2002.

REMO'CONSCIOUS

FOR COMPACT DISKS, CASSETTES, AND RECORDS FEATURING MUSIC (U.S. CLS. 21, 23, 26, 36 AND 38).
FIRST USE 11-1-2001; IN COMMERCE 2-1-2002.

SN 78-108,264. GREAT LAKES CASE & CABINET CO., INC., EDINBORO, PA. FILED 2-12-2002.

WE RACK YOUR WORLD

FOR CABINETS, ENCLOSURES AND SUPPORTS FOR COMPUTERS AND ELECTRONIC EQUIPMENT (U.S. CLS. 21, 23, 26, 36 AND 38).

SN 78-108,306. BETWEENMARKETS, INC., AUSTIN, TX. FILED 2-12-2002.



FOR COMPUTER SOFTWARE FOR SUPPLY CHAIN MANAGEMENT; COMPUTER GRAPHICAL USER INTERFACE SOFTWARE FOR BUSINESS APPLICATIONS (U.S. CLS. 21, 23, 26, 36 AND 38).

SN 78-108,592. AZTEC WIRELESS TECHNOLOGIES, INC., LOS GATOS, CA. FILED 2-13-2002.

MINITRON

FOR HAND-HELD, PERSONAL, ELECTRONIC DEVICE USED TO RECEIVE, DISPLAY, NAVIGATE, AND TRANSMIT SPORTS AND ENTERTAINMENT CONTENT (U.S. CLS. 21, 23, 26, 36 AND 38).

CLASS 9—(Continued).

SN 78-108,610. ACCELA, INC., SOUTH SAN FRANCISCO, CA. FILED 2-13-2002.

GOVXML

FOR COMPUTER SOFTWARE AND COMPUTER PROGRAMMING LANGUAGES, NAMELY, COMPUTER SOFTWARE AND PROGRAMS FOR APPLYING FOR AND OBTAINING PERMITS, FOR TRACKING STATUS OF PERMITS, AND SCHEDULING PERMIT-RELATED INSPECTIONS (U.S. CLS. 21, 23, 26, 36 AND 38).

SN 78-108,693. DEERFIELD COMMUNICATIONS INC., GAYLORD, MI. FILED 2-14-2002.

VISNETIC

FOR COMPUTER SOFTWARE FOR ENSURING SECURITY ON AN INDIVIDUAL COMPUTER OR A COMPUTER NETWORK BY INVENTORYING WHAT IS PASSING INTO AND OUT OF THE COMPUTER OR COMPUTER NETWORK AND ASSURING ITS ACCEPTABILITY, NAMELY FIREWALL SOFTWARE, AUDITING SOFTWARE, AND ANTIVIRUS SOFTWARE IN THE FIELD OF COMPUTERS AND COMPUTER NETWORKS (U.S. CLS. 21, 23, 26, 36 AND 38).

SN 78-109,198. FOUNDSTONE, INC., MISSION VIEJO, CA. FILED 2-15-2002.

VULNTRAK

FOR COMPUTER SOFTWARE FOR IDENTIFYING, MONITORING, EVALUATING AND MANAGING THE SECURITY OF COMPUTER NETWORKS, DATABASES, AND APPLICATIONS, FOR RECORDING COMPUTER NETWORK, DATABASE AND APPLICATION SECURITY VIOLATIONS, AND FOR TRAINING TO IMPROVE, IDENTIFY, MONITOR, EVALUATE AND MANAGE THE SECURITY OF COMPUTER NETWORKS, DATABASES AND APPLICATIONS (U.S. CLS. 21, 23, 26, 36 AND 38).

SN 78-109,516. SCOTT LEVY PRODUCTION GROUP, DALLAS, TX. FILED 2-18-2002.

SYNERGY

FOR PROJECT MANAGEMENT SOFTWARE (U.S. CLS. 21, 23, 26, 36 AND 38).

SN 78-109,528. SMC CORPORATION OF AMERICA, INDIANAPOLIS, IN. FILED 2-18-2002.

INFINIFLOW

FOR AUTOMATIC VALVES (U.S. CLS. 21, 23, 26, 36 AND 38).

CLASS 9—(Continued).

SN 78-109,593. PDAFIT, L.L.C., MADISON, WI. FILED 2-19-2002.

PDAFIT

FOR COMPUTER SOFTWARE FOR USE IN PERSONAL HEALTH AND FITNESS MONITORING AND TRAINING (U.S. CLS. 21, 23, 26, 36 AND 38).

SN 78-109,595. ACE LABEL SYSTEMS, INC., GOLDEN VALLEY, MN. FILED 2-19-2002.

LABELSNAP

FOR COMPUTER SOFTWARE FOR PRINTING ON LABEL, TAG AND PAPER STOCK (U.S. CLS. 21, 23, 26, 36 AND 38).

SN 78-109,972. PORTSMOUTH SOFTWARE, INC., PORTSMOUTH, NH. FILED 2-20-2002.

EASYFILER

FOR COMPUTER HARDWARE AND SOFTWARE FOR USE IN DOCUMENT IMAGING, MANAGEMENT AND STORAGE (U.S. CLS. 21, 23, 26, 36 AND 38).

SN 78-110,005. INTERACTIVE SOLUTIONS INTERNATIONAL, LLC, HARRISON, OH. FILED 2-20-2002.

2GROM

FOR MULTI MEDIA SOFTWARE RECORDED ON A CD ROM FOR BUSINESS TO SHARE THEIR COMPANIES INFORMATION WITH THEIR CLIENTS. THE CD ROM IS ALSO A BUSINESS CARD THAT CAN BE USED AT TRADE SHOWS AND NETWORKING EVENTS. (U.S. CLS. 21, 23, 26, 36 AND 38).

FIRST USE 10-14-2000; IN COMMERCE 10-14-2000.

SN 78-110,108. SATELLITE AVENUE LLC, COLUMBIA FALLS, MT. FILED 2-21-2002.

SATELLITE AVENUE

NO CLAIM IS MADE TO THE EXCLUSIVE RIGHT TO USE "SATELLITE", APART FROM THE MARK AS SHOWN. FOR SATELLITES (U.S. CLS. 21, 23, 26, 36 AND 38).

CLASS 9—(Continued).

SN 78-111,560. FRUZYNA, ALEKSANDRA B, REDWOOD VALLEY, CA. FILED 2-27-2002.

DATAMOLOGY

FOR COMPUTER SOFTWARE FOR INFORMATION VISUALIZATION (U.S. CLS. 21, 23, 26, 36 AND 38).

SN 78-111,595. DENTSPLY INTERNATIONAL INC., YORK, PA. FILED 2-28-2002.

VIXWIN

FOR COMPUTER X-RAY IMAGING SOFTWARE (U.S. CLS. 21, 23, 26, 36 AND 38).
FIRST USE 2-8-2002; IN COMMERCE 2-8-2002.

SN 78-112,016. BLONDIE ROCKWELL, INC., NEW YORK, NY. FILED 3-1-2002.

FETISH

FOR EYEWEAR; SUNGLASSES; EYEGLASSES; EYEGLASS FRAMES; EYEGLASS, SUNGLASSES AND SPECTACLE CASES; EYEGLASS, SUNGLASSES AND SPECTACLE STRAPS; EYEGLASS, SUNGLASSES AND SPECTACLE CHAINS; EYEGLASS, SUNGLASSES AND SPECTACLE CLEANING CLOTHS (U.S. CLS. 21, 23, 26, 36 AND 38).

SN 78-112,019. DIRECT IMPRESSIONS ENGRAVING, AURORA, CO. FILED 3-1-2002.

MR. SAND MAN

FOR GAMING MACHINES, NAMELY SLOT MACHINES WITH OR WITHOUT A VIDEO OUTPUT (U.S. CLS. 21, 23, 26, 36 AND 38).

SN 78-112,056. METAEDGE CORPORATION, SUNNYVALE, CA. FILED 3-1-2002.

C-INSIGHT

FOR COMPUTER SOFTWARE APPLICATION FOR USE IN ANALYZING CUSTOMER PROFILES, CUSTOMER ACTIVITIES AND RELATED STATISTICAL ANALYSIS IN THE FIELD OF ELECTRONIC COMMERCE (U.S. CLS. 21, 23, 26, 36 AND 38).

FIRST USE 1-0-2000; IN COMMERCE 8-0-2000.

CLASS 9—(Continued).

SN 78-112,149. KIDVID, INC., ALPHARETTA, GA. FILED 3-2-2002.

PEACEFUL BABY

NO CLAIM IS MADE TO THE EXCLUSIVE RIGHT TO USE "BABY", APART FROM THE MARK AS SHOWN.

FOR PRERECORDED MUSIC AUDIO CASSETTES, COMPACT DISCS AND VIDEO TAPES FEATURING SONGS AND MUSICAL PIECES TO STIMULATE THE INTELLIGENCE AND COGNITIVE DEVELOPMENT OF INFANTS AND CHILDREN (U.S. CLS. 21, 23, 26, 36 AND 38).

SN 78-112,150. KIDVID, INC., ALPHARETTA, GA. FILED 3-2-2002.

JOYFUL BABY

NO CLAIM IS MADE TO THE EXCLUSIVE RIGHT TO USE "BABY", APART FROM THE MARK AS SHOWN.

FOR PRERECORDED MUSIC AUDIO CASSETTES, COMPACT DISCS AND VIDEO TAPES FEATURING SONGS AND MUSICAL PIECES TO STIMULATE THE INTELLIGENCE AND COGNITIVE DEVELOPMENT OF INFANTS AND CHILDREN (U.S. CLS. 21, 23, 26, 36 AND 38).

SN 78-112,151. KIDVID, INC., ALPHARETTA, GA. FILED 3-2-2002.

BUCKLE-UP BABY

NO CLAIM IS MADE TO THE EXCLUSIVE RIGHT TO USE "BABY", APART FROM THE MARK AS SHOWN.

FOR PRERECORDED MUSIC AUDIO CASSETTES, COMPACT DISCS AND VIDEO TAPES FEATURING SONGS AND MUSICAL PIECES TO STIMULATE THE INTELLIGENCE AND COGNITIVE DEVELOPMENT OF INFANTS AND CHILDREN (U.S. CLS. 21, 23, 26, 36 AND 38).

SN 78-112,152. KIDVID, INC., ALPHARETTA, GA. FILED 3-2-2002.

TRAVELING BABY

NO CLAIM IS MADE TO THE EXCLUSIVE RIGHT TO USE "BABY", APART FROM THE MARK AS SHOWN.

FOR PRERECORDED MUSIC AUDIO CASSETTES, COMPACT DISCS AND VIDEO TAPES FEATURING SONGS AND MUSICAL PIECES TO STIMULATE THE INTELLIGENCE AND COGNITIVE DEVELOPMENT OF INFANTS AND CHILDREN (U.S. CLS. 21, 23, 26, 36 AND 38).

CLASS 9—(Continued).

SN 78-112,153. KIDVID, INC., ALPHARETTA, GA. FILED 3-2-2002.

SILLY BABY

NO CLAIM IS MADE TO THE EXCLUSIVE RIGHT TO USE "BABY", APART FROM THE MARK AS SHOWN.

FOR PRERECORDED MUSIC AUDIO CASSETTES, COMPACT DISCS AND VIDEO TAPES FEATURING SONGS AND MUSICAL PIECES TO STIMULATE THE INTELLIGENCE AND COGNITIVE DEVELOPMENT OF INFANTS AND CHILDREN (U.S. CLS. 21, 23, 26, 36 AND 38).

SN 78-112,161. KIDVID, INC., ALPHARETTA, GA. FILED 3-2-2002.

PRAISE PHONICS

NO CLAIM IS MADE TO THE EXCLUSIVE RIGHT TO USE "PHONICS", APART FROM THE MARK AS SHOWN.

FOR SERIES OF PRERECORDED VIDEO TAPES, AUDIO CASSETTES, DIGITAL VIDEO DISCS, AND COMPACT DISCS FEATURING LIVE ACTION AND ANIMATION TO STIMULATE THE INTELLIGENCE AND COGNITIVE DEVELOPMENT OF INFANTS AND CHILDREN (U.S. CLS. 21, 23, 26, 36 AND 38).

SN 78-112,173. FISHSTRIKER INDUSTRIES INC., VICTORIA, BRITISH COLUMBIA, CANADA, FILED 3-2-2002.

FISHSTRIKER

FOR ELECTRONIC VIDEO GAME MACHINE FOR PLAYING VIDEO GAMES ON PERSONAL COMPUTERS; ELECTRONIC GAME PROGRAMS THAT SIMULATE SPORTS FISHING AND ARE PLAYABLE ON PERSONAL COMPUTERS; PLAYER-OPERATED ELECTRONIC CONTROLLERS FOR ELECTRONIC VIDEO GAME MACHINES AND PERSONAL COMPUTERS (U.S. CLS. 21, 23, 26, 36 AND 38).

SN 78-112,250. TRIGRAM SOFTWARE, LLC, OAKLAND, CA. FILED 3-4-2002.

ACUBASE

FOR COMPUTER SOFTWARE USED FOR ACUPUNCTURE PRACTICE MANAGEMENT (U.S. CLS. 21, 23, 26, 36 AND 38).

CLASS 9—(Continued).

SN 78-112,689. MANHATTAN ASSOCIATES, INC., ATLANTA, GA. FILED 3-5-2002.

X-SCE

FOR COMPUTER SOFTWARE FOR MANAGING A SUPPLY CHAIN OF GOODS AND MATERIALS (U.S. CLS. 21, 23, 26, 36 AND 38).

SN 78-112,690. BUSINESS APPLICATIONS PERFORMANCE CORPORATION, SANTA CLARA, CA. FILED 3-5-2002.

MOBILEMARK

FOR COMPUTER PROGRAMS THAT MEASURE THE SPEED, PERFORMANCE AND/OR BATTERY LIFE OF PORTABLE COMPUTERS (U.S. CLS. 21, 23, 26, 36 AND 38).

SN 78-113,229. OAKLEY, INC., FOOTHILL RANCH, CA. FILED 3-7-2002.

TANGENT

FOR PROTECTIVE EYEWEAR, NAMELY SPECTACLES, PRESCRIPTION EYEWEAR, ANTI-GLARE GLASSES AND SUNGLASSES AND THEIR PARTS AND ACCESSORIES, NAMELY REPLACEMENT LENSES, FRAMES, EARSTEMS, AND NOSE PIECES; CASES SPECIALLY ADAPTED FOR SPECTACLES AND SUNGLASSES AND THEIR PARTS AND ACCESSORIES (U.S. CLS. 21, 23, 26, 36 AND 38).

SN 78-113,230. OAKLEY, INC., FOOTHILL RANCH, CA. FILED 3-7-2002.

COSINE

FOR PROTECTIVE EYEWEAR, NAMELY SPECTACLES, PRESCRIPTION EYEWEAR, ANTI-GLARE GLASSES AND SUNGLASSES AND THEIR PARTS AND ACCESSORIES, NAMELY REPLACEMENT LENSES, FRAMES, EARSTEMS, AND NOSE PIECES; CASES SPECIALLY ADAPTED FOR SPECTACLES AND SUNGLASSES AND THEIR PARTS AND ACCESSORIES (U.S. CLS. 21, 23, 26, 36 AND 38).

CLASS 9—(Continued).

SN 78-113,235. OAKLEY, INC., FOOTHILL RANCH, CA. FILED 3-7-2002.

SINE

FOR PROTECTIVE EYEWEAR, NAMELY SPECTACLES, PRESCRIPTION EYEWEAR, ANTI-GLARE GLASSES AND SUNGLASSES AND THEIR PARTS AND ACCESSORIES, NAMELY REPLACEMENT LENSES, FRAMES, EARSTEMS, AND NOSE PIECES; CASES SPECIALLY ADAPTED FOR SPECTACLES AND SUNGLASSES AND THEIR PARTS AND ACCESSORIES (U.S. CLS. 21, 23, 26, 36 AND 38).

SN 78-113,239. BERKELEY * IEOR, BERKELEY, CA. FILED 3-7-2002.

FFAPM

FOR COMPUTER SOFTWARE, NAMELY BUSINESS ACCOUNTING SOFTWARE THAT PROCESSES LARGE AMOUNTS OF DATA TO MEASURE A BUSINESS FINANCIAL PERFORMANCE (U.S. CLS. 21, 23, 26, 36 AND 38).

SN 78-113,254. LEGALZOOM.COM, INC., LOS ANGELES, CA. FILED 3-7-2002.

LEGALWIZ

FOR COMPUTER SOFTWARE FOR COORDINATING THE END-TO-END CREATION AND PREPARATION OF LEGAL, BUSINESS AND GOVERNMENT DOCUMENTS, INCLUDING DATA COLLECTION AND DOCUMENT PREPARATION (U.S. CLS. 21, 23, 26, 36 AND 38).
FIRST USE 10-15-2000; IN COMMERCE 10-15-2000.

SN 78-113,318. DIGITAL HOUSE, INC., POWAY, CA. FILED 3-7-2002.

XCTV

FOR BURGLAR ALARMS; CLOSED CIRCUIT TELEVISION CAMERAS, VIDEO AND SURVEILLANCE CAMERAS; VIDEO MONITORS; VIDEO SYSTEMS, NAMELY DIGITAL VIDEO RECORDERS, DIGITAL STORAGE SYSTEMS FOR DIGITAL VIDEO RECORDERS, AND TIME-LAPSE DIGITAL VIDEO RECORDERS FOR USE WITH CLOSED CIRCUIT TELEVISION OR SURVEILLANCE SYSTEMS, INCLUDING VIDEO CAMERAS, TRANSMITTERS, RECEIVERS, MULTIPLEXERS, QUADS, VIDEO CAMERA CONTROLLERS, MATRIX SWITCHERS; FACILITIES MANAGEMENT SOFTWARE, NAMELY, COMPUTER CONTROL OVER CLOSED CIRCUIT CAMERAS AND VIDEO CAMERAS, ACCESS AND SECURITY SYSTEMS (U.S. CLS. 21, 23, 26, 36 AND 38).

CLASS 9—(Continued).

SN 78-113,334. DIGITAL HOUSE, INC., POWAY, CA. FILED 3-7-2002.

XDTV

FOR BURGLAR ALARMS; CLOSED CIRCUIT TELEVISION CAMERAS, VIDEO AND SURVEILLANCE CAMERAS; VIDEO MONITORS; VIDEO SYSTEMS, NAMELY DIGITAL VIDEO RECORDERS, DIGITAL STORAGE SYSTEMS FOR DIGITAL VIDEO RECORDERS, AND TIME-LAPSE DIGITAL VIDEO RECORDERS FOR USE WITH CLOSED CIRCUIT TELEVISION OR SURVEILLANCE SYSTEMS, INCLUDING VIDEO CAMERAS, TRANSMITTERS, RECEIVERS, MULTIPLEXERS, QUADS, VIDEO CAMERA CONTROLLERS, MATRIX SWITCHERS; FACILITIES MANAGEMENT SOFTWARE, NAMELY, COMPUTER CONTROL OVER CLOSED CIRCUIT CAMERAS AND VIDEO CAMERAS, ACCESS AND SECURITY SYSTEMS (U.S. CLS. 21, 23, 26, 36 AND 38).

SN 78-113,511. HARMAN INTERNATIONAL INDUSTRIES, INCORPORATED, NORTHRIDGE, CA. FILED 3-8-2002.

GNX

FOR ELECTRONIC AUDIO SIGNAL PROCESSORS AND SOUND MODIFICATION UNITS FOR USE WITH MUSICAL INSTRUMENTS (U.S. CLS. 21, 23, 26, 36 AND 38).

SN 78-113,512. HARMAN INTERNATIONAL INDUSTRIES, INCORPORATED, NORTHRIDGE, CA. FILED 3-8-2002.

TONE DRIVER

FOR ELECTRONIC AUDIO SIGNAL PROCESSORS AND SOUND MODIFICATION UNITS FOR USE WITH MUSICAL INSTRUMENTS (U.S. CLS. 21, 23, 26, 36 AND 38).

SN 78-113,516. HARMAN INTERNATIONAL INDUSTRIES, INCORPORATED, NORTHRIDGE, CA. FILED 3-8-2002.

MAIN SQUEEZE

FOR ELECTRONIC AUDIO SIGNAL PROCESSORS AND SOUND MODIFICATION UNITS FOR USE WITH MUSICAL INSTRUMENTS (U.S. CLS. 21, 23, 26, 36 AND 38).

CLASS 9—(Continued).

SN 78-113,575. ION TRACK INSTRUMENTS, INC., WILMINGTON, MA. FILED 3-8-2002.



FOR ELECTRONIC APPARATUS FOR DETECTING TRACE AMOUNTS OF SUBSTANCES, NAMELY, NARCOTICS, EXPLOSIVES AND CONTRABAND (U.S. CLS. 21, 23, 26, 36 AND 38).

SN 78-113,678. KOURY, DONALD CARRINGTON, LEBANON, NH. FILED 3-8-2002.

MEDLYNX

FOR COMPUTER SOFTWARE FOR USE IN BROWSING THE GLOBAL COMPUTER NETWORK (U.S. CLS. 21, 23, 26, 36 AND 38).

SN 78-114,110. 3COM CORPORATION, SANTA CLARA, CA. FILED 3-11-2002.

XRN

FOR EXPANDABLE AND REDUNDANT MODULES AND SWITCHES FOR USE IN CONNECTION WITH COMPUTERS AND COMPUTER NETWORKS AND INSTRUCTION MANUALS SOLD AS A UNIT THEREWITH (U.S. CLS. 21, 23, 26, 36 AND 38).

SN 78-114,148. PHARMEDICA COMMUNICATIONS, LLC, KILLINGWORTH, CT. FILED 3-12-2002.

DXTX

FOR SOFTWARE USED FOR MARKETING PHARMACEUTICAL PRODUCTS TO PRESCRIBERS OF THE PHARMACEUTICAL PRODUCTS, AND ALSO SOFTWARE FOR EDUCATING THE PRESCRIBERS ABOUT THE PRODUCTS AND RELATED DISEASE STATES (U.S. CLS. 21, 23, 26, 36 AND 38).

SN 78-114,356. SURROMED, INC., MOUNTAIN VIEW, CA. FILED 3-12-2002.

DEELOOK

FOR SCIENTIFIC INSTRUMENTS, NAMELY MASS SPECTROMETERS (U.S. CLS. 21, 23, 26, 36 AND 38).

CLASS 9—(Continued).

SN 78-114,878. NATIONAL RESOURCE MANAGEMENT, INC., MEDFIELD, MA. FILED 3-14-2002.

COOLTROL

FOR COMPUTER SOFTWARE FOR USE IN DATABASE DECOMPRESSION AND ANALYSIS IN THE FIELD OF HEATING, COOLING, AND HUMIDITY MANAGEMENT WITHIN REFRIGERATION SYSTEMS (U.S. CLS. 21, 23, 26, 36 AND 38).

FIRST USE 9-0-2001; IN COMMERCE 9-0-2001.

SN 78-115,514. RIVERA, JOHN C., PLANO, TX. FILED 3-18-2002.

QUIKSPEX

FOR EYEGLASSES, EYEGLASS FRAMES, EYEGLASS LENSES (U.S. CLS. 21, 23, 26, 36 AND 38).

SN 78-116,321. SYNCRON TECHNOLOGIES, LLC, SCOTTSDALE, AZ. FILED 3-20-2002.

UDN

FOR WEB-BASED SOFTWARE WHICH INTEGRATES ELECTRONIC PRODUCT DESIGN AND VALIDATION, DESIGN PROCESS, TEAM MANAGEMENT AND PARTS PROCUREMENT (U.S. CLS. 21, 23, 26, 36 AND 38).

SN 78-116,449. ARELNET, LTD., YAVNE, ISRAEL, FILED 3-21-2002.

I-TONE PRIMO

OWNER OF U.S. REG. NOS. 2,382,301 AND 2,487,704. FOR COMPUTER HARDWARE AND COMPUTER TELEPHONY SOFTWARE; COMPUTER HARDWARE AND SOFTWARE, SOLD AS A UNIT, THAT PROVIDES REMOTE ACCESS AND MANAGEMENT OF COMPUTER NETWORKS, PROVIDES GATEWAYS FOR USE IN PUBLIC AND PRIVATE NETWORK COMMUNICATIONS, COMBINES VOICE AND FAX SERVICES OVER PUBLIC AND PRIVATE NETWORKS (U.S. CLS. 21, 23, 26, 36 AND 38).

FIRST USE 8-15-2000; IN COMMERCE 9-1-2000.

CLASS 10—MEDICAL APPARATUS

SN 75-295,105. SMITH & NEPHEW, INC., MEMPHIS, TN. FILED 5-20-1997.

CONTOUR

FOR ORTHOPAEDIC IMPLANTS; NAMELY ACETABULAR CUPS, HIP STEMS, AND RELATED INSTRUMENTS AND RELATED INSTRUMENTATION FOR IMPLANTING AND FASTENING IMPLANTS AND FOR HOLDERS FOR IMPLANTS AND INSTRUMENTS (U.S. CLS. 26, 39 AND 44).



SN 75-552,900. BAXTER INTERNATIONAL INC., DEERFIELD, IL. FILED 9-14-1998.

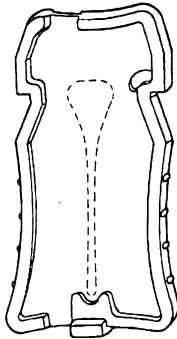

SEC. 2(F).
FOR NON-METAL SLIDE CLAMPS FOR MEDICAL USE WITH INFUSION SETS (U.S. CLS. 26, 39 AND 44).
FIRST USE 1-0-1996; IN COMMERCE 1-0-1996.

CLASS 10—(Continued).

SN 75-583,491. SURER, PATRICK, 44110 CHATEAUBRIANT, FRANCE, FILED 11-5-1998.

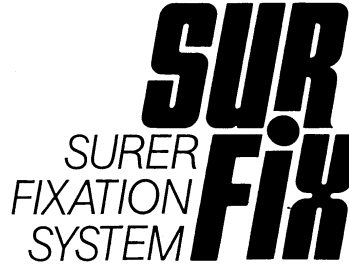

OWNER OF FRANCE REG. NO. 1595581, DATED 6-5-1990, RENEWED AS REG. NO. 2169314, DATED 3-30-2000, EXPIRES 3-30-2010.

NO CLAIM IS MADE TO THE EXCLUSIVE RIGHT TO USE "FIXATION SYSTEM", APART FROM THE MARK AS SHOWN.
THE DOT, IN THE LETTER "I," IN THE WORD "FIX", IS IN RED.

FOR MEDICAL INSTRUMENTS, NAMELY - ORTHOPEDIC AND TRAUMATOLOGIC SURGICAL INSTRUMENTS, NAMELY, OSTEOSYNTHESIS OF MEMBERS AND TRUNK, OSTEOARTICULAR PROSTHESIS, SURGICAL ANCILLARY EQUIPMENT, NAMELY, PLIERS OR PIN PULLER, RULER, PRIMARY X-RAY OVERLAY, REVISION X-RAY OVERLAY, TOTAL KNEE ARTHROPLASTY MECHANICAL ALIGNMENT TEMPLATE, AND STILLE HOLDING FORCEPS (U.S. CLS. 26, 39 AND 44).



SN 75-601,316. LINDEN, SIGURD, SE-582 18 LINKOPING, SWEDEN, FILED 12-9-1998.

INDEX

FOR MAGNETIC HOLDERS FOR DENTAL BURS, REAMERS, CLAMPS, MATRIX BANDS AND DENTAL INSTRUMENTS (U.S. CLS. 26, 39 AND 44).
FIRST USE 5-1-1999; IN COMMERCE 5-1-1999.



SN 75-713,880. DAW INDUSTRIES, INC., SAN DIEGO, CA. FILED 5-25-1999.

CINCH

FOR ORTHODIC/PROSTHETIC DEVICE IN THE NATURE OF A TUBULAR SLEEVE THAT FITS OVER A LIMB FOR USE IN ATTACHING PROSTHESIS DEVICES TO THE REMAINING PORTION ON THE USER'S LIMB (U.S. CLS. 26, 39 AND 44).
FIRST USE 3-3-1999; IN COMMERCE 4-20-1999.

CLASS 10—(Continued).

SN 75-834,400. HAMILTON MEDICAL, INC., RENO, NV.
FILED 10-28-1999.

ASV

FOR MEDICAL DEVICES, NAMELY, ADAPTIVE SUPPORT VENTILATION SYSTEMS CONSISTING PRIMARILY OF A CONTROLLER TO DELIVER GAS TO A PATIENT AND SOFTWARE TO MODIFY DELIVERY (U.S. CLS. 26, 39 AND 44).

FIRST USE 9-0-1997; IN COMMERCE 12-31-1997.

SN 75-886,963. CENTRAL MEDICAL TECHNOLOGIES INC.,
TAIPEI, TAIWAN, FILED 1-4-2000.

VIGOR

PRIORITY CLAIMED UNDER SEC. 44(D) ON TAIWAN APPLICATION NO. 88062997, FILED 12-15-1999, REG. NO. 00925073, DATED 1-16-2001, EXPIRES 1-15-2011.

FOR BONE SCREWS; BONE PLATES; SPINAL RESTORATION FIXATOR; ARTIFICIAL INTERVERTEBRAL DISK IMPLANTS; INTERVERTEBRAL FUSION DEVICES, NAMELY, FUSION PUMPS; INTERVERTEBRAL FUSION DEVICES, NAMELY, RETRACTORS; INTERVERTEBRAL FUSION IMPLANTS; EXTERNAL FIXATOR FOR ORTHOPEDIC SURGERY; OCULAR IMPLANTS; ORTHOPEDIC JOINT IMPLANTS; BONE IMPLANTS (U.S. CLS. 26, 39 AND 44).

SN 75-903,541. RESPIRONICS, INC., PITTSBURGH, PA.
FILED 1-26-2000.

MILLENNIUM RESPIRONICS

OWNER OF U.S. REG. NO. 1,520,737.

FOR MEDICAL DEVICES FOR USE IN OXYGEN THERAPY, NAMELY, OXYGEN CONCENTRATORS FOR IN-HOME, NON-NEONATAL USE (U.S. CLS. 26, 39 AND 44).

FIRST USE 8-7-1998; IN COMMERCE 8-7-1998.

SN 75-943,449. ACCUWAVE, LLC, ALEXANDRIA, VA.
FILED 3-3-2000.

ACCUWAVE

FOR MEDICAL DEVICES, NAMELY, ELECTROTHERAPY STIMULATION APPARATUS (U.S. CLS. 26, 39 AND 44).

CLASS 10—(Continued).

SN 76-007,401. PRODONTA, 1207 GENEVA, SWITZERLAND,
FILED 3-22-2000.

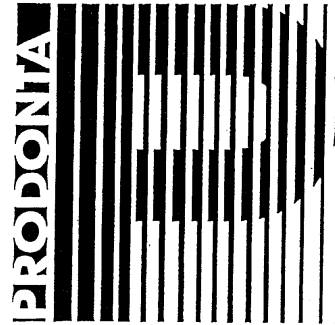

PRIORITY CLAIMED UNDER SEC. 44(D) ON SWITZERLAND APPLICATION NO. 09270/1999, FILED 10-14-1999, REG. NO. 470555, DATED 5-4-2000, EXPIRES 10-14-2009.

THE LINING IS A FEATURE OF THE MARK AND DOES NOT INDICATE COLOR.

FOR DENTAL APPARATUS AND ELECTRIC DENTAL APPARATUS, NAMELY, CONTRA ANGLES FOR USE IN DENTAL AND DENTAL SURGICAL PROCEDURES; HEADS FOR CONTRA ANGLES; HAND PIECES FOR CONTRA ANGLES; FILES, REAMERS, NERVE BROACHES, FILLERS, CLEANING BITS AND SHAPERS FOR DENTAL INSTRUMENTS; DENTAL INSTRUMENT TRAYS; BROKEN ROOT CANAL INSTRUMENT EXTRACTION KITS COMPRISED OF PLIERS, WRENCH, HANDLE, BUTTON, FLAT GAUGE, STAR GAUGES, BORING BITS AND CASE ALL SOLD AS A UNIT; PINS FOR ARTIFICIAL TEETH; AND DENTAL MIRRORS (U.S. CLS. 26, 39 AND 44).

SN 76-008,437. PIONEER LABORATORIES, INC., MARQUETTE, MI. FILED 3-23-2000.

HEX BUTTON

NO CLAIM IS MADE TO THE EXCLUSIVE RIGHT TO USE "BUTTON", APART FROM THE MARK AS SHOWN.

FOR IMPLANTABLE ORTHOPEDIC SCREW RETAINING AND ANTI-BACKOUT DEVICE WHICH SECURES ORTHOPEDIC BONE SCREWS IN PLACE (U.S. CLS. 26, 39 AND 44).

FIRST USE 2-8-1999; IN COMMERCE 2-8-1999.

SN 76-012,212. SCIMED LIFE SYSTEMS, INC., MAPLE GROVE, MN. FILED 3-29-2000.

EAG

FOR VASCULAR GRAFTS, NAMELY, SURGICAL IMPLANTS COMPRISING ARTIFICIAL MATERIALS; AND PERCUTANEOUS SURGICAL INSTRUMENTS FOR USE IN DEPLOYING VASCULAR GRAFTS (U.S. CLS. 26, 39 AND 44).

CLASS 10—(Continued).

SN 76-052,696. MATRIX TECHNOLOGIES CORP., HUDSON, NH. FILED 5-19-2000.

FLO-THRU

FOR LABORATORY RACK FOR DISPOSABLE PIPET-TOR TIPS (U.S. CLS. 26, 39 AND 44).
FIRST USE 1-29-1999; IN COMMERCE 1-29-1999.

SN 76-075,409. RADI MEDICAL SYSTEMS AB, S-754 50 UPPSALA, SWEDEN, FILED 6-22-2000.

**RADI MEDICAL
TECHNOLOGIES**

OWNER OF U.S. REG. NOS. 2,361,151 AND 2,361,152.
NO CLAIM IS MADE TO THE EXCLUSIVE RIGHT TO USE "MEDICAL TECHNOLOGIES", APART FROM THE MARK AS SHOWN.

FOR MEDICAL APPARATUS AND MEDICAL INSTRUMENTS, NAMELY, A FULL LINE OF MEDICAL INSTRUMENTS FOR USE IN DELIVERING AND DETECTING RADIATION AND ADMINISTERING RADIATION TREATMENT (U.S. CLS. 26, 39 AND 44).

SN 76-078,713. ROCHE DIAGNOSTICS GMBH, D-68305 MANNHEIM, FED REP GERMANY, FILED 6-27-2000.

ACCU-CHEK INFORM

OWNER OF U.S. REG. NO. 2,336,435.
FOR BLOOD GLUCOSE MONITOR WITH DATA MANAGEMENT CAPABILITIES (U.S. CLS. 26, 39 AND 44).

SN 76-081,246. SMITHKLINE BEECHAM PLC, BRENTFORD, MIDDLESEX, UNITED KINGDOM, FILED 6-30-2000.

GLAXOSMITHKLINE

PRIORITY CLAIMED UNDER SEC. 44(D) ON UNITED KINGDOM APPLICATION NO. 2221100, FILED 2-2-2000, REG. NO. 2221100, DATED 2-2-2000, EXPIRES 2-2-2010.

OWNER OF U.S. REG. NOS. 649,600, 2,407,367 AND OTHERS.

FOR MEDICAL APPARATUS, NAMELY INHALERS FOR THERAPEUTIC USE (U.S. CLS. 26, 39 AND 44).

SN 76-086,647. KOVEN TECHNOLOGY, INC., ST. LOUIS, MO. FILED 7-11-2000.

MINIDOPPLER

SEC. 2(F).
FOR HAND HELD ULTRASONIC BLOOD FLOW DETECTOR (U.S. CLS. 26, 39 AND 44).
FIRST USE 0-0-1995; IN COMMERCE 0-0-1995.

CLASS 10—(Continued).

SN 76-092,524. LEVIN, ANDREW, JENSEN BEACH, FL. FILED 7-10-2000.

EZ-IV

FOR MEDICAL APPARATUS, NAMELY, AN INSULATED BOX CONTAINING A HEATING ELEMENT FOR WARMING PADS WHICH ARE APPLIED TO THE SKIN TO MAKE INTRAVENOUS NEEDLES EASIER TO INSERT (U.S. CLS. 26, 39 AND 44).

SN 76-112,304. EDGE SYSTEMS CORPORATION, SIGNAL HILL, CA. FILED 8-17-2000.

The Edge System

NO CLAIM IS MADE TO THE EXCLUSIVE RIGHT TO USE "SYSTEM", APART FROM THE MARK AS SHOWN.

FOR MEDICAL APPARATUS, NAMELY, SYSTEMS COMPRISED PRIMARILY OF A VACUUM SOURCE AND HAND PIECE USED FOR MEDICAL BODY CARE TREATMENTS, MICRODERMABRASION, AND MASSAGE THERAPY (U.S. CLS. 26, 39 AND 44).

SN 76-120,067. BONO, MICHEAL, SANTA BARBARA, CA. BY ASSIGNMENT CONSULTA, INC., SANTA BARBARA, CA. FILED 8-30-2000.

TELANGITRON

FOR MEDICAL DEVICES, NAMELY, AN ELECTRONIC CONTROL BOX, PROBE CORDS, ELECTRICAL CORDS, PHORESIS ROLLERS AND ULTRA FINE NEEDLES USED IN THE REMOVAL OF TELANGIECTASIA, CHERRY ANGIOMA AND OTHER SMALL VASCULAR BLEMISHES AND LEGIONS (U.S. CLS. 26, 39 AND 44).
FIRST USE 6-2-1999; IN COMMERCE 6-2-1999.

SN 76-169,776. DARBY DRUG CO., INC., WESTBURY, NY. FILED 11-20-2000.

PERFORM

FOR MEDICAL, DENTAL AND VETERINARY SUPPLIES, NAMELY, EXAMINATION GLOVES (U.S. CLS. 26, 39 AND 44).
FIRST USE 6-1-1986; IN COMMERCE 6-1-1986.

CLASS 10—(Continued).

SN 76-182,824. CARES BUILT, INC, KEYPORT, NJ. FILED 12-19-2000.

ZEUS

FOR RADIOGRAPHY AND FLUOROSCOPY X-RAY APPARATUS, NAMELY A BATTERY POWERED AND LINE POWERED X-RAY GENERATOR FOR MEDICAL USE (U.S. CLS. 26, 39 AND 44).

SN 76-183,562. APOLLO DENTAL PRODUCTS, INCORPORATED, CLOVIS, CA. FILED 12-20-2000.

GOLDSERIES

FOR DENTAL APPARATUSES, NAMELY, LIQUID-RING VACUUM PUMPS (U.S. CLS. 26, 39 AND 44). FIRST USE 1-1-1993; IN COMMERCE 1-1-1993.

SN 76-195,703. CALIFORNIA BIOSOLUTIONS, LLC, SAN DIEGO, CA. FILED 1-19-2001.

BIO SOLUTIONS

NO CLAIM IS MADE TO THE EXCLUSIVE RIGHT TO USE "BIO", APART FROM THE MARK AS SHOWN. FOR HOME ELECTRICAL HEALTH CARE EQUIPMENT, NAMELY, SIGNAL GENERATORS FOR KILLING MICROORGANISMS AND VIRUSES AND TO ENHANCE TISSUE REGENERATION (U.S. CLS. 26, 39 AND 44). FIRST USE 3-1-1999; IN COMMERCE 1-21-2000.

SN 76-196,542. LINVATEC CORPORATION, LARGO, FL. FILED 1-16-2001.

TRIDENT

FOR SURGICAL CUTTING INSTRUMENTS, NAMELY, ARTHROSCOPIC SHAVEN BLADES AND HANDPIECES FOR MECHANICALLY CUTTING AND RESECTING AND ELECTROSURGICALLY ABLATING SOFT TISSUE DURING ARTHROSCOPIC SURGICAL PROCEDURES IN SALINE FILLED CAVITIES (U.S. CLS. 26, 39 AND 44).

CLASS 10—(Continued).

SN 76-197,993. POWER MEDICAL INTERVENTIONS, INC., NEW HOPE, PA. FILED 1-23-2001.



FOR REMOTE CONTROLLED SURGICAL STAPLERS (U.S. CLS. 26, 39 AND 44).

SN 76-201,985. RETRACTABLE TECHNOLOGIES, INC., LITTLE ELM, TX. FILED 1-31-2001.

VANISHPOINT

OWNER OF U.S. REG. NO. 2,070,833. FOR MEDICAL DEVICES; NAMELY, MEDICAL SYRINGES, BLOOD COLLECTION TUBE HOLDERS, CATHETERS, DENTAL NEEDLE DEVICES, AND DISPOSABLE CONTAINERS FOR SHARP MEDICAL DEVICES (U.S. CLS. 26, 39 AND 44). FIRST USE 1-29-1997; IN COMMERCE 1-29-1997.

SN 76-206,841. SPECTRAL DIAGNOSTICS INC., TORONTO, ONTARIO M9C 1C2, CANADA, FILED 2-8-2001.

ALADDIN MICROLAB

FOR MEDICAL TEST KITS, CONSISTING PRIMARILY OF IN VITRO DIAGNOSTIC REAGENTS USEFUL IN THE DIAGNOSIS OF MEDICAL CONDITIONS, DISORDERS AND DISEASES, ALL FOR MEDICAL DIAGNOSTIC USE (U.S. CLS. 26, 39 AND 44).

SN 76-216,435. ARES TRADING S.A., 2028 VAUMARCUS, SWITZERLAND, FILED 2-26-2001.

SEROJET

FOR MEDICAL APPARATUS, NAMELY, NON-INVASIVE POWER INJECTOR USED FOR SUBCUTANEOUS INJECTION OF MEDICINE EXCLUDING DENTAL USE (U.S. CLS. 26, 39 AND 44). FIRST USE 2-4-2002; IN COMMERCE 2-4-2002.

CLASS 10—(Continued).

SN 76-220,607. MICROVENA CORPORATION, WHITE BEAR LAKE, MN. FILED 3-5-2001.

HEPROTEC

FOR VASCULAR FILTRATION DEVICES, NAMELY VASCULAR FILTERS AND VASCULAR GUIDEWIRES (U.S. CLS. 26, 39 AND 44).

SN 76-227,845. NEXELL THERAPEUTICS INC., IRVINE, CA. FILED 3-21-2001.

CYTOMATE

FOR MEDICAL DEVICES, NAMELY, AUTOMATED AND INTEGRATED CELL WASHING AND FLUID TRANSFER DEVICES TO WASH AND CONCENTRATE BLOOD CELL PRODUCTS (U.S. CLS. 26, 39 AND 44).

SN 76-245,443. ELA MEDICAL, 92120 MONTROUGE, FRANCE, FILED 4-24-2001.

SYMPHONY

PRIORITY CLAIMED UNDER SEC. 44(D) ON FRANCE APPLICATION NO. 013079736, FILED 1-24-2001, REG. NO. 013079736, DATED 1-24-2001, EXPIRES 1-24-2011.

OWNER OF U.S. REG. NO. 1,938,506.
FOR PACEMAKERS, PACING LEADS, DEFIBRILLATORS AND DEFIBRILLATOR LEADS (U.S. CLS. 26, 39 AND 44).

SN 76-246,637. DENBUR, INC., HINSDALE, IL. FILED 4-25-2001.

MULTI-BRUSH

FOR DENTAL INSTRUMENTS, NAMELY, DISPOSABLE DENTAL APPLICATORS (U.S. CLS. 26, 39 AND 44).
FIRST USE 2-0-1991; IN COMMERCE 2-0-1991.

SN 76-260,627. BIO-LOGIC SYSTEMS CORP, MUNDELEIN, IL. FILED 5-21-2001.

EAR MUFFINS

NO CLAIM IS MADE TO THE EXCLUSIVE RIGHT TO USE "EAR", APART FROM THE MARK AS SHOWN.
FOR MEDICAL DEVICE, NAMELY, EAR COUPLERS FOR MEDICAL DIAGNOSTIC USE (U.S. CLS. 26, 39 AND 44).

CLASS 10—(Continued).

SN 76-263,313. BELTONE ELECTRONICS CORPORATION, CHICAGO, IL. FILED 5-23-2001.

INVISIA

FOR HEARING AIDS (U.S. CLS. 26, 39 AND 44).
FIRST USE 2-15-1994; IN COMMERCE 5-16-1994.

SN 76-266,493. ADVANCED CARDIOVASCULAR SYSTEMS, INC., SANTA CLARA, CA. FILED 6-5-2001.

HI-TORQUE FINESSE

NO CLAIM IS MADE TO THE EXCLUSIVE RIGHT TO USE "HI-TORQUE", APART FROM THE MARK AS SHOWN.
FOR MEDICAL GUIDE WIRES (U.S. CLS. 26, 39 AND 44).

SN 76-266,495. ADVANCED CARDIOVASCULAR SYSTEMS, INC., SANTA CLARA, CA. FILED 6-5-2001.

HI-TORQUE UNIVERSAL

OWNER OF U.S. REG. NOS. 1,353,440, 2,302,008 AND OTHERS.

NO CLAIM IS MADE TO THE EXCLUSIVE RIGHT TO USE "HI-TORQUE", APART FROM THE MARK AS SHOWN.
FOR MEDICAL GUIDE WIRES (U.S. CLS. 26, 39 AND 44).

SN 76-269,849. TRIAGE MEDICAL, INC., IRVINE, CA. FILED 6-11-2001.

TRIASGE MEDICAL

NO CLAIM IS MADE TO THE EXCLUSIVE RIGHT TO USE "MEDICAL", APART FROM THE MARK AS SHOWN.
FOR MEDICAL DEVICES, NAMELY, SCREWS, BOLTS AND OTHER BONE IMPLANTS AND FASTENERS FOR USE IN CONNECTION WITH ORTHOPEDIC TRAUMA, OSTEOTOMIES, FUSIONS AND FRACTURES (U.S. CLS. 26, 39 AND 44).

SN 76-271,334. EMPHASYS MEDICAL, INC., REDWOOD CITY, CA. FILED 6-13-2001.

EMPHASYS MEDICAL, INC.

NO CLAIM IS MADE TO THE EXCLUSIVE RIGHT TO USE "MEDICAL, INC.", APART FROM THE MARK AS SHOWN.
FOR MEDICAL DEVICES FOR THE TREATMENT OF RESPIRATORY CONDITIONS, NAMELY, CATHETERS, FLOW CONTROL DEVICES AND ANCILLARY DEVICES FOR THE USE OF THE FLOW CONTROL DEVICES (U.S. CLS. 26, 39 AND 44).

CLASS 10—(Continued).

SN 76-271,435. EMPHASYS MEDICAL, INC., REDWOOD CITY, CA. FILED 6-13-2001.



FOR MEDICAL DEVICES FOR THE TREATMENT OF RESPIRATORY CONDITIONS, NAMELY, CATHETERS, FLOW CONTROL DEVICES AND ANCILLARY DEVICES FOR THE USE OF THE FLOW CONTROL DEVICES (U.S. CLS. 26, 39 AND 44).

SN 76-280,616. ADVANCED CARDIOVASCULAR SYSTEMS, INC., SANTA CLARA, CA. FILED 7-6-2001.

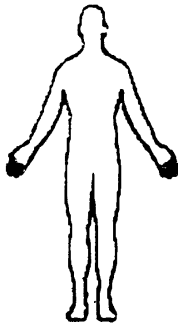

OWNER OF U.S. REG. NO. 2,523,076.
FOR MEDICAL CATHETERS, MEDICAL GUIDE WIRES, STENTS, AND MEDICAL STENTS COMPRISING MEDICAL CATHETERS, MEDICAL GUIDE WIRES AND STENTS (U.S. CLS. 26, 39 AND 44).
FIRST USE 4-12-2000; IN COMMERCE 4-12-2000.

SN 76-284,420. AMERICAN BIOSYSTEMS, INC., DBA ADVANCED RESPIRATORY, ST. PAUL, MN. FILED 7-12-2001.

ADVANCED RESPIRATORY

NO CLAIM IS MADE TO THE EXCLUSIVE RIGHT TO USE "RESPIRATORY", APART FROM THE MARK AS SHOWN.

FOR MEDICAL APPARATUS, NAMELY, A DEVICE THAT PROVIDES HIGH-FREQUENCY, CHEST WALL OSCILLATION FOR AIRWAY CLEARANCE THERAPY (U.S. CLS. 26, 39 AND 44).

FIRST USE 4-23-2001; IN COMMERCE 7-3-2001.

CLASS 10—(Continued).

SN 76-287,069. COMPUTER MOTION, INC., SANTA BARBARA, CA. FILED 7-17-2001.

MICROWRIST

FOR SURGICAL INSTRUMENTS, NAMELY, A HANDLE FOR A ROBOTICALLY CONTROLLED SURGICAL INSTRUMENT INCLUDING SCALPELS, SCISSORS, NEEDLE DRIVERS, FORCEPS, GRASPERS AND CAUTERY PROBES (U.S. CLS. 26, 39 AND 44).

SN 76-289,844. WELL-LIFE HEALTHCARE INC., TAIPEI, TAIWAN, FILED 7-25-2001.



FOR ELECTRIC AND NON-ELECTRIC MASSAGE MACHINES; ELECTRIC AND NON-ELECTRIC LOW FREQUENCY MASSAGE MACHINES; ELECTRIC AND NON-ELECTRIC SLIMMING MACHINES FOR TONING THE HUMAN BODY; ELECTRIC HEALTH AND BEAUTY MACHINES, NAMELY, THERMAL FAR INFRARED WAVE LAMPS, ELECTRIC MOXIBUSTION MACHINES, ELECTRIC FACIAL TONERS, ELECTRIC ACUPUNCTURE MACHINES, AND ELECTRIC MUSCLE STIMULATORS; ANTI-SNORING MACHINES IN THE NATURE OF AN ELECTRICAL DEVICE FOR PROVIDING AN ELECTRICAL STIMULUS OR ALARM WHEN A PERSON SNORES (U.S. CLS. 26, 39 AND 44).

SN 76-289,864. I-STAT CORPORATION, EAST WINDSOR, NJ. FILED 7-23-2001.

CG4+

FOR CARTRIDGES FOR USE IN PORTABLE CLINICAL BLOOD ANALYZERS (U.S. CLS. 26, 39 AND 44).
FIRST USE 5-0-2000; IN COMMERCE 5-0-2000.

SN 76-294,650. FLOTEC, INC., INDIANAPOLIS, IN. FILED 8-6-2001.

EMERALD

FOR GAS PRESSURE REGULATORS, COMBINATION GAS PRESSURE REGULATORS WITH FLOW METERING DEVICES, FLOW METERING DEVICES AND VACUUM REGULATOR DEVICES FOR DELIVERY OF GASES FOR MEDICAL USE (U.S. CLS. 26, 39 AND 44).

CLASS 10—(Continued).

SN 76-299,725. SORBA MEDICAL SYSTEMS, INC., DBA SORBA MEDICAL SYSTEMS, BROOKFIELD, WI. FILED 8-15-2001.

RTEA

FOR MEDICAL EQUIPMENT, NAMELY, IMPEDANCE CARDIOGRAPHS (U.S. CLS. 26, 39 AND 44).

SN 76-301,908. MATTIOLI ENGINEERING LTD., LONDON, UNITED KINGDOM, FILED 8-17-2001.

TRANSDERM

FOR EQUIPMENT FOR TRANSDERMAL DELIVERY OF DRUGS AND ACTIVE SUBSTANCES, NAMELY, ELECTROMECHANICAL FACIAL AND SKIN TONING MACHINES FOR COSMETIC USE (U.S. CLS. 26, 39 AND 44).

SN 76-303,623. LASER DIAGNOSTIC TECHNOLOGIES, INC., SAN DIEGO, CA. FILED 8-23-2001.

laser  diagnostic
technologies

NO CLAIM IS MADE TO THE EXCLUSIVE RIGHT TO USE "LASER DIAGNOSTIC TECHNOLOGIES", APART FROM THE MARK AS SHOWN.

THE MARK "LASER DIAGNOSTIC TECHNOLOGIES" WHEREIN THE WORDS "LASER" AND "DIAGNOSTIC" ARE SEPARATED BY THREE OBLONGS OF VARYING LENGTHS.

FOR LASERS FOR MEASURING AND ANALYZING OCULAR TISSUE (U.S. CLS. 26, 39 AND 44).

FIRST USE 7-31-2001; IN COMMERCE 7-31-2001.

CLASS 10—(Continued).

SN 76-307,415. SNIADACH, JOSEPH A., BALTIMORE, MD. FILED 8-30-2001.

THE AIRWAY AUTHORITY

NO CLAIM IS MADE TO THE EXCLUSIVE RIGHT TO USE "AIRWAY", APART FROM THE MARK AS SHOWN.

FOR MEDICAL DEVICES AND INSTRUMENTS FOR AIRWAY MANAGEMENT, NAMELY, RESUSCITATORS, FACIAL MASKS, LARYNGOSCOPES, TRACHEOSTOMY TUBES, ENDOTRACHEAL TUBES, INSTRUMENTS FOR DIFFICULT AIRWAYS AND MEDICAL AIRWAY MANAGEMENT KITS COMPRISED OF RESUSCITATORS, FACIAL MASKS, LARYNGOSCOPES, TRACHEOSTOMY TUBES, ENDOTRACHEAL TUBES, INSTRUMENTS FOR DIFFICULT AIRWAYS AND FLEXIBLE TUBING (U.S. CLS. 26, 39 AND 44).

SN 76-311,471. LIFEGEAR, INC., ARCADIA, CA. FILED 9-12-2001.

LIFEGEAR

OWNER OF U.S. REG. NO. 2,045,861.
FOR MASSAGE APPARATUS, NAMELY, NON-ELECTRIC MASSAGE TABLES AND MASSAGE CHAIRS (U.S. CLS. 26, 39 AND 44).

FIRST USE 1-0-1999; IN COMMERCE 1-0-1999.

SN 76-311,705. CERT HEALTH SCIENCES, INC., OCEAN CITY, MD. FILED 9-14-2001.

SpineMED

THE STIPLING IS A FEATURE OF THE MARK.
FOR MEDICAL DEVICES, NAMELY A SPLIT TABLE FOR USE IN DECOMPRESSING THE INTERVERTEBRAL DISCS DURING BACK TREATMENT (U.S. CLS. 26, 39 AND 44).

SN 76-318,699. VIVANT MEDICAL, INC., MOUNTAIN VIEW, CA. FILED 9-27-2001.

CONFIANT

FOR MEDICAL DEVICES, NAMELY ABLATION DEVICE, SURGICAL AIDS FOR REMOVAL OF BREAST LUMPS AND LOCATION MARKERS FOR INDICATION LOCATION OF BIOPSY, ALL IN THE FIELD OF BREAST CANCER TREATMENT, SURGERY AND BIOPSY PROCEDURES (U.S. CLS. 26, 39 AND 44).

CLASS 10—(Continued).

SN 76-320,755. MEDENNIUM, INC., IRVINE, CA. FILED 10-3-2001.

MATRIX ACRYLIC

NO CLAIM IS MADE TO THE EXCLUSIVE RIGHT TO USE "ACRYLIC", APART FROM THE MARK AS SHOWN. FOR MEDICAL/SURGICAL DEVICES, NAMELY, ACRYLIC INTRAOCULAR LENS FOR CATARACT SURGERY (U.S. CLS. 26, 39 AND 44).

SN 76-327,131. GLAUKOS CORPORATION, LAGUNA HILLS, CA. FILED 10-17-2001.

GLAUKOS

FOR MEDICAL DEVICES AND APPARATUS, NAMELY SHUNTS, STENTS, OPHTHALMIC CUTTING INSTRUMENTS, SHUNT AND STENT APPLICATORS, VISION SCREENING INSTRUMENTS (U.S. CLS. 26, 39 AND 44).

SN 76-331,888. INSEAT SOLUTIONS, LLC, COSTA MESA, CA. FILED 10-30-2001.

ROAD COMFORT

OWNER OF U.S. REG. NOS. 2,304,679 AND 2,339,152. FOR MASSAGE APPARATUS, NAMELY, ELECTRO-MECHANICAL VIBRATORY SYSTEM COMPRISING A VIBRATOR AND CONTROLLER FOR USE WITH COMMERCIAL, DOMESTIC AND VEHICULAR SEATING (U.S. CLS. 26, 39 AND 44). FIRST USE 6-0-2001; IN COMMERCE 6-0-2001.

SN 76-333,958. JENSEN, NATHAN W., LAKE OSWEGO, OR. FILED 11-5-2001.

THE HEAD BUTLER

FOR OPERATING ROOM EQUIPMENT, NAMELY, AN ANESTHESIA SCREEN (U.S. CLS. 26, 39 AND 44). FIRST USE 9-1-2001; IN COMMERCE 9-1-2001.

SN 76-338,209. UNIVERSAL COMPANIES, INC., BRISTOL, VA. FILED 11-16-2001.

UNIVERSAL TOUCH

FOR MASSAGE TABLES (U.S. CLS. 26, 39 AND 44).

CLASS 10—(Continued).

SN 76-341,545. BREMER GROUP COMPANY, THE, JACKSONVILLE, FL. FILED 11-26-2001.

COMFALIGN

FOR SPINAL SUPPORTS IN THE NATURE OF ORTHOPEDIC SPINAL SUPPORTS AND ORTHOPEDIC SPINAL BRACES (U.S. CLS. 26, 39 AND 44).

SN 76-350,785. ELECTONE, INC., LONGWOOD, FL. FILED 12-14-2001.



NO CLAIM IS MADE TO THE EXCLUSIVE RIGHT TO USE "100% DIGITAL", APART FROM THE MARK AS SHOWN. FOR HEARING AIDS (U.S. CLS. 26, 39 AND 44). FIRST USE 7-1-2001; IN COMMERCE 7-1-2001.

SN 76-354,616. EXELINT INTERNATIONAL CO., DBA EXCEL INTERNATIONAL, LOS ANGELES, CA. FILED 1-4-2002.

COMFORT JECT

FOR MEDICAL AND SURGICAL DEVICES, NAMELY, SYRINGES AND NEEDLES (U.S. CLS. 26, 39 AND 44). FIRST USE 3-8-1999; IN COMMERCE 3-8-1999.

SN 76-354,617. EXELINT INTERNATIONAL CO., DBA EXEL INTERNATIONAL, LOS ANGELES, CA. FILED 1-4-2002.

FOR MEDICAL AND SURGICAL DEVICES, NAMELY, SYRINGES AND NEEDLES (U.S. CLS. 26, 39 AND 44). FIRST USE 3-8-1999; IN COMMERCE 3-8-1999.

CLASS 10—(Continued).

SN 76-354,619. EXELINT INTERNATIONAL CO., DBA EXEL INTERNATIONAL, LOS ANGELES, CA. FILED 1-4-2002.

vaculet

FOR DISPOSABLE BLOOD COLLECTING VACUUM TUBES; DISPOSABLE BLOOD COLLECTING PRODUCTS FOR USE WITH BLOOD COLLECTING VACUUM TUBES, NAMELY, SCALP VEIN SETS WITH ATTACHED MULTI-SAMPLE LUER-ADAPTER; BLOOD COLLECTING KITS CONSISTING OF MULTI-DRAWING NEEDLE, LUER-ADAPTER, HOLDER, BLOOD TUBE, SWAB, ALCOHOL PADS AND BANDAGES (U.S. CLS. 26, 39 AND 44).

FIRST USE 6-21-2001; IN COMMERCE 6-21-2001.

SN 76-356,967. DATEX-OHMEDA, INC., MADISON, WI. FILED 1-8-2002.

REALMOTION

FOR MEDICAL MEASUREMENT DEVICES, NAMELY, NON-INVASIVE PULSE OXIMETRY DEVICES FOR MEASURING BLOOD OXYGEN SATURATION (U.S. CLS. 26, 39 AND 44).

SN 76-357,957. MACROPORE, INC., SAN DIEGO, CA. FILED 1-11-2002.

SURGI-WRAP

FOR MEDICAL IMPLANTS, NAMELY, NON-LIVING TISSUE IMPLANTS, AND RELATED FITTINGS AND REPLACEMENT PARTS (U.S. CLS. 26, 39 AND 44).

CLASS 10—(Continued).

SN 76-360,599. ALARIS MEDICAL SYSTEMS, INC., SAN DIEGO, CA. FILED 1-18-2002.



FOR MEDICAL COMPUTER PROGRAMS TO CONTROL MEDICAL DEVICES FOR INFUSING MEDICAL FLUID INTO A PATIENT, NAMELY VOLUMETRIC INFUSION PUMPS, SYRINGE PUMPS, VOLUMETRIC CONTROLLERS, AND PATIENT-CONTROLLED ANALGESIA INSTRUMENTS; AND TO CONTROL PATIENT MONITORING DEVICES, NAMELY PULSE OXIMETRY MONITORS AND SENSORS, BLOOD PRESSURE MONITORS, THERMOMETERS, INVASIVE PRESSURE MONITORS, AND ELECTROCARDIOGRAM MONITORS; AND TO CONTROL MEDICATION MANAGEMENT SYSTEMS, NAMELY BAR CODE SCANNING, AND POINT OF CARE OPEN AND CLOSED LOOP THERAPY INSTRUMENTS (U.S. CLS. 26, 39 AND 44).

SN 76-364,433. BOYD, NAOMI, CHICAGO, IL. FILED 1-25-2002.

DNI PACII

FOR INFANT PACIFIERS (U.S. CLS. 26, 39 AND 44).

SN 76-366,336. SURGICAL SPECIALTIES CORPORATION, READING, PA. FILED 2-4-2002.

POLYSYN FA

FOR SUTURES FOR HUMAN AND VETERINARY USE (U.S. CLS. 26, 39 AND 44).

SN 76-366,338. SURGICAL SPECIALTIES CORPORATION, READING, PA. FILED 2-4-2002.

POLYSYN

FOR SUTURES FOR HUMAN AND VETERINARY USE (U.S. CLS. 26, 39 AND 44).

CLASS 10—(Continued).

SN 76-367,254. ALLIED HEALTHCARE PRODUCTS, INC., ST. LOUIS, MO. FILED 2-5-2002.

SURGEX

FOR VALVES FOR DISPENSING MEDICAL GASES (U.S. CLS. 26, 39 AND 44).

SN 76-370,150. JUNIOR LEAGUE OF SANTA BARBARA, INC., SANTA BARBARA, CA. FILED 2-13-2002.

WELLGOWNS

FOR MEDICAL GOWNS (U.S. CLS. 26, 39 AND 44). FIRST USE 9-6-2001; IN COMMERCE 9-6-2001.

SN 76-371,593. RESPOND SYSTEMS, INC., BRANFORD, CT. FILED 2-19-2002.

PONY-PULSE

FOR MAGNETIC FIELD THERAPY SYSTEM FOR MEDICAL USE FOR PONIES, NAMELY, PULSING COILS, PULSE GENERATOR, BATTERY CHARGER, TEST MAGNET (U.S. CLS. 26, 39 AND 44). FIRST USE 2-8-2002; IN COMMERCE 2-8-2002.

SN 76-372,219. CVS VANGUARD, INC., SCARSDALE, NY. FILED 2-19-2002.

CVS/PHARMACY

FOR MEDICAL OR HYPODERMIC SYRINGES (U.S. CLS. 26, 39 AND 44). FIRST USE 2-6-2001; IN COMMERCE 2-6-2001.

SN 76-378,987. SONIC INNOVATIONS, INC., SALT LAKE CITY, UT. FILED 3-5-2002.

TRIBUTE

FOR HEARING AIDS (U.S. CLS. 26, 39 AND 44).

CLASS 10—(Continued).

SN 76-383,581. MEDTEX, LLC, GLEN ALLEN, VA. FILED 3-14-2002.

MEDTEXTILE

FOR DISPOSABLE PROTECTIVE COVERINGS FOR MEDICAL DEVICES, EQUIPMENT AND SUPPLIES, ENVIRONMENTAL SURFACES, AND INDIVIDUALS THAT REDUCE THE OPPORTUNITIES FOR THE TRANSMISSION OF INFECTIOUS AGENTS (U.S. CLS. 26, 39 AND 44).

SN 76-384,544. ORTHO ORGANIZERS, INC., SAN MARCOS, CA. FILED 3-12-2002.

TWIN FORCE

FOR ORTHODONTIC APPLIANCES, NAMELY, BITE CORRECTORS (U.S. CLS. 26, 39 AND 44). FIRST USE 11-29-1999; IN COMMERCE 11-29-1999.

SN 76-387,573. ORTHO DEVELOPMENT CORPORATION, DRAPER, UT. FILED 3-26-2002.

CANTILEVER-TLIF

FOR ORTHOPEDIC IMPLANTS AND PROSTHESES (U.S. CLS. 26, 39 AND 44).

SN 76-389,726. ADVANCED RESPIRATORY, INC., SAINT PAUL, MN. FILED 3-27-2002.

**SETTING THE STANDARD
FOR AIRWAY CLEARANCE**

FOR MEDICAL APPARATUS, NAMELY, A DEVICE THAT PROVIDES HIGH FREQUENCY CHEST WALL OSCILLATION FOR AIRWAY CLEARANCE THERAPY (U.S. CLS. 26, 39 AND 44).

SN 76-390,361. NOVASYS MEDICAL, INC., NEWARK, CA. FILED 4-1-2002.

**IMPROVING WOMEN'S
LIVES**

FOR MEDICAL DEVICES, NAMELY RADIOFREQUENCY ENERGY GENERATORS, NEEDLE ELECTRODES, CATHETERS, MEDICAL ELECTRODES AND ENERGY-DELIVERING ELECTRODES FOR DELIVERY OF RADIOFREQUENCY ENERGY, ALL FOR USE IN THE DIAGNOSIS AND TREATMENT OF UROGENITAL AND GYNECOLOGICAL CONDITIONS (U.S. CLS. 26, 39 AND 44).

CLASS 10—(Continued).

SN 78-045,134. BIOCOSM, INC., LATHAM, NY. FILED 1-26-2001.

BIOCOSM

FOR STENTS, STENT SHEATHS, DRUG DELIVERY SYSTEMS, NANODEVICES, NAMELY, ENZYME AND BIOMATTER SENSORS, MICRODEVICES, NAMELY, FLUID FLOW SENSORS, WIRELESS DATA TRANSMITTERS, PRESSURE SENSORS, ALL FOR MEDICAL USE (U.S. CLS. 26, 39 AND 44).

SN 78-046,990. COLBAR R&D LTD., RAMAT HASHARON, ISRAEL, FILED 2-7-2001.

OSSIX

FOR REGENERATIVE MEMBRANES FOR USE IN DENTISTRY (U.S. CLS. 26, 39 AND 44).

SN 78-049,214. AMERICAN HOME PRODUCTS CORPORATION, MADISON, NJ. FILED 2-20-2001.

RAPA-STENT

OWNER OF U.S. REG. NOS. 1,909,128, 2,407,270 AND 2,425,667.
FOR CORONARY STENTS (U.S. CLS. 26, 39 AND 44).

SN 78-057,077. MEDSERV GROUP, INC., VISTA, CA. FILED 4-5-2001.

BioMEDICAL
LIFE • SYSTEMS

OWNER OF U.S. REG. NO. 1,800,313.
SEC. 2(F).
FOR MEDICAL EQUIPMENT; NAMELY, TRANSCUTANEOUS ELECTRONEURAL STIMULATORS, ELECTRONEURAL MUSCULAR STIMULATORS, AND ACCESSORIES SOLD THEREWITH (U.S. CLS. 26, 39 AND 44).
FIRST USE 5-11-1989; IN COMMERCE 5-11-1989.

CLASS 10—(Continued).

SN 78-066,940. SURGRX, LLC, MOUNTAIN VIEW, CA. FILED 6-1-2001.

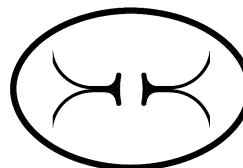

FOR SURGICAL DEVICE, NAMELY, TISSUE SEALING AND HEMOSTASIS DEVICE COMPRISED OF A DISPOSABLE LAPROSCOPIC DEVICE AND REUSABLE EXTENSION CABLE AND ADAPTOR WHICH ADAPTS TO ELECTRO SURGICAL GENERATORS (U.S. CLS. 26, 39 AND 44).

SN 78-066,941. SURGRX, LLC., MOUNTIAN VIEW, CA. FILED 6-1-2001.

ENSEAL, EN-SEAL, INSEAL, IN-SEAL

FOR SURGICAL DEVICE, NAMELY, TISSUE SEALING AND HEMOSTASIS DEVICE COMPRISED OF A DISPOSABLE LAPROSCOPIC DEVICE AND REUSABLE EXTENSION CABLE AND ADAPTOR, WHICH ADAPTS TO ELECTRO SURGICAL GENERATORS (U.S. CLS. 26, 39 AND 44).

SN 78-075,022. FREELIN-WADE COMPANY, MCMINNVILLE, OR. FILED 7-20-2001.

ASEPSI-FLEX

FOR MEDICAL INSTRUMENT AND APPARATUS, NAMELY, PLASTIC TUBING FOR USE WITH VACUUM AND SUCTION MACHINES FOR USE BY THE DENTAL INDUSTRY (U.S. CLS. 26, 39 AND 44).
FIRST USE 8-21-1990; IN COMMERCE 8-21-1990.

SN 78-082,513. CHI INSTITUTE, SAN CLEMENTE, CA. FILED 9-4-2001.

INFRATONIC

FOR ELECTRIC MESSAGE APPARATUS FOR THERAPEUTIC USE (U.S. CLS. 26, 39 AND 44).

CLASS 10—(Continued).

SN 78-082,737. BRUE, VESTA, L., IRVING, TX. FILED 9-5-2001.

CIGNALS

FOR COMPUTERIZED CASING, NAMELY, A HOLDER FOR CONTAINING TOBACCO PRODUCTS WHICH RECORDS A USER'S SMOKING HABITS FOR AIDING IN COMPLIANCE WITH A PRE-PROGRAMMED SCHEDULE FOR THE REDUCTION AND CESSATION OF NICOTINE INTAKE (U.S. CLS. 26, 39 AND 44).

SN 78-083,122. ALPS SOUTH CORPORATION, ST. PETERSBURG, FL. FILED 9-7-2001.

EASYLINER

FOR PROSTHETIC APPLIANCE WORN ON A RESIDUAL LIMB BY AN AMPUTEE THAT CUSHIONS AND PROTECTS THE RESIDUAL LIMB FROM A HARD SOCKET (U.S. CLS. 26, 39 AND 44).
FIRST USE 9-30-1997; IN COMMERCE 9-30-1997.

SN 78-085,010. AUDIA TECHNOLOGY, INC., CUPERTINO, CA. FILED 9-21-2001.

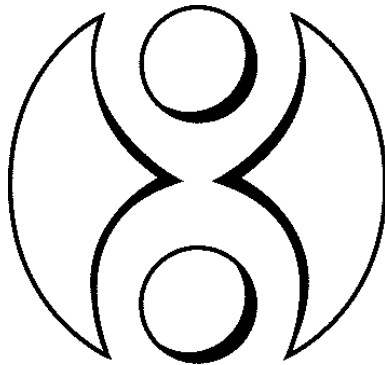

THE MARK CONSISTS OF A STYLIZED DESIGN REPRESENTING A PAIR OF EARS.
FOR AUDIO PRODUCTS, NAMELY, HEARING AIDS AND DIGITAL HEARING DEVICES IN THE NATURE OF HEARING AIDS (U.S. CLS. 26, 39 AND 44).

SN 78-095,677. BAYER CORPORATION, PITTSBURGH, PA. FILED 11-29-2001.

ASCENSIA

FOR MEDICAL DIAGNOSTIC INSTRUMENTS FOR OBTAINING BLOOD SAMPLES, NAMELY LANCETS (U.S. CLS. 26, 39 AND 44).

CLASS 10—(Continued).

SN 78-097,510. BAYER CORPORATION, PITTSBURGH, PA. FILED 12-10-2001.

ASCENTIAL

FOR MEDICAL DIAGNOSTIC INSTRUMENTS, NAMELY, BLOOD GLUCOSE METERS, FOR THE ANALYSIS OF BODY FLUIDS (U.S. CLS. 26, 39 AND 44).

SN 78-102,849. NOVARTIS AG, BASEL, SWITZERLAND, FILED 1-15-2002.

EZ SPIKE

NO CLAIM IS MADE TO THE EXCLUSIVE RIGHT TO USE "SPIKE", APART FROM THE MARK AS SHOWN.
FOR CONTAINER FOR USE WITH CLOSED SYSTEM ENTERAL TUBE FEEDING SYSTEM (U.S. CLS. 26, 39 AND 44).

SN 78-103,765. IMPAC, SALEM, OR. FILED 1-20-2002.

VIBRACUSSOR

FOR THERAPEUTIC VIBRATOR (U.S. CLS. 26, 39 AND 44).
FIRST USE 6-30-1997; IN COMMERCE 6-30-1997.

SN 78-103,946. ROTHWELL, ROBIN G., SEATTLE, WA. FILED 1-21-2002.

NUTRIPAX

FOR ELECTRONIC MICRO CURRENT STIMULATOR FOR THE HEAD (U.S. CLS. 26, 39 AND 44).
FIRST USE 9-1-2001; IN COMMERCE 9-25-2001.

SN 78-104,516. ISOCOMFORTER, INC., PALM CITY, FL. FILED 1-24-2002.

CRYOTECH100

FOR MEDICAL CRYOTHERAPY EQUIPMENT, NAMELY, COLD THERAPY WATER CIRCULATION SYSTEMS FOR THE TREATMENT AND REHABILITATION OF BONES, JOINTS AND MUSCLES (U.S. CLS. 26, 39 AND 44).

CLASS 10—(Continued).

SN 78-104,869. ELI, BRADLEY A., ENCINITAS, CA. FILED 1-25-2002.

MIGRATAB

FOR MOUTH GUARDS FOR MEDICAL PURPOSES, DENTAL ARTICULATORS, AND DENTAL BITE TRAYS (U.S. CLS. 26, 39 AND 44).

SN 78-107,571. PEPIN MANUFACTURING, INC., LAKE CITY, MN. FILED 2-8-2002.

THRIFTYTRODE

FOR NERVE AND MUSCLE STIMULATION ELECTRODES FOR MEDICAL USE (U.S. CLS. 26, 39 AND 44). FIRST USE 2-6-2002; IN COMMERCE 2-6-2002.

SN 78-108,593. NANOBIO MAGNETICS, INC, OKLAHOMA CITY, OK. FILED 2-13-2002.

NANOBIO MAGNETICS

FOR MAGNETS FOR MEDICAL PURPOSES (U.S. CLS. 26, 39 AND 44).

SN 78-109,188. MICRODENTAL LABORATORIES, DUBLIN, CA. FILED 2-15-2002.

MICROFIT

FOR PRESSURE INJECTED CUSTOM DENTURE PLATE (U.S. CLS. 26, 39 AND 44).

SN 78-111,593. DENTSPLY INTERNATIONAL INC., YORK, PA. FILED 2-28-2002.

GX-S

FOR DIGITAL X-RAY DIAGNOSTIC APPARATUS (U.S. CLS. 26, 39 AND 44). FIRST USE 2-7-2002; IN COMMERCE 2-7-2002.

SN 78-111,902. SOURCE-RAY, INC., BOHEMIA, NY. FILED 3-1-2002.

SOURCEBLOCK

FOR X-RAY DIAGNOSTIC APPARATUS COMPRISING X-RAY TUBE AND HIGH VOLTAGE GENERATOR COMBINED INTO ONE UNIT (U.S. CLS. 26, 39 AND 44).

CLASS 10—(Continued).

SN 78-112,083. EVERYTHING FOR LOVE, INC., PINE MOUNTAIN, CA. FILED 3-1-2002.

SQWIGGLER

FOR MASSAGE APPARATUS, ELECTRIC AND NON-ELECTRIC (U.S. CLS. 26, 39 AND 44).

SN 78-112,190. NOVASONICS, INC., MOUNTAIN VIEW, CA. FILED 3-2-2002.

INNOSONIX

FOR MEDICAL ULTRASOUND APPARATUS (U.S. CLS. 26, 39 AND 44).

SN 78-112,686. BLUE MOON DIAGNOSTICS, WARSAW, IN. FILED 3-5-2002.

BIOVIBE

FOR MEDICAL DEVICE THAT DETECTS THE VIBRATION EMITTED FROM THE JOINTS OF HUMANS AND ANIMALS (U.S. CLS. 26, 39 AND 44).

SN 78-112,922. MEDTRONIC SOFAMOR DANEK USA, INC., MINNEAPOLIS, MN. FILED 3-6-2002.

INSET

FOR SYNTHETIC BONE CEMENT USED TO FILING BOND VOIDS OR DEFECTS OF THE SKELETAL AND CRANIAL SYSTEMS (U.S. CLS. 26, 39 AND 44).

SN 78-113,193. BAXTER INTERNATIONAL INC., DEERFIELD, IL. FILED 3-7-2002.

SOLITAIRY

FOR BREATHING CIRCUIT FOR USE IN OPERATING ROOMS BY ANESTHESIOLOGISTS (U.S. CLS. 26, 39 AND 44).

SN 78-113,273. RADIANT REFLECTIONS, LLC, LEXINGTON, KY. FILED 3-7-2002.

RADIANT IMPRESSIONS

FOR PROSTHETIC BREASTS FOR MASTECTOMY PATIENTS (U.S. CLS. 26, 39 AND 44).

CLASS 10—(Continued).

SN 78-114,845. BAYER CORPORATION, PITTSBURGH, PA.
FILED 3-14-2002.

ASCENSIA ELITE

FOR MEDICAL DIAGNOSTIC INSTRUMENTS FOR
THE ANALYSIS OF BODY FLUIDS; LANCING DEVICES
(U.S. CLS. 26, 39 AND 44).

**CLASS 11—ENVIRONMENTAL CONTROL AP-
PARATUS**

SN 75-766,587. ZHOU YUAN INTERNATIONAL CORPORA-
TION, SAN LEANDRO, CA. FILED 8-2-1999.

FOREVER PURE

NO CLAIM IS MADE TO THE EXCLUSIVE RIGHT TO
USE "PURE", APART FROM THE MARK AS SHOWN.
FOR WATER TREATMENT EQUIPMENT, NAMELY,
WATER DESALINATION UNITS AND WATER FILTRA-
TION UNITS (U.S. CLS. 13, 21, 23, 31 AND 34).
FIRST USE 12-17-1998; IN COMMERCE 12-17-1998.

SN 75-842,187. ETABLISSEMENTS MESURA, 57600 FOR-
BACH, FRANCE, FILED 11-6-1999.



OWNER OF FRANCE REG. NO. 1,723,956, DATED 10-7-
1998, EXPIRES 10-7-2008.

THE ENGLISH TRANSLATION OF THE WORD "ME-
SURA" IN THE MARK IS "HE" OR "SHE" OR "IT
MEASURED".

FOR GAS REGULATOR UNITS FOR REGULATING
GAS AND GAS PRESSURE AND PARTS AND FITTINGS
THEREFOR; GAS PRESSURE REDUCER UNITS AND
PARTS AND FITTINGS THEREFOR; REGULATORS
AND FITTING BOXES FOR THE REGULATION OF
GAS; GAS DISTRIBUTION APPARATUS; ALL OF THE
ABOVE FOR INDUSTRIAL AND DOMESTIC USE (U.S.
CLS. 13, 21, 23, 31 AND 34).

SN 75-930,609. W.E. HALL COMPANY, NEWPORT BEACH,
CA. FILED 2-28-2000.

Q-CLEAN

FOR UNDERGROUND WATER QUALITY TREAT-
MENT RESERVOIRS FOR FILTERING STORM WATER
RUNOFF (U.S. CLS. 13, 21, 23, 31 AND 34).

CLASS 11—(Continued).

SN 75-955,516. MARTINEZ, JOHN R., RANCHO PALOS
VERDES, CA. FILED 3-8-2000.

MIDNIGHT EYES

FOR DECORATIVE LIGHTING STRING (U.S. CLS. 13,
21, 23, 31 AND 34).

SN 75-982,273. T-SYSTEMS INTERNATIONAL, INC., SAN
DIEGO, CA. FILED 12-8-2000.

T-SYSTEMS

FOR DRIP IRRIGATION EQUIPMENT, NAMELY FIL-
TERS (U.S. CLS. 13, 21, 23, 31 AND 34).
FIRST USE 2-0-2001; IN COMMERCE 2-0-2001.

SN 75-982,274. T-SYSTEMS INTERNATIONAL, INC., SAN
DIEGO, CA. FILED 12-8-2000.



FOR DRIP IRRIGATION EQUIPMENT, NAMELY FIL-
TERS (U.S. CLS. 13, 21, 23, 31 AND 34).
FIRST USE 2-0-2001; IN COMMERCE 2-0-2001.

SN 76-024,737. CHEF TECH LLC, KNOXVILLE, TN. FILED 4-
14-2000.

GRILLMATE

FOR CATALYTIC OXIDIZING APPARATUS FOR USE
IN GRILLS, BROILERS, OVENS AND SMOKERS TO
OXIDIZE FATS AND GREASES AND TO INHIBIT
FLAMES (U.S. CLS. 13, 21, 23, 31 AND 34).

CLASS 11—(Continued).

SN 76-052,284. VENTEX COMPANY, INC., SPARTANBURG, SC. FILED 5-19-2000.



NO CLAIM IS MADE TO THE EXCLUSIVE RIGHT TO USE "AMERICA'S FOOD EQUIPMENT" AND "COMPANY", APART FROM THE MARK AS SHOWN.

FOR RESTAURANT EQUIPMENT, NAMELY, COMMERCIAL COOKING OVENS, DEEP FAT FRYERS, ELECTRIC GRIDDLES, ICE MAKING MACHINES, REFRIGERATORS, FREEZERS, AND ELECTRIC FOOD STREAMERS (U.S. CLS. 13, 21, 23, 31 AND 34).

FIRST USE 3-1-1998; IN COMMERCE 3-1-1998.

SN 76-116,379. STORMTECH, INC., OLD SAYBROOK, CT. FILED 8-24-2000.

STORMTECH

FOR STORMWATER CONTAINMENT AND OIL/SEDIMENT SEPARATION SYSTEMS AND COMPONENTS THEREFOR, NAMELY NON-METALLIC CHAMBERS AND ENDPLATES, SOLD AS A UNIT, AND FILTERS AND CATCH BASINS FOR USE THEREWITH (U.S. CLS. 13, 21, 23, 31 AND 34).

FIRST USE 4-25-2000; IN COMMERCE 4-25-2000.

SN 76-134,369. NITRO-PAK PREPAREDNESS CENTER, INC., HEBER CITY, UT. FILED 9-25-2000.

CODE-4

FOR EQUIPMENT FOR PUBLIC SAFETY, LAW ENFORCEMENT, MILITARY, SECURITY AND EMERGENCY PERSONNEL, NAMELY, FLASHLIGHTS AND EMERGENCY WATER KITS (U.S. CLS. 13, 21, 23, 31 AND 34).

SN 76-150,764. LOUIS POULSEN LIGHTING A/S, 2450 KOBENHAVN SV, DENMARK, FILED 10-20-2000.

ICON

FOR OUTDOOR POLE FIXTURES, NAMELY, ELECTRIC LIGHT FIXTURES (U.S. CLS. 13, 21, 23, 31 AND 34).

CLASS 11—(Continued).

SN 76-162,179. WOODHEAD INDUSTRIES, INC., DEERFIELD, IL. FILED 11-7-2000.

"PRO-YELLOW"

OWNER OF U.S. REG. NOS. 660,051, 674,913 AND 2,494,606.

NO CLAIM IS MADE TO THE EXCLUSIVE RIGHT TO USE "YELLOW", APART FROM THE MARK AS SHOWN.

FOR ELECTRIC STRING LIGHT (U.S. CLS. 13, 21, 23, 31 AND 34).

FIRST USE 3-1-2001; IN COMMERCE 3-1-2001.

SN 76-190,173. ARMAMENT SYSTEMS AND PROCEDURES, INC., APPLETON, WI. FILED 1-5-2001.

SUBMARINER

FOR FLASHLIGHTS (U.S. CLS. 13, 21, 23, 31 AND 34).

SN 76-191,571. MHE CORP., ROGERSVILLE, MO. FILED 1-9-2001.

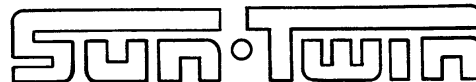

FOR ELECTRONIC ZONE HEATERS (U.S. CLS. 13, 21, 23, 31 AND 34).

SN 76-240,002. PERFECTION-SCHWANK, INC., WAYNESBORO, GA. FILED 4-12-2001.

HOT TOT

NO CLAIM IS MADE TO THE EXCLUSIVE RIGHT TO USE "HOT", APART FROM THE MARK AS SHOWN.

FOR GAS POWERED CONSTRUCTION HEATERS (U.S. CLS. 13, 21, 23, 31 AND 34).

FIRST USE 5-1-1971; IN COMMERCE 5-1-1971.

SN 76-252,049. STREAMLIGHT, INC., NORRISTOWN, PA. FILED 5-4-2001.

TRIDENT

FOR GENERAL RECREATIONAL AND INDUSTRIAL HEAD-MOUNTED OR HELMET-MOUNTED LIGHT, NOT INTENDED FOR UNDERWATER USE (U.S. CLS. 13, 21, 23, 31 AND 34).

CLASS 11—(Continued).

SN 76-272,278. ALPHA WESTERN CORPORATION, GARDEN, CA. FILED 6-15-2001.

ELEKTRA

OWNER OF U.S. REG. NOS. 1,829,326 AND 2,023,170.
FOR WATER HEATERS FOR POOLS, SPAS, AND HOT TUBS (U.S. CLS. 13, 21, 23, 31 AND 34).
FIRST USE 11-1-1985; IN COMMERCE 11-1-1985.

SN 76-284,126. STULZ AIR TECHNOLOGY SYSTEMS, INC., FREDERICK, MD. FILED 7-11-2001.

DESICAIR

FOR DEHUMIDIFIERS FOR INDUSTRIAL USE (U.S. CLS. 13, 21, 23, 31 AND 34).

SN 76-286,188. FX LUMINAIRE, DBA JOSHUA Z. AND ELEANOR E. BEADLE, SAN DIEGO, CA. FILED 7-18-2001.

TAPERLOX

FOR ELECTRICAL LIGHT MOUNTING BRACKETS AND ELECTRICAL LIGHT MOUNTING POSTS AND MOUNTING CONNECTORS (U.S. CLS. 13, 21, 23, 31 AND 34).

FIRST USE 6-1-2000; IN COMMERCE 6-1-2000.

SN 76-303,118. TURBO POWER, INC., FLUSHING, NY. FILED 7-2-2001.

TURBO 1500

NO CLAIM IS MADE TO THE EXCLUSIVE RIGHT TO USE "TURBO", APART FROM THE MARK AS SHOWN.

FOR ELECTRIC HAND-HELD HAIR DRYERS (U.S. CLS. 13, 21, 23, 31 AND 34).

FIRST USE 1-1-1982; IN COMMERCE 1-1-1982.

SN 76-304,322. BAKER COMPANY, INC., THE, SANFORD, ME. FILED 8-23-2001.

BIOGARD

FOR VENTILATING EXHAUST FAN CABINET AND HOOD WITH HEPA FILTERS, FOR CONTAMINATION-FREE STERILE AIRFLOW THROUGHOUT WORK AREAS (U.S. CLS. 13, 21, 23, 31 AND 34).

FIRST USE 12-5-1969; IN COMMERCE 12-5-1969.

CLASS 11—(Continued).

SN 76-306,302. PRESBY ENVIRONMENTAL, INC., SUGAR HILL, NH. FILED 8-28-2001.

PRESBY MAZE

FOR WASTE WATER PURIFICATION UNIT INSERTED INSIDE SEWAGE OR WASTE WATER TREATMENT TANKS TO TRAP SOLIDS (U.S. CLS. 13, 21, 23, 31 AND 34).

FIRST USE 4-0-1993; IN COMMERCE 4-0-1993.

SN 76-307,688. REIKER COMPANY, THE, SHALIMAR, FL. FILED 8-31-2001.



NO CLAIM IS MADE TO THE EXCLUSIVE RIGHT TO USE "ROOM CONDITIONER", APART FROM THE MARK AS SHOWN.

THE MARK DEPICTS IN PART, A BALD EAGLE GRASPING A BROKEN LIGHTENING BOLT BETWEEN ITS TALONS.

FOR AIR RECIRCULATING AND HEATING DEVICES, NAMELY ELECTRIC CEILING FANS, ELECTRIC CEILING FANS IN COMBINATION WITH ELECTRIC HEATERS, ELECTRIC HEATERS IN COMBINATION WITH ELECTRIC FANS AND ELECTRIC SPACE HEATERS (U.S. CLS. 13, 21, 23, 31 AND 34).

SN 76-311,083. H.H. FLUORESCENT PARTS, INC., CHELTENHAM, PA. FILED 9-12-2001.

HH

FOR FLUORESCENT BULB LAMP HOLDERS (U.S. CLS. 13, 21, 23, 31 AND 34).

FIRST USE 0-0-1952; IN COMMERCE 0-0-1952.

CLASS 11—(Continued).

SN 76-311,855. COX ENGINEERING COMPANY, CANTON, MA. FILED 9-12-2001.

PSYCHROMETRIC SOLUTIONS

NO CLAIM IS MADE TO THE EXCLUSIVE RIGHT TO USE "PSYCHROMETRIC", APART FROM THE MARK AS SHOWN.

FOR AIR HANDLING UNITS, NAMELY, UNITS THAT CONTROL AIR MOISTURE, UNITS THAT CONTROL HEAT EXCHANGE, UNITS THAT CONTROL AIR TEMPERATURE, UNITS THAT CONTROL AIR FLOW, UNITS THAT CONTROL AIR QUALITY, AND UNITS THAT CONTROL COMBINATIONS OF AIR MOISTURE, HEAT EXCHANGE, AIR TEMPERATURE, AIR FLOW, AND AIR QUALITY (U.S. CLS. 13, 21, 23, 31 AND 34).

FIRST USE 6-20-2001; IN COMMERCE 8-23-2001.

SN 76-312,206. APCOM, INC., FRANKLIN, TN. FILED 9-14-2001.



NO CLAIM IS MADE TO THE EXCLUSIVE RIGHT TO USE "ELEMENT", APART FROM THE MARK AS SHOWN.

FOR WATER HEATER PARTS, NAMELY ELECTRICAL HEATING ELEMENT FOR WATER HEATERS (U.S. CLS. 13, 21, 23, 31 AND 34).

SN 76-312,208. APCOM, INC., FRANKLIN, TN. FILED 9-14-2001.

SANDHOG

NO CLAIM IS MADE TO THE EXCLUSIVE RIGHT TO USE "ELEMENT", APART FROM THE MARK AS SHOWN.

FOR WATER HEATER PARTS, NAMELY ELECTRICAL HEATING ELEMENT FOR WATER HEATERS (U.S. CLS. 13, 21, 23, 31 AND 34).

CLASS 11—(Continued).

SN 76-312,210. STATE INDUSTRIES, INC., ASHLAND CITY, TN. FILED 9-14-2001.

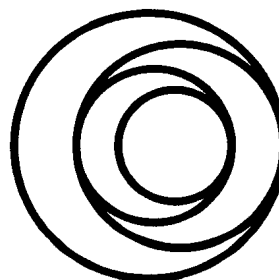

FOR WATER HEATERS FOR DOMESTIC, COMMERCIAL OR INDUSTRIAL USE (U.S. CLS. 13, 21, 23, 31 AND 34).

FIRST USE 7-25-1977; IN COMMERCE 7-25-1977.

SN 76-312,213. STATE INDUSTRIES, INC., ASHLAND CITY, TN. FILED 9-14-2001.

HYDROHEAT

FOR HEATING SYSTEMS FOR SINGLE AND MULTI-FAMILY RESIDENCES COMPRISING PRIMARILY AN AIR HANDLING UNIT CONNECTED TO AN AUTOMATIC WATER HEATER (U.S. CLS. 13, 21, 23, 31 AND 34).

FIRST USE 9-30-1982; IN COMMERCE 9-30-1982.

SN 76-312,214. STATE INDUSTRIES, INC., ASHLAND CITY, TN. FILED 9-14-2001.

STATE

FOR WATER HEATERS FOR DOMESTIC, COMMERCIAL OR INDUSTRIAL USE (U.S. CLS. 13, 21, 23, 31 AND 34).

FIRST USE 12-23-1957; IN COMMERCE 12-23-1957.

SN 76-316,486. PATIO CLASSIC, LLC, LOUISVILLE, KY. FILED 9-24-2001.

MEET THE GRILL OF YOUR DREAMS!

FOR CHARCOAL GRILLS AND GAS GRILLS (U.S. CLS. 13, 21, 23, 31 AND 34).

FIRST USE 0-0-1999; IN COMMERCE 0-0-1999.

CLASS 11—(Continued).

SN 76-319,201. THERMAL CORP, GEORGETOWN, DE. FILED 9-28-2001.

HXi

FOR COMPONENTS AND PARTS FOR THE COOLING AND HEATING OF EQUIPMENT - NAMELY IMPINGEMENT HEAT EXCHANGERS (U.S. CLS. 13, 21, 23, 31 AND 34).

SN 76-319,202. THERMAL CORP., GEORGETOWN, DE. FILED 9-28-2001.

HXc

FOR COMPONENTS AND PARTS FOR THE COOLING AND HEATING OF EQUIPMENT - NAMELY CROSS-FLOW HEAT EXCHANGERS (U.S. CLS. 13, 21, 23, 31 AND 34).

SN 76-333,560. TURBOCHEF TECHNOLOGIES, INC., DALLAS, TX. FILED 11-2-2001.

TURBOCHEF

OWNER OF U.S. REG. NO. 1,762,672.
THE DRAWING IS LINED FOR THE COLORS BLUE AND ORANGE.
FOR HIGH SPEED MICROWAVE OVENS AND COMMERCIAL COOKING OVENS (U.S. CLS. 13, 21, 23, 31 AND 34).
FIRST USE 10-1-2001; IN COMMERCE 10-1-2001.

SN 76-340,311. COOKTEK, LLC, CHICAGO, IL. FILED 11-16-2001.

FLASHPAK

FOR INDUCTION COOKING AND HEATING SYSTEMS COMPRISED OF INDUCTION COOKTOPS OR CHARGERS AND INDUCIBLE PELLETS (U.S. CLS. 13, 21, 23, 31 AND 34).

CLASS 11—(Continued).

SN 76-341,781. INNOWAVE INCORPORATED, OMAHA, NE. FILED 11-27-2001.

INNOWAVE LF

OWNER OF U.S. REG. NOS. 2,095,101, 2,361,312 AND OTHERS.
NO CLAIM IS MADE TO THE EXCLUSIVE RIGHT TO USE "LF", APART FROM THE MARK AS SHOWN.
FOR WATER DISTILLATION AND WATER FILTERING UNITS TO PURIFY WATER IN DOMESTIC AND FOREIGN HOMES, COMMERCIAL AND INDUSTRIAL APPLICATIONS (U.S. CLS. 13, 21, 23, 31 AND 34).
FIRST USE 8-29-2001; IN COMMERCE 8-29-2001.

SN 76-367,225. NORDYNE, INC., O'FALLON, MO. FILED 2-5-2002.

ROOFKING

OWNER OF U.S. REG. NO. 1,230,992.
FOR AIR HEATING UNIT; EVAPORATIVE AIR COOLING UNITS FOR DOMESTIC AND BUSINESS USE; AIR CONDITIONING UNITS; AIR HANDLING EQUIPMENT, NAMELY, PUMPS, FILTERS, FANS, HEATERS, COOLERS, HEAT EXCHANGERS, DAMPERS AND CONTROLS SOLD AS A UNIT FOR VENTILATING AND HEATING (U.S. CLS. 13, 21, 23, 31 AND 34).

SN 76-369,887. WATERMAN INDUSTRIES, INC., EXETER, CA. FILED 2-12-2002.

WATER CHAIN

NO CLAIM IS MADE TO THE EXCLUSIVE RIGHT TO USE "WATER", APART FROM THE MARK AS SHOWN.
FOR DRIP AND MICRO-IRRIGATION UNITS AND PARTS THEREOF, NAMELY, IRRIGATION DRIP TUBING WITH EMITTERS AT USER-DETERMINE INTERVALS, TUBING CONNECTORS, TUBING SCREENS, TUBING PLUGS, SPRAYERS; WATER FILTERS (U.S. CLS. 13, 21, 23, 31 AND 34).
FIRST USE 12-31-1982; IN COMMERCE 12-31-1982.

CLASS 11—(Continued).

SN 76-371,326. SHANGHAI GOLDLUCK ACCESSORIES CO., LTD., SHANGHAI, CHINA, FILED 2-16-2002.



THE MARK CONSISTS OF THE STYLIZED LETTER "G". FOR APPARATUS FOR LIGHTING, HEATING, STEAM GENERATING, COOKING AND REFRIGERATION, NAMELY ELECTRIC GRILLS, BARBECUE OVENS, ELECTRIC RICE COOKERS AND ELECTRIC WOKS (U.S. CLS. 13, 21, 23, 31 AND 34).

SN 76-371,820. W.C. BRADLEY COMPANY, COLUMBUS, GA. FILED 2-15-2002.

LIVE FIRE

FOR GAS, ELECTRIC, AND CHARCOAL BARBECUE GRILLS, AND REPLACEMENT PARTS THEREFOR (U.S. CLS. 13, 21, 23, 31 AND 34).

SN 76-371,862. J&I INVESTMENT COMPANY, DBA INTERNATIONAL TANNING EQUIPMENT, SAGINAW, MI. FILED 2-14-2002.

NORTHERN LIGHTS

FOR SUNTANNING LAMPS (U.S. CLS. 13, 21, 23, 31 AND 34).

SN 76-374,667. SLOAN VALVE COMPANY, FRANKLIN PARK, IL. FILED 2-21-2002.

OPTIMA PLUS IQ

OWNER OF U.S. REG. NOS. 1,473,023, 1,586,647 AND 1,769,197.
FOR ELECTRICALLY-OPERATED FAUCETS (U.S. CLS. 13, 21, 23, 31 AND 34).

CLASS 11—(Continued).

SN 76-375,309. SLOAN VALVE COMPANY, FRANKLIN PARK, IL. FILED 2-21-2002.

OPTIMA IQ

OWNER OF U.S. REG. NOS. 1,473,023, 1,586,647 AND 1,769,197.
FOR ELECTRICALLY-OPERATED FAUCETS (U.S. CLS. 13, 21, 23, 31 AND 34).

SN 76-375,674. SPOT COOLERS, INC., BOCA RATON, FL. FILED 2-27-2002.

COLDER COOLER

NO CLAIM IS MADE TO THE EXCLUSIVE RIGHT TO USE "COOLER", APART FROM THE MARK AS SHOWN.
FOR PORTABLE AIR CONDITIONERS (U.S. CLS. 13, 21, 23, 31 AND 34).

SN 76-377,917. LITEGLOW INDUSTRIES, INC., POMPANO BEACH, FL. FILED 3-4-2002.

The word "LITESCAN" in a stylized, outlined, blocky font.

THE MARK CONSISTS OF THE STYLIZED WORDING "LITESCAN".
FOR DECORATIVE SEQUENCING SPECIALTY LIGHTS FOR AUTOMOTIVE INTERIORS (U.S. CLS. 13, 21, 23, 31 AND 34).

SN 76-377,918. LITEGLOW INDUSTRIES, INC., POMPANO BEACH, FL. FILED 3-4-2002.

The word "SCANSTICK" in a stylized, outlined, blocky font with a slight slant.

THE MARK CONSISTS OF THE STYLIZED WORDING "SCANSTICK".
FOR DECORATIVE SEQUENCING SPECIALTY LIGHTS FOR AUTOMOTIVE INTERIORS (U.S. CLS. 13, 21, 23, 31 AND 34).

CLASS 11—(Continued).

SN 76-378,541. NIGRELLI SYSTEMS, KIEL, WI. FILED 3-5-2002.

ULTIMAX

FOR WATER AERATION EQUIPMENT, NAMELY, A SUBMERGED ELECTRIC WATER PUMP FOR CIRCULATING WATER FROM THE BOTTOM TO THE TOP OF LAKES OR PONDS (U.S. CLS. 13, 21, 23, 31 AND 34).

SN 76-378,542. NIGRELLI SYSTEMS, KIEL, WI. FILED 3-5-2002.

MASTERS SERIES

NO CLAIM IS MADE TO THE EXCLUSIVE RIGHT TO USE "SERIES", APART FROM THE MARK AS SHOWN. FOR WATER FOUNTAINS AND POND AERATORS (U.S. CLS. 13, 21, 23, 31 AND 34).

SN 76-380,626. ALOHA HOUSEWARES, INC., MANSFIELD, TX. FILED 3-11-2002.

PROSTAR

FOR ELECTRIC FANS AND LIGHTING FIXTURES (U.S. CLS. 13, 21, 23, 31 AND 34).

SN 76-381,318. CHERNE INDUSTRIES INCORPORATED, MINNEAPOLIS, MN. FILED 3-13-2002.

I-SERIES

FOR PLUMBING SUPPLIES, NAMELY, PNEUMATIC PIPELINE PLUGS (U.S. CLS. 13, 21, 23, 31 AND 34).

SN 76-383,512. GARLAND COMMERCIAL INDUSTRIES INC., FREELAND, PA. FILED 3-18-2002.

MENUFLEX

FOR HIGH SPEED ELECTRIC COMMERCIAL COOKING OVEN (U.S. CLS. 13, 21, 23, 31 AND 34).

SN 76-386,234. TARGET BRANDS, INC., MINNEAPOLIS, MN. FILED 3-22-2002.

EERIE!DESCENTS

FOR DECORATIVE ELECTRIC LIGHTS (U.S. CLS. 13, 21, 23, 31 AND 34).

CLASS 11—(Continued).

SN 76-389,816. WANG, SHAO, HOUSTON, TX. FILED 3-29-2002.

A & H

FOR PLUMBING FIXTURES, NAMELY, SINKS, VANITY BOWLS, AND TOILETS (U.S. CLS. 13, 21, 23, 31 AND 34).

SN 76-390,077. YORK INTERNATIONAL CORPORATION, YORK, PA. FILED 3-29-2002.

LUXAIRE

OWNER OF U.S. REG. NOS. 514,340 AND 1,993,176. FOR HEAT PUMPS, AIR CONDITIONERS, AIR HUMIDIFIERS AND DEHUMIDIFIERS; EVAPORATORS OF ALL TYPES FOR AIR, GAS AND LIQUID COOLING IN REFRIGERATION SERVICE; REFRIGERATION UNITS; AND AIR HANDLERS (U.S. CLS. 13, 21, 23, 31 AND 34). FIRST USE 0-0-1981; IN COMMERCE 0-0-1981.

SN 76-390,079. PURE HEALTH SOLUTIONS, INC., SANDPOINT, ID. FILED 4-1-2002.

**THE CLEAN COOLER
CONCEPT COMPANY**

FOR WATER PURIFICATION SYSTEMS COMPRISING PROPRIETARY ELECTRONICS AND SOFTWARE, INCLUDING FILTRATION AND ON-BOARD OZONE GENERATOR, UTILIZING OZONE INJECTION TO PRODUCE POTABLE WATER FOR DOMESTIC AND COMMERCIAL USE (U.S. CLS. 13, 21, 23, 31 AND 34). FIRST USE 10-1-2001; IN COMMERCE 10-1-2001.

SN 76-390,650. CH2M HILL INDUSTRIAL DESIGN & CONSTRUCTION, INC., PORTLAND, OR. FILED 4-2-2002.

MICROHOT

FOR ULTRAPURE WATER HEATER (U.S. CLS. 13, 21, 23, 31 AND 34).

SN 76-390,792. MANITOWOC FOODSERVICE COMPANIES, INC., SPARKS, NV. FILED 4-1-2002.

GUARDIAN

FOR ICE MACHINE ACCESSORY PRODUCT, NAMELY HOUSING FOR A CHEMICAL SACHET USED FOR SANITATION OF AIR TO INHIBIT GROWTH OF BACTERIA AND FUNGI IN AN ICE MACHINE (U.S. CLS. 13, 21, 23, 31 AND 34). FIRST USE 9-11-2001; IN COMMERCE 2-11-2002.

CLASS 11—(Continued).

SN 76-392,109. SPOT COOLERS, INC., BOCA RATON, FL. FILED 4-8-2002.

DUCT-A-WAY

FOR DUCTWORK FOR USE IN PORTABLE AIR CONDITIONERS AND HEATERS (U.S. CLS. 13, 21, 23, 31 AND 34).

SN 76-392,110. SPOT COOLERS, INC., BOCA RATON, FL. FILED 4-8-2002.

DISPOS-A-DUCT

FOR DUCTWORK FOR USE IN PORTABLE AIR CONDITIONERS AND HEATERS (U.S. CLS. 13, 21, 23, 31 AND 34).

SN 76-393,128. ELECTRIC POWER RESEARCH INSTITUTE, INC., PALO ALTO, CA. FILED 4-9-2002.

ELECTROCORE

FOR AIR FILTERS FOR INDUSTRIAL USES (U.S. CLS. 13, 21, 23, 31 AND 34).

SN 76-393,129. ELECTRIC POWER RESEARCH INSTITUTE, INC., PALO ALTO, CA. FILED 4-9-2002.

MERCAP

FOR AIR FILTERS FOR INDUSTRIAL USES (U.S. CLS. 13, 21, 23, 31 AND 34).

SN 76-393,130. ELECTRIC POWER RESEARCH INSTITUTE, INC., PALO ALTO, CA. FILED 4-9-2002.

TOXECON

FOR AIR FILTERS FOR INDUSTRIAL USES (U.S. CLS. 13, 21, 23, 31 AND 34).

CLASS 11—(Continued).

SN 76-393,181. HUSSONG MANUFACTURING CO., INC., LAKEFIELD, MN. FILED 4-10-2002.



OWNER OF U.S. REG. NO. 1,956,583.
FOR FIREPLACES AND FIREPLACE INSERTS (U.S. CLS. 13, 21, 23, 31 AND 34).
FIRST USE 1-7-1999; IN COMMERCE 1-7-1999.

SN 76-394,369. LITEGLOW INDUSTRIES, INC., POMPANO BEACH, FL. FILED 4-10-2002.

STREETBURNER

FOR AUTOMOTIVE LIGHTING ACCESSORIES, NAMELY, ILLUMINATED TIPS FOR AUTOMOBILE EXHAUST PIPES (U.S. CLS. 13, 21, 23, 31 AND 34).

SN 76-396,359. ACUITY BRANDS, INC., ATLANTA, GA. FILED 4-16-2002.

PRISMATRON

FOR ELECTRIC LIGHTING FIXTURES (U.S. CLS. 13, 21, 23, 31 AND 34).

SN 78-036,623. DK CONSULT, INC., EXCELSIOR, MN. FILED 11-27-2000.

NEDGAS

FOR ELECTRIC HEATERS AND PRESSURE VESSELS USED TO HEAT GASES AND FLUIDS IN THE PETRO-CHEMICAL INDUSTRY, CHEMICAL INDUSTRY, ELECTRICITY PRODUCTION INDUSTRY AND IN THE NUTRITIONAL MANUFACTURING INDUSTRY, AND PARTS THEREFOR (U.S. CLS. 13, 21, 23, 31 AND 34).

SN 78-058,448. AQUAGENX CORP., STATEN ISLAND, NY. FILED 4-13-2001.

AQUAGENX

FOR PLUMBING FIXTURES, NAMELY SHOWER HEADS AND SHOWER PIPES FOR USE IN HYDROTHERAPY (U.S. CLS. 13, 21, 23, 31 AND 34).

CLASS 11—(Continued).

SN 78-058,449. D'UGO, CARL, STATEN ISLAND, NY. FILED 4-13-2001.

POW'R-SHOW'R

FOR PLUMBING FIXTURES FOR PERSONAL USE, NAMELY SHOWER HEADS AND SHOWER PIPES FOR USE IN HYDROTHERAPY (U.S. CLS. 13, 21, 23, 31 AND 34).

SN 78-059,440. PAUL, SNYDER E., MIAMI, FL. FILED 4-20-2001.

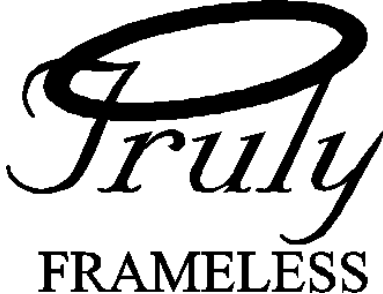

Truly
FRAMELESS

NO CLAIM IS MADE TO THE EXCLUSIVE RIGHT TO USE "FRAMELESS", APART FROM THE MARK AS SHOWN.

FOR CUSTOM SHOWER ENCLOSURES (U.S. CLS. 13, 21, 23, 31 AND 34).

SN 78-067,111. GENERAL ELECTRIC COMPANY, SCHECTADY, NY. FILED 6-4-2001.



OWNER OF U.S. REG. NOS. 929,056, 1,051,200 AND OTHERS.

FOR MICROWAVE OVENS FOR COOKING; WALL COOKING OVENS FOR DOMESTIC USE; FOOD WARMING DRAWERS; CONVECTION OVENS; ELECTRIC AND GAS COOK TOPS; ELECTRIC AND GAS COOKING OVENS AND RANGES; VENTILATION HOODS FOR STOVES; AND VENTILATING EXHAUST FANS; WATER FILTERS; WATER SOFTENING UNITS; CLOTHES DRYERS; ELECTRIC FANS, CEILING FANS, FLASHLIGHTS; LAMPS AND LIGHTS FOR VEHICLE; ELECTRIC LIGHTS FOR CHRISTMAS TREES (U.S. CLS. 13, 21, 23, 31 AND 34).

FIRST USE 12-31-1912; IN COMMERCE 12-31-1912.

CLASS 11—(Continued).

SN 78-080,626. MCDERMOTT, VICTORIA ANN, HAMPSTEAD, MD. FILED 8-22-2001.

BELLABEAM

FOR LIGHTING PRODUCTS, NAMELY, ELECTRIC LIGHTING FIXTURES, ELECTRIC LIGHTING TUBES AND FLASHLIGHTS (U.S. CLS. 13, 21, 23, 31 AND 34).
FIRST USE 3-1-2001; IN COMMERCE 3-1-2001.

SN 78-085,411. PARAGON HOLDINGS INC., ST. PETERSBURG, FL. FILED 9-25-2001.

PERFECT AIR

NO CLAIM IS MADE TO THE EXCLUSIVE RIGHT TO USE "AIR", APART FROM THE MARK AS SHOWN.

FOR OZONE GENERATING AIR PURIFYING UNITS FOR COMMERCIAL AND DOMESTIC USE (U.S. CLS. 13, 21, 23, 31 AND 34).

FIRST USE 7-1-1999; IN COMMERCE 7-1-1999.

SN 78-109,606. FIRMENICH S.A., GENEVE 8, SWITZERLAND, FILED 2-19-2002.

OSMOPHONE

PRIORITY CLAIMED UNDER SEC. 44(D) ON SWITZERLAND APPLICATION NO. 104492001, FILED 10-30-2001, REG. NO. 498321, DATED 4-25-2002, EXPIRES 10-30-2021.

FOR PORTABLE ODOR DIFFUSER (U.S. CLS. 13, 21, 23, 31 AND 34).

SN 78-110,033. SALTON, INC., LAKE FOREST, IL. FILED 2-20-2002.

COOL & CLEAN

FOR TOASTERS AND TOASTER OVENS (U.S. CLS. 13, 21, 23, 31 AND 34).

SN 78-112,735. TECHNICAL CONSUMER PRODUCTS, INC., AURORA, OH. FILED 3-5-2002.

LIGHTING THE WAY TO ENERGY EFFICIENCY

FOR ELECTRIC DISCHARGE LAMPS, NAMELY COMPACT FLUORESCENTS WITH INTEGRAL BALLASTS SOLD AS A UNIT (U.S. CLS. 13, 21, 23, 31 AND 34).

FIRST USE 10-5-2001; IN COMMERCE 10-5-2001.

CLASS 11—(Continued).

SN 78-112,997. BUILD-A-BEAR WORKSHOP, INC., ST. LOUIS, MO. FILED 3-6-2002.

ALL THE STUFF BEST FRIENDS SHARE

FOR LAMPS (U.S. CLS. 13, 21, 23, 31 AND 34).

SN 78-113,259. SALTON, INC., LAKE FOREST, IL. FILED 3-7-2002.

MINUTE MASTER

FOR ELECTRIC TOASTERS AND ELECTRIC TOASTER OVENS (U.S. CLS. 13, 21, 23, 31 AND 34).

CLASS 12—VEHICLES

SN 75-702,165. AMAZON, INC., NEW YORK, NY. FILED 5-10-1999.

THE MISSILE

OWNER OF U.S. REG. NO. 2,109,616.
FOR BICYCLES AND BICYCLE PARTS AND ACCESSORIES SOLD THEREWITH, NAMELY, FENDERS, PEDALS, TIRES, HANDLEBARS, HANDLEBAR STEMS, FORKS, WHEELS, BRAKES, CHAINS, GRIPS, WATER BOTTLES AND WATER BOTTLE CAGES, CRANKS, CHAIN RINGS AND SPROCKETS, GEAR SHIFTS, SEATS, FRAMES, TUBES, SPOKES AND SEAT POSTS (U.S. CLS. 19, 21, 23, 31, 35 AND 44).

SN 75-930,613. IRIS BUS FRANCE, S.A., 69200 VENISSIEUX, FRANCE, FILED 2-28-2000.

CRISTALIS

PRIORITY CLAIMED UNDER SEC. 44(D) ON FRANCE APPLICATION NO. 94-1104, FILED 9-2-1999, REG. NO. 99.810.363, DATED 9-2-1999, EXPIRES 9-2-2009.
FOR MOTOR COACHES, MOTOR BUSES (U.S. CLS. 19, 21, 23, 31, 35 AND 44).

CLASS 12—(Continued).

SN 76-001,200. NORTH AMERICAN ROYALTIES, INC., CHATTANOOGA, TN. FILED 3-15-2000.



FOR AUTOMOBILE PARTS, NAMELY, CAST BRAKE DRUMS, ROTORS, HUBS, CLUTCH PLATES, CALIPERS, SUSPENSION BRACKETS, ANCHORS, SUPPORT BRACKETS, STEERING KNUCKLES, ENGINE BEARING CAPS AND DIFFERENTIAL CASES (U.S. CLS. 19, 21, 23, 31, 35 AND 44).
FIRST USE 2-1-2000; IN COMMERCE 2-1-2000.

SN 76-001,201. NORTH AMERICAN ROYALTIES, INC., CHATTANOOGA, TN. FILED 3-15-2000.

WHELAND

FOR AUTOMOBILE PARTS, NAMELY, CAST BRAKE DRUMS, ROTORS, HUBS, CLUTCH PLATES, CALIPERS, SUSPENSION BRACKETS, ANCHORS, SUPPORT BRACKETS, STEERING KNUCKLES, ENGINE BEARING CAPS AND DIFFERENTIAL CASES (U.S. CLS. 19, 21, 23, 31, 35 AND 44).
FIRST USE 0-0-1866; IN COMMERCE 0-0-1866.

SN 76-003,042. SKIER'S CHOICE, INC., MARYVILLE, TN. FILED 3-17-2000.

MOOMBA

OWNER OF U.S. REG. NOS. 2,222,613 AND 2,222,616.
"MOOMBA" IS AN AUSTRALIAN ABORIGINAL WORD THAT TRANSLATES INTO ENGLISH AS FOLLOWS; "LET'S GET TOGETHER AND HAVE FUN".
FOR BOATS (U.S. CLS. 19, 21, 23, 31, 35 AND 44).
FIRST USE 3-31-1991; IN COMMERCE 3-31-1991.

SN 76-044,090. MILLENIA AIRCRAFT, INC., SNOHOMISH, WA. FILED 5-8-2000.

AURORA

FOR KIT AIRPLANES AND STRUCTURAL PARTS THEREFOR; NAMELY FIXED WING AIRPLANE (U.S. CLS. 19, 21, 23, 31, 35 AND 44).

CLASS 12—(Continued).

SN 76-090,280. MV AGUSTA MOTOR S.P.A., VARESE, ITALY, FILED 7-17-2000.



PRIORITY CLAIMED UNDER SEC. 44(D) ON ERP N CMNTY TM OFC APPLICATION NO. 1756113, FILED 7-14-2000, REG. NO. 1756113, DATED 9-24-2001, EXPIRES 9-24-2011.

THE MARK CONSISTS OF THE STYLIZED DESIGN OF AN ELEPHANT'S HEAD.

FOR VEHICLES AND APPARATUS FOR LOCOMOTION BY LAND, NAMELY, BICYCLES, TRICYCLES, MOTORCYCLES, MOTORIZED TRICYCLES, SIDECARS, MOPEDS AND MOTORIZED BICYCLES (U.S. CLS. 19, 21, 23, 31, 35 AND 44).

FIRST USE 1-19-2000; IN COMMERCE 1-19-2000.

SN 76-102,242. KLEEMANN A/S, 3520 FARUM, DENMARK, FILED 8-2-2000.

KLEEMANN

OWNER OF DENMARK REG. NO. VR199600176, DATED 1-1-1996, EXPIRES 1-1-2006.

SEC. 2(F).

FOR LAND MOTOR VEHICLE PARTS, NAMELY COMPRESSOR SYSTEMS COMPRISED OF COMPRESSORS, INTERCOOLER, FUEL SYSTEM, MANAGEMENT SYSTEM AND RADIATOR, WHEELS, BRAKES, SUSPENSION, BOOST KITS COMPRISED OF PULLY-WHEEL, FUEL SYSTEM AND MANAGEMENT SYSTEM; SPORT STEERING WHEELS, INTERIOR AERODYNAMIC SPOILERS FOR LAND VEHICLES (U.S. CLS. 19, 21, 23, 31, 35 AND 44).

SN 76-163,299. HYUNDAI MOTOR AMERICA, FOUNTAIN VALLEY, CA. FILED 11-13-2000.

SHIFTRONIC

FOR COMPONENT PARTS OF AUTOMOBILES, NAMELY, AUTOMATIC TRANSMISSIONS (U.S. CLS. 19, 21, 23, 31, 35 AND 44).

FIRST USE 9-12-2000; IN COMMERCE 9-12-2000.

CLASS 12—(Continued).

SN 76-259,994. AMERICAN SEATING COMPANY, GRAND RAPIDS, MI. FILED 3-2-2001.

SECURA

THE ENGLISH TRANSLATION OF THE TERM "SECURA" IS "DRYNESS".

FOR SAFETY RESTRAINTS FOR SECURING WHEELCHAIRS AND WHEELCHAIR PASSENGERS IN BUSES, MOTOR COACHES, TRAINS, TRANSITS, AND SHUTTLES (U.S. CLS. 19, 21, 23, 31, 35 AND 44).

SN 76-264,514. BANDAG LICENSING CORPORATION, MUSCATINE, IA. FILED 5-31-2001.

COI

FOR TIRE REPAIR PRODUCTS, NAMELY TREAD TRACING TEMPLATES, RADIAL REPAIR PATCHES AND REPAIR SUPPORT PLATES (U.S. CLS. 19, 21, 23, 31, 35 AND 44).

FIRST USE 3-0-1998; IN COMMERCE 3-0-1998.

SN 76-287,363. DE-STA-CO MANUFACTURING, RUSSELLVILLE, AR. FILED 7-19-2001.

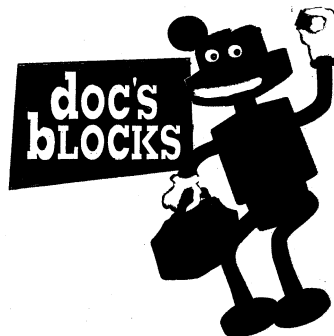

NO CLAIM IS MADE TO THE EXCLUSIVE RIGHT TO USE "BLOCKS", APART FROM THE MARK AS SHOWN.

THE MARK CONSISTS OF IN PART, OF A SMILING ROBOT MADE OF CAR PARTS WITH HEAD LAMP HOLDING AN AIR CONDITIONING BLOCK AND A TOOL-BOX.

FOR AUTOMOTIVE PARTS, NAMELY BLOCKS, FITTINGS AND TUBING AS REPLACEMENT PARTS FOR AUTOMOTIVE AIR CONDITIONING SYSTEMS (U.S. CLS. 19, 21, 23, 31, 35 AND 44).

FIRST USE 7-1-2000; IN COMMERCE 7-1-2000.

SN 76-306,168. HARRIS-KAYOT, INC., FORT WAYNE, IN. FILED 8-28-2001.

A WAKE OTHERS FOLLOW

FOR BOATS (U.S. CLS. 19, 21, 23, 31, 35 AND 44).

CLASS 12—(Continued).

SN 76-307,131. SUZUKI MOTOR CORPORATION, SHIZUOKA-PREF. 432-8611, JAPAN, FILED 8-29-2001.

V-STROM

PRIORITY CLAIMED UNDER SEC. 44(D) ON JAPAN APPLICATION NO. 2001-19094, FILED 3-5-2001.

FOR VEHICLES FOR LOCOMOTION BY LAND NAMELY MOTORCYCLES AND STRUCTURAL AND REPLACEMENT PARTS AND FITTINGS THEREOF (U.S. CLS. 19, 21, 23, 31, 35 AND 44).

SN 76-309,196. EMOTION MOBILITY LLC, ATLANTA, GA. FILED 9-5-2001.



OWNER OF U.S. REG. NOS. 2,044,292 AND 2,055,838. FOR VEHICLES, NAMELY, ELECTRIC, HYBRID ELECTRIC, AND FUEL CELL CARS, TRUCKS, DELIVERY VANS, BUSES, MOTORCYCLES, MOTOR SCOOTERS, BICYCLES, AND NEIGHBORHOOD VEHICLES (U.S. CLS. 19, 21, 23, 31, 35 AND 44).

SN 76-313,169. TOYO TIRE & RUBBER CO., LTD., OSAKA, JAPAN, FILED 9-17-2001.



FOR TIRES AND INNER TUBES FOR VEHICLES (U.S. CLS. 19, 21, 23, 31, 35 AND 44).

SN 76-314,250. TELEVISION EVENTS AND MARKETING, INC., HONOLULU, HI. FILED 9-18-2001.

XTERRA

FOR BICYCLES (U.S. CLS. 19, 21, 23, 31, 35 AND 44).

SN 76-318,909. FLEETWOOD ENTERPRISES, INC., RIVERSIDE, CA. FILED 9-28-2001.

YUMA

FOR FOLDING CAMPING TRAILERS (U.S. CLS. 19, 21, 23, 31, 35 AND 44).

CLASS 12—(Continued).

SN 76-321,308. KEIPER GMBH & CO., 67657 KAISERSLUTERN, FED REP GERMANY, FILED 10-4-2001.

FOLD 2000

PRIORITY CLAIMED UNDER SEC. 44(D) ON FED REP GERMANY APPLICATION NO. 30123802.2/1, FILED 4-11-2001, REG. NO. 30123802, DATED 9-10-2001, EXPIRES 4-30-2011.

FOR VEHICLE SEATS AND THEIR PARTS AND ACCESSORIES, NAMELY, VEHICLE SEAT FRAMES, VEHICLE SEAT CUSHIONS, VEHICLE SEAT COVERS, VEHICLE SEAT FASTENING DEVICES, VEHICLE SEAT LONGITUDINAL ADJUSTERS, VEHICLE SEAT HEIGHT ADJUSTERS, VEHICLE SEAT INCLINATION ADJUSTERS, BACKRESTS, BACKREST INCLINATION ADJUSTERS, VEHICLE SEAT LUMBAR SUPPORTS, VEHICLE SEAT HEADRESTS, PASSENGER RESTRAINTS FOR VEHICLE SEATS, AND SAFETY BELT SYSTEMS (U.S. CLS. 19, 21, 23, 31, 35 AND 44).

SN 76-321,315. KEIPER GMBH & CO., 67657 KAISERSLUTERN, FED REP GERMANY, FILED 10-4-2001.

TRACK 2000

PRIORITY CLAIMED UNDER SEC. 44(D) ON FED REP GERMANY APPLICATION NO. 30123803.0/1, FILED 4-11-2001, REG. NO. 30123803, DATED 9-10-2001, EXPIRES 4-30-2011.

FOR VEHICLE SEATS AND THEIR PARTS AND ACCESSORIES, NAMELY, VEHICLE SEAT FRAMES, VEHICLE SEAT CUSHIONS, VEHICLE SEAT COVERS, VEHICLE SEAT FASTENING DEVICES, VEHICLE SEAT LONGITUDINAL ADJUSTERS, VEHICLE SEAT HEIGHT ADJUSTERS, VEHICLE SEAT INCLINATION ADJUSTERS, BACKRESTS, BACKREST INCLINATION ADJUSTERS, VEHICLE SEAT LUMBAR SUPPORTS, VEHICLE SEAT HEADRESTS, PASSENGER RESTRAINTS FOR VEHICLE SEATS, AND SAFETY BELT SYSTEMS (U.S. CLS. 19, 21, 23, 31, 35 AND 44).

SN 76-321,325. KEIPER GMBH & CO., 67657 KAISERSLUTERN, FED REP GERMANY, FILED 10-4-2001.

SIDE-TRACK 2000

PRIORITY CLAIMED UNDER SEC. 44(D) ON FED REP GERMANY APPLICATION NO. 30123813.8/1, FILED 4-11-2001, REG. NO. 30123813, DATED 9-10-2001, EXPIRES 4-30-2011.

FOR VEHICLE SEATS AND THEIR PARTS AND ACCESSORIES, NAMELY, VEHICLE SEAT FRAMES, VEHICLE SEAT CUSHIONS, VEHICLE SEAT COVERS, VEHICLE SEAT FASTENING DEVICES, VEHICLE SEAT LONGITUDINAL ADJUSTERS, VEHICLE SEAT HEIGHT ADJUSTERS, VEHICLE SEAT INCLINATION ADJUSTERS, BACKRESTS, BACKREST INCLINATION ADJUSTERS, VEHICLE SEAT LUMBAR SUPPORTS, VEHICLE SEAT HEADRESTS, PASSENGER RESTRAINTS FOR VEHICLE SEATS, AND SAFETY BELT SYSTEMS (U.S. CLS. 19, 21, 23, 31, 35 AND 44).

CLASS 12—(Continued).

SN 76-323,881. FEULING R&D INC., VENTURA, CA. FILED 10-12-2001.

BIG FOOT

FOR BICYCLES (U.S. CLS. 19, 21, 23, 31, 35 AND 44).
FIRST USE 2-1-1987; IN COMMERCE 2-1-1987.

SN 76-328,782. MARIN MOUNTAIN BIKES, INC., NOVATO, CA. FILED 10-22-2001.

ALP

FOR BICYCLES (U.S. CLS. 19, 21, 23, 31, 35 AND 44).
FIRST USE 6-0-2001; IN COMMERCE 6-0-2001.

SN 76-329,375. NORTH RIVER JET BOATS, INC., ROSEBURG, OR. FILED 10-25-2001.

NORTH RIVER

FOR WELDED ALUMINUM JET-PROPELLED SHALLOW DRAFT RIVER BOATS (U.S. CLS. 19, 21, 23, 31, 35 AND 44).
FIRST USE 0-0-1974; IN COMMERCE 0-0-1974.

SN 76-332,436. BLUE RIDGE INTERNATIONAL PRODUCTS COMPANY, FREEPORT, FL. FILED 10-30-2001.

EURO CLIP

NO CLAIM IS MADE TO THE EXCLUSIVE RIGHT TO USE "CLIP", APART FROM THE MARK AS SHOWN.
FOR VEHICLE SEAT BELT ADJUSTERS (U.S. CLS. 19, 21, 23, 31, 35 AND 44).
FIRST USE 3-29-2002; IN COMMERCE 3-29-2002.

SN 76-337,201. TOYOTA JIDOSHA KABUSHIKI KAISHA, TA TOYOTA MOTOR CORPORATION, AICHI-KEN, JAPAN, FILED 11-14-2001.

IDENTITY

FOR MOTOR VEHICLES, NAMELY, AUTOMOBILES AND STRUCTURAL PARTS THEREOF (U.S. CLS. 19, 21, 23, 31, 35 AND 44).

CLASS 12—(Continued).

SN 76-337,902. BRIDGESTONE CORPORATION, CHUO-KU, TOKYO, JAPAN, FILED 11-15-2001.

**BATTLAX TANDEM
HIGHWAY**

OWNER OF U.S. REG. NO. 1,656,197.
NO CLAIM IS MADE TO THE EXCLUSIVE RIGHT TO USE "TANDEM" AND "HIGHWAY", APART FROM THE MARK AS SHOWN.

FOR AUTOMOBILES, AUTOMOBILE TIRES AND INNER TUBES, PARTS AND FITTINGS FOR AUTOMOBILES, MOTORCYCLES, MOTORCYCLE TIRES AND INNER TUBES, PARTS AND FITTINGS FOR MOTORCYCLES (U.S. CLS. 19, 21, 23, 31, 35 AND 44).

SN 76-340,853. TOYOTA JIDOSHA KABUSHIKI KAISHA, TA TOYOTA MOTOR CORPORATION, TOYOTA-SHI, AICHI-KEN, JAPAN, FILED 11-23-2001.

SPLIT & STOW 3RD ROW

NO CLAIM IS MADE TO THE EXCLUSIVE RIGHT TO USE "SPLIT" AND "3RD ROW", APART FROM THE MARK AS SHOWN.
FOR VEHICLE SEATS (U.S. CLS. 19, 21, 23, 31, 35 AND 44).

SN 76-342,355. ACME MANUFACTURING LLC, BOSTON, MA. FILED 11-26-2001.



THE MARK CONSISTS, IN PART, OF A STYLIZED PERSON RIDING A HUMAN TRANSPORTER.
FOR MOTORIZED, SELF-PROPELLED, WHEELED PERSONAL MOBILITY DEVICES, NAMELY, WHEELCHAIRS, SCOOTERS, UTILITY CARTS, AND CHARIOTS (U.S. CLS. 19, 21, 23, 31, 35 AND 44).

CLASS 12—(Continued).

SN 76-344,339. PULLMAN INDUSTRIES, INC., TROY, MI. FILED 12-3-2001.



THE MARK CONSISTS, IN PART, OF THE STYLIZED REPRESENTATION OF THE LETTER "P".

FOR AUTOMOBILE BUMPERS, AND INTRUSION-PROTECTIVE BEAMS FOR USE IN AUTOMOBILE BUMPERS AND IN AUTOMOBILE BODIES (U.S. CLS. 19, 21, 23, 31, 35 AND 44).

SN 76-359,448. PACCAR INC, BELLEVUE, WA. FILED 1-17-2002.

PACCAR

FOR ENGINES FOR LAND VEHICLES (U.S. CLS. 19, 21, 23, 31, 35 AND 44).

SN 76-373,379. BLUEDESERT LTD., BELGRADE, MT. FILED 2-20-2002.

BLUEDESERT

FOR AUTOMOTIVE ACCESSORIES, NAMELY BACK SEAT ORGANIZERS, VISOR ORGANIZERS, AND CARGO SPACE ORGANIZERS (U.S. CLS. 19, 21, 23, 31, 35 AND 44).

SN 76-374,772. ROCKSHOX, INC., COLORADO SPRINGS, CO. FILED 2-25-2002.

GPS

FOR BICYCLE PARTS, NAMELY, BICYCLE SHOCK ABSORBERS, BICYCLE SUSPENSIONS AND BICYCLE FORKS (U.S. CLS. 19, 21, 23, 31, 35 AND 44).

SN 76-379,316. MIDWEST MOTORCYCLE SUPPLY DISTRIBUTORS CORP., ARNOLD, MO. FILED 3-7-2002.

BORN IN THE USA

FOR MOTORCYCLES AND STRUCTURAL PARTS THEREFOR (U.S. CLS. 19, 21, 23, 31, 35 AND 44).

CLASS 12—(Continued).

SN 76-386,536. NISSAN JIDOSHA KABUSHIKI KAISHA, TA NISSAN MOTOR CO., LTD., YOKOHAMA-SHI, KANAGAWA-KEN, JAPAN, FILED 3-21-2002.

SHIFT—REALITY

FOR MOTOR VEHICLES, NAMELY, AUTOMOBILES, TRUCKS, VANS, SPORT UTILITY VEHICLES, AND STRUCTURAL PARTS THEREFOR (U.S. CLS. 19, 21, 23, 31, 35 AND 44).

SN 76-386,537. NISSAN JIDOSHA KABUSHIKI KAISHA, TA NISSAN MOTOR CO., LTD., YOKOHAMA-SHI, KANAGAWA-KEN, JAPAN, FILED 3-21-2002.

SHIFT REALITY

FOR MOTOR VEHICLES, NAMELY, AUTOMOBILES, TRUCKS, VANS, SPORT UTILITY VEHICLES, AND STRUCTURAL PARTS THEREFOR (U.S. CLS. 19, 21, 23, 31, 35 AND 44).

SN 76-386,873. DOTCOM PARTNERSHIPS.COM, INC., FORMERLY SAMSON SECURITY SYSTEMS, INC., MIAMI, FL. FILED 3-25-2002.

SAMSON

FOR ANTI-THEFT ALARMS FOR MOTOR VEHICLES (U.S. CLS. 19, 21, 23, 31, 35 AND 44). FIRST USE 6-16-1987; IN COMMERCE 6-16-1987.

SN 76-387,619. MONACO COACH CORPORATION, COBURG, OR. FILED 3-25-2002.

BARON

FOR RECREATIONAL VEHICLES, NAMELY, MOTORHOMES (U.S. CLS. 19, 21, 23, 31, 35 AND 44).

SN 76-388,394. GENMAR IP LLC, MINNEAPOLIS, MN. FILED 3-27-2002.

TECHNOLOGY FOR CAREFREE BOATING

FOR BOATS AND STRUCTURAL PARTS THEREFOR (U.S. CLS. 19, 21, 23, 31, 35 AND 44).

CLASS 12—(Continued).

SN 76-388,796. TREK BICYCLE CORPORATION, WATER-
LOO, WI. FILED 3-29-2002.

OCLV CARBON

OWNER OF U.S. REG. NOS. 2,010,166, 2,123,200 AND
OTHERS.

NO CLAIM IS MADE TO THE EXCLUSIVE RIGHT TO
USE "CARBON", APART FROM THE MARK AS SHOWN.

FOR BICYCLES, BICYCLE FRAMES, AND BICYCLE
STRUCTURAL PARTS THEREFORE (U.S. CLS. 19, 21, 23,
31, 35 AND 44).

FIRST USE 8-0-1992; IN COMMERCE 8-0-1992.

SN 76-390,096. NOKIAN TYRES, INC., LAVERGNE, TN.
FILED 4-2-2002.

VATIIVA

FOR VEHICULAR TIRES (U.S. CLS. 19, 21, 23, 31, 35
AND 44).

SN 76-390,099. AMERICAN RACING EQUIPMENT, INC.,
RANCHO DOMINGUEZ, CA. FILED 4-2-2002.

**THE ULTIMATE
AUTOMOTIVE EXPRESSION**

FOR AUTOMOTIVE VEHICLE WHEELS AND COM-
PONENTS THEREOF (U.S. CLS. 19, 21, 23, 31, 35 AND
44).

SN 76-390,122. SUNDIRO CENTURY CO., LTD., ANAHEIM,
CA. FILED 4-1-2002.



OWNER OF U.S. REG. NO. 2,583,784.
FOR ALL TERRAIN VEHICLES, MOTOR CYCLES,
SCOOTERS, MOPEDS, GO KARTS, PLAY BIKES AND
DIRT BIKES (U.S. CLS. 19, 21, 23, 31, 35 AND 44).
FIRST USE 8-1-2001; IN COMMERCE 8-1-2001.

SN 76-390,536. MONACO COACH CORPORATION, CO-
BURG, OR. FILED 4-1-2002.

**TRAVELER BY HOLIDAY
RAMBLER**

OWNER OF U.S. REG. NOS. 847,292, 1,342,461 AND
1,463,410.

FOR RECREATIONAL VEHICLES, NAMELY, MO-
TORHOMES (U.S. CLS. 19, 21, 23, 31, 35 AND 44).

CLASS 12—(Continued).

SN 76-390,806. COACHMEN INDUSTRIES, INC., ELKHART,
IN. FILED 3-29-2002.

SPORTSCOACH

FOR RECREATION VEHICLES, NAMELY, MOTOR
HOMES (U.S. CLS. 19, 21, 23, 31, 35 AND 44).
FIRST USE 12-16-1969; IN COMMERCE 12-16-1969.

SN 76-391,855. SUBARU OF AMERICA, INC., CHERRY
HILL, NJ. FILED 4-5-2002.

**WHEN YOU GET IT, YOU
GET IT**

FOR AUTOMOBILES AND STRUCTURAL PARTS
THEREFORE (U.S. CLS. 19, 21, 23, 31, 35 AND 44).

SN 76-391,874. FLEX-N-GATE CORPORATION, INC., URBA-
NA, IL. FILED 4-5-2002.

FLEX-STEP

FOR RUNNING BOARDS AND STEPS FOR SPORT
UTILITY VEHICLES AND PICKUP TRUCKS (U.S. CLS.
19, 21, 23, 31, 35 AND 44).

SN 78-043,959. VOLVO PERSONVAGNAR AB, GOTEBOG,
SWEDEN, FILED 1-19-2001.

XC70

FOR MOTOR VEHICLES, NAMELY, AUTOMOBILES,
TRUCKS, VANS, SPORTS-UTILITY VEHICLES; AUTO-
MOTIVE PARTS, COMPONENTS AND ACCESSORIES,
NAMELY, ELECTRIC HORNS, FUEL TANKS, SUSPEN-
SION SYSTEMS, SUSPENSION SPRINGS AND
SHACKLES, SPRING CLIPS, STRUCTURAL BRACKETS
AND SUPPORTS, BATTERY MOUNTINGS, AXLE
SHAFTS, AXLES, AXLE BEARINGS, PRESSURE RELIEF
VALVES FOR GEAR HOUSING, STEERING GEAR
COVERS, WHEELS, CHASSIS STRUCTURAL PARTS
AND BODY STRUCTURAL PARTS, BRAKE LININGS,
BRAKE SHOES, DRIVE GEARS, TRANSMISSIONS,
DRIVE SHAFTS, BRAKE CYLINDERS AND PISTONS
AND SPRINGS THEREFOR, VEHICLE HOODS AND
MEMBERS, VEHICLE FENDERS AND FENDER PARTS,
RUNNING BOARDS, HUBS, HUB CAPS, DEMOUNTA-
BLE WHEEL RIMS, BRAKE CALIPERS AND PADS
THEREFOR, VEHICLE BUMPERS, SHOCK ABSORBERS,
CAR TOPS, REARVIEW AND SIDE VIEW MIRRORS,
GLASS WINDOWS AND WINDSHIELDS, WINDSHIELD
WIPERS, WINDSHIELD WIPER ARMS AND WIPER
BLADES, ENGINES, CLUTCHES, CLUTCH FACINGS,
SEATS, INTERIOR TRIM, INSTRUMENTAL PANELS,
COCKPITS, STEERING WHEELS, EXTERIOR TRIM,
ANTI-THEFT ALARMS FOR VEHICLES, HORNS, AIR-
BAGS, SEAT BELTS, DIRECTIONAL SIGNALS, ELEC-
TRIC POWER WINDOW MOTORS FOR VEHICLES;
FITTED OR SEMI-FITTED SEAT COVERS, DRIVE
BELTS AND DRIVE CHAINS (U.S. CLS. 19, 21, 23, 31,
35 AND 44).

CLASS 12—(Continued).

SN 78-046,774. DAIMLERCHRYSLER CORPORATION, AUBURN HILLS, MI. FILED 2-6-2001.

UP COUNTRY

FOR LAND VEHICLE EQUIPMENT PACKAGE, NAMELY A VEHICLE SUSPENSION SYSTEM COMPRISED OF ALL TERRAIN TIRES; SKID PLATES TO PROTECT THE FRONT SUSPENSION; FUEL TANK, AND TRANSFER CASE; HIGH PRESSURE SHOCK ABSORBERS; TOW HOOKS; COIL SPRINGS AND LEAF SPRINGS SOLD AS A COMPONENT PART OF TRUCKS AND SPORT UTILITY VEHICLES (U.S. CLS. 19, 21, 23, 31, 35 AND 44).

FIRST USE 9-15-1998; IN COMMERCE 9-15-1998.

SN 78-058,854. FORD MOTOR COMPANY, DEARBORN, MI. FILED 4-17-2001.

LINCOLN LCC

OWNER OF U.S. REG. NOS. 170,692, 2,431,030 AND OTHERS.

FOR MOTOR VEHICLES, NAMELY, AUTOMOBILES, TRUCKS, VANS, SPORT-UTILITY VEHICLES, AND THEIR STRUCTURAL PARTS AND ENGINES (U.S. CLS. 19, 21, 23, 31, 35 AND 44).

SN 78-058,856. FORD MOTOR COMPANY, DEARBORN, MI. FILED 4-17-2001.

LINCOLN LS

OWNER OF U.S. REG. NOS. 170,692, 2,431,030 AND OTHERS.

NO CLAIM IS MADE TO THE EXCLUSIVE RIGHT TO USE "LS", APART FROM THE MARK AS SHOWN.

FOR MOTOR VEHICLES, NAMELY, AUTOMOBILES, TRUCKS, VANS, SPORT-UTILITY VEHICLES, AND THEIR STRUCTURAL PARTS AND ENGINES (U.S. CLS. 19, 21, 23, 31, 35 AND 44).

SN 78-083,589. FIAT AUTO S.P.A., TORINO, ITALY, FILED 9-12-2001.

DUETTO

OWNER OF ITALY REG. NO. 817636, DATED 6-12-2000, EXPIRES 10-27-2008.

THE ENGLISH TRANSLATION OF "DUETTO" IS "DUET".

FOR MOTOR VEHICLES AND STRUCTURAL PARTS THEREOF (U.S. CLS. 19, 21, 23, 31, 35 AND 44).

CLASS 12—(Continued).

SN 78-083,991. FORD MOTOR COMPANY, DEARBORN, MI. FILED 9-14-2001.

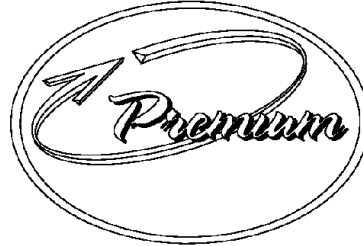

NO CLAIM IS MADE TO THE EXCLUSIVE RIGHT TO USE "PREMIUM", APART FROM THE MARK AS SHOWN.

FOR AUTOMOTIVE PARTS, NAMELY AIR BAGS; AUTOMOTIVE ENGINES AND TRANSMISSIONS; TRIM PANELS; VEHICLE HOODS AND HOOD MEMBERS; VEHICLE FENDERS; VEHICLE BODIES, DOORS, QUARTER PANELS AND TRUCK LIDS; BUMPERS; SIDE MIRRORS AND WINDSHIELDS FOR AUTOMOTIVE VEHICLES (U.S. CLS. 19, 21, 23, 31, 35 AND 44).

SN 78-112,687. DAEWOO MOTOR CO., LTD., BUPYUNG-KU, INCHEON, REPUBLIC OF KOREA, FILED 3-5-2002.

FORTE

FOR PASSENGER CARS, SPORTS CARS, VANS AND BUSES (U.S. CLS. 19, 21, 23, 31, 35 AND 44).

SN 78-112,835. VECTOR BOATS, LLC, NORTH CHARLESTON, SC. FILED 3-5-2002.

"FISH FASTER!"

FOR FIBERGLASS BOATS (U.S. CLS. 19, 21, 23, 31, 35 AND 44).

CLASS 13—FIREARMS

SN 76-228,690. SUHLER JAGD- UND SPORTWAFFEN GMBH, D-98627 SUHL, FED REP GERMANY, FILED 3-15-2001.

Gebr. Merkel Suhl

NO CLAIM IS MADE TO THE EXCLUSIVE RIGHT TO USE "SUHL", APART FROM THE MARK AS SHOWN.

THE ENGLISH TRANSLATION OF THE WORD "GEBR." IN THE MARK IS "BROTHERS".

FOR FIREARMS, PISTOLS, RIFLES, AND SHOTGUNS, AND PARTS THEREOF (U.S. CLS. 2 AND 9).

FIRST USE 3-12-1999; IN COMMERCE 3-12-1999.

CLASS 13—(Continued).

SN 76-372,778. EBSCO INDUSTRIES, INC., BIRMINGHAM, AL. FILED 2-20-2002.

#1 IN MUZZLELOADING

NO CLAIM IS MADE TO THE EXCLUSIVE RIGHT TO USE "MUZZLELOADING", APART FROM THE MARK AS SHOWN.

SEC. 2(F).
FOR MUZZLELOADING FIREARMS (U.S. CLS. 2 AND 9).
FIRST USE 2-20-1995; IN COMMERCE 2-20-1995.

SN 76-381,550. IMR POWDER COMPANY INC., MISSISSAUGA, ONTARIO, CANADA, FILED 3-12-2002.

IMR

FOR SHOT SHELL, RIFLE AND HANDGUN AMMUNITION, NAMELY, NITROCELLULOSE BASED, AND NITROCELLULOSE AND NITROGLYCERIN BASED, SMOKELESS POWDER (U.S. CLS. 2 AND 9).

FIRST USE 12-0-1959; IN COMMERCE 12-0-1959.

SN 76-391,804. DIGI-TWIST, INC., LOUDON, TN. FILED 4-3-2002.

DEADZERO

FOR GUNS AND GUN BARRELS (U.S. CLS. 2 AND 9).

SN 78-086,473. NICHOLSON'S OF THE SOUTHWEST, KAUFMAN, TX. FILED 10-2-2001.

**RAGING TIGER BRAND
FIREWORKS**

NO CLAIM IS MADE TO THE EXCLUSIVE RIGHT TO USE "BRAND FIREWORKS", APART FROM THE MARK AS SHOWN.

FOR FIREWORKS (U.S. CLS. 2 AND 9).

CLASS 13—(Continued).

SN 78-102,092. CELEBRATION FIREWORKS II, INC., INDIANAPOLIS, IN. FILED 1-11-2002.



NO CLAIM IS MADE TO THE EXCLUSIVE RIGHT TO USE "BRAND FIREWORKS", APART FROM THE MARK AS SHOWN.

FOR FIREWORKS (U.S. CLS. 2 AND 9).
FIRST USE 1-1-1998; IN COMMERCE 1-1-1998.

SN 78-113,178. B.J. ALAN COMPANY, YOUNGSTOWN, OH. FILED 3-7-2002.

OPERATION ANACONDA

FOR FIREWORKS (U.S. CLS. 2 AND 9).

CLASS 14—JEWELRY

SN 75-264,784. SANDYS, EDWINA, NEW YORK, NY. FILED 3-27-1997.

MILLENNIUM WOMAN

FOR JEWELRY (U.S. CLS. 2, 27, 28 AND 50).
FIRST USE 10-20-1995; IN COMMERCE 10-20-1995.

SN 75-302,316. GODINGER SILVER ART CO., LTD., NEW YORK, NY. FILED 6-3-1997.

CRYSTAL DIAMONDS

NO CLAIM IS MADE TO THE EXCLUSIVE RIGHT TO USE "CRYSTAL", APART FROM THE MARK AS SHOWN.

FOR CRYSTAL GIFTWARE NAMELY, BOXES, BOWLS, CANDLESTICKS, BEVERAGEWARE AND FIGURINES (U.S. CLS. 2, 27, 28 AND 50).

CLASS 14—(Continued).

SN 75-611,232. L.C. LICENSING, INC., NEW YORK, NY. FILED 12-23-1998.

**C R a Z Y
H O R S E**

OWNER OF U.S. REG. NOS. 759,737, 2,271,076 AND OTHERS.
FOR NECKLACES EARRINGS, JEWELRY BRACELETS, ORNAMENTAL PINS, AND RINGS BEING JEWELRY (U.S. CLS. 2, 27, 28 AND 50).
FIRST USE 10-1-1998; IN COMMERCE 10-1-1998.

SN 75-690,082. SCINTO, GREGORY, SOUTH ORLEANS, MA. FILED 5-17-1999.



FOR CLOCKS AND WATCHES (U.S. CLS. 2, 27, 28 AND 50).

SN 75-824,338. BOSTON 2000, INC., BOSTON, MA. FILED 10-15-1999.

B2K

FOR JEWELRY, WATCHES AND ORNAMENTAL PINS AND PINS BEING JEWELRY (U.S. CLS. 2, 27, 28 AND 50).

SN 75-981,314. MONTRES UNIVERSAL S.A., 1227 LES ACACIAS - GENEVE, SWITZERLAND, FILED 8-21-2000.

AERO-COMPAX

FOR JEWELRY, AND PARTS THEREFOR (U.S. CLS. 2, 27, 28 AND 50).

CLASS 14—(Continued).

SN 76-094,254. BURNHAM, JENNIFER, REISTERSTOWN, MD. FILED 7-11-2000.

BZAR BUTTONWARE

FOR JEWELRY, NAMELY, ANKLETS, BRACELETS, NECKLACES, RINGS, TOE RINGS, CHOKERS, ARM BANDS IN THE NATURE OF JEWELRY WORN AROUND THE UPPER ARM, WRIST BANDS IN THE NATURE OF JEWELRY WORN JEWELRY WORN AROUND THE WRIST AND AS WATCH BAND, BROACHES, ORNAMENTAL AND DECORATIVE PINS NOT MADE OF PRECIOUS METAL, HAT PINS IN THE NATURE OF JEWELRY PINS FOR ON HATS NOT MADE OF PRECIOUS METAL AND STICK PINS WITH ALL GOODS BEING IN INTERNATIONAL CLASS 14 (U.S. CLS. 2, 27, 28 AND 50).

SN 76-166,192. LE VIAN CORPORATION, NEW YORK, NY. FILED 11-16-2000.

PRINCESS ALEXANDRA

FOR PRECIOUS METALWARE, NAMELY, GOLD, SILVER AND PLATINUM (U.S. CLS. 2, 27, 28 AND 50).
FIRST USE 8-22-1998; IN COMMERCE 8-22-1998.

SN 76-166,538. A CLASSIC TIME WATCH CO., INC., NEW YORK, NY. FILED 11-16-2000.

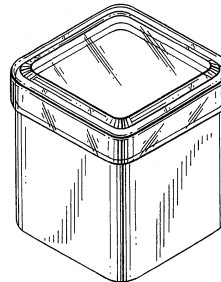

THE LINING IN THE DRAWING IS FOR SHADING PURPOSES ONLY.
THE MARK CONSISTS OF THE OVERALL DESIGN OF PACKAGING FOR WATCHES.
FOR WATCHES (U.S. CLS. 2, 27, 28 AND 50).

SN 76-183,065. NICHOLS, ROSEMARIE, MANHATTAN BEACH, CA. BY ASSIGNMENT LIP-INK INTERNATIONAL, EL SEGUNDO, CA. FILED 12-18-2000.

DIETJEWELRY

FOR JEWELRY, WATCHBANDS, WATCHES AND CHARMS (U.S. CLS. 2, 27, 28 AND 50).

CLASS 14—(Continued).

SN 76-220,589. GOLD BACKFRIEDER GMBH., HAIDER-SHOFEN-VESTENTHAL 17, AUSTRIA, FILED 3-6-2001.

CLASS 14—(Continued).

SN 76-233,413. PROFESSIONAL RODEO BRONZES & ART, LTD., LAFAYETTE, LA. FILED 4-2-2001.

JEWELLNESS

OWNER OF AUSTRIA REG. NO. 197612, DATED 7-16-2001, EXPIRES 7-16-2011.

FOR PRECIOUS METALS IN GENERAL AND THEIR ALLOYS; PRECIOUS STONES; JEWELRY MADE FROM OR PLATED WITH PRECIOUS METALS AND THEIR ALLOYS; CLOCKS, WATCHES AND CHRONOMETERS (U.S. CLS. 2, 27, 28 AND 50).



THE STIPLING IS A FEATURE OF THE MARK AND DOES NOT INDICATE COLOR.

FOR PRECIOUS METALS AND THEIR ALLOYS SOLD IN BULK AND GOODS OF PRECIOUS METALS OR COATED THEREWITH, NAMELY, ANIMAL STATUES, WILDLIFE STATUES, BIRD STATUES, TROPHIES AND PLAQUES (U.S. CLS. 2, 27, 28 AND 50).

SN 76-224,869. THE JEREMIAH GROUP, LTD, WHITE LAKE, MI. BY ASSIGNMENT DAVIS, GLEN, WHITE LAKE, MI. FILED 3-14-2001.

PRECIOUS DATES

FOR INSCRIPTED AND MILLED BULLION, NAMELY, INGOTS, PLATES AND BARS OF PRECIOUS METAL (U.S. CLS. 2, 27, 28 AND 50).

SN 76-248,248. ROSY BLUE N.V., 2018 ANTWERP, BELGIUM, FILED 4-30-2001.

STUDS... N MORE

NO CLAIM IS MADE TO THE EXCLUSIVE RIGHT TO USE "STUDS", APART FROM THE MARK AS SHOWN.

FOR DIAMONDS AND PRECIOUS GEMSTONES; JEWELRY, NAMELY, EARRINGS, RINGS, BRACELETS, CHARMS, NECKLACES, PENDANTS, PINS AND BROOCHES (U.S. CLS. 2, 27, 28 AND 50).

SN 76-226,311. ILC INTERNATIONAL LUXURY COMPANY SA, 1204 GENEVA, SWITZERLAND, FILED 3-16-2001.



SN 76-261,486. ROSY BLUE N.V., 2018 ANTWERP, BELGIUM, FILED 5-23-2001.

CENTO... N MORE

PRIORITY CLAIMED UNDER SEC. 44(D) ON SWITZERLAND APPLICATION NO. 11112/2000, FILED 9-18-2000, REG. NO. 482244, DATED 2-28-2001, EXPIRES 9-18-2010.

NO CLAIM IS MADE TO THE EXCLUSIVE RIGHT TO USE "INTERNATIONAL", "COMPANY", APART FROM THE MARK AS SHOWN.

FOR JEWELRY, PRECIOUS STONES; HOROLOGICAL AND CHRONOMETRIC INSTRUMENTS, NAMELY, WATCHES AND SMALL CLOCKS (U.S. CLS. 2, 27, 28 AND 50).

FOR DIAMONDS AND PRECIOUS GEMSTONES; JEWELRY, NAMELY, EARRINGS, RINGS, BRACELETS, CHARMS, NECKLACES, PENDANTS, PINS AND BROOCHES (U.S. CLS. 2, 27, 28 AND 50).

CLASS 14—(Continued).

SN 76-267,887. FREEDMAN, GEORGENE L., MIDDLETOWN, NY. FILED 6-7-2001.

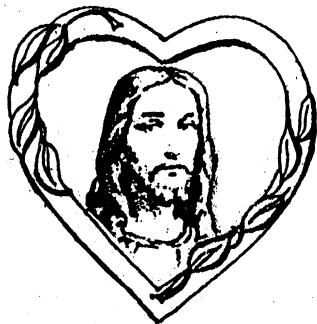

NO CLAIM IS MADE TO THE EXCLUSIVE RIGHT TO USE A DESIGN OF THE FACE OF JESUS CHRIST, APART FROM THE MARK AS SHOWN.

THE MARK CONSISTS OF FIGURE OF JESUS CHRIST INSIDE A HEART SHAPE DESIGN.

FOR JEWELRY CHARM TO BE APPLIED TO NECKLACES TO BE WORN AROUND THE NECK (U.S. CLS. 2, 27, 28 AND 50).

SN 76-271,454. VIACOM INTERNATIONAL INC., NEW YORK, NY. FILED 6-13-2001.

**DELETE DISCRIMINATION**

FOR ORNAMENTAL PINS (U.S. CLS. 2, 27, 28 AND 50).

SN 76-272,728. CAPRIO, JILL SHARON, NEW FAIRFIELD, CT. FILED 6-18-2001.

EAR-GEAR

SEC. 2(F).
FOR WOMEN'S COSTUME JEWELRY; NAMELY, EARRINGS (U.S. CLS. 2, 27, 28 AND 50).
FIRST USE 10-0-1990; IN COMMERCE 9-0-1992.

CLASS 14—(Continued).

SN 76-282,918. WESTPHAL, GAEL L., STAMFORD, CT. FILED 7-10-2001.

**FAMILY HEIRLOOM
JEWELRY**

NO CLAIM IS MADE TO THE EXCLUSIVE RIGHT TO USE "JEWELRY", APART FROM THE MARK AS SHOWN.
FOR NEW COSTUME JEWELRY (U.S. CLS. 2, 27, 28 AND 50).

SN 76-287,459. BUCHERER AG LUZERN, LUZERN, SWITZERLAND, FILED 7-18-2001.

PATRAVI

PRIORITY CLAIMED UNDER SEC. 44(D) ON SWITZERLAND APPLICATION NO. 01458/2001, FILED 2-12-2001, REG. NO. 486544, DATED 7-3-2001, EXPIRES 7-3-2011.

FOR PRECIOUS METALS AND THEIR ALLOYS; JEWELRY; PRECIOUS STONES; TIMEPIECES AND CHRONOMETRIC INSTRUMENTS, NAMELY, WATCHES AND CLOCKS (U.S. CLS. 2, 27, 28 AND 50).

SN 76-300,095. OWN THE POWER ENTERPRISES, INC., LOS ANGELES, CA. FILED 8-14-2001.

OWN THE POWER

FOR JEWELRY, NAMELY BRACELETS, PINS AND RINGS, PENDANTS, NECKLACES AND EARRINGS (U.S. CLS. 2, 27, 28 AND 50).

FIRST USE 8-3-2001; IN COMMERCE 8-3-2001.

SN 76-302,405. CHAUMET INTERNATIONAL, S.A., 75001 PARIS, FRANCE, FILED 8-16-2001.

NIGHT SPIRIT

PRIORITY CLAIMED UNDER SEC. 44(D) ON FRANCE APPLICATION NO. 013087894, FILED 3-9-2001, REG. NO. 013087894, DATED 3-9-2001, EXPIRES 3-9-2011.

FOR WATCH-CASES, WATCH-BRACELETS, WATCH-BUCKLES, WATCH-CROWNS, WATCH-DIALS, TABLE CLOCKS, ALARM CLOCKS, CLOCKS, NECKLACES, BRACELETS, EARRINGS, PENDANTS, AND RINGS (U.S. CLS. 2, 27, 28 AND 50).

CLASS 14—(Continued).

SN 76-313,264. RUSSELL, KRISTA L., KEIZER, OR. FILED 9-14-2001.

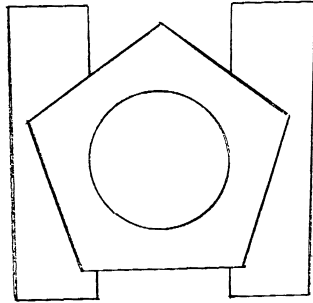

FOR JEWELRY (U.S. CLS. 2, 27, 28 AND 50).

CLASS 14—(Continued).

SN 76-322,347. DIAMINTANGIBLES INTERNATIONAL, LTD., NASSAU, BAHAMAS, FILED 10-10-2001.

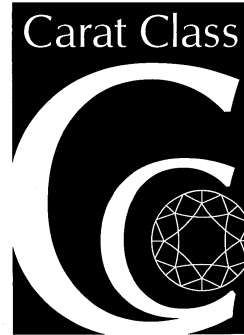

NO CLAIM IS MADE TO THE EXCLUSIVE RIGHT TO USE "CARAT", APART FROM THE MARK AS SHOWN. FOR DIAMONDS AND DIAMOND JEWELRY (U.S. CLS. 2, 27, 28 AND 50).

SN 76-314,561. POMMES DE CLAIRE ORCHARDS, INC., HIGHLAND, NY. FILED 9-19-2001.

LET FREEDOM RING

FOR JEWELRY (U.S. CLS. 2, 27, 28 AND 50).

SN 76-329,249. NATIONAL CHAIN COMPANY, WARWICK, RI. FILED 10-24-2001.



FOR JEWELRY (U.S. CLS. 2, 27, 28 AND 50). FIRST USE 1-0-1954; IN COMMERCE 1-0-1954.

SN 76-318,367. BUCKLEY, MORTON C, AVONDALE, AZ. FILED 9-27-2001.



THE STIPPLING IS A FEATURE OF THE MARK AND DOES NOT INDICATE COLOR. FOR TURQUOISE STONES AND SUBSTITUTES WHICH SIMULATE TURQUOISE THAT ARE INLAID WITH GOLD OR GOLD SUBSTITUTES AND USED IN JEWELRY AND OTHER ITEMS IN WHICH GEMSTONES ARE UTILIZED (U.S. CLS. 2, 27, 28 AND 50).

SN 76-332,932. UNITED WAY OF AMERICA, ALEXANDRIA, VA. FILED 11-1-2001.

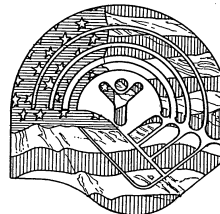

United Way

OWNER OF U.S. REG. NO. 1,493,849. THE MARK IS LINED FOR THE COLORS, RED, WHITE AND BLUE. FOR LAPEL PINS (U.S. CLS. 2, 27, 28 AND 50).

CLASS 14—(Continued).

SN 76-343,429. BOND STREET COLLECTIONS, DALLAS, TX. FILED 12-3-2001.

BOND STREET

OWNER OF U.S. REG. NO. 2,375,491.
FOR WATCHES AND JEWELRY (U.S. CLS. 2, 27, 28 AND 50).
FIRST USE 8-0-1997; IN COMMERCE 8-0-1997.

SN 76-349,679. BRITO, DIRK DE, BEVERLY HILLS, CA. FILED 12-17-2001.

EXAMINATOR

FOR WATCHES AND CLOCKS CONTAINING AN ELECTRONIC PACING FUNCTION FOR TEST TAKING PURPOSES (U.S. CLS. 2, 27, 28 AND 50).

SN 76-356,083. S.A. KITSINIAN INC., VAN NUYS, CA. FILED 1-8-2002.

SKA

FOR JEWELRY (U.S. CLS. 2, 27, 28 AND 50).
FIRST USE 1-0-1987; IN COMMERCE 1-0-1987.

SN 76-356,210. CHARLOTTE RUSSE MERCHANDISING, INC., SAN DIEGO, CA. FILED 1-7-2002.

refuge.

FOR WATCHES, WATCH BANDS AND STRAPS, BRACELETS, BROOCHES, JEWELRY PINS, JEWELRY, JEWELRY CHAINS, RINGS, WATCH CHAINS, CHARMS, EARRINGS AND NECKLACES (U.S. CLS. 2, 27, 28 AND 50).

SN 76-357,042. GEMESIS CORPORATION, THE, LONGBOAT KEY, FL. FILED 1-9-2002.

GEMESIS CULTURED DIAMOND

OWNER OF U.S. REG. NO. 2,516,250.
NO CLAIM IS MADE TO THE EXCLUSIVE RIGHT TO USE "CULTURED DIAMOND", APART FROM THE MARK AS SHOWN.

FOR SYNTHETIC DIAMONDS (U.S. CLS. 2, 27, 28 AND 50).
FIRST USE 8-0-1998; IN COMMERCE 11-0-1999.

CLASS 14—(Continued).

SN 76-358,648. MORRIS, RALPH D., DBA STUART NYE SILVER SHOP, ASHEVILLE, NC. FILED 1-14-2002.

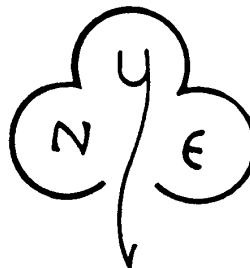

FOR HAND WROUGHT JEWELRY (U.S. CLS. 2, 27, 28 AND 50).
FIRST USE 1-1-1937; IN COMMERCE 1-1-1937.

SN 76-359,530. ALLISON REED GROUP, INC., EAST PROVIDENCE, RI. FILED 1-16-2002.

Hayward

OWNER OF U.S. REG. NOS. 511,599, 933,545 AND 1,442,016.
SEC. 2(F).
FOR JEWELRY (U.S. CLS. 2, 27, 28 AND 50).
FIRST USE 6-1-1996; IN COMMERCE 6-1-1996.

SN 76-361,007. SHE BEADS COMPANY, WILMETTE, IL. FILED 1-18-2002.

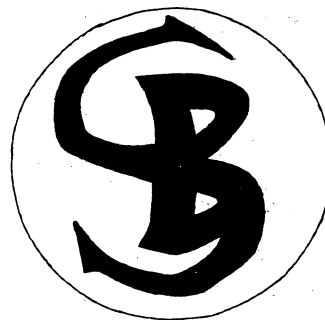

FOR HAND-ROLLED CLAY BEAD JEWELRY (U.S. CLS. 2, 27, 28 AND 50).
FIRST USE 6-0-1995; IN COMMERCE 6-0-1995.

CLASS 14—(Continued).

SN 76-362,802. ED LEVIN, INC., CAMBRIDGE, NY. FILED 1-28-2002.

SHAPING AMERICAN DESIGN SINCE 1950

NO CLAIM IS MADE TO THE EXCLUSIVE RIGHT TO USE "SINCE 1950", APART FROM THE MARK AS SHOWN. FOR JEWELRY (U.S. CLS. 2, 27, 28 AND 50).

CLASS 14—(Continued).

SN 76-374,274. DIAMONIQUE CORPORATION., HORSHAM, PA. FILED 2-22-2002.

Diamonique

OWNER OF U.S. REG. NOS. 1,538,103 AND 1,552,950. FOR JEWELRY (U.S. CLS. 2, 27, 28 AND 50). FIRST USE 1-1-2000; IN COMMERCE 1-1-2000.

SN 76-370,072. ASCH/GROSSBARDT INC., NEW YORK, NY. FILED 2-13-2002.

THE ERIC GROSSBARDT COLLECTION

OWNER OF U.S. REG. NO. 2,142,497. NO CLAIM IS MADE TO THE EXCLUSIVE RIGHT TO USE "COLLECTION", APART FROM THE MARK AS SHOWN.

THE NAME "ERIC GROSSBARDT" IDENTIFIES A LIVING INDIVIDUAL WHOSE CONSENT IS OF RECORD.

FOR JEWELRY, NAMELY, PINS, PENDANTS, BROOCHES, RINGS, BRACELETS, EARRINGS, ANKLETS, CUFF LINKS AND NECKLACES (U.S. CLS. 2, 27, 28 AND 50).

SN 76-375,325. JOHN C. NORDT CO. INC., DBA GUERTIN BROTHERS, ROANOKE, VA. FILED 2-25-2002.

SANMARIL

FOR JEWELRY, FINGER RINGS (U.S. CLS. 2, 27, 28 AND 50). FIRST USE 1-23-2002; IN COMMERCE 1-23-2002.

SN 76-376,097. SHANGHAI GOLDLUCK ACCESSORIES CO., LTD., SHANGHAI, CHINA, FILED 2-28-2002.

GOLDLUCK

FOR TIE CLIPS; TIE TACKS; TIE PINS; CUFF LINKS; PRECIOUS METAL MONEY CLIPS; BROOCHES; HAT PINS OF PRECIOUS METAL; COSTUME JEWELRY; BRACELETS; JEWELRY BOXES OF PRECIOUS METAL; JEWELRY, NAMELY, CHAINS, CROSSES, AMULETS, HAT PINS AND RINGS (U.S. CLS. 2, 27, 28 AND 50).

SN 76-370,373. SPHATIKA INTERNATIONAL LLC, NEW YORK, NY. FILED 2-12-2002.

SPHATIKA

FOR JEWELRY, NAMELY EARRINGS, RINGS, NECKLACES, BRACELETS, PENDANTS (U.S. CLS. 2, 27, 28 AND 50).

SN 76-376,288. ALDI INC., BATAVIA, IL. FILED 3-1-2002.

BAROLO

FOR WATCHES (U.S. CLS. 2, 27, 28 AND 50).

SN 76-372,844. YOUNG, CARL E., WICKFORD, RI. FILED 2-20-2002.

EARJAMS

FOR JEWELRY, NAMELY, EARRINGS (U.S. CLS. 2, 27, 28 AND 50).

SN 76-379,009. POMMES DE CLAIRE, INC., NEW YORK, NY. FILED 3-6-2002.

LOVEWORDS

FOR JEWELRY (U.S. CLS. 2, 27, 28 AND 50).

CLASS 14—(Continued).

SN 76-379,448. MOVADO LLC, WILMINGTON, DE. FILED 3-6-2002.

MONTO

FOR WATCHES (U.S. CLS. 2, 27, 28 AND 50).

SN 76-380,442. EMERALDS INTERNATIONAL, INC., KEY WEST, FL. FILED 3-11-2002.

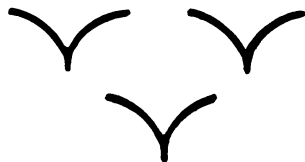

FOR JEWELRY (U.S. CLS. 2, 27, 28 AND 50).
FIRST USE 1-0-1968; IN COMMERCE 2-0-1968.

SN 78-029,081. BALL & CHAIN INDUSTRIES, L.L.C., AUSTIN, TX. FILED 10-4-2000.

TongueJoy

FOR JEWELRY (U.S. CLS. 2, 27, 28 AND 50).
FIRST USE 11-22-2000; IN COMMERCE 11-22-2000.

SN 78-062,355. RUTOSKI, JERRY J., ANCHORAGE, AK. FILED 5-7-2001.

**SWORDS INTO
PLOWSHARES ORIGINALS**

NO CLAIM IS MADE TO THE EXCLUSIVE RIGHT TO USE "ORIGINALS", APART FROM THE MARK AS SHOWN.
FOR JEWELRY (U.S. CLS. 2, 27, 28 AND 50).

CLASS 14—(Continued).

SN 78-090,784. THE BRITISH MASTERS SA, 2300 LA CHAUX-DE-FONDS, SWITZERLAND, FILED 10-30-2001.

GRAHAM CHRONOFIGHTER

PRIORITY CLAIMED UNDER SEC. 44(D) ON SWITZERLAND APPLICATION NO. 04723/2001, FILED 5-11-2001, REG. NO. 488605, DATED 9-3-2001, EXPIRES 5-11-2011.

FOR PRECIOUS METALS AND THEIR ALLOYS SOLD IN BULK; JEWELRY, PRECIOUS STONES; HOROLOGICAL AND CHRONOMETRIC INSTRUMENTS, NAMELY, WATCHES, CLOCKS AND CHRONOMETERS (U.S. CLS. 2, 27, 28 AND 50).

SN 78-100,074. SHAUN V. ROBERTS, CAPISTRANO BEACH, CA. FILED 12-27-2001.

SPACE CASE

NO CLAIM IS MADE TO THE EXCLUSIVE RIGHT TO USE "CASE", APART FROM THE MARK AS SHOWN.
FOR METAL GIFT BOXES OF PRECIOUS METAL (U.S. CLS. 2, 27, 28 AND 50).

SN 78-102,916. ABSOLUTE DESIGN STUDIOS, MONTREAL QC, CANADA, FILED 1-15-2002.

**THE TENSION IS
MOUNTING**

FOR CLOCKS; WATCHES; JEWELRY; MEN'S FASHION ACCESSORIES MADE OF PRECIOUS METALS IN THE NATURE OF CUFFLINKS, TIE CLIPS, MONEY CLIPS, AND CIGAR TUBES (U.S. CLS. 2, 27, 28 AND 50).
FIRST USE 0-0-1999; IN COMMERCE 0-0-2000.

SN 78-105,103. NANOJEWELRY LLC, RENO, NV. FILED 1-27-2002.

NANOJEWELRY

FOR JEWELRY (U.S. CLS. 2, 27, 28 AND 50).
FIRST USE 10-15-2001; IN COMMERCE 10-15-2001.

SN 78-110,237. NEUENSCHWANDER, SUSAN, FARGO, ND. FILED 2-21-2002.

WHIRLY GIRLS

FOR JEWELRY (U.S. CLS. 2, 27, 28 AND 50).
FIRST USE 2-20-2002; IN COMMERCE 2-20-2002.

CLASS 14—(Continued).

SN 78-112,999. BUILD-A-BEAR WORKSHOP, INC., ST. LOUIS, MO. FILED 3-6-2002.

**ALL THE STUFF BEST
FRIENDS SHARE**

FOR CLOCKS; JEWELRY; WATCHES (U.S. CLS. 2, 27, 28 AND 50).

CLASS 14—(Continued).

SN 78-116,206. LAWRENCE CHALSON, INC., CEDAR-HURST, NY. FILED 3-20-2002.

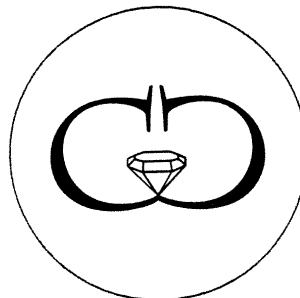

FOR JEWELRY (U.S. CLS. 2, 27, 28 AND 50).

SN 78-113,666. RAVO, DAVID, LOS ANGELES, CA. AND RAVO, AARON, LOS ANGELES, CA. FILED 3-8-2002.



CLASS 15—MUSICAL INSTRUMENTS

SN 76-341,323. KAUFFMAN, JODI, NEW YORK, NY. FILED 11-26-2001.

JODI HEAD

"JODI HEAD" IS A NICKNAME OF A LIVING INDIVIDUAL WHOSE CONSENT TO THE REGISTRATION OF THE NAME IS OF RECORD.

FOR GUITAR STRAPS, EITHER IN SINGLE UNIT OR MULTI-UNIT CONFIGURATIONS (U.S. CLS. 2, 21 AND 36).

FIRST USE 9-1-1994; IN COMMERCE 9-1-1994.

FOR WATCHES, CLOCKS, STOP WATCHES, TIE FASTENERS, TIE CLIPS, TIE PINS, PRECIOUS METAL MONEY CLIPS, PENDANTS, BRACELETS, MEDALLIONS, BELT BUCKLES OF PRECIOUS METAL, NAPKIN RINGS OF PRECIOUS METAL, LAPEL PINS, BRACELETS, ANKLETS, TOE RINGS, NECKLACES, EARRINGS, RINGS BEING JEWELRY, COSTUME JEWELRY, CIGARETTE LIGHTERS AND ASHTRAYS MADE OF PRECIOUS METAL (U.S. CLS. 2, 27, 28 AND 50).

SN 76-365,211. SHANGHAI LANSHENG CORPORATION, SHANGHAI, CHINA, FILED 1-25-2002.



SN 78-114,365. SID & DEBRA MARCOVITCH, SANTA ROSA, CA. FILED 3-12-2002.

EARSTRINGS

FOR JEWELRY (U.S. CLS. 2, 27, 28 AND 50).

THE MARK CONSISTS OF THE WORD "BESTLER". THE LETTER "B" IS REPRESENTED BY A STYLIZED DESIGN OF A STRINGED INSTRUMENT.

FOR MUSICAL INSTRUMENTS, INCLUDING STRING INSTRUMENTS, NAMELY, VIOLIN, VIOLA, CELLO, GUITAR; WIND INSTRUMENTS, NAMELY, CLARINET, SAXOPHONE, FLUTE, PICCOLO, OBOE; BRASS INSTRUMENTS, NAMELY, TRUMPET, CORNET, TROMBONE; HARMONICA, ACCORDION, BOWS FOR STRING INSTRUMENTS; STRINGS FOR MUSICAL INSTRUMENTS; CASES FOR MUSICAL INSTRUMENTS AND MUSIC STANDS, FRENCH HORN, EUPHONIUM, BARITONE (U.S. CLS. 2, 21 AND 36).

FIRST USE 10-0-1965; IN COMMERCE 2-0-1995.

CLASS 15—(Continued).

SN 76-389,980. KOENIG, CHARLES HENRY, III, DBA ARTCOM COMPANY, PARK RIDGE, IL. FILED 4-2-2002.

ARTCOM

FOR MUSICAL INSTRUMENT STRINGS AND PICKS (U.S. CLS. 2, 21 AND 36).
FIRST USE 9-1-1965; IN COMMERCE 9-1-1965.

SN 78-098,448. EASTMAN STRINGS, INC., GAITHERSBURG, MD. FILED 12-14-2001.

MOJAVE

FOR GUITARS (U.S. CLS. 2, 21 AND 36).
FIRST USE 10-1-2001; IN COMMERCE 10-1-2001.

SN 78-116,457. SCHULTZ, KLAY V., EAU CLAIRE, WI. FILED 3-21-2002.

KLA-TOH

FOR GUITAR PICKS (U.S. CLS. 2, 21 AND 36).

CLASS 16—PAPER GOODS AND PRINTED MATTER

SN 75-238,778. EVERSHARP PEN COMPANY, FRANKLIN PARK, IL. FILED 2-10-1997.

SKYLINE

FOR WRITING INSTRUMENTS (U.S. CLS. 2, 5, 22, 23, 29, 37, 38 AND 50).
FIRST USE 5-0-1996; IN COMMERCE 5-0-1996.

SN 75-339,441. CAMBRIDGE ENERGY RESEARCH ASSOCIATES, INC., CAMBRIDGE, MA. BY ASSIGNMENT CAMBRIDGE ENERGY RESEARCH ASSOCIATES LIMITED PARTNERSHIP, CAMBRIDGE, MA. FILED 8-12-1997.

GLOBAL POWER FORUM

FOR BROCHURES, NEWSLETTERS AND REPORTS IN THE FIELD OF WORLD ENERGY, ENERGY RESOURCES AND ENVIRONMENTAL ISSUES (U.S. CLS. 2, 5, 22, 23, 29, 37, 38 AND 50).
FIRST USE 9-0-1996; IN COMMERCE 9-0-1996.

CLASS 16—(Continued).

SN 75-411,056. REED ELSEVIER INC., NEWTON, MA. BY ASSIGNMENT MEDIA PUBLISHING INTERNATIONAL L.L.C., LOS ANGELES, CA. FILED 12-29-1997.

411 DIGITAL NORTH AMERICA

NO CLAIM IS MADE TO THE EXCLUSIVE RIGHT TO USE "DIGITAL NORTH AMERICA", APART FROM THE MARK AS SHOWN.

FOR PRINTED DIRECTORY FEATURING INFORMATION ABOUT SECURING DIGITAL PRODUCTION SERVICES AND EQUIPMENT (U.S. CLS. 2, 5, 22, 23, 29, 37, 38 AND 50).

FIRST USE 12-17-1997; IN COMMERCE 12-18-1997.

SN 75-460,290. GOLD PEAK INDUSTRIES (HOLDINGS) LIMITED, NEW TERRITORIES, HONG KONG, FILED 4-1-1998.



FOR PAPER ARTICLES, NAMELY BANNERS, FLAGS, NAME BADGES, PAPER TABLE NAPKINS, PAPER TABLE LINENS, PAPER PARTY DECORATIONS; PAPER, NAMELY, WRITING PAPER, BOND PAPER, COPY PAPER, LETTER PAPER, COMPUTER PRINTOUT PAPER, PAPER FOR PACKAGING, RECEIPT BOOKS AND INVOICE FORMS; CARDBOARD; PRINTED PUBLICATIONS, NAMELY MANUALS; MAGAZINES, BOOKS, BOOKLETS, BROCHURES, PAMPHLETS, LEAFLETS, CATALOGS, DIARIES, CALENDARS ALL IN THE FIELD OF COMMERCE, INDUSTRY, SALE AND BUSINESS PROMOTION; UNMOUNTED PHOTOGRAPHIC PRINTS; STATIONERY; PLASTIC MATERIALS FOR PACKAGING, NAMELY, BUBBLE PACKS, BAGS, ENVELOPES AND POUCHES FOR MERCHANDISE PACKAGING; CARDS, NAMELY, NOTE CARDS, BLANK CARDS, FILE CARDS, FLASH CARDS, GREETING CARDS; PRINTED FORMS, PRINTED LABELS, PAPER IDENTIFICATION TAGS, FILE FOLDERS, WRITING PADS, MEMO PADS, NOTE BOOKS, POSTERS, ENVELOPES, BOOKBINDING MATERIALS IN THE NATURE OF CLOTH, WIRE AND TAPE; PRINTED PAPER SIGNS; OFFICE REQUISITES, NAMELY, PAPER WEIGHTS, STAPLERS, STAPLES, MACHINE RIBBONS, PUNCHES AND RUBBER BANDS; WRAPPING PAPERS AND BOXES, NAMELY, CARDBOARD BOXES, CORRUGATED RECORD STORAGE BOXES, PAPER BOXES, CARTON BOXES, PENCIL BOXES, STATIONERY BOXES, FILE BOXES FOR STORAGE OF BUSINESS AND PERSONAL RECORDS, AND SOUVENIR BOXES MADE FROM PAPER (U.S. CLS. 2, 5, 22, 23, 29, 37, 38 AND 50).

CLASS 16—(Continued).

SN 75-594,433. MARTHA STEWART LIVING OMNIMEDIA LLC, NEW YORK, NY. FILED 11-24-1998.

MARTHA STEWART WEDDINGS

OWNER OF U.S. REG. NO. 1.709,962.
NO CLAIM IS MADE TO THE EXCLUSIVE RIGHT TO USE "WEDDINGS", APART FROM THE MARK AS SHOWN. THE NAME "MARTHA STEWART" IDENTIFIES A LIVING INDIVIDUAL WHOSE CONSENT IS OF RECORD.

FOR GIFT WRAPPING RIBBONS, STICKERS, WRAPPING PAPER, AND PAPER GIFT BAGS (U.S. CLS. 2, 5, 22, 23, 29, 37, 38 AND 50).

SN 75-641,304. JACOBS, TERESA COOPER, MISSOULA, MT. FILED 2-20-1999.

PLAYGROUND ENHANCEMENT PROJECT

SEC. 2(F).
FOR PRINTED INSTRUCTIONAL, EDUCATIONAL AND HANDS-ON TEACHING MATERIALS IN KIT FORM FOR USE BY SCHOOLS AND RECREATIONAL PROGRAMS IN TEACHING COOPERATIVE GAMES, ACTIVITIES AND GAME-PLAYING SKILLS (U.S. CLS. 2, 5, 22, 23, 29, 37, 38 AND 50).

FIRST USE 9-22-1994; IN COMMERCE 5-4-1995.

SN 75-821,252. KOFRICA ENTERTAINMENT INC., MALIBU, CA. FILED 10-13-1999.

THE NEXT REAL THING

FOR PAPER GOODS, NAMELY, BUMPER STICKERS, NOTE PADS, POSTERS AND BANNERS (U.S. CLS. 2, 5, 22, 23, 29, 37, 38 AND 50).

FIRST USE 8-22-1998; IN COMMERCE 8-22-1998.

SN 75-890,638. SAKURA COLOR PRODUCTS OF AMERICA, INC., HAYWARD, CA. FILED 1-6-2000.

STARDUST

FOR WRITING INSTRUMENTS AND STATIONERY, NAMELY, BALL POINT PENS, ROLLER BALL PENS, AND GEL INK PENS ALL WITH DUAL-COLOR INK AND WITH INK CONTAINING FLUORESCENT AND SPARKLING MATTER; BLANK NOTEBOOKS, BLANK DIARIES, AND FILLERS FOR NOTEBOOKS AND COMBINATIONS THEREOF (U.S. CLS. 2, 5, 22, 23, 29, 37, 38 AND 50).

CLASS 16—(Continued).

SN 75-932,378. HERMAN MILLER, INC., ZEELAND, MI. FILED 3-1-2000.

CONSTELLATION

FOR PRINTED PAPER TEMPLATES FOR VARIOUS OFFICE FURNITURE CONFIRATIONS (U.S. CLS. 2, 5, 22, 23, 29, 37, 38 AND 50).

SN 75-950,873. IVEY, CHARLOTTE ANNE, PARK CITY, UT. FILED 3-2-2000.



FOR PRINTED EDUCATIONAL MATERIALS, NAMELY, INSTRUCTION MANUALS, TUTOR'S MANUALS, STUDENT TIME LOGS, AND WORKBOOKS SOLD AS A UNIT FOR TEACHING MATHEMATICS (U.S. CLS. 2, 5, 22, 23, 29, 37, 38 AND 50).

FIRST USE 11-1-1999; IN COMMERCE 11-1-1999.

SN 76-002,727. EIDOS INTERACTIVE LIMITED, WIMBLEDON, LONDON, SW19 3RU, UNITED KINGDOM, FILED 3-17-2000.

HITMAN: CODENAME 47

FOR STATIONERY, BOOKS, IN THE FIELD OF INTERACTIVE ELECTRONIC ADVENTURE SPY/SUSPENSE GAMES IN A SERIES; INSTRUCTION MANUALS RELATED TO INTERACTIVE ELECTRONIC ADVENTURE SPY/SUSPENSE GAMES IN A SERIES; PERIODICAL PUBLICATIONS, NAMELY, A MAGAZINE AND BROCHURES RELATED TO ADVENTURE SPY/SUSPENSE GAMES IN A SERIES; POSTERS RELATED TO ADVENTURE SPY/SUSPENSE GAMES IN A SERIES (U.S. CLS. 2, 5, 22, 23, 29, 37, 38 AND 50).

CLASS 16—(Continued).

SN 76-012,840. STURGIS BIKE WEEK, INC., STURGIS, SD.
FILED 3-29-2000.

STURGIS BIKE WEEK

NO CLAIM IS MADE TO THE EXCLUSIVE RIGHT TO USE "BIKE", APART FROM THE MARK AS SHOWN.

FOR PAPER GOODS, NAMELY, STATIONERY, POSTCARDS, TABLE MATS AND NAPKINS; AND PRINTED PUBLICATIONS, NAMELY, PAMPHLETS, BROCHURES AND MAGAZINES RELATING TO AN ANNUAL MOTORCYCLE EVENT (U.S. CLS. 2, 5, 22, 23, 29, 37, 38 AND 50).

SN 76-013,770. U.S. HEALTH CLUB, INC., HASTINGS-ON-HUDSON, NY. FILED 3-30-2000.

HEALTHPOWER

FOR NEWSLETTER DEALING WITH HEALTH AND NUTRITION (U.S. CLS. 2, 5, 22, 23, 29, 37, 38 AND 50).
FIRST USE 1-0-1998; IN COMMERCE 1-0-1998.

SN 76-025,588. SOCIETE FRANCAISE DE PROMOTION ARTISTIQUE, 75002 PARIS, FRANCE, FILED 4-13-2000.

PLAISIR DE FRANCE

OWNER OF FRANCE REG. NO. 1397939, DATED 3-28-1997, EXPIRES 3-28-2007.

NO CLAIM IS MADE TO THE EXCLUSIVE RIGHT TO USE "FRANCE", APART FROM THE MARK AS SHOWN.

THE ENGLISH TRANSLATION OF "PLAISIR" IS "PLEASURE".

FOR PRINTED MATTER, NAMELY, NEWSPAPERS FOR GENERAL CIRCULATION; PERIODICALS IN THE FIELD OF FASHION, DECORATION, GASTRONOMY, TOURISM, ART AND CULTURE; BOOKS IN THE FIELD OF FASHION, DECORATION, GASTRONOMY, TOURISM, ART AND CULTURE; AND GENERAL INTEREST MAGAZINES (U.S. CLS. 2, 5, 22, 23, 29, 37, 38 AND 50).

SN 76-041,274. MERZ & KRELL GMBH & CO, FED REP GERMANY, FILED 5-4-2000.

AQUA-WONDER

PRIORITY CLAIMED UNDER SEC. 44(D) ON FED REP GERMANY APPLICATION NO. 30001078.8, FILED 1-8-2000, REG. NO. 30001078, DATED 2-8-2000, EXPIRES 1-31-2010.

FOR WRITING INSTRUMENTS (U.S. CLS. 2, 5, 22, 23, 29, 37, 38 AND 50).

CLASS 16—(Continued).

SN 76-064,191. YOUNG LIFE, COLORADO SPRINGS, CO.
FILED 6-6-2000.

YOUNG LIFE CAMPAIGNERS

OWNER OF U.S. REG. NO. 1,626,453.

NO CLAIM IS MADE TO THE EXCLUSIVE RIGHT TO USE "CAMPAIGNERS", APART FROM THE MARK AS SHOWN.

FOR PRINTED MATERIALS, NAMELY, NEWSLETTERS, PERIODICALS, BROCHURES, AND NOTEPADS FEATURING INFORMATION ABOUT RECREATIONAL ACTIVITIES, MINISTERIAL PROGRAMS AND ENTERTAINMENT DIRECTED TOWARD YOUNG PEOPLE, NAMELY THEATRICAL AND MUSICAL PERFORMANCES, AND NOTEPADS (U.S. CLS. 2, 5, 22, 23, 29, 37, 38 AND 50).

SN 76-107,251. DREW, CLARICE S., DBA IMAGECOUNTS, GRAND RAPIDS, MI. FILED 8-10-2000.



FOR GREETING CARDS (U.S. CLS. 2, 5, 22, 23, 29, 37, 38 AND 50).

SN 76-112,548. FURUICHI, MICHELLE, DBA PIGMENTS OF IMAGINATION, FAIRFAX, CA. FILED 8-18-2000.

PIGMENTS OF IMAGINATION

FOR ADDRESS BOOKS, ADDRESS LABELS, ADDRESS PLATES, PHOTOGRAPH ALBUMS, ANNOUNCEMENT CARDS, APPOINTMENT BOOKS, ART ETCHINGS, ART PICTURES, ART PRINTS, GRAPHIC AND PRINTED ART REPRODUCTIONS, BABY BOOKS, PAPER PARTY BAGS, PAPER BAGS, BALL-POINT PENS, BASKETS FOR DESK ACCESSORIES, BOOK COVERS, BOOK PLATES, BOOKENDS, BOOKMARKS, TRAVEL, RECIPE AND SKETCH BOOKS, PAPER GIFT WRAP BOWS, PAPER, PENCIL AND STATIONERY BOXES, BUSINESS CARDS, CALENDAR DESK PADS, CALENDAR DESK STANDS, CALENDAR STANDS, WALL, DESK AND POCKET CALENDARS, BLANK CARDS, CHRISTMAS CARDS, FILE CARDS, FLASH CARDS, GIFT CARDS, GREETING CARDS, INDEX CARDS, NOTE CARDS, OCCASION CARDS, PLAYING CARDS, TRADING CARDS, TRIVIA CARDS, PEN AND PENCIL CASES, GLOBES, COLOR PRINTS, COLORING BOOKS, CONFETTI, CONSTRUCTION PAPER, DECALS, PAPER DECORATIONS, DESK FILE TRAYS, DESK PADS, DESK SETS, DESK STANDS AND HOLDERS FOR PENS, PENCILS, AND INK, DESK TOP ORGANIZERS, DESK TOP PLANNERS, DIARIES, ENGAGEMENT BOOKS, ERASERS, PAPER GIFT WRAPPING,

CLASS 16—(Continued).

PAPER BOWS FOR GIFT WRAP, PAPER GIFT WRAPPING, PAPER GIFT WRAPPING RIBBONS, TRAVEL AND TOURISM GUIDE BOOKS, PAPER HANDKERCHIEFS, PARTY HATS, BOOK, PEN AND PENCIL HOLDERS, PAPER IDENTIFICATION TAGS, PRINTED INVITATIONS, LETTER OPENERS, PAPER TABLE LINEN, LOG BOOKS, PAPER NAME BADGES, NOTE BOOKS, NOTE PAPER, PAPER ENVELOPES FOR PACKAGING, PAPER POUCHES FOR PACKAGING, PLASTIC BAGS FOR PACKAGING, PACKING PAPER, INKING PADS, NOTE PADS, SCORE PADS, SCRATCH PADS, SKETCH PADS, STAMP PADS, WRITING PADS, PAPER BANNERS, PAPER BIBS, PAPER BOWS, PAPER CLIPS, PAPER CONTAINERS, PAPER DOLLIES, PAPER EMBLEMS, PARTY PAPER DECORATIONS, PAPER NAPKINS, PAPER PENNANTS, PAPER PLACEMATS, PAPER RIBBONS, PAPER TRAY COVERS, PAPER TRAYS, PENCIL SHARPENERS, PEN/PENCIL ORNAMENT TOPS, ART AND PICTORIAL PRINTS, PICTURE BOOKS, CORKBOARD PINS, POSTCARDS, POSTERS, DRAWING RULERS, STICKERS, STENCILS, THUMB-TACKS, AND TISSUE PAPER (U.S. CLS. 2, 5, 22, 23, 29, 37, 38 AND 50).

SN 76-117,968. TRANSCONTINENTAL MEDIA INC./ MEDIA TRANSCONTINENTAL INC., MONTREAL, QUEBEC, CANADA, BY CHANGE OF NAME PUBLICATIONS TRANSCONTINENTAL INC., QUEBEC, CANADA, FILED 8-29-2000.

THE HOCKEY NEWS MVP

PRIORITY CLAIMED UNDER SEC. 44(D) ON CANADA APPLICATION NO. 1,060,819., FILED 5-26-2000.
OWNER OF U.S. REG. NOS. 2,374,264 AND 2,376,563.
NO CLAIM IS MADE TO THE EXCLUSIVE RIGHT TO USE "NEWS", APART FROM THE MARK AS SHOWN.
SEC. 2(F) AS TO "THE HOCKEY NEWS".
FOR PUBLICATIONS, NAMELY— HOCKEY MAGAZINES (U.S. CLS. 2, 5, 22, 23, 29, 37, 38 AND 50).
FIRST USE 10-0-2000; IN COMMERCE 10-0-2000.

SN 76-153,122. FORD, SEVERIO, HEMPSTEAD, NY. FILED 10-24-2000.

PANAMA EXCLUSIVA

NO CLAIM IS MADE TO THE EXCLUSIVE RIGHT TO USE "PANAMA", APART FROM THE MARK AS SHOWN.
THE ENGLISH TRANSLATION OF "EXCLUSIVA" IS "EXCLUSIVE".
FOR MAGAZINE CONCERNING MATTERS OF GENERAL INTEREST TO THE PANAMANIAN COMMUNITY IN THE FIELDS OF NEWS AND CURRENT EVENTS; FASHION AND BEAUTY; HEALTH AND PERSONAL CARE; CULINARY; LITERATURE, ENTERTAINMENT AND THE ARTS; FINANCE, BUSINESS, CAREER OPPORTUNITIES; HISTORY, BIOGRAPHY, FICTION; POLITICS; SPORTS; TRAVEL; EDUCATION, CULTURE, AND PERSONAL RELATIONSHIPS (U.S. CLS. 2, 5, 22, 23, 29, 37, 38 AND 50).
FIRST USE 7-0-1996; IN COMMERCE 7-0-1996.

CLASS 16—(Continued).

SN 76-161,861. CHARTER ONE FINANCIAL, INC., CLEVELAND, OH. FILED 11-9-2000.

CHARTER ONE TIMES

NO CLAIM IS MADE TO THE EXCLUSIVE RIGHT TO USE "TIMES", APART FROM THE MARK AS SHOWN.

FOR PRINTED PUBLICATIONS, NAMELY, A BROCHURE FEATURING INFORMATION ON BANKING SERVICES (U.S. CLS. 2, 5, 22, 23, 29, 37, 38 AND 50).

SN 76-165,053. CMP MEDIA LLC., MANHASSET, NY. FILED 11-14-2000.

M-INVESTOR

FOR PRINT PUBLICATION NAMELY MAGAZINES RELATING TO MOBILE BUSINESS (U.S. CLS. 2, 5, 22, 23, 29, 37, 38 AND 50).

SN 76-166,879. THIBIERGE ET COMAR SA, PARIS, FRANCE, FILED 11-16-2000.

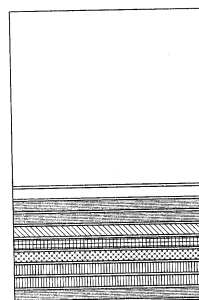

THE LINING AND DESIGN ELEMENTS OF THE MARK ARE USED SOLELY TO REPRESENT THE AFOREMENTIONED COLORS.

THE MARK IS IN THE FORM OF A COLOR CHART. THE MARK HAS TEN HORIZONTALLY DISPOSED RECTANGULAR MAIN STRIPES LOCATED ONE ABOVE THE OTHER, AND TEN VERY NARROW WHITE RECTANGULAR STRIPES, ONE IMMEDIATELY UNDER EACH OF THE MAIN STRIPES. FROM TOP TO BOTTOM, MAIN STRIPE NUMBER 1 IS LARGE AND MAIN STRIPES 2 TO 10 ARE NARROW. FROM TOP TO BOTTOM, MAIN STRIPES NUMBER 1 AND 2 ARE EXTRA WHITE, MAIN STRIPE NUMBER 3 IS AZURE, MAIN STRIPE NUMBER 4 IS TURQUOISE, MAIN STRIPE NUMBER 5 IS ANISE, MAIN STRIPE NUMBER 6 IS YELLOW, AND MAIN STRIPE NUMBER 7 IS ORANGE, MAIN STRIPE NUMBER 8 IS VERMILION, MAIN STRIPE NUMBER 9 IS CARMINE, AND MAIN STRIPE NUMBER 10 IS INDIGO.

FOR PRINTING PAPER AND CARDBOARD IN SHEETS AND ROLLS, AND ENVELOPES USED FOR ADVERTISEMENT PUBLISHING AND FOR PRINTING, AND TRANSPARENT AND TRANSLUCENT PAPER (U.S. CLS. 2, 5, 22, 23, 29, 37, 38 AND 50).

CLASS 16—(Continued).

SN 76-168,634. R & B 21, SUMIDAKU, TOKYO, JAPAN,
FILED 11-17-2000.

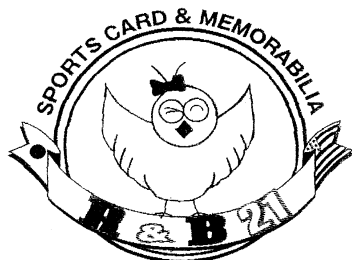

NO CLAIM IS MADE TO THE EXCLUSIVE RIGHT TO USE "SPORTS CARD & MEMORABILIA", APART FROM THE MARK AS SHOWN.

THE LINING SHOWN IN THE DRAWING IS A FEATURE OF THE MARK.

FOR PLASTIC TRADING CARD CASES (U.S. CLS. 2, 5, 22, 23, 29, 37, 38 AND 50).

FIRST USE 7-1-1999; IN COMMERCE 7-1-1999.

SN 76-169,573. BREAKAWAY PUBLISHING, LTD., ALBANY,
TX. FILED 11-22-2000.

BRIGHT SKY PRESS

NO CLAIM IS MADE TO THE EXCLUSIVE RIGHT TO USE "PRESS", APART FROM THE MARK AS SHOWN.

FOR BOOKS ON A VARIETY OF TOPICS, NAMELY FICTION, NON-FICTION, ILLUSTRATED, NON-ILLUSTRATED AND CHILDREN'S BOOKS; CALENDARS, ADDRESS BOOKS; APPOINTMENT BOOKS; JOURNALS; NOTECARDS; POSTERS; BOOKMARKS; ART PRINTS (U.S. CLS. 2, 5, 22, 23, 29, 37, 38 AND 50).

SN 76-173,417. SOUTHWEST RESEARCH INSTITUTE, SAN ANTONIO, TX. FILED 11-30-2000.

TECHNOLOGY
today

SEC. 2(F) AS TO "TECHNOLOGY".
FOR MAGAZINE FEATURING THE RESEARCH AND DEVELOPMENT ACTIVITIES OF SOUTHWEST RESEARCH INSTITUTE (U.S. CLS. 2, 5, 22, 23, 29, 37, 38 AND 50).

FIRST USE 0-0-1984; IN COMMERCE 0-0-1984, 1978.

CLASS 16—(Continued).

SN 76-174,288. NATIONAL PAINTBALL SUPPLY, INC.,
MANTUA, NJ. FILED 12-1-2000.



THE STIPPLING IS FOR SHADING PURPOSES.
FOR MAGAZINES IN THE FIELD OF RECREATIONAL PAINTBALL (U.S. CLS. 2, 5, 22, 23, 29, 37, 38 AND 50).

FIRST USE 5-0-1998; IN COMMERCE 5-0-1998.

SN 76-178,253. GROTE, STEVEN E, DBA CREATABLES, ST CHARLES, MO. FILED 12-11-2000.

CREATABLES

FOR BINDERS, BLANK NOTE CARDS, BOOK COVERS, BUMPER STICKERS, PRESSURE SENSITIVE GRAPHICS FOR APPLICATION TO AUTOMOBILES, CALENDARS, STICKERS, DECALS, FILE FOLDERS, POST CARDS, AND NOTE BOOKS (U.S. CLS. 2, 5, 22, 23, 29, 37, 38 AND 50).

FIRST USE 6-3-2000; IN COMMERCE 6-3-2000.

SN 76-178,440. FLASH4.COM, LLC, BLACK RIVER FALLS, WI. FILED 12-11-2000.

FLASH4.COM

FOR PAPER GOODS AND PRINTED MATTER, NAMELY ADDRESS LABELS, SHIPPING LABELS, PRINTED LABELS NOT OF TEXTILE, AND BLANK OR PARTIALLY PRINTED LABELS NOT OF TEXTILE (U.S. CLS. 2, 5, 22, 23, 29, 37, 38 AND 50).

FIRST USE 1-22-1998; IN COMMERCE 1-22-1998.

SN 76-182,073. KLUTZ, INC., PALO ALTO, CA. FILED 12-14-2000.

YOU CAN SCRATCH OFF

FOR NOTE PADS WITH CONCEALED IMAGES WHICH ARE REVEALED BY REMOVING A COVERED LAYER (U.S. CLS. 2, 5, 22, 23, 29, 37, 38 AND 50).

CLASS 16—(Continued).

SN 76-190,995. TARA MATERIALS, INC., LAWRENCEVILLE, GA. FILED 1-8-2001.



OWNER OF U.S. REG. NO. 822,522.
 NO CLAIM IS MADE TO THE EXCLUSIVE RIGHT TO USE "ARCHIVAL", "SINCE 1868" AND "SEAL OF QUALITY", APART FROM THE MARK AS SHOWN.
 FOR CANVAS ARTIST PANELS (U.S. CLS. 2, 5, 22, 23, 29, 37, 38 AND 50).
 FIRST USE 8-0-1995; IN COMMERCE 8-0-1995.

SN 76-194,449. SENIOR IMPACT PUBLICATIONS LLC, CINCINNATI, OH. FILED 1-16-2001.

OLDER ADULTS

SEC. 2(F).
 FOR HANDBOOKS CONTAINING SENIOR CITIZENS-RELATED INFORMATION (U.S. CLS. 2, 5, 22, 23, 29, 37, 38 AND 50).
 FIRST USE 6-1-1996; IN COMMERCE 6-1-1996.

SN 76-199,276. INTERVARSITY CHRISTIAN FELLOWSHIP/USA, MADISON, WI. FILED 1-25-2001.



OWNER OF U.S. REG. NOS. 1,489,276 AND 1,908,451.
 FOR RELIGIOUS BOOKS, LEAFLETS, AND BROCHURES (U.S. CLS. 2, 5, 22, 23, 29, 37, 38 AND 50).

CLASS 16—(Continued).

SN 76-203,549. INTERNATIONAL BUSINESS MACHINES CORPORATION, ARMONK, NY. FILED 2-1-2001.

SOLUTIONS FOR A SMALL PLANET

OWNER OF U.S. REG. NO. 2,360,688.
 FOR PRINTED MATTER, NAMELY, BROCHURES, MANUALS, BOOKS AND MAGAZINES RELATING TO COMPUTER HARDWARE, SOFTWARE AND SERVICES (U.S. CLS. 2, 5, 22, 23, 29, 37, 38 AND 50).
 FIRST USE 5-12-2000; IN COMMERCE 5-12-2000.

SN 76-203,644. ASK GOD PUBLICATIONS, INC., ERICKSON, B.C., CANADA, FILED 2-1-2001.

...ASK GOD

FOR PRINTED MATERIAL AND PUBLICATIONS, NAMELY, POSTERS, BOOKS, CALENDARS, NOTE PADS, GREETING CARDS, BEARING MOTIVATIONAL AND SPIRITUAL TEACHINGS (U.S. CLS. 2, 5, 22, 23, 29, 37, 38 AND 50).
 FIRST USE 8-1-1998; IN COMMERCE 8-1-1998.

SN 76-209,629. ELMORE SPORTS GROUP, LTD., MANHATTAN BEACH, CA. FILED 2-13-2001.



NO CLAIM IS MADE TO THE EXCLUSIVE RIGHT TO USE "SPORTS GROUP LTD.", APART FROM THE MARK AS SHOWN.

THE MARK CONSISTS OF THE WORD "ELMORE" IN CAPITAL LETTERS INSIDE A RECTANGLE, ALL SUPERIMPOSED OVER A SHADED CIRCLE BEARING THE WORDS "SPORTS GROUP LTD." AND STYLIZED DEPICTIONS OF A SOCCER BALL, A FOOTBALL, A HOCKEY STICK AND A BASEBALL BAT.

FOR PAPER GOODS AND PRINTED MATTER, NAMELY, DECALS AND WRITING PADS (U.S. CLS. 2, 5, 22, 23, 29, 37, 38 AND 50).

CLASS 16—(Continued).

SN 76-215,858. SCHMITT, MARK, WHEATON, IL. FILED 2-26-2001.

SCT HOLLANDMARKER

FOR TEMPLATES FOR MARKING BRICKS (U.S. CLS. 2, 5, 22, 23, 29, 37, 38 AND 50).

SN 76-220,636. ESTES, CLARISSA PINKOLA, DENVER, CO. FILED 3-5-2001.

SKELETON WOMAN

NO CLAIM IS MADE TO THE EXCLUSIVE RIGHT TO USE "WOMAN", APART FROM THE MARK AS SHOWN.
FOR POSTERS, ARTWORK, NAMELY ART PRINTS AND ART PICTURES (U.S. CLS. 2, 5, 22, 23, 29, 37, 38 AND 50).

SN 76-220,660. PFIZER INC., NEW YORK, NY. FILED 3-5-2001.

SANA LA RANA

"SANA LA RANA" IS THE SPANISH LANGUAGE EQUIVALENT OF "THE HEALTHY FROG".
FOR PRINTED MATERIALS, NAMELY, PAMPHLETS AND BROCHURES REGARDING HEALTH EDUCATION, HEALTH AWARENESS AND HEALTH ISSUES (U.S. CLS. 2, 5, 22, 23, 29, 37, 38 AND 50).

SN 76-240,060. CATALOG VENTURES, INC., CHELMSFORD, MA. FILED 4-16-2001.

FAVORITES

FOR MAIL ORDER CATALOGS FEATURING JEWELRY, HARDWARE, SPORTING GOODS, TOYS AND GAMES, FOOD AND HOME FURNISHINGS, NAMELY, FURNITURE, APPLIANCES, HOUSEWARES, HOME ACCESSORIES, DOMESTICS, TEXTILE GOODS, ELECTRICAL APPLIANCES, AND ELECTRONICS (U.S. CLS. 2, 5, 22, 23, 29, 37, 38 AND 50).
FIRST USE 8-31-1998; IN COMMERCE 8-31-1998.

CLASS 16—(Continued).

SN 76-240,772. CATALOG VENTURES, INC., CHELMSFORD, MA. FILED 4-16-2001.

CATALOG VENTURES
FAVORITES

NO CLAIM IS MADE TO THE EXCLUSIVE RIGHT TO USE "CATALOG", APART FROM THE MARK AS SHOWN.
FOR MAIL ORDER CATALOGS FEATURING JEWELRY, HARDWARE, SPORTING GOODS, TOYS AND GAMES, FOOD AND HOME FURNISHINGS, NAMELY, FURNITURE, APPLIANCES, HOUSEWARES, HOME ACCESSORIES, DOMESTICS, TEXTILE GOODS, ELECTRICAL APPLIANCES, AND ELECTRONICS (U.S. CLS. 2, 5, 22, 23, 29, 37, 38 AND 50).
FIRST USE 8-31-1998; IN COMMERCE 8-31-1998.

SN 76-245,102. RUST-OLEUM CORPORATION, VERNON HILLS, IL. FILED 4-24-2001.

RUST-OLEUM SMART TOOLS

OWNER OF U.S. REG. NOS. 590,496, 2,284,874 AND OTHERS.
NO CLAIM IS MADE TO THE EXCLUSIVE RIGHT TO USE "TOOLS", APART FROM THE MARK AS SHOWN.
FOR PAINTING TOOLS, NAMELY, BRUSHES AND ROLLERS (U.S. CLS. 2, 5, 22, 23, 29, 37, 38 AND 50).

SN 76-247,469. FRANKLIN COVEY CO., SALT LAKE CITY, UT. FILED 4-28-2001.

MODERN GLADIATOR

FOR PUBLICATIONS, NAMELY BOOKS, MANUALS, PERIODICALS, PAMPHLETS, DAILY PLANNERS, DAILY ORGANIZERS, BINDERS, PRINTED TIME PLANNING SHEETS, CALENDARS, AND NOTEBOOKS; ALL IN THE FIELDS OF LEADERSHIP, TIME MANAGEMENT, COMMUNICATIONS, BUSINESS EDUCATION AND CORPORATE AND PERSONAL ASSESSMENT, MEASUREMENT AND DEVELOPMENT (U.S. CLS. 2, 5, 22, 23, 29, 37, 38 AND 50).

SN 76-248,367. PSY-ED CORPORATION, ORADELL, NJ. FILED 4-30-2001.

EXCEPTIONAL PARENT

FOR PRINTED MAGAZINES FOR PARENTS OF CHILDREN WITH DISABILITIES (U.S. CLS. 2, 5, 22, 23, 29, 37, 38 AND 50).
FIRST USE 6-1-1971; IN COMMERCE 6-1-1971.

CLASS 16—(Continued).

SN 76-249,438. MIGHTY FINE, LOS ANGELES, CA. FILED 4-23-2001.

DOE

FOR PAPER GIFT BAGS, PAPER GIFT WRAP AND ILLUSTRATED TEEN STORY BOOKS (U.S. CLS. 2, 5, 22, 23, 29, 37, 38 AND 50).

FIRST USE 11-0-1998; IN COMMERCE 11-1-1998.

SN 76-250,075. KEEPSTONE, LLC, ATLANTA, GA. FILED 5-2-2001.

LANDMARK DIPLOMA IDEA BOOK

NO CLAIM IS MADE TO THE EXCLUSIVE RIGHT TO USE "DIPLOMA IDEA BOOK", APART FROM THE MARK AS SHOWN.

FOR FRAMED ARTWORK, NAMELY, FRAMED PICTORIAL OR GRAPHIC ART REPRODUCTIONS; MAT BOARDS FOR PICTURE AND DOCUMENT FRAMING; PRINTED MATERIALS, NAMELY, STATIONERY NOTES AND NOTE PADS CONTAINING ADHESIVE ON ONE SIDE OF THE SHEETS FOR ATTACHMENT TO SURFACES, NOTEPADS, AND PRODUCT CATALOGUES FEATURING FRAMES, MATTING, AND ARTWORK (U.S. CLS. 2, 5, 22, 23, 29, 37, 38 AND 50).

FIRST USE 4-2-2001; IN COMMERCE 4-2-2001.

SN 76-257,854. CHILD TRENDS, INC., WASHINGTON, DC. FILED 5-17-2001.

CHILD TRENDS

NO CLAIM IS MADE TO THE EXCLUSIVE RIGHT TO USE "CHILD", APART FROM THE MARK AS SHOWN.

FOR PRINTED PUBLICATIONS, NAMELY, NEWSLETTERS, REPORTS, RESEARCH BRIEFS, AND FACT SHEETS THAT SUMMARIZE SOCIAL SCIENCE RESEARCH ON CHILDREN, YOUTH, AND FAMILIES FOR USE BY GOVERNMENT AND PUBLIC INTEREST FOUNDATIONS IN DRAFTING LEGISLATION (U.S. CLS. 2, 5, 22, 23, 29, 37, 38 AND 50).

FIRST USE 0-0-1979; IN COMMERCE 0-0-1979.

SN 76-259,565. HESSLER, STEPHANIE, WELLESLEY, MA. FILED 5-21-2001.

EXTRA MILERS

FOR EDUCATIONAL PUBLICATIONS, NAMELY, CHILDREN'S BOOKS, CALENDARS, AND INSTRUCTIONAL GUIDES IN THE FIELD OF SOCIAL SCIENCES; NEWSPAPER CARTOONS AND CARTOON PRINTS AND STRIPS (U.S. CLS. 2, 5, 22, 23, 29, 37, 38 AND 50).

CLASS 16—(Continued).

SN 76-259,860. LIDL STIFTUNG & CO. KG, 74172 NECK-ARSULM, FED REP GERMANY, FILED 5-21-2001.

FLORALYS

OWNER OF UNITED KINGDOM REG. NO. 2102411, DATED 4-25-1997, EXPIRES 6-11-2006.

FOR PAPER, NAMELY, ART PAPER; BOND PAPER; CARDBOARD; GOODS MADE FROM PAPER AND CARDBOARD, NAMELY, PAPER TOWELS; FACIAL TISSUE; PAPER NAPKINS; PAPER SERVIETTES; PAPER HANDKERCHIEFS; TISSUE PAPER; FILTER PAPER; BABY PAPER NAPKINS; PAPER BAGS; PAPER CARRYING CASES FOR PACKAGING (U.S. CLS. 2, 5, 22, 23, 29, 37, 38 AND 50).

SN 76-260,531. MCCOY, JONNI, COLORADO SPRINGS, CO. FILED 5-18-2001.

MISERLY MOMS

NO CLAIM IS MADE TO THE EXCLUSIVE RIGHT TO USE "MOMS", APART FROM THE MARK AS SHOWN.

FOR PRINTED MATERIALS, NAMELY, BOOKS, MAGAZINES, PAMPHLETS, BROCHURES, AND NEWSLETTERS, ALL FOR EDUCATIONAL PURPOSES IN THE FIELD OF ECONOMIZING AND SYNDICATED NEWS-PAPER COLUMN ARTICLES IN THE FIELD OF ECONOMIZING (U.S. CLS. 2, 5, 22, 23, 29, 37, 38 AND 50).

FIRST USE 5-25-1992; IN COMMERCE 5-25-1992.

SN 76-266,042. LICO BRANDS, INC., STOCKTON, CA. FILED 6-4-2001.

EL MOLCAJETE

EL MOLCAJETE MAY BE TRANSLATED INTO ENGLISH AS "MORTAR".

FOR PERIODICAL NEWSLETTERS DIRECTED TO OWNERS AND MANAGERS OF THE FOOD SERVICES AND RESTAURANT INDUSTRIES (U.S. CLS. 2, 5, 22, 23, 29, 37, 38 AND 50).

SN 76-267,246. MEREDITH CORPORATION, DES MOINES, IN. FILED 6-6-2001.

MEN'S LIFE

NO CLAIM IS MADE TO THE EXCLUSIVE RIGHT TO USE "MEN'S", APART FROM THE MARK AS SHOWN.

FOR PERIODIC PUBLICATION, NAMELY A MAGAZINE FEATURING ARTICLES ON HOBBIES, SPORTS, HOME AND GARDEN PRODUCTS, HOME IMPROVEMENT PROJECTS AND MAINTENANCE, HEALTH ISSUES, FASHION, TRAVEL AND OTHER GENERAL INTEREST SUBJECT MATTER (U.S. CLS. 2, 5, 22, 23, 29, 37, 38 AND 50).

CLASS 16—(Continued).

SN 76-267,805. FOOD ALLERGY INITIATIVE, NEW YORK, NY. FILED 6-5-2001.



NO CLAIM IS MADE TO THE EXCLUSIVE RIGHT TO USE FOOD ALLERGY, APART FROM THE MARK AS SHOWN.

FOR NEWSLETTERS TO PROMOTE AWARENESS ABOUT FOOD ALLERGIES IN SCHOOLS, CAMPS, MEDICAL CENTERS AND RESTAURANTS (U.S. CLS. 2, 5, 22, 23, 29, 37, 38 AND 50).

SN 76-268,649. AMERICAN SOCIETY FOR QUALITY, INC., MILWAUKEE, WI. FILED 6-8-2001.

SIGMAPOWER

FOR PUBLICATIONS, NAMELY BOOKS AND MAGAZINES IN THE FIELD OF QUALITY MANAGEMENT (U.S. CLS. 2, 5, 22, 23, 29, 37, 38 AND 50).

SN 76-271,456. VIACOM INTERNATIONAL INC., NEW YORK, NY. FILED 6-13-2001.

**DELETE DISCRIMINATION**

FOR PRINTED MATTER, NAMELY, NOTE PAPER AND LOOSE LEAF PAPER, SERIES OF FICTION BOOKS, NOTEBOOKS, PLAYING CARDS, DECALS, STICKERS, BUMPER STICKERS, TRADING CARDS, NOTE CARDS, POSTERS, FOLDERS, PENCILS, PENS, CALENDARS (U.S. CLS. 2, 5, 22, 23, 29, 37, 38 AND 50).

CLASS 16—(Continued).

SN 76-271,803. DAVIS GROUP OF COMPANIES CORP., MARKHAM, ONTARIO, L3R 8N4, CANADA, FILED 6-15-2001.

QUICK FIT

OWNER OF CANADA REG. NO. TMA484,813, DATED 10-29-1997, EXPIRES 10-29-2012.

FOR CATALOGUE BINDERS, DATA BINDERS, DISPLAY BINDERS, LOOSE-LEAF BINDERS, POST BINDERS, PRESENTATION BINDERS, RING BINDERS, NOTEPADS; ORGANIZERS, NAMELY, PERSONAL ORGANIZERS AND DESKTOP ORGANIZERS; PLANNERS, NAMELY, DAILY PLANNERS AND DESKTOP PLANNERS; STATIONERY-TYPE PORTFOLIOS, CLIPBOARDS, FILE FOLDERS, FILE CARDS, FILE INDEX CARDS, NAME AND ADDRESS BOOKS, WRITING BOOKS, NOTEBOOKS, BOOK BINDINGS, WRITING PAPER, CARDBOARD, AND STATIONERY FASTENERS (U.S. CLS. 2, 5, 22, 23, 29, 37, 38 AND 50).

FIRST USE 10-0-1997; IN COMMERCE 12-0-1999.

SN 76-273,794. BLACK, DONALD E., CAMP SPRINGS, MD. FILED 6-21-2001.

THE LLAMA FAMILY IN AMERICA

OWNER OF U.S. REG. NOS. 1,766,002, 1,880,730 AND 2,382,399.

FOR EDUCATIONAL MATERIALS, NAMELY, PRINTED ENGLISH-SPANISH EDUCATIONAL READERS (U.S. CLS. 2, 5, 22, 23, 29, 37, 38 AND 50).

FIRST USE 11-0-1997; IN COMMERCE 11-0-1997.

SN 76-279,429. TM ACQUISITION CORP., PHOENIX, AZ. FILED 7-2-2001.

CENTURY 21

FOR PRINTED PUBLICATIONS, NAMELY MAGAZINES FOR HOMEOWNERS DEALING WITH INTERIOR AND EXTERIOR DECORATING PUBLISHED EVERY OTHER MONTH AND/OR AT VARIOUS INTERVALS (U.S. CLS. 2, 5, 22, 23, 29, 37, 38 AND 50).

FIRST USE 3-31-1996; IN COMMERCE 3-31-1996.

SN 76-279,672. DIRSON ENTERPRISES INC., LAS VEGAS, NV. FILED 7-2-2001.

GamingToday
NEWS YOU CAN BET ON

NO CLAIM IS MADE TO THE EXCLUSIVE RIGHT TO USE "GAMINGTODAY", APART FROM THE MARK AS SHOWN.

FOR WEEKLY NEWSPAPER COVERING ALL ASPECTS OF THE GAMING INDUSTRY (U.S. CLS. 2, 5, 22, 23, 29, 37, 38 AND 50).

FIRST USE 6-26-2001; IN COMMERCE 6-26-2001.

CLASS 16—(Continued).

SN 76-281,030. CLEARPRINT PAPER COMPANY, INC., EMERYVILLE, CA. FILED 7-3-2001.

1020

FOR DRAFTING PAPER (U.S. CLS. 2, 5, 22, 23, 29, 37, 38 AND 50).
FIRST USE 0-0-1954; IN COMMERCE 0-0-1954.

SN 76-281,031. CLEARPRINT PAPER COMPANY, INC., EMERYVILLE, CA. FILED 7-3-2001.

1000H

FOR DRAFTING PAPER (U.S. CLS. 2, 5, 22, 23, 29, 37, 38 AND 50).
FIRST USE 0-0-1933; IN COMMERCE 0-0-1933.

SN 76-281,229. PATRIOTS' TRAIL GIRL SCOUT COUNCIL, INC., BOSTON, MA. FILED 7-9-2001.

GIRLS' PIPELINE TO POWER

FOR PUBLICATIONS, NAMELY, EDUCATIONAL BOOKS, MANUALS, NEWSLETTERS, FLYERS, PAMPHLETS, BROCHURES, AND REPORTS IN THE FIELDS OF GIRLS' POLITICAL, SCHOOL, AND COMMUNITY ACTIVISM, POLITICAL INFORMATION, AND LEADERSHIP TRAINING (U.S. CLS. 2, 5, 22, 23, 29, 37, 38 AND 50).

FIRST USE 9-1-1994; IN COMMERCE 9-1-1994.

SN 76-281,706. GAYOT, ANDRE, LOS ANGELES, CA. FILED 7-5-2001.

GAYOT

FOR GUIDE BOOKS IN THE FIELDS OF TRAVEL AND RESTAURANTS (U.S. CLS. 2, 5, 22, 23, 29, 37, 38 AND 50).

FIRST USE 5-0-1995; IN COMMERCE 5-0-1995.

SN 76-282,848. ADVANCED RESEARCH PRESS, INC., HAUPPAUGE, NY. FILED 7-11-2001.

**FITNESS RX YOUR
ULTIMATE PRESCRIPTION
FOR THE PERFECT BODY**

NO CLAIM IS MADE TO THE EXCLUSIVE RIGHT TO USE "FITNESS", APART FROM THE MARK AS SHOWN. FOR MAGAZINES IN THE FIELD OF HEALTH, NUTRITION, PERSONAL ENHANCEMENT AND BODY-BUILDING (U.S. CLS. 2, 5, 22, 23, 29, 37, 38 AND 50).
FIRST USE 1-7-2002; IN COMMERCE 1-7-2002.

CLASS 16—(Continued).

SN 76-283,685. AIR CONDITIONING CONTRACTORS OF AMERICA, ARLINGTON, VA. FILED 7-12-2001.

MANUAL J

NO CLAIM IS MADE TO THE EXCLUSIVE RIGHT TO USE "MANUAL", APART FROM THE MARK AS SHOWN.

FOR BOOKS AND PUBLICATIONS, NAMELY MANUALS, AND GUIDES IN THE FIELD OF RESIDENTIAL LOAD CALCULATION (U.S. CLS. 2, 5, 22, 23, 29, 37, 38 AND 50).

FIRST USE 0-0-1960; IN COMMERCE 0-0-1960.

SN 76-285,641. CMP MEDIA LLC, MANHASSET, NY. FILED 7-16-2001.

**TRANSFORMATION
WEBLOG**

NO CLAIM IS MADE TO THE EXCLUSIVE RIGHT TO USE "WEBLOG", APART FROM THE MARK AS SHOWN.

FOR PRINT PUBLICATIONS, NAMELY, MAGAZINES IN THE FIELD OF BUSINESS TECHNOLOGY (U.S. CLS. 2, 5, 22, 23, 29, 37, 38 AND 50).

SN 76-285,964. AMERICAN CITY BUSINESS JOURNALS, INC., CHARLOTTE, NC. FILED 7-18-2001.

**BUSINESS COURIER
SERVING THE CINCINNATI-
NORTHERN KENTUCKY
REGION**

SEC. 2(F).

FOR GENERAL CIRCULATION NEWSPAPERS (U.S. CLS. 2, 5, 22, 23, 29, 37, 38 AND 50).

FIRST USE 5-30-1997; IN COMMERCE 5-30-1997.

SN 76-287,138. CLUBCORP, INC., DALLAS, TX. FILED 7-19-2001.

CLUBCORP

FOR STATIONERY, NAMELY, WRITING PAPER AND ENVELOPES; PENS AND PENCILS; PLAYING CARDS AND GOLF SCORE CARDS (U.S. CLS. 2, 5, 22, 23, 29, 37, 38 AND 50).

FIRST USE 1-30-1997; IN COMMERCE 1-30-1997.

CLASS 16—(Continued).

SN 76-290,340. KABUSHIKI KAISHA UENO SHOKAI, TAI-TO-KU, TOKYO, JAPAN, FILED 7-26-2001.



THE STIPPLING IS A FEATURE OF THE MARK.
SEC. 2(F).
FOR STICKERS (U.S. CLS. 2, 5, 22, 23, 29, 37, 38 AND 50).
FIRST USE 2-1-1996; IN COMMERCE 2-1-1996.

SN 76-291,149. CREATIVE VENTURES, INC., TIGARD, OR.
FILED 7-26-2001.

EMS FIELD GUIDE

NO CLAIM IS MADE TO THE EXCLUSIVE RIGHT TO USE "FIELD GUIDE", APART FROM THE MARK AS SHOWN.
SEC. 2(F).
FOR GUIDE BOOKS IN THE FIELD OF MEDICAL INSTRUCTION (U.S. CLS. 2, 5, 22, 23, 29, 37, 38 AND 50).
FIRST USE 7-1-1990; IN COMMERCE 7-1-1990.

SN 76-292,480. DEITEL & ASSOCIATES, INC., SUDBURY, MA. FILED 7-31-2001.

DEITEL

FOR PRINTED MATERIAL, NAMELY, TEXT BOOKS, TRAINING MANUALS AND REFERENCE MANUALS IN THE FIELD OF COMPUTER PROGRAMMING (U.S. CLS. 2, 5, 22, 23, 29, 37, 38 AND 50).
FIRST USE 12-0-2000; IN COMMERCE 12-0-2000.

SN 76-294,960. MARTEK BIOSCIENCES CORPORATION, COLUMBIA, MD. FILED 8-6-2001.

**PREGNANT PHYSICIANS
FOR DHA**

FOR NEWSLETTERS, SCIENTIFIC BULLETINS, AND OTHER WRITTEN MATERIALS CONCERNING THE BENEFIT OF DOCOSAHEXAENOIC ACID FOR MOTHERS (U.S. CLS. 2, 5, 22, 23, 29, 37, 38 AND 50).
FIRST USE 1-0-1998; IN COMMERCE 1-0-1998.

CLASS 16—(Continued).

SN 76-295,343. BCNY INTERNATIONAL INC., NEW YORK, NY. FILED 8-2-2001.

**SHOP BY COLOR FIND
YOUR SIZE WITH
ACTIONFLEX**

NO CLAIM IS MADE TO THE EXCLUSIVE RIGHT TO USE "SHOP BY COLOR FIND YOUR SIZE", APART FROM THE MARK AS SHOWN.
FOR PACKAGING, NAMELY, CORRUGATED CARDBOARD SHOEBOXES AND PRINTED PAPER SIGNS FOR OTHERS (U.S. CLS. 2, 5, 22, 23, 29, 37, 38 AND 50).

SN 76-295,344. BCNY INTERNATIONAL INC., NEW YORK, NY. FILED 8-2-2001.



NO CLAIM IS MADE TO THE EXCLUSIVE RIGHT TO USE "SHOP BY COLOR FIND YOUR SIZE", APART FROM THE MARK AS SHOWN.
FOR PACKAGING, NAMELY, CORRUGATED CARDBOARD SHOEBOXES AND PRINTED PAPER SIGNS FOR OTHERS (U.S. CLS. 2, 5, 22, 23, 29, 37, 38 AND 50).

SN 76-298,796. CONTITECH ELASTOMER-BESCHICHTUNGEN GMBH, 37154 NORTHEIM, FED REP GERMANY, FILED 8-13-2001.

HYBRID

OWNER OF FED REP GERMANY REG. NO. 30093818, DATED 3-26-2001, EXPIRES 12-31-2010.
FOR PRINTER'S BLANKETS NOT OF TEXTILE (U.S. CLS. 2, 5, 22, 23, 29, 37, 38 AND 50).

SN 76-300,517. PENTON MEDIA, INC., CLEVELAND, OH. FILED 8-17-2001.

MDN

FOR PUBLICATIONS PUBLISHED FROM TIME TO TIME, NAMELY, MAGAZINES IN THE FIELD OF MEDICAL DESIGN (U.S. CLS. 2, 5, 22, 23, 29, 37, 38 AND 50).
FIRST USE 2-0-2001; IN COMMERCE 2-0-2001.

CLASS 16—(Continued).

SN 76-302,183. REED ELSEVIER INC., NEWTON, MA. FILED 8-20-2001.

AGENTS & MANAGERS 411

NO CLAIM IS MADE TO THE EXCLUSIVE RIGHT TO USE "AGENTS & MANAGERS", APART FROM THE MARK AS SHOWN.

FOR DIRECTORY OF INFORMATION NAMELY RESOURCES FOR THE FILM, ENTERTAINMENT AND VIDEO INDUSTRIES (U.S. CLS. 2, 5, 22, 23, 29, 37, 38 AND 50).

FIRST USE 6-0-2001; IN COMMERCE 6-0-2001.

SN 76-305,545. MATCHBOX TWENTY, LLC, WEST HOLLYWOOD, CA. FILED 8-28-2001.

MATCHBOX TWENTY

OWNER OF U.S. REG. NO. 2,384,693.
FOR POSTERS, STICKERS, PLASTIC BAGS, AND POSTCARDS (U.S. CLS. 2, 5, 22, 23, 29, 37, 38 AND 50).
FIRST USE 5-16-2000; IN COMMERCE 5-16-2000.

SN 76-308,124. INTERNATIONAL PADI, INC., RANCHO SANTA MARGARITA, CA. FILED 9-4-2001.

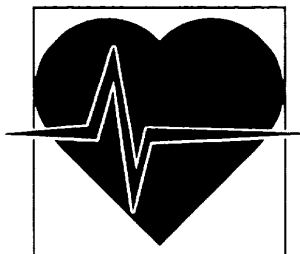

EMERGENCY
first response

FOR PUBLICATIONS AND INSTRUCTION MATERIALS FOR FIRST AID AND CARDIO-PULMONARY RESUSCITATION FOR TRAINING INSTRUCTORS AND STUDENTS, NAMELY, INSTRUCTION MANUALS, PRINTED TEACHING MATERIALS NAMELY, BOOKS, MAGAZINES, INSTRUCTION MANUALS, PRINTED TEACHING AIDS, PRACTICE EXAMS, POSTERS, PRINTED CERTIFICATES, PRACTICE TEACHING TESTS, INSTRUCTOR GUIDES, AND A SERIES OF BOOKS AND BOOKLETS FEATURING FIRST AID AND CARDIO-PULMONARY RESUSCITATION (U.S. CLS. 2, 5, 22, 23, 29, 37, 38 AND 50).

CLASS 16—(Continued).

SN 76-308,235. INTERNATIONAL FOODS & CONFECTIONS, INC., ALPHARETTA, GA. FILED 8-31-2001.

BAGPIPER

FOR DISPOSABLE PLASTIC PASTRY BAGS (U.S. CLS. 2, 5, 22, 23, 29, 37, 38 AND 50).
FIRST USE 6-15-2000; IN COMMERCE 6-15-2000.

SN 76-309,928. DOUBLE R. PUBLISHING, L.L.C., MIAMI, FL. FILED 9-10-2001.

MUY BIEN

THE ENGLISH TRANSLATION OF "MUY BIEN" IS "VERY GOOD".

FOR TEACHING MATERIALS, NAMELY, TEXTBOOKS, WORKBOOKS AND FLASHCARDS FOR TEACHING THE SPANISH LANGUAGE (U.S. CLS. 2, 5, 22, 23, 29, 37, 38 AND 50).

SN 76-314,300. PLEASANT COMPANY, MIDDLETON, WI. FILED 9-19-2001.

AMERICAN GIRL TODAY

OWNER OF U.S. REG. NOS. 2,159,193, 2,318,248 AND OTHERS.

FOR SERIES OF CHILDREN'S FICTION BOOKS (U.S. CLS. 2, 5, 22, 23, 29, 37, 38 AND 50).

FIRST USE 9-4-2001; IN COMMERCE 9-4-2001.

SN 76-319,120. THE UPPER DECK COMPANY, LLC, CARLSBAD, CA. FILED 9-27-2001.

HONOR ROLL

FOR TRADING CARDS (U.S. CLS. 2, 5, 22, 23, 29, 37, 38 AND 50).
FIRST USE 4-10-2000; IN COMMERCE 4-10-2000.

SN 76-321,625. L'OREAL USA CREATIVE, INC., NEW YORK, NY. FILED 10-4-2001.

CHANGE YOUR SKIN FOREVER

FOR CATALOGS, BROCHURES, PAMPHLETS AND INFORMATIONAL LITURATURE RELATING TO SKIN TREATMENTS AND SKIN CARE PRODUCTS (U.S. CLS. 2, 5, 22, 23, 29, 37, 38 AND 50).

FIRST USE 0-0-1996; IN COMMERCE 0-0-1996.

CLASS 16—(Continued).

SN 76-323,072. INSIGNIA SYSTEMS, INC., PLYMOUTH, MN. FILED 10-9-2001.

POPS SELECT

NO CLAIM IS MADE TO THE EXCLUSIVE RIGHT TO USE "POPS", APART FROM THE MARK AS SHOWN.

FOR DISPENSING PAD CONTAINING MULTIPLE SHEETS, EACH SHEET CONTAINING PRINTED OFFERS OR RELEVANT INFORMATION REGARDING A PRODUCT DISTRIBUTED TO RETAILERS AND WHOLESALERS (U.S. CLS. 2, 5, 22, 23, 29, 37, 38 AND 50). FIRST USE 10-7-2001; IN COMMERCE 10-7-2001.

SN 76-325,924. MCCLATCHY MANAGEMENT SERVICES, INC., SACRAMENTO, CA. BY ASSIGNMENT TACOMA NEWS, INC., SACRAMENTO, CA. FILED 10-16-2001.

THE NEWS TRIBUNE

NO CLAIM IS MADE TO THE EXCLUSIVE RIGHT TO USE "NEWS", APART FROM THE MARK AS SHOWN.

THE STIPPLING IN THE MARK IS FOR SHADING PURPOSES ONLY.

THE MARK CONSISTS OF THE WORDS "THE NEWS TRIBUNE" WITH A BLUE AND WHITE MOUNTAIN AS BACKGROUND.

FOR NEWSPAPERS, FOR GENERAL CIRCULATION (U.S. CLS. 2, 5, 22, 23, 29, 37, 38 AND 50). FIRST USE 10-4-1993; IN COMMERCE 10-4-1993.

SN 76-327,135. BREWSTER WALLPAPER CORP., RANDOLPH, MA. FILED 10-17-2001.

BY THE SHORE

FOR WALLCOVERING SAMPLE BOOKS (U.S. CLS. 2, 5, 22, 23, 29, 37, 38 AND 50). FIRST USE 5-0-1998; IN COMMERCE 5-0-1998.

SN 76-327,894. MAGAZINE LIMITED PARTNERS, L.P., DALLAS, TX. FILED 10-22-2001.

BEST OF BIG D

FOR TITLE OF AN ANNUAL EDITORIAL FEATURE IN A CITY MAGAZINE (U.S. CLS. 2, 5, 22, 23, 29, 37, 38 AND 50). FIRST USE 8-1-2001; IN COMMERCE 8-1-2001.

CLASS 16—(Continued).

SN 76-328,285. BARNES & NOBLE, INC., NEW YORK, NY. FILED 10-22-2001.

NOW WHAT?!

FOR PUBLICATIONS, NAMELY, A SERIES OF BOOKS IN THE FIELDS OF FITNESS, COMPUTERS AND PERSONAL ELECTRONICS, HOME ELECTRONICS AND ENTERTAINMENT SYSTEMS, FINANCE, BUSINESS, HEALTH, CITY GUIDES, INCLUDING MAPS, CITYSCAPES AND BUILDINGS, CONSUMER GUIDES, TEENAGE RESOURCE BOOKS, TEENAGE FICTION, MEMOIRS, AUTOBIOGRAPHIES, WRITING, CAREERS, COOKING, WINE TASTING, ENTERTAINING, PETS, DECORATING, HOUSE BUILDING, HOME BUYING, CAR BUYING, CAR REPAIR, MARRIAGE, GARDENING, HOME OFFICE, RETIREMENT, PERSONAL FINANCE, JOB HUNTING, FASHION, DIETING, SPIRITUAL GUIDES, NEW AGE HEALING, ALTERNATIVE MEDICINE, CHILDREN'S BOOKS, LABOR, LAW, HISTORY, PSYCHOLOGY, MEDICAL, ELDER CARE, HOME AND HEARTH, SPORTS AND EDUCATION BOOKS IN THE FIELDS OF MUSIC AND ART, EXCLUDING PARENTING (U.S. CLS. 2, 5, 22, 23, 29, 37, 38 AND 50).

FIRST USE 7-31-2000; IN COMMERCE 7-31-2000.

SN 76-328,353. IDD INTERNATIONAL TELENET, INC., ARCADIA, CA. FILED 10-22-2001.

IDD

**International
Fiber Phone Card**

NO CLAIM IS MADE TO THE EXCLUSIVE RIGHT TO USE "INTERNATIONAL FIBER PHONE CARD", APART FROM THE MARK AS SHOWN.

FOR PRE-PAID TELEPHONE CALLING CARDS, NOT MAGNETICALLY ENCODED (U.S. CLS. 2, 5, 22, 23, 29, 37, 38 AND 50).

FIRST USE 8-27-2001; IN COMMERCE 8-27-2001.

SN 76-329,192. SHEPPARD ENVELOPE COMPANY, WORCESTER, MA. FILED 10-24-2001.

PEEK-A-BOO

FOR STATIONERY PRODUCTS, NAMELY, ENVELOPES (U.S. CLS. 2, 5, 22, 23, 29, 37, 38 AND 50).

CLASS 16—(Continued).

SN 76-329,232. RECIPROCAL ALLIANCE (RISK RETENTION GROUP), THE, NASHVILLE, TN. FILED 10-24-2001.

BRIEFCASE

FOR EDUCATIONAL AND TRAINING KIT IN THE FIELD OF DIRECTORS AND OFFICERS LIABILITY RISK MANAGEMENT, COMPOSED PRIMARILY OF SAMPLE EMPLOYMENT AND CORPORATE GOVERNANCE POLICIES, FORMS, CHECKLISTS, ASSESSMENT TOOLS AND MATERIALS COMPRISING HUMAN RESOURCES AND COMPLIANCE FORMS, NEWSLETTERS, AND VIDEO TAPES (U.S. CLS. 2, 5, 22, 23, 29, 37, 38 AND 50).

FIRST USE 8-15-2001; IN COMMERCE 8-15-2001.

SN 76-331,230. CLIFF, MARY LOU, HILBERT, WI. AND CLIFF, TANYA, WAUNAKEE, WI. FILED 10-29-2001.

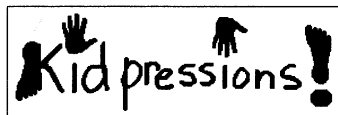

FOR BABY/INFANT/CHILD INTERACTIVE BOOKS (U.S. CLS. 2, 5, 22, 23, 29, 37, 38 AND 50).

SN 76-333,322. OHTO KABUSHIKI KAISHA, TA OHTO CO. LTD., TAITO-KU, TOKYO, JAPAN, FILED 11-1-2001.

OHTO

FOR BALL POINT PENS (U.S. CLS. 2, 5, 22, 23, 29, 37, 38 AND 50).
FIRST USE 5-7-1974; IN COMMERCE 6-30-1980.

SN 76-336,574. ARVCO CONTAINER CORPORATION, KALAMAZOO, MI. FILED 11-13-2001.

SANDWICH-TAINER

FOR PAPER FOOD PACKAGING (U.S. CLS. 2, 5, 22, 23, 29, 37, 38 AND 50).
FIRST USE 1-0-2002; IN COMMERCE 1-0-2002.

CLASS 16—(Continued).

SN 76-338,486. WILLIAM ROGERS & ASSOC., LLC, ST. LOUIS, MO. FILED 11-16-2001.

BIOMETRIC DIGEST

NO CLAIM IS MADE TO THE EXCLUSIVE RIGHT TO USE "DIGEST", APART FROM THE MARK AS SHOWN. SEC. 2(F).

FOR PERIODICALS RELATING TO TECHNOLOGY FOR IDENTIFICATION, NAMELY, FINGER SCAN, SIGNATURE VALIDATION, VOICE RECOGNITION, IRIS AND RETINAL SCAN, FACIAL SCAN, HAND SCAN AND OTHER MEANS OF POSITIVE IDENTIFICATION FOR FRAUD PREVENTION, SECURITY, CONVENIENCE AND CUSTOMER SERVICE PURPOSES (U.S. CLS. 2, 5, 22, 23, 29, 37, 38 AND 50).

FIRST USE 4-0-1996; IN COMMERCE 4-0-1996.

SN 76-338,532. EIKO, LTD., SHAWNEE, KS. FILED 11-15-2001.

DMT

FOR ADHESIVES FOR STATIONERY PURPOSES, NAMELY, ADHESIVES IN THE FORM OF TISSUE-TYPE SHEETS FOR USE IN BONDING POROUS PAPER, FIBER BASED PRINTS AND COLOR PHOTOGRAPHS (U.S. CLS. 2, 5, 22, 23, 29, 37, 38 AND 50).

FIRST USE 3-6-1990; IN COMMERCE 3-6-1990.

SN 76-338,710. AEROTECH LABORATORIES, INC., PHOENIX, AZ. FILED 11-16-2001.

AEROTECH MONITOR

NO CLAIM IS MADE TO THE EXCLUSIVE RIGHT TO USE "MONITOR", APART FROM THE MARK AS SHOWN. FOR INDUSTRY NEWSLETTER IN THE FIELDS OF ENVIRONMENTAL ANALYSIS AND MICROBIAL, CHEMICAL AND INDOOR AIR QUALITY ANALYSIS (U.S. CLS. 2, 5, 22, 23, 29, 37, 38 AND 50).

FIRST USE 3-1-1997; IN COMMERCE 3-1-1997.

SN 76-338,735. GLORY TO GOD MINISTRIES, INTERNATIONAL, CATHEDRAL CITY, CA. FILED 11-19-2001.



NO CLAIM IS MADE TO THE EXCLUSIVE RIGHT TO USE "MINISTRIES INTERNATIONAL", APART FROM THE MARK AS SHOWN.

THE MARK CONSISTS OF TEXT ENCLOSED IN A CELESTIAL BODY (CLOUD).

FOR BOOKS, PRINTED TEACHING MATERIALS AND STATIONERY ALL IN THE FIELD OF RELIGION (U.S. CLS. 2, 5, 22, 23, 29, 37, 38 AND 50).

FIRST USE 9-20-1978; IN COMMERCE 9-20-1978.

CLASS 16—(Continued).

SN 76-341,741. COTTAGE GARDEN, INC., BAINBRIDGE, IN.
FILED 11-26-2001.

MARY'S MOMENTS

FOR STATIONERY, PAINTINGS, WATERCOLOR PICTURES, ART PICTURES, ART PRINTS, SKETCHES, ART ETCHINGS, PICTURE POSTCARDS, GIFT CARDS, CHRISTMAS CARDS, OCCASION CARDS, GREETING CARDS, ANNOUNCEMENT CARDS AND WALL CALENDARS (U.S. CLS. 2, 5, 22, 23, 29, 37, 38 AND 50).
FIRST USE 11-13-2001; IN COMMERCE 11-13-2001.

SN 76-343,856. SOCIETY FOR BIOMOLECULAR SCREENING, INC., THE, DANBURY, CT. FILED 12-3-2001.

JOURNAL OF BIOMOLECULAR SCREENING

NO CLAIM IS MADE TO THE EXCLUSIVE RIGHT TO USE "JOURNAL", APART FROM THE MARK AS SHOWN. SEC. 2(F).
FOR PUBLICATIONS, NAMELY, A JOURNAL IN THE FIELD OF MOLECULAR BIOLOGY (U.S. CLS. 2, 5, 22, 23, 29, 37, 38 AND 50).
FIRST USE 3-0-1996; IN COMMERCE 3-0-1996.

SN 76-344,440. BRAIN TECHNOLOGIES CORPORATION, PLANO, TX. FILED 12-4-2001.

ASSET REPORT

NO CLAIM IS MADE TO THE EXCLUSIVE RIGHT TO USE "REPORT", APART FROM THE MARK AS SHOWN. FOR PRINTED GUIDE TO PERSONAL THINKING SKILLS (U.S. CLS. 2, 5, 22, 23, 29, 37, 38 AND 50).
FIRST USE 9-1-1998; IN COMMERCE 9-1-1998.

SN 76-344,792. HACHETTE FILIPACCHI PRESSE, 92534 LEVALLOIS-PERROT, CEDEX, FRANCE, FILED 12-3-2001.

BON VOYAGE

FOR MAGAZINES CONCERNING TRAVEL, THE TRAVEL INDUSTRY, AND TRAVEL-RELATED ACTIVITIES (U.S. CLS. 2, 5, 22, 23, 29, 37, 38 AND 50).

CLASS 16—(Continued).

SN 76-346,303. ROSENBLATT, ALISA, NEW YORK, NY.
FILED 12-7-2001.

CANDYCARD GREETINGS

NO CLAIM IS MADE TO THE EXCLUSIVE RIGHT TO USE "GREETINGS", APART FROM THE MARK AS SHOWN.
FOR HANDMADE GREETING CARDS FOR ALL OCCASIONS (U.S. CLS. 2, 5, 22, 23, 29, 37, 38 AND 50).
FIRST USE 10-13-2001; IN COMMERCE 10-13-2001.

SN 76-346,519. GENERAL CONFERENCE CORPORATION OF SEVENTH-DAY ADVENTISTS, SILVER SPRING, MD.
FILED 12-10-2001.

ADVENTIST LAWYER

OWNER OF U.S. REG. NOS. 1,176,153, 1,851,435 AND OTHERS.
NO CLAIM IS MADE TO THE EXCLUSIVE RIGHT TO USE "LAWYER", APART FROM THE MARK AS SHOWN. SEC. 2(F) AS TO "ADVENTIST".
FOR LEGAL JOURNAL CONTAINING ARTICLES OF INTEREST TO SEVENTH-DAY ADVENTIST LAWYERS, CHRISTIAN LAWYERS AND MEMBERS OF THE LEGAL PROFESSION IN GENERAL; AND A LEGAL DIRECTORY OF SEVENTH-DAY ADVENTIST LAWYERS WORLDWIDE (U.S. CLS. 2, 5, 22, 23, 29, 37, 38 AND 50).
FIRST USE 3-1-2002; IN COMMERCE 3-1-2002.

SN 76-347,411. LINDY BOWMAN COMPANY, THE, ELLICOTT CITY, MD. FILED 12-12-2001.

GIFT WRAP IN A SNAP

NO CLAIM IS MADE TO THE EXCLUSIVE RIGHT TO USE "GIFT WRAP", APART FROM THE MARK AS SHOWN. FOR PRE-FORMED GIFT WRAP KITS COMPRISED OF PRE-FOLDED GIFT WRAP, WITH OR WITHOUT RIBBON, WITH OR WITHOUT GIFT CARDS, AND AT LEAST ONE FOLDING GIFT BOX (U.S. CLS. 2, 5, 22, 23, 29, 37, 38 AND 50).

SN 76-348,386. KAISER, DAVID, DBA PETITJEAN CARDS, SOUTH BEND, IN. AND KAISER, KATHLEEN, DBA PETITJEAN CARDS, SOUTH BEND, IN. FILED 12-14-2001.

It's a Puppy!

FOR GREETING CARD (U.S. CLS. 2, 5, 22, 23, 29, 37, 38 AND 50).

CLASS 16—(Continued).

SN 76-348,566. COTTAGES & GARDENS PUBLICATIONS, LLC, NEW YORK, NY. FILED 12-13-2001.



NO CLAIM IS MADE TO THE EXCLUSIVE RIGHT TO USE "HAMPTONS COTTAGES AND GARDENS", APART FROM THE MARK AS SHOWN.
FOR PUBLICATIONS, NAMELY, GENERAL INTEREST MAGAZINES (U.S. CLS. 2, 5, 22, 23, 29, 37, 38 AND 50).

SN 76-348,573. WORLDATWORK, SCOTTSDALE, AZ. FILED 12-13-2001.

BUILDING BLOCKS

OWNER OF U.S. REG. NO. 1,744,506.
FOR PRINTED PUBLICATIONS, NAMELY, BOOKS, BROCHURES, JOURNALS, MAGAZINES, NEWSLETTERS, AND PAMPHLETS RELATED TO ALL FORMS OF EMPLOYEE REMUNERATION, EMPLOYEE REWARD SYSTEMS, EMPLOYEE MOTIVATION, AND EMPLOYEE PRODUCTIVITY (U.S. CLS. 2, 5, 22, 23, 29, 37, 38 AND 50).
FIRST USE 1-0-1999; IN COMMERCE 1-0-1999.

SN 76-350,308. HUNT HOLDINGS, INC., WILMINGTON, DE. FILED 12-19-2001.

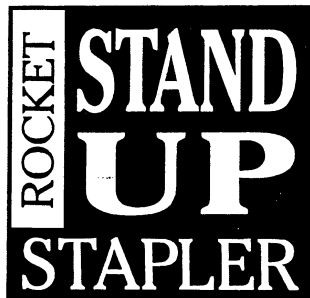

OWNER OF U.S. REG. NOS. 2,177,221, 2,499,147 AND OTHERS.
NO CLAIM IS MADE TO THE EXCLUSIVE RIGHT TO USE "STAPLER", APART FROM THE MARK AS SHOWN.
FOR PAPER STAPLERS (U.S. CLS. 2, 5, 22, 23, 29, 37, 38 AND 50).

CLASS 16—(Continued).

SN 76-351,717. CLEVER FACTORY, INC., THE, GALLATIN, TN. FILED 12-21-2001.

CUDDLY DUCK PRODUCTIONS

NO CLAIM IS MADE TO THE EXCLUSIVE RIGHT TO USE "PRODUCTIONS", APART FROM THE MARK AS SHOWN.
FOR CHILDREN'S BOOKS (U.S. CLS. 2, 5, 22, 23, 29, 37, 38 AND 50).
FIRST USE 6-8-2001; IN COMMERCE 6-8-2001.

SN 76-352,263. BORDERS UNLIMITED, INC., SHELBYVILLE, KY. FILED 12-26-2001.

ROOM TATTOOS

NO CLAIM IS MADE TO THE EXCLUSIVE RIGHT TO USE "ROOM", APART FROM THE MARK AS SHOWN.
FOR VINYL, PLASTIC OR PAPER DECALS FOR USE ON WALLS AND OTHER SURFACES IN THE HOME (U.S. CLS. 2, 5, 22, 23, 29, 37, 38 AND 50).
FIRST USE 1-29-2002; IN COMMERCE 1-29-2002.

SN 76-353,986. MENTAL IMAGES G. M. B. H. & CO. KG., D-10623 BERLIN, FED REP GERMANY, FILED 12-7-2001.

SPM

FOR INSTRUCTIONAL MANUALS AND PRINTED INSTRUCTION MATERIALS FOR COMPUTER SOFTWARE THAT PROVIDES PROTECTION AGAINST UNAUTHORIZED COPYING OR USAGE OF COMPUTER PROGRAMS (U.S. CLS. 2, 5, 22, 23, 29, 37, 38 AND 50).
FIRST USE 10-13-1995; IN COMMERCE 10-13-1995.

SN 76-354,657. OLD NAVY (APPAREL) INC., SAN BRUNO, CA. FILED 12-19-2001.

OLD NAVY

OWNER OF U.S. REG. NOS. 1,928,001, 2,006,872 AND 2,207,288.
FOR CATALOGS IN THE FIELDS OF CLOTHING, CLOTHING ACCESSORIES (U.S. CLS. 2, 5, 22, 23, 29, 37, 38 AND 50).
FIRST USE 11-21-2001; IN COMMERCE 11-21-2001.

CLASS 16—(Continued).

SN 76-358,140. AMERICAN PHYTOPATHOLOGICAL SOCIETY, INC. THE, ST. PAUL, MN. FILED 1-11-2002.



FOR PRINTED MATTER, NAMELY BOOKS, PERIODICAL JOURNALS, BROCHURES AND CATALOGS DEALING WITH PLANT PATHOLOGY MATTERS (U.S. CLS. 2, 5, 22, 23, 29, 37, 38 AND 50).

FIRST USE 10-0-2001; IN COMMERCE 10-0-2001.

SN 76-358,293. DAYSPRING CARDS, INC., SILOAM SPRINGS, AZ. FILED 1-14-2002.

PASSWORD KEEPER

NO CLAIM IS MADE TO THE EXCLUSIVE RIGHT TO USE "PASSWORD", APART FROM THE MARK AS SHOWN. FOR ADDRESS BOOKS (U.S. CLS. 2, 5, 22, 23, 29, 37, 38 AND 50).

FIRST USE 1-1-2002; IN COMMERCE 1-1-2002.

SN 76-361,032. LF, LLC, WILMINGTON, DE. BY CHANGE OF NAME LF CORPORATION, WILMINGTON, DE. FILED 1-22-2002.

CREATIVE IDEAS FOR HOME AND GARDEN

NO CLAIM IS MADE TO THE EXCLUSIVE RIGHT TO USE "HOME AND GARDEN", APART FROM THE MARK AS SHOWN.

FOR MAGAZINES FEATURING HOME IMPROVEMENT INFORMATION AND IDEAS (U.S. CLS. 2, 5, 22, 23, 29, 37, 38 AND 50).

FIRST USE 0-0-1998; IN COMMERCE 0-0-1998.

SN 76-361,627. BERNSTEIN, MICHAEL S., NEWTON, MA. FILED 1-22-2002.

FANIMATION

FOR CHILDREN'S FLIP BOOKS AND FLIP CARDS (U.S. CLS. 2, 5, 22, 23, 29, 37, 38 AND 50).

CLASS 16—(Continued).

SN 76-362,166. SAKURA COLOR PRODUCTS OF AMERICA, INC., HAYWARD, CA. FILED 1-24-2002.

GELATO

OWNER OF U.S. REG. NOS. 1,692,910, 2,497,750 AND OTHERS.

THE ENGLISH TRANSLATION OF THE WORD "GELATO" IS "A SOFT RICH ICE CREAM CONTAINING LITTLE OR NO AIR".

FOR WRITING INSTRUMENTS, NAMELY, PENCILS, BALL-POINT PENS, FOUNTAIN PENS, MARKERS, ROLLER BALL PENS, HIGHLIGHTING MARKERS AND PENS, DRAFTING PENS, CALLIGRAPHY PENS, ALL SOLD INDIVIDUALLY AND IN SETS; DRAWING MATERIALS, NAMELY, CRAYONS, PASTELS, DRAFTING INKS, ALL SOLD INDIVIDUALLY AND IN SETS (U.S. CLS. 2, 5, 22, 23, 29, 37, 38 AND 50).

SN 76-363,092. LINKIN PARK, LLC, SHERMAN OAKS, CA. FILED 1-25-2002.

PROJEKT REVOLUTION

FOR POSTERS, TOUR BOOKS, CALENDARS, SONG BOOKS, PENS PENCILS GREETING CARDS CHRISTMAS CARDS, AUTOGRAPH BOOKS POSTER BOOKS ALBUMS, ADDRESS BOOKS APPOINTMENT BOOKS PAPER PLACE MATS, PAPER COASTERS, DECALS, STICKERS, NOTEBOOKS AND LITHOGRAPHS (U.S. CLS. 2, 5, 22, 23, 29, 37, 38 AND 50).

SN 76-363,835. MEAD CORPORATION, THE, DAYTON, OH. FILED 1-28-2002.



OWNER OF U.S. REG. NOS. 2,089,902 AND 2,102,068. FOR BINDERS, NOTEBOOKS, STATIONERY-TYPE PORTFOLIOS, PENCIL POUCHES, COMPOSITION BOOKS (U.S. CLS. 2, 5, 22, 23, 29, 37, 38 AND 50).

SN 76-364,289. HOUGHTON MIFFLIN COMPANY, BOSTON, MA. FILED 1-29-2002.

MEASURING LESS WOULD BE UNBEARABLE

FOR PRINTED MATERIALS, NAMELY TESTS FOR ASSESSMENT OF READING AND LANGUAGE ARTS COMPREHENSION AND SKILLS FOR GRADES K-3 (U.S. CLS. 2, 5, 22, 23, 29, 37, 38 AND 50).

FIRST USE 1-11-2002; IN COMMERCE 1-11-2002.

CLASS 16—(Continued).

SN 76-364,300. BORDEN, EDWARD, COLUMBIA, SC. FILED 1-25-2002.

ALEXANDER THE BEAR

NO CLAIM IS MADE TO THE EXCLUSIVE RIGHT TO USE "BEAR", APART FROM THE MARK AS SHOWN.
FOR SERIES OF CHILDREN'S BOOKS (U.S. CLS. 2, 5, 22, 23, 29, 37, 38 AND 50).

SN 76-364,466. HACHETTE FILIPACCHI MEDIA U.S., INC., NEW YORK, NY. FILED 1-28-2002.

WHAT THE PROS KNOW

OWNER OF U.S. REG. NO. 1,973,567.
SEC. 2(F).
FOR MAGAZINE SECTION RELATING TO PROFESSIONAL ADVICE ON THE TOPICS OF HOME DECORATION, RENOVATION AND REPAIR (U.S. CLS. 2, 5, 22, 23, 29, 37, 38 AND 50).
FIRST USE 10-0-1992; IN COMMERCE 10-0-1992.

SN 76-365,968. COATING EXCELLENCE INTERNATIONAL LLC, WRIGHTSTOWN, WI. FILED 2-1-2002.

SHARKSKIN

FOR REAM WRAP (U.S. CLS. 2, 5, 22, 23, 29, 37, 38 AND 50).
FIRST USE 7-0-1998; IN COMMERCE 7-0-1998.

SN 76-367,439. BEAR STEARNS COMPANIES INC., THE, NEW YORK, NY. FILED 2-4-2002.

ENTERTAIN THESE THOUGHTS...

FOR PRINTED NEWSLETTERS IN THE FIELD OF SECURITIES RESEARCH (U.S. CLS. 2, 5, 22, 23, 29, 37, 38 AND 50).
FIRST USE 1-24-2002; IN COMMERCE 1-24-2002.

SN 76-367,852. HEARST HOLDINGS, INC., NEW YORK, NY. FILED 2-6-2002.

BEETLE BAILEY

OWNER OF U.S. REG. NOS. 557,353 AND 2,472,403.
FOR COLORED MARKERS (U.S. CLS. 2, 5, 22, 23, 29, 37, 38 AND 50).
FIRST USE 4-0-1999; IN COMMERCE 4-0-1999.

CLASS 16—(Continued).

SN 76-368,627. ROSS SCHOOL, THE, EAST HAMPTON, NY. FILED 2-6-2002.

@ROSS

FOR NEWSLETTERS RELATED TO EDUCATION AND RECENT DEVELOPMENTS IN CONNECTION WITH A SCHOOL (U.S. CLS. 2, 5, 22, 23, 29, 37, 38 AND 50).

SN 76-368,633. ROSS SCHOOL, THE, EAST HAMPTON, NY. FILED 2-6-2002.

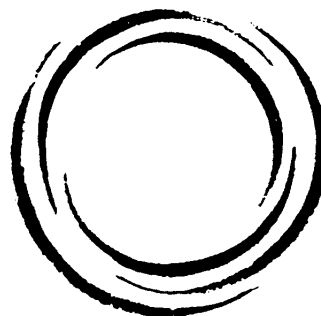

FOR NEWSLETTERS RELATED TO EDUCATION, CULTURAL HISTORY, ENGLISH, SCIENCE, MATH, FOREIGN LANGUAGE, VISUAL ARTS, PERFORMING ARTS, TECHNOLOGY, MEDIA STUDIES, SELF-AWARENESS, RELIGION, SPIRITUALITY, HEALTH, DANCE, PHYSICAL FITNESS AND WELLNESS, YOGA AND MEDITATION, COMMUNICATIONS, TECHNOLOGY, HEALTH CARE, WELL-BEING, PERFORMING ARTS, INTERNATIONAL EXCHANGE AND ENVIRONMENTAL CONCERNS (U.S. CLS. 2, 5, 22, 23, 29, 37, 38 AND 50).

SN 76-369,073. BRESNAHAN, GEORGE M., SAN DIEGO, CA. FILED 2-11-2002.

RAINBOW CAT

NO CLAIM IS MADE TO THE EXCLUSIVE RIGHT TO USE "CAT", APART FROM THE MARK AS SHOWN.
FOR SERIES OF FICTION BOOKS (U.S. CLS. 2, 5, 22, 23, 29, 37, 38 AND 50).

CLASS 16—(Continued).

SN 76-369,291. KOCH, KATHLEEN K., WHITMORE LAKE, MI. FILED 2-11-2002.

THE FAN HAND

NO CLAIM IS MADE TO THE EXCLUSIVE RIGHT TO USE "HAND", APART FROM THE MARK AS SHOWN.

FOR VISUAL TEACHING AND SPEAKING AID IN THE FORM OF A TWO-DIMENSIONAL HAND SHAPED SURFACE CONTAINING PRINTED REMINDERS TO ASSIST PUBLIC SPEAKERS AND TEACHERS (U.S. CLS. 2, 5, 22, 23, 29, 37, 38 AND 50).

SN 76-370,176. INNODESK, INC., WARRENSVILLE HEIGHTS, OH. FILED 2-13-2002.



The logo for RETRAC-TIP features the words "RETRAC-TIP" in a bold, black, sans-serif font. Below the text is a thick, black, wavy line that resembles a marker stroke.

FOR CAPLESS MARKERS AND HIGHLIGHTING MARKERS (U.S. CLS. 2, 5, 22, 23, 29, 37, 38 AND 50).

SN 76-370,456. TELCORDIA TECHNOLOGIES, INC., MORRISTOWN, NJ. FILED 1-10-2002.

PERFORMANCE FROM EXPERIENCE

FOR TECHNICAL PUBLICATIONS ABOUT COMMUNICATIONS HARDWARE AND SOFTWARE AND RELATED SERVICES, NAMELY, JOURNALS, MAGAZINES, NEWSLETTERS, BROCHURES, PRINTED INSTRUCTIONAL MATERIALS, GENERIC REQUIREMENTS DOCUMENTS AND CATALOGUES (U.S. CLS. 2, 5, 22, 23, 29, 37, 38 AND 50).
FIRST USE 2-1-1999; IN COMMERCE 2-1-1999.

SN 76-370,695. DAISY PRODUCTIONS, INC., NEW YORK, NY. FILED 2-14-2002.

THAT GIRL

FOR CHILDREN'S BOOKS (U.S. CLS. 2, 5, 22, 23, 29, 37, 38 AND 50).

CLASS 16—(Continued).

SN 76-370,841. WOMEN'S HEALTHCARE CONSULTANTS, INC., EVANSTON, IL. FILED 2-13-2002.

HEALTHY DECISIONS

OWNER OF U.S. REG. NOS. 1,953,891 AND 2,281,819.
NO CLAIM IS MADE TO THE EXCLUSIVE RIGHT TO USE "HEALTHY", APART FROM THE MARK AS SHOWN.
FOR NEWSLETTERS IN THE FIELD OF HEALTH AND/OR HEALTHCARE (U.S. CLS. 2, 5, 22, 23, 29, 37, 38 AND 50).
FIRST USE 1-31-1992; IN COMMERCE 9-1-1992.

SN 76-371,217. J.S. HOMESTYLE LLC, MANDEVILLE, LA. FILED 2-14-2002.

DECORABLES

FOR DECORATIVE STICKERS (U.S. CLS. 2, 5, 22, 23, 29, 37, 38 AND 50).

SN 76-371,622. KIMBERLY-CLARK CORPORATION, NEENAH, WI. FILED 2-19-2002.

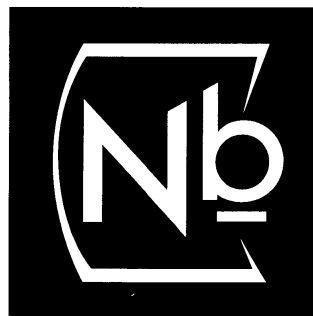

FOR BOND, PRINTING AND WRITING PAPERS, ENVELOPES (U.S. CLS. 2, 5, 22, 23, 29, 37, 38 AND 50).
FIRST USE 1-17-2001; IN COMMERCE 1-17-2001.

SN 76-372,160. GROLIER PUBLISHING CO., INC., DANBURY, CT. FILED 2-15-2002.



The logo features the word "Rookie" in a large, bold, black, sans-serif font. Below it, the word "choices" is written in a smaller, black, cursive font.

OWNER OF U.S. REG. NOS. 1,381,361 AND 1,734,024.
FOR SERIES OF FICTION BOOKS FOR CHILDREN (U.S. CLS. 2, 5, 22, 23, 29, 37, 38 AND 50).
FIRST USE 8-5-2001; IN COMMERCE 8-5-2001.

CLASS 16—(Continued).

SN 76-374,003. D'EON, CHRISTOPHER E., SAN DIEGO, CA. FILED 2-21-2002.

INSIDE SUCCESS

FOR PUBLICATIONS, NAMELY MAGAZINES AND PERIODICALS IN THE FIELD OF BUSINESS (U.S. CLS. 2, 5, 22, 23, 29, 37, 38 AND 50).

SN 76-374,046. CROSSGENERATION COMICS, INC., OLDSMAR, FL. FILED 1-24-2002.

WAY OF THE RAT

FOR PRINTED MATERIALS AND PUBLICATIONS, NAMELY COMIC BOOKS, COMIC MAGAZINES AND PRINTED STORIES IN ILLUSTRATED FORM FEATURED IN BOOKS AND MAGAZINES (U.S. CLS. 2, 5, 22, 23, 29, 37, 38 AND 50).

SN 76-374,206. EDITORIAL TELEVISA INTERNATIONAL, S.A., 01210 MEXICO, D.F., MEXICO, FILED 2-21-2002.

CONOZCA MAS

THE FOREIGN WORDING IN THE MARK TRANSLATES INTO ENGLISH AS "LEARN MORE".

FOR MAGAZINE DEVOTED TO RECENT INFORMATION ON TECHNOLOGY, HEALTH, HISTORY, SCIENCE AND CULTURE (U.S. CLS. 2, 5, 22, 23, 29, 37, 38 AND 50).

SN 76-374,308. SINGLETON, RICHARD O., SOUTHFIELD, MI. FILED 2-25-2002.

THE GOLF CHEAT SHEET

NO CLAIM IS MADE TO THE EXCLUSIVE RIGHT TO USE "GOLF", APART FROM THE MARK AS SHOWN.

FOR PORTABLE PRINTED CARD FOR GOLFERS TO CARRY TO ASSIST THEM WITH CALCULATING THE SWING ARC THAT THEY NEED FOR THE BALL TO CARRY A CERTAIN DISTANCE (U.S. CLS. 2, 5, 22, 23, 29, 37, 38 AND 50).

CLASS 16—(Continued).

SN 76-374,377. MCDONNELL-FURUICHI, MICHELLE, FAIRFAX, CA. FILED 2-25-2002.

THE LITTLEST PIGGY

FOR PHOTOGRAPH ALBUMS, SCRAPBOOK ALBUMS, ART PADS, ARTS AND CRAFT PAINT KITS, PRINTED AWARDS, DESK BASKETS FOR DESK ACCESSORIES, PAPER BABY BIBS, BOOK COVERS, ADDRESS BOOKS, APPOINTMENT BOOKS, BABY BOOKS, CHILDREN'S ACTIVITY BOOKS, CHILDREN'S BOOKS, TRAVEL BOOKS, LOG BOOKS, NOTEBOOKS, PICTURE BOOKS, RECIPE BOOKS, SKETCHBOOKS, SKETCH-PADS, WRITING PADS, WIREBOUND BOOKS, PHOTO ALBUM BRAG BOOKS, BUMPER STICKERS, CALENDARS, PENCIL CASES, COLORING BOOKS, CARDBOARD CONTAINERS, PAPER CONTAINERS, DICTIONARIES, GIFT WRAP, GREETING CARDS, CHILDREN'S TRAVEL GUIDE BOOKS, BLANK JOURNALS, MARKERS, PHOTO MEMORY BOOKS, NOTE CARDS, NOTE PADS, NOTE PAPER, NUMBERING GUIDES, DESK TOP ORGANIZERS, PERSONAL ORGANIZERS, PAPER BAGS FOR PACKAGING, PLASTIC BAGS FOR PACKAGING, PAPER POUCHES FOR PACKAGING, CALENDAR DESK PADS, DESK PADS, PAINTING SETS FOR CHILDREN, GREETING CARDS, GIFT CARDS, NOTE CARDS, BLANK CARDS, WRAPPING PAPER, PAPER GIFT BAGS, PENCIL BOXES, PENCIL CASES, PENS, PICTURE BOOKS, PICTURE POSTCARDS, POCKET CALENDARS, POSTCARDS, POSTERS, RUBBER STAMPS, DRAWING RULERS, SCRAPBOOK ALBUMS, SCRAPBOOKS, STAMP PADS, STATIONERY, STATIONERY BOXES, STICKERS, WALL CALENDARS, AND WRITING TABLETS (U.S. CLS. 2, 5, 22, 23, 29, 37, 38 AND 50).

SN 76-374,797. CRAVE ENTERTAINMENT, INC., RANCHO DOMINGUEZ, CA. FILED 2-21-2002.

AXIS OF EVIL

FOR PRINTED USER AND INSTRUCTION MANUALS FOR VIDEO GAMES AND COMPUTER GAMES; PRINTED STRATEGY GUIDES FOR VIDEO GAMES AND COMPUTER GAMES; NEWSLETTERS CONCERNING VIDEO GAMES AND COMPUTER GAMES; A SERIES OF NON-FICTION BOOKS CONCERNING VIDEO GAMES AND COMPUTER GAMES; POSTERS; COMIC BOOKS (U.S. CLS. 2, 5, 22, 23, 29, 37, 38 AND 50).

SN 76-375,152. RHODES, JULIA M, SONORA, CA. FILED 2-20-2002.



The logo for 'KLEEN SLATE' features the word 'KLEEN' in a bold, black, sans-serif font. To its right is a stylized 'S' inside a black square, followed by the word 'SLATE' in the same bold, black, sans-serif font. The 'S' is white and has a black outline, creating a high-contrast graphic element.

FOR ATTACHABLE ERASER FOR THE DRY-ERASE MARKER (U.S. CLS. 2, 5, 22, 23, 29, 37, 38 AND 50).

CLASS 16—(Continued).

SN 76-375,537. SOUTH WORTH COMPANY, AGAWAM, MA.
FILED 2-26-2002.

THE PROFESSIONAL DIFFERENCE YOU SEE AND FEEL

FOR WRITING PAPER, PRINTING PAPER, TYPING
PAPER AND ENVELOPES (U.S. CLS. 2, 5, 22, 23, 29, 37, 38
AND 50).

SN 76-375,887. H. E. BUTT FOUNDATION, KERRVILLE, TX.
FILED 2-27-2002.

Connections

FOR NEWSLETTERS IN THE FIELDS OF SPIRITUAL-
ITY, SELF-HELP, AND PERSONAL EMPOWERMENT
AND REPORTING NEWS, EVENTS AND INFORMA-
TION REGARDING H E BUTT FOUNDATION (U.S.
CLS. 2, 5, 22, 23, 29, 37, 38 AND 50).
FIRST USE 10-15-1999; IN COMMERCE 10-15-1999.

SN 76-376,348. CTA INC., DBA CLIFTON TELECARD
ALLIANCE, NORTH BERGEN, NJ. FILED 2-27-2002.

BACHATA

FOR NON-MAGANETIC PHONE CARDS (U.S. CLS. 2,
5, 22, 23, 29, 37, 38 AND 50).
FIRST USE 8-1-2001; IN COMMERCE 8-1-2001.

SN 76-376,349. CTA INC., DBA CLIFTON TELECARD
ALLIANCE, NORTH BERGEN, NJ. FILED 2-27-2002.

CTA

FOR NON-MAGANETIC PHONE CARDS (U.S. CLS. 2,
5, 22, 23, 29, 37, 38 AND 50).
FIRST USE 7-15-1999; IN COMMERCE 7-15-1999.

SN 76-376,577. ADESA CORPORATION, INDIANAPOLIS, IN.
FILED 2-28-2002.

PULSE

FOR PERIODICAL CONTAINING ECONOMIC RE-
PORTS, INFORMATION, AND ARTICLES RELATED
TO THE VEHICLE REMARKETING INDUSTRY (U.S.
CLS. 2, 5, 22, 23, 29, 37, 38 AND 50).
FIRST USE 6-0-2001; IN COMMERCE 6-0-2001.

CLASS 16—(Continued).

SN 76-377,808. KYESUNG PAPER CO., LTD., OSAN,
KYUNGKI-DO, REPUBLIC OF KOREA, FILED 3-4-2002.

INTERJET

OWNER OF REPUBLIC OF KOREA REG. NO. 0484740,
DATED 1-3-2001, EXPIRES 1-3-2011.
FOR COPYING PAPER, PRINTING PAPER, TYPE-
WRITING PAPER, CARBON PAPER, STATIONERY,
NAMELY, DOCUMENT FILES, FOLDERS FOR PAPER,
WRITING AND DRAWING PAPER, FACSIMILE PAPER,
TRANSFER PAPER, AND RULED PAPER (U.S. CLS. 2, 5,
22, 23, 29, 37, 38 AND 50).

SN 76-379,405. KIMBERLY-CLARK CORPORATION, NEE-
NAH, WI. FILED 3-8-2002.

LEAK LOCK

OWNER OF U.S. REG. NO. 2,450,246.
FOR DISPOSABLE DIAPERS AND COMPONENTS
THEREOF (U.S. CLS. 2, 5, 22, 23, 29, 37, 38 AND 50).
FIRST USE 5-26-1994; IN COMMERCE 5-26-1994.

SN 76-379,461. DAY RUNNER, INC., FULLERTON, CA.
FILED 3-7-2002.

E-BINDER

FOR PERSONAL ORGANIZERS, DESK TOP ORGANI-
ZERS, PERSONAL PLANNERS AND DESK TOP PLAN-
NERS, ALL CONTAINING PRINTED INFORMATION
AND HAVING PROVISIONS FOR RECORDING ADDI-
TIONAL INFORMATION; AND REPLACEMENT PAGES
THEREFOR IN THE NATURE OF CALENDARS, AL-
PHABETICAL INDEXES AND PREPRINTED INDEX
LABELS, ACADEMIC SCHEDULES, AND LOOSE LEAF
BINDERS (U.S. CLS. 2, 5, 22, 23, 29, 37, 38 AND 50).

SN 76-380,277. GAREB SHAMUS ENTERPRISES, INC.,
CONGERS, NY. FILED 2-28-2002.

BEAUTIFUL KILLER

FOR COMIC BOOKS (U.S. CLS. 2, 5, 22, 23, 29, 37, 38
AND 50).

SN 76-380,301. COOK COMMUNICATIONS MINISTRIES,
COLORADO SPRINGS, CO. FILED 3-8-2002.

JESUS EXPEDITION

FOR PRINTED TEACHING AND INSTRUCTIONAL
MATERIALS, ALL IN THE FIELD OF CHRISTIANITY
(U.S. CLS. 2, 5, 22, 23, 29, 37, 38 AND 50).
FIRST USE 12-1-1995; IN COMMERCE 12-1-1995.

CLASS 16—(Continued).

SN 78-013,696. WORLD LIBRARY PUBLICATIONS, SCHILLER PARK, IL. FILED 6-21-2000.

VOICES AS ONE

FOR RELIGIOUS WORSHIP AIDS NAMELY RELIGIOUS BOOKS AND SUPPORT BOOKS (U.S. CLS. 2, 5, 22, 23, 29, 37, 38 AND 50).
FIRST USE 12-5-1998; IN COMMERCE 12-5-1998.

SN 78-036,821. CINGULAR WIRELESS LLC, ATLANTA, GA. FILED 11-28-2000.

CINGULAR EXPRESSION

FOR CUSTOMER NEWSLETTER IN THE FIELD OF WIRELESS TELECOMMUNICATIONS (U.S. CLS. 2, 5, 22, 23, 29, 37, 38 AND 50).

SN 78-052,945. TIME WARNER ENTERTAINMENT COMPANY, L.P., NEW YORK, NY. FILED 3-13-2001.

FAWKES

FOR PRINTED MATTER AND PAPER GOODS, NAMELY, BOOKS FEATURING CHARACTERS FROM ANIMATED, ACTION ADVENTURE, COMEDY AND DRAMA FEATURES, COMIC BOOKS, CHILDREN'S BOOKS, MAGAZINES FEATURING CHARACTERS FROM ANIMATED, ACTION ADVENTURE, COMEDY AND DRAMA FEATURES, COLORING BOOKS, CHILDREN'S ACTIVITY BOOKS; STATIONERY, WRITING PAPER, ENVELOPES, NOTEBOOKS, DIARIES, NOTE CARDS, GREETING CARDS, TRADING CARDS; LITHOGRAPHS; PENS, PENCILS, CASES THEREFOR, ERASERS, CRAYONS, MARKERS, COLORED PENCILS, PAINTING SETS, CHALK AND CHALKBOARDS; DECALS, HEAT TRANSFERS; POSTERS; MOUNTED AND UNMOUNTED PHOTOGRAPHS; BOOK COVERS, BOOK MARKS, CALENDARS, GIFT WRAPPING PAPER; PAPER PARTY FAVORS AND PAPER PARTY DECORATIONS, NAMELY, PAPER NAPKINS, PAPER DOILIES, PAPER PLACE MATS, CREPE PAPER, PAPER HATS, INVITATIONS, PAPER TABLE CLOTHS, PAPER CAKE DECORATIONS; PRINTED TRANSFERS FOR EMBROIDERY OR FABRIC APPLIQUES; PRINTED PATTERNS FOR COSTUMES, PAJAMAS, SWEATSHIRTS AND T-SHIRTS (U.S. CLS. 2, 5, 22, 23, 29, 37, 38 AND 50).

SN 78-056,680. JUSTPEACE CENTER FOR MEDIATION AND CONFLICT TRANSFORMATION, EVANSTON, IL. FILED 4-4-2001.

PATHWAYS TO JUSTPEACE

OWNER OF U.S. REG. NO. 2,442,430.
FOR THEOLOGICAL NEWSLETTER FEATURING ARTICLES, EVENTS AND INFORMATION REGARDING MEDIATION AND CONFLICT TRANSFORMATION FOR THE CHURCH COMMUNITY (U.S. CLS. 2, 5, 22, 23, 29, 37, 38 AND 50).
FIRST USE 1-16-2001; IN COMMERCE 1-19-2001.

CLASS 16—(Continued).

SN 78-072,593. TRIBUNE LICENSE, INC., CHICAGO, IL. FILED 7-6-2001.

NEWSDAY'S MARKETEEER

FOR PUBLICATIONS CONTAINING ADVERTISING, PRINTED ADVERTISING COUPONS, AND ADVERTISING CIRCULARS (U.S. CLS. 2, 5, 22, 23, 29, 37, 38 AND 50).
FIRST USE 5-12-2001; IN COMMERCE 5-12-2001.

SN 78-083,894. HEALTH OPTIONS & ALTERNATIVES, INC., FORT WORTH, TX. FILED 9-14-2001.

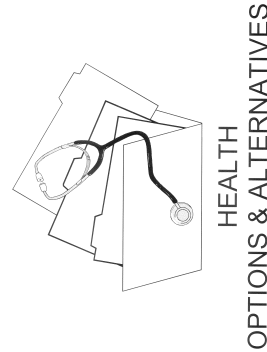

NO CLAIM IS MADE TO THE EXCLUSIVE RIGHT TO USE "HEALTH OPTIONS & ALTERNATIVES", APART FROM THE MARK AS SHOWN.
FOR BROCHURES ABOUT ALTERNATIVE HEALTH-CARE OPTIONS AND SOLUTIONS (U.S. CLS. 2, 5, 22, 23, 29, 37, 38 AND 50).

SN 78-089,040. PALO ALTO MEDICAL PUBLISHING, INC., LOS GATOS, CA. FILED 10-18-2001.

THE COLON CANCER-FREE ZONE

NO CLAIM IS MADE TO THE EXCLUSIVE RIGHT TO USE "COLON CANCER-FREE", APART FROM THE MARK AS SHOWN.
FOR MEDICAL BOOKS PUBLISHED PERIODICALLY (U.S. CLS. 2, 5, 22, 23, 29, 37, 38 AND 50).

SN 78-090,000. GIFTCO, INC., VERNON HILLS, IL. FILED 10-24-2001.

SPEEDY-SEALER

FOR HAND-HELD APPLICATORS, NAMELY, TRANSFER TAPE APPLICATORS FOR STATIONERY USE, SOLD IN CONNECTION WITH CHARITABLE FUND RAISING FOR EDUCATION (U.S. CLS. 2, 5, 22, 23, 29, 37, 38 AND 50).

CLASS 16—(Continued).

SN 78-090,348. INTERNATIONAL PAPER TRADEMARK COMPANY, TUXEDO, NY. FILED 10-26-2001.

CENTENNIAL

FOR COATED COVER COMMERCIAL PRINTING GRADE PAPER (U.S. CLS. 2, 5, 22, 23, 29, 37, 38 AND 50). FIRST USE 7-31-1999; IN COMMERCE 7-31-1999.

SN 78-090,753. B. P. SALES, INC., YOUNGSTOWN, OH. FILED 10-30-2001.

Biker Angel



NO CLAIM IS MADE TO THE EXCLUSIVE RIGHT TO USE "BIKER", APART FROM THE MARK AS SHOWN. FOR SILK-SCREEN TRANSFERS FOR LADIES SHIRTS, DOO-RAGS AND BIKER APPAREL (U.S. CLS. 2, 5, 22, 23, 29, 37, 38 AND 50).

SN 78-090,994. CORNETTE, DANIEL J., SCOTTSDALE, AZ. FILED 10-31-2001.

SPOOKMASTER

FOR STENCILS FOR USE IN CARVING AND PAINTING HALLOWEEN PUMPKINS (U.S. CLS. 2, 5, 22, 23, 29, 37, 38 AND 50).

SN 78-091,503. WISHING STAR DESIGNS, SALT LAKE CITY, UT. FILED 11-2-2001.

TREASURE POCKET JOURNAL

NO CLAIM IS MADE TO THE EXCLUSIVE RIGHT TO USE "POCKET JOURNAL", APART FROM THE MARK AS SHOWN.

FOR JOURNALING AND SCRAPBOOKING SUPPLIES, NAMELY JOURNALS, RUBBER STAMPS, STICKERS, AND STATIONERY (U.S. CLS. 2, 5, 22, 23, 29, 37, 38 AND 50).

CLASS 16—(Continued).

SN 78-093,389. FSBO FIRST AID, LLC, PHOENIX, AZ. FILED 11-14-2001.

FSBO FIRST AID KIT

NO CLAIM IS MADE TO THE EXCLUSIVE RIGHT TO USE "FSBO", APART FROM THE MARK AS SHOWN.

FOR SALE BY OWNER MARKETING KIT CONTAINING MANUALS ON BEST WAY FOR OWNERS TO SELL GOODS, PRINTED PAPER SIGNS, SAMPLE ADVERTISING FLYERS, BROCHURES ON HOW TO GET WEBSITE LISTINGS FOR THE GOODS FOR SALE, AND SAMPLE PRINTED CONTRACTS (U.S. CLS. 2, 5, 22, 23, 29, 37, 38 AND 50).

SN 78-094,803. BURKS, CAROL HILTON, MONTEBELLO, VA. FILED 11-23-2001.

Scrooge, Inc.



NO CLAIM IS MADE TO THE EXCLUSIVE RIGHT TO USE "INC.", APART FROM THE MARK AS SHOWN.

FOR GREETING CARDS, NEWSPAPER AND MAGAZINE CARTOONS, STATIONERY, NOTEBOOKS, CALENDARS, BOOKMARKS, PENCILS, BOOK BINDINGS, AND BOOKLETS FEATURING JOKES OR STORIES ABOUT CHRISTMAS (U.S. CLS. 2, 5, 22, 23, 29, 37, 38 AND 50).

SN 78-106,153. WELLS, MELANIE K., DALLAS, TX. FILED 2-1-2002.

THERAPIST IN A BOX

FOR GIFT ITEM, NAMELY, A SET OF PRE-PRINTED CARDS IN A BOX WHICH CONTAIN THERAPY SAYINGS (U.S. CLS. 2, 5, 22, 23, 29, 37, 38 AND 50).

SN 78-107,019. CHUCK SNYDER & ASSOCIATES, INC., EDMONDS, WA. FILED 2-5-2002.

READING THE MALE

FOR SYNDICATED NEWSPAPER COLUMNS, ARTICLES, AND BOOKS IN THE FIELD OF PERSONAL ADVICE (U.S. CLS. 2, 5, 22, 23, 29, 37, 38 AND 50).

CLASS 16—(Continued).

SN 78-107,117. HALLMARK LICENSING, INC., KANSAS CITY, MO. FILED 2-6-2002.

HALLMARK CREATIVE CONNECTIONS

FOR GREETING CARDS (U.S. CLS. 2, 5, 22, 23, 29, 37, 38 AND 50).

SN 78-108,136. Z-PRO INTERNATIONAL, INC., PORTLAND, OR. FILED 2-11-2002.

PRO APPLICATOR

NO CLAIM IS MADE TO THE EXCLUSIVE RIGHT TO USE "APPLICATOR", APART FROM THE MARK AS SHOWN.

FOR PAINT BRUSHES AND PAINT ROLLER COVERS (U.S. CLS. 2, 5, 22, 23, 29, 37, 38 AND 50).

SN 78-108,263. POPE, BENJAMIN, CLINTON TOWNSHIP, MI. FILED 2-12-2002.

PAINTIER

FOR MULTI-LEVEL CARROUSEL ORGANIZER FOR CRAFT AND HOBBY PAINTS (U.S. CLS. 2, 5, 22, 23, 29, 37, 38 AND 50).

SN 78-108,748. THE PROCTER & GAMBLE COMPANY, CINCINNATI, OH. FILED 2-14-2002.

"A CHARMIN CLEAN, NOW THAT FEELS GOOD!"

OWNER OF U.S. REG. NOS. 248,549, 1,496,757 AND OTHERS.

FOR TOILET TISSUE (U.S. CLS. 2, 5, 22, 23, 29, 37, 38 AND 50).

SN 78-109,318. ATWOOD, DUNCAN F., KENMORE, WA. FILED 2-17-2002.

POCKET VIDEOS

NO CLAIM IS MADE TO THE EXCLUSIVE RIGHT TO USE "POCKET", APART FROM THE MARK AS SHOWN.

FOR FLIPBOOKS, CONSISTING OF A SEQUENCE OF PHOTOGRAPHS THAT, WHEN VIEWED IN RAPID SUCCESSION BY "FLIPPING THROUGH" THE BOOK, CREATE AN IMPRESSION OF MOTION (U.S. CLS. 2, 5, 22, 23, 29, 37, 38 AND 50).

FIRST USE 6-1-2000; IN COMMERCE 7-3-2000.

CLASS 16—(Continued).

SN 78-109,658. A.T.X. INTERNATIONAL, INC., LINCOLN, RI. FILED 2-19-2002.

PERMIE

FOR WRITING INSTRUMENTS (U.S. CLS. 2, 5, 22, 23, 29, 37, 38 AND 50).

SN 78-110,608. MUD PIE PRODUCTIONS, INC., CHICAGO, IL. FILED 2-22-2002.

IT'S YOUR KITCHEN ... DESIGN IT THAT WAY!

FOR BOOKS RELATING TO KITCHEN DESIGN AND KITCHEN FURNISHING (U.S. CLS. 2, 5, 22, 23, 29, 37, 38 AND 50).

SN 78-110,611. MUD PIE PRODUCTIONS, INC., CHICAGO, IL. FILED 2-22-2002.

IT'S YOUR BED & BATH ... DESIGN IT THAT WAY!

FOR BOOKS RELATING TO BED AND BATH DESIGN AND BED AND BATH FURNISHING (U.S. CLS. 2, 5, 22, 23, 29, 37, 38 AND 50).

SN 78-111,721. KAPLAN, ANDREW S., YONKERS, NY. FILED 2-28-2002.

WORLD OF GOOD

FOR NEWSPAPER COMIC STRIPS (U.S. CLS. 2, 5, 22, 23, 29, 37, 38 AND 50).

CLASS 16—(Continued).

SN 78-112,095. DC COMICS, NEW YORK, NY. FILED 3-1-2002.

JUSTICE LEAGUE

FOR PRINTED MATTER AND PAPER GOODS—NAMESLY, BOOKS FEATURING CHARACTERS FROM ANIMATED, ACTION ADVENTURE, COMEDY AND/OR DRAMA FEATURES, COMIC BOOKS, CHILDREN'S BOOKS, MAGAZINES FEATURING CHARACTERS FROM ANIMATED, ACTION ADVENTURE, COMEDY AND/OR DRAMA FEATURES, COLORING BOOKS, CHILDREN'S ACTIVITY BOOKS; STATIONERY, WRITING PAPER, ENVELOPES, NOTEBOOKS, DIARIES, NOTE CARDS, GREETING CARDS, TRADING CARDS; LITHOGRAPHS; PENS, PENCILS, CASES THEREFOR, ERASERS, CRAYONS, MARKERS, COLORED PENCILS, PAINTING SETS, CHALK AND CHALKBOARDS; DECALS, HEAT TRANSFERS; POSTERS; MOUNTED AND/OR UNMOUNTED PHOTOGRAPHS; BOOK COVERS, BOOK MARKS, CALENDARS, GIFT WRAPPING PAPER; PAPER PARTY FAVORS AND PAPER PARTY DECORATIONS—NAMESLY, PAPER NAPKINS, PAPER DOILIES, PAPER PLACE MATS, CREPE PAPER, PAPER HATS, INVITATIONS, PAPER TABLE CLOTHS, PAPER CAKE DECORATIONS; PRINTED TRANSFERS FOR EMBROIDERY OR FABRIC APPLIQUES; PRINTED PATTERNS FOR COSTUMES, PAJAMAS, SWEATSHIRTS AND T-SHIRTS (U.S. CLS. 2, 5, 22, 23, 29, 37, 38 AND 50).

SN 78-112,102. TIME WARNER ENTERTAINMENT COMPANY, L.P., NEW YORK, NY. FILED 3-1-2002.

ALIENQUEST

FOR PRINTED MATTER AND PAPER GOODS—NAMESLY, BOOKS FEATURING CHARACTERS FROM ANIMATED, ACTION ADVENTURE, COMEDY AND/OR DRAMA FEATURES, COMIC BOOKS, CHILDREN'S BOOKS, MAGAZINES FEATURING CHARACTERS FROM ANIMATED, ACTION ADVENTURE, COMEDY AND/OR DRAMA FEATURES, COLORING BOOKS, CHILDREN'S ACTIVITY BOOKS; STATIONERY, WRITING PAPER, ENVELOPES, NOTEBOOKS, DIARIES, NOTE CARDS, GREETING CARDS, TRADING CARDS; LITHOGRAPHS; PENS, PENCILS, CASES THEREFOR, ERASERS, CRAYONS, MARKERS, COLORED PENCILS, PAINTING SETS, CHALK AND CHALKBOARDS; DECALS, HEAT TRANSFERS; POSTERS; MOUNTED AND/OR UNMOUNTED PHOTOGRAPHS; BOOK COVERS, BOOK MARKS, CALENDARS, GIFT WRAPPING PAPER; PAPER PARTY FAVORS AND PAPER PARTY DECORATIONS—NAMESLY, PAPER NAPKINS, PAPER DOILIES, PAPER PLACE MATS, CREPE PAPER, PAPER HATS, INVITATIONS, PAPER TABLE CLOTHS, PAPER CAKE DECORATIONS; PRINTED TRANSFERS FOR EMBROIDERY OR FABRIC APPLIQUES; PRINTED PATTERNS FOR COSTUMES, PAJAMAS, SWEATSHIRTS AND T-SHIRTS (U.S. CLS. 2, 5, 22, 23, 29, 37, 38 AND 50).

SN 78-112,181. THOMSEN, RUSSEL J., SILVERDALE, WA. FILED 3-2-2002.

COUNTING THE DAYS

FOR CALENDARS, NAMESLY, PREGNANCY, PRENATAL, AND NEWBORN CALENDARS AND JOURNALS (U.S. CLS. 2, 5, 22, 23, 29, 37, 38 AND 50).
FIRST USE 2-15-2002; IN COMMERCE 2-15-2002.

CLASS 16—(Continued).

SN 78-112,196. FUNDUSA, ALBANY, NY. FILED 3-2-2002.

MIRACLE DINING CARD

NO CLAIM IS MADE TO THE EXCLUSIVE RIGHT TO USE "DINING CARD", APART FROM THE MARK AS SHOWN.

FOR NONMAGNETICALLY CODED DISCOUNT CARDS USED FOR FUNDRAISING, NAMESLY, DISCOUNT AND DINING CARDS USED TO PURCHASE MERCHANDISE AND MEALS FOR DISCOUNT UPON PRESENTATION BY PURCHASER AS SPECIFIED (U.S. CLS. 2, 5, 22, 23, 29, 37, 38 AND 50).

SN 78-112,203. FUNDUSA, ALBANY, NY. FILED 3-3-2002.

MIRACLE CARD

NO CLAIM IS MADE TO THE EXCLUSIVE RIGHT TO USE "CARD", APART FROM THE MARK AS SHOWN.

FOR NONMAGNETICALLY CODED DISCOUNT CARDS USED FOR FUNDRAISING, NAMESLY, DISCOUNT AND DINING CARDS USED TO PURCHASE MERCHANDISE AND MEALS FOR DISCOUNT UPON PRESENTATION BY PURCHASER AS SPECIFIED (U.S. CLS. 2, 5, 22, 23, 29, 37, 38 AND 50).

SN 78-112,204. FUNDUSA, ALBANY, NY. FILED 3-3-2002.

MIRACLE SKI CARD

NO CLAIM IS MADE TO THE EXCLUSIVE RIGHT TO USE "SKI CARD", APART FROM THE MARK AS SHOWN.

FOR NONMAGNETICALLY CODED DISCOUNT CARDS USED FOR FUNDRAISING, NAMESLY, SKI DISCOUNT CARDS USED TO PURCHASE SKI MERCHANDISE AND SERVICES FOR DISCOUNT UPON PRESENTATION BY PURCHASER AS SPECIFIED (U.S. CLS. 2, 5, 22, 23, 29, 37, 38 AND 50).

SN 78-112,205. FUNDUSA, ALBANY, NY. FILED 3-3-2002.

MIRACLE GOLF CARD

NO CLAIM IS MADE TO THE EXCLUSIVE RIGHT TO USE "GOLF CARD", APART FROM THE MARK AS SHOWN.

FOR NONMAGNETICALLY CODED DISCOUNT CARDS USED FOR FUNDRAISING, NAMESLY, GOLF DISCOUNT CARDS USED TO PURCHASE GOLF MERCHANDISE AND SERVICES FOR DISCOUNT UPON PRESENTATION BY PURCHASER AS SPECIFIED (U.S. CLS. 2, 5, 22, 23, 29, 37, 38 AND 50).

CLASS 16—(Continued).

SN 78-112,208. WOOD, LISA J., DBA ARTINUTERO, HIGHLAND VILLAGE, TX. FILED 3-3-2002.

ArtInUtero

FOR ORIGINAL WORKS OF ART, NAMELY, GICLEES (U.S. CLS. 2, 5, 22, 23, 29, 37, 38 AND 50).
FIRST USE 10-0-2000; IN COMMERCE 0-0-2001.

SN 78-113,080. MORRIS, RICHARD, WILLIAM, SANDY, UT. FILED 3-7-2002.

DOCTOR-DOODLE

FOR ACTIVITY PAGES FOR CHILDREN FEATURING A VARIETY OF ACTIVITIES, NAMELY COMICS, WORD PUZZLES, RIDDLES, JOKES, NOTABLE FACTS, OPTICAL ILLUSIONS, MAZES, COLORING AND THE LIKE; ACTIVITY PAGES FOR ADULTS FEATURING A VARIETY OF ACTIVITIES, NAMELY COMICS, WORD PUZZLES, RIDDLES, JOKES, NOTABLE FACTS, OPTICAL ILLUSIONS, MAZES, AND THE LIKE (U.S. CLS. 2, 5, 22, 23, 29, 37, 38 AND 50).

SN 78-113,158. FORT JAMES OPERATING COMPANY, ATLANTA, GA. FILED 3-7-2002.

QUILTED NORTHERN

SEC. 2(F).
FOR PACK OF BATH TISSUE (U.S. CLS. 2, 5, 22, 23, 29, 37, 38 AND 50).
FIRST USE 1-7-1993; IN COMMERCE 1-7-1993.

SN 78-113,290. LISA FRANK, INC., TUCSON, AZ. FILED 3-7-2002.

PAINT KIX

NO CLAIM IS MADE TO THE EXCLUSIVE RIGHT TO USE "PAINT", APART FROM THE MARK AS SHOWN.

FOR CHILDREN'S ARTS AND CRAFTS PAINT KIT COMPRISING PAINT, PAINT TRAY, SPONGE, PAINT ROLLER, STAMP PAINT ROLLER, PAPER STENCILS, PAINT BRUSHES, PAPER, AND MINI-STAMPS (U.S. CLS. 2, 5, 22, 23, 29, 37, 38 AND 50).

FIRST USE 9-30-1997; IN COMMERCE 9-30-1997.

CLASS 16—(Continued).

SN 78-113,306. BROWNSTONE PUBLISHERS, INC., NEW YORK, NY. FILED 3-7-2002.

OPPS INSIDER IMPLEMENT, COMPLY AND GET PAID

FOR NEWSLETTER DIRECTED TO HOSPITAL FINANCIAL OFFICERS, MEDICAL RECORDS DEPARTMENT HEADS, HEALTH INFORMATION SYSTEMS ADMINISTRATORS, AND DIRECTORS OF HOSPITAL DEPARTMENTS THAT TREAT PATIENTS WHO ARE NOT ADMITTED AS INPATIENTS, ON HOW TO ADAPT BUSINESS OPERATIONS IN ACCORDANCE WITH NEW FEDERAL RULES GOVERNING REIMBURSEMENT FOR CERTAIN MEDICAL SERVICES PROVIDED TO PATIENTS COVERED BY MEDICARE, MEDICAID, AND OTHER FEDERAL HEALTH INSURANCE PROGRAMS (U.S. CLS. 2, 5, 22, 23, 29, 37, 38 AND 50).

SN 78-113,314. LISA FRANK, INC., TUCSON, AZ. FILED 3-7-2002.

PAINTOPIA

FOR CHILDREN'S ARTS AND CRAFTS PAINT KIT COMPRISING PAINT, SEQUINS, BEADS, AND PAINT BRUSHES AND ONE OR MORE OF THE FOLLOWING ITEMS TO BE PAINTED— PLASTIC JEWELRY BOX, PLASTIC SWITCHPLATE, PLASTIC PICTURE FRAME, VINYL TOTE (U.S. CLS. 2, 5, 22, 23, 29, 37, 38 AND 50).
FIRST USE 8-23-2001; IN COMMERCE 8-23-2001.

SN 78-113,661. RAVO, DAVID, LOS ANGELES, CA. AND RAVO, AARON, LOS ANGELES, CA. FILED 3-8-2002.



FOR CALENDARS, DECALS, NAMELY, APPLIQUES IN THE FORM OF DECALS, PLASTIC PRINTED TRANSFERS, BUMPER AND DECORATIVE STICKERS, TRADING CARDS, FOLDERS, NOTEPADS, NOTEBOOKS AND BINDERS, POSTERS (U.S. CLS. 2, 5, 22, 23, 29, 37, 38 AND 50).

CLASS 16—(Continued).

SN 78-114,533. NORTH AMERICAN MENOPAUSE SOCIETY, THE, MAYFIELD HEIGHTS, OH. FILED 3-13-2002.

CLASS 17—(Continued).

SN 74-590,719. PARAGON FILMS, INC., BROKEN ARROW, OK. FILED 10-26-1994.

FLASHES

FOR NEWSLETTERS DEALING WITH ISSUES RELATING TO MENOPAUSE (U.S. CLS. 2, 5, 22, 23, 29, 37, 38 AND 50).

FIRST USE 6-30-1991; IN COMMERCE 6-30-1991.



SN 78-114,895. MARVEL CHARACTERS, INC., LOS ANGELES, CA. FILED 3-14-2002.

DOUBLE-SHOT

FOR PUBLICATIONS, NAMELY COMIC BOOKS AND COMIC MAGAZINES AND STORIES IN ILLUSTRATED FORM FEATURED IN BOOKS AND MAGAZINES (U.S. CLS. 2, 5, 22, 23, 29, 37, 38 AND 50).

NO CLAIM IS MADE TO THE EXCLUSIVE RIGHT TO USE "WRAP", APART FROM THE MARK AS SHOWN.

FOR PLASTIC MULTI-LAYER FILMS, NAMELY CAST STRETCH FILMS FOR INDUSTRIAL OR COMMERCIAL WRAPPING (U.S. CLS. 1, 5, 12, 13, 35 AND 50).

FIRST USE 8-24-1994; IN COMMERCE 8-24-1994.

SN 75-837,353. ENICHEM UK LIMITED, HYTHE SOUTHAMPTON SO45 3YY, UNITED KINGDOM, FILED 11-1-1999.

INTENE

SN 78-114,916. INTERNATIONAL MASTERS PUBLISHERS AB, MALMO, SWEDEN, FILED 3-14-2002.

INTO THE WILD!

FOR PERIODICAL PUBLICATION ON THE SUBJECT OF ANIMALS AND ANIMAL HABITATS, IN THE NATURE OF A SERIES OF CONTINUITY CARDS AND MAPS FOR INSERTION INTO A BINDER, AND A BINDER FOR USE IN CONNECTION THEREWITH (U.S. CLS. 2, 5, 22, 23, 29, 37, 38 AND 50).

OWNER OF U.S. REG. NO. 882,336.

FOR RAW SYNTHETIC RUBBER FOR USE IN THE MANUFACTURE OF AUTOMOBILE TIRES, BUMPERS AND FASCIAE, AIRPLANE TIRES, RUBBER SEALS AND PIPE SEALS FOR DRAINS AND SEWERS, CONVEYOR BELTS, FLOORING AND FLOOR COVERINGS, NAMELY CARPET UNDERLAYS, SHEETING AND MATTING, GOLF BALLS, TENNIS BALLS, SOLES FOR SHOES AND ATHLETIC SHOES, ADHESIVES, BITUMEN COMPOUNDS FOR ROAD SURFACING AND ROOFING MATERIALS, MACHINERY USED FOR BARK STRIPPING AND ORE GRINDING, PLASTICS (U.S. CLS. 1, 5, 12, 13, 35 AND 50).

SN 75-902,997. LARA REINMANN GMBH, 72379 HECHINGEN, FED REP GERMANY, FILED 1-24-2000.

CLASS 17—RUBBER GOODS

SN 74-590,718. PARAGON FILMS, INC., BROKEN ARROW, OK. FILED 10-26-1994.

LARATAPE**GLOBAL WRAP**

NO CLAIM IS MADE TO THE EXCLUSIVE RIGHT TO USE "WRAP", APART FROM THE MARK AS SHOWN.

FOR PLASTIC MULTI-LAYER FILMS, NAMELY, CAST STRETCH FILMS FOR INDUSTRIAL OR COMMERCIAL WRAPPING (U.S. CLS. 1, 5, 12, 13, 35 AND 50).

FIRST USE 8-24-1994; IN COMMERCE 8-24-1994.

PRIORITY CLAIMED UNDER SEC. 44(D) ON FED REP GERMANY APPLICATION NO. 38943961.7, FILED 7-24-1999, REG. NO. 39943961, DATED 11-22-1999, EXPIRES 7-31-2009.

FOR PLASTIC SHEETS FOR COATING AND INSULATION, CONSISTING ESSENTIALLY OF SINTERED AND NON-SINTERED SHEETS OF PTFE FOR INSULATING CABLES OR WIRES, FOR MANUFACTURING OF CABLES, FOR USE IN THE FIELD OF MEDICINE AND SEALING AND IN THE CLOTHING INDUSTRY (U.S. CLS. 1, 5, 12, 13, 35 AND 50).

CLASS 17—(Continued).

SN 76-036,861. FREETECH PLASTICS, INC., FREMONT, CA. FILED 4-28-2000.

FREETECH

FOR PLASTIC ENCLOSURES, ENCASEMENTS AND INTERNAL ASSEMBLY COMPONENTS IN THE EXTRUDED, MOLDED, FABRICATED AND MACHINED FORM FOR USE IN THE MANUFACTURE OF MEDICAL EQUIPMENT, SCIENTIFIC EQUIPMENT, TELECOMMUNICATIONS EQUIPMENT, COMPUTER EQUIPMENT, FOOD SERVICE EQUIPMENT, TOYS, SPORTING GOODS, AUTOMOTIVE PARTS, AND ELECTRONIC DEVICES (U.S. CLS. 1, 5, 12, 13, 35 AND 50).
FIRST USE 9-23-1980; IN COMMERCE 10-0-1980.

SN 76-076,776. BILTRITE CORPORATION, THE, WALTHAM, MA. FILED 6-26-2000.

SOLEGUARD

SEC. 2(F).
FOR SHEET AND PIECE MATERIALS MADE OF RUBBER AND PLASTIC COMPOSITIONS FOR USE IN MAKING SHOE SOLES (U.S. CLS. 1, 5, 12, 13, 35 AND 50).
FIRST USE 3-20-1981; IN COMMERCE 5-28-1982.

SN 76-210,862. GENERAL ELECTRIC COMPANY, SCHE-NECTADY, NY. FILED 2-15-2001.

FIRST LIGHT

FOR POLYMERIC RESINS IN PELLET OR SHEET FORM THAT PROVIDE AESTHETIC QUALITIES IN THE FINISHED PRODUCTS OF OTHERS (U.S. CLS. 1, 5, 12, 13, 35 AND 50).

SN 76-210,864. GENERAL ELECTRIC COMPANY, SCHE-NECTADY, NY. FILED 2-15-2001.

ARES

FOR POLYMERIC RESINS IN PELLET OR SHEET FORM THAT PROVIDE AESTHETIC QUALITIES IN THE FINISHED PRODUCTS OF OTHERS (U.S. CLS. 1, 5, 12, 13, 35 AND 50).

SN 76-210,865. GENERAL ELECTRIC COMPANY, SCHE-NECTADY, NY. FILED 2-15-2001.

FAHRENHEIT

FOR POLYMERIC RESINS IN PELLET OR SHEET FORM THAT PROVIDE AESTHETIC QUALITIES IN THE FINISHED PRODUCTS OF OTHERS (U.S. CLS. 1, 5, 12, 13, 35 AND 50).

CLASS 17—(Continued).

SN 76-210,867. GENERAL ELECTRIC COMPANY, SCHE-NECTADY, NY. FILED 2-15-2001.

MAKE-UP

FOR POLYMERIC RESINS IN PELLET OR SHEET FORM THAT PROVIDE AESTHETIC QUALITIES IN THE FINISHED PRODUCTS OF OTHERS (U.S. CLS. 1, 5, 12, 13, 35 AND 50).

SN 76-242,574. HUNT HOLDINGS, INC., WILMINGTON, DE. FILED 4-18-2001.

STOPLIGHT

FOR BACKING FILM FOR USE IN LAMINATING APPLICATIONS, NAMELY, CREATING SIGNS, EXHIBITS AND DISPLAYS (U.S. CLS. 1, 5, 12, 13, 35 AND 50).
FIRST USE 3-11-1997; IN COMMERCE 6-3-1998.

SN 76-287,298. TRUSTEE OF THE SCHNEE-MOREHEAD BUSINESS TRUST, A DELAWARE TRUST, THE TRUSTEE COMPRISING ROBERT A. SCHNEE, A U.S. CITIZEN, THE, IRVING, TX. FILED 7-18-2001.

ACRYL SIL

OWNER OF U.S. REG. NO. 859,182.
FOR CAULKING COMPOUND (U.S. CLS. 1, 5, 12, 13, 35 AND 50).

SN 76-293,827. ACOUSTICS FIRST CORPORATION, RICHMOND, VA. FILED 8-2-2001.

TRANSFUSOR

FOR ARCHITECTURAL ACOUSTICAL PRODUCTS, NAMELY, SOUND ABSORBERS AND DIFFUSORS (U.S. CLS. 1, 5, 12, 13, 35 AND 50).

SN 76-313,966. SHINNISSAN DIAMOND KOGYOU KABUSHIKI KAISHA, KANAGAWA-KEN, JAPAN, FILED 9-18-2001.

CEPLA

OWNER OF JAPAN REG. NO. 2252194, DATED 7-30-1990, EXPIRES 7-30-2010.

FOR SEMI-FINISHED PLASTIC SUBSTANCES FOR USE IN INDUSTRIAL PURPOSES (U.S. CLS. 1, 5, 12, 13, 35 AND 50).

CLASS 17—(Continued).

SN 76-317,997. MANCO, INC., AVON, OH. FILED 9-27-2001.

SOCKET SEALERS

SEC. 2(F).
FOR INSULATING FOAM PADS TO BE PLACED UNDER THE COVERS FOR ELECTRIC SOCKETS OR ELECTRIC SWITCHES (U.S. CLS. 1, 5, 12, 13, 35 AND 50).
FIRST USE 3-8-1979; IN COMMERCE 3-8-1979.

SN 76-328,198. KURIYAMA OF AMERICA, INC., ELK GROVE VILLAGE, IL. FILED 10-9-2001.

POLYWIRE

FOR FLEXIBLE PVC VACUUM/TRANSFER HOSES FOR USE IN INDUSTRIAL, WATER, AND VENTILATION APPLICATIONS AND IN THE PREPARATION AND STORAGE OF FOODS AND BEVERAGES (U.S. CLS. 1, 5, 12, 13, 35 AND 50).
FIRST USE 0-0-1974; IN COMMERCE 0-0-1974.

SN 76-328,199. KURIYAMA OF AMERICA, INC., ELK GROVE VILLAGE, IL. FILED 10-9-2001.

POLYSPRING

FOR FLEXIBLE PVC VACUUM/TRANSFER HOSES FOR USE IN INDUSTRIAL, WATER, AND VENTILATION APPLICATIONS AND IN THE PREPARATION AND STORAGE OF FOODS AND BEVERAGES (U.S. CLS. 1, 5, 12, 13, 35 AND 50).
FIRST USE 0-0-1988; IN COMMERCE 0-0-1988.

SN 76-350,400. RAPAC, INC., OAKLAND, TN. FILED 12-20-2001.

PAD LOC

FOR PACKAGING, NAMELY, POLYSTYRENE BEADS IN A BAG (U.S. CLS. 1, 5, 12, 13, 35 AND 50).

SN 76-353,248. BIRMINGHAM, SAMUEL D., BENTON, LA. FILED 12-31-2001.



FOR AIR TRANSFER HOSES FOR TIRES (U.S. CLS. 1, 5, 12, 13, 35 AND 50).

CLASS 17—(Continued).

SN 76-363,882. BEMIS ASSOCIATES, INC., SHIRLEY, MA. FILED 1-25-2002.

CLARENSE

FOR POLYURETHANE FILM USED TO REINFORCE A SEWN SEAM (U.S. CLS. 1, 5, 12, 13, 35 AND 50).

SN 76-363,883. BEMIS ASSOCIATES, INC., SHIRLEY, MA. FILED 1-25-2002.



FOR POLYURETHANE FILM USED TO REINFORCE A SEWN SEAM (U.S. CLS. 1, 5, 12, 13, 35 AND 50).

SN 76-365,048. PRES-ON TAPE AND GASKET, CORPORATION, ADDISON, IL. FILED 1-30-2002.

PRES-ON

OWNER OF U.S. REG. NOS. 729,922 AND 878,452.
FOR PADS, NAMELY, PADDING FOR IMPACT PROTECTION, COMFORT AND FIT COMPOSED OF VINYL FOAM USED IN INDUSTRY, PADS, NAMELY, PADDING FOR IMPACT PROTECTION, COMFORT AND FIT COMPOSED OF POLYURETHANE FOAM USED IN INDUSTRY, PADS, NAMELY, PADDING FOR IMPACT PROTECTION, COMFORT AND FIT COMPOSED OF SPONGE RUBBER USED IN INDUSTRY AND GASKETING TAPE (U.S. CLS. 1, 5, 12, 13, 35 AND 50).
FIRST USE 0-0-1977; IN COMMERCE 0-0-1977.

SN 76-382,425. COOLEY GROUP HOLDINGS, INC., PAWTUCKET, RI. FILED 3-14-2002.

COOLEY H2O

FOR POLYMER SUBSTRATE FOR USE IN THE MANUFACTURE OF SIGNS AND BANNERS (U.S. CLS. 1, 5, 12, 13, 35 AND 50).

CLASS 17—(Continued).

SN 76-383,288. LINEAR PRODUCTS, INC., VANCOUVER, WA. FILED 3-11-2002.

ADALIS

FOR ADHESIVE HOT MELT TAPES, REINFORCING TAPES AND PULL-OPENING TAPES FOR PACKAGING FOR INDUSTRIAL AND COMMERCIAL USE; HEAT ACTIVATED ADHESIVE TAPE FOR COMMERCIAL USE, APPLIED TO THE INSIDE OF CARDBOARD BOXES WITH A STRING-LIKE MATERIAL; ADHESIVE TAPE FOR SEALING CARTONS FOR INDUSTRIAL AND COMMERCIAL USE (U.S. CLS. 1, 5, 12, 13, 35 AND 50).

SN 76-384,018. GREENE, TWEED OF DELAWARE, INC., WILMINGTON, DE. FILED 3-19-2002.

XYFLUOR

FOR NON-METAL GASKETS, O-RINGS, T-RINGS AND TUBING FOR FLUID HANDLING EQUIPMENT AND SEMICONDUCTOR PROCESSING EQUIPMENT (U.S. CLS. 1, 5, 12, 13, 35 AND 50).

SN 76-384,088. LMK ENTERPRISES, INC., OTTAWA, IL. FILED 3-7-2002.

T-LINER

FOR PIPE LINER USED TO RENEW A MAINLINE SECTION OF PIPE AND A LATERAL PIPE (U.S. CLS. 1, 5, 12, 13, 35 AND 50).
FIRST USE 0-0-1998; IN COMMERCE 0-0-1998.

SN 76-384,256. ACQUIRED TECHNOLOGY, INC., ALPHARETTA, GA. FILED 3-12-2002.



FOR PLASTIC FILM FOR USE IN MANUFACTURING (U.S. CLS. 1, 5, 12, 13, 35 AND 50).

CLASS 17—(Continued).

SN 78-050,463. REYNOLDS CONSUMER PRODUCTS, INC., RICHMOND, VA. FILED 2-27-2001.

ROLGARD

FOR PLASTIC STRETCH FILM FOR INDUSTRIAL PACKING USE (U.S. CLS. 1, 5, 12, 13, 35 AND 50).

SN 78-079,737. HANS GROHE AG, SCHILTACH, FED REP GERMANY, FILED 8-17-2001.

TECHNIFLEX

FOR NON-METAL SANITARY HOSES FOR USE IN PLUMBING (U.S. CLS. 1, 5, 12, 13, 35 AND 50).
FIRST USE 5-17-1996; IN COMMERCE 5-17-1996.

CLASS 18—LEATHER GOODS

SN 75-487,057. L.C. INDUSTRIES, LLC, CHICAGO, IL. BY CHANGE OF NAME; BY ASSIGNMENT L.C. INDUSTRIES, INC., CHICAGO, IL. FILED 5-18-1998.

T CLASS

FOR LUGGAGE, NAMELY, BRIEF CASES, DUFFEL BAGS, BACK PACKS, SECURITY WALLETS, SHAVING BAGS SOLD EMPTY, FANNY PACKS, TRAVEL WALLETS CONVERTIBLE SHOULDER BAGS, TIE CASES TRAVEL PACKS, TOILETRY CASES SOLD EMPTY AND LUGGAGE ACCESSORIES, NAMELY, CARRIER BAGS DESIGNED TO TRANSPORT SHIRTS (U.S. CLS. 1, 2, 3, 22 AND 41).

SN 75-595,249. TWENTIETH CENTURY FOX FILM CORPORATION, LOS ANGELES, CA. FILED 11-25-1998.



NO CLAIM IS MADE TO THE EXCLUSIVE RIGHT TO USE "SPORTS", APART FROM THE MARK AS SHOWN.
FOR KNAPSACKS AND BACKPACKS; WALLETS; ALL-PURPOSE SPORTS BAGS, TOTE BAGS, BOOK BAGS, BEACH BAGS; FANNY PACKS (U.S. CLS. 1, 2, 3, 22 AND 41).

CLASS 18—(Continued).

SN 75-910,836. BLITZ U.S.A, INC., MIAMI, OK. FILED 2-7-2000.



OWNER OF U.S. REG. NOS. 906,982, 1,972,304 AND OTHERS.

NO CLAIM IS MADE TO THE EXCLUSIVE RIGHT TO USE "A GENUINE BUILT PRODUCT" AND "PET", APART FROM THE MARK AS SHOWN.

FOR PET CARRIERS (U.S. CLS. 1, 2, 3, 22 AND 41).
FIRST USE 6-0-2000; IN COMMERCE 6-0-2000.

SN 76-103,937. HINDALY, JOHN, CAPITAL FEDERAL, ARGENTINA, FILED 8-4-2000.



PRIORITY CLAIMED UNDER SEC. 44(D) ON ARGENTINA APPLICATION NO. 2286226, FILED 5-12-2000, REG. NO. 286226, DATED 7-24-2001, EXPIRES 7-24-2011.

FOR LEATHER AND IMITATION LEATHER AND GOODS MADE FROM LEATHER OR IMITATION LEATHER, NAMELY, TRUNKS, TRAVEL BAGS, UMBRELLAS, PARASOLS, WHIPS, HARNESSSES AND SADDLES (U.S. CLS. 1, 2, 3, 22 AND 41).

SN 76-127,366. YOUR UNIVERSE L.L.C., WANAMASSA, NJ. FILED 9-13-2000.

DOLLUNIVERSE

FOR TOTE BAGS, (U.S. CLS. 1, 2, 3, 22 AND 41).
FIRST USE 3-0-2000; IN COMMERCE 3-0-2000.

CLASS 18—(Continued).

SN 76-141,444. RUFFO S.P.A., 56030 CALCINAIA (PISA), ITALY, FILED 10-4-2000.

RUFFO

OWNER OF U.S. REG. NOS. 1,306,013 AND 1,795,063.
SEC. 2(F).

FOR ALL PURPOSE ATHLETIC BAGS, ATTACHE CASES, BABY BACK PACKS, CARRY-ON BAGS, CLUTCH BAGS, DUFFEL BAGS, SHOULDER BAGS, TOTE BAGS, GARMENT TRAVEL BAGS, BILLFOLDS, HAT BOXES FOR TRAVEL, HORSE BRIDLES, BRIEFCASES, WALKING CANES, CARD CASES FOR CALLING, BUSINESS AND CREDIT CARDS, KEY CASES, CLUTCH PURSES, COSMETIC CASES SOLD EMPTY, FUR PELTS, HAND BAGS, ANIMAL LEASHES, LUGGAGE, OVERNIGHT CASES MADE OF LEATHER, BACK PACKS, PASSPORT CASES, NAMELY, HOLDERS AND WALLETS, LEATHER GOODS, NAMELY, CASES FOR CARRYING CARDS, BRIEFCASE TYPE PORTFOLIOS, DRAWSTRING AND FELT POUCHES, RUCKSACKS, SADDLES, SUITCASES, TOILETRY CASES SOLD EMPTY, TRUNKS FOR TRAVELING, PATIO AND BEACH UMBRELLAS, VALISES, VANITY CASES SOLD EMPTY, AND WALKING STICKS (U.S. CLS. 1, 2, 3, 22 AND 41).

FIRST USE 0-0-1985; IN COMMERCE 0-0-1985.

SN 76-158,071. LACOSTE ALLIGATOR S.A., CH-1211, GENEVA 3, SWITZERLAND, FILED 11-2-2000.

LACOSTE

OWNER OF U.S. REG. NOS. 879,171, 1,947,111 AND OTHERS.

FOR LUGGAGE; RUCKSACKS; FANNY PACKS; WAIST PACKS; BELT BAGS; BELT POUCHES; TOILETRY CASES SOLD EMPTY; COSMETIC CASES SOLD EMPTY; SHOE BAGS FOR TRAVEL; TOTE BAGS; ALL PURPOSE SPORT BAGS; GYM BAGS; HAND BAGS; SHOULDER BAGS; ATTACHE CASES; BRIEFCASES; BRIEFCASE-TYPE PORTFOLIOS; CASES FOR PORTABLE TELEPHONES; WALLETS; CREDIT CARD CASES; BUSINESS CARD CASES; KEY CASES; PASSPORT CASES; LUGGAGE TAGS (U.S. CLS. 1, 2, 3, 22 AND 41).

SN 76-242,651. OUTKAST, INC., LOS ANGELES, CA. FILED 4-18-2001.

OUTKAST

OWNER OF U.S. REG. NO. 2,246,708.

FOR BACKPACKS, MESSENGER BAGS, HANDBAGS, PURSES, LUGGAGE, ATHLETIC BAGS, TOTE BAGS, TOILETRY CASES SOLD EMPTY, BRIEFCASES, UMBRELLAS, KEY CASES, AND WALLETS (U.S. CLS. 1, 2, 3, 22 AND 41).

CLASS 18—(Continued).

SN 76-254,931. DIANA SPA, 36051 CREAZZO (VICENZA), ITALY, FILED 5-10-2001.

ILARIA NUTI

THE NAME "ILARIA NUTI" IDENTIFIES A LIVING INDIVIDUAL WHOSE CONSENT IS OF RECORD.
 FOR GOODS MADE OF LEATHER AND IMITATION LEATHER, NAMELY ANIMAL SKINS, BARREL BAGS, CLUTCH BAGS, TOTE BAGS, HANDBAGS, SUITCASES, OVERNIGHT CASES, PURSES, RUCKSACKS, BRIEF-CASES, WALLETS, LEATHER KEY-CASES, SHOULDER STRAPS AND HANDLES FOR THE FOREGOING (U.S. CLS. 1, 2, 3, 22 AND 41).

CLASS 18—(Continued).

SN 76-282,162. VIDEOTOURS, INC., PERRYSBURG, OH. FILED 7-9-2001.

JACK HANNA'S ANIMAL ADVENTURES SAFARI TOUGH SAFARI TESTED

THE NAME "JACK HANNA" IDENTIFIES A LIVING INDIVIDUAL WHOSE CONSENT IS OF RECORD.
 FOR LUGGAGE (U.S. CLS. 1, 2, 3, 22 AND 41).

SN 76-256,972. HADLOCK & FOX MANUFACTURING CO., NEW BRAUNFELS, TX. FILED 5-15-2001.

BRETTON

FOR SADDLES AND HORSE BLANKETS CUSTOM FITTED TO A HORSE (U.S. CLS. 1, 2, 3, 22 AND 41).

SN 76-289,007. TUSCHMAN, PAULA W., TOLEDO, OH. FILED 7-20-2001.

SOMETHING HAS CAUGHT YOUR EYE VINTAGEPIECES JUST FOR YOU. PAULA W.

OWNER OF U.S. REG. NO. 2,536,525.
 NO CLAIM IS MADE TO THE EXCLUSIVE RIGHT TO USE "VINTAGE PIECES", APART FROM THE MARK AS SHOWN.
 FOR PURSES AND HANDBAGS (U.S. CLS. 1, 2, 3, 22 AND 41).
 FIRST USE 7-1-2001; IN COMMERCE 7-1-2001.

SN 76-263,190. ELIZABETH LANGE, LLC, NEW YORK, NY. FILED 5-29-2001.



OWNER OF U.S. REG. NO. 2,360,437.
 THE NAME "LIZ LANGE" IDENTIFIES A LIVING INDIVIDUAL WHOSE CONSENT IS OF RECORD.
 FOR BAGS, NAMELY DIAPER TOTES (U.S. CLS. 1, 2, 3, 22 AND 41).
 FIRST USE 3-0-2000; IN COMMERCE 3-0-2000.

SN 76-292,416. DEAN, LEROY, CHARLOTTE, NC. FILED 7-30-2001.

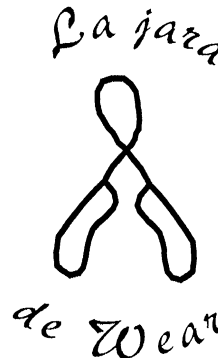

SN 76-263,191. ELIZABETH LANGE, LLC, NEW YORK, NY. FILED 5-29-2001.

LIZ LANGE

OWNER OF U.S. REG. NO. 2,360,437.
 THE NAME "LIZ LANGE" IDENTIFIES A LIVING INDIVIDUAL WHOSE CONSENT IS OF RECORD.
 FOR BAGS, NAMELY, DIAPER TOTES (U.S. CLS. 1, 2, 3, 22 AND 41).
 FIRST USE 3-0-2000; IN COMMERCE 3-0-2000.

NO CLAIM IS MADE TO THE EXCLUSIVE RIGHT TO USE "WEAR", APART FROM THE MARK AS SHOWN.
 THE MARK IS DESCRIBED AS A DESIGN OF LOOP WITH IRREGULAR OVALS AT EITHER END. THE MARK IS AN ARBITRARY STYLIZED DESIGN THAT DOES NOT REFLECT ANY FOOTWEAR.
 FOR SHOE BAG FOR TRAVEL (U.S. CLS. 1, 2, 3, 22 AND 41).

CLASS 18—(Continued).

SN 76-296,287. SIMMONS, RUSSELL, NEW YORK, NY. FILED 8-7-2001.

PREMIUM COLLECTION BY RUSSELL SIMMONS

OWNER OF U.S. REG. NOS. 2,385,227 AND 2,391,293.
NO CLAIM IS MADE TO THE EXCLUSIVE RIGHT TO USE "PREMIUM COLLECTION BY", APART FROM THE MARK AS SHOWN.

FOR BACKPACKS, MESSENGER BAGS, ATHLETIC BAGS, TOTE BAGS, UMBRELLAS, WALLETS, PURSES, COIN PURSES, KEY CASES, CREDIT CARD CASES (U.S. CLS. 1, 2, 3, 22 AND 41).

SN 76-305,690. PARK, HYUN, LOS ANELES, CA. FILED 8-27-2001.

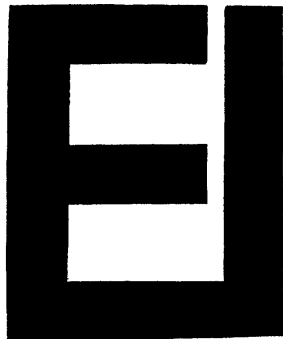

FOR BAGS NAMELY, HANDBAGS, PURSES, WALLETS, AND TOTE BAGS (U.S. CLS. 1, 2, 3, 22 AND 41).

SN 76-332,109. HERCULES LUGGAGE INC., NEW YORK, NY. FILED 10-29-2001.

Hercules

FOR BACKPACKS, TRAVEL BAGS, GARMENT BAGS, BRIEF BAGS, DUFFEL BAGS, LUGGAGE, ALL-PURPOSE SPORTS BAGS, ALL-PURPOSE ATHLETIC BAGS, ATHLETIC BAGS, CARRY-ON-BAGS, AND GYM BAGS (U.S. CLS. 1, 2, 3, 22 AND 41).

FIRST USE 6-1-1978; IN COMMERCE 6-1-1978.

CLASS 18—(Continued).

SN 76-337,425. MONARCH LUGGAGE CO., INC., NEW YORK, NY. FILED 11-13-2001.

SPORTIF

THE ENGLISH TRANSLATION OF "SPORTIF" IS "SPORTY".

FOR LUGGAGE, DUFFEL BAGS, TOTE BAGS, TRAVEL KITS IN THE NATURE OF TRAVEL AND TOILETRY CASES AND BAGS SOLD EMPTY, BACKPACKS, WALLETS, PURSES, HANDBAGS, ATTACHE CASES, WAIST PACKS, ALL PURPOSE SPORTS BAGS, SUITCASES, TOILETRY CASES SOLD EMPTY, BRIEF CASES, SHOULDER BAGS, GARMENT BAGS FOR TRAVEL, ROLL BAGS, LUGGAGE ON WHEELS, CARRY ON BAGS AND LUGGAGE ENSEMBLES CONSISTING OF THE AFOREMENTIONED LUGGAGE AND BAGS (U.S. CLS. 1, 2, 3, 22 AND 41).

FIRST USE 0-0-1991; IN COMMERCE 0-0-1991.

SN 76-339,665. HORSEWARE PRODUCTS LTD., COUNTY LOUTH, IRELAND, FILED 11-20-2001.

HANDY PAD

NO CLAIM IS MADE TO THE EXCLUSIVE RIGHT TO USE "PAD", APART FROM THE MARK AS SHOWN.

FOR HARNESS AND SADDLERY; HORSE BLANKETS AND COVERS; SADDLE COVERS, SADDLE PADS, NUMNAHS, SURCINGLES; HORSE TRAVELLING BOOTS AND HORSE LEG PROTECTIVE BOOTS, NAMELY, WRAP-AROUND PROTECTIVE LEG PADS MADE OF SYNTHETIC FABRICS FOR COVERING THE LOWER LEGS OF A HORSE DURING TRAVEL (U.S. CLS. 1, 2, 3, 22 AND 41).

SN 76-353,827. SASHA HANDBAGS, INC., NEW YORK, NY. FILED 12-31-2001.

PERFECT 4 PROM

FOR ANIMAL SKINS AND HIDES, IMITATION ANIMAL SKINS AND HIDES, LEATHER AND IMITATION LEATHER ALL FOR USE IN THE MANUFACTURE OF ATHLETIC BAGS, SHOES BAGS FOR TRAVEL, UMBRELLAS, OVERNIGHT BAGS, TOTE BAGS, DUFFEL BAGS, LUGGAGE, VALISES, ATTACHE CASES, WALLETS, BRIEFCASES, BOOK BAGS, PURSES, FANNY PACKS, WAIST PACKS, COSMETIC CASES SOLD EMPTY, KNAPSACKS, SUITCASES, TOILETRY CASES SOLD EMPTY, TRUNKS FOR TRAVELING, BUSINESS CARD CASES, ALL-PURPOSE SPORT BAGS, CABIN BAGS, WEEKENDER BAGS, SHOPPING BAGS, AND BAGS AND POUCHES FOR MERCHANDISE PACKAGING (U.S. CLS. 1, 2, 3, 22 AND 41).

FIRST USE 10-0-2001; IN COMMERCE 10-0-2001.

CLASS 18—(Continued).

SN 76-356,205. CHARLOTTE RUSSE MERCHANDISING, INC., SAN DIEGO, CA. FILED 1-7-2002.

refuge.

FOR PURSES, HANDBAGS, BACKPACKS, FANNY PACKS, TOTE BAGS, COSMETIC CASES SOLD EMPTY, TOILETRY CASES SOLD EMPTY, COIN PURSES, WALLET AND BELTS (U.S. CLS. 1, 2, 3, 22 AND 41).

SN 76-364,687. YANG, ROGER, CITY OF INDUSTRY, CA. FILED 1-29-2002.

PACSPORTS

FOR LUGGAGE, INCLUDING SUITCASES, TRAVEL BAGS, GARMENT BAGS, OVERNIGHT BAGS, ROLL BAGS, TOILETRY CASES SOLD EMPTY, COSMETIC BAGS SOLD EMPTY; ALL-PURPOSE UTILITY BAGS, INCLUDING BACKPACKS, KNAPSACKS, SHOULDER BAGS, TOTE BAGS, DUFFEL BAGS, FANNY PACKS, CLUTCHES; ALL-PURPOSE SPORT BAGS, INCLUDING GYM BAGS, SPORTS EQUIPMENT BAGS, BEACH BAGS; BRIEFCASES; HANDBAGS (U.S. CLS. 1, 2, 3, 22 AND 41).

SN 76-364,688. YANG, ROGER, CITY OF INDUSTRY, CA. FILED 1-29-2002.

TRAVELAIDE

FOR LUGGAGE, INCLUDING SUITCASES, TRAVEL BAGS, GARMENT BAGS, OVERNIGHT BAGS, ROLL BAGS, TOILETRY CASES SOLD EMPTY, COSMETIC BAGS SOLD EMPTY; ALL-PURPOSE UTILITY BAGS, INCLUDING BACKPACKS, KNAPSACKS, SHOULDER BAGS, TOTE BAGS, DUFFEL BAGS, FANNY PACKS, CLUTCHES; ALL-PURPOSE SPORT BAGS, INCLUDING GYM BAGS, SPORTS EQUIPMENT BAGS, BEACH BAGS; BRIEFCASES; HANDBAGS (U.S. CLS. 1, 2, 3, 22 AND 41).

SN 76-368,246. BOLLE, INC., OVERLAND PARK, KS. FILED 2-8-2002.

BOLLE

SEC. 2(F).
FOR TRAVELING BAGS, BRIEFCASES, BACK PACKS, LUGGAGE (U.S. CLS. 1, 2, 3, 22 AND 41).
FIRST USE 1-1-1988; IN COMMERCE 1-1-1988.

CLASS 18—(Continued).

SN 76-370,502. T.F.H. PUBLICATIONS, INC., NEPTUNE CITY, NJ. FILED 2-12-2002.

NYLABONE DENTAL CHEW

OWNER OF U.S. REG. NOS. 1,170,441 AND 2,143,584.
NO CLAIM IS MADE TO THE EXCLUSIVE RIGHT TO USE "DENTAL CHEW", APART FROM THE MARK AS SHOWN.

FOR NON-EDIBLE CHEW FOR DOGS (U.S. CLS. 1, 2, 3, 22 AND 41).

SN 76-379,031. ACCESSORY NETWORK GROUP, INC., NEW YORK, NY. FILED 3-5-2002.

RUGGED FOR LIFE

FOR TRAVEL BAGS, TOTE BAGS, BACKPACKS, KNAPSACKS, DUFFLE BAGS, BELT BAGS, ROLL BAGS, BOOK BAGS, HANDBAGS, GYM BAGS, OVERNIGHT BAGS, MESSENGER BAGS AND ATTACHES (U.S. CLS. 1, 2, 3, 22 AND 41).

SN 76-382,287. ANTHONY CAPUTO, LLC, BRIDGEHAMPTON, NY. FILED 3-14-2002.

ANTHONY CAPUTO

THE MARK IDENTIFIES THE NAME OF A LIVING INDIVIDUAL WHOSE CONSENT IS OF RECORD.

FOR ALL-PURPOSE SPORTS AND ATHLETIC BAGS, FANNY PACKS, BACKPACKS, KNAPSACKS, SPORTS PACKS, WAIST PACKS, GYM BAGS, DUFFEL BAGS, TOTE BAGS, BOOK BAGS, HAND BAGS, PURSES, CLUTCH PURSES, CHANGE PURSES, SHOULDER BAGS, CARRY-ON BAGS, TRAVEL BAGS, GARMENT BAGS FOR TRAVEL, BEACH BAGS, SATCHELS, LUGGAGE, LUGGAGE TAGS, TRUNKS, SUITCASES, COSMETIC CASES SOLD EMPTY, TOILETRY CASES SOLD EMPTY, VANITY CASES SOLD EMPTY, COSMETIC BAGS SOLD EMPTY, TOOL BAGS SOLD EMPTY, ATTACHE CASES, BRIEF CASES, BRIEF-CASE TYPE PORTFOLIOS, MEN'S CLUTCHES, BUSINESS CASES, BUSINESS CARD CASES, CREDIT CARD CASES, CALLING CARD CASES, PASSPORT CASES AND HOLDERS, KEY CASES, COIN POUCHES, WALLETS, BILLFOLDS, UMBRELLAS AND PARASOLS (U.S. CLS. 1, 2, 3, 22 AND 41).

SN 78-072,067. CARDAMON, CHERYL, SAN JOSE, CA. FILED 7-2-2001.

ISLAND DOG

NO CLAIM IS MADE TO THE EXCLUSIVE RIGHT TO USE "DOG", APART FROM THE MARK AS SHOWN.
FOR COLLARS, LEASHES, HARNESSES AND CLOTHING FOR DOGS (U.S. CLS. 1, 2, 3, 22 AND 41).

CLASS 18—(Continued).

SN 78-079,695. ANJALI KUMAR, INC., NEW YORK, NY.
FILED 8-16-2001.

ANJALI KUMAR

FOR PURSES AND HANDBAGS (U.S. CLS. 1, 2, 3, 22
AND 41).
FIRST USE 11-10-1999; IN COMMERCE 11-10-1999.

SN 78-083,738. BROGAN, TINA MARIE, LUBBOCK, TX.
FILED 9-13-2001.

**STORY TIME SNUGGLE
SACK**

NO CLAIM IS MADE TO THE EXCLUSIVE RIGHT TO
USE "SACK", APART FROM THE MARK AS SHOWN.
FOR BOOK SACK WITH QUILT AND A BOOK LIST,
ALL SOLD AS A UNIT (U.S. CLS. 1, 2, 3, 22 AND 41).

SN 78-101,186. NATURAL WORLD DEVELOPMENT LIM-
ITED, KOWLOON, HONG KONG, HONG KONG, FILED
1-7-2002.



THE MARK CONSISTS OF TWO CURVE LINES FORM-
ING THE LETTER "N" IN FRONT OF THE WORD "AT-
WOOD" WITH A CURVE LINE ABOVE THE STYLIZED
WORD "NATWOOD".

FOR HANDBAGS, SHOULDER BAGS, ALL PURPOSE
SPORT BAGS, BACKPACKS, WALLETS, KEYCASES,
BRIEFCASES, ATTACHE CASES, TRAVELLING
TRUNKS, LUGGAGE, GARMENT BAGS FOR TRAVEL-
LING, UMBRELLAS (U.S. CLS. 1, 2, 3, 22 AND 41).

SN 78-108,699. SARA LEE CORPORATION, WINSTON-
SALEM, NC. FILED 2-14-2002.

L'EGGS

OWNER OF U.S. REG. NOS. 891,626, 1,269,999 AND
1,755,430.
FOR PURSES (U.S. CLS. 1, 2, 3, 22 AND 41).

**CLASS 19—NON-METALLIC BUILDING MA-
TERIALS**

SN 75-823,329. LATHAM PLASTICS, INC., LATHAM, NY. BY
ASSIGNMENT COOKSON PLASTIC MOLDING CORP.,
LATHAM, NY. FILED 10-14-1999.

PERFORMANCE STEPS

NO CLAIM IS MADE TO THE EXCLUSIVE RIGHT TO
USE "STEPS", APART FROM THE MARK AS SHOWN.
FOR NON-METALLIC, MOLDED PLASTIC SWIM-
MING POOL STEPS (U.S. CLS. 1, 12, 33 AND 50).
FIRST USE 1-0-1985; IN COMMERCE 1-0-1985.

SN 75-830,040. CRANE PLASTICS COMPANY LIMITED
PARTNERSHIP, COLUMBUS, OH. FILED 11-9-1999.

DRYSPACE

FOR NON-METALLIC BUILDING MATERIALS,
NAMELY, DRAINAGE SYSTEM FOR DECKS COM-
PRISED OF NON-METALLIC PANELS AND FASTEN-
ING CLIPS (U.S. CLS. 1, 12, 33 AND 50).

SN 76-097,947. ECB-ROCHAS ORNAMENTAIS DO BRASIL
LTDA., PIAUI, BRAZIL, FILED 7-27-2000.

MORISCA

FOR SANDSTONE USED FOR PAVING AND WALL
CLADDING IN THE CONSTRUCTION INDUSTRY (U.S.
CLS. 1, 12, 33 AND 50).
FIRST USE 7-13-1998; IN COMMERCE 7-13-1998.

SN 76-116,117. UNITED RESOURCE TECHNOLOGIES, INC.,
HAMERSVILLE, OH. FILED 8-24-2000.

CERMAXX

FOR SOLID SURFACE CERAMIC MATRIX NON-
STRUCTURAL BUILDING MATERIAL SOLD AS A
COMPONENT OF PRE-FORMED VANITY TOPS AND
VANITY TOPS WITH INTEGRATED BOWLS (U.S. CLS.
1, 12, 33 AND 50).
FIRST USE 12-30-1999; IN COMMERCE 12-30-1999.

SN 76-124,573. VIKING POOLS, INC., MIDLAND, TX. FILED
9-8-2000.

WWW.VIKINGPOOLS.NET

FOR NON-METAL SWIMMING POOLS; AND CON-
STRUCTION MATERIALS USED FOR SWIMMING
POOL CONSTRUCTION OF SWIMMING POOLS,
NAMELY TILE, PLASTER, CONCRETE, AND COMPO-
SITES (U.S. CLS. 1, 12, 33 AND 50).
FIRST USE 0-0-1998; IN COMMERCE 0-0-1998.

CLASS 19—(Continued).

SN 76-130,795. RICHVALE YORK BLOCK INC., GORMLEY, ONTARIO, CANADA, FILED 8-29-2000.

RICHVALE YORK

PRIORITY CLAIMED UNDER SEC. 44(D) ON CANADA APPLICATION NO. 1066569, FILED 7-11-2000, REG. NO. TMA561878, DATED 5-13-2002, EXPIRES 5-13-2017.
FOR CONCRETE BLOCKS (U.S. CLS. 1, 12, 33 AND 50).

SN 76-131,071. FERNANDO DIAGO PINON, S.L., CASTELLON, SPAIN, FILED 9-15-2000.

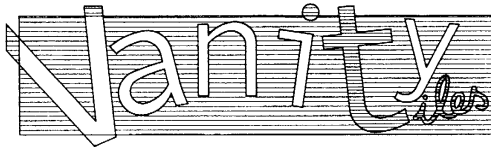

THE DRAWING IS LINED FOR THE COLOR BLUE AND COLOR IS CLAIMED AS A FEATURE OF THE MARK. THE RECTANGULAR BACKGROUND IS LIGHT BLUE AND THE WORD "TILES" IS IN DARK BLUE.

FOR CERAMIC BUILDING MATERIALS, NAMELY, CERAMIC WALL TILES, CERAMIC FLOOR TILES (U.S. CLS. 1, 12, 33 AND 50).

SN 76-143,283. G.H. COOK LUMBER CO., INC., DOWAGIAC, MI. FILED 10-10-2000.

APPALACHIAN DOOR

NO CLAIM IS MADE TO THE EXCLUSIVE RIGHT TO USE "DOOR", APART FROM THE MARK AS SHOWN.
SEC. 2(F).

FOR NON-METAL DOORS (U.S. CLS. 1, 12, 33 AND 50).

FIRST USE 3-0-1997; IN COMMERCE 3-0-1997.

SN 76-161,870. KRONOSPAN AG, SWITZERLAND, FILED 11-8-2000.

SWISS EDGING TAPE
by kronoswiss

PRIORITY CLAIMED UNDER SEC. 44(D) ON SWITZERLAND APPLICATION NO. 09097-2000, FILED 9-14-2000, REG. NO. 481328, DATED 2-18-2002, EXPIRES 9-14-2010.

NO CLAIM IS MADE TO THE EXCLUSIVE RIGHT TO USE "SWISS EDGING TAPE", APART FROM THE MARK AS SHOWN.

FOR LAMINATED WOOD PANELS (U.S. CLS. 1, 12, 33 AND 50).

CLASS 19—(Continued).

SN 76-177,784. WEYERHAEUSER COMPANY, FEDERAL WAY, WA. FILED 12-8-2000.

**CEDARONE PERFORMANCE
KNOTTY**

NO CLAIM IS MADE TO THE EXCLUSIVE RIGHT TO USE "KNOTTY", APART FROM THE MARK AS SHOWN.

FOR NON-METALLIC BUILDING MATERIALS, NAMELY, WOOD SIDING, LUMBER FOR DECKING, WOOD POSTS AND EXTERIOR TRIM (U.S. CLS. 1, 12, 33 AND 50).

SN 76-200,866. JAMES HARDIE RESEARCH PTY LIMITED, NEW SOUTH WALES 2142, AUSTRALIA, FILED 1-25-2001.

HARDIE WEATHERBOARD

OWNER OF U.S. REG. NOS. 1,545,068, 1,664,138 AND OTHERS.

NO CLAIM IS MADE TO THE EXCLUSIVE RIGHT TO USE "WEATHERBOARD", APART FROM THE MARK AS SHOWN.

FOR FIBER-CEMENT BUILDING PRODUCTS, NAMELY, PLANKS, BOARDS, SHEETS, PANELS, SOFFITS, UNDERLAYMENT, AND TRIM (U.S. CLS. 1, 12, 33 AND 50).

SN 76-225,201. VECCHIO, FRANCO, SHERMAN OAKS, CA. FILED 3-2-2001.



NO CLAIM IS MADE TO THE EXCLUSIVE RIGHT TO USE "HANDPRINTS", APART FROM THE MARK AS SHOWN.

FOR CEMENT BASED WALL HANGING PANEL IN MULTIPLE SIZES WITHIN WHICH AN INDIVIDUAL ACTUAL HANDPRINT AND SIGNATURE IS IMPRINTED BY USE OF PRESSURE (U.S. CLS. 1, 12, 33 AND 50).

FIRST USE 3-1-1999; IN COMMERCE 3-1-1999.

SN 76-246,986. DESIGN VENTURES, INC., ROCKY RIVER, OH. FILED 4-26-2001.

BRITE STRIPE

FOR NON-METAL DECORATIVE TRIM AND MOLDING (U.S. CLS. 1, 12, 33 AND 50).

CLASS 19—(Continued).

SN 76-264,090. ELKEM ASA, 0377 OSLO, NORWAY, FILED 5-30-2001.

ELKEM MULTIGROUT

PRIORITY CLAIMED UNDER SEC. 44(D) ON NORWAY APPLICATION NO. 200106158, FILED 5-14-2001, REG. NO. 212383, DATED 12-13-2001, EXPIRES 12-13-2011.

OWNER OF U.S. REG. NOS. 438,894, 1,921,331 AND 2,411,847.

FOR CEMENT-BASED INJECTION GROUTS FOR SOILS AND TUNNELS (U.S. CLS. 1, 12, 33 AND 50).

SN 76-272,888. ROYAL GROUP TECHNOLOGIES LIMITED, VAUGHAN, ONTARIO, CANADA, FILED 6-14-2001.

RBS DIRECT

FOR STRUCTURAL COMPONENTS OF EXTRUDED PLASTIC, NAMELY, WALL FORMING PANELS, BOX CONNECTORS, ROOF PANELS, RIDGE BEAMS, GABLE MEMBERS, LINTELS, AND WALL FORMING PANELS AND BOX CONNECTORS WHICH FORM CONCRETE RECEIVING FORMS (U.S. CLS. 1, 12, 33 AND 50).

SN 76-276,880. LEE MASONRY PRODUCTS, LLC, BOWLING GREEN, KY. FILED 6-26-2001.

ARMORTURF

OWNER OF U.S. REG. NOS. 1,352,839 AND 1,361,927.
FOR INTERLOCKING PAVING STONE WITH OPEN AREAS TO ALLOW FOR DRAINAGE AND VEGETATION GROWTH (U.S. CLS. 1, 12, 33 AND 50).

SN 76-279,843. CDS MANUFACTURING, INC., QUINCY, FL. FILED 7-3-2001.

CDS CAST STONE

NO CLAIM IS MADE TO THE EXCLUSIVE RIGHT TO USE "CAST STONE", APART FROM THE MARK AS SHOWN.

FOR BUILDING MATERIALS, NAMELY, ARTIFICIAL MOLDED STONE WHICH SIMULATES NATURAL CUT LIMESTONE, CORAL, SANDSTONE, TRAVERTINE, COQUINA, AND DOLOMITE, AND IS COMPOSED OF NATURAL MINERALS AND FIBERS WHICH ARE FORMED INTO PRODUCTS SUCH AS WALL PANELS, CROWN AND BASE MOLDINGS, AND A VARIETY OF DECORATIVE AND ARCHITECTURAL ELEMENTS (U.S. CLS. 1, 12, 33 AND 50).

FIRST USE 9-0-1999; IN COMMERCE 9-0-1999.

CLASS 19—(Continued).

SN 76-293,488. JOEL BERMAN GLASS STUDIOS INTL. LTD., VANCOUVER, BRITISH COLUMBIA, CANADA, FILED 7-31-2001.

Tactiles

FOR GLASS TILES FOR USE IN KITCHENS, BATHROOMS, SHOWERS, BACKSPLASHES, FIREPLACES, FLOORING, STAIR TREADS AND COUNTERTOPS (U.S. CLS. 1, 12, 33 AND 50).

FIRST USE 5-0-1998; IN COMMERCE 7-0-1999.

SN 76-298,464. ARCHITECTURAL SYSTEMS, INC., NEW YORK, NY. FILED 8-1-2001.

SPACE ELEMENTS

FOR FANCY FLOORS TILES MADE OF VINYL (U.S. CLS. 1, 12, 33 AND 50).

SN 76-308,308. RIMNETICS, INC., MOUNTAIN VIEW, CA. FILED 8-31-2001.

RIMWOOD

FOR POLYURETHANE WOOD SUBSTITUTE, IN THE NATURE OF MILLWORK, MADE THROUGH A REACTION INJECTION MOLDING PROCESS DESIGNED TO IMPART THERMAL INSULATION AND NON-ROTTING QUALITIES (U.S. CLS. 1, 12, 33 AND 50).

SN 76-324,064. YORK AG PRODUCTS, INC., YORK, PA. FILED 10-12-2001.

DIVOT ERASER

NO CLAIM IS MADE TO THE EXCLUSIVE RIGHT TO USE "DIVOT", APART FROM THE MARK AS SHOWN.
FOR SILICA SAND MIXED WITH GRASS SEED AND FERTILIZER (U.S. CLS. 1, 12, 33 AND 50).

FIRST USE 6-0-2001; IN COMMERCE 6-0-2001.

SN 76-344,032. AMERIFLOOR TECHNICAL, INC., SAN DIEGO, CA. FILED 12-3-2001.

FRESCOCRETE

FOR CONCRETE FLOORING (U.S. CLS. 1, 12, 33 AND 50).

CLASS 19—(Continued).

SN 76-347,442. LITTLE, STEVIN, FRESNO, CA. FILED 12-12-2001.



NO CLAIM IS MADE TO THE EXCLUSIVE RIGHT TO USE "THE ULTIMATE BUNKER SYSTEM", APART FROM THE MARK AS SHOWN.

FOR WALL PANELS NOT OF METAL, NAMELY, COATED FOAM WALL PANELS OF VARIOUS SIZES (U.S. CLS. 1, 12, 33 AND 50).

SN 76-351,083. CHARAH ENVIRONMENTAL, INC., MADISONVILLE, KY. FILED 12-20-2001.

PRICELITE

FOR AGGREGATE, NAMELY COAL COMBUSTION PRODUCTS, FOR CONCRETE MANUFACTURE AND LANDSCAPING (U.S. CLS. 1, 12, 33 AND 50).

SN 76-353,994. CITADEL ARCHITECTURAL PRODUCTS, INC., INDIANAPOLIS, IN. FILED 12-14-2001.

SINOCORE

FOR ARCHITECTURAL WALL PANELS FOR EXTERIOR AND INTERIOR USE WITH A CORE PRIMARILY COMPOSED OF NON-METALLIC MATERIAL AND WITH A METAL FACING (U.S. CLS. 1, 12, 33 AND 50).
FIRST USE 4-0-1997; IN COMMERCE 4-0-1997.

SN 76-363,429. WHITE RIVER HARDWOODS-WOODWORKS, INC., FAYETTEVILLE, AR. FILED 1-29-2002.

MARBLEWOOD

FOR WOOD, WOOD COMPOSITE AND RESIN PRODUCTS FOR INTERIOR TRIM, MOULDINGS AND ACCESSORIES, NAMELY, SMOOTH AND DECORATIVELY EMBOSSED MOULDINGS, PLINTH BLOCKS, ROSETTES, APPLIQUES, KEYSTONES, CORNER BLOCKS AND CORBELS, ALL MADE OF MEDIUM DENSITY FIBERBOARD; SMOOTH AND DECORATIVELY EMBOSSED HARDWOOD MOULDINGS, MACHINE AND HAND-CARVED WOOD PLINTH BLOCKS, WOOD ROSETTES, WOOD APPLIQUES, WOOD CORBELS, WOOD KEYSTONES AND WOOD CORNER BLOCKS; SCULPTURED WOOD FIBER/RESIN COMPOSITION OVERLAY ON WOOD MOULDINGS OR WOOD PRODUCTS SUBSTRATE, RESIN PLINTH BLOCKS, RESIN ROSETTES, RESIN KEYSTONES, RESIN CORNER BLOCKS, RESIN APPLIQUES, RESIN CORBELS AND RESIN MOULDINGS (U.S. CLS. 1, 12, 33 AND 50).

CLASS 19—(Continued).

SN 76-363,451. MARTIN STONE QUARRIES, INC., BECHTELSTVILLE, PA. FILED 1-28-2002.

MARTIN INFIELD MIX

NO CLAIM IS MADE TO THE EXCLUSIVE RIGHT TO USE "INFIELD MIX", APART FROM THE MARK AS SHOWN.

FOR MIXTURE OF CLAY, SAND, LOAM, TOPSOIL AND STONE FOR USE ON BASEBALL AND OTHER ATHLETIC FIELDS (U.S. CLS. 1, 12, 33 AND 50).

FIRST USE 3-21-1985; IN COMMERCE 3-21-1985.

SN 76-367,141. MARLEY MOULDINGS LIMITED, MARION, VA. FILED 2-6-2002.

HOME IS YOUR BEST INVESTMENT

FOR PLASTIC MOULDINGS FOR BUILDING PURPOSES, PLASTIC MILLWORK EXCLUSIVE OF CABINETS; AND NON-METAL WINDOWS (U.S. CLS. 1, 12, 33 AND 50).

SN 76-367,142. MARLEY MOULDINGS LIMITED, MARION, VA. FILED 2-6-2002.

HOME IS YOUR SAFEST INVESTMENT

FOR PLASTIC MOULDINGS FOR BUILDING PURPOSES, PLASTIC MILLWORK EXCLUSIVE OF CABINETS; AND NON-METAL WINDOWS (U.S. CLS. 1, 12, 33 AND 50).

SN 76-367,397. CENTEX CORPORATION, DALLAS, TX. FILED 2-4-2002.

VILLAGER

FOR PREFABRICATED RESIDENTIAL AND COMMERCIAL BUILDINGS MANUFACTURED OF A COMBINATION OF PRIMARILY NON-METAL MATERIALS (U.S. CLS. 1, 12, 33 AND 50).

FIRST USE 1-7-1996; IN COMMERCE 1-7-1996.

SN 76-386,858. VERCERAM CO., L.L.C., THE, SEGUIN, TX. FILED 3-22-2002.

VERCERART

OWNER OF U.S. REG. NO. 2,585,198.
FOR NON-METAL ARCHITECTURAL CLADDING FOR CONSTRUCTION AND BUILDING (U.S. CLS. 1, 12, 33 AND 50).

CLASS 19—(Continued).

SN 76-388,824. UNIVERSAL STONE, INC., BETHLEHEM, PA.
FILED 3-27-2002.

VILLAGE  ROCK

NO CLAIM IS MADE TO THE EXCLUSIVE RIGHT TO
USE "ROCK", APART FROM THE MARK AS SHOWN.

FOR PRECAST SYNTHETIC STONE VENEER SIDING
FOR COMMERCIAL AND RESIDENTIAL BUILDINGS
(U.S. CLS. 1, 12, 33 AND 50).

FIRST USE 3-5-2002; IN COMMERCE 3-5-2002.

SN 76-390,663. MIDWEST PADDING, L.L.C., NORFOLK, NE.
FILED 4-2-2002.

NATURSTONE

FOR NON-METAL FLOOR TILES (U.S. CLS. 1, 12, 33
AND 50).

SN 76-391,889. TNEMEC COMPANY, INC., KANSAS CITY,
MO. FILED 4-4-2002.

U-TREAD

FOR CEMENTITIOUS URETHANE USED FOR RE-
PAIR AND RESURFACING OF CONCRETE FLOORS
(U.S. CLS. 1, 12, 33 AND 50).

SN 76-393,891. FAUX EFFICIENT, INC., EFFINGHAM, IL.
FILED 4-11-2002.

TUSCAN JEWEL

FOR FULL LINE OF COLORED PLASTERS (U.S. CLS.
1, 12, 33 AND 50).

SN 78-067,440. CERTAINTTEED CORPORATION, VALLEY
FORGE, PA. FILED 6-5-2001.

SYMMETRY

FOR NON-METAL FENCE PANELS, POSTS AND
RAILS FOR FENCES, RAILINGS, DECKS AND GAR-
DEN ACCENTS FOR RESIDENTIAL AND COMMER-
CIAL USE (U.S. CLS. 1, 12, 33 AND 50).

CLASS 19—(Continued).

SN 78-071,202. INTERNATIONAL PAPER COMPANY,
STAMFORD, CT. FILED 6-27-2001.

DAVINCI CLASSIC DECKING

NO CLAIM IS MADE TO THE EXCLUSIVE RIGHT TO
USE "CLASSIC DECKING", APART FROM THE MARK AS
SHOWN.

FOR NON-METALLIC BUILDING MATERIALS,
NAMELY COMPOSITE WOOD AND PLASTIC MOLDED
PRODUCTS, NAMELY, BOARDS, BALUSTERS, RAILS,
POSTS, PLANKS, DECKING FOR USE IN THE CON-
STRUCTION OF DECKS (U.S. CLS. 1, 12, 33 AND 50).

SN 78-081,247. TRUSTONE AMERICA, INC., PROVIDENCE,
RI. FILED 8-27-2001.



NO CLAIM IS MADE TO THE EXCLUSIVE RIGHT TO
USE "AMERICA", APART FROM THE MARK AS SHOWN.

FOR AERATED AUTOCLAVED CONCRETE BLOCKS
(U.S. CLS. 1, 12, 33 AND 50).

FIRST USE 0-0-1996; IN COMMERCE 0-0-1996.

SN 78-088,039. LOV NOTES, TACOMA, WA. FILED 10-11-
2001.



FOR HEART-SHAPED GRAVE MARKERS OF STONE,
CONCRETE, OR MARBLE (U.S. CLS. 1, 12, 33 AND 50).

SN 78-107,210. INTERPANE GLASS COMPANY, CLINTON,
NC. FILED 2-6-2002.

VARI-TRAN

FOR VACUUM COATED FLAT GLASS AND CURVED
GLASS, LAMINATED GLASS, AND MULTIPLE SHEET
GLAZING UNITS MADE THEREFROM (U.S. CLS. 1, 12,
33 AND 50).

CLASS 19—(Continued).

SN 78-107,582. W.R. GRACE & CO.-CONN., NEW YORK, NY.
FILED 2-8-2002.

FLORPRUFE

FOR NON-METALLIC BUILDING MATERIALS, NAMELY, PRE-FORMED WATERPROOFING FLOORING MEMBRANES IN SHEET AND STRIP FORM AND COMPRISED OF WATERPROOF ADHESIVE AND POLYMERIC CARRIER SUPPORT SOLD TOGETHER AS A UNIT (U.S. CLS. 1, 12, 33 AND 50).

SN 78-107,938. THE IMAGE GROUP INTERNATIONAL CORPORATION, MIAMI, FL. FILED 2-11-2002.

BALDEX

FOR RUSTIC CLAY FLOOR TILES (U.S. CLS. 1, 12, 33 AND 50).

SN 78-108,129. WERNICK, NEIL D., ELKINS PARK, PA.
FILED 2-11-2002.



FOR SCULPTURES MADE FROM CEMENT, MARBLE OR STONE EACH OF WHICH IS DESIGNED TO COMMEMORATE A SPECIFIC LIFE EVENT OR OTHER SPECIAL OCCASION (U.S. CLS. 1, 12, 33 AND 50).

SN 78-108,706. WILDER CONSTRUCTION COMPANY, EVERETT, WA. FILED 2-14-2002.

MATCON

FOR ASPHALT; ASPHALT LINERS AND CAPS FOR SOLID WASTE CONTAINMENT (U.S. CLS. 1, 12, 33 AND 50).

CLASS 20—FURNITURE AND ARTICLES NOT OTHERWISE CLASSIFIED

CLASS 20—(Continued).

SN 75-506,957. LINGO MANUFACTURING COMPANY, INC., FLORENCE, KY. FILED 6-22-1998.



THE DRAWING IS LINED FOR THE COLOR RED. FOR CUSTOM-DESIGNED PERMANENT DISPLAY RACKS (U.S. CLS. 2, 13, 22, 25, 32 AND 50). FIRST USE 6-1-1995; IN COMMERCE 6-1-1995.

SN 75-870,416. FABIO CORSI, DOTT., TRIESTE, ITALY,
FILED 12-24-1999.



OWNER OF ITALY REG. NO. TS99C000026, DATED 6-18-1999, EXPIRES 6-18-2009.

THE MARK CONSISTS OF WRITING "YANARY" IN BORDEAUX COLOUR (PANTONE 1807C) - WITH WHITE AND LIGHT BLUE SEA-GULL, BLACK HEAD AND CLAWS SUPERIMPOSED.

"YANARY" IS THE TRANSLITERATION OF AN INDIAN (FROM INDIA) WORD WHICH MAY BE TRANSLATED AS "LOVE".

FOR FURNITURE FOR ANY PURPOSE (U.S. CLS. 2, 13, 22, 25, 32 AND 50).

SN 75-879,998. SOCIALLY HAZARDOUS, INC., HUNTINGTON BEACH, CA. FILED 12-22-1999.

SOCIALLY HAZARDOUS

FOR NOVELTY TALKING PILLOWS (U.S. CLS. 2, 13, 22, 25, 32 AND 50).
FIRST USE 6-15-1998; IN COMMERCE 6-15-1998.

SN 76-033,626. LZB PROPERTIES, INC., MONROE, MI.
FILED 4-20-2000.

DESIGNER'S CHOICE COLLECTION

NO CLAIM IS MADE TO THE EXCLUSIVE RIGHT TO USE "COLLECTION", APART FROM THE MARK AS SHOWN.

FOR FURNITURE, NAMELY, CHAIRS SOLD ONLY THROUGH THE OWNER'S AUTHORIZED DEALERS (U.S. CLS. 2, 13, 22, 25, 32 AND 50).

FIRST USE 10-2-2000; IN COMMERCE 10-2-2000.

CLASS 20—(Continued).

SN 76-058,001. FORMTECH ENTERPRISES, INC., STOW, OH. BY ASSIGNMENT YATES COMPANY, ERIE, PA. FILED 5-30-2000.

ZIP STRIP

NO CLAIM IS MADE TO THE EXCLUSIVE RIGHT TO USE "STRIP", APART FROM THE MARK AS SHOWN.

FOR SHELF ATTACHMENT SYSTEM, NAMELY, CLIP-ON SIGN HOLDERS PREDOMINANTLY MADE OF PLASTIC HAVING SEPARABLE FRONT AND REAR SIDES TO ACCOMMODATE A SIGN AND WHICH ATTACH INTO "C" CHANNELS OF SHELVING (U.S. CLS. 2, 13, 22, 25, 32 AND 50).

FIRST USE 11-18-1999; IN COMMERCE 5-25-2000.

SN 76-075,156. FUTURA S.R.L., SOVICO (MILANO), ITALY, FILED 6-22-2000.



THE ENGLISH LANGUAGE TRANSLATION OF "FUTURA" IS "FUTURE".

FOR INDOOR FURNISHINGS, NAMELY, SOFAS, SOFA BEDS, ARMCHAIRS, COUCHES, LOVE SEATS, ARMCHAIR BEDS, FURNITURE SEATS, FURNITURE TABLES, SMALL FURNITURE TABLES, MOBILE FURNITURE TROLLEYS, AND FURNITURE COMPLEMENTS, NAMELY, CORNER UNITS, HASSOCKS, OTTOMANS AND FOOTRESTS (U.S. CLS. 2, 13, 22, 25, 32 AND 50).

FIRST USE 6-22-2000; IN COMMERCE 6-22-2000.

CLASS 20—(Continued).

SN 76-083,767. SYMPHONY GROUP PLC, THE, LEEDS, WEST YORKSHIRE, LS12 6AL, ENGLAND, FILED 7-6-2000.



PRIORITY CLAIMED UNDER SEC. 44(D) ON UNITED KINGDOM APPLICATION NO. 2232340, FILED 5-13-2000, REG. NO. 2232340, DATED 1-12-2001, EXPIRES 5-13-2010.

THE NAME SHOWN IN THE MARK DOES NOT IDENTIFY A PARTICULAR LIVING INDIVIDUAL, AND IS MERELY A FANCIFUL TERM MADE UP BY THE APPLICANT.

THE LATIN WORDS "DOMI FOCIQUE" IS TRANSLATED INTO ENGLISH TO MEAN "A FATHERED HOME".

FOR FURNITURE AND PARTS AND FITTINGS THEREFOR (U.S. CLS. 2, 13, 22, 25, 32 AND 50).

SN 76-095,435. DECK AMERICA, INC., WOODBRIDGE, VA. FILED 7-25-2000.

RHINO P.A.C.K.

FOR PRE-ENGINEERED FOUNDATION SUPPORT KITS COMPRISED OF NON-METAL FOOTERS, POSTS, POST SUPPORTS, AND CANTILEVER POST SUPPORTS FOR RECREATIONAL AND COMMERCIAL WOODEN DECKS AND AUXILIARY STRUCTURES, NAMELY BENCHES, WINDOWS, SUNPORCH TYPE STRUCTURES AND SUNROOMS AND NOT COMPRISED OF WORK TABLES, WORK BENCHES, INDUSTRIAL SHELVING, OR STORAGE RACKS (U.S. CLS. 2, 13, 22, 25, 32 AND 50).

SN 76-107,921. VIAD CORP, PHOENIX, AZ. FILED 8-14-2000.

EXHIBITGROUP GILTSPUR

OWNER OF U.S. REG. NOS. 1,133,684 AND 1,958,562.

FOR FURNITURE, NAMELY, EXHIBITS FOR TRADE SHOWS, EXHIBITS FOR MUSEUMS, AND RETAIL STORE DISPLAYS CONSISTING OF FREE STANDING MERCHANDISING DISPLAY RACKS, WALL MOUNTED MERCHANDISING DISPLAY RACKS, AND KIOSKS FOR DISPLAYING MERCHANDISE; EXHIBIT DISPLAY SYSTEMS COMPRISED OF MODULAR WALL UNITS, MODULAR COUNTERS, MERCHANDISING DISPLAY TOWERS, GRAPHIC DISPLAY TOWERS; SALES AND DISPLAY COUNTERS; DISPLAY RACKS; POINT OF PURCHASE DISPLAYS; PLASTIC FRAME DISPLAY UNITS FOR BUSINESS PRESENTATIONS AND EXHIBITS; PORTABLE EXHIBITS AND COMPONENTS FOR USE IN CONSTRUCTING EXHIBIT DISPLAY SYSTEMS; TABLES AND CHAIRS; AND BACKDROPS FOR DISPLAYING PRODUCTS AND SERVICES (U.S. CLS. 2, 13, 22, 25, 32 AND 50).

FIRST USE 12-1-1995; IN COMMERCE 12-1-1995.

CLASS 20—(Continued).

SN 76-111,866. FONNEGRA, GUIDO ANTONIO WILLIS, QUINTANA ROO, MEXICO, FILED 8-16-2000.

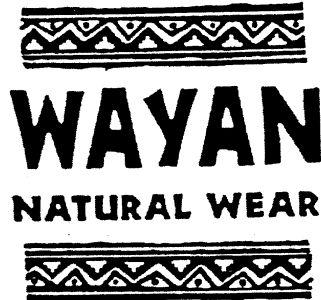

NO CLAIM IS MADE TO THE EXCLUSIVE RIGHT TO USE "NATURAL", APART FROM THE MARK AS SHOWN. FOR FURNITURE, NAMELY, CHAIRS, SOFAS, SHELVES, CORNER SHELVES, CHESTS WITH DRAWERS, DRAWERS, BEDS, FURNITURE FOR TELEVISIONS, TABLES, SIDE TABLES, BED FRAMES, TABLE FRAMES, STANDS, SHOWCASES, HEADBOARDS, BENCHES, SCREENS; NATURAL AND PAINTED WOOD HANDCRAFT, NAMELY, WOODEN ANIMAL, HUMAN, AND ABSTRACT FIGURES, DIFFERENT SIZE WOODEN BOXES, NAMELY, SQUARE AND ROUND WOODEN BOXES FOR HOLDING DIFFERENT ACCESSORIES; PICTURE FRAMES; MIRROR FRAMES; IRON GOODS, NAMELY, FIRE SCREENS FOR DOMESTIC USE AND FURNITURE SCREENS; GOODS MADE FROM COCONUT HARD SKIN, NAMELY, PICTURE FRAMES AND ABSTRACT AND ANIMAL FIGURES; AND GOODS MADE FROM PLASTIC AND RESIN, NAMELY, FIGURES, PICTURE FRAMES, MIRROR FRAMES, DECORATIVE MOBILES, AND ABSTRACT FIGURES (U.S. CLS. 2, 13, 22, 25, 32 AND 50).

SN 76-128,082. IMPORTACIONES Y EXPORTACIONES BARAK, S.A., PANAMA, PANAMA, FILED 9-14-2000.

MIRO

THE ENGLISH TRANSLATION OF THE "SPANISH" WORD "MIRO" IN THE MARK IS "I LOOK" OR "LOOKED". FOR POLYRESIN FIGURINES (U.S. CLS. 2, 13, 22, 25, 32 AND 50).

SN 76-136,142. HARTLAND COLLECTIBLES, L.L.C., HERMANN, MO. FILED 9-27-2000.

HARTLAND

FOR PLASTIC FIGURINES (U.S. CLS. 2, 13, 22, 25, 32 AND 50).
FIRST USE 2-10-1983; IN COMMERCE 2-10-1983.

CLASS 20—(Continued).

SN 76-136,143. HARTLAND COLLECTIBLES, L.L.C., HERMANN, MO. FILED 9-27-2000.



FOR PLASTIC FIGURINES (U.S. CLS. 2, 13, 22, 25, 32 AND 50).
FIRST USE 2-10-1983; IN COMMERCE 2-10-1983.

SN 76-202,147. JACK'S PLASTIC WELDING INC, AZTEC, NM. FILED 1-30-2001.

PACO PADS

NO CLAIM IS MADE TO THE EXCLUSIVE RIGHT TO USE "PADS", APART FROM THE MARK AS SHOWN. FOR INFLATABLE WATERPROOF FOAM MATTRESS PADS MADE WITH PLASTIC COATED FABRICS AND POLYURETHANE FOAM RUBBER FOR CAMPING USE (U.S. CLS. 2, 13, 22, 25, 32 AND 50).
FIRST USE 4-1-1984; IN COMMERCE 4-1-1984.

SN 76-217,765. EXPAND INTERNATIONAL AB, SE-131 30 STOCKHOLM, SWEDEN, FILED 3-1-2001.

EXPAND QUICKSCREEN

OWNER OF U.S. REG. NO. 1,766,731.
FOR FURNITURE FOR DECORATIVE AND DISPLAY PURPOSES, NAMELY PORTABLE SEMI-PERMANENT STRUCTURES; COLLAPSIBLE AND RAISABLE SUPPORTING STRUCTURES INCLUDING FRAMED STANDS, PORTABLE ROLLER SCREENS FOR DISPLAY OF POSTERS, PICTURES AND MESSAGES; PARTS FOR ALL THE AFORESAID GOODS (U.S. CLS. 2, 13, 22, 25, 32 AND 50).

SN 76-233,303. CONTAINER TECHNOLOGY, INC., SANTA BARBARA, CA. FILED 3-30-2001.

ISOPURE

FOR 1-TO-330 GALLON HIGH DENSITY POLYETHYLENE (HDPE) NON-METAL LIQUID CONTAINERS FOR USE IN THE ELECTRONIC CHEMICAL INDUSTRY (U.S. CLS. 2, 13, 22, 25, 32 AND 50).

CLASS 20—(Continued).

SN 76-244,146. HARDIN MANUFACTURING CO., HENDERSONVILLE, NC. FILED 4-20-2001.

Leandra Jardin

"LEANDRA JARDIN" IS NOT THE NAME OF A PARTICULAR LIVING INDIVIDUAL.

FOR FORMS AND INSERTS FOR USE AS FILLER MATERIAL FOR PILLOWS; FORMS AND INSERTS FOR USE AS A CUSHION FOR DUVETS (U.S. CLS. 2, 13, 22, 25, 32 AND 50).

SN 76-259,885. SMITHERS-OASIS COMPANY, CUYAHOGA FALLS, OH. FILED 5-22-2001.

PRIMAVERA

FOR FOAM SUPPORTS FOR FLORAL AND CRAFT ARRANGEMENTS (U.S. CLS. 2, 13, 22, 25, 32 AND 50). FIRST USE 5-11-2001; IN COMMERCE 5-11-2001.

SN 76-260,010. GLEN OAK LUMBER & MILLING INC., MONTEELLO, WI. FILED 5-21-2001.

CABINET CONTOURS

NO CLAIM IS MADE TO THE EXCLUSIVE RIGHT TO USE "CABINET", APART FROM THE MARK AS SHOWN.

FOR CABINET DOORS, DRAWER FRONTS, AND READY-TO-ASSEMBLE CABINETS SOLD AS A KIT (U.S. CLS. 2, 13, 22, 25, 32 AND 50).

SN 76-266,554. BABY BUNK, INC., WEST ROXBURY, MA. FILED 6-4-2001.



NO CLAIM IS MADE TO THE EXCLUSIVE RIGHT TO USE "BABY BUNK", APART FROM THE MARK AS SHOWN.

FOR INFANT SLEEPING APPARATUS, NAMELY, INFANT BEDS THAT CAN BE ATTACHED ALONGSIDE AN ADULT BED (U.S. CLS. 2, 13, 22, 25, 32 AND 50).

FIRST USE 1-31-1998; IN COMMERCE 1-31-1998.

CLASS 20—(Continued).

SN 76-267,545. SALTON, INC., MOUNT PROSPECT, IL. FILED 6-6-2001.

SANDPLAY

FOR DECORATIVE DESKTOP OR TABLETOP WATER FOUNTAINS, WITH PUMP FOR WATER CIRCULATION, SOLD AS A UNIT (U.S. CLS. 2, 13, 22, 25, 32 AND 50).

SN 76-300,107. ECOLOGIC WASTE SYSTEMS CORPORATION, KITCHENER, ONTARIO, CANADA, FILED 8-16-2001.

CUBET

FOR ROTATIONALLY MOLDED PLASTIC CONTAINERS FOR THE STORING AND DISPENSING OF FLUIDS FOR COMMERCIAL AND INDUSTRIAL USE (U.S. CLS. 2, 13, 22, 25, 32 AND 50).

SN 76-302,571. JOHN HENRY COMPANY, THE, LANSING, MI. FILED 8-21-2001.

CANDY CANE

FOR NON-METAL PLANT TAGS (U.S. CLS. 2, 13, 22, 25, 32 AND 50).

SN 76-311,876. TRION INDUSTRIES, INC., WILKES-BARRE, PA. FILED 9-13-2001.

OPTISTORE

FOR STORE FURNITURE AND FIXTURES, NAMELY DISPLAY STANDS, DISPLAY SHELVES, DISPLAY PANELS, DISPLAY STANDS, DISPLAY RACKS, SALES AND DISPLAY COUNTERS, SHELF DIVIDERS, SIGN BOARDS, AND PARTS AND COMPONENTS FOR DISPLAY SHELVES, NAMELY, GRAVITY FEED AND SPRING FEED PRODUCT CHANNELS, PRODUCT STEPS AND BACK SUPPORTS, FRONT STOPS, DATA STRIPS, AND SHELF TRAYS (U.S. CLS. 2, 13, 22, 25, 32 AND 50).

SN 76-315,930. ROBERT J. PELC, LACKAWANNA, NY. FILED 9-24-2001.

IPE CLIP

FOR PLASTIC BISCUITS FOR ALIGNMENT OF WOODEN, METAL, PLASTIC AND COMPOSITE MATERIAL BOARDS, PANELS AND THE LIKE (U.S. CLS. 2, 13, 22, 25, 32 AND 50).

CLASS 20—(Continued).

SN 76-318,114. CD DESIGNS, MECHANICSVILLE, VA.
FILED 9-26-2001.

TRAZOTIC ART

NO CLAIM IS MADE TO THE EXCLUSIVE RIGHT TO USE "ART", APART FROM THE MARK AS SHOWN.

FOR WORKS OF ART; NAMELY, SCULPTURES MADE PRIMARILY OF WOOD (U.S. CLS. 2, 13, 22, 25, 32 AND 50).

SN 76-323,728. SPACEWISE BROADCAST FURNITURE,
PHOENIX, AZ. FILED 10-12-2001.

BLENDEDTONE

FOR STUDIO FURNITURE FOR BROADCAST AND RECORDING (U.S. CLS. 2, 13, 22, 25, 32 AND 50).
FIRST USE 9-10-2001; IN COMMERCE 9-10-2001.

SN 76-326,901. FISHER HAMILTON LLC, TWO RIVERS, WI.
FILED 10-18-2001.

LABORATORY IN A BOX

FOR FURNITURE (U.S. CLS. 2, 13, 22, 25, 32 AND 50).

SN 76-331,474. BROYHILL FURNITURE INDUSTRIES, INC.,
LENOIR, NC. FILED 10-30-2001.

**EVERY 30 SECONDS
SOMEONE CHOOSES
BROYHILL**

FOR FURNITURE (U.S. CLS. 2, 13, 22, 25, 32 AND 50).
FIRST USE 4-15-1999; IN COMMERCE 6-8-1999.

SN 76-341,824. FRES-CO SYSTEM USA, INC., TELFORD, PA.
FILED 11-26-2001.

FRES-CO HI-FLO

FOR VALVES FOR FLEXIBLE PACKAGING, NAMELY, NON-METAL VALVES FOR CONTAINERS (U.S. CLS. 2, 13, 22, 25, 32 AND 50).

FIRST USE 9-14-2001; IN COMMERCE 9-14-2001.

CLASS 20—(Continued).

SN 76-349,566. LEISURE ARTS, INC., BIRMINGHAM, AL.
FILED 12-18-2001.

DOOR CREATURES

NO CLAIM IS MADE TO THE EXCLUSIVE RIGHT TO USE "DOOR", APART FROM THE MARK AS SHOWN.

FOR HALLOWEEN DECORATIONS NAMELY, PRINTED VINYL WITH THREE DIMENSIONAL VACU-FORMED PVC FACES ON THEM IN THE IMAGES OF TYPICAL HALLOWEEN CHARACTERS MEANT TO BE DISPLAYED BY HANGING FROM A DOOR OR DOORFRAME (U.S. CLS. 2, 13, 22, 25, 32 AND 50).

SN 76-358,688. TEGOMETALL (INTERNATIONAL) AG, 8574
LENGWIL, SWITZERLAND, FILED 1-15-2002.

HDS

FOR SHELVINGS, CABINETS, SHOWCASES, GLASS CASES, TABLES, COUNTERS, SALES GONDOLAS; SHELVING PARTS INCLUDING SHELVES, SUPPORTS, BRACKETS, CONSOLES, SHELVING TROUGHES, BOXES, BACK PANELS, DIVIDING PANELS AND COVER PANELS, PERFORATED PLATES, CANOPIES, SHELF BARS, RAILS, PANELLING ELEMENTS, DRAWERS, BOOK SUPPORTS AS SHELVING PARTS; TOOL HOLDERS AS SHELVING PARTS, HOLDING AND FASTENING ELEMENTS AS SHELVING PARTS, ALL OF THE AFORESAID GOODS BEING MADE OF METAL AND/OR PLASTIC AND/ OR WOOD (U.S. CLS. 2, 13, 22, 25, 32 AND 50).

SN 76-364,449. RUDELL, LINDA, POINT LOOKOUT, NY.
FILED 1-25-2002.

FOR SOCKS ONLY

FOR FURNITURE, NAMELY FOOT STOOLS AND OTTOMANS (U.S. CLS. 2, 13, 22, 25, 32 AND 50).

SN 76-365,322. DECADE INDUSTRIES, INC., DBA SANUS
SYSTEMS, ROSEVILLE, MN. FILED 1-31-2002.

SANUS SYSTEMS

NO CLAIM IS MADE TO THE EXCLUSIVE RIGHT TO USE "SYSTEMS", APART FROM THE MARK AS SHOWN.

FOR AUDIO, VIDEO AND HOME THEATER FURNISHINGS, NAMELY AUDIO SPEAKER STANDS, AUDIO AND VIDEO EQUIPMENT STANDS AND AUDIO AND VIDEO EQUIPMENT WALL MOUNTS (U.S. CLS. 2, 13, 22, 25, 32 AND 50).

FIRST USE 7-0-1987; IN COMMERCE 7-0-1987.

CLASS 20—(Continued).

SN 76-372,777. IORIO, JENNIFER J., CORAL SPRINGS, FL. AND IORIO, ROBERT A., CORAL SPRINGS, FL. FILED 2-21-2002.

JENNOOP

FOR PLASTIC STAND FOR EMBROIDERY AND QUILTING (U.S. CLS. 2, 13, 22, 25, 32 AND 50).

SN 76-375,830. IMPERIAL COMPONENTS, INC., AGOURA, CA. FILED 2-25-2002.

DURASOFT

FOR PARTS OF OFFICE CHAIRS, NAMELY, ARM PADS, COMPLETE CHAIR ARMS, BACK SUPPORTS, SEAT CUSHIONS, BACK CUSHIONS, WRIST RESTS (U.S. CLS. 2, 13, 22, 25, 32 AND 50).

SN 76-378,824. CHATEAU MERISIER, INC., DURHAM, NC. FILED 3-7-2002.

CHÂTEAU MERISIER

FOR HOME FURNITURE; NAMELY TABLES, DESKS, CHESTS, SIDEBARDS, HUNT BOARDS, CABINETS, CHAIRS; MIRRORS AND PICTURE FRAMES (U.S. CLS. 2, 13, 22, 25, 32 AND 50).

FIRST USE 1-31-1997; IN COMMERCE 1-31-1997.

SN 76-379,233. USL PRODUCTS, INC., MINNEAPOLIS, MN. FILED 3-5-2002.

PET LODGE

NO CLAIM IS MADE TO THE EXCLUSIVE RIGHT TO USE "PET", APART FROM THE MARK AS SHOWN.

FOR PORTABLE KENNELS (U.S. CLS. 2, 13, 22, 25, 32 AND 50).

SN 76-380,426. KEROTEST MANUFACTURING CORP., PITTSBURGH, PA. FILED 3-11-2002.

POLYBALL

FOR PLASTIC VALVES FOR INDUSTRIAL USE, SUCH VALVES NOT BEING MACHINE PARTS (U.S. CLS. 2, 13, 22, 25, 32 AND 50).

CLASS 20—(Continued).

SN 76-380,464. SHADY CHARACTER UNLIMITED LTD., NEW YORK, NY. FILED 3-11-2002.

CAVE CANEM

THE ENGLISH TRANSLATION OF THE FRENCH WORDS, "CAVE CANEM", IS "BEWARE OF DOG".
FOR BEDS FOR PETS (U.S. CLS. 2, 13, 22, 25, 32 AND 50).

SN 76-380,777. KIMBALL INTERNATIONAL, INC., JASPER, IN. FILED 3-8-2002.

KITE

FOR FURNITURE (U.S. CLS. 2, 13, 22, 25, 32 AND 50).

SN 76-381,086. MICHAELS MANAGEMENT SERVICES, LP, IRVING, TX. FILED 3-8-2002.

**VILLAGE CRAFTS BY
MICHAELS**

OWNER OF U.S. REG. NOS. 1,222,952, 2,486,259 AND OTHERS.

NO CLAIM IS MADE TO THE EXCLUSIVE RIGHT TO USE "VILLAGE CRAFTS", APART FROM THE MARK AS SHOWN.

FOR PICTURE FRAMES (U.S. CLS. 2, 13, 22, 25, 32 AND 50).

SN 76-381,936. TOFASCO OF AMERICA, INC., LAVERNE, CA. FILED 3-13-2002.

SEASON TICKET

FOR OUTDOOR FURNITURE (U.S. CLS. 2, 13, 22, 25, 32 AND 50).

FIRST USE 8-31-2001; IN COMMERCE 8-31-2001.

SN 78-055,015. BASSETT FURNITURE INDUSTRIES, INC., BASSETT, VA. FILED 3-26-2001.

BASSETT AT WORK

OWNER OF U.S. REG. NOS. 1,175,208, 2,492,153 AND OTHERS.

FOR OFFICE FURNITURE, NAMELY, CHAIRS, DESKS, COMPUTER DESKS, FILING AND STORAGE CABINETS, BOOK AND STORAGE SHELVES AND FUNCTIONAL ACCESSORIES, NAMELY, HUTCHES (U.S. CLS. 2, 13, 22, 25, 32 AND 50).

CLASS 20—(Continued).

SN 78-060,898. DEVORE & SON, INC., WICHITA, KS. FILED 4-27-2001.

CHRISTAL

FOR RELIGIOUS ITEMS, NAMELY, CROSSES AND CRUCIFIXES MADE OF ACRYLIC (U.S. CLS. 2, 13, 22, 25, 32 AND 50).
FIRST USE 4-25-2001; IN COMMERCE 4-30-2001.

SN 78-082,840. FARNAM COMPANIES, INC., PHOENIX, AZ. FILED 9-6-2001.

ERGOGROOM

FOR PET PRODUCTS, NAMELY, GROOMING TABLES FOR COMPANION ANIMALS AND THE ASSOCIATED PARTS; NAMELY, PADS, TABLE TOPS AND GROOMING ARMS TO BE SOLD WITH THE TABLE AS A UNIT OR AS REPLACEMENT PARTS THEREFOR (U.S. CLS. 2, 13, 22, 25, 32 AND 50).
FIRST USE 7-21-2000; IN COMMERCE 7-21-2000.

SN 78-083,406. OMT ENTERPRISES, INC., GARDENA, CA. FILED 9-10-2001.

ARCHITECT COLLECTION

NO CLAIM IS MADE TO THE EXCLUSIVE RIGHT TO USE "COLLECTION", APART FROM THE MARK AS SHOWN.
FOR WOODEN SHELVES, WOODEN PICTURE FRAMES, DECORATIVE WOODEN WALL SCONCES (U.S. CLS. 2, 13, 22, 25, 32 AND 50).
FIRST USE 10-31-2000; IN COMMERCE 10-31-2000.

SN 78-086,872. GENERAL MOTORS CORPORATION, DETROIT, MI. FILED 10-4-2001.

MALIBU

FOR CLEAR PLASTIC BADGE HOLDERS, BEDS, CHAIRS, NON-METAL CLAMPS; DESK ORNAMENTS MADE OF BONE, IVORY, PLASTER, PLASTIC, WAX, WOOD, CHINA, CRYSTAL, GLASS AND PORCELAIN, JEWELRY BOXES NOT OF METAL; NON-METAL KEY CHAINS, NON-METAL KEY FOBS, NON-METAL KEY HOLDERS, NON-METAL KEY RINGS, NONMETAL KEY TAGS, NON-METAL LICENSE PLATES, MIRRORS, NON-METAL MONEY CLIPS, PLASTIC NAME BADGES, NONMETAL NAMEPLATES; PICTURE FRAMES, PILLOWS, PLAQUES, PLASTIC FLAGS, PLASTIC STORAGE BINS; SEAT CUSHIONS AND STOOLS (U.S. CLS. 2, 13, 22, 25, 32 AND 50).
FIRST USE 8-1-1997; IN COMMERCE 8-1-1997.

CLASS 20—(Continued).

SN 78-087,892. PAUL FLUM IDEAS, INC., ST. LOUIS, MO. FILED 10-11-2001.

STOCKMASTER

FOR MOVABLE INVENTORY CONTROL STORAGE RACKS (U.S. CLS. 2, 13, 22, 25, 32 AND 50).

SN 78-098,082. JJI INTERNATIONAL, INC., WARWICK, RI. FILED 12-13-2001.

GARDEN ART WORKS

NO CLAIM IS MADE TO THE EXCLUSIVE RIGHT TO USE "GARDEN", APART FROM THE MARK AS SHOWN.
FOR FURNITURE, NAMELY OUTDOOR FURNITURE AND LAWN FURNITURE, AND NON-METAL MAILBOXES (U.S. CLS. 2, 13, 22, 25, 32 AND 50).

SN 78-106,727. LUMINO INC., MADISON, WI. FILED 2-4-2002.

Intercrown

FOR WINDOW BLINDS (U.S. CLS. 2, 13, 22, 25, 32 AND 50).
FIRST USE 2-1-2002; IN COMMERCE 2-1-2002.

SN 78-108,502. LEWIN, ROSS B, THIENSVILLE, WI. FILED 2-13-2002.

PLUG BLOCKER

NO CLAIM IS MADE TO THE EXCLUSIVE RIGHT TO USE "PLUG", APART FROM THE MARK AS SHOWN.
FOR PLASTIC SECURITY LOCK COVER FOR LOCKING UP, GUARDING AND/OR COVERING AN ELECTRICAL CORD PLUG (U.S. CLS. 2, 13, 22, 25, 32 AND 50).

CLASS 20—(Continued).

SN 78-109,260. GIROLIMON, TARA, SCHARTON, PLAYA DEL REY, CA. FILED 2-16-2002.



NO CLAIM IS MADE TO THE EXCLUSIVE RIGHT TO USE "BABY", APART FROM THE MARK AS SHOWN.

FOR ELONGATED STUFFED FABRIC TUBE CUSHION INTENDED FOR USE AS A POSITIONING AND COMFORT DEVICE WITH BABIES (U.S. CLS. 2, 13, 22, 25, 32 AND 50).

SN 78-109,601. SENTECH MEDICAL SYSTEMS, INC., FORT LAUDERDALE, FL. FILED 2-19-2002.

MICROVENT TECHNOLOGY

FOR PRESSURE RELIEVING THERAPY MATTRESSES (U.S. CLS. 2, 13, 22, 25, 32 AND 50).

SN 78-109,608. SIEMBOR, WILLIAM LOUIS, NOVI, MI. FILED 2-19-2002.

RECOLLECTIONS

FOR HOME AND OFFICE FURNITURE (U.S. CLS. 2, 13, 22, 25, 32 AND 50).

SN 78-109,924. KRUPA, PAUL, ASSONET, MA. FILED 2-20-2002.

"MIGHTY-GRIP"

FOR NON-METAL FASTENER KIT COMPRISED PRIMARILY OF PIECES OF HOOK AND LOOP MATERIAL TO APPLY BETWEEN A SHOWER CURTAIN AND BATHTUB TO PREVENT THE CURTAIN FROM GETTING PUSHED IN BY AIR (U.S. CLS. 2, 13, 22, 25, 32 AND 50).

CLASS 20—(Continued).

SN 78-113,233. GENESIS FURNITURE INDUSTRIES INC, PONTOTOC, MS. FILED 3-7-2002.

ARTISAN

FOR UPHOLSTERED FURNITURE (U.S. CLS. 2, 13, 22, 25, 32 AND 50).

SN 78-115,634. STATE LINE FURNITURE INC., CANA, VA. FILED 3-18-2002.

STATE IMPRESSIONS

FOR FURNITURE (U.S. CLS. 2, 13, 22, 25, 32 AND 50).

CLASS 21—HOUSEWARES AND GLASS

SN 75-501,565. COPAMEX, S.A. DE C.V., C.P. 66260. GARZA GARCIA, NUEVO LEON, MEXICO, FILED 6-12-1998.



OWNER OF U.S. REG. NO. 2,199,258.
NO CLAIM IS MADE TO THE EXCLUSIVE RIGHT TO USE "MEX", APART FROM THE MARK AS SHOWN.
FOR PAPER TOWEL DISPENSERS; SOAP DISPENSERS; NAPKIN HOLDERS; BROOMS; MOPS; BRUSHES, NAMELY, FLOOR BRUSHES; AND SPONGES, NAMELY, SPONGES FOR HOUSEHOLD PURPOSES (U.S. CLS. 2, 13, 23, 29, 30, 33, 40 AND 50).

SN 75-616,186. DEL DESIGNS, DELMAR, NY. FILED 1-6-1999.

MINI MUFF

NO CLAIM IS MADE TO THE EXCLUSIVE RIGHT TO USE "MUFF", APART FROM THE MARK AS SHOWN.
FOR FLEXIBLE INSULATING BAG FOR CARRYING AND INSULATING WARM OR COOL FOOD (U.S. CLS. 2, 13, 23, 29, 30, 33, 40 AND 50).

CLASS 21—(Continued).

SN 75-660,734. JOHN SULLIVAN, DBA OKAYAMA COMPANY, SOUTH ORANGE, NJ. FILED 3-15-1999.

BUBBLE BRUSH

NO CLAIM IS MADE TO THE EXCLUSIVE RIGHT TO USE "BRUSH", APART FROM THE MARK AS SHOWN.
FOR HAIR BRUSHES (U.S. CLS. 2, 13, 23, 29, 30, 33, 40 AND 50).

SN 75-692,799. INTUNE CORPORATION, VENTURA, CA. FILED 4-28-1999.

GET IN THE GAME

FOR BEVERAGE AND FOOD CONTAINERS THAT ARE PRIMARILY USED TO HOLD BEVERAGES AND FOOD, AND CAN BE USED AS A NOISEMAKER, AND A MEGAPHONE (U.S. CLS. 2, 13, 23, 29, 30, 33, 40 AND 50).

SN 76-002,833. KANEBO KABUSHIKI KAISHA (KANEBO, LTD), SUMIDA-KU, TOKYO, JAPAN, FILED 3-17-2000.

**Kanebo
IB**

FOR PERFUME ATOMIZERS SOLD EMPTY; COSMETIC BRUSHES, EYEBROW BRUSHES, HAIR BRUSHES, NAIL BRUSHES, SHAVING BRUSHES; HAIR COMBS, COMPACTS SOLD EMPTY; ALL PURPOSE PORTABLE HOUSEHOLD CONTAINERS; COSMETIC REMOVING PAPER, COTTON BALLS; DISPENSERS FOR LIQUID SOAP; SOAP HOLDERS, SPONGE HOLDERS, PERFUME SPRAYERS SOLD EMPTY, POWDER PUFFS; SPONGES FOR HOUSEHOLD PURPOSES (U.S. CLS. 2, 13, 23, 29, 30, 33, 40 AND 50).

CLASS 21—(Continued).

SN 76-038,448. THIS, LLC, MADISON, CT. FILED 5-2-2000.

**THE PERFECT
MARSHMALLOW
ROASTING STIX**

NO CLAIM IS MADE TO THE EXCLUSIVE RIGHT TO USE "MARSHMALLOW ROASTING STICKS", APART FROM THE MARK AS SHOWN.

FOR UTENSIL FOR ROASTING MARSHMALLOWS OVER AN OPEN FIRE OR IN A FIREPLACE, NAMELY WOOD ROASTING STICKS; BOXED ASSORTMENT OF PRODUCTS CONSISTING OF A UTENSIL, NAMELY WOOD ROASTING STICKS FOR ROASTING MARSHMALLOWS OVER AN OPEN FIRE OR A FIREPLACE, WRITTEN INSTRUCTIONS, CHOCOLATE CANDY BARS, GRAHAM CRACKERS AND MARSHMALLOWS, ALL SOLD AS A UNIT (U.S. CLS. 2, 13, 23, 29, 30, 33, 40 AND 50).

FIRST USE 7-3-1999; IN COMMERCE 8-17-1999.

SN 76-045,304. MARS, INCORPORATED, MCLEAN, VA. FILED 5-10-2000.

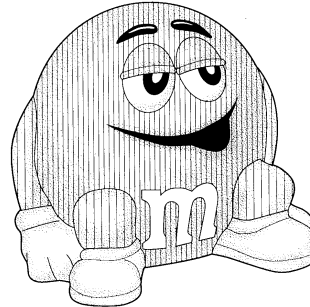

OWNER OF U.S. REG. NOS. 981,235, 2,533,687 AND OTHERS.

THE DRAWING IS LINED FOR THE COLORS RED AND FLESH. THE STIPLING IS FOR SHADING PURPOSES ONLY AND DOES NOT INDICATE COLOR.

SEC. 2(F).

FOR SCOURING PAD HOLDERS (U.S. CLS. 2, 13, 23, 29, 30, 33, 40 AND 50).

FIRST USE 8-0-1999; IN COMMERCE 8-0-1999.

SN 76-066,757. ACUMEN CO., LTD., SAN-CHUNG CITY, TAIPEI HSIEN, TAIWAN, FILED 6-2-2000.

HIFLEX

FOR BRISTLES MADE OF NYLON AND PLASTIC FOR ELECTRIC AND NON-ELECTRIC TOOTHBRUSHES, AND ELECTRIC AND NON-ELECTRIC TOOTHBRUSHES, FOR CLEANING TEETH (U.S. CLS. 2, 13, 23, 29, 30, 33, 40 AND 50).

CLASS 21—(Continued).

SN 76-108,949. XITEC MANUFACTURING INC., IRVINE, CA. FILED 8-11-2000.

PURICLE

FOR TOILET BOWL DISPENSERS FOR MOUNTING IN A TOILET TANK FOR DISPENSING CLEANER FOR THE TANK BOWL AND OTHER COMPONENTS OF A TOILET (U.S. CLS. 2, 13, 23, 29, 30, 33, 40 AND 50).
FIRST USE 5-15-2000; IN COMMERCE 5-15-2000.

SN 76-159,865. SCHULTZ, DANIEL J., BRIDGETON, MO. AND SCHULTZ, STEVEN D., BRIDGETON, MO. FILED 11-6-2000.

REAL FLAVOR

FOR BARBECUE UTENSILS, TOOLS AND ACCESSORIES, NAMELY BARBECUE FORKS, TONGS, BRUSHES AND SPATULAS (U.S. CLS. 2, 13, 23, 29, 30, 33, 40 AND 50).

SN 76-241,304. PRESLEY, LISA MARIE, MEMPHIS, TN. FILED 4-6-2001.

LISA MARIE PRESLEY

THE NAME "LISA MARIE PRESLEY" IDENTIFIES A LIVING INDIVIDUAL WHOSE CONSENT IS OF RECORD. FOR HOUSEWARES AND GLASS, NAMELY COFFEE MUGS AND BEVERAGE WARE (U.S. CLS. 2, 13, 23, 29, 30, 33, 40 AND 50).

SN 76-246,576. DENBUR, INC., HINSDALE, IL. FILED 4-25-2001.

MULTI-BRUSH

FOR DISPOSABLE MAKEUP AND COSMETIC APPLICATORS (U.S. CLS. 2, 13, 23, 29, 30, 33, 40 AND 50).
FIRST USE 3-0-2001; IN COMMERCE 3-0-2001.

SN 76-246,636. 7-ELEVEN, INC., DALLAS, TX. FILED 4-25-2001.

SPORT GULP

FOR BEVERAGE CONTAINERS, NAMELY PLASTIC BOTTLES (U.S. CLS. 2, 13, 23, 29, 30, 33, 40 AND 50).

CLASS 21—(Continued).

SN 76-271,455. VIACOM INTERNATIONAL INC., NEW YORK, NY. FILED 6-13-2001.

**DELETE DISCRIMINATION**

FOR MUGS, CUPS (U.S. CLS. 2, 13, 23, 29, 30, 33, 40 AND 50).

SN 76-274,246. APOLLO THEATRE FOUNDATION, INC., THE, NEW YORK, NY. FILED 6-14-2001.

APOLLO THEATRE

FOR BEVERAGE WARE, NAMELY, MUGS, DRINKING GLASSES, COFFEE CUPS AND BOTTLE OPENERS; HAIR COMBS AND BRUSHES; COMMEMORATIVE CHINA PLATES AND ORNAMENTS FOR COLLECTING AND DISPLAYING (U.S. CLS. 2, 13, 23, 29, 30, 33, 40 AND 50).

SN 76-280,568. MOUNTAIN WEST CONFERENCE, COLORADO SPRINGS, CO. FILED 7-2-2001.



NO CLAIM IS MADE TO THE EXCLUSIVE RIGHT TO USE "CONFERENCE", APART FROM THE MARK AS SHOWN.

THE STIPPLING IS A FEATURE OF THE MARK, AND IS NOT INTENDED TO INDICATE COLOR.

FOR MUGS; BEVERAGE GLASSWARE, NAMELY, TUMBLERS, CUPS, DRINKING GLASSES, THERMAL INSULATED CONTAINERS FOR FOOD OR BEVERAGE (U.S. CLS. 2, 13, 23, 29, 30, 33, 40 AND 50).

FIRST USE 1-10-1999; IN COMMERCE 7-1-1999.

CLASS 21—(Continued).

SN 76-284,804. ANDE ROONEY INC., HIGHLAND, NY.
FILED 7-12-2001.

HAPPY HOOKER

FOR BARBECUE COOKING UTENSILS, NAMELY
FORKS, TONGS, AND SKEWERS (U.S. CLS. 2, 13, 23,
29, 30, 33, 40 AND 50).
FIRST USE 9-1-2000; IN COMMERCE 1-23-2001.

SN 76-288,100. HOLTON INDUSTRIES, INC., TA BIO-SERV,
FRENCHTOWN, NJ. FILED 7-23-2001.

MOUSE IGLOO

NO CLAIM IS MADE TO THE EXCLUSIVE RIGHT TO
USE "MOUSE", APART FROM THE MARK AS SHOWN.
FOR SHELTERS FOR SMALL ANIMALS, I.E. MICE
(U.S. CLS. 2, 13, 23, 29, 30, 33, 40 AND 50).
FIRST USE 12-0-1999; IN COMMERCE 12-0-1999.

SN 76-297,424. THE MARICOPA COUNTY COMMUNITY
COLLEGE DISTRICT, TEMPE, AZ. FILED 8-9-2001.



NO CLAIM IS MADE TO THE EXCLUSIVE RIGHT TO
USE "MARICOPA", APART FROM THE MARK AS SHOWN.
FOR CERAMIC COFFEE MUGS (U.S. CLS. 2, 13, 23, 29,
30, 33, 40 AND 50).
FIRST USE 6-1-2001; IN COMMERCE 6-1-2001.

SN 76-299,072. HILLERICH & BRADSBY CO., LOUISVILLE,
KY. FILED 8-13-2001.

LOUISVILLE SLUGGER

OWNER OF U.S. REG. NOS. 379,405, 2,538,047 AND
OTHERS.
SEC. 2(F) AS TO "LOUISVILLE".
FOR KITCHEN UTENSILS, NAMELY, BARBECUE
TOOLS, NAMELY, FORKS, TONGS, AND SPATULAS
(U.S. CLS. 2, 13, 23, 29, 30, 33, 40 AND 50).
FIRST USE 9-1-2001; IN COMMERCE 11-15-2001.

CLASS 21—(Continued).

SN 76-306,239. KATZ, SIDNEY I., LAGUNA WOODS, CA.
FILED 8-27-2001.

**WE OPERATE THE NUMBER
2 BUSINESS IN AMERICA**

FOR PET WASTE REMOVAL PRODUCTS, NAMELY,
MECHANICALLY OPERABLE SCOOPS FOR REMOVAL
OF PET WASTE AND PET WASTE RECEPTACLES
MOUNTABLE ON THE PET BODY PORTIONS (U.S.
CLS. 2, 13, 23, 29, 30, 33, 40 AND 50).

SN 76-315,259. FLORACRAFT CORPORATION, LUDING-
TON, MI. FILED 9-21-2001.

TIMELESS ACCENTS

FOR POLYCLAY POTTERY, NAMELY FLORAL CON-
TAINERS AND VASES, PLANTERS, URNS, HOME
DECOR ACCESSORIES, AND DECORATIVE SCULP-
TURES (U.S. CLS. 2, 13, 23, 29, 30, 33, 40 AND 50).
FIRST USE 1-31-2000; IN COMMERCE 1-31-2000.

SN 76-319,764. HOWW MANUFACTURING COMPANY,
INC., BARRINGTON, IL. FILED 10-1-2001.

LITES UP

FOR DRINKING GLASSES AND GLASSWARE, AND
HOUSEHOLD AND KITCHEN UTENSILS AND CON-
TAINERS (U.S. CLS. 2, 13, 23, 29, 30, 33, 40 AND 50).

SN 76-330,225. PHILLIPS, CHRISTOPHER, SAN BRUNO, CA.
FILED 10-29-2001.

SOCRATES CAFÉ

FOR COFFEE CUPS (U.S. CLS. 2, 13, 23, 29, 30, 33, 40
AND 50).
FIRST USE 10-1-2001; IN COMMERCE 10-1-2001.

SN 76-330,449. PRIMED CANADA, INC., CALGARY, AL-
BERTA, CANADA, FILED 10-26-2001.

O.R.GANIZE

FOR HAND HELD BRUSHES USED FOR CLEANING
MEDICAL INSTRUMENTS (U.S. CLS. 2, 13, 23, 29, 30, 33,
40 AND 50).

CLASS 21—(Continued).

SN 76-332,394. PENN BOTTLE AND SUPPLY CO., ESSINGTON, PA. FILED 10-31-2001.

TITAN PLASTICS, CO.

NO CLAIM IS MADE TO THE EXCLUSIVE RIGHT TO USE "PLASTICS, CO.", APART FROM THE MARK AS SHOWN.

FOR PLASTIC BOTTLES SOLD EMPTY (U.S. CLS. 2, 13, 23, 29, 30, 33, 40 AND 50).

FIRST USE 0-0-1971; IN COMMERCE 0-0-1971.

SN 76-342,650. ADVANCE MAGAZINE PUBLISHERS INC., NEW YORK, NY. FILED 11-29-2001.

GOLF DIGEST

OWNER OF U.S. REG. NOS. 2,310,354, 2,354,011 AND 2,365,347.

NO CLAIM IS MADE TO THE EXCLUSIVE RIGHT TO USE "GOLF", APART FROM THE MARK AS SHOWN.

FOR MUGS AND BEVERAGE GLASSWARE (U.S. CLS. 2, 13, 23, 29, 30, 33, 40 AND 50).

SN 76-345,369. FRANKOMA INDUSTRIES, INC., SAPULPA, OK. FILED 12-5-2001.

FRANKOMA

FOR CERAMIC SCULPTURE, AND CERAMIC DINNERWARE, NAMELY PLATES, MUGS, TUMBLERS, CASSEROLES, PLATTERS, VASES, SOUP LADLES AND LIMITED EDITION COLLECTORS' PLATES (U.S. CLS. 2, 13, 23, 29, 30, 33, 40 AND 50).

FIRST USE 2-0-1934; IN COMMERCE 2-0-1934.

SN 76-345,852. BRINCAT, KEN, LOS ANGELES, CA. FILED 12-6-2001.

BRINCATTI

FOR REFILLABLE BOTTLES OF VARIOUS SHAPES AND SIZES, SOLD EMPTY (U.S. CLS. 2, 13, 23, 29, 30, 33, 40 AND 50).

CLASS 21—(Continued).

SN 76-351,439. CHROME HEARTS, INC., HOLLYWOOD, CA. FILED 12-21-2001.



OWNER OF U.S. REG. NOS. 2,216,569, 2,293,634 AND OTHERS.

FOR GARDENING TOOLS; NAMELY, WATER HOSE NOZZLES (U.S. CLS. 2, 13, 23, 29, 30, 33, 40 AND 50).

FIRST USE 1-0-2000; IN COMMERCE 1-0-2000.

SN 76-351,762. INNOVATIVE COOKWARE, L.L.C., SARASOTA, FL. FILED 12-20-2001.

VISTA CHEF

NO CLAIM IS MADE TO THE EXCLUSIVE RIGHT TO USE "CHEF", APART FROM THE MARK AS SHOWN.

FOR COOKWARE, NAMELY POTS AND PANS AND INTERCHANGEABLE LIDS FOR POTS AND PANS (U.S. CLS. 2, 13, 23, 29, 30, 33, 40 AND 50).

SN 76-362,841. INTERNATIONAL DISPENSING CORPORATION, MILLERSVILLE, MD. FILED 1-25-2002.

FAST CLICK

FOR SELF-SEALING TAPS FOR CONTAINERS THAT HOLD BEVERAGES AND LIQUID FOOD PRODUCTS (U.S. CLS. 2, 13, 23, 29, 30, 33, 40 AND 50).

SN 76-364,432. GALLEGOS, STELLA, TUSTIN, CA. FILED 1-25-2002.

PERFECT PUZZLE SAVER

NO CLAIM IS MADE TO THE EXCLUSIVE RIGHT TO USE "PUZZLE", APART FROM THE MARK AS SHOWN.

FOR PLASTIC CONTAINERS, NAMELY A CONTAINER FOR HOLDING PUZZLE PIECES (U.S. CLS. 2, 13, 23, 29, 30, 33, 40 AND 50).

CLASS 21—(Continued).

SN 76-368,977. BAKER, JOSEPHINE L., NIXA, MO. FILED 2-8-2002.

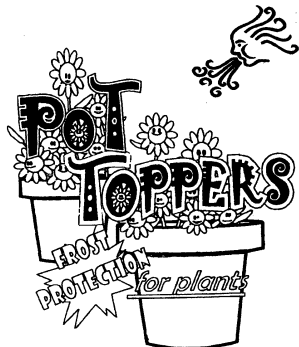

NO CLAIM IS MADE TO THE EXCLUSIVE RIGHT TO USE "POT" AND "FROST PROTECTION FOR PLANTS", APART FROM THE MARK AS SHOWN.

FOR POT COVERS NOT MADE OF PAPER, FOR PROVIDING A PLANT PROTECTION SYSTEM AND A LENGTHY GROWING PERIOD TO POTTED PLANTS (U.S. CLS. 2, 13, 23, 29, 30, 33, 40 AND 50).

SN 76-374,591. FRASER, FRANK, DBA THE FRANK FRASER COMPANY, LANCASTER, CA. AND FRASER, TERRI, DBA THE FRANK FRASER COMPANY, LANCASTER, CA. FILED 2-21-2002.



FOR DRINKING GLASSES, BEER MUGS, COFFEE CUPS, COFFEE MUGS, DISHES, PLATES, BOWLS, BOTTLE OPENERS, THERMAL INSULATED CONTAINERS FOR BEVERAGES, PLASTIC JUGS FOR BEVERAGES, CONTAINERS FOR FOOD, PITCHERS AND JARS (U.S. CLS. 2, 13, 23, 29, 30, 33, 40 AND 50).

SN 76-381,077. MAY DEPARTMENT STORES INTERNATIONAL, INC., ST. LOUIS, MO. FILED 3-12-2002.

LITTLE TOWN U.S.A.

NO CLAIM IS MADE TO THE EXCLUSIVE RIGHT TO USE "U.S.A.", APART FROM THE MARK AS SHOWN.

FOR MINIATURE CERAMIC BUILDINGS, FIGURES AND FIGURINES (U.S. CLS. 2, 13, 23, 29, 30, 33, 40 AND 50).

CLASS 21—(Continued).

SN 76-382,221. WAXMAN CONSUMER PRODUCTS GROUP INC., BEDFORD HEIGHTS, OH. FILED 3-15-2002.



FOR TOWEL BARS, DRAIN STOPPERS AND SOAP DISHES (U.S. CLS. 2, 13, 23, 29, 30, 33, 40 AND 50). FIRST USE 2-0-1992; IN COMMERCE 2-0-1992.

SN 76-383,362. PEGASUS INTERNATIONAL, INC., FORT WASHINGTON, PA. FILED 3-15-2002.

SURE-STICK

FOR ADHESIVE TRAPS FOR RODENTS AND INSECTS FOR INDOOR USE (U.S. CLS. 2, 13, 23, 29, 30, 33, 40 AND 50).

SN 76-384,125. ARIZONA LIGHT CREATIONS, INC., SCOTTSDALE, AZ. FILED 3-13-2002.

NECTAR CAFE

FOR BIRD FEEDERS (U.S. CLS. 2, 13, 23, 29, 30, 33, 40 AND 50).

SN 76-388,640. LIBBEY GLASS INC., TOLEDO, OH. FILED 3-27-2002.

PERCEPTION

FOR GLASS BEVERAGeware (U.S. CLS. 2, 13, 23, 29, 30, 33, 40 AND 50). FIRST USE 0-0-1999; IN COMMERCE 0-0-1999.

SN 76-388,641. LIBBEY GLASS INC., TOLEDO, OH. FILED 3-27-2002.

NOB HILL

FOR GLASS BEVERAGeware (U.S. CLS. 2, 13, 23, 29, 30, 33, 40 AND 50). FIRST USE 0-0-1965; IN COMMERCE 0-0-1965.

CLASS 21—(Continued).

SN 76-388,642. LIBBEY GLASS INC., TOLEDO, OH. FILED 3-27-2002.

SHAZAM

FOR GLASS BEVERAGeware (U.S. CLS. 2, 13, 23, 29, 30, 33, 40 AND 50).

SN 78-049,762. HARPER CORPORATION, DBA TEXAS FEATHERS, FAIRFIELD, IA. FILED 2-22-2001.

SPOTLESS!

FOR CLEANING PRODUCTS, NAMELY, FEATHER, ELECTROSTATIC, NATURAL WOOL AND SYNTHETIC WOOL WINDOW AND FURNITURE DUSTERS; CLOTHS USED FOR WIPING, CLEANING OR DUSTING, NAMELY, SCRUBBING CLOTHS, WASHING CLOTHS, DUSTING CLOTHS, CLEANING CLOTHS AND WIPING CLOTHS; MOPS; DUST MOPS; DUST PANS; BROOMS; SPONGES; CLOTHES BRUSHES; DISHWASHING BRUSHES; DUSTING BRUSHES; FIREPLACE BRUSHES; FLOOR BRUSHES; POT CLEANING BRUSHES; SCOURING PADS; SCRAPING BRUSHES; SCRUBBING BRUSHES; TOILET BRUSHES; SQUEEGEES; AND GLOVES, NAMELY, CLEANING GLOVES, DUSTING GLOVES, AND HOUSEHOLD GLOVES FOR CLEANING (U.S. CLS. 2, 13, 23, 29, 30, 33, 40 AND 50).

SN 78-066,873. MARK, UTTER A., EVERGREEN, CO. FILED 6-1-2001.



FOR PLANT WATERING DEVICE USED FOR WATERING HARD TO REACH INDOOR PLANTS COMPRISING A SYRINGE-LIKE UNIT, SPOUT AND DIFFUSER (U.S. CLS. 2, 13, 23, 29, 30, 33, 40 AND 50).

SN 78-082,713. WINNEY, MARK, LAS VEGAS, NV. FILED 9-5-2001.

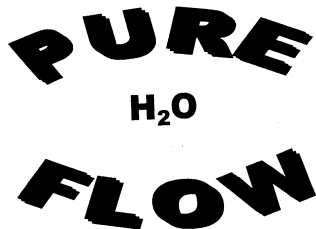

FOR PAILS FOR USE BY TILE SETTERS (U.S. CLS. 2, 13, 23, 29, 30, 33, 40 AND 50).

CLASS 21—(Continued).

SN 78-102,921. RYLE, KAY E., KENNESAW, GA. FILED 1-15-2002.

WINE MINDERS

NO CLAIM IS MADE TO THE EXCLUSIVE RIGHT TO USE "WINE", APART FROM THE MARK AS SHOWN.

FOR PRODUCT USED TO IDENTIFY AN INDIVIDUAL'S WINE GLASS IN THE NATURE OF A WIRE LOOP WITH AN ATTACHED COLORED BEAD OR CHARM THAT CLASPS AROUND THE STEM OF A WINE GLASS (U.S. CLS. 2, 13, 23, 29, 30, 33, 40 AND 50). FIRST USE 9-12-2000; IN COMMERCE 9-12-2000.

SN 78-108,128. WILSON-JACKSON, CELESTE S., BARRINGTON, IL. FILED 2-11-2002.

EVENEYES

FOR COSMETIC APPLICATION BRUSH (U.S. CLS. 2, 13, 23, 29, 30, 33, 40 AND 50).

SN 78-108,944. FORD MOTOR COMPANY, DEARBORN, MI. FILED 2-15-2002.

FORD FIELD

OWNER OF U.S. REG. NOS. 1,577,830, 2,070,025 AND OTHERS.

FOR HOUSEWARES AND GLASS, NAMELY, BEVERAGE GLASSWARE, MUGS, STEINS, BOTTLE OPENERS, VACUUM BOTTLES, THERMAL INSULATED CONTAINERS FOR FOOD AND BEVERAGE, PORTABLE COOLERS, THERMAL INSULATED CUPS, THERMAL INSULATED CAN WRAPS, SQUEEZE BOTTLES (U.S. CLS. 2, 13, 23, 29, 30, 33, 40 AND 50).

SN 78-116,274. GEORGIA-PACIFIC CORPORATION, ATLANTA, GA. FILED 3-20-2002.

INSTANT CUPGRADE

FOR PAPER CUPS (U.S. CLS. 2, 13, 23, 29, 30, 33, 40 AND 50).

CLASS 22—CORDAGE AND FIBERS

CLASS 22—(Continued).

SN 75-814,898. MILLEPEDE HOLDINGS LIMITED, KENT, CT1 3JF, UNITED KINGDOM, BY CHANGE OF NAME MILLEPEDE CABLE TIES LIMITED, CANTERBURY, KENT, UNITED KINGDOM, FILED 10-5-1999.

MILLEPEDE

PRIORITY CLAIMED UNDER SEC. 44(D) ON AUSTRALIA APPLICATION NO. 795416, FILED 5-27-1999, REG. NO. 2201929, DATED 1-7-1999, EXPIRES 1-7-2009.

FOR PLASTIC TIES, NAMELY CABLE TIES (U.S. CLS. 1, 2, 7, 19, 22, 42 AND 50).

SN 78-102,925. ANDERSON, SHANNA L, CHANDLER, AZ. FILED 1-15-2002.

FUNKY FIBERS

NO CLAIM IS MADE TO THE EXCLUSIVE RIGHT TO USE "FIBERS", APART FROM THE MARK AS SHOWN.

FOR DECORATIVE FIBERS IN THE NATURE OF SYNTHETIC AND COTTON FIBERS FOR EMBELLISHMENT OF SCRAPBOOKS, CUSTOM GREETING CARDS, OR CRAFTS (U.S. CLS. 1, 2, 7, 19, 22, 42 AND 50).

FIRST USE 9-1-2001; IN COMMERCE 9-1-2001.

SN 78-109,609. BFS DIVERSIFIED PRODUCTS, LLC, CARMEL, IN. FILED 2-19-2002.

MULTILINER RPP

FOR POLYMERIC LINERS FOR CONTAINING WATER AND OTHER LIQUIDS WITHIN DEFINED EARTHEN BOUNDARIES (U.S. CLS. 1, 2, 7, 19, 22, 42 AND 50).

CLASS 23—YARNS AND THREADS

SN 76-378,908. NATURIN GMBH & CO., D-69469 WEINHEIM, FED REP GERMANY, FILED 3-6-2002.

CO-STRING

PRIORITY CLAIMED UNDER SEC. 44(D) ON SPAIN APPLICATION NO. 2458653, FILED 2-28-2002.

FOR EDIBLE YARN MADE FROM COLLAGEN FOR TYING FOOD (U.S. CL. 43).

CLASS 24—FABRICS

SN 75-746,156. TUKI INTERNATIONAL, INC, N. CHARLESTON, SC. FILED 7-8-1999.

TUKI COVERS

NO CLAIM IS MADE TO THE EXCLUSIVE RIGHT TO USE "COVERS", APART FROM THE MARK AS SHOWN.

FOR NYLON/FOAM LAMINATED FABRIC USED TO MANUFACTURE PROTECTIVE COVERS AND BAGS USED FOR AUDIO AND OTHER MISCELLANEOUS EQUIPMENT (U.S. CLS. 42 AND 50).

FIRST USE 1-1-1988; IN COMMERCE 1-1-1988.

SN 76-067,910. TABLE TRENDS, INC., NEW YORK, NY. FILED 6-12-2000.

TABLE TRENDS

NO CLAIM IS MADE TO THE EXCLUSIVE RIGHT TO USE "TABLE", APART FROM THE MARK AS SHOWN.

FOR TABLE CLOTHS NOT OF PAPER, TEXTILE PLACE MATS, TEXTILE NAPKINS, FABRIC TABLE RUNNERS AND FABRIC TABLE PADS (U.S. CLS. 42 AND 50).

FIRST USE 1-0-1995; IN COMMERCE 1-0-1995.

SN 76-113,401. TOYO BOSEKI KABUSHIKI KAISHA, OSAKA, JAPAN, FILED 8-18-2000.

EKSLIVE

THE MARK CONSISTS OF THE WORDING "EKSLIVE" WITH A DESIGN OF ITS THIRD LETTER "S".

FOR WOVEN FABRICS, KNITTED FABRICS AND NON-WOVEN CLOTH FOR THE MANUFACTURE OF CLOTHING, LINING FOR CLOTHING, BOOTS, SHOES, TOWELS, BATHMATS, NAPKINS, PLACEMATS, CURTAINS, CARPET, FUTON MATTRESSES, FUTON COVERS, BED SHEETS, PILLOWCASES AND BLANKETS (U.S. CLS. 42 AND 50).

CLASS 24—(Continued).

SN 76-125,822. RUG BARN, INC., THE, ABBEVILLE, SC.
FILED 9-11-2000.

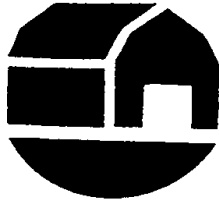

FOR THROWS MADE OF TEXTILE MATERIAL; AFGHANS, TEXTILE BELL PULLS; BEDDING, NAMELY, SKIRTS, PILLOW CASES, DUVET COVERS, BLANKETS, PILLOW SHAMS, BED SKIRTS, COVERS AND MATTRESS COVERS; TEXTILE TABLETOP PLACE MATS, RUNNERS AND COVERS; WASH CLOTHS, TOWELS, TEXTILE SHOWER CURTAINS AND POTHOLDERS; UNFITTED FABRIC FURNITURE COVERS; UPHOLSTERY FABRICS, DRAPERIES CURTAINS, TEXTILE WALL HANGINGS AND TAPESTRIES; RUGS AND CARPETS (U.S. CLS. 42 AND 50).
FIRST USE 1-1-1991; IN COMMERCE 1-1-1991.

SN 76-250,182. CARPENTER CO., RICHMOND, VA. FILED 5-1-2001.

MORNING GLORY

OWNER OF U.S. REG. NOS. 510,113, 1,983,841 AND OTHERS.
FOR MATTRESS PADS (U.S. CLS. 42 AND 50).
FIRST USE 4-24-2001; IN COMMERCE 4-24-2001.

SN 76-263,713. BI PROPERTIES I INC., GREENSBORO, NC.
FILED 5-29-2001.

C4

FOR FABRICS FOR USE IN THE MANUFACTURE OF GARMENTS USED IN CLEANROOMS (U.S. CLS. 42 AND 50).
FIRST USE 11-11-1999; IN COMMERCE 11-11-1999.

SN 76-263,774. BI PROPERTIES I INC., GREENSBORO, NC.
FILED 5-29-2001.

C5

FOR FABRICS FOR USE IN THE MANUFACTURE OF GARMENTS USED IN CLEAN ROOMS (U.S. CLS. 42 AND 50).
FIRST USE 8-27-1999; IN COMMERCE 8-27-1999.

CLASS 24—(Continued).

SN 76-265,055. BI PROPERTIES I INC., GREENSBORO, NC.
FILED 5-31-2001.

FLEXSTAR

FOR FABRICS FOR USE IN THE MANUFACTURE OF CLOTHING, EXCLUDING SAFETY APPAREL, SOLD EXCLUSIVELY AND DIRECTLY TO THE MANUFACTURERS OF CLOTHING, EXCLUDING THE MANUFACTURERS OF SAFETY APPAREL (U.S. CLS. 42 AND 50).

SN 76-266,446. L & P PROPERTY MANAGEMENT COMPANY, SOUTH GATE, CA. FILED 6-4-2001.

DURAFLEX

FOR MATTRESS INSULATOR PADS (U.S. CLS. 42 AND 50).

SN 76-268,664. BI PROPERTIES I INC., GREENSBORO, NC.
FILED 6-8-2001.

C1

FOR FABRICS FOR USE IN THE MANUFACTURE OF GARMENTS USED IN CLEANROOMS (U.S. CLS. 42 AND 50).
FIRST USE 4-4-2001; IN COMMERCE 4-4-2001.

SN 76-277,711. CONWAY, SUSAN GAIL, GRASS VALLEY, CA. FILED 6-28-2001.

PILLOWSHEET

FOR SMALL FABRIC SHEETS FOR USE IN AROMATHERAPY (U.S. CLS. 42 AND 50).
FIRST USE 6-1-2001; IN COMMERCE 6-1-2001.

SN 76-279,238. KIMBERLY-CLARK CORPORATION, NEENAH, WI. FILED 7-2-2001.

DURALOCK

FOR NONWOVEN FABRIC SOLD IN THE PIECE HAVING A SURFACE OF LOOPS USED TO FASTEN ABRASIVE DISKS TO TOOLS FOR SANDING OR SMOOTHING (U.S. CLS. 42 AND 50).

CLASS 24—(Continued).

SN 76-284,946. SIMPLY FABRICS, L.L.C., KENILWORTH, NJ. FILED 7-16-2001.

SIMPLY FABRICS

NO CLAIM IS MADE TO THE EXCLUSIVE RIGHT TO USE "FABRICS", APART FROM THE MARK AS SHOWN. FOR TEXTILE FABRICS FOR MAKING CLOTHING, INCLUDING DECORATIVE FABRICS (U.S. CLS. 42 AND 50).

FIRST USE 1-11-2001; IN COMMERCE 1-11-2001.

CLASS 24—(Continued).

SN 76-312,981. NAS MANUFACTURING, INC., CLARKSVILLE, GA. FILED 9-12-2001.

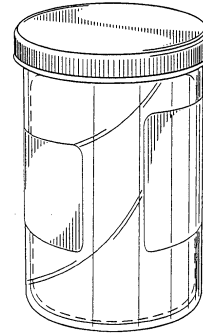

THE ILLUSTRATION OF THE TRADEADDRESS INCLUDED SHADING AND PHANTOM LINES TO INDICATE REPRESENTATIVE GOODS STORED WITHIN THE CONTAINER. THE SHADING AND PHANTOM LINES ARE NOT CONSIDERED PARTS OF THE TRADEADDRESS.

THE MARK CONSISTS OF A CONTAINER FOR BEDDING PRODUCTS.

FOR BEDDING PRODUCTS; NAMELY PILLOW CASES, PILLOW SHAMS, MATTRESS COVERS, MATTRESS PADS, AND COMFORTERS (U.S. CLS. 42 AND 50).

SN 76-286,539. SIMPLY FABRICS, L.L.C., KENILWORTH, NJ. FILED 7-18-2001.



NO CLAIM IS MADE TO THE EXCLUSIVE RIGHT TO USE "FABRICS", APART FROM THE MARK AS SHOWN. FOR TEXTILE FABRICS FOR MAKING CLOTHING, INCLUDING DECORATIVE FABRICS (U.S. CLS. 42 AND 50).

FIRST USE 1-11-2001; IN COMMERCE 1-11-2001.

SN 76-318,029. HURLEY INTERNATIONAL LLC, COSTA MESA, CA. FILED 9-20-2001.

HURLEY TO BED

FOR TEXTILES AND FABRICS, NAMELY, SHEETS, BLANKETS, QUILTS, PILLOW CASES, SHAMS, DUVETS, DUVET COVERS, MATTRESS COVERS, MATTRESS PADS, CURTAINS, DUST RUFFLES, CLOTH FLAGS, DISH CLOTHS, WASH CLOTHS, DRAPERIES, UNFITTED FABRIC FURNITURE COVERS, HANDKERCHIEFS, BATH LINENS, HOUSEHOLD LINENS, TABLE LINENS, TEXTILE BATH MATS, TEXTILE PLACE MATS, TEXTILE TABLE CLOTHS, TEXTILE NAPKINS, TAPESTRIES OF TEXTILE, TEXTILE WALL HANGINGS, TOWELS AND WASHCLOTHS (U.S. CLS. 42 AND 50).

SN 76-339,787. PEKING HANDICRAFT, INC., SOUTH SAN FRANCISCO, CA. FILED 11-19-2001.

AUBURN HILLS

FOR QUILTS, BEDSPREADS, COMFORTERS, COVERLETS, DUVETS, PILLOW SHAMS, BED SHEETS, PILLOW CASES, BED RUFFLES, TEXTILE TABLE CLOTHS, TEXTILE PLACE MATS, TEXTILE NAPKINS, TEXTILE TOWELS (U.S. CLS. 42 AND 50).

FIRST USE 12-12-2001; IN COMMERCE 12-12-2001.

CLASS 24—(Continued).

SN 76-345,263. AEIOU, INC., WESTFIELD, NJ. FILED 12-3-2001.

AEIOU

FOR ZIP QUILTS, COMFORTERS, CRIB BUMPERS, COMFORTER SETS COMPRISED OF COMFORTERS, DUST RUFFLES AND PILLOW SHAMS, CRIB AND BASSINET SHEETS, DUST RUFFLES, PILLOW CASES, CRIB BLANKETS, THERMAL CRIB BLANKETS, RECEIVING BLANKETS, WASHCLOTHS, TOWELS, BURP CLOTHS, HOODED TOWELS (U.S. CLS. 42 AND 50).

SN 76-352,620. REVERE MILLS, INC., NILES, IL. FILED 12-26-2001.

BATH SOLUTIONS

NO CLAIM IS MADE TO THE EXCLUSIVE RIGHT TO USE "BATH", APART FROM THE MARK AS SHOWN. FOR HAND TOWELS OF TEXTILE, BATH TOWELS, AND WASH CLOTHS (U.S. CLS. 42 AND 50).

SN 76-357,986. TRIBORO QUILT MFG. CORP., WHITE PLAINS, NY. FILED 1-10-2002.

SPLISH SPLASH

FOR TOWELS, WASHCLOTHS AND BATH LINENS (U.S. CLS. 42 AND 50).

SN 76-364,009. SARAGA, PEPE, DBA PHOTORACK LLC, HENDERSON, NV. FILED 1-25-2002.

MEMORIES ON A ROLL

FOR FLEXIBLE FABRIC WALL HANGING AND ROLLABLE CARRYING CASE WITH BUILT IN LEDGES THAT HOLD PHOTOGRAPHS, POSTCARDS AND OTHER NOTABLE ITEMS (U.S. CLS. 42 AND 50).

SN 76-366,550. HERB SOURCE, INC., LA VERNE, CA. FILED 2-1-2002.

HARVESTEX

FOR KITCHEN TOWELS (U.S. CLS. 42 AND 50).

CLASS 24—(Continued).

SN 76-371,137. NAMKUNG, GEORGE, COSTA MESA, CA. FILED 2-14-2002.

FRAME-A-FLAG

FOR PATRIOTIC MEMORABILIA NAMELY FLAGS (U.S. CLS. 42 AND 50).

SN 76-372,052. QVC, INC., WEST CHESTER, PA. FILED 2-19-2002.

AMADEUS

FOR BED AND BATH LINENS (U.S. CLS. 42 AND 50).

SN 78-106,278. SUN PORTS INTERNATIONAL, INC., DALLAS, TX. FILED 2-1-2002.

SHADESURE

FOR HIGH-DENSITY POLYETHYLENE FABRIC USED TO COVER SHADE SYSTEMS (U.S. CLS. 42 AND 50).

SN 78-109,747. MILLIKEN & COMPANY, NEW YORK, NY. FILED 2-19-2002.

KREATURE KOMFORT

FOR FABRICS TO BE USED IN THE MANUFACTURE OF BUG SUITS (U.S. CLS. 42 AND 50).

SN 78-111,554. CUTLER, PATRICIA R., SHERBORN, MA. FILED 2-27-2002.

MEMORYWRAP

FOR QUILT STYLE BLANKETS IN MEMORY OF DECEASED LOVED ONES (U.S. CLS. 42 AND 50).

SN 78-113,204. MILLIKEN & COMPANY, NEW YORK, NY. FILED 3-7-2002.

SOFI

FOR FABRIC SUITABLE FOR COATING IN THE MANUFACTURE OF UPHOLSTERY (U.S. CLS. 42 AND 50).

CLASS 25—CLOTHING

SN 73-807,326. VIVA L.A., DBA VIVA L.A., LOS ANGELES, CA. FILED 6-19-1989.

CAPPUCCINO

FOR MEN'S DRESS SHIRTS (U.S. CL. 39).
FIRST USE 1-0-1988; IN COMMERCE 6-0-1988.

SN 74-228,510. WRANGLER CLOTHING CORP., WILMINGTON, DE. BY ASSIGNMENT BRITANNIA SPORTSWEAR LTD., SAN FRANCISCO, CA. FILED 11-25-1991.

ECO-DENIM

FOR MEN'S, WOMEN'S AND CHILDREN'S PANTS, TROUSERS, SHORTS, SKIRTS, JACKETS, SHIRTS AND BLOUSES MADE PRIMARILY OF COTTON DENIM (U.S. CLS. 22 AND 39).

SN 74-541,198. REGATTA LTD., UNITED KINGDOM, BY CHANGE OF NAME RISOL LIMITED, URMSTON, MANCHESTER, LANCASHIRE, M31 2LT, UNITED KINGDOM, FILED 6-23-1994.

**REGATTA GREAT
OUTDOORS**

OWNER OF UNITED KINGDOM REG. NO. 1525979, DATED 3-25-1994, EXPIRES 2-5-2010.
FOR WATERPROOF CLOTHING USED FOR HIKING, NAMELY, JACKETS, COATS, NAMELY, ANORAKS, PARKAS, AND OVERTROUSERS, SOLD THROUGH SPECIALTY OUTDOOR SPORTS AND SPORTING GOODS STORES (U.S. CLS. 22 AND 39).

SN 74-565,326. STERN, STEPHEN, HIALEAH GARDENS, FL. AND STERN, BRETT, HIALEAH GARDENS, FL. BY ASSIGNMENT GILLMAN KNITWEAR CO., THE, CINCINNATI, OH. FILED 8-25-1994.

FAIRWAY OUTFITTERS

NO CLAIM IS MADE TO THE EXCLUSIVE RIGHT TO USE "OUTFITTERS", APART FROM THE MARK AS SHOWN.

FOR MENS AND WOMENS KNITWEAR MADE IN WHOLE OR A SIGNIFICANT PART OF COTTON; NAMELY PANTS, SHORTS, SWEATERS, SWEATSHIRTS, T-SHIRTS, SWEATPANTS, LEOTARDS, GYM SUITS, JOGGING SUITS AND SWEATSUITS (U.S. CLS. 22 AND 39).

FIRST USE 8-0-1995; IN COMMERCE 8-0-1995.

CLASS 25—(Continued).

SN 74-717,219. ANHEUSER-BUSCH, INCORPORATED, ST. LOUIS, MO. FILED 8-18-1995.

**THE COOLEST GAME ON
EARTH**

FOR CLOTHING, NAMELY SHIRTS, JACKETS AND HEADWEAR (U.S. CLS. 22 AND 39).

SN 75-108,331. TROJAN, ERICA E., EVANSTON, IL. FILED 5-23-1996.

THE DRIVE FOR FIVE

FOR CLOTHING, NAMELY, T-SHIRTS, SWEATSHIRTS, HATS, JACKETS, TIES, AND UNDERWEAR (U.S. CLS. 22 AND 39).

SN 75-267,016. GET ON-LINE SPORTSWEAR INC., NEW YORK, NY. FILED 3-31-1997.

FEEL THE POWER

FOR CLOTHING, NAMELY, T-SHIRTS, POLO SHIRTS, JACKETS, DENIM JEANS, PANTS, FOOTWEAR, SNEAKERS, SWEATERS, SWEATSHIRTS, SWEATPANTS, SHORTS, CAPS AND HATS (U.S. CLS. 22 AND 39).
FIRST USE 8-30-1996; IN COMMERCE 8-30-1996.

SN 75-326,199. FILIPPA K AB, S-118 46 STOCKHOLM, SWEDEN, FILED 7-17-1997.

FILIPPA K

OWNER OF SWEDEN REG. NO. 344408, DATED 2-9-2001, EXPIRES 2-9-2011.

"FILIPPA K" IDENTIFIES A LIVING INDIVIDUAL WHOSE CONSENT IS OF RECORD.

THE WORD "FILIPPA" IS A SWEDISH FIRST NAME AND HAS NO MEANING IN THE ENGLISH LANGUAGE.

FOR CLOTHING, NAMELY, BLOUSES, TROUSERS, JACKETS, JEANS, COATS, BUSINESS SUITS, SKIRTS, DRESSES, CARDIGANS, VESTS, OVERCOATS, SHIRTS, T-SHIRTS, SWEATERS AND JERSEYS (U.S. CLS. 22 AND 39).

CLASS 25—(Continued).

SN 75-495,503. BALLIN, INC., ST. LAURENT, QUEBEC, CANADA, FILED 6-3-1998.

GRAND LEGACY

FOR MEN'S DRESS AND CASUAL PANTS AND SHORTS, JEANS, SHORTS, BLAZERS, OVERALLS, JACKETS, SWEAT TOPS, SWEAT PANTS, SWEATERS, T-SHIRTS, VESTS, TOP COATS, SPORTS COATS, SPORTS JACKETS, BATHING SUITS, COVER-UPS, BRIEFS, CAMISOLES, NIGHTSHIRTS, PYJAMAS, ROBES, UNDERWEAR, SOCKS (U.S. CLS. 22 AND 39).

SN 75-529,406. DAMA S.P.A., 21100 VARESE, ITALY, FILED 8-3-1998.



FOR CLOTHING, NAMELY JACKETS, PULLOVERS, CARDIGANS, T-SHIRTS, TROUSERS, SHORTS, SWIM SUITS, BATHROBES, GYM SUITS, PLAY SUITS, SOCKS, STOCKINGS, CAPS, BLAZERS, SHIRTS, TIES, SKIRTS, COATS, RAINCOATS, HATS, SWEAT SHIRTS, JOGGING SUITS, BELTS, SCARVES, GLOVES, POLO SHIRTS, BLOUSONS, BOXER PANTS, UNDERSHIRTS, AND SHOES (U.S. CLS. 22 AND 39).

SN 75-617,306. KELLWOOD COMPANY, CHESTERFIELD, MO. FILED 1-8-1999.

LES JEUNES

THE ENGLISH TRANSLATION OF "LES JEUNES IS "THE YOUNG"

FOR CHILDREN'S APPAREL, NAMELY, KNIT TOPS, BLOUSES, SWEATER, SKIRTS, PANTS, SHORTS, DRESSES, CAPES, JACKETS, KERCHIEFS AND HATS (U.S. CLS. 22 AND 39).

FIRST USE 8-12-1999; IN COMMERCE 8-12-1999.

SN 75-701,140. DARLING BABY SHOE COMPANY, INC., MARYLAND HEIGHTS, MO. FILED 5-7-1999.

DARLING

FOR PREEMIE, NEWBORN, INFANT, TODDLER, CHILDREN'S, AND MISSES' SHOES (U.S. CLS. 22 AND 39).

FIRST USE 3-0-1939; IN COMMERCE 3-0-1939.

CLASS 25—(Continued).

SN 75-701,148. DARLING BABY SHOE COMPANY, INC., MARYLAND HEIGHTS, MO. FILED 5-7-1999.

The word "Darling" in a stylized, cursive font with a thick outline.

FOR PREEMIE, NEWBORN, INFANT, TODDLER, CHILDREN'S, AND MISSES' SHOES (U.S. CLS. 22 AND 39).

FIRST USE 10-0-1996; IN COMMERCE 10-0-1996.

SN 75-747,006. MOUNTAIN HORSE INTL. AB, SE-434 VALLDA, SWEDEN, FILED 6-1-1999.



PRIORITY CLAIMED UNDER SEC. 44(D) ON SWEDEN APPLICATION NO. 99-01591, FILED 2-25-1999, REG. NO. 341060, DATED 10-6-2000, EXPIRES 10-6-2010.

OWNER OF U.S. REG. NO. 1,817,986.

NO CLAIM IS MADE TO THE EXCLUSIVE RIGHT TO USE "MOST TECHNICAL RIDINGWEAR WORLDWIDE", APART FROM THE MARK AS SHOWN.

FOR CLOTHING NAMELY, SHIRTS, JACKETS, SWEATERS, SCARVES, GLOVES, SHOES, BOOTS, HIGH BOOTS, PANTS AND HEADWEAR, HATS AND CAPS (U.S. CLS. 22 AND 39).

SN 75-749,959. NINE WEST DEVELOPMENT CORPORATION, WHITE PLAINS, NY. FILED 7-14-1999.



FOR FOOTWEAR; CLOTHING, NAMELY, SHIRTS, SHORTS, PANTS, SWEATERS, JACKETS, DRESSES, SWEATSHIRTS, SWEAT-PANTS, T-SHIRTS, SKIRTS, HOSIERY, SOCKS; AND BELTS (U.S. CLS. 22 AND 39).

CLASS 25—(Continued).

SN 75-779,927. LE CHATEAU INC., MONTREAL, QUEBEC, CANADA, BY CHANGE OF NAME CHATEAU STORES OF CANADA LTD., MONTREAL, QUEBEC, CANADA, FILED 8-20-1999.



PRIORITY CLAIMED UNDER SEC. 44(D) ON CANADA APPLICATION NO. 1026277, FILED 8-19-1999, REG. NO. 550079, DATED 8-23-2001, EXPIRES 8-23-2016.

FOR MEN'S CLOTHING, NAMELY - SHIRTS, SWEATERS, SUITS, SPORTS JACKETS, TOPCOATS, PANTS, COATS, JUMPSUITS, VESTS, T-SHIRTS, BLAZERS, RAINCOATS, PONCHOS, CAFTANS, SWEATSHIRTS, SWEAT PANTS, JERSEYS, SKIWEAR, NAMELY - SKI JACKETS, SKI PANTS, SKI SUITS, ONE-PIECE SKI SUITS; SWIMWEAR, NAMELY - BATHING SUITS, ROBES; UNDERWEAR, NAMELY - SHORTS, PYJAMAS, ROBES, STOCKINGS; FASHION ACCESSORIES, NAMELY - SCARVES, HATS, BELTS, GLOVES, TIES; FOOTWEAR, NAMELY - SHOES, BOOTS, SANDALS, SLIPPERS (U.S. CLS. 22 AND 39).

SN 75-850,051. RICE-PITA, ANNA, BROOKLYN, NY. FILED 12-2-1999.



THE NAME "ANNAMOON" DOES NOT IDENTIFY A LIVING INDIVIDUAL. THE NAME "ANNA MARIE RICE-PITA" DOES IDENTIFY A LIVING INDIVIDUAL WHOSE CONSENT IS OF RECORD.

FOR WOMEN'S CLOTHING, NAMELY, BLOUSES, PANTS, SKIRTS, DRESSES, SUITS, JACKETS, COATS, JUMPERS, SCARVES, HATS AND VESTS (U.S. CLS. 22 AND 39).

FIRST USE 0-0-1985; IN COMMERCE 1-5-1990.

SN 75-866,367. PROCTOR, SHAWN M., FLORENCE, SC. FILED 12-7-1999.

AQUAMODE

FOR CLOTHING, NAMELY, SWEATSHIRTS, SWEAT PANTS, WARMUP SUITS, T-SHIRTS, POLO SHIRTS, SPORT SHIRTS, DRESSES, SKIRTS, BLOUSES, SWEATERS, PANTS, SHORTS, SUITS, COATS, JACKETS, RAINCOATS, HATS, VISORS, BELTS, TIES, SCARVES, GLOVES, STOCKINGS, UNDERWEAR, BRAS, BOXER SHORTS, BRIEFS, PANTIES, SLEEPWEAR, AND SWIMWEAR (U.S. CLS. 22 AND 39).

FIRST USE 1-24-2001; IN COMMERCE 1-24-2001.

CLASS 25—(Continued).

SN 75-871,761. DOWNERS, LLP, APPLETON, WI. FILED 12-14-1999.

COLLEGE KIDS

NO CLAIM IS MADE TO THE EXCLUSIVE RIGHT TO USE "KIDS", APART FROM THE MARK AS SHOWN.

FOR CLOTHING, NAMELY, T-SHIRTS, CREEPERS, ROMPERS, SWEATSHIRTS, SWEATPANTS, SHORTS, JACKETS, WOVEN SHIRTS, OVERALLS, JUMPERS, UNION SUITS, BOXER SHORTS, LONG SLEEVE-T-SHIRTS, BABY DOLL T-SHIRTS, TURTLENECKS, POLO SHIRTS, JERSEYS, HOODED SWEATSHIRTS, CLOTH BIBS, KNIT CAPS, BASEBALL CAPS, CLOTHING CAPS FOR INFANTS, HATS, BATHROBES, AND COVER-UPS, IN INFANT, TODDLER, AND YOUTH SIZES (U.S. CLS. 22 AND 39).

FIRST USE 3-15-1999; IN COMMERCE 11-17-1999.

SN 75-887,005. BLUE PLANET APPAREL, INC., LOS ANGELES, CA. FILED 1-4-2000.

BLUE CACTUS

FOR CLOTHING, NAMELY, T-SHIRTS, SHIRTS, SWEATERS, SWEAT SHIRTS, DRESSES, SKIRTS, PANTS, SHORTS, SWEAT PANTS, JUMPSUITS, JACKETS, SOCKS AND HEAD WEAR (U.S. CLS. 22 AND 39).

FIRST USE 1-2-1991; IN COMMERCE 1-2-1991.

SN 75-887,326. ELEFANTEN KG, D-47533 KLEVE, FED REP GERMANY, FILED 1-4-2000.



THE ENGLISH TRANSLATION OF "ELEFANTAN" IS "ELEPHANT".

FOR FOOTWEAR AND COMPONENT PARTS OF FOOTWEAR; NAMELY, BOOTS, SHOES, SLIPPERS, HEELS, SOLES, INNER SOLES, TOE STIFFENERS, HEEL PIECES, LINERS, HEEL INSERTS, INSOLES, METAL IMPACT PROTECTORS AND REINFORCEMENTS FOR BOOTS AND SHOES, BOOT AND SHOE UPPERS, SOCKS WITH SOLES FUSED THERETO MADE OF PVC PLASTIC OR TEXTILE MATERIAL (U.S. CLS. 22 AND 39).

CLASS 25—(Continued).

SN 75-906,381. SCHACHTER, BENITA, WESTBOROUGH, MA. FILED 1-9-2000.



THE APPLICANT CLAIMS THAT THE MARK CONTAINS COLOR. THE DUCK IS YELLOW WITH GREEN WINGS, AN ORANGE BEAK AND ORANGE FEET. THE DUCK'S HAT IS GREEN, PURPLE, BLUE, BLACK, WHITE AND RED. THE LETTERS OF THE WORD "TOOTALOO" ARE EACH IN COLOR: THE FIRST "T" IS GREEN, THE FIRST "O" IS BLUE, THE SECOND "O" IS PURPLE, THE SECOND "T" IS ORANGE, THE "A" IS YELLOW, THE "L" IS GREEN, THE THIRD "O" IS BLUE AND THE FOURTH "O" IS PURPLE.

FOR CLOTHING ACCESSORIES, NAMELY, HATS (U.S. CLS. 22 AND 39).
FIRST USE 10-1-1999; IN COMMERCE 10-1-1999.

SN 75-982,144. SKECHERS U.S.A., INC. II, MANHATTAN BEACH, CA. FILED 1-9-2002.

4-W

FOR FOOTWEAR (U.S. CLS. 22 AND 39).
FIRST USE 1-15-2002; IN COMMERCE 1-15-2002.

SN 76-004,283. ARAKS, INC., SPRINGFIELD, PA. FILED 3-20-2000.

ARAKS

FOR WOMENS UNDERWEAR AND LINGERIE (U.S. CLS. 22 AND 39).
FIRST USE 10-0-1998; IN COMMERCE 12-15-1999.

SN 76-023,651. BUCHANAN, RICARDO, BROOKLYN, NY, AND THOMAS, CLAUDE, QUEENS, NY. FILED 4-6-2000.

IN THE GAME ITG 365

FOR CLOTHING, NAMELY T-SHIRTS, SHIRTS, SWEATSHIRTS, PANTS, SHORTS, CAPS, HATS, COATS, JACKETS, SOCKS, UNDERGARMENTS, AND BANDANNAS (U.S. CLS. 22 AND 39).
FIRST USE 5-0-1997; IN COMMERCE 5-0-1997.

CLASS 25—(Continued).

SN 76-034,607. BODY TEASE, INC., DBA BODY DREAMS, SAN CLEMENTE, CA. FILED 4-25-2000.

BODY DREAMS

NO CLAIM IS MADE TO THE EXCLUSIVE RIGHT TO USE "BODY", APART FROM THE MARK AS SHOWN.
FOR OVERSIZED BODY COVER-UP T-SHIRTS (U.S. CLS. 22 AND 39).
FIRST USE 1-15-1998; IN COMMERCE 1-15-1998.

SN 76-048,802. DAVIS, MICHELE, ST. ALBANS, NY. BY ASSIGNMENT DAVIS, MICHELE, ST. ALBANS, NY. AND JOHNSON, YOLANDA, JAMAICA, NY. FILED 5-11-2000.

JAYA JUST AS U 'R

FOR WOMEN'S CLOTHING, NAMELY SHIRTS, T-SHIRTS, BLOUSES, PANTS, SHORTS, DRESSES, AND SKIRTS (U.S. CLS. 22 AND 39).
FIRST USE 6-0-1999; IN COMMERCE 6-0-1999.

SN 76-049,504. GMAC COMMERCIAL CREDIT LLC, NEW YORK, NY. BY CHANGE OF NAME; BY ASSIGNMENT CAPITAL-MERCURY SHIRT CORP., NEW YORK, NY. FILED 5-16-2000.

SAN MATEO ISLAND

FOR WOVEN SHIRTS, KNIT SHIRTS, SWEATERS, SLACKS, SHORTS, COATS AND JACKETS (U.S. CLS. 22 AND 39).

SN 76-049,831. GIG CONSULTING GROUP, THE, GERMANTOWN, MD. FILED 5-16-2000.

**WORK HARD HAVE FUN
AND DO IT WITH PASSION**

FOR SHIRTS, T-SHIRTS, JACKETS, VESTS, CAPS (U.S. CLS. 22 AND 39).

CLASS 25—(Continued).

SN 76-065,939. STEMRICH, CYNTHIA, TEMECULA, CA. FILED 6-9-2000.

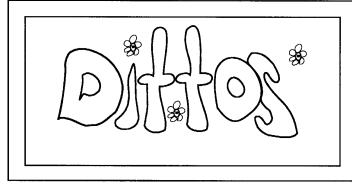

FOR CLOTHING, NAMELY, YOUNG MEN'S, CHILDREN'S AND JUNIOR'S JEANS, SHORTS, T-SHIRTS, TOPS, JACKETS AND COATS (U.S. CLS. 22 AND 39).

CLASS 25—(Continued).

SN 76-076,759. GUBERMAN, HARRIET, DBA JAMMARAMA, SAN RAFAEL, CA. FILED 6-26-2000.



SN 76-069,079. DESCHAMP, GLORIA J., GRAND JUNCTION, CO. FILED 6-12-2000.

THE NECK PRO-TECT

FOR HEADGEAR ACCESSORY, NAMELY A SMALL PIECE OF FLAT CLOTH MATERIAL WHICH ATTACHES OR DETACHES TO AND FROM A CAP OR HAT (U.S. CLS. 22 AND 39).

THE MARK CONSISTS OF THE COINED TERM "JAMMARAMA" AND THE DESIGN OF A LAPTOP COMPUTER. FOR MEN'S AND WOMEN'S CLOTHING FOR AT-HOME WORK WEAR, NAMELY, JEANS, PANTS, SHORTS, OVERALLS, SHORTALLS, LEGGINGS, KHAKIS, POLO SHIRTS, JACKETS, WIND-RESISTANT JACKETS, COATS, ANORAKS, SWEATSHIRTS, SWEAT PANTS, FLEECE TOPS AND PANTS, JOGGING SUITS, SWEATERS, T-SHIRTS, BLOUSES, SHIRTS, VESTS, SKIRTS, DRESSES, SCARVES, GLOVES, CAPS, HATS, SOCKS, BELTS, SHOES, BOOTS, SLIPPERS, SNEAKERS, TIGHTS, HOSIERY, NECKTIES, SLEEPWEAR, LOUNGEWEAR, DRESSING GOWNS, APRONS, BATHING SUITS, BEACHWEAR, BATHROBES, PAJAMAS, NIGHTGOWNS, LINGERIE, UNDERWEAR, KNIT CAPS, AND MITTENS (U.S. CLS. 22 AND 39).

SN 76-069,604. DISTURBED PARTNERSHIP, THE, CHICAGO, IL. FILED 6-14-2000.

DISTURBED

FOR SHIRTS, T-SHIRTS; HOCKEY JERSEYS, CAPS AND HEADWEAR (U.S. CLS. 22 AND 39). FIRST USE 8-2-1997; IN COMMERCE 8-2-1997.

SN 76-076,760. GUBERMAN, HARRIET, DBA JAMMARAMA, SAN RAFAEL, CA. FILED 6-26-2000.

SN 76-076,174. GUESS?, INC., LOS ANGELES, CA. FILED 6-22-2000.

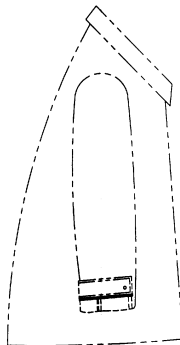

FOR MEN'S, WOMEN'S, BOYS', GIRLS', CHILDREN'S, AND INFANTS' APPAREL, NAMELY, SHIRTS, JACKETS, AND TOPS (U.S. CLS. 22 AND 39).



THE MARK CONSISTS OF THE COINED TERM "JAMMARAMA" AND THE DESIGN OF A LAPTOP COMPUTER. FOR MEN'S AND WOMEN'S CLOTHING FOR AT-HOME WORK WEAR, NAMELY, JEANS, PANTS, SHORTS, OVERALLS, SHORTALLS, LEGGINGS, KHAKIS, POLO SHIRTS, JACKETS, WIND-RESISTANT JACKETS, COATS, ANORAKS, SWEATSHIRTS, SWEAT PANTS, FLEECE TOPS AND PANTS, JOGGING SUITS, SWEATERS, T-SHIRTS, BLOUSES, SHIRTS, VESTS, SKIRTS, DRESSES, SCARVES, GLOVES, CAPS, HATS, SOCKS, BELTS, SHOES, BOOTS, SLIPPERS, SNEAKERS, TIGHTS, HOSIERY, NECKTIES, SLEEPWEAR, LOUNGEWEAR, DRESSING GOWNS, APRONS, BATHING SUITS, BEACHWEAR, BATHROBES, PAJAMAS, NIGHTGOWNS, LINGERIE, UNDERWEAR, KNIT CAPS, AND MITTENS (U.S. CLS. 22 AND 39).

CLASS 25—(Continued).

SN 76-078,577. LCN APPAREL, INC., NEW YORK, NY.
FILED 6-26-2000.



NO CLAIM IS MADE TO THE EXCLUSIVE RIGHT TO USE "DUNS", APART FROM THE MARK AS SHOWN.

THE TERM "WILLIE ESCO" DOES NOT IDENTIFY A LIVING INDIVIDUAL.

FOR CLOTHING, NAMELY SHIRTS, VESTS, SWEATERS, SHOES, CAPS, BANDANNAS, SHORTS, SWEAT SHIRTS, PANTS, BELTS FOR CLOTHING, SOCKS, SWIM WEAR, JACKETS, RAIN WEAR, BLOUSES, DRESSES, FOOTWEAR, HOSIERY, SCARVES, HATS, HEAD BANDS, PAJAMAS AND SLEEP WEAR (U.S. CLS. 22 AND 39).

FIRST USE 10-0-1998; IN COMMERCE 10-0-1998.

SN 76-088,244. PSYCHOBABBLE ORIGINALS, INC., RENO, NV. FILED 5-26-2000.



NO CLAIM IS MADE TO THE EXCLUSIVE RIGHT TO USE "ORIGINALS", APART FROM THE MARK AS SHOWN. THE MARK CONSISTS OF A CARICATURE OF EINSTEIN.

FOR SHIRTS AND HATS (U.S. CLS. 22 AND 39).

SN 76-092,101. SUMITOMO RUBBER INDUSTRIES, LTD., CHUO-KU, KOBE-SHI, HYOGO, JAPAN, FILED 7-20-2000.

OUTTEC

FOR FOOTWEAR (U.S. CLS. 22 AND 39).

CLASS 25—(Continued).

SN 76-094,219. REGATTA LTD., MANCHESTER, M41 7RR, UNITED KINGDOM, FILED 7-21-2000.

REGATTA
GREAT OUTDOORS

OWNER OF U.S. REG. NO. 2,490,991.
FOR WATERPROOF CLOTHING USED FOR HIKING, NAMELY, JACKETS, COATS, ANORAKS, PARKAS, AND OVERTROUSERS, SOLD THROUGH SPECIALTY OUTDOOR SPORTS AND SPORTING GOODS STORES (U.S. CLS. 22 AND 39).

SN 76-096,930. AMTEX IMPORTS, INC., NORTHLAKE, IL. FILED 7-26-2000.

PEREGRINE BAY

FOR APPAREL, NAMELY, MEN'S, WOMEN'S AND CHILDREN'S SHIRTS, SPORT SHIRTS, GOLF SHIRTS, DENIM SHIRTS, TWILL SHIRTS, T-SHIRTS, SWEATSHIRTS, SHORTS, DENIM SHORTS, GOLF SHORTS, SWEATPANTS, TRACK SUITS, JOGGING SUITS, AND SPORTS JACKETS (U.S. CLS. 22 AND 39).

SN 76-097,725. RED OAK SPORTSWEAR, INC., COLLEGE STATION, TX. FILED 7-26-2000.



THE MARK CONSISTS OF STYLIZED LETTERS "L" AND "C" OVERLAPPING, WITH "LEAGUE" BELOW AND "CITY" BELOW THAT WITH A STAR AND OVAL BEHIND THE LETTERS "LC" WITH VERTICAL STRIPES IN THE BACKGROUND BORDERED BY THICKER VERTICAL STRIPES.

FOR SPORTWEAR NAMELY, SHORTS, PANTS, SKIRTS, SHIRTS, SWEATSHIRTS, SWEATPANTS, T-SHIRTS, DRESSES, JACKETS (U.S. CLS. 22 AND 39).

FIRST USE 6-15-1999; IN COMMERCE 6-15-1999.

CLASS 25—(Continued).

SN 76-112,056. 17 PARIS PAIX, PARIS, FRANCE, FILED 8-17-2000.



NO CLAIM IS MADE TO THE EXCLUSIVE RIGHT TO USE "COUTURE", APART FROM THE MARK AS SHOWN. FOR CLOTHING, NAMELY, PANTS, POLO SHIRTS, SWEAT SHIRTS, SWEATERS, PULLOVERS, T-SHIRTS, JACKETS, TIES, POCKET, POCKET SQUARES, COATS, VESTS, PAJAMAS, WAIST COATS, SHIRTS, SUITS, BLOUSONS, RAINCOATS, SHOES, UNDERWEAR AND BELTS (U.S. CLS. 22 AND 39).
FIRST USE 5-17-1997; IN COMMERCE 5-17-1997.

SN 76-116,766. HENRY, EMMANUEL, STATEN ISLAND, NY. FILED 8-28-2000.

YABA

THE MARK IS "YABA" AND IT STANDS FOR "YOUNG AND BORN AGAIN".
FOR SHIRTS, NAMELY, T-SHIRTS, DRESS SHIRTS, AND BLOUSES; CASUAL AND NON-CASUAL PANTS, JEANS, KHAKI PANTS; CASUAL AND NON-CASUAL DRESSES; SHOES, NAMELY, SNEAKERS AND BOOTS; CLOTHING ACCESSORIES, NAMELY, SOCKS, BELTS, CAPS, AND HATS (U.S. CLS. 22 AND 39).

SN 76-130,633. BROWN, NICHOLAS, WADHURST, EAST SUSSEX TN5 6DF, UNITED KINGDOM, FILED 9-19-2000.

ANALOGY

OWNER OF UNITED KINGDOM REG. NO. 2178690, DATED 10-2-1998, EXPIRES 10-2-2008.
FOR WATERPROOF, WINDPROOF, WATER-SHEDDING, MOISTURE-TRANSMITTING, AND BREATHABLE CLOTHING, NAMELY, SALOPETTES, BALACLAVAS, CAPS, JACKETS, GAITERS, AND TROUSERS CONTAINING ONE OR MORE OF THE FOLLOWING FEATURES— BRACES, SIDE ZIPPERS, WATERPROOF ZIPPED FLYS, DRAW CORD WAISTS, DROP SEATS, DOUBLE LAYER SEATS, DOUBLE LAYER KNEES, FOAM KNEE INSERTS, FOAM SEAT INSERTS, SNOW CUFFS, STORM FLAPS, ARTICULATED KNEES, HAND WARMING POCKETS, STORAGE POCKETS, AND ADJUSTABLE ANKLES, ALL OF THE FOREGOING GOODS BEING USED FOR OUTDOOR ACTIVITIES SUCH AS MOUNTAINEERING, CLIMBING, ICE CLIMBING, SNOWBOARDING, SKIING, SKI TOURING, BACKPACKING, MOUNTAIN BIKING, CYCLING, RAMBLING, WALKING, FELL WALKING, TRAIL WALKING, RUNNING, AND TREKKING; AND UNDERCLOTHING, BELTS, FOOTWEAR, CAPS, AND HATS (U.S. CLS. 22 AND 39).

CLASS 25—(Continued).

SN 76-138,944. DAVID CHARLES CHILDREN'S WEAR, LTD, N7 7NU, LONDON, ENGLAND, FILED 10-2-2000.

BLUE MOON

FOR CHILDREN'S CLOTHING; NAMELY, DRESSES, SKIRTS, TROUSERS, BLOUSES, SHORTS, T-SHIRTS, TOPS, JACKETS, COATS AND KNITWEAR; NAMELY, CARDIGANS, SWEATERS AND TANKS (U.S. CLS. 22 AND 39).
FIRST USE 6-1-1992; IN COMMERCE 6-1-1992.

SN 76-147,062. DIGUGLIELMO, STEPHEN E., EAST PETERSBURG, PA. FILED 10-13-2000.

CHOPPER GEAR

NO CLAIM IS MADE TO THE EXCLUSIVE RIGHT TO USE "GEAR", APART FROM THE MARK AS SHOWN.
FOR CLOTHING, NAMELY, SHIRTS, SKIRTS, SHORTS, PANTS, DRESSES, BUTTON DOWN SHIRTS, GOLF SHIRTS, SWEATERS, TANK TOPS, T SHIRTS, SWEAT SHIRTS, SWEAT PANTS, JACKETS, UNDER GARMENTS, SOCKS, PAJAMAS, AND HATS FOR MEN, WOMAN AND CHILDREN (U.S. CLS. 22 AND 39).
FIRST USE 10-5-2000; IN COMMERCE 10-5-2000.

SN 76-148,840. BOARD OF REGENTS OF THE UNIVERSITY OF NEBRASKA, THE, LINCOLN, NE. FILED 10-18-2000.

NU

FOR CLOTHING, NAMELY, CAPS, JACKETS, SHIRTS, SWEAT PANTS, SWEATSHIRTS, T-SHIRTS, BOXER SHORTS, INFANT WEAR AND ATHLETIC UNIFORMS, ALL EXCLUSIVELY FOR PROMOTING ACTIVITIES OF, SHOWING SUPPORT FOR, AND/OR SHOWING AFFILIATION WITH THE UNIVERSITY OF NEBRASKA (U.S. CLS. 22 AND 39).
FIRST USE 0-0-1970; IN COMMERCE 0-0-1970.

CLASS 25—(Continued).

SN 76-156,436. HILLSDALE COLLEGE, HILLSDALE, MI.
FILED 10-30-2000.



OWNER OF U.S. REG. NOS. 1,620,488, 1,622,955 AND OTHERS.

THE LINING IS A FEATURE OF THE MARK.
THE ENGLISH TRANSLATION OF "VIRTUS" IS "EXCELLENCE" OR "VIRTUE"; THE ENGLISH TRANSLATION OF THE TERM "ET" IS "AND"; AND THE ENGLISH TRANSLATION OF THE TERM "SAPIENTIA" IS "INTELLIGENCE", "WISDOM" OR "KNOWLEDGE".

SEC. 2(F) AS TO "HILLSDALE".
FOR SWEATSHIRTS, POLO SHIRTS, T-SHIRTS AND BLAZERS (U.S. CLS. 22 AND 39).
FIRST USE 0-0-1998; IN COMMERCE 0-0-1998.

SN 76-160,634. STOCKER-EDWARDS, DODD, PHILADELPHIA, PA. FILED 11-7-2000.

SW4 SPORTS

NO CLAIM IS MADE TO THE EXCLUSIVE RIGHT TO USE "SPORTS", APART FROM THE MARK AS SHOWN.

FOR SPORTSWEAR APPAREL, NAMELY, T-SHIRTS, TANK TOPS, GYM SHORTS, RUNNING SHORTS, SWEAT SUITS, WARM-UP SUITS, SWEATERS, SWEATSHIRTS, JERSEYS, PULLOVERS, TOPS, SHORTS, PANTS, SHIRTS, UNDERWEAR, LEOTARDS, BATHING SUITS, ROBES, BELTS, SOCKS, WRIST BANDS, CAPS, JACKETS (U.S. CLS. 22 AND 39).

FIRST USE 7-20-2000; IN COMMERCE 7-20-2000.

SN 76-178,055. BRAW MARKETING, INC., DBA DO WRAP MOTION WEAR CO., CHICAGO, IL. FILED 12-8-2000.

DO WRAP

OWNER OF U.S. REG. NO. 2,075,383.
NO CLAIM IS MADE TO THE EXCLUSIVE RIGHT TO USE "WRAP", APART FROM THE MARK AS SHOWN.

SEC. 2(F).
FOR ABSORBENT CAPS FOR WEAR BY ATHLETES (U.S. CLS. 22 AND 39).

FIRST USE 8-0-1993; IN COMMERCE 6-0-1994.

CLASS 25—(Continued).

SN 76-178,893. LL INTERNATIONAL SHOE COMPANY, INC., LOS ANGELES, CA. FILED 12-11-2000.

DRAULICS

FOR ATHLETIC FOOTWEAR (U.S. CLS. 22 AND 39).

SN 76-180,551. INNOVA INC., DAVENPORT, IA. FILED 12-13-2000.

ULTREX COOKWARE

OWNER OF U.S. REG. NOS. 2,277,412, 2,384,191 AND OTHERS.

NO CLAIM IS MADE TO THE EXCLUSIVE RIGHT TO USE "COOKWARE", APART FROM THE MARK AS SHOWN.

FOR DOMESTIC KITCHEN APRONS (U.S. CLS. 22 AND 39).

SN 76-183,797. SPECIALTY BRANDS LIMITED, GREY LYNN AUCKLAND, NEW ZEALAND, FILED 12-21-2000.



FOR CLOTHING, NAMELY, PANTS, SHIRTS, HATS, CAPS, NECKWEAR, JACKETS, RAINJACKETS, COATS, WATERPROOF LEGGINGS, PARKAS, VESTS, UNDERWEAR, SKIRTS, DRESSES, SPORTS SHIRTS, KNITTED SHIRTS, WOOLEN SHIRTS, T-SHIRTS, SINGLETTS, TRACKSUITS, SHORTS, SOCKS, SHOES, SANDALS, BOOTS, SLIPPERS, TIES, CRAVATS, SCARVES (U.S. CLS. 22 AND 39).

SN 76-188,808. KIDS REIGN SUPREME, INC., DAVIE, FL. FILED 1-2-2001.



THE MARK IS LINED FOR COLORS BLUE, RED, GREEN AND YELLOW.

THE MARK CONSISTS OF A BOY WITH HIS HAND IN A COOKIE JAR.

FOR CLOTHING AND ACCESSORIES, FOR MEN, WOMEN, AND CHILDREN NAMELY, SLEEPWEAR, UNDERWEAR, SWIMWEAR, T-SHIRTS, TANK TOPS, WOVEN TOPS, KNIT TOPS, PANTS, SWEATPANTS, SWEATSHIRTS, SHORTS, SWEATERS, DRESSES, JACKETS, BELTS, HATS, HOSE, AND FOOTWEAR (U.S. CLS. 22 AND 39).

CLASS 25—(Continued).

SN 76-190,092. LOS ANGELES SPORTING CLUB, INC., LOS ANGELES, CA. FILED 1-5-2001.

MICHAEL

THE NAME "MICHAEL MEEHALL" DOES NOT IDENTIFY A LIVING INDIVIDUAL.

FOR CLOTHING, OUTERWEAR, AND ATHLETIC WEAR FOR MEN AND WOMEN, NAMELY, SHIRTS, SWEATERS, SUITS, PANTS, SKIRTS, DRESSES, SWEATSHIRTS, TOPS, CAMISOLES, BLOUSES, VESTS, T-SHIRTS, TANK TOPS, TIES, BELTS, JACKETS, COATS, SHORTS, SWIMSUITS, SOCKS, GLOVES, FOOTWEAR AND HEADWEAR (U.S. CLS. 22 AND 39).

FIRST USE 1-4-1999; IN COMMERCE 2-1-1999.

SN 76-206,810. KARL BAEDEKER GMBH, 73760 OSTFILDERN, FED REP GERMANY, FILED 2-2-2001.

Baedeker

PRIORITY CLAIMED UNDER SEC. 44(D) ON FED REP GERMANY APPLICATION NO. 30057534, FILED 8-2-2000, REG. NO. 30057534, DATED 9-21-2000, EXPIRES 8-2-2010.

OWNER OF U.S. REG. NO. 1,483,352.

THE MARK CONSISTS OF THE WORD "BAEDEKER" STYLIZED IN A CURSIVE FONT.

FOR CLOTHING, NAMELY, LADIES' AND MEN'S OVERCOATS MADE OF TEXTILES, LEATHER AND OTHER MATERIALS BATH ROBES, HEADGEAR, NAMELY HATS, CAPS, VISOR, HEADBANDS, BANDANAS, AND BEANIES, SHAWLS, SCARVES, NECKTIES, BELTS, GLOVES, SHOES, BOOTS AND SLIPPERS (U.S. CLS. 22 AND 39).

SN 76-214,980. AXARA, F-75003 PARIS, FRANCE, FILED 2-26-2001.

AXARA

FOR SUITS; JACKETS; CLOTHING FOR GOLF, NAMELY, T-SHIRTS, PANTS, SKIRTS, SOCKS, POLOS; CLOTHING FOR CYCLING, NAMELY, RACING SHORTS, JERSEYS, T-SHIRTS, SOCKS; CLOTHING FOR SOCCER, NAMELY, SHORTS, BERMUDAS, T-SHIRTS AND JERSEYS; CLOTHING FOR TENNIS, NAMELY, SKIRTS, T-SHIRTS, SHORTS AND DRESSES; FOOTWEAR, NAMELY, BOOTS, SHOES AND SANDALS; CLOTHING, NAMELY, TROUSERS, VESTS, COATS, DRESS SHIRTS, JUMPERS, SAFARI JACKETS, POLO SHIRTS, T-SHIRTS, SPORT SHIRTS, SWEATERS, SLACKS, BLOUSES, PAJAMAS, ONE-PIECE DRESSES, SKIRTS, SHORTS, UNDERWEAR, PARKAS, MINK COATS, SWIMSUITS, SKI SUITS, HATS, CAPS, SOCKS, STOCKINGS, BATHING CAPS, SKI BOOTS, MOUNTAIN-CLIMBING BOOTS, BOWLING SHOES, SOCCER SHOES, GOLF SHOES, SHOES, SLIPPERS, SANDALS, GLOVES, SCARVES, MUFFLERS, NECKTIES, BELTS, SUSPENDERS FOR TROUSERS (U.S. CLS. 22 AND 39).

FIRST USE 2-10-1993; IN COMMERCE 1-0-1997.

CLASS 25—(Continued).

SN 76-232,592. NEW YORK ROAD RUNNERS CLUB, INC., NEW YORK, NY. FILED 3-23-2001.



OWNER OF U.S. REG. NOS. 1,326,360 AND 1,430,310.
NO CLAIM IS MADE TO THE EXCLUSIVE RIGHT TO USE "NEW YORK CITY", APART FROM THE MARK AS SHOWN.

FOR SHIRTS, T-SHIRTS, GOLF SHIRTS, POLO SHIRTS, TANK TOPS, WARM-UP SUITS, SWEATSHIRTS, SWEATPANTS, SWEATSHORTS, SHORTS, COMPRESSION SHORTS, TRUNKS, JACKETS, REVERSIBLE JACKETS, COATS, RAINWEAR, SWEATERS, TURTLENECK SHIRTS AND SWEATERS, VESTS, FLEECE VESTS, RUNNER'S VEST WITH REFLECTIVE STRIPES AND ADJUSTABLE STRAPS, TIGHTS, BODY STOCKINGS, KNIT HOSIERY, BODYSUITS, LEOTARDS, UNITARDS, BRIEFS, UNDERWEAR, BRAS, SPORTS BRAS, SINGLETTS, HATS, CAPS, HEADBANDS, GLOVES, SCARVES, LOUNGEWEAR, SLEEPWEAR, SOCKS, SLIPPERS AND FOOTWEAR (U.S. CLS. 22 AND 39).

FIRST USE 2-1-2000; IN COMMERCE 2-1-2000.

SN 76-235,171. UNIVERSITY OF NEW MEXICO, THE, ALBUQUERQUE, NM. FILED 4-4-2001.



THE LINING OR STIPPLING CONTAINED IN THE MARK IS A FEATURE OF THE MARK AND DOES NOT INDICATE COLOR.

FOR CLOTHING, NAMELY, SHIRTS AND CAPS (U.S. CLS. 22 AND 39).

FIRST USE 8-0-1999; IN COMMERCE 8-0-1999.

SN 76-238,621. CONQUEROR INTERNATIONAL, INC., MARIKINA CITY, PHILIPPINES, FILED 4-10-2001.

RUSTY LOPEZ

THE NAME IN THE MARK "RUSTY LOPEZ" IDENTIFIES A LIVING INDIVIDUAL WHOSE CONSENT IS OF RECORD.

THE MARK CONSISTS OF THE WORDS "RUSTY LOPEZ", THE LETTERS "RL" AND AN ARBITRARY DEVICE.
FOR CLOTHING, NAMELY, T-SHIRTS, POLO SHIRTS, JEANS, AND PANTS; SHOES (U.S. CLS. 22 AND 39).

CLASS 25—(Continued).

SN 76-241,556. LOS ARCOS SPORS, LLC, PHOENIX, AZ. FILED 4-16-2001.

COYOTES

OWNER OF U.S. REG. NOS. 2,109,714, 2,424,929 AND OTHERS.

FOR CLOTHING, NAMELY BANDANNAS, BOXER SHORTS, CAPS, COATS GLOVES, HATS, HOSIERY, JACKETS, JERSEYS, MITTENS, NIGHTSHIRTS, PAJAMAS, PANTS, RAIN COATS, RAINWEAR SHIRTS SHORTS, SOCKS, SUN VISORS, SWEATPANTS, SWEATSHIRTS, SWIMSUITS, SWIMTRUNKS, T-SHIRTS, TIES, TOQUES, WARM-UP SUITS AND WRISTBANDS (U.S. CLS. 22 AND 39).

FIRST USE 6-1-1996; IN COMMERCE 6-1-1996.

SN 76-243,053. THOMAS AND KING, INC., LEXINGTON, KY. FILED 4-19-2001.



FOR GOLF SHIRTS, T-SHIRTS AND BASEBALL CAPS DISTRIBUTED IN CONJUNCTION WITH RESTAURANT AND BAR OPERATIONS (U.S. CLS. 22 AND 39).

FIRST USE 8-0-1996; IN COMMERCE 8-0-1996.

SN 76-245,712. LEDER & SCHUH AKTIENGESELLSCHAFT, A-8021, GRAZ, AUSTRIA, FILED 4-24-2001.

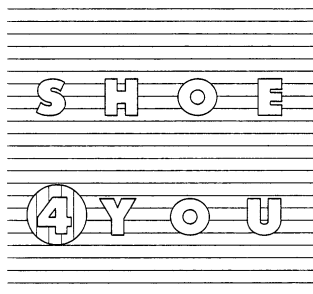

OWNER OF AUSTRIA REG. NO. 151192, DATED 2-14-1994, EXPIRES 2-28-2004.

NO CLAIM IS MADE TO THE EXCLUSIVE RIGHT TO USE "SHOE", APART FROM THE MARK AS SHOWN.

THE MARK IS LINED FOR THE COLORS BLUE AND RED, THE RED BEING CONTAINED IN THE CIRCLE SURROUNDING THE NUMBER 4.

FOR FOOTWEAR (U.S. CLS. 22 AND 39).

CLASS 25—(Continued).

SN 76-246,563. PROPPER INTERNATIONAL SALES, INC., ST. CHARLES, MO. FILED 4-25-2001.

BATTLE RIP

OWNER OF U.S. REG. NO. 2,283,915. FOR UNISEX CLOTHING, NAMELY, RAINWEAR, TROUSERS, JEANS, SHIRTS, JACKETS, PARKAS, COVERALLS, OVERALLS, HATS, FLIGHT SUITS, SWEATSHIRTS, SWEATPANTS, GLOVES, VISORS, UNDERWEAR, VESTS AND PONCHOS (U.S. CLS. 22 AND 39).

FIRST USE 1-3-2001; IN COMMERCE 1-3-2001.

SN 76-248,100. HAWKES BAY SPORTSWEAR LTD., TORONTO, ONTARIO, CANADA, FILED 4-27-2001.

VALLIANI

PRIORITY CLAIMED UNDER SEC. 44(D) ON CANADA APPLICATION NO. 1081186, FILED 11-2-2000.

FOR APPAREL, NAMELY PANTS, SHIRTS, BLOUSES, JACKETS, AND JEANS (U.S. CLS. 22 AND 39).

SN 76-250,407. CONCORDIA TRADERS, INC, LAWRENCE, KS. FILED 5-3-2001.

SMART ORANGE

NO CLAIM IS MADE TO THE EXCLUSIVE RIGHT TO USE "ORANGE", APART FROM THE MARK AS SHOWN.

FOR CLOTH PANELS OF MATERIAL TO BE ATTACHED TO HUNTING CLOTHING (U.S. CLS. 22 AND 39).

SN 76-254,064. N.V. ORGANON, 5349 AB OSS, NETHERLANDS, FILED 5-8-2001.

ORGANON

PRIORITY CLAIMED UNDER SEC. 44(D) ON BENELUX APPLICATION NO. 977395, FILED 11-9-2000, REG. NO. 6474497, DATED 11-9-2000, EXPIRES 11-9-2010.

FOR CLOTHING, NAMELY, SHIRTS, T-SHIRTS, SWEATSHIRTS, SWEATPANTS, CAPS, HATS, SHAWLS, SWEATERS AND COATS (U.S. CLS. 22 AND 39).

SN 76-259,432. C2:8, PERRIS, CA. FILED 5-18-2001.

NOTW

FOR CLOTHING, NAMELY, FOOTWEAR AND HEADWEAR FOR MEN, WOMEN, YOUTH, CHILDREN AND INFANTS (U.S. CLS. 22 AND 39).

FIRST USE 12-20-2000; IN COMMERCE 5-4-2001.

CLASS 25—(Continued).

SN 76-261,044. SHANGHAI SAIYANG TECHNOLOGICAL EXPERIMENTALISM CO., LTD., SHANGHAI, CHINA, FILED 5-23-2001.



THE TRANSLITERATION OF THE CHINESE CHARACTERS ON THE MARK IS "BEI JI RONG". THERE IS NO ENGLISH TRANSLATION AS IT IS A COINED WORD AND HAS NO MEANING.

FOR NON-ELECTRICALLY HEATED THERMAL UNDERWEAR, JERSEYS, SWEAT-ABSORBENT UNDERWEAR, UNDERWEAR, DRAWERS, NAMELY, UNDERWEAR PANTS, DOWN CLOTHING, NAMELY, DOWN JACKETS, DOWN OVERCOATS, DOWN VESTS, DOWN HATS AND DOWN GLOVES (U.S. CLS. 22 AND 39).

SN 76-261,045. SHANGHAI SAIYANG TECHNOLOGICAL EXPERIMENTALISM CO., LTD., HUANGPU DISTRICT, SHANGHAI, CHINA, FILED 5-23-2001.



THE TRANSLITERATION OF THE CHINESE CHARACTERS ON THE MARK IS "HUO LONG MIAN". THERE IS NO ENGLISH TRANSLATION AS IT IS A COINED WORD AND HAS NO MEANING.

FOR NON-ELECTRICALLY HEATED THERMAL UNDERWEAR, JERSEYS, SWEAT-ADSORBENT UNDERWEAR, UNDERWEAR, DRAWERS, NAMELY, UNDERWEAR PANTS, DOWN CLOTHING, NAMELY, DOWN JACKETS, DOWN OVERCOATS, DOWN VESTS, DOWN HATS AND DOWN GLOVES (U.S. CLS. 22 AND 39).

CLASS 25—(Continued).

SN 76-261,046. SHANGHAI SAIYANG TECHNOLOGICAL EXPERIMENTALISM CO., LTD., SHANGHAI, CHINA, FILED 5-23-2001.



THE TRANSLITERATION OF THE CHINESE CHARACTERS ON THE MARK IS "NAN JI REN". THERE IS NO ENGLISH TRANSLATION AS IT IS A COINED WORD AND HAS NO MEANING.

FOR NON-ELECTRICALLY HEATED THERMAL UNDERWEAR, JERSEYS, SWEAT-ABSORBENT UNDERWEAR, DRAWERS, NAMELY, UNDERWEAR PANTS, DOWN CLOTHING, NAMELY DOWN JACKETS, DOWN OVERCOATS, DOWN VESTS, DOWN HATS AND DOWN GLOVES (U.S. CLS. 22 AND 39).

SN 76-261,068. WATSON, JACKIE, JACKSON, MS. FILED 5-24-2001.

CALENDARUNDERWEAR

FOR UNDERWEAR (U.S. CLS. 22 AND 39).

SN 76-263,192. ELIZABETH LANGE, LLC, NEW YORK, NY. FILED 5-29-2001.



OWNER OF U.S. REG. NO. 2,360,437. THE NAME "LIZ LANGE" IDENTIFIES A LIVING INDIVIDUAL WHOSE CONSENT IS OF RECORD. FOR WOMEN'S CLOTHING, NAMELY, JACKETS, COATS, SKIRTS, DRESSES, PANTS, TUNICS, BLOUSES, T-SHIRTS AND STRETCH JEANS (U.S. CLS. 22 AND 39). FIRST USE 3-0-2000; IN COMMERCE 3-0-2000.

CLASS 25—(Continued).

SN 76-265,860. CLUETT PEABODY RESOURCES CORPORATION, NEW YORK, NY. FILED 6-1-2001.

ARROW BLUE

OWNER OF U.S. REG. NOS. 1,683,039, 1,879,843 AND OTHERS.

NO CLAIM IS MADE TO THE EXCLUSIVE RIGHT TO USE "BLUE", APART FROM THE MARK AS SHOWN.

FOR ARTICLES OF CLOTHING, NAMELY, MEN'S AND BOYS' SHIRTS, SWEATERS, PANTS, JEANS AND SHORTS (U.S. CLS. 22 AND 39).

FIRST USE 8-31-2001; IN COMMERCE 8-31-2001.

SN 76-266,556. SCHOOL APPAREL, INC., SAN BRUNO, CA. FILED 6-4-2001.

WEAR WARRANTY

FOR CLOTHING, NAMELY SCHOOL AND CAREER UNIFORMS (U.S. CLS. 22 AND 39).

SN 76-267,149. SUSAN & STEVEN LURIE, HIGHLAND PARK, IL. FILED 6-4-2001.

ENAZ

OWNER OF U.S. REG. NOS. 1,838,748 AND 2,448,941. FOR CLOTHING, NAMELY, JEANS, SLACKS AND PANTS (U.S. CLS. 22 AND 39).

FIRST USE 1-1-1986; IN COMMERCE 1-1-1986.

SN 76-271,780. OLANG SRL, 31040 VOLPAGO DEL MONTELLO (TREVISO), ITALY, FILED 6-12-2001.

OLANG

OWNER OF ITALY REG. NO. 0.566.300, DATED 4-10-1992, EXPIRES 4-10-2012.

FOR CLOTHING FOR MEN, WOMEN AND CHILDREN; NAMELY, TOPS, SWEATPANTS, SWEATSHIRTS, FOOTWEAR AND HATS (U.S. CLS. 22 AND 39).

CLASS 25—(Continued).

SN 76-273,079. MICHELLE SIMON, DBA LOBA, NEW YORK, NY. AND PAMELA RUMPH, DBA LOBA, NEW YORK, NY. FILED 6-18-2001.



THE ENGLISH TRANSLATION OF MARK IS "SHE WOLF".

FOR CLOTHING FOR WOMEN NAMELY SHIRTS, T-SHIRTS, BLOUSES, JERSEYS, TANK TOPS, TUBE TOPS, SWEATERS, SHORTS, CULOTTES, PANTS, SLACKS, TROUSERS, JEANS, BLAZERS, BATHING SUITS, JACKETS, COATS, UNDERWEAR, LINGERIE, BUSTIERS, HATS, CAPS, SCARVES, SHAWLS, GLOVES, HEADBANDS, DRESSES, (U.S. CLS. 22 AND 39).

FIRST USE 1-0-2001; IN COMMERCE 1-0-2001.

SN 76-273,767. EVELYN & ARTHUR, INC., PALM BEACH, FL. FILED 6-19-2001.

TRAVELERS COTTON

NO CLAIM IS MADE TO THE EXCLUSIVE RIGHT TO USE "COTTON", APART FROM THE MARK AS SHOWN.

FOR LADIES AND MEN'S APPAREL MADE OF COTTON, NAMELY, SHIRTS, PANTS, HATS, JACKETS, VESTS, SKIRTS, AND SWEATERS (U.S. CLS. 22 AND 39).

SN 76-276,569. ODLO INTERNATIONAL LTD., 6331 HUNENBERG, SWITZERLAND, FILED 6-26-2001.



OWNER OF SWITZERLAND REG. NO. 480030, DATED 12-19-2000, EXPIRES 12-19-2020.

FOR CLOTHING, NAMELY, UNDERWEAR, SOCKS, GLOVES; SPORTSWEAR, NAMELY, SHORTS, TOPS, SHIRTS, PANTS, SWEATERS, JACKETS, SWEATSHIRTS; UNDERWEAR; VESTS FOR RUNNING, BIKING, CROSS-COUNTRY SKIING AND DOWNHILL SKIING; HEADWEAR (U.S. CLS. 22 AND 39).

CLASS 25—(Continued).

SN 76-277,793. WELCH, JACK, COPPERAS COVE, TX. FILED 6-28-2001.



FOR SHOES, NAMELY ATHLETIC SHOES AND GOLF SHOES; BASEBALL CAPS AND CLOTHING CAPS; SWEAT BANDS; SWEAT SUITS AND SWEAT SHIRTS; SHIRTS, NAMELY GOLF SHIRTS, KNIT SHIRTS, NIGHT SHIRTS, POLO SHIRTS, SPORT SHIRTS, UNDER SHIRTS, T-SHIRTS; SHORTS AND PANTS; ANKLETS, SOCKS, THERMAL SOCKS AND WATER SOCKS (U.S. CLS. 22 AND 39).

FIRST USE 7-1-2000; IN COMMERCE 7-1-2000.

SN 76-279,532. ALSTYLE APPAREL & ACTIVEWEAR MANUFACTURING COMPANY, ANAHEIM, CA. FILED 7-2-2001.



OWNER OF U.S. REG. NO. 2,017,574.
NO CLAIM IS MADE TO THE EXCLUSIVE RIGHT TO USE "APPAREL", APART FROM THE MARK AS SHOWN.
FOR CLOTHING, NAMELY SHIRTS (U.S. CLS. 22 AND 39).

SN 76-280,219. COMO SETA, INC., LOS ANGELES, CA. FILED 6-22-2001.

GIORGIO VALENZI

THE NAME "GIORGIO VALENZI" DOES NOT IDENTIFY A LIVING INDIVIDUAL.
FOR MEN'S CLOTHING, NAMELY, SHIRTS, SWEATERS, JACKETS, PANTS, TIES, SUITES, AND KNITWEAR, NAMELY KNIT SWEATERS AND KNIT SHIRTS (U.S. CLS. 22 AND 39).

CLASS 25—(Continued).

SN 76-280,567. MOUNTAIN WEST CONFERENCE, COLORADO SPRINGS, CO. FILED 7-2-2001.



NO CLAIM IS MADE TO THE EXCLUSIVE RIGHT TO USE "CONFERENCE", APART FROM THE MARK AS SHOWN.

THE STIPPLING SHOWN IN THE DRAWING IS A FEATURE OF THE MARK, AND IS NOT INTENDED TO INDICATE COLOR.

FOR CLOTHING, NAMELY T-SHIRTS, SWEATSHIRTS, SWEAT PANTS, SPORT SHIRTS, GOLF SHIRTS, POLO SHIRTS, SWEATERS, BELTS, TIES, NIGHTSHIRTS, PARKAS, COATS, HATS, HEADBANDS, WRISTBANDS, PANTS, SOCKS, JERSEYS, JACKETS, SHORTS, WARMUP SUITS, SCARVES, BIBS, TIES, AND APRONS (U.S. CLS. 22 AND 39).

FIRST USE 1-10-1999; IN COMMERCE 7-1-1999.

SN 76-280,862. CHAD KNOX & ALONZO SMALLEY PARTNERSHIP, THE, DETROIT, MI. FILED 7-2-2001.

215 GEAR

NO CLAIM IS MADE TO THE EXCLUSIVE RIGHT TO USE "GEAR", APART FROM THE MARK AS SHOWN.

FOR CLOTHING FOR MEN, WOMEN AND CHILDREN, NAMELY, T-SHIRTS, SWEATSHIRTS, JOGGING SUITS, PANTS, JACKETS, COATS, HATS, SOCKS, SHOES, JERSEYS, TIES, BELTS, VESTS, HOODS, SWEATERS AND JEANS (U.S. CLS. 22 AND 39).

SN 76-283,253. RHODES, VIRGINIA, DBA CYCLE SHIRTS, FAIRFIELD, AL. FILED 7-11-2001.

**NOT FOR A LONG TIME,
BUT FOR A GOOD TIME**

SEC. 2(F).
FOR CLOTHING, NAMELY T-SHIRTS (U.S. CLS. 22 AND 39).
FIRST USE 0-0-1985; IN COMMERCE 0-0-1985.

CLASS 25—(Continued).

SN 76-284,808. DALI OVERSEAS CORP., MIAMI, FL. FILED 7-16-2001.

BANDETTA

FOR MEN'S CLOTHING, NAMELY JEANS, SHORTS, PANTS, JACKETS, COATS, SWEATERS, SWEATSHIRTS, TANK TOPS, SHIRTS, T-SHIRTS, SUITS, JUMPSUITS, SLACKS, SOCKS, BELTS, FOOTWEAR, UNDERWEAR, PAJAMAS, HATS, CAPS (U.S. CLS. 22 AND 39).

SN 76-285,713. SALVI ENTERPRISES CORP., MIAMI, FL. FILED 7-16-2001.

NEW MAX

FOR CLOTHING, NAMELY PANTS, SLACKS, TROUSERS, JEANS, SHORTS, OVERALLS, SHIRTS, T-SHIRTS, BLOUSES, VESTS, SKIRTS, JEAN SKIRTS, DRESSES, JACKETS, COATS, SWEATERS, HATS, TIES, BELTS, AND SOCKS (U.S. CLS. 22 AND 39).

FIRST USE 7-0-1972; IN COMMERCE 3-23-2001.

SN 76-286,700. GINLEY, VANESSA NOEL, NEW YORK, NY. FILED 7-18-2001.

VANNO.COM

FOR WOMEN'S SHOES, WOMEN'S ACCESSORIES, NAMELY BELTS AND SCARVES (U.S. CLS. 22 AND 39).

FIRST USE 3-1-1999; IN COMMERCE 3-1-1999.

SN 76-291,510. TAYLOR MADE GOLF COMPANY, INC., CARLSBAD, CA. FILED 7-27-2001.

FIT FOAM

NO CLAIM IS MADE TO THE EXCLUSIVE RIGHT TO USE "FOAM", APART FROM THE MARK AS SHOWN. FOR SHOES (U.S. CLS. 22 AND 39).

CLASS 25—(Continued).

SN 76-298,009. SCOTT, ERIC JACKSON, INGLEWOOD, CA. FILED 8-13-2001.



Valence
infinite

FOR HATS, SWEATSHIRTS, T-SHIRTS, PANTS, SHORTS, AND JACKETS (U.S. CLS. 22 AND 39).

SN 76-298,335. OVIEDO, MARCELA ALEJANDRA JOYAS, PONTEVEDRA, SPAIN, FILED 8-13-2001.



Nawik

PRIORITY CLAIMED UNDER SEC. 44(D) ON SPAIN APPLICATION NO. 2.417.658, FILED 7-26-2001.

FOR CLOTHING, NAMELY, AEROBIC EXERCISE GARMENTS, STRETCH PANTS, TROUSERS, TANK TOPS, AND SHIRTS; FOOTWEAR; AND HEADWEAR (U.S. CLS. 22 AND 39).

SN 76-298,440. EL CHARRO NORTENO, INC., ATWATER, CA. FILED 8-13-2001.

SILVER BULL

FOR FOOTWEAR, WESTERN FOOTWEAR AND WORKBOOTS (U.S. CLS. 22 AND 39).

FIRST USE 5-16-2001; IN COMMERCE 5-16-2001.

CLASS 25—(Continued).

SN 76-299,351. KYUNG IN DISTRUBUTION CO., LTD., SEOUL, REPUBLIC OF KOREA, FILED 8-13-2001.



OWNER OF REPUBLIC OF KOREA REG. NO. 362974, DATED 5-26-1997, EXPIRES 5-26-2007.
OWNER OF U.S. REG. NOS. 1,874,956 AND 2,021,567.
FOR FORMAL SHOES, SUITS, TROUSERS, MEN'S OVERCOATS, DRESSES, JACKETS, MEN'S JEANS, SHIRTS, UNDERWEAR, NECKTIES, AND SOCKS (U.S. CLS. 22 AND 39).

SN 76-300,787. KAWAHARA MFG. CO., LTD., ONOMICHI-SHI HIROSHIMA-KEN, 722-0221, JAPAN, FILED 8-15-2001.



FOR NON-JAPANESE STYLE OUTERWEAR, NAMELY, JACKETS; COATS; SWEATERS; SHIRTS; NIGHTWEAR, NAMELY, NIGHT SHIRTS; UNDERWEAR; SWIMSUITS AND BATHING SUITS; BATHING CAPS; JAPANESE STYLE CLOTHING, NAMELY, KIMONOS; GARTERS; SUSPENDERS; WAISTBANDS; BELTS; SHOES AND BOOTS, OTHER THAN SHOE DOWELS/SHOE PEGS/SHOE HANDLES/HOBNAI LS/METAL PIECES FOR PREVENTION OF SHOE SOLE WEARING; SPECIAL SPORTING/GYMNASTIC WEAR, NAMELY, SPORTS SHIRTS; SPECIAL SPORTING/GYMNASTIC FOOTWEAR, EXCLUDING HORSE RIDING BOOTS (U.S. CLS. 22 AND 39).

SN 76-301,161. EXEL OYJ, FIN-52701 MANTYHARJU, FINLAND, FILED 8-17-2001.



NO CLAIM IS MADE TO THE EXCLUSIVE RIGHT TO USE "WALKER", APART FROM THE MARK AS SHOWN.
FOR SPORTS CLOTHING; NAMELY, T-SHIRTS, PANTS, SWEATSHIRTS, JACKETS, SOCKS, AND GLOVES; SPORTS FOOTWEAR; SPORTS HEADWEAR, NAMELY, CLOTHING CAPS, HATS, AND VISORS (U.S. CLS. 22 AND 39).

CLASS 25—(Continued).

SN 76-304,509. MURIEL, EDDIE, PROVIDENCE, RI. FILED 8-27-2001.



FOR CLOTHING, NAMELY, SWEATERS, JACKETS PANTS SNEAKERS, HATS, DRESS SHIRTS, JEAN JACKETS, JEAN PANTS, T-SHIRTS AND BUTTON-DOWN SHIRTS (U.S. CLS. 22 AND 39).

SN 76-305,353. PLATYPUS WEAR, INC., SAN DIEGO, CA. FILED 8-27-2001.

BAD GIRL

OWNER OF U.S. REG. NOS. 1,564,707 AND 2,095,747.
FOR CLOTHING, NAMELY, SHIRTS, BLOUSES, TOPS, JACKETS, JERSEYS, SWEATSHIRTS, COVERALLS, WRAPS, VESTS, SWEATPANTS, T-SHIRTS, TANK TOPS, SHORTS, PANTS, DRESSES, SKIRTS, SWIMSUITS, BELTS, HATS AND SHOES (U.S. CLS. 22 AND 39).
FIRST USE 10-17-1988; IN COMMERCE 10-17-1988.

SN 76-306,976. DRD APPAREL INC., EDMONTON, ALBERTA, CANADA, FILED 8-30-2001.



THE LINING SHOWN IN THE DRAWING IS A FEATURE OF THE MARK AND DOES NOT INDICATE COLOR.
FOR CLOTHING, NAMELY SHORT SLEEVED T-SHIRTS, LONG SLEEVED T-SHIRTS, SWEATSHIRTS, HATS, CAPS, WIND SHIRTS, SWEATERS, RAINWEAR, WIND RESISTANT PARKAS, JACKETS AND COATS; SHORTS, PANTS, UNDERWEAR, SOCKS AND NIGHT SHIRTS (U.S. CLS. 22 AND 39).

CLASS 25—(Continued).

SN 76-307,836. CINQ, LTD., NEW YORK, NY. FILED 9-4-2001.

NICOLE G

THE MARK COMPRISES THE NAME OF A LIVING INDIVIDUAL.

FOR WOMEN'S SPORTSWEAR NAMELY, JACKETS, PANTS, SKIRTS, BLOUSES, DRESSES, SHIRTS AND KNIT TOPS (U.S. CLS. 22 AND 39).

SN 76-308,131. BRASKING, INC., VERNON, CA. FILED 8-31-2001.

ALL THE RAGE

FOR BATHROBES, BELTS, BLOUSES, BODY SUITS, BOOTS, BOTTOMS, BRASSIERES, CAPS, CARDIGANS, COATS, CORSETS, DRESSES, DRESSING GOWNS, FOOTWEAR, GLOVES, GYM SUITS, HATS, HEADWEAR, HOSIERY, JACKETS, JEANS, JERSEYS, JUMPERS, JUMPSUITS, KNICKERS, LEGGINGS, MITTENS, NIGHTGOWNS, OVERALLS, OVERCOATS, PAJAMAS, PANTS, PARKAS, PETTICOATS, POLO SHIRTS, PULL-OVERS, RAINCOATS, SANDALS, SCARVES, SHIRTS, SHOES, SHORTALLS, SHORTS, SKIRTS, SKORTS, SLEEPWEAR, SLIPPERS, SOCKS, SPORTSHIRTS, STOCKINGS, SUITS, SUSPENDERS, SWEAT PANTS, SWEAT-SHIRTS, SWEATERS, SWIMMING SUITS, SWIMWEAR, T-SHIRTS, TIGHTS, TOPS, TRACKSUITS, UNDERWEAR, VESTS AND WAISTCOATS (U.S. CLS. 22 AND 39).

SN 76-308,902. HAYADOIN? ENTERTAINMENT INC., NEW ROCHELLE, NY. FILED 9-6-2001.

HOW YOU DOIN'?

FOR MEN'S, WOMEN'S AND CHILDREN'S CLOTHING AND SPORTSWEAR, MORE SPECIFICALLY, T-SHIRTS, SHIRTS, PANTS, HATS, CAPS, JACKETS, AND SHORTS (U.S. CLS. 22 AND 39).

SN 76-309,745. DAVIS, WAYDE JEFFERY, NEW ORLEANS, LA. FILED 9-6-2001.



FOR CLOTHING, NAMELY SHIRTS, T-SHIRTS, SWEATSHIRTS, SWEATPANTS, SHORTS, JACKETS, VISORS, VESTS, HATS AND FOOTWEAR (U.S. CLS. 22 AND 39).

CLASS 25—(Continued).

SN 76-309,884. EASTERN MOUNTAIN SPORTS, INC., PETERBOROUGH, NH. FILED 9-6-2001.

TECHWICK

FOR T-SHIRTS, SHORTS, TIGHTS, PANTS, SOCKS AND HEADWEAR (U.S. CLS. 22 AND 39).

SN 76-310,624. VANDERBILT UNIVERSITY, NASHVILLE, TN. FILED 9-10-2001.



OWNER OF U.S. REG. NOS. 1,639,680, 1,893,919 AND OTHERS.

FOR CLOTHING, NAMELY SWEATSHIRTS (U.S. CLS. 22 AND 39).

FIRST USE 7-1-1999; IN COMMERCE 7-1-1999.

SN 76-310,797. SPORTS JEANS, INCORPORATED, LOS ANGELES, CA. FILED 9-12-2001.

HABANA CARGO

NO CLAIM IS MADE TO THE EXCLUSIVE RIGHT TO USE "CARGO", APART FROM THE MARK AS SHOWN.

FOR CLOTHING AND APPAREL FOR MEN, WOMEN AND CHILDREN, NAMELY, JEANS, PANTS, T-SHIRTS, SWEATSHIRTS, SWEATERS, ANORAKS, COATS, SHORTS, SOCKS, UNDERWEAR, HATS, AND CAPS (U.S. CLS. 22 AND 39).

SN 76-311,708. REPICE, AGATHA, SOUTH HACKENSACK, NJ. AND REPICE, JULIE, SOUTH HACKENSACK, NJ. AND REPICE, JOSEPH, SOUTH HACKENSACK, NJ. FILED 9-14-2001.

NEW YORK THE WORLD IN ONE CITY

NO CLAIM IS MADE TO THE EXCLUSIVE RIGHT TO USE "NEW YORK", APART FROM THE MARK AS SHOWN. FOR SHIRTS (U.S. CLS. 22 AND 39).

CLASS 25—(Continued).

SN 76-314,431. CROOKED 1 LTD., CLEVELAND, OH. FILED 9-19-2001.

CROOKED 1

FOR HATS AND T-SHIRTS (U.S. CLS. 22 AND 39).

SN 76-314,908. DR. MARTENS INTERNATIONAL TRADING GMBH, D-81241 MUNICH, FED REP GERMANY, FILED 9-20-2001.



OWNER OF U.S. REG. NOS. 1,454,323, 2,397,734 AND OTHERS.

NO CLAIM IS MADE TO THE EXCLUSIVE RIGHT TO USE "AIR CUSHION SOLE", APART FROM THE MARK AS SHOWN.

THE NAME "DR. MARTENS" DOES NOT IDENTIFY A LIVING INDIVIDUAL.

THE MARK CONSISTS OF THE WORDS "DR. MARTENS AIR CUSHION SOLE" AND A DESIGN.

FOR CLOTHING, NAMELY, FOOTWEAR, COATS, JACKETS, ANORAKS, PARKAS, T-SHIRTS, POLO SHIRTS, LONG AND SHORT SLEEVE SHIRTS, BLOUSES, TANK TOPS, SWEATERS, SWEATSHIRTS, SWEATPANTS, PANTS, JEANS, SKIRTS, BELTS, SOCKS, AND HEAD WEAR (U.S. CLS. 22 AND 39).

FIRST USE 0-0-1983; IN COMMERCE 0-0-1983.

CLASS 25—(Continued).

SN 76-316,728. IOU-YE INTERNATIONAL CO., LTD., TAIPEI, TAIWAN, CHINA, FILED 9-25-2001.



THE WORD "HAOSHOU" IS AN ENGLISH TRANSLITERATION OF CHINESE CHARACTERS WHICH IS TRANSLATED INTO ENGLISH AS "TRUMPETER".

FOR CLOTHING, NAMELY, LADIES DRESSES, FORMAL DRESSES, LEISURE SUITS, SPORTS SUITS, CHILDREN PANTS, AND SHIRTS, UNDERWEAR, PAJAMAS, SWEATERS, SWIMSUITS, VESTS, T-SHIRTS, BUSINESS SUITS, MATERNITY BLOUSES, SKIRTS AND PANTS, BABY DRESSES, UNDERSHIRTS AND PANTS, KIMONOS, HEAD WEAR FOR BRIDES, SKIRTS, LEATHER PANTS, WIND RESISTANT JACKETS, SCARVES, HEAD SCARVES, NECKTIES, BOW TIES, CAPS, SPORTS CAPS, SHOES, RAINCOATS, CANVAS SHOES, RUBBER SHOES, JOGGING SHOES, SPORTS SHOES, RIDING BOOTS, SOCKS, PANTYHOSE, SILK SOCKS, WOOLEN SOCKS, CLOTHING BELTS, LEATHER BELTS, APRONS, GLOVES FOR COLD WEATHER, EARMUFFS, SWIMMING CAPS, SILK SCARVES, BODY SUITS FOR FITNESS, INFORMAL FOOTWEAR, NAMELY, LOAFERS, WALKING SHOES, SNEAKERS (U.S. CLS. 22 AND 39).

FIRST USE 9-10-1996; IN COMMERCE 2-14-2001.

SN 76-319,203. ADAMS CHILDRENSWEAR LIMITED, NU-NEATON, WARWICKSHIRE CV11 6RU, ENGLAND, FILED 9-28-2001.

ICKLE

PRIORITY CLAIMED UNDER SEC. 44(D) ON UNITED KINGDOM APPLICATION NO. 2,276,432, FILED 7-27-2001, REG. NO. 2276432, DATED 1-4-2002, EXPIRES 7-27-2011.

FOR CHILDREN'S AND BABIES' CLOTHING, NAMELY, SHIRTS, BLOUSES, SWEATERS, JUMPERS, CARDIGANS, PANTS, SKIRTS, DRESSES, JACKETS, PAJAMAS, UNDERWEAR, T-SHIRTS, COATS, SCARVES, GLOVES, MITTENS, SOCKS, ROMPER SUITS, SNOW SUITS, SLEEPSUITS, BIBSHORTS SETS; FOOTWEAR, NAMELY, SHOES, SLIPPERS, BOOTS AND BOOTIES; HEADGEAR, NAMELY, HATS, CAPS AND BONNETS (U.S. CLS. 22 AND 39).

SN 76-320,199. DIVEGEAR, INC., NEWPORT BEACH, CA. FILED 10-1-2001.

DIVEGEAR

FOR CLOTHING, NAMELY, SHIRTS, T-SHIRTS, ROBES, SHORTS, SWEATSHIRTS, SWEATPANTS, PANTS, SWIMSUITS, SWIM TRUNKS, HATS, CAPS AND VISORS (U.S. CLS. 22 AND 39).

FIRST USE 3-0-1996; IN COMMERCE 3-0-1996.

CLASS 25—(Continued).

SN 76-321,512. SWENSON, NORMAN V., JR., CHARLOTTE, NC. FILED 10-5-2001.

PERRY SWENSON

THE NAME "PERRY SWENSON" IDENTIFIES A LIVING INDIVIDUAL WHOSE CONSENT IS OF RECORD.
FOR WOMEN'S CLOTHING, NAMELY, SHIRTS, TOPS, SWEATERS, PANTS, SLACKS, JACKETS, HATS AND SHOES (U.S. CLS. 22 AND 39).

SN 76-321,815. SIMMS, SEAN A., YOUNGSTOWN, OH. FILED 10-5-2001.

MINAGE JEANZ CO.

NO CLAIM IS MADE TO THE EXCLUSIVE RIGHT TO USE "JEANS CO.", APART FROM THE MARK AS SHOWN.
FOR WEARING APPAREL, NAMELY, PANTS, SHORTS, SHIRTS, VESTS, SUITS, DRESSES, UNDERGARMENTS, GLOVES, HATS, JACKETS, COATS, AND ACTIVE APPAREL, NAMELY, SWEATSHIRTS, SWEAT PANTS (U.S. CLS. 22 AND 39).

SN 76-322,072. ARCTIA PRODUCTIONS LTDA., BARUERI, BRAZIL, FILED 10-5-2001.

ARCTIA

FOR ADULT AND CHILDREN'S APPAREL, NAMELY, SHIRTS, T-SHIRTS, PANTS, SHORTS, UNDERGARMENTS, DRESSES, SKIRTS, HATS, SWIMWEAR, MASQUERADE COSTUMES, PAJAMAS, LEGGINGS, HOSIERY, FOOTWEAR, JACKETS, SWEATERS, SCARVES, GLOVES, MITTENS (U.S. CLS. 22 AND 39).

SN 76-322,157. GENE POOL JEANS, INC., SAN GABRIEL, CA. FILED 10-5-2001.

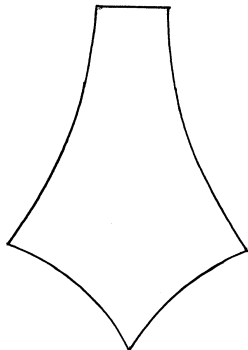

FOR CLOTHING, NAMELY PANTS, SHIRTS, HATS AND BELTS (U.S. CLS. 22 AND 39).
FIRST USE 6-8-2001; IN COMMERCE 6-8-2001.

CLASS 25—(Continued).

SN 76-322,380. BROWN, NYJGEL A., EAST ORANGE, NJ. FILED 10-3-2001.



NO CLAIM IS MADE TO THE EXCLUSIVE RIGHT TO USE "WEAR", APART FROM THE MARK AS SHOWN.
FOR CLOTHING, NAMELY, SHIRTS, HATS, SWEATERS, JACKETS (U.S. CLS. 22 AND 39).

SN 76-322,565. E.S. ORIGINALS, INC., NEW YORK, NY. FILED 10-9-2001.

STICKY GRIP

NO CLAIM IS MADE TO THE EXCLUSIVE RIGHT TO USE "GRIP", APART FROM THE MARK AS SHOWN.
FOR FOOTWEAR (U.S. CLS. 22 AND 39).

SN 76-322,740. JOYCHIME INDUSTRIAL CORP., TAIPEI, TAIWAN, FILED 10-9-2001.



THE MARK CONSISTS OF LETTERS "E" AND "Z" IN STYLIZED FORM, WITH THE WORDING "HEALTHAID" CROSSING THE LETTER "E" AND "Z" IN GRADUALLY LARGER SIZE. THE LETTER "D" CONNECTING THE STYLIZED LETTER "Z".
FOR JOGGING SUITS, SHIRTS, SHOES, BOOTS, HATS, T-SHIRTS, BRASSIERES, SOCKS, STOCKINGS, UNDERGARMENTS, SLEEP WEAR, NECKERCHIEFS (U.S. CLS. 22 AND 39).

CLASS 25—(Continued).

SN 76-324,592. DIAXIS, LLC, EL SEGUNDO, CA. FILED 10-11-2001.



OWNER OF U.S. REG. NOS. 1,795,090 AND 2,227,210.
FOR CLOTHING, NAMELY, PANTS, SHORTS, T-SHIRTS, SWEATSHIRTS, JACKETS, AND HATS (U.S. CLS. 22 AND 39).
FIRST USE 6-0-2000; IN COMMERCE 6-0-2000.

SN 76-324,784. GONZALES, ROBERT R., COVINA, CA. FILED 10-15-2001.

ANCIENT WAYS

FOR CLOTHING, NAMELY, T-SHIRTS, TANK TOPS, SWEATSHIRTS, POLO SHIRTS, JACKETS, SHORTS, SWEAT PANTS, SWEATERS, TUBE TOPS, HALTER TOPS, HATS, WIND RESISTANT JACKETS, SUN VISORS, SUN DRESSES; SURF WEAR, NAMELY, SWIM TRUNKS, BIKINIS, BATHING SUITS, TANK TOPS; SWIMWEAR, NAMELY, SWIM TRUNKS, BIKINIS, BATHING SUITS, SHORTS, T-SHIRTS, SUN VISORS, HATS, TANK TOPS, HALTER TOPS, TUBE TOPS (U.S. CLS. 22 AND 39).

SN 76-325,412. CHELSEA ROAD PRODUCTIONS, KILBRIDE, ONTARIO, CANADA, FILED 10-15-2001.

GOD ROCKS

FOR BELTS; RAIN COATS MEN'S, WOMEN'S AND CHILDREN'S CLOTHING, NAMELY, NECKTIES, BUTTON DOWN SHIRTS, AND POLO-STYLE SHIRTS; CHILDREN'S SLEEPWEAR AND LOUNGEWEAR CONSISTING OF LONG AND SHORT TWO-PIECE SETS; GOWNS; DORM SHIRTS AND LOUNGEWEAR SEPARATES; FASHION UNDERWEAR, NAMELY, PANTIES, CAMISOLES, UNDERSHIRTS, BOXERS AND BOXER BRIEFS; CAPS, HATS, AND VISORS; HEAD BANDS, GLOVES, MITTENS, SCARVES; JOG SUITS; SHORTS; PANTS; JEANS; TOPS; PANTS; DRESSES; COVERALLS; ROMPERS; CREEPERS; OVERALLS; SHORTALLS; T-SHIRTS; SWEATERS; OUTERWEAR, NAMELY, JACKETS, WIND RESISTANT JACKETS AND PANTS; RAIN WEAR, NAMELY, RAIN JACKETS, PONCHOS; SWIMWEAR; BODY WEAR, NAMELY, TIGHTS AND LEOTARDS (U.S. CLS. 22 AND 39).

SN 76-325,488. PARIS GLOVE OF CANADA LTD., CANADA, FILED 10-15-2001.

LAURENTIDE

FOR GLOVES (U.S. CLS. 22 AND 39).

CLASS 25—(Continued).

SN 76-326,320. MILLER, SCOTT, VALPARAISO, IN. AND RICHARDSON, ROBERT, LOCKPORT, IL. FILED 10-17-2001.

UFFIZI

FOR WOMEN'S SHOES (U.S. CLS. 22 AND 39).

SN 76-327,103. TIASA, INC., PLANTATION, FL. FILED 10-17-2001.

TIASA

FOR CLOTHING, NAMELY GIRL'S AND WOMEN'S DRESSES, SHIRTS, AND COVERUPS (U.S. CLS. 22 AND 39).
FIRST USE 1-19-1999; IN COMMERCE 4-21-2000.

SN 76-328,239. MOSE UNLTD CO., INC., CALUMET PARK, IL. FILED 10-22-2001.

MOSELLE

FOR MEN'S, WOMEN'S AND CHILDREN'S CLOTHING, NAMELY, ANORAKS, ASCOTS, ATHLETIC FOOTWEAR, ATHLETIC SHOES, BATHING SUITS, BATHING TRUNKS, BEACH COVERUPS, BEACHWEAR, BELTS, BLAZERS, BLOUSES, BODYSUITS, BOLEROS, BOOTS, BOW TIES, BRASSIERES, BRIEFS, BOXER SHORTS, BUSTIERS, CAMISOLES, CAPS, CARDIGANS, CHEMISES, COATS, CULOTTES, CUMMERBUNDS, DRESSES, EVENING GOWNS, FOOTWEAR, FOUNDATION GARMENTS, GALOSHES, GARTER BELTS, GLOVES, GYM SUITS, HALTER TOPS, HATS, HEADBANDS, HEADWEAR, HOODS, HOSIERY, INFANT WEAR, JACKETS, JEANS, JERSEYS, JOGGING SUITS, JUMPERS, JUMPSUITS, LEGGINGS, LEG WARMERS, LINGERIE, LOUNGEWEAR, MITTENS, NECKERCHIEFS, NECKTIES, NEGLIGEEES, NIGHTGOWNS, NIGHTSHIRTS, OVERALLS, PAJAMAS, PANTIES, PANTS, PARKAS, POCKET SQUARES, RAINCOATS, ROBES, ROMPERS, SARONGS, SASHES, SCARVES, SHAWLS, SHIRTS, SHOES, SHORTALLS, SHORTS, SKI GLOVES, SKI PANTS, SKI SUITS, SKI WEAR, SKIRTS, SKORTS, SLACKS, SLIPS, SOCKS, SPORT COATS, SUITS, SWEAT PANTS, SWEATERS, SWEATSHIRTS, SWIMWEAR, T-SHIRTS, TANK TOPS, THERMAL SOCKS, THERMAL UNDERWEAR, TROUSERS, TUNICS, TUXEDOS, UNDERPANTS, UNDERSHIRTS, UNITARDS, VESTS, WIND RESISTANT JACKETS (U.S. CLS. 22 AND 39).

SN 76-328,544. NEW GEN ENTERPRISE, INC, DBA BLOOM, LOS ANGELES, CA. FILED 10-22-2001.

B-9 BIO-JEANS

FOR MEN'S, WOMEN'S AND CHILDREN'S CLOTHING, NAMELY, JEANS, PANTS, SKIRTS, DRESSES, SLACKS, SHORTS, JEAN JACKETS, SHIRTS, T-SHIRTS, VESTS, SWEATERS, SHOES, BELTS, HATS, CAPS, AND SOCKS (U.S. CLS. 22 AND 39).

CLASS 25—(Continued).

SN 76-328,946. BIANCA-MODEN GMBH & CO. KG, 48607 OCHTRUP, FED REP GERMANY, FILED 10-23-2001.

BIANCALDI

OWNER OF FED REP GERMANY REG. NO. 30125923, DATED 5-17-2001, EXPIRES 4-30-2011.

FOR CLOTHING, NAMELY BELTS, DRESSES, FOOTWEAR, LINGERIE, HEADWEAR, INFANTWEAR, JACKETS, PANTS, SHIRTS, SHORTS, SKIRTS, SLEEPWEAR, SWEATERS, SWIMWEAR, TOPS, UNDERGARMENTS, SCARVES, MUFFLERS, COATS, TIES, ROBES, AND HOSIERY (U.S. CLS. 22 AND 39).

SN 76-329,336. TBAC INVESTMENT TRUST, ARLINGTON, TX. FILED 10-24-2001.

**ROYALLE COLLECTION BY
PRINCESS GARDNER**

NO CLAIM IS MADE TO THE EXCLUSIVE RIGHT TO USE "COLLECTION", APART FROM THE MARK AS SHOWN.

THE NAME IN THE MARK DOES NOT IDENTIFY A LIVING INDIVIDUAL.

FOR BELTS (U.S. CLS. 22 AND 39).

SN 76-330,172. NOVONT ENTERPRISES INC., LOS ANGELES, CA. FILED 10-26-2001.

NURLINGTON NINE

FOR MEN'S, WOMEN'S AND CHILDREN'S APPAREL, NAMELY, SHIRTS, PANTS, SHORTS AND JACKETS (U.S. CLS. 22 AND 39).

FIRST USE 3-20-2001; IN COMMERCE 3-20-2001.

SN 76-330,541. OFFICIAL BUGLE BOY, LLC, COLUMBUS, OH. FILED 10-26-2001.

BUGLE BOY

OWNER OF U.S. REG. NOS. 1,113,214, 2,445,620 AND OTHERS.

FOR CLOTHING, NAMELY, JEANS, T-SHIRTS, SWIMWEAR, JUMPERS, HATS, SOCKS, BASEBALL CAPS, VISORS, SWEATERS, BLOUSES, SKIRTS, DRESSES, ROMPERS, UNDERGARMENTS, TOPS AND OVERALLS (U.S. CLS. 22 AND 39).

CLASS 25—(Continued).

SN 76-335,158. COLLETTE DINNIGAN INTERNATIONAL LIMITED, HONG KONG, FILED 10-29-2001.

WILD HEARTS

FOR CLOTHING FOR MEN, WOMEN, AND CHILDREN, NAMELY, LINGERIE, CORSETS, DRESSES, SKIRTS, TROUSERS, SHIRTS, TOPS, PANTS, SUITS, FROCKS, JUMPERS, BLOUSES, SCARVES, JACKETS, COATS, JERSEYS, NIGHTWEAR, SWIMWEAR, SWEATERS AND HOSIERY; FOOTWEAR; HEADGEAR NAMELY, HATS, CAPS, AND VISORS (U.S. CLS. 22 AND 39).

SN 76-335,585. LEISURE ARTS, INC., BIRMINGHAM, AL. FILED 11-9-2001.



NO CLAIM IS MADE TO THE EXCLUSIVE RIGHT TO USE "HALLOWEEN", APART FROM THE MARK AS SHOWN.

THE STIPPLING IS FOR SHADING PURPOSES ONLY. FOR HALLOWEEN COSTUMES AND HALLOWEEN COSTUMES THAT INCLUDE HALLOWEEN MASKS AS A FEATURE OF THE COSTUME (U.S. CLS. 22 AND 39).

SN 76-336,203. FRED MEYER STORES, INC., PORTLAND, OR. FILED 11-9-2001.

CURFEW SPORT

NO CLAIM IS MADE TO THE EXCLUSIVE RIGHT TO USE "SPORT", APART FROM THE MARK AS SHOWN.

FOR CLOTHING; NAMELY, SHIRTS, SHORTS, PANTS AND JACKETS (U.S. CLS. 22 AND 39).

CLASS 25—(Continued).

SN 76-336,592. SMILING CHEF INC., THE, HAMPTON BAYS, NY. FILED 11-13-2001.

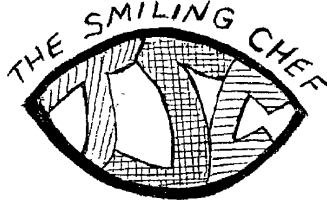

NO CLAIM IS MADE TO THE EXCLUSIVE RIGHT TO USE "CHEF", APART FROM THE MARK AS SHOWN.

THE "T" IS LINED FOR THE COLOR RED; THE "S" IS LINED FOR THE COLOR YELLOW AND THE "C" IS LINED FOR THE COLOR BLUE.

FOR CLOTHING; NAMELY T-SHIRTS, GOLF SHIRTS, CHEF COATS, BASEBALL CAPS, CHEF HATS, AND BERETS (U.S. CLS. 22 AND 39).

FIRST USE 5-23-2000; IN COMMERCE 6-2-2001.

SN 76-336,768. RUSSELL ASSET MANAGEMENT, INC., WILMINGTON, DE. FILED 11-13-2001.

JERZEES CAZUALS

OWNER OF U.S. REG. NOS. 1,280,293, 2,363,671 AND OTHERS.

NO CLAIM IS MADE TO THE EXCLUSIVE RIGHT TO USE "CASUALS", APART FROM THE MARK AS SHOWN.

SEC. 2(F) "JERZEES".

FOR CLOTHING, NAMELY, VESTS, TUNICS, SKIRTS, PANTS, TOPS, T-SHIRTS, TANK-TOPS, PLACKET SHIRTS, SKIRTS, SHORTS, PANTS, BUTTON-DOWN SHIRTS, SLEEPWEAR, AND SOCKS (U.S. CLS. 22 AND 39).

FIRST USE 11-0-2000; IN COMMERCE 11-0-2000.

SN 76-338,242. WEIDER NUTRITION INTERNATIONAL, INC., SALT LAKE CITY, UT. FILED 11-13-2001.



FOR CLOTHING, NAMELY MEN'S, WOMEN'S AND CHILDREN'S CLOTHING, NAMELY T-SHIRTS; SWEATSHIRTS; TANK TOPS; SHORTS; PANTS; SWEATPANTS; CAPS; HATS; WOMEN'S BODYSUITS; LEGGING; SWEATSUITS; JACKETS; COATS; SWEATERS; SHIRTS; TOPS, NAMELY, FLEECE TOPS; SKIRTS; DRESSES; GLOVES; BELTS; SOCKS; BATHING SUITS; SLEEPWEAR; BEACHWEAR; UNDERWEAR; ROMPERS; AND INFANTWEAR (U.S. CLS. 22 AND 39).

CLASS 25—(Continued).

SN 76-345,676. INTELLIGENT STREET CLOTHING, NEW YORK, NY. FILED 12-6-2001.



FOR OUTERWEAR, NAMELY, RAINWEAR, DOWN JACKETS, AND LEATHER JACKETS (U.S. CLS. 22 AND 39).

SN 76-346,663. WEPA, INC., CHICAGO, IL. FILED 12-10-2001.

WEPA WEAR

NO CLAIM IS MADE TO THE EXCLUSIVE RIGHT TO USE "WEAR", APART FROM THE MARK AS SHOWN.

FOR SHIRTS, PANTS, CAPS, JACKETS, SWEATERS, JACKETS, JEANS, BELTS, SWEATSHIRTS, UNDERWEAR (U.S. CLS. 22 AND 39).

SN 76-346,664. WEPA, INC., CHICAGO, IL. FILED 12-10-2001.



NO CLAIM IS MADE TO THE EXCLUSIVE RIGHT TO USE "WEAR", APART FROM THE MARK AS SHOWN.

FOR SHIRTS, PANTS, CAPS, JACKETS, SWEATERS, JACKETS, JEANS, BELTS, SWEATSHIRTS, UNDERWEAR (U.S. CLS. 22 AND 39).

SN 76-347,865. WARNACO U.S., INC., MILFORD, CT. FILED 12-12-2001.

OLGA FLOWER COUNTRY

OWNER OF U.S. REG. NOS. 780,385, 2,248,479 AND OTHERS.

FOR INTIMATE APPAREL AND FIGURE ENHANCING GARMENTS, NAMELY, BRAS, PANTIES, UNDERWEAR, UNDERPANTS, UNDERGARMENTS, UNDERCLOTHES, TEDDIES, SLIPS, SARONGS, NEGLIGES, LINGERIE, FOUNDATION GARMENTS, GIRDLES, CORSETS, CAMISOLES, BODY SLIPS AND BODY SUITS, SLEEPWEAR AND NIGHTGOWNS (U.S. CLS. 22 AND 39).

CLASS 25—(Continued).

SN 76-347,883. P & Y HALAS PTY LIMITED, ALEXANDRIA, NSW, 2015, AUSTRALIA, FILED 12-12-2001.

BODYPAINT

FOR SKIRTS (U.S. CLS. 22 AND 39).
FIRST USE 6-0-1999; IN COMMERCE 6-0-1999.

SN 76-347,917. STABLE MATES INC., LOS ANGELES, CA. FILED 12-11-2001.

OOPARTS

FOR CLOTHING AND APPAREL, NAMELY, SHIRTS, SKIRTS, T-SHIRTS, SWEATSHIRTS, SWEATERS, JACKETS, COATS, HATS, CAPS, JEANS, PANTS, SWEAT-PANTS AND SOCKS (U.S. CLS. 22 AND 39).

SN 76-349,950. L.C. LICENSING, INC., NEW YORK, NY. FILED 12-19-2001.

CLAIBORNE COMPONENTS

OWNER OF U.S. REG. NOS. 1,454,345, 2,545,212 AND OTHERS.
NO CLAIM IS MADE TO THE EXCLUSIVE RIGHT TO USE "COMPONENTS", APART FROM THE MARK AS SHOWN.
SEC. 2(F).
FOR PANTS, SHIRTS, VESTS, SUIT JACKETS AND SWEATERS (U.S. CLS. 22 AND 39).

SN 76-352,089. YOUR CONNECTION, INC., LOS ANGELES, CA. FILED 12-24-2001.

It's a beautiful thing!



FOR T-SHIRTS AND SWEATSHIRTS (U.S. CLS. 22 AND 39).

CLASS 25—(Continued).

SN 76-352,133. BETE NOIRE IMPORTS, INC., MONTREAL, QUEBEC, CANADA, FILED 12-21-2001.

BEAU MONDE

OWNER OF CANADA REG. NO. TMA343,166, DATED 7-29-1988, EXPIRES 7-29-2003.

THE ENGLISH TRANSLATION OF THE WORD "BEAU MONDE" IN THE MARK IS "HIGH SOCIETY".

FOR CLOTHING, NAMELY— MEN'S SHIRTS, PANTS, COATS, SCARVES, HATS, BELTS, GLOVES, VESTS, SWEATERS, T-SHIRTS, BLAZERS, RAINCOATS, BATHING SUITS, SOCKS, TIES, JACKETS, SUITS, SPORTS JACKETS, TOPCOATS; AND LADIES' TUNICS, DRESSES, PANTS, SCARVES, HATS, BELTS, GLOVES, SWEATERS, T-SHIRTS, BLOUSES, SHIRTS, COATS, JACKETS, VESTS, SKIRTS, BATHING SUITS, JUMP-SUITS, SUITS, RAINCOATS, BLAZERS (U.S. CLS. 22 AND 39).

SN 76-352,889. SHIMANO INC., SAKAI, OSAKA 590-8577, JAPAN, FILED 12-27-2001.



FOR SHOES AND BOOTS, NAMELY, BICYCLING SHOES, FISHING SHOES, FISHING WADERS, GOLF SHOES; CLOTHING FOR SPORTS, NAMELY, SHIRTS, T-SHIRTS, JERSEYS, TOPS, VESTS, FISHING VESTS, TANK TOPS, BOTTOMS, PANTS, SHORTS, LEGGINGS, TIGHTS, UNITARDS, LEOTARDS, SOCKS, UNDERWEAR, ATHLETIC UNIFORMS, COATS, JACKETS, PULLOVERS, CAPS AND GLOVES; CLOTHING FOR CYCLISTS, NAMELY, SHIRTS, T-SHIRTS, JERSEYS, TOPS, VESTS, FISHING VESTS, TANK TOPS, BOTTOMS, PANTS, SHORTS, LEGGINGS, TIGHTS, UNITARDS, LEOTARDS, SOCKS, UNDERWEAR, ATHLETIC UNIFORMS, COATS, JACKETS, PULLOVERS, CAPS AND GLOVES; CLOTHING FOR GYMNASTICS, NAMELY, SHIRTS, T-SHIRTS, JERSEYS, TOPS, VESTS, FISHING VESTS, TANK TOPS, BOTTOMS, PANTS, SHORTS, LEGGINGS, TIGHTS, UNITARDS, LEOTARDS, SOCKS, UNDERWEAR, ATHLETIC UNIFORMS, COATS, JACKETS, PULLOVERS, CAPS AND GLOVES; RAIN WEAR, NAMELY, RAIN COATS, RAIN SUITS AND RAIN HATS; CAPS, GLOVES, SOCKS, SHIRTS, JACKETS, JERSEYS, FISHING VESTS, PANTS, TIGHTS AND UNDERWEAR (U.S. CLS. 22 AND 39).

CLASS 25—(Continued).

SN 76-353,233. EIGHT AND NINE DESIGNS, LLC, NORTH MIAMI, FL. FILED 12-31-2001.



THE MARK CONSISTS OF THE NUMBER "8", FOLLOWED BY A "&" SIGN, FOLLOWED BY THE NUMBER "9".

FOR SHIRTS, PANTS, SHORTS, SKIRTS, AND HEADWEAR, NAMELY, BANDANAS, HEADBANDS, AND HATS (U.S. CLS. 22 AND 39).

SN 76-355,088. MP&P INC., PLAINVIEW, NY. FILED 1-4-2002.



THE STIPPLING IS FOR SHADING PURPOSES ONLY AND DOES NOT INDICATE COLOR.

FOR MEN'S, WOMEN'S AND CHILDREN'S WEARING APPAREL, NAMELY SWEATERS, SWEATSHIRTS, JACKETS, PANTS, JOGGING SUITS AND HATS (U.S. CLS. 22 AND 39).

FIRST USE 1-1-2001; IN COMMERCE 2-1-2001.

SN 76-355,329. INTER-BRIGHT INC., CITY OF INDUSTRY, CA. FILED 1-4-2002.

JOLIE VICKI

THE TRANSLATION OF THE WORD "JOLIE" IS "PRETTY".

FOR FOOTWEAR, NAMELY SHOES (U.S. CLS. 22 AND 39).

CLASS 25—(Continued).

SN 76-356,321. JAY, KENNETH S., WEST NYACK, NY. FILED 1-4-2002.



THE LEAVES IN THE DRAWING ARE IN THE COLOR GREEN. THE APPLICANT CLAIMS COLOR AS A FEATURE OF THE MARK.

FOR LADIES APPAREL, NAMELY, KNIT TOPS, KNIT BOTTOMS, WOVEN TOPS, WOVEN BOTTOMS, JACKETS, CARDIGANS, SKIRTS, PANTS, DRESSES, SWEATERS, AND SWIMSUITS (U.S. CLS. 22 AND 39).

SN 76-357,149. FOX, JAMES E., ARLINGTON, VA. FILED 1-11-2002.

DRY IT UP, YOU GOT YOUR SUCKER!

FOR SHIRTS, JERSEYS, POLOSHIRTS, SWEATSHIRTS, HATS, HEADWEAR, JACKETS, BOOTS, GLOVES, SOCKS, COATS, CAPS, PANTS, AND T-SHIRTS (U.S. CLS. 22 AND 39).

SN 76-357,963. WARNACO U.S., INC., MILFORD, CT. FILED 1-11-2002.

STRIPE HAPPY

OWNER OF U.S. REG. NOS. 1,564,700, 1,949,676 AND OTHERS.

NO CLAIM IS MADE TO THE EXCLUSIVE RIGHT TO USE "STRIPE", APART FROM THE MARK AS SHOWN.

FOR INTIMATE APPAREL AND FIGURE ENHANCING GARMENTS, NAMELY, BRAS, PANTIES, UNDERWEAR, UNDERPANTS, UNDERGARMENTS, UNDERCLOTHES, TEDDIES, SLIPS, SARONGS, NEGLIGES, LINGERIE, FOUNDATION GARMENTS, GIRDLES, CORSETS, CAMISOLES, BODY SLIPS AND BODY SUITS, SLEEP WEAR AND NIGHTGOWNS (U.S. CLS. 22 AND 39).

SN 76-357,964. WARNACO U.S., INC., MILFORD, CT. FILED 1-11-2002.

SUGAR & STRIPES

OWNER OF U.S. REG. NOS. 1,564,701, 1,584,795 AND OTHERS.

FOR INTIMATE APPAREL AND FIGURE ENHANCING GARMENTS, NAMELY, BRAS, PANTIES, UNDERWEAR, UNDERPANTS, UNDERGARMENTS, UNDERCLOTHES, TEDDIES, SLIPS, SARONGS, NEGLIGES, LINGERIE, FOUNDATION GARMENTS, GIRDLES, CORSETS, CAMISOLES, BODY SLIPS AND BODY SUITS, SLEEPWEAR AND NIGHTGOWNS (U.S. CLS. 22 AND 39).

CLASS 25—(Continued).

SN 76-357,966. WARNACO U.S., INC., MILFORD, CT. FILED 1-11-2002.

WARNER'S PURE PLEASURES

OWNER OF U.S. REG. NOS. 50,062, 1,960,088 AND OTHERS.

FOR INTIMATE APPAREL AND FIGURE ENHANCING GARMENTS, NAMELY, BRAS, PANTIES, UNDERWEAR, UNDERPANTS, UNDERGARMENTS, UNDERCLOTHES, TEDDIES, SLIPS, SARONGS, NEGLIGES, LINGERIE, FOUNDATION GARMENTS, GIRDLES, CORSETS, CAMISOLES, BODY SLIPS AND BODY SUITS, SLEEPWEAR AND NIGHTGOWNS (U.S. CLS. 22 AND 39).

SN 76-360,766. TURNER ENTERTAINMENT CO., ATLANTA, GA. FILED 1-17-2002.

GONE WITH THE WIND

FOR CLOTHING FOR MEN, WOMEN AND CHILDREN - NAMELY, SHIRTS, T-SHIRTS, SWEATSHIRTS, JOGGING SUITS, TROUSERS, PANTS, SHORTS, TANK TOPS, RAINWEAR, CLOTH BIBS, SKIRTS, BLOUSES, DRESSES, SUSPENDERS, SWEATERS, JACKETS, COATS, RAINCOATS, SNOW SUITS, TIES, ROBES, HATS, CAPS, SUN VISORS, BELTS, SCARVES, SLEEPWEAR, PAJAMAS, LINGERIE, UNDERWEAR, BOOTS, SHOES, SNEAKERS, SANDALS, BOOTIES, SLIPPER SOCKS, SWIMWEAR, AND MASQUERADE AND HALLOWEEN COSTUMES AND MASKS SOLD IN CONNECTION THEREWITH (U.S. CLS. 22 AND 39).

SN 76-362,136. CHICAGO BEARS FOOTBALL CLUB, INC., LAKE FOREST, IL. FILED 1-23-2002.

MIRACLES OF THE MIDWAY

FOR MEN'S, WOMEN'S AND CHILDREN'S CLOTHING, NAMELY, FLEECE TOPS AND BOTTOMS, CAPS, HEADWEAR, T-SHIRTS, SWEATSHIRTS, SHORTS, TANK TOPS, JEANS, SWEATERS, PANTS, JACKETS, TURTLENECKS, JUMPSUITS, GOLF SHIRTS, WOVEN SHIRTS, KNIT SHIRTS, JERSEYS, WRISTBANDS, WARM UP SUITS, SWIMWEAR, WIND RESISTANT JACKETS, RAINCOATS, PARKAS, PONCHOS, GLOVES, TIES, SUSPENDERS, CLOTH BIBS, SLEEPWEAR, NAMELY, ROBES, NIGHT SHIRTS AND PAJAMAS, MITTENS, KNIT HATS AND CAPS, SCARVES, APRONS, HEADBANDS, EAR MUFFS, UNDERWEAR, SNEAKERS AND SLIPPERS (U.S. CLS. 22 AND 39).

CLASS 25—(Continued).

SN 76-362,217. C.S.F. CORPORATION, WILMINGTON, DE. FILED 1-24-2002.

LIQUID WONDER

NO CLAIM IS MADE TO THE EXCLUSIVE RIGHT TO USE "LIQUID", APART FROM THE MARK AS SHOWN, FOR WOMEN'S APPAREL, NAMELY BRAS (U.S. CLS. 22 AND 39).
FIRST USE 8-28-2000; IN COMMERCE 8-28-2000.

SN 76-362,302. WARNACO U.S., INC., MILFORD, CT. FILED 1-24-2002.

WARNERS FREEDOM MOVEMENT

OWNER OF U.S. REG. NOS. 50,062, 1,524,600 AND OTHERS.

FOR INTIMATE APPAREL AND FIGURE ENHANCING GARMENTS, NAMELY, BRAS, PANTIES, UNDERWEAR, UNDERPANTS, UNDERGARMENTS, UNDERCLOTHES, LINGERIE, FOUNDATION GARMENTS AND CAMISOLES (U.S. CLS. 22 AND 39).

SN 76-362,405. RAHAMIM, ABRAHAM, BROOKLYN, NY. FILED 1-24-2002.

COMFORT MAVEN BY MERCY

NO CLAIM IS MADE TO THE EXCLUSIVE RIGHT TO USE "COMFORT", APART FROM THE MARK AS SHOWN, FOR FOOTWEAR (U.S. CLS. 22 AND 39).
FIRST USE 7-0-2000; IN COMMERCE 7-0-2000.

SN 76-362,736. MAY DEPARTMENT STORES INTERNATIONAL, INC., ST. LOUIS, MO. FILED 1-25-2002.

EMERGE

FOR CLOTHING, NAMELY, PANTS, SHORTS, SHIRTS, SWEATERS, JACKETS, COATS AND SHOES; AND ACCESSORIES, NAMELY, TIES, SOCKS, GLOVES AND BELTS (U.S. CLS. 22 AND 39).

SN 76-363,947. WILLIAMSON-DICKIE MANUFACTURING COMPANY, FORT WORTH, TX. FILED 1-25-2002.

DICKIES SCUFFGARD

OWNER OF U.S. REG. NOS. 594,540, 594,541 AND OTHERS.

FOR MEN'S AND WOMEN'S PANTS AND SLACKS (U.S. CLS. 22 AND 39).

CLASS 25—(Continued).

SN 76-364,002. LIEN YEAR ENTERPRISE CORP., TAI-
CHUNG, TAIWAN, FILED 1-30-2002.



FOR FOOT WEAR, NAMELY, SHOES, SHOE OUT-
SOLES, SHOE UPPERS, SHOE PADS, SANDALS, SLIP-
PERS, BEACH SHOES, SPORTING SHOES, ATHLETIC
SHOES, GOLF SHOES, BOOTS, SKI BOOTS, PARTS AND
FITTINGS FOR ALL THE AFORESAID GOODS (U.S.
CLS. 22 AND 39).

SN 76-365,206. CONVENTURES, INC., BOSTON, MA. FILED
1-24-2002.

PROVIDENCE COOKS

OWNER OF U.S. REG. NO. 2,198,090.
NO CLAIM IS MADE TO THE EXCLUSIVE RIGHT TO
USE "PROVIDENCE", APART FROM THE MARK AS
SHOWN.

FOR CLOTHING, NAMELY SHIRTS, T-SHIRTS, JACK-
ETS, SWEAT SHIRTS, VESTS, HATS, AND CAPS (U.S.
CLS. 22 AND 39).

SN 76-365,625. COLDWATER CREEK INC., SANDPOINT, ID.
FILED 2-1-2002.

COLDWATER CREEK SPIRIT

OWNER OF U.S. REG. NOS. 1,531,418, 2,312,899 AND
OTHERS.

FOR CLOTHING, NAMELY, SHIRTS, JACKETS,
BLOUSES, PANTS, SWEATSHIRTS, SWEAT PANTS,
DRESSES, LINGERIE, SWIMSUITS, SLEEP WEAR AND
SHOES (U.S. CLS. 22 AND 39).

SN 76-366,046. O.N.K. N.Y.C. INC., JAMAICA, NY. FILED 2-
4-2002.



NO CLAIM IS MADE TO THE EXCLUSIVE RIGHT TO
USE "NYC", APART FROM THE MARK AS SHOWN.

FOR SHIRTS, T-SHIRTS, SWEAT SUITS, AND HATS
(U.S. CLS. 22 AND 39).

FIRST USE 8-1-1999; IN COMMERCE 8-1-1999.

CLASS 25—(Continued).

SN 76-366,482. ROBANTE, JOEL G., HAYWARD, CA. FILED
2-4-2002.

BANTE

FOR CLOTHING, NAMELY SHIRTS, PANTS, SHORTS,
SOCKS, JACKETS, HATS AND FOOTWEAR (U.S. CLS. 22
AND 39).

SN 76-367,086. KIM, CHARLES H., GLENDALE, CA. FILED
2-6-2002.



FOR CLOTHING, NAMELY MEN'S; WOMEN'S AND
CHILDREN'S; PANTS, SHIRTS, SHORTS, CAPS, VISORS,
SKIRTS, JACKETS, T-SHIRTS, BELTS, HATS, JERSEYS,
TOPS, SOCKS, ANKLETS, BANDANAS, GLOVES,
GOWNS, HALTER TOPS, HEAD BANDS, WRIST BANDS,
SWIMWEAR, BATHING CAPS, BATHING TRUNKS,
BATHROBES, BEACH COVER-UPS, BEACHWEAR,
BLOUSES, BODY SUITS, TANK TOPS, TIES, BRAS,
UNDERWEAR, COATS, COVERALLS, COVER-UPS,
DRESSES, VESTS, INFANTWEAR, JEANS, JUMPERS,
KILTS, KERCHIEFS, SWEATERS, LEGGINGS, LEO-
TARDS, LINGERIE, MINISKIRTS, MITTENS, PAJAMAS,
PANTIES, PANTYHOSE, PONCHOS, PULLOVERS,
RAINWEAR, ROBES, SHOES, BOOTS, SANDALS, AND
ROMPERS (U.S. CLS. 22 AND 39).

SN 76-367,152. MELTZ, STEVEN Y., LEXINGTON, MA.
FILED 2-4-2002.

**THE SHOCK HEARD 'ROUND
THE WORLD**

FOR CLOTHING, NAMELY T-SHIRTS (U.S. CLS. 22
AND 39).

SN 76-367,284. QVC, INC., WEST CHESTER, PA. FILED 2-5-
2002.

CENTIGRADE

FOR OUTERWEAR, NAMELY COATS, RAINCOATS,
PARKAS AND HATS (U.S. CLS. 22 AND 39).

CLASS 25—(Continued).

SN 76-367,650. WHITE, BEN JAMON, ST. LOUIS, MO. FILED 2-7-2002.

14A-ONE FOR ALL

FOR SHORTS, PANTS, T-SHIRTS, JACKETS, BLOUSES, JEANS, OVERALLS (U.S. CLS. 22 AND 39).

SN 76-367,956. YELLOW BOX CORPORATION, DBA YBC FOOTWEAR, CITY OF INDUSTRY, CA. FILED 2-6-2002.

AQUAGIRL

FOR WOMENS FOOTWEAR (U.S. CLS. 22 AND 39). FIRST USE 1-29-2002; IN COMMERCE 1-29-2002.

SN 76-368,205. CHEN, KEVIN, SAN FRANCISCO, CA. FILED 2-8-2002.

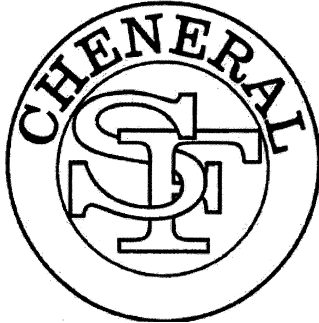

OWNER OF U.S. REG. NO. 2,558,881.
NO CLAIM IS MADE TO THE EXCLUSIVE RIGHT TO USE "SF", APART FROM THE MARK AS SHOWN.
THE NAME "CHENERAL" DOES NOT IDENTIFY A LIVING INDIVIDUAL.
FOR CLOTHING, NAMELY HATS, JACKETS AND SHIRTS (U.S. CLS. 22 AND 39).

SN 76-368,226. QVC, INC., WEST CHESTER, PA. FILED 2-7-2002.

FREE WILL

FOR APPAREL; NAMELY JACKETS, SWEATERS, TOPS, DUSTERS, SHORTS, SKIRTS, PANTS AND DRESSES (U.S. CLS. 22 AND 39).

CLASS 25—(Continued).

SN 76-369,072. BETTY LAVERN POWERS, DBA IN BETTY'S SHOES, WESTLAKE VILLAGE, CA. FILED 2-11-2002.

LIZ JOHNSON

THIS MARK DOES NOT IDENTIFY A PARTICULAR LIVING INDIVIDUAL.
FOR WOMEN'S FOOTWEAR (U.S. CLS. 22 AND 39). FIRST USE 11-1-2001; IN COMMERCE 11-1-2001.

SN 76-369,361. GRABEBOOTIE, INC., ORLANDO, FL. FILED 2-11-2002.



FOR CLOTHING, NAMELY, SHIRTS, T-SHIRTS, SWEATSHIRTS, SINGLETs, TANK TOPS, COATS, JACKETS, SWEATERS, PULLOVERS, BELTS, SNEAKERS, BOOTS, SOCKS, UNDERGARMENTS, SHORTS, JEANS, CAPS, HATS AND VISORS (U.S. CLS. 22 AND 39). FIRST USE 1-29-2002; IN COMMERCE 1-29-2002.

SN 76-369,732. WHALING MFG. CO., INC., FALL RIVER, MA. FILED 2-12-2002.

MICROSETTA

FOR CLOTHING, NAMELY RAINWEAR (U.S. CLS. 22 AND 39).

SN 76-369,822. WATERSHIP TRADING COMPANIE, INC., BELLINGHAM, WA. FILED 2-12-2002.

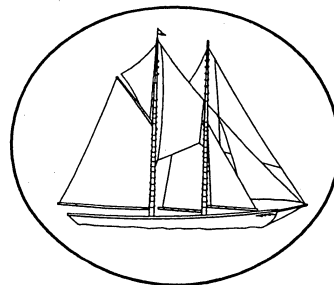

FOR HATS (U.S. CLS. 22 AND 39). FIRST USE 2-0-1990; IN COMMERCE 2-0-1990.

CLASS 25—(Continued).

SN 76-370,372. SPHATIKA INTERNATIONAL LLC, NEW YORK, NY. FILED 2-12-2002.

SPHATIKA

FOR CLOTHING, NAMELY ROBES, BATHROBES, LOUNGEWEAR, T-SHIRTS, TANK TOPS, UNDERGARMENTS, COVERUPS, SLEEPWEAR, SOCKS, FOOTWEAR, SLIPPERS, SCARVES, SWIMWEAR, SHIRTS, PANTS, SHORTS, SLACKS, SKIRTS, DRESSES, SWEAT SHIRTS, SWEAT PANTS, SWEAT SUITS (U.S. CLS. 22 AND 39).

SN 76-370,639. UNIVERSITY CLUB OF WASHINGTON, D.C., THE, WASHINGTON, DC. FILED 2-14-2002.



THE TEWAARATON TROPHY

FOR CAPS AND T-SHIRTS (U.S. CLS. 22 AND 39).
FIRST USE 6-6-2001; IN COMMERCE 6-15-2001.

SN 76-371,123. WEAR-IT APPAREL, INC., ST. LOUIS, MO.
FILED 2-14-2002.

JUST GAME

FOR CLOTHING, NAMELY, JACKETS, COATS, SHIRTS, SWEAT SHIRTS, T-SHIRTS, PANTS, SWEAT PANTS, SHORTS, SOCKS, HEADWEAR, GLOVES, MITTENS, SHOES (U.S. CLS. 22 AND 39).

SN 76-371,318. GOTHE, AXEL, NEW YORK, NY. FILED 2-15-2002.



NO CLAIM IS MADE TO THE EXCLUSIVE RIGHT TO USE THE REPRESENTATION OF THE GLOBE, APART FROM THE MARK AS SHOWN.

FOR T-SHIRTS, SWEAT SUITS, BLOUSES, DRESSES, TIES, SCARFS, HEADWEAR, JACKETS (U.S. CLS. 22 AND 39).

CLASS 25—(Continued).

SN 76-371,385. SHANGHAI GOLDLUCK ACCESSORIES CO., LTD., SHANGHAI, CHINA, FILED 2-16-2002.



OWNER OF CHINA REG. NO. 1234872, DATED 12-28-1998, EXPIRES 12-28-2008.

THE MARK CONSISTS OF THE STYLIZED LETTER "G".
FOR CLOTHING, NAMELY, RAINCOATS, HATS, HOSIERY, GLOVES, NECKTIES, SCARVES, GIRDLES, JACKETS, COATS, VESTS, SHIRTS, SHOES, UNDERWEAR, AND BABIES' CLOTHING, NAMELY SHIRTS, PANTS, LAYETTES, JUMPERS, AND UNDERWEAR (U.S. CLS. 22 AND 39).

SN 76-371,560. KBD, L.L.C., NEW HYDE PARK, NY. FILED 2-19-2002.

1ST

FOR CLOTHING, NAMELY, ATHLETIC UNIFORMS, BANDANAS, BASEBALL CAPS, CAPS, GOLF SHIRTS, HATS, HEADBANDS, JACKETS, JEANS, JERSEYS, PANTS, POLO SHIRTS, ROBES, SHIRTS, SHORTS, SOCKS, SWEAT PANTS, SWEAT SHIRTS, SWEAT SHORTS, SWEAT SUITS, SWEATERS, T-SHIRTS, TANK TOPS, TURTLENECKS, UNIFORMS, VESTS, VISORS, WARMUP SUITS, AND WRIST BANDS (U.S. CLS. 22 AND 39).

SN 76-371,797. EDEN, ESTHER GINSBERG, PACIFIC PALISADES, CA. FILED 2-15-2002.

SKIRDLE

FOR CLOTHING, NAMELY, SKIRTS, DRESSES, PANTS, SHORTS AND BLOUSES (U.S. CLS. 22 AND 39).

SN 76-372,013. LIVIT PARTNERSHIP, VISTA, CA. FILED 2-19-2002.

LIVIT

FOR CLOTHING, NAMELY, T-SHIRTS, SHIRTS, AND HATS (U.S. CLS. 22 AND 39).
FIRST USE 12-0-1996; IN COMMERCE 1-11-1998.

CLASS 25—(Continued).

SN 76-372,061. MAC MARBLE, INC., LAKE PLACID, FL.
FILED 2-19-2002.



FOR CLOTHING, NAMELY BOOTS AND JEANS (U.S.
CLS. 22 AND 39).

SN 76-372,786. FOOTSTAR CORPORATION, WEST NYACK,
NY. FILED 2-20-2002.



FOR FOOTWEAR (U.S. CLS. 22 AND 39).

SN 76-373,452. CHIANG, WING HUNG, MIRAMAR, FL.
FILED 2-20-2002.

C. WONDER

FOR SHOES (U.S. CLS. 22 AND 39).

SN 76-373,565. ROMICK, ALAN, CINCINNATI, OH. FILED 2-
22-2002.

Sweat Tech

FOR CLOTHING, NAMELY, HEADWEAR, HEAD-
BANDS, WRISTBANDS, NECK KERCHIEFS, PANTS,
SHIRTS AND SMOCKS (U.S. CLS. 22 AND 39).

CLASS 25—(Continued).

SN 76-374,008. ALARMEX HOLDINGS, LLC, NEW YORK,
NY. FILED 2-21-2002.

LA CABAÑA

FOR CLOTHING, NAMELY MEN'S SHIRTS, SWEA-
TERS, JACKETS, PANTS, SHORTS AND COATS; WO-
MEN'S SWEATERS, JACKETS, BLOUSES, SHORTS,
PANTS, DRESSES AND COATS (U.S. CLS. 22 AND 39).

SN 76-374,727. HAGGAR CLOTHING CO., DALLAS, TX.
FILED 2-22-2002.

TEMPRATECH

FOR MEN'S PANTS, SHORTS, SHIRTS, WOVEN TOPS,
KNIT TOPS, SUITS, JACKETS, NECKWEAR, WIND
RESISTANT JACKETS, PARKAS, RAINCOATS, COATS,
UNDERWEAR, LOUNGE WEAR, SHOES, SOCKS, HOSI-
ERY, BELTS, SWEATERS, VESTS, HEADWEAR, FOOT-
WEAR AND GLOVES (U.S. CLS. 22 AND 39).

SN 76-374,738. G4 MEDIA, LLC, LOS ANGELES, CA. FILED
2-22-2002.

WATCH WHAT YOU PLAY

FOR CLOTHING FOR MEN, WOMEN AND CHIL-
DREN, NAMELY, HEADWEAR; SHIRTS, T-SHIRTS,
SPORT SHIRTS, SWEATSHIRTS, JERSEYS, JOGGING
SUITS, TROUSERS, PANTS, SHORTS, TANK TOPS,
CLOTH BIBS, SKIRTS, BLOUSES, DRESSES, SWEATERS,
JACKETS, COATS, GLOVES AND MITTENS, SNOW
SUITS; RAINWEAR; BELTS, SUSPENDERS, SCARVES,
ROBES, LINGERIE; FOOTWEAR; SOCKS; NECKWEAR;
SLEEPWEAR; UNDERWEAR; SWIMWEAR; MASQUER-
ADE COSTUMES AND MASKS SOLD IN CONNECTION
THERewith (U.S. CLS. 22 AND 39).

FIRST USE 2-8-2002; IN COMMERCE 2-8-2002.

SN 76-374,765. ANHEUSER-BUSCH, INCORPORATED, ST.
LOUIS, MO. FILED 2-25-2002.

SPIRIT OF FREEDOM

FOR CLOTHING, NAMELY, SHIRTS, JACKETS AND
HEADWEAR (U.S. CLS. 22 AND 39).

CLASS 25—(Continued).

SN 76-374,834. G2ZZ INC., AUSTIN, TX. FILED 2-25-2002.

TOO CUTE TO BE NASTY

FOR CLOTHING, NAMELY, SHIRTS, T-SHIRTS, SWEATSHIRTS, HATS, VISORS, CAMISOLES, PANTIES, AND BOXER SHORTS (U.S. CLS. 22 AND 39).
FIRST USE 1-7-2002; IN COMMERCE 1-7-2002.

SN 76-374,846. VALENTI, NINA, BROOKLYN, NY. FILED 2-25-2002.

NATUREVSFUTURE

FOR JACKETS, PANTS, TOPS, SHIRTS, JUMPSUITS, SKIRTS, DRESSES, SWEATERS, SHORTS, T-SHIRTS, VESTS, BELTS, SCARVES, SWEATPANTS, SWEATSHIRTS AND LINGERIE (U.S. CLS. 22 AND 39).

SN 76-375,269. ANHEUSER-BUSCH, INCORPORATED, ST. LOUIS, MO. FILED 2-26-2002.

MICH LIGHT

FOR CLOTHING, NAMELY SHIRTS, T-SHIRTS, JACKETS AND HATS (U.S. CLS. 22 AND 39).

SN 76-375,380. SAUCONY, INC., PEABODY, MA. FILED 2-26-2002.

GRID

OWNER OF U.S. REG. NO. 1,678,640.
FOR FOOTWEAR (U.S. CLS. 22 AND 39).
FIRST USE 5-0-1996; IN COMMERCE 5-0-1996.

SN 76-375,529. SCHOOL APPAREL, INC., SAN BRUNO, CA. FILED 2-26-2002.

TUFF-TEST FABRICS

NO CLAIM IS MADE TO THE EXCLUSIVE RIGHT TO USE "FABRIC", APART FROM THE MARK AS SHOWN.
FOR BOYS AND GIRLS CLOTHING, NAMELY SWEATERS, KNIT SHIRTS, TURTLENECKS, PANTS, SLACKS, SHORTS, JUMPERS, WOVEN BLOUSES AND SKIRTS (U.S. CLS. 22 AND 39).

CLASS 25—(Continued).

SN 76-376,465. CHENGDU KAMEIDO SHOES CO., LTD, SICHUAN, PR CHINA, CHINA, FILED 2-27-2002.

KAMEIDO

FOR CLOTHING, NAMELY, SHIRTS, SUITS, JEANS, COATS, TOPCOATS, TROUSERS, JACKETS, SWEATERS, AND DRESSES; FOOTWEAR, ATHLETIC FOOTWEAR, SHOES, LEATHER SHOES, GYMNASIIC SHOES, SNEAKERS, AND BOOTS (U.S. CLS. 22 AND 39).
FIRST USE 6-0-2000; IN COMMERCE 5-3-2001.

SN 76-376,544. WARNACO U.S., INC., MILFORD, CT. FILED 2-26-2002.

FRESH TWIST

OWNER OF U.S. REG. NO. 2,282,193.
FOR INTIMATE APPAREL AND FIGURE ENHANCING GARMENTS, NAMELY, BRAS, PANTIES, UNDERWEAR, UNDERPANTS, UNDERGARMENTS, UNDERCLOTHES, LINGERIE, FOUNDATION GARMENTS AND CAMISOLES (U.S. CLS. 22 AND 39).

SN 76-376,747. HOB CONCERTS COMPANY, UNIVERSAL CITY, CA. FILED 2-28-2002.

GRASS PASS

FOR CLOTHING, NAMELY, T-SHIRTS, SWEATSHIRTS, COATS, JACKETS, SWEATPANTS, SHORTS, CAPS, HATS, BANDANAS, BERETS, SOCKS, HEADBANDS, JOGGING SUITS, NECK BANDS, NECKERCHIEFS, NECKWEAR, NIGHTSHIRTS, SUSPENDERS, WARM UP SUITS, SWEATBANDS, TANK TOPS, VESTS, WIND RESISTANT JACKETS (U.S. CLS. 22 AND 39).

SN 76-377,380. STRATEGIC PARTNERS, INC., PACOIMA, CA. FILED 2-28-2002.

DBL

FOR FOOTWEAR (U.S. CLS. 22 AND 39).

SN 76-377,518. KOHL'S ILLINOIS, INC., AURORA, IL. FILED 3-4-2002.

SO...GSJC

OWNER OF U.S. REG. NO. 2,361,799.
FOR SLEEPWEAR, LOUNGEWEAR, ROBES, SOCKS AND HOSIERY (U.S. CLS. 22 AND 39).

CLASS 25—(Continued).

SN 76-377,682. KIA INCORPORATED, SAN DIEGO, CA. FILED 3-1-2002.



THE MARK COMPRISES A STYLIZED WORD "DIV" WITH THE LETTERS "D" AND "V" SHOWN IN YELLOW-GOLD COLOR.

FOR WEARING APPAREL, NAMELY, SHOES, SWEATSHIRTS, T-SHIRTS, KNITTED PANTS, KNITTED SHORTS, JEANS, WOVEN SHIRTS, WOVEN JACKETS, WOVEN SKIRTS, WOVEN OVERALLS, SWEATERS, WINTER COATS, CAPS, AND HATS (U.S. CLS. 22 AND 39).

SN 76-377,892. VANESSA RYAN, INC., MIAMI, FL. FILED 3-4-2002.

SHOW YOUR TOES

FOR LADIES HOSIERY, NAMELY PANTY HOSE AND CAPRI LENGTH HOSE (U.S. CLS. 22 AND 39). FIRST USE 5-1-2001; IN COMMERCE 8-1-2001.

SN 76-378,010. BOATHOUSE ROW SPORTS, LTD., PHILADELPHIA, PA. FILED 3-6-2002.

ALTIS

FOR CLOTHING, NAMELY, JACKETS, PARKAS, PULLOVERS, PANTS, SWEATSHIRTS, HOODED SWEATSHIRTS, SWEAT PANTS, RAIN JACKETS, RAIN PANTS, TEAM JERSEYS, ANORAKS, SINGLET, CAPES, VESTS, T-SHIRTS, SHORTS, AND HATS (U.S. CLS. 22 AND 39).

SN 76-378,314. LAWRENCE, MARTIN, BEVERLY HILLS, CA. FILED 3-4-2002.

YOU GO BOY

FOR CLOTHING FOR MEN, WOMEN, AND CHILDREN; NAMELY, SHIRTS, JACKETS, SWEATERS, PANTS, FOOTWEAR, BELTS, T-SHIRTS, SOCKS, COORDINATED SHIRTS, JACKETS AND SLACKS, TENNIS SHOES, SWEAT SHIRTS, JERSEYS, SHORTS, JOGGING SUITS, SWEAT PANTS, HATS/CAPS, SCARVES, GLOVES, HOSIERY, NECKTIES, RAINWEAR, PAJAMAS, ROBES, NIGHT SHIRTS, THERMAL UNDERWEAR, HEADBANDS, AND WRISTBANDS (U.S. CLS. 22 AND 39).

CLASS 25—(Continued).

SN 76-378,327. LEE, JUNSOO, GOYANG-SI, KYUNGGI-DO 411-380, REPUBLIC OF KOREA, FILED 3-4-2002.



FOR FOOTWEAR; FOOTWEAR ACCESSORIES, NAMELY INNER SOLES, OUTER SOLES, AND FOOTWEAR WITHOUT A SOLE; CLOTHING, NAMELY ATHLETIC UNIFORMS, POLO SHIRTS, T-SHIRTS, AND SOCKS; AND HEADGEAR, NAMELY HATS AND CAPS (U.S. CLS. 22 AND 39).

SN 76-378,341. BUTTON FRONTS (LONDON) LTD., SLOUGH, BERKSHIRE SL1 3SE, UNITED KINGDOM, FILED 3-4-2002.

RAINPETS

FOR RAINCOATS, RAIN JACKETS, RAIN PANTS, RAIN SUITS (U.S. CLS. 22 AND 39).

SN 76-378,716. TIME4 MEDIA, INC., NEW YORK, NY. FILED 3-6-2002.

THE SOUL OF THE AMERICAN OUTDOORS

FOR CLOTHING, NAMELY SHOES, SOCKS, SUN VISORS, T-SHIRTS, SWEATSHIRTS, SWEATPANTS, PANTS, CAPS, VESTS, SHIRTS, KNIT AND WOVEN TOPS AND BOTTOMS, SLEEPWEAR AND FOOTWEAR (U.S. CLS. 22 AND 39).

SN 76-378,727. BOATHOUSE ROW SPORTS, LTD., PHILADELPHIA, PA. FILED 3-5-2002.

ALTIS SPORTS

NO CLAIM IS MADE TO THE EXCLUSIVE RIGHT TO USE "SPORTS", APART FROM THE MARK AS SHOWN.

FOR CLOTHING, NAMELY, JACKETS, PARKAS, PULLOVERS, PANTS, SWEATSHIRTS, HOODED SWEATSHIRTS, SWEAT PANTS, RAIN JACKETS, RAIN PANTS, TEAM JERSEYS, ANORAKS, SINGLET, CAPES, VESTS, T-SHIRTS, SHORTS, AND HATS (U.S. CLS. 22 AND 39).

CLASS 25—(Continued).

SN 76-378,867. LEISURE ARTS, INC., BIRMINGHAM, AL.
FILED 3-7-2002.

TIGHTY WHITEY

FOR HALLOWEEN COSTUMES MADE OF COTTON
AND NYLON BLEND FABRICS (U.S. CLS. 22 AND 39).

SN 76-378,918. DEJA BLEU, LLC, NEW YORK, NY. FILED 3-
6-2002.

SUGAR DOLLS

FOR OVERALLS, JUMPSUITS, SKIRTS SHORTS,
SHORTALLS, CAPRIALLS, PANTS, DRESSES AND
JACKETS (U.S. CLS. 22 AND 39).

SN 76-379,659. K.P. SPORTS, INCORPORATED, BALTI-
MORE, MD. FILED 3-8-2002.

TURFGEAR

FOR CLOTHING, NAMELY, LONG SLEEVE SHIRTS,
TURTLE NECKS, MOCK TURTLE NECKS, SHORTS,
SHIRTS, LEGGINGS, UNDERWEAR, SHORTS (U.S.
CLS. 22 AND 39).
FIRST USE 7-1-1998; IN COMMERCE 7-1-1998.

SN 76-379,863. HARBOR FOOTWEAR GROUP, LTD., PORT
WASHINGTON, NY. FILED 3-7-2002.

GBX GEAR

OWNER OF U.S. REG. NO. 1,844,520.
NO CLAIM IS MADE TO THE EXCLUSIVE RIGHT TO
USE "GEAR", APART FROM THE MARK AS SHOWN.
FOR FOOTWEAR (U.S. CLS. 22 AND 39).

CLASS 25—(Continued).

SN 76-380,160. PYUNG AN TEXTILE CO., LTD., SEOUL,
REPUBLIC OF KOREA, FILED 3-11-2002.



THE MARK CONSISTS OF A FANCIFUL DEPICTION OF
AN OWL.

FOR CLOTHING, NAMELY, SHORTS, SHIRTS, T-
SHIRTS, SWIMSUITS, BLOUSES, SKIRTS, SCARVES,
GLOVES, PANTS, SWEATERS, JERSEYS, SOCKS, JACK-
ETS, SUITS, TRAINING SUITS, VESTS, NECKTIES,
BELTS, SUSPENDERS, DRESSES, COATS, RAINCOATS,
OVERCOATS, SMOCKS, UNDERWEAR, PAJAMAS,
BRASSIERES, CORSETS, SLIPS, LINGERIE; HEAD-
WEAR, NAMELY, HATS, CAPS AND BERETS; FOOT-
WEAR, NAMELY, BOOTS, SANDALS, SHOES AND
SLIPPERS (U.S. CLS. 22 AND 39).

SN 76-380,211. JAMES, JESSE, LONG BEACH, CA. FILED 3-8-
2002.

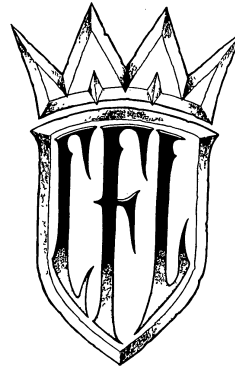

FOR CLOTHING, NAMELY, SHIRTS, T-SHIRTS,
HATS, JACKETS, PANTS; FOOTWEAR, NAMELY,
SNEAKERS AND BOOTS (U.S. CLS. 22 AND 39).
FIRST USE 1-1-1999; IN COMMERCE 1-1-1999.

SN 76-380,279. LEISURE ARTS, INC., BIRMINGHAM, AL.
FILED 3-1-2002.

TINY GIANTS

FOR COSTUMES WITH ATTACHED MASKS (U.S.
CLS. 22 AND 39).

CLASS 25—(Continued).

SN 76-380,460. C&G LINGERIE (1998), INC., MONTREAL QUEBEC, CANADA, FILED 3-11-2002.

CONRAD

FOR BATHROBES, DUSTERS, HOUSECOATS, HOSTESS ROBES, PAJAMAS, NIGHT SHIRTS, CHEMISES; UNDERWEAR; SLIPS; UNDERSHIRTS; TANK TOPS; NIGHT GOWNS, PEIGNOIRS COATS, PEIGNOIR SETS CONSISTING OF NEGLIGEEES AND NIGHT GOWNS AND NIGHT JACKETS; AND SLACK AND SHORT OUTFITS; BATHING ROBES; DUSTERS; SUNDRESSES (U.S. CLS. 22 AND 39).

FIRST USE 1-1-1952; IN COMMERCE 1-8-1989.

SN 76-380,642. KAYSER-ROTH CORPORATION, GREENSBORO, NC. FILED 3-11-2002.

PRIMASPORT XPLOREERS

OWNER OF U.S. REG. NO. 1,334,454.
FOR SOCKS (U.S. CLS. 22 AND 39).

SN 76-381,018. GRANDOE CORPORATION, THE, GLOVERS-VILLE, NY. FILED 3-12-2002.

grandoe
Everything Else Is Just a Glove!

OWNER OF U.S. REG. NO. 1,130,476.
FOR GLOVES (U.S. CLS. 22 AND 39).
FIRST USE 11-0-2000; IN COMMERCE 11-0-2000.

SN 76-381,021. GRANDOE CORPORATION, THE, GLOVERS-VILLE, NY. FILED 3-12-2002.

grandoe
Handwear Beyond Compare

OWNER OF U.S. REG. NO. 1,130,476.
FOR GLOVES (U.S. CLS. 22 AND 39).
FIRST USE 11-0-1994; IN COMMERCE 11-0-1994.

CLASS 25—(Continued).

SN 76-381,137. DEMA GRIM, INC., SAN FRANCISCO, CA. FILED 3-12-2002.

DEMA

THE MARK IDENTIFIES THE NAME OF A LIVING INDIVIDUAL WHOSE CONSENT IS OF RECORD.

FOR CLOTHING, NAMELY FORMAL AND CASUAL DRESSES, WEDDING DRESSES, WOMEN'S AND MEN'S PANTS, SHORTS, SKIRTS, BLOUSES, KNIT TOPS, SCARVES, OUTERWEAR COATS AND JACKETS, VESTS, HATS AND MEN'S SHIRTS (U.S. CLS. 22 AND 39).

FIRST USE 4-1-1985; IN COMMERCE 4-15-1991.

SN 76-381,570. CATTON APPAREL GROUP, INC., NEW YORK, NY. FILED 3-12-2002.

POLAR PRAM

FOR INFANTS' WEARING APPAREL, NAMELY, BUNTINGS (U.S. CLS. 22 AND 39).

SN 76-381,790. G. STAR APPAREL, INC., NEW YORK, NY. FILED 3-8-2002.

SUGAR RUSH

FOR MEN'S, WOMEN'S AND JUNIOR LADIES' CLOTHING, NAMELY SWEATERS, SWEATSHIRTS, JEANS, PANTS, SHORTS, T-SHIRTS, SHIRTS, TOPS, DRESSES, VESTS, JACKETS AND SKIRTS (U.S. CLS. 22 AND 39).

SN 76-382,058. LIQUID BLAINO DESIGNS, INC., SANTA MONICA, CA. FILED 3-14-2002.

SPECIAL SAUCE

FOR CLOTHING, NAMELY JACKETS, SWEATERS, VESTS, SWEAT SHIRTS, SWEAT PANTS, SHIRTS, BLOUSES, T-SHIRTS, PANTS, SHORTS, SKIRTS, SKORTS, DRESSES, SWIMWEAR, COVER-UPS, HEADWEAR, AND FOOTWEAR (U.S. CLS. 22 AND 39).

SN 76-382,175. STONE, DURWARD WAYNE, CHERRY LOG, GA. FILED 3-15-2002.

RUNNIN' SHINE

FOR T-SHIRTS, SWEATSHIRTS, LONG-SLEEVE SHIRTS, HATS (U.S. CLS. 22 AND 39).

CLASS 25—(Continued).

SN 76-383,449. BOATHOUSE ROW SPORTS, LTD., PHILADELPHIA, PA. FILED 3-19-2002.



FOR CLOTHING, NAMELY, JACKETS, PARKAS, PULLOVERS, PANTS, SWEATSHIRTS, HOODED SWEATSHIRTS, SWEAT PANTS, RAIN JACKETS, RAIN PANTS, TEAM JERSEYS, ANORAKS, SINGLETs, CAPES, VESTS, T-SHIRTS, SHORTS, AND HATS (U.S. CLS. 22 AND 39).

SN 76-401,991. STONE, DURWARD WAYNE, CHERRY LOG, GA. FILED 4-30-2002.

'SHINE RUNNER

FOR T-SHIRTS, SWEATSHIRTS, LONG-SLEEVE SHIRTS, HATS (U.S. CLS. 22 AND 39).

SN 78-002,930. OVERSEAS MANUFACTURING SYSTEMS OF AMERICA, INC., EL PASO, TX. FILED 4-6-2000.

M&O
Knits
SuperCotton

NO CLAIM IS MADE TO THE EXCLUSIVE RIGHT TO USE "KNITS" AND "SUPER COTTON", APART FROM THE MARK AS SHOWN.

FOR CLOTHING, NAMELY, T-SHIRTS, PANTS, SHIRTS, PAJAMAS, SKIRTS, SWEATSHIRTS, AND PULLOVERS, ALL MADE ENTIRELY OR PRIMARILY OF COTTON (U.S. CLS. 22 AND 39).

CLASS 25—(Continued).

SN 78-045,396. SUNDRA, JAMES E., MEDIA, PA. FILED 1-29-2001.



NO CLAIM IS MADE TO THE EXCLUSIVE RIGHT TO USE "HOCKEY", APART FROM THE MARK AS SHOWN.

HOCKEY PLAYER, ARMS RAISED IN CELEBRATION, WITH A GLOWING GOAL LIGHT IN PLACE OF HIS HEAD. THE WORDS "HOCKEY HEAD" BENEATH THE PLAYERS SHOULDERS

FOR CLOTHING FOR ICE HOCKEY, NAMELY, SHIRTS, HATS (U.S. CLS. 22 AND 39).

SN 78-048,063. MARBLE SPORTSWEAR, INC., BEVERLY HILLS, CA. FILED 2-13-2001.

CAMP GM

FOR BATHING SUITS, BLAZERS, BLOUSES, BOOTS, BRAS, UNDERWEAR BRIEFS, CAMISOLES, CAPS, COATS, DRESSES, GLOVES, HATS, JACKETS, JEANS, JUMPSUITS, LEOTARDS, NECKTIES, NIGHTGOWNS, OVERALLS, PAJAMAS, PANTS, PANTYHOSE, RAINCOATS, ROBES, SANDALS, SHIRTS, SHOES, SHORTS, SHORTS, SKIRTS, SLIPPERS, SLIPS, SOCKS, STOCKINGS, SUITS, SWEATERS, SWEATPANTS, SWEATSHIRTS, T-SHIRTS, TIGHTS, TUXEDOS, VESTS, WARM-UP SUITS (U.S. CLS. 22 AND 39).

CLASS 25—(Continued).

SN 78-054,599. VIEWPOINT INTERNATIONAL, INC., NEW YORK, NY. FILED 3-22-2001.



THE MARK CONSISTS, IN PART, OF THE LETTERS "I" AND "B" IN STYLIZED FORMAT.
FOR CLOTHING, NAMELY, DENIM PANTS, SHIRTS AND JACKETS (U.S. CLS. 22 AND 39).

SN 78-055,642. TURK, STEPHANIE M., PASADENA, CA. FILED 3-28-2001.

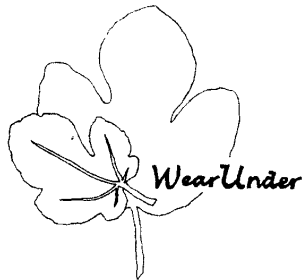

When your cup runneth over

OWNER OF U.S. REG. NO. 2,470,551.
FOR INTIMATE WEAR, NAMELY, LINGERIE, UNDERGARMENTS, PAJAMAS, AND SLEEPWEAR; AND CLOTHING, NAMELY, SHIRTS, SKIRTS, VESTS, SWEATERS, SHORTS, SWIMWEAR, AND DRESSES (U.S. CLS. 22 AND 39).
FIRST USE 7-22-2000; IN COMMERCE 7-22-2000.

CLASS 25—(Continued).

SN 78-056,742. FORD MOTOR COMPANY, DEARBORN, MI. FILED 4-4-2001.



FOR CLOTHING, NAMELY, T-SHIRTS, POLO SHIRTS, GOLF SHIRTS, SWEATSHIRTS, SWEATERS, VESTS, JACKETS, RAINWEAR, WORK COATS, TOP COATS, OVER COATS, OVERALLS, SHORTS, SLACKS, SWEAT PANTS, SLEEPWEAR, SOCKS, SCARVES, NECKTIES, CAPS, HATS, SUNVISORS, HEADBANDS, SHOES, ATHLETIC SHOES, SLIPPERS AND MOCCASINS (U.S. CLS. 22 AND 39).
FIRST USE 1-0-2001; IN COMMERCE 1-0-2001.

SN 78-058,558. SARAMAR, L.L.C., CHICAGO, IL. FILED 4-16-2001.

**BODY BY BALI
CONCEALERS**

OWNER OF U.S. REG. NOS. 861,054, 2,116,829 AND OTHERS.
NO CLAIM IS MADE TO THE EXCLUSIVE RIGHT TO USE "CONCEALERS", APART FROM THE MARK AS SHOWN.
FOR BRAS, PANTIES, SHAPEWEAR, NAMELY, GIRDLES AND CONTROL PANTIES (U.S. CLS. 22 AND 39).

SN 78-059,434. TREASURE INDUSTRIES, INC., ROWLAND HEIGHTS, CA. FILED 4-20-2001.



THE LINING IN THE DRAWING IS A FEATURE OF THE MARK AND DOES NOT INDICATE COLOR.
FOR SHOES (U.S. CLS. 22 AND 39).
FIRST USE 2-1-2001; IN COMMERCE 2-15-2001.

CLASS 25—(Continued).

SN 78-060,409. CALLAWAY GOLF COMPANY, CARLSBAD, CA. FILED 4-25-2001.



NO CLAIM IS MADE TO THE EXCLUSIVE RIGHT TO USE "VARIABLE FACE THICKNESS" AND "GOLF", APART FROM THE MARK AS SHOWN.

FOR CLOTHING FOR GOLF, NAMELY GOLF SHIRTS, GOLF SLACKS, SWEAT PANTS, SWEAT SHIRTS, JACKETS, WIND-RESISTANT SHIRTS, SHORTS, SKIRTS, SOCKS, SWEATERS, T-SHIRTS, VESTS, WARM-UP SHIRTS, AND HEADGEAR, NAMELY CAPS, HATS, AND VISORS (U.S. CLS. 22 AND 39).

FIRST USE 10-1-2000; IN COMMERCE 10-1-2000.

SN 78-063,652. JANE FOX, INC., NEW YORK, NY. FILED 5-15-2001.



FOR BELTS AND HATS (U.S. CLS. 22 AND 39).
FIRST USE 4-0-2001; IN COMMERCE 4-0-2001.

SN 78-064,024. PHYSICAL SCIENCE THC LLC, SOUTH RIVER, NJ. FILED 5-16-2001.

PHYS.SCI.

FOR MEN'S, WOMEN'S AND CHILDREN'S APPAREL AND CLOTHING OF ALL TYPES, NAMELY, JERSEYS, SWEATBANDS, JUMPSUITS, UNIFORMS, SPORTS PANTS, KNIT SHIRTS, SHIRTS, T-SHIRTS, POLO SHIRTS, TANK-TOPS, SLACKS, JEANS, SHORTS, UNDERWEAR, STOCKINGS, SOCKS, SWIMWEAR, COATS, JACKETS, PARKAS, OVERCOATS, PULLOVERS, SWEATSHIRTS AND SWEATERS; HEADWEAR (U.S. CLS. 22 AND 39).

FIRST USE 9-0-2000; IN COMMERCE 9-0-2000.

CLASS 25—(Continued).

SN 78-064,031. PHYSICAL SCIENCE THC LLC, SOUTH RIVER, NJ. FILED 5-16-2001.

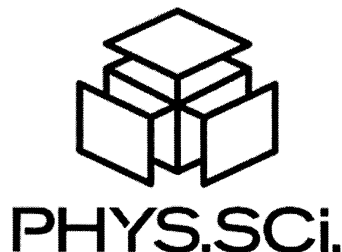

FOR MEN'S, WOMEN'S AND CHILDREN'S APPAREL AND CLOTHING OF ALL TYPES, NAMELY, JERSEYS, SWEATBANDS, JUMPSUITS, UNIFORMS, SPORTS PANTS, KNIT SHIRTS, SHIRTS, T-SHIRTS, POLO SHIRTS, TANK-TOPS, SLACKS, JEANS, SHORTS, UNDERWEAR, STOCKINGS, SOCKS, SWIMWEAR, COATS, JACKETS, PARKAS, OVERCOATS, PULLOVERS, SWEATSHIRTS AND SWEATERS; HEADWEAR (U.S. CLS. 22 AND 39).

FIRST USE 9-1-2000; IN COMMERCE 9-1-2000.

SN 78-067,470. MERVIN MANUFACTURING, INC., SEATTLE, WA. FILED 6-5-2001.

GNU

OWNER OF U.S. REG. NOS. 1,941,340 AND 2,331,395.
FOR FOOTWEAR; NAMELY BOOTS AND ATHLETIC FOOTWEAR (U.S. CLS. 22 AND 39).
FIRST USE 8-1-1993; IN COMMERCE 8-1-1993.

SN 78-067,603. VANITY FAIR, INC., WILMINGTON, DE. FILED 6-6-2001.

SATIN SENSATIONS

NO CLAIM IS MADE TO THE EXCLUSIVE RIGHT TO USE "SATIN", APART FROM THE MARK AS SHOWN.
FOR LINGERIE AND SLEEPWEAR (U.S. CLS. 22 AND 39).

SN 78-071,691. RAYMOND, RICHARD N., PLANO, TX. FILED 6-29-2001.

JUNIOR VARSITY

FOR CLOTHING FOR CHILDREN AND TEENAGERS, NAMELY, T-SHIRTS, SHIRTS, BLOUSES, PANTS, TROUSERS, SLACKS, SHORTS, OVERALLS, JUMPERS, JUMP SUITS, DRESSES, SKIRTS, GOWNS, SWEATERS, SWEAT SHIRTS, JACKETS, SPORT JACKETS, OUTER JACKETS, COATS, SUITS, TIES, SCARVES, NECKWEAR, HEADWEAR, SWIMWEAR, UNDERGARMENTS, SOCKS, SHOES, BELTS AND GLOVES (U.S. CLS. 22 AND 39).

CLASS 25—(Continued).

SN 78-073,923. WIDE-OPEN PRODUCTS LLC, ROELAND PARK, KS. FILED 7-14-2001.

REAPERWEAR

FOR CLOTHING, NAMELY, T-SHIRTS, HATS AND JACKETS (U.S. CLS. 22 AND 39).
FIRST USE 7-31-2000; IN COMMERCE 7-31-2000.

SN 78-079,691. ANJALI KUMAR, INC., NEW YORK, NY. FILED 8-16-2001.

ANJALI KUMAR

FOR SHOES; BOOTS; AND CLOTHING, NAMELY SHIRTS, DRESSES, PANTS, SKIRTS, BLOUSES, JEANS, SUITS, GYM SUITS, JOGGING SUITS, SKI SUITS, SWEATERS, T-SHIRTS, LINGERIE, COATS, SWIM WEAR, PAJAMAS, LEGGINGS, STOCKINGS, SOCKS, HOSIERY, PANTYHOSE, SWEAT PANTS, SWEAT SHIRTS, TANK TOPS, HALTER TOPS, AND SHORTS (U.S. CLS. 22 AND 39).
FIRST USE 11-10-1999; IN COMMERCE 11-20-1999.

SN 78-079,702. FLAVIA HIATT, LONG BEACH, CA. FILED 8-17-2001.

BELLABLU

THE ENGLISH TRANSLATION OF THE WORD "BELLABLU" IN THE MARK IS "BEAUTIFUL BLUE".
FOR WOMEN'S CLOTHING, NAMELY, SHIRTS, BLOUSES, PANTS, SKIRTS, SUITS (U.S. CLS. 22 AND 39).

SN 78-079,711. FORIA INTERNATIONAL INC., CITY OF INDUSTRY, CA. FILED 8-17-2001.

PURE DRIVE

FOR MEN'S AND WOMEN'S APPAREL, NAMELY, SHOES, SHIRTS, SHORTS, PANTS, AND ACCESSORIES, NAMELY, BELTS, HATS AND SOCKS (U.S. CLS. 22 AND 39).
FIRST USE 6-1-2001; IN COMMERCE 6-1-2001.

SN 78-079,858. STEIN, ALEX, HUDSON, OH. FILED 8-17-2001.

ASHLEY WHIPPET

OWNER OF U.S. REG. NO. 1,263,828.
THE NAME "ASHLEY WHIPPET" DOES NOT IDENTIFY A LIVING INDIVIDUAL.
FOR T-SHIRTS (U.S. CLS. 22 AND 39).

CLASS 25—(Continued).

SN 78-080,472. MAN, XU JIA, GREENWOOD, AUSTRALIA, FILED 8-22-2001.

AUSHOOW

THE ENGLISH TRANSLATION OF "AUSHOOW" IS "ELEGANCE FOR A PERSON OF TALENT".
FOR SUITS, PANTS, SHIRTS (U.S. CLS. 22 AND 39).

SN 78-080,663. PAYLESS SHOESOURCE WORLDWIDE, INC., TOPEKA, KS. FILED 8-22-2001.

STATE STREET

FOR FOOTWEAR (U.S. CLS. 22 AND 39).
FIRST USE 2-1-2002; IN COMMERCE 2-1-2002.

SN 78-080,913. DELGADO, RAUL, F, SAN DIEGO, CA. FILED 8-23-2001.



FOR SHIRTS, PANTS, DRESSES, SWIM SUITS, AND UNDERGARMENTS (U.S. CLS. 22 AND 39).
FIRST USE 4-7-2000; IN COMMERCE 4-7-2000.

SN 78-083,720. FAME JEANS, INC., MONTREAL, QUEBEC, FILED 9-13-2001.



FOR GIRLS', INFANTS', AND TODDLERS' CLOTHING, NAMELY, T-SHIRTS, BLOUSES, SHIRTS, PANTS, SHORTS, SKIRTS, JUMPERS, JACKETS AND VESTS (U.S. CLS. 22 AND 39).
FIRST USE 10-1-1969; IN COMMERCE 10-1-1969.

CLASS 25—(Continued).

SN 78-086,076. SWEET VICTORIAN S.R.L., BUENOS AIRES, ARGENTINA, FILED 9-28-2001.

SWEET VICTORIAN

FOR SANDALS, SWIMSUITS AND SOCKS (U.S. CLS. 22 AND 39).

SN 78-089,356. WRIGHT, SHIMON, BROOKLYN, NY. FILED 10-19-2001.

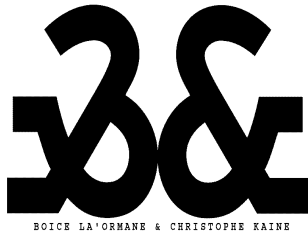

THE NAMES "BOICE LA'ORMANE" AND "CHRISTOPHE KAINÉ" IDENTIFY LIVING INDIVIDUALS WHOSE CONSENT IS OF RECORD.

FOR CLOTHING, NAMELY, T-SHIRTS, SWEATSHIRTS, DRESS SHIRTS, POLO SHIRTS; SUITS, NAMELY, JOGGING SUITS, LEISURE SUITS, SWEATSUITS AND LINEN SUITS, NAMELY, SUITS MADE OF LINEN MATERIAL; SPORT DRESSES; FOOTWEAR, NAMELY, SWEAT SOCKS, DRESS AND COTTON SOCKS; HEADGEAR, NAMELY, BASEBALL HATS AND KNIT WINTER HATS; DENIM CLOTHES, NAMELY, JEANS (U.S. CLS. 22 AND 39).

SN 78-094,457. SCREEN IRRIX, NEW ROCHELLE, NY. FILED 11-20-2001.



FOR CLOTHING AND APPAREL, NAMELY T-SHIRTS, HATS, SWEATSHIRTS, SHORTS, CAPS, PANTS, AND JACKETS (U.S. CLS. 22 AND 39).

CLASS 25—(Continued).

SN 78-096,249. MARRIOTT INTERNATIONAL, INC., BETHESDA, MD. FILED 12-3-2001.

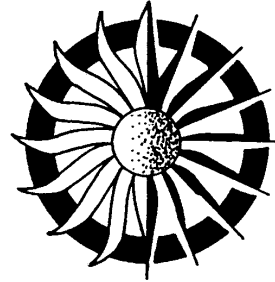

THE STIPLING IN THE DRAWING IS FOR SHADING PURPOSES ONLY AND DOES NOT INDICATE COLOR. THE MARK CONSISTS OF A STYLIZED SUN DESIGN. FOR POOL WRAPS, SHIRTS, HATS, SWEATERS, JACKETS AND SOCKS (U.S. CLS. 22 AND 39).

SN 78-099,543. VARASTEHE, STEVE, TUCSON, AZ. AND BABIARZ, DAVID, TUCSON, AZ. FILED 12-20-2001.

CHRISTIAN MAN YES I AM

FOR CLOTHING NAMELY TOPS AND BOTTOMS, SHIRTS, T-SHIRTS, SWEATSHIRTS, SWEATERS, POLO SHIRTS, TANK TOPS, SWEATSUITS, PANTS, SWEATPANTS, SHORTS, SLEEPWEAR, JACKETS, PARKAS, UNDERWEAR, SOCKS, BOOTS, SHOES, SLIPPERS, BELTS, SUSPENDERS, TIES, SWEATBANDS, HEADWEAR (U.S. CLS. 22 AND 39). FIRST USE 9-20-2001; IN COMMERCE 9-20-2001.

SN 78-100,964. AGUILERA, DEWEY A., CREST PARK, CA. FILED 1-4-2002.



FOR T-SHIRTS, SHIRTS, SWEATSHIRTS, SWEATPANTS, HATS, BEANIES, SHORT PANTS, PANTS, POLO SHIRTS, JERSEYS, SHOES (U.S. CLS. 22 AND 39). FIRST USE 1-1-2001; IN COMMERCE 1-1-2001.

CLASS 25—(Continued).

SN 78-101,231. V SECRET CATALOGUE, INC., WILMINGTON, DE. FILED 1-7-2002.

VICTORIA'S SECRET VSX

OWNER OF U.S. REG. NOS. 1,146,199, 2,557,051 AND OTHERS.

FOR CLOTHING, NAMELY, BATHROBES, BEACH COVER-UPS, BEACHWEAR, BELTS, BLAZERS, BLOUSES, BODY SHAPERS, BODY SUITS, BOXER SHORTS, BRAS, BUSTIERS, CAMISOLES, CAPS, COATS, DRESSES, FOOTWEAR, FOUNDATION GARMENTS, GARTER BELTS, GIRDLES, GLOVES, GOWNS, HALTER TOPS, HATS, HEADBANDS, HOSIERY, JACKETS, JEANS, JOGGING SUITS, KNEE HIGHS, KNIT SHIRTS, KNIT TOPS, LEOTARDS, LINGERIE, LOUNGWEAR, MITTENS, NEGLIGEEES, NIGHT GOWNS, NIGHT SHIRTS, PAJAMAS, PANTIES, PANTS, PANTYHOSE, SARONGS, SCARVES, SHIRTS, SHORTS, SKIRTS, SLACKS, SLEEPWEAR, SLIPS, SOCKS, STOCKINGS, SUITS, SWEAT PANTS, SWEAT SHIRTS, SWEAT SHORTS, SWEAT SUITS, SWEATERS, SWIM WEAR, T-SHIRTS, TANK TOPS, TAP PANTS, TEDDIES, TIES, TIGHTS, UNDERPANTS, UNDERSHIRTS, UNDERWEAR AND VESTS (U.S. CLS. 22 AND 39).

SN 78-101,899. FIKSE, JULIA C., LOS ANGELES, CA. FILED 1-10-2002.



FOR DRESSES, SKIRTS, SHIRTS, MASQUERADE COSTUMES, NAMELY HALOS, JACKETS, SWEATERS, AND PANTS (U.S. CLS. 22 AND 39).

SN 78-103,528. C CORPORATION; ROAM THE EARTH, INC., ANNANDALE, NJ. FILED 1-18-2002.

ROAM THE EARTH

FOR CLOTHING, NAMELY, T-SHIRTS, HATS SWEATSHIRTS, PANTS, AND FEATURING GEOGRAPHIC THEMES (U.S. CLS. 22 AND 39).

CLASS 25—(Continued).

SN 78-104,417. PEARSON DESIGN LABS, LLC, KELSEYVILLE, CA. FILED 1-23-2002.



FOR SHOE INSOLES, HEEL CUSHIONS, HEEL PADS, SOCKS, AND HOSIERY (U.S. CLS. 22 AND 39).

SN 78-104,897. CHARLOTTE HORNETS NBA LIMITED PARTNERSHIP, CHARLOTTE, NC. FILED 1-25-2002.

NEW ORLEANS HORNETS

OWNER OF U.S. REG. NOS. 1,649,730, 2,195,363 AND OTHERS.

NO CLAIM IS MADE TO THE EXCLUSIVE RIGHT TO USE "NEW ORLEANS", APART FROM THE MARK AS SHOWN.

FOR CLOTHING, NAMELY HOSIERY, FOOTWEAR, BASKETBALL SHOES, BASKETBALL SNEAKERS, T-SHIRTS, SHIRTS, SWEATSHIRTS, SWEATPANTS, PANTS, TANK TOPS, JERSEYS, SHORTS, PAJAMAS, SPORT SHIRTS, RUGBY SHIRTS, SWEATERS, BELTS, TIES, NIGHTSHIRTS, HATS, WARM-UP SUITS, WARM-UP PANTS, WARM-UP TOPS, JACKETS, PARKAS, COATS, CLOTH BIBS, HEAD BANDS, WRIST BANDS, APRONS, BOXER SHORTS, SLACKS, CAPS, EAR MUFFS, GLOVES, MITTENS, WOVEN AND KNIT SHIRTS (U.S. CLS. 22 AND 39).

SN 78-104,967. COTE DE FRANCE INC, NEW-YORK, NY. FILED 1-25-2002.

DRILL SOMETHING!

FOR MEN'S AND LADY'S CLOTHING, NAMELY KNITTED AND WOVEN SHIRTS, PANTS, JACKETS, SUITS, DENIM SHIRTS AND PANTS, LEATHER SHIRTS, AND LEATHER JACKETS (U.S. CLS. 22 AND 39).

CLASS 25—(Continued).

SN 78-105,045. NEXTEL COMMUNICATIONS INC., RESTON, VA. FILED 1-26-2002.

DIRECT CONNECT

OWNER OF U.S. REG. NO. 2,236,098.
FOR CLOTHING NAMELY CARDIGANS, CHILDREN'S CLOTH BIBS, CHILDREN'S OVERALLS, SWEATERS, TANK TOPS, CLOTHING TOPS, TURTLENECK SWEATERS, V-NECK SWEATERS, VESTS, APRONS, ATHLETIC UNIFORMS, HEAD BANDS, BATHING CAPS, SWEAT BANDS, WRIST BANDS, NECK BANDS, BATHING SUITS, BATHING TRUNKS, BATHROBES, BLAZERS, BLOUSES, BOW TIES, BOXER SHORTS, CAPS, LEATHER COATS, COVERALLS, GLOVES, GYM SHORTS, HEAD WEAR, JACKETS, KNIT SHIRTS, NECKTIES, NECKWEAR, NIGHT SHIRTS, PAJAMAS, SWEAT PANTS, PULLOVERS, ROBES, GOLF SHIRTS, POLO SHIRTS, SPORT SHIRTS, SWEAT SHIRTS, SHORTS, SOCKS, JOGGING SUITS, PLAY SUITS, SWEAT SUITS, WARM-UP SUITS, GYM SUITS, SUN VISORS, T-SHIRTS, TENNIS WEAR, TURTLENECKS, VISORS, WIND RESISTANT JACKETS, WRIST BANDS (U.S. CLS. 22 AND 39).

SN 78-107,018. BENECCI CORPORATION, ORANGE, CA. FILED 2-5-2002.

BOCACIO

FOR PANTS, SUITS, SPORT COATS, SWEATERS, SHIRTS, NECKWEAR, SHOES AND SKIRTS (U.S. CLS. 22 AND 39).

SN 78-108,695. SARA LEE CORPORATION, WINSTON-SALEM, NC. FILED 2-14-2002.

CELEBRITY BY HANES HER WAY

OWNER OF U.S. REG. NOS. 1,292,401, 2,125,934 AND 2,436,642.
FOR PANTIES (U.S. CLS. 22 AND 39).

SN 78-109,394. PATCH LICENSING LLC, WESTPORT, CT. FILED 2-18-2002.

HATHAWAY SPORT

OWNER OF U.S. REG. NOS. 1,411,403, 2,292,973 AND OTHERS.
NO CLAIM IS MADE TO THE EXCLUSIVE RIGHT TO USE "SPORT", APART FROM THE MARK AS SHOWN.
FOR CLOTHING, NAMELY, SHIRTS, SWEATERS, PANTS, T-SHIRTS, VESTS, JACKETS, UNDERWEAR, SLEEPWEAR, LOUNGEWEAR, RAINWEAR, OUTERWEAR, NAMELY, WIND-RESISTANT JACKETS, INSULATED JACKETS AND ACTIVEWEAR, NAMELY, WARM-UP SUITS, SWEATPANTS, SWEATSHIRTS AND SWEATSHORTS (U.S. CLS. 22 AND 39).

CLASS 25—(Continued).

SN 78-110,008. B2 HOLDINGS, LLC, AMHERST, MA. FILED 2-20-2002.

NOR'EASTER

FOR FOOTWEAR; BOOTS (U.S. CLS. 22 AND 39).

SN 78-111,309. SUN AND SKIN CARE RESEARCH, INC., COCOA, FL. FILED 2-27-2002.

OCEAN POTION

FOR ARTICLES OF CLOTHING FOR MEN, WOMEN AND CHILDREN, NAMELY, TEE SHIRTS, HEADWEAR, HATS, CAPS FOOTWEAR, SHIRTS, PANTS, JACKETS, SWEATSHIRTS, SWEATPANTS, SOCKS, UNDERWEAR, SWIMSUITS, SUN VISORS, BELTS AND DRESSES (U.S. CLS. 22 AND 39).
FIRST USE 5-1-1999; IN COMMERCE 5-1-1999.

SN 78-112,097. DC COMICS, NEW YORK, NY. FILED 3-1-2002.

JUSTICE LEAGUE

FOR CLOTHING FOR MEN, WOMEN AND CHILDREN - NAMELY, SHIRTS, T-SHIRTS, SWEATSHIRTS, JOGGING SUITS, TROUSERS, PANTS, SHORTS, TANK TOPS, RAINWEAR, CLOTH BIBS, SKIRTS, BLOUSES, DRESSES, SUSPENDERS, SWEATERS, JACKETS, COATS, RAINCOATS, SNOW SUITS, TIES, ROBES, HATS, CAPS, SUNVISORS, BELTS, SCARVES, SLEEPWEAR, PAJAMAS, LINGERIE, UNDERWEAR, BOOTS, SHOES, SNEAKERS, SANDALS, BOOTIES, SLIPPER SOCKS, SWIMWEAR AND MASQUERADE AND HALLOWEEN COSTUMES AND MASKS SOLD IN CONNECTION THEREWITH (U.S. CLS. 22 AND 39).

SN 78-112,103. TIME WARNER ENTERTAINMENT COMPANY, L.P., NEW YORK, NY. FILED 3-1-2002.

ALIENQUEST

FOR CLOTHING FOR MEN, WOMEN AND CHILDREN - NAMELY, SHIRTS, T-SHIRTS, SWEATSHIRTS, JOGGING SUITS, TROUSERS, PANTS, SHORTS, TANK TOPS, RAINWEAR, CLOTH BIBS, SKIRTS, BLOUSES, DRESSES, SUSPENDERS, SWEATERS, JACKETS, COATS, RAINCOATS, SNOW SUITS, TIES, ROBES, HATS, CAPS, SUNVISORS, BELTS, SCARVES, SLEEPWEAR, PAJAMAS, LINGERIE, UNDERWEAR, BOOTS, SHOES, SNEAKERS, SANDALS, BOOTIES, SLIPPER SOCKS, SWIMWEAR AND MASQUERADE AND HALLOWEEN COSTUMES AND MASKS SOLD IN CONNECTION THEREWITH (U.S. CLS. 22 AND 39).

CLASS 25—(Continued).

SN 78-112,526. SARAH'S MILE, LLC, NEW YORK, NY.
FILED 3-5-2002.

FED UP WE NEED FREEDOM & UNITY

FOR T-SHIRTS (U.S. CLS. 22 AND 39).

SN 78-112,712. MARBLE SPORTSWEAR, INC., BEVERLY
HILLS, CA. FILED 3-5-2002.

LUCKY BAMBOO

FOR BATHING SUITS, BLAZERS, BLOUSES, BOOTS,
BRAS, BRIEFS, CAMISOLES, CAPS, COATS, DRESSES,
GLOVES, HATS, JACKETS, JEANS, JUMPSUITS, LEOTARDS,
NECKTIES, NIGHTGOWNS, OVERALLS, PAJAMAS,
PANTS, PANTYHOSE, RAINCOATS, ROBES,
SANDALS, SHIRTS, SHOES, SHORTALLS, SHORTS,
SKIRTS, SLIPPERS, SLIPS, SOCKS, STOCKINGS, SUITS,
SWEATERS, T-SHIRTS, TIGHTS, TUXEDOS, VESTS
AND WARM-UP SUITS (U.S. CLS. 22 AND 39).

SN 78-112,721. MARBLE SPORTSWEAR, INC., BEVERLY
HILLS, CA. FILED 3-5-2002.

CAMP BAMBOO

FOR BATHING SUITS, BLAZERS, BLOUSES, BOOTS,
BRAS, BRIEFS, CAMISOLES, CAPS, COATS, DRESSES,
GLOVES, HATS, JACKETS, JEANS, JUMPSUITS, LEOTARDS,
NECKTIES, NIGHTGOWNS, OVERALLS, PAJAMAS,
PANTS, PANTYHOSE, RAINCOATS, ROBES,
SANDALS, SHIRTS, SHOES, SHORTALLS, SHORTS,
SKIRTS, SLIPPERS, SLIPS, SOCKS, STOCKINGS, SUITS,
SWEATERS, T-SHIRTS, TIGHTS, TUXEDOS, VESTS
AND WARM-UP SUITS (U.S. CLS. 22 AND 39).

SN 78-113,081. TOO, INC., COLUMBUS, OH. FILED 3-7-2002.

TOO ZZZZ'S

OWNER OF U.S. REG. NOS. 2,344,946 AND 2,400,834.
FOR CLOTHING, NAMELY, PAJAMAS (U.S. CLS. 22
AND 39).

CLASS 25—(Continued).

SN 78-113,167. WRANGLER APPAREL CORP., WILMING-
TON, DE. FILED 3-7-2002.

COOL LOCK

FOR JEANS, CASUAL PANTS, PANTS, SLACKS,
TROUSERS AND SHORTS OF ALL KINDS; PULL-OVER
SHIRTS, BUTTON-FRONT SHIRTS, BLOUSES, T-
SHIRTS, AND ALL OTHER TYPES OF SHIRTS
WHETHER KNIT, WOVEN OR OTHERWISE CON-
STRUCTED; SWEATERS, VESTS, SKIRTS, CAPS, HATS,
SHOES (U.S. CLS. 22 AND 39).

SN 78-113,603. DOOLEY, PATRICK J., POMPANO BEACH,
FL. FILED 3-8-2002.



FOR SHIRTS, SHORTS, AND HATS (U.S. CLS. 22 AND
39).

SN 78-113,653. RAVO, DAVID, LOS ANGELES, CA. AND
RAVO, AARON, LOS ANGELES, CA. FILED 3-8-2002.



FOR MEN'S, WOMEN'S AND CHILDREN'S CLOTH-
ING, NAMELY T-SHIRTS, TANK TOPS, JACKETS,
JERSEYS, SHORTS, PANTS, SWEATSHIRTS, SWEAT
PANTS, HEAD WEAR, FOOTWEAR, SANDALS, SNEA-
KERS, BOOTS, SHOES, SOCKS, DRESSES, LEOTARDS,
BANDANNAS, HEADBANDS, SWEATBANDS, BELTS,
UNDERGARMENTS, TIES, SKI-PANTS, SWEATERS,
SKI-BIBS, GLOVES, SKI-JACKETS; SWIM WEAR,
NAMELY, BATHING SUITS, BATHING TRUNKS, AND
BIKINIS (U.S. CLS. 22 AND 39).

CLASS 25—(Continued).

SN 78-114,267. SAMUELS, KEVIN, G., LOS ANGELES, CA.
FILED 3-12-2002.

NUTRITIOUS

FOR CLOTHING, NAMELY SHIRTS, PANTS, HATS,
JACKETS AND UNDERWEAR (U.S. CLS. 22 AND 39).

SN 78-115,837. GAP (APPAREL) INC., SAN BRUNO, CA.
FILED 3-19-2002.

NINETEEN SIXTY-NINE

OWNER OF U.S. REG. NOS. 1,129,294, 1,576,510 AND
2,449,575.

FOR CLOTHING, NAMELY, PANTS, SHORTS,
SWEATPANTS, OVERALLS, SHIRTS, TEE-SHIRTS,
SKIRTS, DRESSES, SWEATSHIRTS, BLOUSES, JACK-
ETS, VESTS, COATS RAINWEAR, SHOES, LINGERIE,
SLEEPWEAR, LOUNGEWEAR, SWIMWEAR, GLOVES,
SOCKS, HOISERY, BELTS, SCARVES, HATS, TIES,
SLIPPERS (U.S. CLS. 22 AND 39).

SN 78-116,267. SARAMAR, L.L.C., CHICAGO, IL. FILED 3-20-
2002.

INVISIBLE ATTRACTION

FOR BRAS, PANTIES, TANK TOPS, CAMISOLES,
FOUNDATION GARMENTS, NAMELY THIGH SHA-
PERS, CONTROL PANTIES AND BRIEFS, BODY SHA-
PERS AND SLIPS WHICH SHAPE THE BODY (U.S. CLS.
22 AND 39).

CLASS 26—FANCY GOODS

SN 76-186,369. HAIR ZONE, INC., NEW YORK, NY. FILED
12-26-2000.

**New Yaki
Gold**

NO CLAIM IS MADE TO THE EXCLUSIVE RIGHT TO
USE "YAKI", APART FROM THE MARK AS SHOWN.
FOR WIGS AND HAIR PIECES (U.S. CLS. 37, 39, 40, 42
AND 50).
FIRST USE 1-1-2000; IN COMMERCE 1-1-2000.

CLASS 26—(Continued).

SN 76-219,748. YKK CORPORATION, TOKYO, JAPAN,
FILED 3-5-2001.

GRADATION

PRIORITY CLAIMED UNDER SEC. 44(D) ON JAPAN
APPLICATION NO. 2001-14,002, FILED 2-20-2001, REG. NO.
4534980, DATED 1-11-2002, EXPIRES 1-22-2012.

FOR SLIDE FASTENERS, HOOK AND LOOP FASTEN-
ERS, ADJUSTABLE FASTENERS, BUTTONS FOR
CLOTHING, SNAP BUTTONS, STUD BUTTONS, BELT
BUCKLES NOT OF PRECIOUS METAL FOR CLOTHING,
SHOE BUCKLES, BUCKLES FOR SUSPENDERS, HOOK
AND EYES, EYELETS FOR CLOTHES, EYELETS FOR
SHOES, STRAP HOLDERS, SWIVEL HOOKS, CORD END
STOPPERS, RIBBONS, ELASTIC RIBBONS, WEBBING IN
THE NATURE OF WOVEN FABRIC TAPE AND WOVEN
ELASTIC TAPE, SHOULDER PADS FOR CLOTHING,
BRAIDS (U.S. CLS. 37, 39, 40, 42 AND 50).

SN 76-260,884. WILLIAM PRYM GMBH & CO. KG, D-52206
STOLBERG, FED REP GERMANY, FILED 5-22-2001.

FLEXISNAP

PRIORITY CLAIMED UNDER SEC. 44(D) ON FED REP
GERMANY APPLICATION NO. 30104200.4, FILED 1-23-2001,
REG. NO. 30104200, DATED 3-29-2001, EXPIRES 1-31-2011.

FOR FASTENERS FOR CLOTHING, NAMELY, BELT
AND GARMENT CLASPS AND CLIPS, GARTER FAS-
TENERS, BUTTONS FOR CLOTHING, ORNAMENTAL
NOVELTY BUTTONS, PRESS BUTTONS, SHIRT BUT-
TONS, SNAP FASTENERS, RIVET BUTTONS, UNDER-
WEAR BUTTONS, GARMENT BUCKLES, GARMENT
SNAPS FASTENERS AND FASTENERS FOR SUSPEN-
DERS (U.S. CLS. 37, 39, 40, 42 AND 50).

SN 76-305,035. GIRL MANIA, INC., LOS ANGELES, CA.
FILED 8-24-2001.

GIRL MANIA

FOR HAIR ACCESSORIES, NAMELY, BARRETTES,
PONYTAIL HOLDERS, HAIR EXTENSIONS, HAIR
CLIPS, HAIR PINS, HAIR RIBBONS, AND HAIR ORNA-
MENTS (U.S. CLS. 37, 39, 40, 42 AND 50).

SN 76-326,794. SOHO FASHION INC., SANTA ANA, CA.
FILED 10-17-2001.

SASHA

FOR HAIR ACCESSORIES, NAMELY HAIR EXTEN-
SIONS (U.S. CLS. 37, 39, 40, 42 AND 50).

CLASS 26—(Continued).

SN 76-354,872. REVLON CONSUMER PRODUCTS CORPORATION, NEW YORK, NY. FILED 1-3-2002.

REVLON

OWNER OF U.S. REG. NOS. 647,222, 1,886,476 AND OTHERS.
FOR WIGS AND HAIRPIECES (U.S. CLS. 37, 39, 40, 42 AND 50).
FIRST USE 3-2-1992; IN COMMERCE 3-2-1992.

SN 76-356,211. CHARLOTTE RUSSE MERCHANDISING, INC., SAN DIEGO, CA. FILED 1-7-2002.

refuge.

FOR HAIR PINS, HAIR BANDS, HAIR BOWS, HAIR CLIPS, HAIR ORNAMENTS, HAIR RIBBONS AND BARRETTES (U.S. CLS. 37, 39, 40, 42 AND 50).

SN 76-378,306. OKUN, MILTON, CANTON, MA. FILED 3-4-2002.

BUTTON TURN-ONS

NO CLAIM IS MADE TO THE EXCLUSIVE RIGHT TO USE "BUTTONS", APART FROM THE MARK AS SHOWN.
FOR BUTTONS FOR CLOTHING, REPLACEMENT BUTTONS WITH SCREW TYPE ATTACHMENT MEANS (U.S. CLS. 37, 39, 40, 42 AND 50).

CLASS 26—(Continued).

SN 78-069,999. RENAUD, PHILIP, FRANCIS, DELRAY BEACH, FL. FILED 6-19-2001.



NO CLAIM IS MADE TO THE EXCLUSIVE RIGHT TO USE "WEAR", APART FROM THE MARK AS SHOWN.

THE MARK CONSISTS OF WHITE SNAKE IN THE SHAPE OF AN "S" WITH RED HAT AND RED SCARF WITH "SONNY" ON THE TOP AND "WEAR" ON THE BOTTOM.

FOR EMBROIDERED CLOTH PATCHES FOR CHILDREN'S CLOTHING (U.S. CLS. 37, 39, 40, 42 AND 50).

SN 78-107,220. SCHMIDT, SUSAN MAXWELL, MIDDLETOWN, DE. FILED 2-6-2002.

LONGLOCKS HAIRSTICKS

NO CLAIM IS MADE TO THE EXCLUSIVE RIGHT TO USE "HAIRSTICKS", APART FROM THE MARK AS SHOWN.

FOR HAIR ORNAMENTS, NAMELY, HAND CRAFTED HAIR JEWELRY (U.S. CLS. 37, 39, 40, 42 AND 50).

SN 78-112,089. EVERYTHING FOR LOVE, INC., PINE MOUNTAIN, CA. FILED 3-1-2002.

TOILET TREES

FOR ARTIFICIAL PLANTS FOR STORING TOILET CLEANING BRUSHES, AND FOR STORING PLUNGERS FOR CLEARING BLOCKED DRAINS (U.S. CLS. 37, 39, 40, 42 AND 50).

CLASS 27—FLOOR COVERINGS

CLASS 27—(Continued).

SN 75-590,300. THE TRUSTEES OF THE THEODORE H. ROBINSON ACCUMULATION TRUST, A GEORGIA TRUST, THE TRUSTEE COMPRISED OF THEODORE H. ROBINSON A U.S. CITIZEN, NORCROSS, GA. BY ASSIGNMENT ROBINSON, THEODORE H., MARIETTA, GA. FILED 11-17-1998.

GOD AT WORK

FOR DOOR MATS (U.S. CLS. 19, 20, 37, 42 AND 50).

SN 76-032,522. STANTON ACQUISITION CORPORATION, SYOSSET, NY. FILED 4-24-2000.

ATELIER CARPETS

NO CLAIM IS MADE TO THE EXCLUSIVE RIGHT TO USE "CARPETS", APART FROM THE MARK AS SHOWN. FOR CARPETS AND RUGS (U.S. CLS. 19, 20, 37, 42 AND 50).

FIRST USE 2-0-1996; IN COMMERCE 2-0-1996.

SN 76-312,994. ETABLISSEMENTS JULES FLIPO SOCIETE ANONYME, 59200 TOURCOING, FRANCE, FILED 9-18-2001.

JULES FLIPO

THE NAME "JULES FLIP" DOES NOT IDENTIFY A PARTICULAR LIVING A PARTICULAR LIVING

FOR CARPETS, RUGS, MATS AND MATTING, FOR INDOOR AND OUTDOOR USE, MADE OF FIBER, RUBBER, AND WOOD; LINOLEUM FLOOR COVERINGS; NYLON, VINYL AND RUBBER FLOOR COVERINGS; WALL TAPESTRY NOT MADE OF TEXTILE MATERIAL (U.S. CLS. 19, 20, 37, 42 AND 50).

SN 76-317,159. SUPERIOR MANUFACTURING GROUP, INC., CHICAGO, IL. FILED 9-26-2001.

PREFERENCE

FOR INDOOR AND OUTDOOR FLOOR MATS FOR COMMERCIAL USE (U.S. CLS. 19, 20, 37, 42 AND 50).

SN 76-317,610. SUPERIOR MANUFACTURING GROUP, INC., CHICAGO, IL. FILED 9-26-2001.

POLYNIB

FOR VINYL BACKED TEXTILE FLOOR MATS FOR COMMERCIAL USE (U.S. CLS. 19, 20, 37, 42 AND 50).

CLASS 27—(Continued).

SN 76-331,780. LEISURE ARTS, INC., BIRMINGHAM, AL. FILED 10-29-2001.



THE NAME "MARIO CHIODO" IDENTIFIES A LIVING INDIVIDUAL WHOSE CONSENT IS OF RECORD.

THE MARK CONSISTS OF A RECTANGLE, THE LONG SIDE VERTICAL, WITH THE WORDS "NEW VISION" NEAR THE TOP OF THE RECTANGLE, AN ARTIST'S BRUSH STROKE OF THE LETTER "C" IN THE MIDDLE OF THE RECTANGLE, AND THE WORDS "BY MARIO CHIODO" NEAR THE BOTTOM OF THE RECTANGLE.

FOR PRINTED VINYL WALL AND DOOR COVERINGS (U.S. CLS. 19, 20, 37, 42 AND 50).

SN 76-355,274. ARMSTRONG WORLD INDUSTRIES, INC., LANCASTER, PA. FILED 1-7-2002.



OWNER OF U.S. REG. NOS. 1,055,367, 1,686,011 AND 2,227,937.

SEC. 2(F).

FOR FLOORING MATERIAL, NAMELY CARPETS, RUGS AND UNDERLAY THEREFOR, LINOLEUM, LAMINATE BONDED TO FIBER BOARD, RESILIENT HARD SURFACE COVERINGS IN SHEET AND TILE FORM FOR FLOORS, WALLS AND OTHER SURFACES (U.S. CLS. 19, 20, 37, 42 AND 50).

SN 76-360,159. NOVALIS INTERNATIONAL LIMITED, WANCHAI, HONG KONG, FILED 1-17-2002.

NOVAFLOOR

FOR FLOORING PRODUCTS, NAMELY, HARD SOLID VINYL COVERINGS FOR FLOORS (U.S. CLS. 19, 20, 37, 42 AND 50).

FIRST USE 1-30-1998; IN COMMERCE 1-30-1998.

CLASS 27—(Continued).

SN 76-390,781. KIMBERLY-CLARK CORPORATION, NEENAH, WI. FILED 4-1-2002.

READY FOR ANYTHING

FOR FLOOR MATS OF NONWOVEN FABRIC (U.S. CLS. 19, 20, 37, 42 AND 50).

CLASS 28—TOYS AND SPORTING GOODS

SN 75-816,612. HONG KONG CITY TOYS FACTORY LIMITED, KOWLOON, HONG KONG, FILED 10-7-1999.

L'L CUDDLES

OWNER OF U.S. REG. NO. 1,919,970.
FOR DOLLS, DOLL CLOTHING AND DOLL ACCESSORIES (U.S. CLS. 22, 23, 38 AND 50).
FIRST USE 11-0-1993; IN COMMERCE 11-0-1993.

SN 75-892,375. HYI, COVINA, CA. FILED 1-7-2000.



FOR FISHING ACCESSORIES, NAMELY, FISHING REEL COVERS, TACKLE BOXES AND FISHING EQUIPMENT BAGS (U.S. CLS. 22, 23, 38 AND 50).

SN 75-932,786. M & C TOY CENTRE LTD., TSIMSHATSUI EAST, KOWLOON, HONG KONG, FILED 3-1-2000.

CHRISTINA

FOR DOLLS, DOLL CLOTHING AND DOLL ACCESSORIES, TOY VEHICLES AND PLAYSETS THEREFOR (U.S. CLS. 22, 23, 38 AND 50).
FIRST USE 9-28-2000; IN COMMERCE 9-28-2000.

SN 75-982,335. SARCOS L.C., SALT LAKE CITY, UT. BY ASSIGNMENT SARCOS, INC., SALT LAKE CITY, UT. FILED 6-10-1998.

HYDROBOT

FOR ROBOTS THAT OPERATE UNDER WATER FOR RECREATIONAL USE (U.S. CLS. 22, 23, 38 AND 50).

CLASS 28—(Continued).

SN 76-061,415. BVS ENTERTAINMENT, INC., LOS ANGELES, CA. BY CHANGE OF NAME SABAN ENTERTAINMENT, INC., LOS ANGELES, CA. FILED 6-1-2000.

TITANIUM LASER

NO CLAIM IS MADE TO THE EXCLUSIVE RIGHT TO USE "LASER", APART FROM THE MARK AS SHOWN.
FOR TOYS AND PLAYTHINGS, NAMELY TOY WEAPONS AND ACCESSORIES THEREFOR; BATTERY-OPERATED ACTION TOYS; MULTIPLE ACTIVITY TOYS, ROLE-PLAYING GAMES (U.S. CLS. 22, 23, 38 AND 50).
FIRST USE 2-8-1999; IN COMMERCE 2-8-1999.

SN 76-084,687. TUNTURI OY, LTD., 20360, TURKU, FINLAND, FILED 7-6-2000.

SKIFIT

FOR EXERCISE APPARATUS SIMULATING SKIING (U.S. CLS. 22, 23, 38 AND 50).

SN 76-095,524. SPORTMASTER, INC., BOULDER CITY, NV. FILED 7-24-2000.

ALL DYNAMIC STRETCH

NO CLAIM IS MADE TO THE EXCLUSIVE RIGHT TO USE "DYNAMIC STRETCH", APART FROM THE MARK AS SHOWN.
FOR EXERCISE EQUIPMENT, NAMELY, EXERCISE MACHINES FOR PERFORMING A PLURALITY OF EXERCISES TO DEVELOP MUSCLE STRENGTHENING AND FLEXIBILITY (U.S. CLS. 22, 23, 38 AND 50).

SN 76-110,205. TACK CHEUNG CORPORATION, VERNON, CA. FILED 8-17-2000.

SIGHT N SOUND

FOR TOY KITCHEN APPLIANCES, TOY KITCHEN AND COOKING ACCESSORIES, AND TOY COOKING UTENSILS (U.S. CLS. 22, 23, 38 AND 50).

SN 76-180,339. HASELHURST, PETER JAMES, WESTERN AUSTRALIA 6010, AUSTRALIA, FILED 12-13-2000.

GRYPHON

OWNER OF AUSTRALIA REG. NO. 752994, DATED 1-20-1998, EXPIRES 1-20-2008.
FOR HOCKEY EQUIPMENT, NAMELY, HOCKEY STICKS, HOCKEY BALLS, HOCKEY EQUIPMENT BAGS, GLOVES, PROTECTIVE SHIN GUARDS AND LEG GUARDS; AND GOAL KEEPING EQUIPMENT, NAMELY, PADS, KICKERS, CHEST GUARDS AND BODY GUARDS (U.S. CLS. 22, 23, 38 AND 50).

CLASS 28—(Continued).

SN 76-194,954. RADICA CHINA LTD., ROAD TOWN, TORTOLA, BR.VIRGIN ISLANDS, FILED 1-16-2001.

UJALU

FOR HAND HELD UNIT FOR PLAYING AN ELECTRONIC GAME (U.S. CLS. 22, 23, 38 AND 50).

SN 76-196,631. WANG, KEVIN, WALNUT, CA. FILED 1-22-2001.

kingHawk

FOR FISHING RODS, FISHING REELS, FISHING TACKLES, FISHING HOOKS (U.S. CLS. 22, 23, 38 AND 50).

SN 76-197,742. TABATA CO., LTD., TOKYO, JAPAN, FILED 1-22-2001.

XPERT ZOOM

PRIORITY CLAIMED UNDER SEC. 44(D) ON JAPAN APPLICATION NO. 2000-9027, FILED 8-16-2000. OWNER OF U.S. REG. NOS. 1,336,897, 2,353,066 AND OTHERS. FOR SWIMMING FINS AND SNORKELS (U.S. CLS. 22, 23, 38 AND 50). FIRST USE 12-2-2000; IN COMMERCE 12-2-2000.

SN 76-201,722. GOLDEN INDUSTRIES LLC., TEQUESTA, FL. FILED 1-29-2001.

CHADS

FOR FAMILY BOARD GAMES (U.S. CLS. 22, 23, 38 AND 50).

CLASS 28—(Continued).

SN 76-207,722. BLUE BOX TOY FACTORY LIMITED, KOWLOON, HONG KONG, FILED 2-7-2001.

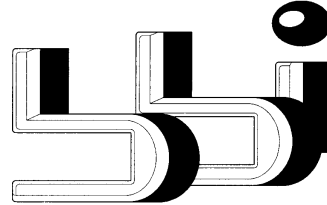

FOR TOYS AND GAMES, NAMELY, CASES FOR TOY VEHICLES, COLLECTABLE TOY FIGURES, MODELED PLASTIC TOY FIGURINES, POSITIONABLE TOY FIGURES, TOY ACTION FIGURES, TOY ACTION FIGURES AND ACCESSORIES THEREFOR, TOY AIRPLANES, TOY ARMOR, TOY FIGURES, TOY GUNS, TOY MODEL CARS, TOY MODEL HOBBYCRAFT KITS, TOY MODEL KIT CARS, TOY MODEL VEHICLES AND RELATED ACCESSORIES SOLD AS A UNIT, TOY VEHICLES, TOY VEHICLES AND ACCESSORIES THEREFOR, TOY WEAPONS, ACTION TOYS, PLAYTHINGS, NAMELY, TOY AIR PISTOLS, TOY AIR RIFLES, AIR SHOT AND PELLETS THEREFOR, AND TOY PISTOLS AND PARTS THEREFOR, BENDABLE TOYS, CONSTRUCTION TOYS, FANTASY CHARACTER TOYS, PLASTIC CHARACTER TOYS, PROMOTIONAL GAME CARDS, TOY FIGURINES AND ACCESSORIES THEREFOR (U.S. CLS. 22, 23, 38 AND 50).

SN 76-207,724. BLUE BOX TOY FACTORY LIMITED, KOWLOON, HONG KONG, FILED 2-7-2001.

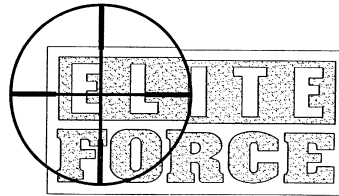

THE STIPLING IN THE MARK IS FOR SHADING PURPOSES ONLY

FOR TOYS AND GAMES, NAMELY, CASES FOR TOY VEHICLES, COLLECTABLE TOY FIGURES, MODELED PLASTIC TOY FIGURINES, POSITIONABLE TOY FIGURES, THREE DIMENSIONAL TOY MODELS FOR EDUCATIONAL PURPOSES, TOY ACTION FIGURES, TOY ACTION FIGURES AND ACCESSORIES THEREFOR, TOY AIRPLANES, TOY ARMOR, TOY FIGURES, TOY GUNS, TOY MODEL CARS, TOY MODEL HOBBYCRAFT KITS, TOY MODEL KIT CARS, TOY MODEL VEHICLES AND RELATED ACCESSORIES SOLD AS UNITS, TOY VEHICLES, TOY VEHICLES AND ACCESSORIES THEREFOR, TOY WEAPONS, ELECTRICAL ACTION TOYS, MECHANICAL ACTION TOYS, TOY AIR PISTOLS, TOY AIR RIFLES, AIR SHOT OR PELLETS FOR TOY PISTOLS AND RIFLES, BENDABLE TOYS, CONSTRUCTION TOYS, FANTASY CHARACTER TOYS, TOY PISTOLS AND PARTS THEREOF, PLASTIC CHARACTER TOYS, PROMOTIONAL GAME CARDS, TOY FIGURINES AND ACCESSORIES THEREFOR (U.S. CLS. 22, 23, 38 AND 50).

CLASS 28—(Continued).

SN 76-209,726. KENZER & COMPANY, MUNDELEIN, IL.
FILED 2-14-2001.

HACKMASTER

FOR ROLE-PLAYING GAMES, BOARD GAMES,
CARD GAMES (U.S. CLS. 22, 23, 38 AND 50).
FIRST USE 7-1-1994; IN COMMERCE 7-1-1994.

SN 76-210,525. CHRISTIAN, DAVID L., PALM SPRINGS, CA.
FILED 2-14-2001.

FAT DRAGONS

NO CLAIM IS MADE TO THE EXCLUSIVE RIGHT TO
USE "DRAGON", APART FROM THE MARK AS SHOWN.
FOR DOLLS, PLUSH TOYS AND TOY FIGURES (U.S.
CLS. 22, 23, 38 AND 50).
FIRST USE 6-0-1991; IN COMMERCE 6-0-1991.

SN 76-236,085. TRENDMASTERS, INC., ST. LOUIS, MO.
FILED 4-5-2001.

STORM ENERGY ROD

FOR TOYS, NAMELY, WATER GUNS AND ACCES-
SORIES THEREFOR, NAMELY, BACKPACKS FOR
STORING AND LANYARDS FOR ATTACHING WATER
GUNS, ALL SOLD AS A UNIT TOGETHER (U.S. CLS. 22,
23, 38 AND 50).
FIRST USE 10-19-2001; IN COMMERCE 10-19-2001.

SN 76-240,731. FUNDEX GAMES, LTD., INDIANAPOLIS, IN.
FILED 4-13-2001.

FLOATEE FRIENDS

FOR WATER TOYS, NAMELY, WATER RINGS AND
WATER WING SWIM AIDS FOR RECREATIONAL USE
(U.S. CLS. 22, 23, 38 AND 50).
FIRST USE 7-15-2000; IN COMMERCE 1-17-2001.

SN 76-245,046. FEDERATED BRANDS, INC., MANCHE-
STER, NH. FILED 4-23-2001.

GREENDOG

FOR PLUSH ANIMALS AND PLUSH TOYS, BUT NOT
INCLUDING GREEN DOGS (U.S. CLS. 22, 23, 38 AND
50).
FIRST USE 3-1-2000; IN COMMERCE 3-1-2000.

CLASS 28—(Continued).

SN 76-245,047. FEDERATED BRANDS, INC., MANCHE-
STER, NH. FILED 4-23-2001.



FOR PLUSH ANIMALS AND PLUSH TOYS, BUT NOT
INCLUDING GREEN DOGS (U.S. CLS. 22, 23, 38 AND
50).
FIRST USE 3-1-2000; IN COMMERCE 3-1-2000.

SN 76-249,418. VIACOM INTERNATIONAL INC., NEW
YORK, NY. FILED 5-1-2001.

**SPRING BREAK**

OWNER OF U.S. REG. NOS. 1,372,705, 1,385,041 AND
OTHERS.
SEC. 2(F) AS TO "MUSIC TELEVISION".
FOR STAND ALONE VIDEO GAME MACHINES UTI-
LIZING CD ROM'S, STAND ALONE VIDEO GAME
MACHINES, STAND ALONE AUDIO OUTPUT GAME
MACHINES (U.S. CLS. 22, 23, 38 AND 50).

SN 76-258,641. FORUM SNOWBOARDS, INC., SAN CLEM-
ENTE, CA. FILED 5-17-2001.

I LOCK

FOR SNOWBOARD BINDINGS AND PARTS THERE-
FOR (U.S. CLS. 22, 23, 38 AND 50).

SN 76-264,716. T.F.H. PUBLICATIONS, INC., NEPTUNE
CITY, NJ. FILED 5-31-2001.

ION CLEAN

NO CLAIM IS MADE TO THE EXCLUSIVE RIGHT TO
USE "CLEAN", APART FROM THE MARK AS SHOWN.
FOR PLASTIC DOG CHEW (U.S. CLS. 22, 23, 38 AND
50).

CLASS 28—(Continued).

SN 76-271,479. BOLDT ENTERTAINMENT, INC., MINNEAPOLIS, MN. FILED 6-14-2001.

DUCK T

NO CLAIM IS MADE TO THE EXCLUSIVE RIGHT TO USE "DUCK", APART FROM THE MARK AS SHOWN. FOR TOYS, NAMELY SOFT SCULPTURE AND PLUSH TOYS (U.S. CLS. 22, 23, 38 AND 50).



SN 76-273,329. EBAY INC., SAN JOSE, CA. FILED 6-19-2001.



FOR BOARD GAMES (U.S. CLS. 22, 23, 38 AND 50). FIRST USE 12-0-1999; IN COMMERCE 12-0-1999.



SN 76-275,682. EBAY INC., SAN JOSE, CA. FILED 6-19-2001.

EBAY

FOR BOARD GAMES (U.S. CLS. 22, 23, 38 AND 50). FIRST USE 12-0-1999; IN COMMERCE 12-0-1999.



SN 76-277,088. LEE MIDDLETON ORIGINAL DOLLS, INC., WESTERVILLE, OH. FILED 6-27-2001.

**SMALL WONDER LIFE'S
LITTLE LESSONS**

FOR DOLLS AND PLAY SETS CONSISTING PRIMARILY OF DOLL CLOTHING, DOLL ACCESSORIES AND INTERACTIVE STORY BOOKS (U.S. CLS. 22, 23, 38 AND 50).

CLASS 28—(Continued).

SN 76-278,918. MCCRANE, INC., DBA HARBINGER, NAPA, CA. FILED 7-2-2001.

BIG GRIP

NO CLAIM IS MADE TO THE EXCLUSIVE RIGHT TO USE "GRIP", APART FROM THE MARK AS SHOWN. FOR GLOVES FOR USE IN THE SPORTS OF BASEBALL, GOLF, ICE AND FIELD HOCKEY, TENNIS, RACQUETBALL, SQUASH, CRICKET, WEIGHT AND RESISTANCE EXERCISE, ROWING, BOAT AND CANOE PADDING, JAVELIN THROWING, TRAPEZE PERFORMANCE, GYMNASIAC BAR EXERCISE, ARCHERY, AND LACROSSE (U.S. CLS. 22, 23, 38 AND 50).



SN 76-279,573. K & M INTERNATIONAL, TWINSBURG, OH. FILED 7-3-2001.

Backyard Birds

NO CLAIM IS MADE TO THE EXCLUSIVE RIGHT TO USE "BIRDS", APART FROM THE MARK AS SHOWN. FOR PLUSH TOYS (U.S. CLS. 22, 23, 38 AND 50). FIRST USE 12-6-2000; IN COMMERCE 1-4-2001.



SN 76-282,406. AMERICAN OUTDOORS, INC., MOUNT PLEASANT, IA. FILED 7-6-2001.



FOR DEER LURES; ELK LURES; HUNTERS' SCENT CAMOUFLAGE; HUNTING ACCESSORIES, NAMELY, POWDERS FOR DETERMINING WIND DIRECTION (U.S. CLS. 22, 23, 38 AND 50). FIRST USE 10-15-1991; IN COMMERCE 10-15-1991.

CLASS 28—(Continued).

SN 76-290,049. IRON GRIP BARBELL COMPANY, COSTA MESA, CA. FILED 7-24-2001.

IRON GRIP SPORT

OWNER OF U.S. REG. NOS. 1,848,270 AND 2,259,789. NO CLAIM IS MADE TO THE EXCLUSIVE RIGHT TO USE "SPORT", APART FROM THE MARK AS SHOWN.

FOR EXERCISE AND TRAINING EQUIPMENT, NAMELY, STRENGTH TRAINING MACHINES, SELECTORIZED RESISTANCE MACHINES, PLATE-LOADED RESISTANCE MACHINES; FREE WEIGHT EQUIPMENT, NAMELY, DUMBBELLS, BARBELLS, WEIGHT PLATES, WEIGHTLIFTING BARS, COLLARS; FRAMED EXERCISE EQUIPMENT, NAMELY, BENCHES, DUMBBELL RACKS, PLATE TREES; CARDIOVASCULAR MACHINES, NAMELY TREADMILLS, STATIONARY BICYCLES, ELLIPTICAL TRAINERS, STAIR-CLIMBING MACHINES; HAND EXERCISE EQUIPMENT, NAMELY, AEROBIC HAND WEIGHTS, RESISTANCE BANDS AND TUBES FOR STRENGTH TRAINING; INFLATABLE SWISS BALLS; AND ABWHEELS (U.S. CLS. 22, 23, 38 AND 50).

SN 76-290,575. PLACO CORPORATION LIMITED, KOWLOON, HONG KONG, FILED 7-27-2001.

TURBO BUBBLES 500

OWNER OF U.S. REG. NOS. 2,211,837, 2,264,806 AND 2,428,297.

NO CLAIM IS MADE TO THE EXCLUSIVE RIGHT TO USE "BUBBLES", APART FROM THE MARK AS SHOWN.

FOR BATTERY OPERATED, HAND-HELD BUBBLE TOYS, NAMELY BUBBLE GUNS, BUBBLE MACHINES, BUBBLE WANDS, AND BUBBLE SOLUTION CONTAINERS; AND NON-BATTERY OPERATED, HAND-HELD BUBBLE TOYS, NAMELY BUBBLE GUNS, BUBBLE MACHINES, BUBBLE WANDS, AND BUBBLE SOLUTION CONTAINERS (U.S. CLS. 22, 23, 38 AND 50).

SN 76-296,361. DSI TOYS, INC., HOUSTON, TX. FILED 8-8-2001.

BIANCA

"BIANCA" DOES NOT IDENTIFY A LIVING INDIVIDUAL.

FOR TOYS, NAMELY, DOLLS, DOLL CLOTHING, AND DOLL ACCESSORIES (U.S. CLS. 22, 23, 38 AND 50).

CLASS 28—(Continued).

SN 76-297,765. PLACO CORPORATION LIMITED, KOWLOON, HONG KONG, FILED 8-13-2001.

TURBO BUBBLES TECHNOLOGY

OWNER OF U.S. REG. NOS. 2,211,837, 2,264,806 AND 2,428,297.

NO CLAIM IS MADE TO THE EXCLUSIVE RIGHT TO USE "BUBBLES", APART FROM THE MARK AS SHOWN.

FOR BATTERY OPERATED, HAND-HELD BUBBLE TOYS, NAMELY BUBBLE GUNS, BUBBLE MACHINES, BUBBLE WANDS, AND BUBBLE SOLUTION CONTAINERS; AND NON-BATTERY OPERATED, HAND-HELD BUBBLE TOYS, NAMELY BUBBLE GUNS, BUBBLE MACHINES, BUBBLE WANDS, AND BUBBLE SOLUTION CONTAINERS (U.S. CLS. 22, 23, 38 AND 50).

SN 76-300,516. NANO'S POLO MALLETS, INC., WELLINGTON, FL. FILED 8-17-2001.

NANO'S

FOR POLO MALLETS (U.S. CLS. 22, 23, 38 AND 50). FIRST USE 12-13-1993; IN COMMERCE 12-13-1993.

SN 76-301,785. HEILBRUNN, EVA, SAN DIEGO, CA. FILED 8-20-2001.

BINGO DAWG

NO CLAIM IS MADE TO THE EXCLUSIVE RIGHT TO USE "BINGO", APART FROM THE MARK AS SHOWN.

FOR BINGO GAME PLAYING EQUIPMENT, NAMELY, BINGO BAGS, BINGO GAME SHEETS MADE OF PAPER OR PLASTIC, AND BINGO CHIPS (U.S. CLS. 22, 23, 38 AND 50).

FIRST USE 1-1-2001; IN COMMERCE 1-1-2001.

SN 76-303,547. ORTHOPEDIC SYSTEMS, INC., UNION CITY, CA. FILED 8-21-2001.

SWING DYNAMICS

OWNER OF U.S. REG. NOS. 2,250,629 AND 2,521,177. FOR GOLF EQUIPMENT, NAMELY GOLF CLUB COVERS AND GOLF GLOVES (U.S. CLS. 22, 23, 38 AND 50).

CLASS 28—(Continued).

SN 76-304,810. GIRL MANIA, INC., LOS ANGELES, CA.
FILED 8-24-2001.

GIRL MANIA

FOR GAMES AND TOYS, NAMELY, ACTION FIGURES AND ACCESSORIES FOR USE THEREWITH, STUFFED TOYS, STUFFED TOY ANIMALS, TOY VEHICLES, TOY FIGURES, TOY ANIMALS, MECHANICAL TOYS, BUILDING TOYS, PUSH TOYS, PULL TOYS, MUSICAL TOYS, PLASTIC TOY HOOPS, TOY BANKS, BATHTUB TOYS, BOARD GAMES, PARLOR GAMES, CARD GAMES; DOLLS, DOLL CLOTHING AND ACCESSORIES; HAND HELD ELECTRONIC GAMES, PARTY FAVORS NAMELY CRACKERS, NOISEMAKERS AND SMALL TOYS, HAND HELD VIDEO GAMES, JIGSAW PUZZLES, MANIPULATIVE PUZZLES, PAPER DOLLS, PLUSH TOYS, THREE-DIMENSIONAL PUZZLES, ROLLER-SKATES, SKATEBOARDS, IN-LINE SKATES, WATER SQUIRTING TOYS, AIR AND SPRING LOADED TOY GUNS FOR SHOOTING FOAM DISCS AND FOAM BALLS AND ACCESSORIES FOR USE THEREWITH, NAMELY FOAM DISC AND FOAM BALLS, WIND-UP TOYS, FLYING DISCS AND YO-YOS (U.S. CLS. 22, 23, 38 AND 50).

SN 76-305,109. VICEISZA, FIORELLA L. G., ATLANTA, GA.
FILED 8-24-2001.

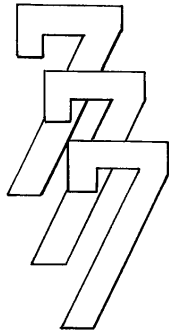

THE MARK CONSISTS OF THE NUMBER "777" IN AN OVERLAPPING DESIGN.

FOR RUBBER ACTION BALLS; ARCHERY EQUIPMENT, NAMELY, ARM GUARDS, ARROWS, ARROW FLETCHING DEVICES, BOW CASES, BOWS AND QUIVERS; BACKBOARDS FOR BASKETBALL; BADMINTON GAME PLAYING EQUIPMENT, NAMELY, RACKETS, SHUTTLECOCKS AND UPRIGHTS; BOWLING BAGS; GOLF BAGS; PADDLEBALL GAMES; GOLF BALL MARKERS; BALLPITCHING MACHINES; GOLF BALL RETRIEVERS; TENNIS BALL RETRIEVERS; BASEBALLS; BASKETBALLS; BILLIARD BALLS; BOWLING BALLS; CRICKET BALLS; FIELD HOCKEY BALLS; FOOTBALLS; GOLF BALLS; HANDBALLS; LACROSSE BALLS; RACKET BALLS; RUGBY BALLS; SOCCER BALLS; SPORTS BALLS; SQUASH BALLS; TABLE TENNIS BALLS; TENNIS BALLS; TETHER BALLS; VOLLEYBALLS; BASEBALL BASES; BASEBALL BATS; BASEBALL BATTING GLOVES; BASEBALL BATTING TEES; BASEBALL GLOVES; BASEBALL MITTS; BASKETBALL GOALS; BASKETBALL NETS; CRICKET BATS; SOFTBALL BATS; BOBSLEDS; BOXING GLOVES; CATCHER'S MASKS; CHEST PROTECTORS FOR

CLASS 28—(Continued).

SPORTS; CLAY PIGEON TARGETS; CROSSBOWS; DARTS; DARTBOARDS; DISCUSSES; DUMBBELLS AND DUMBBELL SETS; FENCING EQUIPMENT, NAMELY, FOILS, GAUNTLETS AND MASKS; FISHING CREELS; FISHING FLIES; FISHING FLOATS; FISHING HOOKS; FISHING LEADERS; FISHING LINES; FISHING LURE BOXES; FISHING LURES; FISHING REELS; FISHING RODS; FOOTBALL BODY PROTECTORS; GOLF CLUB HEADS; GOLF CLUB SHAFTS; GOLF CLUBS; GOLF GLOVES; GOLF TEES; HOCKEY BODY PROTECTION EQUIPMENT, NAMELY, GLOVES, BODY PADS AND GOALIE PADS; HOCKEY PUCKS; HOCKEY STICKS; ICE SKATES; LACROSSE STICKS; POOL CUES; SAILBOARDS; SCUBA FINS, FLIPPERS, GOGGLES, MASKS AND SNORKELS; SKATEBOARDS; ROLLER SKATES; SKI POLES; SKI RACKS; SNOW SKIS; WATER SKIS; SNOW BOARDS; SNOW SAUCERS; SNOW SHOES; TABLE TENNIS NETS; TABLE TENNIS PADDLES; TABLE TENNIS POST SETS; TABLE TENNIS TABLES; TABLES FOR BILLIARDS; AND TARGETS FOR ARCHERY AND FIREARMS (U.S. CLS. 22, 23, 38 AND 50).

SN 76-305,238. INTELLINITIATIVE, INC., NEW YORK, NY.
FILED 8-23-2001.

DECADENT DAN

FOR GAMES, NAMELY, BOARD GAMES (U.S. CLS. 22, 23, 38 AND 50).

SN 76-307,846. FREZZELL, TROILINE, LOUISVILLE, KY.
FILED 9-4-2001.

**HOURGLASS LOUNGE THE
ADULT BOARD GAME**

NO CLAIM IS MADE TO THE EXCLUSIVE RIGHT TO USE "ADULT BOARD GAME", APART FROM THE MARK AS SHOWN.

FOR ADULT BOARD GAME (U.S. CLS. 22, 23, 38 AND 50).

CLASS 28—(Continued).

SN 76-309,980. BABY EINSTEIN COMPANY, LLC, THE, LONE TREE, CO. FILED 9-7-2001.

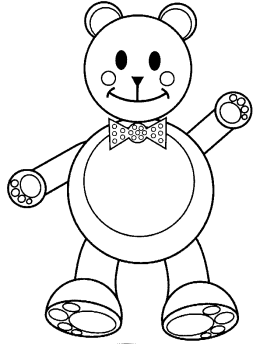

FOR GAMES, PLAYTHINGS AND TOYS FOR CHILDREN, NAMELY PUPPETS, PLUSH TOYS, PULL TOYS, CRIB TOYS, ELECTRONIC ACTION TOYS, BOARD GAMES, HAND-HELD ELECTRONIC GAMES, ROLE-PLAYING GAMES, AND MUSIC, ART, LANGUAGE, POETRY, MATH AND SCIENCE MULTIPLE-ACTIVITY TOYS (U.S. CLS. 22, 23, 38 AND 50).

SN 76-313,072. HYPERFLITE, INC., ATLANTA, GA. FILED 9-14-2001.

K-10

FOR CANINE TOYS; NAMELY, FLYING DISCS (U.S. CLS. 22, 23, 38 AND 50).

SN 76-316,297. WINNER TOYS MANUFACTORY LTD., KOWLOON, HONG KONG, AND WNR INDUSTRIES LTD., KOWLOON, HONG KONG, FILED 9-24-2001.

THE MEGAMARKET

FOR TOYS, NAMELY, TOY TROLLEYS, TOY TEA CARTS, TOY SHOPPING BASKETS, TOY SUPERMARKET STANDS, TOY SUPERMARKET CENTERS, TOY SUPERMARKET STORES, TOY CASH REGISTERS, TOY SCALES, TOY FOOD, TOY KITCHENS, TOY OVENS, TOY TOASTERS, TOY MIXERS, TOYS TEAPOTS, TOY COFFEE POTS, TOY BROOMS AND TOY DUSTPAN AND BRUSH SETS (U.S. CLS. 22, 23, 38 AND 50).

CLASS 28—(Continued).

SN 76-316,472. FISHEL TOYS LTD., TSIMSHATSUI, KOWLOON, HONG KONG, FILED 9-24-2001.

FOR TOYS, NAMELY, MUSIC BOXES AND MUSICAL TOYS, DOLLS AND ACCESSORIES THEREFOR, STUFFED TOYS, TOY GUNS, SWIM MASKS, SNORKELS, SWIM FINS, TOY VEHICLES, TOY RACING SETS, WIND-UP TOYS FIGURES, TOY MECHANICAL OR PLASTIC FIGURES, BATTERY POWERED TOY HOUSEHOLD APPLIANCES AND ACCESSORIES THEREFORE AND FANTASY DRESS UP PLAYSETS (U.S. CLS. 22, 23, 38 AND 50).

FIRST USE 3-0-1980; IN COMMERCE 3-0-1980.

SN 76-317,468. WINNER TOYS MANUFACTORY LTD. & WNR INDUSTRIES LTD, KOWLOON, HONG KONG, FILED 9-25-2001.

KIDS CAN LEARN

FOR TOYS, NAMELY, CHILDREN'S MULTIPLE ACTIVITY TOYS, SPECIFICALLY ACTIVITY TABLES, ACTIVITY BOARDS AND ACTIVITY HOUSES; PLAY HOUSES, TOY STEERING WHEELS, CRIB MOBILES, TOY MOBILES, PUSH AND PULL TOYS, BOARD GAMES, TOY BUILDING BLOCKS, DOLLS, JIGSAW PUZZLES, MANIPULATIVE PUZZLES AND/OR CUBE-TYPE PUZZLES, JUNGLE GYMS, RIDE-ON TOYS, TOY MUSICAL INSTRUMENTS, BATH TOYS; NESTING, STACKING AND SORTING TOYS; TOY OVENS, TOY TOASTERS, TOY MIXERS, TOY COFFEE POTS, TOY KITCHENS, TOY BROOMS, TOY DUSTPAN AND BRUSH SETS (U.S. CLS. 22, 23, 38 AND 50).

SN 76-320,113. SHEEHY, PATRICK J., YONKERS, NY. FILED 10-1-2001.

**ELECTING A PRESIDENT
THE ROAD TO THE WHITE
HOUSE**

NO CLAIM IS MADE TO THE EXCLUSIVE RIGHT TO USE "ELECTING A PRESIDENT", APART FROM THE MARK AS SHOWN.

FOR BOARD GAME (U.S. CLS. 22, 23, 38 AND 50).

CLASS 28—(Continued).

SN 76-320,657. PILOT INK CO., LTD., THE, AICHI, JAPAN, FILED 10-3-2001.

AQUA DOODLE

PRIORITY CLAIMED UNDER SEC. 44(D) ON JAPAN APPLICATION NO. 2001-048848, FILED 5-30-2001, REG. NO. 4558705, DATED 4-12-2002, EXPIRES 4-12-2012.

NO CLAIM IS MADE TO THE EXCLUSIVE RIGHT TO USE "DOODLE", APART FROM THE MARK AS SHOWN.

FOR DRAWING TOYS AND DOLLS (U.S. CLS. 22, 23, 38 AND 50).

SN 76-322,022. ENDRIZZI, ELISE V., SAN DIEGO, CA. FILED 10-9-2001.

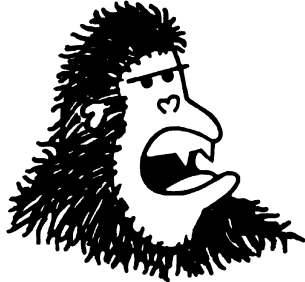
JIMMY SLINGER

THE NAME DOES NOT IDENTIFY A LIVING INDIVIDUAL.

FOR SKATEBOARD DECKS (U.S. CLS. 22, 23, 38 AND 50).

SN 76-323,260. TRENDMASTERS, INC., ST. LOUIS, MO. FILED 10-9-2001.

KING EL SMASHO

FOR REMOTE CONTROLLED TOYS, NAMELY ROBOTS, ACTION FIGURES AND TOY VEHICLES, AND PARTS THEREFOR; CARD GAMES (U.S. CLS. 22, 23, 38 AND 50).

SN 76-324,683. SCHERER, ROBERT, CYPRESS, TX. FILED 10-12-2001.



NO CLAIM IS MADE TO THE EXCLUSIVE RIGHT TO USE "AMERICAN", APART FROM THE MARK AS SHOWN. FOR FISHING RODS (U.S. CLS. 22, 23, 38 AND 50).

CLASS 28—(Continued).

SN 76-329,307. DAVIS, JOHN WILEY, LAKEWOOD, CO. FILED 10-25-2001.

CIVIL WAR 2061

FOR BOARD GAMES (U.S. CLS. 22, 23, 38 AND 50). FIRST USE 9-5-2000; IN COMMERCE 9-5-2000.

SN 76-331,069. WALSH, KATHRYN G., SAN ANTONIO, TX. FILED 10-29-2001.

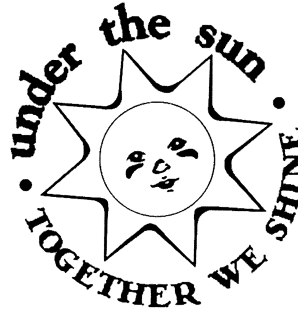

FOR TOYS, NAMELY, DOLLS AND DOLL ACCESSORIES (U.S. CLS. 22, 23, 38 AND 50).

SN 76-334,519. TORNABENE, DEAN G., MARINA DEL REY, CA. FILED 11-5-2001.

CROUCHING TIGER

FOR MANUALLY OPERATED EXERCISE EQUIPMENT USED IN THE HOME OR GYMNASIUM (U.S. CLS. 22, 23, 38 AND 50). FIRST USE 6-11-2001; IN COMMERCE 6-11-2001.

SN 76-338,521. MILTON SALES, INC., MAIDEN, WV. FILED 11-16-2001.

BONUS MOOSE

FOR GAMES OF CHANCE, NAMELY, RAFFLE PULL TAB TICKETS (U.S. CLS. 22, 23, 38 AND 50). FIRST USE 0-0-1992; IN COMMERCE 0-0-1992.

CLASS 28—(Continued).

SN 76-342,763. JAKKS PACIFIC, INC., MALIBU, CA. FILED 11-29-2001.

FRIDAE DURAN

THE NAME "FRIDAE DURAN" DOES NOT IDENTIFY A LIVING INDIVIDUAL.

FOR TOYS, NAMELY STUFFED TOYS AND PLUSH TOYS (U.S. CLS. 22, 23, 38 AND 50).

SN 76-345,006. TOEI ANIMATION CO., INC., TOKYO, 162, JAPAN, FILED 12-6-2001.

BUU

FOR GAMES, PLAYTHINGS AND SPORTING GOODS, NAMELY, COLLECTIBLE TOY FIGURES AND ACTION FIGURES AND ACTION FIGURE ACCESSORIES, TALKING TOY FIGURES, ELECTRONIC OR MECHANICAL TOY BATONS, TOY MILK CAPS, WIND-UP-TOYS, TOY VEHICLES, DOLLS AND ROLL-PLAYING GAME EQUIPMENT IN THE NAME OF MALE ACTION TOYS AND MODELS, ACTIVITY SETS AND PLAYSET ENVIRONMENTS COMPRISED OF MINI FIGURES/SCENE DISPLAYS, TOY FIGURES, SPIN-TOP TOYS; ELECTRONIC TOYS, NAMELY COIN-OPERATED VIDEO GAMES; HAND HELD UNIT FOR PLAYING VIDEO GAMES; STAND ALONE VIDEO GAME MACHINES; STAND ALONE VIDEO OUTPUT GAME MACHINES (U.S. CLS. 22, 23, 38 AND 50).

SN 76-346,225. AXIS HOLDING CORPORATION, SALT LAKE CITY, UT. BY ASSIGNMENT AXIS CORPORATION, SALT LAKE CITY, UT. FILED 12-6-2001.

My Way

 The logo for "My Way Babies" features the words "My Way" in a simple sans-serif font above the word "Babies" in a large, bold, cursive script. A decorative dotted line arches under the word "Babies", starting from a small butterfly icon on the left and ending with a small star on the right.

NO CLAIM IS MADE TO THE EXCLUSIVE RIGHT TO USE "BABIES", APART FROM THE MARK AS SHOWN. FOR PORCELAIN AND VINYL DOLLS AND ACCESSORIES THEREFOR (U.S. CLS. 22, 23, 38 AND 50). FIRST USE 2-0-2001; IN COMMERCE 2-0-2001.

SN 76-348,312. EVERYDAY PRODUCTS (AUSTRALIA) (PTY) LTD., FAIRFIELD, CT. FILED 12-14-2001.

FUNKY FRAMES

NO CLAIM IS MADE TO THE EXCLUSIVE RIGHT TO USE "FRAMES", APART FROM THE MARK AS SHOWN. FOR TOY ACTIVITY KITS FOR CHILDREN TO PAINT AND DECORATE PLASTIC PICTURE FRAMES (U.S. CLS. 22, 23, 38 AND 50).

CLASS 28—(Continued).

SN 76-351,076. KALE, RANDOLPH H., SPARTANBURG, SC. FILED 12-20-2001.

TUBEBALL

FOR ACTION SKILL GAME FOR CHILDREN (U.S. CLS. 22, 23, 38 AND 50).

SN 76-352,695. WHITE, GILBERT TIMOTHY, DBA TIM WHITE SLEDS, GRAND MARAIS, MN. FILED 12-21-2001.

QCR

FOR DOG SLED SKI RUNNER ASSEMBLIES AND PARTS THEREFOR (U.S. CLS. 22, 23, 38 AND 50). FIRST USE 12-0-1983; IN COMMERCE 12-0-1983.

SN 76-356,452. PLASTIC INJECTION COMMAND, INC., CHAPPAQUA, NY. FILED 1-8-2002.

ORBY DISC

NO CLAIM IS MADE TO THE EXCLUSIVE RIGHT TO USE "DISC", APART FROM THE MARK AS SHOWN. FOR SPORTS EQUIPMENT, NAMELY, NIGHT FLYING DISKS; ILLUMINATED FLYING DISKS AND HAND THROWN FLYING DISKS (U.S. CLS. 22, 23, 38 AND 50).

SN 76-358,135. KID GALAXY, INC., MANCHESTER, NH. FILED 1-11-2002.

AUTOMITES

FOR REMOTE CONTROLLED TOY VEHICLES (U.S. CLS. 22, 23, 38 AND 50).

SN 76-358,513. DANU USA, INC., GLENDORA, CA. FILED 1-15-2002.

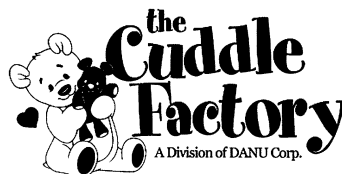

NO CLAIM IS MADE TO THE EXCLUSIVE RIGHT TO USE "FACTORY", "A DIVISION OF" AND "CORP.", APART FROM THE MARK AS SHOWN. FOR PLUSH ANIMALS (U.S. CLS. 22, 23, 38 AND 50). FIRST USE 11-27-2001; IN COMMERCE 11-27-2001.

CLASS 28—(Continued).

SN 76-359,926. POWER PULL, INC., GREENWOOD, MS. FILED 1-18-2002.

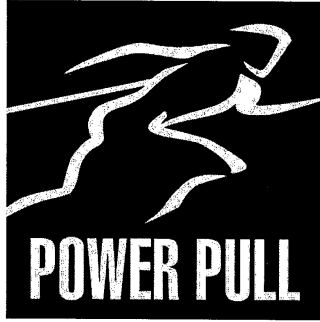

THE STIPPLING IS A FEATURE OF THE MARK AND DOES NOT INDICATE COLOR.
FOR EXERCISE MACHINE (U.S. CLS. 22, 23, 38 AND 50).

SN 76-362,135. CHICAGO BEARS FOOTBALL CLUB, INC., LAKE FOREST, IL. FILED 1-23-2002.

MIRACLES OF THE MIDWAY

FOR TOYS AND SPORTING GOODS, NAMELY, PLUSH TOYS, STUFFED ANIMALS, PLAY FIGURES, GOLF BALLS, GOLF BAGS, GOLF CLUBS, GOLF CLUB COVERS, BOWLING BALLS, BOWLING BAGS, FOOTBALLS, TOY BANKS, HAND HELD UNIT FOR PLAYING ELECTRONIC GAMES; HAND HELD UNIT FOR PLAYING VIDEO GAMES; BOARD GAMES RELATING TO FOOTBALL, CHRISTMAS TREE ORNAMENTS, BALLOONS, JIGSAW PUZZLES, WINDSOCKS, KITES, TOY TRUCKS (U.S. CLS. 22, 23, 38 AND 50).

SN 76-362,762. DIMAC CORPORATION, DBA CUBBY FISHING TACKLE, CRETE, IL. FILED 1-23-2002.

TRANS-GLO

FOR FISHING LURES, NAMELY, JIGS CONSISTING OF METALLIC JIG HEADS AND SOFT BODIES (U.S. CLS. 22, 23, 38 AND 50).
FIRST USE 1-3-2002; IN COMMERCE 1-3-2002.

CLASS 28—(Continued).

SN 76-363,130. HILLERICH & BRADSBY CO., LOUISVILLE, KY. FILED 1-25-2002.



OWNER OF U.S. REG. NOS. 321,855, 2,077,673 AND OTHERS.

FOR GOLF CLUBS, GOLF BAGS, GOLF GLOVES, GOLF CLUB HEADCOVERS, GOLF BALLS, GOLF BALL MARKERS, DIVOT REPAIR TOOLS, AND GOLF TEES (U.S. CLS. 22, 23, 38 AND 50).

SN 76-365,216. JADA TOYS, INC., LOS ANGELES, CA. FILED 1-30-2002.

DUB RIM

FOR DIECAST TOY CARS, TOY TRUCKS AND TOY VEHICLES (U.S. CLS. 22, 23, 38 AND 50).

SN 76-365,217. JADA TOYS, INC., LOS ANGELES, CA. FILED 1-30-2002.

RIDING ON DUBZ

FOR DIECAST TOY CARS, TOY TRUCKS AND TOY VEHICLES (U.S. CLS. 22, 23, 38 AND 50).

CLASS 28—(Continued).

SN 76-366,720. X CONCEPTS, LLC, ESCONDIDO, CA. FILED 2-4-2002.

SUPER KINETIC ULTRA MAGNETIC MEN

NO CLAIM IS MADE TO THE EXCLUSIVE RIGHT TO USE "MAGNETIC MEN", APART FROM THE MARK AS SHOWN.

FOR TOYS, NAMELY, BOARD GAMES AND EQUIPMENT SOLD AS A UNIT FOR PLAYING BOARD GAMES, ACTION FIGURES, MINIATURE TOY FIGURES, MINIATURE TOY STATUETTES AND FIGURINES, AND PLAY SETS FOR USE WITH SUCH FIGURES AND STATUETTES, NAMELY, MINIATURE TOY CLOTHING, MINIATURE TOY BUILDINGS AND MINIATURE TOY STRUCTURES, MINIATURE TOY VEHICLES, NAMELY, MINIATURE SKATEBOARDS, MINIATURE SNOWBOARDS, MINIATURE SURFBOARDS, MINIATURE SNOW SKIS, MINIATURE WAKE BOARDS, MINIATURE SKIM BOARDS, MINIATURE BODY BOARDS, MINIATURE JET SKIS, MINIATURE RECREATIONAL WATERCRAFT, MINIATURE CARS, MINIATURE TRUCKS, MINIATURE MOTORCYCLES, MINIATURE BICYCLES, MINIATURE OFF-ROAD VEHICLES, AND ACCESSORIES FOR MINIATURE TOY VEHICLES, NAMELY, PLAY SETS FOR USE WITH MINIATURE BUILDINGS, MINIATURE STRUCTURES, MINIATURE TOOLS AND MINIATURE HARDWARE FOR USE WITH THE MINIATURE TOY VEHICLES, AND CARRYING CASES FOR TOY STRUCTURES AND TOY VEHICLES (U.S. CLS. 22, 23, 38 AND 50).

SN 76-366,955. ACUSHNET COMPANY, FAIRHAVEN, MA. FILED 2-6-2002.

731 PM

FOR GOLF EQUIPMENT, NAMELY, GOLF CLUBS (U.S. CLS. 22, 23, 38 AND 50).

SN 76-367,626. TRYON, WILLIAM A., III, ORLANDO, FL. AND BOGRETTE, KEVIN P., ORLANDO, FL. FILED 2-7-2002.

PUTTLOCK

FOR GOLF TRAINING AID, NAMELY, REMOVABLE EXTENSION FROM TOP OF GOLF CLUB THAT RESTS AGAINST GOLFER'S FOREARM TO ASSIST IN PUTTING (U.S. CLS. 22, 23, 38 AND 50).

CLASS 28—(Continued).

SN 76-369,503. J-NAS, INC., SAN ANTONIO, TX. FILED 2-7-2002.



FOR CARD GAME (U.S. CLS. 22, 23, 38 AND 50).
FIRST USE 2-4-2002; IN COMMERCE 2-4-2002.

SN 76-369,995. ELITE GAMING, LLC, DUMONT, NJ. FILED 2-12-2002.

GRAND MAJESTY

FOR CARD GAME (U.S. CLS. 22, 23, 38 AND 50).

SN 76-370,225. HASBRO, INC., PAWTUCKET, RI. FILED 2-14-2002.

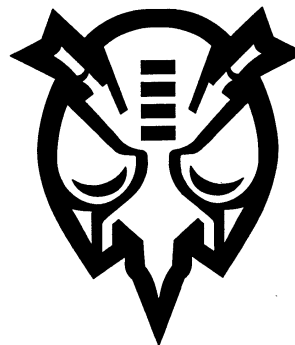

FOR TOY ACTION FIGURES, TOY VEHICLES AND TOY ROBOTS CONVERTIBLE INTO OTHER VISUAL FORMS (U.S. CLS. 22, 23, 38 AND 50).
FIRST USE 1-6-1997; IN COMMERCE 1-6-1997.

CLASS 28—(Continued).

SN 76-370,538. HASBRO, INC., PAWTUCKET, RI. FILED 2-14-2002.

THE GREATEST HERO OF THEM ALL

FOR TOY ACTION FIGURES AND ACCESSORIES FOR USE THEREWITH (U.S. CLS. 22, 23, 38 AND 50).

SN 76-370,565. SHIN, KU HYON, DIAMOND BAR, CA. FILED 2-14-2002.



FOR SPORTING GOODS, NAMELY, GOLF GLOVES, GOLF CLUBS, GOLF BAGS, GOLF BALLS, GOLF MARKERS, GOLF TEES (U.S. CLS. 22, 23, 38 AND 50). FIRST USE 1-4-2002; IN COMMERCE 1-4-2002.

SN 76-370,709. BRASS EAGLE, INC., BENTONVILLE, AR. FILED 2-14-2002.

I-BALZ

FOR PAINTBALLS (U.S. CLS. 22, 23, 38 AND 50).

SN 76-370,717. KARSTEN MANUFACTURING CORPORATION, PHOENIX, AZ. FILED 1-28-2002.

VSL

FOR GOLF EQUIPMENT - NAMELY, GOLF CLUBS AND HEAD COVERS (U.S. CLS. 22, 23, 38 AND 50). FIRST USE 10-2-2001; IN COMMERCE 10-2-2001.

CLASS 28—(Continued).

SN 76-371,207. PLEASANT COMPANY, MIDDLETON, WI. FILED 2-14-2002.



GIRLS of MANY LANDS

OWNER OF U.S. REG. NO. 2,025,965. FOR DOLLS, DOLL CLOTHING, AND DOLL ACCESSORIES; AND STUFFED TOYS AND CLOTHING AND ACCESSORIES FOR STUFFED TOYS (U.S. CLS. 22, 23, 38 AND 50).

SN 76-372,673. LIFETIME PRODUCTS, INC., CLEARFIELD, UT. FILED 2-19-2002.

BALL HOG

FOR BASKETBALL EQUIPMENT, NAMELY, PORTABLE BASKETBALL STANDARDS WITH A WEIGHT BEARING BASE BALLAST, BACKBOARDS AND GOALS (U.S. CLS. 22, 23, 38 AND 50).

SN 76-374,036. MVP MARINE PRODUCTS, L.L.C., RALEIGH, NC. FILED 2-25-2002.

'HOO HOUSE

FOR BAIT BOXES FOR SALTWATER FISHING (U.S. CLS. 22, 23, 38 AND 50). FIRST USE 1-1-2002; IN COMMERCE 1-1-2002.

SN 76-374,246. MCILHENNY COMPANY, AVERY ISLAND, LA. FILED 2-22-2002.

TABASCO HOT NUMBER

OWNER OF U.S. REG. NO. 223,310. FOR SCRATCH-OFF LOTTERY TICKETS, NAMELY, DISPOSABLE TICKETS FOR PLAYING A GAME OF CHANCE (U.S. CLS. 22, 23, 38 AND 50). FIRST USE 6-18-2001; IN COMMERCE 6-18-2001.

SN 76-374,334. MCILHENNY COMPANY, AVERY ISLAND, LA. FILED 2-22-2002.

TABASCO HOT CASH

OWNER OF U.S. REG. NO. 223,310. FOR SCRATCH-OFF LOTTERY TICKETS, NAMELY, DISPOSABLE TICKETS FOR PLAYING A GAME OF CHANCE (U.S. CLS. 22, 23, 38 AND 50). FIRST USE 6-18-2001; IN COMMERCE 6-18-2001.

CLASS 28—(Continued).

SN 76-374,378. MCDONNELL-FURUICHI, MICHELLE, FAIRFAX, CA. FILED 2-25-2002.

THE LITTLEST PIGGY

FOR MECHANICAL ACTION TOYS, STUFFED TOY ANIMALS, BALLOONS, TOY BANKS, BATH TOYS, INFLATABLE BATH TOYS, STUFFED TOY BEARS, TEDDY BEARS, MUSIC BOX TOYS, TOY BOXES, CRIB MOBILES, DRAWING TOYS, ACTION FIGURES, PLAY FIGURES, BOARD GAMES, CARD GAMES, CHRISTMAS TREE ORNAMENTS, PAPER AIRPLANES, PAPER DOLLS, PAPER FACE MASKS, PARTY FAVORS IN THE NATURE OF SMALL TOYS, PLUSH TOYS, SOFT SCULPTURE PLUSH TOYS, PUPPETS, JIGSAW PUZZLES, MANIPULATIVE PUZZLES, THREE-DIMENSIONAL PUZZLES, CUBE-TYPE PUZZLES, SAND TOYS, SANDBOX TOYS, PLAYING CARDS, PLAYING CARD CASES, AND TOY SCOOTERS (U.S. CLS. 22, 23, 38 AND 50).

SN 76-375,056. BELOW, ELLEN JILL, SANTA ROSA, CA. FILED 2-26-2002.



FOR CARD GAME (U.S. CLS. 22, 23, 38 AND 50).

SN 76-375,433. WAHL, CANDACE J., NORTH HOLLYWOOD, CA. FILED 2-26-2002.

COCOON FAERIES

FOR DOLL, DOLL CLOTHING AND DOLL ACCESSORIES (U.S. CLS. 22, 23, 38 AND 50).
FIRST USE 10-11-2001; IN COMMERCE 12-11-2001.

SN 76-375,707. JAKKS PACIFIC, INC., MALIBU, CA. FILED 2-25-2002.

FIST DROP

FOR TOYS, NAMELY TOY ACTION FIGURES, TOY PLAYSETS FOR USE WITH TOY ACTION FIGURES AND ACCESSORIES THEREFOR (U.S. CLS. 22, 23, 38 AND 50).

CLASS 28—(Continued).

SN 76-375,709. ANDERSON, DAVID BRADLEY, LA JOLLA, CA. FILED 2-27-2002.



FOR CUSTOM SKATEBOARDS (U.S. CLS. 22, 23, 38 AND 50).

SN 76-375,995. CURLY'S DISTRIBUTION, L.L.C., SCOTTSDALE, AZ. FILED 2-28-2002.

CURLY'S HUB KAPS

FOR SKATE BOARD BALL BEARING SHIELDS (U.S. CLS. 22, 23, 38 AND 50).

SN 76-376,182. KAMP, DOUGLAS R., SR., ST. CHARLES, MO. FILED 2-28-2002.

SPORTSWASHERS

FOR SPORTING TYPE GAMES, NAMELY TOSS TYPE SKILL GAMES (U.S. CLS. 22, 23, 38 AND 50).
FIRST USE 8-0-2000; IN COMMERCE 8-0-2000.

SN 76-376,642. INDIAN INDUSTRIES, INC., EVANSVILLE, IN. FILED 2-28-2002.

PLAY THE BEST

FOR TABLE TENNIS PRODUCTS, NAMELY TABLES, BALLS, RACKETS, NETS, TABLE COVERS AND RACKET COVERS (U.S. CLS. 22, 23, 38 AND 50).

SN 76-377,058. JAKKS PACIFIC, INC., MALIBU, CA. FILED 2-27-2002.

WRENCH HEAD COMPETITION

FOR TOYS, NAMELY TOY VEHICLES, TOY PLAYSETS FOR USE WITH TOY VEHICLES AND ACCESSORIES THEREFOR (U.S. CLS. 22, 23, 38 AND 50).

CLASS 28—(Continued).

SN 76-377,511. LUCAS, JAMES O. III, ST. AUGUSTINE, FL.
FILED 3-4-2002.

ACCU-LOC

FOR JOINTS FOR POOL CUES (U.S. CLS. 22, 23, 38
AND 50).
FIRST USE 10-31-2001; IN COMMERCE 10-31-2001.

SN 76-380,266. HOLTIER, ELISE JANSSON, OLMSTED
FALLS, OH. FILED 3-11-2002.

NOT JUST BEARS

FOR PLUSH TOYS, COLLECTIBLE TOY FIGURES
AND ACCESSORIES (U.S. CLS. 22, 23, 38 AND 50).
FIRST USE 4-0-2000; IN COMMERCE 4-0-2000.

SN 76-380,283. LEISURE ARTS, INC., BIRMINGHAM, AL.
FILED 3-1-2002.

FEARSOME FAN

FOR LATEX COSTUME MASKS (U.S. CLS. 22, 23, 38
AND 50).

SN 76-380,606. EVERGRASS INTERNATIONAL CO., LTD.,
CHANG-HUA CITY, TAIWAN, FILED 3-11-2002.

STRIKE PRO

FOR ARTIFICIAL FISHING BAIT, FISHING LURES,
FISHING TACKLE (U.S. CLS. 22, 23, 38 AND 50).
FIRST USE 7-0-2000; IN COMMERCE 7-0-2000.

SN 76-380,805. EBSCO INDUSTRIES, INC., BIRMINGHAM,
AL. FILED 3-11-2002.

DEVIL'S HORSE

OWNER OF U.S. REG. NO. 1,854,748.
FOR FISHING LURES (U.S. CLS. 22, 23, 38 AND 50).
FIRST USE 12-31-1951; IN COMMERCE 12-31-1951.

CLASS 28—(Continued).

SN 76-380,806. EBSCO INDUSTRIES, INC., BIRMINGHAM,
AL. FILED 3-11-2002.



FOR FISHING EQUIPMENT, NAMELY FISHING
LURES AND TERMINAL TACKLE (U.S. CLS. 22, 23, 38
AND 50).

SN 76-381,050. JADA TOYS, INC., LOS ANGELES, CA. FILED
3-11-2002.



FOR DIECAST TOY CARS, TOY TRUCKS AND TOY
VEHICLES (U.S. CLS. 22, 23, 38 AND 50).

SN 76-381,182. APOGEE SOFTWARE, LTD., GARLAND, TX.
FILED 3-11-2002.

BOMBSHELL

FOR TOYS, NAMELY, ACTION FIGURES AND AC-
CESSORIES THEREFOR, MECHANICAL ACTION TOYS,
CARD GAMES, BOARD GAMES, COIN-OPERATED PIN-
BALL MACHINES, ROLE PLAYING GAMES, JIGSAW
PUZZLES, MANIPULATIVE PUZZLES AND CUBE PUZ-
ZLES, TOY FIGURES, PLUSH TOYS, TOY VEHICLES,
AND COSTUME MASK; STAND ALONE VIDEO GAME
MACHINES; HAND HELD UNIT FOR PLAYING ELEC-
TRONIC GAMES; AND COIN-OPERATED VIDEO
GAMES (U.S. CLS. 22, 23, 38 AND 50).

CLASS 28—(Continued).

SN 76-387,519. LEMANS CORPORATION, JANESVILLE, WI.
FILED 3-27-2002.



FOR SPORTING EQUIPMENT, NAMELY KNEE GUARDS, CHEST PROTECTORS, ANKLE SUPPORTS, ELBOW SUPPORTS, WRIST SUPPORTS, KIDNEY BELTS FOR USE IN ALL TERRAIN VEHICLE ACTIVITIES, MOTORCYCLE RIDING AND SNOWMOBILE RIDING (U.S. CLS. 22, 23, 38 AND 50).
FIRST USE 10-0-2000; IN COMMERCE 10-0-2000.

SN 76-387,753. BENSUSSEN DEUTSCH & ASSOCIATES, INC., WOODINVILLE, WA. FILED 3-26-2002.

HEAR ME OUT THE GAME THAT'S MORE THAN AGAME

FOR BOARD GAMES; PLUSH TOYS; SNOW GLOBES; BOBBLEHEAD DOLLS (U.S. CLS. 22, 23, 38 AND 50).

SN 78-008,185. ATOMIC TOYS, L.L.C., SAN DIEGO, CA.
FILED 5-15-2000.



THE STIPPLING IS FOR SHADING PURPOSES ONLY.
THE MARK CONSISTS OF THE NAME "ZOCGER" WITH A LARGE RED "Z" SHAPED BRUSH STROKE AND A SOCCER BALL AS THE "O".

FOR MINIATURE TOY SPORTING EQUIPMENT AND MANUALLY CONTROLLED SPORTS GAMES, NAMELY FINGER SOCCER GAMES AND ACCESSORIES THEREFORE, MINIATURE SPORTS TOY STRUCTURES, MINIATURE SPORTS FIGURES AND MINIATURE TOY CLOTHING, NAMELY TABLETOP SOCCER GAME, MINIATURE SOCCER UNIFORMS AND MINIATURE SOCCER BALLS (U.S. CLS. 22, 23, 38 AND 50).
FIRST USE 4-30-2000; IN COMMERCE 5-5-2000.

CLASS 28—(Continued).

SN 78-067,504. CALLAWAY GOLF COMPANY, CARLSBAD, CA. FILED 6-5-2001.

REV STAND

NO CLAIM IS MADE TO THE EXCLUSIVE RIGHT TO USE "STAND", APART FROM THE MARK AS SHOWN.
FOR GOLF BAGS (U.S. CLS. 22, 23, 38 AND 50).

SN 78-074,924. MATTEL, INC., EL SEGUNDO, CA. FILED 7-20-2001.

MUSIC 2 GO

NO CLAIM IS MADE TO THE EXCLUSIVE RIGHT TO USE "MUSIC", APART FROM THE MARK AS SHOWN.
FOR TOY PORTABLE ELECTRONIC DEVICE FOR PLAYING, RECORDING AND STORING MUSIC AND DATA (U.S. CLS. 22, 23, 38 AND 50).

SN 78-076,200. JAS. D. EASTON, INC., VAN NUYS, CA.
FILED 7-27-2001.

CARBON RACING

NO CLAIM IS MADE TO THE EXCLUSIVE RIGHT TO USE "CARBON", APART FROM THE MARK AS SHOWN.
FOR SPORTING GOODS, NAMELY, ARCHERY ARROWS (U.S. CLS. 22, 23, 38 AND 50).
FIRST USE 5-1-1995; IN COMMERCE 5-1-1995.

SN 78-083,798. MATTEL, INC., EL SEGUNDO, CA. FILED 9-13-2001.

REV TREDZ

FOR TOYS, GAMES, AND PLAYTHINGS, NAMELY, TOY VEHICLES AND ACCESSORIES THEREFOR (U.S. CLS. 22, 23, 38 AND 50).

SN 78-084,088. LECLAIR, ROBERT S., HUMBLE, TX. FILED 9-16-2001.

THE GOD BLESS NEW YORK BEAR

OWNER OF U.S. REG. NO. 2,420,014.
NO CLAIM IS MADE TO THE EXCLUSIVE RIGHT TO USE "BEAR", APART FROM THE MARK AS SHOWN.
FOR PLUSH TOYS (U.S. CLS. 22, 23, 38 AND 50).

CLASS 28—(Continued).

SN 78-084,094. LECLAIR, ROBERT, STEPHEN, HUMBLE, TX. FILED 9-16-2001.

THE GOD BLESS OUR FIREFIGHTERS BEAR

OWNER OF U.S. REG. NO. 2,420,014.
NO CLAIM IS MADE TO THE EXCLUSIVE RIGHT TO
USE "BEAR", APART FROM THE MARK AS SHOWN.
FOR PLUSH TOYS (U.S. CLS. 22, 23, 38 AND 50).
FIRST USE 3-26-2001; IN COMMERCE 3-26-2001.

SN 78-088,896. MATTEL, INC., EL SEGUNDO, CA. FILED 10-17-2001.

BOWLING FOR HUNNY POTS

FOR TOYS, GAMES, AND PLAYTHINGS, NAMELY,
PARLOR GAMES AND BOARD GAMES FOR CHILDREN
(U.S. CLS. 22, 23, 38 AND 50).

SN 78-088,897. MATTEL, INC., EL SEGUNDO, CA. FILED 10-17-2001.

ARCTIC STRIKE

FOR TOYS, NAMELY, TOY ACTION FIGURES AND
ACCESSORIES THEREFOR (U.S. CLS. 22, 23, 38 AND 50).

SN 78-088,899. MATTEL, INC., EL SEGUNDO, CA. FILED 10-17-2001.

FASHION FUN DATE

FOR TOYS, GAMES AND PLAYTHINGS, NAMELY,
DOLL CLOTHING AND DOLL ACCESSORIES (U.S. CLS.
22, 23, 38 AND 50).

SN 78-088,902. MATTEL, INC., EL SEGUNDO, CA. FILED 10-17-2001.

CALLIE

FOR TOYS, GAMES, AND PLAYTHINGS, NAMELY,
PLUSH TOYS AND ACCESSORIES THEREFOR (U.S.
CLS. 22, 23, 38 AND 50).

CLASS 28—(Continued).

SN 78-088,909. MATTEL, INC., EL SEGUNDO, CA. FILED 10-17-2001.

FAB FASHION!

FOR TOYS, NAMELY, DOLL CLOTHING, DOLL
ACCESSORIES, MARKING PENS AND STAMPERS;
SOLD TOGETHER AS A UNIT (U.S. CLS. 22, 23, 38
AND 50).

SN 78-090,174. CALLAWAY GOLF COMPANY, CARLSBAD,
CA. FILED 10-25-2001.

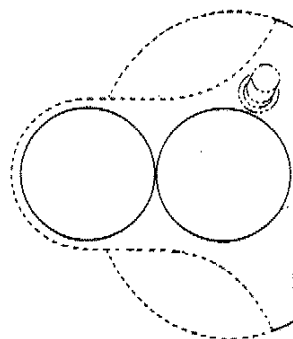

THE APPLICANT CLAIMS THE COLOR WHITE ON THE
TWO CIRCLES AS PART OF THE MARK. THE DOTTED
LINES DO NOT FORM PART OF THE MARK BUT ARE
RATHER FOR ILLUSTRATIVE PURPOSES ONLY.

SEC. 2(F).
FOR GOLF CLUBS (U.S. CLS. 22, 23, 38 AND 50).
FIRST USE 10-1-2001; IN COMMERCE 10-1-2001.

SN 78-093,318. HUANG, YA-CHIN, TAINAN HSIEN, TAI-
WAN, FILED 11-14-2001.



NO CLAIM IS MADE TO THE EXCLUSIVE RIGHT TO
USE "FITNESS" OR "EST. 1921", APART FROM THE MARK
AS SHOWN.

FOR SHIN GUARDS, LEG GUARDS, WRIST PADS,
CHEST PROTECTORS, FACE MASKS, AND KNEE
PADS, ALL FOR ATHLETIC USE; EXERCISE MA-
CHINES, NAMELY, CHEST PULL, SIT-UP MACHINE,
SIT-UP CHAIR, ROWING MACHINE, UNIVERSAL
GYM, MANUALLY OPERATED JOGGING MACHINE,
ABDOMINAL AND ARM MACHINE, WEIGHT MA-
CHINE, STATIONARY EXERCISE BICYCLE (U.S. CLS.
22, 23, 38 AND 50).

CLASS 28—(Continued).

SN 78-099,944. KWIK TEK INC., DENVER, CO. FILED 12-26-2001.

ZX-1

FOR INFLATABLE TOWABLE FLOATS FOR RECREATIONAL USE (U.S. CLS. 22, 23, 38 AND 50).
FIRST USE 4-16-2001; IN COMMERCE 6-7-2001.

SN 78-099,945. KWIK TEK INC., DENVER, CO. FILED 12-26-2001.

BIG SHOT

FOR INFLATABLE TOWABLE FLOATS FOR RECREATIONAL USE (U.S. CLS. 22, 23, 38 AND 50).
FIRST USE 4-13-2000; IN COMMERCE 6-1-2000.

SN 78-103,921. AISLESNIPER.COM, LANGHORNE, PA. FILED 1-21-2002.



THE MARK CONSISTS OF CROSS-HAIRS AROUND AN ACTION FIGURE PACKAGING BACKER CARD SILHOUETTE.

FOR COLLECTIBLE ACTION FIGURES AND ACTION FIGURE ACCESSORIES THEREFOR (U.S. CLS. 22, 23, 38 AND 50).

SN 78-104,626. KEANE, TEAL ANN, STERLING, VA. FILED 1-24-2002.

SPANKY THE SPIDER

NO CLAIM IS MADE TO THE EXCLUSIVE RIGHT TO USE "SPIDER", APART FROM THE MARK AS SHOWN.

FOR STUFFED TOYS, STUFFED TOY ANIMALS, DOLLS, PUPPETS, MARIONETTES, AND PLUSH TOYS (U.S. CLS. 22, 23, 38 AND 50).

CLASS 28—(Continued).

SN 78-105,876. HOWARD, JOHN, R. JR., SOUTHBOROUGH, MA. FILED 1-31-2002.

CHICKERS

FOR BOARD GAMES (U.S. CLS. 22, 23, 38 AND 50).

SN 78-110,180. FANTASY FLIGHT PUBLISHING INC., ROSEVILLE, MN. FILED 2-21-2002.

DRAGONSTAR

FOR ROLE PLAYING GAME EQUIPMENT IN THE NATURE OF GAME BOOK MANUALS (U.S. CLS. 22, 23, 38 AND 50).
FIRST USE 8-15-2001; IN COMMERCE 12-28-2001.

SN 78-112,104. TIME WARNER ENTERTAINMENT COMPANY, L.P., NEW YORK, NY. FILED 3-1-2002.

ALIENQUEST

FOR TOYS AND SPORTING GOODS, INCLUDING GAMES AND PLAYTHINGS—NAMELY, ACTION FIGURES AND ACCESSORIES THEREFOR; PLUSH TOYS; BALLOONS; BATHTUB TOYS; RIDE-ON TOYS; EQUIPMENT SOLD AS A UNIT FOR PLAYING CARD GAMES; TOY VEHICLES; DOLLS; FLYING DISCS; ELECTRONIC HAND-HELD GAME UNIT; GAME EQUIPMENT SOLD AS A UNIT FOR PLAYING A BOARD GAME, A CARD GAME, A MANIPULATIVE GAME, A PARLOR GAME AND AN ACTION TYPE TARGET GAME; STAND ALONE VIDEO OUTPUT GAME MACHINES; JIGSAW AND MANIPULATIVE PUZZLES; PAPER FACE MASKS; SKATEBOARDS; ICE SKATES; WATER SQUIRTING TOYS; BALLS—NAMELY, PLAYGROUND BALLS, SOCCER BALLS, BASEBALLS, BASKETBALLS; BASEBALL GLOVES; SWIMMING FLOATS FOR RECREATIONAL USE; KICKBOARD FLOTATION DEVICES FOR RECREATIONAL USE; SURFBOARDS; SWIM BOARDS FOR RECREATIONAL USE; SWIM FINS; TOY BAKEWARE AND TOY COOKWARE; TOY BANKS; TOY SNOW GLOBES; AND CHRISTMAS TREE ORNAMENTS (U.S. CLS. 22, 23, 38 AND 50).

SN 78-112,421. EATON CORPORATION, CLEVELAND, OH. FILED 3-4-2002.

WHISPER WRAP

NO CLAIM IS MADE TO THE EXCLUSIVE RIGHT TO USE "WRAP", APART FROM THE MARK AS SHOWN.

FOR HAND GRIPS, NAMELY, GOLF CLUB GRIPS (U.S. CLS. 22, 23, 38 AND 50).

CLASS 28—(Continued).

SN 78-114,280. SUPER DUPER INC., DBA SUPER DUPER PUBLICATIONS, GREENVILLE, SC. FILED 3-12-2002.

GO FOR THE DOUGH

FOR EDUCATIONAL GAME, NAMELY, BOARD GAME IN THE FIELD OF SPEECH, LANGUAGE, VOICE, FLUENCY, AND HEARING, FOR USE BY THE GENERAL PUBLIC, PUBLIC AND PRIVATE TEACHERS, HEALTH PROFESSIONALS OR THERAPISTS (U.S. CLS. 22, 23, 38 AND 50).

SN 78-114,357. BUTLER, WILLIAM E, MINNEAPOLIS, MN. FILED 3-12-2002.

THROW-YO

FOR FLYING DISC RETURN TETHER FOR PRACTICING LONG-RANGE THROWS (U.S. CLS. 22, 23, 38 AND 50).

SN 78-114,564. BARNHART, JOHN DAVID, ALBUQUERQUE, NM. FILED 3-13-2002.

FLIP STRIP

FOR BOARD GAME (U.S. CLS. 22, 23, 38 AND 50).

SN 78-114,861. PANLINE USA, INC., NORTHVALE, NJ. FILED 3-14-2002.

CHEER IT!

FOR SPORTS THEMED ACTIVITY KIT COMPRISING BEADS AND STRING (U.S. CLS. 22, 23, 38 AND 50).

SN 78-114,890. GONZALES, DAVID, RICHMOND, CA. FILED 3-14-2002.

HOMIEHOPPERZ

FOR TOY BATTERY OPERATED MOTORIZED CARS, MADE PRIMARILY OF PLASTIC RESIN (U.S. CLS. 22, 23, 38 AND 50).

SN 78-116,052. FLOYD, CHARLES MITCHELL, CORPUS CHRISTI, TX. FILED 3-19-2002.

SALT WEAPON

FOR SURFBOARDS (U.S. CLS. 22, 23, 38 AND 50).

CLASS 28—(Continued).

SN 78-116,455. EATON CORPORATION, CLEVELAND, OH. FILED 3-21-2002.

PREMIUM BLEND

FOR HAND GRIPS, NAMELY, GOLF CLUB GRIPS (U.S. CLS. 22, 23, 38 AND 50).

SN 78-117,021. RENO WILSON, INC., POWAY, CA. FILED 3-22-2002.

suspect

THE MARK CONSISTS OF STYLIZED LETTERS SPELLING "SUSPECT", INCLUDING A BACKWARDS "E", FOR METAL SPORTS BOARDS (U.S. CLS. 22, 23, 38 AND 50).

FIRST USE 11-1-2000; IN COMMERCE 11-1-2000.

CLASS 29—MEATS AND PROCESSED FOODS

SN 75-501,395. AGROPUR COOPERATIVE, GRANBY, QUEBEC, CANADA. BY ASSIGNMENT NATREL INC., LONGUEUIL, QUEBEC, CANADA, FILED 6-12-1998.



PRIORITY CLAIMED UNDER SEC. 44(D) ON CANADA APPLICATION NO. 877666, FILED 5-8-1998, REG. NO. TMA536708, DATED 11-6-2000, EXPIRES 11-6-2015.

OWNER OF U.S. REG. NO. 1,813,883.

THE MARK CONSISTS OF A FANCIFUL DRAWING OF INDIVIDUALS ENJOYING OUTDOOR ACTIVITIES, SUCH AS HIKING, BICYCLING AND IN-LINE SKATING. THE WORDS "NATREL MOOSTACHE" APPEAR ABOVE STYLIZED DRAWINGS OF TREES AND CLOUDS.

FOR FLUID MILK, NAMELY, WHITE MILK, MILK-BASED BEVERAGES AND COFFEE FLAVORED MILK (U.S. CL. 46).

CLASS 29—(Continued).

SN 75-696,809. CONSERVES MODERNES CHTAURA, S.A.L., CHTAURA, LEBANON, FILED 5-1-1999.



NO CLAIM IS MADE TO THE EXCLUSIVE RIGHT TO USE "TRUE MEDITERRANEAN CUISINE AND MEDITERRANEAN GOURMET", APART FROM THE MARK AS SHOWN.

THE STIPPLING IS FOR SHADING PURPOSES ONLY AND DOES NOT INDICATE COLOR.

FOR HOMMOS TAHINI DIPS, CONSISTING OF CHICKPEA DIPS WITH VARIOUS SEASONINGS AND FLAVORS, AND EGGPLANT DIPS WITH VARIOUS SEASONINGS AND FLAVORS (U.S. CL. 46).

SN 76-055,517. SAVELLO USA INC., WILKES BARRE, PA. FILED 5-24-2000.

SAVELLO

FOR CHEESE (U.S. CL. 46).
FIRST USE 1-1-1998; IN COMMERCE 1-1-1998.

CLASS 29—(Continued).

SN 76-065,338. MORVEN PARTNERS, L.P., RICHMOND, VA. FILED 6-8-2000.



OWNER OF U.S. REG. NO. 1,342,973.
FOR PROCESSED NUTS AND NUT PRODUCTS, NAMELY, ROASTED IN-SHELL AND SALTED IN-SHELL VIRGINIA PEANUTS; SALTED IN-SHELL ALMONDS; HICKORY SMOKED ALMONDS; BLANCHED ALMONDS; DICED ALMONDS; SLICED ALMONDS; SLIVERED ALMONDS; PECAN PRALINES; PEANUT BUTTER; SALTED IN-SHELL PEANUTS; ROASTED IN-SHELL PEANUTS; HOT AND SPICY PEANUTS; DRY ROASTED PEANUTS; SWEET AND SALTED PEANUTS; DICED PEANUTS; PRALINED WALNUTS; TRAIL SNACK MIXES CONSISTING PRIMARILY OF PROCESSED FRUIT, PROCESSED NUTS, AND RAISINS; ROASTED, SALTED PISTACHIO NUTS; HONEY ROASTED ALMONDS, HONEY ROASTED PEANUTS AND HONEY ROASTED CASHEWS; DRY ROASTED MIXED NUTS; ROASTED, SALTED CASHEWS; DRY ROASTED MACADAMIAS; ROASTED, SALTED CASH- EW PIECES; MAPLE GLAZED WALNUTS; CINNAMON TOASTED PEANUTS; CINNAMON TOASTED AL- MONDS; ROASTED, SALTED IN-SHELL PUMPKIN SEEDS; ROASTED, SALTED SUNFLOWER SEEDS; SHELLED PIGNOLIAS; AND ROASTED PEPITAS, WITH OR WITHOUT SALT (U.S. CL. 46).

SN 76-098,862. ALASKA OCEAN SEAFOOD LIMITED PART- NERSHIP, ANACORTES, WA. FILED 7-28-2000.

ALASKA OCEAN SEAFOOD

NO CLAIM IS MADE TO THE EXCLUSIVE RIGHT TO USE "OCEAN SEAFOOD", APART FROM THE MARK AS SHOWN.
SEC. 2(F).
FOR SEAFOOD (U.S. CL. 46).
FIRST USE 9-28-1990; IN COMMERCE 9-28-1990.

CLASS 29—(Continued).

SN 76-099,031. UNIVERSAL FOODS CORPORATION, MILWAUKEE, WI. FILED 7-28-2000.

SENSIENT TECHNOLOGIES

NO CLAIM IS MADE TO THE EXCLUSIVE RIGHT TO USE "TECHNOLOGIES", APART FROM THE MARK AS SHOWN.

FOR PRESERVED FRUIT MIXTURES USED IN THE MANUFACTURE OF FROZEN CONFECTIONS; PROCESSED FRUIT FOR USE IN THE MANUFACTURE OF DAIRY PRODUCTS SNACK FOOD PRODUCTS AND NUTRITIONAL FOOD SUPPLEMENT PRODUCTS; DEHYDRATED VEGETABLES FOR USE IN THE MANUFACTURE OF FOOD PRODUCTS; FREEZE-DRIED MUSHROOMS, FRUITS AND VEGETABLES FOR USE IN THE MANUFACTURE OF FOOD PRODUCTS; MEAT EXTRACTS (U.S. CL. 46).

SN 76-128,807. TEC LAC CONSULTORES S.A. DE C.V., SALTILLO, COAHUILA, MEXICO, FILED 9-15-2000.

CHEN'ET

OWNER OF MEXICO REG. NO. 367018, DATED 9-14-1989, EXPIRES 3-15-2003.

FOR YOGURT, YOGURT-BASED BEVERAGES, CHEESE AND DAIRY-BASED BEVERAGE DRINKS (U.S. CL. 46).

SN 76-130,646. UNIVERSAL FOODS CORPORATION, MILWAUKEE, WI. FILED 9-19-2000.

WE BRING LIFE TO PRODUCTS

FOR PRESERVED FRUIT MIXTURES USED IN THE MANUFACTURE OF FROZEN CONFECTIONS; PROCESSED FRUIT FOR USE IN THE MANUFACTURE OF DAIRY PRODUCTS, SNACK FOOD PRODUCT AND NUTRITIONAL FOOD SUPPLEMENT PRODUCTS; DEHYDRATED VEGETABLES FOR USE IN THE MANUFACTURE OF FOOD PRODUCTS; FREEZE-DRIED MUSHROOMS, FRUITS AND VEGETABLES FOR USE IN THE MANUFACTURE OF FOOD PRODUCTS; MEAT EXTRACTS; MILK OR MEAT-BASED BIONUTRIENTS, NAMELY PROTEIN HYDROLISATES FOR USE TO SUPPORT OR PROMOTE THE GROWTH OF MICROBIOLOGICAL ORGANISMS (U.S. CL. 46).

SN 76-155,364. LIDL STIFTUNG & CO. KG, 74172 NECKARSULM, FED REP GERMANY, FILED 10-26-2000.

BLEU VILLE

OWNER OF FED REP GERMANY REG. NO. 39833342.4, DATED 7-8-1998, EXPIRES 6-30-2008.

THE ENGLISH TRANSLATION OF "BLEU VILLE" IS "BLUE CITY".

FOR MILK AND DAIRY PRODUCTS EXCLUDING ICE CREAM, ICE MILK AND FROZEN YOGURT (U.S. CL. 46).

CLASS 29—(Continued).

SN 76-160,780. ADVANCE BRANDS, LLC, OKLAHOMA CITY, OK. BY ASSIGNMENT EXCEL CORPORATION, WICHITA, KS. FILED 11-7-2000.

ADVANCE BRANDS

NO CLAIM IS MADE TO THE EXCLUSIVE RIGHT TO USE "BRANDS", APART FROM THE MARK AS SHOWN. FOR MEATS, INCLUDING PARTIALLY COOKED, FULLY COOKED, BATTERED AND CHARRED MEATS, AND CHILI (U.S. CL. 46).

FIRST USE 4-1-2001; IN COMMERCE 4-1-2001.

SN 76-169,809. QUESOS COLIMA S.A. DE C.V., C.P.15010 MEXICO DF, MEXICO, FILED 11-20-2000.



NO CLAIM IS MADE TO THE EXCLUSIVE RIGHT TO USE "DAIRY", APART FROM THE MARK AS SHOWN. FOR CHEESE (U.S. CL. 46).

SN 76-175,365. PANDA RESTAURANT GROUP, INC., SOUTH PASADENA, CA. BY ASSIGNMENT PANDA MANAGEMENT COMPANY, INC, SOUTH PASADENA, CA. FILED 11-30-2000.

PANDA KID'S

OWNER OF U.S. REG. NOS. 1,477,152, 1,709,012 AND OTHERS.

NO CLAIM IS MADE TO THE EXCLUSIVE RIGHT TO USE "KID'S", APART FROM THE MARK AS SHOWN.

FOR COMBINATION MEAL CONSISTING OF PRIMARILY OF SPECIALLY PREPARED CHINESE FOOD COMPRISED OF MEAT OR VEGETABLES AND A SOFT DRINK FOR CONSUMPTION ON OR OFF THE PREMISES (U.S. CL. 46).

FIRST USE 10-22-2000; IN COMMERCE 10-22-2000.

CLASS 29—(Continued).

SN 76-179,133. VAL D'ARVE SA, 1228 PLANS-LES-OUATES (GE), SWITZERLAND, FILED 12-12-2000.



PRIORITY CLAIMED UNDER SEC. 44(D) ON SWITZERLAND APPLICATION NO. 07053/2000, FILED 6-14-2000, REG. NO. 479479, DATED 6-14-2000, EXPIRES 6-14-2010.

NO CLAIM IS MADE TO THE EXCLUSIVE RIGHT TO USE "AU POIVRE VERT" AND "SWISS NATURA", APART FROM THE MARK AS SHOWN.

"NATURA" MAY BE TRANSLATED AS "NATURE". "AU POIVRE VERT" IS FRENCH AND MAY BE TRANSLATED AS "OF GREEN PEPPER".

FOR CHEESES OF SWISS ORIGIN (U.S. CL. 46).

SN 76-196,401. GROVE, INC., THE, NEW ORLEANS, LA. FILED 1-19-2001.

THE GROVE NATURAL SNACKS

NO CLAIM IS MADE TO THE EXCLUSIVE RIGHT TO USE "NATURAL SNACKS", APART FROM THE MARK AS SHOWN.

FOR CANDIED FRUITS (U.S. CL. 46).

FIRST USE 1-3-1980; IN COMMERCE 11-30-1982.

SN 76-207,197. JONMOR INVESTMENTS, INC., WILMINGTON, DE. FILED 2-9-2001.



OWNER OF U.S. REG. NOS. 1,054,792, 1,747,277 AND 1,898,218.

THE NAME "JOHN MORRELL" DOES NOT IDENTIFY A LIVING INDIVIDUAL.

FOR MEAT (U.S. CL. 46).

CLASS 29—(Continued).

SN 76-212,379. P.G. LEASING A/S, DK-9230 SVENSTRUP J., DENMARK, FILED 2-15-2001.



PRIORITY CLAIMED UNDER SEC. 44(D) ON ERP CMNTY TM OFC APPLICATION NO. 001838804, FILED 8-30-2000, REG. NO. 1838804, DATED 12-12-2001, EXPIRES 12-12-2011.

NO CLAIM IS MADE TO THE EXCLUSIVE RIGHT TO USE "DANISH DELI", APART FROM THE MARK AS SHOWN.

THE STIPLING IS A FEATURE OF THE MARK AND DOES NOT INDICATE COLOR.

FOR MEAT PRODUCTS, NAMELY SAUSAGES AND SALAMI (U.S. CL. 46).

SN 76-237,870. CAROLINA TURKEYS, MOUNT OLIVE, NC. FILED 4-9-2001.

CAROLINA TURKEY BROADWAY FAMOUS

OWNER OF U.S. REG. NOS. 1,501,484, 1,706,993 AND 1,883,722.

NO CLAIM IS MADE TO THE EXCLUSIVE RIGHT TO USE "TURKEY", APART FROM THE MARK AS SHOWN.

FOR DELI MEATS, NAMELY TURKEY, HAM, ROAST BEEF, CHICKEN AND BOLOGNA (U.S. CL. 46).

FIRST USE 6-1-2000; IN COMMERCE 6-1-2000.

SN 76-242,287. LINDEN OAKS CORPORATION, WILMINGTON, DE. FILED 4-18-2001.

OVEN ROASTERS

FOR PREPARED ENTREES CONSISTING PRIMARILY OF POTATOES AND VEGETABLES WITH MEAT (U.S. CL. 46).

CLASS 29—(Continued).

SN 76-257,606. EMPRESS INTERNATIONAL, LTD., ALBANY, NY. FILED 5-16-2001.



FOR FROZEN SEAFOOD (U.S. CL. 46).
FIRST USE 3-27-2001; IN COMMERCE 3-27-2001.

SN 76-279,052. BONGRAIN S.A., FRANCE, FILED 7-2-2001.

GIZEH

FOR MILK; CHEESE; DAIRY PRODUCTS EXCLUDING ICE CREAM, ICE MILK AND FROZEN YOGURT (U.S. CL. 46).

SN 76-287,863. LIDL STIFTUNG & CO. KG, 74172 NECK-ARSULM, FED REP GERMANY, FILED 7-18-2001.

LE PIQUEBROCHE

OWNER OF FED REP GERMANY REG. NO. 39807858, DATED 6-25-1998, EXPIRES 2-13-2008.

THE ENGLISH TRANSLATION OF "LE PIQUEBROCHE" IS SPEAR SPEED, SPADE SPEED, SPEAR LANCE, SPEAR SPEAR, SPEED SPEED, OR LANCE LANCE.

FOR POULTRY AND POULTRY PRODUCTS, NAMELY ROTISSERIE CHICKEN, POULTRY SAUSAGES, POULTRY SALAD, POULTRY DRUMSTICKS, POULTRY ROAST; READY-TO-SERVE MEALS CONSISTING PRIMARILY OF POULTRY WITH THE ADDITION OF VEGETABLES, POTATOES, FARINACEOUS PASTES, MUSHROOMS AND/OR RICE (U.S. CL. 46).

SN 76-292,214. CONAGRA GROCERY PRODUCTS COMPANY, IRVINE, CA. FILED 7-31-2001.

SUPER QUIK-BLEND

OWNER OF U.S. REG. NO. 536,656.
SEC. 2(F).
FOR SHORTENING (U.S. CL. 46).
FIRST USE 0-0-1978; IN COMMERCE 0-0-1978.

CLASS 29—(Continued).

SN 76-295,203. LIDL STIFTUNG & CO. KG, 74172 NECK-ARSULM, FED REP GERMANY, FILED 8-2-2001.

DELIZIE DEL CONTADINO

OWNER OF ITALY REG. NO. 693821, DATED 12-4-1996, EXPIRES 3-10-2004.

THE ENGLISH TRANSLATION OF "DELIZIE DEL CONTADINO" IS "ITALIAN FARMER'S DELIGHT".

FOR SAUSAGES, MEATS, CHEESES (U.S. CL. 46).

SN 76-299,238. READY FOOD PRODUCTS, INC., PHILADELPHIA, PA. FILED 8-15-2001.

COFFEE DREAM

NO CLAIM IS MADE TO THE EXCLUSIVE RIGHT TO USE "COFFEE", APART FROM THE MARK AS SHOWN.

FOR NON-DAIRY CREAMER (U.S. CL. 46).

FIRST USE 1-0-1963; IN COMMERCE 1-0-1963.

SN 76-299,593. MAPLE LEAF FOODS INC., TORONTO, ONTARIO, CANADA, FILED 8-14-2001.

BITTNER'S SLO-ROAST

OWNER OF U.S. REG. NOS. 2,011,221 AND 2,175,273.

NO CLAIM IS MADE TO THE EXCLUSIVE RIGHT TO USE "SLOW ROAST", APART FROM THE MARK AS SHOWN.

FOR PROCESSED MEATS AND PROCESSED POULTRY INCLUDING SALAMI, SAUSAGE, PASTRAMI, HAM, AND SIMILAR CURED, SMOKED OR PICKLED MEATS (U.S. CL. 46).

SN 76-302,148. CHAMBERS, ANN, CINCINNATI, OH. FILED 8-20-2001.

I WANT MY MAME!

THE ENGLISH TRANSLATION OF "MAME" IS A JAPANESE TERM WHICH MEANS "BEANS".

FOR PROCESSED GREEN SOYBEANS (U.S. CL. 46).

CLASS 29—(Continued).

SN 76-303,718. GALAXY NUTRITIONAL FOODS, INC., ORLANDO, FL. FILED 8-22-2001.



NO CLAIM IS MADE TO THE EXCLUSIVE RIGHT TO USE "VEGGIE", APART FROM THE MARK AS SHOWN. FOR CHEESE SUBSTITUTES AND IMITATION CHEESE, SOY-BASED BEVERAGES, SOUR CREAM SUBSTITUTES, LACTOSE-FREE DAIRY-BASED BEVERAGES, CREAM CHEESE SUBSTITUTES, BUTTER SUBSTITUTES, AND YOGURT SUBSTITUTES (U.S. CL. 46).

FIRST USE 1-0-1979; IN COMMERCE 1-0-1979.

SN 76-304,569. CREATIVE FOODS LLC, OSCEOLA, AR. FILED 8-24-2001.

ONION WINGS

NO CLAIM IS MADE TO THE EXCLUSIVE RIGHT TO USE "ONION", APART FROM THE MARK AS SHOWN. FOR FRIED ONIONS (U.S. CL. 46).

SN 76-308,320. BROOKS PROVISIONS INC., PHILADELPHIA, PA. FILED 9-4-2001.

OCEANSTREAM

FOR FISH AND SEAFOOD (U.S. CL. 46).

SN 76-309,937. OMEGATECH INC., BOULDER, CO. FILED 9-5-2001.

DHA GOLD

OWNER OF U.S. REG. NOS. 2,047,242 AND 2,234,342. NO CLAIM IS MADE TO THE EXCLUSIVE RIGHT TO USE "DHA", APART FROM THE MARK AS SHOWN. FOR EGGS (U.S. CL. 46). FIRST USE 3-0-1998; IN COMMERCE 3-0-1998.

CLASS 29—(Continued).

SN 76-310,218. BANGKOK MEATBALL CORP, LYNWOOD, CA. FILED 9-10-2001.

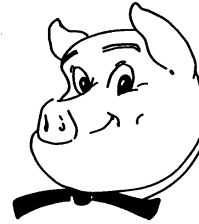

NO CLAIM IS MADE TO THE EXCLUSIVE RIGHT TO USE "BANGKOK MEATBALL CO", APART FROM THE MARK AS SHOWN.

FOR MEATBALL SOLD IN MARKETS AND GROCERIES (U.S. CL. 46). FIRST USE 3-0-1980; IN COMMERCE 3-0-1980.

SN 76-312,996. ZOZA'S FRESH MEXICAN KITCHEN CORPORATION, PARK CITY, UT. FILED 9-17-2001.

ZOZA'S FRESH MEXICAN KITCHEN

NO CLAIM IS MADE TO THE EXCLUSIVE RIGHT TO USE "FRESH MEXICAN KITCHEN", APART FROM THE MARK AS SHOWN.

FOR FROZEN AND PACKAGED MEXICAN FOOD ENTREES CONSISTING PRIMARILY OF MEAT, FISH, POULTRY, OR VEGETABLES (U.S. CL. 46).

SN 76-314,807. FOSTER POULTRY FARMS, DBA FOSTER FARMS, LIVINGSTON, CA. FILED 9-18-2001.

FOSTER FARMS CALIFORNIA WINGS

OWNER OF U.S. REG. NOS. 1,214,225, 2,133,791 AND OTHERS.

NO CLAIM IS MADE TO THE EXCLUSIVE RIGHT TO USE "CALIFORNIA WINGS", APART FROM THE MARK AS SHOWN.

FOR COOKED POULTRY WINGS AND WING SECTIONS; BREADED COOKED POULTRY WINGS AND WING SECTIONS, BREADED COOKED POULTRY WINGS AND WING SECTIONS WITH A GLAZING SAUCE PACKET OR COOKED POULTRY WINGS AND WING SECTIONS WITH A GLAZING SAUCE PACKET (U.S. CL. 46).

CLASS 29—(Continued).

SN 76-320,173. WILBUR CHOCOLATE CO., INC., LITITZ, PA.
FILED 10-2-2001.

WILBUR

FOR COCOA BUTTER FOR FOOD PURPOSES (U.S.
CL. 46).
FIRST USE 6-20-2001; IN COMMERCE 6-20-2001.

SN 76-322,520. VITA FOOD PRODUCTS, INC., CHICAGO, IL.
FILED 10-5-2001.

ATLANTIC BAY CLASSIC

NO CLAIM IS MADE TO THE EXCLUSIVE RIGHT TO
USE "ATLANTIC" OR "CLASSIC", APART FROM THE
MARK AS SHOWN.
FOR PROCESSED FISH (U.S. CL. 46).

SN 76-322,924. SUPERIOR QUALITY FOODS, INC., ONTAR-
IO, CA. FILED 10-9-2001.



OWNER OF U.S. REG. NOS. 1,763,045 AND 1,833,430.
FOR FOODS; NAMELY, SOUP BASES (U.S. CL. 46).
FIRST USE 6-10-1992; IN COMMERCE 6-10-1992.

SN 76-326,116. HICKORY FARMS, INC., MAUMEE, OH.
FILED 10-15-2001.

UNCLE WALTS CHEDDAR

NO CLAIM IS MADE TO THE EXCLUSIVE RIGHT TO
USE "CHEDDAR", APART FROM THE MARK AS SHOWN.
THE NAME "UNCLE WALTS" DOES NOT IDENTIFY A
LIVING INDIVIDUAL.
FOR CHEESE (U.S. CL. 46).

SN 76-328,458. L.M. SANDLER & SONS, INC., VIRGINIA
BEACH, VA. FILED 10-22-2001.

ARCTIC CLASSIC

NO CLAIM IS MADE TO THE EXCLUSIVE RIGHT TO
USE "ARCTIC", APART FROM THE MARK AS SHOWN.
FOR SHRIMP (U.S. CL. 46).

CLASS 29—(Continued).

SN 76-337,085. URSUS, LLC, NEW YORK, NY. FILED 11-8-
2001.

ALEXIA YUKON GOLD

NO CLAIM IS MADE TO THE EXCLUSIVE RIGHT TO
USE "YUKON GOLD", APART FROM THE MARK AS
SHOWN.

FOR POTATO PRODUCTS, NAMELY, FRENCH
FRIED POTATOES, INSTANT POTATOES, AND PRO-
CESSED POTATOES; POTATO-BASED SNACK FOODS
(U.S. CL. 46).

SN 76-337,087. URSUS, LLC, NEW YORK, NY. FILED 11-8-
2001.

ALEXIA OVEN FRIES

NO CLAIM IS MADE TO THE EXCLUSIVE RIGHT TO
USE "OVEN FRIES", APART FROM THE MARK AS
SHOWN.

FOR POTATO PRODUCTS, NAMELY, FRENCH
FRIED POTATOES, INSTANT POTATOES, AND PRO-
CESSED POTATOES; POTATO-BASED SNACK FOODS
(U.S. CL. 46).

SN 76-341,460. CONAGRA BRANDS, INC., OMAHA, NE.
FILED 11-26-2001.

SMART PATTIES

NO CLAIM IS MADE TO THE EXCLUSIVE RIGHT TO
USE "PATTIES", APART FROM THE MARK AS SHOWN.
FOR SOY BASED FOOD PRODUCTS USED AS MEAT
SUBSTITUTES (U.S. CL. 46).

SN 76-345,939. HADLEY DATE GARDENS, INC., THERMAL,
CA. FILED 12-7-2001.

ORIGINAL TRAIL MIX

NO CLAIM IS MADE TO THE EXCLUSIVE RIGHT TO
USE "TRAIL MIX", APART FROM THE MARK AS SHOWN.
SEC. 2(F).

FOR SNACK FOOD MIX CONSISTING PRIMARILY
OF RAISINS, PROCESSED SUNFLOWER SEEDS, PRO-
CESSED PUMPKIN SEEDS, PROCESSED PEANUTS,
PROCESSED CASHEWS, PROCESSED ALMONDS, SOY-
BEAN OIL AND/OR COTTONSEED OIL AND/OR CA-
NOLA OIL AND/OR ALMOND OIL AND SALT (U.S. CL.
46).

FIRST USE 0-0-1968; IN COMMERCE 0-0-1977.

CLASS 29—(Continued).

SN 76-349,780. SUIZA DAIRY GROUP, L.P., DALLAS, TX.
FILED 12-18-2001.

PINEMONT FARMS

NO CLAIM IS MADE TO THE EXCLUSIVE RIGHT TO USE "FARMS", APART FROM THE MARK AS SHOWN.
FOR MILK, SOUR CREAM AND COTTAGE CHEESE (U.S. CL. 46).
FIRST USE 0-0-1953; IN COMMERCE 0-0-1953.

SN 76-355,091. TROMBINO'S RESTAURANT, MASSENA, NY. FILED 1-4-2002.

CRAZY BILL'S HOT WINGS

NO CLAIM IS MADE TO THE EXCLUSIVE RIGHT TO USE "HOT WINGS", APART FROM THE MARK AS SHOWN.
FOR FOOD PRODUCT, NAMELY, CHICKEN WINGS AND SAUCE, SERVED READY TO EAT OR AS A KIT (U.S. CL. 46).

SN 76-356,512. 8TH CONTINENT, LLC, MINNEAPOLIS, MN.
FILED 1-8-2002.

SIMPLE CHANGE, BETTER HEALTH

FOR SOY-BASED FOOD BEVERAGES USED AS A MILK-SUBSTITUTE (U.S. CL. 46).
FIRST USE 7-23-2001; IN COMMERCE 7-23-2001.

SN 76-360,152. FRESH EXPRESS INCORPORATED, SALINAS, CA. FILED 1-17-2002.

COOL WATERMELON

NO CLAIM IS MADE TO THE EXCLUSIVE RIGHT TO USE "WATERMELON", APART FROM THE MARK AS SHOWN.
FOR PRECUT PACKAGED FRUITS AND SALADS AND SNACK KITS COMPRISED IN PART OF PRECUT FRUIT AND SALADS (U.S. CL. 46).

CLASS 29—(Continued).

SN 76-361,892. CHIPPER SNAX, INC., SALT LAKE CITY, UT.
FILED 1-23-2002.



OWNER OF U.S. REG. NOS. 2,103,553, 2,156,301 AND OTHERS.
NO CLAIM IS MADE TO THE EXCLUSIVE RIGHT TO USE "MEAT MARKET FRESH", APART FROM THE MARK AS SHOWN.
FOR BEEF JERKY (U.S. CL. 46).

SN 76-363,224. BISON PRODUCTS COMPANY, INC., BUFFALO, NY. FILED 1-28-2002.



THE ENGLISH TRANSLATION OF "DEL ORO" IS "OF GOLD".
FOR SAUSAGES (U.S. CL. 46).
FIRST USE 4-6-2000; IN COMMERCE 5-1-2000.

SN 76-365,352. CONSORCIO CONDOR, S.A. DE C.V., COL. EL VERGEL MEXICO, D.F. 09880, MEXICO, FILED 1-31-2002.

LAUTREC

FOR COFFEE CREAMER MILK SUBSTITUTE POWDER (U.S. CL. 46).
FIRST USE 0-0-1983; IN COMMERCE 0-0-1983.

CLASS 29—(Continued).

SN 76-367,349. BAYOU CITY FISH COMPANY, HOUSTON, TX. FILED 2-6-2002.



NO CLAIM IS MADE TO THE EXCLUSIVE RIGHT TO USE "FISH CO.", APART FROM THE MARK AS SHOWN. FOR SEAFOOD, NAMELY FISH AND SHELLFISH, FOR FOOD PURPOSES (U.S. CL. 46). FIRST USE 2-1-1995; IN COMMERCE 2-1-1995.

SN 76-367,422. XIAMEN CANNERY, XIAMEN, FUJIAN, CHINA, FILED 2-7-2002.



THE FOREIGN CHARACTERS IN THE MARK ARE TRANSLITERATED TO THE LETTERS "GULONG" WHICH MEANS "ANCIENT DRAGON" IN ENGLISH. FOR CANNED FRUITS, CANNED MUSHROOMS, CANNED PEAS, CANNED MEAT, CANNED SEAFOOD, CANNED VEGETABLES (U.S. CL. 46). FIRST USE 12-31-1985; IN COMMERCE 1-31-1995.

SN 76-367,508. JONMOR INVESTMENTS, INC., WILMINGTON, DE. FILED 2-7-2002.



FOR MEAT (U.S. CL. 46).

CLASS 29—(Continued).

SN 76-367,810. MEXICAN CHEESE PRODUCERS, INC., MONROE, WI. FILED 2-6-2002.



NO CLAIM IS MADE TO THE EXCLUSIVE RIGHT TO USE "AUTHENTIC", "OLD WORLD QUALITY", OR "HECHO POR MEXICANOS", APART FROM THE MARK AS SHOWN.

"THE MARK CONSISTS OF A HORIZONTAL, UNFURLED BANNER WITH THREE DIFFERENTLY COLORED FIELDS, WHICH FIELDS ARE, RUNNING FROM LEFT TO RIGHT: GREEN (GREEN COLOR P348); WHITE; AND RED (RED COLOR P1797). IN THE CENTER OF THE WHITE FIELD IS A BROWN EAGLE (BROWN COLOR P731) WITH A GREEN SNAKE (GREEN COLOR P348) IN ITS BEAK, PERCHED UPON A YELLOW BASE (YELLOW COLOR P136), WITH SMALL, IRREGULARLY SHAPED GREEN OBJECTS (GREEN COLOR P348) EXTENDING FROM THE YELLOW BASE TO THE LEFT AND TO THE RIGHT OF THE BASE. UNDER THE EAGLE AND THE BASE UPON WHICH IT SITS ARE GREEN LAUREL BRANCHES (GREEN COLOR P348) WITH A RED BOW (RED COLOR P 1797) TIED AROUND THE MIDDLE OF THE LAUREL BRANCHES, IMMEDIATELY ABOVE THE UNFURLED BANNER, AND LOCATED OVER THE FIRST (GREEN) AND SECOND (WHITE) FIELDS OF THE BANNER IS THE HEAD AND UPPER BODY OF A BLACK AND WHITE COW, LOOKING FORWARD. UNDERNEATH THE UNFURLED BANNER ARE THE WORDS AND PHRASES "AUTHENTIC", "OLD WORLD QUALITY", AND "HECHO POR MEXICANOS", WITH EACH OF THESE THREE WORDS OR PHRASES SEPARATED BY DOTS BETWEEN THEM. THE ENGLISH TRANSLATION OF "HECHO POR MEXICANOS" IS "MADE FOR MEXICANS"."

THE FOREIGN WORDING IN THE MARK TRANSLATES INTO ENGLISH AS "MADE FOR MEXICANS". FOR MEXICAN STYLE CHEESES AND OTHER MEXICAN STYLE FOOD PRODUCTS, NAMELY, CHICHARON, WHICH IS DRY PORK SKINS, CUERITOS, WHICH IS PORK SKINS IN VINEGAR, AND CHORIZO, WHICH IS A BEEF AND PORK MEAT PRODUCT (U.S. CL. 46). FIRST USE 12-1-1998; IN COMMERCE 12-1-1998.

SN 76-368,751. RELIGIOUS OF THE SACRED HEART, NEW YORK PROVINCE, INC., DBA SPROUT CREEK FARM, POUGHKEEPSIE, NY. FILED 2-8-2002.

SPROUT CREEK FARM

NO CLAIM IS MADE TO THE EXCLUSIVE RIGHT TO USE "FARM", APART FROM THE MARK AS SHOWN. FOR CHEESE (U.S. CL. 46). FIRST USE 6-9-2001; IN COMMERCE 6-9-2001.

SN 76-372,194. DR. CHUNG'S SOY AND DAIRY, INC., TIGARD, OR. FILED 2-5-2002.

PRE-SCHOOLSOY

FOR SOY MILK, SOY-BASED FOOD BEVERAGES USED AS MILK SUBSTITUTE; BLENDED SOY AND COW MILK (U.S. CL. 46).

CLASS 29—(Continued).

SN 76-373,570. COOKING EXCELLENCE, LLC, TRENTON, NJ. FILED 2-22-2002.

SIMPLY ICELAND

NO CLAIM IS MADE TO THE EXCLUSIVE RIGHT TO USE "ICELAND", APART FROM THE MARK AS SHOWN. FOR BUTTER, CHEESE, MILK, HALF AND HALF, COCOA MILK AND LONG SHELF LIFE MILK DRINKS (U.S. CL. 46).

SN 76-375,233. MAZZETTA COMPANY, THE, HIGHLAND PARK, IL. FILED 2-26-2002.

CRAB PRIDE

NO CLAIM IS MADE TO THE EXCLUSIVE RIGHT TO USE "CRAB", APART FROM THE MARK AS SHOWN. FOR CRAB (U.S. CL. 46).

SN 76-376,776. BORDER FOODS, INC., DEMING, NM. FILED 2-28-2002.

JALAPENO ZERO

NO CLAIM IS MADE TO THE EXCLUSIVE RIGHT TO USE "JALAPENO", APART FROM THE MARK AS SHOWN. FOR PROCESSED PEPPERS (U.S. CL. 46).

SN 76-377,160. EXPRESS FITNESS, LLC, PARAMUS, NJ. FILED 3-1-2002.

SHAPES

FOR PROTEIN BASED NUTRIENT-DENSE SNACK BARS (U.S. CL. 46).
FIRST USE 9-0-2001; IN COMMERCE 9-0-2001.

SN 76-383,083. PEOPLE GOTTA EAT, INC., SANTA FE, NM. FILED 3-18-2002.

HOOTCHIE-COOTCHIE CASHEWS

NO CLAIM IS MADE TO THE EXCLUSIVE RIGHT TO USE "CASHEWS", APART FROM THE MARK AS SHOWN. FOR PROCESSED NUTS (U.S. CL. 46).

CLASS 29—(Continued).

SN 76-384,441. SEA WATCH INTERNATIONAL, LTD., EASTON, MD. FILED 3-19-2002.

OLD SALT

OWNER OF U.S. REG. NO. 2,087,557.
FOR SEAFOOD, NAMELY, CANNED CLAMS, CLAM JUICE AND CHOWDERS, FROZEN BREADED CLAM STRIPS, CHOPPED CLAMS, STUFFED CLAMS, BREADED SOFT SHELL CLAMS, CHOWDERS, BREADED FORMED SHRIMP, CRAB CAKES, CRAB CUTLETS, AND BREADED CALAMARI RINGS (U.S. CL. 46).

FIRST USE 0-0-1935; IN COMMERCE 0-0-1935.

SN 76-385,506. GROVE, INC., THE, NEW ORLEANS, LA. FILED 3-21-2002.

MUNCH'N DOWN THE MILES

FOR DRIED FRUITS AND PROCESSED NUTS (U.S. CL. 46).

FIRST USE 0-0-1986; IN COMMERCE 0-0-1986.

SN 76-385,509. GROVE, INC., THE, NEW ORLEANS, LA. FILED 3-21-2002.

MUNCH'N DOWN THE MILES

FOR CANDIED FRUITS (U.S. CL. 46).
FIRST USE 0-0-1986; IN COMMERCE 0-0-1986.

SN 76-385,510. GROVE, INC., THE, NEW ORLEANS, LA. FILED 3-21-2002.

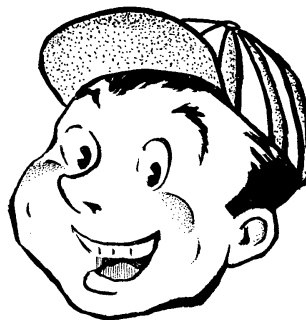

THE STIPPLING IS A FEATURE OF THE MARK AND DOES NOT INDICATE COLOR.
THE LIKENESS (OR, "PORTRAIT") IN THE MARK DOES NOT IDENTIFY A LIVING INDIVIDUAL.
FOR CANDIED FRUITS (U.S. CL. 46).
FIRST USE 0-0-1986; IN COMMERCE 0-0-1986.

CLASS 29—(Continued).

SN 78-044,716. O'STEEN MEAT SPECIALTIES, INCORPORATED, OKLAHOMA CITY, OK. FILED 1-24-2001.

O'STEEN

SEC. 2(F).
FOR BULK PACKAGED FOOD PRODUCTS FOR INSTITUTIONAL AND RESTAURANT USE, NAMELY MEAT, FISH, POULTRY AND VEGETABLES (U.S. CL. 46).
FIRST USE 3-31-1989; IN COMMERCE 1-1-1990.

CLASS 29—(Continued).

SN 78-100,814. KING KUNG HEALTHFOOD CO., LTD., TAIPEI, TAIWAN, FILED 1-3-2002.



SN 78-054,960. DELI STARS LLC, PATERSON, NJ. FILED 3-26-2001.

NO CLAIM IS MADE TO THE EXCLUSIVE RIGHT TO USE "DELI", APART FROM THE MARK AS SHOWN.
FOR PACKAGE COMBINATIONS CONSISTING PRIMARILY OF CHEESE, MEAT AND/OR PROCESSED FRUIT (FOOD) (U.S. CL. 46).
FIRST USE 4-26-2001; IN COMMERCE 4-26-2001.

THE ENGLISH TRANSLITERATION OF THE CHINESE CHARACTER IN THE MARK IS "JING GONG", WHICH MEANS "CAPITAL WORK".
FOR VEGETABLE-BASED FOOD BEVERAGES, VEGETABLE SOUP, SOUP STOCK, DRIED BEANS, FROZEN FRUITS, DRIED FRUITS, DEHYDRATED VEGETABLES AND FRUITS, PICCALILLI, AND PICKLED VEGETABLES (U.S. CL. 46).

SN 78-103,579. DOMINO'S PIZZA PMC, INC., ANN ARBOR, MI. FILED 1-18-2002.

**BUFFALO CHICKEN
KICKERS**

NO CLAIM IS MADE TO THE EXCLUSIVE RIGHT TO USE "BUFFALO CHICKEN", APART FROM THE MARK AS SHOWN.
FOR CHICKEN, NAMELY SPICY BONELESS CHICKEN STRIPS (U.S. CL. 46).

SN 78-085,587. SARAMAR, L.L.C., CHICAGO, IL. FILED 9-26-2001.

BRYAN SMOKEHOUSE

OWNER OF U.S. REG. NO. 1,467,793.
NO CLAIM IS MADE TO THE EXCLUSIVE RIGHT TO USE "SMOKEHOUSE", APART FROM THE MARK AS SHOWN.
FOR PROCESSED MEATS NAMELY, PORK (U.S. CL. 46).
FIRST USE 1-1-2000; IN COMMERCE 1-1-2000.

SN 78-109,598. LANCE MFG. LLC, CHARLOTTE, NC. FILED 2-19-2002.

FOR SNACK FOODS, NAMELY POTATO CHIPS (U.S. CL. 46).
FIRST USE 2-18-2002; IN COMMERCE 2-18-2002.

CLASS 29—(Continued).

SN 78-109,599. LANCE MFG. LLC, CHARLOTTE, NC. FILED 2-19-2002.

THUNDER BOOMERS

FOR SNACK FOODS, NAMELY POTATO CHIPS (U.S. CL. 46).
FIRST USE 2-18-2002; IN COMMERCE 2-18-2002.

SN 78-111,689. DIONYSUS, INC., CHICAGO, IL. FILED 2-28-2002.

VICTORIA'S GOURMET

NO CLAIM IS MADE TO THE EXCLUSIVE RIGHT TO USE "GOURMET", APART FROM THE MARK AS SHOWN. FOR FOOD PRODUCT, NAMELY, PROCESSED PEPPERS (U.S. CL. 46).
FIRST USE 9-1-2000; IN COMMERCE 5-1-2001.

CLASS 30—STAPLE FOODS

SN 75-082,248. HARDEE'S FOOD SYSTEMS, INC., ROCKY MOUNT, NC. FILED 4-1-1996.

THE BOSS

SUBJECT TO CONCURRENT USE PROCEEDING WITH US REGISTRATION NO. 2232525 APPLICANT CLAIMS EXCLUSIVE RIGHT TO USE THE MARK IN THE AREA COMPRISING THE ENTIRE UNITED STATES OF AMERICA, AND ALL OTHER TERRITORIES REGULATED BY CONGRESS, EXCEPT THE STATES OF ARIZONA, CALIFORNIA AND NEVADA.
FOR SANDWICHES (U.S. CL. 46).
FIRST USE 2-26-1996; IN COMMERCE 2-26-1996.

SN 75-459,929. IPANEMA AGRICOLA LTDA, RIO DE JANEIRO, BRAZIL. BY CHANGE OF NAME IPANEMA AGRO INDUSTRIA S/A, RIO DE JANEIRO, BRAZIL, FILED 3-31-1998.

FAZENDA IPANEMA

OWNER OF BRAZIL REG. NO. 817016007, DATED 12-14-1992, EXPIRES 12-5-2005.
THE ENGLISH TRANSLATION OF "FAZENDA" IS "FARM".
FOR COFFEE (U.S. CL. 46).

CLASS 30—(Continued).

SN 75-546,631. DENALI FLAVORS, L.L.C., HILLSDALE, MI. FILED 9-1-1998.

MACKINAC ISLAND FUDGE

NO CLAIM IS MADE TO THE EXCLUSIVE RIGHT TO USE "FUDGE", APART FROM THE MARK AS SHOWN. SEC. 2(F).
FOR ICE CREAM AND FROZEN YOGURT (U.S. CL. 46).
FIRST USE 6-30-1986; IN COMMERCE 6-30-1986.

SN 75-701,356. FOREIGN CANDY COMPANY, INC., THE, HULL, IA. FILED 5-10-1999.

MEGA SOUR

OWNER OF U.S. REG. NO. 2,312,501.
NO CLAIM IS MADE TO THE EXCLUSIVE RIGHT TO USE "SOUR", APART FROM THE MARK AS SHOWN. FOR CANDY AND GUM, NAMELY, BUBBLE GUM OR CHEWING GUM (U.S. CL. 46).

SN 75-867,447. SEATTLE CHOCOLATE COMPANY LLC, SEATTLE, WA. FILED 12-9-1999.

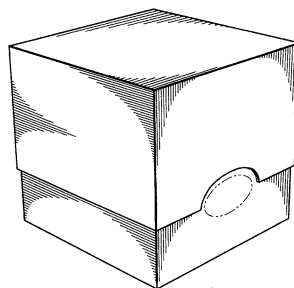

THE LINING IS FOR SHADING PURPOSES ONLY AND DOES NOT INDICATE COLOR.

THE MARK IS A SUBSTANTIALLY CUBICLE BOX HAVING A LID TELESCOPED OVER THE BASE. A SIDE OF THE LID HAS AN ARCUATE RECESS ALONG ITS BOTTOM EDGE WHICH CAN FORM A FRAME FOR THE UPPER PART OF A STICKER OR PRINTING ON THE BOX OF SIMILAR SHAPE. SUCH A STICKER/PRINTING IS SHOWN IN BROKEN LINES IN THE DRAWING AND IS NOT PART OF THE MARK.

SEC. 2(F).
FOR CANDY (U.S. CL. 46).
FIRST USE 9-0-1995; IN COMMERCE 9-0-1995.

CLASS 30—(Continued).

SN 75-917,242. ALICORP S.A., SAN ISIDRO, CORPAC, PERU, FILED 2-14-2000.

DON VITTORIO

THE NAME "DON VITTORIO" DOES NOT IDENTIFY A LIVING INDIVIDUAL.

FOR FLOUR AND PREPARATIONS MADE OF CEREALS, NAMELY BREAKFAST CEREALS; BREAD; COOKIES; VERMICELLI; PASTA; PASTRIES; CONFECTIONS, NAMELY, CANDY AND FROZEN CONFECTIONS; SAUCES; CONDIMENTS, NAMELY, HONEY, SYRUP, SALT, KETCHUP, MUSTARD, DRESSINGS, MAYONNAISE, ICE, RELISH, SPICES, AND VINEGAR (U.S. CL. 46).

SN 76-037,295. ACETO BALSAMICO DEL DUCA DI ADRIANO GROSOLI - SOCIETA A RESPONSABILITA LIMITATA, SPILAMBERTO FRAZIONE SAN VITO (MODENA), ITALY, FILED 4-28-2000.

ACETO



DEL DUCA

NO CLAIM IS MADE TO THE EXCLUSIVE RIGHT TO USE "ACETO", APART FROM THE MARK AS SHOWN.

THE LINING SHOWN IN THE DRAWING IS A FEATURE OF THE MARK AND IS NOT INTENDED TO INDICATE COLOR. THE STIPPLING SHOWN IN THE DRAWING IS FOR SHADING PURPOSES ONLY AND IS NOT INTENDED TO INDICATE COLOR.

THE PORTRAIT DEPICTED IN THE DRAWING DOES NOT REPRESENT A LIVING INDIVIDUAL.

FOR VINEGAR (U.S. CL. 46).

SN 76-048,070. WORTHINGTON, GARY, LINDON, UT. AND WORTHINGTON, COLLEEN, LINDON, UT. FILED 5-15-2000.

KNEADERS

FOR BREADS, PASTRIES AND BAKERY PRODUCTS (U.S. CL. 46).

FIRST USE 12-0-1997; IN COMMERCE 12-0-1997.

CLASS 30—(Continued).

SN 76-072,924. GBSI MANAGEMENT CORPORATION, METRO, MANILA, PHILIPPINES, FILED 6-19-2000.

GIGABITE

FOR BAKERY GOODS, NAMELY COOKIES AND CRACKERS (U.S. CL. 46).

SN 76-092,837. PARMALAT DAIRY & BAKERY INC., ETOBICOKE, CANADA, FILED 7-21-2000.

BLACKOUT

PRIORITY CLAIMED UNDER SEC. 44(D) ON CANADA APPLICATION NO. 1060206, FILED 5-23-2000.

FOR BAKERY PRODUCTS, NAMELY, COOKIES (U.S. CL. 46).

SN 76-104,709. HUHTAMAKI FINANCE B.V., 1181NC AMSTELVEEN, NETHERLANDS, FILED 8-7-2000.

JOLLY RANCHER

FOR FLAVORED, SWEETENED GELATIN-BASED SNACKS; FLAVORED, SWEETENED GELATIN-BASED DESSERTS (U.S. CL. 46).

FIRST USE 9-25-2000; IN COMMERCE 9-25-2000.

SN 76-115,828. LA COSTA HOTEL AND SPA CORPORATION, CARLSBAD, CA. BY ASSIGNMENT LA COSTA COMPANY LP, THE, ROCKVILLE, MD. FILED 8-23-2000.



OWNER OF U.S. REG. NOS. 1,481,948 AND 1,484,909. FOR BRAN MUFFIN MIX; TABLE SYRUP; PANCAKE MIX; BAGEL CHIPS; MARINARA SAUCE; PASTA; SALAD DRESSING; PROCESSED GRAINS (U.S. CL. 46).

CLASS 30—(Continued).

SN 76-140,356. H. J. HEINZ COMPANY, PITTSBURGH, PA.
FILED 7-21-2000.

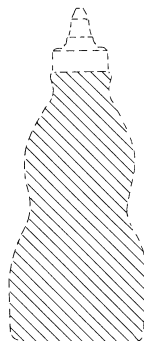

THE MARK CONSISTS OF THE COLOR GREEN AS APPLIED TO THE ENTIRETY OF THE GOODS. THE DOTTED OUTLINE OF THE CONTAINER FOR THE GOODS IS INTENDED TO SHOW THE POSITION OF THE MARK ON THE GOODS AND IT IS NOT A FEATURE OF THE MARK. THE MARK IS LINED FOR THE COLOR GREEN.

FOR KETCHUP MADE FROM RIPE RED TOMATOES WITH GREEN COLOR (U.S. CL. 46).
FIRST USE 10-7-2000; IN COMMERCE 10-7-2000.

SN 76-155,082. LIDL STIFTUNG & CO. KG, NECKARSULM,
FED REP GERMANY, FILED 10-26-2000.

AMANIE

PRIORITY CLAIMED UNDER SEC. 44(D) ON FED REP GERMANY APPLICATION NO. 30037540.9/3, FILED 5-17-2000, REG. NO. 30037540, DATED 8-11-2000, EXPIRES 5-17-2010.

FOR CHOCOLATE; CHOCOLATE PRODUCTS, NAMELY, CHOCOLATE BARS, CHOCOLATE TRUFFLES, CHOCOLATE CANDIES, CHOCOLATE COOKIES, CHOCOLATE BISCUITS, CHOCOLATE TARTS; LONG-KEEPING PASTRIES; EDIBLE ICE (U.S. CL. 46).

SN 76-174,015. I.D.C. HOLDING, A.S., 821 01 BRATISLAVA,
SLOVAKIA, FILED 11-30-2000.

VERBENA

OWNER OF SLOVAKIA REG. NO. 191985, DATED 8-23-2000, EXPIRES 11-18-2008.

FOR CONFECTIONERY, NAMELY, SUGAR CONFECTIONERY, CONFECTIONERY FOR DECORATING CHRISTMAS TREES, CHOCOLATE, PASTILLES AND FONDANTS, PASTRIES, CANDY CARAMELS, PETITS FOURS CAKES, WAFFLES, GINGERBREAD, PETIT-BEURRE BISCUITS, BISCUITS, SWEET BISCUITS, MALT BISCUITS, CEREAL AND CEREAL PREPARATIONS, NAMELY, CEREAL BASED SNACK FOOD, LOLLIPOP SUCKER, JELLY (U.S. CL. 46).

CLASS 30—(Continued).

SN 76-191,232. GRAVYMASTER INC., BRANFORD, CT.
FILED 1-8-2001.

DRYDEN & PALMER

FOR ROCK CANDY, ROCK CANDY ON A STICK,
ROCK CANDY SWIZZLE STICKS (U.S. CL. 46).
FIRST USE 0-0-1884; IN COMMERCE 0-0-1884.

SN 76-191,805. FLARONIS S.A., 4701 EUPEN KETTENIS,
BELGIUM, FILED 1-9-2001.

D' ARTAGNAN

OWNER OF BENELUX REG. NO. 0671634, DATED 9-12-2000, EXPIRES 9-12-2010.

OWNER OF U.S. REG. NO. 1,409,690.

FOR COFFEE, TEA, CHICORY AND GRAIN BASED COFFEE SUBSTITUTES, FLOUR AND PREPARATIONS MADE FROM CEREALS, NAMELY, PROCESSED AND BREAKFAST CEREALS AND CEREAL BASED SNACK FOOD, PASTRY AND CONFECTIONERY, NAMELY, CANDY, BAKERY PRODUCTS, CHOCOLATE, COCOA, CAKES, WAFFLES AND FLATCAKES, PRALINES, CHOCOLATE TRUFFLES, NOUGAT, MARZIPAN (U.S. CL. 46).

SN 76-207,316. ETHEL M CHOCOLATES, INC., HENDERSON, NV. FILED 2-9-2001.

FUDGE BUNDLES

NO CLAIM IS MADE TO THE EXCLUSIVE RIGHT TO USE "FUDGE", APART FROM THE MARK AS SHOWN.

FOR CONFECTIONERY, NAMELY, CANDY (U.S. CL. 46).

FIRST USE 11-28-2000; IN COMMERCE 11-28-2000.

CLASS 30—(Continued).

SN 76-210,013. BUENDIA COFFEE LLC, NEW YORK, NY. FILED 2-12-2001.

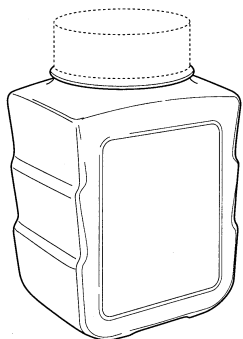

THE MARK CONSISTS OF A THREE-DIMENSIONAL CONFIGURATION OF THE CONTAINER FOR THE GOODS, NAMELY, A RECTANGULAR SHAPED JAR HAVING TWO HORIZONTAL INDENTED RIDGES ON EACH SIDE AND HAVING A RECTANGULAR INDENTED PANEL ON THE FRONT AND BACK. THE COLOR OF THE CAP FOR THE JAR AND THE CAP ITSELF IS NOT CLAIMED AS PART OF THE MARK AND IS, THEREFORE, SHOWN IN DOTTED LINES.
FOR COFFEE (U.S. CL. 46).

SN 76-233,147. HANNAFORD LICENSING CORP., SCARBOROUGH, ME. FILED 3-30-2001.



OWNER OF U.S. REG. NOS. 1,138,096, 2,218,522 AND OTHERS.
NO CLAIM IS MADE TO THE EXCLUSIVE RIGHT TO USE "COOKIES", APART FROM THE MARK AS SHOWN.
THE STIPPLING IS FOR SHADING PURPOSES ONLY.
FOR COOKIES (U.S. CL. 46).
FIRST USE 11-10-1997; IN COMMERCE 11-10-1997.

CLASS 30—(Continued).

SN 76-243,327. VAN MELLE NEDERLAND B.V., BREDA, NETHERLANDS, FILED 4-19-2001.

AIR ACTION

PRIORITY CLAIMED UNDER SEC. 44(D) ON BENELUX APPLICATION NO. 987699, FILED 4-10-2001, REG. NO. 687899, DATED 4-10-2001, EXPIRES 4-10-2011.

FOR COCOA, COCOA MIXES; CHOCOLATE, CHOCOLATE POWDER, CHOCOLATE SYRUP, CHOCOLATE CHIPS, CHOCOLATE-BASED FILLINGS FOR CAKES AND PIES, CHOCOLATE TOPPING; CHOCOLATE FOOD BEVERAGES NOT BEING DAIRY-BASED OR VEGETABLE-BASED; PASTRIES; FROZEN CONFECTIONS; CONFECTIONERY CHIPS FOR BAKING; CARAMEL AND CARAMEL POPCORN; PEPPERMINT CANDY CHIPS FOR BAKING; PEPPERMINT CANDY, CANDY, LIQUORICE; ICE; CEREAL-BASED SNACK FOOD, RICE-BASED SNACK FOOD, GRANOLA-BASED SNACK BARS, AND WHEAT-BASED SNACK FOODS (U.S. CL. 46).

SN 76-247,111. NOODLE HOUSE INDUSTRIAL CO., LTD., N.T., HONG KONG, FILED 4-27-2001.



NO CLAIM IS MADE TO THE EXCLUSIVE RIGHT TO USE THE FIRST AND SECOND CHINESE CHARACTERS IN THE MARK, READING FROM LEFT TO RIGHT, WHICH TRANSLATES IN ENGLISH AS "CRISPY FRAGRANCE", APART FROM THE MARK AS SHOWN.

THE CHINESE CHARACTERS IN THE MARK, READING FROM LEFT TO RIGHT, TRANSLITERATE IN THE CANTONESE DIALECT AS "CHUAI HERNG YUEN" AND IN THE MANDARIN DIALECT AS "TSUI HSIANG YUAN". THE FIRST CHARACTER TRANSLATES LITERALLY INTO ENGLISH AS "CRISPY", THE SECOND CHARACTER AS "FRAGRANCE", AND THE THIRD CHARACTER AS "GARDEN".

THE FIRST CHARACTER TRANSLATES LITERALLY INTO ENGLISH AS "CRISPY", THE SECOND CHARACTER AS "FRAGRANCE", AND THE THIRD CHARACTER AS "GARDEN".

FOR COOKIES SHAPED LIKE DRY EGG ROLLS; PASTRIES; CONFECTIONERY CHIPS FOR BAKING (U.S. CL. 46).

FIRST USE 10-0-1995; IN COMMERCE 8-0-1996.

SN 76-248,272. KABUSHIKI KAISHA TIVOLI, KANAGAWA 259-0303, JAPAN, FILED 4-30-2001.



FOR PASTRY AND CONFECTIONERY, NAMELY COOKIES (U.S. CL. 46).

CLASS 30—(Continued).

SN 76-248,409. JIMMY JOHN'S ENTERPRISES, INC., ELGIN, IL. FILED 4-18-2001.

JIMMY JOHN'S BIG JOHN

OWNER OF U.S. REG. NOS. 1,702,263 AND 2,555,213.
FOR SANDWICHES (U.S. CL. 46).
FIRST USE 1-1-1984; IN COMMERCE 1-1-1984.

SN 76-249,385. PHOENIX INTANGIBLES HOLDING COMPANY, WILMINGTON, DE. FILED 5-1-2001.

FROMAGE PER FAVORE

THE ENGLISH TRANSLATION OF THE MARK IS "CHEESE IF YOU PLEASE".
FOR CHEESE (U.S. CL. 46).
FIRST USE 7-0-1995; IN COMMERCE 7-0-1995.

SN 76-256,231. KAGI FRET AG, LICHTENSTEIG, 9620, SWITZERLAND, FILED 5-11-2001.

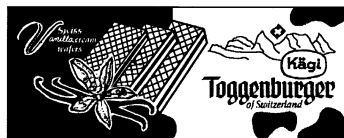

OWNER OF U.S. REG. NOS. 1,640,679, 2,503,436 AND OTHERS.

NO CLAIM IS MADE TO THE EXCLUSIVE RIGHT TO USE "SWISS VANILLA CREAM WAFERS" AND "SWITZERLAND", APART FROM THE MARK AS SHOWN.

THE LINING IN THE MARK IS A FEATURE OF THE MARK AND DOES NOT INDICATE COLOR.
FOR WAFERS (U.S. CL. 46).

SN 76-257,612. CANDELARIO, ERIBERTO, ZAPOPAN, JALISCO C.P. 44050, MEXICO, FILED 5-16-2001.

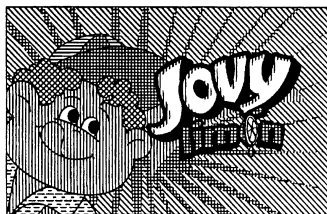

NO CLAIM IS MADE TO THE EXCLUSIVE RIGHT TO USE "LIMON", APART FROM THE MARK AS SHOWN.

THE DRAWING IS LINED FOR THE COLOR(S) RED/PINK, BLUE, ORANGE, GREEN AND YELLOW/GOLD.

THE ENGLISH TRANSLATION OF "LIMON" IS "LEMON".

FOR CANDY, NAMELY, LIME AND CHILI FLAVORED CANDY (U.S. CL. 46).

CLASS 30—(Continued).

SN 76-265,837. IRICAF ITALIA SPA, ROMA, ITALY, FILED 6-1-2001.

PALOMBINI

SEC. 2(F).
FOR CAFFE', NAMELY, COFFEE AND COFFEE SUBSTITUTES (U.S. CL. 46).
FIRST USE 0-0-1946; IN COMMERCE 0-0-1993.

SN 76-269,749. SULA, SULEIMAN SAM, SOUTHAMPTON, NJ. FILED 6-11-2001.

PIZZA LA POCKET

NO CLAIM IS MADE TO THE EXCLUSIVE RIGHT TO USE "PIZZA" AND "POCKET", APART FROM THE MARK AS SHOWN.

FOR STUFFED PIZZA ENFOLDED IN A POCKET OF DOUGH (U.S. CL. 46).

SN 76-272,588. KENT'S ICE CREAM, INC., FORT ATKINSON, WI. FILED 6-15-2001.



FOR ICE CREAM AND FROZEN NOVELTY ITEMS, NAMELY ICE CREAM BARS, YOGURT BARS AND ITALIAN ICE BARS (U.S. CL. 46).

FIRST USE 4-28-2001; IN COMMERCE 4-28-2001.

CLASS 30—(Continued).

SN 76-280,689. HEERLEIN, PAUL E., KAILUA-KONA, HI. FILED 7-6-2001.



NO CLAIM IS MADE TO THE EXCLUSIVE RIGHT TO USE "SALT", APART FROM THE MARK AS SHOWN. FOR SPICES AND SEASONINGS (U.S. CL. 46). FIRST USE 10-17-2000; IN COMMERCE 10-17-2000.

CLASS 30—(Continued).

SN 76-281,922. CHRISTIE COOKIE COMPANY, THE, NASHVILLE, TN. FILED 7-9-2001.



NO CLAIM IS MADE TO THE EXCLUSIVE RIGHT TO USE "COOKIE" AND "SWEET SELECTIONS", APART FROM THE MARK AS SHOWN. FOR COOKIES, COOKIE DOUGH AND OTHER BAKERY GOODS, NAMELY, BROWNIES (U.S. CL. 46). FIRST USE 8-1-2000; IN COMMERCE 8-1-2000.

SN 76-280,919. VITAL WOMAN PTY LTD, MILSONS, AUSTRALIA, FILED 7-2-2001.



PRIORITY CLAIMED UNDER SEC. 44(D) ON AUSTRALIA APPLICATION NO. 870963, FILED 3-29-2001, REG. NO. 870963, DATED 3-29-2001, EXPIRES 3-29-2011. FOR PROCESSED CEREALS; RICE; SPICES; BREAD CRUMBS; FLOUR; YEAST; TAPIOCA; SAGO, FOOD STARCH; BISCUITS; BREADS; PASTA; CANDY; FROZEN YOGURT; HONEY; BAKING POWDER AND FLAVORED ICES (U.S. CL. 46).

SN 76-283,431. ARCOR S.A.I.C., (1006) BUENOS AIRES, ARGENTINA, FILED 7-11-2001.



FOR CONFECTIONERY, NAMELY, CANDY, CARAMELS, CHEWING GUM, CANDY MINTS, LOLLIPOPS, JELLY CANDY, TURRONES, CHOCOLATE, CHOCOLATE PRODUCTS, NAMELY, CHOCOLATE BARS, CHOCOLATE COVERED NUTS, CHOCOLATE COVERED CANDIES, CHOCOLATE COVERED SANDWICH COOKIES AND BONBONS; PRODUCTS MADE TOTALLY OR PARTIALLY OF FLOUR, NAMELY, BISCUITS, CRACKERS, COOKIES, PUDDINGS, WAFERS; SNACKS, NAMELY, CEREAL BASED SNACK FOOD, GRANOLA BASED SNACK FOOD, RICE BASED SNACK FOOD, WHEAT BASED SNACK FOOD; CAKE MIXES, COCOA POWDER MIXES, POWDER FOR MAKING DESSERTS, PUDDING, ICE CREAM, CUSTARD AND GELATIN; HONEY, SAUCES (U.S. CL. 46).

SN 76-281,791. S&D COFFEE, INC., CONCORD, NC. FILED 7-9-2001.

TAILWINDS

FOR COFFEE AND COFFEE BEANS SOLD TO AIRLINES (U.S. CL. 46).

CLASS 30—(Continued).

SN 76-286,427. LIF HOSPITALITY MINTS, LLC, DALLAS, TX. FILED 7-16-2001.

HospitalityMints
The Mint

OWNER OF U.S. REG. NO. 2,273,365.
NO CLAIM IS MADE TO THE EXCLUSIVE RIGHT TO USE "MINTS", APART FROM THE MARK AS SHOWN.
THE MARK CONSISTS OF THE WORDS "THE MINT HOSPITALITY MINTS" WITH A LEAF DESIGN OVERLAPPING THE TOP OF THE LETTER "T" IN THE WORD "MINT" AND A LEAF DESIGN TO THE RIGHT OF THE LETTER "S" AFTER THE WORD "MINTS".
FOR CANDY (U.S. CL. 46).

SN 76-288,071. SOMMARS OVENS, LLC, PORTLAND, OR. FILED 7-19-2001.

WILD SEED

FOR CEREAL-DERIVED FOOD PRODUCT TO BE USED AS A BREAKFAST CEREAL, SNACK FOOD OR INGREDIENT FOR MAKING FOOD (U.S. CL. 46).

SN 76-290,021. THOMPSON CANDY COMPANY LLC, MERIDEN, CT. FILED 7-25-2001.



NO CLAIM IS MADE TO THE EXCLUSIVE RIGHT TO USE "CANDY", APART FROM THE MARK AS SHOWN.
FOR CANDY (U.S. CL. 46).
FIRST USE 0-0-1994; IN COMMERCE 0-0-1994.

CLASS 30—(Continued).

SN 76-290,469. CANDELARIO, ERIBERTO, JALISCO, MEXICO, FILED 7-26-2001.



NO CLAIM IS MADE TO THE EXCLUSIVE RIGHT TO USE "ACIDITO", APART FROM THE MARK AS SHOWN.
THE DRAWING IS LINED FOR THE COLOR(S) BLUE, VIOLET OR PURPLE, ORANGE, GREEN AND YELLOW.
"ACIDITO" MEANS A DIMINUTIVE WAY OF "BITTERSWEET".
FOR CANDY, NAMELY, CHILI FLAVORED CANDY (U.S. CL. 46).

SN 76-292,113. HOJALMAR S.A., AIRES, ARGENTINA, FILED 7-30-2001.

HOJALMAR

FOR BISCUITS (U.S. CL. 46).

SN 76-296,184. LIFE SERVICES SUPPLEMENTS, INC., NEPTUNE, NJ. FILED 8-8-2001.

KETO CRISP

NO CLAIM IS MADE TO THE EXCLUSIVE RIGHT TO USE "KETO", APART FROM THE MARK AS SHOWN.
FOR BREAKFAST CEREAL (U.S. CL. 46).
FIRST USE 10-2-2000; IN COMMERCE 10-2-2000.

SN 76-298,531. ZETA ESPECIAL S.A., 08191 RUBI (BARCELONA), SPAIN, FILED 8-14-2001.

OLRAIT

FOR CONFECTIONERY, NAMELY CARBONATED CANDY, HARD CANDY, LOLLIPOPS AND CHEWING GUM (U.S. CL. 46).

CLASS 30—(Continued).

SN 76-306,695. COFFEE EXCHANGE LTD., PROVIDENCE, RI. FILED 8-29-2001.

BATE PAPO

OWNER OF U.S. REG. NO. 1,896,628.
THE ENGLISH TRANSLATION OF BATE PAPO IS "A CONVERSATIONAL EXCHANGE OVER A BEVERAGE".
FOR COFFEE (U.S. CL. 46).

SN 76-308,282. BAKERY DE FRANCE, INC., ROCKVILLE, MD. FILED 9-4-2001.

THE BREAKFAST SOLUTION

NO CLAIM IS MADE TO THE EXCLUSIVE RIGHT TO USE "BREAKFAST", APART FROM THE MARK AS SHOWN.

FOR BAKERY PRODUCTS, NAMELY BREADS, PASTRIES AND OTHER DOUGH BASED PRODUCTS, NAMELY CROISSANTS, BAGELS, MUFFINS, DANISHES AND BUNS (U.S. CL. 46).
FIRST USE 1-2-2002; IN COMMERCE 1-2-2002.

SN 76-308,788. INDUSTRIAS DE ALIMENTOS TRENDY S.A., SANTIAGO, CHILE, FILED 9-4-2001.



THE MARK CONSISTS OF THE WORD "TRENDY" IN BLUE WITH A BLUE BORDER AND AN ARBITRARY DESIGN IN RED.

FOR ICE CREAM; CHEWING GUM; BISCUITS; AND CONFECTIONERY, NAMELY CANDIES, CHOCOLATES, CAKES, CARAMELS, AND COOKIES (U.S. CL. 46).

SN 76-309,468. MUZYKA, ZHENA, DBA GYPSY TEA COMPANY, OJAI, CA. FILED 9-6-2001.

ROYAL GYPSY

FOR TEA (U.S. CL. 46).

CLASS 30—(Continued).

SN 76-310,370. MARCO POLO EXPLORERS, INC., CINCINNATI, OH. FILED 9-7-2001.

SOYLENT

FOR READY-TO-EAT CEREAL BASED FOOD BARS (U.S. CL. 46).

SN 76-315,009. ALL AMERICAN SNACKS, L.L.C., LINCOLN, NE. FILED 9-20-2001.

WHITE TRASH

OWNER OF U.S. REG. NO. 2,139,960.
FOR MIXTURE OF CEREALS, NUTS AND PRETZELS ENROBED WITH ALMOND BARK AND/OR CHOCOLATE (U.S. CL. 46).
FIRST USE 11-0-1994; IN COMMERCE 11-0-1994.

SN 76-318,350. ELFIN EQUITY COMPANY, L.L.C., ELMHURST, IL. FILED 9-27-2001.

DOWN HOME FAVORITES

FOR COOKIES (U.S. CL. 46).

SN 76-324,419. FAMOUS FOODS EXPRESS CORPORATION, SHARON, MA. FILED 10-15-2001.

TRY ONE AND I GOTCHA

FOR BAGELS (U.S. CL. 46).
FIRST USE 1-16-2001; IN COMMERCE 1-16-2001.

SN 76-325,647. BOYD COFFEE COMPANY, PORTLAND, OR. FILED 10-15-2001.

RUDOLPH'S ROAST

NO CLAIM IS MADE TO THE EXCLUSIVE RIGHT TO USE "ROAST", APART FROM THE MARK AS SHOWN.
FOR COFFEE (U.S. CL. 46).
FIRST USE 11-0-1996; IN COMMERCE 11-0-1996.

SN 76-329,977. J.H. TRADEMARK COMPANY, L.L.C., PHOENIX, AZ. FILED 10-23-2001.

PHILIPPE'S

OWNER OF U.S. REG. NO. 2,406,355.
FOR PIZZA (U.S. CL. 46).
FIRST USE 8-10-1999; IN COMMERCE 8-10-1999.

CLASS 30—(Continued).

SN 76-330,639. CONAGRA FOODS, INC., OMAHA, NE. FILED 10-29-2001.

MAX SNAX

FOR FROZEN PIZZA, FROZEN PIZZA CRUST FILLED WITH CHEESE AND/OR MEAT, FROZEN SOFT PRETZELS FILLED WITH CHEESE AND/OR MEAT, AND BITE-SIZE PIZZA SNACKS (U.S. CL. 46).

SN 76-335,300. ALIMENTOS NATURALES SABROZA, S.A. DE C.V., NUEVO LEON, MEXICO, FILED 11-7-2001.

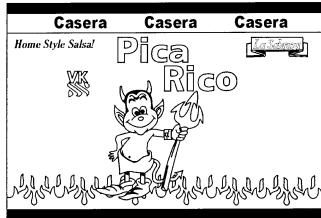

OWNER OF U.S. REG. NO. 1,918,215.
 NO CLAIM IS MADE TO THE EXCLUSIVE RIGHT TO USE "CASERA", "LA SOBROZA" AND "HOME STYLE SALSA" AND VK, APART FROM THE MARK AS SHOWN.
 THE FLAMES, THE DEMON FIGURE AND PITCH FORK IN THE MARK ARE IN THE COLOR RED. THE SHOES AND CLOTHING OF THE DEMON FIGURE ARE IN THE COLOR GREEN. THE WORDING "PICA RICO" IN THE MARK IS GREEN WITH THE TOP TIPS OF THE LETTERS IN YELLOW. THE CENTRAL BACKGROUND BAND IN THE MARK IS IN THE COLOR YELLOW. THE COLORS ARE FEATURES OF THE MARK. THE LETTERS "VK" AND THE SYMBOLS RESEMBLING THE TWO LETTERS "S" IN THE DRAWING ARE THE ACRONYM AND THE EMBLEM OF THE RABBINATE OF MEXICO DESIGNATING THE GOODS AS KOSHER.
 THE ENGLISH TRANSLATION OF "CASERA" IS "HOME MADE". THE ENGLISH TRANSLATION OF "PICA RICO" IS "RICH BITE". THE ENGLISH TRANSLATION OF "LA SABROZA" IS "THE DELICIOUS".
 FOR HOT SAUCES; PICANTE SAUCES (U.S. CL. 46).

CLASS 30—(Continued).

SN 76-338,017. AMERICAN COFFEE COMPANY, INC., NEW ORLEANS, LA. FILED 11-15-2001.



OWNER OF U.S. REG. NOS. 49,057, 2,185,317 AND OTHERS.
 NO CLAIM IS MADE TO THE EXCLUSIVE RIGHT TO USE "NEW ORLEANS" "FAMOUS" "LIGHT", "FRENCH ROAST", "100% PURE", "COFFEE", OR "SINCE 1890", APART FROM THE MARK AS SHOWN.
 THE OVAL AROUND THE "FRENCH MARKET" SCENE IS RED. THE ROOF, EAVES AND FACING OF THE "FRENCH MARKET" ARE PREDOMINATELY RED. THE SKY IS LIGHT BLUE. THE CLOUDS ARE WHITE. THE GROUND IS TAN. THE BACKGROUND OF THE MARK IS COFFEE-BEAN BROWN.
 FOR COFFEE (U.S. CL. 46).

SN 76-339,147. CONAGRA FROZEN FOODS LTD. - ALIMENTOS SURGELES CONAGRA LTEE, BOISBRIAND, QUEBEC J7G 2A7, CANADA, FILED 11-16-2001.

Del Maestro

OWNER OF U.S. REG. NOS. 2,457,975 AND 2,457,976.
 FOR FOOD PRODUCTS, NAMELY, SAUCES AND SPICES USED AS PIZZA TOPPINGS; PIZZA CRUSTS; PIZZA DOUGH; PASTA SAUCES AND DOUGH STUFFED WITH VEGETABLES AND/OR MEATS AND/OR SAUCE AND/OR CHEESE; PREPARED PIZZA; PREPARED CALZONES; PREPARED FOCACCIA BREAD, ALL OF WHICH MAY BE TOPPED OR STUFFED WITH VEGETABLES AND/OR MEATS, FISH, POULTRY OR GAME AND/OR SAUCE AND/OR CHEESE; PASTA, LASAGNA AND OTHER PREPARED PASTA DISHES WITH VEGETABLES AND/OR SAUCE AND/OR CHEESE AND/OR MEAT, FISH, POULTRY OR GAME; BREAD STICKS, GARLIC BREAD (U.S. CL. 46).

CLASS 30—(Continued).

SN 76-339,744. LIPTON INVESTMENTS, INC., WILMINGTON, DE. FILED 11-19-2001.



OWNER OF U.S. REG. NOS. 1,149,979, 2,421,400 AND OTHERS.

NO CLAIM IS MADE TO THE EXCLUSIVE RIGHT TO USE "THE ORIGINAL BRAND", APART FROM THE MARK AS SHOWN.

THE STIPPLING IS FOR SHADING PURPOSES AND ONLY AND DOES NOT INDICATE COLOR.

FOR FROZEN CONFECTIONS (U.S. CL. 46).

SN 76-346,261. ARCOR S.A.I.C., (1006) BUENOS AIRES, ARGENTINA, FILED 12-6-2001.

BIG FRES

FOR CONFECTIONERY, NAMELY, CANDIES, HARD CANDIES, CANDY BARS, FILLED CANDIES, CANDY MINTS, CHEWING GUMS, CARAMELS AND CHEWS, LOLLIPOPS (U.S. CL. 46).

SN 76-347,378. MANHATTAN CHOCOLATES, INC., BROOKLYN, NY. FILED 12-12-2001.

CHOCO-A-LIKE

FOR SUGAR FREE CHOCOLATE CANDY (U.S. CL. 46).

SN 76-350,911. GENERAL BISCUITS BELGIE, B-2200 HERNETALS, BELGIUM, FILED 12-13-2001.

CHOCOPRINCE

FOR BISCUITS, CAKES AND COOKIES (U.S. CL. 46).

CLASS 30—(Continued).

SN 76-351,246. NINTENDO OF AMERICA INC., REDMOND, WA. FILED 12-18-2001.



FOR ALMOND PASTE; BAKERY GOODS, INCLUDING PASTRIES; BAKING POWDER; BASES FOR COAGULATING ICE CREAM; BREAD; BREAKFAST CEREALS; BUBBLE GUM; CANDY; CEREAL- AND GRAIN-BASED SNACK FOODS; CHEWING GUM; COCOA; COFFEE; COFFEE BEANS; FLAVORING ADDITIVES FOR NON-NUTRITIONAL PURPOSES; GRANOLA BASED SNACK BARS; FROZEN CONFECTIONS; FRUIT PIES; GLUTEN FOR COOKING; HAMBURGER SANDWICHES; HOT DOG SANDWICHES; ICE; ICE CREAM; LIQUID AND POWDER SEASONINGS; MALT EXTRACT FOR FOOD; MEAT BALL SANDWICHES; MEAT PIES; MIXES FOR CANDY AND BAKERY GOODS; MIXES FOR ICE CREAM; MIXES FOR SHERBET; NOODLES; PASTA; PIZZA; PROCESSED GRAIN FOOD; PROCESSED UNPOPPED POPCORN; RAVIOLI; RICE; SAKE LEES; SANDWICHES; SPICES; SUSHI; TEA; TENDERIZER FOR COOKING MEAT; THRESHED BARLEY GRAIN; YEAST; YEAST POWDER (U.S. CL. 46).

SN 76-361,126. KALSEC, INC., KALAMAZOO, MI. FILED 1-22-2002.

CAP ROCK RED

NO CLAIM IS MADE TO THE EXCLUSIVE RIGHT TO USE "RED", APART FROM THE MARK AS SHOWN. FOR PAPRIKA (U.S. CL. 46).

SN 76-361,178. SNAK KING CORP., CITY OF INDUSTRY, CA. FILED 1-18-2002.

GUACACHIP

FOR TORTILLA CHIPS (U.S. CL. 46). FIRST USE 2-28-2002; IN COMMERCE 2-28-2002.

SN 76-362,326. MAOLA MILK AND ICE CREAM COMPANY, NEW BERN, NC. FILED 1-25-2002.

SHAKE AND MOO

FOR MILK SHAKE MIX (U.S. CL. 46).

CLASS 30—(Continued).

SN 76-362,916. BOMBAY BURMAH TRADING CORPORATION, LTD., THE, MUMBAI 400 001, INDIA, FILED 1-28-2002.

RAIGODE

FOR COFFEE (U.S. CL. 46).

SN 76-362,917. BOMBAY BURMAH TRADING CORPORATION, LTD., THE, MUMBAI 400 001, INDIA, FILED 1-28-2002.

BEETIEGODE

FOR COFFEE (U.S. CL. 46).

SN 76-363,453. N & T RESTAURANT ASSOCIATES, INC., NEW YORK, NY. FILED 1-24-2002.

THE CHAMPION DOG

NO CLAIM IS MADE TO THE EXCLUSIVE RIGHT TO USE "DOG", APART FROM THE MARK AS SHOWN. FOR SANDWICHES, HOT DOG SANDWICHES AND VEGETARIAN HOT DOG SANDWICHES (U.S. CL. 46). FIRST USE 5-20-2000; IN COMMERCE 5-20-2000.

SN 76-363,454. N & T RESTAURANT ASSOCIATES, INC., NEW YORK, NY. FILED 1-24-2002.

THE FARM DOG

NO CLAIM IS MADE TO THE EXCLUSIVE RIGHT TO USE "DOG", APART FROM THE MARK AS SHOWN. FOR SANDWICHES, HOT DOG SANDWICHES AND VEGETARIAN HOT DOG SANDWICHES (U.S. CL. 46). FIRST USE 5-20-2000; IN COMMERCE 5-20-2000.

SN 76-363,455. N & T RESTAURANT ASSOCIATES, INC., NEW YORK, NY. FILED 1-24-2002.

THE SHEEP DOG

NO CLAIM IS MADE TO THE EXCLUSIVE RIGHT TO USE "DOG", APART FROM THE MARK AS SHOWN. FOR SANDWICHES, HOT DOG SANDWICHES AND VEGETARIAN HOT DOG SANDWICHES (U.S. CL. 46). FIRST USE 5-20-2000; IN COMMERCE 5-20-2000.

CLASS 30—(Continued).

SN 76-363,458. N & T RESTAURANT ASSOCIATES, INC., NEW YORK, NY. FILED 1-24-2002.

THE BULL DOG

NO CLAIM IS MADE TO THE EXCLUSIVE RIGHT TO USE "DOG", APART FROM THE MARK AS SHOWN. FOR SANDWICHES, HOT DOG SANDWICHES AND VEGETARIAN HOT DOG SANDWICHES (U.S. CL. 46). FIRST USE 5-20-2000; IN COMMERCE 5-20-2000.

SN 76-365,344. REISGEN, CRAIG CLIFFORD, CRESTLINE, CA. FILED 1-31-2002.

COOKIE IN THE CRATE

NO CLAIM IS MADE TO THE EXCLUSIVE RIGHT TO USE "COOKIE", APART FROM THE MARK AS SHOWN. FOR COOKIES (U.S. CL. 46). FIRST USE 1-2-2002; IN COMMERCE 1-2-2002.

SN 76-365,954. MERISANT COMPANY, CLAYTON, MO. FILED 2-1-2002.

EQUAL

OWNER OF U.S. REG. NO. 1,158,683. FOR CHOCOLATE BARS, MINTS, PUDDINGS, FLAVORED AND SWEETENED GELATIN, ICE CREAM, BREADS, COOKIES, CAKES, DRESSINGS FOR SALADS, SPECIALTY COFFEE, AND ICE TEA MIX (U.S. CL. 46).

SN 76-368,763. MORRIS NATIONAL, INC., AZUSA, CA. FILED 2-8-2002.

TONGUE TEASERS

FOR CANDY (U.S. CL. 46).

SN 76-371,203. REDSTONE DISTRIBUTING COMPANY, REPUBLIC, PA. FILED 2-14-2002.

REDSTONE

FOR CANDY (U.S. CL. 46). FIRST USE 11-0-1947; IN COMMERCE 11-0-1971.

CLASS 30—(Continued).

SN 76-371,970. SOY COFFEE, LLC, BROOKLYN, NY. FILED 2-19-2002.



NO CLAIM IS MADE TO THE EXCLUSIVE RIGHT TO USE "SOYCOFFEE.COM", APART FROM THE MARK AS SHOWN.

FOR COFFEE SUBSTITUTE IN THE NATURE OF PROCESSED SOY BEANS (U.S. CL. 46).
FIRST USE 1-19-1998; IN COMMERCE 1-19-1998.

SN 76-373,026. MACFARMS OF HAWAII, INC., CAPTAIN COOK, HI. FILED 2-20-2002.

HULA PRINCESS

OWNER OF U.S. REG. NO. 2,394,383.
FOR CHOCOLATE AND CANDY (U.S. CL. 46).

SN 76-373,817. OTIS SPUNKMEYER, INC., SAN LEANDRO, CA. FILED 2-22-2002.

YOUR SWEET STOP

FOR COFFEE; BAKERY GOODS; BAKERY PRODUCTS; COOKIES; MUFFINS; BROWNIES; CAKES; DANISH PASTRIES; COOKIE PIES; PIES; FROZEN COOKIE DOUGH; PRE-MIXED COOKIE DOUGH; COOKIE DOUGH; BAGELS; FRUIT PIES (U.S. CL. 46).

SN 76-374,901. JEL SERT CO., THE, WEST CHICAGO, IL. FILED 2-25-2002.

GO-GREEN-APPLE

FOR FLAVORED LIQUID SOLD IN PACKAGES TO BE FROZEN THEREIN FOR MAKING FROZEN CONFECTIONS; READY-TO-EAT FLAVORED SWEETENED GELATIN DESSERT SNACK FOOD (U.S. CL. 46).

CLASS 30—(Continued).

SN 76-375,060. HI MOUNTAIN JERKY, INC, RIVERTON, WY. FILED 2-26-2002.

HI MOUNTAIN

FOR SEASONINGS FOR MEAT, GAME, FISH AND POULTRY (U.S. CL. 46).
FIRST USE 2-0-1992; IN COMMERCE 2-0-1992.

SN 76-375,351. CLOVERVALE FOODS, INC., LORAIN, OH. FILED 2-27-2002.

BARNYARD CRITTERS

FOR COOKIES (U.S. CL. 46).
FIRST USE 8-1-2001; IN COMMERCE 8-1-2001.

SN 76-376,480. GRUPO AZUCARERO MEXICO, S.A. DE C.V., C.P. 11000, MEXICO, D.F., MEXICO, FILED 2-25-2002.

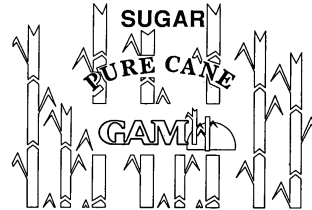

NO CLAIM IS MADE TO THE EXCLUSIVE RIGHT TO USE "SUGAR PURE CANE", APART FROM THE MARK AS SHOWN.

FOR SUGAR (U.S. CL. 46).
FIRST USE 0-0-1998; IN COMMERCE 0-0-1998.

SN 76-376,744. S.A. PIAZZA & ASSOCIATES, LLC, CLACKAMAS, OR. FILED 2-27-2002.



NO CLAIM IS MADE TO THE EXCLUSIVE RIGHT TO USE "SUPER SIZED PIZZA", APART FROM THE MARK AS SHOWN.

FOR PIZZA (U.S. CL. 46).

CLASS 30—(Continued).

SN 76-376,745. S.A. PIAZZA & ASSOCIATES, LLC, CLACK-AMAS, OR. FILED 2-27-2002.

WILD MIKE'S SUPER SIZED PIZZA

NO CLAIM IS MADE TO THE EXCLUSIVE RIGHT TO USE "SUPER SIZED PIZZA", APART FROM THE MARK AS SHOWN.

FOR PIZZA (U.S. CL. 46).

SN 76-376,881. MEIJER, INC., GRAND RAPIDS, MI. FILED 3-4-2002.

PIZZA JR.'S

NO CLAIM IS MADE TO THE EXCLUSIVE RIGHT TO USE "PIZZA", APART FROM THE MARK AS SHOWN.

FOR FROZEN FOOD PRODUCTS, NAMELY, PIZZA BAGELS (U.S. CL. 46).

SN 76-378,370. NICK-N-WILLY'S FRANCHISE COMPANY, LLC, LONE TREE, CO. FILED 3-4-2002.

AEGEAN

FOR UNBAKED PIZZA PREPARED FOR OFF-PRE-MISES BAKING AND CONSUMPTION (U.S. CL. 46).
FIRST USE 1-1-1989; IN COMMERCE 1-1-1989.

SN 76-381,243. ALLTECH, INC., NICHOLASVILLE, KY. FILED 3-12-2002.

THERMOSACC

OWNER OF U.S. REG. NOS. 1,917,580 AND 1,940,658.
FOR HIGH TEMPERATURE FERMENTING YEAST CULTURE FOR USE IN THE DISTILLING PROCESS AND THE ALCOHOL INDUSTRY (U.S. CL. 46).
FIRST USE 8-17-2001; IN COMMERCE 8-17-2001.

SN 76-381,968. RICH-SEAPAK CORPORATION, ST. SIMONS ISLAND, GA. FILED 3-13-2002.

PIZZATAS

FOR LAYERED FROZEN PIZZA SNACK FOOD (U.S. CL. 46).

CLASS 30—(Continued).

SN 76-382,279. ALASKA WILD BERRY PRODUCTS, ANCHORAGE, AK. FILED 3-14-2002.



THE STIPPLING IS FOR SHADING PURPOSES ONLY AND DOES NOT INDICATE COLOR.

FOR CANDY (U.S. CL. 46).
FIRST USE 2-1-2000; IN COMMERCE 3-29-2000.

SN 76-382,280. ALASKA WILD BERRY PRODUCTS, ANCHORAGE, AK. FILED 3-14-2002.



THE STIPPLING IS FOR SHADING PURPOSES ONLY AND DOES NOT INDICATE COLOR.

FOR CANDY (U.S. CL. 46).
FIRST USE 2-1-2000; IN COMMERCE 3-29-2000.

SN 76-382,481. MAN-PRODUCTEN ROTTERDAM B.V., 3012 CN ROTTERDAM, NETHERLANDS, FILED 3-14-2002.

GOLDEN DRAGON BLACK PEPPER

NO CLAIM IS MADE TO THE EXCLUSIVE RIGHT TO USE "BLACK PEPPER", APART FROM THE MARK AS SHOWN.

FOR BLACK PEPPER (U.S. CL. 46).
FIRST USE 7-0-1998; IN COMMERCE 7-0-1998.

CLASS 30—(Continued).

SN 76-382,807. RECOT, INC., PLEASANTON, CA. FILED 3-18-2002.



FOR CONFECTIONERY, NAMELY, CANDY, CHOCOLATE, CHEWING GUM, AND LOLLYPOPS (U.S. CL. 46).

SN 76-384,111. ALDI INC., BATAVIA, IL. FILED 3-18-2002.

HAPPY HARVEST

OWNER OF U.S. REG. NOS. 1,055,229 AND 1,277,278.
FOR VINEGAR (U.S. CL. 46).
FIRST USE 3-1-2002; IN COMMERCE 3-1-2002.

SN 76-384,219. ESPOSITO, MARK, GURNEE, IL. FILED 3-15-2002.

MARFREDO

FOR SAUCE, NAMELY, A PASTA SAUCE USED WITH PASTA, MEATS, OR SEAFOODS (U.S. CL. 46).
FIRST USE 6-15-1996; IN COMMERCE 6-15-1996.

SN 76-385,606. GIAQUINTA, CHRISTOPHER J., LA MESA, CA. FILED 3-21-2002.

DRESSED TO GRILL

FOR FOOD SAUCES, NAMELY, BARBECUE SAUCES, STEAK SAUCES AND MARINADES (U.S. CL. 46).
FIRST USE 4-16-2001; IN COMMERCE 6-1-2001.

SN 78-019,084. LUCY'S BARKERY, PARKVILLE, MO. FILED 7-31-2000.

LUCY'S BARKERY

FOR BAKERY GOODS NAMELY MUFFINS AND BREAD (U.S. CL. 46).

CLASS 30—(Continued).

SN 78-020,587. MOCHA RICA LTD, AURORA, CO. FILED 8-10-2000.



NO CLAIM IS MADE TO THE EXCLUSIVE RIGHT TO USE "MOCHA RICA", APART FROM THE MARK AS SHOWN.

THE ENGLISH TRANSLATION OF THE SPANISH WORD "RICA" IS "FINE-QUALITY", "RICH", AND "VALUABLE".
FOR COFFEE (U.S. CL. 46).

SN 78-057,351. NANABANANA FUN FOODS CORP., NEW YORK, NY. FILED 4-9-2001.

NANABANANA FUN FOODS CORP.

NO CLAIM IS MADE TO THE EXCLUSIVE RIGHT TO USE "FUN FOODS CORP.", APART FROM THE MARK AS SHOWN.

FOR BAKERY GOODS (U.S. CL. 46).

SN 78-068,856. JUST GREAT BAKERS, INC., DOWNSVIEW, ONTARIO, FILED 6-13-2001.

LITTLE DAISY

FOR BAKED GOODS, NAMELY, BROWNIES AND MUFFINS (U.S. CL. 46).

CLASS 30—(Continued).

SN 78-075,294. CHINA MIST TEA COMPANY, SCOTTSDALE, AZ. FILED 7-23-2001.



OWNER OF U.S. REG. NOS. 2,173,054 AND 2,173,055.
NO CLAIM IS MADE TO THE EXCLUSIVE RIGHT TO USE "PURE TEAS", APART FROM THE MARK AS SHOWN.
SEC. 2(F).

FOR TEA, HERBAL TEA, HERBAL ICED TEA, ICED TEA, TEA-BASED BEVERAGES WITH FRUIT FLAVORING, LOOSE TEA, TEA BAGS AND HOT TEA (U.S. CL. 46).

SN 78-080,201. FRENCH GOURMET INC., HONOLULU, HI. FILED 8-20-2001.

THE FRENCH GOURMET

OWNER OF U.S. REG. NOS. 2,023,135 AND 2,051,908.
SEC. 2(F).

FOR CROISSANTS, DANISHES, PUFF PASTRY, MUFFINS, COOKIES, BREADS, PASTRIES AND CAKES IN RAW, SEMI BAKED OR FULLY BAKED STAGE, FRESH AND OR FROZEN (U.S. CL. 46).

FIRST USE 8-24-1984, THE MARK WAS FIRST USED ANYWHERE IN A DIFFERENT FORM OTHER THAN THAT SOUGHT TO BE REGISTERED ON 08/24/1984; IN COMMERCE 8-24-1984, THE MARK WAS FIRST USED IN COMMERCE IN A DIFFERENT FORM OTHER THAN THAT SOUGHT TO BE REGISTERED ON 08/24/1984.

SN 78-082,411. ANFORA QUALITY PRODUCTS, S.L., CORDOBA, SPAIN, FILED 9-4-2001.

COLUMELA

OWNER OF U.S. REG. NO. 1,876,038.
FOR VINEGAR (U.S. CL. 46).
FIRST USE 10-0-1993; IN COMMERCE 11-0-1993.

CLASS 30—(Continued).

SN 78-083,980. KRAFT FOODS HOLDINGS, INC., NORTH-FIELD, IL. FILED 9-14-2001.

CHIPS AHOY! OOEEY GOOEY WARM 'N CHEWY

OWNER OF U.S. REG. NOS. 792,672, 1,891,263 AND OTHERS.

NO CLAIM IS MADE TO THE EXCLUSIVE RIGHT TO USE "CHIPS", APART FROM THE MARK AS SHOWN.
FOR COOKIES (U.S. CL. 46).

SN 78-090,066. FIEDLER, KEITH, C., SHERWOOD, OR. FILED 10-24-2001.

FRESHMIX

FOR SALSAS, SPICE BLENDS, AND DRIED VEGETABLE CONCENTRATES USED FOR SEASONING (U.S. CL. 46).

SN 78-095,652. LANCE MFG. LLC, CHARLOTTE, NC. FILED 11-29-2001.



OWNER OF U.S. REG. NO. 1,098,266.
NO CLAIM IS MADE TO THE EXCLUSIVE RIGHT TO USE "WAFERS", APART FROM THE MARK AS SHOWN.

FOR CRACKERS AND FOOD PACKAGE COMBINATIONS CONSISTING PRIMARILY OF CRACKERS AND CRACKER SANDWICHES (U.S. CL. 46).
FIRST USE 3-28-2001; IN COMMERCE 3-28-2001.

SN 78-097,396. BRATTAIN, JOHN F., VERO BEACH, FL. FILED 12-9-2001.

SENZU BEANS

NO CLAIM IS MADE TO THE EXCLUSIVE RIGHT TO USE "BEANS", APART FROM THE MARK AS SHOWN.
FOR CANDY; GREEN JELLY BEANS IN A DRAW STRING BAG (U.S. CL. 46).

CLASS 30—(Continued).

SN 78-105,425. VIACOM INTERNATIONAL INC., NEW YORK, NY. FILED 1-29-2002.

WHERE'S WALDO?

OWNER OF U.S. REG. NOS. 1,761,924, 2,050,621 AND OTHERS.
FOR POPPED POPCORN AND CANDY (U.S. CL. 46).

SN 78-105,705. KRAFT FOODS HOLDINGS, INC., NORTH-FIELD, IL. FILED 1-30-2002.

LIFE SAVERS FUSIONS

OWNER OF U.S. REG. NOS. 115,895, 1,130,067 AND OTHERS.
FOR CANDY (U.S. CL. 46).

SN 78-106,561. DENI'S SAUCE COMPANY, LLC, ORMOND BEACH, FL. FILED 2-4-2002.

HOT LINE FIERY SAUCE

NO CLAIM IS MADE TO THE EXCLUSIVE RIGHT TO USE "FIERY SAUCE", APART FROM THE MARK AS SHOWN.
FOR HOT SAUCE (U.S. CL. 46).

SN 78-106,933. COFFEE KINETICS, LLC, BURLINGTON, WA. FILED 2-5-2002.



NO CLAIM IS MADE TO THE EXCLUSIVE RIGHT TO USE "ROAST COFFEE", APART FROM THE MARK AS SHOWN.
FOR COFFEE BEANS, NAMELY, GREEN COFFEE BEANS AND ROASTED COFFEE BEANS (U.S. CL. 46).
FIRST USE 10-15-2001; IN COMMERCE 10-15-2001.

CLASS 30—(Continued).

SN 78-108,177. PATTI'S ENTERPRISES, L.L.C., GRAND RIVERS, KY. FILED 2-12-2002.



NO CLAIM IS MADE TO THE EXCLUSIVE RIGHT TO USE "SEASONING FOR PORK CHOPS, STEAKS, CHICKEN & EVERYTHING GOOD IN THE KITCHEN", APART FROM THE MARK AS SHOWN.
THE LIKENESS (OR, "PORTRAIT") IN THE MARK DOES NOT IDENTIFY A LIVING INDIVIDUAL.
FOR SEASONED COATING FOR MEAT, FISH, POULTRY AND VEGETABLES (U.S. CL. 46).
FIRST USE 9-1-1999; IN COMMERCE 9-1-1999.

SN 78-108,184. PATTI'S ENTERPRISES, L.L.C., GRAND RIVERS, KY. FILED 2-12-2002.

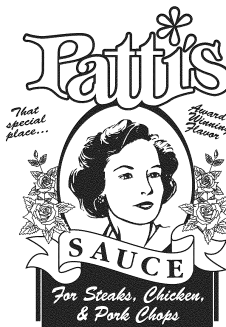

NO CLAIM IS MADE TO THE EXCLUSIVE RIGHT TO USE "SAUCE FOR STEAKS, CHICKEN & PORK CHOPS, AWARD WINNING FLAVOR", APART FROM THE MARK AS SHOWN.
THE LIKENESS (OR, "PORTRAIT") IN THE MARK DOES NOT IDENTIFY A LIVING INDIVIDUAL.
FOR SAUCES (U.S. CL. 46).
FIRST USE 9-1-1999; IN COMMERCE 9-1-1999.

CLASS 30—(Continued).

SN 78-108,219. THE SALT SELLER, INC., HINGHAM, MA. FILED 2-12-2002.

SECRET SALT

NO CLAIM IS MADE TO THE EXCLUSIVE RIGHT TO USE "SALT", APART FROM THE MARK AS SHOWN. FOR SEASONINGS, NAMELY, SEASONED SALT (U.S. CL. 46).
FIRST USE 4-1-2000; IN COMMERCE 4-1-2000.

SN 78-111,390. NOCCHI, ROBERT W., SOUTH WAVERLY, PA. FILED 2-27-2002.

**NOCCHI'S "HOME OF THE
DOUBLE CHEESE
WHAMMIE"**

FOR HOMEMADE HOAGIE ROLL WITH GROUND CHUCK, CHEESE, LETTUCE, TOMATO AND TOP WITH A HOMEMADE RECIPE OIL SAUCE (U.S. CL. 46).

SN 78-112,090. CAMBIASO HNOS. S.A.C., VALPARAISO, CHILE, FILED 3-1-2002.

GARDEN OF THE ANDES

FOR TEA AND HERBAL TEA FOR FOOD PURPOSES (U.S. CL. 46).
FIRST USE 1-25-1993; IN COMMERCE 1-25-1993.

SN 78-114,575. GIMME COFFEE INC., ITHACA, NY. FILED 3-13-2002.

GIMME!

FOR COFFEE AND COFFEE BEANS (U.S. CL. 46).
FIRST USE 4-6-2000; IN COMMERCE 4-6-2000.

SN 78-115,858. BANDAI VISUAL CO. LTD, TAITO-KU, TOKYO, JAPAN, FILED 3-19-2002.

PILOT CANDIDATE

FOR CANDY, CHOCOLATE, BUBBLE GUM AND CHEWING GUM, COOKIES, ICE CREAM, SORBETS AND CONFECTIONS, NAMELY FROZEN CONFECTIONS AND CONFECTIONERS SUGAR (U.S. CL. 46).

CLASS 30—(Continued).

SN 78-116,225. KRAFT FOODS UK LTD., CHELTENHAM, UNITED KINGDOM, FILED 3-20-2002.

**THE ORIGINAL
CELEBRATED CURIOUSLY
STRONG**

OWNER OF U.S. REG. NOS. 1,250,585, 2,262,270 AND OTHERS.
FOR CANDY (U.S. CL. 46).
FIRST USE 3-15-2002; IN COMMERCE 3-15-2002.

CLASS 31—NATURAL AGRICULTURAL PRODUCTS

SN 75-650,846. CHERRY LAKE TREE FARM, INC, GROVELAND, FL. FILED 2-16-1999.

MILLENAIRE

THE ENGLISH TRANSLATION OF THE WORD "MILLENAIRE" IN THE MARK IS "MILLENNIUM".
FOR TREES, NAMELY LIVE OAK TREES (U.S. CLS. 1 AND 46).

SN 75-777,899. BRULAF, S.A., 46500 SAGUNTO VALENCIA, SPAIN, FILED 8-17-1999.



NO CLAIM IS MADE TO THE EXCLUSIVE RIGHT TO USE "NR.1", APART FROM THE MARK AS SHOWN.
THE ENGLISH TRANSLATION OF THE SPANISH WORD "VITAMINA" IS "VITAMIN".
FOR FRESH ORANGES, TANGERINES, LEMONS, ONIONS, MELONS AND WATERMELONS (U.S. CLS. 1 AND 46).

CLASS 31—(Continued).

SN 75-934,132. EXCLUSIVELY PET, INC., MILWAUKEE, WI. FILED 2-14-2000.

Exclusively Cat

NO CLAIM IS MADE TO THE EXCLUSIVE RIGHT TO USE "CAT", APART FROM THE MARK AS SHOWN.
FOR FOODSTUFFS FOR ANIMALS, SPECIFICALLY CAT TREATS (U.S. CLS. 1 AND 46).

SN 76-023,789. MERRICK'S INC., MIDDLETON, WI. FILED 4-11-2000.

MERRICK'S PROTEX

FOR NON-MEDICAL ADDITIVES FOR ANIMAL FEED (U.S. CLS. 1 AND 46).

SN 76-114,455. ITO PACKING CO., REEDLEY, CA. FILED 8-14-2000.



FOR FRESH FRUIT, NAMELY NECTARINES (U.S. CLS. 1 AND 46).

SN 76-155,973. DONATHAN, WAYLON, SANFORD, NC. FILED 10-24-2000.

SANDHILLS SWEETEST

FOR SWEET POTATOES (RAW) (U.S. CLS. 1 AND 46).
FIRST USE 9-11-2000; IN COMMERCE 9-11-2000.

SN 76-184,371. SMITH GARDENS, INC., BELLINGHAM, WA. FILED 12-20-2000.

PACIFIC GROWN

NO CLAIM IS MADE TO THE EXCLUSIVE RIGHT TO USE "GROWN", APART FROM THE MARK AS SHOWN.
FOR HORTICULTURAL PRODUCTS, NAMELY LIVE PLANTS AND FLOWERS; LIVE PLANT MATERIAL, NAMELY PLUGS, STARTERS, AND CUTTINGS (U.S. CLS. 1 AND 46).
FIRST USE 10-1-1999; IN COMMERCE 10-1-1999.

CLASS 31—(Continued).

SN 76-210,708. HEARTLAND HYBRIDS, INC., DASSEL, MN. FILED 2-13-2001.

PRIDELAND DIRECT

NO CLAIM IS MADE TO THE EXCLUSIVE RIGHT TO USE "DIRECT", APART FROM THE MARK AS SHOWN.
FOR AGRICULTURAL SEEDS, NAMELY SOYBEANS FOR COMMERCIAL AGRICULTURAL PURPOSES (U.S. CLS. 1 AND 46).
FIRST USE 8-15-1999; IN COMMERCE 8-15-1999.

SN 76-244,707. MONTEREY MUSHROOM, INC., WATSONVILLE, CA. FILED 4-23-2001.

CLEAN N READY!

FOR MUSHROOMS, NAMELY FRESH MUSHROOMS (U.S. CLS. 1 AND 46).
FIRST USE 10-1-2000; IN COMMERCE 10-1-2000.

SN 76-251,474. PEOTEC SEEDS S.R.L., 43100 PARMA, ITALY, FILED 5-4-2001.

HI-FLESH

PRIORITY CLAIMED UNDER SEC. 44(D) ON ITALY APPLICATION NO. 2000236, FILED 11-10-2000, REG. NO. 837981, DATED 2-20-2001, EXPIRES 11-20-2010.
FOR AGRICULTURAL, HORTICULTURAL AND FORESTRY PRODUCTS, NAMELY, AGRICULTURAL GRAINS FOR PLANTING; FRESH FRUIT AND FRESH VEGETABLE; PLANT SEEDS, LIVING NATURAL PLANTS (U.S. CLS. 1 AND 46).

SN 76-267,428. PURINA MILLS, INC., ST. LOUIS, MO. FILED 6-6-2001.

ZULIFE

FOR BIRD FEED FORTIFIED WITH NUTRITIONAL SUPPLEMENTS FORMULATED FOR BIRDS (U.S. CLS. 1 AND 46).

SN 76-287,109. GARDENLIFE, INC., DBA G. S. GRIMES SEEDS, CONCORD, OH. FILED 7-18-2001.

GARDEN LEADERS

OWNER OF U.S. REG. NO. 1,856,893.
FOR LIVING PLANTS AND TREES, FLOWER AND VEGETABLE SEEDS (U.S. CLS. 1 AND 46).
FIRST USE 6-0-1991; IN COMMERCE 6-0-1991.

CLASS 31—(Continued).

SN 76-298,494. WHITETAIL INSTITUTE OF NORTH AMERICA, INC., PINTLALA, AL. FILED 8-13-2001.

WHITETAIL INSTITUTE

OWNER OF U.S. REG. NOS. 1,693,959, 2,511,844 AND OTHERS.

FOR SEEDS FOR WILDLIFE PLANTINGS, NAMELY, DIFFERENT BLENDS OF CLOVER, ALFALFA, RAPE, AND RYE SEEDS (U.S. CLS. 1 AND 46).

FIRST USE 0-0-1988; IN COMMERCE 0-0-1988.

SN 76-302,122. BAKER WEST, INC., HUBBARD, OR. FILED 8-20-2001.

SNOW SHOWERS

FOR LIVING PLANTS, NAMELY, FLOWERING CHERRY TREES (U.S. CLS. 1 AND 46).

SN 76-302,542. HARVEST VENTURES, INC., WACONIA, MN. FILED 8-21-2001.

ONE BAG ONE CAT ONE MONTH

FOR CAT BOX LITTER (U.S. CLS. 1 AND 46).
FIRST USE 6-25-1998; IN COMMERCE 6-30-1998.

SN 76-304,390. GERMAN, VALENCIA, MIAMI, FL. FILED 8-27-2001.

GALLERIA CLASSIC

FOR FRESH FLOWERS (U.S. CLS. 1 AND 46).
FIRST USE 10-15-2000; IN COMMERCE 10-15-2000.

CLASS 31—(Continued).

SN 76-306,208. JUNGPFANZEN GRUNEWALD GMBH, D-44534 LUNEN-ALTLIUNEN, FED REP GERMANY, FILED 8-28-2001.



PRIORITY CLAIMED UNDER SEC. 44(D) ON FED REP GERMANY APPLICATION NO. 30147840, FILED 8-9-2001, REG. NO. 30147840, DATED 9-18-2001, EXPIRES 6-30-2009.

THE LINING AND STIPPLING IN THE DRAWING ARE FEATURES OF THE MARK AND NOT INTENDED TO INDICATE COLOR.

THE DESIGN DEPICTS A CAT WITH AN ALARMED APPEARANCE.

FOR LIVE PLANTS AND NATURAL FLOWERS (U.S. CLS. 1 AND 46).

SN 76-313,243. FL FOOD LION, INC., SALISBURY, NC. FILED 9-15-2001.

FIELD CHUNKS

NO CLAIM IS MADE TO THE EXCLUSIVE RIGHT TO USE "CHUNKS", APART FROM THE MARK AS SHOWN.

FOR DOG FOOD (U.S. CLS. 1 AND 46).
FIRST USE 2-5-2002; IN COMMERCE 2-5-2002.

SN 76-319,844. PIC'S PRODUCE COMPANY, INC., CINCINNATI, OH. FILED 10-1-2001.

PIC'S PRODUCE
INC.
"TOP OF THE CROP"

NO CLAIM IS MADE TO THE EXCLUSIVE RIGHT TO USE "PRODUCE INC.", APART FROM THE MARK AS SHOWN.

FOR FRESH FRUITS AND VEGETABLES (U.S. CLS. 1 AND 46).

CLASS 31—(Continued).

SN 76-321,170. DICARLO DISTRIBUTORS, INC., HOLTSVILLE, NY. FILED 10-5-2001.



NO CLAIM IS MADE TO THE EXCLUSIVE RIGHT TO USE "FARMS" AND "QUALITY FRUITS & VEGETABLES", APART FROM THE MARK AS SHOWN.
FOR FRESH FRUITS AND VEGETABLES ONLY (U.S. CLS. 1 AND 46).

SN 76-322,690. PET VALU CANADA INC., MARKHAM, ONTARIO L3R 3L3, CANADA, FILED 10-9-2001.



NO CLAIM IS MADE TO THE EXCLUSIVE RIGHT TO USE "CAT", APART FROM THE MARK AS SHOWN.
THE LINING IS A FEATURE OF THE MARK AND DOES NOT INDICATE COLOR.
FOR CAT FOOD (U.S. CLS. 1 AND 46).

SN 76-322,967. ADVANTA USA, INC., SLATER, IA. FILED 10-9-2001.

FRONT RUNNER IN TURF GRASS RESEARCH

FOR SEEDS FOR AGRICULTURAL PURPOSES (U.S. CLS. 1 AND 46).

SN 76-334,551. SUN WORLD INTERNATIONAL, INC., BAKERSFIELD, CA. FILED 11-5-2001.

SOPHIA SEEDLESS

NO CLAIM IS MADE TO THE EXCLUSIVE RIGHT TO USE "SEEDLESS", APART FROM THE MARK AS SHOWN.
FOR FRESH FRUIT, NAMELY, FRESH GRAPES (U.S. CLS. 1 AND 46).

CLASS 31—(Continued).

SN 76-339,496. CALPIS CO., LTD., TOKYO, JAPAN, FILED 11-19-2001.

CALSPORIN

OWNER OF U.S. REG. NO. 2,383,967.
FOR ANIMAL FOODSTUFFS, ADDITIVES TO FODDER, NOT FOR MEDICAL PURPOSES (U.S. CLS. 1 AND 46).
FIRST USE 10-31-1986; IN COMMERCE 3-15-2000.

SN 76-340,340. STAR NURSERY, INC., HENDERSON, NV. FILED 11-19-2001.

EMERALD CARPET

OWNER OF U.S. REG. NO. 1,939,402.
FOR DWARF FESCUE GRASS SEED MIXTURE (U.S. CLS. 1 AND 46).
FIRST USE 3-1-1994; IN COMMERCE 3-1-1994.

SN 76-350,120. BRANDS MANAGEMENT, LLC, MIAMI, FL. FILED 12-18-2001.

RIO ROSES SIGNATURE ARRANGEMENT

NO CLAIM IS MADE TO THE EXCLUSIVE RIGHT TO USE "ROSES" AND "ARRANGEMENT", APART FROM THE MARK AS SHOWN.
FOR CUT FLOWERS (U.S. CLS. 1 AND 46).

SN 76-364,829. HERBTHYME FARMS, INC., SO. SAN FRANCISCO, CA. FILED 1-28-2002.



"Grown in the USA"

NO CLAIM IS MADE TO THE EXCLUSIVE RIGHT TO USE "AMERICAN HERBS, GROWN IN THE USA", APART FROM THE MARK AS SHOWN.
FOR FRESH CULINARY HERBS, SPECIALTY FRUITS AND VEGETABLES, AND EDIBLE FLOWERS (U.S. CLS. 1 AND 46).
FIRST USE 11-1-2001; IN COMMERCE 11-1-2001.

CLASS 31—(Continued).

SN 76-379,787. KAL KAN FOODS, INC., VERNON, CA.
FILED 3-7-2002.

**RAISE THEM WITH LOVE,
PROTECT THEM
WITH PEDIGREE PUPPY**

OWNER OF U.S. REG. NOS. 1,631,808, 1,834,853 AND
OTHERS.
FOR PET FOOD (U.S. CLS. 1 AND 46).

SN 76-381,244. ALLTECH, INC., NICHOLASVILLE, KY.
FILED 3-12-2002.

YEA-SACC

OWNER OF U.S. REG. NOS. 1,917,580 AND 1,940,658.
FOR NON-MEDICATED YEAST CULTURE ADDITIVE
FOR ANIMAL FEED (U.S. CLS. 1 AND 46).
FIRST USE 1-1-1981; IN COMMERCE 1-1-1981.

SN 76-382,433. TREATS 4 PETS LLC, NEW YORK, NY. FILED
3-14-2002.

NANTUCKET NIBBLERS

FOR PET FOOD AND PET TREATS (U.S. CLS. 1 AND
46).

SN 76-383,911. CORONA MARKETING CO., SANTA MARIA,
CA. FILED 3-15-2002.

**FRESH FROM OUR FIELDS
TO YOU**

FOR FRESH FRUITS AND VEGETABLES (U.S. CLS. 1
AND 46).
FIRST USE 1-1-2001; IN COMMERCE 1-1-2001.

SN 76-383,912. CORONA MARKETING CO., SANTA MARIA,
CA. FILED 3-15-2002.

**YOYA CALIFORNIA
STRAWBERRIES**

NO CLAIM IS MADE TO THE EXCLUSIVE RIGHT TO
USE "CALIFORNIA STRAWBERRIES", APART FROM THE
MARK AS SHOWN.
FOR FRESH UNPROCESSED STRAWBERRIES (U.S.
CLS. 1 AND 46).
FIRST USE 3-14-1997; IN COMMERCE 3-14-1997.

CLASS 31—(Continued).

SN 76-385,031. SOUTHERN GRAIN, UVALDE, TX. FILED 3-
20-2002.

SIZE DOES MATTER

FOR FOOD STUFFS FOR ANIMALS, NAMELY GRAIN
OR FOOD PELLETS FOR WILDLIFE (U.S. CLS. 1 AND
46).

SN 76-385,393. MAYACROPS S.A., SAN JOSE PINULA,
GUATEMALA, FILED 3-21-2002.

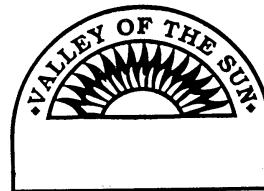

FOR FRESH VEGETABLES, FRUITS, AND BERRIES
(U.S. CLS. 1 AND 46).
FIRST USE 2-3-1988; IN COMMERCE 2-3-1988.

SN 78-048,731. ABI ALFALFA, INC., LENEXA, KS. FILED 2-
16-2001.



NO CLAIM IS MADE TO THE EXCLUSIVE RIGHT TO
USE "ALFALFA GENETICS", APART FROM THE MARK
AS SHOWN.

FOR ALFALFA SEED, CLOVER SEED, PASTURE
SEED MIX, WILDLIFE SEED MIX, FORAGE GRASS
SEED, FORAGE SORGHUM SEED, SORGHUM SUDAN
GRASS SEED, CORN SEED (U.S. CLS. 1 AND 46).

SN 78-065,826. HARVEST VENTURES, INC., WACONIA, MN.
FILED 5-25-2001.

ULTRA CRYSTALS

NO CLAIM IS MADE TO THE EXCLUSIVE RIGHT TO
USE "CRYSTALS", APART FROM THE MARK AS SHOWN.
FOR CAT BOX LITTER (U.S. CLS. 1 AND 46).

CLASS 31—(Continued).

SN 78-106,303. MANNA PRO CORPORATION, ST. LOUIS, MO. FILED 2-1-2002.

MANNA PRO SELECT

NO CLAIM IS MADE TO THE EXCLUSIVE RIGHT TO USE "SELECT", APART FROM THE MARK AS SHOWN. FOR RABBIT FEED (U.S. CLS. 1 AND 46).

SN 78-107,404. NESTLE PURINA PETCARE COMPANY, ST. LOUIS, MO. FILED 2-7-2002.

PROTECTS AND PERFORMS

FOR PET FOOD (U.S. CLS. 1 AND 46).

SN 78-108,164. MACKENZIE, DAVID, SPRING LAKE, MI. FILED 2-12-2002.

LAZY LAWN

FOR LIVING GROUND COVER PLANTS (U.S. CLS. 1 AND 46). FIRST USE 11-15-2001; IN COMMERCE 2-1-2002.

SN 78-108,565. J. L. HONIGBERG & ASSOCIATES, INC., MELROSE PARK, IL. FILED 2-13-2002.

SUN BELLE

FOR FRESH FRUITS AND VEGETABLES (U.S. CLS. 1 AND 46). FIRST USE 11-9-1993; IN COMMERCE 4-19-1994.

SN 78-111,957. REIMER SEEDS, INC., MT. HOLLY, NC. FILED 3-1-2002.



NO CLAIM IS MADE TO THE EXCLUSIVE RIGHT TO USE "SEEDS", APART FROM THE MARK AS SHOWN. FOR PLANT SEEDS (U.S. CLS. 1 AND 46). FIRST USE 3-1-2002; IN COMMERCE 3-1-2002.

CLASS 32—LIGHT BEVERAGES

SN 75-769,148. LABATT BREWING COMPANY LIMITED, TORONTO, ONTARIO, CANADA, FILED 8-6-1999.

BUNGEE

PRIORITY CLAIMED UNDER SEC. 44(D) ON CANADA APPLICATION NO. 1,004,591, FILED 2-8-1999, REG. NO. 560412, DATED 4-18-2002, EXPIRES 4-18-2012.

FOR BREWED MALT-BASED ALCOHOLIC BEVERAGES IN THE NATURE OF BEER WITH FLAVOR (U.S. CLS. 45, 46 AND 48).

SN 76-011,645. DEEB MANAGEMENT LTD., DBA JAFFA CANDIES, BEDFORD PARK, IL. FILED 3-28-2000.

JERICHO WAVE

FOR DRINKING WATER; SPRING WATER; CAFFEINATED AND FLAVORED DRINKING WATER (U.S. CLS. 45, 46 AND 48). FIRST USE 7-0-1997; IN COMMERCE 7-0-1997.

SN 76-020,086. TRIWATER USA, INC., NEPTUNE, NJ. FILED 4-6-2000.



FOR FLAVORED AND UNFLAVORED, CARBONATED AND NON-CARBONATED, OXYGENATED DISTILLED DRINKING WATER (U.S. CLS. 45, 46 AND 48).

SN 76-043,511. ABULJADAYEL BEVERAGES, INC., JEDDAH, SAUDI ARABIA, FILED 5-5-2000.



THE MARK CONSISTS OF THE WORD "CAESAR" AND AN ARBITRARY DEVICE CLAIMING THE COLOR YELLOW.

FOR NATURAL FRUIT JUICES AND NATURAL BLENDED FRUIT AND CARROT JUICES, EXCLUDING TOMATO JUICE (U.S. CLS. 45, 46 AND 48).

CLASS 32—(Continued).

SN 76-067,667. THE TRUSTEES OF AMERICA'S DRIVE-IN TRUST, RENO, NV. FILED 6-8-2000.

SUNSHINE SMOOTHIE

NO CLAIM IS MADE TO THE EXCLUSIVE RIGHT TO USE "SMOOTHIE", APART FROM THE MARK AS SHOWN. FOR SMOOTHIES BLENDED WITH FRUIT OR FRUIT JUICE FOR CONSUMPTION ON OR OFF THE PREMISES (U.S. CLS. 45, 46 AND 48).
FIRST USE 3-1-2000; IN COMMERCE 3-1-2000.

SN 76-075,841. ERBAK-ULUDAG MESRUBAT VE GIDA SANAYI ANONIM SIRKETI, BURSA, TURKEY, BY ASSIGNMENT E.K. IMPORTS, INC., BROOKLYN, NY. FILED 6-22-2000.



THE ENGLISH TRANSLATION OF THE TERM "ULUDAG" IS "OLYMPUS".
FOR LIGHT BEVERAGES, NAMELY, FRUIT FLAVORED SOFT DRINKS (U.S. CLS. 45, 46 AND 48).
FIRST USE 0-0-1994; IN COMMERCE 0-0-1994.

SN 76-113,349. SOUTH FLORIDA WATER TREATMENT CORP., MAIMI, FL. FILED 8-18-2000.



THE SPANISH WORDS "LA COTORRA" TRANSLATES INTO ENGLISH AS "THE COTORRA", WHICH MEANS "THE PUERTO RICAN PARROT".
FOR MINERAL WATER, SPRING WATER, DRINKING WATER AND FRUIT JUICES (U.S. CLS. 45, 46 AND 48).

CLASS 32—(Continued).

SN 76-199,930. INCORPORATED BEVERAGES (JERSEY) LIMITED, ST. HELIER, JERSEY, JE4 8WZ, CHANNEL ISLANDS, FILED 1-25-2001.

ANT

PRIORITY CLAIMED UNDER SEC. 44(D) ON UNITED KINGDOM APPLICATION NO. 2244991, FILED 9-8-2000, REG. NO. 2244991, DATED 9-8-2000, EXPIRES 9-8-2010.
FOR MINERAL AND AERATED WATERS; NON ALCOHOLIC DRINKS, NAMELY, ENERGY AND STIMULATION DRINKS; FRUIT DRINKS AND FRUIT JUICE BEVERAGES; SYRUPS AND PREPARATIONS FOR MAKING ENERGY AND STIMULATION DRINK BEVERAGES (U.S. CLS. 45, 46 AND 48).

SN 76-224,991. MILK PRODUCTS, L.P., DALLAS, TX. FILED 3-15-2001.

GROVE'S PRIDE

FOR ORANGE JUICE, GRAPEFRUIT JUICE (U.S. CLS. 45, 46 AND 48).

SN 76-234,113. SONORAN BLENDS, LLC, ORO VALLEY, AZ. FILED 4-2-2001.

SONORAN BLENDS

NO CLAIM IS MADE TO THE EXCLUSIVE RIGHT TO USE "BLENDS", APART FROM THE MARK AS SHOWN.
FOR NON-ALCOHOLIC FLAVORED BEVERAGES AND MIX CONCENTRATES FOR NON-DIETARY NON-NUTRITIONAL SUPPLEMENT USE, SPECIFICALLY, NON-ALCOHOLIC COCKTAIL MIXES, CONCENTRATES, SYRUPS OR POWDERS USED IN THE PREPARATION OF SOFT DRINKS, FRUIT JUICES AND FRUIT DRINKS (U.S. CLS. 45, 46 AND 48).
FIRST USE 5-1-2000; IN COMMERCE 5-1-2000.

SN 76-269,361. SOCIETE DES PRODUITS NESTLE S.A., 1800 VEVEY, SWITZERLAND, FILED 6-11-2001.



FOR MINERAL WATERS; SOFT DRINKS; FRUIT JUICES; FRUIT JUICE DRINKS CONTAINING WATER; CONCENTRATES, ESSENCES AND SYRUPS FOR USE IN MAKING SOFT DRINKS (U.S. CLS. 45, 46 AND 48).

CLASS 32—(Continued).

SN 76-274,810. PRIVATE LABEL SPECIALTIES LTD.,
GOFFSTOWN, NH. FILED 6-21-2001.

CLASS 32—(Continued).

SN 76-297,543. RPB S.A., (1084) CAPITAL FEDERAL, AR-
GENTINA, FILED 8-10-2001.

PARTYSODA

FOR NON-ALCOHOLIC DRINKS AND BEVERAGES,
NAMESLY, SOFT DRINKS (U.S. CLS. 45, 46 AND 48).
FIRST USE 11-1-1999; IN COMMERCE 1-19-2000.



SN 76-285,138. RED HEAD, INC., DBA CABO WABO
ENTERPRISES, NOVATO, CA. FILED 7-13-2001.

**CABO WABO PLATINUM
BLONDE**

THE TERM "CABO" IS THE SPANISH TRANSLATION
FOR THE ENGLISH WORD "CAPE".
FOR BEER (U.S. CLS. 45, 46 AND 48).

THE MARK IS LINED FOR THE COLORS GREEN AND
RED
THE WORD VIDA MEANS "LIFE" IN ENGLISH.
FOR NON-ALCOHOLIC FRUIT DRINKS CONSISTING
OF FRUIT,FRUIT JUICE AND SOY (U.S. CLS. 45, 46
AND 48).

SN 76-285,379. RED HEAD, INC., DBA CABO WABO
ENTERPRISES, NOVATO, CA. FILED 7-13-2001.

**CABO WABO NATURAL
BLONDE**

THE TERM "CABO" IS SPANISH FOR THE ENGLISH
WORD "CAPE".
FOR BEER (U.S. CLS. 45, 46 AND 48).

SN 76-301,523. AUSTRALIANA GROUP HOLDINGS PTY
LTD., NORTHCOTE VIC.,3070, AUSTRALIA, FILED 8-20-
2001.

SN 76-293,430. SUNTORY WATER GROUP, INC., ATLANTA,
GA. FILED 8-1-2001.



OWNER OF U.S. REG. NOS. 1,750,905, 1,879,984 AND
OTHERS.

NO CLAIM IS MADE TO THE EXCLUSIVE RIGHT TO
USE "GENUINE", APART FROM THE MARK AS SHOWN.
THE STIPPLING IS A FEATURE OF THE MARK AND
DOES NOT INDICATE COLOR.

FOR BOTTLED DRINKING AND SPRING WATER
(U.S. CLS. 45, 46 AND 48).
FIRST USE 7-1-2000; IN COMMERCE 7-1-2000.

FOR MINERAL AND AERATED WATERS AND
OTHER NON-ALCOHOLIC DRINKS, NAMESLY, FRUIT
DRINKS AND FRUIT BASED DRINKS; FRUIT JUICES;
SYRUPS AND OTHER PREPARATIONS FOR MAKING
BEVERAGES, NAMESLY FRUIT BASED DRINKS (U.S.
CLS. 45, 46 AND 48).

CLASS 32—(Continued).

SN 76-314,330. DIAMANT QUELLE KLEE & JUNGBLUT GMBH & CO. KG, D-55767 SCHWOLLEN, FED REP GERMANY, FILED 9-19-2001.



PRIORITY CLAIMED UNDER SEC. 44(D) ON FED REP GERMANY APPLICATION NO. 30122277.0/3, FILED 4-5-2001, REG. NO. 30122277, DATED 7-24-2001, EXPIRES 4-30-2011.

NO CLAIM IS MADE TO THE EXCLUSIVE RIGHT TO USE "FRESH GUARANA", APART FROM THE MARK AS SHOWN.

FOR MINERAL WATERS; AERATED WATERS; NON-ALCOHOLIC BEVERAGES, NAMELY, COLAS, QUININE WATER AND GINGER ALE; FRUIT JUICES; FRUIT JUICE BEVERAGES, NAMELY, FRUIT DRINKS, FRUIT-FLAVORED DRINKS, FRUIT FLAVORED SOFT DRINKS, FRUIT-BASED SOFT DRINKS FLAVORED WITH TEA; LEMONADES; AERATED FRUIT JUICES (U.S. CLS. 45, 46 AND 48).

SN 76-314,963. DUCLAW BREWERY, LLC, TOWSON, MD. FILED 9-20-2001.

MISFIT RED

NO CLAIM IS MADE TO THE EXCLUSIVE RIGHT TO USE "RED", APART FROM THE MARK AS SHOWN.

FOR BEER, ALE AND PORTER (U.S. CLS. 45, 46 AND 48).
FIRST USE 11-0-1997; IN COMMERCE 11-0-1997.

SN 76-318,248. GO GO JUICE COMPANY, AUSTIN, TX. FILED 9-27-2001.

MATADOR ENERGY DRINK

NO CLAIM IS MADE TO THE EXCLUSIVE RIGHT TO USE "ENERGY DRINK", APART FROM THE MARK AS SHOWN.

FOR SOFT DRINK ENRICHED WITH VITAMINS (U.S. CLS. 45, 46 AND 48).
FIRST USE 5-24-2001; IN COMMERCE 9-5-2001.

SN 76-324,334. NATURAL WATERS OF VITI, LTD., ASPEN, CO. FILED 10-11-2001.

A TASTE OF PARADISE

FOR NATURAL, SPRING AND ARTESIAN WATER FOR DRINKING (U.S. CLS. 45, 46 AND 48).
FIRST USE 11-0-1997; IN COMMERCE 11-0-1997.

CLASS 32—(Continued).

SN 76-324,466. WANLIMA INTERNATIONAL CORP., SUN- NYVALE, CA. FILED 10-11-2001.



THE MARK CONSISTS OF THE LETTERS "SHALLOP" WITH "DB" DESIGN.

FOR SPRING AND MINERAL WATER, CARBONATED SOFT DRINKS, BEER, GRAPE AND LEMON FRUIT JUICES, FRUIT JUICE, LEMONADE (U.S. CLS. 45, 46 AND 48).

SN 76-326,148. DREYFUSS, KAREN Y., SIMSBURY, CT. FILED 10-17-2001.

Cool Beats
Natural Spring H₂O



Beat Your Thirst

NO CLAIM IS MADE TO THE EXCLUSIVE RIGHT TO USE "NATURAL SPRING WATER", APART FROM THE MARK AS SHOWN.

FOR BOTTLED SPRING WATER (U.S. CLS. 45, 46 AND 48).
FIRST USE 10-4-2001; IN COMMERCE 10-4-2001.

CLASS 32—(Continued).

SN 76-336,963. SCHULTZ'S CIDER MILL INC., ARMONK, NY. FILED 11-13-2001.



THE STIPPLING IS A FEATURE OF THE MARK AND IS NOT USED TO INDICATE COLORING.
FOR SWEET APPLE CIDER OR JUICE (U.S. CLS. 45, 46 AND 48).

FIRST USE 12-31-1961; IN COMMERCE 12-31-1961.

SN 76-346,336. U.S. SOFT DRINKS INDUSTRIES, INC., MIAMI, FL. FILED 12-10-2001.

LANIO

OWNER OF U.S. REG. NO. 1,198,372.
SEC. 2(F).
FOR CARBONATED SOFT DRINKS (U.S. CLS. 45, 46 AND 48).
FIRST USE 5-17-1978; IN COMMERCE 8-27-1978.

SN 76-348,086. BUFFETT, JIMMY, KEY WEST, FL. FILED 12-11-2001.

MARGARITAVILLE ICE

OWNER OF U.S. REG. NOS. 1,907,542, 2,284,131 AND OTHERS.
NO CLAIM IS MADE TO THE EXCLUSIVE RIGHT TO USE "ICE", APART FROM THE MARK AS SHOWN.
FOR MALT BASED BEVERAGES BREWED IN THE MANNER OF BEER (U.S. CLS. 45, 46 AND 48).

CLASS 32—(Continued).

SN 76-350,580. NINTENDO OF AMERICA INC., REDMOND, WA. FILED 12-18-2001.



NO CLAIM IS MADE TO THE EXCLUSIVE RIGHT TO USE "NEW YORK", APART FROM THE MARK AS SHOWN.
FOR CONCENTRATES, SYRUPS AND POWDERS USED IN THE PREPARATION OF SOFT DRINKS; DRINKING WATER; FRUIT JUICES; FRUIT-FLAVORED DRINKS; LEMONADE; MINERAL WATER; SOFT DRINKS; SPORTS DRINKS; VEGETABLE JUICES BEVERAGES (U.S. CLS. 45, 46 AND 48).

SN 76-351,316. OCEAN SPRAY CRANBERRIES, INC., LAKEVILLE-MIDDLEBORO, MA. FILED 12-20-2001.

¡Y PASALA BERRY BERRY-WELL!

THE ENGLISH TRANSLATION OF "Y PASALA BERRY BERRY-WELL" IS "AND HAVE A BERRY BERRY GOOD TIME".
FOR FRUIT JUICES, FRUIT JUICE DRINKS, CARBONATED NON-ALCOHOLIC SOFT DRINKS (U.S. CLS. 45, 46 AND 48).

SN 76-358,426. LANGER JUICE COMPANY, INC., CITY OF INDUSTRY, CA. FILED 1-14-2002.

HARVEST APPLE

NO CLAIM IS MADE TO THE EXCLUSIVE RIGHT TO USE "APPLE", APART FROM THE MARK AS SHOWN.
FOR FRUIT JUICE COCKTAIL BEVERAGES (U.S. CLS. 45, 46 AND 48).
FIRST USE 4-18-2000; IN COMMERCE 4-18-2000.

SN 76-362,440. THREE PENGUINS BEVERAGE COMPANY, INC., TINLEY PARK, IL. FILED 10-26-2001.

THREE PENGUINS

FOR SPARKLING DRINKING WATER (U.S. CLS. 45, 46 AND 48).
FIRST USE 8-0-1993; IN COMMERCE 8-0-1993.

CLASS 32—(Continued).

SN 76-368,047. ROBBINS, THOMAS M., WAYZATA, MN.
FILED 2-8-2002.

COLD OMAHA

FOR BEER (U.S. CLS. 45, 46 AND 48).

SN 76-372,205. OLD EUROPEAN BREWERY COMPANY,
SAN DIEGO, CA. FILED 2-19-2002.

JOSIAH CUTTER

THE NAME "JOSIAH CUTTER" IDENTIFIES A LIVING
INDIVIDUAL WHOSE CONSENT IS OF RECORD.
FOR BEER (U.S. CLS. 45, 46 AND 48).

SN 76-374,075. MANDISA, INC., EL MONTE, CA. FILED 2-22-
2002.

JELLYADE

FOR NON-ALCOHOLIC DRINKS, NAMELY, FRUIT
FLAVORED DRINKS, FRUIT JUICES, FRUIT JUICE
DRINKS, AND SOFT DRINKS (U.S. CLS. 45, 46 AND 48).

SN 76-377,444. SOUTHERN BEVERAGE PACKERS, INC.,
APPLING, GA. FILED 3-1-2002.

CRYSTALLINE

OWNER OF U.S. REG. NO. 1,981,345.
FOR CARBONATED AND NON-CARBONATED
FRUIT DRINKS (U.S. CLS. 45, 46 AND 48).
FIRST USE 9-0-2001; IN COMMERCE 9-0-2001.

SN 76-381,027. COORS BREWING COMPANY, GOLDEN, CO.
FILED 3-11-2002.



FOR BEER (U.S. CLS. 45, 46 AND 48).

CLASS 32—(Continued).

SN 76-381,619. D'TROFF FOODS, INC., CHARLESTON, SC.
FILED 3-13-2002.

MOLING'S

FOR BEER (U.S. CLS. 45, 46 AND 48).
FIRST USE 1-21-2002; IN COMMERCE 1-21-2002.

SN 76-384,856. RON JON SURF SHOP OF FLA., INC., COCOA
BEACH, FL. FILED 3-18-2002.

RON JON SURF SHOP

OWNER OF U.S. REG. NOS. 1,619,480, 2,365,194 AND
OTHERS.

FOR MINERAL WATERS, AERATED WATERS,
SPRING WATERS AND DRINKING WATERS (U.S.
CLS. 45, 46 AND 48).

SN 78-101,404. MAGIC HAT BREWING COMPANY AND
PERFORMING ARTS CENTER, INC., SOUTH BURLING-
TON, VT. FILED 1-8-2002.

MOTHER

FOR BEER AND ALE (U.S. CLS. 45, 46 AND 48).

SN 78-113,530. TROPICANA PRODUCTS, INC., BRADEN-
TON, FL. FILED 3-8-2002.

**TROPICANA TWISTER
INTENSITY**

OWNER OF U.S. REG. NOS. 617,968, 2,510,655 AND
OTHERS.

FOR FRUIT JUICES AND FRUIT JUICE DRINKS (U.S.
CLS. 45, 46 AND 48).

SN 78-113,594. BONO, STEVEN, BOULDER, CO. FILED 3-8-
2002.

EXPLORE YOUR THIRST

FOR FRUIT JUICE AND BROWN RICE SPORTS
DRINK (U.S. CLS. 45, 46 AND 48).

CLASS 32—(Continued).

SN 78-114,501. PROCUREMENT SYSTEMS INC., BOYNTON BEACH, FL. FILED 3-13-2002.

SOLE SPLASH

FOR COMMERCIAL NON-ALCOHOLIC COCKTAIL MIXES (U.S. CLS. 45, 46 AND 48).

CLASS 33—WINES AND SPIRITS

SN 75-632,731. BODEGAS MONASTERIO, S.L., 11402 JEREZ DE LA FRONTERA (CADIZ), SPAIN, FILED 2-2-1999.



OWNER OF SPAIN REG. NO. 2081278, DATED 5-5-1998, EXPIRES 5-5-2008.
FOR WINES (U.S. CLS. 47 AND 49).
FIRST USE 10-0-1997; IN COMMERCE 10-0-1997.

SN 75-692,114. OPOLO VINEYARDS, INC., WESTLAKE VILLAGE, CA. FILED 4-27-1999.

OPOLO

FOR WINE (U.S. CLS. 47 AND 49).

SN 75-907,281. S SMITH & SON PTY LTD, ANGASTON, SOUTH AUSTRALIA, AUSTRALIA, FILED 2-1-2000.

YALUMBA WILD FERMENT

OWNER OF AUSTRALIA REG. NO. 801215, DATED 7-22-1999, EXPIRES 7-22-2009.

OWNER OF U.S. REG. NO. 2,259,268.
NO CLAIM IS MADE TO THE EXCLUSIVE RIGHT TO USE "WILD FERMENT", APART FROM THE MARK AS SHOWN.

THE ENGLISH TRANSLATION OF "YALUMBA" IS "ALL THE LAND AROUND".

FOR WINES (U.S. CLS. 47 AND 49).

CLASS 33—(Continued).

SN 76-038,334. MORDANT/CONVENTO-SOCIEDADE VITICOLA, S.A., 5120 TABUACO, PORTUGAL, FILED 5-2-2000.

QUINTAS JUNTAS

PRIORITY CLAIMED UNDER SEC. 44(D) ON PORTUGAL APPLICATION NO. 341.102, FILED 11-11-1999, REG. NO. 341.102, DATED 6-4-2001, EXPIRES 6-4-2011.

THE ENGLISH TRANSLATION OF "QUINTAS JUNTAS" IS "JOINED FARMS".

FOR ALCOHOLIC BEVERAGES, NAMELY, WINES AND PORT WINES (U.S. CLS. 47 AND 49).

SN 76-060,019. H.P. BULMER LIMITED, HEREFORD, HR4 OLE, UNITED KINGDOM, FILED 5-30-2000.

SIDEKICK

FOR PREPARED ALCOHOLIC COCKTAILS (U.S. CLS. 47 AND 49).

SN 76-074,144. H.P. BULMER LIMITED, HEREFORD, HR4 OLE, UNITED KINGDOM, FILED 6-20-2000.

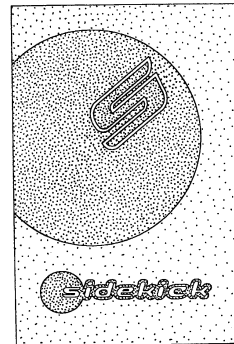

THE STIPLING IN THE DRAWING IS FOR SHADING PURPOSES ONLY AND DOES NOT INDICATE COLOR.
FOR PREPARED ALCOHOLIC COCKTAILS (U.S. CLS. 47 AND 49).

SN 76-076,692. PHILDAN INC., MONTREAL, QUEBEC H3H 1E7, CANADA, FILED 6-23-2000.

STARWOOD

FOR WINES (U.S. CLS. 47 AND 49).

CLASS 33—(Continued).

SN 76-078,789. N. KALOYANNIS BROS S.A., ARGIROUPOLI 16452, GREECE, FILED 6-27-2000.



NO CLAIM IS MADE TO THE EXCLUSIVE RIGHT TO USE "OUZO" AND "1880", APART FROM THE MARK AS SHOWN.

THE MARK CONSISTS OF A DEPICTION OF A SAIL BOAT IN THE WATER WITH HILLS IN THE BACKGROUND, IN GOLD OR WHITE, WITH THE NUMBER 12 SUPERIMPOSED ON IT, ALL ABOVE A RED BLOCK AND ALL OUTLINED WITH A RED LINE; THE RED BLOCK INCLUDES THE WORD "OUZO" AND A CIRCULAR SEAL INCLUDING THE GREEK LETTERS AND THE NUMBER "1880"; THE NUMBER "1880" IS ALSO ABOVE THE SEAL.

FOR OUZO (U.S. CLS. 47 AND 49).

SN 76-133,585. JOSE CUERVO, S.A. DE C.V., ZEDEC SANTA FE DELEGACION A. OBRÉGON, MEXICO, FILED 9-22-2000.

CAFE DE OLLA

NO CLAIM IS MADE TO THE EXCLUSIVE RIGHT TO USE "CAFE", APART FROM THE MARK AS SHOWN.

THE ENGLISH TRANSLATION OF "CAFE DE OLLA" IS "COFFEE IN THE POT".

FOR LIQUEURS (U.S. CLS. 47 AND 49).

CLASS 33—(Continued).

SN 76-144,345. SARL GIACONDA-FAMILLE BRECHET, 84230- CHATEAUNEUF DU PAPE, FRANCE, FILED 10-11-2000.

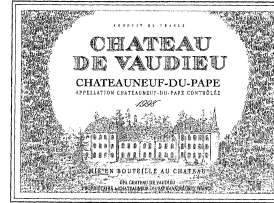

PRIORITY CLAIMED UNDER SEC. 44(D) ON FRANCE APPLICATION NO. 1858364, FILED 9-19-2000, REG. NO. 1858364, DATED 11-6-2001, EXPIRES 9-19-2010.

NO CLAIM IS MADE TO THE EXCLUSIVE RIGHT TO USE "PRODUIT DE FRANCE", "APPELLATION CHATEAUNEUF-DU-PAPE", "APPELLATION CHATEAUNEUF-DU-PAPE CONTROLÉE", "MIS EN BOUTEILLE AU CHATEAU", "PROPRIETAIRE A CHATEAUNEUF-DU-PAPE (VAUCLOSE) FRANCE", APART FROM THE MARK AS SHOWN. THE LINING SHOWN IN THE DRAWING IS A FEATURE OF THE MARK.

THE ENGLISH TRANSLATION OF THE WORDS "PRODUIT DE FRANCE" IS "PRODUCT OF FRANCE". THE ENGLISH TRANSLATION OF THE WORDS "APPELLATION CHATEAUNEUF-DU-PAPE CONTROLÉE" IS "CHATEAUNEUF-DU-PAPE CONTROLLED APPELLATION". THE ENGLISH TRANSLATION OF THE WORDS "MIS EN BOUTEILLE AU CHATEAU" IS "BOTTLE AT THE CHATEAU". THE ENGLISH TRANSLATION OF THE WORDS "PROPRIETAIRE A" IS "OWNER IN".

FOR WINE (U.S. CLS. 47 AND 49).

SN 76-162,558. NUCORP IMPORTS INC., CHICAGO, IL. FILED 11-9-2000.

MAXIMO

FOR TEQUILA (U.S. CLS. 47 AND 49).

FIRST USE 10-24-2000; IN COMMERCE 10-24-2000.

CLASS 33—(Continued).

SN 76-214,575. FERRY ABELL LIMITED, MAIDENHEAD, BERKS, UNITED KINGDOM, FILED 2-22-2001.



THE STIPPLING IS A FEATURE OF THE MARK AND DOES NOT INDICATE COLOR.
 THE NAME PORTRAIT IS NOT REPRESENTATION OF ANY PARTICULAR LIVING INDIVIDUAL.
 THE MARK IS A PORTRAIT OF A CITY GENT.
 FOR DISTILLED SPIRITS AND ALCOHOLIC BEVERAGES, NAMELY, GIN (U.S. CLS. 47 AND 49).

SN 76-217,322. FANUCCI.BARIA.CHARTER OAK WINERY & VINEYARDS, LLC, ST. HELENA, CA. FILED 2-28-2001.

CHARTER OAK WINERY

NO CLAIM IS MADE TO THE EXCLUSIVE RIGHT TO USE "WINERY", APART FROM THE MARK AS SHOWN.
 FOR WINE (U.S. CLS. 47 AND 49).
 FIRST USE 7-20-1990; IN COMMERCE 11-15-1992.

SN 76-226,813. PARKER, CHRISTOPHER R., SURREY GU4 8JW, UNITED KINGDOM, FILED 3-13-2001.

UTKINS U.K.5

FOR DISTILLED SPIRITS AND LIQUEURS (U.S. CLS. 47 AND 49).
 FIRST USE 9-17-2001; IN COMMERCE 9-17-2001.

SN 76-231,776. BELE CASEL DI FERRARO DANILO & C. S.A.S., 31031 CAERANO DI SAN MARCO, ITALY, FILED 3-18-2001.

BELE CASEL

PRIORITY CLAIMED UNDER SEC. 44(D) ON ITALY APPLICATION NO. MI2001C00212, FILED 2-26-2001, REG. NO. 00858339, DATED 1-30-2002, EXPIRES 2-26-2011.
 FOR WINES, SPIRITS, LIQUOR (U.S. CLS. 47 AND 49).

CLASS 33—(Continued).

SN 76-234,462. COUNCIL OF SCIENTIFIC & INDUSTRIAL RESEARCH, NEW DELHI-110001, INDIA, FILED 3-28-2001.

HIGHSTREET SPECIAL

FOR ALCOHOLIC BEVERAGES, NAMELY, WINES (U.S. CLS. 47 AND 49).

SN 76-240,508. DE BORTOLI WINES U.S.A., INC., DOUGLASVILLE, GA. FILED 4-16-2001.



SEC. 2(F).
 FOR WINES (U.S. CLS. 47 AND 49).
 FIRST USE 1-0-1924; IN COMMERCE 0-0-1997.

SN 76-262,101. JACK DANIEL'S PROPERTIES, INC., SAN RAFAEL, CA. FILED 5-24-2001.

GREAT AMERICAN TAILGATE PARTY

OWNER OF U.S. REG. NO. 2,518,234.
 FOR ALCOHOLIC BEVERAGES, NAMELY DISTILLED SPIRITS (U.S. CLS. 47 AND 49).
 FIRST USE 10-0-1999; IN COMMERCE 10-0-1999.

CLASS 33—(Continued).

SN 76-269,938. SOCIETE A.S., 51190 MESNIL SUR OGER, FRANCE, FILED 6-11-2001.



PRIORITY CLAIMED UNDER SEC. 44(D) ON ERP N CMNTY TM OFC APPLICATION NO. 002017705, FILED 12-13-2000, REG. NO. 2017705, DATED 2-12-2002, EXPIRES 2-12-2012.

COLOR IS CLAIMED A FEATURE OF THE MARK. THE BACKGROUND OF THE DRAWING IS DARK GREEN WITH A GOLD RECTANGLE JUST INSIDE THE BORDER. THE WORD "SALON" IN THE MARK IS WHITE. THE "S" COMPONENT OF THE DRAWING IS A MOTTLED BROWN AND OUTLINED IN GOLD.

FOR ALCOHOLIC BEVERAGES, NAMELY WINE, CHAMPAGNE, AND PREPARED ALCOHOLIC COCKTAILS (U.S. CLS. 47 AND 49).

SN 76-272,699. BRL HARDY LIMITED, REYNELLA, SOUTH AUSTRALIA, AUSTRALIA, FILED 6-15-2001.

FLIRT

OWNER OF AUSTRALIA REG. NO. 841352, DATED 7-5-2000, EXPIRES 7-5-2010.
FOR WINES (U.S. CLS. 47 AND 49).

SN 76-274,190. VINA SANTA CAROLINA S.A., SANTIAGO, CHILE, FILED 6-20-2001.

NEBLUS

FOR WINES (U.S. CLS. 47 AND 49).

CLASS 33—(Continued).

SN 76-278,009. PARKER ESTATES PTY LIMITED, NEW SOUTH WALES, AUSTRALIA, FILED 6-28-2001.

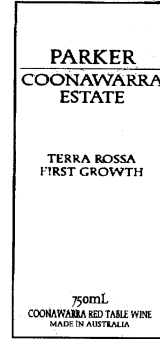

NO CLAIM IS MADE TO THE EXCLUSIVE RIGHT TO USE "COONAWARRA ESTATE TERRA ROSSA FIRST GROWTH 750ML COONAWARRA RED TABLE WINE" AND "MADE IN AUSTRALIA", APART FROM THE MARK AS SHOWN.

THE ENGLISH TRANSLATION OF "COONAWARRA" IS "HONEYSUCKLE" AND THE ENGLISH TRANSLATION OF "TERRA ROSSA" IS "RED EARTH".

FOR WINE (U.S. CLS. 47 AND 49).
FIRST USE 0-0-1992; IN COMMERCE 0-0-1992.

SN 76-279,117. VINA MANQUEHUE S.A., SAN JOAQUIN SANTIAGO, CHILE, FILED 7-2-2001.

CUVEE FREZIER

NO CLAIM IS MADE TO THE EXCLUSIVE RIGHT TO USE "CUVEE", APART FROM THE MARK AS SHOWN.

THE ENGLISH TRANSLATION OF THE WORD "CUVEE" IN THE MARK IS "VINTAGE".

FOR WINES AND SPARKLING WINES (U.S. CLS. 47 AND 49).

SN 76-279,420. CUSUMANO S.R.L, TRAPANI, ITALY, FILED 7-2-2001.

ANGIMBE'

FOR WINES (U.S. CLS. 47 AND 49).

SN 76-279,421. CUSUMANO S.R.L, TRAPANI, ITALY, FILED 7-2-2001.

BENUARA

FOR WINES (U.S. CLS. 47 AND 49).

CLASS 33—(Continued).

SN 76-289,813. BORG SCOPETO S.R.L., VIA MONTANINI, 54, ITALY, FILED 7-13-2001.



PRIORITY CLAIMED UNDER SEC. 44(D) ON ITALY APPLICATION NO. MI2001C00598, FILED 5-29-2001, REG. NO. 852048, DATED 9-19-2001, EXPIRES 5-29-2011.

THE MARK CONSISTS OF THE WORDS "BORGONERO BORG SCOPETO" BELOW A SILHOUETTE OF A VILLAGE AND ABOVE A DIAMOND SHAPE CONTAINING A DARKENED CIRCLE, ALL ENCLOSED IN A RECTANGLE. THE ENGLISH TRANSLATION OF "BORGONERO" IS "BLACK VILLAGE".

FOR WINE (U.S. CLS. 47 AND 49).

SN 76-291,042. LA COMPAGNIE RHODANIENNE, 30210 REMOULINS, FRANCE, FILED 7-27-2001.

LOUXOR

FOR WINES (U.S. CLS. 47 AND 49).
FIRST USE 10-0-2000; IN COMMERCE 3-0-2001.

SN 76-294,003. CAMPO MANSO, S.A., CAPITAL FEDERAL ARGENTINA, ARGENTINA, FILED 8-2-2001.

VAL DE FLORES

THE ENGLISH TRANSLATION OF "VAL DE FLORES" IS "FLOWER VALLEY".

FOR ALCOHOLIC BEVERAGES, NAMELY, WINES, SPARKLING WINES (U.S. CLS. 47 AND 49).

SN 76-296,444. JIM BEAM BRANDS CO., DEERFIELD, IL, FILED 8-8-2001.

REAL FRIENDS. REAL BOURBON.

NO CLAIM IS MADE TO THE EXCLUSIVE RIGHT TO USE "BOURBON", APART FROM THE MARK AS SHOWN. FOR BOURBON (U.S. CLS. 47 AND 49).
FIRST USE 9-6-1999; IN COMMERCE 9-1-2000.

CLASS 33—(Continued).

SN 76-312,222. APPLEBEE'S INTERNATIONAL, INC., OVERLAND PARK, KS. FILED 9-13-2001.



OWNER OF U.S. REG. NO. 2,379,470.

NO CLAIM IS MADE TO THE EXCLUSIVE RIGHT TO USE "MUDSLIDE", APART FROM THE MARK AS SHOWN. THE STIPLING IN THE DRAWING IS FOR SHADING PURPOSES ONLY.

THE ENGLISH TRANSLATION OF "MUCHO" IS "MUCH, MANY, A LOT".

FOR PREPARED ALCOHOLIC BEVERAGES SERVED ON THE PREMISES (U.S. CLS. 47 AND 49).

FIRST USE 8-6-2001; IN COMMERCE 8-6-2001.

SN 76-318,756. SAMPSON, TIMOTHY, DBA YELLOW HAWK CELLAR, WALLA WALLA, WA. FILED 9-28-2001.

YELLOW HAWK CELLAR

NO CLAIM IS MADE TO THE EXCLUSIVE RIGHT TO USE "CELLAR", APART FROM THE MARK AS SHOWN.

FOR WINE (U.S. CLS. 47 AND 49).

FIRST USE 4-28-2000; IN COMMERCE 9-5-2000.

SN 76-337,234. BOULDER IMPORTS, LLC, BOULDER, CO. FILED 11-12-2001.

OTOMI

FOR ALCOHOLIC BEVERAGE PRODUCED FROM A BREWED MAGUEY BASE WITH NATURAL AND FRUIT FLAVORS (U.S. CLS. 47 AND 49).

SN 76-338,538. FINE ESTATES FROM SPAIN, INC., DEDHAM, MA. FILED 11-15-2001.

VENTA MORALES

THE ENGLISH TRANSLATION OF "VENTA MORALES" IS "MORALES ROADSIDE INN".

FOR RED WINE (U.S. CLS. 47 AND 49).

CLASS 33—(Continued).

SN 76-338,995. NATIONAL DISTILLERS PRODUCTS COMPANY, LLC., TAPPAN, NY. FILED 11-19-2001.

PELO DE LOBO

THE ENGLISH TRANSLATION OF "PELO DE LOBO" IS "HAIR OF THE WOLF".
FOR LIQUOR, NAMELY, AGUARDIENTE AND TEQUILA (U.S. CLS. 47 AND 49).

SN 76-347,891. EXTREME BEVERAGE COMPANY, LLC, BRENTWOOD, TN. FILED 12-11-2001.

EXTREME BUMPY

FOR DISTILLED ALCOHOLIC BEVERAGES, NAMELY, LIQUOR AND SPIRITS (U.S. CLS. 47 AND 49).

SN 76-348,091. BUFFETT, JIMMY, KEY WEST, FL. FILED 12-11-2001.

MARGARITAVILLE RITA

OWNER OF U.S. REG. NOS. 1,907,542, 2,284,131 AND OTHERS.
FOR FLAVORED ALCOHOLIC BEVERAGES PRODUCED FROM A BREWED MALT BASE (U.S. CLS. 47 AND 49).

SN 76-355,743. F.LLI LOMBARDO FU GIUSEPPE E C. S.A.S. DI GIUSEPPE LOMBARDO, 91025 MARSALA, TRAPANI, ITALY, FILED 1-4-2002.

MARINI

"MARINI" IS THE PLURAL FORM OF THE ITALIAN WORD MARINO, AN ADJECTIVE MEANING "COMING FROM OR HAVING A CONNECTION WITH THE SEA".

FOR WINES AND ALCOHOLIC BEVERAGES—NAMELY, MARSALA AND CREMOVO (U.S. CLS. 47 AND 49).

FIRST USE 2-0-1994; IN COMMERCE 11-15-2001.

SN 76-363,018. GREEN AND HURON L.P., SAN ANTONIO, TX. FILED 1-25-2002.

BACI MEDITERRANEAN MARGARITA

NO CLAIM IS MADE TO THE EXCLUSIVE RIGHT TO USE "MARGARITA", APART FROM THE MARK AS SHOWN.

THE ENGLISH TRANSLATION OF THE WORD "BACI" IN THE MARK IS "KISS"

FOR DRINKS, NAMELY, PREPARED ALCOHOLIC COCKTAILS (U.S. CLS. 47 AND 49).

CLASS 33—(Continued).

SN 76-365,880. GRAY GHOST VINEYARDS, AMISSVILLE, VA. FILED 2-4-2002.

GRAY GHOST

FOR WINES (U.S. CLS. 47 AND 49).
FIRST USE 7-0-1994; IN COMMERCE 7-0-1994.

SN 76-374,631. VINEDOS ERRAZURIZ OVALLE S.A., SANTIAGO, CHILE, FILED 2-25-2002.

PANILONCO

FOR WINE (U.S. CLS. 47 AND 49).

SN 76-378,237. SPIRIT IMPORTS, INC., SUNRISE, FL. FILED 3-4-2002.

THE SCOTCH MALT WHISKY SOCIETY THE VAULTS LEITH SCOTLAND

NO CLAIM IS MADE TO THE EXCLUSIVE RIGHT TO USE "THE SCOTCH MALT WHISKY SOCIETY" AND "LEITH SCOTLAND", APART FROM THE MARK AS SHOWN.

FOR SCOTCH WHISKY (U.S. CLS. 47 AND 49).
FIRST USE 10-1-1983; IN COMMERCE 6-30-1993.

SN 76-380,529. BERINGER BLASS WINE ESTATES COMPANY, NAPA, CA. FILED 3-11-2002.

HEIRLOOM

FOR WINE (U.S. CLS. 47 AND 49).

SN 76-380,881. HARTFORD-JACKSON, LLC, WINDSOR, CA. FILED 3-8-2002.

SEVENS BENCH

FOR WINES (U.S. CLS. 47 AND 49).
FIRST USE 9-4-2001; IN COMMERCE 9-4-2001.

CLASS 33—(Continued).

SN 76-380,882. HARTFORD-JACKSON, LLC, WINDSOR, CA.
FILED 3-8-2002.

VELVET SISTERS

FOR WINES (U.S. CLS. 47 AND 49).
FIRST USE 9-4-2001; IN COMMERCE 9-4-2001.

SN 76-383,755. LIVE SPIRITS, INC., LIVINGSTON, NJ. FILED
3-14-2002.

INFINITE MONKEYS

FOR LIQUOR; VODKA, RUM AND GIN (U.S. CLS. 47
AND 49).

SN 76-383,988. F. KORBEL & BROS., GUERNEVILLE, CA.
FILED 3-19-2002.

APPELLATION PASSIONATE

FOR WINES (U.S. CLS. 47 AND 49).

SN 76-383,989. F. KORBEL & BROS., GUERNEVILLE, CA.
FILED 3-19-2002.

APPELLATION PASSION

FOR WINES (U.S. CLS. 47 AND 49).

SN 76-384,373. CHILEAN WINE IMPORTS, L.L.C., SAN
ANTONIO, TX. FILED 3-19-2002.

WINECHIL

FOR WINE (U.S. CLS. 47 AND 49).

SN 76-387,866. LIVE SPIRITS, INC., LIVINGSTON, NJ. FILED
3-26-2002.

INFINITE SPIRITS

FOR LIQUOR; VODKA, RUM AND GIN (U.S. CLS. 47
AND 49).

CLASS 33—(Continued).

SN 78-040,740. VEGA DE TORO, S.L., SAN VICENTE DE LA
SONSIERRA (LA RIOJA), SPAIN, FILED 12-27-2000.

NUMANTHIA

OWNER OF SPAIN REG. NO. 2246321, DATED 2-7-2000,
EXPIRES 7-9-2009.
FOR WINES AND DISTILLED LIQUORS (U.S. CLS. 47
AND 49).

SN 78-066,011. STONY BAY WINES LIMITED, HAVELOCK
NORTH, NEW ZEALAND, FILED 5-27-2001.

MATARIKI

OWNER OF NEW ZEALAND REG. NO. 277797, DATED 6-
5-1997, EXPIRES 6-5-2004.
FOR WINES AND DISTILLED SPIRITS (U.S. CLS. 47
AND 49).

SN 78-066,707. S.C.E.A. DOMAINE JULIETTE AVRIL, CHA-
TEAUNEUF DU PAPE, FRANCE, FILED 5-31-2001.

DOMAINE JULIETTE AVRIL

OWNER OF FRANCE REG. NO. 1236547, DATED 5-16-
1983, RENEWED AS REG. NO. 123547, DATED 5-14-1993,
EXPIRES 5-14-2003.

"JULIETTE AVRIL" IDENTIFIES A LIVING INDIVIDUAL
WHOSE CONSENT IS OF RECORD.

THE ENGLISH TRANSLATION OF "DOMAINE" IS "DO-
MAIN".

FOR WINES (U.S. CLS. 47 AND 49).

SN 78-077,225. S.A. PERE ROVIRA ROVIRA, STA. MARGAR-
IDA I ELS MONJOS, SPAIN, FILED 8-2-2001.

CLOS FONTÀ

FOR ALCOHOLIC BEVERAGES EXCLUDING BEERS,
NAMELY, APERITIF BITTERS, PREPARED COCK-
TAILS, LIQUEURS, DISTILLED SPIRITS, AND WINES
(U.S. CLS. 47 AND 49).

CLASS 33—(Continued).

SN 78-078,399. SOCIETE CIVILE MAS AMIEL, MAURY, FRANCE, FILED 8-9-2001.



PRIORITY CLAIMED UNDER SEC. 44(D) ON FRANCE APPLICATION NO. 013083171, FILED 2-15-2001, REG. NO. 013083171, DATED 2-15-2001, EXPIRES 2-15-2011.

NO CLAIM IS MADE TO THE EXCLUSIVE RIGHT TO USE "CUVEE SPECIALE" AND "10 ANS D' AGE", APART FROM THE MARK AS SHOWN.

THE MARK CONSISTS OF A BROWN BACKGROUND WITH THE LETTERS "MA" APPEARING IN BLUE OVER THE WORDS "MAS AMIEL" AND "CUVEE SPECIALE 10 ANS D'AGE" APPEARING IN BLACK.

THE ENGLISH TRANSLATION OF WORDING "CUVEE SPECIALE 10 ANS D'AGE" IS "10 YEAR OLD SPECIAL CUVÉE".

FOR ALCOHOLIC BEVERAGES, NAMELY, WINES (U.S. CLS. 47 AND 49).

SN 78-092,454. NUBECO, L.L.C., EMERYVILLE, CA. FILED 11-8-2001.

MENEHUNE JUICE

OWNER OF U.S. REG. NO. 1,177,644.
NO CLAIM IS MADE TO THE EXCLUSIVE RIGHT TO USE "JUICE", APART FROM THE MARK AS SHOWN.

THE ENGLISH TRANSLATION OF THE WORD "MENEHUNE" IN THE MARK IS "LEGENDARY LITTLE PEOPLE OF HAWAIIAN FOLKLORE".

FOR RUM BASED COCKTAILS FOR CONSUMPTION ON AND OFF THE PREMISES (U.S. CLS. 47 AND 49).
FIRST USE 0-0-1952; IN COMMERCE 0-0-1952.

CLASS 33—(Continued).

SN 78-102,200. EXTREME BEVERAGE LLC, BRENTWOOD, TN. FILED 1-11-2002.



FOR DISTILLED ALCOHOLIC BEVERAGES, NAMELY, LIQUORS AND SPIRITS (U.S. CLS. 47 AND 49).

SN 78-102,462. DESTILERIA SERRALLES, INC., MERCEDITA, PUERTO RICO, FILED 1-14-2002.

DON Q LIMON

OWNER OF U.S. REG. NOS. 341,119 AND 2,104,164.
NO CLAIM IS MADE TO THE EXCLUSIVE RIGHT TO USE "LIMON", APART FROM THE MARK AS SHOWN.
THE ENGLISH TRANSLATION OF "LIMON" IS "LEMON".

FOR RUM (U.S. CLS. 47 AND 49).

SN 78-107,015. BRL HARDY LIMITED, SOUTH AUSTRALIA, AUSTRALIA, FILED 2-5-2002.

FATHER WOODS

FOR WINES (U.S. CLS. 47 AND 49).

SN 78-107,583. RUSSELL, ERICH, SAN FRANCISCO, CA. FILED 2-8-2002.

LE LAPIN

THE ENGLISH TRANSLATION OF THE WORD "LE LAPIN" IN THE MARK IS "THE RABBIT".
FOR WINE (U.S. CLS. 47 AND 49).

CLASS 33—(Continued).

SN 78-109,638. AMERICAN INTERNATIONAL IMPORT EXPORT CORPORATION, BOCA RATON, FL. FILED 2-19-2002.

PETER THE GREAT

THE NAME "PETER THE GREAT" IN THE MARK DOES NOT IDENTIFY A LIVING INDIVIDUAL. FOR VODKA (U.S. CLS. 47 AND 49).

SN 78-109,643. AMERICAN INTERNATIONAL IMPORT EXPORT CORPORATION, BOCA RATON, FL. FILED 2-19-2002.

CATHERINE THE GREAT

THE NAME "CATHERINE THE GREAT" IN THE MARK DOES NOT IDENTIFY A LIVING INDIVIDUAL. FOR VODKA (U.S. CLS. 47 AND 49).

SN 78-109,651. AMERICAN INTERNATIONAL IMPORT EXPORT CORPORATION, BOCA RATON, FL. FILED 2-19-2002.

COUNT ORLOV

THE LIKENESS (OR, "PORTRAIT") IN THE MARK DOES NOT IDENTIFY A LIVING INDIVIDUAL. FOR VODKA (U.S. CLS. 47 AND 49).

SN 78-111,656. DE LA CRUZ, PAULA, NEW YORK, NY. FILED 2-28-2002.

CAVAS Y ALMAS DEL AMANCAY

THE ENGLISH TRANSLATION OF THE MARK IS "CELLARS AND SOULS OF THE YELLOW NARCISSUS". FOR WINE (U.S. CLS. 47 AND 49).

SN 78-112,072. PARAGON VINEYARD CO., INC., SAN LUIS OBISPO, CA. FILED 3-1-2002.

FOXMOOR

FOR WINE (U.S. CLS. 47 AND 49).

CLASS 33—(Continued).

SN 78-112,201. CORBETT, CORNELIUS P., ST. HELENA, CA. FILED 3-3-2002.

VIOGRAH

FOR ALCOHOLIC BEVERAGES, NAMELY, WINE (U.S. CLS. 47 AND 49).

SN 78-113,614. WHITE, PAUL L., LA JOLLA, CA. FILED 3-8-2002.

WOOD HORSES

FOR WINE (U.S. CLS. 47 AND 49).

CLASS 34—SMOKERS' ARTICLES

SN 75-719,571. ROTHMANS, BENSON & HEDGES INC., NORTH YORK, ONTARIO M3B 3L1, CANADA, FILED 6-2-1999.

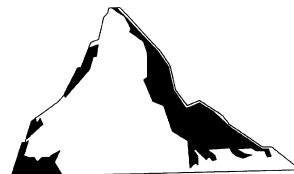

PRIORITY CLAIMED UNDER SEC. 44(D) ON CANADA APPLICATION NO. 1010967, FILED 4-6-1999, REG. NO. TMA542288, DATED 3-13-2001, EXPIRES 3-13-2016.

THE MARK CONSISTS OF A STYLIZED REPRESENTATION OF THE MATTERHORN MOUNTAIN.

FOR MANUFACTURED TOBACCO PRODUCTS, NAMELY CIGARETTES AND FINE CUT TOBACCO (U.S. CLS. 2, 8, 9 AND 17).

CLASS 34—(Continued).

SN 75-881,872. KERFOOT INDUSTRIES INTERNATIONAL, LTD., ROAD TOWN, TORTOLA, BR. VIRGIN ISLANDS, BY ASSIGNMENT O'DONNELL, MICHAEL OWEN, FULWOOD, PRESTON, PR2 8NS, ENGLAND, FILED 12-22-1999.

19TH HOLE

PRIORITY CLAIMED UNDER SEC. 44(D) ON UNITED KINGDOM APPLICATION NO. 2200884, FILED 6-22-1999, REG. NO. 2200884, DATED 12-10-1999, EXPIRES 6-22-2009.

FOR CIGARETTES, TOBACCO, CIGARS, SMOKING PIPES, ASHTRAYS NOT OF PRECIOUS METAL, CIGAR CASES NOT OF PRECIOUS METAL, CIGARETTE CASES NOT OF PRECIOUS METAL, CHEWING TOBACCO, CIGAR CUTTERS, CIGAR HOLDERS NOT OF PRECIOUS METAL, CIGARETTE FILTERS, CIGARETTE HOLDERS, CIGARETTE PAPERS, CIGARETTE TIPS, POCKET MACHINES FOR ROLLING CIGARETTES, MATCHBOXES NOT OF PRECIOUS METAL, MATCH HOLDERS NOT OF PRECIOUS METAL, PIPE CLEANERS, PIPE RACKS, TOBACCO POUCHES, TOBACCO JARS, MATCHES, CIGARETTE, CIGAR AND PIPE LIGHTERS (U.S. CLS. 2, 8, 9 AND 17).

SN 76-119,394. SASKA CORP., JERSEY CITY, NJ. FILED 8-21-2000.

HANA

FOR CIGARETTES, TOBACCO, MATCHES AND CIGARETTE LIGHTERS NOT MADE OF PRECIOUS METAL (U.S. CLS. 2, 8, 9 AND 17).

SN 76-237,225. ROBERT BURTON ASSOCIATES LTD, WEST CALDWELL, NJ. FILED 4-9-2001.



OWNER OF U.S. REG. NOS. 1,087,438, 1,399,769 AND 1,399,770.
FOR CIGARETTE PAPERS (U.S. CLS. 2, 8, 9 AND 17).
FIRST USE 7-0-1999; IN COMMERCE 7-0-1999.

CLASS 34—(Continued).

SN 76-237,226. ROBERT BURTON ASSOCIATES LTD., WEST CALDWELL, NJ. FILED 4-9-2001.

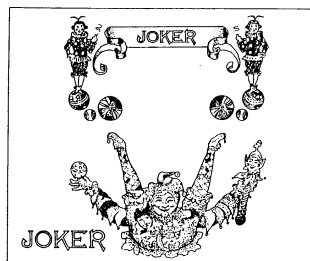

OWNER OF U.S. REG. NOS. 1,087,438, 1,399,769 AND 1,399,770.
FOR CIGARETTE PAPERS (U.S. CLS. 2, 8, 9 AND 17).
FIRST USE 1-0-1997; IN COMMERCE 1-0-1997.

SN 76-239,499. SANTA FE NATURAL TOBACCO COMPANY, INC., SANTA FE, NM. FILED 4-12-2001.



OWNER OF U.S. REG. NOS. 1,759,227 AND 2,081,507.
THE MARK CONSISTS OF THE STYLIZED WORDS "NATURAL AMERICAN SPIRIT" AND THE DESIGN OF AN INDIAN CHIEF ON AN ORANGE BACKGROUND. THE ORANGE COLOR IS APPROXIMATELY PMS 1375. COLOR IS CLAIMED AS A FEATURE OF THE MARK.
SEC. 2(F) AS TO "NATURAL".
FOR CIGARETTES (U.S. CLS. 2, 8, 9 AND 17).
FIRST USE 9-0-1998; IN COMMERCE 9-0-1998.

SN 76-243,619. ONEWORLD ENTERPRISES LIMITED, KOWLOON BAY, HONG KONG, FILED 4-18-2001.

LIGHTER THAN AIR

FOR COMBINATION ASHTRAY CIGARETTE LIGHTER NOT OF PRECIOUS METAL (U.S. CLS. 2, 8, 9 AND 17).

CLASS 34—(Continued).

SN 76-271,463. GMB, INC., KING, NC. FILED 6-13-2001.

EASTON

FOR CIGARETTES (U.S. CLS. 2, 8, 9 AND 17).

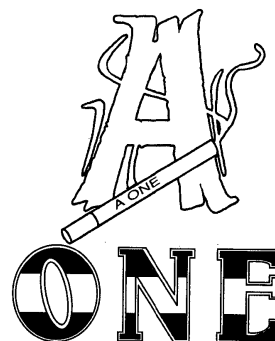
SN 76-286,774. LORILLARD LICENSING COMPANY, LLC,
GREENSBORO, NC. FILED 7-17-2001.**NEWPORT**OWNER OF U.S. REG. NOS. 1,108,816, 2,040,567 AND
OTHERS.FOR CIGARETTES (U.S. CLS. 2, 8, 9 AND 17).
FIRST USE 3-0-2000; IN COMMERCE 3-0-2000.SN 76-300,390. HUGO BOSS AG, 72555 METZINGEN, FED
REP GERMANY, FILED 8-16-2001.**BOSS HUGO BOSS**OWNER OF FED REP GERMANY REG. NO. 1108880,
DATED 7-17-1987, EXPIRES 5-31-2007.FOR TOBACCO PRODUCTS, NAMELY CIGARETTES,
CIGARS AND TOBACCO FOR SMOKING; CIGARETTE
PAPERS AND CASES; ARTICLES FOR SMOKERS,
NAMELY SNUFF BOXES, CIGAR AND CIGARETTE
HOLDERS, CIGAR AND CIGARETTE CASES, ASH-
TRAYS, CIGARETTE LIGHTERS; ALL NOT MADE OF
PRECIOUS METAL, PRECIOUS METAL ALLOYS OR
PLATED WITH PRECIOUS METALS; MATCHES (U.S.
CLS. 2, 8, 9 AND 17).SN 76-301,862. C.A.O. INTERNATIONAL, INC., NASHVILLE,
TN. FILED 8-20-2001.OWNER OF U.S. REG. NO. 2,108,848.
NO CLAIM IS MADE TO THE EXCLUSIVE RIGHT TO
USE "BRASILIA", APART FROM THE MARK AS SHOWN.
FOR CIGARS (U.S. CLS. 2, 8, 9 AND 17).**CLASS 34—(Continued).**SN 76-302,355. THOMPSON & CO. OF TAMPA, INC., TAMPA,
FL. FILED 8-20-2001.**THOMPSON COROJO
CUBANO**OWNER OF U.S. REG. NO. 1,069,489.
NO CLAIM IS MADE TO THE EXCLUSIVE RIGHT TO
USE "COROJO CUBANO", APART FROM THE MARK AS
SHOWN.THE WORD "COROJO" MAY BE TRANSLATED FROM
SPANISH TO ENGLISH AS "A PLANT FROM WHICH ROPE
IS MADE", AND THE WORD "CUBANO" MAY BE TRAN-
SLATED FROM SPANISH TO ENGLISH AS "CUBAN".SEC. 2(F) AS TO "THOMPSON".
FOR CIGARS CONTAINING TOBACCO GROWN
FROM CUBAN SEED (U.S. CLS. 2, 8, 9 AND 17).SN 76-348,469. TWINKLE, INC., DEKALB, IL. FILED 12-13-
2001.FOR CIGARETTES (U.S. CLS. 2, 8, 9 AND 17).
FIRST USE 12-7-2001; IN COMMERCE 12-7-2001.SN 76-352,404. TMG WORLDWIDE GROUP, LTD., SAN
DIEGO, CA. FILED 12-26-2001.NO CLAIM IS MADE TO THE EXCLUSIVE RIGHT TO
USE "CIGARETTES", APART FROM THE MARK AS
SHOWN.
FOR CIGARETTES (U.S. CLS. 2, 8, 9 AND 17).

CLASS 34—(Continued).

SN 76-352,495. BWT BRANDS, INC., MACON, GA. FILED 12-21-2001.



OWNER OF U.S. REG. NOS. 508,538, 2,365,105 AND OTHERS.

THE STIPPLING IS FOR SHADING PURPOSES ONLY, AND DOES NOT DESIGNATE COLOR.

THE DOTTED LINE SURROUNDING THE MARK IS USED TO DESIGNATE POSITION ONLY, AND IS NOT A PART OF THE MARK AS SHOWN.

FOR CIGARETTES (U.S. CLS. 2, 8, 9 AND 17).

SN 76-359,785. NORRIS, DAN, CASTLE HAYNE, NC. FILED 1-17-2002.

POISON, INC.

FOR CIGARETTES (U.S. CLS. 2, 8, 9 AND 17).

SN 76-370,403. STAR SCIENTIFIC, INC., CHESTER, VA. FILED 2-14-2002.

CIGALESS

FOR TOBACCO AND TOBACCO RELATED PRODUCTS, NAMELY, SNUFF, SMOKELESS TOBACCO, CHEWING TOBACCO AND COMPRESSED TOBACCO (U.S. CLS. 2, 8, 9 AND 17).

SN 76-383,731. ZIMPEX CO. LTD., GRAND CAYMAN, CAYMAN ISLANDS, FILED 3-19-2002.

SHOGUN

FOR CIGARETTES, TOBACCO, MATCHES AND CIGARETTE LIGHTERS NOT MADE OF PRECIOUS METAL (U.S. CLS. 2, 8, 9 AND 17).

CLASS 34—(Continued).

SN 76-383,732. ZIMPEX CO. LTD., GRAND CAYMAN, CAYMAN ISLANDS, FILED 3-19-2002.

KUNGFU

FOR CIGARETTES, TOBACCO, MATCHES AND CIGARETTE LIGHTERS NOT MADE OF PRECIOUS METAL (U.S. CLS. 2, 8, 9 AND 17).

SN 76-384,576. TWINKLE, INC., DEKALB, IL. FILED 3-20-2002.

HAT'S OFF

FOR LOOSE TOBACCO (U.S. CLS. 2, 8, 9 AND 17).

SN 78-079,284. SOUTHEAST IMPORTERS, DELCAMBRE, LA. FILED 8-15-2001.

CIGARDIAN

FOR HUMIDORS (U.S. CLS. 2, 8, 9 AND 17). FIRST USE 12-1-1999; IN COMMERCE 12-1-1999.

SN 78-080,824. EGAN, DENNIS H., LEMONT, IL. FILED 8-23-2001.

SAN FELIPE

FOR CIGARS (U.S. CLS. 2, 8, 9 AND 17).

SN 78-113,664. RAVO, DAVID, LOS ANGELES, CA. AND RAVO, AARON, LOS ANGELES, CA. FILED 3-8-2002.



FOR ASHTRAYS, CIGARETTE LIGHTERS AND MATCHBOXES NOT OF PRECIOUS METAL, AND MATCHES (U.S. CLS. 2, 8, 9 AND 17).

CLASS 34—(Continued).

CLASS 35—(Continued).

SN 75-096,678. CREATIVE COMPUTERS, INC., TORRANCE, CA. FILED 4-30-1996.

SERVICE MARKS

PC MALL

CLASS 35—ADVERTISING AND BUSINESS

SN 75-058,493. TRANS-HIGH CORPORATION, INC., NEW YORK, NY. FILED 2-15-1996.

OWNER OF U.S. REG. NOS. 2,006,944, 2,247,889 AND OTHERS.
SEC. 2(F).

FOR DISSEMINATING ADVERTISING FOR OTHERS AND PROMOTING THE GOODS AND SERVICES OF OTHERS VIA ON-LINE TELECOMMUNICATIONS NETWORKS; RETAIL STORE SERVICES, OFFERED THROUGH INDIVIDUAL, SPECIALIZED RETAIL ESTABLISHMENTS, FEATURING COMPUTER-RELATED PRODUCTS, NAMELY, COMPUTER HARDWARE, SOFTWARE, PERIPHERALS, ACCESSORIES, SUPPLIES, BOOKS AND INSTRUCTIONAL MATERIALS; ELECTRONIC RETAILING SERVICES VIA COMPUTER FEATURING COMPUTER-RELATED PRODUCTS, NAMELY, COMPUTER HARDWARE, SOFTWARE, PERIPHERALS, ACCESSORIES, SUPPLIES, BOOKS AND INSTRUCTIONAL MATERIALS; AND OPERATING AN ON-LINE INFORMATION SERVICE PROVIDING INFORMATION IN THE NATURE OF CHARACTERISTICS, PRICING, AND RATING OF GOODS IN THE FIELD OF COMPUTER-RELATED PRODUCTS, NAMELY COMPUTER HARDWARE, SOFTWARE, PERIPHERALS, ACCESSORIES, SUPPLIES, BOOKS AND INSTRUCTIONAL MATERIALS (U.S. CLS. 100, 101 AND 102).
FIRST USE 4-8-1995; IN COMMERCE 4-8-1995.



SN 75-588,737. PRIMESTAT STAFFING, INC., LOUISVILLE, KY. FILED 11-16-1998.

PRIMESTAT STAFFING

NO CLAIM IS MADE TO THE EXCLUSIVE RIGHT TO USE STAFFING, APART FROM THE MARK AS SHOWN.
FOR TEMPORARY EMPLOYMENT AGENCY (U.S. CLS. 100, 101 AND 102).
FIRST USE 10-30-1998; IN COMMERCE 10-30-1998.

SN 75-603,676. HAYS, PLC, SURREY, UNITED KINGDOM, FILED 5-6-1999.

HAYS

OWNER OF UNITED KINGDOM REG. NO. 1,395,974, DATED 10-16-1992, EXPIRES 8-15-2006.
SEC. 2(F).

FOR EMPLOYMENT AGENCY SERVICES, RECRUITMENT AND EMPLOYMENT ADVISORY AND CONSULTANCY SERVICES (U.S. CLS. 100, 101 AND 102).
FIRST USE 10-0-1995; IN COMMERCE 10-0-1995.

NO CLAIM IS MADE TO THE EXCLUSIVE RIGHT TO USE "HEMP", APART FROM THE MARK AS SHOWN.

FOR MAIL ORDER CATALOG SERVICES IN THE FIELD OF CLOTHING, BELTS, HATS AND CAPS, GLOVES, SCARVES, LUGGAGE, PURSES, BAGS AND PERSONAL CARRYING ITEMS, CANDLES, BATH AND BODY CARE PRODUCTS, AROMATHERAPY PRODUCTS, BOOKS AND VIDEOS ABOUT HEMP, FOOTWEAR, SOCKS, GIFT ITEMS, JEWELRY, MASSAGE OIL, KITCHEN ITEMS, HOUSEWARES, TABLEWARE, BEDDING AND LINENS AND ACCESSORIES, SUCH PRODUCTS MADE IN WHOLE OR SIGNIFICANT PART OF HEMP, FIBER OR MATERIAL OR CONTAINING INFORMATION ABOUT HEMP PLANTS, FIBER OR MATERIAL, ITS USES AND PRODUCTS (U.S. CLS. 100, 101 AND 102).
FIRST USE 9-0-1991; IN COMMERCE 9-0-1991.

CLASS 35—(Continued).

SN 75-631,165. CONDAR CONSULTING INC., OTTAWA, ONTARIO KIP 5G4, CANADA, FILED 2-1-1999.

CLOSING THE GAPS IN YOUR CORPORATE MEMORY

PRIORITY CLAIMED UNDER SEC. 44(D) ON CANADA APPLICATION NO. 886184, FILED 7-31-1998, REG. NO. 536193, DATED 10-30-2000, EXPIRES 10-30-2010.

FOR BUSINESS INFORMATION AND RECORDS MANAGEMENT CONSULTING SERVICES, NAMELY ADVISING CLIENTS AS TO THE ORGANIZATION, MANAGEMENT AND DISPOSAL OF PAPER AND ELECTRONIC DOCUMENTS (U.S. CLS. 100, 101 AND 102).

SN 75-633,406. CDW COMPUTER CENTERS, INC., VERNON HILLS, IL. FILED 2-4-1999.

GET REAL. REAL SOLUTIONS REAL VALUE REAL PEOPLE

FOR RETAIL AND WHOLESALE STORE AND MAIL ORDER SERVICES FEATURING ELECTRONIC EQUIPMENT AND COMPUTER SOFTWARE (U.S. CLS. 100, 101 AND 102).

FIRST USE 12-0-1998; IN COMMERCE 12-0-1998.

SN 75-648,095. PROTEAM, INC., LOS ANGELES, CA. BY CHANGE OF NAME GENESIS DIRECT, INC., SECAUCUS, NJ. FILED 2-25-1999.

PROTEAM.COM

OWNER OF U.S. REG. NOS. 1,843,331 AND 2,219,143. SEC. 2(F).

FOR MAIL ORDER SERVICES, ELECTRONIC RETAILING SERVICES VIA COMPUTER, ON-LINE RETAIL STORE SERVICES, TELEPHONE SHOP-AT-HOME SERVICES VIA 800, 888 AND 900 NUMBERS, RETAIL STORE SERVICES AND MAIL ORDER CATALOG SERVICES, ALL FEATURING SPORTING GOODS; CLOTHING; DOLLS; STATIONERY AND RELATED PRODUCTS; HATS; SOUVENIRS; CLUB MEMBERSHIPS FOR OTHERS; PRINTED PUBLICATIONS; ART; COLLECTIBLES AND GENERAL MERCHANDISE (U.S. CLS. 100, 101 AND 102).

CLASS 35—(Continued).

SN 75-662,056. BOARDROOM, INC., GREENWICH, CT. FILED 3-17-1999.

AMERICA'S INSIDE INFORMATION MAGAZINE

NO CLAIM IS MADE TO THE EXCLUSIVE RIGHT TO USE "AMERICA'S" AND "MAGAZINE", APART FROM THE MARK AS SHOWN.

FOR PROMOTING THE GOODS AND SERVICES OF OTHERS THROUGH THE PLACEMENT OF ADVERTISEMENTS IN THE NATURE OF ARTICLES IN A NEWSLETTER AND IN A ON-LINE MAGAZINE ACCESSED OVER THE INTERNET (U.S. CLS. 100, 101 AND 102).

SN 75-662,128. BOARDROOM, INC., GREENWICH, CT. FILED 3-17-1999.

AMERICA'S ONE AND ONLY INSIDE INFORMATION MAGAZINE

NO CLAIM IS MADE TO THE EXCLUSIVE RIGHT TO USE "AMERICA'S" AND "MAGAZINE", APART FROM THE MARK AS SHOWN.

FOR PROMOTING THE GOODS AND SERVICES OF OTHERS THROUGH THE PLACEMENT OF ADVERTISEMENTS IN THE NATURE OF ARTICLES IN A NEWSLETTER AND IN A ON-LINE MAGAZINE ACCESSED OVER THE INTERNET (U.S. CLS. 100, 101 AND 102).

SN 75-743,538. INTEGRATED CONTROL SYSTEMS, INC., PUNTA GORDA, FL. FILED 7-2-1999.

INTEGRATED CONTROL SYSTEMS

NO CLAIM IS MADE TO THE EXCLUSIVE RIGHT TO USE "CONTROL SYSTEMS", APART FROM THE MARK AS SHOWN.

SEC. 2(F).

FOR BUSINESS MANAGEMENT CONSULTING SERVICES IN THE FIELD OF MANAGEMENT CONTROL SYSTEMS, NAMELY, ANALYTICAL SERVICES TO ASCERTAIN PROBLEM AREAS REQUIRING IMPROVEMENT, PREPARATION OF A PLAN FOR IMPROVEMENT, ON-SITE BUSINESS MANAGEMENT CONSULTING SERVICES TO ASSIST IN IMPLEMENTING SAID PLAN, AND LONG TERM FOLLOW UP BUSINESS MANAGEMENT CONSULTING SERVICES TO ASSURE CONTINUED ADHERENCE TO SAID PLAN (U.S. CLS. 100, 101 AND 102).

FIRST USE 8-0-1954; IN COMMERCE 8-0-1954.

CLASS 35—(Continued).

SN 75-796,102. PROPERTY SERVICES, INC., NORCROSS, GA. FILED 9-9-1999.

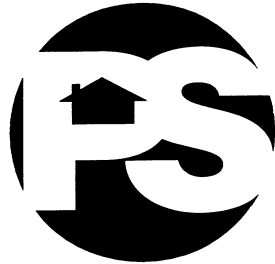

FOR PROVIDING A REFERRAL SERVICE BY MEANS OF A TELEPHONE CALL CENTER AND A GLOBAL COMPUTER NETWORK, TO ASSIST OWNERS, BUYERS AND SELLERS OF REAL ESTATE IN FINDING NATIONAL AND LOCAL VENDORS OF GOODS AND SERVICES THAT ARE OF INTEREST TO REAL ESTATE OWNERS (U.S. CLS. 100, 101 AND 102).
FIRST USE 7-23-1999; IN COMMERCE 7-23-1999.

SN 75-796,411. STATION CASINOS, INC., LAS VEGAS, NV. BY ASSIGNMENT FIESTA HOTEL CORPORATION, LAS VEGAS, NV. FILED 9-9-1999.

FIESTA

FOR CONDUCTING BONUS CARD INCENTIVE AWARDS PROGRAMS TO PROMOTE CASINO SERVICES (U.S. CLS. 100, 101 AND 102).
FIRST USE 12-14-1994; IN COMMERCE 12-14-1994.

SN 75-799,983. UPPER DECK COMPANY, LLC, THE, CARLSBAD, CA. FILED 9-15-1999.

AUTHENTIQUES

FOR PROMOTING THE GOODS AND SERVICES OF OTHERS BY PREPARING AND PLACING ADVERTISEMENTS ACCESSED THROUGH A GLOBAL COMPUTER INFORMATION NETWORK; AUCTIONEERING AND AUCTIONEERING VIA A GLOBAL COMPUTER INFORMATION NETWORK; EXCHANGE SERVICES, NAMELY BARTERING OF GOODS FOR OTHERS VIA A GLOBAL COMPUTER INFORMATION NETWORK; REFERRALS FOR SPORTS COLLECTIBLE OWNERS WILLING TO BUY OR SELL COLLECTIBLES PROVIDED VIA A GLOBAL COMPUTER INFORMATION NETWORK (U.S. CLS. 100, 101 AND 102).

CLASS 35—(Continued).

SN 75-814,158. OH NUTS!, BROOKLYN, NY. FILED 10-4-1999.

OH! GIFTS

NO CLAIM IS MADE TO THE EXCLUSIVE RIGHT TO USE "GIFTS", APART FROM THE MARK AS SHOWN. FOR ON-LINE RETAIL STORE SERVICES FEATURING GIFTS (U.S. CLS. 100, 101 AND 102).
FIRST USE 6-0-2001; IN COMMERCE 6-0-2001.

SN 75-867,771. WEB IDEAL LLC, DOVLESTOWN, PA. FILED 12-10-1999.

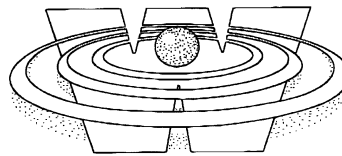

WEB IDEALS

THE STIPPLING IN THE DRAWING IS FOR SHADING PURPOSES ONLY. FOR MARKETING ANALYSIS AND SALES TRACKING SERVICES VIA A GLOBAL COMPUTER NETWORK (U.S. CLS. 100, 101 AND 102).
FIRST USE 6-15-1999; IN COMMERCE 6-15-1999.

SN 75-874,198. MARAMARI, MAPLEWOOD, NJ. FILED 12-17-1999.



N a m e s, E t c.

NO CLAIM IS MADE TO THE EXCLUSIVE RIGHT TO USE "MARAMARI" AND "NAMES", APART FROM THE MARK AS SHOWN. FOR BRAND NAME AND TRADEMARK BUSINESS MARKETING CONSULTING SERVICES, NAMELY, THE CREATION, SCREENING, AND TESTING OF PROPOSED NAMES AND TRADEMARKS AVAILABLE (U.S. CLS. 100, 101 AND 102).
FIRST USE 11-1-1998; IN COMMERCE 11-1-1998.

CLASS 35—(Continued).

SN 75-876,654. COMSORT, BALTIMORE, MD. FILED 12-20-1999.

INFLUENCE NETWORK MARKETING

NO CLAIM IS MADE TO THE EXCLUSIVE RIGHT TO USE "NETWORK MARKETING", APART FROM THE MARK AS SHOWN.

FOR BUSINESS SERVICES, NAMELY THE DISSEMINATION OF PRODUCT INFORMATION OF OTHERS TO TARGET COMMUNITIES AND FOCUSED MARKETS (U.S. CLS. 100, 101 AND 102).

FIRST USE 8-0-1998; IN COMMERCE 8-0-1998.

SN 75-876,813. BEASSURED, INC., SAUSALITO, CAMERON, BY ASSIGNMENT WU, REBEKAH, SAUSALITO, CA. FILED 12-21-1999.

LIBERATING, ISN'T IT?

FOR PROVIDING A WEBSITE FEATURING INFORMATION REGARDING BUSINESS-TO-BUSINESS SERVICES ON A WIDE VARIETY OF TOPICS VIA THE GLOBAL COMPUTER NETWORK (U.S. CLS. 100, 101 AND 102).

SN 75-881,909. AIRDESK, INC., WARMINSTER, PA. FILED 12-27-1999.

AD AIRDESK

FOR RETAIL MAIL ORDER CATALOG SERVICES, ON-LINE ORDERING SERVICES, ON-LINE RETAIL STORE SERVICES, RETAIL SERVICES BY DIRECT SOLICITATION BY SALES AGENTS, RETAIL SHOPS AND SHOWROOMS, RETAIL DISTRIBUTORSHIPS ALL FEATURING WIRELESS VOICE AND DATA PRODUCTS AND THEIR ACCESSORIES, NAMELY, PAGERS, PDAS, TELEMETRY RADIOS, CELLULAR PHONES, MODEMS, CELLULAR ANTENNAS, CELLULAR DATA INTERFACES, CELLULAR FAX MACHINES, HANDHELD PCS AND ORGANIZERS, WIRELESS HEADSETS, WIRELESS ADAPTERS, SOFTWARE, AND WIRELESS EDUCATIONAL PRODUCTS, NAMELY INSTRUCTIONAL SOFTWARE AND EDUCATIONAL MATERIALS ON WIRELESS TECHNOLOGY (U.S. CLS. 100, 101 AND 102).

FIRST USE 7-15-1999; IN COMMERCE 7-15-1999.

CLASS 35—(Continued).

SN 75-896,069. DIAMOND SHAMROCK REFINING AND MARKETING COMPANY, SAN ANTONIO, TX. FILED 1-13-2000.



OWNER OF U.S. REG. NO. 2,128,014.

NO CLAIM IS MADE TO THE EXCLUSIVE RIGHT TO USE "STORE", APART FROM THE MARK AS SHOWN. SEC. 2(F) AS TO "CORNER STORE".

FOR RETAIL GASOLINE AND CONVENIENCE STORE SERVICES (U.S. CLS. 100, 101 AND 102).

FIRST USE 11-0-1999; IN COMMERCE 11-0-1999.

SN 75-903,133. ACTIVE DECISIONS, INC., BURLINGAME, CA. FILED 1-25-2000.

ACTIVE RESEARCH UPDATE

OWNER OF U.S. REG. NO. 2,427,797.

NO CLAIM IS MADE TO THE EXCLUSIVE RIGHT TO USE "RESEARCH UPDATE", APART FROM THE MARK AS SHOWN.

FOR INFORMATION SERVICES, NAMELY, PROVIDING BUYING INFORMATION WITH RESPECT TO A VARIETY OF CONSUMER PRODUCTS VIA A GLOBAL COMPUTER NETWORK AND PROVIDING REAL TIME MARKETING FEEDBACK INFORMATION TO CLIENTS (U.S. CLS. 100, 101 AND 102).

FIRST USE 9-1-1999; IN COMMERCE 9-1-1999.

SN 75-903,321. ACTIVE DECISIONS, INC., BURLINGAME, CA. FILED 1-25-2000.

ACTIVE RESEARCH ADVISOR

OWNER OF U.S. REG. NO. 2,427,797.

NO CLAIM IS MADE TO THE EXCLUSIVE RIGHT TO USE "RESEARCH ADVISOR", APART FROM THE MARK AS SHOWN.

FOR INFORMATION SERVICES, NAMELY, PROVIDING BUYING INFORMATION WITH RESPECT TO A VARIETY OF CONSUMER PRODUCTS VIA A GLOBAL COMPUTER NETWORK AND PROVIDING REAL TIME MARKETING FEEDBACK INFORMATION TO CLIENTS (U.S. CLS. 100, 101 AND 102).

FIRST USE 9-1-1999; IN COMMERCE 9-1-1999.

CLASS 35—(Continued).

SN 75-904,656. UPTIME INSTITUTE, THE, SANTA FE, NM. FILED 1-28-2000.

ENTERPRISE UPTIME MANAGEMENT

NO CLAIM IS MADE TO THE EXCLUSIVE RIGHT TO USE "ENTERPRISE" AND "MANAGEMENT", APART FROM THE MARK AS SHOWN.

FOR BUSINESS MANAGEMENT CONSULTATION SERVICES (U.S. CLS. 100, 101 AND 102).

FIRST USE 2-9-1999; IN COMMERCE 2-9-1999.

SN 75-919,834. WOODEN SPOONS LTD., WESTWOOD, NJ. FILED 2-15-2000.

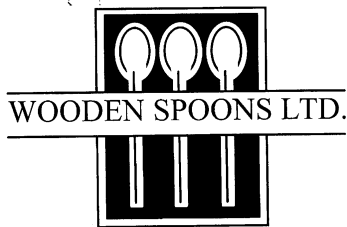

NO CLAIM IS MADE TO THE EXCLUSIVE RIGHT TO USE "WOODEN SPOONS LTD.", APART FROM THE MARK AS SHOWN.

FOR RETAIL STORE SERVICES, FEATURING KITCHEN AND DINING ROOM ITEMS, NAMELY COOKWARE, TABLEWARE, KITCHEN TOOLS AND GADGETS, FURNITURE, LINENS, SPECIALTY FOODS, COFFEES, TEAS, COOKBOOKS AND RELATED ACCESSORIES (U.S. CLS. 100, 101 AND 102).

FIRST USE 9-0-1995; IN COMMERCE 3-0-1996.

SN 75-928,086. RICHESON, JUANITA, SANTA MONICA, CA. FILED 2-25-2000.

METROPOLIS PHOTOS

NO CLAIM IS MADE TO THE EXCLUSIVE RIGHT TO USE "PHOTOS", APART FROM THE MARK AS SHOWN.

FOR RETAILING OF PHOTOGRAPHS; LICENSING REPRODUCTION RIGHTS FOR PHOTOGRAPHS (U.S. CLS. 100, 101 AND 102).

FIRST USE 1-24-2000; IN COMMERCE 1-24-2000.

SN 75-935,383. SIGNAL HILL, INC., WINNETKA, IL. FILED 2-17-2000.

SIGNAL HILL

FOR BUSINESS CONSULTATION SERVICES FOR THE VENTURE CAPITAL INVESTMENT INDUSTRY IN THE FIELDS OF STRATEGIC ANALYSIS AND ADVICE, ADVISORY BOARD CREATION, MONEY MANAGEMENT, INVESTING AND EXECUTIVE COUNSELING EXCLUDING THE UTILITY INDUSTRY (U.S. CLS. 100, 101 AND 102).

CLASS 35—(Continued).

SN 75-938,683. INFOCISION MANAGEMENT CORPORATION, AKRON, OH. FILED 3-8-2000.

CLICK4

FOR BUSINESS CONSULTING SERVICES IN THE TELECOMMUNICATION INDUSTRY REGARDING E-COMMERCE FOR POINT-TO-POINT CONTACT AND BUSINESS-TO-BUSINESS CONTACT (U.S. CLS. 100, 101 AND 102).

SN 76-002,089. MILEPOINT, LLC, EDINA, MN. FILED 3-16-2000.

MILEPOINT MAIL

NO CLAIM IS MADE TO THE EXCLUSIVE RIGHT TO USE "MAIL", APART FROM THE MARK AS SHOWN.

FOR PROMOTING THE GOODS AND SERVICES OF OTHERS BY MANAGING FREQUENT Flier MILES, CONVERTING FREQUENT Flier MILES INTO A CURRENCY IN REDEEMING SUCH FREQUENT Flier MILES VIA THE CURRENCY; MAIL ORDER CATALOG SERVICES FEATURING CLOTHING, SHOES, COSMETICS, LUGGAGE, HARDWARE, TOOLS, POWER EQUIPMENT, KITCHEN EQUIPMENT, AUTOMOTIVE PARTS, PAINT, JEWELRY, PRINTED PUBLICATIONS AND FURNITURE; ON-LINE ORDERING SERVICES FEATURING CLOTHING, SHOES, COSMETICS, LUGGAGE, HARDWARE, TOOLS, POWER EQUIPMENT, KITCHEN EQUIPMENT, AUTOMOTIVE PARTS, PAINT, JEWELRY, PRINTED PUBLICATIONS AND FURNITURE (U.S. CLS. 100, 101 AND 102).

SN 76-005,627. BTF PA CORPORATION, CHICAGO, IL. BY ASSIGNMENT SPREE.COM CORP., WEST CHESTER, PA. FILED 3-21-2000.



OWNER OF U.S. REG. NOS. 2,161,516, 2,258,828 AND OTHERS.

FOR ELECTRONIC ORDER PROCESSING VIA MULTI-USER GLOBAL COMPUTER NETWORKS; ADMINISTERING MULTI-LEVEL MARKETING PROGRAMS, SHOPPING REWARDS PROGRAMS AND AFFILIATE REFERRAL PROGRAMS PROVIDED OVER MULTI-USER GLOBAL NETWORKS; ADVERTISING SERVICES, NAMELY PLACING AND DIRECTING THE ADVERTISEMENTS OF OTHERS OVER MULTI-USER GLOBAL COMPUTER NETWORKS (U.S. CLS. 100, 101 AND 102).

FIRST USE 9-1-1999; IN COMMERCE 9-1-1999.

CLASS 35—(Continued).

SN 76-014,087. INTERLINK ONLINE PTY LTD, STAFFORD, QUEENSLAND, AUSTRALIA, FILED 3-30-2000.

ONE TEST

PRIORITY CLAIMED UNDER SEC. 44(D) ON AUSTRALIA APPLICATION NO. 812952, FILED 11-8-1999, REG. NO. 812952, DATED 11-8-1999, EXPIRES 11-8-2009.

NO CLAIM IS MADE TO THE EXCLUSIVE RIGHT TO USE "TEST", APART FROM THE MARK AS SHOWN.

FOR BUSINESS MANAGEMENT, BUSINESS ADMINISTRATION AND OFFICE FUNCTIONS, NAMELY, BOOKKEEPING, ACCOUNTING, PREPARING BUSINESS REPORTS, AUDITING, OFFERING SECRETARIAL OFFICE SUPPORT SERVICES RELATING TO THE MANAGEMENT AND OPERATION OF INTERNET SERVICES; PROVIDING INFORMATION IN THE FIELD OF PHYSIOLOGICAL TESTING, PHYSIOLOGICAL PROFILING, RECRUITMENT, INDUSTRIAL RELATIONS, EMPLOYMENT SERVICES, SUITABILITY FOR EMPLOYMENT, PERSONNEL, HUMAN RESOURCES AND COUNSELING ON A GLOBAL COMPUTER INFORMATION AND COMMUNICATIONS NETWORK; ONLINE WHOLESALE AND RETAIL STORE SERVICES FEATURING GENERAL MERCHANDISE; INTERACTIVE AND NON-INTERACTIVE PERSONNEL PLACEMENT AND RECRUITMENT, HUMAN RESOURCES AND EMPLOYMENT SERVICES VIA A GLOBAL COMPUTER INFORMATION AND COMMUNICATIONS NETWORK INCLUDING THE INTERNET AND WORLDWIDE WEB; DISSEMINATION OF ADVERTISING FOR OTHERS; PROMOTING AND MARKETING SERVICES IN RELATION TO PERSONNEL, RECRUITMENT, HUMAN RESOURCES AND EMPLOYMENT SERVICES; DATA PROCESSING SERVICES, NAMELY, COMPILING, RECORDING AND COMPUTERIZED DATABASE MANAGEMENT OF DATA IN RELATION TO PERSONNEL, RECRUITMENT, HUMAN RESOURCES AND EMPLOYMENT SERVICES (U.S. CLS. 100, 101 AND 102).

SN 76-016,492. ALLIANCE MSP, INC., BROOKLYN, NY. FILED 4-3-2000.



NO CLAIM IS MADE TO THE EXCLUSIVE RIGHT TO USE "MD" AND "MEDICAL DISCOUNTS", APART FROM THE MARK AS SHOWN.

FOR COST MANAGEMENT FOR THE HEALTH CARE BENEFIT PLANS OF OTHERS (U.S. CLS. 100, 101 AND 102).

SN 76-019,746. METRO ONE TELECOMMUNICATIONS, INC., BEAVERTON, OR. FILED 4-5-2000.

DOMAIN411

FOR PROVIDING VIA LIVE TELEPHONE OPERATORS A DIRECTORY SERVICE FEATURING DOMAIN NAMES, WEBSITES, AND UNIFORM RESOURCE LOCATORS OF WEBSITES OF OTHERS, WHICH HAVE REGISTERED WITH DOMAIN NAME REGISTRAR ORGANIZATIONS (U.S. CLS. 100, 101 AND 102).

CLASS 35—(Continued).

SN 76-021,386. OPEN RATINGS, INC., BOSTON, MA. FILED 4-10-2000.

OPEN RATINGS

NO CLAIM IS MADE TO THE EXCLUSIVE RIGHT TO USE "RATINGS", APART FROM THE MARK AS SHOWN.

FOR PROVIDING AN ON-LINE DATABASE FEATURING SUPPLIER PERFORMANCE RATINGS FOR BUSINESSES, INCLUDING BUSINESS STRESS INDICATORS AND REPUTATION RATINGS; AND CONSULTING SERVICES IN THE FIELD OF SUPPLIER PERFORMANCE RATINGS RELATED TO BUSINESSES FOR ASSISTING PURCHASES OF THE SUPPLIER PERFORMANCE RATINGS (U.S. CLS. 100, 101 AND 102).

FIRST USE 3-13-2000; IN COMMERCE 3-13-2000.

SN 76-025,837. JAZZLAND, INC., NEW ORLEANS, LA. FILED 4-13-2000.

JAZZ MALL GIFT SHOP

NO CLAIM IS MADE TO THE EXCLUSIVE RIGHT TO USE "MALL GIFT SHOP", APART FROM THE MARK AS SHOWN.

FOR RETAIL STORE SERVICES FEATURING ITEMS SUCH AS NEW ORLEANS RELATED GIFT ITEMS; HATS, CLOTHING FOR ALL AGES, JEWELRY, CANDY, TOYS, COLLECTIBLES AND SOUVENIRS (U.S. CLS. 100, 101 AND 102).

SN 76-031,697. ONESCOPE, INC., MIAMI BEACH, FL. FILED 4-20-2000.

FOR OPERATING ONLINE MARKETPLACES FOR SELLERS OF FOOD AND BEVERAGE GOODS AND/OR SERVICES; PROVIDING CONSUMER FOOD AND BEVERAGE PRODUCT INFORMATION BY MEANS OF A GLOBAL COMPUTER NETWORK (U.S. CLS. 100, 101 AND 102).

FIRST USE 8-12-1999; IN COMMERCE 8-12-1999.

CLASS 35—(Continued).

SN 76-034,759. WEE, PATRICK TER, 1693 DB, WERVER-SHOOF, NETHERLANDS, FILED 4-27-2000.

HUN

FOR ON-LINE ORDERING SERVICES FEATURING GREETING CARDS; ON-LINE RETAIL STORE SERVICES FEATURING ADULT VIDEOS, TOYS, BOOKS, DOLLS, NOVELTIES, JEWELRY, OILS AND CREAMS FOR PERSONAL USE, GIFTS AND SEXUAL AIDS; PROMOTING THE GOODS AND SERVICES OF OTHERS BY PLACING ADVERTISEMENTS IN AN ELECTRONIC COMMUNICATIONS NETWORK (U.S. CLS. 100, 101 AND 102).

SN 76-037,797. FUENTES, DANTE, SUNRISE, FL. FILED 5-2-2000.

**BE PROUD AMERICAN BUY
AND DRIVE CARS**

FOR RETAIL DISTRIBUTORSHIP FEATURING CARS, TRUCKS, AND RELATED AUTOMOTIVE; ADVERTISING AND PROMOTING THE AUTOMOBILES OF OTHERS THROUGH THE DISTRIBUTION OF PRINTED AND AUDIO PROMOTING MATERIALS AND BY RENDERING SALES PROMOTION ADVICE (U.S. CLS. 100, 101 AND 102).

SN 76-042,219. FIXTURE CONNECTION, INC., THE, COLUMBUS, OH. FILED 5-5-2000.



NO CLAIM IS MADE TO THE EXCLUSIVE RIGHT TO USE "FIXTURE", APART FROM THE MARK AS SHOWN.

FOR FIXTURE AND EQUIPMENT LIQUIDATION, NAMELY, PROVIDING RETAIL AND WHOLESALE STORE FEATURING FIXTURES AND EQUIPMENT; ONLINE RETAIL AND WHOLESALE SERVICES FEATURING NEW AND USED FIXTURES AND EQUIPMENT; AND RETAIL SERVICES BY DIRECT SOLICITATION BY SALES AGENTS IN THE FIELD OF NEW AND USED FIXTURES AND EQUIPMENT (U.S. CLS. 100, 101 AND 102).

FIRST USE 11-14-1994; IN COMMERCE 12-15-1994.

SN 76-043,140. REMERICA REAL ESTATE CORPORATION, PLYMOUTH, MI. FILED 5-8-2000.

THE WAY HOME

FOR ADVERTISING FOR OTHERS, NAMELY, PROMOTING REAL ESTATE TRANSACTIONS FOR OTHERS (U.S. CLS. 100, 101 AND 102).

CLASS 35—(Continued).

SN 76-052,119. CORPORATE IMAGE BUREAU, LLC, ALTA-MONTE SPRINGS, FL. FILED 5-19-2000.

E-STREET JOURNAL

NO CLAIM IS MADE TO THE EXCLUSIVE RIGHT TO USE "JOURNAL", APART FROM THE MARK AS SHOWN.

FOR ADVERTISING AND MEDIA RELATIONS SERVICES, NAMELY PREPARING, PLACING, AND DISTRIBUTING ADVERTISING FOR OTHERS; ADVERTISING AND MEDIA RELATIONS SERVICES, NAMELY PREPARING, PLACING AND DISTRIBUTING ADVERTISING FOR OTHERS OVER A GLOBAL COMPUTER NETWORK (U.S. CLS. 100, 101 AND 102).

FIRST USE 6-0-2000; IN COMMERCE 7-0-2000.

SN 76-055,939. CRIMI, SR., STEVEN J., ODESSA, FL. FILED 5-19-2000.

ENERGYEARTH

FOR DISSEMINATION OF ADVERTISING FOR OTHERS VIA AN ON-LINE ELECTRONIC COMMUNICATIONS NETWORK (U.S. CLS. 100, 101 AND 102).

SN 76-056,411. R.R.C.B.LLC, SAN DIEGO, CA. FILED 5-22-2000.

ANIMAL COMFORTS

NO CLAIM IS MADE TO THE EXCLUSIVE RIGHT TO USE "ANIMAL", APART FROM THE MARK AS SHOWN.

FOR ON-LINE RETAIL STORE SERVICES FEATURING PET PRODUCTS (U.S. CLS. 100, 101 AND 102).

CLASS 35—(Continued).

SN 76-057,295. SILVER FANTASY LIMITED, TORTOLA, BR. VIRGIN ISLANDS, FILED 5-25-2000.

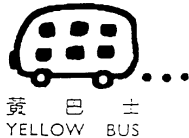

THE TRANSLITERATION OF THE CHINESE CHARACTERS IN THE MARK IS "WONG BAR ZI" AND THIS MEANS "YELLOW BUS" IN ENGLISH.

FOR ADVERTISING SERVICES, NAMELY, PROVIDING ADVERTISING SPACE IN A PERIODICAL; PLACING ADVERTISEMENTS FOR OTHERS, PREPARING ADVERTISEMENTS FOR OTHERS, DIRECT MAIL ADVERTISING, ELECTRONIC BILLBOARD ADVERTISING, PREPARING AUDIO VISUAL PRESENTATIONS FOR USE IN ADVERTISING, COMMERCIAL INFORMATION AND DIRECTORY AGENCY SERVICES, PROVIDING TELEVISION ADVERTISING FOR OTHERS, DISSEMINATION OF ADVERTISING FOR OTHERS VIA AN ON-LINE ELECTRONIC COMMUNICATIONS NETWORK, DISSEMINATION OF ADVERTISING MATTER, RENTAL OF ADVERTISING SPACE, PROMOTING THE GOODS AND SERVICES OF OTHERS BY PREPARING AND PLACING ADVERTISEMENTS IN AN ELECTRONIC MAGAZINE ACCESSED THROUGH A GLOBAL COMPUTER NETWORK, ON-LINE RETAIL STORE SERVICES FEATURING PRINTED MATTERS AND GENERAL MERCHANDISE, STATIONERY, TOYS, COMPUTER SOFTWARE, ON-LINE ELECTRONIC GOODS, CLOTHING, FOOTWEAR AND BAGS; WHOLESALE STORE SERVICES FEATURING PRINTED MATTERS, STATIONERY, TOYS, COMPUTER SOFTWARE, ELECTRONIC GOODS, CLOTHING, FOOTWEAR AND BAGS; ONLINE AUCTION SERVICES CONDUCTED VIA A GLOBAL COMPUTER INFORMATION NETWORK; BUSINESS INFORMATION SERVICES, NAMELY, INFORMATION SERVICES IN THE FIELD OF BUSINESS MANAGEMENT, BUSINESS MERGER, BUSINESS PLANNING, BUSINESS RELOCATION, BUSINESS RESEARCH AND SURVEYS AND BUSINESS SUPERVISION; BUSINESS CONSULTATION SERVICES; BUSINESS MANAGEMENT SERVICES, LICENSING ADVERTISING SLOGANS TO OTHERS, LICENSING BUSINESS MANAGEMENT TECHNIQUES, LICENSING TECHNOLOGIES, LICENSING ENTERTAINMENT, NAMELY CARTOON CHARACTERS, ACTION MOTION PICTURES, MUSICAL PERFORMANCES, CARTOON MOTION PICTURES AND COMIC BOOKS, LICENSING INFORMATION ON CUSTOMERS AND MEMBERS STORED IN COMPUTER DATABASES; COMMERCIAL INFORMATION AGENCY SERVICES; AND PROVIDING AN ON-LINE COMPUTER DATABASE IN THE FIELD OF BUSINESS INFORMATION SERVICES, NAMELY, INFORMATION SERVICES IN THE FIELD OF BUSINESS MANAGEMENT, BUSINESS MERGER, BUSINESS PLANNING, BUSINESS RELOCATION, BUSINESS RESEARCH AND SURVEYS AND BUSINESS SUPERVISION; MANAGEMENT AND ADVERTISING (U.S. CLS. 100, 101 AND 102).

CLASS 35—(Continued).

SN 76-058,998. FASHIONAVENUE.COM, DANBURY, CT. FILED 5-30-2000.

Fashionavenue.com

FOR COMMERCIAL INFORMATION SERVICES, NAMELY, ADVERTISEMENT MANAGEMENT BY PROVIDING REPORTS, CONCERNING AGE, GENDER, INCOME, CITY, STATE, COUNTRY, HOBBIES AND PROFESSION; ADVERTISEMENT TARGETING, NAMELY, PREPARING AND PLACING ADVERTISING FOR OTHERS BASED ON AGE, GENDER, INCOME, CITY, STATE, COUNTRY, HOBBIES AND PROFESSION; AND PROVIDING DEMOGRAPHIC AND CONSUMER INFORMATION FOR USE IN ADVERTISING FOR USE ON THE GLOBAL COMPUTER NETWORK; PROMOTING THE GOODS AND SERVICES OF OTHERS BY PREPARING OR PLACING OR BOTH PREPARING AND PLACING ON-LINE ADVERTISEMENT ON A GLOBAL COMPUTER NETWORK; PLACING ADVERTISEMENT OF OTHERS VIA E-MAIL; ADVERTISING CONSULTATION AND ADVERTISING AGENCY SERVICES AND ON ON-LINE ADVERTISING, NAMELY PREPARING AND PLACING ADVERTISEMENT FOR OTHERS IN THE NATURE OF BANNER ADS, ON-LINE DIRECTORY LISTING, AND ON-LINE PROMOTIONS; AND PROMOTING THE GOODS AND SERVICES OF OTHERS BY ARRANGING FOR SPONSORS TO AFFILIATE THEIR GOODS AND SERVICES OF OTHERS BY ARRANGING FOR SPONSORS TO AFFILIATE THEIR GOODS AND SERVICES WITH FASHION DESIGN COMPETITIONS (U.S. CLS. 100, 101 AND 102).

SN 76-059,251. ACCRETIVE SOLUTIONS, INC., HAUPPAUGE, NY. BY CHANGE OF NAME ACCOUNTEC, INC., HAUPPAUGE, NY. FILED 5-30-2000.

ACCRETIVE FINANCIAL SOLUTIONS

NO CLAIM IS MADE TO THE EXCLUSIVE RIGHT TO USE "FINANCIAL SOLUTIONS", APART FROM THE MARK AS SHOWN.

FOR TEMPORARY AND PERMANENT STAFFING SERVICES; PROJECT OUTSOURCING MAINLY IN THE AREAS OF ACCOUNTING, INFORMATION TECHNOLOGY AND LEGAL (U.S. CLS. 100, 101 AND 102).

SN 76-061,008. SMALL BLUE PLANET, INC, ASTON, PA. FILED 6-1-2000.

SMALL BLUE PLANET

FOR RETAIL STORE, COMPUTERIZED ON LINE RETAIL AND MAIL ORDER SERVICES FEATURING TOYS, TOY RELATED MEMORABILIA AND TOY RELATED COLLECTIBLES; ON-LINE ADVERTISING OF TOY AND TOY COLLECTIBLE RELATED GOODS AND SERVICES OF OTHERS BY PROVIDING BANNER ADS AND LINKS ON INTERNET WEB PAGES; PROVIDING A SEARCHABLE BUSINESS INFORMATION DATABASE RELATED TO TOYS, TOY MEMORABILIA AND TOY COLLECTIBLES THROUGH ON-LINE ELECTRONIC COMMUNICATIONS NETWORKS (U.S. CLS. 100, 101 AND 102).

FIRST USE 11-9-1997; IN COMMERCE 11-9-1997.

CLASS 35—(Continued).

SN 76-066,441. SHAW, KARL, ANNISTON, AL. FILED 6-8-2000.

EVERYTHING SWIMMING POOLS

NO CLAIM IS MADE TO THE EXCLUSIVE RIGHT TO USE "SWIMMING POOLS", APART FROM THE MARK AS SHOWN.

FOR COMPUTERIZED ON-LINE RETAIL SERVICES FEATURING SWIMMING POOLS, SPAS, SAUNAS, POOL ACCESSORIES AND EQUIPMENT AND SUPPLIES THEREFOR (U.S. CLS. 100, 101 AND 102).

CLASS 35—(Continued).

SN 76-077,670. APPLIED CONTROLS, INC., MALVERN, PA. FILED 6-26-2000.

APPLIED CONTROLS

NO CLAIM IS MADE TO THE EXCLUSIVE RIGHT TO USE "CONTROLS", APART FROM THE MARK AS SHOWN. FOR WHOLESALE DISTRIBUTORSHIP SERVICES IN THE FIELD OF FACTORY AUTOMATION DEVICES (U.S. CLS. 100, 101 AND 102).

FIRST USE 12-1-1994; IN COMMERCE 12-1-1994.

SN 76-072,714. ROBERT E. AXELROD ASSOCIATES, INC., CHERRY HILL, NJ. FILED 6-19-2000.



Luggage Online

NO CLAIM IS MADE TO THE EXCLUSIVE RIGHT TO USE "LUGGAGE ONLINE", APART FROM THE MARK AS SHOWN.

FOR RETAIL STORES FOR LUGGAGE AND CARRY BAGS, RETAIL STORE SERVICES FOR LUGGAGE AND CARRY BAGS ON A GLOBAL COMPUTER NETWORK, AND MAIL ORDER SERVICES FOR LUGGAGE AND CARRY BAGS (U.S. CLS. 100, 101 AND 102).

FIRST USE 9-1-1998; IN COMMERCE 9-1-1998.

SN 76-078,096. MANLOVE ADVERTISING, INC., PASADENA, TX. FILED 6-26-2000.

WINNING @ LIFE

FOR DEVELOPING PROMOTIONAL CAMPAIGNS FOR CHURCHES AND CHRISTIAN ORGANIZATIONS (U.S. CLS. 100, 101 AND 102).

FIRST USE 7-16-1999; IN COMMERCE 7-16-1999.

SN 76-079,620. BOCK, ELIZABETH, ENCINITAS, CA. FILED 6-19-2000.

COME PLAY A ROUND WITH US

FOR COOPERATIVE MARKETING AND ADVERTISING; MARKETING AND PROMOTION OF THE REAL ESTATE, GOLF COURSE COMMUNITIES AND GOLF RESORTS OF OTHERS (U.S. CLS. 100, 101 AND 102).

FIRST USE 6-10-1999; IN COMMERCE 6-10-1999.

SN 76-077,367. BASIC BOOKS, L.L.C., OSHKOSH, WI. FILED 6-22-2000.

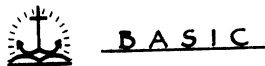

SN 76-079,734. PIEL, DENIS, DBA UMBERSHOOT, NEW YORK, NY. FILED 6-28-2000.

U-PRODUCE

FOR RETAIL STORE SERVICES FEATURING MUSIC, BOOKS AND RELATED PRINTED MATERIALS, ALL FEATURING A CHRISTIAN THEME (U.S. CLS. 100, 101 AND 102).

FIRST USE 12-16-1999; IN COMMERCE 2-1-2000.

FOR PROVIDING BUSINESS INFORMATION SERVICES IN THE FIELD OF DEVELOPING PRODUCTS AND PROJECTS FOR COMMERCIALIZATION VIA THE INTERNET (U.S. CLS. 100, 101 AND 102).

CLASS 35—(Continued).

SN 76-080,244. LAS VEGAS GAMING, INC., LAS VEGAS, NV.
FILED 6-29-2000.



NO CLAIM IS MADE TO THE EXCLUSIVE RIGHT TO USE "LAS VEGAS GAMING INCORPORATED", APART FROM THE MARK AS SHOWN.

FOR MARKETING GAMES OF CHANCE FOR OTHERS IN THE GAMING INDUSTRY BY MEANS OF A PROFIT-SHARING WITH THE LICENSEE (U.S. CLS. 100, 101 AND 102).

FIRST USE 6-1-1998; IN COMMERCE 6-1-1998.

SN 76-080,297. PEDIGO CHEVROLET, INC., INDIANAPOLIS, IN. FILED 6-27-2000.

NO HORSIN' AROUND

FOR PROMOTING THE SERVICES OF OTHERS, NAMELY, AUTOMOBILE DEALERSHIPS, THROUGH THE DISTRIBUTION OF PRINTED AND AUDIO PROMOTIONAL MATERIALS AND BY RENDERING SALES PROMOTION ADVICE (U.S. CLS. 100, 101 AND 102).

SN 76-085,011. ACKERLEY INTERACTIVE MEDIA, INC., SEATTLE, WA. FILED 7-6-2000.

**NETWORK**

NO CLAIM IS MADE TO THE EXCLUSIVE RIGHT TO USE "NETWORK", APART FROM THE MARK AS SHOWN.

FOR ADVERTISING SERVICES, NAMELY PLACING ADVERTISEMENTS PROMOTING THE GOODS AND SERVICES OF OTHERS ON WEB SITES TARGETED TO LOCAL MARKETS (U.S. CLS. 100, 101 AND 102).

CLASS 35—(Continued).

SN 76-085,013. ACKERLEY INTERACTIVE MEDIA, INC., SEATTLE, WA. FILED 7-6-2000.



FOR ADVERTISING SERVICES, NAMELY PLACING ADVERTISEMENTS PROMOTING THE GOODS AND SERVICES OF OTHERS ON WEB SITES TARGETED TO LOCAL MARKETS (U.S. CLS. 100, 101 AND 102).

SN 76-087,405. SPECCIA, MARK, WEST ISLIP, NY. FILED 7-13-2000.

URBANCLICKS

FOR PROMOTING THE GOODS AND SERVICES OF OTHERS BY PREPARING AND PLACING ADVERTISEMENTS VIA THE INTERNET; AND ELECTRONIC RETAILING SERVICES FEATURING CONSUMER ELECTRONICS (U.S. CLS. 100, 101 AND 102).

SN 76-091,178. ITUPSIDE.COM, INC., TUALATIN, OR. FILED 7-17-2000.

ITUPSIDE

FOR PROVIDING REFERRAL SERVICES, NAMELY FACILITATING THE COMMUNICATION BETWEEN AND THE MATCHING OF BUSINESSES AND INDEPENDENT CONTRACTORS VIA A GLOBAL COMPUTER NETWORK, IN THE FIELDS OF INFORMATION TECHNOLOGY, WEBSITE DEVELOPMENT, CAREER OPPORTUNITIES, RECRUITING AND PLACEMENT SERVICES, NETWORK COMMUNICATIONS, MEDIA MARKETING, AND SOFTWARE DESIGN; PROVIDING BUSINESS CONSULTING TO INDEPENDENT CONTRACTORS VIA A GLOBAL COMPUTER NETWORK; PROVIDING ADVERTISING SERVICES, NAMELY ASSISTING INDEPENDENT CONTRACTOR MEDIA COMPANIES TO GENERATE WEB-BASED ADVERTISING REVENUE (U.S. CLS. 100, 101 AND 102).

SN 76-091,743. INNOVATUS CONSULTING INC., CAMPBELLVILLE, ONTARIO, CANADA, FILED 7-20-2000.

INNOVATUS

PRIORITY CLAIMED UNDER SEC. 44(D) ON CANADA APPLICATION NO. 1,043,549, FILED 1-21-2000.

FOR BUSINESS CONSULTING SERVICES (U.S. CLS. 100, 101 AND 102).

FIRST USE 7-20-1999; IN COMMERCE 1-0-2000.

CLASS 35—(Continued).

SN 76-092,698. H.J.G. LIQUOR, INC., NEW YORK, NY. FILED 7-20-2000.

PARK AVENUE LIQUOR SHOP

NO CLAIM IS MADE TO THE EXCLUSIVE RIGHT TO USE "LIQUOR SHOP", APART FROM THE MARK AS SHOWN.

SEC. 2(F).
FOR RETAIL STORES AND SHOPS FEATURING ALCOHOLIC BEVERAGES (U.S. CLS. 100, 101 AND 102).
FIRST USE 8-0-1984; IN COMMERCE 8-0-1984.

SN 76-094,236. STAPLES THE OFFICE SUPERSTORE, INC., FRAMINGHAM, MA. FILED 7-21-2000.

STAPLESLINK.COM

FOR CATALOG SERVICES ON THE GLOBAL COMPUTER NETWORK FEATURING OFFICE SUPPLIES, OFFICE FURNITURE, COMPUTER HARDWARE AND SOFTWARE, COMPUTER ACCESSORIES AND TELEPHONES (U.S. CLS. 100, 101 AND 102).
FIRST USE 10-0-1999; IN COMMERCE 10-0-1999.

SN 76-096,422. BARWATCH, INC., NEW YORK, NY. FILED 7-26-2000.

BARWATCH

FOR OFFERING TECHNICAL ASSISTANCE IN THE ESTABLISHMENT AND/OR OPERATION OF RESTAURANTS (U.S. CLS. 100, 101 AND 102).
FIRST USE 12-30-1999; IN COMMERCE 12-30-1999.

CLASS 35—(Continued).

SN 76-096,699. AMERICAN EXPRESS COMPANY, NEW YORK, NY. FILED 7-26-2000.

MARKETMILE

FOR PROVIDING BUSINESS INFORMATION OVER A GLOBAL COMPUTER INFORMATION NETWORK; BUSINESS CONSULTATION IN THE FIELD OF E-COMMERCE; ELECTRONIC PROCUREMENT, NAMELY, PURCHASING OFFICE EQUIPMENT, OFFICE SUPPLIES, ELECTRICAL SUPPLIES, MAINTENANCE SUPPLIES AND MAINTENANCE REPAIR OPERATIONS, COMPUTER HARDWARE AND SOFTWARE AND SUPPLIES, INDUSTRIAL EQUIPMENT AND SUPPLIES, OFFICE FURNITURE, PAPER GOODS, SNACKS AND BEVERAGES, BUSINESS FORMS, JANITORIAL SUPPLIES, GAS, CHEMICAL AND LABORATORY SUPPLIES, UNIFORMS, TEMPORARY LABOR SERVICES, TRAVEL SERVICES, AND BUSINESS SUPPORT SERVICES, FOR OTHERS; PROVIDING A WEBSITE USED TO PLACE ONLINE ORDERS AND PROVIDING ORDER FULFILLMENT SERVICES FOR OFFICE EQUIPMENT, OFFICE SUPPLIES, ELECTRICAL SUPPLIES, MAINTENANCE SUPPLIES AND MAINTENANCE REPAIR OPERATIONS, COMPUTER HARDWARE AND SOFTWARE AND SUPPLIES, INDUSTRIAL EQUIPMENT AND SUPPLIES, OFFICE FURNITURE, PAPER GOODS, SNACKS AND BEVERAGES, BUSINESS FORMS, JANITORIAL SUPPLIES, GAS, CHEMICAL AND LABORATORY SUPPLIES, UNIFORMS, TEMPORARY LABOR SERVICES, TRAVEL SERVICES, AND BUSINESS SUPPORT SERVICES, AND PROMOTING THE SALE OF GOODS AND SERVICES OF OTHERS THROUGH ONLINE ORDERING AND CATALOGING OF THOSE GOODS AND SERVICES (U.S. CLS. 100, 101 AND 102).

SN 76-098,847. AMERICAN ROYAL ARTS, INC., WESTBURY, NY. FILED 7-27-2000.

AMERICAN ROYAL ARTS

NO CLAIM IS MADE TO THE EXCLUSIVE RIGHT TO USE "ARTS", APART FROM THE MARK AS SHOWN.
SEC. 2(F) AS TO "AMERICAN".

FOR RETAIL SERVICES VIA INTERACTIVE COMPUTER DATABASES AND GLOBAL COMMUNICATION NETWORKS IN THE FIELD OF ART; RETAIL SERVICES VIA COMPUTER NETWORKS AND GLOBAL COMMUNICATION NETWORKS FEATURING DIGITAL IMAGES OF ART, NAMELY, ANIMATION ART, LIMITED EDITION COMIC STRIP ART CARTOON PRINTS, SERIGRAPHS, THREE DIMENSIONAL SERIGRAPHS AND GICLEES (U.S. CLS. 100, 101 AND 102).
FIRST USE 12-0-1986; IN COMMERCE 12-0-1986.

CLASS 35—(Continued).

SN 76-098,931. DESTINASIA, INC., ANDOVER, MA. FILED 7-28-2000.

DESTINASIA

FOR PROVIDING A WEB SITE ON A GLOBAL COMPUTER NETWORK FEATURING INFORMATION IN THE FIELD OF ADVERTISING, NAMELY PROVIDING INFORMATION TO IDENTIFY THE ADVERTISERS OF GOODS AND SERVICES BY REFERENCE TO THE SPECIFIC TIME, GEOGRAPHIC LOCATION AND PROGRAM OR PRINTED PUBLICATION IN WHICH AN ADVERTISEMENT WAS RUN, FOR THE PURPOSE OF ALLOWING THE CONSUMER TO CONTACT THE ADVERTISER FOR THE GOODS AND SERVICES OR LINK DIRECTLY TO THE WEB SITES OF THE ADVERTISERS (U.S. CLS. 100, 101 AND 102).

SN 76-101,081. EJOBS, INC., DALLAS, TX. FILED 8-1-2000.

EJOBS...MAKING GOOD RECRUITERS GREAT

OWNER OF U.S. REG. NO. 2,277,795.
FOR STAFFING AND HUMAN RESOURCES CONSULTING, MANAGEMENT AND PLACEMENT SERVICES; RECRUITING AND JOB PLACEMENT SERVICES RENDERED OVER A GLOBAL COMPUTER NETWORK (U.S. CLS. 100, 101 AND 102).
FIRST USE 6-16-2000; IN COMMERCE 6-16-2000.

SN 76-108,182. OSTERHOUDT, LARRY LEE, DOWNEY, CA. FILED 8-14-2000.



THE WORLD'S GREATEST RIDE

NO CLAIM IS MADE TO THE EXCLUSIVE RIGHT TO USE "THE WORLD'S GREATEST RIDE" AND "RACER", APART FROM THE MARK AS SHOWN.
FOR ON LINE RETAIL STORE SERVICE FEATURING CONSTRUCTION BLUEPRINTS FOR A ROLLER COASTER (U.S. CLS. 100, 101 AND 102).
FIRST USE 3-27-1998; IN COMMERCE 3-27-1998.

CLASS 35—(Continued).

SN 76-114,061. TAHITI TOURISME NORTH AMERICA, EL SEGUNDO, CA. FILED 8-23-2000.



NO CLAIM IS MADE TO THE EXCLUSIVE RIGHT TO USE "TAHITI", APART FROM THE MARK AS SHOWN.
FOR PROMOTING THE ISLANDS OF TAHITI AS A LEISURE TRAVEL DESTINATION ON AN INTERNATIONAL LEVEL (U.S. CLS. 100, 101 AND 102).
FIRST USE 11-0-1992; IN COMMERCE 11-0-1992.

SN 76-115,542. NEWGISTICS, INC., AUSTIN, TX. FILED 8-23-2000.

NEWGISTICS

FOR PROVIDING COMPUTERIZED ON-LINE PRODUCT RETURN SERVICES FOR OTHERS; PROVIDING SUPPLY CHAIN MANAGEMENT FOR OTHERS; FULFILLMENT OF ORDER SERVICES FOR OTHERS; NAMELY, COLLATION, ASSEMBLY, PACKAGING AND WRAPPING OF MERCHANDISE FOR SHIPMENT; ARRANGING FOR PICK UP AND DELIVERY OF PACKAGES FOR OTHERS; REVERSE LOGISTICS FOR OTHERS FOR RETURNING UNWANTED MERCHANDISE FROM A CUSTOMER TO A RETAILER OR MANUFACTURER; GATHERING AND PROCESSING INFORMATION NECESSARY FOR PRODUCT RETURN FOR OTHERS; AND PROVIDING CUSTOMERS, SHIPPERS, RETAILERS AND MANUFACTURERS WITH PRODUCT INFORMATION AND SHIPPING INSTRUCTIONS NECESSARY TO COMPLETE PRODUCT RETURN (U.S. CLS. 100, 101 AND 102).

SN 76-115,544. NEWGISTICS, INC., AUSTIN, TX. FILED 8-23-2000.

PACKAGEVALET

FOR PROVIDING COMPUTERIZED ON-LINE PRODUCT RETURN SERVICES FOR OTHERS; PROVIDING SUPPLY CHAIN MANAGEMENT FOR OTHERS; FULFILLMENT OF ORDER SERVICES FOR OTHERS; NAMELY, COLLATION, ASSEMBLY, PACKAGING AND WRAPPING OF MERCHANDISE FOR SHIPMENT; ARRANGING FOR PICK UP AND DELIVERY OF PACKAGES FOR OTHERS; REVERSE LOGISTICS FOR OTHERS FOR RETURNING UNWANTED MERCHANDISE FROM A CUSTOMER TO A RETAILER OR MANUFACTURER; GATHERING AND PROCESSING INFORMATION NECESSARY FOR PRODUCT RETURN FOR OTHERS; AND PROVIDING CUSTOMERS, SHIPPERS, RETAILERS AND MANUFACTURERS WITH PRODUCT INFORMATION AND SHIPPING INSTRUCTIONS NECESSARY TO COMPLETE PRODUCT RETURN (U.S. CLS. 100, 101 AND 102).

CLASS 35—(Continued).

SN 76-119,926. SIMANTEL GROUP, LTD., PEORIA, IL. FILED 8-29-2000.

BRAND DISCOVERY

NO CLAIM IS MADE TO THE EXCLUSIVE RIGHT TO USE "BRAND", APART FROM THE MARK AS SHOWN. FOR MARKET RESEARCH SERVICES (U.S. CLS. 100, 101 AND 102). FIRST USE 5-1-2000; IN COMMERCE 5-1-2000.

SN 76-119,948. SIMANTEL GROUP, LTD., PEORIA, IL. FILED 8-29-2000.

BRANDING WITH IMPACT

FOR ADVERTISING AND MARKETING SERVICES, NAMELY, CUSTOMER QUALITATIVE AND QUANTITATIVE MARKET RESEARCH AND ANALYSIS, MARKET RESEARCH, BRAND STRATEGY, AND MARKETING CONSULTATION IN THE FIELDS OF MARKETING STRATEGY, COMMUNICATION STRATEGY, CREATIVE STRATEGY, DEVELOPMENT AND MEASUREMENT (U.S. CLS. 100, 101 AND 102). FIRST USE 5-1-2000; IN COMMERCE 5-1-2000.

SN 76-123,869. HUMAN RESOURCE PROFILE, INC, CINCINNATI, OH. FILED 9-1-2000.

HR PROFILE EMPLOYMENT SCREENING

NO CLAIM IS MADE TO THE EXCLUSIVE RIGHT TO USE "HR" AND "EMPLOYMENT SCREENING", APART FROM THE MARK AS SHOWN. SEC. 2(F). FOR EMPLOYMENT SCREENING SERVICES FOR CLIENTS, NAMELY, PRE-EMPLOYMENT AND EMPLOYMENT BACKGROUND INVESTIGATIONS (U.S. CLS. 100, 101 AND 102). FIRST USE 11-0-1991; IN COMMERCE 11-0-1991.

CLASS 35—(Continued).

SN 76-126,843. JOHN WAYNE WELLS, JR, DBA SCOUT OUTDOORS, DYERSBURG, TN. FILED 9-11-2000.



NO CLAIM IS MADE TO THE EXCLUSIVE RIGHT TO USE "OUTDOORS", APART FROM THE MARK AS SHOWN. FOR RETAIL, MAIL ORDER AND ONLINE STORE SERVICES IN THE FIELD OF HUNTING EQUIPMENT, GUN RACKS AND STENCIL KITS, WHOLESALE DISTRIBUTORSHIPS FEATURING HUNTING EQUIPMENT, GUN RACKS AND STENCIL KITS (U.S. CLS. 100, 101 AND 102).

SN 76-130,190. THE DOHRING COMPANY, GLENDALE, CA. FILED 9-19-2000.

... RESEARCH RESULTS IN "INTERNET TIME"

NO CLAIM IS MADE TO THE EXCLUSIVE RIGHT TO USE "RESEARCH RESULTS", APART FROM THE MARK AS SHOWN. FOR BUSINESS TO BUSINESS ONLINE MARKET RESEARCH SERVICES, NAMELY ONLINE SURVEYING AND ANALYSIS OF CONSUMERS' OPINIONS AND OTHER RELATED DATA (U.S. CLS. 100, 101 AND 102). FIRST USE 1-3-2000; IN COMMERCE 3-6-2000.

SN 76-135,088. INFINITY RESOURCES, LLC, BRADLEY BEACH, NJ. FILED 9-25-2000.

INFINITY RESOURCES

NO CLAIM IS MADE TO THE EXCLUSIVE RIGHT TO USE "RESOURCES", APART FROM THE MARK AS SHOWN. FOR EXECUTIVE RECRUITING AND PLACEMENT SERVICES (U.S. CLS. 100, 101 AND 102). FIRST USE 6-8-1999; IN COMMERCE 10-11-1999.

CLASS 35—(Continued).

SN 76-135,104. INDIANAPOLIS CAR EXCHANGE, INC., WHITESTOWN, IN. FILED 9-25-2000.



NO CLAIM IS MADE TO THE EXCLUSIVE RIGHT TO USE "INDIANAPOLIS CAR EXCHANGE", APART FROM THE MARK AS SHOWN.

FOR AUTOMOBILE DEALERSHIP; AUCTIONEERING (U.S. CLS. 100, 101 AND 102).
FIRST USE 4-1-1996; IN COMMERCE 6-28-1996.

SN 76-135,116. I-ONE CONSULTING, INC., BOSTON, MA. FILED 10-10-2000.



OWNER OF U.S. REG. NO. 2,460,603.

NO CLAIM IS MADE TO THE EXCLUSIVE RIGHT TO USE "RAIL.COM GLOBAL MARKETPLACE FOR THE RAIL INDUSTRY", APART FROM THE MARK AS SHOWN.

FOR BUSINESS SERVICES, NAMELY, PROVIDING A WEBSITE ON THE INTERNET FEATURING BUSINESS INFORMATION DIRECTED TO THE RAIL INDUSTRY; OPERATING AN ON-LINE MARKETPLACE FOR SELLERS AND BUYERS OF GOODS AND SERVICES IN THE RAIL INDUSTRY (U.S. CLS. 100, 101 AND 102).
FIRST USE 1-27-2000; IN COMMERCE 1-27-2000.

SN 76-138,868. BUYFIGURE.COM, INC., EXTON, PA. FILED 9-29-2000.

BUYFIGURE

FOR ON-LINE RETAIL AUTOMOBILE DEALERSHIP SERVICES IN THE NATURE OF PROVIDING PRICE QUOTATIONS TO CUSTOMERS AND PURCHASING AUTOMOBILES FOR SUBSEQUENT RESALE (U.S. CLS. 100, 101 AND 102).

CLASS 35—(Continued).

SN 76-140,630. MIXON, STEPHEN K., SAND SPRINGS, OK. AND MIXON, ANGELA D., SAND SPRINGS, OK. FILED 9-29-2000.

AT YOUR DOOR PARTY STORE

FOR WHOLESALE STORE FEATURING PARTY SUPPLIES, NAMELY PAPER PRODUCTS, TABLES, CHAIRS, BALLOONS, INFLATABLE JUMPS, INFLATABLE SLIDES, INFLATABLE GAMES, PARTY GAMES, COTTON CANDY, POPCORN, SNO KONES; RENTAL SERVICES NAMELY RENTAL OF INFLATABLE JUMPS, INFLATABLE SLIDES, INFLATABLE GAMES, TABLES, CHAIRS, COTTON CANDY MACHINES, POPCORN MACHINES SNO KONE MACHINES (U.S. CLS. 100, 101 AND 102).

SN 76-143,587. I-ONE CONSULTING, INC., BOSTON, MA. FILED 10-10-2000.

I-ONE CONSULTING

NO CLAIM IS MADE TO THE EXCLUSIVE RIGHT TO USE "CONSULTING", APART FROM THE MARK AS SHOWN.

FOR BUSINESS MANAGEMENT CONSULTING SERVICES IN THE FIELDS OF BUSINESS STRATEGY, INFORMATION TECHNOLOGY, AND ORGANIZATION PERFORMANCE (U.S. CLS. 100, 101 AND 102).

SN 76-150,503. TRILLIUM EMPLOYEE SERVICES, INC., SNOQUALMIE, WA. FILED 10-18-2000.

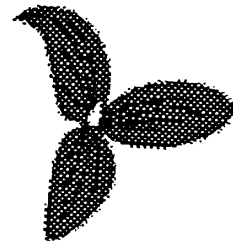

THE STIPPLING IS A FEATURING OF THE MARK AND DOES NOT INDICATE COLOR

FOR OUTSOURCED HUMAN RESOURCES AND ADMINISTRATIVE MANAGEMENT SERVICES ON A GLOBAL COMPUTER NETWORK (U.S. CLS. 100, 101 AND 102).

CLASS 35—(Continued).

SN 76-152,204. EXCELLENCE ALLIANCE GROUP, INC., CINCINNATI, OH. FILED 10-23-2000.

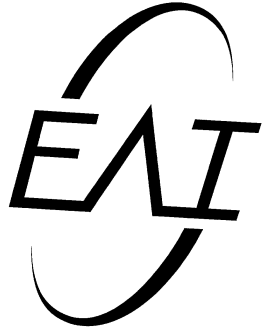

FOR PROVIDING BUSINESS INFORMATION SERVICES, BUSINESS CONSULTATION SERVICES AND BUSINESS MARKETING SERVICES FOR AFFILIATE MEMBERS WHO PROVIDE PLUMBING, HEATING, AIR-CONDITIONING, REFRIGERATION AND ELECTRICAL SERVICES; PROCUREMENT SERVICES PROVIDED FOR OTHERS, NAMELY ASSISTING WITH PURCHASING OF MECHANICAL AND HVAC EQUIPMENT AND OFFICE EQUIPMENT, COMPUTERS, COPIERS AND FAX MACHINES, VEHICLES AND VEHICLE MAINTENANCE PROGRAMS FOR AFFILIATE MEMBERS FOR USE IN THEIR PLUMBING, HEATING, AIR-CONDITIONING, REFRIGERATION AND ELECTRICAL SERVICES BUSINESS (U.S. CLS. 100, 101 AND 102).
FIRST USE 1-1-1998; IN COMMERCE 1-1-1998.

SN 76-155,692. LIGHTHOUSE COMMUNICATIONS, INC., DES MOINES, IA. FILED 10-30-2000.

HIPERWAN

FOR MANAGEMENT OF WIDE AREA NETWORK CONNECTIONS THROUGH A GLOBAL COMPUTER NETWORK, WEB INTERFACES, AND MULTIPLE LOCAL AREA NETWORKS (U.S. CLS. 100, 101 AND 102).

SN 76-158,756. PLAYBOY ENTERPRISES INTERNATIONAL, INC., CHICAGO, IL. FILED 11-2-2000.

PLAYBOY STORE

OWNER OF U.S. REG. NOS. 600,018, 2,420,042 AND OTHERS.

NO CLAIM IS MADE TO THE EXCLUSIVE RIGHT TO USE "STORE", APART FROM THE MARK AS SHOWN.

FOR ONLINE RETAIL STORE SERVICES FEATURING MEN'S AND WOMEN'S CLOTHING, LINGERIE, MAGAZINES, BOOKS, POSTERS, VIDEOS, DVDS, CD-ROMS, JEWELRY, PERSONAL CARE PRODUCTS, MUSICAL INSTRUMENTS, FURNITURE, HOME ACCESSORIES, SPORTING GOODS, COLLECTOR'S ITEMS, GAMES AND TOYS (U.S. CLS. 100, 101 AND 102).
FIRST USE 8-0-1998; IN COMMERCE 8-0-1998.

CLASS 35—(Continued).

SN 76-161,875. ARBIRIS CONSULTING, ST. LOUIS, MO. FILED 11-8-2000.

ARBIRIS

FOR BUSINESS CONSULTING SERVICES IN THE FIELD OF GLOBAL BUSINESS DEVELOPMENT TO NEW OR EXISTING BUSINESSES (U.S. CLS. 100, 101 AND 102).
FIRST USE 12-1-1999; IN COMMERCE 12-1-1999.

SN 76-161,915. U.S. LOYALTY CORP., GAHANNA, OH. FILED 11-8-2000.

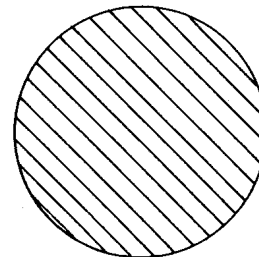

THE DRAWING IS LINED FOR THE COLORS GREEN.
THE BALL DESIGN CONSISTS OF A GREEN SPHERE.
FOR ORGANIZATION, OPERATION AND ADMINISTRATION OF LOYALTY PROGRAMS AND PROMOTIONAL INCENTIVE SCHEMES TO PROMOTE THE GOODS AND SERVICES OF OTHERS; COOPERATIVE ADVERTISING, MARKETING AND PROMOTION OF GOODS AND SERVICES OF OTHERS (U.S. CLS. 100, 101 AND 102).

SN 76-161,943. BRADEN, PAMELA J., CHICAGO, IL. FILED 11-8-2000.

MADAME X LINGERIE

NO CLAIM IS MADE TO THE EXCLUSIVE RIGHT TO USE "LINGERIE", APART FROM THE MARK AS SHOWN.

FOR MAIL ORDER SERVICES AND ONLINE RETAIL STORE FEATURING LINGERIE, SWIMWEAR, SHOES, SLIPPERS, HOSIERY, MEN'S AND WOMEN'S INTIMATE APPAREL, HATS, ROBES, GOWNS, DRESSES, BUSTIERS, BRASSIERES, UNDERWEAR, ACTIVE-WEAR, AND EXERCISE WEAR (U.S. CLS. 100, 101 AND 102).
FIRST USE 1-10-1990; IN COMMERCE 6-26-1993.

CLASS 35—(Continued).

SN 76-162,203. APPLIED INFORMATION MANAGEMENT INSTITUTE, OMAHA, NE. FILED 11-8-2000.



FOR PROVIDING A WEB SITE ON GLOBAL COMPUTER NETWORKS FEATURING INTERACTIVE JOB APPLICATION SERVICES, ON-LINE EMPLOYMENT SEARCHES, AND JOB INFORMATION IN THE FIELD OF EMPLOYMENT AND JOB RECRUITING (U.S. CLS. 100, 101 AND 102).

FIRST USE 9-7-2000; IN COMMERCE 9-7-2000.

SN 76-162,976. SHOWPLACE, LLC, HIGH POINT, NC. FILED 11-9-2000.

SHOWPLACE

FOR ARRANGING AND CONDUCTING TRADE SHOWS IN THE FIELD OF FURNITURE; PROVIDING FACILITIES FOR BUSINESS MEETINGS (U.S. CLS. 100, 101 AND 102).

FIRST USE 9-0-1996; IN COMMERCE 9-0-1996.

SN 76-163,288. CNA UNISOURCE, INC., CHICAGO, IL. FILED 11-9-2000.

IHR ADVANTAGE

NO CLAIM IS MADE TO THE EXCLUSIVE RIGHT TO USE "IHR", APART FROM THE MARK AS SHOWN.

FOR PAYROLL ADMINISTRATIVE SERVICES, NAMELY, PROVIDING PAYROLL SERVICES VIA A GLOBAL COMPUTER NETWORK (U.S. CLS. 100, 101 AND 102).

SN 76-163,293. LOUISIANA TECHNOLOGY PARK, L.L.C., BATON ROUGE, LA. FILED 11-8-2000.



LOUISIANA TECHNOLOGY PARK

NO CLAIM IS MADE TO THE EXCLUSIVE RIGHT TO USE "LOUISIANA TECHNOLOGY PARK", APART FROM THE MARK AS SHOWN.

FOR PROVIDING BUSINESS SERVICES FOR TECHNOLOGY BASED COMPANIES, NAMELY BUSINESS INCUBATOR SERVICES (U.S. CLS. 100, 101 AND 102).

FIRST USE 9-13-2000; IN COMMERCE 9-13-2000.

CLASS 35—(Continued).

SN 76-170,543. PLANTSMART, KIRKLAND, WA. FILED 11-21-2000.

PLANTSMART

FOR RETAIL STORE SERVICES, INCLUDING MAIL ORDER AND ONLINE RETAIL STORE SERVICES, FEATURING GARDEN AND NURSERY PRODUCTS, NAMELY, PLANTS, FERTILIZERS, PLANT FOOD, SOIL CONDITIONERS, POTTING SOIL, MULCH AND ORGANIC MIXES FOR DOMESTIC USE (U.S. CLS. 100, 101 AND 102).

FIRST USE 0-0-1991; IN COMMERCE 0-0-1991.

SN 76-175,798. JEWELBOOK, INC., NEW YORK, NY. FILED 12-6-2000.

JEWELBOOK, INC.

FOR ADVERTISING SERVICES, NAMELY, DIRECT MAIL ADVERTISING SERVICES FOR OTHERS IN THE FIELD OF CUSTOM CATALOGS (U.S. CLS. 100, 101 AND 102).

FIRST USE 11-20-2000; IN COMMERCE 11-20-2000.

SN 76-175,916. LEFKOWITZ, YISROEL, BROOKLYN, NY. FILED 12-5-2000.

DUTY FREE AIRWAYS

FOR WHOLESALE AND RETAIL DISTRIBUTORSHIP SERVICES FEATURING DUTY FREE GOODS (U.S. CLS. 100, 101 AND 102).

SN 76-177,587. B2BMATERIALHANDLING, INC., DALLAS, TX. FILED 12-7-2000.



NO CLAIM IS MADE TO THE EXCLUSIVE RIGHT TO USE "B2B" AND "MATERIAL HANDLING.COM", APART FROM THE MARK AS SHOWN.

FOR COMPUTER SERVICES, NAMELY, PROVIDING A WEBSITE FOR THE PURPOSE OF CONNECTING BUYERS TO SUPPLIERS FOR THE PURCHASE AND SALE OF STORAGE, CONTROL, AND PROTECTION SYSTEMS, PRODUCTS AND EQUIPMENT, SPECIFICALLY FOR USE IN THE MANUFACTURING, DISTRIBUTION, CONSUMPTION AND DISPOSAL OF HARD GOODS INDUSTRY, VIA THE INTERNET (U.S. CLS. 100, 101 AND 102).

FIRST USE 12-0-2000; IN COMMERCE 2-0-2001.

CLASS 35—(Continued).

SN 76-183,130. HARRISON, SHELLEY, DBA LAUNCH PAD, SAN FRANCISCO, CA. FILED 12-18-2000.

LAUNCH PAD

OWNER OF U.S. REG. NO. 2,056,737.
FOR BUSINESS CONSULTING AND RESEARCH SERVICES PROVIDED TO OTHERS, NAMELY, DEVELOPING MARKETING STRATEGIES, DEVELOPING MARKETING PLANS AND EXECUTING MARKETING PLANS, AND INTRODUCING NEW PRODUCTS AND BUSINESSES INTO THE MARKETPLACE (U.S. CLS. 100, 101 AND 102).
FIRST USE 12-20-1994; IN COMMERCE 1-25-1995.

SN 76-183,542. WAL-MART STORES, INC., BENTONVILLE, AR. FILED 12-20-2000.

ALASKA BUSH CATALOG

NO CLAIM IS MADE TO THE EXCLUSIVE RIGHT TO USE "CATALOG", APART FROM THE MARK AS SHOWN. SEC. 2(F).
FOR RETAIL AND WHOLESALE DEPARTMENT STORE SERVICES FEATURING FOOD, CLOTHING, TOOLS, HOUSEWARES AND OTHER GENERAL MERCHANDISE, PROVIDED VIA MAIL ORDER CATALOG (U.S. CLS. 100, 101 AND 102).
FIRST USE 9-15-1995; IN COMMERCE 9-15-1995.

SN 76-184,594. IQSOLUTIONS, INC., ROCKVILLE, MD. FILED 12-21-2000.

**APPLYING GRAY MATTER
TO WHAT REALLY
MATTERS**

FOR BUSINESS CONSULTING SERVICES IN THE FIELDS OF COMMUNICATION AND EDUCATION, PUBLIC RELATIONS, INFORMATION MANAGEMENT, INFORMATION CLEARING HOUSE AND "800" -TYPE CALL CENTERS, BUSINESS ADMINISTRATION, PROJECT MANAGEMENT, CONFERENCE AND MEETING PLANNING, BUSINESS RESEARCH, AND BUSINESS EVALUATION OF GOVERNMENT AND COMMERCIAL BUSINESS VENTURES, DISTRIBUTORSHIPS IN THE FIELD OF PRINT, VIDEO AND INTERACTIVE PRODUCTS IN THE FIELDS OF HEALTHCARE, BUSINESS MANAGEMENT, NAMELY BROCHURES, "HOW-TO" KITS, FACT SHEETS, MONOGRAPHS, ARTICLES, REPORTS, STANDARDS, GUIDELINES, MODEL PROGRAM DESCRIPTIONS, TRAINING MATERIALS, TRAINING AND PRESENTATION SOFTWARE AND PUBLIC SERVICE ANNOUNCEMENTS (U.S. CLS. 100, 101 AND 102).
FIRST USE 10-17-2000; IN COMMERCE 10-17-2000.

CLASS 35—(Continued).

SN 76-186,969. THE LIMITED STORES, INC., COLUMBUS, OH. FILED 12-27-2000.

STYLE MATTERS

NO CLAIM IS MADE TO THE EXCLUSIVE RIGHT TO USE "STYLE", APART FROM THE MARK AS SHOWN. FOR RETAIL CLOTHING STORE SERVICES (U.S. CLS. 100, 101 AND 102).
FIRST USE 9-0-2000; IN COMMERCE 9-0-2000.

SN 76-187,754. HIGHMARK INC., PITTSBURGH, PA. FILED 12-29-2000.

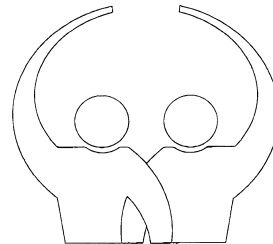
**Pennsylvania Business
Leadership Network**

NO CLAIM IS MADE TO THE EXCLUSIVE RIGHT TO USE "PENNSYLVANIA BUSINESS LEADERSHIP NETWORK", APART FROM THE MARK AS SHOWN.
FOR BUSINESS CONSULTATION SERVICES RENDERED TO EMPLOYERS TO ASSIST THEM IN RECRUITING, MARKETING AND HIRING PEOPLE WITH DISABILITIES (U.S. CLS. 100, 101 AND 102).
FIRST USE 7-1-2000; IN COMMERCE 7-1-2000.

SN 76-187,837. MAGEE COMPANY, DURHAM, CT. FILED 12-29-2000.

moneycounter  **Com**

FOR COMPUTERIZED ON-LINE RETAIL SERVICES IN THE FIELD OF CURRENCY AND COIN HANDLING EQUIPMENT AND CURRENCY AND COIN PROCESSING EQUIPMENT (U.S. CLS. 100, 101 AND 102).
FIRST USE 12-19-2000; IN COMMERCE 12-19-2000.

CLASS 35—(Continued).

SN 76-190,576. JOB PARTNERS LIMITED, LONDON W4 5PY, ENGLAND, FILED 1-5-2001.



OWNER OF UNITED KINGDOM REG. NO. 2238484B, DATED 7-7-2000, EXPIRES 7-7-2010.

FOR PERSONNEL AND HUMAN RESOURCES MANAGEMENT; PERSONNEL MANAGEMENT CONSULTANCY; BUSINESS ADMINISTRATION SERVICES; BUSINESS MANAGEMENT SERVICES; PERSONNEL RECRUITMENT SERVICES; INTERNET COMMERCIAL INFORMATION AND DIRECTORY AGENCY; ADVERTISING AGENCIES, NAMELY PROMOTING THE SERVICES OF THE RECRUITMENT AND HUMAN RESOURCES MANAGEMENT INDUSTRY THROUGH THE DISTRIBUTION OF PRINTED MATTER, ELECTRONIC PUBLICATIONS, AUDIO AND VIDEO PROMOTIONAL MATERIALS AND PROVIDING ADVERTISING SPACE IN A PERIODICAL; RENTAL OF ADVERTISING SPACE ON WEB SITES FOR ADVERTISING GOODS AND SERVICES OF OTHERS; ADVERTISING AGENCIES, NAMELY COMPILATION OF ADVERTISEMENTS FOR OTHERS FOR USE AS WEB PAGES ON THE INTERNET; BUSINESS CONSULTING VIA TELEPHONE, E-MAIL, FACSIMILE OR MAIL CORRESPONDENCE, OR IN PERSON RELATING TO THE AFORESAID SERVICES (U.S. CLS. 100, 101 AND 102).

SN 76-195,453. RELIANT ENERGY, INCORPORATED, HOUSTON, TX. FILED 1-17-2001.

RELIANT ARENA

NO CLAIM IS MADE TO THE EXCLUSIVE RIGHT TO USE "ARENA", APART FROM THE MARK AS SHOWN.

FOR PROMOTING THE GOODS AND SERVICES OF OTHERS BY ARRANGING FOR SPONSORS TO AFFILIATE THEIR GOODS AND SERVICES WITH PROFESSIONAL FOOTBALL; RENTAL OF ADVERTISING SPACE; PROMOTING SPORTS COMPETITIONS AND/OR EVENTS OF OTHERS; DISSEMINATION OF ADVERTISING MATTER AND PROVIDING FACILITIES FOR TRADE SHOWS AND CONVENTIONS; PROMOTING BUSINESS AND TOURISM IN THE AREA OF THE RELIANT STADIUM IN HOUSTON, TEXAS (U.S. CLS. 100, 101 AND 102).

SN 76-196,745. ROGERS, JAY D., MT. PLEASANT, SC. FILED 1-18-2001.

INTOREALTY.COM

FOR REAL ESTATE RELOCATION SERVICES, NAMELY, RELOCATION ASSISTANCE TO RESIDENTIAL REAL ESTATE PURCHASERS AND SELLERS; REAL ESTATE REFERRAL SERVICES, NAMELY, ASSISTANCE TO RESIDENTIAL PURCHASERS AND SELLERS THROUGH REFERRAL OF CONTACTS BETWEEN REAL ESTATE BROKERS (U.S. CLS. 100, 101 AND 102).

CLASS 35—(Continued).

SN 76-197,348. SOLA INTERNATIONAL INC., SUNNYVALE, CA. FILED 1-18-2001.

YOUR EYES

NO CLAIM IS MADE TO THE EXCLUSIVE RIGHT TO USE "EYES", APART FROM THE MARK AS SHOWN.

FOR RETAIL SERVICES FEATURING OPHTHALMIC LENSES AND EYEWEAR; ADVERTISING SERVICES, NAMELY PROVIDING POINT OF SALE AND PROMOTIONAL DISPLAYS OF OPHTHALMIC LENSES AND EYEWEAR FOR OTHERS (U.S. CLS. 100, 101 AND 102).

SN 76-199,601. ALTERNATIVE MEDIA GROUP, INC., LOUISVILLE, KY. FILED 1-19-2001.

PROPERTYSOURCE.COM

FOR BUSINESS MARKETING CONSULTING SERVICES, NAMELY MARKETING SERVICES PROVIDED TO THE REAL ESTATE INDUSTRY; BUSINESS MARKETING CONSULTING SERVICES, NAMELY MARKETING SERVICES PROVIDED TO THE REAL ESTATE INDUSTRY VIA A GLOBAL COMPUTER NETWORK (U.S. CLS. 100, 101 AND 102).

FIRST USE 1-1-1999; IN COMMERCE 1-1-1999.

SN 76-199,725. THE TIDES CENTER, SAN FRANCISCO, CA. FILED 1-24-2001.



SEC. 2(F) AS TO "SOCIAL VENTURE NETWORK". FOR BUSINESS CONSULTATION DESIGNED TO BUILD A SOCIALLY JUST AND ENVIRONMENTALLY SUSTAINABLE ECONOMY THROUGH THE COOPERATIVE EFFORTS OF NETWORK MEMBERS TO DEVELOP BUSINESS MODELS THAT ARE MORE SOCIALLY, SPIRITUALLY, AND ENVIRONMENTALLY CONSCIENTIOUS (U.S. CLS. 100, 101 AND 102).

FIRST USE 4-0-1988; IN COMMERCE 4-0-1988.

CLASS 35—(Continued).

SN 76-201,330. SUBMIT EXPRESS, INC., GLENDALE, CA.
FILED 1-29-2001.



FOR ADVERTISING SERVICES, NAMELY PREPARING AND PLACING ADVERTISEMENTS FOR OTHERS, IN PARTICULAR, PLACING INTERNET WEBSITE ADDRESSES IN BUSINESS DIRECTORIES AND ONLINE BUSINESS CATALOGUES AND DISSEMINATION OF ADVERTISING FOR OTHERS, DISSEMINATION OF INTERNET WEBSITE ADDRESSES VIA ELECTRONIC MAIL (U.S. CLS. 100, 101 AND 102).

FIRST USE 9-13-1998; IN COMMERCE 2-0-1999.

SN 76-201,951. INTERNET VIRTUAL TRADE SHOWS.COM, INC., ROCHELLE PARK, NJ. FILED 1-25-2001.

IVTS

FOR ARRANGING AND CONDUCTING ON-LINE TRADE SHOWS IN A WIDE VARIETY OF FIELDS (U.S. CLS. 100, 101 AND 102).

FIRST USE 5-1-1999; IN COMMERCE 5-1-1999.

SN 76-202,838. COTTONSMITH, SANTA BARBARA, CA.
FILED 1-30-2001.

COTTONSMITH

FOR WHOLESALE DISTRIBUTORSHIPS FEATURING CLOTHING; BUSINESS CONSULTATION SERVICES RELATING TO THE DESIGN, MANUFACTURE, SOURCING AND MARKETING OF APPAREL (U.S. CLS. 100, 101 AND 102).

SN 76-202,880. AUTOMIO, COVINA, CA. FILED 1-30-2001.

TE PONE AL VOLANTE

THE ENGLISH TRANSLATION OF THE WORDS "TE PONE AL VOLANTE" IN THE MARK IS "PUTS YOU AT THE WHEEL".

FOR REFERRAL SERVICES, NAMELY, AUTOMOBILE REFERRAL FOR PURCHASING AUTOMOBILES (U.S. CLS. 100, 101 AND 102).

CLASS 35—(Continued).

SN 76-203,486. DOLLAR'S WORTH, L.L.C., OWEGO, NY.
FILED 2-1-2001.

DOLLAR BAZAAR

NO CLAIM IS MADE TO THE EXCLUSIVE RIGHT TO USE "BAZAAR", APART FROM THE MARK AS SHOWN. SEC. 2(F).

FOR RETAIL STORE SERVICES, FEATURING GENERAL MERCHANDISE AND GROCERY ITEMS (U.S. CLS. 100, 101 AND 102).

FIRST USE 7-11-1995; IN COMMERCE 7-11-1995.

SN 76-204,630. FREIGHTMART.COM CORPORATION, LOS ANGELES, CA. FILED 2-5-2001.

GOT FREIGHT?

NO CLAIM IS MADE TO THE EXCLUSIVE RIGHT TO USE "FREIGHT", APART FROM THE MARK AS SHOWN.

FOR AUCTIONEERING SERVICES FEATURING FREIGHT HAULING SERVICES AVAILABLE VIA A WORLDWIDE WEB COMPUTERIZED NETWORK (U.S. CLS. 100, 101 AND 102).

FIRST USE 5-1-1999; IN COMMERCE 11-1-2000.

SN 76-209,859. APACHE MINNESOTA THOM MCAN, INC., SUFFERN, NY. FILED 2-13-2001.

COOL BRANDS HOT PRICES

FOR RETAIL STORE SERVICES SPECIALIZING IN ATHLETIC AND LEISURE CLOTHING AND FOOTWEAR (U.S. CLS. 100, 101 AND 102).

FIRST USE 1-25-2001; IN COMMERCE 1-25-2001.

SN 76-210,643. LLOYD, ROBERT, SEATTLE, WA. FILED 2-15-2001.

UDEBUT

FOR ADVERTISING SERVICES, NAMELY, DISSEMINATION OF ADVERTISING MATTER FOR OTHERS, VIA GLOBAL COMPUTER NETWORKS (U.S. CLS. 100, 101 AND 102).

CLASS 35—(Continued).

SN 76-211,238. RIVIO, INC., SANTA CLARA, CA. BY ASSIGNMENT NETABACUS CORPORATION, SAN FRANCISCO, CA. FILED 2-14-2001.



THE MARK CONSISTS OF A RECTANGLE INTERSECTED BY SEVERAL SMALLER RECTANGLES.

FOR BUSINESS CONSULTATION; BUSINESS MANAGEMENT CONSULTATION; PROVIDING INFORMATION IN THE FIELD OF BUSINESS MANAGEMENT; PROVIDING INFORMATION FOR ACCESSING AND ORDERING THE GOODS AND SERVICES OF OTHERS IN A WIDE VARIETY OF FIELDS; BUSINESS MANAGEMENT SERVICES FOR OTHERS, NAMELY, TRACKING, FACILITATION, INTEGRATION, AND MANAGEMENT OF COMMERCIAL TRANSACTIONS AND PROCESSES IN THE BUSINESS TO BUSINESS AREA; ALL PROVIDED VIA COMPUTER NETWORKS, COMMUNICATIONS NETWORKS, AND THE INTERNET (U.S. CLS. 100, 101 AND 102).

SN 76-211,265. PRESS ASSOCIATION, INC., NEW YORK, NY. BY ASSIGNMENT NEWSPAPER INDUSTRY COMMUNICATIONS CENTER, L.L.C., DBA NICC, L.L.C., VIENNA, VA. FILED 2-16-2001.

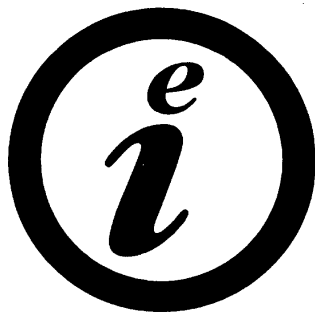

FOR ON-LINE ORDERING SERVICES FEATURING DISPLAY AND FREE STANDING PRESS ADVERTISEMENTS; PROVIDING ON-LINE ORDER TRACKING SERVICES FOR OTHERS REGARDING ORDERS FOR DISPLAY AND FREE STANDING PRESS ADVERTISEMENTS (U.S. CLS. 100, 101 AND 102).
FIRST USE 1-8-2001; IN COMMERCE 1-8-2001.

CLASS 35—(Continued).

SN 76-212,428. REDMON, JEFFREY D., OVERLAND PARK, KS. FILED 2-20-2001.

WEBUYCARSFORYOU!COM

FOR COMPUTERIZED ON-LINE RETAIL SERVICES IN THE FIELD OF VEHICLES, NAMELY, AUTOMOBILES, LIGHT TRUCKS, SPORT UTILITY VEHICLES AND RECREATIONAL VEHICLES, NAMELY MOTOR COACHES; COMPUTERIZED ON-LINE WHOLESALE SERVICES FEATURING VEHICLES, NAMELY, AUTOMOBILES, LIGHT TRUCKS, SPORT UTILITY VEHICLES AND RECREATIONAL VEHICLES, NAMELY MOTOR COACHES (U.S. CLS. 100, 101 AND 102).
FIRST USE 5-1-2000; IN COMMERCE 5-1-2000.

SN 76-212,993. ADIR INTERNATIONAL EXPORT, LTD., LOS ANGELES, CA. FILED 2-20-2001.

UN POCO DE SU PAIS

THE ENGLISH TRANSLATION OF THE SPANISH WORDS "UN POCO DE SU PAIS" IS "A LITTLE OF YOUR COUNTRY".

FOR RETAIL STORE SERVICES FEATURING ELECTRONIC GOODS, FURNITURE, HOME AND KITCHEN APPLIANCES, COMPUTERS, TOYS, HOUSE WARES, JEWELRY, COSMETICS AND A WIDE VARIETY OF CONSUMER GOODS (U.S. CLS. 100, 101 AND 102).
FIRST USE 0-0-1990; IN COMMERCE 0-0-1990.

SN 76-212,994. ADIR INTERNATIONAL EXPORT, LTD., LOS ANGELES, CA. FILED 2-20-2001.



THE STIPPLING IS FOR SHADING PURPOSES ONLY AND DOES NOT INDICATE COLOR.

FOR RETAIL STORE SERVICES FEATURING ELECTRONIC GOODS, FURNITURE, HOME AND KITCHEN APPLIANCES, COMPUTERS, TOYS, HOUSE WARES, JEWELRY, COSMETICS AND A WIDE VARIETY OF CONSUMER GOODS (U.S. CLS. 100, 101 AND 102).
FIRST USE 0-0-1981; IN COMMERCE 0-0-1989.

CLASS 35—(Continued).

SN 76-213,262. INSBANC, INC., OWENSBORO, KY. FILED 2-22-2001.

BRINGING YOU ANSWERS FOR LIFE

FOR CONSULTING IN THE FIELD OF MARKETING INSURANCE SERVICES THROUGH FINANCIAL INSTITUTIONS (U.S. CLS. 100, 101 AND 102).

FIRST USE 1-0-2001; IN COMMERCE 1-0-2001.

SN 76-213,391. CAREDECISION.NET, INC., NEWBURY PARK, CA. FILED 2-21-2001.

MD@PRACTICE PROBE

FOR PROVIDING INFORMATION ABOUT THE MEDICAL GOODS AND SERVICES OF OTHERS VIA A GLOBAL COMPUTER NETWORK; DATA MINING OF INFORMATION RELATING TO THE PRICING AND USE OF MEDICAL PRODUCTS AND SERVICES FOR USE BY HEALTHCARE PROFESSIONALS, HEALTH CARE PROVIDERS, INSURERS AND PATIENTS VIA A GLOBAL COMPUTER NETWORK; PROVIDING AN ON-LINE COMPUTER DATABASE IN THE FIELD OF MEDICAL PRODUCTS AND SERVICES OF OTHERS; ONLINE DATA AUTOMATION AND COLLECTION SERVICES USING PROPRIETARY SOFTWARE TO EVALUATE, ANALYZE AND COLLECT SERVICE DATA RELATING TO THE PURCHASE, PRICING AND USE OF MEDICAL GOODS AND SERVICES OF OTHERS (U.S. CLS. 100, 101 AND 102).

SN 76-218,505. JOHNSONLANE HOLDINGS, LLC, VENICE, FL. FILED 3-2-2001.

THE PROGRAM THAT PAYS

FOR BUSINESS MARKETING SERVICES AND PROMOTING THE SALE OF GOODS AND SERVICES FOR OTHERS OVER A GLOBAL COMMUNICATIONS NETWORK (U.S. CLS. 100, 101 AND 102).

FIRST USE 8-30-2000; IN COMMERCE 8-30-2000.

SN 76-219,386. JENIES TECHNOLOGIES INCORPORATED, GRAND PRAIRIE, TX. FILED 3-5-2001.

KNITTING FAIRY

NO CLAIM IS MADE TO THE EXCLUSIVE RIGHT TO USE "KNITTING", APART FROM THE MARK AS SHOWN. FOR ON-LINE RETAIL SERVICES IN THE FIELD OF KNITTING PATTERNS (U.S. CLS. 100, 101 AND 102).

FIRST USE 1-25-2001; IN COMMERCE 1-25-2001.

CLASS 35—(Continued).

SN 76-221,165. IPRONETWORKS, LLC, NEW YORK, NY. FILED 3-6-2001.

SESSION MAKER

NO CLAIM IS MADE TO THE EXCLUSIVE RIGHT TO USE "SESSION", APART FROM THE MARK AS SHOWN.

FOR TALENT AGENCY SERVICES IN THE NATURE OF WEB BASED VOICE CASTING FACILITATION SERVICES VIA THE INTERNET (U.S. CLS. 100, 101 AND 102).

SN 76-222,845. CELLCESSORIZE, INC., WILSONVILLE, OR. FILED 3-8-2001.

CELLCESSORIZE

FOR RETAIL STORE SERVICES IN THE FIELD OF WIRELESS PHONE ACCESSORIES (U.S. CLS. 100, 101 AND 102).

FIRST USE 8-23-2000; IN COMMERCE 8-23-2000.

SN 76-224,844. RETURNBUY, INC., ASHBURN, VA. FILED 3-15-2001.



FOR MERCHANDISE RETURN SERVICES, NAMELY, PROCESSING CUSTOMER, RETAILER AND DISTRIBUTOR MERCHANDISE RETURNS, RETURNING MERCHANDISE TO MANUFACTURERS AND DISTRIBUTORS, DISTRIBUTION SERVICES AND ON-LINE RETAIL AND DISTRIBUTION SERVICES FEATURING RETURNED MERCHANDISE, EVALUATING RETURNED MERCHANDISE FOR RETAILERS, MANUFACTURERS AND DISTRIBUTORS, PROVIDING INFORMATION ON RETURNED MERCHANDISE TO RETAILERS, MANUFACTURERS, AND DISTRIBUTORS; AND BUSINESS CONSULTATION IN THE FIELD OF MERCHANDISE RETURN MANAGEMENT, ALL FOR MERCHANTS AND INTERMEDIARIES THAT CONDUCT TRANSACTIONS (U.S. CLS. 100, 101 AND 102).

FIRST USE 8-1-2000; IN COMMERCE 8-1-2000.

CLASS 35—(Continued).

SN 76-225,715. VINCITI NETWORKS, INC., SANTA CLARA, CA. FILED 3-16-2001.

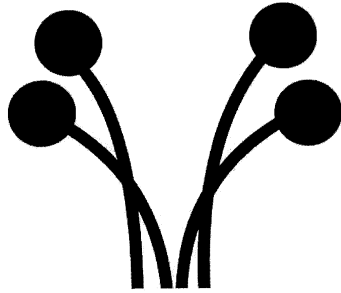

FOR BUSINESS CONSULTING SERVICES FOR TECHNOLOGY COMPANIES, FOR ELECTRONIC COMMERCE COMPANIES, FOR COMMUNICATIONS AND GLOBAL COMPUTER NETWORK-BASED COMPANIES AND FOR EXCHANGES, INFRASTRUCTURE PROVIDERS, AND FOR COMMUNICATIONS AND COMPUTER NETWORK PROVIDERS RELATING TO MANAGEMENT, ENGINEERING, FINANCIAL SECURITY SYSTEMS AND SECURITY SYSTEMS; BUSINESS OPERATIONAL CONSULTING SERVICES (U.S. CLS. 100, 101 AND 102).

SN 76-226,342. RAINBOWS N' DREAMS, INC., OKLAHOMA CITY, OK. FILED 3-19-2001.

I WANT CARDS

FOR RETAIL STORE SERVICES IN THE FIELD OF CLOTHING, NOVELTY ITEMS, STATIONERY, GREETING AND NOTE CARDS AND OTHER RELATED GIFT ITEMS (U.S. CLS. 100, 101 AND 102).
FIRST USE 4-1-1990; IN COMMERCE 4-1-1990.

CLASS 35—(Continued).

SN 76-229,010. WATKINS INCORPORATED, WINONA, MN. FILED 3-22-2001.

WATKINSONLINE

OWNER OF U.S. REG. NOS. 1,028,345, 2,306,014 AND OTHERS.

SEC. 2(F).

FOR CONSULTING SERVICES IN THE NATURE OF THE ESTABLISHMENT AND/OR OPERATION OF PERSON-TO-PERSON MERCHANDISING AND BOTH DIRECT AND INTERNET-BASED DISTRIBUTORSHIP SERVICES OF VARIOUS GOOD; NAMELY, COSMETICS AND TOILETRIES, HAIR SHAMPOOS AND CONDITIONERS, PERFUMED SACHETS, SKIN LOTIONS, DUSTING POWERS, BATH OILS AND SKIN CREAMS; COUGH AND COLD REMEDIES, MINERAL-VITAMIN FOOD SUPPLEMENTS; CANDLES; FOOD PRODUCTS, NAMELY, PACKAGED RICE AND RICE/BEAN BLENDS, COOKING OIL, DESERT MIXES; SOUP BASES, FOOD SAUCES AND MARINADES, AND MUSTARD, PIZZA CRUST MIXES AND SEASONINGS, TEA, COFFEE, BEVERAGE CONCENTRATES, FOOD FLAVORINGS AND SEASONINGS, HERBS AND SPICES, TONICS AND OINTMENTS; BATHROOM AND GLASS CLEANING PRODUCTS, INSECT CONTROL PRODUCTS, PET FOOD AND CLEANING PRODUCTS, DETERGENTS, FABRIC SOFTENER, STAIN, REMOVERS AND DEGREASERS AND AIR FRESHENERS (U.S. CLS. 100, 101 AND 102).

FIRST USE 1-0-2001; IN COMMERCE 1-0-2001.

SN 76-232,234. EDFUND, RANCHO CORDOVA, CA. FILED 3-26-2001.



FOR OPERATION OF A BUSINESS IN THE NATURE OF COLLEGE STUDENT FINANCIAL ASSISTANCE PROGRAMS FOR OTHERS; MANAGEMENT AND ADMINISTRATION ASSISTANCE OF COLLEGE STUDENT FINANCIAL AID PROGRAMS; DISSEMINATION OF ADVERTISING MATERIAL FOR COLLEGE STUDENT FINANCIAL ASSISTANCE PROGRAMS; LICENSING OF COMPUTER SOFTWARE (U.S. CLS. 100, 101 AND 102).
FIRST USE 1-2-1997; IN COMMERCE 1-2-1997.

CLASS 35—(Continued).

SN 76-232,693. CITY CHAIN COMPANY LIMITED, SAN PO KONG, KOWLOON, HONG KONG, FILED 3-28-2001.



THE MARK CONSISTS IN PART OF A STYLIZED VERSION OF THE LETTERS "CC".

THE CHINESE CHARACTERS IN THE MARK TRANSLITERATE TO "SEE KAN LONG" AND THIS MEANS "TIME CORRIDOR", IN ENGLISH.

FOR RETAIL STORES FEATURING WATCHES AND CLOCKS (U.S. CLS. 100, 101 AND 102).

CLASS 35—(Continued).

SN 76-239,546. DR. SPOCK COMPANY, THE, MENLO PARK, CA. FILED 4-11-2001.

DRSPOCK.COM

SN 76-234,381. SRDS, INC., DES PLAINES, IL. FILED 4-2-2001.



OWNER OF U.S. REG. NO. 1,685,263.

NO CLAIM IS MADE TO THE EXCLUSIVE RIGHT TO USE "MEDIA SOLUTIONS", APART FROM THE MARK AS SHOWN.

THE STIPPLING IS A FEATURE OF THE MARK AND DOES NOT INDICATE COLOR.

FOR PROVIDING INFORMATION IN THE FIELD OF MEDIA AND MARKETING VIA THE INTERNET (U.S. CLS. 100, 101 AND 102).

SN 76-236,981. PUMP TOPPER INC., FOLSOM, CA. FILED 4-4-2001.

E TOPPER NETWORK

NO CLAIM IS MADE TO THE EXCLUSIVE RIGHT TO USE "NETWORK", APART FROM THE MARK AS SHOWN.

FOR ADVERTISING AGENCIES, AND PREPARING AND PLACING ADVERTISEMENTS FOR OTHERS (U.S. CLS. 100, 101 AND 102).

SN 76-236,990. DOVER SADDLERY, INC., HOLLISTON, MA. FILED 4-9-2001.

THE SOURCE

FOR RETAIL STORE AND MAIL ORDER SERVICES FEATURING EQUESTRIAN RELATED GOODS (U.S. CLS. 100, 101 AND 102).

FIRST USE 6-0-1996; IN COMMERCE 6-0-1996.

THE NAME "DR. SPOCK" DOES NOT IDENTIFY A LIVING INDIVIDUAL.

FOR PREPARING AND PLACING ADVERTISING FOR CONSUMERS, PROVIDERS, ADMINISTRATORS AND OTHER PARTICIPANTS IN THE HEALTH CARE INDUSTRY IN THE FIELD OF HEALTHCARE, CHILD CARE, NUTRITION, WELLNESS, PARENTING, PREGNANCY, AND BEHAVIOR; DISSEMINATION OF ADVERTISING FOR CONSUMERS, PROVIDERS, ADMINISTRATORS AND OTHER PARTICIPANTS IN THE HEALTH CARE INDUSTRY VIA THE INTERNET IN THE FIELD OF HEALTHCARE, CHILD CARE, NUTRITION, WELLNESS, PARENTING, PREGNANCY, AND BEHAVIOR; PROMOTING THE GOODS AND SERVICES OF OTHERS BY PREPARING AND PLACING ADVERTISEMENTS IN AN ELECTRONIC MAGAZINE IN THE FIELD OF HEALTHCARE, CHILD CARE, NUTRITION, WELLNESS, PARENTING, PREGNANCY, AND BEHAVIOR FOR CONSUMERS, PROVIDERS, ADMINISTRATORS AND OTHER PARTICIPANTS IN THE HEALTHCARE INDUSTRY ACCESSED THROUGH THE INTERNET; ON-LINE DISTRIBUTORSHIPS IN THE FIELD OF BOOKS, MAGAZINES, JOURNALS, PAMPHLETS, BROCHURES, AND NEWSLETTERS FEATURING HEALTHCARE, CHILD CARE, NUTRITION, WELLNESS, PARENTING, PREGNANCY, AND BEHAVIOR FOR CONSUMERS, PROVIDERS, ADMINISTRATORS AND OTHER PARTICIPANTS IN THE HEALTHCARE INDUSTRY; BUSINESS MARKETING CONSULTING SERVICES RENDERED TO THE WIRELESS COMMUNICATIONS INDUSTRY IN THE FIELDS OF HEALTHCARE, CHILD CARE, NUTRITION, WELLNESS, PARENTING, PREGNANCY, AND BEHAVIOR FOR CONSUMERS, PROVIDERS, ADMINISTRATORS AND OTHER PARTICIPANTS IN THE HEALTHCARE INDUSTRY (U.S. CLS. 100, 101 AND 102).

CLASS 35—(Continued).

SN 76-239,547. DR. SPOCK COMPANY, THE, MENLO PARK, CA. FILED 4-11-2001.

DR. BENJAMIN SPOCK

THE NAME "DR. BENJAMIN SPOCK" DOES NOT IDENTIFY A LIVING INDIVIDUAL.

FOR PREPARING AND PLACING ADVERTISING FOR CONSUMERS, PROVIDERS, ADMINISTRATORS AND OTHER PARTICIPANTS IN THE HEALTH CARE INDUSTRY IN THE FIELD OF HEALTHCARE, CHILD CARE, NUTRITION, WELLNESS, PARENTING, PREGNANCY, AND BEHAVIOR; DISSEMINATION OF ADVERTISING FOR CONSUMERS, PROVIDERS, ADMINISTRATORS AND OTHER PARTICIPANTS IN THE HEALTH CARE INDUSTRY VIA THE INTERNET IN THE FIELD OF HEALTHCARE, CHILD CARE, NUTRITION, WELLNESS, PARENTING, PREGNANCY, AND BEHAVIOR; PROMOTING THE GOODS AND SERVICES OF OTHERS BY PREPARING AND PLACING ADVERTISEMENTS IN AN ELECTRONIC MAGAZINE IN THE FIELD OF HEALTHCARE, CHILD CARE, NUTRITION, WELLNESS, PARENTING, PREGNANCY, AND BEHAVIOR FOR CONSUMERS, PROVIDERS, ADMINISTRATORS AND OTHER PARTICIPANTS IN THE HEALTHCARE INDUSTRY ACCESSED THROUGH THE INTERNET; ON-LINE DISTRIBUTORSHIPS IN THE FIELD OF BOOKS, MAGAZINES, JOURNALS, PAMPHLETS, BROCHURES, AND NEWSLETTERS FEATURING HEALTHCARE, CHILD CARE, NUTRITION, WELLNESS, PARENTING, PREGNANCY, AND BEHAVIOR FOR CONSUMERS, PROVIDERS, ADMINISTRATORS AND OTHER PARTICIPANTS IN THE HEALTHCARE INDUSTRY; BUSINESS MARKETING CONSULTING SERVICES RENDERED TO THE WIRELESS COMMUNICATIONS INDUSTRY IN THE FIELDS OF HEALTHCARE, CHILDCARE, NUTRITION, WELLNESS, PARENTING, PREGNANCY, AND BEHAVIOR FOR CONSUMERS, PROVIDERS, ADMINISTRATORS AND OTHER PARTICIPANTS IN THE HEALTHCARE INDUSTRY (U.S. CLS. 100, 101 AND 102).

SN 76-240,764. COMPACTUS, INC., ALTADENA, CA. FILED 4-16-2001.

COMPACTUS

FOR RETAIL STORE AND MAIL ORDER SERVICES SUPPLYING HAIR CARE PRODUCTS, NAMELY, SHAMPOOS, CONDITIONERS, TREATMENTS, MOISTURIZERS, COLORING PREPARATIONS, HAIR SPRAYS, HAIR STYLING CREAMS, GELS, AND COSMETICS, NAMELY, LIPSTICKS, BLUSH, FACE POWDERS, FOUNDATIONS, EYE MAKEUP, AND SKIN MOISTURIZERS, HANDBAGS, ALL PURPOSE CARRYING BAGS, TRAVELING BAGS, SHOULDER BAGS, PURSES, WALLET, COSMETIC GABS, BACKPACKS, ATHLETIC BAGS, AND UMBRELLAS, AND HOUSEWARES AND DINNERWARE NAMELY, BEVERAGE GLASSES, BOWLS, COFFEE POTS, DISHES CONTAINERS FOR HOUSEHOLD OR KITCHEN USE, CUPS, FRYING PANS, PLATES, AND SERVING PLATTERS (U.S. CLS. 100, 101 AND 102).

CLASS 35—(Continued).

SN 76-241,075. SEA TROPICS, INC., LITTLE ROCK, AR. FILED 4-16-2001.



NO CLAIM IS MADE TO THE EXCLUSIVE RIGHT TO USE "FURNISHINGS.COM", APART FROM THE MARK AS SHOWN.

FOR WHOLESALE STORE SERVICES FEATURING IMPORTED FURNITURE AND HOME FURNISHINGS; ON-LINE RETAIL AND WHOLESALE STORE SERVICES FEATURING IMPORTED FURNITURE AND HOME FURNISHINGS (U.S. CLS. 100, 101 AND 102).

FIRST USE 3-1-2001; IN COMMERCE 3-30-2001.

SN 76-243,466. ARTISTA, INC., CHAGRIN FALLS, OH. FILED 4-20-2001.

ARTISTAGALLERY

FOR ART GALLERY SERVICES AND COMPUTERIZED ON-LINE ART GALLERY SERVICES, NAMELY, COMPUTERIZED ON-LINE ORDERING AND RETAIL SERVICES FEATURING ANTIQUE AND NEW JEWELRY, TEXTILES AND ONE-OF-A KIND AND HAND-CRAFTED FINE ARTS (U.S. CLS. 100, 101 AND 102).

SN 76-243,467. ARTISTA, INC., CHAGRIN FALLS, OH. FILED 4-20-2001.

ARTISTA

FOR ART GALLERY SERVICES AND COMPUTERIZED ON-LINE ART GALLERY SERVICES, NAMELY, COMPUTERIZED ON-LINE ORDERING AND RETAIL SERVICES FEATURING ANTIQUE AND NEW JEWELRY, TEXTILES AND ONE-OF-A-KIND AND HAND-CRAFTED FINE ARTS (U.S. CLS. 100, 101 AND 102).

SN 76-243,899. HILL ROM SERVICES INC., BATESVILLE, IN. FILED 4-20-2001.

CENTER FOR SOLUTIONS

NO CLAIM IS MADE TO THE EXCLUSIVE RIGHT TO USE "CENTER", APART FROM THE MARK AS SHOWN. SEC. 2(F).

FOR BUSINESS CONSULTATION SERVICES IN THE FIELD OF HEALTHCARE, NAMELY, EVALUATING THE HANDLING OF MEDICAL ARCHITECTURAL PRODUCTS AND PATIENT RELATED PRODUCTS AND SERVICES FOR THE PURPOSE OF MEETING THE NEEDS OF HEALTHCARE FACILITIES, IMPROVING THE CARE PROCESS OF CAREGIVERS, IMPROVING FUNCTIONAL HEALTH OUTCOMES AND REDUCING TOTAL HEALTHCARE DELIVERY COSTS (U.S. CLS. 100, 101 AND 102).

FIRST USE 8-0-1996; IN COMMERCE 8-0-1996.

CLASS 35—(Continued).

SN 76-253,190. RESOLUTION RESEARCH & MARKETING, INC., DENVER, CO. FILED 5-8-2001.

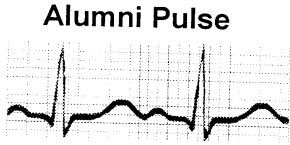

Alumni Pulse

FOR BUSINESS RESEARCH, ANALYSIS, AND CONSULTING SERVICES (U.S. CLS. 100, 101 AND 102).

SN 76-259,364. SI CORPORATION, CHICKAMAUGA, GA. FILED 5-18-2001.

WINNING THE GAME

FOR BUSINESS CONSULTATION, NAMELY, DEVELOPMENT AND IMPLEMENTATION OF BUSINESS TACTICS AND STRATEGIES FOR OTHERS (U.S. CLS. 100, 101 AND 102).
FIRST USE 4-9-2001; IN COMMERCE 4-9-2001.

SN 76-260,024. MERCHANTWIRED LLC, INDIANAPOLIS, IN. FILED 5-21-2001.

MERCHANTONE

FOR BUSINESS MANAGEMENT CONSULTATION SERVICES IN CONNECTION WITH A INTEGRATED PRICING PROGRAM FOR A COMBINATION OF SERVICES DIRECTED AT RETAILERS (U.S. CLS. 100, 101 AND 102).

SN 76-260,471. FUTURE PROPERTY MANAGEMENT, INC. C/O CSC NETWORKS, WILMINGTON, DE. FILED 5-22-2001.

FREQUENT SMILES

NO CLAIM IS MADE TO THE EXCLUSIVE RIGHT TO USE "FREQUENT", APART FROM THE MARK AS SHOWN.
FOR AWARD PROGRAM FOR CUSTOMER LOYALTY PROMOTING GOODS AND SERVICES BY ARRANGING COUPON PROGRAMS, SWEEPSTAKES, PRODUCT PREMIUM PROGRAMS, PRODUCT GIVEAWAYS AND PRODUCT SAMPLING PROGRAMS OF OTHERS (U.S. CLS. 100, 101 AND 102).

CLASS 35—(Continued).

SN 76-260,593. INTERCOMMUNICATIONS, INC., NEWPORT BEACH, CA. FILED 5-22-2001.

IMAGING PLACES

NO CLAIM IS MADE TO THE EXCLUSIVE RIGHT TO USE "IMAGING", APART FROM THE MARK AS SHOWN.
FOR ADVERTISING AGENCY SERVICES, PUBLIC RELATIONS SERVICES (U.S. CLS. 100, 101 AND 102).
FIRST USE 2-0-2001; IN COMMERCE 2-0-2001.

SN 76-261,441. NEWMAN, ROBBIE, PALM HARBOR, FL. FILED 5-23-2001.

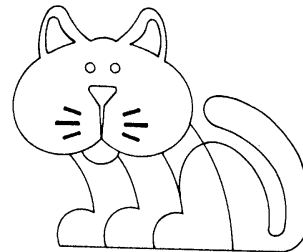

FOR RETAIL STORE, MAIL ORDER AND COMPUTERIZED ON-LINE RETAIL SERVICES IN THE FIELD OF PET FOODS, NUTRITIONAL SUPPLEMENTS FOR PETS, PET TREATS, GROOMING AIDS FOR PETS, AND HARD GOODS FOR PET CARE (U.S. CLS. 100, 101 AND 102).
FIRST USE 3-10-2001; IN COMMERCE 3-10-2001.

SN 76-261,443. NEWMAN, ROBBIE, PALM HARBOR, FL. FILED 5-23-2001.

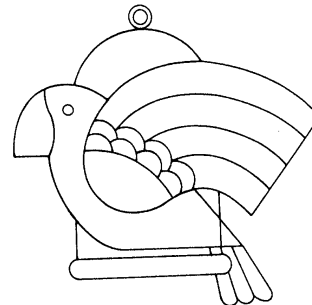

FOR RETAIL STORE, MAIL ORDER AND COMPUTERIZED ON-LINE RETAIL SERVICES IN THE FIELD OF PET FOODS, NUTRITIONAL SUPPLEMENTS FOR PETS, PET TREATS, GROOMING AIDS FOR PETS, AND HARD GOODS FOR PET CARE (U.S. CLS. 100, 101 AND 102).
FIRST USE 3-10-2001; IN COMMERCE 3-10-2001.

CLASS 35—(Continued).

SN 76-262,396. NSI NURSING SOLUTIONS, INC., LITITZ, PA. FILED 5-25-2001.

NURSING SOLUTIONS AMERICA

NO CLAIM IS MADE TO THE EXCLUSIVE RIGHT TO USE "NURSING" OR "AMERICA", APART FROM THE MARK AS SHOWN.

FOR PERSONNEL PLACEMENT AND RECRUITMENT SERVICES IN THE FIELD OF NURSING (U.S. CLS. 100, 101 AND 102).

SN 76-263,594. ASKLIA HOLDING AG, 3123 BELP, SWITZERLAND, FILED 5-25-2001.

MAVENA

FOR MANAGEMENT AND OPERATION OF A BUSINESS FOR OTHERS, NAMELY, HEALTH CARE FACILITIES PROVIDING MEDICAL TREATMENT FOR SKIN AILMENTS (U.S. CLS. 100, 101 AND 102).

SN 76-263,922. GROUP III PROMOTIONS, INC., CHICAGO, IL. FILED 5-30-2001.



THE MARK IS LINED FOR THE COLOR BLUE. FOR BUSINESS MARKETING SERVICES, NAMELY, MARKETING AND PROMOTION THROUGH EVENTS AND EXPERIENTIAL MARKETING OF GOODS AND SERVICES OF OTHERS (U.S. CLS. 100, 101 AND 102). FIRST USE 11-1-2000; IN COMMERCE 11-1-2000.

SN 76-264,741. CREATIVE PROMOTION PARTNERS LLC, PRINCETON, NJ. FILED 5-31-2001.

SPARKS CAN FLY

FOR ADVERTISING AGENCY SERVICES, NAMELY, PROMOTING THE GOODS AND SERVICES OF OTHERS BY DESIGNING AND PLACING ADVERTISEMENTS AND INFORMATIONAL PRODUCT BROCHURES FOR DISSEMINATION VIA TELEVISION, RADIO, PRINT, OR ELECTRONIC MEDIA; DESIGNING AND PREPARING PRODUCT PACKAGING AND IN-STORE DISPLAYS; BUSINESS MARKETING CONSULTING SERVICES, NAMELY, CONSULTING IN THE FIELD OF BRAND MANAGEMENT, DEVELOPING BRAND STRATEGIES, AND IMPLEMENTING MARKETING CAMPAIGNS FOR OTHERS (U.S. CLS. 100, 101 AND 102). FIRST USE 4-1-2001; IN COMMERCE 4-1-2001.

CLASS 35—(Continued).

SN 76-264,927. FRED MARTIN MOTOR COMPANY, BARBERTON, OH. FILED 5-31-2001.



NO CLAIM IS MADE TO THE EXCLUSIVE RIGHT TO USE "CERTIFIED USED CARS & TRUCKS", APART FROM THE MARK AS SHOWN.

THE LINING IS A FEATURE OF THE MARK AND DOES NOT INDICATE COLOR.

FOR DEALERSHIPS IN THE FIELD OF USED AUTOMOBILES (U.S. CLS. 100, 101 AND 102).

FIRST USE 10-0-2000; IN COMMERCE 10-0-2000.

SN 76-266,951. QQUEST CORPORATION, DEARBORN, MI. FILED 5-25-2001.



THE MARK CONSISTS OF A CRESCENT ARC POINTING RIGHT AND A CRESCENT ARC POINTING LEFT WITH THE TWO ARCS FORMING A CIRCULAR OVAL AND A POINT AT THE LOWER RIGHT SIDE MAKING THE UPPER CASE LETTER Q.

FOR BUSINESS PROCESS RE-ENGINEERING SERVICES (U.S. CLS. 100, 101 AND 102).

FIRST USE 4-27-2001; IN COMMERCE 4-27-2001.

CLASS 35—(Continued).

SN 76-269,188. MAINESHINE LLC, THOMASTON, CT. FILED 6-11-2001.



NO CLAIM IS MADE TO THE EXCLUSIVE RIGHT TO USE "COFFEE COMPANY" AND THE DESIGN OF COFFEE BEANS, APART FROM THE MARK AS SHOWN.
 THE LINING SHOWN IN THE DRAWING IS A FEATURE OF THE MARK.
 FOR RETAIL STORE AND WHOLESALE STORE SERVICES FEATURING COFFEE (U.S. CLS. 100, 101 AND 102).
 FIRST USE 5-17-2001; IN COMMERCE 5-17-2001.

SN 76-269,286. ANGELS' FORUM MANAGEMENT CO., LLC, THE, LOS ALTOS, CA. FILED 6-5-2001.

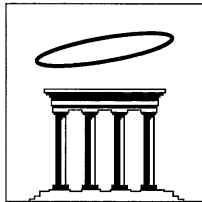

**THE
ANGELS'
FORUM
LLC**

NO CLAIM IS MADE TO THE EXCLUSIVE RIGHT TO USE "FORUM LLC", APART FROM THE MARK AS SHOWN.
 FOR BUSINESS MANAGEMENT AND CONSULTATION SERVICES (U.S. CLS. 100, 101 AND 102).

SN 76-270,661. STARADIO CORP., KANKAKEE, IL. FILED 6-13-2001.

WLRT

FOR ADVERTISING AND PROMOTIONAL SERVICES FOR OTHERS, NAMELY, PROVIDING RADIO COMMERCIAL TIME SPOTS (U.S. CLS. 100, 101 AND 102).
 FIRST USE 0-0-1994; IN COMMERCE 0-0-1994.

CLASS 35—(Continued).

SN 76-271,080. TOWER PRODUCTS INCORPORATED, SAUGERTIES, NY. FILED 6-14-2001.

MARKERTEK

OWNER OF U.S. REG. NO. 1,991,273.
 FOR DISTRIBUTORSHIPS IN THE FIELD OF ELECTRONIC, VIDEO AND AUDIO SUPPLIES; RETAIL AND WHOLESALE STORE SERVICES IN THE FIELD OF ELECTRONIC VIDEO AND AUDIO SUPPLIES OVER THE INTERNET; RETAIL AND WHOLESALE STORE SERVICES IN THE FIELD OF ELECTRONIC VIDEO AND AUDIO SUPPLIES OFFERED THROUGH CATALOGS (U.S. CLS. 100, 101 AND 102).
 FIRST USE 12-15-1998; IN COMMERCE 12-15-1998.

SN 76-271,303. PRIORITY FULFILLMENT SERVICES, INC., PLANO, TX. FILED 6-14-2001.

**THE EVOLUTION OF
OUTSOURCING**

NO CLAIM IS MADE TO THE EXCLUSIVE RIGHT TO USE "OUTSOURCING", APART FROM THE MARK AS SHOWN.
 FOR ORDER FULFILLMENT SERVICES, INTEGRATED TRACKING AND MANAGEMENT OF COMMERCIAL TRANSACTIONS, BILLING SERVICES, AND INVENTORY MANAGEMENT SERVICES AND ON-LINE DISTRIBUTORSHIP SERVICES BOTH IN THE FIELDS OF COMPUTER HARDWARE, SOFTWARE, PERIPHERALS AND SUPPLIES, CONSUMER ELECTRONICS, COSMETICS, APPAREL, NUMISMATICS, HOUSEWARES, BOOKS AND TELECOMMUNICATIONS EQUIPMENT (U.S. CLS. 100, 101 AND 102).

SN 76-272,311. DANA CORPORATION, TOLEDO, OH. FILED 6-18-2001.

ERP → B2B

NO CLAIM IS MADE TO THE EXCLUSIVE RIGHT TO USE "ERP" AND "B2B", APART FROM THE MARK AS SHOWN.
 FOR BUSINESS CONSULTING SERVICES, NAMELY, EVALUATION OF PROCESSES, COLLECTION, AND REGISTRATION OF DATA FOR IMPROVEMENT IN EFFICIENCY (U.S. CLS. 100, 101 AND 102).

CLASS 35—(Continued).

SN 76-277,229. CLASSICS CHICAGO, INC., THE, CHICAGO, IL. FILED 6-27-2001.

THE CLASSIC FIVE

FOR RETAIL STORE SERVICES AND MAIL ORDER CATALOG SERVICES IN THE FIELD OF WOMEN'S CLOTHING, FOOTWEAR, HANDBAGS, JEWELRY AND ACCESSORIES (U.S. CLS. 100, 101 AND 102).

FIRST USE 9-3-2001; IN COMMERCE 9-3-2001.

SN 76-277,878. AFTERMARKET TECHNOLOGY CORP., WESTMONT, IL. FILED 6-25-2001.



FOR INVENTORY CONTROL, NAMELY, INVENTORY TRACKING SERVICES; INVENTORY MANAGEMENT IN THE FIELD OF AUTOMOTIVE PRODUCTS; WHOLESALE DISTRIBUTORSHIP IN THE FIELD OF AUTOMOTIVE PRODUCTS; MERCHANDISE PACKAGING (U.S. CLS. 100, 101 AND 102).

FIRST USE 5-0-1998; IN COMMERCE 5-0-1998.

SN 76-279,681. FIGARO'S ITALIAN PIZZA, INC., SALEM, OR. FILED 7-2-2001.

MOZZA MOVIE & PIZZA

NO CLAIM IS MADE TO THE EXCLUSIVE RIGHT TO USE "AND PIZZA", APART FROM THE MARK AS SHOWN. FOR RETAIL PIZZA STORE SERVICES FEATURING BAKED AND UNBAKED PIZZA AND BREADSTICKS; UNBAKED CALZONE AND LASAGNA AND GARLIC BREAD; COOKIES AND SOFT DRINKS, ALL FOR CUSTOMER TAKE-OUT (U.S. CLS. 100, 101 AND 102).

SN 76-282,747. BELL HELICOPTER TEXTRON INC., FORT WORTH, TX. FILED 7-10-2001.

BELLNETX

FOR COMPUTERIZED ON-LINE ORDERING SERVICES IN THE FIELD OF FLYING VEHICLES (U.S. CLS. 100, 101 AND 102).

CLASS 35—(Continued).

SN 76-283,014. STRATEGIC INITIATIVES, INC., HERNDON, VA. FILED 7-3-2001.

STRATEGIC INITIATIVES

FOR BUSINESS MANAGEMENT AND ORGANIZATIONAL CONSULTING, BUSINESS RESEARCH, MARKETING RESEARCH, BUSINESS PLANNING, AND CONSULTING TO BUSINESSES AND ORGANIZATIONS IN THE FIELDS OF ORGANIZATIONAL DEVELOPMENT AND ORGANIZATIONAL TRANSFORMATION (U.S. CLS. 100, 101 AND 102).

FIRST USE 5-1-1991; IN COMMERCE 5-1-1991.

SN 76-283,224. INTERNATIONAL EXHIBITIONS, INC., HOUSTON, TX. FILED 7-12-2001.

HOUSTON HOME SHOW

NO CLAIM IS MADE TO THE EXCLUSIVE RIGHT TO USE "HOME SHOW", APART FROM THE MARK AS SHOWN.

SEC. 2(F).

FOR CONDUCTING TRADE SHOWS AND EXPOSITIONS IN THE FIELD OF HOME AND GARDEN PRODUCTS AND SERVICES (U.S. CLS. 100, 101 AND 102).

FIRST USE 9-12-1985; IN COMMERCE 9-12-1985.

SN 76-285,624. REAL ESTATE ON THE WEB, INC., COMMERCE, MI. FILED 7-16-2001.

HOMEOWNERS CONNECTION

NO CLAIM IS MADE TO THE EXCLUSIVE RIGHT TO USE "HOMEOWNERS", APART FROM THE MARK AS SHOWN.

FOR PROVIDING MARKETING SERVICES IN THE NATURE OF REAL ESTATE MARKETING SERVICES, NAMELY, ON-LINE SERVICES FEATURING TOURS OF RESIDENTIAL AND COMMERCIAL REAL ESTATE, DIRECT MARKETING ADVERTISING, PROVIDING SPACE AT A WEB SITE FOR THE ADVERTISEMENT OF HOMES AND REAL PROPERTY OF OTHERS FOR REAL ESTATE, BROKER, MORTGAGE, TITLE AND REAL ESTATE AGENTS COMPANIES (U.S. CLS. 100, 101 AND 102).

FIRST USE 4-24-2001; IN COMMERCE 4-24-2001.

CLASS 35—(Continued).

SN 76-285,694. GENERAL MILLS, INC., MINNEAPOLIS, MN.
FILED 7-16-2001.

BETTY'S KITCHEN THE HOME OF GREAT IDEAS

OWNER OF U.S. REG. NO. 2,140,599.
NO CLAIM IS MADE TO THE EXCLUSIVE RIGHT TO
USE "KITCHEN", APART FROM THE MARK AS SHOWN.
FOR ON-LINE MAIL ORDER CATALOG SERVICES
FEATURING KITCHEN AND HOUSE WARE GOODS
(U.S. CLS. 100, 101 AND 102).
FIRST USE 5-7-2001; IN COMMERCE 5-7-2001.

SN 76-286,600. CONTENT DIRECTIONS, INC., BROOKLYN,
NY. FILED 7-17-2001.



NO CLAIM IS MADE TO THE EXCLUSIVE RIGHT TO
USE "CONTENT" OR "INC.", APART FROM THE MARK AS
SHOWN.

FOR CONSULTING AND MANAGEMENT SERVICES
IN THE FIELD OF DIGITAL OBJECTS AND DIGITAL
OBJECT IDENTIFIERS AND REGISTRATION OF DIGI-
TAL OBJECT IDENTIFIERS FOR OTHERS OVER THE
INTERNET (U.S. CLS. 100, 101 AND 102).
FIRST USE 3-16-2001; IN COMMERCE 3-16-2001.

SN 76-289,028. HY-SING HOLDINGS, INC., PLANTATION,
FL. FILED 7-20-2001.



NO CLAIM IS MADE TO THE EXCLUSIVE RIGHT TO
USE "HOME REPAIR & SERVICES", APART FROM THE
MARK AS SHOWN.

FOR COMMERCIAL INFORMATION AND DIREC-
TORY AGENCY, NAMELY, PROVIDING DIRECTORIES
FOR THE GOODS AND SERVICES OF OTHERS IN THE
FIELD OF HOME REPAIR AND SERVICE; CONSULTA-
TION RELATED TO DIRECTORY ADVERTISING PRO-
GRAMS; DESIGNING DIRECTORY ADVERTISEMENTS
AND LISTING FOR PLACEMENT IN DIRECTORIES
(U.S. CLS. 100, 101 AND 102).

CLASS 35—(Continued).

SN 76-290,624. AVALLONE, VINCENT, SMITHTOWN, NY.
FILED 7-27-2001.

AVL COMPONENTS INT'L

NO CLAIM IS MADE TO THE EXCLUSIVE RIGHT TO
USE "COMPONENTS INT'L", APART FROM THE MARK AS
SHOWN.

FOR DISTRIBUTORSHIPS IN THE FIELD OF COM-
PUTER COMPONENTS (U.S. CLS. 100, 101 AND 102).
FIRST USE 11-1-1996; IN COMMERCE 11-1-1996.

SN 76-291,653. W.S. RICHARD ENTERPRISES, INC., DAL-
LAS, TX. FILED 7-30-2001.

EBOARDADS.COM

FOR PROVIDING ELECTRONIC BILLBOARD FOR
BUSINESS ADVERTISEMENTS WITHIN A WEBPAGE
THAT ADVERTISES INFORMATION ONLY ON BUSI-
NESSES AND OTHER BUSINESS ENTITIES CONCUR-
RENTLY AND ALSO PROVIDES LINKS TO THE
RESPECTIVE BUSINESSES OR BUSINESS ENTITY'S
WEBSITE (U.S. CLS. 100, 101 AND 102).
FIRST USE 3-15-2001; IN COMMERCE 3-15-2001.

SN 76-292,700. MV-10, L.L.C., RICHMOND, VA. FILED 7-25-
2001.

mv-10

FOR BUSINESS CONSULTING AND BUSINESS MAN-
AGEMENT CONSULTING SERVICES, NAMELY, CRITI-
CAL ASSESSMENTS OF BUSINESS STRUCTURE AND
PERFORMANCE, STRATEGIC PLANNING, WORK-
FLOW REALIGNMENT, HUMAN RESOURCES DEVELOP-
MENT AND PLANNING, AND PREPARING
BUSINESS PLANS (U.S. CLS. 100, 101 AND 102).
FIRST USE 2-1-2000; IN COMMERCE 2-1-2000.

SN 76-292,888. CFRC, INC., LAS VEGAS, NV. BY ASSIGN-
MENT CROSS COUNTRY, INC., BOCA RATON, FL.
FILED 7-31-2001.

CROSS COUNTRY

OWNER OF U.S. REG. NOS. 1,491,664, 2,122,225 AND
OTHERS.

FOR JOB PLACEMENT, RECRUITING AND COUN-
SELING SERVICES IN THE FIELD OF HEALTH CARE
(U.S. CLS. 100, 101 AND 102).

FIRST USE 7-16-2001; IN COMMERCE 7-16-2001.

CLASS 35—(Continued).

SN 76-293,036. TRANS HEALTHCARE INC., CAMP HILL, PA. FILED 7-31-2001.

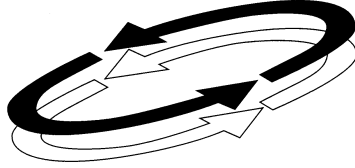

FOR MANAGEMENT FOR OTHERS OF FACILITIES THAT OFFER HEALTH CARE SERVICES, NAMELY, OUTPATIENT CARE; MANAGEMENT FOR OTHERS OF FACILITIES THAT OFFER HEALTH CARE SERVICES, NAMELY EXTENDED CARE, NAMELY, NURSING HOMES, ASSISTED-LIVING FACILITIES, AND CONGREGATE CARE RETIREMENT COMMUNITIES; AND MANAGEMENT FOR OTHERS OF FACILITIES THAT OFFER HEALTH CARE SERVICES, NAMELY, SPECIALTY HOSPITAL CARE, NAMELY, LONG-TERM ACUTE HOSPITAL, REHABILITATION HOSPITALS, SURGICAL HOSPITALS AND ORTHOPEDIC HOSPITALS (U.S. CLS. 100, 101 AND 102).

FIRST USE 1-0-1998; IN COMMERCE 1-0-1998.

SN 76-293,542. SELECT APPOINTMENTS (HOLDINGS) LIMITED, ST. ALBANS, HERTS AL1 3HW, ENGLAND, FILED 8-1-2001.



NO CLAIM IS MADE TO THE EXCLUSIVE RIGHT TO USE "GLOBAL MANAGED SERVICES", APART FROM THE MARK AS SHOWN.

THE STIPPLING IS FOR SHADING PURPOSES ONLY AND IT IS NOT A FEATURE OF THE MARK AND IS NOT INTENDED TO INDICATE COLOR.

FOR EMPLOYMENT AGENCY SERVICES; EMPLOYMENT CONSULTANCY SERVICES; EMPLOYMENT COUNSELING; INFORMATION SERVICES RELATING TO JOBS AND CAREER OPPORTUNITIES; JOB ADVERTISING; PERSONNEL MANAGEMENT SERVICES; PERSONNEL RECRUITMENT; INFORMATION AND ADVISORY SERVICES RELATING TO ALL THE AFORESAID (U.S. CLS. 100, 101 AND 102).

FIRST USE 5-0-2000; IN COMMERCE 5-0-2000.

SN 76-293,652. PROFITLOGIC, INC., CAMBRIDGE, MA. FILED 8-1-2001.

PROFITLOGIC

FOR BUSINESS MANAGEMENT SERVICES IN THE FIELD OF PRICING REVENUE MANAGEMENT AND YIELD MANAGEMENT, PROFIT OPTIMIZATION, MERCHANDISING, INVENTORY OPTIMIZATION, AND PRICING AND INVENTORY ANALYSIS (U.S. CLS. 100, 101 AND 102).

FIRST USE 1-3-2000; IN COMMERCE 1-3-2000.

CLASS 35—(Continued).

SN 76-293,859. STANDEX INTERNATIONAL CORPORATION, SALEM, NH. FILED 8-3-2001.

COMPASS BOOK

NO CLAIM IS MADE TO THE EXCLUSIVE RIGHT TO USE "BOOK", APART FROM THE MARK AS SHOWN.

FOR CATALOG-BASED BOOK CLUB SERVICES; NAMELY, A PROGRAM OF PERIODICALLY DISTRIBUTING CATALOGS AND NEWSLETTERS TO STUDENTS AND TEACHERS DESCRIBING SPECIALLY SELECTED CHRISTIAN-BASED BOOKS AVAILABLE FOR ORDERING (U.S. CLS. 100, 101 AND 102).

FIRST USE 10-10-2000; IN COMMERCE 2-20-2001.

SN 76-294,539. LYNX SERVICES, LLC, PITTSBURGH, PA. FILED 8-2-2001.

REPAIRLYNX

FOR REFERRAL SERVICES FEATURING ON-LINE COMPUTER DATABASES AND TELEPHONIC CALL CENTERS THAT FACILITATE THE SELECTION OF PROVIDERS OF GOODS AND SERVICES BY USERS, NAMELY, CONSUMERS, INSURED AND INSURANCE COMPANIES, IN THE FIELD OF PROPERTY REPAIR, REPLACEMENT, RESTORATION AND REFURBISHING (U.S. CLS. 100, 101 AND 102).

SN 76-294,740. LYNX SERVICES, LLC, PITTSBURGH, PA. FILED 8-2-2001.

HOMEREPAIRLYNX

FOR REFERRAL SERVICES FEATURING ON-LINE COMPUTER DATABASES AND TELEPHONIC CALL CENTERS THAT FACILITATE THE SELECTION OF PROVIDERS OF GOODS AND SERVICES BY USERS, NAMELY, CONSUMERS, INSURED AND INSURANCE COMPANIES, IN THE FIELD OF HOME REPAIR, RESTORATION AND REFURBISHING (U.S. CLS. 100, 101 AND 102).

SN 76-295,215. KOZIOL, DIANNA, NAPA, CA. FILED 8-7-2001.



NO CLAIM IS MADE TO THE EXCLUSIVE RIGHT TO USE "CREATIONS", APART FROM THE MARK AS SHOWN.

FOR WHOLESALE DISTRIBUTORSHIP FEATURING CLOTHING ACCESSORIES (U.S. CLS. 100, 101 AND 102).

CLASS 35—(Continued).

SN 76-296,437. GOLDEN CODE DEVELOPMENT CORPORATION, ROSWELL, GA. FILED 8-8-2001.

GOLDEN CODE

FOR LICENSING OF COMPUTER SOFTWARE (U.S. CLS. 100, 101 AND 102).

SN 76-296,641. CD-COM SYSTEMS, INC., INDIANAPOLIS, IN. FILED 8-8-2001.

DATA IMPACT

NO CLAIM IS MADE TO THE EXCLUSIVE RIGHT TO USE "DATA", APART FROM THE MARK AS SHOWN.
FOR PUBLIC DOCUMENT RETRIEVAL (U.S. CLS. 100, 101 AND 102).

SN 76-298,132. BUDDY KING, INC., LOS ANGELES, CA. FILED 8-11-2001.

**THERE'S GOLD IN THEM
HOLLYWOOD HILLS!**

FOR DISSEMINATION OF ADVERTISING MATTER FOR THE PROMOTION OF ENTERTAINMENT RELATED GOODS AND SERVICES OF OTHERS (U.S. CLS. 100, 101 AND 102).
FIRST USE 7-10-2001; IN COMMERCE 7-10-2001.

SN 76-298,695. WALDMAN, DANIEL PAUL, SANTA BARBARA, CA. FILED 8-10-2001.

STORMCON

FOR CONDUCTING AND ORGANIZING TRADE SHOWS IN THE FIELD OF ENVIRONMENTAL PRESERVATION (U.S. CLS. 100, 101 AND 102).

SN 76-298,769. WOODGRAIN MILLWORK, INC., FRUITLAND, ID. FILED 8-8-2001.

MILLSOURCE

FOR WHOLESALE DISTRIBUTORSHIP SERVICES FEATURING WOOD AND NON-METAL MOULDINGS, DOORS, AND WOODWORK (U.S. CLS. 100, 101 AND 102).

CLASS 35—(Continued).

SN 76-300,682. G & B OIL COMPANY, INCORPORATED, ELKIN, NC. FILED 8-17-2001.

GB EXPRESS

NO CLAIM IS MADE TO THE EXCLUSIVE RIGHT TO USE "EXPRESS", APART FROM THE MARK AS SHOWN.

FOR RETAIL STORE SERVICES FEATURING CONVENIENCE STORE ITEMS AND PETROLEUM PRODUCTS (U.S. CLS. 100, 101 AND 102).
FIRST USE 6-1-1999; IN COMMERCE 6-1-1999.

SN 76-300,786. KAWAHARA MFG. CO., LTD., ONOMICHI-SHI HIROSHIMA-KEN, 722-0221, JAPAN, FILED 8-15-2001.



FOR ADVERTISING AGENCY SERVICES; PROFESSIONAL BUSINESS CONSULTANCY; MARKETING RESEARCH; COMMERCIAL SALES INFORMATION SUPPLY, NAMELY, COMMERCIAL INFORMATION AGENCY SERVICES; PREPARATION, AUDITING AND CERTIFICATION OF FINANCIAL STATEMENTS; REFERRAL SERVICE/PERSONAL PLACEMENT, NAMELY, EMPLOYMENT AGENCY SERVICES; AUCTIONEERING, IMPORT-EXPORT CLEARANCE AGENCIES; DOCUMENT REPRODUCTION; SHORTHAND, NAMELY, STENOGRAPHY; STENOGRAPHIC TRANSCRIPTION AND STENCIL PAPER WRITING SERVICES FOR OTHERS; COMPUTERIZED FILE MANAGEMENT; RENTAL/LEASING OF PUBLICITY MATERIALS; RENTAL/LEASING OF TYPEWRITERS/COPY MACHINE/WORD PROCESSORS; OFFICE MACHINE AND EQUIPMENT RENTALS (U.S. CLS. 100, 101 AND 102).

SN 76-300,899. INTERNATIONAL NETWORK SOLUTIONS, LLC, WESTPORT, CT. FILED 8-16-2001.



NO CLAIM IS MADE TO THE EXCLUSIVE RIGHT TO USE "INTERNATIONAL NETWORK SOLUTIONS", APART FROM THE MARK AS SHOWN.

FOR MARKETING SERVICES IN THE FIELD OF INTERNATIONAL TELECOMMUNICATIONS, NAMELY ACTING AS A BUSINESS INTERMEDIARY BETWEEN PROVIDERS AND USERS OF INTERNATIONAL TELECOMMUNICATIONS SERVICES (U.S. CLS. 100, 101 AND 102).

FIRST USE 12-0-2000; IN COMMERCE 12-0-2000.

CLASS 35—(Continued).

SN 76-301,344. INTERNATIONAL SUPPLY CONSORTIUM, INC., CHARLESTON, SC. FILED 8-20-2001.

INTERNATIONAL SUPPLY CONSORTIUM

OWNER OF U.S. REG. NOS. 1,912,875 AND 2,053,651.
NO CLAIM IS MADE TO THE EXCLUSIVE RIGHT TO USE "CONSORTIUM", APART FROM THE MARK AS SHOWN.

SEC. 2(F).

FOR TELEMARKETING SERVICES AND INVENTORY CONTROL SERVICES IN THE FIELD OF INDUSTRIAL COMPONENTS, NAMELY, BEARINGS, POWER TRANSMISSION DEVICES, RUBBER PRODUCTS, ELECTRICAL PRODUCTS, ELECTRONIC PRODUCTS, MILL SUPPLIES, SAFETY PRODUCTS, PIPES, VALVES, PIPE AND VALVE FITTINGS AND FLUID POWER PRODUCTS; AND, WHOLESALE AND RETAIL STORE SERVICES, MAIL ORDER CATALOG SERVICES IN THE FIELD OF INDUSTRIAL COMPONENTS, NAMELY, BEARINGS, POWER TRANSMISSION DEVICES, RUBBER PRODUCTS, ELECTRICAL PRODUCTS, ELECTRONIC PRODUCTS, MILL SUPPLIES, SAFETY PRODUCTS, PIPES, VALVES, PIPE AND VALVE FITTINGS AND FLUID POWER PRODUCTS (U.S. CLS. 100, 101 AND 102).

FIRST USE 1-0-1995; IN COMMERCE 1-0-1995.

SN 76-301,460. RESOURCE BANCSHARES MORTGAGE GROUP, INC., COLUMBIA, SC. FILED 8-17-2001.

LOANSOURCE
X

FOR LICENSING INTERACTIVE SOFTWARE TO MORTGAGE BROKERS AND CORRESPONDENT BANKS FOR USE BY THEIR CUSTOMERS IN OBTAINING MORTGAGE FINANCING (U.S. CLS. 100, 101 AND 102).

FIRST USE 6-0-2001; IN COMMERCE 6-0-2001.

CLASS 35—(Continued).

SN 76-301,701. CITY OF BALTIMORE, BALTIMORE, MD. FILED 8-20-2001.



NO CLAIM IS MADE TO THE EXCLUSIVE RIGHT TO USE "BALTIMORE", APART FROM THE MARK AS SHOWN.

FOR COMPUTERIZED DATABASE MANAGEMENT (U.S. CLS. 100, 101 AND 102).

FIRST USE 7-1-2000; IN COMMERCE 7-1-2000.

SN 76-306,237. SERVICE MERCHANDISE COMPANY NO. 51, INC., DOWNERS GROVE, IL. FILED 8-27-2001.

SERVICE MERCHANDISE SELECT

OWNER OF U.S. REG. NOS. 1,077,145, 2,183,484 AND 2,183,833.

NO CLAIM IS MADE TO THE EXCLUSIVE RIGHT TO USE "MERCHANDISE", APART FROM THE MARK AS SHOWN.

SEC. 2(F) AS TO "SM".

FOR RETAIL STORE, MAIL ORDER CATALOG, AND ON-LINE RETAIL STORE SERVICES FEATURING A WIDE VARIETY OF CONSUMER GOODS (U.S. CLS. 100, 101 AND 102).

FIRST USE 4-16-2001; IN COMMERCE 4-16-2001.

SN 76-306,241. MOTOR PRIZE, N.V., CURACAO, NETHERLAND ANTILLES, FILED 8-27-2001.

MOTORPRIZE

FOR DEVELOPING, ORGANIZING AND CONDUCTING CONTESTS, INCENTIVE AWARD PROGRAMS AND SWEEPSTAKES TO PROMOTE THE SALE OF PRODUCTS AND SERVICES OF OTHERS (U.S. CLS. 100, 101 AND 102).

CLASS 35—(Continued).

SN 76-307,581. CARROT BUNCH COMPANIES, INC., CARROLLTON, TX. FILED 8-31-2001.

SAVE A BUNCH

FOR COMPUTERIZED ON-LINE RETAIL SERVICES IN THE FIELD OF INKJET PRINTER CARTRIDGES, TONER, IMPACT RIBBONS, AND THERMAL TRANSFER PRODUCTS (U.S. CLS. 100, 101 AND 102).
FIRST USE 9-0-1998; IN COMMERCE 9-0-1998.

SN 76-308,481. KRAUSE PUBLICATIONS, INC., IOLA, WI. FILED 9-4-2001.



SEC. 2(F).
FOR CONDUCTING AWARDS PROGRAMS TO RECOGNIZE OUTSTANDING COIN DESIGN, WORKMANSHIP, AND MARKETING EFFORTS (U.S. CLS. 100, 101 AND 102).
FIRST USE 0-0-1983; IN COMMERCE 0-0-1983.

SN 76-308,940. MICHAEL J. GAUGHAN, DELRAN, NJ. FILED 9-5-2001.



FOR BUSINESS SERVICES, NAMELY PROVIDING SALES CONTACT REFERRALS AND APPOINTMENT SCHEDULING VIA A WEBSITE ON A GLOBAL COMPUTER NETWORK; DISSEMINATION OF PROMOTIONAL ADVERTISING MATTER FOR OTHERS VIA A GLOBAL COMPUTER NETWORK (U.S. CLS. 100, 101 AND 102).
FIRST USE 3-20-2001; IN COMMERCE 3-20-2001.

CLASS 35—(Continued).

SN 76-309,105. OMARTS, INC., HIGH POINT, NC. FILED 9-4-2001.

OMARTS

FOR RETAIL GALLERY SERVICES FEATURING PAINTINGS, FURNITURE AND WALL HANGINGS (U.S. CLS. 100, 101 AND 102).
FIRST USE 9-0-1975; IN COMMERCE 9-0-1975.

SN 76-309,797. SHELF SOLVERS, INC., LOUISVILLE, KY. FILED 9-6-2001.



THE STIPLING SHOWN IN THE DRAWING IS A FEATURE OF THE MARK AND IS NOT INTENDED TO INDICATE COLOR.

FOR PERSONNEL PLACEMENT AND RECRUITMENT, NAMELY, PROVIDING PROFESSIONALLY TRAINED UNIFORMED PERSONNEL FOR STOCKING PRODUCTS, DISPLAYS AND SHELVES, MONITORING PRODUCT MOVEMENT, ROTATING STOCK, REMOVING DAMAGED OR TAMPERED MERCHANDISE, CLEANING AND DUSTING SHELVES AND DISPLAYS, CONDUCTING IN STORE SURVEYS, PERFORMING PRODUCT RESETS AND DISTRIBUTING COUPONS FOR RETAILERS, MANUFACTURERS, BROKERS AND DISTRIBUTORS (U.S. CLS. 100, 101 AND 102).
FIRST USE 9-25-2000; IN COMMERCE 9-25-2000.

SN 76-311,175. ALL IN ONE, INC., GLENDALE, CA. FILED 8-31-2001.

ALL IN 1

FOR BOOKKEEPING AND ACCOUNTING SERVICES; ADMINISTRATIVE BUSINESS MANAGEMENT FOR OTHERS (U.S. CLS. 100, 101 AND 102).
FIRST USE 6-0-1991; IN COMMERCE 6-0-1991.

SN 76-311,521. KEENELAND ASSOCIATION, INC., LEXINGTON, KY. FILED 9-12-2001.

SOURCE OF THE CLASSIC HORSE

FOR AUCTION SERVICES FEATURING THOROUGHBRED RACE HORSES (U.S. CLS. 100, 101 AND 102).

CLASS 35—(Continued).

SN 76-312,924. EHN INC., TORONTO, ONTARIO, CANADA, FILED 9-17-2001.

EHN INC.

OWNER OF CANADA REG. NO. TMA530,216, DATED 7-18-2000, EXPIRES 7-18-2015.

NO CLAIM IS MADE TO THE EXCLUSIVE RIGHT TO USE "INC.", APART FROM THE MARK AS SHOWN.

FOR WHOLESALE DISTRIBUTORSHIPS FEATURING NUTRITIONAL SUPPLEMENTS AND HEALTH CARE PRODUCTS (U.S. CLS. 100, 101 AND 102).

SN 76-313,901. JACKSON ORGANIZATION, INC., THE, COLUMBIA, MD. FILED 9-18-2001.



NO CLAIM IS MADE TO THE EXCLUSIVE RIGHT TO USE "DATA", APART FROM THE MARK AS SHOWN.

FOR BUSINESS CONSULTATION SERVICES; MARKET AND BUSINESS RESEARCH SERVICES; CONDUCTING BUSINESS AND MARKET RESEARCH SURVEYS (U.S. CLS. 100, 101 AND 102).

FIRST USE 8-25-2001; IN COMMERCE 8-25-2001.

SN 76-314,313. L. B. INTERNATIONAL, INC., ST. CLOUD, FL. FILED 9-19-2001.



NO CLAIM IS MADE TO THE EXCLUSIVE RIGHT TO USE "INTERNATIONAL", APART FROM THE MARK AS SHOWN.

FOR LOGISTICS MANAGEMENT SERVICES, NAMELY DYNAMIC STAGING, CROSS-DOCKING, CASE-PICKING, PRODUCTION BUFFERING AND STORAGE SOLUTIONS, AND PROCESS EVALUATION, PROCESS REENGINEERING AND SIMULATION MODELING SERVICES IN THE FIELDS OF MANUFACTURING, WAREHOUSING, AND DISTRIBUTION OF GOODS (U.S. CLS. 100, 101 AND 102).

FIRST USE 10-0-1998; IN COMMERCE 10-0-1998.

CLASS 35—(Continued).

SN 76-314,394. PLEASANT COMPANY, MIDDLETON, WI. FILED 9-19-2001.

AMERICAN GIRL TODAY

OWNER OF U.S. REG. NOS. 2,159,193, 2,318,248 AND OTHERS.

FOR RETAIL STORE SERVICES, ON-LINE RETAIL STORE SERVICES, AND MAIL ORDER CATALOG SERVICES FEATURING CHILDREN'S BOOKS, DOLLS, DOLL CLOTHING, DOLL FURNITURE, AND DOLL ACCESSORIES, STUFFED TOY ANIMALS AND CLOTHING AND ACCESSORIES FOR STUFFED TOYS ANIMALS, AND CLOTHING FOR GIRLS TO MATCH AND COMPLEMENT DOLL CLOTHING (U.S. CLS. 100, 101 AND 102).

FIRST USE 9-8-1998; IN COMMERCE 9-8-1998.

SN 76-315,396. REALREAD INC., NEW YORK, NY. FILED 9-21-2001.

REALREAD

FOR ADVERTISING SERVICES TO PROMOTE MARKETING OF PUBLICATIONS OF OTHERS BY PERMITTING POTENTIAL BUYERS TO ACCESS A PUBLICATION VIA THE GLOBAL COMPUTER INFORMATION NETWORK AND TO BROWSE THROUGH THE PUBLICATION, BUT NOT TO COPY, DOWNLOAD OR PRINT THE PUBLICATION OR ANY PART OF IT (U.S. CLS. 100, 101 AND 102).

FIRST USE 6-2-2000; IN COMMERCE 6-2-2000.

SN 76-315,549. EVENT NETWORKS, INC., HIGHLANDS RANCH, CO. FILED 9-21-2001.

CABLE SNAPSHOT

NO CLAIM IS MADE TO THE EXCLUSIVE RIGHT TO USE "CABLE", APART FROM THE MARK AS SHOWN.

FOR BUSINESS MARKETING CONSULTING AND DATA PROCESSING FOR TRACKING AND ANALYZING PERFORMANCE, GROWTH, AND ADVERTISING OF THE CABLE INDUSTRY BY MARKET AND CUSTOMER-SELECTED PARAMETERS IN THE FIELD OF DIGITAL COMMUNICATIONS (U.S. CLS. 100, 101 AND 102).

FIRST USE 1-15-2001; IN COMMERCE 1-15-2001.

SN 76-315,587. LEO BURNETT WORLDWIDE, INC., CHICAGO, IL. FILED 9-21-2001.

BRANDPROSPECT

FOR ADVERTISING AGENCY SERVICES, NAMELY RESEARCH SERVICES AND STRATEGIC BUSINESS AND MARKETING CONSULTING SERVICES (U.S. CLS. 100, 101 AND 102).

FIRST USE 3-0-2001; IN COMMERCE 3-0-2001.

CLASS 35—(Continued).

SN 76-316,590. VANGUARD MARKETING SERVICES, INC., STAMFORD, CT. FILED 9-25-2001.

PRO DEMONSTRATION SERVICES

NO CLAIM IS MADE TO THE EXCLUSIVE RIGHT TO USE "DEMONSTRATION SERVICES", APART FROM THE MARK AS SHOWN.

FOR PROMOTING THE SALE OF GOODS OF OTHERS THROUGH THE DISTRIBUTION OF PRINTED MATERIAL AND THROUGH THE DEMONSTRATION OF THE PRODUCTS OF OTHERS (U.S. CLS. 100, 101 AND 102).

CLASS 35—(Continued).

SN 76-320,171. WILBUR CHOCOLATE CO., INC., LITITZ, PA. FILED 10-2-2001.

REPLACE YOUR SUPPLIER WITH A PARTNER

FOR PROVIDING CUSTOMER SERVICES, BUSINESS MARKETING CONSULTATION SERVICES, AND TECHNICAL OPERATING ASSISTANCE TO MANUFACTURERS IN THE FOOD, BEVERAGE AND CONFECTION INDUSTRIES (U.S. CLS. 100, 101 AND 102).

FIRST USE 6-20-2001; IN COMMERCE 6-20-2001.

SN 76-319,025. UNITED VAN LINES, LLC, FENTON, MO. FILED 9-27-2001.

RAPIDTRAC

FOR COMPUTERIZED TRACKING BY CUSTOMERS OF INTERSTATE AND INTERNATIONAL SHIPMENTS IN TRANSIT (U.S. CLS. 100, 101 AND 102).

FIRST USE 8-1-2001; IN COMMERCE 8-1-2001.

SN 76-320,784. CARD COMMERCE INTERNATIONAL, INC., LOS ANGELES, CA. FILED 10-2-2001.

VALUE BACK NETWORK

NO CLAIM IS MADE TO THE EXCLUSIVE RIGHT TO USE "NETWORK", APART FROM THE MARK AS SHOWN.

FOR CUSTOMER LOYALTY PROGRAM COMPRISED OF MERCHANTS, SPONSORS, ELECTRONIC SERVICE DATA PROVIDERS AND CONSUMERS WHICH OPERATES TO ENABLE MERCHANTS AND CORPORATE MEMBERS TO OFFER A VARIETY OF REWARDS AND REBATES TO THEIR CUSTOMERS OR THE CUSTOMERS' DESIGNATED BENEFICIARIES TO PROMOTE CUSTOMER LOYALTY (U.S. CLS. 100, 101 AND 102).

FIRST USE 3-1-2001; IN COMMERCE 3-1-2001.

SN 76-319,242. QCOM TV, INC., WEST CHESTER, PA. FILED 9-28-2001.

NEXT VIEW

FOR PROVIDING COMMERCIAL INFORMATION ON TELEVISION VIEWING BEHAVIOR IN THE FIELD OF CABLE AND SATELLITE TELEVISION (U.S. CLS. 100, 101 AND 102).

SN 76-321,293. TRENCHLESS TECHNOLOGY, INC., PENINSULA, OH. FILED 10-3-2001.

SN 76-320,160. SHOPPER'S EDGE LLC, THE, WEEHAWKEN, NJ. BY ASSIGNMENT HANOVER DIRECT, INC., WEEK-HAWKEN, NJ. FILED 10-2-2001.

THE SHOPPER'S EDGE

FOR BUYING CLUB SERVICES (U.S. CLS. 100, 101 AND 102).

FIRST USE 3-10-1999; IN COMMERCE 3-10-1999.

NO CLAIM IS MADE TO THE EXCLUSIVE RIGHT TO USE "HDD" AND "INTERNATIONAL DIRECTIONAL DRILLING", APART FROM THE MARK AS SHOWN.

FOR ARRANGING AND CONDUCTING TRADE SHOW EXHIBITIONS AND COMPETITIONS IN THE FIELD OF CONSTRUCTION NAMELY FIELD PENETRATION, CONSTRUCTION ENGINEERING, UTILITY LOCATING, BORING, TUNNELING, VACUUM EVACUATING, TRENCHLESS APPLICATIONS, AND DIRECTIONAL DRILLING (U.S. CLS. 100, 101 AND 102).

FIRST USE 2-28-1998; IN COMMERCE 2-28-1998.



CLASS 35—(Continued).

SN 76-321,644. VAL-PAK DIRECT MARKETING SYSTEMS, INC., LARGO, FL. FILED 10-4-2001.

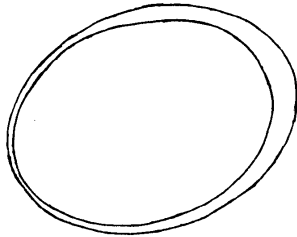

THE MARK CONSISTS OF A REPRESENTATION OF AN ENVELOPE WINDOW.

FOR PROMOTING THE GOODS AND SERVICES OF OTHERS BY DESIGNING AND DISTRIBUTING THE ADVERTISING MATERIALS OF OTHERS AND PROMOTING THE GOODS AND SERVICES OF OTHERS BY DESIGNING AND DISTRIBUTING THE ADVERTISING MATERIALS OF OTHERS VIA A GLOBAL COMPUTER NETWORK (U.S. CLS. 100, 101 AND 102).

SN 76-321,797. INCENTIVE MARKETING, INC., WOODSTOCK, GA. FILED 10-6-2001.



NO CLAIM IS MADE TO THE EXCLUSIVE RIGHT TO USE "ON PREMISE NETWORK", APART FROM THE MARK AS SHOWN.

FOR BUSINESS MARKETING CONSULTING SERVICES; PROVIDING BUSINESS MARKETING INFORMATION; PROMOTING THE SERVICES OF THE BEVERAGE, RESTAURANT AND BAR INDUSTRIES BY RENDERING SALES PROMOTION ADVICE; ADVERTISING SERVICES, NAMELY, CREATING BRAND IDENTITIES FOR OTHERS, DEVELOPING NEW PRODUCT LAUNCH MATERIALS FOR OTHERS, CREATING POINT OF SALE DISPLAYS FOR OTHERS, CREATING PROMOTIONAL CAMPAIGNS FOR OTHERS AND CREATING TRADE ADVERTISING FOR OTHERS; AND INCENTIVE AWARD PROGRAMS TO PROMOTE THE SALE OF PRODUCTS AND SERVICES OF OTHERS (U.S. CLS. 100, 101 AND 102).

FIRST USE 11-0-2000; IN COMMERCE 11-0-2000.

CLASS 35—(Continued).

SN 76-322,448. CALIFORNIA FOREST PRODUCTS COMMISSION, AUBURN, CA. FILED 10-9-2001.



NO CLAIM IS MADE TO THE EXCLUSIVE RIGHT TO USE "CALIFORNIA WOOD SUSTAINABLE FORESTS", APART FROM THE MARK AS SHOWN.

FOR ADVERTISING FOR OTHERS IN THE FIELD OF CALIFORNIA FOREST PRODUCTS, NAMELY, PREPARATION OF MARKETING AND PROMOTIONAL PLANS AND PROGRAMS FOR PRODUCERS OF CALIFORNIA FOREST PRODUCTS; AND PROMOTING THE GOODS OF OTHERS BY PREPARING AND PLACING ADVERTISEMENTS IN OR ON MAGAZINES, TRADE PAPERS, TELEVISION, WEBSITES, AND BILLBOARDS (U.S. CLS. 100, 101 AND 102).

FIRST USE 6-1-2001; IN COMMERCE 6-1-2001.

SN 76-322,509. WHEELCHAIR HAVEN, INC., FEDERAL WAY, WA. FILED 10-5-2001.

WHEELCHAIR HAVEN

NO CLAIM IS MADE TO THE EXCLUSIVE RIGHT TO USE "WHEELCHAIR", APART FROM THE MARK AS SHOWN.

FOR RETAIL STORE SERVICES FEATURING MEDICAL EQUIPMENT, NAMELY, SALES OF WHEELCHAIRS, CUSTOMIZED SEATING, WHEELCHAIR ACCESSORIES, NAMELY, TRAYS, HEADRESTS, ARMRESTS, FOOT POSITIONERS, ELECTRIC LIFT CHAIR RECLINERS, POWERED 3 AND 4 WHEEL SCOOTERS AND WHEELCHAIRS, TOILET RISERS AND BATH BENCHES, COMMODOES, HOSPITAL BEDS, RAILS, GRAB BARS, TRAPEZES, PARTS FOR ALL EQUIPMENT SOLD, BATTERIES, CHARGERS, WHEELS AND UPHOLSTERY (U.S. CLS. 100, 101 AND 102).

FIRST USE 8-30-1995; IN COMMERCE 8-30-1995.

SN 76-322,538. MINDFOLIO LTD., HENLEY-ON-THAMES RG9 4AX, UNITED KINGDOM, FILED 10-9-2001.

MINDFOLIO

FOR BUSINESS MARKETING CONSULTING SERVICES; BUSINESS CONSULTING SERVICES DEALING WITH GROWTH AND INNOVATION ISSUES AS THEY PERTAIN TO THE CREATION AND MARKETING OF PRODUCTS AND SERVICES (U.S. CLS. 100, 101 AND 102).

CLASS 35—(Continued).

SN 76-322,671. PLATINUM ALLIANCE, INC., GAINESVILLE, FL. FILED 10-9-2001.

PLATINUM ALLIANCE

NO CLAIM IS MADE TO THE EXCLUSIVE RIGHT TO USE "ALLIANCE", APART FROM THE MARK AS SHOWN.

FOR DISCOUNT BUYING SERVICES IN THE FIELD OF MAJOR MEDICAL, DENTAL, VISION, PHARMACY, CHIROPRACTIC, AND HEARING (U.S. CLS. 100, 101 AND 102).

SN 76-322,802. RAPID RETURN MEDICAL BILLING, INC., BAXTER, MN. FILED 10-9-2001.

RAPID RETURN MEDICAL BILLING

NO CLAIM IS MADE TO THE EXCLUSIVE RIGHT TO USE "MEDICAL BILLING", APART FROM THE MARK AS SHOWN.

FOR MEDICAL BILLING SERVICES; RETAIL STORE SERVICES FEATURING MEDICAL BILLING SOFTWARE; BUSINESS CONSULTING IN THE FIELD OF MEDICAL BILLING (U.S. CLS. 100, 101 AND 102).

FIRST USE 10-18-1994; IN COMMERCE 11-9-1994.

SN 76-323,801. CODE MANAGEMENT ASSOCIATION, INC., BETHLEHEM, PA. FILED 10-11-2001.

EBFI

FOR ELECTRONIC DIRECTORY SERVICES FEATURING A CODING SYSTEM THAT IDENTIFIES THE TITLES OF INDIVIDUALS PERFORMING BUSINESS FUNCTIONS (U.S. CLS. 100, 101 AND 102).

SN 76-324,541. PACIFICO, INC., SAN JOSE, CA. FILED 10-11-2001.

PACIFICO

FOR ADVERTISING AGENCY, MARKETING AND PUBLIC RELATIONS SERVICES, NAMELY, PROVIDING BUSINESS DEVELOPMENT AND PROMOTIONAL SERVICES IN THE AREAS OF MARKET RESEARCH AND ANALYSIS, SALES AND MARKETING STRATEGY, DEVELOPMENT OF MULTIMEDIA CONCEPTS, INTEGRATED MARKETING COMMUNICATIONS; DISSEMINATION OF ADVERTISING AND PUBLIC RELATIONS FOR OTHERS TARGETED AT ALL CONVENTIONAL MEDIA UTILIZING A GLOBAL COMPUTER NETWORK (U.S. CLS. 100, 101 AND 102).

FIRST USE 6-0-1977; IN COMMERCE 6-0-1977.

CLASS 35—(Continued).

SN 76-326,153. QVC, INC., WEST CHESTER, PA. FILED 10-16-2001.

SINCERELY SOUTHWEST

FOR HOME SHOPPING SERVICES IN THE FIELD OF JEWELRY THROUGH THE USE OF TELEVISION, TELEPHONE AND THE INTERNET (U.S. CLS. 100, 101 AND 102).

SN 76-326,733. COFFEECOL, INC., CORAL GABLES, FL. FILED 10-18-2001.

COFFEECOL, INC.

NO CLAIM IS MADE TO THE EXCLUSIVE RIGHT TO USE "INC.", APART FROM THE MARK AS SHOWN.

FOR WHOLESALE DISTRIBUTORSHIP FEATURING COFFEE GROWN BY OTHERS (U.S. CLS. 100, 101 AND 102).

FIRST USE 0-0-1988; IN COMMERCE 0-0-1988.

SN 76-327,162. YOGA FOR THE YOUNG AT HEART, LLC, PAGOSA SPRINGS, CO. FILED 10-18-2001.

YOGAHEART

FOR ON-LINE RETAIL STORE IN THE FIELD OF INSTRUCTIONAL PRODUCTS; NAMELY, BOOKS, PRE-RECORDED AUDIO TAPES, PRERECORDED VIDEO TAPES AND MULTIMEDIA CD-ROMS (U.S. CLS. 100, 101 AND 102).

FIRST USE 10-9-1998; IN COMMERCE 10-9-1998.

SN 76-327,243. THOMPSON, MICHAEL, DBA BUFORD'S FUN AND NUT COMPANY, SHERMAN, TX. FILED 10-17-2001.



NO CLAIM IS MADE TO THE EXCLUSIVE RIGHT TO USE "NUT COMPANY", APART FROM THE MARK AS SHOWN.

FOR ON-LINE RETAIL STORE AND MAIL ORDER SERVICES FEATURING SALTED MIXED NUTS, PROCESSED NUTS AND ROASTED NUTS (U.S. CLS. 100, 101 AND 102).

FIRST USE 8-30-2000; IN COMMERCE 8-30-2000.

CLASS 35—(Continued).

SN 76-327,730. POWERPLAY RINKS, INC., EXTON, PA. FILED 10-19-2001.

POWER PLAY RINKS

NO CLAIM IS MADE TO THE EXCLUSIVE RIGHT TO USE "RINKS", APART FROM THE MARK AS SHOWN.

FOR BUSINESS MANAGEMENT AND CONSULTATION FOR RECREATIONAL FACILITIES, NAMELY, SKATING RINKS (U.S. CLS. 100, 101 AND 102).

SN 76-327,889. TIRE FACTORY, INC., EAST LANSING, MI. FILED 10-22-2001.

TIRE FACTORY

APPLICANT CLAIMS EXCLUSIVE RIGHTS TO USE THE MARK IN THE AREA ENCOMPASSING THE STATES EAST OF THE MISSISSIPPI RIVER. SUBJECT TO CONCURRENT USE PROCEEDING WITH TIRE FACTORY GROUP LLC, SERIAL NO. 76119734; TIRE FACTORY GROUP L.P., SERIAL NO. 75649509; TIRE FACTORY GROUP, L.P., REGISTRATION NO. 2314658.

NO CLAIM IS MADE TO THE EXCLUSIVE RIGHT TO USE "TIRE", APART FROM THE MARK AS SHOWN.

FOR RETAIL STORE AND WHOLESALE STORE SERVICES FEATURING TIRES AND TIRE ACCESSORIES, NAMELY, CUSTOM WHEELS, RIMS, WHEEL ACCESSORIES, TUBES, LUGNUTS, LOCKS AND CAPS (U.S. CLS. 100, 101 AND 102).

FIRST USE 0-0-1977; IN COMMERCE 0-0-1979.

SN 76-328,283. HERITAGE PRESERVATION CORPORATION, SPARTANBURG, SC. FILED 10-22-2001.

DONNELLINX

FOR PRINT MANAGEMENT SERVICES PROVIDED VIA THE WORLDWIDE COMPUTER NETWORK, NAMELY, TRACKING OF PRINT ORDERS AND DISTRIBUTING PRINT ORDERS TO PRINTERS FOR BIDDING (U.S. CLS. 100, 101 AND 102).

FIRST USE 10-3-2001; IN COMMERCE 10-3-2001.

SN 76-328,303. PRESCOTT LEGAL SEARCH, INC., HOUSTON, TX. FILED 10-22-2001.

WHEN YOU NEED MORE THAN RESUMES

FOR EMPLOYMENT HIRING, RECRUITING, PLACEMENT, STAFFING, AND CAREER NETWORKING SERVICES (U.S. CLS. 100, 101 AND 102).

FIRST USE 2-24-1997; IN COMMERCE 2-24-1997.

CLASS 35—(Continued).

SN 76-328,814. BIRKMAN INTERNATIONAL, INC., HOUSTON, TX. FILED 10-22-2001.

BIRKMAN

OWNER OF U.S. REG. NOS. 1,708,575, 2,350,288 AND OTHERS.

SEC. 2(F).

FOR PERSONNEL MANAGEMENT CONSULTATION SERVICES; PROVIDING BUSINESS MANAGEMENT INFORMATION IN THE FIELD OF HUMAN PERFORMANCE CRITERIA, BY MEANS OF A GLOBAL COMPUTER INFORMATION NETWORK (U.S. CLS. 100, 101 AND 102).

FIRST USE 1-1-1952; IN COMMERCE 1-1-1952.

SN 76-329,155. JONES, SHAUN, CHEVY CHASE, MD. FILED 10-24-2001.

OMATIGENCE

FOR BUSINESS CONSULTATION SERVICES FOR FACILITATING TECHNOLOGICAL INNOVATION; BUSINESS CONSULTATION SERVICES, NAMELY, THE PROVISION OF STRATEGIC ANALYSIS FOR OTHERS; AND PROVIDING BUSINESS FORECASTING INFORMATION TO OTHERS (U.S. CLS. 100, 101 AND 102).

SN 76-329,529. MOODY, LORI, ROCKLIN, CA. FILED 10-22-2001.

SERVICE EVALUATIONS

NO CLAIM IS MADE TO THE EXCLUSIVE RIGHT TO USE "SERVICE EVALUATIONS", APART FROM THE MARK AS SHOWN.

FOR SHOPPING BY RESEARCHERS WHO POSE AS CUSTOMERS TO EVALUATE THE QUALITY OF SERVICE DELIVERED (U.S. CLS. 100, 101 AND 102).

FIRST USE 1-1-2000; IN COMMERCE 1-1-2000.

SN 76-330,615. KYSELA PERE ET FILS, LTD., WINCHESTER, VA. FILED 10-26-2001.

J & D SELECTIONS, INC.

NO CLAIM IS MADE TO THE EXCLUSIVE RIGHT TO USE "SELECTIONS, INC.", APART FROM THE MARK AS SHOWN.

FOR IMPORT AGENCY SERVICES AND WHOLESALE DISTRIBUTORSHIP SERVICES FEATURING ALCOHOLIC BEVERAGES AND FINE FOODS, NAMELY, CHEESES (U.S. CLS. 100, 101 AND 102).

FIRST USE 3-27-2000; IN COMMERCE 3-27-2000.

CLASS 35—(Continued).

SN 76-330,630. LIPE, JAY B., DBA EMERGE MARKETING, MINNEAPOLIS, MN. FILED 10-29-2001.



COLOR IS A FEATURE OF THE MARK. THE PARTS OF THE DRAWING DEPICTED IN BLACK APPEAR IN THE MARK AS THE COLOR OF RED.

THE MARK CONSISTS IN PART OF THE STYLIZED LETTERS "EM".

FOR BUSINESS MARKETING CONSULTING SERVICES (U.S. CLS. 100, 101 AND 102).

FIRST USE 3-8-1998; IN COMMERCE 3-8-1998.

SN 76-330,643. LIPE, JAY B., DBA EMERGE MARKETING, MINNEAPOLIS, MN. FILED 10-29-2001.



COLOR IS A FEATURE OF THE MARK. THE PARTS OF THE DRAWING DEPICTED IN BLACK APPEAR IN THE MARK AS THE COLOR OF RED.

FOR BUSINESS MARKETING CONSULTING SERVICES (U.S. CLS. 100, 101 AND 102).

FIRST USE 4-10-2001; IN COMMERCE 4-10-2001.

SN 76-331,723. BERDICHEVSKY, RUAL, SANTA MONICA, CA. FILED 10-31-2001.

RUALBRANDS

FOR PRODUCT MERCHANDISING; BUSINESS MANAGEMENT, NETWORKING AND PLANNING (U.S. CLS. 100, 101 AND 102).

CLASS 35—(Continued).

SN 76-333,280. FREEEATS.COM, HERNDON, VA. FILED 11-5-2001.

FECADS

FOR ADVERTISING SERVICES, NAMELY, DISSEMINATION OF ADVERTISING FOR OTHERS VIA TELEPHONE, PRINTED MATERIALS AND VIA GLOBAL COMPUTER NETWORK; POLLING SERVICES, NAMELY PUBLIC OPINION POLLING (U.S. CLS. 100, 101 AND 102).

SN 76-333,742. NATIONAL NUTRITIONAL FOODS ASSOCIATION, NEWPORT BEACH, CA. FILED 11-2-2001.



OWNER OF U.S. REG. NOS. 2,288,686, 2,379,129 AND OTHERS.

NO CLAIM IS MADE TO THE EXCLUSIVE RIGHT TO USE "GRASSROOTS ACTION TEAM", APART FROM THE MARK AS SHOWN.

FOR PROMOTING PUBLIC AWARENESS AND ACTIVISM RELATED TO THE NATURAL PRODUCTS INDUSTRIES (U.S. CLS. 100, 101 AND 102).

FIRST USE 8-20-2001; IN COMMERCE 8-20-2001.

SN 76-334,534. PATAGONIA, INC., VENTURA, CA. FILED 11-5-2001.

PATAGONIA

OWNER OF U.S. REG. NOS. 1,189,402, 2,392,685 AND OTHERS.

FOR RETAIL STORE SERVICES FEATURING CLOTHING, FOOTWEAR, LUGGAGE AND A WIDE VARIETY OF SPORTING GOODS AND ACCESSORIES (U.S. CLS. 100, 101 AND 102).

FIRST USE 6-15-1986; IN COMMERCE 6-15-1986.

CLASS 35—(Continued).

SN 76-337,627. COLLIER, OTIS, DBA BLACK GREEK NETWORK, MARIETTA, GA. FILED 11-14-2001.



NO CLAIM IS MADE TO THE EXCLUSIVE RIGHT TO USE "BLACK GREEK NETWORK" AND "2001", APART FROM THE MARK AS SHOWN.

FOR PROMOTING BUSINESS EVENTS, NAMELY, CAREER FAIRS AND WORKSHOPS (U.S. CLS. 100, 101 AND 102).

FIRST USE 1-25-2001; IN COMMERCE 9-28-2001.

SN 76-337,733. ROSEN IMAGES, INC., NEW YORK, NY. FILED 11-13-2001.

ACCESSMR

FOR ACCESS-MARKETING CONSULTATION, ADVERTISING AGENCIES, AND PREPARING PROMOTIONAL AND MERCHANDISING MATERIAL FOR OTHERS (U.S. CLS. 100, 101 AND 102).

FIRST USE 7-28-2001; IN COMMERCE 8-31-2001.

SN 76-338,091. CLOROX COMPANY, THE, OAKLAND, CA. FILED 11-16-2001.

ShelfMaster

FOR BUSINESS CONSULTING SERVICES FOR RETAILERS (U.S. CLS. 100, 101 AND 102).

FIRST USE 9-30-2001; IN COMMERCE 9-30-2001.

SN 76-338,951. BOTTECHNOLOGY.COM, INC., MARCO ISLAND, FL. FILED 11-19-2001.

**BETTER IP PROTECTION
THROUGH DEEPER WEB
MINING**

FOR PROVIDING A SUBSCRIPTION-BASED MONITORING SERVICE OF TRADEMARK USES WITHIN THE INTERNET GLOBAL COMPUTER NETWORK (U.S. CLS. 100, 101 AND 102).

CLASS 35—(Continued).

SN 76-339,623. FLEXIBILITY & CO., LLC, GREAT FALLS, VA. FILED 11-20-2001.

FLEX
RN & Co.

FOR STAFFING AGENCY PLACING NURSES AND RESPIRATORY THERAPISTS ON SHORT TERM ASSIGNMENTS IN HOSPITALS (U.S. CLS. 100, 101 AND 102).

SN 76-341,955. CHERRY CREEK MORTGAGE COMPANY, DENVER, CO. FILED 11-26-2001.

REAL-POWER MARKETING

NO CLAIM IS MADE TO THE EXCLUSIVE RIGHT TO USE "MARKETING", APART FROM THE MARK AS SHOWN.

FOR DIRECT MARKETING ADVERTISING FOR OTHERS IN THE BANKING, MORTGAGE, REAL ESTATE AND FINANCING INDUSTRIES (U.S. CLS. 100, 101 AND 102).

FIRST USE 11-1-1999; IN COMMERCE 11-1-1999.

SN 76-342,592. BOATS.COM, INC., LAKE FOREST, IL. FILED 11-28-2001.

BOATSCENTRAL

FOR ONLINE RETAIL SERVICES FOR BOATS AND MARINE PRODUCTS (U.S. CLS. 100, 101 AND 102).

FIRST USE 8-8-2000; IN COMMERCE 9-19-2000.

SN 76-342,730. RANDALL'S FOOD & DRUGS, LP, HOUSTON, TX. FILED 11-29-2001.

WEE-MARKABLE

FOR GROCERY STORE SERVICES (U.S. CLS. 100, 101 AND 102).

FIRST USE 8-0-1999; IN COMMERCE 8-0-1999.

CLASS 35—(Continued).

SN 76-342,982. ING. LORO PIANA & C. S.P.A, QUARONA, ITALY, FILED 11-29-2001.

THE CASHMERE AFFAIR

NO CLAIM IS MADE TO THE EXCLUSIVE RIGHT TO USE "CASHMERE", APART FROM THE MARK AS SHOWN. FOR RETAIL STORE SERVICES FEATURING CLOTHING FOR MEN, WOMEN AND CHILDREN, NAMELY JACKETS, COATS, SKIRTS, TROUSERS, CLOAKS, MANTLES; OVERCOATS AND KNITTED VESTS; SCARVES, MUFFLERS, SHAWLS AND GLOVES MADE IN WHOLE OR SIGNIFICANT PART OF CASHMERE (U.S. CLS. 100, 101 AND 102).
FIRST USE 4-1-2000; IN COMMERCE 4-1-2000.

CLASS 35—(Continued).

SN 76-346,687. J.R. FOUR LTD., DBA TECHNICAL GLASS PRODUCTS, KIRKLAND, WA. FILED 12-6-2001.

TECHNICAL GLASS PRODUCTS

NO CLAIM IS MADE TO THE EXCLUSIVE RIGHT TO USE "GLASS PRODUCTS", APART FROM THE MARK AS SHOWN.
SEC. 2(F).
FOR WHOLESALE DISTRIBUTORSHIP SERVICES IN THE FIELD OF GLASS AND GLASS FRAMING PRODUCTS (U.S. CLS. 100, 101 AND 102).
FIRST USE 1-0-1984; IN COMMERCE 1-0-1984.

SN 76-343,776. WCI COMMUNITIES, INC., BONITA SPRINGS, FL. FILED 11-30-2001.



OWNER OF U.S. REG. NO. 1,004,084.
FOR RETAIL STORES FEATURING SPORTING GOODS AND ATHLETIC CLOTHING FOR MEN, WOMEN AND CHILDREN (U.S. CLS. 100, 101 AND 102).

SN 76-347,379. PODELL, MARSHAL, SANTA PAULA, CA. FILED 12-11-2001.

GOLDEN AMERICAN

FOR SUPPLYING PRESCRIPTION DRUGS TO HEALTH PLAN PARTICIPANTS OF ASSOCIATIONS, CREDIT UNIONS AND EMPLOYER GROUPS (U.S. CLS. 100, 101 AND 102).

SN 76-345,381. NOMOREFORMS, INC., NEW PORT RICHEY, FL. FILED 12-3-2001.

NOMOREFORMS

FOR COMPUTERIZED DATA PROCESSING SERVICES FOR COLLECTING HUMAN RESOURCES, PERSONNEL AND SALES AGENT CONTRACT AND LICENSING INFORMATION VIA THE INTERNET AND AUTOMATICALLY COMPLETING FORMS DISPLAYED ON INTERNET WEB BROWSERS (U.S. CLS. 100, 101 AND 102).
FIRST USE 4-16-1999; IN COMMERCE 4-16-1999.

SN 76-347,852. ARBORA GROUP, INC., SUPERIOR, CO. FILED 12-12-2001.



FOR RETAIL AND WHOLESALE NURSERY AND LAWN AND GARDEN STORE SERVICES (U.S. CLS. 100, 101 AND 102).

SN 76-345,741. DAVE SMITH CHEVROLET OLDSMOBILE PONTIAC CADILLAC, INC., KELLOGG, ID. FILED 12-4-2001.

DAVE SMITH

THE NAME SHOWN IN THE MARK DOES NOT IDENTIFY A LIVING INDIVIDUAL.
FOR AUTOMOBILE DEALERSHIPS (U.S. CLS. 100, 101 AND 102).
FIRST USE 12-31-1965; IN COMMERCE 12-31-1965.

SN 76-347,860. ARBORA GROUP, INC., SUPERIOR, CO. FILED 12-12-2001.

ARBORA

FOR RETAIL AND WHOLESALE NURSERY AND LAWN AND GARDEN STORE SERVICES (U.S. CLS. 100, 101 AND 102).

CLASS 35—(Continued).

SN 76-347,861. ARBORA GROUP, INC., SUPERIOR, CO.
FILED 12-12-2001.

ARBORA GARDENS

NO CLAIM IS MADE TO THE EXCLUSIVE RIGHT TO USE "GARDENS", APART FROM THE MARK AS SHOWN.

FOR RETAIL AND WHOLESALE NURSERY AND LAWN AND GARDEN STORE SERVICES (U.S. CLS. 100, 101 AND 102).

SN 76-348,648. SPORTS AUTHORITY MICHIGAN, INC.,
THE, FORT LAUDERDALE, FL. FILED 12-13-2001.

**SPORTS
AUTHORITY**

OWNER OF U.S. REG. NOS. 1,527,526, 2,520,657 AND OTHERS.

NO CLAIM IS MADE TO THE EXCLUSIVE RIGHT TO USE "SPORTS", APART FROM THE MARK AS SHOWN.

FOR RETAIL STORE, MAIL ORDER, AND ONLINE RETAILING, ALL IN THE FIELDS OF SPORTING GOODS AND EQUIPMENT APPAREL, FOOTWEAR AND HEAD GEAR; AND ADVERTISING THE GOODS AND SERVICES OF OTHERS VIA PRINT PUBLICATIONS, TELEVISION, RADIO, DIRECT MAIL AND THE INTERNET (U.S. CLS. 100, 101 AND 102).

FIRST USE 3-16-1991; IN COMMERCE 3-16-1991.

SN 76-349,288. UNITED FARMERS AGENTS ASSOCIATION,
INC., ST. LOUIS, MO. FILED 12-18-2001.

**"AGENTS HELPING
AGENTS"**

FOR ASSOCIATION SERVICES, NAMELY, PROMOTING THE INTERESTS OF AGENTS REPRESENTING AN INSURANCE COMPANY; PROMOTING THE INTERESTS OF AGENTS REPRESENTING AN INSURANCE COMPANY (U.S. CLS. 100, 101 AND 102).

FIRST USE 3-31-1998; IN COMMERCE 3-31-1998.

CLASS 35—(Continued).

SN 76-349,390. DOLCE INTERNATIONAL HOLDINGS, INC.,
MONTVALE, NJ. FILED 12-17-2001.

Dolce
INTERNATIONAL
Focus. Learn. Succeed.

NO CLAIM IS MADE TO THE EXCLUSIVE RIGHT TO USE "INTERNATIONAL", APART FROM THE MARK AS SHOWN.

FOR BUSINESS MANAGEMENT OF HOTELS FOR OTHERS; ARRANGING AND CONDUCTING BUSINESS CONFERENCES (U.S. CLS. 100, 101 AND 102).

FIRST USE 1-0-2001; IN COMMERCE 1-0-2001.

SN 76-349,663. DOLCE INTERNATIONAL HOLDINGS, INC.,
MONTVALE, NJ. FILED 12-17-2001.

Dolce
INTERNATIONAL

NO CLAIM IS MADE TO THE EXCLUSIVE RIGHT TO USE "INTERNATIONAL", APART FROM THE MARK AS SHOWN.

FOR BUSINESS MANAGEMENT OF HOTELS FOR OTHERS; ARRANGING AND CONDUCTING BUSINESS CONFERENCES (U.S. CLS. 100, 101 AND 102).

FIRST USE 1-0-2001; IN COMMERCE 1-0-2001.

SN 76-349,855. GSD&M LP, AUSTIN, TX. FILED 12-17-2001.

ALLI PLAN

NO CLAIM IS MADE TO THE EXCLUSIVE RIGHT TO USE "PLAN", APART FROM THE MARK AS SHOWN.

FOR ADVERTISING AGENCY SERVICES, PUBLIC RELATION SERVICES AND ADVERTISING ANALYSIS, PLANNING, AND PLACEMENT SERVICES (U.S. CLS. 100, 101 AND 102).

FIRST USE 10-29-1998; IN COMMERCE 10-29-1998.

CLASS 35—(Continued).

SN 76-350,691. GARCIA, ANGELICA, NATIONAL CITY, CA. AND IBARRA, JAVIER, NATIONAL CITY, CA. FILED 12-20-2001.

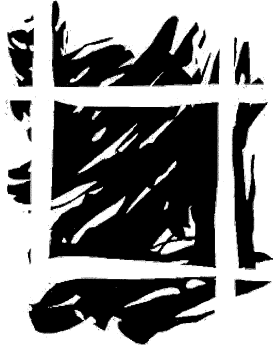

FOR RETAIL STORES, MAIL ORDER AND MAIL ORDER CATALOGUE SERVICES, WHOLESALE DISTRIBUTORSHIPS AND COMPUTERIZED ON-LINE RETAIL SERVICES IN THE FIELD OF CERAMIC AND NATURAL STONE, INCLUDING, BUT NOT LIMITED TO CLAY, GLASS; SLABS, NAMELY, MARBLE, GRANITE, LIMESTONE, ONYX, PORCELAIN, MARBLE/LIME TRAVERTINES, CEMENT, CONCRETE, CLAY AND SLATE; RESIDENTIAL AND COMMERCIAL INTERIOR AND EXTERIOR FLOORS, ROOF TILES, FLOOR TILES, WALL TILES, TILE RELATED PRODUCTS, CERAMIC PAVINGS STONWARE PAVINGS AND CLAY PAVINGS; DECORATIVE HOME FURNISHINGS, HOUSEWARES, FURNITURE INDOOR AND OUTDOOR FOUNTAINS, GARDEN STATUARY, BATHROOM AND KITCHEN FIXTURES, DECORATIVE FRAMES, CRAFTS, HOUSE HARDWARE FIXTURES AND POTTERY (U.S. CLS. 100, 101 AND 102).

FIRST USE 7-10-2000; IN COMMERCE 7-10-2000.

SN 76-350,767. DOLCE INTERNATIONAL HOLDINGS, INC., MONTVALE, NJ. FILED 12-19-2001.

A DOLCE CONFERENCE DESTINATION

NO CLAIM IS MADE TO THE EXCLUSIVE RIGHT TO USE "CONFERENCE DESTINATION", APART FROM THE MARK AS SHOWN.

FOR BUSINESS MANAGEMENT OF HOTELS FOR OTHERS; ARRANGING AND CONDUCTING BUSINESS CONFERENCES (U.S. CLS. 100, 101 AND 102).

FIRST USE 1-0-2001; IN COMMERCE 1-0-2001.

SN 76-350,768. DOLCE INTERNATIONAL HOLDINGS, INC., MONTVALE, NJ. FILED 12-19-2001.

FOCUS. LEARN. SUCCEED.

FOR BUSINESS MANAGEMENT OF HOTELS FOR OTHERS; ARRANGING AND CONDUCTING BUSINESS CONFERENCES (U.S. CLS. 100, 101 AND 102).

FIRST USE 1-0-2001; IN COMMERCE 1-0-2001.

CLASS 35—(Continued).

SN 76-352,010. HEALTHCARE MANAGEMENT GROUP OF ILLINOIS, INC., MT. VERNON, IL. FILED 12-20-2001.

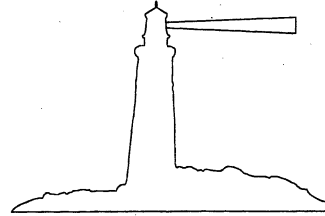

FOR PROVIDE CONSULTATION TO HOME MEDICAL EQUIPMENT DEALERS TO ENABLE CORRECT BILLING AND COMPLIANCE FOR MEDICARE REIMBURSEMENT (U.S. CLS. 100, 101 AND 102).

FIRST USE 10-18-2001; IN COMMERCE 10-18-2001.

SN 76-352,494. LANE AUTOMOTIVE, INC., WATERVLIET, MI. FILED 12-21-2001.

MOTOR STATE PERFORMANCE WAREHOUSE

OWNER OF U.S. REG. NO. 1,929,234. NO CLAIM IS MADE TO THE EXCLUSIVE RIGHT TO USE "PERFORMANCE WAREHOUSE", APART FROM THE MARK AS SHOWN.

SEC. 2(F) AS TO "MOTOR STATE".

FOR WHOLESALE DISTRIBUTORSHIP IN THE FIELD OF HIGH PERFORMANCE AND RACING AUTOMOTIVE PARTS AND ACCESSORIES (U.S. CLS. 100, 101 AND 102).

FIRST USE 10-0-2000; IN COMMERCE 10-0-2000.

SN 76-353,051. WINGMAN HOLDING, INC., NORTHGLENN, CO. BY CHANGE OF NAME; BY ASSIGNMENT WOODY'S WINGS, INC., NORTHGLENN, CO. FILED 12-26-2001.

WINGMAN

FOR FRANCHISING SERVICES, NAMELY, OFFERING TECHNICAL ASSISTANCE IN THE ESTABLISHMENT AND OPERATION OF RESTAURANTS (U.S. CLS. 100, 101 AND 102).

FIRST USE 1-0-2002; IN COMMERCE 1-0-2002.

CLASS 35—(Continued).

SN 76-354,332. VITAL BASICS, INC., PORTLAND, ME. FILED 1-2-2002.

VITAL BASICS

FOR DIRECT MAIL ADVERTISING; TELEMARKETING SERVICES; PLACING ADVERTISEMENTS FOR OTHERS; AND MAIL ORDER SERVICES FEATURING HOUSEWARES, SPORTING EQUIPMENT, JEWELRY, CLOTHING, COSMETICS, BOOKS AND PRINTED MATERIALS, ELECTRONICS, MUSICAL RECORDINGS, GARDEN EQUIPMENT, FOOD AND DIETARY SUPPLEMENTS, AND OTHER GENERAL HOUSEHOLD MERCHANDISE (U.S. CLS. 100, 101 AND 102).

FIRST USE 9-0-2000; IN COMMERCE 9-0-2000.

SN 76-355,754. DECOLAM, INC., ORANGEBURG, SC. FILED 1-7-2002.

PALMETTO INDUSTRIAL COMPONENTS

NO CLAIM IS MADE TO THE EXCLUSIVE RIGHT TO USE "INDUSTRIAL COMPONENTS", APART FROM THE MARK AS SHOWN.

FOR RETAIL STORE SERVICES FEATURING HARDWARE AND INDUSTRIAL FASTENERS (U.S. CLS. 100, 101 AND 102).

SN 76-355,784. VIPER LOGIC CORP., PALM SPRINGS, CA. FILED 1-7-2002.

"WE DON'T BUILD WEBSITES...WE MAKE THEMWORK"

FOR BUSINESS MANAGEMENT INFORMATION AND CONSULTATION; NAMELY PROVIDING A COMPREHENSIVE SUITE OF INTERNET SERVICES DESIGNING TO BRING CLIENTS CURRENT WITH THE FAST CHANGING DEMANDS AND COMPLEXITIES OF LARGE-SCALE BUSINESS GROWTH BY COMBINING BUSINESS LOGIC, BRAND MANAGEMENT AND CUSTOMER INTERACTION NEEDS WITH A PROGRESSIVE AND PROVEN TECHNOLOGY (U.S. CLS. 100, 101 AND 102).

FIRST USE 11-14-2001; IN COMMERCE 11-14-2001.

SN 76-356,080. GEOFFREY, INC., PARAMUS, NJ. FILED 1-4-2002.

RANDOM ACT OF KIDNESS!

FOR PROMOTING THE GOODS AND SERVICES OF OTHERS BY MEANS OF THE GIVING AWAY OF GIFT CARDS; RETAIL DEPARTMENT STORE SERVICES (U.S. CLS. 100, 101 AND 102).

FIRST USE 11-19-2001; IN COMMERCE 11-19-2001.

CLASS 35—(Continued).

SN 76-357,108. INTEGRARX PRESCRIPTION DRUGS ASSOCIATES LLC, KENMORE, WA. FILED 1-10-2002.

THE INTERNET'S MOST TRUSTED PHARMACY

FOR ONLINE AND TELEPHONE ORDERING SERVICES FEATURING GOODS RELATED TO PRESCRIPTION AND NONPRESCRIPTION MEDICINES AND SUPPLEMENTS FOR INDIVIDUAL HEALTH; PROVIDING CONSUMER PRODUCT INFORMATION VIA THE INTERNET AND CALL CENTERS (U.S. CLS. 100, 101 AND 102).

FIRST USE 8-1-2001; IN COMMERCE 8-1-2001.

SN 76-357,748. KUGLER, STEFAN M., INDIAN ROCKS BEACH, FL. FILED 1-11-2002.

BUNKER ONE MUSIC

NO CLAIM IS MADE TO THE EXCLUSIVE RIGHT TO USE "MUSIC", APART FROM THE MARK AS SHOWN.

FOR RETAIL STORE SERVICES AND COMPUTERIZED ON-LINE RETAIL SERVICES FEATURING PRE-RECORDED MUSIC, MOVIES, POSTERS, AND T-SHIRTS (U.S. CLS. 100, 101 AND 102).

FIRST USE 10-2-1997; IN COMMERCE 10-2-1997.

SN 76-358,011. CREATE-IT! INC., NAPERVILLE, IL. FILED 1-14-2002.

POINT, CLICK, SEND

FOR ADVERTISING SERVICES, NAMELY, CREATING, LAUNCHING, AND MANAGING MARKETING CAMPAIGNS FOR OTHERS VIA THE INTERNET (U.S. CLS. 100, 101 AND 102).

FIRST USE 12-1-2001; IN COMMERCE 12-1-2001.

SN 76-359,590. MEDICINE MADE EASY, TORRANCE, CA. FILED 1-16-2002.

MARS

FOR PROMOTING PATIENT ADHERENCE AND PUBLIC AWARENESS OF THE NEED FOR TAKING PRESCRIBED MEDICATION IN A TIMELY AND ACCURATE MANNER (U.S. CLS. 100, 101 AND 102).

FIRST USE 1-1-2001; IN COMMERCE 1-1-2001.

CLASS 35—(Continued).

SN 76-359,906. ENDURANCE ZONE, INC., RENO, NV. FILED 1-16-2002.

ENDURANCE ZONE

FOR RETAIL MAIL ORDER SERVICES AND ON-LINE RETAIL STORE SERVICES PERTAINING TO NUTRITION, HEALTH, EXERCISE, AND FITNESS RELATED GOODS AND SERVICES (U.S. CLS. 100, 101 AND 102).

SN 76-360,052. MAINSTREAM ENGINEERING CORPORATION, ROCKLEDGE, FL. FILED 1-18-2002.

DO IT RIGHT, DO IT QWIK!

FOR RETAIL SHOPS, MAIL ORDER SERVICES, TELEPHONE SHOP-AT-HOME, AND ONLINE RETAIL STORE SERVICES, WHOLESALE DISTRIBUTORSHIPS AND WHOLESALE ORDERING SERVICES FEATURING HEATING AND AIR CONDITIONING TOOLS AND PRODUCTS, NAMELY REFRIGERANT ACID TEST KITS, REFRIGERANT/OIL ACID TREATMENTS, PREVENTATIVE MAINTENANCE KITS AND SERVICES RECORDS, COMPRESSOR TERMINAL REPAIR KITS, REFRIGERANT PERFORMANCE ADDITIVES, SERVICE TOOLS, NAMELY A RESERVOIR DESIGNED TO INJECT ANY LIQUID ADDITIVE INTO OPERATING SYSTEMS, CLEANING KITS DESIGNED FOR USE IN CONNECTION WITH COMPRESSOR BURN-OUTS, SERVICE VALVE MOISTURE INDICATORS, CONDENSATE PAN TREATMENT DESIGNED TO TREAT AND PREVENT CONDENSATE PAN SCUM, SCALE AND DEPOSITS, UV LEAK DETECTOR KITS, UV LEAK DETECTOR FLUID DESIGNED TO WORK WITH ALL REFRIGERANTS AND OILS (U.S. CLS. 100, 101 AND 102).
FIRST USE 12-19-2001; IN COMMERCE 12-19-2001.

SN 76-360,617. SPL WORLDGROUP B.V., SAN FRANCISCO, CA. FILED 1-18-2002.

TOOLS THAT EMPOWER CHANGE

FOR BUSINESS MANAGEMENT CONSULTATION; MANAGEMENT ASSISTANCE; PERSONNEL MANAGEMENT CONSULTATION; BUSINESS PROCESS CONSULTATION (U.S. CLS. 100, 101 AND 102).

SN 76-361,751. BRAND AND CID, L.L.C., NEW YORK, NY. FILED 1-24-2002.

TUNITY

FOR BUSINESS MARKETING CONSULTING SERVICES, NAMELY, IMAGE AND BRAND DEVELOPMENT, CONCEPT CREATION FOR NEW BRANDS, BRAND REPOSITIONING OF PRE-EXISTING BRANDS, MARKET ANALYSIS AND STRATEGY AND CORPORATE IDENTITY SERVICES (U.S. CLS. 100, 101 AND 102).

FIRST USE 7-31-2001; IN COMMERCE 7-31-2001.

CLASS 35—(Continued).

SN 76-362,116. PORPOISE POOL & PATIO, INC., CLEARWATER, FL. FILED 1-23-2002.

PINCH·A·PENNY
Express

OWNER OF U.S. REG. NO. 1,201,596.
NO CLAIM IS MADE TO THE EXCLUSIVE RIGHT TO USE "EXPRESS", APART FROM THE MARK AS SHOWN.
FOR RETAIL STORE SERVICES FEATURING POOL CHEMICALS (U.S. CLS. 100, 101 AND 102).
FIRST USE 3-1-1998; IN COMMERCE 3-1-1998.

SN 76-362,711. WAL-MART STORES, INC., BENTONVILLE, AR. FILED 1-25-2002.

BABY DAYS

NO CLAIM IS MADE TO THE EXCLUSIVE RIGHT TO USE "BABY", APART FROM THE MARK AS SHOWN.
FOR RETAIL DEPARTMENT STORE SERVICES (U.S. CLS. 100, 101 AND 102).

SN 76-362,809. SCHOLASTIC INC., NEW YORK, NY. FILED 1-25-2002.

STAR
BOOK CLUB

NO CLAIM IS MADE TO THE EXCLUSIVE RIGHT TO USE "BOOK CLUB", APART FROM THE MARK AS SHOWN.

FOR MAIL ORDER BOOK CLUB SERVICES (U.S. CLS. 100, 101 AND 102).
FIRST USE 12-15-2001; IN COMMERCE 12-15-2001.

SN 76-362,980. MENDELOVICH, ISAAC, ELKINS PARK, PA. FILED 1-24-2002.

GO UP

FOR CUSTOMER LOYALTY REWARD PROGRAMS PROMOTING THE GOODS AND SERVICES OF OTHERS THROUGH INCENTIVES IN THE NATURE OF COUPONS, PREMIUMS AND/OR FREQUENT FLIER MILES (U.S. CLS. 100, 101 AND 102).

CLASS 35—(Continued).

SN 76-362,991. BRAND AND CID, L.L.C., NEW YORK, NY. FILED 1-28-2002.

TUNITY.NET

FOR BUSINESS MARKETING CONSULTING SERVICES, NAMELY, IMAGE AND BRAND DEVELOPMENT, CONCEPT CREATION FOR NEW BRANDS, BRAND REPOSITIONING OF PRE-EXISTING BRANDS, MARKET ANALYSIS AND STRATEGY AND CORPORATE IDENTITY SERVICES (U.S. CLS. 100, 101 AND 102).

FIRST USE 7-31-2001; IN COMMERCE 7-31-2001.

SN 76-363,134. STAY HOME COMPANIONS, INC., KALAMAZOO, MI. FILED 1-25-2002.

STAY HOME COMPANIONS

NO CLAIM IS MADE TO THE EXCLUSIVE RIGHT TO USE "COMPANIONS", APART FROM THE MARK AS SHOWN.

FOR EMPLOYMENT PLACEMENT OF DOMESTIC CAREGIVERS AND HOUSEKEEPERS (U.S. CLS. 100, 101 AND 102).

SN 76-364,382. TXDC, L.P., IRVING, TX. FILED 1-29-2002.

ZALES OUTLET

OWNER OF U.S. REG. NOS. 720,467, 2,296,939 AND OTHERS.

NO CLAIM IS MADE TO THE EXCLUSIVE RIGHT TO USE "OUTLET", APART FROM THE MARK AS SHOWN.

FOR RETAIL JEWELRY STORE SERVICES (U.S. CLS. 100, 101 AND 102).

FIRST USE 7-1-1993; IN COMMERCE 7-1-1993.

SN 76-364,426. MOREL & GRADOUX-MATT INC., NEW YORK, NY. FILED 1-23-2002.



FOR ON-LINE RETAIL STORE SERVICES IN THE FIELDS OF MUSICAL INSTRUMENTS AND ACCESSORIES THEREFOR, MUSICAL PUBLICATIONS, MUSICAL AUDIO AND VIDEO RECORDINGS; RETAIL MUSIC STORES; RETAIL CONSIGNMENT MUSIC STORES (U.S. CLS. 100, 101 AND 102).

FIRST USE 11-22-2001; IN COMMERCE 11-22-2001.

CLASS 35—(Continued).

SN 76-364,468. NATIONAL ASSOCIATION OF MEN'S SPORTSWEAR BUYERS INC., NEW YORK, NY. FILED 1-28-2002.

NAMSB WORLDSOURCE

FOR ARRANGING AND CONDUCTING TRADE SHOWS IN THE FIELD OF MEN'S APPAREL DIRECTED TO THE MEN'S APPAREL INDUSTRY (U.S. CLS. 100, 101 AND 102).

FIRST USE 3-2-2001; IN COMMERCE 3-2-2001.

SN 76-365,205. CONVENTURES, INC., BOSTON, MA. FILED 1-24-2002.

PROVIDENCE COOKS

OWNER OF U.S. REG. NO. 2,198,090.

NO CLAIM IS MADE TO THE EXCLUSIVE RIGHT TO USE "PROVIDENCE", APART FROM THE MARK AS SHOWN.

FOR EVENTS AND EXHIBITIONS FEATURING PRODUCTS AND SERVICES IN THE FOOD SERVICE, RESTAURANT, KITCHEN, HOUSEWARES, AND CULINARY INDUSTRIES; PROMOTING BUSINESS IN THE FIELD OF RESTAURANTS, FOOD SERVICES, FOOD PRODUCTS, AND CULINARY EDUCATION AND LITERATURE (U.S. CLS. 100, 101 AND 102).

SN 76-365,328. NAGDEMAN, JULIAN J., NORTH CALDWELL, NJ. FILED 2-1-2002.

SUASION RESOURCES

NO CLAIM IS MADE TO THE EXCLUSIVE RIGHT TO USE "RESOURCES", APART FROM THE MARK AS SHOWN.

FOR PROVIDING MARKETING CONSULTING SERVICES TO THE FINANCIAL SERVICES INDUSTRY (U.S. CLS. 100, 101 AND 102).

FIRST USE 10-26-2001; IN COMMERCE 10-26-2001.

SN 76-365,671. TELEMEDIA DEVELOPMENT GROUP, LLC, DENVER, CO. FILED 1-31-2002.



TELEMEDIA DEVELOPMENT
GROUP, LLC

NO CLAIM IS MADE TO THE EXCLUSIVE RIGHT TO USE "DEVELOPMENT GROUP LLC", APART FROM THE MARK AS SHOWN.

FOR ORGANIZATIONAL AND CORPORATE PSYCHOLOGY ASSESSMENT SERVICES TO ASSIST SEED AND EARLY STAGE COMPANIES IN THE PREPARATION AND MANAGEMENT OF RAPID GROWTH (U.S. CLS. 100, 101 AND 102).

FIRST USE 11-18-1999; IN COMMERCE 11-18-1999.

CLASS 35—(Continued).

SN 76-366,780. NASH-FINCH COMPANY, MINNEAPOLIS, MN. FILED 2-4-2002.

AVANZA SUPERMARKET

NO CLAIM IS MADE TO THE EXCLUSIVE RIGHT TO USE "SUPERMARKET", APART FROM THE MARK AS SHOWN.

THE WORD "AVANZA" IS A SPANISH WORD THAT TRANSLATES TO "YOU ADVANCE" IN ENGLISH.

FOR RETAIL GROCERY STORE SERVICES (U.S. CLS. 100, 101 AND 102).

CLASS 35—(Continued).

SN 76-367,286. SLINGSHOT SOLUTIONS, INC., PHILADELPHIA, PA. FILED 2-5-2002.

DELIVERY DOG

NO CLAIM IS MADE TO THE EXCLUSIVE RIGHT TO USE "DELIVERY", APART FROM THE MARK AS SHOWN.

FOR ONLINE RETAIL STORE SERVICES FEATURING GENERAL CONSUMER MERCHANDISE (U.S. CLS. 100, 101 AND 102).

FIRST USE 2-4-2002; IN COMMERCE 2-4-2002.

SN 76-367,007. OWENS, RACHEL A., TUSTIN, CA. AND SORNSTEIN, WILLIAM, TUSTIN, CA. FILED 2-4-2002.

**WE KEEP THE SUCCESS IN
SUCCESSION**

FOR BUSINESS SUCCESSION PLANNING (U.S. CLS. 100, 101 AND 102).

FIRST USE 11-27-2001; IN COMMERCE 11-27-2001.

SN 76-367,171. DCM SOLUTIONS, INC., IRVING, TX. FILED 2-5-2002.

**THE FIRST 10 YARDS OF
THE SUPPLY CHAIN.**

NO CLAIM IS MADE TO THE EXCLUSIVE RIGHT TO USE "SUPPLY CHAIN", APART FROM THE MARK AS SHOWN.

FOR BUSINESS MANAGEMENT AND CONSULTATION IN THE FIELD OF BUSINESS PLANNING AND FORECASTING SALES AND INVENTORY AND MANUFACTURING OF PRODUCT (U.S. CLS. 100, 101 AND 102).

SN 76-367,200. SQAD INC., TARRYTOWN, NY. FILED 2-4-2002.



OWNER OF U.S. REG. NO. 2,514,646.
FOR COMMERCIAL INFORMATION AGENCIES, NAMELY, PROVIDING MARKETING INFORMATION FOR BUSINESSES TO OBTAIN ADVERTISING COST PROJECTIONS BY MEANS OF COMPUTERIZED REPORTS (U.S. CLS. 100, 101 AND 102).

FIRST USE 8-15-2001; IN COMMERCE 8-15-2001.

SN 76-367,616. MARKETING DEPOT, INC., BALDWIN, MO. FILED 2-7-2002.



OWNER OF U.S. REG. NO. 2,410,117.
NO CLAIM IS MADE TO THE EXCLUSIVE RIGHT TO USE "MARKETING", APART FROM THE MARK AS SHOWN.

FOR ADVERTISING AGENCIES; DIRECT ADVERTISING, AND DISSEMINATION OF ADVERTISING MATERIAL FOR OTHERS VIA MAIL, THE INTERNET, POINT OF SALE DISPLAYS, BROCHURES, NEWSPAPERS, MAGAZINES, TELEVISION, RADIO, AND OTHER FORMS OF ELECTRONIC OR DIGITAL MEDIA; ADVERTISING SERVICES, NAMELY, CREATING CORPORATE LOGOS FOR OTHERS; ADVERTISING SERVICES, NAMELY, CREATING CORPORATE AND BRAND IDENTITY FOR OTHERS; BUSINESS MARKETING CONSULTATION, NAMELY, MARKETING PLAN CREATION; AGENCIES FOR ADVERTISING TIME AND SPACE VIA MEDIA FORUMS; DISSEMINATION OF ADVERTISING FOR OTHERS VIA THE INTERNET; PROVIDING BUSINESS MARKETING INFORMATION FOR CORPORATE EVENTS; PUBLIC RELATIONS; PREPARING PROMOTIONAL AND MERCHANDISING MATERIAL FOR OTHERS; PREPARATION OF CUSTOM ADVERTISEMENTS AND CUSTOM PROMOTIONAL PRODUCTS FOR OTHERS; PROMOTING THE SALE OF GOODS AND SERVICES OF OTHERS THROUGH THE DISTRIBUTION OF PRINTED MATERIAL AND PROMOTIONAL CONTESTS; CONDUCTING EMPLOYEE INCENTIVE AWARD PROGRAMS TO PROMOTE ON THE JOB QUALITY AND PRODUCTIVITY; PREPARING AUDIO-VIDEO PRESENTATIONS FOR USE IN ADVERTISING; BUSINESS MARKETING STRATEGY CONSULTING FOR DIGITAL, PRINT, RADIO, TV, AND ELECTRONIC MEDIA (U.S. CLS. 100, 101 AND 102).

FIRST USE 5-1-1999; IN COMMERCE 5-1-1999.

SN 76-368,097. THOTWAVE TECHNOLOGIES, LLC, ANN ARBOR, MI. FILED 2-8-2002.

THOTWAVE

FOR DATA PROCESSING SERVICES IN THE FIELDS OF DATA COLLECTION, DATA MANAGEMENT, DATA ANALYSIS, WORKFLOW AUTOMATION, DOCUMENT MANAGEMENT, RESEARCH PROJECT MANAGEMENT, DATA WAREHOUSING, AND STATISTICAL REPORT GENERATION (U.S. CLS. 100, 101 AND 102).

CLASS 35—(Continued).

SN 76-369,086. GEORGE LITTLE MANAGEMENT, LLC, WHITE PLAINS, NY. FILED 2-11-2002.

ICFF CONNECTED

OWNER OF U.S. REG. NOS. 1,555,369, 1,863,900 AND 2,132,505.
FOR ORGANIZING AND CONDUCTING TRADE SHOWS IN THE HOME FURNISHINGS FIELD (U.S. CLS. 100, 101 AND 102).

SN 76-369,913. HERITAGE CAPITAL CORPORATION, DALLAS, TX. FILED 2-12-2002.

HERITAGE TELEBID

OWNER OF U.S. REG. NO. 2,486,881.
FOR TELEPHONIC BIDDING SERVICES; NAMELY ALLOWING CUSTOMERS TO PARTICIPATE IN AUCTIONS OF COLLECTIBLES VIA THE TELEPHONE (U.S. CLS. 100, 101 AND 102).

SN 76-370,063. SPILSBURY PUZZLE COMPANY, OAKBROOK, IL. FILED 2-13-2002.

WE DELIVER FUN!

FOR MAIL ORDER CATALOGS FEATURING PUZZLES AND GAMES (U.S. CLS. 100, 101 AND 102).
FIRST USE 5-14-2001; IN COMMERCE 5-14-2001.

SN 76-370,909. REKOGNATION, INC., SAN JUAN, PUERTO RICO, FILED 2-13-2002.

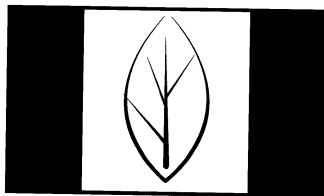

NATURE NATION

THE MARK CONSISTS OF THE WORDS "NATURE NATION" ACCOMPANIED BY A RECTANGULAR BOX WITH A GREEN BACKGROUND, CONTAINING A WHITE-COLORED SQUARE BOX IN THE MIDDLE, WITH A DRAWING OF A STANDING GREEN LEAF WITH BLACK NERVES IN THE CENTER OF THE SQUARE.

FOR RETAIL STORE SERVICES FEATURING A WIDE VARIETY OF CONSUMER GOODS CONSISTING OF FURNITURE AND HOME ORNAMENTS, BATH AND PERSONAL CARE PRODUCTS, AND OTHER AND AROMATHERAPY PRODUCTS AND ACCESSORIES (U.S. CLS. 100, 101 AND 102).
FIRST USE 11-20-2001; IN COMMERCE 11-20-2001.

CLASS 35—(Continued).

SN 76-371,206. PLEASANT COMPANY, MIDDLETON, WI. FILED 2-14-2002.



GIRLS of MANY LANDS

OWNER OF U.S. REG. NO. 2,260,050.
FOR RETAIL STORE SERVICES, MAIL ORDER CATALOG SERVICES, AND COMPUTERIZED ON-LINE RETAIL AND E-COMMERCE SERVICES, ALL FEATURING BOOKS AND BOOKLETS FEATURING FICTIONAL AND NON-FICTIONAL STORIES OF THE HISTORY AND EVENTS OF FOREIGN COUNTRIES; AND RETAIL STORE SERVICES, MAIL ORDER CATALOG SERVICES, AND COMPUTERIZED ON-LINE RETAIL AND E-COMMERCE SERVICES, ALL FEATURING CALENDARS, MAPS, POSTCARDS, POSTERS, BOOKMARKS, TRADING CARDS, CRAFT BOOKS, AND STATIONERY SETS COMPRISED OF STATIONERY, ENVELOPES, NOTE CARDS, AND STICKERS; AND RETAIL STORE SERVICES, MAIL ORDER CATALOG SERVICES, AND COMPUTERIZED ON-LINE RETAIL AND E-COMMERCE SERVICES, ALL FEATURING DOLLS, DOLL CLOTHING, AND DOLL ACCESSORIES; AND STUFFED TOYS AND CLOTHING AND ACCESSORIES FOR STUFFED TOYS (U.S. CLS. 100, 101 AND 102).

SN 76-372,162. SCHOLASTIC INC., NEW YORK, NY. FILED 2-15-2002.



FOR MAIL ORDER BOOK CLUB SERVICES (U.S. CLS. 100, 101 AND 102).
FIRST USE 2-1-2000; IN COMMERCE 2-1-2000.

SN 76-372,247. PETREN ENTERPRISES, ALEXANDRIA, VA. FILED 2-20-2002.



FOR ON-LINE RETAIL STORE SERVICES FEATURING GENERAL MERCHANDISE; PROMOTING THE GOODS AND SERVICES OF OTHERS BY MEANS OF OPERATING AN ON-LINE SHOPPING MALL WITH LINKS TO THE RETAIL WEB SITES OF OTHERS (U.S. CLS. 100, 101 AND 102).

CLASS 35—(Continued).

SN 76-373,722. DB MARKETING TECHNOLOGIES, LLC, NEW YORK, NY. FILED 2-21-2002.

ANALYTICCRM

OWNER OF U.S. REG. NO. 2,509,446.
FOR BUSINESS MARKETING CONSULTING SERVICES (U.S. CLS. 100, 101 AND 102).
FIRST USE 7-0-2001; IN COMMERCE 7-0-2001.

SN 76-374,336. DIAMONIQUE CORPORATION, HORSHAM, PA. FILED 2-22-2002.

Diamonique

OWNER OF U.S. REG. NOS. 1,532,950 AND 1,538,103.
FOR HOME SHOPPING SERVICES IN THE FIELD OF JEWELRY THROUGH THE USE OF TELEVISION, TELEPHONE AND THE INTERNET (U.S. CLS. 100, 101 AND 102).
FIRST USE 1-1-2000; IN COMMERCE 1-1-2000.

SN 76-374,471. ECONOMY.COM, INC., WEST CHESTER, PA. FILED 2-21-2002.

QUICK & DIRTY ECONOMY

NO CLAIM IS MADE TO THE EXCLUSIVE RIGHT TO USE "ECONOMY", APART FROM THE MARK AS SHOWN.
FOR ECONOMIC FORECASTING AND ANALYSIS SERVICES (U.S. CLS. 100, 101 AND 102).

SN 76-374,472. ECONOMY.COM, INC., WEST CHESTER, PA. FILED 2-21-2002.

QDE

FOR ECONOMIC FORECASTING AND ANALYSIS SERVICES (U.S. CLS. 100, 101 AND 102).

SN 76-374,959. IZZY'S ICE CREAM CAFE, LLC, ST. PAUL, MN. FILED 2-25-2002.

IZZYS ICE CREAM CAFE

NO CLAIM IS MADE TO THE EXCLUSIVE RIGHT TO USE "ICE CREAM CAFE", APART FROM THE MARK AS SHOWN.
FOR RETAILS SHOPS FEATURING HOMEMADE ICE CREAM (U.S. CLS. 100, 101 AND 102).

CLASS 35—(Continued).

SN 76-375,186. WALTON, THOMAS, MEMPHIS, TN. FILED 2-26-2002.

LOST IN PARADISE

FOR RETAIL STORE SERVICES FEATURING WOMEN'S CLOTHING, JEWELRY, AND ASSORTED GIFTS (U.S. CLS. 100, 101 AND 102).
FIRST USE 9-8-2000; IN COMMERCE 9-8-2000.

SN 76-375,210. UGLY DUCKLING CAR SALES AND FINANCE CORPORATION, INC., PHOENIX, AZ. FILED 2-26-2002.

DRIVE TIME

FOR AUTOMOBILE DEALERSHIP SERVICES (U.S. CLS. 100, 101 AND 102).

SN 76-375,231. NIELSEN MEDIA RESEARCH, INC., NEW YORK, NY. FILED 2-26-2002.

NQUEST

FOR MARKET RESEARCH SERVICES, NAMELY, MEDIA RESEARCH SERVICES RELATING TO THE LISTENING, VIEWING AND USAGE HABITS OF SIGNAL RECEIVING AUDIENCES; COLLECTING, CORRELATING AND PROVIDING INFORMATION ABOUT CHARACTERISTICS OF AUDIENCES OF SPORTS PROGRAMMING, INCLUDING PROGRAMMING RATING REPORTS, MEDIA RESEARCH RELATING TO AUDIENCE USE AND VIEWING OF SPORTS PROGRAMMING REGARDLESS OF SIGNAL TRANSMISSION AND/OR RECEIVING MEANS, AND DEMOGRAPHIC DATA REGARDING THE SIGNAL RECEIVING AUDIENCES; AND CONDUCTING TELEPHONE SURVEYS AND OTHER CONSUMER POLLING REGARDING PERSONAL MEDIA VIEWING AND USAGE, PRODUCT PURCHASING, PREFERENCES, AND AWARENESS, CURRENT EVENTS, SPORTS INTERESTS, BEHAVIOR, OPINIONS, AND RELATED ACTIVITIES, ADVERTISING AND BRAND AWARENESS AND RECOGNITION, AND CONSUMER DEMOGRAPHICS, AND CREATING REPORTS BASED ON AND PROVIDING SUCH INFORMATION AND ACCESS TO SUCH INFORMATION TO THIRD PARTIES (U.S. CLS. 100, 101 AND 102).

SN 76-375,924. SEE, INC., SOUTHFIELD, MI. FILED 2-27-2002.

FASHIONOMICS

FOR RETAIL OPTICAL STORE SERVICES; AND RETAIL STORE SERVICES FEATURING EYEWEAR, CLOTHING, AND SPORTS EQUIPMENT (U.S. CLS. 100, 101 AND 102).

CLASS 35—(Continued).

SN 76-376,250. WAL-MART STORES, INC., BENTONVILLE, AR. FILED 3-1-2002.

WORLD'S SMARTEST SHOPPER

FOR RETAIL DEPARTMENT STORE SERVICES (U.S. CLS. 100, 101 AND 102).

SN 76-376,615. MISS CHOCOLATE INC., MELVILLE, NY. FILED 2-27-2002.



In School Holiday Shoppes

NO CLAIM IS MADE TO THE EXCLUSIVE RIGHT TO USE "KIDZ BOUTIQUE", "IN SCHOOL" AND "SHOPPES", APART FROM THE MARK AS SHOWN.

FOR RENDERING AID IN THE ESTABLISHMENT AND/OR OPERATION OF IN-SCHOOL GIFT SHOPS FOR CHILDREN (U.S. CLS. 100, 101 AND 102).

SN 76-376,890. M&M GIFT SHOWS, LLC, TOLEDO, OH. FILED 3-4-2002.

THE "ORIGINAL" PIGEON FORGE GIFT SHOW

NO CLAIM IS MADE TO THE EXCLUSIVE RIGHT TO USE "PIGEON FORGE GIFT SHOW", APART FROM THE MARK AS SHOWN.

FOR ARRANGING AND CONDUCTING OF TRADE SHOWS IN THE FIELD OF GIFTS AND RELATED MERCHANDISE (U.S. CLS. 100, 101 AND 102).

FIRST USE 12-0-1999; IN COMMERCE 12-0-1999.

SN 76-377,196. WORLD OF JEANS & TOPS, INC., IRVINE, CA. FILED 3-1-2002.



THE MARK CONSISTS OF THE LETTER "T" AND THE DESIGN, AS SHOWN IN THE DRAWING.

FOR RETAIL STORE SERVICES FEATURING CLOTHING AND SHOES (U.S. CLS. 100, 101 AND 102).

FIRST USE 6-1-2001; IN COMMERCE 6-1-2001.

CLASS 35—(Continued).

SN 76-378,129. X*CELLERATION UNLIMITED, LLC, SCOTTSDALE, AZ. FILED 3-1-2002.

X*CELLERATION

FOR RETAIL STORE SERVICES FEATURING A WIDE VARIETY OF CONSUMER GOODS (U.S. CLS. 100, 101 AND 102).

SN 76-378,353. COKEM INTERNATIONAL, LTD., PLYMOUTH, MN. FILED 3-4-2002.

YOUR PROFIT IS OUR GAME

FOR WHOLESALE AND RETAIL DISTRIBUTORSHIP SERVICES FEATURING VIDEO GAME PROGRAMS AND COMPUTER PROGRAMS (U.S. CLS. 100, 101 AND 102).

SN 76-378,713. THOMAS PUBLISHING COMPANY, NEW YORK, NY. FILED 3-6-2002.

MY TR

FOR PROVIDING AN ONLINE COMPUTER DATABASE IN THE NATURE OF A DIRECTORY OF INDUSTRIAL PRODUCTS, SERVICES, COMPANIES AND EXECUTIVES BY MEANS OF A SITE ON A GLOBAL COMPUTER NETWORK WHO'S CONTENT CAN BE SAVED AND CUSTOMIZED BY THE USER (U.S. CLS. 100, 101 AND 102).

FIRST USE 1-0-2001; IN COMMERCE 1-0-2001.

SN 76-378,851. PALTO, LLC, SAN ANTONIO, TX. FILED 3-6-2002.

FIT RHINO

FOR RETAIL STORE SERVICES FEATURING SPORTS SUPPLEMENTS, VITAMINS AND DIETARY SUPPLEMENTS (U.S. CLS. 100, 101 AND 102).

SN 76-379,436. BRAND SERVICES, INC., CHESTERFIELD, MO. FILED 3-6-2002.

BRANDNOW

FOR INVENTORY MANAGEMENT IN THE FIELDS OF CONSTRUCTION EQUIPMENT AND SCAFFOLDING MATERIALS (U.S. CLS. 100, 101 AND 102).

FIRST USE 4-0-1999; IN COMMERCE 4-0-1999.

CLASS 35—(Continued).

SN 76-380,496. BEER CHILLER ENTERPRISES, INC., NEW YORK, NY. FILED 3-11-2002.

CHILLIN VILLINS

FOR DISSEMINATION OF ADVERTISING FOR BEVERAGE CHILLING DEVICES VIA THE INTERNET, PRINTED MEDIA, RADIO, AND TELEVISION (U.S. CLS. 100, 101 AND 102).

FIRST USE 2-0-2002; IN COMMERCE 2-0-2002.

SN 76-382,447. GREAT SPIRITS COMPANY, LLC, HOUSTON, TX. FILED 3-14-2002.



NO CLAIM IS MADE TO THE EXCLUSIVE RIGHT TO USE "SPIRITS", APART FROM THE MARK AS SHOWN.

FOR WHOLESALE DISTRIBUTORSHIP SERVICES IN THE FIELD OF ALCOHOLIC BEVERAGES (U.S. CLS. 100, 101 AND 102).

FIRST USE 2-5-2002; IN COMMERCE 2-5-2002.

SN 76-383,695. BIG APPLE HERPETOLOGICAL, INC., HOLBROOK, NY. FILED 3-18-2002.

BIG APPLE

FOR RETAIL STORE, MAIL ORDER CATALOG SERVICES, AND COMPUTERIZED ON-LINE RETAIL SERVICES IN THE FIELD OF PET SUPPLIES (U.S. CLS. 100, 101 AND 102).

FIRST USE 1-1-1994; IN COMMERCE 1-1-1994.

SN 76-383,838. REGENCE BLUECROSS BLUESHIELD OF OREGON, PORTLAND, OR. FILED 3-15-2002.

INDIVIDUA

FOR PROGRAM OF COMPREHENSIVE HEALTH CARE CASE MANAGEMENT, CARE MANAGEMENT, UTILIZATION REVIEW AND COST CONTAINMENT SERVICES, PROVIDED ON AN INDIVIDUALIZED BASIS (U.S. CLS. 100, 101 AND 102).

FIRST USE 6-30-2001; IN COMMERCE 6-30-2001.

CLASS 35—(Continued).

SN 76-384,727. MY CORPORATION BUSINESS SERVICES, INC., AGOURA HILLS, CA. FILED 3-18-2002.

MYCORPORATION

OWNER OF U.S. REG. NO. 2,426,818.

FOR BUSINESS CONSULTATION; SECRETARIAL AND DOCUMENT FILING SERVICES FOR BUSINESS ENTITIES; BUSINESS RESEARCH SERVICES (U.S. CLS. 100, 101 AND 102).

FIRST USE 2-1-1998; IN COMMERCE 2-1-1998.

SN 76-385,100. TBN FRANCHISE COMPANY, LLC, CHATTANOOGA, TN. FILED 3-20-2002.

THE BARN NURSERY

OWNER OF U.S. REG. NO. 2,225,442.

NO CLAIM IS MADE TO THE EXCLUSIVE RIGHT TO USE "NURSERY", APART FROM THE MARK AS SHOWN.

FOR WHOLESALE AND RETAIL STORE SERVICES IN THE FIELDS OF PLANTS, TREES, SEEDS, FLOWERS, GARDEN SUPPLIES, NURSERY STOCK AND LANDSCAPE SUPPLIES (U.S. CLS. 100, 101 AND 102).

FIRST USE 4-0-1985; IN COMMERCE 4-0-1985.

SN 76-385,226. B2BWORKS, INC., CHICAGO, IL. FILED 3-21-2002.

CRMWORKS

FOR E-MAIL LIST MANAGEMENT SERVICES FOR OTHER BUSINESSES (U.S. CLS. 100, 101 AND 102).

FIRST USE 3-15-2002; IN COMMERCE 3-15-2002.

SN 76-385,315. RETIRED OFFICERS ASSOCIATION, THE, ALEXANDRIA, VA. FILED 3-18-2002.

MOAA

FOR ASSOCIATION SERVICES; NAMELY, PROMOTING THE INTERESTS OF MILITARY OFFICERS (U.S. CLS. 100, 101 AND 102).

SN 76-386,994. TITLE TEMPS, INC., BURBANK, CA. FILED 3-26-2002.

ONSTAFF

FOR TEMPORARY AND PERMANENT EMPLOYMENT PLACEMENT SERVICES (U.S. CLS. 100, 101 AND 102).

CLASS 35—(Continued).

SN 76-387,517. LEMANS CORPORATION, JANESVILLE, WI.
FILED 3-27-2002.

ARCTIVA

FOR MAIL ORDER AND ON-LINE CATALOG SERVICES FOR DEALERS FEATURING PARTS AND ACCESSORIES FOR ALL TERRAIN VEHICLES, MOTORCYCLES, CLOTHING ITEMS, GEAR BAGS, BACKPACKS, HAND TOOLS, TRAILERS, RAMPS, ALL TERRAIN VEHICLE COVERS AND CABINS (U.S. CLS. 100, 101 AND 102).

FIRST USE 10-0-1998; IN COMMERCE 10-0-1998.

SN 76-387,524. LEMANS CORPORATION, JANESVILLE, WI.
FILED 3-27-2002.

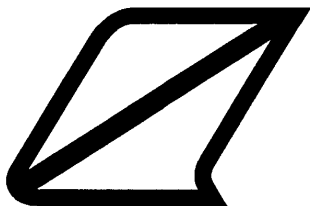

FOR MAIL ORDER AND ON-LINE CATALOG SERVICES FOR DEALERS FEATURING PARTS AND ACCESSORIES FOR ALL TERRAIN VEHICLES, MOTORCYCLES, CLOTHING ITEMS, GEAR BAGS, BACKPACKS, HAND TOOLS, TRAILERS, RAMPS, ALL TERRAIN VEHICLE COVERS AND CABINS (U.S. CLS. 100, 101 AND 102).

SN 76-387,682. TESERA STAFFING, LLC, WOBURN, MA.
FILED 3-27-2002.

TESERA STAFFING

NO CLAIM IS MADE TO THE EXCLUSIVE RIGHT TO USE "STAFFING", APART FROM THE MARK AS SHOWN. THE FOREIGN TERM IN THE MARK TRANSLATES INTO ENGLISH AS THE "NUMBER FOUR".

FOR EMPLOYMENT HIRING, RECRUITING, PLACEMENT, AND STAFFING SERVICES (U.S. CLS. 100, 101 AND 102).

FIRST USE 1-3-2002; IN COMMERCE 1-3-2002.

CLASS 35—(Continued).

SN 76-389,052. SCHNEIDER, DAVID L., SAN DIEGO, CA.
FILED 3-29-2002.

APARTMENTTREE

FOR MARKETING SERVICES, NAMELY, PROVIDING QUALIFIED SALES LEADS FOR OTHERS IN THE REAL ESTATE INDUSTRY; ONLINE REFERRAL SERVICES IN THE REAL ESTATE INDUSTRY; PROVIDING A SEARCHABLE DIRECTORY OF REAL ESTATE AND REAL PROPERTY RELATED INFORMATION FOR OBTAINING DATA AND INFORMATION FROM OTHERS VIA THE INTERNET; ADVERTISING SERVICES, NAMELY, PROVIDING ONLINE MARKETING SERVICES IN THE NATURE OF BANNER ADVERTISING, DISPLAY ADVERTISING, LINK EXCHANGES AND SEARCH ENGINE PLACEMENT SERVICES FOR THE REAL ESTATE INDUSTRY (U.S. CLS. 100, 101 AND 102).

FIRST USE 3-25-2002; IN COMMERCE 3-25-2002.

SN 76-389,065. SCHNEIDER, DAVID L., SAN DIEGO, CA.
FILED 3-29-2002.

INSUREEXPO

FOR MARKETING SERVICES, NAMELY, PROVIDING QUALIFIED SALES LEADS FOR OTHERS FOR THE INSURANCE INDUSTRY; ONLINE REFERRAL SERVICES IN THE INSURANCE INDUSTRY; PROVIDING A SEARCHABLE DIRECTORY OF INSURANCE RELATED INFORMATION FOR OBTAINING DATA AND INFORMATION FROM OTHERS VIA THE INTERNET; ADVERTISING SERVICES, NAMELY, PROVIDING ONLINE MARKETING SERVICES IN THE NATURE OF BANNER ADVERTISING, DISPLAY ADVERTISING, LINK EXCHANGES AND SEARCH ENGINE PLACEMENT SERVICES FOR THE INSURANCE INDUSTRY (U.S. CLS. 100, 101 AND 102).

FIRST USE 3-25-2002; IN COMMERCE 3-25-2002.

SN 76-390,425. R. H. KUHN COMPANY, INC., DBA ROOM-FUL EXPRESS, PITTSBURGH, PA. FILED 4-3-2002.

**WE PUT IT ALL TOGETHER
& SELL IT FOR LESS**

FOR RETAIL STORE SERVICES IN THE FIELD OF HOME FURNISHINGS (U.S. CLS. 100, 101 AND 102).

FIRST USE 10-21-2001; IN COMMERCE 10-21-2001.

CLASS 35—(Continued).

SN 76-390,432. COMPASS GROUP USA, INC., CHARLOTTE, NC. FILED 4-3-2002.

Outtakes

OWNER OF U.S. REG. NO. 2,298,716.
FOR RETAIL CONVENIENCE STORE SERVICES (U.S. CLS. 100, 101 AND 102).
FIRST USE 7-23-2001; IN COMMERCE 7-23-2001.

SN 76-390,434. COMPASS GROUP USA, INC., CHARLOTTE, NC. FILED 4-3-2002.

OUT TAKES

OWNER OF U.S. REG. NO. 2,298,716.
FOR RETAIL CONVENIENCE STORE SERVICES (U.S. CLS. 100, 101 AND 102).
FIRST USE 7-23-2001; IN COMMERCE 7-23-2001.

SN 76-392,259. GRAPE FINDS OF DUPONT, INC., NEW YORK, NY. FILED 4-8-2002.

WORTH A SPLURGE

FOR RETAIL STORE SERVICES FEATURING ALCOHOLIC BEVERAGES AND ACCESSORIES USED IN THE STORAGE AND CONSUMPTION OF ALCOHOLIC BEVERAGES (U.S. CLS. 100, 101 AND 102).
FIRST USE 12-4-1999; IN COMMERCE 12-4-1999.

SN 76-392,260. GRAPE FINDS OF DUPONT, INC., NEW YORK, NY. FILED 4-8-2002.

GRAPE FINDS

FOR RETAIL STORE SERVICES FEATURING ALCOHOLIC BEVERAGES AND ACCESSORIES USED IN THE STORAGE AND CONSUMPTION OF ALCOHOLIC BEVERAGES (U.S. CLS. 100, 101 AND 102).
FIRST USE 12-4-1999; IN COMMERCE 12-4-1999.

CLASS 35—(Continued).

SN 78-010,148. ADCETERA DESIGN STUDIO, HOUSTON, TX. FILED 5-26-2000.

ADCETERA.COM

OWNER OF U.S. REG. NO. 2,033,353.
FOR PREPARATION OF PROMOTIONAL MATERIALS FOR OTHERS TO BE USED ON THE INTERNET, NAMELY, PREPARING ADVERTISING FOR OTHERS, MULTIMEDIA SERVICES FOR OTHERS IN THE NATURE OF PREPARING MULTIMEDIA PRESENTATIONS FOR OTHERS FOR USE IN INTERNET ADVERTISING, ALL OF THE FOREGOING FOR BUSINESSES IN THE ENERGY, FOOD SERVICES, HEALTH CARE, NON-PROFIT, TECHNOLOGY, MANUFACTURING AND TRAVEL AND TOURISM INDUSTRIES (U.S. CLS. 100, 101 AND 102).
FIRST USE 3-31-2000; IN COMMERCE 3-31-2000.

SN 78-017,861. COPPING, ROBIN L., CHICAGO, IL. FILED 7-21-2000.

STRATEGIC FOOD PARTNERS

NO CLAIM IS MADE TO THE EXCLUSIVE RIGHT TO USE "PARTNERS", APART FROM THE MARK AS SHOWN.
FOR EXECUTIVE LEVEL RETAINED SEARCH FIRM SERVICES, NAMELY, PERSONNEL PLACEMENT AND RECRUITMENT FOR EXECUTIVES (U.S. CLS. 100, 101 AND 102).
FIRST USE 9-1-1999; IN COMMERCE 11-1-1999.

SN 78-020,597. BEST OF SAN FRANCISCO INC., SAN FRANCISCO, CA. FILED 8-10-2000.

BEST OF SAN FRANCISCO

SEC. 2(F).
FOR ADVERTISING AND PROMOTION OF GOODS AND SERVICES FOR OTHERS OVER GLOBAL COMPUTER COMMUNICATIONS NETWORKS (U.S. CLS. 100, 101 AND 102).
FIRST USE 7-0-1993; IN COMMERCE 7-0-1993.

CLASS 35—(Continued).

SN 78-022,187. GOALASSIST CORPORATION, MINNEAPOLIS, MN. FILED 8-21-2000.

CHOICETIME

FOR CONSUMER INTERNET AND TOLL-FREE DIRECTORY SERVICE FEATURING COMMERCIAL INFORMATION OF PROVIDERS OF GOODS AND SERVICES; CONSUMER INTERNET AND TOLL-FREE DIRECTORY SERVICE LISTING SPECIAL PROMOTIONAL OFFERS OF PROVIDERS OF GOODS AND SERVICES; PROVIDING BUSINESS MARKETING SERVICES, NAMELY INTERNET AND TOLL-FREE CUSTOMER FEEDBACK COLLECTION AND MONITORING SERVICE FOR CUSTOMERS AND PROVIDERS OF GOODS AND SERVICES; PROMOTING THE GOODS AND SERVICES OF OTHERS THROUGH ON-LINE ORDERING AND CATALOGING OF THOSE GOODS AND SERVICES (U.S. CLS. 100, 101 AND 102).

SN 78-026,057. YAMASHO, INC., ELK GROVE VILLAGE, IL. FILED 9-15-2000.

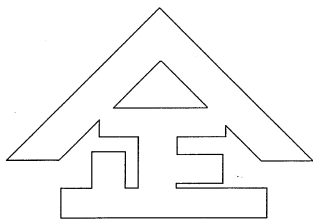

FOR WHOLESALE DISTRIBUTORSHIP SERVICES IN THE FIELD OF ASIAN FOOD PRODUCTS AND RESTAURANT SUPPLIES (U.S. CLS. 100, 101 AND 102).
FIRST USE 7-15-1981; IN COMMERCE 7-15-1981.

SN 78-031,538. BERKOWITZ, DAVID J., HOLLYWOOD, FL. FILED 10-19-2000.



FOR ADVERTISING FOR OTHERS VIA AN ON-LINE ELECTRONIC COMMUNICATIONS NETWORK WITH THE PURPOSE OF DISSEMINATING INFORMATION TO CONSUMERS BY PROFESSIONALS IN THE AREAS OF LAW, HEALTH, REAL ESTATE, FINANCE, TECHNICAL AND OTHER; ADVERTISING FOR OTHERS VIA AN ON-LINE ELECTRONIC COMMUNICATIONS NETWORK WITH THE PURPOSE OF DISSEMINATING INFORMATION TO CONSUMERS BY PROFESSIONALS IN THE AREAS OF LAW, HEALTH, REAL ESTATE, FINANCE, TECHNICAL AND OTHER PROFESSIONS (U.S. CLS. 100, 101 AND 102).

FIRST USE 3-3-2000; IN COMMERCE 3-3-2000.

CLASS 35—(Continued).

SN 78-032,940. CATEGORYWARE, INC., SANTA CRUZ, CA. BY CHANGE OF NAME CATEGORYWEAR, INC., MONTE SERENO, CA. FILED 10-30-2000.

CATEGORYWARE

FOR LICENSING OF COMPUTER SOFTWARE (U.S. CLS. 100, 101 AND 102).

SN 78-035,738. PLANT AUTOMATION SERVICES, INC., HOUSTON, TX. FILED 11-17-2000.

INTEGRITY.MOC

FOR INDUSTRIAL MANAGEMENT ASSISTANCE, SPECIFICALLY RECORDING CHANGES FOR USE BY INDUSTRIAL PLANTS IN THEIR IMPLEMENTATION OF PROCESS SAFETY MANAGEMENT OF HIGHLY HAZARDOUS CHEMICALS (U.S. CLS. 100, 101 AND 102).

SN 78-042,110. AD PEPPER MEDIA INTERNATIONAL N.V., D-90429 NURNBERG, FED REP GERMANY, BY CHANGE OF NAME AP NET N.V., DELFT, NETHERLANDS, FILED 1-8-2001.

AD PEPPER

NO CLAIM IS MADE TO THE EXCLUSIVE RIGHT TO USE "AD", APART FROM THE MARK AS SHOWN.

FOR DEVELOPMENT AND DISSEMINATION OF ON-LINE ADVERTISING FOR OTHERS; CONSULTATION IN THE FIELD OF THE DEVELOPMENT AND DISSEMINATION OF ONLINE ADVERTISING FOR OTHERS (U.S. CLS. 100, 101 AND 102).

FIRST USE 1-31-1999; IN COMMERCE 1-31-1999.

SN 78-042,187. BUSINESS RESPONSE, INC., ST. LOUIS, MO. FILED 1-8-2001.

BRI

FOR BUSINESS SERVICES IN THE NATURE OF PROVIDING INBOUND AND OUTBOUND TELESERVICES, NAMELY, PROCESSING CUSTOMER SERVICE CALLS, PROVIDING CUSTOMER SUPPORT SERVICES, BUSINESS PROJECTS MANAGEMENT, BUSINESS SALES CONSULTATION, ORDER REFERRAL NAMELY, ORDER TAKING FOR PRODUCTS OR INFORMATION, COMPUTERIZED DATABASE MANAGEMENT, FULFILLMENT SERVICES, NAMELY, PRODUCT RECALL SERVICES, MAILING LEGAL NOTICES; BUSINESS MANAGEMENT AND CONSULTATION IN THE AREA OF CLAIMS ADMINISTRATION (U.S. CLS. 100, 101 AND 102).

FIRST USE 6-3-1986; IN COMMERCE 6-3-1986.

CLASS 35—(Continued).

SN 78-042,703. LANDS' END, INC., DODGEVILLE, WI.
FILED 1-11-2001.

BORN HEROES

FOR MAIL ORDER, RETAIL STORE AND COMPUTERIZED ONLINE ORDER SERVICES IN THE FIELD OF CHILDREN'S CLOTHING, FOOTWEAR, HEADWEAR, OUTERWEAR, SLEEPWEAR, LUGGAGE, TOWELS AND BLANKETS (U.S. CLS. 100, 101 AND 102).
FIRST USE 11-30-1999; IN COMMERCE 11-30-1999.

SN 78-048,437. USBX, INC., SANTA MONICA, CA. FILED 2-14-2001.

**USBX PREFERRED
INTERMEDIARY NETWORK**

NO CLAIM IS MADE TO THE EXCLUSIVE RIGHT TO USE "INTERMEDIARY NETWORK", APART FROM THE MARK AS SHOWN.

FOR BUSINESS ACQUISITION AND MERGER CONSULTATION FOR CONSUMERS ON SMALL BUSINESS MERGERS AND ACQUISITIONS VIA A GLOBAL COMMUNICATIONS NETWORK AND OTHER COMMUNICATION CHANNELS, NAMELY WIRELESS DEVICES AND INTRANETS (U.S. CLS. 100, 101 AND 102).

SN 78-050,064. NETYOURWORK, INC., WALNUT CREEK, CA. FILED 2-23-2001.

NETYOURWORK

FOR BUSINESS RECORDS AND INFORMATION MANAGEMENT SERVICES, NAMELY, DOCUMENT INDEXING, REPORTING, UPDATING AND ORGANIZING FOR OTHERS (U.S. CLS. 100, 101 AND 102).

SN 78-050,079. BOOKSTREAM INC., MOUNTAIN LAKES, NJ. FILED 2-23-2001.

BOOKSTREAM

FOR ADVERTISING SERVICES, FOR OTHERS, NAMELY, THE PROMOTION AND MARKETING OF BOOKS VIA AN ELECTRONIC COMPUTER NETWORK THROUGH THE USE OF MULTIMEDIA COMMERCIALS (U.S. CLS. 100, 101 AND 102).

CLASS 35—(Continued).

SN 78-054,117. PROMOCION LATINA, INC., OREM, UT.
FILED 3-20-2001.

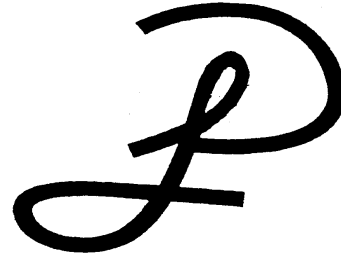

FOR ADVERTISING SERVICES, NAMELY, PROMOTING THE SERVICES OF LATIN AMERICAN SINGERS, WRITERS, ACTORS AND PERFORMING ARTISTS, SPECIFICALLY MARKETING AND PROMOTING CONCERTS AND OTHER PERFORMANCES BY LATIN AMERICAN SINGERS, WRITERS, ACTORS AND PERFORMING ARTISTS THROUGH THE DISTRIBUTION OF PRINTED, AUDIO AND INTERNET PROMOTIONAL MATERIALS AND BY RENDERING SALES PROMOTION ADVICE; ADVERTISING SERVICES, NAMELY, PROMOTING THE SERVICES OF LATIN AMERICAN ENTERPRISES, NAMELY, AUTOMOBILE DEALERSHIPS, REAL ESTATE SALES, BANKING, CLOTHING MANUFACTURERS AND RETAILERS, THROUGH THE DISTRIBUTION OF PRINTED, AUDIO AND INTERNET PROMOTIONAL MATERIALS AND BY RENDERING SALES PROMOTION ADVICE (U.S. CLS. 100, 101 AND 102).

SN 78-057,648. BLUEDOG DESIGN, CHICAGO, IL. FILED 4-10-2001.

BLUEDOG DESIGN

NO CLAIM IS MADE TO THE EXCLUSIVE RIGHT TO USE "DESIGN", APART FROM THE MARK AS SHOWN.

FOR BUSINESS MARKETING CONSULTING SERVICES, NAMELY DESIGN AND CONSULTATION SERVICES ASSOCIATED WITH THE DEVELOPMENT OF BRAND IDENTITIES AND TRADE DRESS FOR THE CONSUMER PRODUCTS AND PACKAGING OF OTHERS (U.S. CLS. 100, 101 AND 102).

FIRST USE 3-24-2000; IN COMMERCE 3-24-2000.

CLASS 35—(Continued).

SN 78-060,226. LAT-LON, L.L.C., DENVER, CO. FILED 4-25-2001.



FOR REMOTE DATA TRACKING OF TRAIN CARS, SHIPPING CONTAINERS, AND HEAVY EQUIPMENT USING GLOBAL POSITIONING SATELLITES AND CELLULAR TELEPHONE TELEMETRY (U.S. CLS. 100, 101 AND 102).

SN 78-060,312. MYKROBEL LLC, CEDAR CREST, NM. FILED 4-25-2001.

MykroBel LLC

NO CLAIM IS MADE TO THE EXCLUSIVE RIGHT TO USE "LLC", APART FROM THE MARK AS SHOWN. FOR BUSINESS PROCESS AND PROJECT MANAGEMENT CONSULTING SERVICES (U.S. CLS. 100, 101 AND 102).
FIRST USE 1-13-2001; IN COMMERCE 3-5-2001.

SN 78-062,446. EASTMORELAND HOLDING CORP., MANALAPAN, NJ. FILED 5-8-2001.

WE CASH CLOTHES FOR A CAUSE

OWNER OF U.S. REG. NOS. 2,379,223 AND 2,401,721. FOR RETAIL USED CLOTHING AND FOOTWEAR STORES AND DISTRIBUTORSHIPS, FEATURING PURCHASE AND PICKUP OF USED OR PRE-OWNED CLOTHING AND FOOTWEAR (U.S. CLS. 100, 101 AND 102).

SN 78-064,128. LOS ANGELES CONVENTION & VISITORS BUREAU, LOS ANGELES, CA. FILED 5-17-2001.

LAWORLDWIDE

FOR PROMOTION OF TRADE, TRAVEL, TOURISM AND CONVENTION BUSINESS IN AND AROUND THE CITY AND COUNTY OF LOS ANGELES (U.S. CLS. 100, 101 AND 102).

CLASS 35—(Continued).

SN 78-064,733. NATIONAL CITY MILE OF CARS, INC., NATIONAL CITY, CA. FILED 5-21-2001.

THE MILE

SEC. 2(F).
FOR ADVERTISING AND PROMOTING THE GOODS AND SERVICES OF AUTOMOBILE DEALERS (U.S. CLS. 100, 101 AND 102).
FIRST USE 0-0-1984; IN COMMERCE 0-0-1984.

SN 78-065,253. VANGUARD GROUP, INC., THE, MALVERN, PA. FILED 5-23-2001.

THE SIGN OF A LEADER.

FOR PERSONNEL PLACEMENT AND RECRUITMENT SERVICES, NAMELY PROVIDING CAREER MANAGEMENT, TRAINING AND COUNSELING IN THE NATURE OF COLLEGE PLANNING AND ACADEMIC ASSISTANCE, PROVIDING ONLINE JOB DIRECTORIES, WORK-LIFE SEMINARS, AND OPERATING A PROFESSIONAL CAREER RESOURCE CENTER CONTAINING PRINTED AND AUDIO-VISUAL MATERIALS FOR EMPLOYEES (U.S. CLS. 100, 101 AND 102).
FIRST USE 4-27-2001; IN COMMERCE 4-27-2001.

SN 78-065,725. D'ALESSANDRO, DAVID F., BOSTON, MA. FILED 5-25-2001.

BRAND WARFARE

NO CLAIM IS MADE TO THE EXCLUSIVE RIGHT TO USE "BRAND", APART FROM THE MARK AS SHOWN. FOR BUSINESS CONSULTATION SERVICES IN THE FIELD OF BRAND MARKETING; PROMOTIONAL SERVICES, NAMELY, PROVIDING SPEAKERS AND INTERVIEWS IN THE FIELD OF BRAND MARKETING (U.S. CLS. 100, 101 AND 102).

SN 78-066,229. PEPSICO, INC., PURCHASE, NY. FILED 5-29-2001.



NO CLAIM IS MADE TO THE EXCLUSIVE RIGHT TO USE "FACTORY", APART FROM THE MARK AS SHOWN. FOR ON-LINE ORDERING SERVICES FEATURING CUSTOMIZED LABELS FOR BEVERAGE CONTAINERS (U.S. CLS. 100, 101 AND 102).
FIRST USE 6-0-2001; IN COMMERCE 6-0-2001.

CLASS 35—(Continued).

SN 78-067,034. JENKINS, ANTHONY LYNN, MURFREESBORO, TN. FILED 6-3-2001.

ACALON

FOR COMPUTERIZED ON-LINE RETAIL STORE SERVICES IN THE FIELD OF COMPUTER SYSTEMS AND COMPUTER PERIPHERALS (U.S. CLS. 100, 101 AND 102).
FIRST USE 10-1-2000; IN COMMERCE 10-1-2000.

SN 78-067,396. THE GOLD DOCTOR, KINGMAN, AZ. FILED 6-5-2001.

THE GOLD DOCTOR

NO CLAIM IS MADE TO THE EXCLUSIVE RIGHT TO USE "GOLD", APART FROM THE MARK AS SHOWN.
FOR RETAIL STORE SERVICES FEATURING JEWELRY (U.S. CLS. 100, 101 AND 102).
FIRST USE 1-1-1996; IN COMMERCE 1-1-1996.

SN 78-069,251. BUSINESS EQUIPMENT RESEARCH AND TEST LABORATORIES LTD, PANGBOURNE, UNITED KINGDOM, FILED 6-15-2001.

DIGITAL TEST LAB

FOR CONSUMER RESEARCH AND ANALYSIS RELATING TO DIGITAL PRODUCTS; PROVIDING CONSUMER PRODUCT NEWS VIA THE INTERNET (U.S. CLS. 100, 101 AND 102).
FIRST USE 0-0-1995; IN COMMERCE 0-0-1995.

SN 78-070,624. ONENECK IT SERVICES, CORPORATION, SCOTTSDALE, AZ. FILED 6-22-2001.



FOR OUTSOURCING SERVICES FOR OTHERS IN THE FIELD OF INFORMATION TECHNOLOGY (U.S. CLS. 100, 101 AND 102).

CLASS 35—(Continued).

SN 78-074,341. J. A. HANSEN PAINTING CONTRACTOR, INC., DBA HANSEN SUPPLY COMPANY, SEATTLE, WA. FILED 7-17-2001.

HANPLY

FOR RETAIL STORE SERVICES AND WHOLESALE DISTRIBUTORSHIPS FEATURING SAFETY EQUIPMENT, NAMELY, SIGNS, SAFETY TAGS, PIPE SAFETY MARKERS, AND VALVE SAFETY MARKERS (U.S. CLS. 100, 101 AND 102).

SN 78-074,389. INTEGRITY INCORPORATED, MOBILE, AL. FILED 7-18-2001.

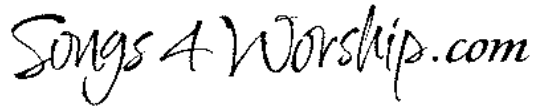

SEC. 2(F) AS TO "SONGS 4 WORSHIP".
FOR MAIL ORDER SERVICES OVER GLOBAL COMPUTER NETWORKS FOR OTHERS FEATURING SOUND RECORDINGS OF RELIGIOUS MUSIC AND ENTERTAINMENT (U.S. CLS. 100, 101 AND 102).
FIRST USE 6-6-2001; IN COMMERCE 6-6-2001.

SN 78-075,332. NELSON, AUREALIA NOVELLA AMBA SIDDHI, RICHMOND, VA. FILED 7-24-2001.



NO CLAIM IS MADE TO THE EXCLUSIVE RIGHT TO USE "INDIA", APART FROM THE MARK AS SHOWN.
THE ENGLISH TRANSLATION OF THE WORD "JAI MATAJI" IN THE MARK IS "ALL HAIL THE RESPECTED MOTHER" IN HINDI.
FOR RETAIL STORE SERVICES FEATURING INDIAN IMPORTS (U.S. CLS. 100, 101 AND 102).

CLASS 35—(Continued).

SN 78-077,630. MEDICAL TRANSACTIONS, INC., ST. PAUL, MN. FILED 8-6-2001.

**Medical Transactions**

NO CLAIM IS MADE TO THE EXCLUSIVE RIGHT TO USE "MEDICAL TRANSACTIONS", APART FROM THE MARK AS SHOWN.

FOR COMPUTERIZED ON-LINE ORDERING SERVICES IN THE FIELD OF MEDICAL SERVICES, PRODUCTS AND EQUIPMENT FOR BUSINESSES IN THE HEALTH-CARE INDUSTRY; PROVIDING INFORMATION IN THE FIELD OF THE PROCUREMENT OF MEDICAL SERVICES, PRODUCTS AND EQUIPMENT FOR BUSINESSES IN THE HEALTH-CARE INDUSTRY VIA THE INTERNET; BUSINESS RESEARCH AND SURVEYS, NAMELY EXTRACTING, PROCESSING AND COMPILING OF MATHEMATICAL OR STATISTICAL DATA CONCERNING THE PROCUREMENT OF MEDICAL SERVICES, PRODUCTS AND EQUIPMENT FOR BUSINESSES IN THE HEALTH-CARE INDUSTRY VIA THE INTERNET (U.S. CLS. 100, 101 AND 102).

FIRST USE 7-16-2001; IN COMMERCE 7-16-2001.

SN 78-077,919. EXO, INC., QUEBEC, CANADA, FILED 8-7-2001.

EXO RECORDS

NO CLAIM IS MADE TO THE EXCLUSIVE RIGHT TO USE "RECORDS", APART FROM THE MARK AS SHOWN. FOR RETAIL STORE SERVICES FEATURING PHONOGRAPH RECORDS (U.S. CLS. 100, 101 AND 102).

SN 78-077,926. EXO, INC., QUEBEC, CANADA, FILED 8-7-2001.

EXO SHOP

NO CLAIM IS MADE TO THE EXCLUSIVE RIGHT TO USE "SHOP", APART FROM THE MARK AS SHOWN. FOR RETAIL STORE SERVICES FEATURING APPAREL AND FOOTWEAR FOR MEN AND WOMEN (U.S. CLS. 100, 101 AND 102).

CLASS 35—(Continued).

SN 78-078,083. AEROHEALTH STAFFING, INC., DENVER, CO. FILED 8-8-2001.

AEROHEALTH

FOR PROVIDING STAFFING SERVICES, NAMELY, TEMPORARY, PER DIEM, INTERIM, CONTRACT AND PERMANENT HEALTHCARE STAFFING SERVICES FOR HOSPITALS, HEALTHCARE SYSTEMS, HEALTHCARE URGENT CARE CENTERS, SURGERY CENTERS, NURSING HOMES AND HOME HEALTHCARE CENTERS; PROVIDING STAFFING PLACEMENT SERVICES FOR NURSES, CERTIFIED NURSING ASSISTANTS, RADIOLOGY TECHNICIANS, ULTRASOUND TECHNICIANS, CT TECHNICIANS, PHARMACISTS, RESPIRATORY THERAPISTS, PHYSICAL THERAPISTS, OCCUPATIONAL THERAPISTS, PHYSICIANS ASSISTANTS, NURSE PRACTITIONERS, CERTIFIED NURSE ANESTHETISTS, LICENSED PRACTICAL NURSES, SURGICAL TECHNICIANS, AND SURGICAL ASSISTANTS (U.S. CLS. 100, 101 AND 102).

SN 78-079,377. SYNCHRONICITY, INC., FRANKFORT, IL. FILED 8-15-2001.

**INTEREST-TO-INTEREST
MARKETING**

NO CLAIM IS MADE TO THE EXCLUSIVE RIGHT TO USE "MARKETING", APART FROM THE MARK AS SHOWN.

FOR BUSINESS MARKETING AND DIRECT MAIL CONSULTING SERVICES, BUSINESS MARKETING CONSULTING SERVICES, AND BUSINESS EVENT MARKETING CONSULTING SERVICES (U.S. CLS. 100, 101 AND 102).

SN 78-080,506. SHUMACKER, JAMES N., CARMEL, IN. FILED 8-22-2001.

**DEFINE AND PERFECT THE
WORK YOU LOVE.**

FOR EMPLOYMENT COUNSELING AND RECRUITING; EMPLOYMENT COUNSELING AND RECRUITING (U.S. CLS. 100, 101 AND 102).

FIRST USE 7-1-2001; IN COMMERCE 8-1-2001.

CLASS 35—(Continued).

SN 78-080,645. MILLS, STANLEY R., LINCOLN, NE. FILED 8-22-2001.

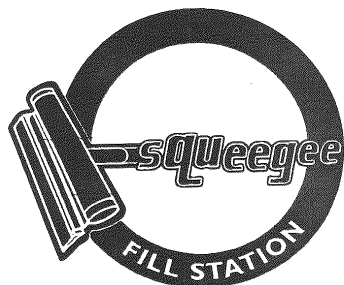

NO CLAIM IS MADE TO THE EXCLUSIVE RIGHT TO USE "FILL STATION", APART FROM THE MARK AS SHOWN.

FOR RETAIL STORE SERVICES FEATURING CONVENIENCE STORE ITEMS AND GASOLINE (U.S. CLS. 100, 101 AND 102).

SN 78-081,706. SASH MANAGEMENT L.L.C., DBA GIFT CHECK SOLUTIONS, BLUFFDALE, UT. FILED 8-29-2001.



NO CLAIM IS MADE TO THE EXCLUSIVE RIGHT TO USE "GIFT CARD", APART FROM THE MARK AS SHOWN. FOR ISSUING GIFT CERTIFICATES FOR RESTAURANT AND RETAIL CHAINS, WHICH MAY THEN BE REDEEMED FOR GOODS OR SERVICES (U.S. CLS. 100, 101 AND 102).

FIRST USE 8-3-2001; IN COMMERCE 8-3-2001.

SN 78-082,412. VIACOM INTERNATIONAL INC., NEW YORK, NY. FILED 9-4-2001.

VIACOM

OWNER OF U.S. REG. NOS. 1,218,627, 2,451,488 AND OTHERS.

FOR INTERNET BASED ORDERING SERVICE FOR THE PROCUREMENT OF OFFICE SUPPLIES, OFFICE TECHNOLOGY, BROADCASTING EQUIPMENT, ELECTRONIC EQUIPMENT, COMPUTERS, COMPUTER ACCESSORIES; AND TRACKING OF ON-LINE RETAIL FOR OTHERS (U.S. CLS. 100, 101 AND 102).

CLASS 35—(Continued).

SN 78-083,034. FAWLS, THOMAS E., ORLANDO, FL. FILED 9-7-2001.



FOR BUSINESS CONSULTATION; BUSINESS CONSULTATION IN THE FIELDS OF BUSINESS PROJECT ANALYSIS AND PLANNING, ORGANIZING AND OPERATING THE MANAGEMENT, FINANCIAL, MARKETING AND ADMINISTRATIVE ASPECTS OF BUSINESSES (U.S. CLS. 100, 101 AND 102).

FIRST USE 4-15-1998; IN COMMERCE 7-16-1998.

SN 78-085,295. COINSTAR, INC., BELLEVUE, WA. FILED 9-24-2001.

COINSTAR

FOR ADVERTISING AND PROMOTING THE SALE OF GOODS AND SERVICES OF OTHERS BY PROVIDING INCENTIVES, PREMIUMS, REBATES, CASH DISCOUNTS, PURCHASE POINTS, COUPONS, CERTIFICATES, DISCOUNT CARDS, VOUCHERS, AND SHOPPING LISTS; DISSEMINATION OF ADVERTISING FOR OTHERS VIA A GLOBAL COMPUTER NETWORK; DISSEMINATION OF ADVERTISING FOR OTHERS VIA KIOSKS; PREPARING AND DISPLAYING VIDEO ADVERTISEMENTS FOR OTHERS; ARRANGING FOR THE DISTRIBUTION OF GOODS AND SERVICES ACQUIRED THROUGH A GLOBAL COMMUNICATIONS NETWORK VIA KIOSKS OR AUTOMATED TRANSACTION MACHINES; ISSUING STORED VALUE CARDS AND CASH CARDS (U.S. CLS. 100, 101 AND 102).

SN 78-086,268. BOLIN-TOLEDO INFORMATICS, LTD., OAK PARK, IL. FILED 10-1-2001.

INTENTION LOGISTICS

NO CLAIM IS MADE TO THE EXCLUSIVE RIGHT TO USE "LOGISTICS", APART FROM THE MARK AS SHOWN. FOR BUSINESS MANAGEMENT AND CONSULTATION (U.S. CLS. 100, 101 AND 102).

CLASS 35—(Continued).

SN 78-087,020. HOWES ENTERPRISE INTERNATIONAL, INC., LOMPOC, CA. FILED 10-4-2001.

HOT ROD CENTRAL

NO CLAIM IS MADE TO THE EXCLUSIVE RIGHT TO USE "HOT ROD", APART FROM THE MARK AS SHOWN. FOR ON LINE RETAIL SERVICES FEATURING AUTOMOBILES, AUTOMOBILE PARTS AND ACCESSORIES VIA THE INTERNET AND ON-LINE TRADING SERVICES IN WHICH SELLER POSTS PRODUCTS TO BE AUCTIONED AND BIDDING IS DONE VIA THE INTERNET (U.S. CLS. 100, 101 AND 102).

SN 78-087,713. BELLSOUTH INTELLECTUAL PROPERTY CORPORATION, WILMINGTON, DE. FILED 10-10-2001.

BELLSOUTH TELESTAT

OWNER OF U.S. REG. NOS. 1,565,559, 2,463,244 AND OTHERS.

FOR BUSINESS SERVICES, NAMELY, PROVIDING A TELEPHONE CALL TRACKING SERVICE WHICH PROVIDES SUBSCRIBERS WITH STATISTICAL REPORTS OF DATES, TIMES, STATUS AND DEMOGRAPHIC INFORMATION ON CALLS PLACED TO THEIR BUSINESS (U.S. CLS. 100, 101 AND 102).

SN 78-087,875. PASS!TIME MARKETING, SAN JOSE, CA. FILED 10-11-2001.

NO BULL EAGLE

NO CLAIM IS MADE TO THE EXCLUSIVE RIGHT TO USE "EAGLE", APART FROM THE MARK AS SHOWN. FOR ADVERTISING SLOGAN AND CARTOON CHARACTER LICENSING (U.S. CLS. 100, 101 AND 102).

SN 78-089,660. LIST IGNITE CORPORATION, FT. LAUDERDALE, FL. FILED 10-23-2001.



FOR COMPUTERIZED DATABASE MANAGEMENT (U.S. CLS. 100, 101 AND 102).
FIRST USE 7-3-2001; IN COMMERCE 8-1-2001.

CLASS 35—(Continued).

SN 78-092,415. EUCLID TECHNOLOGY, LLC, BETHESDA, MD. FILED 11-8-2001.

EUCLID TECHNOLOGY

FOR BUSINESS MANAGEMENT CONSULTING; BUSINESS CONSULTING; BUSINESS PROCESS REENGINEERING SERVICES; AND BUSINESS STRATEGIC MANAGEMENT AND PLANNING SERVICES (U.S. CLS. 100, 101 AND 102).

FIRST USE 1-1-1997; IN COMMERCE 1-1-1997.

SN 78-096,959. POLAR BEAR ORDNANCE, INC., WOODBURY, MN. FILED 12-6-2001.

PBOINC.COM

FOR RETAIL STORE SERVICES FEATURING SPORTING GOODS (U.S. CLS. 100, 101 AND 102).

FIRST USE 6-1-1999; IN COMMERCE 6-1-1999.

SN 78-100,303. PORTER, ROBERT A., VALRICO, FL. FILED 12-29-2001.

KALOOKA

FOR VENDING IN THE FIELD OF CONFECTIONERY FOODS, COTTON CANDY AND SHAVED ICE (U.S. CLS. 100, 101 AND 102).

SN 78-100,929. PC CONNECTION, INC., MERRIMACK, NH. FILED 1-4-2002.

XTREME SERVICE

NO CLAIM IS MADE TO THE EXCLUSIVE RIGHT TO USE "SERVICE", APART FROM THE MARK AS SHOWN.

FOR ONLINE RETAIL STORE SERVICES IN THE FIELD OF COMPUTERS, COMPUTER SYSTEMS, COMPUTER PERIPHERALS, AND COMPUTER SOFTWARE BY MEANS OF A GLOBAL COMPUTER NETWORK (U.S. CLS. 100, 101 AND 102).

SN 78-102,332. CHAMBERS, ANITA M., GOLETA, CA. FILED 1-12-2002.

RAZZO

THE ENGLISH TRANSLATION OF THE WORD "RAZZO" IN THE MARK IS "ROCKET".

FOR COOPERATIVE ADVERTISING AND MARKETING SERVICES, PUBLIC RELATIONS, AND ADVERTISING AGENCIES, ALL RELATED TO THE LAUNCH AND PROMOTION OF NEW PRODUCTS OF OTHERS (U.S. CLS. 100, 101 AND 102).

CLASS 35—(Continued).

SN 78-103,482. 21ST CENTURY ALLIANCE, MANHATTAN, KS. FILED 1-18-2002.

21ST CENTURY ALLIANCE

FOR BUSINESS CONSULTING SERVICES, NAMELY, ASSISTING FARMER MEMBERS OF A COOPERATIVE IN FORMING AND DEVELOPING AGRICULTURAL BUSINESSES (U.S. CLS. 100, 101 AND 102).
FIRST USE 12-28-1995; IN COMMERCE 12-28-1995.

SN 78-104,704. WEBMAGIC VENTURES LLC, PASADENA, CA. FILED 1-24-2002.

GOBLET

FOR PROVIDING INFORMATION ON SHOPPING OPPORTUNITIES PROVIDED BY OTHERS, NAMELY, PROVIDING SHOPPER'S GUIDE INFORMATION VIA A WEBSITE; PROVIDING A GUIDE TO WEB SITES THAT PROVIDE CURRENT NEWS AND INFORMATION ABOUT THE GOODS AND SERVICES OF OTHERS IN THE FIELDS OF RECREATION, BUSINESS, LIVING, SHOPPING, THE HOME AND THE INTERNET AND DIRECT MARKET ADVERTISING SERVICES FOR OTHERS (U.S. CLS. 100, 101 AND 102).
FIRST USE 6-24-1998; IN COMMERCE 6-24-1998.

SN 78-104,705. WEBMAGIC VENTURES LLC, PASADENA, CA. FILED 1-24-2002.

LIFESAVERS

FOR PROVIDING INFORMATION ON SHOPPING OPPORTUNITIES PROVIDED BY OTHERS, NAMELY, PROVIDING SHOPPER'S GUIDE INFORMATION VIA A WEBSITE; PROVIDING A GUIDE TO WEB SITES THAT PROVIDE CURRENT NEWS AND INFORMATION ABOUT THE GOODS AND SERVICES OF OTHERS IN THE FIELDS OF RECREATION, BUSINESS, LIVING, SHOPPING, THE HOME AND THE INTERNET AND DIRECT MARKET ADVERTISING SERVICES FOR OTHERS (U.S. CLS. 100, 101 AND 102).
FIRST USE 11-3-1998; IN COMMERCE 11-3-1998.

SN 78-104,706. WEBMAGIC VENTURES LLC, PASADENA, CA. FILED 1-24-2002.

PEPPERMILL

FOR PROVIDING INFORMATION ON SHOPPING OPPORTUNITIES PROVIDED BY OTHERS, NAMELY, PROVIDING SHOPPER'S GUIDE INFORMATION VIA A WEBSITE; PROVIDING A GUIDE TO WEB SITES THAT PROVIDE CURRENT NEWS AND INFORMATION ABOUT THE GOODS AND SERVICES OF OTHERS IN THE FIELDS OF RECREATION, BUSINESS, LIVING, SHOPPING, THE HOME AND THE INTERNET AND DIRECT MARKET ADVERTISING SERVICES FOR OTHERS (U.S. CLS. 100, 101 AND 102).
FIRST USE 4-10-1998; IN COMMERCE 4-10-1998.

CLASS 35—(Continued).

SN 78-108,026. SHALVARJIAN, ZACHARY, SACRAMENTO, CA. FILED 2-11-2002.

COWABUNGA

FOR WHOLESALE DISTRIBUTORSHIPS AND RETAIL STORE SERVICES FEATURING BEEF JERKY AND SNACK FOODS (U.S. CLS. 100, 101 AND 102).
FIRST USE 6-21-1999; IN COMMERCE 6-21-1999.

SN 78-108,153. REZCONNECT TECHNOLOGIES, INC., ENGLEWOOD CLIFFS, NJ. FILED 2-12-2002.

REZCITY

FOR PROMOTING THE GOODS AND SERVICES OF OTHERS BY PREPARING AND PLACING ADVERTISEMENTS IN AN ELECTRONIC FORMAT ACCESSED THROUGH A GLOBAL COMPUTER NETWORK (U.S. CLS. 100, 101 AND 102).

SN 78-109,731. QUESTION MARKETING, INC., SPRING LAKE PARK, MN. FILED 2-19-2002.



NO CLAIM IS MADE TO THE EXCLUSIVE RIGHT TO USE "MARKETING, INC.", APART FROM THE MARK AS SHOWN.

FOR BUSINESS MARKETING CONSULTING SERVICES (U.S. CLS. 100, 101 AND 102).

CLASS 35—(Continued).

SN 78-110,134. EL PASO CORPORATION, HOUSTON, TX. FILED 2-21-2002.

EL PASO MERCHANT ENERGY

OWNER OF U.S. REG. NOS. 1,876,839, 2,201,934 AND OTHERS.

NO CLAIM IS MADE TO THE EXCLUSIVE RIGHT TO USE "MERCHANT ENERGY", APART FROM THE MARK AS SHOWN.

SEC. 2(F) AS TO "EL PASO".

FOR OPERATION AND MANAGEMENT OF ENERGY AND POWER GENERATING FACILITIES, ENERGY AND POWER TRANSMISSION FACILITIES, NATURAL GAS PIPELINE SYSTEMS AND RELATED FACILITIES FOR OTHERS; PROCUREMENT SERVICES, NAMELY, PURCHASING CRUDE OIL, REFINED PETROLEUM PRODUCTS, NATURAL GAS AND LIQUEFIED NATURAL GAS, ELECTRIC POWER, FOREIGN CURRENCY, EMISSION CREDITS, COAL, AND OTHER FUELS FOR OTHERS; WHOLESALE DISTRIBUTORSHIP AND RETAIL OUTLET SERVICES IN THE FIELDS OF ELECTRICITY, NATURAL GAS AND COMPRESSED NATURAL GAS; OPERATION AND MANAGEMENT OF COMPRESSED OR LIQUEFIED NATURAL GAS TERMINALS AND FACILITIES FOR THE DELIVERY, PROCESSING AND STORAGE OF LIQUEFIED NATURAL GAS; OPERATION AND MANAGEMENT OF PETROLEUM TERMINALS AND FACILITIES FOR THE DELIVERY, PROCESSING AND STORAGE OF PETROLEUM PRODUCTS; BUSINESS MARKETING CONSULTING SERVICES FOR THE ENERGY, NATURAL GAS, PETROLEUM, AND UTILITY INDUSTRIES, ENERGY SERVICE COMPANIES, ENERGY MARKETERS, AND MUNICIPAL ENERGY, NATURAL GAS, AND UTILITY USERS; BUSINESS MARKETING CONSULTING SERVICES IN THE FIELD OF BUYING, SELLING AND TRADING CRUDE OIL, REFINED PETROLEUM PRODUCTS, NATURAL GAS AND LIQUEFIED NATURAL GAS, ELECTRIC POWER, FOREIGN CURRENCY, EMISSION CREDITS, COAL, AND OTHER FUELS (U.S. CLS. 100, 101 AND 102).

FIRST USE 9-20-1999; IN COMMERCE 9-20-1999.

SN 78-111,657. FORD MOTOR COMPANY, DEARBORN, MI. FILED 2-28-2002.

LINCOLN. TRAVEL WELL

FOR PROMOTING THE SALE OF GOODS AND SERVICES OF OTHERS THROUGH THE DISTRIBUTION OF PRINTED MATERIAL, AUDIO AND VIDEO TAPES, TELEVISION AND RADIO BROADCASTS, AND PROMOTIONAL CONTESTS (U.S. CLS. 100, 101 AND 102).

CLASS 35—(Continued).

SN 78-112,165. PERSONALITY.COM, INC., NEW KENSINGTON, PA. FILED 3-2-2002.

A HOME FOR YOUR PERSONALITY

FOR BUSINESS CONSULTATION, NAMELY, PROVIDING AND ADMINISTERING PERSONALITY TESTS, AND DETERMINING PERSONALITY AND CHARACTER TRAITS OF EMPLOYEES FOR USE IN ENABLING BUSINESSES TO MAXIMIZE THE POTENTIAL OF THEIR EMPLOYEES; EMPLOYMENT COUNSELING AND RECRUITING, NAMELY, PROVIDING AND ADMINISTERING PERSONALITY TESTS, AND DETERMINING PERSONALITY AND CHARACTER TRAITS OF SUBJECTS TO DETERMINE THE BEST EMPLOYMENT OPTIONS FOR THEIR PERSONALITY (U.S. CLS. 100, 101 AND 102).

FIRST USE 7-22-2001; IN COMMERCE 7-22-2001.

SN 78-112,423. SOMBERT, ROBERT, CHICAGO, IL. FILED 3-4-2002.



NO CLAIM IS MADE TO THE EXCLUSIVE RIGHT TO USE "PARTNERS", APART FROM THE MARK AS SHOWN.

FOR BUSINESS MANAGEMENT AND CONSULTATION REGARDING INDUSTRIAL COST REDUCTION THROUGH THE APPLICATION OF LEAN MANUFACTURING, SIX SIGMA AND SUPPLY CHAIN MANAGEMENT METHODS (U.S. CLS. 100, 101 AND 102).

SN 78-113,213. IDEASPHERE, INC., WAYLAND, MA. FILED 3-7-2002.

IDEASPHERE

FOR BUSINESS MANAGEMENT AND CONSULTING SERVICES; ARRANGING AND CONDUCTING BUSINESS CONFERENCES; BUSINESS DEVELOPMENT SERVICES, NAMELY, PROVIDING MANAGEMENT SUPPORT FOR BUSINESSES OF OTHERS; PERSONNEL MANAGEMENT CONSULTING (U.S. CLS. 100, 101 AND 102).

SN 78-113,221. CECIL, JOHN, NEWPORT BEACH, CA. FILED 3-7-2002.

GHERKIN RUCKUS

FOR ADVERTISING AGENCIES, NAMELY, PROMOTING THE GOODS, SERVICES, AND IDENTITIES OF OTHERS (U.S. CLS. 100, 101 AND 102).

FIRST USE 9-1-2001; IN COMMERCE 9-1-2001.

CLASS 35—(Continued).

SN 78-113,238. GEOFFREY, INC., PARAMUS, NJ. FILED 3-7-2002.

RIGHT FOR MOM, COOL FOR KIDS

FOR RETAIL DEPARTMENT STORE SERVICES (U.S. CLS. 100, 101 AND 102).

SN 78-113,245. GEOFFREY, INC., PARAMUS, NJ. FILED 3-7-2002.

THE FERRIS OF THEM ALL

FOR RETAIL DEPARTMENT STORE SERVICES (U.S. CLS. 100, 101 AND 102).

SN 78-114,128. SUE, STEVEN JOHN, OAKLAND, CA. FILED 3-11-2002.

PERFECTING YOUR STORY

FOR BUSINESS MANAGEMENT CONSULTING IN THE FIELD OF CREATING AND MAINTAINING CORPORATE AND BRAND IDENTITY IN MARKETING COMMUNICATIONS (U.S. CLS. 100, 101 AND 102).

CLASS 36—INSURANCE AND FINANCIAL

SN 74-711,381. USA FEDERAL CREDIT UNION, TROY, MI. FILED 8-4-1995.

ONLINE USA

NO CLAIM IS MADE TO THE EXCLUSIVE RIGHT TO USE "ONLINE", APART FROM THE MARK AS SHOWN. SEC. 2(F).

FOR ON-LINE FINANCIAL INFORMATION PROVIDED BY ELECTRONIC MEANS, NAMELY ACCOUNT INFORMATION, LOAN INFORMATION, ACCOUNT TRANSFER INFORMATION, ACCOUNT WITHDRAWAL INFORMATION, BILL PAYING INFORMATION, ACCOUNT HISTORY INFORMATION AND INTEREST RATE INFORMATION; ON-LINE BANKING SERVICES PROVIDED VIA GLOBAL COMPUTER NETWORKS, NAMELY BANK ACCOUNT TRANSFERS, BANK ACCOUNT WITHDRAWALS, AND ELECTRONIC BILL PAYING SERVICES; LOAN SERVICES PROVIDED VIA GLOBAL COMPUTER NETWORKS, NAMELY, LOAN FINANCING SERVICES, SAVINGS AND LOAN SERVICES, HOME EQUITY LOANS SERVICES, INSTALLMENT LOAN SERVICES, LEASE-PURCHASE LOANS SERVICES, TEMPORARY LOANS SERVICES (U.S. CLS. 100, 101 AND 102).

FIRST USE 11-0-1995; IN COMMERCE 11-0-1995.

CLASS 36—(Continued).

SN 75-123,072. PROMEDICA HEALTH SYSTEMS, INC., TOLEDO, OH. FILED 6-21-1996.

PROMEDICA

FOR INSURANCE AGENCIES IN THE FIELD OF COMMERCIAL HEALTH INSURANCE, HEALTH MAINTENANCE ORGANIZATIONS, MEDICARE HEALTH MAINTENANCE ORGANIZATIONS, MEDICAID HEALTH MAINTENANCE ORGANIZATIONS, AND PREFERRED PROVIDER ORGANIZATIONS, AND INSURANCE ADMINISTRATION (U.S. CLS. 100, 101 AND 102).

FIRST USE 1-0-1996; IN COMMERCE 1-0-1996.

SN 75-576,931. BANCGROUP MORTGAGE CORPORATION, HICKORY HILLS, IL. FILED S.R. 10-26-1998; AM. P.R. 12-18-2001.

BANCGROUP MORTGAGE CORPORATION

NO CLAIM IS MADE TO THE EXCLUSIVE RIGHT TO USE "MORTGAGE CORPORATION", APART FROM THE MARK AS SHOWN.

SEC. 2(F).

FOR MORTGAGE AND FINANCIAL SERVICES, NAMELY, PRE-QUALIFYING, PRE-APPROVAL, AND APPROVAL MORTGAGE SERVICES; MORTGAGE CONTINGENCIES (U.S. CLS. 100, 101 AND 102).

FIRST USE 8-1-1996; IN COMMERCE 8-1-1996.

SN 75-586,486. CGNU PLC, LONDON 3DQ, UNITED KINGDOM, BY CHANGE OF NAME CGU PLC, LONDON EC3P 3DQ, UNITED KINGDOM, FILED 11-10-1998.

CGU

PRIORITY CLAIMED UNDER SEC. 44(D) ON UNITED KINGDOM APPLICATION NO. 2168267, FILED 6-2-1998, REG. NO. 2168267, DATED 6-2-1998, EXPIRES 6-2-2008.

FOR GUARANTEE ASSURANCE UNDERWRITING; INSURANCE BROKERAGE SERVICES; INSURANCE AGENCY SERVICES IN THE FIELD OF PROPERTY, CASUALTY, ACCIDENT, HEALTH AND LIFE INSURANCE; INSURANCE CONSULTATION SERVICES; INSURANCE UNDERWRITING SERVICES IN THE FIELD OF PROPERTY, CASUALTY, ACCIDENT, HEALTH AND LIFE INSURANCE; REINSURANCE UNDERWRITING SERVICES; SURETY SERVICES; ASSET MANAGEMENT SERVICES (U.S. CLS. 100, 101 AND 102).

CLASS 36—(Continued).

SN 75-687,550. CALIFORNIA LAW ENFORCEMENT ASSOCIATION, MARTELL, CA. FILED 4-21-1999.

CALIFORNIA LAW ENFORCEMENT ASSOCIATION

NO CLAIM IS MADE TO THE EXCLUSIVE RIGHT TO USE "LAW ENFORCEMENT ASSOCIATION", APART FROM THE MARK AS SHOWN.

SEC. 2(F) AS TO "CALIFORNIA", FOR ADMINISTRATION OF LONG-TERM DISABILITY INSURANCE PLANS, LONG-TERM HEALTH CARE INSURANCE PLANS, AND ACCIDENTAL DEATH AND DISMEMBERMENT INSURANCE PLANS; CONSULTATION TO ASSIST OTHERS IN ESTABLISHING PARTIALLY AND FULLY FUNDED PLANS FOR LAW ENFORCEMENTS PERSONNEL (U.S. CLS. 100, 101 AND 102).

FIRST USE 12-5-1985; IN COMMERCE 12-5-1985.

SN 75-696,110. TEXAS CAPITAL BANCSHARES, INC., DALLAS, TX. FILED 5-3-1999.

TEXAS CAPITAL BANKDIRECT

NO CLAIM IS MADE TO THE EXCLUSIVE RIGHT TO USE "TEXAS" OR "BANKDIRECT", APART FROM THE MARK AS SHOWN.

FOR BANKING SERVICES (U.S. CLS. 100, 101 AND 102).

SN 75-732,740. OLSON, A. WAYNE, DBA UNICACHE, LAS VEGAS, NV. FILED 6-15-1999.

UNICACHE

FOR CREDIT CARD SERVICES, NAMELY, ELECTRONIC PAYMENT SERVICES; CREDIT RECOVERY AND COLLECTION SERVICES (U.S. CLS. 100, 101 AND 102).

SN 75-743,643. DLJ LONG TERM INVESTMENT CORPORATION, CHICAGO, IL. FILED 7-6-1999.

TRADETALK

FOR INVESTMENT PORTFOLIO MANAGEMENT AND INVESTMENT ACCOUNT MANAGEMENT, USING AN INTERACTIVE TELEPHONE VOICE RESPONSE SYSTEM; PROVIDING INVESTMENT INFORMATION, SECURITIES TRADING CONSULTATION, SECURITIES TRADING FOR OTHERS ALL VIA AN INTERACTIVE TELEPHONE VOICE RESPONSE SYSTEM (U.S. CLS. 100, 101 AND 102).

FIRST USE 4-0-1996; IN COMMERCE 4-0-1996.

CLASS 36—(Continued).

SN 75-773,993. J.P. MORGAN CHASE & CO., NEW YORK, NY. BY MERGER J.P. MORGAN & CO. INCORPORATED, NEW YORK, NY. FILED 8-12-1999.

ADR ROUNDTABLE

NO CLAIM IS MADE TO THE EXCLUSIVE RIGHT TO USE "ADR", APART FROM THE MARK AS SHOWN. FOR FINANCIAL AND INVESTMENT CONSULTATION SERVICES (U.S. CLS. 100, 101 AND 102).

SN 75-818,435. AMERICAN DATA SOURCE INDIA PRIVATE LIMITED, BANGALORE, INDIA, FILED 10-11-1999.

AMERICAN DATA SOLUTIONS

NO CLAIM IS MADE TO THE EXCLUSIVE RIGHT TO USE "AMERICAN DATA", APART FROM THE MARK AS SHOWN.

FOR ANNUITY AND LIFE INSURANCE SUPPORT, MAINTENANCE AND CLAIMS ADMINISTRATION SERVICES, NAMELY PROVIDING ACTUARIAL SERVICES IN THE NATURE OF ACTUARIAL SUPPORT SERVICES, ADMINISTERING LOANS, SURRENDERS, WITHDRAWALS, ANNUITIZATIONS, POLICY MAINTENANCE, AND ACTUARIAL MODELING AND ANALYSIS SERVICES; AND PROVIDING INFORMATION IN THE FIELD OF FINANCIAL SERVICES (U.S. CLS. 100, 101 AND 102).

SN 75-849,559. EQ PANKKIIRILIIKE OY, 00100 HELSINKI, FINLAND, FILED 11-16-1999.

eQonline

PRIORITY CLAIMED UNDER SEC. 44(D) ON FINLAND APPLICATION NO. T199901549, FILED 5-17-1999, REG. NO. 217319, DATED 4-14-2000, EXPIRES 4-14-2010.

FOR BROKERAGE IN THE FIELD OF SECURITIES, FUTURES AND MONEY-MARKET INSTRUMENTS; SAFEKEEPING AND CUSTODY SERVICES FOR BOOK-ENTRY SECURITIES AND ADR-WARRANTS, AND PROVIDING OF BOOK-ENTRY REGISTERS AND ACCOUNTS; MANAGING PUBLIC AND PRIVATE OFFERINGS, NAMELY, STOCK ISSUES, CAPITAL ISSUES AND BOND ISSUES; SECURITIES, SHARE AND WARRANT UNDERWRITING SERVICES; INVESTMENT CONSULTATION; CURRENCY EXCHANGE SERVICES CONNECTED WITH INVESTMENT SERVICES (U.S. CLS. 100, 101 AND 102).

CLASS 36—(Continued).

SN 75-850,907. ENROLLCOM, INC., OKLAHOMA CITY, OK. FILED 11-17-1999.

ENROLLCOM.COM

FOR EMPLOYEE BENEFIT ADMINISTRATION; NAMELY, PROVIDING ONLINE ENROLLING SERVICES FOR INSURANCE (U.S. CLS. 100, 101 AND 102).

SN 75-854,935. CAPITAL CONCEPTS CONSULTANTS, INC., OCEANSIDE, NY. FILED 11-19-1999.

GOOD FOLKS

NO CLAIM IS MADE TO THE EXCLUSIVE RIGHT TO USE "GOOD", APART FROM THE MARK AS SHOWN. FOR RESIDENTIAL MORTGAGE LENDING AND COMMERCIAL LENDING SERVICES (U.S. CLS. 100, 101 AND 102). FIRST USE 7-16-1999; IN COMMERCE 7-16-1999.

SN 75-899,656. CHOICE ONE COMMUNICATIONS INC., ROCHESTER, NY. FILED 1-20-2000.

CHOICEGUARD

FOR TELECOMMUNICATIONS SERVICES, NAMELY, PROVIDING DOMESTIC AND INTERNATIONAL CALLING CARDS WITH A PRE-SET CREDIT LIMIT DESIGNED TO LIMIT CUSTOMER EXPOSURE DUE TO THEFT (U.S. CLS. 100, 101 AND 102). FIRST USE 8-0-1999; IN COMMERCE 6-0-2000.

SN 75-900,640. PROVIDIAN FINANCIAL CORPORATION, SAN FRANCISCO, CA. FILED 1-21-2000.

MYCREDITPROFILE

FOR FINANCIAL SERVICES, NAMELY, PROVIDING CUSTOMERS WITH REGULARLY UPDATED DETAILED REPORTS REGARDING THE CUSTOMER'S CREDIT RATING (U.S. CLS. 100, 101 AND 102). FIRST USE 10-21-1999; IN COMMERCE 10-21-1999.

CLASS 36—(Continued).

SN 75-900,810. PROVIDIAN FINANCIAL CORPORATION, SAN FRANCISCO, CA. FILED 1-21-2000.



FOR FINANCIAL SERVICES, NAMELY, PROVIDING CUSTOMERS WITH REGULARLY UPDATED DETAILED REPORTS REGARDING THE CUSTOMER'S CREDIT RATING (U.S. CLS. 100, 101 AND 102). FIRST USE 10-21-1999; IN COMMERCE 10-21-1999.

SN 75-910,163. NOMURA CORPORATE RESEARCH AND ASSET MANAGEMENT, INC., NEW YORK, NY. FILED 1-26-2000.

BATTERY PARK

SEC. 2(F). FOR INVESTMENT ADVISORY SERVICES, INCLUDING MUTUAL FUND ADVISORY SERVICES AND OTHER INVESTMENT FUND AND INVESTMENT ACCOUNT ADVISORY SERVICES (U.S. CLS. 100, 101 AND 102). FIRST USE 10-28-1996; IN COMMERCE 10-28-1996.

SN 75-914,929. THIRD CAPITAL MORTGAGE, INC., DBA THIRD CAPITAL MORTGAGE, CLEVELAND, OH. FILED 2-10-2000.

THIRD CAPITAL MORTGAGE

NO CLAIM IS MADE TO THE EXCLUSIVE RIGHT TO USE "CAPITAL MORTGAGE", APART FROM THE MARK AS SHOWN. FOR MORTGAGE BROKERAGE SERVICES (U.S. CLS. 100, 101 AND 102). FIRST USE 8-19-1999; IN COMMERCE 8-19-1999.

SN 75-916,682. GUARDIAN LIFE INSURANCE COMPANY OF AMERICA, THE, NEW YORK, NY. FILED 2-11-2000.

INVESTOR'S BLUEPRINT

NO CLAIM IS MADE TO THE EXCLUSIVE RIGHT TO USE "INVESTOR'S", APART FROM THE MARK AS SHOWN. FOR MUTUAL FUND PORTFOLIO INVESTMENT ADVISORY SERVICES (U.S. CLS. 100, 101 AND 102).

CLASS 36—(Continued).

SN 75-926,190. INTERSTATE NATIONAL CORPORATION, CHICAGO, IL. FILED 2-24-2000.

**INTERSTATE
INSURANCE
GROUP**

NO CLAIM IS MADE TO THE EXCLUSIVE RIGHT TO USE "INSURANCE GROUP", APART FROM THE MARK AS SHOWN.

SEC. 2(F).
FOR INSURANCE SERVICES, NAMELY, UNDERWRITING IN THE FIELD OF PROPERTY, CASUALTY AND LIABILITY (U.S. CLS. 100, 101 AND 102).
FIRST USE 0-0-1981; IN COMMERCE 0-0-1981.

SN 76-000,487. QUOTOPIA.COM, NEW YORK, NY. BY CHANGE OF NAME INSURANCECOUNTRY.COM LLC, NEW YORK, NY. FILED 3-15-2000.

QUOTOPIA.COM

FOR INSURANCE SERVICES, NAMELY, INSURANCE BROKERAGE IN THE FIELD OF PERSONAL AND COMMERCIAL LINES, SPECIFICALLY, TERM LIFE INSURANCE; AND, PROVIDING INSURANCE INFORMATION VIA A GLOBAL COMPUTER NETWORK, NAMELY, PROVIDING PRICE QUOTES FOR ANNUITIES, CRITICAL CARE, HOMEOWNERS, AUTOMOBILE, HEALTH, TRIP TRAVEL, AND LONG-TERM CARE INSURANCE (U.S. CLS. 100, 101 AND 102).

SN 76-009,386. SALLIE MAE, INC., RESTON, VA. FILED 3-24-2000.

WIRESCHOLAR

FOR COMPUTER SERVICES, NAMELY, PROVIDING COLLEGE COSTS INFORMATION AND FINANCIAL AID INFORMATION TO STUDENTS, PARENTS AND GUIDANCE PROFESSIONALS VIA THE GLOBAL COMPUTER NETWORK; PROVIDING AN ON-LINE INTERACTIVE TOOL, NAMELY, AN ON-LINE INTERACTIVE DATABASE FOR ANALYZING COLLEGE COSTS AND COMPARING FINANCIAL AID PACKAGES; AND PROVIDING AN ON-LINE COMPUTER DATABASE IN THE FIELD OF HIGHER EDUCATION FINANCIAL AID LOANS, LENDERS AND SCHOLARSHIPS (U.S. CLS. 100, 101 AND 102).
FIRST USE 12-9-1999; IN COMMERCE 12-22-1999.

CLASS 36—(Continued).

SN 76-022,535. BANCINSURE, INC., OKLAHOMA CITY, OK. FILED 4-11-2000.

MATTERHORN FINANCIAL SERVICES

NO CLAIM IS MADE TO THE EXCLUSIVE RIGHT TO USE "FINANCIAL SERVICES", APART FROM THE MARK AS SHOWN.

FOR INSURANCE SERVICES, NAMELY, PROVIDING INSURANCE UNDERWRITING SERVICES IN THE FIELD OF INSURANCE RELATING TO LENDING AND LEASING ACTIVITIES, INSURANCE CLAIMS ADMINISTRATION SERVICES, INSURANCE CLAIMS PROCESSING SERVICES AND INSURANCE AGENCY SERVICES (U.S. CLS. 100, 101 AND 102).

SN 76-022,754. BANCINSURE, INC., OKLAHOMA CITY, OK. FILED 4-11-2000.

MATTERHORN BANK PROGRAMS

NO CLAIM IS MADE TO THE EXCLUSIVE RIGHT TO USE "BANK PROGRAMS", APART FROM THE MARK AS SHOWN.

FOR INSURANCE SERVICES, NAMELY, PROVIDING INSURANCE UNDERWRITING SERVICES IN THE FIELD OF INSURANCE RELATING TO LENDING AND LEASING ACTIVITIES, INSURANCE CLAIMS ADMINISTRATION SERVICES, INSURANCE CLAIMS PROCESSING SERVICES AND INSURANCE AGENCY SERVICES (U.S. CLS. 100, 101 AND 102).

SN 76-040,241. GLOBAL FOREX LLC, NORTH LOGAN, UT. FILED 5-4-2000.



NO CLAIM IS MADE TO THE EXCLUSIVE RIGHT TO USE "GLOBAL FOREX", APART FROM THE MARK AS SHOWN.

FOR ONLINE CURRENCY EXCHANGE (U.S. CLS. 100, 101 AND 102).
FIRST USE 3-27-1998; IN COMMERCE 3-27-1998.

CLASS 36—(Continued).

SN 76-048,472. CITY OF NEW YORK, THE, NEW YORK, NY. FILED 5-15-2000.

FULTON FISH MARKET

NO CLAIM IS MADE TO THE EXCLUSIVE RIGHT TO USE "FISH MARKET", APART FROM THE MARK AS SHOWN.

SEC. 2(F).

FOR REAL ESTATE SERVICES, NAMELY LEASING AND MANAGEMENT OF COMMERCIAL PROPERTY FOR THE MARKETING, PROCESSING AND DISTRIBUTION OF SEAFOOD AND FOR RETAIL SHOPPING, RESTAURANT AND TAVERN SPACE (U.S. CLS. 100, 101 AND 102).

SN 76-049,056. RED-D-CASH, OMAHA, NE. FILED 5-16-2000.

RED D CASH

NO CLAIM IS MADE TO THE EXCLUSIVE RIGHT TO USE "CASH", APART FROM THE MARK AS SHOWN.

THE MARK IS COMPRISED OF THE STYLIZED PHRASE "RED D CASH," ALL LETTERS OF WHICH ARE COLORED RED.

FOR FINANCIAL SERVICES IN THE NATURE OF CHECK CASHING, DEFERRED DEPOSITS, PAYROLL ADVANCEMENTS SHORT-TERM LOANS (U.S. CLS. 100, 101 AND 102).

FIRST USE 5-1-1992; IN COMMERCE 5-1-1992.

SN 76-052,309. BANNER CAPITAL CORP., CHICAGO, IL. FILED 5-18-2000.

BANNER CAPITAL

NO CLAIM IS MADE TO THE EXCLUSIVE RIGHT TO USE "CAPITAL", APART FROM THE MARK AS SHOWN.

FOR VENTURE CAPITAL SERVICES, NAMELY, PROVIDING FINANCING TO EMERGING AND START-UP COMPANIES (U.S. CLS. 100, 101 AND 102).

FIRST USE 3-17-1997; IN COMMERCE 3-17-1997.

SN 76-066,354. INVESTORFORCE, INC., WAYNE, PA. FILED 6-8-2000.

INVESTORFORCETV

FOR PROVIDING INFORMATION IN THE FIELD OF PENSION FUNDS TO MANAGERS OF LARGE PENSION FUNDS BY MEANS OF MULTIMEDIA PRESENTATIONS OFFERED OVER A GLOBAL COMPUTER NETWORK (U.S. CLS. 100, 101 AND 102).

CLASS 36—(Continued).

SN 76-067,628. FIERTZ, STUART CHAPIN, LONDON SW1V 2NS, ENGLAND, AND LOURIE, JONATHAN HARRY, LONDON SW1V 2NS, ENGLAND, FILED 6-12-2000.

CHEYNE

PRIORITY CLAIMED UNDER SEC. 44(D) ON UNITED KINGDOM APPLICATION NO. 2217132, FILED 12-14-1999, REG. NO. 2217132, DATED 6-9-2000, EXPIRES 12-14-2009.

FOR PROVIDING FINANCIAL MANAGEMENT, INVESTMENT MANAGEMENT AND ADVISORY SERVICES, MUTUAL FUND INVESTMENT AND MANAGEMENT SERVICES; INVESTMENT BANKING SERVICES; CORPORATE AND PRIVATE BANKING SERVICES; TRUSTEE SERVICES; REAL ESTATE MANAGEMENT SERVICES AND ADVISORY SERVICES; VENTURE CAPITAL AND PROJECT CAPITAL INVESTMENT ADVISORY SERVICES; SECURITIES BROKERAGE SERVICES; FINANCING SERVICES; INSURANCE AND MORTGAGE ADVISORY SERVICES; AND CREDIT CARD AND DEBIT CARD SERVICES (U.S. CLS. 100, 101 AND 102).

SN 76-072,038. GENERAL ELECTRIC COMPANY, SCHECTADY, NY. FILED 6-16-2000.

GE CAPITAL MARINE FINANCE

NO CLAIM IS MADE TO THE EXCLUSIVE RIGHT TO USE "MARINE FINANCE", APART FROM THE MARK AS SHOWN.

FOR FINANCING SERVICES, EQUITY AND DEBT INVESTMENTS, AND RELATED FINANCIAL SERVICES TO MEET THE FINANCIAL REQUIREMENT OF CUSTOMERS (U.S. CLS. 100, 101 AND 102).

SN 76-072,040. GENERAL ELECTRIC COMPANY, SCHECTADY, NY. FILED 6-16-2000.

GE CAPITAL OIL & GAS

NO CLAIM IS MADE TO THE EXCLUSIVE RIGHT TO USE "OIL & GAS", APART FROM THE MARK AS SHOWN.

FOR FINANCING SERVICES, EQUITY AND DEBT INVESTMENTS, AND RELATED FINANCIAL SERVICES TO MEET THE FINANCIAL REQUIREMENT OF CUSTOMERS (U.S. CLS. 100, 101 AND 102).

SN 76-075,358. TM ACQUISITION CORP., PHOENIX, AZ. FILED 6-22-2000.

IF WE DON'T SELL YOUR HOUSE, WE'LL BUY IT

OWNER OF U.S. REG. NO. 1,646,268. FOR REAL ESTATE BROKERAGE SERVICES FEATURING A GUARANTEED SALES PROGRAM (U.S. CLS. 100, 101 AND 102).

FIRST USE 2-0-1983; IN COMMERCE 2-0-1983.

CLASS 36—(Continued).

SN 76-078,075. PROSPECT PARTNERS, L.L.C., CHICAGO, IL.
FILED 6-26-2000.

PROSPECT PARTNERS

NO CLAIM IS MADE TO THE EXCLUSIVE RIGHT TO USE "PARTNERS", APART FROM THE MARK AS SHOWN. FOR INVESTMENT SERVICES, NAMELY, PROCURING VENTURE CAPITAL AND MANAGING VENTURE CAPITAL FUNDS (U.S. CLS. 100, 101 AND 102).
FIRST USE 9-0-1997; IN COMMERCE 9-0-1997.

SN 76-084,341. GLINES, JAMES D., SANTA MARIA, CA.
FILED 7-6-2000.

Home of
"Santa Maria Style"
Banking

NO CLAIM IS MADE TO THE EXCLUSIVE RIGHT TO USE "BANKING", APART FROM THE MARK AS SHOWN. FOR COMMERCIAL BANKING SERVICES (U.S. CLS. 100, 101 AND 102).
FIRST USE 9-30-2001; IN COMMERCE 9-30-2001.

SN 76-092,952. BLACKWOOD TRADING, LLC., NEW YORK, NY. FILED 7-20-2000.

SHAVE

FOR ON-LINE STOCK TRADING AND STOCK BROKERAGE SERVICES (U.S. CLS. 100, 101 AND 102).
FIRST USE 4-13-2000; IN COMMERCE 4-13-2000.

SN 76-093,312. BLACKWOOD TRADING, LLC., NEW YORK, NY. FILED 7-20-2000.

HUNT

FOR ON-LINE STOCK TRADING AND STOCK BROKERAGE SERVICES (U.S. CLS. 100, 101 AND 102).
FIRST USE 4-13-2000; IN COMMERCE 4-13-2000.

SN 76-093,317. BLACKWOOD TRADING, LLC., NEW YORK, NY. FILED 7-20-2000.

WAVE

FOR ON-LINE STOCK TRADING AND STOCK BROKERAGE SERVICES (U.S. CLS. 100, 101 AND 102).
FIRST USE 4-13-2000; IN COMMERCE 4-13-2000.

CLASS 36—(Continued).

SN 76-096,853. TRIP.COM, INC., ENGLEWOOD, CO. FILED 7-26-2000.



OWNER OF U.S. REG. NO. 2,224,825.
FOR PROVIDING INSURANCE BROKERAGE SERVICES BY MEANS OF ELECTRONIC COMMUNICATIONS NETWORKS; PROVIDING ONLINE TRAVEL AGENCY SERVICES, NAMELY, ISSUING TRAVELERS CHECKS BY MEANS OF ELECTRONIC COMMUNICATIONS NETWORKS (U.S. CLS. 100, 101 AND 102).

SN 76-102,068. VECTRIX CORPORATION, CARROLLTON, TX. FILED 8-2-2000.

EXPRESS LANE

FOR CREDIT CARD TRANSACTION PROCESSING SERVICES IN THE FIELD OF AUTOMOBILE PARKING SERVICES (U.S. CLS. 100, 101 AND 102).
FIRST USE 9-0-1998; IN COMMERCE 9-0-1998.

SN 76-102,384. SIEGEL GROUP INT'L, INC., THE, NEW ORLEANS, LA. FILED 8-3-2000.

CHICKEN STOCKS

NO CLAIM IS MADE TO THE EXCLUSIVE RIGHT TO USE "STOCKS", APART FROM THE MARK AS SHOWN. FOR FINANCIAL INVESTMENT IN THE FIELD OF SECURITIES (U.S. CLS. 100, 101 AND 102).

CLASS 36—(Continued).

SN 76-106,035. COOPER COMMERCIAL GROUP, LTD., FLINT, MI. FILED 8-9-2000.

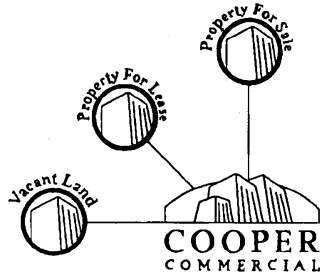

NO CLAIM IS MADE TO THE EXCLUSIVE RIGHT TO USE "COMMERCIAL, VACANT LAND, PROPERTY FOR LEASE, PROPERTY FOR SALE", APART FROM THE MARK AS SHOWN.

FOR COMMERCIAL REAL ESTATE SERVICES, NAMELY, BROKERAGE AND LEASING OF COMMERCIAL PROPERTY (U.S. CLS. 100, 101 AND 102).
FIRST USE 4-30-1999; IN COMMERCE 4-30-1999.

SN 76-109,640. FLEETBOSTON FINANCIAL CORPORATION, BOSTON, MA. FILED 8-14-2000.



A FleetBoston Financial Company

OWNER OF U.S. REG. NOS. 2,196,282, 2,200,183 AND 2,201,811.

NO CLAIM IS MADE TO THE EXCLUSIVE RIGHT TO USE "FINANCIAL COMPANY", APART FROM THE MARK AS SHOWN.

SEC. 2(F) AS TO "VENTURES".
FOR BANKING SERVICES AND FINANCIAL SERVICES, NAMELY, INVESTMENT ADVISORY SERVICES, MUTUAL FUND ADVISORY SERVICES, FINANCIAL INFORMATION AND COUNSELING SERVICES, ASSET SECURITIZATION AND VENTURE CAPITAL SERVICES, REAL ESTATE FINANCING SERVICES AND LEASING SERVICES (U.S. CLS. 100, 101 AND 102).
FIRST USE 2-13-2000; IN COMMERCE 2-13-2000.

SN 76-116,928. VITAE CORPORATION, NEW LENOX, IL. FILED 8-28-2000.

VITAE

THE ENGLISH TRANSLATION OF "VITAE" IS "LIFE".
FOR CREDIT CARD SERVICES (U.S. CLS. 100, 101 AND 102).
FIRST USE 10-0-1996; IN COMMERCE 10-0-1996.

CLASS 36—(Continued).

SN 76-121,703. DIRECT RESPONSE CORPORATION, WHITE PLAINS, NY. FILED 8-31-2000.



NO CLAIM IS MADE TO THE EXCLUSIVE RIGHT TO USE "TEACHERS' INSURANCE PLAN", APART FROM THE MARK AS SHOWN.

FOR INSURANCE SERVICES, NAMELY, UNDERWRITING INSURANCE IN THE FIELDS OF PROPERTY CASUALTY AND AUTOMOBILE INSURANCE; INSURANCE CLAIMS ADMINISTRATION AND PROCESSING; INSURANCE CONSULTATION AND INSURANCE BROKERAGE SERVICES (U.S. CLS. 100, 101 AND 102).

SN 76-124,014. MARCK, JEFFREY C., DES MOINES, IA. FILED 9-7-2000.



FOR CHARITABLE FUNDRAISING SERVICES FOR OVER THE ROAD TRUCK DRIVERS AND THEIR FAMILIES (U.S. CLS. 100, 101 AND 102).
FIRST USE 1-31-2000; IN COMMERCE 1-31-2000.

SN 76-126,532. CHARLES SCHWAB & CO., INC., SAN FRANCISCO, CA. FILED 9-12-2000.

SCHWAB SELL ANALYZER

OWNER OF U.S. REG. NOS. 1,516,641, 1,974,108 AND OTHERS.

NO CLAIM IS MADE TO THE EXCLUSIVE RIGHT TO USE "SELL" OR "ANALYZER", APART FROM THE MARK AS SHOWN.

FOR PROVIDING AN INTERACTIVE ONLINE COMPUTER DATABASE IN THE FIELDS OF FINANCIAL DECISION MAKING, MONITORING PERFORMANCE OF INVESTMENTS, EVALUATING PERFORMANCE OF INVESTMENTS, AND EVALUATING TAX IMPLICATIONS OF INVESTMENT ALTERNATIVES (U.S. CLS. 100, 101 AND 102).
FIRST USE 12-21-2000; IN COMMERCE 12-21-2000.

CLASS 36—(Continued).

SN 76-133,500. OPTION ONE MORTGAGE CORPORATION, IRVINE, CA. FILED 9-22-2000.

OPTION ONE

FOR MORTGAGE LENDING; MORTGAGE BANKING; ADMINISTRATIVE SERVICES FOR OTHERS RELATED TO RESIDENTIAL MORTGAGE LOAN; REAL ESTATE APPRAISAL; INSURANCE AGENCY SERVICES (U.S. CLS. 100, 101 AND 102).

FIRST USE 11-0-1992; IN COMMERCE 11-0-1992.

SN 76-139,716. WILMINGTON TRUST CORPORATION, WILMINGTON, DE. FILED 10-3-2000.

WILMINGTON TRUST

NO CLAIM IS MADE TO THE EXCLUSIVE RIGHT TO USE "TRUST", APART FROM THE MARK AS SHOWN.

SEC. 2(F).

FOR BANKING SERVICES; FINANCIAL SERVICES; NAMELY MORTGAGE LENDING, COMMERCIAL, RETAIL AND CONSUMER LOANS, ISSUANCE OF CREDIT CARDS AND DEBIT CARDS; AND INVESTMENT SERVICES, NAMELY TRUST ADMINISTRATION, INVESTMENT CONSULTATION, AND STOCK BROKERAGE SERVICES (U.S. CLS. 100, 101 AND 102).

FIRST USE 0-0-1903; IN COMMERCE 0-0-1903.

SN 76-145,587. CAPITALSTREAM, INC., SEATTLE, WA. FILED 10-12-2000.

**CAPITALSTREAM
EXCHANGE**

FOR ON-LINE FINANCIAL SERVICES, NAMELY ON-LINE CREDIT APPLICATION PROCESSING SERVICES THAT ALLOWS APPLICATIONS TO BE COMPLETED ON-LINE AND THEN TRANSFERRED TO THE DESK-TOP FOR PROCESSING (U.S. CLS. 100, 101 AND 102).

SN 76-150,763. CHICAGO CONSULTING ACTUARIES LLC, CHICAGO, IL. FILED 10-20-2000.

THE QMAX PROGRAM

NO CLAIM IS MADE TO THE EXCLUSIVE RIGHT TO USE "PROGRAM", APART FROM THE MARK AS SHOWN.

FOR ADMINISTRATION OF EMPLOYEE PENSION PLANS FEATURING FINANCIAL ANALYSIS AND CONSULTATION, AND ACTUARIAL SERVICES (U.S. CLS. 100, 101 AND 102).

FIRST USE 7-1-2000; IN COMMERCE 7-1-2000.

CLASS 36—(Continued).

SN 76-154,013. AMERICAN ESCROW & CLOSING COMPANY, MOUNT PROSPECT, IL. FILED 10-26-2000.

AECC MOVEMONEY

NO CLAIM IS MADE TO THE EXCLUSIVE RIGHT TO USE "MOVEMONEY", APART FROM THE MARK AS SHOWN.

FOR ELECTRONIC DEBIT TRANSACTIONS FOR REIMBURSEMENT OF RELOCATION EXPENSES INCURRED BY TRANSFERRED EMPLOYEE (U.S. CLS. 100, 101 AND 102).

FIRST USE 8-29-2000; IN COMMERCE 8-29-2000.

SN 76-159,234. B.D. OF NEVADA, RENO, NV. FILED 11-3-2000.

**INSTINET EXPRESS TRADER
GROUP**

NO CLAIM IS MADE TO THE EXCLUSIVE RIGHT TO USE "TRADER GROUP", APART FROM THE MARK AS SHOWN.

FOR FINANCIAL SERVICES, NAMELY, FINANCIAL PLANNING, FINANCIAL MANAGEMENT, FINANCIAL ANALYSIS AND CONSULTATION, INVESTMENT ADVICE, INVESTMENT CONSULTATION, PROVIDING INFORMATION ABOUT FINANCIAL INVESTMENTS VIA ON-LINE GLOBAL COMMUNICATIONS NETWORK (U.S. CLS. 100, 101 AND 102).

SN 76-164,177. MANUFACTURERS LIFE INSURANCE COMPANY OF NORTH AMERICA, THE, BOSTON, MA. FILED 11-13-2000.

**VENTURE VUL
ACCUMULATOR**

NO CLAIM IS MADE TO THE EXCLUSIVE RIGHT TO USE "VUL", APART FROM THE MARK AS SHOWN.

FOR LIFE INSURANCE UNDERWRITING (U.S. CLS. 100, 101 AND 102).

SN 76-164,669. PETROLEUM ELECTRONIC PRICING EXCHANGE, LLC, CORAL GABLES, FL. FILED 11-14-2000.

OILENGINE

FOR PROVIDING COMMODITY TRADING SERVICES RELATING TO PETROLEUM AND PETROLEUM PRODUCTS; BROKERAGE SERVICES IN THE FIELD OF PETROLEUM COMMODITIES; RISK MANAGEMENT, NAMELY INSURANCE UNDERWRITING, IN THE FIELD OF PETROLEUM AND PETROLEUM-RELATED SERVICES (U.S. CLS. 100, 101 AND 102).

CLASS 36—(Continued).

SN 76-181,428. FIRST COLONIAL GROUP, INC., NAZARETH, PA. FILED 12-15-2000.

NNB EXPRESS

NO CLAIM IS MADE TO THE EXCLUSIVE RIGHT TO USE "EXPRESS", APART FROM THE MARK AS SHOWN.
FOR PROVIDING BANK ACCOUNT INFORMATION BY TELEPHONE; TELEPHONE BANKING SERVICES (U.S. CLS. 100, 101 AND 102).
FIRST USE 2-23-2001; IN COMMERCE 2-23-2001.

SN 76-182,088. MF RISK, INC., BETHESDA, MD. FILED 12-15-2000.

MF RISK

NO CLAIM IS MADE TO THE EXCLUSIVE RIGHT TO USE "RISK", APART FROM THE MARK AS SHOWN.
FOR FINANCIAL CONSULTING SERVICES (U.S. CLS. 100, 101 AND 102).

SN 76-186,786. INTERNATIONAL MEDICAL GROUP, INC., INDIANAPOLIS, IN. FILED 12-27-2000.

IMG

FOR INSURANCE PLAN ADMINISTRATION SERVICES (U.S. CLS. 100, 101 AND 102).
FIRST USE 1-1-1990; IN COMMERCE 1-1-1990.

SN 76-189,232. CHARLES SCHWAB & CO., INC., SAN FRANCISCO, CA. FILED 1-2-2001.

**MANAGED ACCOUNT
SELECT**

NO CLAIM IS MADE TO THE EXCLUSIVE RIGHT TO USE "MANAGED ACCOUNT", APART FROM THE MARK AS SHOWN.
FOR FINANCIAL SERVICES PROVIDED TO INVESTMENT ADVISORS, NAMELY, CUSTODY OF ASSETS, SECURITIES TRADING, RESEARCH ON MONEY MANAGERS, INVESTMENT PERFORMANCES REPORTING, AND ASSET ALLOCATION TOOLS IN THE NATURE OF ONLINE, INTERACTIVE FINANCIAL CALCULATORS AND QUESTIONNAIRES FOR USE IN FINANCIAL PLANNING AND ANALYSIS (U.S. CLS. 100, 101 AND 102).

CLASS 36—(Continued).

SN 76-200,932. J.P. MORGAN CHASE & CO., NEW YORK, NY. BY ASSIGNMENT MORGAN GUARANTY TRUST COMPANY OF NEW YORK, NEW YORK, NY. FILED 1-29-2001.

**MORGAN WEALTH
ADVISOR**

NO CLAIM IS MADE TO THE EXCLUSIVE RIGHT TO USE "WEALTH ADVISOR", APART FROM THE MARK AS SHOWN.
FOR FINANCIAL SERVICES IN THE NATURE OF AN INVESTMENT SECURITY (U.S. CLS. 100, 101 AND 102).

SN 76-208,216. GULF INVESTMENT CORPORATION, SA-FAT, KUWAIT, FILED 2-12-2001.



OWNER OF KUWAIT REG. NO. 26694, DATED 6-13-1995, EXPIRES 6-13-2005.

NO CLAIM IS MADE TO THE EXCLUSIVE RIGHT TO USE "INVESTMENT CORPORATION", APART FROM THE MARK AS SHOWN.

THE NON-LATIN CHARACTERS IN THE MARK TRANSLATE INTO "MU'ASSAT ALKHALEEJ LELETETHA-MAAR", AND THIS MEANS "GULF INVESTMENT CORPORATION" IN ENGLISH.

FOR FINANCIAL SERVICES, NAMELY, STOCK AND BOND INVESTMENT SERVICES, COMMERCIAL BANKING SERVICES, PRIVATE EQUITY PLACEMENT SERVICES AND PROVIDING FINANCIAL ADVISORY SERVICES TO OTHERS (U.S. CLS. 100, 101 AND 102).

SN 76-209,242. E-QUOTE, INC., SAN DIEGO, CA. FILED 2-12-2001.

GO E*QUOTE

NO CLAIM IS MADE TO THE EXCLUSIVE RIGHT TO USE "E*QUOTE", APART FROM THE MARK AS SHOWN.
FOR LIFE INSURANCE BROKERAGE SERVICES REPRESENTING COMPANIES AND CONSUMERS (U.S. CLS. 100, 101 AND 102).

CLASS 36—(Continued).

SN 76-211,047. SUN LIFE ASSURANCE COMPANY OF CANADA, TORONTO, ONTARIO, M5H 1J9, CANADA, FILED 2-14-2001.



Futurity

FOR UNDERWRITING AND ADMINISTRATION OF LIFE INSURANCE, AND INVESTMENT ADVISORY SERVICES (U.S. CLS. 100, 101 AND 102).
FIRST USE 2-17-1998; IN COMMERCE 2-17-1998.

SN 76-213,458. BRAGDON, JOSEPH H., WOODSTOCK, VT. FILED 2-21-2001.

GLOBAL LAMP INDEX

NO CLAIM IS MADE TO THE EXCLUSIVE RIGHT TO USE "GLOBAL" OR "INDEX", APART FROM THE MARK AS SHOWN.

FOR EQUITY INVESTMENT FUND SERVICES, NAMELY, FINANCIAL PORTFOLIO MANAGEMENT AND INVESTMENT OF FUNDS FOR PENSIONS, ENDOWMENTS, AND MUTUAL FUNDS (U.S. CLS. 100, 101 AND 102).

SN 76-215,868. CREDITQUEST INTERNATIONAL, INC., WOODLAND HILLS, CA. FILED 2-26-2001.

PUTTING YOU IN CHARGE

FOR PROVIDING FINANCIAL INFORMATION BY MEANS OF A WEB PAGE FEATURING INFORMATION FROM BANKS, CREDIT CARD COMPANIES, AND CREDIT REPORTING BUREAUS REGARDING CREDIT CARD PROGRAMS, APPLICATION PROCESS, INTEREST RATES, AND BENEFITS (U.S. CLS. 100, 101 AND 102).

SN 76-216,446. RIA TELECOMMUNICATIONS, INC., NEW YORK, NY. FILED 2-26-2001.

MAS PESOS

THE ENGLISH TRANSLATION OF THE "MAS PESOS" IS "MORE PESOS".
FOR ELECTRONIC FUNDS TRANSFER SERVICES (U.S. CLS. 100, 101 AND 102).

CLASS 36—(Continued).

SN 76-232,718. INTERNATIONAL MEDICAL GROUP, INC., INDIANAPOLIS, IN. FILED 3-29-2001.

PATRIOT TRAVEL MEDICAL INSURANCE

NO CLAIM IS MADE TO THE EXCLUSIVE RIGHT TO USE "TRAVEL MEDICAL INSURANCE", APART FROM THE MARK AS SHOWN.

FOR MEDICAL INSURANCE PLAN ADMINISTRATION SERVICES DIRECTED TOWARD INDIVIDUALS, FAMILIES AND GROUPS LIVING AND TRAVELING INTERNATIONALLY (U.S. CLS. 100, 101 AND 102).

FIRST USE 5-0-1996; IN COMMERCE 5-0-1996.

SN 76-233,182. JR REALTY GROUP, INC., SANIBEL ISLAND, FL. FILED 3-27-2001.

SANIBEL ACCOMMODATIONS

NO CLAIM IS MADE TO THE EXCLUSIVE RIGHT TO USE "ACCOMMODATIONS", APART FROM THE MARK AS SHOWN.

SEC. 2(F).
FOR LEASING AND RENTAL OF TEMPORARY HOUSING ACCOMMODATIONS; REAL ESTATE VACATION TIME SHARE SERVICES (U.S. CLS. 100, 101 AND 102).

FIRST USE 0-0-1976; IN COMMERCE 0-0-1976.

SN 76-237,484. CARTELLIGENT INC., SAUSALITO, CA. FILED 4-2-2001.

CARTELLIGENT

FOR PROVIDING BROKERAGE SERVICES IN THE FIELD OF PURCHASING, LEASING, AND FINANCING CARS AND TRUCKS (U.S. CLS. 100, 101 AND 102).

FIRST USE 12-1-2000; IN COMMERCE 12-1-2000.

SN 76-244,836. SCHAEFFER'S INVESTMENT RESEARCH, INC., CINCINNATI, OH. FILED 4-23-2001.

SCHAEFFER'S DAILY SENTIMENT

NO CLAIM IS MADE TO THE EXCLUSIVE RIGHT TO USE "DAILY", APART FROM THE MARK AS SHOWN.

FOR FINANCIAL SERVICES, NAMELY PROVIDING FINANCIAL ANALYSIS AND PROVIDING FINANCIAL INVESTMENT INFORMATION AND FINANCIAL INVESTMENT DATA INFORMATION TO OTHERS (U.S. CLS. 100, 101 AND 102).

FIRST USE 11-30-1999; IN COMMERCE 11-30-1999.

CLASS 36—(Continued).

SN 76-247,541. FLEETBOSTON FINANCIAL CORPORATION, BOSTON, MA. FILED 4-30-2001.



OWNER OF U.S. REG. NOS. 1,290,001, 2,234,832 AND OTHERS.

NO CLAIM IS MADE TO THE EXCLUSIVE RIGHT TO USE "CAPITAL", APART FROM THE MARK AS SHOWN.

FOR FINANCIAL SERVICES, NAMELY, VENTURE CAPITAL SERVICES, EQUITY FINANCING SERVICES AND INVESTMENT ADVISORY SERVICES (U.S. CLS. 100, 101 AND 102).

FIRST USE 7-17-2000; IN COMMERCE 7-17-2000.

SN 76-248,391. APPRAISAL INSTITUTE, CHICAGO, IL. FILED 4-30-2001.

APPRAISAL INSTITUTE COMMERCIAL DATABASE

OWNER OF U.S. REG. NOS. 1,882,199, 1,885,389 AND OTHERS.

NO CLAIM IS MADE TO THE EXCLUSIVE RIGHT TO USE "COMMERCIAL DATABASE", APART FROM THE MARK AS SHOWN.

SEC. 2(F) AS TO "APPRAISAL INSTITUTE".

FOR PROVIDING INFORMATION AND ONLINE DATABASES IN THE FIELDS OF REAL ESTATE AND REAL ESTATE APPRAISAL; PROVIDING INFORMATION CONCERNING REAL ESTATE AND APPRAISAL VIA GLOBAL COMPUTER NETWORKS; PROVIDING ONLINE DATABASES FEATURING INFORMATION IN THE NATURE OF ARCHIVED NEWSLETTERS AND PERIODICALS IN THE FIELDS OF REAL ESTATE AND APPRAISAL; AND PROVIDING CONSULTATION SERVICES RELATED THERETO (U.S. CLS. 100, 101 AND 102).

FIRST USE 6-22-2001; IN COMMERCE 12-21-2001.

SN 76-251,554. HEALTH INSURANCE PLAN OF GREATER NEW YORK, NEW YORK, NY. FILED 5-4-2001.

HIPDIRECT

OWNER OF U.S. REG. NOS. 1,447,895, 1,751,547 AND 2,415,621.

FOR ADMINISTRATION OF PRE-PAID HEALTH CARE PLAN SERVICES OFFERED EXCLUSIVELY VIA A GLOBAL COMPUTER NETWORK (U.S. CLS. 100, 101 AND 102).

FIRST USE 8-14-2001; IN COMMERCE 8-14-2001.

CLASS 36—(Continued).

SN 76-257,288. GUARDIANS MC INC., NEW MILFORD, CT. FILED 5-7-2001.



NO CLAIM IS MADE TO THE EXCLUSIVE RIGHT TO USE "CONNECTICUT" AND "MC", APART FROM THE MARK AS SHOWN.

FOR CHARITABLE FUNDRAISING SERVICES FOR LAW ENFORCEMENT OFFICERS AND OTHER CHARITIES (U.S. CLS. 100, 101 AND 102).

SN 76-257,415. POWELL, DONALD S., DBA FARMNLAND-COM FRANCHISE SYSTEMS, PUNXSUTAWNEY, PA. FILED 5-15-2001.



FOR PROVIDING ONLINE REAL ESTATE LISTING AND BROKERAGE SERVICES (U.S. CLS. 100, 101 AND 102).

FIRST USE 11-1-2000; IN COMMERCE 11-1-2000.

SN 76-257,877. EBS NOMINEES LIMITED, LONDON, WC2A 3LJ, ENGLAND, FILED 5-16-2001.

RIGHT PRICE, RIGHT AMOUNT, RIGHT TIME

FOR BROKERAGE IN THE FIELD OF COMMODITIES, CURRENCY EXCHANGE AND FINANCIAL INSTRUMENTS AND PROVIDING THE FOREGOING SERVICES VIA AN INTERACTIVE GLOBAL COMPUTER NETWORK (U.S. CLS. 100, 101 AND 102).

FIRST USE 5-0-1997; IN COMMERCE 5-0-1997.

CLASS 36—(Continued).

SN 76-259,567. NEW COVENANT TRUST COMPANY, N.A., JEFFERSONVILLE, IN. FILED 5-21-2001.

NEW COVENANT FUNDS

NO CLAIM IS MADE TO THE EXCLUSIVE RIGHT TO USE "FUNDS", APART FROM THE MARK AS SHOWN.

FOR MUTUAL FUND BROKERAGE, INVESTMENT AND DISTRIBUTION SERVICES; AND ESTABLISHING MUTUAL FUNDS FOR OTHERS (U.S. CLS. 100, 101 AND 102).

FIRST USE 6-0-1999; IN COMMERCE 6-0-1999.



SN 76-259,740. DATATRAC CORPORATION, MILWAUKEE, WI. FILED 5-18-2001.

ALCO PRO

NO CLAIM IS MADE TO THE EXCLUSIVE RIGHT TO USE "PRO", APART FROM THE MARK AS SHOWN.

FOR INFORMATION SERVICES, NAMELY PROVIDING ASSET/LIABILITY CONSULTING AND DATABASE SERVICES FOR THE FINANCIAL INDUSTRY (U.S. CLS. 100, 101 AND 102).



SN 76-260,637. CHAUNCEY AND SHIRAH BELL, INC., ALAMEDA, CA. FILED 5-23-2001.

LIVING WEALTH

NO CLAIM IS MADE TO THE EXCLUSIVE RIGHT TO USE "WEALTH", APART FROM THE MARK AS SHOWN.

FOR FINANCIAL CONSULTATION (U.S. CLS. 100, 101 AND 102).

FIRST USE 5-14-2001; IN COMMERCE 5-14-2001.

CLASS 36—(Continued).

SN 76-261,099. FOLIOFN, INC., VIENNA, VA. FILED 5-23-2001.

FOLIO BUILDER

FOR FINANCIAL MANAGEMENT AND FINANCIAL INVESTMENT SERVICES IN THE FIELD OF TRADABLE INSTRUMENTS, NAMELY, COMMODITIES AND FUTURES, VIA A GLOBAL COMPUTER NETWORK, ELECTRONIC MEANS, COMPUTER COMMUNICATION, TELEPHONE COMMUNICATION, AND OTHER MEANS; FINANCIAL PLANNING IN THE FIELD OF TRADABLE INSTRUMENTS, NAMELY, SECURITIES, COMMODITIES AND FUTURES, VIA A GLOBAL COMPUTER NETWORK, ELECTRONIC MEANS, COMPUTER COMMUNICATION, TELEPHONE COMMUNICATION, AND OTHER MEANS; VENTURE CAPITAL, EQUITY AND DEBT FINANCING; FINANCIAL SERVICES, NAMELY, CONDUCTING PRIVATE PLACEMENTS AND PUBLIC OFFERINGS OF FUTURES AND COMMODITIES; INVESTMENT BANKING SERVICES; MORTGAGE LENDING; FINANCIAL PLANNING SERVICES; MERCHANT BANKING; MUTUAL FUND INVESTMENT SERVICES; INSURANCE AGENCY AND UNDERWRITING SERVICES IN THE FIELDS OF HOME, ACCIDENT, LIFE, FIRE AND DISABILITY INSURANCE, AND INSURANCE AGAINST FINANCIAL LOSSES IN THE VALUE OF FINANCIAL INSTRUMENTS AND PRODUCTS (U.S. CLS. 100, 101 AND 102).



SN 76-262,382. AES POWER DIRECT, L.L.C., PEORIA, IL. FILED 5-24-2001.

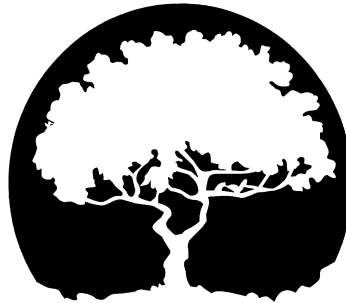

THE MARK CONSISTS OF A TREE IN FULL FOLIAGE INSIDE A NEARLY COMPLETED SHADED CIRCLE REPRESENTING THE MOON.

FOR ENVIRONMENTAL FUNDRAISING PROGRAM TO REDUCE THE ADVERSE IMPACT ON THE ENVIRONMENT BY APPLYING A PORTION OF THE CUSTOMER'S PAYMENT FOR PRODUCTS OR SERVICES TO OFFSET THE ENVIRONMENTAL IMPACT CAUSED BY THE PRODUCTION OF THAT PRODUCT OR SERVICE (U.S. CLS. 100, 101 AND 102).

FIRST USE 11-17-2000; IN COMMERCE 11-17-2000.

CLASS 36—(Continued).

SN 76-262,765. AGCOUNTRY FARM CREDIT SERVICES, ACA, FARGO, ND. FILED 5-25-2001.



NO CLAIM IS MADE TO THE EXCLUSIVE RIGHT TO USE "LEASING", APART FROM THE MARK AS SHOWN.

FOR RETAIL FINANCING SERVICES FOR THE AGRICULTURE, RANCHING AND AGRIBUSINESS INDUSTRIES; CONSUMER LEASING SERVICES FOR THE AGRICULTURE, RANCHING AND AGRIBUSINESS INDUSTRIES (U.S. CLS. 100, 101 AND 102).

FIRST USE 4-24-2001; IN COMMERCE 4-24-2001.

SN 76-266,844. LEND LEASE REAL ESTATE INVESTMENTS, INC., ATLANTA, GA. FILED 6-4-2001.

CAPMARK SERVICES

NO CLAIM IS MADE TO THE EXCLUSIVE RIGHT TO USE "SERVICES", APART FROM THE MARK AS SHOWN.

FOR COMMERCIAL AND MULTI-FAMILY DEBT AND EQUITY SERVICES, NAMELY, MORTGAGE LOAN SERVICING (U.S. CLS. 100, 101 AND 102).

FIRST USE 3-17-2000; IN COMMERCE 3-17-2000.

SN 76-269,285. ANGELS' FORUM MANAGEMENT CO., LLC, THE, LOS ALTOS, CA. FILED 6-5-2001.

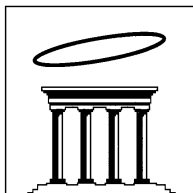

**THE
ANGELS'
FORUM
LLC**

NO CLAIM IS MADE TO THE EXCLUSIVE RIGHT TO USE "FORUM LLC", APART FROM THE MARK AS SHOWN.

FOR VENTURE CAPITAL INVESTMENT CONSULTATION AND INVESTMENT MANAGEMENT SERVICES (U.S. CLS. 100, 101 AND 102).

CLASS 36—(Continued).

SN 76-274,498. BANK RHODE ISLAND, PROVIDENCE, RI. FILED 6-21-2001.

CAMPUSMATE

FOR FINANCIAL SERVICES, NAMELY, ONLINE STUDENT BANK ACCOUNTS, ONLINE FUNDING CAPABILITY, NAMELY, FACILITATING SECURE FINANCIAL TRANSACTIONS, NAMELY, ELECTRONIC FUNDS AND CURRENCY TRANSFER, ELECTRONIC PAYMENT AND CASH DISBURSEMENT SERVICES, ATM, DEBIT AND CREDIT CARD FUNCTIONALITY (U.S. CLS. 100, 101 AND 102).

SN 76-276,208. ROBINSON, SHEILA, STONE MOUNTAIN, GA. FILED 6-26-2001.

100 WATTS

FOR REAL ESTATE AFFAIRS, NAMELY, REAL ESTATE BROKERAGE, REAL ESTATE RENTAL/RENTING, REAL ESTATE INVESTMENT, PROPERTY INVESTMENT, REAL ESTATE MANAGEMENT (U.S. CLS. 100, 101 AND 102).

SN 76-280,259. WALK AWAY TODAY, INC., JACKSONVILLE, FL. FILED 7-3-2001.

WALK AWAY TODAY

FOR FINANCIAL INVESTMENT IN THE FIELD OF REAL ESTATE; AND REAL ESTATE MANAGEMENT SERVICES (U.S. CLS. 100, 101 AND 102).

FIRST USE 1-15-2000; IN COMMERCE 1-21-2001.

SN 76-281,720. UNITED GUARANTY CORPORATION, GREENSBORO, NC. FILED 7-5-2001.

DIRECT SUBMIT

NO CLAIM IS MADE TO THE EXCLUSIVE RIGHT TO USE "SUBMIT", APART FROM THE MARK AS SHOWN.

FOR MORTGAGE GUARANTY INSURANCE UNDERWRITING SERVICES (U.S. CLS. 100, 101 AND 102).

FIRST USE 4-0-2001; IN COMMERCE 4-0-2001.

CLASS 36—(Continued).

SN 76-283,373. JOSEPH L. MANCUSO & SONS, INC.,
BATAVIA, NY. FILED 7-12-2001.

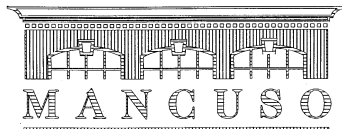

THE MARK IS LINED FOR THE COLOR "BRICK RED" &
"NAVY BLUE".

FOR REAL ESTATE BROKERAGE, REAL ESTATE
LEASING, REAL ESTATE MANAGEMENT AND REAL
ESTATE CONSULTING (U.S. CLS. 100, 101 AND 102).
FIRST USE 11-7-1995; IN COMMERCE 11-7-1995.

SN 76-285,580. NUVEEN INVESTMENTS, CHICAGO, IL.
FILED 7-16-2001.

FIT

FOR INDEX FUND INVESTMENT SERVICES,
NAMELY INDEX FUND INVESTMENT, INDEX FUND
INVESTMENT CONSULTATION, AND INDEX FUND
BROKERAGE (U.S. CLS. 100, 101 AND 102).

SN 76-290,992. AMERICAN FIDELITY ASSURANCE COM-
PANY, OKLAHOMA CITY, OK. FILED 7-26-2001.

CRITICAL SECURITY

FOR INSURANCE UNDERWRITING SERVICES IN
THE FIELD OF LIFE AND HEALTH INSURANCE (U.S.
CLS. 100, 101 AND 102).
FIRST USE 7-2-2001; IN COMMERCE 7-2-2001.

SN 76-291,671. FLEETBOSTON FINANCIAL CORPORA-
TION, BOSTON, MA. FILED 7-30-2001.



OWNER OF U.S. REG. NOS. 1,253,183, 2,211,776 AND
OTHERS.

NO CLAIM IS MADE TO THE EXCLUSIVE RIGHT TO
USE "TRADING", APART FROM THE MARK AS SHOWN.
FOR MARKET MAKER AND BROKER/DEALER SER-
VICES IN THE FIELD OF SECURITIES (U.S. CLS. 100,
101 AND 102).

FIRST USE 8-1-2000; IN COMMERCE 8-1-2000.

CLASS 36—(Continued).

SN 76-291,763. PROGRESSIVE CASUALTY INSURANCE
COMPANY, MAYFIELD VILLAGE, OH. FILED 7-30-2001.

1-800-SEGUROS

THE ENGLISH TRANSLATION OF "SEGUROS" IS "IN-
SURANCE".

SEC. 2(F).

FOR MOTOR VEHICLE INSURANCE UNDERWRIT-
ING AND ADMINISTRATION SERVICES, NAMELY
INSURANCE PREMIUM QUOTING, TAKING AND
PROCESSING INSURANCE APPLICATIONS AND PRO-
VIDING A COMPARISON OF PREMIUM RATES (U.S.
CLS. 100, 101 AND 102).

FIRST USE 8-0-1992; IN COMMERCE 7-1-1995.

SN 76-294,276. PREMIER FINANCIAL PARTNERS, L.L.C.,
ST. LOUIS, MO. FILED 8-6-2001.



Premier Financial Partners

NO CLAIM IS MADE TO THE EXCLUSIVE RIGHT TO
USE "PREMIER FINANCIAL PARTNERS", APART FROM
THE MARK AS SHOWN.

THE MARK CONSISTS IN PART OF TWO OVERLAPPING
DIAMONDS COMPRISED OF CONTRASTING SHADED
HORIZONTAL LINES.

FOR SECURITY BROKERAGE SERVICES AND FI-
NANCIAL SERVICES, NAMELY FINANCIAL PLAN-
NING AND RESEARCH (U.S. CLS. 100, 101 AND 102).
FIRST USE 5-13-1997; IN COMMERCE 5-13-1997.

SN 76-296,671. PHOENIX LIFE INSURANCE COMPANY,
HARTFORD, CT. FILED 8-7-2001.

**PHOENIX INVESTOR'S
EDGE**

NO CLAIM IS MADE TO THE EXCLUSIVE RIGHT TO
USE "INVESTORS", APART FROM THE MARK AS SHOWN.

FOR UNDERWRITING AND ADMINISTRATION OF
VARIABLE ANNUITY POLICIES OFFERED IN NON-
QUALIFIED PLANS (U.S. CLS. 100, 101 AND 102).

SN 76-297,958. PIONEER INVESTMENT MANAGEMENT,
INC., BOSTON, MA. FILED 8-8-2001.

ADVISOR BOT

FOR ONLINE COMPUTER SERVICES PROVIDING
INFORMATION, ADVICE AND ANALYSIS IN THE
FIELDS OF FINANCE AND INVESTMENTS VIA THE
INTERNET (U.S. CLS. 100, 101 AND 102).

CLASS 36—(Continued).

SN 76-300,790. CHARTER BANK, A COOPERATIVE BANK, WALTHAM, MA. FILED 8-15-2001.

CHART BANK

NO CLAIM IS MADE TO THE EXCLUSIVE RIGHT TO USE "BANK", APART FROM THE MARK AS SHOWN.

FOR BANKING SERVICES; FINANCIAL SERVICES, NAMELY INVESTMENT BANKING, BROKERAGE AND INVESTMENT MANAGEMENT SERVICES; INVESTMENT CONSULTATION AND ADVICE SERVICES; FINANCIAL ANALYSIS AND CONSULTATION SERVICES (U.S. CLS. 100, 101 AND 102).

SN 76-303,715. CONCORD DEVELOPMENT CORPORATION OF ILLINOS, PALATINE, IL. FILED 8-22-2001.

MYCONCORD

OWNER OF U.S. REG. NOS. 1,853,829 AND 1,894,694.
FOR PROVIDING INFORMATION IN THE FIELD OF REAL ESTATE PERTAINING TO AVAILABLE NEW RESIDENTIAL DEVELOPMENTS AND PROVIDING INFORMATION IN THE NATURE OF WEBSITE INDEXES TO FINANCIAL RESOURCES AVAILABLE ON-LINE PERTAINING TO MORTGAGE AVAILABILITY AND MORTGAGE COST CALCULATORS; AND PROVIDING INFORMATION IN THE FIELD OF REAL ESTATE BY MEANS OF LINKING THE WEBSITE TO OTHER WEBSITES FEATURING REAL ESTATE LENDING AND HOME PRODUCTS AND SERVICES INFORMATION (U.S. CLS. 100, 101 AND 102).

FIRST USE 1-21-2001; IN COMMERCE 1-21-2001.

SN 76-304,565. MERCHANTS MUTUAL INSURANCE COMPANY, BUFFALO, NY. FILED 8-27-2001.

MERCHANTS INSURANCE GROUP

OWNER OF U.S. REG. NO. 2,170,369.
NO CLAIM IS MADE TO THE EXCLUSIVE RIGHT TO USE "INSURANCE GROUP", APART FROM THE MARK AS SHOWN.

SEC. 2(F).
FOR INSURANCE ADMINISTRATION AND UNDERWRITING IN THE FIELDS OF PROPERTY, CASUALTY AND WORKER'S COMPENSATION (U.S. CLS. 100, 101 AND 102).

FIRST USE 0-0-1987; IN COMMERCE 0-0-1987.

CLASS 36—(Continued).

SN 76-305,380. TBG INSURANCES SERVICES CORPORATION, LOS ANGELES, CA. FILED 8-25-2001.



OWNER OF U.S. REG. NOS. 1,722,422 AND 1,860,513.
NO CLAIM IS MADE TO THE EXCLUSIVE RIGHT TO USE "FINANCIAL STRATEGIC WEALTH ACCUMULATION", APART FROM THE MARK AS SHOWN.

FOR INSURANCE AGENCY; BROKERAGE SERVICES IN THE FIELDS OF SECURITIES, STOCKS, BONDS, MUTUAL FUNDS, MONEY MARKET FUNDS, COMMODITIES, REAL ESTATE, FUTURES, OPTIONS, AND INDICES OF ANY OF THEM; BROKERAGE SERVICES, NAMELY, ADMINISTERING EMPLOYEE BENEFIT PLANS, DEFERRED COMPENSATION PLANS, ESTATE PLANNING SERVICES (U.S. CLS. 100, 101 AND 102).

SN 76-308,477. ADAMS, HAROLD H., JR., COLUMBIA, SC. FILED 9-4-2001.

VOLUNTEER MISSIONARY TRAVEL INSURANCE

NO CLAIM IS MADE TO THE EXCLUSIVE RIGHT TO USE "TRAVEL INSURANCE", APART FROM THE MARK AS SHOWN.

SEC. 2(F).
FOR INSURANCE BROKERAGE SERVICES IN THE FIELD OF ACCIDENT, DISABILITY, MEDICAL AND PROPERTY INSURANCE (U.S. CLS. 100, 101 AND 102).
FIRST USE 12-31-1995; IN COMMERCE 12-31-1995.

SN 76-310,568. WORLD WIDE RECOVERY, INC., GREENWOOD, IN. FILED 9-10-2001.

WORLD WIDE RECOVERY WHERE YOUR COLLATERAL IS OUR BUSINESS

NO CLAIM IS MADE TO THE EXCLUSIVE RIGHT TO USE "WORLD WIDE RECOVERY", APART FROM THE MARK AS SHOWN.

FOR CAR REPOSSESSION FOR COMMERCIAL LENDERS (U.S. CLS. 100, 101 AND 102).

FIRST USE 1-1-1998; IN COMMERCE 1-1-1998.

CLASS 36—(Continued).

SN 76-312,394. MID-MARKET AMERICA, INC., PITTSBURGH, PA. FILED 9-13-2001.

SAVE SIMPLY

NO CLAIM IS MADE TO THE EXCLUSIVE RIGHT TO USE "SAVE", APART FROM THE MARK AS SHOWN.

FOR FINANCIAL SERVICES, NAMELY, PROVIDING INVESTMENT ADVICE SERVICES AND SAVINGS ACCOUNT SERVICES (U.S. CLS. 100, 101 AND 102).

SN 76-312,660. WELLS FARGO & COMPANY, MINNEAPOLIS, MN. FILED 9-12-2001.

**WELLS FARGO
MEMBERSHIP**

OWNER OF U.S. REG. NOS. 779,187, 1,274,680 AND OTHERS.

FOR BANKING SERVICES (U.S. CLS. 100, 101 AND 102).

FIRST USE 9-26-1999; IN COMMERCE 9-26-1999.

SN 76-312,750. FIRST FINANCIAL HOLDINGS, INC., CHARLESTON, SC. FILED 9-17-2001.

AWARDS CHECKING

NO CLAIM IS MADE TO THE EXCLUSIVE RIGHT TO USE "CHECKING", APART FROM THE MARK AS SHOWN.

FOR CHECKING ACCOUNT SERVICES (U.S. CLS. 100, 101 AND 102).

FIRST USE 12-31-2001; IN COMMERCE 12-31-2001.

SN 76-313,715. INFINTIUM TECHNOLOGIES CORP., GLEN ALLEN, VA. FILED 9-18-2001.



FOR BILL MANAGEMENT SERVICES, NAMELY, DESIGNING BILLING AND CUSTOMER CARE SYSTEMS, TRACKING, REPORTING, ANALYZING AND DELIVERING BILLS, AND BILLING INFORMATION (U.S. CLS. 100, 101 AND 102).

CLASS 36—(Continued).

SN 76-314,145. EORLD HOLDINGS, INC., KAHNAWAKE, QUEBEC J0L 1B0, CANADA, FILED 9-14-2001.

**WHERE VIRTUALLY
EVERYONE PLAYS POKER**

FOR BETTING AND WAGERING SERVICES PROVIDED VIA A GLOBAL COMPUTER INFORMATION NETWORK (U.S. CLS. 100, 101 AND 102).

FIRST USE 9-0-1999; IN COMMERCE 9-0-1999.

SN 76-315,553. ADOPT-A-STORMDRAIN, INC., MANHATTAN BEACH, CA. FILED 9-20-2001.

**CLEANER STORMDRAINS
CLEANER OCEANS**

FOR RAISING FUNDS FOR CLEANING AND MAINTAINING STORMDRAIN SYSTEMS AND ABOVE AND BELOW GROUND WATER SHEDS THROUGH CHARITABLE CONTRIBUTIONS OR OTHERWISE (U.S. CLS. 100, 101 AND 102).

SN 76-315,568. ADOPT-A-STORMDRAIN, INC., MANHATTAN BEACH, CA. FILED 9-20-2001.

**CLEANER STORMDRAINS
CLEANER STREAMS**

FOR RAISING FUNDS FOR CLEANING AND MAINTAINING STORMDRAIN SYSTEMS AND ABOVE AND BELOW GROUND WATER SHEDS THROUGH CHARITABLE CONTRIBUTIONS OR OTHERWISE (U.S. CLS. 100, 101 AND 102).

SN 76-316,652. PRIME THERAPEUTICS, INC., EAGAN, MN. FILED 9-24-2001.

FORMULA-1

FOR BROKERAGE SERVICES IN THE FIELD OF PHARMACEUTICALS (U.S. CLS. 100, 101 AND 102).

CLASS 36—(Continued).

SN 76-318,426. HANNAFORD LICENSING CORP., SCARBOROUGH, ME. FILED 9-27-2001.

**HANNAFORD HELPS
SCHOOLS**

OWNER OF U.S. REG. NOS. 1,138,096, 2,130,179 AND OTHERS.

NO CLAIM IS MADE TO THE EXCLUSIVE RIGHT TO USE "SCHOOLS", APART FROM THE MARK AS SHOWN.

FOR CHARITABLE FUND RAISING PROGRAM FOR LOCAL SCHOOLS GENERATED BY GROCERY PURCHASES WHICH PROVIDES DOLLAR COUPONS FROM SELECTED GROCERY STORE PRODUCTS (U.S. CLS. 100, 101 AND 102).

FIRST USE 9-1-2001; IN COMMERCE 9-1-2001.

CLASS 36—(Continued).

SN 76-318,908. YORK CHILDREN'S FOUNDATION, THE, HOUSTON, TX. FILED 9-28-2001.



OWNER OF U.S. REG. NO. 1,762,223.

NO CLAIM IS MADE TO THE EXCLUSIVE RIGHT TO USE "CHILDREN'S FOUNDATION", APART FROM THE MARK AS SHOWN.

THE MARK CONSISTS OF THE STYLIZED WORDING "YORK CHILDREN'S FOUNDATION" TO THE LEFT OF A STYLIZED GEOMETRIC FIGURE REPRESENTING A PERSON REACHING FOR A FIVE-POINTED STAR.

FOR CHARITABLE FUND RAISING SERVICES, NAMELY, COLLECTION AND DISTRIBUTION OF CHARITABLE FUNDS TO CHILDREN'S ORGANIZATIONS ACROSS THE UNITED STATES (U.S. CLS. 100, 101 AND 102).

SN 76-318,903. THE YORK CHILDREN'S FOUNDATION, HOUSTON, TX. FILED 9-28-2001.



SN 76-320,308. HAMPSTEAD EQUITY FUND, LLC, CHICAGO, IL. FILED 10-1-2001.

**HAMPSTEAD ASSET
MANAGEMENT**

THE MARK CONSISTS OF A STYLIZED GEOMETRIC FIGURE REPRESENTING A PERSON REACHING FOR A FIVE-POINTED STAR.

FOR CHARITABLE FUND RAISING SERVICES, NAMELY, COLLECTION AND DISTRIBUTION OF CHARITABLE FUNDS TO CHILDREN'S ORGANIZATIONS ACROSS THE UNITED STATES (U.S. CLS. 100, 101 AND 102).

NO CLAIM IS MADE TO THE EXCLUSIVE RIGHT TO USE "ASSET MANAGEMENT", APART FROM THE MARK AS SHOWN.

FOR FINANCIAL PLANNING, FINANCIAL MANAGEMENT, FINANCIAL PORTFOLIO MANAGEMENT, FINANCIAL RESEARCH, INVESTMENT MANAGEMENT, AND INVESTMENT ADVISORY SERVICES (U.S. CLS. 100, 101 AND 102).

CLASS 36—(Continued).

SN 76-321,824. PARADIGM GROUP, LC, DBA PARADIGM GROUP, LC, THE, HOLLADAY, UT. FILED 10-5-2001.



THE MARK CONSISTS OF COLORS, AND THE COLORS ARE BEING CLAIMED AS A FEATURE OF THE MARK. SPECIFICALLY, THE LAND MASSES ON THE GLOBE ARE BLUE, AND THE WATER IS GRAY. THE DARK AREA BENEATH THE GLOBE REPRESENTS SHADING.
 FOR FINANCIAL SERVICES, NAMELY, PROVIDING MONEY LENDING SERVICES SUCH AS TEMPORARY ASSET-BASED LOANS TO EARLY STAGE GROWTH COMPANIES, AND TEMPORARY REAL-ESTATE LOANS (U.S. CLS. 100, 101 AND 102).

SN 76-321,875. WILLIAM L. LYON & ASSOCIATES, SACRAMENTO, CA. FILED 10-4-2001.



FOR PROVIDING INFORMATION IN THE FIELD OF REAL ESTATE BY MEANS OF A GLOBAL COMPUTER NETWORK (U.S. CLS. 100, 101 AND 102).
 FIRST USE 1-0-2000; IN COMMERCE 1-0-2000.

SN 76-322,581. BRIDGER COMMERCIAL FUNDING, MILL VALLEY, CA. FILED 10-9-2001.

ONTRAC

FOR PROVIDING INFORMATION IN THE FIELD OF COMMERCIAL MORTGAGES AND THE STATUS OF COMMERCIAL MORTGAGES VIA WEBSITES ON THE INTERNET (U.S. CLS. 100, 101 AND 102).

CLASS 36—(Continued).

SN 76-323,444. TRUEPAWS LLC, PORTLAND, OR. FILED 10-9-2001.



FOR INSURANCE UNDERWRITING, ADMINISTRATION, BROKERAGE AND FINANCING SERVICES IN THE FIELD OF VETERINARY CARE (U.S. CLS. 100, 101 AND 102).
 FIRST USE 8-27-2001; IN COMMERCE 8-27-2001.

SN 76-323,629. NATHAN & LEWIS SECURITIES, INC., NEW YORK, NY. FILED 10-10-2001.

NATHAN & LEWIS SECURITIES, INC.

NO CLAIM IS MADE TO THE EXCLUSIVE RIGHT TO USE "SECURITIES INC", APART FROM THE MARK AS SHOWN.
 FOR FINANCIAL SERVICES, NAMELY, SECURITIES BROKERAGE SERVICES AND ONLINE SECURITIES BROKERAGE SERVICES; PROVISION OF FINANCIAL AND SECURITIES RELATED INFORMATION BY MEANS OF A GLOBAL COMPUTER NETWORK; INSURANCE BROKERAGE SERVICES (U.S. CLS. 100, 101 AND 102).
 FIRST USE 0-0-1976; IN COMMERCE 0-0-1976.

SN 76-324,115. BARON CAPITAL GROUP, INC., NEW YORK, NY. FILED 10-11-2001.

BARON FUNDS

NO CLAIM IS MADE TO THE EXCLUSIVE RIGHT TO USE "FUNDS", APART FROM THE MARK AS SHOWN.
 FOR INVESTMENT MANAGEMENT SERVICES AND MUTUAL FUND INVESTMENT (U.S. CLS. 100, 101 AND 102).
 FIRST USE 6-12-1987; IN COMMERCE 6-12-1987.

CLASS 36—(Continued).

SN 76-326,935. HEALTH NET, INC., WOODLAND HILLS, CA. FILED 10-18-2001.

COVERAGE FOR ALL OF LIFE'S EVENTS

FOR INSURANCE BROKERAGE SERVICES IN THE FIELD OF LIFE INSURANCE; INSURANCE CONSULTATION; LIFE INSURANCE ADMINISTRATION; LIFE INSURANCE UNDERWRITING; LIFE INSURANCE CLAIMS ADMINISTRATION AND PROCESSING (U.S. CLS. 100, 101 AND 102).

SN 76-331,636. LOS ALTOS COMMUNITY FOUNDATION, LOS ALTOS, CA. FILED 10-29-2001.



NO CLAIM IS MADE TO THE EXCLUSIVE RIGHT TO USE "LOS ALTOS", APART FROM THE MARK AS SHOWN. THE LINING SHOWN IN THE DRAWING IS MERELY TO INDICATE SHADING.

FOR CHARITABLE FUND RAISING AND PROVIDING GRANTS TO NON-PROFIT ORGANIZATIONS FOR COMMUNITY BUILDING ACTIVITIES (U.S. CLS. 100, 101 AND 102).

FIRST USE 10-7-2001; IN COMMERCE 10-7-2001.

SN 76-339,831. WATERBOR BURN AND CANCER FOUNDATION, THE, NEW YORK, NY. FILED 11-15-2001.

THE WATERBOR BURN AND CANCER FOUNDATION

NO CLAIM IS MADE TO THE EXCLUSIVE RIGHT TO USE "BURN AND CANCER FOUNDATION", APART FROM THE MARK AS SHOWN.

FOR CHARITABLE FUNDRAISING SERVICES (U.S. CLS. 100, 101 AND 102).

FIRST USE 12-0-1997; IN COMMERCE 12-0-1997.

CLASS 36—(Continued).

SN 76-341,536. DAY MONEY, INC., FORT LAUDERDALE, FL. FILED 11-12-2001.

DAY MONEY

FOR FINANCIAL SERVICES, NAMELY, THE PROVISION OF A SYSTEM FOR THE BUYING AND SELLING OF GOODS AND SERVICES AMONG MEMBERS OF A TRADING NETWORK IN WHICH CREDIT UNITS ARE EXCHANGED AND REDEEMABLE IN CURRENCY FROM PARTICIPATING FINANCIAL INSTITUTIONS (U.S. CLS. 100, 101 AND 102).

FIRST USE 12-5-2001; IN COMMERCE 12-5-2001.

SN 76-341,768. CALAMOS ASSET MANAGEMENT, INC., NAPERVILLE, IL. FILED 11-21-2001.

CALAMOS INVESTMENTS

NO CLAIM IS MADE TO THE EXCLUSIVE RIGHT TO USE "INVESTMENTS", APART FROM THE MARK AS SHOWN.

SEC. 2(F) AS TO "CALAMOS".

FOR FINANCIAL ANALYSIS AND CONSULTATION; FINANCIAL PORTFOLIO MANAGEMENT; FINANCIAL INVESTMENT SERVICES IN THE FIELD OF SECURITIES (U.S. CLS. 100, 101 AND 102).

FIRST USE 10-5-2001; IN COMMERCE 10-5-2001.

SN 76-342,135. PAINTED TURTLE CAMP, THE, MALIBU, CA. FILED 11-28-2001.

THE PAINTED TURTLE

FOR CHARITABLE SERVICES, NAMELY, FUNDRAISING FOR DEVELOPMENT OF, AND PROMOTION OF, A CAMP FOR CHILDREN WITH CHRONIC OR LIFE-THREATENING ILLNESSES (U.S. CLS. 100, 101 AND 102).

FIRST USE 5-23-1997; IN COMMERCE 6-2-1997.

SN 76-342,756. MELLEOS CAPITAL MANAGEMENT LLC, NEW YORK, NY. FILED 11-29-2001.

MELLEOS

FOR FINANCIAL SERVICES, NAMELY, FINANCIAL ANALYSIS AND CONSULTATION, FORECASTING AND RESEARCH; FINANCIAL INVESTMENTS IN THE FIELD OF MUTUAL FUNDS, HEDGE FUNDS AND PRIVATE EQUITY INVESTMENTS; OPTIONS TRADING FOR OTHERS; INVESTMENT BROKERAGE SERVICES (U.S. CLS. 100, 101 AND 102).

CLASS 36—(Continued).

SN 76-343,307. ENDEAVOR, L.L.C., MARYLAND HEIGHTS, MO. FILED 11-21-2001.

HOME LENDING WHERE YOU'RE ALWAYS WELCOME

NO CLAIM IS MADE TO THE EXCLUSIVE RIGHT TO USE "HOME LENDING", APART FROM THE MARK AS SHOWN.

FOR MORTGAGE BROKERAGE SERVICES (U.S. CLS. 100, 101 AND 102).

FIRST USE 9-0-2001; IN COMMERCE 9-0-2001.

SN 76-347,138. FMR CORP., BOSTON, MA. FILED 12-11-2001.

FIDELITY ADVISOR MONEY LINE

OWNER OF U.S. REG. NOS. 1,543,851, 2,384,555 AND OTHERS.

NO CLAIM IS MADE TO THE EXCLUSIVE RIGHT TO USE "ADVISOR", APART FROM THE MARK AS SHOWN.

FOR ELECTRONIC TRANSFER SERVICES FOR THE PURCHASE OF SECURITIES (U.S. CLS. 100, 101 AND 102).

FIRST USE 9-0-2000; IN COMMERCE 9-0-2000.

SN 76-348,766. NATIONWIDE LIFE INSURANCE COMPANY, COLUMBUS, OH. FILED 12-14-2001.

NATIONWIDE CAPITAL DEFENDER LIFE

NO CLAIM IS MADE TO THE EXCLUSIVE RIGHT TO USE "LIFE", APART FROM THE MARK AS SHOWN.

FOR INSURANCE UNDERWRITING SERVICES FOR LIFE INSURANCE AND ANNUITIES (U.S. CLS. 100, 101 AND 102).

FIRST USE 4-1-1991; IN COMMERCE 4-1-1991.

SN 76-350,602. HARTFORD FIRE INSURANCE COMPANY, HARTFORD, CT. FILED 12-20-2001.

BOND LOCKER

NO CLAIM IS MADE TO THE EXCLUSIVE RIGHT TO USE "BOND", APART FROM THE MARK AS SHOWN.

FOR PROVIDING PRICE QUOTATIONS FOR SURETY BONDS AND INSURANCE POLICIES AND INSURANCE ADMINISTRATION IN THE FIELD OF CRIME INSURANCE AND FIDUCIARY LIABILITY INSURANCE, NAMELY, ISSUING INSURANCE POLICIES OVER A WORLD-WIDE COMPUTER NETWORK (U.S. CLS. 100, 101 AND 102).

CLASS 36—(Continued).

SN 76-351,588. SAVINGS BANK LIFE INSURANCE COMPANY OF MASSACHUSETTS, THE, WOBURN, MA. FILED 12-26-2001.

THE NO NONSENSE LIFE INSURANCE COMPANY

NO CLAIM IS MADE TO THE EXCLUSIVE RIGHT TO USE "LIFE INSURANCE COMPANY", APART FROM THE MARK AS SHOWN.

FOR INSURANCE SERVICES, NAMELY ISSUING ANNUITIES AND UNDERWRITING LIFE INSURANCE POLICIES (U.S. CLS. 100, 101 AND 102).

FIRST USE 3-0-1997; IN COMMERCE 3-0-1997.

SN 76-351,589. SAVINGS BANK LIFE INSURANCE COMPANY OF MASSACHUSETTS, THE, WOBURN, MA. FILED 12-26-2001.

NO NONSENSE LIFE INSURANCE

NO CLAIM IS MADE TO THE EXCLUSIVE RIGHT TO USE "LIFE INSURANCE", APART FROM THE MARK AS SHOWN.

FOR INSURANCE SERVICES, NAMELY ISSUING ANNUITIES AND UNDERWRITING LIFE INSURANCE POLICIES (U.S. CLS. 100, 101 AND 102).

FIRST USE 3-0-1997; IN COMMERCE 3-0-1997.

SN 76-352,018. FTI INSTITUTIONAL, LLC, NEW YORK, NY. FILED 12-20-2001.

FTI

FOR FINANCIAL SERVICES, NAMELY, PROVIDING ASSET MANAGEMENT AND INVESTMENT ADVISORY SERVICES TO PUBLIC AND PRIVATE ENTITIES OR INSTITUTIONS, TO FOUNDATIONS AND ENDOWMENT FUNDS, AND TO RETIREMENT PLANS (U.S. CLS. 100, 101 AND 102).

SN 76-352,760. NORTH WATERFRONT CORPORATION, SAN FRANCISCO, CA. FILED 12-27-2001.

COME HOME TO YOUR OFFICE

FOR LEASING AND RENTAL OF OFFICE SPACE (U.S. CLS. 100, 101 AND 102).

CLASS 36—(Continued).

SN 76-352,949. PAYTRUST, INC., LAWRENCEVILLE, NJ. FILED 12-28-2001.

**PAYTRUST PRESENT
EVERYTHING**

OWNER OF U.S. REG. NO. 2,325,924.
FOR ELECTRONIC BILL PAYMENT SERVICES,
NAMELY RECEIPT, PROCESSING AND PAYMENT OF
BILLS AND ELECTRONIC TRANSMISSION OF BILL
PAYMENT DATA (U.S. CLS. 100, 101 AND 102).

SN 76-353,027. DELL COMPUTER CORPORATION, ROUND
ROCK, TX. FILED 12-26-2001.

**DELL PREFERRED
ACCOUNT**

OWNER OF U.S. REG. NOS. 1,498,470, 2,527,880 AND
OTHERS.
NO CLAIM IS MADE TO THE EXCLUSIVE RIGHT TO
USE "PREFERRED ACCOUNT", APART FROM THE MARK
AS SHOWN.
FOR CREDIT CARD SERVICES (U.S. CLS. 100, 101
AND 102).

SN 76-353,028. DELL COMPUTER CORPORATION, ROUND
ROCK, TX. FILED 12-26-2001.

**DELL ADVANTAGE
ACCOUNT**

OWNER OF U.S. REG. NOS. 1,498,470, 2,527,880 AND
OTHERS.
NO CLAIM IS MADE TO THE EXCLUSIVE RIGHT TO
USE "ACCOUNT", APART FROM THE MARK AS SHOWN.
FOR CREDIT CARD SERVICES (U.S. CLS. 100, 101
AND 102).

SN 76-354,826. DADE HUMAN RIGHTS FOUNDATION,
INC., DBA PENINSULA FOUNDATION, MIAMI, FL.
FILED 1-2-2002.

PENINSULA FOUNDATION

NO CLAIM IS MADE TO THE EXCLUSIVE RIGHT TO
USE "FOUNDATION", APART FROM THE MARK AS
SHOWN.
FOR CHARITABLE FUNDRAISING SERVICES (U.S.
CLS. 100, 101 AND 102).

CLASS 36—(Continued).

SN 76-354,853. CHARLES W. WARNER COMPANY, GLAS-
TONBURY, CT. FILED 1-3-2002.

LIFECONSERVE

FOR INSURANCE BROKERAGE SERVICES; INSUR-
ANCE CONSULTATION SERVICES; INSURANCE ADVI-
SORY SERVICES; INSURANCE RETENTION SERVICES
(U.S. CLS. 100, 101 AND 102).
FIRST USE 1-1-1988; IN COMMERCE 1-1-1988.

SN 76-356,010. AMERICAN CREDIT SYSTEMS, INC., RO-
SELLE, IL. FILED 1-7-2002.

**AMERICAN CREDIT
SYSTEMS, INC.**

NO CLAIM IS MADE TO THE EXCLUSIVE RIGHT TO
USE "INC.", APART FROM THE MARK AS SHOWN.
SEC. 2(F).
FOR COLLECTION SERVICES FOR COMMERCIAL
AND RETAIL INSTITUTIONS (U.S. CLS. 100, 101 AND
102).
FIRST USE 9-0-1989; IN COMMERCE 9-0-1989.

SN 76-356,040. DIABETES RESEARCH INSTITUTE FOUN-
DATION, INC., HOLLYWOOD, FL. FILED 1-4-2002.

HOPE AND HARMONY

FOR CHARITABLE FUND RAISING SERVICES PER-
TAINING TO THE PREVENTION, DIAGNOSIS, AND
TREATMENT OF DIABETES (U.S. CLS. 100, 101 AND
102).
FIRST USE 6-16-1999; IN COMMERCE 6-16-1999.

CLASS 36—(Continued).

SN 76-356,140. PROTECTIVE LIFE CORPORATION, BIRMINGHAM, AL. FILED 1-8-2002.

DOING THE RIGHT THING ALL OVER AMERICA

FOR FINANCIAL SERVICES, NAMELY, BROKER/DEALER SERVICES IN THE FIELD OF SECURITIES, OPTIONS, MUTUAL FUNDS AND VARIABLE ANNUITIES; MUTUAL FUND BROKERAGE, DISTRIBUTION, AND INVESTMENT SERVICES, AND INVESTMENT ADVISORY SERVICES; INVESTMENT ADVISORY SERVICES, NAMELY, THE FUNDING OF A LEGACY TRUST THROUGH LIFE INSURANCE; BUSINESS CONSULTING SERVICES, NAMELY, LEAD REFERRAL SERVICES IN THE FIELD OF LIFE INSURANCE; INSURANCE SERVICES, NAMELY THE UNDERWRITING OF VARIABLE ANNUITIES, ANNUITY AND GUARANTEED INVESTMENT CONTRACTS; UNDERWRITING ACCIDENT, LIFE, CANCER, CREDIT, DENTAL, DISABILITY, HEALTH AND ANNUITY INSURANCE; UNDERWRITING INSURANCE FOR PREPAID DENTAL PLANS AND UNDERWRITING DENTAL INDEMNITY INSURANCE PLANS; PROVIDING INFORMATION IN THE FIELD OF INSURANCE OVER A GLOBAL COMMUNICATIONS NETWORK; PROVIDING LIFE INSURANCE UNDERWRITING, ADMINISTRATION AND BROKERAGE SERVICES VIA A GLOBAL COMPUTER NETWORK (U.S. CLS. 100, 101 AND 102).

SN 76-356,226. NORTHERN TRUST CORPORATION, CHICAGO, IL. FILED 1-8-2002.

NORTHERN TRUST DESTINATION RETIREMENT

OWNER OF U.S. REG. NO. 2,469,344.
NO CLAIM IS MADE TO THE EXCLUSIVE RIGHT TO USE "TRUST" AND "RETIREMENT", APART FROM THE MARK AS SHOWN.

FOR INVESTMENT SERVICES, NAMELY, INVESTMENT CONSULTATION, INVESTMENT MANAGEMENT, AND ADMINISTRATION OF RETIREMENT PLANS (U.S. CLS. 100, 101 AND 102).

SN 76-356,463. DIRECTCOMP RX, INC., MEMPHIS, TN. FILED 1-8-2002.

DIRECTCOMP RX

FOR FACTORING AGENCY SERVICES IN THE HEALTHCARE INDUSTRY, NAMELY, TIMELY PAYMENT OF INDIVIDUAL GENERATED HEALTHCARE CLAIMS IN EXCHANGE FOR THE RIGHT TO OBTAIN REIMBURSEMENT FOR SAID CLAIMS FROM PRIVATE AND PUBLIC INSURERS (U.S. CLS. 100, 101 AND 102).

CLASS 36—(Continued).

SN 76-358,042. NATIONWIDE LIFE INSURANCE COMPANY, COLUMBUS, OH. FILED 1-14-2002.

BEST OF AMERICA ALL AMERICAN ANNUITY

OWNER OF U.S. REG. NO. 1,518,258.
NO CLAIM IS MADE TO THE EXCLUSIVE RIGHT TO USE "ANNUITY", APART FROM THE MARK AS SHOWN.
FOR FINANCIAL SERVICES, NAMELY, LIFE INSURANCE UNDERWRITING, INVESTMENT MANAGEMENT OF AND DISTRIBUTION OF VARIABLE ANNUITIES AND MUTUAL FUND INVESTMENT (U.S. CLS. 100, 101 AND 102).

SN 76-358,120. WELLS FARGO FINANCIAL, INC., DES MOINES, IA. FILED 1-11-2002.

SPLASHCARD

FOR CREDIT CARD SERVICES (U.S. CLS. 100, 101 AND 102).

SN 76-358,313. WORLD HERITAGE FOUNDATION, SOUTHGATE, MI. FILED 1-7-2002.



THE MARK CONSISTS OF A STYLIZED LETTER "P" WITHIN A CIRCLE SURROUNDED BY A SQUARE.

FOR CHARITABLE FUND RAISING SERVICES FOR RESEARCH ON MANIC DEPRESSION (U.S. CLS. 100, 101 AND 102).

SN 76-358,829. MARSH USA INC., NEW YORK, NY. FILED 1-15-2002.

INSTANT HR

NO CLAIM IS MADE TO THE EXCLUSIVE RIGHT TO USE "HR", APART FROM THE MARK AS SHOWN.

FOR ADMINISTRATION OF EMPLOYEE BENEFITS PLANS AND EMPLOYEE PENSION PLANS; EMPLOYEE BENEFITS CONSULTING (U.S. CLS. 100, 101 AND 102).

CLASS 36—(Continued).

SN 76-358,843. METRIS DIRECT, INC., MINNETONKA, MN. FILED 1-15-2002.

MAGNUS SERVICES

NO CLAIM IS MADE TO THE EXCLUSIVE RIGHT TO USE "SERVICES", APART FROM THE MARK AS SHOWN. FOR COLLECTION AGENCY SERVICES (U.S. CLS. 100, 101 AND 102).

SN 76-360,653. FINCAS CORRAL, S.L., BARCELONA, SPAIN, FILED 1-19-2002.



THE DRAWING IS LINED FOR THE COLORS BROWN AND GRAY. THE ENGLISH TRANSLATION OF "FINCAS" IS "PROPERTY".

FOR REAL ESTATE AGENCIES, REAL ESTATE INVESTMENT, REAL ESTATE MANAGEMENT, AND REAL ESTATE TIMESHARING (U.S. CLS. 100, 101 AND 102).

SN 76-361,141. BANORTE SECURITIES INTERNATIONAL, LTD., NEW YORK, NY. FILED 1-22-2002.

BANORTEONE

FOR INVESTMENT BROKERAGE SERVICES PROVIDED USING AN ASSET-BASED FEE ALTERNATIVE TO COMMISSIONS (U.S. CLS. 100, 101 AND 102).

SN 76-362,158. U.S. BANCORP LICENSING, INC., MINNEAPOLIS, MN. FILED 1-23-2002.



OWNER OF U.S. REG. NOS. 1,481,868, 2,445,732 AND OTHERS.

NO CLAIM IS MADE TO THE EXCLUSIVE RIGHT TO USE "BANK" AND "SERVICE GUARANTEED", APART FROM THE MARK AS SHOWN.

FOR BANKING AND RELATED FINANCIAL SERVICES (U.S. CLS. 100, 101 AND 102).

FIRST USE 10-15-2001; IN COMMERCE 10-15-2001.

CLASS 36—(Continued).

SN 76-362,605. SECURITY TECHNOLOGY VENTURES, LLC, CUPERTINO, CA. FILED 1-23-2002.

STV

FOR VENTURE CAPITAL SERVICES (U.S. CLS. 100, 101 AND 102).

SN 76-362,925. UNITED POLICYHOLDERS, SAN FRANCISCO, CA. FILED 1-28-2002.

UNITED POLICYHOLDERS

NO CLAIM IS MADE TO THE EXCLUSIVE RIGHT TO USE "POLICY HOLDERS", APART FROM THE MARK AS SHOWN.

FOR INFORMATION PROVIDED TO THE PUBLIC FOR PURPOSES OF EDUCATING CONSUMERS ON INSURANCE ISSUES AND CONSUMER RIGHTS WITH RESPECT TO INSURANCE CLAIMS AND INSURANCE COVERAGE AND APPEARANCE IN JUDICIAL, REGULATORY AND LEGISLATIVE PROCEEDINGS (U.S. CLS. 100, 101 AND 102).

FIRST USE 8-0-1991; IN COMMERCE 3-0-1993.

SN 76-365,342. BENEFITS 2000 INC., BROOKFIELD, WI. FILED 2-1-2002.



FOR ADMINISTRATIVE SERVICES OF EMPLOYEE BENEFIT PLANS AND HEALTH CARE INSURANCE FOR OTHERS (U.S. CLS. 100, 101 AND 102).

SN 76-365,343. BENEFITS 2000 INC., BROOKFIELD, WI. FILED 2-1-2002.

THE FLEX COMPANY

OWNER OF U.S. REG. NOS. 1,856,417 AND 1,870,797. NO CLAIM IS MADE TO THE EXCLUSIVE RIGHT TO USE "COMPANY", APART FROM THE MARK AS SHOWN.

FOR ADMINISTRATIVE SERVICES OF EMPLOYEE BENEFIT PLANS AND HEALTH CARE INSURANCE FOR OTHERS (U.S. CLS. 100, 101 AND 102).

CLASS 36—(Continued).

SN 76-365,922. CONTINENTAL PROPERTIES COMPANY, INC., MILWAUKEE, WI. FILED 2-2-2002.

TAKE COMFORT IN BEING HOME

FOR APARTMENT RENTALS AND APARTMENT COMPLEX MANAGEMENT (U.S. CLS. 100, 101 AND 102).

FIRST USE 11-1-2001; IN COMMERCE 11-1-2001.

SN 76-366,799. SPORTSWORKS, INC., HIGH RIDGE, MO. FILED 2-4-2002.

SPORTSWORKS

FOR CHARITABLE FUNDRAISING SERVICES, NAMELY, RAISING FUNDS FOR THE BENEFIT OF A VARIETY OF ORGANIZATIONS BY OPERATION OF ENTERTAINMENT FACILITIES AND BY SOLICITING DONATIONS (U.S. CLS. 100, 101 AND 102).

SN 76-367,223. PAMPERED CHEF, LTD., THE, ADDISON, IL. FILED 2-5-2002.

BRIGHT FUTURES

FOR PROVIDING EDUCATIONAL SCHOLARSHIPS (U.S. CLS. 100, 101 AND 102).

FIRST USE 1-0-2002; IN COMMERCE 1-0-2002.

SN 76-367,705. ANVIL MORTGAGE CORPORATION, ROCKVILLE, MD. FILED 2-6-2002.

ANVIL MORTGAGE

NO CLAIM IS MADE TO THE EXCLUSIVE RIGHT TO USE "MORTGAGE", APART FROM THE MARK AS SHOWN.

FOR MORTGAGE LOAN FINANCING SERVICES (U.S. CLS. 100, 101 AND 102).

FIRST USE 1-10-1998; IN COMMERCE 1-10-1998.

SN 76-367,904. BANK OF EAST ASIA, LIMITED, THE, CENTRAL HONG KONG, HONG KONG, FILED 2-7-2002.



OWNER OF U.S. REG. NO. 1,439,475.
FOR BANKING SERVICES (U.S. CLS. 100, 101 AND 102).

CLASS 36—(Continued).

SN 76-367,919. MISSIONARY ASSOCIATION OF MARY IMMACULATE, BELLEVILLE, IL. FILED 2-7-2002.

ANGEL OF HEALING AND HOPE

FOR CHARITABLE FUND-RAISING SERVICES (U.S. CLS. 100, 101 AND 102).

SN 76-367,964. KM MANAGEMENT LLC, NEW YORK, NY. FILED 2-6-2002.

ZONE OF CONTENTMENT

FOR FINANCIAL AND INVESTMENT ADVICE, MANAGEMENT, PLANNING, ANALYSIS, RESEARCH, FORECASTING, REPORTING AND CONSULTATION; FISCAL ASSESSMENT AND EVALUATION; FINANCIAL PORTFOLIO MANAGEMENT; FINANCIAL VALUATION OF PERSONAL PROPERTY AND REAL ESTATE; RISK MANAGEMENT (U.S. CLS. 100, 101 AND 102).

SN 76-368,717. AMERICAN INTERNATIONAL GROUP, INC., NEW YORK, NY. FILED 2-8-2002.

SUNAMERICA

OWNER OF U.S. REG. NOS. 1,055,824, 1,652,589 AND OTHERS.

FOR FINANCIAL INVESTMENT AND ADVISORY SERVICES IN THE FIELDS OF ANNUITIES, RETIREMENT PLANS AND LIFE INSURANCE PRODUCTS (U.S. CLS. 100, 101 AND 102).

FIRST USE 9-0-1986; IN COMMERCE 9-0-1986.

SN 76-369,044. WELLPOINT HEALTH NETWORKS, INC., THOUSAND OAKS, CA. FILED 2-11-2002.

BUSINESSFLEX

FOR HEALTH INSURANCE UNDERWRITING (U.S. CLS. 100, 101 AND 102).

SN 76-370,592. AMERICAN NATIONAL PROPERTY AND CASUALTY COMPANY, SPRINGFIELD, MO. FILED 2-14-2002.

ANPAC TEXAS STAR

OWNER OF U.S. REG. NOS. 1,179,485, 2,516,320 AND OTHERS.

NO CLAIM IS MADE TO THE EXCLUSIVE RIGHT TO USE "TEXAS", APART FROM THE MARK AS SHOWN.

FOR UNDERWRITING PROPERTY AND CASUALTY INSURANCE (U.S. CLS. 100, 101 AND 102).

CLASS 36—(Continued).

SN 76-370,593. AMERICAN NATIONAL PROPERTY AND CASUALTY COMPANY, SPRINGFIELD, MO. FILED 2-14-2002.

TEXAS STAR

NO CLAIM IS MADE TO THE EXCLUSIVE RIGHT TO USE "TEXAS", APART FROM THE MARK AS SHOWN.
FOR UNDERWRITING PROPERTY AND CASUALTY INSURANCE (U.S. CLS. 100, 101 AND 102).

SN 76-370,992. ASSOCIATED FOREIGN EXCHANGE, INC., ENCINO, CA. FILED 2-14-2002.

AFEX

OWNER OF U.S. REG. NO. 1,183,213.
FOR DOMESTIC AND INTERNATIONAL TRANSMISSION OF MONEY; INTERNATIONAL CURRENCY EXCHANGE SERVICES, NAMELY, BUYING AND SELLING OF FOREIGN CURRENCIES; MONEY ORDER SERVICES; TELEPHONE CARD SERVICES; TRADING GOLD AND SILVER; AND TRAVELERS' CHEQUE ISSUANCE (U.S. CLS. 100, 101 AND 102).
FIRST USE 1-18-1979; IN COMMERCE 1-18-1979.

SN 76-372,482. AON RE INC., CHICAGO, IL. FILED 2-20-2002.

ZipPML

FOR PROVIDING CATASTROPHIC EXPOSURE MANAGEMENT SERVICES FOR USE IN THE FIELDS OF INSURANCE AND REINSURANCE (U.S. CLS. 100, 101 AND 102).
FIRST USE 1-0-1998; IN COMMERCE 1-0-1998.

SN 76-372,821. PEOPLES EXCHANGE BANK OF BEATTYVILLE, KENTUCKY, INC., BEATTYVILLE, KY. FILED 2-21-2002.

THE BEST OF TIMES

FOR BANKING SERVICES (U.S. CLS. 100, 101 AND 102).

CLASS 36—(Continued).

SN 76-373,802. DVI, INC., JAMISON, PA. FILED 2-22-2002.

DVI

FOR FINANCIAL SERVICES, NAMELY, PROVIDING FINANCING TO ENTITIES IN THE HEALTHCARE FIELD (U.S. CLS. 100, 101 AND 102).
FIRST USE 0-0-1987; IN COMMERCE 0-0-1987.

SN 76-375,023. KEYCORP, CLEVELAND, OH. FILED 2-26-2002.

**KEY MCDONALD
FINANCIAL ADVISORS**

OWNER OF U.S. REG. NOS. 1,495,327, 2,500,327 AND OTHERS.

NO CLAIM IS MADE TO THE EXCLUSIVE RIGHT TO USE "FINANCIAL ADVISORS", APART FROM THE MARK AS SHOWN.

FOR BANKING AND FINANCIAL SERVICES, NAMELY, CHECKING AND SAVINGS ACCOUNT SERVICES; CREDIT CARD SERVICES; LENDING SERVICES; ELECTRONIC AND ON-LINE BANKING AND FINANCIAL SERVICES; INVESTMENT CONSULTATION, BROKERAGE AND MANAGEMENT SERVICES; FINANCIAL MANAGEMENT, PLANNING AND PORTFOLIO MANAGEMENT SERVICES; INVESTMENT ADVISORY CONSULTATION; MUTUAL FUND INVESTMENT SERVICES; RETIREMENT FUND INVESTMENT SERVICES; AND SMALL BUSINESS LENDING SERVICES (U.S. CLS. 100, 101 AND 102).

SN 76-375,088. ST. JOE COMPANY, THE, JACKSONVILLE, FL. FILED 2-26-2002.

PASEOS

THE ENGLISH TRANSLATION OF THE WORD "PASEOS" IN THE MARK IS "STROLLS".
FOR REAL ESTATE MANAGEMENT (U.S. CLS. 100, 101 AND 102).

SN 76-375,139. PENN MUTUAL LIFE INSURANCE COMPANY, THE, PHILADELPHIA, PA. FILED 2-25-2002.

PROTECTION BUILDER

FOR LIFE INSURANCE UNDERWRITING (U.S. CLS. 100, 101 AND 102).

CLASS 36—(Continued).

SN 76-375,234. WACHOVIA CORPORATION, CHARLOTTE, NC. FILED 2-26-2002.

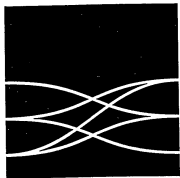

WACHOVIA

OWNER OF U.S. REG. NOS. 883,529, 2,157,952 AND OTHERS.
FOR BANKING AND RELATED FINANCIAL SERVICES (U.S. CLS. 100, 101 AND 102).

SN 76-375,236. KEYCORP, CLEVELAND, OH. FILED 2-26-2002.

**MCDONALD KEY
FINANCIAL ADVISORS**

OWNER OF U.S. REG. NOS. 1,495,327, 2,114,843 AND OTHERS.

NO CLAIM IS MADE TO THE EXCLUSIVE RIGHT TO USE "FINANCIAL ADVISORS", APART FROM THE MARK AS SHOWN.

FOR BANKING AND FINANCIAL SERVICES, NAMELY, CHECKING AND SAVINGS ACCOUNT SERVICES; CREDIT CARD SERVICES; LENDING SERVICES; ELECTRONIC AND ON-LINE BANKING AND FINANCIAL SERVICES; INVESTMENT CONSULTATION, BROKERAGE AND MANAGEMENT SERVICES; FINANCIAL MANAGEMENT, PLANNING AND PORTFOLIO MANAGEMENT SERVICES; INVESTMENT ADVISORY CONSULTATION; MUTUAL FUND INVESTMENT SERVICES; RETIREMENT FUND INVESTMENT SERVICES; AND SMALL BUSINESS LENDING SERVICES (U.S. CLS. 100, 101 AND 102).

SN 76-375,535. FOUNDATION ONE INSURANCE SERVICES, LTD., FRISCO, TX. FILED 2-26-2002.

**FOUNDATION ONE SECURE
CHOICE**

OWNER OF U.S. REG. NO. 2,394,221.
NO CLAIM IS MADE TO THE EXCLUSIVE RIGHT TO USE "FOUNDATION", APART FROM THE MARK AS SHOWN.

FOR ORGANIZING HEALTH INSURANCE PROGRAMS AND HEALTH BENEFIT PROGRAMS FOR OTHERS (U.S. CLS. 100, 101 AND 102).

CLASS 36—(Continued).

SN 76-376,130. CDC CONSUMER DEBT COUNSELING, INC., ST. LOUIS, MO. FILED 2-25-2002.

**SOLVING PERSONAL
FINANCIAL PROBLEMS
THROUGH EDUCATION**

FOR CONSUMER CREDIT AND DEBT COUNSELING SERVICES (U.S. CLS. 100, 101 AND 102).

SN 76-379,807. FANO SECURITIES LLC, GREENWICH, CT. FILED 3-7-2002.

PRIVATESIDE.COM

FOR FINANCIAL AND INVESTMENT BANKING SERVICES PROVIDED VIA AN ON-LINE GLOBAL COMMUNICATION NETWORK (U.S. CLS. 100, 101 AND 102).

FIRST USE 4-25-2001; IN COMMERCE 4-25-2001.

SN 76-380,564. ACCESS FINANCIAL SOLUTIONS, INC., HAGERSTOWN, MD. FILED 3-11-2002.



FOR FINANCIAL SERVICES, NAMELY, PROVIDING LOAN FINANCING, LEASE FINANCING, AND LEASE-PURCHASE LOAN SERVICES IN THE CONSTRUCTION, HEAVY MACHINERY AND EQUIPMENT FIELDS (U.S. CLS. 100, 101 AND 102).

SN 76-380,983. MOST VALUABLE KIDS, ROCKVILLE, MD. FILED 3-5-2002.

MOST VALUABLE KIDS

FOR CHARITABLE FUND-RAISING SERVICES (U.S. CLS. 100, 101 AND 102).

CLASS 36—(Continued).

SN 76-381,944. FLEETBOSTON FINANCIAL CORPORATION, BOSTON, MA. FILED 3-13-2002.

FLASHBRIDGE

FOR MORTGAGE BANKING, MORTGAGE BROKERAGE, AND MORTGAGE LENDING SERVICES (U.S. CLS. 100, 101 AND 102).



SN 76-382,371. TIAGO HOLDINGS, LLC, SYOSSET, NY. FILED 3-14-2002.

EAST RIVER PLAZA

NO CLAIM IS MADE TO THE EXCLUSIVE RIGHT TO USE PLAZA, APART FROM THE MARK AS SHOWN. FOR REAL ESTATE SERVICES, NAMELY, MANAGEMENT AND LEASING OF SHOPPING CENTER SPACE (U.S. CLS. 100, 101 AND 102).



SN 76-382,444. M & M FINANCIAL, INC., HARTWELL, GA. FILED 3-14-2002.

WE BUY, YOU DRIVE

FOR FINANCIAL SERVICES, NAMELY MONEY LENDING (U.S. CLS. 100, 101 AND 102).



SN 76-383,921. FLEET CREDIT CARD SERVICES, L.P., HORSHAM, PA. FILED 3-15-2002.

FLEET RENEW PROGRAM

NO CLAIM IS MADE TO THE EXCLUSIVE RIGHT TO USE "PROGRAM", APART FROM THE MARK AS SHOWN. FOR CREDIT CARD SERVICES (U.S. CLS. 100, 101 AND 102).



SN 76-384,093. MARSICO CAPITAL MANAGEMENT, LLC, DENVER, CO. FILED 3-7-2002.

HELPING YOU APPRECIATE LIFE

FOR MUTUAL FUNDS SERVICES AND INVESTMENT MANAGEMENT SERVICES (U.S. CLS. 100, 101 AND 102). FIRST USE 1-19-2002; IN COMMERCE 1-19-2002.

CLASS 36—(Continued).

SN 76-384,149. MERRILL LYNCH & CO., INC., NEW YORK, NY. FILED 3-15-2002.

WEALTH FOCUS PLUS

FOR FINANCIAL SERVICES, NAMELY, AN INTEGRATED SERVICE THAT COMBINES A VISA CARD, CHECKING ACCOUNT AND BANK DEPOSITS (U.S. CLS. 100, 101 AND 102).



SN 76-384,634. CORPOREX COMPANIES, INC., COVINGTON, KY. FILED 3-19-2002.

CORPOREX

FOR REAL ESTATE MANAGEMENT, INVESTMENT AND FINANCING; CAPITAL INVESTMENT CONSULTATION; ASSET AND INVESTMENT MANAGEMENT; INVESTMENT BANKING AND VENTURE CAPITAL SERVICES (U.S. CLS. 100, 101 AND 102). FIRST USE 1-0-1983; IN COMMERCE 1-0-1983.



SN 76-384,775. THE CLUB FOUNDATION, ALEXANDRIA, VA. FILED 3-15-2002.



The Club Foundation

NO CLAIM IS MADE TO THE EXCLUSIVE RIGHT TO USE "1988" AND "FOUNDATION", APART FROM THE MARK AS SHOWN.

FOR CHARITABLE FUND RAISING SERVICES TO FINANCIALLY SUPPORT THE PROFESSIONAL DEVELOPMENT OF CLUB MANAGERS THROUGH EDUCATION, TRAINING, AND RESEARCH INITIATIVES (U.S. CLS. 100, 101 AND 102).

FIRST USE 2-4-2002; IN COMMERCE 2-4-2002.

CLASS 36—(Continued).

SN 76-386,302. TRANSAMERICA CORPORATION, SAN FRANCISCO, CA. FILED 3-14-2002.

TRANSAMERICA POLICY STARTER

OWNER OF U.S. REG. NOS. 2,277,415, 2,525,199 AND OTHERS.

NO CLAIM IS MADE TO THE EXCLUSIVE RIGHT TO USE "POLICY STARTER", APART FROM THE MARK AS SHOWN.

FOR LIFE INSURANCE UNDERWRITING SERVICES USING A PRE-APPLICATION INFORMATION REQUEST FORM (U.S. CLS. 100, 101 AND 102).

FIRST USE 2-1-2002; IN COMMERCE 2-1-2002.

CLASS 36—(Continued).

SN 78-068,487. CLASSNOTES INC., SACRAMENTO, CA. FILED 6-11-2001.

YOUR STUDENT LOAN SPECIALIST

OWNER OF U.S. REG. NO. 2,200,866.

NO CLAIM IS MADE TO THE EXCLUSIVE RIGHT TO USE "STUDENT LOAN SPECIALIST", APART FROM THE MARK AS SHOWN.

FOR FINANCIAL SERVICES, NAMELY IN THE FIELD OF MONEY LENDING (U.S. CLS. 100, 101 AND 102).

FIRST USE 6-0-2001; IN COMMERCE 6-0-2001.

SN 78-049,601. ERI ECONOMIC RESEARCH INSTITUTE, INC., REDMOND, WA. FILED 2-21-2001.



THE MARK CONSISTS OF THE LETTERS "E", "R", AND "I" EACH IN A DIAMOND SHAPE.

FOR PROVIDING AN INTERNET WEBSITE FEATURING COMPARATIVE INFORMATION IN THE FIELD OF EMPLOYEE AND EXECUTIVE COMPENSATION, BENEFITS, SALARIES AND TOTAL COMPENSATION PACKAGES (U.S. CLS. 100, 101 AND 102).

FIRST USE 4-1-1996; IN COMMERCE 4-1-1996.

SN 78-069,379. EASTERN BANK, LYNN, MA. FILED 6-15-2001.

EASTERN TREASURYCONNECT

OWNER OF U.S. REG. NOS. 1,647,643 AND 2,272,297. SEC. 2(F) AS TO "EASTERN".

FOR FINANCIAL SERVICES, NAMELY, PROVIDING FINANCIAL INFORMATION VIA ELECTRONIC MEANS AND BANKING ACCOUNT SERVICES PERFORMED OVER A GLOBAL COMPUTER NETWORK (U.S. CLS. 100, 101 AND 102).

FIRST USE 1-17-2001; IN COMMERCE 1-17-2001.

SN 78-058,273. UNION FINANCIAL SERVICES, INC., DENVER, CO. FILED 4-12-2001.

UNION FINANCIAL SERVICES

NO CLAIM IS MADE TO THE EXCLUSIVE RIGHT TO USE "FINANCIAL SERVICES", APART FROM THE MARK AS SHOWN.

FOR FINANCIAL SERVICES, NAMELY THE ACQUISITION AND FINANCING OF CONSUMER RECEIVABLES, NAMELY STUDENT LOANS AND OTHER CONSUMER DEBT (U.S. CLS. 100, 101 AND 102).

FIRST USE 1-26-1996; IN COMMERCE 1-26-1996.

SN 78-080,917. HEDGENERGY, INC., GREEN BAY, WI. FILED 8-23-2001.



FOR RISK MANAGEMENT ADVISORY SERVICES PRIMARILY TO THE ENERGY INDUSTRY (U.S. CLS. 100, 101 AND 102).

CLASS 36—(Continued).

SN 78-081,366. SANDIA CORPORATION, ALBUQUERQUE, NM. FILED 8-28-2001.

RAM-T

FOR RISK MANAGEMENT, NAMELY RISK MANAGEMENT FOR HIGH VOLTAGE ELECTRICAL POWER TRANSMISSION FACILITIES, CONSISTING OF ACCESSING THE SECURITY SYSTEM EFFECTIVENESS, IDENTIFYING THE MISSION(S) OF THE TRANSMISSION SYSTEM, IDENTIFYING THE UNDESIRE EVENTS THAT WOULD PREVENT MISSION(S) SUCCESS, IDENTIFYING THE CRITICAL ASSETS THAT MUST BE PROTECTED TO PREVENT UNDESIRE EVENTS FROM OCCURRING, IDENTIFYING THE POTENTIAL ADVERSARY AND THEIR CHARACTERISTICS, IDENTIFYING THE CREDIBLE THREATS TO THE TRANSMISSION SYSTEM, IDENTIFYING THE LEVEL OF RISK THAT CAN BE TOLERATED AT A FACILITY, IDENTIFYING THE OPTIMAL USE OF AVAILABLE FUNDS FOR SECURITY UPGRADES, AND A HOST OF OTHER CONSIDERATIONS (U.S. CLS. 100, 101 AND 102).

SN 78-081,367. SANDIA CORPORATION, ALBUQUERQUE, NM. FILED 8-28-2001.

RAM-D

FOR RISK MANAGEMENT, NAMELY RISK MANAGEMENT FOR DAMS AND WATER RETENTION BARRIERS, CONSISTING OF ASSESSING THE SECURITY SYSTEM EFFECTIVENESS, IDENTIFYING THE MISSION(S) OF THE DAM, IDENTIFYING THE UNDESIRE EVENTS THAT WOULD PREVENT MISSION(S) SUCCESS, IDENTIFYING THE CRITICAL ASSETS THAT MUST BE PROTECTED TO PREVENT UNDESIRE EVENTS FROM OCCURRING, IDENTIFYING THE POTENTIAL ADVERSARY AND THEIR CHARACTERISTICS, IDENTIFYING THE CREDIBLE THREATS TO THE DAM, IDENTIFYING THE LEVEL OF RISK THAT CAN BE TOLERATED AT THE DAM, IDENTIFYING THE OPTIMAL USE OF AVAILABLE FUNDS FOR SECURITY UPGRADES, AND A HOST OF OTHER CONSIDERATIONS (U.S. CLS. 100, 101 AND 102).

SN 78-081,506. AMERICAN EXPRESS COMPANY, NEW YORK, NY. FILED 8-28-2001.

OPEN BUSINESS NETWORK

NO CLAIM IS MADE TO THE EXCLUSIVE RIGHT TO USE "BUSINESS NETWORK", APART FROM THE MARK AS SHOWN.

FOR FINANCIAL SERVICES, NAMELY, CHARGE CARD AND CREDIT CARD SERVICES (U.S. CLS. 100, 101 AND 102).

CLASS 36—(Continued).

SN 78-083,933. CORPORATE ACCOMMODATIONS, INC., CARNEGIE, PA. FILED 9-14-2001.



NO CLAIM IS MADE TO THE EXCLUSIVE RIGHT TO USE "CORPORATE ACCOMMODATIONS, INC.", APART FROM THE MARK AS SHOWN.

FOR RENTAL OF FURNISHED, FULLY-EQUIPPED, SHORT-TERM APARTMENTS (U.S. CLS. 100, 101 AND 102).

SN 78-085,250. WOOD, PAUL F., WALTON, NY. AND WOOD, ANDREW H., WALTON, NY. FILED 9-24-2001.

INHERITANCECARE

FOR BANKING SERVICES; INVESTMENT AND TRUST COMPANY SERVICES; CREATION AND MANAGEMENT OF TRUSTS; BROKERAGE ADMINISTRATION AND UNDERWRITING OF ANNUITIES AND ALL TYPES OF INSURANCE; BROKERAGE OF SECURITIES AND COMMODITIES; FINANCIAL CONSULTATION SERVICES IN THE FIELD OF INVESTMENT ADVICE AND ESTATE PLANNING (U.S. CLS. 100, 101 AND 102).

SN 78-085,291. COINSTAR, INC., BELLEVUE, WA. FILED 9-24-2001.

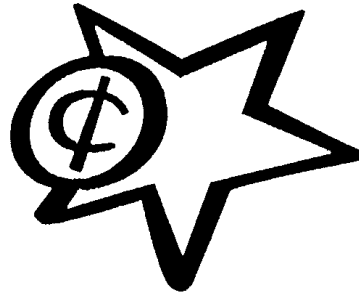

FOR CHARITABLE FUND RAISING SERVICES, NAMELY, PROVIDING AUTOMATED KIOSKS TO PROCESS COINS FOR DONATION TO CHARITABLE, CIVIC AND NOT-FOR-PROFIT ORGANIZATIONS; COIN REDEMPTION SERVICES; FINANCIAL SERVICES, NAMELY, CREDIT CARD TRANSACTION PROCESSING SERVICES (U.S. CLS. 100, 101 AND 102).

CLASS 36—(Continued).

SN 78-085,294. COINSTAR, INC., BELLEVUE, WA. FILED 9-24-2001.

COINSTAR

FOR CHARITABLE FUND RAISING SERVICES, NAMELY, PROVIDING AUTOMATED KIOSKS TO PROCESS COINS FOR DONATION TO CHARITABLE, CIVIC AND NOT-FOR-PROFIT ORGANIZATIONS; COIN REDEMPTION SERVICES; FINANCIAL SERVICES, NAMELY, CREDIT CARD TRANSACTION PROCESSING SERVICES (U.S. CLS. 100, 101 AND 102).

SN 78-085,592. CHITNIS, JAY K., ATLANTA, GA. FILED 9-26-2001.

**ARGENTUM CAPITAL
MANAGEMENT, INC.**

NO CLAIM IS MADE TO THE EXCLUSIVE RIGHT TO USE "CAPITAL MANAGEMENT, INC.", APART FROM THE MARK AS SHOWN.

FOR FINANCIAL MANAGEMENT OF MUTUAL FUNDS (U.S. CLS. 100, 101 AND 102).

SN 78-087,012. FLAG VENTURE MANAGEMENT, LLC, STAMFORD, CT. FILED 10-4-2001.

NEXGEN

FOR FINANCIAL INVESTMENT SERVICES, NAMELY, ORGANIZATION AND OPERATION OF VENTURE CAPITAL FUND-OF-FUNDS (U.S. CLS. 100, 101 AND 102).

FIRST USE 12-31-1996; IN COMMERCE 12-31-1996.

SN 78-087,309. PARK PLACE PROPERTIES INC., BREMER-TON, WA. FILED 10-7-2001.



NO CLAIM IS MADE TO THE EXCLUSIVE RIGHT TO USE "REAL ESTATE", APART FROM THE MARK AS SHOWN.

FOR REAL ESTATE BROKERAGE (U.S. CLS. 100, 101 AND 102).

FIRST USE 9-1-2001; IN COMMERCE 9-1-2001.

CLASS 36—(Continued).

SN 78-088,370. INVESYS INC., WALTHAM, MA. FILED 10-15-2001.



FOR FINANCIAL INFORMATION PROCESSING (U.S. CLS. 100, 101 AND 102).

FIRST USE 6-1-2001; IN COMMERCE 6-1-2001.

SN 78-088,889. MIDLAND NATIONAL LIFE INSURANCE COMPANY, SIOUX FALLS, SD. FILED 10-17-2001.

**NATIONAL ADVANTAGE
VARIABLE ANNUITY**

NO CLAIM IS MADE TO THE EXCLUSIVE RIGHT TO USE "NATIONAL" OR "VARIABLE ANNUITY", APART FROM THE MARK AS SHOWN.

FOR LIFE INSURANCE AND ANNUITY UNDERWRITING SERVICES (U.S. CLS. 100, 101 AND 102).

FIRST USE 4-3-2002; IN COMMERCE 4-3-2002.

SN 78-089,328. METROPOLITAN LIFE INSURANCE COMPANY, NEW YORK, NY. FILED 10-19-2001.

METCARD

OWNER OF U.S. REG. NOS. 1,530,051, 2,263,363 AND OTHERS.

FOR CREDIT CARD SERVICES; ADMINISTRATION SERVICES IN THE FIELDS OF LIFE, DISABILITY, DENTAL, AUTOMOBILE, AND HOMEOWNERS INSURANCE; ADMINISTRATION OF ANNUITIES, MUTUAL FUNDS, RETIREMENT PLANS, AND EMPLOYEE BENEFITS. (U.S. CLS. 100, 101 AND 102).

SN 78-091,394. COULOMB LIMITED, FAREHAM HANTS, UNITED KINGDOM, FILED 11-2-2001.

NETDIALERS

FOR BILL PAYMENT SERVICES AND ELECTRONIC TRANSFER OF FUNDS PROVIDED VIA THE INTERNET, ONLINE OR AN INTERACTIVE COMPUTER NETWORK (U.S. CLS. 100, 101 AND 102).

CLASS 36—(Continued).

SN 78-093,781. ICBA MORTGAGE CORPORATION, ARLINGTON, VA. FILED 11-16-2001.

MAIN STREET MORTGAGE

NO CLAIM IS MADE TO THE EXCLUSIVE RIGHT TO USE "MORTGAGE", APART FROM THE MARK AS SHOWN.

FOR BANKING SERVICES; NAMELY, LOAN FINANCING, MORTGAGE LENDING, COMMERCIAL LENDING SERVICES OFFERING MEMBER BANKS ACCESS TO SECONDARY MORTGAGE MARKETS IN ORDER TO INCREASE MEMBER BANKS PROFITABILITY (U.S. CLS. 100, 101 AND 102).

SN 78-102,219. BARFIELD GROUP, INC., THE, RICHARDSON, TX. FILED 1-11-2002.



FOR INVESTMENT BROKERAGE AND LIFE INSURANCE BROKERAGE (U.S. CLS. 100, 101 AND 102). FIRST USE 1-1-2000; IN COMMERCE 1-1-2000.

SN 78-103,526. NATIONAL CITY CORPORATION, CLEVELAND, OH. FILED 1-18-2002.

RIGHT BY YOU

FOR BANKING SERVICES (U.S. CLS. 100, 101 AND 102).

SN 78-103,787. WABASOFT, SUNNYVALE, CA. FILED 1-21-2002.

WABA

FOR FINANCIAL PLANNING AND MANAGEMENT SERVICES (U.S. CLS. 100, 101 AND 102).

SN 78-104,110. JOHN HANCOCK LIFE INSURANCE COMPANY, BOSTON, MA. FILED 1-22-2002.

SIGNATURENOTES

FOR FINANCIAL SERVICES, NAMELY ISSUANCE OF DEBT SECURITIES (U.S. CLS. 100, 101 AND 102).

CLASS 36—(Continued).

SN 78-104,526. NATIONAL CITY CORPORATION, CLEVELAND, OH. FILED 1-24-2002.

THE LAST LOAN YOU'LL EVER NEED

FOR BANKING SERVICES (U.S. CLS. 100, 101 AND 102).

SN 78-105,537. LOCKHEED FEDERAL CREDIT UNION, BURBANK, CA. FILED 1-29-2002.

MYMONEYMANAGER

FOR FINANCIAL SERVICES, NAMELY FINANCIAL ACCOUNT AGGREGATION SERVICES, FINANCIAL PLANNING ADVISORY SERVICES, AND FINANCIAL BUDGETING SERVICES, RENDERED VIA AN INTERCONNECTED GLOBAL COMPUTER NETWORK (U.S. CLS. 100, 101 AND 102).

SN 78-105,736. RICHFUND, INC., PITTSBURGH, PA. FILED 1-30-2002.

RICHFUND

FOR FINANCIAL SERVICES, NAMELY MORTGAGE BROKERING SERVICES AND LOAN CONSULTATION; FINANCIAL ANALYSIS AND CONSULTATION (U.S. CLS. 100, 101 AND 102).

SN 78-105,904. AETNA INC., BLUE BELL, PA. FILED 1-31-2002.

AETNA BENEFITS CHECKBOOK

OWNER OF U.S. REG. NOS. 822,577, 2,167,068 AND OTHERS.

NO CLAIM IS MADE TO THE EXCLUSIVE RIGHT TO USE "BENEFITS CHECKBOOK", APART FROM THE MARK AS SHOWN.

FOR CASH MANAGEMENT, NAMELY PROVIDING CHECKING ACCOUNT SERVICES FOR MANAGING LIFE INSURANCE PROCEEDS (U.S. CLS. 100, 101 AND 102).

FIRST USE 5-31-1988; IN COMMERCE 5-31-1988.

SN 78-106,559. INDIANA MEMBERS CREDIT UNION, INDIANAPOLIS, IN. FILED 2-4-2002.

1 IN INDY

FOR FINANCIAL SERVICES, NAMELY BANKING AND CREDIT UNION SERVICES (U.S. CLS. 100, 101 AND 102).

CLASS 36—(Continued).

SN 78-106,598. F.N.B. CORPORATION, HERMITAGE, PA. FILED 2-4-2002.

RED CARPET

FOR BANKING SERVICES (U.S. CLS. 100, 101 AND 102).

SN 78-107,251. HARRIS TRUST AND SAVINGS BANK, CHICAGO, IL. FILED 2-6-2002.

HARRIS INVESTOR SERVICES LLC

OWNER OF U.S. REG. NOS. 1,008,229, 2,473,688 AND OTHERS.

NO CLAIM IS MADE TO THE EXCLUSIVE RIGHT TO USE "INVESTOR SERVICES LLC", APART FROM THE MARK AS SHOWN.

SEC. 2(F).
FOR BANKING SERVICES; AND FINANCIAL SERVICES, NAMELY, BROKERAGE SERVICES IN THE FIELDS OF INVESTMENT INSTRUMENTS INCLUDING STOCKS, MUTUAL FUNDS, COMMODITIES, DERIVATIVES, AND BONDS, FINANCIAL ANALYSIS AND CONSULTATION, FINANCIAL PLANNING, FINANCIAL RESEARCH, AND INSURANCE ADMINISTRATION INCLUDING ANNUITIES AND LIFE INSURANCE (U.S. CLS. 100, 101 AND 102).

SN 78-107,664. ZIVAN, GEORGE, TROY, MI. FILED 2-8-2002.

GIFTMAKERS

FOR CHARITABLE SERVICES, NAMELY, PROVIDING FINANCIAL GRANTS OR FINANCIAL GIFTS TO HOME BUYERS TO ASSIST WITH DOWN PAYMENTS, CLOSING COSTS AND OTHER ALLOWABLE EXPENSES, WITH FUNDS FOR SUCH GRANTS BEING REPLENISHED BY CHARGING HOME SELLERS AN ENROLLMENT FEE TO JOIN OUR PROGRAM AND BY CHARITABLE FUND RAISING (U.S. CLS. 100, 101 AND 102).

SN 78-108,052. AMERICAN FAMILY LIFE ASSURANCE COMPANY OF COLUMBUS, COLUMBUS, GA. FILED 2-11-2002.

REDI-FLEX

FOR DIRECT DEPOSIT FEATURE OF EMPLOYEE REIMBURSEMENT BENEFIT PLAN (U.S. CLS. 100, 101 AND 102).

CLASS 36—(Continued).

SN 78-108,762. HUGHES, MILTON N., FOUNTAIN VALLEY, CA. FILED 2-14-2002.

HAVE A SEAT

FOR FINANCIAL SERVICES, NAMELY, PROVIDING SAVINGS PLANS WITH VARIABLE INTEREST PAID BASED ON ENTERTAINMENT EVENT ATTENDANCE (U.S. CLS. 100, 101 AND 102).

SN 78-110,213. LIBERTYVILLE BANK & TRUST COMPANY, LIBERTYVILLE, IL. FILED 2-21-2002.

COMMUNITY CLASSIC

FOR BANKING SERVICES (U.S. CLS. 100, 101 AND 102).

SN 78-110,297. AQUENT, INC., BOSTON, MA. FILED 2-21-2002.

AQUENT

FOR FINANCIAL SERVICES, NAMELY, ACCOUNTS RECEIVABLE FACTORING; ACCOUNTS RECEIVABLE FUNDING; ACCOUNTS RECEIVABLE FINANCING; ACCOUNTS RECEIVABLE MANAGEMENT SERVICES; ASSET-BASED LENDING; PURCHASE ORDER FUNDING; PURCHASE ORDER FINANCING; CONTRACT FUNDING AND FINANCING; CREDIT AND COLLECTIONS SERVICES; COLLECTION AGENCY SERVICES; ACCOUNTS RECEIVABLE COLLECTION SERVICES (U.S. CLS. 100, 101 AND 102).

FIRST USE 7-31-1999; IN COMMERCE 7-31-1999.

SN 78-112,023. JSLGOALS, LLC, TEMPE, AZ. FILED 3-1-2002.

WEHELPUOWN.COM

FOR MORTGAGE LENDING CONSULTATION AND SERVICE PROVIDER, NAMELY BROKERING MORTGAGE TRANSACTIONS (U.S. CLS. 100, 101 AND 102).

SN 78-112,096. CALIFORNIA CENTER BANK, LOS ANGELES, CA. FILED 3-1-2002.

1ST CENTER BANK

NO CLAIM IS MADE TO THE EXCLUSIVE RIGHT TO USE "BANK", APART FROM THE MARK AS SHOWN.
FOR BANKING (U.S. CLS. 100, 101 AND 102).

CLASS 36—(Continued).

SN 78-112,192. EXTRACO CORPORATION, WACO, TX. FILED 3-2-2002.

LEVERAGE YOUR RELATIONSHIP

FOR BANKING SERVICES; FINANCIAL ANALYSIS AND CONSULTATION; FINANCIAL MANAGEMENT; FINANCIAL PLANNING; FINANCIAL INVESTMENT IN THE FIELDS OF SECURITIES, BONDS, PERSONALTY, AND REAL ESTATES; FINANCIAL VALUATION OF PERSONAL PROPERTY, INVESTMENT SECURITIES, REAL ESTATE, BONDS, AND DEBT; INSURANCE BROKERAGE; INSURANCE ANALYSIS, CONSULTATION AND PLANNING; INSURANCE UNDERWRITING IN THE FIELDS OF HEALTH, FIRE, LIFE, CASUALTY, PROPERTY, HOME, AND FLOOD; INVESTMENT BROKERAGE; INVESTMENT ANALYSIS AND CONSULTATION; INVESTMENT MANAGEMENT; INVESTMENT PLANNING; MORTGAGE BROKERAGE, BANKING, ADMINISTRATIVE AND LENDING SERVICES; AND TRUST SERVICES (U.S. CLS. 100, 101 AND 102).

SN 78-112,948. AMERICAN LEBANESE SYRIAN ASSOCIATED CHARITIES, INC., MEMPHIS, TN. FILED 3-6-2002.

ARCHITECT OF HOPE

FOR CHARITABLE FUND-RAISING SERVICES (U.S. CLS. 100, 101 AND 102).

SN 78-113,668. GMAC MORTGAGE CORP., HORSHAM, PA. FILED 3-8-2002.

HELPING YOU MANAGE THE INVESTMENT IN YOUR HOME

FOR FINANCIAL SERVICES, NAMELY MORTGAGE BANKING AND LENDING SERVICES (U.S. CLS. 100, 101 AND 102).

SN 78-114,162. FRONT LINE READY AUTO, LC, GEORGETOWN, KY. FILED 3-12-2002.

FRONT LINE READY

FOR ONLINE AUTOMOBILE BROKERAGE SERVICE FOR CERTIFIED PROFESSIONAL AUTOMOBILE DEALERS (U.S. CLS. 100, 101 AND 102).

CLASS 36—(Continued).

SN 78-115,550. INSTAFI.COM, IRVINE, CA. FILED 3-18-2002.

INSTAFI

FOR REAL ESTATE MORTGAGE LOAN BROKERING SERVICES (U.S. CLS. 100, 101 AND 102). FIRST USE 1-14-2002; IN COMMERCE 3-1-2002.

CLASS 37—CONSTRUCTION AND REPAIR

SN 75-819,526. HOPE, RONALD W., FRANKLIN, TN. FILED 10-12-1999.

SMART REPAIRS

NO CLAIM IS MADE TO THE EXCLUSIVE RIGHT TO USE "REPAIRS", APART FROM THE MARK AS SHOWN.

FOR AUTOMOBILE BODY REPAIR AND FINISHING FOR OTHERS, UPHOLSTERY REPAIR, AND GLASS WINDSHIELD REPLACEMENT (U.S. CLS. 100, 103 AND 106).

FIRST USE 7-1-1999; IN COMMERCE 7-1-1999.

SN 76-109,700. E. ALLEN REEVES, INC., ABINGTON, PA. FILED 8-15-2000.

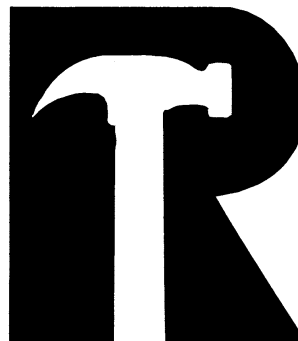

SUBJECT TO CONCURRENT USE PROCEEDING WITH U.S. REGISTRATION NO. 1986323, APPLICANT CLAIMS THE EXCLUSIVE RIGHT TO USE THE MARK IN THE AREA COMPRISING ALL OF THE UNITED STATES, ITS TERRITORIES AND POSSESSIONS, WITH THE EXCEPTION OF THE COUNTY LIMITS OF MONTEREY COUNTY, CALIFORNIA

THE MARK CONSISTS OF A HAMMER FORMING THE INSIDE OF THE LETTER "R".

FOR CONSTRUCTION SERVICES, NAMELY, INDUSTRIAL GENERAL CONTRACTOR SERVICES AND COMMERCIAL GENERAL CONTRACTOR SERVICES FOR HOSPITALS, RELIGIOUS INSTITUTIONS, RETIREMENT COMMUNITIES, SCHOOLS, OFFICE BUILDINGS, COMMERCIAL RETAIL SPACE, HOTELS AND CONVENTION CENTERS AND RESIDENTIAL SPACE; CONSTRUCTION MANAGEMENT SUPERVISION SERVICES (U.S. CLS. 100, 103 AND 106).

FIRST USE 0-0-1966; IN COMMERCE 0-0-1966.

CLASS 37—(Continued).

SN 76-157,623. RAIN MAN SEAMLESS GUTTERS, INC., READING, PA. FILED 11-2-2000.



NO CLAIM IS MADE TO THE EXCLUSIVE RIGHT TO USE "SEAMLESS GUTTERS" AND "SERVICE" AND "REPAIR", APART FROM THE MARK AS SHOWN.
 FOR BUILDING CONSTRUCTION AND REPAIRS; INSTALLATION AND REPAIR IN THE FIELD OF RESIDENTIAL GUTTERS (U.S. CLS. 100, 103 AND 106).
 FIRST USE 10-18-1999; IN COMMERCE 10-18-1999.

SN 76-176,237. SCG GROUP, LLC, LOUISVILLE, KY. FILED 12-7-2000.

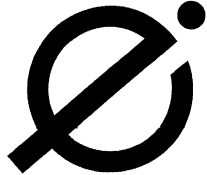

FOR PROVIDING INFORMATION SERVICES IN THE FIELD OF MINING AND HEAVY CONSTRUCTION EQUIPMENT VIA A GLOBAL COMPUTER NETWORK (U.S. CLS. 100, 103 AND 106).

SN 76-205,290. SAPMARKETS INC., PALO ALTO, CA. FILED 2-1-2001.

BUSINESS BEYOND BOUNDARIES

FOR INSTALLATION AND MAINTENANCE OF BUSINESS COMPUTER SYSTEMS (U.S. CLS. 100, 103 AND 106).

CLASS 37—(Continued).

SN 76-212,536. PETER SNELTEN & SONS, INC., WAUCONDA, IL. FILED 2-20-2001.

Peter Snelten & Sons

NO CLAIM IS MADE TO THE EXCLUSIVE RIGHT TO USE "& SONS", APART FROM THE MARK AS SHOWN.
 THE NAME "PETER SNELTEN" IS NOT THE NAME OF A KNOWN LIVING INDIVIDUAL.
 FOR WATER WELL CONSTRUCTION AND REPAIR SERVICES, INCLUDING, WELL PUMP INSTALLATION AND REPAIR, WELL DRILLING, WATER STORAGE TANK INSTALLATION, WELL ABADONMENT AND CHLORINATION SERVICES (U.S. CLS. 100, 103 AND 106).
 FIRST USE 1-1-1923; IN COMMERCE 1-15-2001.

SN 76-225,910. BRAND-REX LIMITED, SURREY KT13 9UX, UNITED KINGDOM, FILED 3-16-2001.

BOP

FOR INSTALLATION AND REPAIR OF TELECOMMUNICATIONS NETWORKS, PIPE WORK, DUCTING AND SEWERS, INSTALLATION AND REPAIR OF TELECOMMUNICATIONS NETWORKS, NAMELY, FIBER OPTIC CABLES WITHIN PIPE WORK, DUCTING AND SEWERS, UNDERGROUND PIPES AND CONDUITS (U.S. CLS. 100, 103 AND 106).

SN 76-252,974. BEDENBAUGH, JOEL E., SAVANNAH, GA. FILED 5-8-2001.

PRINTERMASTERS

FOR REPAIR OF LASER PRINTERS FOR SMALL BUSINESS AND RESIDENTIAL USE (U.S. CLS. 100, 103 AND 106).
 FIRST USE 3-6-2001; IN COMMERCE 3-6-2001.

SN 76-263,903. CONTEC CORPORATION, SCHENECTADY, NY. FILED 5-29-2001.

ATHENA

FOR REPAIR OF ELECTRONIC DEVICES, NAMELY, CABLE SET-TOP TERMINALS AND BOXES, CABLE MODEMS, SATELLITE RECEIVERS AND BOXES, TELEVISIONS, STEREOS, VIDEO CASSETTE RECORDERS, DIGITAL VIDEO DISC PLAYERS, AND SIMILARLY REMOTELY CONTROLLABLE PRODUCTS (U.S. CLS. 100, 103 AND 106).

CLASS 37—(Continued).

SN 76-281,860. TSUMPES, BRADLEY E., FILLMORE, CA. FILED 7-9-2001.

BUILDERS EMBRACING TECHNOLOGY

FOR CONSTRUCTION CONSULTATION SERVICES PERTAINING TO THE INSTALLATION AND DESIGN OF LOCAL AND REMOTE MONITORING AND CONTROL SYSTEMS WHICH OPERATE ON A GLOBAL COMMUNICATIONS NETWORK, WHICH SYSTEMS ARE DESIGNED TO MONITOR AND CONTROL A WIDE RANGE OF FUNCTIONS FOR HOME AND OFFICE ENVIRONMENTS, INCLUDING THOSE PERTAINING TO SECURITY, ENTERTAINMENT, APPLIANCE OPERATIONS AND USAGE, LIGHTING, TEMPERATURE, POWER, SMOKE DETECTION CARBON MONOXIDE DETECTION, MOISTURE DETECTION, AND NETWORKING OF COMPUTERS, WIRED AND WIRELESS COMMUNICATIONS DEVICES (U.S. CLS. 100, 103 AND 106).

FIRST USE 6-28-2001; IN COMMERCE 6-28-2001.

SN 76-292,030. JLG INDUSTRIES, INC., MCCONNELLSBURG, PA. FILED 7-30-2001.

SERVICE PLUS

NO CLAIM IS MADE TO THE EXCLUSIVE RIGHT TO USE "SERVICE", APART FROM THE MARK AS SHOWN.

FOR REPAIR AND MAINTENANCE OF CONSTRUCTION AND INDUSTRIAL EQUIPMENT, SUCH AS AERIAL WORK PLATFORMS, ARTICULATING BOOM LIFTS, TELESCOPIC BOOM LIFTS, SCISSOR LIFTS, VERTICAL PERSONNEL LIFTS AND TELESCOPIC MATERIAL HANDLERS (U.S. CLS. 100, 103 AND 106).

SN 76-296,232. SALVIA, VINCENT, BAYSIDE, NY. FILED 8-8-2001.



U.S.A.
ELECTRIC, Inc.

NO CLAIM IS MADE TO THE EXCLUSIVE RIGHT TO USE "U.S.A. ELECTRIC, INC.", APART FROM THE MARK AS SHOWN.

FOR ELECTRICAL CONTRACTING (U.S. CLS. 100, 103 AND 106).

CLASS 37—(Continued).

SN 76-311,811. JACOBUS ENERGY, INC., MILWAUKEE, WI. FILED 9-12-2001.

JACOBUS ENVIRONMENTAL SERVICES

NO CLAIM IS MADE TO THE EXCLUSIVE RIGHT TO USE "ENVIRONMENTAL SERVICES", APART FROM THE MARK AS SHOWN.

FOR ENVIRONMENTAL REMEDIATION SERVICES, NAMELY, WASTE DISPOSAL FOR OTHERS IN THE NATURE OF THE COLLECTION AND DISPOSAL OF USED OIL, OIL FILTERS, ANTI-FREEZE, CONTAMINATED WATER, AND CONTAMINATED ABSORBENT MATERIALS (U.S. CLS. 100, 103 AND 106).

FIRST USE 0-0-1993; IN COMMERCE 0-0-1993.

SN 76-318,810. MR. CRANE, INC., ORANGE, CA. FILED 10-1-2001.

MR. CRANE

NO CLAIM IS MADE TO THE EXCLUSIVE RIGHT TO USE "CRANE", APART FROM THE MARK AS SHOWN.

FOR PROVIDING CRANE AND RIGGING SERVICES FOR HEAVY LIFTING, PROVIDING RENTAL SERVICES FOR SPECIALIZED EQUIPMENT TO PERFORM HEAVY LIFTING, NAMELY, CRANES AND HOISTING MACHINES, AND CONCRETE TILT-UP WALLS CONSTRUCTION (U.S. CLS. 100, 103 AND 106).

FIRST USE 0-0-1969; IN COMMERCE 0-0-1985.

SN 76-327,992. VECA ELECTRIC COMPANY, INC., SEATTLE, WA. FILED 10-22-2001.



NO CLAIM IS MADE TO THE EXCLUSIVE RIGHT TO USE "COMMUNICATION", APART FROM THE MARK AS SHOWN.

THE MARK CONSISTS OF A 3-DIMENSIONAL "V" IN BLUE AND RED AND ORANGE RAYS OF COLOR SWIRLING AROUND THE "V", APPEARING TO THE LEFT OF OR ABOVE THE LOGO TEXT "VECA". THE LOGO TEXT "VECA" APPEARS IN BLUE AND IS A CUSTOMIZED SANS SERIF FONT. "COMMUNICATIONS" IS DISPLAYED IN AVANTE GARDE FONT UNDER THE "VECA" LOGO TEXT.

FOR PROVIDES INSTALLATION OF ELECTRICAL CABLES, SECURITY SYSTEMS, COMPUTER NETWORKS AND LOW VOLTAGE ELECTRICAL WIRING SYSTEMS; INSTALLATION OF ELECTRICAL CABLES FOR BROADBAND TELECOMMUNICATIONS NETWORKS (U.S. CLS. 100, 103 AND 106).

FIRST USE 9-1-2000; IN COMMERCE 9-1-2000.

CLASS 37—(Continued).

SN 76-332,294. TELCO SYSTEMS, INC., FOXBORO, MA. FILED 10-31-2001.



NO CLAIM IS MADE TO THE EXCLUSIVE RIGHT TO USE "SYSTEMS", APART FROM THE MARK AS SHOWN. THE STIPPLING SHOWN IN THE DRAWING IS A FEATURE OF THE MARK AND NOT INTENDED TO INDICATE COLOR.

FOR INSTALLATION AND MAINTENANCE OF TELECOMMUNICATIONS AND NETWORKING EQUIPMENT FOR OTHERS; REPAIR AND REPLACEMENT OF TELECOMMUNICATIONS AND NETWORKING EQUIPMENT FOR OTHERS; CUSTOMIZED SERVICE PROGRAMS FOR THE REPAIR, MAINTENANCE AND REPLACEMENT OF TELECOMMUNICATIONS AND NETWORKING EQUIPMENT (U.S. CLS. 100, 103 AND 106).

FIRST USE 5-0-1999; IN COMMERCE 5-0-1999.

SN 76-346,422. AMQUIP CORPORATION, BENSALEM, PA. FILED 12-10-2001.



Shane McCrane

THE STIPPLING SHOWN IN THE DRAWING IS FOR SHADING PURPOSES ONLY. THE NAME "SHANE MCCRANE" DOES NOT IDENTIFY A PARTICULAR LIVING INDIVIDUAL. FOR CRANE RENTALS (U.S. CLS. 100, 103 AND 106). FIRST USE 12-3-1984; IN COMMERCE 12-3-1984.

SN 76-358,072. KANSAS CITY MASTER COMPANIES, GRANDVIEW, MO. FILED 1-11-2002.

PIER MASTERS

NO CLAIM IS MADE TO THE EXCLUSIVE RIGHT TO USE "PIER", APART FROM THE MARK AS SHOWN. FOR FOUNDATION REPAIR AND SUPPORT SERVICES IN THE NATURE OF RESTORING AND STABILIZING STRUCTURES (U.S. CLS. 100, 103 AND 106). FIRST USE 12-21-1992; IN COMMERCE 12-21-1992.

CLASS 37—(Continued).

SN 76-358,073. KANSAS CITY MASTER COMPANIES, GRANDVIEW, MO. FILED 1-11-2002.

A SOLID SOLUTION

FOR CONCRETE AND FOUNDATION REPAIR SERVICES IN THE NATURE OF PIER SUPPORT, MUD-JACKING LIFTS, INSTALLATION AND REPAIR OF RETAINING WALLS, AND WATER DIVERSION MAINTENANCE (U.S. CLS. 100, 103 AND 106). FIRST USE 12-21-1992; IN COMMERCE 12-21-1992.

SN 76-358,719. GREENBERG CLARK, INC., SACRAMENTO, CA. FILED 1-14-2002.

MR. TRENCHLESS

NO CLAIM IS MADE TO THE EXCLUSIVE RIGHT TO USE "TRENCHLESS", APART FROM THE MARK AS SHOWN. FOR PLUMBING CONTRACTOR SERVICES (U.S. CLS. 100, 103 AND 106).

SN 76-358,794. GREENBERG CLARK, INC., SACRAMENTO, CA. FILED 1-14-2002.

THE TRENCHLESS CO

NO CLAIM IS MADE TO THE EXCLUSIVE RIGHT TO USE "TRENCHLESS CO", APART FROM THE MARK AS SHOWN. FOR PLUMBING CONTRACTOR SERVICES (U.S. CLS. 100, 103 AND 106). FIRST USE 3-0-2000; IN COMMERCE 3-0-2000.

SN 76-361,453. SONORAN FOOTHILLS, INC., PHOENIX, AZ. FILED 1-18-2002.

SONORAN FOOTHILLS

NO CLAIM IS MADE TO THE EXCLUSIVE RIGHT TO USE "FOOTHILLS", APART FROM THE MARK AS SHOWN. FOR REAL ESTATE DEVELOPMENT SERVICES, NAMELY, DEVELOPMENT OF MASTER PLANNED RESIDENTIAL AND COMMERCIAL COMMUNITIES (U.S. CLS. 100, 103 AND 106).

CLASS 37—(Continued).

SN 76-362,498. TUFly DRYWALL, INC., OMAHA, NE.
FILED 1-16-2002.

"WE'RE ROCKING OMAHA"

NO CLAIM IS MADE TO THE EXCLUSIVE RIGHT TO USE "OMAHA", APART FROM THE MARK AS SHOWN.

FOR CONSTRUCTION AND REPAIR SERVICES FOR BUILDINGS AND HOUSES, NAMELY, INSTALLATION OF DRYWALL, WALLS, AND CEILINGS; PROFESSIONAL PAINTING SERVICES, NAMELY, DRYWALL FINISHING; CONSTRUCTION AND REPAIR SERVICES FOR BUILDINGS AND HOUSES, NAMELY, INSTALLATION OF LIGHT GAUGE METAL FRAMES TO SUPPORT DRYWALL PANELS; CONSTRUCTION AND REPAIR SERVICES, NAMELY, INSTALLATION OF FINISHING FOR EXTERIOR OF BUILDINGS AND HOUSES (U.S. CLS. 100, 103 AND 106).

FIRST USE 1-15-2001; IN COMMERCE 1-15-2001.

CLASS 37—(Continued).

SN 76-372,190. STERICYCLE, INC., LAKE FOREST, IL.
FILED 2-5-2002.

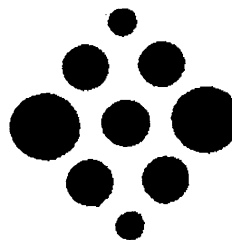

OWNER OF U.S. REG. NO. 1,724,309.

FOR DISPOSAL OF DOMESTIC AND INDUSTRIAL HAZARDOUS AND MEDICAL WASTE; CONSULTING IN THE FIELD OF DISPOSAL OF DOMESTIC AND INDUSTRIAL HAZARDOUS AND MEDICAL WASTE (U.S. CLS. 100, 103 AND 106).

FIRST USE 4-0-2000; IN COMMERCE 4-0-2000.

SN 76-370,745. EXPERT INSULATION, INC., SPRING VALLEY, MN. FILED 2-13-2002.



NO CLAIM IS MADE TO THE EXCLUSIVE RIGHT TO USE "INSULATION", APART FROM THE MARK AS SHOWN.

FOR INSULATION SERVICES, NAMELY THE INSTALLATION OF BUILDING INSULATION (U.S. CLS. 100, 103 AND 106).

FIRST USE 6-1-1998; IN COMMERCE 6-1-1998.

SN 76-372,620. CREDEX AUTO LEASING & FINANCE, INC., MAYFIELD HEIGHTS, OH. FILED 2-19-2002.

COMPUCALL

FOR MAINTENANCE AND REPAIR OF COMPUTER HARDWARE (U.S. CLS. 100, 103 AND 106).

SN 76-372,685. WASTE MANAGEMENT, INC., HOUSTON, TX. FILED 2-14-2002.

THE SERVICE MACHINE

FOR SOLID WASTE LANDFILL SERVICES (U.S. CLS. 100, 103 AND 106).

SN 76-371,273. FOURNIER A/C & REFRIGERATION INC, JACKSONVILLE, FL. FILED 2-15-2002.

**MODERN TECHNOLOGY
WITH OLD FASHIONED
QUALITY AND SERVICE**

FOR INSTALLATION AND REPAIR OF AIR CONDITIONING APPARATUS (U.S. CLS. 100, 103 AND 106).

SN 76-374,658. JOHN T. KYLE FINE HOMES OF HATTERAS ISLAND, INC., AVON, NC. FILED 2-25-2002.

**BUILDING AMERICA'S
DREAM HOMES, ONE AT A
TIME**

FOR REAL ESTATE CONSTRUCTION SERVICES (U.S. CLS. 100, 103 AND 106).

FIRST USE 0-0-1990; IN COMMERCE 0-0-1990.

CLASS 37—(Continued).

SN 76-378,637. BRAND SERVICES, INC., CHESTERFIELD, MO. FILED 3-6-2002.

BRANDPLAN

FOR CONSTRUCTION MANAGEMENT SUPERVISION IN THE CONSTRUCTION OF SCAFFOLDING (U.S. CLS. 100, 103 AND 106).
FIRST USE 4-0-1999; IN COMMERCE 4-0-1999.

SN 76-380,149. BUCCELLI, SAM, WEST ORANGE, NJ. FILED 3-11-2002.

THE WINDOW FACTORY

NO CLAIM IS MADE TO THE EXCLUSIVE RIGHT TO USE "WINDOW", APART FROM THE MARK AS SHOWN. FOR HOME REMODELING SERVICES (U.S. CLS. 100, 103 AND 106).
FIRST USE 11-4-2000; IN COMMERCE 11-4-2000.

SN 76-380,180. KEYSTONE COMPANIES, INC., NORTH-BROOK, IL. FILED 3-1-2002.

THE FINE ART OF PLUMBING

NO CLAIM IS MADE TO THE EXCLUSIVE RIGHT TO USE "PLUMBING", APART FROM THE MARK AS SHOWN. FOR PLUMBING SERVICES, ELECTRICAL WIRING INSTALLATION AND REPAIR SERVICES, HEATING AND COOLING SYSTEM INSTALLATION AND REPAIR SERVICES (U.S. CLS. 100, 103 AND 106).
FIRST USE 12-1-2001; IN COMMERCE 12-1-2001.

SN 76-380,181. KEYSTONE COMPANIES, INC., NORTH-BROOK, IL. FILED 3-1-2002.

**WE HANDLE THE DETAILS
SO THAT YOU CAN ENJOY
EACH SPECIAL MOMENT IN
YOUR HOME**

FOR PLUMBING SERVICES, ELECTRICAL WIRING INSTALLATION AND REPAIR SERVICES, HEATING AND COOLING SYSTEMS INSTALLATION AND REPAIR SERVICES (U.S. CLS. 100, 103 AND 106).
FIRST USE 12-1-2001; IN COMMERCE 12-1-2001.

CLASS 37—(Continued).

SN 76-382,797. CASE DESIGN/REMODELING, INC., BETHESDA, MD. FILED 3-13-2002.



OWNER OF U.S. REG. NO. 1,661,087. FOR RESIDENTIAL AND COMMERCIAL REMODELING AND REPAIR SERVICES (U.S. CLS. 100, 103 AND 106).
FIRST USE 12-0-1988; IN COMMERCE 12-0-1988.

SN 78-065,514. KELLY, TED L., GREENVILLE, SC. FILED 5-24-2001.



NO CLAIM IS MADE TO THE EXCLUSIVE RIGHT TO USE "MAINTENANCE MANAGEMENT SOLUTIONS", APART FROM THE MARK AS SHOWN. FOR MAINTENANCE MANAGEMENT SERVICES FOR COMMERCIAL REFRIGERATION EQUIPMENT, COMMERCIAL FOOD EQUIPMENT, HOUSEHOLD APPLIANCES, AND HEATING AND AIR CONDITIONING (HVAC) (U.S. CLS. 100, 103 AND 106).

SN 78-069,347. ARCH CHEMICALS, INC., NORWALK, CT. FILED 6-15-2001.

SPALIFE

FOR POOL AND SPA SERVICES, NAMELY, SWIMMING POOL AND SPA CLEANING SERVICES, SWIMMING POOL AND SPA MAINTENANCE AND REPAIR AND CONSULTATIONS RELATED THERETO (U.S. CLS. 100, 103 AND 106).

CLASS 37—(Continued).

SN 78-069,399. ARCH CHEMICALS, INC., NORWALK, CT. FILED 6-15-2001.

POOLIFE

OWNER OF U.S. REG. NO. 1,062,213.
FOR POOL AND SPA SERVICES, NAMELY, SWIMMING POOL AND SPA CLEANING SERVICES, SWIMMING POOL AND SPA MAINTENANCE AND REPAIR AND CONSULTATIONS RELATED THERETO (U.S. CLS. 100, 103 AND 106).

SN 78-089,358. MOBISERV, WOODLAND HILLS, CA. FILED 10-19-2001.



FOR PORTABLE AUTOMOBILE SERVICE STATION SERVICES (U.S. CLS. 100, 103 AND 106).

SN 78-093,663. PETERSON, GREGORY J, DALLAS, TX. FILED 11-15-2001.



THE MARK CONSISTS OF THE STYLIZED WORDING "THIS NEW HOUSE" AND A STYLIZED HOUSE DESIGN WITH HOUSE DESIGN IN THE COLOR MAROON OR BLACK, AND THE LETTERING IN BLACK.

FOR HOME RENOVATION, HOME RESTORATION, HOME REPAIR AND CUSTOM CARPENTRY, NAMELY, CARPENTRY CONTRACTOR SERVICES (U.S. CLS. 100, 103 AND 106).
FIRST USE 3-12-2001; IN COMMERCE 5-22-2001.

CLASS 37—(Continued).

SN 78-097,786. MCELROY, MICHAEL, MOUNTAIN VIEW, CA. FILED 12-11-2001.



FOR INTERIOR DOOR REPLACEMENT SERVICES WITH INSTALLATION OF DOORS, LOCKSETS AND PAINTING (U.S. CLS. 100, 103 AND 106).

SN 78-098,328. SHELDRIK, INC., DBA AUTOMOTIVE MAINTENACE SOLUTION, HENDERSONVILLE, NC. FILED 12-14-2001.



NO CLAIM IS MADE TO THE EXCLUSIVE RIGHT TO USE "AUTOMOTIVE MAINTENANCE SOLUTIONS", APART FROM THE MARK AS SHOWN.

THE LINING SHOWN IN THE MARK IS MERELY TO INDICATE SHADING.

FOR AUTOMOBILE REPAIR AND MAINTENANCE, FEATURING AUTOMOBILE SYSTEMS LUBRICATION, AUTOMOBILE SYSTEMS FLUID FLUSHING AND FUEL SYSTEMS CLEANING (U.S. CLS. 100, 103 AND 106).

SN 78-102,124. PULLEN, JOSEPHUS, JR., DBA J. P. COACH & CO., CHICAGO, IL. FILED 1-11-2002.

A MOUSE IN THE HOUSE...A RAT GETTING FAT...GOTTA ROACH, CALL COACH

OWNER OF U.S. REG. NO. 882,325.
FOR CONTROL AND EXTERMINATION OF PESTS AND RODENTS (U.S. CLS. 100, 103 AND 106).
FIRST USE 6-0-1961; IN COMMERCE 1-0-1962.

CLASS 37—(Continued).

SN 78-104,122. ICOM MECHANICAL, INC., SAN JOSE, CA. FILED 1-22-2002.

TECHNOLOGY'S BUILDER

NO CLAIM IS MADE TO THE EXCLUSIVE RIGHT TO USE "BUILDER", APART FROM THE MARK AS SHOWN.
FOR GENERAL CONTRACTOR AND MECHANICAL CONTRACTOR SERVICES, NAMELY, CONSTRUCTION AND MAINTENANCE OF BUILDINGS AND CONSTRUCTION MANAGEMENT SERVICES (U.S. CLS. 100, 103 AND 106).

SN 78-112,518. PEST-TEX SERVICES INC, MESQUITE, TX. FILED 3-4-2002.

PEST-TEX SERVICES INC

NO CLAIM IS MADE TO THE EXCLUSIVE RIGHT TO USE "SERVICES INC", APART FROM THE MARK AS SHOWN.
FOR PEST CONTROL SERVICES (U.S. CLS. 100, 103 AND 106).

SN 78-112,709. EMPLOYERS REINSURANCE COMPANY, OVERLAND PARK, KS. FILED 3-5-2002.

PROJECT SAFEGUARD

NO CLAIM IS MADE TO THE EXCLUSIVE RIGHT TO USE "SAFEGUARD", APART FROM THE MARK AS SHOWN.
FOR PHILANTHROPIC EFFORT, NAMELY, RENOVATION OF UNSAFE CHILDCARE CENTERS AND OTHER BUILDINGS RELATED TO NON-PROFIT ENDEAVORS (U.S. CLS. 100, 103 AND 106).

SN 78-113,076. SHOCKTECH SERVICES, LLC, FAYETTEVILLE, NC. FILED 3-7-2002.

SHOCKTECH

FOR MAINTENANCE AND REPAIR OF MEDICAL EQUIPMENT (U.S. CLS. 100, 103 AND 106).

CLASS 38—COMMUNICATION

SN 75-503,814. S SQUARED L.L.C., CHICAGO, IL. FILED 6-17-1998.

RANGER

FOR DEVELOPING AND PROVIDING ROAMING SERVICES FOR THE WIRELESS TELECOMMUNICATIONS INDUSTRY (U.S. CLS. 100, 101 AND 104).

CLASS 38—(Continued).

SN 75-514,523. CONUS COMMUNICATIONS COMPANY LIMITED PARTNERSHIP, ST. PAUL, MN. BY ASSIGNMENT ALL NEWS CHANNEL JOINT VENTURE, THE, ST. PAUL, MN. FILED 7-7-1998.

ALL NEWS
C H A N N E L

NO CLAIM IS MADE TO THE EXCLUSIVE RIGHT TO USE "ALL NEWS CHANNEL", APART FROM THE MARK AS SHOWN.
FOR TELEVISION BROADCASTING SERVICES (U.S. CLS. 100, 101 AND 104).
FIRST USE 12-31-1992; IN COMMERCE 12-31-1992.

SN 75-543,716. MEDIA DVX, LLC, ARDEN HILLS, MN. BY ASSIGNMENT CONTROL DATA SYSTEMS, INC., ARDEN HILLS, MN. FILED 8-27-1998.

MEDIA DVX

NO CLAIM IS MADE TO THE EXCLUSIVE RIGHT TO USE "MEDIA", APART FROM THE MARK AS SHOWN.
FOR ELECTRONIC DELIVERY OF TELEVISION COMMERCIALS DIRECTLY TO BROADCAST AND CABLE TELEVISION NETWORKS AND LOCAL TELEVISION STATIONS (U.S. CLS. 100, 101 AND 104).

SN 75-752,220. GLOBAL ONE COMMUNICATIONS WORLD HOLDING B.V., 1070 AP AMSTERDAM, NETHERLANDS, FILED 7-15-1999.

Global

NO CLAIM IS MADE TO THE EXCLUSIVE RIGHT TO USE "GLOBAL", APART FROM THE MARK AS SHOWN.
FOR TELECOMMUNICATION SERVICES, NAMELY, TELEPHONE COMMUNICATION SERVICES, VOICE AND DATA SERVICES VIA LAND LINES AND SATELLITES; ELECTRONIC AND DIGITAL TRANSMISSION, DELIVERY AND FORWARDING OF VOICE, DATA, INFORMATION, IMAGES, SIGNALS, MESSAGES, AND DOCUMENTS, WITH OR WITHOUT ENCRYPTION AND DECRYPTION; PROVIDING RENTAL OF TELECOMMUNICATION EQUIPMENT IN GENERAL; SATELLITE TRANSMISSION SERVICES; DIGITAL MESSAGING; PROVIDING TELECOMMUNICATIONS CONNECTIONS AND MULTIPLE-USER ACCESS TO A GLOBAL COMPUTER NETWORK; INTERNET ACCESS PROVIDER SERVICES; PROVIDING TELECOMMUNICATIONS CONNECTIONS TO INTRANET AND EXTRANET NETWORKS; PROVIDING TELECOMMUNICATIONS CONNECTION TO CUSTOMER SITES; COMPUTER-BASED TELEPHONE CALL CENTER TELECOMMUNICATIONS SERVICES (U.S. CLS. 100, 101 AND 104).
FIRST USE 2-1-1996; IN COMMERCE 2-1-1996.

CLASS 38—(Continued).

SN 75-753,094. QWEST COMMUNICATIONS INTERNATIONAL INC., DENVER, CO. FILED 7-16-1999.

TELMAREXPRESS

FOR TELECOMMUNICATION SERVICES, NAMELY ELECTRONIC TRANSMISSION OF VOICE, VIDEO, MESSAGES AND DATA; PROVIDING ACCESS TO A FIBER OPTIC TELECOMMUNICATIONS NETWORK; PROVIDING ACCESS TO A GLOBAL COMPUTER INFORMATION NETWORK; INTRANET (INCLUDING MOBIL ACCESS); PRIVATE LINE SERVICES AND VIRTUAL PRIVATE DATA NETWORK SERVICES; MULTIMEDIA NETWORK SERVICES AND VIDEO TELECONFERENCING SERVICES (U.S. CLS. 100, 101 AND 104).

SN 75-929,923. SPRINT CORPORATION, WESTWOOD, KS. FILED 2-25-2000.

YOU⁵⁰

FOR TELECOMMUNICATIONS SERVICES; NAMELY, THE TRANSMISSION OF VOICE, VIDEO AND DATA VIA DIGITAL SUBSCRIBER LINES (DSL) (U.S. CLS. 100, 101 AND 104).

SN 76-013,961. MIDWEST WIRELESS HOLDINGS L.L.C., MANKATO, MN. FILED 3-31-2000.



FOR TELEPHONE COMMUNICATION SERVICES FOR VOICE AND DATA (U.S. CLS. 100, 101 AND 104). FIRST USE 3-22-2000; IN COMMERCE 3-22-2000.

SN 76-016,542. SORENSON MEDIA, INC., SALT LAKE CITY, UT. FILED 4-3-2000.

SORENSON MEDIA

OWNER OF U.S. REG. NO. 2,235,065.
NO CLAIM IS MADE TO THE EXCLUSIVE RIGHT TO USE "MEDIA", APART FROM THE MARK AS SHOWN.
SEC. 2(F).
FOR BROADCASTING AUDIO AND VIDEO PROGRAMS VIA A GLOBAL COMPUTER NETWORK (U.S. CLS. 100, 101 AND 104).

CLASS 38—(Continued).

SN 76-026,383. YCOM NETWORKS, INC., YELM, WA. FILED 4-17-2000.



NO CLAIM IS MADE TO THE EXCLUSIVE RIGHT TO USE NETWORKS, APART FROM THE MARK AS SHOWN.

THE MARK CONSISTS OF A STYLIZED "Y" THAT STANDS FOR YELM WITH "COM" BOLD AND SHADOWED. "NETWORKS" TO BE PLACED UNDER "YCOM" AT 10% SIZE AND A SWOOSH THAT STARTS AT THE RIGHT SIDE OF "M" TOWARD THE BOTTOM AND DOES A HALF CIRCLE CURVE OVER TO THE LEFT ARM OF THE "Y."

FOR PROVIDING TELECOMMUNICATIONS CONNECTIONS TO A GLOBAL COMPUTER NETWORK; TELECOMMUNICATIONS GATEWAY SERVICES; TELECOMMUNICATIONS SERVICES, NAMELY, PERSONAL COMMUNICATION SERVICES FOR BUSINESS AND RESIDENTIAL CUSTOMERS IN THE LOCAL SERVICE AREA (U.S. CLS. 100, 101 AND 104).

FIRST USE 1-1-2000; IN COMMERCE 1-1-2000.

SN 76-034,927. RAPID TRANSMIT TECHNOLOGY, INC., CINCINNATI, OH. FILED 4-26-2000.

WAKUL

FOR COMMUNICATIONS AND TELECOMMUNICATIONS SERVICES, NAMELY, TELEPHONE COMMUNICATION SERVICES, DIRECT AND DIGITAL TELEVISION BROADCASTING SERVICES, ELECTRONIC TRANSMISSION OF MESSAGES, DATA AND DOCUMENTS VIA UNIVERSAL MESSAGING, AND PROVIDING MULTIPLE-USER ACCESS TO A GLOBAL COMPUTER NETWORK (U.S. CLS. 100, 101 AND 104).

CLASS 38—(Continued).

SN 76-038,675. CNM NETWORK, INC., SIMI VALLEY, CA. FILED 5-2-2000.

IPCENTRIC

FOR TELECOMMUNICATIONS SERVICES, NAMELY, BROADCASTING AND DELIVERY OF AUDIO, VIDEO, AND MULTIMEDIA CONTENT BY MEANS OF RADIO, CELLULAR, AND WIRELESS COMMUNICATION, TELEVISION, CABLE TELEVISION, CLOSED CIRCUIT, ELECTRONIC COMMUNICATIONS NETWORKS, AND COMPUTER NETWORKS; DELIVERY OF MESSAGES BY ELECTRONIC TRANSMISSION; ELECTRONIC MAIL SERVICES; PAGING SERVICES; PROVIDING ON-LINE CHAT ROOMS FOR TRANSMISSION OF MESSAGES AMONG COMPUTER USERS CONCERNING TOPICS OF GENERAL INTEREST; AND TELEPHONY SERVICES, NAMELY, LOCAL AND LONG DISTANCE TELEPHONE SERVICE, VOIP (VOICE OVER INTERNET PROTOCOL), AND VON (VOICE OVER THE NET) PHONE SERVICES PROVIDED VIA A GLOBAL COMPUTER INFORMATION NETWORK, PCS (PERSONAL COMMUNICATION SERVICES) DIGITAL WIRELESS LOCAL AND LONG DISTANCE SERVICE; VOICE MAIL, FAX MAIL, CONFERENCE CALLING AND CALL FORWARDING, SPEED DIALING, VOICE RECOGNITION AND AUTOMATED MESSAGE DELIVERY (U.S. CLS. 100, 101 AND 104).

SN 76-104,411. NEXGEN INTEGRATED COMMUNICATIONS, L.C., CLIVE, IA. FILED 8-7-2000.

NEXGEN INTEGRATED COMMUNICATIONS

NO CLAIM IS MADE TO THE EXCLUSIVE RIGHT TO USE "INTEGRATED COMMUNICATIONS", APART FROM THE MARK AS SHOWN.

FOR TELECOMMUNICATION SERVICES, NAMELY, PERSONAL COMMUNICATION SERVICES (U.S. CLS. 100, 101 AND 104).

CLASS 38—(Continued).

SN 76-115,643. DRIVIN.COM, INC., CAMPBELL, CA. FILED 8-23-2000.

DRIVING MEDIA

NO CLAIM IS MADE TO THE EXCLUSIVE RIGHT TO USE "MEDIA", APART FROM THE MARK AS SHOWN.

FOR ELECTRONIC TRANSMISSION OF DATA, IMAGES AND DOCUMENTS VIA COMPUTER TERMINALS AND NETWORKS REGARDING THE AUTOMOTIVE INDUSTRY, MOTOR VEHICLES AND MOTOR VEHICLES' SALES, LEASING, PRICES AND RATINGS; AUDIO-BROADCASTING, RADIO-BROADCASTING, CABLE TELEVISION BROADCASTING, TELEVISION BROADCASTING, CABLE BROADCASTING AND DELIVERY OF AUDIO, VIDEO AND MULTIMEDIA CONTENT BY MEANS OF RADIO, CELLULAR AND WIRELESS COMMUNICATION DEVICES, TELEVISION, CABLE TELEVISION, CLOSED CIRCUIT TELEVISION, AND GLOBAL COMPUTER NETWORKS REGARDING THE AUTOMOTIVE INDUSTRY, MOTOR VEHICLES AND SALES, LEASING, PRICES AND RATINGS OF MOTOR VEHICLES; PROVIDING ONLINE INTERACTIVE MULTIMEDIA ANIMATED VERSIONS OF ROAD TESTS; PROVIDING ONLINE ELECTRONIC BILLBOARDS FOR TRANSMISSION OF MESSAGES AMONG COMPUTER USERS CONCERNING THE AUTOMOTIVE INDUSTRY, MOTOR VEHICLES AND SALES, LEASING, PRICES AND RATINGS OF MOTOR VEHICLES (U.S. CLS. 100, 101 AND 104).

SN 76-141,431. SPACEVEST MANAGEMENT GROUP, INC., RESTON, VA. FILED 10-4-2000.

INVESTMENT LEADERS FOR A NEW AGE

FOR PROVIDING ON-LINE INFORMATION IN THE FIELDS OF COMMUNICATIONS, SATELLITE COMMUNICATIONS, AND SPACE COMMUNICATIONS TECHNOLOGY (U.S. CLS. 100, 101 AND 104).

SN 76-145,437. MALUSIS, MARC G., BLAUVELT, NY. FILED 10-11-2000.

IF YOU CAN'T PLAY IT, TALK IT

FOR TELECOMMUNICATIONS SERVICES, NAMELY, RADIO BROADCASTING SERVICES (U.S. CLS. 100, 101 AND 104).

FIRST USE 12-19-1999; IN COMMERCE 12-19-1999.

CLASS 38—(Continued).

SN 76-151,335. TERABEAM NETWORKS, INC., SEATTLE, WA. FILED 10-23-2000.

TERABEAM

OWNER OF U.S. REG. NO. 2,398,305.
FOR COMMUNICATIONS SERVICES, NAMELY, PROVIDING HIGH SPEED OPTOELECTRONIC TRANSMISSION OF DATA (U.S. CLS. 100, 101 AND 104).

SN 76-175,246. MINNESOTA TIMBERWOLVES BASKETBALL LIMITED PARTNERSHIP, NORTH MANKATO, MN. FILED 12-4-2000.



OWNER OF U.S. REG. NOS. 2,091,986, 2,212,589 AND OTHERS.
SEC. 2(F) AS TO "MINNESOTA".
FOR PROVIDING ON-LINE CHAT ROOMS FOR TRANSMISSION OF MESSAGES AMONG COMPUTER USERS CONCERNING PROFESSIONAL BASKETBALL; BROADCASTING PROGRAMS VIA A GLOBAL COMPUTER NETWORK (U.S. CLS. 100, 101 AND 104).
FIRST USE 10-28-1995; IN COMMERCE 10-28-1995.

SN 76-178,469. CITIZENS COMMUNICATIONS COMPANY, STANFORD, CT. BY ASSIGNMENT GLOBAL CROSSING NORTH AMERICA, INC., ROCHESTER, NY. FILED 12-4-2000.

FRONTIER XL, LOCAL EXTENDED CALLING PLAN

OWNER OF U.S. REG. NOS. 1,936,139, 2,362,644 AND OTHERS.
NO CLAIM IS MADE TO THE EXCLUSIVE RIGHT TO USE "LOCAL EXTENDED CALLING PLAN", APART FROM THE MARK AS SHOWN.
FOR TELECOMMUNICATIONS SERVICES, NAMELY, LOCAL AND LONG DISTANCE SERVICES (U.S. CLS. 100, 101 AND 104).

CLASS 38—(Continued).

SN 76-190,424. JOB PARTNERS LIMITED, CHISWICK, LONDON, ENGLAND, FILED 1-5-2001.



PRIORITY CLAIMED UNDER SEC. 44(D) ON UNITED KINGDOM APPLICATION NO. GB2238484B, FILED 7-7-2000, REG. NO. 2238484B, DATED 5-2-2001, EXPIRES 7-7-2010.
FOR PROVIDING TELECOMMUNICATIONS CONNECTIONS TO A GLOBAL COMPUTER NETWORK; PROVIDING MULTIPLE-USER ACCESS TO A GLOBAL COMPUTER INFORMATION NETWORK (U.S. CLS. 100, 101 AND 104).

SN 76-204,623. INTERACTIVE PEOPLE UNPLUGGED, AB, DBA IPUNPLUGGED, AB, SE-121 28 STOCKHOLM-GLOBEN, SWEDEN, FILED 2-1-2001.



FOR MOBILE USER ACCESS SERVICES, NAMELY, PROVIDING MOBILE USER ACCESS TO GLOBAL COMPUTER NETWORKS, INTERNAL COMPUTER INFORMATION NETWORKS AND EXTRANETS (U.S. CLS. 100, 101 AND 104).

SN 76-211,266. COX COMMUNICATIONS, INC., ATLANTA, GA. FILED 2-16-2001.

COX OFFICE SOLUTIONS PAK

NO CLAIM IS MADE TO THE EXCLUSIVE RIGHT TO USE "OFFICE SOLUTIONS PAK", APART FROM THE MARK AS SHOWN.
FOR COMMUNICATIONS SERVICES, NAMELY, PROVIDING LOCAL AND LONG DISTANCE TELEPHONE SERVICES, HIGH SPEED INTERNET ACCESS, AND CALL MANAGEMENT SERVICES, NAMELY, CALLER IDENTIFICATION, CALL FORWARDING, VOICEMAIL AND NO-ANSWER TRANSFERS (U.S. CLS. 100, 101 AND 104).

CLASS 38—(Continued).

SN 76-231,625. COX COMMUNICATIONS, INC., ATLANTA, GA. FILED 3-28-2001.

COX OFFICE SOLUTIONS FLEX

NO CLAIM IS MADE TO THE EXCLUSIVE RIGHT TO USE "OFFICE SOLUTIONS FLEX", APART FROM THE MARK AS SHOWN.

FOR TELEPHONE COMMUNICATIONS AND HIGH SPEED INTERNET ACCESS SERVICES (U.S. CLS. 100, 101 AND 104).

SN 76-231,626. COX COMMUNICATIONS, INC., ATLANTA, GA. FILED 3-28-2001.

COX OFFICE SOLUTIONS BASIC

NO CLAIM IS MADE TO THE EXCLUSIVE RIGHT TO USE "OFFICE SOLUTIONS BASIC", APART FROM THE MARK AS SHOWN.

FOR TELEPHONE COMMUNICATIONS SERVICES (U.S. CLS. 100, 101 AND 104).

SN 76-231,632. REYNOLDS RADIO, INC., COLLEGE STATION, TX. FILED 3-28-2001.

THE BLAZE

FOR RADIO BROADCASTING (U.S. CLS. 100, 101 AND 104).
FIRST USE 12-1-1999; IN COMMERCE 12-1-1999.

SN 76-237,390. INTEGRATED GLOBAL CONCEPTS, INC., DES PLAINES, IL. FILED 4-9-2001.

MAXEMAIL

FOR PROVIDING ELECTRONIC MAIL AND FACSIMILE RECEIPT AND DELIVERY SERVICES USING A GLOBAL COMMUNICATIONS NETWORK (U.S. CLS. 100, 101 AND 104).

FIRST USE 7-31-1997; IN COMMERCE 7-31-1997.

CLASS 38—(Continued).

SN 76-239,031. DR. SPOCK COMPANY, THE, MENLO PARK, CA. FILED 4-11-2001.

DR. BENJAMIN SPOCK

THE NAME "DR. BENJAMIN SPOCK" DOES NOT IDENTIFY A LIVING INDIVIDUAL.

FOR ELECTRONIC MAIL SERVICES; DELIVERY OF MESSAGES BY ELECTRONIC TRANSMISSION; PROVIDING ON-LINE CHAT ROOMS AND ELECTRONIC BULLETIN BOARDS FOR THE TRANSMISSION OF MESSAGES AMONG COMPUTER USERS CONCERNING HEALTHCARE, CHILD CARE, NUTRITION, WELLNESS, PARENTING, PREGNANCY AND BEHAVIOR; PROVIDING MULTIPLE USER ACCESS TO A GLOBAL COMPUTER INFORMATION NETWORK FOR THE TRANSFER AND DISSEMINATION OF A WIDE RANGE OF INFORMATION (U.S. CLS. 100, 101 AND 104).

SN 76-257,177. ASAHI SHIMBUN PUBLISHING COMPANY, OSAKA, JAPAN, FILED 5-15-2001.

CLUBAA

PRIORITY CLAIMED UNDER SEC. 44(D) ON JAPAN APPLICATION NO. 200-135446, FILED 12-28-2000, REG. NO. 4547053, DATED 3-1-2002, EXPIRES 3-1-2012.

FOR COMMUNICATION, IE ELECTRONIC MAIL (U.S. CLS. 100, 101 AND 104).

SN 76-258,076. ISKYCOM, INC., EDGEWATER, NJ. FILED 5-16-2001.



THE DESIGN COMPRISES AN ELLIPSE IN THE BACKGROUND WITH THE STYLIZED LETTERS: LOWER CASE "I" AND "C" IN THE FOREGROUND, WITH UPPER CASE "S" IN THE BACKGROUND BETWEEN THE "I" AND "C", AND THE STYLIZED TEXT "ISKYCOM" UNDERNEATH.

FOR DIRECT TO HOME SATELLITE TRANSMISSION SERVICES (U.S. CLS. 100, 101 AND 104).

FIRST USE 4-1-2001; IN COMMERCE 4-1-2001.

CLASS 38—(Continued).

SN 76-267,910. FAIR, RAYMOND C., NEW HAVEN, CT. FILED 6-6-2001.

FAIRMODEL

FOR PROVIDING ACCESS VIA LOCAL AND GLOBAL COMPUTER NETWORKS TO DATABASES OF INFORMATION ABOUT MACROECONOMIC MODELS (U.S. CLS. 100, 101 AND 104).
FIRST USE 0-0-1983; IN COMMERCE 0-0-1983.

SN 76-284,049. SOCKET HOLDINGS CORPORATION, COLUMBIA, MO. BY CHANGE OF NAME SOCKET INTERNET SERVICES, COLUMBIA, MO. FILED 7-12-2001.

SOCKET TELECOM

OWNER OF U.S. REG. NO. 2,054,986.
NO CLAIM IS MADE TO THE EXCLUSIVE RIGHT TO USE "TELECOM", APART FROM THE MARK AS SHOWN.
FOR PROVISION OF WIRELINE AND WIRELESS TELECOMMUNICATION SERVICES, NAMELY, LOCAL INTEREXCHANGE, INTERSTATE AND INTERNATIONAL, SWITCHED AND UNSWITCHED, HIGH SPEED DATA, VOICE AND DATA, AND WIDE AREA NETWORK TRANSMISSION SERVICES (U.S. CLS. 100, 101 AND 104).

SN 76-291,418. PCC HOLDINGS, INC., TAMPA, FL. FILED 7-27-2001.

POWERC

FOR PROVIDING MULTIPLE USER DIAL-UP AND DEDICATED ACCESS TO THE INTERNET; AND LOCAL, LONG DISTANCE AND INTERNATIONAL TELEPHONE COMMUNICATION SERVICES (U.S. CLS. 100, 101 AND 104).

SN 76-291,424. PCC HOLDINGS, INC., TAMPA, FL. FILED 7-27-2001.

EPOWERC

FOR PROVIDING MULTIPLE USER DIAL-UP AND DEDICATED ACCESS TO THE INTERNET; AND LOCAL, LONG DISTANCE AND INTERNATIONAL TELEPHONE COMMUNICATION SERVICES (U.S. CLS. 100, 101 AND 104).

CLASS 38—(Continued).

SN 76-295,300. FIBERRIDE, INC., SAN CLEMENTE, CA. FILED 8-2-2001.

BRINGING TECHNOLOGY HOME

FOR TELECOMMUNICATIONS GATEWAY SERVICES, NAMELY COMMERCIAL AND RESIDENTIAL TELEVISION, INTERNET, AND TELEPHONE ACCESS PROVIDED OVER FIBER OPTIC CABLES, PROVIDING HIGH SPEED INTERNET ACCESS (U.S. CLS. 100, 101 AND 104).
FIRST USE 11-0-2000; IN COMMERCE 11-0-2000.

SN 76-302,118. WORLD BLACK BELT, INC., TARZANA, CA. FILED 8-20-2001.

F.A.N.

FOR TELEVISION BROADCASTING OF FILMS, NEWS, AND SPORTING EVENTS DIRECTED TO MARTIAL ARTS, SELF DEFENSE AND COMBATIVE SPORTS, NAMELY, WRESTLING, BOXING AND KICK BOXING (U.S. CLS. 100, 101 AND 104).

SN 76-308,938. GAUGHAN, MICHAEL J., DELRAN, NJ. FILED 9-5-2001.



FOR ELECTRONIC MAIL SERVICES, INCLUDING GENERATING AND MAINTAINING VIDEO ELECTRONIC MAIL THROUGH A WEBSITE ON A GLOBAL COMPUTER NETWORK; AND ELECTRONIC STORE AND FORWARD MESSAGING SERVICES PROVIDED VIA A WEBSITE ON A GLOBAL COMPUTER NETWORK (U.S. CLS. 100, 101 AND 104).
FIRST USE 3-20-2001; IN COMMERCE 3-20-2001.

SN 76-313,357. NETKEY, INC., BRANFORD, CT. FILED 9-17-2001.

E-ME

FOR ELECTRONIC TRANSMISSION OF DATA AND DOCUMENTS VIA COMPUTER TERMINALS, SPECIFICALLY, THE ELECTRONIC TRANSMISSION OF PRODUCT AND SERVICE INFORMATION FROM ATTENDEES AT MEETINGS, CONFERENCES, AND TRADE SHOWS TO THEMSELVES (U.S. CLS. 100, 101 AND 104).
FIRST USE 8-30-2000; IN COMMERCE 8-30-2000.

CLASS 38—(Continued).

SN 76-320,145. PLANET CASH, LLC, ST. LOUIS, MO. FILED 10-2-2001.

PLANET CASH

NO CLAIM IS MADE TO THE EXCLUSIVE RIGHT TO USE "CASH", APART FROM THE MARK AS SHOWN.
FOR PROVIDING MULTIPLE-USER ACCESS TO A GLOBAL COMPUTER INFORMATION NETWORK (U.S. CLS. 100, 101 AND 104).

SN 76-323,618. DISPATCH PRODUCTIONS, INC., COLUMBUS, OH. FILED 10-10-2001.

ONN

FOR TELEVISION AND RADIO BROADCASTING SERVICES (U.S. CLS. 100, 101 AND 104).
FIRST USE 7-0-1996; IN COMMERCE 7-0-1996.

SN 76-329,340. MANHATTAN TELECOMMUNICATIONS CORPORATION, NEW YORK, NY. FILED 10-24-2001.

MetTel
Metropolitan Telecommunications

OWNER OF U.S. REG. NOS. 2,334,879 AND 2,487,808.
NO CLAIM IS MADE TO THE EXCLUSIVE RIGHT TO USE "TELECOMMUNICATIONS", APART FROM THE MARK AS SHOWN.

FOR TELECOMMUNICATIONS SERVICES, NAMELY LOCAL AND LONG DISTANCE TRANSMISSION OF VOICE, DATA, AND GRAPHICS BY MEANS OF TELEPHONE, TELEGRAPHIC, CABLE, AND SATELLITE TRANSMISSIONS; PROVIDING MULTIPLE-USER ACCESS TO A GLOBAL COMPUTER INFORMATION NETWORK (U.S. CLS. 100, 101 AND 104).

SN 76-329,605. IBASIS SPEECH SOLUTIONS, INC., RESTON, VA. FILED 10-25-2001.

PINPOINT LOCATOR

FOR TELECOMMUNICATIONS SERVICES, NAMELY, PROVIDING A USER WITH ACCESS TO INFORMATION AND DATA RESIDENT ON A GLOBAL COMMUNICATIONS NETWORK IN RESPONSE TO SPEECH AND TELEPHONE KEY COMMANDS; PROCESSING AND TRANSMISSION OF SPEECH; PROCESSING TEXT TO SPEECH AND SPEECH TO TEXT; AND PERSONAL COMMUNICATION SERVICES FEATURING SPEECH RECOGNITION, USING SPEECH-ENABLED TECHNOLOGY (U.S. CLS. 100, 101 AND 104).
FIRST USE 10-0-2001; IN COMMERCE 10-0-2001.

CLASS 38—(Continued).

SN 76-332,342. USCARRIER TELECOM LLC, ATLANTA, GA. FILED 10-30-2001.

DDR BROADBAND NETWORKS

NO CLAIM IS MADE TO THE EXCLUSIVE RIGHT TO USE "BROADBAND NETWORKS", APART FROM THE MARK AS SHOWN.

FOR TELECOMMUNICATIONS SERVICES, NAMELY PROVIDING FIBER OPTIC NETWORK SERVICES (U.S. CLS. 100, 101 AND 104).

FIRST USE 1-1-2002; IN COMMERCE 1-1-2002.

SN 76-339,473. AT&T CORP., NEW YORK, NY. FILED 11-19-2001.



THE DRAWING SUBMITTED IS LINED TO SPECIFY THE COLOR BLUE.

FOR TELECOMMUNICATIONS SERVICES, NAMELY, LOCAL, LONG DISTANCE, AND INTERNATIONAL VOICE, TEXT, FACSIMILE, VIDEO AND DATA TELECOMMUNICATIONS SERVICES; FRAME RELAY TELECOMMUNICATIONS SERVICES; VIRTUAL NETWORK TELECOMMUNICATIONS SERVICES; ELECTRONIC MAIL AND VOICE MAIL AND MESSAGING SERVICES; ELECTRONIC DATA TRANSMISSION PACKET SERVICES; COMPUTER AIDED TRANSMISSION OF MESSAGES AND IMAGES; AUDIO AND VIDEO TELECONFERENCING SERVICES; PRIVATE LINE VOICE, TEXT, FACSIMILE, VIDEO AND DATA TELECOMMUNICATIONS SERVICES; INTEGRATED SERVICES DIGITAL NETWORK (ISDN) TELECOMMUNICATIONS SERVICES; TRANSMISSION OF VOICE, TEXT, FACSIMILE, VIDEO AND DATA VIA SATELLITE, TERRESTRIAL AND UNDERSEA TELECOMMUNICATIONS LINKS; TELEVISION TRANSMISSION SERVICES; 800 TELECOMMUNICATIONS SERVICES; 900 TELECOMMUNICATIONS SERVICES; SWITCHED VOICE, DATA, VIDEO AND MULTIMEDIA SERVICES; ASYNCHRONOUS TRANSFER MODE (ATM) SERVICES; LOCATION INDEPENDENT PERSONAL COMMUNICATIONS SERVICES COMPRISING MOBILE, VOICE, DATA AND FACSIMILE SERVICES; PROVIDING TELECOMMUNICATIONS CONNECTIONS TO WORLDWIDE GLOBAL COMPUTER NETWORKS, OTHER COMPUTER NETWORKS, ON-LINE SERVICES AND BULLETIN BOARDS; PROVIDING BACK BONE TELECOMMUNICATIONS NETWORK SERVICES TO OTHERS TO ENABLE THEM TO DISPLAY CONTENT ON WORLDWIDE GLOBAL COMPUTER NETWORKS, OTHER COMPUTER NETWORKS, ON-LINE SERVICES AND BULLETIN BOARDS; PROVIDING TELECOMMUNICATIONS CONNECTIONS TO ON-LINE INFORMATION SERVICES; THE TRANSMISSION OVER CABLE OF ENTERTAINMENT SERVICES AND VOICE, VIDEO, DATA AND FACSIMILE TELEPHONY SERVICE; WIRELESS TELECOMMUNICATIONS SERVICES, NAMELY, THE WIRELESS TRANSMISSION OF VOICE, FACSIMILE, DATA AND INFORMATION (U.S. CLS. 100, 101 AND 104).
FIRST USE 10-0-1999; IN COMMERCE 10-0-1999.

CLASS 38—(Continued).

SN 76-339,474. AT&T CORP., NEW YORK, NY. FILED 11-19-2001.

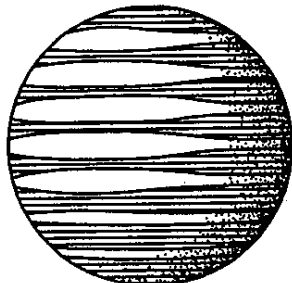

THE DRAWING SUBMITTED IS LINED TO SPECIFY THE COLOR BLUE.

FOR TELECOMMUNICATIONS SERVICES, NAMELY, LOCAL, LONG DISTANCE, AND INTERNATIONAL VOICE, TEXT, FACSIMILE, VIDEO AND DATA TELECOMMUNICATIONS SERVICES; FRAME RELAY TELECOMMUNICATIONS SERVICES; VIRTUAL NETWORK TELECOMMUNICATIONS SERVICES; ELECTRONIC MAIL AND VOICE MAIL AND MESSAGING SERVICES; ELECTRONIC DATA TRANSMISSION PACKET SERVICES; COMPUTER AIDED TRANSMISSION OF MESSAGES AND IMAGES; AUDIO AND VIDEO TELECONFERENCING SERVICES; PRIVATE LINE VOICE, TEXT, FACSIMILE, VIDEO AND DATA TELECOMMUNICATIONS SERVICES; INTEGRATED SERVICES DIGITAL NETWORK (ISDN) TELECOMMUNICATIONS SERVICES; TRANSMISSION OF VOICE, TEXT, FACSIMILE, VIDEO AND DATA VIA SATELLITE, TERRESTRIAL AND UNDERSEA TELECOMMUNICATIONS LINKS; TELEVISION TRANSMISSION SERVICES; 800 TELECOMMUNICATIONS SERVICES; 900 TELECOMMUNICATIONS SERVICES; SWITCHED VOICE, DATA, VIDEO AND MULTIMEDIA SERVICES; ASYNCHRONOUS TRANSFER MODE (ATM) SERVICES; LOCATION INDEPENDENT PERSONAL COMMUNICATIONS SERVICES COMPRISING MOBILE, VOICE, DATA AND FACSIMILE SERVICES; PROVIDING TELECOMMUNICATIONS CONNECTIONS TO WORLDWIDE GLOBAL COMPUTER NETWORKS, OTHER COMPUTER NETWORKS, ON-LINE SERVICES AND BULLETIN BOARDS; PROVIDING BACK BONE TELECOMMUNICATIONS NETWORK SERVICES TO OTHERS TO ENABLE THEM TO DISPLAY CONTENT ON WORLDWIDE GLOBAL COMPUTER NETWORKS, OTHER COMPUTER NETWORKS, ON-LINE SERVICES AND BULLETIN BOARDS; PROVIDING TELECOMMUNICATIONS CONNECTIONS TO ON-LINE INFORMATION SERVICES; THE TRANSMISSION OVER CABLE OF ENTERTAINMENT SERVICES AND VOICE, VIDEO, DATA AND FACSIMILE TELEPHONY SERVICE; WIRELESS TELECOMMUNICATIONS SERVICES, NAMELY, THE WIRELESS TRANSMISSION OF VOICE, FACSIMILE, DATA AND INFORMATION (U.S. CLS. 100, 101 AND 104).

FIRST USE 10-0-1999; IN COMMERCE 10-0-1999.

CLASS 38—(Continued).

SN 76-343,575. EPIK COMMUNICATIONS INCORPORATED, ORLANDO, FL. FILED 12-3-2001.

ENLIGHTENED ETHERNET

NO CLAIM IS MADE TO THE EXCLUSIVE RIGHT TO USE "ETHERNET", APART FROM THE MARK AS SHOWN.

FOR TELECOMMUNICATION SERVICES, NAMELY, ETHERNET TRANSPORT SERVICES FOR SECURE VOICE AND DATA TRANSMISSION FOR BOTH METRO-AREA AND LONG-HAUL CONNECTIVITY WITH FAST AND GIGABIT SPEEDS; SERVICES PROVIDED TO LONG DISTANCE, INTERNATIONAL, AND WIRELESS CARRIERS, INTERNET SERVICE PROVIDERS, AND COMPETITIVE LOCAL EXCHANGE CARRIERS, NAMELY, LOCAL AREA NETWORK AND ETHERNET TRANSPORT SERVICES; TELECOMMUNICATION SERVICES, NAMELY, ETHERNET TECHNOLOGIES, NAMELY, SYNCHRONOUS OPTICAL NETWORK AND INTERNET PROTOCOL ON WAVE OC-192 BACKBONE NETWORK FEATURING MULTI-PROTOCOL LABEL SWITCHING (U.S. CLS. 100, 101 AND 104).

SN 76-350,174. INFINITE CONFERENCING, LLC, SHORT HILLS, NJ. FILED 12-18-2001.

INFINITE CONFERENCING

NO CLAIM IS MADE TO THE EXCLUSIVE RIGHT TO USE "CONFERENCING", APART FROM THE MARK AS SHOWN.

FOR TELECOMMUNICATION SERVICES, NAMELY, PROVIDING TELEPHONE CONFERENCING SERVICES VIA TELEPHONE LINES AND THE INTERNET (U.S. CLS. 100, 101 AND 104).

FIRST USE 4-0-2001; IN COMMERCE 11-0-2001.

SN 76-356,566. CELLCO PARTNERSHIP, DBA VERIZON WIRELESS, BEDMINSTER, NJ. FILED 1-9-2002.

AMERICA'S CHOICE

OWNER OF U.S. REG. NO. 2,472,005.

FOR WIRELESS COMMUNICATION SERVICES, NAMELY, WIRELESS TELEPHONE COMMUNICATION SERVICES AND A RATE PLAN (U.S. CLS. 100, 101 AND 104).

SN 76-376,596. SIERRA BROADCASTING COMPANY, LAS VEGAS, NV. FILED 2-20-2002.

KRNV

FOR TELEVISION BROADCASTING SERVICES (U.S. CLS. 100, 101 AND 104).

FIRST USE 1-22-1990; IN COMMERCE 1-22-1990.

CLASS 38—(Continued).

SN 76-377,995. RCN TELECOM SERVICES, INC., PRINCETON, NJ. FILED 3-1-2002.

MEGAMODEM

FOR INTERNET ACCESS SERVICE (U.S. CLS. 100, 101 AND 104).

SN 76-378,272. PARK-TOURS, INC., SAN DIEGO, CA. FILED 3-6-2002.

PARK-CRUISER

FOR WIRELESS INTERACTIVE COMMUNICATION SERVICES FOR USE BY CONSUMERS IN WIDE-AREA FACILITIES SUCH AS AMUSEMENT PARKS, SHOPPING MALLS, TRADE SHOWS, ZOOS, PARKS, AND THE LIKE, FEATURING MESSAGING, POSITIONING, TELEPHONY, AND TO PROVIDE REAL-TIME INFORMATION ABOUT THE FACILITY VIA HANDHELD COMMUNICATION DEVICES PROVIDED TO PATRONS (U.S. CLS. 100, 101 AND 104).

FIRST USE 8-0-2001; IN COMMERCE 8-0-2001.

SN 76-379,142. MIGRATION MUSIC, INC., APALACHICOLA, FL. FILED 3-7-2002.

MIGRATION RADIO

NO CLAIM IS MADE TO THE EXCLUSIVE RIGHT TO USE "RADIO", APART FROM THE MARK AS SHOWN.

FOR TRANSMISSION OF RADIO PROGRAMMING BY MEANS OF A GLOBAL COMPUTER NETWORK (U.S. CLS. 100, 101 AND 104).

FIRST USE 3-1-2001; IN COMMERCE 3-1-2001.

SN 76-379,271. PETROLEUM COMMUNICATIONS, INC., HARAHAN, LA. FILED 3-8-2002.



OWNER OF U.S. REG. NO. 1,931,188.
FOR PROVIDING CELLULAR TELEPHONE COMMUNICATIONS SERVICES FOR THE OIL AND GAS INDUSTRY (U.S. CLS. 100, 101 AND 104).

CLASS 38—(Continued).

SN 76-380,468. WMTA AM 1380, INC., CENTRAL CITY, KY. FILED 3-11-2002.

WMTA RADIO

NO CLAIM IS MADE TO THE EXCLUSIVE RIGHT TO USE "RADIO", APART FROM THE MARK AS SHOWN.
FOR RADIO BROADCASTING (U.S. CLS. 100, 101 AND 104).

FIRST USE 1-11-1955; IN COMMERCE 1-11-1955.

SN 76-383,972. VERACAST COMMUNICATIONS, INC., SAN FRANCISCO, CA. FILED 3-19-2002.

**VERACAST
COMMUNICATIONS, INC.**

NO CLAIM IS MADE TO THE EXCLUSIVE RIGHT TO USE "COMMUNICATIONS, INC.", APART FROM THE MARK AS SHOWN.

FOR WEBCASTING SERVICES (U.S. CLS. 100, 101 AND 104).

FIRST USE 12-0-1998; IN COMMERCE 2-1-1999.

SN 76-389,806. CBS BROADCASTING INC., NEW YORK, NY. FILED 3-29-2002.

IT'S ALL HERE

FOR TELEVISION BROADCASTING SERVICES (U.S. CLS. 100, 101 AND 104).

FIRST USE 5-31-2000; IN COMMERCE 5-31-2000.

SN 76-390,901. LIGHTHOUSE COMMUNICATIONS, INC., DES MOINES, IA. FILED 4-3-2002.



FOR PROVIDING MULTIPLE USER ACCESS TO A GLOBAL COMMUNICATION NETWORK (U.S. CLS. 100, 101 AND 104).

FIRST USE 12-1-1997; IN COMMERCE 1-1-1998.

CLASS 38—(Continued).

SN 78-051,311. TSUNAMI NETWORKS, INC., NEW YORK, NY. FILED 3-4-2001.

EPANA

"EPANA" IS DERIVED FROM ITS GREEK ROOTS AND APPLICANT BELIEVES THE WORD TO ESSENTIALLY MEAN "REVOLUTION".

FOR ELECTRONIC TRANSMISSION OF DATA, DOCUMENTS AND MESSAGES; PROVIDING CONNECTIVITY SERVICES FOR DATA TRANSFER; PROVIDING TELECOMMUNICATIONS CONNECTIONS TO A GLOBAL COMPUTER NETWORK AND TO A PUBLIC SWITCHED TELEPHONE NETWORK; INTEGRATION OF COMPUTER SYSTEMS AND NETWORKS (U.S. CLS. 100, 101 AND 104).

SN 78-053,139. CUC, INC., BEVERLY HILLS, CA. FILED 3-14-2001.

MIRACLE MONKEY

FOR COMMUNICATION SERVICES, NAMELY, BROADCASTING SERVICES VIA A GLOBAL COMPUTER NETWORK, TELEVISION, RADIO, CABLE, CABLE RADIO, CABLE TELEVISION AND SATELLITE; DIGITAL TRANSMISSION OF VOICE, DATA, INFORMATION, IMAGES, SIGNALS, AND MESSAGES VIA A GLOBAL COMPUTER NETWORK, TELEVISION, RADIO, RADIO CABLE, TELEVISION CABLE, SATELLITE; PROVIDING MULTIPLE USER ACCESS TO ENTERTAINMENT AND EDUCATIONAL CONTENT VIA A GLOBAL INFORMATION NETWORK (U.S. CLS. 100, 101 AND 104).

SN 78-070,531. BCE INC., MONTREAL, QUEBEC, CANADA, FILED 6-22-2001.

BCE CONFERIA

OWNER OF U.S. REG. NOS. 1,468,235 AND 1,528,226. FOR TELECONFERENCING SERVICES, NAMELY, PROVIDING AUDIO TELECONFERENCING TO OTHERS VIA TELEPHONE LINES (U.S. CLS. 100, 101 AND 104).

SN 78-071,795. CAMBRIAN COMMUNICATIONS, LLC, FAIRFAX, VA. FILED 6-29-2001.

ENABLING THE EXPLOSION

FOR PROVIDING TELECOMMUNICATIONS CONNECTIONS TO A GLOBAL COMPUTER NETWORK AND PROVIDING MULTIPLE-USER ACCESS TO A GLOBAL COMPUTER INFORMATION NETWORK (U.S. CLS. 100, 101 AND 104).

FIRST USE 12-0-2000; IN COMMERCE 12-0-2000.

CLASS 38—(Continued).

SN 78-074,752. SIMULSYNC CORP., SAN FRANCISCO, CA. FILED 7-19-2001.

VISUAL800

FOR TELECOMMUNICATIONS SERVICES, NAMELY, PROVIDING ELECTRONIC TRANSMISSIONS OF VOICE, AUDIO, DATA, VIDEO, TEXT, AND INFORMATION SIMULTANEOUSLY OVER A TELEPHONE AND A COMPUTER NETWORK TO TELECOMMUNICATIONS CUSTOMERS USING A TOLL-FREE NUMBER (U.S. CLS. 100, 101 AND 104).

SN 78-074,754. SIMULSYNC CORP., SAN FRANCISCO, CA. FILED 7-19-2001.

VISUAL900

FOR TELECOMMUNICATIONS SERVICES, NAMELY, PROVIDING ELECTRONIC TRANSMISSIONS OF VOICE, AUDIO, DATA, VIDEO, TEXT, AND INFORMATION SIMULTANEOUSLY OVER A TELEPHONE AND A COMPUTER NETWORK TO TELECOMMUNICATIONS CUSTOMER USING A 900 NUMBER (U.S. CLS. 100, 101 AND 104).

SN 78-085,916. TRANS-SITE CORPORATION, GREENFIELD, MA. FILED 9-27-2001.

TRANS-SITE

FOR TELECOMMUNICATIONS SERVICES, NAMELY LEASING SHARED SPACE ON WIRELESS TELECOMMUNICATIONS TRANSMISSION TOWERS (U.S. CLS. 100, 101 AND 104).

FIRST USE 6-30-1972; IN COMMERCE 6-1-1979.

SN 78-086,595. HERMES PHONE, LLC, EAGAN, MN. FILED 10-2-2001.

HERMES

FOR TELECOMMUNICATIONS SERVICES, NAMELY, ELECTRONIC, ELECTRIC AND DIGITAL TRANSMISSION OF VOICE, DATA, IMAGES, SIGNALS AND MESSAGES (U.S. CLS. 100, 101 AND 104).

FIRST USE 7-11-2001; IN COMMERCE 7-11-2001.

SN 78-095,001. ADVENT TELEVISION PTE LTD, SINGAPORE, SINGAPORE, FILED 11-26-2001.

CAPTIVEVISION

FOR AUDIO AND AUDIO VISUAL BROADCASTING SERVICES, CABLE AND SATELLITE BROADCASTING, BROADCASTING PROGRAMS VIA A GLOBAL COMPUTER NETWORK, RADIO AND TELEVISION BROADCASTING (U.S. CLS. 100, 101 AND 104).

CLASS 38—(Continued).

SN 78-095,039. MOORE, ROSCOE M, ARLINGTON, VA. FILED 11-26-2001.

PEERSAT

FOR COMMUNICATION SERVICES, NAMELY, SATELLITES COMMUNICATIONS SERVICES (U.S. CLS. 100, 101 AND 104).

SN 78-103,309. BLACK HILLS FIBERCOM, LLC, RAPID CITY, SD. FILED 1-17-2002.

PC WORKS

NO CLAIM IS MADE TO THE EXCLUSIVE RIGHT TO USE "PC", APART FROM THE MARK AS SHOWN.

FOR DIGITAL CABLE TELEVISION TRANSMISSION SERVICES, TELECOMMUNICATION SERVICES, NAMELY, PROVIDING FIBER OPTIC NETWORK SERVICES/HIGH-SPEED INTERNET ACCESS SERVICES, AND LOCAL AND LONG DISTANCE TELEPHONE SERVICE (U.S. CLS. 100, 101 AND 104).

FIRST USE 9-21-2001; IN COMMERCE 9-21-2001.

SN 78-104,275. DIGITAL TELEMEDIA INC., NEW YORK, NY. FILED 1-23-2002.

LOGICWORKS

FOR COMMUNICATION SERVICES, NAMELY THE STORAGE, PROCESSING, DISTRIBUTION AND ADMINISTRATION OF DIGITAL CONTENT AND MEDIA FOR USE IN CONNECTION WITH DATA TRANSMISSION NETWORKS (U.S. CLS. 100, 101 AND 104).

SN 78-112,647. SAVVIS COMMUNICATIONS CORPORATION, ST. LOUIS, MO. FILED 3-5-2002.

**THE NETWORK THAT
POWERS WALL STREET**

FOR PROVIDING TELECOMMUNICATIONS CONNECTIONS TO A GLOBAL COMPUTER NETWORK (U.S. CLS. 100, 101 AND 104).

CLASS 39—TRANSPORTATION AND STORAGE

CLASS 39—(Continued).

SN 75-697,699. PACIFIC DELIGHT TOURS, INC., NEW YORK, NY. FILED 5-3-1999.

KOREAN FOCUS

OWNER OF U.S. REG. NO. 1,936,316.

NO CLAIM IS MADE TO THE EXCLUSIVE RIGHT TO USE "KOREAN", APART FROM THE MARK AS SHOWN.

FOR ARRANGING AND CONDUCTING TRAVEL TOURS (U.S. CLS. 100 AND 105).

SN 75-855,993. SPANAIR, S.A., 07000 PALMA DE MALLORCA, SPAIN, FILED 11-22-1999.



PRIORITY CLAIMED UNDER SEC. 44(D) ON SPAIN APPLICATION NO. 2253367.2, FILED 8-13-1999, REG. NO. 2253367, DATED 2-2-2000, EXPIRES 8-13-2009.

FOR TRANSPORTATION OF PASSENGERS AND/OR GOODS BY AIR, BOAT, RAIL AND BUS; STORAGE IN GENERAL; AND TRAVEL AGENCY SERVICES, NAMELY, MAKING RESERVATIONS AND BOOKINGS FOR TRANSPORTATION (U.S. CLS. 100 AND 105).

SN 75-879,762. SNV INTERNATIONAL LTD., VANCOUVER, BRITISH COLUMBIA, CANADA, FILED 12-22-1999.

**EXPERIENCE OUR WORLD
CHANGE YOURS FOREVER**

PRIORITY CLAIMED UNDER SEC. 44(D) ON CANADA APPLICATION NO. 1033744, FILED 10-26-1999, REG. NO. TMA545452, DATED 5-22-2001, EXPIRES 5-22-2016.

FOR TRAVEL AGENCY SERVICES, NAMELY, TRAVEL BOOKING SERVICES, TRAVEL CLUB SERVICES, TRAVEL GUIDE SERVICES, TRAVEL INFORMATION SERVICES, TRANSPORTATION RESERVATION AND BOOKING SERVICES, ARRANGING OF CRUISES; TOUR OPERATION SERVICES, NAMELY, ARRANGING TRAVEL TOURS, ARRANGING TRAVEL TOURS AS A BONUS PROGRAM FOR CREDIT CARD CUSTOMERS, TOUR GUIDE SERVICES, ARRANGING EXCURSIONS FOR TOURISTS; AND TOURIST AGENCY SERVICES, NAMELY, CONDUCTING SIGHTSEEING TOURS FOR OTHERS (U.S. CLS. 100 AND 105).

CLASS 39—(Continued).

SN 75-981,725. ANDPAK, INC., MORGAN HILL, CA. FILED 3-18-2000.

IMPACT

FOR PACKING ARTICLES FOR TRANSPORTATION ACCORDING TO THE ORDER AND SPECIFICATION OF OTHERS IN THE CHEMICAL INDUSTRY (U.S. CLS. 100 AND 105).
FIRST USE 6-1-1997; IN COMMERCE 6-1-1997.

SN 76-026,776. ENWAVE DISTRICT ENERGY LIMITED, TORONTO, ONTARIO M5K 1K2, CANADA, FILED 4-12-2000.



PRIORITY CLAIMED UNDER SEC. 44(D) ON CANADA APPLICATION NO. 1053485, FILED 4-3-2000, REG. NO. TMA556501, DATED 1-16-2002, EXPIRES 1-16-2017.
NO CLAIM IS MADE TO THE EXCLUSIVE RIGHT TO USE "ENERGY", APART FROM THE MARK AS SHOWN.
THE LETTERS "EN" ARE IN ORANGE, THE LETTERS "WAVE" ARE IN BLUE, THE DESIGN IS IN BLUE AND COLOR IS CLAIMED AS THE FEATURE OF THE MARK.
THE MARK CONSISTS OF THE WORDING "ENWAVE INNOVATIVE ENERGY SOLUTIONS" AND DESIGN IS SUGGESTIVE OF AN OCEAN WAVE.
FOR PROVIDING FOR OTHERS STEAM AND HOT WATER FOR HEATING, CHILLED WATER FOR COOLING; AND DISTRIBUTION OF ELECTRICITY (U.S. CLS. 100 AND 105).

SN 76-031,263. GETTHERE INC., MENLO PARK, CA. BY CHANGE OF NAME GETTHERE.COM, INC., MENLO PARK, CA. FILED 4-21-2000.

GETTHERE

FOR TRAVEL INFORMATION SERVICES, NAMELY, PROVIDING INFORMATION ABOUT AIRLINES, CAR RENTAL, AND TRAVEL DESTINATIONS (U.S. CLS. 100 AND 105).
FIRST USE 7-15-1999; IN COMMERCE 7-15-1999.

CLASS 39—(Continued).

SN 76-102,824. GAVA INTERNATIONAL FREIGHT CONSOLIDATORS SPA, MILAN, 20060 VIGNATE, ITALY, FILED 8-4-2000.



OWNER OF AUSTRALIA REG. NO. 754359, DATED 2-5-1998, EXPIRES 2-5-2008.
NO CLAIM IS MADE TO THE EXCLUSIVE RIGHT TO USE "GROUP", APART FROM THE MARK AS SHOWN.
FOR FREIGHT FORWARDING (U.S. CLS. 100 AND 105).
FIRST USE 12-0-1979; IN COMMERCE 12-0-1979.

SN 76-142,702. THE PORT AUTHORITY OF NEW YORK AND NEW JERSEY, NEW YORK, NY. FILED 10-6-2000.

AIRTRAIN

FOR TRANSPORTATION SERVICES, NAMELY, COMMERCIAL TRANSPORTATION OF PERSONS AND/OR PROPERTY BY MEANS OF RAIL OR BUS (U.S. CLS. 100 AND 105).

SN 76-148,064. THE PORT AUTHORITY OF NEW YORK AND NEW JERSEY, NEW YORK, NY. FILED 10-17-2000.



FOR TRANSPORTATION SERVICES, NAMELY, COMMERCIAL TRANSPORTATION OF PERSONS AND/OR PROPERTY BY MEANS OF RAIL OR BUS (U.S. CLS. 100 AND 105).

SN 76-149,306. CRUISES INTERNATIONAL, INC., SCHAMBURG, IL. FILED 10-18-2000.

CRUISE REWARDS CARD

NO CLAIM IS MADE TO THE EXCLUSIVE RIGHT TO USE "CRUISE" AND "CARD", APART FROM THE MARK AS SHOWN.
FOR TRAVEL AGENCY SERVICES, NAMELY, MAKING RESERVATIONS AND BOOKINGS FOR TRANSPORTATION (U.S. CLS. 100 AND 105).
FIRST USE 12-1-1999; IN COMMERCE 12-1-1999.

CLASS 39—(Continued).

SN 76-157,680. MOBILITY TECHNOLOGIES, INC., WAYNE, PA. BY CHANGE OF NAME TRAFFIC.COM, INC., WAYNE, PA. FILED 10-30-2000.

TRAFFIC.COM

SEC. 2(F).
FOR TRAFFIC INFORMATION SERVICES (U.S. CLS. 100 AND 105).
FIRST USE 9-25-2000; IN COMMERCE 9-25-2000.

SN 76-192,084. MARS, INCORPORATED, MCLEAN, VA. FILED 1-10-2001.

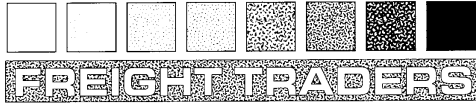

NO CLAIM IS MADE TO THE EXCLUSIVE RIGHT TO USE "FREIGHT", APART FROM THE MARK AS SHOWN.
FOR PROVIDING INFORMATION CONCERNING FREIGHT SHIPPING, FREIGHT CARRYING AND FREIGHT PURCHASING VIA A GLOBAL COMPUTER NETWORK (U.S. CLS. 100 AND 105).
FIRST USE 5-0-2000; IN COMMERCE 5-0-2000.

SN 76-194,719. KEMWEL HOLIDAY AUTOS, LLC, HARRISON, NY. FILED 1-11-2001.

**KEMWEL HOLIDAY AUTOS
THE BEST VALUE IN
EUROPEAN RENTAL CARS**

NO CLAIM IS MADE TO THE EXCLUSIVE RIGHT TO USE "AUTOS" AND "THE BEST VALUE IN EUROPEAN RENTAL CARS", APART FROM THE MARK AS SHOWN.
FOR CAR RENTAL, CAR LEASING, TRAVEL AGENCY SERVICES, NAMELY, MAKING RESERVATIONS AND BOOKINGS FOR TRANSPORTATION AND TOUR GUIDE SERVICES (U.S. CLS. 100 AND 105).

CLASS 39—(Continued).

SN 76-197,507. FLIGHT PARK, NASHVILLE, TN. FILED 1-22-2001.

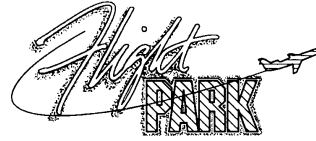

NO CLAIM IS MADE TO THE EXCLUSIVE RIGHT TO USE "PARK", APART FROM THE MARK AS SHOWN.
THE DRAWING IS LINED FOR THE COLORS GREEN AND BLUE. THE STIPPLING IS A FEATURE OF THE MARK AND DOES NOT INDICATE COLOR.
THE MARK CONSISTS OF A BLUE JET WITH SMOKE FORMING A WHITE/BLACK SHADOWED WORD "FLIGHT" OVER THE HUNTER GREEN COLORED WORD "PARK".
FOR PROVIDING VEHICLE PARKING IN LOTS ADJACENT TO AIRPORTS AND TRANSPORTATION OF PERSONS AND THEIR LUGGAGE BY MEANS OF MULTI-PASSENGER VEHICLES - NAMELY, VANS - TO AND FROM AIRPORTS (U.S. CLS. 100 AND 105).

SN 76-216,649. VICTOR VALLEY PROPERTIES, INC., LONG BEACH, CA. FILED 2-26-2001.

POWER STORAGE

NO CLAIM IS MADE TO THE EXCLUSIVE RIGHT TO USE "STORAGE", APART FROM THE MARK AS SHOWN.
FOR SELF STORAGE SERVICES (U.S. CLS. 100 AND 105).
FIRST USE 12-0-2000; IN COMMERCE 12-0-2000.

SN 76-221,660. BEACH RV PARTNERSHIP LTD, HOUSTON, TX. FILED 3-8-2001.



BEACHCOMBER PARK
Lake Buchanan, Texas

NO CLAIM IS MADE TO THE EXCLUSIVE RIGHT TO USE "PARK" AND "LAKE BUCHANAN, TEXAS", APART FROM THE MARK AS SHOWN.
FOR RENTAL OF PARKING SPACES FOR RECREATIONAL VEHICLES (U.S. CLS. 100 AND 105).
FIRST USE 3-0-1999; IN COMMERCE 3-0-1999.

CLASS 39—(Continued).

SN 76-245,954. PACER INTERNATIONAL, INC., WALNUT CREEK, CA. FILED 4-26-2001.

PACER GLOBAL LOGISTICS

NO CLAIM IS MADE TO THE EXCLUSIVE RIGHT TO USE "GLOBAL LOGISTICS", APART FROM THE MARK AS SHOWN.

FOR BROKERING OF FREIGHT TRANSPORTATION BY TRAIN, BOAT, AIR AND TRUCK (U.S. CLS. 100 AND 105).

FIRST USE 1-1-2001; IN COMMERCE 1-1-2001.

SN 76-246,967. VARIG, S. A., RIO DE JANEIRO, BRAZIL, FILED 4-26-2001.

VARIG LOGISTICA

OWNER OF U.S. REG. NOS. 2,142,204, 2,206,117 AND OTHERS.

NO CLAIM IS MADE TO THE EXCLUSIVE RIGHT TO USE "LOGISTICA", APART FROM THE MARK AS SHOWN.

THE ENGLISH TRANSLATION OF "LOGISTICA" IS "LOGISTICS".

FOR AIR TRANSPORTATION SERVICES, NAMELY, TRANSPORTATION OF FREIGHT BY AIR (U.S. CLS. 100 AND 105).

SN 76-252,951. VARIG, S.A., RIO DE JANEIRO, BRAZIL, FILED 5-7-2001.



OWNER OF U.S. REG. NOS. 2,142,204, 2,206,117 AND OTHERS.

THE LINING SHOWN IN THE DRAWING IS A FEATURE OF THE MARK AND NOT INTENDED TO INDICATE COLOR.

THE LETTERS "VARIG" IN THE MARK ARE SHOWN IN THE COLOR BLUE; THE LETTERS "LOG" IN THE MARK ARE SHOWN IN THE COLOR GOLD, THE SERIES OF VERTICAL LINES IN THE CIRCULAR DEVICE TO THE RIGHT OF THE WORDING IS SHOWN IN THE COLOR BLUE, THE TOP UPWARD THRUSTING PORTION OF THE ARROW-LIKE DEVICE TO THE RIGHT OF THE WORDING IS SHOWN IN THE COLOR YELLOW AND THE BOTTOM DOWNWARD THRUSTING PORTION OF THE ARROW-LIKE DEVICE TO THE RIGHT OF THE WORDING IS SHOWN IN THE COLOR GOLD.

FOR AIR TRANSPORTATION SERVICES, NAMELY, TRANSPORTATION OF FREIGHT BY AIR (U.S. CLS. 100 AND 105).

CLASS 39—(Continued).

SN 76-257,836. VARIG, S.A., RIO DE JANEIRO, BRAZIL, FILED 5-15-2001.



OWNER OF U.S. REG. NOS. 2,142,204, 2,206,117 AND OTHERS.

THE LINING SHOWN IN THE DRAWING IS A FEATURE OF THE MARK AND NOT INTENDED TO INDICATE COLOR.

THE LETTERS "VARIG" IN THE MARK ARE SHOWN IN THE COLOR BLUE; THE LETTERS "LOG" IN THE MARK ARE SHOWN IN THE COLOR GOLD, THE SERIES OF VERTICAL LINES IN THE CIRCULAR DEVICE TO THE RIGHT OF THE WORDING IS SHOWN IN THE COLOR BLUE, THE TOP UPWARD THRUSTING PORTION OF THE ARROW-LIKE DEVICE TO THE RIGHT OF THE WORDING IS SHOWN IN THE COLOR YELLOW AND THE BOTTOM DOWNWARD THRUSTING PORTION OF THE ARROW-LIKE DEVICE TO THE RIGHT OF THE WORDING IS SHOWN IN THE COLOR GOLD.

FOR AIR TRANSPORTATION SERVICES, NAMELY, TRANSPORTATION OF FREIGHT BY AIR (U.S. CLS. 100 AND 105).

SN 76-263,134. OPI PRODUCTS, INC., NORTH HOLLYWOOD, CA. FILED 5-29-2001.

NOHO STORAGE

NO CLAIM IS MADE TO THE EXCLUSIVE RIGHT TO USE "STORAGE", APART FROM THE MARK AS SHOWN.

FOR PUBLIC STORAGE FACILITY SERVICES (U.S. CLS. 100 AND 105).

SN 76-275,716. SAME DAY, INC., AKA SAME DAY USA, EAST GRANBY, CT. FILED 6-21-2001.



FOR PACKAGE AND FREIGHT TRANSPORTATION BY MEANS OF TRUCK AND AIR; WAREHOUSE STORAGE (U.S. CLS. 100 AND 105).

FIRST USE 1-1-2000; IN COMMERCE 1-1-2000.

CLASS 39—(Continued).

SN 76-277,877. AFTERMARKET TECHNOLOGY CORP., WESTMONT, IL. FILED 6-25-2001.



FOR WAREHOUSING SERVICES; TRANSPORTATION OF AUTOMOTIVE PRODUCTS FOR OTHERS (U.S. CLS. 100 AND 105).

FIRST USE 5-0-1998; IN COMMERCE 5-0-1998.

SN 76-290,700. EMORY HEALTHCARE, INC., ATLANTA, GA. FILED 7-26-2001.

EMORYFLIGHT

OWNER OF U.S. REG. NOS. 2,222,078 AND 2,225,907. FOR TRANSPORTING PASSENGERS FOR MEDICAL PURPOSES BY MEANS OF HELICOPTER (U.S. CLS. 100 AND 105).

SN 76-304,279. KOESAR, JOSEPH D., ORLANDO, FL. FILED 8-24-2001.

CHEAPER THAN A DUI

OWNER OF U.S. REG. NOS. 2,302,766 AND 2,471,856. FOR TRANSPORTATION SERVICES IN THE NATURE OF TRANSPORTING INTOXICATED INDIVIDUALS AND THEIR VEHICLES (U.S. CLS. 100 AND 105).

FIRST USE 8-20-2000; IN COMMERCE 8-20-2000.

SN 76-308,422. SECRET SEAS, LLC, NEW YORK, NY. FILED 9-4-2001.

SECRET SEAS

FOR TRAVEL AGENCY SERVICES, NAMELY ARRANGING TOURS AND VACATION PACKAGES (U.S. CLS. 100 AND 105).

CLASS 39—(Continued).

SN 76-310,774. MILEPOST TRANSPORTATION SERVICES, LLC, OAKBROOK TERRACE, IL. FILED 9-10-2001.

MILEPOST TRANSPORTATION

NO CLAIM IS MADE TO THE EXCLUSIVE RIGHT TO USE "TRANSPORTATION", APART FROM THE MARK AS SHOWN.

FOR TRANSPORTATION OF PASSENGERS, NAMELY, TRANSPORTATION OF RAILROAD AND AIRLINE CREW PERSONNEL VIA AUTOMOBILE, VAN AND BUS (U.S. CLS. 100 AND 105).

FIRST USE 12-9-1999; IN COMMERCE 12-9-1999.

SN 76-316,100. DELTA CORPORATE IDENTITY, INC., ATLANTA, GA. FILED 9-21-2001.

DELTA AIRELITE

OWNER OF U.S. REG. NOS. 654,915, 1,703,774 AND OTHERS.

FOR AIR TRANSPORTATION (U.S. CLS. 100 AND 105).

FIRST USE 10-15-2001; IN COMMERCE 10-15-2001.

SN 76-318,954. GOLDEN GATE BRIDGE, HIGHWAY AND TRANSPORTATION DISTRICT, SAN FRANCISCO, CA. FILED 9-27-2001.



FOR TRANSPORTATION OF PASSENGERS AND/OR GOODS BY FERRY AND BUS; PROVIDING INFORMATION ABOUT PUBLIC TRANSIT; BRIDGE OPERATION SERVICES (U.S. CLS. 100 AND 105).

FIRST USE 9-4-2001; IN COMMERCE 9-4-2001.

CLASS 39—(Continued).

SN 76-318,955. GOLDEN GATE BRIDGE, HIGHWAY AND TRANSPORTATION DISTRICT, SAN FRANCISCO, CA. FILED 9-27-2001.

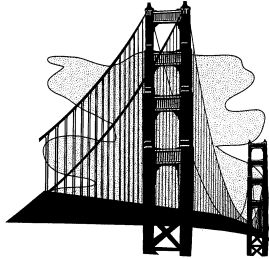

THE STIPPLING IN THE DRAWING IS FOR SHADING PURPOSES AND IS NOT INTENDED TO INDICATE COLOR.

THE MARK CONSISTS OF A BRIDGE AGAINST A BACKGROUND OF SKY.

FOR TRANSPORTATION OF PASSENGERS AND/OR GOODS BY FERRY AND BUS; PROVIDING INFORMATION ABOUT PUBLIC TRANSIT; BRIDGE OPERATION SERVICES (U.S. CLS. 100 AND 105).

FIRST USE 8-1-2001; IN COMMERCE 8-1-2001.

SN 76-319,799. WE STOW, INC., PARIS, TX. FILED 10-1-2001.

WE STOW

NO CLAIM IS MADE TO THE EXCLUSIVE RIGHT TO USE "STOW", APART FROM THE MARK AS SHOWN.

FOR STORAGE AND SELF-STORAGE CONTAINER SERVICES (U.S. CLS. 100 AND 105).

SN 76-322,411. CLEAN DRY AIR, INC., WEST HENRIETTA, NY. FILED 10-9-2001.

ContractAIR

FOR COMPRESSED AIR SERVICES, NAMELY, TRANSMISSION, DISTRIBUTION AND STORAGE OF COMPRESSED AIR FOR GENERAL INDUSTRIAL, COMMERCIAL AND MILITARY USE (U.S. CLS. 100 AND 105).

FIRST USE 5-3-1999; IN COMMERCE 5-3-1999.

SN 76-329,154. DOLLAR RENT A CAR SYSTEMS, INC., TULSA, OK. FILED 10-24-2001.

BUSINESSPLUS

FOR VEHICLE RENTING AND LEASING SERVICES SPECIALLY TAILORED FOR FREQUENT CUSTOMERS (U.S. CLS. 100 AND 105).

FIRST USE 6-24-1997; IN COMMERCE 6-24-1997.

CLASS 39—(Continued).

SN 76-335,980. GOLDEN GATE BRIDGE, HIGHWAY AND TRANSPORTATION DISTRICT, SAN FRANCISCO, CA. FILED 11-8-2001.

GOLDEN GATE FERRY

NO CLAIM IS MADE TO THE EXCLUSIVE RIGHT TO USE FERRY, APART FROM THE MARK AS SHOWN. SEC. 2(F).

FOR TRANSPORTATION OF PASSENGERS AND GOODS BY FERRY; PROVIDING INFORMATION ABOUT PUBLIC TRANSIT (U.S. CLS. 100 AND 105).

FIRST USE 8-15-1970; IN COMMERCE 8-15-1970.

SN 76-339,661. STORAGE WORLD, L.P., DBA STORAGE SPOT, BRADENTON, FL. FILED 11-20-2001.

STORAGE SPOT

SUBJECT TO CONCURRENT USE PROCEEDING WITH STORAGE SPOT, WHOSE ADDRESS IS C/O MARY TEMPLE W. MULLIS, 233 W. LOOKOUT ROAD, NAGS HEAD, N.C. 27939-9461 (THE "CONCURRENT USER"). APPLICANT CLAIMS EXCLUSIVE RIGHT TO USE THE MARK IN THE AREA COMPRISING ALL OF THE UNITED STATES EXCEPT NAGS HEAD, NORTH CAROLINA.

NO CLAIM IS MADE TO THE EXCLUSIVE RIGHT TO USE "STORAGE", APART FROM THE MARK AS SHOWN. FOR PROVIDING SELF-SERVICE STORAGE FACILITIES FOR STORAGE OF GOODS BY OTHERS (U.S. CLS. 100 AND 105).

FIRST USE 7-1-2001; IN COMMERCE 7-1-2001.

SN 76-349,896. COLUMBIA COLSTOR, INC., MOSES LAKE, WA. FILED 12-11-2001.

**SMALL TOWN INTEGRITY,
WORLD CLASS SERVICE**

FOR TRANSPORTATION OF GOODS BY RAILCAR AND TRUCK; STORAGE OF REFRIGERATED AND FROZEN FOOD; DELIVERY OF REFRIGERATED AND FROZEN FOOD AND RELATED PRODUCTS BY MEANS OF RAILCAR AND TRUCK (U.S. CLS. 100 AND 105).

FIRST USE 10-31-1983; IN COMMERCE 10-31-1983.

CLASS 39—(Continued).

SN 76-349,897. COLUMBIA COLSTOR, INC., MOSES LAKE, WA. FILED 12-11-2001.



FOR TRANSPORTATION OF GOODS BY RAILCAR AND TRUCK; STORAGE OF REFRIGERATED AND FROZEN FOOD; DELIVERY OF REFRIGERATED AND FROZEN FOOD AND RELATED PRODUCTS BY MEANS OF RAILCAR AND TRUCK (U.S. CLS. 100 AND 105).
FIRST USE 10-31-1983; IN COMMERCE 10-31-1983.

SN 76-353,304. VACUUM TRUCK RENTALS LLC, RICHLAND, MS. FILED 12-31-2001.



NO CLAIM IS MADE TO THE EXCLUSIVE RIGHT TO USE "VACUUM TRUCK RENTALS LLC", APART FROM THE MARK AS SHOWN.
THE LINING IN THE DRAWING INDICATES SHADING IN THE MARK. THE APPLICANT CLAIMS GREEN AND BLUE AS FEATURES OF THE MARK.
FOR RENTALS OF VACUUM EXCAVATOR TRUCKS THAT ARE USED FOR ENVIRONMENTAL AND INDUSTRIAL CLEANUP, VACUUM LOADING, JETTING, HYDRO-EXCAVATING, TRENCH DIGGING, TUNNELING, FLUID REMOVAL, POTHOLING; DAYLIGHTING, AND AIR CONVEYING (U.S. CLS. 100 AND 105).
FIRST USE 10-1-2000; IN COMMERCE 10-1-2000.

CLASS 39—(Continued).

SN 76-366,637. CRYOGENIC TRANSPORTATION, INC., OMAHA, NE. FILED 2-4-2002.



NO CLAIM IS MADE TO THE EXCLUSIVE RIGHT TO USE "CRYOGENIC TRANSPORTATION INC.", APART FROM THE MARK AS SHOWN.
FOR TRANSPORTATION OF INDUSTRIAL GASES BY TRUCK (U.S. CLS. 100 AND 105).
FIRST USE 1-11-1982; IN COMMERCE 1-11-1982.

SN 76-371,154. DELIVERY EXPRESS - OREGON, L.L.C., PORTLAND, OR. FILED 2-15-2002.

DELEX

FOR COURIER SERVICES (U.S. CLS. 100 AND 105).

SN 76-373,282. CORYN GROUP, INC., THE, NEWTOWN SQUARE, PA. FILED 2-22-2002.



OWNER OF U.S. REG. NOS. 1,462,268, 1,465,887 AND 1,812,427.
FOR ARRANGING TRAVEL TOURS (U.S. CLS. 100 AND 105).
FIRST USE 11-1-1988; IN COMMERCE 11-1-1988.

CLASS 39—(Continued).

SN 76-375,074. GORBETT ENTERPRISES OF SOLON, INC., SOLON, OH. FILED 2-26-2002.



NO CLAIM IS MADE TO THE EXCLUSIVE RIGHT TO USE "COLD STORAGE", APART FROM THE MARK AS SHOWN.
 FOR COLD STORAGE AND REFRIGERATED WAREHOUSE SERVICES (U.S. CLS. 100 AND 105).
 FIRST USE 4-1-1999; IN COMMERCE 4-1-1999.

SN 76-377,006. WANDERING WAITERS, INC., CRYSTAL LAKE, IL. FILED 3-1-2002.

WANDERING WAITERS

FOR RESTAURANT FOOD DELIVERY SERVICES (U.S. CLS. 100 AND 105).

SN 76-377,486. F.O.D. CONTROL CORPORATION, THE, TUCSON, AZ. FILED 3-4-2002.

INCREASE SAFETY, SAVE MONEY

FOR PROVIDING INFORMATION IN THE FIELD OF AVIATION, NAMELY, INFORMATION REGARDING FOREIGN OBJECT DEBRIS AND DAMAGE (U.S. CLS. 100 AND 105).
 FIRST USE 7-16-1998; IN COMMERCE 10-1-1998.

SN 76-378,058. ROYAL CARIBBEAN CRUISES LTD., MIAMI, FL. FILED 3-6-2002.

MARINER OF THE SEAS

OWNER OF U.S. REG. NOS. 1,513,971, 2,173,260 AND OTHERS.
 FOR CRUISE SHIP SERVICES; ARRANGING AND CONDUCTING CRUISES FOR OTHERS; TRANSPORTATION OF PASSENGERS BY SHIP (U.S. CLS. 100 AND 105).

CLASS 39—(Continued).

SN 76-378,059. ROYAL CARIBBEAN CRUISES LTD., MIAMI, FL. FILED 3-6-2002.

NAVIGATOR OF THE SEAS

FOR CRUISE SHIP SERVICES; ARRANGING AND CONDUCTING CRUISES FOR OTHERS; TRANSPORTATION OF PASSENGERS BY SHIP (U.S. CLS. 100 AND 105).

SN 76-380,209. PILOT AIR FREIGHT CORP., LIMA, PA. FILED 3-8-2002.

CO-PILOT

FOR PROVIDING ON-LINE FREIGHT SHIPPING INFORMATION VIA AN INTERNET WEBSITE (U.S. CLS. 100 AND 105).
 FIRST USE 1-15-2002; IN COMMERCE 1-15-2002.

SN 76-380,311. K.L.S. TRANSPORTATION SERVICE, INC., BEVERLY HILLS, CA. FILED 3-8-2002.

KLS LIMOUSINE SERVICE

NO CLAIM IS MADE TO THE EXCLUSIVE RIGHT TO USE "LIMOUSINE SERVICE", APART FROM THE MARK AS SHOWN.
 FOR LIMOUSINE TRANSPORTATION SERVICES (U.S. CLS. 100 AND 105).
 FIRST USE 6-6-2001; IN COMMERCE 7-16-2001.

SN 76-382,451. GOGO TOURS, INC., RAMSEY, NY. FILED 3-13-2002.

EARN MORE MONEY

FOR TRAVEL AGENCY SERVICES, NAMELY, PROVIDING RESERVATIONS AND BOOKINGS FOR TRANSPORTATION (U.S. CLS. 100 AND 105).
 FIRST USE 12-1-2001; IN COMMERCE 12-1-2001.

SN 76-384,264. MAVERICK DISPOSAL SERVICES, FLINT, MI. FILED 3-12-2002.

MAVERICK

FOR TRANSPORTATION AND DISPOSAL OF GARBAGE AND REFUSE (U.S. CLS. 100 AND 105).
 FIRST USE 6-1-2001; IN COMMERCE 8-1-2001.

CLASS 39—(Continued).

SN 76-390,881. LEVINE, LAURENCE CECIL, CAPE TOWN, SOUTH AFRICA, FILED 4-3-2002.



OWNER OF U.S. REG. NO. 2,156,202.
FOR FOOD DELIVERY OF RESTAURANT PREPARED FOOD (U.S. CLS. 100 AND 105).

SN 78-102,938. MASTERSON, GEORGE, C, ANAHEIM HILLS, CA. FILED 1-16-2002.

MOTORSPORT ADVENTURES

NO CLAIM IS MADE TO THE EXCLUSIVE RIGHT TO USE "MOTORSPORT", APART FROM THE MARK AS SHOWN.
FOR ARRANGING TRAVEL TOURS (U.S. CLS. 100 AND 105).

CLASS 40—MATERIAL TREATMENT

SN 76-002,153. PHOTOTIME, INC., PALO ALTO, CA. FILED 3-16-2000.

PHOTOTIME

FOR PHOTOGRAPHIC PROCESSING AND FINISHING SERVICES (U.S. CLS. 100, 103 AND 106).
FIRST USE 1-1-1982; IN COMMERCE 1-1-1982.

SN 76-083,238. BARTON MINES CORPORATION, LAKE GEORGE, NY. FILED 7-5-2000.

THE BARTON GROUP

NO CLAIM IS MADE TO THE EXCLUSIVE RIGHT TO USE "GROUP", APART FROM THE MARK AS SHOWN.
SEC. 2(F).
FOR MANUFACTURE OF CUTTING, FINISHING AND SURFACE PREPARATION PRODUCTS, NAMELY, GARNET ABRASIVE GRAINS AND POWDERS, COATED AND BONDED ABRASIVES AND SAND-BLASTING ABRASIVES FOR INDUSTRIAL AND COMMERCIAL APPLICATIONS TO THE ORDER AND SPECIFICATION OF OTHERS (U.S. CLS. 100, 103 AND 106).
FIRST USE 11-0-1999; IN COMMERCE 11-0-1999.

CLASS 40—(Continued).

SN 76-099,482. PUGA, CARLOS, WEST LOS ANGELES, CA. FILED 7-31-2000.



NO CLAIM IS MADE TO THE EXCLUSIVE RIGHT TO USE "DENTAL STUDIOS", APART FROM THE MARK AS SHOWN.
FOR COSMETIC DENTAL LABORATORY (U.S. CLS. 100, 103 AND 106).
FIRST USE 10-0-1989; IN COMMERCE 10-0-1989.

SN 76-133,719. NEWBIO, INC., WAYZATA, MN. FILED 9-22-2000.

BIOGUARD

FOR ENVIRONMENTAL REMEDIATION SERVICES, NAMELY, SOIL, WASTE AND/OR WATER TREATMENT SERVICES; AND PROVIDING INFORMATION REGARDING POLLUTION AND ENVIRONMENTAL REMEDIATION VIA THE INTERNET (U.S. CLS. 100, 103 AND 106).

SN 76-137,215. FANBUZZ, INC., MINNETONKA, MN. BY CHANGE OF NAME FANBUZZ.COM, INC., HERMITAGE, PA. FILED 9-28-2000.

CUSTOMFAN

FOR DECORATING AND PERSONALIZING SPORTSWEAR FOR OTHERS BY MEANS OF IMPRINTING, HEAT TRANSFER, EMBROIDERY AND APPLIQUE (U.S. CLS. 100, 103 AND 106).
FIRST USE 3-12-2001; IN COMMERCE 3-12-2001.

CLASS 40—(Continued).

SN 76-165,844. FANBUZZ, INC., MINNETONKA, MN. BY CHANGE OF NAME FANBUZZ.COM, INC., HERMITAGE, PA. FILED 11-15-2000.



FOR DECORATING AND PERSONALIZING SPORTSWEAR FOR OTHERS BY MEANS OF IMPRINTING, HEAT TRANSFER, EMBROIDERY AND APPLIQUE (U.S. CLS. 100, 103 AND 106).

FIRST USE 3-12-2001; IN COMMERCE 3-12-2001.

SN 76-198,581. CANAAN ENERGY CORPORATION, OKLAHOMA CITY, OK. FILED 1-23-2001.

CANAAN ENERGY CORPORATION

NO CLAIM IS MADE TO THE EXCLUSIVE RIGHT TO USE "ENERGY CORPORATION", APART FROM THE MARK AS SHOWN.

FOR GAS PRODUCTION SERVICES; OIL PRODUCTION SERVICES (U.S. CLS. 100, 103 AND 106).

FIRST USE 1-13-2000; IN COMMERCE 1-13-2000.

SN 76-210,244. CVG PRODUCT SERVICES INC., PENNSAUKEN, NJ. FILED 2-15-2001.

OMNI OPTICAL LAB

OWNER OF U.S. REG. NO. 2,028,785.
NO CLAIM IS MADE TO THE EXCLUSIVE RIGHT TO USE "OPTICAL LAB", APART FROM THE MARK AS SHOWN.

FOR MANUFACTURE OF EYEGASSES AND CONTACT LENSES TO ORDER AND/OR SPECIFICATION OF OTHERS (U.S. CLS. 100, 103 AND 106).

FIRST USE 3-27-2001; IN COMMERCE 3-27-2001.

SN 76-212,765. VENNETTI, RALPH S., BENSENVILLE, IL. FILED 2-20-2001.

VEEPAK

FOR CONTRACT MANUFACTURING FOR OTHERS OF NON-STERILIZED PRODUCTS IN THE AREA OF PERSONAL CARE, HOUSEHOLD AND OVER-THE-COUNTER DRUG PRODUCTS (U.S. CLS. 100, 103 AND 106).

FIRST USE 2-0-1989; IN COMMERCE 2-0-1989.

CLASS 40—(Continued).

SN 76-216,845. RECYCLING FORESTRY INDUSTRIES HOLDING, INC., WHITE PLAINS, NY. FILED 2-27-2001.

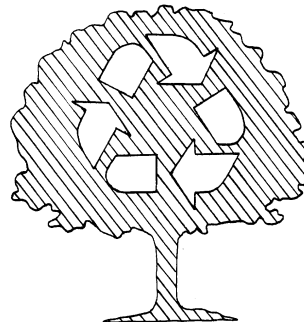

NO CLAIM IS MADE TO THE EXCLUSIVE RIGHT TO USE THE RECYCLING SYMBOL, APART FROM THE MARK AS SHOWN.

THE DRAWING IS LINED FOR THE COLOR(S) GREEN.
FOR WASTE WOOD TRANSFORMATION SERVICES, NAMELY, TRANSFORMING WOOD WASTE AND FORESTRY WOOD REMNANTS INTO USEFUL PRODUCTS (U.S. CLS. 100, 103 AND 106).

FIRST USE 1-1-2001; IN COMMERCE 1-1-2001.

SN 76-235,387. YAKIMA CHIEF, INC., SUNNYSIDE, WA. FILED 4-3-2001.

PHYTASSURE

FOR PROCESSING PLANT BASED MATERIALS FOR OTHERS, FOR USE IN THE MANUFACTURE OF NUTRITIONAL AND DIETARY SUPPLEMENTS AND COSMETIC PRODUCTS (U.S. CLS. 100, 103 AND 106).

SN 76-240,009. HOH CORPORATION, WINSTON-SALEM, NC. FILED 4-12-2001.

HOH

FOR TREATMENT OF NON-HAZARDOUS INDUSTRIAL WASTE (U.S. CLS. 100, 103 AND 106).
FIRST USE 3-26-1991; IN COMMERCE 3-26-1991.

SN 76-246,176. VARCO PRUDEN TECHNOLOGIES, INC., MEMPHIS, TN. BY ASSIGNMENT VP BUILDINGS, INC., MEMPHIS, TN. FILED 4-25-2001.

UNITED COMPOSITES

NO CLAIM IS MADE TO THE EXCLUSIVE RIGHT TO USE "COMPOSITES", APART FROM THE MARK AS SHOWN.

FOR CUSTOM MANUFACTURE OF WALL AND ROOF PANELS (U.S. CLS. 100, 103 AND 106).

CLASS 40—(Continued).

SN 76-253,151. STURM FOODS, INC., MANAWA, WI. FILED 5-4-2001.

STURM FOODS

OWNER OF U.S. REG. NOS. 1,046,946 AND 1,262,561.
 NO CLAIM IS MADE TO THE EXCLUSIVE RIGHT TO USE "FOODS", APART FROM THE MARK AS SHOWN. SEC. 2(F) AS TO "STURM".
 FOR CUSTOM MANUFACTURE OF FOOD AND BEVERAGES FOR OTHERS (U.S. CLS. 100, 103 AND 106).
 FIRST USE 7-0-2000; IN COMMERCE 7-0-2000.

SN 76-266,272. SCHINDLER, A. RUSSEL, TRAVERSE CITY, MI. FILED 6-5-2001.

E-DOT SYSTEMS

NO CLAIM IS MADE TO THE EXCLUSIVE RIGHT TO USE "SYSTEMS", APART FROM THE MARK AS SHOWN. FOR ENVIRONMENTAL REMEDIATION SERVICES, NAMELY GROUNDWATER RECOVERY TREATMENT SERVICES (U.S. CLS. 100, 103 AND 106).
 FIRST USE 12-0-2000; IN COMMERCE 12-0-2000.

SN 76-283,132. GRUNER + JAHR PRINTING AND PUBLISHING CO., WASECA, MN. FILED 7-12-2001.



FOR PRINTING SERVICES, NAMELY HIGH VOLUME PUBLICATION PRINTING OF MAGAZINES, AND COMMERCIAL PRINTING OF CATALOGS AND INSERTS (U.S. CLS. 100, 103 AND 106).
 FIRST USE 12-18-1996; IN COMMERCE 12-18-1996.

SN 76-302,908. DIVIAK, JOHN J. SR., BENSENVILLE, IL. FILED 8-22-2001.



OWNER OF U.S. REG. NO. 1,974,687.
 NO CLAIM IS MADE TO THE EXCLUSIVE RIGHT TO USE "CUT", APART FROM THE MARK AS SHOWN.
 FOR MANUFACTURE OF METAL PARTS TO ORDER AND/OR SPECIFICATION OF OTHERS (U.S. CLS. 100, 103 AND 106).

CLASS 40—(Continued).

SN 76-304,030. KELL CONTAINER CORPORATION, CHIPPEWA FALLS, WI. FILED 8-23-2001.

KELL SPECIALTY PRODUCTS

NO CLAIM IS MADE TO THE EXCLUSIVE RIGHT TO USE "SPECIALTY PRODUCTS", APART FROM THE MARK AS SHOWN.
 SEC. 2(F).
 FOR MANUFACTURE OF CORRUGATED PRODUCTS TO ORDER AND/OR SPECIFICATION OF OTHERS (U.S. CLS. 100, 103 AND 106).
 FIRST USE 4-0-1996; IN COMMERCE 4-0-1996.

SN 76-304,398. LENS DYNAMICS, INC., LAKEWOOD, CO. FILED 8-27-2001.

DYNA INTRA-LIMBAL

NO CLAIM IS MADE TO THE EXCLUSIVE RIGHT TO USE "INTRA-LIMBAL", APART FROM THE MARK AS SHOWN.
 FOR MANUFACTURE OF SPECIALTY RIGID CONTACT LENSES TO ORDER AND/OR SPECIFICATION OF OTHERS (U.S. CLS. 100, 103 AND 106).
 FIRST USE 7-1-2001; IN COMMERCE 7-1-2001.

SN 76-323,577. P. H. GLATFELTER COMPANY, YORK, PA. FILED 10-10-2001.

BEYOND PAPER

FOR APPLYING PROTECTIVE, DECORATIVE, AND PERFORMANCE-ENHANCING COATINGS TO PAPER, SPECIALTY PAPERS, MELTBLOWN NONWOVEN MATERIALS, AND WETLAND NONWOVEN MATERIALS (U.S. CLS. 100, 103 AND 106).

SN 76-338,158. INTECH DIRECT, INC., NORTHBROOK, IL. FILED 11-15-2001.

MAGJET

FOR ELECTRONIC HIGH SPEED IMAGING OF PLASTIC CARDS AND ENCODING OF PLASTIC CARDS PERFORMED TO THE ORDER AND SPECIFICATION OF OTHERS (U.S. CLS. 100, 103 AND 106).
 FIRST USE 5-1-1998; IN COMMERCE 5-1-1998.

CLASS 40—(Continued).

SN 76-350,329. VARC, INC., BOISE, ID. FILED 12-20-2001.

CRYSTAL BALL TECHNOLOGIES

NO CLAIM IS MADE TO THE EXCLUSIVE RIGHT TO USE "TECHNOLOGIES", APART FROM THE MARK AS SHOWN.

FOR ELECTRONIC IMAGING SERVICES, NAMELY ACQUIRING A STILL OR MOVING IMAGE AT A REMOTE SITE, TRANSFERRING THAT IMAGE TO A SERVER ACCESSIBLE TO MULTIPLE USERS ON A GLOBAL COMPUTER NETWORK, AND ALLOWING USERS TO MANIPULATE AND PRINT OR DOWNLOAD THE IMAGE (U.S. CLS. 100, 103 AND 106).

SN 76-356,983. CHARLES BREWER E.D.M., INC., DBA C. BREWER COMPANY, ANAHEIM, CA. FILED 1-8-2002.

PERFECTING THE SCIENCE OF MOLDING

FOR PROVIDING INJECTION MOLDING SERVICES (U.S. CLS. 100, 103 AND 106).
FIRST USE 10-0-2001; IN COMMERCE 10-0-2001.

SN 76-358,988. BECKER GALLAGHER LEGAL PUBLISHING INCORPORATED, CINCINNATI, OH. FILED 1-15-2002.



FOR LEGAL SERVICES, NAMELY LEGAL PUBLISHING, NAMELY, PRINTING OF LEGAL DOCUMENTS FOR OTHERS (U.S. CLS. 100, 103 AND 106).
FIRST USE 10-22-2001; IN COMMERCE 10-22-2001.

SN 76-362,852. EJ FOOTWEAR, LLC, FRANKLIN, TN. FILED 1-24-2002.

BEACON STRATEGIC RESOURCING

NO CLAIM IS MADE TO THE EXCLUSIVE RIGHT TO USE "STRATEGIC RESOURCING", APART FROM THE MARK AS SHOWN.

FOR CONSULTING FOR DOMESTIC COMPANIES IN THE FIELD OF CONTRACTING FOR THE MANUFACTURE OF HARD GOODS BY OVERSEAS FACTORIES FOR IMPORT AND SALE IN THE UNITED STATES (U.S. CLS. 100, 103 AND 106).

CLASS 40—(Continued).

SN 76-364,286. SEAL CUT KNIFE LLC, GREENDALE, WI. FILED 1-29-2002.

SEAL CUT

FOR CUSTOM MANUFACTURE OF KNIVES FOR USE IN THE PACKAGING INDUSTRY (U.S. CLS. 100, 103 AND 106).

FIRST USE 8-17-2001; IN COMMERCE 8-17-2001.

SN 76-371,410. WASTE MANAGEMENT, INC., HOUSTON, TX. FILED 2-14-2002.

THE SERVICE MACHINE

FOR WASTE MANAGEMENT SERVICES (U.S. CLS. 100, 103 AND 106).

SN 76-371,887. BUCKEYE COLOR LAB, INC., NORTH CANTON, OH. FILED 2-19-2002.

BUCKEYE

FOR DEVELOPING AND RETOUCHING SERVICES OF DIGITAL AND OPTICAL PHOTOGRAPHS DIRECTED TO PROFESSIONAL PHOTOGRAPHERS (U.S. CLS. 100, 103 AND 106).

FIRST USE 7-1-1978; IN COMMERCE 7-1-1978.

SN 76-372,892. LABELS UNLIMITED, INC., VIRGINIA BEACH, VA. FILED 2-20-2002.

WE ATTACH IMPORTANCE TO YOUR PRODUCTS

FOR CUSTOM MANUFACTURE OF LABELS USED FOR PROMOTION, PRICING, SHIPPING AND HANDLING, PRODUCT BRANDING, WEIGHT OF PRODUCTS, AND BAR CODES (U.S. CLS. 100, 103 AND 106).
FIRST USE 3-9-1990; IN COMMERCE 3-9-1990.

SN 76-374,181. CHUNG, THAI Q., LEWISVILLE, NC. FILED 2-25-2002.

VISUALLINX

FOR DIGITAL IMAGING SERVICES, NAMELY TAKING DIGITAL IMAGES FOR MAKING PICTURES FOR OTHERS (U.S. CLS. 100, 103 AND 106).

CLASS 40—(Continued).

SN 76-383,398. B.J. TIDWELL INDUSTRIES, INC., SAN ANTONIO, TX. FILED 3-18-2002.

SPECTRUM 360 SERIES

NO CLAIM IS MADE TO THE EXCLUSIVE RIGHT TO USE "SERIES", APART FROM THE MARK AS SHOWN.
 FOR MANUFACTURE OF KITCHEN AND BATHROOM CABINETS TO THE ORDER AND SPECIFICATION OF OTHERS (U.S. CLS. 100, 103 AND 106).
 FIRST USE 1-1-2002; IN COMMERCE 1-1-2002.

SN 76-383,937. VSK PHOTONICS, INC., LAKE FOREST, CA. FILED 3-14-2002.



NO CLAIM IS MADE TO THE EXCLUSIVE RIGHT TO USE "PHOTONICS", APART FROM THE MARK AS SHOWN.
 FOR CUSTOM MANUFACTURE OF HIGH-SPEED OPTOELECTRONIC COMPONENTS, SUBSYSTEMS, MODULES AND SEMICONDUCTORS FOR OTHERS (U.S. CLS. 100, 103 AND 106).

SN 76-391,805. DIGI-TWIST, INC., LOUDON, TN. FILED 4-3-2002.

DIGI-TWIST

FOR MANUFACTURE OF GUNS AND GUN BARRELS FOR OTHERS (U.S. CLS. 100, 103 AND 106).

SN 78-060,308. PHARMACIA & UPJOHN COMPANY, PEAPACK, NJ. FILED 4-25-2001.

**PHARMACIA
CENTERSOURCE**

OWNER OF U.S. REG. NOS. 1,025,527, 2,171,501 AND OTHERS.
 FOR CONTRACT MANUFACTURING SERVICES (U.S. CLS. 100, 103 AND 106).

CLASS 40—(Continued).

SN 78-060,313. PHARMACIA & UPJOHN COMPANY, PEAPACK, NJ. FILED 4-25-2001.

**PHARMACIA
CENTRALSOURCE**

OWNER OF U.S. REG. NOS. 1,025,527, 2,171,501 AND OTHERS.
 FOR CONTRACT MANUFACTURING SERVICES (U.S. CLS. 100, 103 AND 106).

SN 78-077,276. PHARMACIA & UPJOHN COMPANY, PEAPACK, NJ. FILED 8-3-2001.

**PHARMACIA
CENTRESOURCE**

FOR CONTRACT MANUFACTURING SERVICES (U.S. CLS. 100, 103 AND 106).

SN 78-094,110. KNUST-SBO, LTD., HOUSTON, TX. FILED 11-19-2001.

DIOHARD

FOR DIODE LASER POWDERCOAT WELDING SERVICES (U.S. CLS. 100, 103 AND 106).
 FIRST USE 9-27-2001; IN COMMERCE 9-27-2001.

SN 78-098,446. DIE-TECH, INC., YORK HAVEN, PA. FILED 12-14-2001.



NO CLAIM IS MADE TO THE EXCLUSIVE RIGHT TO USE "NEW TECHNOLOGY", APART FROM THE MARK AS SHOWN.
 FOR METAL FABRICATION AND FINISHING (U.S. CLS. 100, 103 AND 106).
 FIRST USE 8-22-2001; IN COMMERCE 12-5-2001.

CLASS 40—(Continued).

SN 78-102,924. NDB DIRECT, LLC, JESSUP, MD. FILED 1-15-2002.

GREAT WINDOWS

OWNER OF U.S. REG. NO. 2,412,321.
FOR CUSTOM MANUFACTURING AND ASSEMBLY OF WINDOW TREATMENTS FEATURING WINDOW COVERINGS, BLINDS, SHADES, VALANCES, CORNICES, FIXTURES, FABRIC AND ACCESSORIES (U.S. CLS. 100, 103 AND 106).

FIRST USE 6-28-1999; IN COMMERCE 6-28-1999.

SN 78-106,068. CONTINENTAL FIELD SYSTEMS, INC., SAVANNAH, GA. FILED 1-31-2002.

CONTINENTAL FIELD SYSTEMS

NO CLAIM IS MADE TO THE EXCLUSIVE RIGHT TO USE "SYSTEMS", APART FROM THE MARK AS SHOWN.

FOR MACHINE SHOP SERVICES, NAMELY, MACHINING PARTS TO THE ORDER AND SPECIFICATION OF OTHERS (U.S. CLS. 100, 103 AND 106).

FIRST USE 0-0-1989; IN COMMERCE 0-0-1989.

SN 78-106,752. MEMSCAP INC., OAKLAND, CA. FILED 2-4-2002.

CAPTURE THE POWER OF MEMS

NO CLAIM IS MADE TO THE EXCLUSIVE RIGHT TO USE "MEMS", APART FROM THE MARK AS SHOWN.

FOR CUSTOM MANUFACTURE OF SENSORS FOR BASED ON MICRO-ELECTROMECHANICAL SYSTEMS (MEMS), FOR USE IN AEROSPACE, BIOMEDICAL, INDUSTRIAL AND CONSUMER APPLICATIONS (U.S. CLS. 100, 103 AND 106).

CLASS 41—EDUCATION AND ENTERTAINMENT

SN 75-105,949. PROFIT ENHANCEMENT GROUP, INC., THE, MARINA DEL REY, CA. FILED 5-17-1996.

SMAART

FOR SCRIPT WRITING SERVICES FOR AUDIO AND VIDEO RECORDINGS, PRODUCTION OF AUDIO AND VIDEO CASSETTE TAPES, RECORDING AND SOUND EDITION OF MASTER TAPES (U.S. CLS. 100, 101 AND 107).

FIRST USE 1-1-1996; IN COMMERCE 1-1-1996.

CLASS 41—(Continued).

SN 75-465,888. JOURDAN, ROCHELLE A., KERHONKSON, NY. FILED 4-10-1998.

WOMEN JOURNEYS AN EMPOWERMENT PLACE

FOR COMPUTER SERVICES, NAMELY PROVIDING ON-LINE MAGAZINES AND NEWSLETTERS IN THE FIELD OF WOMEN'S EMPOWERMENT ISSUES (U.S. CLS. 100, 101 AND 107).

FIRST USE 8-7-1997; IN COMMERCE 8-7-1997.

SN 75-514,524. CONUS COMMUNICATIONS COMPANY LIMITED PARTNERSHIP, ST.PAUL, MN. BY ASSIGNMENT ALL NEWS CHANNEL JOINT VENTURE, THE, ST. PAUL, MN. FILED 7-7-1998.

ALL NEWS
C H A N N E L

NO CLAIM IS MADE TO THE EXCLUSIVE RIGHT TO USE "ALL NEWS CHANNEL", APART FROM THE MARK AS SHOWN.

FOR TELEVISION PRODUCTION SERVICES (U.S. CLS. 100, 101 AND 107).

FIRST USE 12-31-1992; IN COMMERCE 12-31-1992.

SN 75-544,151. POWER GROUP, NEW BRITAIN, PA. FILED 8-27-1998.

POWER GROUP

NO CLAIM IS MADE TO THE EXCLUSIVE RIGHT TO USE "GROUP", APART FROM THE MARK AS SHOWN.

FOR ENTERTAINMENT SERVICES, NAMELY, ORGANIZING AND CONDUCTING PHYSICAL FITNESS CONTESTS FOR MEN AND WOMEN (U.S. CLS. 100, 101 AND 107).

FIRST USE 5-1-1989; IN COMMERCE 5-1-1989.

CLASS 41—(Continued).

SN 75-633,079. FX NETWORKS, LLC, LOS ANGELES, CA. FILED 2-2-1999.



NO CLAIM IS MADE TO THE EXCLUSIVE RIGHT TO USE "SHOW", APART FROM THE MARK AS SHOWN.

FOR ENTERTAINMENT SERVICES IN THE NATURE OF AN ON-GOING TELEVISION GAME SHOW (U.S. CLS. 100, 101 AND 107).

FIRST USE 5-1-1998; IN COMMERCE 5-1-1998.

SN 75-651,157. STALTARI, ANTHONY J., BAYONNE, NJ. FILED 3-1-1999.

AS I AM

FOR ENTERTAINMENT SERVICES IN THE NATURE OF LIVE PERFORMANCES BY A MUSICAL AND VOCAL GROUP (U.S. CLS. 100, 101 AND 107).

FIRST USE 2-0-1996; IN COMMERCE 2-0-1996.

SN 75-666,161. THE HISTORYMAKERS, CHICAGO, IL. FILED 3-23-1999.

THE HISTORYMAKERS

FOR ENTERTAINMENT AND EDUCATIONAL SERVICES IN THE NATURE OF TELEVISION SERIES, INTERNET PUBLICATIONS AND PUBLICATION OF LITERATURE IN THE FIELD OF HISTORY (U.S. CLS. 100, 101 AND 107).

SN 75-787,762. PECK, SCOTT, SOLANA BEACH, CA. AND PECK, SHANNON, SOLANA BEACH, CA. FILED 8-30-1999.



FOR EDUCATIONAL SERVICES, NAMELY SEMINARS, WORKSHOPS, INDIVIDUAL TRAINING AND PROVIDING RELATED EDUCATIONAL MATERIALS IN THE FIELD OF PERSONAL DEVELOPMENT, SELF ESTEEM AND SPIRITUAL HEALING (U.S. CLS. 100, 101 AND 107).

FIRST USE 2-22-1999; IN COMMERCE 2-22-1999.

CLASS 41—(Continued).

SN 75-794,770. IIISERVICE.COM INC., SAN JOSE, CA. FILED 9-9-1999.

IIIGAME.COM

FOR PROVIDING INFORMATION IN THE FIELD OF EDUCATION AND GAMES AND RELATING TO ENTERTAINMENT VIA A GLOBAL COMPUTER NETWORK (U.S. CLS. 100, 101 AND 107).

SN 75-796,409. STATION CASINOS, INC., LAS VEGAS, NV. BY ASSIGNMENT FIESTA HOTEL CORPORATION, LAS VEGAS, NV. FILED 9-9-1999.

FIESTA

OWNER OF U.S. REG. NO. 2,234,239.

FOR CASINO SERVICES, PROVIDING FACILITIES FOR NON-GAMING VIDEO ARCADE GAMES, PROVIDING AMUSEMENT CENTERS AND ARCADES, AND ENTERTAINMENT SERVICES IN THE NATURE OF ARRANGING, CONDUCTING, AND PROVIDING FACILITIES FOR SPECIAL EVENTS (U.S. CLS. 100, 101 AND 107).

FIRST USE 12-14-1994; IN COMMERCE 12-14-1994.

SN 75-800,029. THEROMP, INC., SANTA MONICA, CA. FILED 10-6-1999.

THEROMP IS ON

FOR ENTERTAINMENT SERVICES, NAMELY, PRODUCTION AND DISTRIBUTION OF ENTERTAINMENT PROGRAMMING FOR ADULTS FOR DISTRIBUTION VIA GLOBAL COMPUTER AND COMMUNICATIONS NETWORKS, COMPUTERS, TELEVISION, CABLE AND SATELLITE BROADCASTING; ENTERTAINMENT SERVICES, NAMELY, PROVIDING ON-GOING TELEVISION-LIKE PROGRAMS IN THE FIELDS OF COMEDIES, DRAMAS, SPORTS, MUSIC, ANIMATION, AND FICTION VIA A GLOBAL COMPUTER NETWORK; DISTRIBUTION OF TELEVISION-LIKE PROGRAMS FOR OTHERS; AND PROVIDING INFORMATION IN THE FIELDS OF COMEDIES, DRAMAS, SPORTS, MUSIC, ANIMATION, AND FICTION VIA GLOBAL COMPUTER AND COMMUNICATIONS NETWORKS (U.S. CLS. 100, 101 AND 107).

CLASS 41—(Continued).

SN 75-840,866. EXTRAORDINARY KIDS, LTD., DEERFIELD, IL. FILED 11-4-1999.



NO CLAIM IS MADE TO THE EXCLUSIVE RIGHT TO USE "KIDS LTD." AND "KINDERGARTEN ENRICHMENT PROGRAM" AND "EDUCATIONAL", APART FROM THE MARK AS SHOWN.

THE STIPPLING IN THE DRAWING IS A FEATURE OF THE MARK AND IS NOT INTENDED TO INDICATE COLOR.

FOR EDUCATIONAL SERVICES, NAMELY ENRICHMENT PROGRAMS PROVIDING ACADEMIC COURSES OF INSTRUCTION AND CLASSES AT THE PRE-SCHOOL AND PRIMARY SCHOOL LEVEL (U.S. CLS. 100, 101 AND 107).

FIRST USE 10-18-1999; IN COMMERCE 10-18-1999.

SN 75-887,737. PACERS BASKETBALL CORPORATION, INDIANAPOLIS, IN. FILED 1-5-2000.



THE STIPPLING IS INTENDED TO INDICATE SHADING. FOR ENTERTAINMENT SERVICES IN THE NATURE OF BASKETBALL GAMES AND MASCOT PERFORMANCES (U.S. CLS. 100, 101 AND 107).

CLASS 41—(Continued).

SN 75-906,488. ZEDRON.COM, INC., WARREN, VT. FILED 1-31-2000.

ZEDRON

FOR PROVIDING AN ON-LINE COMPUTER DATABASE IN THE FIELD OF EDUCATION AND ENTERTAINMENT FOR CHILDREN, IN THE NATURE OF GAMES, PUZZLES, RIDDLES, STORIES, ANIMATED CHARACTERS, MULTIMEDIA ENCYCLOPEDIAS, DICTIONARIES, ATLASES, INFORMATION ABOUT HOBBIES, INFORMATION ABOUT PETS, INFORMATION ABOUT WILDLIFE, INFORMATION ABOUT SCIENCE, INFORMATION ABOUT HISTORY, INFORMATION ABOUT SPORTS, INFORMATION ABOUT ARTS AND CRAFTS, INFORMATION ABOUT FAMILY RELATIONSHIPS, INFORMATION ABOUT CONSUMER PRODUCTS, INFORMATION ABOUT TELEVISION PROGRAMS AND MOVIES, AND INFORMATION ABOUT CURRENT EVENTS (U.S. CLS. 100, 101 AND 107).

SN 75-980,723. ALLAN SAVORY CENTER FOR HOLISTIC MANAGEMENT, THE, ALBUQUERQUE, NM. BY CHANGE OF NAME CENTER FOR HOLISTIC MANAGEMENT, ALBUQUERQUE, NM. FILED 12-11-1998.

HOLISTIC MANAGEMENT

SEC. 2(F).

FOR EDUCATIONAL SERVICES, NAMELY, ARRANGING AND CONDUCTING CLASSES AND SEMINARS AND DISTRIBUTING COURSE MATERIAL IN THE FIELD OF NATURAL RESOURCE CONSERVATION, REHABILITATION, UTILIZATION AND MANAGEMENT (U.S. CLS. 100, 101 AND 107).

FIRST USE 9-30-1984; IN COMMERCE 1-31-1988.

SN 76-002,610. AMERICAN INDOOR SOCCER ASSOCIATION, INC., THE, CANTON, OH. FILED 3-16-2000.

MISL

FOR ENTERTAINMENT SERVICES, NAMELY, ORGANIZING, CONDUCTING, AND STAGING SOCCER GAMES, MATCHES, TOURNAMENTS, LEAGUES, CLINICS, AND EXHIBITIONS; PRODUCTION OF RADIO, TELEVISION, COMPUTER-BASED, AND INTERNET-BASED BROADCASTING PROGRAMS IN THE NATURE OF SOCCER GAMES, MATCHES, TOURNAMENTS, LEAGUES, CLINICS, AND EXHIBITIONS VIA RADIO, TELEVISION, AND THE INTERNET (U.S. CLS. 100, 101 AND 107).

SN 76-008,668. MAGNER, JAMES J., BURKE, VA. FILED 3-24-2000.

FILMCITE.COM

FOR PROVIDING A WEBSITE FEATURING INFORMATION IN THE FIELD OF MOTION PICTURE PRODUCTION AND MOTION PICTURE FILM HISTORY AND LOCATION OF ARCHIVED FILMS (U.S. CLS. 100, 101 AND 107).

CLASS 41—(Continued).

SN 76-009,952. KINGSTON COLLEGE INC., BURNABY, BRITISH COLUMBIA, V5B 4Y5, CANADA, FILED 3-23-2000.

KINGSTON COLLEGE

PRIORITY CLAIMED UNDER SEC. 44(D) ON CANADA APPLICATION NO. 1,029,938,, FILED 9-23-1999, REG. NO. 562,136, DATED 5-16-2002, EXPIRES 5-16-2017.

NO CLAIM IS MADE TO THE EXCLUSIVE RIGHT TO USE "COLLEGE", APART FROM THE MARK AS SHOWN.

FOR EDUCATIONAL SERVICES, NAMELY, PROVIDING COURSES OF INSTRUCTION AT THE PRE-SCHOOL, PRIMARY, SECONDARY, COLLEGE AND POST-GRADUATE LEVELS AND DISTRIBUTING COURSE MATERIAL IN CONNECTION THEREWITH (U.S. CLS. 100, 101 AND 107).

SN 76-019,166. AMERICAN HEALTH PUBLISHING COMPANY, DALLAS, TX. FILED 4-6-2000.

THE LIFESTYLE COMPANY

NO CLAIM IS MADE TO THE EXCLUSIVE RIGHT TO USE "COMPANY", APART FROM THE MARK AS SHOWN.

FOR EDUCATIONAL SERVICES, NAMELY, CONDUCTING SEMINARS, CLASSES AND WORKSHOPS IN THE FIELD OF STRESS MANAGEMENT, BODY SELF ESTEEM, EXERCISE, HEALTH MANAGEMENT, FINANCIAL RESPONSIBILITY, SMOKING CESSATION, EATING DISORDERS AND WEIGHT CONTROL, AND DISTRIBUTING COURSE MATERIALS IN CONNECTION THEREWITH (U.S. CLS. 100, 101 AND 107).
FIRST USE 2-29-2000; IN COMMERCE 2-29-2000.

SN 76-019,286. INSTITUTE FOR ADVANCEMENT OF EDUCATION ON ALCOHOL, LLC, KENSINGTON, MD. FILED 4-7-2000.

AWARE!

FOR EDUCATIONAL SERVICES, NAMELY CONDUCTING CLASSES IN THE FIELD OF ALCOHOL EDUCATION (U.S. CLS. 100, 101 AND 107).

FIRST USE 1-31-1999; IN COMMERCE 1-31-1999.

SN 76-026,256. STEPPENWOLF THEATRE COMPANY, THE, CHICAGO, IL. FILED 4-13-2000.

STEPPENWOLF

FOR MOTION PICTURE FILM PRODUCTION; PRODUCTION OF TELEVISION SHOWS (U.S. CLS. 100, 101 AND 107).

CLASS 41—(Continued).

SN 76-045,780. BROCCOLI RABE ENTERTAINMENT COMPLEX, INC., FAIRFIELD, NJ. FILED 5-11-2000.

MC CROONER

FOR ENTERTAINMENT SERVICES IN THE NATURE OF LIVE SINGING PERFORMANCES BY AN INDIVIDUAL (U.S. CLS. 100, 101 AND 107).

FIRST USE 2-12-1998; IN COMMERCE 5-17-1998.

SN 76-045,781. INFORMATION MANAGEMENT FORUM, INC., THE, ATLANTA, GA. FILED 5-11-2000.

**INFORMATION
MANAGEMENT FORUM**

NO CLAIM IS MADE TO THE EXCLUSIVE RIGHT TO USE "FORUM", APART FROM THE MARK AS SHOWN. SEC. 2(F).

FOR SEMINARS ON INFORMATION TECHNOLOGY MANAGEMENT (U.S. CLS. 100, 101 AND 107).

FIRST USE 11-30-1994; IN COMMERCE 11-30-1994.

SN 76-052,079. CLAIR BROWN & RICHARD KATZ, BERKELEY, CA. FILED 5-19-2000.

GetSkilz ... Just Watch!

FOR PROVIDING EDUCATIONAL PROGRAMMING OVER A WORLDWIDE COMPUTER NETWORK (U.S. CLS. 100, 101 AND 107).

SN 76-052,682. WCW, INC., STAMFORD, CT. BY ASSIGNMENT WORLD CHAMPIONSHIP WRESTLING, INC., ATLANTA, GA. FILED 5-19-2000.

NEW BLOOD

FOR ORGANIZING WRESTLING EXHIBITIONS, PRODUCTION OF TELEVISION PROGRAMS, RADIO PROGRAMS AND CABLE TELEVISION PROGRAMS FEATURING WRESTLING EVENTS AND PROVIDING INFORMATION IN THE FIELD OF WRESTLING OVER A GLOBAL COMPUTER NETWORK (U.S. CLS. 100, 101 AND 107).

FIRST USE 4-10-2000; IN COMMERCE 4-10-2000.

CLASS 41—(Continued).

SN 76-053,903. STEPPENWOLF THEATRE COMPANY, THE, CHICAGO, IL. FILED 5-22-2000.

STEPPENWOLF

FOR ENTERTAINMENT SERVICES IN THE NATURE OF THEATER PRODUCTIONS; EDUCATIONAL SERVICES, NAMELY, CONDUCTING CLASSES, SEMINARS, CONFERENCES AND WORKSHOPS IN THE FIELD OF THEATER (U.S. CLS. 100, 101 AND 107).

FIRST USE 9-30-1976; IN COMMERCE 9-30-1982.

SN 76-056,493. ADVANCED QUANTITATIVE & STRATEGIC SOLUTIONS, LLC, WEST ATLANTIC CITY, NJ. FILED 5-25-2000.

ADVANCED QUANTITATIVE & STRATEGIC SOLUTIONS

NO CLAIM IS MADE TO THE EXCLUSIVE RIGHT TO USE "ADVANCED" AND "STRATEGIC SOLUTIONS", APART FROM THE MARK AS SHOWN.

FOR EDUCATIONAL SERVICES, NAMELY, CONDUCTING SEMINARS, CLASSES, CONFERENCES AND WORKSHOPS IN THE FIELDS OF BUSINESS AND BUSINESS MANAGEMENT, AND THE DISTRIBUTION OF COURSE MATERIALS IN CONNECTION THEREWITH (U.S. CLS. 100, 101 AND 107).

FIRST USE 2-6-2000; IN COMMERCE 2-6-2000.

SN 76-058,239. BLOOMBERG L.P., NEW YORK, NY. FILED 5-25-2000.

BLOOMBERG UNIVERSITY

OWNER OF U.S. REG. NO. 2,045,947.

SEC. 2(F) AS TO "BLOOMBERG".

FOR EDUCATIONAL SERVICES, NAMELY, CONDUCTING SEMINARS REGARDING THE UTILIZATION OF COMPUTER HARDWARE AND SOFTWARE AND PROVIDING IN-PERSON TRAINING IN THE USE AND OPERATION OF COMPUTER HARDWARE AND SOFTWARE; PROVIDING ON-LINE SEMINARS AND TUTORIALS REGARDING THE USE AND OPERATION OF COMPUTER HARDWARE AND SOFTWARE (U.S. CLS. 100, 101 AND 107).

FIRST USE 1-0-2000; IN COMMERCE 1-0-2000.

CLASS 41—(Continued).

SN 76-082,431. CHILDREN'S ACADEMIC LEARNING CENTER, TEMPLE CITY, CA. FILED 7-3-2000.

學友教育中心
Children's Academic Learning Center

NO CLAIM IS MADE TO THE EXCLUSIVE RIGHT TO USE "ACADEMIC LEARNING CENTER" OR THE REPRESENTATION OF THE CHINESE CHARACTERS THAT TRANSLATE TO "ACADEMIC LEARNING CENTER", APART FROM THE MARK AS SHOWN.

THE ENGLISH TRANSLATION OF THE CHINESE CHARACTERS IN THE MARK TRANSLITERATE TO "XUE YOU JIAO YU ZHONG XI" AND THIS MEANS "CHILDREN'S ACADEMIC LEARNING CENTER" IN ENGLISH.

SEC. 2(F).

FOR EDUCATIONAL SERVICES NAMELY PROVIDING AFTER SCHOOL ACADEMIC ENRICHMENT (U.S. CLS. 100, 101 AND 107).

FIRST USE 7-7-1995; IN COMMERCE 7-7-1995.

SN 76-086,358. JACKOWSKI, DON C., BALTIMORE, MD. FILED 7-10-2000.

POWERVIZION

FOR RENTAL OF VIRTUAL REALITY ARCADE GAMES FOR PARTIES (U.S. CLS. 100, 101 AND 107).

SN 76-096,548. CAN AM GLOBAL GROUP, INC., JUPITER, FL. FILED 7-19-2000.



THE MARK CONSISTS OF A STYLIZED DRAWING OF AN ICE SKATE.

FOR ORGANIZING AND CONDUCTING CULTURAL EXHIBITS OF ART AND COSTUMES RELATING TO FIGURE SKATING (U.S. CLS. 100, 101 AND 107).

CLASS 41—(Continued).

SN 76-098,833. WOLFF OLINS LIMITED, LONDON, N1 9RL, UNITED KINGDOM, FILED 7-27-2000.

WOLFF OLINS

FOR ARRANGING, CONDUCTING, ORGANIZING AND MANAGING SEMINARS, LECTURES, WORKSHOPS, CLASSES, EDUCATIONAL CONFERENCES AND EDUCATIONAL EXHIBITS IN THE FIELD OF BRAND MANAGEMENT, MARKET RESEARCH, BUSINESS MANAGEMENT AND ADVERTISING AND PROMOTIONAL SERVICES; PRODUCTION AND DISTRIBUTION OF MOTION PICTURE FILMS AND TELEVISION SHOWS; AND CONSULTATION SERVICES RELATING ALL TO THE ABOVE (U.S. CLS. 100, 101 AND 107).

SN 76-098,834. WOLFF OLINS LIMITED, LONDON, N1 9RL, UNITED KINGDOM, FILED 7-27-2000.

WO

FOR ARRANGING, CONDUCTING, ORGANIZING AND MANAGING SEMINARS, LECTURES, WORKSHOPS, CLASSES, EDUCATIONAL CONFERENCES AND EDUCATIONAL EXHIBITS IN THE FIELD OF BRAND MANAGEMENT, MARKET RESEARCH, BUSINESS MANAGEMENT AND ADVERTISING AND PROMOTIONAL SERVICES; PRODUCTION AND DISTRIBUTION OF MOTION PICTURE FILMS AND TELEVISION SHOWS; AND CONSULTATION SERVICES RELATING ALL TO THE ABOVE (U.S. CLS. 100, 101 AND 107).

SN 76-101,463. OSHO ACADEMY, INC., SEDONA, AZ. FILED 8-2-2000.

PSYCHOLOGY OF THE BUDDHAS

SEC. 2(F).
FOR EDUCATIONAL AND INSTRUCTIONAL SERVICES IN THE NATURE OF CLASSES, SEMINARS, WORKSHOPS AND RETREATS ON THE SUBJECT OF MEDITATION, PHILOSOPHY AND RELIGION (U.S. CLS. 100, 101 AND 107).

FIRST USE 9-0-1994; IN COMMERCE 9-0-1994.

SN 76-111,080. INTERNATIONAL BUSINESS SEMINARS, INCORPORATED, SAN DIEGO, CA. FILED 8-11-2000.

EASYWAYUSA

FOR EDUCATIONAL SERVICES, NAMELY CONDUCTING TRAINING THROUGH SEMINARS, COURSES AND WORKSHOPS AND ONLINE TRAINING THROUGH SEMINARS, COURSES AND WORKSHOPS IN THE FIELD OF AMERICAN BUSINESS PROCESSES, CULTURE AND LIFESTYLE (U.S. CLS. 100, 101 AND 107).

CLASS 41—(Continued).

SN 76-111,954. SCHMITZ, SHARON A., SCOTTSDALE, AZ. FILED 8-16-2000.

JUST WHO DO YOU THINK YOU ARE?

FOR EDUCATIONAL AND ENTERTAINMENT SERVICES, NAMELY, PROVIDING MOTIVATIONAL SPEAKERS (U.S. CLS. 100, 101 AND 107).

SN 76-118,616. BARBARIC ENTERTAINMENT CORP., DBA BARBARIC RECORDS, SEATTLE, WA. FILED 8-28-2000.

BARBARIC

FOR PROVIDING INFORMATION REGARDING RECORDING PERFORMANCES OF MUSICAL ARTISTS BY MEANS OF GLOBAL COMPUTER INFORMATION NETWORK; ENTERTAINMENT SERVICES IN THE NATURE OF THE PRODUCTION OF PRERECORDED SOUND RECORDINGS AND PRERECORDED MUSICAL AND NON-MUSICAL VIDEO RECORDINGS (U.S. CLS. 100, 101 AND 107).

SN 76-124,047. THUNDERBIRD, THE AMERICAN GRADUATE SCHOOL OF INTERNATIONAL MANAGEMENT, GLENDALE, AZ. FILED 9-7-2000.

EMERGINGMINDS

FOR EDUCATIONAL SERVICES, NAMELY, CONDUCTING CLASSES IN THE FIELD OF BUSINESS MANAGEMENT (U.S. CLS. 100, 101 AND 107).

SN 76-126,937. ORANGE COUNTY SUPERINTENDENT OF SCHOOLS, COSTA MESA, CA. FILED 9-12-2000.



NO CLAIM IS MADE TO THE EXCLUSIVE RIGHT TO USE "ACADEMIC PENTATHLON", APART FROM THE MARK AS SHOWN.

FOR EDUCATIONAL SERVICES, NAMELY THE ADMINISTRATION OF ACADEMIC COMPETITIONS FOR STUDENTS IN GRAMMAR, JUNIOR HIGH AND HIGH SCHOOL (U.S. CLS. 100, 101 AND 107).

FIRST USE 5-0-1984; IN COMMERCE 5-0-1984.

CLASS 41—(Continued).

SN 76-131,770. ZHELEZNYAKOV, NIKOLAY ALEXANDROVICH, 143900 BALASHIKHA, MOSCOVSKAYA OBLAST, RUSSIAN FEDERATIO, FILED 9-20-2000.

SIGN OF QUALITY

FOR CASINO GAMING SERVICES; ORGANIZATION OF SPORTING COMPETITIONS; ENTERTAINMENT SERVICES, NAMELY, PROVIDING AN ON-LINE COMPUTER GAME; CONDUCTING LOTTERIES FOR OTHERS; CONDUCTING INTERACTIVE LOTTERIES ON TELEVISION WITH THE PARTICIPATION OF THE AUDIENCE; ENTERTAINMENT, NAMELY, PRODUCTION OF TELEVISION SHOWS, VARIETY TELEVISION SHOWS, RADIO SHOWS, AND THEATER SHOWS (U.S. CLS. 100, 101 AND 107).

SN 76-140,447. HERITAGE CLUB, INC., THE, WAKE FOREST, NC. FILED 10-5-2000.

HERITAGE

FOR PROVIDING GOLF CLUB FACILITIES, TENNIS COURT FACILITIES, AND SWIMMING POOL FACILITIES (U.S. CLS. 100, 101 AND 107).
FIRST USE 3-20-2000; IN COMMERCE 3-20-2000.

SN 76-140,989. BEATLABS, L.L.C., SEATTLE, WA. FILED 10-3-2000.

BEATLABS

FOR EDUCATIONAL SERVICES, NAMELY, CONDUCTING CLASSES, TUTORIALS, SEMINARS, CONFERENCES AND WORKSHOPS IN THE FIELD OF MUSIC AND MUSIC-RELATED BUSINESS; ENTERTAINMENT SERVICES, NAMELY, SOUND RECORDING STUDIO; AUDIO RECORDING AND PRODUCTION; CONDUCTING ENTERTAINMENT EXHIBITIONS IN THE NATURE OF CONCERTS, SEMINARS, AND CONFERENCES FEATURING MUSIC AND ART (U.S. CLS. 100, 101 AND 107).

SN 76-143,362. C.S.W.F., INC., LAS VEGAS, NV. FILED 10-10-2000.

CSWF

FOR SPORTS ENTERTAINMENT SHOWS, NAMELY, PROFESSIONAL WRESTLING EVENTS RENDERED LIVE AND THROUGH THE MEDIA OF THE INTERNET (U.S. CLS. 100, 101 AND 107).

CLASS 41—(Continued).

SN 76-143,967. ARCLIGHT CINEMA COMPANY, LOS ANGELES, CA. FILED 10-9-2000.

ARCLIGHT CINEMAS

OWNER OF U.S. REG. NO. 2,511,519.
NO CLAIM IS MADE TO THE EXCLUSIVE RIGHT TO USE "CINEMAS", APART FROM THE MARK AS SHOWN.
FOR CINEMA THEATERS (U.S. CLS. 100, 101 AND 107).
FIRST USE 4-0-2000; IN COMMERCE 4-0-2000.

SN 76-145,331. VULCAN SPORTS MEDIA, INC., CHICAGO, IL. BY CHANGE OF NAME VULCAN PRINT MEDIA, INC., ST. LOUIS, MO. FILED 10-12-2000.

FANTASY SOURCE

NO CLAIM IS MADE TO THE EXCLUSIVE RIGHT TO USE "FANTASY", APART FROM THE MARK AS SHOWN.
FOR PROVISION OF NEWS AND INFORMATION RELATING TO SPORTS AND SPORT FANTASY GAMES; PROVISION OF NEWS AND INFORMATION RELATING TO SPORTS AND SPORT FANTASY GAMES, PROVIDED VIA A GLOBAL COMMUNICATIONS NETWORK (U.S. CLS. 100, 101 AND 107).

SN 76-154,793. ROSEMARY LAKE PTY LTD, PRAHRAN VIC 3181, AUSTRALIA, FILED 10-26-2000.



PRIORITY CLAIMED UNDER SEC. 44(D) ON AUSTRALIA APPLICATION NO. 852340, FILED 10-4-2000, REG. NO. 852340, DATED 10-4-2000, EXPIRES 10-4-2010.

NO CLAIM IS MADE TO THE EXCLUSIVE RIGHT TO USE "ARTIST", APART FROM THE MARK AS SHOWN.

FOR EDUCATIONAL SERVICES, NAMELY, CONDUCTING CLASSES, SEMINARS, CONFERENCES AND WORKSHOPS IN THE FIELD OF FINE ART, AND DISTRIBUTING COURSE MATERIALS IN CONNECTION THEREWITH; TRAINING IN THE USE AND OPERATION OF PAINTING MATERIALS; ORGANIZING EXHIBITIONS FOR ART (U.S. CLS. 100, 101 AND 107).

CLASS 41—(Continued).

SN 76-158,854. INORBIT ENTERTAINMENT, INC., SAN FRANCISCO, CA. FILED 11-2-2000.

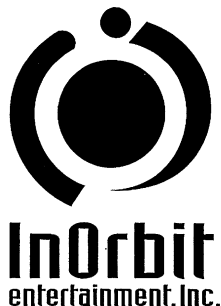

NO CLAIM IS MADE TO THE EXCLUSIVE RIGHT TO USE "ENTERTAINMENT, INC.", APART FROM THE MARK AS SHOWN.

FOR ONLINE SERVICES OF WHOLLY ORIGINAL CREATIVE CONTENT, NAMELY PROVIDING COMPUTER GAMES AND COMPUTER ROLE PLAYING GAMES THAT MAY BE ACCESSED NETWORK-WIDE BY NETWORK USERS; PROVIDING AN ONLINE COMPUTER DATABASE IN THE FIELDS OF COMPUTER GAMES, ROLE PLAYING GAMES, IMMERSIVE THREE-DIMENSIONAL ENTERTAINMENT, AND ARTIFICIAL LIFE COMMUNITIES; ENTERTAINMENT SERVICES, NAMELY, PROVIDING TELEVISION PROGRAMMING IN THE FIELD OF ROLE PLAYING GAMES, IMMERSIVE ENTERTAINMENT AND ARTIFICIAL LIFE COMMUNITIES VIA A GLOBAL COMPUTER NETWORK; ENTERTAINMENT IN THE NATURE OF ON-GOING TELEVISION PROGRAMS IN THE FIELD OF ROLE PLAYING GAMES, IMMERSIVE ENTERTAINMENT AND ARTIFICIAL LIFE COMMUNITIES (U.S. CLS. 100, 101 AND 107).

SN 76-159,552. OSHO INTERNATIONAL FOUNDATION, 8001 ZURICH, SWITZERLAND, FILED 11-3-2000.

NO-THOUGHT FOR THE DAY

FOR PROVIDING AN ONLINE COLUMN IN AN ONLINE MAGAZINE FEATURING THE SPIRITUAL AND MYSTICAL TEACHINGS OF THE MYSTIC OSHO (U.S. CLS. 100, 101 AND 107).

FIRST USE 1-1-1996; IN COMMERCE 1-1-1996.

SN 76-169,447. CORE DESIGN LIMITED, DERBY, DE24 8JE, UNITED KINGDOM, FILED 11-21-2000.

HERDY GERDY

PRIORITY CLAIMED UNDER SEC. 44(D) ON UNITED KINGDOM APPLICATION NO. 2,243,707, FILED 8-26-2000, REG. NO. 2243707, DATED 8-3-2001, EXPIRES 8-26-2010.

FOR ENTERTAINMENT SERVICES, NAMELY, PROVIDING AN ON-LINE COMPUTER GAME; PROVIDING A COMPUTER GAME THAT MAY BE ACCESSED NETWORK-WIDE BY NETWORK USERS (U.S. CLS. 100, 101 AND 107).

CLASS 41—(Continued).

SN 76-169,473. ENDAR EQUINE, INC., TEMECULA, CA. FILED 11-21-2000.

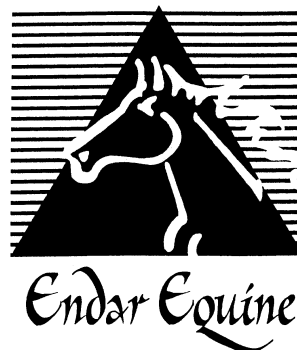

NO CLAIM IS MADE TO THE EXCLUSIVE RIGHT TO USE "EQUINE", APART FROM THE MARK AS SHOWN.

THE LINING IS A FEATURE OF THE MARK AND DOES NOT INDICATE COLOR.

FOR TRAINING SERVICES IN THE FILED OF HORSES (U.S. CLS. 100, 101 AND 107).

FIRST USE 1-1-2000; IN COMMERCE 1-1-2000.

SN 76-169,779. INVERSUS RECORDS INC., NEW YORK, NY. FILED 11-21-2000.

INVERSUS RECORDS

NO CLAIM IS MADE TO THE EXCLUSIVE RIGHT TO USE "RECORDS", APART FROM THE MARK AS SHOWN.

FOR AUDIO RECORDING AND PRODUCTION (U.S. CLS. 100, 101 AND 107).

SN 76-170,202. KRAY, RICHARD WAYNE, LOS ANGELES, CA. FILED 11-22-2000.

THE SKUNKMAN

FOR PROVIDING LIVE ENTERTAINMENT, NAMELY, SINGING, DANCING, COMEDY ACTS; ENTERTAINMENT IN THE NATURE OF ONGOING TELEVISION PROGRAMS IN THE FIELD OF DANCE, SINGING AND COMEDY; ENTERTAINING CHILDREN WITH LIVE DANCE, SONG AND ACTING (U.S. CLS. 100, 101 AND 107).

FIRST USE 1-0-1995; IN COMMERCE 1-0-1995.

CLASS 41—(Continued).

SN 76-171,086. MICEK, JOHN-PAUL, DBA RPM SUCCESS GROUP, NESHANIC STATION, NJ. FILED 11-24-2000.

RPM SUCCESS GROUP

NO CLAIM IS MADE TO THE EXCLUSIVE RIGHT TO USE "GROUP", APART FROM THE MARK AS SHOWN.

FOR BUSINESS COACHING SERVICES, NAMELY, PROVIDING INDIVIDUAL AND GROUP INSTRUCTION ON ENHANCING PERFORMANCE AND EFFICIENCY IN A BUSINESS SETTING USING AN INDIVIDUAL BEHAVIORAL ASSESSMENTS, ON-LINE EXAMINATION, SEMINARS AND THROUGH INDIVIDUAL INTERVIEWS; EDUCATIONAL SERVICES, NAMELY, CONDUCTING TRAINING SEMINARS AND WORKSHOPS IN THE FIELD OF IMPROVING BUSINESS SKILLS IN THE AREAS OF SALES, CUSTOMER RELATIONS; EFFICIENCY AND COMMUNICATION SKILLS. OFFERED ONLINE, IN PERSON AND VIA TELECONFERENCES (U.S. CLS. 100, 101 AND 107).

FIRST USE 7-0-2000; IN COMMERCE 7-0-2000.

SN 76-171,752. REGENTS COLLEGE, ALBANY, NY. FILED 11-28-2000.



OWNER OF U.S. REG. NO. 2,098,266.
NO CLAIM IS MADE TO THE EXCLUSIVE RIGHT TO USE "COLLEGE", APART FROM THE MARK AS SHOWN.

FOR PROVIDING EDUCATIONAL CREDIT ASSESSMENT AND INDEPENDENT STUDY PROGRAMS LEADING TO ASSOCIATE, BACCALAUREATE AND MASTER'S DEGREES AND CERTIFICATES (U.S. CLS. 100, 101 AND 107).

FIRST USE 9-25-2000; IN COMMERCE 9-25-2000.

SN 76-171,753. EXCELSIOR COLLEGE, ALBANY, NY. BY CHANGE OF NAME REGENTS COLLEGE, ALBANY, NY. FILED 11-28-2000.



OWNER OF U.S. REG. NO. 2,098,266.
NO CLAIM IS MADE TO THE EXCLUSIVE RIGHT TO USE "COLLEGE", APART FROM THE MARK AS SHOWN.

FOR PROVIDING EDUCATIONAL CREDIT ASSESSMENT AND INDEPENDENT STUDY PROGRAMS LEADING TO ASSOCIATE, BACCALAUREATE AND MASTER'S DEGREES AND CERTIFICATES (U.S. CLS. 100, 101 AND 107).

FIRST USE 9-25-2000; IN COMMERCE 9-25-2000.

CLASS 41—(Continued).

SN 76-173,937. BRIGGLE, JOHN J., TOLEDO, OH. FILED 12-1-2000.

MEGA PARTY

NO CLAIM IS MADE TO THE EXCLUSIVE RIGHT TO USE "PARTY", APART FROM THE MARK AS SHOWN.

FOR ENTERTAINMENT IN THE NATURE OF BASKETBALL GAMES, PUCK SLIDE GAMES, BALL ROLL GAMES, SHUFFLE ALLEY GAMES, BASEBALL PITCHING GAMES, OBSTACLE COURSE GAMES, BUNGEE RUN GAMES, STICKY WALL GAMES; ENTERTAINMENT IN THE NATURE OF LIVE KARAOKE SING ALONG SHOWS; RENTAL OF VIDEO GAMES; ENTERTAINMENT AND EDUCATIONAL SERVICES, NAMELY, HOSTING SCHOOL PARTIES AND PROVIDING MOTIVATIONAL SPEAKERS (U.S. CLS. 100, 101 AND 107).

FIRST USE 1-15-1998; IN COMMERCE 1-15-1998.

SN 76-174,748. BAHA MEN, SHERMAN OAKS, CA. FILED 11-30-2000.

BAHA MAS

FOR ENTERTAINMENT IN THE NATURE OF LIVE MUSICAL PERFORMANCES BY A MUSICAL GROUP; ENTERTAINMENT SERVICES, NAMELY, SOUND AND VIDEOTAPE RECORDING PRODUCTION, MOTION PICTURE FILM PRODUCTION, PRODUCTION AND DISTRIBUTION OF COMEDY ENTERTAINMENT AND MUSIC PROGRAMS FOR RADIO, TELEVISION, CABLE, SATELLITE, PAY-PER-VIEW, INTERACTIVE MEDIA, HOME VIDEO MARKETS; MULTIMEDIA ENTERTAINMENT SOFTWARE PRODUCTION SERVICES IN THE FIELD OF MUSIC AND ENTERTAINMENT; AND OTHER SERVICES, NAMELY, MUSIC COMPOSITION FOR OTHERS (U.S. CLS. 100, 101 AND 107).

SN 76-177,935. DISCOVERY COMMUNICATIONS, INC., BETHESDA, MD. FILED 12-8-2000.

CASINO DIARIES

NO CLAIM IS MADE TO THE EXCLUSIVE RIGHT TO USE "CASINO", APART FROM THE MARK AS SHOWN.

FOR ENTERTAINMENT SERVICES IN THE NATURE OF A TELEVISION SERIES ON THE SUBJECT OF GAMBLING AND THE GAMING INDUSTRY (U.S. CLS. 100, 101 AND 107).

FIRST USE 1-5-2001; IN COMMERCE 1-5-2001.

SN 76-180,213. VIACOM INTERNATIONAL INC., NEW YORK, NY. FILED 12-13-2000.

ROAD TO FAME

FOR ENTERTAINMENT SERVICES IN THE NATURE OF TELEVISION PROGRAMS FEATURING PUBLIC FIGURES AND CELEBRITIES (U.S. CLS. 100, 101 AND 107).

FIRST USE 7-11-1998; IN COMMERCE 7-11-1998.

CLASS 41—(Continued).

SN 76-186,403. YOUNG WOMEN'S CHRISTIAN ASSOCIATION OF SEATTLE-KING COUNTY-SNOHOMISH COUNTY, DBA SCHOOL'S OUT CONSORTIUM, SEATTLE, WA. FILED 12-26-2000.

SCHOOL'S OUT

FOR EDUCATIONAL TRAINING AND PROFESSIONAL DEVELOPMENT SERVICES, NAMELY, CONDUCTING SEMINARS, CLASSES, CONFERENCES AND WORKSHOPS FOR STAFF OF OUT-OF-SCHOOL AND AFTER-SCHOOL EDUCATIONAL PROGRAMS AND EDUCATION SERVICE PROVIDERS, AND DISTRIBUTING WRITTEN MATERIALS IN CONNECTION THEREWITH (U.S. CLS. 100, 101 AND 107).

FIRST USE 0-0-1987; IN COMMERCE 0-0-1994.

SN 76-189,341. GALA INTERACTIVE LIMITED, NOTTINGHAM, ENGLAND. BY ASSIGNMENT CARLTON COMMUNICATIONS PLC, LONDON, UNITED KINGDOM, FILED 1-2-2001.

JAMBA

FOR ENTERTAINMENT SERVICES, NAMELY PROVIDING ON-LINE COMPUTER GAMES, GAMBLING, INTERACTIVE GAMES, QUIZZES AND COMPETITIONS; PROVIDING ON-LINE INFORMATION IN THE FIELDS OF SPORTS AND ENTERTAINMENT, NAMELY, MUSIC, FILM AND TELEVISION (U.S. CLS. 100, 101 AND 107).

FIRST USE 11-1-1998; IN COMMERCE 11-1-1998.

SN 76-199,042. RITZ CAMERA CENTERS, INC., BELTSVILLE, MD. BY ASSIGNMENT WOLF CAMERA, INC., ALPHARETTA, GA. FILED 1-24-2001.

WOLF UNIVERSITY

NO CLAIM IS MADE TO THE EXCLUSIVE RIGHT TO USE "UNIVERSITY", APART FROM THE MARK AS SHOWN.

FOR EDUCATIONAL SERVICES, NAMELY, CONDUCTING WORKSHOPS IN THE FIELD OF PHOTOGRAPHY (U.S. CLS. 100, 101 AND 107).

FIRST USE 11-5-1998; IN COMMERCE 11-5-1998.

SN 76-200,268. DARMSTADTER, JON, CHICAGO, IL. FILED 1-29-2001.

ZKID

FOR PROVIDING A WEBSITE OF EDUCATIONAL INFORMATION AND INTERACTIVITIES DIRECTED TO CHILDREN THAT IS MONITORED, INCLUDES PARENTAL SAFEGUARDS, AND PROVIDES APPROVED LINKS TO OTHER WEBSITES (U.S. CLS. 100, 101 AND 107).

CLASS 41—(Continued).

SN 76-202,477. PRISON DISCIPLE MINISTRY, INC., MARLETTA, GA. FILED 2-1-2001.

Camp Hope



NO CLAIM IS MADE TO THE EXCLUSIVE RIGHT TO USE "CAMP", "JEREMIAH 29:11" AND "FOR I KNOW THE PLANS I HAVE FOR YOU...PLANS TO GIVE YOU HOPE" AND THE DESIGN OF THE CROSS, APART FROM THE MARK AS SHOWN.

FOR FIVE DAY SUMMER YOUTH CAMP FOR 9-11 YEAR OLD CHILDREN OF PERSONS WHO ARE INCARCERATED IN THE STATE PRISON SYSTEMS; ACTIVITIES OF THE CAMP INCLUDE CHRISTIAN WORSHIP, ARTS AND CRAFTS, OUT-DOOR SPORTS, SWIMMING, SINGING, MUSIC AND OTHER TEAM-BUILDING COORDINATED ACTIVITIES (U.S. CLS. 100, 101 AND 107).

SN 76-205,926. PA KNOWLEDGE LIMITED, GEORGETOWN, GRAND CAYMAN, CAYMAN ISLANDS, BY ASSIGNMENT PA CONSULTING SERVICES INC., WASHINGTON, DC. FILED 2-7-2001.



THE MARK CONSISTS, IN PART, OF THE LETTER "R" STANDING ON TOP OF THE LETTER "O", OVER THE TERM, "RELIABILITYONE".

FOR PROVIDING RECOGNITION AND INCENTIVES BY THE WAY OF AWARDS TO PUBLIC UTILITY COMPANIES TO DEMONSTRATE OUTSTANDING PERFORMANCE AND RELIABILITY (U.S. CLS. 100, 101 AND 107).

FIRST USE 9-26-2000; IN COMMERCE 2-5-2001.

CLASS 41—(Continued).

SN 76-208,221. DICK CLARK PRODUCTIONS, INC., BURBANK, CA. FILED 2-12-2001.

DICK CLARK'S NEW MUSIC AWARD

OWNER OF U.S. REG. NOS. 1,692,014, 1,703,376 AND 1,783,029.

NO CLAIM IS MADE TO THE EXCLUSIVE RIGHT TO USE "NEW MUSIC AWARD", APART FROM THE MARK AS SHOWN.

THE NAME "DICK CLARK" IDENTIFIES A LIVING INDIVIDUAL WHOSE CONSENT IS OF RECORD.

THE TYPED DRAWING IS BROKEN INTO TWO LINES IN COMPLIANCE WITH THE TMEP, AND SUCH PLACEMENT OF THE MARK HAS NO PARTICULAR SIGNIFICANCE TO THE COMMERCIAL IMPRESSION.

FOR ENTERTAINMENT IN THE NATURE OF ON-GOING TELEVISION PROGRAMS IN THE FIELD OF COMEDY AND VARIETY (U.S. CLS. 100, 101 AND 107).

SN 76-210,189. AQUAKIDS, INC., FLOWER MOUND, TX. FILED 2-14-2001.

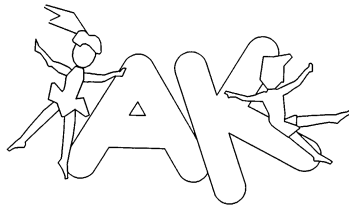

THE MARK CONSISTS OF CAPITAL LETTERS "A" AND "K" FLANKED BY THE DEPICTION OF A BOY AND A GIRL.

FOR EDUCATIONAL SERVICES, NAMELY, PROFESSIONAL SWIM INSTRUCTION (U.S. CLS. 100, 101 AND 107).

FIRST USE 10-1-1998; IN COMMERCE 10-1-1998.

SN 76-212,335. WAGNER, PAUL, CAMBRIDGE, MA. FILED 2-20-2001.

WORLD MEDIA ARTS

NO CLAIM IS MADE TO THE EXCLUSIVE RIGHT TO USE "MEDIA ARTS", APART FROM THE MARK AS SHOWN.

FOR ENTERTAINMENT SERVICES, NAMELY PRODUCING VIDEO RECORDINGS, RADIO, TELEVISION, LIVE THEATRICAL AND FILM PROGRAMS IN THE FIELD OF COMEDY, ANIMATION, CORPORATE EVENTS, TRADE SHOWS, AND PUBLIC SERVICE MESSAGES (U.S. CLS. 100, 101 AND 107).

FIRST USE 1-1-2001; IN COMMERCE 1-1-2001.

CLASS 41—(Continued).

SN 76-212,339. DJR HOLDINGS, LLC, NEW YORK, NY. FILED 2-9-2001.

DEF POETRY JAM

OWNER OF U.S. REG. NOS. 1,790,206, 2,205,275 AND OTHERS.

FOR SCHEDULING TELEVISION PROGRAMMING; ENTERTAINMENT IN THE NATURE OF ON-GOING TELEVISION PROGRAMS IN THE FIELD OF MUSIC, DRAMA, COMEDY, POETRY READINGS, STORYTELLING, VARIETY, NEWS AND SPORTING EVENTS (U.S. CLS. 100, 101 AND 107).

SN 76-213,839. ALLEN, LANG, CUROTTO & PEED, P.A., ORLANDO, FL. FILED 2-23-2001.

THE DIAMONDS

FOR ENTERTAINMENT SERVICES; NAMELY, LIVE MUSICAL PERFORMANCES BY A GROUP (U.S. CLS. 100, 101 AND 107).

SN 76-214,940. CAUSEMEDIA, INC., NEWTONVILLE, MA. FILED 2-22-2001.

BUILDING CONNECTIONS

NO CLAIM IS MADE TO THE EXCLUSIVE RIGHT TO USE "CONNECTIONS", APART FROM THE MARK AS SHOWN.

FOR EDUCATIONAL SERVICES, NAMELY, CONDUCTING A SERIES OF SEMINARS REGARDING THE FORMATION OF PARTNERSHIPS BETWEEN NOT-FOR-PROFIT ORGANIZATIONS AND BUSINESS CORPORATIONS DIRECTED TOWARDS BUSINESS CORPORATIONS INTERESTED IN FORMING PARTNERSHIPS WITH NOT-FOR-PROFIT ORGANIZATIONS IN ORDER TO ADDRESS A SPECIFIC AND RELEVANT SOCIAL ISSUE (U.S. CLS. 100, 101 AND 107).

SN 76-217,167. COLL, FRANCISCO D., WASHINGTON, DC. FILED 2-28-2001.

WAYSHOWERS

FOR EDUCATIONAL SERVICES, NAMELY CONDUCTING WORKSHOPS, COURSES, LECTURES, AND EXTENSION COURSES IN PERSONAL DEVELOPMENT AND DISTRIBUTING RELATED EDUCATIONAL MATERIALS (U.S. CLS. 100, 101 AND 107).

CLASS 41—(Continued).

SN 76-219,009. DISCOVERY COMMUNICATIONS, INC., BETHESDA, MD. FILED 3-2-2001.

DISCOVERY CHANNEL WORLD CHAMPIONSHIP ADVENTURE RACE

OWNER OF U.S. REG. NOS. 883,953, 2,092,711 AND OTHERS.

NO CLAIM IS MADE TO THE EXCLUSIVE RIGHT TO USE "WORLD CHAMPIONSHIP ADVENTURE RACE", APART FROM THE MARK AS SHOWN.

SEC. 2(F) AS TO "DISCOVERY CHANNEL" ONLY. FOR ENTERTAINMENT SERVICES, NAMELY, ARRANGING AND CONDUCTING AN ENDURANCE SPORTS COMPETITION; AND AN ON-GOING TELEVISION PROGRAM FEATURING ENDURANCE SPORTS COMPETITIONS (U.S. CLS. 100, 101 AND 107).

SN 76-219,723. PALA BAND OF MISSION INDIANS, THE, DBA PALA CASINO, PALA, CA. FILED 3-5-2001.

PALA CASINO

NO CLAIM IS MADE TO THE EXCLUSIVE RIGHT TO USE "CASINO", APART FROM THE MARK AS SHOWN.

THE ENGLISH TRANSLATION OF THE WORD "PALA" IN THE MARK IS "WATER".

FOR CASINO ENTERTAINMENT SERVICES, NAMELY, PROVIDING CASINO FACILITIES AND ORGANIZING, CONDUCTING AND SPONSORING CASINO GAMING PROGRAMS AND GAMING TOURNAMENTS (U.S. CLS. 100, 101 AND 107).

SN 76-222,014. ROCHESTER MIDLAND CORPORATION, ROCHESTER, NY. FILED 3-9-2001.

SURFACEGUARD

FOR EDUCATIONAL SERVICES, NAMELY CONDUCTING IN-PLANT TRAINING FOR OTHERS ON PROPER CLEANING AND SANITIZING OF PROCESSING EQUIPMENT AND ENVIRONMENTAL SURFACES PRESENT IN THE FOOD PROCESSING INDUSTRY (U.S. CLS. 100, 101 AND 107).

FIRST USE 4-0-2000; IN COMMERCE 4-0-2000.

SN 76-222,164. PHOENIX SOCIETY, INC., THE, DBA THE PHOENIX SOCIETY FOR BURN SURVIVORS, INC., EAST GRAND RAPIDS, MI. FILED 3-9-2001.

SOAR

FOR EDUCATIONAL SERVICES, NAMELY, PROVIDING WORKSHOPS AND SEMINARS FOR TRAINEES OF BURN SURVIVORS TO ASSIST THEM IN PROVIDING PSYCHOLOGICAL GUIDANCE TO BURN SURVIVORS (U.S. CLS. 100, 101 AND 107).

CLASS 41—(Continued).

SN 76-224,985. CROSS, MICHELE, A-1070 VIENNA, AUSTRIA, FILED 3-15-2001.



PHYSIORHYTHMIC

OWNER OF AUSTRIA REG. NO. 188.438, DATED 5-15-2000, EXPIRES 5-15-2010.

FOR HEALTH CLUBS, PHYSICAL FITNESS INSTRUCTION, AND EDUCATIONAL SERVICES, NAMELY, CONDUCTING CLASSES, SEMINARS, CONFERENCES, WORKSHOPS AND TRAINING IN THE FIELD OF FITNESS, WELLNESS, HEALTH, SPORTS, AND BODY AND MIND (U.S. CLS. 100, 101 AND 107).

SN 76-226,656. CAPITAL FILM STUDIOS LLC, MANASSAS, VA. FILED 3-16-2001.

CAPITAL FILM STUDIOS

NO CLAIM IS MADE TO THE EXCLUSIVE RIGHT TO USE "FILM STUDIOS", APART FROM THE MARK AS SHOWN.

FOR ENTERTAINMENT SERVICES IN THE NATURE OF A MULTIMEDIA PRODUCTION FACILITY, NAMELY, PRODUCTION, EDITING AND DISTRIBUTION OF MOTION PICTURE FILMS, VIDEO CASSETTES, DIGITAL VIDEO DISCS, TELEVISION PROGRAMS, RADIO PROGRAMS, AUDIO RECORDINGS, LIVE PERFORMANCES, SCRIPTS, COMMERCIALS AND MULTIMEDIA ENTERTAINMENT; PROVIDING INFORMATION IN THE FIELD OF MOTION PICTURE, TELEVISION AND MULTIMEDIA ENTERTAINMENT AND PRODUCTION OVER THE INTERNET; SOUND RECORDING STUDIOS; RENTAL OF MOTION PICTURE FILMS, VIDEOTAPES AND FILM PROJECTION EQUIPMENT (U.S. CLS. 100, 101 AND 107).

SN 76-228,154. DINIZIO, PATRICK M, SCOTCH PLAINS, NJ. FILED 3-19-2001.

THE SMITHEREENS

FOR ENTERTAINMENT SERVICES IN THE NATURE OF LIVE MUSICAL PERFORMANCES BY A MUSICAL BAND (U.S. CLS. 100, 101 AND 107).

FIRST USE 3-1-1980; IN COMMERCE 3-1-1980.

CLASS 41—(Continued).

SN 76-229,110. PARK NICOLLET HEALTH SERVICES, ST. LOUIS PARK, MN. FILED 3-22-2001.

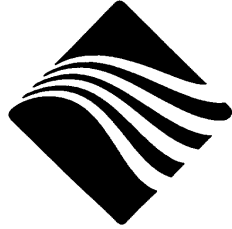

FOR EDUCATIONAL SERVICES, NAMELY, PROVIDING CLASSES, WORKSHOPS, AND SEMINARS REGARDING HEALTH, FITNESS, AND WELLNESS (U.S. CLS. 100, 101 AND 107).
FIRST USE 9-15-2000; IN COMMERCE 9-15-2000.

SN 76-231,787. HADASSAH, THE WOMEN'S ZIONIST ORGANIZATION OF AMERICA, INC., NEW YORK, NY. FILED 3-14-2001.



OWNER OF U.S. REG. NOS. 2,376,815, 2,493,950 AND OTHERS.

THE NAME "HADASSAH" DOES NOT IDENTIFY A LIVING INDIVIDUAL.

THE ENGLISH TRANSLATION OF THE WORD "HADASSAH" IN THE MARK IS "ESTHER".

FOR EDUCATIONAL SERVICES, PROVIDING SEMINARS, WORKSHOPS, AND CONFERENCES IN THE FIELD OF WOMEN, STEREOTYPES AND THE ENTERTAINMENT INDUSTRY; COMPUTER ON-LINE SERVICES OFFERED OVER THE WORLDWIDE GLOBAL COMMUNICATIONS NETWORK FEATURING INFORMATION ABOUT WOMEN, STEREOTYPES AND THE ENTERTAINMENT INDUSTRY (U.S. CLS. 100, 101 AND 107).

SN 76-236,138. PARENTING GROUP INC., THE, NEW YORK, NY. FILED 4-5-2001.

BONDING & BEYOND

FOR EDUCATIONAL SEMINARS ON CHILDBIRTH; CONTINUING EDUCATION PROGRAMS ON CHILDBIRTH (U.S. CLS. 100, 101 AND 107).
FIRST USE 3-0-2000; IN COMMERCE 3-0-2000.

CLASS 41—(Continued).

SN 76-238,046. BENNETT, DANIELLE, CAMBRIA HEIGHTS, NY. FILED 4-11-2001.

DANNI WHISPERZ

"DANNI WHISPERZ" IDENTIFIES A LIVING INDIVIDUAL WHOSE CONSENT IS OF RECORD.

FOR ENTERTAINMENT, NAMELY, LIVE PERFORMANCES BY A MUSICAL ARTIST AND ACTRESS; SONGWRITING SERVICES (U.S. CLS. 100, 101 AND 107).
FIRST USE 3-10-2001; IN COMMERCE 4-7-2001.

SN 76-244,425. CITY OF WORTHINGTON, WORTHINGTON, OH. FILED 4-23-2001.



NO CLAIM IS MADE TO THE EXCLUSIVE RIGHT TO USE "1803," "2003," "WORTHINGTON," AND "OHIO", APART FROM THE MARK AS SHOWN.

FOR PROMOTING AND SPONSORING THE BICENTENNIAL OF THE CITY OF WORTHINGTON, OHIO (U.S. CLS. 100, 101 AND 107).
FIRST USE 9-13-2000; IN COMMERCE 9-13-2000.

SN 76-245,581. SIMMS, KEVIN D, CARTERSVILLE, GA. FILED 4-24-2001.



THE STIPLING IN THE DRAWING IS INTENDED TO INDICATE SHADING ONLY.

FOR MUSIC PRODUCTION SERVICES; ENTERTAINMENT SERVICES IN THE NATURE OF LIVE MUSICAL GROUP; AND ENTERTAINMENT SERVICES, NAMELY, ORGANIZING AND PROMOTING LIVE MUSICAL GROUPS (U.S. CLS. 100, 101 AND 107).

CLASS 41—(Continued).

SN 76-248,526. AVENUE MAGAZINE, INC., NEW YORK, NY. FILED 4-30-2001.

AVENUE INVITATIONS

OWNER OF U.S. REG. NOS. 1,198,358, 2,331,251 AND OTHERS.

NO CLAIM IS MADE TO THE EXCLUSIVE RIGHT TO USE "INVITATIONS", APART FROM THE MARK AS SHOWN.

FOR PROVIDING INFORMATION RELATING TO CULTURAL, SOCIAL, MUSICAL INTERNET, AND SPORTING EVENTS VIA THE INTERNET; DISTRIBUTING INVITATIONS AND TICKETS, IN ELECTRONIC FORM, TO CULTURAL, SOCIAL, MUSICAL, AND SPORTING EVENTS THROUGH THE INTERNET (U.S. CLS. 100, 101 AND 107).

FIRST USE 10-0-2000; IN COMMERCE 10-0-2000.

SN 76-248,733. NIGERIAN REUNION CORPORATION, DETROIT, MI. FILED 4-30-2001.



Nigerian Reunion Corporation

NO CLAIM IS MADE TO THE EXCLUSIVE RIGHT TO USE "NIGERIAN REUNION CORPORATION", APART FROM THE MARK AS SHOWN.

THE COLOR GREEN IS A CLAIMED FEATURE OF THE MARK.

FOR SPECIAL EVENT PLANNING, NAMELY ORGANIZING AND CONDUCTING REUNIONS, PICNICS, BANQUETS AND CONCERTS (U.S. CLS. 100, 101 AND 107).

SN 76-248,974. NWC.EDUCEXPERT INC., QUEBEC, CANADA, FILED 4-30-2001.

EDUCEXPERT .COM

NO CLAIM IS MADE TO THE EXCLUSIVE RIGHT TO USE ".COM", APART FROM THE MARK AS SHOWN.

FOR TECHNICAL INFORMATION PROVIDED ONLINE THROUGH THE INTERNET IN THE FIELD OF FIRE AND SMOKE PROPAGATION, NAMELY, CONDUCTING EDUCATIONAL CLASSES AND WORKSHOPS IN THE FIELD OF FIRE FIGHTING (U.S. CLS. 100, 101 AND 107).

FIRST USE 8-31-2000; IN COMMERCE 8-31-2000.

CLASS 41—(Continued).

SN 76-249,551. VALVINO LAMORE, LLC, LAS VEGAS, NV. FILED 4-30-2001.

WORLD WIDE WYNN

NO CLAIM IS MADE TO THE EXCLUSIVE RIGHT TO USE "WORLD WIDE", APART FROM THE MARK AS SHOWN.

FOR CASINO SERVICES; GOLF COURSE SERVICES; ENTERTAINMENT SERVICES, NAMELY LIVE PERFORMANCES FEATURING LIVE PERFORMANCES OF A MUSICAL BAND AND LIVE PERFORMANCES OF A MUSICAL BAND, SINGERS, DANCERS, MAGICIANS, ACTORS, ACROBATS, AND COMEDIANS, INTEGRATED WITH PRERECORDED MUSIC AND VIDEO; ORGANIZING ATHLETIC AND SPORTING EVENTS, NAMELY BOXING MATCHES, WRESTLING MATCHES, TEAM SPORTS (U.S. CLS. 100, 101 AND 107).

SN 76-254,228. TEXAS WATER SAFARI CORPORATION, THE, SAN MARCOS, TX. FILED 5-7-2001.



NO CLAIM IS MADE TO THE EXCLUSIVE RIGHT TO USE "TEXAS WATER", APART FROM THE MARK AS SHOWN.

THE MARK CONSISTS OF A CANOE CARRYING A CARTOON DEVIL AND ALLIGATOR SUPERIMPOSED OVER THE SHAPE OF THE STATE OF TEXAS.

FOR PROVIDING INFORMATION ABOUT WATER SPORTS ACCESSIBLE VIA A GLOBAL COMPUTER COMMUNICATION NETWORK (U.S. CLS. 100, 101 AND 107).

FIRST USE 2-26-1999; IN COMMERCE 2-26-1999.

CLASS 41—(Continued).

SN 76-255,166. IT'S WHO YOU KNOW LTD., SAN ANTONIO, TX. FILED 5-14-2001.

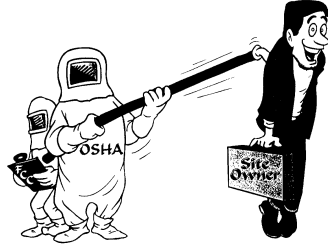

NO CLAIM IS MADE TO THE EXCLUSIVE RIGHT TO USE "FCC, OSHA, AND SITE OWNER", APART FROM THE MARK AS SHOWN.

FOR EDUCATIONAL SERVICES, NAMELY CONDUCTING CLASSES, SEMINARS, CONFERENCES, AND WORKSHOPS IN THE FIELD OF RADIO FREQUENCY TRANSMISSION AND RECEPTION SITES (U.S. CLS. 100, 101 AND 107).

FIRST USE 9-26-1999; IN COMMERCE 9-26-1999.

CLASS 41—(Continued).

SN 76-259,623. PENNI, JAY, BROOKLINE, MA. FILED 5-18-2001.



NO CLAIM IS MADE TO THE EXCLUSIVE RIGHT TO USE "DRIVERS", APART FROM THE MARK AS SHOWN.

FOR PRODUCING TELEVISION, RADIO AND GLOBAL COMPUTER NETWORK ANIMATED SPOTS IN THE FIELD OF AUTOMOBILE DRIVING EDUCATION (U.S. CLS. 100, 101 AND 107).

SN 76-256,086. DIRECT IMAGES INTERACTIVE, INC., SAN LEANDRO, CA. FILED 5-10-2001.

DIRECT IMAGES

OWNER OF U.S. REG. NOS. 2,445,367 AND 2,477,657. SEC. 2(F). FOR MOTION PICTURE, FILM, AND VIDEOTAPE PRODUCTION SERVICES (U.S. CLS. 100, 101 AND 107). FIRST USE 6-8-1987; IN COMMERCE 2-19-1992.

SN 76-257,038. RAINLAKE, LLC, NEW YORK, NY. FILED 5-15-2001.

RAINLAKE

FOR ENTERTAINMENT SERVICES, NAMELY, MOTION PICTURE AND TELEVISION PROGRAM PRODUCTION, POST-PRODUCTION AND DISTRIBUTION SERVICES; COMPOSITION, RECORDING AND PRODUCTION OF MUSIC FOR OTHERS; RECORD PRODUCTION SERVICES; AND ANIMATION PRODUCTION SERVICES (U.S. CLS. 100, 101 AND 107).

SN 76-257,770. CONCORD REVIEW, INC., THE, CONCORD, MA. FILED 5-16-2001.

VARSITY ACADEMICS

NO CLAIM IS MADE TO THE EXCLUSIVE RIGHT TO USE "ACADEMICS", APART FROM THE MARK AS SHOWN.

FOR SERVICES PROMOTING ACADEMIC EXCELLENCE THROUGH THE ASSESSMENT OF ACADEMIC WRITING AND PUBLICATION OF ESSAYS BY STUDENTS (U.S. CLS. 100, 101 AND 107).

FIRST USE 4-0-1995; IN COMMERCE 4-0-1995.

SN 76-260,837. SANDERS, PERRY R., JR., LAKE CHARLES, LA. FILED 5-18-2001.

PHARATIC PIT

FOR ENTERTAINMENT SERVICES, NAMELY A CONTINUING TELEVISION SHOW FEATURING NEWS, NEWS MAGAZINES, COMEDY AND POLITICAL COMMENTARY (U.S. CLS. 100, 101 AND 107).

SN 76-261,704. SEMPRA FIBER LINKS, SAN DIEGO, CA. FILED 5-23-2001.

SEMPRA FIBER LINKS

NO CLAIM IS MADE TO THE EXCLUSIVE RIGHT TO USE "FIBER LINKS", APART FROM THE MARK AS SHOWN.

FOR EDUCATIONAL TRAINING SERVICES, NAMELY, PROVIDING WORKSHOPS AND COURSES OF INSTRUCTION TO USERS ON INSTALLING, OPERATING, INSPECTING AND MAINTAINING FIBER OPTIC CABLES AND RELATED COMPONENTS AND SYSTEMS IN NATURAL GAS AND OTHER SURFACE AND SUBSURFACE CONDUITS AND PIPELINES, AND PROVIDING RELATED TRAINING MATERIALS AND OPERATING MANUALS USED THEREFOR (U.S. CLS. 100, 101 AND 107).

CLASS 41—(Continued).

SN 76-262,890. CASTLE WORLDWIDE, INC., RESEARCH TRIANGLE PARK, NC. FILED 5-29-2001.

CASTLE WORLDWIDE, INC.

NO CLAIM IS MADE TO THE EXCLUSIVE RIGHT TO USE "WORLDWIDE, INC.", APART FROM THE MARK AS SHOWN.

FOR DEVELOPMENT AND DISSEMINATION OF STANDARDIZED EXAMINATIONS AND EDUCATIONAL MATERIALS, NAMELY, PROCTOR MANUALS, STUDY GUIDES, PRACTICE TESTS AND CANDIDATE TESTS, FOR USE IN CERTIFICATION, LICENSURE, EDUCATIONAL AND INDUSTRIAL TESTING; ADMINISTERING STANDARDIZED TESTS (U.S. CLS. 100, 101 AND 107).

FIRST USE 7-23-2000; IN COMMERCE 7-23-2000.

SN 76-264,695. NATIONAL SPORTS TRAINING FOUNDATION, INC., PORT WASHINGTON, NY. FILED 5-31-2001.



NO CLAIM IS MADE TO THE EXCLUSIVE RIGHT TO USE "NATIONAL SPORTS TRAINING FOUNDATION", APART FROM THE MARK AS SHOWN.

FOR SELF DEFENSE INSTRUCTION DIRECTED TO THE HANDICAPPED (U.S. CLS. 100, 101 AND 107).

SN 76-265,067. MORRIS COMMUNICATIONS CORPORATION, AUGUSTA, GA. FILED 6-1-2001.

ASK THE GUIDE

FOR PROVIDING TO PEOPLE AND ORGANIZATIONS INFORMATION IN THE FIELDS OF ARTS, MUSIC, ENTERTAINMENT, RESTAURANTS, BUSINESSES, HOTELS, AND TRANSPORTATION (U.S. CLS. 100, 101 AND 107).

FIRST USE 7-10-1999; IN COMMERCE 7-10-1999.

CLASS 41—(Continued).

SN 76-267,020. DAUBLE, STEPHANIE, SAINT CLAIR, MI. FILED 6-5-2001.

LEONA SUGAR

THE NAME "LEONA SUGAR" DOES NOT IDENTIFY A LIVING INDIVIDUAL.

FOR ENTERTAINMENT, NAMELY, LIVE SINGING PERFORMANCES BY AN INDIVIDUAL WITH A MUSICAL BAND (U.S. CLS. 100, 101 AND 107).

SN 76-274,554. UNIVERSITY OF SANTA MONICA, SANTA MONICA, CA. FILED 6-21-2001.

UNIVERSITY OF SANTA MONICA

NO CLAIM IS MADE TO THE EXCLUSIVE RIGHT TO USE "UNIVERSITY", APART FROM THE MARK AS SHOWN.

SEC. 2(F).

FOR ORGANIZING AND CONDUCTING SEMINARS AND WORKSHOPS TO HELP OTHERS DEVELOP PERSONAL GROWTH, INTERPERSONAL RELATIONSHIPS AND PERSONAL EXPRESSION; DISTRIBUTING COURSE MATERIALS IN CONNECTION WITH SEMINARS AND WORKSHOPS; AND EDUCATIONAL SERVICES, NAMELY CONDUCTING TRAINING CLASSES AND COURSES RELATING TO PERSONAL GROWTH, INTERPERSONAL RELATIONSHIPS AND PERSONAL EXPRESSION (U.S. CLS. 100, 101 AND 107).

FIRST USE 0-0-1990; IN COMMERCE 0-0-1990.

SN 76-275,527. ROOSTERTAIL, INC., DETROIT, MI. FILED 6-25-2001.



FOR ENTERTAINMENT SERVICES IN THE FORM OF PARTIES FEATURING FOOD, DRINKS LIVE MUSIC AND CELEBRITY APPEARANCES (U.S. CLS. 100, 101 AND 107).

FIRST USE 7-1-1998; IN COMMERCE 7-1-1998.

CLASS 41—(Continued).

SN 76-277,305. LES MILLS INTERNATIONAL LIMITED, AUCKLAND, NEW ZEALAND, FILED 6-26-2001.



NO CLAIM IS MADE TO THE EXCLUSIVE RIGHT TO USE "BODY TRAINING SYSTEMS", APART FROM THE MARK AS SHOWN.

FOR RECREATIONAL SERVICES, NAMELY, FITNESS TRAINING SERVICES; EDUCATIONAL SERVICES; NAMELY CONDUCTING WORKSHOPS AND SEMINARS IN THE FIELD OF PHYSICAL FITNESS AND MUSIC; GYMNASIUM SERVICES; HEALTH CLUB SERVICES; SPORTS CLUB SERVICES; FITNESS CLUB SERVICES; EXERCISE INSTRUCTION; PROVIDING FACILITIES FOR SPORTS TOURNAMENTS; RENTAL OF SPORTS AND EXERCISE EQUIPMENT; PROVIDING INFORMATION IN THE FIELD OF SPORTS (U.S. CLS. 100, 101 AND 107).

SN 76-279,259. FOCOLARE MOVEMENT, MEN'S BRANCH (MARIAPOLIS LUMINOSA), HYDE PARK, NY. FILED 7-2-2001.

NEW CITY PICTURES

NO CLAIM IS MADE TO THE EXCLUSIVE RIGHT TO USE "PICTURES", APART FROM THE MARK AS SHOWN.

FOR TELEVISION AND FILM PRODUCTION AND ORIGINAL VIDEO AND FILM PROGRAM SERVICES, NAMELY, PROVIDING CONCEPT CREATION, SCRIPT WRITING, ART DIRECTION, FILMING, SOUND RECORDING, AND EDITING OF VIDEO AND FILM PROGRAMS FOR CLIENTS IN THE TELEVISION AND FILM INDUSTRY (U.S. CLS. 100, 101 AND 107).

FIRST USE 1-1-2000; IN COMMERCE 1-1-2000.

SN 76-280,652. IMPACT PERFORMANCE GROUP, INC., WELLESLEY, MA. FILED 7-6-2001.

FIND

FOR EDUCATIONAL SERVICES, NAMELY, CONDUCTING SEMINARS, CONFERENCES, WORKSHOP AND CLASSES FOR CLIENTS, SUCH SERVICES PROVIDING INSTRUCTIONAL INFORMATION ON HOW A CLIENT CAN DETERMINE THE COMMUNICATION STYLE OF ITS CUSTOMER BY DETERMINING THE CUSTOMER'S NEED FOR CONTROL, THE CUSTOMER'S TOLERANCE FOR DETAIL, AND THE CUSTOMER'S DESIRE FOR SUPPORT FOR THE CLIENT TO BETTER COMMUNICATE WITH ITS CUSTOMER TO DETERMINE THE CUSTOMER'S OBJECTIVES IN ORDER TO INCREASE THE CLIENT'S SALES TO THE CUSTOMER (U.S. CLS. 100, 101 AND 107).

FIRST USE 8-0-1999; IN COMMERCE 8-0-1999.

CLASS 41—(Continued).

SN 76-283,351. MIDWEST TRAINING GROUP, INC., WEST-FIELD, IN. FILED 7-12-2001.

MIDWEST TRAINING GROUP

NO CLAIM IS MADE TO THE EXCLUSIVE RIGHT TO USE "TRAINING GROUP", APART FROM THE MARK AS SHOWN.

FOR EDUCATIONAL SERVICES, NAMELY, PROVIDING TRAINING, SEMINARS AND WORKSHOPS IN THE FIELD OF PUBLIC AND POLICE MATTERS (U.S. CLS. 100, 101 AND 107).

SN 76-283,543. NINTENDO OF AMERICA INC., REDMOND, WA. FILED 7-10-2001.

POKEMON CARD-E READER

OWNER OF U.S. REG. NOS. 2,510,803, 2,515,000 AND OTHERS.

NO CLAIM IS MADE TO THE EXCLUSIVE RIGHT TO USE "READER", APART FROM THE MARK AS SHOWN.

FOR PROVIDING ELECTRONIC GAME NEWS, HINTS AND OTHER ELECTRONIC GAME INFORMATION THROUGH A GLOBAL COMPUTER NETWORK; PROVIDING A WEB SITE FEATURING EDUCATIONAL SERVICES AND INFORMATION REGARDING ELECTRONIC GAME PROGRAMS, ELECTRONIC GAME PRODUCTS, AND ELECTRONICALLY TRANSMITTED NEWS AND INFORMATION REGARDING ENTERTAINMENT TOPICS IN THE FIELD OF COMPUTER AND VIDEO GAMES; PRODUCTION OF TELEVISION PROGRAMS IN THE FIELD OF CHILDREN'S ENTERTAINMENT; PROVIDING ON-LINE INTERACTIVE GAMES (U.S. CLS. 100, 101 AND 107).

SN 76-283,907. BLAM, INC., SAN FRANCISCO, CA. FILED 7-11-2001.

BLAM!

OWNER OF U.S. REG. NOS. 2,005,996, 2,356,301 AND 2,417,770.

FOR ENTERTAINMENT SERVICES, NAMELY PROVIDING ONLINE COMPUTER GAMES VIA THE INTERNET, CABLE, TELEVISION, WIRELESS AND CELLULAR MEDIA; AND ENTERTAINMENT SERVICES, NAMELY PROVIDING ENTERTAINMENT CONTENT IN THE NATURE OF VIDEOGAMES AND COMPUTER SOFTWARE GAMES VIA THE INTERNET, CABLE, TELEVISION, WIRELESS AND CELLULAR MEDIA; AND COMPUTER SERVICES, NAMELY, OFFERING VIDEO AND ELECTRONIC GAME INFORMATION VIA THE INTERNET (U.S. CLS. 100, 101 AND 107).

CLASS 41—(Continued).

SN 76-291,853. MARSHALL, TAWANNA A., TEMPLE HILLS, MD. FILED 7-27-2001.



NO CLAIM IS MADE TO THE EXCLUSIVE RIGHT TO USE "SYSTEM", APART FROM THE MARK AS SHOWN. FOR EDUCATIONAL SERVICES, NAMELY, PROVIDING CLASSES, SEMINARS, WORKSHOPS AND CONFERENCES IN THE FIELD OF READING INSTRUCTION AND DISTRIBUTION OF COURSE MATERIALS RELATED THERETO (U.S. CLS. 100, 101 AND 107).

FIRST USE 7-27-2001; IN COMMERCE 7-27-2001.

CLASS 41—(Continued).

SN 76-298,085. NEW YORK JETS LLC, HEMPSTEAD, NY. FILED 8-10-2001.

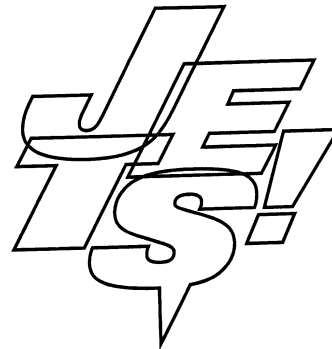

SN 76-295,454. CASTELLANO, SANTO, BELLMORE, NY. FILED 8-7-2001.

DREW KIDD

THE NAME "DREW KIDD" DOES NOT IDENTIFY A LIVING INDIVIDUAL.

FOR ENTERTAINMENT IN THE NATURE OF LIVE PERFORMANCES BY A MUSICAL GROUP (U.S. CLS. 100, 101 AND 107).

FOR EDUCATION AND ENTERTAINMENT SERVICES IN THE NATURE OF PROFESSIONAL FOOTBALL GAMES AND EXHIBITIONS; PROVIDING SPORTS AND ENTERTAINMENT INFORMATION RELATING TO THE SPORT OF AMERICAN FOOTBALL VIA A GLOBAL COMPUTER NETWORK OR A COMMERCIAL ON-LINE SERVICE; ORGANIZATION OF SPORTS EVENTS; FAN CLUB SERVICES; EDUCATIONAL SERVICES, NAMELY, PHYSICAL EDUCATION PROGRAMS; ARRANGING AND CONDUCTING ATHLETIC COMPETITIONS, NAMELY PROFESSIONAL FOOTBALL GAMES AND EXHIBITIONS; ENTERTAINMENT SERVICES, NAMELY, MUSICAL AND DANCE PERFORMANCES PROVIDED DURING INTERVALS AT SPORTS EVENTS; EDUCATIONAL SERVICES, NAMELY, PHYSICAL EDUCATION PROGRAMS; PRODUCTION OF RADIO AND TELEVISION PROGRAMS, LIVE SHOWS FEATURING FOOTBALL GAMES, EXHIBITIONS, COMPETITIONS AND MUSICAL, COMEDY AND DANCE PERFORMANCES (U.S. CLS. 100, 101 AND 107).

CLASS 41—(Continued).

SN 76-298,846. FASTER FILMS, LOS ANGELES, CA. FILED 8-3-2001.

FASTER FILMS

NO CLAIM IS MADE TO THE EXCLUSIVE RIGHT TO USE "FILMS", APART FROM THE MARK AS SHOWN.

FOR ENTERTAINMENT SERVICES, NAMELY, PRODUCTION AND DISTRIBUTION OF MOTION PICTURES, FILMS, TELEVISION PROGRAMS, RADIO PROGRAMS, INTERACTIVE TELEVISION PROGRAMS, IN THE FIELDS OF ANIMATED AND LIVE-ACTION ENTERTAINMENT, SCIENCE FICTION, COMEDY, DRAMA, MYSTERY, PSYCHIC PHENOMENA, SPORTS, NEWS, TALK SHOWS, VARIETY, TRAVEL, DOCUMENTARIES, MOVIE REVIEWS, PSYCHOLOGY, EDUCATION, RECREATION, LIVE PERFORMANCES, INDIVIDUAL ENTERTAINERS, CULTURES AND CULTURAL EVENTS, AND MUSIC; AUDIO RECORDING AND PRODUCTION OF ANIMATED AND LIVE ACTION ENTERTAINMENT, SCIENCE FICTION, COMEDY, DRAMA, MYSTERY, PSYCHIC PHENOMENA, SPORTS, NEWS, TALK SHOWS, VARIETY, TRAVEL, DOCUMENTARIES, MOVIE REVIEWS, PSYCHOLOGY, EDUCATION, RECREATION, LIVE PERFORMANCES, INDIVIDUAL ENTERTAINERS, CULTURES AND CULTURAL EVENTS, AND MUSIC; ENTERTAINMENT IN THE NATURE OF THEATER PRODUCTIONS IN THE FIELDS OF ANIMATED AND LIVE-ACTION ENTERTAINMENT, SCIENCE FICTION, COMEDY, DRAMA, MYSTERY, PSYCHIC PHENOMENA, SPORTS, NEWS, TALK SHOWS, VARIETY, TRAVEL, DOCUMENTARIES, MOVIE REVIEWS, PSYCHOLOGY, EDUCATION, RECREATION, LIVE PERFORMANCES, INDIVIDUAL ENTERTAINERS, CULTURES AND CULTURAL EVENTS, AND MUSIC; PUBLICATION OF BOOKS, MAGAZINES, CARTOONS, COMIC STRIPS AND COMIC BOOKS; FAN CLUB SERVICES (U.S. CLS. 100, 101 AND 107).

SN 76-299,212. LEVINSOHN, LUCY, LOS ANGELES, CA. AND MINARIK, MARC, LOS ANGELES, CA. FILED 8-15-2001.

LILY'S SIREN

NO CLAIM IS MADE TO THE EXCLUSIVE RIGHT TO USE "SIREN", APART FROM THE MARK AS SHOWN.

FOR ENTERTAINMENT SERVICES IN THE NATURE OF LIVE MUSICAL PERFORMANCES BY A GROUP; SONGWRITING, AND PRODUCTION OF ORIGINAL MUSIC COMPOSITIONS (U.S. CLS. 100, 101 AND 107).
FIRST USE 9-1-1998; IN COMMERCE 9-1-1998.

SN 76-299,296. COSTA, LORAIN, SAN DIEGO, CA. FILED 8-15-2001.

soundwrite

FOR PERSONAL COACHING SERVICES IN THE FIELD OF WRITING FOR THE EAR, NAMELY, WRITING FOR SOUND WHEN PREPARING SPEECHES, SCRIPTS AND OTHER ORAL PRESENTATIONS (U.S. CLS. 100, 101 AND 107).

FIRST USE 8-10-2001; IN COMMERCE 8-10-2001.

CLASS 41—(Continued).

SN 76-301,589. GRAPHIC ARTS EDUCATION AND RESEARCH FOUNDATION, RESTON, VA. FILED 8-20-2001.

PrintED

FOR EDUCATIONAL SERVICES, NAMELY PROVIDING ACCREDITATION PROGRAMS IN THE FIELD OF GRAPHIC COMMUNICATIONS FOR INSTRUCTORS AND EDUCATION INSTITUTIONS (U.S. CLS. 100, 101 AND 107).

FIRST USE 6-0-1988; IN COMMERCE 6-0-1988.

SN 76-301,911. HEALTHSOUTH CORPORATION, BIRMINGHAM, AL. FILED 8-17-2001.



FOR EDUCATIONAL AND ENTERTAINMENT SERVICES, NAMELY, A TRAVELING ROAD SHOW PRESENTING SPORTS PERSONALITIES AND EDUCATIONAL PRESENTATIONS PROMOTING CHILDREN'S HEALTH AND FITNESS ISSUES; ENTERTAINMENT IN THE NATURE OF ON-GOING TELEVISION PROGRAMS IN THE FIELD OF CHILDREN'S HEALTH AND FITNESS (U.S. CLS. 100, 101 AND 107).

FIRST USE 1-0-1995; IN COMMERCE 1-0-1995.

SN 76-302,676. COSMETIC CAR CARE, INC., DBA DYNAMIC DRIVES, IRVINE, CA. FILED 8-21-2001.

DYNAMIC DRIVES

FOR ENTERTAINMENT SERVICES IN THE NATURE OF ARRANGING AND CONDUCTING MOTOR VEHICLE DRIVING EVENTS (U.S. CLS. 100, 101 AND 107).

FIRST USE 5-0-2001; IN COMMERCE 5-0-2001.

SN 76-303,447. USAGENCY, INC., LEWISBURG, PA. FILED 8-23-2001.

COUNTRY ROCKS !

NO CLAIM IS MADE TO THE EXCLUSIVE RIGHT TO USE "COUNTRY", APART FROM THE MARK AS SHOWN.

FOR ENTERTAINMENT, NAMELY, LIVE PERFORMANCES BY MUSICAL BAND AND CONCERT TOURS BY A MUSICAL BAND (U.S. CLS. 100, 101 AND 107).

FIRST USE 8-10-2001; IN COMMERCE 8-10-2001.

CLASS 41—(Continued).

SN 76-303,987. COOK & COMPANY, DENVER, CO. FILED 8-22-2001.

COACHING AT THE INFLECTION POINT

NO CLAIM IS MADE TO THE EXCLUSIVE RIGHT TO USE "COACHING", APART FROM THE MARK AS SHOWN. FOR EDUCATIONAL SERVICES, NAMELY, CONDUCTING WORKSHOPS AND SEMINARS IN THE FIELD OF BUSINESS MANAGEMENT, CAREER MANAGEMENT, AND CRISIS MANAGEMENT (U.S. CLS. 100, 101 AND 107).

SN 76-304,487. WRIGHT, MARK R., WESTERVILLE, OH. FILED 8-27-2001.

SOLUTIONS FOR LEARNING

NO CLAIM IS MADE TO THE EXCLUSIVE RIGHT TO USE "LEARNING", APART FROM THE MARK AS SHOWN. FOR EDUCATIONAL SERVICES IN THE NATURE OF DEVELOPING COGNITIVE LEARNING SKILLS (U.S. CLS. 100, 101 AND 107).

SN 76-305,668. PORTLAND PIRATES LLC, PORTLAND, ME. FILED 8-27-2001.



NO CLAIM IS MADE TO THE EXCLUSIVE RIGHT TO USE "PORTLAND", APART FROM THE MARK AS SHOWN. FOR ENTERTAINMENT SERVICES, NAMELY, PROVIDING PROFESSIONAL ICE HOCKEY EXHIBITIONS AND GAMES (U.S. CLS. 100, 101 AND 107).

CLASS 41—(Continued).

SN 76-306,430. LEAH'S SISTERS, IRVING, TX. FILED 8-30-2001.



THE LINING SHOWN IN THE DRAWING IS A FEATURE OF THE MARK AND IS NOT INTENDED TO INDICATE COLOR.

THE MARK CONSISTS OF AN OVAL, REPRESENTING A GLOBE, WITH GRID LINES ON THE LEFT SIDE AND THREE WOMEN'S PROFILES ON THE RIGHT SIDE, ALL ABOVE THE WORDING "LEAH'S SISTERS REBUILDING NATIONS THROUGH RESTORED WOMEN".

FOR PUBLIC SPEAKING LECTURES, SEMINARS AND CONFERENCES FOR MOTIVATING AND DEVELOPING WOMEN (U.S. CLS. 100, 101 AND 107).

SN 76-307,147. PERRYSBURG BOARD OF EDUCATION, PERRYSBURG, OH. FILED 9-4-2001.



NO CLAIM IS MADE TO THE EXCLUSIVE RIGHT TO USE "PERRYSBURG", APART FROM THE MARK AS SHOWN.

FOR EDUCATION SERVICES, NAMELY, PROVIDING COURSES OF INSTRUCTION AT THE JUNIOR HIGH SCHOOL AND HIGH SCHOOL LEVEL; ENTERTAINMENT IN THE NATURE OF EVENTS IN THE FIELDS OF JUNIOR HIGH SCHOOL AND HIGH SCHOOL FOOTBALL, BASKETBALL, HOCKEY, WRESTLING, SWIMMING, BASEBALL, VOLLEYBALL, SOCCER, TRACK, CROSS-COUNTRY, LACROSSE, BAND, ORCHESTRA, THEATER, ACADEMIC CLUB ACTIVITIES, AND ACADEMIC COMPETITIONS (U.S. CLS. 100, 101 AND 107).

FIRST USE 1-6-2001; IN COMMERCE 1-6-2001.

CLASS 41—(Continued).

SN 76-308,230. LB ROSE RANCH LLC, SAN FRANCISCO, CA. FILED 8-31-2001.



NO CLAIM IS MADE TO THE EXCLUSIVE RIGHT TO USE "CLUB" AND "RANCH", APART FROM THE MARK AS SHOWN.

THE MARK CONSISTS OF A CIRCULAR EMBLEM THAT CONTAINS A STYLIZED MOUNTAIN RANGE AND RIVER ADJACENT TO A GOLF COURSE PUTTING GREEN ABOVE THE WORDS "THE SIENNA CLUB ROSE RANCH". FOR GOLF CLUB SERVICES (U.S. CLS. 100, 101 AND 107).

SN 76-308,503. ALIYEW, FAIG, 51109 KOLN, FED REP GERMANY, FILED 9-4-2001.

**LUX STELLARIS**

PRIORITY CLAIMED UNDER SEC. 44(D) ON FED REP GERMANY APPLICATION NO. 30114252, FILED 3-2-2001, REG. NO. 30114252, DATED 7-2-2001, EXPIRES 3-31-2011.

THE ENGLISH TRANSLATION OF "LUX STELLARIS" IS "STARLIGHT".

FOR EDUCATION SERVICES, NAMELY, CONDUCTING, CLASSES, SEMINARS, CONFERENCES, WORKSHOPS IN THE ARTISTIC FIELDS, NAMELY, POETRY, COMPOSITION, FINE ARTS, DANCE, THEATER, ACTING, SONG, SOLO, ENSEMBLE OR ORCHESTRA MUSIC, MIME AND FILM ART; EDUCATIONAL SERVICE IN THE NATURE OF MUSICAL AND ARTISTIC KINDERGARTEN SCHOOLS; ORGANIZING COMMUNITY CULTURAL AND EDUCATIONAL EVENTS IN THE FORM OF SEMINARS, COURSES, CONCERTS, PRIVATE VIEWINGS, MATINEES AND SOIREES FOR THE ADVANCEMENT OF THE FINE ARTS AND PERFORMING ARTS (U.S. CLS. 100, 101 AND 107).

CLASS 41—(Continued).

SN 76-309,429. GUY WALKS INTO A BAR, INC., LOS ANGELES, CA. FILED 9-5-2001.

GUY WALKS INTO A NOIR

THE WORD "NOIR" MEANS "BLACK" OR "DARK" IN FRENCH.

FOR ENTERTAINMENT SERVICES, NAMELY, PRODUCTION OF MOTION PICTURES AND TELEVISION PROGRAMS; AND ENTERTAINMENT SERVICES, NAMELY, DISTRIBUTION OF MOTION PICTURES AND TELEVISION PROGRAMS FOR OTHERS (U.S. CLS. 100, 101 AND 107).

SN 76-309,860. NATIONAL ASSOCIATION OF BASKETBALL COACHES, OVERLAND PARK, KS. FILED 9-6-2001.

GUARDIANS OF THE GAME CLASSIC

OWNER OF U.S. REG. NO. 2,500,370.
FOR ENTERTAINMENT IN THE NATURE OF A BASKETBALL TOURNAMENT (U.S. CLS. 100, 101 AND 107).

SN 76-311,072. SEATTLE MARATHON ASSOCIATION, THE, SEATTLE, WA. FILED 9-10-2001.

SEATTLE MARATHON

NO CLAIM IS MADE TO THE EXCLUSIVE RIGHT TO USE "MARATHON", APART FROM THE MARK AS SHOWN.

SEC. 2(F).
FOR ARRANGING AND CONDUCTING ATHLETIC COMPETITIONS IN THE NATURE OF RUNNING COMPETITIONS; ORGANIZING AND PROMOTING SPORTING EVENTS, NAMELY, RUNNING RACES AND WALKS (U.S. CLS. 100, 101 AND 107).
FIRST USE 0-0-1970; IN COMMERCE 0-0-1970.

SN 76-311,087. MARIAH MEDIA INC., SANTA FE, NM. FILED 9-12-2001.

GEAR OF THE YEAR

FOR PROVIDING RECOGNITION AND INCENTIVES BY THE WAY OF AWARDS TO DEMONSTRATE EXCELLENCE IN THE FIELD OF OUTDOOR SPORTS, FITNESS AND RECREATIONAL SERVICES (U.S. CLS. 100, 101 AND 107).

CLASS 41—(Continued).

SN 76-311,356. PASSION MEDIA INC., TORONTO ONTARIO M4L 3R6, CANADA, FILED 9-12-2001.

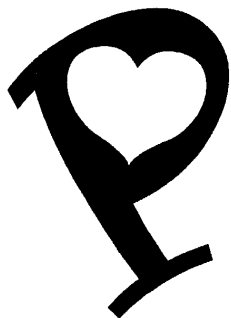

FOR ENTERTAINMENT SERVICES IN THE NATURE OF ONGOING TELEVISION PROGRAMS, STREAMING MEDIA AND INTERACTIVE TELEVISION PROGRAMS IN THE FIELD OF ADULT ENTERTAINMENT, HUMAN SEXUALITY, SEXUAL HEALTH AND EDUCATION AND THE UNMARRIED LIFESTYLE (U.S. CLS. 100, 101 AND 107).

SN 76-311,357. PASSION MEDIA INC., TORONTO ONTARIO M4L 3R6, CANADA, FILED 9-12-2001.

ONE-OF-A-KIND TV

NO CLAIM IS MADE TO THE EXCLUSIVE RIGHT TO USE "TV", APART FROM THE MARK AS SHOWN.

FOR ENTERTAINMENT SERVICES IN THE NATURE OF ONGOING TELEVISION PROGRAMS, STREAMING MEDIA AND INTERACTIVE TELEVISION PROGRAMS IN THE FIELD OF ADULT ENTERTAINMENT, HUMAN SEXUALITY, SEXUAL HEALTH AND EDUCATION AND THE UNMARRIED LIFESTYLE (U.S. CLS. 100, 101 AND 107).

SN 76-311,522. KEENELAND ASSOCIATION, INC., LEXINGTON, KY. FILED 9-12-2001.

RACING AS IT WAS MEANT TO BE

FOR ENTERTAINMENT, NAMELY, CONDUCTING HORSE RACES (U.S. CLS. 100, 101 AND 107).

SN 76-311,525. WALTER, TOMMY, LOS ANGELES, CA. FILED 9-10-2001.

ABANDONED POOLS

FOR ENTERTAINMENT SERVICES, NAMELY, LIVE AND RECORDED PERFORMANCES BY A MUSICAL GROUP (U.S. CLS. 100, 101 AND 107).

CLASS 41—(Continued).

SN 76-311,764. GRIFFIN, JUDITH, MANHATTAN BEACH, CA. AND COLLINS, PENNY, MANHATTAN BEACH, CA. FILED 9-13-2001.

WEAR YOUR CHAIR

FOR EDUCATIONAL SERVICES, NAMELY, PROVIDING CLASSES AND SEMINARS IN THE FIELDS OF INTERIOR DESIGN, CLOTHING DESIGN, AND FURNITURE DESIGN (U.S. CLS. 100, 101 AND 107).

SN 76-311,971. SANCHEZ, HECTOR, PRESIDIO, TX. FILED 9-13-2001.



THE ENGLISH TRANSLATION OF "EL DE OJINAGA HECTOR SANCHEZ Y SUS NORTENITOS" IS "THE ONE FROM OJINAGA HECTOR SANCHEZ AND HIS LITTLE NORTHERNERS".

FOR ENTERTAINMENT SERVICES IN THE NATURE OF LIVE MUSICAL PERFORMANCES (U.S. CLS. 100, 101 AND 107).

FIRST USE 1-1-2001; IN COMMERCE 1-1-2001.

SN 76-313,728. RADOVCIC, ANTHONY, SAN PEDRO, CA. FILED 9-19-2001.

PAUL LUCION

THE NAME "PAUL LUCION" DOES NOT IDENTIFY A LIVING INDIVIDUAL.

FOR ENTERTAINMENT SERVICES IN THE NATURE OF WRESTLING CONTESTS (U.S. CLS. 100, 101 AND 107).

SN 76-313,924. HEADLINER PRODUCTIONS, LLC, TAMPA, FL. FILED 9-18-2001.



NO CLAIM IS MADE TO THE EXCLUSIVE RIGHT TO USE "MUSIC ENTERTAINMENT NETWORK", APART FROM THE MARK AS SHOWN.

FOR PRODUCTION OF AUDIO MUSIC PROGRAMS FOR OTHERS (U.S. CLS. 100, 101 AND 107).

CLASS 41—(Continued).

SN 76-315,293. GOOD SHEPHERD HOSPICE, AUBURN-DALE, FL. FILED 9-21-2001.



NO CLAIM IS MADE TO THE EXCLUSIVE RIGHT TO USE "CENTRAL FLORIDA WINE FESTIVAL", APART FROM THE MARK AS SHOWN.

FOR ENTERTAINMENT SERVICES NAMELY, CONDUCTING WINE FESTIVALS, WINE TASTINGS AND COOKING DEMONSTRATIONS TO BENEFIT A NOT-FOR-PROFIT ORGANIZATION (U.S. CLS. 100, 101 AND 107).

FIRST USE 4-1-1999; IN COMMERCE 4-1-1999.

SN 76-316,303. ROGERS BLUE JAYS BASEBALL PARTNERSHIP, TORONTO, ONTARIO, CANADA, FILED 9-24-2001.

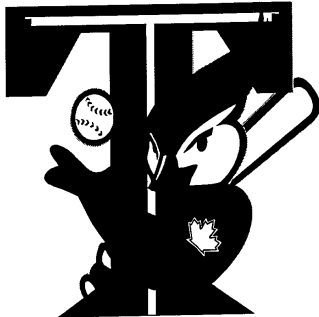

FOR ENTERTAINMENT SERVICES, NAMELY, BASEBALL GAMES FAN CLUBS, COMPETITIONS AND EXHIBITIONS RENDERED LIVE, THROUGH BROADCAST MEDIA INCLUDING TELEVISION AND RADIO AND VIA A GLOBAL COMPUTER NETWORK OF COMMERCIAL ON-LINE SERVICES; PROVIDING INFORMATION IN THE FIELD OF SPORTS, ENTERTAINMENT AND RELATED TOPICS AND PROVIDING FOR INFORMATIONAL MESSAGES RELATING TO BASEBALL, PROVIDING MULTIPLE USER INTERACTIVE COMPUTER GAMES, ALL OF WHICH MAY BE ACCESSED VIA A GLOBAL COMPUTER NETWORK OF COMMERCIAL ON-LINE SERVICES, EDUCATION SERVICES IN THE NATURE OF BASEBALL SKILLS INSTRUCTION (U.S. CLS. 100, 101 AND 107).

CLASS 41—(Continued).

SN 76-317,331. KENT STATE UNIVERSITY, KENT, OH. FILED 9-25-2001.



FOR EDUCATIONAL SERVICES, NAMELY, PROVIDING INSTRUCTION AND TRAINING COURSES AT THE UNIVERSITY AND GRADUATE SCHOOL LEVELS; AND, RELATED ENTERTAINMENT SERVICES, NAMELY, PRESENTATION OF SPORTING EVENTS, LECTURES, CONCERTS, AND THEATER PRODUCTIONS (U.S. CLS. 100, 101 AND 107).

SN 76-317,620. ADVANCED RESEARCH AND TECHNOLOGY INSTITUTE, INC., BLOOMINGTON, IN. FILED 9-26-2001.

INGEN

FOR EDUCATIONAL RESEARCH SERVICES, NAMELY, CONDUCTING AND SPONSORING RESEARCH PROGRAMS IN THE FIELDS OF GENOMICS, NAMELY, INFORMATION TECHNOLOGY, PROTEOMICS, GENOTYPING, PHENOTYPING, BIOETHICS, BIOLOGY, CHEMISTRY, BIOINFORMATICS, MEDICAL INFORMATICS AND SUPERCOMPUTING (U.S. CLS. 100, 101 AND 107).

SN 76-318,949. TELEvisa, S.A. DE C.V., DELEGACION ALVARO OBREGON, MEXICO, FILED 9-28-2001.

HIJAS DE LA MADRE TIERRA

PRIORITY CLAIMED UNDER SEC. 44(D) ON MEXICO APPLICATION NO. 502796, FILED 8-21-2001, REG. NO. 502796, DATED 8-21-2001, EXPIRES 8-21-2011.

THE ENGLISH TRANSLATION OF "HIJAS DE LA MADRE TIERRA" IS "DAUGHTERS OF MOTHER EARTH".
FOR ENTERTAINMENT IN THE NATURE OF ONGOING TELEVISION PROGRAMS IN THE FIELD OF VARIETY (U.S. CLS. 100, 101 AND 107).

SN 76-319,369. JACKSON, G. MICHAEL, BELLINGHAM, WA. FILED 9-28-2001.

ASAP

FOR EDUCATIONAL SERVICES, NAMELY, PREPARING AND CONDUCTING COURSES AND SEMINARS AND DISTRIBUTING EDUCATIONAL MATERIALS RELATED TO MOUNTAIN SAFETY IN CONNECTION THEREWITH (U.S. CLS. 100, 101 AND 107).

FIRST USE 2-28-1999; IN COMMERCE 2-28-1999.

CLASS 41—(Continued).

SN 76-319,823. DEY L.P., NAPA, CA. FILED 10-2-2001.

DEY UNIVERSITY

NO CLAIM IS MADE TO THE EXCLUSIVE RIGHT TO USE "UNIVERSITY", APART FROM THE MARK AS SHOWN.

FOR CONFERENCES, SEMINARS, EDUCATIONAL AND TRAINING PROGRAMS, ALL IN THE FIELDS OF BUSINESS DEVELOPMENT, EXECUTIVE DEVELOPMENT, MANAGEMENT AND SUPERVISORY DEVELOPMENT, EMPLOYEE DEVELOPMENT, PROJECT MANAGEMENT, TEAM BUILDING, MEETING MANAGEMENT, EFFECTIVE BUSINESS WRITING, CONFLICT MANAGEMENT AND GOOD MANUFACTURING PRACTICES AND DISTRIBUTION OF COURSE MATERIALS IN CONNECTION THEREWITH (U.S. CLS. 100, 101 AND 107).

SN 76-322,117. VOICES IN HARMONY, LOS ANGELES, CA. FILED 10-9-2001.

VOICES IN HARMONY

FOR ENTERTAINMENT IN THE NATURE OF LIVE DRAMATIC PERFORMANCES BY A PERFORMANCE GROUP; ENTERTAINMENT IN THE NATURE OF THEATRICAL PRODUCTIONS; ENTERTAINMENT IN THE NATURE OF DANCE PERFORMANCES; PRODUCTION OF THEATRICAL PLAYS AND PERFORMANCES; EDUCATIONAL SERVICES, NAMELY, PROVIDING TUTORING, MENTORING, TRAINING, AND ARRANGING AND CONDUCTING CLASSES, WORKSHOPS AND SEMINARS IN THE FIELDS OF ETHNIC AND SOCIAL DIVERSITY, RACISM, DRUG AND ALCOHOL ABUSE, PEER PRESSURE, VIOLENCE, FILMS, PLAYS, SCRIPT WRITING AND THEATER; AND EDUCATIONAL SERVICES, NAMELY PRESENTING PRE-RECORDED VIDEO TAPES AND CASSETTES OF DRAMATIC PERFORMANCES AND PLAYS REGARDING ETHNIC AND SOCIAL DIVERSITY, RACISM, DRUG AND ALCOHOL ABUSE, PEER PRESSURE AND VIOLENCE (U.S. CLS. 100, 101 AND 107).

FIRST USE 7-17-1998; IN COMMERCE 7-17-1998.

SN 76-322,822. NATALIE SLOBODIN & ASSOCIATES, INC., RESTON, VA. FILED 10-10-2001.

ESL EXPRESS

FOR ONE ON ONE TUTORING SERVICES FOR STUDENTS WHERE ENGLISH IS NOT THEIR PRIMARY LANGUAGE (U.S. CLS. 100, 101 AND 107).

CLASS 41—(Continued).

SN 76-323,367. BREAK OUT FITNESS, INC., CLEVELAND, OH. FILED 10-10-2001.



NO CLAIM IS MADE TO THE EXCLUSIVE RIGHT TO USE "FITNESS CLUBS", APART FROM THE MARK AS SHOWN.

FOR PROVIDING FITNESS AND EXERCISE FACILITIES DESIGNED TO MEET THE SPECIALIZED NEEDS OF PEOPLE WITH PHYSICAL DISABILITIES (U.S. CLS. 100, 101 AND 107).

FIRST USE 9-29-2001; IN COMMERCE 9-29-2001.

SN 76-323,842. PRECISE ICE OF NEBRASKA, INC., OMAHA, NE. FILED 10-11-2001.

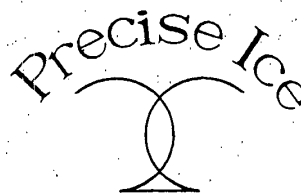

NO CLAIM IS MADE TO THE EXCLUSIVE RIGHT TO USE "ICE", APART FROM THE MARK AS SHOWN.

FOR PROVIDING FACILITIES FOR ICE-RELATED RECREATIONAL ACTIVITIES, INCLUDING ICE SKATING; AND EDUCATIONAL SERVICES, NAMELY, CONDUCTING CLASSES AND TRAINING IN THE AREA OF ICE-RELATED RECREATIONAL ACTIVITIES, INCLUDING ICE SKATING (U.S. CLS. 100, 101 AND 107).

FIRST USE 12-31-1998; IN COMMERCE 6-30-2001.

SN 76-324,373. CARPENTER, ROBERTA, OCONOMOWOC, WI. FILED 10-15-2001.

ZENITH MUSIC INTERNATIONAL

NO CLAIM IS MADE TO THE EXCLUSIVE RIGHT TO USE "MUSICAL INTERNATIONAL", APART FROM THE MARK AS SHOWN.

FOR MUSIC PUBLISHING; AUDIO RECORDING AND PRODUCTION (U.S. CLS. 100, 101 AND 107).

CLASS 41—(Continued).

SN 76-324,414. ETHICS RESOURCE CENTER, WASHINGTON, DC. FILED 10-15-2001.

MAXIMIZE THE MOMENT

FOR EDUCATIONAL SERVICES, NAMELY CONDUCTING WEEKLY PROGRAMS VIA ON-LINE SUBSCRIPTION OVER A GLOBAL COMPUTER NETWORK AND VIA FACSIMILE TRANSMISSION TO TEACH LESSONS ABOUT MORAL CHARACTER UTILIZING INFORMATIONAL ANNOUNCEMENTS THAT RELATE TO MAXIM TO A STORY BASED ON CURRENT EVENTS OR EVERYDAY ISSUES; PROVIDING A SECURED WEBSITE FEATURING LESSON IDEAS AND LESSON PLANS FOR THE ABOVE PROGRAMS; AND DISTRIBUTING COURSE MATERIALS IN CONNECTION WITH THE ABOVE PROGRAMS (U.S. CLS. 100, 101 AND 107).

FIRST USE 9-27-2001; IN COMMERCE 9-27-2001.

SN 76-324,851. ETHICS RESOURCE CENTER, WASHINGTON, DC. FILED 10-15-2001.



FOR EDUCATIONAL SERVICES, NAMELY CONDUCTING WEEKLY PROGRAMS VIA ON-LINE SUBSCRIPTION OVER A GLOBAL COMPUTER NETWORK AND VIA FACSIMILE TRANSMISSION TO TEACH LESSONS ABOUT MORAL CHARACTER UTILIZING INFORMATIONAL ANNOUNCEMENTS THAT RELATE A MAXIM TO A STORY BASED ON CURRENT EVENTS OR EVERYDAY ISSUES; PROVIDING A SECURED WEBSITE FEATURING LESSON IDEAS AND LESSON PLANS FOR THE ABOVE PROGRAMS; AND DISTRIBUTING COURSE MATERIALS IN CONNECTION WITH THE ABOVE PROGRAMS (U.S. CLS. 100, 101 AND 107).

FIRST USE 9-27-2001; IN COMMERCE 9-27-2001.

SN 76-327,646. LEAPFROG ENTERPRISES, INC., EMERYVILLE, CA. FILED 10-19-2001.

LEARN SOMETHING NEW EVERY DAY

FOR PROVIDING EDUCATIONAL INFORMATION TO, AND ABOUT CHILDREN AND TEENAGERS NAMELY, INFORMATION ABOUT GENERAL ACADEMIC SUBJECTS TO PROMOTE LEARNING IN MATH, SCIENCE, SOCIAL SCIENCE, AND LANGUAGE ARTS; AND PROGRESS REPORTS ON CHILDREN'S EDUCATION, ALL VIA A NETWORK SERVER (U.S. CLS. 100, 101 AND 107).

CLASS 41—(Continued).

SN 76-328,293. NATIONAL RESTAURANT ASSOCIATION, WASHINGTON, D.C., DC. FILED 10-23-2001.

NATIONAL RESTAURANT ASSOCIATION INFO TO GO

OWNER OF U.S. REG. NOS. 1,240,672, 1,243,949 AND 1,530,292.

SEC. 2(F) AS TO "NATIONAL RESTAURANT ASSOCIATION".

FOR PROVIDING ON-LINE SERVICES TO MEMBERS FEATURING ABSTRACTS FROM TRADE PERIODICALS RELATING TO RESTAURANTS AND THE RESTAURANT INDUSTRY (U.S. CLS. 100, 101 AND 107).

SN 76-329,171. FINLOW-BATES, TERENCE, 4311 NL BRUINISSE, NETHERLANDS, AND FINLOW-BATES GILLING, CHRISTINE DESLEY, 4311 NL BRUINISSE, NETHERLANDS, FILED 10-24-2001.

RCI

PRIORITY CLAIMED UNDER SEC. 44(D) ON BENELUX APPLICATION NO. 0988526, FILED 4-25-2001, REG. NO. 0683481, DATED 4-25-2001, EXPIRES 4-25-2011.

FOR EDUCATIONAL TRAINING COURSES AND SEMINARS FOR BUSINESS DESIGNED TO HELP PERSONNEL IDENTIFY, ISOLATE, AND ANALYZE A WIDE RANGE OF WORK-PLACE ISSUES IN ORDER TO SOLVE PROBLEMS AND REDUCE RISKS (U.S. CLS. 100, 101 AND 107).

SN 76-329,439. LEROUX, PATRICK BOUVIER, MESA, AZ. AND VELOUDOS, STEVE, CHANDLER, AZ. FILED 10-19-2001.

RATTLESNAKE SHAKE

FOR ENTERTAINMENT SERVICES IN THE NATURE OF PROFESSIONAL BASEBALL GAMES AND EXHIBITIONS (U.S. CLS. 100, 101 AND 107).

SN 76-330,463. NATHAN & LEWIS SECURITIES, INC, NEW YORK, NY. FILED 10-26-2001.

NATHAN & LEWIS SECURITIES, INC.

NO CLAIM IS MADE TO THE EXCLUSIVE RIGHT TO USE "SECURITIES INC", APART FROM THE MARK AS SHOWN.

FOR EDUCATIONAL SERVICES, NAMELY, PROVIDING COURSES OF INSTRUCTION IN THE FIELDS OF THE FINANCIAL, BROKERAGE AND INSURANCE AREAS BY MEANS OF A GLOBAL COMPUTER NETWORK; PROVIDING SEMINARS AND CONFERENCES RELATED TO RELATED TO THE FINANCIAL, BROKERAGE AND INSURANCE INDUSTRIES AND DISTRIBUTING COURSE MATERIALS IN CONNECTION THEREWITH (U.S. CLS. 100, 101 AND 107).

FIRST USE 0-0-1976; IN COMMERCE 0-0-1976.

CLASS 41—(Continued).

SN 76-331,179. GALLANT, KEVIN, TEQUESTA, FL. FILED 10-29-2001.

G.I.F.T.S. & P.A.P.E.R.

FOR CONDUCTING INSTRUCTIONAL SEMINARS IN THE FIELDS OF BUSINESS MANAGEMENT, SALES AND MARKETING, MOTIVATIONAL SKILLS AND HUMAN RELATIONS (U.S. CLS. 100, 101 AND 107).

SN 76-332,303. LE MIGNOT, SUZANNE, CHICAGO, IL. FILED 10-30-2001.

STORIES OF DISTINCTION

NO CLAIM IS MADE TO THE EXCLUSIVE RIGHT TO USE "STORIES", APART FROM THE MARK AS SHOWN.

FOR ENTERTAINMENT IN THE NATURE OF ONGOING RADIO AND TELEVISION PROGRAMS IN THE FIELD OF NEWS (U.S. CLS. 100, 101 AND 107).

SN 76-332,810. PLYMOUTH MUSIC SERIES, MINNEAPOLIS, MN. FILED 10-31-2001.

VOCALESSENCE

FOR MUSICAL ENTERTAINMENT SERVICES, NAMELY LIVE PERFORMANCES BY A MUSICAL GROUP (U.S. CLS. 100, 101 AND 107).

SN 76-333,501. PEARL PICTURES, INC., VIRGINIA BEACH, VA. FILED 11-2-2001.



FOR PRODUCING FEATURE FILMS FOR ENTERTAINMENT (U.S. CLS. 100, 101 AND 107).

SN 76-334,378. CIHLAR, MARK T., CHICAGO, IL. FILED 11-5-2001.

HER 10K

NO CLAIM IS MADE TO THE EXCLUSIVE RIGHT TO USE "10K", APART FROM THE MARK AS SHOWN.

FOR ENTERTAINMENT SERVICES, NAMELY, ARRANGING AND CONDUCTING A RUNNING CONTEST (U.S. CLS. 100, 101 AND 107).

CLASS 41—(Continued).

SN 76-336,823. FESTIVAL OF FLIGHT 2003, FAYETTEVILLE, NC. FILED 11-13-2001.



NO CLAIM IS MADE TO THE EXCLUSIVE RIGHT TO USE "FESTIVAL OF FLIGHT 2003", APART FROM THE MARK AS SHOWN.

FOR ENTERTAINMENT IN THE NATURE OF A FESTIVAL TO COMMEMORATE AND SHOWCASE FLIGHT (U.S. CLS. 100, 101 AND 107).

FIRST USE 1-31-2001; IN COMMERCE 1-31-2001.

SN 76-337,455. WAYNE BROWN INSTITUTE, SALT LAKE CITY, UT. FILED 11-14-2001.

INVESTOR TARGETED

NO CLAIM IS MADE TO THE EXCLUSIVE RIGHT TO USE "INVESTOR", APART FROM THE MARK AS SHOWN.

FOR EDUCATIONAL SERVICES, NAMELY CONDUCTING CONFERENCES IN THE FIELD OF VENTURE CAPITAL FUNDRAISING (U.S. CLS. 100, 101 AND 107).

SN 76-338,360. CIVILSHIELD, INC., LOS GATOS, CA. FILED 11-16-2001.

FOR PERSONAL SECURITY TRAINING (U.S. CLS. 100, 101 AND 107).

SN 76-339,736. MCWHINNEY, JOAQUIN, EL CAJON, CA. FILED 11-19-2001.

BIG MOUNTAIN

FOR ENTERTAINMENT SERVICES, NAMELY, LIVE PERFORMANCE BY A MUSICAL GROUP (U.S. CLS. 100, 101 AND 107).

FIRST USE 2-1-1992; IN COMMERCE 2-1-1992.

CLASS 41—(Continued).

SN 76-340,335. BELLAGIO, LLC., LAS VEGAS, NV. FILED 11-19-2001.

XPRESS PLAY

NO CLAIM IS MADE TO THE EXCLUSIVE RIGHT TO USE "PLAY", APART FROM THE MARK AS SHOWN.
FOR CASINO SERVICES (U.S. CLS. 100, 101 AND 107).

SN 76-342,576. BOARD OF TRUSTEES OF THE ILLINOIS MATHEMATICS AND SCIENCE ACADEMY, AURORA, IL. FILED 11-28-2001.

IMSA GREAT MINDS PROGRAM

NO CLAIM IS MADE TO THE EXCLUSIVE RIGHT TO USE "PROGRAM", APART FROM THE MARK AS SHOWN.
FOR EDUCATIONAL SERVICES, NAMELY, CONDUCTING LECTURE SERIES, SEMINARS, AND TELECONFERENCING SEMINARS AND ON-LINE WORKSHOPS IN THE FIELD OF SCIENCE, LAW, MATHEMATICS, RELIGION, AND GOVERNMENT WHEREBY EDUCATORS, STUDENTS, AND THE GENERAL PUBLIC CAN INTERACT WITH SCIENTISTS, MEDIA PERSONALITIES, EDUCATORS, LAWYERS, MATHEMATICIANS, RELIGIOUS LEADERS, STATE AND FEDERAL GOVERNMENTAL REPRESENTATIVES, AND BUSINESS LEADERS FROM AROUND THE NATION AND THE WORLD (U.S. CLS. 100, 101 AND 107).

FIRST USE 12-31-1998; IN COMMERCE 12-31-1998.

SN 76-342,645. BOARD OF TRUSTEES OF THE ILLINOIS MATHEMATICS AND SCIENCE ACADEMY, AURORA, IL. FILED 11-28-2001.

IMSA KIDS INSTITUTE

NO CLAIM IS MADE TO THE EXCLUSIVE RIGHT TO USE "KIDS INSTITUTE", APART FROM THE MARK AS SHOWN.

FOR EDUCATIONAL SERVICES, NAMELY, CONDUCTING SEMINARS, EDUCATIONAL PROGRAMS, AND WORKSHOPS FOR GRADES THREE THROUGH NINE IN THE FIELD OF SCIENCE AND TECHNOLOGY (U.S. CLS. 100, 101 AND 107).

FIRST USE 12-31-1998; IN COMMERCE 12-31-1998.

CLASS 41—(Continued).

SN 76-343,185. POGO PICTURES, INC., ATLANTA, GA. FILED 11-29-2001.



THE MARK CONSISTS OF A SERIES OF STRAIGHT GENERALLY VERTICAL LINES AND SEVERAL CURVED LINES SURROUNDING THE STRAIGHT LINES.

FOR MOTION PICTURE FILM PRODUCTION (U.S. CLS. 100, 101 AND 107).

FIRST USE 11-0-1999; IN COMMERCE 11-0-1999.

SN 76-345,364. PENNSYLVANIA OPTOMETRIC ASSOCIATION, HARRISBURG, PA. FILED 12-5-2001.

VISION IS ELEMENTARY

NO CLAIM IS MADE TO THE EXCLUSIVE RIGHT TO USE "VISION", APART FROM THE MARK AS SHOWN.

FOR DISSEMINATING EDUCATIONAL MATERIALS, NAMELY, POSTERS, PAMPHLETS, BROCHURES AND BOOKLETS, RELATING TO PEDIATRIC VISION CARE TO HEALTH PROFESSIONALS OTHER THAN OPTOMETRISTS (U.S. CLS. 100, 101 AND 107).

FIRST USE 9-10-2001; IN COMMERCE 9-10-2001.

SN 76-346,640. 1483839 ONTARIO INC., TORONTO, ONTARIO M4P 1E4, CANADA, FILED 12-6-2001.

TH!NKFilm

FOR PRODUCTION AND DISTRIBUTION OF MOTION PICTURES (U.S. CLS. 100, 101 AND 107).

FIRST USE 9-6-2001; IN COMMERCE 9-6-2001.

CLASS 41—(Continued).

SN 76-346,833. JEFFERS, JAMES JAY, MAYWOOD, NJ. FILED 12-10-2001.

WORDMAN PRODUCTIONS

NO CLAIM IS MADE TO THE EXCLUSIVE RIGHT TO USE "PRODUCTIONS", APART FROM THE MARK AS SHOWN.

FOR SONG WRITING SERVICES (U.S. CLS. 100, 101 AND 107).

FIRST USE 6-21-2000; IN COMMERCE 4-1-2001.

SN 76-348,475. NAGEL, SANDRA M., EVANSTON, IL. FILED 12-12-2001.

**EDUCATIONAL SERVICES
FOR YOUR FUTURE**

NO CLAIM IS MADE TO THE EXCLUSIVE RIGHT TO USE "EDUCATIONAL SERVICES", APART FROM THE MARK AS SHOWN.

FOR EDUCATIONAL SERVICES, NAMELY, PROVIDING TUTORING, SEMINARS, AND CLASSES IN THE FIELDS OF MATHEMATICS, LANGUAGE ARTS, READING AND READING COMPREHENSION, SCIENCE, SOCIAL STUDIES, LITERATURE, HISTORY, WRITING AND STUDY SKILLS AT THE PRE-SCHOOL, ELEMENTARY SCHOOL, GRADE SCHOOL, HIGH SCHOOL, COLLEGIATE, POST-GRADUATE, ADULT AND PROFESSIONAL LEVELS (U.S. CLS. 100, 101 AND 107).

FIRST USE 10-0-1982; IN COMMERCE 11-0-1995.

SN 76-348,632. STARZ ENCORE GROUP LLC, ENGLEWOOD, CO. FILED 12-13-2001.

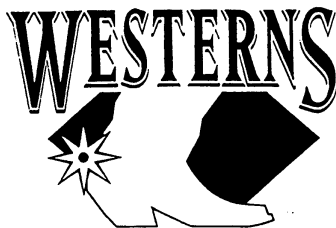

OWNER OF U.S. REG. NO. 2,002,369.

NO CLAIM IS MADE TO THE EXCLUSIVE RIGHT TO USE "WESTERNS", APART FROM THE MARK AS SHOWN.

FOR ENTERTAINMENT SERVICES IN THE NATURE OF PROGRAMMING, PRODUCTION, AND DISTRIBUTION OF MOTION PICTURES AND TELEVISION PROGRAMS FOR CABLE AND SATELLITE TELEVISION BROADCASTING (U.S. CLS. 100, 101 AND 107).

FIRST USE 5-1-1997; IN COMMERCE 5-1-1997.

CLASS 41—(Continued).

SN 76-349,570. WOODWARD, MAE, SALINAS, CA. FILED 12-18-2001.



THE MARK CONSISTS OF AN IMAGE OF A HUMAN IN A YOGA POSITION.

FOR PROVIDING ON-SITE WELLNESS AND SELF-HEALING SERVICES IN THE NATURE OF YOGA INSTRUCTION (U.S. CLS. 100, 101 AND 107).

FIRST USE 1-0-2001; IN COMMERCE 1-0-2001.

SN 76-349,849. CASEY SILVER PRODUCTIONS, LOS ANGELES, CA. FILED 12-17-2001.

**CASEY SILVER
PRODUCTIONS**

NO CLAIM IS MADE TO THE EXCLUSIVE RIGHT TO USE "PRODUCTIONS", APART FROM THE MARK AS SHOWN.

FOR PRODUCTION OF MOTION PICTURES AND TELEVISION PROGRAMS; PRODUCTION OF VIDEO RECORDINGS FOR OTHERS (U.S. CLS. 100, 101 AND 107).

SN 76-349,868. 3RD STRIKE, LONG BEACH, CA. FILED 12-17-2001.

3RD STRIKE

FOR ENTERTAINMENT SERVICES IN THE NATURE OF LIVE MUSICAL PERFORMANCES (U.S. CLS. 100, 101 AND 107).

FIRST USE 4-3-2000; IN COMMERCE 4-3-2000.

SN 76-350,326. ROCK THE DESERT, LLC, MIDLAND, TX. FILED 12-20-2001.

RTD ROCK THE DESERT

FOR ENTERTAINMENT SERVICES IN THE NATURE OF LIVE MUSICAL PRODUCTIONS, CONCERTS, PLAYS, AND PERFORMING ARTS PRODUCTIONS (U.S. CLS. 100, 101 AND 107).

FIRST USE 2-0-2000; IN COMMERCE 5-0-2000.

CLASS 41—(Continued).

SN 76-350,749. GRAYE, JOYCE, NORTHPORT, NY. AND KURTE, LAURIE, NORTHPORT, NY. FILED 12-20-2001.

SISTERS OF THE MONA LISA

FOR ENTERTAINMENT, NAMELY, LIVE PERFORMANCES BY A MUSICAL BAND AND MUSIC PRODUCTION SERVICES (U.S. CLS. 100, 101 AND 107).
FIRST USE 0-0-1997; IN COMMERCE 0-0-1997.

SN 76-351,543. CHAMBERS, RICHARD, LIMASSOL, CYPRUS, FILED 12-22-2001.

BINGOGALA

FOR ENTERTAINMENT SERVICES IN THE NATURE OF ONLINE GAMING SERVICES (U.S. CLS. 100, 101 AND 107).
FIRST USE 12-0-2000; IN COMMERCE 12-0-2000.

SN 76-352,067. EPHILANTHROPYFOUNDATION.ORG, INC., WASHINGTON, DC. FILED 12-21-2001.

THE RULES STILL APPLY.

FOR EDUCATIONAL SERVICES, NAMELY, DEVELOPMENT AND DISSEMINATION OF EDUCATIONAL MATERIALS, AND CONDUCTING WORKSHOPS, SEMINARS, AND CONFERENCES, ALL IN THE FIELD OF INTERNET USE BY NOT-FOR-PROFIT ORGANIZATIONS AND DONORS FOR CHARITABLE AND PHILANTHROPIC FUNDRAISING PURPOSES (U.S. CLS. 100, 101 AND 107).

SN 76-352,454. INCENDIO MUSIC, LOS ANGELES, CA. FILED 12-27-2001.

INCENDIO

THE TERM "INCENDIO" MEANS "FIRE" IN BOTH SPANISH AND ITALIAN.
FOR ENTERTAINMENT SERVICES PROVIDED BY A MUSICAL GROUP IN THE FORM OF LIVE PERFORMANCES (U.S. CLS. 100, 101 AND 107).
FIRST USE 6-1-2000; IN COMMERCE 7-25-2000.

CLASS 41—(Continued).

SN 76-352,917. SPANISH CONNECTION, INC., THE COLORADO SPRINGS, CO. FILED 12-26-2001.

THE SPANISH CONNECTION, INC.

NO CLAIM IS MADE TO THE EXCLUSIVE RIGHT TO USE "SPANISH" AND "INC.", APART FROM THE MARK AS SHOWN.
FOR LANGUAGE INTERPRETATION AND LANGUAGE TRANSLATION FROM ENGLISH TO SPANISH AND FROM SPANISH TO ENGLISH, LANGUAGE INSTRUCTION IN THE FIELD OF SPANISH (U.S. CLS. 100, 101 AND 107).
FIRST USE 11-1-1999; IN COMMERCE 11-1-1999.

SN 76-353,323. JACKSON, ANGELA, NEW YORK, NY. FILED 12-31-2001.

ONE HAUTE NIGHT

FOR ENTERTAINMENT IN THE NATURE OF FASHION SHOWS (U.S. CLS. 100, 101 AND 107).

SN 76-353,488. PERFORMING OPTION OF NEW YORK, INC., THE, NEW YORK, NY. FILED 12-31-2001.

THE PERFORMING OPTION

FOR EDUCATIONAL SERVICES, NAMELY, CONDUCTING SEMINARS IN THE FIELD OF COMMUNICATION AND ACTING SKILLS (U.S. CLS. 100, 101 AND 107).
FIRST USE 8-2-1991; IN COMMERCE 8-2-1991.

SN 76-354,104. YEARBOOK CENTRAL, INC., CRETE, IL. FILED 12-31-2001.



NO CLAIM IS MADE TO THE EXCLUSIVE RIGHT TO USE "YEARBOOK CENTRAL, INC.", APART FROM THE MARK AS SHOWN.
FOR COMPUTER SERVICES NAMELY PROVIDING ONLINE PUBLICATIONS OF CURRENT AND PAST YEARBOOKS POSTED ONLINE FOR VIEWING FOR A FEE (U.S. CLS. 100, 101 AND 107).

CLASS 41—(Continued).

SN 76-354,319. MURDOCK, VICKI, PHILADELPHIA, PA. FILED 1-3-2002.

THE READING RANGER

NO CLAIM IS MADE TO THE EXCLUSIVE RIGHT TO USE "READING", APART FROM THE MARK AS SHOWN. FOR READING PROGRAMS FOR CHILDREN OFFERED IN ELEMENTARY SCHOOLS (U.S. CLS. 100, 101 AND 107).

FIRST USE 12-0-1999; IN COMMERCE 12-0-1999.

SN 76-354,380. ZENITH INSTITUTE, THE, NEW LEBANON, NY. FILED 1-3-2002.

THE UNIVERSEL

THE ENGLISH TRANSLATION OF "UNIVERSEL" IS "UNIVERSAL".

FOR EDUCATIONAL SERVICES, NAMELY CONDUCTING CLASSES, WORKSHOPS, CONFERENCES, AND SEMINARS IN THE FIELD OF SPIRITUAL AWARENESS AND PERSONAL DEVELOPMENT (U.S. CLS. 100, 101 AND 107).

FIRST USE 9-6-2001; IN COMMERCE 9-6-2001.

SN 76-354,715. SANDLER, RIC, VENTNOR CITY, NJ. FILED 12-26-2001.

RICH ID RECORDS

NO CLAIM IS MADE TO THE EXCLUSIVE RIGHT TO USE "RECORDS", APART FROM THE MARK AS SHOWN.

FOR ENTERTAINMENT SERVICES, PRODUCTION OF MUSIC, VIDEO AND AUDIO RECORDINGS (U.S. CLS. 100, 101 AND 107).

SN 76-355,529. URBA, BRAD, PORTLAND, OR. FILED 1-4-2002.

ELIONAI

FOR ENTERTAINMENT SERVICES, NAMELY LIVE PERFORMANCES BY A MUSICAL GROUP (U.S. CLS. 100, 101 AND 107).

FIRST USE 6-1-2000; IN COMMERCE 6-16-2000.

CLASS 41—(Continued).

SN 76-359,479. XWF, LLC, DALLAS, TX. FILED 1-16-2002.

KIMONA

FOR ENTERTAINMENT SERVICES, NAMELY RING VALET SERVICES PERFORMED IN CONNECTION WITH WRESTLING EXHIBITIONS AND PERSONAL APPEARANCES; AND ARRANGING AND CONDUCTING WRESTLING EXHIBITIONS AND PERSONAL APPEARANCES BY A PROFESSIONAL WRESTLER RENDERED LIVE IN THE RING AND VIA BROADCAST TELEVISION, CABLE TV AND THROUGH VIDEO STREAMING THAT ALLOWS VIEWERS TO RECEIVE LIVE AND ARCHIVED AUDIO AND VIDEO PROGRAMMING VIA A GLOBAL COMPUTER NETWORK (U.S. CLS. 100, 101 AND 107).

SN 76-360,211. BIG TICKET TELEVISION INC., HOLLYWOOD, CA. FILED 1-11-2002.

THE JAMIE KENNEDY EXPERIMENT

THE NAME "JAMIE KENNEDY" IDENTIFIES A LIVING INDIVIDUAL WHOSE CONSENT IS OF RECORD.

FOR ENTERTAINMENT SERVICES IN THE NATURE OF A REALITY/COMEDY TELEVISION SERIES (U.S. CLS. 100, 101 AND 107).

FIRST USE 1-13-2002; IN COMMERCE 1-13-2002.

SN 76-360,277. AF2 ENTERPRISES LLC, CHICAGO, IL. FILED 1-18-2002.

SAN DIEGO RIPTIDE

NO CLAIM IS MADE TO THE EXCLUSIVE RIGHT TO USE "SAN DIEGO", APART FROM THE MARK AS SHOWN.

FOR ENTERTAINMENT SERVICES, NAMELY ORGANIZING AND PRESENTING FOOTBALL GAMES BEFORE LIVE AUDIENCES AND ON TELEVISION, RADIO, FOR GLOBAL COMPUTER NETWORK DISPLAY AND OTHER MEDIA (U.S. CLS. 100, 101 AND 107).

SN 76-361,131. KELLY, ZELDA, SAUSALITO, CA. FILED 1-22-2002.

BRAVO SPEAKERS BUREAU

NO CLAIM IS MADE TO THE EXCLUSIVE RIGHT TO USE "SPEAKERS BUREAU", APART FROM THE MARK AS SHOWN.

FOR BOOKING KEYNOTE SPEAKERS FOR MEETINGS AND CONVENTIONS (U.S. CLS. 100, 101 AND 107).

CLASS 41—(Continued).

SN 76-362,653. WINE NEWS, INC., ELMSFORD, NY. FILED 1-25-2002.

TOAST OF THE TOWN

FOR ENTERTAINMENT SERVICES, NAMELY, WINE TASTINGS (U.S. CLS. 100, 101 AND 107).

SN 76-364,226. SHIELDS/HALL, LLC, WEST FRIENDSHIP, MD. FILED 1-22-2002.

OMNILEARN

FOR EDUCATIONAL SERVICES, NAMELY, PROVIDING OF TRAINING IN THE FIELDS OF SPORTS AND BUSINESS (U.S. CLS. 100, 101 AND 107).

SN 76-364,227. SHIELDS/HALL, LLC, WEST FRIENDSHIP, MD. FILED 1-22-2002.

OMNITEST

FOR EDUCATIONAL SERVICES, NAMELY, PROVIDING OF TRAINING IN THE FIELDS OF SPORTS AND BUSINESS (U.S. CLS. 100, 101 AND 107).

SN 76-364,439. IGT, RENO, NV. FILED 1-27-2002.

SPOOKY

FOR ENTERTAINMENT SERVICES, NAMELY, CONDUCTING A GAME OF CHANCE SIMULTANEOUSLY AT MULTIPLE, INDEPENDENT GAMING ESTABLISHMENTS (U.S. CLS. 100, 101 AND 107).

SN 76-364,720. POMPEO & ASSOCIATES, LLC, BASKING RIDGE, NJ. FILED 1-31-2002.

ITAR

FOR EDUCATIONAL SERVICES NAMELY CONDUCTING SEMINARS IN THE FIELD OF INFORMATION TECHNOLOGY AND DISTRIBUTING COURSE MATERIALS IN CONNECTION THEREWITH (U.S. CLS. 100, 101 AND 107).

CLASS 41—(Continued).

SN 76-364,897. JONES, KIMBERLY, NEW YORK, NY. FILED 1-30-2002.

LIL' KIM

THE NAME IN THE MARK IDENTIFIES A LIVING INDIVIDUAL WHOSE CONSENT IS OF RECORD.

FOR ENTERTAINMENT SERVICES IN THE NATURE OF LIVE MUSICAL AND VOCAL PERFORMANCES BY A SOLO RECORDING ARTIST; AND PROVIDING INFORMATION RELATED TO A SOLO RECORDING ARTIST BY MEANS OF A GLOBAL COMPUTER INFORMATION NETWORK (U.S. CLS. 100, 101 AND 107). FIRST USE 0-0-1996; IN COMMERCE 0-0-1996.

SN 76-366,322. PHOENIX EVENTS, LLC, SALT LAKE CITY, UT. FILED 2-1-2002.

THINK OF IT AS YOUR OWN

FOR ENTERTAINMENT SERVICES, NAMELY, HOSTING WEDDING RECEPTIONS, BUSINESS MEETINGS, SOCIAL EVENTS AND FAMILY REUNIONS AT APPLICANT'S RECEPTION CENTER (U.S. CLS. 100, 101 AND 107).

SN 76-370,370. SPHATIKA INTERNATIONAL LLC, NEW YORK, NY. FILED 2-12-2002.

SPHATIKA

FOR HEALTH AND FITNESS CLUB SERVICES (U.S. CLS. 100, 101 AND 107).

SN 76-371,328. CRAWFORD, MARC, BATON ROUGE, LA. FILED 2-16-2002.

ACME

FOR ENTERTAINMENT SERVICES IN THE NATURE OF LIVE MUSICAL AND VOCAL PERFORMANCES BY A MUSICAL GROUP (U.S. CLS. 100, 101 AND 107). FIRST USE 6-2-1994; IN COMMERCE 6-2-1994.

CLASS 41—(Continued).

SN 76-371,701. GROOVE FITNESS, LLC, LOS ANGELES, CA. FILED 2-19-2002.



NO CLAIM IS MADE TO THE EXCLUSIVE RIGHT TO USE "FITNESS", APART FROM THE MARK AS SHOWN. FOR HEALTH AND FITNESS CLUBS; CONDUCTING OF PHYSICAL TRAINING (U.S. CLS. 100, 101 AND 107). FIRST USE 1-1-2001; IN COMMERCE 1-1-2001.

SN 76-371,965. FOCUSED IMAGES PHOTOGRAPHY, INC., RESTON, VA. FILED 2-19-2002.

PEDIGREE PORTRAITS

NO CLAIM IS MADE TO THE EXCLUSIVE RIGHT TO USE "PORTRAITS", APART FROM THE MARK AS SHOWN. FOR PHOTOGRAPHY SERVICES WITH RESPECT TO ANIMALS (U.S. CLS. 100, 101 AND 107). FIRST USE 1-0-1992; IN COMMERCE 1-0-1992.

SN 76-372,447. HOOPER, JEAN M., LOS ANGELES, CA. FILED 2-13-2002.

HOOP'N GROOVE

FOR EDUCATIONAL SERVICES, NAMELY, CONDUCTING PROGRAMS IN THE FIELD OF HEALTH, ATHLETIC TRAINING AND FITNESS; PRODUCTION OF VIDEO CASSETTES IN THE FIELD OF ATHLETIC TRAINING; AUDIO RECORDING AND PRODUCTION IN THE FIELD OF ATHLETIC TRAINING (U.S. CLS. 100, 101 AND 107).

SN 76-374,041. HESSTON COLLEGE, INC., HESSTON, KS. FILED 2-25-2002.

START HERE, GO EVERYWHERE

FOR EDUCATIONAL SERVICES, NAMELY, PROVIDING COURSES OF INSTRUCTION AT THE COLLEGE LEVEL (U.S. CLS. 100, 101 AND 107). FIRST USE 6-0-2001; IN COMMERCE 6-0-2001.

CLASS 41—(Continued).

SN 76-374,155. MONARCHY ENTERPRISES S.A.R.L. SUCCESSOR IN INTEREST TO MONARCHY ENTERPRISES B.V., L-2163 LUXEMBOURG, LUXEMBOURG, FILED 2-25-2002.

NEW REGENCY PRODUCTION

NO CLAIM IS MADE TO THE EXCLUSIVE RIGHT TO USE "PRODUCTION", APART FROM THE MARK AS SHOWN.

FOR ENTERTAINMENT SERVICES, NAMELY, MOTION PICTURE FILM AND TELEVISION PRODUCTION SERVICES, AND RECORD PRODUCTION SERVICES (U.S. CLS. 100, 101 AND 107).

FIRST USE 12-31-1993; IN COMMERCE 12-31-1993.

SN 76-374,630. LOERA, GEORGE, PARK RIDGE, IL. FILED 2-25-2002.

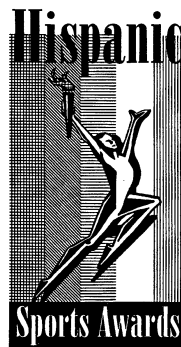

NO CLAIM IS MADE TO THE EXCLUSIVE RIGHT TO USE "HISPANIC SPORTS AWARDS", APART FROM THE MARK AS SHOWN.

THE DRAWING IS LINED FOR THE COLORS YELLOW, GREEN, BLUE AND RED.

THE MARK CONSISTS OF A STYLIZED HUMAN FIGURE HOLDING A TORCH SUPERIMPOSED OVER BARS COLORED YELLOW, GREEN, BLUE, WHITE AND RED.

FOR ENTERTAINMENT SERVICES, NAMELY, ORGANIZING AND CONDUCTING A RECOGNITION AWARDS PROGRAM TO HONOR ATHLETES OF HISPANIC/LATINO HERITAGE IN THE FIELD OF ATHLETICS (U.S. CLS. 100, 101 AND 107).

SN 76-374,742. JACO, CHARLES, KIRKWOOD, MO. FILED 2-22-2002.

NIGHTWATCH

FOR ENTERTAINMENT SERVICES IN THE NATURE OF AN ON-GOING RADIO AND TELEVISION PROGRAM FEATURING INTERVIEWS IN A CONVERSATIONAL FORMAT (U.S. CLS. 100, 101 AND 107).

CLASS 41—(Continued).

SN 76-374,798. CRAVE ENTERTAINMENT, INC., RANCHO DOMINGUEZ, CA. FILED 2-21-2002.

AXIS OF EVIL

FOR ENTERTAINMENT SERVICES, NAMELY, PROVIDING ON-LINE ACCESS TO COMPUTER GAMES ACCESSED VIA GLOBAL COMPUTER NETWORK (U.S. CLS. 100, 101 AND 107).

SN 76-375,006. DICK CLARK PRODUCTIONS, INC., BURBANK, CA. FILED 2-26-2002.

THE CHAMBER

FOR ENTERTAINMENT SERVICES, NAMELY, ENTERTAINMENT IN THE NATURE OF AN ONGOING TELEVISION PROGRAM CONSTITUTING A QUIZ/ GAME SHOW (U.S. CLS. 100, 101 AND 107).
FIRST USE 1-13-2002; IN COMMERCE 1-13-2002.

SN 76-375,090. ST. JOE COMPANY, THE, JACKSONVILLE, FL. FILED 2-26-2002.

PASEOS

THE ENGLISH TRANSLATION OF THE WORD "PASEOS" IN THE MARK IS "STROLLS".
FOR PROVIDING FACILITIES FOR RECREATIONAL ACTIVITIES (U.S. CLS. 100, 101 AND 107).

SN 76-375,497. EDUCATIONAL INSTITUTE OF THE AMERICAN HOTEL & MOTEL ASSOCIATION, THE, ORLANDO, FL. FILED 2-26-2002.

COURSELINE

FOR EDUCATIONAL SERVICES, NAMELY PROVIDING ONLINE COURSES OF INSTRUCTION AND EXAMS IN HOUSING MANAGEMENT AND SUPERVISION (U.S. CLS. 100, 101 AND 107).
FIRST USE 2-1-1999; IN COMMERCE 2-1-1999.

CLASS 41—(Continued).

SN 76-375,719. CHILDREN'S DEFENSE FUND, WASHINGTON, DC. FILED 2-27-2002.

**CHILDREN'S DEFENSE
FUND HALEY FARM**

OWNER OF U.S. REG. NOS. 1,163,177, 2,120,713 AND 2,120,735.

NO CLAIM IS MADE TO THE EXCLUSIVE RIGHT TO USE "FARM", APART FROM THE MARK AS SHOWN.

FOR EDUCATIONAL SERVICES, NAMELY CONDUCTING CLASSES, SEMINARS, CONFERENCES, WORKSHOPS, RETREATS AND MOTIVATIONAL PROGRAMS FOR STUDENTS, SCHOOLS, CHURCHES, COMMUNITY LEADERS AND INDIVIDUALS IN THE FIELDS OF CHILDREN'S ADVOCACY, HEALTH AND WELFARE, WOMEN'S ISSUES AND MULTI-CULTURALISM (U.S. CLS. 100, 101 AND 107).

SN 76-375,720. CHILDREN'S DEFENSE FUND, WASHINGTON, DC. FILED 2-27-2002.

**BLACK COMMUNITY
CRUSADE FOR CHILDREN
FREEDOM SCHOOL**

OWNER OF U.S. REG. NO. 2,222,503.

NO CLAIM IS MADE TO THE EXCLUSIVE RIGHT TO USE "SCHOOL", APART FROM THE MARK AS SHOWN.

FOR EDUCATIONAL SERVICES, NAMELY CONDUCTING CLASSES, SEMINARS, CONFERENCES, WORKSHOPS, RETREATS AND MOTIVATIONAL PROGRAMS FOR STUDENTS, SCHOOLS, CHURCHES, COMMUNITY LEADERS AND INDIVIDUALS IN THE FIELDS OF CHILDREN'S ADVOCACY, HEALTH AND WELFARE, WOMEN'S ISSUES AND MULTI-CULTURALISM (U.S. CLS. 100, 101 AND 107).

SN 76-375,721. CHILDREN'S DEFENSE FUND, WASHINGTON, DC. FILED 2-27-2002.

**CHILDREN'S DEFENSE
FUND FREEDOM SCHOOL**

OWNER OF U.S. REG. NOS. 1,163,177, 2,120,713 AND 2,120,735.

NO CLAIM IS MADE TO THE EXCLUSIVE RIGHT TO USE "SCHOOL", APART FROM THE MARK AS SHOWN.

FOR EDUCATIONAL SERVICES, NAMELY CONDUCTING CLASSES, SEMINARS, CONFERENCES, WORKSHOPS, RETREATS AND MOTIVATIONAL PROGRAMS FOR STUDENTS, SCHOOLS, CHURCHES, COMMUNITY LEADERS AND INDIVIDUALS IN THE FIELDS OF CHILDREN'S ADVOCACY, HEALTH AND WELFARE, WOMEN'S ISSUES AND MULTI-CULTURALISM (U.S. CLS. 100, 101 AND 107).

CLASS 41—(Continued).

SN 76-375,722. CHILDREN'S DEFENSE FUND, WASHINGTON, DC. FILED 2-27-2002.

HALEY FARM FREEDOM SCHOOL

NO CLAIM IS MADE TO THE EXCLUSIVE RIGHT TO USE "FARM" AND "SCHOOL", APART FROM THE MARK AS SHOWN.

FOR EDUCATIONAL SERVICES, NAMELY CONDUCTING CLASSES, SEMINARS, CONFERENCES, WORKSHOPS, RETREATS AND MOTIVATIONAL PROGRAMS FOR STUDENTS, SCHOOLS, CHURCHES, COMMUNITY LEADERS AND INDIVIDUALS IN THE FIELDS OF CHILDREN'S ADVOCACY, HEALTH AND WELFARE, WOMEN'S ISSUES AND MULTI-CULTURALISM (U.S. CLS. 100, 101 AND 107).

SN 76-375,896. SAN GABRIEL VALLEY BASKETBALL CLUB INC., MONTEBELLO, CA. FILED 2-27-2002.

INTENSITY BASKETBALL

NO CLAIM IS MADE TO THE EXCLUSIVE RIGHT TO USE "BASKETBALL", APART FROM THE MARK AS SHOWN.

FOR BASKETBALL CAMPS AND CLINICS (U.S. CLS. 100, 101 AND 107).
FIRST USE 7-8-2001; IN COMMERCE 7-8-2001.

SN 76-376,161. CONGELLO, PHILIP JR., EASTON, CT. FILED 2-25-2002.

TURNING LOOSE CHANGE INTO LOTTERY DOLLARS

FOR LOTTERY SERVICES (U.S. CLS. 100, 101 AND 107).

SN 76-376,180. LEARNING GORILLA LLC, QUINCY, MA. FILED 2-28-2002.

GORILLA INTERACTIVE

NO CLAIM IS MADE TO THE EXCLUSIVE RIGHT TO USE "INTERACTIVE", APART FROM THE MARK AS SHOWN.

FOR EDUCATIONAL SERVICES, NAMELY, CONDUCTING CLASSES, SEMINARS, CONFERENCES AND WORKSHOPS IN THE FIELD OF EMPLOYMENT TRAINING (U.S. CLS. 100, 101 AND 107).

CLASS 41—(Continued).

SN 76-377,463. WIZARDS OF THE COAST, INC., PAWTUCKET, RI. FILED 3-4-2002.

SPELLJAMMER

OWNER OF U.S. REG. NO. 1,684,531.

FOR ENTERTAINMENT SERVICES IN THE NATURE OF AN ON-GOING TELEVISION SERIES AND PRODUCTION OF MOTION PICTURES (U.S. CLS. 100, 101 AND 107).

SN 76-377,468. WIZARDS OF THE COAST, INC., PAWTUCKET, RI. FILED 3-4-2002.

DRAGONLANCE

OWNER OF U.S. REG. NOS. 1,382,312, 1,764,036 AND OTHERS.

FOR ENTERTAINMENT SERVICES, NAMELY PRODUCTION OF MOTION PICTURES (U.S. CLS. 100, 101 AND 107).

SN 76-377,728. TURPEN, DAVID W., WADESVILLE, IN. FILED 3-5-2002.

AMERICAN DREAM

FOR ENTERTAINMENT SERVICES, NAMELY, PARTICIPATION IN MONSTER TRUCK EXHIBITIONS (U.S. CLS. 100, 101 AND 107).

FIRST USE 1-4-2002; IN COMMERCE 1-4-2002.

SN 76-378,111. PANDOL, STEVE P., OAK PARK, CA. FILED 3-4-2002.

BONFIRE

FOR ENTERTAINMENT SERVICES, NAMELY THE RENDERING OF LIVE MUSICAL PERFORMANCES (U.S. CLS. 100, 101 AND 107).

FIRST USE 7-24-2001; IN COMMERCE 7-24-2001.

SN 76-378,572. GUNTER, CHRISTOPHER E., CAPE GIRARDEAU, MO. FILED 3-5-2002.

SHADOW THIEVES

FOR ENTERTAINMENT IN THE NATURE OF PERFORMANCES BY A LIVE MUSICAL GROUP (U.S. CLS. 100, 101 AND 107).

CLASS 41—(Continued).

SN 76-378,801. KITTELSON, LINDA, KIRKLAND, WA. FILED 3-7-2002.

MAMMOS ARE A MUST BUT CHECK YOUR BUST

FOR DEVELOPMENT AND DISSEMINATION OF EDUCATIONAL MATERIALS IN THE FIELD OF BREAST CANCER AWARENESS (U.S. CLS. 100, 101 AND 107).

SN 76-378,948. PEACH BOWL, INC., ATLANTA, GA. FILED 3-6-2002.

PEACH BOWL

OWNER OF U.S. REG. NOS. 1,261,995 AND 2,320,426. NO CLAIM IS MADE TO THE EXCLUSIVE RIGHT TO USE "BOWL", APART FROM THE MARK AS SHOWN. FOR ENTERTAINMENT SERVICES, NAMELY ORGANIZING AND CONDUCTING COLLEGIATE POST-SEASON FOOTBALL GAMES AND FESTIVALS (U.S. CLS. 100, 101 AND 107).
FIRST USE 5-7-1968; IN COMMERCE 5-7-1968.

SN 76-379,279. BUSCH ENTERTAINMENT CORPORATION, ST. LOUIS, MO. FILED 3-7-2002.

IMAGINIQUE

FOR ENTERTAINMENT SERVICES IN THE NATURE OF AN AMUSEMENT PARK SHOW (U.S. CLS. 100, 101 AND 107).

SN 76-379,384. DOW JONES & COMPANY, INC., NEW YORK, NY. FILED 3-6-2002.

FISCALLY FIT

FOR COMPUTER SERVICES, NAMELY, PROVIDING AN ONLINE NEWSPAPER COLUMN FOCUSING ON FINANCIAL PLANNING ISSUES (U.S. CLS. 100, 101 AND 107).
FIRST USE 2-19-2002; IN COMMERCE 2-19-2002.

SN 76-380,241. KICKSTAND, MILWAUKEE, WI. FILED 3-11-2002.

KICKSTAND

FOR ENTERTAINMENT SERVICES, NAMELY, LIVE PERFORMANCES BY A MUSICAL BAND (U.S. CLS. 100, 101 AND 107).
FIRST USE 1-1-1997; IN COMMERCE 1-1-1997.

CLASS 41—(Continued).

SN 76-380,802. M/X ENTERTAINMENT, INC., SAN FRANCISCO, CA. FILED 3-11-2002.

M/X ENTERTAINMENT

NO CLAIM IS MADE TO THE EXCLUSIVE RIGHT TO USE "ENTERTAINMENT", APART FROM THE MARK AS SHOWN.

FOR ENTERTAINMENT SERVICES, NAMELY THE PRODUCTION AND DEVELOPMENT OF DIGITAL MUSIC VIDEO PRODUCTS AND ENTERTAINMENT PROGRAMS (U.S. CLS. 100, 101 AND 107).

SN 76-381,732. SCARSDALE SYNAGOGUE/ TREMONT TEMPLE, SCARSDALE, NY. FILED 3-12-2002.

MAZEL TOTS

FOR NURSERY SCHOOL SERVICES (U.S. CLS. 100, 101 AND 107).
FIRST USE 9-1-2001; IN COMMERCE 9-1-2001.

SN 76-382,072. GUSTAVUS ADOLPHUS COLLEGE, SAINT PETER, MN. FILED 3-14-2002.

EXTRAORDINARY PEOPLE. EXTRAORDINARY PLACE.

FOR EDUCATION SERVICES, NAMELY PROVIDING COURSES OF INSTRUCTION AT THE COLLEGE LEVEL AND DISTRIBUTING COURSE MATERIALS IN CONNECTION THEREWITH (U.S. CLS. 100, 101 AND 107).
FIRST USE 3-1-2002; IN COMMERCE 3-1-2002.

SN 76-382,073. GUSTAVUS ADOLPHUS COLLEGE, SAINT PETER, MN. FILED 3-14-2002.

EXCEPTIONAL PEOPLE. EXCEPTIONAL PLACE.

FOR EDUCATION SERVICES, NAMELY PROVIDING COURSES OF INSTRUCTION AT THE COLLEGE LEVEL AND DISTRIBUTING COURSE MATERIALS IN CONNECTION THEREWITH (U.S. CLS. 100, 101 AND 107).
FIRST USE 3-1-2002; IN COMMERCE 3-1-2002.

CLASS 41—(Continued).

SN 76-382,956. ONRAMP PRODUCTIONS, LLC, YONKERS, NY. FILED 3-18-2002.

AMERICAN FREEDOM JAM

NO CLAIM IS MADE TO THE EXCLUSIVE RIGHT TO USE "AMERICAN" AND "JAM", APART FROM THE MARK AS SHOWN.

FOR ENTERTAINMENT SERVICES, NAMELY, LIVE MUSICAL CONCERTS AND DISTRIBUTION OF MUSIC ON MULTIPLE MEDIA FORMATS (U.S. CLS. 100, 101 AND 107).

SN 76-384,185. COLLEGE PARTNERSHIP, INC., THE, GRAND PRAIRIE, TX. FILED 3-15-2002.

COLLEGE ACTION PLAN

FOR EDUCATIONAL WORKSHOPS DESIGNED TO SHOW THE NEED FOR A PERSONALIZED INDIVIDUAL PLAN TO ASSIST FAMILIES IN THEIR COLLEGE CHOICE, ADMISSION, AND AID PROCESS (U.S. CLS. 100, 101 AND 107).

FIRST USE 1-8-2000; IN COMMERCE 1-8-2000.

SN 76-384,301. BLUECROSS BLUESHIELD OF TENNESSEE, CHATTANOOGA, TN. FILED 3-13-2002.

PRECIOUS CARGO

FOR PRENATAL EDUCATION PROGRAM FOR EXPECTANT PARENTS PROVIDED TO SUBSCRIBERS OF A HEALTH INSURANCE PLAN (U.S. CLS. 100, 101 AND 107).

FIRST USE 1-25-1993; IN COMMERCE 1-25-1993.

SN 76-387,074. GOLDILOX COMPANY, INC., PRINCETON, NJ. FILED 3-26-2002.

SHAIRING

FOR EDUCATIONAL SERVICES, NAMELY, COACHING AND CONDUCTING WORKSHOPS IN THE FIELD OF BUSINESS CONSULTATION (U.S. CLS. 100, 101 AND 107).

FIRST USE 11-1-2001; IN COMMERCE 11-1-2001.

SN 76-387,476. MCLAIN, RYAN, MADISON, WI. AND RONEY, SARAH, MADISON, WI. AND THEIS, SCOTT, VERONA, WI. FILED 3-25-2002.

SAVING FACE

FOR ENTERTAINMENT SERVICES IN THE NATURE OF LIVE MUSICAL PERFORMANCES (U.S. CLS. 100, 101 AND 107).

FIRST USE 6-1-2000; IN COMMERCE 6-1-2000.

CLASS 41—(Continued).

SN 76-387,500. TARAUIIN, BRIAN, N HOLLYWOOD, CA. FILED 3-26-2002.

ASPHALT JUNGLE

FOR ENTERTAINMENT SERVICES, NAMELY, LIVE PERFORMANCES BY A MUSICAL ARTIST (U.S. CLS. 100, 101 AND 107).

FIRST USE 8-15-1997; IN COMMERCE 8-15-1997.

SN 76-388,216. TARGET BRANDS, INC., MINNEAPOLIS, MN. FILED 3-26-2002.

GLAMORAMA

FOR ENTERTAINMENT SERVICES IN THE NATURE OF MUSICAL PERFORMANCES, MULTIMEDIA PRESENTATIONS AND FASHION SHOWS (U.S. CLS. 100, 101 AND 107).

SN 76-390,423. ROCKWOOD, PAUL, DBA ROC-SOC TRAINING CENTERS, CINCINNATI, OH. FILED 4-3-2002.

ROC SOC

FOR SPORT CAMPS, TRAINING CENTERS, AND CLINICS, ALL RELATED TO SOCCER (U.S. CLS. 100, 101 AND 107).

FIRST USE 1-0-1990; IN COMMERCE 1-0-1990.

SN 76-394,070. DAYTONA INTERNATIONAL SPEEDWAY, LLC, DAYTONA BEACH, FL. FILED 4-11-2002.



THE MARK FEATURES A STYLIZED RACE CAR SUPERIMPOSED ON TWO (2) TRIANGULAR SHAPES AND THE PHRASE "CENTENNIAL OF SPEED".

FOR ENTERTAINMENT SERVICES IN THE NATURE OF RACING EVENTS, NAMELY, AUTOMOBILE, MOTORCYCLE, TRUCK AND GO-CART RACES; CONDUCTING, PROMOTING AND ORGANIZING MOTORSPORTS EVENTS AND EXHIBITIONS IN THE NATURE OF COMMUNITY FESTIVALS AND FAIRS, PARADES, CAR SHOWS AND EXHIBITIONS, EDUCATIONAL CONFERENCES AND EXHIBITIONS AND LIVE MUSIC CONCERTS (U.S. CLS. 100, 101 AND 107).

CLASS 41—(Continued).

SN 76-394,091. DAYTONA INTERNATIONAL SPEEDWAY, LLC, DAYTONA BEACH, FL. FILED 4-11-2002.

CENTENNIAL OF SPEED

FOR ENTERTAINMENT SERVICES IN THE NATURE OF RACING EVENTS, NAMELY, AUTOMOBILE, MOTORCYCLE, TRUCK AND GO-CART RACES; CONDUCTING, PROMOTING AND ORGANIZING MOTORSPORTS EVENTS AND EXHIBITIONS IN THE NATURE OF COMMUNITY FESTIVALS AND FAIRS, PARADES, CAR SHOWS AND EXHIBITIONS, EDUCATIONAL CONFERENCES AND EXHIBITIONS AND LIVE MUSIC CONCERTS (U.S. CLS. 100, 101 AND 107).

SN 78-012,664. NEWPOWER HOLDINGS, INC., PURCHASE, NY. BY CHANGE OF NAME TNPC, INC., HOUSTON, TX. FILED 6-14-2000.

NEWPOWER

FOR EDUCATIONAL SERVICES, NAMELY, CONDUCTING SEMINARS AND SYMPOSIUMS AT ENERGY INFORMATION CENTERS, IN THE FIELDS OF ENERGY AND ELECTRICAL POWER (U.S. CLS. 100, 101 AND 107).

SN 78-028,096. EQUIBASE COMPANY LLC, LEXINGTON, KY. FILED 9-28-2000.

CHARTPLUS

FOR ENTERTAINMENT SERVICES, NAMELY, PROVIDING RESULTS AND STATISTICS FROM PARTICULAR THOROUGHBRED HORSE RACES, BOTH THROUGH THE USE OF TRADITIONAL HORSE RACING CHARTS AND THROUGH THE USE OF ANIMATED GRAPHICS THAT SHOW EACH HORSE'S POSITION THROUGHOUT THE RACE, VIA WEBSITES ON THE INTERNET (U.S. CLS. 100, 101 AND 107).

FIRST USE 10-1-1999; IN COMMERCE 4-28-2000.

CLASS 41—(Continued).

SN 78-037,260. GIGANTIC ENTERTAINMENT, INC., VENICE, CA. FILED 11-30-2000.



FOR CONDUCTING ENTERTAINMENT EXHIBITS IN THE NATURE OF FILM, SPORTS AND MUSIC FESTIVALS; ENTERTAINMENT, NAMELY LIVE MUSIC CONCERTS AND CONDUCTING CONTESTS AT MUSIC VENUES; ANIMATION PRODUCTION SERVICES; ENTERTAINMENT ONLINE SERVICES, NAMELY, PROVIDING WEBSITE LINKS TO OTHER CONTENT PROVIDERS IN THE FIELD OF ENTERTAINMENT; PRODUCTION AND DISTRIBUTION OF TELEVISION SHOWS, FILM STUDIES AND CABLE TELEVISION PROGRAMS FOR OTHERS; VIDEOTAPE PRODUCTION (U.S. CLS. 100, 101 AND 107).

SN 78-038,693. HOPCRAFT, CYNTHIA A., ORLANDO, FL. FILED 12-11-2000.

HELPING OTHER PEOPLE SUCCEED, A BYTE AT A TIME

FOR COMPUTER EDUCATION AND TRAINING SERVICES PRIMARILY THROUGH CLASSES (U.S. CLS. 100, 101 AND 107).

SN 78-040,140. NEW YORK IS BOOK COUNTRY, INC., NEW YORK, NY. FILED 12-20-2000.

**NEW YORK BOOK FESTIVAL
NEW YORK IS
BOOKCOUNTRY**

OWNER OF U.S. REG. NO. 2,206,965.

NO CLAIM IS MADE TO THE EXCLUSIVE RIGHT TO USE "NEW YORK BOOK FESTIVAL", APART FROM THE MARK AS SHOWN.

FOR ORGANIZING AND CONDUCTING BOOK FAIRS; ORGANIZING AND CONDUCTING ACTIVITIES AND EVENTS IN SCHOOL, LIBRARIES, MUSEUMS, AND BOOKSTORES, INTENDED TO INCREASE THE LOVE OF BOOKS AND READING AMONG THE GENERAL PUBLIC, NAMELY, BOOK FAIRS, FORUMS, BOOK READINGS, CLASSROOM PROJECTS, PERSONAL APPEARANCES BY AUTHORS AND ILLUSTRATORS, STORYTELLING SESSIONS, SCREENINGS OF BOOK-RELATED FILMS, AND PANEL DISCUSSIONS BY AUTHORS, SCREENWRITERS, FILMMAKERS, AND PLAYWRIGHTS (U.S. CLS. 100, 101 AND 107).

CLASS 41—(Continued).

SN 78-056,672. IWONDER INC., ORLANDO, FL. FILED 4-4-2001.

IWONDER FILM

NO CLAIM IS MADE TO THE EXCLUSIVE RIGHT TO USE "FILM", APART FROM THE MARK AS SHOWN.

FOR MOTION PICTURE FILM PRODUCTION (U.S. CLS. 100, 101 AND 107).

SN 78-057,849. WORLD TEAMTENNIS, INC., CHICAGO, IL. FILED 4-11-2001.

PHILADELPHIA FREEDOMS

NO CLAIM IS MADE TO THE EXCLUSIVE RIGHT TO USE "PHILADELPHIA", APART FROM THE MARK AS SHOWN.

FOR ORGANIZING, CONDUCTING AND STAGING TENNIS COMPETITIONS, CLINICS AND EXHIBITIONS (U.S. CLS. 100, 101 AND 107).

SN 78-059,053. VIACOM INTERNATIONAL INC., NEW YORK, NY. FILED 4-18-2001.

BUBBLEMASTERS

FOR PROVIDING INFORMATION IN THE FIELD OF ENTERTAINMENT, NAMELY PARTICIPATING IN A MULTI-MEDIA GAME, NAMELY, PROVIDING INFORMATION AND ENTERTAINMENT RENDERED VIA COMPUTER BY MEANS OF A GLOBAL COMPUTER NETWORK (U.S. CLS. 100, 101 AND 107).

SN 78-060,179. BYRD, JASON H., POMONA PARK, FL. FILED 4-24-2001.

BUGS, BONES, AND BOTANY

FOR EDUCATIONAL SERVICES, NAMELY, CONDUCTING FORENSIC SCIENCE TRAINING WORKSHOPS IN WHICH THE MULTIDISCIPLINARY NATURE OF CRIME SCENE PROCESSING FOR THE COLLECTION AND PRESERVATION OF ANTHROPOLOGICAL, BOTANICAL, AND ENTOMOLOGICAL EVIDENCE IS INSTRUCTED IN BOTH A TRADITIONAL CLASSROOM LECTURE AND FIELD ENVIRONMENT WITH MOCK CRIME SCENES (U.S. CLS. 100, 101 AND 107).

FIRST USE 6-7-1999; IN COMMERCE 6-7-1999.

CLASS 41—(Continued).

SN 78-061,880. DOCUMENT MANAGEMENT INDUSTRIES ASSOCIATION, ALEXANDRIA, VA. FILED 5-3-2001.

Solutions

A joint symposium for manufacturer education

NO CLAIM IS MADE TO THE EXCLUSIVE RIGHT TO USE "A JOINT SYMPOSIUM FOR MANUFACTURER EDUCATION", APART FROM THE MARK AS SHOWN.

FOR PROVIDING A MANUFACTURING AND TECHNOLOGY SYMPOSIUM PRESENTED TO OWNERS AND MANAGERS OF MANUFACTURING AND DISTRIBUTION COMPANIES THROUGHOUT THE UNITED STATES (U.S. CLS. 100, 101 AND 107).

SN 78-062,225. DESIGN4X, ATHERTON, CA. FILED 5-6-2001.

DESIGN4X

FOR EDUCATIONAL SERVICES, NAMELY, PROVIDING COURSES OF INSTRUCTION VIA AN ELECTRONIC COMPUTER COMMUNICATIONS NETWORK, IN THE FIELDS OF PRODUCT ENGINEERING, PRODUCT DESIGN, AND INDUSTRIAL MANUFACTURING (U.S. CLS. 100, 101 AND 107).

SN 78-063,474. TIME WARNER ENTERTAINMENT COMPANY, L.P., NEW YORK, NY. FILED 5-14-2001.

THE FROG

OWNER OF U.S. REG. NO. 1,873,917.

FOR ENTERTAINMENT SERVICES IN THE NATURE OF LIVE-ACTION, COMEDY, DRAMA AND ANIMATED ON-GOING TELEVISION PROGRAMS; PRODUCTION OF LIVE-ACTION, COMEDY, DRAMA AND ANIMATED TELEVISION PROGRAMS; PRODUCTION OF LIVE-ACTION, COMEDY, DRAMA AND ANIMATED MOTION PICTURE THEATRICAL FILMS; THEATRICAL PERFORMANCES BOTH ANIMATED AND LIVE ACTION; PROVIDING AN ON-LINE COMPUTER DATABASE IN THE FIELD OF GENERAL INTEREST NEWS, ENTERTAINMENT AND EDUCATIONAL INFORMATION IN THE NATURE OF LIVE-ACTION, COMEDY, DRAMA AND ANIMATED TELEVISION PROGRAM; PRODUCTION OF LIVE-ACTION COMEDY, ACTION AND ANIMATED MOTION PICTURE FILMS FOR TELEVISION VIA A GLOBAL COMPUTER NETWORK (U.S. CLS. 100, 101 AND 107).

CLASS 41—(Continued).

SN 78-063,478. TIME WARNER ENTERTAINMENT COMPANY, L.P., NEW YORK, NY. FILED 5-14-2001.

FLIX FROM THE FROG



FOR ENTERTAINMENT SERVICES IN THE NATURE OF LIVE-ACTION, COMEDY, DRAMA AND ANIMATED ON-GOING TELEVISION PROGRAMS; PRODUCTION OF LIVE-ACTION, COMEDY, DRAMA AND ANIMATED TELEVISION PROGRAMS; PRODUCTION OF LIVE-ACTION, COMEDY, DRAMA AND ANIMATED MOTION PICTURE THEATRICAL FILMS; THEATRICAL PERFORMANCES BOTH ANIMATED AND LIVE ACTION; PROVIDING AN ON-LINE COMPUTER DATABASE IN THE FIELD OF GENERAL INTEREST NEWS, ENTERTAINMENT AND EDUCATIONAL INFORMATION IN THE NATURE OF LIVE-ACTION, COMEDY, DRAMA AND ANIMATED TELEVISION PROGRAM; PRODUCTION OF LIVE-ACTION COMEDY, ACTION AND ANIMATED MOTION PICTURE FILMS FOR TELEVISION VIA A GLOBAL COMPUTER NETWORK (U.S. CLS. 100, 101 AND 107).

SN 78-063,481. TIME WARNER ENTERTAINMENT COMPANY, L.P., NEW YORK, NY. FILED 5-14-2001.

THE FROG



OWNER OF U.S. REG. NO. 1,971,247.
 FOR ENTERTAINMENT SERVICES IN THE NATURE OF LIVE-ACTION, COMEDY, DRAMA AND ANIMATED ON-GOING TELEVISION PROGRAMS; PRODUCTION OF LIVE-ACTION, COMEDY, DRAMA AND ANIMATED TELEVISION PROGRAMS; PRODUCTION OF LIVE-ACTION, COMEDY, DRAMA AND ANIMATED MOTION PICTURE THEATRICAL FILMS; THEATRICAL PERFORMANCES BOTH ANIMATED AND LIVE ACTION; PROVIDING AN ON-LINE COMPUTER DATABASE IN THE FIELD OF GENERAL INTEREST NEWS, ENTERTAINMENT AND EDUCATIONAL INFORMATION IN THE NATURE OF LIVE-ACTION, COMEDY, DRAMA AND ANIMATED TELEVISION PROGRAM; PRODUCTION OF LIVE-ACTION COMEDY, ACTION AND ANIMATED MOTION PICTURE FILMS FOR TELEVISION VIA A GLOBAL COMPUTER NETWORK (U.S. CLS. 100, 101 AND 107).

CLASS 41—(Continued).

SN 78-065,501. JULIE ANN TURNER & COMPANY, PLANO, TX. FILED 5-24-2001.

CHANGING COURSE

FOR EDUCATIONAL SERVICES, NAMELY WORKSHOPS, SEMINARS, COLLABORATIVE SESSIONS/FACILITATIONS AND PRESENTATIONS IN THE FIELD OF INDIVIDUAL AND BUSINESS POTENTIAL, INNOVATION/CREATIVITY, PLANNING AND ORGANIZATIONAL DEVELOPMENT/MANAGEMENT, AND DISTRIBUTING EDUCATIONAL/COURSE MATERIALS IN CONNECTION THEREWITH (U.S. CLS. 100, 101 AND 107).
 FIRST USE 4-25-2000; IN COMMERCE 6-10-2001.

SN 78-073,961. SPACE ASPIRATIONS, INC., BEDFORD HILLS, NY. FILED 7-15-2001.

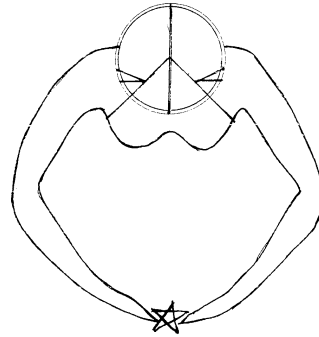

FOR EDUCATIONAL SERVICES, NAMELY, CONDUCTING CLASSES, SEMINARS, CONFERENCES, AND WORKSHOPS IN THE FIELD OF UNIVERSAL ENERGIES, NAMELY, TEACHING STUDENTS ABOUT THE POWER AND DYNAMIC OF THESE ENERGIES, AND HOW TO CHOOSE OPTIMISM, WITHIN THE COMPLEX GRID OF ENERGIES WHICH IMPACTS THEIR DAILY LIVES; IN ORDER TO UNDERSTAND HOW TO BEST DEAL WITH NEGATIVE ENERGY; AND HOW TO HARNESS, DEVELOP AND CIRCULATE THE ENERGY OF OPTIMISM TO RESTORE YOUTH, AND DISTRIBUTING COURSE MATERIAL IN CONNECTION THEREWITH (U.S. CLS. 100, 101 AND 107).

SN 78-077,102. INTERNATIONAL FITNESS FEDERATION INC., BELIZE CITY, BELIZE, FILED 8-2-2001.

FITNESSMAN

FOR ENTERTAINMENT SERVICES, NAMELY, ORGANIZING AND CONDUCTING SPORTS EVENTS AND ATHLETIC CONTESTS FOR ATHLETES (U.S. CLS. 100, 101 AND 107).

CLASS 41—(Continued).

SN 78-079,384. URIBE, PATRICIA J., NEW YORK, NY. FILED 8-15-2001.

CLOWNVIS

FOR ENTERTAINMENT AND EDUCATIONAL SERVICES IN THE NATURE OF LIVE PERFORMANCES BY A COSTUMED CHARACTER; ENTERTAINMENT IN THE NATURE OF VISUAL AND AUDIO PERFORMANCES, AND MUSICAL, VARIETY, AND COMEDY SHOWS DIRECTED TO CHILDREN; ENTERTAINMENT IN THE NATURE OF ON-GOING TELEVISION PROGRAMS IN THE FIELD OF MUSICAL, COMEDY AND VARIETY; ENTERTAINMENT SERVICES, NAMELY, PROVIDING A TELEVISION PROGRAM IN THE FIELD OF MUSICAL, COMEDY AND VARIETY VIA A GLOBAL COMPUTER NETWORK; ELECTRONIC PUBLISHING SERVICES, NAMELY PUBLICATION OF ONLINE BOOKS AND GRAPHIC WORKS FEATURING PERFORMANCE OF A COSTUMED CHARACTER AND THE CHARACTER'S LIKENESS; ENTERTAINMENT SERVICES, NAMELY, PROVIDING A WEBSITE FEATURING MUSICAL, COMEDY AND VARIETY PERFORMANCES, MUSICAL VIDEOS, RELATED FILM CLIPS, PHOTOGRAPHS, AND OTHER MULTIMEDIA MATERIALS (U.S. CLS. 100, 101 AND 107).

SN 78-079,653. IAN PERCY CORPORATION, THE, SCOTTS-DALE, AZ. FILED 8-16-2001.

PEAK PURPOSE

FOR TRAINING AND EDUCATIONAL SERVICES, NAMELY, CONDUCTING SEMINARS AND TRAINING IN THE FIELD OF BUSINESS DEVELOPMENT AND MANAGEMENT (U.S. CLS. 100, 101 AND 107).

SN 78-080,951. FASHION FOX, 21, INC., BROOKLYN, NY. FILED 8-24-2001.

MISS CENTURY 21 AMERICA

NO CLAIM IS MADE TO THE EXCLUSIVE RIGHT TO USE "AMERICA", APART FROM THE MARK AS SHOWN. FOR ENTERTAINMENT IN THE NATURE OF BEAUTY PAGEANTS (U.S. CLS. 100, 101 AND 107).

SN 78-081,561. GRAHAM, ROBERT, J., HAMBURG, NY. FILED 8-28-2001.

WORLD CONGRESS OF THE SHINTANI KARATE FEDERATION WADO-KAI

NO CLAIM IS MADE TO THE EXCLUSIVE RIGHT TO USE "WORLD CONGRESS" AND "KARATE FEDERATION WADO-KAI", APART FROM THE MARK AS SHOWN. THE NAME "SHINTANI" DOES NOT IDENTIFY ANY LIVING INDIVIDUAL.

FOR KARATE AND MARTIAL ARTS INSTRUCTION AND LESSONS FOR THE PURPOSE OF SELF DEFENSE AND PHYSICAL FITNESS (U.S. CLS. 100, 101 AND 107).

CLASS 41—(Continued).

SN 78-082,064. ROBINSON, JOSEPH R., JR., ENGLEWOOD, NJ. FILED 8-31-2001.

SUGARHILL GANG

FOR ENTERTAINMENT SERVICES NAMELY LIVE MUSICAL PERFORMANCES (U.S. CLS. 100, 101 AND 107).

FIRST USE 9-0-1979; IN COMMERCE 9-0-1979.

SN 78-083,956. SILVER DOLLAR CITY, INC., BRANSON, MO. FILED 9-14-2001.

THE GREAT BARN

NO CLAIM IS MADE TO THE EXCLUSIVE RIGHT TO USE "BARN", APART FROM THE MARK AS SHOWN.

FOR ENTERTAINMENT SERVICES, NAMELY PROVIDING AN INDOOR INTERACTIVE PLAYGROUND AND FACILITIES FOR RECREATIONAL ACTIVITIES FOR CHILDREN (U.S. CLS. 100, 101 AND 107).

SN 78-084,051. GRANT, DAVID, SLIDELL, LA. FILED 9-15-2001.

LIEMAILS

FOR ENTERTAINMENT SERVICES, NAMELY, PROVIDING INFORMATION ABOUT FALSE CLAIMS MADE IN COMMONLY CIRCULATED E-MAILS (U.S. CLS. 100, 101 AND 107).

FIRST USE 12-25-2000; IN COMMERCE 12-29-2000.

SN 78-084,061. DAVIDDS-GARRIDO, YASMIN, CHINO HILLS, CA. FILED 9-15-2001.

EMPOWERING LATINAS INCORPORATED

NO CLAIM IS MADE TO THE EXCLUSIVE RIGHT TO USE "INCORPORATED", APART FROM THE MARK AS SHOWN.

FOR ORGANIZING AND CONDUCTING EDUCATIONAL SEMINARS FOR LATINA WOMEN ON ISSUES RELATING TO SELF-ESTEEM, PSYCHOLOGY, POLITICS, FINANCE, CULTURE, RELATIONSHIPS, LEADERSHIP AND BUSINESS (U.S. CLS. 100, 101 AND 107).

CLASS 41—(Continued).

SN 78-084,354. SANTANA, DAMASO V., MIAMI, FL. AND DIAZ, ARMANDO H., MIAMI, FL. FILED 9-18-2001.

TV MUJER

NO CLAIM IS MADE TO THE EXCLUSIVE RIGHT TO USE "TV", APART FROM THE MARK AS SHOWN.

THE ENGLISH TRANSLATION OF THE WORD "MUJER" IN THE MARK IS "WOMAN".

FOR ENTERTAINMENT IN THE NATURE OF ONGOING SPANISH TELEVISION PROGRAMS FOR WOMEN IN THE FIELDS OF SOAP OPERAS, HOME DESIGN, FASHION, HEALTH, COOKING AND TALK SHOWS, PROVIDED VIA REGULAR TELEVISION, CABLE TELEVISION, SATELLITE TELEVISION AND GLOBAL COMPUTER NETWORKS (U.S. CLS. 100, 101 AND 107).

SN 78-085,289. COINSTAR, INC., BELLEVUE, WA. FILED 9-24-2001.

COINSTAR

FOR PROVIDING GENERAL INTEREST ENTERTAINMENT INFORMATION ON A VARIETY OF TOPICS VIA KIOSKS FOR CUSTOMER VIEWING; ENTERTAINMENT SERVICES, NAMELY, PROVIDING KIOSKS OR AUTOMATED TRANSACTION MACHINES FEATURING MUSICAL PERFORMANCES, MUSICAL VIDEOS, FILM CLIPS, PHOTOGRAPHS, AND OTHER MULTIMEDIA MATERIALS; ARRANGING FOR TICKET RESERVATIONS AND DISPENSING OF TICKETS FOR TRAVEL, SHOWS AND OTHER ENTERTAINMENT EVENTS (U.S. CLS. 100, 101 AND 107).

SN 78-085,292. COINSTAR, INC., BELLEVUE, WA. FILED 9-24-2001.

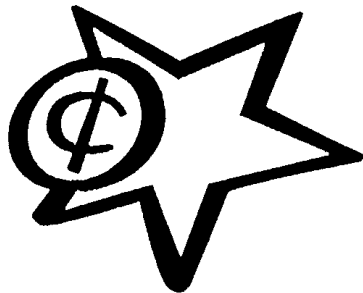

FOR PROVIDING GENERAL INTEREST ENTERTAINMENT INFORMATION ON A VARIETY OF TOPICS VIA KIOSKS FOR CUSTOMER VIEWING; ENTERTAINMENT SERVICES, NAMELY, PROVIDING KIOSKS OR AUTOMATED TRANSACTION MACHINES FEATURING MUSICAL PERFORMANCES, MUSICAL VIDEOS, FILM CLIPS, PHOTOGRAPHS, AND OTHER MULTIMEDIA MATERIALS; ARRANGING FOR TICKET RESERVATIONS AND DISPENSING OF TICKETS FOR TRAVEL, SHOWS AND OTHER ENTERTAINMENT EVENTS (U.S. CLS. 100, 101 AND 107).

CLASS 41—(Continued).

SN 78-085,380. COMMUNITY, INC., WESTFIELD, NJ. FILED 9-25-2001.

FORWARDFOCUS

FOR PERSONAL COACHING SERVICES IN THE FIELD OF PERSONAL AND PROFESSIONAL DEVELOPMENT (U.S. CLS. 100, 101 AND 107).

FIRST USE 11-14-1994; IN COMMERCE 11-14-1994.

SN 78-086,338. ACUFF, DANIEL, S., SHERMAN OAKS, CA. AND REIHER, ROBERT H., LA CANADA-FLINTRIDGE, CA. FILED 10-1-2001.

WILDABOUTS

FOR ENTERTAINMENT IN THE NATURE OF AN ONGOING TELEVISION PROGRAM FOR CHILDREN; AND MOTION PICTURE FILM PRODUCTION (U.S. CLS. 100, 101 AND 107).

SN 78-086,758. PRE-PREP SHOWCASE, STONEHAM, MA. FILED 10-3-2001.

PRE-PREP SHOWCASE

SEC. 2(F).
FOR ARRANGE AND CONDUCTING ATHLETIC COMPETITIONS AND EDUCATIONAL CONFERENCES (U.S. CLS. 100, 101 AND 107).

FIRST USE 1-1-1994; IN COMMERCE 1-1-1994.

SN 78-087,118. JOHNSON & JOHNSON, NEW BRUNSWICK, NJ. FILED 10-5-2001.

ANSWERS

FOR EDUCATIONAL SERVICES, NAMELY, CONDUCTING CLASSES, SEMINARS, CONFERENCES AND WORKSHOPS TO EDUCATE MEDICAL PROFESSIONALS ON WOUND AND SKIN CARE PREVENTION AND DISEASE STATE MANAGEMENT AND TREATMENT OPTIONS (U.S. CLS. 100, 101 AND 107).

CLASS 41—(Continued).

SN 78-089,324. STUDIO FOGLIO, SEATTLE, WA. FILED 10-19-2001.

GIRL GENIUS

FOR ENTERTAINMENT SERVICES IN THE NATURE OF LIVE-ACTION, COMEDY, DRAMA, AND ANIMATED TELEVISION PROGRAMS; PRODUCTION OF LIVE-ACTION, COMEDY, DRAMA, AND ANIMATED TELEVISION PROGRAMS; LIVE-ACTION, COMEDY, DRAMA, AND ANIMATED MOTION PICTURE THEATRICAL FILMS; PRODUCTION OF LIVE-ACTION, COMEDY, DRAMA, AND ANIMATED MOTION PICTURE THEATRICAL FILMS; THEATRICAL PERFORMANCES BOTH ANIMATED AND LIVE-ACTION; COMPUTER SERVICES, NAMELY PROVIDING INFORMATION IN THE FIELD OF ENTERTAINMENT RELATING SPECIFICALLY TO MUSIC, MOVIES, AND TELEVISION VIA AN ELECTRONIC GLOBAL COMPUTER NETWORK; COMPUTER SERVICES, NAMELY PROVIDING DATABASES FEATURING ENTERTAINMENT AND EDUCATIONAL INFORMATION VIA AN ELECTRONIC GLOBAL COMPUTER NETWORK; PROVIDING INFORMATION ABOUT AND ACTUAL ENTERTAINMENT VIA AN ELECTRIC GLOBAL COMPUTER COMMUNICATIONS NETWORK IN THE NATURE OF LIVE-ACTION, COMEDY, DRAMA, AND ANIMATED PROGRAMS; AND PRODUCTION OF LIVE-ACTION, COMEDY, DRAMA, AND ANIMATED PROGRAMS FOR DISTRIBUTION VIA AN ELECTRONIC GLOBAL COMPUTER NETWORK (U.S. CLS. 100, 101 AND 107).

SN 78-090,685. UNITED ILLUMINATING COMPANY, THE, NEW HAVEN, CT. FILED 10-29-2001.

I'M A DINO-SAVER

FOR EDUCATIONAL SERVICES FOR SCHOOL AGE CHILDREN IN K-12, NAMELY, CONDUCTING CLASSES, SEMINARS, CONFERENCES, WORKSHOPS AND CLASSROOM INSTRUCTION IN THE FIELDS OF ENERGY, ENERGY AWARENESS, ENERGY CONSERVATION AND ENERGY EFFICIENT LIVING AND ALL CONDUCTED IN PERSON AND VIA THE INTERNET, AND DISTRIBUTION OF RELEVANT COURSE MATERIALS IN CONNECTION THEREWITH; DEVELOPMENT AND DISSEMINATION OF COMPUTER, INTERNET AND WEB-BASED EDUCATIONAL MATERIALS FOR OTHERS IN THE FIELD OF ENERGY, ENERGY AWARENESS, ENERGY CONSERVATION AND ENERGY EFFICIENT LIVING (U.S. CLS. 100, 101 AND 107).
FIRST USE 10-22-2001; IN COMMERCE 10-22-2001.

SN 78-092,303. BLANCO, WILLIAM ERIC WATSON, GLENDALE, CA. FILED 11-8-2001.

KUMBIAMBE

FOR ENTERTAINMENT IN THE NATURE OF LIVE MUSICAL GROUP (U.S. CLS. 100, 101 AND 107).

CLASS 41—(Continued).

SN 78-095,570. SERGE, SANDRA S., MARIETTA, GA. FILED 11-28-2001.

MUSIC MORSELS

NO CLAIM IS MADE TO THE EXCLUSIVE RIGHT TO USE "MUSIC", APART FROM THE MARK AS SHOWN.

FOR PROVIDING ON-LINE NON-DOWNLOADABLE INTERNET MAGAZINES IN THE FIELD OF MUSIC (U.S. CLS. 100, 101 AND 107).

SN 78-096,962. NETWORK ENTERPRISES, INC., NASHVILLE, TN. FILED 12-6-2001.

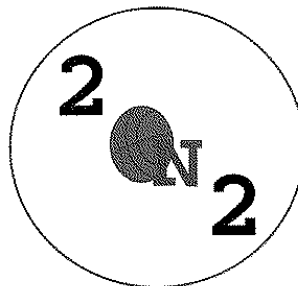
TNN' s

OWNER OF U.S. REG. NOS. 1,426,014, 1,560,188 AND 2,444,091.

THE STIPPLING IS FOR SHADING PURPOSES.

FOR ENTERTAINMENT SERVICES IN THE NATURE OF ON-GOING TELEVISION PROGRAMS FEATURING LIVE ACTION; PROVIDING INFORMATION IN THE FIELD OF ENTERTAINMENT AND MUSIC BY MEANS OF A GLOBAL COMPUTER NETWORK (U.S. CLS. 100, 101 AND 107).

SN 78-097,809. BAKER, RANDALL K., COVINGTON, GA. FILED 12-12-2001.

SILENT SCREAM

FOR AUDIO RECORDING AND PRODUCTION, MOTION PICTURE FILM PRODUCTION, TELEVISION PRODUCTION (U.S. CLS. 100, 101 AND 107).

CLASS 41—(Continued).

SN 78-099,783. DAMPHIER, PATRICK, KANE, BRENT-
WOOD, TN. FILED 12-21-2001.



NO CLAIM IS MADE TO THE EXCLUSIVE RIGHT TO
USE "RECORDS", APART FROM THE MARK AS SHOWN.
COLOR IS NOT A FEATURE OF THE MARK.

THE MARK CONSISTS OF AN IMAGE OF THE WORDS
"GIZE RECORDS". AN IMAGE OF A PYRAMID OF LITTLE
MEN SITS DIRECTLY TO THE RIGHT OF THE WORDS
"GIZE RECORDS".

FOR RECORD LABEL SERVICES, NAMELY, AUDIO
RECORDINGS AND RECORD PRODUCTION (U.S. CLS.
100, 101 AND 107).

CLASS 41—(Continued).

SN 78-101,318. WORLD WRESTLING FEDERATION EN-
TERTAINMENT, INC., STAMFORD, CT. FILED 1-7-2002.

RIKISHI

THE NAME "RIKISHI" DOES NOT IDENTIFY A LIVING
INDIVIDUAL.

THE ENGLISH TRANSLATION OF THE WORD "RI-
KISHI" IN THE MARK IS "SUMO WRESTLER".

FOR ENTERTAINMENT SERVICES, NAMELY WRES-
TLING EXHIBITS AND PERFORMANCES BY A PRO-
FESSIONAL WRESTLER AND ENTERTAINER;
PROVIDING WRESTLING NEWS AND INFORMATION
VIA A GLOBAL COMPUTER NETWORK (U.S. CLS. 100,
101 AND 107).

SN 78-100,343. RACE ACROSS AMERICA LLC, MESA, AZ.
FILED 12-29-2001.



NO CLAIM IS MADE TO THE EXCLUSIVE RIGHT TO
USE "RACE ACROSS AMERICA", APART FROM THE
MARK AS SHOWN.

FOR ENTERTAINMENT IN THE NATURE OF AN-
NUAL BICYCLE RACES IN AND ACROSS THE UNITED
STATES (U.S. CLS. 100, 101 AND 107).

SN 78-102,288. RED CIRCLE, INC., SANTA MONICA, CA.
AND SOLIS, EMILIO F., SANTA MONICA, CA. FILED 1-
11-2002.

**THE FUTURE SOUND
FESTIVAL**

NO CLAIM IS MADE TO THE EXCLUSIVE RIGHT TO
USE "FESTIVAL", APART FROM THE MARK AS SHOWN,
FOR ENTERTAINMENT IN THE NATURE OF LIVE
MUSICAL FESTIVAL (U.S. CLS. 100, 101 AND 107).

FIRST USE 4-1-1996; IN COMMERCE 4-1-1996.

SN 78-101,003. FENELON DESIGN, MADISON, NJ. FILED 1-
4-2002.



FOR "ENTERTAINMENT SERVICES, NAMELY, ANI-
MATED CARTOON PROGRAMS FOR TELEVISION,
VIDEO AND MOTION PICTURES" (U.S. CLS. 100, 101
AND 107).

SN 78-102,377. BURGESS, AARON VINCENT, CLEVELAND,
OH. FILED 1-13-2002.

LAST EYE

FOR EDITORIAL CONSULTATION (U.S. CLS. 100, 101
AND 107).

CLASS 41—(Continued).

SN 78-102,379. BOYD, JOHN, A., ST. CROIX, US VIRGIN ISLANDS, FILED 1-13-2002.

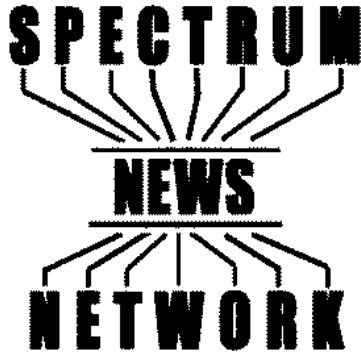

NO CLAIM IS MADE TO THE EXCLUSIVE RIGHT TO USE "NEWS NETWORK", APART FROM THE MARK AS SHOWN.

THE MARK CONSISTS OF THE LETTERS OF "SPECTRUM" AND "NETWORK" ARE RED, ORANGE, YELLOW, GREEN, BLUE, INDIGO AND VIOLET.

FOR NEWS REPORTING SERVICES VIA THE INTERNET AND BROADBAND CABLE TELEVISION (U.S. CLS. 100, 101 AND 107).

FIRST USE 10-22-2001; IN COMMERCE 10-28-2001.

CLASS 41—(Continued).

SN 78-103,697. TUTORBOTS, INC., JENKINTOWN, PA. FILED 1-18-2002.

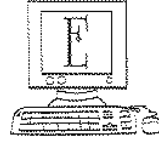

Einstein Academy
Charter School

NO CLAIM IS MADE TO THE EXCLUSIVE RIGHT TO USE "ACADEMY CHARTER SCHOOL", APART FROM THE MARK AS SHOWN.

FOR EDUCATION SERVICES IN THE NATURE OF COURSES AT THE KINDERGARTEN THROUGH 12TH GRADE LEVEL (U.S. CLS. 100, 101 AND 107).

SN 78-103,783. BLISS PATH PRODUCTIONS, INC., EL-KHART, IN. FILED 1-20-2002.

BLISS PATH

FOR CONDUCTING WORKSHOPS AND SEMINARS IN PERSONAL AWARENESS, DEVELOPMENT AND DISSEMINATION OF EDUCATIONAL MATERIALS OF OTHERS IN THE FIELD OF PERSONAL DEVELOPMENT, CAREER COUNSELING, AUDIO AND VIDEO RECORDING AND PRODUCTION, ELECTRONIC PUBLISHING SERVICES FEATURING PERSONAL DEVELOPMENT TOPICS, PRODUCTION OF RADIO AND TELEVISION PROGRAMS, MASTER OF CEREMONY SERVICES FOR PARTIES AND SPECIAL EVENTS, MUSIC COMPOSITION, PRODUCTION AND PUBLISHING, ENTERTAINMENT IN THE NATURE OF THEATER PRODUCTIONS, ALL OF THE ABOVE RELATED TO PERSONAL DEVELOPMENT (U.S. CLS. 100, 101 AND 107).

FIRST USE 1-14-2002; IN COMMERCE 1-16-2002.

SN 78-102,442. COPPOLETTA, JOSEPH CARL, REDONDO BCH., CA. FILED 1-14-2002.



NO CLAIM IS MADE TO THE EXCLUSIVE RIGHT TO USE "PICTURES", APART FROM THE MARK AS SHOWN.

THE ENGLISH TRANSLATION OF THE WORD "BELLA LUNA" IN THE MARK IS "BEAUTIFUL MOON".

FOR MOTION PICTURE FILM PRODUCTION FOR TELEVISION AND CINEMA (U.S. CLS. 100, 101 AND 107).

SN 78-104,680. CUSTOMER DRIVEN SOLUTIONS, INC., DBA ENABLEWORKS, HIGHLANDS RANCH, CO. FILED 1-24-2002.

ENABLEWORKS

FOR PROVIDING ON-LINE CORPORATE TRAINING SERVICES (U.S. CLS. 100, 101 AND 107).

FIRST USE 8-27-1999; IN COMMERCE 8-27-1999.

CLASS 41—(Continued).

SN 78-105,774. INTEGRITY SYSTEMS, INC., PHOENIX, AZ. FILED 1-30-2002.

INTEGRITY FORUM

OWNER OF U.S. REG. NOS. 1,424,332, 2,363,163 AND OTHERS.

NO CLAIM IS MADE TO THE EXCLUSIVE RIGHT TO USE "FORUM", APART FROM THE MARK AS SHOWN.

FOR EDUCATIONAL SERVICES, NAMELY CONDUCTING SEMINARS, CONFERENCES AND GROUP DISCUSSIONS RELATING TO BUSINESS MANAGEMENT, CORPORATE MANAGEMENT, PERSONNEL MANAGEMENT, PUBLIC RELATIONS, SALES AND MARKETING (U.S. CLS. 100, 101 AND 107).

SN 78-105,863. KEOHAN, PHILIP, WELLFLEET, MA. FILED 1-30-2002.

VISUAL MEDITATIONS

NO CLAIM IS MADE TO THE EXCLUSIVE RIGHT TO USE "VISUAL", APART FROM THE MARK AS SHOWN.
FOR PHOTOGRAPHY (U.S. CLS. 100, 101 AND 107).

SN 78-106,741. IRONIC TIMES, SANTA MONICA, CA. FILED 2-4-2002.

IRONIC TIMES

FOR COMPUTER SERVICES, NAMELY PROVIDING ONLINE NEWSPAPERS IN THE FIELD OF HUMOR AND ENTERTAINMENT (U.S. CLS. 100, 101 AND 107).
FIRST USE 9-23-2000; IN COMMERCE 9-23-2000.

SN 78-106,860. NAVIANCE LLC, WASHINGTON, DC. FILED 2-5-2002.

NAVIANCE

FOR CAREER COUNSELING SERVICES, NAMELY PROVIDING INFORMATION VIA A GLOBAL COMPUTER NETWORK RELATING TO ADMISSIONS, COLLEGE GUIDANCE AND PLANNING, AND GRADUATE AND PROFESSIONAL SCHOOL ENTRY (U.S. CLS. 100, 101 AND 107).
FIRST USE 6-13-2001; IN COMMERCE 8-24-2001.

CLASS 41—(Continued).

SN 78-107,010. NEW CENTURY WRITER AWARDS, NEW HAVEN, CT. FILED 2-5-2002.

NEW CENTURY WRITER AWARDS

NO CLAIM IS MADE TO THE EXCLUSIVE RIGHT TO USE "WRITER AWARDS", APART FROM THE MARK AS SHOWN.

FOR EDUCATIONAL SERVICES, NAMELY PROVIDING INCENTIVES TO AUTHORS TO DEMONSTRATE EXCELLENCE IN THE FIELD OF WRITING THROUGH THE ISSUANCE OF AWARDS (U.S. CLS. 100, 101 AND 107).

FIRST USE 4-1-1997; IN COMMERCE 9-1-1997.

SN 78-107,473. AMERICAN MOTORCYCLIST ASSOCIATION, PICKERINGTON, OH. FILED 2-7-2002.



AMA FLAT TRACK

OWNER OF U.S. REG. NOS. 975,179 AND 1,070,002.
NO CLAIM IS MADE TO THE EXCLUSIVE RIGHT TO USE "FLAT TRACK", APART FROM THE MARK AS SHOWN.

THE MARK CONSISTS OF A RECTANGULAR BOX WITH THE LEFT HALF OF THE RECTANGLE IN BLUE AND THE RIGHT HALF OF THE RECTANGLE IN RED AND THE MOTORCYCLE RIDER IN WHITE.

FOR CONDUCTING ENTERTAINMENT EXHIBITIONS IN THE NATURE OF RACING EVENTS, NAMELY, MOTORCYCLE RACING EVENTS (U.S. CLS. 100, 101 AND 107).

SN 78-107,526. BARBA, DENNIS P. JR., CLEVELAND, OH. FILED 2-7-2002.

THE SCARCEST COMMODITY

FOR EDUCATIONAL AND TRAINING SERVICES, NAMELY, SEMINARS AND WORKSHOPS FOR INDIVIDUAL INVESTORS IN THE FIELDS OF FINANCIAL PLANNING AND INVESTMENT MANAGEMENT (U.S. CLS. 100, 101 AND 107).

CLASS 41—(Continued).

SN 78-109,035. STUPID AND CLEVER MUSIC, CAMBRIDGE, MA. FILED 2-15-2002.

LIVESEXACT

FOR ENTERTAINMENT SERVICES, NAMELY, LIVE PERFORMANCES BY A MUSICAL BAND (U.S. CLS. 100, 101 AND 107).

FIRST USE 10-18-1997; IN COMMERCE 10-18-1997.

SN 78-110,245. VIACOM INTERNATIONAL INC., NEW YORK, NY. FILED 2-21-2002.

VH1 BEING

OWNER OF U.S. REG. NOS. 1,353,809, 2,537,600 AND OTHERS.

FOR ENTERTAINMENT SERVICES IN THE NATURE OF A LIVE ACTION TELEVISION SERIES FEATURING MUSIC; PROVIDING INFORMATION IN THE FIELD OF ENTERTAINMENT AND MUSIC BY MEANS OF A GLOBAL COMPUTER NETWORK (U.S. CLS. 100, 101 AND 107).

SN 78-110,681. ROTH, ROBERT, NOVATO, CA. FILED 2-24-2002.

TASTE THE EXPERIENCE

FOR EDUCATIONAL SERVICES, NAMELY, CONDUCTING CLASSES AND DEMONSTRATIONS IN THE FIELD OF COOKING (U.S. CLS. 100, 101 AND 107).

SN 78-111,320. SANDLER SYSTEMS, INC., STEVENSON, MD. FILED 2-27-2002.



Sandler Sales Institute
180° From Traditional Sales Training

OWNER OF U.S. REG. NOS. 1,774,492, 2,149,211 AND OTHERS.

NO CLAIM IS MADE TO THE EXCLUSIVE RIGHT TO USE "SALES INSTITUTE", APART FROM THE MARK AS SHOWN.

THE MARK CONSISTS OF "S SANDLER SALES INSTITUTE 180 FROM TRADITIONAL SALES TRAINING" AND DESIGN.

FOR EDUCATIONAL SERVICES, NAMELY, PROVIDING TRAINING THROUGH SEMINARS, MEETINGS, WORKSHOPS AND ON-LINE PRESENTATIONS, ALL IN THE FIELD OF SALES OR SALES MANAGEMENT (U.S. CLS. 100, 101 AND 107).

FIRST USE 1-11-2002; IN COMMERCE 1-25-2002.

CLASS 41—(Continued).

SN 78-111,615. IOWA LOTTERY, DES MOINES, IA. FILED 2-28-2002.

HAVE SOME FUN ALREADY!

FOR LOTTERY AND LOTTO GAME SERVICES (U.S. CLS. 100, 101 AND 107).

FIRST USE 9-30-1999; IN COMMERCE 9-30-1999.

SN 78-111,635. WIN SEMINARS, INC., TULSA, OK. FILED 2-28-2002.

THE WORLD'S ONLY IRRITATIONAL SPEAKER

NO CLAIM IS MADE TO THE EXCLUSIVE RIGHT TO USE "SPEAKER", APART FROM THE MARK AS SHOWN.

FOR EDUCATION AND TRAINING SERVICES, NAMELY, PROVIDING MOTIVATIONAL SEMINARS (U.S. CLS. 100, 101 AND 107).

FIRST USE 5-0-1998; IN COMMERCE 5-0-1998.

SN 78-111,757. SOUTHERN TRAVELLER, LLC, ATLANTA, GA. FILED 2-28-2002.

TWO LANE TRAVELLER

FOR ENTERTAINMENT SERVICES, NAMELY, PROVIDING AN ON-GOING TELEVISION PROGRAM IN THE FIELDS OF TRAVEL, ENTERTAINMENT AND LIFESTYLES (U.S. CLS. 100, 101 AND 107).

FIRST USE 9-10-2001; IN COMMERCE 9-10-2001.

SN 78-112,086. MARCUS CORPORATION, THE, MILWAUKEE, WI. FILED 3-1-2002.

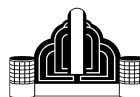

THE LINING IS A FEATURE OF THE MARK AND DOES NOT INDICATE COLOR.

FOR MOVIE THEATERS (U.S. CLS. 100, 101 AND 107).

CLASS 41—(Continued).

SN 78-112,099. DC COMICS, NEW YORK, NY. FILED 3-1-2002.

JUSTICE LEAGUE

FOR ENTERTAINMENT SERVICES IN THE NATURE OF LIVE-ACTION, COMEDY, DRAMA AND/OR ANIMATED TELEVISION SERIES; PRODUCTION OF LIVE-ACTION, COMEDY, DRAMA AND/OR ANIMATED TELEVISION SERIES; PRODUCTION OF LIVE-ACTION, COMEDY, DRAMA AND/OR ANIMATED MOTION PICTURE THEATRICAL FILMS; THEATRICAL PERFORMANCES BOTH ANIMATED AND LIVE ACTION; INTERNET SERVICES PROVIDING INFORMATION VIA AN ELECTRONIC GLOBAL COMPUTER NETWORK IN THE FIELD OF ENTERTAINMENT RELATING SPECIFICALLY TO MUSIC, MOVIES, AND TELEVISION; PROVIDING GENERAL INTEREST NEWS, ENTERTAINMENT, AND EDUCATIONAL INFORMATION VIA A GLOBAL COMPUTER NETWORK; AND PROVIDING INFORMATION FOR AND/OR ACTUAL ENTERTAINMENT VIA ELECTRONIC GLOBAL COMMUNICATIONS NETWORK IN THE NATURE OF LIVE-ACTION, COMEDY, DRAMA AND/OR ANIMATED PROGRAMS AND PRODUCTION OF LIVE-ACTION COMEDY, ACTION AND/OR ANIMATED MOTION FILMS FOR DISTRIBUTION VIA A GLOBAL COMPUTER NETWORK (U.S. CLS. 100, 101 AND 107).

SN 78-112,105. TIME WARNER ENTERTAINMENT COMPANY, L.P., NEW YORK, NY. FILED 3-1-2002.

ALIENQUEST

FOR ENTERTAINMENT SERVICES IN THE NATURE OF LIVE-ACTION, COMEDY, DRAMA AND ANIMATED TELEVISION SERIES; PRODUCTION OF LIVE-ACTION, COMEDY, DRAMA AND ANIMATED TELEVISION SERIES; PRODUCTION OF LIVE-ACTION, COMEDY, DRAMA AND ANIMATED MOTION PICTURE THEATRICAL FILMS; THEATRICAL PERFORMANCES BOTH ANIMATED AND LIVE ACTION; INTERNET SERVICES PROVIDING INFORMATION VIA AN ELECTRONIC GLOBAL COMPUTER NETWORK IN THE FIELD OF ENTERTAINMENT RELATING SPECIFICALLY TO MUSIC, MOVIES, AND TELEVISION; PROVIDING GENERAL INTEREST NEWS, ENTERTAINMENT, AND EDUCATIONAL INFORMATION VIA A GLOBAL COMPUTER NETWORK; AND PROVIDING INFORMATION FOR AND ACTUAL ENTERTAINMENT VIA ELECTRONIC GLOBAL COMMUNICATIONS NETWORK IN THE NATURE OF LIVE-ACTION, COMEDY, DRAMA AND ANIMATED PROGRAMS AND PRODUCTION OF LIVE-ACTION COMEDY, ACTION AND ANIMATED MOTION FILMS FOR DISTRIBUTION VIA A GLOBAL COMPUTER NETWORK (U.S. CLS. 100, 101 AND 107).

SN 78-112,206. BLACKWELL, BRETT D, WEST PALM BEACH, FL. FILED 3-3-2002.

WHATSERFACE

FOR ENTERTAINMENT, NAMELY, LIVE PERFORMANCES BY A MUSICAL BAND (U.S. CLS. 100, 101 AND 107).

CLASS 41—(Continued).

SN 78-112,235. WILLIAMS, CASEY RAY, DALLAS, TX. FILED 3-3-2002.

AUTOBULLET

FOR NEWS AGENCIES, NAMELY, GATHERING AND DISSEMINATION (U.S. CLS. 100, 101 AND 107).

SN 78-112,467. MILIEFSKY, GARY, S, TYNGSBORO, MA. FILED 3-4-2002.

TUNEZAP

FOR ENTERTAINMENT SERVICES, NAMELY, PROVIDING PRERECORDED MUSIC, INFORMATION IN THE FIELD OF MUSIC, AND COMMENTARY AND ARTICLES ABOUT MUSIC, ALL ONLINE VIA A GLOBAL COMPUTER NETWORK (U.S. CLS. 100, 101 AND 107).

SN 78-112,807. TAHOE-DOUGLAS VISITORS AUTHORITY, LAKE TAHOE, NV. FILED 3-5-2002.

LAKE TAHOE
Food & Wine
IN • THE • PINES



NO CLAIM IS MADE TO THE EXCLUSIVE RIGHT TO USE "LAKE TAHOE" OR "FOOD & WINE", APART FROM THE MARK AS SHOWN.

FOR ENTERTAINMENT SERVICES, NAMELY, ORGANIZING AND CONDUCTING FESTIVALS (U.S. CLS. 100, 101 AND 107).

FIRST USE 7-15-2001; IN COMMERCE 7-15-2001.

CLASS 41—(Continued).

SN 78-113,155. TEXAS ASSOCIATION OF SCHOOL NURSES, FLOWER MOUND, TX. FILED 3-7-2002.



FOR PROFESSIONAL CONTINUING EDUCATION SERVICES, NAMELY, PROVIDING CLASSES IN FIELD OF PUBLIC EDUCATION, CHILD ADVOCACY, AND SCHOOL NURSING (U.S. CLS. 100, 101 AND 107).
FIRST USE 6-7-1983; IN COMMERCE 6-26-1983.

SN 78-113,183. EMMA RILEY, INC., EAST ROCHESTER, NY. FILED 3-7-2002.

TRIPPING BILLIES

FOR ENTERTAINMENT SERVICES, NAMELY, LIVE PERFORMANCES BY A MUSICAL BAND, LIVE STUDIO RECORDING SESSIONS BY A MUSICAL GROUP, SPECIAL PERSONAL APPEARANCES, AND PRODUCTION OF MUSIC RECORDINGS, SHOWS AND VIDEOS (U.S. CLS. 100, 101 AND 107).
FIRST USE 4-20-1997; IN COMMERCE 4-20-1997.

SN 78-113,200. FOX INTERACTIVE TELEVISION, LLC, LOS ANGELES, CA. FILED 3-7-2002.

HIT THE PROS

FOR ENTERTAINMENT SERVICES, NAMELY, PROVIDING AN ON-LINE COMPUTER GAME (U.S. CLS. 100, 101 AND 107).
FIRST USE 8-31-2001; IN COMMERCE 8-31-2001.

SN 78-113,504. LOS ANGELES SCIENCE FANTASY SOCIETY, INC., NORTH HOLLYWOOD, CA. FILED 3-8-2002.

WESTERCON

FOR ORGANIZING AND CONDUCTION SCIENCE FICTION AND FANTASY CONVENTIONS (U.S. CLS. 100, 101 AND 107).

CLASS 41—(Continued).

SN 78-113,582. LANDMARK EDUCATION CORPORATION, SAN FRANCISCO, CA. FILED 3-8-2002.

ALREADY ALWAYS LISTENING

FOR EDUCATIONAL SERVICES, NAMELY, CONDUCTING WORKSHOPS AND SEMINARS IN THE FIELDS OF EFFECTIVENESS, PRODUCTIVITY, COMMUNICATION, LEADERSHIP, MANAGEMENT, AND PERSONAL AND ORGANIZATIONAL DEVELOPMENT (U.S. CLS. 100, 101 AND 107).

SN 78-113,599. LANDMARK EDUCATION CORPORATION, SAN FRANCISCO, CA. FILED 3-8-2002.

VICIOUS CIRCLE

FOR EDUCATIONAL SERVICES, NAMELY, CONDUCTING WORKSHOPS AND SEMINARS IN THE FIELDS OF EFFECTIVENESS, PRODUCTIVITY, COMMUNICATION, LEADERSHIP, MANAGEMENT, AND PERSONAL AND ORGANIZATIONAL DEVELOPMENT (U.S. CLS. 100, 101 AND 107).

SN 78-114,132. HARRINGTON, CORTNEY LYNN, MARS HILL, NC. FILED 3-12-2002.

AMA DIVER

FOR ENTERTAINMENT, NAMELY LIVE PERFORMANCES BY A ROCK MUSIC GROUP (U.S. CLS. 100, 101 AND 107).
FIRST USE 1-31-1999; IN COMMERCE 8-15-2001.

CLASS 42—SCIENTIFIC, COMPUTER AND LEGAL SERVICES

SN 75-285,612. BONINA & BONINA, P.C., BROOKLYN, NY. FILED 5-2-1997.

1-888-MED-LAW-1

FOR LEGAL SERVICES (U.S. CLS. 100 AND 101).
FIRST USE 4-24-1996; IN COMMERCE 4-24-1996.

CLASS 42—(Continued).

SN 75-316,331. STOLTE ENTERPRISES, INC., CEDAR RAPIDS, IA. FILED 6-27-1997.

WEB SITE DYNAMICS

NO CLAIM IS MADE TO THE EXCLUSIVE RIGHT TO USE "WEB SITE", APART FROM THE MARK AS SHOWN. FOR CUSTOM DESIGN FOR OTHERS OF COMPUTER PROGRAMS AND WEB SITES FOR USE ON A GLOBAL COMPUTER NETWORK (U.S. CLS. 100 AND 101).
FIRST USE 5-1-1997; IN COMMERCE 5-1-1997.

SN 75-561,595. AEROSPACE DATA INTERNATIONAL (ADI), LAHABRA, CA. FILED 9-29-1998.



NO CLAIM IS MADE TO THE EXCLUSIVE RIGHT TO USE "AEROSPACE DATA INTERNATIONAL", APART FROM THE MARK AS SHOWN.

FOR CONSULTING SERVICES IN THE FIELD OF AIRCRAFT DESIGN, MODIFICATION, AND MAINTENANCE DATA DOCUMENTATION; DESIGN AND DRAFTING OF DOCUMENTATION FOR OTHERS IN CONNECTION WITH AIRCRAFT DESIGN, MODIFICATIONS AND MAINTENANCE DATA (U.S. CLS. 100 AND 101).

FIRST USE 1-1-1998; IN COMMERCE 1-1-1998.

SN 75-621,167. USSI, INC., SCOTTSDALE, AZ. FILED 1-15-1999.



FOR COMPUTER SOFTWARE DESIGN, CONSULTATION AND PROGRAMMING FOR OTHERS (U.S. CLS. 100 AND 101).

CLASS 42—(Continued).

SN 75-634,192. DIXON, JOSEPH, DETROIT, MI. FILED 2-10-1999.

SERVNU

FOR COMPUTER CONSULTATION, COMPUTER DIAGNOSTIC SERVICES, COMPUTER DISASTER RECOVERY PLANNING, COMPUTER PROGRAMMING FOR OTHERS, ON-LINE BATCH COMPUTER SERVICES, COMPUTER SERVICES, NAMELY, CREATING AND MAINTAINING WEB SITES FOR OTHERS, COMPUTER SERVICES, NAMELY, DESIGNING AND IMPLEMENTING NETWORK WEB PAGES FOR OTHERS, COMPUTER SERVICES, NAMELY, DESIGNING AND IMPLEMENTING WEB SITES FOR OTHERS, COMPUTER SITE DESIGN, INSTALLATION OF COMPUTER SOFTWARE, UPDATING OF COMPUTER SOFTWARE, COMPUTER SOFTWARE DESIGN FOR OTHERS, COMPUTER SYSTEMS ANALYSIS, DATA CONVERSION OF COMPUTER PROGRAM DATA OR INFORMATION, NAMELY CONVERTING FROM ONE DATABASE MANAGEMENT SOFTWARE TO ANOTHER DATABASE MANAGEMENT SOFTWARE, DESIGN FOR OTHERS IN THE FIELD OF COMPUTERS, HOSTING THE WEB SITES OF OTHERS ON A COMPUTER SERVER FOR A GLOBAL COMPUTER NETWORK, INTEGRATION OF COMPUTER SYSTEMS AND NETWORKS, MAINTENANCE OF COMPUTER SOFTWARE, MONITORING OF COMPUTER SYSTEMS REMOTE OR ON-SITE FOR OTHERS, COMPUTER PROGRAMMING FOR OTHERS, NAMELY, WEB SITES AND ON-SITE PROGRAMMING, AND RECOVERY OF COMPUTER DATA (U.S. CLS. 100 AND 101).

FIRST USE 1-18-1996; IN COMMERCE 6-18-1996.

SN 75-686,965. DATA BASED SYSTEMS INTERNATIONAL, INC., BETHLEHEM, PA. FILED 4-20-1999.

DBS

FOR COMPUTER CONSULTING IN PROVIDING COMPUTER SYSTEMS, COMPUTER NETWORK SYSTEMS, COMPUTER SERVER ARCHITECTURE, DATABASE ACCESS AND CONTROL SYSTEMS; COMPUTER SERVICE AND SUPPORT SERVICES, NAMELY, TROUBLESHOOTING OF COMPUTER SOFTWARE AND HARDWARE PROBLEMS; SOFTWARE CONSULTING SERVICES AND TECHNICAL CONSULTATION IN THE FIELD OF COMPUTER ENGINEERING; COMPUTER PROGRAMMING FOR OTHERS; PROVIDING TEMPORARY USE OF NONDOWNLOADABLE SOFTWARE APPLICATIONS FOR ACCOUNTING, WAREHOUSING, INVENTORY MANAGEMENT, DISTRIBUTION AND MANUFACTURING, AND BUSINESS MANAGEMENT VIA A GLOBAL COMPUTER INFORMATION NETWORK; LEASING SERVICES IN THE FIELD OF COMPUTER HARDWARE AND COMPUTER SOFTWARE (U.S. CLS. 100 AND 101).

FIRST USE 0-0-1982; IN COMMERCE 0-0-1982.

CLASS 42—(Continued).

SN 75-689,390. CONTACT INTERNATIONAL, INC., BALTIMORE, MD. FILED 4-27-1999.

THE CENTER FOR TECHNICAL TRANSLATION

NO CLAIM IS MADE TO THE EXCLUSIVE RIGHT TO USE "TECHNICAL TRANSLATION", APART FROM THE MARK AS SHOWN.

SEC. 2(F).
FOR LANGUAGE TRANSLATION SERVICES (U.S. CLS. 100 AND 101).
FIRST USE 1-1-1997; IN COMMERCE 1-1-1997.

SN 75-772,872. TIMES NEWSPAPER, LONDON, UNITED KINGDOM, FILED 8-10-1999.

LONDONTIMES.COM

FOR COMPUTER SERVICES, NAMELY, PROVIDING ON-LINE GENERAL INFORMATION NEWSPAPER; DISTRIBUTION OF NEWS EXCERPTS VIA MULTI-USER GLOBAL COMPUTER INFORMATION NETWORK (U.S. CLS. 100 AND 101).

SN 75-784,495. PEOPLEWEB COMMUNICATIONS, INC., SAN JOSE, CA. FILED 8-25-1999.

VIETCHAT

FOR HOSTING THE WEB SITES OF OTHERS ON A COMPUTER SERVER FOR A GLOBAL COMPUTER NETWORK; PROVIDING INFORMATION ON A WIDE VARIETY OF TOPICS INCLUDING NEWS, POETRY, SPORTS, CHINESE CHESS, MUSIC, TEENS, COLLEGES, MARRIED LIFE, SINGLE AND FAMILY LIFE (U.S. CLS. 100 AND 101).

FIRST USE 10-31-1997; IN COMMERCE 10-31-1997.

SN 75-790,682. LAMBERT, JAMES K., MEDINA, OH. FILED 9-2-1999.

LeanDimensions QTC

FOR CONSULTING SERVICES IN THE FIELD OF MANUFACTURING (U.S. CLS. 100 AND 101).
FIRST USE 4-1-1999; IN COMMERCE 7-22-1999.

CLASS 42—(Continued).

SN 75-813,010. NORTHERN LIGHT TECHNOLOGY LLC, CAMBRIDGE, MA. FILED 9-29-1999.

USGOVSEARCH

FOR COMPUTER SERVICES, NAMELY PROVIDING SEARCH ENGINES FOR OBTAINING DATA ON GLOBAL COMPUTER NETWORKS (U.S. CLS. 100 AND 101).

SN 75-820,775. ACCU-STATS VIDEO PRODUCTIONS, BLOOMINGDALE, NJ. FILED 10-12-1999.



FOR VIDEOTAPING PROFESSIONAL BILLIARDS TOURNAMENTS (U.S. CLS. 100 AND 101).
FIRST USE 0-0-1981; IN COMMERCE 0-0-1986.

SN 75-830,190. ADOPTION.COM, INC., TEMPE, AZ. FILED 11-10-1999.



adoption.com

NO CLAIM IS MADE TO THE EXCLUSIVE RIGHT TO USE "ADOPTION.COM", APART FROM THE MARK AS SHOWN.

FOR PROVIDING A WEBSITE FEATURING INFORMATION, RESOURCES AND WEB LINKS IN THE FIELD OF ADOPTION (U.S. CLS. 100 AND 101).

FIRST USE 11-0-1995; IN COMMERCE 11-0-1995.

CLASS 42—(Continued).

SN 75-835,324. JASON, MARIUS J., VILNIUS, LITHUANIA,
FILED 11-17-1999.



OWNER OF U.S. REG. NO. 2,237,911.
FOR LEGAL SERVICES FOR BUSINESS, TRADE-
MARK, PATENT, INDUSTRIAL DESIGN AND COPY-
RIGHT PROTECTION (U.S. CLS. 100 AND 101).
FIRST USE 1-0-1992; IN COMMERCE 4-0-1992.

SN 75-862,896. AMERICA ONLINE, INC., DULLES, VA.
FILED 12-3-1999.

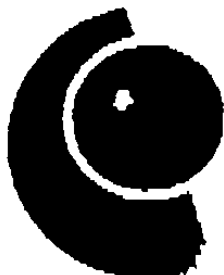

FOR COMPUTER SOFTWARE AND COMPUTER PRO-
GRAM DESIGN SERVICES FOR OTHERS; DESKTOP
PUBLISHING FOR OTHERS; PROVIDING A WIDE
RANGE OF GENERAL INTEREST INFORMATION VIA
COMPUTER NETWORKS (U.S. CLS. 100 AND 101).
FIRST USE 4-0-1998; IN COMMERCE 4-0-1998.

SN 75-877,123. WISCONSIN STATE TELECOMMUNICA-
TIONS ASSOCIATION, INC., MADISON, WI. FILED 12-
21-1999.



NO CLAIM IS MADE TO THE EXCLUSIVE RIGHT TO
USE "WI" AND "ISP", APART FROM THE MARK AS
SHOWN.

FOR ASSOCIATION SERVICES, NAMELY, PROMOT-
ING THE INTERESTS OF INDIVIDUALS AND ORGA-
NIZATIONS THAT PROVIDE INTERNET SERVICES
(U.S. CLS. 100 AND 101).
FIRST USE 9-0-1999; IN COMMERCE 9-0-1999.

CLASS 42—(Continued).

SN 75-882,279. SENTIUS CORPORATION, PALO ALTO, CA.
FILED 12-27-1999.

RICHLINK

FOR COMPUTER SERVICES, NAMELY, PROVIDING
WEB SITES AND ELECTRONIC DOCUMENT ARCHIVES
CONTAINING POP-UP NAVIGATION AND MENUS
WHICH PROVIDE RELEVANT INFORMATION,
NAMELY, DEFINITIONS, TRANSLATIONS, EXPLANA-
TIONS, HYPERLINKS, GRAPHICS, AUDIO, VIDEO ON
A WIDE VARIETY OF SUBJECTS WITHOUT READERS
HAVING TO LEAVE THE WEB SITE; PROVIDING ON-
LINE NON-DOWNLOADABLE SOFTWARE USED FOR
CONTENT MANAGEMENT, DOCUMENT MANAGE-
MENT, ARCHIVING ELECTRONIC DOCUMENTS BY
CONNECTING THE WEB SITE, CONTENT MANAGE-
MENT SYSTEM, DOCUMENT MANAGEMENT SYSTEM
OR ELECTRONIC DOCUMENT ARCHIVE WITH DATA-
BASES AND OTHER RESOURCES ON THE INTERNET
(U.S. CLS. 100 AND 101).

SN 75-883,838. DRTANGO.COM, INC., ROSWELL, GA.
FILED 12-31-1999.

DRTANGO

FOR PROVIDING ON-LINE COMPUTER SERVICES,
NAMELY, TEMPORARY USE OF ON-LINE NON-
DOWNLOADABLE SOFTWARE WHICH, BY PROVID-
ING HEALTHCARE INFORMATION AND ANALYSIS,
FUNCTIONS AS AN AID TO MANAGING HEALTH-
CARE, DIET, EXERCISE AND HEALTHCARE EDUCA-
TION PROGRAMS AND FUNCTIONS TO DISSEMINATE
HEALTHCARE INFORMATION, ALL FOR PARTICI-
PANTS IN HEALTHCARE INDUSTRY IN THE FIELDS
OF COMMUNICATION, MEDICAL INFORMATION,
EDUCATION AND TRANSACTION SERVICES; INFOR-
MATION SERVICES IN THE FIELDS OF MEDICINE
AND HEALTHCARE (U.S. CLS. 100 AND 101).
FIRST USE 8-5-1999; IN COMMERCE 8-5-1999.

SN 75-888,721. PARK, JAE WOO, SEOUL, REPUBLIC OF
KOREA, FILED 1-6-2000.

MPARTICLE

FOR COMPUTER SERVICES, NAMELY, PROVIDING
HEALTH CARE INFORMATION, HEALTH SERVICES,
NAMELY, MENTAL HEALTH SERVICES IN THE NA-
TURE OF ASSISTING INDIVIDUALS TO PROMOTE
METAL HEALTH AND THEIR CAPACITY TO MANAGE
THEIR LIFE (U.S. CLS. 100 AND 101).

SN 75-898,481. SURVEILLANCE DATA, INC., PLYMOUTH
MEETING, PA. FILED 1-18-2000.

POLLEN.COM

SEC. 2(F).
FOR ON-LINE INFORMATION SERVICE IN THE
FIELD OF DISEASES (U.S. CLS. 100 AND 101).
FIRST USE 1-18-1996; IN COMMERCE 1-18-1996.

CLASS 42—(Continued).

SN 75-900,946. TRAILTOSUCCESS.COM, PROVIDENCE, RI. FILED 1-21-2000.

ICANDATE

FOR PROVIDING INFORMATION IN THE AREA OF COMPUTER DATING AND DATING SERVICES SPECIFICALLY RELEVANT TO THE DISABILITY COMMUNITY VIA A WEBSITE ON THE INTERNET (U.S. CLS. 100 AND 101).

SN 75-911,803. VERACOM, L.L.C., WICHITA, KS. FILED 2-7-2000.

TAKE CONTROL OF THE INTERNET

FOR COMPUTER SERVICES, NAMELY, PROVIDING FILTERING SERVICES FOR BLOCKING AND PREVENTING ACCESS TO OFFENSIVE WEB SITES AND INFORMATION (U.S. CLS. 100 AND 101).
FIRST USE 9-1-1999; IN COMMERCE 9-1-1999.

SN 75-933,616. PERFECTLY LEGAL, INC., ALBUQUERQUE, NM. FILED 3-1-2000.

PERFECTLY LEGAL, INC.

FOR PROVIDING PARALEGAL AND LEGAL ASSISTANCE SERVICES; LITIGATION SUPPORT SERVICES; AND GRAPHIC ILLUSTRATION SERVICES FOR OTHERS (U.S. CLS. 100 AND 101).
FIRST USE 12-0-1997; IN COMMERCE 12-0-1997.

SN 75-933,676. OASIS ALIGNMENT SERVICES, INC., ROCHESTER, NH. FILED 3-1-2000.



OWNER OF U.S. REG. NO. 1,988,085.
FOR ALIGNMENT INSPECTION, MEASUREMENT, AND PRECISION ALIGNMENT OF PAPER MAKING AND PAPER CONVERTING EQUIPMENT, NAMELY, PAPER MACHINES, CORRUGATORS, PAPER CONVERTING EQUIPMENT AND PRINTING PRESSES (U.S. CLS. 100 AND 101).
FIRST USE 1-15-1982; IN COMMERCE 1-15-1982.

CLASS 42—(Continued).

SN 75-936,553. NEOKISMET, LLC, SAN FRANCISCO, CA. FILED 3-6-2000.

NEOKISMET

FOR TECHNICAL CONSULTATION SERVICES IN THE FIELD OF ENERGY POWER SOURCES BASED ON CHEMICAL REACTIONS, FOR USE IN BATTERIES AND OTHER SIMILAR APPLICATIONS (U.S. CLS. 100 AND 101).

SN 75-940,868. CASSIDY & ASSOCIATES, WASHINGTON, DC. FILED 3-10-2000.

**GLOBAL TRADE
Strategies**

NO CLAIM IS MADE TO THE EXCLUSIVE RIGHT TO USE "GLOBAL TRADE STRATEGIES", APART FROM THE MARK AS SHOWN.

FOR CONSULTING SERVICES TO POLICE AND PREVENT THE COUNTERFEITING OF GOODS IN FOREIGN COUNTRIES (U.S. CLS. 100 AND 101).
FIRST USE 12-20-1999; IN COMMERCE 12-20-1999.

SN 75-941,256. CMP MEDIA INC., MANHASSET, NY. FILED 3-10-2000.

**SECURITY ALERT
CONSENSUS**

NO CLAIM IS MADE TO THE EXCLUSIVE RIGHT TO USE "SECURITY ALERT", APART FROM THE MARK AS SHOWN.

FOR PROVIDING AN ELECTRONIC NEWSLETTER FOR INFORMATION TECHNOLOGY PROFESSIONALS VIA THE INTERNET (U.S. CLS. 100 AND 101).
FIRST USE 3-2-2000; IN COMMERCE 3-2-2000.

CLASS 42—(Continued).

SN 75-981,655. PROMETHEUS LABORATORIES, INC., SAN DIEGO, CA. FILED 7-3-2001.

IBD FIRST STEP

NO CLAIM IS MADE TO THE EXCLUSIVE RIGHT TO USE "IBD", APART FROM THE MARK AS SHOWN.

FOR DIAGNOSTIC AND REPORTING SERVICES FOR GASTROINTESTINAL DISEASES (U.S. CLS. 100 AND 101).

FIRST USE 5-27-1998; IN COMMERCE 9-1-1998.

SN 75-982,193. PERFORMANT, INC., BELLEVUE, WA. FILED 1-31-2001.

PERFORMANT

FOR COMPUTER SERVICES, NAMELY, BACKEND INTEGRATION OF COMPUTER SYSTEMS, COMPUTER NETWORKS, AND DATA SYSTEMS; TECHNICAL AND COMPUTER CONSULTING IN THE FIELD OF SOFTWARE APPLICATIONS AND WEB SITE PERFORMANCE (U.S. CLS. 100 AND 101).

FIRST USE 10-1-1999; IN COMMERCE 5-1-2000.

SN 75-982,621. LAN CHILE S.A., RENCA SANTIAGO, CHILE, FILED 9-15-2000.

LANFULFILLMENT.COM

PRIORITY CLAIMED UNDER SEC. 44(D) ON CHILE APPLICATION NO. 497,057, FILED 8-11-2000, REG. NO. 590560, DATED 2-21-2001, EXPIRES 2-21-2011.

FOR SERVICES RELATED TO COMPUTER SOFTWARE, INCLUDING DATA DESIGN AND PROCESSING; ANALYSIS, DESIGN, RESEARCH, CONSULTING, ADVICE, PROFESSIONAL AND TECHNICAL ORIENTATION RELATING TO COMPUTERS AND TO ELECTRONIC COMMERCE LOGISTICS; CONSULTING, STUDY, SCIENTIFIC RESEARCH, AND DEVELOPMENT OF TOPICS RELATED TO LOGISTICS IN CONNECTION WITH ELECTRONIC COMMERCE (U.S. CLS. 100 AND 101).

SN 76-003,594. RKS DESIGN, INC., THOUSAND OAKS, CA. FILED 3-18-2000.

PSYCHO-AESTHETICS

FOR DESIGN OF NEW PRODUCTS FOR OTHERS (U.S. CLS. 100 AND 101).

FIRST USE 2-15-1999; IN COMMERCE 2-15-1999.

CLASS 42—(Continued).

SN 76-008,046. VIPDESK.COM, INC., ALEXANDRIA, VA. BY CHANGE OF NAME CONCIERGECLUB.COM, INC., ALEXANDRIA, VA. FILED 3-23-2000.

VIPDESK.COM

FOR CONCIERGE SERVICES FOR OTHERS COMPRISING MAKING REQUESTED PERSONAL ARRANGEMENTS AND RESERVATIONS AND PROVIDING CUSTOMER-SPECIFIC INFORMATION, NAMELY, HOME REPAIR, REAL ESTATE, HOME CLEANING AND MAINTENANCE, SHOPPING, GIFTS, TRAVEL, RESTAURANTS, ENTERTAINMENT, FITNESS, PERSONAL FINANCE, SPORTS AND RECREATION, AND HEALTH AND BEAUTY, TO MEET INDIVIDUAL NEEDS RENDERED TOGETHER TO A CUSTOMERS AND EMPLOYEES OF BUSINESSES VIA TELEPHONE AND ELECTRONIC COMMUNICATIONS NETWORKS (U.S. CLS. 100 AND 101).

FIRST USE 1-2-2000; IN COMMERCE 1-2-2000.

SN 76-017,193. BARAL, HOWARD, ENCINO, CA. FILED 4-4-2000.

BUBBIEKNOWS

FOR INTERACTIVE WEBSITE THAT REMINDS USERS OF IMPORTANT DATES; PROVIDING CUSTOMIZED ONLINE WEB PAGES FEATURING USER-DEFINED INFORMATION, WHICH INCLUDES SEARCH ENGINES AND ONLINE WEB LINKS TO OTHER WEBSITES FEATURING SERVICES AND GOODS (U.S. CLS. 100 AND 101).

SN 76-021,198. COFFEY, CHRISTOPHER, GARDENA, CA. FILED 4-10-2000.

**CONSTRUCTION
PROTECTIVE SERVICES**

NO CLAIM IS MADE TO THE EXCLUSIVE RIGHT TO USE "PROTECTIVE SERVICES", APART FROM THE MARK AS SHOWN.

SEC. 2(F).

FOR UNARMED GUARD SERVICES FOR THE CONSTRUCTION INDUSTRY AND AT CONSTRUCTION SITES (U.S. CLS. 100 AND 101).

FIRST USE 0-0-1992; IN COMMERCE 0-0-1992.

CLASS 42—(Continued).

SN 76-022,170. FIG LEAF SOFTWARE, WASHINGTON, DC. FILED 4-10-2000.

FIG LEAF INTERACTIVE SERVICES

NO CLAIM IS MADE TO THE EXCLUSIVE RIGHT TO USE "INTERACTIVE SERVICES", APART FROM THE MARK AS SHOWN.

FOR COMPUTER CONSULTATION AND PRODUCT DEVELOPMENT CONSULTATION SERVICES IN THE FIELD OF WEB-BASED CLIENT SERVER APPLICATIONS, DATABASE SOFTWARE, AND DATA-DRIVEN WEBSITES (U.S. CLS. 100 AND 101).

SN 76-026,277. SIMUTILITY, INC., WESTFORD, MA. FILED 4-13-2000.

SIMUTILITY.COM

FOR COMPUTER SOFTWARE DESIGN FOR OTHERS NAMELY SCALABLE, EXTENSIBLE, FLEXIBLE, CUSTOMIZABLE, LARGE-SCALE, MULTI-DISCIPLINARY SIMULATION APPLICATIONS SOFTWARE ENABLING THE CREATION AND OPERATION OF COMPLETE TURNKEY HIGH-PERFORMANCE COMPUTER (HPC) APPLICATION SERVICE PLATFORM (ASP) SYSTEMS; TECHNICAL SUPPORT SERVICE, NAMELY OF COMPUTER HARDWARE AND SOFTWARE PROBLEMS RELATED TO SCALABLE, EXTENSIBLE, FLEXIBLE, CUSTOMIZABLE, LARGE-SCALE, MULTI-DISCIPLINARY SIMULATION APPLICATIONS SOFTWARE ENABLING THE CREATION AND OPERATION OF COMPLETE TURNKEY HIGH-PERFORMANCE COMPUTING (HPC) APPLICATION SERVICE PLATFORM (ASP) SYSTEMS (U.S. CLS. 100 AND 101).

SN 76-030,055. ELECTRONIC M.D. PEER REVIEW, INC., FORT WAYNE, IN. FILED 4-19-2000.

ELECTRONIC M.D. PEER REVIEW

NO CLAIM IS MADE TO THE EXCLUSIVE RIGHT TO USE "ELECTRONIC" AND "REVIEW", APART FROM THE MARK AS SHOWN.

FOR MEDICAL CHART REVIEW SERVICES (U.S. CLS. 100 AND 101).

FIRST USE 3-5-2000; IN COMMERCE 3-5-2000.

SN 76-033,239. 50 NORTH, INC., LOS ANGELES, CA. FILED 4-24-2000.

50 NORTH

FOR HYGIENIC AND BEAUTY CARE SERVICES, NAMELY BEAUTY SALONS (U.S. CLS. 100 AND 101). FIRST USE 3-16-2000; IN COMMERCE 3-16-2000.

CLASS 42—(Continued).

SN 76-034,098. MULTIMEDIA LIVE, INC., PETALUMA, CA. FILED 4-25-2000.



multimedia live

FOR TECHNOLOGY SERVICES, NAMELY, DESIGNING AND IMPLEMENTING NETWORK WEB PAGES FOR OTHERS VIA A GLOBAL COMPUTER NETWORK (U.S. CLS. 100 AND 101).

SN 76-047,554. ON TARGET TECHNOLOGIES, INC., DOYLESTOWN, PA. FILED 5-15-2000.

ON TARGET TECHNOLOGIES

NO CLAIM IS MADE TO THE EXCLUSIVE RIGHT TO USE "TECHNOLOGIES", APART FROM THE MARK AS SHOWN.

FOR COMPUTER CONSULTING SERVICES IN THE FIELD OF BUSINESS INTELLIGENCE SYSTEMS (U.S. CLS. 100 AND 101).

FIRST USE 3-11-1998; IN COMMERCE 3-11-1998.

SN 76-048,069. WORTHINGTON, GARY, LINDON, UT. AND WORTHINGTON, COLLEEN, LINDON, UT. FILED 5-15-2000.

KNEADERS

FOR RESTAURANT AND CARRY OUT RESTAURANT SERVICES (U.S. CLS. 100 AND 101).

FIRST USE 12-0-1997; IN COMMERCE 12-0-1997.

SN 76-050,330. STAY'N SAVE MOTOR INN SERVICES INC., VICTORIA, BRITISH COLUMBIA, CANADA, FILED 5-15-2000.

ACCENT INNS

PRIORITY CLAIMED UNDER SEC. 44(D) ON CANADA APPLICATION NO. 1,051,283, FILED 3-22-2000, REG. NO. TMA556483, DATED 1-16-2002, EXPIRES 1-16-2017.

NO CLAIM IS MADE TO THE EXCLUSIVE RIGHT TO USE "INNS", APART FROM THE MARK AS SHOWN.

FOR HOTEL AND MOTEL SERVICES (U.S. CLS. 100 AND 101).

CLASS 42—(Continued).

SN 76-051,525. WOODS, RAY, NEW SOUTH WALES 2170, AUSTRALIA, FILED 5-18-2000.

THE WOODS TECHNIQUE OF HAIR TRANSPLANTATION

NO CLAIM IS MADE TO THE EXCLUSIVE RIGHT TO USE "TECHNIQUE OF HAIR TRANSPLANTATION", APART FROM THE MARK AS SHOWN.

FOR AUTOLOGUS HAIR TRANSPLANTATION SERVICES (U.S. CLS. 100 AND 101).

CLASS 42—(Continued).

SN 76-071,238. ZYRIS, PLC, HERTFORDSHIRE, HP2 6EX, ENGLAND, FILED 6-15-2000.

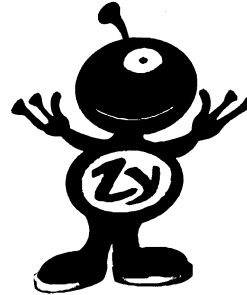

SN 76-060,574. STATE BOARD OF AGRICULTURE, THE, DENVER, CO. FILED 5-31-2000.

CONSORTIUM FOR AGRICULTURAL SOILS MITIGATION OF GREENHOUSE GASES (CASMGS)

NO CLAIM IS MADE TO THE EXCLUSIVE RIGHT TO USE "CONSORTIUM FOR AGRICULTURAL SOILS MITIGATION OF GREENHOUSE GASES", APART FROM THE MARK AS SHOWN.

FOR SCIENTIFIC RESEARCH SERVICES; PROVIDING INFORMATION IN THE FIELD OF CARBON SEQUESTRATION; SCIENTIFIC ANALYSIS FOR OTHERS IN THE FIELD OF CARBON SEQUESTRATION AND PRODUCT DEVELOPMENT SERVICES IN THE FIELD OF CARBON SEQUESTRATION (U.S. CLS. 100 AND 101).
FIRST USE 2-0-1999; IN COMMERCE 2-0-1999.

FOR ONLINE COMPUTER SERVICES, NAMELY, PROVIDING WEB PAGE AUTHORIZING AND GRAPHIC DESIGN THAT IS ACCESSED THROUGH A GLOBAL COMPUTER INFORMATION NETWORK (U.S. CLS. 100 AND 101).

FIRST USE 3-20-2000; IN COMMERCE 3-20-2000.

SN 76-077,715. SEMANDEX NETWORKS, INC., PRINCETON, NJ. FILED 6-22-2000.

SEMANDEX NETWORKS

NO CLAIM IS MADE TO THE EXCLUSIVE RIGHT TO USE "NETWORKS", APART FROM THE MARK AS SHOWN.

FOR PROVIDING ON-LINE COMPUTER SERVICES FOR SEARCHING, RETRIEVAL, INDEXING AND ORGANIZING DATA; ENHANCING THE PERFORMANCE AND FUNCTION OF COMPUTER NETWORKS; HOSTING SOFTWARE APPLICATIONS OF OTHERS ON A COMPUTER SERVER FOR A GLOBAL COMPUTER NETWORK; AND COMPUTER SOFTWARE DESIGN FOR OTHERS (U.S. CLS. 100 AND 101).

SN 76-069,505. QWEST COMMUNICATIONS INTERNATIONAL INC., DENVER, CO. BY MERGER U S WEST, INC., DENVER, CO. FILED 6-14-2000.

MYBUILDINGONLINE

FOR COMMUNICATION SERVICES, NAMELY, PROVIDING DATABASES ALLOWING BUILDING TENANTS TO COMMUNICATE WITH BUILDING MANAGERS AND FEATURING GENERAL AND LOCAL NEWS, AND INFORMATION OF INTEREST TO SPECIFIC GEOGRAPHIC AREAS (U.S. CLS. 100 AND 101).

SN 76-083,367. CYBERERHOOKUP1.COM, LLC., CINCINNATI, OH. FILED 7-5-2000.

WWW.CYBERHOOKP1.COM MINDS AT WORK 24/7

FOR COMPUTER SERVICES, NAMELY, DESIGNING AND IMPLEMENTING NETWORK WEB PAGES FOR OTHERS (U.S. CLS. 100 AND 101).

CLASS 42—(Continued).

SN 76-085,010. ACKERLEY INTERACTIVE MEDIA, INC., SEATTLE, WA. FILED 7-6-2000.



NETWORK

NO CLAIM IS MADE TO THE EXCLUSIVE RIGHT TO USE "NETWORK", APART FROM THE MARK AS SHOWN. FOR COMPUTER SERVICES, NAMELY DEVELOPING AND OPERATING WEB SITES TO PROVIDE LOCALIZED NEWS, WEATHER, SPORTS, CIVIC, BUSINESS, AND ENTERTAINMENT INFORMATION TAILORED TO LOCAL MARKETS BY MEANS OF A GLOBAL COMPUTER NETWORK (U.S. CLS. 100 AND 101).

SN 76-085,012. ACKERLEY INTERACTIVE MEDIA, INC., SEATTLE, WA. FILED 7-6-2000.



FOR COMPUTER SERVICES, NAMELY DEVELOPING AND OPERATING WEB SITES TO PROVIDE LOCALIZED NEWS, WEATHER, SPORTS, CIVIC, BUSINESS, AND ENTERTAINMENT INFORMATION TAILORED TO LOCAL MARKETS BY MEANS OF A GLOBAL COMPUTER NETWORK (U.S. CLS. 100 AND 101).

SN 76-089,905. DNA SCIENCES, INC., MOUNTAIN VIEW, CA. FILED 7-13-2000.

THE DNA SCIENCES GENE TRUST PROJECT

NO CLAIM IS MADE TO THE EXCLUSIVE RIGHT TO USE "DNA" OR "GENE TRUST PROJECT", APART FROM THE MARK AS SHOWN. FOR RESEARCH, TESTING, AND CONSULTATION SERVICES IN THE FIELD OF GENETICS FOR THE BIOPHARMACEUTICAL INDUSTRY, ACADEMIC INSTITUTIONS, PHYSICIANS AND INDIVIDUAL CONSUMERS (U.S. CLS. 100 AND 101).

CLASS 42—(Continued).

SN 76-099,740. CREMASCO, OSCAR D., SAN DIEGO, CA. FILED 8-1-2000.



THE BIG STEAK HOUSE

NO CLAIM IS MADE TO THE EXCLUSIVE RIGHT TO USE "THE BIG STEAK HOUSE", APART FROM THE MARK AS SHOWN. FOR RESTAURANT, NAMELY STEAKHOUSE AND ARGENTINEAN FOOD CUISINE (U.S. CLS. 100 AND 101).

SN 76-105,778. VAUGHAN, JEANETTE V., BUMPASS, VA. FILED 8-9-2000.

Angel Eyes Permanent Make Up



NO CLAIM IS MADE TO THE EXCLUSIVE RIGHT TO USE "PERMANENT MAKE UP", APART FROM THE MARK AS SHOWN. FOR PERMANENT MAKEUP APPLICATION TATTOOING (U.S. CLS. 100 AND 101).

SN 76-107,291. COMMUNITY HOSPITALS OF INDIANA, INC., INDIANAPOLIS, IN. FILED 8-10-2000.

EHEALTHINDIANA.COM

FOR COMPUTER SERVICES, NAMELY, PROVIDING ON-LINE SERVICES IN THE FIELD OF HEALTH CARE AND HOSPITAL SERVICES; PROVIDING AN ON-LINE INTERACTIVE DATABASE FOR PATIENTS AND MEDICAL PROFESSIONALS TO MONITOR PATIENT CLINICAL INFORMATION AND MEDICAL RESEARCH (U.S. CLS. 100 AND 101).

CLASS 42—(Continued).

SN 76-107,411. ENCOVER, INC., MOUNTAIN VIEW, CA. FILED 8-11-2000.

SERVSMART

FOR COMPUTER SOFTWARE DESIGN FOR OTHERS; APPLICATION SERVICE PROVIDER (ASP) FEATURING SOFTWARE IN THE FIELD OF INTERNET SERVICE AGREEMENTS; APPLICATION SERVICE PROVIDER (ASP), NAMELY, HOSTING COMPUTER SOFTWARE APPLICATIONS OF OTHERS (U.S. CLS. 100 AND 101).

SN 76-107,413. ENCOVER, INC., MOUNTAIN VIEW, CA. FILED 8-11-2000.

ENCOVER

FOR COMPUTER SOFTWARE DESIGN FOR OTHERS; APPLICATION SERVICE PROVIDER (ASP) FEATURING SOFTWARE IN THE FIELD OF INTERNET SERVICE AGREEMENTS; APPLICATION SERVICE PROVIDER (ASP), NAMELY, HOSTING COMPUTER SOFTWARE APPLICATIONS OF OTHERS (U.S. CLS. 100 AND 101).

SN 76-109,744. KINTANA, INC., SUNNYVALE, CA. FILED 8-15-2000.

KINTANA ACCELERATOR

NO CLAIM IS MADE TO THE EXCLUSIVE RIGHT TO USE "ACCELERATOR", APART FROM THE MARK AS SHOWN.

FOR COMPUTER CONSULTING SERVICES IN THE FIELD OF COMPUTER HARDWARE AND SOFTWARE; CONSULTING SERVICES IN THE FIELD OF COMPUTER SOFTWARE PRODUCTION, TESTING, UPDATING, DEPLOYMENT, OPTIMIZATION, IMPLEMENTATION AND INTEGRATION WITH EXISTING COMPUTER HARDWARE AND SOFTWARE; CONSULTING SERVICES IN THE FIELD OF BUSINESS PROCESS AUTOMATION; APPLICATION SERVICE PROVIDER (ASP), NAMELY, HOSTING BUSINESS PROCESS AUTOMATION SOFTWARE APPLICATIONS FOR OTHERS; SOFTWARE INTEGRATION SERVICES, NAMELY, INTEGRATING COMPUTER SOFTWARE WITH EXISTING COMPUTER HARDWARE AND SOFTWARE; PROVIDING ONLINE INFORMATION IN THE FIELD OF COMPUTER HARDWARE AND SOFTWARE AND BUSINESS PROCESS AUTOMATION SERVICES (U.S. CLS. 100 AND 101).

SN 76-112,450. FORD, KATHRYN CHENAULT, LAGUNA BEACH, CA. FILED 8-18-2000.

THE DOG MOB

NO CLAIM IS MADE TO THE EXCLUSIVE RIGHT TO USE "DOG", APART FROM THE MARK AS SHOWN.

FOR PRIVATE CLUB FOR DOG AND CAT OWNERS (U.S. CLS. 100 AND 101).

FIRST USE 10-0-1999; IN COMMERCE 1-0-2000.

CLASS 42—(Continued).

SN 76-115,270. FOREST LAWN MORTUARY, GLENDALE, CA. FILED 8-23-2000.

CELEBRATE A LIFE

FOR ARRANGING AND CONDUCTING FUNERAL AND MEMORIAL SERVICES; CEMETERY PLOT BEAUTIFICATION, MAINTENANCE AND CONTINUAL UP-KEEP OF CEMETERY GROUNDS (U.S. CLS. 100 AND 101).

FIRST USE 2-21-2000; IN COMMERCE 2-21-2000.

SN 76-115,728. DRIVIN.COM, INC., CAMPBELL, CA. FILED 8-23-2000.

DRIVING RADIO

FOR PROVIDING ONLINE INFORMATION, REGARDING SALES, HISTORY, MODEL, VALUE AND PERFORMANCE CONCERNING THE AUTOMOTIVE INDUSTRY, MOTOR VEHICLES AND MOTOR VEHICLES' SALES, PRICES AND RATINGS; DESIGNING, CREATING, MAINTAINING AND HOSTING WEBSITES OF OTHERS ON A COMPUTER SERVER FOR A GLOBAL COMPUTER NETWORK; COMPUTER CONSULTATION IN THE FIELDS OF DESIGNING, CREATING, HOSTING, MAINTAINING, OPERATING, ADVERTISING AND MARKETING ONLINE COMMERCE WEBSITES RELATING TO THE AUTOMOTIVE INDUSTRY, MOTOR VEHICLES AND SALES, LEASING, PRICES AND RATINGS OF MOTOR VEHICLES; AND TECHNICAL SUPPORT SERVICES, NAMELY, TROUBLESHOOTING OF COMPUTER HARDWARE AND SOFTWARE PROBLEMS RELATED TO DESIGNING, CREATING, HOSTING, MAINTAINING AND OPERATING ONLINE COMMERCE WEBSITES RELATING TO THE AUTOMOTIVE INDUSTRY, MOTOR VEHICLES AND SALES, LEASING, PRICES AND RATINGS OF MOTOR VEHICLES VIA EMAIL; PROVIDING ONLINE INTERACTIVE MULTIMEDIA ANIMATED VERSIONS OF ROAD TESTS (U.S. CLS. 100 AND 101).

SN 76-116,679. S. CASH, LARRY, ANCHORAGE, AK. FILED 8-25-2000.

RIM DESIGN

NO CLAIM IS MADE TO THE EXCLUSIVE RIGHT TO USE "DESIGN", APART FROM THE MARK AS SHOWN.

FOR INTERIOR DECORATING; INTERIOR DECORATING CONSULTATION (U.S. CLS. 100 AND 101).

CLASS 42—(Continued).

SN 76-119,133. DRIVIN.COM, INC., CAMPBELL, CA. FILED 8-23-2000.

DRIVING MEDIA

NO CLAIM IS MADE TO THE EXCLUSIVE RIGHT TO USE "MEDIA", APART FROM THE MARK AS SHOWN.

FOR PROVIDING ONLINE INFORMATION REGARDING SALES, HISTORY, MODEL, VALUE AND PERFORMANCE CONCERNING THE AUTOMOTIVE INDUSTRY, MOTOR VEHICLES AND MOTOR VEHICLES' SALES, PRICES AND RATINGS; DESIGNING, CREATING, MAINTAINING AND HOSTING WEBSITES OF OTHERS ON A COMPUTER SERVER FOR A GLOBAL COMPUTER NETWORK; COMPUTER CONSULTATION IN THE FIELDS OF DESIGNING, CREATING, HOSTING, MAINTAINING, OPERATING, ADVERTISING AND MARKETING ONLINE COMMERCE WEBSITES RELATING TO THE AUTOMOTIVE INDUSTRY, MOTOR VEHICLES AND SALES, LEASING, PRICES AND RATINGS OF MOTOR VEHICLES; AND TECHNICAL SUPPORT SERVICES, NAMELY, TROUBLESHOOTING OF COMPUTER HARDWARE AND SOFTWARE PROBLEMS RELATED TO DESIGNING, CREATING, HOSTING, MAINTAINING AND OPERATING ONLINE COMMERCE WEBSITES RELATING TO THE AUTOMOTIVE INDUSTRY, MOTOR VEHICLES AND SALES, LEASING, PRICES AND RATINGS OF MOTOR VEHICLES VIA EMAIL (U.S. CLS. 100 AND 101).

SN 76-119,919. CONNIE ROSE ENTERPRISES INC., KENLOWNA, BRITISH COLUMBIA, FILED 8-31-2000.

FASHION FEATURE

NO CLAIM IS MADE TO THE EXCLUSIVE RIGHT TO USE "FASHION", APART FROM THE MARK AS SHOWN.

FOR COMPUTER SERVICES, NAMELY PROVIDING A SEARCH ENGINE FOR OBTAINING DATA ON A GLOBAL COMPUTER NETWORK (U.S. CLS. 100 AND 101).

FIRST USE 6-0-2000; IN COMMERCE 6-0-2000.

SN 76-121,010. MYGOALS.COM, INC., SCOTTSDALE, AZ. FILED 9-1-2000.

GOALPLAN

FOR ONLINE COMPUTER SERVICES PROVIDING INFORMATION ON PERSONAL GROWTH AND PROFESSIONAL GROWTH (U.S. CLS. 100 AND 101).

CLASS 42—(Continued).

SN 76-123,041. PERFORMANCE ASSESSMENT NETWORK, INC., INDIANAPOLIS, IN. FILED 9-6-2000.

PAN BOX

FOR AUTOMATED TEST ADMINISTRATION SERVICES NOT FOR EDUCATIONAL PURPOSES, NAMELY, AUTOMATED TEST ADMINISTRATION SERVICES IN THE FIELDS OF EMPLOYMENT, PSYCHOLOGY, PERSONALITY AND CLINICAL ASSESSMENT, LEADERSHIP DEVELOPMENT, ORGANIZATIONAL DEVELOPMENT, MECHANICAL SKILLS, TECHNICAL SKILLS AND CAREER EXPLORATION (U.S. CLS. 100 AND 101).

FIRST USE 9-10-1998; IN COMMERCE 9-10-1998.

SN 76-124,960. LTT NET SOLUTIONS, WALNUT, CA. FILED 9-11-2000.

CYBER COMPUTER SHOW

NO CLAIM IS MADE TO THE EXCLUSIVE RIGHT TO USE "CYBER COMPUTER", APART FROM THE MARK AS SHOWN.

FOR COMPUTER SERVICES, NAMELY, COMPUTER SOFTWARE DESIGN FOR OTHERS; UPDATING OF COMPUTER SOFTWARE; DESIGNING, LEASING, HOSTING, AND IMPLEMENTING NETWORK WEB PAGES AND WEB SITES FOR OTHERS; COMPUTER PROGRAMMING FOR OTHERS; COMPUTER CONSULTATION; COMPUTER SITE DESIGN; COMPUTER NETWORK DESIGN; LEASING COMPUTER FACILITIES; RENTAL OF COMPUTERS AND SOFTWARE; PROVIDING SEARCH ENGINES FOR OBTAINING DATA ON A GLOBAL COMPUTER NETWORK; TECHNICAL CONSULTATION IN THE FIELD OF COMPUTERS AND INFORMATION TECHNOLOGY; NEWS AGENCIES, NAMELY, GATHERING AND DISSEMINATION OF NEWS (U.S. CLS. 100 AND 101).

SN 76-125,979. XO COMMUNICATIONS, INC., RESTON, VA. BY CHANGE OF NAME NEXTLINK COMMUNICATIONS, INC. MCLEAN, VA. FILED 9-8-2000.

XOPTIONS

FOR SOFTWARE CONSULTING AND DESIGN SERVICES FOR OTHERS; COMPUTER HARDWARE CONSULTING AND DESIGN SERVICES; CONSULTING SERVICES RELATING TO INFORMATION TECHNOLOGY AND COMPUTER NETWORKING; CONSULTING SERVICES RELATING TO VOICE AND DATA COMMUNICATIONS AND DATABASES; PROVIDING ON-LINE OR INTERNET INFORMATION SERVICES IN THE FIELDS OF COMPUTERS, COMPUTER AND INTERNET SECURITY; COMPUTER SERVICES, NAMELY, CREATING INDEXES OF INFORMATION, SITES, AND OTHER RESOURCES AVAILABLE ON COMPUTER NETWORKS, AND REGISTRATION OF INTERNET WEB SITES WITH INDEXES AND SEARCH ENGINES FOR OTHERS; DESIGN OF TELECOMMUNICATIONS SYSTEMS, NAMELY, CELLULAR TELEPHONE SYSTEMS AND VOICE, DATA, FACSIMILE, AND VIDEO COMMUNICATIONS SYSTEMS; TECHNICAL CONSULTING SERVICES IN THE FIELD OF TELECOMMUNICATIONS; COMPILATION, ANALYSIS, RETRIEVAL, AND PROVISION OF INFORMATION REGARDING MANAGED SECURITY, INTERNET USAGE, GLOBAL COMPUTER NETWORK USAGE, TELEPHONE USAGE, OR INTRANET NETWORK USAGE AND EXTRANET NETWORK USAGE; WRITING, DEVELOPMENT, UPDATING, AND

CLASS 42—(Continued).

DESIGN OF COMPUTER SOFTWARE FOR OTHERS; DESIGN, DRAWING, AND COMMISSIONED WRITING, ALL FOR THE COMPILATION OF WEB PAGES ON THE INTERNET; INFORMATION AND ADVISORY SERVICES RELATING TO THE WEATHER AND RESTAURANTS; HOSTING OF WEB SITES, COMPUTER DATABASES, COMPUTER NETWORKS, INTERACTIVE COMPUTER COMMUNICATIONS NETWORKS, AND ELECTRONIC PUBLICATIONS, NAMELY, WEB PAGES AND NEWSLETTERS FOR OTHERS; COMPUTER PROGRAMMING DESIGN FOR OTHERS; DATABASE DEVELOPMENT SERVICES; CONSULTING SERVICES RELATING TO INTERACTIVE DATABASES; MAINTENANCE AND SERVICING OF COMPUTER SOFTWARE, TELECOMMUNICATIONS SOFTWARE, AND INTERNET SOFTWARE; CONSULTING AND RESEARCH IN THE FIELDS OF COMPUTERS, TELECOMMUNICATIONS, AND WEB HOSTING; AND COMPUTER SERVICES, NAMELY, CREATING, MAINTAINING, AND MANAGING WEB SITES FOR OTHERS; TELECOMMUNICATION NETWORK PLANNING, MANAGEMENT, AND SUPPORT; HOSTING OF COMPUTER BULLETIN BOARDS FOR OTHERS (U.S. CLS. 100 AND 101).

CLASS 42—(Continued).

ALL FOR THE COMPILATION OF WEB PAGES ON THE INTERNET; INFORMATION AND ADVISORY SERVICES RELATING TO THE WEATHER AND RESTAURANTS; HOSTING OF WEB SITES, COMPUTER DATABASES, COMPUTER NETWORKS, INTERACTIVE COMPUTER COMMUNICATIONS NETWORKS, AND ELECTRONIC PUBLICATIONS, NAMELY, WEB PAGES AND NEWSLETTERS FOR OTHERS; COMPUTER PROGRAMMING DESIGN FOR OTHERS; DATABASE DEVELOPMENT SERVICES; CONSULTING SERVICES RELATING TO INTERACTIVE DATABASES; MAINTENANCE AND SERVICING OF COMPUTER SOFTWARE, TELECOMMUNICATIONS SOFTWARE, AND INTERNET SOFTWARE; CONSULTING AND RESEARCH IN THE FIELDS OF COMPUTERS, TELECOMMUNICATIONS, AND WEB HOSTING; COMPUTER SERVICES, NAMELY, CREATING, MAINTAINING, AND MANAGING WEB SITES FOR OTHERS; TELECOMMUNICATION NETWORK PLANNING, MANAGEMENT, AND SUPPORT; AND HOSTING OF COMPUTER BULLETIN BOARDS FOR OTHERS (U.S. CLS. 100 AND 101).

SN 76-125,988. NEXTLINK COMMUNICATIONS, INC., MCLEAN, VA. BY CHANGE OF NAME NEXTLINK COMMUNICATIONS, INC., MCLEAN, VA. FILED 9-8-2000.

SN 76-126,782. NEXTLINK COMMUNICATIONS, INC., MCLEAN, VA. BY CHANGE OF NAME NEXTLINK COMMUNICATIONS, INC., MCLEAN, VA. FILED 9-8-2000.

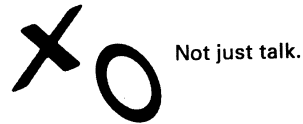
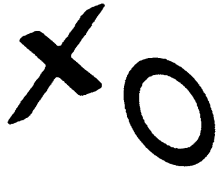

THE MARK CONSISTS OF THE LETTERS "XO" IN STYLIZED FORM, AS SHOWN ON THE ATTACHED DRAWING PAGE.

FOR SOFTWARE CONSULTING AND DESIGN SERVICES FOR OTHERS; COMPUTER HARDWARE CONSULTING AND DESIGN SERVICES; CONSULTING SERVICES RELATING TO INFORMATION TECHNOLOGY AND COMPUTER NETWORKING; CONSULTING SERVICES RELATING TO VOICE AND DATA COMMUNICATIONS AND DATABASES; PROVIDING ON-LINE OR INTERNET INFORMATION SERVICES IN THE FIELDS OF COMPUTERS, COMPUTER AND INTERNET SECURITY; COMPUTER SERVICES, NAMELY, CREATING INDEXES OF INFORMATION, SITES, AND OTHER RESOURCES AVAILABLE ON COMPUTER NETWORKS, AND REGISTRATION OF INTERNET WEB SITES WITH INDEXES AND SEARCH ENGINES FOR OTHERS; DESIGN OF TELECOMMUNICATIONS SYSTEMS, NAMELY, CELLULAR TELEPHONE SYSTEMS AND VOICE, DATA, FACSIMILE, AND VIDEO COMMUNICATIONS SYSTEMS; TECHNICAL CONSULTING SERVICES IN THE FIELD OF TELECOMMUNICATIONS; COMPILATION, ANALYSIS, RETRIEVAL, AND PROVISION OF INFORMATION REGARDING MANAGED SECURITY, INTERNET USAGE, GLOBAL COMPUTER NETWORK USAGE, TELEPHONE USAGE, OR INTRANET NETWORK USAGE AND EXTRANET NETWORK USAGE; WRITING, DEVELOPMENT, UPDATING, AND DESIGN OF COMPUTER SOFTWARE FOR OTHERS; DESIGN, DRAWING, AND COMMISSIONED WRITING,

FOR SOFTWARE CONSULTING AND DESIGN SERVICES FOR OTHERS; COMPUTER HARDWARE CONSULTING AND DESIGN SERVICES; CONSULTING SERVICES RELATING TO INFORMATION TECHNOLOGY AND COMPUTER NETWORKING; CONSULTING SERVICES RELATING TO VOICE AND DATA COMMUNICATIONS AND DATABASES; PROVIDING ON-LINE OR INTERNET INFORMATION SERVICES IN THE FIELDS OF COMPUTERS, COMPUTER AND INTERNET SECURITY; COMPUTER SERVICES, NAMELY, CREATING INDEXES OF INFORMATION, SITES, AND OTHER RESOURCES AVAILABLE ON COMPUTER NETWORKS, AND REGISTRATION OF INTERNET WEB SITES WITH INDEXES AND SEARCH ENGINES FOR OTHERS; DESIGN OF TELECOMMUNICATIONS SYSTEMS, NAMELY, CELLULAR TELEPHONE SYSTEMS AND VOICE, DATA, FACSIMILE, AND VIDEO COMMUNICATIONS SYSTEMS; TECHNICAL CONSULTING SERVICES IN THE FIELD OF TELECOMMUNICATIONS; COMPILATION, ANALYSIS, RETRIEVAL, AND PROVISION OF INFORMATION REGARDING MANAGED SECURITY, INTERNET USAGE, GLOBAL COMPUTER NETWORK USAGE, TELEPHONE USAGE, OR INTRANET NETWORK USAGE AND EXTRANET NETWORK USAGE; WRITING, DEVELOPMENT, UPDATING, AND DESIGN OF COMPUTER SOFTWARE FOR OTHERS; DESIGN, DRAWING, AND COMMISSIONED WRITING,

CLASS 42—(Continued).

ALL FOR THE COMPILATION OF WEB PAGES ON THE INTERNET; INFORMATION AND ADVISORY SERVICES RELATING TO THE WEATHER AND RESTAURANTS; HOSTING OF WEB SITES, COMPUTER DATABASES, COMPUTER NETWORKS, INTERACTIVE COMPUTER COMMUNICATIONS NETWORKS, AND ELECTRONIC PUBLICATIONS, NAMELY, WEB PAGES AND NEWSLETTERS FOR OTHERS; COMPUTER PROGRAMMING DESIGN FOR OTHERS; DATABASE DEVELOPMENT SERVICES; CONSULTING SERVICES RELATING TO INTERACTIVE DATABASES; MAINTENANCE AND SERVICING OF COMPUTER SOFTWARE, TELECOMMUNICATIONS SOFTWARE, AND INTERNET SOFTWARE; CONSULTING AND RESEARCH IN THE FIELDS OF COMPUTERS, TELECOMMUNICATIONS, AND WEB HOSTING; COMPUTER SERVICES, NAMELY, CREATING, MAINTAINING, AND MANAGING WEB SITES FOR OTHERS; TELECOMMUNICATIONS NETWORK PLANNING, MANAGEMENT, AND SUPPORT; AND HOSTING OF COMPUTER BULLETIN BOARDS FOR OTHERS (U.S. CLS. 100 AND 101).

SN 76-126,791. XO COMMUNICATIONS, INC., RESTON, VA. BY CHANGE OF NAME; BY CHANGE OF NAME NEXTLINK COMMUNICATIONS, INC., MCLEAN, VA. FILED 9-8-2000.

XOFFERINGS

FOR SOFTWARE CONSULTING AND DESIGN SERVICES FOR OTHERS; COMPUTER HARDWARE CONSULTING AND DESIGN SERVICES; CONSULTING SERVICES RELATING TO INFORMATION TECHNOLOGY AND COMPUTER NETWORKING; CONSULTING SERVICES RELATING TO VOICE AND DATA COMMUNICATIONS AND DATABASES; PROVIDING ON-LINE OR INTERNET INFORMATION SERVICES IN THE FIELDS OF COMPUTERS, COMPUTER AND INTERNET SECURITY; COMPUTER SERVICES, NAMELY, CREATING INDEXES OF INFORMATION, SITES, AND OTHER RESOURCES AVAILABLE ON COMPUTER NETWORKS, AND REGISTRATION OF INTERNET WEB SITES WITH INDEXES AND SEARCH ENGINES FOR OTHERS; DESIGN OF TELECOMMUNICATIONS SYSTEMS, NAMELY, CELLULAR TELEPHONE SYSTEMS AND VOICE, DATA, FACSIMILE, AND VIDEO COMMUNICATIONS SYSTEMS; TECHNICAL CONSULTING SERVICES IN THE FIELD OF TELECOMMUNICATIONS; COMPILATION, ANALYSIS, RETRIEVAL, AND PROVISION OF INFORMATION REGARDING MANAGED SECURITY, INTERNET USAGE, GLOBAL COMPUTER NETWORK USAGE, TELEPHONE USAGE, OR INTRANET NETWORK USAGE AND EXTRANET NETWORK USAGE; WRITING, DEVELOPMENT, UPDATING, AND DESIGN OF COMPUTER SOFTWARE FOR OTHERS; DESIGN, DRAWING, AND COMMISSIONED WRITING, ALL FOR THE COMPILATION OF WEB PAGES ON THE INTERNET; INFORMATION AND ADVISORY SERVICES RELATING TO THE WEATHER AND RESTAURANTS; HOSTING OF WEB SITES, COMPUTER DATABASES, COMPUTER NETWORKS, INTERACTIVE COMPUTER COMMUNICATIONS NETWORKS, AND ELECTRONIC PUBLICATIONS, NAMELY, WEB PAGES AND NEWSLETTERS FOR OTHERS; COMPUTER PROGRAMMING DESIGN FOR OTHERS; DATABASE DEVELOPMENT SERVICES; CONSULTING SERVICES RELATING TO INTERACTIVE DATABASES; MAINTENANCE AND SERVICING OF COMPUTER SOFTWARE, TELECOMMUNICATIONS SOFTWARE, AND INTERNET SOFTWARE; CONSULTING AND RESEARCH IN THE FIELDS OF COMPUTERS, TELECOMMUNICATIONS, AND WEB HOSTING; AND COMPUTER SERVICES, NAMELY, CREATING, MAINTAINING, AND MANAGING WEB SITES FOR OTHERS; TELECOMMUNICATIONS NETWORK PLANNING, MANAGEMENT, AND SUPPORT; AND HOSTING OF COMPUTER BULLETIN BOARDS FOR OTHERS (U.S. CLS. 100 AND 101).

CLASS 42—(Continued).

SN 76-129,074. NATIONAL AIR TRAFFIC CONTROLLERS ASSOCIATION, WASHINGTON, DC. FILED 9-15-2000.

NATIONAL AIR TRAFFIC CONTROLLERS ASSOCIATION

NO CLAIM IS MADE TO THE EXCLUSIVE RIGHT TO USE "ASSOCIATION", APART FROM THE MARK AS SHOWN.

SEC. 2(F).
FOR ASSOCIATION SERVICES; NAMELY, PROMOTION OF THE INTEREST OF LABOR UNION MEMBERS (U.S. CLS. 100 AND 101).
FIRST USE 9-1-1987; IN COMMERCE 9-1-1987.

SN 76-131,384. VAN BENEDEN, JAMES P., MARIETTA, GA. FILED 9-13-2000.

JOES TO GOES

FOR RESTAURANT FEATURING HOME DELIVERY (U.S. CLS. 100 AND 101).
FIRST USE 8-1-1988; IN COMMERCE 8-1-1988.

SN 76-134,870. CAPITALSTREAM, INC., SEATTLE, WA. FILED 9-25-2000.

CAPITALSTREAM ADVANTAGE

FOR PROVIDING TEMPORARY USE OF ON-LINE NON-DOWNLOADABLE 32-BIT SOFTWARE PROGRAMS FOR TRACKING CUSTOMER INFORMATION, CREDIT EVALUATIONS, CREDIT REPORTING AND UCC FILINGS, AND MANAGING CONTRACT DOCUMENTATION FOR ASSET-BASED FINANCIAL TRANSACTIONS ALL FOR USE IN THE EQUIPMENT LEASING AND FINANCIAL SERVICES INDUSTRIES (U.S. CLS. 100 AND 101).

CLASS 42—(Continued).

SN 76-135,114. MULLINAX, JOSEPH L., II, CHARLESTON, SC. FILED 9-25-2000.

PHARMACY FORUM

NO CLAIM IS MADE TO THE EXCLUSIVE RIGHT TO USE "PHARMACY", APART FROM THE MARK AS SHOWN.

FOR PROVIDING ONLINE HEALTHCARE AND PHARMACEUTICAL INFORMATION, NAMELY INFORMATION CONCERNING THE PRACTICE OF PHARMACY, HEALTH CARE, PHARMACEUTICALS, PHARMACEUTICAL INDUSTRY, HEALTH CARE INDUSTRY, REIMBURSEMENT BY THE GOVERNMENT AND OTHER THIRD PARTIES, SCOPE OF PRACTICE OF THE PHARMACY PROFESSION AND OTHER HEALTH CARE PROFESSIONS, PHARMACY EDUCATION BOTH TRADITIONAL AND DISTANCE EDUCATION; AND COMPUTER SERVICES, NAMELY PROVIDING ON-LINE COPIES OF PHARMACY LAWS AND REGULATIONS, MINUTES AND NOTICES OF PHARMACY AND DRUG REGULATORY AGENCIES BOTH STATE AND FEDERAL AND EXCERPTS OF ARTICLES FROM NEWS MEDIA IN THE FIELD OF THE PRACTICE OF PHARMACY, HEALTH CARE, PHARMACEUTICALS, PHARMACEUTICAL INDUSTRY, HEALTH CARE INDUSTRY, GOVERNMENT REGULATION OF THE PHARMACY PROFESSION AND THE HEALTH CARE INDUSTRY, REIMBURSEMENT BY THE GOVERNMENT AND OTHER THIRD PARTIES, SCOPE OF PRACTICE OF THE PHARMACY PROFESSION AND OTHER HEALTH CARE PROFESSIONS, PHARMACY EDUCATION BOTH TRADITIONAL AND DISTANCE EDUCATION (U.S. CLS. 100 AND 101).

FIRST USE 9-1-1996; IN COMMERCE 9-1-1996.

SN 76-145,634. JACKSONVILLE CENTER FOR CLINICAL RESEARCH, LTD., SOUTH JACKSONVILLE, FL. FILED 10-12-2000.



THE STIPPLING IN THE DRAWING IS FOR SHADING PURPOSES.

FOR COMPUTER ASSISTED MEDICAL RESEARCH; PROVIDING A WEB PAGE FEATURING MEDICAL RESEARCH INFORMATION AND MATERIALS RELATING TO CLINICAL MEDICAL RESEARCH (U.S. CLS. 100 AND 101).

SN 76-147,755. FRONTIER MEDICAL, INC., PICO RIVERA, CA. FILED 10-16-2000.

FRONTIER MEDICAL INC.

NO CLAIM IS MADE TO THE EXCLUSIVE RIGHT TO USE "MEDICAL, INC.", APART FROM THE MARK AS SHOWN.

FOR RENTAL OF MEDICAL EQUIPMENT (U.S. CLS. 100 AND 101).

FIRST USE 4-0-1986; IN COMMERCE 4-0-1986.

CLASS 42—(Continued).

SN 76-150,315. PAPA ZEKOS EXPRESS GRILL, INC., NEW CASTLE, PA. FILED 10-20-2000.

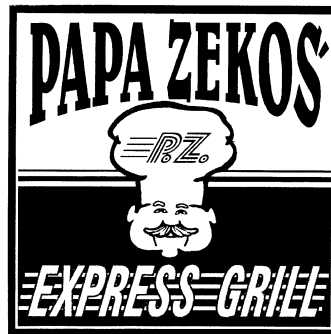

NO CLAIM IS MADE TO THE EXCLUSIVE RIGHT TO USE "EXPRESS GRILL", APART FROM THE MARK AS SHOWN.

FOR RESTAURANT SERVICES FEATURING AMERICAN AND ETHNIC FOOD AND DRINK (U.S. CLS. 100 AND 101).

FIRST USE 10-14-2000; IN COMMERCE 10-14-2000.

SN 76-152,497. BAHWAN CYBERTEK TECHNOLOGIES, INC., NATICK, MA. FILED 10-24-2000.

EVOLVING YOUR BUSINESS

FOR COMPUTER SERVICES, NAMELY, DEVELOPING, DESIGNING AND HOSTING WEBSITES FOR OTHERS; DEVELOPING, DESIGNING, RE-ENGINEERING, MIGRATING AND HOSTING COMPUTER APPLICATION SOFTWARE; PROVIDING COMPUTER HELP DESK SERVICES, NAMELY, PROVIDING ON-LINE OR TELEPHONE ASSISTANCE TO COMPUTER AND COMPUTER PROGRAM USERS; TECHNICAL CONSULTATION IN THE FIELD OF E-COMMERCE, COMMERCIAL TRANSACTIONS, COMPUTER SYSTEMS, COMPUTER NETWORKS AND INFORMATION TECHNOLOGY; COMPUTER NETWORK SYSTEM DIAGNOSTICS, CONFIGURING, INTEGRATING, IMPLEMENTING AND OPERATION (U.S. CLS. 100 AND 101).

SN 76-153,282. TELE-TRACKING TECHNOLOGIES, INC., PITTSBURGH, PA. FILED 10-24-2000.

BED TRACKING

OWNER OF U.S. REG. NO. 1,860,092.

FOR PROVIDING COMPUTERIZED GUEST TURN-OVER INFORMATION TO HOTELS (U.S. CLS. 100 AND 101).

CLASS 42—(Continued).

SN 76-158,353. HELMS, GRECO & WHITENACK, PH.D., LLP, ATLANTA, GA. FILED 11-2-2000.



NO CLAIM IS MADE TO THE EXCLUSIVE RIGHT TO USE "CONSULTING", APART FROM THE MARK AS SHOWN.

FOR PSYCHOLOGICAL CONSULTATION AND TESTING SERVICES (U.S. CLS. 100 AND 101).
FIRST USE 6-1-2000; IN COMMERCE 6-1-2000.

SN 76-159,539. INGRAM MICRO INC., SANTA ANA, CA. FILED 11-3-2000.

CLICK2LICENSE

FOR COMPUTER CONSULTATION SERVICES IN THE FIELD OF COMPUTER INTEGRATION AND CONFIGURATION OF COMPUTER SYSTEMS AND NETWORKS; DESIGN OF COMPUTER SYSTEMS FOR OTHERS AND COMPUTER DESIGN SERVICES FOR RESELLERS, NAMELY, INTEGRATION AND CONFIGURATION OF COMPUTERS; TECHNICAL CONSULTATION IN THE FIELD OF COMPUTER HARDWARE AND SOFTWARE; PROVIDING INFORMATION RELATED TO COMPUTER HARDWARE AND SOFTWARE VIA A GLOBAL COMPUTER NETWORK OR BY OTHER MEANS; AND, CUSTOM CONFIGURATION OF COMPUTER HARDWARE AND SOFTWARE FOR OTHERS (U.S. CLS. 100 AND 101).

SN 76-161,010. ILLUMIGEN BIOSCIENCES INC., SEATTLE, WA. FILED 11-6-2000.

**REPLICATED NATURAL
RESISTANCE**

FOR SCIENTIFIC RESEARCH; RESEARCH AND DEVELOPMENT, DESIGN AND TESTING OF PHARMACEUTICALS, SYNTHETIC AGENTS, AND REAGENTS FOR OTHERS; MEDICAL RESEARCH FOR OTHERS (U.S. CLS. 100 AND 101).

CLASS 42—(Continued).

SN 76-161,799. DUPONT PHARMACEUTICALS COMPANY, WILMINGTON, DE. FILED 11-8-2000.

HEARTFIRST

FOR PROVIDING HEALTH INFORMATION (U.S. CLS. 100 AND 101).

SN 76-163,265. BAXTER INTERNATIONAL INC., DEERFIELD, IL. FILED 11-10-2000.



THE MARK CONSISTS OF THREE STICK FIGURES, THE FAR LEFT STICK FIGURE BEING RED, THE MIDDLE STICK FIGURE BEING YELLOW AND THE FAR RIGHT STICK FIGURE BEING GREEN. "KIDS" AND "KIDS INTERACTING & DEVELOPING SUPPORT" IS IN BLUE.

FOR SERVICES OFFERED TO CHILDREN WITH BLEEDING DISORDERS AND THEIR SIBLINGS, NAMELY, PROVIDING INFORMATION ON BLEEDING DISORDERS AND ACTIVITIES RELATED TO BLEEDING DISORDERS (U.S. CLS. 100 AND 101).

SN 76-166,242. CRYSTAL DECISIONS, INC., PALO ALTO, CA. BY CHANGE OF NAME SEAGATE SOFTWARE INFORMATION MANAGEMENT GROUP HOLDINGS, INC., SCOTTS VALLEY, CA. FILED 11-14-2000.

CRYSTAL INSIDER

OWNER OF U.S. REG. NOS. 234,280 AND 2,351,281. FOR COMPUTER SERVICES, NAMELY PROVIDING ONLINE NEWSLETTERS DESCRIBING COMPUTER SOFTWARE PRODUCTS (U.S. CLS. 100 AND 101).
FIRST USE 9-26-2000; IN COMMERCE 9-26-2000.

SN 76-168,934. JEAH COMMUNICATIONS, LLC, MADISON, WI. BY ASSIGNMENT BYRNES, CHRIS, DBA JEAH COMMUNICATIONS, MADISON, WI. FILED 11-21-2000.

JEAH

FOR HOSTING THE WEB SITES OF OTHERS ON A COMPUTER SERVER FOR A GLOBAL COMPUTER NETWORK (U.S. CLS. 100 AND 101).
FIRST USE 4-6-1999; IN COMMERCE 4-6-1999.

CLASS 42—(Continued).

SN 76-168,995. LONGEST, TERA, SAN DIEGO, CA. FILED 11-17-2000.

WOMENMOTO

FOR ASSOCIATION SERVICES, NAMELY, PROMOTING THE INTERESTS OF WOMEN BY BRINGING WOMEN TOGETHER IN AN ATMOSPHERE OF FRIENDSHIP, TO PROMOTE MOTORCYCLE RIDING, AND TO INSTILL A SENSE OF ADVENTURE (U.S. CLS. 100 AND 101).

FIRST USE 2-9-2000; IN COMMERCE 2-9-2000.

SN 76-170,702. COMMUNICATIONS TERDOR INC., MONTREAL, PROVINCE OF QUEBEC, CANADA, FILED 11-22-2000.

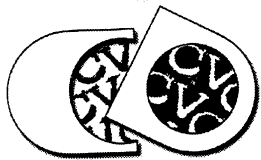

THE MARK CONSISTS OF STYLIZED VERSIONS OF THE LETTERS "C" AND "D" AND INSIDE THE LETTER "D", THERE ARE STYLIZED VERSIONS OF THE LETTERS "C" AND "V".

FOR DESIGN, EDITING, AND PRODUCTION OF AN INTERACTIVE CURRICULUM VITAE AND PORTFOLIO ON MULTIMEDIA MEDIUM IN THE NATURE OF AN INTERACTIVE COMMUNICATION ON MULTIFORM CD-ROMS (VIRTUAL BUSINESS CARDS, CD-ROMS AND DVDS) FOR USE BY BUSINESSES, INSTITUTIONAL, GOVERNMENTAL AND CULTURAL ORGANIZATIONS, ARTISTS AND PROVIDERS OF CULTURAL EVENTS (U.S. CLS. 100 AND 101).

SN 76-172,841. BOYD GAMING CORPORATION, LAS VEGAS, NV. FILED 11-27-2000.



NO CLAIM IS MADE TO THE EXCLUSIVE RIGHT TO USE "A PLACE FOR KIDS", APART FROM THE MARK AS SHOWN.

FOR CHILD CARE CENTER (U.S. CLS. 100 AND 101).

CLASS 42—(Continued).

SN 76-176,879. COLOSTAR HOLDINGS, INC, LOS ANGELES, CA. FILED 12-5-2000.

COLOSTAR

FOR COLOCATION AND TECHNICAL SUPPORT FOR COMMUNICATIONS NETWORKS, LOCAL INTERNET PROTOCOL EXCHANGES, VOICE OVER INTERNET PROTOCOL, INTERNATIONAL PRIVATE LINES, INTERNET ACCESS, VIRTUAL PRIVATE NETWORK, NETWORK MANAGEMENT SERVICES AND PRIVATE NETWORK SOLUTIONS (U.S. CLS. 100 AND 101).

SN 76-179,681. CHRISTIAN CHURCHES OF GOD, MEDICAL LAKE, WA. FILED 12-11-2000.



CHRISTIAN CHURCHES OF GOD

NO CLAIM IS MADE TO THE EXCLUSIVE RIGHT TO USE "CHRISTIAN CHURCHES OF GOD", APART FROM THE MARK AS SHOWN.

FOR RELIGIOUS SERVICES, NAMELY EVANGELISTIC AND MINISTERIAL SERVICES AIMED AT PROCLAIMING THE GOSPEL THROUGH ALL FORMS OF MEDIA (U.S. CLS. 100 AND 101).

FIRST USE 5-9-1997; IN COMMERCE 5-9-1997.

SN 76-181,125. KINDERSTART, LLC, NORWALK, CA. FILED 12-14-2000.



NO CLAIM IS MADE TO THE EXCLUSIVE RIGHT TO USE "SEARCH ENGINE", APART FROM THE MARK AS SHOWN.

FOR PROVIDING INFORMATION OVER A GLOBAL COMPUTER INFORMATION NETWORK IN THE FIELDS OF CHILD ADOPTION, INFANT AND CHILD CARE, FOOD AND NUTRITION, HEALTH, MEDICINE, DENTISTRY, LEGAL SERVICES, WEATHER AND ANIMALS (U.S. CLS. 100 AND 101).

FIRST USE 8-1-2000; IN COMMERCE 8-1-2000.

SN 76-181,488. ANTHONY'S PIZZA & PASTA INTERNATIONAL, INC., DENVER, CO. BY CHANGE OF NAME PIZZA & PASTA INTERNATIONAL, INC., DENVER, CO. FILED 12-15-2000.

ANTHONY'S PIZZA & PASTA

NO CLAIM IS MADE TO THE EXCLUSIVE RIGHT TO USE "PIZZA & PASTA", APART FROM THE MARK AS SHOWN.

FOR RESTAURANT SERVICES (U.S. CLS. 100 AND 101).

FIRST USE 8-1-1984; IN COMMERCE 8-1-1984.

CLASS 42—(Continued).

SN 76-186,495. POSITION TECHNOLOGIES, INC., GENEVA, IL. FILED 12-27-2000.

POSITIONPRO

FOR CONSULTING SERVICES FOR WEBSITE OWNERS IN THE FIELD OF SEARCH ENGINE TECHNOLOGY, NAMELY DEVELOPING AND IMPLEMENTING STRATEGIES FOR INCREASING WEBSITE PERFORMANCE AND RANKINGS; MAINTAINING WEBSITES FOR OTHERS (U.S. CLS. 100 AND 101).
FIRST USE 10-0-1998; IN COMMERCE 10-0-1998.

SN 76-187,570. IMPACT ENGINEERING, INC., BROWNS POINT, WA. FILED 12-29-2000.

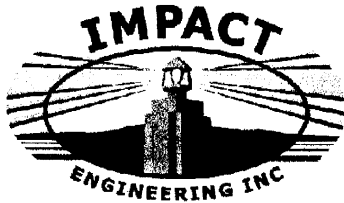

NO CLAIM IS MADE TO THE EXCLUSIVE RIGHT TO USE "ENGINEERING, INC.", APART FROM THE MARK AS SHOWN.

THE STIPPLING IN THE DRAWING IS FOR SHADING PURPOSES ONLY.

LIGHTHOUSE - LIGHT BLUE WITH SHADOWS IN DARK BLUE. LIGHT RAYS EMANATING FROM LIGHTHOUSE - HEAVY LINES ARE DARK BLUE WITH ALTERNATE AMBER LINES ADJACENT AND IN BETWEEN THE DARK BLUE LINES. THE LIGHT ITSELF IS AMBER. HORIZONTAL LINE OF HILLS CENTERED BEHIND LIGHTHOUSE - DARK BLUE. WATER DEPICTED BEHIND LIGHTHOUSE AND UNDERNEATH HILLS - ALTERNATE HORIZONTAL LINES OF DARK BLUE AND LIGHT BLUE. ALL LETTERS AND HEAVY LINED ELLIPSE - BLACK.

FOR TECHNICAL CONSULTATION IN THE FIELD OF MECHANICAL ENGINEERING (U.S. CLS. 100 AND 101).

FIRST USE 6-1-2000; IN COMMERCE 6-1-2000.

CLASS 42—(Continued).

SN 76-188,065. ROLIN HILLS DENTAL CARE INC., P.C., NASHVILLE, TN. FILED 1-2-2001.

ROLIN HILLS



DENTAL CARE

NO CLAIM IS MADE TO THE EXCLUSIVE RIGHT TO USE "DENTAL CARE", APART FROM THE MARK AS SHOWN.

THE WORDS "ROLIN HILLS" ABOVE A DRAWING OF A TOOTH CENTERED IN THE SUN RISING ABOVE ROLLING HILLS WITH THE WORDS "DENTAL CARE" BELOW THE DRAWING.

FOR PROVIDING DENTAL CARE SERVICES (U.S. CLS. 100 AND 101).

FIRST USE 7-1-1996; IN COMMERCE 7-1-1996.

SN 76-192,709. LAWYER'S WEEKLY, INC., BOSTON, MA. FILED 1-11-2001.

VIRGINIALAW.COM

OWNER OF U.S. REG. NOS. 1,195,678, 2,490,230 AND OTHERS.

SEC. 2(F).

FOR PROVIDING NEWS AND PROFESSIONAL INFORMATION OF INTEREST TO LAWYERS, THE JUDICIARY, AND RELATED INTEREST GROUPS BY MEANS OF A GLOBAL COMPUTER NETWORK (U.S. CLS. 100 AND 101).

FIRST USE 3-9-1996; IN COMMERCE 3-9-1996.

SN 76-194,713. INFOBALL GMBH, FED REP GERMANY, FILED 1-12-2001.

INFOBALL

OWNER OF FED REP GERMANY REG. NO. 39905342, DATED 5-20-1999, EXPIRES 2-28-2009.

FOR COMPUTER SERVICES, NAMELY, PROVIDING SEARCH ENGINES FOR OBTAINING DATA ON THE INTERNET; PROVIDING AN ON-LINE COMPUTER DATABASE IN THE FIELDS OF BOOKS, ARTICLES, AUDIO MATERIALS, VIDEO MATERIALS AND OTHER MATERIALS ON SPECIALIZED TOPICS (U.S. CLS. 100 AND 101).

CLASS 42—(Continued).

SN 76-195,099. CITIZEN SCHOOLS, INC., BOSTON, MA. FILED 1-17-2001.

TECH@HOME

FOR PHILANTHROPIC SERVICES, NAMELY PROVIDING NEW AND REFURBISHED COMPUTERS, MODEMS, PRINTERS, HARDWARE, SOFTWARE AND TRAINING MATERIALS TO EDUCATIONAL AND CHARITABLE ORGANIZATIONS, FAMILIES, INDIVIDUALS AND COMMUNITY BUSINESSES (U.S. CLS. 100 AND 101).

FIRST USE 3-8-2000; IN COMMERCE 3-8-2000.

CLASS 42—(Continued).

SN 76-197,219. GAIN TECHNOLOGY CORPORATION, TUCSON, AZ. FILED 1-22-2001.



SN 76-195,356. 360 INCORPORATED, FT. WASHINGTON, MD. FILED 1-17-2001.



NO CLAIM IS MADE TO THE EXCLUSIVE RIGHT TO USE "TECHNOLOGY", APART FROM THE MARK AS SHOWN.

FOR DESIGN AND TESTING FOR OTHERS, NAMELY THE DESIGN AND DEVELOPMENT OF INTEGRATED CIRCUITS FOR SEMICONDUCTOR AND ORIGINAL EQUIPMENT MANUFACTURERS (U.S. CLS. 100 AND 101).

FIRST USE 5-6-1996; IN COMMERCE 5-6-1996.

NO CLAIM IS MADE TO THE EXCLUSIVE RIGHT TO USE "INCORPORATED", APART FROM THE MARK AS SHOWN.

FOR CONSULTING SERVICES, NAMELY, HARDWARE AND SOFTWARE DEVELOPMENT FOR FINANCIAL MANAGEMENT (U.S. CLS. 100 AND 101).

FIRST USE 5-1-1999; IN COMMERCE 5-1-1999.

SN 76-200,335. IIG GROUP, INC., DALLAS, TX. FILED 1-29-2001.



SN 76-197,100. FISHER, MIKE, SCOTTSDALE, AZ. FILED 1-18-2001.

MARKETFACE

FOR COMPUTER SERVICES, NAMELY, WEB SITE DEVELOPMENT; CONSULTING SERVICES IN THE FIELD OF WEBSITE INTEGRATION DEVELOPMENT AND STRATEGY; PROVIDING WEB SITE INTEGRATION SERVICES; COMPUTER CONSULTATION SERVICES, NAMELY, PERFORMING USER TESTING, USER INTERFACE DESIGN, AND USABILITY TESTING (U.S. CLS. 100 AND 101).

FIRST USE 11-4-2000; IN COMMERCE 11-15-2000.

NO CLAIM IS MADE TO THE EXCLUSIVE RIGHT TO USE "GROUP INC.", APART FROM THE MARK AS SHOWN.

FOR INFORMATION TECHNOLOGY DEVELOPMENT, PROGRAMMING AND CONSULTING SERVICES (U.S. CLS. 100 AND 101).

FIRST USE 5-1-2000; IN COMMERCE 5-1-2000.

CLASS 42—(Continued).

SN 76-203,326. YSEEK, INC., AKA SWIFTYNET.COM, INC., TAMPA, FL. FILED 1-18-2001.

YSEEK.COM.

FOR COMPUTER SERVICES, NAMELY CREATING INDEXES OF INFORMATION, SITES AND OTHER RESOURCES AVAILABLE ON COMPUTER NETWORKS FOR OTHERS; COMPUTERIZED SEARCHING AND RETRIEVAL OF INFORMATION, SITES, AND OTHER RESOURCES AVAILABLE ON COMPUTER NETWORKS (U.S. CLS. 100 AND 101).

FIRST USE 1-10-2001; IN COMMERCE 1-10-2001.

SN 76-203,788. CLEAN ENERGY SYSTEMS, INC., SACRAMENTO, CA. FILED 1-31-2001.

WE PUT A MAN ON THE MOON WE CAN MAKE POWER WITHOUT POLLUTION

FOR DESIGN AND DEVELOPMENT OF POWER PRODUCTION HARDWARE AND POWER PRODUCTION SYSTEMS (U.S. CLS. 100 AND 101).

SN 76-206,530. INTERNET-JOURNALS, INC., BERKELEY, CA. FILED 2-7-2001.

EDIKIT

FOR EDITORIAL CONSULTATION SERVICES AND PROVIDING TEMPORARY USE OF ON-LINE NON-DOWNLOADABLE SOFTWARE FOR USE IN THE MANAGEMENT OF THE ELECTRONIC PUBLICATION PROCESS (U.S. CLS. 100 AND 101).

FIRST USE 1-24-2000; IN COMMERCE 1-24-2000.

SN 76-207,610. GOBOSH, INC., SAN JOSE, CA. BY CHANGE OF NAME CENTRAL DESIGN SYSTEMS, INC., SAN JOSE, CA. FILED 2-8-2001.



FOR DESIGN AND IMPLEMENTATION FOR OTHERS OF EBUSINESS INFRASTRUCTURES, NAMELY, COMPUTERS, NETWORK EQUIPMENT, AND SOFTWARE MAINTENANCE OF COMPUTER SOFTWARE (U.S. CLS. 100 AND 101).

FIRST USE 7-27-2000; IN COMMERCE 7-27-2000.

CLASS 42—(Continued).

SN 76-208,374. CAMITRO CORPORATION, MENLO PARK, CA. FILED 2-8-2001.

LANDSCAPE

FOR COMPUTATIONAL COMPUTER MODELING SERVICES IN THE FIELD OF DESIGNING AND SELECTING PHARMACEUTICAL DRUG CANDIDATES; ANALYSIS OF CHEMICAL COMPOUNDS TO ASSESS THEIR POTENTIAL BIOLOGICAL ACTIVITY (U.S. CLS. 100 AND 101).

SN 76-210,380. I LOVE U.COM, INC., SANTA MONICA, CA. FILED 2-15-2001.



FOR PROVIDING LOVE AND RELATIONSHIP ADVICE, AND DATING SERVICES VIA A GLOBAL COMPUTER NETWORK; HOSTING THE RETAIL WEB SITES OF OTHERS ON A COMPUTER SERVER FOR A GLOBAL COMPUTER NETWORK (U.S. CLS. 100 AND 101).

FIRST USE 12-15-2000; IN COMMERCE 12-15-2000.

SN 76-210,520. BIZTECH FOR ENERGY FOUNDATION, HOUSTON, TX. FILED 2-14-2001.

BIZTECH FOR ENERGY

NO CLAIM IS MADE TO THE EXCLUSIVE RIGHT TO USE "FOR ENERGY", APART FROM THE MARK AS SHOWN.

FOR STANDARDS DEVELOPMENT AND PROMOTION, NAMELY, DEVELOPING AND PROVIDING SPECIFICATIONS AND STANDARDS THAT ALLOW THE INTEGRATION OF OPERATIONAL, FINANCIAL, AND MANAGEMENT SOFTWARE IN THE ENERGY INDUSTRY (U.S. CLS. 100 AND 101).

CLASS 42—(Continued).

SN 76-211,016. ALPHA RESEARCH & CONSULTING, JUN-COS, PUERTO RICO, FILED 2-15-2001.

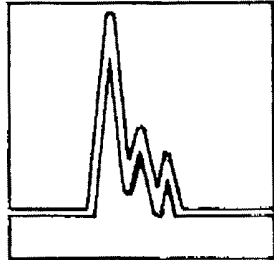

THE DESIGN IS DIVIDED BY A JAGGED LINE EXTENDING HORIZONTALLY THERE THROUGH. THE PORTION OF THE DESIGN ABOVE THE JAGGED LINE IS TEAL-BLUE; THE PORTION OF THE DESIGN BELOW THE JAGGED LINE IS PURPLE.

FOR SCIENTIFIC AND INDUSTRIAL RESEARCH; PHARMACEUTICAL PRODUCT DEVELOPMENT CONSULTATION (U.S. CLS. 100 AND 101).

FIRST USE 11-30-1999; IN COMMERCE 11-30-1999.

SN 76-215,205. WOW TV, INC., SOUTH JORDAN, UT. FILED 2-23-2001.

WOW.TV

FOR CONSULTING AND DESIGN SERVICES FOR OTHERS IN THE FIELD OF WIRELESS DIGITAL TELEVISION, NAMELY CONSULTING WITH TELEVISION BROADCASTERS AND LOCAL TELEVISION STATIONS IN THE DESIGNING OF DIGITAL WIRELESS TRANSMISSION HARDWARE AND SOFTWARE AND DIGITAL WIRELESS RECEPTION HARDWARE AND SOFTWARE (U.S. CLS. 100 AND 101).

SN 76-215,377. ANAM SEMICONDUCTOR, INC., SEOUL, REPUBLIC OF KOREA, FILED 2-26-2001.

IP COMMUNITY

PRIORITY CLAIMED UNDER SEC. 44(D) ON NOT PROVIDED APPLICATION NO. 41-2000-0031, FILED 12-18-2000.

FOR SEMICONDUCTOR TESTING FOR OTHERS; DESIGN OF SEMICONDUCTORS FOR OTHERS; INTEGRATED CIRCUIT TESTING FOR OTHERS; WAFERS TESTING FOR OTHERS, TECHNICAL RESEARCH OF INTEGRATED CIRCUIT DESIGN FOR OTHERS; COMPUTER SOFTWARE DESIGN FOR OTHERS; MAINTENANCE OF COMPUTER SOFTWARE; COMPUTER SYSTEM ANALYSIS THROUGH THE INTERNET; COMPUTER PROGRAMMING FOR OTHERS WITH ALL SAID SERVICES (U.S. CLS. 100 AND 101).

CLASS 42—(Continued).

SN 76-217,467. CASEY FAMILY PROGRAMS, SEATTLE, WA. FILED 2-27-2001.

FOUNDATIONS FOR THE FUTURE

NO CLAIM IS MADE TO THE EXCLUSIVE RIGHT TO USE "FOUNDATIONS", APART FROM THE MARK AS SHOWN.

FOR SOCIAL WELFARE SERVICES, NAMELY, PLACING AND OTHERWISE ASSISTING CHILDREN AND FAMILIES IN FOSTER CARE (U.S. CLS. 100 AND 101).

FIRST USE 10-15-2000; IN COMMERCE 10-15-2000.

SN 76-220,661. PFIZER INC., NEW YORK, NY. FILED 3-5-2001.

SANA LA RANA

THE ENGLISH TRANSLATION OF "SANA LA RANA" IS "THE HEALTHY FROG".

FOR PROVIDING HEALTH CARE SERVICES, NAMELY PROVIDING INFORMATION TO PHYSICIANS, HEALTH CARE PROFESSIONALS AND PATIENTS ON THE TOPIC OF HEALTH ISSUES AND HEALTH AWARENESS (U.S. CLS. 100 AND 101).

SN 76-222,017. ROCHESTER MIDLAND CORPORATION, ROCHESTER, NY. FILED 3-9-2001.

AUDITGUARD

FOR FOOD SANITATION CONSULTATION, NAMELY, PROVIDING SERVICES TO IDENTIFY SANITATION PROGRAM DEFICIENCIES OF BUSINESSES IN THE FOOD PROCESSING INDUSTRY (U.S. CLS. 100 AND 101).

FIRST USE 4-0-2000; IN COMMERCE 4-0-2000.

SN 76-222,179. RADISSON HOTELS INTERNATIONAL, INC., MINNEAPOLIS, MN. FILED 3-9-2001.

GOLD CLASS

FOR HOTEL SERVICES FOR PREFERRED CUSTOMERS FEATURING A FREQUENT CUSTOMER LOYALTY AND PROMOTION PROGRAM (U.S. CLS. 100 AND 101).

FIRST USE 8-15-2001; IN COMMERCE 8-15-2001.

CLASS 42—(Continued).

SN 76-222,765. DANIEL POWERS, M.D., INC., LOS ANGELES, CA. FILED 3-9-2001.

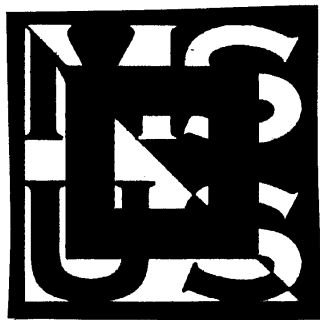

NO CLAIM IS MADE TO THE EXCLUSIVE RIGHT TO USE "MSUS", APART FROM THE MARK AS SHOWN.
FOR MEDICAL SERVICES, NAMELY DIAGNOSIS FOR JOINT INJURIES (U.S. CLS. 100 AND 101).
FIRST USE 2-0-2001; IN COMMERCE 2-0-2001.

SN 76-223,849. BIG MOUTH PRODUCTIONS, INC., NEW YORK, NY. FILED 3-14-2001.

MEDIA THAT MATTERS

FOR COMPUTER SERVICES, NAMELY, PROVIDING A DIRECTORY OF INFORMATION REGARDING SOCIAL ISSUE DOCUMENTARIES AND ADVOCACY VIDEOS AVAILABLE ON A GLOBAL COMPUTER NETWORK (U.S. CLS. 100 AND 101).
FIRST USE 4-27-2000; IN COMMERCE 4-27-2000.

SN 76-224,030. CYBERLINK CORP., TAIPEI HSIEN, TAIWAN, CHINA, FILED 3-14-2001.



NO CLAIM IS MADE TO THE EXCLUSIVE RIGHT TO USE "i", APART FROM THE MARK AS SHOWN.
FOR PROVIDING INFORMATION THROUGH INTERNET WEBSITE FOR COMPUTER SOFTWARE, AUDIO AND VIDEO PROGRAMS (U.S. CLS. 100 AND 101).
FIRST USE 1-17-2001; IN COMMERCE 1-17-2001.

CLASS 42—(Continued).

SN 76-227,012. LAU ACQUISITION CORPORATION, DBA LAU TECHNOLOGIES, LITTLETON, MA. FILED 3-20-2001.

FACE OFF

FOR TECHNICAL SUPPORT SERVICES IN THE FIELD OF FACIAL RECOGNITION PRODUCTS, NAMELY, TROUBLESHOOTING COMPUTER HARDWARE AND SOFTWARE USED IN FACIAL RECOGNITION PRODUCTS; CONSULTING SERVICES IN THE FIELD OF FACIAL RECOGNITION PRODUCTS (U.S. CLS. 100 AND 101).

SN 76-227,091. ROADWARE GROUP INC., PARIS, ONTARIO N3L 3T6, CANADA, FILED 3-21-2001.



THE LINING IS A FEATURE OF THE MARK AND DOES NOT INDICATE COLOR.

THE MARK CONSISTS, IN PART, OF THE DESIGN OF A ROAD AND THE SHAPE OF AN ARROW WITHIN THE LETTER "O", AND A RING AROUND THE LETTER "O".

FOR ENGINEERING SERVICES; DESIGN OF COMPUTER HARDWARE AND SOFTWARE FOR OTHERS; COMPUTER CONSULTATION, NAMELY, DESIGN AND IMPLEMENTATION OF HARDWARE AND SOFTWARE INFRASTRUCTURE MANAGEMENT SYSTEMS (U.S. CLS. 100 AND 101).

FIRST USE 0-0-1991; IN COMMERCE 0-0-1991.

SN 76-230,397. DAVIDOV, MIKHAIL M., BELLEVUE, WA. AND MAZEPA, LOURI E., BELLEVUE, WA. FILED 3-26-2001.

MAILOID

FOR COMPUTER PROGRAMMING FOR OTHERS, ENGINEERING (U.S. CLS. 100 AND 101).

SN 76-231,179. CITY OF WORTHINGTON, WORTHINGTON, OH. FILED 3-26-2001.



SEC. 2(F) AS TO "WORTHINGTON".
FOR MUNICIPAL SERVICES (U.S. CLS. 100 AND 101).
FIRST USE 5-1-1993; IN COMMERCE 5-1-1993.

CLASS 42—(Continued).

SN 76-231,553. VERISIGN, INC., HERNDON, VA. FILED 3-27-2001.

VERISIGN GRS

OWNER OF U.S. REG. NO. 2,302,350.
FOR DOMAIN NAME MANAGEMENT SERVICES, NAMELY, DOMAIN NAME SYSTEM MANAGEMENT AND MAINTENANCE, DOMAIN NAME DIRECTORY MANAGEMENT AND MAINTENANCE, DOMAIN NAME SYSTEM INFRASTRUCTURE SERVICES, DOMAIN NAME AND DOMAIN NAME SYSTEM INFORMATION PROPAGATION AND RESOLUTION OF DOMAIN NAME SYSTEM REQUESTS (U.S. CLS. 100 AND 101).

FIRST USE 10-31-2000; IN COMMERCE 10-31-2000.

SN 76-232,971. CORPORATE EXPRESS, INC., BROOMFIELD, CO. FILED 3-28-2001.

SOGOLOGOS

FOR PROVIDING A WEB SITE FOR CUSTOM IMPRINTING OF FULL LINE OF MERCHANDISE WITH DECORATIVE DESIGNS (U.S. CLS. 100 AND 101).

FIRST USE 1-4-2001; IN COMMERCE 1-4-2001.

SN 76-233,186. COACT, INC., COLUMBIA, MD. FILED 3-23-2001.



NO CLAIM IS MADE TO THE EXCLUSIVE RIGHT TO USE "INC.", APART FROM THE MARK AS SHOWN.

THE LINING SHOWN IN THE DRAWING IS A FEATURE OF THE MARK AND IS NOT INTENDED TO INDICATE COLOR.

FOR COMPUTER ENGINEERING SERVICES IN THE FIELD OF COMPUTER SECURITY (U.S. CLS. 100 AND 101).

FIRST USE 2-13-1990; IN COMMERCE 2-13-1990.

SN 76-235,092. FELDMAN, IRA, ROCKVILLE, MD. FILED 4-3-2001.

GREENTRACK

FOR LEGAL, REGULATORY AND MANAGEMENT CONSULTING SERVICES IN THE ENVIRONMENTAL FIELD (U.S. CLS. 100 AND 101).

FIRST USE 2-28-1995; IN COMMERCE 2-28-1995.

CLASS 42—(Continued).

SN 76-235,240. STELLAR INTERACTIVE SOLUTIONS, INC., JACKSONVILLE, FL. FILED 4-4-2001.

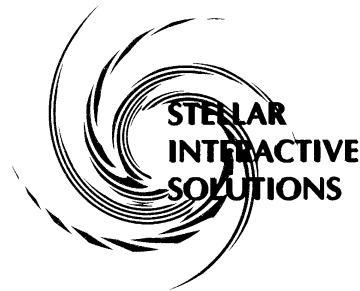

FOR COMPUTER AND ON-LINE SERVICES PROVIDING TEMPORARY USE OF ON-LINE NON-DOWNLOADABLE SOFTWARE FOR ESTABLISHING, IMPLEMENTING, MAINTAINING AND ENSURING COMPLIANCE WITH CERTAIN LAWS, RULES, REGULATIONS AND REQUIREMENT OF GOVERNMENTAL AUTHORITIES, ADMINISTRATIONS AND AGENCIES SUCH AS THE OCCUPATIONAL SAFETY AND HEALTH ADMINISTRATION AND THE ENVIRONMENTAL PROTECTION AGENCY (U.S. CLS. 100 AND 101).

FIRST USE 2-19-2001; IN COMMERCE 7-15-2001.

SN 76-238,243. VERITAS MEDICINE, INC., CAMBRIDGE, MA. FILED 4-9-2001.

VERITAS MEDICINE

NO CLAIM IS MADE TO THE EXCLUSIVE RIGHT TO USE "MEDICINE", APART FROM THE MARK AS SHOWN. THE TERM "VERITAS" IS LATIN AND TRANSLATES INTO "TRUTH".

FOR MEDICAL RESEARCH SERVICES, NAMELY, PROVIDING PROSPECTIVE PATIENTS FOR ENROLLMENT IN PUBLIC AND PRIVATE SPONSORED CLINICAL TRIALS AND MEDICAL STUDIES VIA INTERNET-BASED RESOURCES (U.S. CLS. 100 AND 101).

FIRST USE 11-2-1999; IN COMMERCE 11-2-1999.

CLASS 42—(Continued).

SN 76-239,615. DR. SPOCK COMPANY, THE, MENLO PARK, CA. FILED 4-11-2001.

DR. BENJAMIN SPOCK

THE NAME "DR. BENJAMIN SPOCK" DOES NOT IDENTIFY A LIVING INDIVIDUAL.

FOR COMPUTER SERVICES, NAMELY, PROVIDING ON-LINE MAGAZINES, NEWSLETTERS AND BOOKS IN THE FIELD OF HEALTHCARE, CHILD CARE, NUTRITION, WELLNESS, PARENTING, PREGNANCY, AND BEHAVIOR TO CONSUMERS, PROVIDERS, ADMINISTRATORS AND OTHER PARTICIPANTS IN THE HEALTH CARE INDUSTRY; PROVIDING INFORMATION VIA A WEBSITE ON THE INTERNET IN THE FIELD OF HEALTHCARE, CHILD CARE, NUTRITION, WELLNESS, PARENTING PREGNANCY, AND BEHAVIOR TO CONSUMERS, PROVIDERS, ADMINISTRATORS AND OTHER PARTICIPANTS IN THE HEALTHCARE INDUSTRY; MEDICAL CONSULTATION AND MEDICAL CONSULTATION VIA THE INTERNET, NAMELY, CONSULTATION TO CONSUMERS, PROVIDERS, ADMINISTRATORS AND OTHER PARTICIPANTS IN THE HEALTHCARE INDUSTRY IN THE FIELD OF HEALTHCARE, CHILD CARE, NUTRITION, WELLNESS, PARENTING, PREGNANCY, AND BEHAVIOR; PROVIDING AN ON-LINE COMPUTER DATABASE FOR CONSUMERS, PROVIDERS, ADMINISTRATORS, AND OTHER PARTICIPANTS IN THE HEALTHCARE INDUSTRY IN THE FIELD OF HEALTHCARE, CHILD CARE, NUTRITION, WELLNESS, PARENTING, PREGNANCY, AND BEHAVIOR (U.S. CLS. 100 AND 101).

SN 76-239,723. SATELLITE STATION, INC., NAKANO-KU, TOKYO 164-0001, JAPAN, FILED 4-12-2001.

SATELLITE STATION

FOR TRANSLATION OF COMPUTER SOFTWARE, COMPUTER MANUALS, AND NETWORK WEB PAGES FROM ENGLISH INTO ASIAN LANGUAGES AND FROM ASIAN LANGUAGES INTO ENGLISH; TECHNICAL WRITING FOR OTHERS; COMPUTER CODE CONVERSION FOR OTHERS; COMPUTER PROGRAMMING FOR OTHERS; COMPUTER SOFTWARE DESIGN FOR OTHERS; UPDATING OF COMPUTER SOFTWARE FOR OTHERS; COMPUTER CONSULTATION; WEB SITE DESIGN FOR OTHERS; GRAPHIC ART DESIGN; PRINTING; PACKAGING DESIGN FOR OTHERS; HOSTING THE WEB SITES OF OTHERS ON A COMPUTER SERVER FOR A GLOBAL COMPUTER NETWORK (U.S. CLS. 100 AND 101).

FIRST USE 1-0-1990; IN COMMERCE 10-20-1998.

SN 76-240,036. TGI FRIDAY'S OF MINNESOTA, INC., DALLAS, TX. FILED 4-12-2001.

**TIMPANO ITALIAN
CHOPHOUSE**

NO CLAIM IS MADE TO THE EXCLUSIVE RIGHT TO USE "ITALIAN CHOPHOUSE", APART FROM THE MARK AS SHOWN.

THE ENGLISH TRANSLATION OF FOREIGN WORDING "TIMPANO" IS "KETTLEDRUM"

FOR RESTAURANT AND BAR SERVICES (U.S. CLS. 100 AND 101).

FIRST USE 6-18-1998; IN COMMERCE 6-18-1998.

CLASS 42—(Continued).

SN 76-241,250. SEAWEB, WASHINGTON, DC. FILED 4-16-2001.

**SEAFOOD CHOICES
ALLIANCE**

NO CLAIM IS MADE TO THE EXCLUSIVE RIGHT TO USE "SEAFOOD" AND "ALLIANCE", APART FROM THE MARK AS SHOWN.

FOR PROMOTING PUBLIC AWARENESS OF THE NEED FOR CONSUMING SUSTAINABLE SOURCES OF SEAFOOD (U.S. CLS. 100 AND 101).

FIRST USE 6-7-2001; IN COMMERCE 6-7-2001.

SN 76-242,536. ULTIMATE FRANCHISE SYSTEMS, INC., HEATHROW, FL. FILED 4-18-2001.

ULTIMATE'S PIT ROAD

NO CLAIM IS MADE TO THE EXCLUSIVE RIGHT TO USE "ULTIMATE'S", APART FROM THE MARK AS SHOWN.

FOR RESTAURANT SERVICES (U.S. CLS. 100 AND 101).

SN 76-242,771. LOCAL INITIATIVE HEALTH AUTHORITY FOR LOS ANGELES COUNTY, THE, DBA L.A. CARE HEALTH PLAN, LOS ANGELES, CA. FILED 4-17-2001.

HEALTH EXPRESS

NO CLAIM IS MADE TO THE EXCLUSIVE RIGHT TO USE "HEALTH", APART FROM THE MARK AS SHOWN.

FOR COMPUTER SERVICES, NAMELY PROVIDING ON-LINE INFORMATION REGARDING QUALIFICATION FOR HEALTH PLANS (U.S. CLS. 100 AND 101).

CLASS 42—(Continued).

SN 76-244,174. WALTER GRAY & ASSOCIATES, INC., SILOAM SPRINGS, AR. FILED 4-23-2001.



THE MARK CONSISTS OF A STANDING PIG HOLDING A SANDWICH, WEARING BLUE OVERALLS AND A BASEBALL CAP WITH A RED BILL, RED BACK, AND A RED IMAGE SUPERIMPOSED ON AN OTHERWISE WHITE FRONT.

FOR RESTAURANT (U.S. CLS. 100 AND 101).
FIRST USE 6-1-1988; IN COMMERCE 6-1-1988.

CLASS 42—(Continued).

SN 76-244,741. MAYBERRY AMERICA LLC, SUN CITY, AZ. FILED 4-20-2001.

MAYBERRY AMERICA

NO CLAIM IS MADE TO THE EXCLUSIVE RIGHT TO USE "AMERICA", APART FROM THE MARK AS SHOWN.
FOR COMPUTER SERVICES, NAMELY, INTERNET CONTENT FILTERING SERVICES TO PREVENT COMPUTERIZED ACCESS TO OBJECTIONABLE MATERIAL OVER THE INTERNET, NAMELY, PORNOGRAPHIC MATERIAL, INFORMATION ON HOW TO CONSTRUCT WEAPONS SUCH AS BOMBS AND GUNS AND OTHER WEAPONS DESIGNED TO KILL PEOPLE, MATERIAL THAT IS CAPABLE OF ENCOURAGING OR PROPAGATING HATE, DISLIKE, DISAPPROVAL, BIAS, RACISM OR BIGOTRY TOWARD OTHERS, AND THE LIKE (U.S. CLS. 100 AND 101).

SN 76-244,268. CREATIVE OPTICS, INC., BEDFORD, NH. FILED 4-17-2001.

**LEARN HOW TO FIGHT FIRE
WITH FIRE FIRE
INSTRUCTOR'S REALITY
ENHANCEMENT**

NO CLAIM IS MADE TO THE EXCLUSIVE RIGHT TO USE "FIRE INSTRUCTOR'S REALITY ENHANCEMENT", APART FROM THE MARK AS SHOWN.

FOR TECHNICAL CONSULTATION IN THE FIELD OF ENGINEERING AND ENGINEERING SERVICES (U.S. CLS. 100 AND 101).
FIRST USE 4-6-2001; IN COMMERCE 6-0-1999.

SN 76-247,108. BUILDING STUDIO, LLP, THE, NEW YORK, NY. FILED 4-27-2001.

THE BUILDING STUDIO

SN 76-244,510. THE PARKER COMPANY LTD, INC., LYNN, MA. FILED 4-23-2001.

THE PARKER COMPANY

NO CLAIM IS MADE TO THE EXCLUSIVE RIGHT TO USE "COMPANY", APART FROM THE MARK AS SHOWN. SEC. 2(F).

FOR RENTAL OF VACATION VILLAS, APARTMENTS, CASTLES, AND/OR COTTAGES IN ITALY TO THE GENERAL PUBLIC AND BUSINESS ENTITIES (U.S. CLS. 100 AND 101).
FIRST USE 0-0-1993; IN COMMERCE 0-0-1993.

NO CLAIM IS MADE TO THE EXCLUSIVE RIGHT TO USE "STUDIO", APART FROM THE MARK AS SHOWN.
FOR ARCHITECTURAL DESIGN (U.S. CLS. 100 AND 101).
FIRST USE 0-0-1992; IN COMMERCE 0-0-1992.

CLASS 42—(Continued).

SN 76-247,435. WHEELING JESUIT UNIVERSITY, WHEELING, WV. FILED 4-27-2001.

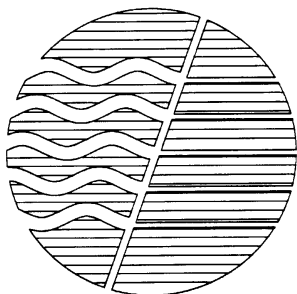

OWNER OF U.S. REG. NO. 2,245,631.

THE MARK IS LINED FOR THE COLOR BLUE.

THE MARK CONSISTS OF A CIRCLE BISECTED BY A DIAGONAL LINE, TO THE LEFT OF WHICH ARE FIVE WAVY HORIZONTAL LINES, AND TO THE RIGHT OF WHICH ARE FIVE STRAIGHT HORIZONTAL LINES.

FOR CONSULTATION SERVICES PERTAINING TO FURTHER PRODUCT DEVELOPMENT BY PRIVATE SECTOR FIRMS OF TECHNOLOGIES DEVELOPED THROUGH PUBLIC FUNDING IN THE FIELDS OF HEALTH AND MEDICINE; TRANSPORTATION; PUBLIC SAFETY; CONSUMER, HOME, AND RECREATION; ENVIRONMENT; COMPUTER TECHNOLOGY; INDUSTRIAL PRODUCTIVITY; AND MANUFACTURING TECHNOLOGY; AND CUSTOMIZED SEARCHES OF COMPUTER DATABASES AND TIME-LEASING TO AN INTERACTIVE COMPUTER DATABASE IN THE FIELD OF PUBLICLY FUNDED TECHNOLOGY DEVELOPMENT IN AREAS SUCH AS FEDERAL AND UNIVERSITY LICENSABLE TECHNOLOGIES AND PATENTS (U.S. CLS. 100 AND 101).

FIRST USE 7-2-2001; IN COMMERCE 7-2-2001.

SN 76-249,095. GRASSROOTS ENTERPRISE, INC., SAN FRANCISCO, CA. FILED 4-23-2001.

NO CLAIM IS MADE TO THE EXCLUSIVE RIGHT TO USE "GRASSROOTS ENTERPRISE", APART FROM THE MARK AS SHOWN.

THE MARK CONSISTS, IN PART, OF A STYLIZED TORCH FORMING THE LETTER "I" IN THE WORD "GRASSROOTS".

FOR COMPUTER SERVICES, NAMELY PROVIDING TEMPORARY USE OF ON-LINE NON-DOWNLOADABLE SOFTWARE FOR USE IN PROMOTING THE MANAGEMENT, MOBILIZATION AND COMMUNICATION OF ADVOCACY ORGANIZATIONS WITH CONSTITUENTS VIA A GLOBAL COMPUTER INFORMATION NETWORK THROUGH EMAILS, AUTOMATED FAXES, WEB PAGES AND WEB SITES, ELECTRONIC REPORTS AND NOTIFICATIONS AND PERSONALIZED MESSAGING; PROVIDING INFORMATION IN THE FIELD OF POLITICAL, SOCIAL AND ENVIRONMENTAL ORGANIZATIONS, GROUPS, AND EVENTS BY MEANS OF A WEB SITE FEATURING LINKS TO OTHER WEB SITES (U.S. CLS. 100 AND 101).

FIRST USE 4-2-2001; IN COMMERCE 4-2-2001.

CLASS 42—(Continued).

SN 76-252,899. DATA SYSTEMS ANALYSTS, INC., PENNSAUKEN, DE. FILED 5-4-2001.

NETSCOPE

FOR EVALUATING AND ASSESSING OF COMPUTER NETWORK INFRASTRUCTURE FOR OTHERS TO ASSESS THE RISK OF SECURITY VULNERABILITIES, AND DETECT SECURITY VULNERABILITIES, TO SUCH NETWORKS (U.S. CLS. 100 AND 101).

FIRST USE 10-0-2000; IN COMMERCE 10-0-2000.

SN 76-255,184. DR. SPOCK COMPANY, THE, MENLO PARK, CA. FILED 5-9-2001.



THE NAME "DR. SPOCK" DOES NOT IDENTIFY A LIVING INDIVIDUAL.

FOR COMPUTER SERVICES, NAMELY, PROVIDING ON-LINE MAGAZINES, NEWSLETTERS AND BOOKS IN THE FIELD OF HEALTHCARE, CHILD CARE, NUTRITION, WELLNESS, PARENTING, PREGNANCY, AND BEHAVIOR TO CONSUMERS, PROVIDERS, ADMINISTRATORS AND OTHER PARTICIPANTS IN THE HEALTH CARE INDUSTRY; PROVIDING INFORMATION VIA A WEBSITE ON THE INTERNET IN THE FIELD OF HEALTHCARE, CHILD CARE, NUTRITION, WELLNESS, PARENTING, PREGNANCY, AND BEHAVIOR TO CONSUMERS, PROVIDERS, ADMINISTRATORS AND OTHER PARTICIPANTS IN THE HEALTHCARE INDUSTRY; MEDICAL CONSULTATION AND MEDICAL CONSULTATION VIA THE INTERNET, NAMELY, CONSULTATION TO CONSUMERS, PROVIDERS, ADMINISTRATORS AND OTHER PARTICIPANTS IN THE HEALTHCARE INDUSTRY IN THE FIELD OF HEALTHCARE, CHILD CARE, NUTRITION, WELLNESS, PARENTING, PREGNANCY, AND BEHAVIOR; PROVIDING AN ON-LINE COMPUTER DATABASE FOR CONSUMERS, PROVIDERS, ADMINISTRATORS, AND OTHER PARTICIPANTS IN THE HEALTHCARE INDUSTRY IN THE FIELD OF HEALTHCARE, CHILD CARE, NUTRITION, WELLNESS, PARENTING, PREGNANCY, AND BEHAVIOR (U.S. CLS. 100 AND 101).

FIRST USE 4-18-2001; IN COMMERCE 4-18-2001.

SN 76-255,731. RESPITE HOUSE, INC., LISLE, IL. FILED 5-11-2001.

RESPITE HOUSE

NO CLAIM IS MADE TO THE EXCLUSIVE RIGHT TO USE "HOUSE", APART FROM THE MARK AS SHOWN.

FOR PROMOTING PUBLIC AWARENESS OF THE NEED FOR RESEARCH AND DEVELOPMENT OF MEDICAL CARE SERVICES FOR MEDICALLY FRAGILE CHILDREN AND THEIR FAMILIES; CHARITABLE SERVICES, NAMELY, PROVIDING FACILITIES AND MEDICAL SERVICES FOR MEDICALLY FRAGILE CHILDREN AND THEIR FAMILIES (U.S. CLS. 100 AND 101).

CLASS 42—(Continued).

SN 76-257,037. RAINLAKE, LLC, NEW YORK, NY. FILED 5-15-2001.

RAINLAKE

FOR COMPUTER SERVICES, NAMELY, WEB SITE, DESIGN, DEVELOPMENT AND IMPLEMENTATION FOR OTHERS (U.S. CLS. 100 AND 101).

SN 76-257,846. VERISIGN, INC., HERNDON, VA. FILED 5-15-2001.

**VERISIGN GLOBAL
REGISTRY SERVICES**

OWNER OF U.S. REG. NO. 2,302,350.
NO CLAIM IS MADE TO THE EXCLUSIVE RIGHT TO USE "GLOBAL REGISTRY SERVICES", APART FROM THE MARK AS SHOWN.

FOR DOMAIN NAME MANAGEMENT SERVICES, NAMELY, DOMAIN NAME SYSTEM MANAGEMENT AND MAINTENANCE, DOMAIN NAME DIRECTORY MANAGEMENT AND MAINTENANCE, DOMAIN NAME SYSTEM INFRASTRUCTURE SERVICES, DOMAIN NAME AND DOMAIN NAME SYSTEM INFORMATION PROPAGATION AND RESOLUTION OF DOMAIN NAME SYSTEM REQUESTS (U.S. CLS. 100 AND 101).

FIRST USE 10-31-2000; IN COMMERCE 10-31-2000.

SN 76-258,958. BEARDSLEE, CRAIG ANDREW, SAN DIEGO, CA. FILED 5-17-2001.

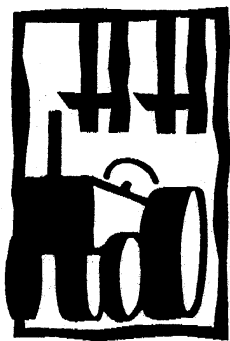

FOR RESTAURANT (U.S. CLS. 100 AND 101).
FIRST USE 4-1-2000; IN COMMERCE 7-1-2000.

CLASS 42—(Continued).

SN 76-259,214. PLASTIC PRINT, LLC, TOWSON, MD. FILED 5-21-2001.

PLASTIC PRINT

NO CLAIM IS MADE TO THE EXCLUSIVE RIGHT TO USE "PRINT", APART FROM THE MARK AS SHOWN. SEC. 2(F).

FOR COMMERCIAL PRINTING SERVICES, NAMELY, PLASTIC RELATED DESIGN, PRINTING AND FINISHING SERVICES (U.S. CLS. 100 AND 101).

FIRST USE 9-1-1996; IN COMMERCE 9-1-1996.

SN 76-263,597. ASKLIA HOLDING AG, 3123 BELP, SWITZERLAND, FILED 5-25-2001.

MAVENA

FOR HEALTH CARE SERVICES, NAMELY, PROVIDING MEDICAL TREATMENT FOR SKIN AILMENTS (U.S. CLS. 100 AND 101).

SN 76-265,429. MCCORMACK, JEFFREY J., INDEPENDENCE, OH. FILED 6-1-2001.

GUMBO

FOR DESIGN CONSULTING IN CONNECTION WITH CORPORATE IDENTITY, PACKAGING, BROADCAST GRAPHICS, INTERIORS AND PRODUCTS (U.S. CLS. 100 AND 101).

SN 76-266,070. STATE OF KANSAS - KANSAS DEPARTMENT OF HEALTH AND ENVIRONMENT, TOPEKA, KS. FILED 6-4-2001.

METH WATCH

NO CLAIM IS MADE TO THE EXCLUSIVE RIGHT TO USE "METH", APART FROM THE MARK AS SHOWN.

FOR PROMOTING PUBLIC AWARENESS AMONG RETAILERS OF THE NEED FOR PREVENTING ILLEGAL METHAMPHETAMINE PRODUCTION AND DRUG ABUSE (U.S. CLS. 100 AND 101).

FIRST USE 4-5-2001; IN COMMERCE 4-5-2001.

CLASS 42—(Continued).

SN 76-267,589. STRADLING YOCCA CARLSON & RAUTH, NEWPORT BEACH, CA. FILED 6-6-2001.

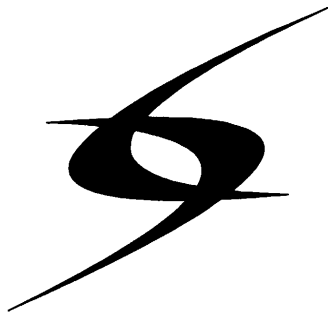

FOR LEGAL SERVICES AND PROVIDING INFORMATION IN THE FIELD OF LAW AND LEGAL SERVICES VIA A GLOBAL COMPUTER INFORMATION NETWORK (U.S. CLS. 100 AND 101).
FIRST USE 3-0-2001; IN COMMERCE 3-0-2001.

SN 76-267,659. ZIBIO, INCORPORATED, LEBANON, NJ. FILED 6-6-2001.

MAKING COMMUNITIES CLICK

FOR PROVIDING COMPUTER SERVICES FOR OTHERS, NAMELY PROVIDING DATABASES FEATURING NEWS AND INFORMATION OF INTEREST TO PERSONS IN SPECIFIC LOCAL GEOGRAPHIC AREAS, NAMELY, LISTINGS OF REAL ESTATE AND CLASSIFIED ADVERTISING, LOCAL ORGANIZATIONS, GOVERNMENTAL BODIES, ASSOCIATIONS, BUSINESSES, PARKS, RECREATION AREAS AND LOCAL WEATHER (U.S. CLS. 100 AND 101).

SN 76-268,605. CUNNINGHAM, G. STORM, ARLINGTON, VA. FILED 6-11-2001.

RESTORICA

FOR PROMOTING PUBLIC AWARENESS OF THE NEED FOR REHABILITATION OF BOTH NATURAL ENVIRONMENTS AND MAN MADE OBJECTS AND STRUCTURES, NAMELY, WORKS OF ART, FISHERIES, WATERSHEDS, BROWNFIELDS, AND HISTORIC BUILDINGS, VIA A NETWORK OF PRIVATE COMPANIES AND ORGANIZATIONS, EDUCATIONAL INSTITUTIONS AND GOVERNMENT AGENCIES (U.S. CLS. 100 AND 101).

FIRST USE 3-30-2001; IN COMMERCE 4-5-2001.

CLASS 42—(Continued).

SN 76-270,216. CALIFORNIA TAX EDUCATION COUNCIL, SACRAMENTO, CA. FILED 6-12-2001.



FOR REVIEWING STANDARDS AND PRACTICES TO ASSURE COMPLIANCE WITH TAX PREPARATION LAWS AND REGULATIONS; EVALUATION OF THE TAX PREPARATION SERVICES OF OTHERS FOR THE PURPOSE OF CERTIFICATION; AND, FACILITATING TAX PREPARER COMPLIANCE BY PROVIDING INFORMATION IN THE FIELD OF TAX EDUCATION STANDARDS (U.S. CLS. 100 AND 101).
FIRST USE 1-5-1998; IN COMMERCE 1-5-1998.

SN 76-270,217. CALIFORNIA TAX EDUCATION COUNCIL, SACRAMENTO, CA. FILED 6-12-2001.

CTEC

FOR REVIEWING STANDARDS AND PRACTICES TO ASSURE COMPLIANCE WITH TAX PREPARATION LAWS AND REGULATIONS; EVALUATION OF THE TAX PREPARATION SERVICES OF OTHERS FOR THE PURPOSE OF CERTIFICATION; AND, FACILITATING TAX PREPARER COMPLIANCE BY PROVIDING INFORMATION IN THE FIELD OF TAX EDUCATION STANDARDS (U.S. CLS. 100 AND 101).
FIRST USE 1-5-1998; IN COMMERCE 1-5-1998.

SN 76-272,704. SHREINER TREE CARE SPECIALISTS, INC., BRYN MAWR, PA. FILED 6-18-2001.



TREE CARE SPECIALISTS, INC.

NO CLAIM IS MADE TO THE EXCLUSIVE RIGHT TO USE "TREE CARE SPECIALISTS, INC.", APART FROM THE MARK AS SHOWN.

FOR TREE SURGERY (U.S. CLS. 100 AND 101).
FIRST USE 6-1-1986; IN COMMERCE 6-1-1986.

SN 76-273,800. KSL LAKE LANIER, INC., LA QUINTA, CA. FILED 6-20-2001.

EMERALD POINTE RESORT

NO CLAIM IS MADE TO THE EXCLUSIVE RIGHT TO USE "RESORT", APART FROM THE MARK AS SHOWN.

FOR RESORT, HOTEL AND HEALTH SPA SERVICES (U.S. CLS. 100 AND 101).

FIRST USE 8-0-2000; IN COMMERCE 8-0-2000.

CLASS 42—(Continued).

SN 76-274,318. TAQUERIA DEL SOL, INC., ATLANTA, GA. FILED 6-20-2001.

TAQUERIA DEL SOL

NO CLAIM IS MADE TO THE EXCLUSIVE RIGHT TO USE "TAQUERIA", APART FROM THE MARK AS SHOWN. THE ENGLISH TRANSLATION OF THE SPANISH PHRASE "TAQUERIA DEL SOL" IS "TACO STAND OF THE SUN".
FOR RESTAURANT SERVICES, PREPARATION OF FOOD FOR DINE-IN AND CARRY-OUT CONSUMPTION, AND DELIVERY (U.S. CLS. 100 AND 101).
FIRST USE 6-0-1999; IN COMMERCE 2-0-2000.

SN 76-276,210. 408 SIXTH, L.P., AUSTIN, TX. FILED 6-26-2001.

DAIQUIRI FACTORY

NO CLAIM IS MADE TO THE EXCLUSIVE RIGHT TO USE "DAIQUIRI", APART FROM THE MARK AS SHOWN. FOR COCKTAIL LOUNGE AND BAR SERVICES (U.S. CLS. 100 AND 101).
FIRST USE 7-20-1992; IN COMMERCE 7-20-1992.

SN 76-276,656. OUTLOOK GROUP CORP., NEENAH, WI. FILED 6-26-2001.

LENTICULAR SOLUTIONS

NO CLAIM IS MADE TO THE EXCLUSIVE RIGHT TO USE "LENTICULAR", APART FROM THE MARK AS SHOWN. FOR PRINTING (U.S. CLS. 100 AND 101).

SN 76-276,960. LIONCOM GROUP INC., NEW YORK, NY. FILED 6-27-2001.

LIONCOM

FOR STRATEGIC ADVICE CONCERNING WEB TECHNOLOGIES FOR BUSINESS AND E-BUSINESS (U.S. CLS. 100 AND 101).
FIRST USE 7-2-1996; IN COMMERCE 7-2-1996.

CLASS 42—(Continued).

SN 76-278,579. DELAWARE LICENSING CORPORATION, CLAYMONT, DE. FILED 6-29-2001.

ISI CUSTOM INFORMATION SERVICES

OWNER OF U.S. REG. NO. 1,009,710.
NO CLAIM IS MADE TO THE EXCLUSIVE RIGHT TO USE "CUSTOM INFORMATION SERVICES", APART FROM THE MARK AS SHOWN.
FOR PROVIDING CUSTOMIZED INFORMATION PROVIDED BY ELECTRONIC MEANS IN THE FIELD OF SCIENCE, MEDICINE AND TRADE JOURNALS, WHICH INDEXES, PROVIDES ABSTRACTS AND TRANSLATIONS (U.S. CLS. 100 AND 101).

SN 76-279,454. CULTURAL ACCESS CONSORTIUM, INC., BOSTON, MA. FILED 7-2-2001.

ON THE HOUSE

FOR CHARITABLE SERVICES, NAMELY RECRUITING AND COORDINATING THE SERVICES OF PERFORMING ARTISTS AND PERFORMING ARTS ORGANIZATIONS WHEREBY SUCH ARTISTS AND ORGANIZATIONS TRAVEL TO SCHOOLS, HOSPITALS, AND OTHER COMMUNITY SITES TO PERFORM AND INTERACT WITH STUDENTS WITH DISABILITIES, ELDERS, HOSPITAL PATIENTS AND OTHERS WHO ARE NOT ABLE TO TRAVEL TO PERFORMING ARTS VENUES (U.S. CLS. 100 AND 101).

SN 76-280,684. CARGIOLI, LEISA ANNETTE, NOBLESVILLE, IN. FILED 7-6-2001.

EMOTIONAL POLARITY TECHNIQUE

SEC. 2(F).
FOR HOLISTIC HEALING SERVICES TO IDENTIFY AND BALANCE UNHEALTHY EMOTIONAL LIFE PATTERNS (U.S. CLS. 100 AND 101).
FIRST USE 7-1-1994; IN COMMERCE 7-1-1994.

CLASS 42—(Continued).

SN 76-283,783. SHOOK, HARDY & BACON L.L.P., KANSAS CITY, MO. FILED 7-13-2001.

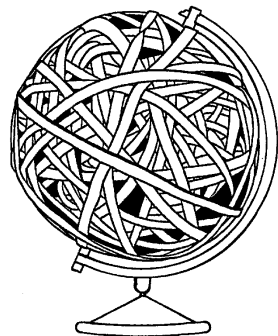

FOR LEGAL SERVICES (U.S. CLS. 100 AND 101).
FIRST USE 1-0-2001; IN COMMERCE 1-0-2001.

SN 76-286,285. UNITED STATES ANTI-DOPING AGENCY,
THE, COLORADO SPRINGS, CO. FILED 7-12-2001.



NO CLAIM IS MADE TO THE EXCLUSIVE RIGHT TO USE "UNITED STATES ANTI-DOPING AGENCY", APART FROM THE MARK AS SHOWN.

FOR DRUG TESTING FOR THE USE OF ILLEGAL OR PROHIBITED PERFORMANCE ENHANCING SUBSTANCES OR METHODS BY PARTICIPANTS IN VARIOUS SPORTS (U.S. CLS. 100 AND 101).

FIRST USE 12-1-2000; IN COMMERCE 12-1-2000.

CLASS 42—(Continued).

SN 76-286,517. COMBUSTION SCIENCE & ENGINEERING, INC., COLUMBIA, MD. FILED 7-17-2001.



NO CLAIM IS MADE TO THE EXCLUSIVE RIGHT TO USE "COMBUSTION" AND "SCIENCE & ENGINEERING, INC.", APART FROM THE MARK AS SHOWN.

FOR MECHANICAL, CHEMICAL AND FIRE PROTECTION ENGINEERING SERVICES; HEAT TRANSFER AND FLUID MECHANICAL SERVICES, NAMELY COMBUSTION FIRE PROTECTION AND DESIGN, ANALYSIS, AND DEVELOPMENT OF TURBO MACHINERY COMPONENTS; CONSULTING SERVICES AND RESEARCH SERVICES IN THE FIELDS OF HEAT TRANSFER AND FLUID MECHANICS; CONSULTING SERVICES AND RESEARCH SERVICES IN THE FIELDS OF COMBUSTION AND FIRE PROTECTION; SAFETY ANALYSIS SERVICES; AND FIRE INVESTIGATION RESEARCH AND SERVICES (U.S. CLS. 100 AND 101).

FIRST USE 1-0-1998; IN COMMERCE 1-0-1998.

SN 76-288,172. HIGHLANDS FAMILY MEDICINE, P.C.,
LEBANON, VA. FILED 7-20-2001.



THE MARK CONSISTS OF THREE ABSTRACT PEOPLE IN INCREASING SIZES.

FOR MEDICAL SERVICES, (U.S. CLS. 100 AND 101).
FIRST USE 7-24-2000; IN COMMERCE 7-24-2000.

SN 76-289,840. HATCH MEDICAL, L.L.C., SNELLVILLE, GA.
FILED 7-25-2001.



FOR MEDICAL DEVICE PRODUCT DEVELOPMENT (U.S. CLS. 100 AND 101).

FIRST USE 1-20-2000; IN COMMERCE 1-20-2000.

CLASS 42—(Continued).

SN 76-289,893. AMERICAN FORESTS, WASHINGTON, DC. FILED 7-25-2001.

THE NATIONAL REGISTER OF BIG TREES

SEC. 2(F).
FOR ASSOCIATION SERVICES, NAMELY PROMOTING PRESERVATION OF HISTORIC AND LARGE TREES (U.S. CLS. 100 AND 101).
FIRST USE 0-0-1940; IN COMMERCE 0-0-1940.

SN 76-290,808. ION COMPUTER SYSTEMS, INC., HAUPAUGE, NY. FILED 7-25-2001.



OWNER OF U.S. REG. NOS. 1,991,125 AND 2,369,796.
NO CLAIM IS MADE TO THE EXCLUSIVE RIGHT TO USE "COMPUTER SYSTEMS", APART FROM THE MARK AS SHOWN.
FOR COMPUTER AND ENGINEERING CONSULTING SERVICES FOR COMPUTERS, COMPUTER NETWORKING SYSTEMS, AND REAL-TIME OPERATING SYSTEMS (U.S. CLS. 100 AND 101).
FIRST USE 1-5-1998; IN COMMERCE 1-12-1998.

SN 76-291,351. PEPPER HAMILTON LLP, PHILADELPHIA, PA. FILED 7-27-2001.

START CLOSER TO THE RIGHT ANSWER

FOR LEGAL SERVICES (U.S. CLS. 100 AND 101).
FIRST USE 11-17-1999; IN COMMERCE 11-17-1999.

SN 76-291,352. PEPPER HAMILTON LLP, PHILADELPHIA, PA. FILED 7-27-2001.

DEFINING VALUE IN LEGAL SERVICES

FOR LEGAL SERVICES (U.S. CLS. 100 AND 101).
FIRST USE 11-17-1999; IN COMMERCE 11-17-1999.

CLASS 42—(Continued).

SN 76-291,563. WORLDCOM, INC., JACKSON, MS. FILED 4-9-2001.

DIGITAL VENTURES PROGRAM

NO CLAIM IS MADE TO THE EXCLUSIVE RIGHT TO USE "DIGITAL" AND "PROGRAM", APART FROM THE MARK AS SHOWN.

FOR HOSTING THE WEB SITES OF OTHERS ON A COMPUTER SERVER FOR A GLOBAL COMPUTER NETWORK (U.S. CLS. 100 AND 101).
FIRST USE 3-31-2000; IN COMMERCE 3-31-2000.

SN 76-293,463. JOHN LEE HOOKER LIMITED FAMILY PARTNERSHIP, THE, SAN RAFAEL, CA. FILED 7-31-2001.

JOHN LEE HOOKERS BOOM BOOM ROOM

THE NAME IN THE MARK DOES NOT IDENTIFY A LIVING INDIVIDUAL.
FOR RESTAURANT AND NIGHTCLUB SERVICES (U.S. CLS. 100 AND 101).
FIRST USE 10-0-1997; IN COMMERCE 10-0-1997.

SN 76-296,203. GRAPHIC SURGERY, LLC, SYRACUSE, NY. FILED 7-27-2001.

GRAPHIC SURGERY, LLC

NO CLAIM IS MADE TO THE EXCLUSIVE RIGHT TO USE "LLC", APART FROM THE MARK AS SHOWN.
FOR COMPUTER SOFTWARE CONSULTATION AND COMPUTER SOFTWARE DESIGN AND DEVELOPMENT SERVICES FOR OTHERS IN THE FIELDS OF PATIENT EDUCATION AND MEDICAL RISK MANAGEMENT (U.S. CLS. 100 AND 101).
FIRST USE 10-11-2000; IN COMMERCE 10-11-2000.

SN 76-297,166. RESTAURANT 192 FINALLY, INC., NEW YORK, NY. FILED 8-10-2001.

IL BAGATTO

THE ENGLISH TRANSLATION OF THE MARK "IL BAGATTO" IS THE NAME IN THE ITALIAN LANGUAGE OF THE ONE CARD IN A DECK OF TAROT CARDS.

FOR RESTAURANT SERVICES (U.S. CLS. 100 AND 101).
FIRST USE 6-0-1995; IN COMMERCE 6-0-1995.

CLASS 42—(Continued).

SN 76-297,171. MOTARY NOTARY, NEW YORK, NY. FILED 8-10-2001.

MOTARY NOTARY

NO CLAIM IS MADE TO THE EXCLUSIVE RIGHT TO USE "NOTARY", APART FROM THE MARK AS SHOWN.
FOR NOTARY PUBLIC SERVICES (U.S. CLS. 100 AND 101).

FIRST USE 11-0-2000; IN COMMERCE 11-0-2000.

SN 76-298,095. OSTEOTECH, INC., EATONTOWN, NJ. FILED 8-10-2001.

GRAFTRAC

FOR MAINTAINING FILES AND RECORDS TRACKING TRANSPLANTED GRAFTS (U.S. CLS. 100 AND 101).

SN 76-298,818. OSTEOTECH, INC., EATONTOWN, NJ. FILED 8-10-2001.

GRAFTRACK

FOR MAINTAINING FILES AND RECORDS TRACKING TRANSPLANTED GRAFTS (U.S. CLS. 100 AND 101).

SN 76-299,204. BAT ACQUISITION, LLC, PITTSBURGH, PA. FILED 8-15-2001.

BAY FABRICATED MATERIALS

OWNER OF U.S. REG. NOS. 2,268,864 AND 2,284,834.
NO CLAIM IS MADE TO THE EXCLUSIVE RIGHT TO USE "FABRICATED MATERIALS", APART FROM THE MARK AS SHOWN.

FOR DESIGN, DRAFTING AND ENGINEERING IN THE FIELD OF METAL AND PLASTIC FABRICATION FOR PNEUMATIC AND/OR ELECTRONIC AUTOMATIC CONTROL SYSTEMS (U.S. CLS. 100 AND 101).

SN 76-301,732. NET TECHNOLOGIES, INC., CHICAGO, IL. FILED 8-21-2001.

NTI

FOR COMPUTER CONSULTATION SERVICES IN THE FIELD OF BUSINESS TRANSACTIONS VIA A GLOBAL COMPUTER NETWORK (U.S. CLS. 100 AND 101).
FIRST USE 2-11-2001; IN COMMERCE 2-11-2001.

CLASS 42—(Continued).

SN 76-303,213. CALIFORNIA SOCIETY OF PLASTIC SURGEONS, INC., EL SOBRANTE, CA. FILED 8-20-2001.

CSPS

FOR PROMOTING THE INTERESTS OF PLASTIC SURGEONS AND THEIR PATIENTS; NON-PROFIT ASSOCIATION SERVICES, NAMELY, PROMOTING THE INTERESTS OF PLASTIC SURGEONS AND THEIR PATIENTS (U.S. CLS. 100 AND 101).

FIRST USE 1-1-1989; IN COMMERCE 1-1-1989.

SN 76-305,182. PRIMADONNA COMPANY, LLC, THE, PRIMM, NV. FILED 8-23-2001.



NO CLAIM IS MADE TO THE EXCLUSIVE RIGHT TO USE "RESORTS", APART FROM THE MARK AS SHOWN.
FOR RESORT HOTELS, HOTEL, RESTAURANT, BAR AND LOUNGE SERVICES (U.S. CLS. 100 AND 101).
FIRST USE 4-23-2001; IN COMMERCE 4-23-2001.

SN 76-305,662. KUEBERMAN CO., INC., RADCLIFF, KY. FILED 8-27-2001.



NO CLAIM IS MADE TO THE EXCLUSIVE RIGHT TO USE "SUNTAN", APART FROM THE MARK AS SHOWN.
FOR TANNING SALON SERVICES (U.S. CLS. 100 AND 101).

SN 76-305,718. PAPPAS TELECASTING COMPANIES, VISALIA, CA. FILED 8-28-2001.

BUY INTO IT!

FOR PROMOTING PUBLIC AWARENESS OF THE NEED FOR INVESTMENT IN LOCAL COMMUNITIES (U.S. CLS. 100 AND 101).
FIRST USE 8-2-2001; IN COMMERCE 8-2-2001.

CLASS 42—(Continued).

SN 76-306,049. CIENCIA, INC., HARTFORD, CT. FILED 8-28-2001.



NO CLAIM IS MADE TO THE EXCLUSIVE RIGHT TO USE "SCIENCE", APART FROM THE MARK AS SHOWN. THE ENGLISH TRANSLATION OF THE WORD "CIENCIA" IN THE MARK IS "SCIENCE".

FOR RESEARCH AND DEVELOPMENT AND ENGINEERING SERVICES, IN THE PHYSICAL AND BIOLOGICAL SCIENCES (U.S. CLS. 100 AND 101).
FIRST USE 9-1-1998; IN COMMERCE 9-1-1998.

SN 76-306,115. RIU HOTELS, S.A., BALEARIC ISLANDS, SPAIN, FILED 8-22-2001.

WE'RE ALL ABOUT YOU

FOR HOTEL AND RESTAURANT SERVICES (U.S. CLS. 100 AND 101).

SN 76-306,169. CAPTRADES, LP, HOUSTON, TX. FILED 8-28-2001.

CAPTRADES

FOR APPLICATION SERVICE PROVIDER (ASP), NAMELY, HOSTING COMPUTER SOFTWARE APPLICATIONS OF OTHERS; APPLICATION SERVICE PROVIDER (ASP) FEATURING SOFTWARE IN THE FIELD OF ELECTRICAL POWER AND GENERATING CAPACITY; APPLICATION SERVICE PROVIDER (ASP) FEATURING SOFTWARE IN THE FIELD OF AUCTIONING (U.S. CLS. 100 AND 101).

SN 76-306,562. INTERNATIONAL BUSINESS MACHINES CORPORATION, ARMONK, NY. FILED 8-28-2001.

NAVCODE

FOR COMPUTER SERVICES, NAMELY, PROVIDING A SEARCH ENGINE FOR OBTAINING DATA ON A GLOBAL COMPUTER NETWORK, NAMELY, PROVIDING AN ONLINE SERVICE THAT ALLOWS USERS TO IDENTIFY AND OBTAIN INFORMATION CONCERNING VARIOUS COMPUTER HARDWARE AND SOFTWARE PRODUCT AND SERVICE OFFERINGS (U.S. CLS. 100 AND 101).

FIRST USE 3-1-2001; IN COMMERCE 3-1-2001.

CLASS 42—(Continued).

SN 76-307,096. J & B AVIATION SERVICES, INC., FAIRFIELD, CA. FILED 8-30-2001.



NO CLAIM IS MADE TO THE EXCLUSIVE RIGHT TO USE "AVIATION", APART FROM THE MARK AS SHOWN.

THE DRAWING IS A COLOR DRAWING THAT UTILIZES MAROON, BLUE, AND BLACK IN ITS DESIGN. THE TWO OUTERMOST ARCS ARE DONE IN BLUE WHILE THE TWO INNERMOST ARCS ARE IN MAROON. THE TEXT AND LINE ARE IN BLACK. FOR PRINTING PURPOSES THE PANTONE COLORS FOR UNCOATED STOCK ARE 484U MAROON AND 284U BLUE. FOR COATED STOCK THE PANTONE COLORS ARE 483C MAROON AND 285C BLUE.

FOR DESIGN FOR OTHERS IN THE FIELD OF GROUND SERVICING EQUIPMENT FOR COMMERCIAL, MILITARY AND PRIVATE AIRCRAFT (U.S. CLS. 100 AND 101).

FIRST USE 8-16-2000; IN COMMERCE 8-16-2000.

SN 76-309,274. PLEXENT CORPORATE, L.P., ADDISON, TX. FILED 9-5-2001.

PLEXENT

FOR INFRASTRUCTURE TECHNOLOGY AND NETWORK AND COMPUTER SERVICES AND COMPUTER CONSULTING SERVICES, NAMELY, NETWORK AND COMPUTER SYSTEMS ASSESSMENT AND ANALYSIS; COMPUTER NETWORK DESIGN FOR OTHERS; AND DESIGN, SELECTION AND IMPLEMENTATION OF COMPUTER HARDWARE AND SOFTWARE SYSTEMS FOR OTHERS (U.S. CLS. 100 AND 101).

CLASS 42—(Continued).

SN 76-310,297. TRIRIGA INC., LAS VEGAS, NV. FILED 9-7-2001.

INTELLIGENT CATALOGS

NO CLAIM IS MADE TO THE EXCLUSIVE RIGHT TO USE "CATALOGS", APART FROM THE MARK AS SHOWN.

FOR COMPUTER SERVICES, NAMELY PROVIDING A COMPUTER SYSTEM WHICH ALLOWS REAL TIME AND SIMULTANEOUS MULTI-USER CREATION, REVISION, CATEGORIZATION, TRACKING AND PRODUCTION OF DESIGN AND BUILD PROJECT RESOURCES, NAMELY, MANUFACTURING, ARCHITECTURAL, CONSTRUCTION AND SPACE PLANNING DESIGNS, PLANS, DATA, SCHEDULES, ORDERS, LISTS AND ROSTERS THROUGH A LOCAL AREA NETWORK, WIDE AREA NETWORK AND GLOBAL COMPUTER NETWORK; COMPUTER SERVICES, NAMELY PROVIDING ONLINE TECHNICAL AND CUSTOMER SUPPORT RELATED TO THE OPERATION OF A DATABASE WHICH ALLOWS REAL TIME AND SIMULTANEOUS MULTI-USER CREATION, REVISION, CATEGORIZATION, TRACKING AND PRODUCTION OF DESIGN AND BUILD PROJECT RESOURCES, NAMELY, MANUFACTURING, ARCHITECTURAL, CONSTRUCTION AND SPACE PLANNING DESIGNS, PLANS, DATA, SCHEDULES, ORDERS, LISTS AND ROSTERS THROUGH A LOCAL AREA NETWORK, WIDE AREA NETWORK AND GLOBAL COMPUTER NETWORK; COMPUTER SERVICES, NAMELY PROVIDING ONLINE CUSTOMER TECHNICAL SUPPORT WITH RESPECT TO THE OPERATION OF A MARKETPLACE EXISTING THROUGH A LOCAL AREA NETWORK, WIDE AREA NETWORK AND GLOBAL COMPUTER NETWORK WHICH PLACES BUYERS IN COMMUNICATION WITH SUPPLIERS OF DESIGN AND BUILD PROJECT RESOURCES, NAMELY MANUFACTURING, ARCHITECTURAL, CONSTRUCTION AND SPACE PLANNING LABOR AND MATERIALS (U.S. CLS. 100 AND 101).

SN 76-310,914. MESO SCALE DIAGNOSTICS, LLC, GAITHERSBURG, MD. FILED 9-10-2001.

MESO SCALE DIAGNOSTICS

NO CLAIM IS MADE TO THE EXCLUSIVE RIGHT TO USE "DIAGNOSTICS", APART FROM THE MARK AS SHOWN.

FOR RESEARCH AND DEVELOPMENT IN THE FIELDS OF ASSAYS, SELECTION, SCREENING, TESTING, IMAGING AND DIAGNOSTICS USING ELECTROCHEMILUMINESCENCE (U.S. CLS. 100 AND 101).

FIRST USE 11-30-1995; IN COMMERCE 11-30-1995.

SN 76-310,977. YOUR LABORATORY, L.P., VICTORIA, TX. FILED 9-10-2001.

your health lab
Your Choice For Medical Tests

NO CLAIM IS MADE TO THE EXCLUSIVE RIGHT TO USE "HEALTH LAB" AND "MEDICAL TESTS", APART FROM THE MARK AS SHOWN.

FOR COLLECTION AND PRESERVATION OF HUMAN BIOLOGICAL SPECIMENS FOR LABORATORY ANALYSIS (U.S. CLS. 100 AND 101).

FIRST USE 11-12-2001; IN COMMERCE 11-12-2001.

CLASS 42—(Continued).

SN 76-311,375. ADAMOWICZ, ROBERT, FARMINGTON, CT. FILED 9-13-2001.

the first name in
ADAMService

FOR TECHNICAL SUPERVISION, CONSULTATION AND INSPECTION IN THE FIELD OF FLOOR COVERING PRODUCTS (U.S. CLS. 100 AND 101).

FIRST USE 1-2-1985; IN COMMERCE 1-2-1985.

SN 76-313,690. OLY ROSE LLC, DALLAS, TX. FILED 9-14-2001.

ROSARIO

THE ENGLISH TRANSLATION OF THE MARK "ROSARIO" IS "ROSARY".

FOR HOTEL, MOTEL AND RESORT HOTEL SERVICES; RESTAURANT AND BAR SERVICES; MAKING HOTEL RESERVATIONS FOR OTHERS (U.S. CLS. 100 AND 101).

FIRST USE 6-15-1906; IN COMMERCE 6-15-1906.

SN 76-315,463. ACTIVEBUDDY, INC., NEW YORK, NY. FILED 9-20-2001.

SMARTERCHILD

FOR PROVIDING TEMPORARY USE OF ONLINE NON-DOWNLOADABLE COMPUTER SOFTWARE ACCESSED VIA THE INTERNET, NAMELY, INTERACTIVE AGENTS OR BOTS THAT ARE PROGRAMMED TO RESPOND TO NATURAL LANGUAGE INSTANT MESSAGING REQUESTS BY DELIVERING RESPONSIVE CONTENT OR SERVICES INTO INSTANT MESSENGER WINDOWS AND WIRED AND WIRELESS DEVICES, NAMELY COMPUTERS, PERSONAL DIGITAL ASSISTANTS, AND WIRELESS TELEPHONES (U.S. CLS. 100 AND 101).

FIRST USE 12-0-2000; IN COMMERCE 12-0-2000.

SN 76-315,802. BAKER HUGHES INCORPORATED, HOUSTON, TX. FILED 9-21-2001.

TCRT

FOR GEOPHYSICAL EXPLORATION FOR MEASURING RESISTIVITY OF UNDERGROUND FORMATIONS MADE AVAILABLE TO THE OIL, GAS AND MINING INDUSTRIES (U.S. CLS. 100 AND 101).

CLASS 42—(Continued).

SN 76-315,948. INTERNATIONAL RESCUE COMMITTEE, INC., NEW YORK, NY. FILED 9-24-2001.



FOR CHARITABLE SERVICES, NAMELY, PROVIDING NON-SECTARIAN ASSISTANCE IN THE FORM OF FOOD, CLOTHING, MEDICINE, SANITATION, PUBLIC HEALTH, AND PSYCHOLOGICAL CONSULTATION TO PEOPLE WHO ARE THE VICTIMS OF RACIAL, RELIGIOUS AND ETHNIC PERSECUTION AND OPPRESSION, AND TO PEOPLE UPROOTED BY WAR, VIOLENCE AND FAMINE; AND PROGRAMS TO ASSIST REFUGEES WITH LIFE IN EXILE (U.S. CLS. 100 AND 101).

FIRST USE 6-7-2000; IN COMMERCE 6-7-2000.

SN 76-315,992. SUPER PHOTO LABORATORY, INC., LOS ANGELES, CA. FILED 9-24-2001.



NO CLAIM IS MADE TO THE EXCLUSIVE RIGHT TO USE "NETWORK", APART FROM THE MARK AS SHOWN. THE MARK CONSISTS OF TWO WORDS AND A SYMBOL IN COLOR. WHEN PLACED ON WHITE THE FIRST "I" OF "IVIA" AND THE "NETWORK" ARE BLUE PMS #294 AND THE "VIA" OF "IVIA" AND THE SYMBOL ARE ORANGE PMS #717. WHEN THE MARK IS PLACED ON A COLOR DARKER THEN THE MARK ITSELF THE FIRST "I" OF "IVIA" AND THE "NETWORK" ARE BLUE PMS #644 AND THE "VIA" OF "IVIA" AND THE SYMBOL ARE PMS #717. THE WORD "IVIA" IS WRITTEN IN A MODIFIED VERSION OF THE FONT HELVETICA NEW BLACK AND THE NETWORK IS WRITTEN IN THE FONT HELVETICA NEW ROMAN.

FOR APPLICATION SERVICE PROVIDER (ASP), NAMELY, HOSTING COMPUTER SOFTWARE APPLICATIONS OF OTHERS (U.S. CLS. 100 AND 101).

SN 76-316,144. SPIRAL DESIGN STUDIO, LLC, ALBANY, NY. FILED 9-24-2001.

SPIRAL DESIGN & INTERACTIVE

OWNER OF U.S. REG. NO. 2,002,782.

NO CLAIM IS MADE TO THE EXCLUSIVE RIGHT TO USE "DESIGN & INTERACTIVE", APART FROM THE MARK AS SHOWN.

FOR GRAPHIC ART DESIGN, WEB PAGE DEVELOPMENT, WEB PAGE PROGRAMMING AND INTERNET-BASED APPLICATION DEVELOPMENT FOR OTHERS (U.S. CLS. 100 AND 101).

CLASS 42—(Continued).

SN 76-316,212. INDEL SYSTEMS, LLC, CHERRY HILL, NJ. FILED 9-22-2001.

INDEL SYSTEMS

NO CLAIM IS MADE TO THE EXCLUSIVE RIGHT TO USE "SYSTEM", APART FROM THE MARK AS SHOWN.

FOR ENGINEERING, TECHNICAL CONSULTATION AND RESEARCH IN THE FIELDS OF VACUUM-BASED DEPOSITION, COATING DEPOSITION, THIN-FILM DEPOSITION (U.S. CLS. 100 AND 101).

FIRST USE 12-1-1998; IN COMMERCE 1-0-1999.

SN 76-316,834. THOMAS MAGNETE GMBH, D-57557 HERDORF, FED REP GERMANY, FILED 9-24-2001.

TM

FOR ENGINEERING SERVICES; SCIENTIFIC AND INDUSTRIAL RESEARCH (U.S. CLS. 100 AND 101).

SN 76-319,512. POWERGIG, LC, DES MOINES, IA. FILED 10-1-2001.



FOR PROVIDING TEMPORARY USE OF ON-LINE NON-DOWNLOADABLE SOFTWARE FOR BOOKING PERFORMANCES, GENERATING CONTRACTS, SCHEDULING, AND NOTIFICATION (U.S. CLS. 100 AND 101).

FIRST USE 9-20-2000; IN COMMERCE 2-23-2001.

SN 76-319,672. BLUESOCKET, INC., BURLINGTON, MA. FILED 10-1-2001.

SECURE MOBILITY

FOR CONSULTING SERVICES IN THE FIELD OF SELECTION, IMPLEMENTATION, AND USE OF COMPUTER HARDWARE AND SOFTWARE SYSTEMS FOR OTHERS FOR USE IN THE CONSTRUCTION OF WIRELESS LOCAL AREA NETWORKS AND WIRELESS CONNECTIVITY; TECHNICAL SUPPORT SERVICES, NAMELY, TROUBLESHOOTING OF COMPUTER HARDWARE AND SOFTWARE PROBLEMS WHICH MAY ARISE IN THE CONSTRUCTION OF WIRELESS LOCAL AREA NETWORKS AND WIRELESS CONNECTIVITY (U.S. CLS. 100 AND 101).

CLASS 42—(Continued).

SN 76-320,163. ADVANCED RESEARCH AND TECHNOLOGY INSTITUTE, INC., BLOOMINGTON, IN. FILED 10-2-2001.

MIDWEST PROTON RADIATION INSTITUTE

NO CLAIM IS MADE TO THE EXCLUSIVE RIGHT TO USE "PROTON RADIATION INSTITUTE", APART FROM THE MARK AS SHOWN.

SEC. 2(F).

FOR MEDICAL SERVICES, NAMELY, PROVIDING PROTON RADIATION THERAPY SERVICES (U.S. CLS. 100 AND 101).

FIRST USE 7-0-1996; IN COMMERCE 7-0-1996.

SN 76-320,200. C/HCA, INC., NASHVILLE, TN. FILED 10-2-2001.



NO CLAIM IS MADE TO THE EXCLUSIVE RIGHT TO USE "MEDICAL CENTER", APART FROM THE MARK AS SHOWN.

FOR HEALTH CARE AND MEDICAL SERVICES; PROVIDING MEDICAL AND HEALTH INFORMATION; COUNSELING IN THE FIELD OF HEALTH; MEDICAL CLINICS AND LABORATORIES; HOSPITAL SERVICES; MEDICAL RESEARCH (U.S. CLS. 100 AND 101).

FIRST USE 5-9-1994; IN COMMERCE 5-9-1994.

SN 76-321,276. ARM LIMITED, CAMBRIDGE, UNITED KINGDOM, FILED 10-3-2001.

The Architecture for the Digital World

FOR PRODUCT RESEARCH AND DEVELOPMENT, DESIGN FOR OTHERS, AND CONSULTATION IN THE AREAS OF COMPUTER HARDWARE, NAMELY, INTEGRATED CIRCUITS, MICROPROCESSORS, MICROPROCESSOR CORES, MACRO CELLS, MICROCONTROLLERS, BUS INTERFACES AND PRINTED CIRCUIT BOARDS; PRODUCT RESEARCH AND DEVELOPMENT, DESIGN FOR OTHERS AND CONSULTATION IN THE AREAS OF COMPUTER SOFTWARE, NAMELY, SOFTWARE USED IN AND FOR USE IN THE DESIGN AND DEVELOPMENT OF, INTEGRATED CIRCUITS, MICROPROCESSORS, MICROPROCESSOR CORES, MACRO CELLS, MICROCONTROLLERS, BUS INTERFACES AND PRINTED CIRCUIT BOARDS, AND SOFTWARE INTEGRATED CIRCUITS, MICROPROCESSORS, MICROPROCESSOR CORES, MACRO CELLS, MICROCONTROLLERS, BUS INTERFACES AND PRINTED CIRCUIT BOARDS; TECHNICAL SUPPORT SERVICES, NAMELY, TROUBLESHOOTING OF COMPUTER HARDWARE AND SOFTWARE PROBLEMS VIA TELEPHONE, WRITTEN CONSULTATION, AND IN-PERSON VISITS (U.S. CLS. 100 AND 101).

FIRST USE 10-0-1999; IN COMMERCE 2-0-2000.

CLASS 42—(Continued).

SN 76-321,367. WE'VE ONLY JUST BEGUN WEDDING CHAPELS, INC., LAS VEGAS, NV. FILED 10-3-2001.

A LITTLE WHITE CHAPEL

NO CLAIM IS MADE TO THE EXCLUSIVE RIGHT TO USE "CHAPEL", APART FROM THE MARK AS SHOWN.

SEC. 2(F).

FOR WEDDING SERVICES, NAMELY, PROVIDING VARIOUS FACILITIES AND LOCATIONS FOR HOLDING WEDDING CEREMONIES; WEDDING CONSULTING AND PLANNING SERVICES, COORDINATING THE MARRIAGE CEREMONY, AND OFFICIATING THE CEREMONY (U.S. CLS. 100 AND 101).

FIRST USE 6-12-1954; IN COMMERCE 6-12-1954.

SN 76-321,368. WE'VE ONLY JUST BEGUN WEDDING CHAPELS, INC., LAS VEGAS, NV. FILED 10-3-2001.

THE LITTLE WHITE WEDDING CHAPEL

NO CLAIM IS MADE TO THE EXCLUSIVE RIGHT TO USE "WEDDING CHAPEL", APART FROM THE MARK AS SHOWN.

SEC. 2(F).

FOR WEDDING SERVICES, NAMELY, PROVIDING VARIOUS FACILITIES AND LOCATIONS FOR HOLDING WEDDING CEREMONIES; WEDDING CONSULTING AND PLANNING SERVICES, COORDINATING THE MARRIAGE CEREMONY, AND OFFICIATING THE CEREMONY (U.S. CLS. 100 AND 101).

FIRST USE 6-12-1954; IN COMMERCE 6-12-1954.

SN 76-322,265. NEW YORK STATE DEPARTMENT OF HEALTH, THE, ALBANY, NY. FILED 10-4-2001.

SCIENCE IN THE PURSUIT OF HEALTH

FOR LABORATORY RESEARCH IN THE FIELD OF BIOMEDICAL AND ENVIRONMENTAL SCIENCES (U.S. CLS. 100 AND 101).

FIRST USE 10-6-1995; IN COMMERCE 10-6-1995.

SN 76-323,076. WHITE AND WILLIAMS LLP, PHILADELPHIA, PA. FILED 10-9-2001.

White and Williams LLP



NO CLAIM IS MADE TO THE EXCLUSIVE RIGHT TO USE "LLP", APART FROM THE MARK AS SHOWN.

FOR LEGAL SERVICES (U.S. CLS. 100 AND 101).

FIRST USE 1-1-1999, THE MARK WAS FIRST USED ANYWHERE IN A DIFFERENT FORM OTHER THAN THAT SOUGHT TO BE REGISTERED ON 00/00/1958; IN COMMERCE 1-1-1999, THE MARK WAS FIRST USED IN COMMERCE IN A DIFFERENT FORM OTHER THAN THAT SOUGHT TO BE REGISTERED ON 00/00/1958.

CLASS 42—(Continued).

SN 76-326,706. L.F.P., INC., BEVERLY HILLS, CA. FILED 10-17-2001.

SKIN & INK

OWNER OF U.S. REG. NO. 1,826,926.
FOR COMPUTER SERVICES, NAMELY, ON-LINE MAGAZINES RELATING TO TATTOOS PROVIDED VIA THE INTERNET, WORLD WIDE WEB AND OTHER ELECTRONIC AND TELECOMMUNICATIONS TRANSMISSION SYSTEMS (U.S. CLS. 100 AND 101).
FIRST USE 11-30-1998; IN COMMERCE 11-30-1998.

CLASS 42—(Continued).

SN 76-328,191. MARTY'S FOOD & WINE, INC., DALLAS, TX. FILED 10-22-2001.

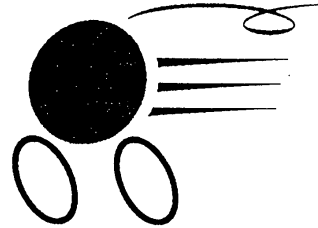

FOR RESTAURANT TAKE OUT SERVICES (U.S. CLS. 100 AND 101).

SN 76-327,118. DOUG'S CLASSIC 57, INC., ALLIANCE, STARK COUNTY, OH. FILED 10-19-2001.



NO CLAIM IS MADE TO THE EXCLUSIVE RIGHT TO USE "CLASSIC DINER", APART FROM THE MARK AS SHOWN.
THE STIPPLING IN THE DRAWING IS FOR SHADING PURPOSES ONLY.
FOR RESTAURANT, CATERING AND FOOD SERVICES (U.S. CLS. 100 AND 101).
FIRST USE 12-20-1993; IN COMMERCE 5-24-2001.

SN 76-328,566. POSITION TECHNOLOGIES, INC., GENEVA, IL. FILED 10-23-2001.



FOR CONSULTING SERVICES FOR WEBSITE OWNERS IN THE FIELD OF INTERNET SEARCH ENGINES AND INTERNET WEBSITES (U.S. CLS. 100 AND 101).
FIRST USE 8-5-2001; IN COMMERCE 8-5-2001.

SN 76-327,867. INNOVATIVE SYSTEMS, INC., PITTSBURGH, PA. FILED 10-18-2001.

I/LYTICS

FOR CONSULTING SERVICES IN THE FIELD OF DESIGN, SELECTION, IMPLEMENTATION AND USE OF COMPUTER SOFTWARE PROPRIETARY SYSTEMS FOR OTHERS, NAMELY, SOFTWARE SYSTEMS FOR DATA ANALYSIS, DATA QUALITY, DATA LINKING AND INFORMATION CHANGE MANAGEMENT THAT PROVIDES A COMPLETE END-TO-END SOLUTION FOR THE ANALYSIS, MIGRATION AND CONSOLIDATION OF LARGE SCALE DATABASES (U.S. CLS. 100 AND 101).

SN 76-328,813. BIRKMAN INTERNATIONAL, INC., HOUSTON, TX. FILED 10-22-2001.

BIRKMAN

OWNER OF U.S. REG. NOS. 1,708,575, 2,350,288 AND OTHERS.
SEC. 2(F).
FOR COUNSELING SERVICES IN THE FIELDS OF CAREERS, PERSONALITY AND SKILLS ASSESSMENT (U.S. CLS. 100 AND 101).
FIRST USE 1-1-1952; IN COMMERCE 1-1-1952.

SN 76-328,829. WARD, CHRISTIAN, DBA AWARD CONSULTING, EXCELSIOR, MN. FILED 10-24-2001.

AWARD CONSULTING

NO CLAIM IS MADE TO THE EXCLUSIVE RIGHT TO USE "CONSULTING", APART FROM THE MARK AS SHOWN.
FOR COMPUTER INFORMATION SYSTEMS MANAGEMENT, COMPUTER NETWORK PROJECT MANAGEMENT, INSTALLATION OF COMPUTER SOFTWARE (U.S. CLS. 100 AND 101).
FIRST USE 9-21-2001; IN COMMERCE 9-21-2001.

CLASS 42—(Continued).

SN 76-329,448. LUMPINEE, INC., SEATTLE, WA. FILED 10-22-2001.

RACHA NOODLES AND THAI CUISINE

NO CLAIM IS MADE TO THE EXCLUSIVE RIGHT TO USE "NOODLES AND THAI CUISINE", APART FROM THE MARK AS SHOWN.

THE FOREIGN WORDING "RANCHA" IN THE MARK TRANSLATES INTO ENGLISH AS "KING"

FOR RESTAURANT SERVICES (U.S. CLS. 100 AND 101).

FIRST USE 10-31-1997; IN COMMERCE 10-31-1997.

SN 76-330,593. NATIONAL MULTIPLE SCLEROSIS SOCIETY, NEW YORK, NY. FILED 10-26-2001.

MS LEARN ONLINE

OWNER OF U.S. REG. NOS. 1,653,041 AND 1,863,950. NO CLAIM IS MADE TO THE EXCLUSIVE RIGHT TO USE "ONLINE", APART FROM THE MARK AS SHOWN. SEC. 2(F).

FOR EDUCATIONAL SERVICES, NAMELY PROVIDING INFORMATION ABOUT MULTIPLE SCLEROSIS TO PATIENTS AND PHYSICIANS (U.S. CLS. 100 AND 101).

FIRST USE 1-0-1999; IN COMMERCE 1-0-1999.

SN 76-330,885. FEEL GOOD COMPANY, LLC, THE, LITTLETON, CO. FILED 10-29-2001.

WATER THAT MOVES YOU

NO CLAIM IS MADE TO THE EXCLUSIVE RIGHT TO USE "WATER", APART FROM THE MARK AS SHOWN. FOR MASSAGE SERVICES (U.S. CLS. 100 AND 101).

SN 76-331,148. BIGEISEN, DAVID M., SAN FRANCISCO, CA. FILED 10-29-2001.

your
PHOTO-free



FOR PORTRAIT PHOTOGRAPHY SERVICES, NAMELY, PHOTOGRAPHING PEOPLE IN EXCHANGE FOR PERMISSION TO UTILIZE THE IMAGES IN THE PHOTOS FOR DISPLAY, PUBLICATION, AND OTHER USES IN ANY MEDIUM OR FORM (U.S. CLS. 100 AND 101).

FIRST USE 9-30-2001. THE MARK WAS FIRST USED ANYWHERE IN A DIFFERENT FORM OTHER THAN THAT SOUGHT TO BE REGISTERED ON 09/27/1998; IN COMMERCE 9-30-2001, THE MARK WAS FIRST USED IN COMMERCE IN A DIFFERENT FORM OTHER THAN THAT SOUGHT TO BE REGISTERED ON 09/27/1998.

CLASS 42—(Continued).

SN 76-331,433. FAEGRE & BENSON LLP, MINNEAPOLIS, MN. FILED 10-24-2001.

FAEGRE BENSON HOBSON AUDLEY

FOR LEGAL SERVICES (U.S. CLS. 100 AND 101). FIRST USE 0-0-1997; IN COMMERCE 0-0-1997.

SN 76-331,763. PREMIER SYSTEM INTEGRATORS, INC., SMYRNA, TN. FILED 10-30-2001.

ENTEGRASYS

FOR MANUFACTURING CONSULTING SERVICES, NAMELY, PROVIDING FOR THE INTEGRATION OF HARDWARE, SOFTWARE, AND INDUSTRIAL EQUIPMENT IN THE FIELDS OF FACTORY AUTOMATION CONTROL AND INFORMATION TECHNOLOGY (U.S. CLS. 100 AND 101).

SN 76-332,053. K-FOUR, INC., ROCKVILLE, MD. FILED 10-30-2001.



THE MARK CONSISTS OF A STYLIZED HUMAN BEING EXERCISING.

FOR WEIGHT REDUCTION DIET PLANNING AND SUPERVISION; CONSULTATION IN THE FIELDS OF PHYSICAL FITNESS AND NUTRITION (U.S. CLS. 100 AND 101).

FIRST USE 0-0-1991; IN COMMERCE 0-0-1991.

SN 76-332,056. K-FOUR, INC., ROCKVILLE, MD. FILED 10-30-2001.

NOT JUST LIGHTER BUT LEANER

FOR WEIGHT REDUCTION DIET PLANNING AND SUPERVISION; CONSULTATION IN THE FIELDS OF PHYSICAL FITNESS AND NUTRITION (U.S. CLS. 100 AND 101).

FIRST USE 0-0-1991; IN COMMERCE 0-0-1991.

CLASS 42—(Continued).

SN 76-333,107. JEFFERSON & NORTH WING COMPANY, INC., BUFFALO, NY. FILED 11-2-2001.

ANCHOR BAR

OWNER OF U.S. REG. NOS. 1,549,347 AND 2,172,483. NO CLAIM IS MADE TO THE EXCLUSIVE RIGHT TO USE "BAR", APART FROM THE MARK AS SHOWN. FOR RESTAURANT SERVICES (U.S. CLS. 100 AND 101). FIRST USE 0-0-1935; IN COMMERCE 0-0-1985.

SN 76-337,331. PEOPLE FOR THE ETHICAL TREATMENT OF ANIMALS, INC., NORFOLK, VA. FILED 11-14-2001.

LETTUCE LADIES

FOR PROMOTING PUBLIC AWARENESS OF THE NEED FOR VEGETARIANISM (U.S. CLS. 100 AND 101). FIRST USE 8-0-1996; IN COMMERCE 8-0-1996.

SN 76-337,855. ADVANCED HOME ENVIRONMENT AUTOMATION DESIGNS, REDONDO BEACH, CA. FILED 11-13-2001.

THE FUTURE OF LIVING

FOR CUSTOM DESIGN, ENGINEERING, AND PROGRAMMING FOR OTHERS OF ELECTRONIC HOME SYSTEMS TO INTEGRATE HVAC SYSTEMS, AUTOMATED LIGHTING SYSTEMS, AUTOMATED SECURITY SYSTEMS IN THE NATURE OF BURGLAR AND FIRE ALARMS, AUTOMATED COMPUTER SYSTEMS, AUTOMATED COMPUTER NETWORKS, AUTOMATED TELEPHONE SYSTEMS, AUTOMATED INTERCOMS, AUTOMATED APPLIANCES, AUTOMATED WINDOW TREATMENTS, AUTOMATED CLIMATE CONTROL, AUTOMATED SWIMMING POOL AND SPA SYSTEMS AND AUTOMATED LAWN WATERING SYSTEMS; AND THE CUSTOM DESIGN, ENGINEERING AND PROGRAMMING FOR OTHERS OF AUTOMATED ELECTRONIC HOME ENTERTAINMENT SYSTEMS IN THE NATURE OF AUDIO, VIDEO AND FILM SYSTEMS (U.S. CLS. 100 AND 101).

CLASS 42—(Continued).

SN 76-337,856. ADVANCED HOME ENVIRONMENT AUTOMATION DESIGNS, REDONDO BEACH, CA. FILED 11-13-2001.

AHEAD

FOR CUSTOM DESIGN, ENGINEERING, AND PROGRAMMING FOR OTHERS OF ELECTRONIC HOME SYSTEMS TO INTEGRATE HVAC SYSTEMS, AUTOMATED LIGHTING SYSTEMS, AUTOMATED SECURITY SYSTEMS IN THE NATURE OF BURGLAR AND FIRE ALARMS, AUTOMATED COMPUTER SYSTEMS, AUTOMATED COMPUTER NETWORKS, AUTOMATED TELEPHONE SYSTEMS, AUTOMATED INTERCOMS, AUTOMATED APPLIANCES, AUTOMATED WINDOW TREATMENTS, AUTOMATED CLIMATE CONTROL, AUTOMATED SWIMMING POOL AND SPA SYSTEMS AND AUTOMATED LAWN WATERING SYSTEMS; AND THE CUSTOM DESIGN, ENGINEERING AND PROGRAMMING FOR OTHERS OF AUTOMATED ELECTRONIC HOME ENTERTAINMENT SYSTEMS IN THE NATURE OF AUDIO, VIDEO AND FILM SYSTEMS (U.S. CLS. 100 AND 101).

SN 76-337,994. TEKNECON ENERGY RISK ADVISORS, LLC, AUSTIN, TX. FILED 11-14-2001.

TERA

FOR ENERGY CONSULTATION (U.S. CLS. 100 AND 101). FIRST USE 0-0-1998; IN COMMERCE 0-0-1998.

SN 76-339,271. SAUCKE, KELLY, ROCHESTER, NY. FILED 11-19-2001.

DEVA DOES

FOR COUNSELING IN THE FIELD OF WOMEN'S ISSUES, HEALTH AND WELLNESS (U.S. CLS. 100 AND 101).

SN 76-339,689. IMIRAGE INCORPORATED, DBA PROFITFORCE, ALLENTOWN, PA. FILED 11-19-2001.

PROFITFORCE

FOR PROVIDING TEMPORARY USE OF ON-LINE NON-DOWNLOADABLE BUSINESS MANAGEMENT SOFTWARE CONSISTING OF FOUR CORE ELEMENTS, NAMELY, TEAM, MESSAGE, CONTACTS, AND CALENDAR FOR SIMULTANEOUS MANAGEMENT OF MULTIPLE PROJECTS, RESOURCE ALLOCATION AND MEASUREMENT (U.S. CLS. 100 AND 101). FIRST USE 7-23-2001; IN COMMERCE 7-23-2001.

CLASS 42—(Continued).

SN 76-339,987. OMEROS MEDICAL SYSTEMS, INC., SEATTLE, WA. FILED 11-20-2001.



FOR MEDICAL INFORMATION SERVICES, NAMELY PROVIDING INFORMATION OVER A GLOBAL COMPUTER NETWORK CONCERNING PHARMACEUTICAL PRODUCTS, METHODS AND DRUG DELIVERY SYSTEMS FOR THE INHIBITION OF PAIN, INFLAMMATION, CARTILAGE LOSS, SMOOTH MUSCLE SPASM AND TUMOR CELL ADHESION ASSOCIATED WITH SURGICAL PROCEDURES AND OTHER TRAUMA, AND IMPLANTABLE BIOABSORBABLE DEVICES FOR THE REPAIR OF TENDONS, LIGAMENTS, NERVES AND SOFT TISSUE (U.S. CLS. 100 AND 101).

SN 76-340,234. OMEROS MEDICAL SYSTEMS, INC., SEATTLE, WA. FILED 11-20-2001.



FOR MEDICAL INFORMATION SERVICES, NAMELY PROVIDING INFORMATION OVER A GLOBAL COMPUTER NETWORK CONCERNING PHARMACEUTICAL PRODUCTS, METHODS AND DRUG DELIVERY SYSTEMS FOR THE INHIBITION OF PAIN, INFLAMMATION, CARTILAGE LOSS, SMOOTH MUSCLE SPASM AND TUMOR CELL ADHESION ASSOCIATED WITH SURGICAL PROCEDURES AND OTHER TRAUMA, AND IMPLANTABLE BIOABSORBABLE DEVICES FOR THE REPAIR OF TENDONS, LIGAMENTS, NERVES AND SOFT TISSUE (U.S. CLS. 100 AND 101).

CLASS 42—(Continued).

SN 76-340,237. OMEROS MEDICAL SYSTEMS, INC., SEATTLE, WA. FILED 11-20-2001.

OMEROS

FOR MEDICAL INFORMATION SERVICES, NAMELY PROVIDING INFORMATION OVER A GLOBAL COMPUTER NETWORK CONCERNING PHARMACEUTICAL PRODUCTS, METHODS AND DRUG DELIVERY SYSTEMS FOR THE INHIBITION OF PAIN, INFLAMMATION, CARTILAGE LOSS, SMOOTH MUSCLE SPASM AND TUMOR CELL ADHESION ASSOCIATED WITH SURGICAL PROCEDURES AND OTHER TRAUMA, AND IMPLANTABLE BIOABSORBABLE DEVICES FOR THE REPAIR OF TENDONS, LIGAMENTS, NERVES AND SOFT TISSUE (U.S. CLS. 100 AND 101).

SN 76-340,295. PHOTRONICS, INC., BROOKFIELD, CT. FILED 11-21-2001.

CYBERMASK

FOR CUSTOM DESIGN FOR OTHERS OF PHOTO MASKS, USING COMPUTER SOFTWARE THAT RECEIVES, VIA THE INTERNET, CUSTOMER PHOTOGRAPHS AND PHOTO MASK ORDER SPECIFICATIONS AND PREPARES PATTERN DATA FOR MANUFACTURE OF THE PHOTO MASKS (U.S. CLS. 100 AND 101).

SN 76-340,389. DATABEACON INC., OTTAWA, ONTARIO, CANADA, FILED 11-21-2001.

STORYDATA

FOR DATA ANALYSIS SERVICES ACCESSIBLE OVER A GLOBAL COMPUTER NETWORK, NAMELY, OFFERING UNIQUE STATISTICAL VIEWS OF PUBLISHED INFORMATION IN ALL FIELDS (U.S. CLS. 100 AND 101).

FIRST USE 10-3-2001; IN COMMERCE 10-3-2001.

CLASS 42—(Continued).

SN 76-341,210. TAO OF WELLNESS, A PROFESSIONAL ACUPUNCTURE CORPORATION, SANTA MONICA, CA. FILED 11-26-2001.

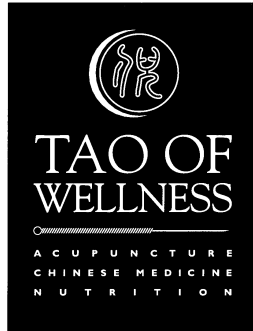

NO CLAIM IS MADE TO THE EXCLUSIVE RIGHT TO USE "TAO", "WELLNESS", "ACUPUNCTURE", "CHINESE MEDICINE", "NUTRITION", OR THE CHINESE CHARACTER, APART FROM THE MARK AS SHOWN.
 THE ENGLISH TRANSLATION OF THE WORD CHINESE CHARACTER IN THE MARK IS "NI".
 FOR HEALTHCARE SERVICES FEATURING NATURAL HEALING PRACTICES (U.S. CLS. 100 AND 101).
 FIRST USE 5-8-1997; IN COMMERCE 5-8-1997.

SN 76-341,416. FAMILY AND CHILDREN'S AID, INC., DANBURY, CT. FILED 11-26-2001.

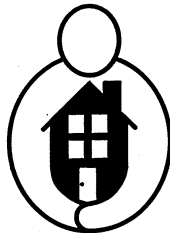

**Family and
Children's Aid**

NO CLAIM IS MADE TO THE EXCLUSIVE RIGHT TO USE "FAMILY AND CHILDREN'S AID", APART FROM THE MARK AS SHOWN.
 FOR COUNSELING SERVICES, NAMELY, PROVIDING GUIDANCE COUNSELING FOR CHILDREN, COUNSELING FOR FAMILIES TO ENHANCE COMMUNICATION, SAFE HOMES AND TEMPORARY HOUSING FOR CHILDREN, HOME CARE AND CHORE SERVICES, JUVENILE MENTAL HEALTH SERVICES FEATURING PSYCHIATRIC TREATMENT, AND MENTORING FOR OLDER FOSTER CHILDREN (U.S. CLS. 100 AND 101).
 FIRST USE 9-1-2001; IN COMMERCE 9-1-2001.

CLASS 42—(Continued).

SN 76-342,508. LIBRARY CONVERSIONS LIMITED COMPANY, SCOTTSDALE, AZ. FILED 11-29-2001.



OWNER OF U.S. REG. NO. 2,252,633.
 NO CLAIM IS MADE TO THE EXCLUSIVE RIGHT TO USE "MARC" AND "MEDIA", APART FROM THE MARK AS SHOWN.
 FOR COMPUTER SERVICES, NAMELY, ELECTRONIC CATALOGING OF RECORDS FOR SCHOOLS IN A MACHINE READABLE FORMAT (U.S. CLS. 100 AND 101).
 FIRST USE 9-1-2001; IN COMMERCE 9-1-2001.

SN 76-343,034. SUMMA HEALTH SYSTEM HOSPITALS, AKRON, OH. FILED 11-30-2001.



OWNER OF U.S. REG. NOS. 1,695,565 AND 1,698,517.
 NO CLAIM IS MADE TO THE EXCLUSIVE RIGHT TO USE "HEALTH SYSTEM", APART FROM THE MARK AS SHOWN.
 FOR HOSPITAL SERVICES (U.S. CLS. 100 AND 101).
 FIRST USE 8-0-2000; IN COMMERCE 8-0-2000.

SN 76-345,122. NATIONAL AUDUBON SOCIETY, INC., NEW YORK, NY. FILED 12-3-2001.

AUDUBON ADVISORY

OWNER OF U.S. REG. NOS. 769,589 AND 1,951,346.
 NO CLAIM IS MADE TO THE EXCLUSIVE RIGHT TO USE "ADVISORY", APART FROM THE MARK AS SHOWN.
 FOR COMPUTER SERVICES, NAMELY, PROVIDING ON-LINE REPORTS IN THE FIELD OF CONSERVATION POLICIES AND ENVIRONMENTAL ISSUES VIA A GLOBAL COMPUTER NETWORK (U.S. CLS. 100 AND 101).
 FIRST USE 10-1-1996; IN COMMERCE 10-1-1996.

CLASS 42—(Continued).

SN 76-346,011. MEDNICK LAW CORPORATION, IRVINE, CA. FILED 12-7-2001.

MEDNICK LAW CORPORATION STRATEGIC IN-HOUSE COUNSEL

NO CLAIM IS MADE TO THE EXCLUSIVE RIGHT TO USE "LAW CORPORATION STRATEGIC IN-HOUSE COUNSEL", APART FROM THE MARK AS SHOWN.
FOR LEGAL SERVICES (U.S. CLS. 100 AND 101).
FIRST USE 11-2-2001; IN COMMERCE 11-2-2001.

SN 76-347,896. VENTURE LAW GROUP, A PROFESSIONAL CORPORATION, MENLO PARK, CA. FILED 12-11-2001.



OWNER OF U.S. REG. NOS. 2,374,150 AND 2,404,041.
FOR LEGAL SERVICES, AND PROVIDING DATABASES FEATURING LEGAL DOCUMENT ACCESS FOR LAW FIRM CLIENTS RENDERED VIA THE INTERNET (U.S. CLS. 100 AND 101).
FIRST USE 11-9-2001; IN COMMERCE 11-9-2001.

SN 76-348,899. KAVADO INC., NEW YORK, NY. FILED 12-17-2001.

SCANDO

FOR COMPUTER PROGRAMMING; UPDATING OF COMPUTER SOFTWARE; UPDATING OF COMPUTER SOFTWARE FOR SECURITY PURPOSES; UPDATING OF COMPUTER SOFTWARE FOR INTERNET SECURITY; CONSULTANCY IN THE FIELD OF COMPUTER'S SECURITY; CONSULTANCY IN THE FIELD OF COMPUTER HARDWARE; RENTAL OF COMPUTER SOFTWARE AND HARDWARE; AUDIT AND ASSESSMENT OF COMPUTER PROGRAMS FOR SECURITY PURPOSES; CONSULTATION IN THE FIELD OF TELECOMMUNICATION (U.S. CLS. 100 AND 101).

SN 76-349,750. FLORIDA HEART INSTITUTE, INC., ORLANDO, FL. FILED 12-19-2001.

FLORIDA HEART INSTITUTE

NO CLAIM IS MADE TO THE EXCLUSIVE RIGHT TO USE "HEART INSTITUTE", APART FROM THE MARK AS SHOWN.

SEC. 2(F).
FOR HEALTHCARE, CARDIOLOGY AND CARDIOVASCULAR SURGERY AND PHYSICAL REHABILITATION (U.S. CLS. 100 AND 101).
FIRST USE 1-22-1973; IN COMMERCE 1-22-1973.

CLASS 42—(Continued).

SN 76-349,818. TEAM INVESTMENTS, LLC, WISCONSIN DELLS, WI. FILED 12-17-2001.

SUNDARA LODGE & SPA

NO CLAIM IS MADE TO THE EXCLUSIVE RIGHT TO USE "LODGE & SPA", APART FROM THE MARK AS SHOWN.

FOR HEALTH SPA SERVICES (U.S. CLS. 100 AND 101).

SN 76-350,994. COMPUTER SCIENCES CORPORATION, EL SEGUNDO, CA. FILED 12-19-2001.

INFRASHIELD

FOR COMPUTER SERVICES, NAMELY, DESIGNING AND IMPLEMENTING COMPUTER HARDWARE AND SOFTWARE SYSTEMS THAT ENSURE THE SECURITY OF COMPUTER NETWORKS; AND TECHNICAL CONSULTATION IN THE FIELD OF COMPUTER SECURITY SYSTEMS, NAMELY, THE TESTING AND EVALUATION OF THE SECURITY OF COMPUTER SYSTEMS FOR OTHERS (U.S. CLS. 100 AND 101).

SN 76-351,100. IMPRESST BUSINESS SOLUTIONS, INC., BURTONSVILLE, MD. FILED 12-13-2001.

IMPRESST

FOR COMPUTER SERVICES, NAMELY CONSULTING SERVICES IN THE FIELD OF DESIGN, SELECTION, IMPLEMENTATION AND USE OF COMPUTER HARDWARE AND SOFTWARE SYSTEMS FOR OTHERS; COMPUTER SERVICES, NAMELY, DESIGNING AND IMPLEMENTING WEB SITES FOR OTHERS; COMPUTER SOFTWARE AND NETWORK DESIGN FOR OTHERS; COMPUTER DIAGNOSTIC SERVICES, MAINTENANCE AND REPAIR; COMPUTER SERVICES, NAMELY, INSTALLATION OF COMPUTER SOFTWARE; COMPUTER SERVICES, NAMELY, DATA RECOVERY SERVICES (U.S. CLS. 100 AND 101).

FIRST USE 10-14-1993; IN COMMERCE 10-14-1993.

SN 76-351,572. NIELSEN MEDIA RESEARCH, NEW YORK, NY. FILED 12-21-2001.

FEEDPOINT WEB

NO CLAIM IS MADE TO THE EXCLUSIVE RIGHT TO USE "WEB", APART FROM THE MARK AS SHOWN.

FOR PROVIDING TEMPORARY USE OF ON-LINE NON-DOWNLOADABLE SOFTWARE FOR USE IN ENTERING, MAINTAINING AND DELIVERING TELEVISION PROGRAM BROADCAST, VIEWING, MARKETING, AND RATING INFORMATION IN A COMPUTER DATABASE (U.S. CLS. 100 AND 101).

FIRST USE 3-14-2001; IN COMMERCE 3-14-2001.

CLASS 42—(Continued).

SN 76-351,794. CARDIFF MASON DEVELOPMENT, INC., DANVILLE, CA. FILED 12-21-2001.

ANNEXT

FOR COMPUTER SERVICES PROVIDED FOR AND AMONG THE BUSINESS COMMUNITY, NAMELY, PROVIDING DATA CENTER SERVICES IN THE NATURE OF NETWORK MONITORING AND INTERNET SERVER SECURITY SERVICES AND APPLICATION SERVICE PROVIDER, NAMELY HOSTING THE COMPUTER SOFTWARE APPLICATIONS OF OTHERS (U.S. CLS. 100 AND 101).

SN 76-352,197. GLOBAL EMBEDDED TECHNOLOGIES, INC., SOUTHFIELD, MI. FILED 12-26-2001.



NO CLAIM IS MADE TO THE EXCLUSIVE RIGHT TO USE "GLOBAL", APART FROM THE MARK AS SHOWN.

THE MARK CONSISTS, IN PART, OF TWO SEMI-CIRCLES, CONNECTED TO MAKE AN OVAL THAT IS LEANING TOWARDS THE RIGHT FROM THE TOP AND TOWARDS THE LEFT FROM THE BOTTOM. THE TOP PART OF THE OVAL IS BLUE AND THE BOTTOM IS GREEN. COLOR IS CLAIMED AS PART OF THE MARK.

FOR ENGINEERING (U.S. CLS. 100 AND 101).

SN 76-354,867. CYTODYN OF NEW MEXICO, INC., STUDIO CITY, CA. FILED 1-4-2002.



FOR RESEARCH AND DEVELOPMENT IN THE FIELD OF MEDICINES, PHARMACEUTICAL PREPARATIONS AND BIOLOGICAL PREPARATIONS FOR THE TREATMENT OF IMMUNOLOGICAL MEDIATED DISEASES, DISORDERS AND CONDITIONS (U.S. CLS. 100 AND 101).

FIRST USE 3-0-1995; IN COMMERCE 8-0-1995.

CLASS 42—(Continued).

SN 76-359,237. CHEMREG INTERNATIONAL, LLC, LAKE RIDGE, VA. FILED 1-16-2002.

CHEMREG

FOR PROVIDING REGULATORY AND CONSULTING SERVICES TO CHEMICAL, PESTICIDE, BIO-CHEMICAL AND LIFE SCIENCES COMPANIES, NAMELY REGULATORY STRATEGIES, REGISTRATION SUPPORT, DATA GENERATION AND COMPENSATION, QUALITY ASSURANCE, STUDY DESIGN AND SCIENTIFIC MATTERS (U.S. CLS. 100 AND 101).

FIRST USE 1-0-1999; IN COMMERCE 1-0-1999.

SN 76-359,705. EXPORT INTERNET TRADE SOFTWARE, INC., EASTON, CT. FILED 1-17-2002.



FOR APPLICATION SERVICE PROVIDER (ASP) FEATURING SOFTWARE FOR USE IN DIRECTING THE FLOW OF PURCHASE ORDERS, ARRANGING EXPEDITED SHIPMENT BOOKING, TRACING SHIPMENTS, REVIEWING CUSTOMS CLEARANCE DETAILS AND MAINTAINING WAREHOUSE INVENTORIES; COMPUTER SOFTWARE DESIGN FOR OTHERS (U.S. CLS. 100 AND 101).

SN 76-359,894. HALLIBURTON ENERGY SERVICES, INC., CARROLLTON, TX. FILED 1-18-2002.

ADT

FOR DEVELOPMENT OF NEW TECHNOLOGY IN THE FIELD OF OIL AND GAS WELLS FOR OTHERS IN THE FIELD OF DRILLING PARAMETERS AND SUBSURFACE CONDITIONS IN BOREHOLE DRILLING OPERATIONS (U.S. CLS. 100 AND 101).

SN 76-365,474. ACTIVEBUDDY, INC., NEW YORK, NY. FILED 1-31-2002.

SMARTESTCHILD

FOR PROVIDING TEMPORARY USE OF ON-LINE NON-DOWNLOADABLE COMPUTER SOFTWARE ACCESSED VIA THE INTERNET, NAMELY, INTERACTIVE AGENTS OR BOTS THAT ARE PROGRAMMED TO RESPOND TO NATURAL LANGUAGE INSTANT MESSAGING REQUESTS BY DELIVERING RESPONSIVE CONTENT OR SERVICES INTO INSTANT MESSENGER WINDOWS AND WIRED AND WIRELESS DEVICES, NAMELY COMPUTERS, PERSONAL DIGITAL ASSISTANTS, AND WIRELESS TELEPHONES (U.S. CLS. 100 AND 101).

CLASS 42—(Continued).

SN 76-365,633. SYRRX, INC., SAN DIEGO, CA. FILED 1-31-2002.

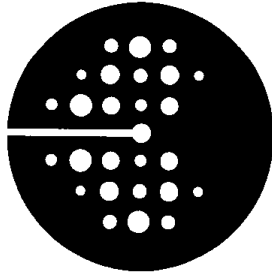

FOR PHARMACEUTICAL RESEARCH AND DRUG DEVELOPMENT SERVICES IN THE FIELD OF STRUCTURAL PROTEOMICS (U.S. CLS. 100 AND 101).
FIRST USE 1-0-2001; IN COMMERCE 1-0-2001.

SN 76-372,667. CRAIG EPIFANIO, P.A., ST. PETERSBURG, FL. FILED 2-19-2002.

HELPING GOOD PEOPLE IN UNFORTUNATE SITUATIONS

FOR LEGAL SERVICES (U.S. CLS. 100 AND 101).
FIRST USE 12-0-2000; IN COMMERCE 12-0-2000.

SN 76-373,304. DIGITAL EVOLUTION, INC., SANTA MONICA, CA. FILED 2-20-2002.



FOR COMPUTER SITE DESIGN; COMPUTER SOFTWARE CONSULTATION; COMPUTER SOFTWARE DESIGN FOR OTHERS; COMPUTER SOFTWARE DEVELOPMENT (U.S. CLS. 100 AND 101).
FIRST USE 8-1-2001; IN COMMERCE 8-1-2001.

CLASS 42—(Continued).

SN 76-374,030. SALES AUTOMATION SUPPORT, LLC, MILWAUKEE, WI. FILED 2-25-2002.

MOBILE MARKETER

FOR APPLICATION SERVICE PROVIDER FEATURING SOFTWARE FOR DATABASE MANAGEMENT AND WORD PROCESSING IN THE FIELD OF CUSTOMER RELATIONSHIP MANAGEMENT (U.S. CLS. 100 AND 101).

FIRST USE 9-21-2001; IN COMMERCE 9-21-2001.

SN 76-374,799. KNUPP, DANIEL F., HOUSTON, TX. FILED 2-21-2002.

FAST TRACK

FOR COMPUTER SERVICES, NAMELY, COMPUTER DATA ANALYSIS OF GEOLOGIC FORMATIONS (U.S. CLS. 100 AND 101).

FIRST USE 4-30-1997; IN COMMERCE 4-30-1997.

SN 76-376,479. KHAN, FEROUN, DANVILLE, CA. FILED 2-25-2002.

POCKETONE

FOR APPLICATION SERVICE PROVIDER (ASP) FEATURING SOFTWARE WHICH IS LOCALLY INSTALLED AND CENTRALLY LOCATED ON ONE OR MORE NETWORK SERVERS FOR USE IN THE COLLECTION AND TRANSMISSION OF ELECTRONIC DATA FROM REMOTE HANDHELD COMPUTERS TO ONE OR MORE NETWORK SERVERS, CENTRALIZED PROCESSING AND MANAGEMENT BY THOSE SERVERS, AND FURTHER TRANSMISSION AND DISTRIBUTION TO END USERS AND TO THIRD-PARTY SOFTWARE FOR END-USER USE AND FOR ADDITIONAL PROCESSING BY THIRD-PARTY SOFTWARE APPLICATIONS, (U.S. CLS. 100 AND 101).

SN 76-377,751. WILLIAMS & CONNOLLY LLP, WASHINGTON, DC. FILED 3-5-2002.

THE FIRM TO SEE

FOR LEGAL SERVICES (U.S. CLS. 100 AND 101).

CLASS 42—(Continued).

SN 76-381,862. BERGANA COMMUNICATIONS, INC., PALO ALTO, CA. FILED 3-11-2002.

BERMAI

FOR DESIGNING APPLICATION SPECIFIC INTEGRATED CIRCUITS, AND CONSULTATION SERVICES FOR OTHERS IN THE WIRELESS COMMUNICATION INDUSTRY REGARDING WIRELESS AND WIRELINE COMMUNICATION DEVICES AND SYSTEMS (U.S. CLS. 100 AND 101).



SN 76-382,463. VSK PHOTONICS, INC., LAKE FOREST, CA. FILED 3-14-2002.



NO CLAIM IS MADE TO THE EXCLUSIVE RIGHT TO USE "PHOTONICS", APART FROM THE MARK AS SHOWN.

FOR DESIGN, DEVELOPMENT, RESEARCH AND ENGINEERING OF OPTOELECTRONIC COMPONENTS, SUBSYSTEMS, MODULES AND SEMICONDUCTORS FOR OTHERS; TECHNICAL CONSULTING IN THE FIELD OF OPTOELECTRONICS (U.S. CLS. 100 AND 101).



SN 76-383,209. LAWSON NOBLE & WEBB INC., WEST PALM BEACH, FL. FILED 3-12-2002.

**SETTING THE STANDARD ...
LEADING THE WAY**

FOR ENGINEERING SERVICES (U.S. CLS. 100 AND 101).
FIRST USE 4-1-2002; IN COMMERCE 4-1-2002.



SN 76-384,728. MY CORPORATION BUSINESS SERVICES, INC., AGOURA HILLS, CA. FILED 3-18-2002.

MYCORPORATION

OWNER OF U.S. REG. NO. 2,426,818.
FOR PROVIDING INTELLECTUAL PROPERTY RESEARCH AND FILING SERVICES; PROVIDING INFORMATION IN THE FIELD OF INTELLECTUAL PROPERTY VIA A GLOBAL COMPUTER NETWORK (U.S. CLS. 100 AND 101).
FIRST USE 2-1-1998; IN COMMERCE 2-1-1998.

CLASS 42—(Continued).

SN 76-388,527. PERKIN-ELMER CORPORATION, THE, FOSTER CITY, CA. FILED 1-21-1999.

PROTAG

FOR BIOTECHNOLOGY SERVICES, NAMELY PREDICTING PEPTIDE AND PROTEIN FRAGMENTS (U.S. CLS. 100 AND 101).



SN 76-404,416. ACCESS BIO, L.C., LOVETTSVILLE, VA. FILED 4-30-2002.



FOR PRECLINICAL CONSULTING SERVICES IN SCIENCE-BASED STRATEGIES AND DEVELOPMENT SERVICES TO FACILITATE BIOMEDICAL RESEARCH, EMERGING TECHNOLOGIES AND BIOTECHNOLOGY DEVELOPMENT (U.S. CLS. 100 AND 101).
FIRST USE 9-9-1999; IN COMMERCE 9-10-1999.



SN 78-004,836. DUFFIN, DAVID A., SANDY, UT. FILED 4-19-2000.

RUMBI ISLAND GRILL

NO CLAIM IS MADE TO THE EXCLUSIVE RIGHT TO USE "GRILL", APART FROM THE MARK AS SHOWN.
FOR RESTAURANT (U.S. CLS. 100 AND 101).

CLASS 42—(Continued).

SN 78-015,446. STRATECOMM, WASHINGTON, DC. FILED 7-5-2000.

STRATECOMM: INTEGRATED WEB SOLUTIONS & SUPPORT

NO CLAIM IS MADE TO THE EXCLUSIVE RIGHT TO USE "INTEGRATED WEB SOLUTIONS & SUPPORT", APART FROM THE MARK AS SHOWN.

FOR COMPUTER SERVICES, NAMELY, CONSULTATION SERVICES REGARDING WEB SITES; DESIGNING WEB SITES FOR OTHERS; WEB SITE PROGRAMMING FOR OTHERS, NAMELY, CREATING SOFTWARE FOR OTHERS THAT COLLECT INFORMATION FROM THE INTERNET, UPDATE AND POST INFORMATION ON THE INTERNET, AND ALLOW OTHERS TO CREATE INTERACTIVE WEBSITES; DATABASE PROGRAMMING AND INTEGRATION, NAMELY, CREATING LINKED DATABASES THAT ALLOW FOR ON-LINE COLLECTION OF USER- INFORMATION, AS WELL AS ON-LINE ACCESS TO DATABASE INFORMATION; COMPUTER PROGRAMMING FOR OTHERS, NAMELY, CREATING COMPUTER SOFTWARE PROGRAMS FOR OTHERS WHICH FACILITATE ELECTRONIC COMMERCE BY ALLOWING USERS TO CREATE WEBSITES WHICH PROCESS ORDERS, COLLECT PAYMENTS FOR GOODS AND TRACK RECEIPT OF GOODS; MAINTAINING WEBSITES FOR OTHERS; COMPUTER PROGRAMMING FOR OTHERS IN THE FIELD OF CONTENT DEVELOPMENT, NAMELY, CREATION OF GRAPHICS, LOGOS, IMAGES, TEXT; COMPUTER PROGRAMMING FOR OTHERS, NAMELY DEVELOPING INFORMATION ARCHITECTURE FOR WEBSITES USING HYPERLINKS TO CONNECT PAGES IN STRUCTURED FORMAT; ALL OF THE FOREGOING FOR USE IN CREATING AND MAINTAINING WEBSITES; HOSTING THE WEB SITES OF OTHERS ON A COMPUTER SERVER FOR A GLOBAL COMPUTER NETWORK; COMPUTER PROGRAMMING FOR OTHERS, NAMELY, CREATING PROGRAMS FOR OTHERS THAT CREATE NETWORKS BETWEEN WEB BROWSERS AND THE INTERNET AND BETWEEN WEB BROWSERS AND EXTRANETS; AND DOMAIN REGISTRATION, NAMELY, REGISTRATION OF DOMAIN NAMES FOR IDENTIFICATION OF USERS ON A GLOBAL NETWORK (U.S. CLS. 100 AND 101).

FIRST USE 2-9-1999; IN COMMERCE 2-9-1999.

CLASS 42—(Continued).

SN 78-017,310. ADOBE SYSTEMS INCORPORATED, SAN JOSE, CA. FILED 7-18-2000.

CLEARLY ADOBE IMAGING

OWNER OF U.S. REG. NOS. 1,475,793, 2,116,527 AND OTHERS.

NO CLAIM IS MADE TO THE EXCLUSIVE RIGHT TO USE "IMAGING", APART FROM THE MARK AS SHOWN.

FOR COMPUTER SERVICES, NAMELY, HOSTING OF DIGITAL CONTENT ON THE INTERNET; HOSTING THE WEB SITES OF OTHERS ON A COMPUTER SERVER FOR A GLOBAL COMPUTER NETWORK; PROVIDING INFORMATION IN THE FIELD OF DESKTOP PUBLISHING, DIGITAL PUBLISHING, ELECTRONIC PUBLISHING, PRINTING, WEB DESIGN, INTERACTIVE GRAPHICS AND ANIMATION, GRAPHIC DESIGN, MULTIMEDIA CONTENT DESIGN AND DEVELOPMENT, SOFTWARE DESIGN AND DEVELOPMENT, AND THE RETRIEVAL, MANAGEMENT AND MANIPULATION OF INTERACTIVE CONTENT VIA THE INTERNET; PROVIDING ON-LINE COMPUTER LINKS FEATURING INFORMATION IN THE FIELDS OF GRAPHIC DESIGN AND PUBLISHING; ON-LINE COMPUTER PROJECT MANAGEMENT SERVICES IN THE FIELDS OF PRINT AND WEB PUBLISHING; APPLICATION SERVICE PROVIDER (ASP), NAMELY, HOSTING COMPUTER SOFTWARE APPLICATIONS OF OTHERS; COMPUTER SOFTWARE DEVELOPMENT AND DESIGN SERVICES FOR OTHERS; TECHNICAL SUPPORT SERVICES, NAMELY TROUBLESHOOTING OF COMPUTER HARDWARE AND SOFTWARE PROBLEMS VIA TELEPHONE, E-MAIL OR COMPUTER NETWORKS, WIRELESS NETWORKS AND GLOBAL COMMUNICATIONS NETWORKS; CONSULTING SERVICES IN THE FIELD OF COMPUTER SOFTWARE DEVELOPMENT AND DESIGN; AND CREATING AND MAINTAINING WEB SITES FOR OTHERS; SOFTWARE RENTAL OR LEASING SERVICES (U.S. CLS. 100 AND 101).

SN 78-018,490. INTERCORR INTERNATIONAL, INC., HOUSTON, TX. FILED 7-26-2000.

THE CORROSION PORTAL

OWNER OF U.S. REG. NOS. 2,344,241, 2,463,030 AND OTHERS.

NO CLAIM IS MADE TO THE EXCLUSIVE RIGHT TO USE "PORTAL", APART FROM THE MARK AS SHOWN.

FOR PROVIDING INFORMATION, NAMELY, TECHNICAL REPORTS AND DATA ON THE CORROSIVE PROPERTIES OF METALLIC AND NON-METALLIC MATERIALS, VIA A GLOBAL COMMUNICATIONS NETWORK (U.S. CLS. 100 AND 101).

FIRST USE 6-15-1999; IN COMMERCE 6-15-1999.

CLASS 42—(Continued).

SN 78-022,891. JAN H. MATSSON I BROMMA AB, BROMMA, SWEDEN, FILED 8-24-2000.

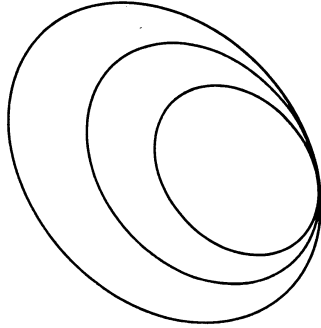

FOR COUNSELING SERVICES IN THE FIELD OF PERSONAL, PROFESSIONAL AND SPIRITUAL DEVELOPMENT; COUNSELING SERVICES OVER COMPUTER NETWORKS AND GLOBAL COMMUNICATION NETWORKS IN THE FIELD OF PERSONAL, PROFESSIONAL AND SPIRITUAL DEVELOPMENT; CONSULTING SERVICES IN THE FIELD OF PERSONAL, PROFESSIONAL AND SPIRITUAL DEVELOPMENT (U.S. CLS. 100 AND 101).

FIRST USE 11-30-1999; IN COMMERCE 1-25-2000.

CLASS 42—(Continued).

SN 78-027,516. HARD DOLLAR CORPORATION, TEMPE, AZ. FILED 9-25-2000.

HARD DOLLAR BID

OWNER OF U.S. REG. NO. 1,585,440.
NO CLAIM IS MADE TO THE EXCLUSIVE RIGHT TO USE "BID", APART FROM THE MARK AS SHOWN.
FOR PROVIDING TEMPORARY USE OF ON-LINE NON-DOWNLOADABLE SOFTWARE FOR BID ESTIMATION AND PROPOSAL PREPARATION FOR USE IN THE FIELD OF INFRASTRUCTURE CONSTRUCTION MANAGEMENT (U.S. CLS. 100 AND 101).

SN 78-031,922. BRISTOL-MYERS SQUIBB COMPANY, NEW YORK, NJ. FILED 10-23-2000.

SUGAR PRINCIPAL

NO CLAIM IS MADE TO THE EXCLUSIVE RIGHT TO USE "SUGAR", APART FROM THE MARK AS SHOWN.
FOR PROMOTING AWARENESS OF THE HEALTH RISKS ASSOCIATED WITH HIGH BLOOD SUGAR BY DISTRIBUTING EDUCATIONAL BROCHURES AND PRESS RELEASES FOR OTHERS (U.S. CLS. 100 AND 101).

SN 78-023,785. APPLIED MECHANICAL CONSULTING GROUP, INC., AUSTIN, TX. FILED 8-30-2000.

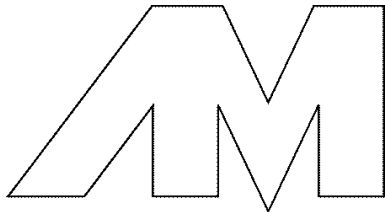

THE MARK CONSISTS OF THE LETTERS "AM".
FOR PROVIDING QUALITY ASSURANCE SERVICES IN THE FIELD OF THE SEMICONDUCTOR, CHEMICAL, PHARMACEUTICAL, BIOTECH, MANUFACTURING, AND UTILITY INDUSTRIES; QUALITY CONTROL FOR OTHERS; CONSULTING SERVICES AND CONTRACT NEGOTIATION CONSULTATION IN THE SEMICONDUCTOR, CHEMICAL, PHARMACEUTICAL, BIOTECH, MANUFACTURING, AND UTILITY INDUSTRIES; REVIEWING STANDARDS AND PRACTICES TO ASSURE COMPLIANCE WITH LOCAL BUILDING AND SAFETY CODES, TRADE ASSOCIATION STANDARDS, AND CONTRACTUAL REQUIREMENTS; AND TESTING, ANALYSIS AND EVALUATION OF THE GOODS AND SERVICES OF OTHERS FOR THE PURPOSE OF CERTIFICATION (U.S. CLS. 100 AND 101).

SN 78-033,269. SANDOR G. VARI, M.D., VAN NUYS, CA. FILED 11-1-2000.



NO CLAIM IS MADE TO THE EXCLUSIVE RIGHT TO USE "E.COM" AND "CERT", APART FROM THE MARK AS SHOWN.
FOR QUALITY CONTROL FOR OTHERS; TESTING, ANALYSIS AND EVALUATION OF THE GOODS AND SERVICES AND SERVICES OF OTHERS FOR THE PURPOSE OF CERTIFICATION IN THE FIELDS OF CORPORATE MANAGEMENT SYSTEMS, ISO 9001, ISO 14001, HACCP AND PRODUCTS MANUFACTURING, PROCESSING METHODS OF PRODUCTIONS, INFORMATION TECHNOLOGY, AND MONETARY AND FINANCIAL CONTROLLING (U.S. CLS. 100 AND 101).

CLASS 42—(Continued).

SN 78-033,777. TENSA, SAN FRANCISCO, CA. FILED 11-3-2000.

NETVOCATE

FOR ONLINE ADVOCACY AND INFORMATION SERVICES, PROVIDING DATABASES AND WEBSITE LINKS FOR SOCIAL CHANGE AND NONPROFIT ORGANIZATIONS; APPLICATION SERVICE PROVIDER, NAMELY, HOSTING COMPUTER SOFTWARE APPLICATIONS OF AND FOR SOCIAL CHANGE AND NON-PROFIT ORGANIZATIONS (U.S. CLS. 100 AND 101).

SN 78-033,912. FRUSH, KENNETH J, IRVING, TX. FILED 11-5-2000.

RADIO FREE INTERNET

NO CLAIM IS MADE TO THE EXCLUSIVE RIGHT TO USE "RADIO" AND "INTERNET", APART FROM THE MARK AS SHOWN.

FOR SEARCH ENGINE SERVICES TO LOCATE LOCAL RADIO STATIONS VIA A GLOBAL COMPUTER NETWORK (U.S. CLS. 100 AND 101).

SN 78-040,573. MOGULWORKS, L.L.C., BRIARWOOD, NY. FILED 12-24-2000.

MOGULGATE

FOR COMPUTER SERVICES, NAMELY PROVIDING SEARCH ENGINES FOR OBTAINING DATA ON A GLOBAL COMPUTER NETWORK AND CREATING INDEXES OF INFORMATION, SITES AND OTHER RESOURCES AVAILABLE ON COMPUTER NETWORKS (U.S. CLS. 100 AND 101).

CLASS 42—(Continued).

SN 78-046,519. IT'S A MATTER OF TASTE, BEAVERCREEK, OH. FILED 2-5-2001.

*It's A
Matter of Taste*



THE LINING IS A FEATURE OF THE MARK AND DOES NOT INDICATE COLOR.

THE MARK CONSISTS OF A DEPICTION OF A TUXEDO SUIT FRONT AND A PLATTER OF FOOD AND TWO CHAMPAGNE GLASSES AND THE WORDING "IT'S A MATTER OF TASTE" IN STYLIZED LETTERING ABOVE THE DESIGN.

FOR CONTRACT FOOD SERVICES, CATERING (U.S. CLS. 100 AND 101).

FIRST USE 1-1-2001; IN COMMERCE 1-1-2001.

SN 78-049,030. POTZ, KENDRA, LEE, NEWTON, UPPER FALLS, MA. FILED 2-19-2001.

TYTL HOUSE

NO CLAIM IS MADE TO THE EXCLUSIVE RIGHT TO USE "HOUSE", APART FROM THE MARK AS SHOWN.

FOR PROVIDING ASSISTED LIVING FACILITIES AND PSYCHOLOGICAL COUNSELING FOR CHILDREN IN NEED (U.S. CLS. 100 AND 101).

SN 78-052,463. BCL VISION LIMITED, LONDON, UNITED KINGDOM, BY ASSIGNMENT SALES2CASH.COM LLC, FAIRFAX, CA. FILED 3-11-2001.

SALES2CASH

FOR PROVIDING TEMPORARY USE OF NON-DOWNLOADABLE MULTI-CURRENCY AND MULTI-LINGUAL SOFTWARE FOR CASH COLLECTIONS AND INVOICE DISPUTE MANAGEMENT (U.S. CLS. 100 AND 101).

CLASS 42—(Continued).

SN 78-052,477. LONG ISLAND WINE COUNCIL, PECONIC, NY. FILED 3-11-2001.

LONG ISLAND WINE COUNTRY

NO CLAIM IS MADE TO THE EXCLUSIVE RIGHT TO USE "WINE COUNTRY", APART FROM THE MARK AS SHOWN.

SEC. 2(F).

FOR ASSOCIATION SERVICES, NAMELY, PROMOTING THE INTERESTS OR AWARENESS OF REGIONAL WINERIES (U.S. CLS. 100 AND 101).

FIRST USE 0-0-1987; IN COMMERCE 0-0-1987.

SN 78-056,205. INTERNATIONAL MICRO SOLUTIONS, INC., SAN JUAN, PUERTO RICO. FILED 4-2-2001.



THE MARK CONSISTS OF A PROFILE OF A HUMAN BEING CONTAINED INSIDE A UNIQUELY DESIGNED GLOBE.

FOR APPLICATION SERVICE PROVIDER (ASP), NAMELY, HOSTING COMPUTER SOFTWARE APPLICATIONS OF OTHERS; CONSULTING SERVICES IN THE FIELD OF DESIGN, SELECTION, IMPLEMENTATION AND USE OF COMPUTER HARDWARE AND SOFTWARE SYSTEMS FOR OTHERS; COMPUTER CONSULTATION; COMPUTER DIAGNOSTIC SERVICES; COMPUTER DISASTER RECOVERY PLANNING; COMPUTER GRAPHICS SERVICES; COMPUTER HARDWARE DEVELOPMENT; COMPUTER NETWORK DESIGN FOR OTHERS; COMPUTER PROGRAMMING FOR OTHERS; COMPUTER PROJECT MANAGEMENT SERVICES; COMPUTER SERVICES, NAMELY, CREATING AND MAINTAINING WEB SITES FOR OTHERS; COMPUTER SERVICES, NAMELY, DATA RECOVERY SERVICES; COMPUTER SERVICES, NAMELY, DESIGNING AND IMPLEMENTING NETWORK WEB PAGES FOR OTHERS; COMPUTER SERVICES, NAMELY, DESIGNING AND IMPLEMENTING WEB SITES FOR OTHERS; COMPUTER SERVICES, NAMELY, MANAGING WEB SITES FOR OTHERS; COMPUTER SITE DESIGN; COMPUTER SOFTWARE DESIGN FOR OTHERS; COMPUTER SOFTWARE DEVELOPMENT, COMPUTER SYSTEM ANALYSIS; DATABASE DEVELOPMENT SERVICES; DESIGN OF COMPUTERS FOR OTHERS; INSTALLATION OF COMPUTER SOFTWARE; INTEGRATION OF COMPUTER SYSTEMS AND NETWORKS; LICENSING OF INTELLECTUAL PROPERTY; MAINTENANCE OF COMPUTER SOFTWARE; RECOVERY OF COMPUTER DATA; REPAIR OF COMPUTER SOFTWARE; TECHNICAL CONSULTATION AND RESEARCH IN THE FIELD OF COMPUTER ENGINEERING; TECHNICAL SUPPORT SERVICES, NAMELY, TROUBLESHOOTING OF COMPUTER HARDWARE AND SOFTWARE PROBLEMS; UPDATING COMPUTER SOFTWARE FOR OTHERS; UP-DATING OF COMPUTER SOFTWARE (U.S. CLS. 100 AND 101).

FIRST USE 9-1-2000; IN COMMERCE 9-1-2000.

CLASS 42—(Continued).

SN 78-057,478. DEPOT, INC., METAIRIE, LA. FILED 4-9-2001.

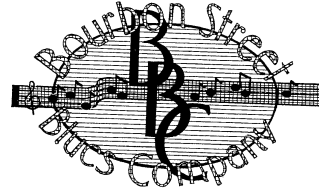

NO CLAIM IS MADE TO THE EXCLUSIVE RIGHT TO USE "BOURBON STREET" AND "BLUES COMPANY", APART FROM THE MARK AS SHOWN.

THE LINING IS FOR SHADING PURPOSES ONLY.

FOR BAR AND NIGHTCLUB SERVICES (U.S. CLS. 100 AND 101).

FIRST USE 7-1-1996; IN COMMERCE 7-1-1996.

SN 78-058,295. SANDHOO, HERSH, GERMANTOWN, MD. FILED 4-12-2001.

WEBMATION

FOR HOSTING THE WEB SITES OF OTHERS ON A COMPUTER SERVER FOR A GLOBAL COMPUTER NETWORK; COMPUTER SERVICES, NAMELY, DESIGNING NETWORK WEB PAGES FOR OTHERS; COMPUTER GRAPHICS SERVICES (U.S. CLS. 100 AND 101).

FIRST USE 4-10-2001; IN COMMERCE 5-4-2001.

SN 78-060,306. WORLD PUBLICATIONS, LLC, WINTER PARK, FL. BY CHANGE OF NAME WORLD PUBLICATIONS, INC., WINTER PARK, FL. FILED 4-25-2001.



OWNER OF U.S. REG. NO. 2,264,599.

NO CLAIM IS MADE TO THE EXCLUSIVE RIGHT TO USE "UNIVERSAL SYMBOL FOR DIVING" AND "INTERACTIVE", APART FROM THE MARK AS SHOWN.

SEC. 2(F).

FOR COMPUTER SERVICES, NAMELY PROVIDING ON-LINE MAGAZINES IN THE FIELDS OF SCUBA DIVING, SNORKELING, SWIMMING AND RECREATIONAL WATER-SPORTS (U.S. CLS. 100 AND 101).

FIRST USE 12-15-2000; IN COMMERCE 3-1-2001.

CLASS 42—(Continued).

SN 78-063,087. SOLUTIONWORX, INC., RESTON, VA. FILED 5-11-2001.

SOLUTIONWORX

FOR COMPUTER NETWORK DESIGN FOR SMALL AND MEDIUM-SIZED BUSINESSES; TECHNICAL SUPPORT SERVICES IN THE NATURE OF ESTABLISHING AND MONITORING THE COMPUTER SYSTEMS OF OTHERS FOR TECHNICAL PURPOSES; PROVIDING BACK-UP COMPUTER PROGRAMS, AND PROVIDING HELP DESK SUPPORT FOR SMALL AND MEDIUM-SIZED BUSINESSES (U.S. CLS. 100 AND 101).

FIRST USE 7-31-2000; IN COMMERCE 7-31-2000.

SN 78-063,163. COHERENZ CORPORATION, MADISON, AL. FILED 5-11-2001.

COHERENZ

FOR COMPUTER CONSULTATION IN THE FIELD OF WEB DESIGN, WEB DEVELOPMENT, SOFTWARE DEVELOPMENT, COMPUTER NETWORKS, NETWORK SECURITY; DESIGN AND DEVELOPMENT OF SOFTWARE FOR OTHERS; DESIGN, DEVELOPMENT AND CREATION OF WEBSITES AND MULTIMEDIA PRESENTATIONS FOR OTHERS; DESIGN FOR OTHERS OF BUSINESS CARDS, LETTERHEAD AND LOGOS; HOSTING THE WEB SITES OF OTHERS; AND COMPUTER SYSTEMS ANALYSIS (U.S. CLS. 100 AND 101).

FIRST USE 11-17-1998; IN COMMERCE 11-17-1998.

SN 78-070,469. SUBURBAN EMERGENCY ASSOCIATES, P.A., EDEN PRAIRIE, MN. FILED 6-22-2001.

WHEN QUALITY MAKES A DIFFERENCE

FOR EMERGENCY PHYSICIAN HEALTHCARE SERVICES (U.S. CLS. 100 AND 101).

FIRST USE 4-3-2000; IN COMMERCE 4-30-2000.

SN 78-070,541. ENFORSYS IP, INC., WHIPPANY, NJ. FILED 6-22-2001.

MUNISYS

FOR PROVIDING COMPUTER, SECURITY, AND MEDICAL INFORMATION SERVICES TO MUNICIPALITIES AND MUNICIPAL GOVERNMENT ENTITIES BY ASSISTING WITH DISPATCHING OF EMERGENCY CALLS, COORDINATING LOGISTICS TO ENSURE THE FASTEST EMERGENCY VEHICLE RESPONSE TIME, RETRIEVING RECORDS AND DATA, AND CREATING REPORTS VIA A GLOBAL COMPUTER INFORMATION NETWORK ALL TO ASSIST WITH THE PERFORMANCE AND FUNCTION OF GOVERNMENT, CORPORATIONS, AND GOVERNMENT BUREAUS (U.S. CLS. 100 AND 101).

CLASS 42—(Continued).

SN 78-070,732. NET VENTURES, INC., WEST BLOOMFIELD, MI. FILED 6-24-2001.



OWNER OF U.S. REG. NO. 2,100,532.

NO CLAIM IS MADE TO THE EXCLUSIVE RIGHT TO USE "CANCER NEWS", APART FROM THE MARK AS SHOWN.

FOR PROVIDING INFORMATION ABOUT CANCER AND PROVIDING A NATIONAL CALENDAR OF CANCER-RELATED EVENTS FOR PATIENTS AND PHYSICIANS VIA A GLOBAL COMPUTER INFORMATION NETWORK; PROVIDING AN ON-LINE CO-BRANDED NEWSLETTER FEATURING CANCER-RELATED INFORMATION; PROVIDING AN ON-LINE DATABASE FEATURING CANCER-RELATED ARTICLES; PROVIDING AN ACTIVE CONTENT SHARING WEBSITE FEATURING CANCER-RELATED INFORMATION FOR OTHER CONTENT PROVIDERS TO USE AS CONTENT ON THEIR WEBSITES (U.S. CLS. 100 AND 101).

SN 78-076,101. OPEN SKY SOFTWARE, INC., AUSTIN, TX. FILED 7-27-2001.

OPEN SKY

FOR COMPUTER SOFTWARE DEVELOPMENT SERVICES IN THE RESIDENTIAL AND COMMERCIAL CONSTRUCTION INDUSTRY, NAMELY, DESIGN FOR OTHERS OF ONLINE BUSINESS APPLICATIONS AND DATA SYSTEMS; MAINTENANCE OF COMPUTER SOFTWARE; TECHNICAL SUPPORT SERVICES FOR TROUBLESHOOTING OF COMPUTER SOFTWARE; COMPUTER SYSTEMS INTEGRATION SERVICES IN THE RESIDENTIAL AND COMMERCIAL CONSTRUCTION INDUSTRY; CONSULTING SERVICES IN THE FIELD OF DESIGN FOR OTHERS OF COMPUTER SYSTEMS AND NETWORKS IN THE RESIDENTIAL AND COMMERCIAL CONSTRUCTION INDUSTRY, TECHNICAL SUPPORT SERVICES FOR THE TROUBLESHOOTING OF COMPUTER SYSTEMS AND NETWORKS (U.S. CLS. 100 AND 101).

SN 78-077,211. OUTREACH MARKETING, INC., OCEANSIDE, CA. FILED 8-2-2001.

OUTREACH

OWNER OF U.S. REG. NO. 2,218,691.

FOR PRINTING, GRAPHIC DESIGN AND WEB DESIGN SERVICES TO CHURCHES AND MINISTRIES (U.S. CLS. 100 AND 101).

CLASS 42—(Continued).

SN 78-077,217. OUTREACH MARKETING, INC., OCEAN-SIDE, CA. FILED 8-2-2001.

OUTREACH.COM

OWNER OF U.S. REG. NO. 2,218,691.
FOR PRINTING, GRAPHIC DESIGN AND WEB DESIGN SERVICES TO CHURCHES AND MINISTRIES (U.S. CLS. 100 AND 101).

SN 78-079,663. NATIONAL MULTIPLE SCLEROSIS SOCIETY, NEW YORK, NY. FILED 8-16-2001.

GATEWAY TO WELLNESS

NO CLAIM IS MADE TO THE EXCLUSIVE RIGHT TO USE "WELLNESS", APART FROM THE MARK AS SHOWN.
FOR PROVIDING INFORMATION ABOUT MULTIPLE SCLEROSIS TO PATIENTS AND PHYSICIANS (U.S. CLS. 100 AND 101).

SN 78-079,974. DYNAZECK TECHNOLOGIES INC., DALLAS, TX. FILED 8-18-2001.



THE DESIGN PORTION OF THE MARK REPRESENTS THE LETTER "D".
FOR CONSULTING SERVICES IN THE FIELD OF DESIGN, SELECTION, IMPLEMENTATION AND USE OF COMPUTER HARDWARE AND SOFTWARE SYSTEMS FOR OTHERS (U.S. CLS. 100 AND 101).

SN 78-081,711. JAVA DRIVE INC., SAINT PAUL, MN. FILED 8-29-2001.



NO CLAIM IS MADE TO THE EXCLUSIVE RIGHT TO USE "JAVA" AND "DRIVE", APART FROM THE MARK AS SHOWN.
FOR RESTAURANT SERVICES FEATURING A DRIVE THROUGH COFFEE HOUSE (U.S. CLS. 100 AND 101).
FIRST USE 8-15-1994; IN COMMERCE 8-17-1995.

CLASS 42—(Continued).

SN 78-083,220. CHARON SOFTWARE, INC., OREM, UT. FILED 9-9-2001.

FALCON LABS

NO CLAIM IS MADE TO THE EXCLUSIVE RIGHT TO USE "LABS", APART FROM THE MARK AS SHOWN.
FOR COMPUTER PROGRAMMING FOR OTHERS; RESEARCH AND DEVELOPMENT FOR REVISION TO EXISTING PRODUCTS AND FOR NEW PRODUCTS OF OTHERS, MAINLY IN THE FIELD OF COMPUTERIZED, ELECTRONIC AND OTHER DIGITAL DEVICES (U.S. CLS. 100 AND 101).

SN 78-083,763. NXEGEN, INC., MIDDLETOWN, CT. FILED 9-13-2001.

RTIS

FOR ENERGY CONSULTATION, NAMELY, EVALUATION OF ENERGY OPPORTUNITIES, ENERGY DATA COLLECTION AND ANALYSIS, AND CONSULTATION ON THE AGGREGATION AND CONTROL OF ENERGY (U.S. CLS. 100 AND 101).

SN 78-083,955. AIR LIQUIDE AMERICA CORPORATION, HOUSTON, TX. FILED 9-14-2001.

BALAZS

SEC. 2(F).
FOR ANALYTICAL SERVICES, NAMELY, ANALYSIS OF WATER, CHEMICALS, GASES, AIR, EQUIPMENT, COMPONENTS, THIN FILMS, BARE WAFERS, WET STATIONS, METALS, IONS, PARTICLES AND ORGANICS; CONSULTING SERVICES, NAMELY, PROBLEM SOLVING IN THE FIELD OF CONTAMINATION (U.S. CLS. 100 AND 101).
FIRST USE 10-10-1992; IN COMMERCE 10-10-1992.

CLASS 42—(Continued).

SN 78-084,340. LEE, BRIAN, WEST COVINA, CA. FILED 9-18-2001.

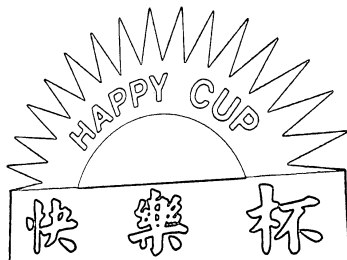

PORTION OF THE SERVICE MARK COMPRISES OF THREE CHINESE CHARACTERS IN THE MARK THAT TRANSLITERATE TO "KAUI", "LE", AND "PEI", AND EACH TRANSLATES TO "HAPPY", "PLEASURE", AND "CUP" WHICH MAY BE INTERPRETED TO GENERALLY MEAN "HAPPY CUP" IN ENGLISH.

FOR CAFE SERVICE THAT SERVES COLD AND HOT BEVERAGES (U.S. CLS. 100 AND 101).

FIRST USE 9-13-2001; IN COMMERCE 9-13-2001.

SN 78-085,002. AUDIA TECHNOLOGY, INC., CUPERTINO, CA. FILED 9-21-2001.

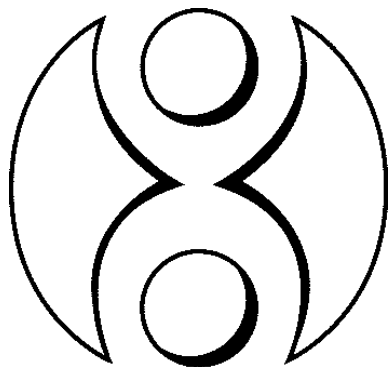

THE MARK CONSISTS OF A STYLIZED DESIGN REPRESENTING A PAIR OF EARS.

FOR HEARING AID SERVICES; HEARING EVALUATION AND EXAMINATION SERVICES; HEARING TESTING; ON-LINE HEARING TESTING; HEARING LOSS EVALUATION; AND HEARING LOSS SIMULATION, NAMELY, HEARING EVALUATION AND EXAMINATION SERVICES (U.S. CLS. 100 AND 101).

FIRST USE 9-5-2001; IN COMMERCE 9-5-2001.

SN 78-085,689. BAXTER INTERNATIONAL INC., DEERFIELD, IL. FILED 9-26-2001.

BIOLIFE PLASMA SERVICES

NO CLAIM IS MADE TO THE EXCLUSIVE RIGHT TO USE "PLASMA SERVICES", APART FROM THE MARK AS SHOWN.

FOR MEDICAL SERVICES, NAMELY, BLOOD COMPONENT COLLECTION SERVICES (U.S. CLS. 100 AND 101).

CLASS 42—(Continued).

SN 78-087,432. INTERNATIONAL ORANGE, SAN FRANCISCO, CA. FILED 10-8-2001.

INTERNATIONAL ORANGE

FOR BEAUTY SPA AND PERSONAL CARE SERVICES, NAMELY, FACIALS, FULL BODY MASSAGE, BODY WRAPS, BODY SCRUBS, PEELS, REFLEXOLOGY, HYDROTUB THERAPIES, MICRODERMABRASION, NAIL SERVICES, HAND AND FOOT TREATMENTS, HAIR CUTTING AND STYLING SERVICES, MAKE-UP CONSULTATION, AROMATHERAPY, NUTRITION COUNSELING, PARAFFIN TREATMENT, EYEBROW AND EYELASH TINTING AND BODY AND FACIAL WAXING (U.S. CLS. 100 AND 101).

SN 78-087,628. RELIGIOUS TECHNOLOGY CENTER, LOS ANGELES, CA. FILED 10-9-2001.

CLEAR CERTAINTY RUNDOWN

NO CLAIM IS MADE TO THE EXCLUSIVE RIGHT TO USE "RUNDOWN", APART FROM THE MARK AS SHOWN.

FOR COUNSELING IN THE FIELD OF RELIGION; MINISTERIAL SERVICES, NAMELY, PASTORAL COUNSELLING (U.S. CLS. 100 AND 101).

FIRST USE 0-0-1985; IN COMMERCE 0-0-1985.

SN 78-088,639. SAFEHARBOR TECHNOLOGY CORPORATION, SATSOP, WA. FILED 10-16-2001.

SAFEHARBOR KNOWLEDGE PORT

OWNER OF U.S. REG. NO. 2,374,779.

FOR TECHNICAL SUPPORT SERVICES, NAMELY, TROUBLESHOOTING OF COMPUTER HARDWARE AND SOFTWARE PROBLEMS VIA THE INTERNET AND BY TELEPHONE; COMPUTER SERVICES, NAMELY, MANAGING FOR OTHERS THE STORAGE AND RETRIEVAL OF DOCUMENTS OVER COMPUTER NETWORKS; COMPUTER SERVICES, NAMELY, PROVIDING HARDWARE AND SOFTWARE UPDATES VIA THE INTERNET (U.S. CLS. 100 AND 101).

CLASS 42—(Continued).

SN 78-092,644. CUCKOO'S INC., BAYFIELD, CO. FILED 11-9-2001.



NO CLAIM IS MADE TO THE EXCLUSIVE RIGHT TO USE "CHICKEN HOUSE & WATERIN' HOLE", APART FROM THE MARK AS SHOWN.

THE MARK CONSISTS OF THE TERMS "CUCKOO'S CHICKEN HOUSE & WATERIN' HOLE" WITH A PICTURE OF A STYLIZED BIRD HOLDING A MUG OF BEER. THE TERM "CUCKOO'S", THE MUG OF BEER, AND THE BEAK AND FEET OF THE BIRD APPEAR IN THE COLOR YELLOW.

FOR RESTAURANT SERVICES, NAMELY, RESTAURANTS SPECIALIZING IN BROASTED CHICKEN (U.S. CLS. 100 AND 101).

FIRST USE 3-1-1999; IN COMMERCE 3-1-1999.

SN 78-093,752. BEZUAYEHU, LULIT, OAKLAND, CA. FILED 11-16-2001.

LULABS

FOR USER INTERFACE TESTING AND EVALUATION OF COMPUTER HARDWARE, SOFTWARE AND WEB APPLICATION PRODUCTS ON BEHALF OF OTHERS (U.S. CLS. 100 AND 101).

SN 78-095,119. ARACHNIDS CORPORATION OF AMERICA, NOKOMIS, FL. FILED 11-26-2001.

ARACHNIDS

FOR REGISTRATION OF DOMAIN NAMES FOR IDENTIFICATION OF USERS ON A GLOBAL COMPUTER NETWORK; HOSTING OF DIGITAL CONTENT ON THE INTERNET; CONSULTING SERVICES IN THE FIELD OF DESIGN, SELECTION, IMPLEMENTATION AND USE OF COMPUTER HARDWARE AND SOFTWARE SYSTEMS FOR OTHERS; DESIGNING AND IMPLEMENTING WEB SITES FOR OTHERS; COMPUTER PROJECT MANAGEMENT SERVICES; COMPUTER PROGRAMMING FOR OTHERS; COMPUTER SOFTWARE DEVELOPMENT; APPLICATION SERVICE PROVIDER (ASP) FEATURING SOFTWARE FOR USE IN CONDUCTING ONLINE E-COMMERCE TRANSACTIONS, DATABASE MANAGEMENT, AND DESIGN OF SOFTWARE, GRAPHICS, AND APPLICATIONS; COMPUTER HARDWARE DEVELOPMENT (U.S. CLS. 100 AND 101).

FIRST USE 4-20-1997; IN COMMERCE 9-14-1998.

CLASS 42—(Continued).

SN 78-095,339. FEDERAL INFORMATION & NEWS DISPATCH, INC., WASHINGTON, DC. FILED 11-27-2001.

CONTENTWORKS

FOR DATA AUTOMATION AND COLLECTION SERVICES USING PROPRIETARY SOFTWARE TO EVALUATE, ANALYZE AND COLLECT SERVICE DATA; AND DATA CONVERSION OF COMPUTER PROGRAM DATA OR INFORMATION (U.S. CLS. 100 AND 101).

FIRST USE 4-0-2001; IN COMMERCE 4-0-2001.

SN 78-095,424. PENNY HILL SALADS AND SUBS INC., VERO BEACH, FL. FILED 11-28-2001.

PENNY HILL

THE NAME "PENNY HILL" DOES NOT IDENTIFY A LIVING INDIVIDUAL.

FOR RESTAURANTS FEATURING SUBMARINE SANDWICHES AND SALADS (U.S. CLS. 100 AND 101).

SN 78-095,440. BAKER, MELISSA C., NEW YORK, NY. FILED 11-28-2001.

PULLTAB

FOR DESIGN FOR OTHERS IN THE FIELDS OF ARCHITECTURAL AND INDUSTRIAL PRODUCTS (U.S. CLS. 100 AND 101).

SN 78-095,598. TWO WEST, INC., KANSAS CITY, MO. FILED 11-29-2001.

CODE-A-STORE

FOR PROVIDING ON-LINE COMPUTER SERVICES, NAMELY, PLANNING AND PLACEMENT OF STORE SIGNAGE AND INVENTORY PLACEMENT AND MONITORING REGULATORY COMPLIANCE WHEREBY THIS INFORMATION IS SHARED BY STORES (U.S. CLS. 100 AND 101).

SN 78-096,595. UPKAMP INVESTMENTS, INC., DBA HELPSPOT.NET, FARMVILLE, VA. FILED 12-4-2001.

HELPSPOT.NET

FOR PROVIDING SPECIFIC INFORMATION AS REQUESTED BY CUSTOMERS VIA THE INTERNET (U.S. CLS. 100 AND 101).

CLASS 42—(Continued).

SN 78-097,111. ARSZYLA, EDWARD M., BRIDGEPORT, CT. FILED 12-6-2001.

NECOM

FOR WEBSITE DESIGN FOR OTHERS; COMPUTER PROGRAMMING FOR OTHERS; STANDALONE AND NETWORKED DATABASE DESIGN SERVICES IN THE FIELDS OF PROJECT ANALYSIS AND COMPUTER BASED MULTIMEDIA SERVICES FOR MULTIMEDIA AUTHORING, MULTIMEDIA PRODUCTION, AUDIO AND VIDEO RECORDING AND EDITING, DIGITAL ENCODING FOR INTERNET AND ELECTRONIC MEDIA DISTRIBUTION OF VIDEO, AUDIO AND DIGITAL IMAGING (U.S. CLS. 100 AND 101).

SN 78-097,682. DUNCAN, ROBERT B., ORLANDO, FL. FILED 12-11-2001.

INSION

FOR COMPUTER PROGRAMMING SERVICES FOR INSURANCE COMPANIES (U.S. CLS. 100 AND 101). FIRST USE 12-1-2001; IN COMMERCE 12-1-2001.

SN 78-097,777. SOL SYSTEMS INC., AUSTIN, TX. FILED 12-11-2001.



NO CLAIM IS MADE TO THE EXCLUSIVE RIGHT TO USE "TAN", APART FROM THE MARK AS SHOWN. FOR TANNING SALONS (U.S. CLS. 100 AND 101).

SN 78-098,054. BRENNER, ROBERT W., SCOTTSDALE, AZ. FILED 12-12-2001.

BIZCOMMUTE

FOR CONSULTATION SERVICES FOR WIRELESS BUSINESS SYSTEMS, NAMELY, TELECOMMUNICATIONS CONSULTATION (U.S. CLS. 100 AND 101). FIRST USE 9-13-2001; IN COMMERCE 12-12-2001.

SN 78-098,153. NATIONAL CENTER FOR APPROPRIATE TECHNOLOGY, BUTTE, MT. FILED 12-13-2001.

ATTRA

FOR PROVIDING INFORMATION ABOUT SUSTAINABLE AGRICULTURE PRACTICES, NAMELY ORGANIC PRODUCTION OF LIVESTOCK AND CROPS, WHOLE-FARM PLANNING, RANGE POULTRY PRODUCTION, REDUCED NUTRIENT POLLUTION WATERSHEDS, AND ECOLOGICAL AND ENVIRONMENTALLY NEUTRAL FARMING PRACTICES (U.S. CLS. 100 AND 101).

CLASS 42—(Continued).

SN 78-102,283. THEODEN INC., MORRISON, CO. FILED 1-11-2002.

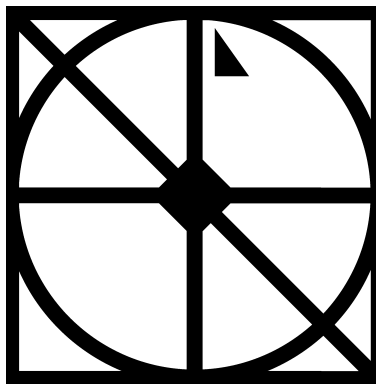

THE MARK CONSISTS OF A STYLIZED SPELLING OF "THEODEN" WITH EACH LETTER OVERLAYED ON TOP OF THE OTHER AND A SMALLER RIGHT TRIANGLE PLACED IN THE UPPER PORTION OF, AND SLIGHTLY OFF-CENTER FROM THE LETTERS.

FOR COMPUTER PROGRAMMING FOR OTHERS AND COMPUTER CONSULTING SERVICES (U.S. CLS. 100 AND 101).

FIRST USE 8-7-2001; IN COMMERCE 8-7-2001.

SN 78-103,945. GEN3TV INC., MANASSAS, VA. FILED 1-21-2002.

VIDEOSCRIBE

FOR INTEGRATION OF BROADCAST, COMPUTER AND NETWORK SYSTEMS (U.S. CLS. 100 AND 101).

SN 78-104,119. ICOM MECHANICAL, INC., SAN JOSE, CA. FILED 1-22-2002.

TECHNOLOGY'S BUILDER

NO CLAIM IS MADE TO THE EXCLUSIVE RIGHT TO USE "BUILDER", APART FROM THE MARK AS SHOWN.

FOR COMMERCIAL DESIGN OF NON-RESIDENTIAL CONSTRUCTION, INDUSTRIAL DESIGN AND ENGINEERING SERVICES FOR OTHERS (U.S. CLS. 100 AND 101).

SN 78-104,748. DIGITAL VELOCITY, LLC, CATONSVILLE, MD. FILED 1-25-2002.

DIGITALVELOCITY

FOR GRAPHIC ART DESIGN SERVICES; 3-D MODELING AND ANIMATION DESIGN FOR OTHERS; COMPUTER SERVICES, NAMELY, DESIGNING AND IMPLEMENTING WEB SITES FOR OTHERS (U.S. CLS. 100 AND 101).

FIRST USE 5-8-1998; IN COMMERCE 5-8-1998.

CLASS 42—(Continued).

SN 78-104,830. BARON SERVICES, INC., HUNTSVILLE, AL. FILED 1-25-2002.

SAF-T-NET

FOR WEATHER FORECASTING AND/OR REPORTING VIA TELEPHONE AND THE INTERNET (U.S. CLS. 100 AND 101).
FIRST USE 8-17-2001; IN COMMERCE 8-17-2001.

SN 78-106,660. GRAVES, JOEL C., OLYMPIA, WA. FILED 2-4-2002.

SUMMIT BAY

FOR COMPUTER SERVICES, NAMELY, CREATING AND MAINTAINING WEB SITES FOR OTHERS; AND COMPUTER SERVICES, NAMELY, DESIGNING AND IMPLEMENTING NETWORK WEB PAGES FOR OTHERS (U.S. CLS. 100 AND 101).

SN 78-106,800. CLINGER, PATRICK, A, LAKE FOREST, CA. FILED 2-5-2002.

PROBOARDS

FOR HOSTING THE ONLINE MESSAGE BOARDS OF OTHERS ON A COMPUTER SERVER FOR A GLOBAL COMPUTER NETWORK (U.S. CLS. 100 AND 101).
FIRST USE 1-1-2000; IN COMMERCE 1-1-2000.

SN 78-109,603. HIAWATHA ISLAND SOFTWARE COMPANY, INC., CONCORD, NH. FILED 2-19-2002.

ACCESSIBILITYWATCH

FOR REVIEWING CLIENT BUSINESS STANDARDS AND PRACTICES TO ASSURE COMPLIANCE WITH INTERNET WEBSITE SITE ACCESSIBILITY LAWS AND REGULATIONS (U.S. CLS. 100 AND 101).
FIRST USE 6-1-2001; IN COMMERCE 6-1-2001.

SN 78-111,472. TILLES, PETER, SKILLMAN, NJ. FILED 2-27-2002.

MEDAVANTE

FOR TECHNOLOGY CONSULTATION, NAMELY, PROVIDING TECHNOLOGY SOLUTIONS FOR CONDUCTING CLINICAL TRIALS AND/OR MEDICAL RESEARCH (U.S. CLS. 100 AND 101).

CLASS 42—(Continued).

SN 78-111,622. TALONPR, INC., TOPEKA, KS. FILED 2-28-2002.

FOREVER LEGACIES

FOR CUSTOM WRITING SERVICES FOR OTHERS, NAMELY, WRITING BRIEF BIOGRAPHIES OF INDIVIDUALS (U.S. CLS. 100 AND 101).

SN 78-112,319. CAMPMINDER, LLC, NEW YORK, NY. FILED 3-4-2002.

CAMP MINDER

FOR APPLICATION SERVICE PROVIDER SERVICES, NAMELY, COMPUTER APPLICATION SOFTWARE USED ON A COMPUTER SERVER THAT IS NETWORKED VIA A GLOBAL COMPUTER NETWORK AND IS RELATED TO THE CHILD CARE INDUSTRY, FEATURING- DATABASE MANAGEMENT AND BILLING; STAFF RECRUITMENT AND TIME MANAGEMENT; MARKETING MANAGEMENT; SCHEDULING MANAGEMENT; ACTIVITY MANAGEMENT; ENROLLMENT TRACKING; AND PERSONAL HISTORY MANAGEMENT OF STAFF AND CHILDREN (U.S. CLS. 100 AND 101).

SN 78-112,676. WELLOGIX, INC., GREENWOOD VILLAGE, CO. FILED 3-5-2002.

MAKING THE COMPLEX SIMPLE

FOR APPLICATION SERVICE PROVIDER SERVICES IN THE FIELDS OF COMMERCIAL AND INDUSTRIAL PROJECT MANAGEMENT FEATURING NON-DOWNLOADABLE COMPUTER SOFTWARE FOR PROJECT MANAGEMENT ON A GLOBAL COMPUTER INFORMATION NETWORK TO FACILITATE WORKFLOW FOR COMPLEX PROJECTS AND SERVICES (U.S. CLS. 100 AND 101).

SN 78-112,921. BUCKINGHAM, DOOLITTLE & BROUGHES, LLP, AKRON, OH. FILED 3-6-2002.

BDB

OWNER OF U.S. REG. NO. 2,228,888 AND OTHERS. FOR LEGAL SERVICES (U.S. CLS. 100 AND 101).
FIRST USE 1-1-1998; IN COMMERCE 1-1-1998.

CLASS 42—(Continued).

SN 78-113,191. APPLIED TRUST ENGINEERING, INC., BOULDER, CO. FILED 3-7-2002.

CLASS 42—(Continued).

SN 78-114,163. GLASGOW LAW FIRM, PLLC, RALEIGH, NC. FILED 3-12-2002.

GEOSECURITY

FOR COMPUTER PROGRAMMING FOR OTHERS AND COMPUTER CONSULTING SERVICES FOCUSED ON DIGITAL SECURITY AND INFRASTRUCTURE, REQUIRING HIGH DEGREE OF MENTAL EFFORT (U.S. CLS. 100 AND 101).

FIRST USE 9-25-2001; IN COMMERCE 9-25-2001.



SN 78-113,640. KINETICS FLUID SYSTEMS, SANTA CLARA, CA. FILED 3-8-2002.

FOR LEGAL SERVICES, NAMELY LEGAL SERVICES FOR INTELLECTUAL PROPERTY LAW, PATENTS, TRADEMARKS, AND COPYRIGHTS (U.S. CLS. 100 AND 101).

FIRST USE 10-12-2001; IN COMMERCE 10-12-2001.

CERES

FOR ENGINEERING AND DESIGN FOR OTHERS IN THE FIELD OF SEMICONDUCTOR, BIOTECHNOLOGY, AEROSPACE AND FUEL CELL INDUSTRIES OF INTEGRATED FLUID DELIVERY SYSTEMS (U.S. CLS. 100 AND 101).

CLASS 43—HOTEL AND RESTAURANT SERVICES

SN 76-308,976. STRICKSTEIN, JILL R., LOS ANGELES, CA. FILED 9-5-2001.

SN 78-113,679. CARRIER ACCESS CORPORATION, BOULDER, CO. FILED 3-8-2002.

DOGGYOGA

FOR KENNEL SERVICES (U.S. CLS. 100 AND 101).

WICK

FOR APPLICATION SERVICE PROVIDER, NAMELY, HOSTING COMPUTER PROGRAMS AND COMPUTER DATABASES ON A SERVER FOR USE BY OTHERS OVER A GLOBAL COMPUTER NETWORK FOR DESIGNING, CONFIGURING, MAINTAINING, TROUBLESHOOTING, AND OPTIMIZING THE EFFICIENCY OF TELECOMMUNICATIONS NETWORKS; CONSULTING SERVICES RELATING TO DESIGNING, CONFIGURING, MAINTAINING, TROUBLESHOOTING, AND OPTIMIZING THE EFFICIENCY OF TELECOMMUNICATIONS NETWORKS (U.S. CLS. 100 AND 101).

FIRST USE 2-22-2002; IN COMMERCE 2-22-2002.

SN 76-308,977. STRICKSTEIN, JILL R., LOS ANGELES, CA. FILED 9-5-2001.

DOGURU

FOR KENNEL SERVICES (U.S. CLS. 100 AND 101).

SN 78-113,945. SAUNDERS, STEPHEN, H., WINTHROP, WA. FILED 3-11-2002.

SN 76-338,123. JOEY'S ONLY FRANCHISING (INTERNATIONAL) LTD., PROVIDENCIALES, TURKS/CAICOS IS., FILED 11-13-2001.

SMILING COUNTRY

FOR COMPUTER SOFTWARE CONSULTATION, COMPUTER SOFTWARE DEVELOPMENT, PROVIDING TEMPORARY USE OF ON-LINE NON-DOWNLOADABLE SOFTWARE FOR DATABASE MANAGEMENT (U.S. CLS. 100 AND 101).

FIRST USE 3-18-1995; IN COMMERCE 1-15-1996.

IT'S A TASTY PLACE FOR SEAFOOD

NO CLAIM IS MADE TO THE EXCLUSIVE RIGHT TO USE "SEAFOOD", APART FROM THE MARK AS SHOWN. FOR RESTAURANT AND TAKE OUT SERVICES (U.S. CLS. 100 AND 101).

FIRST USE 7-29-2000; IN COMMERCE 7-29-2000.

CLASS 43—(Continued).

SN 76-350,234. PREPAID VACATION INTERNATIONAL INC., MIAMI, FL. FILED 12-20-2001.

KINGSTONIAN RESORTS

NO CLAIM IS MADE TO THE EXCLUSIVE RIGHT TO USE "RESORTS", APART FROM THE MARK AS SHOWN. FOR HOTEL AND RESORT ACCOMMODATIONS (U.S. CLS. 100 AND 101).

SN 76-356,687. MARCUS CORPORATION, THE, MILWAUKEE, WI. FILED 1-9-2002.

WORTH CHECKING INTO

FOR HOTEL AND MOTEL SERVICES (U.S. CLS. 100 AND 101).
FIRST USE 7-1-1999; IN COMMERCE 7-1-1999.

SN 76-358,391. PARADISE LAKES, INC., LAND O' LAKES, FL. FILED 1-14-2002.

PARADISE LAKES RESORT

NO CLAIM IS MADE TO THE EXCLUSIVE RIGHT TO USE "RESORT", APART FROM THE MARK AS SHOWN. FOR RESORT LODGING SERVICES (U.S. CLS. 100 AND 101).
FIRST USE 8-0-1981; IN COMMERCE 8-0-1981.

SN 76-362,324. COMPASS GROUP USA, CHARLOTTE, NC. FILED 1-25-2002.

BAJA FLATS

FOR RESTAURANT, CAFETERIA, AND CATERING SERVICES; AND FOOD AND DRINK PREPARATION SERVICES (U.S. CLS. 100 AND 101).

SN 76-365,056. WINGS MANAGEMENT CORPORATION, TUSCALOOSA, AL. FILED 1-28-2002.

WINGFINGERS

OWNER OF U.S. REG. NO. 1,795,414.
FOR RESTAURANT SERVICES (U.S. CLS. 100 AND 101).

CLASS 43—(Continued).

SN 76-365,680. TWIN FARMS COLLECTION, L.L.C., THE, BARNARD, VT. FILED 2-4-2002.

**THE TWIN FARMS
COLLECTION**

FOR RESORT HOTELS (U.S. CLS. 100 AND 101).

SN 76-365,681. TWIN FARMS COLLECTION, L.L.C., THE, BARNARD, VT. FILED 2-4-2002.

**THE TWIN FARMS
COLLECTION**

FOR RESORT HOTELS (U.S. CLS. 100 AND 101).

SN 76-366,364. BOB EVANS RESTAURANTS OF MICHIGAN, INC., ANN ARBOR, MI. FILED 2-5-2002.

**BOB EVANS RESTAURANT
GENERAL STORE**

OWNER OF U.S. REG. NOS. 846,356, 992,146 AND OTHERS.

NO CLAIM IS MADE TO THE EXCLUSIVE RIGHT TO USE "RESTAURANT", APART FROM THE MARK AS SHOWN.

THE "BOB EVANS" IDENTIFIES A LIVING INDIVIDUAL WHO HAS GIVEN APPLICANT CONSENT TO REGISTER THIS MARK.

FOR RESTAURANT SERVICES (U.S. CLS. 100 AND 101).

FIRST USE 1-0-1992; IN COMMERCE 1-0-1992.

SN 76-369,695. BOUTBOUL, COLETTE, LOS ANGELES, CA. FILED 2-11-2002.

COLETTE BAKERY CAFE

NO CLAIM IS MADE TO THE EXCLUSIVE RIGHT TO USE "BAKERY CAFE", APART FROM THE MARK AS SHOWN.

FOR RESTAURANT SERVICES AND RESTAURANT CARRY-OUT SERVICES (U.S. CLS. 100 AND 101).

CLASS 43—(Continued).

SN 76-369,735. KROPLE, KEVIN S., DWIGHT, IL. FILED 2-12-2002.



FOR RESTAURANT AND BAR SERVICES (U.S. CLS. 100 AND 101).
FIRST USE 11-0-1994; IN COMMERCE 11-0-1994.

SN 76-369,868. TREND LAND DEVELOPMENT, INC., SAN ANTONIO, TX. FILED 2-12-2002.

FAMILY GARDENS INN & SUITES

OWNER OF U.S. REG. NO. 1,676,272.
NO CLAIM IS MADE TO THE EXCLUSIVE RIGHT TO USE "INN & SUITES", APART FROM THE MARK AS SHOWN.
FOR MOTEL SERVICES (U.S. CLS. 100 AND 101).
FIRST USE 11-15-2001; IN COMMERCE 11-15-2001.

SN 76-370,740. HALL OF FAME DEVELOPMENT, INC., COLUMBUS, OH. FILED 2-13-2002.

MOUNTAINEER HALL OF FAME CAFE

NO CLAIM IS MADE TO THE EXCLUSIVE RIGHT TO USE "CAFE", APART FROM THE MARK AS SHOWN.
FOR RESTAURANT SERVICES (U.S. CLS. 100 AND 101).

SN 76-371,248. BOTT INC., MATAWAN, NJ. FILED 2-15-2002.

Merri-Makers

FOR CATERING SERVICES (U.S. CLS. 100 AND 101).

CLASS 43—(Continued).

SN 76-374,892. LEE KAM KEE CORPORATION, ALHAMBRA, CA. FILED 2-25-2002.

Lee Kam Kee Vietnamese Restaurant

NO CLAIM IS MADE TO THE EXCLUSIVE RIGHT TO USE "VIETNAMESE RESTAURANT", APART FROM THE MARK AS SHOWN.
FOR RESTAURANT SERVICES (U.S. CLS. 100 AND 101).
FIRST USE 9-1-2001; IN COMMERCE 9-1-2001.

SN 76-375,971. QDOBA RESTAURANT CORPORATION, WHEAT RIDGE, CO. FILED 2-27-2002.

NOT JUST BIG BURRITOS. BIG FLAVOR.

FOR RESTAURANT SERVICES (U.S. CLS. 100 AND 101).
FIRST USE 1-1-2002; IN COMMERCE 1-1-2002.

SN 76-376,406. SEKISUI, INC., MEMPHIS, TN. FILED 2-27-2002.

SEKISUI

"SEKISUI" IS A JAPANESE WORD MEANING "STONE AND WATER".
FOR RESTAURANT SERVICES (U.S. CLS. 100 AND 101).
FIRST USE 8-19-1989; IN COMMERCE 8-19-1989.

SN 76-377,566. GLASNER, LAWRENCE M., THOUSAND OAKS, CA. FILED 3-4-2002.

JOHNNY PACIFIC

THE NAME JOHNNY PACIFIC DOES NOT IDENTIFY A PARTICULAR LIVING INDIVIDUAL.
FOR CATERING (U.S. CLS. 100 AND 101).

SN 76-377,866. RASPUTIN SUPPER CLUB, INC., ELIZABETH, NJ. FILED 3-4-2002.

RASPUTIN

FOR RESTAURANT (U.S. CLS. 100 AND 101).
FIRST USE 2-14-1997; IN COMMERCE 2-14-1997.

CLASS 43—(Continued).

SN 76-378,865. ALANTE 2, LLC, LOS ANGELES, CA. FILED 3-7-2002.

PALADAR

FOR RESTAURANT SERVICES (U.S. CLS. 100 AND 101).

SN 76-379,124. FALZARANO, GAETANO T., EDISON, NJ. FILED 3-6-2002.

RAINBOW ACADEMY

NO CLAIM IS MADE TO THE EXCLUSIVE RIGHT TO USE "ACADEMY", APART FROM THE MARK AS SHOWN. FOR CHILD CARE CENTERS (U.S. CLS. 100 AND 101). FIRST USE 9-1-1997; IN COMMERCE 9-1-1997.

SN 76-379,841. BRUNO CATALDO, INC., SOUTH BEND, IN. FILED 3-7-2002.

BRUNO'S ARDORÉ PIZZA

NO CLAIM IS MADE TO THE EXCLUSIVE RIGHT TO USE "PIZZA", APART FROM THE MARK AS SHOWN. THE ENGLISH TRANSLATION OF "ARDORE" IS "ARDOR".

FOR RESTAURANT SERVICES (U.S. CLS. 100 AND 101). FIRST USE 1-1-2001; IN COMMERCE 1-1-2001.

SN 76-381,927. AL'S PIZZA, INC., ATLANTIC BEACH, FL. FILED 3-15-2002.

AL'S PIZZA

NO CLAIM IS MADE TO THE EXCLUSIVE RIGHT TO USE "PIZZA", APART FROM THE MARK AS SHOWN.

FOR RESTAURANT SERVICES (U.S. CLS. 100 AND 101). FIRST USE 3-0-1988; IN COMMERCE 3-0-1988.

SN 76-399,614. BCGC FAMILY LIMITED PARTNERSHIP, CHICAGO, IL. FILED 10-9-2001.

FOGETABOUTIT

FOR RESTAURANT SERVICES (U.S. CLS. 100 AND 101).

CLASS 43—(Continued).

SN 78-074,886. SBC COMMUNICATIONS INC., SAN ANTONIO, TX. FILED 7-20-2001.

SBC CENTER

NO CLAIM IS MADE TO THE EXCLUSIVE RIGHT TO USE "CENTER", APART FROM THE MARK AS SHOWN. FOR ENTERTAINMENT SERVICES NAMELY, PROVIDING GENERAL PURPOSE FACILITIES FOR SPORTS, ENTERTAINMENT, TRADESHOWS, EXHIBITIONS AND CONVENTIONS (U.S. CLS. 100 AND 101).

SN 78-106,846. DOLL, LAWRENCE K., MANASSAS PARK, VA. FILED 2-5-2002.

FAT PUNKS'

FOR RESTAURANT FOOD SERVICES, NAMELY, DINE-IN, CARRY-OUT, AND HOME DELIVERY (U.S. CLS. 100 AND 101).

SN 78-109,997. HILTON HOSPITALITY, INC., BEVERLY HILLS, CA. FILED 2-20-2002.

**WINTER FAMILY SUITE
RETREAT**

OWNER OF U.S. REG. NO. 1,874,324. NO CLAIM IS MADE TO THE EXCLUSIVE RIGHT TO USE "WINTER FAMILY SUITE", APART FROM THE MARK AS SHOWN. FOR HOTELS (U.S. CLS. 100 AND 101). FIRST USE 1-31-2001; IN COMMERCE 1-31-2001.

SN 78-110,015. HILTON HOSPITALITY, INC., BEVERLY HILLS, CA. FILED 2-20-2002.

HAWAIIAN VILLAGE

OWNER OF U.S. REG. NO. 1,561,531. FOR HOTELS (U.S. CLS. 100 AND 101). FIRST USE 2-0-1961; IN COMMERCE 2-0-1961.

CLASS 44—MEDICAL, BEAUTY AND AGRICULTURAL SERVICES

SN 76-325,266. SOUTH BAY HEAD & NECK MEDICAL GROUP, INC., CHULA VISTA, CA. FILED 10-12-2001.

**WEEKEND RECOVERY
MICROLIPO**

NO CLAIM IS MADE TO THE EXCLUSIVE RIGHT TO USE "MICROLIPO", APART FROM THE MARK AS SHOWN.

FOR COSMETIC SURGERY (U.S. CLS. 100 AND 101).
FIRST USE 7-1-1999; IN COMMERCE 7-1-1999.

SN 76-350,420. PROGRESSIVE HEALTHCARE PROVIDERS, INC, BROOKS, GA. FILED 12-14-2001.

**PROGRESSIVE
HEALTHCARE PROVIDERS**

NO CLAIM IS MADE TO THE EXCLUSIVE RIGHT TO USE "HEALTHCARE PROVIDERS", APART FROM THE MARK AS SHOWN.

FOR PROVIDING NURSING HOMES, LONG TERM HEALTH CARE FACILITIES, HOSPITALS, INTERMEDIATE TERM HEALTH CARE FACILITIES, GROUP HOME HEALTH CARE SERVICES, PERSONAL HOME HEALTH CARE SERVICES, PHYSICAL HABILITATION SERVICES, MENTAL HEALTH CARE AND HABILITATION FACILITIES; PROVIDING SERVICES FOR THE MENTALLY DISABLED, NAMELY, NURSING HOMES, LONG TERM HEALTH CARE FACILITIES, HOSPITALS, INTERMEDIATE TERM HEALTH CARE FACILITIES, GROUP HOME HEALTH CARE SERVICES, PERSONAL HOME HEALTH CARE SERVICES, PHYSICAL HABILITATION SERVICES, MENTAL HEALTH CARE AND HABILITATION FACILITIES (U.S. CLS. 100 AND 101).
FIRST USE 11-15-1990; IN COMMERCE 11-15-1990.

SN 76-355,977. ROBERT A. DE STEFANO, M.D., CALABASAS, CA. FILED 1-7-2002.

MULTILIFT

FOR DERMATOLOGY SERVICES; PROVIDING MEDICAL TREATMENTS USING NON INVASIVE LIGHT PULSES TO DESTROY OR CORRECT SKIN BLEMISHES, SUN DAMAGE, AGING CHANGES, SUPERFICIAL VESSELS, VASCULAR ABNORMALITIES, PIGMENTATIONS AND UNWANTED HAIR; AND PROVIDING MEDICAL AND HEALTH INFORMATION AND CONSULTATION IN THE FIELDS OF DERMATOLOGY, SKIN TREATMENTS AND SKIN CARE (U.S. CLS. 100 AND 101).

CLASS 44—(Continued).

SN 76-357,427. HUMANA, INC., LOUISVILLE, KY. FILED 1-14-2002.

HUMANA GOLD CLASSIC

OWNER OF U.S. REG. NOS. 2,180,786, 2,180,789 AND 2,186,854.

FOR HEALTH CARE SERVICE; HEALTH CARE SERVICES IN THE NATURE OF HEALTH MAINTENANCE AND PREFERRED PROVIDER ORGANIZATION, PRESCRIPTION DRUG PROGRAMS, AND HEALTH MANAGEMENT ORGANIZATIONS (U.S. CLS. 100 AND 101).
FIRST USE 11-0-1999; IN COMMERCE 11-0-1999.

SN 76-363,179. SOUTHERN COLORADO WELLNESS CENTER MANAGEMENT, L.L.C., TRINIDAD, CO. FILED 1-28-2002.



**Southern Colorado
Wellness Center**

NO CLAIM IS MADE TO THE EXCLUSIVE RIGHT TO USE "SOUTHERN COLORADO WELLNESS CENTER", APART FROM THE MARK AS SHOWN.

FOR HEALTH CARE SERVICES (U.S. CLS. 100 AND 101).
FIRST USE 1-2-2002; IN COMMERCE 1-2-2002.

SN 76-365,688. DATAPHARM FOUNDATION, COLUMBIA, MD. FILED 1-28-2002.

DAILY MED

NO CLAIM IS MADE TO THE EXCLUSIVE RIGHT TO USE "MED", APART FROM THE MARK AS SHOWN.

FOR PROVIDING AN ONLINE COMPUTER DATABASE IN THE FIELD OF PHARMACEUTICALS, DIETARY SUPPLEMENTS, MEDICINES, AND OVER-THE-COUNTER DRUGS (U.S. CLS. 100 AND 101).

SN 76-371,378. JAMACA ME TAN, INC., BOISE, ID. FILED 2-16-2002.

JAMACA ME TAN

FOR TANNING SALONS (U.S. CLS. 100 AND 101).
FIRST USE 8-13-1996; IN COMMERCE 8-13-1996.

CLASS 44—(Continued).

SN 76-372,177. JOHNSON & JOHNSON, NEW BRUNSWICK, NJ. FILED 2-20-2002.

BE HEARD. LIVE WELL.

FOR COMPUTER SERVICES, NAMELY, PROVIDING INFORMATION ON WOMEN'S HEALTH TOPICS (U.S. CLS. 100 AND 101).
FIRST USE 2-12-2002; IN COMMERCE 2-12-2002.

CLASS 44—(Continued).

SN 76-379,077. GREAT SMOKIES DIAGNOSTIC LABORATORY, INC., ASHEVILLE, NC. FILED 3-5-2002.

OSTEOGENOMIC

FOR MEDICAL DIAGNOSTIC TESTING SERVICES (U.S. CLS. 100 AND 101).

SN 76-376,681. A+ LAWN & LANDSCAPE, ANKENY, IA. FILED 3-1-2002.

A + LAWN & LANDSCAPE

NO CLAIM IS MADE TO THE EXCLUSIVE RIGHT TO USE "LAWN & LANDSCAPE", APART FROM THE MARK AS SHOWN.
FOR LAWN CARE AND LANDSCAPING SERVICES (U.S. CLS. 100 AND 101).
FIRST USE 11-1-2001; IN COMMERCE 11-1-2001.

SN 76-381,455. MAGNIFIQUE COSMETIC SURGERY, INC., DBA MAGNIFIQUE COSMETIC SURGERY, BRENTWOOD, TN. FILED 3-12-2002.

MAGNIFIQUE COSMETIC SURGERY

NO CLAIM IS MADE TO THE EXCLUSIVE RIGHT TO USE "COSMETIC SURGERY", APART FROM THE MARK AS SHOWN.
FOR COSMETIC SURGERY SERVICES (U.S. CLS. 100 AND 101).

SN 76-378,714. KORNFELD, HOWARD G., MILL VALLEY, CA. FILED 3-6-2002.

COMPASSIONATE PHARMACOLOGY

NO CLAIM IS MADE TO THE EXCLUSIVE RIGHT TO USE "PHARMACOLOGY", APART FROM THE MARK AS SHOWN.
FOR PROVIDING MEDICAL SERVICES IN THE FIELD OF PHARMACOLOGY SPECIALIZING IN TREATING PATIENTS WHO SUFFER FROM CHRONIC PAIN, MOOD DISORDERS, OR ADDICTIONS, IN WHICH A PATIENT'S NEED FOR MEDICATION IS DETERMINED ACCORDING TO THE INDIVIDUAL'S SYMPTOMS, RATHER THAN BY ORTHODOX, OFTEN OUTDATED, PROTOCOLS (U.S. CLS. 100 AND 101).

SN 76-382,466. MONKEY DOOZ, LLC, YAKIMA, WA. FILED 3-14-2002.

MONKEY DOOZ

FOR BEAUTY AND HYGIENIC SERVICES FOR CHILDREN, NAMELY BEAUTY SALONS (U.S. CLS. 100 AND 101).
FIRST USE 7-0-2001; IN COMMERCE 7-0-2001.

SN 76-378,979. GREAT SMOKIES DIAGNOSTIC LABORATORY, INC., ASHEVILLE, NC. FILED 3-5-2002.

CARDIOGENOMIC

FOR MEDICAL DIAGNOSTIC TESTING SERVICES (U.S. CLS. 100 AND 101).

SN 76-383,537. TOMY STARCK, M.D., P.A, SAN ANTONIO, TX. FILED 3-13-2002.

ULTRAVISION

FOR LASER EYE SURGERY SERVICES (U.S. CLS. 100 AND 101).

SN 76-379,075. GREAT SMOKIES DIAGNOSTIC LABORATORY, INC., ASHEVILLE, NC. FILED 3-5-2002.

DETOXIGENOMIC

FOR MEDICAL DIAGNOSTIC TESTING SERVICES (U.S. CLS. 100 AND 101).

SN 76-388,375. STORANDT PANN MARGOLIS & PARTNERS, LAGRANGE, IL. FILED 3-27-2002.

ADVANCING THE POWERS OF MEDICINE

FOR HOSPITAL AND HEALTHCARE SERVICES (U.S. CLS. 100 AND 101).

CLASS 44—(Continued).

SN 78-092,295. SOMERVILLE, DARIA L., DIX HILLS, NY. FILED 11-8-2001.

**S M I L E: STIMULATING
MASSAGE IMPROVES LIFE
EVERYDAY**

FOR MASSAGE THERAPY (U.S. CLS. 100 AND 101).

SN 78-096,573. ALABAMA BAPTIST CHILDREN'S HOMES & FAMILY MINISTRIES, DBA PATHWAYS PROFESSIONAL COUNSELING, BIRMINGHAM, AL. FILED 12-4-2001.



FOR COUNSELING IN THE FIELD OF MENTAL HEALTH (U.S. CLS. 100 AND 101).

SN 78-102,918. TAILS OF JOY, INC., COVENTRY, CT. FILED 1-15-2002.



Tails of Joy

FOR ANIMAL ASSISTED THERAPY SERVICES (U.S. CLS. 100 AND 101).
FIRST USE 1-1-1995; IN COMMERCE 1-1-1995.

SN 78-108,063. AMERICAN ACADEMY OF NEUROLOGY, THE, ST. PAUL, MN. FILED 2-11-2002.

THE BRAIN MATTERS

FOR PROVIDING INFORMATION IN THE FIELD OF NEUROLOGY VIA THE INTERNET (U.S. CLS. 100 AND 101).
FIRST USE 5-0-1996; IN COMMERCE 5-0-1996.

SN 78-113,828. RULON LLC, JERSEY CITY, NJ. FILED 3-10-2002.

AKASA

FOR MEDICAL SERVICES (U.S. CLS. 100 AND 101).

CLASS 44—(Continued).

SN 78-114,271. TREVISANI, THOMAS P., WINTER PARK, FL. FILED 3-12-2002.

CELEBRITYCOSMETICSURGERY.COM

FOR MEDICAL SERVICES IN THE FIELD OF COSMETIC SURGERY (U.S. CLS. 100 AND 101).

CLASS 45—PERSONAL SERVICES

SN 76-363,427. DEBACKER, CAROL, TOPEKA, KS. FILED 1-29-2002.

ASIA THREADS

NO CLAIM IS MADE TO THE EXCLUSIVE RIGHT TO USE "ASIA", APART FROM THE MARK AS SHOWN, FOR ADOPTION INFORMATION SERVICES, NAMELY, PROVIDING ADOPTIVE PARENTS WITH PHOTOGRAPHS AND MAPS OF THE BIRTH CITIES/ ABANDONMENT SITES OF THEIR CHILDREN BORN IN AND ADOPTED FROM ASIA (U.S. CLS. 100 AND 101).

FIRST USE 1-15-2002; IN COMMERCE 1-15-2002.

SN 76-363,778. TRANSNATIONAL SECURITY GROUP, LLC, NUTLEY, NJ. FILED 1-28-2002.



NO CLAIM IS MADE TO THE EXCLUSIVE RIGHT TO USE "TRANSNATIONAL SECURITY GROUP LLC", APART FROM THE MARK AS SHOWN.

FOR PROVIDING PRIVATE INVESTIGATION AND CIVIL PROTECTION SERVICES THROUGH A NETWORK OF REGIONAL AFFILIATED INDEPENDENT PROVIDERS; SERVICES, NAMELY, PROVIDING SECURITY GUARD AND OFFICER SERVICES, MONITORING OF SECURITY SYSTEMS AND SECURITY AND BURGLAR ALARMS, BODYGUARD SERVICES; SECURITY RISK ASSESSMENT CONSULTATION SERVICES (U.S. CLS. 100 AND 101).

FIRST USE 0-0-1998; IN COMMERCE 0-0-1998.

CLASS 45—(Continued).

SN 76-386,170. TACOMA CHRISTIAN CENTER, TACOMA, WA. FILED 3-22-2002.

CLASS 45—(Continued).

SN 78-104,821. PHYSICIANS' ORGANIZATION OF WESTERN MICHIGAN, INC., GRAND RAPIDS, MI. FILED 1-25-2002.

VERY IMPORTANT PATIENT

ALWAYS PUT JESUS FIRST

NO CLAIM IS MADE TO THE EXCLUSIVE RIGHT TO USE "JESUS", APART FROM THE MARK AS SHOWN. FOR EVANGELISTIC AND MINISTERIAL SERVICES (U.S. CLS. 100 AND 101).

NO CLAIM IS MADE TO THE EXCLUSIVE RIGHT TO USE "PATIENT", APART FROM THE MARK AS SHOWN. FOR CONCIERGE SERVICES FOR OTHERS IN THE NATURE OF PROVIDING GUARANTEED PREFERRED PRIORITY STATUS TO PARTICIPATING MEMBER MEDICAL PATIENTS BY PARTICIPATING PHYSICIANS' OFFICES IN MAKING MEDICAL APPOINTMENTS, PROVIDING EXPANDED PATIENT TELEPHONE ACCESS TO PHYSICIANS, PROVIDING GUARANTEED SAME DAY MEDICAL OFFICE VISIT APPOINTMENTS AND GUARANTEEING THE PRESENCE OF THE PATIENT'S PRIMARY CARE PHYSICIAN DURING MEDICAL EXAMINATION OF PATIENTS BY A REFERRED MEDICAL SPECIALIST (U.S. CLS. 100 AND 101).

* * * * *

SECTION 4.—PRIOR UNITED STATES CLASSIFICATION

APPLICATION IN ONE CLASS

COLLECTIVE MEMBERSHIP MARKS

CLASS 200—COLLECTIVE MEMBERSHIP
SN 76-197,478. CITY CHURCH, THE, KIRKLAND, WA.
FILED 1-16-2001.



The City Church

NO CLAIM IS MADE TO THE EXCLUSIVE RIGHT TO USE "CITY CHURCH", APART FROM THE MARK AS SHOWN.

FOR INDICATING MEMBERSHIP IN A CHURCH.
FIRST USE 8-1-1992; IN COMMERCE 8-1-1992.

SN 76-207,145. INTERNATIONAL GROOVING & GRINDING ASSOCIATION, COXSACKIE, NY. FILED 2-8-2001.

INTERNATIONAL
GROOVING & GRINDING
ASSOCIATION

OWNER OF U.S. REG. NO. 1,204,130.
SEC. 2(F).

FOR INDICATING MEMBERSHIP IN AN ASSOCIATION OF PERSONS INTERESTED IN THE GROOVING AND GRINDING OF CONCRETE, ASPHALT AND OTHER TYPES OF PAVEMENT AND SURFACES.
FIRST USE 10-15-1972; IN COMMERCE 10-15-1972.

CERTIFICATION MARKS

CLASS A—GOODS

SN 76-261,657. CONCURRENT TECHNOLOGIES CORPORATION, JOHNSTOWN, PA. FILED 5-23-2001.

ADL

THE CERTIFICATION MARK, INTENDED TO BE USED BY AUTHORIZED PERSONS, CERTIFIES THAT A THIRD

TM 932

PARTY'S INTERNET-BASED COURSEWARE MANAGEMENT SOFTWARE HAS THE FOLLOWING - (1) THE ABILITY TO LAUNCH EXECUTABLE CONTENT AUTHORED USING TOOLS FROM DIFFERENT VENDORS AND TO EXCHANGE DATA WITH THAT CONTENT, (2) THE ABILITY TO LAUNCH THE SAME EXECUTABLE CONTENT AND EXCHANGE DATA WITH THAT CONTENT DURING EXECUTION, AND (3) THE ABILITY TO ACCESS A COMMON REPOSITORY OF EXECUTABLE CONTENT AND TO LAUNCH SUCH CONTENT.

FOR COMPUTER SOFTWARE, NAMELY, INTERNET-BASED EDUCATIONAL COURSEWARE MANAGEMENT SOFTWARE USED IN THE FIELD OF DISTANCE LEARNING.

SN 76-301,305. AMERICAN SHEEP INDUSTRY ASSOCIATION, INC., ENGLEWOOD, CO. FILED 8-17-2001.



OWNER OF U.S. REG. NOS. 1,667,965, 2,206,433 AND OTHERS.

NO CLAIM IS MADE TO THE EXCLUSIVE RIGHT TO USE "FRESH" AND "LAMB", APART FROM THE MARK AS SHOWN.

THE CERTIFICATION MARK, AS USED BY PERSONS AUTHORIZED BY THE CERTIFIER, WILL CERTIFY THAT THE PACKAGED PRODUCT BEARING THE CERTIFICATION MARK CONTAINS FRESH OR CHILLED LAMB THAT HAS BEEN BORN, GROWN, SLAUGHTERED AND PROCESSED WITHIN THE CONTINENTAL UNITED STATES AND THAT A HOT OR CHILLED LAMB CARCASS, AS CERTIFIED AT THE POINT OF SLAUGHTER, MEETS THE OFFICIAL UNITED STATES DEPARTMENT OF AGRICULTURE STANDARDS FOR QUALITY AND MATURITY.

FOR PACKAGED FRESH OR CHILLED LAMB CARCASSES AND PROCESSED FRESH OR CHILLED LAMB CARCASS PRODUCTS, WHICH LAMB HAS BEEN BORN, GROWN, SLAUGHTERED AND PROCESSED WITHIN THE CONTINENTAL UNITED STATES.

SN 76-330,937. GEOSHARE USERS GROUP, INC., HOUSTON, TX. FILED 10-29-2001.

GEOSHARE

THE CERTIFICATION MARK, AS USED BY AUTHORIZED PERSONS, CERTIFIES: SAID SOFTWARE OR DATA CONFORMS TO THE RP66 STANDARD FOR SYNTAX AND USES THE GEOSHARE DATA MODEL FOR SEMANTICS. FOR COMPUTER SOFTWARE AND DATA PROGRAMS WHICH CONFORM TO THE RP66 STANDARD FOR SYNTAX.

FIRST USE 11-30-1995; IN COMMERCE 11-30-1995.

SEC. 2(F).
FOR FINANCIAL ANALYSIS SERVICES.
FIRST USE 5-1-1999; IN COMMERCE 5-1-1999.

SN 76-336,069. HARVEST TECHNOLOGIES CORPORATION, PLYMOUTH, MA. FILED 11-9-2001.

SMARTCLOT

THE CERTIFICATION MARK INTENDED TO BE USED BY AUTHORIZED PERSONS IS INTENDED TO CERTIFY THAT THE PRODUCT IS MADE ACCORDING TO THE STANDARDS AND PROCEDURES SET BY APPLICANT.

FOR PLATELET RICH PLASMA AND THROMBIN FORMULA FOR PHYSIOLOGICAL USE.



SN 76-053,794. SEVENTH SUCCESS, INC., PHOENIX, AZ. FILED 5-19-2000.

SN 76-361,643. TIMBERCO, INC., DBA TECO, MADISON, WI. FILED 1-22-2002.

SHEATHING SPAN

OWNER OF U.S. REG. NOS. 701,546 AND 1,922,749. NO CLAIM IS MADE TO THE EXCLUSIVE RIGHT TO USE "SHEATHING", APART FROM THE MARK AS SHOWN.

THE CERTIFICATION MARK, AS USED BY AUTHORIZED PERSONS, CERTIFIES THAT THE GOODS HAVE BEEN PRODUCED UNDER AND HAVE BEEN TESTED IN ACCORDANCE WITH STANDARDS ADAPTED BY APPLICANT. THE CERTIFICATION MARK IS USED BY APPLYING IT DIRECTLY ON THE GOODS BY MEANS OF A RUBBER STAMP.

FOR ORIENTED STRAND BOARD, ALSO KNOWN AS "OSB" SHEATHING PANELS.

FIRST USE 10-11-1984; IN COMMERCE 10-11-1984.

THE STIPPLING IS A FEATURE OF THE MARK. THE CERTIFICATION MARK, AS USED BY CERTIFIER, IS INTENDED TO CERTIFY THAT AUTHORIZED MEMBER OPHTHALMOLOGIST, PHYSICIANS, AND DOCTORS MEET THE CERTIFIER'S STANDARDS AS TO EDUCATION, STATE MEDICAL LICENSING, HOSPITAL APPOINTMENTS, PROFESSIONAL COMPETENCE, AND RETENTION OF ACTIVE STATUS CERTIFYING ORGANIZATION.

FOR CERTIFICATION, AS USED BY AUTHORIZED PERSONS, IS TO CERTIFY THE QUALIFICATIONS AND TRAINING OF PHYSICIANS WHO PRACTICE AND PROVIDE OPHTHALMOLOGIC SERVICES, REFRACTIVE SURGERY PROCEDURES, LASER EYE SURGERY PROCEDURES, VISION CORRECTION PROCEDURES, AND EYE HEALTH CARE SERVICES.

FIRST USE 4-14-2000; IN COMMERCE 4-14-2000.

SN 76-208,401. CANADIAN STANDARDS ASSOCIATION, ONTARIO M9W 1R3, CANADA, FILED 2-12-2001.

CLASS B—SERVICES

SN 75-788,557. ASSOCIATION FOR INVESTMENT MANAGEMENT AND RESEARCH, CHARLOTTESVILLE, VA. FILED 8-30-1999.



OWNER OF U.S. REG. NO. 935,504. THE CERTIFICATION MARK IS USED ON PROMOTIONAL MATERIALS DIRECTED AT POTENTIAL EMPLOYERS AND OTHER PROMOTIONAL MATERIALS.

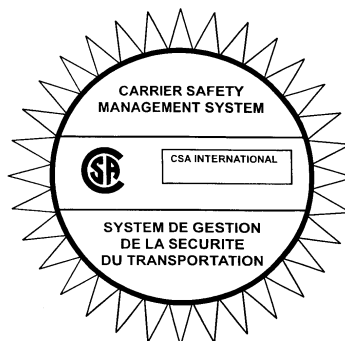

OWNER OF U.S. REG. NOS. 967,896, 2,470,248 AND OTHERS.

NO CLAIM IS MADE TO THE EXCLUSIVE RIGHT TO USE "CARRIER SAFETY MANAGEMENT SYSTEM", "INTERNATIONAL", AND "SYSTEM DE GESTION DE LA SECURITE DU TRANSPORTATION", APART FROM THE MARK AS SHOWN.

THE ENGLISH TRANSLATION OF THE FRENCH PHRASE "SYSTEM DE GESTION DE LA SECURITE DU TRANSPORTATION" IS "CARRIER SAFETY MANAGEMENT SYSTEM".

THE CERTIFICATION, AS INTENDED TO BE USED, CERTIFIES CARRIER SAFETY MANAGEMENT REQUIREMENTS THAT A CARRIER ADOPTS IN ORDER TO ACHIEVE AND DEMONSTRATE A COMMITMENT TO SAFETY THAT EXCEEDS THE MINIMUM LEGAL REQUIREMENTS. NO ONE OTHER THAN THOSE AUTHORIZED BY THE APPLICANT HAS A RIGHT TO USE THE MARK.

FOR CONFORMITY-ASSESSMENT SERVICES TO INDICATE COMPLIANCE WITH SAFETY MANAGEMENT SYSTEM STANDARDS FOR CARRIERS, NAMELY, ORGANIZATIONS ENGAGED IN THE TRANSPORTATION OF GOODS AND/OR PEOPLE, BY MEANS OF ROADWAY VEHICLES, RAILWAYS, OR WATER CRAFT, EITHER LOCALLY OR INTERNATIONALLY.

SN 76-349,505. AMERICAN INSTITUTE OF CERTIFIED PUBLIC ACCOUNTANTS, NEW YORK, NY. FILED 12-17-2001.



ACCREDITED IN BUSINESS VALUATION

OWNER OF U.S. REG. NO. 2,563,922.

NO CLAIM IS MADE TO THE EXCLUSIVE RIGHT TO USE "CPA" AND "ACCREDITED IN BUSINESS VALUATION", APART FROM THE MARK AS SHOWN.

THE CERTIFICATION MARK, AS USED BY PERSONS AUTHORIZED BY THE CERTIFIER, CERTIFIES THAT SUCH PERSONS HAVE SATISFIED THE RIGID STANDARDS OF TRAINING, CONTINUING EDUCATION AND EXPERIENCE IN THE FIELD OF ENTERPRISE APPRAISING, AS ESTABLISHED BY THE CERTIFIER.

SEC. 2(F) AS TO "ABV".

FOR BUSINESS ENTERPRISE APPRAISING SERVICES.

* * * * *

TRADEMARK REGISTRATIONS ISSUED

PRINCIPAL REGISTER

SECTION 1.— INTERNATIONAL CLASSIFICATION

The short titles associated below with the international class numbers are terms designed merely for quick identification and are not an official part of the international classification. The full names of international classes are given in section 6.1 of the trademark rules of practice.

The designation "U.S. Cl." appearing in this section refers to the U.S. class in effect prior to Sep. 1, 1973 rather than the international class which applies to applications filed on or after that date. For adoption of international classification see notice in the OFFICIAL GAZETTE of Jun. 26, 1973 (911 O.G. TM 210).

CLASS 1—CHEMICALS

- 2,622,509. **DYNAGRA**. BEISEKER AGRI SERVICES LTD., BY CHANGE OF NAME FROM; BY ASSIGNMENT; BY ASSIGNMENT; BY CHANGE OF NAME SHERRITT INC., MULTIPLE CLASS, (INT. CLS. 1, 5 AND 7), (U.S. CLS. 1, 5, 6, 10, 13, 18, 19, 21, 23, 26, 31, 34, 35, 44, 46, 51 AND 52). SN 75-039,336. PUB. 4-17-2001. FILED 1-2-1996.
- 2,622,533. **METXIA**. OXFORD BIOMEDICA PLC, MULTIPLE CLASS, (INT. CLS. 1, 5 AND 10), (U.S. CLS. 1, 5, 6, 10, 18, 26, 39, 44, 46, 51 AND 52). SN 75-381,002. PUB. 7-2-2002. FILED 10-28-1997.
- 2,622,560. **NAPISAN**. RECKITT BENCKISER N.V., BY MERGER, BY CHANGE OF NAME BENCKISER N.V., MULTIPLE CLASS, (INT. CLS. 1, 3 AND 5), (U.S. CLS. 1, 4, 5, 6, 10, 18, 26, 44, 46, 50, 51 AND 52). SN 75-502,197. PUB. 4-2-2002. FILED 6-15-1998.
- 2,622,566. **SUPERFINE**. ALCAN ALUMINIUM UK LIMITED, (U.S. CLS. 1, 5, 6, 10, 26 AND 46). SN 75-521,536. PUB. 7-2-2002. FILED 7-20-1998.
- 2,622,574. **HYDROXYAMBRAN**. FRA FRAGRANCE RESOURCES AGENCY, S.A., (U.S. CLS. 1, 5, 6, 10, 26 AND 46). SN 75-544,209. PUB. 11-30-1999. FILED 8-27-1998.
- 2,622,660. **APOTECH**. APOTECH S.A., MULTIPLE CLASS, (INT. CLS. 1, 5 AND 42), (U.S. CLS. 1, 5, 6, 10, 18, 26, 44, 46, 51, 52, 100 AND 101). SN 75-709,579. PUB. 10-10-2000. FILED 5-19-1999.
- 2,622,680. **JUVANTIA**. OY JUVANTIA PHARMA LTD., MULTIPLE CLASS, (INT. CLS. 1, 5 AND 42), (U.S. CLS. 1, 5, 6, 10, 18, 26, 44, 46, 51, 52, 100 AND 101). SN 75-740,609. PUB. 7-2-2002. FILED 6-30-1999.
- 2,622,699. **QUAD+ AND DESIGN**. STAPLETON TECHNOLOGIES INC., MULTIPLE CLASS, (INT. CLS. 1 AND 40), (U.S. CLS. 1, 5, 6, 10, 26, 46, 100, 103 AND 106). SN 75-770,485. PUB. 11-27-2001. FILED 9-2-1999.
- 2,622,731. **BLACK MAGIC**. CALLAWAY, RICHARD E., MULTIPLE CLASS, (INT. CLS. 1 AND 19), (U.S. CLS. 1, 5, 6, 10, 12, 26, 33, 46 AND 50). SN 75-818,658. PUB. 1-23-2001. FILED 10-8-1999.
- 2,622,804. **PERESTANE**. SOLVAY (SOCIETE ANONYME), MULTIPLE CLASS, (INT. CLS. 1 AND 5), (U.S. CLS. 1, 5, 6, 10, 18, 26, 44, 46, 51 AND 52). SN 75-886,711. PUB. 7-2-2002. FILED 1-4-2000.
- 2,622,966. **BOXMARK**. LEDERWERKE SCHMIDT FELD-BACH GMBH & CO. KG, (U.S. CLS. 1, 5, 6, 10, 26 AND 46). SN 76-036,804. PUB. 7-2-2002. FILED 4-28-2000.
- 2,622,973. **ACCU-TREAD**. STORM PRODUCTS, INC., (U.S. CLS. 1, 5, 6, 10, 26 AND 46). SN 76-039,750. PUB. 7-2-2002. FILED 5-3-2000.
- 2,622,974. **PRO-THANE**. STORM PRODUCTS, INC., (U.S. CLS. 1, 5, 6, 10, 26 AND 46). SN 76-039,752. PUB. 7-2-2002. FILED 5-3-2000.
- 2,622,990. **AHCARE (STYLIZED)**. COGNIS DEUTSCHLAND GMBH, (U.S. CLS. 1, 5, 6, 10, 26 AND 46). SN 76-049,468. PUB. 7-2-2002. FILED 5-16-2000.
- 2,623,044. **PHIBRO AND DESIGN**. PHILIPP BROTHERS CHEMICALS, INC., (U.S. CLS. 1, 5, 6, 10, 26 AND 46). SN 76-066,169. PUB. 7-2-2002. FILED 6-8-2000.
- 2,623,068. **MISCELLANEOUS DESIGN**. MERISTEM THERAPEUTICS, MULTIPLE CLASS, (INT. CLS. 1, 3, 5 AND 42), (U.S. CLS. 1, 4, 5, 6, 10, 18, 26, 44, 46, 50, 51, 52, 100 AND 101). SN 76-075,378. PUB. 7-2-2002. FILED 6-16-2000.
- 2,623,083. **GENEZOMES**. COLLABORATIVE GROUP, LTD., THE, (U.S. CLS. 1, 5, 6, 10, 26 AND 46). SN 76-080,611. PUB. 7-2-2002. FILED 6-28-2000.
- 2,623,106. **LABDACUIR**. KAO KABUSHIKI KAISHA, TA KAO CORPORATION, (U.S. CLS. 1, 5, 6, 10, 26 AND 46). SN 76-089,328. PUB. 7-2-2002. FILED 7-14-2000.
- 2,623,114. **TILTH**. FUSION 360, (U.S. CLS. 1, 5, 6, 10, 26 AND 46). SN 76-091,352. PUB. 7-2-2002. FILED 7-17-2000.
- 2,623,115. **INTEGRITY**. FUSION 360, (U.S. CLS. 1, 5, 6, 10, 26 AND 46). SN 76-091,355. PUB. 7-2-2002. FILED 7-17-2000.
- 2,623,148. **MTM LABORATORIES AND DESIGN**. MTM LABORATORIES AG, MULTIPLE CLASS, (INT. CLS. 1, 5 AND 42), (U.S. CLS. 1, 5, 6, 10, 18, 26, 44, 46, 51, 52, 100 AND 101). SN 76-101,801. PUB. 7-2-2002. FILED 8-2-2000.
- 2,623,161. **PROSURE**. HEALTHLINK, MULTIPLE CLASS, (INT. CLS. 1 AND 5), (U.S. CLS. 1, 5, 6, 10, 18, 26, 44, 46, 51 AND 52). SN 76-105,600. PUB. 7-2-2002. FILED 8-9-2000.
- 2,623,170. **COMMERCIALON**. J&J INDUSTRIES, INC., MULTIPLE CLASS, (INT. CLS. 1 AND 2), (U.S. CLS. 1, 5, 6, 10, 11, 16, 26 AND 46). SN 76-109,537. PUB. 7-2-2002. FILED 8-16-2000.
- 2,623,386. **ALPHADRI**. ALPHA RESOURCES, INC., (U.S. CLS. 1, 5, 6, 10, 26 AND 46). SN 76-154,558. PUB. 7-2-2002. FILED 10-27-2000.
- 2,623,455. **OSMOCOTE SLOW RELEASE PLANT FOOD AND DESIGN**. OMS INVESTMENTS, INC., (U.S. CLS. 1, 5, 6, 10, 26 AND 46). SN 76-166,520. PUB. 7-2-2002. FILED 11-14-2000.
- 2,623,456. **GUARANTEE YOUR PLANTS NEVER SKIP A MEAL**. OMS INVESTMENTS, INC., (U.S. CLS. 1, 5, 6, 10, 26 AND 46). SN 76-166,521. PUB. 7-2-2002. FILED 11-14-2000.
- 2,623,483. **PERSYNT**. DEGUSSA-HULS AG, (U.S. CLS. 1, 5, 6, 10, 26 AND 46). SN 76-170,965. PUB. 7-2-2002. FILED 11-21-2000.
- 2,623,518. **ALOMIT**. MITSUI CHEMICALS, INC., AKA MITSUI KAGAKU, (U.S. CLS. 1, 5, 6, 10, 26 AND 46). SN 76-175,592. PUB. 7-2-2002. FILED 12-5-2000.
- 2,623,585. **HERMES**. HERMES SWEETENERS LTD., (U.S. CLS. 1, 5, 6, 10, 26 AND 46). SN 76-185,687. PUB. 7-2-2002. FILED 12-22-2000.
- 2,623,607. **F-500 MICELLE ENCAPSULATOR TECHNOLOGY**. HAZARD CONTROL TECHNOLOGIES, INC., (U.S. CLS. 1, 5, 6, 10, 26 AND 46). SN 76-188,810. PUB. 7-2-2002. FILED 1-2-2001.
- 2,623,609. **NUTRIVEG**. OCEAN ORGANICS, INC., (U.S. CLS. 1, 5, 6, 10, 26 AND 46). SN 76-188,876. PUB. 7-2-2002. FILED 1-2-2001.
- 2,623,691. **EDLONG FLAVORS SINCE 1914 AND DESIGN**. EDLONG CORPORATION, THE, MULTIPLE CLASS, (INT. CLS. 1, 29 AND 30), (U.S. CLS. 1, 5, 6, 10, 26 AND 46). SN 76-198,950. PUB. 7-2-2002. FILED 1-24-2001.
- 2,623,725. **IMMUNOVISION**. IVAX DIAGNOSTICS, INC., MULTIPLE CLASS, (INT. CLS. 1 AND 5), (U.S. CLS. 1, 5, 6, 10, 18, 26, 44, 46, 51 AND 52). SN 76-202,939. PUB. 7-2-2002. FILED 1-31-2001.
- 2,623,733. **TRA AND DESIGN**. KROY INTERNATIONAL INC., (U.S. CLS. 1, 5, 6, 10, 26 AND 46). SN 76-203,702. PUB. 7-2-2002. FILED 2-1-2001.

- 2,623,816. **SEAL-UP**. CARGO CHEMICAL CORPORATION, (U.S. CLS. 1, 5, 6, 10, 26 AND 46). SN 76-215,026. PUB. 7-2-2002. FILED 2-23-2001.
- 2,623,827. **FLOTREAT**. S.N.F., (U.S. CLS. 1, 5, 6, 10, 26 AND 46). SN 76-216,004. PUB. 7-2-2002. FILED 2-26-2001.
- 2,623,841. **MARKEE WATER-BASED OIL AND DESIGN**. MARKEE INTERNATIONAL CORPORATION, MULTIPLE CLASS, (INT. CLS. 1, 3 AND 4), (U.S. CLS. 1, 4, 5, 6, 10, 15, 26, 46, 50, 51 AND 52). SN 76-218,814. PUB. 7-2-2002. FILED 3-2-2001.
- 2,623,907. **DRAGADOS GRUPO DRAGADOS, S.A. AND DESIGN**. GRUPO DRAGADOS, S.A., MULTIPLE CLASS, (INT. CLS. 1, 6, 11, 16, 19, 20, 35, 36, 37, 38, 39, 40 AND 42), (U.S. CLS. 1, 2, 5, 6, 10, 12, 13, 14, 21, 22, 23, 25, 26, 29, 31, 32, 33, 34, 37, 38, 46, 50, 100, 101, 102, 103, 104, 105 AND 106). SN 76-226,526. PUB. 7-2-2002. FILED 3-19-2001.
- 2,623,918. **SYLVARES**. ARIZONA CHEMICAL COMPANY, (U.S. CLS. 1, 5, 6, 10, 26 AND 46). SN 76-228,555. PUB. 7-2-2002. FILED 3-21-2001.
- 2,623,919. **SYLVAGUM**. ARIZONA CHEMICAL COMPANY, MULTIPLE CLASS, (INT. CLS. 1 AND 2), (U.S. CLS. 1, 5, 6, 10, 11, 16, 26 AND 46). SN 76-228,556. PUB. 7-2-2002. FILED 3-21-2001.
- 2,623,948. **RETAMINOL**. BAYER AKTIENGESELLSCHAFT, (U.S. CLS. 1, 5, 6, 10, 26 AND 46). SN 76-232,805. PUB. 7-2-2002. FILED 3-29-2001.
- 2,623,950. **OPTICAL DYNAMICS AND DESIGN**. OPTICAL DYNAMICS CORPORATION, MULTIPLE CLASS, (INT. CLS. 1, 7 AND 9), (U.S. CLS. 1, 5, 6, 10, 13, 19, 21, 23, 26, 31, 34, 35, 36, 38 AND 46). SN 76-232,973. PUB. 7-2-2002. FILED 4-2-2001.
- 2,623,951. **MISCELLANEOUS DESIGN**. OPTICAL DYNAMICS CORPORATION, MULTIPLE CLASS, (INT. CLS. 1, 7 AND 9), (U.S. CLS. 1, 5, 6, 10, 13, 19, 21, 23, 26, 31, 34, 35, 36, 38 AND 46). SN 76-233,138. PUB. 7-2-2002. FILED 4-2-2001.
- 2,623,972. **WETLINK**. CROMPTON CORPORATION, (U.S. CLS. 1, 5, 6, 10, 26 AND 46). SN 76-235,878. PUB. 7-2-2002. FILED 4-4-2001.
- 2,624,003. **FADAIET (STYLIZED)**. FADA ITALIA S.P.A., MULTIPLE CLASS, (INT. CLS. 1, 5 AND 10), (U.S. CLS. 1, 5, 6, 10, 18, 26, 39, 44, 46, 51 AND 52). SN 76-238,489. PUB. 7-2-2002. FILED 4-10-2001.
- 2,624,031. **PREGMAGIC**. ZYVAX, INC., (U.S. CLS. 1, 5, 6, 10, 26 AND 46). SN 76-241,336. PUB. 7-2-2002. FILED 4-16-2001.
- 2,624,032. **DEPARTURE**. ZYVAX, INC., (U.S. CLS. 1, 5, 6, 10, 26 AND 46). SN 76-241,337. PUB. 7-2-2002. FILED 4-16-2001.
- 2,624,033. **SHONOL**. SHOWA HIGHPOLYMER CO., LTD., (U.S. CLS. 1, 5, 6, 10, 26 AND 46). SN 76-241,791. PUB. 7-2-2002. FILED 4-17-2001.
- 2,624,111. **UCECRYL**. UCB, SOCIETE ANONYME, (U.S. CLS. 1, 5, 6, 10, 26 AND 46). SN 76-250,567. PUB. 7-2-2002. FILED 5-3-2001.
- 2,624,112. **UCEFIX**. UCB, SOCIETE ANONYME, (U.S. CLS. 1, 5, 6, 10, 26 AND 46). SN 76-250,568. PUB. 7-2-2002. FILED 5-3-2001.
- 2,624,113. **RETROPLATE**. CURECRETE CHEMICAL CO., INC., (U.S. CLS. 1, 5, 6, 10, 26 AND 46). SN 76-250,664. PUB. 7-2-2002. FILED 5-3-2001.
- 2,624,313. **RIBOMAP**. VENTANA MEDICAL SYSTEMS, INC., (U.S. CLS. 1, 5, 6, 10, 26 AND 46). SN 76-273,338. PUB. 7-2-2002. FILED 6-19-2001.
- 2,624,396. **NOMURA AND DESIGN**. NOMURA TRADING CO., LTD., (U.S. CLS. 1, 5, 6, 10, 26 AND 46). SN 76-286,435. PUB. 7-2-2002. FILED 7-16-2001.
- 2,624,408. **BOLIKEL**. AKZO NOBEL CHEMICALS B.V., (U.S. CLS. 1, 5, 6, 10, 26 AND 46). SN 76-287,999. PUB. 7-2-2002. FILED 7-21-2001.
- 2,624,516. **ET-1 ACTIVATED CLAY**. AQUA TECHNOLOGIES INC., (U.S. CLS. 1, 5, 6, 10, 26 AND 46). SN 76-304,228. PUB. 7-2-2002. FILED 8-24-2001.
- 2,624,724. **IB**. NU-GRO AMERICA CORP., (U.S. CLS. 1, 5, 6, 10, 26 AND 46). SN 76-335,439. PUB. 7-2-2002. FILED 11-7-2001.
- 2,624,740. **DUR-O-COTE**. INDOPCO, INC., DBA NATIONAL STARCH & CHEMICAL COMPANY, (U.S. CLS. 1, 5, 6, 10, 26 AND 46). SN 76-337,581. PUB. 7-2-2002. FILED 11-15-2001.
- 2,624,748. **ACTIVIN**. DRY CREEK NUTRITION, INC., MULTIPLE CLASS, (INT. CLS. 1, 5, 29, 30 AND 32), (U.S. CLS. 1, 5, 6, 10, 18, 26, 44, 45, 46, 48, 51 AND 52). SN 76-338,197. PUB. 7-2-2002. FILED 11-15-2001.
- 2,624,772. **MAJIK DUST (STYLIZED)**. ROSZKOWSKI, JEFFREY JOSEPH, DBA ISLAND FLOWERS, INC., (U.S. CLS. 1, 5, 6, 10, 26 AND 46). SN 76-343,145. PUB. 7-2-2002. FILED 11-30-2001.
- 2,624,929. **VARIHIB-6N1**. CLEARWATER, INC., (U.S. CLS. 1, 5, 6, 10, 26 AND 46). SN 76-366,841. PUB. 7-2-2002. FILED 2-5-2002.
- 2,624,935. **PARA CLEAR**. CLEARWATER, INC., (U.S. CLS. 1, 5, 6, 10, 26 AND 46). SN 76-367,637. PUB. 7-2-2002. FILED 2-7-2002.
- 2,624,936. **PARA-MINUS**. CLEARWATER, INC., (U.S. CLS. 1, 5, 6, 10, 26 AND 46). SN 76-367,638. PUB. 7-2-2002. FILED 2-7-2002.
- 2,624,937. **CLEAR-COOL**. CLEARWATER, INC., (U.S. CLS. 1, 5, 6, 10, 26 AND 46). SN 76-367,656. PUB. 7-2-2002. FILED 2-7-2002.
- 2,624,947. **MISCELLANEOUS DESIGN**. GIVAUDAN SA, MULTIPLE CLASS, (INT. CLS. 1, 4 AND 42), (U.S. CLS. 1, 5, 6, 10, 15, 26, 46, 100 AND 101). SN 76-369,938. PUB. 7-2-2002. FILED 2-12-2002.
- 2,624,990. **WASTE LOCK**. M2 POLYMER TECHNOLOGIES, INC., (U.S. CLS. 1, 5, 6, 10, 26 AND 46). SN 78-029,873. PUB. 7-2-2002. FILED 10-10-2000.
- 2,625,120. **COMBISAN**. TWO LITTLE FISHIES INC., (U.S. CLS. 1, 5, 6, 10, 26 AND 46). SN 78-066,246. PUB. 7-2-2002. FILED 5-29-2001.
- 2,625,153. **FLEXMOUNT**. FLEXCON COMPANY, INC., (U.S. CLS. 1, 5, 6, 10, 26 AND 46). SN 78-073,536. PUB. 7-2-2002. FILED 7-12-2001.
- 2,625,160. **MIRRORCOAT AND DESIGN**. SYSTEM THREE RESINS, INC., (U.S. CLS. 1, 5, 6, 10, 26 AND 46). SN 78-076,435. PUB. 7-2-2002. FILED 7-30-2001.
- 2,625,170. **PARALENE**. CLARIANT AG, (U.S. CLS. 1, 5, 6, 10, 26 AND 46). SN 78-078,667. PUB. 7-2-2002. FILED 8-10-2001.
- 2,625,193. **ANCHOR**. THOMAS SWAN & COMPANY, (U.S. CLS. 1, 5, 6, 10, 26 AND 46). SN 78-083,274. PUB. 7-2-2002. FILED 9-10-2001.
- 2,625,226. **GOLDEN HARVEST PLANT FOOD**. DEUTREL INDUSTRIES, (U.S. CLS. 1, 5, 6, 10, 26 AND 46). SN 78-089,313. PUB. 7-2-2002. FILED 10-19-2001.
- 2,625,281. **TENSION-TITE**. ILLINOIS TOOL WORKS INC., (U.S. CLS. 1, 5, 6, 10, 26 AND 46). SN 78-098,850. PUB. 7-2-2002. FILED 12-18-2001.
- 2,625,307. **IRUS**. SHELL TRADEMARK MANAGEMENT B.V., (U.S. CLS. 1, 5, 6, 10, 26 AND 46). SN 78-104,333. PUB. 7-2-2002. FILED 1-23-2002.

CLASS 2—PAINTS

- 2,622,752. **BIOSIL**. KEIMFARBEN GMBH & CO. KG, (U.S. CLS. 6, 11 AND 16). SN 75-834,451. PUB. 1-30-2001. FILED 10-27-1999.
- 2,622,810. **SWOP**. SWOP, INC., MULTIPLE CLASS, (INT. CLS. 2, 9 AND 16), (U.S. CLS. 2, 5, 6, 11, 16, 21, 22, 23, 26, 29, 36, 37, 38 AND 50). SN 75-889,799. PUB. 7-2-2002. FILED 1-7-2000.
- 2,623,170. (*See Class 1 for this trademark*).
- 2,623,547. **SEIKAFAST**. DAINICHISEIKA COLOR & CHEMICALS MFG. CO., LTD., (U.S. CLS. 6, 11 AND 16). SN 76-179,364. PUB. 7-2-2002. FILED 12-12-2000.
- 2,623,592. **SPRAYMAX**. PETER KWASNY GMBH, MULTIPLE CLASS, (INT. CLS. 2 AND 7), (U.S. CLS. 6, 11, 13, 16, 19, 21, 23, 31, 34 AND 35). SN 76-186,961. PUB. 7-2-2002. FILED 12-27-2000.
- 2,623,650. **SICOPEARL**. BASF AKTIENGESELLSCHAFT, (U.S. CLS. 6, 11 AND 16). SN 76-194,315. PUB. 7-2-2002. FILED 1-16-2001.
- 2,623,745. **MISCELLANEOUS DESIGN**. SQUID INK MANUFACTURING, INC., MULTIPLE CLASS, (INT. CLS. 2 AND 9), (U.S. CLS. 6, 11, 16, 21, 23, 26, 36 AND 38). SN 76-204,268. PUB. 7-2-2002. FILED 2-2-2001.
- 2,623,919. (*See Class 1 for this trademark*).
- 2,624,830. **PDQ**. ALLPRO CORPORATION, (U.S. CLS. 6, 11 AND 16). SN 76-349,430. PUB. 7-2-2002. FILED 12-17-2001.

CLASS 3—COSMETICS AND CLEANING PREPARATIONS

- 2,622,560 (*See Class 1 for this trademark*).
- 2,622,575. **SPRING BLOSSOM**. COLGATE-PALMOLIVE COMPANY, (U.S. CLS. 1, 4, 6, 50, 51 AND 52). SN 75-554,969. PUB. 7-2-2002. FILED 9-17-1998.
- 2,622,577. **PHYTOSCAN**. MEDIATRONIC SA, MULTIPLE CLASS, (INT. CLS. 3, 5, 8 AND 10), (U.S. CLS. 1, 4, 6, 18, 23, 26, 28, 39, 44, 46, 50, 51 AND 52). SN 75-557,577. PUB. 8-15-2000. FILED 9-24-1998.
- 2,622,606. **SUNDANCE FARMS**. SUNDANCE ENTERPRISES, INC., MULTIPLE CLASS, (INT. CLS. 3 AND 21), (U.S. CLS. 1, 2, 4, 6, 13, 23, 29, 30, 33, 40, 50, 51 AND 52). SN 75-602,441. PUB. 7-2-2002. FILED 12-10-1998.
- 2,622,626. **HYALOSPHERE**. FIDIA S.P.A., MULTIPLE CLASS, (INT. CLS. 3 AND 5), (U.S. CLS. 1, 4, 6, 18, 44, 46, 50, 51 AND 52). SN 75-632,718. PUB. 2-26-2002. FILED 2-2-1999.
- 2,622,652. **CARMA**. WHOLLEY, VIRGINIA, (U.S. CLS. 1, 4, 6, 50, 51 AND 52). SN 75-694,320. PUB. 7-2-2002. FILED 4-30-1999.
- 2,622,839. **S BODY & SHINE AND DESIGN**. SHISEIDO CO., LTD., (U.S. CLS. 1, 4, 6, 50, 51 AND 52). SN 75-908,389. PUB. 7-2-2002. FILED 2-3-2000.
- 2,622,855. **AM AMERICAN MALE AND DESIGN**. GREGORY RANDOLPH FOR MEN, INC., (U.S. CLS. 1, 4, 6, 50, 51 AND 52). SN 75-921,424. PUB. 7-2-2002. FILED 2-16-2000.
- 2,622,903. **DEAD SEA SPA MAGIK**. FINDERS INTERNATIONAL LIMITED, (U.S. CLS. 1, 4, 6, 50, 51 AND 52). SN 76-004,473. PUB. 4-23-2002. FILED 3-20-2000.
- 2,622,925. **PHYTO-AROMATHERAPY FOUR SEASONS SUMMER**. ICB MANUFACTURING CORP., DBA TIME LABORATORIES, INC., MULTIPLE CLASS, (INT. CLS. 3 AND 5), (U.S. CLS. 1, 4, 6, 18, 44, 46, 50, 51 AND 52). SN 76-015,958. PUB. 12-11-2001. FILED 4-3-2000.
- 2,622,988. **PRODIGIEUX**. LABORATOIRE NUXE, (U.S. CLS. 1, 4, 6, 50, 51 AND 52). SN 76-048,773. PUB. 7-2-2002. FILED 5-15-2000.
- 2,623,010. **IMAGE ESSENTIALS**. KMART PROPERTIES, INC., (U.S. CLS. 1, 4, 6, 50, 51 AND 52). SN 76-056,084. PUB. 7-2-2002. FILED 5-24-2000.
- 2,623,020. **CURLY CUES**. ROUX LABORATORIES, INC., (U.S. CLS. 1, 4, 6, 50, 51 AND 52). SN 76-059,342. PUB. 7-2-2002. FILED 5-30-2000.
- 2,623,047. **T'STORE TRUSSARDI (STYLIZED)**. TRUSSARDI S.P.A., MULTIPLE CLASS, (INT. CLS. 3, 18 AND 25), (U.S. CLS. 1, 2, 3, 4, 6, 22, 39, 41, 50, 51 AND 52). SN 76-067,529. PUB. 7-2-2002. FILED 6-9-2000.
- 2,623,058. **MOISTURE BALANCE**. REVLON CONSUMER PRODUCTS CORPORATION, (U.S. CLS. 1, 4, 6, 50, 51 AND 52). SN 76-071,160. PUB. 7-2-2002. FILED 6-15-2000.
- 2,623,068 (*See Class 1 for this trademark*).
- 2,623,097. **TOMORROW AND DESIGN**. TOMORROW, L.L.C., (U.S. CLS. 1, 4, 6, 50, 51 AND 52). SN 76-086,800. PUB. 7-2-2002. FILED 7-10-2000.
- 2,623,146. **THE SWEET GRASS COMPANY AND DESIGN**. SWEET GRASS COMPANY, THE, (U.S. CLS. 1, 4, 6, 50, 51 AND 52). SN 76-100,812. PUB. 7-2-2002. FILED 7-26-2000.
- 2,623,203. **NORIGINALS**. KNAPP, FRIEDRICH, AND CZECH, ANDREAS, AND SCHMITT, FRANZ, AND AHRENS, HANS-JOACHIM, MULTIPLE CLASS, (INT. CLS. 3, 9, 14, 18, 25 AND 28), (U.S. CLS. 1, 2, 3, 4, 6, 21, 22, 23, 26, 27, 28, 36, 38, 39, 41, 50, 51 AND 52). SN 76-117,034. PUB. 7-2-2002. FILED 8-25-2000.
- 2,623,247. **CHLOROPHYLLA AND DESIGN**. CHLOROPHYLLA PHITOCOSMETICA LTDA., (U.S. CLS. 1, 4, 6, 50, 51 AND 52). SN 76-131,733. PUB. 7-2-2002. FILED 9-18-2000.
- 2,623,293. **TERAX ORIGINAL BODY AND DESIGN**. TERAX ITALIA S.N.C. DI CANE FRANCA & C., MULTIPLE CLASS, (INT. CLS. 3 AND 5), (U.S. CLS. 1, 4, 6, 18, 44, 46, 50, 51 AND 52). SN 76-138,837. PUB. 7-2-2002. FILED 10-2-2000.
- 2,623,315. **WIDMER**. LOUIS WIDMER AG, MULTIPLE CLASS, (INT. CLS. 3 AND 5), (U.S. CLS. 1, 4, 6, 18, 44, 46, 50, 51 AND 52). SN 76-143,043. PUB. 7-2-2002. FILED 10-6-2000.
- 2,623,440. **TRANSLUCENCE**. HELENA RUBINSTEIN, (U.S. CLS. 1, 4, 6, 50, 51 AND 52). SN 76-163,538. PUB. 7-2-2002. FILED 11-13-2000.
- 2,623,450. **DERMANAIL**. SUMMERS LABORATORIES, INC., (U.S. CLS. 1, 4, 6, 50, 51 AND 52). SN 76-165,911. PUB. 7-2-2002. FILED 11-9-2000.
- 2,623,515. **DERMATOLOGIC COSMETIC LABORATORIES**. DERMATOLOGIC COSMETIC LABORATORIES, LTD., (U.S. CLS. 1, 4, 6, 50, 51 AND 52). SN 76-174,989. PUB. 7-2-2002. FILED 12-2-2000.
- 2,623,578. **LOST ART**. M.D. INTERNATIONAL MARKETING, INC., (U.S. CLS. 1, 4, 6, 50, 51 AND 52). SN 76-184,461. PUB. 8-28-2001. FILED 12-20-2000.
- 2,623,580. **THENAILBAR**. WOLPER WOOTTEN & COMPANY, INC., (U.S. CLS. 1, 4, 6, 50, 51 AND 52). SN 76-185,074. PUB. 7-2-2002. FILED 12-20-2000.
- 2,623,594. **PHYTO-LIPID HYDRATING SCRUB**. AGUILAR, NOEL, (U.S. CLS. 1, 4, 6, 50, 51 AND 52). SN 76-187,109. PUB. 7-2-2002. FILED 12-29-2000.
- 2,623,608. **NATURALLY SMOOTH**. KAO KABUSHIKI KAISHA, TA KAO CORPORATION, (U.S. CLS. 1, 4, 6, 50, 51 AND 52). SN 76-188,864. PUB. 7-2-2002. FILED 1-2-2001.
- 2,623,620. **KROGER**. KROGER CO. OF MICHIGAN, THE, MULTIPLE CLASS, (INT. CLS. 3, 4, 5, 6, 8, 16, 20 AND 21), (U.S. CLS. 1, 2, 4, 5, 6, 12, 13, 14, 15, 18, 22, 23, 25, 28, 29, 30, 32, 33, 37, 38, 40, 44, 46, 50, 51 AND 52). SN 76-189,921. PUB. 7-2-2002. FILED 1-8-2001.
- 2,623,634. **FOR YOUNGER ACTING SKIN**. IMMUNOCORP, (U.S. CLS. 1, 4, 6, 50, 51 AND 52). SN 76-192,406. PUB. 7-2-2002. FILED 1-10-2001.
- 2,623,653. **LIP PRESERVER**. TOO, INC., (U.S. CLS. 1, 4, 6, 50, 51 AND 52). SN 76-194,493. PUB. 7-2-2002. FILED 1-16-2001.
- 2,623,661. **MILLERIAL TRANSFER**. LAPORTE, ALBERT, (U.S. CLS. 1, 4, 6, 50, 51 AND 52). SN 76-195,224. PUB. 7-2-2002. FILED 1-17-2001.
- 2,623,708. **JACKRABBITS**. MCDOWELL, THOMAS JOHN, MULTIPLE CLASS, (INT. CLS. 3 AND 21), (U.S. CLS. 1, 2, 4, 6, 13, 23, 29, 30, 33, 40, 50, 51 AND 52). SN 76-201,103. PUB. 7-2-2002. FILED 1-30-2001.
- 2,623,721. **VILLE D'ITALIA AND DESIGN**. BIO ESSENZA S.R.L., (U.S. CLS. 1, 4, 6, 50, 51 AND 52). SN 76-202,820. PUB. 7-2-2002. FILED 1-31-2001.
- 2,623,738. **PROTIENT ACTIF PUR**. JOHNSON & JOHNSON, (U.S. CLS. 1, 4, 6, 50, 51 AND 52). SN 76-203,946. PUB. 7-2-2002. FILED 2-2-2001.
- 2,623,749. **DOUSSY**. LIDL STIFTUNG & CO. KG, (U.S. CLS. 1, 4, 6, 50, 51 AND 52). SN 76-204,979. PUB. 7-2-2002. FILED 2-5-2001.
- 2,623,803. **MASTER FEED AND DESIGN**. HERMANN, REGINA, MULTIPLE CLASS, (INT. CLS. 3, 5 AND 31), (U.S. CLS. 1, 4, 6, 18, 44, 46, 50, 51 AND 52). SN 76-212,980. PUB. 7-2-2002. FILED 2-20-2001.
- 2,623,815. **OPTISANA**. LIDL STIFTUNG & CO. KG, MULTIPLE CLASS, (INT. CLS. 3 AND 5), (U.S. CLS. 1, 4, 6, 18, 44, 46, 50, 51 AND 52). SN 76-215,025. PUB. 7-2-2002. FILED 2-23-2001.
- 2,623,841 (*See Class 1 for this trademark*).
- 2,623,873. **UNITERS**. UNITERS S.P.A., (U.S. CLS. 1, 4, 6, 50, 51 AND 52). SN 76-222,453. PUB. 7-2-2002. FILED 3-9-2001.
- 2,623,874. **UNITERS AND DESIGN**. UNITERS S.P.A., (U.S. CLS. 1, 4, 6, 50, 51 AND 52). SN 76-222,455. PUB. 7-2-2002. FILED 3-9-2001.
- 2,623,893. **ADVANCE TECHNIQUES**. AVON PRODUCTS, INC., (U.S. CLS. 1, 4, 6, 50, 51 AND 52). SN 76-225,190. PUB. 7-2-2002. FILED 3-16-2001.
- 2,623,957. **NITE LITES GLOW IN THE DARK**. DIAMOND COSMETICS, INC., (U.S. CLS. 1, 4, 6, 50, 51 AND 52). SN 76-234,027. PUB. 7-2-2002. FILED 3-30-2001.
- 2,623,974. **ZONE SKIN CARE**. ZONE SKIN CARE, INC., (U.S. CLS. 1, 4, 6, 50, 51 AND 52). SN 76-236,045. PUB. 7-2-2002. FILED 3-30-2001.
- 2,624,067. **R-MC**. ECT INC., (U.S. CLS. 1, 4, 6, 50, 51 AND 52). SN 76-244,950. PUB. 7-2-2002. FILED 4-23-2001.
- 2,624,089. **IT'S THE LITTLE THINGS THAT COUNT MANDIE AND DESIGN**. BIG M, INC., MULTIPLE CLASS, (INT. CLS. 3, 16 AND 20), (U.S. CLS. 1, 2, 4, 5, 6, 13, 22, 23, 25, 29, 32, 37, 38, 50, 51 AND 52). SN 76-247,681. PUB. 7-2-2002. FILED 4-23-2001.
- 2,624,105. **ILISSA (STYLIZED)**. GOLD, MICHAEL H., (U.S. CLS. 1, 4, 6, 50, 51 AND 52). SN 76-249,171. PUB. 7-2-2002. FILED 5-1-2001.
- 2,624,125. **BIKER BALM**. HOLT, PAULA, DBA HIGH MOUN-

- TAIN HERBALS, (U.S. CLS. 1, 4, 6, 50, 51 AND 52). SN 76-252,387. PUB. 7-2-2002. FILED 5-7-2001.
- 2,624,194. **MACH III BREAKING ALL YOUR CLEANING BARRIERS AND DESIGN.** CARL, CHARLENE, (U.S. CLS. 1, 4, 6, 50, 51 AND 52). SN 76-260,771. PUB. 7-2-2002. FILED 5-22-2001.
- 2,624,206. **AIRKEM.** ECOLAB INC., MULTIPLE CLASS, (INT. CLS. 3 AND 5), (U.S. CLS. 1, 4, 6, 18, 44, 46, 50, 51 AND 52). SN 76-262,601. PUB. 7-2-2002. FILED 5-27-2001.
- 2,624,230. **A FRAGRANCE FOR EVERY EMOTION.** BONNE BELL, INC., (U.S. CLS. 1, 4, 6, 50, 51 AND 52). SN 76-264,929. PUB. 7-2-2002. FILED 5-31-2001.
- 2,624,276. **ARCALIANCE.** PIERRE FABRE DERMO-COSMETIQUE, MULTIPLE CLASS, (INT. CLS. 3 AND 5), (U.S. CLS. 1, 4, 6, 18, 44, 46, 50, 51 AND 52). SN 76-268,899. PUB. 7-2-2002. FILED 6-8-2001.
- 2,624,318. **JOINT FUNCTION GL.** K.G.M. CONSUMER GROUP, INC., (U.S. CLS. 1, 4, 6, 50, 51 AND 52). SN 76-274,394. PUB. 7-2-2002. FILED 6-19-2001.
- 2,624,369. **DRAIN-IT.** A AAABAM CO., DBA DRAIN-IT, (U.S. CLS. 1, 4, 6, 50, 51 AND 52). SN 76-281,910. PUB. 7-2-2002. FILED 7-9-2001.
- 2,624,371. **ON YOUR MARK.** ON YOUR MARK, LTD., MULTIPLE CLASS, (INT. CLS. 3, 5 AND 21), (U.S. CLS. 1, 2, 4, 6, 13, 18, 23, 29, 30, 33, 40, 44, 46, 50, 51 AND 52). SN 76-281,919. PUB. 7-2-2002. FILED 7-9-2001.
- 2,624,376. **60 SECOND SENSATION.** COLUMBIA BEAUTY SUPPLY, INC., (U.S. CLS. 1, 4, 6, 50, 51 AND 52). SN 76-282,402. PUB. 7-2-2002. FILED 7-6-2001.
- 2,624,384. **ESSENTIAL SHORE.** CLASSICS CHICAGO, INC., THE, MULTIPLE CLASS, (INT. CLS. 3 AND 4), (U.S. CLS. 1, 4, 6, 15, 50, 51 AND 52). SN 76-284,151. PUB. 7-2-2002. FILED 7-12-2001.
- 2,624,385. **ESSENTIAL PURITY.** CLASSICS CHICAGO, INC., THE, (U.S. CLS. 1, 4, 6, 50, 51 AND 52). SN 76-284,152. PUB. 7-2-2002. FILED 7-12-2001.
- 2,624,386. **ESSENTIAL TOWN.** CLASSICS CHICAGO, INC., THE, MULTIPLE CLASS, (INT. CLS. 3 AND 4), (U.S. CLS. 1, 4, 6, 15, 50, 51 AND 52). SN 76-284,199. PUB. 7-2-2002. FILED 7-12-2001.
- 2,624,391. **ONE-FOR-ALL FS101 AND DESIGN.** CONSOLIDATED CHEMICAL COMPANY, (U.S. CLS. 1, 4, 6, 50, 51 AND 52). SN 76-285,409. PUB. 7-2-2002. FILED 7-16-2001.
- 2,624,417. **SUBSTANTIFIC.** GUERLAIN S.A., (U.S. CLS. 1, 4, 6, 50, 51 AND 52). SN 76-289,233. PUB. 7-2-2002. FILED 7-20-2001.
- 2,624,435. **PLASTRONA.** PAUL HARTMANN AG, MULTIPLE CLASS, (INT. CLS. 3, 5 AND 10), (U.S. CLS. 1, 4, 6, 18, 26, 39, 44, 46, 50, 51 AND 52). SN 76-291,152. PUB. 7-2-2002. FILED 7-27-2001.
- 2,624,446. **RR (STYLIZED).** AL-MAWARED NATURAL BEAUTY PRODUCTS CORP., (U.S. CLS. 1, 4, 6, 50, 51 AND 52). SN 76-292,220. PUB. 7-2-2002. FILED 7-31-2001.
- 2,624,461. **FX EYES.** REVLON CONSUMER PRODUCTS CORPORATION, (U.S. CLS. 1, 4, 6, 50, 51 AND 52). SN 76-294,834. PUB. 7-2-2002. FILED 8-3-2001.
- 2,624,472. **AROMA MOMENTS.** SUGGS, YOLANDA GAIL, (U.S. CLS. 1, 4, 6, 50, 51 AND 52). SN 76-296,094. PUB. 7-2-2002. FILED 8-8-2001.
- 2,624,482. **MISCELLANEOUS DESIGN.** COMING ATTRACTIONS PARTIES, INC., MULTIPLE CLASS, (INT. CLS. 3, 5, 16, 25 AND 35), (U.S. CLS. 1, 2, 4, 5, 6, 18, 22, 23, 29, 37, 38, 39, 44, 46, 50, 51, 52, 100, 101 AND 102). SN 76-297,195. PUB. 7-2-2002. FILED 8-10-2001.
- 2,624,486. **COOL MINT LISTERINE POCKETPAKS.** WARNER-LAMBERT COMPANY, MULTIPLE CLASS, (INT. CLS. 3 AND 5), (U.S. CLS. 1, 4, 6, 18, 44, 46, 50, 51 AND 52). SN 76-298,313. PUB. 7-2-2002. FILED 8-10-2001.
- 2,624,498. **TATCARE.** COTTEN, STEPHEN S., (U.S. CLS. 1, 4, 6, 50, 51 AND 52). SN 76-302,197. PUB. 7-2-2002. FILED 8-20-2001.
- 2,624,508. **GELBOND.** CREATIVE NAIL DESIGN, INC., (U.S. CLS. 1, 4, 6, 50, 51 AND 52). SN 76-303,358. PUB. 7-2-2002. FILED 8-22-2001.
- 2,624,542. **DOOZY.** BLACHFORD, STEPHEN R., (U.S. CLS. 1, 4, 6, 50, 51 AND 52). SN 76-309,907. PUB. 7-2-2002. FILED 9-6-2001.
- 2,624,559. **NATURE & BRONZE.** LANCOMER PARFUMS ET BEAUTE & CIE, (U.S. CLS. 1, 4, 6, 50, 51 AND 52). SN 76-312,753. PUB. 3-26-2002. FILED 9-14-2001.
- 2,624,564. **ISIS.** VITAL DYNAMICS, INC., (U.S. CLS. 1, 4, 6, 50, 51 AND 52). SN 76-313,426. PUB. 7-2-2002. FILED 9-12-2001.
- 2,624,570. **PETITE POTIONS.** ALBERTSON'S, INC., (U.S. CLS. 1, 4, 6, 50, 51 AND 52). SN 76-313,783. PUB. 7-2-2002. FILED 9-18-2001.
- 2,624,573. **HENNA 'N' PLACENTA.** ALLEGHANY PHARMACAL CORPORATION, (U.S. CLS. 1, 4, 6, 50, 51 AND 52). SN 76-314,676. PUB. 7-2-2002. FILED 9-20-2001.
- 2,624,587. **WIPE 'N CLEAR.** FLENTS PRODUCTS CO., INC., (U.S. CLS. 1, 4, 6, 50, 51 AND 52). SN 76-317,806. PUB. 3-5-2002. FILED 9-28-2001.
- 2,624,601. **C THERAPY AND DESIGN.** CREATIVE NAIL DESIGN, INC., (U.S. CLS. 1, 4, 6, 50, 51 AND 52). SN 76-320,298. PUB. 7-2-2002. FILED 10-2-2001.
- 2,624,615. **LULA PRETTY PACKETS.** JAQUA GIRLS, INC., (U.S. CLS. 1, 4, 6, 50, 51 AND 52). SN 76-321,943. PUB. 7-2-2002. FILED 10-9-2001.
- 2,624,635. **EARTHEN INSTANTPEEL.** EARTHEN INC., (U.S. CLS. 1, 4, 6, 50, 51 AND 52). SN 76-323,993. PUB. 7-2-2002. FILED 10-12-2001.
- 2,624,641. **RETURNAL.** LAVENIR, LLC, (U.S. CLS. 1, 4, 6, 50, 51 AND 52). SN 76-324,792. PUB. 7-2-2002. FILED 10-15-2001.
- 2,624,650. **ULTRA LITE.** FRAME SPECIALTIES INC., (U.S. CLS. 1, 4, 6, 50, 51 AND 52). SN 76-325,739. PUB. 7-2-2002. FILED 10-15-2001.
- 2,624,705. **BUG ERASER.** J & S MANUFACTURERS, (U.S. CLS. 1, 4, 6, 50, 51 AND 52). SN 76-332,697. PUB. 7-2-2002. FILED 11-2-2001.
- 2,624,714. **LYS.** LANCE ENTERPRISES, INC., (U.S. CLS. 1, 4, 6, 50, 51 AND 52). SN 76-333,813. PUB. 7-2-2002. FILED 11-6-2001.
- 2,624,733. **MADLEN'S DREAM FORMULA.** POSTAJIAN, MADLEN, (U.S. CLS. 1, 4, 6, 50, 51 AND 52). SN 76-336,528. PUB. 7-2-2002. FILED 11-9-2001.
- 2,624,781. **PREVENTAGE.** JAMIESON, JAMES, AND JAMIESON, JENNIFER, DBA NUTRACEUTICS CORPORATION, (U.S. CLS. 1, 4, 6, 50, 51 AND 52). SN 76-343,999. PUB. 7-2-2002. FILED 11-30-2001.
- 2,624,797. **THE ALCHEMY OF AROMATHERAPY.** OROZ, LLC, (U.S. CLS. 1, 4, 6, 50, 51 AND 52). SN 76-345,522. PUB. 7-2-2002. FILED 10-19-2001.
- 2,624,798. **BIOLAGE AND DESIGN.** L'OREAL USA CREATIVE, INC., (U.S. CLS. 1, 4, 6, 50, 51 AND 52). SN 76-345,704. PUB. 7-2-2002. FILED 12-5-2001.
- 2,624,810. **FUNGUS MD.** ORLY INTERNATIONAL, INC., (U.S. CLS. 1, 4, 6, 50, 51 AND 52). SN 76-347,340. PUB. 7-2-2002. FILED 12-11-2001.
- 2,624,823. **EFFLOR-X.** ACRY-TECH COATINGS, INC., (U.S. CLS. 1, 4, 6, 50, 51 AND 52). SN 76-348,818. PUB. 7-2-2002. FILED 12-17-2001.
- 2,624,824. **EZR.** MAKE-UP ART COSMETICS INC., (U.S. CLS. 1, 4, 6, 50, 51 AND 52). SN 76-348,967. PUB. 7-2-2002. FILED 12-14-2001.
- 2,624,844. **DAYWEAR.** ESTEE LAUDER INC., (U.S. CLS. 1, 4, 6, 50, 51 AND 52). SN 76-350,918. PUB. 7-2-2002. FILED 12-20-2001.
- 2,624,945. **SAFE-T-FLUE.** RUTLAND FIRE CLAY COMPANY, DBA RUTLAND PRODUCTS, (U.S. CLS. 1, 4, 6, 50, 51 AND 52). SN 76-369,095. PUB. 7-2-2002. FILED 2-11-2002.
- 2,625,042. **RADICAL APPLE.** JOHNSON & JOHNSON, (U.S. CLS. 1, 4, 6, 50, 51 AND 52). SN 78-052,634. PUB. 7-2-2002. FILED 3-12-2001.
- 2,625,043. **STRAWBERRY SENSATION.** JOHNSON & JOHNSON, (U.S. CLS. 1, 4, 6, 50, 51 AND 52). SN 78-052,645. PUB. 7-2-2002. FILED 3-12-2001.
- 2,625,044. **TERME DI MONTECATINI SPA.** TERME DI MONTECATINI S.P.A., (U.S. CLS. 1, 4, 6, 50, 51 AND 52). SN 78-053,267. PUB. 7-2-2002. FILED 3-15-2001.
- 2,625,047. **OH MY CAT!** DOG GENERATION, (U.S. CLS. 1, 4, 6, 50, 51 AND 52). SN 78-053,403. PUB. 7-2-2002. FILED 3-15-2001.
- 2,625,048. **PHYCO-SLIM.** BEAUTE CREATEURS (SOCIETE ANONYME), BY ASSIGNMENT BEAUTE CREATEURS (SOCIETE ANONYME), (U.S. CLS. 1, 4, 6, 50, 51 AND 52).

SN 78-053,577. PUB. 7-2-2002. FILED 3-16-2001.
 2,625,054. **SEEING IS BELIEVING**. PARADIGM INTERNATIONAL, INC., (U.S. CLS. 1, 4, 6, 50, 51 AND 52). SN 78-054,528. PUB. 7-2-2002. FILED 3-22-2001.
 2,625,113. **RX3**. KANG, JOHN, (U.S. CLS. 1, 4, 6, 50, 51 AND 52). SN 78-064,787. PUB. 7-2-2002. FILED 5-21-2001.
 2,625,119. **ABSOLUTION**. BAUMGARTEL, JOHANN-GEORG, (U.S. CLS. 1, 4, 6, 50, 51 AND 52). SN 78-066,182. PUB. 7-2-2002. FILED 5-29-2001.
 2,625,148. **FRESCO ROCIO**. COLGATE-PALMOLIVE COMPANY, (U.S. CLS. 1, 4, 6, 50, 51 AND 52). SN 78-072,458. PUB. 7-2-2002. FILED 7-5-2001.
 2,625,150. **COLD SWEAT**. NICKEL SA, (U.S. CLS. 1, 4, 6, 50, 51 AND 52). SN 78-073,027. PUB. 7-2-2002. FILED 7-10-2001.
 2,625,188. **CORSODYL**. SMITHKLINE BEECHAM P.L.C., (U.S. CLS. 1, 4, 6, 50, 51 AND 52). SN 78-082,428. PUB. 7-2-2002. FILED 9-4-2001.
 2,625,206. **ELECTRASOL**. RECKITT BENCKISER NV, (U.S. CLS. 1, 4, 6, 50, 51 AND 52). SN 78-086,054. PUB. 7-2-2002. FILED 9-28-2001.
 2,625,263. **BOTANICAL EARTH**. HENDRON, DEBRA A, (U.S. CLS. 1, 4, 6, 50, 51 AND 52). SN 78-096,372. PUB. 7-2-2002. FILED 12-3-2001.
 2,625,264. **BE (STYLIZED)**. HENDRON, DEBRA, A, (U.S. CLS. 1, 4, 6, 50, 51 AND 52). SN 78-096,377. PUB. 7-2-2002. FILED 12-3-2001.
 2,625,273. **CERO-CERO**. CERO-CERO, INC., (U.S. CLS. 1, 4, 6, 50, 51 AND 52). SN 78-097,790. PUB. 7-2-2002. FILED 12-11-2001.
 2,625,274. **AJAX SPRING FLOWERS**. COLGATE-PALMOLIVE COMPANY, (U.S. CLS. 1, 4, 6, 50, 51 AND 52). SN 78-097,896. PUB. 7-2-2002. FILED 12-12-2001.

CLASS 4—LUBRICANTS AND FUELS

2,622,568. **HOME FOR THE HOLIDAYS**. YANKEE CANDLE COMPANY, INC., THE, (U.S. CLS. 1, 6 AND 15). SN 75-523,699. PUB. 7-2-2002. FILED 7-23-1998.
 2,622,582. **OOB AND DESIGN**. O.O.B. INC., (U.S. CLS. 1, 6 AND 15). SN 75-565,791. PUB. 10-24-2000. FILED 10-6-1998.
 2,623,101. **ACQUA DI PARMA AND DESIGN**. ACQUA DI PARMA S.R.L., (U.S. CLS. 1, 6 AND 15). SN 76-087,848. PUB. 7-2-2002. FILED 7-12-2000.
 2,623,383. **U.S. LUBRICANTS**. AMALIE AOC, LTD., (U.S. CLS. 1, 6 AND 15). SN 76-154,061. PUB. 7-2-2002. FILED 10-25-2000.
 2,623,620 (*See Class 3 for this trademark*).
 2,623,695. **MISCELLANEOUS DESIGN**. SAUR INTERNATIONAL, MULTIPLE CLASS, (INT. CLS. 4, 37 AND 40), (U.S. CLS. 1, 6, 15, 100, 103 AND 106). SN 76-199,489. PUB. 7-2-2002. FILED 1-24-2001.
 2,623,698. **CHEVRON ECO**. CHEVRON CORPORATION, (U.S. CLS. 1, 6 AND 15). SN 76-200,108. PUB. 7-2-2002. FILED 1-26-2001.
 2,623,766. **MIGHTY LITES**. RADDON, STANLEY JAMES, (U.S. CLS. 1, 6 AND 15). SN 76-207,246. PUB. 7-2-2002. FILED 2-9-2001.
 2,623,841 (*See Class 1 for this trademark*).
 2,623,961. **BUTANE BATTERY**. JFA LIMITED, (U.S. CLS. 1, 6 AND 15). SN 76-234,540. PUB. 7-2-2002. FILED 4-3-2001.
 2,624,348. **LOVE JAM**. LUVJAM INDUSTRIES, L.L.C., MULTIPLE CLASS, (INT. CLS. 4 AND 5), (U.S. CLS. 1, 6, 15, 18, 44, 46, 51 AND 52). SN 76-277,707. PUB. 7-2-2002. FILED 6-28-2001.
 2,624,384 (*See Class 3 for this trademark*).
 2,624,386 (*See Class 3 for this trademark*).
 2,624,686. **DREAMERS CANDLES**. DREAMERS CANDLES, LTD., (U.S. CLS. 1, 6 AND 15). SN 76-330,049. PUB. 7-2-2002. FILED 10-18-2001.
 2,624,947 (*See Class 1 for this trademark*).
 2,625,112. **RICHARD ROBERTS LTD.**, RICHARD ROBERTS LTD., INC., (U.S. CLS. 1, 6 AND 15). SN 78-064,493. PUB. 7-2-2002. FILED 5-18-2001.
 2,625,131. **THECANDLEDISTRICT AND DESIGN**. CANDLE DISTRICT INC., THE, (U.S. CLS. 1, 6 AND 15). SN 78-069,907. PUB. 7-2-2002. FILED 6-19-2001.

2,625,171. **FAMM AND DESIGN**. FUEL AND MARINE MARKETING LLC, (U.S. CLS. 1, 6 AND 15). SN 78-079,039. PUB. 7-2-2002. FILED 8-14-2001.
 2,625,308. **ONDINA**. SHELL TRADEMARK MANAGEMENT B.V., (U.S. CLS. 1, 6 AND 15). SN 78-104,336. PUB. 7-2-2002. FILED 1-23-2002.

CLASS 5—PHARMACEUTICALS

2,622,509 (*See Class 1 for this trademark*).
 2,622,533 (*See Class 1 for this trademark*).
 2,622,539. **OCTEGRA**. BAYER AKTIENGESELLSCHAFT, (U.S. CLS. 6, 18, 44, 46, 51 AND 52). SN 75-404,804. PUB. 7-2-2002. FILED 12-12-1997.
 2,622,542. **RAPHEX**. ASTRAZENECA AB, BY CHANGE OF NAME ASTRA AKTIEBOLAG, (U.S. CLS. 6, 18, 44, 46, 51 AND 52). SN 75-420,278. PUB. 7-2-2002. FILED 1-20-1998.
 2,622,560 (*See Class 1 for this trademark*).
 2,622,577 (*See Class 3 for this trademark*).
 2,622,580. **ANTIFERON**. NEOVACS, (U.S. CLS. 6, 18, 44, 46, 51 AND 52). SN 75-559,481. PUB. 5-23-2000. FILED 9-25-1998.
 2,622,583. **DUMEX**. DUMEX MEDICAL SURGICAL PRODUCTS, LTD., MULTIPLE CLASS, (INT. CLS. 5, 10 AND 35), (U.S. CLS. 6, 18, 26, 39, 44, 46, 51, 52, 100, 101 AND 102). SN 75-568,073. PUB. 9-21-1999. FILED 10-9-1998.
 2,622,592. **iodo-san**. 139001 CANADA, INC., DBA VINO THEQUE, (U.S. CLS. 6, 18, 44, 46, 51 AND 52). SN 75-582,623. PUB. 7-2-2002. FILED 11-4-1998.
 2,622,596. **MOSKIRIX**. SMITHKLINE BEECHAM BIOLOGICALS S.A., (U.S. CLS. 6, 18, 44, 46, 51 AND 52). SN 75-588,306. PUB. 7-2-2002. FILED 11-13-1998.
 2,622,604. **HEPAR-PASC (STYLIZED)**. PASCOE PHARMAZEUTISCHE PRAPARATE GMBH, (U.S. CLS. 6, 18, 44, 46, 51 AND 52). SN 75-599,855. PUB. 8-22-2000. FILED 12-4-1998.
 2,622,605. **HIPPODYNAMIX**. PELLEGRINUS HOLDING AG, BY ASSIGNMENT HIPPO DYNAMIX PFERDEPRODUKTE GESELLSCHAFT M.B.H. MULTIPLE CLASS, (INT. CLS. 5, 6, 8, 16, 20, 35, 41 AND 42), (U.S. CLS. 2, 5, 6, 12, 13, 14, 18, 22, 23, 25, 28, 29, 32, 37, 38, 44, 46, 50, 51, 52, 100, 101, 102 AND 107). SN 75-601,194. PUB. 9-5-2000. FILED 12-2-1998.
 2,622,614. **OPTREX**. OPTREX LIMITED, (U.S. CLS. 6, 18, 44, 46, 51 AND 52). SN 75-618,124. PUB. 4-24-2001. FILED 1-11-1999.
 2,622,615. **VITAFRUIT**. SUNRIDER CORPORATION, THE, DBA SUNRIDER, (U.S. CLS. 6, 18, 44, 46, 51 AND 52). SN 75-618,754. PUB. 12-28-1999. FILED 1-11-1999.
 2,622,619. **BST-GEL**. BIO SYNTTECH CANADA INC., (U.S. CLS. 6, 18, 44, 46, 51 AND 52). SN 75-625,187. PUB. 7-2-2002. FILED 1-22-1999.
 2,622,626 (*See Class 3 for this trademark*).
 2,622,657. **KOLLOIDEAL**. FRESENIUS AG, (U.S. CLS. 6, 18, 44, 46, 51 AND 52). SN 75-702,810. PUB. 8-8-2000. FILED 5-11-1999.
 2,622,660 (*See Class 1 for this trademark*).
 2,622,680 (*See Class 1 for this trademark*).
 2,622,684. **HINT-ELS**. HINTERSEHR, JOSEF, MULTIPLE CLASS, (INT. CLS. 5, 9, 10 AND 16), (U.S. CLS. 2, 5, 6, 18, 21, 22, 23, 26, 29, 36, 37, 38, 39, 44, 46, 50, 51 AND 52). SN 75-749,050. PUB. 11-20-2001. FILED 6-14-1999.
 2,622,687. **MALARONE**. WELLCOME FOUNDATION LIMITED, THE, (U.S. CLS. 6, 18, 44, 46, 51 AND 52). SN 75-751,708. PUB. 7-2-2002. FILED 7-15-1999.
 2,622,706. **ENSIV**. DAICHI PHARMACEUTICAL CO., LTD., (U.S. CLS. 6, 18, 44, 46, 51 AND 52). SN 75-776,991. PUB. 12-5-2000. FILED 8-16-1999.
 2,622,721. **PURISTA**. AVECIA LIMITED, BY CHANGE OF NAME; BY ASSIGNMENT ZENECA LIMITED, (U.S. CLS. 6, 18, 44, 46, 51 AND 52). SN 75-801,155. PUB. 7-2-2002. FILED 9-16-1999.
 2,622,734. **MISCELLANEOUS DESIGN**. ANESTA CORPORATION, (U.S. CLS. 6, 18, 44, 46, 51 AND 52). SN 75-819,823. PUB. 7-2-2002. FILED 10-12-1999.
 2,622,758. **MINIMABS**. CELLTECH R & D LIMITED, BY CHANGE OF NAME; BY CHANGE OF NAME CELLTECH THERAPEUTICS LIMITED, (U.S. CLS. 6, 18, 44, 46, 51 AND

- 52). SN 75-843,729. PUB. 6-6-2000. FILED 11-9-1999.
- 2,622,763. **CHAMBERLIN'S YOUR NATURAL FOOD CENTER AND DESIGN.** FOOD FOR HEALTH CO., INC., (U.S. CLS. 6, 18, 44, 46, 51 AND 52). SN 75-849,140. PUB. 11-27-2001. FILED 11-15-1999.
- 2,622,781. **THERMO BOOST.** ADVANTAGE NUTRACEUTICALS, INC., (U.S. CLS. 6, 18, 44, 46, 51 AND 52). SN 75-861,956. PUB. 7-2-2002. FILED 12-1-1999.
- 2,622,797. **VISCO-GEL.** PEDIFIX, INC., MULTIPLE CLASS, (INT. CLS. 5 AND 10), (U.S. CLS. 6, 18, 26, 39, 44, 46, 51 AND 52). SN 75-882,800. PUB. 7-2-2002. FILED 12-29-1999.
- 2,622,804 (*See Class 1 for this trademark*).
- 2,622,815. **LUXA.** ERNST MUHLBAUER GMBH & CO. KG, BY CHANGE OF NAME ERNST MUHLBAUER KG, (U.S. CLS. 6, 18, 44, 46, 51 AND 52). SN 75-892,777. PUB. 10-30-2001. FILED 1-10-2000.
- 2,622,847. **LEVITRA.** BAYER AKTIENGESELLSCHAFT, (U.S. CLS. 6, 18, 44, 46, 51 AND 52). SN 75-913,260. PUB. 7-2-2002. FILED 2-8-2000.
- 2,622,877. **I CHEAT.** HEALTH AND NUTRITIONAL SYSTEMS INTERNATIONAL, INC., (U.S. CLS. 6, 18, 44, 46, 51 AND 52). SN 75-939,009. PUB. 7-2-2002. FILED 3-8-2000.
- 2,622,883. **NUTRACLUB.** CHRISTY, JOSEPH AND CHRISTY, MARTHA, (U.S. CLS. 6, 18, 44, 46, 51 AND 52). SN 75-943,894. PUB. 7-2-2002. FILED 3-14-2000.
- 2,622,898. **AEGIS.** ELASTIC CORPORATION OF AMERICA, INC., MULTIPLE CLASS, (INT. CLS. 5 AND 10), (U.S. CLS. 6, 18, 26, 39, 44, 46, 51 AND 52). SN 76-000,301. PUB. 7-2-2002. FILED 3-14-2000.
- 2,622,924. **KNESS PEST SEALANT.** KNESS MFG. CO., INC., (U.S. CLS. 6, 18, 44, 46, 51 AND 52). SN 76-015,890. PUB. 7-2-2002. FILED 4-3-2000.
- 2,622,925 (*See Class 3 for this trademark*).
- 2,622,991. **SYSTALA.** MEDAC GESELLSCHAFT FOR KLINISCHE SPEZIALPRAPARATE MBH, (U.S. CLS. 6, 18, 44, 46, 51 AND 52). SN 76-049,511. PUB. 7-2-2002. FILED 5-16-2000.
- 2,623,068 (*See Class 1 for this trademark*).
- 2,623,086. **PLANT-PROD.** PLANT PRODUCTS CO. LTD., (U.S. CLS. 6, 18, 44, 46, 51 AND 52). SN 76-081,738. PUB. 4-10-2001. FILED 6-30-2000.
- 2,623,131. **OLEDA.** OLEDA AND COMPANY, INC., (U.S. CLS. 6, 18, 44, 46, 51 AND 52). SN 76-095,307. PUB. 7-2-2002. FILED 7-24-2000.
- 2,623,137. **GLOFIL.** QUESTCOR PHARMACEUTICALS, INC., (U.S. CLS. 6, 18, 44, 46, 51 AND 52). SN 76-098,030. PUB. 7-2-2002. FILED 7-27-2000.
- 2,623,138. **ELASTOSOFT.** BEIERSDORF AKTIENGESELLSCHAFT, MULTIPLE CLASS, (INT. CLS. 5 AND 10), (U.S. CLS. 6, 18, 26, 39, 44, 46, 51 AND 52). SN 76-098,198. PUB. 7-2-2002. FILED 7-27-2000.
- 2,623,143. **ARGININE ULTRA.** FREELIFE INTERNATIONAL LLC, (U.S. CLS. 6, 18, 44, 46, 51 AND 52). SN 76-099,725. PUB. 11-6-2001. FILED 8-1-2000.
- 2,623,148 (*See Class 1 for this trademark*).
- 2,623,161 (*See Class 1 for this trademark*).
- 2,623,209. **ARISE & SHINE AND DESIGN.** ARISE & SHINE HERBAL PRODUCTS, INC., (U.S. CLS. 6, 18, 44, 46, 51 AND 52). SN 76-119,700. PUB. 7-2-2002. FILED 8-31-2000.
- 2,623,218. **HERACERAM (STYLIZED).** HERAEUS KULZER GMBH & CO. KG, (U.S. CLS. 6, 18, 44, 46, 51 AND 52). SN 76-121,924. PUB. 10-9-2001. FILED 9-5-2000.
- 2,623,282. **LIGAPLANT.** NATURAL IMPLANT, (U.S. CLS. 6, 18, 44, 46, 51 AND 52). SN 76-137,052. PUB. 7-2-2002. FILED 9-28-2000.
- 2,623,293 (*See Class 3 for this trademark*).
- 2,623,308. **BOVFLY.** BURKMANN INDUSTRIES, INC., DBA BURKMANN FEEDS, (U.S. CLS. 6, 18, 44, 46, 51 AND 52). SN 76-142,322. PUB. 7-2-2002. FILED 10-10-2000.
- 2,623,315 (*See Class 3 for this trademark*).
- 2,623,382. **FLORADIX.** SALUS HAUS DR. MED. OTTO GREITHER NACHF, GMBH & CO. KG, MULTIPLE CLASS, (INT. CLS. 5 AND 30), (U.S. CLS. 6, 18, 44, 46, 51 AND 52). SN 76-153,800. PUB. 1-15-2002. FILED 10-25-2000.
- 2,623,398. **UTROGESTAN.** LABORATOIRES BESINS INTERNATIONAL, (U.S. CLS. 6, 18, 44, 46, 51 AND 52). SN 76-157,443. PUB. 7-2-2002. FILED 11-1-2000.
- 2,623,562. **GREEN-HOPE.** INAMCO INTERNATIONAL CORP., (U.S. CLS. 6, 18, 44, 46, 51 AND 52). SN 76-181,383. PUB. 7-2-2002. FILED 12-11-2000.
- 2,623,620 (*See Class 3 for this trademark*).
- 2,623,699. **FERRISELTZ.** OTSUKA PHARMACEUTICAL CO., LTD., (U.S. CLS. 6, 18, 44, 46, 51 AND 52). SN 76-200,158. PUB. 7-2-2002. FILED 1-26-2001.
- 2,623,712. **MISCELLANEOUS DESIGN.** MERIAL LIMITED, (U.S. CLS. 6, 18, 44, 46, 51 AND 52). SN 76-201,679. PUB. 7-2-2002. FILED 1-30-2001.
- 2,623,725 (*See Class 1 for this trademark*).
- 2,623,803 (*See Class 3 for this trademark*).
- 2,623,815 (*See Class 3 for this trademark*).
- 2,623,833. **DONA GLUCOSAMINE SULFATE THE ORIGINAL AND DESIGN.** ROTTAPHARM LTD., (U.S. CLS. 6, 18, 44, 46, 51 AND 52). SN 76-217,729. PUB. 7-2-2002. FILED 3-1-2001.
- 2,623,871. **POSURDEX.** OCULEX PHARMACEUTICALS, INC., (U.S. CLS. 6, 18, 44, 46, 51 AND 52). SN 76-222,027. PUB. 7-2-2002. FILED 3-8-2001.
- 2,623,926. **DAVIDSON.** BRADLEY PRODUCTS, INC., MULTIPLE CLASS, (INT. CLS. 5 AND 9), (U.S. CLS. 6, 18, 21, 23, 26, 36, 38, 44, 46, 51 AND 52). SN 76-229,379. PUB. 7-2-2002. FILED 3-26-2001.
- 2,624,003 (*See Class 1 for this trademark*).
- 2,624,036. **DIAMOND V YEAST CULTURE FERMENTATION FORTIFIED AND DESIGN.** DIAMOND V MILLS, INC., (U.S. CLS. 6, 18, 44, 46, 51 AND 52). SN 76-242,103. PUB. 7-2-2002. FILED 4-17-2001.
- 2,624,060. **BOGAMOVE.** BOGAR AG, MULTIPLE CLASS, (INT. CLS. 5 AND 31), (U.S. CLS. 1, 6, 18, 44, 46, 51 AND 52). SN 76-244,156. PUB. 7-2-2002. FILED 4-20-2001.
- 2,624,078. **TORPEX.** BOEHRINGER INGELHEIM VETMEDICA GMBH, (U.S. CLS. 6, 18, 44, 46, 51 AND 52). SN 76-246,605. PUB. 9-25-2001. FILED 4-25-2001.
- 2,624,206 (*See Class 3 for this trademark*).
- 2,624,237. **GENERAL VITAMIN.** GENERAL VITAMIN OF NORTH CAROLINA, INC., MULTIPLE CLASS, (INT. CLS. 5 AND 35), (U.S. CLS. 6, 18, 44, 46, 51, 52, 100, 101 AND 102). SN 76-265,549. PUB. 7-2-2002. FILED 5-31-2001.
- 2,624,276 (*See Class 3 for this trademark*).
- 2,624,294. **RENDIX.** BOEHRINGER INGELHEIM PHARMA KG, (U.S. CLS. 6, 18, 44, 46, 51 AND 52). SN 76-270,856. PUB. 3-12-2002. FILED 6-12-2001.
- 2,624,348 (*See Class 4 for this trademark*).
- 2,624,371 (*See Class 3 for this trademark*).
- 2,624,390. **MISCELLANEOUS DESIGN.** NEW OPTION INTL., INC., THE, (U.S. CLS. 6, 18, 44, 46, 51 AND 52). SN 76-285,325. PUB. 7-2-2002. FILED 7-16-2001.
- 2,624,394. **ANACAPS.** PIERRE FABRE DERMO-COSMETIQUE, (U.S. CLS. 6, 18, 44, 46, 51 AND 52). SN 76-285,647. PUB. 7-2-2002. FILED 7-16-2001.
- 2,624,428. **OMNISTRIP.** PAUL HARTMANN AG, (U.S. CLS. 6, 18, 44, 46, 51 AND 52). SN 76-290,718. PUB. 7-2-2002. FILED 7-26-2001.
- 2,624,429. **TELASORB.** PAUL HARTMANN AG, (U.S. CLS. 6, 18, 44, 46, 51 AND 52). SN 76-290,720. PUB. 7-2-2002. FILED 7-26-2001.
- 2,624,435 (*See Class 3 for this trademark*).
- 2,624,444. **ODOR STOP.** BK ENTERPRISES, A DIVISION OF TOMORROW, INC., (U.S. CLS. 6, 18, 44, 46, 51 AND 52). SN 76-291,923. PUB. 7-2-2002. FILED 7-31-2001.
- 2,624,455. **MAXIMUM PERFORMANCE HERBALS.** CHINESE HERBAL USA, INC., (U.S. CLS. 6, 18, 44, 46, 51 AND 52). SN 76-293,516. PUB. 7-2-2002. FILED 8-2-2001.
- 2,624,459. **HYGISOL.** RAINBOW FOODS LLC, (U.S. CLS. 6, 18, 44, 46, 51 AND 52). SN 76-294,346. PUB. 7-2-2002. FILED 8-2-2001.
- 2,624,482 (*See Class 3 for this trademark*).
- 2,624,486 (*See Class 3 for this trademark*).
- 2,624,522. **RAPIRUN.** OTSUKA PHARMACEUTICAL CO., LTD., (U.S. CLS. 6, 18, 44, 46, 51 AND 52). SN 76-306,329. PUB. 7-2-2002. FILED 8-28-2001.
- 2,624,530. **L.E.A.D.S. LIVE ENZYME ACTIVATED DELIVERY SYSTEM.** NATURAL WELLNESS CENTERS OF AMERICA, (U.S. CLS. 6, 18, 44, 46, 51 AND 52). SN 76-307,863. PUB. 7-2-2002. FILED 9-4-2001.
- 2,624,555. **MISCELLANEOUS DESIGN.** BIOFARMA, (U.S. CLS. 6, 18, 44, 46, 51 AND 52). SN 76-312,226. PUB. 7-2-

2002. FILED 9-14-2001.
- 2,624,659. **FERRISELTZ AND DESIGN**. OTSUKA PHARMACEUTICAL CO, LTD., (U.S. CLS. 6, 18, 44, 46, 51 AND 52). SN 76-326,749. PUB. 7-2-2002. FILED 10-17-2001.
- 2,624,673. **TRIO, FACE & BODY PROFESSIONALS, INC.**, (U.S. CLS. 6, 18, 44, 46, 51 AND 52). SN 76-328,367. PUB. 7-2-2002. FILED 10-22-2001.
- 2,624,748 (*See Class 1 for this trademark*).
- 2,624,762. **DEXONE**. SOLVAY PHARMA PROPERTIES, INC., (U.S. CLS. 6, 18, 44, 46, 51 AND 52). SN 76-340,714. PUB. 7-2-2002. FILED 11-21-2001.
- 2,624,880. **GABITRIL AND DESIGN**. CEPHALON, INC., (U.S. CLS. 6, 18, 44, 46, 51 AND 52). SN 76-356,141. PUB. 7-2-2002. FILED 1-8-2002.
- 2,624,941. **ATWATER CAREY**. WPC BRANDS, INC., (U.S. CLS. 6, 18, 44, 46, 51 AND 52). SN 76-368,779. PUB. 7-2-2002. FILED 2-8-2002.
- 2,624,943. **TRI-CLA**. THORNE RESEARCH, INC., (U.S. CLS. 6, 18, 44, 46, 51 AND 52). SN 76-369,040. PUB. 7-2-2002. FILED 2-11-2002.
- 2,625,069. **TRIG-TRAK**. NOVARTIS AG, MULTIPLE CLASS, (INT. CLS. 5 AND 10), (U.S. CLS. 6, 18, 26, 39, 44, 46, 51 AND 52). SN 78-058,188. PUB. 7-2-2002. FILED 4-12-2001.
- 2,625,093. **AZMIRA HOLISTIC ANIMAL CARE**. TOBY-O INCORPORATED, MULTIPLE CLASS, (INT. CLS. 5, 31 AND 41), (U.S. CLS. 1, 6, 18, 44, 46, 51, 52, 100, 101 AND 107). SN 78-062,753. PUB. 7-2-2002. FILED 5-9-2001.
- 2,625,108. **BACCHUS AND DESIGN**. DONG-A PHARMACEUTICAL CO., LTD., (U.S. CLS. 6, 18, 44, 46, 51 AND 52). SN 78-064,352. PUB. 7-2-2002. FILED 5-18-2001.
- 2,625,126. **TEAMSPIRE AND DESIGN**. HUGHES, MARK ELVIN, (U.S. CLS. 6, 18, 44, 46, 51 AND 52). SN 78-068,890. PUB. 7-2-2002. FILED 6-13-2001.
- 2,625,202. **EXTENCAPS**. AMERICAN HOME PRODUCTS CORPORATION, (U.S. CLS. 6, 18, 44, 46, 51 AND 52). SN 78-085,425. PUB. 7-2-2002. FILED 9-25-2001.
- 2,625,248. **CHEW CLEAN**. PURI-CLEAN ENTERPRISES, INC., (U.S. CLS. 6, 18, 44, 46, 51 AND 52). SN 78-094,354. PUB. 7-2-2002. FILED 11-20-2001.
- 2,625,250. **CONDOMANIA AND DESIGN**. ADDAZI, INC., (U.S. CLS. 6, 18, 44, 46, 51 AND 52). SN 78-095,043. PUB. 7-2-2002. FILED 11-26-2001.
- 2,625,252. **VARIMUNE**. DISS, JUDITH, AND HOWARD, TIM, (U.S. CLS. 6, 18, 44, 46, 51 AND 52). SN 78-095,135. PUB. 7-2-2002. FILED 11-26-2001.
- 2,625,306. **CARBOTAME**. JARROW FORMULAS, INC., (U.S. CLS. 6, 18, 44, 46, 51 AND 52). SN 78-104,332. PUB. 7-2-2002. FILED 1-23-2002.
- 2,625,309. **NATURAL LIVING**. NATURAL LIVING, (U.S. CLS. 6, 18, 44, 46, 51 AND 52). SN 78-104,348. PUB. 7-2-2002. FILED 1-23-2002.
-
- 38, 50, 100 AND 101), SN 76-005,170. PUB. 10-30-2001. FILED 3-20-2000.
- 2,622,942. **LEVPANO**. ROGER MONDELIN S.A., MULTIPLE CLASS, (INT. CLS. 6, 7, 8, 12, 19 AND 20), (U.S. CLS. 1, 2, 12, 13, 14, 19, 21, 22, 23, 25, 28, 31, 32, 33, 34, 35, 44 AND 50). SN 76-023,287. PUB. 7-2-2002. FILED 4-11-2000.
- 2,623,001. **TRU-START**. RESEARCH ENGINEERING AND MANUFACTURING, INC., (U.S. CLS. 2, 12, 13, 14, 23, 25 AND 50). SN 76-052,686. PUB. 7-2-2002. FILED 5-19-2000.
- 2,623,100. **MAR MAC SPEED WIRE**. MAR-MAC WIRE, INC., (U.S. CLS. 2, 12, 13, 14, 23, 25 AND 50). SN 76-087,696. PUB. 7-2-2002. FILED 7-13-2000.
- 2,623,166. **WINDMASTER AND DESIGN**. MARKETING DISPLAYS, INC., (U.S. CLS. 2, 12, 13, 14, 23, 25 AND 50). SN 76-108,778. PUB. 7-2-2002. FILED 8-11-2000.
- 2,623,182. **W AND DESIGN**. WORTHINGTON INDUSTRIES, INC., (U.S. CLS. 2, 12, 13, 14, 23, 25 AND 50). SN 76-112,756. PUB. 7-2-2002. FILED 8-18-2000.
- 2,623,220. **METROSHINGLE**. METROTILE (N.Z.) LIMITED, (U.S. CLS. 2, 12, 13, 14, 23, 25 AND 50). SN 76-123,769. PUB. 7-2-2002. FILED 9-6-2000.
- 2,623,234. **PROTEUS**. EDG. INC., (U.S. CLS. 2, 12, 13, 14, 23, 25 AND 50). SN 76-127,898. PUB. 7-2-2002. FILED 9-15-2000.
- 2,623,271. **MISCELLANEOUS DESIGN**. WELLSTREAM, INC., MULTIPLE CLASS, (INT. CLS. 6 AND 17), (U.S. CLS. 1, 2, 5, 12, 13, 14, 23, 25, 35 AND 50). SN 76-135,441. PUB. 10-23-2001. FILED 9-26-2000.
- 2,623,359. **HIATTS**. HIATT AND COMPANY LIMITED, (U.S. CLS. 2, 12, 13, 14, 23, 25 AND 50). SN 76-151,399. PUB. 7-2-2002. FILED 10-23-2000.
- 2,623,428. **FORT WAYNE POOLS INC. AND DESIGN**. FORT WAYNE POOLS, INC., MULTIPLE CLASS, (INT. CLS. 6 AND 19), (U.S. CLS. 1, 2, 12, 13, 14, 23, 25, 33 AND 50). SN 76-160,799. PUB. 7-2-2002. FILED 11-7-2000.
- 2,623,548. **ROOF RUNNER**. ALAN DICK & COMPANY LIMITED, MULTIPLE CLASS, (INT. CLS. 6, 9 AND 20), (U.S. CLS. 2, 12, 13, 14, 21, 22, 23, 25, 26, 32, 36, 38 AND 50). SN 76-179,371. PUB. 4-16-2002. FILED 12-12-2000.
- 2,623,558. **WINDOWGRID**. PERKINS & WILL, S.E. (U.S. CLS. 2, 12, 13, 14, 23, 25 AND 50). SN 76-181,033. PUB. 7-2-2002. FILED 12-14-2000.
- 2,623,560. **WINDOWFRAME**. PERKINS & WILL, S.E., (U.S. CLS. 2, 12, 13, 14, 23, 25 AND 50). SN 76-181,211. PUB. 7-2-2002. FILED 12-14-2000.
- 2,623,620 (*See Class 3 for this trademark*).
- 2,623,770. **PROMISTAR AND DESIGN**. PROMISTAR FINANCIAL CORPORATION, (U.S. CLS. 2, 12, 13, 14, 23, 25 AND 50). SN 76-208,315. PUB. 7-2-2002. FILED 2-12-2001.
- 2,623,875. **WORLDMARK USA**. DONPRINT, INC., MULTIPLE CLASS, (INT. CLS. 6 AND 20), (U.S. CLS. 2, 12, 13, 14, 22, 23, 25, 32 AND 50). SN 76-222,594. PUB. 7-2-2002. FILED 3-12-2001.
- 2,623,907 (*See Class 1 for this trademark*).
- 2,624,017. **BUBL**. H. BUTTING GMBH & CO. KG, MULTIPLE CLASS, (INT. CLS. 6, 7 AND 11), (U.S. CLS. 2, 12, 13, 14, 19, 21, 23, 25, 31, 34, 35 AND 50). SN 76-240,222. PUB. 7-2-2002. FILED 4-12-2001.
- 2,624,046. **VENTANA**. WEISER LOCK CORPORATION, (U.S. CLS. 2, 12, 13, 14, 23, 25 AND 50). SN 76-242,609. PUB. 7-2-2002. FILED 4-18-2001.
- 2,624,050. **CIDER MILL AND DESIGN**. ASPEN PET PRODUCTS, INC, MULTIPLE CLASS, (INT. CLS. 6, 18 AND 28), (U.S. CLS. 1, 2, 3, 12, 13, 14, 22, 23, 25, 38, 41 AND 50). SN 76-242,783. PUB. 7-2-2002. FILED 4-18-2001.
- 2,624,088. **LIFE'S A CHARM AND DESIGN**. LIFE'S A CHARM, INC., (U.S. CLS. 2, 12, 13, 14, 23, 25 AND 50). SN 76-247,231. PUB. 7-2-2002. FILED 4-27-2001.
- 2,624,142. **WATERPURE**. KAYDON ACQUISITION XI, INC., (U.S. CLS. 2, 12, 13, 14, 23, 25 AND 50). SN 76-255,247. PUB. 7-2-2002. FILED 5-10-2001.
- 2,624,144. **WATERSAFE**. KAYDON ACQUISITION XI, INC., (U.S. CLS. 2, 12, 13, 14, 23, 25 AND 50). SN 76-255,398. PUB. 7-2-2002. FILED 5-10-2001.
- 2,624,147. **RECOBULK (STYLIZED)**. SCHUTZ GMBH & CO. KGAA, MULTIPLE CLASS, (INT. CLS. 6 AND 20), (U.S. CLS. 2, 12, 13, 14, 22, 23, 25, 32 AND 50). SN 76-255,836. PUB. 7-2-2002. FILED 5-11-2001.
- 2,624,215. **STORMLOCS**. CAMERON ASHLEY BUILDING

CLASS 6—METAL GOODS

- 2,622,590. **DILO AND DESIGN**. FIRMA DILO ARMATUREN UND ANLAGEN GMBH, MULTIPLE CLASS, (INT. CLS. 6, 7, 9, 11 AND 17), (U.S. CLS. 1, 2, 5, 12, 13, 14, 19, 21, 23, 25, 26, 31, 34, 35, 36, 38 AND 50). SN 75-581,910. PUB. 10-30-2001. FILED 11-3-1998.
- 2,622,597. **CLIMBMATE AND DESIGN**. JEFFS, MICHAEL, (U.S. CLS. 2, 12, 13, 14, 23, 25 AND 50). SN 75-590,470. PUB. 12-14-1999. FILED 11-17-1998.
- 2,622,605 (*See Class 5 for this trademark*).
- 2,622,711. **LABOXACT**. KNF NEUBERGER GMBH, MULTIPLE CLASS, (INT. CLS. 6, 7, 11 AND 17), (U.S. CLS. 1, 2, 5, 12, 13, 14, 19, 21, 23, 25, 31, 34, 35 AND 50). SN 75-788,741. PUB. 7-2-2002. FILED 8-30-1999.
- 2,622,757. **PRADA (STYLIZED)**. PRADA S.A., BY CHANGE OF NAME PREFEL S.A., MULTIPLE CLASS, (INT. CLS. 6, 8, 11, 22, 23, 24, 26, 27, 28, 32, 33, 35, 36, 39 AND 41), (U.S. CLS. 1, 2, 7, 12, 13, 14, 19, 20, 21, 22, 23, 25, 28, 31, 34, 37, 38, 39, 40, 42, 43, 44, 45, 46, 47, 48, 49, 50, 100, 101, 102, 105 AND 107). SN 75-843,401. PUB. 7-2-2002. FILED 11-8-1999.
- 2,622,905. **NORCO INDUSTRIAL DOORS**. NORCO MANUFACTURING CORPORATION, MULTIPLE CLASS, (INT. CLS. 6, 9 AND 42), (U.S. CLS. 2, 12, 13, 14, 21, 23, 25, 26, 36,

- PRODUCTS, INC., (U.S. CLS. 2, 12, 13, 14, 23, 25 AND 50). SN 76-263,253. PUB. 7-2-2002. FILED 5-29-2001.
- 2,624,217. **WE BRING THE STORE TO YOU!**. HI-LINE ELECTRIC INC., MULTIPLE CLASS, (INT. CLS. 6 AND 9), (U.S. CLS. 2, 12, 13, 14, 21, 23, 25, 26, 36, 38 AND 50). SN 76-263,619. PUB. 7-2-2002. FILED 5-29-2001.
- 2,624,301. **CHINROSE**. ROSE HILL ENTERPRISES LLC, (U.S. CLS. 2, 12, 13, 14, 23, 25 AND 50). SN 76-271,841. PUB. 7-2-2002. FILED 6-18-2001.
- 2,624,663. **MOBELLA**. MOBELLA, AB, MULTIPLE CLASS, (INT. CLS. 6 AND 20), (U.S. CLS. 2, 12, 13, 14, 22, 23, 25, 32 AND 50). SN 76-327,050. PUB. 7-2-2002. FILED 10-18-2001.
- 2,624,720. **POLYFAST**. SEMBLEX CORPORATION, (U.S. CLS. 2, 12, 13, 14, 23, 25 AND 50). SN 76-334,632. PUB. 7-2-2002. FILED 11-7-2001.
- 2,624,773. **SPIRASEAL**. LAMONS METAL GASKET CO., MULTIPLE CLASS, (INT. CLS. 6 AND 17), (U.S. CLS. 1, 2, 5, 12, 13, 14, 23, 25, 35 AND 50). SN 76-343,193. PUB. 7-2-2002. FILED 11-30-2001.
- 2,624,894. **WILSON**. WILSON DOORS INC., (U.S. CLS. 2, 12, 13, 14, 23, 25 AND 50). SN 76-357,142. PUB. 7-2-2002. FILED 1-11-2002.
- 2,624,911. **SILVERGLEEM**. KAYDON ACQUISITION XI, INC., (U.S. CLS. 2, 12, 13, 14, 23, 25 AND 50). SN 76-360,582. PUB. 7-2-2002. FILED 1-18-2002.
- 2,624,920. **UNISERT**. CONTINENTAL DISC CORPORATION, (U.S. CLS. 2, 12, 13, 14, 23, 25 AND 50). SN 76-363,630. PUB. 7-2-2002. FILED 1-28-2002.
- 2,625,051. **H2 (STYLIZED)**. GENERAL MOTORS CORPORATION, (U.S. CLS. 2, 12, 13, 14, 23, 25 AND 50). SN 78-054,005. PUB. 7-2-2002. FILED 3-20-2001.
- 2,625,101. **MISCELLANEOUS DESIGN**. GENERAL MOTORS CORPORATION, (U.S. CLS. 2, 12, 13, 14, 23, 25 AND 50). SN 78-063,928. PUB. 7-2-2002. FILED 5-16-2001.
- 2,625,102. **BUICK**. GENERAL MOTORS CORPORATION, (U.S. CLS. 2, 12, 13, 14, 23, 25 AND 50). SN 78-063,931. PUB. 7-2-2002. FILED 5-16-2001.
-
- CLASS 7—MACHINERY**
- 2,622,509 (*See Class 1 for this trademark*).
- 2,622,520. **ARCAM**. ARCAM AB, ASSIGNEE OF; ASSIGNEE OF; BY ASSIGNMENT LARSON, RALF, MULTIPLE CLASS, (INT. CLS. 7 AND 9), (U.S. CLS. 13, 19, 21, 23, 26, 31, 34, 35, 36 AND 38). SN 75-220,512. PUB. 8-29-2000. FILED 1-2-1997.
- 2,622,553. **UNIVERSALBINDER**. HEIDELBERGER DRUCKMASCHINEN AKTIENGESELLSCHAFT, MULTIPLE CLASS, (INT. CLS. 7, 9 AND 20), (U.S. CLS. 2, 13, 19, 21, 22, 23, 25, 26, 31, 32, 34, 35, 36, 38 AND 50). SN 75-474,679. PUB. 7-2-2002. FILED 4-27-1998.
- 2,622,559. **AUTOMATED LOADING SYSTEM (ALS)**. UNAXIS USA, INC., BY CHANGE OF NAME PLASMA-THERM, INC., (U.S. CLS. 13, 19, 21, 23, 31, 34 AND 35). SN 75-499,296. PUB. 7-2-2002. FILED 6-10-1998.
- 2,622,587. **DEMARCO MAX VAC AND DESIGN**. DEMARCO MAXVAC CORPORATION, (U.S. CLS. 13, 19, 21, 23, 31, 34 AND 35). SN 75-571,127. PUB. 7-2-2002. FILED 10-15-1998.
- 2,622,590 (*See Class 6 for this trademark*).
- 2,622,640. **SUN-MAR HOME COMPOSTER**. SUN-MAR CORPORATION, (U.S. CLS. 13, 19, 21, 23, 31, 34 AND 35). SN 75-672,470. PUB. 7-2-2002. FILED 4-1-1999.
- 2,622,689. **ROK**. IPT WEINFELDEN AG, MULTIPLE CLASS, (INT. CLS. 7, 9 AND 40), (U.S. CLS. 13, 19, 21, 23, 26, 31, 34, 35, 36, 38, 100, 103 AND 106). SN 75-756,769. PUB. 7-2-2002. FILED 7-21-1999.
- 2,622,696. **RUMBLERS**. SUMMIT INDUSTRIES, INC., (U.S. CLS. 13, 19, 21, 23, 31, 34 AND 35). SN 75-764,083. PUB. 7-2-2002. FILED 7-30-1999.
- 2,622,711 (*See Class 6 for this trademark*).
- 2,622,733. **TITAN**. MONOTUB INDUSTRIES, PLC, MULTIPLE CLASS, (INT. CLS. 7 AND 11), (U.S. CLS. 13, 19, 21, 23, 31, 34 AND 35). SN 75-819,165. PUB. 1-9-2001. FILED 10-8-1999.
- 2,622,774. **THE TOOL THAT KNOWS NO LIMITS.** BLACK & DECKER CORPORATION, THE, (U.S. CLS. 13, 19, 21, 23, 31, 34 AND 35). SN 75-856,953. PUB. 7-2-2002. FILED 11-23-1999.
- 2,622,801. **CMF OMAT AND DESIGN**. CMF OMAT S.R.L., (U.S. CLS. 13, 19, 21, 23, 31, 34 AND 35). SN 75-885,673. PUB. 1-29-2002. FILED 1-3-2000.
- 2,622,846. **BONTAZ CENTRE (STYLIZED)**. BONTAZ CENTRE, MULTIPLE CLASS, (INT. CLS. 7 AND 12), (U.S. CLS. 13, 19, 21, 23, 31, 34, 35 AND 44). SN 75-912,811. PUB. 7-2-2002. FILED 2-8-2000.
- 2,622,875. **US AND DESIGN**. EMERSON ELECTRIC CO., MULTIPLE CLASS, (INT. CLS. 7, 9 AND 11), (U.S. CLS. 13, 19, 21, 23, 26, 31, 34, 35, 36 AND 38). SN 75-937,768. PUB. 7-2-2002. FILED 3-7-2000.
- 2,622,876. **ESPRO**. TOFTEJORG TECHNOLOGY A/S, MULTIPLE CLASS, (INT. CLS. 7 AND 37), (U.S. CLS. 13, 19, 21, 23, 31, 34, 35, 100, 103 AND 106). SN 75-938,652. PUB. 7-2-2002. FILED 3-8-2000.
- 2,622,919. **MYLAM**. GMP CO., LTD., (U.S. CLS. 13, 19, 21, 23, 31, 34 AND 35). SN 76-009,939. PUB. 7-2-2002. FILED 3-20-2000.
- 2,622,920. **SAN**. GROZ-BECKERT KG, (U.S. CLS. 13, 19, 21, 23, 31, 34 AND 35). SN 76-012,266. PUB. 6-19-2001. FILED 3-29-2000.
- 2,622,921. **JIC HYDRAULICS AND DESIGN**. MCSUN INC., (U.S. CLS. 13, 19, 21, 23, 31, 34 AND 35). SN 76-012,974. PUB. 7-2-2002. FILED 3-29-2000.
- 2,622,938. **BAR-B-QUE CHEF**. BONJOUR, INC., (U.S. CLS. 13, 19, 21, 23, 31, 34 AND 35). SN 76-021,851. PUB. 7-2-2002. FILED 4-7-2000.
- 2,622,940. **IMAGEPERF**. INDUSTRIAL AUTOMATION INTEGRATORS (IAI) B.V., (U.S. CLS. 13, 19, 21, 23, 31, 34 AND 35). SN 76-022,561. PUB. 4-9-2002. FILED 4-11-2000.
- 2,622,942 (*See Class 6 for this trademark*).
- 2,622,971. **E AND DESIGN**. SLE SALES & SERVICE ELECTRONIC GMBH, MULTIPLE CLASS, (INT. CLS. 7, 9 AND 37), (U.S. CLS. 13, 19, 21, 23, 26, 31, 34, 35, 36, 38, 100, 103 AND 106). SN 76-039,021. PUB. 7-2-2002. FILED 5-2-2000.
- 2,623,011. **ELECTROGLIDE**. H-P PRODUCTS, INC., (U.S. CLS. 13, 19, 21, 23, 31, 34 AND 35). SN 76-056,176. PUB. 7-2-2002. FILED 5-25-2000.
- 2,623,033. **EXCLUSIVE TRUE-LINK PERFORMANCE (STYLIZED)**. EMC DOCUMENT SYSTEMS, INC., (U.S. CLS. 13, 19, 21, 23, 31, 34 AND 35). SN 76-063,324. PUB. 7-2-2002. FILED 6-5-2000.
- 2,623,040. **DOLLFUS & MULLER**. DOLLFUS ET MULLER, MULTIPLE CLASS, (INT. CLS. 7, 17 AND 24), (U.S. CLS. 1, 5, 12, 13, 19, 21, 23, 31, 34, 35, 42 AND 50). SN 76-065,076. PUB. 5-21-2002. FILED 6-7-2000.
- 2,623,054. **MONTAPLAST**. MONTAPLAST GMBH, MULTIPLE CLASS, (INT. CLS. 7, 9 AND 12), (U.S. CLS. 13, 19, 21, 23, 26, 31, 34, 35, 36, 38 AND 44). SN 76-069,123. PUB. 7-2-2002. FILED 6-13-2000.
- 2,623,085. **STAK SYSTEM**. STANLEY LOGISTICS, INC., (U.S. CLS. 13, 19, 21, 23, 31, 34 AND 35). SN 76-081,662. PUB. 7-2-2002. FILED 7-3-2000.
- 2,623,103. **GEBO AND DESIGN**. GEBO CONVOYEURS CONSULTANTS AND SYSTEMES INC., MULTIPLE CLASS, (INT. CLS. 7, 41 AND 42), (U.S. CLS. 13, 19, 21, 23, 31, 34, 35, 100, 101 AND 107). SN 76-088,408. PUB. 7-2-2002. FILED 7-13-2000.
- 2,623,173. **ARTWORK DIES MACHINERY FOILS SERVICE EST 2000 HOT STAMP SUPPLY COMPANY 141-2 MARCEL DRIVE WINCHESTER, VA 22602-4844 (877) 343-4321 FAX (877) 448-1001 WWW.HOTSTAMPSSUPPLY.COM AND DESIGN**. HOT STAMP SUPPLY COMPANY, MULTIPLE CLASS, (INT. CLS. 7 AND 37), (U.S. CLS. 13, 19, 21, 23, 31, 34, 35, 100, 103 AND 106). SN 76-110,887. PUB. 7-2-2002. FILED 8-16-2000.
- 2,623,229. **ORNAMOTION**. ORNAMOTOR, INC., (U.S. CLS. 13, 19, 21, 23, 31, 34 AND 35). SN 76-126,970. PUB. 7-2-2002. FILED 9-11-2000.
- 2,623,279. **EVOMAT**. WANDRES GMBH MICRO-CLEANING, (U.S. CLS. 13, 19, 21, 23, 31, 34 AND 35). SN 76-136,734. PUB. 7-2-2002. FILED 9-27-2000.
- 2,623,287. **SPEEDMASTER DI**. HEIDELBERGER DRUCKMASCHINEN AKTIENGESELLSCHAFT, (U.S. CLS. 13, 19, 21, 23, 31, 34 AND 35). SN 76-138,430. PUB. 7-2-2002. FILED 9-29-2000.

- 2,623,289. **MAS.** AARON PROCESS EQUIPMENT COMPANY, (U.S. CLS. 13, 19, 21, 23, 31, 34 AND 35). SN 76-138,491. PUB. 1-8-2002. FILED 10-2-2000.
- 2,623,301. **SIC MARKING AND DESIGN.** SIC MARKING, MULTIPLE CLASS, (INT. CLS. 7 AND 37), (U.S. CLS. 13, 19, 21, 23, 31, 34, 35, 100, 103 AND 106). SN 76-140,807. PUB. 3-26-2002. FILED 10-4-2000.
- 2,623,367. **TRIMAX.** AARON PROCESS EQUIPMENT COMPANY, (U.S. CLS. 13, 19, 21, 23, 31, 34 AND 35). SN 76-151,991. PUB. 7-2-2002. FILED 10-24-2000.
- 2,623,385. **WEILER AND DESIGN.** WEILER ENGINEERING, INC., (U.S. CLS. 13, 19, 21, 23, 31, 34 AND 35). SN 76-154,386. PUB. 12-25-2001. FILED 10-26-2000.
- 2,623,393. **SCHINDLER ARAMID.** SCLINDLER AUFZUGE AG, MULTIPLE CLASS, (INT. CLS. 7, 22 AND 37), (U.S. CLS. 1, 2, 7, 13, 19, 21, 22, 23, 31, 34, 35, 42, 50, 100, 103 AND 106). SN 76-156,178. PUB. 7-2-2002. FILED 10-30-2000.
- 2,623,449. **ECO.** SINCLAIR EQUIPMENT COMPANY, (U.S. CLS. 13, 19, 21, 23, 31, 34 AND 35). SN 76-165,883. PUB. 10-30-2001. FILED 11-14-2000.
- 2,623,507. **EVOLIFT.** INVENTIO AG, MULTIPLE CLASS, (INT. CLS. 7, 9 AND 37), (U.S. CLS. 13, 19, 21, 23, 26, 31, 34, 35, 36, 38, 100, 103 AND 106). SN 76-173,961. PUB. 4-30-2002. FILED 12-1-2000.
- 2,623,573. **UWL.** SNAP-ON DEUTSCHLAND HOLDING GMBH, MULTIPLE CLASS, (INT. CLS. 7, 8 AND 37), (U.S. CLS. 13, 19, 21, 23, 28, 31, 34, 35, 44, 100, 103 AND 106). SN 76-183,809. PUB. 7-2-2002. FILED 12-21-2000.
- 2,623,592 (*See Class 2 for this trademark*).
- 2,623,669. **AT (STYLIZED).** AMTROL, INC., (U.S. CLS. 13, 19, 21, 23, 31, 34 AND 35). SN 76-196,701. PUB. 7-2-2002. FILED 1-17-2001.
- 2,623,682. **KEYENCE.** KEYENCE CORPORATION, MULTIPLE CLASS, (INT. CLS. 7 AND 9), (U.S. CLS. 13, 19, 21, 23, 26, 31, 34, 35, 36 AND 38). SN 76-197,732. PUB. 7-2-2002. FILED 1-22-2001.
- 2,623,705. **CALNETIX INNOVATIVE MAGNETIC TECHNOLOGIES AND DESIGN.** CALNETIX, INNOVATIVE MAGNETIC TECHNOLOGIES INC., (U.S. CLS. 13, 19, 21, 23, 31, 34 AND 35). SN 76-200,614. PUB. 7-2-2002. FILED 1-26-2001.
- 2,623,717. **FLEXFRAMER.** ABB BODY IN WHITE, MULTIPLE CLASS, (INT. CLS. 7 AND 9), (U.S. CLS. 13, 19, 21, 23, 26, 31, 34, 35, 36 AND 38). SN 76-202,393. PUB. 7-2-2002. FILED 1-29-2001.
- 2,623,779. **MULTIFLOW SYSTEM.** PARKER HANNIFIN SA, (U.S. CLS. 13, 19, 21, 23, 31, 34 AND 35). SN 76-209,688. PUB. 7-2-2002. FILED 2-13-2001.
- 2,623,812. **POWERFUL TECHNOLOGY MADE SIMPLE.** ADVANCED DIGITAL, INC., MULTIPLE CLASS, (INT. CLS. 7 AND 9), (U.S. CLS. 13, 19, 21, 23, 26, 31, 34, 35, 36 AND 38). SN 76-214,569. PUB. 7-2-2002. FILED 2-26-2001.
- 2,623,902. **BRS.** VINCI ENVIRONNEMENT, MULTIPLE CLASS, (INT. CLS. 7, 11 AND 40), (U.S. CLS. 13, 19, 21, 23, 31, 34, 35, 100, 103 AND 106). SN 76-225,885. PUB. 7-2-2002. FILED 3-16-2001.
- 2,623,904. **MOONEY.** DRESSER, INC., BY CHANGE OF NAME DRESSER EQUIPMENT GROUP, INC., MULTIPLE CLASS, (INT. CLS. 7 AND 9), (U.S. CLS. 13, 19, 21, 23, 26, 31, 34, 35, 36 AND 38). SN 76-226,023. PUB. 7-2-2002. FILED 3-16-2001.
- 2,623,950 (*See Class 1 for this trademark*).
- 2,623,951 (*See Class 1 for this trademark*).
- 2,623,967. **ATTEXOR.** ATTEXOR TOOLS S.A., MULTIPLE CLASS, (INT. CLS. 7 AND 8), (U.S. CLS. 13, 19, 21, 23, 28, 31, 34, 35 AND 44). SN 76-235,493. PUB. 7-2-2002. FILED 4-5-2001.
- 2,624,017 (*See Class 6 for this trademark*).
- 2,624,109. **GCC (STYLIZED).** GREAT COMPUTER CORP., MULTIPLE CLASS, (INT. CLS. 7 AND 9), (U.S. CLS. 13, 19, 21, 23, 26, 31, 34, 35, 36 AND 38). SN 76-250,199. PUB. 7-2-2002. FILED 5-3-2001.
- 2,624,114. **TERRCO.** TERRCO, INC., (U.S. CLS. 13, 19, 21, 23, 31, 34 AND 35). SN 76-250,696. PUB. 12-4-2001. FILED 5-3-2001.
- 2,624,293. **LONGVIE.** LONGVIE S.A., MULTIPLE CLASS, (INT. CLS. 7 AND 11), (U.S. CLS. 13, 19, 21, 23, 31, 34 AND 35). SN 76-270,823. PUB. 7-2-2002. FILED 6-13-2001.
- 2,624,295. **GX XXX.** ATLAS COPCO AIRPOWER, NAAM-LOZE VENNOOTSCHAP, (U.S. CLS. 13, 19, 21, 23, 31, 34 AND 35). SN 76-271,208. PUB. 7-2-2002. FILED 6-13-2001.
- 2,624,327. **MECOS.** MECOS TRAXLER AG, MULTIPLE CLASS, (INT. CLS. 7, 9 AND 42), (U.S. CLS. 13, 19, 21, 23, 26, 31, 34, 35, 36, 38, 100 AND 101). SN 76-275,642. PUB. 7-2-2002. FILED 6-21-2001.
- 2,624,328. **MECOS LEADERS IN MAGNETIC BEARINGS AND DESIGN.** MECOS TRAXLER AG, MULTIPLE CLASS, (INT. CLS. 7, 9 AND 42), (U.S. CLS. 13, 19, 21, 23, 26, 31, 34, 35, 36, 38, 100 AND 101). SN 76-275,643. PUB. 7-2-2002. FILED 6-21-2001.
- 2,624,337. **QUADLUBE.** ROLLER BEARING COMPANY OF AMERICA, INC., (U.S. CLS. 13, 19, 21, 23, 31, 34 AND 35). SN 76-276,594. PUB. 7-2-2002. FILED 6-27-2001.
- 2,624,502. **TWIN TURBO.** KAIM & ASSOCIATES INTERNATIONAL MARKETING, INC., (U.S. CLS. 13, 19, 21, 23, 31, 34 AND 35). SN 76-302,807. PUB. 7-2-2002. FILED 8-17-2001.
- 2,624,552. **ULTRA KOOL.** SPARKS BELTING COMPANY, A DIVISION OF JSJ CORPORATION, (U.S. CLS. 13, 19, 21, 23, 31, 34 AND 35). SN 76-312,016. PUB. 7-2-2002. FILED 9-13-2001.
- 2,624,582. **KEYSTONE DRILL SERVICES INC. AND DESIGN.** KEYSTONE DRILL SERVICES, INC., MULTIPLE CLASS, (INT. CLS. 7 AND 37), (U.S. CLS. 13, 19, 21, 23, 31, 34, 35, 100, 103 AND 106). SN 76-316,611. PUB. 7-2-2002. FILED 9-24-2001.
- 2,624,681. **IMASAF AND DESIGN.** IMA-SAF S.P.A., (U.S. CLS. 13, 19, 21, 23, 31, 34 AND 35). SN 76-329,016. PUB. 7-2-2002. FILED 10-24-2001.
- 2,624,752. **CTM.** CALIFORNIA TOMATO MACHINERY, LLC, (U.S. CLS. 13, 19, 21, 23, 31, 34 AND 35). SN 76-338,854. PUB. 7-2-2002. FILED 11-14-2001.
- 2,624,765. **UNDERWUNDER.** LAMB CORPORATION, THE, (U.S. CLS. 13, 19, 21, 23, 31, 34 AND 35). SN 76-341,770. PUB. 7-2-2002. FILED 11-26-2001.
- 2,624,809. **HAWK AND DESIGN.** SEED HAWK INC., (U.S. CLS. 13, 19, 21, 23, 31, 34 AND 35). SN 76-346,715. PUB. 7-2-2002. FILED 12-10-2001.
- 2,624,811. **NIMIX.** CHEMINEER, INC., (U.S. CLS. 13, 19, 21, 23, 31, 34 AND 35). SN 76-347,370. PUB. 7-2-2002. FILED 12-11-2001.
- 2,624,815. **GMPTOOLS.** GENERAL MACHINE PRODUCTS CO., INC., MULTIPLE CLASS, (INT. CLS. 7 AND 8), (U.S. CLS. 13, 19, 21, 23, 28, 31, 34, 35 AND 44). SN 76-347,980. PUB. 7-2-2002. FILED 12-6-2001.
- 2,624,843. **MILWAUKEE.** MILWAUKEE ELECTRIC TOOL CORPORATION, (U.S. CLS. 13, 19, 21, 23, 31, 34 AND 35). SN 76-350,658. PUB. 7-2-2002. FILED 12-19-2001.
- 2,624,874. **NEWSTACK.** MID-AMERICA GRAPHICS INCORPORATED, (U.S. CLS. 13, 19, 21, 23, 31, 34 AND 35). SN 76-354,893. PUB. 7-2-2002. FILED 12-31-2001.
- 2,624,912. **THE DRIVING FORCE IN POWER TRANSMISSION.** GATES CORPORATION, THE, (U.S. CLS. 13, 19, 21, 23, 31, 34 AND 35). SN 76-360,591. PUB. 7-2-2002. FILED 1-18-2002.
- 2,624,927. **ADD-A-VEYOR.** CONVEYOR INDUSTRIES CORPORATION, DBA CHRIS INDUSTRIES CORPORATION, (U.S. CLS. 13, 19, 21, 23, 31, 34 AND 35). SN 76-366,315. PUB. 7-2-2002. FILED 2-1-2002.
- 2,625,053. **HIJET VACUUM & COMPRESSION SYSTEMS AND DESIGN.** HIJET, INC., (U.S. CLS. 13, 19, 21, 23, 31, 34 AND 35). SN 78-054,435. PUB. 7-2-2002. FILED 3-22-2001.
- 2,625,106. **EDGESELECT.** EDGE CRAFT CORPORATION, (U.S. CLS. 13, 19, 21, 23, 31, 34 AND 35). SN 78-064,218. PUB. 7-2-2002. FILED 5-17-2001.
- 2,625,123. **POW R RIP.** ATTACHMENT TECHNOLOGIES, INC., (U.S. CLS. 13, 19, 21, 23, 31, 34 AND 35). SN 78-067,944. PUB. 7-2-2002. FILED 6-7-2001.
- 2,625,176. **ODYSSEY.** PROTOTYPE EQUIPMENT CORP., DBA GOODMAN PACKAGING EQUIPMENT, (U.S. CLS. 13, 19, 21, 23, 31, 34 AND 35). SN 78-080,233. PUB. 7-2-2002. FILED 8-20-2001.
- 2,625,179. **GETT AND DESIGN.** SRJ INCORPORATED, (U.S. CLS. 13, 19, 21, 23, 31, 34 AND 35). SN 78-080,686. PUB. 7-2-2002. FILED 8-22-2001.
- 2,625,180. **AV AIRVANTAGE TOOLS (STYLIZED).** JACKCO TRANSNATIONAL INC., (U.S. CLS. 13, 19, 21, 23, 31, 34 AND 35). SN 78-081,240. PUB. 7-2-2002. FILED 8-27-2001.

CLASS 8—HAND TOOLS

- 2,622,577 (*See Class 3 for this trademark.*)
 2,622,605 (*See Class 5 for this trademark.*)
 2,622,757 (*See Class 6 for this trademark.*)
 2,622,768. **CAMPAGNOLO (STYLIZED)**. CAMPAGNOLO SRL, MULTIPLE CLASS, (INT. CLS. 8, 9 AND 25), (U.S. CLS. 21, 22, 23, 26, 28, 36, 38, 39 AND 44). SN 75-851,701. PUB. 7-2-2002. FILED 11-17-1999.
 2,622,890. **ACTIVE AND DESIGN**. METRO SB-HANDELS AG, MULTIPLE CLASS, (INT. CLS. 8, 9, 12, 18, 25, 27 AND 28), (U.S. CLS. 1, 2, 3, 19, 20, 21, 22, 23, 26, 28, 31, 35, 36, 37, 38, 39, 41, 42, 44 AND 50). SN 75-980,960. PUB. 7-2-2002. FILED 1-7-2000.
 2,622,942 (*See Class 6 for this trademark.*)
 2,623,462. **PIVOT PRO**. ANDIS COMPANY, (U.S. CLS. 23, 28 AND 44). SN 76-167,199. PUB. 7-2-2002. FILED 11-17-2000.
 2,623,573 (*See Class 7 for this trademark.*)
 2,623,620 (*See Class 3 for this trademark.*)
 2,623,843. **KIT RAE FANTASY ART AND DESIGN**. RAE, KIT, (U.S. CLS. 23, 28 AND 44). SN 76-218,973. PUB. 7-2-2002. FILED 3-5-2001.
 2,623,844. **KIT RAE**. RAE, KIT, (U.S. CLS. 23, 28 AND 44). SN 76-219,261. PUB. 7-2-2002. FILED 3-5-2001.
 2,623,845. **KIT RAE (STYLIZED)**. RAE, KIT, (U.S. CLS. 23, 28 AND 44). SN 76-219,262. PUB. 7-2-2002. FILED 3-5-2001.
 2,623,905. **T TRIUMPH TWIST DRILL AND DESIGN**. PRECISION TWIST DRILL CO., (U.S. CLS. 23, 28 AND 44). SN 76-226,054. PUB. 7-2-2002. FILED 3-19-2001.
 2,623,967 (*See Class 7 for this trademark.*)
 2,624,471. **JIM BOWIE**. RISNER, CLARENCE, (U.S. CLS. 23, 28 AND 44). SN 76-296,041. PUB. 7-2-2002. FILED 8-8-2001.
 2,624,572. **STRUCTRON**. STRUCTRON CORPORATION, (U.S. CLS. 23, 28 AND 44). SN 76-314,283. PUB. 7-2-2002. FILED 9-19-2001.
 2,624,815 (*See Class 7 for this trademark.*)
 2,624,897. **STIRUP**. UNIONTOOLS, INC., (U.S. CLS. 23, 28 AND 44). SN 76-357,646. PUB. 7-2-2002. FILED 1-11-2002.
 2,624,914. **ALU-COBA (STYLIZED)**. TOKYO RIKI CO., LTD., (U.S. CLS. 23, 28 AND 44). SN 76-361,310. PUB. 7-2-2002. FILED 1-18-2002.

CLASS 9—ELECTRICAL AND SCIENTIFIC APPARATUS

- 2,622,507. **T AND DESIGN**. DEUTSCHE TELEKOM AG, MULTIPLE CLASS, (INT. CLS. 9, 14, 16, 18, 25, 28, 36, 37, 38, 41 AND 42), (U.S. CLS. 1, 2, 3, 5, 21, 22, 23, 26, 27, 28, 29, 36, 37, 38, 39, 41, 50, 100, 101, 102, 103, 104, 106 AND 107). SN 74-720,653. PUB. 11-11-1997. FILED 8-24-1995.
 2,622,508. **MIKISSIMES AND DESIGN**. MIKISSIMES, S.A., MULTIPLE CLASS, (INT. CLS. 9, 14 AND 42), (U.S. CLS. 2, 21, 23, 26, 27, 28, 36, 38, 50, 100 AND 101). SN 74-736,037. PUB. 12-2-1997. FILED 9-29-1995.
 2,622,511. **SAVANSYS**. SAVANTAGE, INC., (U.S. CLS. 21, 23, 26, 36 AND 38). SN 75-081,639. PUB. 12-3-1996. FILED 4-1-1996.
 2,622,513. **RED HOT 7S**. POWERHOUSE TECHNOLOGIES, INC., BY CHANGE OF NAME VIDEO LOTTERY TECHNOLOGIES, INC., (U.S. CLS. 21, 23, 26, 36 AND 38). SN 75-133,871. PUB. 7-2-2002. FILED 7-15-1996.
 2,622,514. **NOKIA MEDIAMASTER**. NOKIA CORPORATION, MULTIPLE CLASS, (INT. CLS. 9 AND 38), (U.S. CLS. 21, 23, 26, 36, 38, 100, 101 AND 104). SN 75-143,068. PUB. 10-31-2000. FILED 7-30-1996.
 2,622,518. **POSTMASTER**. SNELL & WILCOX LIMITED, (U.S. CLS. 21, 23, 26, 36 AND 38). SN 75-193,085. PUB. 7-2-2002. FILED 11-1-1996.
 2,622,520 (*See Class 7 for this trademark.*)
 2,622,525. **THINK IT.PRINT IT..** TLC PRODUCTIVITY PROPERTIES, LLC, BY ASSIGNMENT; BY MERGER; BY MERGER; BY ASSIGNMENT BRODERBUND SOFTWARE, INC., (U.S. CLS. 21, 23, 26, 36 AND 38). SN 75-275,737. PUB. 7-2-2002. FILED 4-15-1997.
 2,622,536. **VALUE INNOVATORS**. SYSTEM GESELLSCHAFT AG, BY ASSIGNMENT ANCORA S.A., MULTIPLE CLASS, (INT. CLS. 9, 35 AND 42), (U.S. CLS. 21, 23, 26, 36, 38, 100, 101 AND 102). SN 75-400,922. PUB. 10-12-1999. FILED 12-5-1997.
 2,622,538. **SFDC-COM**. AMANO CORPORATION, (U.S. CLS. 21, 23, 26, 36 AND 38). SN 75-404,164. PUB. 3-7-2000. FILED 12-10-1997.
 2,622,545. **SCANAX (STYLIZED)**. AXIS BIOCHEMICALS ASA, (U.S. CLS. 21, 23, 26, 36 AND 38). SN 75-440,115. PUB. 10-5-1999. FILED 2-25-1998.
 2,622,547. **CLEARNET AND DESIGN**. CLEARNET COMMUNICATIONS INC., MULTIPLE CLASS, (INT. CLS. 9 AND 38), (U.S. CLS. 21, 23, 26, 36, 38, 100, 101 AND 104). SN 75-448,371. PUB. 7-2-2002. FILED 3-11-1998.
 2,622,553 (*See Class 7 for this trademark.*)
 2,622,570. **EVER SOUND**. DUNRITE PRODUCTIONS, INC., (U.S. CLS. 21, 23, 26, 36 AND 38). SN 75-527,350. PUB. 7-2-2002. FILED 7-29-1998.
 2,622,572. **LE KIOSQUE LE MULTIMEDIA PER FRANCE TELECOM AND DESIGN**. FRANCE TELECOM, MULTIPLE CLASS, (INT. CLS. 9, 35, 38 AND 42), (U.S. CLS. 21, 23, 26, 36, 38, 100, 101, 102 AND 104). SN 75-541,384. PUB. 10-17-2000. FILED 8-24-1998.
 2,622,585. **IC (STYLIZED)**. CINCOM SYSTEMS, INC., (U.S. CLS. 21, 23, 26, 36 AND 38). SN 75-568,854. PUB. 7-2-2002. FILED 10-13-1998.
 2,622,586. **18 EIGHTEEN SOUND AND DESIGN**. A.E.B. S.R.L., (U.S. CLS. 21, 23, 26, 36 AND 38). SN 75-570,773. PUB. 7-2-2002. FILED 10-15-1998.
 2,622,590 (*See Class 6 for this trademark.*)
 2,622,595. **BELBIN**. BELBIN ASSOCIATES, MULTIPLE CLASS, (INT. CLS. 9, 16 AND 41), (U.S. CLS. 2, 5, 21, 22, 23, 26, 29, 36, 37, 38, 50, 100, 101 AND 107). SN 75-584,125. PUB. 7-2-2002. FILED 11-6-1998.
 2,622,623. **LIFESTREAM TECHNOLOGIES AND DESIGN**. LIFESTREAM TECHNOLOGIES, INC., (U.S. CLS. 21, 23, 26, 36 AND 38). SN 75-630,522. PUB. 7-2-2002. FILED 1-28-1999.
 2,622,627. **THE DIFFERENCE ENGINE**. RATBAG PTY LTD, (U.S. CLS. 21, 23, 26, 36 AND 38). SN 75-636,819. PUB. 9-4-2001. FILED 2-9-1999.
 2,622,629. **SWINGCHIP**. KONINKLIJKE PHILIPS ELECTRONICS N.V., (U.S. CLS. 21, 23, 26, 36 AND 38). SN 75-642,274. PUB. 1-9-2001. FILED 2-17-1999.
 2,622,630. **I TALK! AND DESIGN**. TELLISOFT TECHNOLOGIES, INC., BY MERGER TELLISOFT TECHNOLOGIES, INC., (U.S. CLS. 21, 23, 26, 36 AND 38). SN 75-649,846. PUB. 7-2-2002. FILED 3-1-1999.
 2,622,632. **ONE ALLIANCE**. DEUTSCHE TELEKOM AG, MULTIPLE CLASS, (INT. CLS. 9, 16, 38 AND 42), (U.S. CLS. 2, 5, 21, 22, 23, 26, 29, 36, 37, 38, 50, 100, 101 AND 104). SN 75-656,071. PUB. 11-13-2001. FILED 3-8-1999.
 2,622,649. **CONSULTING FOR OFFICE AND INFORMATION MANAGEMENT COI INTERNATIONAL (STYLIZED)**. COI CONSULTING FUR OFFICE UND INFORMATION MANAGEMENT GMBH, MULTIPLE CLASS, (INT. CLS. 9 AND 42), (U.S. CLS. 21, 23, 26, 36, 38, 100 AND 101). SN 75-692,032. PUB. 7-2-2002. FILED 4-26-1999.
 2,622,650. **DBAUDIO (STYLIZED)**. D&B AUDIOTECHNIK AG., (U.S. CLS. 21, 23, 26, 36 AND 38). SN 75-692,069. PUB. 8-28-2001. FILED 4-26-1999.
 2,622,655. **SELECTSOUND**. OWENS-CORNING FIBERGLAS TECHNOLOGY INC., MULTIPLE CLASS, (INT. CLS. 9 AND 17), (U.S. CLS. 1, 5, 12, 13, 21, 23, 26, 35, 36, 38 AND 50). SN 75-701,922. PUB. 7-2-2002. FILED 5-10-1999.
 2,622,656. **U.S. MAGNETIX AND DESIGN**. SCREEN DOOR GRAPHICS, INC., (U.S. CLS. 21, 23, 26, 36 AND 38). SN 75-702,540. PUB. 7-2-2002. FILED 6-12-1998.
 2,622,661. **PARENTLINK**. PARLANT TECHNOLOGY, INC., (U.S. CLS. 21, 23, 26, 36 AND 38). SN 75-711,090. PUB. 7-2-2002. FILED 5-20-1999.
 2,622,669. **INSURE3 (STYLIZED)**. CASTEK SOFTWARE FACTORY INC., MULTIPLE CLASS, (INT. CLS. 9, 41 AND 42), (U.S. CLS. 21, 23, 26, 36, 38, 100, 101 AND 107). SN 75-721,954. PUB. 7-2-2002. FILED 6-4-1999.
 2,622,671. **SKILL4**. HUTHWAITE RESEARCH GROUP LIMITED, MULTIPLE CLASS, (INT. CLS. 9, 16, 35, 38 AND 41), (U.S. CLS. 2, 5, 21, 22, 23, 26, 29, 36, 37, 38, 50, 100, 101, 102, 104 AND 107). SN 75-729,244. PUB. 3-12-2002. FILED 6-15-

- 1999.
- 2,622,672. **FIRERANGE**. WEINBRENNER SHOE COMPANY, INC., (U.S. CLS. 21, 23, 26, 36 AND 38). SN 75-729,715. PUB. 7-2-2002. FILED 6-16-1999.
- 2,622,674. **ITELFACS**. ENTERPRISE MESSAGING SERVICES, INC., MULTIPLE CLASS, (INT. CLS. 9 AND 38), (U.S. CLS. 21, 23, 26, 36, 38, 100, 101 AND 104). SN 75-733,457. PUB. 7-2-2002. FILED 6-14-1999.
- 2,622,675. **ITELFACS AND DESIGN**. ENTERPRISE MESSAGING SERVICES, INC., MULTIPLE CLASS, (INT. CLS. 9 AND 38), (U.S. CLS. 21, 23, 26, 36, 38, 100, 101 AND 104). SN 75-733,458. PUB. 7-2-2002. FILED 6-14-1999.
- 2,622,677. **SIPARIO AND DESIGN**. ALFA WASSERMAN S.P.A., BY MERGER ALFA BIOTECH S.P.A., MULTIPLE CLASS, (INT. CLS. 9 AND 16), (U.S. CLS. 2, 5, 21, 22, 23, 26, 29, 36, 37, 38 AND 50). SN 75-737,898. PUB. 11-13-2001. FILED 6-16-1999.
- 2,622,678. **MISCELLANEOUS DESIGN**. HAUSER TECHNOLOGY INTEGRATION, INC., MULTIPLE CLASS, (INT. CLS. 9 AND 42), (U.S. CLS. 21, 23, 26, 36, 38, 100 AND 101). SN 75-738,169. PUB. 7-2-2002. FILED 6-28-1999.
- 2,622,679. **E-TRAINDATA AND DESIGN**. CATEYE CO., LTD., (U.S. CLS. 21, 23, 26, 36 AND 38). SN 75-739,837. PUB. 12-4-2001. FILED 6-30-1999.
- 2,622,684 (*See Class 5 for this trademark*).
- 2,622,689 (*See Class 7 for this trademark*).
- 2,622,695. **EXECUTIVE COMPENSATION ASSESSOR**. ERI ECONOMIC RESEARCH INSTITUTE, INC., (U.S. CLS. 21, 23, 26, 36 AND 38). SN 75-763,978. PUB. 7-2-2002. FILED 7-29-1999.
- 2,622,698. **A AMBITION ENTERTAINMENT AND DESIGN**. WILLIAMS, DEMETRIUS A., (U.S. CLS. 21, 23, 26, 36 AND 38). SN 75-768,108. PUB. 7-2-2002. FILED 8-5-1999.
- 2,622,707. **KIDTRAX AND DESIGN**. SWMG PRODUCTIONS, INC., DBA NFOCUS.COM, (U.S. CLS. 21, 23, 26, 36 AND 38). SN 75-778,033. PUB. 7-2-2002. FILED 8-18-1999.
- 2,622,709. **MISCELLANEOUS DESIGN**. DISCTRONICS LIMITED, MULTIPLE CLASS, (INT. CLS. 9, 16, 39, 40, 41 AND 42), (U.S. CLS. 2, 5, 21, 22, 23, 26, 29, 36, 37, 38, 50, 100, 101, 103, 105, 106 AND 107). SN 75-786,185. PUB. 7-2-2002. FILED 8-26-1999.
- 2,622,710. **L.A. SOUND**. LA SOUND USA, INC., (U.S. CLS. 21, 23, 26, 36 AND 38). SN 75-787,807. PUB. 7-2-2002. FILED 8-30-1999.
- 2,622,712. **UNISOFT (STYLIZED)**. UNILENS CORP., U.S.A., (U.S. CLS. 21, 23, 26, 36 AND 38). SN 75-789,040. PUB. 3-28-2000. FILED 8-30-1999.
- 2,622,737. **ZALPHA**. WWAV RAPP COLLINS GROUP LTD., MULTIPLE CLASS, (INT. CLS. 9 AND 35), (U.S. CLS. 21, 23, 26, 36, 38, 100, 101 AND 102). SN 75-822,208. PUB. 7-2-2002. FILED 10-13-1999.
- 2,622,741. **QUICKIR**. IRRISOFT, LLC, (U.S. CLS. 21, 23, 26, 36 AND 38). SN 75-825,054. PUB. 7-2-2002. FILED 11-4-1999.
- 2,622,747. **ZAQ**. 9080-3628 QUEBEC INC., MULTIPLE CLASS, (INT. CLS. 9 AND 42), (U.S. CLS. 21, 23, 26, 36, 38, 100 AND 101). SN 75-831,196. PUB. 7-2-2002. FILED 10-21-1999.
- 2,622,748. **ZAQING**. 9080-3628 QUEBEC INC., MULTIPLE CLASS, (INT. CLS. 9 AND 42), (U.S. CLS. 21, 23, 26, 36, 38, 100 AND 101). SN 75-831,198. PUB. 7-2-2002. FILED 10-21-1999.
- 2,622,754. **VALUCUT**. CENTRICUT, LLC, (U.S. CLS. 21, 23, 26, 36 AND 38). SN 75-837,039. PUB. 7-2-2002. FILED 11-1-1999.
- 2,622,756. **SPIN**. BLUE COLLAR COMMERCE, LTD., (U.S. CLS. 21, 23, 26, 36 AND 38). SN 75-841,274. PUB. 7-2-2002. FILED 11-4-1999.
- 2,622,764. **PORTAWATTZ POWERPAC**. XANTREX INTERNATIONAL, BY CHANGE OF NAME STATPOWER TECHNOLOGIES PARTNERSHIP, (U.S. CLS. 21, 23, 26, 36 AND 38). SN 75-849,180. PUB. 7-2-2002. FILED 11-12-1999.
- 2,622,768 (*See Class 8 for this trademark*).
- 2,622,778. **TIGIR**. C.U. PROCESSING, INC., (U.S. CLS. 21, 23, 26, 36 AND 38). SN 75-859,343. PUB. 7-2-2002. FILED 11-29-1999.
- 2,622,785. **CANDESIGN**. CANDESIGN, INC., (U.S. CLS. 21, 23, 26, 36 AND 38). SN 75-863,552. PUB. 7-2-2002. FILED 12-3-1999.
- 2,622,791. **S@M (STYLIZED)**. EHP INFORMATIK GMBH, (U.S. CLS. 21, 23, 26, 36 AND 38). SN 75-871,083. PUB. 7-2-2002. FILED 12-14-1999.
- 2,622,808. **KAKADU**. ARISTOCRAT TECHNOLOGIES AUSTRALIA PTY. LIMITED, BY CHANGE OF NAME ARISTOCRAT LEISURE INDUSTRIES PTY LTD., (U.S. CLS. 21, 23, 26, 36 AND 38). SN 75-889,335. PUB. 10-23-2001. FILED 1-6-2000.
- 2,622,810 (*See Class 2 for this trademark*).
- 2,622,821. **FARM CHEM**. MAGLA WORLD WIDE, LTD, MULTIPLE CLASS, (INT. CLS. 9 AND 21), (U.S. CLS. 2, 13, 21, 23, 26, 29, 30, 33, 36, 38, 40 AND 50). SN 75-897,426. PUB. 7-2-2002. FILED 1-6-2000.
- 2,622,822. **SUPER CHEM**. MAGLA WORLD WIDE, LTD, MULTIPLE CLASS, (INT. CLS. 9 AND 21), (U.S. CLS. 2, 13, 21, 23, 26, 29, 30, 33, 36, 38, 40 AND 50). SN 75-897,427. PUB. 7-2-2002. FILED 1-6-2000.
- 2,622,828. **TRADENETONE.COM**. TRADENETONE.COM AG, BY ASSIGNMENT TRADENETONE.COM OHG, MULTIPLE CLASS, (INT. CLS. 9, 16, 35, 36, 38, 41 AND 42), (U.S. CLS. 2, 5, 21, 22, 23, 26, 29, 36, 37, 38, 50, 100, 101, 102, 104 AND 107). SN 75-901,778. PUB. 7-2-2002. FILED 1-24-2000.
- 2,622,832. **MEVINET**. IMS MESSSYSTEME GMBH, MULTIPLE CLASS, (INT. CLS. 9 AND 42), (U.S. CLS. 21, 23, 26, 36, 38, 100 AND 101). SN 75-906,321. PUB. 7-2-2002. FILED 1-31-2000.
- 2,622,833. **CUBEWERX**. SECTOR 42 TECHNOLOGY INC., (U.S. CLS. 21, 23, 26, 36 AND 38). SN 75-906,505. PUB. 7-2-2002. FILED 1-31-2000.
- 2,622,834. **EONTEC**. EON TECHNOLOGIES, LTD., (U.S. CLS. 21, 23, 26, 36 AND 38). SN 75-906,935. PUB. 7-2-2002. FILED 1-26-2000.
- 2,622,842. **LEAK CHEK PLUS AND DESIGN**. MOTORVAC TECHNOLOGIES, INC., (U.S. CLS. 21, 23, 26, 36 AND 38). SN 75-910,440. PUB. 7-2-2002. FILED 1-28-2000.
- 2,622,845. **METRON**. METRON TECHNOLOGY, INC., MULTIPLE CLASS, (INT. CLS. 9 AND 35), (U.S. CLS. 21, 23, 26, 36, 38, 100, 101 AND 102). SN 75-912,754. PUB. 7-2-2002. FILED 2-8-2000.
- 2,622,848. **EGRADE**. ORR, JOHN LINDSAY, (U.S. CLS. 21, 23, 26, 36 AND 38). SN 75-915,384. PUB. 7-2-2002. FILED 2-2-2000.
- 2,622,850. **HAKKASAN**. ALAN YAU LIMITED, MULTIPLE CLASS, (INT. CLS. 9, 16, 25, 29, 30, 31, 32, 33 AND 42), (U.S. CLS. 1, 2, 5, 21, 22, 23, 26, 29, 36, 37, 38, 39, 45, 46, 47, 48, 49, 50, 100 AND 101). SN 75-917,399. PUB. 7-2-2002. FILED 2-14-2000.
- 2,622,852. **GOOD TO GROW ENTERTAINMENT STORIES THAT TEACH LIFE'S LESSONS. AND DESIGN**. MCCALL, GEOFF E., (U.S. CLS. 21, 23, 26, 36 AND 38). SN 75-918,562. PUB. 7-2-2002. FILED 2-15-2000.
- 2,622,854. **MISCELLANEOUS DESIGN**. ACROPRINT, INC., (U.S. CLS. 21, 23, 26, 36 AND 38). SN 75-920,812. PUB. 7-2-2002. FILED 2-16-2000.
- 2,622,862. **TOKYO XTREME RACER**. CRAVE ENTERTAINMENT, INC., (U.S. CLS. 21, 23, 26, 36 AND 38). SN 75-926,178. PUB. 7-2-2002. FILED 2-24-2000.
- 2,622,866. **ORIEL**. ORIEL CORPORATION, MULTIPLE CLASS, (INT. CLS. 9 AND 11), (U.S. CLS. 13, 21, 23, 26, 31, 34, 36 AND 38). SN 75-927,079. PUB. 7-2-2002. FILED 2-23-2000.
- 2,622,873. **SHOWBOT**. LIVEONTHE.NET.COM, INC., (U.S. CLS. 21, 23, 26, 36 AND 38). SN 75-936,281. PUB. 7-2-2002. FILED 3-6-2000.
- 2,622,875 (*See Class 7 for this trademark*).
- 2,622,889. **HIGH OCTANE**. OGER, PATRICK LOUIS MICHEL, (U.S. CLS. 21, 23, 26, 36 AND 38). SN 75-980,851. PUB. 7-2-2002. FILED 4-5-1999.
- 2,622,890 (*See Class 8 for this trademark*).
- 2,622,891. **TRAFFICOM**. MA SYSTEM AB, (U.S. CLS. 21, 23, 26, 36 AND 38). SN 75-981,097. PUB. 12-4-2001. FILED 3-16-1999.
- 2,622,901. **MOORHUHN**. PHENOMEDIA AG, MULTIPLE CLASS, (INT. CLS. 9, 14, 16, 18, 25, 28, 30, 34, 35, 38, 41 AND 42), (U.S. CLS. 1, 2, 3, 5, 8, 9, 17, 21, 22, 23, 26, 27, 28, 29, 36, 37, 38, 39, 41, 46, 50, 100, 101, 102, 104 AND 107). SN 76-003,999. PUB. 7-2-2002. FILED 3-20-2000.
- 2,622,905 (*See Class 6 for this trademark*).
- 2,622,923. **MISCELLANEOUS DESIGN**. DURATION SOFT-

- WARE, INC., MULTIPLE CLASS, (INT. CLS. 9 AND 42), (U.S. CLS. 21, 23, 26, 36, 38, 100 AND 101). SN 76-013,300. PUB. 7-2-2002. FILED 3-30-2000.
- 2,622,929. **MITEQ**. MITEQ, INC., MULTIPLE CLASS, (INT. CLS. 9 AND 42), (U.S. CLS. 21, 23, 26, 36, 38, 100 AND 101). SN 76-018,103. PUB. 7-2-2002. FILED 4-1-2000.
- 2,622,931. **PRIMOPUEL**. KABUSHIKI KAISHA BANDAI, (U.S. CLS. 21, 23, 26, 36 AND 38). SN 76-018,655. PUB. 10-2-2001. FILED 4-5-2000.
- 2,622,937. **GLOBASE**. PROJEKTGRUPPEN A/S, MULTIPLE CLASS, (INT. CLS. 9, 35 AND 42), (U.S. CLS. 21, 23, 26, 36, 38, 100, 101 AND 102). SN 76-021,676. PUB. 7-2-2002. FILED 4-10-2000.
- 2,622,947. **OZEO**. KONINKLIJKE PHILIPS ELECTRONICS N.V., (U.S. CLS. 21, 23, 26, 36 AND 38). SN 76-026,267. PUB. 7-2-2002. FILED 4-13-2000.
- 2,622,953. **MITEQ AND DESIGN**. MITEQ, INC., MULTIPLE CLASS, (INT. CLS. 9 AND 42), (U.S. CLS. 21, 23, 26, 36, 38, 100 AND 101). SN 76-029,527. PUB. 7-2-2002. FILED 4-19-2000.
- 2,622,955. **KAOS BOX**. ARKAOS S.A., MULTIPLE CLASS, (INT. CLS. 9, 41 AND 42), (U.S. CLS. 21, 23, 26, 36, 38, 100, 101 AND 107). SN 76-030,897. PUB. 7-2-2002. FILED 4-20-2000.
- 2,622,963. **MEN ARE PIGS**. ACTIVE RESEARCH INC., DBA MSR VIDEOS, (U.S. CLS. 21, 23, 26, 36 AND 38). SN 76-036,423. PUB. 7-2-2002. FILED 4-28-2000.
- 2,622,964. **AZALIS**. KONINKLIJKE PHILIPS ELECTRONICS N.V., (U.S. CLS. 21, 23, 26, 36 AND 38). SN 76-036,553. PUB. 7-2-2002. FILED 4-27-2000.
- 2,622,971 (*See Class 7 for this trademark*).
- 2,622,972. **MAGIC STORY READER**. TRENDMASTERS, INC., (U.S. CLS. 21, 23, 26, 36 AND 38). SN 76-039,677. PUB. 7-2-2002. FILED 5-3-2000.
- 2,622,980. **ROAL ELECTRONICS**. ROAL ELECTRONICS S.P.A., BY CHANGE OF NAME BAFIN S.P.A., (U.S. CLS. 21, 23, 26, 36 AND 38). SN 76-045,815. PUB. 7-2-2002. FILED 5-10-2000.
- 2,622,983. **MISCELLANEOUS DESIGN**. EORIGINAL, INC., MULTIPLE CLASS, (INT. CLS. 9, 38 AND 39), (U.S. CLS. 21, 23, 26, 36, 38, 100, 101, 104 AND 105). SN 76-046,855. PUB. 7-2-2002. FILED 5-12-2000.
- 2,622,999. **SYNTRODE**. METROHM LTD., (U.S. CLS. 21, 23, 26, 36 AND 38). SN 76-052,219. PUB. 7-2-2002. FILED 5-19-2000.
- 2,623,003. **SOLVOTRODE**. METROHM LTD., (U.S. CLS. 21, 23, 26, 36 AND 38). SN 76-053,265. PUB. 7-2-2002. FILED 5-22-2000.
- 2,623,004. **POROTRODE**. METROHM LTD., (U.S. CLS. 21, 23, 26, 36 AND 38). SN 76-053,266. PUB. 7-2-2002. FILED 5-22-2000.
- 2,623,005. **AQUATRODE**. METROHM LTD., (U.S. CLS. 21, 23, 26, 36 AND 38). SN 76-053,267. PUB. 7-2-2002. FILED 5-22-2000.
- 2,623,012. **OPEN PRINT BACKSTAGE**. SEFAS TECHNOLOGIES, S.A., MULTIPLE CLASS, (INT. CLS. 9 AND 42), (U.S. CLS. 21, 23, 26, 36, 38, 100 AND 101). SN 76-056,319. PUB. 3-19-2002. FILED 5-24-2000.
- 2,623,013. **ENLIGHTEN**. DISTRIBUTOR INFORMATION SYSTEMS CORPORATION, (U.S. CLS. 21, 23, 26, 36 AND 38). SN 76-056,386. PUB. 7-2-2002. FILED 5-25-2000.
- 2,623,021. **HOLOSPOT**. TESA AG, BY ASSIGNMENT BEIERSDORF AKTIENGESELLSCHAFT, MULTIPLE CLASS, (INT. CLS. 9, 16 AND 17), (U.S. CLS. 1, 2, 5, 12, 13, 21, 22, 23, 26, 29, 35, 36, 37, 38 AND 50). SN 76-059,748. PUB. 7-2-2002. FILED 5-31-2000.
- 2,623,025. **AMMOS**. ROHDE & SCHWARZ GMBH & CO. KG, (U.S. CLS. 21, 23, 26, 36 AND 38). SN 76-060,248. PUB. 7-2-2002. FILED 6-2-2000.
- 2,623,042. **SOUTH HAMPTON**. EYE CARE CENTERS OF AMERICA, INC., (U.S. CLS. 21, 23, 26, 36 AND 38). SN 76-065,571. PUB. 7-2-2002. FILED 6-8-2000.
- 2,623,048. **LASER**. ROWENTA-WERKE GMBH, (U.S. CLS. 21, 23, 26, 36 AND 38). SN 76-067,704. PUB. 3-19-2002. FILED 6-12-2000.
- 2,623,054 (*See Class 7 for this trademark*).
- 2,623,061. **RADIOFRAME**. RADIOFRAME NETWORKS, INC., MULTIPLE CLASS, (INT. CLS. 9 AND 38), (U.S. CLS. 21, 23, 26, 36, 38, 100, 101 AND 104). SN 76-072,430. PUB. 7-2-2002. FILED 6-16-2000.
- 2,623,063. **RSA**. RSA BIOMEDICAL INNOVATIONS AB, MULTIPLE CLASS, (INT. CLS. 9 AND 10), (U.S. CLS. 21, 23, 26, 36, 38, 39 AND 44). SN 76-073,789. PUB. 7-2-2002. FILED 6-20-2000.
- 2,623,064. **ORIGINLAB**. ORIGINLAB CORPORATION, BY CHANGE OF NAME MICROCAL SOFTWARE, INC., (U.S. CLS. 21, 23, 26, 36 AND 38). SN 76-074,276. PUB. 7-2-2002. FILED 6-20-2000.
- 2,623,067. **COPERNIC AND DESIGN**. COPERNIC TECHNOLOGIES INC., (U.S. CLS. 21, 23, 26, 36 AND 38). SN 76-074,630. PUB. 7-2-2002. FILED 6-21-2000.
- 2,623,069. **XPOWER**. XANTREX INTERNATIONAL, BY CHANGE OF NAME STATPOWER TECHNOLOGIES PARTNERSHIP, (U.S. CLS. 21, 23, 26, 36 AND 38). SN 76-075,643. PUB. 7-2-2002. FILED 6-20-2000.
- 2,623,079. **T THINAIRAPPS AND DESIGN**. THINAIRAPPS, INC., MULTIPLE CLASS, (INT. CLS. 9, 38 AND 42), (U.S. CLS. 21, 23, 26, 36, 38, 100, 101 AND 104). SN 76-079,560. PUB. 7-2-2002. FILED 6-28-2000.
- 2,623,089. **SOPHEON TERMS**. SOPHEON N.V., (U.S. CLS. 21, 23, 26, 36 AND 38). SN 76-082,079. PUB. 7-2-2002. FILED 7-3-2000.
- 2,623,090. **B AND DESIGN**. BARTON INSTRUMENT SYSTEMS, LLC, (U.S. CLS. 21, 23, 26, 36 AND 38). SN 76-082,426. PUB. 7-2-2002. FILED 6-19-2000.
- 2,623,102. **SOFTWARE DIMENSIONS**. EXECUTIVE DIMENSIONS, LTD, DBA SOFTWARE DIMENSIONS, (U.S. CLS. 21, 23, 26, 36 AND 38). SN 76-088,130. PUB. 7-2-2002. FILED 7-14-2000.
- 2,623,105. **EUCAM (STYLIZED)**. UMAX DATA SYSTEMS INC., (U.S. CLS. 21, 23, 26, 36 AND 38). SN 76-089,036. PUB. 7-2-2002. FILED 7-17-2000.
- 2,623,119. **SIMPLEX SIGILLUM VERI VAST**. VAST SYSTEMS TECHNOLOGY CORPORATION, (U.S. CLS. 21, 23, 26, 36 AND 38). SN 76-092,203. PUB. 7-2-2002. FILED 7-20-2000.
- 2,623,134. **ZEN GOLF KEYS TO SUCCESS SELF HYPNOSIS SERIES BY ZEN GOLF AND DESIGN**. FARHAT, ERNIE, DBA ZEN GOLF, (U.S. CLS. 21, 23, 26, 36 AND 38). SN 76-096,687. PUB. 7-2-2002. FILED 7-26-2000.
- 2,623,151. **WE'RE ALL IN THIS TOGETHER**. OPERA SYSTEMS, INC., MULTIPLE CLASS, (INT. CLS. 9 AND 42), (U.S. CLS. 21, 23, 26, 36, 38, 100 AND 101). SN 76-102,903. PUB. 7-2-2002. FILED 8-7-2000.
- 2,623,154. **NIC IOG**. DIGITAL LIGHTWAVE, INC., (U.S. CLS. 21, 23, 26, 36 AND 38). SN 76-104,177. PUB. 7-2-2002. FILED 8-7-2000.
- 2,623,155. **MULTIMODEM**. MULTI-TECH SYSTEMS, INC., (U.S. CLS. 21, 23, 26, 36 AND 38). SN 76-104,283. PUB. 7-2-2002. FILED 8-7-2000.
- 2,623,156. **AGENTS OBJECT SYSTEM**. QUASAR KNOWLEDGE SYSTEMS, INC., (U.S. CLS. 21, 23, 26, 36 AND 38). SN 76-104,735. PUB. 7-2-2002. FILED 8-7-2000.
- 2,623,172. **ANACONDA BRAND AND DESIGN**. GENERAL CABLE TECHNOLOGIES CORPORATION, (U.S. CLS. 21, 23, 26, 36 AND 38). SN 76-110,528. PUB. 7-2-2002. FILED 8-16-2000.
- 2,623,178. **TL (STYLIZED)**. TED LAPIDUS, MULTIPLE CLASS, (INT. CLS. 9, 14, 18 AND 25), (U.S. CLS. 1, 2, 3, 21, 22, 23, 26, 27, 28, 36, 38, 39, 41 AND 50). SN 76-112,100. PUB. 7-2-2002. FILED 8-18-2000.
- 2,623,189. **SUDDEN FEVER**. DE SMET, FRANCIS, (U.S. CLS. 21, 23, 26, 36 AND 38). SN 76-114,407. PUB. 7-2-2002. FILED 8-23-2000.
- 2,623,200. **MISCELLANEOUS DESIGN**. VOICEDATA WARE INC., MULTIPLE CLASS, (INT. CLS. 9 AND 38), (U.S. CLS. 21, 23, 26, 36, 38, 100, 101 AND 104). SN 76-116,708. PUB. 7-2-2002. FILED 8-25-2000.
- 2,623,203 (*See Class 3 for this trademark*).
- 2,623,204. **HACIENDA RECORDS**. HACIENDA RECORDS, L. P., (U.S. CLS. 21, 23, 26, 36 AND 38). SN 76-117,954. PUB. 7-2-2002. FILED 8-28-2000.
- 2,623,224. **A BALANCED APPROACH TO CASE MANAGEMENT**. CASE MANAGEMENT SYSTEMS, LLC, MULTIPLE CLASS, (INT. CLS. 9 AND 42), (U.S. CLS. 21, 23, 26, 36, 38, 100 AND 101). SN 76-124,506. PUB. 7-2-2002. FILED 9-8-2000.

- 2,623,225. **BIO SHIELD AND DESIGN**. SCHUBERTH HELME GMBH, (U.S. CLS. 21, 23, 26, 36 AND 38). SN 76-124,715. PUB. 7-2-2002. FILED 9-8-2000.
- 2,623,226. **PARTSWATCH**. ICARZ, INC., MULTIPLE CLASS, (INT. CLS. 9 AND 35), (U.S. CLS. 21, 23, 26, 36, 38, 100, 101 AND 102). SN 76-125,230. PUB. 7-2-2002. FILED 9-8-2000.
- 2,623,241. **JABBER**. JABBER.COM, INC., MULTIPLE CLASS, (INT. CLS. 9 AND 42), (U.S. CLS. 21, 23, 26, 36, 38, 100 AND 101). SN 76-130,296. PUB. 7-2-2002. FILED 9-18-2000.
- 2,623,252. **STOREFRONT MARKUP LANGUAGE**. MACDONALD, MURRAY G., (U.S. CLS. 21, 23, 26, 36 AND 38). SN 76-133,041. PUB. 7-2-2002. FILED 9-22-2000.
- 2,623,275. **CLEANFIT**. ENDRESS + HAUSER CONDUCTA MESS- UND REGELTECHNIK GMBH & CO., (U.S. CLS. 21, 23, 26, 36 AND 38). SN 76-136,204. PUB. 7-2-2002. FILED 9-27-2000.
- 2,623,288. **PURCHASINGNET, INC. EPROCUREMENT MADE EASY AND DESIGN**. PURCHASINGNET, INC., (U.S. CLS. 21, 23, 26, 36 AND 38). SN 76-138,449. PUB. 7-2-2002. FILED 9-29-2000.
- 2,623,300. **MYDVD**. SONIC SOLUTIONS, (U.S. CLS. 21, 23, 26, 36 AND 38). SN 76-139,763. PUB. 7-2-2002. FILED 10-2-2000.
- 2,623,302. **JXP**. IDEAMAX CORP., MULTIPLE CLASS, (INT. CLS. 9, 35 AND 41), (U.S. CLS. 21, 23, 26, 36, 38, 100, 101, 102 AND 107). SN 76-140,866. PUB. 7-2-2002. FILED 10-4-2000.
- 2,623,304. **POLY PAD**. H.H.H., INC., (U.S. CLS. 21, 23, 26, 36 AND 38). SN 76-141,799. PUB. 7-2-2002. FILED 10-5-2000.
- 2,623,306. **MISCELLANEOUS DESIGN**. CONTENT TECHNOLOGIES LIMITED, MULTIPLE CLASS, (INT. CLS. 9, 41 AND 42), (U.S. CLS. 21, 23, 26, 36, 38, 100, 101 AND 107). SN 76-142,204. PUB. 7-2-2002. FILED 10-5-2000.
- 2,623,319. **THE T SECTOR**. T SECTOR, INC., THE, MULTIPLE CLASS, (INT. CLS. 9, 16, 35, 36, 41 AND 42), (U.S. CLS. 2, 5, 21, 22, 23, 26, 29, 36, 37, 38, 50, 100, 101, 102 AND 107). SN 76-144,130. PUB. 7-2-2002. FILED 10-6-2000.
- 2,623,338. **HNET (STYLIZED)**. AND ARTIFICIAL NEURAL DEVICES, CORPORATION, (U.S. CLS. 21, 23, 26, 36 AND 38). SN 76-147,262. PUB. 7-2-2002. FILED 10-17-2000.
- 2,623,339. **HNET**. AND ARTIFICIAL NEURAL DEVICES, CORPORATION, (U.S. CLS. 21, 23, 26, 36 AND 38). SN 76-147,263. PUB. 7-2-2002. FILED 10-17-2000.
- 2,623,341. **MAGNUS MEDIA**. MUNDUS-VERLAGSGSELLSCHAFT M.B.H., MULTIPLE CLASS, (INT. CLS. 9 AND 16), (U.S. CLS. 2, 5, 21, 22, 23, 26, 29, 36, 37, 38 AND 50). SN 76-147,882. PUB. 7-2-2002. FILED 10-16-2000.
- 2,623,342. **CORPORATEFLYWAY**. DEUTSCHE LUFTHANSA AG, MULTIPLE CLASS, (INT. CLS. 9, 38, 39 AND 42), (U.S. CLS. 21, 23, 26, 36, 38, 100, 101, 104 AND 105). SN 76-148,034. PUB. 7-2-2002. FILED 10-13-2000.
- 2,623,364. **CYGRON**. CYGRON PTE LTD., (U.S. CLS. 21, 23, 26, 36 AND 38). SN 76-151,631. PUB. 7-2-2002. FILED 10-19-2000.
- 2,623,373. **T AND DESIGN**. THINAIRAPPS, INC., MULTIPLE CLASS, (INT. CLS. 9, 38 AND 42), (U.S. CLS. 21, 23, 26, 36, 38, 100, 101 AND 104). SN 76-152,879. PUB. 7-2-2002. FILED 10-24-2000.
- 2,623,381. **B & G AND DESIGN**. ITT INDUSTRIES, INC., (U.S. CLS. 21, 23, 26, 36 AND 38). SN 76-153,612. PUB. 7-2-2002. FILED 10-26-2000.
- 2,623,384. **LEXIO**. KONICA CORPORATION, (U.S. CLS. 21, 23, 26, 36 AND 38). SN 76-154,110. PUB. 7-2-2002. FILED 10-25-2000.
- 2,623,389. **OPTISTREAMS BROADBAND BROWSER**. OPTISTREAMS, INC., (U.S. CLS. 21, 23, 26, 36 AND 38). SN 76-154,781. PUB. 11-13-2001. FILED 10-27-2000.
- 2,623,397. **MOCOL (STYLIZED)**. WIELAND ELECTRIC GMBH, (U.S. CLS. 21, 23, 26, 36 AND 38). SN 76-157,270. PUB. 7-2-2002. FILED 11-1-2000.
- 2,623,402. **CYBERBEE**. JOSEPH, LINDA, MULTIPLE CLASS, (INT. CLS. 9 AND 16), (U.S. CLS. 2, 5, 21, 22, 23, 26, 29, 36, 37, 38 AND 50). SN 76-157,931. PUB. 7-2-2002. FILED 11-2-2000.
- 2,623,403. **I/O MAGIC**. I/OMAGIC CORPORATION, (U.S. CLS. 21, 23, 26, 36 AND 38). SN 76-157,967. PUB. 7-2-2002. FILED 10-31-2000.
- 2,623,411. **COMPURECORD**. ANESTHESIA RECORDING, INC., (U.S. CLS. 21, 23, 26, 36 AND 38). SN 76-158,644. PUB. 7-2-2002. FILED 10-31-2000.
- 2,623,445. **ZEBRA IMAGING**. ZEBRA IMAGING, INC., (U.S. CLS. 21, 23, 26, 36 AND 38). SN 76-164,862. PUB. 7-2-2002. FILED 11-13-2000.
- 2,623,451. **SYNGO (STYLIZED)**. SIEMENS AKTIENGESELLSCHAFT, MULTIPLE CLASS, (INT. CLS. 9, 41 AND 42), (U.S. CLS. 21, 23, 26, 36, 38, 100, 101 AND 107). SN 76-166,029. PUB. 7-2-2002. FILED 11-15-2000.
- 2,623,460. **SPHEON (STYLIZED)**. BOV AKTIENGESELLSCHAFT, MULTIPLE CLASS, (INT. CLS. 9 AND 42), (U.S. CLS. 21, 23, 26, 36, 38, 100 AND 101). SN 76-167,040. PUB. 7-2-2002. FILED 11-18-2000.
- 2,623,461. **MISCELLANEOUS DESIGN**. FOOTBALL LIMITED, MULTIPLE CLASS, (INT. CLS. 9, 16, 35 AND 42), (U.S. CLS. 2, 5, 21, 22, 23, 26, 29, 36, 37, 38, 50, 100, 101 AND 102). SN 76-167,187. PUB. 7-2-2002. FILED 11-17-2000.
- 2,623,469. **KNOWLEDGEPARK AND DESIGN**. KNOWLEDGEPARK AG, MULTIPLE CLASS, (INT. CLS. 9 AND 42), (U.S. CLS. 21, 23, 26, 36, 38, 100 AND 101). SN 76-168,798. PUB. 7-2-2002. FILED 11-22-2000.
- 2,623,478. **BEST SHOT INC. AND DESIGN**. BEST SHOT, INC., MULTIPLE CLASS, (INT. CLS. 9, 35 AND 42), (U.S. CLS. 21, 23, 26, 36, 38, 100, 101 AND 102). SN 76-170,593. PUB. 7-2-2002. FILED 11-21-2000.
- 2,623,479. **BEST SHOT**. BEST SHOT, INC., MULTIPLE CLASS, (INT. CLS. 9, 35 AND 42), (U.S. CLS. 21, 23, 26, 36, 38, 100, 101 AND 102). SN 76-170,594. PUB. 7-2-2002. FILED 11-21-2000.
- 2,623,481. **SIGNATURE**. SIGNATURE CONTROL SYSTEMS, INC., MULTIPLE CLASS, (INT. CLS. 9 AND 11), (U.S. CLS. 13, 21, 23, 26, 31, 34, 36 AND 38). SN 76-170,719. PUB. 7-2-2002. FILED 11-22-2000.
- 2,623,487. **DATATAPPER**. DAUGHERTY SYSTEMS, INC., (U.S. CLS. 21, 23, 26, 36 AND 38). SN 76-171,499. PUB. 7-2-2002. FILED 11-27-2000.
- 2,623,495. **BALANCE OF POWER**. WORDEN BROTHERS, INC., (U.S. CLS. 21, 23, 26, 36 AND 38). SN 76-172,474. PUB. 7-2-2002. FILED 11-29-2000.
- 2,623,499. **SKYVIEW**. XSILOGY, INC., (U.S. CLS. 21, 23, 26, 36 AND 38). SN 76-172,890. PUB. 7-2-2002. FILED 11-30-2000.
- 2,623,501. **JESTCAM**. JESTERTEK, INC., (U.S. CLS. 21, 23, 26, 36 AND 38). SN 76-173,181. PUB. 7-2-2002. FILED 11-28-2000.
- 2,623,503. **ALLEN RESOURCES**. ALLEN RESOURCES, INC., MULTIPLE CLASS, (INT. CLS. 9 AND 16), (U.S. CLS. 2, 5, 21, 22, 23, 26, 29, 36, 37, 38 AND 50). SN 76-173,459. PUB. 7-2-2002. FILED 11-30-2000.
- 2,623,505. **CAN D AND DESIGN**. CAN-D ELECTRIFICATION SYSTEMS LTD., (U.S. CLS. 21, 23, 26, 36 AND 38). SN 76-173,701. PUB. 7-2-2002. FILED 12-1-2000.
- 2,623,507 (See Class 7 for this trademark).
- 2,623,513. **CASHDISC AND DESIGN**. CASHDISC.COM INC., MULTIPLE CLASS, (INT. CLS. 9 AND 35), (U.S. CLS. 21, 23, 26, 36, 38, 100, 101 AND 102). SN 76-174,740. PUB. 7-2-2002. FILED 11-30-2000.
- 2,623,514. **CVCOM**. ALSTOM, (U.S. CLS. 21, 23, 26, 36 AND 38). SN 76-174,902. PUB. 7-2-2002. FILED 12-4-2000.
- 2,623,517. **AUDIODNA**. HARMAN INTERNATIONAL INDUSTRIES, INCORPORATED, (U.S. CLS. 21, 23, 26, 36 AND 38). SN 76-175,472. PUB. 7-2-2002. FILED 12-4-2000.
- 2,623,522. **PORTAL CONNECT AND DESIGN**. PORTAL CONNECT, INC., (U.S. CLS. 21, 23, 26, 36 AND 38). SN 76-176,307. PUB. 7-2-2002. FILED 12-6-2000.
- 2,623,528. **FYDOLLA HO**. SMITH, SHAWNEE, (U.S. CLS. 21, 23, 26, 36 AND 38). SN 76-176,922. PUB. 7-2-2002. FILED 12-5-2000.
- 2,623,529. **IPG PHOTONICS**. IPG PHOTONICS CORPORATION, MULTIPLE CLASS, (INT. CLS. 9, 40 AND 42), (U.S. CLS. 21, 23, 26, 36, 38, 100, 101, 103 AND 106). SN 76-176,925. PUB. 7-2-2002. FILED 12-7-2000.
- 2,623,531. **IPG**. IPG PHOTONICS CORPORATION, MULTIPLE CLASS, (INT. CLS. 9, 40 AND 42), (U.S. CLS. 21, 23, 26, 36, 38, 100, 101, 103 AND 106). SN 76-176,945. PUB. 7-2-2002. FILED 12-7-2000.
- 2,623,540. **MPRESS RECORDS**. WEITZMAN, KAREN, (U.S. CLS. 21, 23, 26, 36 AND 38). SN 76-177,816. PUB. 7-2-2002. FILED 12-8-2000.
- 2,623,541. **RACHAEL SAGE**. WEITZMAN, KAREN, (U.S. CLS. 21, 23, 26, 36 AND 38). SN 76-177,818. PUB. 7-2-2002. FILED 12-8-2000.
- 2,623,546. **MANAGING RESEARCH INFORMATION**

- WORLDWIDE. DATATRAK INTERNATIONAL, INC.**, MULTIPLE CLASS, (INT. CLS. 9 AND 35), (U.S. CLS. 21, 23, 26, 36, 38, 100, 101 AND 102). SN 76-178,858. PUB. 7-2-2002. FILED 12-11-2000.
- 2,623,548 (*See Class 6 for this trademark*).
- 2,623,559. **GLOBENEXT. TELEDIFFUSION DE FRANCE**, MULTIPLE CLASS, (INT. CLS. 9, 16, 28, 35, 38, 41 AND 42), (U.S. CLS. 2, 5, 21, 22, 23, 26, 29, 36, 37, 38, 50, 100, 101, 102, 104 AND 107). SN 76-181,181. PUB. 7-2-2002. FILED 12-14-2000.
- 2,623,561. **SOULARD BLUES BAND. DWYER, ARTHUR**, MULTIPLE CLASS, (INT. CLS. 9 AND 41), (U.S. CLS. 21, 23, 26, 36, 38, 100, 101 AND 107). SN 76-181,318. PUB. 7-2-2002. FILED 12-18-2000.
- 2,623,564. **TOUCHA. LEISURE LINK GROUP LIMITED**, MULTIPLE CLASS, (INT. CLS. 9 AND 41), (U.S. CLS. 21, 23, 26, 36, 38, 100, 101 AND 107). SN 76-181,595. PUB. 7-2-2002. FILED 12-15-2000.
- 2,623,571. **PRESENTATION SOURCE. WIDMAIER, JAMES T.**, (U.S. CLS. 21, 23, 26, 36 AND 38). SN 76-183,001. PUB. 7-2-2002. FILED 12-18-2000.
- 2,623,572. **MISCELLANEOUS DESIGN. GATEWAY, INC.**, (U.S. CLS. 21, 23, 26, 36 AND 38). SN 76-183,413. PUB. 7-2-2002. FILED 12-19-2000.
- 2,623,590. **ICARIAN WORKFORCE. ICARIAN, INC.**, (U.S. CLS. 21, 23, 26, 36 AND 38). SN 76-186,574. PUB. 7-2-2002. FILED 12-26-2000.
- 2,623,601. **VISUAL LANDSCAPE (STYLIZED). CAICE SOFTWARE CORPORATION**, (U.S. CLS. 21, 23, 26, 36 AND 38). SN 76-187,787. PUB. 7-2-2002. FILED 12-27-2000.
- 2,623,603. **AUTOVOX. FLOW AUTOMATION INC.**, (U.S. CLS. 21, 23, 26, 36 AND 38). SN 76-188,040. PUB. 7-2-2002. FILED 12-29-2000.
- 2,623,619. **SCHOOL OF LIFE. WORD OF LIFE CHURCH, INC.**, MULTIPLE CLASS, (INT. CLS. 9 AND 42), (U.S. CLS. 21, 23, 26, 36, 38, 100 AND 101). SN 76-189,663. PUB. 7-2-2002. FILED 1-5-2001.
- 2,623,625. **THE RITE BRAIN. CHURCH PUBLISHING INCORPORATED**, (U.S. CLS. 21, 23, 26, 36 AND 38). SN 76-190,373. PUB. 7-2-2002. FILED 1-5-2001.
- 2,623,641. **DVD STUDIO PRO. APPLE COMPUTER, INC.**, (U.S. CLS. 21, 23, 26, 36 AND 38). SN 76-193,465. PUB. 7-2-2002. FILED 1-9-2001.
- 2,623,647. **ADEPTVISION. ADEPT TECHNOLOGY, INC.**, (U.S. CLS. 21, 23, 26, 36 AND 38). SN 76-193,902. PUB. 7-2-2002. FILED 1-11-2001.
- 2,623,658. **A-ZOOM2. AVIMO PRECISION INSTRUMENTS, INC.**, (U.S. CLS. 21, 23, 26, 36 AND 38). SN 76-195,088. PUB. 7-2-2002. FILED 1-17-2001.
- 2,623,662. **FARENHEIT. EPSILON ELECTRONICS, INC.**, (U.S. CLS. 21, 23, 26, 36 AND 38). SN 76-195,324. PUB. 12-18-2001. FILED 1-17-2001.
- 2,623,671. **ENTEROTACH. WESTERN RESEARCH COMPANY, INCORPORATED**, (U.S. CLS. 21, 23, 26, 36 AND 38). SN 76-196,811. PUB. 7-2-2002. FILED 1-17-2001.
- 2,623,672. **CYNTHESIZER. C2 DESIGN AUTOMATION**, (U.S. CLS. 21, 23, 26, 36 AND 38). SN 76-196,852. PUB. 7-2-2002. FILED 1-19-2001.
- 2,623,679. **SPEEDLIBRARIAN. OLDHAM ASSOCIATES, LLC**, (U.S. CLS. 21, 23, 26, 36 AND 38). SN 76-197,462. PUB. 7-2-2002. FILED 1-12-2001.
- 2,623,680. **CFD-VISCART. CFD RESEARCH CORPORATION**, (U.S. CLS. 21, 23, 26, 36 AND 38). SN 76-197,544. PUB. 10-30-2001. FILED 1-23-2001.
- 2,623,682 (*See Class 7 for this trademark*).
- 2,623,693. **SYNBIOSIS. SYNOPTICS LIMITED**, (U.S. CLS. 21, 23, 26, 36 AND 38). SN 76-199,338. PUB. 7-2-2002. FILED 1-25-2001.
- 2,623,702. **DYNAMITE JACK. ARISTOCRAT TECHNOLOGIES AUSTRALIA PTY LTD**, (U.S. CLS. 21, 23, 26, 36 AND 38). SN 76-200,484. PUB. 7-2-2002. FILED 1-26-2001.
- 2,623,703. **HYPERBUNCH. ARISTOCRAT TECHNOLOGIES AUSTRALIA PTY LTD**, (U.S. CLS. 21, 23, 26, 36 AND 38). SN 76-200,485. PUB. 7-2-2002. FILED 1-26-2001.
- 2,623,710. **TARGETED SELECTION:WEB INTERVIEW GUIDE GENERATOR. DEVELOPMENT DIMENSIONS INTERNATIONAL, INC.**, (U.S. CLS. 21, 23, 26, 36 AND 38). SN 76-201,535. PUB. 7-2-2002. FILED 1-29-2001.
- 2,623,717 (*See Class 7 for this trademark*).
- 2,623,719. **MOLDI. INSTITUT FRANCAIS DU PETROLE**, MULTIPLE CLASS, (INT. CLS. 9, 35 AND 42), (U.S. CLS. 21, 23, 26, 36, 38, 100, 101 AND 102). SN 76-202,809. PUB. 7-2-2002. FILED 1-31-2001.
- 2,623,724. **FMB4. DE GOEIJ, MARC ALEXANDER, TA EFFECTIVE MANAGEMENT CONSULTANCY**, MULTIPLE CLASS, (INT. CLS. 9, 35 AND 42), (U.S. CLS. 21, 23, 26, 36, 38, 100, 101 AND 102). SN 76-202,932. PUB. 7-2-2002. FILED 2-1-2001.
- 2,623,729. **SOFTWARE YOU'LL NEVER OUTGROW. MACOLA, INC.**, (U.S. CLS. 21, 23, 26, 36 AND 38). SN 76-203,225. PUB. 7-2-2002. FILED 2-1-2001.
- 2,623,745 (*See Class 2 for this trademark*).
- 2,623,761. **PORTIVA AND DESIGN. PORTIVA CORPORATION**, (U.S. CLS. 21, 23, 26, 36 AND 38). SN 76-206,596. PUB. 7-2-2002. FILED 2-8-2001.
- 2,623,762. **EQUINUX. EQUINUX USA, INC.**, MULTIPLE CLASS, (INT. CLS. 9 AND 42), (U.S. CLS. 21, 23, 26, 36, 38, 100 AND 101). SN 76-206,628. PUB. 7-2-2002. FILED 2-7-2001.
- 2,623,765. **JBS AND DESIGN. JIN BEN SUN CO., LTD.**, (U.S. CLS. 21, 23, 26, 36 AND 38). SN 76-206,968. PUB. 7-2-2002. FILED 2-8-2001.
- 2,623,767. **ACCURATE SWITCHBOARD. ACCURATE DATA SYSTEMS, INC.**, (U.S. CLS. 21, 23, 26, 36 AND 38). SN 76-207,294. PUB. 7-2-2002. FILED 2-5-2001.
- 2,623,778. **TACNAV. KVH INDUSTRIES, INC.**, (U.S. CLS. 21, 23, 26, 36 AND 38). SN 76-209,686. PUB. 7-2-2002. FILED 2-13-2001.
- 2,623,793. **TOPMARK. GIANT ELECTRIC TRANSFORMER CO., LTD.**, (U.S. CLS. 21, 23, 26, 36 AND 38). SN 76-211,794. PUB. 7-2-2002. FILED 2-20-2001.
- 2,623,805. **LTC WORKS!. PENN TREATY AMERICAN CORPORATION**, (U.S. CLS. 21, 23, 26, 36 AND 38). SN 76-213,450. PUB. 7-2-2002. FILED 2-21-2001.
- 2,623,809. **SDOFFICE. SYNERGETIC DATA SYSTEMS, INC.**, (U.S. CLS. 21, 23, 26, 36 AND 38). SN 76-214,002. PUB. 7-2-2002. FILED 2-21-2001.
- 2,623,812 (*See Class 7 for this trademark*).
- 2,623,818. **SAFETYSIZE. ANDERSON GREENWOOD LP**, (U.S. CLS. 21, 23, 26, 36 AND 38). SN 76-215,084. PUB. 7-2-2002. FILED 2-23-2001.
- 2,623,820. **PACCAP. DUFF, WILLIAM B., JR.**, (U.S. CLS. 21, 23, 26, 36 AND 38). SN 76-215,536. PUB. 7-2-2002. FILED 2-23-2001.
- 2,623,828. **MEDSTAT PERFORMANCE MEASUREMENT WORKSTATION. MEDSTAT GROUP, INC., THE**, (U.S. CLS. 21, 23, 26, 36 AND 38). SN 76-216,726. PUB. 7-2-2002. FILED 2-27-2001.
- 2,623,829. **ALIOSCOPY. PIERRE ALLIO**, (U.S. CLS. 21, 23, 26, 36 AND 38). SN 76-216,923. PUB. 7-2-2002. FILED 2-27-2001.
- 2,623,832. **EPIUM. EPIUM PLC**, MULTIPLE CLASS, (INT. CLS. 9, 36, 41 AND 42), (U.S. CLS. 21, 23, 26, 36, 38, 100, 101, 102 AND 107). SN 76-217,585. PUB. 7-2-2002. FILED 2-28-2001.
- 2,623,834. **GATEWAY SELECT. GATEWAY, INC.**, (U.S. CLS. 21, 23, 26, 36 AND 38). SN 76-217,832. PUB. 7-2-2002. FILED 3-1-2001.
- 2,623,835. **FLEX-STIK. AMETEK, INC.**, (U.S. CLS. 21, 23, 26, 36 AND 38). SN 76-217,998. PUB. 7-2-2002. FILED 3-1-2001.
- 2,623,836. **HALOGEN. HALOGEN SOFTWARE, INC., BY CHANGE OF NAME MANTA CORPORATION**, MULTIPLE CLASS, (INT. CLS. 9 AND 35), (U.S. CLS. 21, 23, 26, 36, 38, 100, 101 AND 102). SN 76-218,284. PUB. 7-2-2002. FILED 3-1-2001.
- 2,623,840. **READY READ. CAPLAN INDUSTRIES INC.**, (U.S. CLS. 21, 23, 26, 36 AND 38). SN 76-218,584. PUB. 7-2-2002. FILED 3-5-2001.
- 2,623,852. **NEXTECH PRACTICE. NEXTECH, INC.**, (U.S. CLS. 21, 23, 26, 36 AND 38). SN 76-219,859. PUB. 7-2-2002. FILED 3-5-2001.
- 2,623,859. **ELAXY. ELAXY AG, BY ASSIGNMENT HEYDE AKTIENGESELLSCHAFT**, MULTIPLE CLASS, (INT. CLS. 9, 41 AND 42), (U.S. CLS. 21, 23, 26, 36, 38, 100, 101 AND 107). SN 76-220,880. PUB. 7-2-2002. FILED 11-22-2000.
- 2,623,864. **REV TACH. BCD ELECTRONICS LTD.**, (U.S. CLS. 21, 23, 26, 36 AND 38). SN 76-221,721. PUB. 7-2-2002. FILED 3-9-2001.

- 2,623,869. **SPY FOX**. INFOGRAMES, INC., BY MERGER; BY MERGER HUMONGOUS ENTERTAINMENT, INC., (U.S. CLS. 21, 23, 26, 36 AND 38). SN 76-221,919. PUB. 8-28-2001. FILED 3-7-2001.
- 2,623,888. **RWCORBO AND DESIGN**. SAMSUNG ELECTRONICS CO., LTD., (U.S. CLS. 21, 23, 26, 36 AND 38). SN 76-224,054. PUB. 7-2-2002. FILED 3-12-2001.
- 2,623,891. **MICROSTATION**. BENTLEY SOFTWARE, INC., MULTIPLE CLASS, (INT. CLS. 9 AND 42), (U.S. CLS. 21, 23, 26, 36, 38, 100 AND 101). SN 76-225,001. PUB. 7-2-2002. FILED 3-12-2001.
- 2,623,894. **MRM**. DATARADIO, INC., (U.S. CLS. 21, 23, 26, 36 AND 38). SN 76-225,203. PUB. 7-2-2002. FILED 3-5-2001.
- 2,623,901. **WEBGATE**. MU NET, INC., (U.S. CLS. 21, 23, 26, 36 AND 38). SN 76-225,788. PUB. 7-2-2002. FILED 3-19-2001.
- 2,623,904 (*See Class 7 for this trademark*).
- 2,623,913. **CONNECTING PEOPLE**. NOKIA CORPORATION, MULTIPLE CLASS, (INT. CLS. 9 AND 38), (U.S. CLS. 21, 23, 26, 36, 38, 100, 101 AND 104). SN 76-227,835. PUB. 7-2-2002. FILED 3-21-2001.
- 2,623,920. **RESCUE POD**. SWITLIK PARACHUTE COMPANY, INC., (U.S. CLS. 21, 23, 26, 36 AND 38). SN 76-228,751. PUB. 7-2-2002. FILED 3-23-2001.
- 2,623,924. **HIPERSMART (STYLIZED)**. KONINKLIJKE PHILIPS ELECTRONICS N.V., (U.S. CLS. 21, 23, 26, 36 AND 38). SN 76-229,114. PUB. 7-2-2002. FILED 3-22-2001.
- 2,623,926 (*See Class 5 for this trademark*).
- 2,623,930. **WAVESHIELD AND DESIGN**. INTERACT COMMUNICATIONS, INC., (U.S. CLS. 21, 23, 26, 36 AND 38). SN 76-230,755. PUB. 7-2-2002. FILED 3-12-2001.
- 2,623,933. **MISCELLANEOUS DESIGN**. MICRO ACCESSORIES TAIWAN LTD., (U.S. CLS. 21, 23, 26, 36 AND 38). SN 76-231,091. PUB. 7-2-2002. FILED 3-28-2001.
- 2,623,941. **IT'S ACADEMIC**. IT'S ACADEMIC OF ILLINOIS, INC., MULTIPLE CLASS, (INT. CLS. 9 AND 16), (U.S. CLS. 2, 5, 21, 22, 23, 26, 29, 36, 37, 38 AND 50). SN 76-232,186. PUB. 7-2-2002. FILED 3-28-2001.
- 2,623,944. **GET RIPPED**. NCP MARKETING GROUP, INC., (U.S. CLS. 21, 23, 26, 36 AND 38). SN 76-232,535. PUB. 7-2-2002. FILED 3-29-2001.
- 2,623,950 (*See Class 1 for this trademark*).
- 2,623,951 (*See Class 1 for this trademark*).
- 2,623,964. **MISCELLANEOUS DESIGN**. ADIVAN HIGH TECH AG, (U.S. CLS. 21, 23, 26, 36 AND 38). SN 76-234,855. PUB. 7-2-2002. FILED 4-2-2001.
- 2,623,970. **QCONNECT**. QUINTESSENT COMMUNICATIONS, INC., (U.S. CLS. 21, 23, 26, 36 AND 38). SN 76-235,784. PUB. 7-2-2002. FILED 4-3-2001.
- 2,623,983. **ACU-SIGHT**. HUNTSINC.COM CORPORATION, (U.S. CLS. 21, 23, 26, 36 AND 38). SN 76-236,742. PUB. 7-2-2002. FILED 4-6-2001.
- 2,623,996. **PRIMELINK**. SHERWOOD SERVICES AG, (U.S. CLS. 21, 23, 26, 36 AND 38). SN 76-237,594. PUB. 7-2-2002. FILED 4-4-2001.
- 2,624,002. **BULKMATE**. MICROBAR, INC., (U.S. CLS. 21, 23, 26, 36 AND 38). SN 76-238,448. PUB. 7-2-2002. FILED 4-10-2001.
- 2,624,010. **IDC**. IDEAMAX CORP., MULTIPLE CLASS, (INT. CLS. 9 AND 41), (U.S. CLS. 21, 23, 26, 36, 38, 100, 101 AND 107). SN 76-239,237. PUB. 7-2-2002. FILED 4-12-2001.
- 2,624,011. **DYNAMOVIE (STYLIZED)**. MATSUSHITA ELECTRIC CORPORATION OF AMERICA, (U.S. CLS. 21, 23, 26, 36 AND 38). SN 76-239,526. PUB. 7-2-2002. FILED 4-12-2001.
- 2,624,012. **MISCELLANEOUS DESIGN**. TORFINO ENTERPRISES, INC., (U.S. CLS. 21, 23, 26, 36 AND 38). SN 76-239,771. PUB. 7-2-2002. FILED 4-13-2001.
- 2,624,022. **METALWORKS**. SPRINGFIELD PRECISION INSTRUMENTS, INC., MULTIPLE CLASS, (INT. CLS. 9 AND 14), (U.S. CLS. 2, 21, 23, 26, 27, 28, 36, 38 AND 50). SN 76-240,754. PUB. 7-2-2002. FILED 4-16-2001.
- 2,624,039. **LAKESIDE SOFTWARE**. LAKESIDE SOFTWARE, INC., MULTIPLE CLASS, (INT. CLS. 9 AND 42), (U.S. CLS. 21, 23, 26, 36, 38, 100 AND 101). SN 76-242,191. PUB. 7-2-2002. FILED 4-10-2001.
- 2,624,040. **!PRONTO! (STYLIZED)**. ASTRO-MED, INC., (U.S. CLS. 21, 23, 26, 36 AND 38). SN 76-242,252. PUB. 7-2-2002. FILED 4-17-2001.
- 2,624,041. **PERMANENT LEGACY**. EVEREST DOMAIN SERVICES, LLC, MULTIPLE CLASS, (INT. CLS. 9 AND 42), (U.S. CLS. 21, 23, 26, 36, 38, 100 AND 101). SN 76-242,293. PUB. 7-2-2002. FILED 4-18-2001.
- 2,624,044. **FUNNIEST MAN IN AMERICA**. GREGORY, JAMES, MULTIPLE CLASS, (INT. CLS. 9, 25 AND 41), (U.S. CLS. 21, 22, 23, 26, 36, 38, 39, 100, 101 AND 107). SN 76-242,475. PUB. 7-2-2002. FILED 4-11-2001.
- 2,624,054. **MISCELLANEOUS DESIGN**. TIME DOMAIN CORPORATION, (U.S. CLS. 21, 23, 26, 36 AND 38). SN 76-243,604. PUB. 7-2-2002. FILED 4-19-2001.
- 2,624,061. **TLT-ON-TIME SERVICE**. ENERNET, INC., DBA ENERPATH, (U.S. CLS. 21, 23, 26, 36 AND 38). SN 76-244,228. PUB. 7-2-2002. FILED 4-20-2001.
- 2,624,064. **BUCK3EIGHTY**. SABATINO, DOMINICK R., AND NOCITO, MATTHEW M., AND ESPOSITO, FRANK, AND RAINEY, KENNETH J., MULTIPLE CLASS, (INT. CLS. 9 AND 41), (U.S. CLS. 21, 23, 26, 36, 38, 100, 101 AND 107). SN 76-244,518. PUB. 7-2-2002. FILED 4-23-2001.
- 2,624,079. **ECONOPIM**. EUPEC EUROPAISCHE GESELLSCHAFT FUR LEISTUNGSHALBLEITER MBH & CO. KG, (U.S. CLS. 21, 23, 26, 36 AND 38). SN 76-246,748. PUB. 7-2-2002. FILED 4-25-2001.
- 2,624,080. **HUMID**. FULL SAIL, INC., (U.S. CLS. 21, 23, 26, 36 AND 38). SN 76-246,755. PUB. 7-2-2002. FILED 4-25-2001.
- 2,624,091. **RFQ WMS**. QDATA INC., (U.S. CLS. 21, 23, 26, 36 AND 38). SN 76-247,772. PUB. 7-2-2002. FILED 4-30-2001.
- 2,624,109 (*See Class 7 for this trademark*).
- 2,624,117. **THE YELLOW HAT TRIBE**. GEORGE, IRENE, AND TYACK, VINCE, MULTIPLE CLASS, (INT. CLS. 9, 16 AND 25), (U.S. CLS. 2, 5, 21, 22, 23, 26, 29, 36, 37, 38, 39 AND 50). SN 76-250,972. PUB. 7-2-2002. FILED 5-2-2001.
- 2,624,124. **PLANCONVERT**. PYRAMID DIGITAL SOLUTIONS, LLC, (U.S. CLS. 21, 23, 26, 36 AND 38). SN 76-252,206. PUB. 7-2-2002. FILED 5-4-2001.
- 2,624,148. **ARCHITECTS OF THE VIRTUAL ENTERPRISE**. TRINITY CORPORATION, MULTIPLE CLASS, (INT. CLS. 9, 35 AND 42), (U.S. CLS. 21, 23, 26, 36, 38, 100, 101 AND 102). SN 76-255,904. PUB. 7-2-2002. FILED 5-11-2001.
- 2,624,152. **WWW.MAUJIM.COM**. MAUI JIM, INC., MULTIPLE CLASS, (INT. CLS. 9 AND 35), (U.S. CLS. 21, 23, 26, 36, 38, 100, 101 AND 102). SN 76-256,567. PUB. 7-2-2002. FILED 5-15-2001.
- 2,624,154. **OFF-THE-GLASS**. PHAROS SYSTEMS USA, INC., (U.S. CLS. 21, 23, 26, 36 AND 38). SN 76-256,660. PUB. 7-2-2002. FILED 5-14-2001.
- 2,624,159. **FAGOE**. VINCENT, JEAN, MULTIPLE CLASS, (INT. CLS. 9 AND 28), (U.S. CLS. 21, 22, 23, 26, 36, 38 AND 50). SN 76-257,184. PUB. 7-2-2002. FILED 5-15-2001.
- 2,624,161. **SUCCESS MOTIVATION**. SUCCESS MOTIVATION, INC., (U.S. CLS. 21, 23, 26, 36 AND 38). SN 76-257,845. PUB. 7-2-2002. FILED 5-15-2001.
- 2,624,167. **FUEL CELL SAFETY SYSTEMS AND DESIGN**. FAMILY SAFETY PRODUCTS, INC., (U.S. CLS. 21, 23, 26, 36 AND 38). SN 76-258,636. PUB. 7-2-2002. FILED 5-17-2001.
- 2,624,172. **SPRING COMMUNICATIONS**. SPRING COMMUNICATIONS II, LLC, (U.S. CLS. 21, 23, 26, 36 AND 38). SN 76-259,102. PUB. 7-2-2002. FILED 5-18-2001.
- 2,624,186. **QDRIVE**. CLEVER FELLOWS INNOVATION CONSORTIUM, INC., (U.S. CLS. 21, 23, 26, 36 AND 38). SN 76-260,127. PUB. 7-2-2002. FILED 5-21-2001.
- 2,624,189. **INTEHEALTH**. INTEHEALTH INCORPORATED, MULTIPLE CLASS, (INT. CLS. 9 AND 42), (U.S. CLS. 21, 23, 26, 36, 38, 100 AND 101). SN 76-260,357. PUB. 7-2-2002. FILED 5-21-2001.
- 2,624,198. **WWW.DIGI.COM**. DIGI INTERNATIONAL INC., MULTIPLE CLASS, (INT. CLS. 9 AND 42), (U.S. CLS. 21, 23, 26, 36, 38, 100 AND 101). SN 76-261,216. PUB. 7-2-2002. FILED 5-22-2001.
- 2,624,207. **MINICYCLER**. MJ RESEARCH, INCORPORATED, (U.S. CLS. 21, 23, 26, 36 AND 38). SN 76-262,675. PUB. 7-2-2002. FILED 5-25-2001.
- 2,624,208. **PTC-100**. MJ RESEARCH, INCORPORATED, (U.S. CLS. 21, 23, 26, 36 AND 38). SN 76-262,676. PUB. 7-2-2002. FILED 5-25-2001.
- 2,624,217 (*See Class 6 for this trademark*).
- 2,624,219. **MARANATHA!**. CORINTHIAN GROUP, INC., THE, MULTIPLE CLASS, (INT. CLS. 9, 16 AND 41), (U.S. CLS. 2, 5, 21, 22, 23, 26, 29, 36, 37, 38, 50, 100, 101 AND 107).

- SN 76-263,682. PUB. 7-2-2002. FILED 5-29-2001.
- 2,624,220. **KOA SPEER**. KOA SPEER ELECTRONICS, INC., (U.S. CLS. 21, 23, 26, 36 AND 38). SN 76-263,857. PUB. 7-2-2002. FILED 5-29-2001.
- 2,624,221. **MICROSTATION I/RAS B**. BENTLEY SOFTWARE, INC., (U.S. CLS. 21, 23, 26, 36 AND 38). SN 76-263,865. PUB. 7-2-2002. FILED 5-29-2001.
- 2,624,225. **A I R 2 W E B AND DESIGN**. AIR2WEB, INC., (U.S. CLS. 21, 23, 26, 36 AND 38). SN 76-264,407. PUB. 7-2-2002. FILED 5-30-2001.
- 2,624,229. **LIFEDGE**. STAND-BY SYSTEMS, INC., (U.S. CLS. 21, 23, 26, 36 AND 38). SN 76-264,772. PUB. 7-2-2002. FILED 5-24-2001.
- 2,624,273. **NETSEATS**. INTELLEGO, INC., (U.S. CLS. 21, 23, 26, 36 AND 38). SN 76-268,846. PUB. 7-2-2002. FILED 6-8-2001.
- 2,624,282. **TOPAZ**. NEWPORT CORPORATION, (U.S. CLS. 21, 23, 26, 36 AND 38). SN 76-269,350. PUB. 7-2-2002. FILED 6-7-2001.
- 2,624,284. **M-SYSTEMS FLASH DISK PIONEERS**. M-SYSTEMS FLASH DISK PIONEERS, LTD., (U.S. CLS. 21, 23, 26, 36 AND 38). SN 76-269,881. PUB. 7-2-2002. FILED 6-11-2001.
- 2,624,285. **PACIFIC DIGITAL**. PACIFIC DIGITAL CORPORATION, MULTIPLE CLASS, (INT. CLS. 9, 35 AND 42), (U.S. CLS. 21, 23, 26, 36, 38, 100, 101 AND 102). SN 76-270,088. PUB. 7-2-2002. FILED 6-11-2001.
- 2,624,290. **STRATA**. KABUSHIKI KAISHA TOSHIBA, TA TOSHIBA CORPORATION, (U.S. CLS. 21, 23, 26, 36 AND 38). SN 76-270,712. PUB. 7-2-2002. FILED 6-14-2001.
- 2,624,299. **FLEX-CORE**. MORLAN & ASSOCIATES, INC., (U.S. CLS. 21, 23, 26, 36 AND 38). SN 76-271,673. PUB. 7-2-2002. FILED 6-14-2001.
- 2,624,306. **MISCELLANEOUS DESIGN**. SPRING COMMUNICATIONS II, LLC, (U.S. CLS. 21, 23, 26, 36 AND 38). SN 76-272,365. PUB. 7-2-2002. FILED 6-14-2001.
- 2,624,309. **DGX AND DESIGN**. SHALLBETTER, INC., (U.S. CLS. 21, 23, 26, 36 AND 38). SN 76-272,510. PUB. 7-2-2002. FILED 6-18-2001.
- 2,624,315. **PDF SOLUTIONS**. PDF SOLUTIONS, INC., MULTIPLE CLASS, (INT. CLS. 9 AND 42), (U.S. CLS. 21, 23, 26, 36, 38, 100 AND 101). SN 76-273,762. PUB. 7-2-2002. FILED 6-19-2001.
- 2,624,327 (*See Class 7 for this trademark*).
- 2,624,328 (*See Class 7 for this trademark*).
- 2,624,335. **BERMUDA REEFS RECORDS**. WILSON, RAY, (U.S. CLS. 21, 23, 26, 36 AND 38). SN 76-276,467. PUB. 7-2-2002. FILED 6-26-2001.
- 2,624,342. **BLITZFIRE**. TASK FORCE TIPS, INC., (U.S. CLS. 21, 23, 26, 36 AND 38). SN 76-277,108. PUB. 7-2-2002. FILED 6-27-2001.
- 2,624,349. **DDS2000**. MIDTECH R&D, INC., (U.S. CLS. 21, 23, 26, 36 AND 38). SN 76-277,887. PUB. 7-2-2002. FILED 6-25-2001.
- 2,624,358. **PSEXPLORER**. FIRE PROGRAM SOLUTIONS, LLC, AND CALVIN, MICHAEL, DBA ACACIA SERVICES, (U.S. CLS. 21, 23, 26, 36 AND 38). SN 76-279,448. PUB. 7-2-2002. FILED 7-2-2001.
- 2,624,361. **NAVALIS**. HANCOCK INTERNATIONAL CORPORATION, (U.S. CLS. 21, 23, 26, 36 AND 38). SN 76-280,296. PUB. 7-2-2002. FILED 7-5-2001.
- 2,624,368. **LOCARTA 2020 AND DESIGN**. LOCARTA TECHNOLOGIES, INC., (U.S. CLS. 21, 23, 26, 36 AND 38). SN 76-281,821. PUB. 7-2-2002. FILED 7-10-2001.
- 2,624,395. **FALKO**. SIEMENS AKTIENGESELLSCHAFT, (U.S. CLS. 21, 23, 26, 36 AND 38). SN 76-286,307. PUB. 7-2-2002. FILED 7-11-2001.
- 2,624,400. **SKYSCAPE**. SKYSCAPE, INC., (U.S. CLS. 21, 23, 26, 36 AND 38). SN 76-286,910. PUB. 7-2-2002. FILED 7-18-2001.
- 2,624,407. **BINGO CASH**. HANCO SYSTEMS, INC., MULTIPLE CLASS, (INT. CLS. 9 AND 36), (U.S. CLS. 21, 23, 26, 36, 38, 100, 101 AND 102). SN 76-287,883. PUB. 7-2-2002. FILED 7-20-2001.
- 2,624,414. **CONVAT**. SYSTEMS ENGINEERING SERVICE, INC., (U.S. CLS. 21, 23, 26, 36 AND 38). SN 76-288,702. PUB. 7-2-2002. FILED 7-23-2001.
- 2,624,419. **MOAM**. MOAM, INC., (U.S. CLS. 21, 23, 26, 36 AND 38). SN 76-289,567. PUB. 10-23-2001. FILED 7-24-2001.
- 2,624,424. **MICHELANGELO**. BERTHOLD TYPES LIMITED, (U.S. CLS. 21, 23, 26, 36 AND 38). SN 76-290,437. PUB. 7-2-2002. FILED 7-26-2001.
- 2,624,436. **MAS AND DESIGN**. 4THPASS INC., (U.S. CLS. 21, 23, 26, 36 AND 38). SN 76-291,277. PUB. 7-2-2002. FILED 7-26-2001.
- 2,624,450. **MISCELLANEOUS DESIGN**. VISIWORLD AS, MULTIPLE CLASS, (INT. CLS. 9, 35 AND 42), (U.S. CLS. 21, 23, 26, 36, 38, 100, 101 AND 102). SN 76-292,678. PUB. 7-2-2002. FILED 7-30-2001.
- 2,624,451. **MISCELLANEOUS DESIGN**. VISIWORLD AS, MULTIPLE CLASS, (INT. CLS. 9, 35 AND 42), (U.S. CLS. 21, 23, 26, 36, 38, 100, 101 AND 102). SN 76-292,679. PUB. 7-2-2002. FILED 7-30-2001.
- 2,624,452. **OPTICONX AND DESIGN**. OPTICONX, INC., (U.S. CLS. 21, 23, 26, 36 AND 38). SN 76-292,707. PUB. 7-2-2002. FILED 7-31-2001.
- 2,624,464. **LEGISSTREAM**. DECISION MANAGEMENT COMPANY, INC., (U.S. CLS. 21, 23, 26, 36 AND 38). SN 76-295,051. PUB. 7-2-2002. FILED 8-6-2001.
- 2,624,465. **HOTELINEX**. NEXUS WORLD SERVICES, MULTIPLE CLASS, (INT. CLS. 9 AND 42), (U.S. CLS. 21, 23, 26, 36, 38, 100 AND 101). SN 76-295,327. PUB. 7-2-2002. FILED 8-3-2001.
- 2,624,479. **AMAZON QUEEN**. ARISTOCRAT TECHNOLOGIES AUSTRALIA PTY LTD, (U.S. CLS. 21, 23, 26, 36 AND 38). SN 76-296,776. PUB. 7-2-2002. FILED 8-7-2001.
- 2,624,480. **GS3**. TYCO ELECTRONICS CORPORATION, (U.S. CLS. 21, 23, 26, 36 AND 38). SN 76-296,797. PUB. 7-2-2002. FILED 8-9-2001.
- 2,624,481. **VIRTUAL MBA AND DESIGN**. INTEGRIMED, INC., (U.S. CLS. 21, 23, 26, 36 AND 38). SN 76-297,091. PUB. 7-2-2002. FILED 8-10-2001.
- 2,624,485. **IRT**. HEDSON TECHNOLOGIES AB, MULTIPLE CLASS, (INT. CLS. 9 AND 11), (U.S. CLS. 13, 21, 23, 26, 31, 34, 36 AND 38). SN 76-298,255. PUB. 7-2-2002. FILED 8-13-2001.
- 2,624,496. **CF—EZCART**. SCHNEEHAGEN, EDWARD L., DBA TROPICAL WEB CREATIONS, (U.S. CLS. 21, 23, 26, 36 AND 38). SN 76-301,756. PUB. 7-2-2002. FILED 8-20-2001.
- 2,624,525. **SANDY THE STARFISH**. MUASHER, GHADA, (U.S. CLS. 21, 23, 26, 36 AND 38). SN 76-307,042. PUB. 7-2-2002. FILED 8-30-2001.
- 2,624,534. **ROOTCAUSE AND DESIGN**. OC SYSTEMS, INCORPORATED, MULTIPLE CLASS, (INT. CLS. 9 AND 42), (U.S. CLS. 21, 23, 26, 36, 38, 100 AND 101). SN 76-308,237. PUB. 7-2-2002. FILED 8-31-2001.
- 2,624,578. **MAESTRO (STYLIZED)**. GIBSON GUITAR CORP., MULTIPLE CLASS, (INT. CLS. 9 AND 15), (U.S. CLS. 2, 21, 23, 26, 36 AND 38). SN 76-316,231. PUB. 7-2-2002. FILED 9-24-2001.
- 2,624,585. **RF POWER AND DESIGN**. ANAREN MICROWAVE, INC., (U.S. CLS. 21, 23, 26, 36 AND 38). SN 76-317,703. PUB. 7-2-2002. FILED 9-26-2001.
- 2,624,586. **MINI XINGER**. ANAREN MICROWAVE, INC., (U.S. CLS. 21, 23, 26, 36 AND 38). SN 76-317,705. PUB. 7-2-2002. FILED 9-26-2001.
- 2,624,594. **BOXLIGHT PRESENTING A BETTER WAY**. BOXLIGHT CORPORATION, (U.S. CLS. 21, 23, 26, 36 AND 38). SN 76-319,373. PUB. 7-2-2002. FILED 9-28-2001.
- 2,624,596. **ALPHAMICRON**. ALPHAMICRON, INC., (U.S. CLS. 21, 23, 26, 36 AND 38). SN 76-319,491. PUB. 7-2-2002. FILED 9-29-2001.
- 2,624,604. **EYE-POINT TECHNOLOGY**. SHAMIR INSIGHT, INC., (U.S. CLS. 21, 23, 26, 36 AND 38). SN 76-320,559. PUB. 7-2-2002. FILED 10-2-2001.
- 2,624,609. **PCT PEST CONTROL TECHNOLOGY**. GIE MEDIA, INC., (U.S. CLS. 21, 23, 26, 36 AND 38). SN 76-321,294. PUB. 7-2-2002. FILED 10-3-2001.
- 2,624,642. **CERTIFY SC**. SYNPLICITY, INC., (U.S. CLS. 21, 23, 26, 36 AND 38). SN 76-324,900. PUB. 7-2-2002. FILED 10-15-2001.
- 2,624,651. **X XYBERNAUT AND DESIGN**. XYBERNAUT CORPORATION, MULTIPLE CLASS, (INT. CLS. 9, 41 AND 42), (U.S. CLS. 21, 23, 26, 36, 38, 100, 101 AND 107). SN 76-325,998. PUB. 7-2-2002. FILED 10-16-2001.
- 2,624,654. **OMNIVIZ PRO**. OMNIVIZ, INC., (U.S. CLS. 21, 23, 26, 36 AND 38). SN 76-326,296. PUB. 7-2-2002. FILED 10-17-2001.

- 2,624,657. **JAPANESE ANGEL**. IDEAMAX CORP., (U.S. CLS. 21, 23, 26, 36 AND 38). SN 76-326,507. PUB. 7-2-2002. FILED 10-18-2001.
- 2,624,665. **ITW**. ILLINOIS TOOL WORKS INC., (U.S. CLS. 21, 23, 26, 36 AND 38). SN 76-327,114. PUB. 7-2-2002. FILED 10-19-2001.
- 2,624,676. **401(K)EASY ONLINE**. 401(K) PRO, INC., (U.S. CLS. 21, 23, 26, 36 AND 38). SN 76-328,548. PUB. 7-2-2002. FILED 10-22-2001.
- 2,624,687. **VISION SUITE**. VISION SOLUTIONS, INC., (U.S. CLS. 21, 23, 26, 36 AND 38). SN 76-330,144. PUB. 7-2-2002. FILED 10-23-2001.
- 2,624,693. **TERRALIGN**. METRON, INC., MULTIPLE CLASS, (INT. CLS. 9 AND 35), (U.S. CLS. 21, 23, 26, 36, 38, 100, 101 AND 102). SN 76-330,610. PUB. 7-2-2002. FILED 10-26-2001.
- 2,624,694. **PROGRAMACUBE (STYLIZED)**. SSAC INC., (U.S. CLS. 21, 23, 26, 36 AND 38). SN 76-330,645. PUB. 7-2-2002. FILED 10-29-2001.
- 2,624,710. **SECRET LEVEL**. SECRET LEVEL, INC., MULTIPLE CLASS, (INT. CLS. 9 AND 42), (U.S. CLS. 21, 23, 26, 36, 38, 100 AND 101). SN 76-333,296. PUB. 7-2-2002. FILED 11-5-2001.
- 2,624,735. **DYNAMODEL**. CIRCUIT SEMANTICS, INC., (U.S. CLS. 21, 23, 26, 36 AND 38). SN 76-336,865. PUB. 7-2-2002. FILED 11-13-2001.
- 2,624,742. **INNOGEAR**. INNOGEAR, INC., (U.S. CLS. 21, 23, 26, 36 AND 38). SN 76-337,652. PUB. 7-2-2002. FILED 11-8-2001.
- 2,624,749. **WAVESNOOP**. REAL-TIME INNOVATIONS, INC., (U.S. CLS. 21, 23, 26, 36 AND 38). SN 76-338,234. PUB. 7-2-2002. FILED 11-16-2001.
- 2,624,760. **WEATHER CENTRAL, INC.**. WEATHER CENTRAL, INC., MULTIPLE CLASS, (INT. CLS. 9 AND 42), (U.S. CLS. 21, 23, 26, 36, 38, 100 AND 101). SN 76-340,240. PUB. 7-2-2002. FILED 11-20-2001.
- 2,624,778. **DIGITEK**. DIGITEK TECHNOLOGY CO., LTD, (U.S. CLS. 21, 23, 26, 36 AND 38). SN 76-343,449. PUB. 7-2-2002. FILED 11-30-2001.
- 2,624,782. **HANDY READERS**. WATERS INDUSTRIES, INC., (U.S. CLS. 21, 23, 26, 36 AND 38). SN 76-344,011. PUB. 7-2-2002. FILED 11-30-2001.
- 2,624,783. **HUSTLER PLATINUM**. L.F.P., INC., (U.S. CLS. 21, 23, 26, 36 AND 38). SN 76-344,048. PUB. 7-2-2002. FILED 12-3-2001.
- 2,624,784. **FUNNIX**. ROYAL LIMITED PARTNERSHIP, MULTIPLE CLASS, (INT. CLS. 9 AND 16), (U.S. CLS. 2, 5, 21, 22, 23, 26, 29, 36, 37, 38 AND 50). SN 76-344,100. PUB. 7-2-2002. FILED 12-3-2001.
- 2,624,791. **INTERNET DETECTIVE**. CYBERSPACE TO PARADISE, INC., (U.S. CLS. 21, 23, 26, 36 AND 38). SN 76-344,983. PUB. 7-2-2002. FILED 12-4-2001.
- 2,624,792. **POSI-PLUG**. SWENCO PRODUCTS, INC., (U.S. CLS. 21, 23, 26, 36 AND 38). SN 76-345,003. PUB. 7-2-2002. FILED 12-5-2001.
- 2,624,801. **OC 5 (STYLIZED)**. DIGINEER, INC., (U.S. CLS. 21, 23, 26, 36 AND 38). SN 76-346,065. PUB. 7-2-2002. FILED 12-6-2001.
- 2,624,812. **EARTHPAK**. SEISMIC MICRO-TECHNOLOGY, INC., (U.S. CLS. 21, 23, 26, 36 AND 38). SN 76-347,407. PUB. 7-2-2002. FILED 12-12-2001.
- 2,624,825. **THOMAS REGISTER INDUSTRY.ANSWERS.RESULTS..** THOMAS PUBLISHING COMPANY, MULTIPLE CLASS, (INT. CLS. 9 AND 35), (U.S. CLS. 21, 23, 26, 36, 38, 100, 101 AND 102). SN 76-348,984. PUB. 7-2-2002. FILED 12-17-2001.
- 2,624,829. **BIDPILOT**. ZINELOGIC, INC., (U.S. CLS. 21, 23, 26, 36 AND 38). SN 76-349,311. PUB. 7-2-2002. FILED 12-18-2001.
- 2,624,839. **ONE GIFT. A WORLD OF RESTAURANTS..** DINNERGUEST, INC., (U.S. CLS. 21, 23, 26, 36 AND 38). SN 76-350,271. PUB. 7-2-2002. FILED 12-18-2001.
- 2,624,840. **NIGHTWATCHMAN**. IE LIMITED, (U.S. CLS. 21, 23, 26, 36 AND 38). SN 76-350,511. PUB. 7-2-2002. FILED 12-19-2001.
- 2,624,856. **SMARTWAVE**. ELGAR ELECTRONICS CORPORATION, (U.S. CLS. 21, 23, 26, 36 AND 38). SN 76-351,975. PUB. 7-2-2002. FILED 12-21-2001.
- 2,624,857. **TW**. ELGAR ELECTRONICS CORPORATION, (U.S. CLS. 21, 23, 26, 36 AND 38). SN 76-351,977. PUB. 7-2-2002. FILED 12-21-2001.
- 2,624,871. **XACTLYWRITE**. XACTWARE, INC., (U.S. CLS. 21, 23, 26, 36 AND 38). SN 76-354,551. PUB. 7-2-2002. FILED 12-21-2001.
- 2,624,965. **STERO-LINK.COM AND DESIGN**. TROUVERE, INC., (U.S. CLS. 21, 23, 26, 36 AND 38). SN 78-008,637. PUB. 7-2-2002. FILED 5-18-2000.
- 2,624,967. **SILICORE**. SILICORE CORPORATION, (U.S. CLS. 21, 23, 26, 36 AND 38). SN 78-010,634. PUB. 7-2-2002. FILED 5-31-2000.
- 2,624,969. **VALITEQ**. LAB SAFETY CORPORATION, (U.S. CLS. 21, 23, 26, 36 AND 38). SN 78-011,768. PUB. 7-2-2002. FILED 6-8-2000.
- 2,624,972. **REK-O-KUT**. STOSICH, MICHAEL N., (U.S. CLS. 21, 23, 26, 36 AND 38). SN 78-013,920. PUB. 7-2-2002. FILED 6-22-2000.
- 2,624,976. **AUTOPURE LS**. GENTRA SYSTEMS, INC., (U.S. CLS. 21, 23, 26, 36 AND 38). SN 78-018,836. PUB. 7-2-2002. FILED 7-28-2000.
- 2,624,978. **TRADEPOWER AND DESIGN**. TRADEPOWER, INC., MULTIPLE CLASS, (INT. CLS. 9 AND 35), (U.S. CLS. 21, 23, 26, 36, 38, 100, 101 AND 102). SN 78-020,813. PUB. 7-2-2002. FILED 8-11-2000.
- 2,624,980. **VALULIFE**. VERBATIM CORPORATION, (U.S. CLS. 21, 23, 26, 36 AND 38). SN 78-022,655. PUB. 1-22-2002. FILED 8-23-2000.
- 2,624,981. **SCREENEXCHANGE**. FAME INTERNATIONAL LIMITED, MULTIPLE CLASS, (INT. CLS. 9, 35, 38, 41 AND 42), (U.S. CLS. 21, 23, 26, 36, 38, 100, 101, 102, 104 AND 107). SN 78-023,897. PUB. 7-2-2002. FILED 8-31-2000.
- 2,624,985. **READER-BOOKS**. DONALD, THOMAS C., (U.S. CLS. 21, 23, 26, 36 AND 38). SN 78-025,887. PUB. 7-2-2002. FILED 9-14-2000.
- 2,624,989. **HAWKEYE**. NORCROSS MARINE PRODUCTS, INC., (U.S. CLS. 21, 23, 26, 36 AND 38). SN 78-029,500. PUB. 7-2-2002. FILED 10-6-2000.
- 2,625,001. **JSOLVE AND DESIGN**. DYNAMIC COMMERCE APPLICATIONS, INC., BY CHANGE OF NAME DATABASE CONSULTING ASSOCIATES, INC, (U.S. CLS. 21, 23, 26, 36 AND 38). SN 78-040,296. PUB. 7-2-2002. FILED 12-21-2000.
- 2,625,005. **TRACK 'N TRADE**. TURNER, LAN H., (U.S. CLS. 21, 23, 26, 36 AND 38). SN 78-041,712. PUB. 7-2-2002. FILED 1-4-2001.
- 2,625,007. **SUMMER PRODUCTIONS**. SUMMER PRODUCTIONS, INC., MULTIPLE CLASS, (INT. CLS. 9, 41 AND 42), (U.S. CLS. 21, 23, 26, 36, 38, 100, 101 AND 107). SN 78-041,941. PUB. 7-2-2002. FILED 1-5-2001.
- 2,625,008. **ALLISON TRANSMISSION AND DESIGN**. GENERAL MOTORS CORPORATION, (U.S. CLS. 21, 23, 26, 36 AND 38). SN 78-042,735. PUB. 7-2-2002. FILED 1-11-2001.
- 2,625,009. **STRA-D**. FEA SOFT CO., LTD., (U.S. CLS. 21, 23, 26, 36 AND 38). SN 78-042,757. PUB. 7-2-2002. FILED 1-11-2001.
- 2,625,011. **KINET (STYLIZED)**. NBG RADIO NETWORK, INC., (U.S. CLS. 21, 23, 26, 36 AND 38). SN 78-043,329. PUB. 7-2-2002. FILED 1-16-2001.
- 2,625,017. **WEI-YA AND DESIGN**. YOUNG, DAVID, (U.S. CLS. 21, 23, 26, 36 AND 38). SN 78-045,119. PUB. 7-2-2002. FILED 1-26-2001.
- 2,625,034. **ERI AND DESIGN**. ERI ECONOMIC RESEARCH INSTITUTE, INC., (U.S. CLS. 21, 23, 26, 36 AND 38). SN 78-049,821. PUB. 7-2-2002. FILED 2-22-2001.
- 2,625,038. **SPINFO (STYLIZED)**. NOTSOLDSEPARATELY.-COM, LLC, (U.S. CLS. 21, 23, 26, 36 AND 38). SN 78-050,783. PUB. 7-2-2002. FILED 3-1-2001.
- 2,625,055. **SUNEIDO**. AXON DEVELOPMENT CORPORATION, (U.S. CLS. 21, 23, 26, 36 AND 38). SN 78-054,727. PUB. 7-2-2002. FILED 3-23-2001.
- 2,625,066. **FIRESTORM**. BLACK & DECKER CORPORATION, THE, (U.S. CLS. 21, 23, 26, 36 AND 38). SN 78-056,939. PUB. 12-25-2001. FILED 4-5-2001.
- 2,625,080. **MLCSOFT**. PTW-NEW YORK CORPORATION, (U.S. CLS. 21, 23, 26, 36 AND 38). SN 78-060,087. PUB. 7-2-2002. FILED 4-24-2001.
- 2,625,082. **BREAK IT, FIX IT, RIDE IT AND DESIGN**. BREAK IT, FIX IT, RIDE IT, INC., (U.S. CLS. 21, 23, 26, 36 AND 38). SN 78-060,869. PUB. 7-2-2002. FILED 4-27-2001.
- 2,625,083. **CIOTE**. NATIONAL SECURITY AGENCY AS

EXECUTIVE AGENT FOR THE INFORMATION OPERATIONS TECHNOLOGY CENTER, (U.S. CLS. 21, 23, 26, 36 AND 38). SN 78-060,920. PUB. 7-2-2002. FILED 4-27-2001.

2,625,087. **TRAINZ**. AURAN HOLDINGS PTY LTD, MULTIPLE CLASS, (INT. CLS. 9 AND 41), (U.S. CLS. 21, 23, 26, 36, 38, 100, 101 AND 107). SN 78-061,683. PUB. 7-2-2002. FILED 5-2-2001.

2,625,099. **VOXELGEO**. PARADIGM GEOPHYSICAL LTD., (U.S. CLS. 21, 23, 26, 36 AND 38). SN 78-063,303. PUB. 7-2-2002. FILED 5-14-2001.

2,625,110. **TRIGON ELECTRONICS, INC. AND DESIGN**. TRIGON ELECTRONICS, INC., (U.S. CLS. 21, 23, 26, 36 AND 38). SN 78-064,447. PUB. 7-2-2002. FILED 5-18-2001.

2,625,111. **GX 550**. LUCENT TECHNOLOGIES INC., (U.S. CLS. 21, 23, 26, 36 AND 38). SN 78-064,470. PUB. 7-2-2002. FILED 5-18-2001.

2,625,125. **WRESTLEMANIA**. WORLD WRESTLING FEDERATION ENTERTAINMENT, INC., (U.S. CLS. 21, 23, 26, 36 AND 38). SN 78-068,199. PUB. 7-2-2002. FILED 6-8-2001.

2,625,127. **INSIGHTBUILDER**. INTERNATIONAL MARKETING SERVICES, INC., MULTIPLE CLASS, (INT. CLS. 9 AND 42), (U.S. CLS. 21, 23, 26, 36, 38, 100 AND 101). SN 78-069,524. PUB. 7-2-2002. FILED 6-16-2001.

2,625,130. **XPRESSNET AND DESIGN**. LENZ ELEKTRONIK, GMBH, (U.S. CLS. 21, 23, 26, 36 AND 38). SN 78-069,804. PUB. 7-2-2002. FILED 6-19-2001.

2,625,133. **MY MEDICAL RECORDS**. ANDERSON, DAVID, HOY, (U.S. CLS. 21, 23, 26, 36 AND 38). SN 78-070,027. PUB. 7-2-2002. FILED 6-20-2001.

2,625,143. **MACH-NET BUILDING AUTOMATION SYSTEM**. RELIABLE CONTROLS CORPORATION, (U.S. CLS. 21, 23, 26, 36 AND 38). SN 78-071,412. PUB. 7-2-2002. FILED 6-28-2001.

2,625,163. **E EASYDISK (STYLIZED)**. GLOBAL CHANNEL SOLUTIONS, INC., (U.S. CLS. 21, 23, 26, 36 AND 38). SN 78-077,460. PUB. 7-2-2002. FILED 8-3-2001.

2,625,168. **HEALTHLOGIC**. AINS, INC., (U.S. CLS. 21, 23, 26, 36 AND 38). SN 78-078,360. PUB. 7-2-2002. FILED 8-9-2001.

2,625,182. **DR. DOOLITTLE**. TWENTIETH CENTURY FOX FILM CORPORATION, (U.S. CLS. 21, 23, 26, 36 AND 38). SN 78-081,325. PUB. 7-2-2002. FILED 8-27-2001.

2,625,190. **PRIMMERA EYEWEAR AND DESIGN**. PIAZZA OPTICAL CORP., (U.S. CLS. 21, 23, 26, 36 AND 38). SN 78-082,675. PUB. 7-2-2002. FILED 9-5-2001.

2,625,205. **VISIR**. THERMOTEKNIK SYSTEMS LTD, (U.S. CLS. 21, 23, 26, 36 AND 38). SN 78-086,034. PUB. 7-2-2002. FILED 9-28-2001.

2,625,212. **SAFCO**. SAFCO PRODUCTS COMPANY, MULTIPLE CLASS, (INT. CLS. 9, 12, 16, 20 AND 21), (U.S. CLS. 2, 5, 13, 19, 21, 22, 23, 25, 26, 29, 30, 31, 32, 33, 35, 36, 37, 38, 40, 44 AND 50). SN 78-087,688. PUB. 7-2-2002. FILED 10-10-2001.

2,625,219. **AQUAWATCH**. MARTIN, JOHN R., (U.S. CLS. 21, 23, 26, 36 AND 38). SN 78-088,094. PUB. 7-2-2002. FILED 10-12-2001.

2,625,222. **BLUE CHEER**. HOLDEN, RANDY, MULTIPLE CLASS, (INT. CLS. 9 AND 41), (U.S. CLS. 21, 23, 26, 36, 38, 100, 101 AND 107). SN 78-088,866. PUB. 7-2-2002. FILED 10-17-2001.

2,625,228. **DIRECTMIXER**. DIAMONDWARE, LTD., (U.S. CLS. 21, 23, 26, 36 AND 38). SN 78-089,598. PUB. 7-2-2002. FILED 10-22-2001.

2,625,253. **BEAUTYTRACK**. OAKES, JEFF, (U.S. CLS. 21, 23, 26, 36 AND 38). SN 78-095,150. PUB. 7-2-2002. FILED 11-26-2001.

2,625,261. **PACKAGEIT**. VISIONARY SOLUTIONS, INC., (U.S. CLS. 21, 23, 26, 36 AND 38). SN 78-095,587. PUB. 7-2-2002. FILED 11-29-2001.

2,625,277. **MAKETRACKS**. TECHNISOFT OF LOUISIANA, INC., (U.S. CLS. 21, 23, 26, 36 AND 38). SN 78-098,129. PUB. 7-2-2002. FILED 12-13-2001.

2,625,278. **ANDREU HAND MADE**. ANRA PROPERTY MANAGEMENT, INC., (U.S. CLS. 21, 23, 26, 36 AND 38). SN 78-098,336. PUB. 7-2-2002. FILED 12-14-2001.

2,625,279. **RACE++ SERIES**. MERCURY COMPUTER SYSTEMS, INC., (U.S. CLS. 21, 23, 26, 36 AND 38). SN 78-098,731. PUB. 7-2-2002. FILED 12-17-2001.

2,625,282. **NEXTRAK**. INTELLISYS CORPORATION, (U.S. CLS. 21, 23, 26, 36 AND 38). SN 78-099,398. PUB. 7-2-2002.

FILED 12-20-2001.

2,622,297. **I-VIEW**. MEDIVISION, INC., MULTIPLE CLASS, (INT. CLS. 9 AND 10), (U.S. CLS. 21, 23, 26, 36, 38, 39 AND 44). SN 78-101,046. PUB. 7-2-2002. FILED 1-4-2002.

CLASS 10—MEDICAL APPARATUS

2,622,533 (*See Class 1 for this trademark*).

2,622,548. **TOKUSO**. TOKUYAMA CORPORATION, (U.S. CLS. 26, 39 AND 44). SN 75-451,649. PUB. 4-11-2000. FILED 3-18-1998.

2,622,551. **SOFTSCAN**. ART AEROSPATIAL RECHERCHES ET TECHNOLOGIES INC./ART AEROSPACE RESEARCH TECHNOLOGIES INC., (U.S. CLS. 26, 39 AND 44). SN 75-468,074. PUB. 11-6-2001. FILED 4-14-1998.

2,622,555. **THE TRIPLE S**. SCHAFFER, BERND, BY ASSIGNMENT; BY ASSIGNMENT SCHAFFER MICOMED GMBH, MULTIPLE CLASS, (INT. CLS. 10, 40 AND 42), (U.S. CLS. 26, 39, 44, 100, 101, 103 AND 106). SN 75-483,803. PUB. 3-20-2001. FILED 5-12-1998.

2,622,556. **SUPERCUP**. JOHNSON & JOHNSON, (U.S. CLS. 26, 39 AND 44). SN 75-486,739. PUB. 7-2-2002. FILED 5-18-1998.

2,622,577 (*See Class 3 for this trademark*).

2,622,583 (*See Class 5 for this trademark*).

2,622,611. **JEL BLAST**. J. F. JELENKO & CO., (U.S. CLS. 26, 39 AND 44). SN 75-612,039. PUB. 4-10-2001. FILED 12-24-1998.

2,622,651. **ISCREEN**. ISCREEN, LLC, BY MERGER VISION PARTNERS, L.P., MULTIPLE CLASS, (INT. CLS. 10 AND 42), (U.S. CLS. 26, 39, 44, 100 AND 101). SN 75-693,101. PUB. 7-2-2002. FILED 4-28-1999.

2,622,684 (*See Class 5 for this trademark*).

2,622,690. **ZIP-Y-CAST**. STRUYF, JOHAN, (U.S. CLS. 26, 39 AND 44). SN 75-757,498. PUB. 7-11-2000. FILED 7-6-1999.

2,622,729. **SYNERGY**. SCIMED LIFE SYSTEMS, INC., (U.S. CLS. 26, 39 AND 44). SN 75-817,729. PUB. 7-2-2002. FILED 10-7-1999.

2,622,797 (*See Class 5 for this trademark*).

2,622,884. **TURBO-ACCELERATOR**. FIRST MEDICA, (U.S. CLS. 26, 39 AND 44). SN 75-950,736. PUB. 7-2-2002. FILED 3-2-2000.

2,622,898 (*See Class 5 for this trademark*).

2,622,968. **JASACTION (STYLIZED)**. JOINT ACTIVE SYSTEMS INC., (U.S. CLS. 26, 39 AND 44). SN 76-037,166. PUB. 7-2-2002. FILED 4-28-2000.

2,623,063 (*See Class 9 for this trademark*).

2,623,138 (*See Class 5 for this trademark*).

2,623,468. **HELIGRAFT**. ENDOART SA, (U.S. CLS. 26, 39 AND 44). SN 76-168,675. PUB. 7-2-2002. FILED 11-20-2000.

2,623,530. **TIMX**. DEPUY, INC., (U.S. CLS. 26, 39 AND 44). SN 76-176,931. PUB. 7-2-2002. FILED 12-7-2000.

2,623,686. **ISODAM**. FOUR D RUBBER CO. LIMITED, (U.S. CLS. 26, 39 AND 44). SN 76-198,033. PUB. 7-2-2002. FILED 1-23-2001.

2,623,739. **RUGGED AND DESIGN**. STRYKER CORPORATION, (U.S. CLS. 26, 39 AND 44). SN 76-203,973. PUB. 7-2-2002. FILED 2-1-2001.

2,623,797. **EPIPROBE**. MYOCOR, INC., (U.S. CLS. 26, 39 AND 44). SN 76-212,242. PUB. 7-2-2002. FILED 2-20-2001.

2,623,862. **HESKA AND DESIGN**. HESKA CORPORATION, (U.S. CLS. 26, 39 AND 44). SN 76-221,281. PUB. 7-2-2002. FILED 3-7-2001.

2,623,968. **PROBPH (STYLIZED)**. CELON AG MEDICAL INSTRUMENTS, (U.S. CLS. 26, 39 AND 44). SN 76-235,737. PUB. 7-2-2002. FILED 4-4-2001.

2,624,003 (*See Class 1 for this trademark*).

2,624,015. **TLC THRIFTY LIFT COMPANY AND DESIGN**. SUNRISE MACHINE & TOOL, INC., (U.S. CLS. 26, 39 AND 44). SN 76-240,101. PUB. 7-2-2002. FILED 4-9-2001.

2,624,062. **HOWELL D.A.S.H. DIRECT ACCESS SYSTEM**. WILSON-COOK MEDICAL INC., (U.S. CLS. 26, 39 AND 44). SN 76-244,253. PUB. 7-2-2002. FILED 4-20-2001.

2,624,063. **M MEDONE AND DESIGN**. MEDONE SURGICAL, INC., (U.S. CLS. 26, 39 AND 44). SN 76-244,472. PUB. 7-2-2002. FILED 4-20-2001.

2,624,070. **ULTRASAFE**. SAFETY SYRINGES, INC., MULTIPLE CLASS, (INT. CLS. 10 AND 40), (U.S. CLS. 26, 39, 44,

- 100, 103 AND 106). SN 76-244,996. PUB. 7-2-2002. FILED 4-17-2001.
- 2,624,077. **BEECH**. BMP MEDICAL PRODUCTS, INC., (U.S. CLS. 26, 39 AND 44). SN 76-246,477. PUB. 7-2-2002. FILED 4-24-2001.
- 2,624,174. **ENCORE ACCLAIM**. ANSELL HEALTHCARE PRODUCTS INC., (U.S. CLS. 26, 39 AND 44). SN 76-259,508. PUB. 7-2-2002. FILED 5-17-2001.
- 2,624,197. **ALL CLEAR AND DESIGN**. EDWARDS, RAYMOND A., (U.S. CLS. 26, 39 AND 44). SN 76-261,128. PUB. 7-2-2002. FILED 5-7-2001.
- 2,624,292. **MICRO-HYSTEROFLATOR**. KARL STORZ GMBH & CO. KG, (U.S. CLS. 26, 39 AND 44). SN 76-270,816. PUB. 7-2-2002. FILED 6-13-2001.
- 2,624,373. **ACCUVAC**. MERIAL LIMITED, (U.S. CLS. 26, 39 AND 44). SN 76-282,179. PUB. 7-2-2002. FILED 7-9-2001.
- 2,624,435 (*See Class 3 for this trademark*).
- 2,624,608. **BENDY**. NOVAMETRIX MEDICAL SYSTEMS INC., (U.S. CLS. 26, 39 AND 44). SN 76-321,200. PUB. 7-2-2002. FILED 10-4-2001.
- 2,624,624. **PALOMAR ESTELUX**. PALOMAR MEDICAL TECHNOLOGIES, INC., (U.S. CLS. 26, 39 AND 44). SN 76-323,188. PUB. 7-2-2002. FILED 10-9-2001.
- 2,624,734. **DREW AND DESIGN**. DREW SHOE CORPORATION, MULTIPLE CLASS, (INT. CLS. 10 AND 25), (U.S. CLS. 22, 26, 39 AND 44). SN 76-336,760. PUB. 7-2-2002. FILED 11-13-2001.
- 2,624,738. **ROOKE P.A.D. BOOT**. OSBORN MEDICAL CORP., (U.S. CLS. 26, 39 AND 44). SN 76-337,143. PUB. 7-2-2002. FILED 11-14-2001.
- 2,624,755. **CRITSCAN**. HEMAMETRICS, FORMERLY IN-LINE DIAGNOSTICS CORPORATION, (U.S. CLS. 26, 39 AND 44). SN 76-339,184. PUB. 7-2-2002. FILED 11-19-2001.
- 2,624,761. **PIGG-O-STAT**. MODERN WAY IMMOBILIZERS, INC., (U.S. CLS. 26, 39 AND 44). SN 76-340,693. PUB. 7-2-2002. FILED 11-21-2001.
- 2,624,919. **TOP HAT**. SULZER CARBOMEDICS INC., (U.S. CLS. 26, 39 AND 44). SN 76-362,281. PUB. 7-2-2002. FILED 1-24-2002.
- 2,624,942. **PEDIA PALS**. HNT HOLDINGS ACQUISITION, LLC, (U.S. CLS. 26, 39 AND 44). SN 76-368,905. PUB. 7-2-2002. FILED 2-8-2002.
- 2,625,000. **IMPACT**. IMPACT INSTRUMENTATION, INC., (U.S. CLS. 26, 39 AND 44). SN 78-040,235. PUB. 7-2-2002. FILED 12-21-2000.
- 2,625,069 (*See Class 5 for this trademark*).
- 2,625,196. **RHEIN MEDICAL AND DESIGN**. RHEIN MEDICAL, INC., (U.S. CLS. 26, 39 AND 44). SN 78-083,577. PUB. 7-2-2002. FILED 9-12-2001.
- 2,625,197. **RHEIN MEDICAL**. RHEIN MEDICAL, INC., (U.S. CLS. 26, 39 AND 44). SN 78-083,579. PUB. 7-2-2002. FILED 9-12-2001.
- 2,625,297 (*See Class 9 for this trademark*).
- (U.S. CLS. 13, 21, 23, 31 AND 34). SN 75-863,137. PUB. 7-2-2002. FILED 11-29-1999.
- 2,622,794. **ULTRABAR**. THAMES WATER PRODUCTS LIMITED, MULTIPLE CLASS, (INT. CLS. 11, 32 AND 40), (U.S. CLS. 13, 21, 23, 31, 34, 45, 46, 48, 100, 103 AND 106). SN 75-876,902. PUB. 7-2-2002. FILED 12-22-1999.
- 2,622,818. **GERMINATOR**. UVIEW ULTRAVIOLET SYSTEMS INC., (U.S. CLS. 13, 21, 23, 31 AND 34). SN 75-893,978. PUB. 7-2-2002. FILED 1-7-2000.
- 2,622,860. **TOP SAN**. SEBACH S.R.L., (U.S. CLS. 13, 21, 23, 31 AND 34). SN 75-923,225. PUB. 7-2-2002. FILED 2-18-2000.
- 2,622,866 (*See Class 9 for this trademark*).
- 2,622,875 (*See Class 7 for this trademark*).
- 2,622,911. **GREENLITE**. GREENLITE LIGHTING CORPORATION / LA CORPORATION D'ECLAIRAGE GREENLITE, MULTIPLE CLASS, (INT. CLS. 11 AND 35), (U.S. CLS. 13, 21, 23, 31, 34, 100, 101 AND 102). SN 76-007,449. PUB. 7-2-2002. FILED 3-22-2000.
- 2,623,031. **ITV AND DESIGN**. INDUSTRIA TECNICA VALENCIANA, S. A., MULTIPLE CLASS, (INT. CLS. 11, 35 AND 37), (U.S. CLS. 13, 21, 23, 31, 34, 100, 101, 102, 103 AND 106). SN 76-063,013. PUB. 7-2-2002. FILED 6-5-2000.
- 2,623,214. **REESE OUTFITTER**. REESE PRODUCTS, INC., MULTIPLE CLASS, (INT. CLS. 11 AND 12), (U.S. CLS. 13, 19, 21, 23, 31, 34, 35 AND 44). SN 76-120,991. PUB. 7-2-2002. FILED 9-1-2000.
- 2,623,417. **VIRTUAL SUN**. UVA SUN SYSTEMS, INC., (U.S. CLS. 13, 21, 23, 31 AND 34). SN 76-159,798. PUB. 7-2-2002. FILED 11-6-2000.
- 2,623,481 (*See Class 9 for this trademark*).
- 2,623,504. **DESJOYAUX AND DESIGN**. PISCINES DESJOYAUX S.A, MULTIPLE CLASS, (INT. CLS. 11 AND 19), (U.S. CLS. 1, 12, 13, 21, 23, 31, 33, 34 AND 50). SN 76-173,638. PUB. 7-2-2002. FILED 11-30-2000.
- 2,623,622. **WILLIAMSON**. MARLEY COMPANY, THE, (U.S. CLS. 13, 21, 23, 31 AND 34). SN 76-190,223. PUB. 7-2-2002. FILED 1-5-2001.
- 2,623,674. **A T (STYLIZED)**. AMTROL, INC., (U.S. CLS. 13, 21, 23, 31 AND 34). SN 76-197,071. PUB. 7-2-2002. FILED 1-17-2001.
- 2,623,785. **FRENCH PRESS-PLUS**. EDGE CRAFT CORPORATION, (U.S. CLS. 13, 21, 23, 31 AND 34). SN 76-210,804. PUB. 7-2-2002. FILED S.R. 2-15-2001; AM. P.R. 11-1-2001.
- 2,623,786. **ELECTRIC FRENCH PRESS-PLUS**. EDGE CRAFT CORPORATION, (U.S. CLS. 13, 21, 23, 31 AND 34). SN 76-210,805. PUB. 7-2-2002. FILED S.R. 2-15-2001; AM. P.R. 11-1-2001.
- 2,623,789. **SELEX**. OSMONICS, INC., (U.S. CLS. 13, 21, 23, 31 AND 34). SN 76-210,947. PUB. 7-2-2002. FILED 2-15-2001.
- 2,623,810. **SWIVELLER**. AGF MANUFACTURING INC., (U.S. CLS. 13, 21, 23, 31 AND 34). SN 76-214,530. PUB. 7-2-2002. FILED 2-22-2001.
- 2,623,846. **T/33**. OMNIPURE FILTER COMPANY, (U.S. CLS. 13, 21, 23, 31 AND 34). SN 76-219,283. PUB. 7-2-2002. FILED 3-2-2001.
- 2,623,902 (*See Class 7 for this trademark*).
- 2,623,907 (*See Class 1 for this trademark*).
- 2,623,925. **HG5 MERCURY REMOVAL STRATEGIES FOR TODAY'S DENTAL PRACTICE. AND DESIGN**. SOLMETEX, INCORPORATED, (U.S. CLS. 13, 21, 23, 31 AND 34). SN 76-229,149. PUB. 7-2-2002. FILED 3-26-2001.
- 2,623,955. **ROD-N-BOBB'S**. ROD-N-BOBB'S INC., (U.S. CLS. 13, 21, 23, 31 AND 34). SN 76-233,629. PUB. 7-2-2002. FILED 3-30-2001.
- 2,624,013. **INFRASAVE**. PERFECTION-SCHWANK, INC., (U.S. CLS. 13, 21, 23, 31 AND 34). SN 76-240,005. PUB. 7-2-2002. FILED 4-12-2001.
- 2,624,017 (*See Class 6 for this trademark*).
- 2,624,127. **VAC-ALERT**. VAC-ALERT IP HOLDINGS, L.L.C., (U.S. CLS. 13, 21, 23, 31 AND 34). SN 76-252,816. PUB. 7-2-2002. FILED 4-30-2001.
- 2,624,130. **STYLOX**. SIMILOR S.A., (U.S. CLS. 13, 21, 23, 31 AND 34). SN 76-253,264. PUB. 7-2-2002. FILED 5-4-2001.
- 2,624,165. **KWC SUPRIMO**. KWC AG, (U.S. CLS. 13, 21, 23, 31 AND 34). SN 76-258,427. PUB. 7-2-2002. FILED 5-17-2001.
- 2,624,179. **FULL MOON**. ROCHESTER PORTABLE, (U.S. CLS. 13, 21, 23, 31 AND 34). SN 76-259,832. PUB. 7-2-2002. FILED 5-18-2001.

CLASS 11—ENVIRONMENTAL CONTROL APPARATUS

- 2,624,180. **HALF MOON**. ROCHESTER PORTABLE, (U.S. CLS. 13, 21, 23, 31 AND 34). SN 76-259,833. PUB. 7-2-2002. FILED 5-18-2001.
- 2,624,253. **KWC SODA**. KWC AG, (U.S. CLS. 13, 21, 23, 31 AND 34). SN 76-267,091. PUB. 7-2-2002. FILED 6-4-2001.
- 2,624,262. **SCHREIBER FLEX AND DESIGN**. SCHREIBER CORPORATION, INC., (U.S. CLS. 13, 21, 23, 31 AND 34). SN 76-268,420. PUB. 7-2-2002. FILED 6-8-2001.
- 2,624,272. **HEVOC2 (STYLIZED)**. PLASTON AG KUNSTSTOFFWERK, (U.S. CLS. 13, 21, 23, 31 AND 34). SN 76-268,771. PUB. 7-2-2002. FILED 6-8-2001.
- 2,624,293 (*See Class 7 for this trademark*).
- 2,624,316. **FIRE & WATER AND DESIGN**. BERGMAN, DAVID, (U.S. CLS. 13, 21, 23, 31 AND 34). SN 76-273,917. PUB. 7-2-2002. FILED 6-21-2001.
- 2,624,485 (*See Class 9 for this trademark*).
- 2,624,517. **CONRICH**. LIU, KUI FANG, (U.S. CLS. 13, 21, 23, 31 AND 34). SN 76-304,230. PUB. 7-2-2002. FILED 8-24-2001.
- 2,624,595. **HEAT HELPER**. KATICA, LC, (U.S. CLS. 13, 21, 23, 31 AND 34). SN 76-319,406. PUB. 7-2-2002. FILED 10-1-2001.
- 2,624,656. **VICTORY ENERGY AND DESIGN**. VICTORY ENERGY OPERATIONS, L.L.C., (U.S. CLS. 13, 21, 23, 31 AND 34). SN 76-326,493. PUB. 7-2-2002. FILED 10-17-2001.
- 2,624,688. **COMBO**. RSA LIGHTING, LLC, (U.S. CLS. 13, 21, 23, 31 AND 34). SN 76-330,173. PUB. 7-2-2002. FILED 10-26-2001.
- 2,624,850. **FOOT RETREAT SPA**. WATER PIK, INC., (U.S. CLS. 13, 21, 23, 31 AND 34). SN 76-351,800. PUB. 7-2-2002. FILED S.R. 12-21-2001; AM. P.R. 3-25-2002.
- 2,624,870. **COMMAND FLAME**. GRAND HALL ENTERPRISE CO., LTD., (U.S. CLS. 13, 21, 23, 31 AND 34). SN 76-354,271. PUB. 7-2-2002. FILED 12-26-2001.
- 2,624,901. **CATHAY**. HUNTER FAN COMPANY, (U.S. CLS. 13, 21, 23, 31 AND 34). SN 76-358,490. PUB. 7-2-2002. FILED 1-13-2002.
- 2,624,918. **FOGCO**. FOGCO SYSTEMS, INC., (U.S. CLS. 13, 21, 23, 31 AND 34). SN 76-361,993. PUB. 7-2-2002. FILED 1-22-2002.
- 2,624,966. **A AND DESIGN**. LES PRODUITS ADDICO, INC., (U.S. CLS. 13, 21, 23, 31 AND 34). SN 78-009,926. PUB. 7-2-2002. FILED 5-25-2000.
- 2,624,992. **SOLARCOMBO (STYLIZED)**. DONALD R. KONOLD AND ANNEMARIE H. KONOLD PARTNERSHIP, THE, (U.S. CLS. 13, 21, 23, 31 AND 34). SN 78-032,798. PUB. 7-2-2002. FILED 10-28-2000.
- 2,624,994. **OPTIMIZER**. MYKROLIS CORPORATION, BY ASSIGNMENT MILLIPORE CORPORATION, (U.S. CLS. 13, 21, 23, 31 AND 34). SN 78-034,992. PUB. 7-2-2002. FILED 11-13-2000.
- 2,625,015. **Z AND DESIGN**. GLACIER INDUSTRIES LTD., (U.S. CLS. 13, 21, 23, 31 AND 34). SN 78-044,689. PUB. 7-2-2002. FILED 1-24-2001.
- 2,625,105. **PIZZELLEPRO**. EDGE CRAFT CORPORATION, (U.S. CLS. 13, 21, 23, 31 AND 34). SN 78-064,210. PUB. 7-2-2002. FILED 5-17-2001.
- 2,625,107. **QUAD**. EDGE CRAFT CORPORATION, (U.S. CLS. 13, 21, 23, 31 AND 34). SN 78-064,220. PUB. 7-2-2002. FILED 5-17-2001.
- 2,625,207. **ETROMAC (STYLIZED)**. AGGADHAMVONG, MANODHAM, (U.S. CLS. 13, 21, 23, 31 AND 34). SN 78-086,634. PUB. 7-2-2002. FILED 10-3-2001.
- 2,625,241. **MOONSHINE**. TOPEAK, INC., (U.S. CLS. 13, 21, 23, 31 AND 34). SN 78-092,735. PUB. 7-2-2002. FILED 11-12-2001.
- 2,625,298. **CLEARTAP**. AMERICAN STANDARD INC., (U.S. CLS. 13, 21, 23, 31 AND 34). SN 78-101,861. PUB. 7-2-2002. FILED 1-10-2002.
- CLASS, (INT. CLS. 12 AND 13), (U.S. CLS. 2, 9, 19, 21, 23, 31, 35 AND 44). SN 75-621,271. PUB. 7-2-2002. FILED 1-15-1999.
- 2,622,642. **BRAKEWORKS**. BRAKEWORKS, INC., (U.S. CLS. 19, 21, 23, 31, 35 AND 44). SN 75-673,623. PUB. 7-2-2002. FILED 4-2-1999.
- 2,622,715. **CLK 55**. DAIMLERCHRYSLER AG, (U.S. CLS. 19, 21, 23, 31, 35 AND 44). SN 75-794,473. PUB. 4-16-2002. FILED 9-8-1999.
- 2,622,792. **MICRA**. NISSAN JIDOSHA KABUSHIKI KAISHA, TA NISSAN MOTOR CO., LTD., (U.S. CLS. 19, 21, 23, 31, 35 AND 44). SN 75-871,337. PUB. 5-15-2001. FILED 12-14-1999.
- 2,622,846 (*See Class 7 for this trademark*).
- 2,622,863. **MIELE**. GROUPE PROCYCLE INC./PROCYCLE GROUP INC., (U.S. CLS. 19, 21, 23, 31, 35 AND 44). SN 75-926,330. PUB. 3-12-2002. FILED 2-23-2000.
- 2,622,890 (*See Class 8 for this trademark*).
- 2,622,934. **FLO-TRAC RIB**. TITAN INTERNATIONAL, INC., (U.S. CLS. 19, 21, 23, 31, 35 AND 44). SN 76-019,890. PUB. 7-2-2002. FILED 4-5-2000.
- 2,622,935. **FLO-TRAC LUG**. TITAN INTERNATIONAL, INC., (U.S. CLS. 19, 21, 23, 31, 35 AND 44). SN 76-019,891. PUB. 7-2-2002. FILED 4-5-2000.
- 2,622,942 (*See Class 6 for this trademark*).
- 2,622,946. **TRU-COIL RACING SPRINGS AND DESIGN**. SPEEDWAY MOTORS, INC., (U.S. CLS. 19, 21, 23, 31, 35 AND 44). SN 76-025,716. PUB. 7-2-2002. FILED 4-14-2000.
- 2,622,952. **FINDLAY INDUSTRIES**. FINDLAY INDUSTRIES, INC., (U.S. CLS. 19, 21, 23, 31, 35 AND 44). SN 76-029,245. PUB. 7-2-2002. FILED 4-19-2000.
- 2,622,956. **HI LOAD RADIAL**. TITAN INTERNATIONAL, INC., (U.S. CLS. 19, 21, 23, 31, 35 AND 44). SN 76-031,068. PUB. 7-2-2002. FILED 4-18-2000.
- 2,622,996. **ADVANCED ACTIVITY CAR**. VOLKSWAGEN AKTIENGESELLSCHAFT, MULTIPLE CLASS, (INT. CLS. 12, 28 AND 37), (U.S. CLS. 19, 21, 22, 23, 31, 35, 38, 44, 50, 100, 103 AND 106). SN 76-051,302. PUB. 7-2-2002. FILED 5-18-2000.
- 2,623,023. **IPSI**. HAMWORTHY KSE AB, (U.S. CLS. 19, 21, 23, 31, 35 AND 44). SN 76-059,915. PUB. 7-2-2002. FILED 5-30-2000.
- 2,623,054 (*See Class 7 for this trademark*).
- 2,623,135. **AIRCOMP**. COMPAGNIE GENERALE DES ETABLISSEMENTS MICHELIN MICHELIN & CIE, (U.S. CLS. 19, 21, 23, 31, 35 AND 44). SN 76-096,918. PUB. 7-31-2001. FILED 7-26-2000.
- 2,623,192. **SUPR-GRIP HIWAY**. BCATCO ARL, (U.S. CLS. 19, 21, 23, 31, 35 AND 44). SN 76-115,332. PUB. 7-2-2002. FILED 8-23-2000.
- 2,623,193. **SUPR-DITCH'R**. BCATCO ARL, (U.S. CLS. 19, 21, 23, 31, 35 AND 44). SN 76-115,336. PUB. 7-2-2002. FILED 8-23-2000.
- 2,623,194. **SUPR-TRAK**. BCATCO ARL, (U.S. CLS. 19, 21, 23, 31, 35 AND 44). SN 76-115,337. PUB. 7-2-2002. FILED 8-23-2000.
- 2,623,195. **SUPR-CROSS BAR**. BCATCO ARL, (U.S. CLS. 19, 21, 23, 31, 35 AND 44). SN 76-115,339. PUB. 7-2-2002. FILED 8-23-2000.
- 2,623,202. **RETRO RED AND DESIGN**. RADIO FLYER INC., (U.S. CLS. 19, 21, 23, 31, 35 AND 44). SN 76-116,835. PUB. 7-2-2002. FILED 8-25-2000.
- 2,623,214 (*See Class 11 for this trademark*).
- 2,623,243. **SOLO**. THOR TECH, INC., (U.S. CLS. 19, 21, 23, 31, 35 AND 44). SN 76-130,773. PUB. 7-2-2002. FILED 9-19-2000.
- 2,623,296. **GROUNDDESIGNS 2000**. GROUND DESIGNS 2000, (U.S. CLS. 19, 21, 23, 31, 35 AND 44). SN 76-138,961. PUB. 7-2-2002. FILED 10-2-2000.
- 2,623,357. **DOCK-PRO**. DOCK-PRO, LTD., (U.S. CLS. 19, 21, 23, 31, 35 AND 44). SN 76-150,970. PUB. 7-2-2002. FILED 10-20-2000.
- 2,623,409. **CURTAINET**. JHRG, LLC, (U.S. CLS. 19, 21, 23, 31, 35 AND 44). SN 76-158,411. PUB. 7-2-2002. FILED 11-2-2000.
- 2,623,533. **PARA-RING**. HADASH, KIMBERLY A., (U.S. CLS. 19, 21, 23, 31, 35 AND 44). SN 76-177,229. PUB. 7-2-2002. FILED 12-1-2000.
- 2,623,534. **PARA-BUCKLE**. HADASH, KIMBERLY A., (U.S. CLS. 19, 21, 23, 31, 35 AND 44). SN 76-177,230. PUB. 7-2-2002. FILED 12-1-2000.

CLASS 12—VEHICLES

2,623,776. **TOP JOGG.** RED CASTLE FRANCE, (U.S. CLS. 19, 21, 23, 31, 35 AND 44). SN 76-209,602. PUB. 7-2-2002. FILED 2-14-2001.

2,623,937. **APP.** ALUMINUM PRECISION PRODUCTS, INC., (U.S. CLS. 19, 21, 23, 31, 35 AND 44). SN 76-231,765. PUB. 7-2-2002. FILED 3-28-2001.

2,623,952. **DISCMATE.** ALCOA INC., (U.S. CLS. 19, 21, 23, 31, 35 AND 44). SN 76-233,164. PUB. 7-2-2002. FILED 4-2-2001.

2,624,072. **SURLY (STYLIZED).** QUALITY BICYCLE PRODUCTS, INC., (U.S. CLS. 19, 21, 23, 31, 35 AND 44). SN 76-245,242. PUB. 7-2-2002. FILED 4-24-2001.

2,624,076. **EAGER BEAVER TRAILERS (STYLIZED).** GENERAL ENGINES CO., INC., (U.S. CLS. 19, 21, 23, 31, 35 AND 44). SN 76-246,236. PUB. 7-2-2002. FILED 4-26-2001.

2,624,115. **ABACO.** BISHOP, MICHAEL, (U.S. CLS. 19, 21, 23, 31, 35 AND 44). SN 76-250,785. PUB. 9-25-2001. FILED 5-2-2001.

2,624,209. **WABASH.** WABASH NATIONAL, L.P., (U.S. CLS. 19, 21, 23, 31, 35 AND 44). SN 76-262,685. PUB. 7-2-2002. FILED 5-25-2001.

2,624,367. **DAYANG AND DESIGN.** LUOYANG NORTHERN EK CHOR MOTORCYCLE CO., LTD., (U.S. CLS. 19, 21, 23, 31, 35 AND 44). SN 76-281,496. PUB. 7-2-2002. FILED 7-5-2001.

2,624,500. **DIRT JUMPER.** DYNACRAFT INDUSTRIES, INC., (U.S. CLS. 19, 21, 23, 31, 35 AND 44). SN 76-302,364. PUB. 7-2-2002. FILED 8-20-2001.

2,624,549. **FENDOCKER.** PUFFIN INDUSTRIES, L.L.C., (U.S. CLS. 19, 21, 23, 31, 35 AND 44). SN 76-311,388. PUB. 7-2-2002. FILED 9-13-2001.

2,624,558. **NAPA.** TREK BICYCLE CORPORATION, (U.S. CLS. 19, 21, 23, 31, 35 AND 44). SN 76-312,515. PUB. 7-2-2002. FILED 9-14-2001.

2,624,588. **ALUMATECH.** EVERLITE, INC., (U.S. CLS. 19, 21, 23, 31, 35 AND 44). SN 76-318,140. PUB. 7-2-2002. FILED 9-24-2001.

2,624,593. **CAPITOLA.** TREK BICYCLE CORPORATION, (U.S. CLS. 19, 21, 23, 31, 35 AND 44). SN 76-319,258. PUB. 7-2-2002. FILED 9-28-2001.

2,624,606. **LSW49H.** TITAN INTERNATIONAL, INC., (U.S. CLS. 19, 21, 23, 31, 35 AND 44). SN 76-321,083. PUB. 7-2-2002. FILED 10-3-2001.

2,624,627. **SCOOTERBUG AND DESIGN.** SCOOTERBUG, INC., MULTIPLE CLASS, (INT. CLS. 12 AND 39), (U.S. CLS. 19, 21, 23, 31, 35, 44, 100 AND 105). SN 76-323,270. PUB. 7-2-2002. FILED 10-9-2001.

2,624,628. **SCOOTERBUG.** SCOOTERBUG, INC., MULTIPLE CLASS, (INT. CLS. 12 AND 39), (U.S. CLS. 19, 21, 23, 31, 35, 44, 100 AND 105). SN 76-323,271. PUB. 7-2-2002. FILED 10-9-2001.

2,624,704. **E AND DESIGN.** ACCUBUILT, INC., (U.S. CLS. 19, 21, 23, 31, 35 AND 44). SN 76-332,466. PUB. 7-2-2002. FILED 10-30-2001.

2,624,725. **VAN'S TAILGATOR.** VAN ROOY ENTERPRISES, LLC, (U.S. CLS. 19, 21, 23, 31, 35 AND 44). SN 76-335,612. PUB. 7-2-2002. FILED 11-6-2001.

2,624,932. **OHTSU.** OHTSU TIRE & RUBBER CO., LTD., THE, (U.S. CLS. 19, 21, 23, 31, 35 AND 44). SN 76-367,184. PUB. 7-2-2002. FILED 2-5-2002.

2,625,027. **MEYER.** MEYER DISTRIBUTING LLC, (U.S. CLS. 19, 21, 23, 31, 35 AND 44). SN 78-047,939. PUB. 7-2-2002. FILED 2-12-2001.

2,625,028. **LOW RIDER.** INDUSTRI AB THULE, (U.S. CLS. 19, 21, 23, 31, 35 AND 44). SN 78-048,056. PUB. 7-2-2002. FILED 2-13-2001.

2,625,140. **PEDALSOFT AND DESIGN.** MENG, HORIZON PETER, (U.S. CLS. 19, 21, 23, 31, 35 AND 44). SN 78-070,950. PUB. 7-2-2002. FILED 6-26-2001.

2,625,146. **PRO STITCH.** DENCOMPANY LLC, DBA BUS PARTS WAREHOUSE, MULTIPLE CLASS, (INT. CLS. 12 AND 40), (U.S. CLS. 19, 21, 23, 31, 35, 44, 100, 103 AND 106). SN 78-071,769. PUB. 7-2-2002. FILED 6-29-2001.

2,625,147. **HYDRO-BOOST.** ROBERT BOSCH CORPORATION, (U.S. CLS. 19, 21, 23, 31, 35 AND 44). SN 78-072,050. PUB. 7-2-2002. FILED 7-2-2001.

2,625,212 (See Class 9 for this trademark).

CLASS 13—FIREARMS

2,622,603. **S. SCHERER, ANTHONY,** (U.S. CLS. 2 AND 9). SN 75-599,697. PUB. 7-2-2002. FILED 12-4-1998.

2,622,617 (See Class 12 for this trademark).

2,622,849. **MAPAM.** SM SWISS AMMUNITION ENTERPRISE CORP., (U.S. CLS. 2 AND 9). SN 75-916,025. PUB. 7-2-2002. FILED 2-10-2000.

2,623,123. **LANTIS.** LANTIS PRODUCTIONS, INC., MULTIPLE CLASS, (INT. CLS. 13 AND 41), (U.S. CLS. 2, 9, 100, 101 AND 107). SN 76-093,139. PUB. 7-2-2002. FILED 7-19-2000.

2,624,655. **HELLFIRE II.** HELLFIRE SYSTEMS, L.L.C., (U.S. CLS. 2 AND 9). SN 76-326,339. PUB. 7-2-2002. FILED 10-18-2001.

CLASS 14—JEWELRY

2,622,507 (See Class 9 for this trademark).

2,622,508 (See Class 9 for this trademark).

2,622,517. **BRUNEL (STYLIZED).** BRUNEL S.R.L. PREZIOSI D'AUTORE, (U.S. CLS. 2, 27, 28 AND 50). SN 75-165,672. PUB. 7-2-2002. FILED 9-12-1996.

2,622,523. **SECLUS.** SECLUS DA AMZONIA S/A JOIAS E RELOGIOS, (U.S. CLS. 2, 27, 28 AND 50). SN 75-272,229. PUB. 5-9-2000. FILED 4-10-1997.

2,622,811. **NATPAK AND DESIGN.** NATIONALPAK LIMITED, (U.S. CLS. 2, 27, 28 AND 50). SN 75-891,734. PUB. 7-2-2002. FILED 1-7-2000.

2,622,901 (See Class 9 for this trademark).

2,623,055. **I AM GOD'S ORIGINAL CREATION AND DESIGN.** KRUISPUNT B.V., MULTIPLE CLASS, (INT. CLS. 14, 20 AND 25), (U.S. CLS. 2, 13, 22, 25, 27, 28, 32, 39 AND 50). SN 76-069,176. PUB. 10-16-2001. FILED 6-13-2000.

2,623,062. **GODDESS BEADS AND DESIGN.** SAX, AMY, (U.S. CLS. 2, 27, 28 AND 50). SN 76-073,119. PUB. 7-2-2002. FILED 6-19-2000.

2,623,092. **PASPALLEY.** PASPALLEY PEARL SALES PTY LIMITED, MULTIPLE CLASS, (INT. CLS. 14, 20, 29 AND 35), (U.S. CLS. 2, 13, 22, 25, 27, 28, 32, 46, 50, 100, 101 AND 102). SN 76-084,883. PUB. 7-2-2002. FILED 7-7-2000.

2,623,159. **MARIA AND DESIGN.** PAMP S.A., (U.S. CLS. 2, 27, 28 AND 50). SN 76-105,429. PUB. 7-2-2002. FILED 8-7-2000.

2,623,174. **TAROS.** DESCO VON SCHULTHESS AG, (U.S. CLS. 2, 27, 28 AND 50). SN 76-111,086. PUB. 7-2-2002. FILED 8-9-2000.

2,623,178 (See Class 9 for this trademark).

2,623,188. **AERO- COMPAX.** MONTRES UNIVERSAL S.A., (U.S. CLS. 2, 27, 28 AND 50). SN 76-113,990. PUB. 7-2-2002. FILED 8-21-2000.

2,623,203 (See Class 3 for this trademark).

2,623,221. **TENO AND DESIGN.** HEINZ SCHWARZ GMBH, (U.S. CLS. 2, 27, 28 AND 50). SN 76-124,317. PUB. 7-2-2002. FILED 9-8-2000.

2,623,365. **POLAR JADE.** POLAR GEMSTONES LTD., (U.S. CLS. 2, 27, 28 AND 50). SN 76-151,687. PUB. 7-2-2002. FILED 10-19-2000.

2,623,437. **CRYSTALARIUM.** BANCHIK, ROBIN F., DBA CRYSTALARIUM, MULTIPLE CLASS, (INT. CLS. 14, 35 AND 40), (U.S. CLS. 2, 27, 28, 50, 100, 101, 102, 103 AND 106). SN 76-162,035. PUB. 7-2-2002. FILED 11-8-2000.

2,623,500. **KG AND DESIGN.** GOLDSMITHS KAUI, INC., (U.S. CLS. 2, 27, 28 AND 50). SN 76-173,053. PUB. 7-2-2002. FILED 11-30-2000.

2,623,626. **FLEUR.** MOVADO LLC, BY ASSIGNMENT MOVADO CORPORATION, (U.S. CLS. 2, 27, 28 AND 50). SN 76-190,385. PUB. 2-19-2002. FILED 1-4-2001.

2,623,645. **TWINSIES.** TWINSIES INC., MULTIPLE CLASS, (INT. CLS. 14 AND 26), (U.S. CLS. 2, 27, 28, 37, 39, 40, 42 AND 50). SN 76-193,774. PUB. 7-2-2002. FILED 1-12-2001.

2,623,688. **INTERTECH.** GRAPHIC ARTS TECHNICAL FOUNDATION, MULTIPLE CLASS, (INT. CLS. 14, 16, 20 AND 25), (U.S. CLS. 2, 5, 13, 22, 23, 25, 27, 28, 29, 32, 37, 38, 39 AND 50). SN 76-198,687. PUB. 7-2-2002. FILED 1-23-2001.

2,623,887. **2087 AL.** CAPRA SRL, (U.S. CLS. 2, 27, 28 AND 50). SN 76-223,904. PUB. 7-2-2002. FILED 3-14-2001.

2,623,960. **HAVING LIGHT WE PASS IT ON TO OTHERS**

- WITTENBERG UNIVERSITY FOUNDED 1845 SPRINGFIELD, OHIO AND DESIGN.** BOARD OF DIRECTORS OF WITTENBERG COLLEGE, THE, DBA WITTENBERG UNIVERSITY, MULTIPLE CLASS, (INT. CLS. 14, 16, 20, 21, 25 AND 41), (U.S. CLS. 2, 5, 13, 22, 23, 25, 27, 28, 29, 30, 32, 33, 37, 38, 39, 40, 50, 100, 101 AND 107). SN 76-234,394. PUB. 7-2-2002. FILED 4-2-2001.
- 2,623,986. **JIVAN.** JIVAN, LTD., (U.S. CLS. 2, 27, 28 AND 50). SN 76-236,878. PUB. 7-2-2002. FILED 4-6-2001.
- 2,624,019. **JUNIOR SENSE.** KIM, SANG S., (U.S. CLS. 2, 27, 28 AND 50). SN 76-240,622. PUB. 7-2-2002. FILED 4-16-2001.
- 2,624,022 (*See Class 9 for this trademark.*)
- 2,624,232. **SEALAND.** CARTIER INTERNATIONAL B.V., (U.S. CLS. 2, 27, 28 AND 50). SN 76-265,062. PUB. 7-2-2002. FILED 6-1-2001.
- 2,624,234. **TECHNOLADY.** POMAIR TRADING INC., (U.S. CLS. 2, 27, 28 AND 50). SN 76-265,264. PUB. 7-2-2002. FILED 6-1-2001.
- 2,624,281. **SUSANLEEDESIGNS AND DESIGN.** EISNER, SUSAN, (U.S. CLS. 2, 27, 28 AND 50). SN 76-269,196. PUB. 7-2-2002. FILED 6-11-2001.
- 2,624,426. **TALISMAN.** TERRYBERRY COMPANY LIMITED PARTNERSHIP, (U.S. CLS. 2, 27, 28 AND 50). SN 76-290,570. PUB. 7-2-2002. FILED 7-27-2001.
- 2,624,536. **MISCELLANEOUS DESIGN.** BANNER DIAMONDS, INC., (U.S. CLS. 2, 27, 28 AND 50). SN 76-308,765. PUB. 7-2-2002. FILED 9-4-2001.
- 2,624,745. **UNIFORM BASICS.** TOUCAN, INC., (U.S. CLS. 2, 27, 28 AND 50). SN 76-337,890. PUB. 7-2-2002. FILED 11-15-2001.
- 2,624,833. **DOMAINE LTD..** DOMAINE LTD., (U.S. CLS. 2, 27, 28 AND 50). SN 76-349,856. PUB. 7-2-2002. FILED 12-17-2001.
- 2,625,059. **S AND DESIGN.** SACRAMENTO RIVER CATS BASEBALL CLUB, LLC, MULTIPLE CLASS, (INT. CLS. 14, 16, 25 AND 28), (U.S. CLS. 2, 5, 22, 23, 27, 28, 29, 37, 38, 39 AND 50). SN 78-055,840. PUB. 7-2-2002. FILED 3-29-2001.
- 2,625,060. **RC (STYLIZED).** SACRAMENTO RIVER CATS BASEBALL CLUB, LLC, MULTIPLE CLASS, (INT. CLS. 14 AND 25), (U.S. CLS. 2, 22, 27, 28, 39 AND 50). SN 78-055,863. PUB. 11-6-2001. FILED 3-29-2001.
-
- CLASS 15—MUSICAL INSTRUMENTS**
- 2,622,544. **STAGES.** DAVITT & HANSER MUSIC CO., INC., (U.S. CLS. 2, 21 AND 36). SN 75-431,256. PUB. 7-2-2002. FILED 2-9-1998.
- 2,623,947. **BIG BELL GLOBAL SERIES AND DESIGN.** CANONBALL MUSICAL INSTRUMENTS, LLC, (U.S. CLS. 2, 21 AND 36). SN 76-232,724. PUB. 7-2-2002. FILED 3-29-2001.
- 2,624,523. **MAESTRO AND DESIGN.** GIBSON GUITAR CORP., (U.S. CLS. 2, 21 AND 36). SN 76-306,539. PUB. 7-2-2002. FILED 8-28-2001.
- 2,624,578 (*See Class 9 for this trademark.*)
- 2,624,996. **BURSWOOD (STYLIZED).** KANSAS INT'L LIMITED, (U.S. CLS. 2, 21 AND 36). SN 78-036,740. PUB. 7-2-2002. FILED 11-28-2000.
- 2,625,216. **ANDREAS EASTMAN.** EASTMAN STRINGS, INC., (U.S. CLS. 2, 21 AND 36). SN 78-087,997. PUB. 7-2-2002. FILED 10-11-2001.
- 2,625,217. **IVAN DUNOV.** EASTMAN STRINGS, INC., (U.S. CLS. 2, 21 AND 36). SN 78-088,001. PUB. 7-2-2002. FILED 10-11-2001.
-
- CLASS 16—PAPER GOODS AND PRINTED MATTER**
- 2,622,507 (*See Class 9 for this trademark.*)
- 2,622,527. **STORY GRAMMAR MARKER.** DISCOURSE SKILLS PRODUCTIONS, INC., (U.S. CLS. 2, 5, 22, 23, 29, 37, 38 AND 50). SN 75-292,576. PUB. 7-2-2002. FILED 5-15-1997.
- 2,622,535. **SOHO ROCK 'N' ROLL.** SOHO CORPORATION, (U.S. CLS. 2, 5, 22, 23, 29, 37, 38 AND 50). SN 75-399,043. PUB. 7-2-2002. FILED 12-2-1997.
- 2,622,550. **WHITE STAR.** CUNARD LINE LIMITED, (U.S. CLS. 2, 5, 22, 23, 29, 37, 38 AND 50). SN 75-467,611. PUB. 7-2-2002. FILED 4-14-1998.
- 2,622,563. **MISCELLANEOUS DESIGN.** RUGBY WORLD CUP LIMITED, MULTIPLE CLASS, (INT. CLS. 16 AND 41), (U.S. CLS. 2, 5, 22, 23, 29, 37, 38, 50, 100, 101 AND 107). SN 75-504,357. PUB. 4-10-2001. FILED 6-18-1998.
- 2,622,578. **PLANETE BLEUE AND DESIGN.** SOCIETE AIR FRANCE, BY CHANGE OF NAME COMPAGNIE NATIONALE AIR FRANCE, MULTIPLE CLASS, (INT. CLS. 16, 18, 25, 28, 39, 41 AND 42), (U.S. CLS. 1, 2, 3, 5, 22, 23, 29, 37, 38, 39, 41, 50, 100, 101, 105 AND 107). SN 75-558,658. PUB. 7-2-2002. FILED 9-24-1998.
- 2,622,595 (*See Class 9 for this trademark.*)
- 2,622,605 (*See Class 5 for this trademark.*)
- 2,622,632 (*See Class 9 for this trademark.*)
- 2,622,648. **FC&A MEDICAL PUBLISHING.** FRANK W. CAWOOD & ASSOCIATES, (U.S. CLS. 2, 5, 22, 23, 29, 37, 38 AND 50). SN 75-691,726. PUB. 7-2-2002. FILED 4-26-1999.
- 2,622,654. **REVOLUTION.** PACIFIC TRADING CARDS, INC., (U.S. CLS. 2, 5, 22, 23, 29, 37, 38 AND 50). SN 75-700,660. PUB. 7-2-2002. FILED 5-7-1999.
- 2,622,671 (*See Class 9 for this trademark.*)
- 2,622,673. **POINT CLICK PARTY! AND DESIGN.** MOREL, JULIO, MULTIPLE CLASS, (INT. CLS. 16 AND 35), (U.S. CLS. 2, 5, 22, 23, 29, 37, 38, 50, 100, 101 AND 102). SN 75-730,621. PUB. 7-2-2002. FILED 6-16-1999.
- 2,622,677 (*See Class 9 for this trademark.*)
- 2,622,684 (*See Class 5 for this trademark.*)
- 2,622,685. **KLICKCLOSE.** CONVENIENCE FOOD SYSTEMS B.V., MULTIPLE CLASS, (INT. CLS. 16, 20 AND 39), (U.S. CLS. 2, 5, 13, 22, 23, 25, 29, 32, 37, 38, 50, 100 AND 105). SN 75-749,845. PUB. 1-23-2001. FILED 7-14-1999.
- 2,622,686. **MONSTERBOOK.** MONSTER CABLE PRODUCTS, INC., BY ASSIGNMENT MONSTERBOOK.COM, LLC, MULTIPLE CLASS, (INT. CLS. 16 AND 35), (U.S. CLS. 2, 5, 22, 23, 29, 37, 38, 50, 100, 101 AND 102). SN 75-750,288. PUB. 11-14-2000. FILED 8-6-1999.
- 2,622,709 (*See Class 9 for this trademark.*)
- 2,622,735. **BUFFALO TRACE AND DESIGN.** SAZERAC CO., INC., MULTIPLE CLASS, (INT. CLS. 16, 21, 25 AND 33), (U.S. CLS. 2, 5, 13, 22, 23, 29, 30, 33, 37, 38, 39, 40, 47, 49 AND 50). SN 75-819,932. PUB. 6-19-2001. FILED 10-12-1999.
- 2,622,745. **GRAND AMERICAN ROAD RACING AND DESIGN.** NATIONAL ASSOCIATION FOR STOCK CAR AUTO RACING, INC., (U.S. CLS. 2, 5, 22, 23, 29, 37, 38 AND 50). SN 75-828,343. PUB. 7-2-2002. FILED 10-21-1999.
- 2,622,783. **THE FUN AND EASY WAY.** IDG BOOKS WORLDWIDE, INC., (U.S. CLS. 2, 5, 22, 23, 29, 37, 38 AND 50). SN 75-862,854. PUB. 7-2-2002. FILED 12-3-1999.
- 2,622,810 (*See Class 2 for this trademark.*)
- 2,622,828 (*See Class 9 for this trademark.*)
- 2,622,840. **EMPIRE.** TWO QUEENS, INC., (U.S. CLS. 2, 5, 22, 23, 29, 37, 38 AND 50). SN 75-908,542. PUB. 7-2-2002. FILED 2-2-2000.
- 2,622,850 (*See Class 9 for this trademark.*)
- 2,622,851. **UNIVERSAL TRACKING SERVICES.** UNIVERSAL TRACKING SERVICES, INC., MULTIPLE CLASS, (INT. CLS. 16, 41 AND 42), (U.S. CLS. 2, 5, 22, 23, 29, 37, 38, 50, 100, 101 AND 107). SN 75-918,320. PUB. 7-2-2002. FILED 2-14-2000.
- 2,622,853. **WINK.** WINK PUBLISHING VENTURES, INC., (U.S. CLS. 2, 5, 22, 23, 29, 37, 38 AND 50). SN 75-920,793. PUB. 7-2-2002. FILED 2-16-2000.
- 2,622,857. **THE BHOYS AND DESIGN.** CELTIC PLC, MULTIPLE CLASS, (INT. CLS. 16, 25, 26 AND 28), (U.S. CLS. 2, 5, 22, 23, 29, 37, 38, 39, 40, 42 AND 50). SN 75-921,883. PUB. 10-9-2001. FILED 2-17-2000.
- 2,622,879. **RSS EXPANDED.** UNIFORM CODE COUNCIL, INC., (U.S. CLS. 2, 5, 22, 23, 29, 37, 38 AND 50). SN 75-939,641. PUB. 7-2-2002. FILED 3-9-2000.
- 2,622,896. **KIDS ROCK FREE.** FENDER MUSEUM OF THE ARTS FOUNDATION, MULTIPLE CLASS, (INT. CLS. 16, 21, 25 AND 28), (U.S. CLS. 2, 5, 13, 22, 23, 29, 30, 33, 37, 38, 39, 40 AND 50). SN 75-982,328. PUB. 7-3-2001. FILED 10-12-2000.
- 2,622,901 (*See Class 9 for this trademark.*)
- 2,622,936. **FOOD ADDICTS ANONYMOUS.** FOOD ADDICTS

- ANONYMOUS, INC., (U.S. CLS. 2, 5, 22, 23, 29, 37, 38 AND 50). SN 76-020,130. PUB. 7-2-2002. FILED 4-7-2000.
- 2,622,960. **SAFETYCLING. SPELLBOUND DEVELOPMENT GROUP, INC., MULTIPLE CLASS, (INT. CLS. 16 AND 20), (U.S. CLS. 2, 5, 13, 22, 23, 25, 29, 32, 37, 38 AND 50).** SN 76-033,831. PUB. 7-2-2002. FILED 4-25-2000.
- 2,622,969. **SP (STYLIZED), SP NEWSPRINT COMPANY, DBA SP NEWSPRINT SALES CO., (U.S. CLS. 2, 5, 22, 23, 29, 37, 38 AND 50).** SN 76-037,716. PUB. 7-2-2002. FILED 5-1-2000.
- 2,622,979. **BUZZWORDS FOR THE BOARDS, LIPPINCOTT WILLIAMS & WILKINS, INC., (U.S. CLS. 2, 5, 22, 23, 29, 37, 38 AND 50).** SN 76-043,223. PUB. 7-2-2002. FILED 5-10-2000.
- 2,623,021 (*See Class 9 for this trademark*).
- 2,623,030. **RAMBLER NO.23 GILT EDGES SUPERIOR ALUMINUM SURFACE WATER-PROOF FINISH PLAYING CARDS ALUMINUM SLIP & FINISH MADE IN U.S.A. THE U.S. PLAYING CARD CO. THE NATIONAL CARD CO. 23 RAMBLER ALUMINUM SURFACE RAMBLERS AND DESIGN. UNITED STATES PLAYING CARD COMPANY, THE, (U.S. CLS. 2, 5, 22, 23, 29, 37, 38 AND 50).** SN 76-062,594. PUB. 7-2-2002. FILED 6-2-2000.
- 2,623,034. **AARP LIFEANSWERS, AARP, MULTIPLE CLASS, (INT. CLS. 16, 35 AND 42), (U.S. CLS. 2, 5, 22, 23, 29, 37, 38, 50, 100, 101 AND 102).** SN 76-063,571. PUB. 7-2-2002. FILED 5-23-2000.
- 2,623,049. **DMA (STYLIZED), DIETARY MANAGERS ASSOCIATION, MULTIPLE CLASS, (INT. CLS. 16, 35, 41 AND 42), (U.S. CLS. 2, 5, 22, 23, 29, 37, 38, 50, 100, 101, 102 AND 107).** SN 76-068,058. PUB. 7-2-2002. FILED 6-12-2000.
- 2,623,057. **THE MAKING, SHAPING AND TREATING OF STEEL. AISE STEEL FOUNDATION, THE, (U.S. CLS. 2, 5, 22, 23, 29, 37, 38 AND 50).** SN 76-070,899. PUB. 7-2-2002. FILED 6-14-2000.
- 2,623,116. **FOODSAVER, TILIA INTERNATIONAL, INC., MULTIPLE CLASS, (INT. CLS. 16, 20 AND 21), (U.S. CLS. 2, 5, 13, 22, 23, 25, 29, 30, 32, 33, 37, 38, 40 AND 50).** SN 76-091,453. PUB. 5-21-2002. FILED 7-18-2000.
- 2,623,117. **EMB EMBROIDERY / MONOGRAM BUSINESS. VNU BUSINESS MEDIA, INC. A DELAWARE CORPORATION, BY ASSIGNMENT MFI HOLDINGS, INC., (U.S. CLS. 2, 5, 22, 23, 29, 37, 38 AND 50).** SN 76-091,663. PUB. 7-2-2002. FILED 7-17-2000.
- 2,623,130. **NEW CENTURY. WINNING MOVES, INC., (U.S. CLS. 2, 5, 22, 23, 29, 37, 38 AND 50).** SN 76-095,086. PUB. 7-2-2002. FILED 7-25-2000.
- 2,623,136. **MACHINERY TRADER.COM. SANDHILLS PUBLISHING COMPANY, MULTIPLE CLASS, (INT. CLS. 16 AND 42), (U.S. CLS. 2, 5, 22, 23, 29, 37, 38, 50, 100 AND 101).** SN 76-097,581. PUB. 7-2-2002. FILED 7-27-2000.
- 2,623,145. **EASY INTERNET AND DESIGN. ZIFF DAVIS PUBLISHING HOLDINGS INC., (U.S. CLS. 2, 5, 22, 23, 29, 37, 38 AND 50).** SN 76-100,599. PUB. 7-2-2002. FILED 8-1-2000.
- 2,623,150. **RAPID DEBT REPAYMENT PLAN. HUNT, MARY M., (U.S. CLS. 2, 5, 22, 23, 29, 37, 38 AND 50).** SN 76-102,741. PUB. 7-2-2002. FILED 8-4-2000.
- 2,623,157. **GOLF MINNESOTA. WIRES, GREG, DBA GOLF MINNESOTA, MULTIPLE CLASS, (INT. CLS. 16 AND 42), (U.S. CLS. 2, 5, 22, 23, 29, 37, 38, 50, 100 AND 101).** SN 76-104,923. PUB. 7-2-2002. FILED 8-8-2000.
- 2,623,169. **GARLAND. TAYLOR & FRANCIS BOOKS, INC., MULTIPLE CLASS, (INT. CLS. 16 AND 42), (U.S. CLS. 2, 5, 22, 23, 29, 37, 38, 50, 100 AND 101).** SN 76-109,071. PUB. 7-2-2002. FILED 8-14-2000.
- 2,623,215. **THE ONLY WAY TO BUILD E-SOLUTIONS. ZIFF DAVIS PUBLISHING HOLDINGS INC., MULTIPLE CLASS, (INT. CLS. 16 AND 42), (U.S. CLS. 2, 5, 22, 23, 29, 37, 38, 50, 100 AND 101).** SN 76-121,049. PUB. 7-2-2002. FILED 9-1-2000.
- 2,623,223. **POWERFUL EXPRESSIONS FROM GOD'S HEART TO YOURS. SHECUT ENTERPRISES, INC., DBA WHIRLWIND GREETING CARDS, (U.S. CLS. 2, 5, 22, 23, 29, 37, 38 AND 50).** SN 76-124,478. PUB. 7-2-2002. FILED 9-8-2000.
- 2,623,256. **SENIOR GOLF JOURNAL. SENIOR GOLFERS ASSOCIATION OF AMERICA INC., (U.S. CLS. 2, 5, 22, 23, 29, 37, 38 AND 50).** SN 76-133,742. PUB. 7-2-2002. FILED 9-22-2000.
- 2,623,303. **WRITERS ON THE VERGE. VILLAGE VOICE MEDIA, INC., (U.S. CLS. 2, 5, 22, 23, 29, 37, 38 AND 50).** SN 76-141,592. PUB. 7-2-2002. FILED 10-5-2000.
- 2,623,314. **SOLIKAMSKBUMPROM AND DESIGN. OTKRVTOE AKTSIONERNOE OBSHESTVO "SOLIKAMSK-BUMPROM", (U.S. CLS. 2, 5, 22, 23, 29, 37, 38 AND 50).** SN 76-143,002. PUB. 7-2-2002. FILED 10-6-2000.
- 2,623,319 (*See Class 9 for this trademark*).
- 2,623,341 (*See Class 9 for this trademark*).
- 2,623,352. **EBSI AND DESIGN. CASHFLOW TECHNOLOGIES, INC., (U.S. CLS. 2, 5, 22, 23, 29, 37, 38 AND 50).** SN 76-149,482. PUB. 7-2-2002. FILED 10-18-2000.
- 2,623,353. **IT'S UP TO YOU. ZULAUF, INC., (U.S. CLS. 2, 5, 22, 23, 29, 37, 38 AND 50).** SN 76-149,982. PUB. 7-2-2002. FILED 10-19-2000.
- 2,623,371. **FYI FOCUSED YOUNG INVESTORS AND DESIGN. JEANNE D'ARC CREDIT UNION, MULTIPLE CLASS, (INT. CLS. 16 AND 36), (U.S. CLS. 2, 5, 22, 23, 29, 37, 38, 50, 100, 101 AND 102).** SN 76-152,489. PUB. 7-2-2002. FILED 10-24-2000.
- 2,623,402 (*See Class 9 for this trademark*).
- 2,623,431. **DIMAGININGS (STYLIZED), DESTINATION IMAGINATION, INC., (U.S. CLS. 2, 5, 22, 23, 29, 37, 38 AND 50).** SN 76-161,137. PUB. 7-2-2002. FILED 11-7-2000.
- 2,623,448. **TRAVEL GOODS SHOWCASE. TRAVEL GOODS ASSOCIATION, (U.S. CLS. 2, 5, 22, 23, 29, 37, 38 AND 50).** SN 76-165,650. PUB. 7-2-2002. FILED 11-15-2000.
- 2,623,461 (*See Class 9 for this trademark*).
- 2,623,472. **INTELLIGENCE FOR YOUR FUTURE. WYPER, BONNIE, (U.S. CLS. 2, 5, 22, 23, 29, 37, 38 AND 50).** SN 76-169,677. PUB. 7-2-2002. FILED 11-22-2000.
- 2,623,503 (*See Class 9 for this trademark*).
- 2,623,559 (*See Class 9 for this trademark*).
- 2,623,575. **PURO MEXICO. HIRANANDANI, DEEPAK J., (U.S. CLS. 2, 5, 22, 23, 29, 37, 38 AND 50).** SN 76-183,966. PUB. 7-2-2002. FILED 12-20-2000.
- 2,623,579. **KEYNOTES. PIONEER-STANDARD ELECTRONICS, INC., (U.S. CLS. 2, 5, 22, 23, 29, 37, 38 AND 50).** SN 76-184,525. PUB. 7-2-2002. FILED 12-20-2000.
- 2,623,606. **BUSINESS BREAKS DEVELOPED BY AVP ASSOCIATES AND DESIGN. AVP ASSOCIATES, (U.S. CLS. 2, 5, 22, 23, 29, 37, 38 AND 50).** SN 76-188,531. PUB. 7-2-2002. FILED 1-2-2001.
- 2,623,620 (*See Class 3 for this trademark*).
- 2,623,633. **PSMJ BEST PRACTICES. PSMJ RESOURCES, INC., (U.S. CLS. 2, 5, 22, 23, 29, 37, 38 AND 50).** SN 76-192,212. PUB. 7-2-2002. FILED 1-10-2001.
- 2,623,640. **CHICAGOLAND TRAVEL IDEAS. MEREDITH CORPORATION, (U.S. CLS. 2, 5, 22, 23, 29, 37, 38 AND 50).** SN 76-193,077. PUB. 7-2-2002. FILED 1-12-2001.
- 2,623,642. **HOME OF THE ROOKIE CARD. TOPPS COMPANY, INC., THE, (U.S. CLS. 2, 5, 22, 23, 29, 37, 38 AND 50).** SN 76-193,549. PUB. 7-2-2002. FILED 1-15-2001.
- 2,623,654. **SOUTHERN MISS. UNIVERSITY OF SOUTHERN MISSISSIPPI, THE, MULTIPLE CLASS, (INT. CLS. 16, 20, 21 AND 25), (U.S. CLS. 2, 5, 13, 22, 23, 25, 29, 30, 32, 33, 37, 38, 39, 40 AND 50).** SN 76-194,526. PUB. 7-2-2002. FILED 1-17-2001.
- 2,623,656. **W (STYLIZED). WEIL PUBLISHING CO., INC., MULTIPLE CLASS, (INT. CLS. 16 AND 41), (U.S. CLS. 2, 5, 22, 23, 29, 37, 38, 50, 100, 101 AND 107).** SN 76-194,803. PUB. 7-2-2002. FILED 1-16-2001.
- 2,623,683. **CARH. COUNCIL FOR AFFORDABLE AND RURAL HOUSING, MULTIPLE CLASS, (INT. CLS. 16, 35 AND 41), (U.S. CLS. 2, 5, 22, 23, 29, 37, 38, 50, 100, 101, 102 AND 107).** SN 76-197,736. PUB. 7-2-2002. FILED 1-22-2001.
- 2,623,685. **AMHERST MEDIA. AMHERST MEDIA, INC., (U.S. CLS. 2, 5, 22, 23, 29, 37, 38 AND 50).** SN 76-197,960. PUB. 7-2-2002. FILED 1-22-2001.
- 2,623,687. **SYSFORMANCE. SYSFORMANCE AG, MULTIPLE CLASS, (INT. CLS. 16, 38 AND 42), (U.S. CLS. 2, 5, 22, 23, 29, 37, 38, 50, 100, 101 AND 104).** SN 76-198,494. PUB. 7-2-2002. FILED 1-23-2001.
- 2,623,688 (*See Class 14 for this trademark*).
- 2,623,713. **KEAYKOLOUR. ARJO WIGGINS FINE PAPERS LIMITED, (U.S. CLS. 2, 5, 22, 23, 29, 37, 38 AND 50).** SN 76-201,805. PUB. 7-2-2002. FILED 1-29-2001.
- 2,623,728. **BIG EAST CONFERENCE AND DESIGN. BIG EAST CONFERENCE, THE, MULTIPLE CLASS, (INT. CLS. 16,**

- 18, 21, 25, 28, 41 AND 42), (U.S. CLS. 1, 2, 3, 5, 13, 22, 23, 29, 30, 33, 37, 38, 39, 40, 41, 50, 100, 101 AND 107). SN 76-203,203. PUB. 7-2-2002. FILED 1-31-2001.
- 2,623,737. **WELLCONNECTED**. BP P.L.C., BY CHANGE OF NAME BP AMOCO P.L.C., (U.S. CLS. 2, 5, 22, 23, 29, 37, 38 AND 50). SN 76-203,940. PUB. 7-2-2002. FILED 2-2-2001.
- 2,623,757. **DOLLAR-WISE**. FONDA GROUP, INC., THE, (U.S. CLS. 2, 5, 22, 23, 29, 37, 38 AND 50). SN 76-206,054. PUB. 7-2-2002. FILED 2-6-2001.
- 2,623,788. **THE HUMANITARIAN**. AMERICAN NATIONAL RED CROSS, (U.S. CLS. 2, 5, 22, 23, 29, 37, 38 AND 50). SN 76-210,882. PUB. 7-2-2002. FILED 2-16-2001.
- 2,623,814. **TEAM CLEANING**. PRO-TEAM, INC., MULTIPLE CLASS, (INT. CLS. 16 AND 41), (U.S. CLS. 2, 5, 22, 23, 29, 37, 38, 50, 100, 101 AND 107). SN 76-214,826. PUB. 7-2-2002. FILED 2-26-2001.
- 2,623,821. **GARBORG'S**. DAYSRING CARDS, INC., (U.S. CLS. 2, 5, 22, 23, 29, 37, 38 AND 50). SN 76-215,554. PUB. 7-2-2002. FILED 2-23-2001.
- 2,623,837. **THE HELLENIC VOICE**. MOSAIC COMMUNICATIONS GROUP LLC, (U.S. CLS. 2, 5, 22, 23, 29, 37, 38 AND 50). SN 76-218,318. PUB. 7-2-2002. FILED 2-28-2001.
- 2,623,842. **UPPER DECK ENTERTAINMENT**. UPPER DECK COMPANY, LLC, THE, MULTIPLE CLASS, (INT. CLS. 16, 25 AND 28), (U.S. CLS. 2, 5, 22, 23, 29, 37, 38, 39 AND 50). SN 76-218,876. PUB. 7-2-2002. FILED 3-2-2001.
- 2,623,847. **COOPERATING WITH GOD FOR A CHANGE**. DYNAMICS OF GROWTH, INC., (U.S. CLS. 2, 5, 22, 23, 29, 37, 38 AND 50). SN 76-219,429. PUB. 7-2-2002. FILED 3-5-2001.
- 2,623,855. **BEEF MADE EASY**. CATTLEMEN'S BEEF PROMOTION AND RESEARCH BOARD, THE, AKA CATTLEMEN'S BEEF BOARD, AKA BEEF BOARD, AND NATIONAL CATTLEMEN'S BEEF ASSOCIATION, (U.S. CLS. 2, 5, 22, 23, 29, 37, 38 AND 50). SN 76-220,075. PUB. 7-2-2002. FILED 3-6-2001.
- 2,623,889. **STOCKCARTOONS (STYLIZED)**. SMITH, MIKE, (U.S. CLS. 2, 5, 22, 23, 29, 37, 38 AND 50). SN 76-224,127. PUB. 7-2-2002. FILED 3-14-2001.
- 2,623,898. **EYVIND EARLE PUBLISHING LLC EYVIND EARLE ESTATE AND DESIGN**. EYVIND EARLE PUBLISHING LLC, (U.S. CLS. 2, 5, 22, 23, 29, 37, 38 AND 50). SN 76-225,740. PUB. 7-2-2002. FILED 3-15-2001.
- 2,623,900. **SURETRAK**. GENETIC SOLUTIONS PTY LTD, MULTIPLE CLASS, (INT. CLS. 16, 35 AND 42), (U.S. CLS. 2, 5, 22, 23, 29, 37, 38, 50, 100, 101 AND 102). SN 76-225,781. PUB. 7-2-2002. FILED 3-19-2001.
- 2,623,907 (*See Class 1 for this trademark*).
- 2,623,909. **MISCELLANEOUS DESIGN**. SHALEM CENTER, THE, MULTIPLE CLASS, (INT. CLS. 16, 36, 41 AND 42), (U.S. CLS. 2, 5, 22, 23, 29, 37, 38, 50, 100, 101, 102 AND 107). SN 76-227,212. PUB. 7-2-2002. FILED 3-19-2001.
- 2,623,929. **THE DETROIT NEWS READ IT. UNDERSTAND IT. USE IT.**. DETROIT NEWSPAPER AGENCY, (U.S. CLS. 2, 5, 22, 23, 29, 37, 38 AND 50). SN 76-230,552. PUB. 7-2-2002. FILED 3-26-2001.
- 2,623,941 (*See Class 9 for this trademark*).
- 2,623,954. **RIPPLES**. KIMBERLY-CLARK CORPORATION, (U.S. CLS. 2, 5, 22, 23, 29, 37, 38 AND 50). SN 76-233,504. PUB. 7-2-2002. FILED 4-2-2001.
- 2,623,956. **ESMOD**. ESMOD, MULTIPLE CLASS, (INT. CLS. 16, 35, 40, 41 AND 42), (U.S. CLS. 2, 5, 22, 23, 29, 37, 38, 50, 100, 101, 102, 103, 106 AND 107). SN 76-233,709. PUB. 7-2-2002. FILED 3-30-2001.
- 2,623,960 (*See Class 14 for this trademark*).
- 2,623,962. **REAL CRYSTAL**. INTERNATIONAL CRYSTAL LABORATORIES, (U.S. CLS. 2, 5, 22, 23, 29, 37, 38 AND 50). SN 76-234,595. PUB. 7-2-2002. FILED 4-3-2001.
- 2,623,990. **BOATU.S. AND DESIGN**. BOAT OWNERS ASSOCIATION OF THE UNITED STATES, MULTIPLE CLASS, (INT. CLS. 16, 35, 36 AND 42), (U.S. CLS. 2, 5, 22, 23, 29, 37, 38, 50, 100, 101 AND 102). SN 76-237,260. PUB. 7-2-2002. FILED 4-9-2001.
- 2,623,997. **B@D**. D-GENERATION, INC., MULTIPLE CLASS, (INT. CLS. 16, 25 AND 28), (U.S. CLS. 2, 5, 22, 23, 29, 37, 38, 39 AND 50). SN 76-237,656. PUB. 7-2-2002. FILED 4-6-2001.
- 2,624,000. **CLEAR N'TUFF**. FORTUNE PLASTICS, INC., (U.S. CLS. 2, 5, 22, 23, 29, 37, 38 AND 50). SN 76-238,271. PUB. 7-2-2002. FILED 4-10-2001.
- 2,624,023. **MOTHERS' LIVING STORIES PROJECT**. BLACHMAN, LINDA, MULTIPLE CLASS, (INT. CLS. 16, 41 AND 42), (U.S. CLS. 2, 5, 22, 23, 29, 37, 38, 50, 100, 101 AND 107). SN 76-240,931. PUB. 7-2-2002. FILED 4-13-2001.
- 2,624,028. **ANTIQUÉ TRADER**. KRAUSE PUBLICATIONS, INC., (U.S. CLS. 2, 5, 22, 23, 29, 37, 38 AND 50). SN 76-241,292. PUB. 7-2-2002. FILED 4-16-2001.
- 2,624,058. **CREATE-A-KID**. MCDONALD, CEOLA, (U.S. CLS. 2, 5, 22, 23, 29, 37, 38 AND 50). SN 76-243,724. PUB. 7-2-2002. FILED 4-20-2001.
- 2,624,089 (*See Class 3 for this trademark*).
- 2,624,099. **AMERICAN COLLEGE OF VETERINARY ANESTHESIOLOGISTS**. AMERICAN COLLEGE OF VETERINARY ANESTHESIOLOGISTS, (U.S. CLS. 2, 5, 22, 23, 29, 37, 38 AND 50). SN 76-248,633. PUB. 7-2-2002. FILED 4-26-2001.
- 2,624,117 (*See Class 9 for this trademark*).
- 2,624,162. **REFLECTIONS OF COLOUR**. ANTIOCH COMPANY, THE, (U.S. CLS. 2, 5, 22, 23, 29, 37, 38 AND 50). SN 76-257,937. PUB. 7-2-2002. FILED 5-15-2001.
- 2,624,190. **NPNI AND DESIGN**. ADAMS/HUNTER PUBLISHING, INC., (U.S. CLS. 2, 5, 22, 23, 29, 37, 38 AND 50). SN 76-260,382. PUB. 7-2-2002. FILED 5-22-2001.
- 2,624,193. **FIRST STEPS IN MUSIC AND DESIGN**. FIRST STEPS IN MUSIC LLC, MULTIPLE CLASS, (INT. CLS. 16 AND 41), (U.S. CLS. 2, 5, 22, 23, 29, 37, 38, 50, 100, 101 AND 107). SN 76-260,764. PUB. 7-2-2002. FILED 5-22-2001.
- 2,624,200. **HARVARD BUSINESS REVIEW**. PRESIDENT AND FELLOWS OF HARVARD COLLEGE, (U.S. CLS. 2, 5, 22, 23, 29, 37, 38 AND 50). SN 76-261,825. PUB. 7-2-2002. FILED 5-23-2001.
- 2,624,202. **NEW SKETE**. MONKS OF THE BROTHERHOOD OF ST. FRANCIS, INC., THE, MULTIPLE CLASS, (INT. CLS. 16 AND 29), (U.S. CLS. 2, 5, 22, 23, 29, 37, 38, 46 AND 50). SN 76-261,968. PUB. 7-2-2002. FILED 5-24-2001.
- 2,624,219 (*See Class 9 for this trademark*).
- 2,624,227. **SLOAN-C AND DESIGN**. ALFRED P. SLOAN FOUNDATION, MULTIPLE CLASS, (INT. CLS. 16, 35 AND 41), (U.S. CLS. 2, 5, 22, 23, 29, 37, 38, 50, 100, 101, 102 AND 107). SN 76-264,672. PUB. 7-2-2002. FILED 5-31-2001.
- 2,624,242. **CAPTAIN RIBMAN**. SPRENGELMEYER, JOHN, AND DAVIS, II, RICH, MULTIPLE CLASS, (INT. CLS. 16 AND 41), (U.S. CLS. 2, 5, 22, 23, 29, 37, 38, 50, 100, 101 AND 107). SN 76-265,830. PUB. 7-2-2002. FILED 6-1-2001.
- 2,624,243. **NEW YORK MAGAZINE SHOPS (STYLIZED)**. PRIMEDIA MAGAZINE FINANCE, INC., (U.S. CLS. 2, 5, 22, 23, 29, 37, 38 AND 50). SN 76-265,884. PUB. 7-2-2002. FILED 6-1-2001.
- 2,624,259. **DRAFTCO**. DRAFTCO, INC., (U.S. CLS. 2, 5, 22, 23, 29, 37, 38 AND 50). SN 76-268,020. PUB. 7-2-2002. FILED 6-8-2001.
- 2,624,268. **SINCERELY NOT YOURS**. BERG, LYNNE, (U.S. CLS. 2, 5, 22, 23, 29, 37, 38 AND 50). SN 76-268,713. PUB. 7-2-2002. FILED 6-6-2001.
- 2,624,274. **WILOPEN BROCHURE**. WILEN MEDIA CORPORATION, (U.S. CLS. 2, 5, 22, 23, 29, 37, 38 AND 50). SN 76-268,857. PUB. 7-2-2002. FILED 6-11-2001.
- 2,624,287. **HOME CARE COMMUNICATOR**. HOME HEALTH CARE MANAGEMENT, INC., (U.S. CLS. 2, 5, 22, 23, 29, 37, 38 AND 50). SN 76-270,281. PUB. 7-2-2002. FILED 6-12-2001.
- 2,624,324. **THE JOURNAL OF MEDICAL PRACTICE MANAGEMENT**. GREENBRANCH PUBLISHING, L.L.C., (U.S. CLS. 2, 5, 22, 23, 29, 37, 38 AND 50). SN 76-275,011. PUB. 7-2-2002. FILED 6-22-2001.
- 2,624,334. **RV TRAVELER**. AFFINITY GROUP, INC., (U.S. CLS. 2, 5, 22, 23, 29, 37, 38 AND 50). SN 76-276,316. PUB. 7-2-2002. FILED 6-25-2001.
- 2,624,346. **INDISPENSABLE**. MARQUARDT S.A., (U.S. CLS. 2, 5, 22, 23, 29, 37, 38 AND 50). SN 76-277,563. PUB. 7-2-2002. FILED 6-28-2001.
- 2,624,350. **ABE ARIZONA'S BLACK EXECUTIVE AND DESIGN**. ABE MAGAZINE, INC., (U.S. CLS. 2, 5, 22, 23, 29, 37, 38 AND 50). SN 76-278,144. PUB. 7-2-2002. FILED 6-28-2001.
- 2,624,401. **OG**. RODALE INC., MULTIPLE CLASS, (INT. CLS. 16 AND 42), (U.S. CLS. 2, 5, 22, 23, 29, 37, 38, 50, 100 AND 101). SN 76-287,090. PUB. 7-2-2002. FILED 7-18-2001.
- 2,624,409. **PHOTO TECHNIQUES**. PRESTON INDUSTRIES,

- INC., (U.S. CLS. 2, 5, 22, 23, 29, 37, 38 AND 50). SN 76-288,090. PUB. 7-2-2002. FILED 7-23-2001.
- 2,624,433. **MOTION PICTURE CASE TO GO**. PANLINE USA, (U.S. CLS. 2, 5, 22, 23, 29, 37, 38 AND 50). SN 76-291,072. PUB. 7-2-2002. FILED 7-27-2001.
- 2,624,442. **POMEGRANATE**. POMEGRANATE COMMUNICATIONS, INC., (U.S. CLS. 2, 5, 22, 23, 29, 37, 38 AND 50). SN 76-291,808. PUB. 7-2-2002. FILED 7-30-2001.
- 2,624,460. **THUNDER'S MOUTH PRESS**. AVALON PUBLISHING GROUP, INC., (U.S. CLS. 2, 5, 22, 23, 29, 37, 38 AND 50). SN 76-294,684. PUB. 7-2-2002. FILED 8-2-2001.
- 2,624,467. **THE HORSE BACKSTREET CHOPPERS**. IRON CROSS LTD., (U.S. CLS. 2, 5, 22, 23, 29, 37, 38 AND 50). SN 76-295,463. PUB. 7-2-2002. FILED 8-7-2001.
- 2,624,468. **TRANSACTION TRENDS AND DESIGN**. ELECTRONIC TRANSACTIONS ASSOCIATION, (U.S. CLS. 2, 5, 22, 23, 29, 37, 38 AND 50). SN 76-295,937. PUB. 7-2-2002. FILED 8-7-2001.
- 2,624,470. **MISCELLANEOUS DESIGN**. OTTINGER, MAUREEN, (U.S. CLS. 2, 5, 22, 23, 29, 37, 38 AND 50). SN 76-295,982. PUB. 7-2-2002. FILED 8-8-2001.
- 2,624,476. **MAPPLETHORPE**. MICHAEL WARD STOUT, DBA EXECUTRIX OF ROBERT MAPPLETHORPE ESTATE, AN ESTATE OF NEW YORK., MULTIPLE CLASS, (INT. CLS. 16 AND 35), (U.S. CLS. 2, 5, 22, 23, 29, 37, 38, 50, 100, 101 AND 102). SN 76-296,354. PUB. 7-2-2002. FILED 8-8-2001.
- 2,624,482 (*See Class 3 for this trademark*).
- 2,624,488. **APA LIFETOOLS (STYLIZED)**. AMERICAN PSYCHOLOGICAL ASSOCIATION, (U.S. CLS. 2, 5, 22, 23, 29, 37, 38 AND 50). SN 76-299,397. PUB. 7-2-2002. FILED 8-15-2001.
- 2,624,490. **OFFICER SNOOK**. 7-DIPPITY, INC., MULTIPLE CLASS, (INT. CLS. 16, 25, 28 AND 42), (U.S. CLS. 2, 5, 22, 23, 29, 37, 38, 39, 50, 100 AND 101). SN 76-299,958. PUB. 7-2-2002. FILED 8-15-2001.
- 2,624,521. **BUSINESS AND THE ENVIRONMENT**. ASPEN PUBLISHERS, INC., BY ASSIGNMENT CUTTER INFORMATION CORP., (U.S. CLS. 2, 5, 22, 23, 29, 37, 38 AND 50). SN 76-306,215. PUB. 2-19-2002. FILED 8-28-2001.
- 2,624,532. **AVANCES**. APEX THERAPEUTIC CARE, INC., (U.S. CLS. 2, 5, 22, 23, 29, 37, 38 AND 50). SN 76-308,132. PUB. 7-2-2002. FILED 8-31-2001.
- 2,624,535. **TECHNI-PRINT**. WYNDSTONE SPECIALTY PRODUCTS, L.L.C., (U.S. CLS. 2, 5, 22, 23, 29, 37, 38 AND 50). SN 76-308,556. PUB. 7-2-2002. FILED 9-4-2001.
- 2,624,541. **CEDAR RIVER PAPER COMPANY**. CEDAR RIVER PAPER COMPANY, (U.S. CLS. 2, 5, 22, 23, 29, 37, 38 AND 50). SN 76-309,609. PUB. 7-2-2002. FILED 9-5-2001.
- 2,624,613. **A JIGSAW JONES MYSTERY AND DESIGN**. SCHOLASTIC INC., (U.S. CLS. 2, 5, 22, 23, 29, 37, 38 AND 50). SN 76-321,757. PUB. 7-2-2002. FILED 10-5-2001.
- 2,624,622. **QUIET TIME DIARY**. WORD OF LIFE FELLOWSHIP, INC., (U.S. CLS. 2, 5, 22, 23, 29, 37, 38 AND 50). SN 76-323,082. PUB. 7-2-2002. FILED 10-9-2001.
- 2,624,637. **MISCELLANEOUS DESIGN**. ALPHA-M, INC., (U.S. CLS. 2, 5, 22, 23, 29, 37, 38 AND 50). SN 76-324,480. PUB. 7-2-2002. FILED 10-11-2001.
- 2,624,649. **ON THE FRONT LINE OF GAME INNOVATION**. CMP MEDIA LLC, MULTIPLE CLASS, (INT. CLS. 16 AND 41), (U.S. CLS. 2, 5, 22, 23, 29, 37, 38, 50, 100, 101 AND 107). SN 76-325,497. PUB. 7-2-2002. FILED 10-15-2001.
- 2,624,658. **APPLIED PHYSICS LETTERS**. AMERICAN INSTITUTE OF PHYSICS INCORPORATED, AKA AIP, (U.S. CLS. 2, 5, 22, 23, 29, 37, 38 AND 50). SN 76-326,564. PUB. 7-2-2002. FILED 10-18-2001.
- 2,624,668. **BETLE BAILEY**. HEARST HOLDINGS, INC., MULTIPLE CLASS, (INT. CLS. 16 AND 24), (U.S. CLS. 2, 5, 22, 23, 29, 37, 38, 42 AND 50). SN 76-327,514. PUB. 7-2-2002. FILED 10-19-2001.
- 2,624,674. **UTOPIA ONE X**. APPLETON COATED LLC, (U.S. CLS. 2, 5, 22, 23, 29, 37, 38 AND 50). SN 76-328,475. PUB. 7-2-2002. FILED 10-19-2001.
- 2,624,695. **GENETI KEY**. GENETICA DNA LABORATORIES, INC., (U.S. CLS. 2, 5, 22, 23, 29, 37, 38 AND 50). SN 76-330,671. PUB. 7-2-2002. FILED 10-26-2001.
- 2,624,699. **FLASH ANATOMY**. BRYAN EDWARDS, A PUBLISHING COMPANY, INC., (U.S. CLS. 2, 5, 22, 23, 29, 37, 38 AND 50). SN 76-331,676. PUB. 7-2-2002. FILED 10-30-2001.
- 2,624,706. **GOD'S WORD FOR A LITTLE KID'S WORLD!**. GOSPEL LIGHT, (U.S. CLS. 2, 5, 22, 23, 29, 37, 38 AND 50). SN 76-332,726. PUB. 7-2-2002. FILED 11-2-2001.
- 2,624,712. **SETTING THE STANDARD IN BALANCE AND MOBILITY**. NEUROCOM INTERNATIONAL, INC., MULTIPLE CLASS, (INT. CLS. 16 AND 42), (U.S. CLS. 2, 5, 22, 23, 29, 37, 38, 50, 100 AND 101). SN 76-333,646. PUB. 7-2-2002. FILED 11-1-2001.
- 2,624,715. **BOLD BRIGHTS**. STAMPIN' UP! INC., (U.S. CLS. 2, 5, 22, 23, 29, 37, 38 AND 50). SN 76-333,993. PUB. 7-2-2002. FILED 11-5-2001.
- 2,624,716. **EARTH ELEMENTS**. STAMPIN' UP! INC., (U.S. CLS. 2, 5, 22, 23, 29, 37, 38 AND 50). SN 76-333,995. PUB. 7-2-2002. FILED 11-5-2001.
- 2,624,751. **GOTHIC BEAUTY**. HOLIDAY, STEVEN GEFLEN, (U.S. CLS. 2, 5, 22, 23, 29, 37, 38 AND 50). SN 76-338,357. PUB. 7-2-2002. FILED 11-16-2001.
- 2,624,758. **ANNUAL REVIEW OF BIOPHYSICS AND BIOMOLECULAR STRUCTURE**. ANNUAL REVIEWS, INC., (U.S. CLS. 2, 5, 22, 23, 29, 37, 38 AND 50). SN 76-339,389. PUB. 7-2-2002. FILED 11-16-2001.
- 2,624,766. **IKON THE WAY BUSINESS GETS COMMUNICATED**. IKON OFFICE SOLUTIONS WEST, INC., (U.S. CLS. 2, 5, 22, 23, 29, 37, 38 AND 50). SN 76-341,921. PUB. 7-2-2002. FILED 11-26-2001.
- 2,624,776. **ISLAND WAYS**. KOLADIS, RANDALL S., (U.S. CLS. 2, 5, 22, 23, 29, 37, 38 AND 50). SN 76-343,397. PUB. 7-2-2002. FILED 11-26-2001.
- 2,624,779. **THE PLAY REAL GAME**. BARRY, WILLIAM, DBA THE REAL GAME, INC., MULTIPLE CLASS, (INT. CLS. 16 AND 41), (U.S. CLS. 2, 5, 22, 23, 29, 37, 38, 50, 100, 101 AND 107). SN 76-343,818. PUB. 7-2-2002. FILED 11-30-2001.
- 2,624,780. **THE MAKE IT REAL GAME**. BARRY, WILLIAM, DBA THE REAL GAME, INC., MULTIPLE CLASS, (INT. CLS. 16 AND 41), (U.S. CLS. 2, 5, 22, 23, 29, 37, 38, 50, 100, 101 AND 107). SN 76-343,820. PUB. 7-2-2002. FILED 11-30-2001.
- 2,624,784 (*See Class 9 for this trademark*).
- 2,624,786. **STEINWAY**. STEINWAY, INC, (U.S. CLS. 2, 5, 22, 23, 29, 37, 38 AND 50). SN 76-344,580. PUB. 7-2-2002. FILED 11-29-2001.
- 2,624,805. **ITS PLAYTIME LAS VEGAS FOR THOSE WHO LIVE LIFE TO THE FULLEST (STYLIZED)**. G.F.I. PUBLISHING, INC., (U.S. CLS. 2, 5, 22, 23, 29, 37, 38 AND 50). SN 76-346,166. PUB. 7-2-2002. FILED 12-7-2001.
- 2,624,818. **ODDIBLES**. TISHERMAN, WILLIAM R., (U.S. CLS. 2, 5, 22, 23, 29, 37, 38 AND 50). SN 76-348,405. PUB. 7-2-2002. FILED 12-13-2001.
- 2,624,828. **NABTALK**. NATIONAL ASSOCIATION OF BANKRUPTCY TRUSTEES, (U.S. CLS. 2, 5, 22, 23, 29, 37, 38 AND 50). SN 76-349,305. PUB. 7-2-2002. FILED 12-18-2001.
- 2,624,889. **M AND DESIGN**. MARS, INCORPORATED, (U.S. CLS. 2, 5, 22, 23, 29, 37, 38 AND 50). SN 76-357,081. PUB. 7-2-2002. FILED 1-10-2002.
- 2,624,890. **M AND DESIGN**. MARS, INCORPORATED, (U.S. CLS. 2, 5, 22, 23, 29, 37, 38 AND 50). SN 76-357,082. PUB. 7-2-2002. FILED 1-10-2002.
- 2,624,891. **M AND DESIGN**. MARS, INCORPORATED, (U.S. CLS. 2, 5, 22, 23, 29, 37, 38 AND 50). SN 76-357,086. PUB. 7-2-2002. FILED 1-10-2002.
- 2,624,892. **M AND DESIGN**. MARS, INCORPORATED, (U.S. CLS. 2, 5, 22, 23, 29, 37, 38 AND 50). SN 76-357,091. PUB. 7-2-2002. FILED 1-10-2002.
- 2,624,893. **M AND DESIGN**. MARS, INCORPORATED, (U.S. CLS. 2, 5, 22, 23, 29, 37, 38 AND 50). SN 76-357,092. PUB. 7-2-2002. FILED 1-10-2002.
- 2,624,977. **HEALTH ON HAND AND DESIGN**. HEALTH ON HAND, (U.S. CLS. 2, 5, 22, 23, 29, 37, 38 AND 50). SN 78-020,005. PUB. 4-16-2002. FILED 8-7-2000.
- 2,624,982. **DAVID (STYLIZED)**. HARDEN, DAVID, (U.S. CLS. 2, 5, 22, 23, 29, 37, 38 AND 50). SN 78-024,736. PUB. 7-2-2002. FILED 9-7-2000.
- 2,624,984. **OCCUPY THE LAND**. Bammel Baptist Church, Inc., (U.S. CLS. 2, 5, 22, 23, 29, 37, 38 AND 50). SN 78-025,885. PUB. 7-2-2002. FILED 9-14-2000.
- 2,624,987. **SOBER CAMEL**. JEUP, CHRISTY L., (U.S. CLS. 2, 5, 22, 23, 29, 37, 38 AND 50). SN 78-028,500. PUB. 7-2-2002. FILED 10-1-2000.

2,625,029. **NU IMAGE**. RUSSELL, JANIE, (U.S. CLS. 2, 5, 22, 23, 29, 37, 38 AND 50). SN 78-048,109. PUB. 7-2-2002. FILED 2-13-2001.

2,625,035. **BIBLE SEED AND DESIGN**. MURDOCK, ROSE-MARY, ANN, MULTIPLE CLASS, (INT. CLS. 16 AND 42), (U.S. CLS. 2, 5, 22, 23, 29, 37, 38, 50, 100 AND 101). SN 78-050,037. PUB. 7-2-2002. FILED 2-23-2001.

2,625,040. **PERSONAL EXPRESSIONS**. SWIMC, INC., BY ASSIGNMENT SHERWIN-WILLIAMS COMPANY, THE, (U.S. CLS. 2, 5, 22, 23, 29, 37, 38 AND 50). SN 78-051,116. PUB. 7-2-2002. FILED 3-2-2001.

2,625,041. **COPYRIGHT OFFICE**. COPYRIGHT OFFICE, LIBRARY OF CONGRESS, (U.S. CLS. 2, 5, 22, 23, 29, 37, 38 AND 50). SN 78-052,281. PUB. 7-2-2002. FILED 3-9-2001.

2,625,059 (*See Class 14 for this trademark*).

2,625,061. **IPDISCLOSURE**. IPCAPITAL GROUP, INC., MULTIPLE CLASS, (INT. CLS. 16 AND 42), (U.S. CLS. 2, 5, 22, 23, 29, 37, 38, 50, 100 AND 101). SN 78-056,028. PUB. 7-2-2002. FILED 3-30-2001.

2,625,089. **HEART-VELOPES**. GREEN SNEAKERS, INC., (U.S. CLS. 2, 5, 22, 23, 29, 37, 38 AND 50). SN 78-062,272. PUB. 7-2-2002. FILED 5-7-2001.

2,625,121. **NO WAY OUT**. WORLD WRESTLING FEDERATION ENTERTAINMENT, INC., (U.S. CLS. 2, 5, 22, 23, 29, 37, 38 AND 50). SN 78-067,609. PUB. 7-2-2002. FILED 6-6-2001.

2,625,136. **MISCELLANEOUS DESIGN**. TRUSECURE CORPORATION, (U.S. CLS. 2, 5, 22, 23, 29, 37, 38 AND 50). SN 78-070,183. PUB. 7-2-2002. FILED 6-20-2001.

2,625,199. **TODAY'S INSURANCE PROFESSIONALS**. NATIONAL ASSOCIATION OF INSURANCE WOMEN (INTERNATIONAL), (U.S. CLS. 2, 5, 22, 23, 29, 37, 38 AND 50). SN 78-083,984. PUB. 7-2-2002. FILED 9-14-2001.

2,625,212 (*See Class 9 for this trademark*).

2,625,213. **KIDCHEF (STYLIZED)**. SERRAO, MAUREEN ANNE, (U.S. CLS. 2, 5, 22, 23, 29, 37, 38 AND 50). SN 78-087,811. PUB. 7-2-2002. FILED 10-10-2001.

2,625,234. **DERMTOPICS (STYLIZED)**. MARKETING RESOURCES & SOLUTIONS, (U.S. CLS. 2, 5, 22, 23, 29, 37, 38 AND 50). SN 78-091,778. PUB. 7-2-2002. FILED 11-5-2001.

2,625,251. **FINAL ANALYSIS**. FINAL ANALYSIS, INC., (U.S. CLS. 2, 5, 22, 23, 29, 37, 38 AND 50). SN 78-095,048. PUB. 7-2-2002. FILED 11-26-2001.

2,625,255. **SWI AND DESIGN**. STRATEGIC WORLD IMPACT, (U.S. CLS. 2, 5, 22, 23, 29, 37, 38 AND 50). SN 78-095,265. PUB. 7-2-2002. FILED 11-27-2001.

2,625,275. **NATIONAL EXAMINER AND DESIGN**. AMERICAN MEDIA OPERATIONS, INC., (U.S. CLS. 2, 5, 22, 23, 29, 37, 38 AND 50). SN 78-097,907. PUB. 7-2-2002. FILED 12-12-2001.

2,625,294. **THANK GOD FOR FRIENDS**. THANK GOD FOR FRIENDS, TGFF, LLC, MULTIPLE CLASS, (INT. CLS. 16, 21 AND 30), (U.S. CLS. 2, 5, 13, 22, 23, 29, 30, 33, 37, 38, 40, 46 AND 50). SN 78-100,404. PUB. 7-2-2002. FILED 12-31-2001.

CLASS 17—RUBBER GOODS

2,622,590 (*See Class 6 for this trademark*).

2,622,655 (*See Class 9 for this trademark*).

2,622,711 (*See Class 6 for this trademark*).

2,622,817. **DELTA DECK PLUGS**. ROCK WOOL MANUFACTURING COMPANY, (U.S. CLS. 1, 5, 12, 13, 35 AND 50). SN 75-893,574. PUB. 7-2-2002. FILED 1-10-2000.

2,622,831. **CUMULUS**. SIMMONS COMPANY, (U.S. CLS. 1, 5, 12, 13, 35 AND 50). SN 75-903,491. PUB. 7-2-2002. FILED 1-25-2000.

2,622,978. **D&K**. D&K INTERNATIONAL, INC., (U.S. CLS. 1, 5, 12, 13, 35 AND 50). SN 76-042,627. PUB. 7-2-2002. FILED 5-5-2000.

2,623,007. **DICHTOMATIK**. DICHTOMATIK VERTRIEBSGESELLSCHAFT FUR TECHNISCHE DICHTUNGEN MBH, (U.S. CLS. 1, 5, 12, 13, 35 AND 50). SN 76-055,331. PUB. 7-2-2002. FILED 5-24-2000.

2,623,021 (*See Class 9 for this trademark*).

2,623,040 (*See Class 7 for this trademark*).

2,623,080. **TP (STYLIZED)**. TP COMPOSITES, INC., (U.S. CLS.

1, 5, 12, 13, 35 AND 50). SN 76-079,582. PUB. 11-13-2001. FILED 6-28-2000.

2,623,271 (*See Class 6 for this trademark*).

2,623,294. **DEPEND-O-LOK**. VICTAULIC DEPEND-O-LOK, INC., BY CHANGE OF NAME BRICO INDUSTRIES, INC., (U.S. CLS. 1, 5, 12, 13, 35 AND 50). SN 76-138,918. PUB. 7-2-2002. FILED 10-2-2000.

2,623,648. **CELAIN AND DESIGN**. CELAIN ENTERPRISE CO., LTD., (U.S. CLS. 1, 5, 12, 13, 35 AND 50). SN 76-193,980. PUB. 7-2-2002. FILED 1-12-2001.

2,623,773. **PIPS**. M. E. TAYLOR ENGINEERING, INC., (U.S. CLS. 1, 5, 12, 13, 35 AND 50). SN 76-208,881. PUB. 7-2-2002. FILED 2-13-2001.

2,623,883. **JMP**. JMP INDUSTRIES, INC., (U.S. CLS. 1, 5, 12, 13, 35 AND 50). SN 76-223,173. PUB. 7-2-2002. FILED 3-12-2001.

2,624,106. **GATOR LOCK AND DESIGN**. GREEN LEAF, INC., (U.S. CLS. 1, 5, 12, 13, 35 AND 50). SN 76-249,542. PUB. 7-2-2002. FILED 5-1-2001.

2,624,128. **LOCO FOAM**. STEEVES, HARRISON, AND CHOCKLETT, BLANE, AND CHOCKLETT, JENNIFER S., (U.S. CLS. 1, 5, 12, 13, 35 AND 50). SN 76-252,863. PUB. 7-2-2002. FILED 5-7-2001.

2,624,773 (*See Class 6 for this trademark*).

2,624,926. **MISCELLANEOUS DESIGN**. ROYAL STONE INDUSTRIES, INC., (U.S. CLS. 1, 5, 12, 13, 35 AND 50). SN 76-366,172. PUB. 7-2-2002. FILED 1-31-2002.

CLASS 18—LEATHER GOODS

2,622,507 (*See Class 9 for this trademark*).

2,622,530. **BRETTOS**. INDUSTRIA DE DISENO TEXTIL, S.A., AKA INDITEX, S.A., (U.S. CLS. 1, 2, 3, 22 AND 41). SN 75-341,643. PUB. 7-2-2002. FILED 8-15-1997.

2,622,578 (*See Class 16 for this trademark*).

2,622,688. **HENBURY**. HENBURY LIMITED, MULTIPLE CLASS, (INT. CLS. 18 AND 25), (U.S. CLS. 1, 2, 3, 22, 39 AND 41). SN 75-752,311. PUB. 11-7-2000. FILED 7-15-1999.

2,622,841. **RB (STYLIZED)**. BRUNN, RONI, (U.S. CLS. 1, 2, 3, 22 AND 41). SN 75-910,402. PUB. 7-2-2002. FILED 1-28-2000.

2,622,868. **HAVANA JOE AND DESIGN**. GRUPP LINTERNACIONAL, SA, MULTIPLE CLASS, (INT. CLS. 18 AND 25), (U.S. CLS. 1, 2, 3, 22, 39 AND 41). SN 75-927,659. PUB. 7-2-2002. FILED 2-24-2000.

2,622,886. **MOSCHINO LIFE AND DESIGN**. MOONSHADOW, S.P.A., MULTIPLE CLASS, (INT. CLS. 18 AND 25), (U.S. CLS. 1, 2, 3, 22, 39 AND 41). SN 75-980,170. PUB. 7-2-2002. FILED 9-16-1999.

2,622,890 (*See Class 8 for this trademark*).

2,622,901 (*See Class 9 for this trademark*).

2,623,018. **MARIO'S WORLD AND DESIGN**. SEAN A. LEDEIT, (U.S. CLS. 1, 2, 3, 22 AND 41). SN 76-059,086. PUB. 7-2-2002. FILED 5-26-2000.

2,623,047 (*See Class 3 for this trademark*).

2,623,113. **SHEDROW**. GREENHAWK INC., MULTIPLE CLASS, (INT. CLS. 18 AND 25), (U.S. CLS. 1, 2, 3, 22, 39 AND 41). SN 76-091,000. PUB. 3-27-2001. FILED 7-18-2000.

2,623,175. **WATERSKINS**. WATERBABIES LLC, (U.S. CLS. 1, 2, 3, 22 AND 41). SN 76-111,240. PUB. 7-2-2002. FILED 8-18-2000.

2,623,178 (*See Class 9 for this trademark*).

2,623,203 (*See Class 3 for this trademark*).

2,623,284. **EUROLINE**. WYLSON, S.A., (U.S. CLS. 1, 2, 3, 22 AND 41). SN 76-137,820. PUB. 7-2-2002. FILED 9-29-2000.

2,623,295. **BOO! AND DESIGN**. GULCK, TONY VAN, (U.S. CLS. 1, 2, 3, 22 AND 41). SN 76-138,945. PUB. 7-2-2002. FILED 10-2-2000.

2,623,376. **SMARTPAK IQ AND DESIGN**. CARTER, WALLACE T., (U.S. CLS. 1, 2, 3, 22 AND 41). SN 76-153,197. PUB. 7-2-2002. FILED 10-24-2000.

2,623,471. **BEAR-USA (STYLIZED)**. BEAR U.S.A., INC., MULTIPLE CLASS, (INT. CLS. 18 AND 25), (U.S. CLS. 1, 2, 3, 22, 39 AND 41). SN 76-169,089. PUB. 7-2-2002. FILED 11-21-2000.

2,623,587. **GEMINI**. TIME/DESIGN, INC., (U.S. CLS. 1, 2, 3, 22 AND 41). SN 76-186,098. PUB. 7-2-2002. FILED 12-26-2000.

2,623,605. **DEGELER**. BRUNO MARKETING UND VER-

- TRIEB GMBH, MULTIPLE CLASS, (INT. CLS. 18 AND 25), (U.S. CLS. 1, 2, 3, 22, 39 AND 41). SN 76-188,445. PUB. 7-2-2002. FILED 1-2-2001.
- 2,623,728 (*See Class 16 for this trademark*).
- 2,623,804. **HI-TOUCH (STYLIZED)**. TAYANG SPORTING GOODS CO., LTD., (U.S. CLS. 1, 2, 3, 22 AND 41). SN 76-213,338. PUB. 7-2-2002. FILED 2-21-2001.
- 2,623,884. **HOLMES PLACE**. HOLMES PLACE PLC, MULTIPLE CLASS, (INT. CLS. 18 AND 25), (U.S. CLS. 1, 2, 3, 22, 39 AND 41). SN 76-223,210. PUB. 7-2-2002. FILED 3-12-2001.
- 2,623,916. **ALBERTO ASPESI**. ALBERTO ASPESI & C.S.P.A., (U.S. CLS. 1, 2, 3, 22 AND 41). SN 76-228,143. PUB. 7-2-2002. FILED 3-16-2001.
- 2,624,021. **BUCKLES AND BUNS**. GLICK, ELIZABETH D. VICK, MULTIPLE CLASS, (INT. CLS. 18, 24 AND 25), (U.S. CLS. 1, 2, 3, 22, 39, 41, 42 AND 50). SN 76-240,745. PUB. 7-2-2002. FILED 4-13-2001.
- 2,624,043. **DIBA**. DIBA IMPORTS L.P., MULTIPLE CLASS, (INT. CLS. 18, 25 AND 35), (U.S. CLS. 1, 2, 3, 22, 39, 41, 100, 101 AND 102). SN 76-242,444. PUB. 7-2-2002. FILED 4-18-2001.
- 2,624,050 (*See Class 6 for this trademark*).
- 2,624,359. **L AND DESIGN**. LEGENT INTERNATIONAL, LTD., (U.S. CLS. 1, 2, 3, 22 AND 41). SN 76-280,011. PUB. 7-2-2002. FILED 7-6-2001.
- 2,624,529. **GEORG AACHERNER**. LIBERTYVILLE SADDLE SHOP, INC., (U.S. CLS. 1, 2, 3, 22 AND 41). SN 76-307,701. PUB. 6-18-2002. FILED 8-31-2001.
- 2,624,546. **WIGGLES, WAGS, & WHISKERS**. BREZINSKI, JESSICA MARIE, DBA WIGGLES, WAGS, & WHISKERS, (U.S. CLS. 1, 2, 3, 22 AND 41). SN 76-310,750. PUB. 7-2-2002. FILED 9-8-2001.
- 2,624,847. **SNUFFY'S**. ASPEN PET PRODUCTS, INC., (U.S. CLS. 1, 2, 3, 22 AND 41). SN 76-351,483. PUB. 7-2-2002. FILED 12-13-2001.
- 2,624,876. **A VIEW FROM A BROAD**. RELEVANT PRODUCTS, LLC, (U.S. CLS. 1, 2, 3, 22 AND 41). SN 76-355,350. PUB. 7-2-2002. FILED 1-4-2002.
- 2,624,896. **WEBPAK PLUS**. TRG ACCESSORIES, L.L.C., (U.S. CLS. 1, 2, 3, 22 AND 41). SN 76-357,405. PUB. 7-2-2002. FILED 1-11-2002.
- 2,625,036. **MUDDY PAWS LEASHES**. MCCULLOCH, SAUNDRA, DIANE, (U.S. CLS. 1, 2, 3, 22 AND 41). SN 78-050,121. PUB. 3-5-2002. FILED 2-24-2001.
- 2,625,151. **MISCELLANEOUS DESIGN**. GENERAL MOTORS CORPORATION, (U.S. CLS. 1, 2, 3, 22 AND 41). SN 78-073,035. PUB. 7-2-2002. FILED 7-10-2001.
- 2,625,152. **OLDSMOBILE**. GENERAL MOTORS CORPORATION, (U.S. CLS. 1, 2, 3, 22 AND 41). SN 78-073,040. PUB. 7-2-2002. FILED 7-10-2001.
- 2,625,220. **BRITISH OPEN GOLF**. CHAMPIONSHIP COMMITTEE MERCHANDISING LIMITED, THE, (U.S. CLS. 1, 2, 3, 22 AND 41). SN 78-088,253. PUB. 7-2-2002. FILED 10-13-2001.
- 2,625,269. **WESTPORT**. SKYWAY LUGGAGE COMPANY, (U.S. CLS. 1, 2, 3, 22 AND 41). SN 78-097,242. PUB. 7-2-2002. FILED 12-7-2001.
- 2,622,941. **WINDOWS BY CERAMICHE GARDENIA ORCHIDEA AND DESIGN**. CERAMICHE GARDENIA ORCHIDEA S.P.A., (U.S. CLS. 1, 12, 33 AND 50). SN 76-022,980. PUB. 7-2-2002. FILED 4-11-2000.
- 2,622,942 (*See Class 6 for this trademark*).
- 2,622,951. **ANTHONY AND DESIGN**. ANTHONY FOREST PRODUCTS COMPANY, (U.S. CLS. 1, 12, 33 AND 50). SN 76-028,620. PUB. 7-2-2002. FILED 4-18-2000.
- 2,622,977. **MANNINGTON**. MANNINGTON MILLS, INC., MULTIPLE CLASS, (INT. CLS. 19 AND 27), (U.S. CLS. 1, 12, 19, 20, 33, 37, 42 AND 50). SN 76-041,930. PUB. 7-2-2002. FILED 5-5-2000.
- 2,623,026. **UNILOCK AUTHORIZED CONTRACTOR AND DESIGN**. UNILOCK, LTD., MULTIPLE CLASS, (INT. CLS. 19 AND 42), (U.S. CLS. 1, 12, 33, 50, 100 AND 101). SN 76-060,858. PUB. 7-2-2002. FILED 6-1-2000.
- 2,623,027. **UNILOCK AUTHORIZED DEALER AND DESIGN**. UNILOCK, LTD., MULTIPLE CLASS, (INT. CLS. 19 AND 42), (U.S. CLS. 1, 12, 33, 50, 100 AND 101). SN 76-060,859. PUB. 7-2-2002. FILED 6-1-2000.
- 2,623,245. **PLATO AND DESIGN**. PLATO BEHEER B.V., MULTIPLE CLASS, (INT. CLS. 19 AND 40), (U.S. CLS. 1, 12, 33, 50, 100, 103 AND 106). SN 76-131,335. PUB. 7-2-2002. FILED 9-18-2000.
- 2,623,343. **LOCTEC**. WITEX AG, MULTIPLE CLASS, (INT. CLS. 19 AND 27), (U.S. CLS. 1, 12, 19, 20, 33, 37, 42 AND 50). SN 76-148,432. PUB. 4-23-2002. FILED 10-17-2000.
- 2,623,366. **MISCELLANEOUS DESIGN**. TEMPLE-INLAND FOREST PRODUCTS CORPORATION, (U.S. CLS. 1, 12, 33 AND 50). SN 76-151,771. PUB. 7-2-2002. FILED 10-23-2000.
- 2,623,428 (*See Class 6 for this trademark*).
- 2,623,504 (*See Class 11 for this trademark*).
- 2,623,798. **ARTESIA**. ARTESIA COMPANIES, INC., THE, MULTIPLE CLASS, (INT. CLS. 19, 35, 37 AND 39), (U.S. CLS. 1, 12, 33, 50, 100, 101, 102, 103, 105 AND 106). SN 76-212,251. PUB. 7-2-2002. FILED 2-20-2001.
- 2,623,799. **TEAMWORKS**. ARTESIA COMPANIES, INC., THE, MULTIPLE CLASS, (INT. CLS. 19, 35, 37 AND 39), (U.S. CLS. 1, 12, 33, 50, 100, 101, 102, 103, 105 AND 106). SN 76-212,252. PUB. 7-2-2002. FILED 2-20-2001.
- 2,623,800. **MISCELLANEOUS DESIGN**. ARTESIA COMPANIES, INC., THE, MULTIPLE CLASS, (INT. CLS. 19, 35, 37 AND 39), (U.S. CLS. 1, 12, 33, 50, 100, 101, 102, 103, 105 AND 106). SN 76-212,253. PUB. 7-2-2002. FILED 2-20-2001.
- 2,623,907 (*See Class 1 for this trademark*).
- 2,623,914. **HOLLY PARK**. INDIANA BUILDING SYSTEMS, LLC, (U.S. CLS. 1, 12, 33 AND 50). SN 76-228,005. PUB. 7-2-2002. FILED 3-21-2001.
- 2,623,965. **PRECISION PRIME PINE**. DAROS INTERNATIONAL, INC., (U.S. CLS. 1, 12, 33 AND 50). SN 76-235,348. PUB. 7-2-2002. FILED 3-28-2001.
- 2,624,330. **BEBAP**. CEMENTS CALCIA, MULTIPLE CLASS, (INT. CLS. 19 AND 37), (U.S. CLS. 1, 12, 33, 50, 100, 103 AND 106). SN 76-275,704. PUB. 7-2-2002. FILED 6-25-2001.
- 2,624,366. **NOVATECH**. NOVATECH GLASS INC./ LES PRODUITS VERRIERS NOVATECH INC., (U.S. CLS. 1, 12, 33 AND 50). SN 76-281,471. PUB. 7-2-2002. FILED 7-6-2001.
- 2,624,423. **SANDTRAPPER**. INDIAN VALLEY INDUSTRIES, INC., (U.S. CLS. 1, 12, 33 AND 50). SN 76-290,348. PUB. 7-2-2002. FILED 7-26-2001.
- 2,624,457. **MISCELLANEOUS DESIGN**. SAROYAN LUMBER COMPANY, (U.S. CLS. 1, 12, 33 AND 50). SN 76-293,908. PUB. 7-2-2002. FILED 8-3-2001.
- 2,624,700. **I-Q GLASS**. HANSONS' WINDOWS & CONSTRUCTION, INC., (U.S. CLS. 1, 12, 33 AND 50). SN 76-331,820. PUB. 7-2-2002. FILED 10-30-2001.
- 2,624,878. **PATRIOT PINE**. LUMBER FINISHERS INCORPORATED, (U.S. CLS. 1, 12, 33 AND 50). SN 76-355,377. PUB. 7-2-2002. FILED 1-7-2002.
- 2,624,888. **ROSBORO PLUS**. ROSBORO LUMBER COMPANY, (U.S. CLS. 1, 12, 33 AND 50). SN 76-357,006. PUB. 7-2-2002. FILED 1-8-2002.
- 2,624,909. **STRUCTURWOOD EDGE**. WEYERHAEUSER COMPANY, (U.S. CLS. 1, 12, 33 AND 50). SN 76-360,134. PUB. 7-2-2002. FILED 1-16-2002.
- 2,624,917. **MISCELLANEOUS DESIGN**. CALIFORNIA TRUSS COMPANY, INC., (U.S. CLS. 1, 12, 33 AND 50). SN 76-

CLASS 19—NON-METALLIC BUILDING MATERIALS

- 2,622,564 (*See Class 11 for this trademark*).
- 2,622,665. **FORTIFLASH**. FORTIFIBER CORPORATION, DBA FORTIFIBER BUILDING PRODUCTS SYSTEMS, (U.S. CLS. 1, 12, 33 AND 50). SN 75-719,321. PUB. 7-2-2002. FILED 6-2-1999.
- 2,622,731 (*See Class 1 for this trademark*).
- 2,622,743. **SMOOTH BLUE**. BLUE CIRCLE CANADA, INC., (U.S. CLS. 1, 12, 33 AND 50). SN 75-827,142. PUB. 7-2-2002. FILED 10-19-1999.
- 2,622,761. **CLEAR STEEL**. CLEAR STEEL AUSTRALIA PTY, LTD., BY CHANGE OF NAME JESTELLE PTY LTD, (U.S. CLS. 1, 12, 33 AND 50). SN 75-847,047. PUB. 7-2-2002. FILED 11-12-1999.
- 2,622,909. **EVEREST**. EMCO LIMITED, (U.S. CLS. 1, 12, 33 AND 50). SN 76-007,128. PUB. 7-2-2002. FILED 3-22-2000.

- 361,981. PUB. 7-2-2002. FILED 1-22-2002.
 2,625,013. **ORNAMENTAL POLES AND DESIGN**. POWER POLES, INC., (U.S. CLS. 1, 12, 33 AND 50). SN 78-043,879. PUB. 7-2-2002. FILED 1-19-2001.
 2,625,246. **OWENS CORNING**. OWENS-CORNING FIBER-GLAS TECHNOLOGY INC., (U.S. CLS. 1, 12, 33 AND 50). SN 78-094,118. PUB. 7-2-2002. FILED 11-19-2001.
 2,625,301. **FRENCHWOOD**. ANDERSEN CORPORATION, (U.S. CLS. 1, 12, 33 AND 50). SN 78-102,570. PUB. 7-2-2002. FILED 1-14-2002.

CLASS 20—FURNITURE AND ARTICLES NOT OTHERWISE CLASSIFIED

- 2,622,553 (*See Class 7 for this trademark*).
 2,622,605 (*See Class 5 for this trademark*).
 2,622,653. **MAPLE CREEK**. NHB INDUSTRIES LIMITED, (U.S. CLS. 2, 13, 22, 25, 32 AND 50). SN 75-694,861. PUB. 7-2-2002. FILED 4-30-1999.
 2,622,685 (*See Class 16 for this trademark*).
 2,622,825. **MUSIPACK**. DURAWELD LIMITED, (U.S. CLS. 2, 13, 22, 25, 32 AND 50). SN 75-900,947. PUB. 7-2-2002. FILED 1-21-2000.
 2,622,872. **MISCELLANEOUS DESIGN**. DOREL JUVENILE GROUP, INC., BY MERGER COSCO, INC., (U.S. CLS. 2, 13, 22, 25, 32 AND 50). SN 75-933,934. PUB. 7-2-2002. FILED 2-22-2000.
 2,622,927. **BITTERS CO.**. BITTERS CO., (U.S. CLS. 2, 13, 22, 25, 32 AND 50). SN 76-016,524. PUB. 7-2-2002. FILED 4-3-2000.
 2,622,942 (*See Class 6 for this trademark*).
 2,622,960 (*See Class 16 for this trademark*).
 2,623,024. **THE PEABODY (STYLIZED)**. PEABODY MANAGEMENT, INC., (U.S. CLS. 2, 13, 22, 25, 32 AND 50). SN 76-059,920. PUB. 7-2-2002. FILED 5-31-2000.
 2,623,055 (*See Class 14 for this trademark*).
 2,623,092 (*See Class 14 for this trademark*).
 2,623,116 (*See Class 16 for this trademark*).
 2,623,250. **HAMPSHIRE**. DREXEL HERITAGE FURNISHINGS INC., (U.S. CLS. 2, 13, 22, 25, 32 AND 50). SN 76-132,677. PUB. 7-2-2002. FILED 9-21-2000.
 2,623,351. **BURSON E-Z FILL**. BURSON, WILLIAM C., (U.S. CLS. 2, 13, 22, 25, 32 AND 50). SN 76-149,414. PUB. 7-2-2002. FILED 10-17-2000.
 2,623,521. **HOT HANG-UPS! AND DESIGN**. OSTERHOLT, GERALD, AND OSTERHOLT, LANA, (U.S. CLS. 2, 13, 22, 25, 32 AND 50). SN 76-176,195. PUB. 6-4-2002. FILED 12-5-2000.
 2,623,524. **PROBILT**. INTEGRATED TECHNOLOGY CORPORATION, (U.S. CLS. 2, 13, 22, 25, 32 AND 50). SN 76-176,457. PUB. 7-2-2002. FILED 12-5-2000.
 2,623,548 (*See Class 6 for this trademark*).
 2,623,620 (*See Class 3 for this trademark*).
 2,623,654 (*See Class 16 for this trademark*).
 2,623,688 (*See Class 14 for this trademark*).
 2,623,780. **POLY STACKER II**. CANADIAN ATLAS FURNITURE CORPORATION, (U.S. CLS. 2, 13, 22, 25, 32 AND 50). SN 76-210,138. PUB. 7-2-2002. FILED 2-14-2001.
 2,623,801. **SALLI SADDLE CHAIR**. EASYDOING OY (LTD.), (U.S. CLS. 2, 13, 22, 25, 32 AND 50). SN 76-212,761. PUB. 7-2-2002. FILED 2-20-2001.
 2,623,823. **VISIONS AWARDS AND DESIGN**. RENOIR VISIONS LLC, (U.S. CLS. 2, 13, 22, 25, 32 AND 50). SN 76-215,836. PUB. 7-2-2002. FILED 2-26-2001.
 2,623,875 (*See Class 6 for this trademark*).
 2,623,907 (*See Class 1 for this trademark*).
 2,623,949. **BELLA LUNA AND DESIGN**. DYNASTY CONSOLIDATED INDUSTRIES, INC., (U.S. CLS. 2, 13, 22, 25, 32 AND 50). SN 76-232,875. PUB. 7-2-2002. FILED 3-30-2001.
 2,623,960 (*See Class 14 for this trademark*).
 2,623,999. **POSTURXPRESS (STYLIZED)**. PHILLIPS, FAY, (U.S. CLS. 2, 13, 22, 25, 32 AND 50). SN 76-238,252. PUB. 7-2-2002. FILED 4-10-2001.
 2,624,081. **BILLY BALDWIN (STYLIZED)**. VENTRY, LTD., (U.S. CLS. 2, 13, 22, 25, 32 AND 50). SN 76-246,867. PUB. 7-2-2002. FILED 4-26-2001.
 2,624,089 (*See Class 3 for this trademark*).
 2,624,100. **DECAR**. SICO INCORPORATED, MULTIPLE CLASS, (INT. CLS. 20 AND 40), (U.S. CLS. 2, 13, 22, 25, 32, 50, 100, 103 AND 106). SN 76-248,785. PUB. 7-2-2002. FILED 4-30-2001.
 2,624,129. **SIGNATURE LEATHER**. LZB PROPERTIES, INC., (U.S. CLS. 2, 13, 22, 25, 32 AND 50). SN 76-253,081. PUB. 7-2-2002. FILED 5-1-2001.
 2,624,147 (*See Class 6 for this trademark*).
 2,624,171. **SPRING AIR JUST RIGHT. AND DESIGN**. SPRING AIR COMPANY, THE, (U.S. CLS. 2, 13, 22, 25, 32 AND 50). SN 76-259,053. PUB. 7-2-2002. FILED 5-16-2001.
 2,624,305. **MASTER DESIGN FURNITURE (STYLIZED)**. MASTER DESIGN FURNITURE, (U.S. CLS. 2, 13, 22, 25, 32 AND 50). SN 76-272,362. PUB. 7-2-2002. FILED 6-14-2001.
 2,624,308. **SUPER STRAP**. LOGISTICK, INC., (U.S. CLS. 2, 13, 22, 25, 32 AND 50). SN 76-272,432. PUB. 7-2-2002. FILED 6-15-2001.
 2,624,317. **VGS VISUAL GRAPHIC SYSTEMS INC. AND DESIGN**. VISUAL GRAPHIC SYSTEMS INC., (U.S. CLS. 2, 13, 22, 25, 32 AND 50). SN 76-274,296. PUB. 7-2-2002. FILED 6-19-2001.
 2,624,357. **SMASHING TIMES**. SMASHING TIMES, INC., MULTIPLE CLASS, (INT. CLS. 20, 35 AND 41), (U.S. CLS. 2, 13, 22, 25, 32, 50, 100, 101, 102 AND 107). SN 76-279,335. PUB. 7-2-2002. FILED 7-2-2001.
 2,624,413. **TOMWAY**. TOMWAY LLC, (U.S. CLS. 2, 13, 22, 25, 32 AND 50). SN 76-288,669. PUB. 7-2-2002. FILED 7-24-2001.
 2,624,524. **LEMICA (STYLIZED)**. LEMICA CORPORATION, (U.S. CLS. 2, 13, 22, 25, 32 AND 50). SN 76-306,867. PUB. 7-2-2002. FILED 8-29-2001.
 2,624,610. **VENDITIONS**. VISUAL GRAPHIC SYSTEMS INC., (U.S. CLS. 2, 13, 22, 25, 32 AND 50). SN 76-321,359. PUB. 7-2-2002. FILED 10-3-2001.
 2,624,662. **PLAS-STAX**. DES-L INDUSTRIES, INC., (U.S. CLS. 2, 13, 22, 25, 32 AND 50). SN 76-327,035. PUB. 7-2-2002. FILED 10-18-2001.
 2,624,663 (*See Class 6 for this trademark*).
 2,624,775. **SASHAY SOUTH**. PHILLIPS, LINDANNE, (U.S. CLS. 2, 13, 22, 25, 32 AND 50). SN 76-343,252. PUB. 7-2-2002. FILED 11-30-2001.
 2,624,838. **THE PERFECT EDGE**. DENVER MATTRESS CO., LLC, (U.S. CLS. 2, 13, 22, 25, 32 AND 50). SN 76-350,263. PUB. 7-2-2002. FILED 12-18-2001.
 2,625,019. **THE POWER OF POSITIVE HUGGING**. HATCH, BRENT, (U.S. CLS. 2, 13, 22, 25, 32 AND 50). SN 78-045,986. PUB. 7-2-2002. FILED 2-1-2001.
 2,625,078. **HOME AND OUTDOOR LIVING**. JOHN RICH & SONS INVESTMENT HOLDING COMPANY, MULTIPLE CLASS, (INT. CLS. 20, 24, 25 AND 27), (U.S. CLS. 2, 13, 19, 20, 22, 25, 32, 37, 39, 42 AND 50). SN 78-059,991. PUB. 7-2-2002. FILED 4-24-2001.
 2,625,172. **FASHION TECH AND DESIGN**. FASHION TECH, INC., (U.S. CLS. 2, 13, 22, 25, 32 AND 50). SN 78-079,084. PUB. 7-2-2002. FILED 8-14-2001.
 2,625,212 (*See Class 9 for this trademark*).

CLASS 21—HOUSEWARES AND GLASS

- 2,622,537. **SYMBIO**. COSMOFORM B.V., (U.S. CLS. 2, 13, 23, 29, 30, 33, 40 AND 50). SN 75-402,400. PUB. 12-15-1998. FILED 12-9-1997.
 2,622,552. **TCHARODEI AND DESIGN**. BELVEDERE, MULTIPLE CLASS, (INT. CLS. 21 AND 33), (U.S. CLS. 2, 13, 23, 29, 30, 33, 40, 47, 49 AND 50). SN 75-474,045. PUB. 4-10-2001. FILED 4-24-1998.
 2,622,606 (*See Class 3 for this trademark*).
 2,622,631. **FLAPNEST**. IPL INC., (U.S. CLS. 2, 13, 23, 29, 30, 33, 40 AND 50). SN 75-651,233. PUB. 7-2-2002. FILED 3-2-1999.
 2,622,646. **TUFFWARE AND DESIGN**. PRIMEWARE CERAMICS LIMITED, (U.S. CLS. 2, 13, 23, 29, 30, 33, 40 AND 50). SN 75-686,985. PUB. 7-2-2002. FILED 4-20-1999.
 2,622,735 (*See Class 16 for this trademark*).
 2,622,821 (*See Class 9 for this trademark*).
 2,622,822 (*See Class 9 for this trademark*).
 2,622,894. **SANTA & COLE AND DESIGN**. SANTA & COLE EDICIONES DE DISENO S.A., (U.S. CLS. 2, 13, 23, 29, 30, 33,

40 AND 50). SN 75-981,959. PUB. 7-2-2002. FILED 2-7-2000.
2,622,896 (*See Class 16 for this trademark*).
2,623,094. **ZURICH**. ZURICH AMERICAN INSURANCE
COMPANY, (U.S. CLS. 2, 13, 23, 29, 30, 33, 40 AND 50).
SN 76-085,378. PUB. 7-2-2002. FILED 7-7-2000.
2,623,116 (*See Class 16 for this trademark*).
2,623,124. **SOAP STATION**. HYGIENIC SOLUTIONS, L.L.C.,
(U.S. CLS. 2, 13, 23, 29, 30, 33, 40 AND 50). SN 76-093,436.
PUB. 7-2-2002. FILED 7-20-2000.
2,623,251. **KNESS**. KNESS MFG. CO., INC., (U.S. CLS. 2, 13,
23, 29, 30, 33, 40 AND 50). SN 76-132,822. PUB. 7-2-2002.
FILED 9-22-2000.
2,623,305. **KERM-N-DON**. THE TRUSTEES OF CORNER-
STONE FINANCIAL MANAGEMENT, AN ARKANSAS
TRUST, THE TRUSTEE COMPRISING VERN M. ROW, A
U.S. CITIZEN, (U.S. CLS. 2, 13, 23, 29, 30, 33, 40 AND 50). SN
76-141,925. PUB. 7-2-2002. FILED 10-6-2000.
2,623,425. **A CHRISTMAS STORY**. INTERNATIONAL CHI-
NA COMPANY, INC., (U.S. CLS. 2, 13, 23, 29, 30, 33, 40 AND
50). SN 76-160,426. PUB. 7-2-2002. FILED 11-3-2000.
2,623,543. **MAKE-A-GIFT**. SNAPWARE CORPORATION, (U.S.
CLS. 2, 13, 23, 29, 30, 33, 40 AND 50). SN 76-177,920. PUB. 7-2-
2002. FILED 12-11-2000.
2,623,586. **CESAR'S WORLD WWW.CESARSWORLD.COM
AND DESIGN**. PALMAVIVA, INC., (U.S. CLS. 2, 13, 23, 29,
30, 33, 40 AND 50). SN 76-186,058. PUB. 7-2-2002. FILED 12-
26-2000.
2,623,620 (*See Class 3 for this trademark*).
2,623,654 (*See Class 16 for this trademark*).
2,623,708 (*See Class 3 for this trademark*).
2,623,715. **SM SNACK MAN AND DESIGN**. HOUSEWARES
INTERNATIONAL, INC., (U.S. CLS. 2, 13, 23, 29, 30, 33, 40
AND 50). SN 76-202,145. PUB. 7-2-2002. FILED 1-30-2001.
2,623,728 (*See Class 16 for this trademark*).
2,623,960 (*See Class 14 for this trademark*).
2,623,994. **ROCK**. L & P PROPERTY MANAGEMENT COM-
PANY, (U.S. CLS. 2, 13, 23, 29, 30, 33, 40 AND 50). SN 76-
237,467. PUB. 7-2-2002. FILED 4-6-2001.
2,624,156. **ALTIVA**. SEARS, ROEBUCK AND CO., (U.S. CLS.
2, 13, 23, 29, 30, 33, 40 AND 50). SN 76-256,978. PUB. 7-2-2002.
FILED 5-16-2001.
2,624,255. **BIG STINKY**. HONADELS, INC., (U.S. CLS. 2, 13,
23, 29, 30, 33, 40 AND 50). SN 76-267,342. PUB. 7-2-2002.
FILED 6-5-2001.
2,624,265. **MISCELLANEOUS DESIGN**. REGAL WARE, INC.,
(U.S. CLS. 2, 13, 23, 29, 30, 33, 40 AND 50). SN 76-268,650.
PUB. 7-2-2002. FILED 6-8-2001.
2,624,266. **MISCELLANEOUS DESIGN**. REGAL WARE, INC.,
(U.S. CLS. 2, 13, 23, 29, 30, 33, 40 AND 50). SN 76-268,651.
PUB. 7-2-2002. FILED 6-8-2001.
2,624,270. **MISCELLANEOUS DESIGN**. REGAL WARE, INC.,
(U.S. CLS. 2, 13, 23, 29, 30, 33, 40 AND 50). SN 76-268,748.
PUB. 7-2-2002. FILED 6-8-2001.
2,624,271. **MISCELLANEOUS DESIGN**. REGAL WARE, INC.,
(U.S. CLS. 2, 13, 23, 29, 30, 33, 40 AND 50). SN 76-268,749.
PUB. 7-2-2002. FILED 6-8-2001.
2,624,304. **COL: DARTMOUTH NOV: HANT IN: AMERICA 1769
AND DESIGN**. TRUSTEES OF DARTMOUTH COLLEGE,
DBA DARTMOUTH COLLEGE, (U.S. CLS. 2, 13, 23, 29, 30,
33, 40 AND 50). SN 76-272,059. PUB. 7-2-2002. FILED 6-15-
2001.
2,624,371 (*See Class 3 for this trademark*).
2,624,458. **GRACIOUS GOODNESS HINSDALE, IL AND DE-
SIGN**. CALABRESE, LINDA, (U.S. CLS. 2, 13, 23, 29, 30, 33,
40 AND 50). SN 76-293,970. PUB. 7-2-2002. FILED 8-3-2001.
2,624,832. **MACMOP**. MACDONALD LUMBER COMPANY,
(U.S. CLS. 2, 13, 23, 29, 30, 33, 40 AND 50). SN 76-349,836.
PUB. 7-2-2002. FILED 12-19-2001.
2,624,851. **MZG**. SANDMAR MARKETING, (U.S. CLS. 2, 13,
23, 29, 30, 33, 40 AND 50). SN 76-351,856. PUB. 7-2-2002.
FILED 12-21-2001.
2,624,852. **MOO-2-GO**. SANDMAR MARKETING, (U.S. CLS.
2, 13, 23, 29, 30, 33, 40 AND 50). SN 76-351,857. PUB. 7-2-2002.
FILED 12-21-2001.
2,624,868. **BIG TEX**. STATE FAIR OF TEXAS, INC., (U.S. CLS.
2, 13, 23, 29, 30, 33, 40 AND 50). SN 76-353,772. PUB. 7-2-2002.
FILED 12-28-2001.
2,625,212 (*See Class 9 for this trademark*).

2,625,294 (*See Class 16 for this trademark*).

CLASS 22—CORDAGE AND FIBERS

2,622,757 (*See Class 6 for this trademark*).
2,623,318. **CANDY CANE**. DELAWARE CAPITAL FORMA-
TION, INC., (U.S. CLS. 1, 2, 7, 19, 22, 42 AND 50). SN 76-
143,765. PUB. 7-2-2002. FILED 10-10-2000.
2,623,325. **SHINE UP**. KURARAY CO., LTD., MULTIPLE
CLASS, (INT. CLS. 22 AND 23), (U.S. CLS. 1, 2, 7, 19, 22, 42,
43 AND 50). SN 76-145,256. PUB. 7-2-2002. FILED 10-11-2000.
2,623,370. **MARTIN COLOR-FI**. MARTIN COLOR-FI INCOR-
PORATED, MULTIPLE CLASS, (INT. CLS. 22 AND 23),
(U.S. CLS. 1, 2, 7, 19, 22, 42, 43 AND 50). SN 76-152,362. PUB.
7-2-2002. FILED 10-24-2000.
2,623,393 (*See Class 7 for this trademark*).
2,624,354. **GOLDEN VALLEY**. UNIVERSAL COOPERATIVES,
INC., (U.S. CLS. 1, 2, 7, 19, 22, 42 AND 50). SN 76-279,126.
PUB. 7-2-2002. FILED 7-2-2001.
2,624,721. **REPEAT**. COLLINS & AIKMAN FLOORCOVER-
INGS, INC., (U.S. CLS. 1, 2, 7, 19, 22, 42 AND 50). SN 76-
335,000. PUB. 7-2-2002. FILED 11-7-2001.

CLASS 23—YARNS AND THREADS

2,622,750. **QIVIUK AS SOFT AS A CLOUD AND DESIGN**.
JACQUES CARTIER CLOTHIERS, BANFF INC., MULTI-
PLE CLASS, (INT. CLS. 23 AND 25), (U.S. CLS. 22, 39 AND
43). SN 75-831,588. PUB. 7-2-2002. FILED 10-25-1999.
2,622,757 (*See Class 6 for this trademark*).
2,623,325 (*See Class 22 for this trademark*).
2,623,370 (*See Class 22 for this trademark*).

CLASS 24—FABRICS

2,622,618. **AREA AND DESIGN**. AREA, INC., (U.S. CLS. 42
AND 50). SN 75-624,196. PUB. 7-2-2002. FILED 1-20-1999.
2,622,757 (*See Class 6 for this trademark*).
2,622,777. **SNUGGLE POUCH**. QUINTANA, DANIEL T., (U.S.
CLS. 42 AND 50). SN 75-858,651. PUB. 7-2-2002. FILED 11-
29-1999.
2,622,780. **CHLOROBAN**. SIBIU PTY LTD, (U.S. CLS. 42 AND
50). SN 75-861,429. PUB. 7-2-2002. FILED 12-1-1999.
2,622,932. **CALIWEB**. SCHMIDT, GUNTER F., MULTIPLE
CLASS, (INT. CLS. 24 AND 25), (U.S. CLS. 22, 39, 42 AND
50). SN 76-018,765. PUB. 7-2-2002. FILED 4-5-2000.
2,622,957. **MAS D'OUSVAN AND DESIGN**. LAMY, BRUNO,
(U.S. CLS. 42 AND 50). SN 76-033,079. PUB. 7-2-2002. FILED
4-21-2000.
2,623,008. **MY LITTLE BLANKIE (STYLIZED)**. DAYDREA-
MERS INC., (U.S. CLS. 42 AND 50). SN 76-055,831. PUB. 7-2-
2002. FILED 5-19-2000.
2,623,040 (*See Class 7 for this trademark*).
2,623,099. **CLASSIC POOH AND DESIGN**. DISNEY ENTER-
PRISES, INC., (U.S. CLS. 42 AND 50). SN 76-087,645. PUB. 7-
2-2002. FILED 7-12-2000.
2,623,567. **WENDY BELLISSIMO BABY 'N' KIDS AND DE-
SIGN**. FREDDIE'S DAISY, INC., MULTIPLE CLASS, (INT.
CLS. 24, 25 AND 42), (U.S. CLS. 22, 39, 42, 50, 100 AND 101).
SN 76-182,781. PUB. 7-2-2002. FILED 12-18-2000.
2,623,722. **LISA CORTI**. SANTINI, ANNA LUISA, MULTIPLE
CLASS, (INT. CLS. 24 AND 25), (U.S. CLS. 22, 39, 42 AND
50). SN 76-202,821. PUB. 7-2-2002. FILED 1-31-2001.
2,623,975. **COCOON AND DESIGN**. COCOON (NORTH
AMERICA) INC., (U.S. CLS. 42 AND 50). SN 76-236,052.
PUB. 7-2-2002. FILED 4-6-2001.
2,624,021 (*See Class 18 for this trademark*).
2,624,543. **XAMAX**. XAMAX INDUSTRIES, INC., (U.S. CLS.
42 AND 50). SN 76-310,050. PUB. 7-2-2002. FILED 9-10-2001.
2,624,668 (*See Class 16 for this trademark*).
2,624,922. **AQUASPA**. DARREN FORBES, INC., (U.S. CLS. 42

AND 50). SN 76-365,437. PUB. 7-2-2002. FILED 2-1-2002.
 2,624,998. **TECHNOWOOL**. JOHN RICH AND SONS INVESTMENT HOLDING COMPANY, MULTIPLE CLASS, (INT. CLS. 24 AND 25), (U.S. CLS. 22, 39, 42 AND 50). SN 78-039,327. PUB. 7-2-2002. FILED 12-14-2000.
 2,625,058. **ROTARY INTERNATIONAL**. ROTARY INTERNATIONAL, (U.S. CLS. 42 AND 50). SN 78-055,178. PUB. 7-2-2002. FILED 3-27-2001.
 2,625,078 (*See Class 20 for this trademark*).
 2,625,305. **BESTGUARD**. BEST VALUE TEXTILES, INC., (U.S. CLS. 42 AND 50). SN 78-104,158. PUB. 7-2-2002. FILED 1-22-2002.

CLASS 25—CLOTHING

2,622,501. **OLYMPUS GYM AND DESIGN**. OLYMPUS GYM, INC., (U.S. CL. 39). SN 74-186,613. PUB. 9-28-1993. FILED 7-19-1991.
 2,622,504. **COWBOY UP**. WYOMING WEST DESIGNS, LLC, ASSIGNEE OF; BY ASSIGNMENT CRAIG, MELVIN, (U.S. CLS. 22 AND 39). SN 74-557,077. PUB. 7-2-2002. FILED 8-4-1994.
 2,622,507 (*See Class 9 for this trademark*).
 2,622,519. **FORSYTHE**. FORSYTHE RACING, INC., (U.S. CLS. 22 AND 39). SN 75-220,215. PUB. 1-8-2002. FILED 12-31-1996.
 2,622,529. **DIGITALMONSTER**. KABUSHIKI KAISHA BANDAI, (U.S. CLS. 22 AND 39). SN 75-328,712. PUB. 3-21-2000. FILED 7-22-1997.
 2,622,531. **MARINE BIOLOGICAL LABORATORY WOODS HOLE 1888 AND DESIGN**. MARINE BIOLOGICAL LABORATORY, (U.S. CLS. 22 AND 39). SN 75-370,471. PUB. 7-2-2002. FILED 10-8-1997.
 2,622,557. **FLOAT THE FLOATING FASHION AND DESIGN**. FLOAT SRL, (U.S. CLS. 22 AND 39). SN 75-487,560. PUB. 3-28-2000. FILED 5-19-1998.
 2,622,578 (*See Class 16 for this trademark*).
 2,622,581. **JR JESUS RULES (STYLIZED)**. JETER, RODERICK, BY ASSIGNMENT JETER REAL ESTATE, (U.S. CLS. 22 AND 39). SN 75-561,994. PUB. 7-2-2002. FILED 9-12-1998.
 2,622,584. **LOVEYWEAR AND DESIGN**. NELSON, IRIS, (U.S. CLS. 22 AND 39). SN 75-568,787. PUB. 9-5-2000. FILED 10-9-1998.
 2,622,591. **BAINBRIDGE AND DESIGN**. MARINE ENTERPRISE PROJECTS - SOCIETA' UNIPERSONALE DI ALBERTO FIORENZI - S.R.L., (U.S. CLS. 22 AND 39). SN 75-582,031. PUB. 11-7-2000. FILED 11-3-1998.
 2,622,599. **IT'S ALL GOOD**. SWALLET, INC., (U.S. CLS. 22 AND 39). SN 75-596,911. PUB. 7-2-2002. FILED 11-30-1998.
 2,622,628. **D-ISAPPEAR**. COURTAULDS TEXTILES (HOLDINGS) LIMITED, (U.S. CLS. 22 AND 39). SN 75-640,584. PUB. 7-2-2002. FILED 2-12-1999.
 2,622,634. **CRYPTO**. TWO TSUNAMI PRODUCTIONS, INC., (U.S. CLS. 22 AND 39). SN 75-660,805. PUB. 5-21-2002. FILED 3-15-1999.
 2,622,663. **CLUTCH AND DESIGN**. GUKURAKUCHO KABUSHIKI KAISHA, BY CHANGE OF NAME KABUSHIKI KAISHA KURATCHI, (U.S. CLS. 22 AND 39). SN 75-716,160. PUB. 8-15-2000. FILED 5-26-1999.
 2,622,670. **CAC AND DESIGN**. CAMPBELLSVILLE APPAREL COMPANY, LLC, (U.S. CLS. 22 AND 39). SN 75-728,759. PUB. 7-2-2002. FILED 10-30-1999.
 2,622,681. **ALTAVISTA**. ABACUS 2000 S.R.L., BY ASSIGNMENT ALTA VISTA SRL, (U.S. CLS. 22 AND 39). SN 75-742,386. PUB. 10-31-2000. FILED 7-2-1999.
 2,622,688 (*See Class 18 for this trademark*).
 2,622,702. **LEMME LICKIT AND DESIGN**. RICHARD WAYNE CAMPBELL, INC., BY ASSIGNMENT CAMPBELL, RICHARD WAYNE, (U.S. CLS. 22 AND 39). SN 75-773,978. PUB. 7-2-2002. FILED 8-12-1999.
 2,622,708. **MISCELLANEOUS DESIGN**. CAMPER, S.L., (U.S. CLS. 22 AND 39). SN 75-783,018. PUB. 12-4-2001. FILED 8-24-1999.
 2,622,735 (*See Class 16 for this trademark*).
 2,622,739. **TULA'S TUTUS**. TULA'S TUTUS, LLC, (U.S. CLS. 22 AND 39). SN 75-824,368. PUB. 7-2-2002. FILED 10-18-1999.
 2,622,750 (*See Class 23 for this trademark*).
 2,622,753. **SPORTSPHERE**. SOCCER INTERNATIONAL J.S. INC., DBA SPORTSPHERE, (U.S. CLS. 22 AND 39). SN 75-836,334. PUB. 7-2-2002. FILED 10-28-1999.
 2,622,755. **PARTICIPATE IN LIFE**. BRENT ALLEN, INC., MULTIPLE CLASS, (INT. CLS. 25, 35 AND 41), (U.S. CLS. 22, 39, 100, 101, 102 AND 107). SN 75-837,328. PUB. 8-28-2001. FILED 11-1-1999.
 2,622,762. **BOSOM BUDDIES BODYWEAR (STYLIZED)**. BODYWEAR BY BOSOM BUDDIES, INC., (U.S. CLS. 22 AND 39). SN 75-848,253. PUB. 7-2-2002. FILED 11-10-1999.
 2,622,768 (*See Class 8 for this trademark*).
 2,622,788. **D&K SPORT AND DESIGN**. ARACHNE INC., (U.S. CLS. 22 AND 39). SN 75-869,265. PUB. 7-2-2002. FILED 12-13-1999.
 2,622,805. **WASSERMAN**. ANNA GROUP, INC., THE, (U.S. CLS. 22 AND 39). SN 75-888,414. PUB. 7-2-2002. FILED 1-6-2000.
 2,622,820. **JACK FROST**. HABAND COMPANY, INC., (U.S. CLS. 22 AND 39). SN 75-897,002. PUB. 7-2-2002. FILED 1-13-2000.
 2,622,844. **WAYNESBOROUGH COUNTRY CLUB**. WAYNESBOROUGH COUNTRY CLUB, MULTIPLE CLASS, (INT. CLS. 25, 28, 41 AND 42), (U.S. CLS. 22, 23, 38, 39, 50, 100, 101 AND 107). SN 75-911,715. PUB. 7-2-2002. FILED 2-8-2000.
 2,622,850 (*See Class 9 for this trademark*).
 2,622,857 (*See Class 16 for this trademark*).
 2,622,868 (*See Class 18 for this trademark*).
 2,622,878. **LEA ROME**. LEA ROME PARIS, (U.S. CLS. 22 AND 39). SN 75-939,280. PUB. 7-2-2002. FILED 3-9-2000.
 2,622,886 (*See Class 18 for this trademark*).
 2,622,890 (*See Class 8 for this trademark*).
 2,622,896 (*See Class 16 for this trademark*).
 2,622,901 (*See Class 9 for this trademark*).
 2,622,932 (*See Class 24 for this trademark*).
 2,622,998. **FASHION CLICK**. FASHION CLICK, INC., (U.S. CLS. 22 AND 39). SN 76-052,024. PUB. 7-2-2002. FILED 5-19-2000.
 2,623,045. **ESQUIVEL**. ESQUIVEL APPAREL, (U.S. CLS. 22 AND 39). SN 76-066,259. PUB. 7-2-2002. FILED 6-7-2000.
 2,623,047 (*See Class 3 for this trademark*).
 2,623,055 (*See Class 14 for this trademark*).
 2,623,074. **OUTERSPORT**. ALLEN AND ASSOCIATES, INC., (U.S. CLS. 22 AND 39). SN 76-077,613. PUB. 7-2-2002. FILED 6-26-2000.
 2,623,084. **MOONDOGGIES**. MOONDOGGIES, INC., MULTIPLE CLASS, (INT. CLS. 25 AND 42), (U.S. CLS. 22, 39, 100 AND 101). SN 76-081,488. PUB. 7-2-2002. FILED 6-30-2000.
 2,623,110. **SE SENTIR LIBRE**. REDCATS SOCIETE ANONYME, (U.S. CLS. 22 AND 39). SN 76-089,743. PUB. 7-2-2002. FILED 7-17-2000.
 2,623,113 (*See Class 18 for this trademark*).
 2,623,118. **BRICE**. DISTRI-GROS, (U.S. CLS. 22 AND 39). SN 76-091,745. PUB. 7-2-2002. FILED 7-20-2000.
 2,623,176. **A + A2**. JAMATEX, INC., (U.S. CLS. 22 AND 39). SN 76-111,396. PUB. 7-2-2002. FILED 8-17-2000.
 2,623,177. **G-RAG**. GOLDEN CROSS TRADING, INC., (U.S. CLS. 22 AND 39). SN 76-111,789. PUB. 7-2-2002. FILED 8-17-2000.
 2,623,178 (*See Class 9 for this trademark*).
 2,623,183. **KANSAS CITY MONARCHS**. NEGRO LEAGUES BASEBALL MUSEUM, INC., (U.S. CLS. 22 AND 39). SN 76-112,771. PUB. 7-2-2002. FILED 8-18-2000.
 2,623,186. **SWINE AND DESIGN**. CLAYTON D. RILEY AND DARRELL J. HICKEY PARTNERSHIP, THE, (U.S. CLS. 22 AND 39). SN 76-113,782. PUB. 7-2-2002. FILED 8-21-2000.
 2,623,203 (*See Class 3 for this trademark*).
 2,623,236. **HIDE-A-POCKET**. MARSHALL, RUTH, (U.S. CLS. 22 AND 39). SN 76-128,341. PUB. 7-2-2002. FILED 9-15-2000.
 2,623,239. **EH EVERETT HALL (STYLIZED)**. HALL, EVERETT T., (U.S. CLS. 22 AND 39). SN 76-128,876. PUB. 7-2-2002. FILED 8-7-2000.
 2,623,297. **ICIX AND DESIGN**. SHOETRADING.COM INCORPORATED, (U.S. CLS. 22 AND 39). SN 76-139,166. PUB. 7-2-2002. FILED 10-2-2000.
 2,623,346. **DOBY BRODA (STYLIZED)**. BRODA, DOMINIQUE, (U.S. CLS. 22 AND 39). SN 76-148,711. PUB. 7-2-2002. FILED 10-17-2000.

- 2,623,391. **WINDSPRINT**. BMC PLAYERS INC., (U.S. CLS. 22 AND 39). SN 76-155,885. PUB. 7-2-2002. FILED 10-30-2000.
- 2,623,394. **FLYDANNA**. BALBOA MANUFACTURING CO. LLC, (U.S. CLS. 22 AND 39). SN 76-156,513. PUB. 7-2-2002. FILED 10-31-2000.
- 2,623,422. **LILICA RIPILICA AND DESIGN**. MARISOL S.A., (U.S. CLS. 22 AND 39). SN 76-160,159. PUB. 7-2-2002. FILED 11-6-2000.
- 2,623,442. **VERONIQUE DELACHAUX (STYLIZED)**. JACADI, (U.S. CLS. 22 AND 39). SN 76-164,010. PUB. 7-2-2002. FILED 11-13-2000.
- 2,623,459. **MISCELLANEOUS DESIGN**. ADOLF RIEDL GMBH & CO., (U.S. CLS. 22 AND 39). SN 76-166,877. PUB. 7-2-2002. FILED 11-16-2000.
- 2,623,471 (*See Class 18 for this trademark*).
- 2,623,486. **MODISCH**. MODISCH SPORTSWEAR, INC., (U.S. CLS. 22 AND 39). SN 76-171,160. PUB. 7-2-2002. FILED 11-27-2000.
- 2,623,493. **ST. JOHN**. ST. JOHN KNITS, INC., (U.S. CLS. 22 AND 39). SN 76-172,224. PUB. 7-2-2002. FILED 11-28-2000.
- 2,623,511. **OBIE AND DESIGN**. OBREGON, TEODORO, (U.S. CLS. 22 AND 39). SN 76-174,185. PUB. 7-2-2002. FILED 12-1-2000.
- 2,623,535. **A AND DESIGN**. INTERSPORT, INC., (U.S. CLS. 22 AND 39). SN 76-177,327. PUB. 7-2-2002. FILED 12-7-2000.
- 2,623,536. **BE WILD AND DESIGN**. P.W.H. ORIGINALS AVV, (U.S. CLS. 22 AND 39). SN 76-177,574. PUB. 7-2-2002. FILED 12-7-2000.
- 2,623,537. **THE CHEMISTRY OF FASHION**. KMT ENTERPRISES, LLC, (U.S. CLS. 22 AND 39). SN 76-177,710. PUB. 7-2-2002. FILED 12-8-2000.
- 2,623,538. **SAJEDA AND DESIGN**. MOH'D ABU TAHA & RIZEQ BANI HANI CO, (U.S. CLS. 22 AND 39). SN 76-177,717. PUB. 7-2-2002. FILED 12-7-2000.
- 2,623,565. **CASAMODA**. LORDMOND CORP., (U.S. CLS. 22 AND 39). SN 76-181,848. PUB. 8-14-2001. FILED 12-18-2000.
- 2,623,567 (*See Class 24 for this trademark*).
- 2,623,574. **O OKLAHOMA STATE UNIVERSITY AND DESIGN**. BOARD OF REGENTS FOR OKLAHOMA STATE UNIVERSITY, (U.S. CLS. 22 AND 39). SN 76-183,863. PUB. 7-2-2002. FILED 12-19-2000.
- 2,623,605 (*See Class 18 for this trademark*).
- 2,623,614. **POTBELLY SANDWICH WORKS AND DESIGN**. POTBELLY SANDWICH WORKS, LLC, BY CHANGE OF NAME POTBELLY SANDWICH WORKS, LLC, (U.S. CLS. 22 AND 39). SN 76-189,215. PUB. 7-2-2002. FILED 1-3-2001.
- 2,623,654 (*See Class 16 for this trademark*).
- 2,623,675. **DRITTI**. ROGERS, FAWN, (U.S. CLS. 22 AND 39). SN 76-197,124. PUB. 7-2-2002. FILED 1-18-2001.
- 2,623,677. **MISCELLANEOUS DESIGN**. WOODS COMMUNICATIONS LTD., MULTIPLE CLASS, (INT. CLS. 25 AND 41), (U.S. CLS. 22, 39, 100, 101 AND 107). SN 76-197,321. PUB. 7-2-2002. FILED 1-19-2001.
- 2,623,688 (*See Class 14 for this trademark*).
- 2,623,716. **PURPLE SUNDAY**. FREEDMAN, MICHAEL A., (U.S. CLS. 22 AND 39). SN 76-202,366. PUB. 7-2-2002. FILED 1-30-2001.
- 2,623,722 (*See Class 24 for this trademark*).
- 2,623,728 (*See Class 16 for this trademark*).
- 2,623,740. **CINTI**. CINTI S.P.A., (U.S. CLS. 22 AND 39). SN 76-203,979. PUB. 7-2-2002. FILED 2-2-2001.
- 2,623,752. **VANS AND DESIGN**. VANS, INC., (U.S. CLS. 22 AND 39). SN 76-205,239. PUB. 7-2-2002. FILED 2-6-2001.
- 2,623,754. **RICE AND DESIGN**. WILLIAM MARSH RICE UNIVERSITY, (U.S. CLS. 22 AND 39). SN 76-205,724. PUB. 7-2-2002. FILED 2-6-2001.
- 2,623,842 (*See Class 16 for this trademark*).
- 2,623,851. **FLORIDA STATE AND DESIGN**. FLORIDA STATE UNIVERSITY, THE, BY CHANGE OF NAME FLORIDA BOARD OF REGENTS, FOR AND ON BEHALF OF FLORIDA STATE UNIVERSITY, MULTIPLE CLASS, (INT. CLS. 25 AND 41), (U.S. CLS. 22, 39, 100, 101 AND 107). SN 76-219,842. PUB. 7-2-2002. FILED 3-5-2001.
- 2,623,880. **VITTORIO ST. ANGELO**. HUA XIN INTERNATIONAL, INC., (U.S. CLS. 22 AND 39). SN 76-222,942. PUB. 7-2-2002. FILED 3-12-2001.
- 2,623,884 (*See Class 18 for this trademark*).
- 2,623,890. **VIA MARTE AND DESIGN**. ARMANI SHOES CORPORATION, THE, (U.S. CLS. 22 AND 39). SN 76-224,759. PUB. 7-2-2002. FILED 3-15-2001.
- 2,623,908. **RADAR**. BURTON CORPORATION, THE, (U.S. CLS. 22 AND 39). SN 76-226,926. PUB. 7-2-2002. FILED 3-19-2001.
- 2,623,945. **SPEEDDIVA**. SPEEDDIVA LLC, (U.S. CLS. 22 AND 39). SN 76-232,600. PUB. 2-19-2002. FILED 3-28-2001.
- 2,623,960 (*See Class 14 for this trademark*).
- 2,623,984. **SATIN SULTRESS**. MISS ELAINE, INC., (U.S. CLS. 22 AND 39). SN 76-236,794. PUB. 7-2-2002. FILED 4-6-2001.
- 2,623,997 (*See Class 16 for this trademark*).
- 2,624,005. **LORD OF THE MANOR**. BARELA, THEODORE, (U.S. CLS. 22 AND 39). SN 76-238,575. PUB. 7-2-2002. FILED 4-11-2001.
- 2,624,020. **WOMEN'S BASKETBALL HALL OF FAME**. GREATER KNOXVILLE SPORTS CORPORATION, (U.S. CLS. 22 AND 39). SN 76-240,711. PUB. 7-2-2002. FILED 4-13-2001.
- 2,624,021 (*See Class 18 for this trademark*).
- 2,624,034. **CONDOR RIDGE**. ZOOLOGICAL SOCIETY OF SAN DIEGO, INC., MULTIPLE CLASS, (INT. CLS. 25, 28 AND 41), (U.S. CLS. 22, 23, 38, 39, 50, 100, 101 AND 107). SN 76-241,860. PUB. 7-2-2002. FILED 4-17-2001.
- 2,624,043 (*See Class 18 for this trademark*).
- 2,624,044 (*See Class 9 for this trademark*).
- 2,624,045. **S AND DESIGN**. SOUTHERN SUN, (U.S. CLS. 22 AND 39). SN 76-242,604. PUB. 7-2-2002. FILED 4-17-2001.
- 2,624,092. **BIG BOB GIBSON BAR-B-Q**. BIG BOB GIBSON BAR-B-Q, INC., MULTIPLE CLASS, (INT. CLS. 25, 30 AND 42), (U.S. CLS. 22, 39, 46, 100 AND 101). SN 76-247,785. PUB. 7-2-2002. FILED 4-30-2001.
- 2,624,096. **TANISHA**. CITICRAZE CASUALWEAR INC, (U.S. CLS. 22 AND 39). SN 76-248,120. PUB. 7-2-2002. FILED 4-30-2001.
- 2,624,117 (*See Class 9 for this trademark*).
- 2,624,157. **BAY MILLS RESORT & CASINOS AND DESIGN**. BAY MILLS INDIAN COMMUNITY, MULTIPLE CLASS, (INT. CLS. 25 AND 41), (U.S. CLS. 22, 39, 100, 101 AND 107). SN 76-257,027. PUB. 7-2-2002. FILED 5-14-2001.
- 2,624,177. **KARL KANI JEANS**. KARL KANI INTERNATIONAL, INC., (U.S. CLS. 22 AND 39). SN 76-259,680. PUB. 7-2-2002. FILED 5-21-2001.
- 2,624,191. **MPC**. M/T OWNER AB, (U.S. CLS. 22 AND 39). SN 76-260,484. PUB. 7-2-2002. FILED 5-21-2001.
- 2,624,192. **AV (STYLIZED)**. ABACUS 2000 SRL, (U.S. CLS. 22 AND 39). SN 76-260,604. PUB. 7-2-2002. FILED 5-22-2001.
- 2,624,210. **MAJU (STYLIZED)**. MARISOL S/A., (U.S. CLS. 22 AND 39). SN 76-262,735. PUB. 7-2-2002. FILED 5-24-2001.
- 2,624,278. **SPONGEBOB SQUAREPANTS**. VIACOM INTERNATIONAL INC., (U.S. CLS. 22 AND 39). SN 76-269,056. PUB. 7-2-2002. FILED 6-7-2001.
- 2,624,283. **OPRY MILLS AND DESIGN**. OPRY MILLS LIMITED PARTNERSHIP, (U.S. CLS. 22 AND 39). SN 76-269,784. PUB. 7-2-2002. FILED 6-11-2001.
- 2,624,289. **VAN HEUSEN**. PHILLIPS-VAN HEUSEN CORPORATION, (U.S. CLS. 22 AND 39). SN 76-270,443. PUB. 7-2-2002. FILED 6-13-2001.
- 2,624,303. **DARTMOUTH COLLEGE**. TRUSTEES OF DARTMOUTH COLLEGE, DBA DARTMOUTH COLLEGE, (U.S. CLS. 22 AND 39). SN 76-272,058. PUB. 7-2-2002. FILED 6-15-2001.
- 2,624,352. **STEAM BY JACQUI**. STEAM BY JACQUI, (U.S. CLS. 22 AND 39). SN 76-278,504. PUB. 7-2-2002. FILED 7-2-2001.
- 2,624,356. **STEAMIES**. STEAM BY JACQUI, (U.S. CLS. 22 AND 39). SN 76-279,266. PUB. 7-2-2002. FILED 7-2-2001.
- 2,624,360. **FRUIT BUNCH (STYLIZED)**. FRUIT OF THE LOOM, INC., (U.S. CLS. 22 AND 39). SN 76-280,210. PUB. 7-2-2002. FILED 6-26-2001.
- 2,624,454. **CLUB MYSTIC**. LITTLE SIX, INC., (U.S. CLS. 22 AND 39). SN 76-293,356. PUB. 7-2-2002. FILED 8-1-2001.
- 2,624,469. **DREAMPOST**. WALKER, SANDRA S., AND WALKER, DON D., (U.S. CLS. 22 AND 39). SN 76-295,957. PUB. 7-2-2002. FILED 8-7-2001.
- 2,624,482 (*See Class 3 for this trademark*).
- 2,624,490 (*See Class 16 for this trademark*).
- 2,624,504. **GRIFONI**. MANILA S.R.L., (U.S. CLS. 22 AND 39). SN 76-302,938. PUB. 7-2-2002. FILED 8-22-2001.

2,624,539. **DRYJOYS**. ACUSHNET COMPANY, (U.S. CLS. 22 AND 39). SN 76-309,221. PUB. 7-2-2002. FILED 9-6-2001.

2,624,540. **EILEEN FISHER**. EILEEN FISHER, INC., (U.S. CLS. 22 AND 39). SN 76-309,460. PUB. 7-2-2002. FILED 9-6-2001.

2,624,617. **ARTVALE**. RICK FRIEDMAN ENTERPRISES, LTD. (U.S. CLS. 22 AND 39). SN 76-322,567. PUB. 7-2-2002. FILED 10-9-2001.

2,624,672. **ZONNERRE AND DESIGN**. TSANG, SHIRLEY M, (U.S. CLS. 22 AND 39). SN 76-327,965. PUB. 7-2-2002. FILED 10-22-2001.

2,624,690. **DANNY NOBLE OFF THE CUFF (STYLIZED)**. NOBLE & CO., INC., (U.S. CLS. 22 AND 39). SN 76-330,239. PUB. 7-2-2002. FILED 10-29-2001.

2,624,707. **AP AND DESIGN**. ALWAYS POSITIVE, INC., (U.S. CLS. 22 AND 39). SN 76-332,743. PUB. 7-2-2002. FILED 11-2-2001.

2,624,711. **WHEN ONLY THE FINEST WILL DO**. MERELINDA FARM L.L.C., DBA ALPACA.COM L.L.C., MULTIPLE CLASS. (INT. CLS. 25 AND 35), (U.S. CLS. 22, 39, 100, 101 AND 102). SN 76-333,434. PUB. 7-2-2002. FILED 11-1-2001.

2,624,734 (*See Class 10 for this trademark*).

2,624,763. **ODOR-EATERS**. COMBE INCORPORATED, (U.S. CLS. 22 AND 39). SN 76-341,274. PUB. 7-2-2002. FILED 11-26-2001.

2,624,794. **SASSY SENSE**. SUH, MYUNG IN, (U.S. CLS. 22 AND 39). SN 76-345,266. PUB. 7-2-2002. FILED 12-6-2001.

2,624,802. **BABY UGGS**. UGG HOLDINGS, INC., (U.S. CLS. 22 AND 39). SN 76-346,080. PUB. 7-2-2002. FILED 12-6-2001.

2,624,821. **SPORT ATTACK**. JOY ATHLETIC, INC., (U.S. CLS. 22 AND 39). SN 76-348,645. PUB. 7-2-2002. FILED 12-13-2001.

2,624,863. **RUMBLE TUMBLE**. BOSCORALE OPERATING, LLC, (U.S. CLS. 22 AND 39). SN 76-352,978. PUB. 7-2-2002. FILED 12-28-2001.

2,624,873. **RUNTELDTAT TOUR**. LAWRENCE, MARTIN, (U.S. CLS. 22 AND 39). SN 76-354,805. PUB. 7-2-2002. FILED 1-2-2002.

2,624,877. **A VIEW FROM A BROAD**. RELEVANT PRODUCTS, LLC, (U.S. CLS. 22 AND 39). SN 76-355,351. PUB. 7-2-2002. FILED 1-4-2002.

2,624,907. **C LEBA AND DESIGN**. LEBA, CHRIS DUNG, (U.S. CLS. 22 AND 39). SN 76-359,449. PUB. 7-2-2002. FILED 1-17-2002.

2,624,923. **CHAIN SAW**. OAKLEY, INC., (U.S. CLS. 22 AND 39). SN 76-365,634. PUB. 7-2-2002. FILED 1-31-2002.

2,624,924. **AUTHORITEASE**. COOLNOTCRUEL, INC., (U.S. CLS. 22 AND 39). SN 76-365,642. PUB. 7-2-2002. FILED 1-31-2002.

2,624,934. **MISCELLANEOUS DESIGN**. ADAMS, BRIAN, AND DESIRE, WOODLORD, (U.S. CLS. 22 AND 39). SN 76-367,489. PUB. 7-2-2002. FILED 2-6-2002.

2,624,939. **CLEARWATER LIGHT**. AVADO BRANDS INC., (U.S. CLS. 22 AND 39). SN 76-368,058. PUB. 7-2-2002. FILED 2-7-2002.

2,624,940. **ENTICE**. ALLURE, INC., (U.S. CLS. 22 AND 39). SN 76-368,145. PUB. 7-2-2002. FILED 2-8-2002.

2,624,998 (*See Class 24 for this trademark*).

2,625,010. **ONLY YOU**. PLAYTEX APPAREL, INC., (U.S. CLS. 22 AND 39). SN 78-042,995. PUB. 7-2-2002. FILED 1-12-2001.

2,625,012. **HANES HER WAY SOFT & SEAMLESS**. SARA LEE CORPORATION, (U.S. CLS. 22 AND 39). SN 78-043,420. PUB. 7-2-2002. FILED 1-16-2001.

2,625,059 (*See Class 14 for this trademark*).

2,625,060 (*See Class 14 for this trademark*).

2,625,065. **PARADE P AND DESIGN**. PAYLESS SHOE-SOURCE WORLDWIDE, INC., (U.S. CLS. 22 AND 39). SN 78-056,776. PUB. 7-2-2002. FILED 4-4-2001.

2,625,078 (*See Class 20 for this trademark*).

2,625,094. **MOTOXGIRL**. BLACK HOLE INDUSTRIES, (U.S. CLS. 22 AND 39). SN 78-063,006. PUB. 7-2-2002. FILED 5-10-2001.

2,625,181. **SPORTS PRODUCTS USA AND DESIGN**. PATRIOT INDUSTRIES, INC., (U.S. CLS. 22 AND 39). SN 78-081,244. PUB. 7-2-2002. FILED 8-27-2001.

2,625,198. **JUDI FLOWERS FOR BONJOUR FLEURETTE (STYLIZED)**. FLOWERS, JUDITH T., (U.S. CLS. 22 AND 39). SN 78-083,657. PUB. 7-2-2002. FILED 9-12-2001.

2,625,208. **MOTOR BRANDS USA**. POPKAPSULE, INC., (U.S.

CLS. 22 AND 39). SN 78-087,194. PUB. 7-2-2002. FILED 10-5-2001.

2,625,280. **MARI ART**. MARIA'S BOUTIQUE, (U.S. CLS. 22 AND 39). SN 78-098,749. PUB. 7-2-2002. FILED 12-17-2001.

2,625,300. **DUNNRIGHT & DUNNRIGHT**. DRAYTON, SHAWN, AND VASQUEZ, ARGEE, (U.S. CLS. 22 AND 39). SN 78-102,564. PUB. 7-2-2002. FILED 1-14-2002.

CLASS 26—FANCY GOODS

2,622,757 (*See Class 6 for this trademark*).

2,622,857 (*See Class 16 for this trademark*).

2,623,645 (*See Class 14 for this trademark*).

2,623,668. **STORM AND DESIGN**. RIRI SA, (U.S. CLS. 37, 39, 40, 42 AND 50). SN 76-196,686. PUB. 7-2-2002. FILED 1-19-2001.

2,624,571. **TAKE OUR DAUGHTERS TO WORK**. MS. FOUNDATION FOR WOMEN, (U.S. CLS. 37, 39, 40, 42 AND 50). SN 76-314,213. PUB. 7-2-2002. FILED 9-19-2001.

2,624,603. **RHINE STONE ART (STYLIZED)**. IT'S SO EASY, LTD., (U.S. CLS. 37, 39, 40, 42 AND 50). SN 76-320,421. PUB. 7-2-2002. FILED 10-3-2001.

2,624,648. **PICKDINI**. SCHACH, BERNADINE, (U.S. CLS. 37, 39, 40, 42 AND 50). SN 76-325,354. PUB. 7-2-2002. FILED 10-15-2001.

2,624,793. **HOT STUFF COLLECTION AND DESIGN**. BEAUTY PLUS TRADING CO., INC., (U.S. CLS. 37, 39, 40, 42 AND 50). SN 76-345,082. PUB. 7-2-2002. FILED 12-6-2001.

2,625,050. **HUMMER**. GENERAL MOTORS CORPORATION, (U.S. CLS. 37, 39, 40, 42 AND 50). SN 78-053,985. PUB. 7-2-2002. FILED 3-20-2001.

CLASS 27—FLOOR COVERINGS

2,622,757 (*See Class 6 for this trademark*).

2,622,890 (*See Class 8 for this trademark*).

2,622,977 (*See Class 19 for this trademark*).

2,623,343 (*See Class 19 for this trademark*).

2,624,047. **ALMA AND DESIGN**. ILLINOIS TOOL WORKS, INC., BY ASSIGNMENT ALMA INC., (U.S. CLS. 19, 20, 37, 42 AND 50). SN 76-242,633. PUB. 7-2-2002. FILED 4-18-2001.

2,624,630. **OUR GRASS IS ALWAYS GREENER**. SOUTHWEST RECREATIONAL INDUSTRIES, INC., (U.S. CLS. 19, 20, 37, 42 AND 50). SN 76-323,398. PUB. 7-2-2002. FILED 10-10-2001.

2,625,078 (*See Class 20 for this trademark*).

2,625,191. **CORNER MAGIC**. GANDY, SUSAN, AND GANDY, ALLAN, (U.S. CLS. 19, 20, 37, 42 AND 50). SN 78-082,986. PUB. 7-2-2002. FILED 9-6-2001.

CLASS 28—TOYS AND SPORTING GOODS

2,622,507 (*See Class 9 for this trademark*).

2,622,578 (*See Class 16 for this trademark*).

2,622,588. **FOX**. FOX DESIGN INTERNATIONAL LIMITED, (U.S. CLS. 22, 23, 38 AND 50). SN 75-572,329. PUB. 12-14-1999. FILED 10-19-1998.

2,622,616. **MISCELLANEOUS DESIGN**. KABUSHIKI KAISHA BANDAI, (U.S. CLS. 22, 23, 38 AND 50). SN 75-620,746. PUB. 4-18-2000. FILED 1-14-1999.

2,622,641. **CTL AND DESIGN**. CHI HONG TOY FACTORY LTD., (U.S. CLS. 22, 23, 38 AND 50). SN 75-672,471. PUB. 7-2-2002. FILED 4-1-1999.

2,622,746. **DREAM COLLECTION**. GI-GO TOYS FACTORY LTD., (U.S. CLS. 22, 23, 38 AND 50). SN 75-831,144. PUB. 7-2-2002. FILED 10-13-1999.

2,622,757 (*See Class 6 for this trademark*).

2,622,844 (*See Class 25 for this trademark*).

2,622,857 (*See Class 16 for this trademark*).

2,622,885. **MULTIPLE LAUNCH ROCKET SYSTEM**. LOCKHEED MARTIN CORPORATION, (U.S. CLS. 22, 23, 38

- AND 50). SN 75-979,663. PUB. 7-2-2002. FILED 1-14-1999.
2,622,890 (*See Class 8 for this trademark*).
2,622,896 (*See Class 16 for this trademark*).
2,622,901 (*See Class 9 for this trademark*).
2,622,914. **SALMO**. SALMO S.C., (U.S. CLS. 22, 23, 38 AND 50).
SN 76-007,965. PUB. 7-2-2002. FILED 3-23-2000.
2,622,918. **SNAPPIT**. SNAPPIT TOY, INC., MULTIPLE
CLASS. (INT. CLS. 28 AND 35), (U.S. CLS. 22, 23, 38, 50,
100, 101 AND 102). SN 76-009,768. PUB. 7-2-2002. FILED 3-
27-2000.
2,622,970. **WHO'S HAVING THIS BABY ANYWAY?**. BABY'S
BIRTH BENEFITS, LLC, (U.S. CLS. 22, 23, 38 AND 50). SN
76-038,721. PUB. 7-2-2002. FILED 4-27-2000.
2,622,982. **AUTO RESPONDERS**. TACK CHEUNG COR-
PORATION, (U.S. CLS. 22, 23, 38 AND 50). SN 76-046,216.
PUB. 1-30-2001. FILED 5-12-2000.
2,622,996 (*See Class 12 for this trademark*).
2,623,129. **EXECUTOYS**. CYI, INC., (U.S. CLS. 22, 23, 38 AND
50). SN 76-094,986. PUB. 7-2-2002. FILED 7-24-2000.
2,623,203 (*See Class 3 for this trademark*).
2,623,307. **STRATAKEY**. LEARNING KEY, INC., THE, (U.S.
CLS. 22, 23, 38 AND 50). SN 76-142,308. PUB. 7-2-2002.
FILED 10-6-2000.
2,623,408. **CHANNEL LOCK**. PACIFIC BAY INTERNA-
TIONAL, INC., (U.S. CLS. 22, 23, 38 AND 50). SN 76-
158,357. PUB. 12-11-2001. FILED 11-2-2000.
2,623,420. **LIGHTQUEST**. SIMMONS, THOMAS E II, (U.S.
CLS. 22, 23, 38 AND 50). SN 76-159,943. PUB. 7-2-2002.
FILED 11-6-2000.
2,623,439. **NAVIGATOR**. FORD MOTOR COMPANY, (U.S.
CLS. 22, 23, 38 AND 50). SN 76-163,096. PUB. 7-2-2002.
FILED 11-9-2000.
2,623,490. **SMARTBAITER**. BAITER-UP, INC., (U.S. CLS. 22,
23, 38 AND 50). SN 76-172,088. PUB. 7-2-2002. FILED 11-28-
2000.
2,623,559 (*See Class 9 for this trademark*).
2,623,568. **MISCELLANEOUS DESIGN**. GATEWAY, INC.,
(U.S. CLS. 22, 23, 38 AND 50). SN 76-182,826. PUB. 7-2-
2002. FILED 12-19-2000.
2,623,604. **STRIVE**. STRIVE ENTERPRISES, INC., (U.S. CLS.
22, 23, 38 AND 50). SN 76-188,217. PUB. 7-2-2002. FILED 1-2-
2001.
2,623,611. **WORLDS APART**. WORLDS APART LIMITED,
(U.S. CLS. 22, 23, 38 AND 50). SN 76-188,963. PUB. 7-2-2002.
FILED 1-3-2001.
2,623,618. **ANYTHING GOES AND DESIGN**. BROADNAX,
JOHN, (U.S. CLS. 22, 23, 38 AND 50). SN 76-189,651. PUB. 7-
2-2002. FILED 1-5-2001.
2,623,663. **HEX-CHEX**. CLASSIC SPORTING ENTERPRISES,
INC., (U.S. CLS. 22, 23, 38 AND 50). SN 76-195,712. PUB. 7-2-
2002. FILED 1-19-2001.
2,623,664. **SUPER S-D**. CLASSIC SPORTING ENTERPRISES,
INC., (U.S. CLS. 22, 23, 38 AND 50). SN 76-195,713. PUB. 7-2-
2002. FILED 1-19-2001.
2,623,670. **NEWFORM AND DESIGN**. VITAWELL S.P. A.,
(U.S. CLS. 22, 23, 38 AND 50). SN 76-196,797. PUB. 7-2-2002.
FILED 1-22-2001.
2,623,728 (*See Class 16 for this trademark*).
2,623,735. **SUSHI PARTY**. KABUSHIKI KAISHA BANDAI,
(U.S. CLS. 22, 23, 38 AND 50). SN 76-203,860. PUB. 7-2-2002.
FILED 2-2-2001.
2,623,839. **CAPT. HARRY'S FISHING SUPPLY AND DESIGN**.
CAPT. HARRY'S FISHING SUPPLY, MULTIPLE CLASS,
(INT. CLS. 28 AND 35), (U.S. CLS. 22, 23, 38, 50, 100, 101
AND 102). SN 76-218,489. PUB. 7-2-2002. FILED 3-2-2001.
2,623,842 (*See Class 16 for this trademark*).
2,623,881. **DIGGER**. ILLINOIS HIGH SCHOOL ASSOCIA-
TION, (U.S. CLS. 22, 23, 38 AND 50). SN 76-222,965. PUB.
7-2-2002. FILED 3-12-2001.
2,623,997 (*See Class 16 for this trademark*).
2,623,998. **FLOWBEE**. HUNTS, RICK, (U.S. CLS. 22, 23, 38
AND 50). SN 76-238,113. PUB. 7-2-2002. FILED 4-9-2001.
2,624,025. **KALEID-O-DISK AND DESIGN**. HEITZ, JAMES M.,
(U.S. CLS. 22, 23, 38 AND 50). SN 76-241,148. PUB. 7-2-2002.
FILED 4-13-2001.
2,624,027. **PROGRESSION WEIGHTED**. DUNLOP SLAZEN-
GER GROUP AMERICAS, (U.S. CLS. 22, 23, 38 AND 50). SN
76-241,184. PUB. 7-2-2002. FILED 4-16-2001.
2,624,034 (*See Class 25 for this trademark*).
2,624,050 (*See Class 6 for this trademark*).
2,624,069. **THE CHAD CHALLENGE**. HANKINS, R. JOHN,
DBA J & J FAMILY FUN, (U.S. CLS. 22, 23, 38 AND 50). SN
76-244,991. PUB. 7-2-2002. FILED 4-16-2001.
2,624,095. **CLUB CLIP AND DESIGN**. K.V. DREAMS, INC.,
(U.S. CLS. 22, 23, 38 AND 50). SN 76-248,027. PUB. 7-2-2002.
FILED 4-30-2001.
2,624,097. **BLACKBURNE**. ROBIN BLACKBURNE, LTD.,
DBA BLACKBURNE ADVANCED RACQUET SYSTEMS,
(U.S. CLS. 22, 23, 38 AND 50). SN 76-248,270. PUB. 7-2-2002.
FILED 4-30-2001.
2,624,107. **TORSO ROLLER**. IMPEX, INC., (U.S. CLS. 22, 23,
38 AND 50). SN 76-249,861. PUB. 7-2-2002. FILED 5-3-2001.
2,624,133. **COMBAT MATS**. BOWLING, MICHAEL A., (U.S.
CLS. 22, 23, 38 AND 50). SN 76-253,666. PUB. 7-2-2002.
FILED 5-8-2001.
2,624,135. **RED TOP TOY COMPANY**. FRONT PORCH
CLASSICS, INC., BY MERGER FRONT PORCH CLAS-
SICS, LLC, (U.S. CLS. 22, 23, 38 AND 50). SN 76-254,425.
PUB. 7-2-2002. FILED 5-8-2001.
2,624,159 (*See Class 9 for this trademark*).
2,624,181. **BUBBA DUCK**. AMERICAN PLASTICS INC., (U.S.
CLS. 22, 23, 38 AND 50). SN 76-259,884. PUB. 7-2-2002.
FILED 5-22-2001.
2,624,182. **THE ORIGINAL S'MORES**. MIDWEST OF CAN-
NON FALLS, INC., (U.S. CLS. 22, 23, 38 AND 50). SN 76-
259,937. PUB. 7-2-2002. FILED 5-21-2001.
2,624,275. **SILVER O DIAMOND AND DESIGN**. KENT
SPORTS INC., (U.S. CLS. 22, 23, 38 AND 50). SN 76-
268,885. PUB. 7-2-2002. FILED 6-11-2001.
2,624,297. **SWINGBUILDER**. GOLF COACH, INC., THE, (U.S.
CLS. 22, 23, 38 AND 50). SN 76-271,581. PUB. 7-2-2002.
FILED 6-14-2001.
2,624,322. **TAZER LIGHT (STYLIZED)**. SENARIO LLC, (U.S.
CLS. 22, 23, 38 AND 50). SN 76-274,874. PUB. 7-2-2002.
FILED 6-22-2001.
2,624,339. **ANIMAL BUDDIES**. SUPER DUPER INC., DBA
SUPER DUPER PULICATIONS, (U.S. CLS. 22, 23, 38 AND
50). SN 76-276,849. PUB. 7-2-2002. FILED 6-27-2001.
2,624,341. **SNOOT AND DESIGN**. ARROW INTERNA-
TIONAL, INC., (U.S. CLS. 22, 23, 38 AND 50). SN 76-
277,091. PUB. 7-2-2002. FILED 6-27-2001.
2,624,380. **TITANIUM LITE**. HARRISON SPORTS, INC., (U.S.
CLS. 22, 23, 38 AND 50). SN 76-283,598. PUB. 7-2-2002.
FILED 7-10-2001.
2,624,427. **GUARANTEE**. GUARANTEE KOREA CO., LTD.,
(U.S. CLS. 22, 23, 38 AND 50). SN 76-290,612. PUB. 7-2-2002.
FILED 7-26-2001.
2,624,434. **LAPDOODLE BOARD TO GO**. PANLINE USA,
(U.S. CLS. 22, 23, 38 AND 50). SN 76-291,078. PUB. 7-2-2002.
FILED 7-27-2001.
2,624,447. **CRAFTY'S TACKLEWORKS**. CRAFTY'S FEATH-
ERWORKS, INC., (U.S. CLS. 22, 23, 38 AND 50). SN 76-
292,278. PUB. 7-2-2002. FILED 7-30-2001.
2,624,449. **COLOR YOUR TUB**. PANLINE USA, (U.S. CLS. 22,
23, 38 AND 50). SN 76-292,604. PUB. 7-2-2002. FILED 7-31-
2001.
2,624,477. **KRYPTOLYTE**. WARRIOR LACROSSE, INC., (U.S.
CLS. 22, 23, 38 AND 50). SN 76-296,394. PUB. 11-27-2001.
FILED 8-8-2001.
2,624,490 (*See Class 16 for this trademark*).
2,624,614. **TROUT COUNTRY**. HARVANEK, DANIEL, (U.S.
CLS. 22, 23, 38 AND 50). SN 76-321,783. PUB. 7-2-2002.
FILED 10-4-2001.
2,624,623. **TEAM SOUNDWAVE**. 12TH MAN PRODUCTIONS,
INC., (U.S. CLS. 22, 23, 38 AND 50). SN 76-323,172. PUB. 7-2-
2002. FILED 10-9-2001.
2,624,629. **TIME FORCE MEGAZORD JET MODE**. BVS
ENTERTAINMENT, INC., BY CHANGE OF NAME SA-
BAN ENTERTAINMENT, INC., (U.S. CLS. 22, 23, 38 AND
50). SN 76-323,379. PUB. 7-2-2002. FILED 10-10-2001.
2,624,645. **ABI**. BOATENG, JOSEPH O., (U.S. CLS. 22, 23, 38
AND 50). SN 76-325,125. PUB. 7-2-2002. FILED 10-15-2001.
2,624,647. **POWER RANGERS TIME FORCE CONTROL
CENTER**. BVS ENTERTAINMENT, INC., BY CHANGE
OF NAME SABAN ENTERTAINMENT, INC., (U.S. CLS.
22, 23, 38 AND 50). SN 76-325,217. PUB. 7-2-2002. FILED 10-

- 10-2001.
- 2,624,691. **EMERAY MEZORE' (STYLIZED)**. CHEVALIER ORIGINALS, INC., (U.S. CLS. 22, 23, 38 AND 50). SN 76-330,338. PUB. 7-2-2002. FILED 10-25-2001.
- 2,624,718. **POLE TENDER**. JEFFREY JOSEPH CARSWELL, DBA CARSWELL PRODUCT DESIGNS, (U.S. CLS. 22, 23, 38 AND 50). SN 76-334,529. PUB. 7-2-2002. FILED 11-5-2001.
- 2,624,727. **HARD MAPLE POWER**. BROOKVILLE WOOD PRODUCTS, INC., (U.S. CLS. 22, 23, 38 AND 50). SN 76-335,859. PUB. 7-2-2002. FILED 11-8-2001.
- 2,624,753. **BLACKBEARY**. COMMONWEALTH OF PENNSYLVANIA, DEPARTMENT OF CONSERVATION & NATURAL RESOURCES, (U.S. CLS. 22, 23, 38 AND 50). SN 76-338,963. PUB. 7-2-2002. FILED 11-19-2001.
- 2,625,003. **NVA NEW VISION ATHLETICS AND DESIGN**. NEW VISION ATHLETICS, INC., (U.S. CLS. 22, 23, 38 AND 50). SN 78-041,126. PUB. 7-2-2002. FILED 12-29-2000.
- 2,625,057. **OUTRIGGER**. WHAM-O, INC., (U.S. CLS. 22, 23, 38 AND 50). SN 78-054,802. PUB. 7-2-2002. FILED 3-23-2001.
- 2,625,059 (*See Class 14 for this trademark*).
- 2,625,063. **VIRUS**. NALU KAI INCORPORATED, (U.S. CLS. 22, 23, 38 AND 50). SN 78-056,346. PUB. 7-2-2002. FILED 4-2-2001.
- 2,625,134. **FROM RAGS TO RICHES**. SUPER DUPER INC., DBA SUPER DUPER PUBLICATIONS, (U.S. CLS. 22, 23, 38 AND 50). SN 78-070,158. PUB. 7-2-2002. FILED 6-20-2001.
- 2,625,224. **I FOUND IT! IT'S AS FUN AS HUNTING FOR COLORED EGGS!**. OBERBILLIG, KAREN L., (U.S. CLS. 22, 23, 38 AND 50). SN 78-089,136. PUB. 7-2-2002. FILED 10-18-2001.
- 2,625,285. **POWER TO BURN AND DESIGN**. ARTIN INDUSTRIAL CO.LTD., (U.S. CLS. 22, 23, 38 AND 50). SN 78-099,742. PUB. 7-2-2002. FILED 12-21-2001.
- 2,625,288. **SLASH**. KWIK TEK INC., (U.S. CLS. 22, 23, 38 AND 50). SN 78-099,950. PUB. 7-2-2002. FILED 12-26-2001.
- 2,625,292. **BIGHT KICKER**. BAKER, DONALD A., (U.S. CLS. 22, 23, 38 AND 50). SN 78-100,210. PUB. 7-2-2002. FILED 12-28-2001.
-
- CLASS 29—MEATS AND PROCESSED FOODS**
- 2,622,512. **BROWN BETTY**. BEDESSEE IMPORTS LTD., DBA BROWN BETTY FOODS, MULTIPLE CLASS, (INT. CLS. 29 AND 30), (U.S. CL. 46). SN 75-127,702. PUB. 7-2-2002. FILED 7-1-1996.
- 2,622,602. **FLAT CHICKEN**. DOROTHY LANE MARKET, INC., (U.S. CL. 46). SN 75-599,385. PUB. 7-2-2002. FILED 7-28-1998.
- 2,622,612. **YAKULT AND DESIGN**. KABUSHIKI KAISHA YAKULT HONSHA, MULTIPLE CLASS, (INT. CLS. 29, 30 AND 32), (U.S. CLS. 45, 46 AND 48). SN 75-613,638. PUB. 6-27-2000. FILED 12-30-1998.
- 2,622,666. **ASTRO**. PARMALAT DAIRY & BAKERY INC., (U.S. CL. 46). SN 75-721,164. PUB. 7-4-2000. FILED 6-3-1999.
- 2,622,751. **APPETITO**. APPETITO PROVISIONS CO., INC., MULTIPLE CLASS, (INT. CLS. 29 AND 30), (U.S. CL. 46). SN 75-834,433. PUB. 7-2-2002. FILED 10-28-1999.
- 2,622,793. **ACTIVATE YOUR LIFE**. CASCADE FRESH, INC., (U.S. CL. 46). SN 75-871,541. PUB. 7-2-2002. FILED 12-14-1999.
- 2,622,824. **EGGS & MORE ENTREE KIT**. EGGLAND'S BEST, INC., AND HERBRUCK'S POULTRY RANCH, MULTIPLE CLASS, (INT. CLS. 29 AND 30), (U.S. CL. 46). SN 75-899,442. PUB. 7-2-2002. FILED 1-19-2000.
- 2,622,850 (*See Class 9 for this trademark*).
- 2,622,881. **LOBSTER POT**. JARL INVESTMENTS, L.P., (U.S. CL. 46). SN 75-941,267. PUB. 7-2-2002. FILED 3-10-2000.
- 2,622,897. **JACK'S CATCH AND DESIGN**. NEWPORT INTERNATIONAL OF TIERRA VERDE, FLORIDA, INC., (U.S. CL. 46). SN 76-000,077. PUB. 7-2-2002. FILED 3-14-2000.
- 2,622,948. **WORCESTER**. MID-ATLANTIC FOODS, INC., (U.S. CL. 46). SN 76-026,317. PUB. 5-28-2002. FILED 4-14-2000.
- 2,622,984. **SUPER BRAND AND DESIGN**. KIM SENG COMPANY, MULTIPLE CLASS, (INT. CLS. 29 AND 30), (U.S. CL. 46). SN 76-047,425. PUB. 5-21-2002. FILED 5-12-2000.
- 2,623,073. **MISCELLANEOUS DESIGN**. STATE OF CALIFORNIA, DEPARTMENT OF FOOD AND AGRICULTURE, THE, MULTIPLE CLASS, (INT. CLS. 29 AND 35), (U.S. CLS. 46, 100, 101 AND 102). SN 76-076,589. PUB. 7-2-2002. FILED 6-23-2000.
- 2,623,092 (*See Class 14 for this trademark*).
- 2,623,133. **DAKOTA FARMS AND DESIGN**. WALTER, TIM, MULTIPLE CLASS, (INT. CLS. 29 AND 31), (U.S. CLS. 1 AND 46). SN 76-095,880. PUB. 8-7-2001. FILED 7-25-2000.
- 2,623,164. **VILLANI V AND DESIGN**. VILLANI S.P.A., (U.S. CL. 46). SN 76-107,556. PUB. 3-5-2002. FILED 8-11-2000.
- 2,623,207. **C AND DESIGN**. SEA PORT PRODUCTS CORPORATION, (U.S. CL. 46). SN 76-119,399. PUB. 7-2-2002. FILED 8-31-2000.
- 2,623,249. **DAKOTASKINS AND DESIGN**. AVIKO USA L.L.C., (U.S. CL. 46). SN 76-132,529. PUB. 7-2-2002. FILED 9-21-2000.
- 2,623,255. **MAURI AND DESIGN**. EMILIO MAURI S.P.A., (U.S. CL. 46). SN 76-133,398. PUB. 7-2-2002. FILED 9-22-2000.
- 2,623,436. **GOLDLINE**. TRACY FOODS, INC., (U.S. CL. 46). SN 76-161,857. PUB. 11-13-2001. FILED 11-9-2000.
- 2,623,473. **PREP CHEF**. JENNIE-O TURKEY STORE, INC., BY CHANGE OF NAME JENNIE-O FOODS, INC., (U.S. CL. 46). SN 76-169,968. PUB. 7-2-2002. FILED 11-22-2000.
- 2,623,596. **CHIRA**. LIDL STIFTUNG & CO. KG, MULTIPLE CLASS, (INT. CLS. 29, 31 AND 32), (U.S. CLS. 1, 45, 46 AND 48). SN 76-187,196. PUB. 7-2-2002. FILED 12-28-2000.
- 2,623,597. **CONFISERIE FIRENZE (STYLIZED)**. LIDL STIFTUNG & CO. KG, MULTIPLE CLASS, (INT. CLS. 29 AND 30), (U.S. CL. 46). SN 76-187,233. PUB. 7-2-2002. FILED 12-28-2000.
- 2,623,598. **COMBINO**. LIDL STIFTUNG & CO. KG, MULTIPLE CLASS, (INT. CLS. 29 AND 30), (U.S. CL. 46). SN 76-187,235. PUB. 7-2-2002. FILED 12-28-2000.
- 2,623,628. **HEATHER FEDBETTER**. EGG INNOVATIONS, LLC, (U.S. CL. 46). SN 76-190,542. PUB. 7-2-2002. FILED 1-5-2001.
- 2,623,631. **EPT ECOSHIELD-EPT AND DESIGN**. SASIB S.P.A., MULTIPLE CLASS, (INT. CLS. 29, 30 AND 32), (U.S. CLS. 45, 46 AND 48). SN 76-191,250. PUB. 7-2-2002. FILED 1-9-2001.
- 2,623,657. **CHEVRE IN BLUE (STYLIZED)**. CHEVRE DIFFUSION, INC., (U.S. CL. 46). SN 76-194,817. PUB. 7-2-2002. FILED 1-16-2001.
- 2,623,691 (*See Class 1 for this trademark*).
- 2,623,726. **MISCELLANEOUS DESIGN**. KING COLE DUCKS LIMITED, (U.S. CL. 46). SN 76-203,106. PUB. 7-2-2002. FILED 2-1-2001.
- 2,623,730. **GIOPESCAL AND DESIGN**. GIOLFO & CALCAGNO S.P.A., (U.S. CL. 46). SN 76-203,238. PUB. 7-2-2002. FILED 2-1-2001.
- 2,623,750. **DULANO**. LIDL STIFTUNG & CO. KG, (U.S. CL. 46). SN 76-204,981. PUB. 7-2-2002. FILED 2-5-2001.
- 2,623,777. **TENDER BURGER AND DESIGN**. KENOSHA BEEF INTERNATIONAL LTD., (U.S. CL. 46). SN 76-209,639. PUB. 7-2-2002. FILED 2-13-2001.
- 2,623,794. **FAIR MARKET INC. GOOD TO GO KEEP FROZEN QUALITY AT THE BEST PRICE AND DESIGN**. FAIR MARKET, INC., (U.S. CL. 46). SN 76-211,900. PUB. 7-2-2002. FILED 2-20-2001.
- 2,623,817. **OCEAN SEA**. LIDL STIFTUNG & CO. KG, MULTIPLE CLASS, (INT. CLS. 29 AND 31), (U.S. CLS. 1 AND 46). SN 76-215,043. PUB. 7-2-2002. FILED 2-23-2001.
- 2,623,922. **FRESH TASTE. GUARANTEED! AND DESIGN**. SARAMAR, L.L.C., (U.S. CL. 46). SN 76-228,799. PUB. 7-2-2002. FILED 3-22-2001.
- 2,623,976. **MISCELLANEOUS DESIGN**. BELGIOIOSO CHEESE, INC., (U.S. CL. 46). SN 76-236,130. PUB. 7-2-2002. FILED 4-5-2001.
- 2,623,992. **CHEESE MERCHANTS OF AMERICA**. CHEESE MERCHANTS OF AMERICA, LLC, MULTIPLE CLASS, (INT. CLS. 29 AND 30), (U.S. CL. 46). SN 76-237,407. PUB. 7-2-2002. FILED 4-10-2001.
- 2,624,073. **ALMOND BROTHERS**. ALMOND BROTHERS, LLC, MULTIPLE CLASS, (INT. CLS. 29 AND 30), (U.S. CL. 46). SN 76-245,659. PUB. 7-2-2002. FILED 4-24-2001.
- 2,624,090. **BROOKSIDE REAL FRUITCHIPS**. BROOKSIDE FOODS LTD., (U.S. CL. 46). SN 76-247,763. PUB. 7-2-2002. FILED 4-30-2001.

2,624,116. **MISCELLANEOUS DESIGN**. VIENNA SAUSAGE MANUFACTURING COMPANY, (U.S. CL. 46). SN 76-250,902. PUB. 7-2-2002. FILED 5-3-2001.

2,624,134. **FAMILY QUALITY**. FAMILY QUALITY PORK PROCESSORS COOPERATIVE, (U.S. CL. 46). SN 76-254,023. PUB. 7-2-2002. FILED 5-8-2001.

2,624,202 (*See Class 16 for this trademark*).

2,624,280. **TAJ**. ETHNIC GOURMET FOODS, INC., (U.S. CL. 46). SN 76-269,167. PUB. 7-2-2002. FILED 6-8-2001.

2,624,288. **NATURELLE**. WAYNE FARMS LLC., (U.S. CL. 46). SN 76-270,301. PUB. 3-12-2002. FILED 6-12-2001.

2,624,298. **AL KANATER**. ALKANATER S.A.L., MULTIPLE CLASS, (INT. CLS. 29, 30 AND 32), (U.S. CLS. 45, 46 AND 48). SN 76-271,619. PUB. 7-2-2002. FILED 6-14-2001.

2,624,475. **SARGENTO CHEEZE AND STICKS**. SARGENTO FOODS INC., (U.S. CL. 46). SN 76-296,289. PUB. 7-2-2002. FILED 8-7-2001.

2,624,544. **ROSIE'S VERMONT BEEF JERKY AND DESIGN**. ROSIE'S VERMONT BEEF JERKY, (U.S. CL. 46). SN 76-310,439. PUB. 7-2-2002. FILED 9-10-2001.

2,624,599. **THE CULTURED WAY! AND DESIGN**. TROIS AMIS LLC, (U.S. CL. 46). SN 76-319,649. PUB. 7-2-2002. FILED 10-1-2001.

2,624,612. **AHIMSA VEGETARIAN NO KILLING AND DESIGN**. SHIN-DER ENTERPRISE CO., LTD., (U.S. CL. 46). SN 76-321,546. PUB. 5-28-2002. FILED 10-5-2001.

2,624,748 (*See Class 1 for this trademark*).

2,624,764. **SMITHFIELD**. SF INVESTMENTS, INC., (U.S. CL. 46). SN 76-341,753. PUB. 7-2-2002. FILED 11-27-2001.

2,624,808. **DUTCH VALLEY**. WMK HOLDINGS, INC., (U.S. CL. 46). SN 76-346,623. PUB. 7-2-2002. FILED 12-7-2001.

2,624,826. **16 OZ. 32 OZ. 5 LB. AND DESIGN**. BUNN, LOUIS J., (U.S. CL. 46). SN 76-349,141. PUB. 7-2-2002. FILED 12-17-2001.

2,624,865. **JT AND DESIGN**. JINTOWN ENTERPRISE LTD., (U.S. CL. 46). SN 76-353,243. PUB. 7-2-2002. FILED 12-31-2001.

2,624,867. **BECAUSE BUTTER SHOULD BE BEAUTIFUL**. LION ROCK HOLDINGS L.L.C., (U.S. CL. 46). SN 76-353,614. PUB. 7-2-2002. FILED 12-19-2001.

2,624,899. **HOMESTEAD**. ROTH KASE U.S.A. LTD., (U.S. CL. 46). SN 76-357,871. PUB. 7-2-2002. FILED 1-14-2002.

2,624,962. **PREMIUM PORK NATURALLY AND DESIGN**. FARM & HOME FOODS, INC., (U.S. CL. 46). SN 78-005,338. PUB. 9-18-2001. FILED 4-24-2000.

2,625,031. **MISCELLANEOUS DESIGN**. LEE, SUN-JA, (U.S. CL. 46). SN 78-048,458. PUB. 7-2-2002. FILED 2-15-2001.

2,625,032. **BATEY**. MIAVANA WHOLESALE CO., INC., MULTIPLE CLASS, (INT. CLS. 29, 30 AND 32), (U.S. CLS. 45, 46 AND 48). SN 78-049,749. PUB. 7-2-2002. FILED 2-22-2001.

2,625,075. **VALLEY MEAT CO. AND DESIGN**. VALLEY MEAT COMPANY, (U.S. CL. 46). SN 78-059,497. PUB. 7-2-2002. FILED 4-20-2001.

2,625,116. **FARM HOUSE AND DESIGN**. SARAMAR, L.L.C., (U.S. CL. 46). SN 78-065,479. PUB. 7-2-2002. FILED 5-24-2001.

2,625,158. **SUNTERRA FARMS AND DESIGN**. SUNTERRA FOOD CORPORATION, MULTIPLE CLASS, (INT. CLS. 29 AND 31), (U.S. CLS. 1 AND 46). SN 78-075,253. PUB. 7-2-2002. FILED 7-23-2001.

2,625,183. **ALMOND TOPPERS**. SUGAR FOODS CORPORATION, (U.S. CL. 46). SN 78-081,421. PUB. 7-2-2002. FILED 8-28-2001.

2,625,184. **ILOLAY**. SUCESORES DE ALFREDO WILLINER S.A., MULTIPLE CLASS, (INT. CLS. 29 AND 30), (U.S. CL. 46). SN 78-081,686. PUB. 7-2-2002. FILED 8-29-2001.

2,625,203. **MCCORMICK GOURMET COLLECTION AND DESIGN**. MCCORMICK DELAWARE, INC., MULTIPLE CLASS, (INT. CLS. 29 AND 30), (U.S. CL. 46). SN 78-085,600. PUB. 7-2-2002. FILED 9-26-2001.

2,625,256. **STORMY**. LANCE MFG. LLC, (U.S. CL. 46). SN 78-095,298. PUB. 7-2-2002. FILED 11-27-2001.

2,625,257. **STORMY (STYLIZED)**. LANCE MFG. LLC, (U.S. CL. 46). SN 78-095,309. PUB. 7-2-2002. FILED 11-27-2001.

CLASS 30—STAPLE FOODS

2,622,512 (*See Class 29 for this trademark*).

2,622,524. **D&R MEDALLION BRAND WORLD CLASS SAUCES AND DESIGN**. D&R ASSOCIATES, INC., (U.S. CL. 46). SN 75-274,330. PUB. 7-2-2002. FILED 4-14-1997.

2,622,612 (*See Class 29 for this trademark*).

2,622,683. **DIE EXQUISITEN MOZARTKUGELN VON HOFBAUER IN MILCH- UND ZABITTER-SCHOKOLADE FEINSTE WIENER CONFISERIE-KUNST. SEIT 1882. AND DESIGN**. CHOCOLADEFABRIKEN LINDT & SPRUNGLI AG, (U.S. CL. 46). SN 75-746,464. PUB. 11-13-2001. FILED 7-9-1999.

2,622,751 (*See Class 29 for this trademark*).

2,622,759. **GUMMYLAND**. ICAM S.P.A., (U.S. CL. 46). SN 75-843,833. PUB. 11-7-2000. FILED 11-8-1999.

2,622,773. **OTELLO**. ELAH DUFOUR SOCIETA' ALIMEN-TARI RIUNITE S.R.L., (U.S. CL. 46). SN 75-856,579. PUB. 7-2-2002. FILED 11-23-1999.

2,622,819. **MISCELLANEOUS DESIGN**. SWEET POTATO PIE, INC., (U.S. CL. 46). SN 75-894,847. PUB. 7-2-2002. FILED 1-12-2000.

2,622,824 (*See Class 29 for this trademark*).

2,622,850 (*See Class 9 for this trademark*).

2,622,901 (*See Class 9 for this trademark*).

2,622,959. **BAJA**. BAJA TRADING CO., INC., (U.S. CL. 46). SN 76-033,317. PUB. 7-2-2002. FILED 4-24-2000.

2,622,984 (*See Class 29 for this trademark*).

2,623,016. **SICAMOR AND DESIGN**. BENEFICIO CUSTEPEC, S.A. DE C.V., (U.S. CL. 46). SN 76-058,586. PUB. 1-22-2002. FILED 5-30-2000.

2,623,028. **DESSERT CENTER**. FRIENDLY ICE CREAM CORPORATION, (U.S. CL. 46). SN 76-061,760. PUB. 7-2-2002. FILED 6-2-2000.

2,623,082. **PACIFIC INTERNATIONAL RICE MILLS AND DESIGN**. BUSCH AGRICULTURAL RESOURCES, INC., (U.S. CL. 46). SN 76-079,857. PUB. 7-2-2002. FILED 6-28-2000.

2,623,088. **AUNTIE BRANDY'S AND DESIGN**. DIVERSIFIED RESTAURANT VENTURES LLC, MULTIPLE CLASS, (INT. CLS. 30 AND 35), (U.S. CLS. 46, 100, 101 AND 102). SN 76-081,823. PUB. 7-2-2002. FILED 7-3-2000.

2,623,122. **MARTINELLI'S (STYLIZED)**. S. MARTINELLI & COMPANY, (U.S. CL. 46). SN 76-092,346. PUB. 7-2-2002. FILED 7-18-2000.

2,623,162. **CANDY YOU ATE AS A KID**. BRIDGE, DONALD RAY, (U.S. CL. 46). SN 76-106,416. PUB. 7-2-2002. FILED 8-10-2000.

2,623,219. **DR. CHEF**. DR. CHEF, INC., (U.S. CL. 46). SN 76-122,282. PUB. 7-2-2002. FILED 9-5-2000.

2,623,285. **DR. CHEF AND DESIGN**. DR. CHEF, INC., (U.S. CL. 46). SN 76-137,863. PUB. 7-2-2002. FILED 9-29-2000.

2,623,382 (*See Class 5 for this trademark*).

2,623,435. **SWEET BLESSINGS**. SWEET BLESSINGS LLC, (U.S. CL. 46). SN 76-161,849. PUB. 7-2-2002. FILED 11-8-2000.

2,623,441. **HILL COUNTRY FARE**. HEB GROCERY COMPANY, LP, BY ASSIGNMENT H. E. BUTT GROCERY COMPANY, (U.S. CL. 46). SN 76-163,984. PUB. 7-2-2002. FILED 11-14-2000.

2,623,506. **VILLAGE GARDEN**. PERFORMANCE FOOD GROUP COMPANY, (U.S. CL. 46). SN 76-173,916. PUB. 7-2-2002. FILED 12-1-2000.

2,623,576. **JAVA CITY**. JAVA CITY, (U.S. CL. 46). SN 76-184,172. PUB. 7-2-2002. FILED 12-19-2000.

2,623,577. **MISCELLANEOUS DESIGN**. J. M. SMUCKER COMPANY, THE, (U.S. CL. 46). SN 76-184,192. PUB. 7-2-2002. FILED 12-21-2000.

2,623,583. **CHOCO BALL AND DESIGN**. LIDL STIFTUNG & CO. KG, (U.S. CL. 46). SN 76-185,444. PUB. 7-2-2002. FILED 12-22-2000.

2,623,597 (*See Class 29 for this trademark*).

2,623,598 (*See Class 29 for this trademark*).

2,623,631 (*See Class 29 for this trademark*).

2,623,681. **LA GITANA AND DESIGN**. CARLOS A. CASTA-NEDA Y COMPANIA, S.C., (U.S. CL. 46). SN 76-197,570. PUB. 7-2-2002. FILED 1-22-2001.

2,623,691 (*See Class 1 for this trademark*).

2,623,774. **THAI ORIGINAL BBQ & RESTAURANT AND DESIGN**. THAI ORIGINAL BBQ FRANCHISE, INC., (U.S. CL. 46). SN 76-209,112. PUB. 7-2-2002. FILED 2-12-2001.

- 2,623,782. **S.T.A.C.S.**. STACS CORPORATION, (U.S. CL. 46). SN 76-210,382. PUB. 7-2-2002. FILED 2-15-2001.
- 2,623,813. **CHOCOLOGIE**. LITTLE MOON INC., (U.S. CL. 46). SN 76-214,782. PUB. 11-6-2001. FILED 2-26-2001.
- 2,623,824. **FLAVIA AND DESIGN**. MARS, INCORPORATED, (U.S. CL. 46). SN 76-215,846. PUB. 7-2-2002. FILED 2-26-2001.
- 2,623,831. **HOME OF THE WARM 'N FRESH DONUT**. WINCHELL'S DONUT HOUSES OPERATING COMPANY, L.P., MULTIPLE CLASS, (INT. CLS. 30 AND 42), (U.S. CLS. 46, 100 AND 101). SN 76-217,358. PUB. 7-2-2002. FILED 2-28-2001.
- 2,623,868. **ANNIE CHUN'S**. ANNIE CHUN'S INC., BY CHANGE OF NAME ANNIE CHUN'S GOURMET FOODS, INC., (U.S. CL. 46). SN 76-221,805. PUB. 7-2-2002. FILED 3-7-2001.
- 2,623,878. **INSTASTRIPZ**. VITECH AMERICA CORPORATION, (U.S. CL. 46). SN 76-222,727. PUB. 7-2-2002. FILED 3-9-2001.
- 2,623,910. **MALABAR GOLD**. JOSUMA CORPORATION, (U.S. CL. 46). SN 76-227,275. PUB. 7-2-2002. FILED 3-19-2001.
- 2,623,969. **GITS**. GITS FOOD PRODUCTS PVT. LTD., (U.S. CL. 46). SN 76-235,750. PUB. 7-2-2002. FILED 4-3-2001.
- 2,623,979. **STONED CLASSICS TORTILLA CHIPS AND DESIGN**. CLASSIC FOODS INC., (U.S. CL. 46). SN 76-236,536. PUB. 7-2-2002. FILED 4-9-2001.
- 2,623,989. **PATCHINO**. CHOUCAIR, NIZAR AHMAD, (U.S. CL. 46). SN 76-237,137. PUB. 7-2-2002. FILED 4-9-2001.
- 2,623,992 (*See Class 29 for this trademark*).
- 2,624,008. **DONUT THOUGHTS**. SUPER BAKERY, INCORPORATED, (U.S. CL. 46). SN 76-238,989. PUB. 7-2-2002. FILED 4-6-2001.
- 2,624,073 (*See Class 29 for this trademark*).
- 2,624,092 (*See Class 25 for this trademark*).
- 2,624,298 (*See Class 29 for this trademark*).
- 2,624,302. **CHINROSE**. ROSE HILL ENTERPRISES LLC, (U.S. CL. 46). SN 76-271,842. PUB. 7-2-2002. FILED 6-18-2001.
- 2,624,389. **DUNK'S HOT SAUCE**. DUNK'S HOT SAUCE, LLC., (U.S. CL. 46). SN 76-285,258. PUB. 1-29-2002. FILED 7-16-2001.
- 2,624,405. **SUPREME BREADER**. CONCORD FOODS, INC., (U.S. CL. 46). SN 76-287,633. PUB. 7-2-2002. FILED 7-19-2001.
- 2,624,421. **BIG D'S AND DESIGN**. SERFLING, LINDA, AND SERFLING, DALE, (U.S. CL. 46). SN 76-290,098. PUB. 7-2-2002. FILED 7-25-2001.
- 2,624,439. **CANDY MATIC**. NATIONAL BULK FOOD DISTRIBUTORS, INC., (U.S. CL. 46). SN 76-291,531. PUB. 7-2-2002. FILED 7-27-2001.
- 2,624,441. **CHANDLER & LEEDS**. NATIONAL BULK FOOD DISTRIBUTORS, INC., (U.S. CL. 46). SN 76-291,705. PUB. 7-2-2002. FILED 7-27-2001.
- 2,624,448. **CANDY'S**. GRUMA CORPORATION, (U.S. CL. 46). SN 76-292,295. PUB. 7-2-2002. FILED 7-30-2001.
- 2,624,510. **CHOCOLATE EXCELLENCE**. MORLEY CANDY MAKERS, INC., (U.S. CL. 46). SN 76-303,463. PUB. 7-2-2002. FILED 8-22-2001.
- 2,624,511. **SNOCONUTS**. MORLEY CANDY MAKERS, INC., (U.S. CL. 46). SN 76-303,464. PUB. 7-2-2002. FILED 8-22-2001.
- 2,624,515. **DARRELL LEA**. D.L.N. PTY LTD, (U.S. CL. 46). SN 76-304,161. PUB. 7-2-2002. FILED 8-23-2001.
- 2,624,557. **SARGENTO CHOCOLATEY CHIP**. SARGENTO FOODS INC., (U.S. CL. 46). SN 76-312,406. PUB. 7-2-2002. FILED 9-17-2001.
- 2,624,563. **JESS HALL'S SERENDIPITY SEASONED SALT**. JESS HALL'S SEASONED SALT COMPANY, (U.S. CL. 46). SN 76-313,207. PUB. 5-28-2002. FILED 9-17-2001.
- 2,624,591. **FREEZEPOINT**. DESERT COOL FOODS, INC., (U.S. CL. 46). SN 76-319,074. PUB. 7-2-2002. FILED 10-1-2001.
- 2,624,619. **SUPERIOR TOUCH CROCKERY GOURMET AND DESIGN**. SUPERIOR QUALITY FOODS, INC., (U.S. CL. 46). SN 76-322,959. PUB. 7-2-2002. FILED 10-9-2001.
- 2,624,626. **JUST MERINGUES! AND DESIGN**. CHOCOLATE CHIX, INC., (U.S. CL. 46). SN 76-323,240. PUB. 7-2-2002. FILED 10-10-2001.
- 2,624,713. **CELESTIAL SEASONINGS**. CELESTIAL SEASONINGS, INC., (U.S. CL. 46). SN 76-333,784. PUB. 7-2-2002. FILED 11-5-2001.
- 2,624,717. **SWEET LILLY'S**. FELLER, BRIAN D., (U.S. CL. 46). SN 76-334,306. PUB. 7-2-2002. FILED 11-6-2001.
- 2,624,748 (*See Class 1 for this trademark*).
- 2,624,789. **TRIGUENAS (STYLIZED)**. GRUMA CORPORATION, (U.S. CL. 46). SN 76-344,812. PUB. 7-2-2002. FILED 12-3-2001.
- 2,624,819. **REINDEER BLEND**. ARABICA FUNDING, INC., (U.S. CL. 46). SN 76-348,602. PUB. 7-2-2002. FILED 12-12-2001.
- 2,624,836. **TAMMIE'S DADDY'S**. SHOWERS, DAVID C., AND SHOWERS, KIM M., DBA D & K BAR-B-QUE, (U.S. CL. 46). SN 76-349,961. PUB. 7-2-2002. FILED 12-19-2001.
- 2,624,846. **MARAVONDA**. TRILIMAR LLC, (U.S. CL. 46). SN 76-351,154. PUB. 7-2-2002. FILED 12-20-2001.
- 2,624,875. **BAT MAGIC (STYLIZED)**. THANKSGIVING COFFEE COMPANY, (U.S. CL. 46). SN 76-355,086. PUB. 7-2-2002. FILED 1-4-2002.
- 2,624,881. **KHYBER**. NICE BLENDS CORP., (U.S. CL. 46). SN 76-356,790. PUB. 7-2-2002. FILED 1-10-2002.
- 2,624,988. **PAPPY'S XXX WHITE LIGHTNIN**. PROSPECT PETE ENTERPRISES, INC., (U.S. CL. 46). SN 78-029,428. PUB. 7-2-2002. FILED 10-6-2000.
- 2,625,006. **CORNY ISLAND DOGS**. STATE FAIR FOODS, INC., (U.S. CL. 46). SN 78-041,823. PUB. 7-2-2002. FILED 1-5-2001.
- 2,625,032 (*See Class 29 for this trademark*).
- 2,625,085. **DOCJAVA**. LYON, DOUGLAS, (U.S. CL. 46). SN 78-061,254. PUB. 7-2-2002. FILED 5-1-2001.
- 2,625,090. **SNOWY ROAD**. TRIFLES, LLC, (U.S. CL. 46). SN 78-062,425. PUB. 7-2-2002. FILED 5-8-2001.
- 2,625,091. **COUNTRY ROAD**. TRIFLES, LLC, (U.S. CL. 46). SN 78-062,432. PUB. 7-2-2002. FILED 5-8-2001.
- 2,625,122. **BLUEBERRY HILL DESSERTERY AND DESIGN**. BLUEBERRY HILL DESSERTERY, INC., MULTIPLE CLASS, (INT. CLS. 30 AND 35), (U.S. CLS. 46, 100, 101 AND 102). SN 78-067,671. PUB. 7-2-2002. FILED 6-6-2001.
- 2,625,164. **KELLIE'S CANDIES NUT-FREE CONFECTIONS AND DESIGN**. MACDOUGALL, TIMOTHY F., DBA KELLIE'S CANDIES NUT-FREE CONFECTIONS, AND MACDOUGALL, MARTHA A., DBA KELLIE'S CANDIES NUT-FREE CONFECTIONS, (U.S. CL. 46). SN 78-077,507. PUB. 7-2-2002. FILED 8-4-2001.
- 2,625,184 (*See Class 29 for this trademark*).
- 2,625,185. **KAURINA'S DELICIOUSLY DIFFERENT AND DESIGN**. SINGH, HARI P., (U.S. CL. 46). SN 78-081,817. PUB. 7-2-2002. FILED 8-30-2001.
- 2,625,203 (*See Class 29 for this trademark*).
- 2,625,229. **BEE HAPPY. BEE HEALTHY.**. GENERAL MILLS, INC., (U.S. CL. 46). SN 78-090,711. PUB. 7-2-2002. FILED 10-29-2001.
- 2,625,244. **CHOC-O LUNCH COOKIES AND DESIGN**. LANCE MFG. LLC, (U.S. CL. 46). SN 78-093,828. PUB. 7-2-2002. FILED 11-16-2001.
- 2,625,247. **LEM-O LUNCH COOKIES AND DESIGN**. LANCE MFG. LLC, (U.S. CL. 46). SN 78-094,127. PUB. 7-2-2002. FILED 11-19-2001.
- 2,625,289. **MISCELLANEOUS DESIGN**. GRANDE CHEESE COMPANY, (U.S. CL. 46). SN 78-100,097. PUB. 7-2-2002. FILED 12-27-2001.
- 2,625,290. **MISCELLANEOUS DESIGN**. GRANDE CHEESE COMPANY, (U.S. CL. 46). SN 78-100,099. PUB. 7-2-2002. FILED 12-27-2001.
- 2,625,291. **MISCELLANEOUS DESIGN**. GRANDE CHEESE COMPANY, (U.S. CL. 46). SN 78-100,101. PUB. 7-2-2002. FILED 12-27-2001.
- 2,625,294 (*See Class 16 for this trademark*).

CLASS 31—NATURAL AGRICULTURAL PRODUCTS

- 2,622,549. **PACIFIC CATCH AND DESIGN**. SILVER HARVEST FOODS INC., (U.S. CLS. 1 AND 46). SN 75-460,040. PUB. 3-27-2001. FILED 4-1-1998.
- 2,622,771. **BXN SYSTEM AND DESIGN**. RHONE-POULENC AGRO (SOCIETE ANONYME), (U.S. CLS. 1 AND 46). SN 75-852,913. PUB. 7-2-2002. FILED 11-19-1999.
- 2,622,795. **TERRA NOVA**. TERRA NOVA NURSERIES, INC., MULTIPLE CLASS, (INT. CLS. 31 AND 42), (U.S. CLS. 1, 46,

100 AND 101), SN 75-877,790. PUB. 7-2-2002. FILED 12-20-1999.

2,622,802. **R.H. SHUMWAY'S AND DESIGN**. SEEDS FOR THE WORLD, INC., (U.S. CLS. 1 AND 46). SN 75-885,849. PUB. 7-2-2002. FILED 12-29-1999.

2,622,816. **DESERT SUNRISE**. PLANTS FOR THE WESTERN GARDEN, INC., (U.S. CLS. 1 AND 46). SN 75-893,043. PUB. 7-2-2002. FILED 1-10-2000.

2,622,823. **TROJKA AND DESIGN**. H. APPELBOOM B.V., (U.S. CLS. 1 AND 46). SN 75-898,645. PUB. 7-2-2002. FILED 1-20-2000.

2,622,850 (*See Class 9 for this trademark*).

2,622,939. **TAPESTRY**. PAN AMERICAN NURSERY PRODUCTS INC., (U.S. CLS. 1 AND 46). SN 76-021,992. PUB. 7-2-2002. FILED 4-7-2000.

2,622,986. **HINES COLOR**. BANKERS TRUST COMPANY, BY ASSIGNMENT; BY ASSIGNMENT HINES HORTICULTURE, INC., (U.S. CLS. 1 AND 46). SN 76-048,315. PUB. 7-2-2002. FILED 5-15-2000.

2,623,125. **CPN CAMPONIJAR AND DESIGN**. COPROHNIJAR S. COOP. AND., (U.S. CLS. 1 AND 46). SN 76-093,744. PUB. 7-2-2002. FILED 7-21-2000.

2,623,133 (*See Class 29 for this trademark*).

2,623,244. **MISCELLANEOUS DESIGN**. POULSEN ROSER APS, (U.S. CLS. 1 AND 46). SN 76-130,883. PUB. 7-2-2002. FILED 9-19-2000.

2,623,312. **60'S DREAM**. STAGECOACH VINEYARDS LIMITED PARTNERSHIP, (U.S. CLS. 1 AND 46). SN 76-142,674. PUB. 7-2-2002. FILED 10-6-2000.

2,623,363. **ROSEIE' S**. ROSEBUD INCORPORATED, (U.S. CLS. 1 AND 46). SN 76-151,611. PUB. 7-2-2002. FILED 10-23-2000.

2,623,463. **ANTHONY TESSELAAR AND DESIGN**. ANTHONY TESSELAAR INTERNATIONAL PTY LTD, (U.S. CLS. 1 AND 46). SN 76-167,947. PUB. 7-2-2002. FILED 11-20-2000.

2,623,464. **ANTHONY TESSELAAR**. ANTHONY TESSELAAR INTERNATIONAL PTY LTD, (U.S. CLS. 1 AND 46). SN 76-167,948. PUB. 7-2-2002. FILED 11-20-2000.

2,623,596 (*See Class 29 for this trademark*).

2,623,803 (*See Class 3 for this trademark*).

2,623,817 (*See Class 29 for this trademark*).

2,623,993. **STRIVE FOR 5 FRUITS & VEGETABLES A DAY AND DESIGN**. WEGMANS FOOD MARKETS, INC., (U.S. CLS. 1 AND 46). SN 76-237,438. PUB. 7-2-2002. FILED 4-9-2001.

2,624,051. **SCHEFFLERA SUMO**. JUNGLE JACK'S, INC., (U.S. CLS. 1 AND 46). SN 76-243,172. PUB. 7-2-2002. FILED 4-20-2001.

2,624,060 (*See Class 5 for this trademark*).

2,624,118. **COCONUT QUEEN**. JUNGLE JACK'S, INC., (U.S. CLS. 1 AND 46). SN 76-251,112. PUB. 7-2-2002. FILED 5-4-2001.

2,624,256. **ADVANCED BEDDING MANAGEMENT**. PRINCETON CO-GENERATION CORPORATION, (U.S. CLS. 1 AND 46). SN 76-267,429. PUB. 7-2-2002. FILED 6-6-2001.

2,624,269. **OMEGA NIBBLERS**. ENRECO, INC., (U.S. CLS. 1 AND 46). SN 76-268,743. PUB. 7-2-2002. FILED 6-8-2001.

2,624,440. **MEDUSA FERN**. ADES & GISH NURSERIES, INC., (U.S. CLS. 1 AND 46). SN 76-291,590. PUB. 7-2-2002. FILED 7-30-2001.

2,624,680. **MORNING CALM**. PACIFIC RIM INTERNATIONAL BROKERAGE INC., (U.S. CLS. 1 AND 46). SN 76-328,874. PUB. 7-2-2002. FILED 10-24-2001.

2,624,741. **NAW SOMES!**. PROMARK INTERNATIONAL, INC., (U.S. CLS. 1 AND 46). SN 76-337,617. PUB. 7-2-2002. FILED 11-15-2001.

2,624,767. **SUMMIT**. DUMMEN GMBH & CO. KG, (U.S. CLS. 1 AND 46). SN 76-341,927. PUB. 7-2-2002. FILED 11-20-2001.

2,624,862. **SO BIG AND JUICY, YOU EAT THEM WITH A SPOON**. HARRY AND DAVID, (U.S. CLS. 1 AND 46). SN 76-352,649. PUB. 7-2-2002. FILED 12-21-2001.

2,625,016. **ANIMAL NUTRITION AT ITS BEST**. VIGORTONE AG PRODUCTS, INC., (U.S. CLS. 1 AND 46). SN 78-044,840. PUB. 2-12-2002. FILED 1-25-2001.

2,625,093 (*See Class 5 for this trademark*).

2,625,155. **MUSTANG**. OCEAN RIDER, INC., (U.S. CLS. 1 AND 46). SN 78-074,058. PUB. 7-2-2002. FILED 7-16-2001.

2,625,158 (*See Class 29 for this trademark*).

CLASS 32—LIGHT BEVERAGES

2,622,526. **POCONO RASPBERRY**. LION BREWERY INC., THE, (U.S. CLS. 45, 46 AND 48). SN 75-290,432. PUB. 7-2-2002. FILED 5-9-1997.

2,622,543. **WINDFALLS SUMO**. SEARS, MIKE, MULTIPLE CLASS, (INT. CLS. 32 AND 33), (U.S. CLS. 45, 46, 47, 48 AND 49). SN 75-425,418. PUB. 7-2-2002. FILED 1-29-1998.

2,622,546. **EMERALD MOUNTAIN**. POPPE, INC., (U.S. CLS. 45, 46 AND 48). SN 75-443,385. PUB. 7-2-2002. FILED 3-2-1998.

2,622,612 (*See Class 29 for this trademark*).

2,622,638. **DE KONINCK 1833 AND DESIGN**. BROUWERIJ DE KONINCK, N.V., (U.S. CLS. 45, 46 AND 48). SN 75-669,005. PUB. 7-11-2000. FILED 3-26-1999.

2,622,757 (*See Class 6 for this trademark*).

2,622,794 (*See Class 11 for this trademark*).

2,622,850 (*See Class 9 for this trademark*).

2,622,949. **EUREKA**. OLD EUROPEAN BREWERY COMPANY, (U.S. CLS. 45, 46 AND 48). SN 76-026,567. PUB. 7-2-2002. FILED 4-14-2000.

2,623,596 (*See Class 29 for this trademark*).

2,623,631 (*See Class 29 for this trademark*).

2,624,026. **EL MORRITO**. BROOKLYN BOTTLING CORPORATION, (U.S. CLS. 45, 46 AND 48). SN 76-241,176. PUB. 7-2-2002. FILED 4-16-2001.

2,624,298 (*See Class 29 for this trademark*).

2,624,514. **MILCA AND DESIGN**. MILCA BOTTLING CO., (U.S. CLS. 45, 46 AND 48). SN 76-304,110. PUB. 7-2-2002. FILED 8-24-2001.

2,624,748 (*See Class 1 for this trademark*).

2,624,837. **SWEETEN THE DEAL!**. COCA-COLA COMPANY, THE, (U.S. CLS. 45, 46 AND 48). SN 76-350,011. PUB. 7-2-2002. FILED 12-17-2001.

2,625,032 (*See Class 29 for this trademark*).

2,625,259. **CABANA ICE**. CALYPSO ICE, LLC, (U.S. CLS. 45, 46 AND 48). SN 78-095,455. PUB. 7-2-2002. FILED 11-28-2001.

2,625,287. **CAMO HIGH GRAVITY LAGER**. WILLIAMS III, ROBERT K., (U.S. CLS. 45, 46 AND 48). SN 78-099,849. PUB. 7-2-2002. FILED 12-23-2001.

CLASS 33—WINES AND SPIRITS

2,622,516. **LOS CABOS**. UNITED SPIRITS COMPANY, (U.S. CLS. 47 AND 49). SN 75-162,180. PUB. 7-2-2002. FILED 9-6-1996.

2,622,543 (*See Class 32 for this trademark*).

2,622,552 (*See Class 21 for this trademark*).

2,622,607. **WATERPROOF**. OLIVER WOLFENBERGER, MULTIPLE CLASS, (INT. CLS. 33, 35, 41 AND 42), (U.S. CLS. 47, 49, 100, 101, 102 AND 107). SN 75-602,984. PUB. 9-25-2001. FILED 12-10-1998.

2,622,608. **RON BARAIMA CITRUS AND DESIGN**. PEDRO DOMEQ MEXICO, S.A. DE C.V., (U.S. CLS. 47 AND 49). SN 75-605,483. PUB. 7-2-2002. FILED 12-10-1998.

2,622,735 (*See Class 16 for this trademark*).

2,622,757 (*See Class 6 for this trademark*).

2,622,767. **MISCELLANEOUS DESIGN**. NGATARAWA WINES LIMITED, (U.S. CLS. 47 AND 49). SN 75-851,279. PUB. 7-2-2002. FILED 11-16-1999.

2,622,850 (*See Class 9 for this trademark*).

2,623,056. **GLEN ELLEN AND DESIGN**. GUINNESS UDV NORTH AMERICA, INC., BY CHANGE OF NAME UDV NORTH AMERICA, INC., (U.S. CLS. 47 AND 49). SN 76-070,481. PUB. 7-2-2002. FILED 6-13-2000.

2,623,199. **DEWAR'S SCOTCH WHISKY ESTD. 1846 AND DESIGN**. BACARDI & COMPANY LIMITED, (U.S. CLS. 47 AND 49). SN 76-116,696. PUB. 7-2-2002. FILED 8-25-2000.

2,623,327. **CHARLOTTE STREET**. AMBERLEY ESTATE PTY LTD, (U.S. CLS. 47 AND 49). SN 76-145,688. PUB. 8-21-2001. FILED 10-12-2000.

2,623,355. **DUQUE DE VISEU**. SOGRAPE-VINHOS DE PORTUGAL, S.A., (U.S. CLS. 47 AND 49). SN 76-150,782. PUB. 7-2-2002. FILED 10-20-2000.

2,623,421. **WOODCUTTER'S RED**. TORBRECK VINEYARDS PTY LTD, (U.S. CLS. 47 AND 49). SN 76-160,040. PUB. 5-28-

2002. FILED 11-6-2000.
 2,623,444. **CASTELGY (STYLIZED)**. LIDL STIFTUNG & CO. KG, (U.S. CLS. 47 AND 49). SN 76-164,101. PUB. 7-2-2002. FILED 11-13-2000.
 2,623,584. **ALKOOMI**. LANGE, MERVYN DOUGLAS, AND LANGE, JUDITH ANN, (U.S. CLS. 47 AND 49). SN 76-185,643. PUB. 7-2-2002. FILED 12-22-2000.
 2,623,676. **CUVEE DES CHAMPS**. CHAMP CELLARS, INC., (U.S. CLS. 47 AND 49). SN 76-197,180. PUB. 7-2-2002. FILED 1-19-2001.
 2,623,978. **MISCELLANEOUS DESIGN**. MARCHIO, ALBERTO D'ATTIMIS-MANIAGO, (U.S. CLS. 47 AND 49). SN 76-236,215. PUB. 7-2-2002. FILED 4-5-2001.
 2,624,136. **QUINTA DO CASTELINHO**. CASTELINHO (VINHOS) S.A., (U.S. CLS. 47 AND 49). SN 76-254,472. PUB. 7-2-2002. FILED 5-9-2001.
 2,624,226. **SOLIGO**. CANTINA COLLI DEL SOLIGO - SOC. FRA PRODUTTORI DI UVE PREGIATE - COOP. A RESP. LIMITATA, (U.S. CLS. 47 AND 49). SN 76-264,653. PUB. 7-2-2002. FILED 5-31-2001.
 2,624,566. **JACK DANIEL (STYLIZED)**. JACK DANIEL'S PROPERTIES, INC., (U.S. CLS. 47 AND 49). SN 76-313,440. PUB. 7-2-2002. FILED 9-12-2001.
 2,624,636. **TRAVEL COMPANION 3-PAK**. CRISTALL U.S.A., INC., (U.S. CLS. 47 AND 49). SN 76-324,288. PUB. 7-2-2002. FILED 10-12-2001.
 2,624,664. **START A TRADITION**. PALM BAY IMPORTS, INC., (U.S. CLS. 47 AND 49). SN 76-327,094. PUB. 7-2-2002. FILED 10-18-2001.
 2,624,860. **STELLA**. WINEBOW, INC., (U.S. CLS. 47 AND 49). SN 76-352,546. PUB. 7-2-2002. FILED 12-26-2001.
 2,625,227. **RIDGE CALIFORNIA BUCHIGNANI RANCH AND DESIGN**. RIDGE VINEYARDS, INC., (U.S. CLS. 47 AND 49). SN 78-089,344. PUB. 7-2-2002. FILED 10-19-2001.

CLASS 34—SMOKERS' ARTICLES

- 2,622,503. **ROBUST**. GENERAL CIGAR CO., INC., (U.S. CLS. 2, 8, 9 AND 17). SN 74-490,920. PUB. 7-2-2002. FILED 2-15-1994.
 2,622,567. **ROBUST R AND DESIGN**. GENERAL CIGAR CO., INC., (U.S. CLS. 2, 8, 9 AND 17). SN 75-523,421. PUB. 7-2-2002. FILED 7-22-1998.
 2,622,569. **ALAMO**. FINCK CIGAR COMPANY, (U.S. CLS. 2, 8, 9 AND 17). SN 75-526,255. PUB. 7-2-2002. FILED 7-27-1998.
 2,622,714. **TREASURES**. DSI, LIMITED, (U.S. CLS. 2, 8, 9 AND 17). SN 75-793,383. PUB. 7-2-2002. FILED 9-7-1999.
 2,622,827. **WEST INDIES VANILLA AND DESIGN**. DSI, LIMITED, (U.S. CLS. 2, 8, 9 AND 17). SN 75-901,640. PUB. 8-28-2001. FILED 1-24-2000.
 2,622,901 (*See Class 9 for this trademark*).
 2,623,066. **FIVE AND DIME**. STICHTING LODESTAR, (U.S. CLS. 2, 8, 9 AND 17). SN 76-074,329. PUB. 7-2-2002. FILED 6-20-2000.
 2,624,228. **MARBLE**. HTS HONGTA SUISSE SA, (U.S. CLS. 2, 8, 9 AND 17). SN 76-264,740. PUB. 7-2-2002. FILED 5-31-2001.
 2,624,399. **NEWPORT LIGHTS MENTHOL BOX AND DESIGN**. LORILLARD LICENSING COMPANY, LLC, (U.S. CLS. 2, 8, 9 AND 17). SN 76-286,853. PUB. 7-2-2002. FILED 7-17-2001.
 2,624,634. **LOOK INTERNATIONAL AND DESIGN**. HOUSE OF PRINCE A/S, (U.S. CLS. 2, 8, 9 AND 17). SN 76-323,857. PUB. 7-2-2002. FILED 10-11-2001.
 2,624,913. **DURANGO CHEWING TOBACCO AND DESIGN**. NATIONAL TOBACCO CO., L.P., (U.S. CLS. 2, 8, 9 AND 17). SN 76-361,255. PUB. 7-2-2002. FILED 1-23-2002.
 2,624,974. **HONEY DELIGHTS BY VICTOR SINCLAIR**. SOUTHERN SMOKE LLC, (U.S. CLS. 2, 8, 9 AND 17). SN 78-017,088. PUB. 7-2-2002. FILED 7-17-2000.
 2,624,975. **HONEY DELIGHTS**. SOUTHERN SMOKE LLC, (U.S. CLS. 2, 8, 9 AND 17). SN 78-017,093. PUB. 7-2-2002. FILED 7-17-2000.

SERVICE MARKS

CLASS 35—ADVERTISING AND BUSINESS

- 2,622,499. **TALKING FINGERS**. DIRECTORIESAMERICA, INC., (U.S. CL. 101). SN 73-709,122. PUB. 1-31-1989. FILED 2-2-1988.
 2,622,500. **TALKING FINGERS (STYLIZED)**. DIRECTORIESAMERICA, INC., (U.S. CL. 101). SN 73-718,588. PUB. 7-25-1989. FILED 3-24-1988.
 2,622,505. **OVERTURE**. OVERTURE LIMITED LIABILITY COMPANY, (U.S. CLS. 100, 101 AND 102). SN 74-626,474. PUB. 7-2-2002. FILED 1-27-1995.
 2,622,521. **SHORE HEALTH SERVICES**. SHORE HEALTH SERVICES, INC., MULTIPLE CLASS, (INT. CLS. 35, 41 AND 42), (U.S. CLS. 100, 101, 102 AND 107). SN 75-223,048. PUB. 7-2-2002. FILED 1-9-1997.
 2,622,532. **RFP EXPRESS**. TEL.N.FORM INTERACTIVE COMMUNICATION CORPORATION, (U.S. CLS. 100, 101 AND 102). SN 75-374,421. PUB. 7-2-2002. FILED 10-14-1997.
 2,622,536 (*See Class 9 for this trademark*).
 2,622,558. **COLOR ART**. COLOR ART OFFICE INTERIORS, INC., (U.S. CLS. 100, 101 AND 102). SN 75-493,398. PUB. 7-2-2002. FILED 5-29-1998.
 2,622,571. **CINCINNATI BELL NETWORK SOLUTIONS**. CINCINNATI BELL TELEPHONE COMPANY, MULTIPLE CLASS, (INT. CLS. 35, 37 AND 42), (U.S. CLS. 100, 101, 102, 103 AND 106). SN 75-539,776. PUB. 1-4-2000. FILED 8-20-1998.
 2,622,572 (*See Class 9 for this trademark*).
 2,622,576. **HOMEDELIVERY.COM AND DESIGN**. ADF VENTURES, LTD., (U.S. CLS. 100, 101 AND 102). SN 75-557,550. PUB. 11-27-2001. FILED 9-24-1998.
 2,622,583 (*See Class 5 for this trademark*).
 2,622,593. **BILL'S FAMILY FOODS AND DESIGN**. BILL'S FOREST CITY SUPERMARKET, INC., MULTIPLE CLASS, (INT. CLS. 35 AND 42), (U.S. CLS. 100, 101 AND 102). SN 75-583,398. PUB. 12-7-1999. FILED 11-5-1998.
 2,622,594. **BYTES UNLIMITED**. BRIAN L. GOLDBERG, MULTIPLE CLASS, (INT. CLS. 35 AND 37), (U.S. CLS. 100, 101, 102, 103 AND 106). SN 75-583,791. PUB. 7-2-2002. FILED 11-18-1998.
 2,622,605 (*See Class 5 for this trademark*).
 2,622,607 (*See Class 33 for this trademark*).
 2,622,613. **OUTPOST.COM**. CYBERIAN OUTPOST, INC., (U.S. CLS. 100, 101 AND 102). SN 75-617,717. PUB. 7-2-2002. FILED 1-11-1999.
 2,622,620. **CMS**. CONSOLIDATED MEDIA SYSTEMS, MULTIPLE CLASS, (INT. CLS. 35, 37 AND 41), (U.S. CLS. 100, 101, 102, 103, 106 AND 107). SN 75-627,022. PUB. 7-2-2002. FILED 1-25-1999.
 2,622,621. **CONSOLIDATED MEDIA SYSTEMS**. CONSOLIDATED MEDIA SYSTEMS, MULTIPLE CLASS, (INT. CLS. 35, 37 AND 41), (U.S. CLS. 100, 101, 102, 103, 106 AND 107). SN 75-627,023. PUB. 7-2-2002. FILED 1-25-1999.
 2,622,635. **TCC AND DESIGN**. TAKE CHARGE CONSULTANTS, INC., (U.S. CLS. 100, 101 AND 102). SN 75-660,975. PUB. 7-2-2002. FILED 3-15-1999.
 2,622,636. **E-DEALS! AND DESIGN**. BARNESANDNOBLE.COM LLC, (U.S. CLS. 100, 101 AND 102). SN 75-664,745. PUB. 7-2-2002. FILED 3-22-1999.
 2,622,643. **SAVE4YOU**. SAVE4YOU, (U.S. CLS. 100, 101 AND 102). SN 75-674,946. PUB. 7-2-2002. FILED 4-6-1999.
 2,622,644. **DISCOUNT SPORT NUTRITION**. DISCOUNT SPORT NUTRITION, L.L.C., (U.S. CLS. 100, 101 AND 102). SN 75-683,123. PUB. 7-2-2002. FILED 4-15-1999.
 2,622,659. **E-LYNXX**. E-LYNXX CORPORATION, DBA E-LYNXX, BY ASSIGNMENT ABC ADVISORS, INC., (U.S. CLS. 100, 101 AND 102). SN 75-706,903. PUB. 7-2-2002. FILED 5-14-1999.
 2,622,662. **NOB HILL FOODS (STYLIZED)**. RALEY'S, (U.S. CLS. 100, 101 AND 102). SN 75-714,014. PUB. 7-2-2002. FILED 5-25-1999.
 2,622,664. **SEASONAL CONCEPTS**. SEASONAL CONCEPTS, INC., (U.S. CLS. 100, 101 AND 102). SN 75-717,603. PUB. 7-2-2002. FILED 5-28-1999.
 2,622,667. **ART OF THE GAME**. PHOTO FILE, INC., (U.S.

- CLS. 100, 101 AND 102). SN 75-721,256. PUB. 7-2-2002. FILED 6-4-1999.
- 2,622,671 (*See Class 9 for this trademark*).
- 2,622,673 (*See Class 16 for this trademark*).
- 2,622,676. **GIRVIN**. TIM GIRVIN DESIGN, INC., MULTIPLE CLASS, (INT. CLS. 35 AND 42), (U.S. CLS. 100, 101 AND 102). SN 75-734,274. PUB. 7-2-2002. FILED 6-23-1999.
- 2,622,682. **ITEC NETWORK**. ITEC ENTERTAINMENT CORPORATION, MULTIPLE CLASS, (INT. CLS. 35 AND 41), (U.S. CLS. 100, 101, 102 AND 107). SN 75-744,373. PUB. 7-2-2002. FILED 7-7-1999.
- 2,622,686 (*See Class 16 for this trademark*).
- 2,622,701. **GETRONICS**. GETRONICS NEDERLAND B.V., (U.S. CLS. 100, 101 AND 102). SN 75-772,221. PUB. 7-2-2002. FILED 8-10-1999.
- 2,622,713. **CRESCENDO**. GNP - CRESCENDO RECORD CO., INC., MULTIPLE CLASS, (INT. CLS. 35 AND 41), (U.S. CLS. 100, 101, 102 AND 107). SN 75-792,299. PUB. 7-2-2002. FILED 9-1-1999.
- 2,622,720. **GRAND SUMMIT RESORT**. GRAND SUMMIT RESORT PROPERTIES, INC., MULTIPLE CLASS, (INT. CLS. 35 AND 42), (U.S. CLS. 100, 101 AND 102). SN 75-800,697. PUB. 7-2-2002. FILED 9-13-1999.
- 2,622,724. **L'ENTREPOT DU HOCKEY AND DESIGN**. LANDRY, JEAN, (U.S. CLS. 100, 101 AND 102). SN 75-804,798. PUB. 10-16-2001. FILED 9-21-1999.
- 2,622,726. **ONLINE RINGMAN AND DESIGN**. AUCTION MANAGEMENT SOLUTIONS, INC., (U.S. CLS. 100, 101 AND 102). SN 75-811,904. PUB. 7-2-2002. FILED S.R. 9-30-1999; AM. P.R. 8-22-2001.
- 2,622,727. **ENJOY AMERICA! AMERICA'S FINEST DISCOUNT CAMPING AND DESIGN**. RESORT PARKS INTERNATIONAL, INC., (U.S. CLS. 100, 101 AND 102). SN 75-812,094. PUB. 7-2-2002. FILED 9-29-1999.
- 2,622,730. **WORLD E-TRADERS**. WORLD E-TRADERS, L.L.C, (U.S. CLS. 100, 101 AND 102). SN 75-817,946. PUB. 7-2-2002. FILED 10-8-1999.
- 2,622,736. **MISCELLANEOUS DESIGN**. EDUCATION WORLD, INC., BY CHANGE OF NAME CONCOURSE C, INC., MULTIPLE CLASS, (INT. CLS. 35 AND 41), (U.S. CLS. 100, 101, 102 AND 107). SN 75-822,108. PUB. 7-2-2002. FILED 10-12-1999.
- 2,622,737 (*See Class 9 for this trademark*).
- 2,622,755 (*See Class 25 for this trademark*).
- 2,622,757 (*See Class 6 for this trademark*).
- 2,622,766. **QCOMM**. MICRO E.D.S., INC., (U.S. CLS. 100, 101 AND 102). SN 75-849,463. PUB. 6-5-2001. FILED 11-16-1999.
- 2,622,769. **NOVATEK**. XYTEK, INC., (U.S. CLS. 100, 101 AND 102). SN 75-851,777. PUB. 7-2-2002. FILED 11-17-1999.
- 2,622,770. **LA CUMBRE AND DESIGN**. LA CUMBRE, INC., (U.S. CLS. 100, 101 AND 102). SN 75-851,816. PUB. 7-2-2002. FILED 11-18-1999.
- 2,622,779. **IDEAS...THE PROGRAM FOR CHANGE**. WORKFLOW DYNAMICS, INC., (U.S. CLS. 100, 101 AND 102). SN 75-859,819. PUB. 7-2-2002. FILED 11-29-1999.
- 2,622,790. **IP INVESTMENT PARTNERS AND DESIGN**. STUDI, PHILIPPE, MULTIPLE CLASS, (INT. CLS. 35, 36, 41 AND 42), (U.S. CLS. 100, 101, 102 AND 107). SN 75-870,800. PUB. 7-2-2002. FILED 12-13-1999.
- 2,622,796. **OUT OF THE BLUE**. BERUDA DEPARTMENT OF TOURISM, (U.S. CLS. 100, 101 AND 102). SN 75-882,529. PUB. 7-2-2002. FILED 12-23-1999.
- 2,622,806. **NO EXTRAS EVER**. BELLE TIRE DISTRIBUTORS, INC., (U.S. CLS. 100, 101 AND 102). SN 75-888,989. PUB. 7-2-2002. FILED 1-7-2000.
- 2,622,807. **AUTO PARTS COUNTER AND DESIGN**. UNISELECT INC., (U.S. CLS. 100, 101 AND 102). SN 75-889,179. PUB. 7-2-2002. FILED 1-6-2000.
- 2,622,814. **P PERFORMANCE HOSPITALITY MANAGEMENT AND DESIGN**. PERFORMANCE HOSPITALITY MANAGEMENT CORPORATION, MULTIPLE CLASS, (INT. CLS. 35 AND 36), (U.S. CLS. 100, 101 AND 102). SN 75-892,399. PUB. 11-6-2001. FILED 1-7-2000.
- 2,622,826. **ISPHERES AND DESIGN**. ISPHERES CORPORATION, BY CHANGE OF NAME INFOSPHERES CORPORATION, (U.S. CLS. 100, 101 AND 102). SN 75-901,259. PUB. 7-2-2002. FILED 1-20-2000.
- 2,622,828 (*See Class 9 for this trademark*).
- 2,622,835. **THE WORLD OF ENERGY IS CHANGING. LET POWERCHOICE HOME SHOW YOU THE WAY**. POTO-MAC ELECTRIC POWER COMPANY, MULTIPLE CLASS, (INT. CLS. 35, 36 AND 42), (U.S. CLS. 100, 101 AND 102). SN 75-907,651. PUB. 7-2-2002. FILED 2-1-2000.
- 2,622,836. **GO LENDER DIRECT**. GO LENDER DIRECT, INC., (U.S. CLS. 100, 101 AND 102). SN 75-907,992. PUB. 7-2-2002. FILED 1-27-2000.
- 2,622,837. **GOLENDERDIRECT.COM**. GO LENDER DIRECT, INC., (U.S. CLS. 100, 101 AND 102). SN 75-907,993. PUB. 7-2-2002. FILED 1-27-2000.
- 2,622,845 (*See Class 9 for this trademark*).
- 2,622,856. **RED FOX EXECUTIVE SEARCH**. RED FOX EXECUTIVE SEARCH, INC., (U.S. CLS. 100, 101 AND 102). SN 75-921,840. PUB. 7-2-2002. FILED 2-7-2000.
- 2,622,861. **ACTIVE BODY**. ROSENBLUM, CARMEN E., AND ROSENBLUM, ALLAN S., (U.S. CLS. 100, 101 AND 102). SN 75-925,416. PUB. 7-2-2002. FILED 2-9-2000.
- 2,622,865. **IGROUP AND DESIGN**. COMPUTACENTER (UK) LIMITED, (U.S. CLS. 100, 101 AND 102). SN 75-927,017. PUB. 11-20-2001. FILED 2-23-2000.
- 2,622,870. **GLOBEXPLORER AND DESIGN**. GLOBEXPLORER, INC., (U.S. CLS. 100, 101 AND 102). SN 75-930,611. PUB. 7-2-2002. FILED 2-28-2000.
- 2,622,871. **ETF GROUP**. ETF GROUP, (U.S. CLS. 100, 101 AND 102). SN 75-932,197. PUB. 7-2-2002. FILED 3-2-2000.
- 2,622,887. **EAGLEDIRECT.COM AND DESIGN**. PREMIER GRAPHICS, INC., BY MERGER EAGLEDIRECT.COM, INC., MULTIPLE CLASS, (INT. CLS. 35 AND 42), (U.S. CLS. 100, 101 AND 102). SN 75-980,510. PUB. 6-19-2001. FILED 12-21-1999.
- 2,622,888. **VERTIS**. PRINTCO., INC., BY ASSIGNMENT; BY ASSIGNMENT TREASURE CHEST ADVERTISING COMPANY, INC., (U.S. CLS. 100, 101 AND 102). SN 75-980,666. PUB. 7-2-2002. FILED 7-5-2000.
- 2,622,892. **ALOHA! (STYLIZED)**. HAWAII VISITORS & CONVENTION BUREAU, (U.S. CLS. 100, 101 AND 102). SN 75-981,515. PUB. 7-2-2002. FILED 5-9-2000.
- 2,622,899. **RECRUITUSA**. RECRUITUSA INC., (U.S. CLS. 100, 101 AND 102). SN 76-000,861. PUB. 7-2-2002. FILED 3-15-2000.
- 2,622,900. **AUDIOBOOKCLUB.COM AND DESIGN**. MEDIABAY, INC., BY ASSIGNMENT MEDIABAY.COM, INC., (U.S. CLS. 100, 101 AND 102). SN 76-002,478. PUB. 7-2-2002. FILED 3-17-2000.
- 2,622,901 (*See Class 9 for this trademark*).
- 2,622,904. **V TWIN EXPO BY EASYRIDERS AND DESIGN**. PAISANO PUBLICATIONS, INC., (U.S. CLS. 100, 101 AND 102). SN 76-004,696. PUB. 7-2-2002. FILED 3-20-2000.
- 2,622,907. **GREATER PITTSBURGH CONVENTION & VISITORS BUREAU**. GREATER PITTSBURGH CONVENTION & VISITORS BUREAU, INC., (U.S. CLS. 100, 101 AND 102). SN 76-006,466. PUB. 7-2-2002. FILED 3-21-2000.
- 2,622,911 (*See Class 11 for this trademark*).
- 2,622,913. **ECLECTIC**. ECLECTIC INTERNATIONAL B.V., (U.S. CLS. 100, 101 AND 102). SN 76-007,512. PUB. 7-2-2002. FILED 3-23-2000.
- 2,622,917. **CITIESUNLIMITED.COM**. MORITZ, ROB, (U.S. CLS. 100, 101 AND 102). SN 76-009,610. PUB. 7-2-2002. FILED 3-14-2000.
- 2,622,918 (*See Class 28 for this trademark*).
- 2,622,926. **HEALTHCARE AMERICA.COM**. WALSH HEALTHCARE SOLUTIONS, INC., BY CHANGE OF NAME WALSH DISTRIBUTION, INC., MULTIPLE CLASS, (INT. CLS. 35 AND 42), (U.S. CLS. 100, 101 AND 102). SN 76-016,145. PUB. 7-2-2002. FILED 4-3-2000.
- 2,622,937 (*See Class 9 for this trademark*).
- 2,622,943. **BUDGET PRO CODING SYSTEM AND DESIGN**. CENTURY SERVICES, L.P., (U.S. CLS. 100, 101 AND 102). SN 76-024,778. PUB. 7-2-2002. FILED 4-14-2000.
- 2,622,950. **SMART STARTERS**. SMART STARTERS INC., BY ASSIGNMENT SMART STARTERS LLC, MULTIPLE CLASS, (INT. CLS. 35 AND 36), (U.S. CLS. 100, 101 AND 102). SN 76-027,352. PUB. 7-2-2002. FILED 4-18-2000.
- 2,622,954. **AREA 51 AND DESIGN**. AREA 51, INC., (U.S. CLS. 100, 101 AND 102). SN 76-029,872. PUB. 7-2-2002. FILED 4-17-2000.
- 2,622,962. **TEXT 100 PUBLIC RELATIONS AND DESIGN**.

- ONEMONDAY GROUP PLC, BY CHANGE OF NAME TEXT 100 GROUP PLC, (U.S. CLS. 100, 101 AND 102). SN 76-035,329. PUB. 12-11-2001. FILED 4-26-2000.
- 2,622,965. **GOOD GUYS. GREAT BUYS.**. USI GROUP, INC., (U.S. CLS. 100, 101 AND 102). SN 76-036,773. PUB. 7-2-2002. FILED 4-28-2000.
- 2,622,967. **JOBTRUST (STYLIZED)**. ROSS-SMITH, PHILIP MICHAEL, (U.S. CLS. 100, 101 AND 102). SN 76-037,154. PUB. 7-2-2002. FILED 4-28-2000.
- 2,622,981. **CENTURY STAFFING SERVICES**. CENTURY STAFFING SERVICES, INC., (U.S. CLS. 100, 101 AND 102). SN 76-046,060. PUB. 3-27-2001. FILED 5-11-2000.
- 2,622,989. **OPENFORFEEDBACK.COM (STYLIZED)**. M.H.J. MEELIS, DBA MEELIX INFORMATION TECHNOLOGY, (U.S. CLS. 100, 101 AND 102). SN 76-049,054. PUB. 7-2-2002. FILED 5-16-2000.
- 2,622,993. **THE WEST ADVANTAGE PROGRAM**. WEST MARINE IHC I, INC., BY ASSIGNMENT; BY ASSIGNMENT WEST MARINE IHC II, INC., (U.S. CLS. 100, 101 AND 102). SN 76-049,770. PUB. 1-29-2002. FILED 5-16-2000.
- 2,622,994. **WHAT DO YOU WANT YOUR BRAND TO SAY?**. CARPE DIEM DESIGN PTY. LIMITED, MULTIPLE CLASS, (INT. CLS. 35 AND 42), (U.S. CLS. 100, 101 AND 102). SN 76-049,885. PUB. 7-2-2002. FILED 5-16-2000.
- 2,622,995. **E-LYNXX AND DESIGN**. E-LYNXX CORPORATION, (U.S. CLS. 100, 101 AND 102). SN 76-050,407. PUB. 7-2-2002. FILED 5-18-2000.
- 2,622,997. **SMARTBOOTH**. V.T.S.S., INC., (U.S. CLS. 100, 101 AND 102). SN 76-051,638. PUB. 11-6-2001. FILED 5-19-2000.
- 2,623,029. **PREDATOR RIDGE**. PREDATOR RIDGE GOLF CLUB LTD., MULTIPLE CLASS, (INT. CLS. 35, 37, 41 AND 42), (U.S. CLS. 100, 101, 102, 103, 106 AND 107). SN 76-062,210. PUB. 7-2-2002. FILED 5-30-2000.
- 2,623,031 (*See Class 11 for this trademark*).
- 2,623,032. **PRECISIONPROSPECTOR**. FEEDBACK SYSTEMS, INC., (U.S. CLS. 100, 101 AND 102). SN 76-063,068. PUB. 7-2-2002. FILED 6-2-2000.
- 2,623,034 (*See Class 16 for this trademark*).
- 2,623,035. **MISCELLANEOUS DESIGN**. DICTATIONS & TRANSCRIPTIONS LTD., (U.S. CLS. 100, 101 AND 102). SN 76-063,776. PUB. 4-16-2002. FILED 6-2-2000.
- 2,623,038. **SHOPFOOD.COM**. SHOP FOOD, L.P., (U.S. CLS. 100, 101 AND 102). SN 76-064,063. PUB. 7-2-2002. FILED 6-5-2000.
- 2,623,039. **CLAIRE'S AND DESIGN**. CLAIRE'S BOUTIQUES, INC., (U.S. CLS. 100, 101 AND 102). SN 76-064,166. PUB. 7-2-2002. FILED 6-6-2000.
- 2,623,041. **CONFLUENCE GROUP**. CONFLUENCE GROUP, INC., THE, MULTIPLE CLASS, (INT. CLS. 35, 36 AND 42), (U.S. CLS. 100, 101 AND 102). SN 76-065,290. PUB. 11-13-2001. FILED 6-5-2000.
- 2,623,046. **EMISSARY**. EMISSARY, LLC, MULTIPLE CLASS, (INT. CLS. 35 AND 42), (U.S. CLS. 100, 101 AND 102). SN 76-067,508. PUB. 7-2-2002. FILED 6-2-2000.
- 2,623,049 (*See Class 16 for this trademark*).
- 2,623,070. **HERMES AND DESIGN**. HERMES INTERNATIONAL, MULTIPLE CLASS, (INT. CLS. 35, 37, 39, 40 AND 41), (U.S. CLS. 100, 101, 102, 103, 105, 106 AND 107). SN 76-075,934. PUB. 7-2-2002. FILED 6-23-2000.
- 2,623,072. **CONVERGENCE**. GREAT PLAINS SOFTWARE, INC., (U.S. CLS. 100, 101 AND 102). SN 76-076,370. PUB. 7-2-2002. FILED 6-23-2000.
- 2,623,073 (*See Class 29 for this trademark*).
- 2,623,081. **GOLFPROPS.COM**. BOCK, ELIZABETH, MULTIPLE CLASS, (INT. CLS. 35 AND 36), (U.S. CLS. 100, 101 AND 102). SN 76-079,621. PUB. 7-2-2002. FILED 6-19-2000.
- 2,623,087. **USA WOODS INTERNATIONAL**. USA WOODS INTERNATIONAL, INC., (U.S. CLS. 100, 101 AND 102). SN 76-081,752. PUB. 7-2-2002. FILED 6-30-2000.
- 2,623,088 (*See Class 30 for this trademark*).
- 2,623,091. **CLICKTC.COM**. ANTHOLOGY, INC., (U.S. CLS. 100, 101 AND 102). SN 76-082,622. PUB. 7-2-2002. FILED 7-3-2000.
- 2,623,092 (*See Class 14 for this trademark*).
- 2,623,107. **THE BLUE BOOK BUILDING AND CONSTRUCTION**. CONTRACTORS REGISTER, INC., (U.S. CLS. 100, 101 AND 102). SN 76-089,461. PUB. 7-2-2002. FILED 7-17-2000.
- 2,623,108. **THE BLUE BOOK**. CONTRACTORS REGISTER, INC., (U.S. CLS. 100, 101 AND 102). SN 76-089,462. PUB. 7-2-2002. FILED 7-17-2000.
- 2,623,109. **MAREXPOL**. MAREX, INC., BY CHANGE OF NAME MAREX.COM, INC., (U.S. CLS. 100, 101 AND 102). SN 76-089,693. PUB. 7-2-2002. FILED 7-13-2000.
- 2,623,126. **STELLCOM AND DESIGN**. STELLCOM, INC., MULTIPLE CLASS, (INT. CLS. 35 AND 42), (U.S. CLS. 100, 101 AND 102). SN 76-093,895. PUB. 7-2-2002. FILED 7-21-2000.
- 2,623,127. **IC2**. PRINTCO., INC., BY MERGER; BY MERGER; BY ASSIGNMENT IMAGING CONSORTIUM, INC., MULTIPLE CLASS, (INT. CLS. 35, 41 AND 42), (U.S. CLS. 100, 101, 102 AND 107). SN 76-094,140. PUB. 7-2-2002. FILED 7-20-2000.
- 2,623,140. **PETROTRENDS**. OILSPOT.COM, INC., (U.S. CLS. 100, 101 AND 102). SN 76-098,673. PUB. 7-2-2002. FILED 7-28-2000.
- 2,623,152. **IN2M**. IN2M.COM LLC, MULTIPLE CLASS, (INT. CLS. 35 AND 36), (U.S. CLS. 100, 101 AND 102). SN 76-103,634. PUB. 7-2-2002. FILED 8-4-2000.
- 2,623,160. **FROM THE FIRST QUESTIONS TO THE LAST CONNECTIONS.**. VECTREN COMMUNICATIONS SERVICES, INC., MULTIPLE CLASS, (INT. CLS. 35, 37 AND 42), (U.S. CLS. 100, 101, 102, 103 AND 106). SN 76-105,458. PUB. 7-2-2002. FILED 8-8-2000.
- 2,623,165. **UTURN AND DESIGN**. ZELMAN, STEPHANIE, DBA UTURN DESIGN, MULTIPLE CLASS, (INT. CLS. 35 AND 42), (U.S. CLS. 100, 101 AND 102). SN 76-107,875. PUB. 7-2-2002. FILED 8-14-2000.
- 2,623,179. **BILLBOARD VIDEO**. BILLBOARD VIDEO, INC., (U.S. CLS. 100, 101 AND 102). SN 76-112,149. PUB. 7-2-2002. FILED 8-18-2000.
- 2,623,180. **SOLD IS A FORE LETTER WORD**. BOCK, ELIZABETH, MULTIPLE CLASS, (INT. CLS. 35 AND 36), (U.S. CLS. 100, 101 AND 102). SN 76-112,367. PUB. 7-2-2002. FILED 8-18-2000.
- 2,623,181. **LIBRARYHQ**. SIRSI CORPORATION, MULTIPLE CLASS, (INT. CLS. 35 AND 41), (U.S. CLS. 100, 101, 102 AND 107). SN 76-112,372. PUB. 7-2-2002. FILED 8-18-2000.
- 2,623,184. **TRADEATTACHE.COM**. TRADEATTACHE.COM, INC., (U.S. CLS. 100, 101 AND 102). SN 76-112,878. PUB. 7-2-2002. FILED 8-21-2000.
- 2,623,198. **SMARTROOM**. MUDHOUSE, LLC, (U.S. CLS. 100, 101 AND 102). SN 76-116,601. PUB. 7-2-2002. FILED 8-28-2000.
- 2,623,201. **SOFTWARE OF THE MONTH CLUB**. SOMC GROUP, INC., (U.S. CLS. 100, 101 AND 102). SN 76-116,740. PUB. 7-2-2002. FILED 8-28-2000.
- 2,623,211. **OUTSPOKIN'**. OUTSPOKIN' BICYCLE AND SPORT, LLC, (U.S. CLS. 100, 101 AND 102). SN 76-120,875. PUB. 7-2-2002. FILED 9-5-2000.
- 2,623,212. **ECOMMERCE FOR THE REAL WORLD**. KENT ELECTRONICS CORPORATION, MULTIPLE CLASS, (INT. CLS. 35 AND 42), (U.S. CLS. 100, 101 AND 102). SN 76-120,893. PUB. 7-2-2002. FILED 9-1-2000.
- 2,623,213. **SILVERCLICKS.COM AND DESIGN**. SILVERCLICKS.COM, INC., (U.S. CLS. 100, 101 AND 102). SN 76-120,899. PUB. 7-2-2002. FILED 9-1-2000.
- 2,623,226 (*See Class 9 for this trademark*).
- 2,623,227. **A AND DESIGN**. ACORN CONSULTING INC., MULTIPLE CLASS, (INT. CLS. 35 AND 41), (U.S. CLS. 100, 101, 102 AND 107). SN 76-125,768. PUB. 7-2-2002. FILED 9-11-2000.
- 2,623,230. **MISCELLANEOUS DESIGN**. RIVERS WEST APPAREL, INC., (U.S. CLS. 100, 101 AND 102). SN 76-127,005. PUB. 7-2-2002. FILED 9-12-2000.
- 2,623,237. **I W IMAGWORKS AND DESIGN**. IMAGEWORKS, MULTIPLE CLASS, (INT. CLS. 35 AND 42), (U.S. CLS. 100, 101 AND 102). SN 76-128,402. PUB. 3-26-2002. FILED 9-15-2000.
- 2,623,254. **GE FLEET CONSULTANT**. GENERAL ELECTRIC COMPANY, BY ASSIGNMENT GELCO CORPORATION, DBA GE CAPITAL FLEET SERVICES, (U.S. CLS. 100, 101 AND 102). SN 76-133,216. PUB. 7-2-2002. FILED 9-22-2000.
- 2,623,260. **AUNT PATTY'S**. KERRIGAN, PATRICIA J., (U.S. CLS. 100, 101 AND 102). SN 76-134,419. PUB. 7-2-2002. FILED 9-25-2000.

- 2,623,261. **MR. TINT. MR. TINT.** (U.S. CLS. 100, 101 AND 102). SN 76-134,604. PUB. 7-2-2002. FILED 9-21-2000.
- 2,623,262. **FREELANCERS AND DESIGN.** FREELANCERS B.V.B.A., (U.S. CLS. 100, 101 AND 102). SN 76-134,693. PUB. 7-2-2002. FILED 9-25-2000.
- 2,623,264. **SAN ANTONIO VACATION EXPERIENCE.** SAN ANTONIO CONVENTION & VISITORS BUREAU, (U.S. CLS. 100, 101 AND 102). SN 76-134,740. PUB. 7-2-2002. FILED 9-25-2000.
- 2,623,278. **FROM CLICK TO CONSUMER.** ASD SYSTEMS, INC., DBA ASCENDANT SOLUTIONS, (U.S. CLS. 100, 101 AND 102). SN 76-136,615. PUB. 7-2-2002. FILED 9-27-2000.
- 2,623,283. **EXECUTIVE TALENT FOR THE DIGITAL AGE.** SUNNY BATES ASSOCIATES, INC., (U.S. CLS. 100, 101 AND 102). SN 76-137,621. PUB. 7-2-2002. FILED 9-29-2000.
- 2,623,302 (*See Class 9 for this trademark*).
- 2,623,309. **SIoux VALLEY.** SIOUX VALLEY HOSPITAL & HEALTH SYSTEM, MULTIPLE CLASS, (INT. CLS. 35 AND 44), (U.S. CLS. 100, 101 AND 102). SN 76-142,355. PUB. 7-2-2002. FILED 10-6-2000.
- 2,623,319 (*See Class 9 for this trademark*).
- 2,623,320. **IMPERIAL AND DESIGN.** IMPERIAL POOLS, INC., (U.S. CLS. 100, 101 AND 102). SN 76-144,377. PUB. 7-2-2002. FILED 10-11-2000.
- 2,623,321. **PATIO.COM OUTDOOR FURNITURE AND DESIGN.** R&R POOL & PATIO, INC., (U.S. CLS. 100, 101 AND 102). SN 76-144,456. PUB. 7-2-2002. FILED 10-11-2000.
- 2,623,324. **HOSPITALAR.** HOSPITALAR FEIRAS, CONGRESSOS E EMPREENDIMENTOS LTDA., (U.S. CLS. 100, 101 AND 102). SN 76-144,963. PUB. 12-11-2001. FILED 10-11-2000.
- 2,623,328. **OPENING THE DOOR TO A WORLD OF TECHNOLOGY.** EXACTO INC., (U.S. CLS. 100, 101 AND 102). SN 76-145,791. PUB. 7-2-2002. FILED 10-13-2000.
- 2,623,335. **VEEV AND DESIGN.** BANK OF MONTREAL, MULTIPLE CLASS, (INT. CLS. 35, 36 AND 42), (U.S. CLS. 100, 101 AND 102). SN 76-146,762. PUB. 7-2-2002. FILED 10-13-2000.
- 2,623,336. **MINDWIDTH.** CLARKSTON-POTOMAC GROUP, INC., MULTIPLE CLASS, (INT. CLS. 35 AND 42), (U.S. CLS. 100, 101 AND 102). SN 76-146,774. PUB. 7-2-2002. FILED 10-13-2000.
- 2,623,337. **EDFUND.** EDFUND, (U.S. CLS. 100, 101 AND 102). SN 76-147,092. PUB. 7-2-2002. FILED 10-12-2000.
- 2,623,340. **PROFESSIONALS NETWORK GROUP.** PROFESSIONALS NETWORK GROUP, INC., (U.S. CLS. 100, 101 AND 102). SN 76-147,452. PUB. 7-2-2002. FILED 10-17-2000.
- 2,623,348. **GREENMATCHMAKER.COM.** HRSERV, INCORPORATED, BY CHANGE OF NAME FSJ SERVICES, INC., (U.S. CLS. 100, 101 AND 102). SN 76-148,918. PUB. 6-4-2002. FILED 10-18-2000.
- 2,623,354. **AMERICAN POWER CONFERENCE.** PENNWELL CORPORATION, (U.S. CLS. 100, 101 AND 102). SN 76-150,062. PUB. 7-2-2002. FILED 10-18-2000.
- 2,623,369. **SONOMA EYEWORKS AND DESIGN.** SONOMA EYEWORKS INC., MULTIPLE CLASS, (INT. CLS. 35 AND 42), (U.S. CLS. 100, 101 AND 102). SN 76-152,253. PUB. 7-2-2002. FILED 10-23-2000.
- 2,623,372. **ASIADEMAND.** ASIADEMAND, INC., MULTIPLE CLASS, (INT. CLS. 35 AND 36), (U.S. CLS. 100, 101 AND 102). SN 76-152,782. PUB. 7-2-2002. FILED 10-24-2000.
- 2,623,375. **SHOP 02.** 02 HOLDINGS, LLC, (U.S. CLS. 100, 101 AND 102). SN 76-152,977. PUB. 7-2-2002. FILED 10-24-2000.
- 2,623,377. **PORTER MATTHEWS AND DESIGN.** PORTER MATTHEWS PLACEMENT SERVICES, INC., (U.S. CLS. 100, 101 AND 102). SN 76-153,214. PUB. 7-2-2002. FILED 10-25-2000.
- 2,623,380. **MISCELLANEOUS DESIGN.** PHYSICIAN WEBLINK, INC., MULTIPLE CLASS, (INT. CLS. 35 AND 36), (U.S. CLS. 100, 101 AND 102). SN 76-153,511. PUB. 7-2-2002. FILED 10-25-2000.
- 2,623,392. **FLAGEMPORIUM.** DUTSON, DALLAS, (U.S. CLS. 100, 101 AND 102). SN 76-155,902. PUB. 7-2-2002. FILED 10-26-2000.
- 2,623,395. **VEN DEX AND DESIGN.** FOOD DISTRIBUTORS INTERNATIONAL - - NAWGA/IFDA, INC., (U.S. CLS. 100, 101 AND 102). SN 76-156,520. PUB. 7-2-2002. FILED 10-31-2000.
- 2,623,400. **MISCELLANEOUS DESIGN.** CONSUMER BROADCAST GROUP, (U.S. CLS. 100, 101 AND 102). SN 76-157,718. PUB. 7-2-2002. FILED 11-2-2000.
- 2,623,407. **ADVERCARD.** INTERACTIVE VOICE, DATA & FAX, INC., (U.S. CLS. 100, 101 AND 102). SN 76-158,322. PUB. 7-2-2002. FILED 11-2-2000.
- 2,623,414. **LEMON LEADERSHIP.** INSTITUTE FOR INNOVATION, INTEGRATION & IMPACT, INC., THE, (U.S. CLS. 100, 101 AND 102). SN 76-159,005. PUB. 7-2-2002. FILED 11-6-2000.
- 2,623,416. **GFI AND DESIGN.** FDMC HOLDINGS, INC., (U.S. CLS. 100, 101 AND 102). SN 76-159,767. PUB. 7-2-2002. FILED 11-1-2000.
- 2,623,419. **IGA HOMETOWN KIDS FEST AND DESIGN.** IGA, INC., (U.S. CLS. 100, 101 AND 102). SN 76-159,849. PUB. 7-2-2002. FILED 11-6-2000.
- 2,623,424. **STREET MASTERS AND DESIGN.** MCNEIL, MELVIN, (U.S. CLS. 100, 101 AND 102). SN 76-160,379. PUB. 7-2-2002. FILED 11-7-2000.
- 2,623,437 (*See Class 14 for this trademark*).
- 2,623,443. **MISCELLANEOUS DESIGN.** KEYBOARD CONCEPTS, INC., (U.S. CLS. 100, 101 AND 102). SN 76-164,086. PUB. 7-2-2002. FILED 11-13-2000.
- 2,623,461 (*See Class 9 for this trademark*).
- 2,623,465. **JOSHUA CREEK RANCH GAME PRESERVE & RESORT AND DESIGN.** JOSHUA CREEK SHOOTING RESORT, INC., DBA JOSHUA CREEK RANCH, MULTIPLE CLASS, (INT. CLS. 35, 41 AND 42), (U.S. CLS. 100, 101, 102 AND 107). SN 76-167,978. PUB. 7-2-2002. FILED 11-20-2000.
- 2,623,467. **ICE MILLER.** ICE MILLER, MULTIPLE CLASS, (INT. CLS. 35 AND 42), (U.S. CLS. 100, 101 AND 102). SN 76-168,285. PUB. 7-2-2002. FILED 11-17-2000.
- 2,623,474. **OPTIEM.** OPTIEM LLC, MULTIPLE CLASS, (INT. CLS. 35 AND 42), (U.S. CLS. 100, 101 AND 102). SN 76-170,178. PUB. 7-2-2002. FILED 11-22-2000.
- 2,623,478 (*See Class 9 for this trademark*).
- 2,623,479 (*See Class 9 for this trademark*).
- 2,623,482. **MISCELLANEOUS DESIGN.** SCOOTER STORE, INC., THE, MULTIPLE CLASS, (INT. CLS. 35, 36, 37 AND 39), (U.S. CLS. 100, 101, 102, 103, 105 AND 106). SN 76-170,752. PUB. 7-2-2002. FILED 11-22-2000.
- 2,623,488. **MISCELLANEOUS DESIGN.** WORLD WIDE PET SUPPLY ASSOCIATION, INC., MULTIPLE CLASS, (INT. CLS. 35 AND 41), (U.S. CLS. 100, 101, 102 AND 107). SN 76-171,741. PUB. 7-2-2002. FILED 11-28-2000.
- 2,623,489. **QTC AND DESIGN.** QTC MANAGEMENT, INC., MULTIPLE CLASS, (INT. CLS. 35 AND 36), (U.S. CLS. 100, 101 AND 102). SN 76-171,927. PUB. 7-2-2002. FILED 11-28-2000.
- 2,623,496. **FIND YOUR FREEDOM.** SCOOTER STORE, INC., THE, MULTIPLE CLASS, (INT. CLS. 35, 36, 37 AND 39), (U.S. CLS. 100, 101, 102, 103, 105 AND 106). SN 76-172,527. PUB. 7-2-2002. FILED 11-29-2000.
- 2,623,498. **STEPBEYOND.** MYERS INTERNATIONAL, LTD., (U.S. CLS. 100, 101 AND 102). SN 76-172,788. PUB. 7-2-2002. FILED 11-27-2000.
- 2,623,508. **BOUCHER.** BOUCHER GROUP, INC., THE, (U.S. CLS. 100, 101 AND 102). SN 76-174,121. PUB. 7-2-2002. FILED 12-1-2000.
- 2,623,512. **REVCARE.** REVCARE, INC, MULTIPLE CLASS, (INT. CLS. 35 AND 36), (U.S. CLS. 100, 101 AND 102). SN 76-174,429. PUB. 7-2-2002. FILED 11-28-2000.
- 2,623,513 (*See Class 9 for this trademark*).
- 2,623,516. **ALIGN360.** ALIGN360, LLC, BY ASSIGNMENT; BY CHANGE OF NAME ALIGN360, INC., MULTIPLE CLASS, (INT. CLS. 35 AND 42), (U.S. CLS. 100, 101 AND 102). SN 76-175,200. PUB. 7-2-2002. FILED 12-5-2000.
- 2,623,546 (*See Class 9 for this trademark*).
- 2,623,549. **STRATEGY IN A BOX PLAN. DO. WIN! AND DESIGN.** VECTOR STRATEGIC RESOURCES, INC., MULTIPLE CLASS, (INT. CLS. 35 AND 41), (U.S. CLS. 100, 101, 102 AND 107). SN 76-180,036. PUB. 7-2-2002. FILED 12-13-2000.
- 2,623,551. **AMOUR.** PEEKAY, INC., (U.S. CLS. 100, 101 AND 102). SN 76-180,496. PUB. 7-2-2002. FILED 12-13-2000.
- 2,623,554. **EMC.** EMC CORPORATION, (U.S. CLS. 100, 101 AND 102). SN 76-181,000. PUB. 7-2-2002. FILED 12-14-2000.

- 2,623,557. **EMC2 (STYLIZED)**. EMC CORPORATION, (U.S. CLS. 100, 101 AND 102). SN 76-181,022. PUB. 7-2-2002. FILED 12-14-2000.
- 2,623,559 (*See Class 9 for this trademark*).
- 2,623,563. **EBUSINESSWARE INNOVATING BUSINESS THROUGH TECHNOLOGY AND DESIGN**. EBUSINESSWARE, INC., MULTIPLE CLASS, (INT. CLS. 35 AND 42), (U.S. CLS. 100, 101 AND 102). SN 76-181,469. PUB. 7-2-2002. FILED 12-15-2000.
- 2,623,566. **MONSTER BUCKS**. MONSTER CABLE PRODUCTS, INC., (U.S. CLS. 100, 101 AND 102). SN 76-182,065. PUB. 7-2-2002. FILED 12-14-2000.
- 2,623,569. **E-CORRIDOR (STYLIZED)**. STIRLING ENTERPRISES, LLC., (U.S. CLS. 100, 101 AND 102). SN 76-182,871. PUB. 7-2-2002. FILED 12-13-2000.
- 2,623,570. **E-CORRIDOR AND DESIGN**. STIRLING ENTERPRISES, LLC., (U.S. CLS. 100, 101 AND 102). SN 76-182,872. PUB. 7-2-2002. FILED 12-13-2000.
- 2,623,582. **MUE**. BECTON DICKINSON AND COMPANY, (U.S. CLS. 100, 101 AND 102). SN 76-185,430. PUB. 7-2-2002. FILED 12-22-2000.
- 2,623,588. **C-STORE CENTRAL**. NATIONAL ASSOCIATION OF CONVENIENCE STORES, (U.S. CLS. 100, 101 AND 102). SN 76-186,199. PUB. 7-2-2002. FILED 12-22-2000.
- 2,623,623. **INFOSTRENGTH**. INFOSTRENGTH BUSINESS SOLUTIONS INC., MULTIPLE CLASS, (INT. CLS. 35 AND 42), (U.S. CLS. 100, 101 AND 102). SN 76-190,254. PUB. 7-2-2002. FILED 1-5-2001.
- 2,623,624. **INFOSTRENGTH AND DESIGN**. INFOSTRENGTH BUSINESS SOLUTIONS INC., MULTIPLE CLASS, (INT. CLS. 35 AND 42), (U.S. CLS. 100, 101 AND 102). SN 76-190,255. PUB. 7-2-2002. FILED 1-5-2001.
- 2,623,630. **ALESIE**. FLORIDA GRAINS, INC., (U.S. CLS. 100, 101 AND 102). SN 76-190,976. PUB. 7-2-2002. FILED 1-8-2001.
- 2,623,643. **DIABETES - THE THINKING PERSON'S DISEASE**. DIABETIC YOUTH FOUNDATION, (U.S. CLS. 100, 101 AND 102). SN 76-193,566. PUB. 7-2-2002. FILED 1-16-2001.
- 2,623,665. **SERVICE SOLUTIONS**. SPX CORPORATION, MULTIPLE CLASS, (INT. CLS. 35, 41 AND 42), (U.S. CLS. 100, 101, 102 AND 107). SN 76-195,738. PUB. 7-2-2002. FILED 1-18-2001.
- 2,623,683 (*See Class 16 for this trademark*).
- 2,623,690. **INTER/MEDIA ADVERTISING**. INTER/MEDIA TIME BUYING CORPORATION, (U.S. CLS. 100, 101 AND 102). SN 76-198,909. PUB. 7-2-2002. FILED 1-24-2001.
- 2,623,694. **ONE SEGUROSMARKET AND DESIGN**. SPINSIT.COM, INC., DBA SEGUROSMARKET.COM, MULTIPLE CLASS, (INT. CLS. 35, 36 AND 38), (U.S. CLS. 100, 101, 102 AND 104). SN 76-199,472. PUB. 7-2-2002. FILED 1-23-2001.
- 2,623,697. **AABACA**. KRAUT, BILLEE, AND JOHNSON, HOWARD R., (U.S. CLS. 100, 101 AND 102). SN 76-199,603. PUB. 7-2-2002. FILED 1-19-2001.
- 2,623,700. **INTERNETIX**. INTERNETIX, INC., MULTIPLE CLASS, (INT. CLS. 35 AND 42), (U.S. CLS. 100, 101 AND 102). SN 76-200,186. PUB. 7-2-2002. FILED 1-25-2001.
- 2,623,704. **COACH ILLUSTRATED**. COACHPATEMO.COM, INC., MULTIPLE CLASS, (INT. CLS. 35, 38 AND 42), (U.S. CLS. 100, 101, 102 AND 104). SN 76-200,548. PUB. 7-2-2002. FILED 1-26-2001.
- 2,623,711. **INTEROPS**. INTEROPS MANAGEMENT SOLUTIONS, INC., BY CHANGE OF NAME INTEROPS, MULTIPLE CLASS, (INT. CLS. 35 AND 42), (U.S. CLS. 100, 101 AND 102). SN 76-201,639. PUB. 7-2-2002. FILED 1-30-2001.
- 2,623,719 (*See Class 9 for this trademark*).
- 2,623,724 (*See Class 9 for this trademark*).
- 2,623,727. **INNOVATIVE LEADER IN CUSTOMER SATISFACTION**. PERFORMANCE FOOD GROUP COMPANY, MULTIPLE CLASS, (INT. CLS. 35 AND 42), (U.S. CLS. 100, 101 AND 102). SN 76-203,117. PUB. 7-2-2002. FILED 2-1-2001.
- 2,623,732. **ARGOSI.NET**. CROSS COUNTRY AUTOMOTIVE SERVICES, INC., MULTIPLE CLASS, (INT. CLS. 35, 36, 37 AND 42), (U.S. CLS. 100, 101, 102, 103 AND 106). SN 76-203,391. PUB. 7-2-2002. FILED 2-1-2001.
- 2,623,744. **ADCONTENT BRAND GUARANTOR**. ADPLEX, INC., (U.S. CLS. 100, 101 AND 102). SN 76-204,211. PUB. 7-2-2002. FILED 2-2-2001.
- 2,623,751. **VTRANSCRIBE**. VTRANSCRIBE, INC., (U.S. CLS. 100, 101 AND 102). SN 76-205,237. PUB. 7-2-2002. FILED 2-6-2001.
- 2,623,755. **GROOVE RIDERS**. DIMENT, ELMAR, (U.S. CLS. 100, 101 AND 102). SN 76-205,733. PUB. 7-2-2002. FILED 2-2-2001.
- 2,623,756. **MYRRIWORLD**. RELOCATION RESOURCES INTERNATIONAL, INC., MULTIPLE CLASS, (INT. CLS. 35 AND 36), (U.S. CLS. 100, 101 AND 102). SN 76-205,814. PUB. 7-2-2002. FILED 2-6-2001.
- 2,623,760. **BIZDEGREE**. APPLIED INFORMATION TECHNOLOGY, LLC, (U.S. CLS. 100, 101 AND 102). SN 76-206,394. PUB. 7-2-2002. FILED 2-8-2001.
- 2,623,775. **STRATCOM**. STRATCOM, LLC, (U.S. CLS. 100, 101 AND 102). SN 76-209,167. PUB. 7-2-2002. FILED 2-12-2001.
- 2,623,790. **PCI AND DESIGN**. PCI-SIG, INC., (U.S. CLS. 100, 101 AND 102). SN 76-211,378. PUB. 7-2-2002. FILED 2-14-2001.
- 2,623,796. **TEXAS INSTRUMENTS**. TEXAS INSTRUMENTS INCORPORATED, (U.S. CLS. 100, 101 AND 102). SN 76-212,218. PUB. 7-2-2002. FILED 2-14-2001.
- 2,623,798 (*See Class 19 for this trademark*).
- 2,623,799 (*See Class 19 for this trademark*).
- 2,623,800 (*See Class 19 for this trademark*).
- 2,623,808. **TRESTLEWOOD. BECAUSE THEY DON'T MAKE WOOD LIKE THEY USED TO.** CANNON STRUCTURES, INC., (U.S. CLS. 100, 101 AND 102). SN 76-213,943. PUB. 7-2-2002. FILED 2-21-2001.
- 2,623,811. **LANDMAR E STREET NEIGHBORHOOD NETWORK**. LANDMAR GROUP, LLC, (U.S. CLS. 100, 101 AND 102). SN 76-214,545. PUB. 7-2-2002. FILED 2-26-2001.
- 2,623,822. **A HIGHER STANDARD**. AUTOMATIC PRODUCTS INTERNATIONAL, LTD., (U.S. CLS. 100, 101 AND 102). SN 76-215,593. PUB. 7-2-2002. FILED 2-26-2001.
- 2,623,826. **FUN EXPRESS AND DESIGN**. ORIENTAL TRADING COMPANY, INC., BY ASSIGNMENT FUN EXPRESS, INC., (U.S. CLS. 100, 101 AND 102). SN 76-215,965. PUB. 7-2-2002. FILED 2-26-2001.
- 2,623,836 (*See Class 9 for this trademark*).
- 2,623,839 (*See Class 28 for this trademark*).
- 2,623,850. **SEE WHAT YOU'VE BEEN MISSING!** SAFETY VISION, (U.S. CLS. 100, 101 AND 102). SN 76-219,807. PUB. 7-2-2002. FILED 3-5-2001.
- 2,623,853. **INTERNATIONAL DRIVE RESORT AREA ORLANDO'S MOST DYNAMIC DESTINATION AND DESIGN**. INTERNATIONAL DRIVE TRANSIT & IMPROVEMENT DISTRICT, (U.S. CLS. 100, 101 AND 102). SN 76-219,894. PUB. 7-2-2002. FILED 3-2-2001.
- 2,623,860. **HBR TECHNOLOGIES AND DESIGN**. HBR COMPUTER STORES, INC., DBA HBR TECHNOLOGIES, (U.S. CLS. 100, 101 AND 102). SN 76-220,892. PUB. 7-2-2002. FILED 3-5-2001.
- 2,623,861. **BOB MARRIOTT'S FLYFISHING STORE AND DESIGN**. PISCATORY, INC., DBA BOB MARRIOTT'S FLYFISHING STORE, (U.S. CLS. 100, 101 AND 102). SN 76-220,958. PUB. 7-2-2002. FILED 3-7-2001.
- 2,623,885. **MURTECH AND DESIGN**. MURTECH'S CONSULTING, LLC, (U.S. CLS. 100, 101 AND 102). SN 76-223,378. PUB. 7-2-2002. FILED 3-12-2001.
- 2,623,886. **M MEASURE THIS! AND DESIGN**. MEASURE THIS, L.L.C., (U.S. CLS. 100, 101 AND 102). SN 76-223,617. PUB. 7-2-2002. FILED 3-13-2001.
- 2,623,892. **PHH PARTNERSPLUS**. PHH VEHICLE MANAGEMENT SERVICES, LLC, (U.S. CLS. 100, 101 AND 102). SN 76-225,044. PUB. 7-2-2002. FILED 3-13-2001.
- 2,623,897. **GRAHAM IS SERVICE**. GRAHAM FORD, INC., (U.S. CLS. 100, 101 AND 102). SN 76-225,626. PUB. 7-2-2002. FILED 3-19-2001.
- 2,623,900 (*See Class 16 for this trademark*).
- 2,623,907 (*See Class 1 for this trademark*).
- 2,623,917. **AMONTIS**. DU VOITEL, ROLAND DUMONT, MULTIPLE CLASS, (INT. CLS. 35, 41 AND 42), (U.S. CLS. 100, 101, 102 AND 107). SN 76-228,501. PUB. 7-2-2002. FILED 3-22-2001.
- 2,623,927. **THE NORMAN ROCKWELL GALLERY**. NORMAN ROCKWELL ESTATE LICENSING COMPANY, THE, (U.S. CLS. 100, 101 AND 102). SN 76-229,535. PUB. 7-2-2002. FILED 3-23-2001.
- 2,623,931. **1 TO ORDER GOLF.COM (STYLIZED)**. MAKE QUICK MONEY, INC., (U.S. CLS. 100, 101 AND 102). SN 76-

- 230,866. PUB. 7-2-2002. FILED 3-14-2001.
- 2,623,932. **1 TO ORDER DVD.COM (STYLIZED)**. MAKE QUICK MONEY, INC., (U.S. CLS. 100, 101 AND 102). SN 76-230,872. PUB. 7-2-2002. FILED 3-14-2001.
- 2,623,936. **SENIOR ACHIEVEMENT**. PLUS GROUP, INC. THE, (U.S. CLS. 100, 101 AND 102). SN 76-231,591. PUB. 7-2-2002. FILED 3-27-2001.
- 2,623,942. **EDFUND AND DESIGN**. EDFUND, (U.S. CLS. 100, 101 AND 102). SN 76-232,235. PUB. 7-2-2002. FILED 3-26-2001.
- 2,623,956 (See Class 16 for this trademark).
- 2,623,959. **JTK**. STANLEY LOGISTICS, INC., (U.S. CLS. 100, 101 AND 102). SN 76-234,296. PUB. 7-2-2002. FILED 4-3-2001.
- 2,623,977. **SIMPLIFYING THE PROCESS: LESS PAPER, MORE PROFIT**. ANNUITYNET, INC., MULTIPLE CLASS, (INT. CLS. 35 AND 36), (U.S. CLS. 100, 101 AND 102). SN 76-236,158. PUB. 7-2-2002. FILED 4-5-2001.
- 2,623,981. **MANDALA MAPPING (STYLIZED)**. KHJ INTEGRATED MARKETING INC., (U.S. CLS. 100, 101 AND 102). SN 76-236,615. PUB. 7-2-2002. FILED 3-29-2001.
- 2,623,990 (See Class 16 for this trademark).
- 2,624,001. **BROADLAWNS MEDICAL CENTER**. BROADLAWNS MEDICAL CENTER, MULTIPLE CLASS, (INT. CLS. 35 AND 42), (U.S. CLS. 100, 101 AND 102). SN 76-238,440. PUB. 5-28-2002. FILED 4-10-2001.
- 2,624,006. **MISCELLANEOUS DESIGN**. DANBURY HEALTH SYSTEMS, INC., MULTIPLE CLASS, (INT. CLS. 35 AND 42), (U.S. CLS. 100, 101 AND 102). SN 76-238,579. PUB. 7-2-2002. FILED 4-7-2001.
- 2,624,007. **DUTCH FLOWER MARKET**. DUTCH BROTHERS FLOWER MARKET, LLC, (U.S. CLS. 100, 101 AND 102). SN 76-238,932. PUB. 7-2-2002. FILED 4-5-2001.
- 2,624,009. **APEX ADVANCED PRODUCTIVITY EXPOSITIONS SME AMTDA AMT AND DESIGN**. SOCIETY OF MANUFACTURING ENGINEERS, (U.S. CLS. 100, 101 AND 102). SN 76-239,082. PUB. 7-2-2002. FILED 4-11-2001.
- 2,624,014. **SOFTWARE AND DESIGN**. SALESFORCE.COM, INC., MULTIPLE CLASS, (INT. CLS. 35 AND 42), (U.S. CLS. 100, 101 AND 102). SN 76-240,032. PUB. 7-2-2002. FILED 4-12-2001.
- 2,624,029. **SOLUTIONS FOR AT-RISK YOUTH**. CHILDREN'S COMPREHENSIVE SERVICES, INC., MULTIPLE CLASS, (INT. CLS. 35 AND 42), (U.S. CLS. 100, 101 AND 102). SN 76-241,305. PUB. 7-2-2002. FILED 4-11-2001.
- 2,624,030. **KIDS OUR FOCUS OUR FUTURE**. CHILDREN'S COMPREHENSIVE SERVICES, INC., MULTIPLE CLASS, (INT. CLS. 35 AND 42), (U.S. CLS. 100, 101 AND 102). SN 76-241,306. PUB. 7-2-2002. FILED 4-11-2001.
- 2,624,038. **SIGNAL LAKE AND DESIGN**. SIGNAL LAKE MANAGEMENT, LLC, (U.S. CLS. 100, 101 AND 102). SN 76-242,180. PUB. 7-2-2002. FILED 4-6-2001.
- 2,624,043 (See Class 18 for this trademark).
- 2,624,052. **DATA CONNECT INC AND DESIGN**. DATA CONNECT, INC., (U.S. CLS. 100, 101 AND 102). SN 76-243,293. PUB. 7-2-2002. FILED 4-19-2001.
- 2,624,055. **KINDERLANGUAGE**. KINDERLANGUAGE LLC, BY ASSIGNMENT BOBO, LINDA, MULTIPLE CLASS, (INT. CLS. 35 AND 41), (U.S. CLS. 100, 101, 102 AND 107). SN 76-243,676. PUB. 7-2-2002. FILED 4-20-2001.
- 2,624,057. **MARSHALL SOLUTIONS**. MARSHALL SOLUTIONS, INC., (U.S. CLS. 100, 101 AND 102). SN 76-243,685. PUB. 7-2-2002. FILED 4-20-2001.
- 2,624,074. **INSTALLER CHALLENGE AND DESIGN**. SELECT DISTRIBUTORS, INC., DBA SELECT PRODUCTS, (U.S. CLS. 100, 101 AND 102). SN 76-246,183. PUB. 7-2-2002. FILED 4-25-2001.
- 2,624,082. **SEISINT AND DESIGN**. SEISINT, INC., MULTIPLE CLASS, (INT. CLS. 35 AND 42), (U.S. CLS. 100, 101 AND 102). SN 76-246,969. PUB. 7-2-2002. FILED 4-26-2001.
- 2,624,103. **MISCELLANEOUS DESIGN**. LEUCADIA NATIONAL CORPORATION, MULTIPLE CLASS, (INT. CLS. 35 AND 42), (U.S. CLS. 100, 101 AND 102). SN 76-248,958. PUB. 4-9-2002. FILED 4-30-2001.
- 2,624,108. **TALENT PROFILE**. TALENT PLUS, INC., DBA TALENT +, (U.S. CLS. 100, 101 AND 102). SN 76-250,090. PUB. 7-2-2002. FILED 5-3-2001.
- 2,624,126. **A:11**. GAGE MARKETING GROUP, LLC, (U.S. CLS. 100, 101 AND 102). SN 76-252,535. PUB. 7-2-2002. FILED 5-4-2001.
- 2,624,139. **BURDINES BRINGING IT TOGETHER**. FEDERATED WESTERN PROPERTIES, INC., (U.S. CLS. 100, 101 AND 102). SN 76-254,991. PUB. 7-2-2002. FILED 5-9-2001.
- 2,624,143. **BRINGING IT TOGETHER**. FEDERATED DEPARTMENT STORES, INC., (U.S. CLS. 100, 101 AND 102). SN 76-255,298. PUB. 7-2-2002. FILED 5-10-2001.
- 2,624,148 (See Class 9 for this trademark).
- 2,624,151. **UP FRONT**. MULLINAX FORD OF CENTRAL FLORIDA, INC., (U.S. CLS. 100, 101 AND 102). SN 76-256,390. PUB. 7-2-2002. FILED 5-14-2001.
- 2,624,152 (See Class 9 for this trademark).
- 2,624,153. **BAINBRIDGE, INC. MANAGEMENT CONSULTING**. BAINBRIDGE, INC., (U.S. CLS. 100, 101 AND 102). SN 76-256,642. PUB. 7-2-2002. FILED 5-15-2001.
- 2,624,155. **BAINBRIDGE**. BAINBRIDGE, INC., (U.S. CLS. 100, 101 AND 102). SN 76-256,955. PUB. 7-2-2002. FILED 5-15-2001.
- 2,624,185. **MERCADO HISPANICO AND DESIGN**. FLEMING COMPANIES, INC., (U.S. CLS. 100, 101 AND 102). SN 76-260,075. PUB. 7-2-2002. FILED 5-22-2001.
- 2,624,187. **CHOCOVISION.COM**. CHOCOVISION CORPORATION, (U.S. CLS. 100, 101 AND 102). SN 76-260,248. PUB. 7-2-2002. FILED 5-17-2001.
- 2,624,201. **EXACTTARGET**. EXACTTARGET, LLC, (U.S. CLS. 100, 101 AND 102). SN 76-261,936. PUB. 7-2-2002. FILED 5-24-2001.
- 2,624,203. **WINE SHOPPING ONLINE, THE WAY IT SHOULD BE**. ZACHYS WINE AND LIQUOR STORE, INC., (U.S. CLS. 100, 101 AND 102). SN 76-262,001. PUB. 7-2-2002. FILED 5-24-2001.
- 2,624,205. **HISPANIC INSIGHT SYSTEM**. ACENTO ADVERTISING, INC., (U.S. CLS. 100, 101 AND 102). SN 76-262,550. PUB. 7-2-2002. FILED 5-29-2001.
- 2,624,212. **S TIOSH AND DESIGN**. BOARD OF REGENTS, THE UNIVERSITY OF TEXAS SYSTEM, MULTIPLE CLASS, (INT. CLS. 35, 41 AND 42), (U.S. CLS. 100, 101, 102 AND 107). SN 76-262,748. PUB. 7-2-2002. FILED 5-24-2001.
- 2,624,214. **PERFORMINGPEOPLE AND DESIGN**. PERFORMINGPEOPLE CONSULTING, INC., (U.S. CLS. 100, 101 AND 102). SN 76-263,161. PUB. 7-2-2002. FILED 5-29-2001.
- 2,624,223. **NLJEXPERTS**. NLP IP COMPANY, (U.S. CLS. 100, 101 AND 102). SN 76-264,265. PUB. 7-2-2002. FILED 5-30-2001.
- 2,624,224. **Varsity Access**. ACCESS VG, L.L.C., (U.S. CLS. 100, 101 AND 102). SN 76-264,270. PUB. 7-2-2002. FILED 5-30-2001.
- 2,624,227 (See Class 16 for this trademark).
- 2,624,237 (See Class 5 for this trademark).
- 2,624,250. **J-MAC RADIATOR WAREHOUSE**. RADIATORS, INC., (U.S. CLS. 100, 101 AND 102). SN 76-266,682. PUB. 7-2-2002. FILED 6-4-2001.
- 2,624,252. **YOU ARE UNIQUE... YOUR JEWELRY SHOULD BE TOO!**. GEMS OF THE PAST, INC., (U.S. CLS. 100, 101 AND 102). SN 76-266,909. PUB. 7-2-2002. FILED 6-5-2001.
- 2,624,260. **WWW.PEDIAFED.COM**. PEDIATRIC FEDERATION, LLC, (U.S. CLS. 100, 101 AND 102). SN 76-268,206. PUB. 7-2-2002. FILED 6-8-2001.
- 2,624,279. **SECURITY POLICE FIRE PROFESSIONALS OF AMERICA AND DESIGN**. INTERNATIONAL UNION, SECURITY, POLICE AND FIRE PROFESSIONALS OF AMERICA (SPFPA), (U.S. CLS. 100, 101 AND 102). SN 76-269,146. PUB. 7-2-2002. FILED 4-4-2001.
- 2,624,285 (See Class 9 for this trademark).
- 2,624,291. **HARPERLINK**. HARPER ENGRAVING & PRINTING COMPANY, MULTIPLE CLASS, (INT. CLS. 35 AND 42), (U.S. CLS. 100, 101 AND 102). SN 76-270,761. PUB. 7-2-2002. FILED 6-14-2001.
- 2,624,300. **ITX (STYLIZED)**. ITX INTERNATIONAL HOLDINGS, INC., MULTIPLE CLASS, (INT. CLS. 35, 36, 41 AND 42), (U.S. CLS. 100, 101, 102 AND 107). SN 76-271,706. PUB. 7-2-2002. FILED 6-14-2001.
- 2,624,320. **PANGEO**. PANGEO COLLECTIONS LTD., (U.S. CLS. 100, 101 AND 102). SN 76-274,741. PUB. 7-2-2002. FILED 6-21-2001.
- 2,624,323. **A NATIONWIDE SCOPE WITH A LOCAL PRESENCE**. SPECTRUM HEALTHCARE RESOURCES, INC., (U.S. CLS. 100, 101 AND 102). SN 76-274,895. PUB. 7-2-2002.

- FILED 6-21-2001.
- 2,624,343. **ARTIST HELP NETWORK AND DESIGN**. AUDIO INFORMATION NETWORK, INC., DBA ARTIST HELP NETWORK, (U.S. CLS. 100, 101 AND 102). SN 76-277,174. PUB. 7-2-2002. FILED 6-25-2001.
- 2,624,347. **GCF AND DESIGN**. GOODWILL COMMUNITY FOUNDATION, INC., MULTIPLE CLASS, (INT. CLS. 35, 36 AND 41), (U.S. CLS. 100, 101, 102 AND 107). SN 76-277,609. PUB. 7-2-2002. FILED 6-27-2001.
- 2,624,357 (*See Class 20 for this trademark*).
- 2,624,363. **GETFINANCIALADVICE.COM AND DESIGN**. GET FINANCIAL ADVICE, INC., (U.S. CLS. 100, 101 AND 102). SN 76-281,364. PUB. 7-2-2002. FILED 7-6-2001.
- 2,624,375. **WORLD STATISTICS LTD.**, WORLD STATISTICS LTD., MULTIPLE CLASS, (INT. CLS. 35 AND 42), (U.S. CLS. 100, 101 AND 102). SN 76-282,300. PUB. 7-2-2002. FILED S.R. 7-9-2001; AM. P.R. 3-7-2002.
- 2,624,377. **RESEARCH TRIANGLE REGIONAL PARTNERSHIP AND DESIGN**. RESEARCH TRIANGLE REGIONAL PARTNERSHIP, (U.S. CLS. 100, 101 AND 102). SN 76-282,901. PUB. 7-2-2002. FILED 7-5-2001.
- 2,624,378. **RESEARCH TRIANGLE REGION NORTH CAROLINA AND DESIGN**. RESEARCH TRIANGLE REGIONAL PARTNERSHIP, (U.S. CLS. 100, 101 AND 102). SN 76-282,902. PUB. 7-2-2002. FILED 7-5-2001.
- 2,624,381. **THE HIT SHOW CLUB**. HIT SHOW CLUB, INC., (U.S. CLS. 100, 101 AND 102). SN 76-283,774. PUB. 7-2-2002. FILED 7-11-2001.
- 2,624,383. **STRATEGIC TRACTION**. KALUDIS CONSULTING GROUP, INC., DBA KALUDIS CONSULTING, (U.S. CLS. 100, 101 AND 102). SN 76-284,069. PUB. 7-2-2002. FILED 7-12-2001.
- 2,624,398. **MISCELLANEOUS DESIGN**. PLAY LIKE THE PROS, LLC, (U.S. CLS. 100, 101 AND 102). SN 76-286,596. PUB. 7-2-2002. FILED 7-17-2001.
- 2,624,404. **REINVENTBUSINESS.COM**. MATZDORFF, JAMES A., DBA JAMES A. MATZDORFF & CO., (U.S. CLS. 100, 101 AND 102). SN 76-287,628. PUB. 7-2-2002. FILED 7-19-2001.
- 2,624,410. **KITCHEN GLAMOR**. ABC APPLIANCE, INC., (U.S. CLS. 100, 101 AND 102). SN 76-288,167. PUB. 7-2-2002. FILED 7-20-2001.
- 2,624,412. **CALLISMA**. CALLISMA, INC., MULTIPLE CLASS, (INT. CLS. 35, 37 AND 42), (U.S. CLS. 100, 101, 102, 103 AND 106). SN 76-288,430. PUB. 7-2-2002. FILED 7-18-2001.
- 2,624,420. **S AND DESIGN**. SCRIPT TO SCREEN PRODUCTIONS, (U.S. CLS. 100, 101 AND 102). SN 76-289,612. PUB. 7-2-2002. FILED 7-25-2001.
- 2,624,430. **BARKER & MEOWSKY**. BARKER & MEOWSKY, INC., (U.S. CLS. 100, 101 AND 102). SN 76-290,930. PUB. 7-2-2002. FILED 7-26-2001.
- 2,624,432. **L'PL DAVINCI**. TINKER'S DEN, (U.S. CLS. 100, 101 AND 102). SN 76-291,049. PUB. 7-2-2002. FILED 7-27-2001.
- 2,624,450 (*See Class 9 for this trademark*).
- 2,624,451 (*See Class 9 for this trademark*).
- 2,624,466. **FPBA**. FPBA GROUP, LLC, (U.S. CLS. 100, 101 AND 102). SN 76-295,424. PUB. 7-2-2002. FILED 8-6-2001.
- 2,624,476 (*See Class 16 for this trademark*).
- 2,624,478. **INK IS MORE THAN COLOR AT SUN CHEMICAL, IT'S TECHNOLOGY**. SUN CHEMICAL CORP., (U.S. CLS. 100, 101 AND 102). SN 76-296,425. PUB. 7-2-2002. FILED 8-8-2001.
- 2,624,482 (*See Class 3 for this trademark*).
- 2,624,483. **F AND DESIGN**. FOUNDATION SURGERY AFFILIATES, INC., (U.S. CLS. 100, 101 AND 102). SN 76-298,019. PUB. 7-2-2002. FILED 8-13-2001.
- 2,624,484. **FOUNDATION**. FOUNDATION SURGERY AFFILIATES, INC., (U.S. CLS. 100, 101 AND 102). SN 76-298,023. PUB. 7-2-2002. FILED 8-13-2001.
- 2,624,494. **TELETRON**. TELETRON, L.P., MULTIPLE CLASS, (INT. CLS. 35, 36 AND 42), (U.S. CLS. 100, 101 AND 102). SN 76-301,643. PUB. 7-2-2002. FILED 8-17-2001.
- 2,624,497. **EZFREEBEE.COM AND DESIGN**. DAY, DAVID, (U.S. CLS. 100, 101 AND 102). SN 76-302,008. PUB. 7-2-2002. FILED 8-20-2001.
- 2,624,499. **GRAND CENTRAL RACQUET STRINGERS**. METROPOLITAN TRANSPORTATION AUTHORITY, MULTIPLE CLASS, (INT. CLS. 35 AND 37), (U.S. CLS. 100, 101, 102, 103 AND 106). SN 76-302,269. PUB. 7-2-2002. FILED 8-21-2001.
- 2,624,505. **TRUST YOUR INSTINCTS**. LANDATA SYSTEMS, INC., MULTIPLE CLASS, (INT. CLS. 35, 36 AND 39), (U.S. CLS. 100, 101, 102 AND 105). SN 76-303,230. PUB. 7-2-2002. FILED 8-21-2001.
- 2,624,507. **CAL FARLEY'S BOYS RANCH & AFFILIATES**. CAL FARLEY'S BOYS RANCH AND AFFILIATES, (U.S. CLS. 100, 101 AND 102). SN 76-303,309. PUB. 7-2-2002. FILED 8-22-2001.
- 2,624,513. **THE ZONE BOOK AND DESIGN**. J.T.M. CHARITABLE FOUNDATION, INC., DBA THE ZONE BOOK, (U.S. CLS. 100, 101 AND 102). SN 76-303,915. PUB. 7-2-2002. FILED 8-23-2001.
- 2,624,518. **HELPING YOU STAY IN TOUCH WITH YOUR CUSTOMERS**. LOGIX COMPANIES, LLC, THE, (U.S. CLS. 100, 101 AND 102). SN 76-304,527. PUB. 7-2-2002. FILED 8-24-2001.
- 2,624,520. **SOUTHERN CALIFORNIA AIR CONDITIONING DISTRIBUTORS**. S.C.A.C.D., INC., (U.S. CLS. 100, 101 AND 102). SN 76-305,305. PUB. 7-2-2002. FILED 8-27-2001.
- 2,624,533. **T TRESTLETREE AND DESIGN**. TRESTLETREE, INC., MULTIPLE CLASS, (INT. CLS. 35 AND 42), (U.S. CLS. 100, 101 AND 102). SN 76-308,176. PUB. 7-2-2002. FILED 8-30-2001.
- 2,624,537. **COMMITMENT, COMMUNICATION AND QUALITY = VALUE**. CUSTOM ENTERPRISES, INC., (U.S. CLS. 100, 101 AND 102). SN 76-308,804. PUB. 7-2-2002. FILED 9-6-2001.
- 2,624,545. **W AND DESIGN**. FAIRCHILD PUBLICATIONS, INC., MULTIPLE CLASS, (INT. CLS. 35 AND 42), (U.S. CLS. 100, 101 AND 102). SN 76-310,564. PUB. 7-2-2002. FILED 9-10-2001.
- 2,624,550. **RUBY TECHNOLOGIES, INC. AND DESIGN**. RUBY TECHNOLOGIES, INC., (U.S. CLS. 100, 101 AND 102). SN 76-311,709. PUB. 7-2-2002. FILED 9-14-2001.
- 2,624,554. **ECPA WHERE TOMORROW'S PROFITS BEGIN AND DESIGN**. LEVITAN YEGIDIS & GOLDSTEIN LLP, (U.S. CLS. 100, 101 AND 102). SN 76-312,087. PUB. 7-2-2002. FILED 9-13-2001.
- 2,624,567. **KNOWING YOUR INDUSTRY, UNDERSTANDING YOUR BUSINESS**. FOLEY & LARDNER, MULTIPLE CLASS, (INT. CLS. 35 AND 42), (U.S. CLS. 100, 101 AND 102). SN 76-313,721. PUB. 7-2-2002. FILED 9-18-2001.
- 2,624,576. **ERGOFLEX**. ERGOFLEX, INC., (U.S. CLS. 100, 101 AND 102). SN 76-315,565. PUB. 7-2-2002. FILED 9-21-2001.
- 2,624,581. **EYE EXAMS AVAILABLE AND DESIGN**. PEARLE VISION, INC., MULTIPLE CLASS, (INT. CLS. 35 AND 42), (U.S. CLS. 100, 101 AND 102). SN 76-316,594. PUB. 7-2-2002. FILED 9-24-2001.
- 2,624,583. **HR CONSULTLINE (STYLIZED)**. MILLER, GAY J., (U.S. CLS. 100, 101 AND 102). SN 76-317,111. PUB. 7-2-2002. FILED 9-24-2001.
- 2,624,589. **S SOUNDAIR INC AND DESIGN**. SOUNDAIR, INC., (U.S. CLS. 100, 101 AND 102). SN 76-318,588. PUB. 7-2-2002. FILED 10-1-2001.
- 2,624,597. **WEB REQ**. MAXIM GROUP, INC., (U.S. CLS. 100, 101 AND 102). SN 76-319,517. PUB. 7-2-2002. FILED 10-1-2001.
- 2,624,620. **ENTERPRISE-PCL**. CENTURY DISTRIBUTION SYSTEMS, INC., (U.S. CLS. 100, 101 AND 102). SN 76-322,972. PUB. 7-2-2002. FILED 10-9-2001.
- 2,624,621. **STEPHEN SPORTS**. ILORI, STEPHEN, (U.S. CLS. 100, 101 AND 102). SN 76-323,021. PUB. 7-2-2002. FILED 9-27-2001.
- 2,624,640. **STATPROBE**. STATPROBE, INC., MULTIPLE CLASS, (INT. CLS. 35 AND 42), (U.S. CLS. 100, 101 AND 102). SN 76-324,768. PUB. 7-2-2002. FILED 10-12-2001.
- 2,624,653. **SILENTFROG**. SHELBY ONE, LLC, (U.S. CLS. 100, 101 AND 102). SN 76-326,238. PUB. 7-2-2002. FILED 10-17-2001.
- 2,624,660. **STANDRIS**. STANDRIS MEDICAL SUPPLY, INC., (U.S. CLS. 100, 101 AND 102). SN 76-326,806. PUB. 7-2-2002. FILED 10-18-2001.
- 2,624,666. **REGARDS**. TARGET BRANDS, INC., MULTIPLE CLASS, (INT. CLS. 35 AND 36), (U.S. CLS. 100, 101 AND 102). SN 76-327,147. PUB. 7-2-2002. FILED 10-17-2001.
- 2,624,677. **THE SPORTSMAN'S GUIDE AND DESIGN**.

- SPORTSMAN'S GUIDE, INC., THE, (U.S. CLS. 100, 101 AND 102). SN 76-328,680. PUB. 7-2-2002. FILED 10-19-2001.
- 2,624,682. **WALDENMAIL**. WALDENBOOKS PROPERTIES, INC., (U.S. CLS. 100, 101 AND 102). SN 76-329,026. PUB. 7-2-2002. FILED 10-23-2001.
- 2,624,683. **NAME STREAM**. LIPSON ASSOCIATES, INC., DBA LIPSON ALPORT GLASS & ASSOCIATES, (U.S. CLS. 100, 101 AND 102). SN 76-329,183. PUB. 7-2-2002. FILED 10-24-2001.
- 2,624,684. **BURBERRY**. BURBERRY LIMITED, (U.S. CLS. 100, 101 AND 102). SN 76-329,199. PUB. 7-2-2002. FILED 10-24-2001.
- 2,624,693 (*See Class 9 for this trademark*).
- 2,624,702. **THE ROSEMAN INSTITUTE**. BUCHANAN INGERSOLL PROFESSIONAL CORPORATION, (U.S. CLS. 100, 101 AND 102). SN 76-332,259. PUB. 7-2-2002. FILED 10-29-2001.
- 2,624,708. **CASCO**. UNITED DOMINION INDUSTRIES, INC., (U.S. CLS. 100, 101 AND 102). SN 76-333,233. PUB. 7-2-2002. FILED 11-2-2001.
- 2,624,711 (*See Class 25 for this trademark*).
- 2,624,719. **POLKONE**. R. L. POLK & CO., (U.S. CLS. 100, 101 AND 102). SN 76-334,624. PUB. 7-2-2002. FILED 11-7-2001.
- 2,624,722. **GOURMET A GO GO**. GOURMET A GO GO L.L.C., MULTIPLE CLASS, (INT. CLS. 35 AND 42), (U.S. CLS. 100, 101 AND 102). SN 76-335,296. PUB. 7-2-2002. FILED 11-8-2001.
- 2,624,774. **PATHWAYS TO WORK**. DISABILITY CONSULTING GROUP, AND REED GROUP, LTD, MULTIPLE CLASS, (INT. CLS. 35 AND 36), (U.S. CLS. 100, 101 AND 102). SN 76-343,251. PUB. 7-2-2002. FILED 11-30-2001.
- 2,624,787. **DIRECTION AND ALIGNMENT ASSESSMENT (DNA)**. VICERE ASSOCIATES, INC., (U.S. CLS. 100, 101 AND 102). SN 76-344,772. PUB. 7-2-2002. FILED 12-5-2001.
- 2,624,788. **DIRECTION AND ALIGNMENT ASSESSMENT**. VICERE ASSOCIATES, INC., (U.S. CLS. 100, 101 AND 102). SN 76-344,773. PUB. 7-2-2002. FILED 12-5-2001.
- 2,624,795. **POLARIS MANAGEMENT PARTNERS**. POLARIS MANAGEMENT PARTNERS, L.L.C., (U.S. CLS. 100, 101 AND 102). SN 76-345,377. PUB. 7-2-2002. FILED 12-3-2001.
- 2,624,799. **ZINSIGHTS**. ZYMAN MARKETING GROUP, INC., (U.S. CLS. 100, 101 AND 102). SN 76-345,754. PUB. 7-2-2002. FILED 12-4-2001.
- 2,624,803. **T D TOYS BY THE DOZEN AND DESIGN**. GAMEDAY, INC., (U.S. CLS. 100, 101 AND 102). SN 76-346,089. PUB. 7-2-2002. FILED 12-6-2001.
- 2,624,804. **GENESISCARD**. PREFERRED ALLIANCE, INC., (U.S. CLS. 100, 101 AND 102). SN 76-346,117. PUB. 7-2-2002. FILED 12-10-2001.
- 2,624,813. **MISCELLANEOUS DESIGN**. HIRESHARP PARTNERS, LLC, (U.S. CLS. 100, 101 AND 102). SN 76-347,586. PUB. 7-2-2002. FILED 12-11-2001.
- 2,624,825 (*See Class 9 for this trademark*).
- 2,624,827. **GENERIC FIRST**. MERCK-MEDCO MANAGED CARE, LLC, (U.S. CLS. 100, 101 AND 102). SN 76-349,176. PUB. 7-2-2002. FILED 12-14-2001.
- 2,624,848. **OCEAN BLUE COMMUNICATIONS**. OCEAN BLUE COMMUNICATIONS, INC., (U.S. CLS. 100, 101 AND 102). SN 76-351,648. PUB. 7-2-2002. FILED 12-26-2001.
- 2,624,854. **CHILDU**. CHILDU, INC., (U.S. CLS. 100, 101 AND 102). SN 76-351,914. PUB. 7-2-2002. FILED 12-21-2001.
- 2,624,855. **BROKERSECURE**. INSUREZONE, INC., MULTIPLE CLASS, (INT. CLS. 35, 36 AND 42), (U.S. CLS. 100, 101 AND 102). SN 76-351,941. PUB. 7-2-2002. FILED 12-21-2001.
- 2,624,861. **MERCERMERGE**. WILLIAM M. MERCER, INCORPORATED, (U.S. CLS. 100, 101 AND 102). SN 76-352,581. PUB. 7-2-2002. FILED 12-21-2001.
- 2,624,869. **DOCTORSPY**. SCHNEIDER, DAVID L., (U.S. CLS. 100, 101 AND 102). SN 76-353,938. PUB. 7-2-2002. FILED 12-26-2001.
- 2,624,882. **POWERSUITE**. OPENFIRST, INC., (U.S. CLS. 100, 101 AND 102). SN 76-356,796. PUB. 7-2-2002. FILED 1-9-2002.
- 2,624,883. **YOUR SOURCE FOR BUSINESS SOLUTIONS**. VIDERE GROUP LLP, THE, (U.S. CLS. 100, 101 AND 102). SN 76-356,817. PUB. 7-2-2002. FILED 1-10-2002.
- 2,624,885. **OPENFIRST**. OPENFIRST, INC., MULTIPLE CLASS, (INT. CLS. 35 AND 40), (U.S. CLS. 100, 101, 102, 103 AND 106). SN 76-356,878. PUB. 7-2-2002. FILED 1-9-2002.
- 2,624,886. **POWERPLAN**. OPENFIRST, INC., (U.S. CLS. 100, 101 AND 102). SN 76-356,883. PUB. 7-2-2002. FILED 1-9-2002.
- 2,624,887. **POWERTRAK**. OPENFIRST, INC., (U.S. CLS. 100, 101 AND 102). SN 76-356,945. PUB. 7-2-2002. FILED 1-9-2002.
- 2,624,900. **T' LATTE (STYLIZED)**. T'LATTE COMPANY, L.L.C., THE, (U.S. CLS. 100, 101 AND 102). SN 76-358,258. PUB. 7-2-2002. FILED 1-14-2002.
- 2,624,910. **WAY TO GO**. LEARNING IS FUN, (U.S. CLS. 100, 101 AND 102). SN 76-360,365. PUB. 7-2-2002. FILED 1-18-2002.
- 2,624,925. **PHARSIGHT**. PHARSIGHT CORPORATION, (U.S. CLS. 100, 101 AND 102). SN 76-365,657. PUB. 7-2-2002. FILED 1-31-2002.
- 2,624,928. **COOLESTATE.COM**. COOLESTATE.COM, (U.S. CLS. 100, 101 AND 102). SN 76-366,832. PUB. 7-2-2002. FILED 2-5-2002.
- 2,624,930. **MISCELLANEOUS DESIGN**. COUNCILOR, BUCHANAN & MITCHELL, P.C., MULTIPLE CLASS, (INT. CLS. 35 AND 36), (U.S. CLS. 100, 101 AND 102). SN 76-366,849. PUB. 7-2-2002. FILED 2-5-2002.
- 2,624,931. **COMMITTED TO BEING PART OF YOUR FINANCIAL SUCCESS**. COUNCILOR, BUCHANAN & MITCHELL, P.C., MULTIPLE CLASS, (INT. CLS. 35 AND 36), (U.S. CLS. 100, 101 AND 102). SN 76-366,949. PUB. 7-2-2002. FILED 2-5-2002.
- 2,624,933. **DRESS UP YOUR CAR**. WANG, CHUNG HAO, (U.S. CLS. 100, 101 AND 102). SN 76-367,474. PUB. 7-2-2002. FILED 2-6-2002.
- 2,624,948. **CONNECTING ADVERTISERS WITH AUDIENCES**. COX TARGET MEDIA, INC., (U.S. CLS. 100, 101 AND 102). SN 76-369,945. PUB. 7-2-2002. FILED 2-11-2002.
- 2,624,950. **INSURANCEPATROL**. SCHNEIDER, DAVID L., (U.S. CLS. 100, 101 AND 102). SN 76-373,217. PUB. 7-2-2002. FILED 2-21-2002.
- 2,624,951. **INSURANCEATLAS**. SCHNEIDER, DAVID L., (U.S. CLS. 100, 101 AND 102). SN 76-373,579. PUB. 7-2-2002. FILED 2-21-2002.
- 2,624,952. **INSURANCERACE**. SCHNEIDER, DAVID L., (U.S. CLS. 100, 101 AND 102). SN 76-373,585. PUB. 7-2-2002. FILED 2-21-2002.
- 2,624,953. **INSURANCERUNNER**. SCHNEIDER, DAVID L., (U.S. CLS. 100, 101 AND 102). SN 76-373,586. PUB. 7-2-2002. FILED 2-21-2002.
- 2,624,954. **INSURANCESCOPE**. SCHNEIDER, DAVID L., (U.S. CLS. 100, 101 AND 102). SN 76-373,587. PUB. 7-2-2002. FILED 2-21-2002.
- 2,624,955. **INSURANCESTORY**. SCHNEIDER, DAVID L., (U.S. CLS. 100, 101 AND 102). SN 76-373,589. PUB. 7-2-2002. FILED 2-21-2002.
- 2,624,956. **INSURANCECHOOSE**. SCHNEIDER, DAVID L., (U.S. CLS. 100, 101 AND 102). SN 76-389,069. PUB. 7-2-2002. FILED 3-29-2002.
- 2,624,957. **REINDEER LANE GIFT SHOP**. LEROUX, ROBERT J., (U.S. CLS. 100, 101 AND 102). SN 78-000,643. PUB. 7-2-2002. FILED 3-23-2000.
- 2,624,961. **TOP GUN LEATHER LIVE IT...IN LEATHER!**. HOD, AYAL, (U.S. CLS. 100, 101 AND 102). SN 78-005,185. PUB. 7-2-2002. FILED 4-22-2000.
- 2,624,968. **BUSINESS 4 BUSINESS**. STEVEN M. COTTON SERVICES, INCORPORATED, (U.S. CLS. 100, 101 AND 102). SN 78-010,987. PUB. 7-2-2002. FILED 6-2-2000.
- 2,624,970. **GET NOTICED AND DESIGN**. MGH ADVERTISING INC., (U.S. CLS. 100, 101 AND 102). SN 78-013,058. PUB. 7-2-2002. FILED 6-16-2000.
- 2,624,978 (*See Class 9 for this trademark*).
- 2,624,981 (*See Class 9 for this trademark*).
- 2,624,983. **INFOCHAIN EXPRESS**. AVERY DENNISON CORPORATION, (U.S. CLS. 100, 101 AND 102). SN 78-025,402. PUB. 7-2-2002. FILED 9-11-2000.
- 2,624,986. **PHARMAWARE**. CATALINA MARKETING INTERNATIONAL, INC., (U.S. CLS. 100, 101 AND 102). SN 78-026,983. PUB. 7-2-2002. FILED 9-21-2000.
- 2,625,014. **TAU CERAMICA (STYLIZED)**. TAULELL, S.A., (U.S. CLS. 100, 101 AND 102). SN 78-044,039. PUB. 7-2-2002. FILED 1-19-2001.
- 2,625,018. **ABC A BLESSED COOKIE CO. AND DESIGN**. A BLESSED COOKIE COMPANY, INC., (U.S. CLS. 100, 101 AND 102). SN 78-045,766. PUB. 7-2-2002. FILED 1-30-2001.

- 2,625,023. **SURFACESCAPE**. ZR ASSOCIATES LLC, MULTIPLE CLASS, (INT. CLS. 35 AND 37), (U.S. CLS. 100, 101, 102, 103 AND 106). SN 78-047,678. PUB. 7-2-2002. FILED 2-10-2001.
- 2,625,025. **HEALTHCAREMATCH.COM**. PRACTICEMATCH, INC., (U.S. CLS. 100, 101 AND 102). SN 78-047,833. PUB. 7-2-2002. FILED 2-12-2001.
- 2,625,026. **PRACTICEMATCH**. PRACTICEMATCH, INC., (U.S. CLS. 100, 101 AND 102). SN 78-047,835. PUB. 7-2-2002. FILED 2-12-2001.
- 2,625,037. **I INTERNETINN.COM EXPRESS AND DESIGN**. INTERNETINNS.COM CORPORATION, (U.S. CLS. 100, 101 AND 102). SN 78-050,214. PUB. 7-2-2002. FILED 2-26-2001.
- 2,625,039. **RESTAURANTBEAST**. A.S GIBBS & ASSOCIATES, INC., (U.S. CLS. 100, 101 AND 102). SN 78-051,085. PUB. 7-2-2002. FILED 3-2-2001.
- 2,625,045. **BROOKSBROTHERS.COM**. BROOKS BROTHERS, INC., (U.S. CLS. 100, 101 AND 102). SN 78-053,282. PUB. 7-2-2002. FILED 3-15-2001.
- 2,625,049. **PROJECT SOLVERS**. PROJECT SOLVERS, INC., (U.S. CLS. 100, 101 AND 102). SN 78-053,598. PUB. 7-2-2002. FILED 3-16-2001.
- 2,625,052. **NEWCO PRODUCTIONS AND DESIGN**. NEWCO PRODUCTIONS, (U.S. CLS. 100, 101 AND 102). SN 78-054,366. PUB. 7-2-2002. FILED 3-21-2001.
- 2,625,070. **OIC ORGANIZATION IMPROVEMENT CONSULTING AND DESIGN**. ABRAHAM, JOSEPH D., (U.S. CLS. 100, 101 AND 102). SN 78-058,625. PUB. 7-2-2002. FILED 4-16-2001.
- 2,625,072. **STATION.COM AND DESIGN**. VERANT INTERACTIVE, INC., MULTIPLE CLASS, (INT. CLS. 35, 38, 41 AND 42), (U.S. CLS. 100, 101, 102, 104 AND 107). SN 78-059,131. PUB. 7-2-2002. FILED 4-18-2001.
- 2,625,076. **DIALOGBUILDER**. MWW GROUP, THE, MULTIPLE CLASS, (INT. CLS. 35 AND 42), (U.S. CLS. 100, 101 AND 102). SN 78-059,685. PUB. 7-2-2002. FILED 4-21-2001.
- 2,625,077. **WARRIOR COACHING**. FARMER, PETER P., MULTIPLE CLASS, (INT. CLS. 35 AND 41), (U.S. CLS. 100, 101, 102 AND 107). SN 78-059,706. PUB. 7-2-2002. FILED 4-21-2001.
- 2,625,079. **LEADERS TRUST**. LEADERS-TRUST, MANAGEMENT CONSULTANTS S.A., MULTIPLE CLASS, (INT. CLS. 35 AND 42), (U.S. CLS. 100, 101 AND 102). SN 78-060,001. PUB. 7-2-2002. FILED 4-24-2001.
- 2,625,088. **ACT**. JIM MUDD ADVERTISING, INC., DBA THE MUDD GROUP, (U.S. CLS. 100, 101 AND 102). SN 78-061,834. PUB. 7-2-2002. FILED 5-3-2001.
- 2,625,092. **ESERVISYS**. PENNROSE SERVICE COMPANY, MULTIPLE CLASS, (INT. CLS. 35, 37 AND 42), (U.S. CLS. 100, 101, 102, 103 AND 106). SN 78-062,529. PUB. 7-2-2002. FILED 5-8-2001.
- 2,625,096. **CLASSBRAIN**. CLASSBRAIN.COM, (U.S. CLS. 100, 101 AND 102). SN 78-063,071. PUB. 7-2-2002. FILED 5-11-2001.
- 2,625,097. **CLASSBRAIN AND DESIGN**. CLASSBRAIN.COM, (U.S. CLS. 100, 101 AND 102). SN 78-063,076. PUB. 7-2-2002. FILED 5-11-2001.
- 2,625,109. **MISCELLANEOUS DESIGN**. SOCIAL & SCIENTIFIC SYSTEMS, INC., MULTIPLE CLASS, (INT. CLS. 35, 41 AND 42), (U.S. CLS. 100, 101, 102 AND 107). SN 78-064,378. PUB. 7-2-2002. FILED 5-18-2001.
- 2,625,114. **MISCELLANEOUS DESIGN**. CONNEXIM, MULTIPLE CLASS, (INT. CLS. 35 AND 37), (U.S. CLS. 100, 101, 102, 103 AND 106). SN 78-064,954. PUB. 7-2-2002. FILED 5-22-2001.
- 2,625,117. **TAG DIRECT**. TARGETED ADVERTISING GROUP INC, (U.S. CLS. 100, 101 AND 102). SN 78-065,530. PUB. 7-2-2002. FILED 5-24-2001.
- 2,625,122 (See Class 30 for this trademark).
- 2,625,132. **PROJECT BEAUTY**. PROJECT SOLVERS, INC., (U.S. CLS. 100, 101 AND 102). SN 78-070,013. PUB. 7-2-2002. FILED 6-19-2001.
- 2,625,138. **WEBACE AND DESIGN**. KEENER MARKETING, INC., (U.S. CLS. 100, 101 AND 102). SN 78-070,368. PUB. 7-2-2002. FILED 6-21-2001.
- 2,625,156. **FPL E-MAIL BILL**. FLORIDA POWER AND LIGHT COMPANY, (U.S. CLS. 100, 101 AND 102). SN 78-074,090. PUB. 7-2-2002. FILED 7-16-2001.
- 2,625,157. **XRADICAL**. XRADICAL, INC., (U.S. CLS. 100, 101 AND 102). SN 78-074,659. PUB. 7-2-2002. FILED 7-19-2001.
- 2,625,165. **SAGAX**. LUC, HARDY, R, MULTIPLE CLASS, (INT. CLS. 35 AND 36), (U.S. CLS. 100, 101 AND 102). SN 78-077,758. PUB. 7-2-2002. FILED 8-6-2001.
- 2,625,166. **THE FUTURE IS HERE TODAY!**. 2001 STEREO SYSTEMS, INC., (U.S. CLS. 100, 101 AND 102). SN 78-077,765. PUB. 7-2-2002. FILED 8-6-2001.
- 2,625,169. **ART OF INNOVATION**. RELATIONSHIP MARKETING, INC., (U.S. CLS. 100, 101 AND 102). SN 78-078,609. PUB. 7-2-2002. FILED 8-10-2001.
- 2,625,174. **GALLERY M**. GALLERY M, (U.S. CLS. 100, 101 AND 102). SN 78-080,046. PUB. 7-2-2002. FILED 8-20-2001.
- 2,625,177. **CONNECT 4 PROFIT**. TRUSERV CORPORATION, (U.S. CLS. 100, 101 AND 102). SN 78-080,345. PUB. 7-2-2002. FILED 8-21-2001.
- 2,625,211. **USHCC**. UNITED STATES HISPANIC CHAMBER OF COMMERCE, (U.S. CLS. 100, 101 AND 102). SN 78-087,557. PUB. 7-2-2002. FILED 10-9-2001.
- 2,625,225. **CAPRX**. GORDON, DANA J., (U.S. CLS. 100, 101 AND 102). SN 78-089,145. PUB. 7-2-2002. FILED 10-18-2001.
- 2,625,230. **JAVA ZONE**. NORDSTROM OIL COMPANY, DBA HANDIMART FOOD STORES, (U.S. CLS. 100, 101 AND 102). SN 78-090,787. PUB. 7-2-2002. FILED 10-30-2001.
- 2,625,232. **EDPLUS**. SCHUMACHER GROUP OF DELAWARE, INC., THE, MULTIPLE CLASS, (INT. CLS. 35, 36 AND 41), (U.S. CLS. 100, 101, 102 AND 107). SN 78-091,053. PUB. 7-2-2002. FILED 10-31-2001.
- 2,625,236. **CONSCIOUS BUSINESS**. THE MCNAUGHTON GROUP, INC., (U.S. CLS. 100, 101 AND 102). SN 78-092,488. PUB. 7-2-2002. FILED 11-8-2001.
- 2,625,239. **FURNITURE CONCEPTS AND DESIGN**. FURNITURE CONCEPTS, INC., (U.S. CLS. 100, 101 AND 102). SN 78-092,604. PUB. 7-2-2002. FILED 11-9-2001.
- 2,625,240. **NAVCAT**. PUMPHREY MARKETING, INC., (U.S. CLS. 100, 101 AND 102). SN 78-092,700. PUB. 7-2-2002. FILED 11-10-2001.
- 2,625,243. **NLGS**. MIKULAS, ROBERT, FRANK, (U.S. CLS. 100, 101 AND 102). SN 78-093,031. PUB. 7-2-2002. FILED 11-13-2001.
- 2,625,249. **GOTTA HAVE IT!**. GOTTA HAVE IT! COLLECTIBLES, INC., (U.S. CLS. 100, 101 AND 102). SN 78-094,954. PUB. 7-2-2002. FILED 11-26-2001.
- 2,625,258. **GETMEMBERS**. COUPONS, INC., (U.S. CLS. 100, 101 AND 102). SN 78-095,348. PUB. 7-2-2002. FILED 11-27-2001.
- 2,625,268. **SALUKI CENTRAL AND DESIGN**. SAVKA, AARON C., (U.S. CLS. 100, 101 AND 102). SN 78-097,035. PUB. 7-2-2002. FILED 12-6-2001.
- 2,625,283. **THE OPTIMO EXCHANGE**. OPTIMO, INC., (U.S. CLS. 100, 101 AND 102). SN 78-099,540. PUB. 7-2-2002. FILED 12-20-2001.
- 2,625,286. **MISCELLANEOUS DESIGN**. MAY LONG TECHNOLOGY GROUP, INC, (U.S. CLS. 100, 101 AND 102). SN 78-099,774. PUB. 7-2-2002. FILED 12-21-2001.
- 2,625,295. **MISCELLANEOUS DESIGN**. AARDVARK TACTICAL, INC., (U.S. CLS. 100, 101 AND 102). SN 78-100,503. PUB. 7-2-2002. FILED 1-2-2002.

CLASS 36—INSURANCE AND FINANCIAL

- 2,622,502. **HMA**. HEALTHCARE MANAGEMENT ADVISORS, INC., (U.S. CLS. 100, 101 AND 102). SN 74-268,570. PUB. 7-2-2002. FILED 4-23-1992.
- 2,622,507 (See Class 9 for this trademark).
- 2,622,510. **VIRGIN AND DESIGN**. VIRGIN ENTERPRISES LIMITED, (U.S. CLS. 100, 101 AND 102). SN 75-045,561. PUB. 7-2-2002. FILED 1-18-1996.
- 2,622,534. **BLUE NOTE THE FINEST IN JAZZ SINCE 1939 AND DESIGN**. CAPITOL RECORDS, INC., (U.S. CLS. 100, 101 AND 102). SN 75-397,925. PUB. 7-2-2002. FILED 12-1-1997.
- 2,622,601. **CUSTOM CHOICE**. GE FINANCIAL ASSURANCE HOLDINGS, INC., (U.S. CLS. 100, 101 AND 102). SN 75-598,255. PUB. 7-2-2002. FILED 12-2-1998.

- 2,622,693. **SELECT MILES**. WELLS FARGO & COMPANY, (U.S. CLS. 100, 101 AND 102). SN 75-762,646. PUB. 11-27-2001. FILED 7-28-1999.
- 2,622,694. **CQS**. CQS MANAGEMENT LIMITED, (U.S. CLS. 100, 101 AND 102). SN 75-763,179. PUB. 11-27-2001. FILED 7-29-1999.
- 2,622,716. **CERTIFIED CAR CARE**. SERVICE CONTRACT SYSTEMS CORPORATION, (U.S. CLS. 100, 101 AND 102). SN 75-795,924. PUB. 7-2-2002. FILED 9-9-1999.
- 2,622,717. **REAL CARE**. ENTRUST AGENCIES, INC., (U.S. CLS. 100, 101 AND 102). SN 75-796,106. PUB. 7-2-2002. FILED 9-9-1999.
- 2,622,732. **BRAIN**. BOHAN GROUP, LLC, THE, (U.S. CLS. 100, 101 AND 102). SN 75-819,063. PUB. 6-19-2001. FILED 10-8-1999.
- 2,622,757 (*See Class 6 for this trademark*).
- 2,622,765. **CHATHAM AND DESIGN**. CHATHAM HOLDINGS CORPORATION, (U.S. CLS. 100, 101 AND 102). SN 75-849,275. PUB. 7-2-2002. FILED 11-15-1999.
- 2,622,789. **SMITH ADVANTAGE**. CHARLES E. SMITH MANAGEMENT, INC., BY ASSIGNMENT CHARLES E. SMITH RESIDENTIAL REALTY, L.P., (U.S. CLS. 100, 101 AND 102). SN 75-869,929. PUB. 7-2-2002. FILED 12-13-1999.
- 2,622,790 (*See Class 35 for this trademark*).
- 2,622,814 (*See Class 35 for this trademark*).
- 2,622,828 (*See Class 9 for this trademark*).
- 2,622,829. **FLEET OFFICELINK**. FLEETBOSTON FINANCIAL CORPORATION, BY CHANGE OF NAME; BY CHANGE OF NAME FLEET BOSTON CORPORATION, (U.S. CLS. 100, 101 AND 102). SN 75-902,215. PUB. 7-2-2002. FILED 1-27-2000.
- 2,622,835 (*See Class 35 for this trademark*).
- 2,622,843. **AFFORDABLEONE**. AMERICAN MEDICAL SECURITY GROUP, INC., (U.S. CLS. 100, 101 AND 102). SN 75-911,673. PUB. 7-2-2002. FILED 2-7-2000.
- 2,622,859. **FIN ACTIVE**. L'IMPERIALE, COMPAGNIE D'ASSURANCE- VIE/THE IMPERIAL LIFE ASSURANCE COMPANY OF CANADA, (U.S. CLS. 100, 101 AND 102). SN 75-922,325. PUB. 7-2-2002. FILED 2-17-2000.
- 2,622,880. **PRIVACYSHIELD**. CITADEL GROUP, INC., (U.S. CLS. 100, 101 AND 102). SN 75-941,163. PUB. 10-30-2001. FILED 3-10-2000.
- 2,622,882. **ONEPOINT**. GREENPOINT FINANCIAL CORP., (U.S. CLS. 100, 101 AND 102). SN 75-943,212. PUB. 7-2-2002. FILED 3-13-2000.
- 2,622,944. **PROFILE**. AMERICAN INTERNATIONAL GROUP, INC., (U.S. CLS. 100, 101 AND 102). SN 76-025,035. PUB. 7-2-2002. FILED 4-14-2000.
- 2,622,945. **TRANSMITTAL LETTER**. INTERIM FUNDING L.L.C., (U.S. CLS. 100, 101 AND 102). SN 76-025,394. PUB. 7-2-2002. FILED 4-13-2000.
- 2,622,950 (*See Class 35 for this trademark*).
- 2,623,006. **VISA BUXX**. VISA INTERNATIONAL SERVICE ASSOCIATION, (U.S. CLS. 100, 101 AND 102). SN 76-053,702. PUB. 7-2-2002. FILED 5-22-2000.
- 2,623,015. **SONOMA SPA RESORTS**. SONOMA SPA RESORTS, L.P., (U.S. CLS. 100, 101 AND 102). SN 76-058,491. PUB. 7-2-2002. FILED 5-30-2000.
- 2,623,022. **BANK STAR**. BANCSTAR, INC., (U.S. CLS. 100, 101 AND 102). SN 76-059,876. PUB. 7-2-2002. FILED 5-31-2000.
- 2,623,041 (*See Class 35 for this trademark*).
- 2,623,071. **SEMPERIS**. VMS-KEYTRADE S.A., MULTIPLE CLASS, (INT. CLS. 36, 38 AND 42), (U.S. CLS. 100, 101, 102 AND 104). SN 76-075,974. PUB. 7-2-2002. FILED 6-23-2000.
- 2,623,076. **FERRARI PERSONAL SERVICES AND DESIGN**. FERRARI S.P.A., (U.S. CLS. 100, 101 AND 102). SN 76-078,541. PUB. 7-2-2002. FILED 6-27-2000.
- 2,623,081 (*See Class 35 for this trademark*).
- 2,623,093. **MISCELLANEOUS DESIGN**. SONOMA SPA RESORTS, L.P., (U.S. CLS. 100, 101 AND 102). SN 76-084,965. PUB. 7-2-2002. FILED 7-7-2000.
- 2,623,111. **MASTRAPASQUA GROWTH VALUE**. MASTRAPASQUA & ASSOCIATES, (U.S. CLS. 100, 101 AND 102). SN 76-089,892. PUB. 7-2-2002. FILED 7-14-2000.
- 2,623,112. **ENERGY MARKETING FOR THE THIRD MILLENIUM**. WITTSICHE, GARY L., (U.S. CLS. 100, 101 AND 102). SN 76-090,319. PUB. 7-2-2002. FILED 7-17-2000.
- 2,623,149. **BRX-10**. N.A.C.O.L.A.H., (U.S. CLS. 100, 101 AND 102). SN 76-102,309. PUB. 7-2-2002. FILED 8-1-2000.
- 2,623,152 (*See Class 35 for this trademark*).
- 2,623,180 (*See Class 35 for this trademark*).
- 2,623,196. **ESAI**. ENVIRONMENTAL SITE ASSESSMENTS, LLC, (U.S. CLS. 100, 101 AND 102). SN 76-116,072. PUB. 7-2-2002. FILED 8-24-2000.
- 2,623,197. **IDEAL PARTNERS**. IDEAL PARTNERS, LLC, (U.S. CLS. 100, 101 AND 102). SN 76-116,448. PUB. 7-2-2002. FILED 8-25-2000.
- 2,623,205. **NATIONAL EQUITY TRUST**. PRUDENTIAL INSURANCE COMPANY OF AMERICA, THE, (U.S. CLS. 100, 101 AND 102). SN 76-118,135. PUB. 7-2-2002. FILED 8-28-2000.
- 2,623,228. **SHARED GLOBAL**. SHARED GLOBAL SYSTEMS, INC., (U.S. CLS. 100, 101 AND 102). SN 76-126,602. PUB. 7-2-2002. FILED 9-8-2000.
- 2,623,235. **POWERPAC**. WELLPOINT HEALTH NETWORKS INC., (U.S. CLS. 100, 101 AND 102). SN 76-128,326. PUB. 7-2-2002. FILED 9-15-2000.
- 2,623,253. **A AND DESIGN**. FIRST AMERICAN BANK, SSB, (U.S. CLS. 100, 101 AND 102). SN 76-133,158. PUB. 7-2-2002. FILED 9-20-2000.
- 2,623,258. **WWW.SYB.COM ONLINE AND DESIGN**. STOCK YARDS BANK & TRUST COMPANY, (U.S. CLS. 100, 101 AND 102). SN 76-133,908. PUB. 7-2-2002. FILED 9-22-2000.
- 2,623,272. **40ISOURCE SELECT ACCOUNT**. PAINWEBBER INCORPORATED, (U.S. CLS. 100, 101 AND 102). SN 76-135,761. PUB. 7-2-2002. FILED 9-26-2000.
- 2,623,276. **NRA CIVIL RIGHTS DEFENSE FUND AND DESIGN**. NATIONAL RIFLE ASSOCIATION OF AMERICA, MULTIPLE CLASS, (INT. CLS. 36 AND 42), (U.S. CLS. 100, 101 AND 102). SN 76-136,408. PUB. 7-2-2002. FILED 9-27-2000.
- 2,623,319 (*See Class 9 for this trademark*).
- 2,623,326. **MISCELLANEOUS DESIGN**. PERFORMANCE ADMINISTRATION CORP., (U.S. CLS. 100, 101 AND 102). SN 76-145,453. PUB. 7-2-2002. FILED 10-13-2000.
- 2,623,335 (*See Class 35 for this trademark*).
- 2,623,371 (*See Class 16 for this trademark*).
- 2,623,372 (*See Class 35 for this trademark*).
- 2,623,380 (*See Class 35 for this trademark*).
- 2,623,390. **CLIMATE CONTROL FOR THE BOTTOM LINE**. XL CAPITAL LTD, (U.S. CLS. 100, 101 AND 102). SN 76-154,836. PUB. 7-2-2002. FILED 10-26-2000.
- 2,623,410. **WEALTH ADVOCACY PARTNERS (STYLIZED)**. DIAL, KELLI K, AND RASKIN, LEONARD, (U.S. CLS. 100, 101 AND 102). SN 76-158,627. PUB. 7-2-2002. FILED 11-2-2000.
- 2,623,438. **PEGASUS ADVISORS**. TOWERS, PERRIN, FORSTER & CROSBY, INC., (U.S. CLS. 100, 101 AND 102). SN 76-162,185. PUB. 7-2-2002. FILED 11-8-2000.
- 2,623,458. **HORIZON BANK**. FIRST TENNESSEE NATIONAL CORPORATION, (U.S. CLS. 100, 101 AND 102). SN 76-166,846. PUB. 7-2-2002. FILED 11-16-2000.
- 2,623,476. **BUSINESS EDITION**. FIRST NATIONAL BANK OF OMAHA, (U.S. CLS. 100, 101 AND 102). SN 76-170,488. PUB. 7-2-2002. FILED 11-24-2000.
- 2,623,477. **PURCHASING EDITION**. FIRST NATIONAL BANK OF OMAHA, (U.S. CLS. 100, 101 AND 102). SN 76-170,489. PUB. 7-2-2002. FILED 11-24-2000.
- 2,623,482 (*See Class 35 for this trademark*).
- 2,623,485. **AMERICAN EXPRESS COMMUNITY BUSINESS**. AMERICAN EXPRESS COMPANY, (U.S. CLS. 100, 101 AND 102). SN 76-170,974. PUB. 7-2-2002. FILED 11-27-2000.
- 2,623,489 (*See Class 35 for this trademark*).
- 2,623,491. **MERRILL LYNCH STRATEGIC PORTFOLIO ADVISOR**. MERRILL LYNCH & CO., INC., (U.S. CLS. 100, 101 AND 102). SN 76-172,141. PUB. 7-2-2002. FILED 11-28-2000.
- 2,623,496 (*See Class 35 for this trademark*).
- 2,623,502. **TRIPLE-S SSS (STYLIZED)**. TRIPLE-S MANAGEMENT CORPORATION, (U.S. CLS. 100, 101 AND 102). SN 76-173,367. PUB. 7-2-2002. FILED 11-30-2000.
- 2,623,512 (*See Class 35 for this trademark*).
- 2,623,520. **SKYBRANCH**. UNITED AIRLINES EMPLOYEES' CREDIT UNION, (U.S. CLS. 100, 101 AND 102). SN 76-175,972. PUB. 7-2-2002. FILED 12-5-2000.
- 2,623,591. **IMG AND DESIGN**. INTERNATIONAL MEDICAL GROUP, INC., (U.S. CLS. 100, 101 AND 102). SN 76-186,787.

- PUB. 7-2-2002. FILED 12-27-2000.
- 2,623,612. **INSURANCECOMPANY.COM AND DESIGN.** BLUNT, DAVID, (U.S. CLS. 100, 101 AND 102). SN 76-189,085. PUB. 7-2-2002. FILED 1-3-2001.
- 2,623,621. **START2CLOSE AND DESIGN.** STEWART TITLE COMPANY, (U.S. CLS. 100, 101 AND 102). SN 76-190,189. PUB. 7-2-2002. FILED 1-3-2001.
- 2,623,632. **LET UNITED GUARANTY SHOWER YOU WITH OUR SERVICES.** UNITED GUARANTY CORPORATION, (U.S. CLS. 100, 101 AND 102). SN 76-191,288. PUB. 7-2-2002. FILED 1-9-2001.
- 2,623,637. **HEROES FOR A CURE.** NATIONAL NEUROFIBROMATOSIS FOUNDATION, INC., MULTIPLE CLASS, (INT. CLS. 36 AND 42), (U.S. CLS. 100, 101 AND 102). SN 76-192,633. PUB. 7-2-2002. FILED 1-11-2001.
- 2,623,678. **"KIDUCATION" WE TURN USED CLOTHING INTO NEW KIDS THROUGH EDUCATION. AND DESIGN.** COMMUNITY CRUSADE FOR CHILDREN, INC., (U.S. CLS. 100, 101 AND 102). SN 76-197,373. PUB. 7-2-2002. FILED 1-22-2001.
- 2,623,694 (*See Class 35 for this trademark*).
- 2,623,701. **WELLS FARGO HOMEBUYERS CLUB.** WELLS FARGO HOME MORTGAGE, INC, (U.S. CLS. 100, 101 AND 102). SN 76-200,235. PUB. 7-2-2002. FILED 1-25-2001.
- 2,623,709. **MBL FINANCIAL SERVICES AND DESIGN.** MBL FINANCIAL SERVICES, INC., (U.S. CLS. 100, 101 AND 102). SN 76-201,211. PUB. 7-2-2002. FILED 1-29-2001.
- 2,623,732 (*See Class 35 for this trademark*).
- 2,623,734. **J2.** JANUS INTERNATIONAL HOLDING COMPANY, (U.S. CLS. 100, 101 AND 102). SN 76-203,771. PUB. 7-2-2002. FILED 1-31-2001.
- 2,623,753. **MEMBERPAY.** CORPORATE NETWORK ECOM, LLC, (U.S. CLS. 100, 101 AND 102). SN 76-205,585. PUB. 7-2-2002. FILED 2-6-2001.
- 2,623,756 (*See Class 35 for this trademark*).
- 2,623,759. . . . **SO YOU CAN ENJOY LIFE!** HOME-LINK SERVICES, INC., (U.S. CLS. 100, 101 AND 102). SN 76-206,310. PUB. 7-2-2002. FILED 2-7-2001.
- 2,623,763. **SALSA.** BROWN BROTHERS HARRIMAN & CO., (U.S. CLS. 100, 101 AND 102). SN 76-206,904. PUB. 7-2-2002. FILED 2-8-2001.
- 2,623,764. **SALSA (STYLIZED).** BROWN BROTHERS HARRIMAN & CO, (U.S. CLS. 100, 101 AND 102). SN 76-206,905. PUB. 7-2-2002. FILED 2-8-2001.
- 2,623,787. **WE'RE LISTENING AND DESIGN.** PACIFICARE HEALTH SYSTEMS, INC., (U.S. CLS. 100, 101 AND 102). SN 76-210,833. PUB. 7-2-2002. FILED 2-14-2001.
- 2,623,791. **SYSTEMS PRIME AND DESIGN.** BAE SYSTEMS PLC, (U.S. CLS. 100, 101 AND 102). SN 76-211,458. PUB. 7-2-2002. FILED 2-16-2001.
- 2,623,806. **REACH FOR TOMORROW.** REACH FOR TOMORROW, (U.S. CLS. 100, 101 AND 102). SN 76-213,453. PUB. 7-2-2002. FILED 2-21-2001.
- 2,623,832 (*See Class 9 for this trademark*).
- 2,623,876. **PAYDENFUNDS PF AND DESIGN.** W.D. HILTON, JR., JAMES CLAYBURN LAFORCE, GERALD S. LEVEY, M.D., THOMAS V. MCKERNAN, JR., CHRISTOPHER N. ORNDORFF, JOAN A. PAYDEN, DENNIS C. POULSEN, STENDER E. SWEENEY AND MARY BETH SYAL, ALL UNITED STATES CITIZENS, AS TRUSTEES OF THE THE PAYDEN & RYGEL INVESTMENT GROUP, (U.S. CLS. 100, 101 AND 102). SN 76-222,616. PUB. 7-2-2002. FILED 3-8-2001.
- 2,623,882. **LAKESIDE ELINK.** LAKESIDE BANK, (U.S. CLS. 100, 101 AND 102). SN 76-223,154. PUB. 7-2-2002. FILED 3-12-2001.
- 2,623,907 (*See Class 1 for this trademark*).
- 2,623,909 (*See Class 16 for this trademark*).
- 2,623,928. **VALDORO MOUNTAIN LODGE.** PEAKS LODGE DEVELOPMENT, LLC, (U.S. CLS. 100, 101 AND 102). SN 76-229,572. PUB. 7-2-2002. FILED 3-26-2001.
- 2,623,934. **ROCKBRIDGE CAPITAL, INC.** ROCKBRIDGE CAPITAL, INC., (U.S. CLS. 100, 101 AND 102). SN 76-231,177. PUB. 7-2-2002. FILED 3-26-2001.
- 2,623,935. **KIDS FLOWERS BRINGING SCHOOL FUNDRAISING TO LIFE. AND DESIGN.** ISCHOOLFUND.COM, DBA KIDS FLOWERS, (U.S. CLS. 100, 101 AND 102). SN 76-231,259. PUB. 7-2-2002. FILED 3-27-2001.
- 2,623,943. **NEW START.** INDEPENDENCE COMMUNITY BANK, (U.S. CLS. 100, 101 AND 102). SN 76-232,379. PUB. 7-2-2002. FILED 3-29-2001.
- 2,623,973. **THERE'S A PLACE FOR FUN IN YOUR LIFE.** SIMON PROPERTY GROUP, L.P., (U.S. CLS. 100, 101 AND 102). SN 76-235,960. PUB. 7-2-2002. FILED 4-5-2001.
- 2,623,977 (*See Class 35 for this trademark*).
- 2,623,990 (*See Class 16 for this trademark*).
- 2,624,035. **SIG SUSQUEHANNA AND DESIGN.** SUSQUEHANNA INTERNATIONAL GROUP, LLP, BY CHANGE OF NAME SUSQUEHANNA PARTNERS, GP, (U.S. CLS. 100, 101 AND 102). SN 76-241,883. PUB. 7-2-2002. FILED 4-17-2001.
- 2,624,037. **SIGNAL LAKE AND DESIGN.** SIGNAL LAKE MANAGEMENT, LLC, (U.S. CLS. 100, 101 AND 102). SN 76-242,179. PUB. 7-2-2002. FILED 4-6-2001.
- 2,624,093. **PERFORMANCE LE.** GAST MANUFACTURING, INC., (U.S. CLS. 100, 101 AND 102). SN 76-247,883. PUB. 7-2-2002. FILED 4-27-2001.
- 2,624,101. **AEROSPACE EDUCATION FOUNDATION AND DESIGN.** AEROSPACE EDUCATION FOUNDATION, (U.S. CLS. 100, 101 AND 102). SN 76-248,807. PUB. 7-2-2002. FILED 5-1-2001.
- 2,624,104. **BB&T ELITE BUSINESS ACCOUNT.** BB&T CORPORATION, (U.S. CLS. 100, 101 AND 102). SN 76-249,127. PUB. 7-2-2002. FILED 5-2-2001.
- 2,624,119. **CPP.** OLYMPUS AMERICA INC., MULTIPLE CLASS, (INT. CLS. 36 AND 42), (U.S. CLS. 100, 101 AND 102). SN 76-251,465. PUB. 7-2-2002. FILED 5-4-2001.
- 2,624,120. **SHARKCOLLECTOR.** SHARKCOLLECTOR, (U.S. CLS. 100, 101 AND 102). SN 76-251,679. PUB. 7-2-2002. FILED 5-7-2001.
- 2,624,137. **BE THE PEOPLE.** PALLOTTA TEAMWORKS, (U.S. CLS. 100, 101 AND 102). SN 76-254,960. PUB. 7-2-2002. FILED 5-11-2001.
- 2,624,141. **THE ATLANTIC PHILANTHROPIES.** ATLANTIC FOUNDATION, THE, (U.S. CLS. 100, 101 AND 102). SN 76-255,215. PUB. 7-2-2002. FILED 5-10-2001.
- 2,624,145. **F FLEETWOOD MANAGEMENT AND DESIGN.** FLEETWOOD MANAGEMENT, LLC, (U.S. CLS. 100, 101 AND 102). SN 76-255,750. PUB. 7-2-2002. FILED 5-11-2001.
- 2,624,146. **ILLINI BANK AND DESIGN.** ILLINI CORPORATION, (U.S. CLS. 100, 101 AND 102). SN 76-255,786. PUB. 7-2-2002. FILED 5-14-2001.
- 2,624,149. **LOCKTON.** LOCKTON COMPANIES, INC., (U.S. CLS. 100, 101 AND 102). SN 76-255,981. PUB. 7-2-2002. FILED 5-11-2001.
- 2,624,150. **EQUIBANC MORTGAGE CORPORATION.** SOUTHTRUST MORTGAGE CORPORATION, (U.S. CLS. 100, 101 AND 102). SN 76-256,141. PUB. 7-2-2002. FILED 5-11-2001.
- 2,624,160. **RELOFLEX.** RELOCATION EXCHANGE CORP., THE, (U.S. CLS. 100, 101 AND 102). SN 76-257,781. PUB. 7-2-2002. FILED 5-16-2001.
- 2,624,168. **THE LEGACY SPECIALISTS.** LEGACY SPECIALISTS, LLC, THE, (U.S. CLS. 100, 101 AND 102). SN 76-258,747. PUB. 7-2-2002. FILED 5-16-2001.
- 2,624,169. **NASDAQ TRADER.** NASDAQ STOCK MARKET, INC., THE, (U.S. CLS. 100, 101 AND 102). SN 76-258,878. PUB. 7-2-2002. FILED 5-18-2001.
- 2,624,173. **HARFORD MALL.** MID-ATLANTIC REALTY TRUST, (U.S. CLS. 100, 101 AND 102). SN 76-259,213. PUB. 7-2-2002. FILED 5-21-2001.
- 2,624,216. **INTENSIVE CARE SELECT.** AEGON USA, INC., (U.S. CLS. 100, 101 AND 102). SN 76-263,579. PUB. 7-2-2002. FILED 5-25-2001.
- 2,624,233. **THE REAL EDGE IN HOMEOWNERSHIP.** LONG & FOSTER COMPANIES, INC., MULTIPLE CLASS, (INT. CLS. 36 AND 42), (U.S. CLS. 100, 101 AND 102). SN 76-265,075. PUB. 7-2-2002. FILED 6-1-2001.
- 2,624,236. **HEART SELECT.** AEGON USA, INC., (U.S. CLS. 100, 101 AND 102). SN 76-265,437. PUB. 7-2-2002. FILED 6-1-2001.
- 2,624,238. **CANCER SELECT.** AEGON USA, INC., (U.S. CLS. 100, 101 AND 102). SN 76-265,746. PUB. 7-2-2002. FILED 6-1-2001.
- 2,624,239. **FIRST OCCURRENCE SELECT.** AEGON USA, INC., (U.S. CLS. 100, 101 AND 102). SN 76-265,747. PUB. 7-

- 2-2002. FILED 6-1-2001.
- 2,624,240. **HOSPITAL SELECT.** AEGON USA, INC., (U.S. CLS. 100, 101 AND 102). SN 76-265,748. PUB. 7-2-2002. FILED 6-1-2001.
- 2,624,249. **MAJOR ILLNESS SELECT.** AEGON USA, INC., (U.S. CLS. 100, 101 AND 102). SN 76-266,612. PUB. 7-2-2002. FILED 6-4-2001.
- 2,624,254. **HELPING GOOD PEOPLE DO GREAT THINGS.** WAITT FAMILY FOUNDATION, DBA TED W. WAITT FAMILY FOUNDATION, MULTIPLE CLASS, (INT. CLS. 36 AND 42), (U.S. CLS. 100, 101 AND 102). SN 76-267,099. PUB. 7-2-2002. FILED 6-4-2001.
- 2,624,258. **ALL INSURANCE COMPANIES ARE PRETTY MUCH THE SAME UNTIL YOU SUBMIT A CLAIM.** GRANGE INSURANCE ASSOCIATION, (U.S. CLS. 100, 101 AND 102). SN 76-267,567. PUB. 7-2-2002. FILED 6-6-2001.
- 2,624,277. **BECAUSE IT'S TIME.** FOSTER, TOM, (U.S. CLS. 100, 101 AND 102). SN 76-269,045. PUB. 7-2-2002. FILED 6-11-2001.
- 2,624,286. **AMERICA'S CUTTING EDGE AND DESIGN.** AMERICA'S CUTTING EDGE HOLDINGS INC., (U.S. CLS. 100, 101 AND 102). SN 76-270,144. PUB. 7-2-2002. FILED 6-12-2001.
- 2,624,300 (*See Class 35 for this trademark*).
- 2,624,307. **TRUSTTOUCHPC.** TRUSTMARK NATIONAL BANK, (U.S. CLS. 100, 101 AND 102). SN 76-272,386. PUB. 7-2-2002. FILED 6-15-2001.
- 2,624,310. **SEACOAST UNDERWRITERS, INC. AND DESIGN.** SEACOAST UNDERWRITERS, INC., (U.S. CLS. 100, 101 AND 102). SN 76-272,564. PUB. 7-2-2002. FILED 6-18-2001.
- 2,624,329. **ACCIDENT SELECT.** AEGON USA, INC., (U.S. CLS. 100, 101 AND 102). SN 76-275,652. PUB. 7-2-2002. FILED 6-22-2001.
- 2,624,347 (*See Class 35 for this trademark*).
- 2,624,365. **SPYDERNET.** SPYDERNET, (U.S. CLS. 100, 101 AND 102). SN 76-281,462. PUB. 7-2-2002. FILED 7-9-2001.
- 2,624,388. **STRATAMED.** SPECTRUM UNDERWRITING MANAGERS, INC., (U.S. CLS. 100, 101 AND 102). SN 76-285,179. PUB. 7-2-2002. FILED 7-16-2001.
- 2,624,407 (*See Class 9 for this trademark*).
- 2,624,416. **BULLSEYE.** DTN FINANCIAL SERVICES, LLC, (U.S. CLS. 100, 101 AND 102). SN 76-288,872. PUB. 7-2-2002. FILED 7-24-2001.
- 2,624,422. **CITYMEALS-ON-WHEELS.** CITYMEALS-ON-WHEELS, MULTIPLE CLASS, (INT. CLS. 36 AND 42), (U.S. CLS. 100, 101 AND 102). SN 76-290,280. PUB. 7-2-2002. FILED 7-26-2001.
- 2,624,431. **CARRIAGE REALTY, INC. AND DESIGN.** CARRIAGE REALTY, INC., (U.S. CLS. 100, 101 AND 102). SN 76-290,934. PUB. 7-2-2002. FILED 7-27-2001.
- 2,624,437. **CAPITAL TRANSFER TECHNIQUE.** PROFESSIONAL FINANCIAL SERVICES L.P., (U.S. CLS. 100, 101 AND 102). SN 76-291,396. PUB. 7-2-2002. FILED 7-26-2001.
- 2,624,473. **SIGNATURE CHECKING.** MIDFIRST BANK, (U.S. CLS. 100, 101 AND 102). SN 76-296,191. PUB. 7-2-2002. FILED 7-18-2001.
- 2,624,487. **MISCELLANEOUS DESIGN.** KEYES COMPANY, THE, (U.S. CLS. 100, 101 AND 102). SN 76-298,920. PUB. 7-2-2002. FILED 8-14-2001.
- 2,624,494 (*See Class 35 for this trademark*).
- 2,624,505 (*See Class 35 for this trademark*).
- 2,624,531. **NICK NACK SAVINGS PACK.** US AIRWAYS FEDERAL CREDIT UNION, (U.S. CLS. 100, 101 AND 102). SN 76-307,989. PUB. 7-2-2002. FILED 8-31-2001.
- 2,624,561. **AMANDA'S ANGEL ALLIANCE.** DUNBAR, AMANDA, (U.S. CLS. 100, 101 AND 102). SN 76-313,054. PUB. 7-2-2002. FILED 9-14-2001.
- 2,624,579. **FXACCESS.** BB&T CORPORATION, (U.S. CLS. 100, 101 AND 102). SN 76-316,405. PUB. 7-2-2002. FILED 9-24-2001.
- 2,624,584. **SEVIN ROSEN FUNDS.** SEVIN ROSEN BAYLESS MANAGEMENT COMPANY, (U.S. CLS. 100, 101 AND 102). SN 76-317,116. PUB. 7-2-2002. FILED 9-26-2001.
- 2,624,618. **WHAT MAY WE DO FOR YOU TODAY?.** SIMON PROPERTY GROUP, L.P., (U.S. CLS. 100, 101 AND 102). SN 76-322,699. PUB. 7-2-2002. FILED 10-9-2001.
- 2,624,638. **REALIZING THE FUTURE.** PG RESEARCH FOUNDATION, INC., MULTIPLE CLASS, (INT. CLS. 36 AND 42), (U.S. CLS. 100, 101 AND 102). SN 76-324,505. PUB. 7-2-2002. FILED 10-12-2001.
- 2,624,639. **GLOBAL CHAMPIONS.** SG HOLDINGS, INC., (U.S. CLS. 100, 101 AND 102). SN 76-324,616. PUB. 7-2-2002. FILED 10-15-2001.
- 2,624,666 (*See Class 35 for this trademark*).
- 2,624,679. **INVENTORYLINE.** TEXTRON FINANCIAL CORPORATION, (U.S. CLS. 100, 101 AND 102). SN 76-328,807. PUB. 7-2-2002. FILED 10-23-2001.
- 2,624,692. **MULTI-FLEX.** NATIONWIDE LIFE INSURANCE COMPANY, (U.S. CLS. 100, 101 AND 102). SN 76-330,501. PUB. 7-2-2002. FILED 10-26-2001.
- 2,624,736. **SECNET (STYLIZED).** CCH INCORPORATED, (U.S. CLS. 100, 101 AND 102). SN 76-336,885. PUB. 7-2-2002. FILED 11-13-2001.
- 2,624,739. **DYNAMIC RISK STRATEGIES.** AON RISK SERVICES COMPANIES, INC., (U.S. CLS. 100, 101 AND 102). SN 76-337,326. PUB. 7-2-2002. FILED 11-14-2001.
- 2,624,754. **LIBERTY MARKETING.** LIBERTY MARKETING GROUP, INC., (U.S. CLS. 100, 101 AND 102). SN 76-339,124. PUB. 7-2-2002. FILED 11-16-2001.
- 2,624,771. **GEMS FOR A JEWEL.** ELLIS, LYNDA, (U.S. CLS. 100, 101 AND 102). SN 76-342,937. PUB. 7-2-2002. FILED 11-29-2001.
- 2,624,774 (*See Class 35 for this trademark*).
- 2,624,785. **THE CREDIT UNION FOR THE WAY YOU DEFINE SERVICE.** ARIZONA FEDERAL CREDIT UNION, (U.S. CLS. 100, 101 AND 102). SN 76-344,256. PUB. 7-2-2002. FILED 11-30-2001.
- 2,624,822. **US AND DESIGN.** U.S. HOME MORTGAGE, LLC, (U.S. CLS. 100, 101 AND 102). SN 76-348,708. PUB. 7-2-2002. FILED 12-17-2001.
- 2,624,831. **EP AND DESIGN.** EVERYTHING PREPAID, INC., (U.S. CLS. 100, 101 AND 102). SN 76-349,774. PUB. 7-2-2002. FILED 12-17-2001.
- 2,624,842. **THE WAY YOU INVEST MATTERS.** DOMINI SOCIAL INVESTMENTS LLC, (U.S. CLS. 100, 101 AND 102). SN 76-350,583. PUB. 7-2-2002. FILED 12-18-2001.
- 2,624,845. **FIED AND DESIGN.** FINANCIAL EDUCATION, INC., MULTIPLE CLASS, (INT. CLS. 36 AND 41), (U.S. CLS. 100, 101, 102 AND 107). SN 76-351,037. PUB. 7-2-2002. FILED 12-20-2001.
- 2,624,855 (*See Class 35 for this trademark*).
- 2,624,906. **IMCO AND DESIGN.** INDEPENDENT MEDICAL CO-OP, INC., (U.S. CLS. 100, 101 AND 102). SN 76-359,435. PUB. 7-2-2002. FILED 1-16-2002.
- 2,624,930 (*See Class 35 for this trademark*).
- 2,624,931 (*See Class 35 for this trademark*).
- 2,624,946. **YOU GOTTA GET OUTLET MORE OFTEN.** CHARTER OAK GROUP, LTD., (U.S. CLS. 100, 101 AND 102). SN 76-369,497. PUB. 7-2-2002. FILED 2-12-2002.
- 2,624,949. **WE ONLY MAKE MONEY WHEN YOU MAKE MONEY.** LEADER CAPITAL CORP, (U.S. CLS. 100, 101 AND 102). SN 76-370,066. PUB. 7-2-2002. FILED 2-13-2002.
- 2,624,971. **VIZMONEY.** INTERNET VENTURE COMPANY LTD., THE, (U.S. CLS. 100, 101 AND 102). SN 78-013,841. PUB. 8-21-2001. FILED 6-21-2000.
- 2,624,979. **GAYHEALTHINSURANCE.COM AND DESIGN.** GAYHEALTHINSURANCE SERVICES, INC., (U.S. CLS. 100, 101 AND 102). SN 78-021,459. PUB. 10-9-2001. FILED 8-16-2000.
- 2,624,997. **INVESTORTAINMENT!. INVESTFORCLOSURES.-COM.** (U.S. CLS. 100, 101 AND 102). SN 78-036,761. PUB. 7-2-2002. FILED 11-28-2000.
- 2,624,999. **ENSKILDA.** ENSKILDA SECURITIES HOLDING AB, (U.S. CLS. 100, 101 AND 102). SN 78-039,435. PUB. 7-2-2002. FILED 12-15-2000.
- 2,625,002. **GOLFANDHOME.COM THE GOLF REAL ESTATE COMPANY AND DESIGN.** GOLF AND HOME, INC., MULTIPLE CLASS, (INT. CLS. 36 AND 42), (U.S. CLS. 100, 101 AND 102). SN 78-040,461. PUB. 7-2-2002. FILED 12-22-2000.
- 2,625,030. **SPRINGBOARDANGELS.** SPRINGBOARD ANGELS, (U.S. CLS. 100, 101 AND 102). SN 78-048,182. PUB. 7-2-2002. FILED 2-13-2001.
- 2,625,033. **MAKING YOURHOMEDREAMS.COM TRUE!. FORD LISA BETH,** (U.S. CLS. 100, 101 AND 102). SN 78-049,781. PUB. 7-2-2002. FILED 2-22-2001.

- 2,625,046. **REMITDATA**. REMITDATA, INC., (U.S. CLS. 100, 101 AND 102). SN 78-053,371. PUB. 7-2-2002. FILED 3-15-2001.
- 2,625,074. **NANTAHALA MOUNTAIN RETREAT**. RONALD N. BAKER AND DONNA L. BAKER PARTNERSHIP, THE, (U.S. CLS. 100, 101 AND 102). SN 78-059,359. PUB. 7-2-2002. FILED 4-19-2001.
- 2,625,159. **PIMEDICAL**. EDMONDS, MARY J., (U.S. CLS. 100, 101 AND 102). SN 78-075,544. PUB. 7-2-2002. FILED 7-25-2001.
- 2,625,165 (*See Class 35 for this trademark*).
- 2,625,187. **MEZRA**. MEZRA FINANCE LTD, (U.S. CLS. 100, 101 AND 102). SN 78-082,243. PUB. 7-2-2002. FILED 9-1-2001.
- 2,625,204. **PRUDENTIAL FINANCIAL MULTI-GOAL ALLOCATION ANALYZER**. PRUDENTIAL INSURANCE COMPANY OF AMERICA, THE, (U.S. CLS. 100, 101 AND 102). SN 78-085,894. PUB. 7-2-2002. FILED 9-27-2001.
- 2,625,214. **ZERO BASED ESTATE PLANNING**. BROOKS III, LONNIE W., (U.S. CLS. 100, 101 AND 102). SN 78-087,978. PUB. 7-2-2002. FILED 10-11-2001.
- 2,625,232 (*See Class 35 for this trademark*).
- 2,625,260. **ACCO AND DESIGN**. ACCO-AIR CONDITIONING COMPANY, INC., MULTIPLE CLASS, (INT. CLS. 36, 37, 40 AND 42), (U.S. CLS. 100, 101, 102, 103 AND 106). SN 78-095,530. PUB. 7-2-2002. FILED 11-28-2001.
- 2,625,267. **ST. PAUL SELECTONE**. ST. PAUL COMPANIES, INC., THE, (U.S. CLS. 100, 101 AND 102). SN 78-096,969. PUB. 7-2-2002. FILED 12-6-2001.
- 2,625,270. **EFFCU**. EASTERN FINANCIAL FEDERAL CREDIT UNION, (U.S. CLS. 100, 101 AND 102). SN 78-097,281. PUB. 7-2-2002. FILED 12-7-2001.
- 2,625,284. **PRODUCER WORLD**. AETNA INC., (U.S. CLS. 100, 101 AND 102). SN 78-099,694. PUB. 7-2-2002. FILED 12-21-2001.
- 2,625,296. **MSN**. MICROSOFT CORPORATION, (U.S. CLS. 100, 101 AND 102). SN 78-100,761. PUB. 7-2-2002. FILED 1-3-2002.
- 2,625,299. **STRATEGIC ADVANTAGE**. VANGUARD GROUP, INC., THE, (U.S. CLS. 100, 101 AND 102). SN 78-101,869. PUB. 7-2-2002. FILED 1-10-2002.

CLASS 37—CONSTRUCTION AND REPAIR

- 2,622,507 (*See Class 9 for this trademark*).
- 2,622,571 (*See Class 35 for this trademark*).
- 2,622,594 (*See Class 35 for this trademark*).
- 2,622,620 (*See Class 35 for this trademark*).
- 2,622,621 (*See Class 35 for this trademark*).
- 2,622,697. **THE BRIDGES AT RANCHO SANTA FE**. HCC INVESTORS, LLC, (U.S. CLS. 100, 103 AND 106). SN 75-764,300. PUB. 7-2-2002. FILED 10-30-1999.
- 2,622,718. **IQ BUILDING SOLUTIONS**. SYNET, INC., (U.S. CLS. 100, 103 AND 106). SN 75-797,128. PUB. 7-2-2002. FILED 9-13-1999.
- 2,622,786. **FAPS (STYLIZED)**. FAPS, INC., (U.S. CLS. 100, 103 AND 106). SN 75-866,327. PUB. 7-2-2002. FILED 12-7-1999.
- 2,622,838. **OTAY RANCH THE OTAY RANCH COMPANY EST. 1988 AND DESIGN**. OTAY PROJECT L.P., (U.S. CLS. 100, 103 AND 106). SN 75-908,359. PUB. 11-27-2001. FILED 2-3-2000.
- 2,622,876 (*See Class 7 for this trademark*).
- 2,622,902. **H E M M E R AND DESIGN**. PAUL HEMMER CONSTRUCTION COMPANY, (U.S. CLS. 100, 103 AND 106). SN 76-004,355. PUB. 7-2-2002. FILED 3-20-2000.
- 2,622,971 (*See Class 7 for this trademark*).
- 2,622,996 (*See Class 12 for this trademark*).
- 2,623,002. **WATERLEFE AND DESIGN**. WATERMARK COMMUNITIES, INC., (U.S. CLS. 100, 103 AND 106). SN 76-052,759. PUB. 7-2-2002. FILED 5-22-2000.
- 2,623,017. **SONOMA COMPANIES**. SONOMA SPA RESORTS, L.P., (U.S. CLS. 100, 103 AND 106). SN 76-058,876. PUB. 7-2-2002. FILED 5-30-2000.
- 2,623,029 (*See Class 35 for this trademark*).
- 2,623,031 (*See Class 11 for this trademark*).
- 2,623,036. **OPEN UP**. NET2S (S.A.), MULTIPLE CLASS, (INT. CLS. 37, 38, 41 AND 42), (U.S. CLS. 100, 101, 103, 104, 106 AND 107). SN 76-063,840. PUB. 7-2-2002. FILED 6-6-2000.
- 2,623,052. **FINFOAM**. K-MONT INDUSTRIES, INC., (U.S. CLS. 100, 103 AND 106). SN 76-068,495. PUB. 12-18-2001. FILED 6-13-2000.
- 2,623,070 (*See Class 35 for this trademark*).
- 2,623,153. **SEAL-A-FRIDGE**. SEAL-A-FRIDGE, INC., (U.S. CLS. 100, 103 AND 106). SN 76-103,893. PUB. 7-2-2002. FILED 8-4-2000.
- 2,623,160 (*See Class 35 for this trademark*).
- 2,623,173 (*See Class 7 for this trademark*).
- 2,623,232. **SCHOLTEN ROOFING**. SCHOLTEN ROOFING INC., (U.S. CLS. 100, 103 AND 106). SN 76-127,537. PUB. 7-2-2002. FILED 9-12-2000.
- 2,623,269. **TOP VALUE CAR & TRUCK SERVICE CENTER AND DESIGN**. INTERNATIONAL TOP VALUE AUTOMOTIVE, L.L.C., (U.S. CLS. 100, 103 AND 106). SN 76-134,966. PUB. 7-2-2002. FILED 9-25-2000.
- 2,623,301 (*See Class 7 for this trademark*).
- 2,623,322. **MISCELLANEOUS DESIGN**. CAMBATA AVIATION S.A., MULTIPLE CLASS, (INT. CLS. 37 AND 39), (U.S. CLS. 100, 103, 105 AND 106). SN 76-144,556. PUB. 7-2-2002. FILED 10-11-2000.
- 2,623,323. **PLUG AND CHILL**. STELLAR GROUP, INC., MULTIPLE CLASS, (INT. CLS. 37, 40 AND 42), (U.S. CLS. 100, 101, 103 AND 106). SN 76-144,816. PUB. 7-2-2002. FILED 10-11-2000.
- 2,623,332. **SKYTHEATER**. SKYTHEATER, INC., MULTIPLE CLASS, (INT. CLS. 37 AND 42), (U.S. CLS. 100, 101, 103 AND 106). SN 76-146,323. PUB. 7-2-2002. FILED 10-13-2000.
- 2,623,393 (*See Class 7 for this trademark*).
- 2,623,482 (*See Class 35 for this trademark*).
- 2,623,496 (*See Class 35 for this trademark*).
- 2,623,507 (*See Class 7 for this trademark*).
- 2,623,573 (*See Class 7 for this trademark*).
- 2,623,666. **"NIPM IN THE BUG!"**. STRUWE, MARK B., DBA NATIONAL INTEGRATED PEST MANAGEMENT, (U.S. CLS. 100, 103 AND 106). SN 76-196,020. PUB. 7-2-2002. FILED 1-16-2001.
- 2,623,692. **EXELUS**. EXELUS, LLC, (U.S. CLS. 100, 103 AND 106). SN 76-199,144. PUB. 7-2-2002. FILED 1-24-2001.
- 2,623,695 (*See Class 4 for this trademark*).
- 2,623,714. **CLEAN CITY SUPER LAUNDROMAT AND DESIGN**. ENGLEWOOD PARTNERS LLC, (U.S. CLS. 100, 103 AND 106). SN 76-202,030. PUB. 7-2-2002. FILED 1-31-2001.
- 2,623,720. **TRITON INDUSTRIES AND DESIGN**. TRITON INDUSTRIES LLC, MULTIPLE CLASS, (INT. CLS. 37 AND 40), (U.S. CLS. 100, 103 AND 106). SN 76-202,817. PUB. 7-2-2002. FILED 1-30-2001.
- 2,623,732 (*See Class 35 for this trademark*).
- 2,623,747. **NTH GENERATION COMPUTING, INC. (STYLIZED)**. NTH GENERATION COMPUTING, INC., MULTIPLE CLASS, (INT. CLS. 37 AND 42), (U.S. CLS. 100, 101, 103 AND 106). SN 76-204,633. PUB. 7-2-2002. FILED 2-5-2001.
- 2,623,771. **CITY (STYLIZED)**. CITY ELECTRIC COMPANY OF BOULDER, INC., (U.S. CLS. 100, 103 AND 106). SN 76-208,605. PUB. 7-2-2002. FILED 2-12-2001.
- 2,623,781. **JOEAUTO**. JOEAUTO, INC., BY CHANGE OF NAME JOEAUTO.COM, INC., MULTIPLE CLASS, (INT. CLS. 37 AND 42), (U.S. CLS. 100, 101, 103 AND 106). SN 76-210,274. PUB. 7-2-2002. FILED 2-14-2001.
- 2,623,798 (*See Class 19 for this trademark*).
- 2,623,799 (*See Class 19 for this trademark*).
- 2,623,800 (*See Class 19 for this trademark*).
- 2,623,819. **AVTURF**. AVTURF L.L.C., MULTIPLE CLASS, (INT. CLS. 37 AND 42), (U.S. CLS. 100, 101, 103 AND 106). SN 76-215,267. PUB. 7-2-2002. FILED 2-24-2001.
- 2,623,825. **WESTRA CONSTRUCTION**. WESTRA CONSTRUCTION, INC., (U.S. CLS. 100, 103 AND 106). SN 76-215,898. PUB. 7-2-2002. FILED 2-27-2001.
- 2,623,838. **THE EXCELLENT BUSINESS CLIMATE PEOPLE**. LANCAUX, FRANCIS E., JR., (U.S. CLS. 100, 103 AND 106). SN 76-218,388. PUB. 7-2-2002. FILED 3-1-2001.
- 2,623,863. **SONITROL**. SONITROL CORPORATION, MULTIPLE CLASS, (INT. CLS. 37 AND 42), (U.S. CLS. 100, 101, 103 AND 106). SN 76-221,572. PUB. 7-2-2002. FILED 3-7-2001.
- 2,623,907 (*See Class 1 for this trademark*).
- 2,623,911. **MISCELLANEOUS DESIGN**. TRIUMPH BRANDS, INC., MULTIPLE CLASS, (INT. CLS. 37, 40 AND 42), (U.S.

- CLS. 100, 101, 103 AND 106). SN 76-227,351. PUB. 7-2-2002. FILED 3-20-2001.
- 2,623,915. **RR REDI-REFRIGERATION, INC. (STYLIZED)**. REDI-REFRIGERATION, INC., (U.S. CLS. 100, 103 AND 106). SN 76-228,104. PUB. 7-2-2002. FILED 3-22-2001.
- 2,623,991. **TOW BOAT U.S. AND DESIGN**. BOAT OWNERS ASSOCIATION OF THE UNITED STATES, MULTIPLE CLASS, (INT. CLS. 37 AND 39), (U.S. CLS. 100, 103, 105 AND 106). SN 76-237,261. PUB. 7-2-2002. FILED 4-9-2001.
- 2,624,164. **TOW-N-GO**. BOAT OWNERS ASSOCIATION OF THE UNITED STATES, MULTIPLE CLASS, (INT. CLS. 37 AND 39), (U.S. CLS. 100, 103, 105 AND 106). SN 76-258,363. PUB. 7-2-2002. FILED 5-17-2001.
- 2,624,188. **SKI LAKE AND DESIGN**. SKI LAKE CORPORATION, (U.S. CLS. 100, 103 AND 106). SN 76-260,334. PUB. 7-2-2002. FILED 5-22-2001.
- 2,624,244. **FULLER'S CAR WASH**. FULLER'S CAR WASH, INC., (U.S. CLS. 100, 103 AND 106). SN 76-265,899. PUB. 6-4-2002. FILED 6-1-2001.
- 2,624,261. **R (STYLIZED)**. RIHA DESIGN GROUP, INC., MULTIPLE CLASS, (INT. CLS. 37 AND 42), (U.S. CLS. 100, 101, 103 AND 106). SN 76-268,223. PUB. 7-2-2002. FILED 6-7-2001.
- 2,624,311. **TEXTURE-CRETE**. PACIFIC PEBBLES CORPORATION, DBA LIFE DECK, (U.S. CLS. 100, 103 AND 106). SN 76-272,753. PUB. 7-2-2002. FILED 6-18-2001.
- 2,624,312. **FREEWAY FRIENDLY AND DESIGN**. SUNDQUIST HOMES, INC., (U.S. CLS. 100, 103 AND 106). SN 76-273,224. PUB. 7-2-2002. FILED 6-18-2001.
- 2,624,330 (*See Class 19 for this trademark*).
- 2,624,370. **DRAIN-IT**. A AABAM CO., DBA DRAIN-IT, (U.S. CLS. 100, 103 AND 106). SN 76-281,911. PUB. 6-25-2002. FILED 7-9-2001.
- 2,624,412 (*See Class 35 for this trademark*).
- 2,624,495. **BMR AND DESIGN**. BMR BATH MASTER REGLAZING LTD., (U.S. CLS. 100, 103 AND 106). SN 76-301,721. PUB. 1-15-2002. FILED 8-20-2001.
- 2,624,499 (*See Class 35 for this trademark*).
- 2,624,503. **C CARUSO HOMES (STYLIZED)**. CARUSO, JEFFREY V., (U.S. CLS. 100, 103 AND 106). SN 76-302,818. PUB. 7-2-2002. FILED 8-22-2001.
- 2,624,547. **J.A. CROSON COMPANY**. AMPAM CORPORATE SERVICES, L.P., (U.S. CLS. 100, 103 AND 106). SN 76-310,840. PUB. 7-2-2002. FILED 9-10-2001.
- 2,624,568. **THE TITAN OF AUTOMOTIVE TECHNOLOGY!**. PRECISION FRANCHISING LLC, BY ASSIGNMENT PRECISION TUNE AUTO CARE, INC., (U.S. CLS. 100, 103 AND 106). SN 76-313,774. PUB. 7-2-2002. FILED 9-18-2001.
- 2,624,575. **BA BOB ADAMS HOMES THE TIME OF YOUR LIFE AND DESIGN**. BOB ADAMS HOMES, INC., (U.S. CLS. 100, 103 AND 106). SN 76-315,511. PUB. 7-2-2002. FILED 9-21-2001.
- 2,624,580. **RUG DOCTOR**. RUG DOCTOR, L.P., (U.S. CLS. 100, 103 AND 106). SN 76-316,500. PUB. 7-2-2002. FILED 9-25-2001.
- 2,624,582 (*See Class 7 for this trademark*).
- 2,624,590. **SOUNDAIR**. SOUNDAIR, INC., MULTIPLE CLASS, (INT. CLS. 37 AND 39), (U.S. CLS. 100, 103, 105 AND 106). SN 76-318,770. PUB. 7-2-2002. FILED 10-1-2001.
- 2,624,605. **WE'RE ON A MISSION HERE**. MCSTAIN ENTERPRISES, INC., (U.S. CLS. 100, 103 AND 106). SN 76-320,829. PUB. 7-2-2002. FILED 9-26-2001.
- 2,624,643. **DEVELOPERS DIVERSIFIED REALTY AND DESIGN**. DEVELOPERS DIVERSIFIED REALTY CORPORATION, (U.S. CLS. 100, 103 AND 106). SN 76-325,043. PUB. 7-2-2002. FILED 10-15-2001.
- 2,624,644. **DEVELOPERS DIVERSIFIED REALTY**. DEVELOPERS DIVERSIFIED REALTY CORPORATION, (U.S. CLS. 100, 103 AND 106). SN 76-325,044. PUB. 7-2-2002. FILED 10-15-2001.
- 2,624,689. **ROYAL DOOR**. BMCW SOUTHCENTRAL, L.P., (U.S. CLS. 100, 103 AND 106). SN 76-330,202. PUB. 7-2-2002. FILED 10-26-2001.
- 2,624,728. **ELEVATING SCREENING TECHNOLOGY TO A NEW STANDARD**. FIEDLER, L.P., MULTIPLE CLASS, (INT. CLS. 37 AND 40), (U.S. CLS. 100, 103 AND 106). SN 76-335,884. PUB. 7-2-2002. FILED 11-8-2001.
- 2,624,757. **ROCKY MOUNTAIN PORTABLE COOLING AND DESIGN**. ROCKY MOUNTAIN PORTABLE COOLING, INC., (U.S. CLS. 100, 103 AND 106). SN 76-339,214. PUB. 7-2-2002. FILED 11-19-2001.
- 2,624,858. **MISCELLANEOUS DESIGN**. PIVOTAL PROMONTORY DEVELOPMENT, L.L.C., (U.S. CLS. 100, 103 AND 106). SN 76-352,242. PUB. 7-2-2002. FILED 12-20-2001.
- 2,624,864. **STRATICON**. STRATICON CONSTRUCTION SERVICES, LLC, (U.S. CLS. 100, 103 AND 106). SN 76-352,985. PUB. 7-2-2002. FILED 12-28-2001.
- 2,624,915. **MISCELLANEOUS DESIGN**. LAWN DOCTOR, INC., MULTIPLE CLASS, (INT. CLS. 37 AND 44), (U.S. CLS. 100, 101, 103 AND 106). SN 76-361,369. PUB. 7-2-2002. FILED 1-22-2002.
- 2,624,995. **DR.KONCRETE**. WINTERS, KRIS, F, (U.S. CLS. 100, 103 AND 106). SN 78-036,697. PUB. 7-2-2002. FILED 11-27-2000.
- 2,625,023 (*See Class 35 for this trademark*).
- 2,625,064. **PIEDMONT AND DESIGN**. PIEDMONT LC, (U.S. CLS. 100, 103 AND 106). SN 78-056,360. PUB. 7-2-2002. FILED 4-2-2001.
- 2,625,092 (*See Class 35 for this trademark*).
- 2,625,114 (*See Class 35 for this trademark*).
- 2,625,175. **HAPPY TODAY OR YOU DON'T PAY**. VENVEST, INC., (U.S. CLS. 100, 103 AND 106). SN 78-080,171. PUB. 7-2-2002. FILED 8-20-2001.
- 2,625,186. **GRASSROOTS**. GRASSROOTS SERVICES CORP., MULTIPLE CLASS, (INT. CLS. 37 AND 42), (U.S. CLS. 100, 101, 103 AND 106). SN 78-082,120. PUB. 7-2-2002. FILED 8-31-2001.
- 2,625,201. **ZAVAR**. ZAVAR INC., (U.S. CLS. 100, 103 AND 106). SN 78-084,995. PUB. 7-2-2002. FILED 9-21-2001.
- 2,625,260 (*See Class 36 for this trademark*).
- 2,625,265. **CARELOOM**. ACME LAUNDRY AND CLEANERS, INC., (U.S. CLS. 100, 103 AND 106). SN 78-096,743. PUB. 7-2-2002. FILED 12-5-2001.

CLASS 38—COMMUNICATION

- 2,622,507 (*See Class 9 for this trademark*).
- 2,622,514 (*See Class 9 for this trademark*).
- 2,622,547 (*See Class 9 for this trademark*).
- 2,622,572 (*See Class 9 for this trademark*).
- 2,622,589. **FLEXTEL**. TELUS CORPORATION, MULTIPLE CLASS, (INT. CLS. 38 AND 42), (U.S. CLS. 100, 101 AND 104). SN 75-580,283. PUB. 11-6-2001. FILED 10-30-1998.
- 2,622,609. **MISCELLANEOUS DESIGN**. URBAN WIRELESS, INC., (U.S. CLS. 100, 101 AND 104). SN 75-610,466. PUB. 7-2-2002. FILED 12-22-1998.
- 2,622,632 (*See Class 9 for this trademark*).
- 2,622,671 (*See Class 9 for this trademark*).
- 2,622,674 (*See Class 9 for this trademark*).
- 2,622,675 (*See Class 9 for this trademark*).
- 2,622,691. **SAFE SCHOOL HELPLINE**. SECURITY VOICE, INC., (U.S. CLS. 100, 101 AND 104). SN 75-761,215. PUB. 7-2-2002. FILED 7-26-1999.
- 2,622,700. **GETRONICS**. GETRONICS NEDERLAND B.V., (U.S. CLS. 100, 101 AND 104). SN 75-772,220. PUB. 7-2-2002. FILED 8-10-1999.
- 2,622,704. **PEAK PERFORMANCE FOR THE WIRELESS INDUSTRY**. SCOREBOARD, INC., BY CHANGE OF NAME SCOREBOARD WIRELESS CORPORATION, MULTIPLE CLASS, (INT. CLS. 38, 39 AND 42), (U.S. CLS. 100, 101, 104 AND 105). SN 75-774,716. PUB. 7-2-2002. FILED 8-13-1999.
- 2,622,722. **NORTHEASTNET AND DESIGN**. NORTHEAST TELECOM, INC., (U.S. CLS. 100, 101 AND 104). SN 75-801,605. PUB. 7-2-2002. FILED 9-17-1999.
- 2,622,728. **BLUEWATER NETWORK**. DOHRING, RAHN, (U.S. CLS. 100, 101 AND 104). SN 75-815,256. PUB. 7-2-2002. FILED 10-25-1999.
- 2,622,775. **A REVOLUTION IN FILE SHARING**. ONSHARE, LLC, (U.S. CLS. 100, 101 AND 104). SN 75-857,265. PUB. 7-2-2002. FILED 11-24-1999.
- 2,622,803. **CLICK INTO ASIAN AMERICA**. COMMUNITY CONNECT INC., MULTIPLE CLASS, (INT. CLS. 38 AND

- 42), (U.S. CLS. 100, 101 AND 104). SN 75-885,957. PUB. 7-2-2002. FILED 12-30-1999.
- 2,622,828 (*See Class 9 for this trademark*).
- 2,622,830. **E-MAIL RELAY AND DESIGN**. BELL MOBILITY CELLULAR, INC., (U.S. CLS. 100, 101 AND 104). SN 75-903,017. PUB. 7-2-2002. FILED 1-26-2000.
- 2,622,901 (*See Class 9 for this trademark*).
- 2,622,928. **MOBILESET**. VIDERE, LLC, MULTIPLE CLASS, (INT. CLS. 38 AND 42), (U.S. CLS. 100, 101 AND 104). SN 76-017,940. PUB. 7-2-2002. FILED 4-4-2000.
- 2,622,983 (*See Class 9 for this trademark*).
- 2,623,036 (*See Class 37 for this trademark*).
- 2,623,061 (*See Class 9 for this trademark*).
- 2,623,071 (*See Class 36 for this trademark*).
- 2,623,077. **EAN AND DESIGN**. CAVU, INC., BY MERGER CAVU, INC., (U.S. CLS. 100, 101 AND 104). SN 76-078,639. PUB. 7-2-2002. FILED 6-22-2000.
- 2,623,079 (*See Class 9 for this trademark*).
- 2,623,158. **SIGNAL ONE**. SIGNAL ONE, L.L.C., (U.S. CLS. 100, 101 AND 104). SN 76-105,086. PUB. 7-2-2002. FILED 8-8-2000.
- 2,623,167. **IS (STYLIZED)**. INFOSERVE TELECOM CORPORATION, MULTIPLE CLASS, (INT. CLS. 38 AND 42), (U.S. CLS. 100, 101 AND 104). SN 76-108,827. PUB. 7-2-2002. FILED 8-14-2000.
- 2,623,200 (*See Class 9 for this trademark*).
- 2,623,233. **HOT VALUES**. RECREATIONAL EQUIPMENT, INC., (U.S. CLS. 100, 101 AND 104). SN 76-127,538. PUB. 9-18-2001. FILED 9-12-2000.
- 2,623,263. **SUPERCHANNEL**. ASSOCIATED CHRISTIAN TELEVISION SYSTEM, INC., (U.S. CLS. 100, 101 AND 104). SN 76-134,694. PUB. 7-2-2002. FILED 9-25-2000.
- 2,623,270. **MISCELLANEOUS DESIGN**. GENUITY INC., MULTIPLE CLASS, (INT. CLS. 38 AND 42), (U.S. CLS. 100, 101 AND 104). SN 76-135,219. PUB. 7-2-2002. FILED 9-26-2000.
- 2,623,280. **TMC AND DESIGN**. SHOWTIME NETWORKS INC., (U.S. CLS. 100, 101 AND 104). SN 76-136,845. PUB. 7-2-2002. FILED 9-27-2000.
- 2,623,311. **BRINGING BROADBAND HOME**. WIDEPENWEST NETWORKS, LLC, (U.S. CLS. 100, 101 AND 104). SN 76-142,468. PUB. 7-2-2002. FILED 10-6-2000.
- 2,623,342 (*See Class 9 for this trademark*).
- 2,623,373 (*See Class 9 for this trademark*).
- 2,623,526. **CARGOCONNECT**. BRITISH TELECOMMUNICATIONS PUBLIC LIMITED COMPANY, MULTIPLE CLASS, (INT. CLS. 38, 39 AND 42), (U.S. CLS. 100, 101, 104 AND 105). SN 76-176,755. PUB. 7-2-2002. FILED 12-6-2000.
- 2,623,559 (*See Class 9 for this trademark*).
- 2,623,595. **RADAR MAIL**. ESOLO.COM, INC., (U.S. CLS. 100, 101 AND 104). SN 76-187,150. PUB. 7-2-2002. FILED 12-26-2000.
- 2,623,610. **STARZ! CINEMA**. STARZ ENCORE GROUP LLC, MULTIPLE CLASS, (INT. CLS. 38 AND 41), (U.S. CLS. 100, 101, 104 AND 107). SN 76-188,927. PUB. 7-2-2002. FILED 1-3-2001.
- 2,623,617. **VIRTUALEQUESTRIAN AND DESIGN**. VIRTUAL EQUESTRIAN, LLC, (U.S. CLS. 100, 101 AND 104). SN 76-189,453. PUB. 7-2-2002. FILED 1-3-2001.
- 2,623,660. **SPRINT CLASSROOM SOLUTIONS**. SPRINT COMMUNICATIONS COMPANY L.P., (U.S. CLS. 100, 101 AND 104). SN 76-195,200. PUB. 7-2-2002. FILED 1-17-2001.
- 2,623,673. **WE DARE YOU TO CHALLENGE**. NETAMIN COMMUNICATIONS CORP., MULTIPLE CLASS, (INT. CLS. 38 AND 41), (U.S. CLS. 100, 101, 104 AND 107). SN 76-197,011. PUB. 7-2-2002. FILED 1-22-2001.
- 2,623,687 (*See Class 16 for this trademark*).
- 2,623,694 (*See Class 35 for this trademark*).
- 2,623,704 (*See Class 35 for this trademark*).
- 2,623,857. **MYWEBCAST**. MYWEBCAST.NET, INC., (U.S. CLS. 100, 101 AND 104). SN 76-220,613. PUB. 7-2-2002. FILED 3-5-2001.
- 2,623,907 (*See Class 1 for this trademark*).
- 2,623,913 (*See Class 9 for this trademark*).
- 2,623,938. **ACTIVECONFERENCE**. ACTIVATE.NET CORP., (U.S. CLS. 100, 101 AND 104). SN 76-232,044. PUB. 7-2-2002. FILED 3-26-2001.
- 2,623,939. **ACTIVEAUDIO**. ACTIVATE.NET CORP., (U.S. CLS. 100, 101 AND 104). SN 76-232,046. PUB. 7-2-2002. FILED 3-26-2001.
- 2,624,048. **THE DIGITAL SUITE FROM MTV NETWORKS**. VIACOM INTERNATIONAL INC., (U.S. CLS. 100, 101 AND 104). SN 76-242,759. PUB. 7-2-2002. FILED 4-17-2001.
- 2,624,121. **LIVEN UP YOUR WIRELESS**. CELLCO PARTNERSHIP, DBA VERIZON WIRELESS, (U.S. CLS. 100, 101 AND 104). SN 76-251,731. PUB. 7-2-2002. FILED 5-4-2001.
- 2,624,122. **DALE VIDA A TU MUNDO MOVIL**. CELLCO PARTNERSHIP, DBA VERIZON WIRELESS, (U.S. CLS. 100, 101 AND 104). SN 76-251,733. PUB. 7-2-2002. FILED 5-4-2001.
- 2,624,332. **LIBERTY LINE**. TRUSTEES OF THE VARTEC BUSINESS TRUST, THE, BY ASSIGNMENT VARTEC TELECOM, INC., (U.S. CLS. 100, 101 AND 104). SN 76-275,721. PUB. 7-2-2002. FILED 6-21-2001.
- 2,624,462. **U OF E**. SPARTACOM TECHNOLOGIES, INC., (U.S. CLS. 100, 101 AND 104). SN 76-294,994. PUB. 7-2-2002. FILED 8-3-2001.
- 2,624,493. **FOX ENHANCED TV AND DESIGN**. TWENTIETH CENTURY FOX FILM CORPORATION, (U.S. CLS. 100, 101 AND 104). SN 76-301,632. PUB. 7-2-2002. FILED 8-17-2001.
- 2,624,519. **ADDICTIVE AUDIO**. IT NETWORK, INC., (U.S. CLS. 100, 101 AND 104). SN 76-304,742. PUB. 7-2-2002. FILED 8-24-2001.
- 2,624,661. **FLASH ACCESS**. TRAVELERS EXPRESS COMPANY, INC., (U.S. CLS. 100, 101 AND 104). SN 76-326,833. PUB. 7-2-2002. FILED 10-16-2001.
- 2,624,800. **RETURN ON COMMUNICATIONS AND DESIGN**. AT&T CORP., (U.S. CLS. 100, 101 AND 104). SN 76-345,899. PUB. 7-2-2002. FILED 12-6-2001.
- 2,624,916. **GLRC AND DESIGN**. REGENTS OF THE UNIVERSITY OF MICHIGAN, THE, (U.S. CLS. 100, 101 AND 104). SN 76-361,558. PUB. 7-2-2002. FILED 1-23-2002.
- 2,624,921. **MUSIC THAT MOVES THE WORLD**. INFINITY BROADCASTING CORPORATION OF SAN FRANCISCO, (U.S. CLS. 100, 101 AND 104). SN 76-364,735. PUB. 7-2-2002. FILED 1-29-2002.
- 2,624,963. **POWERIT-UP**. POWERIT-UP, INCORPORATED, MULTIPLE CLASS, (INT. CLS. 38 AND 42), (U.S. CLS. 100, 101 AND 104). SN 78-005,768. PUB. 7-2-2002. FILED 4-26-2000.
- 2,624,981 (*See Class 9 for this trademark*).
- 2,625,072 (*See Class 35 for this trademark*).
- 2,625,084. **UNIRADIO AND DESIGN**. UNIRADIO CORP., MULTIPLE CLASS, (INT. CLS. 38 AND 41), (U.S. CLS. 100, 101, 104 AND 107). SN 78-060,922. PUB. 7-2-2002. FILED 4-27-2001.
- 2,625,086. **SHOW TRUE HEROES**. SHOWTIME NETWORKS INC., (U.S. CLS. 100, 101 AND 104). SN 78-061,280. PUB. 7-2-2002. FILED 5-1-2001.
- 2,625,128. **ACCESS ADVANTAGE PLUS**. SBC COMMUNICATIONS INC., (U.S. CLS. 100, 101 AND 104). SN 78-069,757. PUB. 7-2-2002. FILED 6-18-2001.
- 2,625,129. **ACCESS ADVANTAGE**. SBC COMMUNICATIONS INC., (U.S. CLS. 100, 101 AND 104). SN 78-069,759. PUB. 7-2-2002. FILED 6-18-2001.

CLASS 39—TRANSPORTATION AND STORAGE

- 2,622,578 (*See Class 16 for this trademark*).
- 2,622,685 (*See Class 16 for this trademark*).
- 2,622,704 (*See Class 38 for this trademark*).
- 2,622,709 (*See Class 9 for this trademark*).
- 2,622,738. **COLLETTE DISCOVERY VACATIONS**. COLLETTE TRAVEL SERVICE, INC., MULTIPLE CLASS, (INT. CLS. 39 AND 42), (U.S. CLS. 100, 101 AND 105). SN 75-824,136. PUB. 7-2-2002. FILED 10-15-1999.
- 2,622,744. **ICRUISE.COM**. I-CRUISE.COM CORP., (U.S. CLS. 100 AND 105). SN 75-827,466. PUB. 7-2-2002. FILED 10-20-1999.
- 2,622,757 (*See Class 6 for this trademark*).
- 2,622,864. **TAXION**. KANG, DAE SUM, (U.S. CLS. 100 AND 105). SN 75-926,685. PUB. 7-2-2002. FILED 2-24-2000.
- 2,622,869. **BRITRAIL**. RAIL SETTLEMENT PLAN LIMITED, MULTIPLE CLASS, (INT. CLS. 39 AND 42), (U.S. CLS. 100,

- 101 AND 105). SN 75-928,604. PUB. 7-2-2002. FILED 2-28-2000.
- 2,622,908. **HOS AND DESIGN**. HORNBECK, TODD M., AND HORNBECK, TROY A., DBA HORNBECK-LEEVAAC MARINE SERVICES, INC., (U.S. CLS. 100 AND 105). SN 76-007,030. PUB. 7-2-2002. FILED 3-22-2000.
- 2,622,910. **HOS**. HORNBECK, TODD M., AND HORNBECK, TROY A., DBA HORNBECK-LEEVAAC MARINE SERVICES, INC., (U.S. CLS. 100 AND 105). SN 76-007,341. PUB. 7-2-2002. FILED 3-22-2000.
- 2,622,930. **I ORLANDO AND DESIGN**. CENTRAL FLORIDA INVESTMENTS, INC., (U.S. CLS. 100 AND 105). SN 76-018,476. PUB. 7-2-2002. FILED 4-6-2000.
- 2,622,933. **BALTIMORE BASEBALL CRUISE AND DESIGN**. CRUISE LADY, INC., THE, (U.S. CLS. 100 AND 105). SN 76-019,045. PUB. 7-2-2002. FILED 4-6-2000.
- 2,622,983 (*See Class 9 for this trademark*).
- 2,622,992. **AW AMERICA WEST CLUB AND DESIGN**. AMERICA WEST AIRLINES, INC., (U.S. CLS. 100 AND 105). SN 76-049,536. PUB. 7-2-2002. FILED 5-16-2000.
- 2,623,009. **GOING PLACES**. AAA AUTO CLUB SOUTH, INC., (U.S. CLS. 100 AND 105). SN 76-055,938. PUB. 7-2-2002. FILED 5-19-2000.
- 2,623,014. **QUEST ENERGY**. QUEST-ENERGY, LLC, (U.S. CLS. 100 AND 105). SN 76-058,344. PUB. 7-2-2002. FILED 5-30-2000.
- 2,623,043. **GHEISA AND DESIGN**. BAIXAULI Y LAFUENTE CORPORATION, S.L., MULTIPLE CLASS, (INT. CLS. 39 AND 42), (U.S. CLS. 100, 101 AND 105). SN 76-065,750. PUB. 7-2-2002. FILED 6-8-2000.
- 2,623,050. **SPACE4RENT.COM AND DESIGN**. SPACE4RENT.COM, LLC, (U.S. CLS. 100 AND 105). SN 76-068,183. PUB. 7-2-2002. FILED 6-12-2000.
- 2,623,051. **THE CALM BEHIND.COM**. SPACE4RENT.COM, LLC, (U.S. CLS. 100 AND 105). SN 76-068,184. PUB. 7-2-2002. FILED 6-12-2000.
- 2,623,070 (*See Class 35 for this trademark*).
- 2,623,098. **REZNET**. PAYLESS CAR RENTAL SYSTEM, INC., (U.S. CLS. 100 AND 105). SN 76-087,341. PUB. 7-2-2002. FILED 7-10-2000.
- 2,623,171. **PREMIER PARTNER**. UNITED AIR LINES, INC., (U.S. CLS. 100 AND 105). SN 76-110,473. PUB. 7-2-2002. FILED 8-16-2000.
- 2,623,206. **SEA DIFFERENT**. CMA CGM, SOCIETE ANONYME, (U.S. CLS. 100 AND 105). SN 76-118,160. PUB. 7-2-2002. FILED 8-25-2000.
- 2,623,274. **MISCELLANEOUS DESIGN**. LAS VEGAS HELICOPTERS, INC., (U.S. CLS. 100 AND 105). SN 76-136,159. PUB. 7-2-2002. FILED 9-27-2000.
- 2,623,322 (*See Class 37 for this trademark*).
- 2,623,342 (*See Class 9 for this trademark*).
- 2,623,350. **CRUISESAVERS (STYLIZED)**. CRUISES INTERNATIONAL, INC., (U.S. CLS. 100 AND 105). SN 76-149,304. PUB. 7-2-2002. FILED 10-18-2000.
- 2,623,360. **MOL LOGISTICS AND DESIGN**. MITSUI O.S.K. LINES, LTD., (U.S. CLS. 100 AND 105). SN 76-151,505. PUB. 7-2-2002. FILED 10-18-2000.
- 2,623,361. **MOL LOGISTICS**. MITSUI O.S.K. LINES, LTD., (U.S. CLS. 100 AND 105). SN 76-151,506. PUB. 7-2-2002. FILED 10-18-2000.
- 2,623,368. **NO DRAWING-SENSORY MARK**. EASYTEL, (U.S. CLS. 100 AND 105). SN 76-152,168. PUB. 7-2-2002. FILED 10-23-2000.
- 2,623,405. **WE BRING SAFETY TO FOOD**. SAFE CHOICE FOOD INC, (U.S. CLS. 100 AND 105). SN 76-158,166. PUB. 7-2-2002. FILED 10-30-2000.
- 2,623,406. **WEBLOPE.COM**. WEBLOPE, INC., (U.S. CLS. 100 AND 105). SN 76-158,277. PUB. 7-2-2002. FILED 11-2-2000.
- 2,623,418. **S SENTIL 2000 AND DESIGN**. SENTIL 2000, S.L., (U.S. CLS. 100 AND 105). SN 76-159,811. PUB. 7-2-2002. FILED 11-6-2000.
- 2,623,454. **B CLUB SUPERFLYERS AND DESIGN**. IBERIA, LINEAS AEREAS DE ESPANA S.A., (U.S. CLS. 100 AND 105). SN 76-166,402. PUB. 7-2-2002. FILED 11-16-2000.
- 2,623,470. **STAGE DOOR**. RADIO CITY TRADEMARKS, LLC, (U.S. CLS. 100 AND 105). SN 76-168,810. PUB. 7-2-2002. FILED 11-20-2000.
- 2,623,482 (*See Class 35 for this trademark*).
- 2,623,496 (*See Class 35 for this trademark*).
- 2,623,497. **BRUNEL WORLDWIDE CHAUFFEUR DRIVE (STYLIZED)**. BRUNEL CARRIAGE PLC, (U.S. CLS. 100 AND 105). SN 76-172,787. PUB. 7-2-2002. FILED 11-29-2000.
- 2,623,526 (*See Class 38 for this trademark*).
- 2,623,542. **PLATINUM GUARANTEE AND DESIGN**. PILOT AIR FREIGHT CORP, (U.S. CLS. 100 AND 105). SN 76-177,855. PUB. 7-2-2002. FILED 12-8-2000.
- 2,623,550. **ROVOS RAIL**. ROVOS RAIL TOURS (PROPRIETARY) LIMITED, (U.S. CLS. 100 AND 105). SN 76-180,093. PUB. 7-2-2002. FILED 12-13-2000.
- 2,623,613. **ESCAPES UNLIMITED (STYLIZED)**. OERDING, JAMES B., AND PELLETIER, SANDRA L., DBA ESCAPES UNLIMITED, (U.S. CLS. 100 AND 105). SN 76-189,136. PUB. 7-2-2002. FILED 1-4-2001.
- 2,623,629. **AUSTRO TOURS AND DESIGN**. SKI MARKETING CORPORATION, (U.S. CLS. 100 AND 105). SN 76-190,924. PUB. 7-2-2002. FILED 1-8-2001.
- 2,623,644. **ITRAVELZHAWAII**. ROYAL ADVENTURE TRAVEL, INC., (U.S. CLS. 100 AND 105). SN 76-193,661. PUB. 7-2-2002. FILED 1-16-2001.
- 2,623,652. **STORAGE ACCESS**. STORAGE ACCESS, INC., MULTIPLE CLASS, (INT. CLS. 39 AND 42), (U.S. CLS. 100, 101 AND 105). SN 76-194,456. PUB. 7-2-2002. FILED 1-16-2001.
- 2,623,736. **VACATION OUTLET AND DESIGN**. NATIONAL LEISURE GROUP, INC., MULTIPLE CLASS, (INT. CLS. 39 AND 42), (U.S. CLS. 100, 101 AND 105). SN 76-203,895. PUB. 7-2-2002. FILED 2-2-2001.
- 2,623,783. **WEBLOPE AND DESIGN**. WEBLOPE, INC., (U.S. CLS. 100 AND 105). SN 76-210,581. PUB. 7-2-2002. FILED 2-15-2001.
- 2,623,798 (*See Class 19 for this trademark*).
- 2,623,799 (*See Class 19 for this trademark*).
- 2,623,800 (*See Class 19 for this trademark*).
- 2,623,807. **SOUTHWEST.COM (STYLIZED)**. SOUTHWEST AIRLINES CO., (U.S. CLS. 100 AND 105). SN 76-213,800. PUB. 7-2-2002. FILED 2-21-2001.
- 2,623,854. **AMTRAK VACATIONS**. NATIONAL RAILROAD PASSENGER CORPORATION, MULTIPLE CLASS, (INT. CLS. 39 AND 43), (U.S. CLS. 100, 101 AND 105). SN 76-219,990. PUB. 7-2-2002. FILED 3-6-2001.
- 2,623,903. **TEMPO**. DAKOTA SYSTEMS, INC., (U.S. CLS. 100 AND 105). SN 76-225,991. PUB. 7-2-2002. FILED 3-19-2001.
- 2,623,907 (*See Class 1 for this trademark*).
- 2,623,963. **MISCELLANEOUS DESIGN**. SAN CRISTOBAL, LTD., BY CHANGE OF NAME SAN CRISTOBAL MANAGEMENT, LTD., (U.S. CLS. 100 AND 105). SN 76-234,623. PUB. 7-2-2002. FILED 4-3-2001.
- 2,623,991 (*See Class 37 for this trademark*).
- 2,624,018. **RECOMMITTED**. COMMONWEALTH EDISON COMPANY, (U.S. CLS. 100 AND 105). SN 76-240,354. PUB. 7-2-2002. FILED 4-11-2001.
- 2,624,164 (*See Class 37 for this trademark*).
- 2,624,245. **THE EUROPEAN CRUISE LINE AMERICANS LOVE TO CRUISE**. FESTIVAL SHIPPING & TOURIST ENTERPRISES LTD., MULTIPLE CLASS, (INT. CLS. 39 AND 42), (U.S. CLS. 100, 101 AND 105). SN 76-265,977. PUB. 7-2-2002. FILED 6-1-2001.
- 2,624,314. **TOTAL WAREHOUSING**. TOTAL WAREHOUSING, INC., (U.S. CLS. 100 AND 105). SN 76-273,670. PUB. 7-2-2002. FILED 6-19-2001.
- 2,624,321. **TANNER**. CARL FREUDENBERG, MULTIPLE CLASS, (INT. CLS. 39, 41 AND 42), (U.S. CLS. 100, 101, 105 AND 107). SN 76-274,806. PUB. 7-2-2002. FILED 6-21-2001.
- 2,624,402. **VICC**. BURLINGTON NORTHERN AND SANTA FE RAILWAY COMPANY, THE, (U.S. CLS. 100 AND 105). SN 76-287,376. PUB. 7-2-2002. FILED 7-18-2001.
- 2,624,505 (*See Class 35 for this trademark*).
- 2,624,527. **GIVING ENERGY TO LIFE**. SCANA CORPORATION, MULTIPLE CLASS, (INT. CLS. 39 AND 40), (U.S. CLS. 100, 103, 105 AND 106). SN 76-307,550. PUB. 7-2-2002. FILED 8-31-2001.
- 2,624,590 (*See Class 37 for this trademark*).
- 2,624,627 (*See Class 12 for this trademark*).
- 2,624,628 (*See Class 12 for this trademark*).
- 2,624,678. **GLOBALSTAR**. HICKORY TRAVEL SYSTEMS, INC., (U.S. CLS. 100 AND 105). SN 76-328,731. PUB. 7-2-

2002. FILED 10-24-2001.
- 2,624,731. **COSTA RICA IS PEACE**. MANALASTAS, RALPH, (U.S. CLS. 100 AND 105). SN 76-336,164. PUB. 7-2-2002. FILED 11-9-2001.
- 2,624,746. **UNITED (STYLIZED)**. UNITED VAN LINES, LLC, (U.S. CLS. 100 AND 105). SN 76-338,011. PUB. 7-2-2002. FILED 11-15-2001.
- 2,624,747. **H2O HELP TO OTHERS PROGRAM AND DESIGN**. PENNSYLVANIA-AMERICAN WATER COMPANY, (U.S. CLS. 100 AND 105). SN 76-338,148. PUB. 7-2-2002. FILED 11-15-2001.
- 2,624,769. **VIA XEROX**. XEROX CORPORATION, (U.S. CLS. 100 AND 105). SN 76-342,861. PUB. 7-2-2002. FILED 11-29-2001.
- 2,624,777. **GAMMA FREIGHT FORWARDERS, INC. AND DESIGN**. GAMMA FREIGHT FORWARDERS, INC., (U.S. CLS. 100 AND 105). SN 76-343,419. PUB. 7-2-2002. FILED 12-3-2001.
- 2,624,807. **TRIP SAVER**. WINNEBAGO INDUSTRIES, INC., (U.S. CLS. 100 AND 105). SN 76-346,529. PUB. 7-2-2002. FILED 12-10-2001.
- 2,624,866. **OTTER TAIL**. OTTER TAIL CORPORATION, (U.S. CLS. 100 AND 105). SN 76-353,250. PUB. 7-2-2002. FILED 12-21-2001.
- 2,624,903. **DURO-LITE**. TECH-MED SERVICES, INC., (U.S. CLS. 100 AND 105). SN 76-358,770. PUB. 7-2-2002. FILED 1-14-2002.
- 2,624,964. **AVACATION.COM AND DESIGN**. BANKA, PAUL E., MULTIPLE CLASS, (INT. CLS. 39 AND 42), (U.S. CLS. 100, 101 AND 105). SN 78-007,898. PUB. 1-30-2001. FILED 5-12-2000.
- 2,625,021. **CROSSROADS DISTRIBUTION AND DESIGN**. CROSSROADS DISTRIBUTION, LTD., (U.S. CLS. 100 AND 105). SN 78-047,110. PUB. 7-2-2002. FILED 2-7-2001.
- 2,625,100. **MISCELLANEOUS DESIGN**. ACCELERATED MOVING AND STORAGE, INC., (U.S. CLS. 100 AND 105). SN 78-063,372. PUB. 7-2-2002. FILED 5-14-2001.
- 2,625,142. **MOVING UNLIMITED**. JOSLYN, GLENN X., (U.S. CLS. 100 AND 105). SN 78-071,247. PUB. 7-2-2002. FILED 6-27-2001.
- 2,625,167. **GET IN THE GAME!**. ISLANDQUEST VACATIONS LLC, (U.S. CLS. 100 AND 105). SN 78-077,981. PUB. 7-2-2002. FILED 8-7-2001.
- 2,625,215. **ONLINE HIGHWAYS**. ONLINE HIGHWAYS, (U.S. CLS. 100 AND 105). SN 78-087,991. PUB. 7-2-2002. FILED 10-11-2001.
- 2,623,245 (*See Class 19 for this trademark*).
- 2,623,246. **LOOKING FURTHER, SEEING MORE**. INDIGOVISION LIMITED, BY CHANGE OF NAME INDIGOVISION LIMITED, (U.S. CLS. 100, 103 AND 106). SN 76-131,546. PUB. 7-2-2002. FILED 9-13-2000.
- 2,623,323 (*See Class 37 for this trademark*).
- 2,623,362. **DOODLELAB.COM**. DOODLELAB, INC., (U.S. CLS. 100, 103 AND 106). SN 76-151,607. PUB. 7-2-2002. FILED 10-23-2000.
- 2,623,404. **PICTURE PLANE**. HAMIGAMI/CARROLL & ASSOCIATES, MULTIPLE CLASS, (INT. CLS. 40 AND 42), (U.S. CLS. 100, 101, 103 AND 106). SN 76-158,078. PUB. 7-2-2002. FILED 11-2-2000.
- 2,623,437 (*See Class 14 for this trademark*).
- 2,623,529 (*See Class 9 for this trademark*).
- 2,623,531 (*See Class 9 for this trademark*).
- 2,623,589. **DALTON BOX & CONTAINER**. NATIONAL PACKAGING SOLUTIONS GROUP, INC., (U.S. CLS. 100, 103 AND 106). SN 76-186,429. PUB. 7-2-2002. FILED 12-26-2000.
- 2,623,695 (*See Class 4 for this trademark*).
- 2,623,720 (*See Class 37 for this trademark*).
- 2,623,743. **CANDOIL**. IU, STEPHEN C., (U.S. CLS. 100, 103 AND 106). SN 76-204,153. PUB. 7-2-2002. FILED 2-2-2001.
- 2,623,849. **SEE WHAT YOU'RE MISSING**. SAFETY VISION, (U.S. CLS. 100, 103 AND 106). SN 76-219,806. PUB. 7-2-2002. FILED 3-5-2001.
- 2,623,902 (*See Class 7 for this trademark*).
- 2,623,907 (*See Class 1 for this trademark*).
- 2,623,911 (*See Class 37 for this trademark*).
- 2,623,912. **HDM AND DESIGN**. HIGHER DIMENSION MEDICAL, INC., (U.S. CLS. 100, 103 AND 106). SN 76-227,558. PUB. 7-2-2002. FILED 3-20-2001.
- 2,623,956 (*See Class 16 for this trademark*).
- 2,623,988. **YOUR NAME PROFESSIONAL BRANDS**. MANA PRODUCTS, INC., MULTIPLE CLASS, (INT. CLS. 40 AND 41), (U.S. CLS. 100, 101, 103, 106 AND 107). SN 76-237,110. PUB. 7-2-2002. FILED 4-6-2001.
- 2,624,004. **MEMS AT THE CUTTING EDGE**. VERIMETRA, INC., MULTIPLE CLASS, (INT. CLS. 40 AND 42), (U.S. CLS. 100, 101, 103 AND 106). SN 76-238,548. PUB. 7-2-2002. FILED 4-10-2001.
- 2,624,070 (*See Class 10 for this trademark*).
- 2,624,100 (*See Class 20 for this trademark*).
- 2,624,247. **MAV SYSTEMS**. SCHINDLER, A. RUSSELL, (U.S. CLS. 100, 103 AND 106). SN 76-266,271. PUB. 7-2-2002. FILED 6-5-2001.
- 2,624,333. **FLEXTREAT**. ALTIVIA, (U.S. CLS. 100, 103 AND 106). SN 76-275,796. PUB. 7-2-2002. FILED 6-25-2001.
- 2,624,527 (*See Class 39 for this trademark*).
- 2,624,598. **RCL VCE**, INC, (U.S. CLS. 100, 103 AND 106). SN 76-319,540. PUB. 7-2-2002. FILED 10-2-2001.
- 2,624,728 (*See Class 37 for this trademark*).
- 2,624,759. **PSS PRESTIGE SPORTS SYSTEMS AND DESIGN**. PRESTIGE ENTERPRISE INTERNATIONAL INC., (U.S. CLS. 100, 103 AND 106). SN 76-339,789. PUB. 7-2-2002. FILED 11-19-2001.
- 2,624,849. **OTTER TAIL**. OTTER TAIL CORPORATION, (U.S. CLS. 100, 103 AND 106). SN 76-351,651. PUB. 7-2-2002. FILED 12-21-2001.
- 2,624,885 (*See Class 35 for this trademark*).
- 2,624,908. **GENMECH AEROSPACE**. GENMECH AEROSPACE CORPORATION, (U.S. CLS. 100, 103 AND 106). SN 76-359,844. PUB. 7-2-2002. FILED 1-18-2002.
- 2,625,146 (*See Class 12 for this trademark*).
- 2,625,260 (*See Class 36 for this trademark*).
-
- CLASS 40—MATERIAL TREATMENT**
- 2,622,540. **WINIKOFF KEEN JUNK AND DESIGN**. WINIKOFF, NEIL, (U.S. CLS. 100, 103 AND 106). SN 75-415,065. PUB. 7-2-2002. FILED 1-8-1998.
- 2,622,555 (*See Class 10 for this trademark*).
- 2,622,624. **FLAGSHIP**. RANDALL'S FOOD & DRUGS, INC., (U.S. CLS. 100, 103 AND 106). SN 75-630,652. PUB. 7-2-2002. FILED 1-29-1999.
- 2,622,633. **FEATURE FACTORY**. 1318120 ONTARIO INC., MULTIPLE CLASS, (INT. CLS. 40 AND 42), (U.S. CLS. 100, 101, 103 AND 106). SN 75-657,982. PUB. 11-6-2001. FILED 3-10-1999.
- 2,622,658. **MISCELLANEOUS DESIGN**. COLONIAL CIRCUITS, INC., MULTIPLE CLASS, (INT. CLS. 40 AND 42), (U.S. CLS. 100, 101, 103 AND 106). SN 75-705,653. PUB. 7-2-2002. FILED 5-14-1999.
- 2,622,689 (*See Class 7 for this trademark*).
- 2,622,699 (*See Class 1 for this trademark*).
- 2,622,709 (*See Class 9 for this trademark*).
- 2,622,794 (*See Class 11 for this trademark*).
- 2,622,799. **ECCLECTIC CONTRACT FURNITURE INDUSTRIES, INC. AND DESIGN**. ECCLECTIC CONTRACT FURNITURE INDUSTRIES, INC., (U.S. CLS. 100, 103 AND 106). SN 75-883,423. PUB. 7-2-2002. FILED 12-30-1999.
- 2,622,916. **MISCELLANEOUS DESIGN**. SPORTVISION, INC., (U.S. CLS. 100, 103 AND 106). SN 76-009,549. PUB. 7-2-2002. FILED 3-23-2000.
- 2,623,070 (*See Class 35 for this trademark*).
-
- CLASS 41—EDUCATION AND ENTERTAINMENT**
- 2,622,507 (*See Class 9 for this trademark*).
- 2,622,521 (*See Class 35 for this trademark*).
- 2,622,563 (*See Class 16 for this trademark*).
- 2,622,565. **CARVING AND SLICING**. OUIDAD, INC., (U.S. CLS. 100, 101 AND 107). SN 75-518,242. PUB. 7-2-2002. FILED 7-13-1998.

- 2,622,578 (See Class 16 for this trademark).
2,622,579. **PRISM. COMPLEX SALE, INC., THE**, (U.S. CLS. 100, 101 AND 107). SN 75-558,722. PUB. 7-2-2002. FILED 9-23-1998.
2,622,595 (See Class 9 for this trademark).
2,622,600. **AIR CARE INTERNATIONAL AND DESIGN. ALLEN CAMPBELL**, (U.S. CLS. 100, 101 AND 107). SN 75-597,295. PUB. 7-2-2002. FILED 7-15-1999.
2,622,605 (See Class 5 for this trademark).
2,622,607 (See Class 33 for this trademark).
2,622,620 (See Class 35 for this trademark).
2,622,621 (See Class 35 for this trademark).
2,622,625. **SABANET. SABA SOFTWARE, INC., MULTIPLE CLASS**, (INT. CLS. 41 AND 42), (U.S. CLS. 100, 101 AND 107). SN 75-630,800. PUB. 7-2-2002. FILED 1-29-1999.
2,622,637. **WE GOT GAME. NBA PROPERTIES, INC.**, (U.S. CLS. 100, 101 AND 107). SN 75-666,738. PUB. 7-2-2002. FILED 3-23-1999.
2,622,647. **PREMIER GOLF PASS. AMERICAN GOLF CORPORATION**, (U.S. CLS. 100, 101 AND 107). SN 75-689,550. PUB. 7-2-2002. FILED 4-22-1999.
2,622,669 (See Class 9 for this trademark).
2,622,671 (See Class 9 for this trademark).
2,622,682 (See Class 35 for this trademark).
2,622,703. **UICN UNION MUNDIAL PARA LA NATURALEZA (STYLIZED). IUCN, INTERNATIONAL UNION FOR THE CONSERVATION OF NATURE AND NATURAL RESOURCES**, MULTIPLE CLASS, (INT. CLS. 41 AND 42), (U.S. CLS. 100, 101 AND 107). SN 75-774,155. PUB. 7-2-2002. FILED 8-12-1999.
2,622,709 (See Class 9 for this trademark).
2,622,713 (See Class 35 for this trademark).
2,622,719. **TRIPLE THREAT. MARTIN, TROY A.**, (U.S. CLS. 100, 101 AND 107). SN 75-797,619. PUB. 3-14-2000. FILED 9-10-1999.
2,622,723. **PBR. PLAY BY THE RULES ATHLETIC CONSULTING, LLC**, MULTIPLE CLASS, (INT. CLS. 41 AND 42), (U.S. CLS. 100, 101 AND 107). SN 75-801,829. PUB. 7-2-2002. FILED 9-20-1999.
2,622,725. **LEAH. LEAGUE FOR EDUCATIONAL AWARENESS OF THE HOLOCAUST INC**, (U.S. CLS. 100, 101 AND 107). SN 75-810,866. PUB. 7-2-2002. FILED 9-29-1999.
2,622,736 (See Class 35 for this trademark).
2,622,755 (See Class 25 for this trademark).
2,622,757 (See Class 6 for this trademark).
2,622,772. **MISCELLANEOUS DESIGN. BRANCH OFFICE, INC., THE**, (U.S. CLS. 100, 101 AND 107). SN 75-853,329. PUB. 7-2-2002. FILED 11-18-1999.
2,622,787. **HIGH STEPPIN' COUNTRY. P.G. PRODUCTIONS**, (U.S. CLS. 100, 101 AND 107). SN 75-868,996. PUB. 7-2-2002. FILED 12-10-1999.
2,622,790 (See Class 35 for this trademark).
2,622,813. **NWO NEW WORLD ORDER. WCW, INC., BY ASSIGNMENT WORLD CHAMPIONSHIP WRESTLING, INC.**, (U.S. CLS. 100, 101 AND 107). SN 75-892,109. PUB. 7-2-2002. FILED 1-7-2000.
2,622,828 (See Class 9 for this trademark).
2,622,844 (See Class 25 for this trademark).
2,622,851 (See Class 16 for this trademark).
2,622,893. **FORENSIC INVESTIGATORS. DISCOVERY COMMUNICATIONS, INC.**, (U.S. CLS. 100, 101 AND 107). SN 75-981,908. PUB. 7-2-2002. FILED 12-13-2000.
2,622,901 (See Class 9 for this trademark).
2,622,906. **WETAIR.COM STREAMING CONSCIOUSNESS AND DESIGN. CTN MEDIA GROUP, INC.**, (U.S. CLS. 100, 101 AND 107). SN 76-006,312. PUB. 7-2-2002. FILED 3-21-2000.
2,622,912. **NEXTED. NEXTED LIMITED**, (U.S. CLS. 100, 101 AND 107). SN 76-007,502. PUB. 7-2-2002. FILED 3-23-2000.
2,622,915. **BUILDING CHAMPIONS. BUILDING CHAMPIONS, INC.**, (U.S. CLS. 100, 101 AND 107). SN 76-008,451. PUB. 7-2-2002. FILED 3-23-2000.
2,622,922. **WHERE THE DREAM BEGINS. THESPORTS-COACH.COM, INC.**, (U.S. CLS. 100, 101 AND 107). SN 76-013,279. PUB. 7-2-2002. FILED 3-28-2000.
2,622,955 (See Class 9 for this trademark).
2,622,961. **AMAZON RISING. SHEDD AQUARIUM SOCIETY**, (U.S. CLS. 100, 101 AND 107). SN 76-034,613. PUB. 7-2-2002. FILED 4-25-2000.
2,623,019. **THE SONOMA CLUB. SONOMA SPA RESORTS, L.P.**, (U.S. CLS. 100, 101 AND 107). SN 76-059,259. PUB. 7-2-2002. FILED 5-30-2000.
2,623,029 (See Class 35 for this trademark).
2,623,036 (See Class 37 for this trademark).
2,623,049 (See Class 16 for this trademark).
2,623,053. **INGHAM METHOD. INTERNATIONAL INSTITUTE OF REFLEXOLOGY, INC.**, (U.S. CLS. 100, 101 AND 107). SN 76-069,090. PUB. 7-2-2002. FILED 6-12-2000.
2,623,070 (See Class 35 for this trademark).
2,623,075. **REAL NEWS FOR KIDS AND DESIGN. TURNER LEARNING, INC.**, (U.S. CLS. 100, 101 AND 107). SN 76-078,532. PUB. 7-2-2002. FILED 6-27-2000.
2,623,096. **WINTERFEST AND DESIGN. WINTERFEST GROUP, INC.**, (U.S. CLS. 100, 101 AND 107). SN 76-086,376. PUB. 7-2-2002. FILED 7-11-2000.
2,623,103 (See Class 7 for this trademark).
2,623,120. **SALIENCE. SALIENCE ASSOCIATES, INC.**, (U.S. CLS. 100, 101 AND 107). SN 76-092,298. PUB. 7-2-2002. FILED 7-18-2000.
2,623,121. **WORLDS.COM. WORLDS.COM, INC.**, (U.S. CLS. 100, 101 AND 107). SN 76-092,307. PUB. 7-2-2002. FILED 7-17-2000.
2,623,123 (See Class 13 for this trademark).
2,623,127 (See Class 35 for this trademark).
2,623,128. **KIDS ON HANDS. STATE INDUSTRIAL PRODUCTS CORPORATION**, (U.S. CLS. 100, 101 AND 107). SN 76-094,428. PUB. 7-2-2002. FILED 7-24-2000.
2,623,141. **LARGER CIRCLES. GLASS, PHYLLIS**, MULTIPLE CLASS, (INT. CLS. 41 AND 42), (U.S. CLS. 100, 101 AND 107). SN 76-098,882. PUB. 7-2-2002. FILED 7-28-2000.
2,623,147. **TOMMY GUNN SLOT MACHINE. GAMESVILLE-COM, INC.**, (U.S. CLS. 100, 101 AND 107). SN 76-101,539. PUB. 9-18-2001. FILED 8-1-2000.
2,623,168. **R ROCKET 9 5 .1 AND DESIGN. STG MEDIA, LLC**, (U.S. CLS. 100, 101 AND 107). SN 76-108,924. PUB. 7-2-2002. FILED 8-14-2000.
2,623,181 (See Class 35 for this trademark).
2,623,190. **WELOVETOPARTY*COM AND DESIGN. SBZ PRODUCTIONS LTD.**, (U.S. CLS. 100, 101 AND 107). SN 76-114,841. PUB. 7-2-2002. FILED 8-21-2000.
2,623,216. **CHILD STUDY CENTER BRINGING POTENTIAL TO LIGHT AND DESIGN. CHILD STUDY CENTER**, MULTIPLE CLASS, (INT. CLS. 41 AND 42), (U.S. CLS. 100, 101 AND 107). SN 76-121,535. PUB. 7-2-2002. FILED 8-31-2000.
2,623,217. **WEBED AND DESIGN. WEBED, INC.**, (U.S. CLS. 100, 101 AND 107). SN 76-121,754. PUB. 7-2-2002. FILED 9-1-2000.
2,623,222. **TRIATHLETE. TRIATHLON GROUP NORTH AMERICA LLC**, (U.S. CLS. 100, 101 AND 107). SN 76-124,386. PUB. 7-2-2002. FILED 9-8-2000.
2,623,227 (See Class 35 for this trademark).
2,623,240. **RADIO CITY ENTERTAINMENT BACKSTAGE ACCESS. RADIO CITY TRADEMARKS LLC**, (U.S. CLS. 100, 101 AND 107). SN 76-129,898. PUB. 7-2-2002. FILED 9-15-2000.
2,623,257. **SENIOR GOLFERS ASSOCIATION OF AMERICA. SENIOR GOLFERS ASSOCIATION OF AMERICA INC.**, MULTIPLE CLASS, (INT. CLS. 41 AND 42), (U.S. CLS. 100, 101 AND 107). SN 76-133,743. PUB. 7-2-2002. FILED 9-22-2000.
2,623,265. **MISCELLANEOUS DESIGN. SPINNAKER MEDICAL CONSULTANTS INTERNATIONAL, LLC**, MULTIPLE CLASS, (INT. CLS. 41 AND 42), (U.S. CLS. 100, 101 AND 107). SN 76-134,814. PUB. 7-2-2002. FILED 9-18-2000.
2,623,286. **MILWAUKEE BREWERS AND DESIGN. MILWAUKEE BREWERS BASEBALL CLUB**, (U.S. CLS. 100, 101 AND 107). SN 76-138,422. PUB. 7-2-2002. FILED 9-29-2000.
2,623,292. **CHAPTER A DAY. BOARD OF REGENTS OF THE UNIVERSITY OF WISCONSIN SYSTEM, THE, DBA WHA RADIO/UNIVERSITY OF WISCONSIN-EXTENSION**, (U.S. CLS. 100, 101 AND 107). SN 76-138,810. PUB. 7-2-2002. FILED 9-29-2000.
2,623,302 (See Class 9 for this trademark).
2,623,306 (See Class 9 for this trademark).
2,623,310. **SHOWTIME BEYOND (STYLIZED). SHOWTIME**

- NETWORKS INC., (U.S. CLS. 100, 101 AND 107). SN 76-142,405. PUB. 7-2-2002. FILED 10-6-2000.
- 2,623,316. **CYBERPROFS (STYLIZED)**. UNIVERSITY OF IOWA, THE, MULTIPLE CLASS, (INT. CLS. 41 AND 42), (U.S. CLS. 100, 101 AND 107). SN 76-143,170. PUB. 7-2-2002. FILED 10-10-2000.
- 2,623,317. **MANCHESTER CRAFTSMEN'S GUILD**. MANCHESTER CRAFTSMEN'S GUILD, (U.S. CLS. 100, 101 AND 107). SN 76-143,722. PUB. 7-2-2002. FILED 10-10-2000.
- 2,623,319 (*See Class 9 for this trademark*).
- 2,623,330. **MISCELLANEOUS DESIGN**. BALTIMORE ORIOLES LIMITED PARTNERSHIP, (U.S. CLS. 100, 101 AND 107). SN 76-146,052. PUB. 7-2-2002. FILED 10-12-2000.
- 2,623,331. **UF AND DESIGN**. UNIQUEFOCUS, INC., MULTIPLE CLASS, (INT. CLS. 41 AND 42), (U.S. CLS. 100, 101 AND 107). SN 76-146,064. PUB. 7-2-2002. FILED 10-16-2000.
- 2,623,334. **MISCELLANEOUS DESIGN**. PRANDIUM, INC. (U.S. CLS. 100, 101 AND 107). SN 76-146,698. PUB. 7-2-2002. FILED 10-12-2000.
- 2,623,344. **MUSIC PARTNERS USA**. ACADEMY OF COMMUNITY MUSIC, (U.S. CLS. 100, 101 AND 107). SN 76-148,471. PUB. 7-2-2002. FILED 10-17-2000.
- 2,623,347. **RECHARGE & RENEWAL**. VIR-AMERICA, INC. (U.S. CLS. 100, 101 AND 107). SN 76-148,892. PUB. 7-2-2002. FILED 10-18-2000.
- 2,623,349. **AMERICAN BLACK-BELT CHAMPIONSHIPS MARITALS ARTS FINEST AND DESIGN**. BLACK BELT CHAMPIONSHIPS, LLC, (U.S. CLS. 100, 101 AND 107). SN 76-149,166. PUB. 7-2-2002. FILED 10-18-2000.
- 2,623,358. **CHICAGO STEEL**. CHICAGO JUNIOR HOCKEY LLC, (U.S. CLS. 100, 101 AND 107). SN 76-151,084. PUB. 7-2-2002. FILED 10-18-2000.
- 2,623,374. **KC R ROYALS AND DESIGN**. KANSAS CITY ROYALS BASEBALL CORPORATION, (U.S. CLS. 100, 101 AND 107). SN 76-152,921. PUB. 7-2-2002. FILED 10-23-2000.
- 2,623,379. **BELIEVERS IN THE ART OF BECOMING**. SYRACUSE UNIVERSITY, (U.S. CLS. 100, 101 AND 107). SN 76-153,326. PUB. 7-2-2002. FILED 10-20-2000.
- 2,623,412. **COMPENDIUM**. COMPENDIUM PROFESSIONAL DEVELOPMENT SERVICES, LLC, (U.S. CLS. 100, 101 AND 107). SN 76-158,670. PUB. 7-2-2002. FILED 10-27-2000.
- 2,623,429. **MTV FEAR**. VIACOM INTERNATIONAL INC., (U.S. CLS. 100, 101 AND 107). SN 76-160,979. PUB. 7-2-2002. FILED 11-7-2000.
- 2,623,432. **DJO**. DALLAS JAZZ ORCHESTRA OF DALLAS TEXAS, (U.S. CLS. 100, 101 AND 107). SN 76-161,155. PUB. 7-2-2002. FILED 11-7-2000.
- 2,623,433. **SI SURVIVAL INSTINCT ENTERTAINMENT AND DESIGN**. SURVIVAL INSTINCT ENTERTAINMENT, LLC, (U.S. CLS. 100, 101 AND 107). SN 76-161,267. PUB. 7-2-2002. FILED 11-8-2000.
- 2,623,451 (*See Class 9 for this trademark*).
- 2,623,452. **ADMIRED LEADERSHIP**. COMMUNICATION RESEARCH ASSOCIATES, INC., (U.S. CLS. 100, 101 AND 107). SN 76-166,177. PUB. 7-2-2002. FILED 11-16-2000.
- 2,623,453. **ADMIRED LEADERSHIP INSTITUTE**. COMMUNICATION RESEARCH ASSOCIATES, INC., (U.S. CLS. 100, 101 AND 107). SN 76-166,193. PUB. 7-2-2002. FILED 11-16-2000.
- 2,623,465 (*See Class 35 for this trademark*).
- 2,623,466. **RIF NET A SERVICE OF READING IS FUNDAMENTAL, INC. AND DESIGN**. READING IS FUNDAMENTAL, INC., (U.S. CLS. 100, 101 AND 107). SN 76-168,073. PUB. 7-2-2002. FILED 11-20-2000.
- 2,623,484. **THE SMILEY GROUP INC. AND DESIGN**. SMILEY GROUP, INC., THE, (U.S. CLS. 100, 101 AND 107). SN 76-170,969. PUB. 7-2-2002. FILED 11-27-2000.
- 2,623,488 (*See Class 35 for this trademark*).
- 2,623,492. **DARK ANGEL**. TWENTIETH CENTURY FOX FILM CORPORATION, (U.S. CLS. 100, 101 AND 107). SN 76-172,151. PUB. 7-24-2001. FILED 11-27-2000.
- 2,623,494. **MISCELLANEOUS DESIGN**. ROBERTS, JOHN T, (U.S. CLS. 100, 101 AND 107). SN 76-172,358. PUB. 7-2-2002. FILED 11-28-2000.
- 2,623,525. **FYDOLLA HO**. SMITH, SHAWNEE, (U.S. CLS. 100, 101 AND 107). SN 76-176,689. PUB. 7-2-2002. FILED 12-5-2000.
- 2,623,532. **DSL COMFORUM**. PROFESSIONAL EDUCATION INTERNATIONAL, INC., (U.S. CLS. 100, 101 AND 107). SN 76-176,984. PUB. 7-2-2002. FILED 12-7-2000.
- 2,623,539. **TEE TIMES TOMORROW AND DESIGN**. SPECTRUM GOLF, INC., (U.S. CLS. 100, 101 AND 107). SN 76-177,781. PUB. 7-2-2002. FILED 12-8-2000.
- 2,623,544. **SUPERKARTS! USA**. SUPERKARTS! U.S.A., INC., MULTIPLE CLASS, (INT. CL. 41 AND U.S. CL. 200), (U.S. CLS. 100, 101 AND 107). SN 76-178,087. PUB. 7-2-2002. FILED 12-8-2000.
- 2,623,545. **RACHAEL SAGE**. WEITZMAN, KAREN, (U.S. CLS. 100, 101 AND 107). SN 76-178,648. PUB. 7-2-2002. FILED 12-11-2000.
- 2,623,549 (*See Class 35 for this trademark*).
- 2,623,553. **EMC**. EMC CORPORATION, (U.S. CLS. 100, 101 AND 107). SN 76-180,985. PUB. 7-2-2002. FILED 12-14-2000.
- 2,623,559 (*See Class 9 for this trademark*).
- 2,623,561 (*See Class 9 for this trademark*).
- 2,623,564 (*See Class 9 for this trademark*).
- 2,623,599. **NFCA AND DESIGN**. NATIONAL FAMILY CAREGIVERS ASSOCIATION, MULTIPLE CLASS, (INT. CLS. 41 AND 42), (U.S. CLS. 100, 101 AND 107). SN 76-187,417. PUB. 7-2-2002. FILED 12-28-2000.
- 2,623,602. **SWEET ENTERTAINMENT**. SWEET ENTERTAINMENT GROUP, (U.S. CLS. 100, 101 AND 107). SN 76-187,955. PUB. 7-2-2002. FILED 12-29-2000.
- 2,623,610 (*See Class 38 for this trademark*).
- 2,623,615. **WIENER WEDNESDAY**. INTERNATIONAL BROADCASTING CORPORATION, AND ROYCE INTERNATIONAL BROADCASTING CORPORATION, (U.S. CLS. 100, 101 AND 107). SN 76-189,267. PUB. 7-2-2002. FILED 1-2-2001.
- 2,623,616. **1844 VIRTUS TENTAMINE GAUDET AND DESIGN**. HILLSDALE COLLEGE, (U.S. CLS. 100, 101 AND 107). SN 76-189,430. PUB. 7-2-2002. FILED 1-3-2001.
- 2,623,646. **SONIC RANCH VOYAGER 51**. SONIC RANCH VOYAGER 51, INC., (U.S. CLS. 100, 101 AND 107). SN 76-193,901. PUB. 7-2-2002. FILED 1-11-2001.
- 2,623,649. **SONIC RANCH**. SONIC RANCH VOYAGER 51, INC., (U.S. CLS. 100, 101 AND 107). SN 76-194,010. PUB. 7-2-2002. FILED 1-11-2001.
- 2,623,651. **LEADING FOR BUSINESS RESULTS**. STRATEGIC MANAGEMENT GROUP, INC., (U.S. CLS. 100, 101 AND 107). SN 76-194,345. PUB. 7-2-2002. FILED 1-16-2001.
- 2,623,656 (*See Class 16 for this trademark*).
- 2,623,665 (*See Class 35 for this trademark*).
- 2,623,673 (*See Class 38 for this trademark*).
- 2,623,677 (*See Class 25 for this trademark*).
- 2,623,683 (*See Class 16 for this trademark*).
- 2,623,696. **O THE OVATIONS LEADERS OF SERVICE PROVIDER INNOVATION AND DESIGN**. CMP MEDIA LLC, BY CHANGE OF NAME CMP MEDIA INC., (U.S. CLS. 100, 101 AND 107). SN 76-199,536. PUB. 7-2-2002. FILED 1-23-2001.
- 2,623,723. **ADVANCING FOOD SAFETY WORLDWIDE**. INTERNATIONAL ASSOCIATION OF FOOD PROTECTION, FORMERLY THE INTERNATIONAL ASSOCIATION OF MILK, FOOD AND ENVIRONMENT, (U.S. CLS. 100, 101 AND 107). SN 76-202,924. PUB. 7-2-2002. FILED 1-31-2001.
- 2,623,728 (*See Class 16 for this trademark*).
- 2,623,731. **REPUBLIC OF THE RIO GRANDE**. WEBB COUNTY HERITAGE FOUNDATION, (U.S. CLS. 100, 101 AND 107). SN 76-203,307. PUB. 7-2-2002. FILED 2-1-2001.
- 2,623,746. **OPERA ON THE FARM**. REGENTS OF THE UNIVERSITY OF MINNESOTA, (U.S. CLS. 100, 101 AND 107). SN 76-204,632. PUB. 7-2-2002. FILED 2-5-2001.
- 2,623,769. **AAPC AMERICAN ACADEMY OF PROFESSIONAL CODERS AND DESIGN**. AMERICAN ACADEMY OF PROFESSIONAL CODERS, INC., (U.S. CLS. 100, 101 AND 107). SN 76-208,118. PUB. 7-2-2002. FILED 2-9-2001.
- 2,623,802. **MYPDM.NET**. WORKGROUP TECHNOLOGY CORPORATION, MULTIPLE CLASS, (INT. CLS. 41 AND 42), (U.S. CLS. 100, 101 AND 107). SN 76-212,912. PUB. 7-2-2002. FILED 2-20-2001.
- 2,623,814 (*See Class 16 for this trademark*).
- 2,623,832 (*See Class 9 for this trademark*).
- 2,623,848. **SATURDAY NIGHT DANCE PARTY**. INFINITY BROADCASTING CORPORATION OF PENNSYLVANIA,

- (U.S. CLS. 100, 101 AND 107). SN 76-219,588. PUB. 7-2-2002. FILED 3-5-2001.
- 2,623,851 (*See Class 25 for this trademark*).
- 2,623,856. **THE COLLAPSE PROCESS**. DEMARTINI, JOHN F., (U.S. CLS. 100, 101 AND 107). SN 76-220,265. PUB. 7-2-2002. FILED 3-2-2001.
- 2,623,859 (*See Class 9 for this trademark*).
- 2,623,865. **ISSI CHEERLEADING UNLIMITED**. INTERNATIONAL SPORTS SPECIALISTS, INC., (U.S. CLS. 100, 101 AND 107). SN 76-221,751. PUB. 7-2-2002. FILED 3-7-2001.
- 2,623,866. **ISSI SPORTS UNLIMITED**. INTERNATIONAL SPORTS SPECIALISTS, INC., (U.S. CLS. 100, 101 AND 107). SN 76-221,755. PUB. 7-2-2002. FILED 3-7-2001.
- 2,623,867. **JUNG SUWON MARTIAL ART ACADEMY AND DESIGN**. JUNG SUWON MARTIAL ART ACADEMY, (U.S. CLS. 100, 101 AND 107). SN 76-221,802. PUB. 7-2-2002. FILED 3-7-2001.
- 2,623,879. **DEVELOPMENTAL THERAPY TEACHING SOCIAL-EMOTIONAL COMPETENCE AND DESIGN**. DEVELOPMENTAL THERAPY INSTITUTE, INC., (U.S. CLS. 100, 101 AND 107). SN 76-222,773. PUB. 7-2-2002. FILED 3-9-2001.
- 2,623,895. **BANANAS AT LARGE AND DESIGN**. NILSEN CORP., (U.S. CLS. 100, 101 AND 107). SN 76-225,482. PUB. 7-2-2002. FILED 3-6-2001.
- 2,623,896. **DA TURDY POINT BUCK AND DESIGN**. NILSEN CORP., (U.S. CLS. 100, 101 AND 107). SN 76-225,483. PUB. 7-2-2002. FILED 3-6-2001.
- 2,623,899. **SUPERJAM**. SUPERFLY PRODUCTION LLC, (U.S. CLS. 100, 101 AND 107). SN 76-225,778. PUB. 7-2-2002. FILED 3-19-2001.
- 2,623,909 (*See Class 16 for this trademark*).
- 2,623,917 (*See Class 35 for this trademark*).
- 2,623,946. **LEARNING TO LOOK**. DARST, DIANE W. AND MASSEY, SUE J., (U.S. CLS. 100, 101 AND 107). SN 76-232,628. PUB. 7-2-2002. FILED 3-29-2001.
- 2,623,956 (*See Class 16 for this trademark*).
- 2,623,960 (*See Class 14 for this trademark*).
- 2,623,966. **TOONAMI REACTOR**. CARTOON NETWORK LP, LLLP, THE, (U.S. CLS. 100, 101 AND 107). SN 76-235,460. PUB. 7-2-2002. FILED 4-4-2001.
- 2,623,987. **UBER**. ESPN, INC., (U.S. CLS. 100, 101 AND 107). SN 76-236,910. PUB. 7-2-2002. FILED 4-6-2001.
- 2,623,988 (*See Class 40 for this trademark*).
- 2,623,995. **FAIRFAX FAIR VIRGINIA'S FAIR OF THE FUTURE AND DESIGN**. CELEBRATE FAIRFAX, INC., (U.S. CLS. 100, 101 AND 107). SN 76-237,486. PUB. 7-2-2002. FILED 4-2-2001.
- 2,624,010 (*See Class 9 for this trademark*).
- 2,624,023 (*See Class 16 for this trademark*).
- 2,624,024. **ANIMAL PRECINCT**. DISCOVERY COMMUNICATIONS, INC., (U.S. CLS. 100, 101 AND 107). SN 76-241,010. PUB. 7-2-2002. FILED 4-13-2001.
- 2,624,034 (*See Class 25 for this trademark*).
- 2,624,042. **TECHNOFILE**. RADIO LAZLOW, INC., (U.S. CLS. 100, 101 AND 107). SN 76-242,338. PUB. 7-2-2002. FILED 4-18-2001.
- 2,624,044 (*See Class 9 for this trademark*).
- 2,624,049. **THE DIGITAL SUITE FROM MTV NETWORKS**. VIACOM INTERNATIONAL INC., (U.S. CLS. 100, 101 AND 107). SN 76-242,760. PUB. 7-2-2002. FILED 4-17-2001.
- 2,624,053. **MINITAB**. MINITAB, INC., (U.S. CLS. 100, 101 AND 107). SN 76-243,579. PUB. 7-2-2002. FILED 4-18-2001.
- 2,624,055 (*See Class 35 for this trademark*).
- 2,624,056. **MISCELLANEOUS DESIGN**. MARSHALL SOLUTIONS, INC., (U.S. CLS. 100, 101 AND 107). SN 76-243,683. PUB. 7-2-2002. FILED 4-20-2001.
- 2,624,064 (*See Class 9 for this trademark*).
- 2,624,068. **SPARKSCIENCE**. SPARKNOTES LLC, (U.S. CLS. 100, 101 AND 107). SN 76-244,952. PUB. 7-2-2002. FILED 4-23-2001.
- 2,624,071. **GA GENOMIC ART AND DESIGN**. STEIN, HOWARD, (U.S. CLS. 100, 101 AND 107). SN 76-245,210. PUB. 7-2-2002. FILED 4-23-2001.
- 2,624,087. **PERFECT STRANGERS**. ROSE, FORREST E., (U.S. CLS. 100, 101 AND 107). SN 76-247,226. PUB. 5-21-2002. FILED 4-27-2001.
- 2,624,094. **ALL ABOUT KIDS**. MID ISLAND THERAPY ASSOCIATES, L.L.C., MULTIPLE CLASS, (INT. CLS. 41 AND 42), (U.S. CLS. 100, 101 AND 107). SN 76-247,911. PUB. 7-2-2002. FILED S.R. 4-27-2001; AM. P.R. 4-9-2002.
- 2,624,123. **TUKACENTER**. SAREEN, IVA, MULTIPLE CLASS, (INT. CLS. 41 AND 42), (U.S. CLS. 100, 101 AND 107). SN 76-252,159. PUB. 7-2-2002. FILED 5-7-2001.
- 2,624,157 (*See Class 25 for this trademark*).
- 2,624,158. **HEAL. TEACH. DISCOVER. SERVE.**. GEISINGER HEALTH SYSTEM FOUNDATION, MULTIPLE CLASS, (INT. CLS. 41 AND 42), (U.S. CLS. 100, 101 AND 107). SN 76-257,140. PUB. 7-2-2002. FILED 5-15-2001.
- 2,624,170. **MISCELLANEOUS DESIGN**. INNER OCEAN PUBLISHING, INC., (U.S. CLS. 100, 101 AND 107). SN 76-258,899. PUB. 7-2-2002. FILED 5-18-2001.
- 2,624,183. **ZOOFORCE**. FUNNY GARBAGE INC., (U.S. CLS. 100, 101 AND 107). SN 76-259,950. PUB. 7-2-2002. FILED 5-16-2001.
- 2,624,184. **RAPTOONS**. FUNNY GARBAGE INC., (U.S. CLS. 100, 101 AND 107). SN 76-259,952. PUB. 7-2-2002. FILED 5-16-2001.
- 2,624,193 (*See Class 16 for this trademark*).
- 2,624,196. **SIERRA-PEARL**. SIERRA PEARL ENTERTAINMENT, LLC, (U.S. CLS. 100, 101 AND 107). SN 76-260,977. PUB. 7-2-2002. FILED 5-23-2001.
- 2,624,199. **HARVARD BUSINESS SCHOOL PRESS**. PRESIDENT AND FELLOWS OF HARVARD COLLEGE, (U.S. CLS. 100, 101 AND 107). SN 76-261,667. PUB. 7-2-2002. FILED 5-23-2001.
- 2,624,212 (*See Class 35 for this trademark*).
- 2,624,219 (*See Class 9 for this trademark*).
- 2,624,222. **CHRISLAR (STYLIZED)**. CASSENTI, LAWRENCE W., AND CASSENTI, CHRISTINE M., (U.S. CLS. 100, 101 AND 107). SN 76-264,177. PUB. 7-2-2002. FILED 5-31-2001.
- 2,624,227 (*See Class 16 for this trademark*).
- 2,624,235. **JUMP FORCE**. NEXT LEVEL FITNESS, INC., (U.S. CLS. 100, 101 AND 107). SN 76-265,395. PUB. 7-2-2002. FILED 6-1-2001.
- 2,624,242 (*See Class 16 for this trademark*).
- 2,624,248. **CPP**. AMERICAN SOCIETY FOR INDUSTRIAL SECURITY, (U.S. CLS. 100, 101 AND 107). SN 76-266,413. PUB. 7-2-2002. FILED 6-4-2001.
- 2,624,300 (*See Class 35 for this trademark*).
- 2,624,321 (*See Class 39 for this trademark*).
- 2,624,331. **HAIL! HAIL! ROCK N' ROLL**. BERRY, CHUCK, (U.S. CLS. 100, 101 AND 107). SN 76-275,709. PUB. 7-2-2002. FILED 6-21-2001.
- 2,624,338. **VANDERBILT CHILDREN'S HOSPITAL AND DESIGN**. VANDERBILT UNIVERSITY, THE, MULTIPLE CLASS, (INT. CLS. 41 AND 42), (U.S. CLS. 100, 101 AND 107). SN 76-276,672. PUB. 7-2-2002. FILED 6-26-2001.
- 2,624,347 (*See Class 35 for this trademark*).
- 2,624,355. **BLADERUNNER**. WOLNEY, BLAKE ANTHONY, (U.S. CLS. 100, 101 AND 107). SN 76-279,242. PUB. 7-2-2002. FILED 7-2-2001.
- 2,624,357 (*See Class 20 for this trademark*).
- 2,624,362. **SOUL STREET**. XM SATELLITE RADIO INC., (U.S. CLS. 100, 101 AND 107). SN 76-281,214. PUB. 7-2-2002. FILED 7-6-2001.
- 2,624,392. **CHIRO + PLUS KINESIOLOGY**. DOWTY, MILTON E., (U.S. CLS. 100, 101 AND 107). SN 76-285,505. PUB. 7-2-2002. FILED 7-16-2001.
- 2,624,397. **BAPTIST MEN ON MISSION AND DESIGN**. NORTH AMERICAN MISSION BOARD OF THE SOUTHERN BAPTIST CONVENTION, INC., THE, (U.S. CLS. 100, 101 AND 107). SN 76-286,569. PUB. 7-2-2002. FILED 7-10-2001.
- 2,624,438. **HEALTHERCISE**. SARACENI, DEANNA, (U.S. CLS. 100, 101 AND 107). SN 76-291,476. PUB. 7-2-2002. FILED 7-30-2001.
- 2,624,443. **GOLFDIGEST SCHOOLS AND DESIGN**. ADVANCE MAGAZINE PUBLISHERS INC., (U.S. CLS. 100, 101 AND 107). SN 76-291,906. PUB. 7-2-2002. FILED 7-31-2001.
- 2,624,445. **VICTORY FOR LIFE**. VANDERBILT UNIVERSITY, THE, MULTIPLE CLASS, (INT. CLS. 41 AND 42), (U.S. CLS. 100, 101 AND 107). SN 76-292,102. PUB. 7-2-2002. FILED 7-30-2001.
- 2,624,453. **SALAAM**. SALAAM, (U.S. CLS. 100, 101 AND 107).

- SN 76-292,819. PUB. 7-2-2002. FILED 7-31-2001.
- 2,624,474. **NADA/NATIONAL AUTOMOBILE DEALERS ASSOCIATION DEALER ACADEMY AND DESIGN.** NATIONAL AUTOMOBILE DEALERS ASSOCIATION, (U.S. CLS. 100, 101 AND 107). SN 76-296,225. PUB. 7-2-2002. FILED 8-8-2001.
- 2,624,492. **REDLINE CUP.** SEATTLE BIKE SUPPLY, INC., (U.S. CLS. 100, 101 AND 107). SN 76-300,985. PUB. 7-2-2002. FILED 8-17-2001.
- 2,624,506. **FP (STYLIZED).** CAL FARLEY'S BOYS RANCH AND AFFILIATES, MULTIPLE CLASS, (INT. CLS. 41 AND 42), (U.S. CLS. 100, 101 AND 107). SN 76-303,305. PUB. 7-2-2002. FILED 8-22-2001.
- 2,624,526. **FRANTICWOMAN.** RULNICK, MARY JO, AND SCHNEIDER, JUDITH BURNETT, (U.S. CLS. 100, 101 AND 107). SN 76-307,536. PUB. 7-2-2002. FILED 8-31-2001.
- 2,624,548. **S.C.O.P.E. STRUCTURAL CHEMICAL ORGAN PSYCHE ELECTRICAL.** DOWTY, MILTON E., (U.S. CLS. 100, 101 AND 107). SN 76-310,973. PUB. 7-2-2002. FILED 9-12-2001.
- 2,624,553. **MISCELLANEOUS DESIGN.** PREVENT CHILD ABUSE ROANOKE VALLEY, INC., (U.S. CLS. 100, 101 AND 107). SN 76-312,078. PUB. 7-2-2002. FILED 9-17-2001.
- 2,624,569. **SUSAN B. ANTHONY HOUSE.** SUSAN B. ANTHONY HOUSE, INC., THE, (U.S. CLS. 100, 101 AND 107). SN 76-313,779. PUB. 7-2-2002. FILED 9-18-2001.
- 2,624,592. **TEXAS BAPTIST ALL-STATE CHOIR & BAND.** BAPTIST GENERAL CONVENTION OF TEXAS, (U.S. CLS. 100, 101 AND 107). SN 76-319,124. PUB. 7-2-2002. FILED 9-27-2001.
- 2,624,602. **JUANA LA IGUANA.** IGUANA PRODUCTIONS LTD. (BVI), (U.S. CLS. 100, 101 AND 107). SN 76-320,306. PUB. 7-2-2002. FILED 10-1-2001.
- 2,624,625. **SUNDAY'S KIND OF COUNTRY.** STEPTOE, ROBBY LYNN, (U.S. CLS. 100, 101 AND 107). SN 76-323,225. PUB. 7-2-2002. FILED 10-9-2001.
- 2,624,631. **FREEMAN WELLBALANCE.** FREEMAN HEALTH SYSTEM, (U.S. CLS. 100, 101 AND 107). SN 76-323,576. PUB. 7-2-2002. FILED 10-11-2001.
- 2,624,649 (*See Class 16 for this trademark.*).
- 2,624,651 (*See Class 9 for this trademark.*).
- 2,624,670. **REAL LIFE WEDDINGS.** STEVEN E. GROSS, INCORPORATED, (U.S. CLS. 100, 101 AND 107). SN 76-327,743. PUB. 7-2-2002. FILED 10-19-2001.
- 2,624,675. **SILVIA'S STEP BY STEP AND DESIGN.** SILVIA'S LANGUAGE SERVICES, INC., (U.S. CLS. 100, 101 AND 107). SN 76-328,543. PUB. 7-2-2002. FILED 10-22-2001.
- 2,624,696. **THE M.O.M. TEAM.** M.O.M. TEAM INC., THE, (U.S. CLS. 100, 101 AND 107). SN 76-330,955. PUB. 7-2-2002. FILED 10-29-2001.
- 2,624,697. **HOCKEY MINISTRIES INTERNATIONAL AND DESIGN.** HOCKEY MINISTRIES INTERNATIONAL, (U.S. CLS. 100, 101 AND 107). SN 76-331,327. PUB. 7-2-2002. FILED 10-29-2001.
- 2,624,701. **THE ACADEMY FOR JEWISH RELIGION THE TORAH HAS MANY FACES AND DESIGN.** ACADEMY FOR JEWISH RELIGION, THE, (U.S. CLS. 100, 101 AND 107). SN 76-331,945. PUB. 7-2-2002. FILED 10-30-2001.
- 2,624,730. **THINK OF ENGLAND AND DESIGN.** THINK OF ENGLAND, LLC, (U.S. CLS. 100, 101 AND 107). SN 76-335,922. PUB. 7-2-2002. FILED 11-9-2001.
- 2,624,732. **H AND DESIGN.** HASTINGS COLLEGE, (U.S. CLS. 100, 101 AND 107). SN 76-336,427. PUB. 7-2-2002. FILED 11-13-2001.
- 2,624,743. **ADOPT-A-DESTINY.** SOULUTION ENTERPRISES, INC., (U.S. CLS. 100, 101 AND 107). SN 76-337,659. PUB. 7-2-2002. FILED 11-14-2001.
- 2,624,744. **MARDI PAWS.** GUTNISKY, DENISE A., (U.S. CLS. 100, 101 AND 107). SN 76-337,798. PUB. 7-2-2002. FILED 11-14-2001.
- 2,624,756. **LAMONT.** LAMONT PARTNERSHIP, THE, (U.S. CLS. 100, 101 AND 107). SN 76-339,186. PUB. 7-2-2002. FILED 11-19-2001.
- 2,624,770. **MISCELLANEOUS DESIGN.** ECOLE INTERNATIONALE DE THEATRE JACQUES LECOQ, (U.S. CLS. 100, 101 AND 107). SN 76-342,923. PUB. 7-2-2002. FILED 11-29-2001.
- 2,624,779 (*See Class 16 for this trademark.*).
- 2,624,780 (*See Class 16 for this trademark.*).
- 2,624,790. **YOQUA.** DEMINICO, JOHN, (U.S. CLS. 100, 101 AND 107). SN 76-344,873. PUB. 7-2-2002. FILED 12-5-2001.
- 2,624,806. **RADIO AT FULL THROTTLE.** XM SATELLITE RADIO INC., (U.S. CLS. 100, 101 AND 107). SN 76-346,517. PUB. 7-2-2002. FILED 12-10-2001.
- 2,624,816. **LIFE IS AN ATTITUDE.** HEAGY, RONALD C., (U.S. CLS. 100, 101 AND 107). SN 76-348,367. PUB. 7-2-2002. FILED 12-14-2001.
- 2,624,817. **RIGHT A.R.M. CONSULTING.** HILL, MEREDITH L., (U.S. CLS. 100, 101 AND 107). SN 76-348,395. PUB. 7-2-2002. FILED 12-12-2001.
- 2,624,841. **METACREDIT.** CDDDB, INC., (U.S. CLS. 100, 101 AND 107). SN 76-350,572. PUB. 7-2-2002. FILED 12-14-2001.
- 2,624,845 (*See Class 36 for this trademark.*).
- 2,624,853. **CHILDU.** CHILDU, INC., (U.S. CLS. 100, 101 AND 107). SN 76-351,912. PUB. 7-2-2002. FILED 12-21-2001.
- 2,624,872. **RUNTEL DAT ENTERTAINMENT.** LAWRENCE, MARTIN, (U.S. CLS. 100, 101 AND 107). SN 76-354,803. PUB. 7-2-2002. FILED 1-2-2002.
- 2,624,884. **STONES THROW.** ORTA, RODNEY L., (U.S. CLS. 100, 101 AND 107). SN 76-356,858. PUB. 7-2-2002. FILED 1-10-2002.
- 2,624,895. **TECH-A-THON.** TRAVEL TRADE PRODUCTIONS, (U.S. CLS. 100, 101 AND 107). SN 76-357,397. PUB. 7-2-2002. FILED 1-11-2002.
- 2,624,898. **MISCELLANEOUS DESIGN.** LITERATE WORLD INC., (U.S. CLS. 100, 101 AND 107). SN 76-357,754. PUB. 7-2-2002. FILED 1-10-2002.
- 2,624,904. **DE MANANITA.** TELEMUNDO NETWORK GROUP LLC, (U.S. CLS. 100, 101 AND 107). SN 76-359,130. PUB. 7-2-2002. FILED 1-15-2002.
- 2,624,938. **THE ROYAL TOUR.** CHECK SIX PRODUCTIONS, INC., (U.S. CLS. 100, 101 AND 107). SN 76-367,957. PUB. 7-2-2002. FILED 2-6-2002.
- 2,624,944. **JABBERWORK.** POWER COMM 2000, INC., (U.S. CLS. 100, 101 AND 107). SN 76-369,090. PUB. 7-2-2002. FILED 2-11-2002.
- 2,624,981 (*See Class 9 for this trademark.*).
- 2,625,007 (*See Class 9 for this trademark.*).
- 2,625,020. **STOP THE CLOCK!** GRAY, REBECCA, (U.S. CLS. 100, 101 AND 107). SN 78-046,362. PUB. 7-2-2002. FILED 2-2-2001.
- 2,625,022. **SONOMIC AND DESIGN.** SOUNDATION, INC., DBA SONOMIC, (U.S. CLS. 100, 101 AND 107). SN 78-047,161. PUB. 7-2-2002. FILED 2-7-2001.
- 2,625,062. **THE POLKA QUEEN.** PHILPOT, IRA J., (U.S. CLS. 100, 101 AND 107). SN 78-056,124. PUB. 7-2-2002. FILED 3-31-2001.
- 2,625,067. **THE VELVET ROPE NIGHTLIFE AWARDS.** CLUB-FONE, INC., (U.S. CLS. 100, 101 AND 107). SN 78-057,002. PUB. 7-2-2002. FILED 4-5-2001.
- 2,625,068. **SEXUAL RADIANCE.** TAYLOR, SUSAN, (U.S. CLS. 100, 101 AND 107). SN 78-057,269. PUB. 7-2-2002. FILED 4-6-2001.
- 2,625,072 (*See Class 35 for this trademark.*).
- 2,625,077 (*See Class 35 for this trademark.*).
- 2,625,084 (*See Class 38 for this trademark.*).
- 2,625,087 (*See Class 9 for this trademark.*).
- 2,625,093 (*See Class 5 for this trademark.*).
- 2,625,104. **THE BABES.** FINGERETT, SALLY, (U.S. CLS. 100, 101 AND 107). SN 78-064,209. PUB. 7-2-2002. FILED 5-17-2001.
- 2,625,109 (*See Class 35 for this trademark.*).
- 2,625,118. **SPEEDFREAKS.** SPEEDFREAKS, LTD., (U.S. CLS. 100, 101 AND 107). SN 78-065,594. PUB. 7-2-2002. FILED 5-24-2001.
- 2,625,124. **REIKINOSIS.** ZALESKI, INESSA, (U.S. CLS. 100, 101 AND 107). SN 78-068,043. PUB. 7-2-2002. FILED 6-8-2001.
- 2,625,135. **TAHOE.COM.** SWIFT NEWSPAPERS, INC., (U.S. CLS. 100, 101 AND 107). SN 78-070,180. PUB. 7-2-2002. FILED 6-20-2001.
- 2,625,141. **BLACK CINEMA CAFE.** BLACK CINEMA CAFE, (U.S. CLS. 100, 101 AND 107). SN 78-070,994. PUB. 7-2-2002. FILED 6-26-2001.
- 2,625,145. **AMERICAN BABY CONTEST.** NATIONAL INFORMATION CORPORATION, (U.S. CLS. 100, 101 AND 107). SN 78-071,752. PUB. 7-2-2002. FILED 6-29-2001.

- 2,625,178. **SBC CHAMPIONSHIP**. SBC COMMUNICATIONS INC., (U.S. CLS. 100, 101 AND 107). SN 78-080,496. PUB. 7-2-2002. FILED 8-22-2001.
- 2,625,189. **GERY LEGRAND**. BELLANGER, PIERRE, (U.S. CLS. 100, 101 AND 107). SN 78-082,481. PUB. 7-2-2002. FILED 9-4-2001.
- 2,625,192. **WAYFARER (STYLIZED)**. MOORE, LAWRENCE WILLIAM, (U.S. CLS. 100, 101 AND 107). SN 78-083,186. PUB. 7-2-2002. FILED 9-8-2001.
- 2,625,194. **WA WESTVIEW ANALYTICS AND DESIGN**. BOYLES, RUSSELL A., (U.S. CLS. 100, 101 AND 107). SN 78-083,387. PUB. 7-2-2002. FILED 9-10-2001.
- 2,625,195. **TRIAL IMAGE (STYLIZED)**. SHIPLEY, CALVERT J., DBA TRIAL IMAGE, (U.S. CLS. 100, 101 AND 107). SN 78-083,410. PUB. 7-2-2002. FILED 9-10-2001.
- 2,625,200. **THE FATHER'S FOUR**. RICHERSON, THOMAS A., (U.S. CLS. 100, 101 AND 107). SN 78-084,442. PUB. 7-2-2002. FILED 9-18-2001.
- 2,625,210. **CHIROPRACTIC TODAY**. NEW YORK CHIROPRACTIC COLLEGE, (U.S. CLS. 100, 101 AND 107). SN 78-087,404. PUB. 7-2-2002. FILED 10-8-2001.
- 2,625,221. **25 DAYS OF CHRISTMAS**. INTERNATIONAL FAMILY ENTERTAINMENT, INC., (U.S. CLS. 100, 101 AND 107). SN 78-088,544. PUB. 7-2-2002. FILED 10-16-2001.
- 2,625,222 (*See Class 9 for this trademark*).
- 2,625,232 (*See Class 35 for this trademark*).
- 2,625,233. **LIFESYNC**. LUCK, JOHN, S., (U.S. CLS. 100, 101 AND 107). SN 78-091,565. PUB. 7-2-2002. FILED 11-3-2001.
- 2,625,235. **GLOBAL HELP**. STAHELI, LYNN T., (U.S. CLS. 100, 101 AND 107). SN 78-091,951. PUB. 7-2-2002. FILED 11-6-2001.
- 2,625,237. **FAR STAR PRODUCTIONS AND DESIGN**. FAR STAR PRODUCTIONS, INC., (U.S. CLS. 100, 101 AND 107). SN 78-092,493. PUB. 7-2-2002. FILED 11-9-2001.
- 2,625,245. **NVCC STUDENT CENTERED. COMMUNITY FOCUSED. AND DESIGN**. NORTHERN VIRGINIA COMMUNITY COLLEGE, (U.S. CLS. 100, 101 AND 107). SN 78-093,833. PUB. 7-2-2002. FILED 11-16-2001.
- 2,625,254. **WHERE THE FIGHT CLUB MEETS THE NIGHT CLUB**. LEWIS, JOHN, (U.S. CLS. 100, 101 AND 107). SN 78-095,263. PUB. 7-2-2002. FILED 11-27-2001.
- 2,625,266. **CPIW**. NATIONAL ASSOCIATION OF INSURANCE WOMEN (INTERNATIONAL), (U.S. CLS. 100, 101 AND 107). SN 78-096,951. PUB. 7-2-2002. FILED 12-6-2001.
- 2,625,271. **KART 2 KART**. A.J.E. LLC, (U.S. CLS. 100, 101 AND 107). SN 78-097,297. PUB. 7-2-2002. FILED 12-7-2001.
- 2,625,272. **CRUDE KNOWLEDGE**. OKLAHOMA ENERGY RESOURCES BOARD, (U.S. CLS. 100, 101 AND 107). SN 78-097,438. PUB. 7-2-2002. FILED 12-10-2001.
- 2,625,293. **OPENING THE DOORS TO A HEALTHY HEART**. BORER, JEFFERY, MULTIPLE CLASS, (INT. CLS. 41 AND 42), (U.S. CLS. 100, 101 AND 107). SN 78-100,289. PUB. 7-2-2002. FILED 12-28-2001.
- 2,625,302. **EDUCATIONAL EXCELLENCE AT YOUR CONVENIENCE**. JONES INTERNATIONAL, LTD., (U.S. CLS. 100, 101 AND 107). SN 78-102,719. PUB. 7-2-2002. FILED 1-15-2002.
- 2,625,304. **V12 RADIO**. AMFM OHIO, INC., (U.S. CLS. 100, 101 AND 107). SN 78-103,357. PUB. 7-2-2002. FILED 1-17-2002.
- DESIGN**. POZZUOLI, ENRICO DAVID, (U.S. CLS. 100 AND 101). SN 75-419,930. PUB. 7-2-2002. FILED 1-20-1998.
- 2,622,554. **GO GREEK**. MR. GREEK RESTAURANTS INC., BY CHANGE OF NAME MR. GREEK SHISH-KEBOB RESTAURANTS INC., (U.S. CLS. 100 AND 101). SN 75-476,591. PUB. 7-11-2000. FILED 4-29-1998.
- 2,622,555 (*See Class 10 for this trademark*).
- 2,622,571 (*See Class 35 for this trademark*).
- 2,622,572 (*See Class 9 for this trademark*).
- 2,622,573. **EASYNEWS AND DESIGN**. EL DORADO SALES, INC., (U.S. CLS. 100 AND 101). SN 75-542,060. PUB. 7-2-2002. FILED 8-24-1998.
- 2,622,578 (*See Class 16 for this trademark*).
- 2,622,589 (*See Class 38 for this trademark*).
- 2,622,593 (*See Class 35 for this trademark*).
- 2,622,605 (*See Class 5 for this trademark*).
- 2,622,607 (*See Class 33 for this trademark*).
- 2,622,622. **COLORFX**. DEVRIES COMMUNICATIONS, INC., DBA COLORFX, (U.S. CLS. 100 AND 101). SN 75-627,705. PUB. 7-2-2002. FILED 1-22-1999.
- 2,622,625 (*See Class 41 for this trademark*).
- 2,622,632 (*See Class 9 for this trademark*).
- 2,622,633 (*See Class 40 for this trademark*).
- 2,622,639. **ESP@CENET (STYLIZED)**. EUROPEAN PATENT ORGANIZATION, THE, (U.S. CLS. 100 AND 101). SN 75-669,572. PUB. 1-9-2001. FILED 3-29-1999.
- 2,622,645. **THEWHIZ.COM AND DESIGN**. ILIFE.COM, INC., BY CHANGE OF NAME INTELLIGENT LIFE CORPORATION, (U.S. CLS. 100 AND 101). SN 75-686,723. PUB. 11-14-2000. FILED 4-19-1999.
- 2,622,649 (*See Class 9 for this trademark*).
- 2,622,651 (*See Class 10 for this trademark*).
- 2,622,658 (*See Class 40 for this trademark*).
- 2,622,660 (*See Class 1 for this trademark*).
- 2,622,668. **COME TO PLAY. PLAN TO STAY!**. STATION CASINOS, INC., (U.S. CLS. 100 AND 101). SN 75-721,902. PUB. 7-2-2002. FILED 6-4-1999.
- 2,622,669 (*See Class 9 for this trademark*).
- 2,622,676 (*See Class 35 for this trademark*).
- 2,622,678 (*See Class 9 for this trademark*).
- 2,622,680 (*See Class 1 for this trademark*).
- 2,622,692. **SHIELDS TAVERN**. COLONIAL WILLIAMSBURG FOUNDATION, THE, (U.S. CLS. 100 AND 101). SN 75-761,495. PUB. 7-2-2002. FILED 7-27-1999.
- 2,622,703 (*See Class 41 for this trademark*).
- 2,622,704 (*See Class 38 for this trademark*).
- 2,622,705. **OM TECHNOLOGY**. OM AKTIEBOLAG, BY CHANGE OF NAME OM GRUPPEN AB, (U.S. CLS. 100 AND 101). SN 75-776,612. PUB. 7-2-2002. FILED 8-16-1999.
- 2,622,709 (*See Class 9 for this trademark*).
- 2,622,720 (*See Class 35 for this trademark*).
- 2,622,723 (*See Class 41 for this trademark*).
- 2,622,738 (*See Class 39 for this trademark*).
- 2,622,740. **CIS SERVICE BUREAU AND DESIGN**. CIS SERVICE BUREAU, LLC, (U.S. CLS. 100 AND 101). SN 75-824,773. PUB. 7-2-2002. FILED 10-12-1999.
- 2,622,742. **THE WORLDWIDE AUTHORITY ON INTERNET COMMERCE**. JUPITER COMMUNICATIONS, INC., (U.S. CLS. 100 AND 101). SN 75-826,707. PUB. 7-2-2002. FILED 10-19-1999.
- 2,622,747 (*See Class 9 for this trademark*).
- 2,622,748 (*See Class 9 for this trademark*).
- 2,622,749. **SUNSET ROOM**. ALAN HAJJAR, CHRIS BREED AND GEORGE NAHAS JOINT VENTURE, THE, (U.S. CLS. 100 AND 101). SN 75-831,537. PUB. 7-2-2002. FILED 10-30-1999.
- 2,622,760. **SPG AND DESIGN**. SPECIALIZED PACKAGING GROUP, INC., (U.S. CLS. 100 AND 101). SN 75-846,183. PUB. 7-2-2002. FILED 11-10-1999.
- 2,622,776. **MISSIONWARE**. INTEGRASOLV CORP., (U.S. CLS. 100 AND 101). SN 75-857,621. PUB. 7-2-2002. FILED 11-24-1999.
- 2,622,782. **DISCOVERY TECHNOLOGIES INCORPORATED AND DESIGN**. DISCOVERY TECHNOLOGIES, INC., (U.S. CLS. 100 AND 101). SN 75-862,288. PUB. 7-2-2002. FILED 12-2-1999.
- 2,622,790 (*See Class 35 for this trademark*).
- 2,622,795 (*See Class 31 for this trademark*).

CLASS 42—SCIENTIFIC, COMPUTER AND LEGAL SERVICES

- 2,622,507 (*See Class 9 for this trademark*).
- 2,622,508 (*See Class 9 for this trademark*).
- 2,622,515. **MEETING WOW (MEETING WITHOUT WALLS)**. AVN, (U.S. CLS. 100 AND 101). SN 75-151,794. PUB. 7-2-2002. FILED 8-16-1996.
- 2,622,521 (*See Class 35 for this trademark*).
- 2,622,522. **THE GRAND PROVIDENCE**. YTC CORPORATION LIMITED, (U.S. CLS. 100 AND 101). SN 75-266,751. PUB. 10-9-2001. FILED 3-31-1997.
- 2,622,528. **CROBAR**. BIG CHICAGO CORP., (U.S. CLS. 100 AND 101). SN 75-292,863. PUB. 4-13-1999. FILED 5-15-1997.
- 2,622,536 (*See Class 9 for this trademark*).
- 2,622,541. **WWWORKSHOP BE ON THE NET TODAY! AND**

- 2,622,798. **SAN DIEGO TAXPAYERS ASSOCIATION**. SAN DIEGO COUNTY TAXPAYERS ASSOCIATION, (U.S. CLS. 100 AND 101). SN 75-883,338. PUB. 7-2-2002. FILED 12-30-1999.
- 2,622,803 (*See Class 38 for this trademark*).
- 2,622,809. **SLI AND DESIGN**. SECURITY LOGISTICS, INC., (U.S. CLS. 100 AND 101). SN 75-889,632. PUB. 7-2-2002. FILED 1-6-2000.
- 2,622,812. **CARE AND DESIGN**. COALITION FOR AUTOMOTIVE REPAIR EQUALITY, INC., (U.S. CLS. 100 AND 101). SN 75-891,870. PUB. 7-2-2002. FILED 1-7-2000.
- 2,622,828 (*See Class 9 for this trademark*).
- 2,622,832 (*See Class 9 for this trademark*).
- 2,622,835 (*See Class 35 for this trademark*).
- 2,622,844 (*See Class 25 for this trademark*).
- 2,622,850 (*See Class 9 for this trademark*).
- 2,622,851 (*See Class 16 for this trademark*).
- 2,622,858. **THE CENTER FOR FETAL DIAGNOSIS AND TREATMENT**. CHILDREN'S HOSPITAL OF PHILADELPHIA, THE, (U.S. CLS. 100 AND 101). SN 75-922,085. PUB. 7-2-2002. FILED 2-17-2000.
- 2,622,867. **MBF-LAW.COM**. MICHAEL BEST & FRIEDRICH LLP, (U.S. CLS. 100 AND 101). SN 75-927,317. PUB. 7-2-2002. FILED 2-24-2000.
- 2,622,869 (*See Class 39 for this trademark*).
- 2,622,874. **THE YIN YANKEE CAFE**. KLOPCIC, KIM, (U.S. CLS. 100 AND 101). SN 75-937,757. PUB. 12-5-2000. FILED 3-7-2000.
- 2,622,887 (*See Class 35 for this trademark*).
- 2,622,901 (*See Class 9 for this trademark*).
- 2,622,905 (*See Class 6 for this trademark*).
- 2,622,923 (*See Class 9 for this trademark*).
- 2,622,926 (*See Class 35 for this trademark*).
- 2,622,928 (*See Class 38 for this trademark*).
- 2,622,929 (*See Class 9 for this trademark*).
- 2,622,937 (*See Class 9 for this trademark*).
- 2,622,953 (*See Class 9 for this trademark*).
- 2,622,955 (*See Class 9 for this trademark*).
- 2,622,958. **CLIPBOARD SOLUTIONS**. AMERICAN DIRECT CARE, INC., (U.S. CLS. 100 AND 101). SN 76-033,310. PUB. 7-2-2002. FILED 4-24-2000.
- 2,622,975. **CTC AND DESIGN**. CONCURRENT TECHNOLOGIES CORPORATION, (U.S. CLS. 100 AND 101). SN 76-040,470. PUB. 7-2-2002. FILED 5-4-2000.
- 2,622,976. **CONCURRENT TECHNOLOGIES CORPORATION**. CONCURRENT TECHNOLOGIES CORPORATION, (U.S. CLS. 100 AND 101). SN 76-040,471. PUB. 7-2-2002. FILED 5-4-2000.
- 2,622,994 (*See Class 35 for this trademark*).
- 2,623,000. **MISCELLANEOUS DESIGN**. ASHBY, RODNEY, (U.S. CLS. 100 AND 101). SN 76-052,616. PUB. 7-2-2002. FILED 5-22-2000.
- 2,623,012 (*See Class 9 for this trademark*).
- 2,623,026 (*See Class 19 for this trademark*).
- 2,623,027 (*See Class 19 for this trademark*).
- 2,623,029 (*See Class 35 for this trademark*).
- 2,623,034 (*See Class 16 for this trademark*).
- 2,623,036 (*See Class 37 for this trademark*).
- 2,623,037. **UPTILT**. UPTILT, INC., (U.S. CLS. 100 AND 101). SN 76-064,055. PUB. 7-2-2002. FILED 6-5-2000.
- 2,623,041 (*See Class 35 for this trademark*).
- 2,623,043 (*See Class 39 for this trademark*).
- 2,623,046 (*See Class 35 for this trademark*).
- 2,623,049 (*See Class 16 for this trademark*).
- 2,623,059. **QUICKFLEX**. VISION INTERNATIONAL, INC., (U.S. CLS. 100 AND 101). SN 76-071,653. PUB. 7-2-2002. FILED 6-16-2000.
- 2,623,060. **STYLEFORLIVING.COM**. ELLIS, JOHN, (U.S. CLS. 100 AND 101). SN 76-072,336. PUB. 7-2-2002. FILED 6-16-2000.
- 2,623,065. **WIRE ROAD**. STICHTING LODESTAR, (U.S. CLS. 100 AND 101). SN 76-074,328. PUB. 7-2-2002. FILED 6-20-2000.
- 2,623,068 (*See Class 1 for this trademark*).
- 2,623,071 (*See Class 36 for this trademark*).
- 2,623,078. **BRING YOUR ENTERPRISE DOCUMENTS TO LIFE**. SEFAS TECHNOLOGIES, S.A., (U.S. CLS. 100 AND 101). SN 76-079,543. PUB. 7-2-2002. FILED 6-28-2000.
- 2,623,079 (*See Class 9 for this trademark*).
- 2,623,084 (*See Class 25 for this trademark*).
- 2,623,095. **COVERING KIDS**. ROBERT WOOD JOHNSON FOUNDATION, THE, (U.S. CLS. 100 AND 101). SN 76-086,325. PUB. 7-2-2002. FILED 7-11-2000.
- 2,623,103 (*See Class 7 for this trademark*).
- 2,623,104. **TRANS-PHAGE TECHNOLOGY**. MEDAREX, INC., (U.S. CLS. 100 AND 101). SN 76-088,615. PUB. 7-2-2002. FILED 7-13-2000.
- 2,623,126 (*See Class 35 for this trademark*).
- 2,623,127 (*See Class 35 for this trademark*).
- 2,623,132. **EXTEND THE ENTERPRISE**. D. T. CONSULTING, INC., DBA DTI, (U.S. CLS. 100 AND 101). SN 76-095,769. PUB. 7-2-2002. FILED 7-24-2000.
- 2,623,136 (*See Class 16 for this trademark*).
- 2,623,139. **REEDERS MEMORIAL HOME A TRADITION OF COMPASSION, THE FUTURE OF CARING IN A CHRISTIAN ATMOSPHERE AND DESIGN**. REEDERS MEMORIAL HOME, (U.S. CLS. 100 AND 101). SN 76-098,267. PUB. 7-2-2002. FILED 7-28-2000.
- 2,623,141 (*See Class 41 for this trademark*).
- 2,623,142. **VETIMAGE**. KARI, SHAWN DVM, (U.S. CLS. 100 AND 101). SN 76-098,992. PUB. 7-2-2002. FILED 7-28-2000.
- 2,623,144. **VALENTINI'S FINE WINE LINE**. BONNER, KATHLEEN L., (U.S. CLS. 100 AND 101). SN 76-100,031. PUB. 7-2-2002. FILED 7-31-2000.
- 2,623,148 (*See Class 1 for this trademark*).
- 2,623,151 (*See Class 9 for this trademark*).
- 2,623,157 (*See Class 16 for this trademark*).
- 2,623,160 (*See Class 35 for this trademark*).
- 2,623,163. **AVN AUTOMATED VOTING NETWORK AND DESIGN**. COOPER, WILLIAM E., (U.S. CLS. 100 AND 101). SN 76-107,381. PUB. 7-2-2002. FILED 8-7-2000.
- 2,623,165 (*See Class 35 for this trademark*).
- 2,623,167 (*See Class 38 for this trademark*).
- 2,623,169 (*See Class 16 for this trademark*).
- 2,623,185. **IRELAY**. CYNOCOM CORPORATION, (U.S. CLS. 100 AND 101). SN 76-113,354. PUB. 7-2-2002. FILED 8-21-2000.
- 2,623,187. **SIREN**. COURTNESSE LLC, DBA SIREN RESTAURANT AND BAR, (U.S. CLS. 100 AND 101). SN 76-113,981. PUB. 7-31-2001. FILED 8-21-2000.
- 2,623,191. **THE KITCHEN BEAUTICIAN**. HALLOWELL, ROBERT LEROY II, (U.S. CLS. 100 AND 101). SN 76-115,324. PUB. 7-2-2002. FILED 8-24-2000.
- 2,623,208. **MISCELLANEOUS DESIGN**. BUCHANAN INGERSOLL PROFESSIONAL CORPORATION, (U.S. CLS. 100 AND 101). SN 76-119,462. PUB. 7-2-2002. FILED 8-30-2000.
- 2,623,210. **SALESGENIE**. SALES MOUNTAIN.COM, INC., (U.S. CLS. 100 AND 101). SN 76-120,821. PUB. 7-2-2002. FILED 9-1-2000.
- 2,623,212 (*See Class 35 for this trademark*).
- 2,623,215 (*See Class 16 for this trademark*).
- 2,623,216 (*See Class 41 for this trademark*).
- 2,623,224 (*See Class 9 for this trademark*).
- 2,623,231. **QFLOW SYSTEMS**. QFLOW SYSTEMS, LLC, (U.S. CLS. 100 AND 101). SN 76-127,310. PUB. 7-2-2002. FILED 9-12-2000.
- 2,623,237 (*See Class 35 for this trademark*).
- 2,623,238. **WWW.HOMEBUSINESS.TO DEDICATED TO THE HOMEPRENEUR AND DESIGN**. HOMEBUSINESS.TO, INC., (U.S. CLS. 100 AND 101). SN 76-128,526. PUB. 7-2-2002. FILED 9-15-2000.
- 2,623,241 (*See Class 9 for this trademark*).
- 2,623,242. **FAST TO MARKET**. WENTWORTH TECHNOLOGIES, INC., (U.S. CLS. 100 AND 101). SN 76-130,683. PUB. 7-2-2002. FILED 9-19-2000.
- 2,623,248. **E-TRANZIT & DESIGN AND DESIGN**. ADS LOGISTICS, LLC, BY ASSIGNMENT ALTERNATIVE DISTRIBUTION SYSTEMS, INC., (U.S. CLS. 100 AND 101). SN 76-132,331. PUB. 7-2-2002. FILED 9-19-2000.
- 2,623,257 (*See Class 41 for this trademark*).
- 2,623,259. **SERVE-EM.COM**. SERVE-EM.COM, INC., (U.S. CLS. 100 AND 101). SN 76-134,120. PUB. 7-2-2002. FILED 9-23-2000.
- 2,623,265 (*See Class 41 for this trademark*).
- 2,623,266. **LENNIE**. KAL KAN FOODS, INC., (U.S. CLS. 100 AND 101). SN 76-134,892. PUB. 7-2-2002. FILED 9-25-2000.

- 2,623,267. **GOLDIE**. KAL KAN FOODS, INC., (U.S. CLS. 100 AND 101). SN 76-134,893. PUB. 7-2-2002. FILED 9-25-2000.
- 2,623,268. **DEZ**. KAL KAN FOODS, INC., (U.S. CLS. 100 AND 101). SN 76-134,895. PUB. 7-2-2002. FILED 9-25-2000.
- 2,623,270 (*See Class 38 for this trademark*).
- 2,623,273. **TENNESSEE ONCOLOGY AND DESIGN**. TENNESSEE ONCOLOGY, PLLC, (U.S. CLS. 100 AND 101). SN 76-135,836. PUB. 7-2-2002. FILED 9-26-2000.
- 2,623,276 (*See Class 36 for this trademark*).
- 2,623,277. **MAVERICK TECHNOLOGIES**. MAVERICK TECHNOLOGIES HOLDINGS, LLC, (U.S. CLS. 100 AND 101). SN 76-136,467. PUB. 7-2-2002. FILED 9-27-2000.
- 2,623,281. **"TOOLS FOR SCHOOL"**. SALVATION ARMY, THE, (U.S. CLS. 100 AND 101). SN 76-136,862. PUB. 7-2-2002. FILED 9-25-2000.
- 2,623,290. **MISCELLANEOUS DESIGN**. KAL KAN FOODS, INC., (U.S. CLS. 100 AND 101). SN 76-138,800. PUB. 7-2-2002. FILED 9-29-2000.
- 2,623,291. **MISCELLANEOUS DESIGN**. KAL KAN FOODS, INC., (U.S. CLS. 100 AND 101). SN 76-138,801. PUB. 7-2-2002. FILED 9-29-2000.
- 2,623,298. **MISCELLANEOUS DESIGN**. KAL KAN FOODS, INC., (U.S. CLS. 100 AND 101). SN 76-139,207. PUB. 7-2-2002. FILED 9-29-2000.
- 2,623,299. **LIFE GOES ON BE AN ORGAN DONOR AND DESIGN**. ILLINOIS SECRETARY OF STATE, (U.S. CLS. 100 AND 101). SN 76-139,220. PUB. 7-2-2002. FILED 10-2-2000.
- 2,623,306 (*See Class 9 for this trademark*).
- 2,623,313. **WAMWARE**. WAMWARE, LTD, (U.S. CLS. 100 AND 101). SN 76-142,944. PUB. 7-2-2002. FILED 10-6-2000.
- 2,623,316 (*See Class 41 for this trademark*).
- 2,623,319 (*See Class 9 for this trademark*).
- 2,623,323 (*See Class 37 for this trademark*).
- 2,623,329. **MASTER VISUALLY**. IDG BOOKS WORLDWIDE, INC., (U.S. CLS. 100 AND 101). SN 76-146,035. PUB. 7-2-2002. FILED 10-12-2000.
- 2,623,331 (*See Class 41 for this trademark*).
- 2,623,332 (*See Class 37 for this trademark*).
- 2,623,333. **INTERNATIONAL CORNEA PROJECT**. SAN DIEGO EYE BANK, (U.S. CLS. 100 AND 101). SN 76-146,623. PUB. 7-2-2002. FILED 10-16-2000.
- 2,623,335 (*See Class 35 for this trademark*).
- 2,623,336 (*See Class 35 for this trademark*).
- 2,623,342 (*See Class 9 for this trademark*).
- 2,623,345. **CURIOUS NETWORKS**. CURIOUS NETWORKS, INC., (U.S. CLS. 100 AND 101). SN 76-148,572. PUB. 7-2-2002. FILED 10-18-2000.
- 2,623,356. **P.S. I LOVE YOU**. ONEPUB.COM, (U.S. CLS. 100 AND 101). SN 76-150,911. PUB. 7-2-2002. FILED 10-20-2000.
- 2,623,369 (*See Class 35 for this trademark*).
- 2,623,373 (*See Class 9 for this trademark*).
- 2,623,378. **MISCELLANEOUS DESIGN**. ARNOLD COMMUNICATIONS, INC., (U.S. CLS. 100 AND 101). SN 76-153,310. PUB. 7-2-2002. FILED 10-25-2000.
- 2,623,387. **COLLEGE-MATCH**. COLLEGE-MATCH, INC., (U.S. CLS. 100 AND 101). SN 76-154,587. PUB. 7-2-2002. FILED 10-26-2000.
- 2,623,388. **SPECIALMADE GOODS AND SERVICES, INC. AND DESIGN**. SPECIALMADE GOODS AND SERVICES, INC., (U.S. CLS. 100 AND 101). SN 76-154,755. PUB. 7-2-2002. FILED 10-30-2000.
- 2,623,396. **BAPS**. BOCHASANWASI SHREE AKSHAR PURUSHOTTAM SWAMINARAYAN SANSTHA INC., (U.S. CLS. 100 AND 101). SN 76-156,846. PUB. 7-2-2002. FILED 10-31-2000.
- 2,623,399. **LITTLEPAWS (STYLIZED)**. PAWLAK, LAURA, (U.S. CLS. 100 AND 101). SN 76-157,578. PUB. 7-2-2002. FILED 10-31-2000.
- 2,623,401. **USE-IT**. SIGNET SYSTEMS, LLC, (U.S. CLS. 100 AND 101). SN 76-157,876. PUB. 7-2-2002. FILED 11-1-2000.
- 2,623,404 (*See Class 40 for this trademark*).
- 2,623,413. **TRUST YOUR EARS TO THE EXPERTS**. CENTRAL INSTITUTE FOR THE DEAF, (U.S. CLS. 100 AND 101). SN 76-158,733. PUB. 7-2-2002. FILED 11-2-2000.
- 2,623,415. **YOUR POINT OF CONVERGENCE**. VISTA INFORMATION TECHNOLOGIES, INC., (U.S. CLS. 100 AND 101). SN 76-159,136. PUB. 7-2-2002. FILED 11-6-2000.
- 2,623,423. **INFOSAGE**. INFOSAGE, INC., (U.S. CLS. 100 AND 101). SN 76-160,190. PUB. 3-12-2002. FILED 11-6-2000.
- 2,623,426. **ACTIVATIONNOW**. SYNCHRONOSS TECHNOLOGIES, INC., (U.S. CLS. 100 AND 101). SN 76-160,606. PUB. 7-2-2002. FILED 11-7-2000.
- 2,623,427. **TACOS EL GORDO DE TIJUANA B.C. AND DESIGN**. ROJAS, MIGUEL, (U.S. CLS. 100 AND 101). SN 76-160,619. PUB. 5-28-2002. FILED 11-7-2000.
- 2,623,430. **MAKINGWWWAVES**. MAKING WAVES HAIR SALON, INC., (U.S. CLS. 100 AND 101). SN 76-161,046. PUB. 7-2-2002. FILED 11-7-2000.
- 2,623,434. **PET SITTERS INTERNATIONAL**. PET SITTERS INTERNATIONAL, INC., (U.S. CLS. 100 AND 101). SN 76-161,660. PUB. 7-2-2002. FILED 11-8-2000.
- 2,623,446. **SYSTEM SAFETY SOCIETY**. SYSTEM SAFETY SOCIETY, INC., (U.S. CLS. 100 AND 101). SN 76-165,356. PUB. 7-2-2002. FILED 11-14-2000.
- 2,623,447. **SEMICONDUCTOR RESEARCH CORPORATION**. SEMICONDUCTOR RESEARCH CORPORATION, (U.S. CLS. 100 AND 101). SN 76-165,596. PUB. 7-2-2002. FILED 11-15-2000.
- 2,623,451 (*See Class 9 for this trademark*).
- 2,623,457. **A WELCOME SIGN**. PARK HOSPITALITY LLC, (U.S. CLS. 100 AND 101). SN 76-166,583. PUB. 7-2-2002. FILED 11-16-2000.
- 2,623,460 (*See Class 9 for this trademark*).
- 2,623,461 (*See Class 9 for this trademark*).
- 2,623,465 (*See Class 35 for this trademark*).
- 2,623,467 (*See Class 35 for this trademark*).
- 2,623,469 (*See Class 9 for this trademark*).
- 2,623,474 (*See Class 35 for this trademark*).
- 2,623,475. **PUNCH**. CIVITALI RESTAURANT CORPORATION, (U.S. CLS. 100 AND 101). SN 76-170,250. PUB. 7-2-2002. FILED 11-24-2000.
- 2,623,478 (*See Class 9 for this trademark*).
- 2,623,479 (*See Class 9 for this trademark*).
- 2,623,480. **BIWATER AND DESIGN**. BIWATER PLC, (U.S. CLS. 100 AND 101). SN 76-170,657. PUB. 7-2-2002. FILED 11-27-2000.
- 2,623,509. **JUKE JOINT'S SUNDAY GOSPEL BRUNCH STIR-RIN' UP YOUR SOUL! AND DESIGN**. BRADY, LEON, LLL, (U.S. CLS. 100 AND 101). SN 76-174,143. PUB. 7-2-2002. FILED 12-4-2000.
- 2,623,510. **CHEMBRIDGE RESEARCH LABORATORIES**. CHEMBRIDGE CORPORATION, (U.S. CLS. 100 AND 101). SN 76-174,168. PUB. 7-2-2002. FILED 12-1-2000.
- 2,623,516 (*See Class 35 for this trademark*).
- 2,623,519. **TOTAL PACKAGE SOLUTION**. LUZENAC AMERICA, INC., (U.S. CLS. 100 AND 101). SN 76-175,930. PUB. 7-2-2002. FILED 12-5-2000.
- 2,623,523. **ATM APOSTOLIC TEAM MINISTRIES, INTERNATIONAL AND DESIGN**. APOSTOLIC TEAM MINISTRIES, INTERNATIONAL, (U.S. CLS. 100 AND 101). SN 76-176,419. PUB. 7-2-2002. FILED 12-6-2000.
- 2,623,526 (*See Class 38 for this trademark*).
- 2,623,527. **MISCELLANEOUS DESIGN**. GETTY, PAUL M., (U.S. CLS. 100 AND 101). SN 76-176,869. PUB. 7-2-2002. FILED 12-7-2000.
- 2,623,529 (*See Class 9 for this trademark*).
- 2,623,531 (*See Class 9 for this trademark*).
- 2,623,552. **KINDERSTART**. KINDERSTART, LLC, (U.S. CLS. 100 AND 101). SN 76-180,781. PUB. 7-2-2002. FILED 12-14-2000.
- 2,623,555. **EMC2 (STYLIZED)**. EMC CORPORATION, (U.S. CLS. 100 AND 101). SN 76-181,002. PUB. 7-2-2002. FILED 12-14-2000.
- 2,623,556. **EMC**. EMC CORPORATION, (U.S. CLS. 100 AND 101). SN 76-181,003. PUB. 7-2-2002. FILED 12-14-2000.
- 2,623,559 (*See Class 9 for this trademark*).
- 2,623,563 (*See Class 35 for this trademark*).
- 2,623,567 (*See Class 24 for this trademark*).
- 2,623,581. **ASHEVILLE NC'S CENTER FOR MASSAGE & NATURAL HEALTH AND DESIGN**. PMG HEALTHCOM, INC., (U.S. CLS. 100 AND 101). SN 76-185,289. PUB. 7-2-2002. FILED 12-21-2000.
- 2,623,593. **UNIVERSE OF FUN.COM**. UNIVERSEOFFUN.COM, INC., (U.S. CLS. 100 AND 101). SN 76-187,080. PUB. 7-2-2002. FILED 12-27-2000.

- 2,623,599 (*See Class 41 for this trademark.*)
 2,623,619 (*See Class 9 for this trademark.*)
 2,623,623 (*See Class 35 for this trademark.*)
 2,623,624 (*See Class 35 for this trademark.*)
 2,623,635. **WASHTECH.COM AND DESIGN.** WASHINGTON-POST.NEWSWEEK INTERACTIVE COMPANY, LLC, (U.S. CLS. 100 AND 101). SN 76-192,440. PUB. 7-2-2002. FILED 1-11-2001.
 2,623,636. **WE BRING TREATMENT, CHRIST DELIVERS THE CURE.** MEDICS FOR CHRIST INT'L., (U.S. CLS. 100 AND 101). SN 76-192,608. PUB. 7-2-2002. FILED 1-8-2001.
 2,623,637 (*See Class 36 for this trademark.*)
 2,623,638. **MOTHER'S KEEPER.** MOTHER'S KEEPER, INC., (U.S. CLS. 100 AND 101). SN 76-192,716. PUB. 7-2-2002. FILED 1-11-2001.
 2,623,639. **FENNEMORE CRAIG.** FENNEMORE CRAIG A PROFESSIONAL, (U.S. CLS. 100 AND 101). SN 76-192,878. PUB. 6-4-2002. FILED 1-11-2001.
 2,623,652 (*See Class 39 for this trademark.*)
 2,623,655. **AI AND DESIGN.** AMERICAN INNOVATIONS, LTD., (U.S. CLS. 100 AND 101). SN 76-194,635. PUB. 7-2-2002. FILED 1-17-2001.
 2,623,659. **LOUIE LEDEAUX CAJUN SEAFOOD KITCHEN AND DESIGN.** CAJUN SEAFOOD KITCHEN LLC, (U.S. CLS. 100 AND 101). SN 76-195,157. PUB. 7-2-2002. FILED 1-12-2001.
 2,623,665 (*See Class 35 for this trademark.*)
 2,623,667. **MISCELLANEOUS DESIGN.** SAFERTEK INTERNATIONAL, INC., (U.S. CLS. 100 AND 101). SN 76-196,470. PUB. 6-11-2002. FILED 1-19-2001.
 2,623,684. **THE INFORMANT.** DBA DIRECT, INC., (U.S. CLS. 100 AND 101). SN 76-197,787. PUB. 7-2-2002. FILED 1-22-2001.
 2,623,687 (*See Class 16 for this trademark.*)
 2,623,689. **PORTOFINO GRILLE.** PORTOFINO GRILLE, INC., (U.S. CLS. 100 AND 101). SN 76-198,809. PUB. 7-2-2002. FILED 1-24-2001.
 2,623,700 (*See Class 35 for this trademark.*)
 2,623,704 (*See Class 35 for this trademark.*)
 2,623,706. **MHT.** SAVANT, INC., (U.S. CLS. 100 AND 101). SN 76-200,706. PUB. 7-2-2002. FILED 1-26-2001.
 2,623,707. **ALIMS.** ITT INDUSTRIES, INC., (U.S. CLS. 100 AND 101). SN 76-200,727. PUB. 7-2-2002. FILED 1-29-2001.
 2,623,711 (*See Class 35 for this trademark.*)
 2,623,718. **B BRENTWOOD BAPTIST CHURCH AND DESIGN.** BRENTWOOD BAPTIST CHURCH, (U.S. CLS. 100 AND 101). SN 76-202,541. PUB. 7-2-2002. FILED 1-16-2001.
 2,623,719 (*See Class 9 for this trademark.*)
 2,623,724 (*See Class 9 for this trademark.*)
 2,623,727 (*See Class 35 for this trademark.*)
 2,623,728 (*See Class 16 for this trademark.*)
 2,623,732 (*See Class 35 for this trademark.*)
 2,623,736 (*See Class 39 for this trademark.*)
 2,623,741. **EBOLOCS.** DESIGNER BRAIDS AND TRADE INC., (U.S. CLS. 100 AND 101). SN 76-204,038. PUB. 10-30-2001. FILED 2-2-2001.
 2,623,742. **POWERWAY.** POWERWAY, INC., (U.S. CLS. 100 AND 101). SN 76-204,105. PUB. 7-2-2002. FILED 2-1-2001.
 2,623,747 (*See Class 37 for this trademark.*)
 2,623,748. **THE END STARTS HERE GOTTAQUIT.COM.** MONROE COUNTY, (U.S. CLS. 100 AND 101). SN 76-204,839. PUB. 5-28-2002. FILED 2-6-2001.
 2,623,758. **SATAMA - WE ARE YOU.** SATAMA INTERACTIVE OYJ, (U.S. CLS. 100 AND 101). SN 76-206,294. PUB. 7-2-2002. FILED 2-7-2001.
 2,623,762 (*See Class 9 for this trademark.*)
 2,623,768. **THE LIFE GIVERS NETWORK.** JAMES HENRY COUNSELING ASSOCIATES, (U.S. CLS. 100 AND 101). SN 76-207,672. PUB. 7-2-2002. FILED 2-9-2001.
 2,623,772. **ECAMSECURE.COM COMMERCIAL PROTECTIVE SERVICES CONSTRUCTION PROTECTIVE SERVICES AND DESIGN.** COFFEY, CHRISTOPHER, (U.S. CLS. 100 AND 101). SN 76-208,844. PUB. 7-2-2002. FILED 2-13-2001.
 2,623,781 (*See Class 37 for this trademark.*)
 2,623,784. **CARANDDRIVER.COM.** HACHETTE FILIPACCHI MEDIA U.S., INC., BY CHANGE OF NAME HACHETTE FILIPACCHI MAGAZINES, INC., (U.S. CLS. 100 AND 101). SN 76-210,734. PUB. 7-2-2002. FILED 2-12-2001.
 2,623,792. **TSC.** TECHNOLOGY SERVICE CORPORATION, (U.S. CLS. 100 AND 101). SN 76-211,728. PUB. 7-2-2002. FILED 2-20-2001.
 2,623,795. **LAS VENTANAS AL PARAISO.** PARAISO LOS CABOS S.A. DE CV, (U.S. CLS. 100 AND 101). SN 76-212,028. PUB. 7-2-2002. FILED 2-15-2001.
 2,623,802 (*See Class 41 for this trademark.*)
 2,623,819 (*See Class 37 for this trademark.*)
 2,623,830. **PEOPLECAPITOL AND DESIGN.** PEOPLECAPITAL, INC., (U.S. CLS. 100 AND 101). SN 76-217,178. PUB. 7-2-2002. FILED 2-27-2001.
 2,623,831 (*See Class 30 for this trademark.*)
 2,623,832 (*See Class 9 for this trademark.*)
 2,623,858. **MONTECRISTO.** CUBAN CIGAR BRANDS, N.V., (U.S. CLS. 100 AND 101). SN 76-220,705. PUB. 7-2-2002. FILED 3-5-2001.
 2,623,859 (*See Class 9 for this trademark.*)
 2,623,863 (*See Class 37 for this trademark.*)
 2,623,870. **MERGER MURMURS.** REED, STANLEY FOSTER, DBA REED ASSOCIATES, BY ASSIGNMENT STANLEY FOSTER REED & ASSOCIATES, INC., (U.S. CLS. 100 AND 101). SN 76-221,951. PUB. 7-2-2002. FILED 3-9-2001.
 2,623,872. **PORTRAITS BY LORRIE.** STUHLMACHER, LORRIE ANN, (U.S. CLS. 100 AND 101). SN 76-222,173. PUB. 7-2-2002. FILED 3-9-2001.
 2,623,877. **OMNICLUSTER.** OMNICLUSTER TECHNOLOGIES, INC., (U.S. CLS. 100 AND 101). SN 76-222,652. PUB. 7-2-2002. FILED 3-9-2001.
 2,623,891 (*See Class 9 for this trademark.*)
 2,623,900 (*See Class 16 for this trademark.*)
 2,623,906. **PIPER-HEIDSIECK.** PIPER-HEIDSIECK - ANCIENNE MAISON HEIDSIECK FONDEE EN 1785 - COMPAGNIE CHAMPENOISE S.A., (U.S. CLS. 100 AND 101). SN 76-226,401. PUB. 7-2-2002. FILED 3-19-2001.
 2,623,907 (*See Class 1 for this trademark.*)
 2,623,909 (*See Class 16 for this trademark.*)
 2,623,911 (*See Class 37 for this trademark.*)
 2,623,917 (*See Class 35 for this trademark.*)
 2,623,921. **MISCELLANEOUS DESIGN.** GULF COAST JEWISH FAMILY SERVICES, INC., DBA GULF COAST COMMUNITY CARE, (U.S. CLS. 100 AND 101). SN 76-228,794. PUB. 7-2-2002. FILED 3-22-2001.
 2,623,923. **BMC BIXBY MEDICAL CENTER AND DESIGN.** EMMA L. BIXBY MEDICAL CENTER, (U.S. CLS. 100 AND 101). SN 76-229,102. PUB. 7-2-2002. FILED 3-22-2001.
 2,623,940. **DIGIQUEST.** DIGIREPROGRAPHICS USA, INC., (U.S. CLS. 100 AND 101). SN 76-232,060. PUB. 7-2-2002. FILED 3-29-2001.
 2,623,953. **VICTORIA EYE CENTER EXCELLENCE IN EYE CARE AND DESIGN.** VICTORIA EYE CENTER, P.A., (U.S. CLS. 100 AND 101). SN 76-233,253. PUB. 7-2-2002. FILED 4-2-2001.
 2,623,956 (*See Class 16 for this trademark.*)
 2,623,958. **MINNESOTA LYNX AND DESIGN.** WNBA ENTERPRISES, LLC, (U.S. CLS. 100 AND 101). SN 76-234,121. PUB. 7-2-2002. FILED 4-2-2001.
 2,623,971. **PUTTER STUDIO.** SCOTT CAMERON GOLF DESIGN INC., (U.S. CLS. 100 AND 101). SN 76-235,796. PUB. 7-2-2002. FILED 4-4-2001.
 2,623,980. **COMIDAS Y BEBIDAS CON AMOR.** PLAZA MEXICO, INC., (U.S. CLS. 100 AND 101). SN 76-236,593. PUB. 7-2-2002. FILED 4-2-2001.
 2,623,982. **LEGALKEY.** LEGALKEY TECHNOLOGIES, INC., (U.S. CLS. 100 AND 101). SN 76-236,686. PUB. 7-2-2002. FILED 4-5-2001.
 2,623,985. **ROBINSON CRUSOE.** EMPRESA PESQUERA ROBINSON CRUSOE, S.A., (U.S. CLS. 100 AND 101). SN 76-236,858. PUB. 7-2-2002. FILED 4-9-2001.
 2,623,990 (*See Class 16 for this trademark.*)
 2,624,001 (*See Class 35 for this trademark.*)
 2,624,004 (*See Class 40 for this trademark.*)
 2,624,006 (*See Class 35 for this trademark.*)
 2,624,014 (*See Class 35 for this trademark.*)
 2,624,016. **SPRINTGUARD.** SPRINT COMMUNICATIONS COMPANY L.P., (U.S. CLS. 100 AND 101). SN 76-240,184. PUB. 7-2-2002. FILED 4-12-2001.
 2,624,023 (*See Class 16 for this trademark.*)

- 2,624,029 (See Class 35 for this trademark).
 2,624,030 (See Class 35 for this trademark).
 2,624,039 (See Class 9 for this trademark).
 2,624,041 (See Class 9 for this trademark).
 2,624,059. **WIRED WORKPLACE**. GLOBALQUEST, LLC, (U.S. CLS. 100 AND 101). SN 76-243,751. PUB. 7-2-2002. FILED 4-23-2001.
 2,624,065. **BUZZWORDS**. GEORGIA TECH ALUMNI ASSOCIATION, (U.S. CLS. 100 AND 101). SN 76-244,543. PUB. 7-2-2002. FILED 4-20-2001.
 2,624,066. **ROUTEMATCH**. ROUTEMATCH SOFTWARE, INC., BY CHANGE OF NAME ROUTEMATCH.COM, INC., (U.S. CLS. 100 AND 101). SN 76-244,586. PUB. 7-2-2002. FILED 4-23-2001.
 2,624,075. **ZT (STYLIZED)**. ZETA-TECH ASSOCIATES, INC., (U.S. CLS. 100 AND 101). SN 76-246,226. PUB. 7-2-2002. FILED 4-26-2001.
 2,624,082 (See Class 35 for this trademark).
 2,624,084. **THE HELP YOU NEED**. NORTHWEST SOFTWARE, INC., (U.S. CLS. 100 AND 101). SN 76-247,116. PUB. 7-2-2002. FILED 4-27-2001.
 2,624,085. **INTOWN SUITES AND DESIGN**. INTOWN SUITES MANAGEMENT, INC., (U.S. CLS. 100 AND 101). SN 76-247,154. PUB. 7-2-2002. FILED 4-26-2001.
 2,624,086. **CUSP**. CREDIT SUISSE FIRST BOSTON CORPORATION, (U.S. CLS. 100 AND 101). SN 76-247,169. PUB. 7-2-2002. FILED 4-26-2001.
 2,624,092 (See Class 25 for this trademark).
 2,624,094 (See Class 41 for this trademark).
 2,624,098. **FAT FLUSH**. ALG INC., (U.S. CLS. 100 AND 101). SN 76-248,283. PUB. 7-2-2002. FILED 4-27-2001.
 2,624,102. **NYPOST.COM**. NYP HOLDINGS, INC., (U.S. CLS. 100 AND 101). SN 76-248,907. PUB. 7-2-2002. FILED 4-30-2001.
 2,624,103 (See Class 35 for this trademark).
 2,624,110. **THE BONEYARD BEER FARM AND MESQUITE GRILL AND DESIGN**. LIQUID LIVING LLC, (U.S. CLS. 100 AND 101). SN 76-250,277. PUB. 7-2-2002. FILED 5-3-2001.
 2,624,119 (See Class 36 for this trademark).
 2,624,123 (See Class 41 for this trademark).
 2,624,131. **SOFTDEVINC. AND DESIGN**. SOFTDEV, INC., (U.S. CLS. 100 AND 101). SN 76-253,471. PUB. 7-2-2002. FILED 5-9-2001.
 2,624,132. **NATIONAL NARCOTICS DETECTOR DOG ASSOC. NNDDA SPONSOR K9 AND DESIGN**. NATIONAL NARCOTIC DETECTOR DOG ASSOCIATION, INC., THE, (U.S. CLS. 100 AND 101). SN 76-253,659. PUB. 7-2-2002. FILED 5-8-2001.
 2,624,138. **ACCUSCAN**. ACCUSIGHT, INC., (U.S. CLS. 100 AND 101). SN 76-254,970. PUB. 7-2-2002. FILED 5-10-2001.
 2,624,140. **GIOVINA INTERNATIONAL INCORPORATION AND DESIGN**. GIOVINA INTERNATIONAL NUTRITION, INC., (U.S. CLS. 100 AND 101). SN 76-255,006. PUB. 7-2-2002. FILED 5-10-2001.
 2,624,148 (See Class 9 for this trademark).
 2,624,158 (See Class 41 for this trademark).
 2,624,163. **WARDINO'S PIZZA AND GRINDERS**. SWEEBE, LAWRENCE EDWARD, (U.S. CLS. 100 AND 101). SN 76-258,267. PUB. 7-2-2002. FILED 5-17-2001.
 2,624,166. **LOTTOTRON**. LOTTOTRON, INC., (U.S. CLS. 100 AND 101). SN 76-258,495. PUB. 7-2-2002. FILED 5-18-2001.
 2,624,175. **ENCHANTED DREAMZ**. LABATOS, DIMITRIS, (U.S. CLS. 100 AND 101). SN 76-259,552. PUB. 7-2-2002. FILED 5-21-2001.
 2,624,176. **YANKEE DOODLE PIZZA AND DESIGN**. DAN'S PUB, INC., (U.S. CLS. 100 AND 101). SN 76-259,578. PUB. 7-2-2002. FILED 5-21-2001.
 2,624,178. **PROFESSIONAL THEATRE ACTORS' EQUITY ASSOCIATION FOUNDED IN 1913 AFL-CIO CLC AND DESIGN**. ACTORS' EQUITY ASSOCIATION, (U.S. CLS. 100 AND 101). SN 76-259,774. PUB. 7-2-2002. FILED 5-22-2001.
 2,624,189 (See Class 9 for this trademark).
 2,624,195. **GLOBAL CONCEPTS**. GLOBAL CONCEPTS, INC., (U.S. CLS. 100 AND 101). SN 76-260,970. PUB. 7-2-2002. FILED 5-23-2001.
 2,624,198 (See Class 9 for this trademark).
 2,624,204. **CAL (STYLIZED)**. CENTRE ANALYTICAL LABORATORIES, INC., (U.S. CLS. 100 AND 101). SN 76-262,511. PUB. 7-2-2002. FILED 5-8-2001.
 2,624,211. **KNOWLEDGE ANYWHERE**. KNOWLEDGE ANYWHERE, INC., (U.S. CLS. 100 AND 101). SN 76-262,738. PUB. 7-2-2002. FILED 5-24-2001.
 2,624,212 (See Class 35 for this trademark).
 2,624,213. **ENABLING BUSINESS THROUGH TECHNOLOGY**. CATAPULT SYSTEMS CORP., (U.S. CLS. 100 AND 101). SN 76-262,866. PUB. 7-2-2002. FILED 5-25-2001.
 2,624,218. **PIXEL LIGHT DIGITAL MEDIA, INC. (STYLIZED)**. PIXEL LIGHT DIGITAL MEDIA, INC., (U.S. CLS. 100 AND 101). SN 76-263,649. PUB. 7-2-2002. FILED 5-29-2001.
 2,624,231. **MORTY'S**. BERGEN BRUNSWIG CORPORATION, (U.S. CLS. 100 AND 101). SN 76-264,970. PUB. 7-2-2002. FILED 6-1-2001.
 2,624,233 (See Class 36 for this trademark).
 2,624,241. **AURICAL**. ADVANTAGE GEOCHEMICAL SOLUTIONS PTY LTD, (U.S. CLS. 100 AND 101). SN 76-265,761. PUB. 7-2-2002. FILED 5-31-2001.
 2,624,245 (See Class 39 for this trademark).
 2,624,246. **ZYGOX**. ZYGOX, INC., (U.S. CLS. 100 AND 101). SN 76-266,143. PUB. 7-2-2002. FILED 5-31-2001.
 2,624,251. **RIGHTFUEL**. INNERACTIVE NUTRITION NETWORK, INC., (U.S. CLS. 100 AND 101). SN 76-266,807. PUB. 7-2-2002. FILED 6-4-2001.
 2,624,254 (See Class 36 for this trademark).
 2,624,257. **GOALCARD AND DESIGN**. LEARNING TOOLS INTERNATIONAL, INC., (U.S. CLS. 100 AND 101). SN 76-267,500. PUB. 7-2-2002. FILED 6-4-2001.
 2,624,261 (See Class 37 for this trademark).
 2,624,263. **OUT OF OUR MINDS AND INTO YOUR EARS**. SOUNDSTORM, INC., (U.S. CLS. 100 AND 101). SN 76-268,549. PUB. 7-2-2002. FILED 6-11-2001.
 2,624,264. **ISOPRINT**. ISOPRINT, INC., (U.S. CLS. 100 AND 101). SN 76-268,625. PUB. 7-2-2002. FILED 6-11-2001.
 2,624,267. **MISCELLANEOUS DESIGN**. W.T. LEY, P. C., (U.S. CLS. 100 AND 101). SN 76-268,677. PUB. 7-2-2002. FILED 6-9-2001.
 2,624,285 (See Class 9 for this trademark).
 2,624,291 (See Class 35 for this trademark).
 2,624,296. **YACHT WATCHMAN INTERNATIONAL, INC. AND DESIGN**. JAMES KNOSKA INDUSTRIES, LTD., (U.S. CLS. 100 AND 101). SN 76-271,360. PUB. 7-2-2002. FILED 6-13-2001.
 2,624,300 (See Class 35 for this trademark).
 2,624,315 (See Class 9 for this trademark).
 2,624,319. **ACCURINT**. SEISINT, INC., (U.S. CLS. 100 AND 101). SN 76-274,566. PUB. 7-2-2002. FILED 6-20-2001.
 2,624,321 (See Class 39 for this trademark).
 2,624,325. **STEVENS DAVIS**. STEVENS, DAVIS, MILLER & MOSHER, (U.S. CLS. 100 AND 101). SN 76-275,208. PUB. 7-2-2002. FILED 6-22-2001.
 2,624,326. **RICH MAY**. RICH MAY, A PROFESSIONAL CORPORATION, (U.S. CLS. 100 AND 101). SN 76-275,271. PUB. 7-2-2002. FILED 6-19-2001.
 2,624,327 (See Class 7 for this trademark).
 2,624,328 (See Class 7 for this trademark).
 2,624,336. **DATAVOX**. DATAVOX BUSINESS COMMUNICATIONS, (U.S. CLS. 100 AND 101). SN 76-276,474. PUB. 7-2-2002. FILED 6-26-2001.
 2,624,338 (See Class 41 for this trademark).
 2,624,340. **THE CAREY COMPANY AND DESIGN**. CAREY COMPANY, THE, (U.S. CLS. 100 AND 101). SN 76-276,873. PUB. 7-2-2002. FILED 6-27-2001.
 2,624,344. **SURESAVER WEEKENDS**. SHERATON CORPORATION, THE, (U.S. CLS. 100 AND 101). SN 76-277,431. PUB. 7-2-2002. FILED 6-25-2001.
 2,624,345. **MISCELLANEOUS DESIGN**. NEW ENGLAND SCIENCE FICTION ASSOCIATION, INC., (U.S. CLS. 100 AND 101). SN 76-277,556. PUB. 7-2-2002. FILED 6-28-2001.
 2,624,351. **CURTIS NATIONAL HAND CENTER**. UNION MEMORIAL HOSPITAL, INC., (U.S. CLS. 100 AND 101). SN 76-278,321. PUB. 7-2-2002. FILED 6-29-2001.
 2,624,353. **NATURAL APPROACH TO WELLNESS BENISON FAMILY CHIROPRACTIC AND DESIGN**. IAN S. BENISON, D.C., P.A., (U.S. CLS. 100 AND 101). SN 76-278,964. PUB. 7-2-2002. FILED 7-2-2001.
 2,624,364. **COOPER, WHITE & COOPER LLP**. COOPER, WHITE AND COOPER LLP, (U.S. CLS. 100 AND 101). SN 76-

- 76-281,405. PUB. 7-2-2002. FILED 7-6-2001.
- 2,624,372. **BISCUIT 'N GRAVY'S**. BOB EVANS RESTAURANTS OF MICHIGAN, INC., (U.S. CLS. 100 AND 101). SN 76-282,123. PUB. 7-2-2002. FILED 7-9-2001.
- 2,624,374. **NETWORKTOLOGY**. NETWORKTOLOGY, INC., (U.S. CLS. 100 AND 101). SN 76-282,231. PUB. 7-2-2002. FILED 7-10-2001.
- 2,624,375 (*See Class 35 for this trademark*).
- 2,624,379. **MEN & WOMEN OF ACTION AND DESIGN**. CHURCH OF GOD, (U.S. CLS. 100 AND 101). SN 76-283,099. PUB. 7-2-2002. FILED 7-6-2001.
- 2,624,382. **BODY PROS**. BODY PROS PHYSICAL THERAPY, LLC, (U.S. CLS. 100 AND 101). SN 76-283,855. PUB. 7-2-2002. FILED 7-10-2001.
- 2,624,387. **PRAGMATIST**. PRAGMATICS, INC., (U.S. CLS. 100 AND 101). SN 76-284,922. PUB. 7-2-2002. FILED 7-12-2001.
- 2,624,393. **CHIRO + PLUS KINESIOLOGY**. DOWTY, MILTON E., (U.S. CLS. 100 AND 101). SN 76-285,506. PUB. 7-2-2002. FILED 7-16-2001.
- 2,624,401 (*See Class 16 for this trademark*).
- 2,624,403. **REALCOLOR AND DESIGN**. SUN CHEMICAL CORPORATION, (U.S. CLS. 100 AND 101). SN 76-287,485. PUB. 7-2-2002. FILED 7-20-2001.
- 2,624,406. **HEAVENLY WEEKENDS**. STARWOOD HOTELS & RESORTS WORLDWIDE, INC., (U.S. CLS. 100 AND 101). SN 76-287,658. PUB. 7-2-2002. FILED 7-19-2001.
- 2,624,411. **SIGNALTREE SOLUTIONS**. SIGNALTREE SOLUTIONS, INC., (U.S. CLS. 100 AND 101). SN 76-288,224. PUB. 7-2-2002. FILED 7-23-2001.
- 2,624,412 (*See Class 35 for this trademark*).
- 2,624,415. **QTL BIOSYSTEMS**. QTL BIOSYSTEMS, LLC, (U.S. CLS. 100 AND 101). SN 76-288,864. PUB. 7-2-2002. FILED 7-23-2001.
- 2,624,418. **PUBSPRING**. HERITAGE PRESERVATION CORPORATION, (U.S. CLS. 100 AND 101). SN 76-289,312. PUB. 7-2-2002. FILED 7-24-2001.
- 2,624,422 (*See Class 36 for this trademark*).
- 2,624,425. **PROJECT S.E.A.R.C.H. SO EVERY AVAILABLE, READY CHILD HAS A HOME**. CHILDREN'S HOME, INC., THE, (U.S. CLS. 100 AND 101). SN 76-290,493. PUB. 7-2-2002. FILED 7-23-2001.
- 2,624,445 (*See Class 41 for this trademark*).
- 2,624,450 (*See Class 9 for this trademark*).
- 2,624,451 (*See Class 9 for this trademark*).
- 2,624,456. **PREFERRED EAP**. LEHIGH VALLEY HEALTH NETWORK, INC., (U.S. CLS. 100 AND 101). SN 76-293,820. PUB. 7-2-2002. FILED 8-1-2001.
- 2,624,463. **LA MELA AND DESIGN**. MATTIOLI, DOMENIC, DBA LA MELA RISTORANTE, (U.S. CLS. 100 AND 101). SN 76-295,003. PUB. 7-2-2002. FILED 8-2-2001.
- 2,624,465 (*See Class 9 for this trademark*).
- 2,624,489. **INTELLISHARE**. INTELLISHARE, LLC, (U.S. CLS. 100 AND 101). SN 76-299,575. PUB. 7-2-2002. FILED 8-14-2001.
- 2,624,490 (*See Class 16 for this trademark*).
- 2,624,491. **MMM (STYLIZED)**. MORRIS, MANNING & MARTIN, LLP, (U.S. CLS. 100 AND 101). SN 76-300,534. PUB. 7-2-2002. FILED 8-16-2001.
- 2,624,494 (*See Class 35 for this trademark*).
- 2,624,501. **SEEKERS COFFEE + MUSIC + COMMUNITY AND DESIGN**. SEEKERS COFFEE HOUSE, (U.S. CLS. 100 AND 101). SN 76-302,694. PUB. 7-2-2002. FILED 8-21-2001.
- 2,624,506 (*See Class 41 for this trademark*).
- 2,624,509. **DODAH**. DODAH, INC., (U.S. CLS. 100 AND 101). SN 76-303,371. PUB. 7-2-2002. FILED 8-22-2001.
- 2,624,512. **ARGOSY HEALTH**. KESSLER REHABILITATION CORPORATION, (U.S. CLS. 100 AND 101). SN 76-303,533. PUB. 7-2-2002. FILED 8-23-2001.
- 2,624,528. **LOS ANGELES MISSION THE CROSSROADS OF HOPE AND DESIGN**. LOS ANGELES MISSION, (U.S. CLS. 100 AND 101). SN 76-307,640. PUB. 7-2-2002. FILED 9-4-2001.
- 2,624,533 (*See Class 35 for this trademark*).
- 2,624,534 (*See Class 9 for this trademark*).
- 2,624,538. **SITECONFIDENCE AND DESIGN**. SITE CONFIDENCE LTD., (U.S. CLS. 100 AND 101). SN 76-309,007. PUB. 7-2-2002. FILED 9-5-2001.
- 2,624,545 (*See Class 35 for this trademark*).
- 2,624,551. **BAJA BLAST**. SWEETRIVER FRANCHISE, L.L.C., (U.S. CLS. 100 AND 101). SN 76-311,944. PUB. 7-2-2002. FILED 9-17-2001.
- 2,624,556. **THE WATCH HILL CONSERVANCY AND DESIGN**. WATCH HILL CONSERVANCY, THE, (U.S. CLS. 100 AND 101). SN 76-312,315. PUB. 7-2-2002. FILED 9-14-2001.
- 2,624,560. **WWW.888CLEANLA.COM (STYLIZED)**. LOS ANGELES COUNTY DEPARTMENT OF PUBLIC WORKS, (U.S. CLS. 100 AND 101). SN 76-312,895. PUB. 7-2-2002. FILED 9-18-2001.
- 2,624,562. **LAZYLAB**. STAR REFINING PLC, (U.S. CLS. 100 AND 101). SN 76-313,064. PUB. 7-2-2002. FILED 9-17-2001.
- 2,624,565. **S AND DESIGN**. SPITZNAGEL, INC., (U.S. CLS. 100 AND 101). SN 76-313,437. PUB. 7-2-2002. FILED 9-12-2001.
- 2,624,567 (*See Class 35 for this trademark*).
- 2,624,574. **PAY YOUR RESPECTS, NOT YOUR LIFE'S SAVINGS**. CHARTER FUNERALS OF MISSOURI, L.L.C., (U.S. CLS. 100 AND 101). SN 76-314,888. PUB. 7-2-2002. FILED 9-21-2001.
- 2,624,577. **DOMMEL RIVER**. KONINKLIJKE PHILIPS ELECTRONICS N.V., (U.S. CLS. 100 AND 101). SN 76-316,084. PUB. 7-2-2002. FILED 9-24-2001.
- 2,624,581 (*See Class 35 for this trademark*).
- 2,624,607. **ZAPATURE.COM**. ZAPATURE.COM, LLC, (U.S. CLS. 100 AND 101). SN 76-321,116. PUB. 7-2-2002. FILED 10-5-2001.
- 2,624,611. **ANGIOMOUSE**. ANTICANCER, INC., (U.S. CLS. 100 AND 101). SN 76-321,428. PUB. 7-2-2002. FILED 10-5-2001.
- 2,624,616. **ALLIED AIDS SERVICES**. PROJECT SAMARITAN AIDS SERVICES, INC., (U.S. CLS. 100 AND 101). SN 76-322,340. PUB. 7-2-2002. FILED 10-9-2001.
- 2,624,632. **AAHRPP**. ASSOCIATION FOR THE ACCREDITATION OF HUMAN RESEARCH PROTECTION PROGRAMS, INC. (AAHRPP), (U.S. CLS. 100 AND 101). SN 76-323,589. PUB. 7-2-2002. FILED 10-11-2001.
- 2,624,633. **ASHTON & PRICE**. ASHTON & PRICE, APC, (U.S. CLS. 100 AND 101). SN 76-323,723. PUB. 7-2-2002. FILED 10-10-2001.
- 2,624,638 (*See Class 36 for this trademark*).
- 2,624,640 (*See Class 35 for this trademark*).
- 2,624,646. **SELEXION**. BABCOCK, JOHN A, (U.S. CLS. 100 AND 101). SN 76-325,195. PUB. 7-2-2002. FILED 10-16-2001.
- 2,624,651 (*See Class 9 for this trademark*).
- 2,624,652. **HAILING FREQUENCIES AT HOME**. WALDENBOOKS PROPERTIES, INC., (U.S. CLS. 100 AND 101). SN 76-326,214. PUB. 7-2-2002. FILED 10-18-2001.
- 2,624,667. **SCHNADERLAW**. SCHNADER HARRISON SEGAL & LEWIS LLP, (U.S. CLS. 100 AND 101). SN 76-327,389. PUB. 7-2-2002. FILED 10-19-2001.
- 2,624,669. **ATS AND DESIGN**. APPALACHIAN TECHNICAL SERVICES, INC., (U.S. CLS. 100 AND 101). SN 76-327,701. PUB. 7-2-2002. FILED 10-22-2001.
- 2,624,671. **STATE OF THE DOMAIN**. SNAPNAMES.COM, INC., (U.S. CLS. 100 AND 101). SN 76-327,862. PUB. 7-2-2002. FILED 10-18-2001.
- 2,624,685. **CELEBRITY CHEF ALLIANCE AND DESIGN**. YIP*EEE, INC., (U.S. CLS. 100 AND 101). SN 76-329,853. PUB. 7-2-2002. FILED 10-23-2001.
- 2,624,703. **A NEW BEGINNING**. GENESIS HEALTH SYSTEMS, LLC, (U.S. CLS. 100 AND 101). SN 76-332,452. PUB. 7-2-2002. FILED 10-31-2001.
- 2,624,709. **AAHRPP ASSOCIATION FOR THE ACCREDITATION OF HUMAN RESEARCH PROTECTION PROGRAMS, INC. (STYLIZED)**. ASSOCIATION FOR THE ACCREDITATION OF HUMAN RESEARCH PROTECTION PROGRAMS, INC. (AAHRPP), (U.S. CLS. 100 AND 101). SN 76-333,257. PUB. 7-2-2002. FILED 11-5-2001.
- 2,624,710 (*See Class 9 for this trademark*).
- 2,624,712 (*See Class 16 for this trademark*).
- 2,624,722 (*See Class 35 for this trademark*).
- 2,624,723. **YOUTH AIDS AND DESIGN**. POPULATION SERVICES INTERNATIONAL, (U.S. CLS. 100 AND 101). SN 76-335,425. PUB. 7-2-2002. FILED 11-8-2001.
- 2,624,726. **AMT AND DESIGN**. APPLIED MATERIAL TECHNOLOGIES, INC., (U.S. CLS. 100 AND 101). SN 76-335,808. PUB. 7-2-2002. FILED 11-9-2001.
- 2,624,729. **CHINA BEAR AND DESIGN**. CHINA BEAR INC.,

- (U.S. CLS. 100 AND 101). SN 76-335,887. PUB. 7-2-2002. FILED 11-7-2001.
- 2,624,737. **IMAVEX**. IMAVEX, LLC, (U.S. CLS. 100 AND 101). SN 76-337,130. PUB. 7-2-2002. FILED 11-14-2001.
- 2,624,760 (*See Class 9 for this trademark*).
- 2,624,768. **WEBVOLUME**. XINET, INC., (U.S. CLS. 100 AND 101). SN 76-342,259. PUB. 7-2-2002. FILED 11-27-2001.
- 2,624,796. **CRAB HOUSE AT PIER 39 - SAN FRANCISCO "HOME OF CRABS ON PARADE" (STYLIZED)**. SFS 39 INC., (U.S. CLS. 100 AND 101). SN 76-345,438. PUB. 7-2-2002. FILED 12-4-2001.
- 2,624,820. **YOU'RE IN GOOD COMPANY HERE..** LITTLE COMPANY OF MARY HOSPITAL AND HEALTH CARE CENTERS, INC., (U.S. CLS. 100 AND 101). SN 76-348,606. PUB. 7-2-2002. FILED 12-12-2001.
- 2,624,834. **SCOTTS AND DESIGN**. OMS INVESTMENTS, INC., (U.S. CLS. 100 AND 101). SN 76-349,867. PUB. 7-2-2002. FILED 12-17-2001.
- 2,624,835. **MISCELLANEOUS DESIGN**. SMART CARD ALLIANCE, (U.S. CLS. 100 AND 101). SN 76-349,881. PUB. 7-2-2002. FILED 12-18-2001.
- 2,624,855 (*See Class 35 for this trademark*).
- 2,624,859. **MISCELLANEOUS DESIGN**. PIVOTAL PROMONTORY DEVELOPMENT, L.L.C, (U.S. CLS. 100 AND 101). SN 76-352,245. PUB. 7-2-2002. FILED 12-20-2001.
- 2,624,902. **MYRICOM**. MYRICOM, INC., (U.S. CLS. 100 AND 101). SN 76-358,682. PUB. 7-2-2002. FILED 1-15-2002.
- 2,624,905. **CODEREFINERY AND DESIGN**. CODE REFINERY, LLC, (U.S. CLS. 100 AND 101). SN 76-359,406. PUB. 7-2-2002. FILED 1-16-2002.
- 2,624,947 (*See Class 1 for this trademark*).
- 2,624,958. **TERABYTE.NET**. TERABYTE COMPUTERS, INC., (U.S. CLS. 100 AND 101). SN 78-004,435. PUB. 7-2-2002. FILED 4-17-2000.
- 2,624,959. **DIVORCE 123**. CRAWFORD & CRAWFORD, (U.S. CLS. 100 AND 101). SN 78-004,872. PUB. 7-2-2002. FILED 4-19-2000.
- 2,624,960. **BLACK DRAGON**. BLACK DRAGON, INC., (U.S. CLS. 100 AND 101). SN 78-005,138. PUB. 7-2-2002. FILED 4-21-2000.
- 2,624,963 (*See Class 38 for this trademark*).
- 2,624,964 (*See Class 39 for this trademark*).
- 2,624,973. **SYPORTSERVER TECHNOLOGIES**. SITESOURCE TECHNOLOGIES, LLC, (U.S. CLS. 100 AND 101). SN 78-015,454. PUB. 7-2-2002. FILED 7-5-2000.
- 2,624,981 (*See Class 9 for this trademark*).
- 2,624,991. **VECTORNET**. VECTORNET INTEGRATED SOLUTIONS, (U.S. CLS. 100 AND 101). SN 78-030,230. PUB. 7-2-2002. FILED 10-11-2000.
- 2,624,993. **OMKAR**. SHAH, KIRAN M., (U.S. CLS. 100 AND 101). SN 78-033,869. PUB. 7-2-2002. FILED 11-4-2000.
- 2,625,002 (*See Class 36 for this trademark*).
- 2,625,004. **NOWHERE? NOW, HERE!**. LIN, GERARD, (U.S. CLS. 100 AND 101). SN 78-041,172. PUB. 7-2-2002. FILED 12-30-2000.
- 2,625,007 (*See Class 9 for this trademark*).
- 2,625,024. **QUI TAM WHISTLEBLOWERLEGAL.COM AND DESIGN**. MCINNIS, TIMOTHY, J., (U.S. CLS. 100 AND 101). SN 78-047,823. PUB. 7-2-2002. FILED 2-12-2001.
- 2,625,035 (*See Class 16 for this trademark*).
- 2,625,056. **WE DO THE HEAVY LIFTING FOR EBUSINESS**. ARCHWING INNOVATIONS LLC, (U.S. CLS. 100 AND 101). SN 78-054,728. PUB. 7-2-2002. FILED 3-23-2001.
- 2,625,061 (*See Class 16 for this trademark*).
- 2,625,071. **3D ON THE LEVEL**. WESTERN, OWEN, C., (U.S. CLS. 100 AND 101). SN 78-058,735. PUB. 7-2-2002. FILED 4-17-2001.
- 2,625,072 (*See Class 35 for this trademark*).
- 2,625,073. **DECORATING DETAILS AND DESIGN**. DECORATING DETAILS, LLC, (U.S. CLS. 100 AND 101). SN 78-059,195. PUB. 7-2-2002. FILED 4-19-2001.
- 2,625,076 (*See Class 35 for this trademark*).
- 2,625,079 (*See Class 35 for this trademark*).
- 2,625,081. **BANDWERKZ**. BYTEAUDIO.COM, INC., (U.S. CLS. 100 AND 101). SN 78-060,510. PUB. 7-2-2002. FILED 4-26-2001.
- 2,625,092 (*See Class 35 for this trademark*).
- 2,625,095. **SOCKETS**. APRISA, INC., (U.S. CLS. 100 AND 101). SN 78-063,015. PUB. 7-2-2002. FILED 5-10-2001.
- 2,625,098. **MOUNTAIN PLEASURE HORSE ASSOCIATION**. MOUNTAIN PLEASURE HORSE ASSOCIATION, INC., (U.S. CLS. 100 AND 101). SN 78-063,095. PUB. 3-12-2002. FILED 5-11-2001.
- 2,625,103. **EXECUPLANET AND DESIGN**. LEE HECHT HARRISON, LLC, (U.S. CLS. 100 AND 101). SN 78-063,979. PUB. 7-2-2002. FILED 5-16-2001.
- 2,625,109 (*See Class 35 for this trademark*).
- 2,625,115. **? HERE2TALK YOUR INTERNET LIVE HELP AND DESIGN**. INTERACTIVE MARKETING CORP., (U.S. CLS. 100 AND 101). SN 78-065,284. PUB. 7-2-2002. FILED 5-23-2001.
- 2,625,127 (*See Class 9 for this trademark*).
- 2,625,137. **MISCELLANEOUS DESIGN**. TRUSECURE CORPORATION, (U.S. CLS. 100 AND 101). SN 78-070,186. PUB. 7-2-2002. FILED 6-20-2001.
- 2,625,139. **BERTL**. BUSINESS EQUIPMENT RESEARCH AND TEST LABORATORIES LTD, (U.S. CLS. 100 AND 101). SN 78-070,700. PUB. 7-2-2002. FILED 6-23-2001.
- 2,625,144. **SART AND DESIGN**. NORTH CAROLINA ANIMAL RELIEF FUND, (U.S. CLS. 100 AND 101). SN 78-071,729. PUB. 7-2-2002. FILED 6-29-2001.
- 2,625,149. **WD WEBVINE DESIGNS AND DESIGN**. MCCLELLAN, JAYME, LYN, (U.S. CLS. 100 AND 101). SN 78-072,806. PUB. 7-2-2002. FILED 7-8-2001.
- 2,625,154. **SSC**. INGERSOLL-RAND COMPANY, (U.S. CLS. 100 AND 101). SN 78-073,782. PUB. 7-2-2002. FILED 7-13-2001.
- 2,625,161. **NWH**. NEWTON-WELLESLEY HOSPITAL, (U.S. CLS. 100 AND 101). SN 78-077,031. PUB. 7-2-2002. FILED 8-2-2001.
- 2,625,162. **NWH AND DESIGN**. NEWTON-WELLESLEY HOSPITAL, (U.S. CLS. 100 AND 101). SN 78-077,034. PUB. 7-2-2002. FILED 8-2-2001.
- 2,625,173. **THE WILL DOCTOR**. SCHREINER, GARY B., (U.S. CLS. 100 AND 101). SN 78-079,699. PUB. 7-2-2002. FILED 8-16-2001.
- 2,625,186 (*See Class 37 for this trademark*).
- 2,625,209. **OURDIVORCEAGREEMENT.COM**. STEIN, STEVEN, MARK, (U.S. CLS. 100 AND 101). SN 78-087,323. PUB. 7-2-2002. FILED 10-8-2001.
- 2,625,218. **G & O GREENHORNE & O'MARA, INC. AND DESIGN**. GREENHORNE & O'MARA, INC., (U.S. CLS. 100 AND 101). SN 78-088,076. PUB. 7-2-2002. FILED 10-12-2001.
- 2,625,223. **SERVERLINKS**. MCKAY, BRYON L., (U.S. CLS. 100 AND 101). SN 78-088,989. PUB. 7-2-2002. FILED 10-18-2001.
- 2,625,238. **AMERICAN CONEY ISLAND**. AMERICAN CONEY ISLAND, INC., (U.S. CLS. 100 AND 101). SN 78-092,517. PUB. 7-2-2002. FILED 11-9-2001.
- 2,625,242. **THE LAGUNA BEACH COLONY HOTEL**. THE RITZ-CARLTON HOTEL COMPANY, L.L.C., (U.S. CLS. 100 AND 101). SN 78-092,751. PUB. 7-2-2002. FILED 11-12-2001.
- 2,625,260 (*See Class 36 for this trademark*).
- 2,625,262. **SMACKDOWN YOUR VOTE**. WORLD WRESTLING FEDERATION ENTERTAINMENT, INC., (U.S. CLS. 100 AND 101). SN 78-095,751. PUB. 7-2-2002. FILED 11-29-2001.
- 2,625,276. **ISPRODUCTIONS**. INFOSOURCE, INC., (U.S. CLS. 100 AND 101). SN 78-097,946. PUB. 7-2-2002. FILED 12-12-2001.
- 2,625,293 (*See Class 41 for this trademark*).
- 2,625,303. **FOCUSED RESOURCES...SUCCESSFUL SOLUTIONS**. SUELTHAUS & WALSH, P.C., (U.S. CLS. 100 AND 101). SN 78-103,349. PUB. 7-2-2002. FILED 1-17-2002.

CLASS 43—HOTEL AND RESTAURANT SERVICES

- 2,622,985. **CUCINA BRAVO! ITALIANA**. BRAVO DEVELOPMENT, INC., (U.S. CLS. 100 AND 101). SN 76-048,071. PUB. 7-2-2002. FILED 5-15-2000.
- 2,622,987. **BRAVO! CUCINA ITALIANA**. BRAVO DEVELOPMENT, INC., (U.S. CLS. 100 AND 101). SN 76-048,342. PUB.

7-2-2002. FILED 5-15-2000.
2,623,854 (*See Class 39 for this trademark*).
2,624,600. **SACO**. SACO FOODS, INC., (U.S. CLS. 100 AND 101). SN 76-320,245. PUB. 7-2-2002. FILED 10-3-2001.
2,624,750. **CATAL. PATINA GROUP, LLC, THE**, (U.S. CLS. 100 AND 101). SN 76-338,235. PUB. 7-2-2002. FILED 11-12-2001.
2,624,814. **JACK'S EST. 1960 AND DESIGN**. JACK'S FAMILY RESTAURANTS, INC., (U.S. CLS. 100 AND 101). SN 76-347,603. PUB. 7-2-2002. FILED 12-11-2001.
2,624,879. **THE PFISTER (STYLIZED)**. MARCUS CORPORATION, THE, (U.S. CLS. 100 AND 101). SN 76-356,077. PUB. 7-2-2002. FILED 1-7-2002.
2,625,231. **JAX**. JAX CAFE, INC., (U.S. CLS. 100 AND 101). SN 78-090,979. PUB. 7-2-2002. FILED 10-31-2001.

CLASS 44—MEDICAL, BEAUTY AND AGRICULTURAL SERVICES

2,622,895. **PETSUITES**. PETSUITES OF AMERICA, LLC, (U.S. CLS. 100 AND 101). SN 75-982,239. PUB. 7-2-2002. FILED 6-28-2000.
2,623,309 (*See Class 35 for this trademark*).
2,624,915 (*See Class 37 for this trademark*).

CLASS 45—PERSONAL SERVICES

2,624,698. **HOCKEY MINISTRIES INTERNATIONAL AND DESIGN**. HOCKEY MINISTRIES INTERNATIONAL, (U.S. CLS. 100 AND 101). SN 76-331,328. PUB. 7-2-2002. FILED 10-29-2001.

* * * * *

SECTION 2.—PRIOR UNITED STATES CLASSIFICATION

COLLECTIVE MEMBERSHIP MARKS

G. JR., SN 76-187,656. PUB. 7-2-2002. FILED 12-19-2000.

CLASS 200—COLLECTIVE MEMBERSHIP

2,623,627. **NIFTY NIBLICKS.** NIFTY NIBLICKS, THE, SN 76-190,392. PUB. 7-2-2002. FILED 1-4-2001.

2,622,800. **SIGMA PI PHI FRATERNITY AND DESIGN.** GRAND BOULE OF THE SIGMA PI PHI FRATERNITY, SN 75-883,801. PUB. 3-12-2002. FILED 1-3-2000.

2,624,083. **MEMBER OF RADTECH INTERNATIONAL NORTH AMERICA UV EB NATURALLY AND DESIGN.** RADTECH INTERNATIONAL NORTH AMERICA, SN 76-247,032. PUB. 7-2-2002. FILED 4-26-2001.

2,623,544 (*See Class 41 for this trademark*).

2,623,600. **MISCELLANEOUS DESIGN.** ZUBRAS, VINCENT

* * * * *

TRADEMARK REGISTRATIONS ISSUED UNDER SECTION 1(d)

The following marks have registered on the Principal Register pursuant to the intent-to-use provisions of Section 1(d) of the Trademark Act of 1946, as amended.

SECTION 1.— INTERNATIONAL CLASSIFICATION

The short titles associated below with the international class numbers are terms designed merely for quick identification and are not an official part of the international classification. The full names of international classes are given in section 6.1 of the trademark rules of practice.

The designation "U.S. Cl." appearing in this section refers to the U.S. class in effect prior to Sep. 1, 1973 rather than the international class which applies to applications filed on or after that date. For adoption of international classification see notice in the OFFICIAL GAZETTE of Jun. 26, 1973 (911 O.G. TM 210).

Application in more than one class

2,625,315. BIG COMFY CORP., TORONTO, ONTARIO M6P 3M9, CANADA. SN 75-048,997. PUB. 5-12-1998, FILED 1-26-1996.

WUZZY DUSTBUNNY

CLASS 9—ELECTRICAL AND SCIENTIFIC APPARATUS

FOR VIDEO CASSETTES AND AUDIO CASSETTES EACH FEATURING MUSIC AND STORIES FOR CHILDREN BASED ON CHARACTERS, SETTINGS, AND STORY LINES FROM APPLICANT'S TELEVISION PROGRAMMING (U.S. CLS. 21, 23, 26, 36 AND 38).
FIRST USE 10-1-1998; IN COMMERCE 10-1-1998.

CLASS 28—TOYS AND SPORTING GOODS

FOR SOFT AND PLUSH DOLLS (U.S. CLS. 22, 23, 38 AND 50).
FIRST USE 10-1-1998; IN COMMERCE 10-1-1998.

2,625,316. BIG COMFY CORP., TORONTO, ONTARIO M6P 3M9, CANADA. SN 75-066,459. PUB. 5-12-1998, FILED 3-1-1996.

**THE BIG
COMFY COUCH**

CLASS 9—ELECTRICAL AND SCIENTIFIC APPARATUS

FOR VIDEO CASSETTES AND AUDIO CASSETTES FEATURING MUSIC AND STORIES FOR CHILDREN BASED ON CHARACTERS, SETTINGS, AND STORY LINES FROM APPLICANT'S TELEVISION PROGRAMMING (U.S. CLS. 21, 23, 26, 36 AND 38).
FIRST USE 10-1-1998; IN COMMERCE 10-1-1998.

CLASS 16—PAPER GOODS AND PRINTED MATTER

FOR BOOKS, SING-ALONG BOOKS, HARD COVER BOOKS, COLORING BOOKS, ACTIVITY BOOKS, GIANT SIZE ACTIVITY BOOKS, WORKBOOKS, AND PAPERBACK BOOKS ALL FEATURING CHARACTERS, SETTINGS AND STORY LINES FROM APPLICANT'S CHILDREN'S TELEVISION PROGRAMMING; PRINTED PAPER MATERIALS AND PARTY FAVORS, NAMELY, INVITATIONS, NAPKINS, TABLE COVERS, GREETING CARDS, GIFT BOXES, STATIONERY, AND STICKERS; AND RUBBER STAMPS (U.S. CLS. 2, 5, 22, 23, 29, 37, 38 AND 50).

FIRST USE 10-1-1998; IN COMMERCE 10-1-1998.

CLASS 28—TOYS AND SPORTING GOODS

FOR TOYS AND GAMES, NAMELY, WOODEN PUZZLES, PAPERBOARD PUZZLES, DOLLS AND DOLL FIGURES, DOLL-SIZED PLAY COUCHES, SOFT AND PLUSH DOLLS, BALLOONS, CHRISTMAS TREE ORNAMENTS, AND JACK-IN-THE-BOXES (U.S. CLS. 22, 23, 38 AND 50).

FIRST USE 10-1-1998; IN COMMERCE 10-1-1998.

CLASS 41—EDUCATION AND ENTERTAINMENT

FOR EDUCATION AND ENTERTAINMENT SERVICES, NAMELY, PROVIDING A SERIES OF CHILDREN'S TELEVISION SHOWS AND EDUCATIONAL TELEVISION PROGRAMS, PERSONAL APPEARANCES BY A COSTUMED CHARACTER, AND MUSICAL STAGE SHOWS (U.S. CLS. 100, 101 AND 107).

FIRST USE 1-31-1995; IN COMMERCE 1-31-1995.

2,625,318. POLYPHALT LLC, EAST HOLLADAY, UT, BY ASSIGNMENT POLYPHALT INC., TORONTO, ONTARIO, CANADA. SN 75-080,702. PUB. 11-11-1997, FILED 3-29-1996.

DVX

CLASS 1—CHEMICALS

FOR BITUMINOUS CHEMICAL COMPOSITIONS FOR USE IN THE MANUFACTURE OF CONSTRUCTION MATERIALS AND SURFACES, SUCH AS COMMERCIAL, INDUSTRIAL AND RESIDENTIAL ROOFING, WATERPROOFING AND PAVING (U.S. CLS. 1, 5, 6, 10, 26 AND 46).

FIRST USE 4-2-2001; IN COMMERCE 5-1-2001.

CLASS 40—MATERIAL TREATMENT

FOR CHEMICAL PROCESSING SERVICES, NAMELY, MANUFACTURE OF BITUMINOUS CONSTRUCTION COMPOSITIONS TO THE ORDER AND/OR SPECIFICATION OF OTHERS, SUCH AS ROOFING MATERIALS, WATERPROOFING AND PAVING COMPOSITIONS (U.S. CLS. 100, 103 AND 106).

FIRST USE 4-2-2001; IN COMMERCE 5-1-2001.

2,625,319. AMERICAN SPORTING GOODS CORPORATION, IRVINE, CA, BY ASSIGNMENT KPR SPORTS INTERNATIONAL, INC., KING OF PRUSSIA, PA. SN 75-115,539. PUB. 1-7-1997, FILED 6-7-1996.

YUKON

OWNER OF U.S. REG. NO. 1,991,726.

CLASS 18—LEATHER GOODS

FOR BACKPACKS AND SOFT LUGGAGE (U.S. CLS. 1, 2, 3, 22 AND 41).

FIRST USE 5-9-2002; IN COMMERCE 5-9-2002.

CLASS 25—CLOTHING

FOR CLOTHING, NAMELY, T-SHIRTS, SWEAT SHIRTS, SWEAT PANTS, JACKETS, HATS, SOCKS, TANK TOPS, SHIRTS, WARM-UP SUITS, SHORTS, GLOVES AND UNDERWEAR (U.S. CLS. 22 AND 39).

FIRST USE 5-9-2002; IN COMMERCE 5-9-2002.

2,625,321. POST APARTMENT HOMES, L.P., ATLANTA, GA. SN 75-177,007. PUB. 1-16-2001, FILED 10-4-1996.

POST RIVERSIDE

OWNER OF U.S. REG. NOS. 1,477,071, 1,724,208, AND OTHERS.

CLASS 36—INSURANCE AND FINANCIAL

FOR REAL ESTATE SERVICES, NAMELY, LEASING AND MANAGING COMMERCIAL AND RESIDENTIAL PROPERTY AND BROKERAGE OF COMMERCIAL AND RESIDENTIAL PROPERTY (U.S. CLS. 100, 101 AND 102).

FIRST USE 7-29-1997; IN COMMERCE 7-29-1997.

CLASS 37—CONSTRUCTION AND REPAIR

FOR PLANNING, LAYING OUT AND DEVELOPING RESIDENTIAL COMMUNITIES AND COMMERCIAL PROPERTY (U.S. CLS. 100, 103 AND 106).

FIRST USE 7-29-1997; IN COMMERCE 7-29-1997.

2,625,325. MACROMEDIA INC., SAN FRANCISCO, CA. SN 75-217,352. PUB. 9-22-1998, FILED 12-23-1996.



CLASS 38—COMMUNICATION

FOR ELECTRONIC TRANSMISSION OF DATA, EXECUTABLES, APPLETS, PRESENTATIONS, PICTURES, SOUND AND VIDEO OVER THE GLOBAL COMPUTER INFORMATION NETWORK AND OTHER COMPUTER AND COMMUNICATION NETWORKS (U.S. CLS. 100, 101 AND 104).

FIRST USE 3-16-1997; IN COMMERCE 3-16-1997.

CLASS 42—SCIENTIFIC, COMPUTER AND LEGAL SERVICES

FOR PROVIDING MULTIPLE USER ACCESS TO ELECTRONIC BULLETIN BOARDS AND PUBLICATIONS, WEB PAGES, PRESENTATIONS AND APPLETS, ENTERTAINMENT, AND COMPUTER PROGRAMS; PROVIDING INFORMATION OVER A GLOBAL COMPUTER NETWORK ABOUT GRAPHIC DESIGN, MULTIMEDIA DESIGN AND DEVELOPMENT, AND SOFTWARE DESIGN AND DEVELOPMENT AND PROVIDING INFORMATION OVER A GLOBAL COMPUTER NETWORK ABOUT RETRIEVING, MANAGING AND MANIPULATING INTERACTIVE CONTENT (U.S. CLS. 100 AND 101).

FIRST USE 3-16-1997; IN COMMERCE 3-16-1997.

2,625,327. TELETECH CUSTOMER CARE MANAGEMENT (CALIFORNIA), INC., DENVER, CO. SN 75-222,467. PUB. 3-30-1999, FILED 1-7-1997.

THE ANSWER FOR YOUR CUSTOMERS

CLASS 35—ADVERTISING AND BUSINESS

FOR TELEPHONE ANSWERING SERVICES; TELEMARKETING; TELESERVICING, IN THE NATURE OF RECEIVING AND RESPONDING TO TELEPHONE INQUIRIES FROM CUSTOMERS OF OTHER BUSINESSES; EMPLOYMENT AND ADVERTISING AGENCY SERVICES FOR OTHERS; CALL CENTER SITE SELECTION AND MANAGEMENT SERVICES FOR OTHERS; PROVIDING CUSTOMER SERVICES AND SALES SUPPORT BY TELEPHONE, GLOBAL COMPUTER NETWORK, AND VIDEO COMMUNICATIONS (U.S. CLS. 100, 101 AND 102).

FIRST USE 1-1-1998; IN COMMERCE 1-1-1998.

CLASS 38—COMMUNICATION

FOR TELECOMMUNICATIONS SERVICES, NAMELY, RESELLING LONG DISTANCE AND LOCAL SERVICE TIME FOR VOICE, DATA, AND VIDEO TRANSMISSIONS (U.S. CLS. 100, 101 AND 104).

FIRST USE 1-1-1998; IN COMMERCE 1-1-1998.

CLASS 41—EDUCATION AND ENTERTAINMENT

FOR EDUCATIONAL SERVICES, NAMELY, CONDUCTING TRAINING COURSES AND SEMINARS IN THE FIELDS OF TELEPHONE ANSWERING, TELEMARKETING, TELESERVICING, COMPUTER SOFTWARE, COMPUTER PROGRAMMING SERVICES, AND PROVIDING CUSTOMER SERVICES AND SALES SUPPORT BY TELEPHONE, GLOBAL COMPUTER NETWORK, AND VIDEO COMMUNICATIONS (U.S. CLS. 100, 101 AND 107).

FIRST USE 1-1-1998; IN COMMERCE 1-1-1998.

CLASS 42—SCIENTIFIC, COMPUTER AND LEGAL SERVICES

FOR COMPUTER PROGRAMMING SERVICES FOR OTHERS; RESEARCH, DEVELOPMENT, AND CONSULTING IN THE FIELDS OF COMPUTER PROGRAMMING AND COMPUTER SOFTWARE; COMPUTER AND CALL CENTER DISASTER RECOVERY PLANNING AND IMPLEMENTATION SERVICES FOR OTHERS; AND RESEARCH, DEVELOPMENT, AND CONSULTING SERVICES RELATED TO COMPUTER AND CALL CENTER DISASTER RECOVERY PLANNING AND IMPLEMENTATION, TELEPHONE ANSWERING SERVICES, TELEMARKETING, TELESERVICING, IN THE NATURE OF RECEIVING AND RESPONDING TO TELEPHONE INQUIRIES FROM CUSTOMERS OF OTHER BUSINESSES, CALL CENTER SITE SELECTION AND MANAGEMENT, AND PROVIDING CUSTOMER SERVICES AND SALES SUPPORT BY TELEPHONE, GLOBAL COMPUTER NETWORK, AND VIDEO COMMUNICATIONS (U.S. CLS. 100 AND 101).

FIRST USE 1-1-1999; IN COMMERCE 1-1-1998.

2,625,329. VIRGIN RENTALS OF AMERICA, INC., NORWALK, CT. SN 75-241,219. PUB. 6-16-1998, FILED 2-13-1997.

VIRGIN RENTALS

NO CLAIM IS MADE TO THE EXCLUSIVE RIGHT TO USE "RENTALS", APART FROM THE MARK AS SHOWN.

CLASS 41—EDUCATION AND ENTERTAINMENT

FOR RENTAL OF ELECTRONIC EQUIPMENT IN THE NATURE OF TELEVISIONS, VCR'S, CAMCORDERS, STEREO SYSTEMS, STEREO EQUIPMENT, AND STEREO COMPONENTS (U.S. CLS. 100, 101 AND 107).

FIRST USE 11-0-1995; IN COMMERCE 10-0-2001.

CLASS 42—SCIENTIFIC, COMPUTER AND LEGAL SERVICES

FOR RENTAL OF HOUSEHOLD APPLIANCES; RENTAL OF WASHERS, DRYERS, REFRIGERATORS, RANGES, AND MICROWAVE OVENS; RENTAL OF FURNITURE; RENTAL OF HOUSEHOLD FURNITURE; RENTAL OF COMPUTERS; AND RENTAL OF PHOTOGRAPHIC EQUIPMENT (U.S. CLS. 100 AND 101).

FIRST USE 11-0-1995; IN COMMERCE 10-0-2001.

2,625,335. GLAXO GROUP LIMITED, GREENFORD, MIDDLESEX UB6 0NN, UNITED KINGDOM. SN 75-286,382. PUB. 10-7-1997, FILED 5-5-1997.

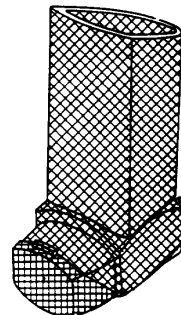

OWNER OF U.S. REG. NOS. 1,930,452 AND 1,930,584.

NO CLAIM IS MADE TO THE EXCLUSIVE RIGHT TO USE THE REPRESENTATION OF THE CONFIGURATION OF THE INHALER, APART FROM THE MARK AS SHOWN.

THE DRAWING IS LINED FOR THE COLOR PEACH, SHOWN BY THE HORIZONTAL-VERTICAL CROSS HATCHING AND THE COLOR ORANGE, SHOWN BY DIAGONAL CROSS-HATCHING.

THE MARK CONSISTS OF THE CONFIGURATION OF AN ORANGE INHALER WITH A PEACH TETHERED CAP. THE CAP HAS GENERALLY FLAT SIDEWALLS TO COVER THE MOUTHPIECE OF THE SAME SHAPE. THE UPRIGHT PORTION HAS A CROSS SECTION SHAPED LIKE THE LETTER "U" WHICH HAS A GENERALLY FLAT SURFACE FACING THE USER.

SEC. 2(F).

CLASS 5—PHARMACEUTICALS

FOR PHARMACEUTICAL PREPARATIONS AND SUBSTANCES FOR THE ALLEVIATION AND TREATMENT OF RESPIRATORY DISORDERS (U.S. CLS. 6, 18, 44, 46, 51 AND 52).

FIRST USE 7-15-1996; IN COMMERCE 7-15-1996.

CLASS 10—MEDICAL APPARATUS

FOR PHARMACEUTICAL AND MEDICAL DEVICES FOR THE ALLEVIATION AND TREATMENT OF RESPIRATORY DISORDERS (U.S. CLS. 26, 39 AND 44).

FIRST USE 7-15-1996; IN COMMERCE 7-15-1996.

2,625,342. AKSHUN & AKSHUN, INC., NORWALK, CA. SN 75-310,155. PUB. 9-7-1999, FILED 6-17-1997.

SPEED PARK**CLASS 25—CLOTHING**

FOR CLOTHING, NAMELY, HATS AND T-SHIRTS (U.S. CLS. 22 AND 39).

FIRST USE 10-1-1997; IN COMMERCE 10-1-1997.

CLASS 42—SCIENTIFIC, COMPUTER AND LEGAL SERVICES

FOR SNACK BARS (U.S. CLS. 100 AND 101).

FIRST USE 10-1-1997; IN COMMERCE 10-1-1997.

2,625,348. EXPANDACARD LTD., RUISLIP, MIDDLESEX, UNITED KINGDOM. SN 75-333,806. PUB. 5-11-1999, FILED 7-31-1997.

EXPANDACARD

CLASS 16—PAPER GOODS AND PRINTED MATTER

FOR IDENTIFICATION CARDS AND MEMBERSHIP CARDS, BOTH IN USE WITH CLUBS, SOCIETIES AND ORGANIZATIONS TO WHICH INDIVIDUALS MAY BELONG; COUPON AND VOUCHER BOOKS; PRINTED LABELS; FORMS; CHARTS; AND PRINTED TABLES OF DATA REPRESENTED IN TABULAR FORM, INCLUDING TIMETABLES FOR BUSES AND TRAINS, AND OTHER NUMERICAL TABLES FOR MEASUREMENT OR MONEY CONVERSION (U.S. CLS. 2, 5, 22, 23, 29, 37, 38 AND 50).

FIRST USE 6-0-1994; IN COMMERCE 12-4-2001.

CLASS 35—ADVERTISING AND BUSINESS

FOR DISSEMINATION OF ADVERTISING MATTER (U.S. CLS. 100, 101 AND 102).

FIRST USE 6-0-1994; IN COMMERCE 12-4-2001.

2,625,351. COLONIAL WILLIAMSBURG FOUNDATION, THE, WILLIAMSBURG, VA. SN 75-352,950. PUB. 3-2-1999, FILED 9-8-1997.

WILLIAMSBURG

OWNER OF U.S. REG. NO. 1,080,718. SEC. 2(F).

CLASS 24—FABRICS

FOR COMFORTERS, FEATHER BEDS, AND MATTRESS PADS (U.S. CLS. 42 AND 50).
FIRST USE 10-0-1998; IN COMMERCE 10-0-1998.

CLASS 26—FANCY GOODS

FOR ARTIFICIAL FLOWER ARRANGEMENTS (U.S. CLS. 37, 39, 40, 42 AND 50).

FIRST USE 1-25-2002; IN COMMERCE 1-25-2002.

CLASS 31—NATURAL AGRICULTURAL PRODUCTS

FOR LIVE FLOWER ARRANGEMENTS (U.S. CLS. 1 AND 46).

FIRST USE 11-26-2001; IN COMMERCE 11-26-2001.

2,625,354. SEALY TECHNOLOGY, LLC, TRINITY, NC, BY ASSIGNMENT OHIO MATTRESS COMPANY LICENSING AND COMPONENTS GROUP, THE, CLEVELAND, OH. SN 75-369,284. PUB. 10-30-2001, FILED 10-7-1997.

SEALY POSTUREPEDIC CROWN JEWEL

OWNER OF U.S. REG. NOS. 426,168, 1,987,201, AND OTHERS.

CLASS 20—FURNITURE AND ARTICLES NOT OTHERWISE CLASSIFIED

FOR PILLOWS (U.S. CLS. 2, 13, 22, 25, 32 AND 50).
FIRST USE 10-0-1998; IN COMMERCE 10-0-1998.

2,625,361. CAMY DEVELOPMENT CORP., PANAMA. SN 75-391,609. PUB. 1-11-2000, FILED 11-15-1997.

SURPRISE! U.S.A.

NO CLAIM IS MADE TO THE EXCLUSIVE RIGHT TO USE "U.S.A.", APART FROM THE MARK AS SHOWN.

CLASS 18—LEATHER GOODS

FOR WOMEN'S HANDBAGS AND PURSES (U.S. CLS. 1, 2, 3, 22 AND 41).

FIRST USE 9-27-2001; IN COMMERCE 9-27-2001.

CLASS 25—CLOTHING

FOR WOMEN'S AND CHILDREN'S CLOTHING, NAMELY, SLACKS, JEANS, KNIT SHIRTS, WOVEN SHIRTS, T-SHIRTS, SHOES, SNEAKERS, CAPS, BELTS AND BATHING SUITS; AND MEN'S UNDERWEAR (U.S. CLS. 22 AND 39).

FIRST USE 9-27-2001; IN COMMERCE 9-27-2001.

2,625,370. ALTO INTERNATIONAL A/S, DK-1050 COPENHAGEN K, DENMARK, BY CHANGE OF NAME INTERNATIONAL CLEANING EQUIPMENT A/S, 1050 KOBENHAVN K, DENMARK. SN 75-419,385. PUB. 7-10-2001, FILED 1-16-1998.



CLASS 7—MACHINERY

FOR FLOOR WASHING MACHINES; HIGH PRESSURE AND LOW PRESSURE CLEANERS; HIGH PRESSURE AND LOW PRESSURE CLEANING MACHINES FOR CLEANING INDOOR SURFACES AND OUTDOOR SURFACES SUCH AS ROOFS, WALLS, AND FLOORS; HIGH PRESSURE AND LOW PRESSURE CLEANING MACHINES FOR CLEANING INDUSTRIAL PRODUCTION EQUIPMENT, INDUSTRIAL MACHINES, AND AGRICULTURAL MACHINES; ELECTRIC AND NON-ELECTRIC EQUIPMENT FOR CLEANING AND WASHING NAMELY, HOT AND COLD WATER WASHING MACHINES, HIGH PRESSURE AND LOW PRESSURE MACHINES FOR CLEANING BUILDING SURFACES, INDUSTRIAL PRODUCTION EQUIPMENT, AND MACHINES IN THE FOODSTUFFS INDUSTRY; CLEANING APPARATUS, NAMELY, SANDERS, POLISHERS, BURNISHERS, SCRUBBERS, SWEEPERS, AND WASHERS FOR CLEANING INDOOR SURFACES, SUCH AS FLOORS, WALLS, AND TABLES INCLUDING THE INTERIORS OF INDUSTRIAL AND COMMERCIAL PREMISES, AND OUTDOOR SURFACES SUCH AS PAVEMENTS AND ROADS; VACUUM CLEANERS (U.S. CLS. 13, 19, 21, 23, 31, 34 AND 35).

FIRST USE 2-0-1998; IN COMMERCE 2-0-1998.

CLASS 11—ENVIRONMENTAL CONTROL APPARATUS

FOR STEAM GENERATORS, STEAM DRYERS, STEAM VALVES (U.S. CLS. 13, 21, 23, 31 AND 34).

FIRST USE 2-0-1998; IN COMMERCE 2-0-1998.

CLASS 21—HOUSEWARES AND GLASS

FOR CLOTHS FOR CLEANING, CLOTHS IMPREGNATED WITH CLEANING DETERGENTS, SCOURING SPONGES, GAS SCRUBBERS, NON-ELECTRIC CARPET SWEEPERS (U.S. CLS. 2, 13, 23, 29, 30, 33, 40 AND 50).

FIRST USE 2-0-1998; IN COMMERCE 2-0-1998.

2,625,372. JOHNSON CONTROLS, INC., MILWAUKEE, WI. SN 75-423,459. PUB. 2-1-2000, FILED 1-20-1998.



OWNER OF U.S. REG. NOS. 1,105,961, 1,241,191, AND OTHERS.

NO CLAIM IS MADE TO THE EXCLUSIVE RIGHT TO USE "CONTROLS", APART FROM THE MARK AS SHOWN.

CLASS 9—ELECTRICAL AND SCIENTIFIC APPARATUS

FOR INTERIOR AUDIO COMPONENT PARTS FOR LAND VEHICLES, VANS AND TRUCKS, NAMELY, AUDIO SPEAKERS, SURROUND-SOUND FLAT-PANEL TRANSDUCERS, AND VOICE RECORDING AND PLAYBACK DEVICES (U.S. CLS. 21, 23, 26, 36 AND 38).

FIRST USE 8-0-1997; IN COMMERCE 8-0-1997.

CLASS 12—VEHICLES

FOR INTERIOR STRUCTURAL COMPONENT PARTS FOR LAND VEHICLES, VANS AND TRUCKS (U.S. CLS. 19, 21, 23, 31, 35 AND 44).

FIRST USE 8-0-1997; IN COMMERCE 8-0-1997.

2,625,378. HOECHST SCHERING AGREVO S.A., 91190 GIF SUR YVETTE, FRANCE, BY ASSIGNMENT; BY MERGER HOECHST SCHERING AGREVO S.A., 75020 PARIS, FRANCE. SN 75-439,172. PUB. 9-7-1999, FILED 2-23-1998.

FFAST

CLASS 1—CHEMICALS

FOR CHEMICALS FOR USE IN THE MANUFACTURE OF INSECTICIDES (U.S. CLS. 1, 5, 6, 10, 26 AND 46).

FIRST USE 3-0-1998; IN COMMERCE 3-27-2000.

CLASS 5—PHARMACEUTICALS

FOR PREPARATIONS FOR DESTROYING VERMIN AND INSECTICIDES FOR AGRICULTURAL USE AND HORTICULTURAL USES (U.S. CLS. 6, 18, 44, 46, 51 AND 52).

FIRST USE 3-0-1998; IN COMMERCE 3-27-2000.

2,625,381. EMITEC GESELLSCHAFT FUR EMISSIONSTECHNOLOGIE MBH, LOHMAR, FED REP GERMANY. SN 75-443,436. PUB. 11-30-1999, FILED 3-2-1998.

SUPER FOIL

NO CLAIM IS MADE TO THE EXCLUSIVE RIGHT TO USE "FOIL", APART FROM THE MARK AS SHOWN.

CLASS 7—MACHINERY

FOR CATALYTIC EXHAUST GAS CONVERTERS AND ELECTRICALLY HEATABLE CATALYTIC EXHAUST GAS CONVERTERS FOR MOTORS AND ENGINES AND REPLACEMENT PARTS THEREFOR (U.S. CLS. 13, 19, 21, 23, 31, 34 AND 35).

FIRST USE 11-0-1997; IN COMMERCE 11-0-1997.

CLASS 11—ENVIRONMENTAL CONTROL APPARATUS

FOR CATALYTIC EXHAUST GAS CONVERTERS AND ELECTRICALLY HEATABLE CATALYTIC EXHAUST GAS CONVERTERS FOR TREATING GASES FROM GAS TURBINES, POWER PLANTS AND OTHER INDUSTRIAL OPERATIONS AND REPLACEMENT PARTS THEREFOR (U.S. CLS. 13, 21, 23, 31 AND 34).

FIRST USE 11-0-1997; IN COMMERCE 11-0-1997.

2,625,382. WE CARE AMERICA, INC., LAWRENCEVILLE, GA. SN 75-443,834. PUB. 6-8-1999, FILED 3-3-1998.

WE CARE AMERICA

CLASS 36—INSURANCE AND FINANCIAL

FOR CHARITABLE FUND RAISING (U.S. CLS. 100, 101 AND 102).
FIRST USE 10-0-1998; IN COMMERCE 10-0-1998.

CLASS 41—EDUCATION AND ENTERTAINMENT

FOR EDUCATIONAL SERVICES, NAMELY, PROVIDING TRAINING TO INDIVIDUALS BY MEANS OF CONFERENCES IN ORDER TO TEACH THE MANNER TO RAISE FUNDS AND ADMINISTER A PROGRAM THROUGH WHICH FOOD, CLOTHING, EDUCATION AND SUPPORT SERVICES ARE PROVIDED TO NEEDY INDIVIDUALS (U.S. CLS. 100, 101 AND 107).
FIRST USE 10-0-1998; IN COMMERCE 10-0-1998.

CLASS 42—SCIENTIFIC, COMPUTER AND LEGAL SERVICES

FOR CHARITABLE SERVICES, NAMELY, PROVIDING FOOD AND CLOTHING TO NEEDY INDIVIDUALS THROUGH VOLUNTEERS (U.S. CLS. 100 AND 101).
FIRST USE 10-0-1998; IN COMMERCE 10-0-1998.

2,625,383. SONY KABUSHIKI KAISHA, TA SONY CORPORATION, TOKYO, JAPAN. SN 75-444,139. PUB. 9-26-2000, FILED 3-4-1998.

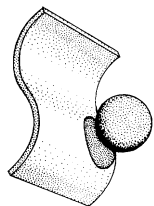

So-net

THE STIPPLING IN THE DRAWING IS A FEATURE OF THE MARK AND DOES NOT INDICATE COLOR.

CLASS 35—ADVERTISING AND BUSINESS

FOR PROVISION OF INFORMATION THROUGH A COMPUTER ON-LINE VIA A GLOBAL COMPUTER NETWORK RELATING TO BUSINESS MANAGEMENT, BUSINESS ADMINISTRATION AND OFFICE FUNCTIONS; DISSEMINATION OF ADVERTISING FOR OTHERS AND ADVERTISING AGENCY SERVICE THROUGH A COMPUTER ON-LINE LINK VIA A GLOBAL COMPUTER NETWORK (U.S. CLS. 100, 101 AND 102).
FIRST USE 6-1-2001; IN COMMERCE 6-1-2001.

CLASS 36—INSURANCE AND FINANCIAL

FOR PROVISION OF INFORMATION THROUGH A COMPUTER ON-LINE LINK VIA A GLOBAL COMPUTER NETWORK RELATING TO INSURANCE, FINANCIAL AFFAIRS, MONETARY AFFAIRS AND REAL ESTATE AFFAIRS (U.S. CLS. 100, 101 AND 102).
FIRST USE 6-1-2001; IN COMMERCE 6-1-2001.

CLASS 37—CONSTRUCTION AND REPAIR

FOR PROVISION OF INFORMATION THROUGH A COMPUTER ON-LINE LINK VIA A GLOBAL COMPUTER NETWORK RELATING TO BUILDING CONSTRUCTION, LAND, INSTALLATION, REPAIR AND MAINTENANCE OF COMPUTER COMMUNICATION APPARATUS; INSTALLATION, REPAIR AND MAINTENANCE OF COMPUTER AND COMMUNICATION APPARATUS (U.S. CLS. 100, 103 AND 106).
FIRST USE 6-1-2001; IN COMMERCE 6-1-2001.

CLASS 38—COMMUNICATION

FOR TELECOMMUNICATION GATEWAY SERVICES, NAMELY, ELECTRICAL, ELECTRONIC, TERRESTRIAL AND SATELLITE COMMUNICATION SERVICES THROUGH A COMPUTER ON-LINE LINK VIA A GLOBAL COMPUTER NETWORK; WEBCASTING OF AUDIO/VISUAL PROGRAMMING VIA A GLOBAL COMPUTER NETWORK (U.S. CLS. 100, 101 AND 104).
FIRST USE 6-1-2001; IN COMMERCE 6-1-2001.

CLASS 39—TRANSPORTATION AND STORAGE

FOR PROVISION OF INFORMATION THROUGH A COMPUTER ON-LINE LINK VIA A GLOBAL COMPUTER NETWORK RELATING TO TRAVEL AND TOURISM (U.S. CLS. 100 AND 105).
FIRST USE 6-1-2001; IN COMMERCE 6-1-2001.

CLASS 41—EDUCATION AND ENTERTAINMENT

FOR PROVIDING INTERACTIVE GAMES AND FORTUNE TELLING THROUGH A COMPUTER ON-LINE LINK VIA A GLOBAL COMPUTER NETWORK (U.S. CLS. 100, 101 AND 107).
FIRST USE 6-1-2001; IN COMMERCE 6-1-2001.

CLASS 42—SCIENTIFIC, COMPUTER AND LEGAL SERVICES

FOR PROVISION OF INFORMATION THROUGH A COMPUTER ON-LINE LINK VIA A GLOBAL COMPUTER NETWORK RELATING TO POTENTIAL MARRIAGE OR DATING PARTNERS, ACCOMMODATION, FOOD AND DRINK (U.S. CLS. 100 AND 101).
FIRST USE 6-1-2001; IN COMMERCE 6-1-2001.

2,625,385. DEGUSSA AG, D-45772 MARL, FED REP GERMANY, BY CHANGE OF NAME; BY ASSIGNMENT DEGUSSA - HULS AKTIENGESELLSCHAFT, 60311 FRANKFURT AM MAIN, FED REP GERMANY. SN 75-448,208. PUB. 8-22-2000, FILED 3-11-1998.



PRIORITY CLAIMED UNDER SEC. 44(D) ON FED REP GERMANY APPLICATION NO. 39743705.6, FILED 9-12-1997, REG. NO. 39743705, DATED 11-30-1997, EXPIRES 9-30-2007.

CLASS 35—ADVERTISING AND BUSINESS

FOR ADVERTISING AND PROMOTING THE INDUSTRIAL SITES OF OTHERS; ORGANIZING AND CONDUCTING TRADE SHOWS AND EXHIBITS IN THE FIELD OF INDUSTRIAL SITE SELECTION (U.S. CLS. 100, 101 AND 102).

FIRST USE 12-9-1997; IN COMMERCE 3-30-1999.

CLASS 36—INSURANCE AND FINANCIAL

FOR REAL ESTATE BROKERAGE IN THE FIELD OF INDUSTRIAL SITES (U.S. CLS. 100, 101 AND 102).

FIRST USE 12-9-1997; IN COMMERCE 3-30-1999.

CLASS 42—SCIENTIFIC, COMPUTER AND LEGAL SERVICES

FOR CONSULTATION IN THE FIELD OF INDUSTRIAL SITE SELECTION (U.S. CLS. 100 AND 101).

FIRST USE 12-9-1997; IN COMMERCE 3-30-1999.

2,625,387. T-TOCS FARMS, LLC, HENDERSONVILLE, TN. SN 75-452,185. PUB. 7-24-2001, FILED S.R. 3-18-1998; AM. P.R. 3-18-1998.

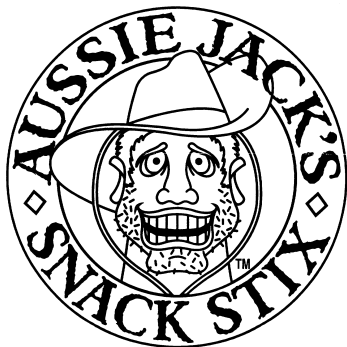

NO CLAIM IS MADE TO THE EXCLUSIVE RIGHT TO USE "SNACK STIX", APART FROM THE MARK AS SHOWN.

THE NAME AUSSIE JACK'S DOES NOT IDENTIFY A LIVING INDIVIDUAL.

CLASS 25—CLOTHING

FOR CLOTHING, NAMELY TEE-SHIRTS, HATS AND CAPS (U.S. CLS. 22 AND 39).

FIRST USE 7-16-2001; IN COMMERCE 7-16-2001.

CLASS 29—MEATS AND PROCESSED FOODS

FOR SNACK STICKS MADE FROM EMU MEAT AND OTHER INGREDIENTS (U.S. CL. 46).

FIRST USE 7-16-2001; IN COMMERCE 7-16-2001.

2,625,388. FORTOP INDUSTRIAL CO., LTD., TAINAN, TAIWAN, CHINA. SN 75-455,664. PUB. 8-29-2000, FILED 3-24-1998.



THE LINING IN THE DRAWING OF THE MARK IS A FEATURE OF THE MARK AND IS NOT INTENDED TO INDICATE COLOR.

CLASS 11—ENVIRONMENTAL CONTROL APPARATUS

FOR LIGHTS FOR VEHICLES, AGRICULTURAL VEHICLES AND SNOWMOBILES, NAMELY, TAIL LIGHTS, SIGNAL LIGHTS, DOME LIGHTS, INTERIOR LIGHTS, LICENSE PLATE LIGHTS, FENDER LIGHTS, REFLEX REFLECTORS, REVERSING LIGHTS, SIDE LIGHTS, FOG LIGHTS, HEAD LIGHTS, STOP LIGHTS, DRIVING LIGHTS, SPOTLIGHTS (U.S. CLS. 13, 21, 23, 31 AND 34).

FIRST USE 9-1-2001; IN COMMERCE 9-1-2001.

CLASS 12—VEHICLES

FOR AUTOMOBILES, MOTORCYCLES AND REPLACEMENT PARTS AND ACCESSORIES THEREFOR, NAMELY, SNOW CHAINS, TIRE CHAINS, SHOCK ABSORBERS, MOTORS FOR AUTOMOBILES, WINDSCREENS, REARVIEW MIRRORS, SIDE MIRRORS, WINDSHIELD WIPERS, STEERING WHEELS, GAS CAPS, BRAKE LININGS, AND DIRECTIONAL LIGHTS (U.S. CLS. 19, 21, 23, 31, 35 AND 44).

FIRST USE 9-1-2001; IN COMMERCE 9-1-2001.

2,625,398. LOEW'S HOTELS, INC., NEW YORK, NY. SN 75-478,103. PUB. 8-3-1999, FILED 4-30-1998.



LOEWS
MIAMI BEACH HOTEL
SOUTH BEACH

OWNER OF U.S. REG. NOS. 1,601,550 AND 1,899,342.

NO CLAIM IS MADE TO THE EXCLUSIVE RIGHT TO USE "MIAMI BEACH HOTEL" OR "SOUTH BEACH", APART FROM THE MARK AS SHOWN.

THE MARK CONSISTS OF THE WORDS "LOEWS MIAMI BEACH HOTEL SOUTH BEACH" WITH AN ARBITRARY DESIGN.

CLASS 3—COSMETICS AND CLEANING PREPARATIONS

FOR SUNTANNING PREPARATIONS; SKIN PROTECTION PRODUCTS, NAMELY, SUN SCREEN PREPARATIONS, SUN BLOCK PREPARATIONS, FACE AND BODY LOTION (U.S. CLS. 1, 4, 6, 50, 51 AND 52).

FIRST USE 12-24-1998; IN COMMERCE 12-24-1998.

CLASS 16—PAPER GOODS AND PRINTED MATTER

FOR POSTCARDS; PRINTS; PRINTED MATTER, NAMELY, BOOKS, BROCHURES, AND MAGAZINES RELATING TO TRAVEL AND TOURISM; GUIDE BOOKS AND MAGAZINES PROVIDING INFORMATION ON THE MIAMI BEACH AREA (U.S. CLS. 2, 5, 22, 23, 29, 37, 38 AND 50).

FIRST USE 12-24-1998; IN COMMERCE 12-24-1998.

CLASS 42—SCIENTIFIC, COMPUTER AND LEGAL SERVICES

FOR HOTEL SERVICES; RESTAURANT SERVICES; PROVIDING GENERAL PURPOSE CONVENTION FACILITIES (U.S. CLS. 100 AND 101).

FIRST USE 12-24-1998; IN COMMERCE 12-24-1998.

2,625,404. PEPIN HEIGHTS ORCHARD, INC., LAKE CITY, MN. SN 75-507,320. PUB. 2-1-2000, FILED 6-23-1998.



NO CLAIM IS MADE TO THE EXCLUSIVE RIGHT TO USE "THE APPLE DESIGN", APART FROM THE MARK AS SHOWN.

THE LINING CONTAINED IN APPLICANT'S DRAWING IS A FEATURE OF THE MARK AND NOT AN INDICATION OF COLOR.

CLASS 31—NATURAL AGRICULTURAL PRODUCTS

FOR FOOD AND DRINKS, NAMELY, FRESH/RAW APPLES (U.S. CLS. 1 AND 46).

FIRST USE 8-1-1998; IN COMMERCE 8-1-1998.

CLASS 32—LIGHT BEVERAGES

FOR SWEET CARBONATED CIDER, FRESH PRESS SWEET CIDER AND FRESH PRESS FLAVORED SWEET CIDER (U.S. CLS. 45, 46 AND 48).

FIRST USE 8-1-1998; IN COMMERCE 8-1-1998.

2,625,399. GOPETS, INC., WESTON, CT. SN 75-479,130. PUB. 3-7-2000, FILED 5-5-1998.

PETCLAN

CLASS 9—ELECTRICAL AND SCIENTIFIC APPARATUS

FOR PRE-RECORDED VIDEOTAPES FEATURING MOTION PICTURES IN THE NAME OF DOCUMENTARIES; PRE-RECORDED VIDEOTAPES FEATURING INFORMATION ABOUT ANIMALS AND PETS; AND COMPUTER PROGRAMS DOWNLOADABLE FROM A GLOBAL COMPUTER NETWORK WHICH PROVIDE A DATABASE OF INFORMATION ABOUT PETS AND ANIMALS (U.S. CLS. 21, 23, 26, 36 AND 38).

FIRST USE 5-15-1999; IN COMMERCE 5-15-1999.

CLASS 41—EDUCATION AND ENTERTAINMENT

FOR PRODUCING TELEVISION PROGRAMS; DISTRIBUTING TELEVISION PROGRAMS; ORGANIZING, ARRANGING AND CONDUCTING PET-RELATED EVENTS IN THE NATURE OF EDUCATIONAL AND ENTERTAINING SEMINARS FEATURING PET CARE AND PET ISSUES; EDUCATIONAL AND ENTERTAINING SEMINARS FEATURING PET CARE AND PET ISSUES; EDUCATIONAL AND ENTERTAINING SERVICES IN THE NATURE OF CONDUCTING CLASSES, SEMINARS, CONFERENCES, WORKSHOPS, LECTURES, EVENTS AND COURSES OF INSTRUCTION FOR THE GENERAL PUBLIC AND PET CARE PROFESSIONALS IN THE FIELD OF PET CARE AND PET RELATED ISSUES (U.S. CLS. 100, 101 AND 107).

FIRST USE 5-15-1999; IN COMMERCE 5-15-1999.

2,625,423. PLANET WIRELESS INC., MESA, AZ. SN 75-556,184. PUB. 5-30-2000, FILED 9-18-1998.



NO CLAIM IS MADE TO THE EXCLUSIVE RIGHT TO USE "WIRELESS", APART FROM THE MARK AS SHOWN.

CLASS 9—ELECTRICAL AND SCIENTIFIC APPARATUS

FOR RADIO PAGERS, CELLULAR TELEPHONES, AND RADIO PAGER AND CELLULAR TELEPHONE ACCESSORIES, NAMELY, BATTERIES, BATTERY CHARGERS, CIGARETTE LIGHTER POWER ADAPTERS, AND HANDS-FREE KITS CONSISTING OF MICROPHONES, SPEAKERS, AND CRADLES (U.S. CLS. 21, 23, 26, 36 AND 38).

FIRST USE 8-1-1998; IN COMMERCE 3-1-2000.

CLASS 38—COMMUNICATION

FOR PAGING SERVICES; CELLULAR TELEPHONE SERVICES; LONG DISTANCE TELEPHONE SERVICES; TELECOMMUNICATION SERVICES, NAMELY, PERSONAL COMMUNICATION SERVICES (PCS); LOCAL HOME TELEPHONE SERVICES; PREPAID LOCAL HOME TELEPHONE SERVICES; PREPAID CELLULAR TELEPHONE SERVICES AND PREPAID LONG DISTANCE TELEPHONE SERVICE (U.S. CLS. 100, 101 AND 104).

FIRST USE 8-1-1998; IN COMMERCE 3-1-2000.

2,625,438. FEDERATION OF DINING ROOM PROFESSIONALS, LLC, MAHWAH, NJ. SN 75-581,858. PUB. 5-23-2000, FILED 11-4-1998.

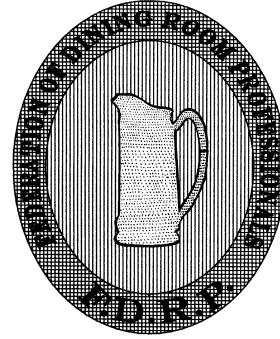

NO CLAIM IS MADE TO THE EXCLUSIVE RIGHT TO USE "FEDERATION OF DINING ROOM PROFESSIONALS", APART FROM THE MARK AS SHOWN.

THE MARK IS LINED FOR THE COLORS RED AND YELLOW AND COLOR IS A FEATURE OF THE MARK. THE STIPLING IN THE DRAWING SHOWS SHADING AND IS NOT A FEATURE OF THE MARK.

2,625,427. JUST LIKE ME 3D STORES, INC., WINDERMERE, FL. SN 75-561,791. PUB. 10-30-2001, FILED 9-29-1998.

JUST LIKE ME 3D

NO CLAIM IS MADE TO THE EXCLUSIVE RIGHT TO USE "3D", APART FROM THE MARK AS SHOWN.

CLASS 20—FURNITURE AND ARTICLES NOT OTHERWISE CLASSIFIED

FOR SCULPTURES AND BUSTS MADE OF PLASTER, PLASTIC WAX, WOOD AND FOAM; WALL DECORATIONS, NAMELY RELIEFS, RELIEFS MADE OF WOOD, PLASTER, PLASTIC WAX, AND FOAM; MOLDS OF PLASTER FOR CASTING CERAMIC MATERIALS (U.S. CLS. 2, 13, 22, 25, 32 AND 50).

FIRST USE 8-28-2000; IN COMMERCE 8-28-2000.

CLASS 28—TOYS AND SPORTING GOODS

FOR ACTION FIGURES, DOLLS AND DOLL ACCESSORIES THEREOF, DOLL CLOTHING, AND JIGSAW PUZZLES, ALL MADE TO RESEMBLE PEOPLE THROUGH COMPUTERIZED THREE DIMENSIONAL IMAGE CAPTURE PROCESS (U.S. CLS. 22, 23, 38 AND 50).

FIRST USE 8-28-2000; IN COMMERCE 8-28-2000.

CLASS 40—MATERIAL TREATMENT

FOR COMPUTERIZED REPRODUCTION SERVICES IN THE FORM OF CUSTOMIZED SCULPTURES, ACTION FIGURES, PUZZLES, DOLLS, DOLL ACCESSORIES AND DOLL CLOTHING MADE TO RESEMBLE PEOPLE THROUGH COMPUTERIZED THREE DIMENSIONAL IMAGE CAPTURE PROCESS (U.S. CLS. 100, 103 AND 106).

FIRST USE 8-28-2000; IN COMMERCE 8-28-2000.

CLASS 9—ELECTRICAL AND SCIENTIFIC APPARATUS

FOR ELECTRONIC PUBLICATIONS, NAMELY, NEWSLETTERS, MAGAZINES, EDUCATIONAL, INSTRUCTIONAL AND TEACHING MATERIALS, REPORTS, BOOKS IN THE FIELD OF THE FOOD SERVICE PROFESSION, AVAILABLE ON CD-ROM, COMPACT DISC AND DVD, PRERECORDED VIDEOTAPES FEATURING INFORMATION ABOUT THE FOOD SERVICE PROFESSION (U.S. CLS. 21, 23, 26, 36 AND 38).

FIRST USE 7-11-2001; IN COMMERCE 8-12-2001.

CLASS 42—SCIENTIFIC, COMPUTER AND LEGAL SERVICES

FOR COMPUTER SERVICES, NAMELY, PROVIDING ONLINE NEWSLETTERS, REPORTS, EDUCATIONAL, INSTRUCTIONAL AND TEACHING MATERIALS, ALL OF THE FOREGOING IN THE FOOD SERVICES PROFESSION, VIA A WEBSITE OR GLOBAL COMPUTER NETWORK (U.S. CLS. 100 AND 101).

FIRST USE 8-1-2001; IN COMMERCE 8-1-2001.

2,625,445. ZONDERVAN CORPORATION, THE, GRAND RAPIDS, MI. SN 75-592,923. PUB. 7-27-1999, FILED 11-20-1998.

ZONDERVAN GROUPWARE

OWNER OF U.S. REG. NO. 1,369,913.

NO CLAIM IS MADE TO THE EXCLUSIVE RIGHT TO USE "GROUPWARE" AS TO INTERNATIONAL CLASS 9 ONLY, APART FROM THE MARK AS SHOWN.

CLASS 9—ELECTRICAL AND SCIENTIFIC APPARATUS

FOR VIDEO AND AUDIO RECORDINGS IN THE FORM OF CASSETTE TAPES AND CD-ROMS AND AN INTERACTIVE MULTIMEDIA COMPUTER PROGRAM ALL FEATURING INSTRUCTIONAL MATERIALS ON RELIGIOUS STUDY (U.S. CLS. 21, 23, 26, 36 AND 38).

FIRST USE 1-1-2001; IN COMMERCE 1-1-2001.

CLASS 16—PAPER GOODS AND PRINTED MATTER

FOR PRINTED MATTER, NAMELY, NON-FICTION BOOKS IN THE NATURE OF INSTRUCTIONAL MATERIALS ON RELIGIOUS STUDY (U.S. CLS. 2, 5, 22, 23, 29, 37, 38 AND 50).

FIRST USE 1-1-2001; IN COMMERCE 1-1-2001.

2,625,448. MASON SHOE MANUFACTURING CO., CHIPPEWA FALLS, WI. SN 75-598,705. PUB. 1-25-2000, FILED 12-3-1998.

MARYLAND SQUARE

OWNER OF U.S. REG. NO. 1,465,955.

CLASS 18—LEATHER GOODS

FOR HANDBAGS (U.S. CLS. 1, 2, 3, 22 AND 41).

FIRST USE 3-15-2002; IN COMMERCE 3-15-2002.

CLASS 25—CLOTHING

FOR FOOTWEAR AND CLOTHING, NAMELY, SCARVES (U.S. CLS. 22 AND 39).

FIRST USE 7-2-2001; IN COMMERCE 7-2-2001.

2,625,455. VIRGIN ENTERPRISES LIMITED, LONDON W8 7AR, ENGLAND. SN 75-607,592. PUB. 10-30-2001, FILED 12-17-1998.

VIRGIN

OWNER OF U.S. REG. NOS. 1,039,574, 2,151,589, AND OTHERS.

CLASS 35—ADVERTISING AND BUSINESS

FOR PROVIDING AN ON-LINE SHOPPING MALL VIA A GLOBAL COMPUTER NETWORK; PROVIDING BUSINESS INFORMATION VIA A GLOBAL COMPUTER NETWORK (U.S. CLS. 100, 101 AND 102).

FIRST USE 12-0-1997; IN COMMERCE 12-0-1997.

CLASS 38—COMMUNICATION

FOR COMPUTERIZED COMMUNICATION SERVICES, NAMELY, ELECTRONIC MAIL SERVICES, AND PROVIDING NETWORKS FOR THE PURPOSE OF TRANSMISSION AND RECEPTION OF ELECTRONIC MAIL, COMPUTER GENERATED MUSIC, NEWS AND OTHER DATA AND INFORMATION; AND BROADCASTING SERVICES BY RADIO AND OVER A GLOBAL COMPUTER NETWORK OF A WIDE VARIETY OF PROGRAMS, NAMELY, CURRENT EVENTS, ECONOMICS, POLITICS, SPORTS, ENTERTAINMENT, THE ARTS AND BUSINESS (U.S. CLS. 100, 101 AND 104).

FIRST USE 11-11-1999; IN COMMERCE 3-21-2000.

2,625,457. FORTRESS MEDICAL SYSTEMS, INC., HOPKINS, MN. SN 75-608,116. PUB. 5-2-2000, FILED 12-18-1998.

CLINDEX**CLASS 9—ELECTRICAL AND SCIENTIFIC APPARATUS**

FOR COMPUTER SOFTWARE DESIGNED FOR MEDICAL COMPANIES TO ASSIST IN THE MANAGEMENT OF MEDICAL TRIAL DATA (U.S. CLS. 21, 23, 26, 36 AND 38).

FIRST USE 12-11-1998; IN COMMERCE 7-1-2000.

CLASS 16—PAPER GOODS AND PRINTED MATTER

FOR COMPUTER SOFTWARE MANUALS (U.S. CLS. 2, 5, 22, 23, 29, 37, 38 AND 50).

FIRST USE 12-11-1998; IN COMMERCE 7-1-2000.

2,625,458. PAGO HOLDING AG, POSTFACH CH-9472, SWITZERLAND. SN 75-609,054. PUB. 12-19-2000, FILED 12-21-1998.

PAGO**CLASS 7—MACHINERY**

FOR INDUSTRIAL AND COMMERCIAL LABELING MACHINES (U.S. CLS. 13, 19, 21, 23, 31, 34 AND 35).

FIRST USE 0-0-1952; IN COMMERCE 0-0-1978.

CLASS 16—PAPER GOODS AND PRINTED MATTER

FOR OFFICE LABELING MACHINES; BLANK OR PARTIALLY PRINTED PAPER LABELS (U.S. CLS. 2, 5, 22, 23, 29, 37, 38 AND 50).

FIRST USE 0-0-1936; IN COMMERCE 0-0-1978.

CLASS 20—FURNITURE AND ARTICLES NOT OTHERWISE CLASSIFIED

FOR PLASTIC LABELS (U.S. CLS. 2, 13, 22, 25, 32 AND 50).

FIRST USE 0-0-1963; IN COMMERCE 0-0-1978.

2,625,459. SYMYX TECHNOLOGIES, SANTA CLARA, CA.
SN 75-609,845. PUB. 6-27-2000, FILED 12-21-1998.

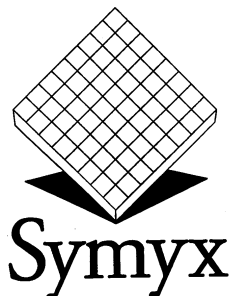

OWNER OF U.S. REG. NO. 2,215,525.

CLASS 1—CHEMICALS

FOR MATERIALS FOR USE IN CHEMICAL AND SCIENTIFIC RESEARCH, NAMELY, HETEROGENEOUS AND HOMOGENEOUS CATALYSTS, AND FORMULATIONS DERIVED BY THE MIXING OF VARIOUS COMPOUNDS (U.S. CLS. 1, 5, 6, 10, 26 AND 46).
FIRST USE 10-0-2001; IN COMMERCE 10-0-2001.

CLASS 9—ELECTRICAL AND SCIENTIFIC APPARATUS

FOR MATERIALS FOR USE IN CHEMICAL AND SCIENTIFIC RESEARCH PRIMARILY IN THE FIELDS OF CHEMICAL AND ELECTRONIC APPLICATIONS, NAMELY, PERMANENT MAGNETS; FORMULATIONS DERIVED BY THE MIXING OF VARIOUS CHEMICAL COMPOUNDS; AND ELECTRONIC MATERIALS, NAMELY, THIN-FILMS, THICK-FILMS, PANEL DISPLAYS, AND PHOSPHORS; LABORATORY RESEARCH TOOLS USED IN THE FIELD OF CHEMICAL AND MATERIALS RESEARCH AND DEVELOPMENT PRIMARILY FOR CHEMICAL AND ELECTRONIC APPLICATIONS, NAMELY, COMBINATORIAL AND HIGH THROUGHPUT METHODS OF MATERIALS RESEARCH AND DEVELOPMENT, NAMELY, SCANNING MASS SPECTROMETERS; PHOTOTHERMAL DEFLECTION APPARATUS; VAPOR DEPOSITION APPARATUS; RAPID FIRE LIGHT SCATTERING APPARATUS; HIGH THROUGHPUT CHARACTERIZATION APPARATUS, NAMELY, POLYMER CHARACTERIZATION APPARATUS; CALORIMETRY APPARATUS, REHOLOGY APPARATUS, MECHANICAL PROPERTY TESTING APPARATUS, SCREENING APPARATUS FOR CATALYSTS AND POLYMERS; AND SOFTWARE FOR CONTROLLING THE OPERATION AND FUNCTION OF THE AFOREMENTIONED RESEARCH EQUIPMENT (U.S. CLS. 21, 23, 26, 36 AND 38).
FIRST USE 6-10-2000; IN COMMERCE 6-10-2000.

2,625,461. CLIGNOSIS, INC., BOSTON, MA. SN 75-612,010.
PUB. 3-28-2000, FILED 12-24-1998.

CLIGNOSIS

CLASS 35—ADVERTISING AND BUSINESS

FOR WHOLESALE DISTRIBUTORSHIPS FEATURING COMPUTER SOFTWARE (U.S. CLS. 100, 101 AND 102).
FIRST USE 3-1-1998; IN COMMERCE 6-1-1998.

CLASS 42—SCIENTIFIC, COMPUTER AND LEGAL SERVICES

FOR DESIGN OF COMPUTER SOFTWARE FOR OTHERS (U.S. CLS. 100 AND 101).
FIRST USE 3-1-1998; IN COMMERCE 6-1-1998.

2,625,474. AMERICAN HOSPITAL ASSOCIATION, CHICAGO, IL. SN 75-634,775. PUB. 8-7-2001, FILED 2-3-1999.



HEALTH FORUM AHA

OWNER OF U.S. REG. NOS. 1,282,946, 1,858,940, AND OTHERS.

NO CLAIM IS MADE TO THE EXCLUSIVE RIGHT TO USE "HEALTH FORUM", APART FROM THE MARK AS SHOWN.

CLASS 9—ELECTRICAL AND SCIENTIFIC APPARATUS

FOR DATABASES REPORTED ON COMPUTER MEDIA CONTAINING INFORMATION RELATING TO THE MANAGEMENT AND OPERATION OF HEALTH CARE PROVIDER ORGANIZATIONS; ELECTRONIC PUBLICATIONS, NAMELY, NEWSLETTERS, MAGAZINES, AND BOOKS RELATING TO THE MANAGEMENT AND OPERATION OF HEALTH CARE ORGANIZATIONS RECORDED ON DIGITAL MEDIA (U.S. CLS. 21, 23, 26, 36 AND 38).
FIRST USE 5-0-1999; IN COMMERCE 5-0-1999.

CLASS 16—PAPER GOODS AND PRINTED MATTER

FOR PUBLICATIONS, NAMELY, NEWSLETTERS, MAGAZINES AND BOOKS CONTAINING INFORMATION RELATING TO THE MANAGEMENT AND OPERATION OF HEALTH CARE ORGANIZATIONS (U.S. CLS. 2, 5, 22, 23, 29, 37, 38 AND 50).
FIRST USE 5-0-1999; IN COMMERCE 5-0-1999.

CLASS 35—ADVERTISING AND BUSINESS

FOR HEALTH CARE BUSINESS CONSULTING, NAMELY, MANAGEMENT CONSULTING, LEADERSHIP DEVELOPMENT CONSULTING AND GOVERNANCE CONSULTING ALL RELATING TO HEALTH CARE ORGANIZATIONS; HEALTH CARE BUSINESS CONSULTING, NAMELY, COLLECTING FINANCIAL, UTILIZATION, DEMOGRAPHIC AND STAFFING INFORMATION RELATING TO THE HEALTH CARE INDUSTRY (U.S. CLS. 100, 101 AND 102).
FIRST USE 5-0-1999; IN COMMERCE 5-0-1999.

CLASS 41—EDUCATION AND ENTERTAINMENT

FOR EDUCATIONAL SERVICES, NAMELY, CONDUCTING CONFERENCES, RETREATS, AND SEMINARS IN THE HEALTH CARE FIELD (U.S. CLS. 100, 101 AND 107).
FIRST USE 5-0-1999; IN COMMERCE 5-0-1999.

2,625,475. ADVANCED TECHNOLOGY MATERIALS, INC., DANBURY, CT. SN 75-638,832. PUB. 9-18-2001, FILED 2-10-1999.

SAGE

CLASS 1—CHEMICALS

FOR SUB-ATMOSPHERIC PRESSURE GAS SOURCES, NAMELY, GASES ADSORBED ON ADSORBENTS IN GAS SUPPLY CONTAINERS (U.S. CLS. 1, 5, 6, 10, 26 AND 46).

FIRST USE 11-16-1998; IN COMMERCE 12-7-1999.

CLASS 9—ELECTRICAL AND SCIENTIFIC APPARATUS

FOR SUB-ATMOSPHERIC PRESSURE STORAGE AND DISPENSING SYSTEMS FOR INDUSTRIAL GASES, COMPRISED OF GAS SUPPLY CONTAINERS HOLDING ADSORBENTS WITH INDUSTRIAL GASES ADSORBED THERON (U.S. CLS. 21, 23, 26, 36 AND 38).

FIRST USE 11-16-1998; IN COMMERCE 12-7-1999.

2,625,482. CATHAY PIGMENTS (INTERNATIONAL) LIMITED, SURREY KT17 1RW, ENGLAND. SN 75-654,230. PUB. 8-22-2000, FILED 3-5-1999.



PRIORITY CLAIMED UNDER SEC. 44(D) ON UNITED KINGDOM APPLICATION NO. 2,177,769, FILED 9-22-1998, REG. NO. 2177769, DATED 9-22-1998, EXPIRES 9-22-2008.

CLASS 1—CHEMICALS

FOR CHEMICAL PREPARATIONS FOR USE IN THE MANUFACTURE OF COLOUR PIGMENTS, COLOURANTS AND DYESTUFFS FOR GENERAL INDUSTRIAL USE; METAL OXIDES FOR USE IN THE MANUFACTURE OF COLOUR PIGMENTS, COLOURANTS AND DYESTUFFS FOR GENERAL INDUSTRIAL USE (U.S. CLS. 1, 5, 6, 10, 26 AND 46).

FIRST USE 8-1-1998; IN COMMERCE 8-1-1998.

CLASS 2—PAINTS

FOR COLOUR PIGMENTS, COLOURANTS AND DYESTUFFS FOR USE IN THE MANUFACTURE OF CONCRETE, CEMENTITIOUS AND OTHER BUILDING PRODUCTS, PLASTICS, PAINTS AND OTHER COATING MATERIALS, PAPER CARDBOARD AND OTHER PACKAGING MATERIALS (U.S. CLS. 6, 11 AND 16).

FIRST USE 8-1-1998; IN COMMERCE 8-1-1998.

2,625,485. CHAMBER OF COMMERCE OF THE UNITED STATES, THE, WASHINGTON, DC. SN 75-657,959. PUB. 9-19-2000, FILED 3-10-1999.

CHAMBERBIZ

CLASS 35—ADVERTISING AND BUSINESS

FOR PROVIDING ON-LINE BUSINESS INFORMATION VIA A GLOBAL COMPUTER NETWORK (U.S. CLS. 100, 101 AND 102).

FIRST USE 11-0-1999; IN COMMERCE 11-0-1999.

CLASS 41—EDUCATION AND ENTERTAINMENT

FOR EDUCATIONAL AND INSTRUCTIONAL SERVICES, NAMELY, PROVIDING ON-LINE WORKSHOPS, SEMINARS, AND TRAINING IN THE FIELD OF BUSINESS; PROVIDING INSTRUCTIONAL COURSES IN THE FIELD OF BUSINESS (U.S. CLS. 100, 101 AND 107).

FIRST USE 11-0-1999; IN COMMERCE 11-0-1999.

CLASS 42—SCIENTIFIC, COMPUTER AND LEGAL SERVICES

FOR ASSOCIATION SERVICES, NAMELY, PROMOTING THE INTERESTS OF BUSINESSMEN AND BUSINESSWOMEN (U.S. CLS. 100 AND 101).

FIRST USE 11-0-1999; IN COMMERCE 11-0-1999.

2,625,486. 1164256 ONTARIO LIMITED, THUNDER BAY, ONTARIO. SN 75-658,129. PUB. 11-6-2001, FILED 3-11-1999.

RUST DEPOT

PRIORITY CLAIMED UNDER SEC. 44(D) ON CANADA APPLICATION NO. 1008129, FILED 3-10-1999, REG. NO. TMA537948, DATED 11-29-2000, EXPIRES 11-29-2015.

NO CLAIM IS MADE TO THE EXCLUSIVE RIGHT TO USE "RUST", APART FROM THE MARK AS SHOWN.

CLASS 4—LUBRICANTS AND FUELS

FOR METALWORKING FLUIDS, NAMELY, RUST INHIBITORS, FOR USE IN THE MOTORIZED VEHICLE INDUSTRY (U.S. CLS. 1, 6 AND 15).

FIRST USE 4-29-2002; IN COMMERCE 4-29-2002.

CLASS 37—CONSTRUCTION AND REPAIR

FOR RUSTPROOFING SERVICES FOR MOTOR VEHICLES (U.S. CLS. 100, 103 AND 106).

FIRST USE 4-29-2002; IN COMMERCE 4-29-2002.

2,625,502. SAUCONY, INC., PEABODY, MA. SN 75-683,304. PUB. 12-5-2000, FILED 4-15-1999.

WINDJAMMER

CLASS 24—FABRICS

FOR WIND RESISTANT FABRIC USED IN ATHLETIC CLOTHING (U.S. CLS. 42 AND 50).

FIRST USE 8-31-1999; IN COMMERCE 8-31-1999.

CLASS 25—CLOTHING

FOR CLOTHING, EXCLUDING SOCKS, NAMELY JACKETS, OUTER SHELLS, PULLOVER JACKETS, PANTS, TIGHT, HATS, GLOVES, MITTENS, VESTS, AND SHOE COVERS ALL FOR USE IN ACTIVE SPORTS SUCH AS CYCLING, SKIING, AND RUNNING (U.S. CLS. 22 AND 39).

FIRST USE 8-30-1989; IN COMMERCE 8-30-1989.

CLASS 32—LIGHT BEVERAGES

FOR NON-ALCOHOLIC DRINKS, NAMELY FLAVORED DRINKS CONTAINING HERBAL, MINERAL AND VITAMIN SUPPLEMENTS, PREPARATIONS FOR NON-ALCOHOLIC DRINKS, NAMELY, HERBAL, MINERAL AND VITAMIN SUPPLEMENTS (U.S. CLS. 45, 46 AND 48).

FIRST USE 11-1-1998; IN COMMERCE 11-1-1998.

2,625,503. DESIGN ENTERPRISES LIMITED, TORTOLA, BR. VIRGIN ISLANDS. SN 75-686,942. PUB. 8-8-2000, FILED 4-20-1999.

2,625,536. JOHNSON, MICHAEL GREGG, WASHINGTON, DC. SN 75-728,064. PUB. 8-21-2001, FILED 6-14-1999.

V2

OWNER OF U.S. REG. NO. 2,257,554.

CLASS 9—ELECTRICAL AND SCIENTIFIC APPARATUS

FOR ON-LINE SOFTWARE DOWNLOADABLE FROM A GLOBAL COMPUTER NETWORK FOR VIEWING AND LISTENING TO AUDIOVISUAL AND SOUND RECORDINGS OR MUSICAL PERFORMANCES AND COMPOSITIONS (U.S. CLS. 21, 23, 26, 36 AND 38).

FIRST USE 3-25-1999; IN COMMERCE 3-25-1999.

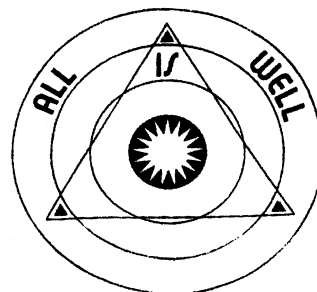
**CLASS 38—COMMUNICATION**

FOR ELECTRONIC TRANSMISSION OF AUDIOVISUAL RECORDINGS AND SOUND RECORDINGS FEATURING MUSICAL COMPOSITIONS, OVER A GLOBAL COMPUTER NETWORK (U.S. CLS. 100, 101 AND 104).

FIRST USE 3-25-1999; IN COMMERCE 3-25-1999.

CLASS 18—LEATHER GOODS

FOR PURSES, LEATHER SHOPPING BAGS, MESH SHOPPING BAGS, TEXTILE SHOPPING BAGS AND UMBRELLAS (U.S. CLS. 1, 2, 3, 22 AND 41).

FIRST USE 6-0-1999; IN COMMERCE 6-0-1999.

CLASS 41—EDUCATION AND ENTERTAINMENT

FOR PROVIDING A WEB SITE ON A GLOBAL COMPUTER NETWORK FEATURING AUDIOVISUAL AND SOUND RECORDINGS OF MUSICAL PERFORMANCES AND COMPOSITIONS (U.S. CLS. 100, 101 AND 107).

FIRST USE 3-25-1999; IN COMMERCE 3-25-1999.

CLASS 25—CLOTHING

FOR CLOTHING NAMELY, SCARVES, SHIRTS, T-SHIRTS, BASEBALL HATS, CAPS, HATS, LIGHT WEIGHT JACKETS AND COATS, PANTS AND SWEATSUITS (U.S. CLS. 22 AND 39).

FIRST USE 6-0-1999; IN COMMERCE 6-0-1999.

CLASS 42—SCIENTIFIC, COMPUTER AND LEGAL SERVICES

FOR PROVIDING ON-LINE NON-DOWNLOADABLE SOFTWARE FOR VIEWING AND LISTENING TO AUDIOVISUAL AND SOUND RECORDINGS OR MUSICAL PERFORMANCES AND COMPOSITIONS OVER A GLOBAL COMPUTER NETWORK (U.S. CLS. 100 AND 101).

FIRST USE 3-25-1999; IN COMMERCE 3-25-1999.

2,625,543. ROGERS, DAVID, NORWOOD, MA. SN 75-732,281. PUB. 6-5-2001, FILED 6-17-1999.

OFFICETEC

CLASS 37—CONSTRUCTION AND REPAIR

FOR INSTALLATION OF WORK STATIONS FOR HOME OFFICES (U.S. CLS. 100, 103 AND 106).

FIRST USE 4-27-2000; IN COMMERCE 4-27-2000.

2,625,515. JURAK HOLDINGS LIMITED, LAS VEGAS, NV. SN 75-703,055. PUB. 7-31-2001, FILED 5-8-1999.

THE YOUTH SOLUTION

CLASS 40—MATERIAL TREATMENT

FOR CUSTOM MANUFACTURE OF WORK STATIONS FOR HOME OFFICES (U.S. CLS. 100, 103 AND 106).

FIRST USE 4-27-2000; IN COMMERCE 4-27-2000.

CLASS 5—PHARMACEUTICALS

FOR HERBAL, MINERAL AND VITAMIN SUPPLEMENTS; DIETARY SUPPLEMENTS (U.S. CLS. 6, 18, 44, 46, 51 AND 52).

FIRST USE 11-1-1998; IN COMMERCE 11-1-1998.

CLASS 42—SCIENTIFIC, COMPUTER AND LEGAL SERVICES

FOR DESIGN FOR OTHERS IN THE FIELD OF WORK STATIONS FOR HOME OFFICES (U.S. CLS. 100 AND 101).

FIRST USE 4-27-2000; IN COMMERCE 4-27-2000.

2,625,554. AGILENT TECHNOLOGIES, INC., PALO ALTO, CA. SN 75-739,923. PUB. 1-16-2001, FILED 6-30-1999.

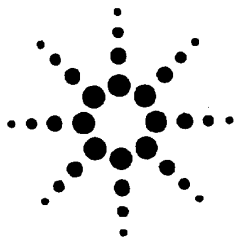

THE MARK CONSISTS OF A STYLIZED EIGHT POINTED STAR FORMED BY SHADED CIRCLES.

CLASS 1—CHEMICALS

FOR CHROMATOGRAPHY CHEMICALS, NAMELY, CHEMICAL STANDARDS AND PACKING MATERIALS USED IN CHROMATOGRAPHY; CHEMICAL STANDARDS USED IN DNA, RNA AND PROTEIN ANALYSIS, CHEMICALS USED IN PROTEIN SEQUENCERS; REAGENTS FOR SCIENTIFIC OR MEDICAL RESEARCH USE; DNA LABELING REAGENTS; DNA HYBRIDIZATION BUFFERS; ULTRASOUND TRANSMISSION GELS (U.S. CLS. 1, 5, 6, 10, 26 AND 46).
FIRST USE 11-0-1999; IN COMMERCE 11-0-1999.

CLASS 9—ELECTRICAL AND SCIENTIFIC APPARATUS

FOR HOUSE MARK FOR A FULL LINE OF ELECTRONIC TEST, SIGNALING AND MEASUREMENT SYSTEMS, EQUIPMENT AND PARTS THEREFOR; HOUSE MARK FOR A FULL LINE OF CHEMICAL AND BIOLOGICAL ANALYTICAL SYSTEMS AND EQUIPMENT, AND PARTS THEREFOR; HOUSE MARK FOR A FULL LINE OF OPTICAL EQUIPMENT AND COMPONENTS, AND PARTS THEREFOR; HOUSE MARK FOR A FULL LINE OF TELECOMMUNICATION EQUIPMENT AND COMPONENTS, AND PARTS THEREFOR; HOUSE MARK FOR A FULL LINE OF ELECTRONIC COMPONENTS; HOUSE MARK FOR A FULL LINE OF COMPUTER SOFTWARE, NAMELY SOFTWARE FOR USE IN CONNECTION WITH TEST, SIGNALING, MEASUREMENT, CHEMICAL OR BIOLOGICAL ANALYTICAL, OPTICAL, TELECOMMUNICATION, SEMICONDUCTOR, MEDICAL, CLINICAL AND PATIENT INFORMATION, NETWORK MANAGEMENT, NETWORK SECURITY, ENGINEERING, AND DATA ACQUISITION APPLICATIONS; COMPUTER HARDWARE AND PARTS THEREFOR; SEMICONDUCTORS; LASERS NOT FOR MEDICAL USE; SIGNAL GENERATORS AND ANALYZERS; OSCILLOSCOPES; NETWORK AND SPECTRUM ANALYZERS; FREQUENCY COUNTERS; ATOMIC CLOCKS IN THE NATURE OF CHRONOMETERS FOR USE AS SPECIALIZED TIME RECORDING APPARATUSES; CHROMATOGRAPHS; ACCESSORIES FOR CHROMATOGRAPHS, NAMELY, CHROMATOGRAPHY COLUMNS, SEPTA, SEALS AND SYRINGES; MASS SPECTROMETERS AND PARTS THEREFOR, NAMELY, IONIZATION SOURCES FOR MASS SPECTROMETERS; SPECTROPHOTOMETERS; AND PROTEIN INSTRUMENTS CONTAINING ELECTRICAL, COMPUTER AND CHEMICAL HARDWARE FOR THE ANALYSIS OF DNA, RNA, CELLS AND PROTEINS; GENE ANALYSIS EQUIPMENT, NAMELY DNA MICROARRAYS, DNA MICROARRAY SCANNERS, DNA HYBRIDIZATION CHAMBERS, AND ASSOCIATED SOFTWARE FOR ANALYZING GENES; DEFIBRILLATOR BATTERIES (U.S. CLS. 21, 23, 26, 36 AND 38).
FIRST USE 11-0-1999; IN COMMERCE 11-0-1999.

CLASS 10—MEDICAL APPARATUS

FOR HOUSE MARK FOR A FULL LINE OF MEDICAL SYSTEMS, MEDICAL EQUIPMENT, AND PARTS THEREFOR; HOUSE MARK FOR A FULL LINE OF MEDICAL MONITORING AND RECORDING DEVICES AND PARTS THEREFOR; ULTRASONIC MEDICAL DIAGNOSTIC APPARATUS AND PARTS THEREFOR; BLOOD PRESSURE MEASURING APPARATUS AND PARTS THEREFOR; BLOOD TESTING APPARATUS; DEFIBRILLATORS AND PARTS THEREFOR; ELECTROCARDIOGRAPHS; STETHOSCOPES; TRANSDUCERS FOR MEDICAL IMAGING; TRANSDUCERS FOR BLOOD PRESSURE, BLOOD GAS AND HEART ACTIVITY DETECTION; SUPPLIES AND ACCESSORIES FOR MEDICAL USE, NAMELY, CABLES, LEADS, ELECTRODES AND PROBES, MEDICAL ICE BUCKETS, MEDICAL PADDLE SETS, DEFIBRILLATOR PADS CARRYING CASES AND STORAGE CABINETS FITTED FOR MEDICAL INSTRUMENTS, BELTS AND STRAPS FOR ATTACHING MEDICAL MONITORS TO PATIENTS, BELT GUIDES FOR ATTACHING MEDICAL MONITORS TO PATIENTS, INTRAUTERINE PRESSURE CATHETERS, AND BITE GUARDS FOR USE WITH ULTRASOUND EQUIPMENT; AND SUPPLIES AND ACCESSORIES FOR USE WITH MEDICAL GAS MONITORING EQUIPMENT, NAMELY, AIRWAY ADAPTERS, AIR FILTERS, BACTERIA FILTERS, CALIBRATION BAGS, CALIBRATION GAS CYLINDERS, CALIBRATION REGULATORS, CALIBRATION TUBES, MEMBRANES, MEMBRANE RETAINER RINGS, MEMBRANE RING DISPENSERS, SENSORS, AND WATER TRAPS (U.S. CLS. 26, 39 AND 44).

FIRST USE 11-0-1999; IN COMMERCE 11-0-1999.

CLASS 14—JEWELRY

FOR CLOCKS; CESIUM CLOCKS; ATOMIC CLOCKS IN THE NATURE OF CHRONOMETERS; CHRONOMETERS FOR SCIENTIFIC, LABORATORY OR INDUSTRIAL APPLICATIONS (U.S. CLS. 2, 27, 28 AND 50).
FIRST USE 9-0-2000; IN COMMERCE 9-0-2000.

CLASS 16—PAPER GOODS AND PRINTED MATTER

FOR NAMELY, NEWSLETTERS, PERIODICALS, BOOKS, BROCHURES, GUIDES, BULLETINS, MAGAZINES, PRODUCT AND PRINTED INSTRUCTIONAL, EDUCATIONAL, AND TEACHING MATERIALS ALL OF SCIENCE, TECHNOLOGY, ELECTRONIC AND OPTICAL EQUIPMENT, TESTING, MEASUREMENT, CHEMICAL OR BIOLOGICAL ANALYSIS, TELECOMMUNICATION, MEDICINE; STATIONERY; NOTE PADS; NOTE CARDS; MEMO PADS; SELF-ADHESIVE NOTES AND WRITING TABLETS; GREETING CARDS; PRINTED MATTER, NAMELY, NEWSLETTERS, PERIODICALS, PAMPHLETS, BOOKS, BROCHURES, GUIDES, BULLETINS, MAGAZINES, PRODUCT AND SERVICE MANUALS, AND PRINTED INSTRUCTIONAL, EDUCATIONAL, AND TEACHING MATERIALS ALL IN THE FIELDS OF SCIENCE, TECHNOLOGY, ELECTRONIC AND OPTICAL EQUIPMENT, TESTING, SIGNALING, MEASUREMENT, CHEMICAL OR BIOLOGICAL ANALYSIS, OPTICS, TELECOMMUNICATION, SEMICONDUCTORS, ELECTRONIC COMPONENTS, COMPUTER HARDWARE, COMPUTER SOFTWARE, OR MEDICINE; PAPER; STATIONERY; NOTE PAPER; NOTE PADS; NOTE CARDS; MEMO PADS; DESK PADS; CALENDAR PADS; SELF-ADHESIVE NOTES AND STICKERS; CALENDARS; ADDRESS BOOKS; APPOINTMENT BOOKS; TABLETS; POSTCARDS; GREETING CARDS; PLAYING CARDS; BOOKMARKS; PAPER NAPKINS; PAPER BAGS; PAPER COASTERS; POSTERS; ART PRINTS; BANNERS; FILE FOLDERS; FILE JACKETS; STATIONARY FOLDERS; AND GIFT WRAP (U.S. CLS. 2, 5, 22, 23, 29, 37, 38 AND 50).

FIRST USE 11-0-1999; IN COMMERCE 11-0-1999.

CLASS 35—ADVERTISING AND BUSINESS

FOR CATALOG SALES SERVICES, AVAILABLE THROUGH, PHONE-IN ORDERS AND ELECTRONIC COMMUNICATIONS NETWORKS, FEATURING - SCIENTIFIC, ELECTRONIC, TEST, SIGNALING, MEASUREMENT, BIOLOGICAL AND CHEMICAL ANALYTICAL, OPTICAL, TELECOMMUNICATION, AND MEDICAL EQUIPMENT, PARTS, SUPPLIES AND ACCESSORIES, SEMICONDUCTORS, ELECTRONIC AND OPTICAL COMPONENTS, COMPUTER HARDWARE, COMPUTER SOFTWARE, AND PRINTED MATTER RELATED TO THE FOREGOING (U.S. CLS. 100, 101 AND 102).

FIRST USE 11-0-1999; IN COMMERCE 11-0-1999.

CLASS 36—INSURANCE AND FINANCIAL

FOR FINANCING SERVICES (U.S. CLS. 100, 101 AND 102).

FIRST USE 11-0-1999; IN COMMERCE 11-0-1999.

CLASS 37—CONSTRUCTION AND REPAIR

FOR REPAIR AND INSTALLATION OF SCIENTIFIC, ELECTRONIC, TEST, SIGNALING, MEASUREMENT, BIOLOGICAL AND CHEMICAL ANALYTICAL, OPTICAL, TELECOMMUNICATION, AND MEDICAL EQUIPMENT, REPAIR AND INSTALLATION OF COMPUTER HARDWARE (U.S. CLS. 100, 103 AND 106).

FIRST USE 11-0-1999; IN COMMERCE 11-0-1999.

CLASS 41—EDUCATION AND ENTERTAINMENT

FOR EDUCATIONAL AND TRAINING SERVICES, NAMELY, OFFERING SEMINARS, CLASSES, WORKSHOPS, AND TUTORIALS, ALL IN THE FIELDS OF - SCIENCE, TECHNOLOGY, ELECTRONIC AND OPTICAL EQUIPMENT, TESTING, SIGNALING, MEASUREMENT, CHEMICAL AND BIOLOGICAL ANALYSIS, OPTICS, TELECOMMUNICATION, SEMICONDUCTORS, ELECTRONIC AND OPTICAL COMPONENTS, COMPUTER HARDWARE, COMPUTER SOFTWARE, AND MEDICINE (U.S. CLS. 100, 101 AND 107).

FIRST USE 1-0-2000; IN COMMERCE 1-0-2000.

CLASS 42—SCIENTIFIC, COMPUTER AND LEGAL SERVICES

FOR COMPUTER PROGRAMMING FOR OTHERS; TECHNICAL SUPPORT SERVICES, NAMELY, PROVIDING INFORMATION CONSULTATION, INSPECTION AND DIAGNOSTIC SERVICES IN THE FIELDS OF SEMICONDUCTORS, ELECTRONIC AND OPTICAL COMPONENTS, , COMPUTER SOFTWARE, AND SCIENTIFIC, ELECTRONIC, TEST, MEASUREMENT, BIOLOGICAL AND CHEMICAL ANALYTICAL, OPTICAL, TELECOMMUNICATION, AND MEDICAL EQUIPMENT, PARTS, SUPPLIES AND RENTAL AND LEASING OF COMPUTER HARDWARE, COMPUTER SOFTWARE, AND SCIENTIFIC, ELECTRONIC, TEST, SIGNALING, MEASUREMENT, BIOLOGICAL AND CHEMICAL ANALYTICAL, OPTICAL, TELECOMMUNICATION, AND MEDICAL EQUIPMENT AND ACCESSORIES; INSTALLATION OF COMPUTER SOFTWARE (U.S. CLS. 100 AND 101).

FIRST USE 11-0-1999; IN COMMERCE 11-0-1999.

2,625,557. STREETSPACE, INC., SAN FRANCISCO, CA. SN 75-740,995. PUB. 9-18-2001, FILED 6-21-1999.

> STREETSPACE

CLASS 9—ELECTRICAL AND SCIENTIFIC APPARATUS

FOR COMPUTER HARDWARE AND SOFTWARE FOR USE IN ACCESSING, UTILIZING AND TRANSMITTING ELECTRONIC DATA OVER A GLOBAL COMPUTER INFORMATION NETWORK OR LOCAL COMPUTER NETWORK (U.S. CLS. 21, 23, 26, 36 AND 38).

FIRST USE 10-0-1999; IN COMMERCE 10-0-1999.

CLASS 35—ADVERTISING AND BUSINESS

FOR DISSEMINATION OF ADVERTISING FOR OTHERS VIA AN ON-LINE ELECTRONIC COMMUNICATIONS NETWORK; ELECTRONIC RETAILING THROUGH MEANS OF PROVIDING AN ELECTRONIC SHOPPING MALL VIA A GLOBAL COMPUTER NETWORK (U.S. CLS. 100, 101 AND 102).

FIRST USE 10-0-1999; IN COMMERCE 10-0-1999.

CLASS 38—COMMUNICATION

FOR PROVIDING MULTIPLE-USER ACCESS TO A GLOBAL COMPUTER INFORMATION NETWORK (U.S. CLS. 100, 101 AND 104).

FIRST USE 10-0-1999; IN COMMERCE 10-0-1999.

CLASS 42—SCIENTIFIC, COMPUTER AND LEGAL SERVICES

FOR DESIGN OF TELECOMMUNICATIONS NETWORK FOR OTHERS (U.S. CLS. 100 AND 101).

FIRST USE 10-0-1999; IN COMMERCE 10-0-1999.

2,625,564. CHAPMAN/LEONARD STUDIO EQUIPMENT, NORTH HOLLYWOOD, CA. SN 75-747,069. PUB. 5-9-2000, FILED 7-6-1999.

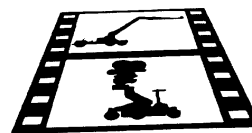

CLASS 37—CONSTRUCTION AND REPAIR

FOR MAINTENANCE AND/OR REPAIR OF CAMERA DOLLIES, CRANES, PEDESTALS AND ACCESSORIES THEREFOR, AND REMOTE CAMERA HEADS (U.S. CLS. 100, 103 AND 106).

FIRST USE 7-1-1999; IN COMMERCE 7-1-1999.

CLASS 42—SCIENTIFIC, COMPUTER AND LEGAL SERVICES

FOR LEASING AND RENTAL OF CAMERA DOLLIES, CRANES, PEDESTALS AND ACCESSORIES THEREFOR, AND REMOTE CAMERA HEADS (U.S. CLS. 100 AND 101).

FIRST USE 7-1-1999; IN COMMERCE 7-1-1999.

2,625,576. DECO PATENTS, INC., EDISON, NJ. SN 75-755,748. PUB. 12-5-2000, FILED 7-20-1999.

2,625,584. VESTEL ELEKTRONIK SANAYI VE TICARET AS, 45030 MANISA, TURKEY. SN 75-767,448. PUB. 9-19-2000, FILED 8-4-1999.

ENVIROGLUV

CLASS 2—PAINTS

FOR PRINTING INKS (U.S. CLS. 6, 11 AND 16).
FIRST USE 9-0-1999; IN COMMERCE 9-0-1999.

CLASS 42—SCIENTIFIC, COMPUTER AND LEGAL SERVICES

FOR PRINTING, NAMELY, THE APPLICATION OF ENVIRONMENTALLY SAFE INK TO SUBSTRATES FOR DECORATIVE PURPOSES (U.S. CLS. 100 AND 101).
FIRST USE 9-0-1999; IN COMMERCE 9-0-1999.

2,625,578. PLAYS MART, INC., BOSTON, MA. SN 75-757,090. PUB. 7-24-2001, FILED 7-21-1999.



CLASS 36—INSURANCE AND FINANCIAL

FOR CHARITABLE FUND RAISING WHERE THE PROCEEDS ARE USED TO PROVIDE EDUCATIONAL AND ATHLETIC OPPORTUNITIES FOR AMERICAN YOUTH (U.S. CLS. 100, 101 AND 102).
FIRST USE 9-1-1998; IN COMMERCE 9-1-1998.

CLASS 42—SCIENTIFIC, COMPUTER AND LEGAL SERVICES

FOR CHARITABLE SERVICES, NAMELY PROVIDING EDUCATIONAL MATERIALS AND ATHLETIC EQUIPMENT FOR AMERICAN YOUTH (U.S. CLS. 100 AND 101).
FIRST USE 9-1-1998; IN COMMERCE 9-1-1998.

VESTEL

CLASS 9—ELECTRICAL AND SCIENTIFIC APPARATUS

FOR ELECTRICAL AND ELECTRONIC APPARATUS, NAMELY, TELEPHONE ANSWERING MACHINES; ANTENNAS; CABINETS FOR LOUDSPEAKERS, LOUD SPEAKERS, STEREO RECEIVERS, STEREO TUNERS, STEREO AMPLIFIERS, DIGITAL AUDIO TAPE PLAYERS, AUDIO TAPE PLAYERS, VIDEO TAPE PLAYERS, AUDIO CASSETTE RECORDERS, VIDEO CASSETTE RECORDERS, COMPACT DISC PLAYERS; TELEVISION SETS; VIDEO DISCS FEATURING MUSIC AND ENTERTAINMENT, MUSICAL SOUND RECORDINGS, MUSICAL VIDEO RECORDINGS; PHOTOGRAPHIC CAMERAS, VIDEO CAMERAS; COMPUTERS, COMPUTER INTERFACE BOARDS, COMPUTER CHIPS, SILICON CHIPS, CIRCUIT BOARDS, ELECTRICAL CIRCUIT BOARDS, PRINTED CIRCUIT BOARDS, ELECTRICAL CIRCUITS, INTEGRATED CIRCUITS, COMPUTER HARDWARE, COMPUTER INTERFACE BOARDS, COMPUTER KEYBOARDS, COMPUTER MEMORIES, COMPUTER MONITORS, COMPUTER MOUSE, COMPUTER PERIPHERALS, COMPUTER PRINTERS, COMPUTER TERMINALS, COMPUTER DISC DRIVES, LASER PRINTERS, COMPUTER MEMORIES, MICROCOMPUTERS, MINI-COMPUTERS, MODEMS, SEMICONDUCTOR DEVICES, ELECTRIC LUMINESCENT DISPLAY PANELS; BLANK DISCS FOR COMPUTERS; FACSIMILE MACHINES (U.S. CLS. 21, 23, 26, 36 AND 38).
FIRST USE 12-12-2000; IN COMMERCE 2-0-2001.

CLASS 11—ENVIRONMENTAL CONTROL APPARATUS

FOR CLOTHES DRYERS; MICROWAVE OVENS FOR COOKING; DOMESTIC COOKING OVENS; AIR CONDITIONING UNITS; REFRIGERATORS (U.S. CLS. 13, 21, 23, 31 AND 34).
FIRST USE 5-15-2002; IN COMMERCE 5-15-2002.

2,625,586. LIBBY, PERSZYK, KATHMAN, INC., CINCINNATI, OH. SN 75-768,495. PUB. 12-19-2000, FILED 8-3-1999.

INNOVENTURES

CLASS 35—ADVERTISING AND BUSINESS

FOR ADVERTISING AGENCY SERVICES, DEVELOPING CORPORATE LOGOS AND CORPORATE AND PRODUCT AND BRAND IDENTITY PROGRAMS FOR OTHERS, AND PROVIDING CREATIVE STRATEGIC THINKING FOR OTHERS IN THE FIELD OF CORPORATE LOGOS AND CORPORATE AND BRAND IDENTITY CONCEPTS (U.S. CLS. 100, 101 AND 102).
FIRST USE 0-0-1999; IN COMMERCE 0-0-1999.

CLASS 42—SCIENTIFIC, COMPUTER AND LEGAL SERVICES

FOR PRINT, PACKAGE, PRODUCT AND INDUSTRIAL DESIGN SERVICES (U.S. CLS. 100 AND 101).
FIRST USE 0-0-1999; IN COMMERCE 0-0-1999.

2,625,587. GUSTAV WOLF SEIL-UND DRAHTWERKE GMBH & CO., D-33332 GUTERSLOH, FED REP GERMANY. SN 75-772,279. PUB. 3-6-2001, FILED 8-10-1999.

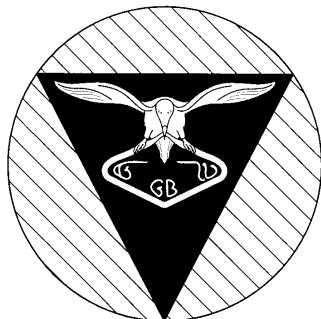

OWNER OF FED REP GERMANY REG. NO. 39549828.7, DATED 2-13-1996, EXPIRES 12-31-2005.

THE MARK CONSISTS OF THE DESIGN OF AN EAGLE CARRYING A PIECE OF ROPE, ENCIRCLING THE LETTERS "GW" AND "GB", APPEARING WITHIN A TRIANGLE AGAINST A GREEN CIRCULAR BACKGROUND.

CLASS 6—METAL GOODS

FOR SINGLE AND MULTISTRAND NON-ELECTRIC METAL WIRE, NAMELY STEEL WIRE AND STEEL WIRE ROPE, METAL CABLES, CABLE WIRES, WIRE ROPE SLINGS (U.S. CLS. 2, 12, 13, 14, 23, 25 AND 50).
FIRST USE 2-0-1973; IN COMMERCE 10-0-1979.

CLASS 22—CORDAGE AND FIBERS

FOR TEXTILE ROPES, TEXTILE BANDS FOR LIFTING CARGO, SLINGS OF ROPE AND FABRIC (U.S. CLS. 1, 2, 7, 19, 22, 42 AND 50).
FIRST USE 2-0-1973; IN COMMERCE 10-0-1979.

2,625,589. LIDCO LTD, LONDON, N1 5QL, UNITED KINGDOM. SN 75-773,286. PUB. 5-22-2001, FILED 8-10-1999.

LIDCO

PRIORITY CLAIMED UNDER SEC. 44(D) ON UNITED KINGDOM APPLICATION NO. 2202362, FILED 7-8-1999, REG. NO. 2202362, DATED 12-24-1999, EXPIRES 7-8-2009.

CLASS 10—MEDICAL APPARATUS

FOR MEDICAL APPARATUS AND INSTRUMENTS, PARTS AND FITTINGS FOR THESE GOODS, NAMELY, HEMODYNAMIC CARDIAC OUTPUT MEASUREMENT SYSTEM CONSISTING OF A TOUCH SCREEN, MONITOR; PERISTALTIC FLOW REGULATOR; LITHIUM SENSOR ELECTRODE; STERILE INDICATOR INJECTATE; CABLE AND DISPOSABLE WASTE BAG (U.S. CLS. 26, 39 AND 44).
FIRST USE 6-0-2001; IN COMMERCE 6-0-2001.

CLASS 42—SCIENTIFIC, COMPUTER AND LEGAL SERVICES

FOR MEDICAL SERVICES; MEDICAL RESEARCH SERVICES AND MEDICAL CONSULTANCY SERVICES (U.S. CLS. 100 AND 101).
FIRST USE 6-0-2001; IN COMMERCE 6-0-2001.

2,625,593. FIRSTDOOR.COM, INC., KENNESAW, GA. SN 75-776,424. PUB. 7-24-2001, FILED 8-16-1999.

FIRSTDOOR

CLASS 35—ADVERTISING AND BUSINESS

FOR PROVIDING INFORMATION VIA A GLOBAL COMPUTER NETWORK IN THE FIELD OF HUMAN RESOURCES MANAGEMENT (U.S. CLS. 100, 101 AND 102).
FIRST USE 4-15-2000; IN COMMERCE 4-15-2000.

CLASS 36—INSURANCE AND FINANCIAL

FOR PROVIDING INFORMATION VIA A GLOBAL COMPUTER NETWORK IN THE FIELD OF EMPLOYEE BENEFIT PLANS (U.S. CLS. 100, 101 AND 102).
FIRST USE 4-15-2000; IN COMMERCE 4-15-2000.

2,625,600. BIO-MEDICAL & PHARMACEUTICAL MANUFACTURING CORPORATION, HOUSTON, TX. SN 75-783,614. PUB. 2-20-2001, FILED 8-24-1999.

PRO-SPECTRUM

CLASS 3—COSMETICS AND CLEANING PREPARATIONS

FOR SUNSCREEN (U.S. CLS. 1, 4, 6, 50, 51 AND 52).
FIRST USE 12-31-2001; IN COMMERCE 12-31-2001.

CLASS 40—MATERIAL TREATMENT

FOR PROCESSING AND TREATMENT OF SUNSCREEN PREPARATIONS (U.S. CLS. 100, 103 AND 106).
FIRST USE 12-31-2001; IN COMMERCE 3-5-2002.

2,625,609. GRIMM & PAUL NEUWERK GMBH, D-98711 SCHMIEDEFELD, FED REP GERMANY. SN 75-794,648. PUB. 3-28-2000, FILED 9-8-1999.

BUBBLE STOPPER

NO CLAIM IS MADE TO THE EXCLUSIVE RIGHT TO USE "STOPPER", APART FROM THE MARK AS SHOWN.

CLASS 6—METAL GOODS

FOR BOTTLE CAPS OF METAL; BOTTLE CLOSURES OF METAL; SEALING CAPS OF METAL FOR CHAMPAGNE BOTTLES AND WINE BOTTLES (U.S. CLS. 2, 12, 13, 14, 23, 25 AND 50).
FIRST USE 6-8-2001; IN COMMERCE 6-8-2001.

CLASS 20—FURNITURE AND ARTICLES NOT OTHERWISE CLASSIFIED

FOR BOTTLE CAPS AND BOTTLE CLOSURES NOT OF METAL; CORKS FOR BOTTLES; SEALING CAPS, NOT OF METAL FOR CHAMPAGNE BOTTLES AND WINE BOTTLES (U.S. CLS. 2, 13, 22, 25, 32 AND 50).
FIRST USE 6-8-2001; IN COMMERCE 6-8-2001.

2,625,611. IRIDES, LLC, WASHINGTON, DC. SN 75-798,394.
PUB. 11-13-2001, FILED 9-13-1999.

2,625,634. INTELLIGROUP, INC., EDISON, NJ. SN 75-
815,954. PUB. 8-28-2001, FILED 10-5-1999.

SOLOSERVER

CLASS 38—COMMUNICATION

FOR PROVIDING TELECOMMUNICATIONS CON-
NECTIONS TO A GLOBAL COMPUTER NETWORK
(U.S. CLS. 100, 101 AND 104).

FIRST USE 5-0-2000; IN COMMERCE 5-0-2000.

CLASS 42—SCIENTIFIC, COMPUTER AND LEGAL SERVICES

FOR HOSTING AND MANAGING THE WEB SITES OF
OTHERS ON A COMPUTER SERVER FOR A GLOBAL
COMPUTER NETWORK (U.S. CLS. 100 AND 101).

FIRST USE 5-0-2000; IN COMMERCE 5-0-2000.

2,625,629. KRONE DIGITAL COMMUNICATIONS INC.,
SIDNEY, NE, BY ASSIGNMENT; BY ASSIGNMENT
PRESTOLITE WIRE CORPORATION, SOUTHFIELD,
MI. SN 75-809,014. PUB. 8-8-2000, FILED 9-27-1999.

CLASS 41—EDUCATION AND ENTERTAIN- MENT

FOR EDUCATIONAL SERVICES, NAMELY, PROVID-
ING VOCATIONAL EDUCATION, PROVIDING EDUCA-
TIONAL DEMONSTRATIONS, PROVIDING SEMINARS,
PROVIDING WORKSHOPS, PROVIDING INTERACTIVE
AND SELF-PACED DISTANCE LEARNING OVER A
GLOBAL COMPUTER NETWORK, ALL IN THE FIELD
OF SELECTION AND INSTALLATION OF DATA
CABLE; TRAINING IN THE SELECTION AND INSTAL-
LATION OF DATA CABLE (U.S. CLS. 100, 101 AND 107).

FIRST USE 9-0-1999; IN COMMERCE 9-0-1999.

CLASS 42—SCIENTIFIC, COMPUTER AND LEGAL SERVICES

FOR CONSULTING SERVICES IN THE FIELD OF
SELECTION, INSTALLATION AND PERFORMANCE
ENHANCEMENT OF DATA CABLE SYSTEMS; THIRD-
PARTY TESTING OF GOODS AND SERVICES OF
OTHERS FOR THE PURPOSE OF CERTIFICATION IN
THE FIELD OF DATA CABLE SYSTEMS (U.S. CLS. 100
AND 101).

FIRST USE 9-0-1999; IN COMMERCE 9-0-1999.

ASPplus

CLASS 35—ADVERTISING AND BUSINESS

FOR MANAGEMENT OF DATABASES FOR OTHERS
(U.S. CLS. 100, 101 AND 102).

FIRST USE 12-15-1999; IN COMMERCE 12-15-1999.

CLASS 42—SCIENTIFIC, COMPUTER AND LEGAL SERVICES

FOR COMPUTER CONSULTING FOR OTHERS;
NAMELY ENTERPRISE AND E-COMMERCE SOFT-
WARE AND WEB SITE DESIGN, DEVELOPMENT,
DEPLOYMENT AND MANAGEMENT, INCLUDING
WEB SITE HOSTING, ENTERPRISE AND E-COMMERCE
SOFTWARE HOSTING, AND COMPUTER CONSULT-
ING IN THE FIELD OF ELECTRONIC COMMERCE
CONDUCTED BY OTHERS OVER A GLOBAL COMPU-
TER NETWORK (U.S. CLS. 100 AND 101).

FIRST USE 12-15-1999; IN COMMERCE 12-15-1999.

2,625,635. TERABEAN CORPORATION, SEATTLE, WA, BY
CHANGE OF NAME; BY CHANGE OF NAME TER-
ABEAN CORPORATION, SEATTLE, WA. SN 75-817,335.
PUB. 7-3-2001, FILED 10-7-1999.

TERABEAM

OWNER OF U.S. REG. NO. 2,398,305.

CLASS 9—ELECTRICAL AND SCIENTIFIC APPARATUS

FOR COMPUTER HARDWARE AND ELECTRONIC
EQUIPMENT, NAMELY, TRANSCEIVERS FOR PROVID-
ING HIGH SPEED OPTOELECTRONIC TRANSMISSION
OF DATA; COMPUTER SOFTWARE FOR TRANSMIT-
TING, ROUTING, ENCRYPTING DATA IN THE FIELD
OF OPTOELECTRONIC COMMUNICATIONS (U.S. CLS.
21, 23, 26, 36 AND 38).

FIRST USE 11-20-1999; IN COMMERCE 3-1-2000.

CLASS 38—COMMUNICATION

FOR COMMUNICATIONS SERVICES, NAMELY, PRO-
VIDING HIGH-SPEED OPTOELECTRONIC TRANSMIS-
SION OF DATA (U.S. CLS. 100, 101 AND 104).

FIRST USE 12-0-1997; IN COMMERCE 3-12-2000.

2,625,649. BEETS N' SNIPS, L.L.C., SALT LAKE CITY, UT. SN 75-826,090. PUB. 12-26-2000, FILED 10-18-1999.

SUGAR BEET

CLASS 25—CLOTHING

FOR CHILDREN AND INFANT CLOTHING, NAMELY, DRESSES, SKIRTS, PANTS, SHORTS, SKORTS, JUMPSUITS, OVERALLS, SHIRTS, T-SHIRTS, BLOUSES, JACKETS, SWEATERS, SWEATSHIRTS, TIGHTS, UNDERGARMENTS, UNDERWEAR, SOCKS, BOOTIES, SHOES, HATS, PAJAMAS, NIGHTGOWNS, NIGHTSHIRTS, CLOTH BIBS, BELTS, AND BATHING SUITS (U.S. CLS. 22 AND 39).

FIRST USE 10-18-1999; IN COMMERCE 10-18-1999.

CLASS 28—TOYS AND SPORTING GOODS

FOR CHILDREN AND INFANT TOYS, NAMELY, STUFFED TOY ANIMALS, SOFT SCULPTURE TOYS, BABY RATTLES, BABY BATHTUB TOYS, AND BABY CRIB TOYS (U.S. CLS. 22, 23, 38 AND 50).

FIRST USE 10-18-1999; IN COMMERCE 10-18-1999.

2,625,650. RAVIZE, JOHN THOMAS, STATELINE, NV. AND RAVIZE, LINDE CHRISTIANA, STATELINE, NV. SN 75-827,030. PUB. 1-16-2001, FILED 10-20-1999.

HEARTS OF LIGHT

CLASS 16—PAPER GOODS AND PRINTED MATTER

FOR CALENDARS, NOTE CARDS, A SERIES OF PHOTOGRAPHY AND POETRY BOOKS, POSTERS AND PHOTOGRAPHIC PRINTS (U.S. CLS. 2, 5, 22, 23, 29, 37, 38 AND 50).

FIRST USE 3-0-1999; IN COMMERCE 3-0-1999.

CLASS 25—CLOTHING

FOR CLOTHING, NAMELY, T-SHIRTS, CAPS, HATS, SWEATSHIRTS, SWEAT PANTS AND SHIRTS (U.S. CLS. 22 AND 39).

FIRST USE 3-0-1999; IN COMMERCE 3-0-1999.

CLASS 35—ADVERTISING AND BUSINESS

FOR COMPUTERIZED ON-LINE RETAIL SERVICES FEATURING CALENDARS, NOTE CARDS, PHOTOGRAPHY AND POETRY BOOKS, POSTERS, PHOTOGRAPHIC PRINTS AND CLOTHING (U.S. CLS. 100, 101 AND 102).

FIRST USE 3-0-1999; IN COMMERCE 3-0-1999.

2,625,653. QVC, INC., WEST CHESTER, PA. SN 75-828,011. PUB. 9-4-2001, FILED 10-22-1999.

SPEED BUY

NO CLAIM IS MADE TO THE EXCLUSIVE RIGHT TO USE "BUY", APART FROM THE MARK AS SHOWN.

CLASS 35—ADVERTISING AND BUSINESS

FOR ON-LINE WHOLESALE DISTRIBUTORSHIP AND RETAIL STORE SERVICES FEATURING GENERAL MERCHANDISE (U.S. CLS. 100, 101 AND 102).

FIRST USE 11-1-1999; IN COMMERCE 11-1-1999.

CLASS 42—SCIENTIFIC, COMPUTER AND LEGAL SERVICES

FOR COMPUTER SERVICES; NAMELY PROVIDING SEARCH ENGINES FOR OBTAINING DATA ON A GLOBAL COMPUTER NETWORK (U.S. CLS. 100 AND 101).

FIRST USE 11-1-1999; IN COMMERCE 11-1-1999.

2,625,659. CAREFIRST OF MARYLAND, INC., DBA CAREFIRST BLUE CROSS BLUE SHIELD, OWINGS MILL, MD. SN 75-831,130. PUB. 11-27-2001, FILED 10-25-1999.

CAREFIRST OPTIONS

OWNER OF U.S. REG. NOS. 1,543,100, 2,010,084, AND OTHERS.

CLASS 35—ADVERTISING AND BUSINESS

FOR HEALTH CARE COST CONTAINMENT SERVICES, NAMELY, SELECTING HEALTH CARE PROVIDERS FOR OFFERING HEALTH CARE SERVICES AT REDUCED COSTS TO PARTICIPATING MEMBERS SO AS TO CONTAIN HEALTHCARE COSTS (U.S. CLS. 100, 101 AND 102).

FIRST USE 9-22-1999; IN COMMERCE 9-22-1999.

CLASS 36—INSURANCE AND FINANCIAL

FOR INSURANCE SERVICES, NAMELY, UNDERWRITING AND ADMINISTRATION SERVICES, ON A PREPAYMENT BASIS, RELATING TO EMERGENCY ALTERNATIVE MEDICAL CARE; PREPAID FINANCING AND ADMINISTRATION OF ALTERNATIVE OR HOLISTIC MEDICAL CARE, ALTERNATIVE OR HOLISTIC PHARMACEUTICAL CARE AND RELATED HEALTHCARE SERVICES; ADMINISTRATION OF PREFERRED PROVIDER PROGRAMS IN THE FIELD OF ALTERNATIVE OR HOLISTIC MEDICINES, NAMELY, PROVIDING MEMBERS WITH A NETWORK OF PHYSICIANS THAT PRACTICE ALTERNATIVE OR HOLISTIC MEDICINES (U.S. CLS. 100, 101 AND 102).

FIRST USE 9-22-1999; IN COMMERCE 9-22-1999.

CLASS 42—SCIENTIFIC, COMPUTER AND LEGAL SERVICES

FOR HEALTHCARE SERVICES IN THE NATURE OF A HEALTH MAINTENANCE ORGANIZATION AND PREFERRED PROVIDER ORGANIZATION; HEALTH CARE CONSULTING SERVICES IN CONNECTION THEREWITH; REHABILITATION SERVICES FOR DISABLED PERSONS; HEALTHCARE SERVICES IN THE NATURE OF A PREFERRED PROVIDER PROGRAM THAT PROVIDES MEMBERS WITH A NETWORK OF PHYSICIANS THAT PRACTICE ALTERNATIVE OR HOLISTIC MEDICINES; ORGANIZATIONAL SERVICES, NAMELY, PROMOTING THE INTEREST OF PERSONS CONCERNED WITH PERSONAL HEALTH MAINTENANCE AND SAFETY (U.S. CLS. 100 AND 101).

FIRST USE 9-22-1999; IN COMMERCE 9-22-1999.

2,625,660. WEST POINT-PEPPERELL ENTERPRISES, INC., WILMINGTON, DE. SN 75-832,705. PUB. 7-18-2000, FILED 10-28-1999.

2,625,667. VIRTUAL, INC., SAN JUAN, PUERTO RICO. SN 75-836,465. PUB. 9-11-2001, FILED 10-29-1999.

MARTEX BARE NECESSITIES

OWNER OF U.S. REG. NOS. 103,027, 2,007,161, AND OTHERS.

CLASS 24—FABRICS

FOR SHEETS, PILLOW CASES, COMFORTERS, BED-SPREADS, PILLOW SHAMS, BED DUST RUFFLES, DUVET COVERS, COMFORTER COVERS, MATTRESS PADS, BLANKETS, TOWELS, WASH CLOTHS, FABRIC BATH MATS, FABRIC SHOWER CURTAINS, CURTAINS, DRAPERIES AND VALENCES (U.S. CLS. 42 AND 50).

FIRST USE 12-1-1999; IN COMMERCE 12-1-1999.

CLASS 27—FLOOR COVERINGS

FOR BATH RUGS (U.S. CLS. 19, 20, 37, 42 AND 50).

FIRST USE 12-1-1999; IN COMMERCE 12-1-1999.

ZONAI.COM

CLASS 35—ADVERTISING AND BUSINESS

FOR WORLD WIDE WEB CONTENT PROVIDER, NAMELY, PROVIDING INFORMATION IN THE FIELD OF COMMERCIAL BUSINESS; PROMOTING THE GOODS AND SERVICES OF OTHERS BY PREPARING AND PLACING ADVERTISEMENTS IN AN ELECTRONIC MAGAZINE ACCESSED THROUGH THE WORLD WIDE WEB; ELECTRONIC COMMERCE SERVICES, NAMELY, BUSINESS TRANSACTIONS IN THE NATURE OF ON LINE RETAIL STORE SERVICES AND ORDERING SERVICES FEATURING A WIDE VARIETY OF CONSUMER GOODS OF OTHERS (U.S. CLS. 100, 101 AND 102).

FIRST USE 10-20-2000; IN COMMERCE 10-20-2000.

CLASS 36—INSURANCE AND FINANCIAL

FOR ELECTRONIC COMMERCE SERVICES, NAMELY, ELECTRONIC CREDIT CARD AND DEBIT TRANSACTIONS, FUNDS TRANSFERS AND PAYMENT PROCESSING (U.S. CLS. 100, 101 AND 102).

FIRST USE 10-20-2000; IN COMMERCE 10-20-2000.

2,625,662. AMERICAN HEART ASSOCIATION, INC., DALLAS, TX. SN 75-833,313. PUB. 6-19-2001, FILED 10-28-1999.

2,625,668. VIRTUAL, INC., SAN JUAN, PUERTO RICO. SN 75-836,468. PUB. 9-11-2001, FILED 10-29-1999.

CHOOSE TO MOVE

CLASS 16—PAPER GOODS AND PRINTED MATTER

FOR PRINTED MATERIALS AND PUBLICATIONS RELATING TO THE PREPARATION FOR AND PARTICIPATION IN PHYSICAL ACTIVITY AND THE HEALTH BENEFITS THEREOF, NAMELY, COOKBOOK, NEWSLETTERS, HAND BOOKS, BOOKMARKS, AND PENCILS (U.S. CLS. 2, 5, 22, 23, 29, 37, 38 AND 50).

FIRST USE 6-0-1998; IN COMMERCE 6-0-1998.

CLASS 42—SCIENTIFIC, COMPUTER AND LEGAL SERVICES

FOR PROVIDING INTER-ACTIVE ON-LINE RESOURCE INFORMATION AND MATERIALS VIA A GLOBAL COMPUTER NETWORK RELATING TO THE PREPARATION FOR AND PARTICIPATION IN PHYSICAL ACTIVITY AND THE HEALTH BENEFITS THEREOF; PROVIDING RESOURCE INFORMATION AND MATERIALS AS PART OF A PROGRAM DESIGNED TO PROMOTE THE PREPARATION FOR AND PARTICIPATION IN PHYSICAL ACTIVITY AND BETTER NUTRITION, AND THE HEALTH BENEFITS THEREOF (U.S. CLS. 100 AND 101).

FIRST USE 6-0-2000; IN COMMERCE 6-0-2000.

ZONAI.COM

CLASS 38—COMMUNICATION

FOR PROVIDING MULTIPLE-USER ACCESS TO THE WORLD WIDE WEB; ELECTRONIC MAIL SERVICES; PROVIDING ON-LINE CHAT ROOMS FOR TRANSMISSION OF MESSAGES AMONG COMPUTER USERS CONCERNING TOPICS OF GENERAL AND SPECIAL INTERESTS; PROVIDING VIRTUAL AND INTERACTIVE INFORMATION EXCHANGE FACILITIES FOR THE USE OF OTHERS, NAMELY, ON-LINE ELECTRONIC BULLETIN BOARDS FOR THE TRANSMISSION OF MESSAGES AMONG COMPUTER USERS CONCERNING TOPICS OF GENERAL AND SPECIAL INTERESTS (U.S. CLS. 100, 101 AND 104).

FIRST USE 10-20-2000; IN COMMERCE 10-20-2000.

CLASS 42—SCIENTIFIC, COMPUTER AND LEGAL SERVICES

FOR COMPUTER SERVICES, NAMELY, HOSTING THE WEB SITES OF OTHERS, DESIGN, DEVELOPMENT, IMPLEMENTATION, AND MAINTENANCE OF WORLD WIDE WEB SITES AND PAGES FOR OTHERS (U.S. CLS. 100 AND 101).

FIRST USE 10-20-2000; IN COMMERCE 10-20-2000.

2,625,674. GUASCOR, S.A., 20750 ZUMAIA (GUIPUZCOA), SPAIN. SN 75-840,883. PUB. 2-20-2001, FILED 11-4-1999.

 **GUASCOR**

CLASS 7—MACHINERY

FOR ELECTRIC AND ELECTROGENIC GENERATORS, BOAT MOTORS, ALTERNATORS (U.S. CLS. 13, 19, 21, 23, 31, 34 AND 35).
FIRST USE 0-0-1974; IN COMMERCE 7-30-1999.

CLASS 9—ELECTRICAL AND SCIENTIFIC APPARATUS

FOR ELECTRIC MATERIAL, NAMELY, CABLES AND WIRES FOR ELECTRICAL CONDUCTION AND CONNECTIONS OF ELECTRICITY, ELECTRICAL TRANSFORMERS ALL USED FOR THE DISTRIBUTION OF ELECTRICITY (U.S. CLS. 21, 23, 26, 36 AND 38).
FIRST USE 0-0-1974; IN COMMERCE 7-30-1999.

CLASS 11—ENVIRONMENTAL CONTROL APPARATUS

FOR GAS AND STEAM GENERATORS, THERMAL EXCHANGERS AND REHEATERS FOR BOILERS (U.S. CLS. 13, 21, 23, 31 AND 34).
FIRST USE 0-0-1974; IN COMMERCE 1-12-2000.

CLASS 37—CONSTRUCTION AND REPAIR

FOR CONSTRUCTION, INSTALLATION, MAINTENANCE AND REPAIR SERVICES OF POWER GENERATION AND CO-GENERATION OF ELECTRIC ENERGY INSTALLATIONS AND REPAIR OF BOAT MOTORS (U.S. CLS. 100, 103 AND 106).
FIRST USE 0-0-1974; IN COMMERCE 7-30-1999.

2,625,675. BASS BARBARIANS, INC., HAYWARD, CA. SN 75-840,948. PUB. 7-17-2001, FILED 11-4-1999.

BASS BARBARIANS

NO CLAIM IS MADE TO THE EXCLUSIVE RIGHT TO USE "BASS", APART FROM THE MARK AS SHOWN.

CLASS 35—ADVERTISING AND BUSINESS

FOR RETAIL STORE SERVICES FEATURING FISHING EQUIPMENT (U.S. CLS. 100, 101 AND 102).
FIRST USE 3-1-2000; IN COMMERCE 3-30-2000.

CLASS 41—EDUCATION AND ENTERTAINMENT

FOR RENTAL OF FISHING EQUIPMENT AND PROVIDING INFORMATION IN THE FIELD OF FISHING VIA A GLOBAL COMPUTER NETWORK (U.S. CLS. 100, 101 AND 107).
FIRST USE 6-1-2000; IN COMMERCE 7-1-2000.

2,625,676. GLOBAL RESOURCE NETWORK, LLC, SOUTHFIELD, MI, BY ASSIGNMENT MICHAEL A. SCHULTZ & ASSOCIATES, INC., SOUTHFIELD, MI. SN 75-841,252. PUB. 4-24-2001, FILED 11-4-1999.



CLASS 35—ADVERTISING AND BUSINESS

FOR COST MANAGEMENT FOR THE HEALTH BENEFIT PLANS OF OTHERS; COOPERATIVE ADVERTISING AND MARKETING (U.S. CLS. 100, 101 AND 102).
FIRST USE 1-0-2000; IN COMMERCE 1-0-2000.

CLASS 36—INSURANCE AND FINANCIAL

FOR ADMINISTRATION OF EMPLOYEE BENEFIT PLANS; FINANCIAL ANALYSIS, FORECASTING, CONSULTATION, RESEARCH PLANNING, MANAGEMENT, PORTFOLIO MANAGEMENT AND INVESTMENT IN THE FIELD OF SECURITIES; FINANCIAL INFORMATION PROVIDED BY ELECTRONIC AND OTHER MEANS; INSURANCE ADMINISTRATION, BROKERAGE, AND CONSULTATION; INSURANCE UNDERWRITING IN THE FIELDS OF LIFE, HEALTH, DISABILITY, VISION, DENTAL, PROPERTY, CASUALTY, PERSONAL LINES, GROUP, PROFESSIONAL LIABILITY, SURPLUS LINES, SELF-INSURANCE AND LONG-TERM CARE; STOCK BROKERAGE (U.S. CLS. 100, 101 AND 102).
FIRST USE 1-0-2000; IN COMMERCE 1-0-2000.

2,625,678. AMBER HOLDINGS INC., CALGARY, ALBERTA, CANADA. SN 75-842,456. PUB. 6-19-2001, FILED 11-6-1999.



OWNER OF CANADA REG. NO. 381182, DATED 3-8-1991, EXPIRES 3-8-2006.

CLASS 16—PAPER GOODS AND PRINTED MATTER

FOR TEDDY BEAR RELATED ITEMS, NAMELY, PICTURES, GREETING CARDS, POSTERS, MAGAZINES REGARDING TEDDY BEARS, BOOKS REGARDING TEDDY BEARS; PRINTED MATERIALS, NAMELY, NEWSLETTERS REGARDING TEDDY BEARS (U.S. CLS. 2, 5, 22, 23, 29, 37, 38 AND 50).

FIRST USE 3-0-1987; IN COMMERCE 3-0-1993.

CLASS 28—TOYS AND SPORTING GOODS

FOR TEDDY BEARS, COLLECTIBLE TOY FIGURES OF BEARS, PLUSH ANIMAL TOYS AND BALLOONS (U.S. CLS. 22, 23, 38 AND 50).

FIRST USE 3-0-1987; IN COMMERCE 3-0-1993.

2,625,684. FIBRES OPTIQUES RECHERCHES ET TECHNOLOGIE, 91410 DOURDAN, FRANCE. SN 75-846,994. PUB. 4-10-2001, FILED 11-11-1999.



THE MARK CONSISTS OF A DESIGN OF A CIRCLE WITH TWO SQUARES FORMING AN ARROW WITH THE WORD MARK "FORT".

CLASS 9—ELECTRICAL AND SCIENTIFIC APPARATUS

FOR ELECTRIC CONDUCTORS FOR LIGHT, OPTICAL FIBRES; OPTO-ELECTRONIC DETECTORS, ENDOSCOPES FOR INDUSTRIAL USE, VIDEO MICROSCOPES AND PARTS THEREOF (U.S. CLS. 21, 23, 26, 36 AND 38).

FIRST USE 1-0-1979; IN COMMERCE 1-0-1979.

CLASS 10—MEDICAL APPARATUS

FOR ENDOSCOPES FOR MEDICAL USE (U.S. CLS. 26, 39 AND 44).

FIRST USE 1-0-1979; IN COMMERCE 1-0-1979.

2,625,690. GRANDWAY USA CORP., SALT LAKE CITY, UT. SN 75-849,857. PUB. 7-10-2001, FILED 11-16-1999.

SOMETHING TO SMILE ABOUT!**CLASS 1—CHEMICALS**

FOR UNEXPOSED CAMERA FILM (U.S. CLS. 1, 5, 6, 10, 26 AND 46).

FIRST USE 3-0-2002; IN COMMERCE 3-0-2002.

CLASS 9—ELECTRICAL AND SCIENTIFIC APPARATUS

FOR SINGLE USE PHOTOGRAPHIC CAMERAS (U.S. CLS. 21, 23, 26, 36 AND 38).

FIRST USE 11-0-2000; IN COMMERCE 11-0-2000.

2,625,697. DESTINATION PRODUCTS INTERNATIONAL, LTD., MISSISSAUGA, ONTARIO L5B 2V2, CANADA. SN 75-851,656. PUB. 4-24-2001, FILED 11-15-1999.

HOMESTYLE MENU

NO CLAIM IS MADE TO THE EXCLUSIVE RIGHT TO USE "HOMESTYLE", APART FROM THE MARK AS SHOWN.

CLASS 29—MEATS AND PROCESSED FOODS

FOR FROZEN MEALS CONSISTING PRIMARILY OF MEAT, VEGETABLES AND SEAFOOD; CHICKEN; PROCESSED POTATOES; BEEF RIBS; PORK RIBS; BEEF PATTIES; APPETIZERS CONSISTING PRIMARILY OF PROCESSED VEGETABLES, NAMELY, JALAPENO PEPPERS HAVING A BREAD COATING; CHEESE-BASED APPETIZERS, NAMELY, CHEESE PIECES HAVING A BREAD COATING (U.S. CL. 46).

FIRST USE 8-0-1999; IN COMMERCE 8-0-1999.

CLASS 30—STAPLE FOODS

FOR FROZEN MEALS CONSISTING PRIMARILY OF RICE AND PASTA; TORTILLAS; PIZZA; BURRITOS AND APPETIZERS CONSISTING PRIMARILY OF BREAD COATING, NAMELY, BREADED JALAPENO PEPPERS AND BREADED CHEESE PIECES (U.S. CL. 46).

FIRST USE 8-0-1999; IN COMMERCE 8-0-1999.

2,625,712. ION STORM, L.P., DALLAS, TX. SN 75-863,510. PUB. 5-22-2001, FILED 12-3-1999.

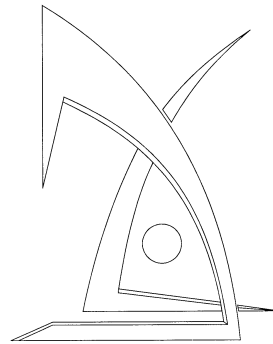

THE MARK CONSISTS OF A CIRCLE AND THE LETTERS "D" AND "L" INTERSECTING.

CLASS 9—ELECTRICAL AND SCIENTIFIC APPARATUS

FOR COMPUTER PROGRAMS DOWNLOADABLE FROM LOCAL AREA NETWORKS, WIDE AREA NETWORKS, GLOBAL COMPUTER NETWORKS OR ELECTRONIC SATELLITE OR TELECOMMUNICATIONS SYSTEMS; MULTIMEDIA SOFTWARE RECORDED ON CD-ROM; PRE-RECORDED VIDEO CASSETTE TAPES, PRE-RECORDED AUDIO CASSETTE TAPES, VIDEO DISCS, COMPACT DISCS AND LASER DISCS ALL FEATURING ANIMATED OR LIVE ACTION CHARACTERS; COMPUTER SOFTWARE, NAMELY, INTERACTIVE COMPUTER ENTERTAINMENT SOFTWARE; COMPUTER PROGRAMS FOR VIDEO AND COMPUTER GAMES; AND ELECTRONIC GAMES; AND INSTRUCTIONAL MANUALS SOLD AS A UNIT (U.S. CLS. 21, 23, 26, 36 AND 38).

FIRST USE 6-0-2000; IN COMMERCE 6-0-2000.

CLASS 16—PAPER GOODS AND PRINTED MATTER

FOR PRINTED MATTER, NAMELY, INSTRUCTIONAL MANUALS AND STRATEGY GUIDES TO ASSIST OR ENHANCE THE USE OF COMPUTER SOFTWARE GAMES AND COMPUTER GAME PROGRAMS (U.S. CLS. 2, 5, 22, 23, 29, 37, 38 AND 50).

FIRST USE 6-0-2000; IN COMMERCE 6-0-2000.

2,625,736. SHELL OIL COMPANY, HOUSTON, TX. SN 75-881,873. PUB. 9-26-2000, FILED 12-21-1999.

LUBRIPLAN**CLASS 9—ELECTRICAL AND SCIENTIFIC APPARATUS**

FOR COMPUTER SOFTWARE FOR USE IN DETERMINING LUBRICATION NEEDS OF MACHINERY AND FOR DATABASE MANAGEMENT OF LUBRICATION INVENTORY (U.S. CLS. 21, 23, 26, 36 AND 38).

FIRST USE 7-1-2001; IN COMMERCE 7-1-2001.

2,625,714. VMG TECHNOLOGIES, ST. PETERSBURG, FL. SN 75-866,820. PUB. 7-17-2001, FILED 12-8-1999.

VMG TECHNOLOGIES

OWNER OF ARAB EMIRATES REG. NO. 1792, DATED 9-28-1993, EXPIRES 9-28-2003.

NO CLAIM IS MADE TO THE EXCLUSIVE RIGHT TO USE "TECHNOLOGIES", APART FROM THE MARK AS SHOWN.

CLASS 16—PAPER GOODS AND PRINTED MATTER

FOR PRINTED MATTER AND PRINTED PUBLICATION, NAMELY, BOOKS, HANDBOOKS, MANUALS AND PAMPHLETS, FEATURING INFORMATION REGARDING MACHINERY LUBRICATION NEEDS AND INVENTORY (U.S. CLS. 2, 5, 22, 23, 29, 37, 38 AND 50).

FIRST USE 7-1-2001; IN COMMERCE 7-1-2001.

CLASS 37—CONSTRUCTION AND REPAIR

FOR COMPUTER INSTALLATION AND REPAIR SERVICES (U.S. CLS. 100, 103 AND 106).

FIRST USE 11-1-1999; IN COMMERCE 11-1-1999.

CLASS 37—CONSTRUCTION AND REPAIR

FOR LUBRICATION AND MAINTENANCE SERVICES FOR MACHINERY AND CONSULTANCY AND ADVISORY SERVICES RELATING THERETO (U.S. CLS. 100, 103 AND 106).

FIRST USE 7-1-2001; IN COMMERCE 7-1-2001.

CLASS 42—SCIENTIFIC, COMPUTER AND LEGAL SERVICES

FOR COMPUTER SERVICES, NAMELY, DESIGNING AND IMPLEMENTING NETWORK WEB PAGES FOR OTHERS; AND COMPUTER SOFTWARE DESIGN FOR OTHERS (U.S. CLS. 100 AND 101).

FIRST USE 11-1-1999; IN COMMERCE 11-1-1999.

2,625,738. CHANCERY SOFTWARE LTD., BURNABY, B.C. V5G 4W1, CANADA. SN 75-883,762. PUB. 9-18-2001, FILED 12-28-1999.

2,625,719. DIGITAS, LLC, BOSTON, MA, BY CHANGE OF NAME BRONNERCOM, LLC, BOSTON, MA. SN 75-869,970. PUB. 8-7-2001, FILED 12-13-1999.

DIGITAS**CLASS 35—ADVERTISING AND BUSINESS**

FOR BUSINESS CONSULTING SERVICES IN THE FIELD OF ELECTRONIC COMMERCE; ADVERTISING AND MARKETING MANAGEMENT AGENCY SERVICES, NAMELY, THE CREATION, DEVELOPMENT AND DISSEMINATION OF ADVERTISING AND PROMOTIONAL MATERIALS VIA DIRECT MAIL, NEWSPAPER, RADIO, TELEVISION, A GLOBAL COMPUTER NETWORK AND OTHER INTERACTIVE MEDIA (U.S. CLS. 100, 101 AND 102).

FIRST USE 12-24-1999; IN COMMERCE 12-24-1999.

CLASS 38—COMMUNICATION

FOR ELECTRONIC TRANSMISSION OF MESSAGES AND DATA VIA A GLOBAL COMPUTER NETWORK THAT PROVIDES DATABASES FEATURING INFORMATION AND COMMUNICATION TOOLS THAT GIVE PARENTS, STUDENTS, TEACHERS AND SCHOOL ADMINISTRATORS SECURE ACCESS TO INDIVIDUAL STUDENT DATA DIRECTLY FROM A SCHOOL'S STUDENT INFORMATION SYSTEM AND THE ABILITY TO COMMUNICATE VIA E-MAIL (U.S. CLS. 100, 101 AND 104).

FIRST USE 5-0-2000; IN COMMERCE 5-0-2000.

CLASS 42—SCIENTIFIC, COMPUTER AND LEGAL SERVICES

FOR COMPUTER SERVICES, NAMELY, DESIGNING AND IMPLEMENTING NETWORK WEB SITES, ELECTRONIC COMMERCE SOFTWARE APPLICATIONS AND INFORMATION TECHNOLOGY COMPUTER NETWORK SYSTEMS FOR OTHERS (U.S. CLS. 100 AND 101).

FIRST USE 12-24-1999; IN COMMERCE 12-24-1999.

CLASS 42—SCIENTIFIC, COMPUTER AND LEGAL SERVICES

FOR COMPUTER SERVICES, NAMELY, PROVIDING DATABASES FEATURING GENERAL AND LOCAL NEWS, AND INFORMATION OF INTEREST TO STUDENTS, STUDENT-PARENTS, EDUCATORS AND SCHOOL ADMINISTRATORS IN THE FIELD OF EDUCATION (U.S. CLS. 100 AND 101).

FIRST USE 5-0-2000; IN COMMERCE 5-0-2000.

K12PLANET

OWNER OF U.S. REG. NO. 2,302,539.

2,625,744. KLX, LLC, WESTLAKE VILLAGE, CA. SN 75-885,118. PUB. 2-13-2001, FILED 1-6-2000.

2,625,751. MASTERMINDS OF FUN, INC., UNION, NJ. SN 75-888,765. PUB. 5-29-2001, FILED 1-5-2000.

DREAM IT.....DO IT

CLASS 25—CLOTHING

FOR CLOTHING, NAMELY, SHIRTS, PANTS, AND JACKETS (U.S. CLS. 22 AND 39).
FIRST USE 3-1-2001; IN COMMERCE 3-1-2001.

CLASS 28—TOYS AND SPORTING GOODS

FOR GOLF EQUIPMENT, NAMELY, GOLF CLUBS, GLOVES, PUTTERS, AND PUTTING AIDS, NAMELY, PORTABLE CUPS, ALIGNMENT RODS, AND GOLF BALLS (U.S. CLS. 22, 23, 38 AND 50).
FIRST USE 3-1-2001; IN COMMERCE 3-1-2001.

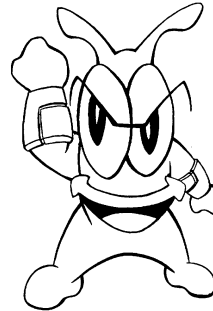

CLASS 25—CLOTHING

FOR CLOTHING, NAMELY T-SHIRTS, NIGHT SHIRTS, SWEATSHIRTS AND SWEATPANTS, SHIRTS, PANTS, BLOUSES, UNDERWEAR, AND JACKETS (U.S. CLS. 22 AND 39).
FIRST USE 10-1-1999; IN COMMERCE 12-1-1999.

CLASS 41—EDUCATION AND ENTERTAINMENT

FOR INTERACTIVE ONLINE EDUCATIONAL SERVICES, NAMELY, PROVIDING COURSES, CLASSES AND SEMINARS ON THE SUBJECT OF THE ALPHABET, MATH, ENGLISH, SOCIAL STUDIES, SCIENCE AND OTHER COURSES TAUGHT TO STUDENTS FROM NURSERY SCHOOL THROUGH HIGH SCHOOL AND INTERACTIVE ONLINE ENTERTAINMENT SERVICES IN THE NATURE OF ON-LINE COMIC STRIPS ON THE SUBJECT OF SUPER HEROES, ON-LINE BOOKS ON THE SUBJECT OF SUPER HEROES, ON-LINE MAGAZINES ON THE SUBJECT OF SUPER HEROES, ON-LINE VIDEO CLIPS ON THE SUBJECT OF SUPER HEROES AND ON-LINE AUDIO CLIPS ON THE SUBJECT OF SUPER HEROES (U.S. CLS. 100, 101 AND 107).
FIRST USE 10-1-1999; IN COMMERCE 12-1-1999.

2,625,749. U.S.E. HICKSON PRODUCTS LTD., SCARBOROUGH, ONTARIO, CANADA. SN 75-888,579. PUB. 10-3-2000, FILED 12-30-1999.

KNIGHT HAWK

OWNER OF U.S. REG. NO. 2,204,580.

CLASS 17—RUBBER GOODS

FOR CAULKINGS AND SEALANTS FOR ROOFS, RECREATIONAL VEHICLES, MOBILE HOMES, BUILDING, CONSTRUCTION AND INDUSTRIAL USE (U.S. CLS. 1, 5, 12, 13, 35 AND 50).
FIRST USE 2-27-2002; IN COMMERCE 2-27-2002.

CLASS 19—NON-METALLIC BUILDING MATERIALS

FOR ASPHALT BASED ROOF AND FOUNDATION COATINGS, ROOF RESURFACERS, ROOF CEMENTS, AND ELASTOMERIC ROOF COATINGS (U.S. CLS. 1, 12, 33 AND 50).
FIRST USE 4-27-2000; IN COMMERCE 4-27-2000.

2,625,752. MASTERMINDS OF FUN, INC., UNION, NJ. SN 75-888,766. PUB. 6-5-2001, FILED 1-5-2000.



THE STIPPLING IN THE MARK IS FOR SHADING PURPOSES.

CLASS 25—CLOTHING

FOR CLOTHING, NAMELY T-SHIRTS, NIGHT SHIRTS, SWEATSHIRTS AND SWEATPANTS, SHIRTS, PANTS, BLOUSES, UNDERWEAR, AND JACKETS (U.S. CLS. 22 AND 39).
FIRST USE 10-1-1999; IN COMMERCE 8-1-2000.

CLASS 41—EDUCATION AND ENTERTAINMENT

FOR INTERACTIVE ONLINE EDUCATIONAL SERVICES, NAMELY, PROVIDING COURSES, CLASSES AND SEMINARS ON THE SUBJECT OF THE ALPHABET, MATH, ENGLISH, SOCIAL STUDIES, SCIENCE AND OTHER COURSES TAUGHT TO STUDENTS FROM NURSERY SCHOOL THROUGH HIGH SCHOOL AND INTERACTIVE ONLINE ENTERTAINMENT SERVICES IN THE NATURE OF ON-LINE COMIC STRIPS ON THE SUBJECT OF SUPER HEROES, ON-LINE BOOKS ON THE SUBJECT OF SUPER HEROES, ON-LINE MAGAZINES ON THE SUBJECT OF SUPER HEROES, ON-LINE VIDEO CLIPS ON THE SUBJECT OF SUPER HEROES AND ON-LINE AUDIO CLIPS ON THE SUBJECT OF SUPER HEROES (U.S. CLS. 100, 101 AND 107).

FIRST USE 10-1-1999; IN COMMERCE 8-1-2000.

2,625,754. SCREAM GRAPHIX, INC., PHILADELPHIA, PA. SN 75-889,641. PUB. 5-1-2001, FILED 1-6-2000.

**CLASS 25—CLOTHING**

FOR CLOTHING, NAMELY PANTS, JACKETS, SHORTS, SOCKS, UNDERWEAR, SHIRTS, SWEATSHIRTS, AND HATS (U.S. CLS. 22 AND 39).

FIRST USE 12-15-1996; IN COMMERCE 1-22-2000.

CLASS 42—SCIENTIFIC, COMPUTER AND LEGAL SERVICES

FOR CUSTOM PRINTING OF SPORTSWEAR AND PROMOTIONAL PRODUCTS (U.S. CLS. 100 AND 101).

FIRST USE 12-15-1996; IN COMMERCE 3-4-1998.

2,625,753. PROS REVENUE MANAGEMENT, INC., HOUSTON, TX. SN 75-889,276. PUB. 10-23-2001, FILED 1-6-2000.

**PROS REVENUE
MANAGEMENT**

NO CLAIM IS MADE TO THE EXCLUSIVE RIGHT TO USE "REVENUE MANAGEMENT", APART FROM THE MARK AS SHOWN.

CLASS 9—ELECTRICAL AND SCIENTIFIC APPARATUS

FOR COMPUTER SOFTWARE FOR REVENUE MANAGEMENT, PRICING ANALYSIS, YIELD MANAGEMENT, INVENTORY OPTIMIZATION, FORECASTING APPLICATIONS, AND TRAVEL INFORMATION MANAGEMENT FOR USE IN THE FIELDS OF AIRLINE, ENERGY AND HEALTHCARE MANAGEMENT (U.S. CLS. 21, 23, 26, 36 AND 38).

FIRST USE 12-28-1999; IN COMMERCE 5-1-2001.

CLASS 35—ADVERTISING AND BUSINESS

FOR BUSINESS MANAGEMENT CONSULTING SERVICES IN THE FIELD OF REVENUE MANAGEMENT, PRICING ANALYSIS, YIELD MANAGEMENT, INVENTORY OPTIMIZATION AND FORECASTING APPLICATIONS (U.S. CLS. 100, 101 AND 102).

FIRST USE 12-28-1999; IN COMMERCE 5-1-2001.

2,625,755. NETILLA NETWORKS INCORPORATED, SOMERSET, NJ. SN 75-889,740. PUB. 11-21-2000, FILED 1-7-2000.

Netilla

CLASS 9—ELECTRICAL AND SCIENTIFIC APPARATUS

FOR COMPUTER NETWORKING EQUIPMENT, NAMELY, COMPUTER HARDWARE AND COMPUTER SOFTWARE FOR INTERFACING A COMPUTER NETWORK TO A VIRTUAL PRIVATE NETWORK FOR INTERCONNECTING REMOTELY LOCATED USERS, LOCAL AREA NETWORKS AND GLOBAL COMPUTER NETWORKS AND OVER WHICH ELECTRONIC COMMERCE AND NETWORK-BASED COMPUTERIZED APPLICATIONS WILL BE CONDUCTED; AND COMPUTER SOFTWARE FOR USE IN CONJUNCTION WITH THE COMPUTER NETWORKING EQUIPMENT FOR IMPLEMENTING ELECTRONIC COMMERCE, NAMELY ELECTRONIC BUSINESS TRANSACTIONS, VIA A GLOBAL COMPUTER NETWORK, AND FOR REMOTELY ACCESSING NETWORK-BASED COMPUTERIZED APPLICATIONS (U.S. CLS. 21, 23, 26, 36 AND 38).

FIRST USE 4-26-2000; IN COMMERCE 4-26-2000.

CLASS 35—ADVERTISING AND BUSINESS

FOR ON-LINE RETAIL STORE SERVICES FEATURING COMPUTER NETWORK PRODUCTS AND SERVICES; DISSEMINATION OF ADVERTISING FOR OTHERS VIA ON-LINE ELECTRONIC COMMUNICATIONS NETWORKS; AND COMPUTERIZED ON-LINE ORDERING SERVICES IN THE FIELD OF COMPUTER AND NETWORKING PRODUCTS AND SERVICES (U.S. CLS. 100, 101 AND 102).

FIRST USE 7-25-2001; IN COMMERCE 7-25-2001.

CLASS 37—CONSTRUCTION AND REPAIR

FOR INSTALLATION AND MAINTENANCE OF COMPUTER HARDWARE AND COMPUTER NETWORKING EQUIPMENT (U.S. CLS. 100, 103 AND 106).

FIRST USE 4-26-2000; IN COMMERCE 4-26-2000.

CLASS 38—COMMUNICATION

FOR COMPUTER NETWORKING SERVICES, NAMELY, PROVIDING A VIRTUAL PRIVATE NETWORK CONNECTION TO REMOTE NETWORKS (U.S. CLS. 100, 101 AND 104).

FIRST USE 4-26-2000; IN COMMERCE 4-26-2000.

CLASS 42—SCIENTIFIC, COMPUTER AND LEGAL SERVICES

FOR INSTALLATION AND MAINTENANCE OF COMPUTER SOFTWARE; TECHNICAL SUPPORT SERVICES, NAMELY, TROUBLESHOOTING OF COMPUTER NETWORKING PROBLEMS VIA TELEPHONE, ELECTRONIC MAIL, IN-PERSON AND THROUGH ON-LINE SUPPORT; AND PROVIDING TEMPORARY USE OF ON-LINE NON-DOWNLOADABLE SOFTWARE FOR ORDERING, CONFIGURING, PROVISIONING, INSTALLING, SERVICING, MARKETING, ACCEPTING PAYMENT FOR, AND SUPPORTING THE COMPUTER NETWORKING SERVICES AND NETWORKING EQUIPMENT (U.S. CLS. 100 AND 101).

FIRST USE 4-26-2000; IN COMMERCE 4-26-2000.

CLASS 42—SCIENTIFIC, COMPUTER AND LEGAL SERVICES

FOR CONDUCTING FEASIBILITY STUDIES CONCERNING THE DEMOLITION OF PROPERTY; ENVIRONMENTAL CONSULTATION IN THE FIELD OF ENVIRONMENTAL IMPACT RESULTING FROM THE DESTRUCTION OF PROPERTY; EXPERT WITNESS SERVICES ON ISSUES RELATING TO ENVIRONMENTAL IMPACT AND INVESTMENT RECOVERY RESULTING FROM THE DEMOLITION OF PROPERTY; TECHNICAL CONSULTATION AND RESEARCH IN THE FIELD OF ENVIRONMENTAL AND PROPERTY SAFETY ISSUES FOR BUILDING AND LAND SITES (U.S. CLS. 100 AND 101).

FIRST USE 2-18-1998; IN COMMERCE 2-18-1998.

2,625,767. ANACOMP, INC., POWAY, CA. SN 75-896,919. PUB. 9-11-2001, FILED 1-14-2000.

**ANY WAY YOU WANT IT.
THAT'S THE WAY YOU GET
IT.**

CLASS 38—COMMUNICATION

FOR ELECTRONIC TRANSMISSION OF DATA AND DOCUMENTS TO AND FROM COMPUTER TERMINALS (U.S. CLS. 100, 101 AND 104).

FIRST USE 4-10-2000; IN COMMERCE 4-10-2000.

CLASS 39—TRANSPORTATION AND STORAGE

FOR ELECTRONIC STORAGE OF DATA; AND PROVIDING INFORMATION IN THE FIELDS OF ELECTRONIC STORAGE OF DATA (U.S. CLS. 100 AND 105).

FIRST USE 4-10-2000; IN COMMERCE 4-10-2000.

CLASS 40—MATERIAL TREATMENT

FOR DIGITAL COMPRESSION OF COMPUTER DATA AND ELECTRONIC DOCUMENT DATA TRANSFER AND PHYSICAL CONVERSION SERVICES FROM ONE MEDIA TO ANOTHER, SPECIFICALLY FROM COMPUTER TAPE, ELECTRONIC AND PAPER DOCUMENTS TO ELECTRONIC, DIGITAL, CD ROM AND MICROFICHE (U.S. CLS. 100, 103 AND 106).

FIRST USE 4-10-2000; IN COMMERCE 4-10-2000.

CLASS 42—SCIENTIFIC, COMPUTER AND LEGAL SERVICES

FOR DATA CONVERSION OF COMPUTER PROGRAM DATA AND INFORMATION; PROVIDING INFORMATION IN THE FIELD OF DATA CONVERSION OF COMPUTER PROGRAM DATA, INFORMATION AND DATA COMMUNICATIONS (U.S. CLS. 100 AND 101).

FIRST USE 4-10-2000; IN COMMERCE 4-10-2000.

2,625,759. ROSE GROUP, LTD., THE, MAINEVILLE, OH. SN 75-890,782. PUB. 7-17-2001, FILED 1-7-2000.

THE ROSE GROUP, LTD.

NO CLAIM IS MADE TO THE EXCLUSIVE RIGHT TO USE "GROUP" AND "LTD.", APART FROM THE MARK AS SHOWN.

CLASS 35—ADVERTISING AND BUSINESS

FOR BUSINESS CONSULTATION IN THE FIELD OF INVESTMENT RECOVERY RESULTING FROM THE DEMOLITION OF PROPERTY; BUSINESS MANAGEMENT RENDERED TO OTHERS IN FACILITATING THE SALE OF BUSINESS ASSETS (U.S. CLS. 100, 101 AND 102).

FIRST USE 2-18-1998; IN COMMERCE 2-18-1998.

2,625,770. DIABETES JUNCTION.COM, INC., PHILADELPHIA, PA. SN 75-897,603. PUB. 7-31-2001, FILED 1-18-2000.

DIABETESJUNCTION

CLASS 35—ADVERTISING AND BUSINESS

FOR MAIL ORDER SERVICES AND ON-LINE ORDERING SERVICES FEATURING DIABETIC PRODUCTS, NAMELY, BLOOD GLUCOSE MONITORING SYSTEMS, BLOOD GLUCOSE STRIPS, STERILE LANCETS, LANCET HOLDERS, STERILE DISPOSABLE ALCOHOL SWABS, DIABETIC SKIN CARE PRODUCTS, DIABETIC VITAMINS, DIABETIC SUGAR FREE SWEETENERS, ANTACIDS, DIABETIC FOODS, MEDICAL BRACELETS, MEDICAL NECKLACES AND IDENTIFICATION JEWELRY, BOOKS AND LITERATURE AND TRAINING MATERIALS ON THE TOPIC OF DIABETES, INSULIN PUMPS, DIABETIC DRUGS AND PHARMACEUTICALS (U.S. CLS. 100, 101 AND 102).

FIRST USE 1-0-2000; IN COMMERCE 1-0-2000.

CLASS 42—SCIENTIFIC, COMPUTER AND LEGAL SERVICES

FOR PROVIDING AN ONLINE COMPUTER DATABASE IN THE FIELD OF DIABETES (U.S. CLS. 100 AND 101).

FIRST USE 1-0-2000; IN COMMERCE 1-0-2000.

2,625,775. ORGANIZED LIVING, INC., LENEXA, KS. SN 75-901,635. PUB. 9-18-2001, FILED 1-24-2000.

ORGANIZED LIVING

OWNER OF U.S. REG. NOS. 1,782,256 AND 2,355,301.

CLASS 6—METAL GOODS

FOR METAL CONTAINERS FOR THE STORAGE AND TRANSPORTATION OF GOODS, METAL BINS, METAL BICYCLE STORAGE RACKS, METAL HAT RACKS, FREE-STANDING METAL TOOL RACKS, BASKETS OF COMMON METAL, METAL STORAGE RACKS, AND METAL CASTERS (U.S. CLS. 2, 12, 13, 14, 23, 25 AND 50).

FIRST USE 12-25-1991; IN COMMERCE 12-25-1991.

CLASS 16—PAPER GOODS AND PRINTED MATTER

FOR CORRUGATED STORAGE CONTAINERS, CARDBOARD STORAGE CONTAINERS, PAPER STORAGE CONTAINERS, CORRESPONDENCE RACKS, DESKTOP DOCUMENT RACKS, PAPER RACKS, DESK BASKETS FOR DESK ACCESSORIES, PICTURES, CORK AND MESSAGE BOARDS (U.S. CLS. 2, 5, 22, 23, 29, 37, 38 AND 50).

FIRST USE 1-0-2000; IN COMMERCE 1-0-2000.

CLASS 20—FURNITURE AND ARTICLES NOT OTHERWISE CLASSIFIED

FOR HOUSEHOLD AND OFFICE FURNITURE, NAMELY, SHELVING, DESKS, CHAIRS, SOFAS, BOOKCASES, BEAN BAG CHAIRS, CHESTS, NON-METAL BINS, DISPLAY RACKS, NON-METAL HAT RACKS, MAGAZINE RACKS, PLATE RACKS, FREE-STANDING NON-METAL TOOL RACKS, PICTURE FRAMES, AND MIRRORS, METAL SHELVES; AND PARTS FOR METAL SHELVING COMPONENT SYSTEMS, NAMELY, POSTS, SHELVES, HOOKS, CLOTHING HANGER RODS, STORAGE BASKETS, DIVIDERS, CART HANDLES, HANGER RAILS, SLIDING DRAWERS AND KEYBOARD TRAYS (U.S. CLS. 2, 13, 22, 25, 32 AND 50).

FIRST USE 12-25-1991; IN COMMERCE 12-25-1991.

CLASS 21—HOUSEWARES AND GLASS

FOR HOUSEWARES AND KITCHENWARE, NAMELY, ALL PURPOSE PORTABLE HOUSEHOLD CONTAINERS, STORAGE CONTAINERS FOR FOOD, CONTAINERS FOR HOUSEHOLD OR KITCHEN USE NOT OF PRECIOUS METAL, DUST BINS, THERMAL INSULATED TOTE BAGS FOR FOOD OR BEVERAGES, PLASTIC BATH RACKS, CLOTHES DRYING RACKS, OVEN-TO-TABLE RACKS, SPICE RACKS, WINE RACKS, PICNIC BASKETS, FLOWER BASKETS, WASTEPAPER BASKETS, WICKER BASKETS, COOKING UTENSILS, NAMELY, LADLES, ROLLING PINS, SPATULAS, TURNERS AND WHISKS, MOPS AND TRASH CANS (U.S. CLS. 2, 13, 23, 29, 30, 33, 40 AND 50).

FIRST USE 12-25-1991; IN COMMERCE 12-25-1991.

2,625,785. PARMALAT S.P.A., 43044 COLLECCHIO, ITALY. SN 75-904,082. PUB. 11-13-2001, FILED 1-31-2000.

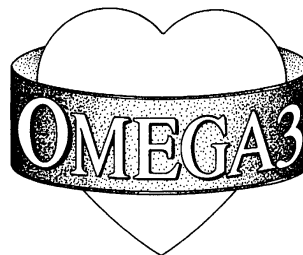

parmalat

NO CLAIM IS MADE TO THE EXCLUSIVE RIGHT TO USE "OMEGA3", APART FROM THE MARK AS SHOWN.

THE STIPPLING IS FOR SHADING PURPOSES ONLY AND DOES NOT INDICATE COLOR.

CLASS 5—PHARMACEUTICALS

FOR DIETETIC MILK FOR MEDICAL USE; FOOD DIETARY SUPPLEMENTS, NAMELY, VITAMINS, MINERALS, PROTEINS, AMINO ACIDS, CARBOHYDRATES, FATS, MILK ENZYMES; CONCENTRATED OR POWDERED MIXES FOR DIETARY SUPPLEMENT DRINKS; MEAL REPLACEMENT DRINKS (U.S. CLS. 6, 18, 44, 46, 51 AND 52).

FIRST USE 9-20-1999; IN COMMERCE 7-0-2001.

CLASS 29—MEATS AND PROCESSED FOODS

FOR SOY BASED AND VEGETABLE BASED MILK SUBSTITUTES; MILK, POWDERED MILK, FLAVORED MILK, NON-FLAVORED MILK-BASED BEVERAGES; CARBONATED OR NON-CARBONATED BEVERAGES WHERE THE WATER PHASE IS PARTIALLY OR TOTALLY CONSTITUTED BY WHEY; DAIRY-BASED DIPS, EGG-NOGS, DAIRY PRODUCTS, NAMELY, CREAM, BUTTER, CHEESE AND YOGURT (U.S. CL. 46).
FIRST USE 9-20-1999; IN COMMERCE 7-0-2001.

2,625,803. TRACE BIOTECH AG, 38124 BRAUNSCHWEIG, FED REP GERMANY. SN 75-909,809. PUB. 9-25-2001, FILED 2-3-2000.



2,625,789. ROCHESTER MIDLAND CORPORATION, ROCHESTER, NY. SN 75-906,004. PUB. 9-25-2001, FILED 1-29-2000.

BRANDGUARD

CLASS 3—COSMETICS AND CLEANING PREPARATIONS

FOR CLEANERS FOR USE IN THE FOOD PROCESSING INDUSTRY (U.S. CLS. 1, 4, 6, 50, 51 AND 52).
FIRST USE 6-30-2000; IN COMMERCE 6-30-2000.

CLASS 5—PHARMACEUTICALS

FOR SANITIZERS FOR USE IN THE FOOD PROCESSING INDUSTRY (U.S. CLS. 6, 18, 44, 46, 51 AND 52).
FIRST USE 6-30-2000; IN COMMERCE 6-30-2000.

CLASS 1—CHEMICALS

FOR CHEMICALS FOR CALIBRATING AND CLEANING ANALYZING AND MEASURING DEVICES IN THE FIELD OF BIOPROCESSING; BUFFER SUBSTANCES IN THE FIELD OF BIOPROCESSING (U.S. CLS. 1, 5, 6, 10, 26 AND 46).
FIRST USE 3-18-2002; IN COMMERCE 3-18-2002.

CLASS 9—ELECTRICAL AND SCIENTIFIC APPARATUS

FOR ELECTRONIC MEASURING AND TESTING DEVICES, NAMELY, SENSORS AND APPARATUS FOR MEASURING CHEMICAL CONCENTRATIONS AND MONITORING CHEMICAL REACTIONS; APPARATUS FOR CONTROLLING CHEMICAL REACTIONS IN THE FIELD OF BIOPROCESSING; AND APPARATUS FOR CONTROLLING AND MONITORING FOOD PROCESSING BY MEANS OF AN ELECTROCHEMICAL BIOSENSOR; APPARATUS FOR CONTROLLING AND MONITORING THE MIXING OF BEVERAGES AND THE FILLING OF BEVERAGE CONTAINERS (U.S. CLS. 21, 23, 26, 36 AND 38).
FIRST USE 3-18-2002; IN COMMERCE 3-18-2002.

2,625,793. FOSTER ASSETS CORPORATION, KWUN TONG, KOWLOON, HONG KONG. SN 75-907,049. PUB. 5-1-2001, FILED 2-1-2000.

DCS

CLASS 1—CHEMICALS

FOR UNEXPOSED PHOTOGRAPHIC FILM; AND PHOTOGRAPHIC FILM HAVING AT LEAST A PORTION THEREOF BEARING PRE-EXPOSED IMAGES AND A PORTION THEREOF WHICH CAN BE EXPOSED BY THE USER (U.S. CLS. 1, 5, 6, 10, 26 AND 46).
FIRST USE 5-0-2001; IN COMMERCE 5-0-2001.

CLASS 9—ELECTRICAL AND SCIENTIFIC APPARATUS

FOR PHOTOGRAPHIC CAMERAS; PHOTOGRAPHIC CAMERAS SOLD AS A UNIT WITH PHOTOGRAPHIC FILM (U.S. CLS. 21, 23, 26, 36 AND 38).
FIRST USE 5-0-2001; IN COMMERCE 5-0-2001.

2,625,804. CLOSETTEC FRANCHISE CORPORATION, NORWOOD, MA. SN 75-909,832. PUB. 10-9-2001, FILED 2-4-2000.

5 STAR SERVICE

NO CLAIM IS MADE TO THE EXCLUSIVE RIGHT TO USE "SERVICE", APART FROM THE MARK AS SHOWN.

CLASS 37—CONSTRUCTION AND REPAIR

FOR INSTALLATION OF CLOSETS FOR OTHERS (U.S. CLS. 100, 103 AND 106).
FIRST USE 1-0-1999; IN COMMERCE 2-0-1999.

CLASS 42—SCIENTIFIC, COMPUTER AND LEGAL SERVICES

FOR DESIGNING OF CLOSETS FOR OTHERS (U.S. CLS. 100 AND 101).
FIRST USE 1-0-1999; IN COMMERCE 2-0-1999.

2,625,809. IMPERIAL PANTS CO. LTD./LA COMPAGNIE DES PANTALONS IMPERIAL LTEE., QUEBEC, CANADA. SN 75-911,938. PUB. 6-19-2001, FILED 2-7-2000.

2,625,841. INTELLISPACE, INC., NEW YORK, NY. SN 75-927,359. PUB. 7-24-2001, FILED 2-24-2000.



KÜKARA

OWNER OF U.S. REG. NO. 2,346,053.

CLASS 25—CLOTHING

FOR MEN'S CLOTHING AND CLOTHING ACCESSORIES, NAMELY, SUITS, COATS, KNITTED JACKETS; WOVEN JACKETS; SLACKS; KNITTED PANTS; WOVEN PANTS; SPORT COATS; HATS; CAPS; JEANS; KNIT TOPS; PULLOVERS; KNITTED SHIRTS; WOVEN SHIRTS; SWEATSHIRTS; T-SHIRTS; SWEATERS; KNITTED SHORTS; WOVEN SHORTS; KNITTED VESTS; WOVEN VESTS; WOVEN TOPS; SWIM TRUNKS; PAJAMAS; NIGHTSHIRTS; ROBES; DRESSING GOWNS; TIES; BELTS; HOSIERY; SCARVES; LOUNGEWEAR, NAMELY, T-SHIRTS, TANK TOPS, OVERALLS, COATS, BELTS AND SPORTS CLOTHING, NAMELY TRAINING AND WARM-UP SUITS, GOLF SHIRTS, JACKETS, SUITS AND RAINJACKETS, SWIMWEAR, SKI SUITS, PANTS, MITTENS; GLOVES, HATS, PARKAS, TURTLENECKS, SOCKS, ATHLETIC HOSIERY; WOMEN'S CLOTHING AND CLOTHING ACCESSORIES, NAMELY, COATS, KNITTED JACKETS; WOVEN JACKETS; BLAZERS; SUITS; PONCHOS; CAPES; STOLEES; BOAS; SCARVES; HATS; VEILS; KNIT TOPS; KNITTED DRESSES; WOVEN DRESSES; GOWNS; GLOVES; BLOUSES; JEANS; PULLOVERS; KNITTED SHIRTS; WOVEN SHIRTS; T-SHIRTS; SWEATSHIRTS; TOPS; SWEATERS; KNITTED SKIRTS; WOVEN SKIRTS; KNITTED SHORTS; WOVEN SHORTS; CULOTTES; JUMPERS; KNITTED PANTS; WOVEN PANTS; OVERALLS; WOVEN TOPS; ROBES; DRESSING GOWNS; LINGERIE; NEGLIGEEES; BED JACKETS; NIGHTGOWNS; PAJAMAS; BRASSIERES; GIRDLES; CORSETS; GARTER BELTS; UNDERWEAR, NAMELY, PANTIES, KNITTED VESTS; WOVEN VEST; SLIPS; UNIFORMS; SCARVES; SHAWLS; BELTS; BATHING SUITS; LOUNGEWEAR, NAMELY, LOUNGING PAJAMAS, CAFTANS AND JUMPSUITS; SPORTS CLOTHING, NAMELY, TRAINING AND WARM-UP SUITS, GOLF SHIRTS, JACKETS, SUITS AND RAINJACKETS, SWIMWEAR, SKI SUITS, PANTS, MITTENS, GLOVES, HATS, PARKAS, TURTLENECKS, SOCKS, ATHLETIC HOSIERY; AND CHILDREN'S CLOTHING, NAMELY, COATS; SNOW SUITS; BLAZERS; KNIT TOPS; KNITTED JACKETS; WOVEN JACKETS; KNITTED PANTS; WOVEN PANTS; KNITTED SHIRTS; WOVEN SHIRTS; BLOUSES; SWEATERS; T-SHIRTS; SWEATSHIRTS; KNITTED SHORTS; WOVEN SHORTS; COVERALLS, JEANS; SUNSUITS; KNITTED VESTS; WOVEN VESTS; WOVEN TOPS; BATHING SUITS; BATHING HATS; SWIM TRUNKS; HATS; CAPS; MITTENS; GLOVES; TIES; HOSIERY; BELTS; UNIFORMS; SUITS; GOWNS; KNITTED DRESSES; WOVEN DRESSES; JUMPERS; SUSPENDERS; SLIPS; KNITTED SHIRTS; WOVEN SKIRTS; CULOTTES; CRAWLERS; JUMP SUITS; PRAM SETS; ROMPERS; SCARVES; SPORT CLOTHING, NAMELY, TRAINING AND WARM-UP SUITS, JACKETS, SUITS AND RAINJACKETS, SWIMWEAR, SKI SUITS, PANTS, MITTENS, GLOVES, HATS, PARKAS, TURTLENECKS, SOCKS AND ATHLETIC HOSIERY (U.S. CLS. 22 AND 39).
FIRST USE 1-12-2000; IN COMMERCE 1-12-2000.

CLASS 26—FANCY GOODS

FOR BUTTONS FOR CLOTHING (U.S. CLS. 37, 39, 40, 42 AND 50).
FIRST USE 1-12-2000; IN COMMERCE 1-12-2000.

CLASS 38—COMMUNICATION

FOR TELECOMMUNICATIONS SERVICES, NAMELY, PROVIDING TELECOMMUNICATIONS CONNECTIONS TO A GLOBAL COMPUTER NETWORK (U.S. CLS. 100, 101 AND 104).
FIRST USE 2-0-2000; IN COMMERCE 2-0-2000.

CLASS 42—SCIENTIFIC, COMPUTER AND LEGAL SERVICES

FOR COMPUTER DISASTER RECOVERY PLANNING AND IMPLEMENTATION SERVICES (U.S. CLS. 100 AND 101).
FIRST USE 8-8-2001; IN COMMERCE 8-8-2001.

2,625,845. DECK HOUSE, INC., ACTON, MA. SN 75-928,713. PUB. 7-10-2001, FILED 2-28-2000.

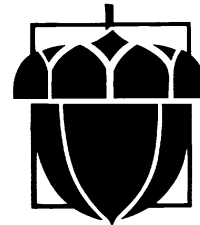

CLASS 6—METAL GOODS

FOR PRE-FABRICATED HOMES CONSISTING PRIMARILY OF METAL, WOOD, AND GLASS AND STRUCTURAL PARTS FOR ALL OF THE ABOVE-MENTIONED GOODS; STAIRS, RAILINGS, BALUSTRADES, AND BANISTERS, ALL MADE PRIMARILY OF METAL AND WOOD AND STRUCTURAL PARTS FOR ALL OF THE ABOVE-MENTIONED GOODS (U.S. CLS. 2, 12, 13, 14, 23, 25 AND 50).
FIRST USE 0-0-1986; IN COMMERCE 0-0-1986.

CLASS 19—NON-METALLIC BUILDING MATERIALS

FOR RESIDENTIAL BUILDINGS ASSEMBLED ON SITE FROM PREFABRICATED NON-METAL COMPONENTS (U.S. CLS. 1, 12, 33 AND 50).
FIRST USE 0-0-1986; IN COMMERCE 0-0-1986.

CLASS 41—EDUCATION AND ENTERTAINMENT

FOR PROVIDING TRAINING SERVICES, NAMELY, TRAINING OTHERS IN THE CONSTRUCTION OF RESIDENTIAL BUILDINGS ASSEMBLED ON SITE FROM PREFABRICATED COMPONENTS (U.S. CLS. 100, 101 AND 107).

FIRST USE 0-0-1986; IN COMMERCE 0-0-1986.

2,625,847. ERRANDS N MORE LLC, MUNCIE, IN. SN 75-930,937. PUB. 7-3-2001, FILED 2-29-2000.

ERRANDS 'N' MORE

NO CLAIM IS MADE TO THE EXCLUSIVE RIGHT TO USE "ERRANDS", APART FROM THE MARK AS SHOWN.

CLASS 39—TRANSPORTATION AND STORAGE

FOR MESSENGER SERVICES FOR CORPORATIONS; ARRANGING FOR TRAVEL VISAS, PASSPORTS AND TRAVEL DOCUMENTS FOR TRAVELERS; ARRANGING TRAVEL TOURS; TRAVEL AGENCY SERVICES, NAMELY, MAKING RESERVATIONS AND BOOKING FOR TRANSPORTATION FOR OTHERS; PICK UP AND DELIVERY OF DRY CLEANING, LAUNDRY, GROCERIES AND MEDICATIONS FOR OTHERS; TAXI TRANSPORT SERVICES; AND AIRPORT AND DEPOT SHUTTLE SERVICES BY MOTOR CARRIER AND COURIER SERVICES (U.S. CLS. 100 AND 105).

FIRST USE 6-4-1999; IN COMMERCE 10-18-2000.

CLASS 42—SCIENTIFIC, COMPUTER AND LEGAL SERVICES

FOR CONDUCTING PERSONAL ERRANDS FOR OTHERS; CONCIERGE SERVICES FOR CORPORATIONS; MAKING HOTEL AND RESTAURANT RESERVATIONS FOR OTHERS; AND PERSONAL SHOPPING SERVICES (U.S. CLS. 100 AND 101).

FIRST USE 6-4-1999; IN COMMERCE 10-18-2000.

2,625,848. HP INTELLECTUAL CORP., WILMINGTON, DE. SN 75-931,219. PUB. 12-5-2000, FILED 2-28-2000.

APPLICA**CLASS 7—MACHINERY**

FOR HOUSE MARK FOR SMALL HOUSEHOLD PRODUCTS, BOTH ELECTRIC AND NON-ELECTRIC, NAMELY, ELECTRIC HAND AND STICK MIXERS, ELECTRIC KNIVES, ELECTRIC CAN OPENERS, ELECTRIC FOOD BLENDERS, ELECTRIC JUICERS, ELECTRIC FOOD CHOPPERS/MINCERS, ELECTRIC FOOD PROCESSORS, ELECTRIC COFFEE BEAN GRINDERS, ELECTRIC STAND MIXERS, VACUUM CLEANERS, FLOOR POLISHERS/WAXERS AND CARPET SHAMPPOERS/STEAM CLEANERS, ELECTRIC PASTA MAKERS, BATTERY-OPERATED CORDLESS CAN OPENERS, AND BATTERY-OPERATED PORTABLE FOOD AND DRINK BLENDERS; ELECTRIC SHOE POLISHERS (U.S. CLS. 13, 19, 21, 23, 31, 34 AND 35).

FIRST USE 6-16-2000; IN COMMERCE 6-16-2000.

CLASS 9—ELECTRICAL AND SCIENTIFIC APPARATUS

FOR HOUSE MARK FOR SMALL HOUSEHOLD AND PERSONAL CARE APPLIANCES, BOTH ELECTRIC AND NON-ELECTRIC, NAMELY, ELECTRIC CLOTHES IRONS; GARMENT STEAMERS; ELECTRIC HAIR CURLING IRONS; ELECTRIC HAIR CURLERS; ELECTRIC HAIR BRUSHES; ELECTRIC HAIRSETTERS; NON-ELECTRIC HAIR CURLING IRONS; THERMAL POUCH FOR CURLING IRONS; HAIR BRUSH ATTACHMENTS FOR ELECTRIC HAIR CURLING IRONS; ELECTRIC HAND-HELD CRIMPERS FOR WAVING HAIR; HEAT STYLING HAIR IRONS; ELECTRIC HAIR STRAIGHTENING IRONS; ELECTRIC HAIR WAVING IRONS; ELECTRICAL EXTENSION CORDS; ELECTRIC WALL SOCKET PLUGS; PORTABLE ELECTRIC PANTS PRESSERS; CERAMIC HEATERS FOR CURLING IRONS AND HOT COMBS; TRAVEL CLOTHES IRONS; AND CLEANING MACHINES FOR CLEANING JEWELRY (U.S. CLS. 21, 23, 26, 36 AND 38).

FIRST USE 1-1-2001; IN COMMERCE 1-1-2001.

CLASS 11—ENVIRONMENTAL CONTROL APPARATUS

FOR HOUSE MARK FOR SMALL HOUSEHOLD AND PERSONAL CARE APPLIANCES, BOTH ELECTRIC AND NON-ELECTRIC, NAMELY, ELECTRIC TOASTERS; ELECTRIC TOASTER OVENS; ELECTRIC COUNTER WATER BOILERS; ELECTRIC COFFEE MAKERS; ELECTRIC ESPRESSO MACHINES; ELECTRIC TEA KETTLES; ELECTRIC POPCORN POPPERS; ELECTRIC INDOOR GRILLS; ELECTRIC WAFFLE MAKERS; ELECTRIC WOKS; ELECTRIC GRIDDLES; ELECTRIC SANDWICH MAKERS; ELECTRIC SKILLETS; ELECTRIC DEEP FRYERS; ELECTRIC BREADMAKERS; ELECTRIC RICE COOKERS; ELECTRIC FOOD STEAMERS; ELECTRIC HOTPLATES; ELECTRIC ICED TEA MAKERS; ELECTRIC SLOW COOKERS; ELECTRIC ROTISSERIES; ELECTRIC TORTILLA WARMERS; ELECTRIC VACUUM SEALERS; ELECTRIC THERMAL BRISTLE HAIR BRUSH STYLERS; FANS; ELECTRIC HAND-HELD HAIR DRYERS; DIFFUSER ATTACHMENTS FOR ELECTRIC HAND-HELD HAIR DRYERS; ELECTRIC ROOM AIR FRESHENER; ELECTRIC FACIAL SAUNAS; STATIONARY AND HAND-HELD HARD AND SOFT BONNET ELECTRIC HAIR DRYERS; ELECTRIC STYLING COMBS; ELECTRIC NAIL DRYING MACHINES; HAIR PICK ATTACHMENTS FOR ELECTRIC HAND-HELD HAIR DRYERS; ELECTRIC CERAMIC HEATERS FOR CURLING IRONS AND HOT COMBS; BOUFFANT-STYLE HAIR CAP ATTACHMENT TO ELECTRIC HAND-HELD HAIR DRYERS; ELECTRIC FOOT BATHS; ELECTRIC WAX HEATERS; ELECTRIC HEAT CAPS; ELECTRIC AND BATTERY-OPERATED FANS; ELECTRIC HAND-HELD HOT AIR DRYER AND STYLING BRUSH; ELECTRIC DUAL HEAT HAND-HELD STYLERS; ELECTRIC AIR FILTER UNITS FOR DOMESTIC USE; SHOWER HEADS; ELECTRIC TOWEL WARMERS; HUMIDIFIERS; DEHUMIDIFIERS; AIR CLEANERS AND AIR FILTERS; ELECTRIC ROOM HEATERS; ELECTRIC FAN HEATERS; DEPILETORY WAX HEATERS; ELECTRIC MANICURE HEATERS; ELECTRIC HEATED BEAUTY MITTS; ELECTRIC HEATING PADS NOT FOR MEDICAL USE, SHOWER MASSAGERS; AND ELECTRIC ROOM DEODORIZERS (U.S. CLS. 13, 21, 23, 31 AND 34).

FIRST USE 5-17-2000; IN COMMERCE 5-17-2000.

2,625,851. THORSMAN & CO. AB, 611 29 NYKOPLNG, SWEDEN. SN 75-933,901. PUB. 9-11-2001, FILED 3-3-2000.

2,625,858. NIELSEN MEDIA RESEARCH, INC., NEW YORK, NY. SN 75-936,545. PUB. 10-17-2000, FILED 3-6-2000.

THORSMAN

CLASS 6—METAL GOODS

FOR DUCTS MADE WHOLLY OR PRINCIPALLY OF METAL FOR TRUNKING PIPES AND CONDUITS FOR GASES OR LIQUIDS; PIPE FITTINGS, FASTENERS AND FASTENING DEVICES, NAMELY, BOLTS, NUTS, RIVETS, SCREWS, WASHERS, PLUGS, CLIPS, CLAMPS, MOUNTING PIECES, BRACKETS AND BANDS, ALL OF METAL AND ALL FOR DUCTS FOR TRUNKING PIPES OR CONDUITS FOR GASES OR LIQUIDS (U.S. CLS. 2, 12, 13, 14, 23, 25 AND 50).

FIRST USE 0-0-1990; IN COMMERCE 0-0-1990.

CLASS 9—ELECTRICAL AND SCIENTIFIC APPARATUS

FOR ELECTRICAL, AUDIO, OPTICAL OR DATA SYSTEMS COMPRISED OF ELECTRICAL CONNECTION ADAPTORS, BRANCH BOXES, DISTRIBUTION BOXES, CONNECTORS, PLUGS, SOCKETS, MOUNTING AND CONNECTION BOXES AND FRAMES; ELECTRICAL TELECOMMUNICATION AND DATA CABLES; FIBER OPTICS; ELECTRICAL CABLE; TRUNKING ELECTRICAL POWER, TELECOMMUNICATIONS AND DATA CABLE COMPRISED OF HOUSINGS, DUCTS AND CONDUITS, SERVICE POLE CONNECTION UNITS; ELECTRICAL TRANSFORMERS; PARTS AND FITTINGS FOR ALL THE AFORESAID GOODS (U.S. CLS. 21, 23, 26, 36 AND 38).

FIRST USE 0-0-1990; IN COMMERCE 0-0-1990.

CLASS 17—RUBBER GOODS

FOR NON-METAL SEALS FOR CABLES, PIPES AND CONDUITS; ELECTRICAL INSULATING MATERIAL, NAMELY TAPE AND NON-METAL MASSES; PIPES AND JUNCTIONS THEREFOR, NOT OF METAL; COMPRESSED AIR PIPE FITTINGS, NOT OF METAL; DUCTS MADE WHOLLY OR PRINCIPALLY OF PLASTICS FOR TRUNKING PIPES OR CONDUITS FOR GASES AND LIQUIDS; AND REPLACEMENT PARTS AND FITTINGS FOR ALL THE AFORESAID GOODS (U.S. CLS. 1, 5, 12, 13, 35 AND 50).

FIRST USE 0-0-1990; IN COMMERCE 0-0-1990.

CLASS 20—FURNITURE AND ARTICLES NOT OTHERWISE CLASSIFIED

FOR NON-METAL MOUNTING PIECES, NAMELY, CLIPS, TIES, PLUGS, WALL-FIXING DEVICES, NAMELY HOOKS, NON-METAL SCREWS, CLAMPS, FASTENERS AND FASTENING DEVICES, NAMELY NUTS, BOLTS, RIVETS AND SCREWS AND REPLACEMENT PARTS AND FITTINGS FOR ALL THE AFORESAID GOODS (U.S. CLS. 2, 13, 22, 25, 32 AND 50).

FIRST USE 0-0-1990; IN COMMERCE 0-0-1990.

FOCUS

CLASS 9—ELECTRICAL AND SCIENTIFIC APPARATUS

FOR DATABASES ON CD-ROM CONTAINING INFORMATION REGARDING AND RELATING TO CABLE HEADEND AND CABLE SYSTEM INFORMATION FOR CABLE TELEVISION, DIGITAL AUDIO, DIGITAL MEDIA, AND BROADBAND (U.S. CLS. 21, 23, 26, 36 AND 38).

FIRST USE 12-15-1999; IN COMMERCE 4-1-2001.

CLASS 35—ADVERTISING AND BUSINESS

FOR PROVIDING DATABASES CONTAINING MARKETING AND RESEARCH INFORMATION REGARDING AND RELATING TO CABLE HEADEND AND CABLE SYSTEM INFORMATION FOR CABLE TELEVISION, DIGITAL AUDIO, DIGITAL MEDIA, AND BROADBAND (U.S. CLS. 100, 101 AND 102).

FIRST USE 12-15-1999; IN COMMERCE 4-1-2001.

2,625,861. MOTHERS IN MOTION, INC., ROUND ROCK, TX. SN 75-937,959. PUB. 8-7-2001, FILED 3-3-2000.

WOMEN IN MOTION

OWNER OF U.S. REG. NO. 2,289,422.

CLASS 25—CLOTHING

FOR EXERCISE GARMENTS, NAMELY, LEOTARDS, UNITARDS, LEGGINGS, BIKE SHORTS, RUNNING SHORTS, SHORT SHORTS, JOGGING BRAS, SWEAT-PANTS, T-SHIRTS, SWIMSUITS AND UNDERWEAR (U.S. CLS. 22 AND 39).

FIRST USE 9-1-2001; IN COMMERCE 9-15-2001.

CLASS 35—ADVERTISING AND BUSINESS

FOR ON-LINE RETAIL STORE SERVICES FEATURING EXERCISE GARMENTS AND ACCESSORIES (U.S. CLS. 100, 101 AND 102).

FIRST USE 9-1-2001; IN COMMERCE 9-15-2001.

CLASS 42—SCIENTIFIC, COMPUTER AND LEGAL SERVICES

FOR PROVIDING FASHION INFORMATION ABOUT EXERCISE GARMENTS AND ACCESSORIES VIA A GLOBAL COMPUTER NETWORK (U.S. CLS. 100 AND 101).

FIRST USE 9-1-2001; IN COMMERCE 9-15-2001.

2,625,870. CROSS, SARA, ALIZE, DENVER, CO. SN 75-950,577. PUB. 7-10-2001, FILED 3-1-2000.

2,625,878. SYMYX TECHNOLOGIES, SANTA CLARA, CA. SN 75-981,181. PUB. 6-27-2000, FILED 12-21-1998.

COOLNOTCRUEL

CLASS 25—CLOTHING

FOR MEN'S, WOMEN'S AND CHILDREN'S SHOES, CLOTHING AND APPAREL ACCESSORIES, NAMELY - SHOES, HATS, HEADWEAR, SCARVES, GLOVES, NECKTIES, COATS, JACKETS, SUITS, PANTS, SHORTS, SKIRTS, DRESSES, SHIRTS, T-SHIRTS, SWEATERS, ROBES, PAJAMAS, UNDERGARMENTS, SOCKS (U.S. CLS. 22 AND 39).

FIRST USE 6-19-2001; IN COMMERCE 6-19-2001.

CLASS 35—ADVERTISING AND BUSINESS

FOR RETAIL, WHOLESALE, DISTRIBUTORSHIP, CATALOGUE, ONLINE STORE SERVICES FEATURING CLOTHES, APPAREL ACCESSORIES, HANDBAGS, BRIEFCASES, SHOES, BED/BATH/KITCHEN TEXTILE ACCESSORIES (U.S. CLS. 100, 101 AND 102).

FIRST USE 6-19-2001; IN COMMERCE 6-19-2001.

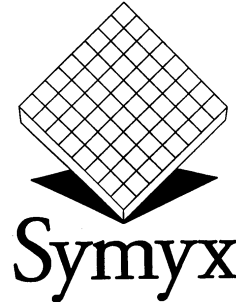

OWNER OF U.S. REG. NO. 2,215,525.

CLASS 9—ELECTRICAL AND SCIENTIFIC APPARATUS

FOR A DATABASE COMPILING SCIENTIFIC RESEARCH, NAMELY, A LISTING OF MATERIALS DISCOVERED OR TESTED USING THE AFOREMENTIONED RESEARCH EQUIPMENT RECORDED ON A COMPUTER MEDIA (U.S. CLS. 21, 23, 26, 36 AND 38).

FIRST USE 6-10-2000; IN COMMERCE 6-10-2000.

CLASS 42—SCIENTIFIC, COMPUTER AND LEGAL SERVICES

FOR CONSULTING, RESEARCH, AND DEVELOPMENT SERVICES PRIMARILY IN THE FIELD OF COMBINATIONAL MATERIALS SCIENCE, NAMELY, LAB AUTOMATION SERVICES AND THE DEVELOPMENT OF EQUIPMENT TO SUPPORT THE RESEARCH AND DEVELOPMENT (U.S. CLS. 100 AND 101).

FIRST USE 3-0-2000; IN COMMERCE 3-0-2000.

2,625,873. PROCTER & GAMBLE COMPANY, THE, CINCINNATI, OH. SN 75-955,232. PUB. 7-3-2001, FILED 3-7-2000.

PANTENE PRO-VOICE

OWNER OF U.S. REG. NOS. 638,163, 1,484,935, AND OTHERS.

CLASS 35—ADVERTISING AND BUSINESS

FOR PROMOTING THE SALE OF GOODS AND SERVICES OF OTHERS BY CONDUCTING CONTESTS WHICH INVOLVE AND PROMOTE SELF EXPRESSION AND INDIVIDUALITY OF WOMEN (U.S. CLS. 100, 101 AND 102).

FIRST USE 12-23-2000; IN COMMERCE 12-23-2000.

CLASS 36—INSURANCE AND FINANCIAL

FOR PROVIDING SCHOLARSHIPS AND GRANTS TO CAUSES PROMOTING SELF EXPRESSION AND INDIVIDUALITY OF WOMEN (U.S. CLS. 100, 101 AND 102).

FIRST USE 12-23-2000; IN COMMERCE 12-23-2000.

CLASS 41—EDUCATION AND ENTERTAINMENT

FOR ENTERTAINMENT IN THE NATURE OF CONTESTS WHICH INVOLVE AND PROMOTE SELF EXPRESSION AND INDIVIDUALITY OF WOMEN (U.S. CLS. 100, 101 AND 107).

FIRST USE 12-23-2000; IN COMMERCE 12-23-2000.

2,625,879. FLUENT BABY, INC., PALO ALTO, CA. SN 75-981,194. PUB. 2-5-2002, FILED 9-22-2000.

BABY DANISH

NO CLAIM IS MADE TO THE EXCLUSIVE RIGHT TO USE "BABY", APART FROM THE MARK AS SHOWN.

CLASS 18—LEATHER GOODS

FOR BABY-ORIENTED TOTE BAGS AND BACKPACKS (U.S. CLS. 1, 2, 3, 22 AND 41).

FIRST USE 9-6-2001; IN COMMERCE 9-6-2001.

CLASS 25—CLOTHING

FOR CLOTHING FOR BABIES, INFANTS AND TODDLERS, NAMELY, T-SHIRTS, SWEATSHIRTS AND HATS (U.S. CLS. 22 AND 39).

FIRST USE 9-6-2001; IN COMMERCE 9-6-2001.

2,625,880. FLUENT BABY, INC., PALO ALTO, CA. SN 75-981,195. PUB. 1-29-2002, FILED 9-22-2000.

2,625,885. BASIC SOLUTIONS, LLC, SAN FERNANDO, CA. SN 75-982,059. PUB. 3-20-2001, FILED 2-23-2000.

BABY PORTUGUESE

NO CLAIM IS MADE TO THE EXCLUSIVE RIGHT TO USE "BABY", APART FROM THE MARK AS SHOWN.

CLASS 18—LEATHER GOODS

FOR BABY-ORIENTED TOTE BAGS AND BACKPACKS (U.S. CLS. 1, 2, 3, 22 AND 41).
FIRST USE 9-6-2001; IN COMMERCE 9-6-2001.

CLASS 25—CLOTHING

FOR CLOTHING FOR BABIES, INFANTS AND TODDLERS, NAMELY, T-SHIRTS, SWEATSHIRTS AND HATS (U.S. CLS. 22 AND 39).
FIRST USE 9-6-2001; IN COMMERCE 9-6-2001.



NO CLAIM IS MADE TO THE EXCLUSIVE RIGHT TO USE "SOLUTIONS", APART FROM THE MARK AS SHOWN.

THE LINING IS A FEATURE OF THE MARK AND DOES NOT INDICATE COLOR.

CLASS 3—COSMETICS AND CLEANING PREPARATIONS

FOR SKIN MOISTURIZERS; VAGINAL MOISTURIZERS, NAMELY, NON-MEDICATED SPRAYS, CREAMS AND LOTIONS; NON-MEDICATED PREPARATIONS, NAMELY, SPRAYS, CREAMS AND LOTIONS TO MAINTAIN THE MOISTURE BALANCE OF THE SKIN AND VAGINAL TISSUE; SKIN MOISTURIZERS AND CONDITIONERS; NON-MEDICATED PREPARATIONS TO PROTECT THE SKIN FROM THE EFFECTS OF WIND, SUN AND ENVIRONMENTAL POLLUTION (U.S. CLS. 1, 4, 6, 50, 51 AND 52).
FIRST USE 9-0-2000; IN COMMERCE 9-0-2000.

CLASS 5—PHARMACEUTICALS

FOR PERSONAL LUBRICANTS, MALE GENITAL DESENSITIZING PREPARATIONS AND PHARMACEUTICAL PREPARATIONS, NAMELY, CREAMS AND LOTIONS TO RETREAT PREMATURE EJACULATION (U.S. CLS. 6, 18, 44, 46, 51 AND 52).
FIRST USE 9-0-2000; IN COMMERCE 9-0-2000.

2,625,884. INTERNATIONAL BUSINESS MACHINES CORPORATION, ARMONK, NY. SN 75-981,987. PUB. 1-18-2000, FILED 10-1-1997.

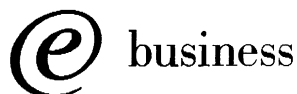

NO CLAIM IS MADE TO THE EXCLUSIVE RIGHT TO USE "E BUSINESS", APART FROM THE MARK AS SHOWN.

CLASS 16—PAPER GOODS AND PRINTED MATTER

FOR PRINTED MATTER, NAMELY, INSTRUCTIONAL MANUALS, MAGAZINES, NEWSLETTERS, NEWSPAPER INSERTS, BOOKLETS ALL RELATING TO COMPUTER HARDWARE AND COMPUTER SOFTWARE FOR USE IN COMMERCIAL INTERACTIONS IN THE FIELD OF GLOBAL COMPUTER NETWORKS (U.S. CLS. 2, 5, 22, 23, 29, 37, 38 AND 50).
FIRST USE 10-0-1997; IN COMMERCE 10-0-1997.

CLASS 42—SCIENTIFIC, COMPUTER AND LEGAL SERVICES

FOR COMPUTER PROGRAMMING FOR OTHERS; COMPUTER SOFTWARE DESIGN FOR OTHERS; COMPUTER SERVICES, NAMELY, DESIGNING, CREATING, IMPLEMENTING AND MAINTAINING WEB SITES FOR OTHERS; COMPUTER SYSTEMS ANALYSIS; INTEGRATION OF COMPUTER SYSTEMS AND NETWORKS; MAINTENANCE OF COMPUTER SOFTWARE (U.S. CLS. 100 AND 101).
FIRST USE 10-0-1997; IN COMMERCE 10-0-1997.

2,625,888. INSTRUMENTARIUM CORPORATION, 00510 HELSINKI, FINLAND. SN 75-982,184. PUB. 10-5-1999, FILED 10-1-1998.

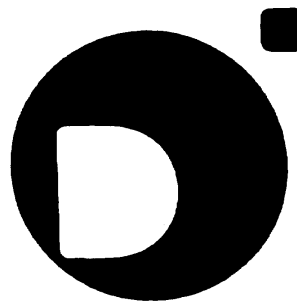

THE MARK CONSISTS OF THE LETTERS "D O" AND A MISCELLANEOUS DESIGN.

CLASS 9—ELECTRICAL AND SCIENTIFIC APPARATUS

FOR COMPUTER SOFTWARE FOR HOSPITAL OPERATING ROOM MANAGEMENT, COMPUTER SOFTWARE FOR CRITICAL CARE INFORMATION MANAGEMENT (U.S. CLS. 21, 23, 26, 36 AND 38).
FIRST USE 6-0-1998; IN COMMERCE 10-0-1998.

2,625,903. MACKLE COMPANY, INC., THE, MIAMI, FL. SN 76-000,797. PUB. 1-1-2002, FILED 3-15-2000.

AVANTI

THE ENGLISH TRANSLATION OF "AVANTI" FROM THE ITALIAN LANGUAGE IS "FORWARD" OR "ADVANCE".

CLASS 10—MEDICAL APPARATUS

FOR GAS ANALYZERS FOR MEDICAL PURPOSES; ANAESTHESIA RECORD KEEPING AND DATA MANAGEMENT SYSTEMS AND PATIENT MONITORING SYSTEMS, NAMELY, GAS MONITORS, PULSE OXIMETERS, MULTIPARAMETER MONITORS, ECG MONITORS, INVASIVE AND NON-INVASIVE BLOOD PRESSURE MONITORS, NEUROMUSCULAR TRANSMISSION MONITORS AND SPIROMETERS FOR ANAESTHESIA, INTENSIVE CARE AND DIAGNOSTIC APPLICATIONS, ANAESTHESIA MACHINES AND VENTILATORS, INTENSIVE CARE AND ANAESTHESIA ACCESSORIES FOR SINGLE PATIENT USE, NAMELY GAS SAMPLING LINES, AIRWAY ADAPTERS, HEAT AND MOISTURE EXCHANGERS, BACTERIA FILTERS, BREATHING CIRCUITS, SPIROMETRY SENSORS AND TUBES, TUBES, WATER TRAPS, PULSE OXIMETRY SENSORS, NONINVASIVE BLOOD PRESSURE CUFFS, FLUSHING SETS, ANAESTHESIA MASKS, CARBON DIOXIDE ABSORBERS, TEMPERATURE PROBES AND NEBULIZERS; CENTRAL NERVOUS SYSTEM MONITORS, GASTROINTESTINAL TONOMETERS, PARTS FOR ALL AFOREMENTIONED GOODS (U.S. CLS. 26, 39 AND 44).
FIRST USE 6-0-1998; IN COMMERCE 10-0-1998.

CLASS 7—MACHINERY

FOR (ITU) VACUUM CLEANERS AND CLOTHES WASHING MACHINES (U.S. CLS. 13, 19, 21, 23, 31, 34 AND 35).
FIRST USE 2-0-1983; IN COMMERCE 2-0-1983.

CLASS 11—ENVIRONMENTAL CONTROL APPARATUS

FOR (BASED ON USE IN COMMERCE) REFRIGERATORS, FREEZERS, CLOTHES DRYERS, MICROWAVE OVENS, ELECTRIC MINI KITCHEN COOKING SYSTEMS CONSISTING OF SMALL OVENS WITH COOKTOPS, WATER COOLING AND DISPENSING UNITS, AND WINE COOLERS, NAMELY, REFRIGERATED CABINETS CONTAINING RACKS FOR WINE BOTTLES AND STORAGE SHELVES (U.S. CLS. 13, 21, 23, 31 AND 34).
FIRST USE 11-14-1977; IN COMMERCE 11-14-1977.

2,625,891. GRAND CYPRESS DEVELOPMENT COMPANY, L.L.C., ATLANTA, GA. SN 75-982,304. PUB. 6-27-2000, FILED 8-10-1998.

2,625,916. PABLOSKY, S.L., TOLEDO, SPAIN. SN 76-011,112. PUB. 9-4-2001, FILED 3-28-2000.



OWNER OF U.S. REG. NO. 1,776,765.
NO CLAIM IS MADE TO THE EXCLUSIVE RIGHT TO USE "RESORT", APART FROM THE MARK AS SHOWN. SEC. 2(F).



OWNER OF U.S. REG. NO. 1,959,878.
THE APPLICANT CLAIMS THE COLORS PURPLE, WHITE, OCHRE, ORANGE, AND BLUE AND SUBMITS THE FOLLOWING STATEMENT DESCRIBING THE PLACEMENT OF THE COLORS: THE LETTERS ARE PURPLE, THE CIRCLES BEHIND THE "P", "B", "O", AND "K" ARE WHITE, THE CIRCLES BEHIND THE "A" AND THE "S" ARE OCHRE, THE CIRCLE BEHIND THE "L" IS ORANGE, THE CIRCLE BEHIND THE "Y" IS BLUE, THE SQUARES BEHIND THE "P", "L", AND "S" ARE PURPLE, THE SQUARES BEHIND THE "A" AND THE "Y" ARE ORANGE, THE SQUARES BEHIND THE "B" AND THE "K" ARE GREEN, AND THE SQUARE BEHIND THE "O" IS BLUE.

CLASS 41—EDUCATION AND ENTERTAINMENT

FOR PROVIDING RESORT AND RECREATIONAL FACILITIES FOR OTHERS, NAMELY, GOLF, TENNIS, SWIMMING AND HORSEBACK RIDING AND PROVIDING ENTERTAINMENT SERVICES FOR RESORT GUESTS AND OTHERS, NAMELY, ORGANIZING AND PROMOTING GOLF AND TENNIS COMPETITIONS (U.S. CLS. 100, 101 AND 107).
FIRST USE 11-14-1998; IN COMMERCE 11-14-1998.

CLASS 25—CLOTHING

FOR CLOTHING, NAMELY, JEANS, SHIRTS, T-SHIRTS, ANORAKS, BATHING SUITS, BEACHWEAR, SHORTS, BLOUSES, COATS, JACKETS, PULLOVERS, POLO SHIRTS, SOCKS, GLOVES, UNDERWEAR AND TROUSERS; FOOTWEAR, NAMELY, BOOTS, SHOES, SANDALS, SLIPPERS, CLOGS AND SPORT SHOES AND HEADGEAR, NAMELY BERETS, HOODS, HATS, BONNETS, CAPS AND SUN VISORS (U.S. CLS. 22 AND 39).
FIRST USE 2-17-2000; IN COMMERCE 8-0-2000.

CLASS 42—SCIENTIFIC, COMPUTER AND LEGAL SERVICES

FOR PROVIDING RESTAURANT COCKTAIL LOUNGE SERVICES (U.S. CLS. 100 AND 101).
FIRST USE 11-14-1998; IN COMMERCE 11-14-1998.

CLASS 35—ADVERTISING AND BUSINESS

FOR ADVERTISING AGENCIES; PLACING AND PREPARING ADVERTISEMENTS FOR OTHERS; BUSINESS MANAGEMENT CONSULTATION; FRANCHISING, NAMELY, OFFERING TECHNICAL ASSISTANCE IN THE ESTABLISHMENT AND/OR OPERATION OF SHOE STORES AND CLOTHING STORES; RETAIL STORE SERVICES FEATURING MEN'S WOMEN'S AND CHILDREN'S APPAREL; EMPLOYMENT COUNSELING (U.S. CLS. 100, 101 AND 102).

FIRST USE 2-17-2000; IN COMMERCE 8-0-2000.

2,625,929. QOL RESTAURANT GROUP, INC., SPOKANE, WA. SN 76-019,274. PUB. 1-16-2001, FILED 4-5-2000.

JUK A MON**CLASS 21—HOUSEWARES AND GLASS**

FOR COFFEE MUGS AND BEVERAGE GLASSWARE (U.S. CLS. 2, 13, 23, 29, 30, 33, 40 AND 50).

FIRST USE 11-30-2001; IN COMMERCE 11-30-2001.

CLASS 42—SCIENTIFIC, COMPUTER AND LEGAL SERVICES

FOR RESTAURANT SERVICES (U.S. CLS. 100 AND 101).

FIRST USE 11-30-2001; IN COMMERCE 11-30-2001.

2,625,917. ROGAN, PETER K., OVERLAND PARK, KS. AND KNOLL, JOAN H., OVERLAND PARK, KS. SN 76-012,549. PUB. 8-7-2001, FILED 3-30-2000.

CYTOGNOMIX**CLASS 1—CHEMICALS**

FOR KITS COMPRISING SOLUTIONS AND REAGENTS FOR PERFORMING FLUORESCENCE IN-SITU HYBRIDIZATION FOR DETECTION OF CHROMOSOMES AND DNA SEQUENCES FOR SCIENTIFIC OR RESEARCH USE; REAGENTS USED FOR DETECTION OF CHROMOSOMES AND DNA SEQUENCES FOR SCIENTIFIC OR RESEARCH USE (U.S. CLS. 1, 5, 6, 10, 26 AND 46).

FIRST USE 2-24-2002; IN COMMERCE 2-24-2002.

2,625,936. FRITZ EGGER GESELLSCHAFT M.B.H. & CO., A-6380 ST. JOHANN IN TIROL, AUSTRIA. SN 76-025,251. PUB. 7-3-2001, FILED 4-13-2000.

EGGER**CLASS 5—PHARMACEUTICALS**

FOR KITS COMPRISING SOLUTIONS AND REAGENTS FOR PERFORMING FLUORESCENCE IN-SITU HYBRIDIZATION FOR DETECTION OF CHROMOSOMES AND DNA SEQUENCES FOR CLINICAL OR MEDICAL LABORATORY USE; REAGENTS USED FOR DETECTION OF CHROMOSOMES AND DNA SEQUENCES FOR CLINICAL OR MEDICAL LABORATORY USE (U.S. CLS. 6, 18, 44, 46, 51 AND 52).

FIRST USE 2-24-2002; IN COMMERCE 2-24-2002.

CLASS 17—RUBBER GOODS

FOR GOODS MADE FROM PLASTIC MATERIAL, NAMELY, SEMI-FINISHED ACRYLIC MOLDED PLASTIC SUBSTANCES FOR INDUSTRIAL USE; PLASTIC LAMINATES, NAMELY, LAMINATED SHEETS AND PANELS FOR USE IN THE MANUFACTURE OF COUNTER TOPS AND LAMINATED CHIP BOARDS (U.S. CLS. 1, 5, 12, 13, 35 AND 50).

FIRST USE 12-31-1985; IN COMMERCE 12-31-1986.

CLASS 19—NON-METALLIC BUILDING MATERIALS

FOR COATED OR UNCOATED WOOD CHIP AND WOOD FIBER BOARDS; FURNITURE ELEMENTS MADE OF CHIP BOARDS AND WOOD FIBER BOARDS, NAMELY, NON-METAL WINDOW SILLS (U.S. CLS. 1, 12, 33 AND 50).

FIRST USE 12-31-1985; IN COMMERCE 12-31-1986.

2,625,921. UNITED SUCCESS INTERNATIONAL INCORPORATED, DALY CITY, CA. SN 76-013,139. PUB. 5-15-2001, FILED 3-30-2000.

CLASS 20—FURNITURE AND ARTICLES NOT OTHERWISE CLASSIFIED

FOR FURNITURE; FURNITURE ELEMENTS MADE OF CHIP BOARDS AND WOOD FIBER BOARDS, NAMELY, INDUSTRIAL WORK TABLES; FURNITURE FRONT PARTS, CORPUS PART AND EDGE ELEMENTS, NAMELY, FURNITURE MOLDINGS, FRAMES, DOOR PARTS AND PARTITIONS; GOODS MADE OF PLASTIC, NAMELY, PLASTIC DOORKNOBS AND PLASTIC DOOR STOPS, PLASTIC DRAWER LINING MATERIAL (U.S. CLS. 2, 13, 22, 25, 32 AND 50).

FIRST USE 12-31-1985; IN COMMERCE 12-31-1986.

G. MEGA

THE NAME SHOWN IN THE MARK DOES NOT IDENTIFY A LIVING INDIVIDUAL.

CLASS 18—LEATHER GOODS

FOR BACK PACKS, TRAVELING BAGS, AND SPORTS BAGS (U.S. CLS. 1, 2, 3, 22 AND 41).

FIRST USE 2-0-2001; IN COMMERCE 2-0-2001.

CLASS 25—CLOTHING

FOR SHIRTS, PANTS, JACKETS, FOOTWEAR, AND HEADWEAR (U.S. CLS. 22 AND 39).

FIRST USE 2-0-2001; IN COMMERCE 2-0-2001.

CLASS 27—FLOOR COVERINGS

FOR NON-TEXTILE WALL HANGINGS AND VINYL LAMINATE FLOOR COVERINGS, RUBBER UNDERLYING MATS FOR LAMINATE FLOORS (U.S. CLS. 19, 20, 37, 42 AND 50).

FIRST USE 12-31-1996; IN COMMERCE 12-31-1996.

2,625,940. GOAR BIESENKAMP, 81825 MUNCHEN, FED REP GERMANY. SN 76-027,388. PUB. 8-28-2001, FILED 4-17-2000.

2,625,943. EAGLE ENGINEERING AEROSPACE CO., LTD., MINATO-KU, TOKYO, JAPAN. SN 76-028,026. PUB. 10-16-2001, FILED 4-18-2000.

LOU BEGA

PRIORITY CLAIMED UNDER SEC. 44(D) ON ERP N CMNTY TM OFC APPLICATION NO. 1,348,481, FILED 10-18-1999.

THE NAME "LOU BEGA" IDENTIFIES A LIVING INDIVIDUAL WHOSE CONSENT IS OF RECORD.

CLASS 25—CLOTHING

FOR CLOTHING, NAMELY SHIRTS, SHORTS, PANTS, JACKETS, VESTS, FOOTWEAR AND HEADWEAR (U.S. CLS. 22 AND 39).

FIRST USE 10-0-1999; IN COMMERCE 11-0-1999.

CLASS 28—TOYS AND SPORTING GOODS

FOR GAMES AND PLAYTHINGS, NAMELY HAND-HELD UNIT FOR PLAYING COMPUTER GAMES, PLUSH TOYS, JIGSAW PUZZLES, MOBILES, MECHANICAL TOYS, ELECTRICAL ACTION TOYS, TOY FIGURES, DOLLS, CARD GAMES, TOY VEHICLES, ACTION SKILL GAMES, BOARD GAMES, STUFFED TOY ANIMALS, RUBBER TOY ANIMALS AND SPORTS EQUIPMENT, NAMELY SPORT BALLS, TENNIS RACKETS, SKIS, SNOWBOARDS, GOLF BAGS, IN-LINE SKATES (U.S. CLS. 22, 23, 38 AND 50).

FIRST USE 3-0-2001; IN COMMERCE 3-0-2001.

EEA

CLASS 7—MACHINERY

FOR AIRCRAFT AND ROCKET ENGINE PARTS, NAMELY, DYNAMIC SEALS, STATIC SEALS, COUPLINGS, FLANGES, JOINTS, VALVES, BULGE FORMED PARTS, GAS SEALS, GASKETS, AND CARBON PARTS OF SEALS (U.S. CLS. 13, 19, 21, 23, 31, 34 AND 35).

FIRST USE 4-18-2000; IN COMMERCE 4-18-2000.

CLASS 12—VEHICLES

FOR STRUCTURAL PARTS FOR AIRCRAFT AND ROCKET ENGINES (U.S. CLS. 19, 21, 23, 31, 35 AND 44).

FIRST USE 4-18-2000; IN COMMERCE 4-18-2000.

2,625,944. INTERACTIVE MULTIMEDIA NETWORK, INC., JERSEY CITY, NJ. SN 76-028,364. PUB. 4-3-2001, FILED 4-18-2000.

SOY SLIM

NO CLAIM IS MADE TO THE EXCLUSIVE RIGHT TO USE "SOY", APART FROM THE MARK AS SHOWN.

CLASS 5—PHARMACEUTICALS

FOR NUTRITIONAL SUPPLEMENTS, NUTRITIONAL DRINK MIXES FOR USE AS A MEAL REPLACEMENT, NUTRITIONAL SUPPLEMENTS IN THE FORM OF COOKIES AND FOOD BARS, POWDERED NUTRITIONAL SHAKES, DIETARY SUPPLEMENTS CONTAINING SOY, AND FOOD SUPPLEMENTS IN POWDER AND LIQUID FORM CONTAINING SOY, ALL OF WHICH ARE TO BE SOLD SEPARATELY OR TOGETHER AS PART OF A COMPREHENSIVE DIETARY REGIME (U.S. CLS. 6, 18, 44, 46, 51 AND 52).

FIRST USE 4-14-2000; IN COMMERCE 5-1-2000.

CLASS 29—MEATS AND PROCESSED FOODS

FOR SOY MILK BEVERAGES, AND OTHER BEVERAGES CONTAINING SOY (U.S. CL. 46).

FIRST USE 4-14-2000; IN COMMERCE 5-1-2000.

CLASS 32—LIGHT BEVERAGES

FOR NUTRITIONAL BEVERAGES AND BEVERAGES CONTAINING SOY PRODUCTS (U.S. CLS. 45, 46 AND 48).

FIRST USE 4-14-2000; IN COMMERCE 5-1-2000.

2,625,942. EAGLE ENGINEERING AEROSPACE CO., LTD., TOKYO, JAPAN. SN 76-027,927. PUB. 9-4-2001, FILED 4-18-2000.

EEA

CLASS 37—CONSTRUCTION AND REPAIR

FOR INSTALLATION, MAINTENANCE AND REPAIR OF INDUSTRIAL EQUIPMENT, NAMELY, PUMP, VALVES, MECHANICAL SEALS AND RELATED EQUIPMENT; REPAIR AND MAINTENANCE OF COMPONENTS OF FUEL, PNEUMATIC AND HYDRAULICS SYSTEMS OF AIRCRAFT VEHICLES (U.S. CLS. 100, 103 AND 106).

FIRST USE 4-18-2000; IN COMMERCE 4-18-2000.

CLASS 42—SCIENTIFIC, COMPUTER AND LEGAL SERVICES

FOR ENGINEERING SERVICES (U.S. CLS. 100 AND 101).

FIRST USE 4-18-2000; IN COMMERCE 4-18-2000.

2,625,950. COMEBACK BREWING, INC., SAN ANTONIO, TX. SN 76-030,121. PUB. 12-11-2001, FILED 4-19-2000.

2,625,957. HUGHES ELECTRONICS CORPORATION, EL SEGUNDO, CA. SN 76-034,236. PUB. 12-4-2001, FILED 4-25-2000.

EBENEZER ALE

NO CLAIM IS MADE TO THE EXCLUSIVE RIGHT TO USE "ALE", APART FROM THE MARK AS SHOWN.

CLASS 25—CLOTHING

FOR CLOTHING, NAMELY, SHIRTS, COATS, SWEATERS, SWEATSHIRTS, PANTS AND HATS (U.S. CLS. 22 AND 39).

FIRST USE 10-15-2001; IN COMMERCE 10-15-2001.

CLASS 32—LIGHT BEVERAGES

FOR BEER AND ALE (U.S. CLS. 45, 46 AND 48).
FIRST USE 10-15-2001; IN COMMERCE 10-15-2001.

2,625,952. SENSCOM, INC., SAN DIEGO, CA. SN 76-031,823.
PUB. 10-2-2001, FILED 4-19-2000.

SENSCOM

CLASS 9—ELECTRICAL AND SCIENTIFIC APPARATUS

FOR MICROPROCESSOR-BASED SOFTWARE FOR ELECTRONIC VOICE AND DATA COMMUNICATION (U.S. CLS. 21, 23, 26, 36 AND 38).

FIRST USE 5-28-2002; IN COMMERCE 5-28-2002.

CLASS 38—COMMUNICATION

FOR COMMUNICATION SERVICES, NAMELY, SERVICES ALLOWING USERS OF MICROPROCESSOR-BASED CLIENT SYSTEMS TO ACCESS FINANCIAL SERVICES PROVIDERS AND FINANCIAL INSTITUTIONS VIA A GLOBAL COMPUTER NETWORK AND PROVIDING MULTIPLE-USER ACCESS TO A GLOBAL COMPUTER INFORMATION NETWORK FOR THE TRANSFER AND DISSEMINATION OF A WIDE RANGE OF INFORMATION (U.S. CLS. 100, 101 AND 104).

FIRST USE 5-25-2000; IN COMMERCE 5-25-2000.

DIRECWAY

CLASS 9—ELECTRICAL AND SCIENTIFIC APPARATUS

FOR EQUIPMENT FOR RECEIVING, PROCESSING, AND TRANSMITTING VOICE, VIDEO, DATA AND INFORMATION VIA TELECOMMUNICATIONS AND WIRELESS SIGNALS, SATELLITE AND COMPUTER NAMELY, RECEIVERS, RECEIVER MODULE, MODULATORS, TRANSMITTERS, MULTIPLEXERS, DECODER BOXES, DATA PROCESSORS, INTEGRATED CIRCUITS, SET-TOP BOXES PRIMARILY COMPRISED OF A RECEIVER AND CIRCUITRY, COMPUTER OPERATING HARDWARE AND SOFTWARE FOR USE IN THE AFOREMENTIONED GOODS, SATELLITE DISHES, SATELLITE EARTH STATIONS, VARY SMALL APERTURE TERMINALS (VSAT) (U.S. CLS. 21, 23, 26, 36 AND 38).

FIRST USE 10-0-2000; IN COMMERCE 10-0-2000.

CLASS 38—COMMUNICATION

FOR TELECOMMUNICATIONS SERVICES, NAMELY THE TRANSMISSION OF VOICE, VIDEO, DATA AND DOCUMENTS VIA SATELLITE, TELEPHONE AND COMPUTER; TELECOMMUNICATIONS GATEWAY SERVICES; PROVIDING TELECOMMUNICATIONS CONNECTIONS TO A GLOBAL COMPUTER NETWORK; BROADCASTING PROGRAMS VIA A GLOBAL COMPUTER NETWORK; ELECTRONIC TRANSMISSION OF MESSAGES AND DATA; VIDEO BROADCASTING AND VIDEO MESSAGING SERVICES; AUDIO BROADCASTING; AND PROVIDING MULTIPLE-USER ACCESS TO A GLOBAL COMPUTER INFORMATION NETWORK (U.S. CLS. 100, 101 AND 104).

FIRST USE 10-0-2000; IN COMMERCE 10-0-2000.

2,625,963. AIR PRODUCTS AND CHEMICALS, INC., ALLENTOWN, PA. SN 76-037,381. PUB. 8-7-2001, FILED 5-1-2000.

MEGABIP

CLASS 1—CHEMICALS

FOR ULTRA HIGH PURITY GRADE INDUSTRIAL GASES AND GAS-GENERATING LIQUIDS FOR USE IN THE PRODUCTION OF SEMI-CONDUCTOR DEVICES AND COMPONENTS (U.S. CLS. 1, 5, 6, 10, 26 AND 46).

FIRST USE 11-2-2000; IN COMMERCE 11-2-2000.

CLASS 7—MACHINERY

FOR MANUALLY OPERATED METAL PURIFIER VALVES FOR USE WITH GAS CYLINDERS IN THE PRODUCTION OF SEMICONDUCTOR DEVICES AND COMPONENTS; METAL INDUSTRIAL CYLINDERS FOR ULTRA HIGH PURITY GRADE GASES SOLD EMPTY; METAL INDUSTRIAL CYLINDERS FOR ULTRA HIGH PURITY GRADE GASES SOLD EMPTY AND AS AN INTEGRAL UNIT WITH PURIFIER VALVES FOR USE IN THE PRODUCTION OF SEMICONDUCTOR DEVICES AND COMPONENTS (U.S. CLS. 13, 19, 21, 23, 31, 34 AND 35).

FIRST USE 11-2-2000; IN COMMERCE 11-2-2000.

2,625,966. TMC BACK TO BUSINESS, INC., ALBANY, NY.
SN 76-038,544. PUB. 1-16-2001, FILED 4-27-2000.

DRESS UP THURSDAYS

CLASS 14—JEWELRY

FOR ORNAMENTAL LAPEL PINS (U.S. CLS. 2, 27, 28 AND 50).
FIRST USE 9-21-2000; IN COMMERCE 9-21-2000.

CLASS 16—PAPER GOODS AND PRINTED MATTER

FOR PERIODIC NEWSLETTERS, PAMPHLETS, FLYERS AND BROCHURES REGARDING SUBJECTS OF INTEREST TO THE MEN'S GARMENT INDUSTRY, NAMELY, RETAIL MEN'S CLOTHING STORES AND MANUFACTURERS OF MEN'S CLOTHING AND ACCESSORIES (U.S. CLS. 2, 5, 22, 23, 29, 37, 38 AND 50).
FIRST USE 9-21-2000; IN COMMERCE 9-21-2000.

CLASS 41—EDUCATION AND ENTERTAINMENT

FOR EDUCATIONAL SERVICES, NAMELY PROVIDING SEMINARS AND CLASSES IN RETAIL MEN'S WEAR SALES TO MEMBERS OF APPLICANT (U.S. CLS. 100, 101 AND 107).
FIRST USE 9-21-2000; IN COMMERCE 9-21-2000.

CLASS 42—SCIENTIFIC, COMPUTER AND LEGAL SERVICES

FOR ASSOCIATION SERVICES, NAMELY PROMOTING THE INTERESTS OF THE MEN'S GARMENT INDUSTRY, NAMELY, RETAIL MEN'S CLOTHING STORES AND MANUFACTURERS OF MEN'S CLOTHING AND ACCESSORIES (U.S. CLS. 100 AND 101).
FIRST USE 9-21-2000; IN COMMERCE 9-21-2000.

2,625,967. TMC BACK TO BUSINESS, INC., ALBANY, NY.
SN 76-038,608. PUB. 1-16-2001, FILED 4-28-2000.

1DRESSUP.COM

CLASS 16—PAPER GOODS AND PRINTED MATTER

FOR PERIODIC NEWSLETTERS, PAMPHLETS, FLYERS AND BROCHURES REGARDING SUBJECTS OF INTEREST TO THE MEN'S GARMENT INDUSTRY, NAMELY, RETAIL MEN'S CLOTHING STORES AND MANUFACTURERS OF MEN'S CLOTHING AND ACCESSORIES (U.S. CLS. 2, 5, 22, 23, 29, 37, 38 AND 50).
FIRST USE 9-21-2000; IN COMMERCE 9-21-2000.

CLASS 41—EDUCATION AND ENTERTAINMENT

FOR EDUCATIONAL SERVICES, NAMELY PROVIDING SEMINARS AND CLASSES IN RETAIL MEN'S WEAR SALES TO MEMBERS OF APPLICANT (U.S. CLS. 100, 101 AND 107).
FIRST USE 9-21-2000; IN COMMERCE 9-21-2000.

CLASS 42—SCIENTIFIC, COMPUTER AND LEGAL SERVICES

FOR ASSOCIATION SERVICES, NAMELY PROMOTING THE INTERESTS OF THE MEN'S GARMENT INDUSTRY, NAMELY, RETAIL MEN'S CLOTHING STORES AND MANUFACTURERS OF MEN'S CLOTHING AND ACCESSORIES, PROVIDING ADVERTISING TO MEMBERS OVER THE GLOBAL COMPUTER NETWORK (U.S. CLS. 100 AND 101).
FIRST USE 9-21-2000; IN COMMERCE 9-21-2000.

2,625,976. NEW CREATIVE ENTERPRISES, INC., MILFORD, OH. SN 76-042,980. PUB. 10-16-2001, FILED 5-8-2000.



CLASS 6—METAL GOODS

FOR CANDLE HOLDERS MADE OF TIN; CANDLE LANTERNS MADE OF TIN; DECORATIVE SIGN POSTS MADE OF METAL (U.S. CLS. 2, 12, 13, 14, 23, 25 AND 50).
FIRST USE 1-0-1999; IN COMMERCE 1-0-1999.

CLASS 11—ENVIRONMENTAL CONTROL APPARATUS

FOR LAMPS (U.S. CLS. 13, 21, 23, 31 AND 34).
FIRST USE 1-0-1999; IN COMMERCE 1-0-1999.

CLASS 15—MUSICAL INSTRUMENTS

FOR MUSIC BOXES (U.S. CLS. 2, 21 AND 36).
FIRST USE 1-0-1999; IN COMMERCE 1-0-1999.

CLASS 18—LEATHER GOODS

FOR CANVAS TOTE BAGS (U.S. CLS. 1, 2, 3, 22 AND 41).
FIRST USE 1-0-1999; IN COMMERCE 1-0-1999.

CLASS 20—FURNITURE AND ARTICLES NOT OTHERWISE CLASSIFIED

FOR CANDLE HOLDERS MADE OF POLYRESIN; PICTURE FRAMES; JACK-O-LANTERN BOXES MADE OF WOOD; CANDLE BOXES MADE OF WOOD; DECORATIVE HALLOWEEN-THEMED LAWN ORNAMENTS MADE OF WOOD; DECORATIVE SIGN POSTS FOR LAWN USE (U.S. CLS. 2, 13, 22, 25, 32 AND 50).
FIRST USE 1-0-1999; IN COMMERCE 1-0-1999.

CLASS 21—HOUSEWARES AND GLASS

FOR BIRD HOUSES; WOODEN SERVING TRAYS; WIND CHIMES (U.S. CLS. 2, 13, 23, 29, 30, 33, 40 AND 50).
FIRST USE 1-0-1999; IN COMMERCE 1-0-1999.

2,625,978. LISIUS, MARTIN, ARLINGTON, TX. SN 76-043,233. PUB. 8-28-2001, FILED 5-4-2000.

PRAIRIE SKY

CLASS 9—ELECTRICAL AND SCIENTIFIC APPARATUS

FOR MOTION PICTURE FILMS, PRERECORDED VIDEO CASSETTES, AND VIDEO DISCS FEATURING PHOTOGRAPHIC IMAGES (U.S. CLS. 21, 23, 26, 36 AND 38).

FIRST USE 12-0-2000; IN COMMERCE 12-0-2001.

CLASS 16—PAPER GOODS AND PRINTED MATTER

FOR PRINTED MATERIALS, NAMELY, PHOTOGRAPHIC PRINTS, POSTERS, AND CALENDARS FEATURING PHOTOGRAPHIC IMAGES (U.S. CLS. 2, 5, 22, 23, 29, 37, 38 AND 50).

FIRST USE 12-0-2000; IN COMMERCE 12-0-2001.

2,625,981. CONSTRUCTION MARKET DATA GROUP, INC., NORCROSS, GA. SN 76-044,501. PUB. 11-6-2001, FILED 5-11-2000.

CMD PLANSDIRECT

CLASS 9—ELECTRICAL AND SCIENTIFIC APPARATUS

FOR PROVIDING A CD-ROM WITH CONSTRUCTION SPECIFICATION AND BID PREPARATION INFORMATION FOR COMMERCIAL CONSTRUCTION PROJECTS (U.S. CLS. 21, 23, 26, 36 AND 38).

FIRST USE 5-29-2001; IN COMMERCE 5-29-2001.

CLASS 37—CONSTRUCTION AND REPAIR

FOR PROVIDING CONSTRUCTION INFORMATION BY MEANS OF AN INTERACTIVE WEBSITE FEATURING PLANS, SPECIFICATIONS AND BID PREPARATION INFORMATION FOR COMMERCIAL CONSTRUCTION PROJECTS (U.S. CLS. 100, 103 AND 106).

FIRST USE 5-29-2001; IN COMMERCE 5-29-2001.

2,625,989. MICHIGAN SPORTING GOODS DISTRIBUTORS, INC., GRAND RAPIDS, MI. SN 76-046,767. PUB. 10-16-2001, FILED 5-11-2000.

DRIFT CREEK

CLASS 25—CLOTHING

FOR SHORTS, PANTS AND BASEBALL CAPS (U.S. CLS. 22 AND 39).

FIRST USE 4-0-2000; IN COMMERCE 4-0-2000.

CLASS 28—TOYS AND SPORTING GOODS

FOR FISHING TACKLE BOXES (U.S. CLS. 22, 23, 38 AND 50).

FIRST USE 2-0-2001; IN COMMERCE 2-0-2001.

2,625,993. NAVIGATOR SYSTEMS, INC., ADDISON, TX. SN 76-048,055. PUB. 8-7-2001, FILED 5-15-2000.

GET SMARTER. FASTER

CLASS 35—ADVERTISING AND BUSINESS

FOR BUSINESS STRATEGY CONSULTING SERVICES (U.S. CLS. 100, 101 AND 102).

FIRST USE 5-17-2000; IN COMMERCE 5-17-2000.

CLASS 42—SCIENTIFIC, COMPUTER AND LEGAL SERVICES

FOR DESIGN OF COMPUTER SOFTWARE FOR OTHERS AND COMPUTER PROGRAMING SERVICES FOR OTHERS (U.S. CLS. 100 AND 101).

FIRST USE 5-17-2000; IN COMMERCE 5-17-2000.

2,626,004. CLEARCROSS INC., NEW YORK, NY. SN 76-053,400. PUB. 3-27-2001, FILED 5-19-2000.

CLEARCROSS

CLASS 9—ELECTRICAL AND SCIENTIFIC APPARATUS

FOR COMPUTER SOFTWARE FOR MANAGING AND EXECUTING INTERNATIONAL TRADE AND LOGISTICS (U.S. CLS. 21, 23, 26, 36 AND 38).

FIRST USE 4-6-2000; IN COMMERCE 4-6-2000.

CLASS 35—ADVERTISING AND BUSINESS

FOR MANAGING AND FACILITATING INTERNATIONAL TRADE AND LOGISTICS, NAMELY SUPPLY CHAIN MANAGEMENT, MANAGEMENT OF GOVERNMENT COMPLIANCE SCREENING, MANAGEMENT OF LETTERS OF CREDIT AND IMPORT LICENSES, MANAGEMENT OF PRODUCTION AND TRANSMISSION OF ESSENTIAL DOCUMENTATION AND LABELS, COMPUTERIZED TRACKING AND TRACING OF SHIPMENTS AND ORDERS IN TRANSIT, MANAGEMENT OF SHIPMENT PREPARATION AND MANAGEMENT OF INFORMATION REGARDING SHIPMENT PREPARATION, ROUTING, BOOKING AND CONTROL OF INVENTORY IN TRANSIT, ACCOUNTING IN THE NATURE OF CALCULATION OF FULL SHIPMENT LANDED COSTS, CUSTOMS-CLEARANCE SERVICES, NAMELY ELECTRONIC FILING OF IMPORT DATA WITH CUSTOMS AUTHORITIES, ELECTRONIC FILING OF CUSTOMS DOCUMENTS AND INFORMATION, CARGO INVENTORY CONTROL AND RELEASE NOTIFICATION FOR CARRIERS, ELECTRONIC INVOICING OF CUSTOMERS, AND CLASSIFICATION OF GOODS FOR CUSTOMS AND COMPLIANCE SCREENING, ALL THROUGH USE OF COMPUTER SOFTWARE AND A GLOBAL COMPUTER NETWORK (U.S. CLS. 100, 101 AND 102).

FIRST USE 4-6-2000; IN COMMERCE 4-6-2000.

CLASS 36—INSURANCE AND FINANCIAL

FOR AUTOMATED ELECTRONIC PAYMENT OF CUSTOMS FEES, DUTIES, TAXES AND OTHER FEES THROUGH USE OF COMPUTER SOFTWARE AND A GLOBAL COMPUTER NETWORK (U.S. CLS. 100, 101 AND 102).

FIRST USE 4-6-2000; IN COMMERCE 4-6-2000.

CLASS 42—SCIENTIFIC, COMPUTER AND LEGAL SERVICES

FOR GOVERNMENT COMPLIANCE SCREENING; COMPUTER CONSULTATION; COMPUTER PROGRAMMING FOR OTHERS; COMPUTER SOFTWARE DESIGN FOR OTHERS; AND INSTALLATION AND SUPPORT OF COMPUTER SOFTWARE IN THE FIELD OF INTERNATIONAL TRADE (U.S. CLS. 100 AND 101).
FIRST USE 4-6-2000; IN COMMERCE 4-6-2000.

2,626,027. CENTRIC GROUP, L.L.C., ST. LOUIS, MO. SN 76-066,617. PUB. 5-22-2001, FILED 6-8-2000.

UNCANNY TASTE AND CONVENIENCE

OWNER OF U.S. REG. NO. 2,388,701.

2,626,011. DANIELS, DONALD R., BOSSIER CITY, LA. SN 76-057,756. PUB. 10-30-2001, FILED 5-26-2000.



THE DESIGN PORTION OF THE MARK CONSISTS OF SIMULATED EYEBROWS AND EYES, SYMBOLIZING "FOCUS ON TASKS AT HAND".

CLASS 24—FABRICS

FOR TOWELS AND FELT TABLE COVERS (U.S. CLS. 42 AND 50).
FIRST USE 5-26-2000; IN COMMERCE 3-28-2002.

CLASS 25—CLOTHING

FOR CLOTHING, NAMELY CAPS, HATS, T-SHIRTS, SHORTS, SPORTS SHIRTS, VISORS, SOCKS, SWEATSHIRTS, SHOES AND JERSEYS (U.S. CLS. 22 AND 39).
FIRST USE 5-26-2000; IN COMMERCE 3-28-2002.

2,626,021. NATIONAL HEAD START ASSOCIATION, ALEXANDRIA, VA. SN 76-062,142. PUB. 2-20-2001, FILED 6-2-2000.

**CLASS 6—METAL GOODS**

FOR METAL KEYRINGS (U.S. CLS. 2, 12, 13, 14, 23, 25 AND 50).
FIRST USE 4-1-2002; IN COMMERCE 4-1-2002.

CLASS 14—JEWELRY

FOR WATCHES (U.S. CLS. 2, 27, 28 AND 50).
FIRST USE 12-0-2001; IN COMMERCE 12-0-2001.

CLASS 29—MEATS AND PROCESSED FOODS

FOR CHILI WITH BEANS, CHILI WITHOUT BEANS, STEWS, BEEF, CHICKEN, SAUSAGE, PROCESSED MEATS, NAMELY PROCESSED BEEF, PROCESSED CHICKEN AND PROCESSED SAUSAGE, SOUPS, PROCESSED VEGETABLES AND PROCESSED FRUITS (U.S. CL. 46).
FIRST USE 10-9-2000; IN COMMERCE 10-9-2000.

CLASS 30—STAPLE FOODS

FOR PREPARED ENTREES CONSISTING PRIMARILY OF PASTAS IN SAUCE, AND SAUCES (U.S. CL. 46).
FIRST USE 12-19-2001; IN COMMERCE 12-19-2001.

2,626,039. LOLLILOCKS KIDS SALON, LLC, LITTLETON, CO. SN 76-074,036. PUB. 2-5-2002, FILED 6-19-2000.

LOLLILOCKS KIDS SALON

NO CLAIM IS MADE TO THE EXCLUSIVE RIGHT TO USE "KIDS SALON", APART FROM THE MARK AS SHOWN.

CLASS 35—ADVERTISING AND BUSINESS

FOR RETAIL STORE SERVICES FEATURING HAIR CARE AND BEAUTY SUPPLIES (U.S. CLS. 100, 101 AND 102).
FIRST USE 5-1-2001; IN COMMERCE 5-1-2001.

CLASS 42—SCIENTIFIC, COMPUTER AND LEGAL SERVICES

FOR HAIR CUTTING AND BEAUTY SALON SERVICES FOR CHILDREN (U.S. CLS. 100 AND 101).
FIRST USE 5-1-2001; IN COMMERCE 5-1-2001.

2,626,043. NICHOLSON, CHRISTINE, ALBUQUERQUE, NM. SN 76-075,707. PUB. 9-18-2001, FILED 6-20-2000.

WORRY DOCTOR**CLASS 41—EDUCATION AND ENTERTAINMENT**

FOR EDUCATIONAL SERVICES, NAMELY PROVIDING INSTRUCTIONAL PROGRAMS, TUTORIALS, COLLOQUIUMS, AND SEMINARS IN THE FIELDS OF PARENTING AND CHILD PSYCHOLOGY, SOCIAL, AND BEHAVIORAL DEVELOPMENT, AWARENESS, AND SOCIALIZATION (U.S. CLS. 100, 101 AND 107).
FIRST USE 10-1-1990; IN COMMERCE 10-1-1990.

CLASS 42—SCIENTIFIC, COMPUTER AND LEGAL SERVICES

FOR PSYCHOLOGICAL, SOCIAL, AND BEHAVIORAL COUNSELING SERVICES FOR INDIVIDUALS AND GROUPS IN THE FIELDS OF PARENTING AND CHILD PSYCHOLOGY, SOCIAL, AND BEHAVIORAL DEVELOPMENT, AWARENESS, AND SOCIALIZATION (U.S. CLS. 100 AND 101).

FIRST USE 10-1-1990; IN COMMERCE 10-1-1990.

2,626,050. D.E.J. PRODUCTIONS INC., DALLAS, TX. SN 76-077,842. PUB. 10-30-2001, FILED 6-26-2000.



DE J PRODUCTIONS

NO CLAIM IS MADE TO THE EXCLUSIVE RIGHT TO USE "PRODUCTIONS", APART FROM THE MARK AS SHOWN.

CLASS 9—ELECTRICAL AND SCIENTIFIC APPARATUS

FOR PRE-RECORDED VIDEOCASSETTES, CD-ROMS, LASER DISKS, VIDEO COMPACT DISKS, DIGITAL VIDEO DISCS, RECORDABLE COMPACT DISKS, DVD-ROMS, DVD-RAMS, AND VIDEO DISKS, FEATURING MOTION PICTURE FILMS IN A VARIETY OF GENRES (U.S. CLS. 21, 23, 26, 36 AND 38).

FIRST USE 7-1-2001; IN COMMERCE 7-1-2001.

CLASS 41—EDUCATION AND ENTERTAINMENT

FOR PRODUCTION AND DISTRIBUTION OF MOTION PICTURE FILMS, PRODUCTION OF VIDEO CASSETTES, CD-ROMS, LASERDISCS, VIDEO COMPACT DISKS, DIGITAL VIDEO DISKS, RECORDABLE COMPACT DISKS, DVD-ROMS, DVD-RAMS, AND VIDEO DISKS (U.S. CLS. 100, 101 AND 107).

FIRST USE 7-1-2001; IN COMMERCE 7-1-2001.

2,626,064. ALLCONNECT.COM, INC., ATLANTA, GA. SN 76-084,900. PUB. 6-12-2001, FILED 7-7-2000.



OWNER OF U.S. REG. NOS. 2,220,770 AND 2,311,828.

CLASS 35—ADVERTISING AND BUSINESS

FOR AGENCY REPRESENTATION OF COMPANIES MARKETING A VARIETY OF SERVICES TO HOME OWNERS AND RENTERS, NAMELY, UTILITY HOOK-UPS, TELECOMMUNICATION SERVICES, HOME SECURITY SERVICES, HOME WARRANTIES, HOME AND YARD MAINTENANCE, FURNITURE AND APPLIANCE RENTAL (U.S. CLS. 100, 101 AND 102).

FIRST USE 8-1-2000; IN COMMERCE 8-1-2000.

CLASS 42—SCIENTIFIC, COMPUTER AND LEGAL SERVICES

FOR CONSULTATIONS RENDERED TO CONSUMERS ON THE SUBJECTS OF UTILITY AND TELECOMMUNICATION SERVICES NAMELY, THE INITIATION AND TERMINATION OF SERVICES WITH UTILITY AND TELECOMMUNICATION PROVIDERS (U.S. CLS. 100 AND 101).

FIRST USE 8-1-2000; IN COMMERCE 8-1-2000.

2,626,080. DIGITAL CONTROLS CORPORATION, SPRINGBORO, OH. SN 76-091,116. PUB. 9-4-2001, FILED 7-18-2000.

OMPLUS**CLASS 9—ELECTRICAL AND SCIENTIFIC APPARATUS**

FOR COMPUTER SOFTWARE, NAMELY, SOFTWARE USED TO CONTROL PRINTERS (U.S. CLS. 21, 23, 26, 36 AND 38).

FIRST USE 1-1-2001; IN COMMERCE 1-1-2001.

CLASS 42—SCIENTIFIC, COMPUTER AND LEGAL SERVICES

FOR COMPUTER SOFTWARE CONSULTING SERVICES (U.S. CLS. 100 AND 101).

FIRST USE 1-1-2001; IN COMMERCE 1-1-2001.

2,626,131. MERCADIEN GROUP, L.L.C., THE, MERCERVILLE, NJ. SN 76-118,501. PUB. 7-3-2001, FILED 8-29-2000.



NO CLAIM IS MADE TO THE EXCLUSIVE RIGHT TO USE "GROUP", APART FROM THE MARK AS SHOWN.

CLASS 35—ADVERTISING AND BUSINESS

FOR TAX COMPLIANCE ANALYSIS AND TAX CONSULTING; GENERAL BUSINESS CONSULTING; INVENTORY CONTROL; MANAGEMENT ASSISTANCE; MERGER AND ACQUISITION CONSULTING; MARKETING CONSULTING; EXECUTIVE RECRUITMENT; HUMAN RESOURCES CONSULTING; BOOKKEEPING; AND HEALTHCARE AUDITS (U.S. CLS. 100, 101 AND 102).

FIRST USE 10-1-2000; IN COMMERCE 10-1-2000.

CLASS 36—INSURANCE AND FINANCIAL

FOR BUSINESS VALUATIONS; REAL ESTATE VALUATIONS; ARBITRAGE CALCULATIONS; INSURANCE BROKERAGE; INSURANCE UNDERWRITING AND CLAIMS ADJUSTMENT SERVICES IN THE FIELDS OF LIFE, ACCIDENT, ANNUITY, FIRE, GUARANTEE, MARINE, MEDICAL, RE-INSURANCE, PREPAID HEALTH CARE, PRE-PAID LEGAL SERVICES, AND PERSONAL PROPERTY; INSURANCE CONSULTATION, SUBROGATION, AND SALVAGE SERVICES; ASSET MANAGEMENT ADVISORY SERVICES, NAMELY, CASH MANAGEMENT, ESTATE TRUSTS MANAGEMENT, 401K PLAN ADMINISTRATION AND MANAGEMENT, AND TRUSTEE SERVICES; FINANCIAL SERVICES, NAMELY, FINANCIAL PORTFOLIO MANAGEMENT; FINANCIAL AND ESTATE PLANNING; FINANCIAL ANALYSIS, CONSULTATION, AND SURETY SERVICES; REGISTERED INVESTMENT ADVISOR SERVICES SUCH AS FUND, MUTUAL FUND AND REAL ESTATE INVESTMENTS; INVESTMENT ADVICE; INVESTMENT BROKERAGE; INVESTMENT CONSULTATION AND INVESTMENT MANAGEMENT; PROVIDING AN ECONOMIC CONDUIT TO SUPPORT COMMUNITY BASED CHARITABLE CAUSES (U.S. CLS. 100, 101 AND 102).

FIRST USE 10-1-2000; IN COMMERCE 10-1-2000.

CLASS 42—SCIENTIFIC, COMPUTER AND LEGAL SERVICES

FOR LITIGATION SUPPORT SERVICES; FEASIBILITY STUDIES; HEALTHCARE COMPLIANCE ANALYSIS; SOFTWARE DESIGN; COMPUTER CONSULTATION SERVICES; COMPUTER PROGRAMMING; COMPUTER SERVICES, NAMELY, DESIGNING AND IMPLEMENTING NETWORKS AND WEB PAGES AND CREATING AND MAINTAINING WEBSITES FOR OTHERS, DEVELOPING AN APPLICATION SERVICE PROVIDER MODEL FOR HOSTING THE WEBSITES OF OTHERS, AND DESIGNING AUTOMATED BUSINESS PROCESS SYSTEMS (U.S. CLS. 100 AND 101).

FIRST USE 10-1-2000; IN COMMERCE 10-1-2000.

2,626,147. CASTELLO DI BORGHESE, LLC, CUTCHOGUE, NY. SN 76-123,574. PUB. 2-12-2002, FILED 9-7-2000.



THE MARK CONSISTS OF THE FAMILY CREST OF THE DI BORGHESE FAMILY AND INCLUDES AN EAGLE WITH SPREAD WINGS IN THE TOP PORTION OF THE CREST AND A STYLIZED DRAGON IN THE BOTTOM, SHADED PORTION OF THE CREST.

CLASS 29—MEATS AND PROCESSED FOODS

FOR SPECIALTY FOODS, NAMELY, EDIBLE OILS, PROCESSED OLIVES, JARS OF CONSERVED PEPPERS, PROCESSED MUSHROOMS, JAMS, CAVIAR, AND CHEESE (U.S. CL. 46).

FIRST USE 2-13-2001; IN COMMERCE 7-3-2001.

CLASS 33—WINES AND SPIRITS

FOR WINE (U.S. CLS. 47 AND 49).

FIRST USE 2-13-2001; IN COMMERCE 7-3-2001.

2,626,139. FISCHER, JEFFREY, BOCA RATON, FL. SN 76-120,863. PUB. 7-3-2001, FILED 9-1-2000.

KALUME

CLASS 14—JEWELRY

FOR JEWELRY HAVING SEMAPHORES INDICATING INTEREST OR PREFERENCES OF THE WEARER (U.S. CLS. 2, 27, 28 AND 50).

FIRST USE 10-31-2001; IN COMMERCE 10-31-2001.

CLASS 25—CLOTHING

FOR CLOTHING, NAMELY, MEN'S, WOMEN'S, AND CHILDREN'S, SHIRTS, PANTS, SKIRTS, HATS, CAPS, JACKETS, COATS, SHORTS, AND T-SHIRTS (U.S. CLS. 22 AND 39).

FIRST USE 10-31-2001; IN COMMERCE 10-31-2001.

2,626,160. SCHLUMBERGER TECHNOLOGY CORPORATION, HOUSTON, TX. SN 76-127,247. PUB. 7-17-2001, FILED 9-13-2000.

ICENTER

CLASS 37—CONSTRUCTION AND REPAIR

FOR DESIGN, CONSTRUCTION, INSTALLATION, AND MAINTENANCE OF COMPUTER HARDWARE FOR NETWORKING IMMERSIVE VISUALIZATION ROOMS, MEETING ROOMS, AND OTHER ROOMS FOR DATA DISPLAY AND EDITING FOR VIDEOCONFERENCING FOR LOCAL AND REMOTE COLLABORATION (U.S. CLS. 100, 103 AND 106).

FIRST USE 12-1-2000; IN COMMERCE 12-1-2001.

CLASS 42—SCIENTIFIC, COMPUTER AND LEGAL SERVICES

FOR DESIGN, INSTALLATION AND MAINTENANCE OF COMPUTER SOFTWARE FOR NETWORKING IMMERSIVE VISUALIZATION ROOMS, MEETING ROOMS, AND OTHER ROOMS FOR DATA DISPLAY AND EDITING FOR VIDEOCONFERENCING FOR LOCAL AND REMOTE COLLABORATION (U.S. CLS. 100 AND 101).

FIRST USE 12-1-2000; IN COMMERCE 12-1-2001.

2,626,161. YOUNG LIFE, A TEXAS NONPROFIT CORPORATION, COLORADO SPRINGS, CO. SN 76-127,593. PUB. 6-19-2001, FILED 9-14-2000.

CLEARWATER COVE

CLASS 25—CLOTHING

FOR MEN'S AND WOMEN'S CLOTHING, NAMELY, SHIRTS, T-SHIRTS, SWEATSHIRTS, SWEATPANTS, SHORTS, POLO-STYLE SHIRTS, JACKETS, SOCKS, BOXER-TYPE SHORTS, AND BASEBALL-STYLE CAPS (U.S. CLS. 22 AND 39).
FIRST USE 2-1-2001; IN COMMERCE 2-1-2001.

CLASS 41—EDUCATION AND ENTERTAINMENT

FOR RECREATIONAL SERVICES, NAMELY PROVIDING CAMPS OF A CHRISTIAN AND EVANGELISTIC NATURE FOR YOUNG PEOPLE (U.S. CLS. 100, 101 AND 107).
FIRST USE 2-1-2001; IN COMMERCE 2-1-2001.

CLASS 42—SCIENTIFIC, COMPUTER AND LEGAL SERVICES

FOR EVANGELISTIC AND CHRISTIAN MINISTERIAL SERVICES DIRECTED TOWARD TEENAGERS (U.S. CLS. 100 AND 101).
FIRST USE 2-1-2001; IN COMMERCE 2-1-2001.

2,626,170. AFL-CIO HOUSING INVESTMENT TRUST, WASHINGTON, DC. SN 76-130,923. PUB. 8-21-2001, FILED 9-15-2000.

HIT HOME

CLASS 36—INSURANCE AND FINANCIAL

FOR MORTGAGE LENDING (U.S. CLS. 100, 101 AND 102).
FIRST USE 10-16-2000; IN COMMERCE 10-16-2000.

CLASS 42—SCIENTIFIC, COMPUTER AND LEGAL SERVICES

FOR PROMOTING AWARENESS OF THE NEED FOR HOME OWNERSHIP AMONG UNION MEMBERS (U.S. CLS. 100 AND 101).
FIRST USE 10-16-2000; IN COMMERCE 10-16-2000.

2,626,183. CENTRAL VIRGINIA EDUCATIONAL TELECOMMUNICATIONS CORPORATION, FALLS CHURCH, VA. SN 76-135,877. PUB. 6-5-2001, FILED 9-22-2000.

MHZ LEARN

CLASS 38—COMMUNICATION

FOR TELEVISION BROADCASTING (U.S. CLS. 100, 101 AND 104).
FIRST USE 10-1-2001; IN COMMERCE 10-1-2001.

CLASS 41—EDUCATION AND ENTERTAINMENT

FOR PRODUCTION AND DISTRIBUTION OF TELEVISION PROGRAMS (U.S. CLS. 100, 101 AND 107).
FIRST USE 10-1-2001; IN COMMERCE 10-1-2001.

2,626,207. AF2 ENTERPRISES LLC, CHICAGO, IL. SN 76-146,302. PUB. 9-11-2001, FILED 10-16-2000.

BOSSIER CITY BATTLE WINGS

NO CLAIM IS MADE TO THE EXCLUSIVE RIGHT TO USE "BOSSIER CITY", APART FROM THE MARK AS SHOWN.

CLASS 16—PAPER GOODS AND PRINTED MATTER

FOR GENERAL MERCHANDISE CATALOGS, BUMPER STICKERS, WRITING PADS AND PENS, TRADING CARDS, POSTERS, POST CARDS, CALENDARS, PAPER STICKERS, APPLIQUES IN THE FORM OF DECALS AND GREETING CARDS (U.S. CLS. 2, 5, 22, 23, 29, 37, 38 AND 50).
FIRST USE 9-15-2000; IN COMMERCE 11-1-2000.

CLASS 25—CLOTHING

FOR MEN'S, WOMEN'S AND CHILDREN'S CLOTHING, NAMELY, PLAYER UNIFORMS, NAMELY, FOOTWEAR, JERSEY TOPS AND PANTS; CHEERLEADER UNIFORMS; REPLICAS UNIFORM SHIRTS, COACHES' CAPS, WOOL HATS, PAINTERS' CAPS, BASEBALL CAPS, VISORS, HEADBANDS, BELTS, T-SHIRTS, TANK TOPS, GOLF SHIRTS, SWEATERS, SWEATSHIRTS, LEATHER JACKETS, NECKTIES, COATS, SHORTS, SWEATPANTS, PANTS, SOCKS AND UNDERWEAR (U.S. CLS. 22 AND 39).
FIRST USE 9-15-2000; IN COMMERCE 11-1-2000.

CLASS 41—EDUCATION AND ENTERTAINMENT

FOR ENTERTAINMENT SERVICES, NAMELY, ORGANIZING AND PRESENTING FOOTBALL GAMES BEFORE LIVE AUDIENCES AND ON TELEVISION, RADIO FOR GLOBAL COMPUTER NETWORK DISPLAY AND OTHER MEDIA (U.S. CLS. 100, 101 AND 107).
FIRST USE 9-15-2000; IN COMMERCE 11-1-2000.

2,626,217. TROWER ENTERPRISES, INC., DBA MONSTRO GRAPHICS, FORT WORTH, TX. SN 76-150,147. PUB. 9-4-2001, FILED 10-19-2000.

MONSTRO

OWNER OF U.S. REG. NOS. 2,149,533, 2,149,537, AND 2,254,777.

CLASS 18—LEATHER GOODS

FOR ALL PURPOSE SPORT AND ATHLETIC BAGS (U.S. CLS. 1, 2, 3, 22 AND 41).
FIRST USE 8-0-2000; IN COMMERCE 8-0-2000.

CLASS 28—TOYS AND SPORTING GOODS

FOR SPORTING GOODS, NAMELY, BASEBALL GLOVES, IN-LINE SKATES, ICE SKATES, ROLLER SKATES, SURF BOARDS, SNOW SKIS, KNEE BOARDS, WATER SKIS, SNOW BOARDS, FOOTBALLS, BASEBALL, BASKETBALLS, SOFTBALLS, TENNIS RACKETS, RACQUETBALL RACKETS, HOCKEY STICKS, HOCKEY PUCKS, BICYCLES, SKATEBOARDS, SAILBOARDS, SOCCER BALLS, GOLF CLUBS, BOWLING BALLS, VOLLEY BALLS, VOLLEY BALL NETS, PORTABLE BASKETBALL BACKBOARD, WALL MOUNTED BASKETBALL BACKBOARD, AND BAGS SPECIFICALLY DESIGNED FOR CARRYING SPORTS EQUIPMENT, NAMELY, BOWLING BAGS, BOXING BAGS, GOLF BAGS, SKATE BAGS, SKI BAGS, TENNIS BAGS AND RACQUETBALL RACKET BAGS (U.S. CLS. 22, 23, 38 AND 50).

FIRST USE 8-0-2000; IN COMMERCE 8-0-2000.

2,626,227. SOCIETE DES PRODUITS NESTLE S.A., 1800 VEVEY, SWITZERLAND. SN 76-153,549. PUB. 8-28-2001, FILED 10-26-2000.



OWNER OF U.S. REG. NOS. 188,089 AND 739,119. THE "NESTLE" PORTION OF THE MARK APPEARS IN RED. THE "NESQUIK" PORTION OF THE MARK APPEARS IN BLUE, IS OUTLINED IN WHITE AND THEN OUTLINED IN LIGHT GOLD. THE "NESTLE" AND "NESQUIK" PORTIONS OF THE MARK APPEAR ON A YELLOW BACKGROUND. THE STRIPE BELOW THE "NESTLE" AND "NESQUIK" PORTIONS OF THE MARK APPEARS IN BLUE, AND A WHITE LINE APPEARS ABOVE AND BELOW THE STRIPE.

CLASS 29—MEATS AND PROCESSED FOODS

FOR FLAVORED MILK, MILK AND MILK BASED BEVERAGES (U.S. CL. 46).

FIRST USE 12-0-2000; IN COMMERCE 12-0-2000.

CLASS 30—STAPLE FOODS

FOR CHOCOLATE MILK, COCOA AND COCOA BASED BEVERAGES, CHOCOLATE AND STRAWBERRY FLAVORINGS FOR USE IN FOOD AND BEVERAGES, BREAKFAST CEREALS, ICE CREAM BARS, CANDY (U.S. CL. 46).

FIRST USE 12-0-2000; IN COMMERCE 12-0-2000.

2,626,240. PARISH PUBLICATIONS, L.L.C., MADISON HEIGHTS, MI. SN 76-156,167. PUB. 9-25-2001, FILED 10-30-2000.

PARISH PUBLISHING SOLUTIONS

NO CLAIM IS MADE TO THE EXCLUSIVE RIGHT TO USE "PUBLISHING", APART FROM THE MARK AS

SHOWN.

CLASS 16—PAPER GOODS AND PRINTED MATTER

FOR RELIGIOUS INFORMATIONAL BULLETINS, PAMPHLETS AND BOOKS (U.S. CLS. 2, 5, 22, 23, 29, 37, 38 AND 50).

FIRST USE 11-1-2000; IN COMMERCE 11-1-2000.

CLASS 35—ADVERTISING AND BUSINESS

FOR ADVERTISING SERVICES, NAMELY, PROVIDING ADVERTISING SPACE IN RELIGIOUS BULLETINS AND OTHER PUBLICATIONS (U.S. CLS. 100, 101 AND 102).

FIRST USE 11-1-2000; IN COMMERCE 11-1-2000.

2,626,263. SPORTS AUTHORITY MICHIGAN, INC., THE, FORT LAUDERDALE, FL. SN 76-164,074. PUB. 7-17-2001, FILED 11-13-2000.



NO CLAIM IS MADE TO THE EXCLUSIVE RIGHT TO USE "SPORTS AMERICA", APART FROM THE MARK AS SHOWN.

CLASS 9—ELECTRICAL AND SCIENTIFIC APPARATUS

FOR SIGNAL WHISTLES AND WHISTLE LANYARDS (U.S. CLS. 21, 23, 26, 36 AND 38).

FIRST USE 8-0-2000; IN COMMERCE 8-0-2000.

CLASS 28—TOYS AND SPORTING GOODS

FOR BASKETBALL NETS; DUMBBELLS; DUMBBELL SETS; KNEE PADS FOR ATHLETIC USE; KICKING TEES; PUMPS AND NEEDLES FOR INFLATING SPORTS EQUIPMENT; WEIGHTLIFTING MACHINES; EXERCISE WEIGHTS; EXERCISE BARS; WEIGHTLIFTING BENCHES AND BENCH ACCESSORIES; WEIGHT RACKS; WEIGHT COLLARS (U.S. CLS. 22, 23, 38 AND 50).

FIRST USE 11-0-2000; IN COMMERCE 11-0-2000.

2,626,264. MATRIX GROUP LIMITED, INC., SAFETY HARBOR, FL. SN 76-164,333. PUB. 8-28-2001, FILED 11-14-2000.

SWEET & POWERFUL

CLASS 25—CLOTHING

FOR ATHLETIC CLOTHING, NAMELY, SHORTS, PANTS, SHIRTS, TOPS, BOTTOMS, JACKETS, SWEAT-SHIRTS, SWEATPANTS, TEE-SHIRTS, WARM-UP SUITS, MEN'S AND WOMEN'S SPORT UNDERGARMENTS, FOOTWEAR, SOCKS (U.S. CLS. 22 AND 39).

FIRST USE 11-17-2000; IN COMMERCE 11-17-2000.

CLASS 35—ADVERTISING AND BUSINESS

FOR ON-LINE COMPUTER SERVICES, NAMELY PROVIDING CONSUMER INFORMATION ON THE GOODS OF OTHERS; MAIL ORDER SERVICES, ONLINE RETAILING AND ONLINE ORDERING SERVICES IN THE FIELD OF SPORTS EQUIPMENT, SPORTS CLOTHING AND RELATED GOODS (U.S. CLS. 100, 101 AND 102).

FIRST USE 11-17-2000; IN COMMERCE 11-17-2000.

2,626,267. RICHARD S. CARSON & ASSOCIATES, INC., BETHESDA, MD. SN 76-166,474. PUB. 8-14-2001, FILED 11-16-2000.

SAINT

OWNER OF U.S. REG. NO. 2,424,047.

CLASS 9—ELECTRICAL AND SCIENTIFIC APPARATUS

FOR COMPUTER PROGRAMS FOR PROVIDING NETWORK SECURITY TESTS AND SECURITY INFORMATION, AND COMPUTER PROGRAMS FOR PRODUCING SECURITY ASSESSMENT REPORTS (U.S. CLS. 21, 23, 26, 36 AND 38).

FIRST USE 7-1-1998; IN COMMERCE 7-1-1998.

CLASS 42—SCIENTIFIC, COMPUTER AND LEGAL SERVICES

FOR COMPUTER NETWORK SECURITY SERVICES, NAMELY, PROVIDING NETWORK SECURITY TESTS AND SECURITY INFORMATION, AND UPDATING OF COMPUTER SOFTWARE (U.S. CLS. 100 AND 101).

FIRST USE 7-1-1998; IN COMMERCE 7-1-1998.

2,626,271. GENERAL WIG MANUFACTURERS, INC., MIAMI LAKES, FL. SN 76-168,375. PUB. 9-4-2001, FILED 11-20-2000.

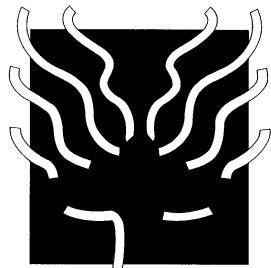
**CLASS 3—COSMETICS AND CLEANING PREPARATIONS**

FOR NON-MEDICATED CARE PREPARATIONS FOR WIGS AND HAIRPIECES, NAMELY, SHAMPOO, CONDITIONER, AND SPRAY GEL (U.S. CLS. 1, 4, 6, 50, 51 AND 52).

FIRST USE 2-9-2001; IN COMMERCE 2-9-2001.

CLASS 18—LEATHER GOODS

FOR TOTE BAGS (U.S. CLS. 1, 2, 3, 22 AND 41).
FIRST USE 12-6-2001; IN COMMERCE 12-6-2001.

CLASS 20—FURNITURE AND ARTICLES NOT OTHERWISE CLASSIFIED

FOR HANDHELD MIRRORS (U.S. CLS. 2, 13, 22, 25, 32 AND 50).
FIRST USE 3-5-2001; IN COMMERCE 3-5-2001.

CLASS 21—HOUSEWARES AND GLASS

FOR HAIR BRUSHES, HAIR COMBS, AND MUGS (U.S. CLS. 2, 13, 23, 29, 30, 33, 40 AND 50).
FIRST USE 3-14-2001; IN COMMERCE 3-14-2001.

CLASS 25—CLOTHING

FOR T-SHIRTS, HATS, POLO SHIRTS (U.S. CLS. 22 AND 39).
FIRST USE 2-16-2001; IN COMMERCE 2-16-2001.

CLASS 26—FANCY GOODS

FOR WIGS, HAIRPIECES, HAIR EXTENSIONS, HAIR ORNAMENTS (U.S. CLS. 37, 39, 40, 42 AND 50).
FIRST USE 2-21-2001; IN COMMERCE 2-21-2001.

2,626,331. GRAHAM CORPORATION, BATAVIA, NY. SN 76-193,402. PUB. 10-23-2001, FILED 1-12-2001.

VACADEMICS**CLASS 16—PAPER GOODS AND PRINTED MATTER**

FOR NEWSLETTERS IN THE FIELD OF VACUUM TECHNOLOGY (U.S. CLS. 2, 5, 22, 23, 29, 37, 38 AND 50).
FIRST USE 12-1-2000; IN COMMERCE 12-1-2000.

CLASS 41—EDUCATION AND ENTERTAINMENT

FOR EDUCATIONAL SERVICES, NAMELY, CONDUCTING SEMINARS IN THE FIELD OF VACUUM TECHNOLOGY AND THE USE OF VACUUM TECHNOLOGY TO INDUSTRIAL AND COMMERCIAL APPLICATIONS (U.S. CLS. 100, 101 AND 107).
FIRST USE 12-1-2000; IN COMMERCE 12-1-2000.

2,626,338. MAILBANK.COM INC., RENO, NV. SN 76-195,879. PUB. 9-18-2001, FILED 1-17-2001.

NETIDENTITY**CLASS 38—COMMUNICATION**

FOR ELECTRONIC MAIL SERVICES FEATURING REROUTING AND FORWARDING OF MESSAGES; TELECOMMUNICATIONS SERVICES, NAMELY, ELECTRONIC TRANSMISSION OF DATA, IMAGES, AND DOCUMENTS OVER LOCAL INTERACTIVE COMPUTER NETWORKS AND/OR OVER A GLOBAL INTERACTIVE COMPUTER NETWORK VIA COMPUTER TERMINALS (U.S. CLS. 100, 101 AND 104).

FIRST USE 4-17-2001; IN COMMERCE 4-17-2001.

CLASS 42—SCIENTIFIC, COMPUTER AND LEGAL SERVICES

FOR COMPUTER SERVICES, NAMELY, PROVIDING USE OF DOMAIN NAMES THAT MAY BE CUSTOMIZED AND PERSONALIZED WITH A CHOSEN SUBDOMAIN; HOSTING THE WEB SITES OF OTHERS ON A COMPUTER SERVER FOR A GLOBAL COMPUTER NETWORK; COMPUTER CONSULTATION; COMPUTER SOFTWARE DESIGN FOR OTHERS; COMPUTER SERVICES, NAMELY, DESIGNING AND IMPLEMENTING NETWORK WEB PAGES FOR OTHERS; COMPUTER PROGRAMMING FOR OTHERS; UPDATING OF COMPUTER SOFTWARE (U.S. CLS. 100 AND 101).

FIRST USE 4-17-2001; IN COMMERCE 4-17-2001.

2,626,386. RESIDENSEA LIMITED, MIAMI, FL. SN 76-213,060. PUB. 3-5-2002, FILED 2-22-2001.

RESIDENSEA**CLASS 39—TRANSPORTATION AND STORAGE**

FOR CRUISE SHIP SERVICES, NAMELY, OCEAN TRANSPORTATION OF PASSENGERS (U.S. CLS. 100 AND 105).

FIRST USE 3-29-2002; IN COMMERCE 3-29-2002.

CLASS 42—SCIENTIFIC, COMPUTER AND LEGAL SERVICES

FOR PROVIDING ACCOMMODATION FOR GENERAL PURPOSE MEETINGS AND CONFERENCES ABOARD SHIPS (U.S. CLS. 100 AND 101).

FIRST USE 3-29-2002; IN COMMERCE 3-29-2002.

2,626,387. RESIDENSEA LIMITED, MIAMI, FL. SN 76-213,061. PUB. 3-5-2002, FILED 2-22-2001.

THE WORLD OF RESIDENSEA**CLASS 39—TRANSPORTATION AND STORAGE**

FOR CRUISE SHIP SERVICES, NAMELY OCEAN TRANSPORTATION OF PASSENGERS (U.S. CLS. 100 AND 105).

FIRST USE 3-29-2002; IN COMMERCE 3-29-2002.

CLASS 42—SCIENTIFIC, COMPUTER AND LEGAL SERVICES

FOR PROVIDING ACCOMMODATION FOR GENERAL PURPOSE MEETINGS AND CONFERENCES ABOARD SHIPS (U.S. CLS. 100 AND 101).

FIRST USE 3-29-2002; IN COMMERCE 3-29-2002.

2,626,404. VOYAGER EXPANDED LEARNING, INC., DALLAS, TX, BY CHANGE OF NAME VOYAGER EXPANDED LEARNING SYSTEMS, INC., DALLAS, TX. SN 76-216,900. PUB. 9-4-2001, FILED 2-27-2001.

VIP**CLASS 16—PAPER GOODS AND PRINTED MATTER**

FOR EDUCATIONAL BOOKS, CHARTS, POSTERS, WORKBOOKS, AND PRINTED CURRICULUM MATERIALS IN THE NATURE OF A TRAINING PROGRAM TO CONDUCT A LEARNING PROGRAM FOR CHILDREN IN KINDERGARTEN, ELEMENTARY AND SECONDARY SCHOOLS (U.S. CLS. 2, 5, 22, 23, 29, 37, 38 AND 50).

FIRST USE 7-0-2001; IN COMMERCE 8-0-2001.

CLASS 41—EDUCATION AND ENTERTAINMENT

FOR EDUCATIONAL SERVICES, NAMELY, EDUCATIONAL TESTING AND ASSESSMENT IN A STUDENT LITERACY PROGRAM (U.S. CLS. 100, 101 AND 107).

FIRST USE 7-0-2001; IN COMMERCE 8-0-2001.

2,626,423. TROPICAL TOURISM AND MARKETING INC., MONCTON (NEW-BRUNSWICK), CANADA. SN 76-223,392. PUB. 9-11-2001, FILED 3-9-2001.



NO CLAIM IS MADE TO THE EXCLUSIVE RIGHT TO USE "TRAVEL", APART FROM THE MARK AS SHOWN.

THE STIPPLING IN THE DRAWING IS A FEATURE OF THE MARK AND IS NOT INTENDED TO INDICATE COLOR.

THE MARK CONSISTS OF THE STYLIZED WORDS "SAN CRISTOBAL TRAVEL" AND, THE STYLIZED SILHOUETTES OF AN HOLY MAN, NAMELY SAN CRISTOBAL, HOLDING A STAFF IN HIS RIGHT HAND, AND HAVING A CHILD SITTING ON HIS LEFT SHOULDER.

THE WORDS "SAN CRISTOBAL" ARE SPANISH WORDS MEANING "SAINT CHRISTOPHER".

CLASS 39—TRANSPORTATION AND STORAGE

FOR TRAVEL AGENCY SERVICES, NAMELY, MAKING RESERVATIONS AND BOOKINGS FOR TRANSPORTATION (U.S. CLS. 100 AND 105).

FIRST USE 6-27-2001; IN COMMERCE 6-27-2001.

CLASS 42—SCIENTIFIC, COMPUTER AND LEGAL SERVICES

FOR TRAVEL AGENCY SERVICES, NAMELY, MAKING RESERVATIONS AND BOOKING FOR TEMPORARY LODGING; AND COMPUTER SERVICES, NAMELY, PROVIDING ON-LINE MAGAZINES ON THE SUBJECT OF TRAVEL INFORMATION DELIVERED VIA A GLOBAL COMPUTER INFORMATION NETWORK (U.S. CLS. 100 AND 101).

FIRST USE 6-27-2001; IN COMMERCE 6-27-2001.

2,626,473. ORTHOPEDIC HOSPITAL OF OKLAHOMA, L.L.C., TULSA, OK. SN 76-246,545. PUB. 12-4-2001, FILED 4-24-2001.

2,626,499. MACGREGOR GROUP, INC., THE, BOSTON, MA. SN 76-259,954. PUB. 9-11-2001, FILED 5-16-2001.



**ORTHOPEDIC HOSPITAL
OF OKLAHOMA**

NO CLAIM IS MADE TO THE EXCLUSIVE RIGHT TO USE "ORTHOPEDIC HOSPITAL OF OKLAHOMA", APART FROM THE MARK AS SHOWN.

CLASS 35—ADVERTISING AND BUSINESS

FOR HOSPITAL MANAGEMENT, MEDICAL COST MANAGEMENT, MEDICAL REFERRALS AND MEDICAL TRANSCRIPTION SERVICES (U.S. CLS. 100, 101 AND 102).

FIRST USE 7-18-2001; IN COMMERCE 7-18-2001.

CLASS 42—SCIENTIFIC, COMPUTER AND LEGAL SERVICES

FOR EMERGENCY MEDICAL ASSISTANCE, MAINTAINING FILES AND RECORDS CONCERNING THE MEDICAL CONDITION OF INDIVIDUALS, MEDICAL CLINICS, MEDICAL COUNSELING, MEDICAL LABORATORIES, MEDICAL RESEARCH, MEDICAL SERVICES, MEDICAL TESTING AND RENTAL OF MEDICAL EQUIPMENT (U.S. CLS. 100 AND 101).

FIRST USE 7-18-2001; IN COMMERCE 7-18-2001.

2,626,481. HTZ INVESTMENT CORP., WILMINGTON, DE. SN 76-249,709. PUB. 10-16-2001, FILED 5-1-2001.

HEALTH MEASURES

OWNER OF U.S. REG. NOS. 2,074,488 AND 2,265,551.

CLASS 10—MEDICAL APPARATUS

FOR NURSING BOTTLES FOR PETS (U.S. CLS. 26, 39 AND 44).

FIRST USE 6-1-2001; IN COMMERCE 6-1-2001.

CLASS 31—NATURAL AGRICULTURAL PRODUCTS

FOR LIQUID AND POWDER MILK REPLACEMENT FOR PETS (U.S. CLS. 1 AND 46).

FIRST USE 6-1-2001; IN COMMERCE 6-1-2001.

UNITE AND CONQUER

CLASS 9—ELECTRICAL AND SCIENTIFIC APPARATUS

FOR COMPUTER SOFTWARE FOR USE IN FINANCIAL DATA MANAGEMENT, FINANCIAL BROKERAGE SERVICES PROCESSING, AND PORTFOLIO MANAGEMENT (U.S. CLS. 21, 23, 26, 36 AND 38).

FIRST USE 2-8-2001; IN COMMERCE 7-2-2001.

CLASS 36—INSURANCE AND FINANCIAL

FOR FINANCIAL INFORMATION PROVIDED BY ELECTRONIC MEANS, NAMELY, FINANCIAL PORTFOLIO REPORTING, FINANCIAL RESEARCH, REGULATORY AND COMPLIANCE INFORMATION; AND FINANCIAL BROKERAGE SERVICES PROCESSING (U.S. CLS. 100, 101 AND 102).

FIRST USE 2-8-2001; IN COMMERCE 7-2-2001.

CLASS 42—SCIENTIFIC, COMPUTER AND LEGAL SERVICES

FOR CONSULTATION, IN THE FIELD OF COMPUTER SOFTWARE AND HARDWARE SYSTEMS ANALYSIS; COMPUTER PROGRAMMING, CUSTOM SOFTWARE DEVELOPMENT AND SYSTEMS INTEGRATION, FOR PROVIDERS OF FINANCIAL SERVICES AND INFORMATION (U.S. CLS. 100 AND 101).

FIRST USE 2-8-2001; IN COMMERCE 7-2-2001.

2,626,508. DUOTONE AUDIO GROUP LTD., NEW YORK, NY. SN 76-266,963. PUB. 12-18-2001, FILED 5-25-2001.

THE CON ARTISTS

CLASS 9—ELECTRICAL AND SCIENTIFIC APPARATUS

FOR COMPACT DISCS, AUDIO CASSETTES, PHONOGRAPH RECORDS, PRERECORDED VIDEO CASSETTES, DIGITAL VIDEO DISCS, AND MULTIMEDIA SOFTWARE RECORDED ON CD ROMS, ALL FEATURING MUSIC AND MUSIC RELATED ENTERTAINMENT; AND VIDEO GAME DISCS (U.S. CLS. 21, 23, 26, 36 AND 38).

FIRST USE 9-2-2001; IN COMMERCE 9-2-2001.

CLASS 41—EDUCATION AND ENTERTAINMENT

FOR ENTERTAINMENT SERVICES, NAMELY LIVE PERFORMANCE BY A MUSICAL GROUP; MUSIC PRODUCTION SERVICES (U.S. CLS. 100, 101 AND 107).

FIRST USE 9-2-2001; IN COMMERCE 9-2-2001.

2,626,535. FLEET CREDIT CARD SERVICES, L.P., HORSHAM, PA. SN 76-294,545. PUB. 11-13-2001, FILED 8-6-2001.

2,626,554. PLUS ZUCCA CO., LTD., TAICHUNG HSIEN, TAIWAN. SN 76-314,711. PUB. 1-15-2002, FILED 9-20-2001.

MILESEGE

CLASS 35—ADVERTISING AND BUSINESS

FOR PROMOTING THE SALE OF CREDIT CARD ACCOUNTS THROUGH THE ADMINISTRATION OF INCENTIVE AWARD PROGRAMS (U.S. CLS. 100, 101 AND 102).

FIRST USE 1-0-2002; IN COMMERCE 1-0-2002.

CLASS 36—INSURANCE AND FINANCIAL

FOR CREDIT CARD SERVICES (U.S. CLS. 100, 101 AND 102).

FIRST USE 1-0-2002; IN COMMERCE 1-0-2002.

2,626,546. A & B PROCESS SYSTEMS CORPORATION, STRATFORD, WI. SN 76-301,097. PUB. 12-18-2001, FILED 8-17-2001.

GREAT SOLUTIONS FLOW THROUGH US

CLASS 40—MATERIAL TREATMENT

FOR CUSTOM MANUFACTURE OF TANKS, SILOS, REACTORS, HEATING VESSELS, COOLING VESSELS, FERMENTERS, PASTEURIZERS, MIXERS, HOPPERS, CONTROLS, PIPING, DUCTS, FITTINGS AND ACCESSORIES FOR THE FOREGOING FOR OTHERS IN THE FIELD OF EQUIPMENT AND CONTROLS FOR STORING, TRANSPORTING, MIXING HEATING, COOLING, AND PROCESSING INGREDIENTS IN THE FOOD BEVERAGE, BREWING, PERSONAL CARE PRODUCTS, PHARMACEUTICAL, CHEMICAL AND INDUSTRIAL FIELDS (U.S. CLS. 100, 103 AND 106).

FIRST USE 8-31-2001; IN COMMERCE 8-31-2001.

CLASS 42—SCIENTIFIC, COMPUTER AND LEGAL SERVICES

FOR TECHNICAL SERVICES, NAMELY, CONSULTATION AND DESIGN SERVICES FOR OTHERS IN THE FIELD OF EQUIPMENT AND CONTROLS FOR STORING, TRANSPORTING, MIXING, HEATING, COOLING, AND PROCESSING INGREDIENTS IN THE FOOD BEVERAGE, BREWING, PERSONAL CARE PRODUCTS, PHARMACEUTICAL, CHEMICAL, AND INDUSTRIAL FIELDS (U.S. CLS. 100 AND 101).

FIRST USE 8-31-2001; IN COMMERCE 8-31-2001.

BELLWINK

CLASS 18—LEATHER GOODS

FOR ALL PURPOSE SPORT BAGS, ATHLETIC BAGS, ATTACHE CASES, BEACH BAGS, BRIEFCASES, CARRY-ON BAGS, DUFFEL BAGS, HANDBAGS, HAVESACKS, PURSES, RUCKSACKS, SHOULDER BAGS, TEXTILE SHOPPING BAGS, TRAVELING BAGS, TRAVELING TRUNKS, VALISES AND WALLETS (U.S. CLS. 1, 2, 3, 22 AND 41).

FIRST USE 1-5-2002; IN COMMERCE 1-5-2002.

CLASS 25—CLOTHING

FOR CLOTHING, NAMELY COATS, GLOVES, HOODS, JACKETS, JERSEYS, OVERALLS, OVERCOATS, PANTS, PULLOVERS, SCARVES, SHIRTS, SINGLETTS, SKIRTS, SOCKS, SPORT SHIRTS, SUITS, SWEAT SHIRTS, T-SHIRTS, TOP COATS, TROUSERS, UNDERWEAR AND UNIFORMS; FOOTWEAR, NAMELY BOOTS, HEELS, SANDALS, SLIPPERS, SHOES, SPORTS SHOES; HEADGEAR, NAMELY HATS (U.S. CLS. 22 AND 39).

FIRST USE 1-5-2002; IN COMMERCE 1-5-2002.

2,626,555. E2GROW, INC., CHESTERLAND, OH. SN 78-000,254. PUB. 7-10-2001, FILED 3-21-2000.

E2GROW

CLASS 35—ADVERTISING AND BUSINESS

FOR BUSINESS AND ADVERTISING SERVICES, NAMELY, DISSEMINATION OF ADVERTISING FOR OTHERS VIA A GLOBAL NETWORK (U.S. CLS. 100, 101 AND 102).

FIRST USE 7-1-2001; IN COMMERCE 7-1-2001.

CLASS 38—COMMUNICATION

FOR PROVIDING MULTIPLE-USER ACCESS TO A GLOBAL COMPUTER INFORMATION NETWORK AND WEB-BASED ELECTRONIC MAIL SERVICES (U.S. CLS. 100, 101 AND 104).

FIRST USE 7-1-2001; IN COMMERCE 7-1-2001.

CLASS 42—SCIENTIFIC, COMPUTER AND LEGAL SERVICES

FOR COMPUTER SERVICES, NAMELY, DESIGNING AND IMPLEMENTING WEB SITES AND HOME PAGES FOR OTHERS; AND HOSTING OF WEB SITES FOR OTHERS ON A COMPUTER SERVER FOR THE GLOBAL COMPUTER INFORMATION NETWORK; AND REGISTRATION OF COMPUTER DOMAIN NAMES FOR OTHERS; AND PROVIDING INFORMATION IN THE FIELD OF GENERAL AND LOCAL NEWS VIA A GLOBAL COMPUTER INFORMATION NETWORK (U.S. CLS. 100 AND 101).

FIRST USE 7-1-2001; IN COMMERCE 7-1-2001.

2,626,558. DREIFUS ASSOCIATES LIMITED, INC., LAKE MARY, FL. SN 78-002,441. PUB. 6-26-2001, FILED 4-4-2000.

CLASS 35—ADVERTISING AND BUSINESS

FOR BUSINESS CONSULTATION (U.S. CLS. 100, 101 AND 102).

FIRST USE 5-10-1995; IN COMMERCE 5-10-1995.

CLASS 36—INSURANCE AND FINANCIAL

FOR FINANCIAL CONSULTATION (U.S. CLS. 100, 101 AND 102).

FIRST USE 5-10-1995; IN COMMERCE 5-10-1995.

CLASS 42—SCIENTIFIC, COMPUTER AND LEGAL SERVICES

FOR TELECOMMUNICATION SYSTEMS CONSULTATION; TECHNOLOGY SYSTEMS DEVELOPMENT CONSULTATION; CONSULTATION CONCERNING SMART CARD COMPUTER SYSTEMS (U.S. CLS. 100 AND 101).
FIRST USE 5-10-1995; IN COMMERCE 5-10-1995.

2,626,563. PROCTER & GAMBLE COMPANY, THE, CINCINNATI, OH. SN 78-006,104. PUB. 1-8-2002, FILED 4-28-2000.



OWNER OF U.S. REG. NO. 665,866.

THE STIPLING IS A FEATURE OF THE MARK.

THE MARK CONSISTS OF MAN'S HEAD WITH SMILING FACE AND BUSHY EYEBROWS, AN EARRING IN HIS LEFT EAR, WEARING A WHITE T-SHIRT, AND FOLDED ARMS.

CLASS 3—COSMETICS AND CLEANING PREPARATIONS

FOR CLEANERS FOR USE ON HARD SURFACES (U.S. CLS. 1, 4, 6, 50, 51 AND 52).

FIRST USE 1-14-2002; IN COMMERCE 1-14-2002.

CLASS 21—HOUSEWARES AND GLASS

FOR DISPOSABLE LATEX CLEANING GLOVES FOR HOUSEHOLD USE (U.S. CLS. 2, 13, 23, 29, 30, 33, 40 AND 50).

FIRST USE 4-1-2000; IN COMMERCE 4-1-2000.

CLASS 28—TOYS AND SPORTING GOODS

FOR ROLE PLAYING GAMES USING KITCHEN IMPLEMENTS (U.S. CLS. 22, 23, 38 AND 50).
FIRST USE 4-1-2001; IN COMMERCE 4-1-2001.

2,626,572. SURYA ROSHNI LIMITED, NEW DELHI, INDIA. SN 78-010,069. PUB. 9-25-2001, FILED 5-26-2000.



THE ENGLISH TRANSLATION OF "SURYA" IS "SUN".

CLASS 9—ELECTRICAL AND SCIENTIFIC APPARATUS

FOR ELECTRIC FIXTURES AND FITTINGS NAMELY ELECTRIC STARTERS, BALLASTS AND ELECTRONIC BALLASTS FOR FLUORESCENT LIGHTING TUBE LAMPS; ELECTRIC SWITCHES, FUSES, PLUGS, SOCKETS, PUSH BUTTONS, FUSE BOXES AND CONNECTORS; ELECTRIC DOOR BELLS AND DOOR BUZZERS; ELECTRIC ADAPTERS; ELECTRICAL TRANSFORMERS; ELECTRIC CONVERTERS; VOLTAGE SURGE PROTECTORS (U.S. CLS. 21, 23, 26, 36 AND 38).

FIRST USE 11-9-2000; IN COMMERCE 11-9-2000.

CLASS 11—ENVIRONMENTAL CONTROL APPARATUS

FOR LIGHTING INSTALLATIONS AND LUMINARIES NAMELY, ELECTRIC LIGHT BULBS AND TRACK LIGHTING LAMPS; FLUORESCENT LIGHTING TUBES; COMPACT FLUORESCENT LIGHTING LAMPS; ELECTRIC TOASTERS OVENS; ELECTRIC COFFEE PERCOLATORS; OVEN GAS IGNITERS; ELECTRIC PRESSURE COOKERS; PORTABLE ELECTRIC ROOM HEATERS (U.S. CLS. 13, 21, 23, 31 AND 34).

FIRST USE 11-9-2000; IN COMMERCE 11-9-2000.

2,626,599. INTEGRATION DIAGNOSTICS LTD, SAVEDALEN, SWEDEN. SN 78-023,413. PUB. 8-28-2001, FILED 8-29-2000.

OSSTELL

CLASS 9—ELECTRICAL AND SCIENTIFIC APPARATUS

FOR MEASURING INSTRUMENTS EACH COMPRISING COMPUTER SOFTWARE, A RESONANCE FREQUENCY ANALYSER AND A TRANSDUCER, FOR USE IN MEASURING STABILITY IN DENTAL AND ORTHOPEDIC IMPLANTS; COMPUTER SOFTWARE FOR USE BY MEMBERS OF THE HEALTHCARE PROFESSION TO STORE AND PRINT PATIENT DATA RELATING TO DENTAL AND ORTHOPEDIC IMPLANTS (U.S. CLS. 21, 23, 26, 36 AND 38).
FIRST USE 7-0-2001; IN COMMERCE 7-0-2001.

CLASS 10—MEDICAL APPARATUS

FOR MEDICAL INSTRUMENTS FOR MEASURING STABILITY IN DENTAL AND ORTHOPEDIC IMPLANTS ANCHORED IN BONE IN HUMANS AND ANIMALS (U.S. CLS. 26, 39 AND 44).
FIRST USE 7-0-2001; IN COMMERCE 7-0-2001.

2,626,618. AMSCO WINDOWS, INC., SALT LAKE CITY, UT. SN 78-032,964. PUB. 7-17-2001, FILED 10-30-2000.

"DELIVERING EXCELLENCE FOR GENERATIONS"

CLASS 6—METAL GOODS

FOR METAL WINDOWS AND METAL DOORS (U.S. CLS. 2, 12, 13, 14, 23, 25 AND 50).
FIRST USE 8-0-2000; IN COMMERCE 9-0-2000.

CLASS 19—NON-METALLIC BUILDING MATERIALS

FOR NON-METALLIC WINDOWS, NON-METALLIC DOORS, AND WINDOW GLASS (U.S. CLS. 1, 12, 33 AND 50).
FIRST USE 8-0-2000; IN COMMERCE 9-0-2000.

2,626,680. EDDIE BAUER, INC., REDMOND, WA. SN 78-049,053. PUB. 8-21-2001, FILED 2-19-2001.

MORE BEDDING, MORE BATH, MORE AT HOME

CLASS 16—PAPER GOODS AND PRINTED MATTER

FOR CATALOGS FEATURING HOME ITEMS AND ACCESSORIES (U.S. CLS. 2, 5, 22, 23, 29, 37, 38 AND 50).
FIRST USE 8-1-2000; IN COMMERCE 8-1-2000.

CLASS 35—ADVERTISING AND BUSINESS

FOR ON LINE RETAIL STORE SERVICES AND RETAIL STORES SERVICES FEATURING HOME ITEMS AND ACCESSORIES (U.S. CLS. 100, 101 AND 102).
FIRST USE 8-1-2000; IN COMMERCE 8-1-2000.

2,626,711. BATH & BODY WORKS, INC., REYNOLDSBURG, OH. SN 78-060,468. PUB. 10-30-2001, FILED 4-26-2001.

EVENING CAMPFIRE

CLASS 3—COSMETICS AND CLEANING PREPARATIONS

FOR POTPOURRI, SCENTED ROOM SPRAYS, AND SACHETS (U.S. CLS. 1, 4, 6, 50, 51 AND 52).
FIRST USE 8-20-2001; IN COMMERCE 8-20-2001.

CLASS 4—LUBRICANTS AND FUELS

FOR CANDLES (U.S. CLS. 1, 6 AND 15).
FIRST USE 8-20-2001; IN COMMERCE 8-20-2001.

2,626,720. VIAQUEST, INC., ENCINO, CA. SN 78-063,039. PUB. 9-25-2001, FILED 5-10-2001.

NO CLAIM IS MADE TO THE EXCLUSIVE RIGHT TO USE "KID", APART FROM THE MARK AS SHOWN.

THE MARK CONSISTS OF THE WORDS "CAFE KID" IN A CUSTOMIZED SAN SERIF FONT WITH BEVELLED EDGES AND SHADOW.

CLASS 20—FURNITURE AND ARTICLES NOT OTHERWISE CLASSIFIED

FOR CHILDREN'S HOME FURNISHINGS, NAMELY, WOOD TABLE AND CHAIR SETS, WOOD STEP STOOLS, WOOD WALL SHELVES, WOOD ROCKING CHAIRS, WOOD TOY BOXES, WOOD BOOKSHELVES, WOOD COAT RACKS, WOOD BEDS, WOOD DRESSERS, WOOD NIGHTSTANDS, WOOD ARMOIRES, WOOD DESKS, WOOD TABLES, WOOD CHAIRS (U.S. CLS. 2, 13, 22, 25, 32 AND 50).
FIRST USE 7-0-1999; IN COMMERCE 12-0-1999.

CLASS 24—FABRICS

FOR CHILDREN'S DOMESTICS, NAMELY, BED SHEETS, BLANKETS, COMFORTERS, DRAPERIES, MATTRESS PADS, DUST RUFFLES, QUILTS, DUVETS, PILLOW SHAMS, TOWELS (U.S. CLS. 42 AND 50).
FIRST USE 5-3-2001; IN COMMERCE 5-3-2001.

2,626,729. TEODORO GROUP INC, THE, MENLO PARK,
CA. SN 78-067,693. PUB. 11-13-2001, FILED 6-6-2001.

GOT WINE?

CLASS 25—CLOTHING

FOR CLOTHING, NAMELY, ADULT SHIRTS, JUVENILE AND INFANT T-SHIRTS, SWEAT SHIRTS, JACKETS, SWEATERS, DENIM SHIRTS, GOLF SHIRTS, BASEBALL HATS, APRONS, AND INFANT ROMPERS AND CLOTH BIBS (U.S. CLS. 22 AND 39).
FIRST USE 6-6-2001; IN COMMERCE 6-6-2001.

CLASS 28—TOYS AND SPORTING GOODS

FOR GOLF BALLS AND STUFFED TOY ANIMALS (U.S. CLS. 22, 23, 38 AND 50).
FIRST USE 6-6-2001; IN COMMERCE 6-6-2001.

* * * * *

SECTION 2.— INTERNATIONAL CLASSIFICATION

The short titles associated below with the international class numbers are terms designed merely for quick identification and are not an official part of the international classification. The full names of international classes are given in section 6.1 of the trademark rules of practice.

The designation "U.S. Cl." appearing in this section refers to the U.S. class in effect prior to Sep. 1, 1973 rather than the international class which applies to applications filed on or after that date. For adoption of international classification see notice in the OFFICIAL GAZETTE of Jun. 26, 1973 (911 O.G. TM 210).

Application in one class

CLASS 1—CHEMICALS

2,625,339. HENKEL CORPORATION, AMBLER, PA. SN 75-294,337. PUB. 11-17-1998, FILED 5-19-1997.

PHOTOMER RM

OWNER OF U.S. REG. NO. 1,175,663.
NO CLAIM IS MADE TO THE EXCLUSIVE RIGHT TO USE "RM", APART FROM THE MARK AS SHOWN.

FOR CHEMICALS, NAMELY, RHEOLOGY MODIFIER RESINS FOR USE IN HIGH ENERGY CURING OF COATINGS, INKS AND PAINTS (U.S. CLS. 1, 5, 6, 10, 26 AND 46).

FIRST USE 2-1-2001; IN COMMERCE 2-15-2001.

2,625,355. CYBERBOND, L.L.C., BATAVIA, IL. SN 75-369,571. PUB. 7-28-1998, FILED 10-3-1997.

CYBERBOND APOLLO

FOR ADHESIVE USED FOR BONDING ALL TYPES OF PARTS FOR INDUSTRIAL AND CONSUMER USE (U.S. CLS. 1, 5, 6, 10, 26 AND 46).

FIRST USE 12-1-1997; IN COMMERCE 12-1-1997.

2,625,364. PROLINX, INC., BOTHELL, WA. SN 75-401,496. PUB. 11-17-1998, FILED 12-8-1997.

SEQUENCE SEEKERS

NO CLAIM IS MADE TO THE EXCLUSIVE RIGHT TO USE "SEQUENCE", APART FROM THE MARK AS SHOWN.

FOR CONJUGATES OF DNA SEQUENCE SPECIFIC DNA MINOR-GROOVE BINDING POLYAMIDES FOR USE IN LIFE SCIENCE RESEARCH, GENOMICS AND GENE PROBE BASED DIAGNOSTICS (U.S. CLS. 1, 5, 6, 10, 26 AND 46).

FIRST USE 7-10-1997; IN COMMERCE 2-4-2002.

CLASS 1—(Continued).

2,625,441. HVL COS., LLC, SEATTLE, WA. SN 75-588,120. PUB. 10-5-1999, FILED 11-13-1998.

CERFLON

FOR CHEMICAL PREPARATION, NAMELY, AN AQUEOUS DISPERSION OF CERAMIC PARTICLES AND PTFE (U.S. CLS. 1, 5, 6, 10, 26 AND 46).

FIRST USE 12-10-2001; IN COMMERCE 12-10-2001.

2,625,477. AOC, LLC, COLLIERVILLE, TN. SN 75-639,161. PUB. 8-22-2000, FILED 2-5-1999.

ALTEK

FOR SYNTHETIC MARINE RESINS FOR USE IN THE MANUFACTURE OF WATER CRAFT (U.S. CLS. 1, 5, 6, 10, 26 AND 46).

FIRST USE 10-28-1998; IN COMMERCE 10-28-1998.

2,625,479. CECIAS, OSCAR MARTINEZ, C.P. 76120, QUERETARO, QRO, MEXICO. SN 75-645,695. PUB. 1-30-2001, FILED 2-23-1999.

TEKEL

FOR FABRIC PROTECTANT FOR CLOTHING AND CARPETS, STAIN REPELLANT FOR CLOTHING AND CARPETS, FLAME RETARDANT FOR CLOTHING AND CARPETS AND ANTI-BACTERIAL CHEMICAL PREPARATIONS BASED ON SILICA DERIVATIVES FOR USE ON CLOTHING AND CARPETS (U.S. CLS. 1, 5, 6, 10, 26 AND 46).

FIRST USE 8-28-1998; IN COMMERCE 8-28-1998.

CLASS 1—(Continued).

2,625,481. REICHHOLD, INC., DURHAM, NC. SN 75-652,940. PUB. 4-3-2001, FILED 2-26-1999.

CLASS 1—(Continued).

2,625,691. UNIMIN CORPORATION, NEW CANAAN, CT. SN 75-849,910. PUB. 11-13-2001, FILED 11-17-1999.

IPN

FOR ADHESIVES USED FOR CARPET BACKING IN THE CARPET INDUSTRY (U.S. CLS. 1, 5, 6, 10, 26 AND 46).
FIRST USE 1-31-2000; IN COMMERCE 1-31-2000.

UNIPAR TOURNAMENT BLEND

2,625,592. HENKEL KGAA, D-40191 DUSSELDORF, FED REP GERMANY. SN 75-776,049. PUB. 5-16-2000, FILED 8-13-1999.

OWNER OF U.S. REG. NO. 1,494,261.
NO CLAIM IS MADE TO THE EXCLUSIVE RIGHT TO USE "BLEND", APART FROM THE MARK AS SHOWN.
FOR GOLF COURSE GROWING MEDIA AND TOP DRESSING CONSISTING OF A MIXTURE OF SILICA SAND AND DIATOMACEOUS EARTH (U.S. CLS. 1, 5, 6, 10, 26 AND 46).
FIRST USE 5-0-1999; IN COMMERCE 5-0-1999.

SAFE-T-MELT

OWNER OF U.S. REG. NOS. 1,366,146, 2,013,688, AND OTHERS.
FOR HOT MELT ADHESIVES FOR THE BOOKBINDING AND GRAPHIC ARTS INDUSTRIES (U.S. CLS. 1, 5, 6, 10, 26 AND 46).
FIRST USE 11-30-2001; IN COMMERCE 11-30-2001.

2,625,709. TAMKO ROOFING PRODUCTS, INC., JOPLIN, MO. SN 75-859,409. PUB. 9-18-2001, FILED 11-29-1999.

2,625,595. BP P.L.C., LONDON, ENGLAND, BY CHANGE OF NAME BP AMOCO P.L.C., LONDON EC2M 7BA, ENGLAND. SN 75-777,577. PUB. 1-16-2001, FILED 8-18-1999.

RIGIPORE

FOR CHEMICAL RAW MATERIALS, NAMELY EXPANDABLE POLYSTYRENE FOR USE IN MANUFACTURING (U.S. CLS. 1, 5, 6, 10, 26 AND 46).
FIRST USE 4-20-2000; IN COMMERCE 4-20-2000.



2,625,673. MANCO, INC., AVON, OH. SN 75-840,830. PUB. 8-28-2001, FILED 11-4-1999.

REPAIR STONE FOR GOOD

FOR ADHESIVES AND FILLER COMPOUNDS FOR USE IN HOME AND BUILDING CONSTRUCTION, RENOVATION, MAINTENANCE AND REPAIR (U.S. CLS. 1, 5, 6, 10, 26 AND 46).
FIRST USE 12-31-1999; IN COMMERCE 12-31-1999.

NO CLAIM IS MADE TO THE EXCLUSIVE RIGHT TO USE "ROOF", APART FROM THE MARK AS SHOWN.
FOR WATER-BASED TREATMENT SYSTEM FOR INHIBITING ALGAE DISCOLORATION AND GROWTH ON ROOFS, WALLS, AND OTHER EXTERIOR SURFACES (U.S. CLS. 1, 5, 6, 10, 26 AND 46).
FIRST USE 5-10-2001; IN COMMERCE 5-10-2001.

CLASS 1—(Continued).

2,625,718. SERVICIOS CORPORATIVOS DE ADMINISTRACION GMZ, S.A. DE C.V., 03100, MEXICO, D. F., MEXICO. SN 75-869,127. PUB. 9-5-2000, FILED 12-10-1999.



FOR GLUES AND ADHESIVES FOR USE IN THE AUTOMOTIVE INDUSTRY, AUTOMOBILE REPAIR INDUSTRY, FOOTWEAR INDUSTRY, PLASTICS INDUSTRY, TOY INDUSTRY AND FURNITURE INDUSTRY (U.S. CLS. 1, 5, 6, 10, 26 AND 46).

FIRST USE 4-26-2002; IN COMMERCE 4-30-2002.

2,625,766. NISSAN CHEMICAL INDUSTRIES, LTD., CHIYODA-KU TOKYO, JAPAN. SN 75-896,898. PUB. 9-11-2001, FILED 1-18-2000.

MT-239

FOR CHEMICALS FOR USE AS A HARDENER IN POWDER COATING (U.S. CLS. 1, 5, 6, 10, 26 AND 46). FIRST USE 3-31-1998; IN COMMERCE 3-31-1998.

2,625,776. AMCOL INTERNATIONAL CORPORATION, ARLINGTON, HEIGHTS, IL, BY ASSIGNMENT EASTMAN CHEMICAL COMPANY, KINGSPORT, TN. SN 75-901,708. PUB. 11-7-2000, FILED 1-21-2000.

IMPERM

FOR UNPROCESSED SYNTHETIC RESINS FOR USE IN THE MANUFACTURE OF PRODUCT PACKAGING (U.S. CLS. 1, 5, 6, 10, 26 AND 46). FIRST USE 12-20-2001; IN COMMERCE 12-20-2001.

CLASS 1—(Continued).

2,625,782. BAYER AKTIENGESELLSCHAFT, D-51368, LEVERKUSEN-BAYERWERK, FED REP GERMANY. SN 75-903,181. PUB. 10-30-2001, FILED 1-26-2000.

MAKROLON

OWNER OF U.S. REG. NOS. 669,449, 1,152,057, AND OTHERS.

FOR CHEMICALS FOR INDUSTRIAL PURPOSES, NAMELY AQUEOUS DISPERSIONS USED TO PROVIDE ANTI-DROP AND SCRATCH RESISTANT COATING MATERIALS FOR PLASTICS (U.S. CLS. 1, 5, 6, 10, 26 AND 46).

FIRST USE 4-0-2002; IN COMMERCE 4-0-2002.

2,625,806. ALBERDINGK BOLEY GMBH, KREFELD, FED REP GERMANY. SN 75-910,656. PUB. 9-25-2001, FILED 2-3-2000.

**ALBERDINGK BOLEY**

FOR POLYMER-DISPERSIONS FOR USE IN THE MANUFACTURE OF ADHESIVES, LACQUERS, PAINTS, PLASTERS AND SURFACE COATINGS FOR USE ON ALL SUBSTRATES; AND POLYMER DISPERSIONS FOR USE IN FINISHING LEATHER AND TEXTILES (U.S. CLS. 1, 5, 6, 10, 26 AND 46).

FIRST USE 5-5-2000; IN COMMERCE 5-5-2000.

2,625,823. BIONUTRATECH, INC., HOUSTON, TX. SN 75-919,010. PUB. 1-23-2001, FILED 2-15-2000.

SEPTIKOS

FOR NUTRIENT-BASED ADDITIVES FOR REMEDIATING SEPTIC TANKS (U.S. CLS. 1, 5, 6, 10, 26 AND 46).

FIRST USE 2-0-2001; IN COMMERCE 2-0-2001.

2,626,006. FUEL ADVANTAGE MARKETING, INC., DERRY, NH. SN 76-055,493. PUB. 4-3-2001, FILED 5-24-2000.

FUEL ADVANTAGE MARKETING

NO CLAIM IS MADE TO THE EXCLUSIVE RIGHT TO USE "FUEL", APART FROM THE MARK AS SHOWN.

FOR FUEL STABILIZATION AGENT AND A DETERGENT, SUSPENDED IN AN INERT FORMULA, WHICH CAUSES HEATING OILS, ESPECIALLY THOSE USED FOR HOME HEATING, TO RESIST SLUDGE FORMATION, THEREBY REDUCING SLUDGE-RELATED FUEL SYSTEM PROBLEMS (U.S. CLS. 1, 5, 6, 10, 26 AND 46).

FIRST USE 7-31-2000; IN COMMERCE 7-31-2000.

CLASS 1—(Continued).

2,626,020. HERBSMART INC., SOUTH SAN FRANCISCO, CA. SN 76-061,380. PUB. 8-7-2001, FILED 6-1-2000.

NATURAL FROM SOURCE TO SHELF

FOR PHYTOCHEMICALS FOR USE IN THE MANUFACTURE OF DIETARY SUPPLEMENTS (U.S. CLS. 1, 5, 6, 10, 26 AND 46).

FIRST USE 3-15-2002; IN COMMERCE 3-15-2002.

2,626,044. PE CORPORATION, FOSTER CITY, CA. SN 76-075,993. PUB. 12-11-2001, FILED 6-23-2000.

CENTRIRED

FOR REAGENTS, FOR USE IN SCIENTIFIC AND LIFE SCIENCE, RESEARCH, GENETIC ANALYSIS, GENOMICS, POLYMERASE CHAIN REACTION (PCR), DRUG DISCOVERY, DRUG DEVELOPMENT, AND FLUORESCENT CELL-BASED AND BEAD-BASED ANALYSIS; KITS COMPRISED PRIMARILY OF REAGENTS FOR USE IN SCIENTIFIC AND LIFE SCIENCE, RESEARCH, GENETIC ANALYSIS, GENOMICS, POLYMERASE CHAIN REACTION (PCR), DRUG DISCOVERY, DRUG DEVELOPMENT, AND FLUORESCENT CELL-BASED AND BEADED-BASED ANALYSIS (U.S. CLS. 1, 5, 6, 10, 26 AND 46).

FIRST USE 1-15-2000; IN COMMERCE 1-15-2000.

2,626,047. INDOPCO, INC., DBA NATIONAL STARCH AND CHEMICAL COMPANY, BRIDGEWATER, NJ. SN 76-077,365. PUB. 3-6-2001, FILED 6-22-2000.

OPTIPLUS

FOR STARCH, PARTICULARLY FOR USE IN THE MANUFACTURING OF PAPER, PAPERBOARD, LINERBOARD AND PAPERMAKING (U.S. CLS. 1, 5, 6, 10, 26 AND 46).

FIRST USE 6-9-2000; IN COMMERCE 6-9-2000.

CLASS 1—(Continued).

2,626,143. CYCLICS CORPORATION, RENSSELEAR, NY. SN 76-121,862. PUB. 10-30-2001, FILED 9-5-2000.

CBT

FOR SYNTHETIC RESINS FOR MOLDING AND EXTRUSION OF THERMOPLASTIC MATERIAL; SYNTHETIC RESINS AND SYNTHETIC RESIN COMPOUNDS FOR USE IN THE MANUFACTURE OF THERMOPLASTIC ARTICLES AND PARTS VIA ROTATIONAL MOLDING, RESIN FILM INFUSION, RESIN TRANSFER MOLDING, PULTRUSION, COMPRESSION MOLDING, FILAMENT WINDING, PREPREG FORMATION AND COATING, ROLL WRAPPING, EXTRUSION, WATER SLURRY, AND RELATED MANUFACTURING PROCESSES; SYNTHETIC RESINS AND SYNTHETIC RESIN COMPOUNDS IN THE FORM OF POWDER, FLAKE, PELLETS, BARS, BOXES, RODS, PASTEELS, AND SHEETS FOR USE IN MANUFACTURING THERMOPLASTIC ARTICLES; SYNTHETIC RESINS AND SYNTHETIC RESIN COMPOUNDS FOR USE IN THE MANUFACTURE OF THERMOPLASTIC POLYESTER FILM, SHEETS, FOAM, AND SHAPED ARTICLES FOR USE IN ELECTRICAL, ELECTRONIC, CONSTRUCTION, RECREATION, AUTOMOTIVE, INSULATING AND ENCLOSURE APPLICATIONS (U.S. CLS. 1, 5, 6, 10, 26 AND 46).

FIRST USE 5-11-2001; IN COMMERCE 5-11-2001.

2,626,193. UNIROYAL CHEMICAL COMPANY, INC., MIDDLEBURY, CT. SN 76-141,303. PUB. 7-24-2001, FILED 10-6-2000.

LEAFLESS

FOR PLANT GROWTH REGULATOR FOR USE IN HORTICULTURE AND AGRICULTURE INDUSTRIES (U.S. CLS. 1, 5, 6, 10, 26 AND 46).

FIRST USE 7-11-2001; IN COMMERCE 7-11-2001.

2,626,222. STRATAGENE, LA JOLLA, CA. SN 76-150,526. PUB. 8-21-2001, FILED 10-18-2000.

YIELDACE

FOR ENZYMES AND LABORATORY REAGENTS FOR SCIENTIFIC AND RESEARCH USE (U.S. CLS. 1, 5, 6, 10, 26 AND 46).

FIRST USE 11-0-2000; IN COMMERCE 11-0-2000.

2,626,261. ATOFINA CHEMICALS, INC., PHILADELPHIA, PA. SN 76-163,466. PUB. 10-30-2001, FILED 11-9-2000.

VOD

FOR SYNTHETIC RESIN POWDER FOR USE IN THE MANUFACTURE OF MOLDING COMPOUNDS (U.S. CLS. 1, 5, 6, 10, 26 AND 46).

FIRST USE 1-31-2002; IN COMMERCE 1-31-2002.

CLASS 1—(Continued).

2,626,291. ICOR INTERNATIONAL, INC., INDIANAPOLIS, IN. SN 76-174,293. PUB. 10-30-2001, FILED 12-1-2000.

NU-22

FOR REFRIGERANTS FOR USE IN HEATING, VENTILATION, AIR CONDITIONING SYSTEMS, AND REFRIGERATION UNITS (U.S. CLS. 1, 5, 6, 10, 26 AND 46).
FIRST USE 10-26-2001; IN COMMERCE 10-26-2001.

2,626,304. PAVE TECH, INC., PRIOR LAKE, MN. SN 76-181,253. PUB. 7-24-2001, FILED 12-15-2000.

PAVERSAFE

FOR CHEMICAL PREPARATIONS FOR MELTING SNOW AND ICE (U.S. CLS. 1, 5, 6, 10, 26 AND 46).
FIRST USE 9-14-2001; IN COMMERCE 9-14-2001.

2,626,326. CARBON NANOTECHNOLOGIES INCORPORATED, HOUSTON, TX. SN 76-192,367. PUB. 11-13-2001, FILED 1-9-2001.

HIPCO

FOR CHEMICAL PREPARATIONS, NAMELY, SINGLE WALLED CARBON NANOTUBES FOR USE IN FURTHER MANUFACTURE (U.S. CLS. 1, 5, 6, 10, 26 AND 46).
FIRST USE 2-13-2001; IN COMMERCE 2-13-2001.

2,626,334. PRESTONE PRODUCTS CORPORATION, DANBURY, CT. SN 76-194,434. PUB. 9-4-2001, FILED 1-16-2001.



OWNER OF U.S. REG. NO. 181,657 AND OTHERS.
NO CLAIM IS MADE TO THE EXCLUSIVE RIGHT TO USE "EASY POUR", APART FROM THE MARK AS SHOWN.
THE MARK INCLUDES A GRAPHIC DEPICTION OF A PARTIAL CONTAINER POURING LIQUID.

FOR ANTIFREEZE; COOLANTS FOR VEHICLE ENGINES; WINDSHIELD ANTIFREEZE FLUIDS; WINDSHIELD DEICER FLUIDS (U.S. CLS. 1, 5, 6, 10, 26 AND 46).
FIRST USE 4-12-2001; IN COMMERCE 4-12-2001.

CLASS 1—(Continued).

2,626,400. NORTHWEST AGRICULTURAL PRODUCTS, INC., PASCO, WA. SN 76-216,562. PUB. 9-4-2001, FILED 2-27-2001.

WILT-GUARD

FOR WATER DISPERSIBLE ORGANIC CONCENTRATE FOR USE AS AN ANTITRANSPIRANT FOR APPLICATION AS A SPRAY OR DIP TO PLANTS, TREES, SHRUBS AND THE LIKE AND SERVING TO PREVENT TRANSPLANTING SHOCK AND TO RETARD WATER EVAPORATION THROUGH THE LEAVES, THEREBY IN GENERAL MAINTAINING HEALTHY FOLIAGE AND PREVENTING WINTER KILL (U.S. CLS. 1, 5, 6, 10, 26 AND 46).
FIRST USE 2-27-2001; IN COMMERCE 2-27-2001.

2,626,448. POLIFACE NORTH AMERICA, INC. BALTIMORE, MD. SN 76-232,891. PUB. 10-9-2001, FILED 3-29-2001.

SECUREBOND

FOR LAMINATED WOOD FLOORING ADHESIVE (U.S. CLS. 1, 5, 6, 10, 26 AND 46).
FIRST USE 3-23-2001; IN COMMERCE 3-23-2001.

2,626,467. HALLIBURTON ENERGY SERVICES, INC., CARROLLTON, TX. SN 76-240,417. PUB. 9-11-2001, FILED 4-14-2001.

COLDTROL

FOR SYNTHETIC BASED THINNER, NAMELY, A FATTY ALCOHOL FOR REDUCING RHEOLOGICAL PROPERTIES IN ESTER BASED FLUIDS USED IN THE DRILLING OF OIL AND GAS WELLS (U.S. CLS. 1, 5, 6, 10, 26 AND 46).
FIRST USE 6-2-2001; IN COMMERCE 6-2-2001.

2,626,476. AGROMAR CORPORATION, BAKERSFIELD, CA. SN 76-248,187. PUB. 9-18-2001, FILED 4-30-2001.

AGROLIZER

FOR FERTILIZERS FOR DOMESTIC AND AGRICULTURAL USE (U.S. CLS. 1, 5, 6, 10, 26 AND 46).
FIRST USE 3-30-2001; IN COMMERCE 3-30-2001.

CLASS 1—(Continued).

2,626,501. PQ CORPORATION, VALLEY FORGE, PA. SN 76-261,485. PUB. 10-9-2001, FILED 5-24-2001.

AGSIL

FOR POTASSIUM SILICATE FOR AGRICULTURAL USE (U.S. CLS. 1, 5, 6, 10, 26 AND 46).
FIRST USE 4-18-2002; IN COMMERCE 4-18-2002.

2,626,519. UNITED STATES FILTER CORPORATION, PALM DESERT, CA. SN 76-278,736. PUB. 12-25-2001, FILED 6-28-2001.

ULTRACARB

FOR CHEMICALS, NAMELY, GRANULAR ACTIVATED CARBON FOR TREATING LIQUIDS IN THE CHEMICAL PROCESS INDUSTRY (U.S. CLS. 1, 5, 6, 10, 26 AND 46).
FIRST USE 9-0-2000; IN COMMERCE 9-0-2000.

2,626,524. AQUATROLS CORPORATION OF AMERICA, INC., CHERRY HILL, NJ. SN 76-284,851. PUB. 10-16-2001, FILED 7-12-2001.

DRIFT

FOR CHEMICALS FOR USE WITH SNOW MAKING EQUIPMENT TO ENHANCE THE QUALITY AND QUANTITY OF SNOW PRODUCED (U.S. CLS. 1, 5, 6, 10, 26 AND 46).
FIRST USE 10-10-2001; IN COMMERCE 10-10-2001.

2,626,547. CYTEC TECHNOLOGY CORP., WILMINGTON, DE. SN 76-301,678. PUB. 11-13-2001, FILED 8-17-2001.

CYDROTHANE

FOR POLYURETHANE RESINS FOR USE IN THE MANUFACTURE OF INKS (U.S. CLS. 1, 5, 6, 10, 26 AND 46).
FIRST USE 10-25-2000; IN COMMERCE 10-25-2000.

2,626,660. EASTMAN CHEMICAL COMPANY, KINGSPORT, TN. SN 78-043,679. PUB. 8-7-2001, FILED 1-18-2001.

HEATWAVE

FOR UNPROCESSED POLYMER RESIN FOR USE IN THE MANUFACTURE OF INJECTION MOLDED AND EXTRUDABLE PRODUCTS FOR USE IN THE FOOD AND BEVERAGE INDUSTRIES (U.S. CLS. 1, 5, 6, 10, 26 AND 46).
FIRST USE 4-15-2002; IN COMMERCE 4-15-2002.

CLASS 1—(Continued).

2,626,712. R.T. VANDERBILT COMPANY, INC., NORWALK, CT. SN 78-060,847. PUB. 12-11-2001, FILED 4-27-2001.

VANCOTE

NO CLAIM IS MADE TO THE EXCLUSIVE RIGHT TO USE "COMPANY", APART FROM THE MARK AS SHOWN. FOR MINERALS TO BE USED AS AN ADDITIVE IN THE MANUFACTURE OF PLASTIC OR RUBBER (U.S. CLS. 1, 5, 6, 10, 26 AND 46).
FIRST USE 0-0-1991; IN COMMERCE 6-18-2001.

CLASS 2—PAINTS

2,625,585. MID-WEST METAL PRODUCTS COMPANY, INC., MUNCIE, IN. SN 75-768,183. PUB. 10-30-2001, FILED 8-5-1999.

ACRI-LOCK

FOR COATINGS IN THE NATURE OF AN ACRYLIC FINISHING PREPARATION FOR USE ON METAL WIRE (U.S. CLS. 6, 11 AND 16).
FIRST USE 9-1-1999; IN COMMERCE 9-1-1999.

2,625,723. CARBOLINE COMPANY, ST. LOUIS, MO. SN 75-874,165. PUB. 9-4-2001, FILED 12-20-1999.

CARBOCOAT

FOR OIL BASED PRIMERS AND COATINGS IN THE NATURE OF PAINT FOR INTERIOR AND EXTERIOR STEEL SURFACES (U.S. CLS. 6, 11 AND 16).
FIRST USE 11-0-1999; IN COMMERCE 11-0-1999.

2,625,807. TNE MEC COMPANY, INC., KANSAS CITY, MO. SN 75-911,091. PUB. 10-30-2001, FILED 2-7-2000.

SPECTRATHANE

FOR DECORATIVE FLAKE-FINISH URETHANE SEALER COATINGS FOR USE IN COATING METAL SURFACES (U.S. CLS. 6, 11 AND 16).
FIRST USE 2-0-2000; IN COMMERCE 2-0-2000.

2,625,918. DALER-ROWNEY USA LIMITED, CRANBURY, NJ. SN 76-012,916. PUB. 3-20-2001, FILED 3-29-2000.

AQUAFINE

FOR ARTISTS' WATER COLOR PAINTS (U.S. CLS. 6, 11 AND 16).
FIRST USE 3-15-2001; IN COMMERCE 3-15-2001.

CLASS 2—(Continued).

2,626,204. WESTEX DESIGN CONCEPTS, LLC, CLEAR-WATER, FL. SN 76-144,496. PUB. 11-13-2001, FILED 10-11-2000.

WESPLEX

FOR COLOR IMPREGNATED WALL AND SURFACE TEXTURED FINISHES, NAMELY, TEXTURED PAINTS FOR INTERIOR AND EXTERIOR USE, VARNISHES, LACQUERS IN THE NATURE OF A GLAZE OR COATING, ENAMELS IN THE NATURE OF HOUSE PAINT, GLAZES IN THE NATURE OF PAINTS AND LACQUERS, PAINT PRIMERS, PAINT SEALERS, WOOD STAINS, SHELLACS FOR USE AS A SURFACE COATING, AND UNDERCOATING FOR SURFACES TO BE PAINTED (U.S. CLS. 6, 11 AND 16).

FIRST USE 4-1-2000; IN COMMERCE 4-1-2000.

2,626,219. DUNN-EDWARDS CORPORATION, LOS ANGELES, CA. SN 76-150,419. PUB. 12-25-2001, FILED 10-19-2000.

THE PAINT THAT PROTECTS

FOR PAINTS, NAMELY, HOUSE PAINT, EXTERIOR AND INTERIOR PAINTS, ENAMELS IN THE NATURE OF HOUSE PAINT, PAINT PRIMER, PAINT SEALERS AND PAINT THINNER (U.S. CLS. 6, 11 AND 16).

FIRST USE 11-30-2000; IN COMMERCE 11-30-2000.

2,626,320. ELECTRONIC LABEL TECHNOLOGY, INC., BROKEN ARROW, OK. SN 76-190,571. PUB. 8-28-2001, FILED 1-5-2001.

ECO ELITE

FOR TONER CARTRIDGES (U.S. CLS. 6, 11 AND 16).
FIRST USE 4-25-2000; IN COMMERCE 4-25-2000.

CLASS 3—COSMETICS AND CLEANING PREPARATIONS

2,625,456. CAUDALIES, 75017 PARIS, FRANCE. SN 75-607,923. PUB. 6-27-2000, FILED 12-18-1998.

FLEUR DE VIGNE

OWNER OF FRANCE REG. NO. 1706344, DATED 11-19-1991, RENEWED AS REG. NO. 1706344, DATED 10-10-2001, EXPIRES 11-19-2010.

THE ENGLISH TRANSLATION OF "FLEUR DE VIGNE" IS "FLOWER OF THE VINE".

FOR COSMETICS, NAMELY, SKIN SOAPS, PERFUMES, ESSENTIAL OILS FOR PERSONAL USE, HAIR LOTION AND DENTIFRICES (U.S. CLS. 1, 4, 6, 50, 51 AND 52).

FIRST USE 4-0-1999; IN COMMERCE 4-0-1999.

CLASS 3—(Continued).

2,625,526. JKA, INC., DBA DIVERSIFIED DISTRIBUTION, WOONSOCKET, RI. SN 75-720,676. PUB. 7-25-2000, FILED 6-4-1999.

Catch Mi

FOR NAIL POLISH AND NAIL POLISH REMOVER; LIPSTICK, ROUGE, AND BODY AND FACE MIST; FACE AND BODY SOAPS; PERFUME AND COLOGNE; ROOM FRAGRANCES, HAIR SHAMPOOS AND CONDITIONERS; SKIN CARE PREPARATIONS NAMELY SKIN LOTION AND SKIN CLEANSER (U.S. CLS. 1, 4, 6, 50, 51 AND 52).

FIRST USE 8-17-2001; IN COMMERCE 8-17-2001.

2,625,652. KOSE CORPORATION, TOKYO, JAPAN. SN 75-827,517. PUB. 8-21-2001, FILED 10-20-1999.

MULTI DIMENSION EYE

NO CLAIM IS MADE TO THE EXCLUSIVE RIGHT TO USE "EYE", APART FROM THE MARK AS SHOWN.

FOR COSMETICS, NAMELY, MASCARA, EYE LINER, EYE SHADOW, EYE BROW PENCIL, EYE CREAM AND CONCEALER (U.S. CLS. 1, 4, 6, 50, 51 AND 52).

FIRST USE 3-1-2000; IN COMMERCE 3-1-2000.

2,625,686. LECTEC CORPORATION, MINNETONKA, MN, BY ASSIGNMENT COSMO INTERNATIONAL GROUP, INC., GARDEN GROVE, CA. SN 75-847,958. PUB. 7-25-2000, FILED 11-13-1999.

NEOSKIN

FOR COSMETIC AND SKIN CARE PRODUCTS, NAMELY, NON-MEDICATED PORE CLEANSING NOSE STRIPS, OIL BLOTTING TISSUES AND FACIAL CLEANSING TOWELETTES, SELF-HEATING MOISTURIZING MASKS, AND ANTI-WRINKLE GEL PATCHES (U.S. CLS. 1, 4, 6, 50, 51 AND 52).

FIRST USE 3-0-2000; IN COMMERCE 3-0-2000.

2,625,727. SOFT SHEEN/CARSON, INC., CHICAGO, IL. SN 75-876,427. PUB. 10-30-2001, FILED 12-17-1999.

ESSENTIAL BENEFITS

FOR CORRECTIVE COSMETICS, NAMELY, SKIN BLEMISH COVER CREAM, SETTING POWDER, SKIN CREAM, FOUNDATION, LIQUID POWDER, AND SKIN MOISTURIZER (U.S. CLS. 1, 4, 6, 50, 51 AND 52).

FIRST USE 8-1-2001; IN COMMERCE 8-1-2001.

CLASS 3—(Continued).

2,625,822. ORLY INTERNATIONAL, INC., CHATSWORTH, CA. SN 75-918,402. PUB. 8-7-2001, FILED 2-16-2000.

NAIL RESCUE

NO CLAIM IS MADE TO THE EXCLUSIVE RIGHT TO USE "NAIL", APART FROM THE MARK AS SHOWN.
FOR NAIL CARE PREPARATIONS (U.S. CLS. 1, 4, 6, 50, 51 AND 52).
FIRST USE 3-8-2000; IN COMMERCE 3-10-2000.

2,625,889. DIVI INTERNATIONAL CO., MIAMI, FL. SN 75-982,198. PUB. 10-31-2000, FILED 7-12-1999.

DEPICURE

FOR SKIN LOTIONS (U.S. CLS. 1, 4, 6, 50, 51 AND 52).
FIRST USE 2-15-2001; IN COMMERCE 2-15-2001.

2,625,983. PAULA DORF COSMETICS, INC., NEW YORK, NY. SN 76-045,097. PUB. 10-9-2001, FILED 5-11-2000.

CLEAN UP STICK

NO CLAIM IS MADE TO THE EXCLUSIVE RIGHT TO USE "STICK", APART FROM THE MARK AS SHOWN.
FOR MAKEUP REMOVER PENCIL (U.S. CLS. 1, 4, 6, 50, 51 AND 52).
FIRST USE 9-7-2001; IN COMMERCE 9-7-2001.

2,625,995. PEGASUS INTERNATIONAL INC., FORT WASHINGTON, PA. SN 76-048,229. PUB. 10-9-2001, FILED 5-15-2000.



OWNER OF U.S. REG. NOS. 2,220,304, 2,328,313, AND OTHERS.

FOR FULL LINE OF HOUSEHOLD LAUNDRY, CARPET, ROOM, FURNITURE AND GENERAL PURPOSE CLEANING PREPARATIONS (U.S. CLS. 1, 4, 6, 50, 51 AND 52).
FIRST USE 1-0-1999; IN COMMERCE 1-0-1999.

CLASS 3—(Continued).

2,626,013. NASH, ALBERT J., MERRICK, NY. SN 76-058,265. PUB. 5-1-2001, FILED 5-26-2000.

TECLEAN

FOR SPRAY CLEANING PREPARATIONS FOR CLEANING AND DISINFECTING HEADSETS (U.S. CLS. 1, 4, 6, 50, 51 AND 52).
FIRST USE 1-8-2002; IN COMMERCE 1-8-2002.

2,626,049. L'OREAL USA CREATIVE, INC., NEW YORK, NY, BY CHANGE OF NAME L'OREAL USA CREATIVE, INC., NEW YORK, NY. SN 76-077,765. PUB. 2-20-2001, FILED 6-26-2000.

WILLPOWER

FOR HAIR STYLING PREPARATION, NAMELY, HAIRSPRAY (U.S. CLS. 1, 4, 6, 50, 51 AND 52).
FIRST USE 2-1-2002; IN COMMERCE 2-1-2002.

2,626,104. LEE PHARMACEUTICALS, INC., SOUTH EL MONTE, CA. SN 76-102,980. PUB. 6-19-2001, FILED 8-3-2000.

SIPPERS

FOR LIP BALM (U.S. CLS. 1, 4, 6, 50, 51 AND 52).
FIRST USE 9-15-2000; IN COMMERCE 9-15-2000.

2,626,169. ORLY INTERNATIONAL, INC., CHATSWORTH, CA. SN 76-130,382. PUB. 7-31-2001, FILED 9-18-2000.

BIODRY

FOR NAIL CARE PREPARATIONS (U.S. CLS. 1, 4, 6, 50, 51 AND 52).
FIRST USE 7-10-2001; IN COMMERCE 7-10-2001.

CLASS 3—(Continued).

2,626,195. DI GIULIO CHIROPRACTIC, INC., BURBANK, CA. SN 76-141,546. PUB. 1-29-2002, FILED 10-6-2000.



NO CLAIM IS MADE TO THE EXCLUSIVE RIGHT TO USE "SKIN CARE", APART FROM THE MARK AS SHOWN.

THE MARK CONSISTS OF A CITY SQUARE WITH A BACKGROUND CONSISTING OF A CLASSIC HISTORICAL PALACE RESEMBLING A FORTRESS IN THE UPPER LEVEL AND A BELL TOWER STANDING HIGH ON THE LEFT HAND SIDE. THE WORD "SIENABELLA" IS SEEN IN THE FOREGROUND ALONG WITH AN ELEGANT LADY SEEN FROM THE BACK WHO CARRIES A BOUQUET OF FLOWERS ON HER RIGHT HAND, WHILE DROPPING PETALS OF FLOWERS WITH HER LEFT HAND THROUGHOUT THE PAVEMENT OF THE SQUARE.

THE ENGLISH TRANSLATION OF "SIENABELLA" IS "BEAUTIFUL SIENA".

FOR PERSONAL CARE PRODUCTS NAMELY SKIN LOTIONS, BODY LOTIONS, MOISTURIZING LOTIONS, HAND LOTIONS, FACE LOTIONS, HAIR SHAMPOOS, HAIR CONDITIONERS, FACIAL OILS, BODY OILS, MASSAGE OILS, HAIR AND SCALP OILS, FACIAL MASKS, TONERS AND MOISTURIZERS; SKIN CLEANSING PREPARATIONS, FACIAL CLEANSERS, FACIALS EXFOLIANTS, FACE CREAMS, FACIAL SCRUBS, FACE AND BODY MASKS, BODY CREAMS, HAND CREAMS, COLD CREAMS, NIGHT CREAMS, SUN-BLOCK LOTIONS, PERSONAL DEODORANTS, HAND AND BODY SOAPS, TOILET SOAPS, SHAVING CREAMS, SHAVING FOAMS, PRE-SHAVE LOTIONS, AFTER-SHAVE LOTIONS; PERFUMES NAMELY EAU DE PERFUME, TOILET WATER, COLOGNE; ESSENTIAL OILS FOR PERSONAL USE AND FOR USE AS INGREDIENTS IN THE MANUFACTURING OF COSMETIC PREPARATIONS (U.S. CLS. 1, 4, 6, 50, 51 AND 52).

FIRST USE 5-1-2002; IN COMMERCE 5-1-2002.

2,626,218. AJR PRODUCTIONS LTD., AVENTURA, FL. SN 76-150,158. PUB. 10-2-2001, FILED 10-19-2000.

CHISELED CHEEKS

NO CLAIM IS MADE TO THE EXCLUSIVE RIGHT TO USE "CHEEKS", APART FROM THE MARK AS SHOWN.

FOR COSMETICS AND SKIN TREATMENTS, NAMELY, SKIN FOUNDATIONS, FACE POWDERS, BLUSHES; SKIN CAMOUFLAGE TREATMENTS, NAMELY, CREAMS, GELS, LOTIONS, SCRUBS AND NON-MEDICATED SERUMS; SKIN ENHANCEMENT TREATMENTS, NAMELY, CREAMS, GELS, LOTIONS, SCRUBS AND NON-MEDICATED SERUMS; BODY BATH PRODUCTS, NAMELY, BODY CLEANSERS, BODY MOISTURIZERS, BODY OILS (U.S. CLS. 1, 4, 6, 50, 51 AND 52).

FIRST USE 3-14-2001; IN COMMERCE 3-14-2001.

CLASS 3—(Continued).

2,626,225. FRAN WILSON CREATIVE COSMETICS, INC., NEW YORK, NY. SN 76-151,434. PUB. 8-28-2001, FILED 10-23-2000.

MOOD PEARL

FOR LIPSTICK (U.S. CLS. 1, 4, 6, 50, 51 AND 52).
FIRST USE 9-7-2000; IN COMMERCE 9-7-2000.

2,626,258. AROUND THE SHOP, INC., BUFORD, GA. SN 76-162,204. PUB. 8-28-2001, FILED 11-8-2000.

PITCH R

FOR CLEANING SOLUTION FOR CUTTING EDGE TOOLS, NAMELY, SAW BLADES, ROUTER BITS, PLANNER BLADES, MOLDING HEADS, CHISELS, PLUG CUTTERS, DRILL BITS, CARVING TOOLS AND KNIVES, FILES AND RASPS, TURNING TOOLS AND CLOTH BACKED SANDING BELTS AND DISCS (U.S. CLS. 1, 4, 6, 50, 51 AND 52).

FIRST USE 1-26-2001; IN COMMERCE 1-27-2001.

2,626,317. RECKITT & COLMAN (OVERSEAS) LIMITED, HULL, UNITED KINGDOM. SN 76-188,033. PUB. 8-14-2001, FILED 12-28-2000.

VEET

FOR TOILET ARTICLES, NAMELY DEPILATORIES, MOISTURIZERS AND SKIN LOTIONS (U.S. CLS. 1, 4, 6, 50, 51 AND 52).

FIRST USE 2-6-2002; IN COMMERCE 2-6-2002.

2,626,328. ONE WORLD NETWORKS INTEGRATED TECHNOLOGIES, INC., LOS ANGELES, CA. SN 76-193,040. PUB. 11-20-2001, FILED 1-11-2001.

CONFIRM

FOR MAKE-UP; EYE CREAM; EYE MAKE-UP; SKIN AND BODY CARE PRODUCTS, NAMELY, SKIN CREAMS, SKIN LOTIONS, AND SKIN SOAPS (U.S. CLS. 1, 4, 6, 50, 51 AND 52).

FIRST USE 4-10-2001; IN COMMERCE 4-10-2001.

CLASS 3—(Continued).

2,626,339. JO MALONE LIMITED, LONDON SW11 4XW, ENGLAND. SN 76-196,163. PUB. 12-4-2001, FILED 1-19-2001.

154

FOR PERFUME, EAU DE TOILETTE, AND COLOGNE; TOILETRIES, NAMELY, HAND CREAM, BODY CREAM, BODY LOTION, BODY GEL, BODY CLEANSERS, BODY WASHES, AND PERSONAL SOAPS (U.S. CLS. 1, 4, 6, 50, 51 AND 52).

FIRST USE 11-1-2001; IN COMMERCE 11-1-2001.

2,626,345. DYNACRAFT INDUSTRIES INC., TA BACK TO NATURE PRODUCTS CO., ENGLISH TOWN, NJ. SN 76-200,045. PUB. 8-14-2001, FILED 1-26-2001.

UH-OH!

FOR DRIED PAINT SPLATTER AND DRIP REMOVER, STAIN AND MARK REMOVER, ALL PURPOSE CLEANER (U.S. CLS. 1, 4, 6, 50, 51 AND 52).

FIRST USE 7-0-2001; IN COMMERCE 7-0-2001.

2,626,389. ROUX LABORATORIES, INC., JACKSONVILLE, FL. SN 76-213,649. PUB. 9-4-2001, FILED 2-21-2001.

RAMBUNCTIOUS

FOR NAIL ENAMEL AND LIPSTICK (U.S. CLS. 1, 4, 6, 50, 51 AND 52).

FIRST USE 9-13-2001; IN COMMERCE 9-13-2001.

2,626,398. ATICO INTERNATIONAL USA INC., FORT LAUDERDALE, FL. SN 76-215,901. PUB. 8-21-2001, FILED 2-26-2001.

GUMMI BEARS

FOR BATH PRODUCTS, NAMELY BATH AND SHOWER GEL, NON-MEDICATED SHAMPOO, CONDITIONER, SOAP, BUBBLE BATH AND NON-MEDICATED BATH SALTS (U.S. CLS. 1, 4, 6, 50, 51 AND 52).

FIRST USE 5-21-2001; IN COMMERCE 8-26-2001.

2,626,440. PACKAGING CONCEPTS ASSOC. INC., BOYNTON BEACH, FL. SN 76-230,994. PUB. 9-25-2001, FILED 3-26-2001.

NUTRIEN

FOR HAIR SPRAY (U.S. CLS. 1, 4, 6, 50, 51 AND 52).

FIRST USE 3-0-2001; IN COMMERCE 6-0-2001.

CLASS 3—(Continued).

2,626,494. SKINMEDICA, INC., CARLSBAD, CA. SN 76-259,042. PUB. 1-22-2002, FILED 5-18-2001.

TNS RECOVERY COMPLEX

NO CLAIM IS MADE TO THE EXCLUSIVE RIGHT TO USE "COMPLEX", APART FROM THE MARK AS SHOWN, FOR COSMETIC CREAMS AND LOTIONS NAMELY, SKIN CARE AND REJUVENATION PRODUCTS USED AND DISTRIBUTED SOLELY BY AND UNDER THE DIRECT SUPERVISION OF LICENSED MEDICAL PRACTITIONERS (U.S. CLS. 1, 4, 6, 50, 51 AND 52).

FIRST USE 7-7-2001; IN COMMERCE 7-7-2001.

2,626,498. GOLDEN BEAR INTERNATIONAL, INC., NORTH PALM BEACH, FL. SN 76-259,638. PUB. 2-19-2002, FILED 5-18-2001.

LADY NICKLAUS

OWNER OF U.S. REG. NOS. 1,855,837, 2,285,898, AND OTHERS.

NO CLAIM IS MADE TO THE EXCLUSIVE RIGHT TO USE "LADY", APART FROM THE MARK AS SHOWN.

FOR SKIN CARE PRODUCTS, NAMELY, GELS, LOTIONS AND OILS; SKIN CLEANSERS, SKIN TONERS, SKIN MOISTURIZERS, SUNSCREEN, SKIN TANNING CREAMS, AND SUNTAN PREPARATIONS, NAMELY, CREAMS, FOAMS, LOTIONS, GELS, OILS; AND NON-MEDICATED LIP BALM (U.S. CLS. 1, 4, 6, 50, 51 AND 52).

FIRST USE 11-1-2001; IN COMMERCE 11-1-2001.

2,626,512. HILLYARD ENTERPRISES, INC., ST. JOSEPH, MO. SN 76-274,743. PUB. 10-30-2001, FILED 6-21-2001.

CARIBBEAN SENSATION

FOR HAND SOAP (U.S. CLS. 1, 4, 6, 50, 51 AND 52).

FIRST USE 10-15-2001; IN COMMERCE 10-15-2001.

2,626,525. HARDCAP LLC, NEW YORK, NY. SN 76-285,340. PUB. 12-18-2001, FILED 7-16-2001.

BEE BIG

FOR HAIR CARE PREPARATIONS (U.S. CLS. 1, 4, 6, 50, 51 AND 52).

FIRST USE 11-0-2001; IN COMMERCE 11-0-2001.

CLASS 3—(Continued).

2,626,533. VI-JON LABORATORIES, INC., DBA VI-JON, INC., ST. LOUIS, MO. SN 76-292,910. PUB. 11-27-2001, FILED 7-31-2001.

CAYMAN ISLAND BAY RUM

OWNER OF U.S. REG. NO. 2,125,975.
FOR AFTER SHAVE AND COLOGNE (U.S. CLS. 1, 4, 6, 50, 51 AND 52).
FIRST USE 3-19-2002; IN COMMERCE 3-19-2002.

2,626,549. MELALEUCA, INC., IDAHO FALLS, ID. SN 76-302,882. PUB. 1-15-2002, FILED 8-22-2001.

DURANGO

FOR FRAGRANCES; NAMELY, COLOGNES, PERFUMES AND EAU DE TOILETTE (U.S. CLS. 1, 4, 6, 50, 51 AND 52).
FIRST USE 10-1-2001; IN COMMERCE 10-1-2001.

2,626,585. SHERWIN-WILLIAMS AUTOMOTIVE FINISHES CORP., CLEVELAND, OH. SN 78-016,015. PUB. 2-20-2001, FILED 7-10-2000.

TEC-STRIP

FOR PAINT REMOVER AND STRIPPER (U.S. CLS. 1, 4, 6, 50, 51 AND 52).
FIRST USE 7-2-2001; IN COMMERCE 7-2-2001.

CLASS 3—(Continued).

2,626,600. BETTER ON YOUR BODY, INC., HOUSTON, TX. SN 78-023,983. PUB. 7-31-2001, FILED 8-31-2000.

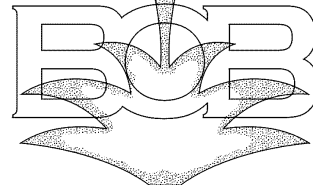
BETTER ON YOUR BODY

THE DRAWING IS STIPPLED FOR SHADING.
FOR COSMETICS, NAMELY FOUNDATION MAKEUP, COVERUP MAKEUP, LIPSTICK, LIP LINER, EYE SHADOW, EYE LINER, MASCARA, BLUSH; BODY SHAMPOO; HAIR SHAMPOO; HAIR CONDITIONER, HAIR LOTION, SKIN SOFTENER, SHOWER GEL, BUBBLE BATH, FACIAL CREAM, HAND CREAM, BODY LOTION, TALCUM POWDER, PERFUME, BATH OIL, BATH SALT, NAIL VARNISH, MAKEUP REMOVER, SKIN CLEANSER, FACIAL CLEANSER, SKIN LOTION, SKIN TONER; FACIAL TONER, AFTER-SHAVE LOTION, AFTER-SHAVE BALM, SHAVING CREAM; SHAVING LOTION; PERSONAL DEODORANT, SUN TANNING CREAM, SUN TANNING LOTION, SUN SCREEN, SUN BLOCK, AFTER SUN LOTION, LIP BALM, SUNLESS TANNING AND CREAM; ANTIPERSPIRANT, FOOT CREAM, FOOT SCRUB, BODY LOTION, BODY TONER, BODY EXFOLIANT (U.S. CLS. 1, 4, 6, 50, 51 AND 52).
FIRST USE 4-18-2001; IN COMMERCE 5-9-2001.

2,626,623. PHYSICIANS FORMULA COSMETICS, INC., AZUSA, CA. SN 78-035,913. PUB. 1-15-2002, FILED 11-17-2000.

SILVER MOON

FOR COSMETICS AND SKIN CARE PRODUCTS; NAMELY, LIP GLOSS, EYE COLOR, BLUSH, MASCARA, EYELINER AND FACE POWDER (U.S. CLS. 1, 4, 6, 50, 51 AND 52).
FIRST USE 6-13-2000; IN COMMERCE 6-13-2000.

2,626,637. AVON PRODUCTS, INC., NEW YORK, NY. SN 78-039,723. PUB. 8-21-2001, FILED 12-18-2000.

CURL-ASCIOUS

FOR COSMETICS, NAMELY - MASCARA (U.S. CLS. 1, 4, 6, 50, 51 AND 52).
FIRST USE 8-0-2001; IN COMMERCE 8-0-2001.

CLASS 3—(Continued).

2,626,664. KISS MY FACE, GARDINER, NY. SN 78-044,305.
PUB. 8-14-2001, FILED 1-22-2001.



FOR BAR SOAPS, LIQUID SOAPS, HAIR SHAMPOOS, HAIR CONDITIONERS, FACIAL CLEANSERS, PERSONAL DEODORANTS, SHOWER GELS AND FOAMING BATHS, SHAVE CREME, AFTER SHAVE LOTION, BODY MOISTURIZERS, FACIAL SCRUBS, NON MEDICATED LIP BALM (U.S. CLS. 1, 4, 6, 50, 51 AND 52).
FIRST USE 4-15-2002; IN COMMERCE 4-15-2002.

2,626,667. AVON PRODUCTS, INC., NEW YORK, NY. SN 78-045,170. PUB. 8-7-2001, FILED 1-26-2001.

SHINING MOMENT

FOR COSMETICS, NAMELY LIP GLOSS (U.S. CLS. 1, 4, 6, 50, 51 AND 52).
FIRST USE 9-0-2001; IN COMMERCE 9-0-2001.

2,626,668. AVON PRODUCTS, INC., NEW YORK, NY. SN 78-045,173. PUB. 8-7-2001, FILED 1-26-2001.

DEFINING MOMENT

FOR COSMETICS, NAMELY LIP LINER AND EYE LINER (U.S. CLS. 1, 4, 6, 50, 51 AND 52).
FIRST USE 9-0-2001; IN COMMERCE 9-0-2001.

2,626,669. AVON PRODUCTS, INC., NEW YORK, NY. SN 78-045,547. PUB. 8-28-2001, FILED 1-30-2001.

RESTORING

FOR FRAGRANCED BODY MIST, SHOWER GEL, BODY LOTION, AND FRAGRANCED MASSAGE OIL (U.S. CLS. 1, 4, 6, 50, 51 AND 52).
FIRST USE 9-0-2001; IN COMMERCE 9-0-2001.

CLASS 3—(Continued).

2,626,677. AVON PRODUCTS, INC., NEW YORK, NY. SN 78-048,343. PUB. 8-28-2001, FILED 2-14-2001.

KEEP IT CLEAN

FOR FACIAL CLEANSER (U.S. CLS. 1, 4, 6, 50, 51 AND 52).
FIRST USE 8-0-2001; IN COMMERCE 8-0-2001.

2,626,678. AVON PRODUCTS, INC., NEW YORK, NY. SN 78-048,349. PUB. 8-28-2001, FILED 2-14-2001.

KEEP IT FRESH

FOR FACIAL TONER (U.S. CLS. 1, 4, 6, 50, 51 AND 52).
FIRST USE 8-0-2001; IN COMMERCE 8-0-2001.

2,626,690. ZOTOS INTERNATIONAL, INC., DARIEN, CT. SN 78-052,544. PUB. 10-9-2001, FILED 3-12-2001.

UPSHOOT

FOR HAIRSPRAY (U.S. CLS. 1, 4, 6, 50, 51 AND 52).
FIRST USE 6-1-2001; IN COMMERCE 6-1-2001.

2,626,691. AVON PRODUCTS, INC., NEW YORK, NY. SN 78-052,575. PUB. 9-25-2001, FILED 3-12-2001.

ASTONISHING LENGTHS

OWNER OF U.S. REG. NO. 2,162,005.
NO CLAIM IS MADE TO THE EXCLUSIVE RIGHT TO USE "LENGTHS", APART FROM THE MARK AS SHOWN.
FOR COSMETICS, NAMELY - MASCARA (U.S. CLS. 1, 4, 6, 50, 51 AND 52).
FIRST USE 5-0-2002; IN COMMERCE 5-0-2002.

2,626,693. JOHNSON & JOHNSON, NEW BRUNSWICK, NJ. SN 78-052,600. PUB. 10-2-2001, FILED 3-12-2001.

FOAM BLASTER

OWNER OF U.S. REG. NOS. 2,096,072 AND 2,096,090.
NO CLAIM IS MADE TO THE EXCLUSIVE RIGHT TO USE "FOAM", APART FROM THE MARK AS SHOWN.
FOR LIQUID SOAP, SKIN CLEANSERS AND BODY WASHES (U.S. CLS. 1, 4, 6, 50, 51 AND 52).
FIRST USE 1-30-2001; IN COMMERCE 1-30-2001.

CLASS 3—(Continued).

2,626,699. CASCO BAY GARDENS, LLC., SOUTH PORTLAND, ME. SN 78-053,715. PUB. 10-2-2001, FILED 3-18-2001.

LOBSTERMAN'S BALM

NO CLAIM IS MADE TO THE EXCLUSIVE RIGHT TO USE "BALM", APART FROM THE MARK AS SHOWN.
FOR NON-MEDICATED SKIN CARE PREPARATION (U.S. CLS. 1, 4, 6, 50, 51 AND 52).
FIRST USE 11-1-2000; IN COMMERCE 11-1-2000.

2,626,716. SARAMAR, L.L.C., CHICAGO, IL. SN 78-061,992. PUB. 9-11-2001, FILED 5-4-2001.

POWDER PEARLS

FOR CLEANING PREPARATIONS FOR TOILETS AND TOILET BOWLS (U.S. CLS. 1, 4, 6, 50, 51 AND 52).
FIRST USE 11-21-2001; IN COMMERCE 11-21-2001.

2,626,722. AVON PRODUCTS, INC., NEW YORK, NY. SN 78-063,118. PUB. 9-25-2001, FILED 5-11-2001.

FLEXI-SHIELD

OWNER OF U.S. REG. NOS. 1,695,172 AND 2,179,401.
FOR COSMETIC INGREDIENT COMPLEX USED AS A COMPONENT IN THE MANUFACTURE OF NAIL CARE PREPARATIONS (U.S. CLS. 1, 4, 6, 50, 51 AND 52).
FIRST USE 1-0-2002; IN COMMERCE 1-0-2002.

2,626,725. NOXELL CORPORATION, HUNT VALLEY, MD. SN 78-066,380. PUB. 9-18-2001, FILED 5-30-2001.

EYESLICKS

FOR COSMETICS, NAMELY, EYE COLOR PENCIL (U.S. CLS. 1, 4, 6, 50, 51 AND 52).
FIRST USE 1-14-2002; IN COMMERCE 1-14-2002.

2,626,730. OLAY COMPANY, INC., CINCINNATI, OH. SN 78-068,419. PUB. 10-23-2001, FILED 6-11-2001.

LOVE THE SKIN YOU'RE IN

FOR NON-MEDICATED SKIN CARE PREPARATIONS AND COSMETICS (U.S. CLS. 1, 4, 6, 50, 51 AND 52).
FIRST USE 2-11-2002; IN COMMERCE 2-11-2002.

CLASS 3—(Continued).

2,626,736. BEAUTIFUL IMAGE COSMETICS, LLC, COSTA MESA, CA. SN 78-071,322. PUB. 10-23-2001, FILED 6-27-2001.

E-MOIST

FOR COSMETICS AND LIPSTICK (U.S. CLS. 1, 4, 6, 50, 51 AND 52).
FIRST USE 11-2-2001; IN COMMERCE 11-2-2001.

CLASS 4—LUBRICANTS AND FUELS

2,625,409. TEXAS ALLIED CHEMICALS, INC., SAN ANTONIO, TX. SN 75-518,659. PUB. 12-28-1999, FILED 7-14-1998.

FIRE POWER

FOR FUELS, OILS AND LUBRICANTS FOR SMALL ENGINES USED IN TOY MODEL HOBBY CRAFTS (U.S. CLS. 1, 6 AND 15).
FIRST USE 9-17-2001; IN COMMERCE 9-17-2001.

2,625,443. HVL COS., LLC, SEATTLE, WA. SN 75-588,515. PUB. 9-14-1999, FILED 11-13-1998.

CERFLON

FOR ANTI-CORROSIVE, FLOW ENHANCING LUBRICANT COATING (U.S. CLS. 1, 6 AND 15).
FIRST USE 12-10-2001; IN COMMERCE 12-10-2001.

2,625,528. S.A.J. JEWELRY, INC., NORTH HOLLYWOOD, CA. SN 75-722,126. PUB. 1-2-2001, FILED 6-4-1999.

WILLOW CREEK

FOR ILLUMINANTS, NAMELY CANDLES (U.S. CLS. 1, 6 AND 15).
FIRST USE 8-30-1999; IN COMMERCE 2-28-2002.

CLASS 4—(Continued).

2,625,898. ATICO INTERNATIONAL USA INC., FORT LAUDERDALE, FL. SN 75-982,417. PUB. 12-18-2001, FILED 6-1-2001.

AMORÉ & MORE

THE MARK IS PRESENTED WITHOUT ANY CLAIM AS TO SPECIAL FORM.

THE ENGLISH TRANSLATION OF THE WORD "AMORE" IN THE MARK IS "LOVE".

FOR CANDLES (U.S. CLS. 1, 6 AND 15).

FIRST USE 7-12-2001; IN COMMERCE 10-3-2001.

2,626,394. DURAFLAME, INC., STOCKTON, CA. SN 76-215,074. PUB. 8-28-2001, FILED 2-22-2001.

OPEN AIR

FOR ARTIFICIAL FIRE LOGS (U.S. CLS. 1, 6 AND 15).
FIRST USE 11-0-2001; IN COMMERCE 11-0-2001.

2,626,741. PENTA, NICHOLAS, MOORPARK, CA. SN 78-074,703. PUB. 10-30-2001, FILED 7-19-2001.

POWER MATRIX

FOR MOTOR OIL (U.S. CLS. 1, 6 AND 15).
FIRST USE 9-1-2001; IN COMMERCE 9-1-2001.

2,626,743. SUMMIT VIEWS, LLC, LOS GATOS, CA. SN 78-076,937. PUB. 12-4-2001, FILED 8-1-2001.

GOODWOOD

FOR FIREWOOD, MANUFACTURED FIRE LOGS, PACKAGES AND BUNDLES OF FIREWOOD AND MANUFACTURED FIRE LOGS (U.S. CLS. 1, 6 AND 15).
FIRST USE 1-7-2002; IN COMMERCE 4-2-2002.

CLASS 5—PHARMACEUTICALS**CLASS 5—(Continued).**

2,625,333. AMYLIN PHARMACEUTICALS, INC. SAN DIEGO, CA. SN 75-285,004. PUB. 9-5-2000, FILED 5-1-1997.

SYMLIN

FOR PHARMACEUTICAL PREPARATIONS CONTAINING AS AN ACTIVE INGREDIENT AN AMYLIN AGONIST COMPOUND, NAMELY, PRAMLINTIDE FOR THE TREATMENT OF FUEL METABOLISM DISORDERS INCLUDING DIABETES AND OBESITY, OSTROPENIA, PAIN, GASTRITIS, PANCREATITIS, AND GASTRIC MOTILITY DISORDERS (U.S. CLS. 6, 18, 44, 46, 51 AND 52).

FIRST USE 11-20-2000; IN COMMERCE 11-20-2000.

2,625,334. AMYLIN PHARMACEUTICALS, INC., SAN DIEGO, CA, BY ASSIGNMENT LIFESCAN, INC., MILPITAS, CA. AND AMYLIN PHARMACEUTICALS, INC., SAN DIEGO, CA. SN 75-285,005. PUB. 7-20-1999, FILED 5-1-1997.

SYMLIN

FOR PHARMACEUTICAL PREPARATIONS USEFUL IN THE TREATMENT OF METABOLIC DISORDERS (U.S. CLS. 6, 18, 44, 46, 51 AND 52).

FIRST USE 11-20-2000; IN COMMERCE 11-20-2000.

2,625,430. ASTRAZENECA AB, 151 85 SODERTALJE, SWEDEN, BY CHANGE OF NAME ASTRA AKTIEBOLAG, S-151 85 SODERTALJE, SWEDEN. SN 75-562,790. PUB. 9-28-1999, FILED 10-1-1998.



OWNER OF U.S. REG. NO. 2,160,791.
FOR PHARMACEUTICAL PREPARATIONS FOR THE TREATMENT OF CARDIOVASCULAR DISEASES (U.S. CLS. 6, 18, 44, 46, 51 AND 52).
FIRST USE 9-30-1998; IN COMMERCE 9-30-1998.

CLASS 5—(Continued).

2,625,449. NEOSE TECHNOLOGIES, INC., HORSHAM, PA. SN 75-599,208. PUB. 11-14-2000, FILED 12-3-1998.

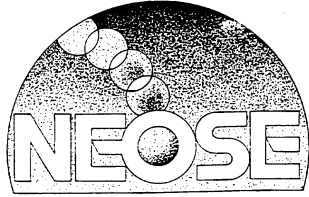

THE STIPPLING SHOWN IN THE DRAWING IS FOR SHADING PURPOSES ONLY.

FOR ANTIBIOTICS, NAMELY, ANTI-PNEUMONIA COMPOUNDS, ANTI-ULCER COMPOUNDS, COMPOUNDS FOR THE TREATMENT OF PNEUMONIA AND ULCERS; NUTRITIONAL SUPPLEMENTS USED FOR NUTRITION; NUTRITIONAL OR DIETARY ADDITIVES FOR INFANT FORMULAS; AND NUTRITIONAL SUPPLEMENTS FOR ADULT USE (U.S. CLS. 6, 18, 44, 46, 51 AND 52).

FIRST USE 7-0-1997; IN COMMERCE 7-0-1997.

2,625,464. DEY LP, NAPA, CA. SN 75-615,398. PUB. 7-27-1999, FILED 1-4-1999.

DUONEB

FOR PHARMACEUTICAL PRODUCTS, NAMELY PREPARATIONS AND FORMULATIONS FOR THE TREATMENT OF RESPIRATORY DISORDERS (U.S. CLS. 6, 18, 44, 46, 51 AND 52).

FIRST USE 8-0-1998; IN COMMERCE 6-0-2001.

2,625,522. AIM INTERNATIONAL, INC., NAMPA, ID. SN 75-715,649. PUB. 1-25-2000, FILED 5-28-1999.

AIM REVITAFEM

OWNER OF U.S. REG. NOS. 1,706,191 AND 2,241,386. FOR A DIETARY SUPPLEMENT; NAMELY A WOMEN'S FORMULA CONTAINING NATURAL HERBS AND BOTANICALS (U.S. CLS. 6, 18, 44, 46, 51 AND 52).

FIRST USE 7-1-1999; IN COMMERCE 7-1-1999.

2,625,524. EXTREME ATHLETIC CORP, SUGAR LAND, TX. SN 75-720,100. PUB. 12-28-1999, FILED 6-25-1999.

PRO STOCK

FOR NUTRITIONAL SUPPLEMENTS; NAMELY, SOLID AND POWDERED FOOD SUPPLEMENTS CONSISTING OF PROTEINS, AMINO ACIDS, CARBOHYDRATES, FATS, VITAMINS AND MINERALS, ANTIOXIDANTS AND HERBS (U.S. CLS. 6, 18, 44, 46, 51 AND 52).

FIRST USE 2-12-2000; IN COMMERCE 3-29-2000.

CLASS 5—(Continued).

2,625,534. JOINT JUICE, INC., SAN FRANCISCO, CA. SN 75-727,560. PUB. 5-8-2001, FILED 6-14-1999.

JOINT JUICE

FOR FOOD SUPPLEMENTS, FOR JOINT FUNCTION ENHANCEMENT (U.S. CLS. 6, 18, 44, 46, 51 AND 52). FIRST USE 11-0-1999; IN COMMERCE 11-0-1999.

2,625,597. COLLAGENEX PHARMACEUTICALS, INC., NEWTOWN, PA. SN 75-778,965. PUB. 4-18-2000, FILED 8-19-1999.

PS 20

FOR MEDICINAL PREPARATION CONTAINING A TETRACYCLINE, FOR TREATING PERIODONTAL DISEASE (U.S. CLS. 6, 18, 44, 46, 51 AND 52). FIRST USE 7-2-2001; IN COMMERCE 7-2-2001.

2,625,613. BIO-BOTANICA, INC., HAUPPAUGE, NY. SN 75-799,749. PUB. 12-11-2001, FILED 9-15-1999.

DRÖGENHAUS

THE ENGLISH TRANSLATION OF "DROGENHAUS" IS "DRUGHOUSE".

FOR BOTANICAL ESSENCES AND EXTRACTS FOR USE AS FOOD AND DIETARY SUPPLEMENTS (U.S. CLS. 6, 18, 44, 46, 51 AND 52).

FIRST USE 8-26-1999; IN COMMERCE 8-26-1999.

2,625,621. ZILA, INC., PHOENIX, AZ. SN 75-804,877. PUB. 7-25-2000, FILED 9-21-1999.

TSRW

FOR PHARMACEUTICAL PREPARATIONS, NAMELY, GEL AND LIQUID PREPARATIONS FOR TREATMENT OF ORAL LESIONS AND ORAL TRAUMA, ORAL ANTISEPTICS, TOOTHACHE REMEDIES, TOPICAL REAGENTS AND RINSE COMPOSITIONS FOR PROTECTION OF EPITHELIAL CANCER (U.S. CLS. 6, 18, 44, 46, 51 AND 52).

FIRST USE 10-9-1999; IN COMMERCE 10-9-1999.

CLASS 5—(Continued).

2,625,765. AMERIFIT, INC., BLOOMFIELD, CT. SN 75-896,013. PUB. 10-30-2001, FILED 1-13-2000.

FLEX ABLE

FOR DIETARY AND NUTRITIONAL SUPPLEMENTS (U.S. CLS. 6, 18, 44, 46, 51 AND 52).
FIRST USE 5-29-2001; IN COMMERCE 5-29-2001.

2,625,812. NATROL, INC., CHATSWORTH, CA. SN 75-913,531. PUB. 3-27-2001, FILED 2-9-2000.



NO CLAIM IS MADE TO THE EXCLUSIVE RIGHT TO USE "PURE INGREDIENTS", APART FROM THE MARK AS SHOWN.

FOR FULL LINE OF DIETARY SUPPLEMENTS (U.S. CLS. 6, 18, 44, 46, 51 AND 52).
FIRST USE 1-0-2001; IN COMMERCE 1-0-2001.

2,625,832. BRAINTREE LABORATORIES, INC., BRAINTREE, MA. SN 75-923,987. PUB. 12-5-2000, FILED 2-22-2000.

SIGPREP

FOR PHARMACEUTICAL PREPARATIONS FOR THE TREATMENT AND DIAGNOSIS OF GASTROINTESTINAL DISORDERS (U.S. CLS. 6, 18, 44, 46, 51 AND 52).
FIRST USE 10-18-2001; IN COMMERCE 10-18-2001.

2,625,894. ZYCOS INC., CAMBRIDGE, MA. SN 75-982,345. PUB. 12-28-1999, FILED 6-9-1999.

ZYCOS

FOR POLYMER-BASED DRUG DELIVERY SYSTEM CONSISTING OF A POLYMER MATRIX USED TO MICROENCAPSULATE PHARMACEUTICAL PREPARATIONS; PHARMACEUTICAL PREPARATIONS FOR USE IN THE TREATMENT OF CANCER, AND CHRONIC VIRAL INFECTIONS (U.S. CLS. 6, 18, 44, 46, 51 AND 52).
FIRST USE 1-22-2002; IN COMMERCE 1-22-2002.

CLASS 5—(Continued).

2,625,928. SCHERING CORPORATION, KENILWORTH, NJ. SN 76-019,001. PUB. 2-20-2001, FILED 4-5-2000.

EZETROL

FOR PHARMACEUTICAL PREPARATION, NAMELY, A CHOLESTEROL ABSORPTION INHIBITOR (U.S. CLS. 6, 18, 44, 46, 51 AND 52).
FIRST USE 9-4-2001; IN COMMERCE 9-4-2001.

2,625,931. BLUE RIDGE PHARMACEUTICALS, INC., GREENSBORO, NC. SN 76-020,276. PUB. 1-30-2001, FILED 4-7-2000.

ACAREXX

FOR PHARMACEUTICAL PREPARATIONS USED TO CONTROL EAR MITES IN DOMESTICATED ANIMALS (U.S. CLS. 6, 18, 44, 46, 51 AND 52).
FIRST USE 12-12-2000; IN COMMERCE 12-12-2000.

2,625,947. XTREME PERFORMANCE, LLC, LITTLETON, CO. SN 76-029,316. PUB. 12-4-2001, FILED 4-19-2000.



THE MARK CONSISTS OF IN PART, OF THE LETTERS "XP" IN STYLIZED FORM.

FOR DIETARY SUPPLEMENTS INTENDED TO AID ATHLETES IN MUSCLE MASS GAIN AND MUSCLE STRENGTH GAIN (U.S. CLS. 6, 18, 44, 46, 51 AND 52).
FIRST USE 4-0-1996; IN COMMERCE 5-0-2002.

2,626,012. INTRABIOTICS PHARMACEUTICALS, INC., MOUNTAIN VIEW, CA. SN 76-058,126. PUB. 4-10-2001, FILED 5-26-2000.

INTRABIOTICS

FOR PHARMACEUTICAL PREPARATIONS FOR THE TREATMENT AND PREVENTION OF INFECTIOUS CONDITIONS (U.S. CLS. 6, 18, 44, 46, 51 AND 52).
FIRST USE 3-27-2002; IN COMMERCE 3-27-2002.

CLASS 5—(Continued).

2,626,058. MEDTOX DIAGNOSTICS, INC., BURLINGTON, NC. SN 76-082,238. PUB. 9-25-2001, FILED 7-3-2000.

LATFLO

FOR DIAGNOSTIC REAGENTS IN THE FORM OF TESTING STRIPS FOR CLINICAL AND MEDICAL USE (U.S. CLS. 6, 18, 44, 46, 51 AND 52).
FIRST USE 10-9-2001; IN COMMERCE 10-9-2001.

2,626,059. BEIERSDORF AKTIENGESELLSCHAFT, 20245 HAMBURG, FED REP GERMANY. SN 76-083,072. PUB. 11-20-2001, FILED 7-5-2000.

CURAD WOUND WIPES

OWNER OF U.S. REG. NOS. 538,723, 598,634, AND OTHERS.
NO CLAIM IS MADE TO THE EXCLUSIVE RIGHT TO USE "WOUND WIPES", APART FROM THE MARK AS SHOWN.

FOR NON-WOVEN ANTIBACTERIAL WIPES FOR CLEANING EVERYDAY CUTS, SCRAPES AND BURNS (U.S. CLS. 6, 18, 44, 46, 51 AND 52).
FIRST USE 1-1-2002; IN COMMERCE 1-1-2002.

2,626,067. PROLAB NUTRITION, INC., BLOOMFIELD, CT. SN 76-087,064. PUB. 4-10-2001, FILED 7-11-2000.

METABONUTRIENT

FOR DIETARY SUPPLEMENTS (U.S. CLS. 6, 18, 44, 46, 51 AND 52).
FIRST USE 8-8-2000; IN COMMERCE 6-21-2001.

2,626,071. CHIRON BEHRING GMBH & CO., D-35006 MARBURG, FED REP GERMANY. SN 76-088,186. PUB. 5-15-2001, FILED 7-14-2000.

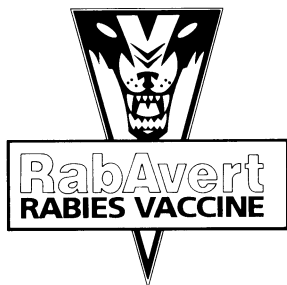

OWNER OF U.S. REG. NO. 2,200,256.
NO CLAIM IS MADE TO THE EXCLUSIVE RIGHT TO USE "RABIES VACCINE", APART FROM THE MARK AS SHOWN.
FOR RABIES VACCINE (U.S. CLS. 6, 18, 44, 46, 51 AND 52).
FIRST USE 4-0-1998; IN COMMERCE 4-0-1998.

CLASS 5—(Continued).

2,626,157. NATROL, INC., CHATSWORTH, CA. SN 76-126,448. PUB. 6-26-2001, FILED 9-11-2000.

CALCI DELITE

FOR DIETARY SUPPLEMENTS (U.S. CLS. 6, 18, 44, 46, 51 AND 52).
FIRST USE 1-19-2001; IN COMMERCE 1-19-2001.

2,626,167. GREAT AMERICAN PRODUCTS, INC., DESTIN, FL. SN 76-130,056. PUB. 6-26-2001, FILED 9-18-2000.

CALABSORB

FOR NUTRITIONAL DIETARY SUPPLEMENT (U.S. CLS. 6, 18, 44, 46, 51 AND 52).
FIRST USE 6-23-2000; IN COMMERCE 6-23-2000.

2,626,173. RAFFELOCK, STEPHANIE, BOULDER, CO. SN 76-132,258. PUB. 7-31-2001, FILED 9-20-2000.

AFTER BABY BOOST

FOR NON-PRESCRIPTION NUTRITIONAL AND DIETARY SUPPLEMENTS (U.S. CLS. 6, 18, 44, 46, 51 AND 52).
FIRST USE 5-15-2002; IN COMMERCE 6-1-2002.

2,626,176. GOLDEN PRIDE, INC., WEST PALM BEACH, FL. SN 76-134,139. PUB. 7-3-2001, FILED 9-25-2000.

FLEXTIME

FOR DIETARY SUPPLEMENTS (U.S. CLS. 6, 18, 44, 46, 51 AND 52).
FIRST USE 9-15-2001; IN COMMERCE 9-15-2001.

2,626,190. NUTRITION 21, PURCHASE, NY. SN 76-140,256. PUB. 7-31-2001, FILED 10-4-2000.

SELENOPURE

FOR DIETARY SUPPLEMENTS CONTAINING SELENIUM FOR HUMAN AND ANIMAL USE (U.S. CLS. 6, 18, 44, 46, 51 AND 52).
FIRST USE 1-22-2001; IN COMMERCE 1-22-2001.

CLASS 5—(Continued).

2,626,201. COSMEDENT, INC., CHICAGO, IL. SN 76-143,110.
PUB. 7-10-2001, FILED 10-6-2000.

SUPERBRITE

FOR DENTAL COMPOSITE RESINS FOR RESTORING
TEETH (U.S. CLS. 6, 18, 44, 46, 51 AND 52).
FIRST USE 11-1-2000; IN COMMERCE 11-1-2000.

2,626,274. EGERT, MARTIN, KEWANEE, IL. AND EGERT,
MICHELLE, KEWANEE, IL. SN 76-169,294. PUB. 8-28-2001,
FILED 11-21-2000.

SMOKE ARREST

FOR DIETARY SUPPLEMENTS, NAMELY, NON-PRE-
SCRIPTION HERBS FORMULATED TO LESSEN NICOTINE
CRAVING AND ASSIST IN CESSATION OF THE
SMOKING HABIT (U.S. CLS. 6, 18, 44, 46, 51 AND 52).
FIRST USE 1-31-2002; IN COMMERCE 1-31-2002.

2,626,298. PASCAL COMPANY, INC., BELLEVUE, WA. SN
76-178,785. PUB. 11-13-2001, FILED 12-11-2000.

CHLORHEXIGARD

FOR DENTAL RINSE, NAMELY, PERIODONTAL
DISEASE TREATMENT SOLUTION (U.S. CLS. 6, 18, 44,
46, 51 AND 52).
FIRST USE 12-6-2001; IN COMMERCE 12-6-2001.

2,626,340. MEDUSA GROUP INC., FORT LAUDERDALE,
FL. SN 76-196,546. PUB. 8-21-2001, FILED 1-16-2001.

**OXIFRESH ODOR
ELIMINATOR**

NO CLAIM IS MADE TO THE EXCLUSIVE RIGHT TO
USE "ODOR ELIMINATOR", APART FROM THE MARK AS
SHOWN.
FOR AIR DEODORANT (U.S. CLS. 6, 18, 44, 46, 51 AND
52).
FIRST USE 1-1-2000; IN COMMERCE 3-28-2000.

CLASS 5—(Continued).

2,626,347. NICHINO AMERICA, INC., WILMINGTON, DE,
BY CHANGE OF NAME NIHON NOHYAKU AMERICA,
INC., WILMINGTON, DE. SN 76-200,308. PUB. 8-21-2001,
FILED 1-26-2001.

MONCOAT MZ

OWNER OF U.S. REG. NO. 1,389,578.
FOR ACARICIDES, MITICIDES, FUNGICIDES, IN-
SECTICIDES AND HERBICIDES FOR AGRICULTURAL
AND DOMESTIC (U.S. CLS. 6, 18, 44, 46, 51 AND 52).
FIRST USE 3-20-2001; IN COMMERCE 3-20-2001.

2,626,354. ONE WORLD NETWORKS INTEGRATED TECH-
NOLOGIES, INC., LOS ANGELES, CA. SN 76-205,335. PUB.
8-7-2001, FILED 2-5-2001.

VITATHERM

FOR NUTRITION SUPPLEMENTS; DIETARY SUPPLE-
MENTS; VITAMIN SUPPLEMENTS (U.S. CLS. 6, 18, 44,
46, 51 AND 52).
FIRST USE 2-20-2001; IN COMMERCE 2-20-2001.

2,626,399. NUTRITION NOW, INC., VANCOUVER, WA. SN
76-216,456. PUB. 9-4-2001, FILED 2-26-2001.

CALCI-BEARS

FOR VITAMINS AND NUTRITIONAL DIETARY SUP-
PLEMENTS (U.S. CLS. 6, 18, 44, 46, 51 AND 52).
FIRST USE 4-10-2001; IN COMMERCE 4-10-2001.

2,626,411. INNOFEED LIMITED, TORONTO, ONTARIO,
CANADA. SN 76-219,220. PUB. 9-11-2001, FILED 3-5-2001.

INNOFEED

FOR ANIMAL FEED ADDITIVES USED FOR ANIMAL
NUTRITION (U.S. CLS. 6, 18, 44, 46, 51 AND 52).
FIRST USE 6-1-2001; IN COMMERCE 6-1-2001.

CLASS 5—(Continued).

2,626,455. ROHTO PHARMACEUTICAL CO., LTD., OSAKA, JAPAN. SN 76-235,711. PUB. 9-4-2001, FILED 4-4-2001.



FOR PHARMACEUTICAL PREPARATIONS FOR OPHTHALMIC USE; PHARMACEUTICAL PREPARATIONS FOR THE TREATMENT AND CARE OF THE EYES; EYE DROPS; EYE WASHES; VITAMIN PREPARATIONS FOR USE AS NUTRITIONAL AIDS FOR EYE-SIGHT (U.S. CLS. 6, 18, 44, 46, 51 AND 52).
FIRST USE 9-19-2001; IN COMMERCE 12-13-2001.

2,626,477. FITNESS LABS NUTRITION CORPORATION, TORRANCE, CA. SN 76-248,235. PUB. 9-11-2001, FILED 4-20-2001.

BURN-A-CAL

FOR DIETARY SUPPLEMENT FOR NUTRITIONAL PURPOSES AND TO AID IN WEIGHT MANAGEMENT (U.S. CLS. 6, 18, 44, 46, 51 AND 52).
FIRST USE 7-2-2001; IN COMMERCE 7-3-2001.

2,626,482. NATURE'S HEALTH CONNECTION, INC., CAMP-TON, KY. SN 76-250,411. PUB. 9-18-2001, FILED 5-1-2001.

AUSTRALIAN DREAM

FOR PAIN RELIEF MEDICATION, NAMELY, FOR THE TREATMENT OF ARTHRITIS (U.S. CLS. 6, 18, 44, 46, 51 AND 52).
FIRST USE 12-0-2001; IN COMMERCE 12-0-2001.

2,626,545. HEALTH TECH, INTERNATIONAL, ST. GEORGE, UT. SN 76-300,102. PUB. 11-13-2001, FILED 8-16-2001.

BIO-MINERALYTE

FOR MINERAL SUPPLEMENTS FOR HUMAN INGESTION, NAMELY SUPPLEMENTS THAT PROVIDE AN ORGANIC MINERAL SOURCE (U.S. CLS. 6, 18, 44, 46, 51 AND 52).
FIRST USE 9-7-2001; IN COMMERCE 9-7-2001.

CLASS 5—(Continued).

2,626,552. BASF CORPORATION, MOUNT OLIVE, NJ. SN 76-306,579. PUB. 12-11-2001, FILED 8-29-2001.

ONESTEP

FOR HERBICIDES, FUNGICIDES, PESTICIDES, INSECTICIDES, ALL FOR AGRICULTURAL USE (U.S. CLS. 6, 18, 44, 46, 51 AND 52).
FIRST USE 5-10-2002; IN COMMERCE 5-10-2002.

2,626,564. GIBBONS, THERESA, MINNEAPOLIS, MN. SN 78-007,246. PUB. 3-13-2001, FILED 5-8-2000.

ALORA

FOR AIR FRESHENERS (U.S. CLS. 6, 18, 44, 46, 51 AND 52).
FIRST USE 10-0-2000; IN COMMERCE 11-13-2000.

2,626,568. PROCTER & GAMBLE COMPANY, THE, CINCINNATI, OH. SN 78-008,201. PUB. 8-21-2001, FILED 5-15-2000.

ELATIONS

FOR DIETARY SUPPLEMENT; VITAMINS (U.S. CLS. 6, 18, 44, 46, 51 AND 52).
FIRST USE 1-11-2001; IN COMMERCE 1-11-2001.

2,626,582. DERMAL RESEARCH LABORATORIES, INC., KANSAS CITY, MO. SN 78-015,343. PUB. 9-25-2001, FILED 7-3-2000.

GENECEUTICS

THE WORDING "GENECEUTICS" HAS NO MEANING OTHER THAN TRADEMARK SIGNIFICANCE.
FOR MEDICAMENTS TO RELIEVE SYMPTOMS OF DISEASES ASSOCIATED WITH INFLAMMATION, AUTOIMMUNITY AND GENETICALLY CONTROLLED CONDITIONS (U.S. CLS. 6, 18, 44, 46, 51 AND 52).
FIRST USE 8-15-2000; IN COMMERCE 8-15-2000.

2,626,583. DERMAL RESEARCH LABORATORIES, INC., KANSAS CITY, MO. SN 78-015,344. PUB. 9-25-2001, FILED 7-3-2000.

AZTEC RUB

NO CLAIM IS MADE TO THE EXCLUSIVE RIGHT TO USE "RUB", APART FROM THE MARK AS SHOWN.
FOR TOPICAL MEDICAMENT FOR USE IN HUMAN AND VETERINARY APPLICATIONS (U.S. CLS. 6, 18, 44, 46, 51 AND 52).
FIRST USE 4-15-2000; IN COMMERCE 4-15-2000.

CLASS 5—(Continued).

2,626,611. GENETIC SERVICES MANAGEMENT, INC., OMAHA, NE. SN 78-029,986. PUB. 7-3-2001, FILED 10-10-2000.

FORMULA #18

NO CLAIM IS MADE TO THE EXCLUSIVE RIGHT TO USE "FORMULA", APART FROM THE MARK AS SHOWN. FOR NUTRITIONAL SUPPLEMENTS, VITAMIN AND MINERAL SUPPLEMENTS, AND HERBAL SUPPLEMENTS, ALL FOR CANCER PREVENTION AND CANCER RISK REDUCTION (U.S. CLS. 6, 18, 44, 46, 51 AND 52).

FIRST USE 9-1-1999; IN COMMERCE 6-27-2001.

2,626,641. ARKOPHARMA S.A., CARROS, FRANCE. SN 78-040,280. PUB. 9-18-2001, FILED 12-21-2000.

X-ZIT

FOR TOPICAL SKIN PREPARATION TO PREVENT ACNE (U.S. CLS. 6, 18, 44, 46, 51 AND 52).

FIRST USE 11-1-2001; IN COMMERCE 11-1-2001.

2,626,687. DELANO COMPANY, INC., GROVER BEACH, CA. SN 78-051,174. PUB. 1-29-2002, FILED 3-2-2001.

PLATFORM MULTI-NUTRIENT FORMULA

NO CLAIM IS MADE TO THE EXCLUSIVE RIGHT TO USE "MULTI-NUTRIENT FORMULA", APART FROM THE MARK AS SHOWN.

FOR MULTI-NUTRIENT FORMULA CONTAINING OVER 100 COMPONENTS (U.S. CLS. 6, 18, 44, 46, 51 AND 52).

FIRST USE 1-1-2002; IN COMMERCE 1-1-2002.

2,626,707. TRISTAR ONLINE SALES CORPORATION, LAS VEGAS, NV. SN 78-057,593. PUB. 10-2-2001, FILED 4-10-2001.

SUBTLE ENERGY

NO CLAIM IS MADE TO THE EXCLUSIVE RIGHT TO USE "ENERGY", APART FROM THE MARK AS SHOWN.

FOR DIETARY SUPPLEMENTS (U.S. CLS. 6, 18, 44, 46, 51 AND 52).

FIRST USE 9-1-2001; IN COMMERCE 9-1-2001.

CLASS 5—(Continued).

2,626,737. JENERIC/PENTRON, INCORPORATED, WALLINGFORD, CT. SN 78-071,736. PUB. 10-30-2001, FILED 6-29-2001.

AVANTE

FOR DENTAL MATERIALS; NAMELY, DENTAL PORCELAIN AND PORCELAIN LIQUIDS (U.S. CLS. 6, 18, 44, 46, 51 AND 52).

FIRST USE 1-17-2002; IN COMMERCE 1-17-2002.

2,626,749. PROTHERA, INC., PLEASANTON, CA. SN 78-081,537. PUB. 12-4-2001, FILED 8-28-2001.



FOR NUTRITIONAL SUPPLEMENTS (U.S. CLS. 6, 18, 44, 46, 51 AND 52).

FIRST USE 9-5-2001; IN COMMERCE 9-5-2001.

CLASS 6—METAL GOODS

2,625,375. PHOENIX ENVIRONMENTAL LTD., PALM DESERT, CA. SN 75-434,104. PUB. 2-23-1999, FILED 2-13-1998.

MAGPEL

FOR METALLIC MINERAL GOODS, NAMELY, SYNTHETIC MAGNETITE IN BULK, GRANULAR, FLAKE, AND SPHERICAL FORM, PRODUCED THROUGH A PYRO-METALLURGICAL PROCESS (U.S. CLS. 2, 12, 13, 14, 23, 25 AND 50).

FIRST USE 8-0-1999; IN COMMERCE 8-0-1999.

2,625,487. ARTHUR P. STEELE, L.L.C., PLYMOUTH, MN. SN 75-658,427. PUB. 4-25-2000, FILED 3-11-1999.

HOUSE KEY

NO CLAIM IS MADE TO THE EXCLUSIVE RIGHT TO USE "KEY", APART FROM THE MARK AS SHOWN.

FOR METAL PADLOCKS (U.S. CLS. 2, 12, 13, 14, 23, 25 AND 50).

FIRST USE 2-1-1999; IN COMMERCE 2-1-1999.

CLASS 6—(Continued).

2,625,510. WELBILT CORPORATION, STAMFORD, CT. SN 75-698,679. PUB. 3-27-2001, FILED 5-4-1999.

NICKELGUARD

FOR NICKEL PLATE COATING SOLD AS AN INTEGRAL COMPONENT OF COMMERCIAL FOOD SERVICE GAS AND ELECTRIC BOILERS (U.S. CLS. 2, 12, 13, 14, 23, 25 AND 50).

FIRST USE 12-6-1999; IN COMMERCE 12-6-1999.



2,625,839. HEXAGON INDUSTRIES, INC., CLEVELAND, OH. SN 75-927,087. PUB. 9-11-2001, FILED 2-23-2000.

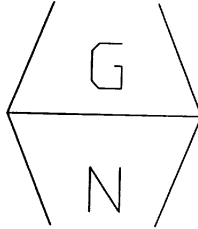

THE MARK CONSISTS OF THE LETTERS "G AND "N" WITHIN A STYLIZED LETTER "H".

FOR METAL FASTENERS, NAMELY BOLTS, SCREWS, RIVETS AND PINS (U.S. CLS. 2, 12, 13, 14, 23, 25 AND 50).

FIRST USE 12-0-1999; IN COMMERCE 12-0-1999.



2,625,866. AKZO NOBEL CHEMICALS INC., CHICAGO, IL. SN 75-940,905. PUB. 12-12-2000, FILED 3-10-2000.

PYROSAFE

FOR METAL SHIPPING CONTAINERS FOR CHEMICALS (U.S. CLS. 2, 12, 13, 14, 23, 25 AND 50).

FIRST USE 7-0-1979; IN COMMERCE 7-0-1979.



2,625,937. STAR SALES & DISTRIBUTING CORP., WOBURN, MA. SN 76-025,893. PUB. 1-30-2001, FILED 4-17-2000.

POSI-FIT

OWNER OF U.S. REG. NOS. 1,833,101 AND 1,854,132. FOR NAILS (U.S. CLS. 2, 12, 13, 14, 23, 25 AND 50).

FIRST USE 4-1-2002; IN COMMERCE 4-1-2002.

CLASS 6—(Continued).

2,626,318. ODL, INCORPORATED, ZEELAND, MI. SN 76-188,973. PUB. 10-23-2001, FILED 12-26-2000.

SLAM-PROOF

FOR RECOIL SYSTEM FOR RETRACTABLE SCREEN DOORS, CONSTRUCTED PRIMARILY OF METAL (U.S. CLS. 2, 12, 13, 14, 23, 25 AND 50).

FIRST USE 2-0-2001; IN COMMERCE 2-0-2001.



2,626,392. CENTRAL STEEL AND WIRE COMPANY, CHICAGO, IL. SN 76-214,950. PUB. 11-27-2001, FILED 2-23-2001.

CLEANFORM

FOR STEEL IN SHEET AND PLATE FORM (U.S. CLS. 2, 12, 13, 14, 23, 25 AND 50).

FIRST USE 4-26-2001; IN COMMERCE 4-26-2001.



2,626,410. UNITED STEEL ENTERPRISES, INC., DBA UNITED STEEL PRODUCTS COMPANY, EAST STROUDSBURG, PA. SN 76-218,718. PUB. 8-28-2001, FILED 3-5-2001.

STRUCTUROLL

FOR METAL STORAGE RACKS AND BINS (U.S. CLS. 2, 12, 13, 14, 23, 25 AND 50).

FIRST USE 2-22-1983; IN COMMERCE 2-22-1983.



2,626,412. TAI CHEER INDUSTRIAL CO., LTD., YUN LIN HSIEN, TAIWAN. SN 76-219,370. PUB. 9-18-2001, FILED 3-5-2001.



FOR METAL PRECISION DRAWER SLIDES AND PARTS THEREFOR (U.S. CLS. 2, 12, 13, 14, 23, 25 AND 50).

FIRST USE 1-20-2002; IN COMMERCE 1-20-2002.

CLASS 6—(Continued).

2,626,656. ARI-ARMATUREN ALBERT RICHTER GMBH & CO. KG, SCHLOB HOLTE-STUKENBROCK, FED REP GERMANY. SN 78-042,601. PUB. 8-28-2001, FILED 1-10-2001.

CONA

FOR CONDENSATION TRAPS OF METAL (U.S. CLS. 2, 12, 13, 14, 23, 25 AND 50).
FIRST USE 6-0-2001; IN COMMERCE 6-0-2001.

2,626,717. MARSON CREATIVE FASTENER, INC., DBA MARSON CORPORATION, STOUGHTON, MA. SN 78-062,091. PUB. 9-25-2001, FILED 5-4-2001.



FOR METALLIC FASTENERS, NAMELY, RIVETS (U.S. CLS. 2, 12, 13, 14, 23, 25 AND 50).
FIRST USE 10-0-2001; IN COMMERCE 10-0-2001.

CLASS 7—MACHINERY

2,625,349. E. I. DU PONT DE NEMOURS AND COMPANY, WILMINGTON, DE. SN 75-337,645. PUB. 8-11-1998, FILED 8-7-1997.

WATERPROOF

OWNER OF U.S. REG. NOS. 1,686,976, 1,726,627, AND 1,759,635.
FOR COATING MACHINE FOR APPLYING BLENDED INKS TO FILM FOR THE PRODUCTION OF COLOR PROOFS IN THE GRAPHIC ARTS INDUSTRY (U.S. CLS. 13, 19, 21, 23, 31, 34 AND 35).
FIRST USE 1-14-1999; IN COMMERCE 1-14-1999.

2,625,360. SHAW MILLWORK, INC., RIDGEFIELD, CT. SN 75-391,173. PUB. 9-21-1999, FILED 11-17-1997.

COPEMASTER

FOR POWER-OPERATED WOODWORKING TOOL THAT COPE THE ENDS OF BOARDS OR MOLDINGS (U.S. CLS. 13, 19, 21, 23, 31, 34 AND 35).
FIRST USE 4-30-2002; IN COMMERCE 4-30-2002.

CLASS 7—(Continued).

2,625,384. EMERSON ELECTRIC CO., ST. LOUIS, MO. SN 75-444,952. PUB. 9-7-1999, FILED 3-5-1998.

MODMAX

FOR ELECTRICAL MOTORS FOR MACHINES AND PARTS THEREFOR (U.S. CLS. 13, 19, 21, 23, 31, 34 AND 35).
FIRST USE 6-1-2001; IN COMMERCE 6-1-2001.

2,625,431. BISHOP, JEFFREY, EASTON, CT. SN 75-564,919. PUB. 7-24-2001, FILED 10-6-1998.

GFE

FOR PUMPS USED WITH MACHINES FOR PUMPING LIQUIDS AND LIQUID COMPOSITIONS, ELECTRIC GENERATORS AND AIR COMPRESSORS FOR NON-VEHICULAR COMPONENT PURPOSES, PUMPS FOR PUMPING WATER AND WATER WITH SOLIDS, NAMELY SUBMERSIBLE SEWAGE PUMPS, SUBMERSIBLE GRINDER PUMPS, CELLAR DRAINAGE PUMPS, SURFACE WATER DRAINAGE PUMPS, WELL WATER PUMPS, DOMESTIC WATER PUMPS, GARDEN PUMPS, NAMELY IRRIGATION WATER PUMPS (U.S. CLS. 13, 19, 21, 23, 31, 34 AND 35).
FIRST USE 9-28-1998; IN COMMERCE 5-15-1999.

2,625,472. PETSMART STORE SUPPORT GROUP, INC., PHOENIX, AZ. BY ASSIGNMENT PETSMART, INC., PHOENIX, AZ. SN 75-631,836. PUB. 9-21-1999, FILED 2-1-1999.

PROQUATICS

OWNER OF U.S. REG. NO. 2,242,917.
FOR AQUARIUM PUMPS (U.S. CLS. 13, 19, 21, 23, 31, 34 AND 35).
FIRST USE 9-1-2001; IN COMMERCE 9-1-2001.

2,625,476. WELKER BEARING COMPANY, TROY, MI. SN 75-639,138. PUB. 7-25-2000, FILED 2-9-1999.

SYNCHRO-LIFT

FOR HYDRAULIC CYLINDERS AND HYDRAULIC MOTORS FOR LIFTING, LOWERING, MOVING AND ADJUSTING WORKPIECES BEING MANUFACTURED IN AN INDUSTRIAL MANUFACTURING PROCESS (U.S. CLS. 13, 19, 21, 23, 31, 34 AND 35).
FIRST USE 10-0-1999; IN COMMERCE 3-29-2001.

CLASS 7—(Continued).

2,625,501. DIEBOLT INTERNATIONAL, INC, PLYMOUTH, MI. SN 75-680,542. PUB. 10-10-2000, FILED 5-6-1999.

MINILINK

FOR MACHINE PARTS, NAMELY, A SYSTEM OF PNEUMATIC CYLINDERS OR SPRINGS AND A CONTROL PANEL INTERCONNECTED BY A HOSE ASSEMBLIES TO CHARGE WITH, REMOVE AND MONITOR THE PRESSURE OF COMPRESSED NITROGEN GAS IN THE PNEUMATIC CYLINDERS (U.S. CLS. 13, 19, 21, 23, 31, 34 AND 35).

FIRST USE 6-30-1999; IN COMMERCE 6-30-1999.

2,625,582. ALVIN E. COX, SANTA ANA, CA. SN 75-765,172. PUB. 6-27-2000, FILED 8-24-1999.

THE 19TH GREEN

NO CLAIM IS MADE TO THE EXCLUSIVE RIGHT TO USE "GREEN", APART FROM THE MARK AS SHOWN.

FOR MECHANICAL DEVICE WHICH ENABLES A SIMULATED GOLF GREEN TO MOVE TO VARIOUS POSITIONS ON A GOLFING RANGE OF ANY TERRAIN FOR THE PURPOSE OF COLLECTING GOLF BALLS AND RETURNING THE COLLECTED GOLF BALLS BACK TO THE TEE-OFF AREA (U.S. CLS. 13, 19, 21, 23, 31, 34 AND 35).

FIRST USE 9-21-2000; IN COMMERCE 9-21-2000.

2,625,721. GRECO MANUFACTURING, INC., BUCHANAN, MI. SN 75-871,632. PUB. 5-1-2001, FILED 12-14-1999.

ACU-TRACK

FOR POWER OPERATED ADHESIVE BEAD DISPENSING APPARATUS HAVING DISPENSING NOZZLES, ACTUATING VALVES FOR STARTING AND STOPPING THE FLOW OF ADHESIVE AND A CONTROL UNIT FOR CONTROLLING THE BEAD DISPENSING APPARATUS (U.S. CLS. 13, 19, 21, 23, 31, 34 AND 35).

FIRST USE 1-14-2000; IN COMMERCE 1-14-2000.

2,625,797. COLEMAN POWERMATE, INC., KEARNEY, NE. SN 75-908,157. PUB. 7-17-2001, FILED 2-2-2000.

POWERSTATION

FOR ELECTRIC GENERATOR AND TRANSFER SWITCH SOLD AS A UNIT (U.S. CLS. 13, 19, 21, 23, 31, 34 AND 35).

FIRST USE 1-10-2000; IN COMMERCE 1-10-2000.

CLASS 7—(Continued).

2,625,869. EFFECTIVE PRODUCTS, INC., DEER PARK, NY, BY CHANGE OF NAME CENTURY 21 PRODUCTS, INC., GREAT NECK, NY. SN 75-943,717. PUB. 5-22-2001, FILED 3-14-2000.



NO CLAIM IS MADE TO THE EXCLUSIVE RIGHT TO USE "MANUALLY OPERATED TRASH COMPACTOR", APART FROM THE MARK AS SHOWN.

FOR MANUAL TRASH COMPACTORS (U.S. CLS. 13, 19, 21, 23, 31, 34 AND 35).

FIRST USE 5-20-2002; IN COMMERCE 5-20-2002.

2,625,938. FARREL CORPORATION, ANSONIA, CT. SN 76-026,488. PUB. 3-27-2001, FILED 4-14-2000.

ULTIMA

FOR TWO-STAGE MACHINE FOR MIXING AND EXTRUDING PLASTIC AND RUBBER MATERIALS (U.S. CLS. 13, 19, 21, 23, 31, 34 AND 35).

FIRST USE 11-12-2001; IN COMMERCE 11-12-2001.

2,626,003. UNILOY MILACRON INC., MANCHESTER, MI. SN 76-051,552. PUB. 1-29-2002, FILED 5-18-2000.

VERSAPET

FOR PLASTICS BLOW MOLDING MACHINES (U.S. CLS. 13, 19, 21, 23, 31, 34 AND 35).

FIRST USE 6-16-2000; IN COMMERCE 6-16-2000.

2,626,247. KOBELCO CONSTRUCTION MACHINERY AMERICA LLC, WILMINGTON, DE, BY CHANGE OF NAME KOBELCO AMERICA INC., STAFFORD, TX. SN 76-157,844. PUB. 7-31-2001, FILED 11-1-2000.

GATE KEEPER

FOR CONSTRUCTION MACHINES, NAMELY, MINI-EXCAVATORS (U.S. CLS. 13, 19, 21, 23, 31, 34 AND 35).

FIRST USE 1-30-2001; IN COMMERCE 1-30-2001.

CLASS 7—(Continued).

2,626,255. HERCULES INCORPORATED, WILMINGTON, DE. SN 76-161,615. PUB. 7-10-2001, FILED 11-8-2000.

ZENIX

OWNER OF U.S. REG. NO. 2,429,889.
FOR INDUSTRIAL MACHINES FOR ADDING CHEMICALS IN THE MANUFACTURE OF PULP, PAPER AND PAPERBOARD (U.S. CLS. 13, 19, 21, 23, 31, 34 AND 35).

FIRST USE 9-28-2001; IN COMMERCE 9-28-2001.

2,626,420. ACCUSPRAY, INC., CLEVELAND, OH. SN 76-221,431. PUB. 8-14-2001, FILED 3-8-2001.

VMX

FOR AIR COMPRESSORS (U.S. CLS. 13, 19, 21, 23, 31, 34 AND 35).

FIRST USE 3-0-2001; IN COMMERCE 3-0-2001.

2,626,483. TELESIS TECHNOLOGIES, INC., CIRCLEVILLE, OH. SN 76-251,541. PUB. 9-4-2001, FILED 5-4-2001.

SABRE

FOR LASER MARKING MACHINES (U.S. CLS. 13, 19, 21, 23, 31, 34 AND 35).

FIRST USE 3-15-2002; IN COMMERCE 3-15-2002.

2,626,485. CARBONTEC ENERGY CORPORATION, BISMARCK, ND. SN 76-252,812. PUB. 9-25-2001, FILED 5-7-2001.

ACCELERON

FOR MACHINES FOR PNEUMATICALLY CONVEYING AND REMOVING MOISTURE FROM PARTICULATE MATERIAL (U.S. CLS. 13, 19, 21, 23, 31, 34 AND 35).

FIRST USE 12-10-2001; IN COMMERCE 12-10-2001.

2,626,608. ARIES ENGINEERING COMPANY, INC., DUNDEE, MI. SN 78-028,926. PUB. 8-28-2001, FILED 10-4-2000.

HYPERPIERCE

FOR AUTOMATED ASSEMBLY MACHINES COMPRISED OF HYDRA-PNEUMATIC CYLINDERS FOR PIERCING RIGID MATERIALS INCLUDING METALS, COMPOSITE MATERIALS, PLASTICS, RUBBER, AND URETHANES (U.S. CLS. 13, 19, 21, 23, 31, 34 AND 35).

FIRST USE 12-0-2001; IN COMMERCE 12-0-2001.

CLASS 7—(Continued).

2,626,620. CHESNUT, WILLIAM RICHARD, FAIRFIELD, NJ. SN 78-033,687. PUB. 7-17-2001, FILED 11-3-2000.

PRIMIS

FOR PRINTING PLATE USED IN PRINTING PRESSES (U.S. CLS. 13, 19, 21, 23, 31, 34 AND 35).

FIRST USE 10-15-2001; IN COMMERCE 10-15-2001.

2,626,661. BARRY GRANT, INC., DAHLONEGA, GA, BY CHANGE OF NAME GPT 300, INC., DAHLONEGA, GA. SN 78-043,712. PUB. 8-21-2001, FILED 1-18-2001.

GIVE YOUR ENGINE A RUSH!

FOR AIR FILTERS FOR INTERNAL COMBUSTION ENGINES (U.S. CLS. 13, 19, 21, 23, 31, 34 AND 35).

FIRST USE 10-0-2000; IN COMMERCE 9-0-2001.

2,626,688. COLUMBIA MARKING TOOLS, INC., HARRISON TWP., MI. SN 78-051,391. PUB. 9-4-2001, FILED 3-5-2001.

MITE-E-HOT

FOR METAL MARKING MACHINE (U.S. CLS. 13, 19, 21, 23, 31, 34 AND 35).

FIRST USE 12-1-1993; IN COMMERCE 7-1-1994.

CLASS 8—HAND TOOLS

2,625,781. DOCCO MANUFACTURING LTD., RICHMOND HILL, ONTARIO, CANADA. SN 75-903,176. PUB. 6-12-2001, FILED 1-26-2000.

RINK RAKE

NO CLAIM IS MADE TO THE EXCLUSIVE RIGHT TO USE "RINK", APART FROM THE MARK AS SHOWN.

FOR HAND OPERATED TOOL, NAMELY, A HOSE ATTACHMENT TOOL FOR PROVIDING WATER TO ARTIFICIAL OR NATURAL ICE SURFACES FOR USE IN FABRICATING AND MAINTAINING SUCH ICE SURFACES (U.S. CLS. 23, 28 AND 44).

FIRST USE 11-0-1997; IN COMMERCE 11-0-1998.

CLASS 8—(Continued).

2,626,232. IMPERIAL SCHRADE CORP., ELLENVILLE, NY.
SN 76-155,622. PUB. 8-21-2001, FILED 10-30-2000.

I-QUIP

FOR MULTI-PURPOSE HAND TOOLS COMPRISED OF A KNIFE, SCISSORS, SAWS, SCREWDRIVERS, AND CAN OPENER WITH SOME OR ALL OF THE FOLLOWING; PLIERS, CORKSCREW, WHISTLES, CIGARETTE LIGHTER, COMPASS, THERMOMETER, BAROMETER OR CLOCK (U.S. CLS. 23, 28 AND 44).

FIRST USE 9-19-2001; IN COMMERCE 9-19-2001.

2,626,313. SPERO FORGE CORPORATION, TAICHUNG, TAIWAN. SN 76-183,808. PUB. 1-8-2002, FILED 12-21-2000.



THE MARK IS LINED FOR THE COLORS BLUE AND YELLOW.

FOR HAND TOOLS, NAMELY, WRENCHES AND SPANNERS (U.S. CLS. 23, 28 AND 44).

FIRST USE 4-16-1998; IN COMMERCE 10-11-2001.

2,626,530. WALLACE INTERNATIONAL SILVERSMITHS, INC., EAST BOSTON, MA. SN 76-289,483. PUB. 11-13-2001, FILED 7-24-2001.

BAGUETTE

FOR STAINLESS STEEL AND SILVER PLATED FLATWARE, NAMELY, FORKS, KNIVES AND SPOONS SOLD TO RESTAURANT, HOTELS AND FOOD SERVICE INDUSTRIES (U.S. CLS. 23, 28 AND 44).

FIRST USE 9-1-2001; IN COMMERCE 12-1-2001.

2,626,531. WALLACE INTERNATIONAL SILVERSMITHS, INC., EAST BOSTON, MA. SN 76-289,681. PUB. 11-13-2001, FILED 7-24-2001.

CASINO

FOR STAINLESS STEEL AND SILVER PLATED FLATWARE, NAMELY, FORKS, KNIVES AND SPOONS SOLD TO RESTAURANT, HOTELS AND FOOD SERVICE INDUSTRIES (U.S. CLS. 23, 28 AND 44).

FIRST USE 9-1-2001; IN COMMERCE 12-1-2001.

CLASS 9—ELECTRICAL AND SCIENTIFIC APPARATUS

2,625,324. AGERE SYSTEMS INC., ALLENTOWN, PA. BY ASSIGNMENT LUCENT TECHNOLOGIES INC., MURRAY HILL, NJ. SN 75-217,220. PUB. 1-4-2000, FILED 12-17-1996.

ATLANTA

FOR INTEGRATED CIRCUITS AND CHIPSETS (U.S. CLS. 21, 23, 26, 36 AND 38).

FIRST USE 7-31-1995; IN COMMERCE 7-31-1995.

2,625,326. COMMSCOPE PROPERTIES, LLC, SPARKS, NV, BY CHANGE OF NAME; BY ASSIGNMENT COMMSCOPE, INC., HICKORY, NC. SN 75-219,557. PUB. 6-16-1998, FILED 12-30-1996.

SITE-PAK

FOR COAXIAL CABLES AND PARTS THEREFOR (U.S. CLS. 21, 23, 26, 36 AND 38).

FIRST USE 3-0-2000; IN COMMERCE 3-0-2000.

2,625,358. POLAROID CORPORATION, CAMBRIDGE, MA. SN 75-380,632. PUB. 12-1-1998, FILED 10-29-1997.



THE MARK CONSISTS OF THE WORD "POLAROID" WITH A SIXTEEN BLOCK CUBE ATTACHED TO THE "P" IN "POLAROID", AND THE SIXTEEN BLOCKS WILL BE IN EITHER BLACK AND WHITE OR COLOR.

FOR BLANK COMPACT DISCS FOR RECORDING DATA, VIDEO AND SOUND (U.S. CLS. 21, 23, 26, 36 AND 38).

FIRST USE 12-0-2001; IN COMMERCE 12-0-2001.

2,625,365. K-SUN CORPORATION, SOMERSET, WI. SN 75-407,288. PUB. 4-27-1999, FILED 12-10-1997.

MAXI SIGNS 99

NO CLAIM IS MADE TO THE EXCLUSIVE RIGHT TO USE "SIGNS", APART FROM THE MARK AS SHOWN.

FOR COMPUTER SOFTWARE FOR MAKING SIGNS AND LABELS (U.S. CLS. 21, 23, 26, 36 AND 38).

FIRST USE 4-1-1998; IN COMMERCE 4-1-1998.

CLASS 9—(Continued).

2,625,377. AMBITECH, INC., CANOGA PARK, CA. SN 75-437,787. PUB. 3-23-1999, FILED 2-20-1998.

**OFFICIAL SPONSOR OF
COMPUTED SONOGRAPHY
PRODUCTS IN THE
MILLENNIUM**

FOR PRINTED CIRCUITS, AND CONTAINERS FOR PRINTED CIRCUIT BOARDS (U.S. CLS. 21, 23, 26, 36 AND 38).

FIRST USE 10-11-2001; IN COMMERCE 10-12-2001.

2,625,391. AMBITECH, INC., CHATSWORTH, CA. SN 75-461,478. PUB. 10-26-1999, FILED 4-2-1998.

**REPRESENTATION FOR THE
NEW MILLENNIUM**

FOR PRINTED CIRCUITS, ELECTRONIC COMPONENTS, NAMELY, HUBS, ROUTERS, SWITCHES, PACKAGING FOR ELECTRONIC CIRCUITS AND CONTAINERS FOR PRINTED CIRCUIT BOARDS (U.S. CLS. 21, 23, 26, 36 AND 38).

FIRST USE 10-11-2001; IN COMMERCE 10-12-2001.

2,625,397. KRONE GMBH, D-14167 BERLIN ZEHLENDORF, FED REP GERMANY. SN 75-477,632. PUB. 3-9-1999, FILED 5-1-1998.

HIGH TAP

NO CLAIM IS MADE TO THE EXCLUSIVE RIGHT TO USE "TAP", APART FROM THE MARK AS SHOWN.

FOR ELECTRICAL CONNECTORS (U.S. CLS. 21, 23, 26, 36 AND 38).

FIRST USE 2-18-2000; IN COMMERCE 2-18-2000.

2,625,402. EIDOS INTERACTIVE LIMITED, WIMBLEDON, LONDON, ENGLAND. SN 75-496,668. PUB. 8-28-2001, FILED 6-5-1998.

**COMMANDOS: BEHIND
ENEMY LINES**

FOR COMPUTER GAME SOFTWARE RECORDED ON CD-ROMS, FLOPPY DISKETTES, MAGNETIC TAPE AND THAT MAY BE DOWNLOADED FROM A GLOBAL COMPUTER NETWORK (U.S. CLS. 21, 23, 26, 36 AND 38).

FIRST USE 8-0-1998; IN COMMERCE 8-0-1998.

CLASS 9—(Continued).

2,625,411. DISTRIBUTION CONTROL SYSTEMS CARIBE, INC., CAGUAS, PUERTO RICO. SN 75-531,360. PUB. 11-14-2000, FILED 8-5-1998.



FOR ELECTRICAL POWER TRANSMISSION APPARATUS, NAMELY, TRANSMITTERS FOR TRANSMITTING INTELLIGENCE OVER ELECTRICAL POWER TRANSMISSION LINES, RECEIVERS FOR RECEIVING INFORMATION FROM POWER TRANSMISSION LINES, ELECTRICAL METER TRANSPONDERS AND COMPUTER SOFTWARE FOR CONTROLLING THE ELECTRICAL POWER TRANSMISSION APPARATUS USED IN THE FIELD OF ELECTRIC DISTRIBUTION (U.S. CLS. 21, 23, 26, 36 AND 38).

FIRST USE 10-0-1998; IN COMMERCE 10-0-1998.

2,625,412. MINDER RESEARCH CORPORATION, BRAMPTON, ONTARIO, CANADA. SN 75-532,474. PUB. 10-9-2001, FILED 8-6-1998.

TEMP MINDER

PRIORITY CLAIMED UNDER SEC. 44(D) ON CANADA APPLICATION NO. 869,078, FILED 2-11-1998, REG. NO. TMA520633, DATED 12-16-1999, EXPIRES 12-16-2014.

NO CLAIM IS MADE TO THE EXCLUSIVE RIGHT TO USE "TEMP", APART FROM THE MARK AS SHOWN.

FOR INDOOR AND OUTDOOR THERMOMETERS NOT FOR MEDICAL USE (U.S. CLS. 21, 23, 26, 36 AND 38).

FIRST USE 4-0-2001; IN COMMERCE 4-0-2001.

2,625,415. PSC INC., WEBSTER, NY. SN 75-544,849. PUB. 6-26-2001, FILED 8-28-1998.

POWERSCAN

FOR INDUSTRIAL HANDHELD BARCODE READER (U.S. CLS. 21, 23, 26, 36 AND 38).

FIRST USE 9-0-1998; IN COMMERCE 9-0-1998.

CLASS 9—(Continued).

2,625,417. LEONICS CO., LTD., CHACHOENSAO 24180, THAILAND. SN 75-547,216. PUB. 12-28-1999, FILED 9-2-1998.



FOR UNINTERRUPTIBLE POWER SUPPLIES (U.S. CLS. 21, 23, 26, 36 AND 38).
FIRST USE 5-17-1991; IN COMMERCE 6-30-2001.

2,625,422. SPACE CONTROL INDUSTRIES, D-82284 GRAFRATH, FED REP GERMANY. SN 75-554,143. PUB. 8-29-2000, FILED 9-16-1998.

ERGO-COMMANDER

FOR ELECTRONIC MULTIFUNCTIONAL SWITCHES AND CONTROLLERS FOR SIMULTANEOUS OR SEQUENTIAL GUIDANCE AND MANIPULATION OF VARIOUS DEGREES OF FREEDOM OF MOTION FOR CONTROLLING MOVEMENT OF ROBOTS AND OTHER MULTI-AXIS MACHINES (U.S. CLS. 21, 23, 26, 36 AND 38).

FIRST USE 7-30-1999; IN COMMERCE 7-30-1999.

2,625,426. CENTRIC SOFTWARE, INC., SAN JOSE, CA. SN 75-559,764. PUB. 7-17-2001, FILED 9-25-1998.

CENTRIC SOFTWARE

NO CLAIM IS MADE TO THE EXCLUSIVE RIGHT TO USE "SOFTWARE", APART FROM THE MARK AS SHOWN.
FOR ENTERPRISE-WIDE COLLABORATIVE VIRTUAL PRODUCT DEVELOPMENT SOFTWARE FOR USE BY MULTIFUNCTIONAL TEAMS IN ORDER TO COLLABORATE ON THE DEVELOPMENT OF A PRODUCT OR PROCESS (U.S. CLS. 21, 23, 26, 36 AND 38).
FIRST USE 10-22-1998; IN COMMERCE 10-22-1998.

2,625,433. ELITE INFORMATION SYSTEMS, INC., LOS ANGELES, CA. SN 75-567,266. PUB. 6-20-2000, FILED 10-9-1998.

ELITE TIMETRAX

FOR COMPUTER PROGRAMS AND MANUALS SOLD AS A UNIT, FOR TIME AND EXPENSE REPORTING FOR USE BY PROFESSIONALS INCLUDING LAW FIRMS, ACCOUNTING FIRMS, AND CONSULTANTS (U.S. CLS. 21, 23, 26, 36 AND 38).
FIRST USE 10-0-1998; IN COMMERCE 10-0-1998.

CLASS 9—(Continued).

2,625,437. OCEANA SENSOR TECHNOLOGIES, INC., VIRGINIA BEACH, VA. SN 75-581,022. PUB. 4-4-2000, FILED 11-13-1998.

SHM

FOR SYSTEM CONSISTING OF A PROCESSING UNIT, NETWORK INTERFACE AND MEMORY THAT COMMUNICATES WITH A LOCAL NETWORK OF DIGITAL, NETWORKABLE SENSORS COMBINED WITH EMBEDDED SIGNAL PROCESSING FOR DETERMINING THE HEALTH OF MACHINERY AND PROCESSES (U.S. CLS. 21, 23, 26, 36 AND 38).

FIRST USE 3-12-1997; IN COMMERCE 6-3-2000.

2,625,453. AGFA CORPORATION, WILMINGTON, MA. SN 75-605,019. PUB. 6-20-2000, FILED 12-14-1998.

INKDRIVE

FOR COMPUTER SOFTWARE FOR CONTROLLING A DIGITAL PRINTING SYSTEM (U.S. CLS. 21, 23, 26, 36 AND 38).

FIRST USE 10-31-1998; IN COMMERCE 10-31-1998.

2,625,465. XEROX CORPORATION, STAMFORD, CT. SN 75-617,240. PUB. 10-5-1999, FILED 1-8-1999.

P1202

FOR LASER PRINTERS, PARTS AND FITTINGS THEREOF (U.S. CLS. 21, 23, 26, 36 AND 38).
FIRST USE 5-10-1999; IN COMMERCE 5-10-1999.

2,625,471. MARTEK (S.A.), 92800 PUTEAUX, FRANCE. SN 75-631,667. PUB. 9-12-2000, FILED 2-2-1999.

MARTEK POWER

NO CLAIM IS MADE TO THE EXCLUSIVE RIGHT TO USE "POWER", APART FROM THE MARK AS SHOWN.

FOR ELECTRICAL POWER SUPPLIES, POWER CONVERSION DEVICES, NAMELY, CONVERTERS AND INVERTORS, CURRENT RECTIFIERS, UNINTERRUPTIBLE ELECTRICAL POWER SUPPLIES, ELECTRIC POWER SYSTEMS COMPRISING ELECTRICAL TRANSFORMERS AND ELECTRICAL CONNECTORS, ELECTRIC MEASUREMENT INSTRUMENTS, NAMELY, ELECTRICAL CONDUCTORS, ELECTRIC TEST SYSTEMS COMPRISING ELECTRICAL CONDUCTORS AND ELECTRICAL TRANSFORMERS (U.S. CLS. 21, 23, 26, 36 AND 38).

FIRST USE 8-0-1998; IN COMMERCE 8-0-1998.

CLASS 9—(Continued).

2,625,478. BROWNE, H. LEE, GREENWICH, CT. SN 75-644,539. PUB. 1-9-2001, FILED 2-17-1999.

SIGNATURE-CARDS

FOR COMPUTER GRAPHICS SOFTWARE THAT ENABLES USERS TO INSERT ELECTRONIC HANDWRITTEN IMAGES INTO ELECTRONIC MAIL (U.S. CLS. 21, 23, 26, 36 AND 38).

FIRST USE 12-9-2000; IN COMMERCE 4-7-2002.

2,625,480. HOLLYWOOD SOUND INTERNATIONAL CORP., DBA HOLLYWOOD SOUND LABS, TEMPLE CITY, CA. SN 75-647,840. PUB. 10-24-2000, FILED 2-25-1999.

HOLLYWOOD DIGITAL

OWNER OF U.S. REG. NOS. 1,821,096 AND 1,858,473. NO CLAIM IS MADE TO THE EXCLUSIVE RIGHT TO USE "DIGITAL", APART FROM THE MARK AS SHOWN.

SEC. 2(F) AS TO "HOLLYWOOD" FOR AUDIO SPEAKERS AND GUITAR AMPLIFIERS (U.S. CLS. 21, 23, 26, 36 AND 38).

FIRST USE 1-28-2001; IN COMMERCE 1-28-2001.

2,625,492. MENTOR ARC INC., FREMONT, CA. SN 75-666,853. PUB. 2-22-2000, FILED 3-24-1999.

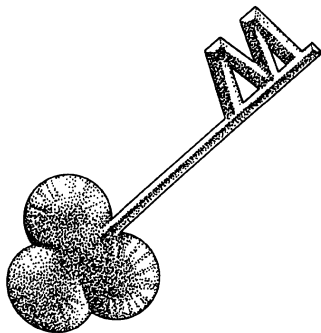

APPLICANT NOTES THAT THE STIPPLING IN THE DRAWING APPEARS TO BE A FEATURE OF THE MARK AND IS NOT INTENDED TO INDICATE COLOR.

FOR COMPUTER, INTEGRATED CIRCUIT (IC) CHIP, INTEGRATED CIRCUIT, MICRO-CONTROLLER, MICROPROCESSOR, CHIPSETS, CONTROL INTEGRATED CIRCUIT, DATA ENCODER/DECODER, ELECTRIC TIMER (U.S. CLS. 21, 23, 26, 36 AND 38).

FIRST USE 10-8-2001; IN COMMERCE 10-8-2001.

2,625,514. CABOT SAFETY INTERMEDIATE CORPORATION, NEWARK, DE. SN 75-701,873. PUB. 9-4-2001, FILED 5-10-1999.

YELLOW NEON BLASTS**CLASS 9—(Continued).**

NO CLAIM IS MADE TO THE EXCLUSIVE RIGHT TO USE "YELLOW NEON", APART FROM THE MARK AS SHOWN.

FOR PERSONAL HEARING PROTECTIVE DEVICES, NAMELY, EAR PLUGS NOT FOR MEDICAL USE (U.S. CLS. 21, 23, 26, 36 AND 38).

FIRST USE 9-0-1999; IN COMMERCE 9-0-1999.

2,625,517. SANDSTORM ENTERPRISES, INC., CAMBRIDGE, MA. SN 75-704,743. PUB. 3-21-2000, FILED 5-13-1999.

NETINTERCEPT

FOR COMPUTER SOFTWARE FOR COMPUTER SYSTEM SECURITY (U.S. CLS. 21, 23, 26, 36 AND 38).

FIRST USE 11-1-2001; IN COMMERCE 11-1-2001.

2,625,525. UNITED ELECTRONIC INDUSTRIES, INC., WATERTOWN, MA. SN 75-720,112. PUB. 2-15-2000, FILED 6-25-1999.

SCXU

FOR COMPUTER HARDWARE, NAMELY, SIGNAL CONDITIONAL EXPANSION UNIT FOR PERSONAL COMPUTER BASED DATA COLLECTION (U.S. CLS. 21, 23, 26, 36 AND 38).

FIRST USE 7-1-1998; IN COMMERCE 7-1-1998.

2,625,532. WANG, PHILLIP H., ALPHARETTA, GA. SN 75-725,061. PUB. 3-14-2000, FILED 7-1-1999.

**THINK-THERMAL
HYDRAULIC INTEGRATED
NETWORK**

NO CLAIM IS MADE TO THE EXCLUSIVE RIGHT TO USE "THERMAL HYDRAULIC INTEGRATED NETWORK", APART FROM THE MARK AS SHOWN.

FOR COMPUTER SOFTWARE WHICH SIMULATES THE PERFORMANCE OF A PROCESS PLANT AND WHICH ALLOWS FOR REVIEWING PLANT OPERATION AND PERFORMANCE, REDUCE DESIGN COSTS AND BETTER UNDERSTAND PANT DYNAMIC BEHAVIOR (U.S. CLS. 21, 23, 26, 36 AND 38).

FIRST USE 2-1-1996; IN COMMERCE 2-1-1996.

CLASS 9—(Continued).

2,625,533. FACTOR 5, LLC, SAN RAFAEL, CA. SN 75-726,602.
PUB. 9-19-2000, FILED 6-11-1999.

FACTOR 5

FOR COMPUTER GAME SOFTWARE, VIDEO GAME SOFTWARE, VIDEO GAME MACHINES FOR USE WITH TELEVISIONS, ACCESSORIES FOR VIDEO GAME MACHINES FOR USE WITH TELEVISIONS, NAMELY, VIDEO GAME PROGRAMS, VIDEO GAME INTERACTIVE CONTROLS, AND MANUALS SUPPLIED THEREWITH (U.S. CLS. 21, 23, 26, 36 AND 38).

FIRST USE 1-1-1996; IN COMMERCE 1-1-1996.

2,625,537. FTL SYSTEMS, INC., ROCHESTER, MN. SN 75-729,424. PUB. 3-21-2000, FILED 6-16-1999.

GIGASIM

FOR COMPUTER SOFTWARE FOR COMPILATION AND SIMULATION OF ELECTRONIC AND ELECTROMECHANICAL DESIGNS (U.S. CLS. 21, 23, 26, 36 AND 38).

FIRST USE 5-14-2002; IN COMMERCE 5-14-2002.

2,625,538. ENTEK IRD INTERNATIONAL CORPORATION, MILFORD, OH. SN 75-729,567. PUB. 5-15-2001, FILED 6-16-1999.

ENWATCH

FOR ELECTRONIC DATA COLLECTION DEVICES FOR USE IN MONITORING THE CONDITION OF INDUSTRIAL EQUIPMENT (U.S. CLS. 21, 23, 26, 36 AND 38).

FIRST USE 12-4-1998; IN COMMERCE 7-23-1999.

2,625,541. AGILE SOFTWARE CORPORATION, SAN JOSE, CA. SN 75-731,843. PUB. 10-30-2001, FILED 6-18-1999.

AGILE ANYWHERE

FOR DOWNLOADABLE COMPUTER SOFTWARE SUITE ALSO AVAILABLE ON CD-ROMS FOR AUTOMATING THE MANAGEMENT OF PRODUCT INFORMATION AND ENGINEERING CHANGE ORDERS ACROSS MANUFACTURING SUPPLY CHAINS, SUCH AS THE SENDING AND RECEIVING PRODUCT INFORMATION ACROSS A SUPPLY CHAIN (U.S. CLS. 21, 23, 26, 36 AND 38).

FIRST USE 6-15-1999; IN COMMERCE 7-14-1999.

CLASS 9—(Continued).

2,625,542. PHOENIX TECHNOLOGIES LTD., SAN JOSE, CA. SN 75-731,917. PUB. 6-19-2001, FILED 6-18-1999.



OWNER OF U.S. REG. NO. 1,739,544.
NO CLAIM IS MADE TO THE EXCLUSIVE RIGHT TO USE "TECHNOLOGIES", APART FROM THE MARK AS SHOWN.

FOR SYSTEM LEVEL SOFTWARE, NAMELY, BASIC INPUT/OUTPUT SYSTEM SOFTWARE, OPERATING SYSTEM SOFTWARE, SOFTWARE FOR USE IN THE INTERPRETATION OF PAGE DESCRIPTION LANGUAGES, SOFTWARE FOR USER AUTHENTICATION DURING REMOTE ACCESS OF A COMPUTER DURING THE LOG-IN PHASE, ALL SOLD TO ORIGINAL EQUIPMENT MANUFACTURERS (U.S. CLS. 21, 23, 26, 36 AND 38).

FIRST USE 6-0-1999; IN COMMERCE 6-0-1999.

2,625,552. KRONOS INCORPORATED, WALTHAM, MA. SN 75-739,150. PUB. 9-25-2001, FILED 6-29-1999.

WORKFORCE ACCRUALS

NO CLAIM IS MADE TO THE EXCLUSIVE RIGHT TO USE "WORKFORCE", APART FROM THE MARK AS SHOWN.

FOR COMPUTER SOFTWARE FOR RECORDING AND MANAGEMENT OF EMPLOYEE VACATION, PERSONAL, SICK AND OTHER BENEFIT TIME (U.S. CLS. 21, 23, 26, 36 AND 38).

FIRST USE 5-0-1999; IN COMMERCE 5-0-1999.

2,625,560. SPX CORPORATION, MUSKEGON, MI. SN 75-743,200. PUB. 4-25-2000, FILED 7-6-1999.

EXXAM

FOR VEHICLE DIAGNOSTIC TOOLS, NAMELY, HAND-HELD COMPUTERIZED DEVICE FOR TROUBLE SHOOTING COMPUTERIZED VEHICLE OPERATING SYSTEM (U.S. CLS. 21, 23, 26, 36 AND 38).

FIRST USE 5-5-2000; IN COMMERCE 5-5-2000.

CLASS 9—(Continued).

2,625,562. FACTOR 5, LLC, SAN RAFAEL, CA. SN 75-746,744. PUB. 9-19-2000, FILED 7-8-1999.

TURRICAN

FOR COMPUTER GAME SOFTWARE; INTERACTIVE MULTIMEDIA COMPUTER GAME PROGRAMS; INTERACTIVE VIDEO GAME PROGRAMS; VIDEO GAME SOFTWARE AND VIDEO GAMES MACHINES FOR USE WITH PERSONAL COMPUTERS AND TELEVISIONS; COMPUTER AND VIDEO GAME TAPES, DISCS, CASSETTES, AND CARTRIDGES; PRERECORDED AUDIO AND VIDEO TAPES, LASER DISCS, DVD DISCS, VIDEO DISCS, COMPACT DISCS, AND CD-ROMS FEATURING VIDEO GAMES; AND MANUALS SUPPLIED THEREWITH (U.S. CLS. 21, 23, 26, 36 AND 38).
FIRST USE 1-1-1996; IN COMMERCE 1-1-1996.

2,625,563. GREAT MEADOW MUSIC, WESTMORELAND, NH. SN 75-746,913. PUB. 2-8-2000, FILED 7-9-1999.

GREAT MEADOW MUSIC

NO CLAIM IS MADE TO THE EXCLUSIVE RIGHT TO USE "MUSIC", APART FROM THE MARK AS SHOWN.
FOR SOUND RECORDINGS, NAMELY, PHONOGRAPH RECORDS AND PRE-RECORDED AUDIO DISCS, AUDIO CASSETTES AND COMPACT DISCS FEATURING MUSIC; PRE-RECORDED VIDEO CASSETTES FEATURING MUSICAL PERFORMANCES (U.S. CLS. 21, 23, 26, 36 AND 38).
FIRST USE 2-4-2000; IN COMMERCE 2-4-2000.

2,625,572. ATMEL CORPORATION, SAN JOSE, CA. SN 75-754,206. PUB. 5-16-2000, FILED 7-19-1999.

CRYPTOMEMORY

FOR SEMICONDUCTOR SERIAL MEMORY CIRCUITS WITH EMBEDDED LOGIC AND WIRED ALGORITHMS FOR USE TO ENCRYPT AND STORE DATA, AND FOR SECURE COMMUNICATIONS, INCLUDING AUTHENTICATION CAPABILITY FOR HOST AND DEVICE, AND A MULTIAPPLICATION PERSONAL IDENTIFICATION NUMBER (PIN) TO REACH SELECTED MEMORY SECTIONS (U.S. CLS. 21, 23, 26, 36 AND 38).
FIRST USE 9-29-2001; IN COMMERCE 12-10-2001.

2,625,574. CIRCUIT RESEARCH LABS, INC., TEMPE, AZ. SN 75-754,856. PUB. 10-16-2001, FILED 7-20-1999.

MILLENNIUM

FOR DIGITAL AUDIO PROCESSORS FOR USE BY COMMERCIAL RADIO AND TELEVISION BROADCASTING STATIONS TO DYNAMICALLY CONTROL BROADCAST TRANSMISSIONS (U.S. CLS. 21, 23, 26, 36 AND 38).
FIRST USE 9-15-1999; IN COMMERCE 9-15-1999.

CLASS 9—(Continued).

2,625,581. TEKTRONIX, INC., BEAVERTON, OR. SN 75-759,174. PUB. 9-19-2000, FILED 7-23-1999.

FRAMESCAN

FOR FEATURE OF AN OSCILLOSCOPE FOR SIGNAL ACQUISITION AND TRIGGERING (U.S. CLS. 21, 23, 26, 36 AND 38).
FIRST USE 2-28-2002; IN COMMERCE 2-28-2002.

2,625,590. IGT, RENO, NV. SN 75-773,672. PUB. 6-19-2001, FILED 8-10-1999.

PICK TO WIN

FOR GAMING MACHINES; NAMELY, SLOT MACHINES WITH OR WITHOUT A VIDEO OUTPUT (U.S. CLS. 21, 23, 26, 36 AND 38).
FIRST USE 5-0-2000; IN COMMERCE 5-0-2000.

2,625,601. AXISOFT TECHNOLOGIES, INC., TAIPEI, TAIWAN. SN 75-784,981. PUB. 7-31-2001, FILED 8-26-1999.

COOLSYNC

FOR COMPUTER CENTRAL PROCESSING UNIT, COMPUTER SOFTWARE FOR PERSONAL INFORMATION MANAGEMENT IN THE FIELD OF HANDHELD COMPUTING (U.S. CLS. 21, 23, 26, 36 AND 38).
FIRST USE 2-20-2002; IN COMMERCE 2-20-2002.

2,625,607. CYGNAL INTEGRATED PRODUCTS, INC., AUSTIN, TX. SN 75-792,242. PUB. 5-1-2001, FILED 9-3-1999.

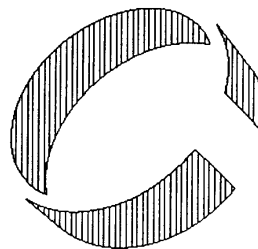

APPLICANT STATES THAT COLOR IS NOT A FEATURE OF THE MARK.

THE MARK CONSISTS OF THE LETTER "C" IN STYLIZED FORM.

FOR INTEGRATED CIRCUITS, NAMELY, INTEGRATED CIRCUITS UTILIZING ANALOG AND DIGITAL CIRCUITRY AND MIXED SIGNAL TECHNOLOGY TO ALLOW INTERFACE IN THE ANALOG DOMAIN, CONVERSION TO THE DIGITAL DOMAIN AND PROCESSING IN THE DIGITAL DOMAIN (U.S. CLS. 21, 23, 26, 36 AND 38).

FIRST USE 7-10-2000; IN COMMERCE 7-10-2000.

CLASS 9—(Continued).

2,625,610. BUSH, DANNY, HUNTINGTON STATION, NY. SN 75-796,414. PUB. 9-5-2000, FILED 9-9-1999.

ADVIVUM

THE ENGLISH TRANSLATION OF "ADVIVUM" IS "TO THE LIFE."

FOR MOTION PICTURE FILMS FEATURING COMEDY, DRAMA, ACTION, ADVENTURE, ANIMATION, MUSIC, AND DOCUMENTARY AND EDUCATIONAL TOPICS (U.S. CLS. 21, 23, 26, 36 AND 38).

FIRST USE 12-16-2001; IN COMMERCE 12-16-2001.

2,625,616. POINT GREY RESEARCH INC., VANCOUVER, BRITISH COLUMBIA. SN 75-800,116. PUB. 10-30-2001, FILED 10-6-1999.

DIGICLOPS

PRIORITY CLAIMED UNDER SEC. 44(D) ON CANADA APPLICATION NO. 1013167, FILED 4-26-1999.

FOR VIDEO CAMERAS; MULTIPLE VIDEO CAMERA ARRAYS, NAMELY, TWO OR MORE LIGHT SENSITIVE DEVICES TO PERFORM STEREO IMAGING; DIGITAL VIDEO INPUT AND STORAGE DEVICES, NAMELY, LIGHT SENSITIVE DEVICES SUCH AS CCDS OR CMOS CAMERAS, WHICH TRANSFER DIGITAL VIDEO AND IMAGE DATA OVER DEVICES SUCH AS, IEEE1394, USB AND ETHERNET INTERFACES, TO RECORDING DEVICES SUCH AS HARD DRIVES, FLOPPY AND COMPACT DISKS AND MEMORY CHIPS; VIDEO INPUT DEVICES FOR COMPUTERS; DIGITAL AND ANALOGUE IMAGING CAMERAS AND SOFTWARE FOR COMPUTER IMAGING USES; COMPUTER AND VIDEO HARDWARE, NAMELY, LIGHT TO ELECTRICITY CONVERTING DEVICES SUCH AS CCD AND CMOS CAMERAS, AND ANY CAMERA THAT HAS IMAGE PROCESSING CAPABILITIES, AND SOFTWARE, FOR CREATING AND CAPTURING STILL AND VIDEO IMAGES; COMPUTER SOFTWARE FOR ACQUIRING, CAPTURING, CREATING, MANIPULATING, CONVERTING, TRANSFERRING, PRESENTING AND STORING STILL AND VIDEO IMAGES; COMPUTER HARDWARE AND SOFTWARE USED AND ASSOCIATED WITH 3-D RANGE SENSING, NAMELY, FOR OBJECT DIMENSIONING, OBJECT CLASSIFICATION, OBJECT TRACKING, AND MOTION CONTROL; COMPUTER HARDWARE AND SOFTWARE ASSOCIATED WITH 3-D DIGITIZATION, NAMELY, FOR 3-D MODELING, VIRTUAL REALITY, ANIMATION AND PHOTO-REALISTIC RENDERING; COMPUTER HARDWARE AND SOFTWARE FOR CAPTURING AND PROCESSING OF IMAGES ASSOCIATED WITH VIDEO SURVEILLANCE; AND INSTRUCTION MANUALS AS A UNIT THEREWITH (U.S. CLS. 21, 23, 26, 36 AND 38).

FIRST USE 2-1-2000; IN COMMERCE 2-14-2000.

2,625,618. QSOUND LABS, INC., CALGARY, ALBERTA T2E 7J2, CANADA. SN 75-803,841. PUB. 10-24-2000, FILED 9-20-1999.

AUDIOPIX

FOR COMPUTER SOFTWARE WHICH INSERTS DIGITAL IMAGES INTO MP3 OR DIGITAL AUDIO FILES IN REAL-TIME (U.S. CLS. 21, 23, 26, 36 AND 38).

FIRST USE 1-24-2000; IN COMMERCE 1-24-2000.

CLASS 9—(Continued).

2,625,628. HIWARE.COM LLC, POTSDAM, NY. SN 75-807,268. PUB. 5-30-2000, FILED 9-23-1999.

HIWARE

FOR COMPUTER SOFTWARE FOR USE BY EMPLOYERS AND LABOR MARKET INTERMEDIARIES, NAMELY, STAFFING FIRMS, PLACEMENT FIRMS, GUIDANCE COUNSELORS AND PLACEMENT OFFICERS AT SCHOOLS, COLLEGES, AND PUBLIC AND PRIVATE EMPLOYMENT AND TRAINING AGENCIES, FOR USE IN RECRUITMENT, SCREENING, ASSESSMENT, PLACEMENT OF JOB APPLICANTS AND NEW HIRES AND FOR USE IN TRAINING STAFF OF LABOR MARKETING INTERMEDIARIES (U.S. CLS. 21, 23, 26, 36 AND 38).

FIRST USE 11-0-1999; IN COMMERCE 11-0-1999.

2,625,630. PHATNOISE, INC., LOS ANGELES, CA. SN 75-810,375. PUB. 9-5-2000, FILED 10-20-1999.

PHATNOISE

FOR COMPUTER SOFTWARE FOR TRANSMISSION OF MUSIC (U.S. CLS. 21, 23, 26, 36 AND 38).

FIRST USE 8-3-2000; IN COMMERCE 8-3-2000.

2,625,644. A.L.S. INDUSTRIES, INC., TORRANCE, CA. SN 75-822,769. PUB. 11-21-2000, FILED 10-14-1999.

STUFFALON

FOR IMITATION NYLON AND IMITATION LEATHER FABRIC USED AS A COMPONENT OF CARRYING CASES FOR VARIOUS ITEMS, NAMELY, COMPACT DISCS, DVD'S, CD GAMES, CAMERAS, CAMCORDERS, FILM, PHOTOGRAPHIC EQUIPMENT AND TRIPODS (U.S. CLS. 21, 23, 26, 36 AND 38).

FIRST USE 5-24-2001; IN COMMERCE 5-24-2001.

2,625,645. KINKO'S VENTURES, INC., VENTURA, CA. SN 75-822,855. PUB. 1-16-2001, FILED 10-14-1999.



FOR COMPUTER SOFTWARE FOR PREPARATION AND TRANSMISSION OF DIGITAL FILES FOR PRINTING (U.S. CLS. 21, 23, 26, 36 AND 38).

FIRST USE 9-30-1999; IN COMMERCE 1-1-2000.

CLASS 9—(Continued).

2,625,654. AUTHENTEC, INCORPORATED, PALM BAY, FL. SN 75-829,062. PUB. 6-27-2000, FILED 10-22-1999.



FOR AUTHENTICATION AND IDENTIFICATION PRODUCTS, NAMELY, COMPUTER SOFTWARE, BIOMETRIC MATCHING SOFTWARE, BIOMETRIC INDEXING SOFTWARE, AND CRYPTOGRAPHIC PROTECTION SOFTWARE, AND RELATED HARDWARE, NAMELY, FINGERPRINT SENSORS AND ASSOCIATED COMPUTER CHIPS AND ELECTRONIC CIRCUITRY FOR USE IN DETERMINING THE IDENTITY OF UNKNOWN PERSONS AND TO VERIFY THE CLAIMED IDENTITY OF PERSONS (U.S. CLS. 21, 23, 26, 36 AND 38).

FIRST USE 11-0-1999; IN COMMERCE 11-0-1999.

2,625,663. LAMBDA PHYSIK AG, GOTTINGEN, FED REP GERMANY, BY CHANGE OF NAME LAMBDA PHYSIK GMBH, GOTTINGEN D-37079, FED REP GERMANY. SN 75-834,210. PUB. 10-10-2000, FILED 10-28-1999.

GATOR

FOR LASERS, NOT FOR MEDICAL USE (U.S. CLS. 21, 23, 26, 36 AND 38).

FIRST USE 1-25-2000; IN COMMERCE 10-24-2000.

2,625,666. CAPITOL SYSTEMS CORPORATION, PHOENIX, AZ. SN 75-836,355. PUB. 9-25-2001, FILED 10-30-1999.

PASSWORD LOCKER

NO CLAIM IS MADE TO THE EXCLUSIVE RIGHT TO USE "PASSWORD", APART FROM THE MARK AS SHOWN. FOR COMPUTER SOFTWARE FOR PROVIDING SECURITY OF, TO, AND FOR COMPUTER NETWORKS; COMPUTER SOFTWARE FOR DATABASE MANAGEMENT, SPECIFICALLY THE MANAGEMENT OF USER IDENTIFICATIONS, UNIFORM RESOURCE LOCATORS, AND COMPUTER NOTES (U.S. CLS. 21, 23, 26, 36 AND 38).

FIRST USE 7-28-1999; IN COMMERCE 11-8-2000.

2,625,681. THERMOQUEST CORPORATION, AUSTIN, TX. SN 75-844,511. PUB. 3-20-2001, FILED 11-9-1999.

TEMPUS

FOR MASS SPECTROMETERS (U.S. CLS. 21, 23, 26, 36 AND 38).

FIRST USE 10-16-2000; IN COMMERCE 11-22-2000.

CLASS 9—(Continued).

2,625,692. BARON SERVICES, INC., HUNTSVILLE, AL. SN 75-850,603. PUB. 7-18-2000, FILED 11-16-1999.

OMNIWXTRAC

FOR COMPUTER HARDWARE AND SOFTWARE FOR DISPLAYING REAL-TIME AND HISTORICAL WEATHER DATA AND INFORMATION IN BOTH TWO-DIMENSIONAL AND THREE-DIMENSIONAL FORMATS (U.S. CLS. 21, 23, 26, 36 AND 38).

FIRST USE 1-21-2002; IN COMMERCE 1-21-2002.

2,625,695. COMPUTER BOARDS, INC., MIDDLEBORO, MA. SN 75-851,160. PUB. 7-17-2001, FILED 11-17-1999.

SOFTWARE

FOR VISUAL PROGRAMMING COMPUTER SOFTWARE FOR GENERATING EXECUTABLE APPLICATION PROGRAMS FOR USE IN THE FIELD OF MEASUREMENT AND CONTROL, AND USER MANUALS THEREFOR (U.S. CLS. 21, 23, 26, 36 AND 38).

FIRST USE 1-17-2000; IN COMMERCE 1-17-2000.

2,625,696. APPLIED PHOTONICS, INC., ORLANDO, FL. SN 75-851,362. PUB. 6-19-2001, FILED 11-17-1999.

ICD

FOR OPTICAL-MECHANICAL DEVICES, NAMELY, FOR CREATING A MICRO CRACK ACROSS A SURFACE BY LASER CUTTING FOR USE IN THE FIELDS OF SEMICONDUCTOR DICING, GLASS CUTTING AND GLASS SINGULATION (U.S. CLS. 21, 23, 26, 36 AND 38).

FIRST USE 11-0-1999; IN COMMERCE 7-0-2000.

2,625,698. N.V. ORGANON, 5349 AB OSS, NETHERLANDS. SN 75-852,034. PUB. 9-11-2001, FILED 11-18-1999.

REMINDHER

FOR ELECTRONIC PERSONAL ORGANIZER FEATURING AN AUDITORY OR VISUAL ALARM WHICH PROMPTS THE USER THE TIME TO TAKE A PILL OR OTHER HEALTH CARE PRODUCTS (U.S. CLS. 21, 23, 26, 36 AND 38).

FIRST USE 6-30-1999; IN COMMERCE 6-30-1999.

CLASS 9—(Continued).

2,625,700. SIMULATION SYSTEMS AND APPLICATIONS, INC., PINELLAS PARK, FL. SN 75-853,239. PUB. 8-28-2001, FILED 11-19-1999.

FLY SAFELY

FOR SIMULATION PARTS, NAMELY, FLIGHT SIMULATORS; FLIGHT SIMULATOR TRAINING AIDS FOR AIRCRAFT PILOT SCHOOLS, NAMELY, ELECTRONIC AIRPLANE MODELS; ALARM DETECTION DEVICES, NAMELY CARBON MONOXIDE DETECTORS, TERRAIN PROXIMITY DETECTORS (U.S. CLS. 21, 23, 26, 36 AND 38).

FIRST USE 12-0-1999; IN COMMERCE 6-7-2000.

CLASS 9—(Continued).

2,625,707. GENERAL INSTRUMENT CORPORATION, HORSHAM, PA. SN 75-858,862. PUB. 7-25-2000, FILED 11-24-1999.



2,625,703. SALZ, JENNIFER B., DEL MAR, CA. AND BENDER, JEANNE, DEL MAR, CA. SN 75-854,906. PUB. 3-6-2001, FILED 11-22-1999.

FOR SET TOP BOXES TO PROVIDE TWO WAY COMMUNICATIONS OVER A BROADBAND TELECOMMUNICATIONS NETWORK (U.S. CLS. 21, 23, 26, 36 AND 38).

FIRST USE 11-0-1999; IN COMMERCE 11-0-1999.



2,625,710. ASIC ADVANTAGE, INC., SUNNYVALE, CA. SN 75-861,410. PUB. 6-19-2001, FILED 12-1-1999.

FOR COMBINATION EYEGLASS HOLDER POUCHES AND BOOKMARKS, EYEGLASS HOLDER POUCHES WHICH ATTACH TO COMPUTER SCREENS, TV REMOTE PROTECTIVE POUCHES, AND CELLULAR TELEPHONE PROTECTIVE POUCHES (U.S. CLS. 21, 23, 26, 36 AND 38).

FIRST USE 12-1-1999; IN COMMERCE 6-10-2000.

IN-PLUG

FOR ELECTRICAL APPARATUS, NAMELY INTEGRATED CIRCUITS (U.S. CLS. 21, 23, 26, 36 AND 38).

FIRST USE 3-8-2000; IN COMMERCE 3-8-2000.

2,625,706. KIDVID, INC., DBA SMALL FRY PRODUCTIONS, ALPHARETTA, GA. SN 75-858,105. PUB. 5-1-2001, FILED S.R. 11-26-1999; AM. P.R. 4-19-2002.

BRIGHTER BABY

NO CLAIM IS MADE TO THE EXCLUSIVE RIGHT TO USE "BABY", APART FROM THE MARK AS SHOWN.

FOR PRERECORDED VIDEO TAPES, AUDIO CASSETTES, DIGITAL VIDEO DISCS, AND COMPACT DISCS CONTAINING MATERIALS INTENDED TO DEVELOP AND/OR IMPROVE THE CREATIVE AND INTELLECTUAL FACULTIES OF INFANTS AND CHILDREN (U.S. CLS. 21, 23, 26, 36 AND 38).

FIRST USE 1-12-2001; IN COMMERCE 1-12-2001.

2,625,711. MOSELLE, MICHAEL D., DBA KING SHIELD PRODUCTIONS, LAKE LAND, FL. SN 75-863,112. PUB. 7-17-2001, FILED 11-29-1999.

UNDER THE INFLUENCE (OF GOD'S LOVE)

FOR MUSICAL SOUND RECORDING (U.S. CLS. 21, 23, 26, 36 AND 38).

FIRST USE 9-1-2001; IN COMMERCE 10-1-2001.

CLASS 9—(Continued).

2,625,713. NETEXS, LTD., OCONOMOWOC, WI. SN 75-863,567. PUB. 5-15-2001, FILED 12-3-1999.



FOR COMPUTER SOFTWARE THAT GENERATES COMPUTER APPLICATIONS FROM DATA, CODE GENERATION AND COMPILATIONS OF DATABASE SPECIFIC STORED PROCEDURES (U.S. CLS. 21, 23, 26, 36 AND 38).

FIRST USE 11-14-1999; IN COMMERCE 12-1-1999.

2,625,715. COHESIA CORPORATION, DAYTON, OH. SN 75-867,934. PUB. 8-29-2000, FILED 12-10-1999.

INTELLIDOC

FOR COMPUTER SOFTWARE FOR STORING, RETRIEVING AND COMPARING SPECIFICATIONS FOR USE IN PRODUCT DEVELOPMENT, PRODUCT ENGINEERING AND MANUFACTURING, AND RELATED DOCUMENTATION, SOLD AS A UNIT (U.S. CLS. 21, 23, 26, 36 AND 38).

FIRST USE 10-31-2001; IN COMMERCE 10-31-2001.

2,625,730. SSI GROUP, INC., THE, MOBILE, AL. SN 75-879,605. PUB. 10-2-2001, FILED 12-27-1999.

ClickON

FOR COMPUTER SOFTWARE FOR INFORMATION MANAGEMENT TECHNOLOGIES, SUCH AS CLAIMS ELIGIBILITY AND PROCESSING, DOCUMENT MANAGEMENT, CASE MANAGEMENT, CONTRACT MANAGEMENT, WORKERS COMPENSATION, OCCUPATIONAL HEALTH, EMPLOYEE HEALTH, FOR USE BY HEALTHCARE PROVIDERS AND PAYERS (U.S. CLS. 21, 23, 26, 36 AND 38).

FIRST USE 11-24-1999; IN COMMERCE 1-1-2000.

CLASS 9—(Continued).

2,625,735. IDEAL, INCORPORATED, MAPLE GROVE, MN. SN 75-881,718. PUB. 6-26-2001, FILED 12-27-1999.

CHARGE! NOT JUST SOFTWARE, IT'S AN ATTITUDE

FOR COMPUTER PROGRAM FOR USE BY MERCHANTS TO PROCESS CREDIT, DEBIT AND SMART CARD TRANSACTIONS (U.S. CLS. 21, 23, 26, 36 AND 38).

FIRST USE 6-10-2000; IN COMMERCE 6-10-2000.

2,625,760. DIEBOLD, INCORPORATED, NORTH CANTON, OH. SN 75-890,865. PUB. 8-14-2001, FILED 1-7-2000.

CAMPUS SYSTEMS GOLD

NO CLAIM IS MADE TO THE EXCLUSIVE RIGHT TO USE "SYSTEMS", APART FROM THE MARK AS SHOWN.

FOR ELECTRONIC COMPUTER TERMINALS USED TO OBTAIN CASH, TO OBTAIN CREDIT, TO PURCHASE GOODS AND SERVICES, TO VERIFY IDENTITY, ELIGIBILITY OR AUTHORIZATION AND TO GAIN ACCESS TO RESTRICTED FACILITIES (U.S. CLS. 21, 23, 26, 36 AND 38).

FIRST USE 4-1-1996; IN COMMERCE 10-1-1996.

2,625,761. DATA BECKER CORPORATION, NEEDHAM, MA. SN 75-890,908. PUB. 2-5-2002, FILED 1-7-2000.

MUSIC CENTER PRO

NO CLAIM IS MADE TO THE EXCLUSIVE RIGHT TO USE "MUSIC" AND "PRO", APART FROM THE MARK AS SHOWN.

FOR COMPUTER SOFTWARE PRODUCTS, NAMELY INTERACTIVE, MULTIMEDIA SOFTWARE FOR THE PURPOSE OF COMPOSING, MIXING, PLAYING AND STORING MUSIC (U.S. CLS. 21, 23, 26, 36 AND 38).

FIRST USE 3-30-2000; IN COMMERCE 4-15-2000.

CLASS 9—(Continued).

2,625,778. CDM TECHNOLOGIES, INCORPORATED, SAN LUIS OBISPO, CA. SN 75-902,096. PUB. 7-17-2001, FILED 1-21-2000.

**TOOLKIT FOR
INFORMATION
REPRESENTATION AND
AGENT COLLABORATION
TIRAC**

NO CLAIM IS MADE TO THE EXCLUSIVE RIGHT TO USE "TOOLKIT FOR INFORMATION REPRESENTATION AND AGENT COLLABORATION", APART FROM THE MARK AS SHOWN.

FOR COMPUTER SOFTWARE FOR IDENTIFYING CONFLICTS AND ASSISTING HUMAN DECISION-MAKERS IN COMPLEX PROBLEM SITUATION REGARDING INFRASTRUCTURE ASSESSMENT AND UTILIZATION, AND COMPRISED OF REAL-TIME INTER-PROCESS COMMUNICATIONS AND COORDINATION FACILITIES, DYNAMIC QUERY GENERATION WITHIN A DISTRIBUTED DATABASE ENVIRONMENT, AND KNOWLEDGE-BASED DECISION-MAKING ASSISTANTS (U.S. CLS. 21, 23, 26, 36 AND 38).

FIRST USE 5-1-2001; IN COMMERCE 5-1-2001.



2,625,788. NEXTCOM, LLC, NORWALK, CT. SN 75-905,352. PUB. 10-9-2001, FILED 1-24-2000.



FOR COMPUTER HARDWARE, NAMELY REMOVABLE COMPUTER MODULES WITH AN INTEGRATED CONNECTOR, FOR USE WITH PORTABLE AND HANDHELD COMPUTERS, FEATURING INTEGRATED SOFTWARE AND MANUALS SOLD THEREWITH, FOR ENABLING WIRELESS LOCAL AREA NETWORKING AND WIRELESS CONNECTIVITY (U.S. CLS. 21, 23, 26, 36 AND 38).

FIRST USE 5-8-2001; IN COMMERCE 11-20-2001.

CLASS 9—(Continued).

2,625,790. NILES AUDIO CORPORATION, MIAMI, FL. SN 75-906,019. PUB. 12-26-2000, FILED 1-31-2000.



NO CLAIM IS MADE TO THE EXCLUSIVE RIGHT TO USE "NET", APART FROM THE MARK AS SHOWN.

FOR SOFTWARE AND MICROPROCESSORS INTEGRATED INTO ELECTRONIC DEVICES, NAMELY, SIGNAL DISTRIBUTION EQUIPMENT, KEYPADS AND RELATED INPUT DEVICES THAT ENABLE AND CONTROL COMMUNICATIONS AND INTERFACING BETWEEN AND AMONG ENTERTAINMENT, ELECTRONIC AND AUTOMATION DEVICES (U.S. CLS. 21, 23, 26, 36 AND 38).

FIRST USE 2-15-2002; IN COMMERCE 2-15-2002.



2,625,796. INDIVIDUAL NETWORK, INC., PLANO, TX. SN 75-908,018. PUB. 8-28-2001, FILED 2-1-2000.

INDIVIDUAL NETWORK

FOR COMPUTER SOFTWARE TO CUSTOMIZE A USER'S ACCESS TO MEDIA FORMATS, NAMELY, TELEVISION, RADIO, INTERNET VIDEO AND AUDIO, FOR PROVIDING PERSONALIZED CONTENT TO THE USER BASED ON THE USER'S DEMOGRAPHIC INFORMATION (U.S. CLS. 21, 23, 26, 36 AND 38).

FIRST USE 6-21-1999; IN COMMERCE 7-1-1999.



2,625,800. BELGARD GROUP, INC., THE, HILLSBORO, OR. SN 75-909,305. PUB. 9-11-2001, FILED 2-3-2000.

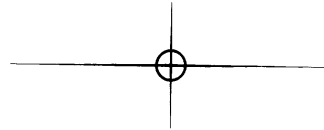

FOR NETWORKABLE COMPUTER SOFTWARE IN THE FIELD OF INTERACTIVE BUSINESS TRAINING AND MANAGEMENT, NAMELY, SOFTWARE FOR USE IN TRAINING BUSINESS WORK TEAMS TO INCREASE AUTONOMY AND BUSINESS MANAGEMENT RESPONSIBILITY THROUGH THE USE OF WORKSHOP ACTIVITIES TO DEVELOP SKILLS TO PERFORM SUCCESSFULLY IN A TEAM-BASED ORGANIZATION (U.S. CLS. 21, 23, 26, 36 AND 38).

FIRST USE 11-1-2001; IN COMMERCE 11-1-2001.

CLASS 9—(Continued).

2,625,802. DRESSER, INC., ADDISON, TX, BY CHANGE OF NAME DRESSER EQUIPMENT GROUP, INC., CARROLLTON, TX. SN 75-909,712. PUB. 3-6-2001, FILED 2-3-2000.

ESM

FOR ELECTRIC CONTROLLERS, NAMELY FOR USE IN THE OPERATION OF ENGINES AND GENERATORS (U.S. CLS. 21, 23, 26, 36 AND 38).

FIRST USE 9-17-2001; IN COMMERCE 9-17-2001.

2,625,810. AQUOR, INC., BOULDER, CO. SN 75-911,996. PUB. 10-17-2000, FILED 2-7-2000.

AQUOR

FOR FLOW METERS AND PARTS THEREOF (U.S. CLS. 21, 23, 26, 36 AND 38).

FIRST USE 4-0-2000; IN COMMERCE 4-0-2000.

2,625,811. SALIENT SYSTEMS, INC., DUBLIN, OH. SN 75-912,690. PUB. 9-5-2000, FILED 2-8-2000.

TRIBORAILER

FOR ELECTRONIC APPARATUS FOR MEASURING SURFACE FRICTION ON RAILROAD TRACKS (U.S. CLS. 21, 23, 26, 36 AND 38).

FIRST USE 6-0-1998; IN COMMERCE 11-0-2000.

2,625,818. NIHON COMPUTER KOGYO KABUSHIKI KAISHA, HIGASHI OSAKA-SHI, OSAKA, JAPAN. SN 75-916,893. PUB. 12-26-2000, FILED 2-11-2000.

JC-CONNECT

FOR PRINT SERVER, USED TO CONNECT BETWEEN A PRINTER AND A NETWORK HUB DEVICE (U.S. CLS. 21, 23, 26, 36 AND 38).

FIRST USE 8-8-2001; IN COMMERCE 8-8-2001.

CLASS 9—(Continued).

2,625,826. PIJNENBURG CUSTOM CHIPS B.V., 5261 NE VUGHT, NETHERLANDS. SN 75-921,859. PUB. 1-9-2001, FILED 2-16-2000.



NO CLAIM IS MADE TO THE EXCLUSIVE RIGHT TO USE "KEY SMART" AND "SECURED", APART FROM THE MARK AS SHOWN.

FOR COMPUTER OPERATING PROGRAMS FOR USE WITH ELECTRICAL CONTROLLERS, ELECTRONIC NETWORK CONTROLLERS, TOUCH-PADS, TOUCH-SCREEN DISPLAYS, KEYPADS FOR CONTROLLING ELECTRONIC DEVICES, AMPLIFIERS AND RECEIVERS (U.S. CLS. 21, 23, 26, 36 AND 38).

FIRST USE 1-6-2000; IN COMMERCE 1-6-2000.

2,625,828. VELIQUETTE, CYNTHIA CHERYL, SOLANA BEACH, CA. SN 75-922,341. PUB. 9-18-2001, FILED 2-17-2000.



OWNER OF U.S. REG. NO. 2,174,011.
NO CLAIM IS MADE TO THE EXCLUSIVE RIGHT TO USE "COMPUTER", APART FROM THE MARK AS SHOWN.

FOR PRERECORDED MOTION PICTURE FILMS, VIDEOTAPES, AUDIO TAPES AND COMPACT DISCS FEATURING EDUCATIONAL PROGRAMS IN THE FIELD OF CHILDREN'S AND PARENTS' SELF-ESTEEM WITH FOCUS ON SAFETY IN USING COMPUTERS AND A GLOBAL COMPUTER NETWORK (U.S. CLS. 21, 23, 26, 36 AND 38).

FIRST USE 5-0-2000; IN COMMERCE 6-0-2001.

CLASS 9—(Continued).

2,625,831. CONTROL.COM INC., HOPKINTON, MA. SN 75-923,636. PUB. 7-3-2001, FILED 2-22-2000.

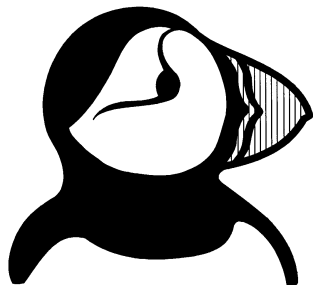

THE LINING IN THE DRAWING IS FOR SHADING PURPOSES ONLY.

FOR PROGRAMMABLE INDUSTRIAL CONTROLLERS AND COMPUTER SOFTWARE FOR OPERATING THE PROGRAMMABLE INDUSTRIAL CONTROLLERS (U.S. CLS. 21, 23, 26, 36 AND 38).

FIRST USE 3-0-2002; IN COMMERCE 3-0-2002.

2,625,833. TASMANIA RESOURCE, INC., NEWARK, DE. SN 75-924,558. PUB. 11-7-2000, FILED 2-18-2000.

FORCEMC

FOR COMPUTER SOFTWARE USED FOR ACCESSING, ANALYZING, REVIEWING, REPORTING AND DISTRIBUTING INFORMATION IN CONNECTION WITH SALES, MARKETING, RETAIL MERCHANDISING AND BUSINESS MANAGEMENT IN THE FIELD OF PHARMACEUTICALS, AND INSTRUCTION MANUALS SOLD AS A UNIT THEREWITH (U.S. CLS. 21, 23, 26, 36 AND 38).

FIRST USE 11-8-2000; IN COMMERCE 11-8-2000.

2,625,835. INTERVIDEO, INC., FREMONT, CA. SN 75-926,912. PUB. 10-23-2001, FILED 2-23-2000.

LINDVD

FOR COMPUTER SOFTWARE THAT EMULATES THE HARDWARE FUNCTIONS OF DIGITAL VIDEO DISC DECODER INTERFACE COMPONENTS FOR USE IN MULTIMEDIA APPLICATIONS IN PERSONAL COMPUTERS TO DECODE, ADJUST, PLAY, PERFORM AND CONTROL AUDIO AND VIDEO INFORMATION INCLUDING SPECIAL EFFECTS, IN MOTION PICTURE EXPERT GROUP (MPEG) FORMATS STORED ON DIGITAL VIDEO DISCS, INTERACTIVE DIGITAL VIDEO DISCS, VIDEO COMPACT DISCS, AND OTHER PERSONAL COMPUTER STORAGE MEDIA (U.S. CLS. 21, 23, 26, 36 AND 38).

FIRST USE 7-15-2001; IN COMMERCE 7-15-2001.

CLASS 9—(Continued).

2,625,836. INTERVIDEO, INC., FREMONT, CA. SN 75-926,914. PUB. 10-23-2001, FILED 2-23-2000.

LINDTV

FOR COMPUTER SOFTWARE FOR USE IN MULTIMEDIA APPLICATIONS TO EMULATE THE HARDWARE FUNCTIONS OF DIGITAL TELEVISION DECODER CHIPS TO ENABLE A PERSONAL COMPUTER EQUIPPED WITH A DIGITAL TELEVISION TUNER TO DECODE AND PLAY DIGITAL TELEVISION SIGNALS RECEIVED THROUGH CABLE NETWORKS OR FROM SATELLITES (U.S. CLS. 21, 23, 26, 36 AND 38).

FIRST USE 11-15-2001; IN COMMERCE 11-15-2001.

2,625,837. INTERVIDEO, INC., FREMONT, CA. SN 75-926,915. PUB. 10-23-2001, FILED 2-23-2000.

WINRIP

FOR COMPUTER SOFTWARE FOR USE IN MULTIMEDIA APPLICATIONS IN PERSONAL COMPUTERS TO COMPRESS AND TO RECORD AUDIO INFORMATION FROM MEDIA INTO A COMPUTER STORAGE DEVICE AND TO PLAY IT BACK IN REAL TIME OR LATER BY DECODING THE ENCODED AUDIO INFORMATION, AND THUS EMULATING THE HARDWARE FUNCTIONS OF CONSUMER MP3 PLAYER (U.S. CLS. 21, 23, 26, 36 AND 38).

FIRST USE 2-15-2001; IN COMMERCE 2-15-2001.

2,625,838. INTERVIDEO, INC., FREMONT, CA. SN 75-926,916. PUB. 12-25-2001, FILED 2-23-2000.

LINRIP

FOR COMPUTER SOFTWARE FOR USE IN MULTIMEDIA APPLICATIONS IN PERSONAL COMPUTERS TO COMPRESS AND RECORD AUDIO INFORMATION FROM MEDIA INTO A COMPUTER STORAGE DEVICE AND TO PLAY IT BACK IN REAL TIME OR LATER BY DECODING THE ENCODED AUDIO INFORMATION, AND THUS EMULATING THE HARDWARE FUNCTIONS OF CONSUMER MP3 PLAYERS (U.S. CLS. 21, 23, 26, 36 AND 38).

FIRST USE 1-15-2002; IN COMMERCE 1-15-2002.

CLASS 9—(Continued).

2,625,844. CALIENT NETWORKS, INC., SAN JOSE, CA. SN 75-928,342. PUB. 6-12-2001, FILED 2-26-2000.

WHERE INNOVATION COMES TO LIGHT

FOR COMPUTER HARDWARE AND SOFTWARE RELATING TO OPTICAL TELECOMMUNICATIONS NETWORKING TECHNOLOGY, NAMELY OPTICAL NETWORK APPLICATIONS, PHOTONIC SWITCHING, EMBEDDED ROUTING AND SIGNALING AND BANDWIDTH MANAGEMENT TOGETHER WITH USER MANUALS IN PRINT AND ELECTRONIC FORMAT PROVIDED THEREWITH; OPTICAL TELECOMMUNICATIONS NETWORK COMPONENTS, NAMELY OPTICAL AND PHOTONIC SWITCHES (U.S. CLS. 21, 23, 26, 36 AND 38).

FIRST USE 6-25-2001; IN COMMERCE 6-25-2001.

2,625,863. KARIDI, INC., BURLINGAME, CA. SN 75-938,896. PUB. 10-30-2001, FILED 3-8-2000.

KADIRI

THE ENGLISH TRANSLATION OF THE WORD "KADIRI" IN THE MARK IS "ACCESS, MEASURE, OR CALCULATE".

FOR COMPUTER SOFTWARE USED TO PROVIDE ORGANIZATION, MANAGEMENT, COMMUNICATION, ANALYSIS AND TRACKING OF MANAGEMENT AND BUSINESS PROCESSES (U.S. CLS. 21, 23, 26, 36 AND 38).

FIRST USE 5-0-2000; IN COMMERCE 5-0-2000.

2,625,877. WOOSHCORPORATION, MORRISON, CO, BY CHANGE OF NAME POLYCOM DEVELOPMENT CORPORATION, MORRISON, CO. SN 75-980,717. PUB. 8-7-2001, FILED 2-17-1999.

WOOSHCORPORATION

FOR ELECTRONIC APPARATUS FOR COMMUNICATING, TRANSMITTING, TRANSLATING, MULTIPLEXING, DEMULTIPLEXING, ROUTING, SWITCHING, MANIPULATING AND MANAGING VIDEO SIGNALS AND DATA STREAMS; COMPUTER SOFTWARE AND EMBEDDED COMPUTER SOFTWARE FOR COMMUNICATING, TRANSMITTING, TRANSLATING, MULTIPLEXING, DEMULTIPLEXING, ROUTING, SWITCHING, MANIPULATING AND MANAGING VIDEO SIGNALS AND DATA STREAMS (U.S. CLS. 21, 23, 26, 36 AND 38).

FIRST USE 1-29-1999; IN COMMERCE 10-22-1999.

CLASS 9—(Continued).

2,625,939. CARRIER ACCESS CORPORATION, BOULDER, CO. SN 76-027,334. PUB. 8-7-2001, FILED 4-17-2000.

ADIT

FOR TELECOMMUNICATIONS EQUIPMENT, NAMELY MULTIPLEXORS, SWITCHES, AND COMMUNICATION DATA STORAGE UNITS FOR USE IN ROUTING VOICE AND DATA COMMUNICATIONS (U.S. CLS. 21, 23, 26, 36 AND 38).

FIRST USE 5-31-2000; IN COMMERCE 6-15-2000.

2,625,948. MATERIAL HANDLING INDUSTRY, CHARLOTTE, NC. SN 76-029,688. PUB. 1-8-2002, FILED 4-18-2000.

E-MHOVE

FOR DOWNLOADABLE ELECTRONIC NEWSLETTERS FEATURING INFORMATION RELEVANT TO THE MATERIAL HANDLING AND LOGISTICS INDUSTRIES (U.S. CLS. 21, 23, 26, 36 AND 38).

FIRST USE 4-0-2000; IN COMMERCE 6-0-2000.

2,625,965. INOVX SOLUTIONS, IRVINE, CA. SN 76-038,309. PUB. 12-25-2001, FILED 4-27-2000.

REALITYLIX VISUALIZER

NO CLAIM IS MADE TO THE EXCLUSIVE RIGHT TO USE "VISUALIZER", APART FROM THE MARK AS SHOWN.

FOR SOFTWARE PROGRAM TOOLS TO ACCESS, VIEW, AND MANIPULATE THE DATABASE OF THE AS-IS PHYSICAL CONDITION OF EXISTING PHYSICAL PLANTS (U.S. CLS. 21, 23, 26, 36 AND 38).

FIRST USE 12-15-1999; IN COMMERCE 5-15-2000.

2,625,968. MIRALINK CORPORATION, PORTLAND, OR. SN 76-039,140. PUB. 1-9-2001, FILED 5-2-2000.

INTELLIBUFFER

FOR DATA MIRRORING PRODUCTS, NAMELY, COMPUTER SOFTWARE AND HARDWARE FOR LOCALLY OR REMOTELY MIRRORING DATA, AND INSTRUCTION MANUALS SOLD AS A UNIT (U.S. CLS. 21, 23, 26, 36 AND 38).

FIRST USE 7-31-2001; IN COMMERCE 7-31-2001.

CLASS 9—(Continued).

2,625,971. CONSULTORES TECNOLOGICOS ALLOY 2107, C.A., LA FLORESTA, CARACAS, VENEZUELA. SN 76-040,650. PUB. 8-7-2001, FILED 5-4-2000.



NO CLAIM IS MADE TO THE EXCLUSIVE RIGHT TO USE "GAMES", APART FROM THE MARK AS SHOWN.

FOR INTERACTIVE ELECTRONIC VIDEO GAMES FEATURING EDUCATIONAL MATERIAL FOR CHILDREN COMPRISED OF COMPUTER HARDWARE AND SOFTWARE AND INSTRUCTION BOOKLET (U.S. CLS. 21, 23, 26, 36 AND 38).

FIRST USE 9-1-2001; IN COMMERCE 9-1-2001.

2,625,999. ANSELL PROTECTIVE PRODUCTS INC., COSHOCTON, OH. SN 76-049,585. PUB. 4-10-2001, FILED 5-16-2000.

THE DUKE

FOR PROTECTIVE INDUSTRIAL WORK GLOVES (U.S. CLS. 21, 23, 26, 36 AND 38).

FIRST USE 1-26-2001; IN COMMERCE 1-26-2001.

2,626,010. UMBANET, INC., NEW YORK, NY. SN 76-057,710. PUB. 9-4-2001, FILED 5-26-2000.

UMBANET

FOR COMPUTER SOFTWARE, NAMELY, TELECOMMUNICATIONS SOFTWARE FOR ELECTRONIC MAIL, INTERNET ACCESS, LAN ACCESS, WAN ACCESS, INSTANT MESSAGING, FILE TRANSFER, AND WIRELESS COMMUNICATION, NETWORK SECURITY SOFTWARE FOR ENCRYPTING, DECRYPTING, PASSWORD PROTECTING, AUTHENTICATION, VIRUS DETECTION, SOFTWARE AND DATA INTEGRITY, COMPONENT BASED DEVELOPMENT TOOLS, ELECTRONIC MAIL SOFTWARE FOR ELECTRONIC MAIL APPLICATIONS, AND COMPONENT SOFTWARE 'PLUG-INS' FOR USE WITH MIDDLEWARE (U.S. CLS. 21, 23, 26, 36 AND 38).

FIRST USE 5-23-2002; IN COMMERCE 5-23-2002.

CLASS 9—(Continued).

2,626,017. MATRIX TECHNOLOGIES CORP., HUDSON, NH. SN 76-060,519. PUB. 1-30-2001, FILED 5-31-2000.

CONTROLMATE

FOR COMPUTER SOFTWARE PROVIDING A GRAPHIC INTERFACE WITH AUTOMATED PIPETTORS AND FOR THE DESIGN AND MANIPULATION OF CONTROL PROGRAMS FOR PIPETTORS (U.S. CLS. 21, 23, 26, 36 AND 38).

FIRST USE 10-15-1999; IN COMMERCE 10-15-1999.

2,626,019. INVICTA NETWORKS, INC., LAUREL, MD. SN 76-060,648. PUB. 9-11-2001, FILED 5-31-2000.

INVICTA

"INVICTA" IS A SPANISH WORD WHICH CAN BE TRANSLATED AS "UNCONQUERABLE".

FOR COMPUTER HARDWARE AND SOFTWARE TO DETECT AND PREVENT COMMUNICATION SYSTEM INTRUSION (U.S. CLS. 21, 23, 26, 36 AND 38).

FIRST USE 6-11-2001; IN COMMERCE 11-26-2001.

2,626,037. HIGHWEB & PAGE GROUP, INC., MISSISSAUGA, ONTARIO, CANADA. SN 76-073,722. PUB. 12-18-2001, FILED 6-19-2000.

IFACTUM

FOR COMPUTER SOFTWARE USED TO DESIGN, DEVELOP, AND MANAGE SOFTWARE APPLICATIONS ON A GLOBAL COMPUTER NETWORK (U.S. CLS. 21, 23, 26, 36 AND 38).

FIRST USE 5-2-2002; IN COMMERCE 5-15-2002.

2,626,052. IGT, RENO, NV. SN 76-078,996. PUB. 6-12-2001, FILED 6-28-2000.

BY GEORGE

FOR GAMING MACHINES (U.S. CLS. 21, 23, 26, 36 AND 38).

FIRST USE 2-15-2002; IN COMMERCE 2-15-2002.

2,626,053. FLOSCAN INSTRUMENT COMPANY, INC., SEATTLE, WA. SN 76-079,160. PUB. 5-29-2001, FILED 6-28-2000.

DATALINK

FOR MARINE AND AUTOMOTIVE INSTRUMENTATION, NAMELY, ELECTRONIC FUEL METERS AND TACHOMETERS (U.S. CLS. 21, 23, 26, 36 AND 38).

FIRST USE 6-14-2000; IN COMMERCE 7-21-2000.

CLASS 9—(Continued).

2,626,054. CHAMPION MICROELECTRONIC CORP., HSINCHU 300, TAIWAN. SN 76-079,690. PUB. 9-18-2001, FILED 6-28-2000.

CLASS D PLUS

NO CLAIM IS MADE TO THE EXCLUSIVE RIGHT TO USE "PLUS", APART FROM THE MARK AS SHOWN.

FOR INTEGRATED CIRCUITS USED FOR AUDIO AMPLIFICATION OF AUDIO AND VIDEO PLAYERS, NAMELY, CD'S, VCD'S, DVD'S, MP3, MPEG, COMPUTER DISC; DESK TOP PERSONAL COMPUTERS, NOTEBOOK COMPUTERS AND SOUND SYSTEMS, NAMELY, AUDIO TRANSMITTERS, AUDIO RECEIVERS, AMPLIFIERS, MICROPHONES AND SPEAKERS (U.S. CLS. 21, 23, 26, 36 AND 38).

FIRST USE 12-31-2001; IN COMMERCE 3-31-2002.

2,626,066. ERB INDUSTRIES, INC., WOODSTOCK, GA. SN 76-086,643. PUB. 7-10-2001, FILED 7-11-2000.

MEGA RATCHET

FOR SAFETY APPARATUS, NAMELY, HARD HAT SUSPENSION FOR SHOCK OR PRESSURE ABSORPTION (U.S. CLS. 21, 23, 26, 36 AND 38).

FIRST USE 2-1-2002; IN COMMERCE 2-1-2002.

2,626,074. DAIRY INNOVATIONS, LLC, ATTICA, NY, BY ASSIGNMENT SKIDMORE, ANDREW L., ATTICA, NY. SN 76-088,863. PUB. 6-5-2001, FILED 7-13-2000.

HIPOMETER

FOR MEASURING INSTRUMENT USED TO ESTIMATE THE BODY WEIGHT OF CATTLE (U.S. CLS. 21, 23, 26, 36 AND 38).

FIRST USE 11-21-2001; IN COMMERCE 11-21-2001.

2,626,078. AGRIMOND, L.L.C., CAPE CANAVERAL, FL. SN 76-089,963. PUB. 9-25-2001, FILED 7-13-2000.

ALCS

FOR ELECTRICAL AND ELECTRONIC APPARATUS FOR CREATING HIGH LEVELS OF DISSOLVED OZONE IN WATER, AND CONTROLLING AND CONVEYING OZONATED WATER TO LAUNDRY WASHING MACHINES (U.S. CLS. 21, 23, 26, 36 AND 38).

FIRST USE 4-22-1998; IN COMMERCE 8-0-1998.

CLASS 9—(Continued).

2,626,103. HARMONIA MUNDI USA INC., LOS ANGELES, CA. SN 76-102,106. PUB. 1-8-2002, FILED 8-3-2000.

CLASSICAL EXPRESS

NO CLAIM IS MADE TO THE EXCLUSIVE RIGHT TO USE "CLASSICAL EXPRESS", APART FROM THE MARK AS SHOWN.

FOR PHONOGRAPH RECORDS, COMPACT DISCS, PRERECORDED VIDEO CASSETTES, AND PRERECORDED AUDIO CASSETTES, ALL FEATURING MUSIC (U.S. CLS. 21, 23, 26, 36 AND 38).

FIRST USE 3-13-2001; IN COMMERCE 3-13-2001.

2,626,134. CRESCENT NETWORKS, INC., LOWELL, MA. SN 76-119,001. PUB. 1-15-2002, FILED 8-29-2000.

CRESCENT NETWORKS

NO CLAIM IS MADE TO THE EXCLUSIVE RIGHT TO USE "NETWORKS", APART FROM THE MARK AS SHOWN.

FOR COMMUNICATIONS EQUIPMENT, NAMELY NETWORK SWITCHES FOR DIRECTING THE FLOW OF INFORMATION IN A COMMUNICATIONS NETWORK AND SOFTWARE FOR MONITORING AND CONTROLLING ONE OR MORE NETWORK SWITCHES IN A COMMUNICATIONS NETWORK (U.S. CLS. 21, 23, 26, 36 AND 38).

FIRST USE 3-1-2002; IN COMMERCE 3-1-2002.

2,626,137. TERABURST NETWORKS, INC., SUNNYVALE, CA. SN 76-120,019. PUB. 5-22-2001, FILED 8-31-2000.

OMS

FOR TELECOMMUNICATIONS EQUIPMENT, NAMELY, CROSS-CONNECT BOXES FOR FIBER OPTIC TELECOMMUNICATIONS SYSTEMS (U.S. CLS. 21, 23, 26, 36 AND 38).

FIRST USE 6-4-2001; IN COMMERCE 10-22-2001.

2,626,145. PORCH SWING PUBLISHING, INC., OREM, UT. SN 76-122,146. PUB. 5-15-2001, FILED 9-5-2000.

FLIPLIETTES

FOR FEATURE OF COMPUTER SOFTWARE FOR MANIPULATING FONTS (U.S. CLS. 21, 23, 26, 36 AND 38).

FIRST USE 10-0-2000; IN COMMERCE 10-0-2000.

CLASS 9—(Continued).

2,626,148. TRANSETRIC LLLC, ST. LOUIS, MO. SN 76-123,632. PUB. 1-1-2002, FILED 9-6-2000.

RAILHAWK

FOR COMPUTER SOFTWARE, NAMELY, SOFTWARE FOR CARRIER TRANSPORTATION MANAGEMENT; ENTERPRISE OPERATING SOFTWARE FOR RAILROADS; MODULES FOR OPERATIONS, BILLING SYSTEMS, TRACK WARRANTS, SIGNAL TESTING, AND CAR HIRE ACCOUNTING (U.S. CLS. 21, 23, 26, 36 AND 38).

FIRST USE 1-14-2002; IN COMMERCE 1-14-2002.

2,626,149. TRANSETRIC LLC, ST. LOUIS, MO. SN 76-123,633. PUB. 1-1-2002, FILED 9-6-2000.

YARDHAWK

FOR COMPUTER SOFTWARE, NAMELY, OPERATING SOFTWARE FOR RAILROAD YARDS; MAP-BASED YARD GRAPHICS; PLANNING TOOLS; ASYNCHRONOUS INFORMATION UPDATE; INTERFACES TO INFORMATION SYSTEMS; YARD INVENTORY AND WORK ORDER CONTROL; COMPUTER MODULES FOR COMPUTER-BASED DECISION SUPPORT AND SHOP PLANNING (U.S. CLS. 21, 23, 26, 36 AND 38).

FIRST USE 6-22-2001; IN COMMERCE 6-22-2001.

2,626,154. AMERICAN CONTACT LENS, INC., SAN DIEGO, CA. SN 76-125,532. PUB. 5-29-2001, FILED 9-11-2000.

TRIO

FOR CONTACT LENSES (U.S. CLS. 21, 23, 26, 36 AND 38).

FIRST USE 9-19-2000; IN COMMERCE 9-19-2000.

2,626,155. DISCOVERTHEOUTDOORS.COM, INC, OVERLAND PARK, KS. SN 76-126,074. PUB. 7-3-2001, FILED 9-11-2000.

POV TRAINING

NO CLAIM IS MADE TO THE EXCLUSIVE RIGHT TO USE "TRAINING", APART FROM THE MARK AS SHOWN. FOR COMPUTER SOFTWARE IN THE FIELD OF TRAINING FOR HUNTERS (U.S. CLS. 21, 23, 26, 36 AND 38).

FIRST USE 11-5-2001; IN COMMERCE 2-1-2002.

CLASS 9—(Continued).

2,626,163. CAPTUS NETWORKS CORP., WOODLAND, CA. SN 76-128,180. PUB. 6-26-2001, FILED 9-15-2000.

CAPTCC

FOR COMMUNICATIONS SOFTWARE FOR CONNECTING COMPUTER NETWORK USERS AND GLOBAL COMPUTER NETWORKS; DATA COMPRESSION SOFTWARE; FACILITIES MANAGEMENT SOFTWARE, NAMELY, SOFTWARE TO CONTROL BUILDING ENVIRONMENTAL, ACCESS AND SECURITY SYSTEMS, COMPUTER HARDWARE FOR COMMUNICATIONS SERVERS (U.S. CLS. 21, 23, 26, 36 AND 38).

FIRST USE 5-8-2001; IN COMMERCE 5-8-2001.

2,626,166. UNION SCIENTIFIC CORPORATION, RANDALLSTOWN, MD. SN 76-129,998. PUB. 8-28-2001, FILED 9-18-2000.

VIBROTURBULATOR

FOR LABORATORY EQUIPMENT, NAMELY VIBRATING MIXING DEVICES FOR LIQUIDS AND LIQUIDS MIXED WITH SOLIDS (U.S. CLS. 21, 23, 26, 36 AND 38).

FIRST USE 3-28-2001; IN COMMERCE 3-28-2001.

2,626,168. DIRAD TELECOM, INC., TORRANCE, CA. SN 76-130,121. PUB. 6-5-2001, FILED 9-18-2000.

TELECOMPRESSION

FOR HARDWARE AND SOFTWARE FOR COMPRESSING AND MULTIPLEXING MULTIPLE PUBLIC SWITCHED TELEPHONE NETWORK (PSTN) CHANNELS FOR TRANSMISSION OVER A FRAME RELAY GATEWAY (U.S. CLS. 21, 23, 26, 36 AND 38).

FIRST USE 9-18-2000; IN COMMERCE 6-11-2001.

2,626,171. EXPRESSIONTOOLS, INC., FUKUOKA-SHI FUKUOKA-KEN, JAPAN. SN 76-131,220. PUB. 2-12-2002, FILED 9-19-2000.

SHADE

FOR THREE DIMENSIONAL COMPUTER GRAPHICS SOFTWARE (U.S. CLS. 21, 23, 26, 36 AND 38).

FIRST USE 12-21-2001; IN COMMERCE 12-21-2001.

CLASS 9—(Continued).

2,626,172. HEALTHNET MANAGEMENT SERVICES, LLC, MARIETTA, GA, BY ASSIGNMENT FREEDMAN, HARRY, MARIETTA, GA. SN 76-131,987. PUB. 7-24-2001, FILED 9-20-2000.

ADVANTOUCH

FOR COMPUTER SOFTWARE THAT PROVIDES AN INTEGRATED APPLICATION DEVELOPMENT ENVIRONMENT TO FACILITATE THE DESIGN, DEVELOPMENT AND ADMINISTRATION OF DATA COLLECTION, DATABASE MANAGEMENT, DATA ANALYSIS AND DATA REPORTING APPLICATIONS (U.S. CLS. 21, 23, 26, 36 AND 38).

FIRST USE 3-13-2002; IN COMMERCE 3-13-2002.

2,626,175. MEDIMPACT HEALTHCARE SYSTEMS, INC., SAN DIEGO, CA. SN 76-133,671. PUB. 6-19-2001, FILED 9-22-2000.

MEDDIVIDEND SQL

OWNER OF U.S. REG. NO. 2,310,831.
FOR COMPUTER SOFTWARE USED FOR ADMINISTERING PRESCRIPTION DRUG REBATE PROGRAMS, NAMELY, PROVIDING REBATES ON THE ORDERING OF PRESCRIPTION DRUGS TO SUBSCRIBERS OF THE SOFTWARE BY COMBINING THE OVERALL DRUG UTILIZATION DATA OF THE CLIENT SUBSCRIBER TO NEGOTIATE VOLUME DISCOUNT CONTRACTS WITH PHARMACEUTICAL COMPANIES (U.S. CLS. 21, 23, 26, 36 AND 38).

FIRST USE 12-0-2000; IN COMMERCE 12-0-2000.

2,626,181. COMPUCREDIT CORPORATION, ATLANTA, GA. SN 76-135,689. PUB. 6-19-2001, FILED 9-26-2000.

EMERGE

FOR MAGNETICALLY ENCODED CREDIT CARDS (U.S. CLS. 21, 23, 26, 36 AND 38).

FIRST USE 11-5-2000; IN COMMERCE 11-5-2000.

2,626,194. INTERNATIONAL EQUIPMENT CO., NEEDHAM HEIGHTS, MA. SN 76-141,501. PUB. 8-21-2001, FILED 10-5-2000.

MEDILITE

FOR LABORATORY CENTRIFUGES AND PARTS THEREFOR (U.S. CLS. 21, 23, 26, 36 AND 38).

FIRST USE 6-0-2001; IN COMMERCE 6-0-2001.

CLASS 9—(Continued).

2,626,198. COCKEYES COMPANY, PERRIS, CA. SN 76-142,250. PUB. 5-15-2001, FILED 10-10-2000.

CHICKEYES

FOR SUNGLASSES (U.S. CLS. 21, 23, 26, 36 AND 38).
FIRST USE 12-22-2000; IN COMMERCE 4-1-2001.

2,626,208. COLTEC INDUSTRIES INC., CHARLOTTE, NC. SN 76-147,128. PUB. 8-7-2001, FILED 10-16-2000.

WEBSYNC

OWNER OF U.S. REG. NO. 2,155,361.
FOR COMPUTER SOFTWARE, ACCESSED BY BROWERS ON THE GLOBAL COMPUTER NETWORK, FOR THE REMOTE MONITORING, OPERATION AND CONTROL OF VARIABLE CAPACITY AIR ENDS IN THE NATURE OF AIR COMPRESSORS (U.S. CLS. 21, 23, 26, 36 AND 38).

FIRST USE 6-0-2001; IN COMMERCE 6-0-2001.

2,626,233. VEE-JAY LIMITED PARTNERSHIP, REDDING, CT. SN 76-155,702. PUB. 8-14-2001, FILED 10-30-2000.



OWNER OF U.S. REG. NO. 2,079,969.
NO CLAIM IS MADE TO THE EXCLUSIVE RIGHT TO USE "RECORDS", APART FROM THE MARK AS SHOWN.
FOR MUSICAL SOUND RECORDINGS (U.S. CLS. 21, 23, 26, 36 AND 38).

FIRST USE 0-0-1963; IN COMMERCE 0-0-1963.

2,626,236. ALLTECH ASSOCIATES, INC., DEERFIELD, IL. SN 76-156,028. PUB. 7-31-2001, FILED 10-30-2000.

DS-PLUS

FOR SOLID-PHASE SUPPRESSORS FOR USE IN ION CHROMATOGRAPHY (U.S. CLS. 21, 23, 26, 36 AND 38).

FIRST USE 2-1-2001; IN COMMERCE 2-1-2001.

CLASS 9—(Continued).

2,626,246. BILL GOOD MARKETING, SOUTH JORDAN, UT.
SN 76-157,531. PUB. 8-14-2001, FILED 11-1-2000.

RED CHERRY

FOR COMPUTER SOFTWARE FOR MAKING AVAILABLE A LISTING OF ONE OR MORE INDIVIDUALS WHO ARE INTERESTED IN INVESTING AND WHOSE INVESTABLE MONEY IS PRESENTLY AVAILABLE (U.S. CLS. 21, 23, 26, 36 AND 38).

FIRST USE 0-0-1994; IN COMMERCE 0-0-1994.

2,626,257. CEREVA NETWORKS INC., MARLBOROUGH, MA. SN 76-161,736. PUB. 8-14-2001, FILED 11-8-2000.



THE DESIGN PORTION OF THE MARK IS COMPRISED OF A CIRCLE, WITH THE LETTERS "VA" CUT INTO IT.

FOR COMPUTER HARDWARE AND COMPUTER SOFTWARE, NAMELY, APPLICATION AND OPERATING SYSTEM SOFTWARE AND COMPUTER NETWORKING EQUIPMENT, NAMELY, HUBS, ROUTERS, SWITCHES, HARD DRIVES, SERVERS ALL FOR NETWORKING, DATA STORAGE, CONTENT MANAGEMENT AND THE DISTRIBUTION OF CONTENT OVER NETWORKS (U.S. CLS. 21, 23, 26, 36 AND 38).

FIRST USE 5-7-2001; IN COMMERCE 8-16-2001.

2,626,273. ORION RESEARCH, INC., BEVERLY, MA. SN 76-169,072. PUB. 7-17-2001, FILED 11-20-2000.

PHUTURE PENTRODE

OWNER OF U.S. REG. NO. 2,378,556.
FOR EQUIPMENT FOR ELECTROCHEMICAL ANALYSIS —NAMELY, ELECTROCHEMICAL ELECTRODES FOR SENSING IONS IN SOLUTION; AND PARTS AND FITTINGS THEREFOR (U.S. CLS. 21, 23, 26, 36 AND 38).

FIRST USE 1-1-2000; IN COMMERCE 1-1-2000.

CLASS 9—(Continued).

2,626,290. HYPERCEL CORPORATION, SAN FERNANDO, CA. SN 76-174,128. PUB. 12-4-2001, FILED 12-1-2000.

HYPER GEAR

NO CLAIM IS MADE TO THE EXCLUSIVE RIGHT TO USE "GEAR", APART FROM THE MARK AS SHOWN.

FOR LEATHER CASES FOR CELLULAR PHONE ACCESSORIES (U.S. CLS. 21, 23, 26, 36 AND 38).

FIRST USE 12-0-2001; IN COMMERCE 12-0-2001.

2,626,292. DEUTSCHE GRAMMOPHON GESELLSCHAFT MBH, D-20148 HAMBURG, FED REP GERMANY. SN 76-174,613. PUB. 8-14-2001, FILED 12-4-2000.



EMIL BERLINER STUDIOS

NO CLAIM IS MADE TO THE EXCLUSIVE RIGHT TO USE "STUDIOS", APART FROM THE MARK AS SHOWN.

"EMIL BERLINER" DOES NOT IDENTIFY A LIVING INDIVIDUAL.

FOR MUSICAL SOUND RECORDINGS AND VIDEO RECORDINGS (U.S. CLS. 21, 23, 26, 36 AND 38).

FIRST USE 8-0-2000; IN COMMERCE 8-0-2000.

2,626,296. FLUOROWARE, INC., CHASKA, MN. SN 76-178,206. PUB. 8-14-2001, FILED 12-8-2000.

RELIANT

FOR FLUID PRESSURE REGULATORS, AND PARTS THEREFORE (U.S. CLS. 21, 23, 26, 36 AND 38).

FIRST USE 12-31-2001; IN COMMERCE 12-31-2001.

2,626,306. CATALINA PERFORMANCE ACCESSORIES, INC., MOUNTAINBURG, AR. SN 76-181,671. PUB. 1-1-2002, FILED 12-15-2000.

SMARTGLOW FUSE

NO CLAIM IS MADE TO THE EXCLUSIVE RIGHT TO USE "FUSE", APART FROM THE MARK AS SHOWN.

FOR AUTOMOTIVE FUSES (U.S. CLS. 21, 23, 26, 36 AND 38).

FIRST USE 9-13-2000; IN COMMERCE 11-20-2000.

CLASS 9—(Continued).

2,626,309. SOUTHWEST RESEARCH INSTITUTE, SAN ANTONIO, TX. SN 76-182,527. PUB. 9-11-2001, FILED 12-18-2000.

WOTCADD

FOR VEHICLE PERFORMANCE MODELING SOFTWARE (U.S. CLS. 21, 23, 26, 36 AND 38).
FIRST USE 3-0-2001; IN COMMERCE 8-0-2001.

2,626,314. CELCO PARTNERSHIP, DBA VERIZON WIRELESS, BEDMINISTER, NJ. SN 76-184,380. PUB. 1-15-2002, FILED 12-21-2000.

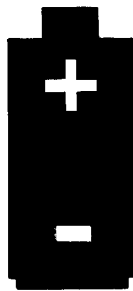

FOR BATTERIES FOR WIRELESS TELEPHONES (U.S. CLS. 21, 23, 26, 36 AND 38).
FIRST USE 11-9-2000; IN COMMERCE 11-9-2000.

2,626,336. SAVVIDES, SAVVAS, NICOSIA 2412, CYPRUS. SN 76-195,355. PUB. 8-28-2001, FILED 1-17-2001.

RISKEASE

FOR COMPUTER SOFTWARE, NAMELY COMPUTER SOFTWARE FOR USE IN MONTE-CARLO SIMULATIONS RISK ANALYSIS APPLICATIONS (U.S. CLS. 21, 23, 26, 36 AND 38).
FIRST USE 8-0-2000; IN COMMERCE 8-0-2000.

2,626,342. AIR-TRAK.COM, SAN DIEGO, CA. SN 76-198,011. PUB. 8-21-2001, FILED 1-22-2001.

DUALTRAK

FOR ELECTRONIC HARDWARE AND SOFTWARE FOR DATA TRANSMISSION AND RECEPTION ACROSS SATELLITE AND TERRESTRIAL NETWORKS (U.S. CLS. 21, 23, 26, 36 AND 38).
FIRST USE 10-22-2001; IN COMMERCE 10-22-2001.

CLASS 9—(Continued).

2,626,346. INPUT/OUTPUT, INC., STAFFORD, TX. SN 76-200,131. PUB. 9-18-2001, FILED 1-25-2001.

FASTRING

FOR SEISMIC CABLES, SEISMIC CABLE CONNECTORS, AND EARPHONE AND ACCELEROMETER SENSOR CASES FOR USE IN SEISMIC EXPLORATION (U.S. CLS. 21, 23, 26, 36 AND 38).
FIRST USE 6-11-2001; IN COMMERCE 6-11-2001.

2,626,351. CLADDAGH COMPANY, THE, HAMMOND, IN. SN 76-203,270. PUB. 10-30-2001, FILED 1-31-2001.



The Claddagh Company

NO CLAIM IS MADE TO THE EXCLUSIVE RIGHT TO USE "COMPANY", APART FROM THE MARK AS SHOWN. FOR COMPACT DISCS, PRE-RECORDED AUDIO-TAPES, PRE-RECORDED AUDIO CASSETTES, AND PHONOGRAPH RECORDS, ALL FEATURING MUSICAL RECORDINGS; MUSICAL SOUND RECORDINGS (U.S. CLS. 21, 23, 26, 36 AND 38).
FIRST USE 2-2-2000; IN COMMERCE 5-4-2000.

2,626,358. MANYWORLDS, INC., HOUSTON, TX. SN 76-206,252. PUB. 8-21-2001, FILED 2-8-2001.

EPITURE

FOR SPECIALIZED KNOWLEDGE MANAGEMENT SOFTWARE USED IN PUBLISHING CONTENT FOR WEBSITES (U.S. CLS. 21, 23, 26, 36 AND 38).
FIRST USE 7-23-2000; IN COMMERCE 7-23-2000.

CLASS 9—(Continued).

2,626,361. BABY EINSTEIN COMPANY, LLC, THE, LONE TREE, CO. SN 76-207,730. PUB. 11-13-2001, FILED 2-7-2001.



FOR PRE-RECORDED VIDEOTAPES, VIDEODISCS, DVD'S, CD-ROMS, AUDIO CASSETTES, AND AUDIO CDS ALL FEATURING MUSIC, PHOTOGRAPHIC IMAGES AND GRAPHIC IMAGES WHICH ARE DESIGNED TO STIMULATE THE LEARNING CAPABILITIES TO INFANTS AND TODDLERS (U.S. CLS. 21, 23, 26, 36 AND 38).
FIRST USE 4-0-2001; IN COMMERCE 4-0-2001.

2,626,372. BOURNS, INC., RIVERSIDE, CA. SN 76-209,156. PUB. 10-2-2001, FILED 2-12-2001.

CHIP GUARD

NO CLAIM IS MADE TO THE EXCLUSIVE RIGHT TO USE "GUARD", APART FROM THE MARK AS SHOWN.
FOR ELECTRICAL SURGE PROTECTORS AND ARRESTORS, ELECTROSTATIC DISCHARGE SUPPRESSORS AND TRANSIENT VOLTAGE PROTECTORS AND SUPPRESSORS (U.S. CLS. 21, 23, 26, 36 AND 38).
FIRST USE 12-0-1997; IN COMMERCE 12-0-1997.

2,626,384. LOCKMAN FOUNDATION, THE, LA HABRA, CA. SN 76-212,269. PUB. 8-21-2001, FILED 2-20-2001.

AMPLIFIED

OWNER OF U.S. REG. NO. 1,860,865.
FOR COMPUTER SOFTWARE, NAMELY BIBLES, SEPARATE PORTIONS THEREOF AND PRINTED MATERIAL RELATED THERETO; DOWNLOADABLE BIBLES AND BIBLE STUDY MATERIAL VIA THE INTERNET (U.S. CLS. 21, 23, 26, 36 AND 38).
FIRST USE 1-0-1999; IN COMMERCE 1-0-1999.

CLASS 9—(Continued).

2,626,385. KATE SPADE, LLC, NEW YORK, NY. SN 76-212,692. PUB. 9-4-2001, FILED 2-9-2001.

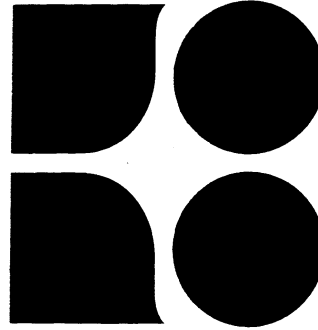

OWNER OF U.S. REG. NOS. 2,064,708, 2,341,633, AND OTHERS.
THE MARK CONSISTS OF A STYLIZED VERSION OF THE LETTER "KS" THE INITIALS FOR KATE SPADE.
FOR EYEWEAR, NAMELY, SUNGLASSES, EYEGLASS FRAMES AND EYEGLASS CASES (U.S. CLS. 21, 23, 26, 36 AND 38).
FIRST USE 3-9-2001; IN COMMERCE 3-9-2001.

2,626,425. PARAMOUNT PICTURES CORPORATION, LOS ANGELES, CA. SN 76-223,713. PUB. 9-25-2001, FILED 3-13-2001.

STAR TREK BRIDGE COMMANDER

FOR COMPUTER GAME SOFTWARE RECORDED ON CD ROM AND COMPUTER GAME JOYSTICKS (U.S. CLS. 21, 23, 26, 36 AND 38).
FIRST USE 3-0-2002; IN COMMERCE 3-0-2002.

2,626,428. NCAST CORPORATION, SUNNYVALE, CA. SN 76-225,072. PUB. 10-9-2001, FILED 3-15-2001.

TELEPRESENTER

FOR COMPUTER HARDWARE AND SOFTWARE USED TO BROADCAST AND PROVIDE ACCESS TO SIMULTANEOUS USERS TO DIGITAL VIDEO, AUDIO AND GRAPHIC INFORMATION AND PRESENTATION OVER THE GLOBAL COMPUTER INFORMATION NETWORK (U.S. CLS. 21, 23, 26, 36 AND 38).
FIRST USE 8-28-2000; IN COMMERCE 8-13-2001.

CLASS 9—(Continued).

2,626,441. EXTECH INSTRUMENTS CORP., WALTHAM, MA. SN 76-231,015. PUB. 8-21-2001, FILED 3-15-2001.

MINIAMP

FOR COMBINED VOLTAGE, RESISTANCE, CURRENT AND CAPACITANCE METERS (U.S. CLS. 21, 23, 26, 36 AND 38).
FIRST USE 5-14-2001; IN COMMERCE 5-14-2001.

2,626,442. INPHI CORPORATION, WESTLAKE VILLAGE, CA. SN 76-231,066. PUB. 8-28-2001, FILED 3-26-2001.

THINK FAST

FOR INTEGRATED CIRCUITS AND SEMICONDUCTOR DEVICES; COMPUTER PROGRAMS FOR USE IN THE DESIGN AND APPLICATION OF INTEGRATED CIRCUITS AND SEMICONDUCTOR DEVICES AND INSTRUCTION MANUALS SOLD THEREWITH (U.S. CLS. 21, 23, 26, 36 AND 38).
FIRST USE 2-0-2001; IN COMMERCE 3-0-2002.

2,626,453. CARTY, DAVID, JR., LOS ANGELES, CA. SN 76-235,577. PUB. 9-11-2001, FILED 4-6-2001.

JELLEESTONE

FOR SERIES OF MUSICAL SOUND RECORDINGS AND PRERECORDED VIDEOTAPES AND VIDEODISCS FEATURING MUSIC (U.S. CLS. 21, 23, 26, 36 AND 38).
FIRST USE 7-17-2001; IN COMMERCE 7-17-2001.

2,626,470. CERAGON NETWORKS LTD., TEL AVIV, ISRAEL. SN 76-244,191. PUB. 10-2-2001, FILED 4-20-2001.

CERAVIEW

FOR COMPUTER SOFTWARE FOR NETWORK MANAGEMENT (U.S. CLS. 21, 23, 26, 36 AND 38).
FIRST USE 7-0-2001; IN COMMERCE 7-0-2001.

2,626,474. DIMARZIO, INC., STATEN ISLAND, NY. SN 76-246,908. PUB. 9-25-2001, FILED 4-26-2001.

M-PATH

FOR CABLES AND WIRES FOR REPRODUCING AND/OR TRANSMITTING ELECTRICAL OR AUDIO SIGNALS (U.S. CLS. 21, 23, 26, 36 AND 38).
FIRST USE 3-0-2001; IN COMMERCE 3-0-2001.

CLASS 9—(Continued).

2,626,495. SAVAJE TECHNOLOGIES, INC., N. CHELMSFORD, MA. SN 76-259,222. PUB. 9-25-2001, FILED 5-21-2001.



FOR COMPUTER OPERATING SYSTEM SOFTWARE FOR USE IN INFORMATION APPLIANCES (U.S. CLS. 21, 23, 26, 36 AND 38).
FIRST USE 11-5-2001; IN COMMERCE 11-5-2001.

2,626,496. SAVAJE TECHNOLOGIES, INC., N. CHELMSFORD, MA. SN 76-259,223. PUB. 9-25-2001, FILED 5-21-2001.

SAVAJE XE

FOR COMPUTER OPERATING SYSTEM SOFTWARE FOR USE IN INFORMATION APPLIANCES (U.S. CLS. 21, 23, 26, 36 AND 38).
FIRST USE 11-5-2001; IN COMMERCE 11-5-2001.

2,626,497. RELY SOFTWARE, INC., NEW YORK, NY. SN 76-259,476. PUB. 12-18-2001, FILED 5-21-2001.

RELY

FOR COMPUTER SOFTWARE FOR SUPPLY CHAIN MANAGEMENT (U.S. CLS. 21, 23, 26, 36 AND 38).
FIRST USE 1-0-2002; IN COMMERCE 1-0-2002.

2,626,502. WALGREEN CO., DEERFIELD, IL. SN 76-261,671. PUB. 9-11-2001, FILED 5-23-2001.

MINDSCAPES

FOR RADIOS (U.S. CLS. 21, 23, 26, 36 AND 38).
FIRST USE 7-1-2001; IN COMMERCE 7-1-2001.

2,626,507. CENTURION TECHNOLOGIES, INC., FENTON, MO. SN 76-266,069. PUB. 11-20-2001, FILED 6-4-2001.

DRIVESHIELD

FOR COMPUTER SOFTWARE FOR USE IN PROTECTING A HARD DRIVE FROM ACCIDENTAL OR UNAUTHORIZED ALTERATIONS AND DELETIONS (U.S. CLS. 21, 23, 26, 36 AND 38).
FIRST USE 10-1-2001; IN COMMERCE 10-1-2001.

CLASS 9—(Continued).

2,626,509. NOVAR CONTROLS CORPORATION, COPLEY, OH. SN 76-268,390. PUB. 10-2-2001, FILED 6-7-2001.

ISCOPE

FOR COMPUTER SOFTWARE FOR COMPUTERIZED CONTROL UNITS FOR MONITORING AND CONTROL OF HEATING, VENTILATION, AIR CONDITIONING AND LIGHTING IN RETAIL, COMMERCIAL AND INDUSTRIAL BUILDINGS (U.S. CLS. 21, 23, 26, 36 AND 38).

FIRST USE 7-23-2001; IN COMMERCE 7-23-2001.

2,626,522. EVEREADY BATTERY COMPANY, INC., ST. LOUIS, MO. SN 76-282,388. PUB. 10-16-2001, FILED 7-10-2001.

DO YOU HAVE THE BUNNY INSIDE?

OWNER OF U.S. REG. NO. 1,769,243.
FOR BATTERIES (U.S. CLS. 21, 23, 26, 36 AND 38).
FIRST USE 10-1-2001; IN COMMERCE 10-1-2001.

2,626,526. COMMORATO, JOHN, INDIANAPOLIS, IN. AND COMMORATO, NORMA, INDIANAPOLIS, IN. SN 76-286,046. PUB. 11-20-2001, FILED 7-16-2001.

RECOGNIZE

FOR COMPUTER SOFTWARE, NAMELY, AN INTERACTIVE SOFTWARE DESIGNED FOR NON-PROFIT ORGANIZATIONS WHICH ALLOWS USERS TO IDENTIFY AND ACCESS DETAILED INFORMATION ABOUT DONORS, EMPLOYEES, MEMBERS, ALUMNAE, STAFF, FACULTY, AND ANY OTHER PERSON OR PRODUCT IN THE DATA BASE AND ALLOWS FOR ON SITE UPDATING AND ADDITION OF NEW INFORMATION INTO THE DATABASE (U.S. CLS. 21, 23, 26, 36 AND 38).
FIRST USE 9-0-2001; IN COMMERCE 9-0-2001.

2,626,532. COMMUNICATION DEVELOPMENT COMPANY, INC., WEST DES MOINES, IA. SN 76-290,521. PUB. 11-13-2001, FILED 7-27-2001.

ARISTOTLE

FOR TEXT ANALYZING AND PROCESSING SOFTWARE (U.S. CLS. 21, 23, 26, 36 AND 38).
FIRST USE 9-5-2001; IN COMMERCE 9-5-2001.

CLASS 9—(Continued).

2,626,544. MATRIX TECHNOLOGIES CORPORATION, HUDSON, NH. SN 76-299,637. PUB. 1-1-2002, FILED 8-14-2001.

TIP TOWER

FOR PIPETTE TIP CHANGER FOR AN AUTOMATED PIPETTER (U.S. CLS. 21, 23, 26, 36 AND 38).
FIRST USE 10-31-2001; IN COMMERCE 10-31-2001.

2,626,571. NETWORK EQUIPMENT TECHNOLOGIES, INC., FREMONT, CA. SN 78-009,798. PUB. 4-10-2001, FILED 5-24-2000.

SHOUTIP

FOR TELEPHONE CONVERGENCE SWITCH FOR VOICE AND DATA SERVICES OVER IP OR ATM NETWORKS (U.S. CLS. 21, 23, 26, 36 AND 38).
FIRST USE 12-29-2000; IN COMMERCE 12-29-2000.

2,626,588. REACTIVE SYSTEMS, INCORPORATED, PORT JEFFERSON, NY. SN 78-017,306. PUB. 6-26-2001, FILED 7-18-2000.

TOMORROW'S SOFTWARE TODAY

FOR COMPUTER SOFTWARE DEVELOPMENT TOOLS (U.S. CLS. 21, 23, 26, 36 AND 38).
FIRST USE 7-11-2000; IN COMMERCE 7-11-2000.

2,626,592. REALNETWORKS, INC., SEATTLE, WA. SN 78-021,193. PUB. 6-12-2001, FILED 8-14-2000.



FOR DOWNLOADABLE COMPUTER SOFTWARE WHICH ALLOWS THE ENCODING, TRANSMITTING, AND RECEIVING OF PICTURES, VIDEO, TEXT, AND/OR AUDIO OVER LOCAL AND GLOBAL NETWORKS (U.S. CLS. 21, 23, 26, 36 AND 38).
FIRST USE 5-22-2000; IN COMMERCE 5-22-2000.

CLASS 9—(Continued).

2,626,594. HP INTELLECTUAL CORP., WILMINGTON, DE. SN 78-021,480. PUB. 7-24-2001, FILED 8-16-2000.

ULTRA TECH

OWNER OF U.S. REG. NO. 2,282,044.
FOR ELECTRIC HAIR STRAIGHTENING IRONS (U.S. CLS. 21, 23, 26, 36 AND 38).
FIRST USE 10-30-1997; IN COMMERCE 10-30-1997.

2,626,595. KINDERSTREET CORPORATION, ANN ARBOR, MI. SN 78-021,515. PUB. 9-4-2001, FILED 8-16-2000.

KINDERSTREET

FOR CHILDCARE FACILITY MANAGEMENT SOFTWARE USED IN TRACKING ATTENDANCE, BILLING, SCHEDULING STAFF, PLANNING FOOD MENUS, PLANNING ACTIVITIES FOR CHILDREN, EDITING, MODIFYING AND CREATING GENERAL DATABASES AND VENDOR/SUPPLIER DATABASES, CREATING MARKETING TOOLS AND TEMPLATES, CREATING AND EDITING REPORTS; ALL FOR USE BY CHILDCARE PROFESSIONALS (U.S. CLS. 21, 23, 26, 36 AND 38).
FIRST USE 11-1-2000; IN COMMERCE 2-6-2002.

2,626,601. SCOUT SOLUTIONS, INC., MT. GRETN, PA. SN 78-024,337. PUB. 5-29-2001, FILED 9-4-2000.

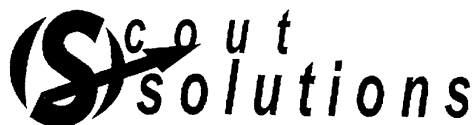

FOR COMPUTER SOFTWARE THAT HELPS BUSINESSES MANAGE INFORMATION ELECTRONICALLY (U.S. CLS. 21, 23, 26, 36 AND 38).
FIRST USE 6-1-2000; IN COMMERCE 6-1-2000.

2,626,602. SCOUT SOLUTIONS, INC., MT. GRETN, PA. SN 78-024,340. PUB. 5-29-2001, FILED 9-4-2000.

APTUS

THE ENGLISH TRANSLATION OF APTUS IS "TO RELATE".
FOR COMPUTER SOFTWARE THAT TRACKS AND MANAGES INFORMATION DESCRIBING THE NATURE OF RELATIONSHIPS BETWEEN PEOPLE WORKING TOGETHER (U.S. CLS. 21, 23, 26, 36 AND 38).
FIRST USE 11-1-2000; IN COMMERCE 12-1-2000.

CLASS 9—(Continued).

2,626,612. SAMSONITE CORPORATION, DENVER, CO. SN 78-031,132. PUB. 7-31-2001, FILED 10-18-2000.

BUSINESSWHERE

FOR COMPUTER CARRYING CASES (U.S. CLS. 21, 23, 26, 36 AND 38).
FIRST USE 1-1-2001; IN COMMERCE 1-1-2001.

2,626,613. WEBB, JAMES W., DBA WEBB ENTERPRISES, TORRANCE, CA. SN 78-031,279. PUB. 9-25-2001, FILED 10-18-2000.

INCLO-MATIC

FOR ALIGNMENT AND REFERENCE INSTRUMENTS, NAMELY, LASER ASSISTED LEVELS COMBINING DIRECTIONAL ALIGNMENT, LEVELING, AND DISTANCE MEASURING (U.S. CLS. 21, 23, 26, 36 AND 38).
FIRST USE 6-7-2000; IN COMMERCE 6-7-2000.

2,626,614. WEBB, JAMES W., DBA WEBB ENTERPRISES, TORRANCE, CA. SN 78-031,289. PUB. 9-18-2001, FILED 10-18-2000.

BEAM-D-CATOR

FOR ALIGNMENT AND REFERENCE INSTRUMENTS, NAMELY LASER ASSISTED LEVELS COMBINING DIRECTIONAL ALIGNMENT, LEVELING, AND DISTANCE MEASURING (U.S. CLS. 21, 23, 26, 36 AND 38).
FIRST USE 1-5-2002; IN COMMERCE 1-5-2002.

2,626,630. LUCENT TECHNOLOGIES INC., MURRAY HILL, NJ. SN 78-037,888. PUB. 8-21-2001, FILED 12-5-2000.

ARTICULATOR

FOR COMPUTER SOFTWARE FOR CONVERTING SPEECH TO TEXT (U.S. CLS. 21, 23, 26, 36 AND 38).
FIRST USE 5-18-2001; IN COMMERCE 5-18-2001.

2,626,636. GALAXY INTERNATIONAL INC., SALT LAKE CITY, UT. SN 78-039,372. PUB. 9-11-2001, FILED 12-14-2000.

UNIWAVE

FOR STEREO EQUIPMENT, NAMELY, AMPLIFIERS, RECEIVERS, TUNERS, CD PLAYERS, TELEVISIONS, VCR'S, DVDS, SPEAKERS, PREAMPLIFIERS, POWER SUPPLY FOR AUDIO EQUIPMENT, CABLES AND CONNECTORS (U.S. CLS. 21, 23, 26, 36 AND 38).
FIRST USE 2-1-2000; IN COMMERCE 10-1-2001.

CLASS 9—(Continued).

2,626,639. CONAIR CORPORATION, STAMFORD, CT. SN 78-039,900. PUB. 8-14-2001, FILED 12-19-2000.

CRUMPLER

FOR ELECTRIC HAIR IRON (U.S. CLS. 21, 23, 26, 36 AND 38).
FIRST USE 1-1-2001; IN COMMERCE 1-1-2001.

2,626,689. TARGET VISION, INC., PITTSFORD, NY. SN 78-052,527. PUB. 10-2-2001, FILED 3-12-2001.

**EMPLOYEE
COMMUNICATION THAT
WORKS**

FOR CLOSED CIRCUIT COMPUTER VIDEO COMMUNICATION SYSTEMS COMPRISING SOFTWARE, PERSONAL COMPUTERS, AND VIDEO HEADEND AND DISPLAY HARDWARE USED FOR ORGANIZATIONAL COMMUNICATIONS WHERE VISUAL CONTENT IS CREATED, SCHEDULED, DISTRIBUTED AND BROADCAST ON TELEVISION MONITORS, COMMUNICATIONS NETWORKS AND THE GLOBAL COMPUTER NETWORK SOLD AS A UNIT (U.S. CLS. 21, 23, 26, 36 AND 38).

FIRST USE 3-23-2001; IN COMMERCE 3-23-2001.

2,626,696. WMS GAMING INC., WAUKEGAN, IL. SN 78-053,368. PUB. 8-28-2001, FILED 3-15-2001.

MONEY GROOVE

FOR CURRENCY AND CREDIT OPERATED SLOT MACHINES AND GAMING DEVICES, NAMELY, GAMING MACHINES FOR USE IN GAMING ESTABLISHMENTS (U.S. CLS. 21, 23, 26, 36 AND 38).

FIRST USE 5-25-2001; IN COMMERCE 5-25-2001.

2,626,697. STARDATE COMPUTER SYSTEMS, INC., BROOKLYN, NY. SN 78-053,376. PUB. 9-25-2001, FILED 3-15-2001.

PAPERSOLVE

FOR COMPUTER SOFTWARE FOR DOCUMENT IMAGING AND SCANNING, DOCUMENT IMAGE PROCESSING, DOCUMENT IMAGE MANAGEMENT, REPORT GENERATION, DOCUMENT INDEXING AND DATABASE MANAGEMENT (U.S. CLS. 21, 23, 26, 36 AND 38).
FIRST USE 6-1-2001; IN COMMERCE 6-1-2001.

CLASS 9—(Continued).

2,626,702. VARCON SYSTEMS, INC., SAN DIEGO, CA. SN 78-055,021. PUB. 1-8-2002, FILED 3-26-2001.



FOR COMPUTER SOFTWARE FOR A MULTI-PLAYER KLONDIKE SOLITAIRE GAME WITH A BINGO TWIST (U.S. CLS. 21, 23, 26, 36 AND 38).

FIRST USE 3-26-2001; IN COMMERCE 3-26-2001.

2,626,732. WMS GAMING INC., WAUKEGAN, IL. SN 78-069,075. PUB. 1-8-2002, FILED 6-14-2001.

CROCODILE CASH

NO CLAIM IS MADE TO THE EXCLUSIVE RIGHT TO USE "CASH", APART FROM THE MARK AS SHOWN.

FOR CURRENCY AND CREDIT OPERATED SLOT MACHINES AND GAMING DEVICES, NAMELY, GAMING MACHINES FOR USE IN GAMING ESTABLISHMENTS (U.S. CLS. 21, 23, 26, 36 AND 38).

FIRST USE 10-1-2001; IN COMMERCE 10-1-2001.

2,626,739. ERGO PARTNERS, L.C., LAKE QUIVIRA, KS. SN 78-072,251. PUB. 10-23-2001, FILED 7-3-2001.

EMERITUS

FOR COMPUTER SOFTWARE THAT ENABLES HEALTH CARE PROVIDERS TO CREATE AND MAINTAIN ELECTRONIC MEDICAL RECORDS (U.S. CLS. 21, 23, 26, 36 AND 38).

FIRST USE 1-8-2002; IN COMMERCE 1-8-2002.

2,626,740. OUTDOOR OPTICS, INC., DBA OLYMPIC OPTICAL CO., MEMPHIS, TN. SN 78-074,154. PUB. 11-20-2001, FILED 7-16-2001.

BRUTE

FOR SAFETY GLASSES (U.S. CLS. 21, 23, 26, 36 AND 38).
FIRST USE 1-30-2002; IN COMMERCE 1-30-2002.

CLASS 9—(Continued).

2,626,748. WMS GAMING INC., WAUKEGAN, IL. SN 78-079,055. PUB. 12-4-2001, FILED 8-14-2001.

DIAMONDS 4 EVER

FOR CURRENCY AND CREDIT OPERATED SLOT MACHINES AND GAMING DEVICES, NAMELY, GAMING MACHINES FOR USE IN GAMING ESTABLISHMENTS (U.S. CLS. 21, 23, 26, 36 AND 38).

FIRST USE 10-1-2001; IN COMMERCE 10-1-2001.

CLASS 10—MEDICAL APPARATUS

2,625,313. MASSENGILL, R. KEMP, LEUCADIA, CA. SN 74-708,867. PUB. 8-6-1996, FILED 7-31-1995.

SAFESCAN

FOR MEDICAL IMAGING DEVICE FOR DETECTING STRUCTURAL ABNORMALITIES AND FOREIGN OBJECTS, INCLUDING FERROUS METALLIC FOREIGN BODIES, IN THE EYE, BRAIN, BREAST, PROSTATE, AND OTHER PARTS OF THE HUMAN BODY (U.S. CLS. 26, 39 AND 44).

FIRST USE 5-28-2002; IN COMMERCE 5-28-2002.

2,625,376. MIDWEST DENTAL PRODUCTS CORPORATION, DES PLAINES, IL. SN 75-435,036. PUB. 12-21-1999, FILED 2-17-1998.

AIRTOUCH

FOR DENTAL EQUIPMENT AND APPARATUS FOR USE IN RESTORATIVE AND PROPHYLAXIS TREATMENT OF TEETH AND DENTAL SURFACES, NAMELY, AIR ABRASION DEVICES (U.S. CLS. 26, 39 AND 44).

FIRST USE 4-16-1998; IN COMMERCE 4-16-1998.

2,625,424. INLET MEDICAL, INC., EDEN PRAIRIE, MN. SN 75-556,244. PUB. 11-6-2001, FILED 9-21-1998.

ELEVEST

FOR LAPROSCOPIC SURGICAL TOOLS, NAMELY, KITS COMPRISING A SUTURE PASSER, SUTURE, A GRASPER, A VIEWING DEVICE, AND A SUTURE TEMPLATE (U.S. CLS. 26, 39 AND 44).

FIRST USE 2-15-2002; IN COMMERCE 2-15-2002.

CLASS 10—(Continued).

2,625,446. ADDITION TECHNOLOGY, INC., FREMONT, CA, BY ASSIGNMENT KERAVISION, INC., FREMONT, CA. SN 75-595,181. PUB. 10-5-1999, FILED 11-24-1998.

INTACS

OWNER OF U.S. REG. NO. 2,423,977.

FOR OPHTHALMIC IMPLANTS, NAMELY, POLYMER SEGMENTS AND INSTRUMENTS FOR INSERTION OF IMPLANTS, FOR DIAGNOSTIC AND THERAPEUTIC TREATMENT OF COMMON VISION PROBLEMS SUCH AS MYOPIA, HYPEROPIA AND ASTIGMATISM (U.S. CLS. 26, 39 AND 44).

FIRST USE 4-15-1999; IN COMMERCE 4-15-1999.

2,625,450. FLEX-FOOT, INC., ALISO VIEJO, CA. SN 75-599,601. PUB. 7-11-2000, FILED 12-4-1998.

K2 SENSATION

FOR PROSTHETIC FEET (U.S. CLS. 26, 39 AND 44).

FIRST USE 5-28-1999; IN COMMERCE 5-28-1999.

2,625,505. NEWDEAL, VIENNE, FRANCE. SN 75-688,859. PUB. 3-7-2000, FILED 4-22-1999.

UNI-CLIP

FOR MEDICAL APPARATUS AND INSTRUMENTS, NAMELY, COMPRESSION STAPLES, CANNULATED INSTRUMENTS, NAMELY CANNULATED SCREWS, CANNULATED SCREW DRIVERS, DRILL GUIDES, SMALL BONE FIXATION DEVICES, DRILLS AND PINS, ALL FOR USE IN PHALANGEAL SHORTENING OSTEOTOMIES, METATARSO-PHALANGEAL ARTHRODESIS AND FOOT ARTHRODESIS OSTEOSYNTHESIS OSTEOTOMIES (U.S. CLS. 26, 39 AND 44).

FIRST USE 6-1-1997; IN COMMERCE 3-1-2000.

2,625,520. MALLINCKRODT INC., ST. LOUIS, MO. SN 75-711,240. PUB. 12-28-1999, FILED 5-20-1999.

HELIOS

FOR OXYGEN SUPPLY SYSTEMS FOR MEDICAL USE, NAMELY, STATIONARY OXYGEN SUPPLY UNITS AND PORTABLE OXYGEN SUPPLY UNITS (U.S. CLS. 26, 39 AND 44).

FIRST USE 11-1-2001; IN COMMERCE 11-1-2001.

2,625,591. MEDTRONIC, INC., MINNEAPOLIS, MN. SN 75-775,675. PUB. 4-18-2000, FILED 8-13-1999.

ADVANTAGE

FOR HEART VALVE (U.S. CLS. 26, 39 AND 44).

FIRST USE 11-30-2000; IN COMMERCE 11-30-2000.

CLASS 10—(Continued).

2,625,605. LABORATORIOS JALOMA S.A DE C.V., JALISCO, MEXICO. SN 75-789,706. PUB. 2-6-2001, FILED 9-1-1999.

JALOMA

FOR PLASTIC BABY BOTTLES AND PACIFIERS (U.S. CLS. 26, 39 AND 44).
FIRST USE 10-18-1960; IN COMMERCE 9-20-1999.

2,625,606. NOVARE SURGICAL SYSTEMS, INC., CUPERTINO, CA, BY CHANGE OF NAME MINUMYS SURGICAL, INC., CUPERTINO, CA. SN 75-789,942. PUB. 3-28-2000, FILED 9-1-1999.

NOVARE SURGICAL SYSTEMS

NO CLAIM IS MADE TO THE EXCLUSIVE RIGHT TO USE "SURGICAL SYSTEMS", APART FROM THE MARK AS SHOWN.

FOR SURGICAL INSTRUMENTS AND ACCESSORIES THEREFOR, NAMELY, CLAMPS, PAD INSERTS, CLIPS AND OTHER OCCLUSION DEVICES (U.S. CLS. 26, 39 AND 44).

FIRST USE 10-12-1999; IN COMMERCE 10-12-1999.

2,625,632. PLAYTEX PRODUCTS, INC., WESTPORT, CT. SN 75-813,398. PUB. 8-1-2000, FILED 10-1-1999.

PRECISION FLO

OWNER OF U.S. REG. NO. 1,959,393.
FOR NIPPLES FOR BABY BOTTLES (U.S. CLS. 26, 39 AND 44).

FIRST USE 11-0-2000; IN COMMERCE 11-0-2000.

2,625,637. INN DIAGNOSTICS LTD., NESS ZIONA 70400, ISRAEL. SN 75-817,788. PUB. 9-26-2000, FILED 10-7-1999.

STONE CONTROL

NO CLAIM IS MADE TO THE EXCLUSIVE RIGHT TO USE "STONE", APART FROM THE MARK AS SHOWN.

FOR DIAGNOSTIC MEDICAL DEVICES USING IMAGE ANALYSIS TO INDICATE THE PROPENSITY OF A PERSON TO FORMATION OF URINARY STONES (U.S. CLS. 26, 39 AND 44).

FIRST USE 3-0-2000; IN COMMERCE 6-0-2000.

CLASS 10—(Continued).

2,625,658. COLOPLAST A/S, DK-3050 HUMLEBAEK, DENMARK. SN 75-831,127. PUB. 6-19-2001, FILED 10-25-1999.

LUXA AIRE

OWNER OF U.S. REG. NO. 2,194,974.
FOR EXTERNAL BREAST PROSTHESES (U.S. CLS. 26, 39 AND 44).

FIRST USE 6-27-2000; IN COMMERCE 6-27-2001.

2,625,748. HOSUK CO., LTD., UMSUNG-GUN, CHOONGBUK 369-830, REPUBLIC OF KOREA. SN 75-888,546. PUB. 9-4-2001, FILED 1-6-2000.

SUREONE

FOR MEDICAL INSTRUMENTS, NAMELY, INJECTION SYRINGES, INFUSION SETS AND DISPOSABLE SYRINGES FOR MEDICAL PURPOSES (U.S. CLS. 26, 39 AND 44).

FIRST USE 5-30-2000; IN COMMERCE 5-30-2000.

2,625,801. GENERAL ELECTRIC COMPANY, WAUKESHA, WI. SN 75-909,380. PUB. 11-28-2000, FILED 2-4-2000.

PROTEUS

FOR X-RAY MEDICAL DIAGNOSTIC IMAGING APPARATUSES; X-RAY TUBES FOR MEDICAL PURPOSES; APPARATUSES AND INSTALLATIONS FOR THE PRODUCTION OF X-RAY FOR MEDICAL PURPOSES; TABLES FOR RADIOLOGY; SHIELDS FOR MEDICAL APPARATUSES; X-RAY PROTECTIVE CLOTHING FOR MEDICAL PURPOSES; WALL STANDS FOR MEDICAL USE IN RADIOLOGICAL EXAMINATIONS; AND COMPONENT PARTS OF ALL THE FOREGOING GOODS (U.S. CLS. 26, 39 AND 44).

FIRST USE 1-31-2000; IN COMMERCE 1-31-2000.

CLASS 10—(Continued).

2,625,825. ST. FRANCIS MEDICAL TECHNOLOGIES, INC., CONCORD, CA, BY ASSIGNMENT ST. FRANCIS MEDICAL TECHNOLOGIES, INC., CONCORD, CA. SN 75-921,686. PUB. 3-27-2001, FILED 2-17-2000.



THE MARK CONSISTS OF STYLIZED LETTERS "SF" IN A CIRCLE, THE LETTERS STANDING FOR ST. FRANCIS. FOR SURGICAL IMPLANTS COMPRISING ARTIFICIAL MATERIAL FOR USE IN THE TREATMENT OF SPINAL AILMENTS AND RELATED AILMENTS, AND OTHER AILMENTS; SURGICAL IMPLANTS COMPRISED PRIMARILY OF ARTIFICIAL MATERIAL AND SOME BIOLOGICAL TISSUE FOR USE IN THE TREATMENT OF SPINAL AILMENTS AND RELATED AILMENTS, AND OTHER AILMENTS (U.S. CLS. 26, 39 AND 44).

FIRST USE 10-15-2001; IN COMMERCE 11-12-2001.

2,625,855. GENZYME CORPORATION, CAMBRIDGE, MA. SN 75-936,145. PUB. 9-4-2001, FILED 3-6-2000.

HIND SITE

FOR MEDICAL INSTRUMENTS, NAMELY, ILLUMINATED RECTAL RETRACTOR (U.S. CLS. 26, 39 AND 44).

FIRST USE 3-28-2000; IN COMMERCE 3-28-2000.

2,625,882. SCHERING-PLOUGH HEALTHCARE PRODUCTS, INC., MEMPHIS, TN. SN 75-981,869. PUB. 2-16-1999, FILED 3-16-1998.



OWNER OF U.S. REG. NOS. 191,089, 2,027,499, AND OTHERS.

"DR. SCHOLL" DOES NOT IDENTIFY A LIVING INDIVIDUAL.

FOR ELECTRICAL AND NON-ELECTRICAL MASSAGERS (U.S. CLS. 26, 39 AND 44).

FIRST USE 6-2-1997; IN COMMERCE 6-2-1997.

CLASS 10—(Continued).

2,625,974. AMEDS, LLC, DUXBURY, MA. SN 76-041,472. PUB. 12-4-2001, FILED 5-5-2000.

AMEDS

FOR FULL LINE OF DISPOSABLE AND DURABLE MEDICAL PRODUCTS, NAMELY, ADULT INCONTINENCE PRODUCTS, EXAMINATION GLOVES, UROLOGICAL PRODUCTS, SKIN LOTIONS, AND WOUND CARE PRODUCTS, WHEELCHAIRS, WALKERS AND CANES (U.S. CLS. 26, 39 AND 44).

FIRST USE 12-0-1997; IN COMMERCE 12-0-1997.

2,625,991. CORDIS CORPORATION, MIAMI LAKES, FL. SN 76-047,136. PUB. 4-3-2001, FILED 5-15-2000.

AVAIL

FOR MEDICAL CATHETERS (U.S. CLS. 26, 39 AND 44).

FIRST USE 9-8-1999; IN COMMERCE 9-8-1999.

2,626,056. ULTRADENT PRODUCTS, INC., SOUTH JORDAN, UT. SN 76-080,741. PUB. 6-26-2001, FILED 6-29-2000.

NAVITIP

FOR DENTAL PRODUCTS, NAMELY SYRINGE DELIVERY TIPS (U.S. CLS. 26, 39 AND 44).

FIRST USE 1-0-2001; IN COMMERCE 1-0-2001.

2,626,086. ENTHERMICS MEDICAL SYSTEMS INC., MENOMONEE FALLS, WI. SN 76-095,384. PUB. 5-1-2001, FILED 7-24-2000.

WARMRIGHT

FOR MEDICAL AND SURGICAL EQUIPMENT, NAMELY, UNITS FOR WARMING FLUIDS AND BLANKETS (U.S. CLS. 26, 39 AND 44).

FIRST USE 1-7-2002; IN COMMERCE 1-7-2002.

2,626,089. HOMEDICS, INC., COMMERCE TOWNSHIP, MI. SN 76-096,483. PUB. 4-3-2001, FILED 7-25-2000.

DOUBLE THE BUBBLES

FOR MASSAGING FOOT BATH APPARATUS (U.S. CLS. 26, 39 AND 44).

FIRST USE 4-1-2001; IN COMMERCE 4-1-2001.

CLASS 10—(Continued).

2,626,111. BILLY-BOB TEETH, INC., MICHAEL, IL. SN 76-106,918. PUB. 5-15-2001, FILED 8-10-2000.

BILLY-BOB PACIFIER

NO CLAIM IS MADE TO THE EXCLUSIVE RIGHT TO USE "PACIFIER", APART FROM THE MARK AS SHOWN, FOR NOVELTY BABY PACIFIERS (U.S. CLS. 26, 39 AND 44).

FIRST USE 5-24-2000; IN COMMERCE 9-22-2000.

CLASS 10—(Continued).

2,626,223. HOME DIAGNOSTICS, INC., FT. LAUDERDALE, FL. SN 76-150,528. PUB. 8-7-2001, FILED 10-18-2000.

PRESTIGE IQ

FOR GLUCOSE, KETONE, AND CHOLESTEROL DIAGNOSTIC TESTING KITS COMPRISED OF ELECTRONIC MONITORS, TEST STRIPS AND LANCING DEVICES (U.S. CLS. 26, 39 AND 44).

FIRST USE 5-0-2001; IN COMMERCE 5-0-2001.

2,626,112. ELLMAN INTERNATIONAL, INC., HEWLETT, NY. SN 76-107,058. PUB. 4-17-2001, FILED 8-11-2000.

ARTHROCISE

FOR ELECTROSURGICAL INSTRUMENTS AND ELECTRODES THEREFOR FOR MEDICAL USE IN TREATING JOINT DISORDERS (U.S. CLS. 26, 39 AND 44).

FIRST USE 11-26-2001; IN COMMERCE 11-26-2001.

2,626,279. OEC MEDICAL SYSTEMS, INC., SALT LAKE CITY, UT. SN 76-171,395. PUB. 8-21-2001, FILED 11-27-2000.

MINIVIEW

FOR MOBILE DIGITAL X-RAY IMAGING MACHINE FOR MEDICAL USE (U.S. CLS. 26, 39 AND 44).

FIRST USE 7-0-2001; IN COMMERCE 7-0-2001.

2,626,121. EDGE SYSTEMS CORPORATION, SIGNAL HILL, CA. SN 76-112,306. PUB. 1-8-2002, FILED 8-17-2000.

DELPHIA II

FOR MEDICAL APPARATUS, NAMELY, SYSTEMS COMPRISED PRIMARILY OF A VACUUM SOURCE AND HAND PIECE USED FOR MEDICAL BODY CARE TREATMENTS, MICRODERMABRASION AND, MASSAGE THERAPY (U.S. CLS. 26, 39 AND 44).

FIRST USE 4-0-2000; IN COMMERCE 4-0-2000.

2,626,303. ELLEX MEDICAL PTY. LTD., ADELAIDE, SOUTH, AUSTRALIA, BY CHANGE OF NAME; BY CHANGE OF NAME TARACAN PTY. LTD, ADELAIDE, SOUTH AUSTRALIA 5000, AUSTRALIA. SN 76-181,046. PUB. 8-28-2001, FILED 12-14-2000.

INTEGRE

FOR OPHTHALMIC LASER INSTRUMENTS AND PARTS (U.S. CLS. 26, 39 AND 44).

FIRST USE 7-31-2001; IN COMMERCE 7-31-2001.

2,626,124. AMBULATORY MONITORING, INC., ARDSLEY, NY. SN 76-113,663. PUB. 7-3-2001, FILED 8-21-2000.

BUZZBEE

FOR PATIENT-WORN MEDICAL DEVICES FOR PHYSIOLOGIC MONITORING AND BIOFEEDBACK (U.S. CLS. 26, 39 AND 44).

FIRST USE 8-11-2000; IN COMMERCE 10-1-2000.

2,626,321. BIOSPHERE MEDICAL, INC., ROCKLAND, MA. SN 76-191,034. PUB. 11-13-2001, FILED 1-8-2001.

EMBOGOLD

FOR MICROSPHERES FOR USE IN VASCULAR EMBOLIZATION (U.S. CLS. 26, 39 AND 44).

FIRST USE 8-20-2001; IN COMMERCE 8-20-2001.

2,626,156. SYNTHES (U.S.A.), PAOLI, PA. SN 76-126,268. PUB. 6-5-2001, FILED 9-12-2000.

CALCEON

FOR ORTHOPEDIC PREPARATIONS, NAMELY, SYNTHETIC BONE GRAFT SUBSTITUTE (U.S. CLS. 26, 39 AND 44).

FIRST USE 12-7-2001; IN COMMERCE 12-7-2001.

2,626,324. SCIMED LIFE SYSTEMS, INC., MAPLE GROVE, MN. SN 76-192,281. PUB. 8-21-2001, FILED 1-10-2001.

MATRIX

FOR EMBOLIZATION COILS (U.S. CLS. 26, 39 AND 44).

FIRST USE 5-13-2002; IN COMMERCE 5-13-2002.

CLASS 10—(Continued).

2,626,397. NOBEL BIOCARE USA, INC., YORBA LINDA, CA. SN 76-215,738. PUB. 11-27-2001, FILED 2-26-2001.

EASY ABUTMENT

NO CLAIM IS MADE TO THE EXCLUSIVE RIGHT TO USE "ABUTMENT", APART FROM THE MARK AS SHOWN.

FOR DENTISTRY AND DENTAL SURGICAL APPLIANCES, NAMELY, DENTAL IMPLANTS AND DEVICES FOR IMPLANTING THE SAME, AND DENTAL PROSTHETIC DEVICES, IMPRESSION PINS, HEALING ABUTMENTS, FINAL ABUTMENTS, HEALING CAPS, COUPLING SCREWS AND COMPONENTS THEREOF (U.S. CLS. 26, 39 AND 44).

FIRST USE 11-30-2000; IN COMMERCE 11-30-2000.

CLASS 10—(Continued).

2,626,465. AD-TECH MEDICAL INSTRUMENT CORPORATION, RACINE, WI. SN 76-238,827. PUB. 12-18-2001, FILED 4-10-2001.



FOR ELECTRICAL CONNECTOR/CABLE APPARATUS FOR ELECTROENCEPHALOGRAPHIC USE (U.S. CLS. 26, 39 AND 44).

FIRST USE 5-7-2001; IN COMMERCE 5-7-2001.

2,626,456. C. R. BARD, INC., MURRAY HILL, NJ. SN 76-235,889. PUB. 9-11-2001, FILED 4-5-2001.

EXPAND 212

FOR MEDICAL DEVICE, NAMELY, A STONE BASKET (U.S. CLS. 26, 39 AND 44).

FIRST USE 8-10-2001; IN COMMERCE 8-10-2001.

2,626,458. ADAC LABORATORIES, MILPITAS, CA. SN 76-236,363. PUB. 9-11-2001, FILED 4-6-2001.

SKYLIGHT

FOR DIAGNOSTIC NUCLEAR MEDICAL APPARATUS, NAMELY, A COMPUTERIZED IMAGING SYSTEM FOR PERFORMING MEDICAL IMAGING PROCEDURES (U.S. CLS. 26, 39 AND 44).

FIRST USE 11-0-1999; IN COMMERCE 6-0-2001.

2,626,464. AD-TECH MEDICAL INSTRUMENT CORPORATION, RACINE, WI. SN 76-238,825. PUB. 12-18-2001, FILED 4-10-2001.

CABRIO

FOR ELECTRICAL CONNECTOR/CABLE APPARATUS FOR ELECTROENCEPHALOGRAPHIC USE (U.S. CLS. 26, 39 AND 44).

FIRST USE 5-7-2001; IN COMMERCE 5-7-2001.

2,626,553. PRIZM MEDICAL, INC., DULUTH, GA. SN 76-309,534. PUB. 1-22-2002, FILED 9-6-2001.

INTELLIGENT TEXTILES

FOR MEDICAL DEVICES, NAMELY CONDUCTIVE AND COMPRESSIVE GLOVES, SLEEVES, SOCKS, WRAPS, BRACES AND GARMENTS FOR CIRCULATORY STIMULATION AND TREATMENT (U.S. CLS. 26, 39 AND 44).

FIRST USE 5-1-2002; IN COMMERCE 5-1-2002.

2,626,593. LIFEPOINT, INC., ONTARIO, CA. SN 78-021,450. PUB. 5-29-2001, FILED 8-16-2000.

IMPACT

FOR NON INVASIVE DIAGNOSTIC TESTING DEVICE TO MEASURE BLOOD EQUIVALENT ANALYTES IN A SAMPLE OF SALIVA AND URINE (U.S. CLS. 26, 39 AND 44).

FIRST USE 12-31-2001; IN COMMERCE 12-31-2001.

2,626,598. ENDOCARE, INC., IRVINE, CA. SN 78-022,752. PUB. 6-26-2001, FILED 8-24-2000.

CRYOGUIDE

FOR MEDICAL DEVICES AND INSTRUMENTS FOR USE IN SURGICAL APPLICATIONS, NAMELY CRYOPROBES FOR THE TREATMENT, ABLATION, AND/OR REMOVAL OF TUMORS (U.S. CLS. 26, 39 AND 44).

FIRST USE 3-27-2001; IN COMMERCE 3-27-2001.

CLASS 10—(Continued).

2,626,746. NEWDEAL, VIENNE, FRANCE. SN 78-078,610. PUB. 2-12-2002, FILED 8-10-2001.

HALLU

FOR ORTHOPEDIC ARTICLES, NAMELY ORTHOPEDIC JOINT IMPLANT, FOOTWEAR AND SOLE, ORTHOPEDIC SPLINT SUTURES, BONE SCREWS, DRILL, SCREW AND PIN FOR USE IN ORTHOPEDIC SURGICAL PROCEDURES; OSTEOSYNTHESIS PLATES (U.S. CLS. 26, 39 AND 44).

FIRST USE 3-15-2001; IN COMMERCE 3-1-2002.

2,626,747. NEWDEAL, VIENNE, FRANCE. SN 78-078,611. PUB. 2-5-2002, FILED 8-10-2001.

K-FIX

FOR ORTHOPEDIC ARTICLES, NAMELY ORTHOPEDIC JOINT IMPLANT, DRILL, SCREW AND PIN FOR USE IN ORTHOPEDIC SURGICAL PROCEDURES; PROTECTION CAP FOR SURGICAL PIN; FOOTWEAR AND SOLE; ORTHOPEDIC SPLINT SUTURES (U.S. CLS. 26, 39 AND 44).

FIRST USE 3-15-2001; IN COMMERCE 3-1-2002.

2,626,750. GODFREY, D. KENT, IDAHO FALLS, ID. SN 78-083,148. PUB. 1-1-2002, FILED 9-7-2001.

CONTACTEASE

FOR DENTAL INSTRUMENT FOR CREATING TIGHT, BROAD CONTACTS ON POSTERIOR COMPOSITE RESTORATIONS (U.S. CLS. 26, 39 AND 44).

FIRST USE 10-8-2001; IN COMMERCE 3-6-2002.

CLASS 11—ENVIRONMENTAL CONTROL APPARATUS

2,625,359. INTERNATIONAL COMFORT PRODUCTS CORPORATION (USA), LEWISBURG, TN. SN 75-380,651. PUB. 1-12-1999, FILED 10-29-1997.

QUIETCOMFORT

FOR COMMERCIAL AND RESIDENTIAL AIR CONDITIONERS, HEAT PUMPS, FURNACES, AND ENVIRONMENTAL CONTROL UNITS (U.S. CLS. 13, 21, 23, 31 AND 34).

FIRST USE 5-0-2001; IN COMMERCE 5-0-2001.

CLASS 11—(Continued).

2,625,367. TUBE ICE, LLC, LOUISVILLE, KY, BY ASSIGNMENT ICE ONE, INC., LOUISVILLE, KS. SN 75-409,877. PUB. 9-14-1999, FILED 12-23-1997.

MINI-TUBE

FOR REFRIGERATION UNITS AND ICE MAKING MACHINES FOR INDUSTRIAL USE (U.S. CLS. 13, 21, 23, 31 AND 34).

FIRST USE 10-18-2001; IN COMMERCE 10-18-2001.

2,625,429. CORSTONE, INC., NORTH ATTLEBORO, MA. SN 75-562,299. PUB. 9-5-2000, FILED 9-30-1998.

PEACHTREE FORGE

FOR KITCHEN AND BATHROOM SINKS (U.S. CLS. 13, 21, 23, 31 AND 34).

FIRST USE 4-4-2002; IN COMMERCE 4-4-2002.

2,625,549. VISTEON CORPORATION, DEARBORN, MI. SN 75-737,607. PUB. 5-9-2000, FILED 6-25-1999.

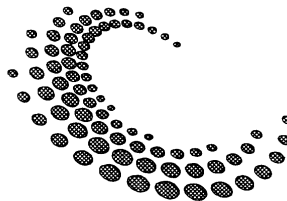

OWNER OF U.S. REG. NOS. 2,239,710 AND 2,241,256. THE MARK IS LINED FOR THE COLOR ORANGE. FOR AUTOMOTIVE PARTS, COMPONENTS, AND ACCESSORIES, NAMELY, ELECTRIC LAMPS AND LIGHT BULBS FOR AUTOMOTIVE APPLICATIONS, SEALED BEAM HEADLAMPS, LAMP SOCKETS, COMBINATION HEATING, VENTILATING, AND AIR CONDITIONING UNITS FOR MOTOR VEHICLES (U.S. CLS. 13, 21, 23, 31 AND 34).

FIRST USE 1-0-2000; IN COMMERCE 1-0-2000.

CLASS 11—(Continued).

2,625,550. VISTEON CORPORATION, DEARBORN, MI. SN 75-737,652. PUB. 5-9-2000, FILED 6-25-1999.



OWNER OF U.S. REG. NOS. 2,175,733, 2,241,256, AND OTHERS.

THE MARK IS LINED FOR THE COLOR ORANGE.
FOR AUTOMOTIVE PARTS, COMPONENTS, AND ACCESSORIES, NAMELY, ELECTRIC LAMPS AND LIGHT BULBS FOR AUTOMOTIVE APPLICATIONS, SEALED BEAM HEADLAMPS, LAMP SOCKETS, COMBINATION HEATING, VENTILATING, AND AIR CONDITIONING UNITS FOR MOTOR VEHICLES (U.S. CLS. 13, 21, 23, 31 AND 34).
FIRST USE 1-0-2000; IN COMMERCE 1-0-2000.

2,625,551. VISTEON CORPORATION, DEARBORN, MI. SN 75-737,680. PUB. 5-9-2000, FILED 6-25-1999.



OWNER OF U.S. REG. NOS. 2,175,733, 2,241,256, AND OTHERS.

FOR AUTOMOTIVE PARTS, COMPONENTS, AND ACCESSORIES, NAMELY, ELECTRIC LAMPS AND LIGHT BULBS FOR AUTOMOTIVE APPLICATIONS, SEALED BEAM HEADLAMPS, LAMP SOCKETS, COMBINATION HEATING, VENTILATING, AND AIR CONDITIONING UNITS FOR MOTOR VEHICLES (U.S. CLS. 13, 21, 23, 31 AND 34).
FIRST USE 1-0-2000; IN COMMERCE 1-0-2000.

CLASS 11—(Continued).

2,625,553. VISTEON CORPORATION, DEARBORN, MI, BY ASSIGNMENT FORD MOTOR COMPANY, DEARBORN, MI. SN 75-739,755. PUB. 5-9-2000, FILED 6-25-1999.

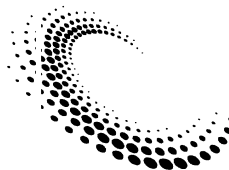

OWNER OF U.S. REG. NOS. 2,239,710 AND 2,241,256.
FOR AUTOMOTIVE PARTS, COMPONENTS, AND ACCESSORIES, NAMELY, ELECTRIC LAMPS AND LIGHT BULBS FOR AUTOMOTIVE APPLICATIONS, SEALED BEAM HEADLAMPS, LAMP SOCKETS, COMBINATION HEATING, VENTILATING, AND AIR CONDITIONING UNITS FOR MOTOR VEHICLES (U.S. CLS. 13, 21, 23, 31 AND 34).

FIRST USE 1-0-2000; IN COMMERCE 1-0-2000.

2,625,677. LENNOX INDUSTRIES INC., RICHARDSON, TX. SN 75-841,821. PUB. 8-21-2001, FILED 11-5-1999.

MERIT

FOR AIR CONDITIONERS; FURNACES; HEAT PUMPS; BLOWER COILS; AND PARTS FOR THE FOREGOING (U.S. CLS. 13, 21, 23, 31 AND 34).

FIRST USE 9-0-2000; IN COMMERCE 9-0-2000.

2,625,764. GRANDWAY USA CORPORATION, SALT LAKE CITY, UT. SN 75-895,033. PUB. 9-5-2000, FILED 1-11-2000.

HOTSHOT

FOR FLASHLIGHTS (U.S. CLS. 13, 21, 23, 31 AND 34).
FIRST USE 8-0-2000; IN COMMERCE 8-0-2000.

2,625,815. MURPHY, EDWARD L., JR., DUXBURY, MA. SN 75-914,507. PUB. 9-4-2001, FILED 2-10-2000.

CHAMELEON

FOR FILTERING MEDIA MADE OF METAL WOOL FOR THE PURIFICATION AND FILTRATION OF AIR AND FLUIDS (U.S. CLS. 13, 21, 23, 31 AND 34).
FIRST USE 5-16-2000; IN COMMERCE 5-16-2000.

CLASS 11—(Continued).

2,625,910. EMHART INC., NEWARK, DE. SN 76-006,101. PUB. 3-12-2002, FILED 3-21-2000.

CONTEMPRA

FOR PLUMBING FITTINGS AND FIXTURES, NAMELY, VALVES, FAUCETS, AERATORS FOR FAUCETS, SPOUTS, SHOWER HEADS, HANDLES, POP-UP DRAINS, SINGLE LEVER FIXTURES FOR LAVATORIES AND SINKS, FLUSH LEVERS AND DRAINS, FAUCET FILTERS; ELECTRIC LIGHTING FIXTURES (U.S. CLS. 13, 21, 23, 31 AND 34).

FIRST USE 7-0-2000; IN COMMERCE 7-0-2000.

2,626,005. AIR MOVEMENT GROUP, LIMITED, LONDON, ENGLAND. SN 76-054,436. PUB. 7-31-2001, FILED 5-22-2000.

AMG PROWLER

FOR GAS EXTRACTORS FOR BUILDINGS AND RADON GAS EXTRACTOR FANS (U.S. CLS. 13, 21, 23, 31 AND 34).

FIRST USE 5-0-2001; IN COMMERCE 5-0-2001.

2,626,065. HAMILTON BEACH/PROCTOR-SILEX, INC., GLEN ALLEN, VA. SN 76-085,784. PUB. 10-30-2001, FILED 7-10-2000.

EASYFILL

FOR TANK FOR HUMIDIFIERS (U.S. CLS. 13, 21, 23, 31 AND 34).

FIRST USE 9-0-1999; IN COMMERCE 9-0-1999.

2,626,106. YVES E. PRIVAS AND TANGUY M. PRIVAS PARTNERSHIP, THE, SEA RANCH LAKES, FL. SN 76-103,844. PUB. 9-18-2001, FILED 8-7-2000.

LIGHTICULAR

FOR ELECTRICALLY ILLUMINATED STANDS FOR DISPLAYING ARTWORK (U.S. CLS. 13, 21, 23, 31 AND 34).

FIRST USE 6-7-2002; IN COMMERCE 6-7-2002.

CLASS 11—(Continued).

2,626,107. MHE CORP., ROGERSVILLE, MO. SN 76-104,083. PUB. 5-22-2001, FILED 8-7-2000.



FOR PORTABLE SPACE HEATERS, NAMELY, ELECTRONIC ZONE HEATERS (U.S. CLS. 13, 21, 23, 31 AND 34).

FIRST USE 8-10-2000; IN COMMERCE 8-10-2000.

2,626,135. ERCO LEUCHTEN GMBH, 58507 LUDENSCHIED, FED REP GERMANY. SN 76-119,687. PUB. 9-4-2001, FILED 8-30-2000.

FOCALFLOOD

FOR ELECTRIC LIGHTING FIXTURES AND PARTS THEREOF, NAMELY, BASES, SOCKETS, SOCKET HOLDERS AND COVERS SOLD TOGETHER (U.S. CLS. 13, 21, 23, 31 AND 34).

FIRST USE 6-30-2001; IN COMMERCE 1-31-2002.

2,626,252. AVECIA LIMITED, BLACKLEY, MANCHESTER M9 8ZS, UNITED KINGDOM. SN 76-160,045. PUB. 1-8-2002, FILED 11-6-2000.

BAQUA PURE

OWNER OF U.S. REG. NOS. 1,236,893, 1,375,447, AND OTHERS.

FOR FILTERS FOR SWIMMING POOLS AND SPAS; WATER FILTERING MACHINES FOR SWIMMING POOLS AND SPAS; EQUIPMENT, NAMELY, FILTERS, PUMPS FOR SWIMMING POOLS AND SPAS SOLD AS A UNIT (U.S. CLS. 13, 21, 23, 31 AND 34).

FIRST USE 5-0-2001; IN COMMERCE 5-0-2001.

CLASS 11—(Continued).

2,626,256. ELECTROLUX HOME PRODUCTS, INC., CLEVELAND, OH. BY MERGER, BY CHANGE OF NAME WHITE CONSOLIDATED INDUSTRIES, INC., CLEVELAND, OH. SN 76-161,664. PUB. 6-26-2001, FILED 11-8-2000.

Frigidaire
Built for Generations

OWNER OF U.S. REG. NOS. 364,709, 2,310,394, AND OTHERS.

FOR CLOTHES DRYERS; MICROWAVE OVENS FOR COOKING; REFRIGERATORS; FREEZERS; ICE MAKERS; WATER PURIFICATION UNITS; AIR CONDITIONERS; DEHUMIDIFIERS; GAS AND ELECTRIC RANGES; GAS AND ELECTRIC STOVES; GAS AND ELECTRIC OVENS; GAS AND ELECTRIC COUNTER COOKTOPS; AND PARTS THEREFOR (U.S. CLS. 13, 21, 23, 31 AND 34).

FIRST USE 12-8-2000; IN COMMERCE 12-8-2000.

2,626,363. FIELD CONTROLS, L.L.C., KINSTON, NC. SN 76-208,041. PUB. 12-18-2001, FILED 2-9-2001.

PHASE 2

FOR AIR PURIFYING UNITS FOR COMMERCIAL, DOMESTIC, AND INDUSTRIAL USE (U.S. CLS. 13, 21, 23, 31 AND 34).

FIRST USE 7-31-2001; IN COMMERCE 8-31-2001.

2,626,430. KOHLER CO., KOHLER, WI. SN 76-225,433. PUB. 8-14-2001, FILED 3-15-2001.

KATHRYN

FOR SUITE OF PLUMBING FIXTURES, NAMELY, BATH TUBS, LAVATORIES, BIDETS, SITZ BATHS, URINALS, TOILETS, WHIRLPOOL BATHS, HOT TUBS AND SPAS (U.S. CLS. 13, 21, 23, 31 AND 34).

FIRST USE 4-0-2001; IN COMMERCE 4-0-2001.

2,626,433. WANG, CHING-YUNG, TAICHUNG HSIEN, TAIWAN. SN 76-226,714. PUB. 10-16-2001, FILED 3-19-2001.

PSL

FOR LIGHTS FOR VEHICLES, NAMELY, BRAKING LIGHTS, REVERSING LIGHTS, INDICATOR LIGHTS, WARNING LIGHTS AND STOP LIGHTS (U.S. CLS. 13, 21, 23, 31 AND 34).

FIRST USE 6-1-2001; IN COMMERCE 7-1-2001.

CLASS 11—(Continued).

2,626,438. KYSOR INDUSTRIAL CORPORATION, CONYERS, GA. SN 76-228,970. PUB. 1-1-2002, FILED 3-15-2001.

E-LINE

FOR COMMERCIAL REFRIGERATED FOOD SERVICE EQUIPMENT, NAMELY, REFRIGERATORS AND REFRIGERATED FOOD SERVICE SYSTEMS COMPRISING OF STORAGE AND DISPLAY UNITS (U.S. CLS. 13, 21, 23, 31 AND 34).

FIRST USE 3-1-2002; IN COMMERCE 3-1-2002.

2,626,471. WILLOUGHBY INDUSTRIES, INC., INDIANAPOLIS, IN. SN 76-245,028. PUB. 2-19-2002, FILED 4-23-2001.

AQUAFOUNT

OWNER OF U.S. REG. NO. 2,335,712.

FOR LAVATORIES (U.S. CLS. 13, 21, 23, 31 AND 34).

FIRST USE 3-2-2002; IN COMMERCE 3-2-2002.

2,626,500. WATKINS MANUFACTURING CORPORATION, VISTA, CA. SN 76-260,806. PUB. 12-11-2001, FILED 5-22-2001.

BRED FOR ENDURANCE

FOR PORTABLE SPAS IN THE NATURE OF HEATED POOLS (U.S. CLS. 13, 21, 23, 31 AND 34).

FIRST USE 8-30-1996; IN COMMERCE 8-30-1996.

2,626,506. COLUMBIA LIGHTING, INC., SPOKANE, WA. SN 76-264,736. PUB. 9-18-2001, FILED 5-31-2001.

BRIO

THE ENGLISH TRANSLATION OF THE WORD "BRIO" IN THE MARK IS "SPIRIT" OR "VIGOR".

FOR ELECTRIC LIGHTING FIXTURES (U.S. CLS. 13, 21, 23, 31 AND 34).

FIRST USE 5-30-2001; IN COMMERCE 5-30-2001.

2,626,670. ARGENTA TRADING & CONSULTING CORP., PEMBROKE PINES, FL. SN 78-045,623. PUB. 8-21-2001, FILED 1-30-2001.

ADOPT A HEALTHY HABIT

FOR BIDETS (U.S. CLS. 13, 21, 23, 31 AND 34).

FIRST USE 5-0-1997; IN COMMERCE 5-0-1997.

CLASS 11—(Continued).

2,626,742. AIR SPONGE FILTER COMPANY, INC., CORAL SPRINGS, FL. SN 78-075,241. PUB. 10-30-2001, FILED 7-23-2001.

MICROSPONGE

FOR AIR FILTERS FOR AIR CONDITIONING UNITS (U.S. CLS. 13, 21, 23, 31 AND 34).
FIRST USE 1-1-1995; IN COMMERCE 1-1-1995.

CLASS 12—VEHICLES

2,625,507. HOWARD BERGER CO., INC., BROOKLYN, NY. SN 75-690,698. PUB. 12-28-1999, FILED 4-23-1999.

PROMAG II

FOR ANTI-THEFT LOCKS FOR USE ON MOTOR VEHICLE STEERING WHEELS AND ANTI-THEFT LOCKS FOR MOTORCYCLES AND BICYCLES (U.S. CLS. 19, 21, 23, 31, 35 AND 44).
FIRST USE 0-0-1999; IN COMMERCE 0-0-1999.

2,625,511. COVE BIKE SHOP LTD., NORTH VANCOUVER, B.C., CANADA. SN 75-698,847. PUB. 7-3-2001, FILED 5-6-1999.

G-SPOT

PRIORITY CLAIMED UNDER SEC. 44(D) ON CANADA APPLICATION NO. 1006580, FILED 2-24-1999.
FOR BICYCLES (U.S. CLS. 19, 21, 23, 31, 35 AND 44).
FIRST USE 5-31-1997; IN COMMERCE 10-31-1997.

2,625,523. SAME DEUTZ-FAHR S.P.A., BERGAMO, ITALY. SN 75-719,190. PUB. 8-1-2000, FILED 5-28-1999.



FOR LAND VEHICLES, NAMELY, TRACTORS AND STRUCTURAL PARTS THEREOF; AND MOTORS FOR TRACTORS (U.S. CLS. 19, 21, 23, 31, 35 AND 44).
FIRST USE 0-0-1971; IN COMMERCE 4-0-1999.

CLASS 12—(Continued).

2,625,716. NAUTICRAFT CORPORATION, MUSKEGON, MI. SN 75-869,096. PUB. 8-1-2000, FILED 12-10-1999.

ENCORE

FOR PERSONAL WATERCRAFT (U.S. CLS. 19, 21, 23, 31, 35 AND 44).
FIRST USE 1-0-2001; IN COMMERCE 1-0-2001.

2,625,768. TRI SPAN, L.L.C., BILOXI, MO. SN 75-897,259. PUB. 9-12-2000, FILED 1-18-2000.

TRI SPAN

FOR BOATS AND STRUCTURAL PARTS THEREFOR (U.S. CLS. 19, 21, 23, 31, 35 AND 44).
FIRST USE 2-5-1999; IN COMMERCE 5-17-2002.

2,625,892. LAWMAN ARMOR CORP., BERWYN, PA. SN 75-982,310. PUB. 9-19-2000, FILED 4-21-1999.

UNBRAKEABLE

FOR ANTI-THEFT LOCKS FOR BOAT EQUIPMENT, NAMELY MOTORS, PROPELLERS AND BOAT TRAILERS; ANTI-THEFT LOCKS FOR USE ON THE BRAKES AND CLUTCHES OF MOTOR VEHICLES (U.S. CLS. 19, 21, 23, 31, 35 AND 44).
FIRST USE 3-0-1999; IN COMMERCE 5-0-1999.

2,625,956. B & M MANUFACTURING, INC., JAMESTOWN, NY. SN 76-033,324. PUB. 12-4-2001, FILED 4-24-2000.

GATE-MATE

FOR MULTI-PURPOSE TRUCK BED EXTENDERS AND TRUCK TAILGATE (U.S. CLS. 19, 21, 23, 31, 35 AND 44).
FIRST USE 4-8-2000; IN COMMERCE 9-25-2000.

2,626,040. MUSTO LIMITED, ESSEX, ENGLAND. SN 76-074,196. PUB. 2-12-2002, FILED 6-20-2000.

MUSTO

SEC. 2(F).
FOR BOATS, SAILING BOATS, AND SKIFFS (U.S. CLS. 19, 21, 23, 31, 35 AND 44).
FIRST USE 7-11-2001; IN COMMERCE 7-11-2001.

CLASS 12—(Continued).

2,626,162. WINNER INTERNATIONAL ROYALTY LLC, SHARON, PA. SN 76-127,597. PUB. 1-29-2002, FILED 9-14-2000.



OWNER OF U.S. REG. NOS. 1,577,674, 1,872,404, AND OTHERS.

THE MARK CONSISTS IN PART OF A STYLIZED DESIGN OF A VEHICLE ANTI-THEFT DEVICE FORMING PART OF THE WORD "CLICK".

FOR ANTI-THEFT DEVICES FOR MOTOR VEHICLES, NAMELY STEERING WHEEL LOCKS (U.S. CLS. 19, 21, 23, 31, 35 AND 44).

FIRST USE 8-0-2000; IN COMMERCE 12-0-2000.

2,626,177. KOOL STOP INTERNATIONAL, INC., LAKE OSWEGO, OR. SN 76-134,580. PUB. 12-18-2001, FILED 9-25-2000.

PHAT PADD

FOR BICYCLE BRAKE SHOES (U.S. CLS. 19, 21, 23, 31, 35 AND 44).

FIRST USE 3-6-2001; IN COMMERCE 3-6-2001.

2,626,250. MULTISORB TECHNOLOGIES, INC., BUFFALO, NY. SN 76-159,003. PUB. 6-12-2001, FILED 11-6-2000.

WIRE-DRI

FOR BAGGED DESICCANT FOR PLACEMENT IN COIL OF WIRE USED FOR MANUFACTURE OF TIRES (U.S. CLS. 19, 21, 23, 31, 35 AND 44).

FIRST USE 2-21-2002; IN COMMERCE 2-21-2002.

2,626,316. AMERICAN SPORTS DESIGN COMPANY, SPRINGBORO, OH. SN 76-185,281. PUB. 12-11-2001, FILED 12-21-2000.

CARPE DIEM

THE ENGLISH TRANSLATION OF "CARPE DIEM" IS "SEIZE THE DAY".

FOR BICYCLES AND STRUCTURAL PARTS THEREOF (U.S. CLS. 19, 21, 23, 31, 35 AND 44).

FIRST USE 10-1-2000; IN COMMERCE 10-1-2000.

CLASS 12—(Continued).

2,626,454. HANKOOK TIRE CO., LTD., SEOUL, 135-723, REPUBLIC OF KOREA. SN 76-235,587. PUB. 10-2-2001, FILED 4-3-2001.

ROCKLAND

FOR TIRES, INNER TUBES FOR VEHICLE TIRES (U.S. CLS. 19, 21, 23, 31, 35 AND 44).

FIRST USE 1-1-2002; IN COMMERCE 1-1-2002.

2,626,520. ABC BUS COMPANIES, INC., FARIBAULT, MN. SN 76-281,196. PUB. 11-13-2001, FILED 7-6-2001.



FOR VEHICLES, NAMELY PASSENGER BUSES (U.S. CLS. 19, 21, 23, 31, 35 AND 44).

FIRST USE 9-10-2001; IN COMMERCE 9-10-2001.

2,626,638. WILSON, LARRY S., DUNWOODY, GA. SN 78-039,793. PUB. 11-27-2001, FILED 12-19-2000.

BARENDER

FOR HANDLEBAR ANTI-THEFT LOCKING DEVICE USED ON MOTOR VEHICLES WITH HANDLEBARS, NAMELY, MOTORCYCLES, ALL-TERRAIN VEHICLES AND PERSONAL WATERCRAFT, TO PREVENT THEFT AND TO LOCK PERSONAL ITEMS, NAMELY, HELMETS AND APPAREL, TO THE VEHICLE (U.S. CLS. 19, 21, 23, 31, 35 AND 44).

FIRST USE 12-16-2001; IN COMMERCE 12-16-2001.

CLASS 12—(Continued).

2,626,704. VETBLE U.S.A. COMPANY, SAN JOSE, CA. SN 78-056,013. PUB. 2-5-2002, FILED 3-30-2001.



THE MARK CONSISTS OF THE WORDS "VETBLE" IN FRONT OF A STYLIZED "V".
 FOR MOTOR VEHICLE ACCESSORY, NAMELY, A PORTABLE AND ANGLE-ADJUSTABLE TABLE FOR USE ON STEERING WHEELS FOR CARS AND TRUCKS (U.S. CLS. 19, 21, 23, 31, 35 AND 44).
 FIRST USE 7-25-2001; IN COMMERCE 7-25-2001.

CLASS 13—FIREARMS

2,625,907. GALAXY FIREWORKS, INC., TAMPA, FL. SN 76-004,586. PUB. 5-8-2001, FILED 3-14-2000.

WARP SPEED

FOR FIREWORKS (U.S. CLS. 2 AND 9).
 FIRST USE 4-1-2000; IN COMMERCE 4-1-2000.

2,626,046. MICHAELS OF OREGON CO., OREGON CITY, OR. SN 76-076,762. PUB. 2-12-2002, FILED 6-26-2000.

COMFORT STRETCH

NO CLAIM IS MADE TO THE EXCLUSIVE RIGHT TO USE "STRETCH", APART FROM THE MARK AS SHOWN.
 FOR FIREARM SLINGS, NAMELY RIFLE AND SHOTGUN SLINGS (U.S. CLS. 2 AND 9).
 FIRST USE 12-1-1989; IN COMMERCE 12-1-1989.

CLASS 14—JEWELRY

CLASS 14—(Continued).

2,625,396. O'LOUGHLIN, KATHERINE MARIE, CULBURRA BEACH NSW 2540, AUSTRALIA. AND O'LOUGHLIN, WILLIAM ROBIN, CULBURRA BEACH NSW 2540, AUSTRALIA. SN 75-474,375. PUB. 3-14-2000, FILED 4-27-1998.



THE STIPPLING IS FOR SHADING PURPOSED ONLY AND DOES NOT INDICATE COLOR.
 FOR JEWELRY ITEMS, INCLUDING BRACELETS, NECKLACES, EARRINGS, RINGS, PENDANTS, BROOCHES, CUFFS, AND COLLARS (U.S. CLS. 2, 27, 28 AND 50).
 FIRST USE 8-29-1997; IN COMMERCE 9-1-1999.

2,625,997. FABBRICA D'ARMI P. BERETTA, S.P.A., PROVINCE OF BRESCIA, ITALY. SN 76-049,073. PUB. 2-6-2001, FILED 5-16-2000.

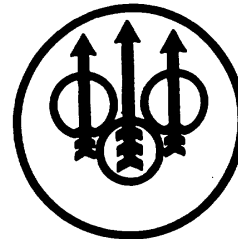

OWNER OF U.S. REG. NOS. 1,611,180, 1,623,667, AND 2,230,222.
 FOR WATCHES (U.S. CLS. 2, 27, 28 AND 50).
 FIRST USE 6-0-2001; IN COMMERCE 6-0-2001.

2,625,998. STULLER, INC., LAFAYETTE, LA, BY CHANGE OF NAME STULLER SETTINGS, INC., LAFAYETTE, LA. SN 76-049,464. PUB. 6-26-2001, FILED 5-16-2000.

SOLSTICE SOLITAIRE

NO CLAIM IS MADE TO THE EXCLUSIVE RIGHT TO USE "SOLITAIRE", APART FROM THE MARK AS SHOWN.
 FOR JEWELRY, NAMELY RINGS AND SETTINGS (U.S. CLS. 2, 27, 28 AND 50).
 FIRST USE 11-0-2000; IN COMMERCE 11-0-2000.

CLASS 14—(Continued).

2,626,023. GANT AB, SE-114 32 STOCKHOLM, SWEDEN. SN 76-062,792. PUB. 10-2-2001, FILED 6-5-2000.

GANT

OWNER OF U.S. REG. NOS. 833,385, 2,255,807, AND OTHERS.
FOR CLOCKS, WATCHES AND CHRONOMETERS (U.S. CLS. 2, 27, 28 AND 50).
FIRST USE 8-20-2001; IN COMMERCE 8-20-2001.

2,626,057. FREDERICK GOLDMAN, INC., NEW YORK, NY. SN 76-081,589. PUB. 3-13-2001, FILED 6-30-2000.

GEMHK

FOR JEWELRY (U.S. CLS. 2, 27, 28 AND 50).
FIRST USE 9-1-2000; IN COMMERCE 9-1-2000.

2,626,073. VAUGHAN, SARABETH, LAFAYETTE, IN, BY ASSIGNMENT VAUGHAN, SARABETH, LAFAYETTE, IN. AND RISK, MELINDA B., WEST LAFAYETTE, IN. SN 76-088,788. PUB. 5-29-2001, FILED 7-14-2000.

A BOUQUET OF BAUBLES

NO CLAIM IS MADE TO THE EXCLUSIVE RIGHT TO USE "BAUBLES", APART FROM THE MARK AS SHOWN.
FOR JEWELRY (U.S. CLS. 2, 27, 28 AND 50).
FIRST USE 9-1-2000; IN COMMERCE 9-1-2000.

2,626,085. DEERE & COMPANY, MOLINE, IL. SN 76-094,550. PUB. 4-24-2001, FILED 7-19-2000.

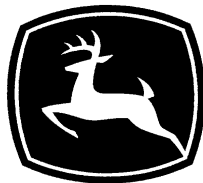

FOR JEWELRY, NAMELY, BELT BUCKLES, WATCH FOBS, KEY RINGS; RINGS, TIE TACS, TIE CLIPS, EARRINGS, KEY CHAINS, CHARMS, AND NECKLACES, ALL MADE OF PRECIOUS METALS (U.S. CLS. 2, 27, 28 AND 50).
FIRST USE 11-1-2000; IN COMMERCE 11-1-2000.

CLASS 14—(Continued).

2,626,102. LILAJON ASSOCIATES, NEW YORK, NY. SN 76-101,528. PUB. 10-30-2001, FILED 8-3-2000.



THE MARK CONSISTS OF A FANCIFUL STYLIZATION OF "LJA".
FOR JEWELRY (U.S. CLS. 2, 27, 28 AND 50).
FIRST USE 8-15-2000; IN COMMERCE 8-15-2000.

2,626,113. BUY-RITE COSTUME JEWELRY, INC., FREEHOLD, NJ. SN 76-108,457. PUB. 6-19-2001, FILED 8-14-2000.

ROMANTIC NOTIONS

FOR COSTUME JEWELRY (U.S. CLS. 2, 27, 28 AND 50).
FIRST USE 8-1-2001; IN COMMERCE 8-1-2001.

2,626,129. STERN/LEACH COMPANY, ATTLEBORO, MA. SN 76-117,167. PUB. 9-11-2001, FILED 8-28-2000.

SL999

FOR SILVER ALLOYS (U.S. CLS. 2, 27, 28 AND 50).
FIRST USE 10-3-2001; IN COMMERCE 10-3-2001.

2,626,213. VAUGHAN, SARABETH, LAFAYETTE, IN. SN 76-148,412. PUB. 8-21-2001, FILED 10-16-2000.

SARABETH

FOR JEWELRY (U.S. CLS. 2, 27, 28 AND 50).
FIRST USE 9-1-2000; IN COMMERCE 3-15-2002.

CLASS 14—(Continued).

2,626,278. BLANCHARD, MARC, SAN DIEGO, CA. SN 76-170,948. PUB. 9-18-2001, FILED 11-24-2000.

ROTOR

FOR WRIST WATCHES, CHRONOGRAPHS, WATCH BANDS, POCKET WATCHES, CLOCK CASES, AND WALL CLOCKS; JEWELRY OF PRECIOUS METALS AND NON-PRECIOUS METALS (U.S. CLS. 2, 27, 28 AND 50).

FIRST USE 1-0-2001; IN COMMERCE 1-0-2001.

2,626,343. GENERAL ELECTRIC COMPANY, SCHENECTADY, NY. SN 76-198,948. PUB. 9-25-2001, FILED 1-24-2001.



FOR DIAMONDS (U.S. CLS. 2, 27, 28 AND 50).
FIRST USE 5-0-2001; IN COMMERCE 5-0-2001.

2,626,416. TIMEX CORPORATION, MIDDLEBURY, CT. SN 76-219,839. PUB. 8-28-2001, FILED 3-5-2001.

TELE-BANK 30

FOR WATCHES, WATCH STRAPS AND WATCH BANDS (U.S. CLS. 2, 27, 28 AND 50).
FIRST USE 9-13-2001; IN COMMERCE 9-13-2001.

2,626,422. M. SCHACHTER & CO. INC., SHORT HILLS, NJ. SN 76-222,699. PUB. 10-16-2001, FILED 3-9-2001.

ROSETTA

FOR DIAMONDS (U.S. CLS. 2, 27, 28 AND 50).
FIRST USE 9-25-2000; IN COMMERCE 9-25-2000.

CLASS 14—(Continued).

2,626,429. HARVEST CHAIN COMPANY, HONG KONG. SN 76-225,165. PUB. 9-4-2001, FILED 3-14-2001.

HCC

FOR JEWELRY (U.S. CLS. 2, 27, 28 AND 50).
FIRST USE 5-15-2002; IN COMMERCE 5-15-2002.

2,626,447. LEO SCHACHTER DIAMONDS, L.L.C., NEW YORK, NY. SN 76-232,734. PUB. 9-11-2001, FILED 3-30-2001.

A WORLD OF BRILLIANCE

FOR DIAMONDS AND FINE JEWELRY (U.S. CLS. 2, 27, 28 AND 50).
FIRST USE 5-21-2002; IN COMMERCE 5-21-2002.

2,626,457. FLANDERS DIAMOND USA, NEW YORK, NY. SN 76-236,209. PUB. 9-18-2001, FILED 4-5-2001.

ELARA

FOR JEWELRY (U.S. CLS. 2, 27, 28 AND 50).
FIRST USE 3-31-2001; IN COMMERCE 3-31-2001.

2,626,475. QVC, INC., WEST CHESTER, PA. SN 76-247,592. PUB. 9-18-2001, FILED 4-27-2001.

ILLUSTRA

FOR SILVER JEWELRY (U.S. CLS. 2, 27, 28 AND 50).
FIRST USE 6-21-2001; IN COMMERCE 6-21-2001.

2,626,479. COMBEX, INC., LAKE GENEVA, WI. SN 76-249,242. PUB. 2-5-2002, FILED 5-1-2001.

SET AND FORGET

FOR CLOCKS AND WATCHES (U.S. CLS. 2, 27, 28 AND 50).
FIRST USE 7-1-2001; IN COMMERCE 7-1-2001.

2,626,503. TIMEX GROUP B.V., 1075 AD AMSTERDAM, NETHERLANDS. SN 76-262,061. PUB. 11-13-2001, FILED 5-24-2001.

PRIZE FIGHTER

FOR WATCHES (U.S. CLS. 2, 27, 28 AND 50).
FIRST USE 8-19-2001; IN COMMERCE 8-19-2001.

CLASS 14—(Continued).

2,626,516. ERNST BENZ LIMITED, WILMINGTON, NC. SN 76-277,691. PUB. 11-13-2001, FILED 6-28-2001.

CHRONOSPORT

FOR WATCHES, CLOCKS, WATCH AND CLOCK PARTS, WATCH WINDERS, AND WATCH BANDS (U.S. CLS. 2, 27, 28 AND 50).

FIRST USE 12-1-2001; IN COMMERCE 12-1-2001.

2,626,517. ERNST BENZ LIMITED, WILMINGTON, NC. SN 76-277,694. PUB. 11-13-2001, FILED 6-28-2001.

CHRONOSCOPE

FOR WATCHES, CLOCKS, WATCH AND CLOCK PARTS, WATCH WINDERS, AND WATCH BANDS (U.S. CLS. 2, 27, 28 AND 50).

FIRST USE 12-1-2001; IN COMMERCE 12-1-2001.

2,626,685. RINGCRAFTERS, INC., FRUIT HEIGHTS, UT. SN 78-051,010. PUB. 11-27-2001, FILED 3-2-2001.

ACT

FOR JEWELRY, RINGS, NECKLACES, BRACELETS (U.S. CLS. 2, 27, 28 AND 50).

FIRST USE 4-5-2002; IN COMMERCE 4-5-2002.

2,626,718. ECHOLS, CATHI, D., ODESSA, TX. SN 78-062,760. PUB. 10-2-2001, FILED 5-9-2001.



FOR JEWELRY (U.S. CLS. 2, 27, 28 AND 50).
FIRST USE 1-3-2001; IN COMMERCE 11-27-2001.

2,626,723. NINE WEST DEVELOPMENT CORP, WILMINGTON, DE. SN 78-063,827. PUB. 9-25-2001, FILED 5-16-2001.

NINE & COMPANY

FOR JEWELRY (U.S. CLS. 2, 27, 28 AND 50).
FIRST USE 3-1-2001; IN COMMERCE 3-1-2001.

CLASS 15—MUSICAL INSTRUMENTS

2,625,728. W. L. GORE & ASSOCIATES, INC., NEWARK, DE. SN 75-878,041. PUB. 10-10-2000, FILED 12-22-1999.

CANMORE

FOR WIND AND PERCUSSION INSTRUMENTS AND PARTS THEREOF (U.S. CLS. 2, 21 AND 36).

FIRST USE 10-10-1995; IN COMMERCE 10-10-1995.

2,625,791. AVEDIS ZILDJIAN CO., NORWELL, MA. SN 75-906,495. PUB. 9-12-2000, FILED 1-31-2000.

DIP

FOR MUSICAL PERCUSSION INSTRUMENTS, NAMELY, DRUMSTICKS (U.S. CLS. 2, 21 AND 36).

FIRST USE 2-3-2000; IN COMMERCE 2-3-2000.

2,626,212. BROOK MAYS MUSIC COMPANY, DALLAS, TX. SN 76-148,351. PUB. 10-23-2001, FILED 10-17-2000.

YORK

FOR MUSICAL INSTRUMENTS (U.S. CLS. 2, 21 AND 36).

FIRST USE 10-30-2000; IN COMMERCE 10-30-2000.

2,626,528. PROTEL RECORDS, INC., MIAMI, FL. SN 76-288,682. PUB. 12-4-2001, FILED 7-20-2001.

MUSICHAUS

FOR MUSICAL SOUND RECORDINGS (U.S. CLS. 2, 21 AND 36).

FIRST USE 10-2-2001; IN COMMERCE 10-2-2001.

CLASS 16—PAPER GOODS AND PRINTED MATTER

2,625,311. GOLDEN CARDS, L.P., MOUNT LAUREL, NJ, BY CHANGE OF NAME; BY CHANGE OF NAME FLEER CORP., MT. LAUREL, NJ. SN 74-625,877. PUB. 9-19-1995, FILED 1-26-1995.

METAL

FOR COLLECTIBLE TRADING CARDS (U.S. CLS. 2, 5, 22, 23, 29, 37, 38 AND 50).
FIRST USE 9-15-1995; IN COMMERCE 9-15-1995.

CLASS 16—(Continued).

2,625,337. COMPUSA MANAGEMENT COMPANY, A DELAWARE BUSINESS TRUST, THE TRUSTEES COMPRISING JAMES F. HALPIN, JAMES E. SKINNER AND MARK R. WALKER, ALL U.S. CITIZENS AND THE COMMONWEALTH TRUST CO., A DELAWARE CORPORATION, DALLAS, TX. SN 75-293,656. PUB. 10-27-1998, FILED 5-19-1997.

COMPVALUE

FOR GIFT CERTIFICATES (U.S. CLS. 2, 5, 22, 23, 29, 37, 38 AND 50).
FIRST USE 10-1-1997; IN COMMERCE 10-1-1997.

2,625,340. KOEFF, MARK JORDAN, RANCHO SANTA MARGARITA, CA. SN 75-300,387. PUB. 3-16-1999, FILED 5-30-1997.

WORDLE

FOR BOARD GAMES, AND GREETING CARDS (U.S. CLS. 2, 5, 22, 23, 29, 37, 38 AND 50).
FIRST USE 6-1-1997; IN COMMERCE 12-1-1997.

2,625,344. ROGERS PUBLISHING LIMITED, TORONTO, ONTARIO, CANADA. SN 75-315,080. PUB. 12-26-2000, FILED 6-26-1997.

FOOD EXPRESS

PRIORITY CLAIMED UNDER SEC. 44(D) ON CANADA APPLICATION NO. 835976, FILED 2-7-1997, REG. NO. 524064, DATED 2-29-2000, EXPIRES 2-7-2014.

NO CLAIM IS MADE TO THE EXCLUSIVE RIGHT TO USE "FOOD", APART FROM THE MARK AS SHOWN.

FOR COOKBOOKS (U.S. CLS. 2, 5, 22, 23, 29, 37, 38 AND 50).
FIRST USE 9-0-1997; IN COMMERCE 4-0-1998.

CLASS 16—(Continued).

2,625,347. DIBLE, DONALD M., SUNNYVALE, CA. SN 75-327,637. PUB. 1-26-1999, FILED 7-21-1997.

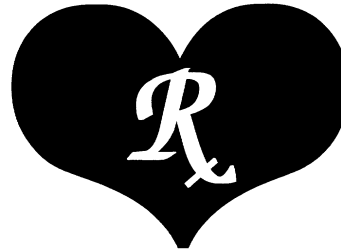

NO CLAIM IS MADE TO THE EXCLUSIVE RIGHT TO USE THE PRESCRIPTION SYMBOL, APART FROM THE MARK AS SHOWN.

FOR SERIES OF BOOKS IN THE FIELD OF SELF-HELP AND INSPIRATION (U.S. CLS. 2, 5, 22, 23, 29, 37, 38 AND 50).

FIRST USE 10-5-2001; IN COMMERCE 10-5-2001.

2,625,371. HEALTHTRAC, INC., MENLO PARK, CA. SN 75-420,832. PUB. 2-23-1999, FILED 1-21-1998.



FOR PRINTED MATTER, NAMELY, NEWSLETTERS AND PRINTED GUIDES, ALL IN THE FIELD OF HEALTH CARE: PRINTED REPORTS ABOUT CHRONIC DISEASES, HEALTH CARE, AND HEALTH MANAGEMENT (U.S. CLS. 2, 5, 22, 23, 29, 37, 38 AND 50).

FIRST USE 5-31-1999; IN COMMERCE 5-31-1999.

CLASS 16—(Continued).

2,625,434. BMS PAPIER CONCEPT GMBH, 65191 WEISBADEN, FED REP GERMANY, BY ASSIGNMENT; BY ASSIGNMENT MOLLER, KARL-HEINZ, 65191 WIESBADEN, FED REP GERMANY. SN 75-570,900. PUB. 3-28-2000, FILED 10-14-1998.

THE FLATTEST BREAD-BIN IN THE WORLD

FOR SHEETS AND BAGS MADE OF PAPER OR PLASTIC FOR WRAPPING FOOD ITEMS (U.S. CLS. 2, 5, 22, 23, 29, 37, 38 AND 50).

FIRST USE 9-10-2001; IN COMMERCE 12-7-2001.

2,625,513. FINKSTROM PRODUCTIONS LLC, EDEN PRAIRIE, MN. SN 75-701,453. PUB. 12-21-1999, FILED 5-10-1999.



FOR CALENDARS, BOOKMARKS, NOTEPADS, POSTERS, AND POSTCARDS (U.S. CLS. 2, 5, 22, 23, 29, 37, 38 AND 50).

FIRST USE 2-0-2001; IN COMMERCE 2-0-2001.

CLASS 16—(Continued).

2,625,717. SERVICIOS CORPORATIVOS DE ADMINISTRACION GMZ, S.A. DE C.V., 03100, MEXICO, D. F., MEXICO. SN 75-869,126. PUB. 9-26-2000, FILED 12-10-1999.



FOR GLUES AND ADHESIVES FOR USE WITH STATIONARY AND OTHER PAPER MATTER, GENERAL HOUSEHOLD USES, AND GENERAL OFFICE USES (U.S. CLS. 2, 5, 22, 23, 29, 37, 38 AND 50).

FIRST USE 5-3-2002; IN COMMERCE 5-13-2002.

2,625,737. SUN SAME ENTERPRISES CO., LTD., YUAN KANG CITY, TAINAN HSIEN 711, TAIWAN. SN 75-883,148. PUB. 8-29-2000, FILED 12-29-1999.

EMINENT

FOR PRE-INKED HAND STAMPS (U.S. CLS. 2, 5, 22, 23, 29, 37, 38 AND 50).

FIRST USE 5-1-2002; IN COMMERCE 5-1-2002.

2,625,746. FLEER/SKYBOX INTERNATIONAL LP, MT. LAUREL, NJ. SN 75-886,600. PUB. 7-3-2001, FILED 7-8-1999.

GENUINE COVERAGE

FOR TRADING CARDS (U.S. CLS. 2, 5, 22, 23, 29, 37, 38 AND 50).

FIRST USE 10-20-1999; IN COMMERCE 10-20-1999.

2,625,780. MARTIN, ROSS DANIEL, STAMPFORD, CT. SN 75-902,691. PUB. 1-16-2001, FILED 1-24-2000.

WORDS WITHOUT END

FOR GIFTS AND NOVELTY ITEMS, NAMELY, PAPER MOBIUS STRIPS FEATURING POETRY, GRAPHICS AND OTHER INSPIRATIONAL EXPRESSIONS (U.S. CLS. 2, 5, 22, 23, 29, 37, 38 AND 50).

FIRST USE 4-10-1998; IN COMMERCE 3-15-2002.

CLASS 16—(Continued).

2,625,805. PROCTER & GAMBLE COMPANY, THE, CINCINNATI, OH. SN 75-910,126. PUB. 10-24-2000, FILED 1-26-2000.

PAMPERS EASY-UPS

OWNER OF U.S. REG. NOS. 745,513, 1,947,621, AND OTHERS.
FOR DISPOSABLE DIAPERS (U.S. CLS. 2, 5, 22, 23, 29, 37, 38 AND 50).
FIRST USE 2-11-2002; IN COMMERCE 2-11-2002.

2,625,840. BENNETT PRODUCTIONS, INC., LOS ANGELES, CA. SN 75-927,091. PUB. 11-14-2000, FILED 2-23-2000.

THE EXTREMISTS

FOR INFORMATIONAL BROCHURES ABOUT TELEVISION PROGRAMMING AND FILM; PRINTED PAPER AND CARDBOARD SIGNS; INSTRUCTIONAL MATERIALS, NAMELY, FOLDERS OF PRINTED BOOKLETS CONTAINING INSTRUCTIONAL MATERIALS; PRINTED ITEMS, NAMELY POSTERS, DECALS, LABELS, STICKERS, AND FOLDERS (U.S. CLS. 2, 5, 22, 23, 29, 37, 38 AND 50).
FIRST USE 0-0-1995; IN COMMERCE 0-0-1995.

2,625,890. 7-ELEVEN, INC., DALLAS, TX, BY CHANGE OF NAME SOUTHLAND CORPORATION, THE, DALLAS, TX. SN 75-982,241. PUB. 9-19-1995, FILED 12-8-1994.



NO CLAIM IS MADE TO THE EXCLUSIVE RIGHT TO USE "QUALITY", APART FROM THE MARK AS SHOWN.
FOR BATHROOM TISSUE, PAPER NAPKINS AND PAPER TOWELS (U.S. CLS. 2, 5, 22, 23, 29, 37, 38 AND 50).
FIRST USE 5-31-1996; IN COMMERCE 5-31-1996.

CLASS 16—(Continued).

2,625,908. DANIELS & ASSOCIATES, ELKINS PARK, PA. SN 76-004,747. PUB. 9-18-2001, FILED 3-22-2000.

POWER TOOLS FOR WOMEN

FOR SERIES OF BOOKS, BOOKLETS CATALOGUES, MANUALS, AND INSTRUCTIONAL GUIDES IN THE FIELD OF INTER-PERSONAL COMMUNICATION SKILLS FOR CORPORATE MANAGEMENT, INSPIRATION, AND SELF-HELP (U.S. CLS. 2, 5, 22, 23, 29, 37, 38 AND 50).
FIRST USE 5-1-2000; IN COMMERCE 5-1-2000.

2,625,977. VALLEY MANUFACTURING, INCORPORATED, TROY, NY. SN 76-043,096. PUB. 12-11-2001, FILED 5-8-2000.

WELLNESS PACKAGING

NO CLAIM IS MADE TO THE EXCLUSIVE RIGHT TO USE "PACKAGING", APART FROM THE MARK AS SHOWN.
FOR PACKAGING FOR USE IN THE MEDICAL FIELD, NAMELY, PLASTIC BAGS FOR PACKAGING, PLASTIC POUCHES FOR PACKAGING, PAPER BAGS FOR PACKAGING, PAPER POUCHES FOR PACKAGING; COLORING BOOKS AND GROWTH CHARTS (U.S. CLS. 2, 5, 22, 23, 29, 37, 38 AND 50).
FIRST USE 3-19-2001; IN COMMERCE 3-19-2001.

2,625,985. SWAFFORD, WILLIAM J., COLORADO SPRINGS, CO. SN 76-046,298. PUB. 8-28-2001, FILED 5-10-2000.



THE LINING IS A FEATURE OF THE MARK AND DOES NOT INDICATE COLOR.
FOR PRINTED MATTER AND PAPER GOODS, NAMELY SPORTS TRADING CARDS PERTAINING TO PLAYER STATISTICS OF PROFESSION SPORTS, SCORE CARDS, SPORTS TRADING CARDS, AND PRINTED TICKETS FOR SPORTING EVENTS (U.S. CLS. 2, 5, 22, 23, 29, 37, 38 AND 50).
FIRST USE 1-1-2001; IN COMMERCE 1-1-2001.

CLASS 16—(Continued).

2,625,992. WATERMAN S.A., 92693 LEVALLOIS-PERRET CEDEX, FRANCE. SN 76-047,350. PUB. 1-23-2001, FILED 5-12-2000.

ICI ET LÀ

THE ENGLISH TRANSLATION OF THE FRENCH WORD "ICI ET LÀ" IS "HERE AND THERE".

FOR WRITING INSTRUMENTS, NAMELY, PENS, PENCILS, MARKERS AND REFILLS FOR WRITING INSTRUMENTS AND WRITING INK (U.S. CLS. 2, 5, 22, 23, 29, 37, 38 AND 50).

FIRST USE 9-21-2000; IN COMMERCE 9-21-2000.

2,626,009. PENNY-FARTHING PRESS, INC., HOUSTON, TX. SN 76-057,460. PUB. 4-10-2001, FILED 5-26-2000.

THE LOCH

FOR BOOKS COMPRISING WORKS OF FICTION AND COMIC BOOKS (U.S. CLS. 2, 5, 22, 23, 29, 37, 38 AND 50).
FIRST USE 12-0-2000; IN COMMERCE 12-0-2000.

2,626,016. HACHETTE FILIPACCHI MEDIA U.S., INC., NEW YORK, NY, BY CHANGE OF NAME HACHETTE FILIPACCHI MAGAZINES, INC., NEW YORK, NY. SN 76-059,789. PUB. 11-27-2001, FILED 5-31-2000.

TECHNOLOGY IN MOTION

FOR PRINTED MATTER, NAMELY, A PERIODIC PUBLICATION CONCERNING THE AUTOMOTIVE ELECTRONICS FIELD (U.S. CLS. 2, 5, 22, 23, 29, 37, 38 AND 50).

FIRST USE 9-26-2000; IN COMMERCE 9-26-2000.

CLASS 16—(Continued).

2,626,025. T.I.M.M.-E. COMPANY, INC., THE, NEW YORK, NY. SN 76-065,933. PUB. 7-31-2001, FILED 6-9-2000.

WE ARE ALL THE SAME INSIDE

FOR OCCASION CARDS, NOTE PADS, ANNOUNCEMENT CARDS, ART PADS, DESK CALENDARS, PRINTED SURVEY ANSWER SHEETS, PRESCRIPTION REMINDER PADS, CARTOON PRINTS, WRITING PADS, SHEET MUSIC, CARTOON STRIPS, CARTOONS, NEWSPAPER CARTOONS, MAGNETIC PAPER, PATTERNS FOR MAKING CLOTHES, PAPER BADGES, RUBBER STAMPS, PAPER BANNERS, STATIONERY, GRAPHIC ART REPRODUCTIONS, COLOR PRINTS, PRINTED ART REPRODUCTIONS, COLORING BOOKS, STATIONERY TYPE PORTFOLIOS, PRINTED AWARDS, COMIC BOOKS, BABY BOOKS, NEWSPAPER COMIC STRIPS, ENVELOPES, COMIC STRIPS, COMIC FEATURES, PICTURE BOOKS, BOOK COVERS, ART AND CRAFTS PAINT KITS, STICKERS, BOOKMARKS, BUMPER STICKERS, CHILDREN'S ACTIVITY BOOKS, EDUCATIONAL BOOKS IN THE FIELDS OF MULTICULTURALISM, SOCIAL TOLERANCE, LOVE AND FRIENDSHIP, PRINTED TEACHING MATERIALS IN THE FIELDS OF MULTICULTURALISM, SOCIAL TOLERANCE, LOVE AND FRIENDSHIP, CHILDREN'S PAPER BOOKS, POSTCARDS, POSTCARDS, DATA BOOKS, STATIONERY FOLDERS, POSTERS, PRINTED AWARDS, EDUCATIONAL BOOKS IN THE AREA OF SOCIAL STUDIES, SONG BOOKS, PRINTED INVITATIONS, WIREBOUND BOOKS, GREETING CARDS, TRADING CARDS, HOLOGRAMS, PAPER TRANSPARENCIES, CALENDARS, PRINTED SURVEY ANSWER SHEETS, MURALS (U.S. CLS. 2, 5, 22, 23, 29, 37, 38 AND 50).

FIRST USE 6-9-2000; IN COMMERCE 7-4-2000.

2,626,179. GAB, GAB, GAB, GLEN ELLYN, IL. SN 76-134,902. PUB. 5-22-2001, FILED 9-25-2000.

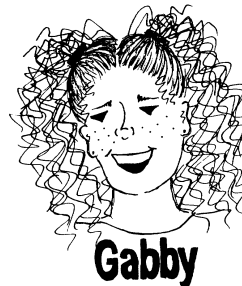

THE STIPPLING IS A FEATURE OF THE MARK. THE LIKENESS (OR, "PORTRAIT") IN THE MARK DOES NOT IDENTIFY A LIVING INDIVIDUAL.

FOR GREETING CARDS, MEMO PADS, ADHESIVE NOTE PADS, AND BOOKMARKS (U.S. CLS. 2, 5, 22, 23, 29, 37, 38 AND 50).

FIRST USE 10-10-2001; IN COMMERCE 6-1-2002.

CLASS 16—(Continued).

2,626,189. STAEDTLER, INC, CHATSWORTH, CA. SN 76-139,937. PUB. 7-3-2001, FILED 10-3-2000.



FOR COMBINATION PENS AND MECHANICAL PENCILS (U.S. CLS. 2, 5, 22, 23, 29, 37, 38 AND 50).
FIRST USE 1-26-1999; IN COMMERCE 1-26-1999.

2,626,234. IDG BOOKS WORLDWIDE, INC., FOSTER CITY, CA. SN 76-155,721. PUB. 8-14-2001, FILED 10-27-2000.

FOR DUMMIES

OWNER OF U.S. REG. NOS. 1,759,840, 2,192,914, AND OTHERS.

FOR DECORATING PATTERNS, CLOTHING AND ACCESSORY PATTERNS; PUBLICATIONS, NAMELY NON-FICTION BOOKS, GUIDES AND MANUALS IN THE FIELD OF SEWING, CRAFTS AND HOME DECORATING (U.S. CLS. 2, 5, 22, 23, 29, 37, 38 AND 50).
FIRST USE 7-0-1999; IN COMMERCE 7-0-1999.

2,626,272. TAGMAR, INC., FRESNO, CA. SN 76-168,980. PUB. 7-3-2001, FILED 11-20-2000.

GORDON'S GUIDE

NO CLAIM IS MADE TO THE EXCLUSIVE RIGHT TO USE "GUIDE", APART FROM THE MARK AS SHOWN.
FOR BOOKS AND NEWSLETTERS IN THE FIELDS OF ADVENTURE TRAVEL AND VACATION PLANNING (U.S. CLS. 2, 5, 22, 23, 29, 37, 38 AND 50).
FIRST USE 9-15-1997; IN COMMERCE 9-15-1997.

2,626,276. PLAYOFF CORPORATION, GRAND PRAIRIE, TX. SN 76-169,819. PUB. 9-4-2001, FILED 11-20-2000.

CHAMPIONSHIP FABRIC

NO CLAIM IS MADE TO THE EXCLUSIVE RIGHT TO USE "FABRIC", APART FROM THE MARK AS SHOWN.
FOR SPORTS TRADING CARDS AND COLLECTIBLE CARDS (U.S. CLS. 2, 5, 22, 23, 29, 37, 38 AND 50).
FIRST USE 12-26-2000; IN COMMERCE 12-26-2000.

CLASS 16—(Continued).

2,626,285. KANTEK INC., EAST ROCKAWAY, NY. SN 76-171,827. PUB. 8-28-2001, FILED 11-28-2000.

PHONE CENTRAL

NO CLAIM IS MADE TO THE EXCLUSIVE RIGHT TO USE "PHONE", APART FROM THE MARK AS SHOWN.
FOR TELEPHONE STAND AND STATIONERY ORGANIZER (U.S. CLS. 2, 5, 22, 23, 29, 37, 38 AND 50).
FIRST USE 7-31-2001; IN COMMERCE 7-31-2001.

2,626,395. E.K. SUCCESS, LTD., CLIFTON, NJ. SN 76-215,290. PUB. 12-11-2001, FILED 2-23-2001.

STAMP-A-MA-JIG

FOR RUBBER STAMP ALIGNMENT DEVICE (U.S. CLS. 2, 5, 22, 23, 29, 37, 38 AND 50).
FIRST USE 8-8-2001; IN COMMERCE 8-8-2001.

2,626,414. TIME4 MEDIA, INC., NEW YORK, NY, BY CHANGE OF NAME TIMES MIRROR MAGAZINES, INC., NEW YORK, NY. SN 76-219,438. PUB. 8-28-2001, FILED 3-5-2001.

TIME4 MEDIA

NO CLAIM IS MADE TO THE EXCLUSIVE RIGHT TO USE "MEDIA", APART FROM THE MARK AS SHOWN.
FOR MAGAZINES AND BOOKS FEATURING INFORMATION ABOUT ENTERTAINMENT, SPORTS, RECREATION, OUTDOOR ACTIVITIES, SCIENCE AND TECHNOLOGY, EDUCATION, AND TOPICS RELATED TO EACH OF THE ABOVE (U.S. CLS. 2, 5, 22, 23, 29, 37, 38 AND 50).
FIRST USE 5-0-2001; IN COMMERCE 5-0-2001.

2,626,437. PARK NICOLLET HEALTH SERVICES, ST. LOUIS PARK, MN. SN 76-228,787. PUB. 10-2-2001, FILED 3-22-2001.



FOR PRINTED MATERIALS, NAMELY, BOOKS, BROCHURES, AND PAMPHLETS IN THE FIELDS OF MEDICINE AND HEALTH CARE (U.S. CLS. 2, 5, 22, 23, 29, 37, 38 AND 50).
FIRST USE 9-0-2000; IN COMMERCE 9-0-2000.

CLASS 16—(Continued).

2,626,452. TTOOLS, LLC, PROVIDENCE, RI. SN 76-234,630. PUB. 3-12-2002, FILED 4-3-2001.

PREMIERPOINT

FOR PENS, PEN ACCESSORIES, AND PARTS THEREFOR (U.S. CLS. 2, 5, 22, 23, 29, 37, 38 AND 50). FIRST USE 9-1-2001; IN COMMERCE 9-1-2001.

2,626,484. HUNT HOLDINGS, INC., WILMINGTON, DE. SN 76-252,300. PUB. 9-25-2001, FILED 5-7-2001.

BUZZ

FOR PENCIL SHARPENERS (U.S. CLS. 2, 5, 22, 23, 29, 37, 38 AND 50). FIRST USE 12-12-2001; IN COMMERCE 1-2-2002.

2,626,486. KABUSHIKI KAISHA PILOT, CHUO-KU, TOKYO, JAPAN. SN 76-254,872. PUB. 10-9-2001, FILED 5-8-2001.

ERASE-A-GEL

FOR BALL-POINT PENS AND OTHER WRITING INSTRUMENTS, STATIONERY (U.S. CLS. 2, 5, 22, 23, 29, 37, 38 AND 50). FIRST USE 11-14-2001; IN COMMERCE 11-14-2001.

2,626,490. LEXINGTON PROFESSIONAL BASEBALL COMPANY, LLC, LEXINGTON, KY. SN 76-257,386. PUB. 9-11-2001, FILED 5-16-2001.

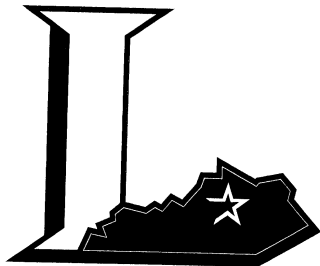

THE MARK CONSISTS OF THE LETTER "L" AND A REPRESENTATION OF THE COMMONWEALTH OF KENTUCKY.

FOR POSTERS, SPORTS TRADING CARDS, STATIONERY, PENS, PENCILS, APPOINTMENT BOOKS, ADDRESS BOOKS, BUMPER STICKERS, SCRAPBOOK ALBUMS, BOOKMARKS, CHILDREN'S ACTIVITY BOOKS, SCORE BOOKS, CALENDARS, GREETING CARDS, COASTERS MADE OF PAPER, DECALS, GIFT WRAPPING PAPER, MEMO PADS, PHOTOGRAPH ALBUMS, AND POSTCARDS (U.S. CLS. 2, 5, 22, 23, 29, 37, 38 AND 50).

FIRST USE 8-3-2000; IN COMMERCE 8-3-2000.

CLASS 16—(Continued).

2,626,504. SOUTHWEST ART, INC., HOUSTON, TX. SN 76-262,591. PUB. 12-18-2001, FILED 5-25-2001.

LIVING WEST

FOR CONSUMER ORIENTED WESTERN LIFESTYLE MAGAZINE (U.S. CLS. 2, 5, 22, 23, 29, 37, 38 AND 50). FIRST USE 11-0-2001; IN COMMERCE 11-0-2001.

2,626,510. METAGENICS, INC., SAN CLEMENTE, CA. SN 76-271,028. PUB. 12-25-2001, FILED 6-13-2001.

FORMULA FOCUS

FOR PRINTED PUBLICATIONS IN THE FIELD OF HEALTH AND NUTRITION (U.S. CLS. 2, 5, 22, 23, 29, 37, 38 AND 50). FIRST USE 3-31-2000; IN COMMERCE 3-31-2000.

2,626,514. SANDERS, ANDREW I., PRATTVILLE, AL. SN 76-276,853. PUB. 2-19-2002, FILED 6-27-2001.



NO CLAIM IS MADE TO THE EXCLUSIVE RIGHT TO USE "AD", APART FROM THE MARK AS SHOWN.

FOR WEEKLY NEWSPAPER IN THE FIELDS OF BUYING, SELLING, AND TRADING CLASSIFIEDS AND LOCAL EVENTS (U.S. CLS. 2, 5, 22, 23, 29, 37, 38 AND 50).

FIRST USE 8-15-2001; IN COMMERCE 8-15-2001.

2,626,540. H.B PAULK GROCERY CO., OPP, AL. SN 76-298,662. PUB. 12-4-2001, FILED 8-14-2001.

ECONOTALK

FOR PREPAID TELEPHONE CALLING CARDS, NOT MAGNETICALLY ENCODED (U.S. CLS. 2, 5, 22, 23, 29, 37, 38 AND 50).

FIRST USE 12-0-2001; IN COMMERCE 12-0-2001.

CLASS 16—(Continued).

2,626,541. NORTHSTAR PRINT GROUP, WATERTOWN, WI. SN 76-298,806. PUB. 11-20-2001, FILED 8-10-2001.

STARBRITE

FOR LABELS (U.S. CLS. 2, 5, 22, 23, 29, 37, 38 AND 50).
FIRST USE 2-19-2002; IN COMMERCE 2-19-2002.

2,626,551. NIOXIN RESEARCH LABORATORIES, INC., LITHIA SPRINGS, GA. SN 76-305,345. PUB. 1-8-2002, FILED 8-23-2001.

THE SCIENCE OF GROWTH

FOR NEWSLETTERS IN THE FIELD OF HAIR CARE PREPARATIONS, HAIR LOSS AND HAIR STYLING TECHNIQUES (U.S. CLS. 2, 5, 22, 23, 29, 37, 38 AND 50).
FIRST USE 6-10-2001; IN COMMERCE 6-23-2001.

2,626,584. GAFFIN, SAMUEL R., DBA ABNORMAL FUN COMICS, WINTER PARK, FL. SN 78-015,449. PUB. 5-22-2001, FILED 7-5-2000.

THE ANOMALIES

FOR COMIC BOOKS, GRAPHIC NOVELS, POSTERS, AND STICKERS (U.S. CLS. 2, 5, 22, 23, 29, 37, 38 AND 50).
FIRST USE 10-31-2000; IN COMMERCE 10-31-2000.

2,626,604. PROCTER & GAMBLE COMPANY, THE, CINCINNATI, OH. SN 78-026,616. PUB. 8-28-2001, FILED 9-19-2000.

PUFFS KIDS

OWNER OF U.S. REG. NO. 697,836 AND OTHERS. NO CLAIM IS MADE TO THE EXCLUSIVE RIGHT TO USE "KIDS", APART FROM THE MARK AS SHOWN. FOR FACIAL TISSUE (U.S. CLS. 2, 5, 22, 23, 29, 37, 38 AND 50).
FIRST USE 6-13-2001; IN COMMERCE 6-13-2001.

2,626,698. REYNOLDS METALS COMPANY, RICHMOND, VA. SN 78-053,529. PUB. 3-19-2002, FILED 3-16-2001.

QWIK-SLIDE

FOR RECLOSABLE BAGS, NAMELY, PLASTIC FOOD STORAGE BAGS (U.S. CLS. 2, 5, 22, 23, 29, 37, 38 AND 50).
FIRST USE 3-21-2002; IN COMMERCE 3-21-2002.

CLASS 16—(Continued).

2,626,701. HESS, LARRY, PHOENIX, AZ. SN 78-054,891. PUB. 1-22-2002, FILED 3-25-2001.

OLCTUN

FOR RELIGIOUS BOOKS (U.S. CLS. 2, 5, 22, 23, 29, 37, 38 AND 50).
FIRST USE 3-1-2002; IN COMMERCE 3-1-2002.

2,626,705. INTERALIGN, LLC, RICHMOND, VA. SN 78-056,571. PUB. 9-25-2001, FILED 4-3-2001.

INTERALIGN

FOR CARRYING CASE FOR ARTWORK (U.S. CLS. 2, 5, 22, 23, 29, 37, 38 AND 50).
FIRST USE 4-2-2002; IN COMMERCE 4-2-2002.

CLASS 17—RUBBER GOODS

2,625,871. FINCASTLE COUNTY CHAIRWORKS, LLC, LOUISVILLE, KY. SN 75-950,644. PUB. 12-5-2000, FILED 3-1-2000.

ANDURE

FOR EXTRUDED OLIFIN PANEL FOR USE IN THE MANUFACTURE OF FURNITURE (U.S. CLS. 1, 5, 12, 13, 35 AND 50).
FIRST USE 5-0-1998; IN COMMERCE 5-0-1998.

2,626,192. TZUNG WEI CO., LTD., FENG YUAN CITY, TAICHUNG HSIEN, TAIWAN. SN 76-140,690. PUB. 9-4-2001, FILED 10-4-2000.

P.C.U

FOR LATEX RUBBER FOR USE IN THE MANUFACTURE OF SHOES; RUBBER AND SYNTHETIC RUBBER FOR USE IN THE MANUFACTURE OF SHOES; SEMI-FINISHED ACRYLIC MOLDED PLASTIC SUBSTANCES FOR USE IN GENERAL MANUFACTURING; EXTRUDED PLASTIC IN THE FORM OF BARS, BLOCKS, PELLETS, RODS, SHEETS AND TUBES FOR USE IN GENERAL MANUFACTURING; POLYVINYL CHLORIDE PLASTIC IN THE FORM OF BARS, BLOCKS, PELLETS, RODS, SHEETS AND TUBES FOR USE IN GENERAL MANUFACTURING; POLYETHYLENE PLASTIC IN THE FORM OF BARS, BLOCKS, PELLETS, RODS, SHEETS AND TUBES FOR USE IN GENERAL MANUFACTURING; PLASTIC IN BARS, BLOCKS, PELLETS, RODS, SHEETS AND TUBES FOR GENERAL INDUSTRIAL USE; PLASTIC IN EXTRUDED FORM FOR GENERAL INDUSTRIAL USE (U.S. CLS. 1, 5, 12, 13, 35 AND 50).
FIRST USE 2-1-2002; IN COMMERCE 2-1-2002.

CLASS 17—(Continued).

2,626,692. ANSUL, INCORPORATED, MARINETTE, WI. SN 78-052,594. PUB. 10-9-2001, FILED 3-12-2001.

ANSULINE

OWNER OF U.S. REG. NOS. 519,740, 1,250,756, AND OTHERS.

FOR NON-METALLIC HOSE FOR USE IN FIRE EXTINGUISHING (U.S. CLS. 1, 5, 12, 13, 35 AND 50).

FIRST USE 7-17-2000; IN COMMERCE 7-17-2000.

2,626,715. ABERDEEN ROAD COMPANY, EMIGSVILLE, PA. SN 78-061,812. PUB. 9-25-2001, FILED 5-3-2001.

SURE-THANE

FOR ELASTOMERIC FILM FOR USE ON HEALTH-CARE FABRICS (U.S. CLS. 1, 5, 12, 13, 35 AND 50).

FIRST USE 2-0-2002; IN COMMERCE 2-0-2002.

2,626,728. FOAMEX L.P., LINWOOD, PA. SN 78-067,443. PUB. 10-30-2001, FILED 6-5-2001.

SENSUS

FOR POLYURETHANE FOAMS USED IN THE CONSTRUCTION OF MATTRESSES, FURNITURE CUSHIONS, FURNITURE SEATS AND FURNITURE BACKS (U.S. CLS. 1, 5, 12, 13, 35 AND 50).

FIRST USE 1-3-2002; IN COMMERCE 1-3-2002.

CLASS 18—LEATHER GOODS

2,625,410. CATALYST APPLIED TECHNOLOGIES, INC., SYOSSET, NY. SN 75-530,156. PUB. 9-28-1999, FILED 8-3-1998.

SPEED BAG

NO CLAIM IS MADE TO THE EXCLUSIVE RIGHT TO USE "BAG", APART FROM THE MARK AS SHOWN.

FOR BAGS; NAMELY TOTE BAGS, GYM BAGS AND HANDBAGS (U.S. CLS. 1, 2, 3, 22 AND 41).

FIRST USE 9-30-2000; IN COMMERCE 9-30-2000.

2,625,565. BRIDGESTONE SPORTS CO., LTD., TOKYO, JAPAN. SN 75-748,441. PUB. 8-29-2000, FILED 7-12-1999.

PRECEPT

OWNER OF U.S. REG. NOS. 2,255,522, 2,260,877, AND OTHERS.

FOR SHOE CASES FOR TRAVEL AND GOLFING (U.S. CLS. 1, 2, 3, 22 AND 41).

FIRST USE 4-2-2002; IN COMMERCE 4-2-2002.

CLASS 18—(Continued).

2,625,932. EIBL, PETER, RHEINE, FED REP GERMANY. SN 76-020,497. PUB. 9-11-2001, FILED 4-7-2000.

RAINDEER

PRIORITY CLAIMED UNDER SEC. 44(D) ON FED REP GERMANY APPLICATION NO. 39963010.4/1, FILED 11-10-1999, REG. NO. 39963010, DATED 10-11-1999, EXPIRES 10-31-2009.

FOR PATIO UMBRELLAS, BEACH UMBRELLAS, GOLF UMBRELLAS, UMBRELLAS (U.S. CLS. 1, 2, 3, 22 AND 41).

FIRST USE 1-17-2002; IN COMMERCE 1-17-2002.

2,625,987. NATIONAL SYNDICATIONS, INC., NEW YORK, NY, BY MERGER NATIONAL SYNDICATIONS, INC., NEW YORK, NY. SN 76-046,464. PUB. 1-9-2001, FILED 5-9-2000.

Comfort Carry-all

FOR SHOULDER BAGS (U.S. CLS. 1, 2, 3, 22 AND 41). FIRST USE 4-9-2000; IN COMMERCE 4-9-2000.

2,626,063. TRAVELPRO INTERNATIONAL, INC., BOCA RATON, FL. SN 76-084,304. PUB. 3-6-2001, FILED 7-6-2000.

AIRPRO

FOR LUGGAGE (U.S. CLS. 1, 2, 3, 22 AND 41). FIRST USE 3-5-2002; IN COMMERCE 3-5-2002.

2,626,319. LEGENT INTERNATIONAL, LTD., NEW YORK, NY. SN 76-189,643. PUB. 12-25-2001, FILED 1-4-2001.

URBAN ACCENTS

FOR LADIES HANDBAGS, WALLETS, CHANGE PURSES, LUGGAGE, BACKPACKS, GYM BAGS AND TOTES (U.S. CLS. 1, 2, 3, 22 AND 41).

FIRST USE 7-0-2001; IN COMMERCE 7-0-2001.

CLASS 18—(Continued).

2,626,431. LEGENT INTERNATIONAL, LTD., NEW YORK, NY. SN 76-225,654. PUB. 12-25-2001, FILED 3-16-2001.



THE DESIGN CONSISTS OF AN OVAL CONTAINING THE WORDS "URBAN ACCENTS" WITH A STYLIZED "A". FOR LADIES HANDBAGS, WALLETTS, CHANGE PURSES, LUGGAGE, BACKPACKS, GYM BAGS AND TOTES (U.S. CLS. 1, 2, 3, 22 AND 41). FIRST USE 7-0-2001; IN COMMERCE 7-0-2001.

2,626,515. WEAVER LEATHER, INC., MT. HOPE, OH. SN 76-277,472. PUB. 1-22-2002, FILED 6-28-2001.

SMART CINCH

NO CLAIM IS MADE TO THE EXCLUSIVE RIGHT TO USE "CINCH", APART FROM THE MARK AS SHOWN. FOR SADDLE CINCHES (U.S. CLS. 1, 2, 3, 22 AND 41). FIRST USE 1-8-2001; IN COMMERCE 1-8-2001.

2,626,565. COACH, INC., NEW YORK, NY. SN 78-007,596. PUB. 6-26-2001, FILED 5-10-2000.



SEC. 2(F). FOR HANDBAGS, PURSES, CLUTCHES, SHOULDER BAGS, PORTFOLIOS, TOTE BAGS, WAIST POUCHES, BACKPACKS, COSMETIC CASES SOLD EMPTY, TOILETRY CASES SOLD EMPTY, BRIEFCASES, LUGGAGE, GARMENT BAGS, BILLFOLDS, WALLETTS, KEY CASES, BUSINESS CARD CASES, CREDIT CARD CASES, PASSPORT HOLDERS, IDENTIFICATION CASES, TIE CASES AND COIN POUCHES (U.S. CLS. 1, 2, 3, 22 AND 41). FIRST USE 4-0-2001; IN COMMERCE 4-0-2001.

CLASS 18—(Continued).

2,626,635. BRENTANO, MIAMI, FL. SN 78-038,987. PUB. 9-11-2001, FILED 12-12-2000.



FOR HANDBAGS, TOTE BAGS, LUGGAGE, PURSES, WALLETTS AND BACKPACKS (U.S. CLS. 1, 2, 3, 22 AND 41). FIRST USE 5-17-1999; IN COMMERCE 5-17-1999.

2,626,703. SAMSONITE CORPORATION, DENVER, CO. SN 78-055,559. PUB. 9-11-2001, FILED 3-28-2001.

SOFTSPIN

FOR LUGGAGE WHEELS (U.S. CLS. 1, 2, 3, 22 AND 41). FIRST USE 1-1-2001; IN COMMERCE 1-1-2001.

2,626,721. SAMSONITE CORPORATION, DENVER, CO. SN 78-063,063. PUB. 10-2-2001, FILED 5-11-2001.

COLOGNE

FOR LUGGAGE (U.S. CLS. 1, 2, 3, 22 AND 41). FIRST USE 11-1-1999; IN COMMERCE 11-1-1999.

2,626,733. AIRWAY INDUSTRIES, INC., ELLWOOD CITY, PA. SN 78-069,281. PUB. 10-23-2001, FILED 6-15-2001.

ENTERPRISE

FOR LUGGAGE (U.S. CLS. 1, 2, 3, 22 AND 41). FIRST USE 2-5-2002; IN COMMERCE 2-5-2002.

CLASS 19—NON-METALLIC BUILDING MATERIALS

2,625,421. CANFIBRE GROUP INC., THE, TORONTO, ONTARIO, CANADA. SN 75-554,066. PUB. 11-2-1999, FILED 9-16-1998.

CANFIBRE

FOR WOOD PANEL PRODUCTS, NAMELY, MEDIUM DENSITY FIBREBOARD, A COMPOSITE BOARD MADE OF RECLAIMED WOOD (U.S. CLS. 1, 12, 33 AND 50). FIRST USE 9-0-1999; IN COMMERCE 9-0-1999.

CLASS 19—(Continued).

2,625,432. 9069-0470 QUEBEC INC., ST-PRIME, CANADA. SN 75-565,475. PUB. 4-18-2000, FILED 10-7-1998.



FOR NON-METALLIC, PREFABRICATED, REBUILDABLE, MODULAR WALL FRAMEWORKS (U.S. CLS. 1, 12, 33 AND 50).
FIRST USE 7-31-2000; IN COMMERCE 7-31-2000.

2,625,680. FLEETWOOD ENTERPRISES, INC., RIVERSIDE, CA. SN 75-843,741. PUB. 3-6-2001, FILED 11-9-1999.

MEADOWBROOK

FOR MANUFACTURED HOMES - NAMELY MOBILE HOMES (U.S. CLS. 1, 12, 33 AND 50).
FIRST USE 12-0-1999; IN COMMERCE 12-0-1999.

2,626,062. MOHAWK BRANDS, INC., WILMINGTON, DE. SN 76-083,383. PUB. 7-17-2001, FILED 7-5-2000.

SNAP TECH BY MOHAWK

OWNER OF U.S. REG. NOS. 1,099,660 AND 2,331,148.
FOR LAMINATE FLOORING (U.S. CLS. 1, 12, 33 AND 50).
FIRST USE 2-10-2002; IN COMMERCE 2-10-2002.

2,626,374. GEORGIA-PACIFIC CORPORATION, ATLANTA, GA. SN 76-210,650. PUB. 8-28-2001, FILED 2-13-2001.

DURAMINE

FOR MELAMINE LAMINATED BUILDING PRODUCTS, NAMELY, PARTICLEBOARD AND MEDIUM DENSITY FIBERBOARD (U.S. CLS. 1, 12, 33 AND 50).
FIRST USE 4-0-2000; IN COMMERCE 5-0-2001.

CLASS 19—(Continued).

2,626,377. ANDERSON-TULLY VENEERS, L.P., VICKSBURG, MS. SN 76-211,145. PUB. 8-14-2001, FILED 2-15-2001.

BARRINGTON

FOR PRE-FINISHED, ENGINEERED HARDWOOD FLOORS (U.S. CLS. 1, 12, 33 AND 50).
FIRST USE 1-28-2001; IN COMMERCE 1-28-2001.

2,626,378. ANDERSON-TULLY VENEERS, L.P., VICKSBURG, MS. SN 76-211,148. PUB. 9-18-2001, FILED 2-15-2001.

CAMBERLEY

FOR PRE-FINISHED, ENGINEERED HARDWOOD FLOORS (U.S. CLS. 1, 12, 33 AND 50).
FIRST USE 1-28-2001; IN COMMERCE 1-28-2001.

2,626,527. EXTERIOR SYSTEMS, INC., MACEDONIA, OH. SN 76-286,054. PUB. 2-12-2002, FILED 7-17-2001.

STONECUT

FOR VINYL SIDING ACCESSORIES, NAMELY OUTSIDE CORNER POSTS (U.S. CLS. 1, 12, 33 AND 50).
FIRST USE 10-15-2001; IN COMMERCE 10-15-2001.

2,626,597. GULF TRADING (ALABAMA) INC., CARNEGIE, PA. SN 78-022,738. PUB. 7-31-2001, FILED 8-24-2000.

JIN MAG-SIL

FOR MINERAL SUBSTANCES IN THE NATURE OF FERROSILICON WITH MAGNESIUM FOR THE MANUFACTURE OF DUCTILE CAST IRON (U.S. CLS. 1, 12, 33 AND 50).
FIRST USE 9-1-2000; IN COMMERCE 9-1-2000.

2,626,616. OWENS-CORNING FIBERGLAS TECHNOLOGY INC., SUMMIT, IL. SN 78-032,079. PUB. 7-17-2001, FILED 10-24-2000.

STRATAGUARD

FOR ROOFING BOARD (U.S. CLS. 1, 12, 33 AND 50).
FIRST USE 3-27-2002; IN COMMERCE 3-27-2002.

CLASS 19—(Continued).

2,626,657. LUDLOW BUILDING PRODUCTS, INC., ADRIAN, MI. SN 78-043,077. PUB. 8-28-2001, FILED 1-13-2001.

CLASS 20—(Continued).

2,625,462. ROYSTON LLC, JASPER, GA. SN 75-612,589. PUB. 2-29-2000, FILED 12-28-1998.

OPTI FLASH

NO CLAIM IS MADE TO THE EXCLUSIVE RIGHT TO USE "FLASH", APART FROM THE MARK AS SHOWN. FOR BUTYL RUBBER WINDOW FLASHING MATERIAL (U.S. CLS. 1, 12, 33 AND 50). FIRST USE 2-1-2001; IN COMMERCE 2-1-2001.



2,626,666. ALCOA INC., PITTSBURGH, PA. SN 78-045,072. PUB. 8-21-2001, FILED 1-26-2001.

PROGRESSIONS

FOR VINYL SIDING AND VINYL SOFFIT (U.S. CLS. 1, 12, 33 AND 50). FIRST USE 6-1-2001; IN COMMERCE 6-1-2001.

FOR FURNITURE, NAMELY, SHELVING, CABINETS FOR USE IN RETAIL STORES AND RESTAURANTS FOR DISPLAYING MERCHANDISE, STORING SUPPLIES AND HOUSING EQUIPMENT AND FOR USE IN SERVICE STATIONS AS COMBINATION WASTE RECEPTACLES AND HOLDERS FOR WATER, SQUEEGIES AND TOWELS FOR WINDSHIELD CLEANING (U.S. CLS. 2, 13, 22, 25, 32 AND 50). FIRST USE 10-4-2001; IN COMMERCE 10-4-2001.

2,626,731. TENDURA, L.L.C., TROY, AL. SN 78-068,542. PUB. 2-5-2002, FILED 6-11-2001.

TENDURA

FOR EXTERIOR FLOORING, NAMELY FLOORING OF WOOD AND POLYETHYLENE COMPOSITE EXTRUDED PLANKS FOR USE IN PORCHES (U.S. CLS. 1, 12, 33 AND 50). FIRST USE 3-0-2001; IN COMMERCE 10-0-2001.

2,625,509. METRO-GOLDWYN-MAYER STUDIOS INC., SANTA MONICA, CA. SN 75-697,008. PUB. 3-20-2001, FILED 5-4-1999.



NO CLAIM IS MADE TO THE EXCLUSIVE RIGHT TO USE "HOME", APART FROM THE MARK AS SHOWN. THE LINING SHOWN IN THE DRAWING IS A FEATURE OF THE MARK AND NOT INTENDED TO INDICATE COLOR.

FOR FURNITURE, NAMELY, TABLES; CHAIRS; COUCHES; FABRIC FURNITURE COVERS; CURTAIN RODS; CURTAIN RINGS; CUSHIONS; PILLOWS; FIRE SCREENS; FOOTSTOOLS; MAGAZINE RACKS; MIRRORS; OTTOMANS; UMBRELLA STANDS; CHEST OF DRAWERS; CABINETS; FLOOR SCREENS; BOOKCASES; STOOLS; PICTURE FRAMES; BEDS, WATERBEDS; WARDROBES; WOOD BOXES; AND WALL UNITS (U.S. CLS. 2, 13, 22, 25, 32 AND 50). FIRST USE 9-2-1999; IN COMMERCE 9-2-1999.

CLASS 20—FURNITURE AND ARTICLES NOT OTHERWISE CLASSIFIED

CLASS 20—(Continued).

2,625,521. HIRSH INDUSTRIES, INC., DES MOINES, IA, BY ASSIGNMENT STEELWORKS, INC., DES MOINES, IA. SN 75-714,595. PUB. 7-11-2000, FILED 5-27-1999.

OFFICE *Designs*

FOR METAL SHELVING; FLOOR STANDING FILE CABINETS; WHEELED FRAMES FOR TRANSPORTING FILE CABINETS; READY-TO-ASSEMBLE FLOOR STANDING FILE CABINETS; STORAGE ORGANIZER KITS COMPOSED OF ONE OR MORE OF DRAWERS, BASKETS, SHELVES, SHELVING UPRIGHT SUPPORTS AND BRACKETS, CLOSET RODS, AND MOUNTING ACCESSORIES; OFFICE FURNITURE; WORKBENCHES; SHELVING (U.S. CLS. 2, 13, 22, 25, 32 AND 50).
FIRST USE 6-0-2000; IN COMMERCE 6-0-2000.

2,625,672. VENGRA DESIGN GROUP, INC., CHANHASSEN, MN. SN 75-840,168. PUB. 6-27-2000, FILED 11-20-1999.

SMART EXHIBIT

NO CLAIM IS MADE TO THE EXCLUSIVE RIGHT TO USE "EXHIBIT", APART FROM THE MARK AS SHOWN.
FOR DISPOSABLE OR REUSABLE TRADE SHOW DISPLAYS, NAMELY, EXHIBIT BOOTHS, PANELING, FRAMES AND PARTITIONS (U.S. CLS. 2, 13, 22, 25, 32 AND 50).
FIRST USE 11-15-1999; IN COMMERCE 11-21-1999.

2,625,747. PUNCH STUDIO, LLC, CULVER CITY, CA, BY ASSIGNMENT WEE GOOD, INC., DBA MICHEL & CO., CULVER CITY, CA. SN 75-888,077. PUB. 6-26-2001, FILED 1-4-2000.

THE GIFTED LINE

OWNER OF U.S. REG. NOS. 1,211,531, 1,834,694, AND OTHERS.
NO CLAIM IS MADE TO THE EXCLUSIVE RIGHT TO USE "LINE", APART FROM THE MARK AS SHOWN.
FOR PICTURE FRAMES (U.S. CLS. 2, 13, 22, 25, 32 AND 50).
FIRST USE 4-18-2001; IN COMMERCE 4-18-2001.

2,626,008. HUNTER DOUGLAS, INC., UPPER SADDLE RIVER, NJ. SN 76-056,458. PUB. 2-6-2001, FILED 5-25-2000.

TITAN

FOR WINDOW BLINDS AND WINDOW SHADES (U.S. CLS. 2, 13, 22, 25, 32 AND 50).
FIRST USE 7-10-2000; IN COMMERCE 7-10-2000.

CLASS 20—(Continued).

2,626,026. EASTERN SLEEP PRODUCTS CO., INC., DBA SYMBOL MATTRESS COMPANY, RICHMOND, VA. SN 76-066,095. PUB. 7-31-2001, FILED 6-8-2000.

THE SYMBOLDREAM COLLECTION

OWNER OF U.S. REG. NOS. 1,195,738, 2,193,442, AND 2,259,845.

NO CLAIM IS MADE TO THE EXCLUSIVE RIGHT TO USE "COLLECTION", APART FROM THE MARK AS SHOWN.

FOR MATTRESSES AND BOX SPRINGS (U.S. CLS. 2, 13, 22, 25, 32 AND 50).

FIRST USE 1-19-2001; IN COMMERCE 1-19-2001.

2,626,092. BANYAN LICENSING, L.C., FORT LAUDERDALE, FL. SN 76-097,593. PUB. 7-10-2001, FILED 7-24-2000.

CONTOUR SECRET

OWNER OF U.S. REG. NOS. 1,443,231, 2,286,858, AND OTHERS.

NO CLAIM IS MADE TO THE EXCLUSIVE RIGHT TO USE "CONTOUR", APART FROM THE MARK AS SHOWN.

FOR PILLOWS (U.S. CLS. 2, 13, 22, 25, 32 AND 50).

FIRST USE 7-9-2000; IN COMMERCE 7-9-2000.

2,626,146. UNITED SLEEP PRODUCTS, INC., DENVER, PA. SN 76-122,473. PUB. 8-28-2001, FILED 9-1-2000.

BEAUTYFLEX

FOR FUTONS, FUTON MATTRESSES AND PARTS SOLD TOGETHER AS A UNIT THEREOF (U.S. CLS. 2, 13, 22, 25, 32 AND 50).

FIRST USE 11-0-2001; IN COMMERCE 11-0-2001.

2,626,235. MAHAR MANUFACTURING, VAN BUREN, AR. SN 76-155,921. PUB. 11-13-2001, FILED 10-30-2000.

CREATIVE COLORS

NO CLAIM IS MADE TO THE EXCLUSIVE RIGHT TO USE "COLORS", APART FROM THE MARK AS SHOWN.

FOR FURNITURE (U.S. CLS. 2, 13, 22, 25, 32 AND 50).

FIRST USE 10-18-2000; IN COMMERCE 5-4-2001.

CLASS 20—(Continued).

2,626,237. L & P PROPERTY MANAGEMENT COMPANY, SOUTH GATE, CA. SN 76-156,069. PUB. 9-4-2001, FILED 10-30-2000.

DECORATOR LINE IT

OWNER OF U.S. REG. NO. 2,001,118.
FOR NON-SLIP PLASTIC DRAWER AND SHELF LINING MATERIAL (U.S. CLS. 2, 13, 22, 25, 32 AND 50).
FIRST USE 10-0-2000; IN COMMERCE 10-0-2000.



2,626,376. SERTA, INC., ITASCA, IL. SN 76-210,842. PUB. 12-11-2001, FILED 2-14-2001.

INTEGRITY EDGE

NO CLAIM IS MADE TO THE EXCLUSIVE RIGHT TO USE "EDGE", APART FROM THE MARK AS SHOWN.
FOR MATTRESS COMPONENT HAVING A REINFORCED EDGE FOR USE WITH A ONE-SIDED MATTRESS (U.S. CLS. 2, 13, 22, 25, 32 AND 50).
FIRST USE 10-1-2000; IN COMMERCE 10-1-2000.



2,626,401. KRUEGER INTERNATIONAL, INC., GREEN BAY, WI. SN 76-216,682. PUB. 9-4-2001, FILED 2-27-2001.



FOR FURNITURE (U.S. CLS. 2, 13, 22, 25, 32 AND 50).
FIRST USE 3-26-2002; IN COMMERCE 3-26-2002.



2,626,653. NATIONAL TOBACCO COMPANY, L.P., NEW YORK, NY. SN 78-042,102. PUB. 1-22-2002, FILED 1-8-2001.

PROFIT STACKER

FOR POINT OF PURCHASE DISPLAYS FOR TOBACCO PRODUCTS (U.S. CLS. 2, 13, 22, 25, 32 AND 50).
FIRST USE 9-20-2000; IN COMMERCE 9-20-2000.



CLASS 21—HOUSEWARES AND GLASS

CLASS 21—(Continued).

2,625,407. NATIONAL OCEANIC AND ATMOSPHERIC ADMINISTRATION U.S. DEPARTMENT OF COMMERCE, WASHINGTON, DC. SN 75-514,065. PUB. 12-14-1999, FILED 7-6-1998.



THE DRAWING IS LINED FOR THE COLOR(S) RED AND BLUE.
FOR BEVERAGE GLASSWARE (U.S. CLS. 2, 13, 23, 29, 30, 33, 40 AND 50).
FIRST USE 11-0-1998; IN COMMERCE 11-0-1998.



2,625,484. COLMAN GROUP, INC., THE ELKHORN, WI. SN 75-656,772. PUB. 11-23-1999, FILED 3-9-1999.

SRT

FOR ROLL TOWEL DISPENSERS (U.S. CLS. 2, 13, 23, 29, 30, 33, 40 AND 50).
FIRST USE 3-19-2002; IN COMMERCE 3-19-2002.



2,625,896. WRIGHT, ANN, GARRISON, NY. SN 75-982,414. PUB. 5-16-2000, FILED 7-28-1999.

RUSSEL WRIGHT

THE NAME SHOWN IN THE MARK DOES NOT IDENTIFY ANY PARTICULAR LIVING INDIVIDUAL.
FOR HOUSEWARE PRODUCTS, NAMELY DISHES, CUPS, SAUCERS, TEA KETTLES, TEAPOTS NOT OF PRECIOUS METAL, AND CAKE PLATES (U.S. CLS. 2, 13, 23, 29, 30, 33, 40 AND 50).
FIRST USE 1-4-2002; IN COMMERCE 1-4-2002.

CLASS 21—(Continued).

2,625,897. WRIGHT, ANN, GARRISON, NY. SN 75-982,415.
PUB. 5-16-2000, FILED 7-28-1999.

THE NAME IN THE MARK DOES NOT IDENTIFY AND PARTICULAR LIVING INDIVIDUAL.

FOR HOUSEWARE PRODUCTS, NAMELY DISHES, CUPS, SAUCERS, TEA KETTLES, TEAPOTS NOT OF PRECIOUS METAL, AN CAKE PLATES (U.S. CLS. 2, 13, 23, 29, 30, 33, 40 AND 50).

FIRST USE 1-4-2002; IN COMMERCE 1-4-2002.

2,625,922. FOODHANDLER INC., WESTBURY, NY, BY CHANGE OF NAME ISLAND POLYETHYLENE BAG & SUPPLY CORP., WESTBURY, NY. SN 76-014,981. PUB. 12-18-2001, FILED 3-31-2000.

BLADEBLOCKER ULTRA

OWNER OF U.S. REG. NO. 2,273,050.
FOR CUT-RESISTANT REUSABLE GLOVES FOR GENERAL USE IN HOUSEHOLD AND COMMERCIAL APPLICATIONS (U.S. CLS. 2, 13, 23, 29, 30, 33, 40 AND 50).

FIRST USE 7-7-2001; IN COMMERCE 7-7-2001.

2,626,015. LINCOLN FOODSERVICE PRODUCTS, LTD., FORT WAYNE, IN. SN 76-059,173. PUB. 12-25-2001, FILED 5-30-2000.



NO CLAIM IS MADE TO THE EXCLUSIVE RIGHT TO USE "HARDCOAT", APART FROM THE MARK AS SHOWN.

THE CIRCLE ELEMENT OF THE DRAWING FEATURES A SHADED GRADIENT.

FOR COOKWARE, NAMELY, POTS AND FRYING PANS FOR USE IN FOOD INDUSTRY (U.S. CLS. 2, 13, 23, 29, 30, 33, 40 AND 50).

FIRST USE 1-10-2002; IN COMMERCE 1-10-2002.

CLASS 21—(Continued).

2,626,094. THINK GOD, INC., FT. WORTH, TX. SN 76-098,017.
PUB. 6-12-2001, FILED 7-28-2000.

GOD FIRST

FOR MUGS; LUNCH BOXES; INSULATING AND NON-INSULATING SLEEVE HOLDERS FOR BEVERAGES CANS; AND THERMAL INSULATED CONTAINERS FOR FOOD AND BEVERAGES (U.S. CLS. 2, 13, 23, 29, 30, 33, 40 AND 50).

FIRST USE 6-1-2001; IN COMMERCE 6-1-2001.

2,626,101. GUTZEES, LLC, ENGLEWOOD, NJ. SN 76-101,399.
PUB. 11-13-2001, FILED 8-1-2000.



THE STIPPLING IN THE DRAWING IS FOR SHADING PURPOSES ONLY.

FOR SHOE TREES (U.S. CLS. 2, 13, 23, 29, 30, 33, 40 AND 50).

FIRST USE 9-24-2000; IN COMMERCE 12-5-2000.

2,626,120. EPOCA, INC., EAST BRUNSWICK, NJ. SN 76-111,231. PUB. 8-28-2001, FILED 8-18-2000.

STOVERUNNER

FOR CASSEROLE DISHES; COLANDERS; DUTCH OVENS; METAL PANS; BROILING PANS; FRYING PANS; COATED FRYING PANS; NON-STICK FRYING PANS; ROASTING PANS; NON-ELECTRIC GRIDDLES; COOKING UTENSILS, NAMELY GRILLS; NON-ELECTRIC KETTLES; SOUP KETTLES; POTS; STEW POTS; LIDS FOR POTS; NON-ELECTRIC PRESSURE COOKERS; SAUCEPANS; AND WOKS (U.S. CLS. 2, 13, 23, 29, 30, 33, 40 AND 50).

FIRST USE 2-13-2001; IN COMMERCE 2-13-2001.

CLASS 21—(Continued).

2,626,262. ENVIRO-DYNAMICS, INC., DALLAS, TX. SN 76-163,588. PUB. 12-11-2001, FILED 11-13-2000.

PET HAIR GRABBER

NO CLAIM IS MADE TO THE EXCLUSIVE RIGHT TO USE "PET HAIR", APART FROM THE MARK AS SHOWN.

FOR SPONGES, CLEANING PADS AND CLEANING CLOTHS FOR REMOVING PET HAIR, LINT, DUST, SOOT AND OTHER UNDESIRABLE MATERIALS FROM CLOTHING, FURNITURE, UPHOLSTERY, CARPETS, PET BEDS, AUTO INTERIORS, FABRICS, WOOD SURFACES, CABINETS, METAL SURFACES, APPLIANCES, WALLS, CEILINGS, FIREPLACES, PAINT, GLASS, TELEVISIONS, COMPUTERS, LIGHT FIXTURES AND OTHER SURFACES (U.S. CLS. 2, 13, 23, 29, 30, 33, 40 AND 50).

FIRST USE 1-0-1999; IN COMMERCE 1-0-1999.

2,626,341. LIBERTY HARDWARE MFG. CORP., WINSTON-SALEM, NC. SN 76-196,848. PUB. 8-21-2001, FILED 1-16-2001.

DUBLIN

FOR BATHROOM ACCESSORIES, NAMELY, TOWEL BARS, TOWEL RINGS, TISSUE HOLDERS, AND TUMBLER-TOOTHBRUSH HOLDERS (U.S. CLS. 2, 13, 23, 29, 30, 33, 40 AND 50).

FIRST USE 2-0-2000; IN COMMERCE 2-0-2000.

2,626,539. HI MOUNTAIN JERKY, INC, RIVERTON, WY. SN 76-297,722. PUB. 2-19-2002, FILED 8-13-2001.

KING OF THE CUT

FOR KIT FOR MAKING JERKY WHICH IS COMPRISED OF A JERKY BOARD, KNIFE, JERKY SCREEN, AND JERKY CURES AND SEASONING (U.S. CLS. 2, 13, 23, 29, 30, 33, 40 AND 50).

FIRST USE 9-1-2001; IN COMMERCE 9-1-2001.

CLASS 22—CORDAGE AND FIBERS

2,626,259. KNIGHT CORPORATION, TORONTO, ONTARIO, CANADA. SN 76-163,125. PUB. 9-11-2001, FILED 11-13-2000.

LINEDUDES

PRIORITY CLAIMED UNDER SEC. 44(D) ON CANADA APPLICATION NO. 1075418, FILED 9-19-2000.

FOR RETRACTABLE BOAT MOORING LINES, NAMELY ROPES AND CORDS THAT ARE RETRACTABLE INTO A HOUSING (U.S. CLS. 1, 2, 7, 19, 22, 42 AND 50).

FIRST USE 12-7-2000; IN COMMERCE 12-7-2000.

CLASS 22—(Continued).

2,626,333. LEVI TOOL & MOLD CORPORATION, FLETCHER, NC. SN 76-193,719. PUB. 11-6-2001, FILED 1-12-2001.

TREEHUGGER

FOR HAMMOCK ACCESSORIES, NAMELY, WRAP-AROUND ANCHOR STRAPS (U.S. CLS. 1, 2, 7, 19, 22, 42 AND 50).

FIRST USE 2-5-2001; IN COMMERCE 2-5-2001.

CLASS 24—FABRICS

2,625,357. TRAMPLANCOMPANY MUSIKPRODUKTION UND WERBEGES. M.B.H., 6290 MAYRHOFEN, AUSTRIA. SN 75-377,785. PUB. 1-26-1999, FILED 10-23-1997.

SCHÜRZENJÄGER

THE ENGLISH TRANSLATION OF THE WORD "SCHURZENJAGER" IS "GIRL CHASERS".

FOR BED LINENS, BATH TOWELS (U.S. CLS. 42 AND 50).

FIRST USE 8-1-2000; IN COMMERCE 8-1-2000.

2,625,400. PRIZMALITE INDUSTRIES, INC., NEW YORK, NY, BY ASSIGNMENT INNOVATIVE CONCEPTS UNLIMITED, LLC, COVENTRY, CT. SN 75-479,389. PUB. 11-23-1999, FILED 5-4-1998.

PRIZMALITE

FOR TEXTILES AND TEXTILE GOODS, NAMELY, WOVEN, KNITTED AND NON-WOVEN FABRICS OF NATURAL, SYNTHETIC OR BLENDED FIBERS AND FILAMENTS TO WHICH MICRO-SIZED PARTICLES OF VARIOUS MATERIALS ARE APPLIED TO THE SURFACE THEREOF OR INTEGRATED INTO THE BULK THEREOF (U.S. CLS. 42 AND 50).

FIRST USE 2-4-2002; IN COMMERCE 2-4-2002.

2,625,436. FIELDCREST CANNON LICENSING, INC., KANNAPOLIS, NC. SN 75-580,954. PUB. 4-18-2000, FILED 11-2-1998.

CHARISMA

OWNER OF U.S. REG. NOS. 1,124,948, 1,127,563, AND 1,562,233.

FOR MATTRESS PADS, COMFORTERS AND PILLOW PROTECTORS (U.S. CLS. 42 AND 50).

FIRST USE 8-5-1977; IN COMMERCE 8-1-1998.

CLASS 24—(Continued).

2,625,843. ERLANGER GROUP, LTD., THE, BRAINTREE, MA. BY CHANGE OF NAME BALSON-HERCULES GROUP LTD., THE, NEW YORK, NY. SN 75-928,228. PUB. 5-29-2001, FILED 2-25-2000.

THE WOODROW STUDIO

NO CLAIM IS MADE TO THE EXCLUSIVE RIGHT TO USE "STUDIO", APART FROM THE MARK AS SHOWN.

FOR TEXTILES AND PIECE GOODS USED IN THE MANUFACTURE OF CLOTHING; FABRIC MADE OF COTTON AND COTTON-POLYESTER BLENDS FOR THE HOME SEWING AND CRAFT MARKET (U.S. CLS. 42 AND 50).

FIRST USE 12-19-2001; IN COMMERCE 12-19-2001.

2,625,972. HAYWIN TEXTILE PRODUCTS, INC., BROOKLYN, NY. SN 76-041,203. PUB. 7-24-2001, FILED 5-8-2000.

THE BEAUTIFUL BED 1-2-3

NO CLAIM IS MADE TO THE EXCLUSIVE RIGHT TO USE "BEAUTIFUL BED", APART FROM THE MARK AS SHOWN.

FOR BED SHEETS, PILLOWCASES, BED RUFFLES, PILLOW SHAMS, COMFORTERS, BEDSPREADS AND CURTAINS (U.S. CLS. 42 AND 50).

FIRST USE 2-0-2002; IN COMMERCE 2-0-2002.

2,626,007. TARGET BRANDS, INC., MINNEAPOLIS, MN. SN 76-056,441. PUB. 2-13-2001, FILED 5-25-2000.

CHATROOM

FOR HOME TEXTILES, NAMELY, BED SHEETS, PILLOW CASES, COMFORTERS, DUST RUFFLES, PILLOW SHAMS, WINDOW VALANCES (U.S. CLS. 42 AND 50).

FIRST USE 5-6-2001; IN COMMERCE 5-6-2001.

2,626,077. DAWKAR, ABSECON, NJ. SN 76-089,821. PUB. 3-13-2001, FILED 7-17-2000.

YUCKIE

FOR CLOTH TOWELS (U.S. CLS. 42 AND 50).
FIRST USE 5-2-2002; IN COMMERCE 5-14-2002.

CLASS 24—(Continued).

2,626,221. NAM LIONG ENTERPRISE CO., LTD., TAINAN, TAIWAN. SN 76-150,475. PUB. 8-14-2001, FILED 10-19-2000.

LIPROTEX

FOR COMBINATION FABRICS, TERRY FABRICS, KNITTING FABRICS, NON-WOVEN FABRICS, CALICO FABRICS, WEAVING FABRICS, FLEXIBLE FABRICS, COMBINATION COTTON FABRICS, INTERLINING BASE FABRICS, SYNTHETIC FABRICS, SEMI-SYNTHETIC FABRICS, ARTIFICIAL FABRICS, AND ABRASION-RESISTANT FABRICS FOR USE IN THE MANUFACTURE OF ATHLETIC AND RECREATIONAL CLOTHING AND EQUIPMENT, NAMELY SKI GLOVES, SKIWEAR, SKI BOOTS, CAR RACING GARMENTS, BICYCLE SEAT COVERS, BAGS, SHOES, AND MOUNTAINEERING EQUIPMENT (U.S. CLS. 42 AND 50).
FIRST USE 10-4-2000; IN COMMERCE 4-1-2002.

2,626,383. HANOVER BRANDS, INC., WEEHAWKEN, NJ. SN 76-211,968. PUB. 12-11-2001, FILED 2-16-2001.

ROYAL PASHMINA

NO CLAIM IS MADE TO THE EXCLUSIVE RIGHT TO USE "PASHMINA", APART FROM THE MARK AS SHOWN.
FOR THROWS MADE OF PASHMINA (U.S. CLS. 42 AND 50).

FIRST USE 8-20-2001; IN COMMERCE 8-20-2001.

2,626,478. SPRINGS LICENSING GROUP, INC., FORT MILL, SC. SN 76-248,978. PUB. 12-25-2001, FILED 4-30-2001.

GUEST BED

NO CLAIM IS MADE TO THE EXCLUSIVE RIGHT TO USE "BED", APART FROM THE MARK AS SHOWN.
FOR SHEETS, PILLOWCASES, COMFORTERS (U.S. CLS. 42 AND 50).

FIRST USE 6-30-2001; IN COMMERCE 6-30-2001.

2,626,557. T & C IMPORTS, ESST DENNIS, MA. SN 78-000,837. PUB. 9-11-2001, FILED 3-24-2000.

FROG TREE

FOR CLOTH LABELS USED FOR VARIOUS ARTICLES OF CLOTHING IMPORTED FROM LATIN AMERICA AND SOUTH AMERICA (U.S. CLS. 42 AND 50).
FIRST USE 3-21-2000; IN COMMERCE 3-21-2000.

CLASS 24—(Continued).

2,626,659. WHIRLPOOL PROPERTIES, INC., ST. JOSEPH, MI. SN 78-043,543. PUB. 10-2-2001, FILED 1-17-2001.



OWNER OF U.S. REG. NOS. 549,810, 2,228,732, AND OTHERS.

THE STIPLING IS FOR SHADING PURPOSES ONLY. FOR KITCHEN TEXTILES, NAMELY, TOWELS, OVEN MITTS, POT/HAND HOLDERS, SEAT COVERS, PLACE MATS, CLOTH NAPKINS, TABLE CLOTHS AND RUNNERS (U.S. CLS. 42 AND 50).

FIRST USE 10-15-2001; IN COMMERCE 10-15-2001.

2,626,673. ALISTAIR SOMERSET PTY. LTD., NUNAWADING, VICTORIA, AUSTRALIA. SN 78-046,286. PUB. 11-27-2001, FILED 2-2-2001.

BREATHEEASY

FOR FABRIC FEATURING A PROTECTIVE BARRIER COATING FOR USE IN MANUFACTURING CLOTHING FOR HUMANS AND BLANKETS AND SHEETS FOR HORSES (U.S. CLS. 42 AND 50).

FIRST USE 8-1-2001; IN COMMERCE 8-1-2001.

2,626,735. LOUISVILLE BEDDING COMPANY, LOUISVILLE, KY. SN 78-071,194. PUB. 1-29-2002, FILED 6-27-2001.

ULTRA ZONE

FOR MATTRESS PADS (U.S. CLS. 42 AND 50). FIRST USE 7-27-2001; IN COMMERCE 7-27-2001.

CLASS 25—CLOTHING

2,625,312. STRAUSS, CAROLYN SUE, NEW YORK, NY. SN 74-705,360. PUB. 4-9-1996, FILED 7-24-1995.

THE PERFECT IMAGE

FOR EXERCISE CLOTHING AND SPORTSWEAR, NAMELY LEOTARDS, LEGGINGS, T-SHIRTS, SWEAT SHIRTS, SWEAT PANTS, JERSEYS, SLACKS, DRESSES, SKIRTS, TANK TOPS, JACKETS, CAPS, SPORTS BRAS AND SOCKS (U.S. CLS. 22 AND 39).

FIRST USE 9-1-2001; IN COMMERCE 9-1-2001.

CLASS 25—(Continued).

2,625,322. CARNIVAL CORPORATION, MIAMI, FL. SN 75-193,358. PUB. 7-8-1997, FILED 11-5-1996.

FUN SHIPS

OWNER OF U.S. REG. NOS. 1,112,889, 1,976,581, AND OTHERS.

FOR CASUAL SHIRTS AND CAPS (U.S. CLS. 22 AND 39).

FIRST USE 11-0-1973; IN COMMERCE 11-0-1973.

2,625,338. C. & J. CLARK AMERICA, INC., KENNETT SQUARE, PA. SN 75-293,954. PUB. 4-14-1998, FILED 5-19-1997.

STRADA

THE ENGLISH TRANSLATION OF "STRADA" IN THE MARK IS "ROAD" OR "STREET."

FOR FOOTWEAR (U.S. CLS. 22 AND 39).

FIRST USE 6-0-1997; IN COMMERCE 11-0-1997.

2,625,345. WARNACO U.S., INC., BRIDGEPORT, CT. SN 75-316,898. PUB. 11-23-1999, FILED 6-30-1997.

SIMPLY SENSATIONAL

OWNER OF U.S. REG. NOS. 1,224,356 AND 1,610,635. FOR INTIMATE APPAREL, NAMELY, BRAS AND PANTIES (U.S. CLS. 22 AND 39).

FIRST USE 1-0-2001; IN COMMERCE 1-0-2001.

2,625,373. PILLOW TECH INTERNATIONAL, LTD., STOUGHTON, MA. SN 75-425,667. PUB. 6-22-1999, FILED 1-29-1998.

EURO-TECH COMFORT

NO CLAIM IS MADE TO THE EXCLUSIVE RIGHT TO USE "COMFORT", APART FROM THE MARK AS SHOWN.

FOR MEN'S SHOES (U.S. CLS. 22 AND 39).

FIRST USE 7-1-2000; IN COMMERCE 7-1-2000.

CLASS 25—(Continued).

2,625,374. VESTIDITOS S.A., BUENOS AIRES, ARGENTINA.
SN 75-430,847. PUB. 12-28-1999, FILED 2-9-1998.

MIMO & CO

NO CLAIM IS MADE TO THE EXCLUSIVE RIGHT TO USE "& COMPANY", APART FROM THE MARK AS SHOWN.

FOR CLOTHING, NAMELY, T-SHIRTS, SWEATSHIRTS, PANTS, SKIRTS AND CAPS; FOOTWEAR (U.S. CLS. 22 AND 39).

FIRST USE 3-1-1985; IN COMMERCE 8-10-2001.

2,625,393. RETAIL ROYALTY COMPANY, LAS VEGAS, NV.
SN 75-468,784. PUB. 4-13-1999, FILED 4-16-1998.

DORMWEAR

NO CLAIM IS MADE TO THE EXCLUSIVE RIGHT TO USE "WEAR", APART FROM THE MARK AS SHOWN.

FOR CLOTHING, FOOTWEAR AND CLOTHING ACCESSORIES, NAMELY, PANTS, SHORTS, SHIRTS, T-SHIRTS, SWEATSHIRTS, SWEAT PANTS, CAPS, HATS, UNDERWEAR, PAJAMAS, SLEEPWEAR, SOCKS, SLIP-PERS AND ROBES (U.S. CLS. 22 AND 39).

FIRST USE 11-1-1998; IN COMMERCE 11-1-1998.

2,625,499. GRIFFIN, HELEN, MANHATTAN BEACH, CA. SN
75-678,931. PUB. 10-9-2001, FILED 4-11-1999.

CHICA

NO CLAIM IS MADE TO THE EXCLUSIVE RIGHT TO USE "CHICA", APART FROM THE MARK AS SHOWN.

THE SPANISH WORD "CHICA" TRANSLATES INTO ENGLISH AS "GIRL".

FOR CLOTHING FOR JUNIORS, NAMELY SHIRTS, PANTS, SHORTS, DRESSES, AND SWIMWEAR (U.S. CLS. 22 AND 39).

FIRST USE 4-20-1999; IN COMMERCE 4-20-1999.

2,625,508. BOXER HOLDINGS, INC, SAN FRANCISCO, CA.
SN 75-696,138. PUB. 12-28-1999, FILED 5-3-1999.

REPUBLIC OF JOE

FOR CLOTHING, NAMELY, BOXER SHORTS, UNDERWEAR, PAJAMAS, NIGHTGOWNS, ROBES, SHIRTS, PANTS, SHORTS, BRAS, CAMISOLES, TANK TOPS AND SHOES (U.S. CLS. 22 AND 39).

FIRST USE 6-1-2000; IN COMMERCE 6-1-2000.

CLASS 25—(Continued).

2,625,512. KIDDIE KORRAL COMPANY, DALLAS, TX. SN
75-699,344. PUB. 2-22-2000, FILED 5-7-1999.



FOR WESTERN WEAR CLOTHING FOR CHILDREN, NAMELY, TOPS, SHIRTS, ROMPERS, T-SHIRT AND INFANT DIAPER COVERS (U.S. CLS. 22 AND 39).

FIRST USE 5-15-2001; IN COMMERCE 5-15-2001.

2,625,545. BLOCK SPORTSWEAR, INC., WILMINGTON, NC.
SN 75-734,263. PUB. 7-18-2000, FILED 6-23-1999.



NO CLAIM IS MADE TO THE EXCLUSIVE RIGHT TO USE "KHAKI'S", APART FROM THE MARK AS SHOWN.

FOR SPORTSWEAR, NAMELY, PANTS, SHORTS, SHIRTS, JACKETS, COATS, SWEATERS AND HEADWEAR (U.S. CLS. 22 AND 39).

FIRST USE 11-1-1999; IN COMMERCE 11-1-1999.

CLASS 25—(Continued).

2,625,568. LANE BRYANT, INC., REYNOLDSBURG, OH. SN 75-752,838. PUB. 7-4-2000, FILED 7-16-1999.



OWNER OF U.S. REG. NOS. 1,797,090, 2,121,469, AND OTHERS.

NO CLAIM IS MADE TO THE EXCLUSIVE RIGHT TO USE "JEANS CLOTHING CO.", APART FROM THE MARK AS SHOWN.

THE ENGLISH TRANSLATION OF THE WORD "VENEZIA" IN THE MARK IS "VENICE".

FOR CLOTHING, NAMELY, T-SHIRTS, HATS, CAPS, JEANS, JACKETS, COATS, VESTS, PANTS, SHORTS, DRESSES, SHIRTS, SWEATERS, HOSIERY, SOCKS, BELTS, SUITS, SWEATPANTS, SWEATSHIRTS, SWIMWEAR, WOVEN TOPS, WOVEN BOTTOMS, KNIT TOPS, KNIT BOTTOMS, SCARVES, GLOVES, SLIPPERS, PAJAMAS, ROBES, BRAS, PANTIES, CONTROL UNDERGARMENTS, UNDERWEAR, CAMISOLES, SLIPS, BODYSUITS AND SLEEP SHIRTS (U.S. CLS. 22 AND 39). FIRST USE 7-13-1998; IN COMMERCE 7-13-1998.

2,625,594. TONY MARGERIE & ASSOCIATES, SAUSALITO, CA. SN 75-777,052. PUB. 6-20-2000, FILED 8-16-1999.

BLAST SPORT

OWNER OF U.S. REG. NOS. 1,613,960, 1,853,164, AND OTHERS.

NO CLAIM IS MADE TO THE EXCLUSIVE RIGHT TO USE "SPORT", APART FROM THE MARK AS SHOWN.

FOR WEARING APPAREL, NAMELY, PANTS, SHORTS, JACKETS, SCARVES, SWEATERS, HATS, TOPS, JERSEYS, T-SHIRTS, SWEATSHIRTS, BELTS, VESTS AND FOOTWEAR (U.S. CLS. 22 AND 39). FIRST USE 1-25-2002; IN COMMERCE 1-25-2002.

CLASS 25—(Continued).

2,625,599. EUGENE STEPTOE, SAN FRANCISCO, CA, BY ASSIGNMENT BOSSALINI, SAN FRANCISCO, CA. SN 75-782,664. PUB. 3-14-2000, FILED 8-23-1999.



FOR CLOTHING, NAMELY, HATS, CAPS, SHIRTS, T-SHIRTS, PANTS AND JACKETS (U.S. CLS. 22 AND 39). FIRST USE 11-0-2000; IN COMMERCE 11-0-2000.

2,625,625. ETIENNE AIGNER, INC., NEW YORK, NY. SN 75-805,836. PUB. 8-29-2000, FILED 9-22-1999.



OWNER OF U.S. REG. NOS. 1,976,758, 2,053,542, AND OTHERS.
FOR WOMEN'S FOOTWEAR (U.S. CLS. 22 AND 39). FIRST USE 9-0-1999; IN COMMERCE 9-0-1999.

2,625,627. KOTLER, BEN, FOUNTAIN VALLEY, CA. SN 75-807,017. PUB. 3-28-2000, FILED 9-24-1999.

NATURAL ORIGINS

NO CLAIM IS MADE TO THE EXCLUSIVE RIGHT TO USE "NATURAL", APART FROM THE MARK AS SHOWN.

FOR CLOTHING, NAMELY, TOPS, BLOUSES, SHIRTS, T-SHIRTS, TANK TOPS, CAMISOLES, VESTS, JACKETS, ANORAKS, BOTTOMS, TROUSERS, SLACKS, SHORTS, JEANS, SKIRTS, DRESSES, JUMPER DRESSES, ONE AND TWO PIECE DRESS SETS AND OVERALLS (U.S. CLS. 22 AND 39).

FIRST USE 3-10-2000; IN COMMERCE 3-10-2000.

CLASS 25—(Continued).

2,625,636. MOORE, BRANDON C., QUEENS VILLAGE, NY.
SN 75-817,602. PUB. 6-12-2001, FILED 10-5-1999.

BMOORE



FOR CLOTHING, NAMELY SHIRTS, T-SHIRTS, BLOUSES, PANTS, SHORTS, JEANS, DRESSES, SKIRTS, HATS, AND CAPS (U.S. CLS. 22 AND 39).
FIRST USE 3-1-2000; IN COMMERCE 3-1-2000.

2,625,641. CHININ U.S.A., INC., OAK BROOK, IL. SN 75-819,848. PUB. 2-27-2001, FILED 10-12-1999.

**ACTIVE BY KNIGHTS
ATHLETICS**

NO CLAIM IS MADE TO THE EXCLUSIVE RIGHT TO USE "ATHLETICS", APART FROM THE MARK AS SHOWN.
FOR CLOTHING, NAMELY, SHIRTS, GOLF SHIRTS, POLO SHIRTS, UNDERSHIRTS, SWEAT SHIRTS, KNIT SHIRTS, T-SHIRTS, PANTS, OUTERWEAR PANTS, SWEAT PANTS, SHORTS, GYM SHORTS, BOXER SHORTS, SWEAT SHORTS, JACKETS AND JERSEYS (U.S. CLS. 22 AND 39).
FIRST USE 11-15-1999; IN COMMERCE 11-15-1999.

2,625,643. DAVID S. PIERPONT AND SHANE L. YATES PARTNERSHIP, THE, LEHI, UT. SN 75-821,819. PUB. 7-18-2000, FILED 10-12-1999.

LEGAL ADDICTION

FOR ACTIVEWEAR, NAMELY, T-SHIRTS SWEAT-SHIRTS AND HATS (U.S. CLS. 22 AND 39).
FIRST USE 5-2-2001; IN COMMERCE 5-30-2001.

2,625,679. COUSINE, HENRY J., DANA POINT, CA. SN 75-842,747. PUB. 12-5-2000, FILED 11-8-1999.

FREEK FREE TO BE ME

FOR CLOTHING FOR MEN, WOMEN, AND CHILDREN, NAMELY; PANTS, SHIRTS, T-SHIRTS, SWEAT-SHIRTS AND SHORTS (U.S. CLS. 22 AND 39).
FIRST USE 7-0-2000; IN COMMERCE 7-0-2000.

CLASS 25—(Continued).

2,625,683. SOUTH AFRICAN RUGBY FOOTBALL UNION, BOUNDARY ROAD, NEWLANDS 7700, SOUTH AFRICA. SN 75-846,030. PUB. 7-24-2001, FILED 11-10-1999.

SA RUGBY

NO CLAIM IS MADE TO THE EXCLUSIVE RIGHT TO USE "RUGBY", APART FROM THE MARK AS SHOWN.
FOR CLOTHING, NAMELY, APRONS, HOSIERY, SCARVES, FOOTWEAR AND HEADWEAR; SPORTSWEAR, NAMELY, RUGBY SHOES, JERSEYS, SHORTS, PANTS, JACKETS, SHIRTS AND CAPS FOR SPORTS PERSONS OR FOR USE IN RELATION TO SPORTS (U.S. CLS. 22 AND 39).
FIRST USE 7-2-1996; IN COMMERCE 6-29-1999.

2,625,685. ADED WEAR, INC., CHICAGO, IL. SN 75-847,794. PUB. 6-13-2000, FILED 11-12-1999.

ADED WEAR

NO CLAIM IS MADE TO THE EXCLUSIVE RIGHT TO USE "WEAR", APART FROM THE MARK AS SHOWN.
FOR CLOTHING, NAMELY, OVERALLS, PANTS, SHIRTS, TOPS, SKIRTS, SHORTS, SWEATSHIRTS, JACKETS, UNDERWEAR, LINGERIE, ROMPERS, SINGLETS, ROBES, COATS, GLOVES AND MITTENS, PAJAMAS, SLIPPERS, HATS, CAPS, VISORS, WRIST BANDS, HEAD BANDS, SOCKS, SCARVES, HEADWEAR FOOTWEAR NECKWEAR, SLEEPWEAR, AND SWIM WEAR (U.S. CLS. 22 AND 39).
FIRST USE 8-20-2000; IN COMMERCE 8-20-2000.

2,625,699. DML MARKETING GROUP, LTD., SYLMAR, CA. SN 75-852,946. PUB. 6-26-2001, FILED 11-19-1999.

ACTIVE INGREDIENTS

FOR SOCKS, STOCKINGS, ANKLETS (U.S. CLS. 22 AND 39).
FIRST USE 3-5-2002; IN COMMERCE 3-5-2002.

CLASS 25—(Continued).

2,625,705. EUROSTAR, INC., LOS ANGELES, CA. SN 75-856,910. PUB. 10-2-2001, FILED 11-23-1999.



NO CLAIM IS MADE TO THE EXCLUSIVE RIGHT TO USE "USA", APART FROM THE MARK AS SHOWN.

FOR CASUAL SHOES, RUNNING SHOES, BASKETBALL SHOES, TENNIS SHOES, CROSS-TRAINING SHOES, AEROBIC SHOES, HIKING SHOES, AND VOLLEYBALL SHOES, AND EXCLUDING SHOES AND FOOTWEAR DESIGNED FOR HORSEBACK RIDING (U.S. CLS. 22 AND 39).

FIRST USE 2-19-1998; IN COMMERCE 2-19-1998.

2,625,720. ALLBALL ATHLETICS, INC., BELLE MEADE, NJ. SN 75-871,612. PUB. 10-24-2000, FILED 12-15-1999.



FOR ATHLETIC APPAREL, NAMELY, T-SHIRTS, SHIRTS, SHORTS, SHOES, JERSEYS, HATS, HEADWEAR, SWEAT BANDS, HEAD BANDS, SOCKS, WARM-UP SUITS, PULLOVERS, AND SWEATSHIRTS (U.S. CLS. 22 AND 39).

FIRST USE 10-15-1999; IN COMMERCE 10-15-1999.

2,625,743. HARRIS AND ROSE, DBA DEME TOTS, LITHONIA, GA. SN 75-885,064. PUB. 9-19-2000, FILED 1-6-2000.

DEMÉ TOTS

NO CLAIM IS MADE TO THE EXCLUSIVE RIGHT TO USE "TOTS", APART FROM THE MARK AS SHOWN.

THE MARK IS PRESENTED WITHOUT ANY CLAIM AS TO SPECIAL FORM

FOR INFANT CLOTHING (U.S. CLS. 22 AND 39).
FIRST USE 5-1-2000; IN COMMERCE 6-1-2000.

CLASS 25—(Continued).

2,625,819. PORKY PIES LLC, SOUTH PASADENA, CA. SN 75-916,956. PUB. 12-5-2000, FILED 2-10-2000.

PORKY PIES

FOR CHILDREN'S CLOTHING, NAMELY, T-SHIRTS, SHORTS, JACKETS, SKIRTS, SHIRTS, TANK TOPS, PANTS, COATS (U.S. CLS. 22 AND 39).

FIRST USE 4-0-2000; IN COMMERCE 4-0-2000.

2,625,820. ELDER-BEERMAN STORES CORPORATION, THE, DAYTON, OH. SN 75-917,174. PUB. 7-10-2001, FILED 2-11-2000.

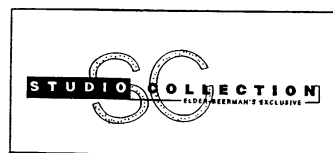

OWNER OF U.S. REG. NO. 1,332,638.

NO CLAIM IS MADE TO THE EXCLUSIVE RIGHT TO USE "STUDIO COLLECTION" AND "EXCLUSIVE", APART FROM THE MARK AS SHOWN.

THE STIPPLING IN THE DRAWING INDICATES SHADING.

THE MARK CONSISTS OF LARGE UPPER CASE LETTERS "S" AND "C", THE WORD "STUDIO" IN A DARK RECTANGULAR BOX AND THE WORD "COLLECTION" NEXT TO "STUDIO". BUT IS NOT WITHIN THE DARK, RECTANGULAR BOX. "ELDER-BEERMAN'S EXCLUSIVE" APPEARS UNDERNEATH "COLLECTION" IN SMALLER SIZED UPPER CASE LETTERS.

FOR SHOES (U.S. CLS. 22 AND 39).

FIRST USE 9-30-2000; IN COMMERCE 9-30-2000.

2,625,824. HARBOR FOOTWEAR GROUP, LTD., PORT WASHINGTON, NY. SN 75-921,054. PUB. 11-14-2000, FILED 2-16-2000.

NYGB

FOR FOOTWEAR (U.S. CLS. 22 AND 39).

FIRST USE 11-14-2000; IN COMMERCE 11-14-2000.

2,625,849. ROSS, CHARLES H., JR., UNION CITY, NJ. SN 75-932,929. PUB. 7-10-2001, FILED 3-2-2000.

REMILIXER

FOR CLOTHING; NAMELY, MEN'S, BOYS' AND WOMEN'S JACKETS, SHIRTS, BLOUSES, PANTS, JEANS SHORTS AND HATS (U.S. CLS. 22 AND 39).

FIRST USE 2-7-2002; IN COMMERCE 2-7-2002.

CLASS 25—(Continued).

2,625,853. TERRAL, MIKE D., CLAREMORE, OK. AND MCCAW, JOHN D., CLAREMORE, OK. SN 75-936,030. PUB. 1-9-2001, FILED 2-24-2000.

DUCKMASTERS

FOR CASUAL CLOTHING FOR DUCK HUNTING ENTHUSIASTS, NAMELY SHIRTS, JACKETS, HATS, PANTS AND GLOVES (U.S. CLS. 22 AND 39).
FIRST USE 9-1-1995; IN COMMERCE 7-1-1997.

2,625,867. HERRING, CONRAD, SAN DIEGO, CA. SN 75-941,299. PUB. 10-3-2000, FILED 3-11-2000.

HINEYVILLE

FOR CLOTHING; NAMELY, T-SHIRTS, SHORTS, UNDERWEAR, JACKETS, AND HATS (U.S. CLS. 22 AND 39).
FIRST USE 12-24-2001; IN COMMERCE 12-24-2001.

2,625,876. PION, LESLIE, NEWPORT BEACH, CA. SN 75-978,173. PUB. 5-4-1999, FILED 1-21-1997.

BUNCO

FOR WEARING APPAREL, NAMELY, SHIRTS, SHORTS, PANTS, HATS, VISORS, CAPS, T-SHIRTS, SWEATSHIRTS, AND JOGGING SUITS (U.S. CLS. 22 AND 39).
FIRST USE 5-0-1996; IN COMMERCE 7-0-1996.

2,625,883. BELLY, S.R.O., PSC 11000, CZECH REPUBLIC. SN 75-981,937. PUB. 1-23-2001, FILED 5-22-2000.

under (belly)

FOR WOMAN'S CLOTHING, NAMELY UNDERWEAR (U.S. CLS. 22 AND 39).
FIRST USE 2-1-2000; IN COMMERCE 6-1-2000.

CLASS 25—(Continued).

2,625,900. CORPORATE EXPRESS, INC., BROOMFIELD, CO. SN 75-982,545. PUB. 2-6-2001, FILED 9-16-1999.

ALIGN

FOR CLOTHING, NAMELY, SHIRTS, T-SHIRTS, SWEATERS, JACKETS, COATS (U.S. CLS. 22 AND 39).
FIRST USE 10-0-2001; IN COMMERCE 10-0-2001.

2,625,902. CHAIKEN AND CAPONE, SAN FRANCISCO, CA. SN 75-982,580. PUB. 9-4-2001, FILED 9-13-1999.

CHAIKEN

OWNER OF U.S. REG. NOS. 2,055,330, 2,170,476, AND 2,302,381.
SEC. 2(F).

FOR MEN'S, WOMEN'S, AND CHILDREN'S CLOTHING, NAMELY, JEANS, PANTS, SWEATERS, COATS, JACKETS, SUITS, SHORTS, SHIRTS, T-SHIRTS, BLOUSES, SKIRTS, DRESSES, BEACHWEAR, LOUNGEWEAR, BERMUDA SHORTS, PEDAL PUSHERS, INFANTWEAR, HEAD WEAR, JUMPSUITS, PARKAS, POLO SHIRTS, VESTS, SPORT SHIRTS, UNIFORMS, HATS, SPORT COATS, OVERCOATS, RAIN COATS, TOP COATS, BATHING SUITS, SWEATSHIRTS, BEACH COVERUPS, BATHROBES, FUR TOPS, FUR JACKETS, AND EVENING WEAR, NAMELY, SUITS, PANTS, JACKETS, SHIRTS, VESTS, BELTS, SHOES, COATS, CAPES, DRESSES, EVENING GOWNS, SKIRTS, BLOUSES, CAMISOLES, HALTER TOPS, BUSTIERS, JUMPERS, FUR TOPS, FUR JACKETS, SHAWLS, STOLE, SCARVES, SHRUGS, SWEATERS, AND WRAPS (U.S. CLS. 22 AND 39).

FIRST USE 9-0-1999; IN COMMERCE 11-0-1999.

2,625,904. ODYSSEY SHOES, INC., CITY OF COMMERCE, CA. SN 76-003,324. PUB. 10-9-2001, FILED 3-17-2000.

HYTERLINK FLEX

NO CLAIM IS MADE TO THE EXCLUSIVE RIGHT TO USE "FLEX", APART FROM THE MARK AS SHOWN.
FOR SHOE INSOLES (U.S. CLS. 22 AND 39).
FIRST USE 8-7-2001; IN COMMERCE 8-7-2001.

CLASS 25—(Continued).

2,625,911. BROOKS SPORTS, INC., BOTHELL, WA. SN 76-006,174. PUB. 12-19-2000, FILED 3-21-2000.

RUN HAPPY

FOR CLOTHING, NAMELY SHOES, BOOTS, SLIPPERS, SOCKS, FOOTWEAR, SHIRTS, PANTS, JACKETS, HATS, CAPS, SHORTS, TIGHTS, HOSIERY, JOGGING SUITS, GLOVES, SWEAT PANTS, SWEAT SUITS, SWEAT SHIRTS, WARM UP SUITS, HEADWEAR, HEAD BANDS, T-SHIRTS, SKIRTS, LEGGINGS, UNITARDS, WIND RESISTANT JACKETS, BELTS, RAINWEAR, INSOLES, VESTS, WATERPROOF JACKETS, WATERPROOF PANTS, WATERPROOF VESTS, SWEATERS, TRACK SUITS, TANK TOPS, TURTLE NECKS, TROUSERS, JERSEYS, VISORS, AND WRIST BANDS (U.S. CLS. 22 AND 39).

FIRST USE 12-0-1999; IN COMMERCE 1-0-2000.

2,625,934. WHITE, STEPHON, LAS VEGAS, NV. SN 76-023,416. PUB. 9-11-2001, FILED 4-12-2000.

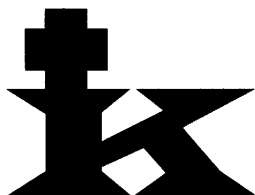

Kingdom Wear

NO CLAIM IS MADE TO THE EXCLUSIVE RIGHT TO USE "WEAR", APART FROM THE MARK AS SHOWN.

FOR SHIRTS, PANTS, SOCKS, JACKETS, HATS, SHOES, UNDERWEAR (U.S. CLS. 22 AND 39).

FIRST USE 9-6-2000; IN COMMERCE 9-6-2000.

2,625,973. RICHARDSON, TYRONE, CINCINNATI, OH. SN 76-041,439. PUB. 1-9-2001, FILED 5-5-2000.

HOODGEAR

FOR SOCKS, PANTS, GYM SHOES, CASUAL BOOTS, SHIRTS, HATS, UNDERWEAR, COATS, DRESSES, SKIRTS, SWEATERS, BANDANNAS, AND JACKETS (U.S. CLS. 22 AND 39).

FIRST USE 3-14-1997; IN COMMERCE 5-15-2001.

CLASS 25—(Continued).

2,625,994. U.B. TUFF LLC, PERTH AMBOY, NJ. SN 76-048,093. PUB. 1-29-2002, FILED 5-15-2000.



NO CLAIM IS MADE TO THE EXCLUSIVE RIGHT TO USE "BRAND" AND "COLLECTION", APART FROM THE MARK AS SHOWN.

FOR LEATHER OUTERWEAR, NAMELY LEATHER JACKETS, LEATHER COATS, LEATHER PANTS, LEATHER GLOVES AND HATS (U.S. CLS. 22 AND 39).

FIRST USE 5-1-2002; IN COMMERCE 5-1-2002.

2,626,000. SAN FRANCISCO CONVENTION & VISITORS BUREAU, SAN FRANCISCO, CA. SN 76-049,829. PUB. 1-23-2001, FILED 5-16-2000.

I LEFT MY HEART IN SAN FRANCISCO

FOR CLOTHING, NAMELY T-SHIRTS, HATS, SWEATERS, JACKETS AND PULLOVERS (U.S. CLS. 22 AND 39).

FIRST USE 3-20-2001; IN COMMERCE 3-20-2001.

2,626,041. YOUNG LIFE, COLORADO SPRINGS, CO. SN 76-075,241. PUB. 3-6-2001, FILED 5-17-2000.

TIMBER WOLF LAKE

FOR MEN'S AND WOMEN'S CLOTHING, NAMELY SHIRTS, T-SHIRTS SWEATSHIRTS SWEATPANTS, SHORTS, POLO-STYLE SHIRTS, JACKETS, SOCKS, BOXER-TYPE SHORTS, AND BASEBALL-STYLE CAPS (U.S. CLS. 22 AND 39).

FIRST USE 6-30-2001; IN COMMERCE 6-30-2001.

2,626,048. CHIEF SUPPLY CORPORATION, EUGENE, OR. SN 76-077,686. PUB. 3-6-2001, FILED 6-26-2000.

THE DUTY MASTER

FOR GLOVES; GLOVES LINED WITH A CUT RESISTANT LINING (U.S. CLS. 22 AND 39).

FIRST USE 10-0-2000; IN COMMERCE 10-0-2000.

CLASS 25—(Continued).

2,626,083. FOOTSTAR CORPORATION, MAHWAH, NJ. SN 76-091,794. PUB. 3-13-2001, FILED 7-19-2000.

OAKWOODS

OWNER OF U.S. REG. NO. 1,439,248.
FOR CLOTHING, NAMELY, SHIRTS AND JACKETS,
AND FOOTWEAR, NAMELY BOOTS (U.S. CLS. 22 AND
39).
FIRST USE 9-12-2001; IN COMMERCE 9-12-2001.

2,626,084. MADTEEZ, INC., CALUMET CITY, IL. SN 76-093,093. PUB. 3-27-2001, FILED 7-20-2000.

JESUS GOT MY BACK

FOR T-SHIRTS, SWEATSHIRTS, JACKETS, CAPS,
BASEBALL HATS (U.S. CLS. 22 AND 39).
FIRST USE 6-21-2001; IN COMMERCE 6-21-2001.

2,626,088. WARNACO U.S., INC., MILFORD, CT. SN 76-095,728. PUB. 1-30-2001, FILED 7-24-2000.

**OLGA BEST OF
EVERYTHING**

OWNER OF U.S. REG. NOS. 780,385, 883,813, AND
OTHERS.
FOR INTIMATE APPAREL AND FIGURE ENHAN-
CING GARMENTS, NAMELY, BRAS AND PANTIES
(U.S. CLS. 22 AND 39).
FIRST USE 2-25-2001; IN COMMERCE 2-25-2001.

2,626,098. CUSTOM LEATHER CANADA LIMITED,
WATERLOO, ONTARIO, N2L 3X2, CANADA. SN 76-100,027. PUB. 6-19-2001, FILED 7-31-2000.

MONTANELLI

FOR MEN'S, LADIES' AND CHILDREN'S BELTS AND
SUSPENDERS (U.S. CLS. 22 AND 39).
FIRST USE 4-0-2000; IN COMMERCE 4-16-2001.

CLASS 25—(Continued).

2,626,118. MITCHELL, RICCO A, MEMPHIS, TN. SN 76-110,307. PUB. 5-15-2001, FILED 8-16-2000.



FOR CLOTHING, NAMELY SOCKS, KNIT SHIRTS,
LINGERIE AND SWIMWEAR (U.S. CLS. 22 AND 39).
FIRST USE 2-0-2002; IN COMMERCE 2-0-2002.

2,626,182. ALTAMA DELTA CORPORATION, ROSWELL,
GA. SN 76-135,812. PUB. 6-26-2001, FILED 9-25-2000.

CONBAT

FOR FOOTWEAR (U.S. CLS. 22 AND 39).
FIRST USE 11-0-2000; IN COMMERCE 11-0-2000.

2,626,231. KAYSER-ROTH CORPORATION, GREENSBORO,
NC. SN 76-155,238. PUB. 9-4-2001, FILED 10-27-2000.

BARE CONTROL

NO CLAIM IS MADE TO THE EXCLUSIVE RIGHT TO
USE "CONTROL", APART FROM THE MARK AS SHOWN.
FOR HOSIERY, NAMELY, PANTYHOSE AND TIGHTS
(U.S. CLS. 22 AND 39).
FIRST USE 3-0-2001; IN COMMERCE 3-0-2001.

2,626,244. O-LINE LLC, GEORGETOWN, DE. SN 76-157,068.
PUB. 7-31-2001, FILED 11-1-2000.

O.W.U.A.

FOR CLOTHING; NAMELY T-SHIRTS, SWEAT-
SHIRTS, JACKETS, SWEATPANTS, GYM SHORTS, SUP-
PORT GARMENTS, NAMELY, ELASTIC SUPPORT
SHORTS, TIGHTS AND CYCLING PANTS, COMPRES-
SION SHORTS, HATS, SWEATBANDS, GLOVES, SOCKS
AND SHOES (U.S. CLS. 22 AND 39).
FIRST USE 12-1-2000; IN COMMERCE 12-1-2000.

CLASS 25—(Continued).

2,626,305. MATHERS, MARSHALL B. III, NEW YORK, NY. SN 76-181,429. PUB. 8-21-2001, FILED 12-15-2000.

SLIM SHADY

FOR CLOTHING; NAMELY, SHIRTS, LONG-SLEEVE T-SHIRTS; SHORT-SLEEVE T-SHIRTS; CAPS, HATS, KNIT HATS AND BASEBALL CAPS (U.S. CLS. 22 AND 39).

FIRST USE 4-0-1999; IN COMMERCE 4-0-1999.

CLASS 25—(Continued).

2,626,322. KAYE, JONATHAN, ENCINO, CA. SN 76-191,368. PUB. 8-14-2001, FILED 1-8-2001.

REALSIZE

FOR CLOTHING, NAMELY, BATHING SUITS, BEACH COVER-UPS, BELTS, CAPS, HATS, DRESSES, PANTIES, PANTS, ROMPERS, SHIRTS, SHORTALLS, SHORTS, SKIRTS, SWEAT PANTS, SWEATERS, TOPS, VESTS, FOOTWEAR (U.S. CLS. 22 AND 39).

FIRST USE 7-0-1998; IN COMMERCE 7-0-1998.

2,626,307. UNIVERSAL CITY STUDIOS, INC., UNIVERSAL CITY, CA. SN 76-181,796. PUB. 11-13-2001, FILED 12-18-2000.

UNIVERSAL' S ISLANDS OF ADVENTURE

FOR CLOTHING, NAMELY, JACKETS, SHIRTS, BLOUSES, T-SHIRTS, SWEATSHIRTS, SWEATPANTS, CAPS, HATS (U.S. CLS. 22 AND 39).

FIRST USE 9-0-2000; IN COMMERCE 9-0-2000.

2,626,348. LL INTERNATIONAL SHOE COMPANY, INC., LOS ANGELES, CA. SN 76-201,375. PUB. 10-2-2001, FILED 1-29-2001.



FOR FOOTWEAR (U.S. CLS. 22 AND 39). FIRST USE 6-0-2001; IN COMMERCE 6-0-2001.

2,626,311. SNYDER, LAVINIA BRANCA, NEW YORK, NY. SN 76-183,617. PUB. 8-14-2001, FILED 12-18-2000.

SOFTI

FOR CAPS AND T-SHIRTS (U.S. CLS. 22 AND 39). FIRST USE 10-22-2001; IN COMMERCE 10-22-2001.

2,626,375. ROYAL INTERCONTINENTAL INC., NEW YORK, NY. SN 76-210,738. PUB. 9-18-2001, FILED 2-12-2001.

CALSANG

FOR CLOTHING, NAMELY, PANTS, SHIRTS, ROBES, PAJAMAS, SCARVES AND SHAWLS (U.S. CLS. 22 AND 39).

FIRST USE 3-1-2001; IN COMMERCE 3-1-2001.

2,626,312. SNYDER, LAVINIA BRANCA, NEW YORK, NY. SN 76-183,619. PUB. 1-8-2002, FILED 12-18-2000.



FOR CAPS AND T-SHIRTS (U.S. CLS. 22 AND 39). FIRST USE 10-22-2001; IN COMMERCE 10-22-2001.

2,626,390. ECG2, L.L.C, DBA RIDDELL FOOTWEAR, ST. LOUIS, MO. SN 76-214,165. PUB. 8-14-2001, FILED 2-22-2001.

TECOBA

FOR FOOTWEAR (U.S. CLS. 22 AND 39). FIRST USE 6-1-2001; IN COMMERCE 6-1-2001.

CLASS 25—(Continued).

2,626,405. KIM, YOUNG TAE, AKA: SEAN KIM, HACK-ENSACK, NJ. SN 76-216,964. PUB. 11-13-2001, FILED 2-27-2001.

SEAN & SAM BROTHER AND SISTER

FOR CLOTHING, NAMELY NECKTIES, DRESS SHIRTS, SCARFS, MUFFLERS, UNDERPANTS, HATS, CAPS, BLOUSES, VESTS, GLOVES, CHEMISES, AND NIGHT WEAR, NAMELY, PAJAMAS, NIGHT GOWNS, NIGHT SHIRTS, BATHROBES, AND NIGHT CAPS; NECKTIES, DRESS SHIRTS, SCARFS, MUFFLERS, UNDERPANTS, HATS, CAPS, CHEMISES, BLOUSES, VESTS, GLOVES, AND NIGHT WEAR, NAMELY, PAJAMAS, NIGHT GOWNS, NIGHT SHIRTS, BATHROBES, AND NIGHT CAPS FOR MEN, WOMEN AND CHILDREN; AND NECKTIES, DRESS SHIRTS, SCARFS, MUFFLERS, UNDERPANTS, HATS, CAPS, CHEMISES, BLOUSES, VESTS, GLOVES, AND NIGHT WEAR, NAMELY, PAJAMAS, NIGHT GOWNS, NIGHT SHIRTS, BATHROBES, AND NIGHT CAPS FOR USE IN THE FIELD OF EVERYDAY WEAR (U.S. CLS. 22 AND 39).

FIRST USE 5-20-2001; IN COMMERCE 10-20-2001.

2,626,426. COLUMBIA INSURANCE COMPANY, OMAHA, NE. SN 76-224,532. PUB. 8-21-2001, FILED 3-12-2001.

VWS

FOR FOOTWEAR (U.S. CLS. 22 AND 39).
FIRST USE 9-0-2001; IN COMMERCE 9-0-2001.

2,626,449. SNYDER, LAVINIA BRANCA, NEW YORK, NY. SN 76-233,424. PUB. 9-11-2001, FILED 3-30-2001.

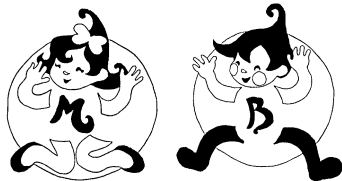

FOR CAPS AND T-SHIRTS (U.S. CLS. 22 AND 39).
FIRST USE 11-2-2001; IN COMMERCE 11-2-2001.

CLASS 25—(Continued).

2,626,466. PENNSYLVANIA INTERNATIONAL RACEWAY, INC., NAZARETH, PA. SN 76-239,164. PUB. 12-11-2001, FILED 4-11-2001.



OWNER OF U.S. REG. NOS. 1,927,735, 1,999,895, AND 2,013,023.

THE MARK FEATURES THE PHRASE "NAZARETH SPEEDWAY" SUPERIMPOSED ON A STYLIZED TRI-OVAL RACETRACK DESIGN.

SEC. 2(F) AS TO "NAZARETH".

FOR CLOTHING, NAMELY T-SHIRTS, COLLARED SHIRTS, SPORT SHIRTS, SWEATSHIRTS, SLEEVELESS TANK TOPS, JACKETS, SWEATERS, CAPS, HATS, SUN VISORS, SHORTS, PANTS, SHOES, SOCKS, AND BELTS (U.S. CLS. 22 AND 39).

FIRST USE 7-1-2001; IN COMMERCE 7-1-2001.

2,626,469. YALEET INC., FARMINGDALE, NY. SN 76-243,105. PUB. 10-2-2001, FILED 4-20-2001.

YALEET

FOR FOOTWEAR, NAMELY, SOCKS (U.S. CLS. 22 AND 39).

FIRST USE 8-23-2001; IN COMMERCE 8-23-2001.

2,626,472. STEPHENS, BARBARA, NORRISTOWN, PA. SN 76-246,274. PUB. 1-1-2002, FILED 4-25-2001.

WEAR "N" FAITH

FOR ATHLETIC AND CASUAL CLOTHING, NAMELY SHIRTS, PANTS, AND HATS (U.S. CLS. 22 AND 39).
FIRST USE 4-1-2002; IN COMMERCE 4-1-2002.

2,626,559. DAYAN, DANIEL, DEAL, NJ. SN 78-002,718. PUB. 6-19-2001, FILED 4-5-2000.

WEEFISH

FOR CLOTHING AND APPAREL NAMELY, PANTSUITS, SHORT SETS, ROMPERS, OVERALL SETS, HATS, SHOES, AND ACCESSORIES SOLD THEREWITH (U.S. CLS. 22 AND 39).

FIRST USE 5-1-2001; IN COMMERCE 5-1-2001.

CLASS 25—(Continued).

2,626,569. NBA PROPERTIES, INC., NEW YORK, NY. SN 78-008,684. PUB. 3-13-2001, FILED 5-18-2000.

NBDL

FOR CLOTHING, NAMELY, HOSIERY, FOOTWEAR, T-SHIRTS, SWEATSHIRTS, SWEATPANTS, PANTS, TANK TOPS, JERSEYS, SHORTS, PAJAMAS, SPORT SHIRTS, RUGBY SHIRTS, SWEATERS, BELTS, TIES, NIGHTSHIRTS, HATS, WARM-UP SUITS, JACKETS, PARKAS, COATS, CLOTH BIBS, HEAD BANDS, WRIST BANDS, APRONS, BOXER SHORTS, SLACKS, CAPS, EAR MUFFS, GLOVES, WOVEN AND KNIT SHIRTS, MITTENS (U.S. CLS. 22 AND 39).

FIRST USE 1-4-2001; IN COMMERCE 1-4-2001.

2,626,610. HUNKERS FOOTWEAR USA INC., ONTARIO, CA. SN 78-029,943. PUB. 10-2-2001, FILED 10-10-2000.



FOR FOOTWEAR (U.S. CLS. 22 AND 39).
FIRST USE 8-0-2001; IN COMMERCE 8-0-2001.

2,626,619. SARAMAR L.L.C., CHICAGO, IL. SN 78-033,674. PUB. 7-31-2001, FILED 11-3-2000.

COTTON CRAZE

NO CLAIM IS MADE TO THE EXCLUSIVE RIGHT TO USE "COTTON", APART FROM THE MARK AS SHOWN.

FOR BRAS; PANTIES; DAYWEAR, NAMELY CROP TOPS, CAMISOLES, SLIPS, BANDEAUS (TUBE TOPS); SHAPE WEAR, NAMELY GIRDLES, BODY BRIEFERS, THIGH SHAPERS, BRIEFS, BODY SUITS (ALL IN ONES) (U.S. CLS. 22 AND 39).

FIRST USE 5-11-2001; IN COMMERCE 5-11-2001.

2,626,621. DABBIERO, FRANK A., BERTHOUD, CO. SN 78-033,837. PUB. 9-4-2001, FILED 11-3-2000.

SE HABLA BASEBALL

NO CLAIM IS MADE TO THE EXCLUSIVE RIGHT TO

CLASS 25—(Continued).

USE "BASEBALL", APART FROM THE MARK AS SHOWN. THE FOREIGN WORDING IN THE MARK TRANSLATES INTO ENGLISH AS "IS SPOKEN"

FOR CLOTHING, NAMELY, SHIRTS, T-SHIRTS, SWEATSHIRTS (U.S. CLS. 22 AND 39).

FIRST USE 7-17-2001; IN COMMERCE 1-26-2002.

2,626,640. PLAYTEX APPAREL, INC., STAMFORD, CT. SN 78-039,916. PUB. 8-21-2001, FILED 12-19-2000.

SHAPE & SMOOTH

OWNER OF U.S. REG. NO. 2,152,548.
FOR SHAPEWEAR, NAMELY, GIRDLES, BRIEFS, BODY BRIEFERS, THIGH SHAPERS, BODY SUITS, ALL-IN-ONES (U.S. CLS. 22 AND 39).

FIRST USE 3-30-2001; IN COMMERCE 3-30-2001.

2,626,684. LEVERING, ROBERT, GRAND RAPIDS, MI. SN 78-050,212. PUB. 9-18-2001, FILED 2-26-2001.

TRACK FORCE

FOR APPAREL, NAMELY, T-SHIRTS (U.S. CLS. 22 AND 39).

FIRST USE 4-13-2001; IN COMMERCE 4-13-2001.

2,626,719. DADA CORPORATION, SEOUL, REPUBLIC OF KOREA. SN 78-062,809. PUB. 10-16-2001, FILED 5-9-2001.

UNIBAND

FOR CLOTHING NAMELY HATS, CAPS AND HEADWEAR, HEADBANDS, BATHING CAPS, BEACHWEAR, JACKETS, JEANS, T-SHIRTS, OVERCOATS, SHOES (U.S. CLS. 22 AND 39).

FIRST USE 1-28-2002; IN COMMERCE 1-28-2002.

2,626,726. LIFUNG.COM, INC., NEW YORK, NY. SN 78-066,652. PUB. 10-16-2001, FILED 5-31-2001.

STEWART DUNCAN

THE NAME SHOWN IN THE MARK DOES NOT IDENTIFY A PARTICULAR LIVING INDIVIDUAL.

FOR CLOTHING FOR MEN, NAMELY, SHIRTS, SHORTS, PANTS, WIND-RESISTANT JACKETS, JACKETS, COATS, SWEATERS, SWEATSHIRTS, SWEATPANTS, PULLOVERS, RAINWEAR, PONCHOS, VESTS, SOCKS, HOSIERY, SCARVES, TIES, GLOVES, BELTS, HATS, CAPS (U.S. CLS. 22 AND 39).

FIRST USE 9-1-2001; IN COMMERCE 9-1-2001.

CLASS 26—FANCY GOODS

CLASS 26—(Continued).

2,625,958. SOUTHERN COMFORT PROPERTIES, INC., SAN RAFAEL, CA. SN 76-034,851. PUB. 7-10-2001, FILED 4-25-2000.

SOUTHERN COMFORT

OWNER OF U.S. REG. NOS. 423,955 AND 2,167,605.
FOR BELT BUCKLES AND CLASPS FOR CLOTHING
ALL MADE OF NON-PRECIOUS METAL; ORNAMEN-
TAL NOVELTY PINS (U.S. CLS. 37, 39, 40, 42 AND 50).
FIRST USE 11-27-2000; IN COMMERCE 11-27-2000.

2,626,114. DESIGNS BY SKAFFLES, INC., NEW YORK, NY.
SN 76-108,892. PUB. 2-12-2002, FILED 8-14-2000.

HOT STYLES

FOR HAIR ACCESSORIES, NAMELY, BARRETTES,
SCRUNCHIES, BANANA CLIPS, HAIRBANDS, HAIR
ORNAMENTS IN THE NATURE OF HAIR WRAPS,
TUBAS, CLAWS, PONYTAIL HOLDERS, BOWS,
PADDED BARRETTES AND SLEEP CLIPS, NAMELY,
HAIRPINS; AND CLOTHING ACCESSORIES, NAMELY,
JACKETS CLIPS AND ZIPPER PULLS (U.S. CLS. 37, 39,
40, 42 AND 50).
FIRST USE 1-3-2002; IN COMMERCE 1-3-2002.

CLASS 27—FLOOR COVERINGS

2,626,744. MOHAWK BRANDS, INC., WILMINGTON, DE.
SN 78-077,871. PUB. 11-27-2001, FILED 8-7-2001.

ENGLISH MANOR

FOR CARPET NAMELY RUGS (U.S. CLS. 19, 20, 37, 42
AND 50).
FIRST USE 9-20-2001; IN COMMERCE 9-20-2001.

CLASS 28—TOYS AND SPORTING GOODS

2,625,341. LUCAS LICENSING LTD., NICASIO, CA. SN 75-
307,151. PUB. 6-29-1999, FILED 6-11-1997.

SITH

FOR TOY ACTION FIGURES (U.S. CLS. 22, 23, 38 AND
50).
FIRST USE 5-31-2000; IN COMMERCE 5-31-2000.

CLASS 28—(Continued).

2,625,362. HTZ INVESTMENT CORP., WILMINGTON, DE.
SN 75-396,165. PUB. 8-3-1999, FILED 11-25-1997.

CHEW 'N CLEAN

FOR DOG TOYS, NAMELY, SYNTHETIC PLASTIC
BONES FOR DOGS (U.S. CLS. 22, 23, 38 AND 50).
FIRST USE 6-0-1998; IN COMMERCE 6-0-1998.

2,625,416. INGERMANN GOLF, INC, ARVADA, CO. SN 75-
546,250. PUB. 9-21-1999, FILED 9-1-1998.

BLACK WIDOW

FOR GOLF CLUBS (U.S. CLS. 22, 23, 38 AND 50).
FIRST USE 8-10-1998; IN COMMERCE 8-10-1998.

2,625,454. MYTRLE KNOLL GAME CO., INC., BROADBENT,
OR. SN 75-605,044. PUB. 5-2-2000, FILED 12-14-1998.

**TACTICAL FOOTBALL
CHALLENGE**

NO CLAIM IS MADE TO THE EXCLUSIVE RIGHT TO
USE "FOOTBALL", APART FROM THE MARK AS SHOWN.
FOR EQUIPMENT SOLD AS A UNIT FOR PLAYING A
BOARD GAME (U.S. CLS. 22, 23, 38 AND 50).
FIRST USE 3-11-2002; IN COMMERCE 3-11-2002.

2,625,470. MATTEL, INC., EL SEGUNDO, CA. SN 75-630,002.
PUB. 10-5-1999, FILED 2-2-1999.

BABY'S FIRST HAIRCUT

NO CLAIM IS MADE TO THE EXCLUSIVE RIGHT TO
USE "BABY'S", APART FROM THE MARK AS SHOWN.
FOR DOLLS, DOLL CLOTHING AND DOLL ACCES-
SORIES (U.S. CLS. 22, 23, 38 AND 50).
FIRST USE 6-15-1999; IN COMMERCE 6-15-1999.

CLASS 28—(Continued).

2,625,497. TWENTIETH CENTURY FOX FILM CORPORATION, LOS ANGELES, CA. SN 75-678,745. PUB. 11-16-1999, FILED 4-9-1999.

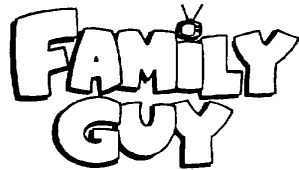

FOR JIGSAW AND MANIPULATIVE PUZZLES; DOLLS; TOY ACTION FIGURES AND ACCESSORIES; TOY VEHICLES AND ACCESSORIES; TOY ACTION FIGURE PLAY ENVIRONMENTS AND ACCESSORIES; ACTION SKILL GAMES; HAND-HELD UNITS FOR PLAYING ELECTRONIC GAMES; BOARD GAMES; PLUSH TOYS (U.S. CLS. 22, 23, 38 AND 50).
FIRST USE 6-30-1999; IN COMMERCE 6-30-1999.

CLASS 28—(Continued).

2,625,547. MATTEL, INC., EL SEGUNDO, CA. SN 75-735,556. PUB. 9-5-2000, FILED 7-21-1999.

BACKPACK BOUNCER

NO CLAIM IS MADE TO THE EXCLUSIVE RIGHT TO USE "BACKPACK", APART FROM THE MARK AS SHOWN, FOR PLUSH TOY ANIMALS ON NON-METAL KEY CHAINS SOLD TOGETHER AS A UNIT (U.S. CLS. 22, 23, 38 AND 50).
FIRST USE 3-1-2000; IN COMMERCE 3-1-2000.

2,625,604. RADICA CHINA LTD., TORTOLA, BRITISH VIRGIN ISLANDS, HONG KONG. SN 75-789,541. PUB. 4-18-2000, FILED 9-1-1999.

JACKPOT SLOT

NO CLAIM IS MADE TO THE EXCLUSIVE RIGHT TO USE "SLOT", APART FROM THE MARK AS SHOWN, FOR HAND-HELD UNITS FOR PLAYING ELECTRONIC GAMES (U.S. CLS. 22, 23, 38 AND 50).
FIRST USE 10-10-1999; IN COMMERCE 10-10-1999.

2,625,529. LUG-STUFF INC., DBA RJ JR. CREATIONS, MARIETTA, GA. SN 75-722,266. PUB. 11-21-2000, FILED 6-7-1999.



FOR ACTION FIGURES, ACTION FIGURES ACCESSORIES, THEREFORE TOY BANKS, BENDABLE TOYS, BOARD GAMES, COLLECTABLE TOY FIGURES, COSTUME MASKS, DOLLS-BEANBAG, DOLLS-PAPER, DOLLS-SOFT SCULPTURE, DOLLS, FANTASY CHARACTER TOYS, FIGURES-ACTION, TOY FIGURES, TOY ACTION FIGURES AND ACCESSORIES THEREFORE GAMES-BOARD, GAMES-CARD, JIGSAW PUZZLES, KITES, MUSIC BOX TOYS, MUSICAL TOYS, ORNAMENTS-CHRISTMAS TREE, PAPER DOLLS, PAPER FACE MASKS, PARTY FAVORS IN THE NATURE OF SMALL TOYS, PINATAS, PLUSH TOYS, PLUSH TOYS-SOFT SCULPTURE, POP-UP TOYS, POSITIONAL TOY FIGURES, PROMOTIONAL GAME CARDS, PROMOTIONAL GAME MATERIALS, PULL TOYS, PUNCHING BAGS, PUNCHING TOYS, PUPPETS, PUSH TOYS, SQUEEZE TOYS, STUFFED TOYS, TALKING TOYS, TOY ACTION FIGURES AND ACCESSORIES THEREFOR TOY ACTION FIGURES, TOY FIGURES, TOYS-BATH, TOYS-BATHTUB, TOYS-PLUSH, TOYS-SOFT SCULPTURE, TOYS-SQUEEZABLE SQUEEKING, TOYS-STUFFED, WIND UP TOYS, WIND UP WALKING TOYS (U.S. CLS. 22, 23, 38 AND 50).
FIRST USE 10-26-2001; IN COMMERCE 10-26-2001.

2,625,642. JACKSON, BRUCE E., NOVELTY, OH. SN 75-821,731. PUB. 5-23-2000, FILED 10-13-1999.

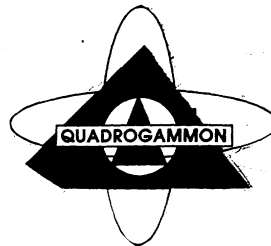

FOR BOARD GAME (U.S. CLS. 22, 23, 38 AND 50).
FIRST USE 11-1-2001; IN COMMERCE 11-1-2001.

CLASS 28—(Continued).

2,625,664. KONAMI CO., LTD., MINATO-KU, TOKYO 105-6021, JAPAN. SN 75-834,572. PUB. 2-6-2001, FILED 10-29-1999.



THE DESIGN PORTION OF THE MARK CONSISTS OF A STYLIZED GLOBE DESIGN LOCATED TO THE LEFT OF AND PARTIALLY CONCEALED BY THE STYLIZED LETTERS "INTERNATIONAL RALLY".

FOR COMPUTER AND VIDEO GAMES, NAMELY, STAND-ALONE VIDEO GAMES, NAMELY, STAND ALONE VIDEO OUTPUT GAME MACHINES, HAND-HELD UNITS FOR PLAYING VIDEO GAMES, AND INSTRUCTIONAL MANUALS SOLD TOGETHER AS A UNIT THEREWITH (U.S. CLS. 22, 23, 38 AND 50).

FIRST USE 3-1-2001; IN COMMERCE 3-1-2001.

2,625,669. SFK CO., INC., ENGLEWOOD, NJ. SN 75-836,726. PUB. 7-4-2000, FILED 11-1-1999.

THE WISHKINS COLLECTION

NO CLAIM IS MADE TO THE EXCLUSIVE RIGHT TO USE "COLLECTION", APART FROM THE MARK AS SHOWN.

FOR COLLECTIBLE DOLLS (U.S. CLS. 22, 23, 38 AND 50).

FIRST USE 12-0-2000; IN COMMERCE 12-0-2000.

2,625,704. CASHFLOW TECHNOLOGIES, INC., PARADISE VALLEY, AZ. SN 75-856,216. PUB. 9-12-2000, FILED 11-23-1999.

INVESTING 202

NO CLAIM IS MADE TO THE EXCLUSIVE RIGHT TO USE "INVESTING", APART FROM THE MARK AS SHOWN.

FOR BOARD GAMES AND EQUIPMENT SOLD AS A UNIT FOR PLAYING BOARD GAMES USED FOR FINANCIAL EDUCATION (U.S. CLS. 22, 23, 38 AND 50).

FIRST USE 5-15-2000; IN COMMERCE 5-15-2000.

CLASS 28—(Continued).

2,625,739. DG PRODUCTIONS, INC., LONGWOOD, FL. SN 75-883,943. PUB. 6-5-2001, FILED 12-31-1999.

PLAY FORCE TOYS

NO CLAIM IS MADE TO THE EXCLUSIVE RIGHT TO USE "PLAY" AND "TOYS", APART FROM THE MARK AS SHOWN.

FOR ACTION FIGURES AND ACCESSORIES, TOY VEHICLES, TRUCKS AND ACCESSORIES SOLD AS A UNIT, INTER-LINKING TOY BLOCKS AND PARTS, MINIATURE TOY ROAD CONSTRUCTION EQUIPMENT, HAND-HELD COMPUTER GAMES (U.S. CLS. 22, 23, 38 AND 50).

FIRST USE 2-14-2000; IN COMMERCE 2-14-2000.

2,625,750. KADER INDUSTRIAL COMPANY LIMITED, KOWLOON BAY, HONG KONG. SN 75-888,716. PUB. 6-5-2001, FILED 1-6-2000.



THE LINING SHOWN IN THE DRAWING IS A FEATURE OF THE MARK AND IS NOT INTENDED TO INDICATE COLOR.

THE MARK CONSISTS OF A STYLIZED DEPICTION OF THE FRONT OF A RAILROAD LOCOMOTIVE WITH A STYLIZED LETTER "B" IN THE CENTER.

FOR MODEL TOY TRAIN SETS AND THEIR ACCESSORIES, NAMELY, TRAIN ENGINES, RAILWAY CARS, RAILWAY TRACKS, MINIATURE HOUSES AND BUILDINGS, TOY ACTION FIGURES, AND ELECTRICAL POWER PACKS FOR USE WITH TOY TRAIN SETS; MODEL AIRPLANES AND MODEL AIRPLANE KITS AND ACCESSORIES SOLD THEREWITH, NAMELY, MODEL AIRPLANE ENGINES, PARTS, INSTRUCTIONS, AND DECALS; AND MODEL TOY CARS AND MODEL TOY CAR KITS (U.S. CLS. 22, 23, 38 AND 50).

FIRST USE 1-19-2000; IN COMMERCE 4-12-2000.

2,625,821. CCL LABEL, INC., ONTARIO, CA. SN 75-918,399. PUB. 9-11-2001, FILED 2-14-2000.

SCREENPLAY

FOR PROMOTION GAME MATERIALS (U.S. CLS. 22, 23, 38 AND 50).

FIRST USE 2-14-2000; IN COMMERCE 2-14-2000.

CLASS 28—(Continued).

2,625,834. BOYDS COLLECTION, LTD, THE, MCSHERRYS-TOWN, PA. SN 75-926,059. PUB. 3-6-2001, FILED 2-23-2000.

IMAGINEBEARY

FOR STUFFED TOYS (U.S. CLS. 22, 23, 38 AND 50).
FIRST USE 2-10-2000; IN COMMERCE 2-10-2000.

2,625,914. ZULA, LTD., COLUMBUS, OH. SN 76-008,585. PUB. 12-11-2001, FILED 3-23-2000.

GORGA

FOR STUFFED TOYS (U.S. CLS. 22, 23, 38 AND 50).
FIRST USE 8-7-1998; IN COMMERCE 8-7-1998.

2,625,951. 21ST CENTURY TOYS, INC., ALAMEDA, CA. SN 76-031,540. PUB. 11-6-2001, FILED 4-24-2000.



OWNER OF U.S. REG. NO. 2,192,266.
NO CLAIM IS MADE TO THE EXCLUSIVE RIGHT TO USE "SOLDIER", "VIETNAM" AND "1961-1973", APART FROM THE MARK AS SHOWN.

THE MARK CONSISTS OF A ROUND INSIGNIA WITH A ROPE-LIKE OUTER CIRCUMFERENCE CONTAINING THE WORDS "1961-1973" WITH LEAF CLUSTERS AROUND THE SIDE AND STARS AT THE BOTTOM, AND THE WORDS "THE ULTIMATE SOLDIER" AND "VIETNAM" HORIZONTALLY PLACED IN THE CENTER FIELD, WITH A COMBAT STYLE RIBBON BENEATH SUCH WORDS.

FOR TOYS, NAMELY ACTION FIGURES AND ACCESSORIES AND PLAYSETS FOR ACTION FIGURES (U.S. CLS. 22, 23, 38 AND 50).
FIRST USE 9-8-2000; IN COMMERCE 9-8-2000.

CLASS 28—(Continued).

2,626,035. LEMOND, GREG, BLOOMINGTON, MN. SN 76-070,829. PUB. 3-13-2001, FILED 6-14-2000.

REVMASTER

FOR EXERCISE MACHINES, PARTS AND FITTINGS FOR EXERCISE MACHINES, EXERCISE GLOVES FOR WEAR WHEN USING EXERCISE MACHINES, AND EXERCISE WEIGHT TRAINING GLOVES (U.S. CLS. 22, 23, 38 AND 50).
FIRST USE 3-0-2000; IN COMMERCE 3-0-2000.

2,626,051. ARDENT, INC., LENEXA, KS. SN 76-077,914. PUB. 4-10-2001, FILED 6-27-2000.

Ardent
 The word "Ardent" is written in a bold, italicized serif font. To the right of the text is a stylized five-pointed star with a horizontal bar across its top points.

FOR SPORTS FISHING EQUIPMENT, NAMELY FISHING REELS (U.S. CLS. 22, 23, 38 AND 50).
FIRST USE 7-1-2000; IN COMMERCE 7-1-2000.

2,626,072. PLAYBOY ENTERPRISES INTERNATIONAL, INC., CHICAGO, IL. SN 76-088,316. PUB. 6-5-2001, FILED 7-11-2000.

PLAYBOY

FOR CHRISTMAS TREE ORNAMENTS (U.S. CLS. 22, 23, 38 AND 50).
FIRST USE 2-8-2001; IN COMMERCE 2-8-2001.

2,626,090. BRIO CORPORATION, GERMANTOWN, WI. SN 76-096,909. PUB. 10-9-2001, FILED 7-26-2000.

TRUMPY

FOR TOY FIGURE, NAMELY A SOFT SCULPTURE TOY ELEPHANT (U.S. CLS. 22, 23, 38 AND 50).
FIRST USE 1-31-2001; IN COMMERCE 1-31-2001.

CLASS 28—(Continued).

2,626,133. PLAYBOY ENTERPRISES INTERNATIONAL, INC., CHICAGO, IL. SN 76-118,862. PUB. 5-29-2001, FILED 8-29-2000.



FOR CHRISTMAS TREE ORNAMENTS (U.S. CLS. 22, 23, 38 AND 50).
FIRST USE 2-8-2001; IN COMMERCE 2-8-2001.

2,626,150. WILD PLANET TOYS, INC., SAN FRANCISCO, CA. SN 76-123,988. PUB. 9-4-2001, FILED 9-7-2000.

SCATTERFISH

FOR GAMES, NAMELY AN ACTION SKILL GAME FOR USE IN WATER (U.S. CLS. 22, 23, 38 AND 50).
FIRST USE 11-30-2000; IN COMMERCE 11-30-2000.

2,626,152. THINKING TECHNOLOGY INC., NASSAU, BAHAMAS. SN 76-125,221. PUB. 9-11-2001, FILED 9-8-2000.

AVA

FOR DOLLS, DOLL CLOTHING, DOLL ACCESSORIES AND DOLL ACTIVITY CENTERS (U.S. CLS. 22, 23, 38 AND 50).
FIRST USE 4-5-2001; IN COMMERCE 4-5-2001.

2,626,211. ANAYA, MICHELLE, MANHATTAN BEACH, CA. SN 76-148,249. PUB. 9-18-2001, FILED 10-17-2000.

TV ALLOWANCE GAME

NO CLAIM IS MADE TO THE EXCLUSIVE RIGHT TO USE "TV" AND "GAME", APART FROM THE MARK AS SHOWN.

FOR GAME CONSISTING OF TV WATCHING TICKETS, TICKET WALLET, LAMINATED GAME RULES AND AGREEMENT SHEET FOR MODIFYING THE AMOUNT OF TELEVISION AND VIDEO WATCHED BY CHILDREN (U.S. CLS. 22, 23, 38 AND 50).
FIRST USE 2-15-2001; IN COMMERCE 4-6-2001.

CLASS 28—(Continued).

2,626,270. AKEYER TEC. CORP., MONTEREY PARK, CA. SN 76-167,725. PUB. 8-28-2001, FILED 11-16-2000.



AKEYER AND DESIGN, IN WHICH THE STYLIZED WORD MARK "AKEYER" IS HORIZONTALLY DISPOSED UNDER TWO GEOMETRIC DESIGN CONSISTING OF A TRIANGLE POSITIONED ON TOP OF A TRAPEZOID AND A V-SHAPE ARROW POINTING TOWARDS THE TRIANGLE AND THE TRAPEZOID.

FOR SPORTS EQUIPMENT, NAMELY, BASEBALL GLOVES, BASEBALL BATS, AND BASEBALLS, BASEBALL MASKS, BASEBALL MITTS, BASEBALL BASES, GLOVES FOR BASEBALL BATTING, BASEBALL BASES, AND CHEST PROTECTORS FOR BASEBALL (U.S. CLS. 22, 23, 38 AND 50).
FIRST USE 10-17-2000; IN COMMERCE 2-1-2001.

2,626,277. STAR BLUE STUDIO, INC., NEW YORK, NY. SN 76-169,864. PUB. 7-24-2001, FILED 11-23-2000.

ULTIMATELY MADRA

FOR DOLLS, DOLL CLOTHING AND DOLL ACCESSORIES (U.S. CLS. 22, 23, 38 AND 50).
FIRST USE 5-8-2001; IN COMMERCE 5-8-2001.

2,626,289. HIGH SPEED METAL & PLASTIC PRODUCTS MFG. CO., LTD., TUEN MUN, N.T., HONG KONG. SN 76-174,105. PUB. 9-11-2001, FILED 12-1-2000.

HIGH SPEED

FOR TOYS AND PLAYTHINGS; NAMELY TOY VEHICLES, TOY TRAINS AND TOY AIRCRAFT (U.S. CLS. 22, 23, 38 AND 50).
FIRST USE 1-0-2001; IN COMMERCE 1-0-2001.

CLASS 28—(Continued).

2,626,302. UNIMAX TOYS LIMITED, KOWLOON, HONG KONG. SN 76-180,426. PUB. 10-23-2001, FILED 12-13-2000.

PANACHE PALS BOUTIQUE COLLECTION

NO CLAIM IS MADE TO THE EXCLUSIVE RIGHT TO USE "BOUTIQUE COLLECTION", APART FROM THE MARK AS SHOWN.
FOR DOLL CLOTHING AND DOLL ACCESSORIES (U.S. CLS. 22, 23, 38 AND 50).
FIRST USE 6-5-2001; IN COMMERCE 6-5-2001.

2,626,308. SKIS DYNASTAR, INC., COLCHESTER, VT. SN 76-182,393. PUB. 8-21-2001, FILED 12-18-2000.

INTUITIV

FOR ALPINE SKIS, ALPINE SKI BINDINGS, SNOW BOARDS AND SNOWBOARD BINDINGS (U.S. CLS. 22, 23, 38 AND 50).
FIRST USE 11-7-2000; IN COMMERCE 12-20-2000.

2,626,368. THOSE CHARACTERS FROM CLEVELAND, INC., CLEVELAND, OH. SN 76-209,013. PUB. 12-18-2001, FILED 2-13-2001.

PIXIE-DOODLE POPPLE

OWNER OF U.S. REG. NOS. 1,386,032, 1,430,199, AND 1,440,047.
FOR TOY FIGURES (U.S. CLS. 22, 23, 38 AND 50).
FIRST USE 7-0-2001; IN COMMERCE 7-0-2001.

2,626,369. THOSE CHARACTERS FROM CLEVELAND, INC., CLEVELAND, OH. SN 76-209,015. PUB. 12-18-2001, FILED 2-13-2001.

PITTER-PATTY POPPLE

OWNER OF U.S. REG. NOS. 1,386,032, 1,430,199, AND 1,440,047.
FOR TOY FIGURES (U.S. CLS. 22, 23, 38 AND 50).
FIRST USE 7-0-2001; IN COMMERCE 7-0-2001.

CLASS 28—(Continued).

2,626,370. THOSE CHARACTERS FROM CLEVELAND, INC., CLEVELAND, OH. SN 76-209,016. PUB. 12-18-2001, FILED 2-13-2001.

STRAWBERRY-SHAKE POPPLE

OWNER OF U.S. REG. NOS. 1,386,032, 1,430,199, AND 1,440,047.
FOR TOY FIGURES (U.S. CLS. 22, 23, 38 AND 50).
FIRST USE 6-0-2001; IN COMMERCE 6-0-2001.

2,626,371. THOSE CHARACTERS FROM CLEVELAND, INC., CLEVELAND, OH. SN 76-209,022. PUB. 12-18-2001, FILED 2-13-2001.

PIZZAZZY-JAZZY POPPLE

OWNER OF U.S. REG. NOS. 1,386,032, 1,430,199, AND 1,440,047.
FOR TOY FIGURES (U.S. CLS. 22, 23, 38 AND 50).
FIRST USE 7-0-2001; IN COMMERCE 7-0-2001.

2,626,379. OPTIMUM PERFORMANCE GOLF, INC., CLARKSTON, MI. SN 76-211,162. PUB. 8-14-2001, FILED 2-16-2001.

B'CONFIDENT

FOR GOLF CLUBS (U.S. CLS. 22, 23, 38 AND 50).
FIRST USE 1-31-2001; IN COMMERCE 1-31-2001.

2,626,388. CORGI CLASSICS LIMITED., MERIDIAN BUSINESS PARK LEICESTER LE3 2RL, ENGLAND. SN 76-213,565. PUB. 8-14-2001, FILED 2-21-2001.

FORGOTTEN HEROES

FOR TOY VEHICLES (U.S. CLS. 22, 23, 38 AND 50).
FIRST USE 11-1-2001; IN COMMERCE 2-1-2002.

2,626,444. HASBRO, INC., PAWTUCKET, RI. SN 76-232,057. PUB. 9-4-2001, FILED 3-29-2001.

SIDEBURN

FOR TOY ACTION FIGURES AND ACCESSORIES (U.S. CLS. 22, 23, 38 AND 50).
FIRST USE 6-4-2001; IN COMMERCE 6-4-2001.

CLASS 28—(Continued).

2,626,460. BAYOU FITNESS PRODUCTS, L.L.C., SHREVEPORT, LA. SN 76-237,774. PUB. 9-18-2001, FILED 4-9-2001.

PULSELINE

FOR HEALTH AND EXERCISE EQUIPMENT, NAMELY, STATIONARY BIKES (U.S. CLS. 22, 23, 38 AND 50).

FIRST USE 4-1-2001; IN COMMERCE 5-31-2002.

2,626,461. BAYOU FITNESS PRODUCTS, L.L.C., SHREVEPORT, LA. SN 76-237,825. PUB. 11-20-2001, FILED 4-9-2001.

BAYOU FITNESS PRODUCTS

NO CLAIM IS MADE TO THE EXCLUSIVE RIGHT TO USE "FITNESS PRODUCTS", APART FROM THE MARK AS SHOWN.

FOR HEALTH AND EXERCISE EQUIPMENT, NAMELY, TREADMILLS STATIONARY BIKES AND WEIGHT LIFTING BENCHES (U.S. CLS. 22, 23, 38 AND 50).

FIRST USE 4-9-2001; IN COMMERCE 7-31-2001.

2,626,489. LEXINGTON PROFESSIONAL BASEBALL COMPANY, LLC, LEXINGTON, KY. SN 76-257,385. PUB. 9-11-2001, FILED 5-16-2001.

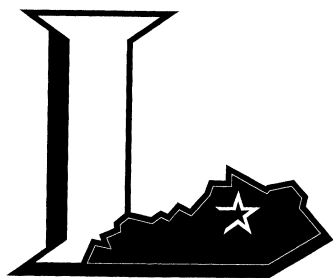

THE MARK CONSISTS OF THE LETTER "L" AND A REPRESENTATION OF THE COMMONWEALTH OF KENTUCKY.

FOR BASEBALLS, BASEBALL BATS, STUFFED TOYS, BENDABLE TOY FIGURINES, BATTING TEES, BASEBALL BASES, BEAN BAGS, YO-YO'S, CHRISTMAS TREE ORNAMENTS, TOY FIGURES, BOARD GAMES, AND CARD GAMES (U.S. CLS. 22, 23, 38 AND 50).

FIRST USE 8-3-2000; IN COMMERCE 8-3-2000.

2,626,543. K-2 CORPORATION, VASHON, WA. SN 76-299,496. PUB. 1-15-2002, FILED 8-13-2001.

SMX

FOR BICYCLE WITH SKI RUNNERS FOR GLIDING OVER SNOW (U.S. CLS. 22, 23, 38 AND 50).

FIRST USE 3-22-2002; IN COMMERCE 3-22-2002.

CLASS 28—(Continued).

2,626,548. UNIMAX TOYS LIMITED, TSIM SHA TSUI, KOWLOON, HONG KONG. SN 76-302,361. PUB. 2-12-2002, FILED 8-20-2001.

DOUGH KIDZ

NO CLAIM IS MADE TO THE EXCLUSIVE RIGHT TO USE "KIDS", APART FROM THE MARK AS SHOWN.

FOR DOLLS AND DOLL ACCESSORIES (U.S. CLS. 22, 23, 38 AND 50).

FIRST USE 1-15-2002; IN COMMERCE 1-15-2002.

2,626,550. SPORTS SOURCE, INC., TORRANCE, CA. SN 76-305,156. PUB. 2-5-2002, FILED 8-27-2001.

SSI SPORTS PRODUCTS

NO CLAIM IS MADE TO THE EXCLUSIVE RIGHT TO USE "SPORTS PRODUCTS", APART FROM THE MARK AS SHOWN.

FOR SPORTING GOODS, NAMELY, BASKETBALLS, BASEBALLS, FOOTBALLS, SOCCER BALLS, TENNIS BALLS, AND VOLLEY BALLS (U.S. CLS. 22, 23, 38 AND 50).

FIRST USE 8-1-2001; IN COMMERCE 10-1-2001.

2,626,574. MATTEL, INC., EL SEGUNDO, CA. SN 78-011,491. PUB. 9-18-2001, FILED 6-6-2000.

ROCK-A-ROO DAYCARE

FOR DOLL PLAYSETS FEATURING DOLLS, TOY ANIMALS AND ACCESSORIES FOR BOTH (U.S. CLS. 22, 23, 38 AND 50).

FIRST USE 2-10-2001; IN COMMERCE 2-10-2001.

2,626,575. MATTEL, INC., EL SEGUNDO, CA. SN 78-011,507. PUB. 9-11-2001, FILED 6-6-2000.

TYPHOON RESCUE

OWNER OF U.S. REG. NO. 1,637,681.

FOR TOY ACTION FIGURES AND ACCESSORIES THEREFOR (U.S. CLS. 22, 23, 38 AND 50).

FIRST USE 1-15-2001; IN COMMERCE 1-15-2001.

2,626,589. RACING CHAMPIONS ERTL, INC., DYERSVILLE, IA. SN 78-018,720. PUB. 5-22-2001, FILED 7-27-2000.

TRICK SHIFTERS

FOR MINIATURE UNPOWERED TOY VEHICLES (U.S. CLS. 22, 23, 38 AND 50).

FIRST USE 11-21-2000; IN COMMERCE 11-21-2000.

CLASS 28—(Continued).

2,626,591. MATTEL, INC., EL SEGUNDO, CA. SN 78-021,051.
 PUB. 7-31-2001, FILED 8-14-2000.

ACCESSORY BONANZA

NO CLAIM IS MADE TO THE EXCLUSIVE RIGHT TO USE "ACCESSORY", APART FROM THE MARK AS SHOWN.

FOR DOLL CLOTHING AND DOLL ACCESSORIES (U.S. CLS. 22, 23, 38 AND 50).
 FIRST USE 10-18-2000; IN COMMERCE 10-18-2000.



2,626,615. CALLAWAY GOLF COMPANY, CARLSBAD, CA.
 SN 78-031,295. PUB. 9-25-2001, FILED 10-18-2000.

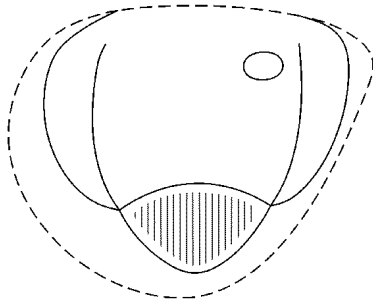

THE MARK CONSISTS OF FOUR FACETS CLAIMING THE COLOR RED IN THE TRIANGULAR FACET OF THE GOLF CLUB HEAD. THE DRAWING DISPLAYS THE MARK AS VIEWED FROM THE BOTTOM OF THE CLUB HEAD. THE DOTTED LINES ARE USED TO SHOW THE MARK'S POSITION ON THE GOODS AND ARE NOT CLAIMED AS A FEATURE OF THE MARK.

SEC. 2(F).
 FOR GOLF CLUBS (U.S. CLS. 22, 23, 38 AND 50).
 FIRST USE 10-1-2000; IN COMMERCE 10-1-2000.



2,626,646. MATTEL, INC., EL SEGUNDO, CA. SN 78-041,547.
 PUB. 8-21-2001, FILED 1-3-2001.

JAM 'N GLAM

FOR DOLLS, DOLL CLOTHING AND DOLL ACCESSORIES (U.S. CLS. 22, 23, 38 AND 50).
 FIRST USE 4-30-2001; IN COMMERCE 4-30-0201.

CLASS 28—(Continued).

2,626,647. MATTEL, INC., EL SEGUNDO, CA. SN 78-041,555.
 PUB. 8-21-2001, FILED 1-3-2001.

SKIING VACATION

OWNER OF U.S. REG. NOS. 1,743,982 AND 2,334,743.
 NO CLAIM IS MADE TO THE EXCLUSIVE RIGHT TO USE "SKIING", APART FROM THE MARK AS SHOWN.
 FOR DOLLS, DOLL CLOTHING AND DOLL ACCESSORIES (U.S. CLS. 22, 23, 38 AND 50).
 FIRST USE 6-18-2001; IN COMMERCE 6-18-2001.

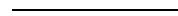

2,626,648. MATTEL, INC., EL SEGUNDO, CA. SN 78-041,557.
 PUB. 8-21-2001, FILED 1-3-2001.

STAR-STUDED WEDDING

OWNER OF U.S. REG. NOS. 1,236,555, 1,632,763, AND 2,005,146.
 NO CLAIM IS MADE TO THE EXCLUSIVE RIGHT TO USE "WEDDING", APART FROM THE MARK AS SHOWN.
 FOR DOLL CLOTHING AND DOLL ACCESSORIES (U.S. CLS. 22, 23, 38 AND 50).
 FIRST USE 12-1-2000; IN COMMERCE 12-1-2000.



2,626,649. MATTEL, INC., EL SEGUNDO, CA. SN 78-041,568.
 PUB. 8-7-2001, FILED 1-3-2001.

TURQUOISE TRENDS

NO CLAIM IS MADE TO THE EXCLUSIVE RIGHT TO USE "TURQUOISE", APART FROM THE MARK AS SHOWN.
 FOR DOLL CLOTHING AND DOLL ACCESSORIES (U.S. CLS. 22, 23, 38 AND 50).
 FIRST USE 12-1-2000; IN COMMERCE 12-1-2000.



2,626,650. MATTEL, INC., EL SEGUNDO, CA. SN 78-041,578.
 PUB. 8-7-2001, FILED 1-3-2001.

PAPPARAZZI PIZZAZ

FOR DOLL CLOTHING AND DOLL ACCESSORIES (U.S. CLS. 22, 23, 38 AND 50).
 FIRST USE 12-1-2000; IN COMMERCE 12-1-2000.



2,626,651. MATTEL, INC., EL SEGUNDO, CA. SN 78-041,582.
 PUB. 8-7-2001, FILED 1-3-2001.

METRO

FOR DOLL CLOTHING AND DOLL ACCESSORIES (U.S. CLS. 22, 23, 38 AND 50).
 FIRST USE 12-1-2000; IN COMMERCE 12-1-2000.

CLASS 28—(Continued).

2,626,652. MATTEL, INC., EL SEGUNDO, CA. SN 78-041,594.
PUB. 8-7-2001, FILED 1-3-2001.

HOMECOMING COURT

OWNER OF U.S. REG. NOS. 2,171,944 AND 2,304,505.
FOR DOLL CLOTHING AND DOLL ACCESSORIES
(U.S. CLS. 22, 23, 38 AND 50).
FIRST USE 12-1-2000; IN COMMERCE 12-1-2000.

2,626,665. CRAFT HOUSE CORPORATION, TOLEDO, OH.
SN 78-044,368. PUB. 10-2-2001, FILED 1-22-2001.

COOL CANDY

NO CLAIM IS MADE TO THE EXCLUSIVE RIGHT TO
USE "CANDY", APART FROM THE MARK AS SHOWN.
FOR CRAFT ACTIVITY KITS FOR MAKING CANDY
(U.S. CLS. 22, 23, 38 AND 50).
FIRST USE 0-0-2001; IN COMMERCE 0-0-2001.

2,626,672. CALLAWAY GOLF COMPANY, CARLSBAD, CA.
SN 78-046,120. PUB. 9-25-2001, FILED 2-1-2001.

ERC II

FOR GOLF CLUBS, BAGS AND HEAD COVERS (U.S.
CLS. 22, 23, 38 AND 50).
FIRST USE 10-1-2000; IN COMMERCE 12-1-2000.

2,626,727. CRANIUM INC., SEATTLE, WA. SN 78-066,943.
PUB. 12-4-2001, FILED 6-1-2001.

CADOO

FOR BOARD GAMES; EQUIPMENT SOLD AS A UNIT
FOR PLAYING A BOARD GAME; QUESTION SETS FOR
BOARD GAME; TOYS, NAMELY, MODELING COM-
POUNDS; MODELING COMPOUNDS AS A UNIT WITH
A BOARD GAME; CARD GAMES; EQUIPMENT SOLD
AS A UNIT FOR PLAYING CARD GAMES (U.S. CLS. 22,
23, 38 AND 50).
FIRST USE 9-1-2001; IN COMMERCE 9-1-2001.

2,626,752. PANLINE USA, INC., NORTHVALE, NJ. SN 78-
086,088. PUB. 2-26-2002, FILED 9-28-2001.

HOORAY USA!

NO CLAIM IS MADE TO THE EXCLUSIVE RIGHT TO
USE "USA", APART FROM THE MARK AS SHOWN.
FOR HOBBY CRAFT KITS COMPRISING PATCHES,
PINS, JEWELRY AND BODY ART JEWELRY FOR
CHILDREN TO CREATE USA-THEMED FASHION
ITEMS (U.S. CLS. 22, 23, 38 AND 50).
FIRST USE 12-30-2000; IN COMMERCE 12-31-2001.

CLASS 29—MEATS AND PROCESSED FOODS

2,625,332. RALEY'S, WEST SACRAMENTO, CA. SN 75-
273,239. PUB. 5-2-2000, FILED 4-11-1997.



NO CLAIM IS MADE TO THE EXCLUSIVE RIGHT TO
USE "DINNER", APART FROM THE MARK AS SHOWN.
FOR PREPARED FOODS CONSISTING PRIMARILY
OF MEAT, FISH, POULTRY OR VEGETABLES (U.S. CL.
46).
FIRST USE 4-15-1996; IN COMMERCE 4-15-1996.

2,625,548. NORTH COAST SEA-FOODS, INC., BOSTON, MA.
SN 75-736,183. PUB. 6-6-2000, FILED 6-21-1999.

**VERMONT SPECIALITY
BUTTERS**

NO CLAIM IS MADE TO THE EXCLUSIVE RIGHT TO
USE "VERMONT" AND "BUTTERS", APART FROM THE
MARK AS SHOWN.
FOR DAIRY PRODUCTS EXCLUDING ICE CREAM,
ICE MILK AND FROZEN YOGURT (U.S. CL. 46).
FIRST USE 1-9-2001; IN COMMERCE 1-9-2001.

2,625,603. DEL MONTE FRESH PRODUCE INTERNA-
TIONAL, INC., MONTE CARLO 98000, MONACO. SN 75-
787,493. PUB. 9-11-2001, FILED 8-30-1999.



FOR FRUIT CONCENTRATES, NAMELY, FRUIT
PRESERVES, FRUIT PUREES, DRIED FRUIT AND
FROZEN PINEAPPLE (U.S. CL. 46).
FIRST USE 5-0-1995; IN COMMERCE 5-0-1995.

CLASS 29—(Continued).

2,625,614. HEB GROCERY COMPANY, LP, SAN ANTONIO, TX. BY ASSIGNMENT H. E. BUTT GROCERY COMPANY, SAN ANTONIO, TX. SN 75-799,894. PUB. 5-22-2001, FILED 9-15-1999.

GOOD TO GO H-E-B

OWNER OF U.S. REG. NOS. 965,785, 1,358,470, AND OTHERS.

FOR PREPARED READY-TO-EAT AND READY-TO-COOK MEALS CONSISTING PRIMARILY OF MEAT, FISH, POULTRY OR VEGETABLES SOLD EXCLUSIVELY THROUGH RETAIL SUPERMARKETS AND SPECIFICALLY EXCLUDING RESTAURANT SERVICES AND FOODS SOLD THROUGH RESTAURANTS (U.S. CL. 46).

FIRST USE 11-0-1999; IN COMMERCE 11-0-1999.

2,625,626. ORLANDO FOOD SALES INC., MAYWOOD, NJ. SN 75-806,139. PUB. 1-9-2001, FILED 9-22-1999.

SOLARIA

FOR PROCESSED FRUITS AND VEGETABLES, PREPARED TOMATOES AND PREPARED ENTREES CONSISTING PRIMARILY OF MEAT, FISH, POULTRY OR VEGETABLES (U.S. CL. 46).

FIRST USE 7-0-2001; IN COMMERCE 7-0-2001.

2,625,701. ZADI FOODS LIMITED, BRAMPTON, ONTARIO, CANADA. SN 75-853,794. PUB. 7-24-2001, FILED 11-22-1999.



PRIORITY CLAIMED UNDER SEC. 44(D) ON CANADA APPLICATION NO. 1032811, FILED 10-14-1999.

NO CLAIM IS MADE TO THE EXCLUSIVE RIGHT TO USE "ITALIA", APART FROM THE MARK AS SHOWN.

THE ENGLISH TRANSLATION OF "CASA ITALIA IL SAPORE DELLA TRADIZIONE" IS "ITALIAN HOUSE, TASTE THE TRADITION".

FOR MEATS, NAMELY, MORTADELLA, COOKED HAMS, COOKED ROASTS, SALAMI, CAPICOLLO, PROSCIUTTO, SAUSAGE, AND ROASTED HAMS (U.S. CL. 46).

FIRST USE 5-15-2002; IN COMMERCE 5-15-2002.

CLASS 29—(Continued).

2,625,777. MIRAGE FINE FOODS, INC., TORRANCE, CA. SN 75-902,042. PUB. 9-11-2001, FILED 1-24-2000.

SoyMaid

FOR SOY BASED DAIRY-FREE PRODUCTS, NAMELY, DAIRY-FREE CHEESE, DAIRY-FREE CREAM CHEESE, DAIRY-FREE BUTTER, DAIRY-FREE MILK, DAIRY-FREE YOGURT, DAIRY-FREE SOUR CREAM, DAIRY-FREE CHEESE SPREADS, DAIRY-FREE DIPS EXCLUDING SALSA AND OTHER SAUCES USED AS DIPS, AND DAIRY-AND-SOY-BLEND MILK (U.S. CL. 46).

FIRST USE 5-31-2002; IN COMMERCE 5-31-2002.

2,625,846. HEB GROCERY COMPANY, LP, SAN ANTONIO, TX. BY ASSIGNMENT H. E. BUTT GROCERY COMPANY, SAN ANTONIO, TX. SN 75-928,791. PUB. 10-31-2000, FILED 2-25-2000.

BORN TO EAT MEAT

FOR PREPARED, READY-TO-SERVE MEATS (U.S. CL. 46).

FIRST USE 2-0-2000; IN COMMERCE 2-0-2000.

2,625,868. J & B WHOLESALE DISTRIBUTING, INC., ST. MICHAEL, MN. SN 75-942,987. PUB. 11-6-2001, FILED 3-13-2000.

CHEF ANDY'S

THE NAME SHOWN IN THE MARK DOES NOT IDENTIFY A LIVING INDIVIDUAL.

FOR MEAT (U.S. CL. 46).

FIRST USE 5-12-2000; IN COMMERCE 5-12-2000.

2,625,906. CONOPCO, INC., NEW YORK, NY. SN 76-004,038. PUB. 12-19-2000, FILED 3-17-2000.

CENTRNAL

OWNER OF U.S. REG. NO. 1,557,027.

FOR NON-LAURIC VEGETABLE OIL (U.S. CL. 46).

FIRST USE 3-0-2001; IN COMMERCE 3-0-2001.

CLASS 29—(Continued).

2,625,913. GREEN OPTIONS, INC., SAN FRANCISCO, CA. SN 76-008,435. PUB. 8-21-2001, FILED 3-23-2000.



FOR FORMED TEXTURED VEGETABLE PROTEIN FOR USE AS A MEAT SUBSTITUTE (U.S. CL. 46). FIRST USE 4-0-2000; IN COMMERCE 4-0-2000.

2,626,024. C.K.F. FOODS, INC., MT. PROSPECT, IL. SN 76-064,455. PUB. 2-19-2002, FILED 6-7-2000.

AUNT BESSIE'S

OWNER OF U.S. REG. NO. 2,051,556. FOR SAUSAGES, HAMBURGER MEAT, PORK RIBS AND PORK CHITTERLINGS (U.S. CL. 46). FIRST USE 8-3-1996; IN COMMERCE 8-3-1996.

2,626,034. BC-USA, INC., NEW HOLLAND, PA. SN 76-069,425. PUB. 12-4-2001, FILED 6-12-2000.

ALOUETTE CREME FRAICHE

OWNER OF U.S. REG. NOS. 1,239,584, 1,668,637, AND 1,936,939.

NO CLAIM IS MADE TO THE EXCLUSIVE RIGHT TO USE "CREME FRAICHE", APART FROM THE MARK AS SHOWN.

THE ENGLISH TRANSLATION OF "ALOUETTE" AND "CREME FRAICHE" IS "LARK" AND "FRESH CREAM", RESPECTIVELY.

FOR REFRIGERATED DAIRY PRODUCTS FOR COOKING AND FOOD PREPARATION, NAMELY COOKING AND TOPPING CREAM (U.S. CL. 46). FIRST USE 6-8-2000; IN COMMERCE 6-8-2000.

CLASS 29—(Continued).

2,626,142. SOCIETE DES PRODUITS NESTLE S.A., 1800 VEVEY, SWITZERLAND. SN 76-121,220. PUB. 7-17-2001, FILED 9-5-2000.

MAKE DINNER AS SUCCESSFUL AS THE REST OF YOUR DAY

FOR PREPARED ENTREES CONSISTING PRIMARILY OF MEAT, FISH OR POULTRY (U.S. CL. 46). FIRST USE 7-1-2000; IN COMMERCE 7-1-2000.

2,626,393. HACKNEY'S ON LAKE, INC., GLENVIEW, IL. SN 76-214,953. PUB. 10-30-2001, FILED 2-23-2001.

HACKNEY'S ORIGINAL FRENCH FRIED ONIONS

OWNER OF U.S. REG. NOS. 1,212,784, 2,318,900, AND OTHERS.

NO CLAIM IS MADE TO THE EXCLUSIVE RIGHT TO USE "ORIGINAL FRENCH FRIED ONIONS", APART FROM THE MARK AS SHOWN.

FOR FRENCH FRIED ONIONS (U.S. CL. 46). FIRST USE 1-1-1973; IN COMMERCE 1-1-1973.

2,626,511. BLACKWOOD INDUSTRIES, INC., BENTONVILLE, AR. SN 76-272,355. PUB. 12-18-2001, FILED 6-13-2001.

PAPA GUIDO'S

FOR PREPARED FOODS, NAMELY, FROZEN MEAT-BALLS (U.S. CL. 46). FIRST USE 10-19-2001; IN COMMERCE 10-19-2001.

2,626,513. TECUMSEH POULTRY LLC, OMAHA, NE. SN 76-275,212. PUB. 1-15-2002, FILED 6-21-2001.

QUICK CHICK

NO CLAIM IS MADE TO THE EXCLUSIVE RIGHT TO USE "CHICK", APART FROM THE MARK AS SHOWN.

FOR POULTRY (U.S. CL. 46). FIRST USE 10-1-2001; IN COMMERCE 10-1-2001.

CLASS 29—(Continued).

2,626,607. KRAFT FOODS HOLDINGS, INC, NORTHFIELD, IL, BY MERGER NABISCO BRANDS COMPANY, WILMINGTON, DE. SN 78-027,582. PUB. 10-2-2001, FILED 9-25-2000.

DIZZY DINOS

FOR FRUIT-BASED SNACK FOODS (U.S. CL. 46).
FIRST USE 2-25-2001; IN COMMERCE 2-25-2001.

2,626,609. CHANG INTERNATIONAL, INC., SEATTLE, WA.
SN 78-028,996. PUB. 8-7-2001, FILED 10-4-2000.

OCEAN GALA

FOR SEAFOOD (U.S. CL. 46).
FIRST USE 10-10-2000; IN COMMERCE 10-10-2000.

2,626,655. KRAFT FOODS HOLDINGS, INC, NORTHFIELD, IL, BY MERGER; BY MERGER NABISCO BRANDS COMPANY, WILMINGTON, DE. SN 78-042,211. PUB. 8-28-2001, FILED 1-8-2001.

VALENTINE PALS

FOR FRUIT-BASED SNACK FOODS (U.S. CL. 46).
FIRST USE 10-30-2001; IN COMMERCE 10-30-2001.

CLASS 30—STAPLE FOODS

2,625,336. PLAIA, GERALDINE O'KEEFE, SPRING LAKE HEIGHTS, NJ. SN 75-287,487. PUB. 4-21-1998, FILED 5-6-1997.

AQUA SMART

FOR HERBAL FOOD BEVERAGES (U.S. CL. 46).
FIRST USE 6-30-1996; IN COMMERCE 2-8-1999.

2,625,390. CHIPWICH, INC., RIDGEWOOD, NJ. SN 75-458,671. PUB. 10-27-1998, FILED 3-30-1998.

DOUBLE DUTCH

OWNER OF U.S. REG. NO. 1,354,515.
FOR ICE CREAM (U.S. CL. 46).
FIRST USE 1-15-2002; IN COMMERCE 1-15-2002.

CLASS 30—(Continued).

2,625,405. SHOPKO STORES, INC., GREEN BAY, WI. SN 75-507,693. PUB. 1-25-2000, FILED 6-22-1998.



OWNER OF U.S. REG. NO. 2,116,330.
NO CLAIM IS MADE TO THE EXCLUSIVE RIGHT TO USE "SUPREME", APART FROM THE MARK AS SHOWN, FOR CONFECTIONERY, NAMELY BAGGED CANDY AND SEASONAL CANDY; TORTILLA CHIPS, CORN CURLS, BAGGED SNACKS, NAMELY PRETZELS, CHEESE FLAVORED CEREAL BASED CURLS, PROCESSED POPCORN, AND GLAZED POPCORN (U.S. CL. 46).

FIRST USE 5-25-2001; IN COMMERCE 5-25-2001.

2,625,428. LUIGINO'S, INC., DULUTH, MN. SN 75-561,819.
PUB. 8-31-1999, FILED 9-30-1998.

MICHELINA'S PIZZA SINGLES

OWNER OF U.S. REG. NO. 1,712,572.
NO CLAIM IS MADE TO THE EXCLUSIVE RIGHT TO USE "PIZZA SINGLES", APART FROM THE MARK AS SHOWN.

FOR FROZEN, MICROWAVABLE, INDIVIDUAL SERVING-SIZED PIZZAS WITH A VARIETY OF TOPPINGS, NAMELY, TOMATO SAUCE, CHEESE, SPICES, MEATS, AND VEGETABLES (U.S. CL. 46).

FIRST USE 10-19-1998; IN COMMERCE 11-19-1998.

2,625,439. BETTER BAKED FOODS, INC., NORTH EAST, PA.
SN 75-585,942. PUB. 6-8-1999, FILED 11-6-1998.

GRAB-A-SNACK

FOR PIZZA AND BAKERY GOODS (U.S. CL. 46).
FIRST USE 5-15-2002; IN COMMERCE 5-15-2002.

CLASS 30—(Continued).

2,625,490. VAN MELLE NEDERLAND B.V., 4815 HK BREDA, NETHERLANDS. SN 75-663,815. PUB. 7-31-2001, FILED 3-19-1999.

RAZZ MA TAZZ

FOR COCOA, COCOA MIXES; CHOCOLATE, CHOCOLATE POWDER, CHOCOLATE SYRUP, CHOCOLATE CHIPS, CHOCOLATE BASED FILLINGS FOR CAKES AND PIES, CHOCOLATE TOPPING; CHOCOLATE FOOD BEVERAGES NOT BEING DAIRY BASED OR VEGETABLE BASED; PASTRIES; FROZEN CONFECTIONS; CONFECTIONERY CHIPS FOR BAKING; CARAMEL AND CARAMEL POPCORN; PEPPERMINT CANDY CHIPS FOR BAKING, PEPPERMINT CANDY, CANDY, LIQUORICE; ICE; CEREAL BASED SNACK FOOD, RICE BASED SNACK FOOD, GRANOLA BASED SNACK BARS, AND WHEAT BASED SNACK FOODS (U.S. CL. 46).

FIRST USE 0-0-1999; IN COMMERCE 0-0-1999.

2,625,633. MOJO'S FAMOUS BARBECUE, L.L.C., CATOOSA, OK. SN 75-814,977. PUB. 7-4-2000, FILED 10-5-1999.

GET YOUR MOJO WORKIN'

FOR BARBECUE SAUCE (U.S. CL. 46).
FIRST USE 1-0-2000; IN COMMERCE 1-0-2000.

2,625,638. BEVERAGE MARKETING USA, INC., LARCHMONT, NY. SN 75-819,194. PUB. 2-27-2001, FILED 10-11-1999.

RXSTRESS

FOR HERBAL FOOD BEVERAGES AND TEA BEVERAGES (U.S. CL. 46).
FIRST USE 11-9-1999; IN COMMERCE 11-9-1999.

2,625,661. LANCE MFG. LLC, CHARLOTTE, NC. SN 75-833,117. PUB. 9-18-2001, FILED 10-27-1999.



NO CLAIM IS MADE TO THE EXCLUSIVE RIGHT TO USE "MINT CHEWS", APART FROM THE MARK AS SHOWN.

FOR CANDY (U.S. CL. 46).
FIRST USE 2-1-2000; IN COMMERCE 3-27-2000.

CLASS 30—(Continued).

2,625,726. FLEMING COMPANIES, INC., OKLAHOMA CITY, OK. SN 75-875,971. PUB. 9-11-2001, FILED 12-20-1999.



OWNER OF U.S. REG. NO. 1,531,367.
NO CLAIM IS MADE TO THE EXCLUSIVE RIGHT TO USE "PIES" AND "FOODS", APART FROM THE MARK AS SHOWN.

FOR BAKERY PRODUCTS (U.S. CL. 46).
FIRST USE 9-6-1998; IN COMMERCE 9-6-1998.

2,625,794. HARIBO OF AMERICA, INC., BALTIMORE, MD. SN 75-907,200. PUB. 8-14-2001, FILED 2-2-2000.

HAPPY-COLA

OWNER OF U.S. REG. NO. 1,341,207.
FOR CANDY (U.S. CL. 46).
FIRST USE 0-0-1986; IN COMMERCE 0-0-1986.

2,625,864. ENGLISH TEA HOUSE, LTD., WASHINGTON, DC. SN 75-939,235. PUB. 2-20-2001, FILED 3-9-2000.

KASHISH—T

NO CLAIM IS MADE TO THE EXCLUSIVE RIGHT TO USE "TEA", APART FROM THE MARK AS SHOWN.

THE ENGLISH TRANSLATION OF "KASHISH" IS AN ARABIC WORD THAT MEANS "ATTRACTION".

FOR TEA IN PACKAGED FORM AND BOTTLED TEA (U.S. CL. 46).

FIRST USE 5-12-2002; IN COMMERCE 5-12-2002.

2,626,045. WESTERN FAMILY FOODS, INC., TIGARD, OR. SN 76-076,066. PUB. 11-6-2001, FILED 6-22-2000.

MAGIC MALLOWS

FOR BREAKFAST CEREALS (U.S. CL. 46).
FIRST USE 10-0-2000; IN COMMERCE 10-0-2000.

CLASS 30—(Continued).

2,626,096. CONOPCO, INC., DBA GOOD HUMOR-BREYERS ICE CREAM, GREEN BAY, WI. SN 76-099,452. PUB. 6-19-2001, FILED 7-28-2000.

CLASS 30—(Continued).

2,626,125. BOLNER'S FIESTA PRODUCTS, INC., SAN ANTONIO, TX. SN 76-114,251. PUB. 9-11-2001, FILED 8-23-2000.

TASTE, NOT TECHNOLOGY

FOR FROZEN CONFECTIONS (U.S. CL. 46).
FIRST USE 3-15-1999; IN COMMERCE 3-15-1999.



2,626,105. SONAFI, 78220 VIROFLAY, FRANCE. SN 76-103,071. PUB. 1-8-2002, FILED 8-7-2000.

THE CHOCOLATE WITH A MESSAGE

FOR COCOA; CHOCOLATE; CHOCOLATE AND CONFECTIONARY, NAMELY CHOCOLATES AND CANDY (U.S. CL. 46).
FIRST USE 2-12-2002; IN COMMERCE 2-12-2002.

OWNER OF U.S. REG. NO. 2,196,600.
NO CLAIM IS MADE TO THE EXCLUSIVE RIGHT TO USE "SOUTHWEST" AND "SPICES", APART FROM THE MARK AS SHOWN.
FOR PROCESSED HERBS, SPICES, AND SEASONINGS (U.S. CL. 46).
FIRST USE 5-23-2002; IN COMMERCE 5-23-2002.

2,626,116. GASLAMP POPCORN CO., SAN DIEGO, CA. SN 76-109,916. PUB. 8-21-2001, FILED 8-14-2000.

2,626,365. MARS, INCORPORATED, MCLEAN, VA. SN 76-208,675. PUB. 8-28-2001, FILED 2-12-2001.

CIRCUS FAIR

FOR CANDY COATED POPCORN, GLAZED POPCORN, CARAMEL POPCORN, POPPED POPCORN, AND PROCESSED POPCORN (U.S. CL. 46).
FIRST USE 6-0-2001; IN COMMERCE 6-0-2001.

FUNWORKS

FOR CONFECTIONERY, NAMELY, CANDY (U.S. CL. 46).
FIRST USE 9-24-2001; IN COMMERCE 9-24-2001.

2,626,122. JACK DANIEL'S PROPERTIES, INC., SAN RAFAEL, CA. SN 76-112,563. PUB. 9-11-2001, FILED 8-18-2000.

2,626,366. URBAN WAFER COMPANY INC., CALGARY, AB T2E 7A4, CANADA. SN 76-208,832. PUB. 8-21-2001, FILED 2-13-2001.

ORIGINAL NO. 7 BARBEQUE RECIPE

NO CLAIM IS MADE TO THE EXCLUSIVE RIGHT TO USE "ORIGINAL" AND "BARBEQUE RECIPE", APART FROM THE MARK AS SHOWN.
FOR SAUCES (U.S. CL. 46).
FIRST USE 2-12-2001; IN COMMERCE 2-12-2001.

URBAN WAFER

NO CLAIM IS MADE TO THE EXCLUSIVE RIGHT TO USE "WAFER", APART FROM THE MARK AS SHOWN.
FOR PROCESSED FOOD NAMELY: BAKED WAFERS STUFFED WITH FILLING AND MADE FROM FLOUR AND BUTTER (U.S. CL. 46).
FIRST USE 11-29-2001; IN COMMERCE 11-29-2001.

CLASS 30—(Continued).

2,626,396. MORINAGA & CO., LTD., TOKYO, JAPAN. SN 76-215,448. PUB. 8-14-2001, FILED 2-23-2001.



FOR CANDY (U.S. CL. 46).
FIRST USE 12-1-2000; IN COMMERCE 4-0-2001.

2,626,542. SHERWOOD BRANDS, LLC, ROCKVILLE, MD. SN 76-299,268. PUB. 11-13-2001, FILED 8-14-2001.

BIG CURL

FOR BUBBLE GUM (U.S. CL. 46).
FIRST USE 12-0-2001; IN COMMERCE 12-0-2001.

2,626,566. INTERNATIONAL SUPREME PRODUCTS, LLC, COPPELL, TX. SN 78-007,606. PUB. 9-11-2001, FILED 5-10-2000.

BISCUIT BITES

NO CLAIM IS MADE TO THE EXCLUSIVE RIGHT TO USE "BISCUIT", APART FROM THE MARK AS SHOWN. FOR FLAVORED PRE-BAKED BISCUITS (U.S. CL. 46). FIRST USE 12-21-2001; IN COMMERCE 12-21-2001.

2,626,573. HELEN, DUCLOS LAURENE, DBA PRETTY GOOD POPCORN, ROCHESTER, NY. SN 78-010,346. PUB. 11-6-2001, FILED 5-29-2000.



NO CLAIM IS MADE TO THE EXCLUSIVE RIGHT TO USE "POPCORN", APART FROM THE MARK AS SHOWN. FOR MICROWAVE POPCORN, POPPED POPCORN (U.S. CL. 46). FIRST USE 5-29-2000; IN COMMERCE 5-29-2000.

CLASS 30—(Continued).

2,626,634. HERSHEY CHOCOLATE & CONFECTIONERY CORPORATION, WHEAT RIDGE, CO. SN 78-038,696. PUB. 7-31-2001, FILED 12-11-2000.

PLAY FIRST EAT LATER

FOR CANDY (U.S. CL. 46).
FIRST USE 5-31-2002; IN COMMERCE 5-31-2002.

CLASS 31—NATURAL AGRICULTURAL PRODUCTS

2,625,425. S.N.C. MOREL & CIE, FREJUS 83600, FRANCE. SN 75-558,311. PUB. 9-25-2001, FILED 9-16-1998.

METIS

PRIORITY CLAIMED UNDER SEC. 44(D) ON FRANCE APPLICATION NO. 000842823, FILED 6-5-1998, REG. NO. 842823, DATED 7-6-1999, EXPIRES 7-6-2009. FOR PLANT SEEDS AND LIVE PLANTS, EXCLUDING GARDEN BEANS AND CABBAGE (U.S. CLS. 1 AND 46). FIRST USE 9-0-1998; IN COMMERCE 6-0-1999.

2,625,463. BRANDT'S FRUIT TREES, INC., WAPATO, WA. SN 75-613,052. PUB. 11-13-2001, FILED 12-29-1998.

TORINEL

FOR ROOTSTOCKS FOR LIVE COMMERCIAL FRUIT TREES (U.S. CLS. 1 AND 46). FIRST USE 9-9-1999; IN COMMERCE 9-9-1999.

2,625,519. CLOROX PET PRODUCTS COMPANY, THE, OAKLAND, CA, BY CHANGE OF NAME A&M PRODUCTS, INC., OAKLAND, CA. SN 75-708,201. PUB. 11-23-1999, FILED 5-17-1999.

ONE SCOOP AND IT'S GONE

FOR CAT LITTER (U.S. CLS. 1 AND 46).
FIRST USE 7-19-1999; IN COMMERCE 1-31-2000.

CLASS 31—(Continued).

2,625,575. HONEY HOUND, LLC, WEST LAFAYETTE, IN, BY ASSIGNMENT ROMJUE, COLLEEN M., WEST LAFAYETTE, IN, AND ROMJUE, JERRY A., WEST LAFAYETTE, IN. SN 75-755,266. PUB. 10-24-2000, FILED 8-13-1999.

HONEY HOUND

NO CLAIM IS MADE TO THE EXCLUSIVE RIGHT TO USE "HONEY", APART FROM THE MARK AS SHOWN.
FOR BISCUITS AND SNACKS FOR PETS TO BE SOLD IN THE USA THROUGH RETAIL, CATALOG AND MAIL ORDER HOUSES, AND/OR VIA A GLOBAL COMPUTER NETWORK (U.S. CLS. 1 AND 46).
FIRST USE 7-31-2000; IN COMMERCE 7-31-2000.

2,625,670. ERWIN-KEITH, INC., WYNNE, AR. SN 75-837,133. PUB. 8-21-2001, FILED 10-29-1999.



NO CLAIM IS MADE TO THE EXCLUSIVE RIGHT TO USE "PROGENY" AND "AG PRODUCTS", APART FROM THE MARK AS SHOWN.
FOR SEED PRODUCT USED IN THE FIELD OF COMMERCIAL AGRICULTURE, NAMELY SOYBEAN SEEDS (U.S. CLS. 1 AND 46).
FIRST USE 9-27-1999; IN COMMERCE 10-23-2000.

2,625,772. PANSING, JEFFREY M., WEST ALEXANDRIA, OH. SN 75-898,450. PUB. 5-22-2001, FILED 1-18-2000.

PINK SPARKLES

NO CLAIM IS MADE TO THE EXCLUSIVE RIGHT TO USE "PINK", APART FROM THE MARK AS SHOWN.
FOR LIVE CRABAPPLE TREES (U.S. CLS. 1 AND 46).
FIRST USE 1-4-2002; IN COMMERCE 1-5-2002.

CLASS 31—(Continued).

2,626,196. STAGECOACH VINEYARDS LIMITED PARTNERSHIP, NAPA, CA. SN 76-142,198. PUB. 8-28-2001, FILED 10-5-2000.

CATAPULT HILL

FOR FRESH WINE GRAPES (U.S. CLS. 1 AND 46).
FIRST USE 6-0-1998; IN COMMERCE 6-0-1998.

2,626,228. LANDEC AG, INC., MONTICELLO, IN. SN 76-153,833. PUB. 2-12-2002, FILED 10-25-2000.

POLLINATOR PLUS

NO CLAIM IS MADE TO THE EXCLUSIVE RIGHT TO USE "POLLINATOR", APART FROM THE MARK AS SHOWN.
FOR COATINGS FOR AGRICULTURAL SEEDS TO REGULATE THE GERMINATION OF INBRED HYBRIDS (U.S. CLS. 1 AND 46).
FIRST USE 11-0-2000; IN COMMERCE 11-0-2000.

2,626,243. BURGESS & BURGESS INC., GURNEE, IL. SN 76-156,860. PUB. 8-28-2001, FILED 10-31-2000.

**GROWN ESPECIALLY FOR
YOU FRESH FROM OUR
FARMS**

FOR FRESH FLOWERS NAMELY ROSES (U.S. CLS. 1 AND 46).
FIRST USE 10-1-2001; IN COMMERCE 10-1-2001.

2,626,709. IAMS COMPANY, THE, DAYTON, OH. SN 78-060,024. PUB. 9-25-2001, FILED 4-24-2001.

IAMS WEIGHT CONTROL

OWNER OF U.S. REG. NOS. 1,169,514, 1,474,391, AND OTHERS.
NO CLAIM IS MADE TO THE EXCLUSIVE RIGHT TO USE "WEIGHT CONTROL", APART FROM THE MARK AS SHOWN.
FOR FOODSTUFFS FOR ANIMALS (U.S. CLS. 1 AND 46).
FIRST USE 7-1-2001; IN COMMERCE 7-1-2001.

CLASS 32—LIGHT BEVERAGES

CLASS 32—(Continued).

2,625,779. TREAT VENTURE LLC, WILMINGTON, DE. SN 75-902,223. PUB. 11-28-2000, FILED 1-27-2000.

RICKSSPIKED.COM

FOR BEER-BASED FLAVORED MALT BEVERAGE (U.S. CLS. 45, 46 AND 48).
FIRST USE 3-31-2001; IN COMMERCE 3-31-2001.

2,626,241. ANHEUSER-BUSCH, INCORPORATED, ST. LOUIS, MO. SN 76-156,252. PUB. 11-13-2001, FILED 10-30-2000.

ONE-EIGHTY

FOR NON-ALCOHOLIC FRUIT BEVERAGES, NAMELY, ENERGY DRINKS (U.S. CLS. 45, 46 AND 48).
FIRST USE 11-13-2000; IN COMMERCE 11-13-2000.

CLASS 33—WINES AND SPIRITS

2,625,518. CHERRY HILL, L.L.C., FOREST GROVE, OR. SN 75-706,642. PUB. 2-1-2000, FILED 5-17-1999.

PATTON VALLEY

FOR WINE (U.S. CLS. 47 AND 49).
FIRST USE 6-1-2001; IN COMMERCE 8-31-2001.

2,625,694. PEPPER TREE WINES PTY LIMITED, NEW SOUTH WALES, 2320, AUSTRALIA. SN 75-851,126. PUB. 12-26-2000, FILED 11-17-1999.

PEPPER TREE

FOR WINES, SPIRITS AND LIQUEURS (U.S. CLS. 47 AND 49).
FIRST USE 10-6-1993; IN COMMERCE 7-17-1996.

2,625,756. VINTNERS EDGE, INC., EAST AMHERST, NY. SN 75-889,758. PUB. 10-16-2001, FILED 1-7-2000.

CRICKLEWOOD

FOR WINE (U.S. CLS. 47 AND 49).
FIRST USE 5-0-2000; IN COMMERCE 5-0-2000.

CLASS 33—(Continued).

2,625,786. BODEGAS Y BEBIDAS, S.A., GUIPUZCOA, SPAIN. SN 75-904,623. PUB. 7-17-2001, FILED 1-28-2000.

ARS VINUM

NO CLAIM IS MADE TO THE EXCLUSIVE RIGHT TO USE "VINUM", APART FROM THE MARK AS SHOWN. THE ENGLISH TRANSLATION OF "VINUM" IS "WINE". FOR WINE AND DISTILLED SPIRITS (U.S. CLS. 47 AND 49).
FIRST USE 3-6-2002; IN COMMERCE 3-6-2002.

2,626,060. REYTER S.R.L., PROVINCE DE MENDOZA, ARGENTINA. SN 76-083,229. PUB. 5-15-2001, FILED 7-5-2000.

FINCA LA MARTINA

THE ENGLISH TRANSLATION OF "FINCA" IS "COUNTRY ESTATE, FARM, OR RANCH DEDICATED TO VINCULATED ACTIVITIES". THE ENGLISH TRANSLATION OF "LA MARTINA" IS "THE MARTINA". FOR WINES (U.S. CLS. 47 AND 49).
FIRST USE 12-28-2001; IN COMMERCE 1-0-2002.

2,626,130. WINESERVE LIMITED, GATLEY, CHESHIRE, UNITED KINGDOM. SN 76-117,615. PUB. 10-9-2001, FILED 8-28-2000.

PAUL BOUTINOT

"PAUL BOUTINOT" IDENTIFIES A LIVING INDIVIDUAL WHOSE CONSENT IS OF RECORD. FOR WINES (U.S. CLS. 47 AND 49).
FIRST USE 11-13-2000; IN COMMERCE 11-13-2000.

2,626,174. BODEGAS Y VINEDOS NICOLAS CATENA S.A., (5579) RIVADAVIA MENDOZA, ARGENTINA. SN 76-133,162. PUB. 11-13-2001, FILED 9-21-2000.

CATENA ALTA

OWNER OF U.S. REG. NO. 1,517,373. THE ENGLISH TRANSLATION OF "CATENA ALTA" IS "CHAIN HIGH". FOR WINE, BRANDY, COGNAC AND LIQUEURS (U.S. CLS. 47 AND 49).
FIRST USE 0-0-1997; IN COMMERCE 0-0-1997.

CLASS 33—(Continued).

2,626,268. VALHALLA VINEYARDS, LLC, ROANOKE, VA.
SN 76-166,923. PUB. 8-28-2001, FILED 11-15-2000.

VALKYRIE

FOR ALCOHOLIC BEVERAGES, NAMELY WINES
AND SPIRITS (U.S. CLS. 47 AND 49).
FIRST USE 4-7-2002; IN COMMERCE 4-7-2002.

2,626,590. AGAVE TEQUILANA PRODUCTORES Y COMER-
CIALIZADORES SA DE CV, ZAPOPAN JALISCO, MEX-
ICO. SN 78-018,760. PUB. 1-8-2002, FILED 7-28-2000.

ORO AZUL

THE ENGLISH TRANSLATION OF THE WORD "ORO
AZUL" IN THE MARK IS "GOLD BLUE".
FOR TEQUILA (U.S. CLS. 47 AND 49).
FIRST USE 10-18-1998; IN COMMERCE 7-28-2000.

CLASS 34—SMOKERS' ARTICLES

2,625,546. ALOIS POSCHL GMBH & CO. KG, D-84144
GEISENHAUSEN BEI LANDSHUT, FED REP GERMANY.
SN 75-734,784. PUB. 1-9-2001, FILED 6-22-1999.

JACK JACKSON

THE NAME SHOWN IN THE MARK DOES NOT IDENTI-
FY A LIVING; PERSON AND IS FICTIONAL
FOR CIGARETTE TOBACCO (U.S. CLS. 2, 8, 9 AND
17).
FIRST USE 11-0-1995; IN COMMERCE 1-10-2001.

2,625,647. MEDALLION BRANDS INTERNATIONAL COM-
PANY, CHICAGO, IL. SN 75-825,734. PUB. 9-19-2000,
FILED 10-18-1999.

KICK

FOR CIGARETTES (U.S. CLS. 2, 8, 9 AND 17).
FIRST USE 2-0-2000; IN COMMERCE 2-0-2000.

2,625,817. SOUTHERN TOBACCO, INC., TAMPA, FL. SN 75-
915,943. PUB. 11-14-2000, FILED 1-24-2000.

OLYMPUS

FOR CIGARETTES (U.S. CLS. 2, 8, 9 AND 17).
FIRST USE 8-1-2000; IN COMMERCE 10-1-2000.

CLASS 34—(Continued).

2,625,959. JACK DANIEL'S PROPERTIES, INC., SAN RA-
FAEL, CA. SN 76-034,872. PUB. 4-10-2001, FILED 4-25-2000.



OWNER OF U.S. REG. NOS. 394,017, 1,290,702, AND
OTHERS.

NO CLAIM IS MADE TO THE EXCLUSIVE RIGHT TO
USE "BRAND", APART FROM THE MARK AS SHOWN.
THE NAME "JACK DANIEL'S" IN THE MARK IS NOT
THE NAME OF A LIVING INDIVIDUAL.

FOR CIGARETTE LIGHTERS MADE OF NON-PRE-
CIOUS METAL; AND ASHTRAYS NOT OF PRECIOUS
METAL (U.S. CLS. 2, 8, 9 AND 17).
FIRST USE 1-31-1997; IN COMMERCE 1-31-1997.

2,626,151. THOMPSON & CO. OF TAMPA, INC., TAMPA, FL.
SN 76-124,714. PUB. 7-31-2001, FILED 9-8-2000.



THE DRAWING IS NOT LINED FOR COLOR.
THE PORTRAIT DOES NOT DEPICT ANY LIVING
PERSON.

THE MARK COMPRISES A STYLIZED PRESENTATION
OF THE WORD AND A PORTRAIT OF A MAN SMOKING A
CIGAR.

FOR CIGARS (U.S. CLS. 2, 8, 9 AND 17).
FIRST USE 4-2-2002; IN COMMERCE 4-2-2002.

2,626,202. CALICO BRANDS, INC., ONTARIO, CA. SN 76-
143,825. PUB. 7-31-2001, FILED 10-10-2000.

CALICO

OWNER OF U.S. REG. NOS. 2,234,161, 2,265,743, AND
2,388,257.

FOR FLINTS FOR LIGHTERS (U.S. CLS. 2, 8, 9 AND
17).

FIRST USE 8-30-2001; IN COMMERCE 8-30-2001.

SERVICE MARKS**CLASS 35—ADVERTISING AND BUSINESS**

CLASS 35—(Continued).

2,625,330. IBEROSTAR S.A., 07012 PALMA DE MALLORCA, SPAIN. SN 75-245,858. PUB. 7-14-1998, FILED 2-6-1997.

IBEROSTAR

FOR HOTEL MANAGEMENT FOR OTHERS (U.S. CLS. 100, 101 AND 102).
FIRST USE 9-0-1983; IN COMMERCE 8-0-1997.

2,625,368. TIME FOR TWO, SAN FRANCISCO, CA. BY CHANGE OF NAME GAMES PARTNERSHIP, LTD., INC., SAN FRANCISCO, CA. SN 75-412,803. PUB. 8-31-1999, FILED 12-31-1997.

Time for Two

FOR PROMOTIONAL SERVICES FOR GOODS AND SERVICES THROUGH THE DISTRIBUTION OF PRINTED, AUDIO, VISUAL AND MULTIMEDIA PROMOTIONAL MATERIALS IN THE FIELD OF TOYS AND GAMES, AUDIO TAPES, TRAVEL AND ENTERTAINMENT SERVICES, RADIO AND TELEVISION PROGRAMS, NEWSLETTERS, BROCHURES, SEMINARS AND WORKSHOPS, CLOTHING, PERFUME AND BAGS (U.S. CLS. 100, 101 AND 102).

FIRST USE 2-1-1999; IN COMMERCE 2-1-1999.

2,625,414. WORKSMART SYSTEMS, INC., INDIANAPOLIS, IN. SN 75-540,616. PUB. 7-18-2000, FILED 8-21-1998.

WORKSMART

FOR EMPLOYEE LEASING SERVICES (U.S. CLS. 100, 101 AND 102).
FIRST USE 10-1-2000; IN COMMERCE 10-1-2000.

2,625,418. KFORCE INC., TAMPA, FL, BY CHANGE OF NAME ROMAC INTERNATIONAL, INC., TAMPA, FL. SN 75-548,765. PUB. 12-28-1999, FILED 9-4-1998.

KFORCE

FOR PERSONNEL PLACEMENT AND RECRUITMENT SERVICES AND BUSINESS MANAGEMENT CONSULTING SERVICES (U.S. CLS. 100, 101 AND 102).
FIRST USE 4-1-2001; IN COMMERCE 4-1-2001.

CLASS 35—(Continued).

2,625,442. CINCINNATI BELL TELEPHONE COMPANY, CINCINNATI, OH. SN 75-588,286. PUB. 3-7-2000, FILED 11-13-1998.

INVOICE ADVANTAGE

NO CLAIM IS MADE TO THE EXCLUSIVE RIGHT TO USE "INVOICE", APART FROM THE MARK AS SHOWN. FOR BILLING SERVICES FOR THE TELECOMMUNICATION INDUSTRY (U.S. CLS. 100, 101 AND 102).
FIRST USE 3-0-2000; IN COMMERCE 3-0-2000.

2,625,444. AVON PRODUCTS, INC., NEW YORK, NY. SN 75-590,121. PUB. 9-18-2001, FILED 11-17-1998.

THE COMPANY FOR WOMEN

SEC. 2(F).

FOR DISTRIBUTORSHIP SERVICES, RETAIL STORE SERVICES, RETAIL SERVICES BY DIRECT SOLICITATION BY INDEPENDENT SALES REPRESENTATIVES, DOOR-TO-DOOR RETAIL MERCHANDISING, TELEPHONE SHOP AT HOME SERVICES, MAIL ORDER CATALOG SERVICES, INTERACTIVE RETAIL STORE SERVICES RENDERED BY MEANS OF A GLOBAL COMPUTER INFORMATION NETWORK, ALL IN THE FIELD OF BEAUTY CARE AND SALON SERVICES, HOUSEWARES, CLOTHING, TOILETRIES, COSMETICS, JEWELRY, GIFT ITEMS, TOYS, PERSONAL CARE PRODUCTS, PRE-RECORDED VIDEOS, AUDIO TAPES, CD'S (U.S. CLS. 100, 101 AND 102).
FIRST USE 6-0-1999; IN COMMERCE 6-0-1999.

2,625,451. BLISS WORLD LLC, BROOKLYN, NY. SN 75-601,081. PUB. 2-15-2000, FILED 12-7-1998.

TOLL & STRESS FREE NUMBER

NO CLAIM IS MADE TO THE EXCLUSIVE RIGHT TO USE "TOLL" OR "FREE NUMBER", APART FROM THE MARK AS SHOWN.

FOR MAIL ORDER CATALOG SERVICES FEATURING COSMETICS, TOILETRIES, SPA, SKIN AND BEAUTY CARE PRODUCTS, SUNGLASSES, CLOTHING AND FOOTWEAR (U.S. CLS. 100, 101 AND 102).
FIRST USE 0-0-1999; IN COMMERCE 0-0-1999.

CLASS 35—(Continued).

2,625,460. WANOKA GROUP, INC., TORRANCE, CA. SN 75-610,662. PUB. 7-11-2000, FILED 12-25-1998.

MITSUWA MARKETPLACE

NO CLAIM IS MADE TO THE EXCLUSIVE RIGHT TO USE "MARKETPLACE", APART FROM THE MARK AS SHOWN.

THE ENGLISH TRANSLATION OF "MITSUWA" IS "THREE IN HARMONY".

FOR ON-LINE RETAIL STORE SERVICES AND CATALOG MAIL ORDER SERVICES FEATURING GROCERIES AND GENERAL MERCHANDISE (U.S. CLS. 100, 101 AND 102).

FIRST USE 6-1-1999; IN COMMERCE 6-1-1999.

2,625,467. FOLLETT COLLEGE STORES CORPORATION, ELMHURST, IL. SN 75-618,304. PUB. 12-21-1999, FILED 1-11-1999.

ECREDIT

FOR PROMOTING THE GOODS OF OTHERS THROUGH THE ADMINISTRATION OF A DISCOUNT PURCHASING PROGRAM BY MEANS OF A GLOBAL COMPUTER NETWORK (U.S. CLS. 100, 101 AND 102).

FIRST USE 1-0-1999; IN COMMERCE 1-0-1999.

2,625,468. MYTEAM.COM, INC, WOBURN, MA, BY CHANGE OF NAME KATZMAN, ELLIOT, NORTH AND-OVER, MA. SN 75-623,085. PUB. 5-2-2000, FILED 1-19-1999.

MYTEAM.COM

FOR COMPUTERIZED ON-LINE ORDERING SERVICES IN THE FIELD OF SPORTING GOODS AND SPORTS EQUIPMENT (U.S. CLS. 100, 101 AND 102).

FIRST USE 2-3-1999; IN COMMERCE 2-3-1999.

CLASS 35—(Continued).

2,625,491. LEO BURNETT WORLDWIDE, INC., CHICAGO, IL. SN 75-666,460. PUB. 5-2-2000, FILED 3-23-1999.



FOR ADVERTISING AGENCY SERVICES (U.S. CLS. 100, 101 AND 102).

FIRST USE 3-24-1999; IN COMMERCE 3-24-1999.

2,625,500. PORT AUTHORITY, INC., DBA JOCKO, LOS ANGELES, CA. SN 75-679,951. PUB. 10-24-2000, FILED 4-12-1999.

JOCKO

FOR RETAIL CLOTHING STORES; COMPUTERIZED ON-LINE RETAIL SERVICES IN THE FIELD OF CLOTHING (U.S. CLS. 100, 101 AND 102).

FIRST USE 10-1-2000; IN COMMERCE 10-1-2000.

2,625,516. EBY HOLDINGS, INC., OLATHE, KS. SN 75-703,826. PUB. 6-20-2000, FILED 5-12-1999.

**BICKFORD HOUSE**

NO CLAIM IS MADE TO THE EXCLUSIVE RIGHT TO USE "HOUSE", APART FROM THE MARK AS SHOWN.

FOR MANAGEMENT OF SENIOR CARE CENTERS (U.S. CLS. 100, 101 AND 102).

FIRST USE 6-1-1998; IN COMMERCE 6-1-1998.

CLASS 35—(Continued).

2,625,530. DEAN & DELUCA BRANDS, INC., NEW YORK, NY. SN 75-722,308. PUB. 3-13-2001, FILED 6-7-1999.

DEANDELUCA.COM

OWNER OF U.S. REG. NOS. 1,369,051, 2,037,326, AND OTHERS.

FOR ON-LINE RETAIL STORE SERVICES FEATURING FINE FOOD AND KITCHENWARE (U.S. CLS. 100, 101 AND 102).

FIRST USE 2-5-1999; IN COMMERCE 2-5-1999.

2,625,539. QUINN, OLIVER H., DBA CITRUSNOW.COM, PALM BEACH, FL. SN 75-730,925. PUB. 7-25-2000, FILED 6-16-1999.

CITRUSNOW.COM

FOR RETAIL DEPARTMENT AND GROCERY STORE DISTRIBUTORSHIP SERVICES OFFERED BY MEANS OF A GLOBAL COMPUTER INFORMATION NETWORK FEATURING FOOD, BEVERAGES, CONDIMENTS, FRUIT, NUTS, SEASONINGS, MARINADES, FRUIT PRESERVES, SAUCES, CHUTNEY, JUICES, HONEY, MIXES FOR BAKED GOODS, COFFEE, TEA, ELECTRONIC AND MANUAL JUICERS, CLOTHING, BOOKS, PRERECORDED COMPACT DISCS, LIVE FLOWERS, PLANTS, AND TREES (U.S. CLS. 100, 101 AND 102).

FIRST USE 2-1-2002; IN COMMERCE 2-1-2002.

2,625,558. PROFILE NETWORK, INC., SKOKIE, IL. SN 75-742,520. PUB. 10-2-2001, FILED 7-2-1999.

ONTRAC PROMOTIONS

NO CLAIM IS MADE TO THE EXCLUSIVE RIGHT TO USE "PROMOTIONS", APART FROM THE MARK AS SHOWN.

FOR PROMOTING THE GOODS AND SERVICES OF OTHERS BY ARRANGING COUPON PROGRAMS, SWEEPSTAKES, PRODUCT PREMIUM PROGRAMS, PRODUCT GIVE-AWAYS, RAFFLES, PRODUCT SAMPLING PROGRAMS, TRADE SHOW EVENTS AND SPONSORSHIPS OF SPORTING AND ENTERTAINMENT EVENTS (U.S. CLS. 100, 101 AND 102).

FIRST USE 5-0-1998; IN COMMERCE 5-0-1998.

2,625,571. PARTNER PLUS, LLC, MINNEAPOLIS, MN. SN 75-753,873. PUB. 11-27-2001, FILED 7-19-1999.

PARTNER PLUS

FOR OUTSOURCING SERVICES IN THE FIELD OF PURCHASING, MANAGEMENT AND COLLECTION OF ACCOUNTS RECEIVABLE ASSETS FOR THIRD PARTIES (U.S. CLS. 100, 101 AND 102).

FIRST USE 6-1-1999; IN COMMERCE 6-1-1999.

CLASS 35—(Continued).

2,625,596. WYETH, LEONARD, IVORYTON, CT. SN 75-777,666. PUB. 10-17-2000, FILED 8-16-1999.



The logo for Acoustic Music .Org features the word "Acoustic" in a serif font, "Music" in a larger serif font, and ".Org" in a smaller serif font. A stylized acoustic guitar is integrated into the design, with its body forming the letter "C" in "Music" and its neck extending upwards.

NO CLAIM IS MADE TO THE EXCLUSIVE RIGHT TO USE "ACOUSTIC MUSIC.ORG", APART FROM THE MARK AS SHOWN.

FOR COMPUTERIZED ON-LINE RETAIL SERVICES IN THE FIELD MUSIC, NAMELY SHEET MUSIC, MUSICAL INSTRUMENTS, ACCESSORIES FOR MUSICAL INSTRUMENTS, SOUND REINFORCEMENT EQUIPMENT, NAMELY LOUDSPEAKERS, AUDIO AND VIDEO RECORDING EQUIPMENT, PHONOGRAPH RECORDS FEATURING MUSIC AND MUSICAL SOUND RECORDINGS, PRE-RECORDED AUDIO COMPACT DISCS, CASSETTES, DVDS AND VIDEO CASSETTES FEATURING MUSIC AND MUSIC INSTRUCTION (U.S. CLS. 100, 101 AND 102).

FIRST USE 9-26-2001; IN COMMERCE 9-26-2001.

2,625,615. HEB GROCERY COMPANY, LP, SAN ANTONIO, TX, BY ASSIGNMENT H. E. BUTT GROCERY COMPANY, SAN ANTONIO, TX. SN 75-799,896. PUB. 7-17-2001, FILED 9-15-1999.

H-E-B GOOD TO GO

OWNER OF U.S. REG. NOS. 965,785, 1,358,470, AND OTHERS.

FOR RETAIL SUPERMARKET SERVICES, NAMELY, A SECTION OF A RETAIL SUPERMARKET FEATURING PREPARED READY-TO-COOK FOODS AND PREPARED READY-TO-EAT FOODS AND SPECIFICALLY EXCLUDING RESTAURANT SERVICES (U.S. CLS. 100, 101 AND 102).

FIRST USE 11-2-2001; IN COMMERCE 11-2-2001.

2,625,622. COIDWATER CREEK, INC., SANDPOINT, ID. SN 75-805,611. PUB. 5-8-2001, FILED 9-21-1999.

**YOUR KIND OF CLOTHES.
ONLINE. ALL THE TIME.**

NO CLAIM IS MADE TO THE EXCLUSIVE RIGHT TO USE "CLOTHES" AND "ONLINE", APART FROM THE MARK AS SHOWN.

FOR RETAIL STORE SERVICES AVAILABLE THROUGH A GLOBAL COMPUTER INFORMATION NETWORK, FEATURING GIFTS, CLOTHING, CRAFTS, JEWELRY, WATCHES, SHOES, BELTS, PURSES, FURNITURE, BEDROOM ACCESSORIES, BATHROOM ACCESSORIES, WALL HANGINGS, AND HOUSEHOLD ITEMS (U.S. CLS. 100, 101 AND 102).

FIRST USE 8-0-2000; IN COMMERCE 8-0-2000.

CLASS 35—(Continued).

2,625,639. CAMPBELL OIL COMPANY, MASSILLON, OH. SN 75-819,207. PUB. 5-15-2001, FILED 10-12-1999.

BELLSTORES

FOR RETAIL STORE SERVICES FEATURING CONVENIENCE STORE ITEMS AND GASOLINE (U.S. CLS. 100, 101 AND 102).

FIRST USE 4-1-1999; IN COMMERCE 4-1-1999.

2,625,655. CREDIT UNION EXECUTIVES SOCIETY, INC., MADISON, WI. SN 75-829,550. PUB. 11-27-2001, FILED 10-18-1999.

CUES TECH PORT

OWNER OF U.S. REG. NO. 783,373.
FOR ONLINE RETAIL SERVICES IN THE FIELD OF COMPUTER SYSTEMS, TECHNOLOGY SERVICES AND TELECOMMUNICATIONS (U.S. CLS. 100, 101 AND 102).
FIRST USE 11-0-1999; IN COMMERCE 11-0-1999.

2,625,682. HYDRAULIC INVESTMENTS, LLC., HOUSTON, TX. SN 75-844,971. PUB. 3-13-2001, FILED 11-10-1999.

HYDRAULIC EXPRESS

NO CLAIM IS MADE TO THE EXCLUSIVE RIGHT TO USE "HYDRAULIC", APART FROM THE MARK AS SHOWN.

FOR RETAIL STORE AND WHOLESALE DISTRIBUTORSHIPS ALL FEATURING MACHINE VALVES, HYDRAULIC MOTORS, HYDRAULIC PUMPS AND HYDRAULIC CYLINDERS (U.S. CLS. 100, 101 AND 102).
FIRST USE 11-15-1999; IN COMMERCE 11-15-1999.

2,625,702. TOPMOST DESIGNS, INC., CITY OF INDUSTRY, CA. SN 75-854,762. PUB. 9-25-2001, FILED 11-19-1999.



NO CLAIM IS MADE TO THE EXCLUSIVE RIGHT TO USE "DESIGNS INC.", APART FROM THE MARK AS SHOWN.

FOR WHOLESALE DISTRIBUTORSHIPS FEATURING ENGRAVABLE BLANKS FOR AWARDS, TROPHIES AND GIFTS (U.S. CLS. 100, 101 AND 102).
FIRST USE 1-15-1998; IN COMMERCE 1-15-1998.

CLASS 35—(Continued).

2,625,708. MCCREA MARKETING, INC., CORNELIUS, NC. SN 75-859,229. PUB. 7-25-2000, FILED 11-30-1999.

LIBERTY BELLE

THE TERM "LIBERTY BELLE" IN THE MARK DOES NOT IDENTIFY A LIVING INDIVIDUAL.

FOR WHOLESALE DISTRIBUTORSHIPS FEATURING FOOD PRODUCTS (U.S. CLS. 100, 101 AND 102).
FIRST USE 5-2-2000; IN COMMERCE 4-23-2001.

2,625,731. SEAL, SUSAN T., DBA BEAD RELISH, ANDERSON, IN. AND PETIT, REBECCA L., DBA BEAD RELISH, LOUISVILLE, KY. AND CARTER, JAMA R., DBA BEAD RELISH, ZIONSVILLE, IN. SN 75-880,580. PUB. 3-27-2001, FILED 1-6-2000.

BEAD RELISH

NO CLAIM IS MADE TO THE EXCLUSIVE RIGHT TO USE "BEAD", APART FROM THE MARK AS SHOWN.

FOR RETAIL STORE SERVICES FEATURING BEAD-EMBELLISHED APPAREL AND HOME DECOR, IN THE NATURE OF JEWELRY, HANDBAGS, TEXTILES AND VARIOUS CONTAINERS (U.S. CLS. 100, 101 AND 102).
FIRST USE 12-20-2001; IN COMMERCE 12-20-2001.

2,625,762. USADVANTAGE HEALTH PRODUCTS, LLC, GREEN BAY, WI, BY ASSIGNMENT ICP, INC., GREEN BAY, WI. SN 75-891,488. PUB. 12-26-2000, FILED 1-7-2000.



NO CLAIM IS MADE TO THE EXCLUSIVE RIGHT TO USE "HEALTH PRODUCTS", APART FROM THE MARK AS SHOWN.

FOR DISTRIBUTORSHIPS IN THE FIELD OF MEDICAL PRODUCTS (U.S. CLS. 100, 101 AND 102).
FIRST USE 1-2-2000; IN COMMERCE 5-31-2000.

CLASS 35—(Continued).

2,625,769. STARCITE, INC., PHILADELPHIA, PA. SN 75-897,294. PUB. 11-20-2001, FILED 1-18-2000.

MAKE MEETINGS HAPPEN

NO CLAIM IS MADE TO THE EXCLUSIVE RIGHT TO USE "MEETINGS", APART FROM THE MARK AS SHOWN.

FOR PROVIDING ON-LINE BUSINESS INFORMATION, NAMELY DESCRIPTIONS OF THE PRODUCTS AND SERVICES OF OTHERS AND BENCH MARK DATA IN THE FIELD OF MEETING CONSOLIDATION AND PLANNING VIA A GLOBAL COMPUTER NETWORK; ONLINE ADVERTISING SERVICES, NAMELY PROVIDING ADVERTISING SPACE ON A WEB SITE TO PROMOTE THE PRODUCTS AND SERVICES OF OTHERS VIA A GLOBAL COMPUTER NETWORK; ON-LINE BUSINESS CONSULTATION SERVICES IN THE FIELDS OF EVENT PLANNING AND MEETING CONSOLIDATION AND PLANNING, NAMELY, EVENT PLANNING, EVENT SCHEDULING, EVENT BUDGETING, EVENT PURCHASING, EVENT DATA ANALYSIS AND TRACKING, SUPPLIER OPPORTUNITY BROKERING, INTERNATIONAL EVENT RESOURCE, EVENT PROGRAM DEVELOPMENT, MEETING AND EVENT REGISTRATION SERVICES, TRACKING EVENT PARTICIPANT REGISTRATION DATA, TRACKING AND LEVERAGING OF SUPPLIER PURCHASING, TRACKING EVENT LOGISTICS AND INVENTORY, VENUE RESEARCHING, POST EVENT SUPPLIER INVOICE AUDITING, BILLING RECONCILIATION, NEGOTIATING AND CONTRACTING SERVICES VIA A GLOBAL COMPUTER NETWORK (U.S. CLS. 100, 101 AND 102).
FIRST USE 2-1-2000; IN COMMERCE 2-1-2000.

2,625,795. CHANNEL ONE, INC., MILWAUKEE, WI. SN 75-907,929. PUB. 6-5-2001, FILED 1-27-2000.

FULLHOUSE MEDIA

NO CLAIM IS MADE TO THE EXCLUSIVE RIGHT TO USE "MEDIA", APART FROM THE MARK AS SHOWN.

FOR PUBLIC RELATIONS; PREPARING ADVERTISEMENTS FOR OTHERS; MODELING FOR ADVERTISING OR SALES PROMOTION (U.S. CLS. 100, 101 AND 102).
FIRST USE 4-3-2000; IN COMMERCE 4-3-2000.

2,625,816. DEEP FOODS, INC., UNION, NJ. SN 75-915,679. PUB. 11-13-2001, FILED 2-10-2000.

GROCERYBABU.COM

FOR COMPUTERIZED ON-LINE SEARCH AND ORDERING SERVICE FOR WHOLESALE AND RETAIL DISTRIBUTION OF FOOD AND NON-FOOD SUPERMARKET GOODS, NAMELY FOOD PRODUCTS, HAND AND BODY LOTION, SOAPS, AND EATING AND COOKING UTENSILS (U.S. CLS. 100, 101 AND 102).
FIRST USE 2-15-2002; IN COMMERCE 2-15-2002.

CLASS 35—(Continued).

2,625,827. DEAKINS, JONI, LOS ANGELES, CA. SN 75-922,114. PUB. 3-6-2001, FILED 2-17-2000.

SCREENSTYLES

FOR MARKETING SERVICES FOR APPAREL AND HOME FURNISHINGS DISPLAYED IN MEDIA EVENTS AND PURCHASED THROUGH THE GLOBAL COMPUTER NETWORK (U.S. CLS. 100, 101 AND 102).
FIRST USE 5-15-2002; IN COMMERCE 5-15-2002.

2,625,829. ALLIED FASHION INC., SAVANNAH, GA. SN 75-922,974. PUB. 7-10-2001, FILED 2-18-2000.

CITI TRENDS

FOR RETAIL DEPARTMENT STORE SERVICES (U.S. CLS. 100, 101 AND 102).
FIRST USE 2-15-2000; IN COMMERCE 2-15-2000.

2,625,856. EJEWELRY, LLC, FAIRFIELD, OH. SN 75-936,175. PUB. 8-7-2001, FILED 3-6-2000.

SHOPPER WATCH

NO CLAIM IS MADE TO THE EXCLUSIVE RIGHT TO USE "SHOPPER", APART FROM THE MARK AS SHOWN.

FOR CUSTOMER INFORMATION MANAGEMENT SERVICES UTILIZING A GLOBAL COMMUNICATION NETWORK, OFFERED TO RETAILERS IN THE JEWELRY BUSINESS (U.S. CLS. 100, 101 AND 102).
FIRST USE 10-1-1999; IN COMMERCE 10-1-1999.

2,625,859. FBCIP, INC., KATY, TX. SN 75-936,636. PUB. 3-6-2001, FILED 3-6-2000.

PEOPLE.TECHNOLOGY.SERVICE.WE'VE GOT IT ALL TOGETHER.

FOR PROMOTING THE GOODS AND SERVICES OF OTHER BY PREPARING AND PLACING ADVERTISEMENTS IN TELEPHONE DIRECTORIES; AND BUSINESS MARKETING CONSULTING SERVICES (U.S. CLS. 100, 101 AND 102).
FIRST USE 1-1-2001; IN COMMERCE 1-1-2001.

CLASS 35—(Continued).

2,625,875. QUALITY STORES SERVICES, INC., MUSKEGON, MI. SN 75-960,672. PUB. 6-12-2001, FILED 3-17-2000.

FARMANDCOUNTRY.COM

FOR ONLINE RETAIL SERVICES FEATURING FARM SUPPLIES AND EQUIPMENT (U.S. CLS. 100, 101 AND 102).

FIRST USE 12-31-2000; IN COMMERCE 12-31-2000.

2,625,881. DATATREASURY CORPORATION, NEW YORK, NY, BY ASSIGNMENT CSP HOLDINGS, LLC, LLOYD HARBOR, NY. SN 75-981,606. PUB. 3-23-1999, FILED 7-3-1997.

DATATREASURY

FOR DATA PROCESSING SERVICES (U.S. CLS. 100, 101 AND 102).

FIRST USE 6-10-2000; IN COMMERCE 6-10-2000.

2,625,895. KROEHLER CORPORATION, COLUMBUS, OH. SN 75-982,346. PUB. 4-11-2000, FILED 4-7-1999.

AMERICAN SIGNATURE GALLERY

OWNER OF U.S. REG. NO. 2,196,253.
NO CLAIM IS MADE TO THE EXCLUSIVE RIGHT TO USE "AMERICAN" AND "GALLERY", APART FROM THE MARK AS SHOWN.

FOR RETAIL STORE SERVICES IN THE FIELD OF FURNITURE, HOME AND OFFICE FURNISHINGS AND DECORATIVE ACCESSORIES (U.S. CLS. 100, 101 AND 102).

FIRST USE 12-0-2001; IN COMMERCE 12-0-2001.

2,625,923. ROLLIN B. CHILD, INC., MINNEAPOLIS, MN. SN 76-015,928. PUB. 11-27-2001, FILED 4-3-2000.

BACK BAY

FOR RETAIL STORE SERVICES AND WHOLESALE DISTRIBUTORSHIPS FEATURING TILE, STONE AND RELATED SETTING MATERIALS, NAMELY GROUT AND ADHESIVE (U.S. CLS. 100, 101 AND 102).

FIRST USE 4-0-2000; IN COMMERCE 4-0-2000.

CLASS 35—(Continued).

2,625,924. MCKENNEY, MARK G., MIAMI BEACH, FL. AND KATARIYA, KUSHAGRA, MIAMI BEACH, FL. SN 76-016,010. PUB. 7-3-2001, FILED 4-3-2000.

JOB2CAREER.COM

FOR CAREER PLACEMENT (U.S. CLS. 100, 101 AND 102).

FIRST USE 1-1-2000; IN COMMERCE 5-1-2000.

2,625,926. SHIMANO AMERICAN CORPORATION, IRVINE, CA. SN 76-017,463. PUB. 7-24-2001, FILED 4-4-2000.

SHIMANO DIRECT

NO CLAIM IS MADE TO THE EXCLUSIVE RIGHT TO USE "DIRECT", APART FROM THE MARK AS SHOWN.

THE ENGLISH TRANSLATION OF THE JAPANESE TERM "SHIMANO" IS "ISLAND FIELDS".

FOR ADVERTISING SERVICES, NAMELY, PROMOTING OF SPORTING GOODS TO RETAIL BUSINESSES AND DEALERS THROUGH THE DISTRIBUTION OF PRINTED, AUDIO AND ELECTRONIC PROMOTIONAL MATERIALS AND BY RENDERING ADVICE; ADVERTISING FOR OTHERS VIA AN ON-LINE ELECTRONIC COMMUNICATIONS NETWORK; TELEVISION ADVERTISING SERVICES; DISSEMINATION OF ADVERTISING MATTER; BUSINESS MANAGEMENT AND BUSINESS ADMINISTRATION SERVICES IN CONNECTION WITH SPORTING GOODS (U.S. CLS. 100, 101 AND 102).

FIRST USE 7-31-2000; IN COMMERCE 9-30-2000.

2,625,927. TREVANNA, LLC, NEW YORK, NY. SN 76-018,133. PUB. 12-25-2001, FILED 4-5-2000.

TREVANNA.COM

FOR ON LINE PORTAL AND DIRECTORY SERVICES FOR ARTS AND ENTERTAINMENT PROFESSIONALS, NAMELY, PROVIDING AND MAINTAINING ON LINE DATABASES FEATURING CONTACT INFORMATION, DESCRIPTIONS, CURRENT PROJECTS, AND CALENDAR OF EVENTS FOR INDIVIDUALS AND BUSINESSES IN THE ARTS AND ENTERTAINMENT INDUSTRIES (U.S. CLS. 100, 101 AND 102).

FIRST USE 1-26-2001; IN COMMERCE 4-16-2001.

CLASS 35—(Continued).

2,625,935. KRAFT FOODS HOLDINGS, INC., NORTHFIELD, IL. SN 76-025,244. PUB. 1-9-2001, FILED 4-13-2000.



OWNER OF U.S. REG. NO. 2,237,759.
FOR PROVIDING BUSINESS, CONSUMER, MARKET AND STATISTICAL INFORMATION AND DATA IN THE FIELD OF FOOD PRODUCTS (U.S. CLS. 100, 101 AND 102).
FIRST USE 11-1-2001; IN COMMERCE 11-1-2001.

2,625,960. DATACORE SOFTWARE CORPORATION, FORT LAUDERDALE, FL. SN 76-035,739. PUB. 1-1-2002, FILED 4-27-2000.

SANVANTAGE

FOR COMPUTER SERVICES, NAMELY, PROVIDING A REVENUE AND ADVERTISING SHARING PROGRAM AND AFFILIATE AND REFERRAL PROGRAM FOR BUSINESSES IN THE COMPUTER INDUSTRY ON A GLOBAL COMPUTER NETWORK (U.S. CLS. 100, 101 AND 102).
FIRST USE 7-9-2001; IN COMMERCE 7-9-2001.

2,625,962. STARLIGHT INTERNATIONAL, LTD. LP, MONTEREY, CA. SN 76-036,392. PUB. 3-27-2001, FILED 4-27-2000.



OWNER OF U.S. REG. NOS. 1,979,303, 2,172,113, AND 2,371,985.
FOR WHOLESALE DISTRIBUTORSHIP SERVICES IN THE FIELD OF VITAMINS, DIETARY SUPPLEMENTS, NUTRIENTS, MINERALS AND HERBS AND HYGIENIC BEAUTY CARE PRODUCTS (U.S. CLS. 100, 101 AND 102).
FIRST USE 6-1-2000; IN COMMERCE 6-1-2000.

CLASS 35—(Continued).

2,625,970. CHILDREN'S SAFETY CARE, GAITHERSBURG, MD. SN 76-040,172. PUB. 8-21-2001, FILED 5-4-2000.

**CHILDREN'S SAFETY CARE**

NO CLAIM IS MADE TO THE EXCLUSIVE RIGHT TO USE "CHILDREN'S SAFETY CARE", APART FROM THE MARK AS SHOWN.
FOR DISTRIBUTORSHIPS IN THE FIELD OF SAFETY DEVICES FOR CHILDREN IN HOMES, DAYCARES AND OFFICES (U.S. CLS. 100, 101 AND 102).
FIRST USE 6-1-1995; IN COMMERCE 6-1-1995.

2,625,980. TALENTBANK, LLC, IRVING, TX. SN 76-044,321. PUB. 6-12-2001, FILED 5-9-2000.

TALENTBANK

FOR TALENT AGENCY SERVICES, NAMELY, MANAGEMENT OF ATHLETES AND SPORTS PERSONALITIES, ENTERTAINERS, EXECUTIVES AND OTHER PROMINENT PERSONALITIES (U.S. CLS. 100, 101 AND 102).
FIRST USE 5-11-2000; IN COMMERCE 5-11-2000.

2,625,986. METRO ONE TELECOMMUNICATIONS, INC., BEAVERTON, OR. SN 76-046,386. PUB. 4-24-2001, FILED 5-10-2000.

AUTOTALLY

FOR COMPUTERIZED DATABASE MANAGEMENT FEATURING A TOOL THAT AUTOMATICALLY TRACKS A CUSTOMIZED COLLECTION OF INFORMATION, NAMELY, CONNECTIONS TO SPECIFIC NUMBERS, SERVICES, URLS, DATA USAGE ACTIVITIES, CALLER AND OPERATOR ACTION, THAT CORRELATES EVENTS VIA CALL SEQUENCE NUMBER (CSN) AND THAT PRESENTS SUMMARY REPORTS OF ACTIONS IN A TELEPHONY PORTAL ENVIRONMENT (U.S. CLS. 100, 101 AND 102).
FIRST USE 5-0-2000; IN COMMERCE 8-22-2001.

CLASS 35—(Continued).

2,625,996. MTS, INCORPORATED, WEST SACRAMENTO, CA. SN 76-048,246. PUB. 7-3-2001, FILED 5-15-2000.

TOWER RECORDS ESSENTIALS COLLECTION

OWNER OF U.S. REG. NOS. 1,869,742 AND 2,213,846.
NO CLAIM IS MADE TO THE EXCLUSIVE RIGHT TO USE "RECORDS" OR "COLLECTION", APART FROM THE MARK AS SHOWN.

FOR RETAIL STORE SERVICES AND TELEPHONE, CATALOG, MAIL AND ONLINE ORDERING SERVICES FEATURING PHONOGRAPH RECORDS, AUDIO-VIDEO CASSETTE TAPES, COMPACT DISCS, CD-ROM'S, DVD'S, BOOKS, MAGAZINES, COMPUTER SOFTWARE, CLOTHING, LASER DISCS, EVENT TICKETS, AND GIFT CERTIFICATES (U.S. CLS. 100, 101 AND 102).
FIRST USE 1-0-2000; IN COMMERCE 1-0-2000.

2,626,030. SHOP'N CHEK, INC., NORCROSS, GA. SN 76-068,080. PUB. 8-28-2001, FILED 6-12-2000.

SnC-Browse

FOR BUSINESS SERVICES, NAMELY, PROVIDING A WEBSITE WHEREON COMPUTER USERS CAN REVIEW MYSTERY SHOPPING RESULTS WHICH ARE COMPILED INTO CUSTOMIZED REPORTS TO BE USED FOR IMPROVING CUSTOMER SERVICE (U.S. CLS. 100, 101 AND 102).

FIRST USE 4-1-1998; IN COMMERCE 4-1-1998.

2,626,031. SHOP'N CHEK, INC., NORCROSS, GA. SN 76-068,374. PUB. 8-28-2001, FILED 6-12-2000.

SnC-Query

FOR BUSINESS SERVICES, NAMELY, PROVIDING A WEBSITE WHEREON COMPUTER USERS CAN REVIEW MYSTERY SHOPPING RESULTS WHICH ARE COMPILED INTO CUSTOMIZED REPORTS TO BE USED FOR IMPROVING CUSTOMER SERVICE (U.S. CLS. 100, 101 AND 102).

FIRST USE 4-1-1998; IN COMMERCE 4-1-1998.

CLASS 35—(Continued).

2,626,055. DAVID RIGBY ASSOCIATES LIMITED, MANCHESTER M1 5AQ, UNITED KINGDOM. SN 76-080,510. PUB. 10-30-2001, FILED 6-29-2000.



DAVID RIGBY ASSOCIATES

NO CLAIM IS MADE TO THE EXCLUSIVE RIGHT TO USE "ASSOCIATES", APART FROM THE MARK AS SHOWN.

THE FOUR SQUARES DEPICTED IN THE DESIGN MARK ARE LINED FOR COLOR. SPECIFICALLY, CLOCKWISE FROM THE TOP LEFT, THE SQUARES ARE LINED FOR THE COLOR GOLD, BLUE, RED AND GREEN.

FOR PROVISION OF BUSINESS MANAGEMENT, MARKETING AND STRATEGY ADVICE AND INFORMATION (U.S. CLS. 100, 101 AND 102).

FIRST USE 1-1-1997; IN COMMERCE 1-1-1997.

2,626,082. C.D.C. APPLIANCES, INC., DBA OHIO VALLEY FLOORING, CINCINNATI, OH. SN 76-091,768. PUB. 5-1-2001, FILED 7-17-2000.

Gems of Distinction
By OVE

FOR WHOLESALE DISTRIBUTORSHIPS FEATURING CARPETING (U.S. CLS. 100, 101 AND 102).

FIRST USE 10-16-2000; IN COMMERCE 10-16-2000.

2,626,091. ROWE DIVERSIFIED, INC., WILMINGTON, DE. SN 76-097,315. PUB. 5-29-2001, FILED 7-24-2000.

ROOM SCENES

OWNER OF U.S. REG. NO. 2,386,500.
FOR RETAIL STORE SERVICES IN THE FIELD OF FURNITURE, HOME FURNISHINGS AND ACCESSORIES (U.S. CLS. 100, 101 AND 102).

FIRST USE 6-0-2000; IN COMMERCE 6-0-2000.

2,626,109. COMSCORE, INC., RESTON, VA. SN 76-105,534. PUB. 11-20-2001, FILED 8-8-2000.

VOICEFIVE

FOR CONDUCTING MARKETING STUDIES, NAMELY, INCENTIVE PROGRAMS FOR ENCOURAGING AND MOTIVATING CONSUMER PARTICIPATING IN MARKETING AND BEHAVIORAL RESEARCH (U.S. CLS. 100, 101 AND 102).

FIRST USE 7-14-2000; IN COMMERCE 10-16-2000.

CLASS 35—(Continued).

2,626,115. SYMMETRICS MARKETING CORPORATION, TEMPE, AZ. SN 76-109,561. PUB. 9-4-2001, FILED 8-15-2000.

CUSTOMER RELATIONSHIP ARCHITECTURE

NO CLAIM IS MADE TO THE EXCLUSIVE RIGHT TO USE "CUSTOMER RELATIONSHIP", APART FROM THE MARK AS SHOWN.

FOR BUSINESS MARKETING CONSULTING SERVICES, NAMELY, DEFINING AND BUILDING A CUSTOMER RELATIONSHIP MANAGEMENT STRATEGY AND ENVIRONMENT, NAMELY, PERFORMING RESEARCH AND PROVIDING MANAGEMENT DECISION SUPPORT FOR DEFINING, OPTIMIZING, AND MANAGING RELATIONSHIPS BETWEEN CUSTOMERS AND A BUSINESS ENTITY CONSISTING OF, CUSTOMER LOYALTY MODELING, MARKET AND SEGMENT MODELING, BRAND EQUITY MODELING, FINANCIAL SIMULATION, EMPLOYEE COMMITMENT MODELING, EMPLOYEE-CUSTOMER-PROFIT CHAIN MODELING, FACILITATING THE DEFINITION AND CREATION OF CUSTOMER RELATIONSHIP STRATEGIES, AND FACILITATING THE DEFINITION AND CREATION OF META-DATA MODELS FOR THE MANAGEMENT AND MAINTENANCE OF CUSTOMER INFORMATION AND INTELLIGENCE SYSTEMS (U.S. CLS. 100, 101 AND 102).

FIRST USE 3-0-2001; IN COMMERCE 3-0-2001.

2,626,123. J.R., INC., UNIVERSAL CITY, TX. SN 76-113,218. PUB. 6-26-2001, FILED 8-21-2000.

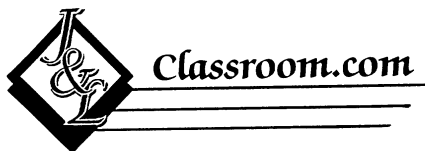

NO CLAIM IS MADE TO THE EXCLUSIVE RIGHT TO USE "CLASSROOM.COM", APART FROM THE MARK AS SHOWN.

FOR CATALOG AND ON-LINE ORDERING IN THE FIELD OF FURNITURE (U.S. CLS. 100, 101 AND 102). FIRST USE 9-15-2001; IN COMMERCE 9-15-2001.

CLASS 35—(Continued).

2,626,127. INTERELATE, INC., EDEN PRAIRIE, MN. SN 76-116,258. PUB. 6-19-2001, FILED 8-24-2000.



FOR BUSINESS CONSULTING SERVICES IN THE FIELD OF MARKET AND CUSTOMER BASE ANALYSIS, SALES CAMPAIGN MANAGEMENT, AND BUSINESS PLAN EXECUTION (U.S. CLS. 100, 101 AND 102). FIRST USE 8-0-2000; IN COMMERCE 8-0-2000.

2,626,164. ALLIED TELESYN INTERNATIONAL CORP., BOTHELL, WA. SN 76-128,960. PUB. 8-28-2001, FILED 9-14-2000.

NET.COVER

FOR PROMOTING THE SALE OF COMPUTER HARDWARE AND COMPUTER SOFTWARE THROUGH THE ADMINISTRATION OF INCENTIVE PROGRAMS FEATURING ENHANCED SUPPORT SERVICES FOR RESSELLERS AND THEIR CUSTOMERS (U.S. CLS. 100, 101 AND 102).

FIRST USE 2-14-2001; IN COMMERCE 2-14-2001.

2,626,185. 800.COM, INC., PORTLAND, OR. SN 76-138,671. PUB. 5-15-2001, FILED 10-2-2000.

SUREPRICE

FOR ON-LINE RETAIL STORE SERVICES IN THE FIELD OF ELECTRONICS, MOVIES, MUSIC AND GAMES (U.S. CLS. 100, 101 AND 102).

FIRST USE 10-7-2000; IN COMMERCE 10-7-2000.

2,626,206. DEPOT DIRECT, INC., PERRYSBURG, OH. SN 76-144,835. PUB. 1-15-2002, FILED 10-11-2000.

KENAKORE SOLUTIONS

NO CLAIM IS MADE TO THE EXCLUSIVE RIGHT TO USE "SOLUTIONS", APART FROM THE MARK AS SHOWN.

FOR INVENTORY MANAGEMENT AND CONTROL FOR OTHERS; LOGISTICS SERVICES FOR OTHERS, NAMELY, TRACKING OF PACKAGES IN TRANSIT; DEMAND FULFILLMENT SERVICES FOR OTHERS IN THE FIELD OF INDUSTRIAL PRODUCTS (U.S. CLS. 100, 101 AND 102).

FIRST USE 2-0-2001; IN COMMERCE 2-0-2001.

CLASS 35—(Continued).

2,626,210. COMSCORE, INC., RESTON, VA. SN 76-148,073. PUB. 11-13-2001, FILED 10-16-2000.

CKP

FOR BUSINESS CONSULTING SERVICES IN THE FIELDS OF ELECTRONIC COMMERCE, MARKETING AND ADVERTISING ON A GLOBAL COMPUTER INFORMATION NETWORK; CONDUCTING BUSINESS MARKETING AND ADVERTISING RESEARCH AND SURVEYS; COMPUTERIZED DATABASE MANAGEMENT SERVICES; PUBLIC OPINION POLLING FOR BUSINESS OR ADVERTISING PURPOSES, NAMELY, MONITORING CONSUMER BEHAVIOR AND PREFERENCES VIA A GLOBAL COMPUTER INFORMATION NETWORK; COMPILING AND PROVIDING AN ON-LINE COMPUTER DATABASE IN THE FIELD OF MONITORING CONSUMER BEHAVIOR AND PREFERENCES VIA A GLOBAL COMPUTER INFORMATION NETWORK (U.S. CLS. 100, 101 AND 102).

FIRST USE 5-1-2000; IN COMMERCE 5-1-2001.

2,626,215. TIER TECHNOLOGIES, INC., WALNUT CREEK, CA. SN 76-149,441. PUB. 7-24-2001, FILED 10-19-2000.

TIER

OWNER OF U.S. REG. NOS. 1,988,474, 2,228,110, AND OTHERS.

FOR BUSINESS MANAGEMENT AND CONSULTING SERVICES (U.S. CLS. 100, 101 AND 102).

FIRST USE 1-0-2001; IN COMMERCE 1-0-2001.

2,626,229. FUEL LINKS, INC., IRVING, TX. SN 76-153,867. PUB. 8-28-2001, FILED 10-25-2000.



FOR PROMOTING THE SALE OF GOODS AND SERVICES OF OTHERS THROUGH THE USE OF PRODUCT AND SERVICE TIE-INS BETWEEN RETAIL ESTABLISHMENTS AND FUEL RETAILERS AND ADMINISTRATION OF INCENTIVE PROGRAMS (U.S. CLS. 100, 101 AND 102).

FIRST USE 5-18-2000; IN COMMERCE 5-18-2000.

2,626,238. DUNKIN' DONUTS USA, INC., PLYMOUTH, MI. SN 76-156,094. PUB. 7-24-2001, FILED 10-31-2000.

REGULAR REFILLS

FOR ON-LINE RETAIL STORE SERVICES FEATURING COFFEE (U.S. CLS. 100, 101 AND 102).

FIRST USE 2-0-2001; IN COMMERCE 2-0-2001.

CLASS 35—(Continued).

2,626,249. SENSE OF SMELL INSTITUTE, LTD., NEW YORK, NY, BY CHANGE OF NAME OLFACTORY RESEARCH FUND, LTD., THE, NEW YORK, NY. SN 76-158,398. PUB. 11-27-2001, FILED 11-3-2000.

SOSI RESEARCH EXCHANGE

NO CLAIM IS MADE TO THE EXCLUSIVE RIGHT TO USE "RESEARCH EXCHANGE", APART FROM THE MARK AS SHOWN.

FOR INFORMATION SERVICES, NAMELY, PROVIDING AN ONLINE DIRECTORY OF SCIENTIFIC RESEARCHERS IN FIELD OF CHEMOSENSORY RESEARCH, SPONSORS OF CHEMOSENSORY RESEARCH AND RELATED INFORMATION (U.S. CLS. 100, 101 AND 102).

FIRST USE 4-22-2002; IN COMMERCE 5-1-2002.

2,626,266. SPINX OIL COMPANY, INC., GREENVILLE, SC. SN 76-166,369. PUB. 7-31-2001, FILED 11-16-2000.



OWNER OF U.S. REG. NOS. 1,100,508 AND 2,011,375. FOR RETAIL CONVENIENCE STORE SERVICES FEATURING FUEL, OIL, AND GASOLINE (U.S. CLS. 100, 101 AND 102).

FIRST USE 8-20-2000; IN COMMERCE 8-20-2000.

2,626,286. WILDMAN, CHRIS T., ORANGE PARK, FL. SN 76-173,280. PUB. 8-14-2001, FILED 11-30-2000.

LISTWIZARD

FOR COMPUTERIZED DATABASE MANAGEMENT FOR OTHERS, NAMELY PROVIDING A SYSTEMATIC METHODOLOGY FOR STIMULATING THE MEMORY OF INDIVIDUALS TO CREATE PERSONALIZED DATABASES OF KNOWN CONTACT, CLIENT OR CUSTOMER INFORMATION, AND MAINTAINING PERSONALIZED DATABASES OF CONTACT, CLIENT OR CUSTOMER INFORMATION IN THE FIELD OF SALES AND MARKETING, ACCESSIBLE VIA A WEB SITE ON A GLOBAL COMMUNICATIONS NETWORK (U.S. CLS. 100, 101 AND 102).

FIRST USE 1-31-2001; IN COMMERCE 1-31-2001.

2,626,288. HARRISON & STAR, INC., NEW YORK, NY. SN 76-173,994. PUB. 8-28-2001, FILED 12-4-2000.

22CLICKS

FOR ADVERTISING AGENCY AND PUBLIC RELATIONS SERVICES IN THE FIELD OF PHARMACEUTICALS (U.S. CLS. 100, 101 AND 102).

FIRST USE 10-1-2000; IN COMMERCE 10-1-2000.

CLASS 35—(Continued).

2,626,294. R.R. MORRISON & SON, INC., VICKSBURG, MS.
SN 76-176,285. PUB. 9-18-2001, FILED 12-6-2000.

FLEETALL

FOR PROVIDING A WEBSITE WITH INFORMATION AND LINKS ABOUT BUSINESSES INVOLVED IN FLEET MANAGEMENT (U.S. CLS. 100, 101 AND 102).
FIRST USE 8-1-2001; IN COMMERCE 8-1-2001.

2,626,325. HERITAGE GOLF GROUP, LLC, SAN DIEGO, CA.
SN 76-192,325. PUB. 12-11-2001, FILED 1-10-2001.

**HERITAGE
GOLF GROUP**

NO CLAIM IS MADE TO THE EXCLUSIVE RIGHT TO USE "GOLF GROUP", APART FROM THE MARK AS SHOWN.

FOR HOTEL AND RESTAURANT MANAGEMENT FOR OTHERS; MANAGEMENT OF GOLF COURSE PROPERTIES FOR OTHERS (U.S. CLS. 100, 101 AND 102).

FIRST USE 4-1-2001; IN COMMERCE 4-1-2001.

2,626,335. CORNERBARPR, KANSAS CITY, MO. SN 76-194,565. PUB. 10-9-2001, FILED 1-16-2001.

CORNERBARPR.COM

FOR PROVIDING PROFESSIONAL INFORMATION IN THE FIELD OF PUBLIC RELATIONS VIA A GLOBAL COMPUTER NETWORK (U.S. CLS. 100, 101 AND 102).
FIRST USE 10-24-2000; IN COMMERCE 10-24-2000.

2,626,408. WORLD WIDE IMPORTS ENTERPRISES, INC., FORT LAUDERDALE, FL. SN 76-217,313. PUB. 9-4-2001, FILED 2-28-2001.

LIVESAND.COM

FOR ON-LINE RETAIL STORE SERVICES FEATURING AQUARIUM PRODUCTS (U.S. CLS. 100, 101 AND 102).
FIRST USE 12-18-2000; IN COMMERCE 12-18-2000.

CLASS 35—(Continued).

2,626,409. BIG WAVE NET VENTURES, LLC, DALLAS, TX.
SN 76-217,440. PUB. 1-8-2002, FILED 2-28-2001.

WATCHPARADISE.COM

FOR PROVIDING WHOLESALE AND RETAIL CUSTOMERS WITH FINE PRE-OWNED WATCHES AND WRIST WATCHES THROUGH SERVICES VIA DIRECT MAIL, MAIL ORDER CATALOGS, TRADE SHOWS AND TRADE PUBLICATIONS; AND THE BRINGING TOGETHER, FOR THE BENEFIT OF OTHERS, OF A VARIETY OF FINE PRE-OWNED POCKET WATCHES AND WRIST WATCHES THROUGH AN INTERACTIVE ELECTRONIC COMMUNICATIONS NETWORK OR A WORLD WIDE GLOBAL COMPUTER NETWORK, ENABLING CUSTOMERS CONVENIENTLY TO VIEW AND PURCHASE THOSE GOODS FROM THE WEB SITE OR OTHER FORM OF ELECTRONIC MEDIA BY MEANS OF TELECOMMUNICATIONS (U.S. CLS. 100, 101 AND 102).
FIRST USE 11-30-2001; IN COMMERCE 11-30-2001.

2,626,413. FIRST MANHATTAN CONSULTING GROUP, NEW YORK, NY. SN 76-219,416. PUB. 8-28-2001, FILED 3-2-2001.

POWER QUESTIONS

FOR MARKETING RESEARCH AND ANALYSIS AND CONSULTING SERVICES, INCLUDING, BUT NOT LIMITED TO, IDENTIFYING TARGET AUDIENCES AND TARGET MARKETS WHICH ASSIST COMPANIES IN THE BUILDING OF ADVERTISING, MARKETING AND PROMOTIONAL STRATEGIES, AND PREPARING REPORTS RELATING THERETO (U.S. CLS. 100, 101 AND 102).
FIRST USE 1-0-2001; IN COMMERCE 1-0-2001.

2,626,418. TAYLOR CORPORATION, NORTH MANKATO, MN. SN 76-220,666. PUB. 8-21-2001, FILED 3-6-2001.

IDOE

FOR ON LINE ORDERING SERVICES FEATURING CUSTOM PRINTED BUSINESS STATIONERY (U.S. CLS. 100, 101 AND 102).
FIRST USE 3-0-2001; IN COMMERCE 3-0-2001.

CLASS 35—(Continued).

2,626,432. CADEC CORPORATION, LONDONDERRY, NH. SN 76-226,128. PUB. 11-27-2001, FILED 3-19-2001.

MYCADEC

OWNER OF U.S. REG. NO. 1,560,536.
 FOR CUSTOMER SERVICES IN THE FIELD OF VEHICLE INFORMATION SYSTEMS, NAMELY, DATA PROCESSING AND INTERCONNECTED STORAGE UNITS, VEHICLE SENSORS, INTERFACE UNITS, GLOBAL POSITIONING TRANSMITTERS AND RECEIVERS, TELECOMMUNICATIONS AND DATA TRANSMITTERS AND RECEIVERS; CUSTOMER SERVICES IN THE FIELD OF INSTALLATION, MAINTENANCE AND REPAIR OF VEHICLE INFORMATION SYSTEMS (U.S. CLS. 100, 101 AND 102).
 FIRST USE 11-15-2001; IN COMMERCE 11-15-2001.

CLASS 35—(Continued).

2,626,492. CIRCUIT CITY STORES WEST COAST, INC., WALNUT, CA. SN 76-258,565. PUB. 9-25-2001, FILED 5-17-2001.

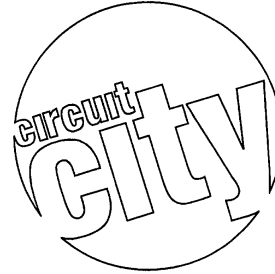

2,626,450. FEDERATED WESTERN PROPERTIES, INC., LAS VEGAS, NV. SN 76-233,664. PUB. 11-27-2001, FILED 3-30-2001.

MACY'S MAS GUSTO MAS TU

OWNER OF U.S. REG. NOS. 78,333, 2,373,705, AND OTHERS.
 THE ENGLISH TRANSLATION OF "MAS GUSTO MAS TU" IS "MORE PLEASURE MORE YOU".
 FOR RETAIL DEPARTMENT STORE SERVICES (U.S. CLS. 100, 101 AND 102).
 FIRST USE 3-1-2001; IN COMMERCE 3-1-2001.

OWNER OF U.S. REG. NOS. 1,121,646, 2,425,092, AND OTHERS.
 FOR RETAIL STORE SERVICES, MAIL ORDER SERVICES, AND RETAIL SERVICES OFFERED THROUGH A GLOBAL COMPUTER NETWORK, ALL OF WHICH FEATURE AUDIO, VIDEO, AND ELECTRONIC EQUIPMENT, COMPUTER HARDWARE, COMPUTER SOFTWARE, CAMERAS, CAMCORDERS, COMPACT DISCS, VIDEO TAPES, DIGITAL VIDEO DISCS, TELEPHONES, WIRELESS TELEPHONES, SATELLITE RECEIVING EQUIPMENT, FACSIMILE MACHINES, AND TOYS (U.S. CLS. 100, 101 AND 102).
 FIRST USE 7-1-2001; IN COMMERCE 7-1-2001.

2,626,451. FEDERATED WESTERN PROPERTIES, INC., LAS VEGAS, NV. SN 76-233,665. PUB. 11-27-2001, FILED 3-30-2001.

MACY'S MORE YOU

OWNER OF U.S. REG. NOS. 78,333, 2,373,705, AND OTHERS.
 FOR RETAIL DEPARTMENT STORE SERVICES (U.S. CLS. 100, 101 AND 102).
 FIRST USE 3-1-2001; IN COMMERCE 3-1-2001.

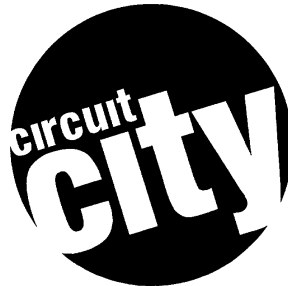

2,626,488. HERRENKOHL, ERIC, ST. LOUIS, MO. SN 76-255,843. PUB. 10-2-2001, FILED 5-11-2001.

CLARIUS

FOR BUSINESS MANAGEMENT AND CONSULTING SERVICES (U.S. CLS. 100, 101 AND 102).
 FIRST USE 4-1-2001; IN COMMERCE 2-1-2001.

OWNER OF U.S. REG. NOS. 1,121,646, 2,425,092, AND OTHERS.
 FOR RETAIL STORE SERVICES, MAIL ORDER SERVICES, AND RETAIL SERVICES OFFERED THROUGH A GLOBAL COMPUTER NETWORK, ALL OF WHICH FEATURE AUDIO, VIDEO, AND ELECTRONIC EQUIPMENT, COMPUTER HARDWARE, COMPUTER SOFTWARE, CAMERAS, CAMCORDERS, COMPACT DISCS, VIDEO TAPES, DIGITAL VIDEO DISCS, TELEPHONES, WIRELESS TELEPHONES, SATELLITE RECEIVING EQUIPMENT, FACSIMILE MACHINES, AND TOYS (U.S. CLS. 100, 101 AND 102).
 FIRST USE 7-1-2001; IN COMMERCE 7-1-2001.

CLASS 35—(Continued).

2,626,505. MANHEIM AUCTIONS, INC., ATLANTA, GA. SN 76-263,252. PUB. 11-27-2001, FILED 5-29-2001.

DEDICATED TO DEALERS

FOR AUTOMOBILE AUCTION SERVICES (U.S. CLS. 100, 101 AND 102).
FIRST USE 1-0-2002; IN COMMERCE 1-0-2002.

2,626,518. AMERICAN ORTHOPEDIC SUPPORTS, INC., HALLANDALE, FL. SN 76-278,102. PUB. 1-15-2002, FILED 6-29-2001.

DOC ORTHO

NO CLAIM IS MADE TO THE EXCLUSIVE RIGHT TO USE "ORTHO", APART FROM THE MARK AS SHOWN.
FOR ONLINE STORE SERVICES FEATURING MEDICAL AND THERAPEUTIC SUPPORTS FOR LIMBS AND JOINTS AND OCCUPATIONAL AND PATIENT CARE PRODUCTS (U.S. CLS. 100, 101 AND 102).
FIRST USE 10-2-2001; IN COMMERCE 10-2-2001.

2,626,523. SCHOLASTIC INC., NEW YORK, NY. SN 76-284,257. PUB. 11-13-2001, FILED 7-12-2001.

DINOFOURS

OWNER OF U.S. REG. NO. 2,395,980.
FOR CATALOG-BASED, MAIL ORDER BOOK CLUB FEATURING BOOKS FOR PARENTS AND CHILDREN, AND ARTS AND CRAFTS PAINT KITS, WOOD STAMP KITS, MAKE-YOUR-OWN LATCH HOOK RUG KITS, ACTIVITY KITS FOR MAKING PAPER COLLAGES, ALL FOR CHILDREN (U.S. CLS. 100, 101 AND 102).
FIRST USE 8-1-2001; IN COMMERCE 8-1-2001.

2,626,534. ANT FARM INTERACTIVE, LLC, ATLANTA, GA. SN 76-293,154. PUB. 11-13-2001, FILED 8-1-2001.

KUNG-FU-KIWI

FOR ADVERTISING SERVICES, NAMELY PROMOTING THE GOODS AND SERVICES OF OTHERS THROUGH THE CREATION AND DISTRIBUTION OF AUDIO-VISUAL PROMOTIONAL MATERIALS (U.S. CLS. 100, 101 AND 102).
FIRST USE 10-1-2001; IN COMMERCE 10-1-2001.

CLASS 35—(Continued).

2,626,537. MENTOR 4, INC., COLUMBIA, MD. SN 76-295,240. PUB. 11-13-2001, FILED 8-6-2001.

MENTOR 4

FOR TEMPORARY AND PERMANENT PERSONNEL RECRUITMENT AND PLACEMENT, AND BUSINESS CONSULTATION (U.S. CLS. 100, 101 AND 102).
FIRST USE 1-1-2002; IN COMMERCE 1-1-2002.

2,626,556. ALEXANDER, STEPHEN J., SANIBEL ISLAND, FL. SN 78-000,471. PUB. 9-11-2001, FILED 3-22-2000.

MERCHO

FOR BUSINESS MARKETING CONSULTATION IN THE FIELD OF PRODUCT PLACEMENT AND CONSUMER SHOPPING HABITS; ADVERTISING SERVICES, NAMELY PROMOTING THE GOODS AND SERVICES OF OTHERS BY PREPARING AND PLACING SIGNS IN STORES AND THROUGH THE DISTRIBUTION OF PRINTED AND AUDIO PROMOTIONAL MATERIAL; AND PROVIDING INFORMATION IN THE FIELD OF ADVERTISING AND MARKETING VIA A GLOBAL COMPUTER NETWORK (U.S. CLS. 100, 101 AND 102).
FIRST USE 11-7-2001; IN COMMERCE 11-7-2001.

2,626,567. CHESAPEAKE CONSULTING, INC., SEVERNA PARK, MD. SN 78-007,818. PUB. 9-25-2001, FILED 5-12-2000.

ENTERPRISE FITNESS

NO CLAIM IS MADE TO THE EXCLUSIVE RIGHT TO USE "ENTERPRISE", APART FROM THE MARK AS SHOWN.
FOR BUSINESS MANAGEMENT CONSULTING SERVICES (U.S. CLS. 100, 101 AND 102).
FIRST USE 3-0-2000; IN COMMERCE 5-0-2000.

CLASS 35—(Continued).

2,626,570. DAH CONSULTING, INC., NEW YORK, NY. SN 78-009,711. PUB. 10-16-2001, FILED 5-24-2000.



DAH Consulting, Inc.

NO CLAIM IS MADE TO THE EXCLUSIVE RIGHT TO USE "CONSULTING, INC.", APART FROM THE MARK AS SHOWN.

FOR BUSINESS MARKETING AND CONSULTING SERVICES; MANAGEMENT SUPPORT SERVICES, NAMELY, BUSINESS CONSULTATION AND MANAGEMENT SERVICES IN THE FIELD OF HEALTHCARE, BUSINESS CONSULTATION IN THE FIELD OF PLANNING, DEVELOPMENT, AND EVALUATION OF PUBLIC AND PRIVATE PROGRAMS AND INTERNATIONAL DEVELOPMENT SERVICES, NAMELY ECONOMIC FORECASTING AND ANALYSIS; DISSEMINATION OF ADVERTISING FOR OTHERS VIA THE INTERNET (U.S. CLS. 100, 101 AND 102).

FIRST USE 3-18-2002; IN COMMERCE 3-18-2002.

2,626,577. ORION INTERNATIONAL CONSULTING GROUP, INC., FRANKLIN, TN. SN 78-013,002. PUB. 6-12-2001, FILED 6-16-2000.

14 DAYS... DONE.

FOR PROFESSIONAL PERSONNEL PLACEMENT AND RECRUITMENT SERVICES (U.S. CLS. 100, 101 AND 102).

FIRST USE 4-14-2000; IN COMMERCE 4-14-2000.

2,626,579. LOUISIANA ONLINE, INC., BATON ROUGE, LA. SN 78-013,788. PUB. 7-17-2001, FILED 6-21-2000.

SPORTS FAN NOW

NO CLAIM IS MADE TO THE EXCLUSIVE RIGHT TO USE "SPORTS FAN", APART FROM THE MARK AS SHOWN.

FOR COMPUTERIZED ON-LINE AND MAIL ORDER RETAIL SERVICES IN THE FIELD OF COLLEGE, ACADEMIC, OR SPORTS THEMED ITEMS, NAMELY, CLOTHING, FLAGS, UMBRELLAS, POSTERS, JEWELRY, ELECTRONICS, HOUSEWARES, SUNGLASSES, VIDEOS, BACKPACKS, BAGS, MUSIC, AND SPORTING GOODS (U.S. CLS. 100, 101 AND 102).

FIRST USE 3-26-2002; IN COMMERCE 3-26-2002.

2,626,596. PAYLESS SHOESOURCE WORLDWIDE, INC., TOPEKA, KS. SN 78-021,914. PUB. 6-19-2001, FILED 8-18-2000.

PAYLESS POINTS

OWNER OF U.S. REG. NO. 1,949,546.

CLASS 35—(Continued).

NO CLAIM IS MADE TO THE EXCLUSIVE RIGHT TO USE "POINTS", APART FROM THE MARK AS SHOWN.

FOR RETAIL STORE SERVICES IN THE FIELD OF FOOTWEAR FEATURING A FREQUENT PATRON PROGRAM IN WHICH POINTS ARE ACCUMULATED TO BE USED FOR DISCOUNTS ON FUTURE PURCHASES (U.S. CLS. 100, 101 AND 102).

FIRST USE 10-2-2000; IN COMMERCE 10-2-2000.

2,626,617. HARRIS, VINNIE G., AUSTIN, TX. SN 78-032,615. PUB. 9-11-2001, FILED 10-27-2000.

GULF COAST WIRELESS

NO CLAIM IS MADE TO THE EXCLUSIVE RIGHT TO USE "WIRELESS", APART FROM THE MARK AS SHOWN.

FOR ONLINE RETAIL STORE SERVICES FEATURING WIRELESS TELECOMMUNICATIONS PRODUCTS AND WIRELESS ELECTRONIC GOODS (U.S. CLS. 100, 101 AND 102).

FIRST USE 12-1-2001; IN COMMERCE 12-1-2001.

2,626,626. BRYDELS, JOHN JR., BATON ROUGE, LA. SN 78-036,535. PUB. 3-5-2002, FILED 11-27-2000.

GENERATION EXODUS

FOR ON LINE RETAIL SERVICES FEATURING BOOKS, ELECTRONICS, AND GIFTS; PROMOTING THE GOODS AND SERVICES OF OTHERS BY PREPARING AND PLACING ADVERTISEMENTS ACCESSED IN ELECTRONIC FORM VIA THE INTERNET AND BY PROVIDING HYPERTEXT LINKS TO THE WEB SITES OF OTHERS (U.S. CLS. 100, 101 AND 102).

FIRST USE 4-15-2002; IN COMMERCE 4-15-2002.

2,626,627. SODEXHO OPERATIONS, LLC, GAITHERSBURG, MD. SN 78-036,634. PUB. 9-11-2001, FILED 11-27-2000.



FOR BUSINESS MARKETING CONSULTING SERVICES RENDERED TO INSTITUTIONS, FEATURING ANALYSES OF THE TASTES, PREFERENCES, AND SPENDING HABITS OF POTENTIAL CUSTOMERS (U.S. CLS. 100, 101 AND 102).

FIRST USE 5-1-1999; IN COMMERCE 5-1-1999.

CLASS 35—(Continued).

2,626,643. GILLESPIE ORGANIZATION, INC., THE, LAWRENCEVILLE, NJ. SN 78-040,797. PUB. 9-11-2001, FILED 12-27-2000.

PERSONALIZED BRAND EXPERIENCE

NO CLAIM IS MADE TO THE EXCLUSIVE RIGHT TO USE "BRAND", APART FROM THE MARK AS SHOWN.

FOR ADVERTISING AGENCY AND BUSINESS MARKETING SERVICES FOR OTHERS INTENDED TO ESTABLISH GREATER CONSUMER BRAND LOYALTY AND AWARENESS AMONG TARGETED AUDIENCES BY MEANS OF A MEDIA MIX LEVERAGING AVAILABLE MARKETING TECHNOLOGIES (U.S. CLS. 100, 101 AND 102).

FIRST USE 1-2-2002; IN COMMERCE 1-2-2002.

2,626,654. BLT PRODUCTIONS, BILLINGS, MT. BY ASSIGNMENT BLOCKIT & LOCKIT SYSTEMS, BILLINGS, MT. SN 78-042,175. PUB. 8-28-2001, FILED 1-8-2001.

BLT PRODUCTIONS

NO CLAIM IS MADE TO THE EXCLUSIVE RIGHT TO USE "PRODUCTIONS", APART FROM THE MARK AS SHOWN.

FOR PROVIDING TELEVISION ADVERTISING FOR OTHERS; ADVERTISING AGENCIES, NAMELY, PROMOTING THE SERVICES FOR OTHERS THROUGH THE DISTRIBUTION OF PRINTED AND AUDIO PROMOTIONAL MATERIALS VIA MAGAZINES AND TELEVISION AND BY RENDERING SALES PROMOTION ADVICE; PRODUCTION OF TELEVISION COMMERCIALS (U.S. CLS. 100, 101 AND 102).

FIRST USE 1-0-2001; IN COMMERCE 1-0-2001.

2,626,675. GOCARD LLC, NEW YORK, NY. SN 78-047,442. PUB. 2-26-2002, FILED 2-9-2001.

GOCUP

FOR ADVERTISING SERVICES IN THE NATURE OF PREPARING AND DISSEMINATING ADVERTISEMENTS PROMOTING THE SALE OF GOODS AND SERVICES OF OTHERS DISPLAYED ON COFFEE CUPS (U.S. CLS. 100, 101 AND 102).

FIRST USE 3-0-2001; IN COMMERCE 3-0-2001.

CLASS 35—(Continued).

2,626,681. HENRY RAK CONSULTING PARTNERS, INC., LIBERTYVILLE, IL. SN 78-049,446. PUB. 11-27-2001, FILED 2-21-2001.



FOR BUSINESS CONSULTING SERVICES, NAMELY DEVELOPING STRATEGIC, MARKETING AND SALES PLANS, ANALYZING AND FORECASTING, AND PLANNING NEW PRODUCTS (U.S. CLS. 100, 101 AND 102).

FIRST USE 7-0-2000; IN COMMERCE 8-0-2001.

2,626,714. SEBA, TONY, SAN FRANCISCO, CA. SN 78-061,445. PUB. 9-25-2001, FILED 5-1-2001.

PONTIVA

FOR BUSINESS MARKETING CONSULTING; EXPORT AND IMPORT AGENCIES; FOREIGN TRADE INFORMATION AND CONSULTATION (U.S. CLS. 100, 101 AND 102).

FIRST USE 6-7-2001; IN COMMERCE 7-28-2001.

2,626,745. TRUSERV CORPORATION, CHICAGO, IL. SN 78-078,163. PUB. 3-12-2002, FILED 8-8-2001.

YOU'RE HERE. YOU'RE HOME. YOU'RE DONE.

FOR RETAIL HARDWARE STORE SERVICES (U.S. CLS. 100, 101 AND 102).

FIRST USE 1-0-2002; IN COMMERCE 1-0-2002.

CLASS 36—INSURANCE AND FINANCIAL

CLASS 36—(Continued).

2,625,343. BOSTON MILLENNIA PARTNERS LIMITED PARTNERSHIP, BOSTON, MA, BY ASSIGNMENT CALLOW, A. DANA, JR., WESTON, MA. SN 75-311,487. PUB. 6-30-1998, FILED 6-19-1997.

MILLENNIA PARTNERS

NO CLAIM IS MADE TO THE EXCLUSIVE RIGHT TO USE "PARTNERS", APART FROM THE MARK AS SHOWN. FOR FINANCIAL, INVESTMENT, MANAGEMENT SERVICES RELATED TO THE OPERATION OF PRIVATE EQUITY AND VENTURE CAPITAL FUNDS (U.S. CLS. 100, 101 AND 102). FIRST USE 1-0-2000; IN COMMERCE 1-0-2000.

2,625,356. REAL ESTATE SUPPORT SYSTEMS, INC., LONGWOOD, FL. SN 75-370,099. PUB. 7-3-2001, FILED 10-8-1997.

RESSI

FOR UNDERWRITING PROFESSIONAL LIABILITY INSURANCE POLICIES FOR REAL ESTATE BROKERAGE FIRMS AND LICENSED REAL ESTATE INDEPENDENT CONTRACTORS (U.S. CLS. 100, 101 AND 102). FIRST USE 2-0-1998; IN COMMERCE 2-0-1998.

2,625,389. NEW ENGLAND LIFE INSURANCE COMPANY, BOSTON, MA. SN 75-458,566. PUB. 5-30-2000, FILED 3-27-1998.



FOR INSURANCE UNDERWRITING SERVICES IN THE AREAS OF LIFE, HEALTH AND DISABILITY; FINANCIAL ADVISORY AND MANAGEMENT SERVICES; BROKERAGE AND INVESTMENT SERVICES, NAMELY, SERVICES IN THE AREAS OF MUTUAL FUNDS, VARIABLE ANNUITIES, MANAGED ACCOUNTS, RETIREMENT PLANNING, INDIVIDUAL RETIREMENT ACCOUNTS; AND EDUCATIONAL FUNDING IN THE NATURE OF FINANCIAL GUARANTEEING AND LENDING IN THE FIELD OF STUDENT LOANS FOR HIGHER EDUCATION AND INVESTING IN EDUCATION LOANS AND EDUCATION LOAN PORTFOLIOS (U.S. CLS. 100, 101 AND 102). FIRST USE 1-29-1998; IN COMMERCE 1-29-1998.

CLASS 36—(Continued).

2,625,401. COMMONWEALTH GENERAL CORPORATION, LOUISVILLE, KY. SN 75-496,577. PUB. 3-27-2001, FILED 6-4-1998.

PEOPLES BENEFIT LIFE INSURANCE COMPANY

NO CLAIM IS MADE TO THE EXCLUSIVE RIGHT TO USE "BENEFIT LIFE INSURANCE COMPANY", APART FROM THE MARK AS SHOWN. FOR INSURANCE SERVICES, NAMELY UNDERWRITING LIFE, HEALTH AND ACCIDENTAL DEATH AND DISMEMBERMENT INSURANCE; UNDERWRITING ANNUITIES, GUARANTEED INVESTMENT CONTRACTS, FUNDING AGREEMENTS AND DEPOSIT ADMINISTRATION CONTACTS; CONSULTATION SERVICES AND FINANCIAL SERVICES IN THE NATURE OF INSURANCE PRODUCTS, GUARANTEED INVESTMENT CONTRACTS, FUNDING AGREEMENTS AND DEPOSIT ADMINISTRATION CONTRACTS (U.S. CLS. 100, 101 AND 102). FIRST USE 6-15-1998; IN COMMERCE 6-15-1998.

2,625,408. U SCRIPT CORP., FLEMINGTON, NJ. SN 75-515,691. PUB. 3-23-1999, FILED 6-26-1998.

U SCRIPT

FOR ADMINISTERING PHARMACEUTICAL PRESCRIPTION PLANS TO LABOR UNIONS AND THEIR MEMBERS (U.S. CLS. 100, 101 AND 102). FIRST USE 1-0-2002; IN COMMERCE 3-0-2002.

2,625,420. CNA FINANCIAL CORPORATION, TORONTO, ONTARIO, MSC 2V9, CANADA. SN 75-550,521. PUB. 3-27-2001, FILED S.R. 9-9-1998; AM. P.R. 9-9-1998.

ONE PRODUCT - ONE SOURCE

FOR INSURANCE SERVICES, NAMELY, UNDERWRITING SERVICES IN THE FIELD OF PROPERTY CASUALTY (U.S. CLS. 100, 101 AND 102). FIRST USE 6-0-1998; IN COMMERCE 6-0-1998.

CLASS 36—(Continued).

2,625,452. CHARLES SCHWAB & CO., INC., SAN FRANCISCO, CA. SN 75-602,222. PUB. 8-28-2001, FILED 12-9-1998.

SCHWAB SIGNATURE SERVICES PLATINUM

OWNER OF U.S. REG. NOS. 1,624,773, 2,126,069, AND OTHERS.

NO CLAIM IS MADE TO THE EXCLUSIVE RIGHT TO USE "SERVICES", APART FROM THE MARK AS SHOWN.

THE NAME "CHARLES SCHWAB" IDENTIFIES A LIVING INDIVIDUAL WHOSE CONSENT IS OF RECORD.

FOR BROKERAGE SERVICES IN THE FIELDS OF FINANCIAL SECURITIES, STOCKS, BONDS, MONEY MARKET FUNDS, MUTUAL FUNDS, COMMODITIES, FUTURES, STOCK OPTIONS, AND INDICES OF FINANCIAL SECURITIES; INVESTMENT SERVICES IN THE FIELDS OF FINANCIAL SECURITIES, STOCKS, BONDS, MONEY MARKET FUNDS, MUTUAL FUNDS, COMMODITIES, FUTURES, STOCK OPTIONS, AND INDICES OF FINANCIAL SECURITIES; INVESTMENT ADVICE AND MANAGEMENT IN THE FIELDS OF FINANCIAL SECURITIES, STOCKS, BONDS, MUTUAL FUNDS, MONEY MARKET FUNDS, COMMODITIES, FUTURES, STOCK OPTIONS, AND INDICES OF FINANCIAL SECURITIES; SECURITIES BROKERAGE ACCOUNT SERVICES THAT FEATURE AN INTEREST BEARING FEATURE FOR CASH BETWEEN INVESTMENTS, ELECTRONIC CASH TRANSACTIONS AND MARGIN LOAN SERVICES; CREDIT CARD AND DEBIT CARD SERVICES; CHECK PROCESSING AND BILL PAYMENT SERVICES; ANNUITY INVESTMENT SERVICES; FINANCIAL INVESTMENT IN THE FIELD OF VARIABLE INSURANCE; FINANCIAL INFORMATION PROVIDED BY ELECTRONIC MEANS; ADMINISTRATION OF EMPLOYEE PENSION PLANS; FINANCIAL PLANNING; INSURANCE BROKERAGE; CASH MANAGEMENT ACCOUNT SERVICES; FIXED INCOME INVESTMENT SERVICES; ELECTRONIC FUNDS TRANSFER; PROVIDING INFORMATION AND ANALYSIS IN THE FIELDS OF FINANCE, ECONOMICS, INVESTMENT, BUSINESS, FINANCIAL PLANNING AND INVESTMENT STRATEGY; PROVIDING FINANCIAL PORTFOLIO MANAGEMENT SERVICES, PROVIDING AND INTERACTIVE ONLINE COMPUTER DATABASE IN THE FIELD OF FINANCIAL PORTFOLIO MANAGEMENT, FINANCIAL DECISION MAKING, INVESTMENT RESEARCH, MONITORING INVESTMENT VALUE AND PERFORMANCE OF INVESTMENTS, ANALYZING INVESTMENT PERFORMANCE, EVALUATING ASSET ALLOCATION, RISK TOLERANCE, FINANCIAL ALTERNATIVE PLANS AND INVESTMENT TIME FRAMES; PROVIDING INFORMATION BY PHONE AND BY ONLINE MEANS IN THE FIELD OF INVESTMENT ACCOUNT INFORMATION AND FINANCIAL RESEARCH; PROVIDING AN ONLINE COMPUTER DATABASE IN THE FIELDS OF INVESTING, FINANCIAL PLANNING, FINANCIAL NEWS, FINANCIAL INFORMATION AND ANALYSIS IN THE FIELDS OF INVESTING, FINANCE, AND FINANCIAL PLANNING (U.S. CLS. 100, 101 AND 102).

FIRST USE 2-15-1999; IN COMMERCE 2-15-1999.

CLASS 36—(Continued).

2,625,466. ALLOY VENTURES, INC., PALO ALTO, CA. SN 75-617,355. PUB. 8-22-2000, FILED 1-8-1999.

ALLOY VENTURES

NO CLAIM IS MADE TO THE EXCLUSIVE RIGHT TO USE "VENTURES", APART FROM THE MARK AS SHOWN.

FOR FINANCIAL INVESTMENT IN THE FIELD OF PUBLIC AND NON-PUBLIC SECURITIES; FINANCIAL SERVICES IN THE NATURE OF AN INVESTMENT SECURITY; FUND INVESTMENT CONSULTATION; INVESTMENT BROKERAGE, MANAGEMENT AND ADVICE; FINANCIAL RESEARCH; FINANCING SERVICES; FINANCIAL ANALYSIS AND CONSULTATION; UNDERWRITING IN THE FIELD OF SECURITIES; VENTURE CAPITAL INVESTING; VENTURE CAPITAL MANAGEMENT; AND INSTITUTIONAL FUND MANAGEMENT (U.S. CLS. 100, 101 AND 102).

FIRST USE 4-25-2000; IN COMMERCE 4-25-2000.

2,625,494. XEVEX INTERNATIONAL CORPORATION, SARASOTA, FL. SN 75-671,095. PUB. 12-7-1999, FILED 3-29-1999.

XEVEX

FOR FINANCIAL SERVICES IN THE NATURE OF ARRANGING FOR, MANAGING AND ACTING AS A HOLDING COMPANY FOR ACQUISITIONS, MERGERS AND STRATEGIC ALLIANCES FOR OTHER BUSINESSES (U.S. CLS. 100, 101 AND 102).

FIRST USE 4-0-1999; IN COMMERCE 4-0-1999.

2,625,498. WEALTHHARBOR CAPITAL GROUP, L.L.C., NEW ORLEANS, LA. SN 75-678,824. PUB. 8-28-2001, FILED 4-9-1999.

WEALTHHARBOR CAPITAL GROUP.

NO CLAIM IS MADE TO THE EXCLUSIVE RIGHT TO USE "CAPITAL GROUP", APART FROM THE MARK AS SHOWN.

FOR FINANCIAL ASSET MANAGEMENT; BUSINESS BROKERAGE; COMMODITY BROKERAGE, INSURANCE BROKERAGE; INVESTMENT BROKERAGE; MUTUAL FUND BROKERAGE; STOCK BROKERAGE; BROKERAGE HOUSES IN THE FIELD OF STOCKS, COMMODITIES, AND FUTURES; INSURANCE BROKERAGE IN THE FIELD OF LIFE INSURANCE AND ANNUITIES; INVESTMENT BROKERAGE IN THE FIELD OF LIFE INSURANCE AND ANNUITIES; MUTUAL FUND BROKERAGE IN THE FIELD OF LIFE INSURANCE AND ANNUITIES; SECURITY BROKERAGE; CAPITAL INVESTMENT CONSULTATION; COMMODITY INVESTMENT ADVICE; FUND INVESTMENT CONSULTATION; INVESTMENT CONSULTATION; FINANCIAL SERVICES IN THE FIELD OF SECURITIES; FINANCIAL SERVICES IN THE NATURE OF AN INVESTMENT SECURITY; FUND INVESTMENT CONSULTATION IN THE FIELD OF SECURITIES; MUTUAL FUND INVESTMENT; FUNDS INVESTMENT; INVESTMENT ADVICE; INVESTMENT MANAGEMENT; INVESTMENT OF FUNDS FOR OTHERS; FINANCIAL SERVICES IN THE NATURE OF A HEDGE FUND; FINANCIAL PORTFOLIO MANAGEMENT (U.S. CLS. 100, 101 AND 102).

FIRST USE 3-8-1999; IN COMMERCE 9-19-2001.

CLASS 36—(Continued).

2,625,573. JERUSALEM TEMPLE FUND, INC., THE, SUGAR LAND, TX. SN 75-754,652. PUB. 1-16-2001, FILED 7-19-1999.



THE JERUSALEM TEMPLE FUND

NO CLAIM IS MADE TO THE EXCLUSIVE RIGHT TO USE "THE JERUSALEM TEMPLE FUND", APART FROM THE MARK AS SHOWN.

FOR CHARITABLE FUND RAISING (U.S. CLS. 100, 101 AND 102).

FIRST USE 1-16-2001; IN COMMERCE 1-16-2001.

2,625,608. CARDCLUES.COM, LLC, LAS VEGAS, NV. SN 75-792,937. PUB. 3-27-2001, FILED 9-7-1999.

CARDCLUES.COM

FOR PROVIDING PRODUCT AND EDUCATIONAL INFORMATION REGARDING CREDIT CARDS, AVAILABLE CREDIT CARDS AND FEATURES AND CONSEQUENCES OF OWNING A CREDIT CARD, NAMELY, COMPARATIVE INFORMATION, OFFERS AND INCENTIVES FROM VARIOUS CREDIT CARD COMPANIES VIA A WEB PAGE ON A GLOBAL COMMUNICATIONS NETWORK (U.S. CLS. 100, 101 AND 102).

FIRST USE 3-0-2001; IN COMMERCE 3-0-2001.

2,625,648. CITIGROUP INC., NEW YORK, NY. SN 75-826,030. PUB. 5-29-2001, FILED 10-15-1999.

women & co.

OWNER OF U.S. REG. NO. 2,359,728.

NO CLAIM IS MADE TO THE EXCLUSIVE RIGHT TO USE "WOMEN", APART FROM THE MARK AS SHOWN.

FOR FINANCIAL AND INSURANCE SERVICES DIRECTED TOWARD WOMEN; NAMELY, BANKING; SECURITIES INVESTMENT, BROKERAGE, MANAGEMENT AND UNDERWRITING; ASSET MANAGEMENT; MUTUAL FUND AND MONEY MARKET FUND INVESTMENT AND ADMINISTRATION; VARIABLE ANNUITIES INVESTMENT AND ADMINISTRATION; INVESTMENT ADVISORY, PLANNING AND MANAGEMENT; ESTATE TRUST AND FIDUCIARY CONSULTING AND MANAGEMENT; COMMERCIAL AND CONSUMER LENDING AND FINANCING; FIDELITY, SURETY AND GUARANTY BONDING SERVICES; UNDERWRITING AND ADMINISTERING SERVICES FOR COMMERCIAL, LIFE, PERSONAL AND GROUP INSURANCE; INSURANCE AGENCY SERVICES IN THE FIELD OF PROPERTY, CASUALTY AND LIFE INSURANCE POLICIES, AND ANNUITY CONTRACTS; INSURANCE CONSULTATION SERVICES; REAL ESTATE INVESTMENT SERVICES; ALL THE AFORESAID TO BE PROVIDED VIA TELEPHONE, COMPUTER, GLOBAL COMPUTER NETWORK AND TRADITIONAL MEANS, NAMELY, IN PERSON AND VIA ATM MACHINES (U.S. CLS. 100, 101 AND 102).

FIRST USE 10-0-2000; IN COMMERCE 10-0-2000.

CLASS 36—(Continued).

2,625,665. POPULAR, INC., SAN JUAN, PUERTO RICO. SN 75-835,076. PUB. 4-10-2001, FILED 11-15-1999.

POPULAR INSURANCE

OWNER OF U.S. REG. NOS. 1,610,074, 2,236,397, AND OTHERS.

NO CLAIM IS MADE TO THE EXCLUSIVE RIGHT TO USE "INSURANCE", APART FROM THE MARK AS SHOWN.

FOR INSURANCE AGENCIES IN THE FIELDS OF HOME, LIFE, AUTO AND ACCIDENT; INSURANCE SERVICES, NAMELY, UNDERWRITING SERVICES AND INSURANCE CLAIMS PROCESSING, INSURANCE BROKERAGE (U.S. CLS. 100, 101 AND 102).

FIRST USE 12-1-2000; IN COMMERCE 12-1-2000.

2,625,689. C/BASE, INC., CONSHOHOCKEN, PA. SN 75-849,384. PUB. 10-23-2001, FILED 11-16-1999.

PRIVATEBUY

FOR FINANCIAL SERVICES, NAMELY, PROVIDING PREPAID SPENDING ACCOUNTS FOR USE IN MAKING SECURE PURCHASES OF GOODS AND SERVICES OVER THE GLOBAL COMPUTER NETWORK (U.S. CLS. 100, 101 AND 102).

FIRST USE 8-0-2000; IN COMMERCE 8-0-2000.

2,625,722. B.D. OF NEVADA, LIMITED PARTNERSHIP, RENO, NV. SN 75-872,538. PUB. 6-26-2001, FILED 12-14-1999.

WELCOME TO THE BIG ARENA

FOR FINANCIAL AND SECURITY BROKERAGE SERVICES; INVESTMENT MANAGEMENT SERVICES; FINANCIAL INFORMATION SERVICES BY ELECTRONIC MEANS; AND FINANCIAL MANAGEMENT AND PORTFOLIO MANAGEMENT SERVICES (U.S. CLS. 100, 101 AND 102).

FIRST USE 12-0-2000; IN COMMERCE 12-0-2000.

2,625,729. B.D. OF NEVADA, LIMITED PARTNERSHIP, RENO, NV. SN 75-879,121. PUB. 6-26-2001, FILED 12-23-1999.

BIG ARENA

FOR FINANCIAL AND SECURITY BROKERAGE SERVICES; INVESTMENT MANAGEMENT SERVICES; FINANCIAL INFORMATION SERVICES BY ELECTRONIC MEANS; AND FINANCIAL MANAGEMENT AND PORTFOLIO MANAGEMENT SERVICES (U.S. CLS. 100, 101 AND 102).

FIRST USE 12-0-2000; IN COMMERCE 12-0-2000.

CLASS 36—(Continued).

2,625,732. MICROSOFT CORPORATION, REDMOND, WA.
SN 75-880,884. PUB. 7-31-2001, FILED 12-27-1999.



OWNER OF U.S. REG. NOS. 2,014,296, 2,153,763, AND OTHERS.

THE STIPPLING IS FOR SHADING ONLY. COLOR IS NOT CLAIMED AS PART OF THE MARK.

THE MARK COMPRISES THE LETTERS "MSN" AND A BUTTERFLY DESIGN.

FOR PROVIDING INFORMATION CONCERNING REAL ESTATE, REAL ESTATE FINANCING, REAL ESTATE AGENTS AND THE PURCHASE, SALE AND RENTAL OF REAL ESTATE, ALL VIA LOCAL COMPUTER NETWORKS AND GLOBAL COMMUNICATION NETWORKS; PROVIDING INFORMATION VIA LOCAL COMPUTER NETWORKS AND GLOBAL COMMUNICATION NETWORKS IN THE FIELDS OF FINANCE, INVESTMENT, MONEY AND BANKING, RETIREMENT PLANNING, ESTATE PLANNING AND WILLS, TAXES, REAL ESTATE, FAMILY BUDGETING AND PURCHASING, AND INSURANCE; PROVIDING FINANCIAL ANALYSIS AND CONSULTATION SERVICES AND FINANCIAL PORTFOLIO MANAGEMENT SERVICES VIA LOCAL COMPUTER NETWORKS GLOBAL COMMUNICATION NETWORKS; PROVIDING INVESTMENT INFORMATION, FINANCIAL AND INVESTMENT NEWS AND ADVICE, AND STOCK AND BOND INFORMATION AND QUOTATIONS, ALL VIA LOCAL COMPUTER NETWORKS AND GLOBAL COMMUNICATION NETWORKS; BILL PAYMENT SERVICES FOR OTHERS; PROVIDING INFORMATION ABOUT INVESTMENT TRADING SERVICES IN THE NATURE OF A WEB PAGE CONTAINING LINKS TO ONLINE INVESTMENT TRADING SERVICES (U.S. CLS. 100, 101 AND 102).
FIRST USE 2-14-2000; IN COMMERCE 2-14-2000.

CLASS 36—(Continued).

2,625,742. MICROSOFT CORPORATION, REDMOND, WA.
SN 75-884,371. PUB. 7-24-2001, FILED 12-30-1999.

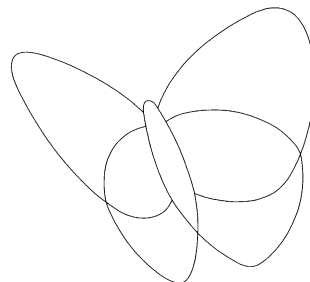

THE MARK COMPRISES A BUTTERFLY DESIGN. THE UPPER PORTION OF THE LEFT WING OF THE BUTTERFLY IS BLUE, THE CENTER PORTION IS DARK GREEN, AND THE LOWER PORTION IS LIGHT GREEN. THE UPPER PORTION OF THE RIGHT WING OF THE BUTTERFLY IS RED, THE MIDDLE PORTION IS ORANGE AND THE LOWER PORTION IS YELLOW. THE BODY OF THE BUTTERFLY IS PURPLE. COLOR IS CLAIMED AS PART OF THE MARK.

FOR PROVIDING INFORMATION CONCERNING REAL ESTATE, REAL ESTATE FINANCING, REAL ESTATE AGENTS AND THE PURCHASE, SALE AND RENTAL OF REAL ESTATE, ALL VIA LOCAL COMPUTER NETWORKS AND GLOBAL COMMUNICATION NETWORKS; PROVIDING INFORMATION VIA LOCAL COMPUTER NETWORKS AND GLOBAL COMMUNICATION NETWORKS IN THE FIELDS OF FINANCE, INVESTMENT, MONEY AND BANKING, RETIREMENT PLANNING, ESTATE PLANNING AND WILLS, TAXES, REAL ESTATE, FAMILY BUDGETING AND PURCHASING, AND INSURANCE; PROVIDING FINANCIAL ANALYSIS AND CONSULTATION SERVICES AND FINANCIAL PORTFOLIO MANAGEMENT SERVICES VIA LOCAL COMPUTER NETWORKS GLOBAL COMMUNICATION NETWORKS; PROVIDING INVESTMENT INFORMATION, FINANCIAL AND INVESTMENT NEWS AND ADVICE, AND STOCK AND BOND INFORMATION AND QUOTATIONS, ALL VIA LOCAL COMPUTER NETWORKS AND GLOBAL COMMUNICATION NETWORKS; BILL PAYMENT SERVICES FOR OTHERS; PROVIDING INFORMATION ABOUT INVESTMENT TRADING SERVICES IN THE NATURE OF A WEB PAGE CONTAINING LINKS TO ONLINE INVESTMENT TRADING SERVICES (U.S. CLS. 100, 101 AND 102).
FIRST USE 2-14-2000; IN COMMERCE 2-14-2000.

2,625,758. PREVOST CAR INC., STE-CLAIRE, QUEBEC. SN
75-890,653. PUB. 4-10-2001, FILED 1-6-2000.

PREVOST SMART SERVICE POWER

NO CLAIM IS MADE TO THE EXCLUSIVE RIGHT TO USE "SERVICE", APART FROM THE MARK AS SHOWN.

FOR UNDERWRITING WARRANTY PROGRAMS IN THE FIELD OF HIGHWAY BUS REPAIR WORK (U.S. CLS. 100, 101 AND 102).

FIRST USE 2-15-2000; IN COMMERCE 2-15-2000.

CLASS 36—(Continued).

2,625,771. MERRILL LYNCH & CO., INC., NEW YORK, NY. SN 75-898,106. PUB. 9-25-2001, FILED 1-19-2000.

**MERRILL LYNCH BANKING
ADVANTAGE**

OWNER OF U.S. REG. NOS. 1,280,908, 2,367,911, AND OTHERS.

NO CLAIM IS MADE TO THE EXCLUSIVE RIGHT TO USE "BANKING", APART FROM THE MARK AS SHOWN. FOR FINANCIAL INVESTMENT SERVICES, NAMELY THE INVESTMENT OF ASSETS IN BANK INSTRUMENTS (U.S. CLS. 100, 101 AND 102).

FIRST USE 1-0-2000; IN COMMERCE 1-0-2000.

CLASS 36—(Continued).

2,625,784. MASSACHUSETTS MUTUAL LIFE INSURANCE COMPANY, SPRINGFIELD, MA. SN 75-903,666. PUB. 9-4-2001, FILED 1-26-2000.

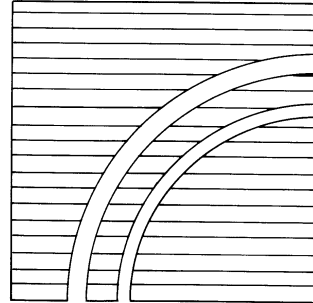

THE COLOR BLUE IS CLAIMED AS A FEATURE OF THE MARK. THE DRAWING IS LINED TO INDICATE THE COLOR BLUE.

THE MARK IS A DESIGN COMPRISED OF A BLUE SQUARE HAVING TWO CURVED WHITE LINES RUNNING THROUGH THE SQUARE

FOR INSURANCE AND FINANCIAL SERVICES, NAMELY, ACTUARIAL SERVICES, INSURANCE ADMINISTRATION, FINANCIAL ANALYSIS AND CONSULTATION, ASSET MANAGEMENT, ANNUITY UNDERWRITING, BANKING, COMMERCIAL LENDING, NAMELY, COMMERCIAL MORTGAGES, PRIVATELY PLACED DEBT SECURITIES AND BANK LOANS, INSURANCE AND SECURITIES BROKERAGE, BROKER-DEALER SERVICES, NAMELY, PURCHASE AND SALE OF SECURITIES PRODUCTS, NAMELY, STOCKS, BONDS, MUTUAL FUNDS AND UNIT INVESTMENT TRUSTS, CREDIT CARD SERVICES, MUTUAL FUND DISTRIBUTION SERVICES, ADMINISTRATION OF EMPLOYEE BENEFIT PLANS, FIDUCIARY REPRESENTATIVE SERVICES, ELECTRONIC FUNDS TRANSFERS, INVESTMENT ADVICE, INVESTMENT MANAGEMENT, MONEY MANAGEMENT, MUTUAL FUND SERVICES, ADMINISTRATION OF EMPLOYEE PENSION PLANS, POOLED INVESTMENT FUND MANAGEMENT, UNDERWRITING REINSURANCE, RETIREMENT INVESTMENT MANAGEMENT, ESTATE TRUST SERVICES, SECURITIES UNDERWRITING AND SECURITIES BROKERAGE (U.S. CLS. 100, 101 AND 102).

FIRST USE 4-30-2000; IN COMMERCE 4-30-2000.

2,625,783. MASSACHUSETTS MUTUAL LIFE INSURANCE COMPANY, SPRINGFIELD, MA. SN 75-903,517. PUB. 7-3-2001, FILED 1-26-2000.

**MASSMUTUAL FINANCIAL
GROUP**

OWNER OF U.S. REG. NOS. 990,411, 1,602,784, AND 1,615,151.

NO CLAIM IS MADE TO THE EXCLUSIVE RIGHT TO USE "FINANCIAL GROUP", APART FROM THE MARK AS SHOWN.

FOR INSURANCE AND FINANCIAL SERVICES, NAMELY, ACTUARIAL SERVICES, INSURANCE ADMINISTRATION, FINANCIAL ANALYSIS AND CONSULTATION, ASSET MANAGEMENT, ANNUITY UNDERWRITING, BANKING, COMMERCIAL LENDING, NAMELY, COMMERCIAL MORTGAGES, PRIVATELY PLACED DEBT SECURITIES AND BANK LOANS, INSURANCE AND SECURITIES BROKERAGE, BROKER-DEALER SERVICES, NAMELY, PURCHASE AND SALE OF SECURITIES PRODUCTS, NAMELY, STOCKS, BONDS, MUTUAL FUNDS AND UNIT INVESTMENT TRUSTS, CREDIT CARD SERVICES, MUTUAL FUND DISTRIBUTION SERVICES, ADMINISTRATION OF EMPLOYEE BENEFIT PLANS, FIDUCIARY REPRESENTATIVE SERVICES, ELECTRONIC FUNDS TRANSFERS, INVESTMENT ADVICE, INVESTMENT MANAGEMENT, MONEY MANAGEMENT, MUTUAL FUND SERVICES, ADMINISTRATION OF EMPLOYEE PENSION PLANS, POOLED INVESTMENT FUND MANAGEMENT, UNDERWRITING REINSURANCE, RETIREMENT INVESTMENT MANAGEMENT, ESTATE TRUST SERVICES, SECURITIES UNDERWRITING AND SECURITIES BROKERAGE (U.S. CLS. 100, 101 AND 102).

FIRST USE 4-30-2000; IN COMMERCE 4-30-2000.

2,625,792. U.S. DEPARTMENT OF THE TREASURY, FINANCIAL MANAGEMENT SERVICE, WASHINGTON, DC. SN 75-906,662. PUB. 8-28-2001, FILED 2-2-2000.

NAVY CASH

FOR FINANCIAL SERVICES, NAMELY, CREDIT CARD SERVICES, DEBIT CARD SERVICES, STORED VALUE CARD SERVICES, AND ELECTRONIC FUND TRANSFER SERVICES (U.S. CLS. 100, 101 AND 102).

FIRST USE 3-19-2001; IN COMMERCE 4-17-2001.

CLASS 36—(Continued).

2,625,808. HOMESTAR FINANCIAL GROUP, INC., MANTENO, IL, BY CHANGE OF NAME MANTENO BANCSHARES, INC., MANTENO, IL. SN 75-911,418. PUB. 9-4-2001, FILED 2-7-2000.

HOMESTAR

OWNER OF U.S. REG. NOS. 2,098,311 AND 2,111,389.
FOR INSURANCE BROKERAGE; INVESTMENT BROKERAGE, CONSULTATION AND MANAGEMENT; REAL ESTATE MANAGEMENT AND ADMINISTRATION; CREDIT AND DEBIT CARD SERVICES; TITLE INSURANCE AGENCIES (U.S. CLS. 100, 101 AND 102).
FIRST USE 7-1-1996; IN COMMERCE 7-1-1996.

2,625,899. BUILD-A-BEAR WORKSHOP, INC., ST. LOUIS, MS. SN 75-982,495. PUB. 1-16-2001, FILED 4-10-2000.

UNITED FOR THE PAWS

FOR CHARITABLE FUNDRAISING SERVICES RELATING TO THE CARE AND PROTECTION OF ANIMALS AND PROMOTING HUMANE ETHICS (U.S. CLS. 100, 101 AND 102).
FIRST USE 5-0-2001; IN COMMERCE 5-0-2001.

2,625,919. TRANS UNION L.L.C., CHICAGO, IL. SN 76-012,972. PUB. 7-24-2001, FILED 3-29-2000.

Trans Union Quick



OWNER OF U.S. REG. NOS. 917,889, 924,279, AND 2,092,132.
FOR CREDIT REPORTING SERVICES, NAMELY, PROCESSING DISPUTES AND UPDATES FOR CREDIT FILES (U.S. CLS. 100, 101 AND 102).
FIRST USE 5-0-2000; IN COMMERCE 5-0-2000.

2,625,945. CLASSNOTES INC., SACRAMENTO, CA. SN 76-028,633. PUB. 3-6-2001, FILED 4-18-2000.

24 TO SCORE

FOR FINANCIAL SERVICES, NAMELY, MONEY LENDING IN THE FIELD OF STUDENT LOANS (U.S. CLS. 100, 101 AND 102).
FIRST USE 5-0-2000; IN COMMERCE 5-0-2000.

CLASS 36—(Continued).

2,625,949. ROTHBERG, SARANNE, ALPINE, NJ. SN 76-029,764. PUB. 6-12-2001, FILED 4-19-2000.

FUNNYRAISER

FOR CHARITABLE FUNDRAISING SERVICES BY TRANSMITTING HUMOROUS MESSAGES VIA PRINT, AUDIO, FACSIMILE, AND ELECTRONIC MEDIA AND DONATING THE PROCEEDS THEREFROM (U.S. CLS. 100, 101 AND 102).
FIRST USE 6-15-1999; IN COMMERCE 6-15-1999.

2,625,964. LIBERTY FINANCIAL COMPANIES, INC., BOSTON, MA. SN 76-038,224. PUB. 2-6-2001, FILED 5-2-2000.

GIVE ME LIBERTY

FOR INVESTMENT ADVISORY SERVICES; FINANCIAL MANAGEMENT SERVICES; MUTUAL FUND INVESTMENT SERVICES; MUTUAL FUND DISTRIBUTION SERVICES (U.S. CLS. 100, 101 AND 102).
FIRST USE 4-0-2002; IN COMMERCE 4-0-2002.

2,626,042. PROFIRST MORTGAGE CORPORATION, LUTHERVILLE, MD. SN 76-075,568. PUB. 8-21-2001, FILED 6-22-2000.

PROFIRST

FOR MORTGAGE LENDING SERVICES (U.S. CLS. 100, 101 AND 102).
FIRST USE 7-1-2000; IN COMMERCE 12-31-2000.

2,626,081. AMERICAN MEDICAL AND LIFE INSURANCE COMPANY, HICKSVILLE, NY. SN 76-091,174. PUB. 6-5-2001, FILED 7-19-2000.

AMLI

FOR INSURANCE UNDERWRITING IN THE FIELD OF GROUP HEALTH INSURANCE AND LIFE INSURANCE (U.S. CLS. 100, 101 AND 102).
FIRST USE 9-4-2001; IN COMMERCE 9-4-2001.

CLASS 36—(Continued).

2,626,087. ANNUITY BOARD OF THE SOUTHERN BAPTIST CONVENTION, DALLAS, TX. SN 76-095,543. PUB. 6-12-2001, FILED 7-21-2000.

AB♥Seniors Plus Plan

NO CLAIM IS MADE TO THE EXCLUSIVE RIGHT TO USE "SENIORS" OR "PLAN", APART FROM THE MARK AS SHOWN.

FOR ADMINISTRATION OF A MEDICAL PLAN WHICH SUPPLEMENTS MEDICARE TO HELP PAY HEALTH CARE COSTS FOR RETIRED MINISTERS, STAFF AND EMPLOYEES OF CHURCHES, DENOMINATIONAL AGENCIES AND DENOMINATIONAL INSTITUTIONS, AND FOR CERTAIN OLDER CHURCH WORKERS (U.S. CLS. 100, 101 AND 102).
FIRST USE 1-1-2001; IN COMMERCE 1-1-2001.

2,626,144. MERCANTILE-SAFE DEPOSIT AND TRUST COMPANY, BALTIMORE, MD. SN 76-122,032. PUB. 9-11-2001, FILED 9-1-2000.

BANKING TWENTY-FOUR ONLINE

NO CLAIM IS MADE TO THE EXCLUSIVE RIGHT TO USE "BANKING" AND "ONLINE", APART FROM THE MARK AS SHOWN.

FOR BANKING SERVICES; AND ON-LINE AND E-COMMERCE BANKING SERVICES (U.S. CLS. 100, 101 AND 102).
FIRST USE 5-20-2002; IN COMMERCE 5-20-2002.

2,626,203. MERRILL LYNCH & CO., INC., NEW YORK, NY. SN 76-144,362. PUB. 10-30-2001, FILED 10-11-2000.

MERRILL LYNCH LEGACY POWER

OWNER OF U.S. REG. NOS. 1,280,908, 2,395,030, AND OTHERS.

NO CLAIM IS MADE TO THE EXCLUSIVE RIGHT TO USE "LEGACY", APART FROM THE MARK AS SHOWN.

FOR FINANCIAL SERVICES, NAMELY THE UNDERWRITING AND ADMINISTRATION OF INSURANCE (U.S. CLS. 100, 101 AND 102).
FIRST USE 2-0-2001; IN COMMERCE 2-0-2001.

CLASS 36—(Continued).

2,626,220. FIRST NATIONAL BANK, RONCEVERTE, WV. SN 76-150,454. PUB. 8-28-2001, FILED 10-19-2000.



FOR ON LINE BANKING SERVICES (U.S. CLS. 100, 101 AND 102).
FIRST USE 9-0-2000; IN COMMERCE 9-0-2000.

2,626,224. ZZYXZ MARKETING INCORPORATED, TUSTIN, CA. SN 76-150,619. PUB. 9-18-2001, FILED 10-23-2000.

MONEYNAVIGATION

FOR FINANCIAL SERVICES, NAMELY, MORTGAGE LENDING, FINANCIAL PLANNING, AUTOMOBILE LOAN FINANCING, LEASE PURCHASE AUTOMOBILE LOAN FINANCING, BILL PAYING SERVICES FOR OTHERS, TAX PAYMENT PROCESSING SERVICES, INSURANCE AGENCIES IN THE FIELDS OF AUTOMOBILE, ACCIDENT, HOME, FIRE, LIFE AND MEDICAL INSURANCE, PROVIDED OVER A GLOBAL COMPUTER NETWORK (U.S. CLS. 100, 101 AND 102).
FIRST USE 1-15-2001; IN COMMERCE 1-15-2001.

2,626,245. PEYTON STREET INDEPENDENT FINANCIAL SERVICES CORPORATION, FARMINGTON, CT. SN 76-157,242. PUB. 7-31-2001, FILED 11-1-2000.



FOR BANKING SERVICES (U.S. CLS. 100, 101 AND 102).
FIRST USE 4-30-2001; IN COMMERCE 4-30-2001.

2,626,280. HANDSOME, L.P., HOUSTON, TX. SN 76-171,397. PUB. 8-14-2001, FILED 11-27-2000.

KIM'S PLACE

FOR CHARITABLE FUND RAISING SERVICES (U.S. CLS. 100, 101 AND 102).
FIRST USE 3-12-1999; IN COMMERCE 3-12-1999.

CLASS 36—(Continued).

2,626,301. FAIRWAY UNDERWRITERS INC, LOWELL, ME. SN 76-179,412. PUB. 11-27-2001, FILED 12-13-2000.

CLUB COMPLETE

FOR PROPERTY AND CASUALTY INSURANCE POLICY, NAMELY, FIRE INSURANCE UNDERWRITING (U.S. CLS. 100, 101 AND 102).
FIRST USE 1-5-2002; IN COMMERCE 1-5-2002.

2,626,315. HERMAN MILLER, INC., ZEELAND, MI. SN 76-184,413. PUB. 9-11-2001, FILED 12-20-2000.

**HERMAN MILLER CAPITAL
GLOBALSOURCE**

OWNER OF U.S. REG. NOS. 733,770, 1,494,492, AND OTHERS.

NO CLAIM IS MADE TO THE EXCLUSIVE RIGHT TO USE "CAPITAL", APART FROM THE MARK AS SHOWN.

THE NAME "HERMAN MILLER" IS NOT A LIVING INDIVIDUAL.

FOR LEASE-PURCHASE FINANCING SERVICES FOR OFFICE FURNITURE; AND LEASE-PURCHASE FINANCING CONSULTATION SERVICES FOR OFFICE FURNITURE (U.S. CLS. 100, 101 AND 102).

FIRST USE 12-0-2000; IN COMMERCE 12-0-2000.

2,626,323. FIRST NATIONAL BANK OF OMAHA, OMAHA, NE. SN 76-191,563. PUB. 8-21-2001, FILED 1-9-2001.

STATE EDITION

FOR CREDIT CARD SERVICES (U.S. CLS. 100, 101 AND 102).

FIRST USE 9-0-2000; IN COMMERCE 9-0-2000.

2,626,344. ZIEGLER COMPANIES, INC., THE, WEST BEND, WI. SN 76-199,122. PUB. 8-28-2001, FILED 1-23-2001.

SHARPEN YOUR FOCUS

FOR FINANCIAL SERVICES, NAMELY CAPITAL INVESTMENT CONSULTING, INVESTMENT ADVICE, MUTUAL FUND DISTRIBUTION, MUTUAL FUND INVESTMENT, FINANCIAL PLANNING, FINANCIAL ANALYSIS AND CONSULTING, FINANCIAL PORTFOLIO MANAGEMENT, STOCK BROKERAGE SERVICES, PROVIDING AUTOMATING SECURITIES BROKERAGE SERVICES AND FINANCIAL INFORMATION BY ELECTRONIC MEANS, UNDERWRITING AND BROKERAGE OF VARIOUS SECURITIES (U.S. CLS. 100, 101 AND 102).
FIRST USE 4-1-2001; IN COMMERCE 4-1-2001.

CLASS 36—(Continued).

2,626,353. AMERICAN LEBANESE SYRIAN ASSOCIATED CHARITIES, INC., MEMPHIS, TN. SN 76-204,938. PUB. 8-28-2001, FILED 2-5-2001.

HELPING CHILDREN LIVE

FOR CHARITABLE FUND-RAISING SERVICES (U.S. CLS. 100, 101 AND 102).
FIRST USE 0-0-1995; IN COMMERCE 0-0-1995.

2,626,355. ILIOS PARTNERS LLC, NEW YORK, NY. SN 76-205,722. PUB. 8-21-2001, FILED 2-6-2001.

HOT TARGETS

FOR STOCK SURVEILLANCE SERVICES, NAMELY IDENTIFYING INSTITUTIONS WHICH ARE BUYING AND SELLING PARTICULAR STOCK AND PROVIDING WRITTEN REPORTS (U.S. CLS. 100, 101 AND 102).

FIRST USE 6-0-2001; IN COMMERCE 6-0-2001.

2,626,380. CHUBB CORPORATION, THE, WARREN, NJ. SN 76-211,431. PUB. 8-21-2001, FILED 2-15-2001.

MASTERPIECE

OWNER OF U.S. REG. NOS. 1,355,804, 1,728,112, AND OTHERS.

FOR INSURANCE UNDERWRITING SERVICES, NAMELY, CAR-JACKING INSURANCE; STALKING THREAT INSURANCE; CHILD ABDUCTION INSURANCE; PREMISES INVASION INSURANCE; ACCIDENTAL DEATH AND DISMEMBERMENT INSURANCE; PERSONAL PROPERTY INSURANCE; AND PERSONAL CASUALTY INSURANCE (U.S. CLS. 100, 101 AND 102).

FIRST USE 6-18-2001; IN COMMERCE 6-18-2001.

2,626,406. NORTHERN TRUST CORPORATION, CHICAGO, IL. SN 76-217,123. PUB. 11-13-2001, FILED 2-27-2001.

FAMILY PASSPORT

OWNER OF U.S. REG. NO. 2,125,051.
FOR PROVIDING FINANCIAL INFORMATION IN THE FIELDS OF BANKING, FINANCE AND INVESTMENTS FOR USE IN MANAGEMENT INFORMATION REPORTING AND FUNDS MOVEMENT DELIVERED VIA THE INTERNET (U.S. CLS. 100, 101 AND 102).
FIRST USE 8-0-2000; IN COMMERCE 8-0-2000.

CLASS 36—(Continued).

2,626,419. INTERNATIONAL MEDICAL GROUP, INC., INDIANAPOLIS, IN. SN 76-221,298. PUB. 11-20-2001, FILED 3-7-2001.

CLASS 36—(Continued).

2,626,468. MASSACHUSETTS MUTUAL LIFE INSURANCE COMPANY, SPRINGFIELD, MA. SN 76-242,568. PUB. 11-27-2001, FILED 4-18-2001.

THE REPATRIOT

FOR INSURANCE PLAN ADMINISTRATION SERVICES (U.S. CLS. 100, 101 AND 102).
FIRST USE 8-0-1993; IN COMMERCE 8-0-1993.

YOU CAN'T PREDICT. YOU CAN PREPARE.

2,626,427. CHUBB CORPORATION, THE, WARREN, NJ. SN 76-224,911. PUB. 8-14-2001, FILED 3-14-2001.

Masterpiece

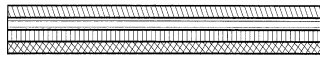

OWNER OF U.S. REG. NOS. 1,355,804, 1,728,112, AND OTHERS.

THE DRAWING IS LINED FOR THE COLORS GREEN, BLUE, RED AND ORANGE.

FOR INSURANCE UNDERWRITING SERVICES, NAMELY, CAR-JACKING INSURANCE; STALKING THREAT INSURANCE; CHILD ABDUCTION INSURANCE; PREMISES INVASION INSURANCE; ACCIDENTAL DEATH AND DISMEMBERMENT INSURANCE; PERSONAL PROPERTY INSURANCE; AND PERSONAL CASUALTY INSURANCE (U.S. CLS. 100, 101 AND 102).
FIRST USE 1-18-2001; IN COMMERCE 1-18-2001.

FOR INSURANCE AND FINANCIAL SERVICES, NAMELY, ACTUARIAL SERVICES, INSURANCE ADMINISTRATION, FINANCIAL ANALYSIS AND CONSULTATION; ASSET MANAGEMENT; ANNUITY UNDERWRITING; BANKING; COMMERCIAL LENDING, NAMELY, COMMERCIAL MORTGAGES, PRIVATELY PLACED DEBT SECURITIES AND BANK LOANS; INSURANCE AND SECURITIES BROKERAGE; BROKER-DEALER SERVICES, NAMELY, PURCHASE AND SALE OF SECURITIES PRODUCTS, NAMELY, STOCKS, BONDS, MUTUAL FUNDS AND UNIT INVESTMENT TRUSTS, CREDIT CARDS SERVICES, MUTUAL FUND DISTRIBUTION SERVICES, ADMINISTRATION OF EMPLOYEE BENEFIT PLANS, FIDUCIARY REPRESENTATIVE SERVICES, ELECTRONIC FUNDS TRANSFERS, INVESTMENT ADVICE, INVESTMENT MANAGEMENT; MONEY MANAGEMENT; MUTUAL FUND SERVICES; ADMINISTRATION OF EMPLOYEE PENSION PLANS, POOLED INVESTMENT FUND MANAGEMENT, UNDERWRITING REINSURANCE, RETIREMENT INVESTMENT MANAGEMENT, ESTATE TRUST MANAGEMENT SERVICES, SECURITIES UNDERWRITING AND SECURITIES BROKERAGE (U.S. CLS. 100, 101 AND 102).

FIRST USE 7-14-2001; IN COMMERCE 8-17-2001.

2,626,434. FEDERAL HOME LOAN MORTGAGE CORPORATION, MCLEAN, VA. SN 76-228,111. PUB. 8-28-2001, FILED 3-22-2001.

EARLYRESOLUTION

FOR FINANCIAL SERVICES RELATED TO THE MANAGEMENT OF DELINQUENT MORTGAGE LOANS (U.S. CLS. 100, 101 AND 102).
FIRST USE 6-0-2000; IN COMMERCE 6-0-2000.

2,626,487. THOMAS F. WHITE & CO., INC., SAN FRANCISCO, CA. SN 76-255,500. PUB. 10-2-2001, FILED 5-9-2001.

ACUMENT

2,626,436. MIDWEST PAYMENT SYSTEMS, CINCINNATI, OH. SN 76-228,440. PUB. 8-28-2001, FILED 3-21-2001.

PREMIER ISSUE

FOR BANKING SERVICES (U.S. CLS. 100, 101 AND 102).
FIRST USE 5-0-2001; IN COMMERCE 5-0-2001.

FOR SECURITIES BROKERAGE SERVICES (U.S. CLS. 100, 101 AND 102).
FIRST USE 5-23-2001; IN COMMERCE 5-23-2001.

CLASS 36—(Continued).

2,626,521. PEOPLES SAVINGS BANK, INC., THE, DBA PEOPLES BANK, HOLYOKE, MA. SN 76-281,561. PUB. 11-13-2001, FILED 7-6-2001.



FOR BANKING SERVICES, NAMELY; DEBIT CARD SERVICES, CREDIT CARD SERVICES, AUTOMATIC TELLER CARD SERVICES; FINANCIAL SERVICES, NAMELY; MORTGAGE LENDING AND MORTGAGE BANKING SERVICES; FINANCIAL INVESTMENT IN THE FIELD OF MUTUAL FUNDS, ANNUITIES AND STOCKS AND BONDS; AND INSURANCE BROKERAGE SERVICES (U.S. CLS. 100, 101 AND 102).
FIRST USE 9-27-2001; IN COMMERCE 9-27-2001.

2,626,622. LONA, ANDREW W., MOUNT VERNON, NY. AND FREY, BRENTLY L., MOUNT VERNON, NY. SN 78-034,275. PUB. 8-28-2001, FILED 11-8-2000.

IDEAS FOR CHANGE

FOR CHARITABLE FUND RAISING AND ELEEMOSYNARY SERVICES IN THE FIELD OF MONETARY DONATIONS (U.S. CLS. 100, 101 AND 102).
FIRST USE 10-31-2001; IN COMMERCE 10-31-2001.

2,626,633. CONOCO INC., PONCA CITY, OK. SN 78-038,479. PUB. 9-11-2001, FILED 12-8-2000.

THE WALLET SIZE WONDER

NO CLAIM IS MADE TO THE EXCLUSIVE RIGHT TO USE "WALLET SIZE", APART FROM THE MARK AS SHOWN.

FOR PREPAID/PRESTORED POINT OF SALE GASOLINE PURCHASE CARD SERVICES, CREDIT CARD AND DEBIT CARD SERVICES, AND TELEPHONE CALLING CARD SERVICES (U.S. CLS. 100, 101 AND 102).
FIRST USE 8-31-2000; IN COMMERCE 8-31-2000.

CLASS 36—(Continued).

2,626,642. BALLIN, SHARON ROSE, STAMFORD, CT. SN 78-040,775. PUB. 9-18-2001, FILED 12-27-2000.

ROOMMATE FINDERS

FOR PROVIDING CREDIT BUREAU DATA FOR OTHERS IN THE NATURE OF CREDIT REPORTS (U.S. CLS. 100, 101 AND 102).
FIRST USE 6-1-2002; IN COMMERCE 6-1-2002.

2,626,644. LONA, ANDREW W., MOUNT VERNON, NY. AND FREY, BRENTLY L., MOUNT VERNON, NY. SN 78-041,500. PUB. 8-21-2001, FILED 1-3-2001.



FOR CHARITABLE FUND RAISING AND ELEEMOSYNARY SERVICES IN THE FIELD OF MONETARY DONATIONS (U.S. CLS. 100, 101 AND 102).
FIRST USE 10-31-2001; IN COMMERCE 10-31-2001.

2,626,674. LILY POND CAPITAL MANAGEMENT LLC, NEW YORK, NY. SN 78-047,261. PUB. 11-13-2001, FILED 2-8-2001.

LILY POND CAPITAL MANAGEMENT

NO CLAIM IS MADE TO THE EXCLUSIVE RIGHT TO USE "CAPITAL MANAGEMENT", APART FROM THE MARK AS SHOWN.

FOR FINANCIAL SERVICES, NAMELY FINANCIAL FUNDS MANAGEMENT (U.S. CLS. 100, 101 AND 102).
FIRST USE 5-1-2001; IN COMMERCE 5-1-2001.

CLASS 36—(Continued).

2,626,679. HM ENTERPRISES, INC., GULFPORT, FL. SN 78-048,610. PUB. 10-23-2001, FILED 2-15-2001.



NO CLAIM IS MADE TO THE EXCLUSIVE RIGHT TO USE "PROGRAM", APART FROM THE MARK AS SHOWN. FOR CHARITABLE GIFT FINANCING SERVICES, NAMELY, PROVIDING DOWN PAYMENT ASSISTANCE TO QUALIFIED BUYERS FOR THE PURCHASE OF A HOME (U.S. CLS. 100, 101 AND 102).
FIRST USE 4-1-2001; IN COMMERCE 4-1-2001.

2,626,682. FMR CORP., BOSTON, MA. SN 78-049,654. PUB. 12-4-2001, FILED 2-22-2001.

EVERYDAY FINANCES

NO CLAIM IS MADE TO THE EXCLUSIVE RIGHT TO USE "FINANCES", APART FROM THE MARK AS SHOWN. FOR FINANCIAL SERVICES, NAMELY, CASH MANAGEMENT, ELECTRONIC BILL PAYMENT, FINANCIAL ADMINISTRATION OF CREDIT CARD ACCOUNTS, LOAN FINANCING, FUND TRANSFER SERVICES AND FINANCIAL INFORMATION PROVIDED BY ELECTRONIC MEANS (U.S. CLS. 100, 101 AND 102).
FIRST USE 3-19-2001; IN COMMERCE 3-19-2001.

2,626,724. INSURANCE CENTRAL CORPORATION, CARPINTERIA, CA. SN 78-065,433. PUB. 2-19-2002, FILED 5-24-2001.

LIFE INSURANCE CENTRAL

OWNER OF U.S. REG. NO. 2,215,250.
NO CLAIM IS MADE TO THE EXCLUSIVE RIGHT TO USE "LIFE INSURANCE", APART FROM THE MARK AS SHOWN. FOR INSURANCE SERVICES, NAMELY BROKERAGE OF LIFE INSURANCE (U.S. CLS. 100, 101 AND 102).
FIRST USE 8-8-2001; IN COMMERCE 8-8-2001.

2,626,734. GENERAL MOTORS ACCEPTANCE CORPORATION, DETROIT, MI. SN 78-070,147. PUB. 10-23-2001, FILED 6-20-2001.

**EXPECT MORE FROM
SOMEONE YOU KNOW.**

FOR BANKING SERVICES (U.S. CLS. 100, 101 AND 102).
FIRST USE 7-24-2001; IN COMMERCE 7-24-2001.

CLASS 37—CONSTRUCTION AND REPAIR

2,625,688. TXI OPERATIONS, LP, DALLAS, TX. SN 75-848,769. PUB. 3-6-2001, FILED 11-15-1999.

METROPORT

FOR LAND DEVELOPMENT SERVICES, NAMELY, THE PLANNING AND LAYING OUT OF COMMERCIAL COMMUNITIES AND RELATED INDUSTRIAL PARKS SERVICEABLE BY GROUND TRANSPORTATION (U.S. CLS. 100, 103 AND 106).
FIRST USE 1-0-2000; IN COMMERCE 1-0-2000.

2,625,857. FBCIP, INC., KATY, TX. SN 75-936,323. PUB. 3-13-2001, FILED 3-6-2000.

PEOPLE.TECHNOLOGY.SERVICE.

FOR INSTALLATION AND MAINTENANCE OF TELECOMMUNICATIONS SYSTEMS AND EQUIPMENT (U.S. CLS. 100, 103 AND 106).
FIRST USE 1-1-2000; IN COMMERCE 1-1-2000.

2,626,108. REBUILDING TOGETHER, INC., WASHINGTON, DC, BY CHANGE OF NAME REBUILDING TOGETHER, INC., WASHINGTON, DC. SN 76-105,143. PUB. 5-15-2001, FILED 8-8-2000.

REBUILDING TOGETHER

FOR RENOVATION AND REPAIR OF HOUSING FOR THE NEEDY, INCLUDING LOW-INCOME, ELDERLY AND HANDICAPPED PERSONS; AND PROVIDING INFORMATION ON RENOVATION AND REPAIR OF HOUSING FOR THE NEEDY, INCLUDING LOW-INCOME, ELDERLY AND HANDICAPPED PERSONS, BY MEANS OF A GLOBAL COMPUTER NETWORK (U.S. CLS. 100, 103 AND 106).
FIRST USE 1-0-2001; IN COMMERCE 1-0-2001.

2,626,200. HOOVER MATERIALS HANDLING GROUP, INC., ALPHARETTA, GA. SN 76-142,640. PUB. 7-17-2001, FILED 10-6-2000.

CHEMSORT

FOR PROVIDING A COMPUTER DATABASE FOR REGISTERED USERS ACCESSED THROUGH A GLOBAL COMPUTER NETWORK IN THE FIELD OF CHEMICAL PROPERTIES, INCLUDING HANDLING, HAZARDS AND BLENDING OF CHEMICALS, FOR PURPOSES OF CLEANING AND REUSING CONTAINERS FOR TRANSPORTATION OF CHEMICALS (U.S. CLS. 100, 103 AND 106).
FIRST USE 7-1-2001; IN COMMERCE 7-1-2001.

CLASS 37—(Continued).

2,626,299. MIRANT CORPORATION, ATLANTA, GA. SN 76-178,842. PUB. 10-23-2001, FILED 12-11-2000.

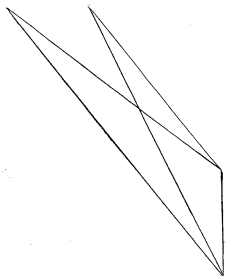

THE MARK CONSISTS OF TWO OVERLAPPING TRIANGLES.

FOR DEVELOPMENT, CONSTRUCTION AND MAINTENANCE FOR OTHERS OF COGENERATION AND INDEPENDENT ELECTRIC POWER PRODUCTION FACILITIES (U.S. CLS. 100, 103 AND 106).

FIRST USE 1-19-2001; IN COMMERCE 1-19-2001.

2,626,327. MIDWAY SPRING TRAILS, INC., HOUSTON, TX. SN 76-192,811. PUB. 8-28-2001, FILED 1-9-2001.

SPRING TRAILS

FOR REAL ESTATE DEVELOPMENT (U.S. CLS. 100, 103 AND 106).

FIRST USE 11-26-2001; IN COMMERCE 11-26-2001.

2,626,329. REH, GEORGE P., CARLSBAD, CA. SN 76-193,129. PUB. 1-1-2002, FILED 1-16-2001.



The Dutch Touch
European Professional Residential
and Commercial Cleaning

NO CLAIM IS MADE TO THE EXCLUSIVE RIGHT TO USE "EUROPEAN PROFESSIONAL RESIDENTIAL AND COMMERCIAL CLEANING", APART FROM THE MARK AS SHOWN.

FOR RESIDENTIAL HOMES AND COMMERCIAL BUILDINGS CLEANING SERVICES; MAID SERVICES (U.S. CLS. 100, 103 AND 106).

FIRST USE 1-1-2000; IN COMMERCE 1-6-2000.

CLASS 37—(Continued).

2,626,337. MIRANT CORPORATION, ATLANTA, GA, BY CHANGE OF NAME SOUTHERN ENERGY, INC., ATLANTA, GA. SN 76-195,767. PUB. 8-14-2001, FILED 1-18-2001.

**WE SEE THE OPPORTUNITY
TO CHANGE THE WORLD
WITH OUR ENERGY**

FOR DEVELOPMENT, CONSTRUCTION AND MAINTENANCE FOR OTHERS OF COGENERATION AND INDEPENDENT ELECTRIC POWER PRODUCTION FACILITIES (U.S. CLS. 100, 103 AND 106).

FIRST USE 1-19-2001; IN COMMERCE 1-19-2001.

2,626,606. GERBER GROUP, INC., THE, SKOKIE, IL. SN 78-027,560. PUB. 7-31-2001, FILED 9-25-2000.

**21ST CENTURY
TECHNOLOGY-OLD
FASHIONED SERVICE**

FOR AUTOMOBILE REPAIR AND RESTORATION SERVICES (U.S. CLS. 100, 103 AND 106).

FIRST USE 8-0-1998; IN COMMERCE 8-0-1998.

CLASS 38—COMMUNICATION

2,625,320. SNAP TRACK, INC., SAN JOSE, CA, BY ASSIGNMENT; BY CHANGE OF NAME PRECISION TRACKING, INC., SAN JOSE, CA. SN 75-164,631. PUB. 1-6-1998, FILED 9-12-1996.

SNAPTRACK

FOR COMMUNICATION AND TELECOMMUNICATION SERVICES IN THE NATURE OF LOCATING, POSITIONING AND NAVIGATION SERVICES UTILIZING GLOBAL POSITIONING SYSTEMS AND RELATED TECHNOLOGY (U.S. CLS. 100, 101 AND 104).

FIRST USE 10-8-2001; IN COMMERCE 10-8-2001.

CLASS 38—(Continued).

2,625,392. MISSOURI BASIN MUNICIPAL POWER AGENCY, SIOUX FALLS, SD. SN 75-468,166. PUB. 11-9-1999, FILED 4-15-1998.

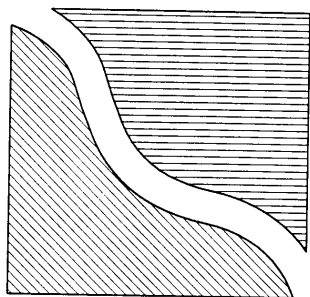

THE DRAWING IS LINED FOR THE COLOR(S) BLUE AND GREEN AND COLOR IS CLAIMED AS A FEATURE OF THE MARK.

FOR TELECOMMUNICATION SERVICES IN THE NATURE OF ELECTRONIC TRANSMISSION OF DATA AND INFORMATION IN THE UTILITY FIELD (U.S. CLS. 100, 101 AND 104).

FIRST USE 7-6-2000; IN COMMERCE 7-6-2000.

2,625,406. Z-TEL TECHNOLOGIES, INC., TAMPA, FL. SN 75-513,870. PUB. 1-18-2000, FILED 7-2-1998.

Z-NODE

FOR TELECOMMUNICATION SERVICES, NAMELY, PROVIDING LOCAL AND LONG DISTANCE TELEPHONE SERVICES; PROVIDING ELECTRONIC VOICE, VOICE MAIL, FACSIMILE AND DATA TRANSMISSION, AND ELECTRONIC MAIL; PROVIDING TELEPHONIC ROUTING SERVICES, NAMELY ACTIVATING CALL FORWARDING FROM TELEPHONE TO TELEPHONE; PROVIDING COMMUNICATION CONNECTIONS FOR THE TRANSMISSION OF VOICE, ELECTRONIC MAIL AND DATA BY LINKING USERS VIA FACSIMILES AND TELEPHONES AND A GLOBAL COMPUTER NETWORK; PROVIDING ELECTRONIC DATA INTERCHANGE SERVICES; PROVIDING MULTIPLE USER ACCESS TO A GLOBAL COMPUTER INFORMATION NETWORK (U.S. CLS. 100, 101 AND 104).

FIRST USE 1-0-1998; IN COMMERCE 12-0-1999.

2,625,473. CARTOON NETWORK LP, LLLP, ATLANTA, GA. SN 75-633,309. PUB. 7-25-2000, FILED 2-3-1999.

COURAGE THE COWARDLY DOG

FOR BROADCASTING PROGRAMS VIA TELEVISION, CABLE TELEVISION AND THE GLOBAL COMPUTER NETWORK (U.S. CLS. 100, 101 AND 104).

FIRST USE 11-12-1999; IN COMMERCE 11-12-1999.

CLASS 38—(Continued).

2,625,612. NGUYEN, THINH V., LOS GATOS, CA. SN 75-798,748. PUB. 1-16-2001, FILED 9-13-1999.

HEALTHGLOBE

FOR PROVIDING ON-LINE CHAT ROOMS FOR TRANSMISSION OF MESSAGES AMONG COMPUTER USERS CONCERNING MEDICAL AND HEALTH ISSUES; PROVIDING ON-LINE ELECTRONIC BULLETIN BOARDS FOR TRANSMISSION OF MESSAGES AMONG COMPUTER USERS CONCERNING MEDICAL AND HEALTH ISSUES (U.S. CLS. 100, 101 AND 104).

FIRST USE 1-12-2000; IN COMMERCE 7-11-2001.

2,625,624. SPORTSSOUTH NETWORK, LTD., ATLANTA, AL. AND SOUTHEASTERN CONFERENCE, BIRMINGHAM, AL. SN 75-805,680. PUB. 3-28-2000, FILED 9-21-1999.

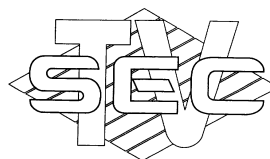

THE LINING SHOWN IN THE DRAWING IS A FEATURE OF THE MARK AND DOES NOT INDICATE COLOR.

FOR CABLE TELEVISION BROADCASTING SERVICES (U.S. CLS. 100, 101 AND 104).

FIRST USE 9-30-1995; IN COMMERCE 9-30-1995.

2,625,671. WALCHEM CORPORATION, HOLLISTON, MA. SN 75-839,666. PUB. 8-14-2001, FILED 11-3-1999.

SHOULDER TAP

FOR COMPUTER SERVICES, NAMELY, PROVIDING AN ON-DEMAND CONNECTION TO A WEB SERVER FOR ACCESSING INFORMATION OVER A GLOBAL COMPUTER INFORMATION NETWORK (U.S. CLS. 100, 101 AND 104).

FIRST USE 6-1-2001; IN COMMERCE 6-1-2001.

CLASS 38—(Continued).

2,625,733. MICROSOFT CORPORATION, REDMOND, WA. SN 75-880,885. PUB. 7-31-2001, FILED 12-27-1999.



OWNER OF U.S. REG. NOS. 2,014,296, 2,153,763, AND OTHERS.

THE STIPPLING IS FOR SHADING ONLY. COLOR IS NOT CLAIMED AS PART OF THE MARK.

THE MARK COMPRISES THE LETTERS "MSN" AND A BUTTERFLY DESIGN.

FOR TELECOMMUNICATION SERVICES, NAMELY, ELECTRONIC TRANSMISSION OF DATA, DOCUMENTS, MESSAGES AND IMAGES VIA COMPUTER TERMINALS; ELECTRONIC MAIL SERVICES; PROVIDING MULTIPLE-USER ACCESS TO A GLOBAL COMPUTER INFORMATION NETWORK; INSTANT MESSAGING SERVICES OFFERED OVER COMPUTER NETWORKS AND GLOBAL COMMUNICATION NETWORKS; PROVIDING ON-LINE CHAT ROOMS FOR TRANSMISSION OF MESSAGES AMONG COMPUTER USERS CONCERNING COMPUTERS AND COMPUTER PROGRAMS (U.S. CLS. 100, 101 AND 104).

FIRST USE 2-14-2000; IN COMMERCE 2-14-2000.

2,625,741. MICROSOFT CORPORATION, REDMOND, WA. SN 75-884,370. PUB. 7-31-2001, FILED 12-30-1999.

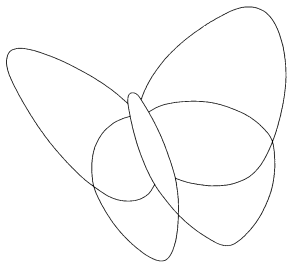

THE MARK COMPRISES A BUTTERFLY DESIGN. THE UPPER PORTION OF THE LEFT WING OF THE BUTTERFLY IS BLUE, THE CENTER PORTION DARK GREEN, AND THE LOWER PORTION IS LIGHT GREEN. THE UPPER PORTION OF THE RIGHT WING OF THE BUTTERFLY IS RED, THE MIDDLE PORTION IS ORANGE AND THE LOWER PORTION IS YELLOW. THE BODY OF THE BUTTERFLY IS PURPLE. COLOR IS CLAIMED AS PART OF THE MARK.

FOR TELECOMMUNICATION SERVICES, NAMELY, ELECTRONIC TRANSMISSION OF DATA, DOCUMENTS, MESSAGES AND IMAGES VIA COMPUTER TERMINALS; ELECTRONIC MAIL SERVICES; PROVIDING MULTIPLE-USER ACCESS TO A GLOBAL COMPUTER INFORMATION NETWORK; INSTANT MESSAGING SERVICES OFFERED OVER COMPUTER NETWORKS AND GLOBAL COMMUNICATION NETWORKS; PROVIDING ON-LINE CHAT ROOMS FOR TRANSMISSION OF MESSAGES AMONG COMPUTER USERS CONCERNING COMPUTERS AND COMPUTER PROGRAMS (U.S. CLS. 100, 101 AND 104).

FIRST USE 2-14-2000; IN COMMERCE 2-14-2000.

CLASS 38—(Continued).

2,625,745. EPIK COMMUNICATION INCORPORATED, ORLANDO, FL. SN 75-886,433. PUB. 11-6-2001, FILED 1-4-2000.

EPIK

OWNER OF U.S. REG. NO. 2,124,646.

FOR TELECOMMUNICATIONS SERVICES, NAMELY, ELECTRONIC AND OPTICAL TRANSMISSION OF VOICE, DATA AND VIDEO VIA FIBER OPTIC NETWORKING; NETWORK INTEGRATION SERVICES (U.S. CLS. 100, 101 AND 104).

FIRST USE 3-13-2000; IN COMMERCE 3-13-2000.

2,625,798. TALK AMERICA HOLDINGS, INC., NEW HOPE, PA. BY MERGER TALK.COM, INC., NEW HOPE, PA. SN 75-908,308. PUB. 9-12-2000, FILED 2-2-2000.

MATCHUP

FOR TELECOMMUNICATIONS SERVICES, NAMELY, LONG DISTANCE TELEPHONE SERVICES FEATURING GIFT CERTIFICATES AND AWARDS BASED ON USAGE (U.S. CLS. 100, 101 AND 104).

FIRST USE 2-15-2000; IN COMMERCE 2-15-2000.

2,625,854. CABLE ONE, INC., PHOENIX, AZ. SN 75-936,067. PUB. 1-23-2001, FILED 3-6-2000.

CABLE ONE DIGITAL

OWNER OF U.S. REG. NOS. 2,280,714 AND 2,283,649.

NO CLAIM IS MADE TO THE EXCLUSIVE RIGHT TO USE "CABLE" AND "DIGITAL", APART FROM THE MARK AS SHOWN.

FOR CABLE TELEVISION TRANSMISSION (U.S. CLS. 100, 101 AND 104).

FIRST USE 3-7-2000; IN COMMERCE 8-1-2000.

2,625,865. EPIK COMMUNICATION INCORPORATED, ORLANDO, FL. SN 75-939,545. PUB. 11-6-2001, FILED 3-8-2000.



OWNER OF U.S. REG. NO. 2,124,646.

NO CLAIM IS MADE TO THE EXCLUSIVE RIGHT TO USE "COMMUNICATIONS", APART FROM THE MARK AS SHOWN.

FOR TELECOMMUNICATIONS SERVICES, NAMELY, ELECTRONIC AND OPTICAL TRANSMISSION OF VOICE, DATA AND VIDEO VIA FIBER OPTIC NETWORKING; NETWORK INTEGRATION SERVICES (U.S. CLS. 100, 101 AND 104).

FIRST USE 3-13-2000; IN COMMERCE 3-13-2000.

CLASS 38—(Continued).

2,625,946. GRANT, BRIAN TANO, LOS ANGELES, CA. SN 76-028,860. PUB. 8-28-2001, FILED 4-19-2000.



FOR ELECTRONIC MAIL SERVICES (U.S. CLS. 100, 101 AND 104).
FIRST USE 1-5-2000; IN COMMERCE 1-5-2000.

2,625,990. PEGASUS COMMUNICATIONS. BALA CYNWYD, PA. SN 76-046,898. PUB. 9-18-2001, FILED 5-12-2000.

WGFL

FOR TELECOMMUNICATION SERVICES, NAMELY, CABLE AND SATELLITE TELEVISION, AUDIO AND INTERNET BROADCASTING SERVICES (U.S. CLS. 100, 101 AND 104).
FIRST USE 3-21-1989; IN COMMERCE 3-21-1989.

2,626,001. DISCOVERY COMMUNICATIONS, INC., BETHESDA, MD. SN 76-050,877. PUB. 7-3-2001, FILED 5-17-2000.

ARE YOU HUMAN?

FOR TELEVISION BROADCASTING SERVICES (U.S. CLS. 100, 101 AND 104).
FIRST USE 5-28-2000; IN COMMERCE 5-28-2000.

2,626,061. VERESTAR, INC., FAIRFAX, VA. SN 76-083,243. PUB. 11-13-2001, FILED 7-5-2000.

VERESTAR

FOR SATELLITE COMMUNICATION SERVICES FOR PROVIDING TELECOMMUNICATIONS CONNECTIONS TO TELECOMMUNICATIONS CARRIERS AND INTERNET SERVICE PROVIDERS (U.S. CLS. 100, 101 AND 104).
FIRST USE 9-27-2000; IN COMMERCE 9-27-2000.

CLASS 38—(Continued).

2,626,186. ROSEMONT HOCKEY PARTNERS, L.P., GLENVIEW, IL. SN 76-138,922. PUB. 8-28-2001, FILED 10-2-2000.



NO CLAIM IS MADE TO THE EXCLUSIVE RIGHT TO USE "CHICAGO" AND "EMAIL", APART FROM THE MARK AS SHOWN.

FOR INTERACTIVE COMMUNICATIONS SERVICES, NAMELY ELECTRONIC TRANSMISSION OF DATA, IMAGES, DOCUMENTS AND INFORMATION, AND ELECTRONIC EMAIL SERVICES PROVIDED BY MEANS OF A GLOBAL COMPUTER NETWORK (U.S. CLS. 100, 101 AND 104).
FIRST USE 10-13-2000; IN COMMERCE 10-13-2000.

2,626,199. SPEED-COMM.COM, L.L.C., TULSA, OK. SN 76-142,396. PUB. 7-17-2001, FILED 10-6-2000.

COLLECT4LESS

FOR TELECOMMUNICATION SERVICES, NAMELY COLLECT TELEPHONE CALLING SERVICES (U.S. CLS. 100, 101 AND 104).
FIRST USE 12-0-2000; IN COMMERCE 12-0-2000.

2,626,580. LOUISIANA ONLINE, INC., BATON ROUGE, LA. SN 78-014,005. PUB. 5-22-2001, FILED 6-22-2000.

BROADBAND GEEKS

NO CLAIM IS MADE TO THE EXCLUSIVE RIGHT TO USE "BROADBAND", APART FROM THE MARK AS SHOWN.

FOR INTERNET ACCESS SERVICES, NAMELY PROVIDING HIGH SPEED INTERNET ACCESS TO OTHERS (U.S. CLS. 100, 101 AND 104).
FIRST USE 4-17-2002; IN COMMERCE 4-17-2002.

CLASS 38—(Continued).

2,626,645. AT&T CORP., NEW YORK, NY. SN 78-041,503. PUB. 9-18-2001, FILED 1-3-2001.

BUILDING BOX COMMUNICATIONS

NO CLAIM IS MADE TO THE EXCLUSIVE RIGHT TO USE "COMMUNICATIONS", APART FROM THE MARK AS SHOWN.

FOR TELECOMMUNICATIONS SERVICES, NAMELY, THE ELECTRONIC TRANSMISSION OF VOICE, DATA, TEXT, FACSIMILE, AND VIDEO (U.S. CLS. 100, 101 AND 104).

FIRST USE 3-11-2002; IN COMMERCE 3-11-2002.

2,626,706. WISNIEWSKI, DAVID ALAN, FAIR OAKS, CA. SN 78-057,363. PUB. 10-16-2001, FILED 4-9-2001.

TAXIWAY

FOR ELECTRONIC MAIL SERVICES (U.S. CLS. 100, 101 AND 104).

FIRST USE 1-8-2002; IN COMMERCE 1-8-2002.

CLASS 39—TRANSPORTATION AND STORAGE

2,625,413. AEROVIAS NACIONALES DE COLOMBIA S.A. AVIANCA, BARRANQUILLA, COLOMBIA. SN 75-533,238. PUB. 6-5-2001, FILED 8-5-1998.

ClubElite

PRIORITY CLAIMED UNDER SEC. 44(D) ON COLOMBIA APPLICATION NO. 6252, FILED 2-6-1998, REG. NO. 225.097, DATED 1-30-1999, EXPIRES 1-30-2009.

FOR PASSENGER AIR TRANSPORT SERVICES IN EXECUTIVE AND FIRST CLASSES (U.S. CLS. 100 AND 105).

FIRST USE 4-27-1998; IN COMMERCE 5-13-1998.

2,625,569. VERMONT TEDDY BEAR COMPANY, INC., THE, SHELBURNE, VT. SN 75-753,152. PUB. 1-11-2000, FILED 7-16-1999.

TEDEX

FOR MESSAGE DELIVERY SERVICES ACCOMPANIED BY A STUFFED ANIMAL (U.S. CLS. 100 AND 105). FIRST USE 1-0-2002; IN COMMERCE 1-0-2002.

CLASS 39—(Continued).

2,625,579. FULFILLMENT PLUS, INC., WALTHAM, MA. SN 75-757,268. PUB. 2-27-2001, FILED 7-21-1999.

FFPLUS

FOR WAREHOUSE STORAGE OF TELECOMMUNICATIONS EQUIPMENT; PACKAGING TELECOMMUNICATIONS EQUIPMENT FOR TRANSPORTATION; SHIPMENT OF TELECOMMUNICATIONS EQUIPMENT VIA GROUND AND AIR TRANSPORTATION (U.S. CLS. 100 AND 105).

FIRST USE 9-15-1999; IN COMMERCE 9-15-1999.

2,625,583. RENAISSANCE POWER, INC., BATON ROUGE, LA. SN 75-765,683. PUB. 5-2-2000, FILED 8-2-1999.

RENAISSANCE POWER

NO CLAIM IS MADE TO THE EXCLUSIVE RIGHT TO USE "POWER", APART FROM THE MARK AS SHOWN.

FOR ELECTRIC UTILITY DISTRIBUTION SERVICES (U.S. CLS. 100 AND 105).

FIRST USE 3-13-2002; IN COMMERCE 3-13-2002.

2,625,734. MICROSOFT CORPORATION, REDMOND, WA. SN 75-880,886. PUB. 7-31-2001, FILED 12-27-1999.



OWNER OF U.S. REG. NOS. 2,014,296, 2,153,763, AND OTHERS.

THE STIPPLING IS FOR SHADING ONLY. COLOR IS NOT CLAIMED AS PART OF THE MARK.

THE MARK COMPRISES THE LETTERS "MSN" AND A BUTTERFLY DESIGN.

FOR PROVIDING INFORMATION CONCERNING TRAVEL AND TRAVEL-RELATED SUBJECTS VIA LOCAL COMPUTER NETWORKS AND GLOBAL COMMUNICATION NETWORKS; PROVIDING INFORMATION CONCERNING MOTOR VEHICLES VIA LOCAL COMPUTER NETWORKS AND GLOBAL COMMUNICATION NETWORKS AND ELECTRONIC STORAGE AND RETRIEVAL OF DOCUMENTS AND DATA VIA LOCAL COMPUTER NETWORKS AND GLOBAL TELECOMMUNICATION NETWORKS IN THE FIELDS OF TRAVEL AND TRAVEL-RELATED SUBJECTS, TRANSPORTATION AND MOTOR VEHICLES; PROVIDING CONSUMERS WITH INFORMATION CONCERNING VARIOUS CARS, TRUCKS, MINI-VANS AND SPORT UTILITY VEHICLES, NAMELY, PRODUCT REVIEWS AND INFORMATION CONCERNING FEATURES, PERFORMANCE, TECHNICAL SPECIFICATIONS AND VEHICLE SPECIFICATIONS; TRAVEL AGENCY SERVICES, NAMELY, MAKING RESERVATIONS AND BOOKINGS FOR TRANSPORTATION; PROVIDING INFORMATION CONCERNING TRAVEL AND TRAVEL-RELATED TOPICS; PROVIDING TRAVEL INFORMATION VIA LOCAL COMPUTER NETWORKS AND GLOBAL COMMUNICATIONS NETWORKS (U.S. CLS. 100 AND 105).

FIRST USE 2-14-2000; IN COMMERCE 2-14-2000.

CLASS 39—(Continued).

2,625,740. MICROSOFT CORPORATION, REDMOND, WA.
SN 75-884,364. PUB. 7-31-2001, FILED 12-30-1999.



OWNER OF U.S. REG. NOS. 2,014,296, 2,153,763, AND OTHERS.

THE MARK COMPRISES THE LETTERS "MSN" AND A BUTTERFLY DESIGN. THE UPPER PORTION OF THE LEFT WING OF THE BUTTERFLY IS BLUE, THE CENTER PORTION DARK GREEN, AND THE LOWER PORTION IS LIGHT GREEN. THE UPPER PORTION OF THE RIGHT WING OF THE BUTTERFLY IS RED, THE MIDDLE PORTION IS ORANGE AND THE LOWER PORTION IS YELLOW. THE BODY OF THE BUTTERFLY IS PURPLE. THE LETTERS "MSN" ARE BLUE. COLOR IS CLAIMED AS PART OF THE MARK.

FOR PROVIDING INFORMATION CONCERNING TRAVEL AND TRAVEL-RELATED SUBJECTS VIA LOCAL COMPUTER NETWORKS AND GLOBAL COMMUNICATION NETWORKS; PROVIDING INFORMATION CONCERNING MOTOR VEHICLES VIA LOCAL COMPUTER NETWORKS AND GLOBAL COMMUNICATION NETWORKS AND ELECTRONIC STORAGE AND RETRIEVAL OF DOCUMENTS AND DATA VIA LOCAL COMPUTER NETWORKS AND GLOBAL TELECOMMUNICATION NETWORKS IN THE FIELDS OF TRAVEL AND TRAVEL-RELATED SUBJECTS, TRANSPORTATION AND MOTOR VEHICLES; PROVIDING CONSUMERS WITH INFORMATION CONCERNING VARIOUS CARS, TRUCKS, MINI-VANS AND SPORT UTILITY VEHICLES, NAMELY, PRODUCT REVIEWS AND INFORMATION CONCERNING FEATURES, PERFORMANCE, TECHNICAL SPECIFICATIONS AND VEHICLE SPECIFICATIONS; TRAVEL AGENCY SERVICES, NAMELY, MAKING RESERVATIONS AND BOOKINGS FOR TRANSPORTATION; PROVIDING INFORMATION CONCERNING TRAVEL AND TRAVEL-RELATED TOPICS; PROVIDING TRAVEL INFORMATION VIA LOCAL COMPUTER NETWORKS AND GLOBAL COMMUNICATIONS NETWORKS (U.S. CLS. 100 AND 105).

FIRST USE 2-14-2000; IN COMMERCE 2-14-2000.

2,626,032. UTXL ENTERPRISES, INC., KANSAS CITY, MO,
BY CHANGE OF NAME UTS, INC., KANSAS CITY, MO.
SN 76-068,491. PUB. 2-27-2001, FILED 6-13-2000.

HAULSTREET.COM

FOR LOGISTICS SERVICES, NAMELY, FREIGHT TRANSPORTATION BY TRUCK; TRANSPORTATION OF GOODS BY TRUCK; AND FREIGHT BROKERAGE SERVICES; SAID SERVICES BEING OFFERED IN PERSON, VIA TELEPHONE AND VIA GLOBAL COMPUTER NETWORK (U.S. CLS. 100 AND 105).

FIRST USE 5-16-2002; IN COMMERCE 5-16-2002.

2,626,070. ROYAL CARIBBEAN CRUISES LTD., MIAMI, FL.
SN 76-087,741. PUB. 4-17-2001, FILED 7-12-2000.

THE WILDERNESS EXPRESS**CLASS 39—(Continued).**

NO CLAIM IS MADE TO THE EXCLUSIVE RIGHT TO USE "EXPRESS", APART FROM THE MARK AS SHOWN.
FOR TRANSPORTATION OF PASSENGERS BY RAIL (U.S. CLS. 100 AND 105).

FIRST USE 5-0-2001; IN COMMERCE 5-0-2001.

2,626,128. ERIE MUNICIPAL AIRPORT AUTHORITY, ERIE,
PA. SN 76-116,479. PUB. 10-9-2001, FILED 8-24-2000.



NO CLAIM IS MADE TO THE EXCLUSIVE RIGHT TO USE "ERIE INTERNATIONAL AIRPORT" AND "FIELD", APART FROM THE MARK AS SHOWN.

THE NAME "TOM RIDGE" IDENTIFIES A LIVING INDIVIDUAL WHOSE CONSENT IS OF RECORD.

FOR AIRPORT SERVICES (U.S. CLS. 100 AND 105).
FIRST USE 7-17-2000; IN COMMERCE 7-17-2000.

2,626,350. NORFOLK SOUTHERN CORPORATION, NORFOLK, VA. SN 76-202,117. PUB. 2-5-2002, FILED 1-31-2001.

MODALGISTICS

FOR DISTRIBUTION OF FREIGHT BY RAIL AND CONSULTING SERVICES RELATED THERETO (U.S. CLS. 100 AND 105).

FIRST USE 9-0-2001; IN COMMERCE 9-0-2001.

2,626,357. KELLY, LARRY A., GRAFTON, OH. SN 76-205,855.
PUB. 9-18-2001, FILED 2-7-2001.



THE MARK CONSISTS, IN PART, OF THE WORDS, "MY OTHER GARAGE", AND DESIGN.

FOR LEASING AND RENTAL OF SELF-STORAGE FACILITIES (U.S. CLS. 100 AND 105).

FIRST USE 12-1-2001; IN COMMERCE 12-1-2001.

CLASS 39—(Continued).

2,626,421. MOBILITY TECHNOLOGIES, INC., WAYNE, PA, BY CHANGE OF NAME TRAFFIC.COM, INC., WAYNE, PA. SN 76-221,765. PUB. 9-25-2001, FILED 3-7-2001.

MOBILITY TECHNOLOGIES

NO CLAIM IS MADE TO THE EXCLUSIVE RIGHT TO USE "TECHNOLOGIES", APART FROM THE MARK AS SHOWN.

FOR TRAFFIC INFORMATION SERVICES (U.S. CLS. 100 AND 105).

FIRST USE 5-31-2001; IN COMMERCE 5-31-2001.

CLASS 40—(Continued).

2,625,912. NORDENIA U.S.A., INC., JACKSON, MO. SN 76-007,564. PUB. 12-26-2000, FILED 3-24-2000.

**NORDENIA
INTERNATIONAL**

NO CLAIM IS MADE TO THE EXCLUSIVE RIGHT TO USE "INTERNATIONAL", APART FROM THE MARK AS SHOWN.

FOR CUSTOM MANUFACTURE OF FLEXIBLE PACKAGING, LAMINATIONS, AND INDUSTRIAL FILMS FOR OTHERS (U.S. CLS. 100, 103 AND 106).

FIRST USE 10-0-2001; IN COMMERCE 10-0-2001.

CLASS 40—MATERIAL TREATMENT

2,625,567. SUNG HYUK CHOI AND JUNG WON KIM PARTNERSHIP, THE, ENGLEWOOD CLIFFS, NJ. SN 75-751,544. PUB. 8-1-2000, FILED 7-12-1999.



FOR CUSTOM MANUFACTURE OF HATS, CAPS AND OTHER HEAD WEAR AND WEARING APPAREL (U.S. CLS. 100, 103 AND 106).

FIRST USE 3-1-1999; IN COMMERCE 3-1-1999.

2,625,915. NORDENIA U.S.A., INC., JACKSON, MO. SN 76-011,008. PUB. 12-26-2000, FILED 3-24-2000.



NO CLAIM IS MADE TO THE EXCLUSIVE RIGHT TO USE "U.S.A.", APART FROM THE MARK AS SHOWN.

FOR CUSTOM MANUFACTURE OF FLEXIBLE PACKAGING, LAMINATIONS, AND INDUSTRIAL FILMS FOR OTHERS (U.S. CLS. 100, 103 AND 106).

FIRST USE 10-0-2001; IN COMMERCE 10-0-2001.

2,625,850. J.T. CUSTOM WORKS, INC., ELKHART, IN. SN 75-933,241. PUB. 11-28-2000, FILED 3-2-2000.

WORK-N-PLAY

FOR VEHICLE CONVERSION SERVICES (U.S. CLS. 100, 103 AND 106).

FIRST USE 9-0-2000; IN COMMERCE 9-0-2000.

2,626,018. KNOWASTE, L.L.C., MISSISSAUGA, ONTARIO, CANADA. SN 76-060,591. PUB. 5-29-2001, FILED 5-31-2000.

**CONVENIENCE WITH A
CONSCIENCE**

FOR DIAPER RECYCLING (U.S. CLS. 100, 103 AND 106).

FIRST USE 2-14-2002; IN COMMERCE 2-14-2002.

2,625,909. C. J. FOODS, INC., PAWNEE CITY, NE. SN 76-005,867. PUB. 11-20-2001, FILED 3-21-2000.

**STAND UP AND BE
COUNTED**

FOR FOOD PACKAGING SERVICES RELATED TO STAND-UP POUCHES (U.S. CLS. 100, 103 AND 106).

FIRST USE 4-3-2000; IN COMMERCE 4-3-2000.

2,626,093. TOWER SOLUTIONS, LLC, PINE CITY, MN, BY ASSIGNMENT; BY CHANGE OF NAME TOWER SOLUTIONS, INC., PINE CITY, MN. SN 76-097,981. PUB. 5-29-2001, FILED 7-27-2000.

TOWER SOLUTIONS

NO CLAIM IS MADE TO THE EXCLUSIVE RIGHT TO USE "TOWER", APART FROM THE MARK AS SHOWN.

FOR MANUFACTURE OF TOWERS AND TO THE ORDER AND/OR SPECIFICATION OF OTHERS (U.S. CLS. 100, 103 AND 106).

FIRST USE 4-16-2001; IN COMMERCE 8-30-2001.

CLASS 40—(Continued).

2,626,136. PROFIT CENTER SYSTEMS, INC., MEMPHIS, TN. SN 76-119,835. PUB. 9-4-2001, FILED 8-30-2000.

PERFECT PRINT BY SMARTART

NO CLAIM IS MADE TO THE EXCLUSIVE RIGHT TO USE "PERFECT PRINT", APART FROM THE MARK AS SHOWN.

FOR PHOTOGRAPHIC AND COMPUTER IMAGING SERVICES, NAMELY, DIGITAL PHOTOCOMPOSITION SERVICES, SCANNING AND REPRODUCTION OF DIGITAL IMAGES, POST PRODUCTION FINISHING SERVICES, NAMELY, SEALING, STRETCHING AND FRAMING, PHOTOGRAPHIC COMPUTER IMAGING, ENLARGEMENT, FILM DEVELOPMENT, PRESERVATION, PRINTING, RESTORATION, RETOUCHING, SLIDE AND/OR PRINT PROCESSING, DIGITAL IMAGE SERVICES AND DIGITAL COMPRESSION SERVICES (U.S. CLS. 100, 103 AND 106).

FIRST USE 5-0-2000; IN COMMERCE 5-0-2000.

2,626,352. INGENIA POLYMERS, INC., HOUSTON, TX. SN 76-204,560. PUB. 8-21-2001, FILED 2-5-2001.

INGENIA SUPERBLEND

FOR CUSTOM MANUFACTURE OF PLASTIC AND POLYMER ADDITIVES FOR OTHERS (U.S. CLS. 100, 103 AND 106).

FIRST USE 12-1-2001; IN COMMERCE 12-1-2001.

2,626,424. LINCOLN GLOBAL, INC., MONTEREY PARK, CA. SN 76-223,438. PUB. 8-14-2001, FILED 3-12-2001.

PROMISES KEPT

FOR WELDING SERVICES (U.S. CLS. 100, 103 AND 106).

FIRST USE 1-0-2001; IN COMMERCE 1-0-2001.

2,626,491. COSTCO WHOLESALE CORPORATION, ISSAQUAH, WA. SN 76-257,930. PUB. 9-25-2001, FILED 5-15-2001.



OWNER OF U.S. REG. NOS. 2,106,027 AND 2,203,024.
THE DRAWING IS LINED TO SHOW THE FOLLOWING COLORS: RED, BLACK, AND WHITE.
THE MARK CONSISTS OF THE WORD KIRKLAND IN STYLIZED FORMAT IN THE COLOR WHITE, WITH THE CROSS BAR OF THE "A" IN THE COLOR RED, AND THE

CLASS 40—(Continued).

WORD SIGNATURE IN STYLIZED FORMAT IN THE COLOR RED, WITH BOTH WORDS INSIDE A BLACK RECTANGULAR BOX.

FOR PHOTOGRAPHIC FILM PROCESSING FOR WAREHOUSE CLUB MEMBERS (U.S. CLS. 100, 103 AND 106).

FIRST USE 10-9-2001; IN COMMERCE 10-9-2001.

2,626,562. BATTLEPLAY INC., CORAL SPRINGS, FL. SN 78-005,207. PUB. 7-3-2001, FILED 4-22-2000.

The logo for BattlePlay, featuring the word "BattlePlay" in a bold, italicized, sans-serif font. A black arrow points to the left, positioned below the "B" and extending under the "t" and "t" of "Battle".

FOR CUSTOM MANUFACTURE OF GAMES, NAMELY, HAND-HELD ELECTRONIC GAMES, SOFTWARE GAMES, BOARD GAMES, CARD GAMES, DICE GAMES, ROLE-PLAYING GAMES, MINIATURE GAMES, COMPUTER GAMES, AND CELL PHONE GAMES (U.S. CLS. 100, 103 AND 106).

FIRST USE 10-1-2000; IN COMMERCE 5-1-2001.

CLASS 41—EDUCATION AND ENTERTAINMENT

2,625,323. WOJECK, JULIE A., MONROE, CT. SN 75-202,420. PUB. 3-9-1999, FILED 11-22-1996.



FOR EDUCATIONAL SERVICES, NAMELY, ARRANGING AND CONDUCTING HOME SCHOOLING COURSES DESIGNED TO ASSIST PARENTS IN REINFORCING PUBLIC/PRIVATE SCHOOL EDUCATION IN THE AREAS OF MATH AND LANGUAGE ARTS FOR ELEMENTARY SCHOOL AGE CHILDREN, FEATURING THE PROVISION OF SMALL TOYS TO CHILDREN UPON COMPLETION AND GOOD EFFORT IN THE PROGRAM (U.S. CLS. 100, 101 AND 107).

FIRST USE 3-14-2002; IN COMMERCE 3-14-2002.

CLASS 41—(Continued).

2,625,328. LEARNING TREE INTERNATIONAL, INC., LOS ANGELES, CA. SN 75-223,018. PUB. 5-12-1998, FILED 1-9-1997.

WE BRING LEARNING TO LIFE

FOR PROVIDING TRAINING IN THE FIELDS OF COMPUTER TECHNOLOGY, COMPUTER SOFTWARE APPLICATIONS AND DESIGNING, COMPUTER GRAPHICS, ELECTRONICS, NETWORK AND DATA COMMUNICATIONS SYSTEMS, DIGITAL CONTROL, DATA PROCESSING, DATA ANALYSIS AND FORECASTING, COMPUTER REPAIR AND MAINTENANCE, PATTERN RECOGNITION, SYSTEMS AND DATA BASE MANAGEMENT, ENGINEERING, SCIENCE, BUSINESS MANAGEMENT, HEALTH, COMMUNICATIONS AND MANUFACTURING, AND COMPUTER BASED TRAINING SERVICES (U.S. CLS. 100, 101 AND 107).

FIRST USE 10-10-1996; IN COMMERCE 10-10-1996.

2,625,352. AMERICAN COLLEGE, THE, BRYN MAWR, PA, BY ASSIGNMENT AMERICAN COLLEGE, THE, BRYN MAWR, PA. AND LIMRA INTERNATIONAL, INC., WINDSOR, CT. SN 75-353,338. PUB. 6-15-1999, FILED 9-8-1997.

CHARTERED LEADERSHIP FELLOW

NO CLAIM IS MADE TO THE EXCLUSIVE RIGHT TO USE "FELLOW", APART FROM THE MARK AS SHOWN.

FOR EDUCATIONAL SERVICES, NAMELY, CONDUCTING COURSES IN THE FIELD OF INSURANCE AND THE MANAGEMENT OF INSURANCE BUSINESSES (U.S. CLS. 100, 101 AND 107).

FIRST USE 5-0-1998; IN COMMERCE 5-0-1998.

2,625,353. AMERICAN COLLEGE, THE, BRYN MAWR, PA, BY ASSIGNMENT AMERICAN COLLEGE, THE, BRYN MAWR, PA. AND LIMRA INTERNATIONAL, INC., WINDSOR, CT. SN 75-353,670. PUB. 6-15-1999, FILED 9-8-1997.

CLF

OWNER OF U.S. REG. NOS. 1,618,597, 1,621,185, AND OTHERS.

FOR EDUCATIONAL SERVICES, NAMELY, CONDUCTING COURSES IN THE FIELD OF INSURANCE AND THE MANAGEMENT OF INSURANCE BUSINESSES (U.S. CLS. 100, 101 AND 107).

FIRST USE 5-0-1998; IN COMMERCE 5-0-1998.

CLASS 41—(Continued).

2,625,363. ZIMMER, KARL R. III, PLAINFIELD, IN. SN 75-401,241. PUB. 3-30-1999, FILED 12-8-1997.

RULE

FOR EDUCATIONAL SERVICES, NAMELY, CONDUCTING SEMINARS, CONFERENCES, WORKSHOPS AND COURSES OF INSTRUCTION IN THE FIELD OF PHYSICAL, MENTAL AND SPIRITUAL DEVELOPMENT OF OTHERS (U.S. CLS. 100, 101 AND 107).

FIRST USE 10-20-2001; IN COMMERCE 10-20-2001.

2,625,366. MACNEIL LEHRER PRODUCTIONS, NEW YORK, NY. SN 75-409,562. PUB. 12-22-1998, FILED 12-22-1997.

"DO YOU SPEAK AMERICAN?"

FOR ENTERTAINMENT SERVICES, NAMELY, A TELEVISION SERIES ON LANGUAGE AND COMMUNICATION (U.S. CLS. 100, 101 AND 107).

FIRST USE 7-1-2001; IN COMMERCE 7-1-2001.

2,625,369. SAN JOAQUIN COUNTY OFFICE OF EDUCATION, ALTERNATIVE PROGRAMS, STOCKTON, CA. SN 75-415,151. PUB. 3-7-2000, FILED 1-8-1998.

ONE.

FOR PUBLIC EDUCATIONAL SERVICES, NAMELY, PROVIDING COURSES OF INSTRUCTION AT THE PRIMARY AND SECONDARY LEVEL (U.S. CLS. 100, 101 AND 107).

FIRST USE 10-17-1986; IN COMMERCE 10-17-1986.

2,625,419. DISNEY ENTERPRISES, INC., BURBANK, CA. SN 75-550,434. PUB. 7-20-1999, FILED 9-9-1998.

PARADISE PIER

FOR AMUSEMENT PARK SERVICES (U.S. CLS. 100, 101 AND 107).

FIRST USE 2-8-2001; IN COMMERCE 2-8-2001.

CLASS 41—(Continued).

2,625,435. MEGA ENTERTAINMENT INTERNATIONAL, INC., NEW YORK, NY. SN 75-571,510. PUB. 10-24-2000, FILED 10-15-1998.

CLASS 41—(Continued).

2,625,527. WILD BRAIN, INC., SAN FRANCISCO, CA. SN 75-721,985. PUB. 5-2-2000, FILED 6-3-1999.

SECRETS OF—

THE BROKEN LINE AREA, NAMELY "—" IS AN INTEGRAL PART OF THE MARK AS SHOWN, THUS THE ENTIRE MARK IS "SECRETS OF—".

FOR ENTERTAINMENT IN THE NATURE OF AN ONGOING TELEVISION SERIES IN THE FIELD OF COMEDY, DRAMA AND EDUCATION, AS WELL AS DOCUMENTARIES OF GENERAL INTEREST (U.S. CLS. 100, 101 AND 107).

FIRST USE 3-0-2000; IN COMMERCE 3-0-2000.



2,625,447. DISNEY ENTERPRISES, INC., BURBANK, CA. SN 75-598,162. PUB. 7-11-2000, FILED 12-2-1998.

PRIMETIME PLAYER

NO CLAIM IS MADE TO THE EXCLUSIVE RIGHT TO USE "PLAYER", APART FROM THE MARK AS SHOWN.

FOR ENTERTAINMENT SERVICES, NAMELY, PROVIDING COMPUTER GAMES VIA A MULTI-USER GLOBAL INFORMATION NETWORK (U.S. CLS. 100, 101 AND 107).

FIRST USE 1-4-1999; IN COMMERCE 1-4-1999.



2,625,483. CARTOON NETWORK LP, LLLP, THE, ATLANTA, GA. SN 75-656,666. PUB. 10-10-2000, FILED 3-10-1999.

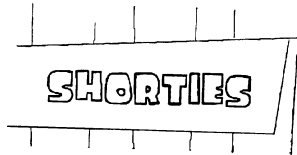

FOR ENTERTAINMENT AND EDUCATION SERVICES, NAMELY SHORT ANIMATED COMEDY PROGRAMS PROVIDED THROUGH CABLE AND BROADCAST TELEVISION, RADIO AND THE GLOBAL INFORMATION SERVICES NETWORK (U.S. CLS. 100, 101 AND 107).

FIRST USE 6-7-1999; IN COMMERCE 6-7-1999.

WILD BRAIN

OWNER OF U.S. REG. NO. 1,985,627.
FOR ENTERTAINMENT SERVICES, NAMELY MOTION PICTURE FILM AND TELEVISION PRODUCTION; PROVIDING A CONTINUING CARTOON SHOW DISTRIBUTED OVER TELEVISION, CABLE, RADIO AND GLOBAL COMPUTER NETWORKS; ELECTRONIC PUBLISHING SERVICES, NAMELY, PUBLICATION OF TEXT AND GRAPHIC WORKS OF OTHERS ON CD-ROMS FEATURING ANIMATED GAMES (U.S. CLS. 100, 101 AND 107).

FIRST USE 1-0-1995; IN COMMERCE 1-0-1995.



2,625,555. UCSF STANFORD HEALTH CARE, SAN FRANCISCO, CA. SN 75-739,978. PUB. 9-12-2000, FILED 6-30-1999.

LUCILE PACKARD CHILDREN'S HOSPITAL

NO CLAIM IS MADE TO THE EXCLUSIVE RIGHT TO USE "CHILDREN'S HOSPITALS", APART FROM THE MARK AS SHOWN.

THE NAME IN THE MARK DOES NOT REPRESENT A LIVING INDIVIDUAL.

FOR EDUCATIONAL SERVICES, NAMELY, CONDUCTING CLASSES, SEMINARS, CONFERENCES AND WORKSHOPS IN THE FIELD OF HEALTH CARE AND DISTRIBUTING COURSE MATERIALS IN CONNECTION THEREWITH; ARRANGING AND CONDUCTING EDUCATIONAL CONFERENCES (U.S. CLS. 100, 101 AND 107).

FIRST USE 3-0-2000; IN COMMERCE 3-0-2000.

CLASS 41—(Continued).

2,625,598. COPPER RIDGE INSTITUTE, INC., THE, SYKESVILLE, MD. SN 75-781,905. PUB. 7-17-2001, FILED 8-23-1999.



THE LINING IN THE DRAWING IS A FEATURE OF THE MARK AND IS NOT INTENDED TO INDICATE COLOR.

FOR EDUCATIONAL SERVICES, NAMELY, CONDUCTING CLASSES, SEMINARS, CONFERENCES AND WORKSHOPS ON DEVELOPMENTS AND CURRENT RESEARCH IN THE FIELD OF AGING WITH A PRIMARY FOCUS ON ALZHEIMER'S DISEASE AND OTHER FORMS OF DEMENTIA; EDUCATIONAL RESEARCH IN THE FIELD OF AGING WITH A PRIMARY FOCUS ON ALZHEIMER'S DISEASE AND OTHER FORMS OF DEMENTIA (U.S. CLS. 100, 101 AND 107).

FIRST USE 10-0-1999; IN COMMERCE 10-0-1999.

2,625,602. STOILOV, VALENTIN, SANTA MONICA, CA. SN 75-785,163. PUB. 5-2-2000, FILED 9-20-1999.

FILMOSOPHY

FOR EDUCATIONAL SERVICES, NAMELY, CONDUCTING CLASSES, EXHIBITIONS, CONFERENCES, LECTURES, AND RESEARCH IN THE FIELDS OF THEORY, HISTORY, AND PRODUCTION OF MOTION PICTURES AND AUDIO-VISUAL MEDIA, AND PRODUCTION OF MOTION PICTURES, VIDEOTAPES, CD-ROMS, AND DVD-ROMS FOR EDUCATION AND ENTERTAINMENT (U.S. CLS. 100, 101 AND 107).

FIRST USE 10-15-1991; IN COMMERCE 1-1-2001.

CLASS 41—(Continued).

2,625,619. FERNANDEZ, RAMON M., LOS ANGELES, CA. SN 75-804,137. PUB. 6-26-2001, FILED 9-16-1999.

VARIETY FITNESS

NO CLAIM IS MADE TO THE EXCLUSIVE RIGHT TO USE "FITNESS", APART FROM THE MARK AS SHOWN.

FOR ARRANGING AND CONDUCTING EDUCATIONAL CONFERENCES, NAMELY ARRANGING AND CONDUCTING WORKSHOPS AND SEMINARS IN THE FIELD OF MEDIATION, SELF-REFLECTION, PHILOSOPHY, RELIGION, MARTIAL ARTS, ROCK CLIMBING, SPORTS NUTRITION, PHYSICAL FITNESS AND EXERCISE, APPLICATION OF MAKEUP, HAIR AND SKIN TREATMENT, COMMUNICATION SKILLS, MAGNETIC THERAPY, THERAPEUTIC MASSAGE, AEROBICS, BOXING, KICK BOXING, AROMA THERAPY, AND DANCE; ARRANGING AND CONDUCTING WORKSHOPS AND SEMINARS IN THE FIELD OF NEURO-LINGUISTIC THERAPY, NAMELY SPEECH THERAPY AND SPEECH PROGRAMMING; ARRANGING AND CONDUCTING WORKSHOPS AND SEMINARS IN THE FIELD OF CRANIOSACRAL THERAPY, NAMELY BRAIN AND SPINAL CORD THERAPY; ARRANGING AND CONDUCTING WORKSHOPS AND SEMINARS IN THE FIELD OF HYPNOTHERAPY, NAMELY THERAPY THROUGH THE USE OF HYPNOSIS; ARRANGING AND CONDUCTING WORKSHOPS AND SEMINARS IN THE FIELD OF VISION IMPROVEMENT, NAMELY EXERCISES FOR EYES INTENDED TO MAINTAIN EYE SHAPE; TRAINING IN THE FIELDS OF SELF-DEFENSE, YOGA, WEIGHT CONDITIONING, NON-IMPACT EXERCISES, AND BODY RESISTANCE EXERCISES; RECREATIONAL AND SPORTS CAMPS FEATURING TRAINING FOR PROFICIENCY IN ACTIVITIES RELATED TO STATIONARY BICYCLES, TABLE TENNIS, BASKETBALL, AND BASEBALL; RECREATIONAL AND SPORTS CAMPS FEATURING TRAINING FOR PROFICIENCY IN ACTIVITIES RELATED TO TRAMPOLINES, NAMELY CARDIOVASCULAR WORKOUTS THROUGH THE USE OF A CANVAS ATTACHED WITH SPRINGS TO A METAL FRAME USED FOR TUMBLING; RECREATIONAL AND SPORTS CAMPS FEATURING TRAINING FOR PROFICIENCY IN ACTIVITIES RELATED TO THE USE OF EQUIPMENT FOR INVERTING AND STRETCHING THE HUMAN BODY AND FOR REPOSITIONING THE HUMAN BODY IN RELATION TO GRAVITY; PROVIDING FACILITIES FOR RECREATIONAL ACTIVITIES, INCLUDING SWIMMING AND CHILD PLAY AREAS; PROVIDING FACILITIES FOR STRESS REDUCTION, NAMELY PROVIDING ROOMS FOR RELIEVING AND REDUCING STRESS; HEALTH CLUBS; PHYSICAL FITNESS INSTRUCTION; MARTIAL ARTS INSTRUCTION; YOGA INSTRUCTION (U.S. CLS. 100, 101 AND 107).

FIRST USE 8-31-1997; IN COMMERCE 2-20-2002.

CLASS 41—(Continued).

2,625,623. SPORTSSOUTH NETWORK, LTD., ATLANTA, GA. AND SOUTHEASTERN CONFERENCE, BIRMINGHAM, AL. SN 75-805,614. PUB. 3-28-2000, FILED 9-21-1999.

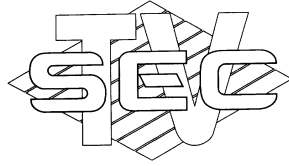

THE LINING SHOWN IN THE DRAWING IS A FEATURE OF THE MARK AND DOES NOT INDICATE COLOR.
 FOR ENTERTAINMENT SERVICES IN THE NATURE OF PRODUCTION AND DISTRIBUTION OF TELEVISION PROGRAMS FEATURING SPORTS (U.S. CLS. 100, 101 AND 107).
 FIRST USE 9-30-1995; IN COMMERCE 9-30-1995.

2,625,631. FETZER INSTITUTE, THE, KALAMAZOO, MI. SN 75-811,183. PUB. 5-1-2001, FILED 9-30-1999.



FOR EDUCATIONAL SERVICES, NAMELY, PROVIDING INSTRUCTION TO OTHERS IN THE FIELD OF LEADERSHIP DEVELOPMENT AND DISTRIBUTING COURSE MATERIALS IN CONNECTION THEREWITH (U.S. CLS. 100, 101 AND 107).
 FIRST USE 1-31-1999; IN COMMERCE 1-31-1999.

2,625,640. GEI, INC., GREENWOOD, IN. SN 75-819,325. PUB. 5-22-2001, FILED 10-12-1999.



FOR CONDUCTING SEMINARS AND TRAINING METHODS IN THE FIELD OF MANUFACTURING EFFICIENCY IMPROVEMENT (U.S. CLS. 100, 101 AND 107).
 FIRST USE 4-1-1999; IN COMMERCE 4-1-1999.

CLASS 41—(Continued).

2,625,651. PIERCE ARROW SOCIETY, THE, ROCHESTER, NY. SN 75-827,149. PUB. 9-4-2001, FILED 10-19-1999.



OWNER OF U.S. REG. NOS. 1,051,583 AND 1,058,801.
 NO CLAIM IS MADE TO THE EXCLUSIVE RIGHT TO USE "FOUNDATION", APART FROM THE MARK AS SHOWN.
 THE MARK CONSISTS OF THE WORDING "PIERCE-ARROW FOUNDATION" TO THE LEFT OF WHICH IS THE BADGING OF A PIERCE-ARROW MOTORCAR.
 FOR EDUCATIONAL AND ENTERTAINMENT SERVICES, NAMELY THE OPERATION OF A MUSEUM DEVOTED TO SPECIFIC CLASSIC OR ANTIQUE MOTORCARS AND RELATED PRODUCTS AND ARTIFACTS AND OFFERING EDUCATIONAL SEMINARS AND WORKSHOPS IN FURTHERANCE OF THE APPRECIATION OF SPECIFIC CLASSIC OR ANTIQUE MOTORCARS AND RELATED PRODUCTS AND ARTIFACTS (U.S. CLS. 100, 101 AND 107).
 FIRST USE 7-20-1998; IN COMMERCE 7-20-1998.

2,625,656. CREDIT UNION EXECUTIVES SOCIETY, INC., MADISON, WI. SN 75-829,551. PUB. 11-27-2001, FILED 10-18-1999.

CUES TECH PORT

OWNER OF U.S. REG. NO. 783,373.
 FOR EDUCATIONAL SERVICES, NAMELY, ONLINE COURSES ON COMPUTER SYSTEMS, TECHNOLOGY SERVICES AND TELECOMMUNICATIONS EQUIPMENT (U.S. CLS. 100, 101 AND 107).
 FIRST USE 11-0-1999; IN COMMERCE 11-0-1999.

2,625,724. JULIE ANN TURNER COMPANY, PLANO, TX. SN 75-875,410. PUB. 7-10-2001, FILED 1-3-2000.

AGE OF IMAGINATION

FOR EDUCATIONAL SERVICES, NAMELY WORKSHOPS, COURSES, SEMINARS, COLLABORATIVE SESSIONS/FACILITATIONS AND PRESENTATIONS IN THE FIELD OF INDIVIDUAL AND BUSINESS POTENTIAL, INNOVATION/CREATIVITY, PLANNING AND ORGANIZATIONAL DEVELOPMENT/MANAGEMENT, AND DISTRIBUTING EDUCATIONAL/COURSE MATERIALS IN CONNECTION THEREWITH (U.S. CLS. 100, 101 AND 107).
 FIRST USE 6-10-2001; IN COMMERCE 6-10-2001.

CLASS 41—(Continued).

2,625,725. JULIE ANN TURNER & COMPANY, PLANO, TX. SN 75-875,413. PUB. 8-28-2001, FILED 1-3-2000.

CREATIVE CONSCIOUSNESS

FOR EDUCATIONAL SERVICES, NAMELY WORKSHOPS, COURSES, SEMINARS, COLLABORATIVE SESSIONS/FACILITATIONS AND PRESENTATIONS IN THE FIELD OF INDIVIDUAL AND BUSINESS POTENTIAL, INNOVATION/CREATIVITY, PLANNING AND ORGANIZATIONAL DEVELOPMENT/MANAGEMENT, AND DISTRIBUTING EDUCATIONAL/COURSE MATERIALS IN CONNECTION THEREWITH (U.S. CLS. 100, 101 AND 107).

FIRST USE 6-10-2001; IN COMMERCE 6-10-2001.

2,625,842. TAYLOR, ROBERT L., DBA TAYLOR ENTERTAINMENT, NORTH EASTON, MA. SN 75-928,042. PUB. 9-11-2001, FILED 2-25-2000.

WORLD-WIDE WEBSTER

THE NAME IN THE MARK DOES NOT IDENTIFY A PARTICULAR LIVING INDIVIDUAL.

FOR ENTERTAINMENT SERVICES, NAMELY PROVIDING A PROGRAM IN THE FIELD OF EDUCATION AND ENTERTAINMENT FOR CHILDREN VIA THE INTERNET AND A CONTINUING ANIMATED SHOW DISTRIBUTED OVER TELEVISION AND VIDEO MEDIA (U.S. CLS. 100, 101 AND 107).

FIRST USE 12-0-1997; IN COMMERCE 3-0-2001.

2,625,860. THUNDERBIRD, THE AMERICAN GRADUATE SCHOOL OF INTERNATIONAL MANAGEMENT, GLENDALE, AZ. SN 75-937,251. PUB. 12-5-2000, FILED 3-7-2000.

MY THUNDERBIRD

OWNER OF U.S. REG. NO. 1,934,989.
FOR EDUCATIONAL SERVICES, NAMELY GRADUATE-LEVEL STUDIES IN THE FIELD OF INTERNATIONAL MANAGEMENT (U.S. CLS. 100, 101 AND 107).

FIRST USE 8-0-1998; IN COMMERCE 8-0-1998.

2,625,872. CHANGEPLANET, INC., WALNUT CREEK, CA. SN 75-955,133. PUB. 5-29-2001, FILED 3-7-2000.

CHANGEPLANET

FOR EDUCATIONAL SERVICES, NAMELY, PROVIDING SEMINARS AND WEB SITES PERTAINING TO SELF-HELP, SELF-IMPROVEMENT, PERSONAL GROWTH/CHANGE AND GOAL SETTING (U.S. CLS. 100, 101 AND 107).

FIRST USE 11-8-2000; IN COMMERCE 11-8-2000.

CLASS 41—(Continued).

2,625,905. METACRITIC.COM, INC., INCLINE VILLAGE, NV. SN 76-003,356. PUB. 12-18-2001, FILED 3-17-2000.

METACRITIC

FOR COMPILING ENTERTAINMENT REVIEW STATISTICS AND PROVIDING INFORMATION ON ENTERTAINMENT REVIEW STATISTICS TO OTHERS (U.S. CLS. 100, 101 AND 107).

FIRST USE 11-10-2000; IN COMMERCE 11-10-2000.

2,625,920. VON STAFF REITZENSTEIN, HANS, D-95176, KONRADSREUTH, FED REP GERMANY. SN 76-013,081. PUB. 8-28-2001, FILED 3-30-2000.

WAP-Gambler

NO CLAIM IS MADE TO THE EXCLUSIVE RIGHT TO USE "WAP-GAMBLER", APART FROM THE MARK AS SHOWN.

FOR ON-LINE COMPUTER ENTERTAINMENT SERVICES, NAMELY, PROVIDING ON-LINE COMPUTER GAMES (U.S. CLS. 100, 101 AND 107).

FIRST USE 4-1-2002; IN COMMERCE 4-1-2002.

2,625,933. RED DELICIOUS, BEVERLY HILLS, CA. SN 76-022,551. PUB. 11-13-2001, FILED 3-21-2000.

RED DELICIOUS

FOR ENTERTAINMENT SERVICES IN THE NATURE OF LIVE PERFORMANCES BY A MUSICAL GROUP (U.S. CLS. 100, 101 AND 107).

FIRST USE 12-0-1998; IN COMMERCE 4-0-2000.

2,625,961. MOYNIHAN, MICHAEL, WASHINGTON, DC. SN 76-036,015. PUB. 4-17-2001, FILED 4-27-2000.

AOTV UNFILTERED

FOR SERVICES ON THE GLOBAL COMMUNICATIONS NETWORK, NAMELY AN INTERACTIVE SERVICE WHICH ALLOWS VISITORS TO A WEBSITE TO EXCHANGE VIDEOS (U.S. CLS. 100, 101 AND 107).

FIRST USE 0-0-1999; IN COMMERCE 0-0-1999.

CLASS 41—(Continued).

2,625,979. CARTOON NETWORK LP, LLLP, THE, ATLANTA, GA. SN 76-044,278. PUB. 1-30-2001, FILED 5-9-2000.



FOR ENTERTAINMENT SERVICES IN THE NATURE OF AN ANIMATED CONTINUING PROGRAM SERIES AND ANIMATED MOTION PICTURE FILMS DIRECTED TOWARD CHILDREN AND YOUNG ADULTS, PROVIDED THROUGH CABLE TELEVISION, BROADCAST TELEVISION, BROADCAST RADIO AND THE GLOBAL COMPUTER INFORMATION NETWORK (U.S. CLS. 100, 101 AND 107).

FIRST USE 8-10-2000; IN COMMERCE 8-10-2000.

2,625,984. FLY IN MY SOUP ENTERTAINMENT, INC., ST. LOUIS PARK, MN. SN 76-045,165. PUB. 1-16-2001, FILED 5-10-2000.

FLY IN MY SOUP ENTERTAINMENT

NO CLAIM IS MADE TO THE EXCLUSIVE RIGHT TO USE "ENTERTAINMENT", APART FROM THE MARK AS SHOWN.

FOR ENTERTAINMENT SERVICES IN THE NATURE OF LIVE MUSICAL AND COMEDY PERFORMANCES (U.S. CLS. 100, 101 AND 107).

FIRST USE 2-11-2002; IN COMMERCE 2-11-2002.

2,626,028. JEFF'S BASEMENT, INC., ST. LOUIS, MO. SN 76-066,794. PUB. 5-29-2001, FILED 6-9-2000.

JEFF'S BASEMENT

FOR ENTERTAINMENT SERVICES, NAMELY, PROVIDING A RADIO AND TELEVISION PROGRAM IN THE FIELD OF MUSIC ENTERTAINMENT VIA A GLOBAL COMPUTER NETWORK (U.S. CLS. 100, 101 AND 107).

FIRST USE 7-23-2000; IN COMMERCE 7-23-2000.

CLASS 41—(Continued).

2,626,068. HUTCHINS, KENNETH M., ALTAMONTE SPRINGS, FL. SN 76-087,381. PUB. 3-20-2001, FILED 7-12-2000.

TEN-TEN

FOR EDUCATIONAL SERVICES, NAMELY CONDUCTING CLASSES AND WORKSHOPS IN THE FIELD OF EXERCISE PROTOCOL AND INDIVIDUAL INSTRUCTION IN THE FIELD OF EXERCISE PROTOCOL (U.S. CLS. 100, 101 AND 107).

FIRST USE 6-9-2002; IN COMMERCE 6-9-2002.

2,626,076. BILL R. STEPHENS ASSOCIATES, INC., SAN ANTONIO, TX. SN 76-089,421. PUB. 5-22-2001, FILED 7-17-2000.

SPORTZHAPPENS

FOR PROVIDING SPORTS RELATED INFORMATION ONLINE (U.S. CLS. 100, 101 AND 107).

FIRST USE 7-0-2000; IN COMMERCE 7-0-2000.

2,626,079. KNOWCONFLICT, LLC, PHOENIX, AZ. SN 76-090,561. PUB. 8-28-2001, FILED 7-18-2000.

KNOWCONFLICT

FOR EDUCATIONAL SERVICES, NAMELY CONDUCTING CLASSES IN THE FIELD OF DISPUTE AND CONFLICT RESOLUTION PROVIDED OVER GLOBAL NETWORK 35 OF COMPUTERS AND DISTRIBUTION OF MATERIALS (U.S. CLS. 100, 101 AND 107).

FIRST USE 1-1-2000; IN COMMERCE 1-1-2000.

2,626,097. DR. SEUSS ENTERPRISES L.P., LA JOLLA, CA. SN 76-100,009. PUB. 5-15-2001, FILED 7-28-2000.

MT. CRUMPIT SNOW PLUMMET

FOR ENTERTAINMENT SERVICES, NAMELY, AMUSEMENT PARK SERVICES, PRODUCTION OF ANIMATED AND LIVE CHILDREN'S INTERACTIVE TELEVISION SHOWS, PRODUCTION OF ANIMATED AND LIVE ENTERTAINMENT PROGRAMS FOR DISTRIBUTION OVER CABLE TELEVISION AND COMPUTER NETWORKS, LIVE THEATER PRODUCTIONS, AND THE PRODUCTION AND DISTRIBUTION OF MOTION PICTURES (U.S. CLS. 100, 101 AND 107).

FIRST USE 12-1-2001; IN COMMERCE 12-1-2001.

CLASS 41—(Continued).

2,626,099. MARENZANA GROUP, INC., WOODBURY, CT.
SN 76-101,034. PUB. 9-11-2001, FILED 8-1-2000.

KLIJ

FOR EDUCATIONAL SERVICES, NAMELY, CONDUCTING ELECTRONIC AND FACE-TO-FACE SEMINARS, CONFERENCES, AND WORKSHOPS IN THE FIELDS OF MANAGEMENT SKILL AND PROFESSIONAL DEVELOPMENT TRAINING, MANAGEMENT DEVELOPMENT AND KNOWLEDGE MANAGEMENT (U.S. CLS. 100, 101 AND 107).

FIRST USE 5-14-2002; IN COMMERCE 5-15-2002.

2,626,100. MARENZANA GROUP, INC., WOODBURY, CT.
SN 76-101,035. PUB. 9-11-2001, FILED 8-1-2000.

MARENZANA KNOWLIJ NETWORK

FOR EDUCATIONAL SERVICES, NAMELY, CONDUCTING ELECTRONIC AND FACE-TO-FACE SEMINARS, CONFERENCES, AND WORKSHOPS IN THE FIELDS OF MANAGEMENT SKILL AND PROFESSIONAL DEVELOPMENT TRAINING, MANAGEMENT DEVELOPMENT AND KNOWLEDGE MANAGEMENT (U.S. CLS. 100, 101 AND 107).

FIRST USE 1-11-2001; IN COMMERCE 1-18-2001.

2,626,158. HELLMAN, PAUL, FRAMINGHAM, MA. SN 76-126,968. PUB. 2-5-2002, FILED 9-11-2000.

EXPRESS POTENTIAL

FOR EDUCATIONAL SERVICES, NAMELY, PROVIDING BUSINESS RELATED COURSES, WORKSHOPS, TRAINING PROGRAMS, AND PROFESSIONAL SPEAKING IN THE FIELD OF PROVIDING IDEAS AND SKILLS ON HOW TO ACHIEVE BETTER RESULTS IN THE WORK PLACE THROUGH DIFFERENT WAYS OF THINKING, COMMUNICATING, AND BEHAVING, AND THE DISTRIBUTION OF MATERIALS IN CONNECTION THEREWITH (U.S. CLS. 100, 101 AND 107).

FIRST USE 10-1-2000; IN COMMERCE 10-1-2000.

CLASS 41—(Continued).

2,626,216. WOMEN'S PROFESSIONAL SOCCER, L.L.C., NEW YORK, NY. SN 76-150,097. PUB. 12-11-2001, FILED 10-19-2000.

ATLANTA BEAT

NO CLAIM IS MADE TO THE EXCLUSIVE RIGHT TO USE "ATLANTA", APART FROM THE MARK AS SHOWN. FOR ENTERTAINMENT SERVICES, NAMELY, ORGANIZING CONDUCTING AND STAGING PROFESSIONAL WOMEN'S SOCCER GAMES AND EXHIBITIONS (U.S. CLS. 100, 101 AND 107).

FIRST USE 4-14-2001; IN COMMERCE 4-14-2001.

2,626,226. PUBLIC BROADCASTING SERVICE, ALEXANDRIA, VA. SN 76-151,660. PUB. 8-21-2001, FILED 10-23-2000.



OWNER OF U.S. REG. NOS. 1,235,634, 2,093,500, AND OTHERS.

FOR CULTURAL, EDUCATIONAL, AND ENTERTAINMENT TELEVISION PROGRAMMING SERVICES, NAMELY TELEVISION PROGRAMS AND TELE-COURSES FEATURING A WIDE RANGE OF CULTURAL, EDUCATIONAL, AND ENTERTAINMENT TOPICS; PROVIDING INFORMATION ON A WIDE RANGE OF CULTURAL, EDUCATIONAL, AND ENTERTAINMENT TOPICS VIA THE INTERNET; EDUCATIONAL SERVICES, NAMELY, PROVIDING EDUCATIONAL PROGRAMS, CLASSES, SEMINARS, COURSES, WORKSHOPS, INFORMATION EXCHANGES AND CONFERENCES, LIVE AND/OR VIA INTERACTIVE AND ELECTRONIC MEANS, NAMELY, TELEVISION, CABLE AND SATELLITE BROADCASTING AND VIA THE INTERNET, FEATURING EDUCATIONAL, LITERACY, BUSINESS, HEALTH CARE, VOCATIONAL, JOB TRAINING AND RE-TRAINING, TEACHER PREPARATION, AND CONTINUING EDUCATION FOR K-12 TEACHERS, DISTANCE LEARNING, CAREER-PLACE-MENT SUBJECTS, AND DISTRIBUTION OF PRINTED AND COURSE MATERIALS IN CONNECTION THEREWITH; CONDUCTING TELEVISION PROGRAMMING FOR USE BY COLLEGES AND UNIVERSITIES FOR COURSE CREDIT AND DISTANCE LEARNING; PROVIDING INSTRUCTION FOR, AND ASSESSMENT OF, ADULT LITERACY SKILLS; AND RENTAL OF TELEVISION PROGRAMS AND FILMS (U.S. CLS. 100, 101 AND 107).

FIRST USE 8-0-1998; IN COMMERCE 8-0-1998.

CLASS 41—(Continued).

2,626,230. COPPER MOUNTAIN, INC., COPPER MOUNTAIN, CO. SN 76-154,322. PUB. 8-28-2001, FILED 10-25-2000.

FOUR PASS

NO CLAIM IS MADE TO THE EXCLUSIVE RIGHT TO USE "PASS", APART FROM THE MARK AS SHOWN.
FOR RECREATIONAL SERVICES, NAMELY, PROVIDING FACILITIES FOR SKIING (U.S. CLS. 100, 101 AND 107).

FIRST USE 12-8-2000; IN COMMERCE 12-8-2000.

2,626,242. JOHN JACOBS GOLF SCHOOLS, INC., SCOTTSDALE, AZ. SN 76-156,603. PUB. 8-14-2001, FILED 10-31-2000.

EAGLEVISION

FOR INSTRUCTING STUDENTS IN THE GAME OF GOLF (U.S. CLS. 100, 101 AND 107).

FIRST USE 1-1-2001; IN COMMERCE 1-1-2001.

2,626,248. CARVALHO, VANIO BORGES, BURBANK, CA. SN 76-158,293. PUB. 10-16-2001, FILED 11-3-2000.

THE MUSIC MESSENGER

NO CLAIM IS MADE TO THE EXCLUSIVE RIGHT TO USE "MUSIC", APART FROM THE MARK AS SHOWN.

FOR ENTERTAINMENT IN THE NATURE OF LIVE PERFORMANCES BY A SINGER; SONG WRITING SERVICES; RECORD PRODUCTION; SOUND RECORDING STUDIOS; MUSIC PUBLISHING SERVICES (U.S. CLS. 100, 101 AND 107).

FIRST USE 12-22-2000; IN COMMERCE 12-22-2000.

2,626,253. TEXACO INC., WHITE PLAINS, NY. SN 76-160,644. PUB. 10-9-2001, FILED 11-6-2000.



OWNER OF U.S. REG. NOS. 57,902, 1,865,727, AND OTHERS.

NO CLAIM IS MADE TO THE EXCLUSIVE RIGHT TO USE "GRAND PRIX OF HOUSTON", APART FROM THE MARK AS SHOWN.

THE STIPPLING IS FOR SHADING PURPOSES ONLY.
FOR ENTERTAINMENT IN THE NATURE OF AN AUTO RACE (U.S. CLS. 100, 101 AND 107).

FIRST USE 8-31-1998; IN COMMERCE 8-31-1998.

CLASS 41—(Continued).

2,626,260. WILDTANGENT, INC., REDMOND, WA. SN 76-163,313. PUB. 8-14-2001, FILED 11-9-2000.

DARK ORBIT

FOR ENTERTAINMENT SERVICES, NAMELY, PROVIDING AN ON-LINE COMPUTER GAME (U.S. CLS. 100, 101 AND 107).

FIRST USE 9-1-2001; IN COMMERCE 9-1-2001.

2,626,282. MORESTEAM.COM LLC, POWELL, OH. SN 76-171,778. PUB. 8-28-2001, FILED 11-17-2000.



FOR EDUCATIONAL SERVICES; NAMELY, CONDUCTING CLASSES IN THE FIELDS OF PRODUCT AND PROCESS QUALITY AND PROCESS IMPROVEMENT (U.S. CLS. 100, 101 AND 107).

FIRST USE 1-25-2001; IN COMMERCE 1-25-2001.

2,626,283. MORESTEAM.COM LLC, POWELL, OH. SN 76-171,779. PUB. 8-28-2001, FILED 11-17-2000.

MORESTEAM

FOR EDUCATIONAL SERVICES; NAMELY, CONDUCTING CLASSES IN THE FIELDS OF PRODUCT AND PROCESS QUALITY AND PROCESS IMPROVEMENT (U.S. CLS. 100, 101 AND 107).

FIRST USE 1-25-2001; IN COMMERCE 1-25-2001.

2,626,284. MORESTEAM.COM LLC, POWELL, OH. SN 76-171,780. PUB. 11-20-2001, FILED 11-17-2000.

THE ENGINE ROOM OF CONTINUOUS IMPROVEMENT

NO CLAIM IS MADE TO THE EXCLUSIVE RIGHT TO USE "CONTINUOUS IMPROVEMENT", APART FROM THE MARK AS SHOWN.

FOR EDUCATIONAL SERVICES; NAMELY, CONDUCTING CLASSES IN THE FIELDS OF PRODUCT AND PROCESS QUALITY AND PROCESS IMPROVEMENT (U.S. CLS. 100, 101 AND 107).

FIRST USE 1-25-2001; IN COMMERCE 1-25-2001.

CLASS 41—(Continued).

2,626,293. MILLER BREWING COMPANY, MILWAUKEE, WI. SN 76-175,300. PUB. 12-18-2001, FILED 12-4-2000.

MILLER LITE DIGITAL FOOTBALL

OWNER OF U.S. REG. NOS. 2,046,348, 2,234,383, AND OTHERS.

NO CLAIM IS MADE TO THE EXCLUSIVE RIGHT TO USE "DIGITAL FOOTBALL", APART FROM THE MARK AS SHOWN.

FOR ENTERTAINMENT SERVICES IN THE NATURE OF PROVIDING AN ONLINE COMPUTER GAME WITH A FOOTBALL MOTIF (U.S. CLS. 100, 101 AND 107).
FIRST USE 1-0-2001; IN COMMERCE 1-0-2001.

2,626,295. SIX FLAGS THEME PARKS, INC., OKLAHOMA CITY, OK. SN 76-178,090. PUB. 9-4-2001, FILED 12-8-2000.

WHERE THRILLS RULE

FOR ENTERTAINMENT SERVICES, NAMELY, AMUSEMENT AND THEME PARK RIDES, ATTRACTIONS, AND AMUSEMENT AND THEME SERVICES (U.S. CLS. 100, 101 AND 107).

FIRST USE 11-0-2000; IN COMMERCE 3-0-2001.

2,626,310. UNIVERSAL CITY STUDIOS, INC., UNIVERSAL CITY, CA. SN 76-182,642. PUB. 8-21-2001, FILED 12-18-2000.



OWNER OF U.S. REG. NOS. 2,241,297, 2,376,104, AND OTHERS.

FOR AMUSEMENT PARK SERVICES (U.S. CLS. 100, 101 AND 107).
FIRST USE 9-0-2000; IN COMMERCE 9-0-2000.

CLASS 41—(Continued).

2,626,349. POETIC DIGITAL GROUP, INC., SAN FRANCISCO, CA. SN 76-201,923. PUB. 1-1-2002, FILED 1-30-2001.

LET US IMPROVE YOUR IMAGE

FOR DIGITAL ANIMATION PRODUCTION AND DIGITAL IMAGE MANIPULATION SERVICES (U.S. CLS. 100, 101 AND 107).

FIRST USE 7-6-2001; IN COMMERCE 7-6-2001.

2,626,360. WILDTANGENT, INC., REDMOND, WA. SN 76-207,721. PUB. 8-28-2001, FILED 2-7-2001.

BETTY BAD

FOR ENTERTAINMENT SERVICES, NAMELY PROVIDING ON-LINE GAMES (U.S. CLS. 100, 101 AND 107).
FIRST USE 1-17-2002; IN COMMERCE 1-17-2002.

2,626,362. ALL CHILDREN'S HOSPITAL FOUNDATION, INC., ST. PETERSBURG, FL. SN 76-207,989. PUB. 8-21-2001, FILED 2-9-2001.

DR. PETE E. ATRIC

FOR ENTERTAINMENT SERVICES NAMELY, PRODUCTION OF CHILDREN'S PLAYS AND TELEVISION SHOWS, AND EDUCATIONAL SERVICES NAMELY PROVIDING WORKSHOPS, SEMINARS AND STRUCTURED PLAY ACTIVITIES FOR EDUCATING CHILDREN AT THE PRE-PRIMARY, PRIMARY AND ELEMENTARY LEVELS IN THE FIELD OF HEALTH AND WELLNESS (U.S. CLS. 100, 101 AND 107).

FIRST USE 9-27-2000; IN COMMERCE 9-27-2000.

2,626,367. NEW YORK UNIVERSITY, NEW YORK, NY. AND LONDON SCHOOL OF ECONOMICS AND POLITICAL SCIENCE, LONDON WC2A 2AE, UNITED KINGDOM. AND HEC PARIS GRADUATE BUSINESS SCHOOL, 78351 JOUY-EN-JOSAS CEDEX, FRANCE. SN 76-208,973. PUB. 9-18-2001, FILED 2-13-2001.

TRIUM

FOR EDUCATIONAL SERVICES, NAMELY, PROVIDING COURSES OF INSTRUCTION AT THE GRADUATE LEVEL (U.S. CLS. 100, 101 AND 107).

FIRST USE 9-7-2000; IN COMMERCE 10-1-2000.

CLASS 41—(Continued).

2,626,402. JONES STAR SPORTS LTD., IRVING, TX. SN 76-216,827. PUB. 11-6-2001, FILED 2-27-2001.

DALLAS DESPERADOS

NO CLAIM IS MADE TO THE EXCLUSIVE RIGHT TO USE "DALLAS", APART FROM THE MARK AS SHOWN.

FOR ENTERTAINMENT SERVICES IN THE NATURE OF PROFESSIONAL FOOTBALL GAMES AND EXHIBITIONS; PROVIDING INFORMATION ABOUT SPORTS AND FOOTBALL ENTERTAINMENT VIA A GLOBAL COMPUTER INFORMATION NETWORK AND/OR THE INTERNET; FAN CLUBS; ORGANIZING SPORTING EVENTS; ENTERTAINMENT IN THE NATURE OF LIVE THEATRICAL, MUSICAL AND MULTIMEDIA PERFORMANCES AND SHOWS DURING PROFESSIONAL FOOTBALL GAMES AND OTHER SPORTING EVENTS; ARRANGING AND CONDUCTING ATHLETIC COMPETITIONS; PRODUCTION OF RADIO AND TELEVISION PROGRAMS; EDUCATIONAL SERVICES IN THE NATURE OF PHYSICAL EDUCATION COURSES (U.S. CLS. 100, 101 AND 107).

FIRST USE 11-1-2001; IN COMMERCE 11-1-2001.

2,626,403. JONES STAR SPORTS LTD., IRVING, TX. SN 76-216,896. PUB. 11-6-2001, FILED 2-27-2001.

DESPERADOS

FOR ENTERTAINMENT SERVICES IN THE NATURE OF PROFESSIONAL FOOTBALL GAMES AND EXHIBITIONS; PROVIDING INFORMATION ABOUT SPORTS AND FOOTBALL ENTERTAINMENT VIA A GLOBAL COMPUTER INFORMATION NETWORK AND/OR THE INTERNET; FAN CLUBS; ORGANIZING SPORTING EVENTS; ENTERTAINMENT IN THE NATURE OF LIVE THEATRICAL, MUSICAL AND MULTIMEDIA PERFORMANCES AND SHOWS DURING PROFESSIONAL FOOTBALL GAMES AND OTHER SPORTING EVENTS; ARRANGING AND CONDUCTING ATHLETIC COMPETITIONS; PRODUCTION OF RADIO AND TELEVISION PROGRAMS; EDUCATIONAL SERVICES IN THE NATURE OF PHYSICAL EDUCATION COURSES (U.S. CLS. 100, 101 AND 107).

FIRST USE 11-1-2001; IN COMMERCE 11-1-2001.

2,626,435. CHILDREN'S MUSEUM OF INDIANAPOLIS, INC., THE, INDIANAPOLIS, IN. SN 76-228,332. PUB. 1-1-2002, FILED 3-21-2001.

BONES: AN EXHIBIT INSIDE YOU

NO CLAIM IS MADE TO THE EXCLUSIVE RIGHT TO USE "BONES", APART FROM THE MARK AS SHOWN.

FOR MUSEUM SERVICES (U.S. CLS. 100, 101 AND 107).

FIRST USE 6-14-2001; IN COMMERCE 6-14-2001.

CLASS 41—(Continued).

2,626,439. NATIONAL BOARD OF YOUNG WOMEN'S CHRISTIAN ASSOCIATION OF THE UNITED STATES OF AMERICA, TA YWCA OF THE USA, NEW YORK, NY. SN 76-229,999. PUB. 1-1-2002, FILED 3-26-2001.

HEART PLUS

NO CLAIM IS MADE TO THE EXCLUSIVE RIGHT TO USE "HEART", APART FROM THE MARK AS SHOWN.

FOR EDUCATIONAL SERVICES, NAMELY CONDUCTING WORKSHOPS AND PUBLIC AWARENESS PROGRAMS ON THE SUBJECTS OF HEALTH, HEART DISEASE AND ELEVATED CHOLESTEROL LEVELS (U.S. CLS. 100, 101 AND 107).

FIRST USE 8-27-1998; IN COMMERCE 8-27-1998.

2,626,443. PARKS, STEVEN JAMES, VA BEACH, VA. SN 76-231,262. PUB. 10-23-2001, FILED 3-27-2001.



THE "AEROBICS" FIGURE IS THE COLOR RED. AEROBI IS THE COLOR BLUE AND "FITT" IS THE COLOR BLACK. FOR FITNESS EDUCATIONAL SERVICES, NAMELY, CONDUCTING CLASSES IN THE FIELD OF CARDIOVASCULAR CONDITIONING, MUSCLE TONING AND BODY SCULPTING (U.S. CLS. 100, 101 AND 107).

FIRST USE 9-1-2001; IN COMMERCE 9-1-2001.

2,626,445. PORTLAND BASEBALL, INC., PORTLAND, OR. SN 76-232,123. PUB. 9-11-2001, FILED 3-27-2001.



FOR ENTERTAINMENT SERVICES IN THE NATURE OF BASEBALL GAMES AND EXHIBITIONS (U.S. CLS. 100, 101 AND 107).

FIRST USE 6-19-2001; IN COMMERCE 6-19-2001.

CLASS 41—(Continued).

2,626,459. ART OF CONTROL, INC., THE, MOUNT KISCO, NY. SN 76-237,311. PUB. 9-11-2001, FILED 4-9-2001.

THE ART OF CONTROL

FOR EDUCATIONAL SERVICES, NAMELY, PROVIDING INSTRUCTION IN METHODS OF EXERCISE (U.S. CLS. 100, 101 AND 107).

FIRST USE 5-5-1997; IN COMMERCE 4-0-1999.

CLASS 41—(Continued).

2,626,480. NATIONAL WILD TURKEY FEDERATION, INC., THE, EDGEFIELD, SC. SN 76-249,314. PUB. 12-18-2001, FILED 5-1-2001.



2,626,462. BOARD OF EDUCATION OF THE TOLEDO CITY SCHOOL DISTRICT, TOLEDO, OH. SN 76-238,041. PUB. 8-21-2001, FILED 4-11-2001.



FOR EDUCATIONAL SERVICES IN THE NATURE OF COURSES AT THE PRIMARY AND SECONDARY SCHOOL LEVEL (U.S. CLS. 100, 101 AND 107).

FIRST USE 8-31-2001; IN COMMERCE 8-31-2001.

OWNER OF U.S. REG. NOS. 2,183,672 AND 2,266,571. NO CLAIM IS MADE TO THE EXCLUSIVE RIGHT TO USE "SPORTSMEN" AND "CAMP", APART FROM THE MARK AS SHOWN.

FOR PROVIDING FACILITIES FOR RECREATIONAL SHOOTING, ARCHERY AND FISHING (U.S. CLS. 100, 101 AND 107).

FIRST USE 11-23-2001; IN COMMERCE 11-23-2001.

2,626,529. LIV IN THE GAME, INC., AUSTIN, TX. SN 76-289,230. PUB. 11-13-2001, FILED 7-20-2001.

LIV IN THE GAME

FOR EDUCATION SERVICES, NAMELY, MENTORING YOUTHS IN THE FIELDS OF SPORTS AND LIFE-SKILLS, NAMELY, CONDUCTING CLASSROOM EDUCATION FOR YOUTH IN THE FIELDS OF SPORTS AND LIFE-SKILLS, AND IMPLEMENTING COMMUNITY EVENTS TO EDUCATE YOUTHS IN THE FIELDS OF SPORTS AND LIFE-SKILLS (U.S. CLS. 100, 101 AND 107).

FIRST USE 1-15-1999; IN COMMERCE 4-15-1999.

2,626,463. DISCOVERY COMMUNICATIONS, INC., BETHESDA, MD. SN 76-238,403. PUB. 9-18-2001, FILED 4-10-2001.

YOU'RE ON THE CASE

FOR ENTERTAINMENT SERVICES IN THE NATURE OF A NON-FICTION TELEVISION SERIES ON THE SUBJECT OF LAW ENFORCEMENT (U.S. CLS. 100, 101 AND 107).

FIRST USE 4-5-2001; IN COMMERCE 4-5-2001.

2,626,578. MULTI-MEDIA COMMUNICATIONS MELBOURNE PTY LTD, BRUNSWICK, VICTORIA, AUSTRALIA. SN 78-013,443. PUB. 10-16-2001, FILED 6-20-2000.

THEATRE OF LEADERSHIP

NO CLAIM IS MADE TO THE EXCLUSIVE RIGHT TO USE "LEADERSHIP", APART FROM THE MARK AS SHOWN.

FOR EDUCATIONAL SERVICES NAMELY, OFFERING SEMINARS, WORKSHOPS, EDUCATIONAL GUIDANCE, AND INSTRUCTION IN THE FIELD OF BUSINESS MANAGEMENT AND LEADERSHIP (U.S. CLS. 100, 101 AND 107).

FIRST USE 1-1-2001; IN COMMERCE 1-1-2001.

CLASS 41—(Continued).

2,626,624. MARRIOTT EMPLOYEES FEDERAL CREDIT UNION, BETHESDA, MD. SN 78-036,169. PUB. 1-1-2002, FILED 11-21-2000.

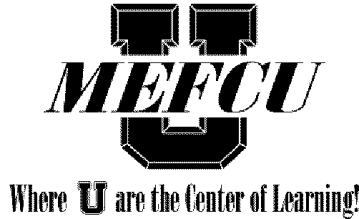

FOR IN HOUSE UNIVERSITY PROGRAMS, NAMELY, CONDUCTING CLASSES, SEMINARS, CONFERENCES, WORKSHOPS, COMPUTER-BASED TRAINING, AND SELF-DIRECTED LEARNING ACTIVITIES IN THE FIELDS OF FINANCIAL SERVICES AND INTERPERSONAL DEVELOPMENT AND DISTRIBUTING COURSE MATERIALS AND PROMOTIONAL ITEMS THEREWITH (U.S. CLS. 100, 101 AND 107).
FIRST USE 11-21-2000; IN COMMERCE 11-21-2000.

2,626,628. SCHMERER, JACK R., DBA RMS PRODUCTIONS, BUFFALO GROVE, IL. SN 78-036,639. PUB. 9-11-2001, FILED 11-27-2000.

TURBO TRIVIA

NO CLAIM IS MADE TO THE EXCLUSIVE RIGHT TO USE "TRIVIA", APART FROM THE MARK AS SHOWN.
FOR ENTERTAINMENT SERVICES, NAMELY, PROVIDING AN ON-LINE COMPUTER GAME (U.S. CLS. 100, 101 AND 107).
FIRST USE 4-1-2002; IN COMMERCE 4-1-2002.

CLASS 41—(Continued).

2,626,658. TIME WARNER ENTERTAINMENT COMPANY, L.P., NEW YORK, NY. SN 78-043,512. PUB. 9-18-2001, FILED 1-17-2001.



OWNER OF U.S. REG. NO. 1,971,247.
FOR ENTERTAINMENT SERVICES IN THE NATURE OF LIVE-ACTION, COMEDY, DRAMA AND/OR ANIMATED ON-GOING TELEVISION PROGRAMS; PRODUCTION OF LIVE-ACTION, COMEDY, DRAMA AND/OR ANIMATED TELEVISION PROGRAMS; ENTERTAINMENT SERVICES IN THE NATURE OF LIVE-ACTION, COMEDY, DRAMA AND/OR ANIMATED MOTION PICTURE THEATRICAL FILMS; PRODUCTION OF LIVE-ACTION, COMEDY, DRAMA AND/OR ANIMATED MOTION PICTURE THEATRICAL FILMS; THEATRICAL PERFORMANCES BOTH ANIMATED AND LIVE ACTION; AND PROVIDING AN ON-LINE COMPUTER DATABASE IN THE FIELD OF GENERAL INTEREST NEWS, ENTERTAINMENT, AND EDUCATIONAL INFORMATION IN THE NATURE OF LIVE-ACTION, COMEDY, DRAMA AND/OR ANIMATED TELEVISION PROGRAM AND PRODUCTION OF LIVE-ACTION COMEDY, ACTION AND/OR ANIMATED MOTION PICTURE FILMS FOR TELEVISION VIA A GLOBAL COMPUTER NETWORK (U.S. CLS. 100, 101 AND 107).
FIRST USE 1-11-1995; IN COMMERCE 1-11-1995.

2,626,663. AMERICAN AUTOMOBILE ASSOCIATION, INC., HEATHROW, FL. SN 78-044,222. PUB. 8-14-2001, FILED 1-22-2001.

THE KEY TO SAFE DRIVING

FOR VEHICLE DRIVING INSTRUCTION SERVICES (U.S. CLS. 100, 101 AND 107).
FIRST USE 6-1-2001; IN COMMERCE 6-1-2001.

CLASS 41—(Continued).

2,626,676. SHOWTIME NETWORKS INC., NEW YORK, NY. SN 78-048,149. PUB. 11-27-2001, FILED 2-13-2001.

FUNNY GIRLS

FOR ENTERTAINMENT SERVICES, NAMELY, PRODUCTION AND DISTRIBUTION OF MOTION PICTURES, COMEDY, MUSICAL AND DRAMATIC SERIES, DOCUMENTARIES, SPORTING EVENTS BY MEANS OF AND FOR CABLE TELEVISION, SATELITE-DELIVERED AND TELEVISION BROADCASTING (U.S. CLS. 100, 101 AND 107).

FIRST USE 3-1-2001; IN COMMERCE 3-1-2001.

2,626,683. ZYFERS, GERALD, REDMOND, WA. SN 78-049,841. PUB. 9-4-2001, FILED 2-22-2001.

SINGLETRACK RANCH

FOR INSTRUCTION IN THE FIELD OF MOUNTAIN BIKING (U.S. CLS. 100, 101 AND 107).

FIRST USE 2-17-2001; IN COMMERCE 6-22-2001.

2,626,686. BRODY COMMUNICATIONS LTD., JENKINTOWN, PA. SN 78-051,027. PUB. 1-8-2002, FILED 3-2-2001.

HELP! WAS THAT A CAREER LIMITING MOVE?

FOR PROVIDING EDUCATIONAL SERVICES, NAMELY, PROVIDING EDUCATIONAL SPEAKERS AND CONDUCTING TRAINING SEMINARS, WORKSHOPS, AND CLASSES IN THE FIELD OF BUSINESS COMMUNICATIONS, AND DISTRIBUTING LEARNING TOOLS, NAMELY, COURSE MATERIALS IN CONNECTION THEREWITH (U.S. CLS. 100, 101 AND 107).

FIRST USE 9-7-2001; IN COMMERCE 9-7-2001.

2,626,700. DC COMICS, NEW YORK, NY. SN 78-054,112. PUB. 3-12-2002, FILED 3-20-2001.

SMALLVILLE

FOR ENTERTAINMENT SERVICES IN THE NATURE OF LIVE-ACTION, COMEDY, DRAMA AND/OR ANIMATED ON-GOING TELEVISION PROGRAMS; PRODUCTION OF LIVE-ACTION, COMEDY, DRAMA AND/OR ANIMATED TELEVISION PROGRAMS; ENTERTAINMENT SERVICES IN THE NATURE OF LIVE-ACTION, COMEDY, DRAMA AND/OR ANIMATED MOTION PICTURE THEATRICAL FILMS; PRODUCTION OF LIVE-ACTION, COMEDY, DRAMA AND/OR ANIMATED MOTION PICTURE THEATRICAL FILMS; THEATRICAL PERFORMANCES BOTH ANIMATED AND LIVE ACTION; AND PROVIDING AN ON-LINE COMPUTER DATABASE IN THE FIELD OF ENTERTAINMENT AND EDUCATIONAL INFORMATION VIA A GLOBAL COMPUTER NETWORK (U.S. CLS. 100, 101 AND 107).

FIRST USE 10-16-2001; IN COMMERCE 10-16-2001.

CLASS 41—(Continued).

2,626,708. CATERPILLAR INC., PEORIA, IL. SN 78-057,610. PUB. 2-12-2002, FILED 4-10-2001.

DESTINATION TECHNOLOGY

NO CLAIM IS MADE TO THE EXCLUSIVE RIGHT TO USE "TECHNOLOGY", APART FROM THE MARK AS SHOWN.

FOR EDUCATIONAL SERVICES, NAMELY, PROVIDING CLASSES AND EDUCATIONAL PROGRAMS FOR MIDDLE AND HIGH-SCHOOL STUDENTS DESIGNED TO FOSTER AN INTEREST IN ENGINEERING AND TECHNOLOGICAL CAREER OPPORTUNITIES (U.S. CLS. 100, 101 AND 107).

FIRST USE 5-15-2001; IN COMMERCE 5-15-2001.

CLASS 42—SCIENTIFIC, COMPUTER AND LEGAL SERVICES

2,625,310. CALEDONIAN PACIFIC LTD., HOUSTON, TX. SN 74-543,769. PUB. 11-18-1997, FILED 6-30-1994.

MAD DOGS

FOR PUB-STYLE BAR AND RESTAURANT SERVICES (U.S. CLS. 100 AND 101).

FIRST USE 1-0-1995; IN COMMERCE 1-0-1995.

2,625,314. COGITO LEARNING MEDIA, INC., NEW YORK, NY. SN 75-048,690. PUB. 8-31-1999, FILED 1-25-1996.

COGITO LEARNING MEDIA, INC.

NO CLAIM IS MADE TO THE EXCLUSIVE RIGHT TO USE "LEARNING MEDIA, INC.", APART FROM THE MARK AS SHOWN.

THE WORDING "COGITO" IN THE MARK MEANS "I THINK" IN ENGLISH.

FOR COMPUTER SERVICES, NAMELY, PROVIDING INFORMATION VIA AN INTERACTIVE COMPUTERIZED DATABASE AND PROVIDING ON-LINE FACILITIES FOR REAL-TIME INTERACTION WITH OTHER COMPUTER USERS, ALL CONCERNING TOPICS OF INTEREST IN THE FIELDS OF SCIENCE, MATHEMATICS, PSYCHOLOGY, ECONOMICS, STATISTICS AND NUTRITION (U.S. CLS. 100 AND 101).

FIRST USE 1-3-2000; IN COMMERCE 1-3-2000.

CLASS 42—(Continued).

2,625,317. MAX, PETER, NEW YORK, NY. SN 75-067,240.
PUB. 8-26-1997, FILED 3-4-1996.

PLANET MAX

FOR RETAIL STORE SERVICES FEATURING - SCULPTURES OF NON-PRECIOUS METAL; POSTERS; EDUCATIONAL BOOKS; TRAVEL BOOKS; PICTURE POSTCARDS; STATIONERY; TOTE BAGS; NOVELTY WORKS OF ART IN THE NATURE OF OVERPAINTED NON-FUNCTIONAL FOOTBALL HELMETS, FOOTBALLS AND SOCCERBALLS; CERAMIC PLATES, MUGS AND VASES; SUNGLASSES; WATCHES; CLOTHING, NAMELY, T-SHIRTS, BASEBALL CAPS AND TIES SOLD BOUTIQUE-STYLE WITH ETCHINGS, OVERPAINTINGS AND GRAPHIC ART; AND ORNAMENTAL NOVELTY PINS (U.S. CLS. 100 AND 101).

FIRST USE 3-0-2000; IN COMMERCE 3-0-2000.

2,625,331. VNA-COMMUNITY SERVICES, INC., ABINGTON, PA. SN 75-271,298. PUB. 1-16-2001, FILED 4-8-1997.



**Visiting Nurse Association
COMMUNITY SERVICES**

NO CLAIM IS MADE TO THE EXCLUSIVE RIGHT TO USE "VISITING NURSE ASSOCIATION" OR "COMMUNITY SERVICES", APART FROM THE MARK AS SHOWN.

FOR HEALTH CARE SERVICES (U.S. CLS. 100 AND 101).

FIRST USE 0-0-1993; IN COMMERCE 0-0-1993.

2,625,346. FMC TECHNOLOGIES, INC., CHICAGO, IL, BY ASSIGNMENT FMC CORPORATION, PHILADELPHIA, PA. SN 75-325,843. PUB. 11-30-1999, FILED 7-17-1997.

NUMERICAL ON-LINE

NO CLAIM IS MADE TO THE EXCLUSIVE RIGHT TO USE "ON-LINE", APART FROM THE MARK AS SHOWN.

FOR MAINTENANCE OF COMPUTER SOFTWARE (U.S. CLS. 100 AND 101).

FIRST USE 12-31-1996; IN COMMERCE 12-31-1996.

2,625,350. BLUE CANARY, INC., WHITE PLAINS, NY, BY ASSIGNMENT ABEL ENTERPRISES, INC., NEW YORK, NY. SN 75-342,781. PUB. 12-22-1998, FILED 8-18-1997.

FRANKENSITE

FOR CONSULTATION AND INFORMATION IN THE FIELD OF WEBSITE DESIGN, PROGRAMMING AND DEVELOPMENT BY A GLOBAL COMPUTER NETWORK (U.S. CLS. 100 AND 101).

FIRST USE 2-1-2002; IN COMMERCE 2-1-2002.

CLASS 42—(Continued).

2,625,379. ADVANCED RESEARCH AND TECHNOLOGY INSTITUTE, INC., BLOOMINGTON, IN. SN 75-439,637. PUB. 3-14-2000, FILED 2-24-1998.

REWARDS

FOR PROVIDING MEDICAL INFORMATION, NAMELY, RADIOLOGICAL INFORMATION SERVICES (U.S. CLS. 100 AND 101).

FIRST USE 4-13-2002; IN COMMERCE 4-13-2002.

2,625,380. CHILDREN'S HEALTH CARE, INC., MINNEAPOLIS, MN. SN 75-440,192. PUB. 11-23-1999, FILED 2-25-1998.



OWNER OF U.S. REG. NO. 1,991,945.
NO CLAIM IS MADE TO THE EXCLUSIVE RIGHT TO USE "CHILDRENS", APART FROM THE MARK AS SHOWN.

FOR HOSPITAL AND RELATED SERVICES OF OUTPATIENT CARE, NAMELY, MEDICAL CLINICS, PHYSICAL REHABILITATION AND OUTPATIENT SURGERY (U.S. CLS. 100 AND 101).

FIRST USE 1-1-1998; IN COMMERCE 1-1-1998.

2,625,386. KUHN, DANIEL, NEW YORK, NY. SN 75-449,540. PUB. 1-5-1999, FILED 3-13-1998.

KUHN TECHNIQUE

NO CLAIM IS MADE TO THE EXCLUSIVE RIGHT TO USE "TECHNIQUE", APART FROM THE MARK AS SHOWN.

FOR PSYCHIATRIC SERVICES PROVIDED IN THE FORM OF A SERIES OF GROUP AND INDIVIDUAL SESSIONS (U.S. CLS. 100 AND 101).

FIRST USE 11-24-1991; IN COMMERCE 10-16-1998.

2,625,394. PASSLOGIX, INC., NEW YORK, NY. SN 75-471,145. PUB. 1-26-1999, FILED 4-21-1998.

PASSLOGIX

FOR CONSULTING SERVICES, DESIGN AND DEVELOPMENT OF SOFTWARE FOR OTHERS FOR USE IN CONNECTION WITH ANY KIND OF ELECTRONIC DEVICE WITH A GRAPHICAL USER INTERFACE TO IDENTIFY AND AUTHENTICATE USERS FOR ANY APPLICATION REQUIRING USER AUTHENTICATION (U.S. CLS. 100 AND 101).

FIRST USE 5-31-2000; IN COMMERCE 5-31-2000.

CLASS 42—(Continued).

2,625,395. NEWPORT ELECTRONICS, INC., SANTA ANA, CA. SN 75-474,339. PUB. 1-26-1999, FILED 4-27-1998.

NEWPORT.ORG

OWNER OF U.S. REG. NOS. 1,656,111, 2,113,672, AND OTHERS.

FOR PROVIDING ON-LINE PUBLICATIONS, NAMELY, CATALOGS, TECHNICAL AND SCIENTIFIC HANDBOOKS, TEXTBOOKS, POSTERS, TECHNICAL REFERENCE TEXTS, AND MANUALS FOR PROVIDING INFORMATION ABOUT MEASURING, CONTROLLING, AND/OR REGULATING TEMPERATURE, HUMIDITY, PRESSURE, STRAIN, FORCE, FLOW, LEVEL, PH, LOAD, VIBRATION, ELECTRICAL RESISTANCE, AIR VELOCITY, AMPERAGE, FREQUENCY, VOLTAGE, ION CONCENTRATION, CONDUCTIVITY, AND INDUSTRIAL PROCESS AND ENVIRONMENTAL MONITORING TECHNOLOGY, DATA ACQUISITION, DISPLAY, AND RETRIEVAL EQUIPMENT, NAMELY, COMPUTERS COMPUTER PERIPHERALS, DATA RECORDERS, AND DATA LOGGERS (U.S. CLS. 100 AND 101).

FIRST USE 10-0-2001; IN COMMERCE 10-0-2001.

2,625,403. SHORE HEALTH SYSTEM, INC., EASTON, MD. SN 75-503,302. PUB. 11-28-2000, FILED 6-17-1998.



NO CLAIM IS MADE TO THE EXCLUSIVE RIGHT TO USE "REHABILITATION SERVICES", APART FROM THE MARK AS SHOWN.

FOR PHYSICAL, OCCUPATIONAL AND SPEECH THERAPY SERVICES (U.S. CLS. 100 AND 101).

FIRST USE 7-0-1997; IN COMMERCE 7-0-1997.

2,625,440. DERWENT INFORMATION LTD., LONDON, ENGLAND. SN 75-586,552. PUB. 5-9-2000, FILED 11-10-1998.

DERWENT DISCOVERY

OWNER OF U.S. REG. NOS. 1,959,728, 2,016,754, AND 2,072,266.

FOR ON-LINE INFORMATION SERVICES, NAMELY, PROVIDING INFORMATION AND MAINTAINING INFORMATION DATABASES IN THE FIELD OF PHARMACEUTICAL RESEARCH AND DEVELOPMENT VIA A GLOBAL COMPUTER NETWORK (U.S. CLS. 100 AND 101).

FIRST USE 11-1-1998; IN COMMERCE 11-1-1998.

CLASS 42—(Continued).

2,625,488. DEFENDERS OF WILDLIFE, WASHINGTON, DC. SN 75-659,735. PUB. 3-6-2001, FILED 3-12-1999.

GREENLINES

FOR ASSOCIATION SERVICES, NAMELY, PROMOTING THE PROTECTION OF WILDLIFE AND HABITATS (U.S. CLS. 100 AND 101).

FIRST USE 11-20-1995; IN COMMERCE 11-20-1995.

2,625,493. PUCHNIAK, STEPHEN C, BOSTON, MA. SN 75-667,386. PUB. 12-28-1999, FILED 3-25-1999.



FOR COMPUTER SERVICES, NAMELY, PROVIDING SEARCH ENGINES FOR OBTAINING DATA ON A GLOBAL COMPUTER NETWORK (U.S. CLS. 100 AND 101).

FIRST USE 1-31-2001; IN COMMERCE 1-31-2001.

2,625,495. AURORA BIOSCIENCES CORPORATION, SAN DIEGO, CA. SN 75-673,100. PUB. 6-27-2000, FILED 4-2-1999.

HOW FAST DO YOU WANT TO GO?

FOR PHARMACEUTICAL RESEARCH AND DEVELOPMENT SERVICES, NAMELY PROVIDING ASSAY DEVELOPMENT AND SCREENING AND COMPOUND AND MOLECULE IDENTIFICATION (U.S. CLS. 100 AND 101).

FIRST USE 1-31-1999; IN COMMERCE 1-31-1999.

2,625,496. HR FIRST CONTACT, LLC, DALLAS, TX. SN 75-676,937. PUB. 5-22-2001, FILED 4-7-1999.

FIRST CONTACT

FOR PRE-EMPLOYMENT EMPLOYEE SCREENING SERVICES (U.S. CLS. 100 AND 101).

FIRST USE 4-1-2001; IN COMMERCE 4-1-2001.

CLASS 42—(Continued).

2,625,504. PNC BANK CORP., PITTSBURGH, PA. SN 75-687,943. PUB. 3-27-2001, FILED 4-20-1999.

PROMISE TO NEIGHBORHOOD CHILDREN

FOR CHARITABLE SERVICES, NAMELY, ORGANIZING VOLUNTEER PROGRAMS THAT PROVIDE COUNSELING, MENTORING, TUTORING, JOB SHADOWING, SEMINARS AND PRESENTATIONS CONCERNING CAREER OPTIONS, AND SIMILAR SERVICES FOR ECONOMICALLY DISADVANTAGED YOUTH IN LOCAL COMMUNITIES TO ENCOURAGE THEM TO STAY IN SCHOOL, ACHIEVE CAREER AND PERSONAL GOALS, AND CONTRIBUTE TO THE COMMUNITY (U.S. CLS. 100 AND 101).

FIRST USE 4-0-1999; IN COMMERCE 4-0-1999.

2,625,531. RAJU, SESHADRI, JACKSON, MS. SN 75-724,467. PUB. 3-7-2000, FILED 6-9-1999.

SPACEDIRECTORY

FOR COMPUTER SERVICES OF CONTROLLING, MANAGING, SEARCHING AND RETRIEVING INFORMATION STORED IN COMPUTER INFORMATION DATABASES ON LOCAL AND GLOBAL COMPUTER NETWORKS (U.S. CLS. 100 AND 101).

FIRST USE 5-21-2002; IN COMMERCE 5-21-2002.

2,625,535. ALABAMA A&M UNIVERSITY RESEARCH INSTITUTE, NORMAL, AL. SN 75-727,617. PUB. 3-7-2000, FILED 6-14-1999.

AAMURI

FOR BASIC AND APPLIED SCIENTIFIC RESEARCH (U.S. CLS. 100 AND 101).

FIRST USE 6-1-1999; IN COMMERCE 7-1-1999.

2,625,540. NIIT (USA), INC., ATLANTA, GA. SN 75-731,333. PUB. 7-10-2001, FILED 6-17-1999.

CONTROL-IT

FOR CONSULTATION SERVICES REGARDING INFORMATION TECHNOLOGY TRAINING PROGRAMS FOR BUSINESSES (U.S. CLS. 100 AND 101).

FIRST USE 12-0-2001; IN COMMERCE 12-0-2001.

CLASS 42—(Continued).

2,625,556. UCSF STANFORD HEALTH CARE, SAN FRANCISCO, CA. SN 75-740,757. PUB. 9-12-2000, FILED 6-30-1999.

LUCILE PACKARD CHILDREN'S HOSPITALS

OWNER OF U.S. REG. NO. 1,697,112.

NO CLAIM IS MADE TO THE EXCLUSIVE RIGHT TO USE "CHILDREN'S HOSPITALS", APART FROM THE MARK AS SHOWN.

THE NAME IN THE MARK DOES NOT REPRESENT A LIVING INDIVIDUAL.

FOR HEALTH CARE SERVICES, HOSPITAL SERVICES, HEALTH CARE CONSULTATION SERVICES, MEDICAL AND SCIENTIFIC RESEARCH (U.S. CLS. 100 AND 101).

FIRST USE 3-0-2000; IN COMMERCE 3-0-2000.

2,625,559. CREATIVE COMPUTER APPLICATIONS, INC., CALABASAS, CA. SN 75-742,707. PUB. 9-19-2000, FILED 7-2-1999.

XYMED.COM

FOR COMPUTER SERVICES, NAMELY, PROVIDING APPLICATION PROGRAMS FOR OTHERS FOR THE MANAGEMENT OF MEDICAL INFORMATION IN THE AREAS OF RADIOLOGY, LABORATORIES, AND PHARMACIES (U.S. CLS. 100 AND 101).

FIRST USE 6-30-1999; IN COMMERCE 9-8-1999.

2,625,561. PROSISE, MICHAEL A. BRISTOW, VA. SN 75-745,236. PUB. 11-27-2001, FILED 8-2-1999.

PC & N CONSULTING

NO CLAIM IS MADE TO THE EXCLUSIVE RIGHT TO USE "CONSULTING", APART FROM THE MARK AS SHOWN.

FOR COMPUTER CONSULTING IN THE FIELD OF COMPUTER NETWORK INSTALLATION, BUT EXCLUDING CONSULTATION AND COMPUTER PROGRAMMING FOR OTHERS IN THE HEALTH CARE INDUSTRY (U.S. CLS. 100 AND 101).

FIRST USE 12-31-2001; IN COMMERCE 12-31-2001.

CLASS 42—(Continued).

2,625,566. MALINCHAK, WILLIAM J., BOCA RATON, FL. SN 75-748,797. PUB. 9-25-2001, FILED 7-12-1999.

JUST RESULTS!

FOR GLOBAL COMPUTER BASED RESOURCE INFORMATION SERVICES AND RESULT-ORIENTED CONSULTATION SERVICES IN THE FIELD OF SELF IMPROVEMENT IN A VARIETY OF FIELDS NAMELY, SKILLS AND TRADES, SPORTS, HOW-TO SKILLS, EDUCATION, FINANCE, BEAUTY, FAMILY RELATIONS, PROFESSIONAL AND BUSINESS SELF IMPROVEMENT (U.S. CLS. 100 AND 101).

FIRST USE 6-13-2002; IN COMMERCE 6-13-2002.

2,625,570. ITOCHU TECHNOLOGY, INC., SANTA CLARA, CA. SN 75-753,644. PUB. 4-25-2000, FILED 7-19-1999.



THE MARK CONSISTS OF A STYLIZED LETTER "G". FOR COMPUTER SERVICES, NAMELY, DESIGNING, IMPLEMENTING, REGISTERING, CUSTOMIZING, MANAGING, AND MAINTAINING WEBSITES AND E-MAIL SYSTEMS FOR OTHERS (U.S. CLS. 100 AND 101).

FIRST USE 8-0-2000; IN COMMERCE 8-0-2000.

2,625,577. FIRST MOVER, INC., BOSTON, MA. SN 75-755,823. PUB. 8-22-2000, FILED 7-20-1999.

WE GET IT RIGHT

FOR CONSULTING SERVICES IN THE FIELD OF INFORMATION TECHNOLOGIES (U.S. CLS. 100 AND 101).

FIRST USE 4-0-2002; IN COMMERCE 4-0-2002.

CLASS 42—(Continued).

2,625,580. MONTGOMERY HOME TITLE, INC., SILVER SPRING, MD. SN 75-757,748. PUB. 7-24-2001, FILED 7-22-1999.

TITLEMANIA.COM

FOR MORTGAGE AND LOAN CLOSING SERVICES, NAMELY, REAL ESTATE SETTLEMENTS, MORTGAGE CLOSINGS AND SETTLEMENTS VIA THE GLOBAL COMPUTER NETWORK AND THE WORLD WIDE WEB (U.S. CLS. 100 AND 101).

FIRST USE 9-0-1999; IN COMMERCE 2-0-2000.

2,625,588. KIDS INCORPORATED, DBA THE CHILDREN'S WORKSHOP, WALTHAM, MA. SN 75-773,164. PUB. 5-23-2000, FILED 8-11-1999.



NO CLAIM IS MADE TO THE EXCLUSIVE RIGHT TO USE "THE CHILDREN'S WORKSHOP", APART FROM THE MARK AS SHOWN.

FOR CHILD CARE SERVICES; CHILD CARE CONSULTING SERVICES (U.S. CLS. 100 AND 101).

FIRST USE 10-28-1996; IN COMMERCE 10-28-1996.

2,625,617. KESSLER/LAKE BUENA VISTA I, LTD., ORLANDO, FL. SN 75-801,833. PUB. 2-13-2001, FILED 9-20-1999.

STUDIO CITY

FOR HOTEL SERVICES (U.S. CLS. 100 AND 101).

FIRST USE 6-1-1999; IN COMMERCE 6-1-1999.

CLASS 42—(Continued).

2,625,620. INTERNATIONAL MISSIONS, INC., READING, PA. SN 75-804,400. PUB. 8-22-2000, FILED 9-21-1999.

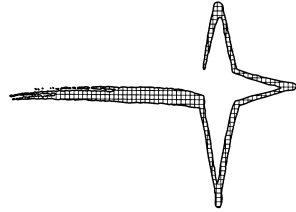

THE DRAWING IS LINED FOR THE COLOR YELLOW OR GOLD.

FOR MINISTERIAL SERVICES, NAMELY, SELECTING, EQUIPPING, SENDING AND PROVIDING SUPPORT FOR PERSONS TO MINISTER IN VARIOUS COUNTRIES TO THOSE IN NEED OF THE WORD OF GOD (U.S. CLS. 100 AND 101).

FIRST USE 10-15-1999; IN COMMERCE 10-15-1999.

2,625,646. STEWARD, DUANE, ARLINGTON, MA. SN 75-823,722. PUB. 11-27-2001, FILED 10-15-1999.

INTEGRATED OUTCOMES

FOR MEDICAL DATABASE DEVELOPMENT SERVICES; COMPUTER SOFTWARE DESIGN FOR OTHERS (U.S. CLS. 100 AND 101).

FIRST USE 4-30-2002; IN COMMERCE 4-30-2002.

2,625,657. CREDIT UNION EXECUTIVES SOCIETY, INC., MADISON, WI. SN 75-829,552. PUB. 11-27-2001, FILED 10-18-1999.

CUES TECH PORT

OWNER OF U.S. REG. NO. 783,373.

FOR CONSULTING SERVICES, NAMELY, PROVIDING ADVICE ON PURCHASING COMPUTER SYSTEMS, TECHNOLOGY SERVICES AND TELECOMMUNICATIONS EQUIPMENT (U.S. CLS. 100 AND 101).

FIRST USE 11-0-1999; IN COMMERCE 11-0-1999.

2,625,693. CITIZENS GAS & COKE UTILITY, INDIANAPOLIS, IN. SN 75-851,029. PUB. 7-17-2001, FILED 11-18-1999.

CITIZENS ENERGY SELECT

OWNER OF U.S. REG. NO. 1,203,218.

NO CLAIM IS MADE TO THE EXCLUSIVE RIGHT TO USE "ENERGY", APART FROM THE MARK AS SHOWN.

FOR INFORMATION SERVICES IN THE FIELDS OF ENERGY, NATURAL GAS, AND NATURAL GAS DELIVERY OPTIONS (U.S. CLS. 100 AND 101).

FIRST USE 11-23-1999; IN COMMERCE 11-23-1999.

CLASS 42—(Continued).

2,625,757. SIMPLE ABUNDANCE, INC., BETHESDA, MD. SN 75-889,835. PUB. 7-31-2001, FILED 1-7-2000.

SIMPLE ABUNDANCE PRESS

OWNER OF U.S. REG. NO. 1,916,924.

NO CLAIM IS MADE TO THE EXCLUSIVE RIGHT TO USE "PRESS", APART FROM THE MARK AS SHOWN.

FOR PROVIDING INFORMATION IN THE FIELD OF SELF-INSPIRATION, SPIRITUALITY, PERSONAL DEVELOPMENT, SELF-FULFILLMENT, SELF-HELP, SELF-ANALYSIS, HERITAGE, ETHNICITY, CULTURAL TRADITIONS AND CUSTOMS, MOTIVATIONAL TOPICS AND INCLUDING INFORMATION ABOUT WOMEN'S STUDIES VIA THE INTERNET; PROVIDING SEARCH ENGINES FOR OBTAINING DATA ON A GLOBAL COMPUTER NETWORK; AND HOSTING WEB SITES OF OTHERS ON A GLOBAL COMPUTER NETWORK (U.S. CLS. 100 AND 101).

FIRST USE 11-1-2000; IN COMMERCE 11-1-2000.

2,625,763. DEVELOPERS@WORK, INC., MAPLEWOOD, NJ. SN 75-894,869. PUB. 11-14-2000, FILED 1-8-2000.

DEVFX.COM

FOR COMPUTER SOFTWARE DESIGN AND DEVELOPMENT SERVICES FOR OTHERS, INSTALLATION OF COMPUTER SOFTWARE, AND COMPUTER SOFTWARE CONSULTATION (U.S. CLS. 100 AND 101).

FIRST USE 1-0-2000; IN COMMERCE 1-0-2000.

2,625,773. HAPPY GUESTS INTERNATIONAL, INC., SEATTLE, WA. SN 75-899,479. PUB. 10-3-2000, FILED 1-18-2000.

LIFE IS A GAMBLE

FOR RESTAURANT SERVICES (U.S. CLS. 100 AND 101).

FIRST USE 7-0-2001; IN COMMERCE 7-0-2001.

2,625,774. CADENCE DESIGN SYSTEMS, INC., SAN JOSE, CA. SN 75-899,765. PUB. 10-3-2000, FILED 1-21-2000.

HOW BIG CAN YOU DREAM?

FOR DESIGN OF NEW PRODUCTS FOR OTHERS, AND CONSULTING SERVICES IN THE FIELD OF ELECTRONIC PRODUCT DESIGN AND DESIGN IMPLEMENTATION (U.S. CLS. 100 AND 101).

FIRST USE 7-0-2000; IN COMMERCE 7-0-2000.

CLASS 42—(Continued).

2,625,787. STEIN, ELIZABETH, NEW YORK, NY. SN 75-905,265. PUB. 9-4-2001, FILED 1-23-2000.

**ASK YOUR MIDWIFE**

FOR PROVIDING INFORMATION IN THE FIELD OF WOMEN'S HEALTHCARE VIA A WEBSITE (U.S. CLS. 100 AND 101).

FIRST USE 7-22-1992; IN COMMERCE 3-24-2002.

2,625,799. BROADCOM CORPORATION, IRVINE, CA. SN 75-909,166. PUB. 6-19-2001, FILED 2-4-2000.



OWNER OF U.S. REG. NOS. 2,132,930 AND 2,326,387. FOR DESIGN OF COMPUTER HARDWARE, INTEGRATED CIRCUITS, COMMUNICATIONS HARDWARE AND SOFTWARE, AND COMPUTER NETWORKS FOR OTHERS (U.S. CLS. 100 AND 101).

FIRST USE 11-7-1994; IN COMMERCE 11-7-1994.

2,625,813. PAX, INC., NEW YORK, NY. SN 75-914,298. PUB. 10-30-2001, FILED 2-8-2000.

ASKING SAVES KIDS

FOR ASSOCIATION SERVICES, NAMELY, PROMOTING THE INTERESTS OF PEOPLE OPPOSED TO GUN VIOLENCE AND ADVOCATING GUN SAFETY AND PROMOTING PUBLIC AWARENESS REGARDING HEALTH, SAFETY AND PREVENTION OF GUN VIOLENCE (U.S. CLS. 100 AND 101).

FIRST USE 7-0-1998; IN COMMERCE 7-0-1998.

CLASS 42—(Continued).

2,625,814. PAX, INC., NEW YORK, NY. SN 75-914,299. PUB. 10-16-2001, FILED 2-8-2000.

ASK

FOR ASSOCIATION SERVICES, NAMELY PROMOTING THE INTERESTS OF PEOPLE OPPOSED TO GUN VIOLENCE AND ADVOCATING GUN SAFETY AND PROMOTING PUBLIC AWARENESS REGARDING HEALTH, SAFETY AND PREVENTION OF GUN VIOLENCE (U.S. CLS. 100 AND 101).

FIRST USE 7-0-1998; IN COMMERCE 7-0-1998.

2,625,830. CARL KARCHER ENTERPRISES, INC., ANAHEIM, CA. SN 75-923,187. PUB. 1-9-2001, FILED 2-18-2000.

DON'T BOTHER ME. I'M EATING

FOR RESTAURANT SERVICES (U.S. CLS. 100 AND 101).

FIRST USE 3-19-2000; IN COMMERCE 3-19-2000.

2,625,852. VICK COMPANIES, INC., WILLIAMSBURG, VA. SN 75-936,016. PUB. 7-3-2001, FILED 3-6-2000.

INFRALOGIX

FOR INFRARED INSPECTION SERVICES OF INDUSTRIAL, ELECTRICAL AND MECHANICAL SYSTEMS AND FOR DETECTION OF ENERGY LOSS FROM BUILDINGS (U.S. CLS. 100 AND 101).

FIRST USE 7-0-2000; IN COMMERCE 7-0-2000.

2,625,862. CRAIG MURRAY PRODUCTIONS, LLC, BURBANK, CA. SN 75-938,540. PUB. 3-27-2001, FILED 3-8-2000.

POSTER CHILD

FOR GRAPHICS ART DESIGN SERVICES FOR OTHERS; PRINTING SERVICES FOR OTHERS (U.S. CLS. 100 AND 101).

FIRST USE 1-17-2000; IN COMMERCE 1-17-2000.

2,625,874. GRACE, MARK T., BRIDGEWATER, NJ. SN 75-956,188. PUB. 3-13-2001, FILED 3-13-2000.

THINK PROCESS

FOR MEASUREMENT EVALUATIONS IN WORKFLOW PRODUCTIVITY IN THE FIELD OF MANUFACTURING (U.S. CLS. 100 AND 101).

FIRST USE 12-18-2001; IN COMMERCE 1-16-2002.

CLASS 42—(Continued).

2,625,886. RENOVIS, INC., BERKELEY, CA. SN 75-982,072. PUB. 4-17-2001, FILED 7-14-2000.

RENOVIS

FOR SCIENTIFIC, PHARMACEUTICAL, MEDICAL, VETERINARY, AGRICULTURAL AND PRODUCT RESEARCH AND DEVELOPMENT SERVICES IN THE FIELDS OF NEUROLOGICAL DISEASES AND DISORDERS, PSYCHIATRIC DISORDERS, THE TREATMENT OF NEUROLOGICAL DISEASES AND DISORDERS, THE TREATMENT OF PSYCHIATRIC DISORDERS AND PHARMACEUTICALS; COMPUTER SERVICES, NAMELY, PROVIDING ONLINE INFORMATION IN THE FIELDS OF DISEASES AND DISORDERS, TREATMENTS FOR DISEASES AND DISORDERS, AND PHARMACEUTICALS (U.S. CLS. 100 AND 101).

FIRST USE 8-24-2001; IN COMMERCE 8-24-2001.

2,625,887. DBC INTERNATIONAL LTD., 01510 VANTAA, FINLAND. SN 75-982,138. PUB. 11-14-2000, FILED 4-20-1998.



NO CLAIM IS MADE TO THE EXCLUSIVE RIGHT TO USE "SPINE CARE", APART FROM THE MARK AS SHOWN.

FOR PHYSICAL REHABILITATION SERVICES, NAMELY LOCOMOTORIUM CLINICS, PHYSIOTHERAPEUTIC CLINICS, REHABILITATION AND TREATMENT SERVICES FOR LOCOMOTOR SYSTEMS INCLUDING TESTING OF PHYSICAL CONDITION, TREATMENT PROGRAMS AND FOLLOW-UP STUDIES, MASSAGE AS REHABILITATION SERVICE, AND PHYSIOTHERAPEUTIC ADVICE AND CONSULTATION (U.S. CLS. 100 AND 101).

FIRST USE 11-0-1997; IN COMMERCE 4-0-1998.

CLASS 42—(Continued).

2,625,893. ALLAFRICA, INC., WASHINGTON, DC. SN 75-982,316. PUB. 6-19-2001, FILED 10-26-1999.

ALLAFRICA

FOR PROVIDING NEWS AND INFORMATION VIA A GLOBAL COMPUTER NETWORK NAMELY, PROVIDING DATABASES AND INDEXES FEATURING GENERAL AND LOCAL NEWS AND GOVERNMENTAL INFORMATION, AND INFORMATION OF INTEREST TO SPECIFIC GEOGRAPHIC AREAS; NEWS AGENCIES, NAMELY THE GATHERING AND DISSEMINATION OF NEWS; DISSEMINATION OF AUDIOVISUAL NEWS CONTENT VIA THE INTERNET; ESTABLISHING AND MAINTAINING WEB SITES OF SPECIALIZED INFORMATION IN THE FIELDS OF HEALTH, TRAVEL, FOOD, SECURITY, AGRICULTURE, EDUCATION, ARTS AND CULTURE, THE ENVIRONMENT, AND GENDER-SPECIFIC ISSUES, AND PROVIDING ON-LINE FACILITIES FOR REAL-TIME INTERACTION WITH OTHER COMPUTER USERS ON THESE TOPICS, INCLUDING VIA BULLETIN BOARDS AND LIVE CHAT FACILITIES; PROVIDING INFORMATION CONCERNING HEALTHCARE, MEDICAL PROFESSIONALS, HOSPITALS AND RELATED MEDICAL SUBJECTS VIA THE INTERNET (U.S. CLS. 100 AND 101).

FIRST USE 2-0-2000; IN COMMERCE 2-0-2000.

2,625,901. EXONHIT THERAPEUTICS SA, PARIS, FRANCE. SN 75-982,571. PUB. 4-24-2001, FILED 3-18-2000.

EXONHIT

FOR PRODUCT RESEARCH AND DEVELOPMENT IN THE FIELD OF THE LIFE SCIENCES CONCERNING GENOMES AND PROTEINS AND THE SCIENTIFIC RESEARCH AND ANALYSIS OF GENE EXPRESSION; SCIENTIFIC RESEARCH IN THE NATURE OF IDENTIFICATION OF THERAPEUTIC TARGETS AND PRODUCTS, PRODUCTION OF NUCLEIC ACID LIBRARIES, PRODUCTION OF BIOCHIPS, AND DNA ARRAYS FOR RESEARCH AND DEVELOPMENT OF THERAPEUTIC TARGETS, AND PHARMACOGENOMIC, GENOTOXICITY AND DIAGNOSTIC PRODUCTS AND TOOLS (U.S. CLS. 100 AND 101).

FIRST USE 11-0-1999; IN COMMERCE 11-0-1999.

2,625,925. EBIZ SOFTWARE, INC., TOPEKA, KS. SN 76-017,185. PUB. 9-18-2001, FILED 4-4-2000.

TECHFORMS

FOR PROVIDING TEMPORARY USE OF ON-LINE, NON-DOWNLOADABLE COMPUTER SOFTWARE FOR USE IN DESIGNING AND PRINTING BUSINESS FORMS (U.S. CLS. 100 AND 101).

FIRST USE 7-18-2001; IN COMMERCE 7-18-2001.

CLASS 42—(Continued).

2,625,930. FREDDIE FRESH'S, INC., SHARON, PA. SN 76-019,531. PUB. 12-18-2001, FILED 4-7-2000.



THE DRAWING IS LINED FOR THE COLORS MAGENTA (PINK) AND CYAN (BLUE).

THE NAME "FREDDIE FRESH" IDENTIFIES A LIVING INDIVIDUAL WHOSE CONSENT IS OF RECORD. FOR DANCE CLUB AND RESTAURANT SERVICES (U.S. CLS. 100 AND 101).

FIRST USE 4-28-2000; IN COMMERCE 4-28-2000.

2,625,941. MIRACLE HILL MINISTRIES, INC., GREENVILLE, SC. SN 76-027,911. PUB. 12-4-2001, FILED 4-18-2000.

HARBOR OF HOPE

FOR CHARITABLE SERVICES, NAMELY, PROVIDING FOOD, CLOTHING, AND SHELTER TO OTHERS (U.S. CLS. 100 AND 101).

FIRST USE 4-1-2000; IN COMMERCE 4-1-2000.

2,625,953. PLANET EARTH FOUNDATION, SEATTLE, WA. SN 76-032,445. PUB. 3-6-2001, FILED 4-24-2000.

EARTH MEDIA

NO CLAIM IS MADE TO THE EXCLUSIVE RIGHT TO USE "MEDIA", APART FROM THE MARK AS SHOWN.

FOR NEWS AGENCY SERVICES, NAMELY, PROVIDING INFORMATION AND RESOURCES TO OTHERS ON LOCAL, GLOBAL AND NATIONAL ISSUES VIA PRINTED PUBLICATIONS, AUDIO MEDIA, AUDIO-VISUAL MEDIA AND VIA A GLOBAL COMPUTER NETWORK (U.S. CLS. 100 AND 101).

FIRST USE 5-1-2000; IN COMMERCE 5-1-2000.

2,625,954. PLANET EARTH FOUNDATION, SEATTLE, WA. SN 76-033,023. PUB. 2-26-2002, FILED 4-24-2000.

WEB PLANET MEDIA

NO CLAIM IS MADE TO THE EXCLUSIVE RIGHT TO USE "WEB" AND "MEDIA", APART FROM THE MARK AS SHOWN.

FOR COMPUTER SERVICES, NAMELY CREATING AND IMPLEMENTING SOCIALLY BENEFICIAL WEB SITES AND WEB PAGES FOR OTHERS (U.S. CLS. 100 AND 101).

FIRST USE 5-1-2000; IN COMMERCE 5-1-2000.

CLASS 42—(Continued).

2,625,955. PLANET EARTH FOUNDATION, SEATTLE, WA. SN 76-033,048. PUB. 5-1-2001, FILED 4-24-2000.

WHOLE WORLD MEDIA

NO CLAIM IS MADE TO THE EXCLUSIVE RIGHT TO USE "MEDIA", APART FROM THE MARK AS SHOWN.

FOR NEWS AGENCY SERVICES, NAMELY, CREATION, PRODUCTION AND DISSEMINATION OF AUDIO, AUDIO-VISUAL AND PRINT PRESENTATIONS (U.S. CLS. 100 AND 101).

FIRST USE 5-1-2000; IN COMMERCE 5-1-2000.

2,625,969. ELECTRO CHECK, INC., HERNDON, VA. SN 76-040,119. PUB. 1-2-2001, FILED 5-4-2000.

INDIVIO

FOR PROVIDING SERVICES FOR IDENTIFYING INDIVIDUALS BASED UPON BIOLOGICAL IDENTIFIERS, NAMELY FINGERPRINTS, IRIS RECOGNITION, FACIAL SCANS, VOICE RECOGNITION (U.S. CLS. 100 AND 101).

FIRST USE 12-30-2001; IN COMMERCE 12-30-2001.

2,625,975. MOSHIER, KEVIN, WEST HOLLYWOOD, CA. SN 76-042,737. PUB. 3-13-2001, FILED 5-8-2000.

PLUSH

FOR HAIR SALON SERVICES (U.S. CLS. 100 AND 101). FIRST USE 1-0-1999; IN COMMERCE 12-1-2001.

2,625,982. PLANET EARTH FOUNDATION, SEATTLE, WA. SN 76-044,874. PUB. 5-1-2001, FILED 5-9-2000.

ALL THE NEW MEDIA

NO CLAIM IS MADE TO THE EXCLUSIVE RIGHT TO USE "MEDIA", APART FROM THE MARK AS SHOWN.

FOR DISSEMINATION OF NEWS AND INFORMATION OF LOCAL, NATIONAL AND GLOBAL INTEREST VIA PRINTED PUBLICATIONS, AUDIO MEDIA, AUDIO-VISUAL MEDIA, AND VIA A GLOBAL COMPUTER NETWORK (U.S. CLS. 100 AND 101).

FIRST USE 5-1-2000; IN COMMERCE 5-1-2000.

2,625,988. JEKIELEK, ELIZABETH ANN, VALENCIA, CA. SN 76-046,684. PUB. 12-25-2001, FILED 5-11-2000.

DUQUESA BAY

FOR COMPUTER SERVICES, NAMELY PROVIDING ON-LINE BOOKS AND ON-LINE GRAPHIC NOVELS IN THE FIELD OF FANTASY AND FICTION (U.S. CLS. 100 AND 101).

FIRST USE 7-1-2000; IN COMMERCE 7-1-2000.

CLASS 42—(Continued).

2,626,002. SEEC, INC., PITTSBURGH, PA. SN 76-051,518. PUB. 1-8-2002, FILED 5-18-2000.

SEEC MOSAIC

FOR COMPUTER CONSULTATION SERVICES IN THE NATURE OF OFFERING TECHNICAL ASSISTANCE TO CUSTOMERS ENABLING THEM TO ANALYZE, DOCUMENT, MAINTAIN AND ENHANCE COMPUTER SOFTWARE AND TO RE-DESIGN, MIGRATE AND EXTEND SUCH SOFTWARE TO NEW SOFTWARE COMPONENTS AND COMPUTER APPLICATIONS TO ACCESS AND MANIPULATE DATA THAT HAS BEEN CREATED AND ACCUMULATED OVER TIME ON A MAINFRAME COMPUTER (LEGACY MAINFRAME DATA) VIA TERMINAL EMULATION AND COTS (COMMERCIAL-OFF-THE-SHELF) APPLICATION SERVERS (U.S. CLS. 100 AND 101).

FIRST USE 5-0-2000; IN COMMERCE 5-0-2000.

2,626,014. SIX COUNTINENTS HOTELS, INC., ATLANTA, GA, BY CHANGE OF NAME BASS HOTELS & RESORTS, INC., ATLANTA, GA. SN 76-058,498. PUB. 7-17-2001, FILED 5-30-2000.

ROOM FOR HOPE

FOR CHARITABLE SERVICES, NAMELY, PROVIDING HOTEL ROOMS TO NON-PROFIT ORGANIZATIONS IN TIMES OF CATASTROPHE BASED ON DONATIONS OF FREQUENT TRAVELER POINTS (U.S. CLS. 100 AND 101).

FIRST USE 3-6-2000; IN COMMERCE 10-26-2000.

2,626,022. HEALTH PROMOTING PRODUCTS AND SERVICES, INC., ROHNERT PARK, CA. SN 76-062,260. PUB. 7-31-2001, FILED 6-5-2000.

THE PLEASURE TRAP

FOR MEDICAL CONSULTING AND COUNSELING, NAMELY, PROVIDING ADVICE FOR PHYSICAL HEALTH AND FOR PSYCHOLOGICAL HEALTH (U.S. CLS. 100 AND 101).

FIRST USE 10-1-2000; IN COMMERCE 11-1-2000.

2,626,029. SOFTWARE SETT CORPORATION, LOS GATOS, CA. SN 76-067,632. PUB. 9-11-2001, FILED 6-12-2000.

KSETT

OWNER OF U.S. REG. NO. 2,001,336.
FOR APPLICATION SERVICE PROVIDER, NAMELY, HOSTING COMPUTER SOFTWARE APPLICATIONS FOR OTHERS, FOR USE IN ENTERPRISE RESOURCE PLANNING, INTERNET, EMBEDDED SYSTEMS AND TELECOMMUNICATIONS PROJECTS, ALL IN THE FIELDS OF PROJECT MANAGEMENT AND SOFTWARE QUALITY ASSURANCE, AND RELATED CONTENT (U.S. CLS. 100 AND 101).

FIRST USE 10-0-2000; IN COMMERCE 10-0-2000.

CLASS 42—(Continued).

2,626,033. HIGHMARK CORPORATION, SARASOTA, FL. SN 76-069,156. PUB. 6-12-2001, FILED 6-13-2000.

ALLMEDCARE

FOR CLINICAL MEDICAL SERVICES (U.S. CLS. 100 AND 101).

FIRST USE 9-30-2000; IN COMMERCE 9-30-2000.

2,626,036. KIDS@HOME, INC., BOCA RATON, FL. SN 76-071,975. PUB. 3-5-2002, FILED 6-16-2000.

KIDS@HOME

FOR CHILD AND FAMILY WELFARE SERVICES, NAMELY, FOSTER CARE SERVICES; ADOPTION SERVICES; SHELTER SERVICES; INDEPENDENT AND TRANSITIONAL LIVING SERVICES; CHILD DAY CARE SERVICES; CHILD ABUSE PREVENTION SERVICES, NAMELY, ADVISORY AND INFORMATIONAL SERVICES RELATING TO THE PREVENTION OF CHILD ABUSE; COUNSELING; LEGAL, CHARITABLE AND VOLUNTARY SERVICES, NAMELY, PROVIDING ADVOCACY FOR AT RISK CHILDREN; AND INFORMATION SERVICES IN THE FIELD OF CHILD AND FAMILY WELFARE, NAMELY, DISSEMINATING INFORMATION RELATED TO THE FOREGOING SERVICES (U.S. CLS. 100 AND 101).

FIRST USE 4-18-2002; IN COMMERCE 4-18-2002.

2,626,038. REGISTER.COM, INC., NEW YORK, NY. SN 76-073,840. PUB. 5-1-2001, FILED 6-19-2000.

TRADEMARK GUARDIAN

NO CLAIM IS MADE TO THE EXCLUSIVE RIGHT TO USE "TRADEMARK", APART FROM THE MARK AS SHOWN.

FOR COMPUTER SERVICES, NAMELY, PROVIDING SEARCH ENGINES FOR OBTAINING DATA ON A GLOBAL COMPUTER NETWORK AND PROVIDING ONLINE PROTECTION AND SECURITY OF INTELLECTUAL PROPERTY (U.S. CLS. 100 AND 101).

FIRST USE 7-1-2000; IN COMMERCE 7-1-2000.

2,626,069. EPSTEIN, DARREN L., FT. LAUDERDALE, FL. SN 76-087,597. PUB. 10-23-2001, FILED 7-13-2000.

DON'T YOU WANT TO KNOW?

FOR PRIVATE INVESTIGATIVE SERVICES (U.S. CLS. 100 AND 101).

FIRST USE 6-0-1997; IN COMMERCE 8-0-1999.

CLASS 42—(Continued).

2,626,075. BIOPATTERNS CENTER FOR HEALTH LLC, THE, LAGRANGE, IL, BY ASSIGNMENT RUSH, PATRICIA, LAGRANGE, IL. SN 76-089,389. PUB. 5-22-2001, FILED 7-14-2000.

BIOPATTERNS

FOR CONSULTING SERVICES IN THE FIELD OF HEALTH CARE (U.S. CLS. 100 AND 101).

FIRST USE 12-0-2000; IN COMMERCE 12-0-2000.

2,626,095. TOWER SOLUTIONS, INC., PINE CITY, MN. SN 76-098,360. PUB. 6-12-2001, FILED 7-27-2000.



NO CLAIM IS MADE TO THE EXCLUSIVE RIGHT TO USE "TOWER", APART FROM THE MARK AS SHOWN.

THE MARK CONSISTS, IN PART, OF THE WORD "TOWER".

FOR CUSTOM DESIGN OF TOWERS AND SCAFFOLDING FOR OTHERS (U.S. CLS. 100 AND 101).

FIRST USE 4-16-2001; IN COMMERCE 8-30-2001.

2,626,110. COUNTERCLAIM.COM INC., EUGENE, OR. SN 76-106,701. PUB. 5-15-2001, FILED 8-8-2000.

COUNTERCLAIM.COM

FOR LIVE AND ON-LINE LEGAL SERVICES (U.S. CLS. 100 AND 101).

FIRST USE 8-20-2000; IN COMMERCE 8-20-2000.

CLASS 42—(Continued).

2,626,117. YAN'S NATURAL HEALTH CARE, ACUPUNCTURIST, P.C., KEW GARDENS, NY. SN 76-110,020. PUB. 8-7-2001, FILED 8-15-2000.



FOR ACUPUNCTURE SERVICES; INFORMATION SERVICES VIA A GLOBAL COMPUTER NETWORK, FEATURING ORIENTAL MEDICINE, HERBAL MEDICINE, ACUPUNCTURE, HEALTH AND WELL BEING (U.S. CLS. 100 AND 101).

FIRST USE 1-1-2001; IN COMMERCE 1-1-2001.

2,626,119. VELARDI, PAUL J., BREWSTER, NY. SN 76-110,754. PUB. 8-14-2001, FILED 8-10-2000.

HELPING YOU WITH THE TRANSITIONS IN YOUR LIFE

FOR LEGAL SERVICES (U.S. CLS. 100 AND 101).

FIRST USE 1-1-1993; IN COMMERCE 1-1-1993.

2,626,126. ROMANCING YOUR HOME, INC., FLOWER MOUND, TX. SN 76-114,810. PUB. 7-17-2001, FILED 8-21-2000.

INTERIORS WITH PASSION

NO CLAIM IS MADE TO THE EXCLUSIVE RIGHT TO USE "INTERIORS", APART FROM THE MARK AS SHOWN. FOR INTERIOR DESIGN AND DECORATING SERVICES (U.S. CLS. 100 AND 101).

FIRST USE 6-0-1998; IN COMMERCE 6-0-1998.

2,626,132. ZPROMPT INC., IRVINE, CA. SN 76-118,760. PUB. 6-26-2001, FILED 8-29-2000.

Z PROMPT INC.

NO CLAIM IS MADE TO THE EXCLUSIVE RIGHT TO USE "INC.", APART FROM THE MARK AS SHOWN.

FOR COMPUTER SERVICES, NAMELY, INFORMATION TECHNOLOGY SUPPORT SERVICES (U.S. CLS. 100 AND 101).

FIRST USE 6-15-2000; IN COMMERCE 6-15-2000.

CLASS 42—(Continued).

2,626,138. CYBERDEL TECHNOLOGY, INC., WHIPPANY, NJ. SN 76-120,327. PUB. 12-25-2001, FILED 9-1-2000.

EMPOWERING THE FUTURE TODAY

FOR COMPUTER CONSULTING SERVICES; DESIGN, DEVELOPMENT AND COMPUTER PROGRAMMING OF SOFTWARE APPLICATIONS FOR OTHERS (U.S. CLS. 100 AND 101).

FIRST USE 12-3-2000; IN COMMERCE 12-3-2000.

2,626,140. ENGINEERING ANALYSIS ASSOCIATES INC., BINGHAM FARMS, MI. SN 76-120,890. PUB. 2-12-2002, FILED 8-31-2000.



OWNER OF U.S. REG. NO. 1.689.452.
NO CLAIM IS MADE TO THE EXCLUSIVE RIGHT TO USE "ENGINEERING ANALYSIS ASSOCIATES", APART FROM THE MARK AS SHOWN.

THE MARK CONSISTS OF THE STYLIZED LETTERS "EAA" COMBINED WITH THE WORDS "ENGINEERING ANALYSIS ASSOCIATES".

FOR ENGINEERING SERVICES (U.S. CLS. 100 AND 101).

FIRST USE 6-0-2001; IN COMMERCE 6-0-2001.

2,626,141. CHARLES BUCKLES CONSULTING, INC., LAKE MARY, FL. SN 76-121,187. PUB. 7-10-2001, FILED 8-29-2000.

PHARMSTREET

FOR PROVIDING AN ON-LINE INTERACTIVE COMPUTER DATABASE IN THE FIELD OF PHARMACEUTICAL INFORMATION AND PHARMACY-RELATED COMMUNICATIONS (U.S. CLS. 100 AND 101).

FIRST USE 10-9-2001; IN COMMERCE 10-9-2001.

2,626,153. EARTHWATCH INCORPORATED, LONGMONT, CO. SN 76-125,410. PUB. 12-18-2001, FILED 9-8-2000.

AGROWATCH

FOR PROVIDING INFORMATION SERVICES, NAMELY PROVIDING GEOGRAPHIC INFORMATION THROUGH THE COLLECTION, MANIPULATION, PROCESSING, AND/OR FORMATTING OF IMAGES AND GEOGRAPHIC MEASUREMENTS OF THE EARTH FOR AGRICULTURAL APPLICATIONS (U.S. CLS. 100 AND 101).

FIRST USE 1-15-2001; IN COMMERCE 1-15-2001.

CLASS 42—(Continued).

2,626,159. PENN-TEX AEROSPACE, INC., AUSTIN, TX. SN 76-127,011. PUB. 7-3-2001, FILED 9-12-2000.

PENN-TEX AEROSPACE

NO CLAIM IS MADE TO THE EXCLUSIVE RIGHT TO USE "AEROSPACE", APART FROM THE MARK AS SHOWN.

FOR CONSULTING SERVICES IN THE FIELD OF AVIATION (U.S. CLS. 100 AND 101).

FIRST USE 11-13-2000; IN COMMERCE 11-13-2000.

2,626,165. ALLIDEX, INC., BOCA RATON, FL. SN 76-129,240. PUB. 8-28-2001, FILED 9-14-2000.

ALLIDEX

FOR COMPUTER SERVICES, NAMELY, INTRA-COMPANY AND INTER-COMPANY COMPUTER SOFTWARE APPLICATION INTEGRATION SERVICES TO AUGMENT BUSINESS TO BUSINESS AND BUSINESS TO CONSUMER COMMERCIAL TECHNOLOGIES (U.S. CLS. 100 AND 101).

FIRST USE 10-0-2000; IN COMMERCE 10-0-2000.

2,626,178. ESJ DESIGN, LLC, GRAND RAPIDS, MI. SN 76-134,794. PUB. 11-27-2001, FILED 9-26-2000.

FOR INTERIOR DECORATING AND INTERIOR DESIGN SERVICES IN THE NATURE OF PLANNING AND DESIGNING OFFICE INTERIORS (U.S. CLS. 100 AND 101).

FIRST USE 4-0-2000; IN COMMERCE 4-0-2000.

CLASS 42—(Continued).

2,626,180. HEALTHCOMMUNITIES.COM, INC., NORTH-AMPTON, MA. SN 76-135,136. PUB. 3-19-2002, FILED 9-25-2000.

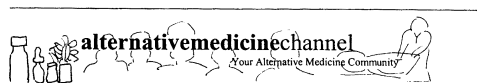

OWNER OF U.S. REG. NO. 2,285,385.
NO CLAIM IS MADE TO THE EXCLUSIVE RIGHT TO USE "ALTERNATIVEMEDICINECHANNEL" AND "YOUR ALTERNATIVE MEDICINE COMMUNITY", APART FROM THE MARK AS SHOWN.

FOR DISSEMINATION OF INFORMATION ON MEDICAL TOPICS GENERALLY AND SPECIFICALLY ALTERNATIVE MEDICINE-RELATED TOPICS, ONLINE, VIA A WEBSITE, ON A GLOBAL COMPUTER NETWORK (U.S. CLS. 100 AND 101).

FIRST USE 3-1-2002; IN COMMERCE 3-1-2002.

2,626,184. RESEARCH TRIANGLE INSTITUTE, RESEARCH TRIANGLE PARK, NC. SN 76-137,061. PUB. 10-9-2001, FILED 9-28-2000.

RTI HEALTH SOLUTIONS

OWNER OF U.S. REG. NO. 1,649,778.
NO CLAIM IS MADE TO THE EXCLUSIVE RIGHT TO USE "HEALTH", APART FROM THE MARK AS SHOWN.
FOR COLLECTING, MEASURING, AND ANALYZING HEALTH-RELATED DATA FOR OTHERS (U.S. CLS. 100 AND 101).

FIRST USE 10-12-2000; IN COMMERCE 10-12-2000.

2,626,187. LIFETOUCH INC., EDEN PRAIRIE, MN. SN 76-138,940. PUB. 7-3-2001, FILED 10-2-2000.

GALLERY SERIES

NO CLAIM IS MADE TO THE EXCLUSIVE RIGHT TO USE "SERIES", APART FROM THE MARK AS SHOWN.
FOR PORTRAIT PHOTOGRAPHY SERVICES (U.S. CLS. 100 AND 101).

FIRST USE 2-0-2001; IN COMMERCE 2-0-2001.

CLASS 42—(Continued).

2,626,188. ERGONOMIC WORLD, INC., TARPON SPRINGS, FL. SN 76-139,345. PUB. 10-16-2001, FILED 10-3-2000.



THE MARK CONSISTS OF FOUR STYLIZED FIGURES, IN PINK, GREEN, ORANGE, AND YELLOW, FROM LEFT TO RIGHT, RESPECTIVELY, WITH THE WORDS "ERGONOMICWORLD" IN GREEN BENEATH THE FIGURES.

FOR PROVIDING AN INTERACTIVE WEB SITE VIA THE INTERNET FEATURING INFORMATION IN THE FIELD OF SAFETY, HEALTH, AND INJURY PROTECTION (U.S. CLS. 100 AND 101).

FIRST USE 10-0-2001; IN COMMERCE 10-0-2001.

2,626,191. SUPREME SMOOTHIE, INC., MIAMI LAKES, FL. SN 76-140,506. PUB. 11-13-2001, FILED 10-5-2000.



NO CLAIM IS MADE TO THE EXCLUSIVE RIGHT TO USE "SUPREME SMOOTHIE", APART FROM THE MARK AS SHOWN.

FOR RESTAURANT SERVICES FEATURING MADE TO ORDER SMOOTHIE FROZEN FRUIT DRINK OR YOGURT ORIENTED PRODUCTS, PITAS, WRAPS, AND KAISER ROLL SANDWICHES, VEQIE BURGERS, TURKEY, GRILLED CHICKEN AND TUNA SALADS, SOUPS SNACK BREAD, BANANA AND CARROT BREADS, COOKIES, JUICES, AND HEALTH FOOD ITEMS SUCH AS PROTEIN BARS, HEALTH SUPPLEMENTS AND HEALTH SNACKS (U.S. CLS. 100 AND 101).

FIRST USE 9-1-2001; IN COMMERCE 9-1-2001.

CLASS 42—(Continued).

2,626,197. AMERICAN INSTITUTE FOR FOREIGN STUDY, INC., STAMFORD, CT. SN 76-142,200. PUB. 10-16-2001, FILED 10-5-2000.



NO CLAIM IS MADE TO THE EXCLUSIVE RIGHT TO USE "EDUCARE IN AMERICA", APART FROM THE MARK AS SHOWN.

FOR CHILD CARE (U.S. CLS. 100 AND 101).
FIRST USE 12-15-2000; IN COMMERCE 1-15-2001.

2,626,205. SCUBAFARES, L.L.C., LAS VEGAS, NV. SN 76-144,567. PUB. 8-7-2001, FILED 10-10-2000.

CUSTOMIZING YOUR QUEST

FOR TRAVEL AGENCY SERVICES, NAMELY, MAKING RESERVATIONS AND BOOKINGS FOR TEMPORARY LODGING (U.S. CLS. 100 AND 101).
FIRST USE 12-15-2000; IN COMMERCE 12-15-2000.

2,626,209. JONES, DAY, REAVIS & POGUE, CLEVELAND, OH. SN 76-148,059. PUB. 8-14-2001, FILED 10-17-2000.

JONES DAY 2.0

OWNER OF U.S. REG. NOS. 2,212,877 AND 2,316,539.
FOR LEGAL SERVICES (U.S. CLS. 100 AND 101).
FIRST USE 2-0-2001; IN COMMERCE 2-0-2001.

2,626,214. WORLDWIDE DRUG FREE YOUTH, INC., NASHVILLE, TN. SN 76-148,813. PUB. 8-21-2001, FILED 10-13-2000.

BE IN THE "CLICK"

FOR PROMOTING PUBLIC AWARENESS OF THE NEED FOR SEAT BELT USAGE (U.S. CLS. 100 AND 101).
FIRST USE 8-31-1999; IN COMMERCE 8-31-2001.

CLASS 42—(Continued).

2,626,239. PCH VENTURES LLC, MALIBU, CA. SN 76-156,145. PUB. 2-12-2002, FILED 10-26-2000.

HOME OF THE HUACHINANGO

NO CLAIM IS MADE TO THE EXCLUSIVE RIGHT TO USE "HUACHINANGO", APART FROM THE MARK AS SHOWN.

FOR ON-PREMISE AND CARRY-OUT RESTAURANT SERVICES FEATURING HISPANIC SEAFOOD CUISINE (U.S. CLS. 100 AND 101).
FIRST USE 7-5-2001; IN COMMERCE 7-5-2001.

2,626,251. SUSAN ANTHONY INC., IRVINGTON, NY. SN 76-159,513. PUB. 8-28-2001, FILED 11-3-2000.

BRIEF DESIGN

NO CLAIM IS MADE TO THE EXCLUSIVE RIGHT TO USE "DESIGN", APART FROM THE MARK AS SHOWN.

FOR INTERIOR DESIGN AND DECORATION SERVICES AND CONSULTATION IN THE FIELD OF INTERIOR DESIGN AND DECORATING (U.S. CLS. 100 AND 101).

FIRST USE 4-26-2002; IN COMMERCE 4-26-2002.

2,626,265. ISLE OF CAPRI CASINOS, INC., BILOXI, MS. SN 76-165,252. PUB. 8-21-2001, FILED 11-15-2000.

ROCK AROUND THE CLOCK

FOR RESTAURANT SERVICES (U.S. CLS. 100 AND 101).

FIRST USE 3-9-2001; IN COMMERCE 3-9-2001.

2,626,269. LUMENOS, INC., ALEXANDRIA, VA. SN 76-167,538. PUB. 9-25-2001, FILED 11-17-2000.

MY FAMILY HEALTH FILE

NO CLAIM IS MADE TO THE EXCLUSIVE RIGHT TO USE "FAMILY HEALTH FILE", APART FROM THE MARK AS SHOWN.

FOR PROVIDING HEALTHCARE SERVICES IN THE NATURE OF AN ONLINE DATABASE WHICH SECURELY STORES AND MANAGES A FAMILY'S HEALTH HISTORY ONLINE (U.S. CLS. 100 AND 101).
FIRST USE 7-12-2000; IN COMMERCE 7-12-2000.

CLASS 42—(Continued).

2,626,275. KAISER, ROLF DIETER, 17012 ALBISSOLA MARINA (SAVONA), ITALY. SN 76-169,519. PUB. 8-28-2001, FILED 11-20-2000.

KONSULENZA

FOR ENVIRONMENTAL, LOGISTICS AND INFORMATION TECHNOLOGY CONSULTING SERVICES, NAMELY, PROVIDING CONSULTING SERVICES IN THE FIELD OF TRANSPORTATION, STORAGE AND HANDLING OF HAZARDOUS WASTE, HAZARDOUS MATERIALS, RADIATION PROTECTION AND STRATEGIC OPTIMIZATION OF THE SUPPLY CHAIN (U.S. CLS. 100 AND 101).

FIRST USE 5-19-2000; IN COMMERCE 6-5-2001.

2,626,281. MEZURE, INC., BEND, OR. SN 76-171,402. PUB. 8-21-2001, FILED 11-27-2000.

BECAUSE THINGS MOVE

FOR MONITORING SERVICES, NAMELY MONITORING THE SEISMIC AND STRUCTURAL CONDITION OF BRIDGES, BUILDINGS, AND OTHER STRUCTURES USING SATELLITE TECHNOLOGY AND OTHER COMMUNICATION CHANNELS; AND COMPUTER AND INFORMATION SERVICES, NAMELY PROVIDING ON-LINE DATA TO SUBSCRIBERS IN THE FIELD OF STRUCTURAL AND SEISMIC MONITORING OF BRIDGES, BUILDINGS, AND OTHER STRUCTURES (U.S. CLS. 100 AND 101).

FIRST USE 1-1-2001; IN COMMERCE 1-1-2001.

2,626,287. DEDICATED NET ACCESS, BEVERLY HILLS, CA. SN 76-173,349. PUB. 12-11-2001, FILED 11-30-2000.

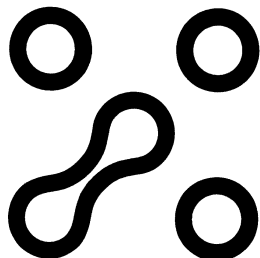

FOR CREATING AND MAINTAINING WEBSITES FOR OTHERS, PERTAINING TO MOTION PICTURES, ENTERTAINMENT PRODUCTIONS, AND OTHER PRODUCTS AND SERVICES OF THIRD PARTIES (U.S. CLS. 100 AND 101).

FIRST USE 11-8-2000; IN COMMERCE 11-8-2000.

CLASS 42—(Continued).

2,626,297. ST. JOE COMPANY, THE, JACKSONVILLE, FL. SN 76-178,398. PUB. 8-14-2001, FILED 12-8-2000.

WATERCOLOR

FOR HOTEL SERVICES AND HOTEL CONCIERGE SERVICES (U.S. CLS. 100 AND 101).

FIRST USE 4-1-2002; IN COMMERCE 4-1-2002.

2,626,300. DORFCO, INC., DAVIE, FL. SN 76-179,081. PUB. 8-14-2001, FILED 12-11-2000.

REGULAR JOE'S

FOR BAR AND RESTAURANT SERVICES (U.S. CLS. 100 AND 101).

FIRST USE 1-0-2001; IN COMMERCE 1-0-2001.

2,626,330. SOCRATICLAW.COM, INC., WILMINGTON, DE. SN 76-193,255. PUB. 8-21-2001, FILED 1-16-2001.

SOCRATICLAW.COM

FOR PROVIDING ON-LINE LEGAL INFORMATION SERVICES CONSISTING OF A SEARCHABLE DATABASE (U.S. CLS. 100 AND 101).

FIRST USE 1-21-2002; IN COMMERCE 5-26-2002.

2,626,332. POWERPLAY RINKS, INC., CHESTER SPRINGS, PA. SN 76-193,636. PUB. 10-16-2001, FILED 1-16-2001.

POWERPLAY RINKS

NO CLAIM IS MADE TO THE EXCLUSIVE RIGHT TO USE "RINKS", APART FROM THE MARK AS SHOWN.

FOR BUSINESS MANAGEMENT AND CONSULTATION FOR RECREATIONAL FACILITIES, NAMELY SKATING RINKS (U.S. CLS. 100 AND 101).

FIRST USE 7-19-2001; IN COMMERCE 7-19-2001.

2,626,356. PAUL, HASTINGS, JANOFSKY & WALKER LLP, LOS ANGELES, CA. SN 76-205,825. PUB. 2-12-2002, FILED 1-22-2001.

Paul Hastings

THE NAME SHOWN IN THE MARK DOES NOT IDENTIFY A PARTICULAR LIVING INDIVIDUAL.

FOR LEGAL SERVICES (U.S. CLS. 100 AND 101).

FIRST USE 2-1-2001; IN COMMERCE 2-1-2001.

CLASS 42—(Continued).

2,626,359. ITP OF USA, INC., ELIZABETHTOWN, PA. SN 76-206,967. PUB. 1-22-2002, FILED 2-8-2001.

ITP

FOR COMMERCIAL PRINTING SERVICES (U.S. CLS. 100 AND 101).
FIRST USE 1-7-2001; IN COMMERCE 3-20-2001.

2,626,364. JACOVINI, STACEY, NEW YORK, NY. SN 76-208,640. PUB. 8-14-2001, FILED 2-9-2001.

ASCAPE

FOR ARCHITECTURE AND DESIGN CONSULTING SERVICES (U.S. CLS. 100 AND 101).
FIRST USE 12-12-2000; IN COMMERCE 12-12-2000.

2,626,373. CONNAUGHT TECHNOLOGY CORPORATION, GREENVILLE, DE. SN 76-209,712. PUB. 12-11-2001, FILED 2-14-2001.

influence

You have the power to beat the flu.

FOR HEALTH CARE SERVICES, NAMELY, PROVIDING VACCINATION PROGRAMS (U.S. CLS. 100 AND 101).
FIRST USE 3-28-2002; IN COMMERCE 3-28-2002.

2,626,381. ADVANCE NEWS SERVICE, INC., WASHINGTON, DC. SN 76-211,815. PUB. 12-4-2001, FILED 2-20-2001.

RELIGION MATTERS

FOR NEWS AGENCIES, NAMELY, GATHERING AND DISSEMINATION OF NEWS TO NEWSPAPERS, PUBLICATIONS, RADIO, TELEVISION AND INTERNET SERVICES (U.S. CLS. 100 AND 101).
FIRST USE 2-1-2001; IN COMMERCE 2-1-2001.

CLASS 42—(Continued).

2,626,382. AUDIOAUDIT, INC., WHITE PLAINS, NY. SN 76-211,944. PUB. 9-4-2001, FILED 2-16-2001.



FOR COMPUTER PROGRAMMING, NAMELY ELECTRONICALLY ENCODING AND WATERMARKING THE DATA OF OTHER (U.S. CLS. 100 AND 101).
FIRST USE 10-10-2000; IN COMMERCE 10-10-2000.

2,626,391. AMERICAN POWER CONVERSION CORPORATION, W. KINGSTON, RI. SN 76-214,684. PUB. 11-27-2001, FILED 2-22-2001.

POWERSTRUXURE

FOR CONSULTING SERVICES IN THE FIELD OF POWER AVAILABILITY, POWER RELIABILITY, POWER PROTECTION NEEDS, POWER PROTECTION DEVICES, DESIGN OF NETWORK AND DATA CENTER POWER SYSTEMS AND CONTROLS, AND DESIGN OF NETWORK AND DATA CENTER ENVIRONMENTAL SYSTEMS AND CONTROLS (U.S. CLS. 100 AND 101).
FIRST USE 2-25-2002; IN COMMERCE 2-25-2002.

2,626,407. GLOBAL SAFETY SURVEILLANCE, INC., LITTLE FALLS, NJ. SN 76-217,269. PUB. 9-25-2001, FILED 2-28-2001.

SENTRX

FOR SAFETY SURVEILLANCE IN THE PHARMACEUTICAL, MEDICAL DEVICE, BIOTECHNOLOGY AND FOOD INDUSTRIES, FOR ALL PRODUCTS REGULATED BY THE UNITED STATES FOOD AND DRUG ADMINISTRATION AND OTHER SIMILAR REGULATORY BODIES IN OTHER COUNTRIES, NAMELY, ASSESSMENT AND EVALUATION OF RISKS INHERENT IN PRODUCTS MANUFACTURED BY PERSONS AND ENTITIES ENGAGED IN THOSE INDUSTRIES, AND EVALUATION OF SAFETY SURVEILLANCE METHODS, PROCESSES AND SYSTEMS USED BY PERSONS AND ENTITIES ENGAGED IN THOSE INDUSTRIES, AND THE CONTRACTED MANAGEMENT OF DRUG AND RELATED PRODUCT SAFETY SURVEILLANCE AND PRODUCT COMPLAINT PROCESSES, INCLUDING THE RECALL OF DEFECTIVE PRODUCTS MANUFACTURED BY THOSE ENGAGED IN THOSE INDUSTRIES, AND INVESTIGATION SERVICES, NAMELY, THE INVESTIGATION OF ALLEGATIONS AND CLAIMS MADE AGAINST PERSONS AND ENTITIES ENGAGED IN THOSE INDUSTRIES IN WHICH PRODUCT DEFECTS OR CLAIMS ARE ALLEGED (U.S. CLS. 100 AND 101).
FIRST USE 2-5-2002; IN COMMERCE 2-5-2002.

CLASS 42—(Continued).

2,626,415. KAUFMANN, JEAN-CLAUDE, NEW YORK, NY. SN 76-219,825. PUB. 8-28-2001, FILED 3-5-2001.

TOURIENT

FOR APPLICATION SERVICE PROVIDER COMPUTER SERVICES, NAMELY HOSTING SOFTWARE FOR USE BY TRAVEL AGENCIES IN THE FIELDS OF DATABASE MANAGEMENT, CUSTOMER RELATIONS, BUSINESS MARKETING AND RESEARCHING AND SCHEDULING TRAVEL ITINERARIES; APPLICATION SERVICE PROVIDER COMPUTER SERVICES, NAMELY HOSTING SOFTWARE FOR USE BY MEMBERS IN RESEARCHING AND SCHEDULING TRAVEL ITINERARIES (U.S. CLS. 100 AND 101).

FIRST USE 3-0-2002; IN COMMERCE 3-0-2002.

2,626,417. QSR CONCEPTS, INC., TARZANA, CA. SN 76-220,571. PUB. 8-28-2001, FILED 2-28-2001.

DAMON & PYTHIAS

FOR RESTAURANTS (U.S. CLS. 100 AND 101).
FIRST USE 7-30-2001; IN COMMERCE 11-15-2001.

2,626,446. DANTEC DYNAMICS, INC., MAHWAY, NJ, BY CHANGE OF NAME DANTEC MEASUREMENT TECHNOLOGY INC., MAHWAH, NJ. SN 76-232,638. PUB. 12-18-2001, FILED 3-29-2001.

DANTEC DYNAMICS

OWNER OF U.S. REG. NO. 1,877,435.
NO CLAIM IS MADE TO THE EXCLUSIVE RIGHT TO USE "DYNAMICS", APART FROM THE MARK AS SHOWN, FOR CONSULTING SERVICES IN THE FIELD OF FLUID DYNAMICS (U.S. CLS. 100 AND 101).
FIRST USE 1-0-2000; IN COMMERCE 1-0-2000.

2,626,536. NETTASKING TECHNOLOGY (BVI) LTD, ROAD TOWN, TORTOLA, BR.VIRGIN ISLANDS. SN 76-295,142. PUB. 11-27-2001, FILED 8-6-2001.



WebVisor

FOR ADVISORY SERVICES RELATING TO COMPUTER SYSTEMS AND COMPUTER NETWORKS, NAMELY, MONITORING AND PROVIDING DATA ON THE PERFORMANCE AND RESPONSE TIME OF WEB SITES ON THE INTERNET, AND MONITORING AND PROVIDING DATA ON USER SATISFACTION WITH SUCH WEB SITES (U.S. CLS. 100 AND 101).
FIRST USE 9-11-2001; IN COMMERCE 9-11-2001.

CLASS 42—(Continued).

2,626,538. EXCEL NETWORKS, INCORPORATED, SWARTHMORE, PA. SN 76-296,568. PUB. 2-12-2002, FILED 8-9-2001.

EXCEL NETWORKS

NO CLAIM IS MADE TO THE EXCLUSIVE RIGHT TO USE "NETWORKS", APART FROM THE MARK AS SHOWN.

FOR COMPUTER NETWORK DESIGN FOR OTHERS, AND TECHNICAL SUPPORT, NAMELY MONITORING OF NETWORK SYSTEMS (U.S. CLS. 100 AND 101).

FIRST USE 7-18-2001; IN COMMERCE 7-18-2001.

2,626,560. KELLER, ANDREW A., LOGAN, UT. SN 78-004,400. PUB. 3-6-2001, FILED 4-17-2000.

HYDROFUTURES

FOR HYDROLOGIC AND CLIMATOLOGIC FORECASTS AND ASSOCIATED CONSULTING SERVICES (U.S. CLS. 100 AND 101).

FIRST USE 1-4-1998; IN COMMERCE 1-20-2000.

2,626,561. MILLER, ANNE MCINTOSH, SAN FRANCISCO, CA. SN 78-005,161. PUB. 8-14-2001, FILED 4-21-2000.



NO CLAIM IS MADE TO THE EXCLUSIVE RIGHT TO USE "BODY", APART FROM THE MARK AS SHOWN, FOR HEALTH AND WELLNESS SERVICES, NAMELY, COLON HYDROTHERAPY (U.S. CLS. 100 AND 101).
FIRST USE 5-31-1997; IN COMMERCE 8-1-1997.

2,626,576. HOLUB, HOWARD J., EMPIRE, CA. SN 78-012,932. PUB. 8-28-2001, FILED 6-15-2000.

**LEATHERNECKS
MOTORCYCLE CLUB**

NO CLAIM IS MADE TO THE EXCLUSIVE RIGHT TO USE "MOTORCYCLE CLUB", APART FROM THE MARK AS SHOWN.

FOR OPERATION OF A MILITARY RELATED CLUB FOR MOTORCYCLE ENTHUSIASTS (U.S. CLS. 100 AND 101).

FIRST USE 3-1-1999; IN COMMERCE 3-1-1999.

CLASS 42—(Continued).

2,626,581. DOMINO'S PIZZA PMC, INC., ANN ARBOR, MI. SN 78-014,495. PUB. 1-1-2002, FILED 6-27-2000.

DOMINO'S TOUCHDOWN TAKE-OFF

OWNER OF U.S. REG. NOS. 1,166,751, 1,520,302, AND OTHERS.

FOR RESTAURANT AND CARRY OUT SERVICES PERTAINING TO THE BAKING OF HOT PIZZA PIES MADE TO ORDER FOR CONSUMPTION ON OR OFF THE PREMISES (U.S. CLS. 100 AND 101).

FIRST USE 10-1-2000; IN COMMERCE 10-1-2000.

CLASS 42—(Continued).

2,626,603. HUDSON PRODUCTS CORPORATION, HOUSTON, TX. SN 78-026,443. PUB. 2-26-2002, FILED 9-18-2000.

HUDSON COOLING SOLUTIONS

OWNER OF U.S. REG. NOS. 595,175, 1,316,841, AND 1,341,486.

NO CLAIM IS MADE TO THE EXCLUSIVE RIGHT TO USE "COOLING SOLUTIONS", APART FROM THE MARK AS SHOWN.

FOR CONSULTATION AND ADVISORY SERVICES RELATING TO THE EVALUATION AND MAINTENANCE OF AIR-COOLED HEAT EXCHANGERS (U.S. CLS. 100 AND 101).

FIRST USE 2-15-2001; IN COMMERCE 2-15-2001.

2,626,586. PRODUCTIVE RESOURCES, INC., COLUMBUS, IN. SN 78-016,824. PUB. 7-3-2001, FILED 7-14-2000.



The logo for Productive Resources features a stylized 'P' icon on the left, composed of two overlapping curved shapes. To the right of the icon, the words 'Productive' and 'Resources' are stacked vertically in a bold, sans-serif font.

NO CLAIM IS MADE TO THE EXCLUSIVE RIGHT TO USE "RESOURCES", APART FROM THE MARK AS SHOWN.

FOR DESIGN FOR OTHERS IN THE FIELD OF ENGINEERING SERVICES (U.S. CLS. 100 AND 101).

FIRST USE 3-1-2000; IN COMMERCE 3-1-2000.

2,626,605. TOP TURF, LAWRENCEVILLE, GA. SN 78-027,198. PUB. 8-14-2001, FILED 9-22-2000.



The logo for Top Turf features the words 'Top' and 'Turf' in a stylized, cursive font. The 'T' in 'Turf' is particularly large and has a long, sweeping underline that extends to the right.

NO CLAIM IS MADE TO THE EXCLUSIVE RIGHT TO USE "TURF", APART FROM THE MARK AS SHOWN.

FOR LAWN CARE, TREE AND SHRUB CARE, AND LANDSCAPE GARDENING FOR OTHERS (U.S. CLS. 100 AND 101).

FIRST USE 1-1-1995; IN COMMERCE 1-1-1995.

2,626,587. MATERIALS AND SYSTEMS RESEARCH, INC., SALT LAKE CITY, UT. SN 78-016,854. PUB. 9-11-2001, FILED 7-14-2000.

MSRI

FOR MATERIALS TESTING AND CHARACTERIZATION, PRODUCT RESEARCH AND DEVELOPMENT, MATERIALS AND CHEMICAL RESEARCH (U.S. CLS. 100 AND 101).

FIRST USE 10-0-1990; IN COMMERCE 10-0-1990.

2,626,625. JONES, RICHARD, H, WASHINGTON, DC. SN 78-036,503. PUB. 1-15-2002, FILED 11-25-2000.

O1N

THE MARK CONSISTS OF THE LETTER "O" THE NUMBER "1" AND THE LETTER "N".

FOR COMPUTER SERVICES, NAMELY CREATING INDEXES OF INFORMATION, SITES AND OTHER RESOURCES AVAILABLE ON COMPUTER NETWORKS; COMPUTER SERVICES, NAMELY PROVIDING AN ONLINE DATABASE IN THE FIELDS OF NEWS, WEATHER AND CURRENT EVENTS (U.S. CLS. 100 AND 101).

FIRST USE 5-1-2001; IN COMMERCE 5-15-2001.

CLASS 42—(Continued).

2,626,629. WALTER, DEBRA A., LINCOLN, NE. SN 78-037,712. PUB. 8-14-2001, FILED 12-4-2000.

SILVER DUCK

FOR GRAPHIC ART DESIGN SERVICES; COMPUTER SERVICES, NAMELY, DESIGNING WEB PAGES FOR OTHERS (U.S. CLS. 100 AND 101).

FIRST USE 7-8-2001; IN COMMERCE 7-8-2001.

CLASS 42—(Continued).

2,626,671. PAGE, SUSAN, L., LOS GATOS, CA. SN 78-046,069. PUB. 10-30-2001, FILED 2-1-2001.

ARE YOU LOOKING FOR YOUR SHAMS?

FOR ONLINE DATING SERVICES; TELEPHONE DATING SERVICES (U.S. CLS. 100 AND 101).

FIRST USE 4-1-2002; IN COMMERCE 4-1-2002.

2,626,631. YESSAYAN, ERNEST, CHARLOTTE, NC. SN 78-038,055. PUB. 8-21-2001, FILED 12-6-2000.

CONSUPRO

FOR COMPUTER CONSULTING SERVICES; COMPUTER SERVICES, NAMELY, CREATING AND MAINTAINING ONLINE PRODUCT CATALOGS AND SECURE PRODUCT ORDERING FACILITIES ON A GLOBAL COMPUTER NETWORK FOR OTHERS (U.S. CLS. 100 AND 101).

FIRST USE 5-7-2002; IN COMMERCE 5-7-2002.

2,626,694. WILD ROSE VINEYARDS, LLC, PASO ROBLES, CA. SN 78-052,657. PUB. 10-2-2001, FILED 3-12-2001.

SEGUNDA VIDA VINEYARDS

NO CLAIM IS MADE TO THE EXCLUSIVE RIGHT TO USE "VINEYARDS", APART FROM THE MARK AS SHOWN.

THE ENGLISH TRANSLATION OF "SEGUNDA VIDA" IN THE MARK IS "SECOND LIFE."

FOR VITICULTURE SERVICES, NAMELY GRAPE GROWING AND CULTIVATION OF GRAPES TO THE SPECIFICATIONS OF OTHERS (U.S. CLS. 100 AND 101).

FIRST USE 1-1-2001; IN COMMERCE 7-1-2001.

2,626,632. YESSAYAN, ERNEST, CHARLOTTE, NC. SN 78-038,056. PUB. 8-21-2001, FILED 12-6-2000.

**SIMPLIFICATION
EMBRACES
SOPHISTICATION**

FOR COMPUTER CONSULTING SERVICES; COMPUTER SERVICES, NAMELY, CREATING AND MAINTAINING ONLINE PRODUCT CATALOGS AND SECURE PRODUCT ORDERING FACILITIES ON A GLOBAL COMPUTER NETWORK FOR OTHERS (U.S. CLS. 100 AND 101).

FIRST USE 5-7-2002; IN COMMERCE 5-7-2002.

2,626,695. KBE, LONG BRANCH, NJ. SN 78-052,772. PUB. 12-18-2001, FILED 3-13-2001.

**IMPLEMENTING
TECHNOLOGIES TODAY
FOR YOUR FUTURE
SUCCESS**

FOR COMPUTER CONSULTATION (U.S. CLS. 100 AND 101).

FIRST USE 3-12-2002; IN COMMERCE 3-12-2002.

2,626,662. RESTAURANT ENTERPRISES, INC., MUSKOGEE, OK. SN 78-043,881. PUB. 8-28-2001, FILED 1-19-2001.

TASTE TOPPERS CAFE

NO CLAIM IS MADE TO THE EXCLUSIVE RIGHT TO USE "CAFE", APART FROM THE MARK AS SHOWN.

FOR FOOD SERVICE CAFE (U.S. CLS. 100 AND 101).

FIRST USE 3-10-2001; IN COMMERCE 3-10-2001.

2,626,710. HARRIS, DAVID BARLOW, NORTH ADAMS, MA. SN 78-060,156. PUB. 9-25-2001, FILED 4-24-2001.

SCHOOLSOLVE

FOR EDUCATION CONSULTING SERVICES FOR PARENTS AND CHILDREN, NAMELY, SCHOOL PLACEMENTS, EVALUATIONS AND COUNSELING, AND REFERRALS THEREFOR (U.S. CLS. 100 AND 101).

FIRST USE 4-20-2001; IN COMMERCE 4-20-2001.

CLASS 42—(Continued).

2,626,713. HALVORSON IT CONSULTING, SAN JOSE, CA.
SN 78-061,195. PUB. 9-25-2001, FILED 4-30-2001.

CLASS 42—(Continued).

2,626,738. SCIENTIFIC-ATLANTA, INC., LAWRENCEVILLE,
GA. SN 78-072,025. PUB. 1-8-2002, FILED 7-2-2001.

SCICONNECTION

FOR TECHNICAL SUPPORT SERVICES, NAMELY,
TESTING AND MONITORING OF NETWORK SYSTEMS
AND PROVIDING INFORMATION RELATING THERE-
TO (U.S. CLS. 100 AND 101).

FIRST USE 8-7-2001; IN COMMERCE 8-7-2001.

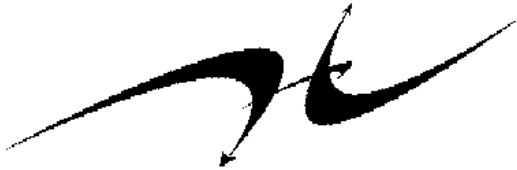

2,626,751. PATCH INDUSTRIES, INC., BOONTON TOWN-
SHIP, NJ. SN 78-084,858. PUB. 2-12-2002, FILED 9-21-2001.

I-PATCH

FOR CONSULTING SERVICES IN THE FIELD OF
COMPUTER SOFTWARE USED FOR DATA BASE MAN-
AGEMENT PURPOSES (U.S. CLS. 100 AND 101).
FIRST USE 6-0-2001; IN COMMERCE 6-0-2001.

FOR PRINTING SERVICES, NAMELY, PRINTING
PRODUCT BROCHURES FOR OTHERS (U.S. CLS. 100
AND 101).
FIRST USE 4-0-2001; IN COMMERCE 4-0-2001.

* * * * *

PRIOR UNITED STATES CLASSIFICATION

APPLICATION IN ONE CLASS

COLLECTIVE MEMBERSHIP MARKS

2,625,469. TUV AMERICA, INC., DANVERS, MA. SN 75-628,715. PUB. 1-15-2002, FILED 1-27-1999.

CLASS 200—COLLECTIVE MEMBERSHIP

2,625,687. COLEMAN, KELLY R., DBA TEAM MONEY TREES, CLEARWATER, FL. SN 75-848,419. PUB. 1-23-2001, FILED 11-15-1999.

TEAM MONEY TREES

FOR INDICATE MEMBERSHIP IN A DIRECT MARKETING ORGANIZATION (U.S. CL. 200).
FIRST USE 10-0-2000; IN COMMERCE 10-0-2000.



2,626,254. ETHICAL INTERNET RETAILERS ASSOCIATION, LLC, BEACHWOOD, OH. SN 76-161,285. PUB. 12-18-2001, FILED 11-7-2000.

NO CLAIM IS MADE TO THE EXCLUSIVE RIGHT TO USE "PRODUCT SERVICES" AND "SAFETY TESTED" AND "PRODUCTION MONITORED", APART FROM THE MARK AS SHOWN.

THE CERTIFICATION MARK, AS USED BY AUTHORIZED PERSONS, CERTIFIES THAT THE RESPECTIVE PRODUCTS, WHERE THE MARK IS AFFIXED COMPLY WITH OSHA ENFORCED STANDARDS.

FOR AEROSPACE GOODS, AUTOMOTIVE GOODS, GENERAL CONSUMER PRODUCTS, MACHINERY, MATERIALS HANDLING EQUIPMENT, MEDICAL GOODS, HEALTHCARE GOODS, SPORTING GOODS, ELECTRICAL AND ELECTRONIC EQUIPMENT, INFORMATION TECHNOLOGY EQUIPMENT, SOFTWARE, AND TELECOMMUNICATIONS PRODUCTS (U.S. CL. A).
FIRST USE 1-25-2002; IN COMMERCE 1-25-2002.



2,625,489. RACK MANUFACTURERS INSTITUTE, CHARLOTTE, NC. SN 75-662,732. PUB. 9-12-2000, FILED 3-18-1999.

NO CLAIM IS MADE TO THE EXCLUSIVE RIGHT TO USE "ETHICAL INTERNET RETAILERS ASSOCIATION" AND "CERTIFIED MEMBER", APART FROM THE MARK AS SHOWN.

THE LINING IN THE DRAWING IS A FEATURE OF THE MARK AND DOES NOT REPRESENT COLOR.

FOR INDICATING MEMBERSHIP IN AN ASSOCIATION OF RETAILERS OF GOODS, PRODUCTS AND SERVICES ON THE INTERNET (U.S. CL. 200).

FIRST USE 4-5-2001; IN COMMERCE 4-5-2001.



CERTIFICATION MARKS

CLASS A—GOODS

OWNER OF U.S. REG. NO. 2,026,861.

TM 1228

NO CLAIM IS MADE TO THE EXCLUSIVE RIGHT TO USE "RACK MANUFACTURERS INSTITUTE", APART FROM THE MARK AS SHOWN.

THIS CERTIFICATION MARK, AS INTENDED TO BE USED BY PERSONS AUTHORIZED BY APPLICANT, IS INTENDED TO CERTIFY THAT THE STEEL STORAGE RACKS CONFORM TO THE SPECIFICATIONS FOR THE DESIGN, TESTING AND UTILIZATION OF SUCH GOODS TO ENSURE UNIFORMITY OF PERFORMANCE AND PUBLIC SAFETY.

FOR STEEL STORAGE RACKS (U.S. CL. A).
FIRST USE 5-1-2000; IN COMMERCE 5-1-2000.

2,625,506. AMERICAN MOVING AND STORAGE ASSOCIATION, ALEXANDRIA, VA. SN 75-689,392. PUB. 1-4-2000, FILED 4-23-1999.



NO CLAIM IS MADE TO THE EXCLUSIVE RIGHT TO USE "AMERICAN MOVING AND STORAGE ASSOCIATION" AND "CERTIFIED MOVER", APART FROM THE MARK AS SHOWN.

THE CERTIFICATION MARK, INTENDED TO BE USED BY AUTHORIZED PERSONS, IS INTENDED TO CERTIFY A SPECIFIC LEVEL OF TRAINING, ETHICS AND EXPERIENCE IN THE MOVING AND STORAGE INDUSTRY.

FOR MOVING OF HOUSEHOLD GOODS (U.S. CL. B).
FIRST USE 6-1-1999; IN COMMERCE 6-1-1999.

CERTIFICATION MARKS

CLASS B—SERVICES

* * * * *

SUPPLEMENTAL REGISTER

These registrations are not subject to opposition.

SECTION 1.— INTERNATIONAL CLASSIFICATION

The short titles associated below with the international class numbers are terms designed merely for quick identification and are not an official part of the international classification. The full names of international classes are given in section 6.1 of the trademark rules of practice.

The designation "U.S. Cl." appearing in this section refers to the U.S. class in effect prior to Sep. 1, 1973 rather than the international class which applies to applications filed on or after that date. For adoption of international classification see notice in the OFFICIAL GAZETTE of Jun. 26, 1973 (911 O.G. TM 210).

Application in more than one class

2,626,759. BABY GATE POOL FENCE MANUFACTURING, INC., INDIAN HARBOUR BEACH, FL. SN 75-489,898. FILED P.R. 5-20-1998; AM. S.R. 6-8-2000.

BABY GATE

NO CLAIM IS MADE TO THE EXCLUSIVE RIGHT TO USE "GATE", APART FROM THE MARK AS SHOWN.

CLASS 6—METAL GOODS

FOR INTEGRATED FENCE SYSTEM COMPRISED OF PRIMARILY METAL INTERLOCKING FENCE PANELS WITH SPECIALIZED NON-METAL LOCKING DEVICES, NAMELY, ENDCAPS AFFIXED TO ADJACENT FENCE PANELS WITH LOCKING, NON-METAL BRIDGING CAPS WHICH CONNECTED IN BETWEEN THEM, ALL FOR USE IN PREVENTING ACCESS BY MINORS (U.S. CLS. 2, 12, 13, 14, 23, 25 AND 50).

FIRST USE 4-0-1998; IN COMMERCE 2-20-1998.

CLASS 37—CONSTRUCTION AND REPAIR

FOR INSTALLATION AND MAINTENANCE SERVICES OF AN INTEGRATED FENCE SYSTEM (U.S. CLS. 100, 103 AND 106).

FIRST USE 4-0-1998; IN COMMERCE 2-20-1998.

2,626,760. INTERNATIONAL DATA GROUP, INC., FRAMINGHAM, MA. SN 75-514,204. FILED P.R. 7-7-1998; AM. S.R. 5-20-2002.

THE LEADER IN NETWORK KNOWLEDGE

CLASS 16—PAPER GOODS AND PRINTED MATTER

FOR PRINT PUBLICATIONS, NAMELY NEWSPAPERS, MAGAZINE, MAGAZINE SUPPLEMENTS, JOURNALS AND NEWSLETTERS IN THE FIELDS OF COMPUTERS, COMPUTER SOFTWARE, ONLINE SERVICES, HIGH TECHNOLOGY, COMMUNICATIONS, INFORMATION TECHNOLOGY AND INFORMATION SERVICES (U.S. CLS. 2, 5, 22, 23, 29, 37, 38 AND 50).

FIRST USE 4-20-2000; IN COMMERCE 4-20-2000.

CLASS 42—SCIENTIFIC, COMPUTER AND LEGAL SERVICES

FOR ONLINE PUBLICATIONS, NAMELY NEWSPAPERS, MAGAZINES, MAGAZINE SUPPLEMENTS, JOURNALS AND NEWSLETTERS FEATURING INFORMATION IN THE FIELDS OF COMPUTERS, COMPUTER SOFTWARE, ONLINE SERVICES, HIGH TECHNOLOGY, COMMUNICATIONS, INFORMATION TECHNOLOGY AND INFORMATION SERVICES; PROVIDING A WEB SITE FEATURING INFORMATION ON COMPUTERS, COMPUTER SOFTWARE, ONLINE SERVICES, HIGH TECHNOLOGY, COMMUNICATIONS, INFORMATION TECHNOLOGY AND INFORMATION SERVICES (U.S. CLS. 100 AND 101).

FIRST USE 7-1-2001; IN COMMERCE 7-1-2001.

2,626,766. SPANG & COMPANY, BUTLER, PA. SN 75-613,863. FILED P.R. 12-30-1998; AM. S.R. 3-6-2002.

VIDEO GEAR

CLASS 20—FURNITURE AND ARTICLES NOT OTHERWISE CLASSIFIED

FOR CHILDREN'S FURNITURE, NAMELY, CHILDREN'S SEATS AND SUPPORTS FOR GAMES AND GAME CONTROLLERS (U.S. CLS. 2, 13, 22, 25, 32 AND 50).

FIRST USE 7-0-1999; IN COMMERCE 7-0-1999.

CLASS 28—TOYS AND SPORTING GOODS

FOR CHILDREN'S TOYS, NAMELY, MOVABLE PLASTIC TOY SEATS AND SUPPORTS FOR GAMES AND GAME CONTROLLERS (U.S. CLS. 22, 23, 38 AND 50).

FIRST USE 7-0-1999; IN COMMERCE 7-0-1999.

2,626,767. SPOTLIGHT ENTERPRISES, INC., WOODLAND HILLS, CA. SN 75-618,487. FILED P.R. 1-11-1999; AM. S.R. 2-8-2000.

THE ACTIVE LEARNING COMPANY

NO CLAIM IS MADE TO THE EXCLUSIVE RIGHT TO USE "COMPANY", APART FROM THE MARK AS SHOWN.

CLASS 28—TOYS AND SPORTING GOODS

FOR PORTABLE STAGES AND PREPACKAGED PLAY KITS HAVING WRITTEN GUIDES, CD-ROMS AND VISUAL BACKDROPS FOR USE IN PERFORMING DRAMATIC PLAYS (U.S. CLS. 22, 23, 38 AND 50).
FIRST USE 11-1-1999; IN COMMERCE 11-1-1999.

CLASS 41—EDUCATION AND ENTERTAINMENT

FOR EDUCATIONAL SERVICES, NAMELY TRAINING IN THE ARTS AND PRODUCTION OF DRAMATIC PLAYS (U.S. CLS. 100, 101 AND 107).
FIRST USE 11-1-1999; IN COMMERCE 11-1-1999.

CLASS 38—COMMUNICATION

FOR PROVIDING HIGH SPEED ELECTRONIC DELIVERY OF DATE, MESSAGES AND DOCUMENTS IN THE FIELD OF ENVIRONMENTAL ISSUES BY MEANS OF THE INTERNET (U.S. CLS. 100, 101 AND 104).
FIRST USE 12-6-1999; IN COMMERCE 12-6-1999.

CLASS 42—SCIENTIFIC, COMPUTER AND LEGAL SERVICES

FOR HOSTING THE WEB SITES OF OTHERS DOCUMENTS IN THE FIELD OF ENVIRONMENTAL ISSUES ON A COMPUTER SERVER VIA THE INTERNET; PROVIDING NEWS AND INFORMATION DOCUMENTS IN THE FIELD OF ENVIRONMENTAL ISSUES VIA THE INTERNET (U.S. CLS. 100 AND 101).
FIRST USE 12-6-1999; IN COMMERCE 12-6-1999.

2,626,773. NEURON THERAPEUTICS, INC., MALVERN, PA. SN 75-677,949. FILED P.R. 4-8-1999; AM. S.R. 5-3-2001.

NEURON THERAPEUTICS, INC.

NO CLAIM IS MADE TO THE EXCLUSIVE RIGHT TO USE "INC.", APART FROM THE MARK AS SHOWN.

CLASS 5—PHARMACEUTICALS

FOR PHARMACEUTICAL PREPARATIONS USED IN THE TREATMENT OF STROKE AND OTHER DISEASES AND INJURIES OF THE CENTRAL NERVOUS SYSTEM AND ISCHEMIA (U.S. CLS. 6, 18, 44, 46, 51 AND 52).
FIRST USE 3-0-2000; IN COMMERCE 10-0-2000.

CLASS 10—MEDICAL APPARATUS

FOR MEDICAL DEVICES, NAMELY, LUMBAR CATHETERS AND DRUG CONDITIONING DEVICES USED TO ADMINISTER FLUIDS TO THE SPINAL CORD AND BRAIN IN THE TREATMENT OF STROKE AND OTHER DISEASES AND INJURIES OF THE CENTRAL NERVOUS SYSTEM AND ISCHEMIA (U.S. CLS. 26, 39 AND 44).
FIRST USE 9-0-2000; IN COMMERCE 10-0-2000.

2,626,779. JAW JOINTS & ALLIED MUSCULO-SKELETAL DISORDERS FOUNDATION, INC., BOSTON, MA. SN 75-710,968. FILED P.R. 5-21-1999; AM. S.R. 3-27-2000.

JAW JOINTS-TMJ AWARENESS

CLASS 41—EDUCATION AND ENTERTAINMENT

FOR EDUCATIONAL SERVICES, NAMELY, CONDUCTING CLASSES, SEMINARS, CONFERENCES AND WORKSHOPS TO EDUCATE THE PUBLIC AND PROFESSIONAL COMMUNITIES ABOUT THE MEDICAL ISSUES RELATING TO THE FUNCTION AND DYSFUNCTION OF THE JAW JOINTS ALSO KNOWN AS TEMPOROMANDIBULAR JOINTS OR TMJ (U.S. CLS. 100, 101 AND 107).
FIRST USE 10-0-1988; IN COMMERCE 10-0-1988.

CLASS 42—SCIENTIFIC, COMPUTER AND LEGAL SERVICES

FOR PROMOTING PUBLIC AND PROFESSIONAL AWARENESS OF THE FUNCTION AND DYSFUNCTION OF THE JAW JOINTS ALSO KNOWN AS TEMPOROMANDIBULAR JOINTS OR TMJ (U.S. CLS. 100 AND 101).
FIRST USE 10-0-1988; IN COMMERCE 10-0-1988.

2,626,777. POLYMER ALLIANCE ZONE, INC., RIPLEY, WV, BY ASSIGNMENT SCIENCE APPLICATIONS INTERNATIONAL CORPORATION, SAN DIEGO, CA. SN 75-693,368. FILED P.R. 4-29-1999; AM. S.R. 4-23-2002.

GREENONLINE

CLASS 35—ADVERTISING AND BUSINESS

FOR EXCHANGE SERVICES, NAMELY BARTERING OF GOODS FOR OTHERS DOCUMENTS IN THE FIELD OF ENVIRONMENTAL ISSUES VIA THE INTERNET (U.S. CLS. 100, 101 AND 102).
FIRST USE 12-6-1999; IN COMMERCE 12-6-1999.

2,626,780. BUYANDHOLD, INC., EDISON, NJ, BY CHANGE OF NAME BUYANDHOLD.COM, INC., NEW YORK, NY. SN 75-713,833. FILED P.R. 5-25-1999; AM. S.R. 6-7-2000.

THE ONLINE BROKER FOR LONG TERM INVESTORS

NO CLAIM IS MADE TO THE EXCLUSIVE RIGHT TO USE "ONLINE BROKER", APART FROM THE MARK AS SHOWN.

CLASS 35—ADVERTISING AND BUSINESS

FOR PROVIDING AN ONLINE COMPUTER DATABASE IN THE FIELD OF BUSINESS INFORMATION, NAMELY, IN ECONOMICS (U.S. CLS. 100, 101 AND 102).
FIRST USE 11-26-1999; IN COMMERCE 11-26-1999.

CLASS 36—INSURANCE AND FINANCIAL

FOR SECURITIES BROKERAGE, FINANCIAL INVESTMENT IN THE FIELDS OF DIVIDEND REINVESTMENT AND DIRECT PURCHASE PLANS AND FINANCIAL PORTFOLIO MANAGEMENT SERVICES RELATING TO DIVIDEND REINVESTMENTS PROVIDED VIA AN ON- LINE ELECTRONICS COMMUNICATIONS NETWORK; FINANCIAL INFORMATION SERVICES, PROVIDING PORTFOLIO MANAGEMENT TOOLS, NAMELY PROVIDING CONSOLIDATED ACCOUNT STATEMENTS, TRANSACTION HISTORIES, AND/OR ACCOUNT INFORMATION VIA ELECTRONIC COMMUNICATION NETWORKS; AND PROVIDING AN ONLINE COMPUTER DATABASE IN THE FIELD OF FINANCIAL AND INVESTMENT INFORMATION (U.S. CLS. 100, 101 AND 102).

FIRST USE 11-26-1999; IN COMMERCE 11-26-1999.

2,626,781. SPANG & COMPANY, BUTLER, PA. SN 75-746,950.
FILED P.R. 7-9-1999; AM. S.R. 3-11-2002.

BACKYARD GEAR

NO CLAIM IS MADE TO THE EXCLUSIVE RIGHT TO USE "GEAR", APART FROM THE MARK AS SHOWN.

CLASS 20—FURNITURE AND ARTICLES NOT OTHERWISE CLASSIFIED

FOR OUTDOOR CHAIRS, TABLES, PICNIC TABLES, AND FURNITURE, NAMELY, OUTDOOR SINK CABINETS; STOOLS, TABLES AND FURNITURE; KNEELERS; AND BOOT BENCHES, NAMELY, SEATING BENCHES FOR USE WHEN APPLYING OR REMOVING BOOTS (U.S. CLS. 2, 13, 22, 25, 32 AND 50).

FIRST USE 5-0-2000; IN COMMERCE 5-0-2000.

CLASS 21—HOUSEWARES AND GLASS

FOR CONTAINERS, NAMELY, PLASTIC CONTAINERS FOR HOLDING TOOLS AND LAWN AND GARDEN SUPPLIES; BARBEQUE ACCESSORIES, NAMELY, UTENSIL HOLDERS (U.S. CLS. 2, 13, 23, 29, 30, 33, 40 AND 50).

FIRST USE 5-0-2000; IN COMMERCE 5-0-2000.

2,626,794. IKON OFFICE SOLUTIONS WEST, INC., PORTLAND, OR. SN 75-857,419. FILED P.R. 11-24-1999; AM. S.R. 11-12-2000.

VIRTUAL FILE ROOM**CLASS 9—ELECTRICAL AND SCIENTIFIC APPARATUS**

FOR COMPUTER SOFTWARE, NAMELY, COMPUTER SOFTWARE THAT ALLOWS USERS TO STORE, ACCESS, MANAGE, PRINT AND TRANSMIT DOCUMENTS VIA A GLOBAL COMPUTER NETWORK (U.S. CLS. 21, 23, 26, 36 AND 38).

FIRST USE 1-17-2000; IN COMMERCE 1-17-2000.

CLASS 35—ADVERTISING AND BUSINESS

FOR COPYING DOCUMENTS FOR OTHERS; COMPUTERIZED DATABASE MANAGEMENT (U.S. CLS. 100, 101 AND 102).

FIRST USE 1-17-2000; IN COMMERCE 1-17-2000.

CLASS 39—TRANSPORTATION AND STORAGE

FOR DOCUMENT MANAGEMENT SERVICES, NAMELY ELECTRONIC STORAGE OF FILES AND DOCUMENTS; STORAGE SERVICES FOR ARCHIVING DATABASES, IMAGES AND OTHER ELECTRONIC DATA (U.S. CLS. 100 AND 105).

FIRST USE 1-17-2000; IN COMMERCE 1-17-2000.

CLASS 42—SCIENTIFIC, COMPUTER AND LEGAL SERVICES

FOR MAINTAINING AND PROVIDING ACCESS TO AN INTERACTIVE AND COMPREHENSIVE COMPUTER-BASED DATA REPOSITORY CONTAINING ELECTRONIC DOCUMENTS IN THE FIELD OF LAW, NAMELY, LITIGATION RECORDS, AND DOCUMENT DISCOVERY FOR THE PURPOSE OF ALLOWING DOCUMENT RETRIEVAL AND DOCUMENT PRINTING AND REPRINTING SERVICES (U.S. CLS. 100 AND 101).

FIRST USE 1-17-2000; IN COMMERCE 1-17-2000.

2,626,795. INTERNATIONAL BUSINESS MACHINES CORPORATION, ARMONK, NY. SN 75-858,841. FILED P.R. 11-24-1999; AM. S.R. 5-16-2002.

MICRODRIVE**CLASS 9—ELECTRICAL AND SCIENTIFIC APPARATUS**

FOR COMPUTERS AND COMPUTER HARD AND FLOPPY DISK DRIVES; COMPUTERS AND COMPUTER HARD AND FLOPPY DISK DRIVES WITH INTEGRATED AND PRINTED CIRCUITS; BLANK MAGNETIC DISKS; COMPUTER PROGRAMS FOR DATA STORAGE ON COMPUTER HARD AND FLOPPY DISK DRIVES; COMPUTER HARD AND FLOPPY DISK DRIVES AND COMPUTER PROGRAMS; COMPUTER SOFTWARE USED TO DIRECTLY STORE DIGITAL IMAGES INTO CAMERAS; INSTRUCTION MANUALS SOLD AS A UNIT THEREWITH FOR THE AFORESAID GOODS (U.S. CLS. 21, 23, 26, 36 AND 38).

FIRST USE 6-30-1999; IN COMMERCE 6-30-1999.

CLASS 16—PAPER GOODS AND PRINTED MATTER

FOR PRINTED MATTER, NAMELY, INSTRUCTIONAL AND TEACHING MATERIAL, BOOKS, NEWSLETTERS AND MAGAZINES RELATING TO COMPUTER HARDWARE AND COMPUTER SOFTWARE FOR DATA STORAGE ON COMPUTER HARD AND FLOPPY DISK DRIVES; PRINTED MATTER, NAMELY, INSTRUCTIONAL AND TEACHING MATERIAL, BOOKS, NEWSLETTERS AND MAGAZINES RELATING TO STORING DIGITAL IMAGES INTO CAMERAS (U.S. CLS. 2, 5, 22, 23, 29, 37, 38 AND 50).

FIRST USE 6-30-1999; IN COMMERCE 6-30-1999.

CLASS 37—CONSTRUCTION AND REPAIR

FOR UPGRADING OF COMPUTER HARDWARE; MAINTENANCE OF COMPUTER HARDWARE, NAMELY, COMPUTER HARD AND FLOPPY DISK DRIVES (U.S. CLS. 100, 103 AND 106).

FIRST USE 6-30-1999; IN COMMERCE 6-30-1999.

CLASS 42—SCIENTIFIC, COMPUTER AND LEGAL SERVICES

FOR COMPUTER HARDWARE DESIGN FOR OTHERS; CONSULTATION SERVICES IN THE FIELD OF COMPUTER HARDWARE; COMPUTER SYSTEMS ANALYSIS; COMPUTER SOFTWARE DESIGN FOR OTHERS; UPDATING OF COMPUTER SOFTWARE FOR OTHERS; MAINTENANCE OF COMPUTER SOFTWARE (U.S. CLS. 100 AND 101).

FIRST USE 6-30-1999; IN COMMERCE 6-30-1999.

2,626,809. GULF OPTICS CORPORATION, DBA A2Z OPTICS CORPORATION, NICEVILLE, FL. SN 75-928,582. FILED P.R. 2-28-2000; AM. S.R. 4-23-2001.

EYECHECK**CLASS 9—ELECTRICAL AND SCIENTIFIC APPARATUS**

FOR DEVICE USED TO MEASURE PUPIL PARAMETERS TO AID IN THE DETECTION OF IMPAIRMENTS IN OTHERS DUE TO DRUGS, ALCOHOL, FATIGUE OR DISEASE EFFECTING THE CENTRAL NERVOUS SYSTEM FOR NON-MEDICAL USE (U.S. CLS. 21, 23, 26, 36 AND 38).

FIRST USE 10-7-2000; IN COMMERCE 10-7-2000.

CLASS 10—MEDICAL APPARATUS

FOR DEVICE USED TO MEASURE PUPIL PARAMETERS TO AID IN THE DETECTION OF IMPAIRMENTS IN OTHERS DUE TO DRUGS, ALCOHOL, FATIGUE OR DISEASE EFFECTING THE CENTRAL NERVOUS SYSTEM FOR MEDICAL USE (U.S. CLS. 26, 39 AND 44).

FIRST USE 10-7-2000; IN COMMERCE 10-7-2000.

2,626,806. CANADIAN BUSINESS MACHINES LIMITED, MISSISSAUGA, ONTARIO, L5T 1C4, CANADA. SN 75-906,415. FILED P.R. 1-31-2000; AM. S.R. 5-17-2002.

**DESIGN DRIVEN
MANUFACTURING**

NO CLAIM IS MADE TO THE EXCLUSIVE RIGHT TO USE "MANUFACTURING", APART FROM THE MARK AS SHOWN.

CLASS 6—METAL GOODS

FOR METAL CASH TRANSACTION DRAWERS AND METAL STRUCTURES IN THE NATURE OF TELLER WINDOWS FOR BANKS AND OTHER FINANCIAL INSTITUTIONS (U.S. CLS. 2, 12, 13, 14, 23, 25 AND 50).

FIRST USE 5-10-2002; IN COMMERCE 5-10-2002.

CLASS 20—FURNITURE AND ARTICLES NOT OTHERWISE CLASSIFIED

FOR OFFICE FURNITURE, NAMELY, VIDEO CABINETS, OFFICE MACHINE STANDS AND STORAGE UNITS, AND COMPUTER FURNITURE (U.S. CLS. 2, 13, 22, 25, 32 AND 50).

FIRST USE 5-10-2002; IN COMMERCE 5-10-2002.

CLASS 40—MATERIAL TREATMENT

FOR DESIGNING AND MANUFACTURING FURNITURE TO THE ORDER AND SPECIFICATION OF OTHERS (U.S. CLS. 100, 103 AND 106).

FIRST USE 5-10-2002; IN COMMERCE 5-10-2002.

2,626,810. BARBILL, INC., THE, TUCSON, AZ. SN 75-932,688. FILED P.R. 3-1-2000; AM. S.R. 1-30-2002.

**CLASS 16—PAPER GOODS AND PRINTED MATTER**

FOR PRINTED MATTER, NAMELY MEMBERSHIP CARDS WHICH ENTITLE THE OWNER TO DISCOUNT SPECIALS ON DRINKS, ADMISSIONS, RETAIL MERCHANDISE, A WIDE VARIETY OF SERVICES AND ENTERTAINMENT PROVIDERS (U.S. CLS. 2, 5, 22, 23, 29, 37, 38 AND 50).

FIRST USE 11-15-1998; IN COMMERCE 11-15-1998.

CLASS 35—ADVERTISING AND BUSINESS

FOR PREPARING AND PLACING ADVERTISEMENTS ON MEMBERSHIP CARDS AND ON DIRECTORIES AVAILABLE VIA GLOBAL COMPUTER NETWORK; PROMOTING THE GOODS AND SERVICES OF OTHER THROUGH THE SALE OF MEMBERSHIP CARDS AND DISTRIBUTION OF DISCOUNT CARDS; ON-LINE RETAIL SERVICES FEATURING MERCHANDISE SOLD AT ENTERTAINMENT ESTABLISHMENTS (U.S. CLS. 100, 101 AND 102).

FIRST USE 11-15-1998; IN COMMERCE 11-15-1998.

2,626,816. TRANSMATION, INC., ROCHESTER, NY. SN 76-007,362. FILED P.R. 3-22-2000; AM. S.R. 12-13-2001.

2,626,832. VDSL SYSTEMS OY, 02150 ESPOO, FINLAND. SN 76-059,720. FILED P.R. 5-31-2000; AM. S.R. 4-26-2002.

METERSANDINSTRUMENTS .COM



CLASS 9—ELECTRICAL AND SCIENTIFIC APPARATUS

FOR ELECTRONIC TESTING DEVICES, NAMELY VOLTAGE DETECTORS (U.S. CLS. 21, 23, 26, 36 AND 38). FIRST USE 1-0-2000; IN COMMERCE 1-0-2000.

PRIORITY CLAIMED UNDER SEC. 44(D) ON FINLAND APPLICATION NO. T200000889, FILED 3-16-2000, REG. NO. 219750, DATED 12-15-2000, EXPIRES 12-15-2010.

CLASS 35—ADVERTISING AND BUSINESS

FOR MAIL ORDER CATALOG SERVICES AND ON-LINE RETAIL STORE SERVICES FEATURING CALIBRATION EQUIPMENT, GENERAL TEST EQUIPMENT AND TEST TOOLS AND TEMPERATURE INSTRUMENTATION AND RELATED ACCESSORY EQUIPMENT FOR USE IN THE ELECTRICAL, ELECTRONIC, TELECOMMUNICATIONS, DATA COMMUNICATIONS AND ENGINEERING FIELDS (U.S. CLS. 100, 101 AND 102). FIRST USE 6-0-1999; IN COMMERCE 6-0-1999.

CLASS 9—ELECTRICAL AND SCIENTIFIC APPARATUS

FOR COMPUTER HARDWARE TO FACILITATE TELECOMMUNICATION ACCESS; COMPUTER SOFTWARE USED IN TELECOMMUNICATIONS FOR CONNECTING TO TELECOMMUNICATION NETWORKS; COMPUTER SOFTWARE USED IN TELECOMMUNICATIONS FOR MONITORING THE QUALITY AND PROPERTIES OF THE INFORMATION IN TELECOMMUNICATION NETWORKS; COMPUTER SOFTWARE USED IN TELECOMMUNICATIONS FOR MONITORING THE FUNCTION OF COMPUTER HARDWARE WHICH FACILITATES TELECOMMUNICATION ACCESS; COMPUTER SOFTWARE USED TO SPEED UP TELECOMMUNICATION ACCESS BY COMPRESSING DATA BEFORE IT IS TRANSMITTED (U.S. CLS. 21, 23, 26, 36 AND 38).

CLASS 37—CONSTRUCTION AND REPAIR

FOR BUILDING CONSTRUCTION AND REPAIR; INSTALLATION, MAINTENANCE AND REPAIR OF COMPUTER NETWORKS, DATA NETWORKS, COMPUTER SYSTEMS AND COMPUTER HARDWARE (U.S. CLS. 100, 103 AND 106).

2,626,831. IMC CONFERENCES, INC., MINNEAPOLIS, MN. SN 76-059,211. FILED P.R. 5-30-2000; AM. S.R. 5-7-2001.

INTERACTIVE MARKETING COUNCIL

2,626,833. DAIRY, LLC, DALLAS, TX. SN 76-072,800. FILED P.R. 6-19-2000; AM. S.R. 5-2-2002.

DAIRY.COM

CLASS 41—EDUCATION AND ENTERTAINMENT

FOR EDUCATIONAL SERVICES, NAMELY CONDUCTING SEMINARS AND CONFERENCES IN THE FIELD OF QUALITY MARKETING PRACTICES ON GLOBAL MEDIA NETWORKS (U.S. CLS. 100, 101 AND 107). FIRST USE 8-4-1995; IN COMMERCE 8-4-1995.

CLASS 35—ADVERTISING AND BUSINESS

FOR PROVIDING AN ON-LINE SERVICE WHICH FACILITATES ELECTRONIC COMMERCE BY ENABLING USERS TO LOCATE BUYERS AND SELLERS FOR AGRICULTURAL COMMODITIES (U.S. CLS. 100, 101 AND 102). FIRST USE 1-0-2001; IN COMMERCE 1-0-2001.

CLASS 42—SCIENTIFIC, COMPUTER AND LEGAL SERVICES

FOR PROMOTING PUBLIC AWARENESS OF THE NEED FOR QUALITY MARKETING PRACTICES ON GLOBAL MEDIA NETWORKS (U.S. CLS. 100 AND 101). FIRST USE 8-4-1995; IN COMMERCE 8-4-1995.

CLASS 36—INSURANCE AND FINANCIAL

FOR ONLINE BROKERAGE SERVICES AND COMMODITY TRADING SERVICES FOR OTHERS IN THE FIELD OF DAIRY PRODUCTS AND OTHER AGRICULTURAL COMMODITIES (U.S. CLS. 100, 101 AND 102). FIRST USE 1-0-2001; IN COMMERCE 1-0-2001.

2,626,834. VERMONT WARE, INC., ST. GEORGE, VT. SN 76-074,112. FILED P.R. 6-19-2000; AM. S.R. 5-25-2001.

Vermont Ware

NO CLAIM IS MADE TO THE EXCLUSIVE RIGHT TO USE "WARE", APART FROM THE MARK AS SHOWN.

CLASS 12—VEHICLES

FOR NON-MOTORIZED GARDEN CARTS AND GARDEN CART PARTS (U.S. CLS. 19, 21, 23, 31, 35 AND 44). FIRST USE 6-0-1952; IN COMMERCE 6-0-1952.

CLASS 40—MATERIAL TREATMENT

FOR APPLYING FINISHES TO WOOD, GLASS, AND METALLIC SURFACES (U.S. CLS. 100, 103 AND 106). FIRST USE 6-0-1998; IN COMMERCE 6-0-1998.

2,626,841. BUREAU OF NATIONAL AFFAIRS, INC., THE, WASHINGTON, D.C., DC. SN 76-099,351. FILED P.R. 7-28-2000; AM. S.R. 8-17-2001.

CLASS ACTION LITIGATION

CLASS 16—PAPER GOODS AND PRINTED MATTER

FOR PERIODICALLY PUBLISHED NEWS REPORTS IN LOOSE LEAF PAMPHLET OR BOOKLET FORMAT IN THE FIELD OF CLASS ACTION LITIGATION (U.S. CLS. 2, 5, 22, 23, 29, 37, 38 AND 50). FIRST USE 4-28-2000; IN COMMERCE 4-28-2000.

CLASS 42—SCIENTIFIC, COMPUTER AND LEGAL SERVICES

FOR PROVIDING INFORMATION, JUDICIAL OPINIONS AND REPORTS, ALL IN THE FIELD OF LAW THROUGH THE GLOBAL COMPUTER NETWORK (U.S. CLS. 100 AND 101).

FIRST USE 4-28-2000; IN COMMERCE 4-28-2000.
2,626,853. MISSISSIPPI BAND OF CHOCTAW INDIANS, PHILADELPHIA, MS. SN 76-121,198. FILED P.R. 8-31-2000; AM. S.R. 9-6-2001.

PEARL RIVER RESORT AT CHOCTAW, MISSISSIPPI

NO CLAIM IS MADE TO THE EXCLUSIVE RIGHT TO USE "RESORT", APART FROM THE MARK AS SHOWN.

CLASS 35—ADVERTISING AND BUSINESS

FOR PROVIDING FACILITIES FOR BUSINESS MEETING; RETAIL STORE SERVICES FEATURING CLOTHING, GIFTS, AND TENNIS AND GOLF EQUIPMENT (U.S. CLS. 100, 101 AND 102). FIRST USE 10-16-2000; IN COMMERCE 10-16-2000.

CLASS 41—EDUCATION AND ENTERTAINMENT

FOR ENTERTAINMENT SERVICES, NAMELY, PROVIDING MUSIC CONCERTS, CASINOS, AND SWIM, TENNIS, AND GOLF CLUB SERVICES (U.S. CLS. 100, 101 AND 107). FIRST USE 10-16-2000; IN COMMERCE 10-16-2000.

CLASS 42—SCIENTIFIC, COMPUTER AND LEGAL SERVICES

FOR RESORT HOTELS AND RESTAURANT SERVICES (U.S. CLS. 100 AND 101). FIRST USE 10-16-2000; IN COMMERCE 10-16-2000.

2,626,856. ELECTRICAL SOUTH LIMITED PARTNERSHIP, GREENSBORO, NC. SN 76-132,617. FILED P.R. 9-20-2000; AM. S.R. 10-2-2001.

REMAN ELECTRONICS

NO CLAIM IS MADE TO THE EXCLUSIVE RIGHT TO USE "ELECTRONICS", APART FROM THE MARK AS SHOWN.

CLASS 9—ELECTRICAL AND SCIENTIFIC APPARATUS

FOR DC DRIVES, AC DRIVES, AC AND DC SERVO DRIVES, VECTOR DRIVES, ELECTRONIC TESTING EQUIPMENT, TIMERS, COUNTERS, ENCODERS, TEMPERATURE CONTROLLERS, PRESSURE CONTROLLERS, TEMPERATURE INDICATORS, PRESSURE INDICATORS, SINGLE POINT PROCESS CONTROLLERS, PROCESS CONTROLLERS, PHOTOELECTRIC CONTROLS, FLOW CONTROLLERS, LEVEL CONTROLLERS, VALVE POSITIONERS, FIELD REGULATORS, TURBINE CONTROLS, PROGRAMMABLE LOGIC CONTROLLERS, MACHINE TOOL CONTROLS, NUMERICAL CONTROLS, ROBOTIC CONTROLS, VIDEO MONITORS, SIGNAL CONDITIONERS, BARCODE SCANNERS, BARCODE PRINTERS, LASER THERMAL PRINTERS, LINE PRINTERS, DOT MATRIX PRINTERS, ELECTRICAL LINEAR POWER SUPPLIES, SWITCHING POWER SUPPLIES, UPS SYSTEMS, SOFTSTART CONTROLS, VOLTAGE REGULATORS, ALPHA NUMERIC DISPLAYS, ASR CONTROLLERS, STATUS MONITORS, EDDY CURRENT DRIVES, DISTRIBUTED CONTROLS, WELDER CONTROLS, GENERATOR CONTROLS, MOTION CONTROLLERS, PATH RECORDERS, CHART RECORDERS, MOTION DETECTORS, STEPPER CONTROLS AND CALIBRATORS (U.S. CLS. 21, 23, 26, 36 AND 38). FIRST USE 9-7-2000; IN COMMERCE 9-7-2000.

CLASS 35—ADVERTISING AND BUSINESS

FOR INTERNET STORE SERVICES FEATURING DC DRIVES, AC DRIVES, AC AND DC SERVO DRIVES, VECTOR DRIVES, ELECTRONIC TESTING EQUIPMENT, TIMERS, COUNTERS, ENCODERS, TEMPERATURE CONTROLLERS, PRESSURE CONTROLLERS, TEMPERATURE INDICATORS, PRESSURE INDICATORS, SINGLE POINT PROCESS CONTROLLERS, PROCESS CONTROLLERS, PHOTOELECTRIC CONTROLS, METERS, FLOW CONTROLLERS, LEVEL CONTROLLERS, VALVE POSITIONERS, FIELD REGULATORS, TURBINE CONTROLS, PROGRAMMABLE LOGIC CONTROLLERS, MACHINE TOOL CONTROLS, NUMERICAL CONTROLS, ROBOTIC CONTROLS, VIDEO MONITORS, SIGNAL CONDITIONERS, BARCODE SCANNERS, BARCODE PRINTERS, LASER THERMAL PRINTERS, LINE PRINTERS, DOT MATRIX PRINTERS, ELECTRICAL LINEAR POWER SUPPLIES, SWITCHING POWER SUPPLIES, UPS SYSTEMS, SOFTSTART CONTROLS, ELECTRONIC BRAKES, SOLID STATE STARTERS, VOLTAGE REGULATORS, ALPHA NUMERIC DISPLAYS, ASR CONTROLLERS, STATUS MONITORS, EDDY CURRENT DRIVES, PROGRAMMERS DISTRIBUTED CONTROLS, WELDER CONTROLS, GENERATOR CONTROLS, MOTION CONTROLLERS, RECORDERS, MOTION DETECTORS, STEPPER CONTROLS AND CALIBRATORS THROUGH A GLOBAL COMPUTER NETWORK (U.S. CLS. 100, 101 AND 102).

FIRST USE 9-7-2000; IN COMMERCE 9-7-2000.

CLASS 41—EDUCATION AND ENTERTAINMENT

FOR PROVIDING EDUCATIONAL INFORMATION IN THE FIELD OF LANGUAGES AND LANGUAGE INSTRUCTION FOR BABIES, INFANTS AND TODDLERS OVER THE INTERNET (U.S. CLS. 100, 101 AND 107).

FIRST USE 8-27-2001; IN COMMERCE 8-27-2001.

2,626,860. FLUENT BABY, INC., PALO ALTO, CA. SN 76-136,956. FILED P.R. 9-22-2000; AM. S.R. 4-29-2002.

BABY VIETNAMESE

2,626,859. FLUENT BABY, INC., PALO ALTO, CA. SN 76-136,952. FILED P.R. 9-22-2000; AM. S.R. 4-29-2002.

BABY NORWEGIAN**CLASS 9—ELECTRICAL AND SCIENTIFIC APPARATUS**

FOR COMPUTER SOFTWARE FOR USE IN FACILITATING THE DEVELOPMENT OF FOREIGN LANGUAGE CAPABILITIES OF BABIES, INFANTS AND TODDLERS; PRE-RECORDED MULTIMEDIA VIDEO TAPES, COMPACT DISKS, CD-ROMS AND DVDS FEATURING ENTERTAINMENT AND INSTRUCTION FOR DEVELOPING THE FOREIGN LANGUAGE CAPABILITIES OF BABIES, INFANTS AND TODDLERS (U.S. CLS. 21, 23, 26, 36 AND 38).

FIRST USE 9-6-2001; IN COMMERCE 9-6-2001.

CLASS 16—PAPER GOODS AND PRINTED MATTER

FOR BOOKS AND PRINTED MATTER, NAMELY, FLASH CARDS, WORKBOOKS, POSTERS AND PRINTED INSTRUCTIONAL, EDUCATIONAL AND TEACHING MATERIALS TO DEVELOP THE FOREIGN LANGUAGE CAPABILITIES OF BABIES, INFANTS AND TODDLERS (U.S. CLS. 2, 5, 22, 23, 29, 37, 38 AND 50).

FIRST USE 9-6-2001; IN COMMERCE 9-6-2001.

CLASS 28—TOYS AND SPORTING GOODS

FOR DOLLS AND DOLL ACCESSORIES; GAMES AND PLAYTHINGS, NAMELY A CARD GAME IN THE NATURE OF A MEMORY GAME TO DEVELOP THE FOREIGN LANGUAGE CAPABILITIES OF BABIES, INFANTS AND TODDLERS (U.S. CLS. 22, 23, 38 AND 50).

FIRST USE 9-6-2001; IN COMMERCE 9-6-2001.

CLASS 9—ELECTRICAL AND SCIENTIFIC APPARATUS

FOR COMPUTER SOFTWARE FOR USE IN FACILITATING THE DEVELOPMENT OF FOREIGN LANGUAGE CAPABILITIES OF BABIES, INFANTS AND TODDLERS; PRE-RECORDED MULTIMEDIA VIDEO TAPES, COMPACT DISKS, CD-ROMS AND DVDS FEATURING ENTERTAINMENT AND INSTRUCTION FOR DEVELOPING THE FOREIGN LANGUAGE CAPABILITIES OF BABIES, INFANTS AND TODDLERS (U.S. CLS. 21, 23, 26, 36 AND 38).

FIRST USE 9-6-2001; IN COMMERCE 9-6-2001.

CLASS 16—PAPER GOODS AND PRINTED MATTER

FOR BOOKS AND PRINTED MATTER, NAMELY, FLASH CARDS, WORKBOOKS, POSTERS AND PRINTED INSTRUCTIONAL, EDUCATIONAL AND TEACHING MATERIALS TO DEVELOP THE FOREIGN LANGUAGE CAPABILITIES OF BABIES, INFANTS AND TODDLERS (U.S. CLS. 2, 5, 22, 23, 29, 37, 38 AND 50).

FIRST USE 9-6-2001; IN COMMERCE 9-6-2001.

CLASS 28—TOYS AND SPORTING GOODS

FOR DOLLS AND DOLL ACCESSORIES; GAMES AND PLAYTHINGS, NAMELY A CARD GAME IN THE NATURE OF A MEMORY GAME TO DEVELOP THE FOREIGN LANGUAGE CAPABILITIES OF BABIES, INFANTS AND TODDLERS (U.S. CLS. 22, 23, 38 AND 50).

FIRST USE 9-6-2001; IN COMMERCE 9-6-2001.

CLASS 41—EDUCATION AND ENTERTAINMENT

FOR PROVIDING EDUCATIONAL INFORMATION IN THE FIELD OF LANGUAGES AND LANGUAGE INSTRUCTION FOR BABIES, INFANTS AND TODDLERS OVER THE INTERNET (U.S. CLS. 100, 101 AND 107).

FIRST USE 8-27-2001; IN COMMERCE 8-27-2001.

2,626,861. FLUENT BABY, INC., PALO ALTO, CA. SN 76-136,961. FILED P.R. 9-22-2000; AM. S.R. 4-29-2002.

BABY THAI

CLASS 9—ELECTRICAL AND SCIENTIFIC APPARATUS

FOR COMPUTER SOFTWARE FOR USE IN FACILITATING THE DEVELOPMENT OF FOREIGN LANGUAGE CAPABILITIES OF BABIES, INFANTS AND TODDLERS; PRE-RECORDED MULTIMEDIA VIDEO TAPES, COMPACT DISKS, CD-ROMS AND DVDS FEATURING ENTERTAINMENT AND INSTRUCTION FOR DEVELOPING THE FOREIGN LANGUAGE CAPABILITIES OF BABIES, INFANTS AND TODDLERS (U.S. CLS. 21, 23, 26, 36 AND 38).

FIRST USE 9-6-2001; IN COMMERCE 9-6-2001.

CLASS 16—PAPER GOODS AND PRINTED MATTER

FOR BOOKS AND PRINTED MATTER, NAMELY, FLASH CARDS, WORKBOOKS, POSTERS AND PRINTED INSTRUCTIONAL, EDUCATIONAL AND TEACHING MATERIALS TO DEVELOP THE FOREIGN LANGUAGE CAPABILITIES OF BABIES, INFANTS AND TODDLERS (U.S. CLS. 2, 5, 22, 23, 29, 37, 38 AND 50).

FIRST USE 9-6-2001; IN COMMERCE 9-6-2001.

CLASS 28—TOYS AND SPORTING GOODS

FOR DOLLS AND DOLL ACCESSORIES; GAMES AND PLAYTHINGS, NAMELY A CARD GAME IN THE NATURE OF A MEMORY GAME TO DEVELOP THE FOREIGN LANGUAGE CAPABILITIES OF BABIES, INFANTS AND TODDLERS (U.S. CLS. 22, 23, 38 AND 50).

FIRST USE 9-6-2001; IN COMMERCE 9-6-2001.

CLASS 41—EDUCATION AND ENTERTAINMENT

FOR PROVIDING EDUCATIONAL INFORMATION IN THE FIELD OF LANGUAGES AND LANGUAGE INSTRUCTION FOR BABIES, INFANTS AND TODDLERS OVER THE INTERNET (U.S. CLS. 100, 101 AND 107).

FIRST USE 8-27-2001; IN COMMERCE 8-27-2001.

2,626,862. FLUENT BABY, INC., PALO ALTO, CA. SN 76-137,236. FILED P.R. 9-22-2000; AM. S.R. 1-22-2002.

BABY SWEDISH

CLASS 9—ELECTRICAL AND SCIENTIFIC APPARATUS

FOR COMPUTER SOFTWARE FOR USE IN FACILITATING THE DEVELOPMENT OF FOREIGN LANGUAGE CAPABILITIES OF BABIES, INFANTS AND TODDLERS; PRE-RECORDED MULTIMEDIA VIDEO TAPES, COMPACT DISKS, CD-ROMS AND DVDS FEATURING ENTERTAINMENT AND INSTRUCTION FOR DEVELOPING THE FOREIGN LANGUAGE CAPABILITIES OF BABIES, INFANTS AND TODDLERS (U.S. CLS. 21, 23, 26, 36 AND 38).

FIRST USE 9-6-2001; IN COMMERCE 9-6-2001.

CLASS 16—PAPER GOODS AND PRINTED MATTER

FOR BOOKS AND PRINTED MATTER, NAMELY, FLASH CARDS, WORKBOOKS, POSTERS AND PRINTED INSTRUCTIONAL, EDUCATIONAL AND TEACHING MATERIALS TO DEVELOP THE FOREIGN LANGUAGE CAPABILITIES OF BABIES, INFANTS AND TODDLERS (U.S. CLS. 2, 5, 22, 23, 29, 37, 38 AND 50).

FIRST USE 9-6-2001; IN COMMERCE 9-6-2001.

CLASS 28—TOYS AND SPORTING GOODS

FOR DOLLS AND DOLL ACCESSORIES; GAMES AND PLAYTHINGS, NAMELY A CARD GAME IN THE NATURE OF A MEMORY GAME TO DEVELOP THE FOREIGN LANGUAGE CAPABILITIES OF BABIES, INFANTS AND TODDLERS (U.S. CLS. 22, 23, 38 AND 50).

FIRST USE 9-6-2001; IN COMMERCE 9-6-2001.

CLASS 41—EDUCATION AND ENTERTAINMENT

FOR PROVIDING EDUCATIONAL INFORMATION IN THE FIELD OF LANGUAGES AND LANGUAGE INSTRUCTION FOR BABIES, INFANTS AND TODDLERS OVER THE INTERNET (U.S. CLS. 100, 101 AND 107).

FIRST USE 8-27-2001; IN COMMERCE 8-27-2001.

2,626,863. FLUENT BABY, INC., PALO ALTO, CA. SN 76-137,240. FILED P.R. 9-22-2000; AM. S.R. 4-29-2002.

BABY HINDI

CLASS 9—ELECTRICAL AND SCIENTIFIC APPARATUS

FOR COMPUTER SOFTWARE FOR USE IN FACILITATING THE DEVELOPMENT OF FOREIGN LANGUAGE CAPABILITIES OF BABIES, INFANTS AND TODDLERS; PRE-RECORDED MULTIMEDIA VIDEO TAPES, COMPACT DISKS, CD-ROMS AND DVDS FEATURING ENTERTAINMENT AND INSTRUCTION FOR DEVELOPING THE FOREIGN LANGUAGE CAPABILITIES OF BABIES, INFANTS AND TODDLERS (U.S. CLS. 21, 23, 26, 36 AND 38).

FIRST USE 9-6-2001; IN COMMERCE 9-6-2001.

CLASS 16—PAPER GOODS AND PRINTED MATTER

FOR BOOKS AND PRINTED MATTER, NAMELY, FLASH CARDS, WORKBOOKS, POSTERS AND PRINTED INSTRUCTIONAL, EDUCATIONAL AND TEACHING MATERIALS TO DEVELOP THE FOREIGN LANGUAGE CAPABILITIES OF BABIES, INFANTS AND TODDLERS (U.S. CLS. 2, 5, 22, 23, 29, 37, 38 AND 50).

FIRST USE 9-6-2001; IN COMMERCE 9-6-2001.

CLASS 28—TOYS AND SPORTING GOODS

FOR DOLLS AND DOLL ACCESSORIES; GAMES AND PLAYTHINGS, NAMELY A CARD GAME IN THE NATURE OF A MEMORY GAME TO DEVELOP THE FOREIGN LANGUAGE CAPABILITIES OF BABIES, INFANTS AND TODDLERS (U.S. CLS. 22, 23, 38 AND 50).

FIRST USE 9-6-2001; IN COMMERCE 9-6-2001.

CLASS 41—EDUCATION AND ENTERTAINMENT

FOR PROVIDING EDUCATIONAL INFORMATION IN THE FIELD OF LANGUAGES AND LANGUAGE INSTRUCTION FOR BABIES, INFANTS AND TODDLERS OVER THE INTERNET (U.S. CLS. 100, 101 AND 107).

FIRST USE 8-27-2001; IN COMMERCE 8-27-2001.

2,626,865. FLUENT BABY, INC., PALO ALTO, CA. SN 76-137,244. FILED P.R. 9-22-2000; AM. S.R. 1-22-2002.

BABY KOREAN**CLASS 9—ELECTRICAL AND SCIENTIFIC APPARATUS**

FOR COMPUTER SOFTWARE FOR USE IN FACILITATING THE DEVELOPMENT OF FOREIGN LANGUAGE CAPABILITIES OF BABIES, INFANTS AND TODDLERS; PRE-RECORDED MULTIMEDIA VIDEO TAPES, COMPACT DISKS, CD-ROMS AND DVDS FEATURING ENTERTAINMENT AND INSTRUCTION FOR DEVELOPING THE FOREIGN LANGUAGE CAPABILITIES OF BABIES, INFANTS AND TODDLERS (U.S. CLS. 21, 23, 26, 36 AND 38).

FIRST USE 9-6-2001; IN COMMERCE 9-6-2001.

CLASS 16—PAPER GOODS AND PRINTED MATTER

FOR BOOKS AND PRINTED MATTER, NAMELY, FLASH CARDS, WORKBOOKS, POSTERS AND PRINTED INSTRUCTIONAL, EDUCATIONAL AND TEACHING MATERIALS TO DEVELOP THE FOREIGN LANGUAGE CAPABILITIES OF BABIES, INFANTS AND TODDLERS (U.S. CLS. 2, 5, 22, 23, 29, 37, 38 AND 50).

FIRST USE 9-6-2001; IN COMMERCE 9-6-2001.

CLASS 28—TOYS AND SPORTING GOODS

FOR DOLLS AND DOLL ACCESSORIES; GAMES AND PLAYTHINGS, NAMELY A CARD GAME IN THE NATURE OF A MEMORY GAME TO DEVELOP THE FOREIGN LANGUAGE CAPABILITIES OF BABIES, INFANTS AND TODDLERS (U.S. CLS. 22, 23, 38 AND 50).

FIRST USE 9-6-2001; IN COMMERCE 9-6-2001.

CLASS 41—EDUCATION AND ENTERTAINMENT

FOR PROVIDING EDUCATIONAL INFORMATION IN THE FIELD OF LANGUAGES AND LANGUAGE INSTRUCTION FOR BABIES, INFANTS AND TODDLERS OVER THE INTERNET (U.S. CLS. 100, 101 AND 107).

FIRST USE 8-27-2001; IN COMMERCE 8-27-2001.

2,626,864. FLUENT BABY, INC., PALO ALTO, CA. SN 76-137,243. FILED P.R. 9-22-2000; AM. S.R. 4-29-2002.

BABY RUSSIAN**CLASS 9—ELECTRICAL AND SCIENTIFIC APPARATUS**

FOR COMPUTER SOFTWARE FOR USE IN FACILITATING THE DEVELOPMENT OF FOREIGN LANGUAGE CAPABILITIES OF BABIES, INFANTS AND TODDLERS; PRE-RECORDED MULTIMEDIA VIDEO TAPES, COMPACT DISKS, CD-ROMS AND DVDS FEATURING ENTERTAINMENT AND INSTRUCTION FOR DEVELOPING THE FOREIGN LANGUAGE CAPABILITIES OF BABIES, INFANTS AND TODDLERS (U.S. CLS. 21, 23, 26, 36 AND 38).

FIRST USE 9-6-2001; IN COMMERCE 9-6-2001.

CLASS 16—PAPER GOODS AND PRINTED MATTER

FOR BOOKS AND PRINTED MATTER, NAMELY, FLASH CARDS, WORKBOOKS, POSTERS AND PRINTED INSTRUCTIONAL, EDUCATIONAL AND TEACHING MATERIALS TO DEVELOP THE FOREIGN LANGUAGE CAPABILITIES OF BABIES, INFANTS AND TODDLERS (U.S. CLS. 2, 5, 22, 23, 29, 37, 38 AND 50).

FIRST USE 9-6-2001; IN COMMERCE 9-6-2001.

CLASS 28—TOYS AND SPORTING GOODS

FOR DOLLS AND DOLL ACCESSORIES; GAMES AND PLAYTHINGS, NAMELY A CARD GAME IN THE NATURE OF A MEMORY GAME TO DEVELOP THE FOREIGN LANGUAGE CAPABILITIES OF BABIES, INFANTS AND TODDLERS (U.S. CLS. 22, 23, 38 AND 50).

FIRST USE 9-6-2001; IN COMMERCE 9-6-2001.

CLASS 41—EDUCATION AND ENTERTAINMENT

FOR PROVIDING EDUCATIONAL INFORMATION IN THE FIELD OF LANGUAGES AND LANGUAGE INSTRUCTION FOR BABIES, INFANTS AND TODDLERS OVER THE INTERNET (U.S. CLS. 100, 101 AND 107).

FIRST USE 8-27-2001; IN COMMERCE 8-27-2001.

2,626,875. GEOPHYSICAL SERVICE INCORPORATED, CALGARY, ALBERTA T2P 0L6, CANADA. SN 76-160,772. FILED P.R. 11-7-2000; AM. S.R. 9-7-2001.

GEOPHYSICAL SERVICE INCORPORATED

NO CLAIM IS MADE TO THE EXCLUSIVE RIGHT TO USE "SERVICE INCORPORATED", APART FROM THE MARK AS SHOWN.

CLASS 35—ADVERTISING AND BUSINESS

FOR LICENSING THE USE OF MARINE AND LAND SEISMIC, MAGNETIC AND GRAVITY DATA; TRANSCRIPTION OF MARINE AND LAND SEISMIC, MAGNETIC AND GRAVITY DATA (U.S. CLS. 100, 101 AND 102).

FIRST USE 7-0-1993; IN COMMERCE 7-0-1993.

CLASS 39—TRANSPORTATION AND STORAGE

2,626,928. PARK B. SMITH, INC., NEW YORK, NY. SN 76-271,310. FILED P.R. 6-14-2001; AM. S.R. 2-13-2002.

FOR ELECTRONIC STORAGE OF MARINE AND LAND SEISMIC, MAGNETIC AND GRAVITY DATA (U.S. CLS. 100 AND 105).

FIRST USE 7-0-1993; IN COMMERCE 7-0-1993.

CLASS 42—SCIENTIFIC, COMPUTER AND LEGAL SERVICES

FOR GEOPHYSICAL CONSULTING SERVICES TO THE EXPLORATION AND PRODUCTION PETROLEUM INDUSTRY; TRANSCRIPTION OF MARINE AND LAND SEISMIC, MAGNETIC AND GRAVITY DATA; ACQUIRING AND PROCESSING MARINE AND LAND SEISMIC, MAGNETIC AND GRAVITY DATA, NAMELY, RECORDING SEISMIC SOUND REFLECTIONS AND PROCESSING THIS INFORMATION INTO SEISMIC DATA REPORTS IN THE FORM OF PAPER SEISMIC SECTIONS, SHOT POINT MAPS, MAGNETIC TAPES AND CD ROMS; LEASING OF SEISMIC RECORDING (U.S. CLS. 100 AND 101).

FIRST USE 7-0-1993; IN COMMERCE 7-0-1993.

DRAW ● TIE ● SWAG

NO CLAIM IS MADE TO THE EXCLUSIVE RIGHT TO USE "SWAG", APART FROM THE MARK AS SHOWN.

CLASS 19—NON-METALLIC BUILDING MATERIALS

FOR WINDOW TREATMENTS, NAMELY, NON-METAL VALANCES (U.S. CLS. 1, 12, 33 AND 50).

FIRST USE 4-0-2001; IN COMMERCE 4-0-2001.

CLASS 20—FURNITURE AND ARTICLES NOT OTHERWISE CLASSIFIED

FOR WINDOW SHADES; WINDOW BLINDS (U.S. CLS. 2, 13, 22, 25, 32 AND 50).

FIRST USE 4-0-2001; IN COMMERCE 4-0-2001.

CLASS 24—FABRICS

FOR WINDOW TREATMENTS, NAMELY, CURTAINS, FABRIC WINDOW BLINDS, SWAGS, DRAPERIES, FABRIC VALANCES AND DRAPERY LINENS (U.S. CLS. 42 AND 50).

FIRST USE 4-0-2001; IN COMMERCE 4-0-2001.

2,626,894. ROSSINI, 75009 PARIS, FRANCE. SN 76-215,288. FILED P.R. 2-23-2001; AM. S.R. 1-22-2002.

ROSSINI

OWNER OF FRANCE REG. NO. 003025443, DATED 5-3-2000, EXPIRES 5-2-2010.

CLASS 35—ADVERTISING AND BUSINESS

FOR DISSEMINATING ADVERTISING FOR OTHERS; BUSINESS CONSULTATION; AUCTIONEERING SERVICES; DOCUMENT REPRODUCTION; PUBLIC RELATIONS; ORGANIZING EXHIBITIONS FOR AUCTIONS SALES AND APPRAISALS; AND RECORDS MANAGEMENT SERVICES, NAMELY, DOCUMENT INDEXING FOR OTHERS (U.S. CLS. 100, 101 AND 102).

CLASS 36—INSURANCE AND FINANCIAL

FOR APPRAISALS FOR INSURANCE CLAIMS OF PERSONAL PROPERTY, INCLUDING ART OBJECTS, ANTIQUES, JEWELRY, STAMPS, PAINTINGS, WINE, AND RUGS; NUMISMATIC APPRAISALS; AND RENTAL OF OFFICE SPACE (U.S. CLS. 100, 101 AND 102).

CLASS 42—SCIENTIFIC, COMPUTER AND LEGAL SERVICES

FOR TECHNICAL RESEARCH IN THE FIELD OF AUTHENTICATION, ORIGIN AND AGE OF OBJECTS; LEASING ACCESS TIME TO A COMPUTER DATABASE IN THE FIELD OF AUCTIONS, APPRAISALS, AND AUTHENTICATION OF OBJECTS; PRINTING SERVICES; AND LEGAL SERVICES (U.S. CLS. 100 AND 101).

2,626,987. PRICEWATERHOUSECOOPERS LLP, NEW YORK, NY. SN 76-328,375. FILED P.R. 10-22-2001; AM. S.R. 5-28-2002.

ADVANCEDBENCHMARKING**CLASS 35—ADVERTISING AND BUSINESS**

FOR BUSINESS MANAGEMENT CONSULTING AND ADVISORY SERVICES, NAMELY, PROVIDING ACCESS TO A DATABASE WITH COMPARATIVE BUSINESS OPERATIONAL AND FINANCIAL DATA; PROVIDING ANALYSIS AND REPORTS COMPARING A BUSINESS' OPERATIONAL AND FINANCIAL DATA TO THAT OF OTHER PRIVATE COMPANIES, ALL PROVIDED VIA A GLOBAL COMPUTER NETWORK (U.S. CLS. 100, 101 AND 102).

FIRST USE 9-25-2001; IN COMMERCE 9-25-2001.

CLASS 41—EDUCATION AND ENTERTAINMENT

FOR EDUCATIONAL SERVICES, NAMELY, PROVIDING TRAINING REGARDING DATA COLLECTION, PROVIDING TRAINING REGARDING COMPARATIVE ANALYSIS OF A COMPANY'S BUSINESS AND FINANCIAL DATA, AND PROVIDING TRAINING REGARDING USE OF SUCH ANALYSIS (U.S. CLS. 100, 101 AND 107).

FIRST USE 9-25-2001; IN COMMERCE 9-25-2001.

2,626,992. ADCHEM CORPORATION, RIVERHEAD, NY. SN 76-347,763. FILED P.R. 12-11-2001; AM. S.R. 5-6-2002.

THE ADHESIVE TAPE ENGINEERS

CLASS 40—MATERIAL TREATMENT

FOR CUSTOM MANUFACTURE OF ADHESIVE TAPE SYSTEMS AND ADHESIVE TAPES, INCLUDING SINGLE-COATED, DOUBLE-COATED AND TRANSFER TAPE PRODUCTS, FOR INDUSTRIAL AND CONSUMER APPLICATIONS (U.S. CLS. 100, 103 AND 106). FIRST USE 2-18-2001; IN COMMERCE 4-18-2001.

CLASS 42—SCIENTIFIC, COMPUTER AND LEGAL SERVICES

FOR DESIGN OF ADHESIVE TAPE SYSTEMS AND ADHESIVE TAPES, INCLUDING SINGLE-COATED, DOUBLE-COATED AND TRANSFER TAPE PRODUCTS, FOR INDUSTRIAL AND CONSUMER APPLICATIONS (U.S. CLS. 100 AND 101). FIRST USE 2-18-2001; IN COMMERCE 4-18-2001.

2,627,005. CHILAY FOODS, INC., CITY OF INDUSTRY, CA. SN 76-374,942. FILED P.R. 2-26-2002; AM. S.R. 7-9-2002.

ULTIMATE DIPS

NO CLAIM IS MADE TO THE EXCLUSIVE RIGHT TO USE "DIPS", APART FROM THE MARK AS SHOWN.

CLASS 29—MEATS AND PROCESSED FOODS

FOR GUACAMOLE (U.S. CL. 46). FIRST USE 11-1-2001; IN COMMERCE 11-1-2001.

CLASS 30—STAPLE FOODS

FOR SALSA (U.S. CL. 46). FIRST USE 11-1-2001; IN COMMERCE 11-1-2001.

2,627,008. ALLEN, CLINTON A, SANTA MONICA, CA. SN 78-002,126. FILED P.R. 4-1-2000; AM. S.R. 2-8-2002.

CAMPUSMAN

CLASS 38—COMMUNICATION

FOR PROVIDING ONLINE ELECTRONIC BULLETIN BOARDS AND CHAT ROOMS FOR TRANSMISSION OF MESSAGES AMONG COMPUTER USERS CONCERNING MEN'S INTERESTS, NAMELY SPORTS, STYLE, MUSIC, ENTERTAINMENT, NEWS, CELEBRITIES, LIFESTYLE, RELATIONSHIPS, INVESTING, FINANCES, MODELS, AND PARTIES AND EVENTS (U.S. CLS. 100, 101 AND 104). FIRST USE 4-1-2000; IN COMMERCE 4-1-2000.

CLASS 41—EDUCATION AND ENTERTAINMENT

FOR PROVIDING INFORMATION IN THE AREA OF MEN'S INTERESTS VIA A GLOBAL COMPUTER NETWORK, NAMELY SPORTS, STYLE, MUSIC, ENTERTAINMENT, NEWS, CELEBRITIES, LIFESTYLE, RELATIONSHIPS, INVESTING, FINANCES, MODELS, AND PARTIES AND EVENTS (U.S. CLS. 100, 101 AND 107). FIRST USE 4-1-2000; IN COMMERCE 4-1-2000.

* * * * *

SECTION 2.— INTERNATIONAL CLASSIFICATION

The short titles associated below with the international class numbers are terms designed merely for quick identification and are not an official part of the international classification. The full names of international classes are given in section 6.1 of the trademark rules of practice.

The designation "U.S. Cl." appearing in this section refers to the U.S. class in effect prior to Sep. 1, 1973 rather than the international class which applies to applications filed on or after that date. For adoption of international classification see notice in the OFFICIAL GAZETTE of Jun. 26, 1973 (911 O.G. TM 210).

Application in one class

CLASS 1—CHEMICALS

2,626,839. PRIVATE EYE SCAPE, LLC, NEW YORK, NY. SN 76-086,294. FILED P.R. 7-11-2000; AM. S.R. 8-9-2001.

AGGRESSIVE MALE REPELLENT

NO CLAIM IS MADE TO THE EXCLUSIVE RIGHT TO USE "MALE REPELLENT", APART FROM THE MARK AS SHOWN.

FOR SELF-DEFENSE REPELLENT SPRAY (U.S. CLS. 1, 5, 6, 10, 26 AND 46).
FIRST USE 8-1-2000; IN COMMERCE 8-1-2000.

2,626,901. MARINE BIOPRODUCTS INC., DELTA, BRITISH COLUMBIA, CANADA. SN 76-238,197. FILED P.R. 4-9-2001; AM. S.R. 1-25-2002.

DNA AGAR

NO CLAIM IS MADE TO THE EXCLUSIVE RIGHT TO USE "AGAR", APART FROM THE MARK AS SHOWN.

FOR ELECTROPHORESIS GEL MEDIA FOR USE IN THE SEPARATION, PURIFICATION AND ANALYSIS OF NUCLEIC FRAGMENTS, NAMELY, DNA, RNA, AND PCR PRODUCTS FOR SCIENTIFIC OR MEDICAL RESEARCH USE (U.S. CLS. 1, 5, 6, 10, 26 AND 46).
FIRST USE 3-31-2001; IN COMMERCE 3-31-2001.

CLASS 2—PAINTS

CLASS 2—(Continued).

2,626,771. CALIDAD HOLDINGS PTY LTD., NEW SOUTH WALES, 2011, AUSTRALIA. SN 75-664,583. FILED P.R. 3-22-1999; AM. S.R. 7-2-2001.

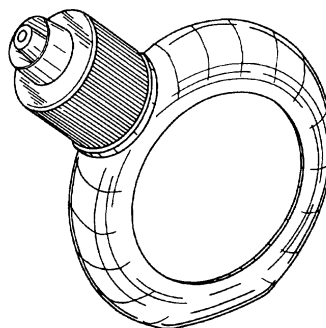

THE MARK IS A BOTTLE CONFIGURATION FOR PRINTING INK CONSISTING IN PART OF AN ANNULAR BOTTLE BODY HAVING A CENTRAL DEPRESSION, A FLATTENED BASE, AND A NOZZLE ON WHICH A BOTTLE CAP RESIDES.

FOR INK FOR REFILLING INK JET CARTRIDGES FOR USE IN INK JET PRINTERS; INK FOR PRINTING PURPOSES (U.S. CLS. 6, 11 AND 16).
FIRST USE 7-0-1996; IN COMMERCE 4-0-2000.

2,626,807. TNEMEC COMPANY, INC., KANSAS CITY, MO. SN 75-906,982. FILED P.R. 1-31-2000; AM. S.R. 1-2-2001.

EVEN FLOW SL

FOR SELF-LEVELING FLOOR COATING FOR CONCRETE (U.S. CLS. 6, 11 AND 16).
FIRST USE 2-0-2000; IN COMMERCE 2-0-2000.

CLASS 3—COSMETICS AND CLEANING PREPARATIONS

CLASS 3—(Continued).

2,627,018. PHARMWEST, INC., MARINA DEL REY, CA. SN 78-049,400. FILED P.R. 2-20-2001; AM. S.R. 3-18-2002.

NATURAL BEAUTY TECHNOLOGY

FOR SKIN CARE PREPARATIONS, NAMELY, CLEANSERS, CLARIFIERS, MOISTURIZERS, CONDITIONERS, TONERS, MASK, TOPICAL SKIN SPRAYS FOR COSMETIC PURPOSES, WRINKLE REMOVERS, BODY LOTION, NON-MEDICATED SKIN PROTECTOR, SUN SCREENS, CREAMS FOR CELLULITE REDUCTION, NON-MEDICATED SKIN SERUM, EYE CREAM AND LOTIONS (U.S. CLS. 1, 4, 6, 50, 51 AND 52).

FIRST USE 12-0-2001; IN COMMERCE 12-0-2001.

CLASS 5—(Continued).

2,626,847. SANTA CRUZ SPORTS AND NUTRITION, LLC, SANTA CRUZ, CA. SN 76-116,492. FILED P.R. 8-25-2000; AM. S.R. 6-10-2002.

SANTA CRUZ NATURALS

NO CLAIM IS MADE TO THE EXCLUSIVE RIGHT TO USE "NATURALS", APART FROM THE MARK AS SHOWN. FOR NUTRITIONAL SUPPLEMENTS (U.S. CLS. 6, 18, 44, 46, 51 AND 52).

FIRST USE 6-15-2000; IN COMMERCE 6-15-2000.

CLASS 5—PHARMACEUTICALS

2,626,753. NATURAL FACTORS NUTRITIONAL PRODUCTS LTD., BURNABY, BRITISH COLUMBIA, CANADA, BY CHANGE OF NAME GAHLER ENTERPRISES LTD., BURNABY, BRITISH COLUMBIA, CANADA. SN 74-473,113. FILED P.R. 12-27-1993; AM. S.R. 12-22-2000.

ENRICHING BEE FACTORS

PRIORITY CLAIMED UNDER SEC. 44(D) ON CANADA APPLICATION NO. 731727, FILED 6-24-1993, REG. NO. TMA463321, DATED 9-13-1996, EXPIRES 9-13-2011.

NO CLAIM IS MADE TO THE EXCLUSIVE RIGHT TO USE "BEE", APART FROM THE MARK AS SHOWN.

FOR VITAMIN AND MINERAL PREPARATIONS; DIETARY AND HERBAL SUPPLEMENTS SOLD IN RETAIL QUANTITIES THROUGH HEALTH FOOD STORES, PHARMACIES AND FOOD STORES (U.S. CLS. 6, 18, 44, 46, 51 AND 52).

FIRST USE 3-8-1996; IN COMMERCE 3-8-1996.

2,626,935. SANTEN PHARMACEUTICAL CO. LTD., OSAKA, JAPAN. SN 76-278,111. FILED P.R. 6-27-2001; AM. S.R. 10-11-2001.

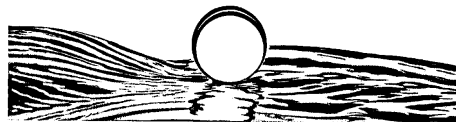

THE MARK CONSISTS OF A WATER WAVE AND A BALL FLOATING ON THE SURFACE OF THE WAVE.

FOR PHARMACEUTICALS, NAMELY, PREPARATIONS FOR THE TREATMENT OF EYE DISEASES; OPHTHALMIC ANTI-ALLERGY DRUGS (U.S. CLS. 6, 18, 44, 46, 51 AND 52).

FIRST USE 8-0-2000; IN COMMERCE 8-0-2000.

2,626,775. RHG AND COMPANY INC., MIDDLETOWN, CT. SN 75-688,076. FILED P.R. 4-22-1999; AM. S.R. 3-16-2000.

VERIFIED QUALITY NATURAL PRODUCTS

NO CLAIM IS MADE TO THE EXCLUSIVE RIGHT TO USE "NATURAL PRODUCTS", APART FROM THE MARK AS SHOWN.

FOR VITAMINS AND NUTRITIONAL SUPPLEMENTS (U.S. CLS. 6, 18, 44, 46, 51 AND 52).

FIRST USE 2-28-2000; IN COMMERCE 2-28-2000.

2,626,983. FREEMAN HEALTH SYSTEM, JOPLIN, MO. SN 76-321,932. FILED P.R. 10-9-2001; AM. S.R. 5-22-2002.

WOMEN'S PAVILION

FOR OUTPATIENT DIAGNOSTIC TESTING FOR WOMEN (U.S. CLS. 6, 18, 44, 46, 51 AND 52).

FIRST USE 1-1-2000; IN COMMERCE 1-1-2000.

2,626,815. VANMOOR, ARTHUR, BOCA RATON, FL. SN 76-002,043. FILED P.R. 3-16-2000; AM. S.R. 4-27-2001.

IMMUNE IMPROVER

FOR VITAMINS AND NUTRITIONAL SUPPLEMENTS (U.S. CLS. 6, 18, 44, 46, 51 AND 52).

FIRST USE 3-16-2000; IN COMMERCE 3-16-2000.

CLASS 6—METAL GOODS

CLASS 6—(Continued).

2,626,757. GENERAL TECHNOLOGIES, INC., STAFFORD, TX. SN 75-411,310. FILED P.R. 12-29-1997; AM. S.R. 7-30-1999.

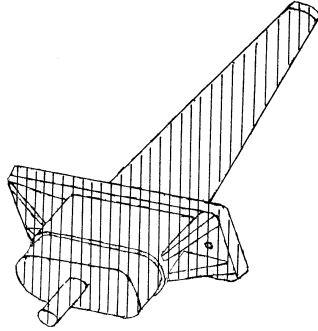

THE MARK AS SHOWN IN THE DRAWINGS IS LINED FOR THE COLOR MAROON.

THE MARK CONSISTS OF THE COLOR MAROON APPLIED TO THE PLASTIC ENCAPSULATION WHICH ENTIRELY SURROUNDS THE GOODS AND THE CONFIGURATION OF THE GOODS. THE RECTANGULAR AND OVAL SHAPES OF THE GOODS ARE NOT FEATURES OF THE MARK.

FOR MAROON PLASTIC ENCAPSULATED STEEL ANCHORS FOR MULTI-STRAND POST-TENSION SYSTEMS (U.S. CLS. 2, 12, 13, 14, 23, 25 AND 50).

FIRST USE 0-0-1998; IN COMMERCE 0-0-1998.

2,626,900. SCHWEISS DISTRIBUTING, INC., FAIRFAX, MN. SN 76-233,078. FILED P.R. 4-2-2001; AM. S.R. 4-12-2002.

LIFT STRAP

FOR METAL BI-FOLD DOORS (U.S. CLS. 2, 12, 13, 14, 23, 25 AND 50).
FIRST USE 5-30-1999; IN COMMERCE 5-30-1999.

CLASS 7—MACHINERY

2,626,804. MARINE EXHAUST SYSTEMS, INC., RIVIERA BEACH, FL. SN 75-901,192. FILED P.R. 1-21-2000; AM. S.R. 4-18-2001.

CROSSOVER SYSTEM

FOR ENGINE MUFFLERS FOR MARINE VESSELS (U.S. CLS. 13, 19, 21, 23, 31, 34 AND 35).
FIRST USE 11-30-1999; IN COMMERCE 11-30-1999.

CLASS 7—(Continued).

2,626,881. H2 FUELS, LLC, SPOKANE, WA. SN 76-178,505. FILED P.R. 12-7-2000; AM. S.R. 3-12-2002.

H2FUEL

FOR INDUSTRIAL PROCESSING EQUIPMENT COMPRISING FUEL PROCESSORS NAMELY A COMBINATION OF CATALYSTS, PROCESSES, VESSELS, CONTROLS, VALVES, PIPING AND HEATERS, BY WHICH A HYDROCARBON FUEL, SUCH AS METHANE, PROPANE, METHANOL, GASOLINE, NAPHTHA, AND DIESEL, IS CONVERTED TO A HYDROGEN-CONTAINING STREAM ALL SOLD AS A UNIT (U.S. CLS. 13, 19, 21, 23, 31, 34 AND 35).
FIRST USE 1-7-2002; IN COMMERCE 1-7-2002.

2,626,891. HI TIDE SALES, INC., FORT PIERCE, FL. SN 76-206,760. FILED P.R. 2-8-2001; AM. S.R. 11-23-2001.

GEAR-DRIVE

FOR POWER-OPERATED BOAT LIFTS (U.S. CLS. 13, 19, 21, 23, 31, 34 AND 35).
FIRST USE 5-24-2000; IN COMMERCE 6-6-2000.

CLASS 8—HAND TOOLS

2,627,026. AMERICAN TOOL COMPANIES, INC., HOFFMAN ESTATES, IL. SN 78-074,662. FILED P.R. 7-19-2001; AM. S.R. 2-21-2002.



THE MARK CONSISTS OF THE WORDS "THE PORTABLE SLIDE-ACTION VISE", THE WORDS "SLIDE-ACTION" PRESENTED IN THE COLOR YELLOW ONLY, AND THE WORDS "THE PORTABLE" AND "VISE" PRESENTED IN ANY CONTRASTING COLOR.

FOR HAND TOOLS, NAMELY PORTABLE VISES (U.S. CLS. 23, 28 AND 44).
FIRST USE 4-30-2001; IN COMMERCE 4-30-2001.

CLASS 9—ELECTRICAL AND SCIENTIFIC APPARATUS

CLASS 9—(Continued).

2,626,756. ACTIVESTATE CORPORATION, VANCOUVER BBC-BRITISH COLUMBIA, CANADA, BY CHANGE OF NAME ACTIVESTATE TOOL CORP., VANCOUVER BRITISH COLUMBIA, CANADA. SN 75-345,784. FILED P.R. 8-25-1997; AM. S.R. 3-20-2002.

VISUALPERL

FOR SOFTWARE, NAMELY, GRAPHICAL INTERFACE FOR DEVELOPING AND DEPLOYING NETWORK SYSTEM ADMINISTRATION PROGRAMS IN PRACTICAL EXTRACTION REPORT LANGUAGE (PERL) (U.S. CLS. 21, 23, 26, 36 AND 38).

FIRST USE 12-6-2000; IN COMMERCE 9-6-2001.

2,626,762. GENEALOGY.COM, LLC, FREMONT, CA, BY ASSIGNMENT; BY ASSIGNMENT BRODERBUND SOFTWARE, INC., NOVATO, CA. SN 75-545,754. FILED P.R. 9-1-1998; AM. S.R. 11-30-2001.

INTERNETREE

FOR FEATURE OF COMPUTER SOFTWARE FOR USE IN MANAGING, RECORDING AND GRAPHICALLY DEPICTING GENEALOGICAL HISTORICAL DATA, AND INSTRUCTIONAL MANUALS SUPPLIED AS UNIT (U.S. CLS. 21, 23, 26, 36 AND 38).

FIRST USE 4-16-1997; IN COMMERCE 4-16-1997.

2,626,763. SPORTS TACTICS L.C., WINDERMERE, FL. SN 75-569,176. FILED P.R. 10-13-1998; AM. S.R. 3-29-2001.

SPORTS TACTICS

FOR PRE-RECORDED VIDEO TAPES FEATURING INSTRUCTIONS AND TRAINING IN A VARIETY OF SPORT ACTIVITIES, INCLUDING GOLF; ELECTRONIC PUBLICATIONS, NAMELY COMPUTER GAME PROGRAMS, COMPUTER GAMES DISCS, COMPUTER GAME CASSETTES AND CARTRIDGES FEATURING INFORMATION ON SPORTS ACTIVITIES AND PUBLICATIONS RECORDED ON AUDIO TAPE, VIDEO TAPE, MAGNETIC DATA CARRIERS, RECORDING DISKS, DVD'S, COMPACT DISCS, DATA DISKETTES, AND VIDEO GAME SOFTWARE FEATURING INFORMATION ON SPORTS ACTIVITIES; PROTECTIVE AND SAFETY HEAD GEAR AND HELMETS (U.S. CLS. 21, 23, 26, 36 AND 38).

FIRST USE 3-0-2000; IN COMMERCE 3-0-2000.

CLASS 9—(Continued).

2,626,765. ENTERTAINMENT SYSTEMS TECHNOLOGY, INC., HUNTINGTON BEACH, CA. SN 75-608,010. FILED P.R. 12-18-1998; AM. S.R. 10-20-2000.

ENTERTAINMENT SYSTEMS TECHNOLOGY

NO CLAIM IS MADE TO THE EXCLUSIVE RIGHT TO USE "TECHNOLOGY", APART FROM THE MARK AS SHOWN.

FOR DOWNLOADABLE COMPUTER SOFTWARE FOR USE IN CREATING, PROJECTING, COMPRESSING, MANIPULATING AND TRACKING THREE-DIMENSIONAL GRAPHICAL IMAGES (U.S. CLS. 21, 23, 26, 36 AND 38).

FIRST USE 5-15-2000; IN COMMERCE 5-15-2000.

2,626,769. SIEMON COMPANY, THE, WATERTOWN, CT. SN 75-635,942. FILED P.R. 2-8-1999; AM. S.R. 1-28-2002.

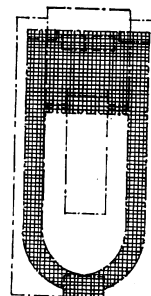

THE DRAWING IS LINED FOR THE COLOR YELLOW. THE MARK CONSISTS OF THE COLOR YELLOW AS APPLIED TO THE GOODS.

THE DOTTED OUTLINE OF THE GOODS IS INTENDED TO SHOW THE POSITION OF THE MARK AND IS NOT A PART OF THE MARK.

FOR TELECOMMUNICATIONS CONNECTORS, NAMELY, MODULAR PLUGS (U.S. CLS. 21, 23, 26, 36 AND 38).

FIRST USE 11-25-1998; IN COMMERCE 11-25-1998.

2,626,783. INTERNATIONAL BUSINESS MACHINES CORPORATION, ARMONK, NY. SN 75-756,017. FILED P.R. 7-20-1999; AM. S.R. 11-9-2001.

ENTERPRISE STORAGE SERVER

NO CLAIM IS MADE TO THE EXCLUSIVE RIGHT TO USE "SERVER", APART FROM THE MARK AS SHOWN.

FOR COMPUTER HARDWARE AND SOFTWARE IN THE FIELD OF MASS DATA STORAGE (U.S. CLS. 21, 23, 26, 36 AND 38).

FIRST USE 9-0-1999; IN COMMERCE 9-0-1999.

CLASS 9—(Continued).

2,626,789. AFCO, INC., MEMPHIS, TN. SN 75-829,320. FILED P.R. 10-22-1999; AM. S.R. 5-30-2002.

MEMPHIS CAR AUDIO

FOR SPEAKERS, AMPLIFIERS AND SIGNAL PROCESSORS FOR CUSTOM AUTOMOTIVE AUDIO SYSTEMS (U.S. CLS. 21, 23, 26, 36 AND 38).

FIRST USE 1-0-1998; IN COMMERCE 1-0-1998.

2,626,790. ESTUDIOLIVE, INC., CHELMSFORD, MA, BY CHANGE OF NAME ECHOLAB, INC., CHELMSFORD, MA. SN 75-831,882. FILED P.R. 10-25-1999; AM. S.R. 10-16-2000.

E-STUDIO

FOR VIDEO EQUIPMENT, NAMELY, COMPUTER HARDWARE, CONTROL PANELS, MODULAR FRAMES, AND VIDEO SWITCHERS USED FOR VIDEO PRODUCTION, VIDEO IMAGING, SPECIAL EFFECTS, AND BROADCASTING AND SIMULCASTING FOR TELEVISION AND INTERCONNECTED COMPUTER NETWORKS; COMPUTER SOFTWARE FOR USE IN VIDEO PRODUCTION, VIDEO IMAGING, SPECIAL EFFECTS, AND BROADCASTING AND SIMULCASTING FOR TELEVISION AND INTERCONNECTED COMPUTER NETWORKS (U.S. CLS. 21, 23, 26, 36 AND 38).

FIRST USE 9-10-1999; IN COMMERCE 9-10-1999.

2,626,799. UNCLE MILTON INDUSTRIES, INC., WESTLAKE VILLAGE, CA. SN 75-889,030. FILED P.R. 1-6-2000; AM. S.R. 4-19-2001.

STAR PLANETARIUM

NO CLAIM IS MADE TO THE EXCLUSIVE RIGHT TO USE "PLANETARIUM", APART FROM THE MARK AS SHOWN.

FOR HALOGEN CONSTELLATION AND STAR PHOTOGRAPHIC PROJECTORS (U.S. CLS. 21, 23, 26, 36 AND 38).

FIRST USE 5-9-1999; IN COMMERCE 5-9-1999.

2,626,801. OPENCONNECT SYSTEMS INCORPORATED, DALLAS, TX. SN 75-896,920. FILED P.R. 1-14-2000; AM. S.R. 9-17-2001.

NETWORK CALLABLE TRANSACTION

NO CLAIM IS MADE TO THE EXCLUSIVE RIGHT TO USE "NETWORK CALLABLE", APART FROM THE MARK AS SHOWN.

FOR COMPUTER SOFTWARE FOR APPLICATION AND OPERATING SYSTEM FUNCTIONS FOR USE IN ELECTRONIC COMMERCE ENTERPRISES OVER GLOBAL COMPUTER NETWORKS (U.S. CLS. 21, 23, 26, 36 AND 38).

FIRST USE 0-0-1999; IN COMMERCE 0-0-1999.

CLASS 9—(Continued).

2,626,818. MSC.SOFTWARE CORPORATION, FORMERLY THE MACNEAL-SCHWENDLER CORPORATION, LOS ANGELES, CA. SN 76-016,157. FILED P.R. 4-4-2000; AM. S.R. 12-29-2000.

SIMULATING REALITY

FOR COMPUTER PROGRAMS FOR ENGINEERING ANALYSIS OF STRUCTURES WITH VIRTUAL MODELS FOR COMPLETE STRUCTURAL, THERMAL, NON-LINEAR, DYNAMIC OR OTHER ANALYSIS (U.S. CLS. 21, 23, 26, 36 AND 38).

FIRST USE 6-0-1999; IN COMMERCE 6-0-1999.

2,626,826. USSERY, TROY A., PLANO, TX. SN 76-050,545. FILED P.R. 5-16-2000; AM. S.R. 4-2-2002.

BUSINESS-TO-INVESTOR

FOR COMPUTER SOFTWARE FOR ENABLING INTERNET-BASED COMMUNICATIONS BETWEEN INVESTORS AND PUBLICLY TRADED COMPANIES (U.S. CLS. 21, 23, 26, 36 AND 38).

FIRST USE 7-0-2000; IN COMMERCE 10-0-2000.

2,626,840. NETIQ CORPORATION, SANTA CLARA, CA. SN 76-091,570. FILED P.R. 7-17-2000; AM. S.R. 4-8-2002.

MISSION CRITICAL SOFTWARE FOR E-BUSINESS

FOR COMPUTER SOFTWARE FOR COMPUTER SYSTEM AND APPLICATION DEVELOPMENT, DEPLOYMENT AND MANAGEMENT (U.S. CLS. 21, 23, 26, 36 AND 38).

FIRST USE 6-5-2000; IN COMMERCE 6-5-2000.

2,626,842. GLASSER, ALAN, SANTA CLARITA, CA. SN 76-099,541. FILED P.R. 7-31-2000; AM. S.R. 4-29-2002.

THE SINGING JUDGE

FOR SERIES OF PRE-RECORDED COMPACT DISCS FEATURING MUSICAL SOUND RECORDINGS AND COMEDIC PERFORMANCES; A SERIES OF PRE-RECORDED AUDIO CASSETTES FEATURING MUSICAL SOUND RECORDINGS AND COMEDIC PERFORMANCES (U.S. CLS. 21, 23, 26, 36 AND 38).

FIRST USE 4-15-2000; IN COMMERCE 4-15-2000.

CLASS 9—(Continued).

2,626,843. ORTHOPEDIC SYSTEMS, INC., UNION CITY, CA. SN 76-102,680. FILED P.R. 8-3-2000; AM. S.R. 4-19-2002.

SWING DYNAMICS

OWNER OF U.S. REG. NO. 2,250,629.
FOR ANALYSIS SYSTEM, COMPRISED OF A MOTION FIELD GENERATOR AND SENSOR VEST, VIDEO CAMERAS, A WEIGHT SENSOR PLATFORM, AND COMPUTER SOFTWARE THAT CALCULATES THE GOLF SWING AND BALL FLIGHT DATA AND ALLOWS FOR THE RECALL OF DATA AND IMAGES IN THE FIELD OF GOLF INSTRUCTION AND ANALYSIS FOR GOLF EQUIPMENT (U.S. CLS. 21, 23, 26, 36 AND 38).

FIRST USE 12-5-1997; IN COMMERCE 12-5-1997.

2,626,866. GENESIS MICROCHIP INC., THORNHILL, ONTARIO, CANADA. SN 76-137,351. FILED P.R. 9-27-2000; AM. S.R. 7-30-2001.

ULTRA-RELIABLE DVI

FOR INTEGRATED CIRCUITS, CRT DISPLAYS, AND FLAT-PANEL DISPLAYS (U.S. CLS. 21, 23, 26, 36 AND 38).

FIRST USE 8-30-2000; IN COMMERCE 9-15-2000.

2,626,867. KREUTER MANUFACTURING CO., INC., NEW PARIS, IN. SN 76-141,193. FILED P.R. 10-5-2000; AM. S.R. 3-11-2002.

WEBLAN

FOR HVAC DIGITAL CONTROLLER AND ASSOCIATED SOFTWARE (U.S. CLS. 21, 23, 26, 36 AND 38).

FIRST USE 9-0-2000; IN COMMERCE 9-0-2000.

2,626,868. MTS SYSTEMS CORPORATION, EDEN PRAIRIE, MN. SN 76-141,379. FILED P.R. 10-5-2000; AM. S.R. 9-4-2001.

SERVOSENSOR

FOR POSITION SENSOR AND SERVO CONTROLLER COUPLED TO THE SENSOR AND SOLD AS A UNIT FOR CLOSED LOOP CONTROL OF HYDRAULIC, PNEUMATIC, AND ELECTROMECHANICAL ACTUATORS (U.S. CLS. 21, 23, 26, 36 AND 38).

FIRST USE 4-14-1999; IN COMMERCE 4-14-1999.

CLASS 9—(Continued).

2,626,872. PELTOR AB, VARNAMO S-331 02, SWEDEN. SN 76-147,781. FILED P.R. 10-16-2000; AM. S.R. 5-16-2002.

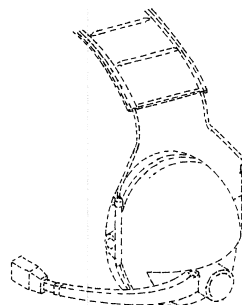

THE MARK CONSISTS OF THE COLOR WHITE AS APPLIED TO THE EAR CUPS OF AVIATION HEADSETS. THE DOTTED LINES SHOWN IN THE DRAWING OF THE MARK ARE INTENDED TO SHOW THE POSITION OF THE MARK, AND ARE NOT PART OF THE MARK.

FOR AVIATION HEADSETS (U.S. CLS. 21, 23, 26, 36 AND 38).

FIRST USE 7-0-1984; IN COMMERCE 7-0-1984.

2,626,878. WATERS INDUSTRIES, INC., WEST DUNDEE, IL. SN 76-168,474. FILED P.R. 11-20-2000; AM. S.R. 4-29-2002.

PERFECTION OPTICS

NO CLAIM IS MADE TO THE EXCLUSIVE RIGHT TO USE "OPTICS", APART FROM THE MARK AS SHOWN.

FOR NONPRESCRIPTION MAGNIFIER EYEGLASSES FOR RETAIL SALE, NAMELY THROUGH DEPARTMENT AND GROCERY STORES (U.S. CLS. 21, 23, 26, 36 AND 38).

FIRST USE 4-0-2001; IN COMMERCE 5-0-2001.

2,626,884. NORTH AMERICAN MEMBERSHIP GROUP INC., MINNETONKA, MN. SN 76-183,905. FILED P.R. 12-20-2000; AM. S.R. 4-9-2002.

NORTH AMERICAN HUNTER

OWNER OF U.S. REG. NOS. 1,206,787, 1,213,653, AND 1,235,693.

FOR BINOCULARS AND SPOTTING SCOPES (U.S. CLS. 21, 23, 26, 36 AND 38).

FIRST USE 8-16-2001; IN COMMERCE 8-16-2001.

CLASS 9—(Continued).

2,626,915. ICP GLOBAL TECHNOLOGIES, MONTREAL, QUEBEC, CANADA. SN 76-255,870. FILED P.R. 5-14-2001; AM. S.R. 4-26-2002.

POCKETPV

FOR SOLAR PHOTOVOLTAIC PANEL USED TO GENERATE POWER (U.S. CLS. 21, 23, 26, 36 AND 38). FIRST USE 4-6-2001; IN COMMERCE 6-4-2001.

2,626,934. AMERICAN PSYCHOLOGICAL ASSOCIATION, WASHINGTON, DC. SN 76-277,207. FILED P.R. 6-27-2001; AM. S.R. 4-23-2002.

EMOTION

FOR DOWNLOADABLE ELECTRONIC JOURNAL PERTAINING TO PSYCHOLOGICAL TOPICS PERIODICALLY PUBLISHED AND DISTRIBUTED TO MEMBERS AND TO OTHER PERSONS IN THE PSYCHOLOGICAL AND SOCIAL SCIENCE COMMUNITIES (U.S. CLS. 21, 23, 26, 36 AND 38). FIRST USE 6-0-2001; IN COMMERCE 6-0-2001.

2,626,942. IACCESS, INC., BLUFFDALE, UT. SN 76-287,448. FILED P.R. 7-19-2001; AM. S.R. 4-15-2002.

CONTENTAUDIT

FOR COMPUTER SOFTWARE FOR HOME AND BUSINESS, NAMELY, WORLD WIDE WEB-BASED SOFTWARE FOR IDENTIFYING OBJECTIONABLE CONTENT IN COMPUTER READABLE FILES THAT ARE LOCATED ON A LOCAL COMPUTER HARD DRIVE OR REMOVABLE MEDIA (U.S. CLS. 21, 23, 26, 36 AND 38). FIRST USE 10-1-2001; IN COMMERCE 10-1-2001.

2,626,943. WITTENBERG, GEORGE J., RANCHO PALOS VERDES, CA. SN 76-288,914. FILED P.R. 7-20-2001; AM. S.R. 3-7-2002.

DECISION MINING

FOR COMPUTER SOFTWARE USED FOR RUNNING DECISION MAKING SIMULATIONS (U.S. CLS. 21, 23, 26, 36 AND 38). FIRST USE 4-1-2001; IN COMMERCE 4-1-2001.

2,626,948. ELECTRONIC INDUSTRIES CORP., PLEASANTVILLE, NJ. SN 76-292,671. FILED P.R. 7-30-2001; AM. S.R. 12-21-2001.

RACING BINOCS**CLASS 9—(Continued).**

NO CLAIM IS MADE TO THE EXCLUSIVE RIGHT TO USE "BINOCS", APART FROM THE MARK AS SHOWN. FOR BINOCULARS (U.S. CLS. 21, 23, 26, 36 AND 38). FIRST USE 4-15-2001; IN COMMERCE 4-15-2001.

2,626,962. HORSE FENCE DIRECT, LLC, FRIDLEY, MN. SN 76-302,568. FILED P.R. 8-21-2001; AM. S.R. 3-6-2002.

EQUINEMESH

FOR ELECTRIC FENCES (U.S. CLS. 21, 23, 26, 36 AND 38). FIRST USE 7-2-2001; IN COMMERCE 7-2-2001.

2,626,977. BOSTON ANCHOR, INC., QUINCY, MA. SN 76-317,087. FILED P.R. 9-24-2001; AM. S.R. 1-28-2002.

BOSTON ANCHOR, INC.

NO CLAIM IS MADE TO THE EXCLUSIVE RIGHT TO USE "ANCHOR, INC.", APART FROM THE MARK AS SHOWN. FOR SAFETY ANCHORS USED FOR FALL ARREST SYSTEMS (U.S. CLS. 21, 23, 26, 36 AND 38). FIRST USE 8-6-2001; IN COMMERCE 8-6-2001.

2,627,006. LC TECHNOLOGY INTERNATIONAL, INC., CLEARWATER, FL. SN 76-378,134. FILED 3-1-2002.

PHOTORECOVERY

FOR COMPUTER SOFTWARE FOR RECOVERING DELETED IMAGES OFF OF FLOPPY DISKS AND DIGITAL FILM (U.S. CLS. 21, 23, 26, 36 AND 38). FIRST USE 1-18-2002; IN COMMERCE 1-18-2002.

2,627,014. NEARTEK INC., WILMINGTON, DE. SN 78-030,943. FILED P.R. 10-17-2000; AM. S.R. 4-19-2002.

VIRTUAL STORAGE ENGINE

FOR COMPUTER HARDWARE; COMPUTER SOFTWARE, NAMELY, APPLICATIONS FOR MANAGING, STORING AND SAVING DATA, IMAGES AND RELATED INFORMATION (U.S. CLS. 21, 23, 26, 36 AND 38). FIRST USE 12-31-2000; IN COMMERCE 12-31-2000.

CLASS 9—(Continued).

2,627,028. XPOINT TECHNOLOGIES, INC., BOCA RATON, FL. SN 78-079,831. FILED P.R. 8-17-2001; AM. S.R. 3-25-2002.

MANAGED RECOVERY

FOR COMPUTER SOFTWARE FOR THE PROVISION OF COMPLETE RECOVERY MANAGEMENT FOR DESKTOP AND MOBILE COMPUTER SYSTEMS AND FOR THE SIMULTANEOUS USE OF END USERS TO LOCALLY MANAGE THEIR OWN DATA BACK-UP AND RECOVERY OPERATIONS (U.S. CLS. 21, 23, 26, 36 AND 38).

FIRST USE 10-9-2001; IN COMMERCE 10-9-2001.

2,627,030. A BROWN SOUN, INC., SAN RAFAEL, CA. SN 78-088,431. FILED P.R. 10-15-2001; AM. S.R. 6-24-2002.

HEMPCONE

FOR COMPONENT OF AN AUDIO SPEAKER MADE IN PART OF HEMP (U.S. CLS. 21, 23, 26, 36 AND 38).

FIRST USE 9-27-2001; IN COMMERCE 10-1-2001.

2,627,031. KATSURANIS, RONALD M., BELMONT, CA. SN 78-096,031. FILED P.R. 11-30-2001; AM. S.R. 5-30-2002.

VOICETEACH

FOR INTERACTIVE VOICE RECOGNITION COMPUTER TUTORIAL SOFTWARE PROGRAMS FOR END USERS FEATURING INSTRUCTION IN THE FIELD OF SPEECH RECOGNITION PROGRAMS (U.S. CLS. 21, 23, 26, 36 AND 38).

FIRST USE 1-6-2001; IN COMMERCE 1-6-2001.

2,627,035. KRUSE, GARY, L. GLENWOOD, IA. SN 78-102,017. FILED P.R. 1-10-2002; AM. S.R. 5-28-2002.

WEB EQUITY MANAGER

FOR COMPUTER SOFTWARE DESIGNED FOR USE BY LENDING INSTITUTIONS TO DETERMINE THE CREDIT WORTHINESS OF VARIOUS CUSTOMER LOAN REQUESTS WITHIN AN INFORMATION TECHNOLOGY ENVIRONMENT THAT UTILIZES INTERNET-BASED PROTOCOLS (U.S. CLS. 21, 23, 26, 36 AND 38).

FIRST USE 1-30-2001; IN COMMERCE 10-1-2001.

CLASS 10—MEDICAL APPARATUS

2,626,787. APPLIED MEDICAL RESOURCES CORPORATION, LAGUNA HILLS, CA. SN 75-789,966. FILED P.R. 9-1-1999; AM. S.R. 6-14-2001.

ARTERIAL PLUG CATHETER**CLASS 10—(Continued).**

NO CLAIM IS MADE TO THE EXCLUSIVE RIGHT TO USE "ARTERIAL" AND "CATHETER", APART FROM THE MARK AS SHOWN.

FOR MEDICAL AND SURGICAL DEVICES, NAMELY, ARTERIAL CATHETERS (U.S. CLS. 26, 39 AND 44).

FIRST USE 2-1-2000; IN COMMERCE 2-1-2000.

2,626,793. MEDICAL RESEARCH LABORATORIES, INC., BUFFALO GROVE, IL. SN 75-855,667. FILED P.R. 11-22-1999; AM. S.R. 3-14-2002.

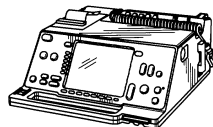

FOR MULTI-PARAMETER PATIENT MONITORING DEVICE, NAMELY, RESPIRATION MONITOR AND HEART MONITOR; HEART PACEMAKER AND DEFIBRILLATOR (U.S. CLS. 26, 39 AND 44).

FIRST USE 3-1-1998; IN COMMERCE 3-1-1998.

2,626,889. R & G MEDICAL AND DEVELOPMENT CORPORATION, BOCA RATON, FL. SN 76-194,996. FILED P.R. 1-16-2001; AM. S.R. 11-9-2001.

SELPAP

FOR MEDICAL INSTRUMENTS, NAMELY, A DISPOSABLE COLLECTION DEVICE USED TO OBTAIN CELLS FROM A WOMAN'S CERVIX AS PART OF SCREENING FOR CERVICAL CANCER; MEDICAL INSTRUMENTS FOR CERVICAL CELL SAMPLING, NAMELY, MEDICAL SYRINGES AND GLOVES FOR MEDICAL USE (U.S. CLS. 26, 39 AND 44).

FIRST USE 3-17-2000; IN COMMERCE 3-17-2000.

2,626,899. WALGREEN CO., DEERFIELD, IL. SN 76-228,638. FILED P.R. 3-22-2001; AM. S.R. 5-20-2002.

FAST READ

FOR MEDICAL APPARATUS, NAMELY, DIGITAL THERMOMETERS (U.S. CLS. 26, 39 AND 44).

FIRST USE 7-31-2001; IN COMMERCE 7-31-2001.

CLASS 10—(Continued).

2,627,004. GENX INTERNATIONAL, INCORPORATED, GUILFORD, CT. SN 76-372,036. FILED P.R. 2-19-2002; AM. S.R. 6-7-2002.

COHEN CATHETER

NO CLAIM IS MADE TO THE EXCLUSIVE RIGHT TO USE "CATHETER", APART FROM THE MARK AS SHOWN. FOR MEDICAL INSTRUMENT USED FOR THE INTRODUCTION OF EMBRYOS INTO THE UTERINE CAVITY FOLLOWING IN VITRO FERTILIZATION (U.S. CLS. 26, 39 AND 44).

FIRST USE 1-31-2002; IN COMMERCE 1-31-2002.

CLASS 11—ENVIRONMENTAL CONTROL APPARATUS

2,626,791. BEADLE, JOSHUA, SAN DIEGO, CA. AND BEADLE, ELEANOR, SAN DIEGO, CA. SN 75-834,060. FILED P.R. 10-28-1999; AM. S.R. 3-29-2002.

LUMINEUX

"LUMINEUX" IS FRENCH FOR "LUMINOUS". FOR DECORATIVE ENVIRONMENTAL LIGHTING SYSTEMS, NAMELY ELECTRICAL LIGHTING FIXTURES AND ELECTRICAL LIGHT BULBS, REFLECTORS FOR ELECTRICAL LIGHTING, ELECTRICAL LIGHTING DIFFUSERS, BAFFLES FOR ELECTRICAL LIGHTING, ELECTRICAL LIGHTING FILTERS, ELECTRIC LIGHT MOUNTING GROUND SPIKES, AND ELECTRIC LIGHTING RISERS, ALL FOR ELECTRICAL LIGHTING FIXTURES (U.S. CLS. 13, 21, 23, 31 AND 34).

FIRST USE 10-10-2001; IN COMMERCE 10-10-2001.

2,626,844. AQUARIA, INC., MOORPARK, CA. SN 76-110,371. FILED P.R. 8-16-2000; AM. S.R. 5-13-2002.

DUAL-TEMP

FOR AQUARIUM HEATERS (U.S. CLS. 13, 21, 23, 31 AND 34).

FIRST USE 6-21-2000; IN COMMERCE 8-1-2000.

2,626,870. MARTECH MARKETING LIMITED, EDMONTON, ALBERTA, CANADA. SN 76-145,004. FILED P.R. 10-12-2000; AM. S.R. 4-30-2002.

CONVEX

OWNER OF CANADA REG. NO. 484778, DATED 10-29-1997, EXPIRES 10-29-2012.

FOR LIGHTING CONTROL ACCESSORIES FOR ELECTRIC LIGHTING FIXTURES, NAMELY, PRISMATIC SHEETS, LOUVERS, AND PANELS MADE OF ACRYLIC, ALUMINUM OR STYRENE; FLUORESCENT LIGHTING TUBE GUARDS AND VAPOR PROOF ENCLOSURES; PROTECTIVE LIGHT GUARDS MADE OF METAL IN THE NATURE OF WIRE GUARDS; AND PLASTIC REPLACEMENT LIGHTING GLOBES (U.S. CLS. 13, 21, 23, 31 AND 34).

CLASS 11—(Continued).

2,626,916. NATIONAL AUTOMOTIVE MANUFACTURING, INC., MCPHERSON, KS. SN 76-256,299. FILED P.R. 5-11-2001; AM. S.R. 5-2-2002.

NATIONAL AUTOMOTIVE MANUFACTURING, INC.

NO CLAIM IS MADE TO THE EXCLUSIVE RIGHT TO USE "INC.", APART FROM THE MARK AS SHOWN.

FOR METAL FABRICATED PRODUCTS FOR AUTOMOTIVE USE, NAMELY, EXHAUST MANIFOLDS, BEARING RETAINERS, HARMONIC BALANCES, AND OIL PANS (U.S. CLS. 13, 21, 23, 31 AND 34).

FIRST USE 1-1-2002; IN COMMERCE 1-1-2002.

2,626,978. MELITTA HAUSHALTSPRODUKTE GMBH & CO. KG, D-32427 MINDEN, FED REP GERMANY. SN 76-317,695. FILED P.R. 9-26-2001; AM. S.R. 5-24-2002.

MILL & BREW

FOR AUTOMATIC ELECTRIC COFFEEMAKERS (U.S. CLS. 13, 21, 23, 31 AND 34).

FIRST USE 4-0-1999; IN COMMERCE 4-0-1999.

2,627,016. CHEN, ZHI, OVERLAND PARK, KS. SN 78-040,778. FILED P.R. 12-27-2000; AM. S.R. 7-8-2002.

BACER

FOR AIR CONDITIONERS, FREEZERS, REFRIGERATORS, DEHUMIDIFIERS, WATER SOFTENERS, WATER HEATERS FOR COMMERCIAL USE, WATER HEATERS FOR DOMESTIC USE, SOLAR WATER HEATING SYSTEMS COMPRISING SOLAR COLLECTORS, STORAGE TANKS, PIPING AND WATER HEATERS (U.S. CLS. 13, 21, 23, 31 AND 34).

FIRST USE 10-18-2001; IN COMMERCE 10-18-2002.

2,627,029. GROUND SPECIALTIES, INC., MILACA, MN. SN 78-084,156. FILED P.R. 9-17-2001; AM. S.R. 6-11-2002.

GROUND SPECIALTIES INCORPORATED

NO CLAIM IS MADE TO THE EXCLUSIVE RIGHT TO USE "INCORPORATED", APART FROM THE MARK AS SHOWN.

FOR GROUND THAWING EQUIPMENT AND ACCESSORIES, NAMELY, A SELF-CONTAINED HEATING SYSTEM COMPRISING A THAW BODY AND AT LEAST ONE HEATING ELEMENT USED TO THAW FROZEN EARTH (U.S. CLS. 13, 21, 23, 31 AND 34).

FIRST USE 8-1-2000; IN COMMERCE 8-1-2000.

CLASS 12—VEHICLES

CLASS 12—(Continued).

2,626,858. BCATCO ARL, ST. HELLIER, JERSEY JE2 3JW, CHANNEL ISLANDS. SN 76-136,459. FILED P.R. 9-27-2000; AM. S.R. 11-9-2001.

SAND TIRE

NO CLAIM IS MADE TO THE EXCLUSIVE RIGHT TO USE "TIRE", APART FROM THE MARK AS SHOWN, FOR TIRES (U.S. CLS. 19, 21, 23, 31, 35 AND 44). FIRST USE 6-1-2000; IN COMMERCE 6-1-2000.

2,626,902. SUZUKI MOTOR CORPORATION, SHIZUOKA-PREF. 432-8611, JAPAN. SN 76-241,118. FILED P.R. 4-13-2001; AM. S.R. 5-28-2002.

VINSON

FOR VEHICLES, NAMELY, ALL TERRAIN VEHICLES, AND STRUCTURAL PARTS AND FITTINGS THEREFOR (U.S. CLS. 19, 21, 23, 31, 35 AND 44). FIRST USE 8-0-2001; IN COMMERCE 8-0-2001.

2,626,921. HUBMAR INC., QUE, CANADA. SN 76-261,230. FILED P.R. 5-23-2001; AM. S.R. 3-22-2002.

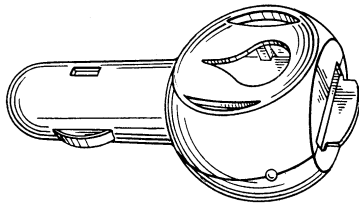

THE LINING IS NOT A FEATURE OF THE MARK AND IS FOR SHADING PURPOSES ONLY.

THE MARK CONSISTS OF THE CONFIGURATION OF A PLUG-IN AIR FRESHENER CONTAINER FOR A CAR COMPRISING A SPHERICAL CONTAINER AND A CYLINDRICAL PLUG-IN PORTION.

FOR DISPENSING UNITS FOR CAR AIR FRESHENERS (U.S. CLS. 19, 21, 23, 31, 35 AND 44).

FIRST USE 12-15-1998; IN COMMERCE 12-15-1998.

CLASS 13—FIREARMS**CLASS 13—(Continued).**

2,626,846. ORICA EXPLOSIVES TECHNOLOGY PTY. LTD., MELBOURNE, VICTORIA, 3000, AUSTRALIA. SN 76-114,229. FILED P.R. 8-21-2000; AM. S.R. 9-7-2001.

DIGITAL ENERGY CONTROL

FOR EXPLOSIVES, BULK AND PACKAGED EXPLOSIVES; EXPLOSIVES COMPOSITIONS FOR USE BY USERS OF EXPLOSIVES IN THE MINING, CONSTRUCTION, EXCAVATION INDUSTRIES; ELECTRIC AND NON-ELECTRIC EXPLOSIVE INITIATORS, NAMELY DEVICES USED TO DETONATE EXPLOSIVES; DETONATORS; EXPLOSIVES ACCESSORIES NAMELY ELECTRIC AND NON-ELECTRIC SHOCK WAVE CONDUCTORS, PLASTIC OR METALLIC SHOCK TUBING, TRANSMITTER CAPS, CONNECTING BLOCKS, PRIMERS, BOOSTERS, AND ELECTRIC AND NON-ELECTRIC FUSES (U.S. CLS. 2 AND 9). FIRST USE 9-30-2000; IN COMMERCE 9-30-2000.

CLASS 16—PAPER GOODS AND PRINTED MATTER

2,626,754. IDG BOOKS WORLDWIDE, INC., FOSTER CITY, CA, BY ASSIGNMENT; BY MERGER INTERNATIONAL DATA GROUP, INC., FRAMINGHAM, MA. SN 74-650,282. FILED P.R. 3-22-1995; AM. S.R. 2-12-1997.

WEBMEDIA

FOR BOOKS IN THE FIELD OF COMPUTERS, COMMUNICATIONS AND INFORMATION TECHNOLOGY (U.S. CLS. 2, 5, 22, 23, 29, 37, 38 AND 50). FIRST USE 12-3-1996; IN COMMERCE 12-3-1996.

2,626,774. DIET FITNESS CORPORATION, GILBERT, AZ. SN 75-684,549. FILED P.R. 4-14-1999; AM. S.R. 4-12-2000.

THE ARIZONA DIET

NO CLAIM IS MADE TO THE EXCLUSIVE RIGHT TO USE "DIET", APART FROM THE MARK AS SHOWN.

FOR PUBLICATIONS, NAMELY PAMPHLETS, BROCHURES, NEWSLETTERS AND JOURNALS FEATURING DIET AND EXERCISE PLANS AND PROGRAMS (U.S. CLS. 2, 5, 22, 23, 29, 37, 38 AND 50).

FIRST USE 2-1-1996; IN COMMERCE 3-1-1996.

2,626,883. CRUISESHIPCENTERS WESTERN CANADA LTD., VANCOUVER, BRITISH COLUMBIA. SN 76-183,319. FILED P.R. 12-20-2000; AM. S.R. 5-7-2002.

CRUISESHIPNEWS

PRIORITY CLAIMED UNDER SEC. 44(D) ON CANADA APPLICATION NO. 1073865, FILED 9-6-2000.

OWNER OF U.S. REG. NOS. 1,521,374 AND 2,420,453.

FOR PRINTED PUBLICATIONS, NAMELY, NEWSLETTERS AND MAGAZINES BOTH IN THE FIELD OF TRAVEL AND VACATION PLANNING (U.S. CLS. 2, 5, 22, 23, 29, 37, 38 AND 50).

FIRST USE 7-0-1996; IN COMMERCE 4-1-1998.

CLASS 16—(Continued).

2,626,892. ESI INTERNATIONAL, ARLINGTON, VA. SN 76-209,308. FILED P.R. 2-13-2001; AM. S.R. 1-17-2002.

RAM

FOR WRITTEN MATERIALS, NAMELY, BOOKS AND BROCHURES IN THE FIELD OF PROJECT VIABILITY ASSESSMENT WHICH ASSESSES THE RISK INVOLVED TO SUCCESSFULLY PURSUE AND COMPLETE ANY PROJECT (U.S. CLS. 2, 5, 22, 23, 29, 37, 38 AND 50).
FIRST USE 6-0-1999; IN COMMERCE 6-0-1999.

2,626,929. FEEDING FRENZY, INC., SUMMERVILLE, SC. SN 76-272,817. FILED P.R. 6-18-2001; AM. S.R. 2-21-2002.

CHARLESTON CUISINE

FOR PRINTED PUBLICATIONS, NAMELY, MAGAZINES IN THE FIELD OF RESTAURANTS (U.S. CLS. 2, 5, 22, 23, 29, 37, 38 AND 50).
FIRST USE 3-0-1998; IN COMMERCE 3-0-1998.

2,626,930. FEEDING FRENZY, INC., SUMMERVILLE, SC. SN 76-272,818. FILED P.R. 6-18-2001; AM. S.R. 2-21-2002.

NEW ORLEANS CUISINE

FOR PRINTED PUBLICATIONS, NAMELY, MAGAZINES IN THE FIELD OF RESTAURANTS (U.S. CLS. 2, 5, 22, 23, 29, 37, 38 AND 50).
FIRST USE 9-0-1999; IN COMMERCE 9-0-1999.

2,626,937. PLAYOFF CORPORATION, GRAND PRAIRIE, TX. SN 76-281,601. FILED P.R. 7-9-2001; AM. S.R. 6-21-2002.

ROOKIES & STARS

FOR SPORTS TRADING CARDS AND GAME CARDS (U.S. CLS. 2, 5, 22, 23, 29, 37, 38 AND 50).
FIRST USE 12-0-1998; IN COMMERCE 12-0-1998.

2,626,938. AMERICAN PSYCHOLOGICAL ASSOCIATION, WASHINGTON, DC. SN 76-281,622. FILED 7-9-2001.

EMOTION

FOR PRINTED JOURNALS PERTAINING TO THE PSYCHOLOGICAL AND SOCIAL SCIENCES (U.S. CLS. 2, 5, 22, 23, 29, 37, 38 AND 50).
FIRST USE 6-0-2001; IN COMMERCE 6-0-2001.

CLASS 16—(Continued).

2,626,954. SPARE PARTS PUBLISHING, LLC, WESTWOOD, NJ. SN 76-294,405. FILED P.R. 8-3-2001; AM. S.R. 6-7-2002.

USHistory^{MONTHLY}

NO CLAIM IS MADE TO THE EXCLUSIVE RIGHT TO USE "MONTHLY", APART FROM THE MARK AS SHOWN. "US" AND "MONTHLY" APPEAR IN BLUE AND "HISTORY" IS IN RED, AND COLOR IS CLAIMED AS A FEATURE OF THE MARK.

FOR PUBLICATIONS NAMELY, NEWSPAPER AND NEWS MAGAZINE PERTAINING TO HISTORY AND HISTORICAL TOPICS (U.S. CLS. 2, 5, 22, 23, 29, 37, 38 AND 50).
FIRST USE 2-2-2001; IN COMMERCE 2-2-2001.

2,626,958. US WEEKLY LLC, NEW YORK, NY. SN 76-298,128. FILED P.R. 8-11-2001; AM. S.R. 4-1-2002.

THE RECORD

FOR ENTERTAINMENT MAGAZINE COLUMN FEATURING CURRENT NEWS AND EVENTS, FOCUSING ON THE ENTERTAINMENT INDUSTRY (U.S. CLS. 2, 5, 22, 23, 29, 37, 38 AND 50).
FIRST USE 3-27-2000; IN COMMERCE 3-27-2000.

2,626,966. MEREDITH CORPORATION, DES MOINES, IA. SN 76-309,006. FILED P.R. 9-5-2001; AM. S.R. 5-14-2002.



OWNER OF U.S. REG. NO. 745,656.

FOR PRINTED PUBLICATIONS, NAMELY A SECTION OF A MAGAZINE FEATURING TECHNIQUES, INSTRUCTIONS, AND INFORMATION RELATING TO GARDENING, LANDSCAPING, HORTICULTURE, FLORICULTURE, AND OUTDOOR PROJECTS (U.S. CLS. 2, 5, 22, 23, 29, 37, 38 AND 50).
FIRST USE 2-11-1999; IN COMMERCE 2-11-1999.

CLASS 16—(Continued).

2,626,968. MEREDITH CORPORATION, DES MOINES, IA. SN 76-309,332. FILED P.R. 9-6-2001; AM. S.R. 5-14-2002.

BETTER HOMES AND GARDENS TEST GARDEN

OWNER OF U.S. REG. NO. 754,656.
FOR PRINTED PUBLICATIONS, NAMELY A SECTION OF A MAGAZINE FEATURING TECHNIQUES, INSTRUCTIONS, AND INFORMATION RELATING TO GARDENING, LANDSCAPING, HORTICULTURE, FLORICULTURE, AND OUTDOOR PROJECTS (U.S. CLS. 2, 5, 22, 23, 29, 37, 38 AND 50).
FIRST USE 2-11-1999; IN COMMERCE 2-11-1999.

2,626,972. CREATIVE IMPRESSIONS, INC., BUENA PARK, CA. SN 76-311,517. FILED P.R. 9-11-2001; AM. S.R. 5-13-2002.

4-VIEW BINDER

NO CLAIM IS MADE TO THE EXCLUSIVE RIGHT TO USE "BINDER", APART FROM THE MARK AS SHOWN.
FOR RING BINDERS (U.S. CLS. 2, 5, 22, 23, 29, 37, 38 AND 50).
FIRST USE 9-14-1998; IN COMMERCE 9-14-1998.

2,626,981. SCRANTON GILLETTE COMMUNICATIONS, INC., DES PLAINES, IL. SN 76-319,938. FILED P.R. 10-1-2001; AM. S.R. 2-15-2002.

LAWN & GARDEN RETAILER

FOR PRINTED PUBLICATIONS IN THE NATURE OF A TRADE PUBLICATION, NAMELY, MAGAZINES FEATURING INFORMATION IN THE FIELDS OF LAWN AND GARDENS DIRECTED TO RETAIL STORES (U.S. CLS. 2, 5, 22, 23, 29, 37, 38 AND 50).
FIRST USE 1-8-2002; IN COMMERCE 1-8-2002.

2,626,990. INTELLISPHERE, LLC, PLAINSBORO, NJ. SN 76-342,306. FILED 11-28-2001.

MD NET GUIDE

OWNER OF U.S. REG. NO. 2,454,261.
NO CLAIM IS MADE TO THE EXCLUSIVE RIGHT TO USE "GUIDE", APART FROM THE MARK AS SHOWN.
FOR MAGAZINE FOR HEALTHCARE PROFESSIONALS (U.S. CLS. 2, 5, 22, 23, 29, 37, 38 AND 50).
FIRST USE 5-15-1999; IN COMMERCE 5-15-1999.

CLASS 16—(Continued).

2,626,999. INTERNATIONAL SCIENTIFIC COMMUNICATIONS, INC., SHELTON, CT. SN 76-358,016. FILED 1-14-2002.

AMERICAN GENOMIC/PROTEOMIC TECHNOLOGY

FOR MAGAZINES RELATING TO RESEARCH AND ANALYTICAL APPLICATIONS IN THE FIELD OF GENOMIC AND PROTEOMIC TECHNOLOGY (U.S. CLS. 2, 5, 22, 23, 29, 37, 38 AND 50).
FIRST USE 8-13-2001; IN COMMERCE 8-13-2001.

2,627,001. FRONTIERS UNLIMITED, INC., DBA MILLER PUBLISHING GROUP, SOUTHAMPTON, NY. SN 76-366,833. FILED P.R. 2-5-2002; AM. S.R. 6-26-2002.

HOMES OF THE HAMPTONS

FOR MAGAZINES CONTAINING EDITORIAL CONTENT, PHOTOGRAPHS, AND RELATED ADVERTISING REGARDING RESIDENTIAL HOMES LOCATED AND SITUATED IN THE HAMPTONS, EASTERN LONG ISLAND, NEW YORK, AND SURROUNDING COUNTIES (U.S. CLS. 2, 5, 22, 23, 29, 37, 38 AND 50).
FIRST USE 10-4-2001; IN COMMERCE 10-4-2001.

2,627,002. FRONTIERS UNLIMITED, INC., DBA MILLER PUBLISHING GROUP, SOUTHAMPTON, NY. SN 76-366,847. FILED P.R. 2-5-2002; AM. S.R. 6-26-2002.

HOMES OF EASTERN LONG ISLAND

FOR MAGAZINES CONTAINING EDITORIAL CONTENT, PHOTOGRAPHS, AND RELATED ADVERTISING REGARDING RESIDENTIAL HOMES LOCATED AND SITUATED IN THE HAMPTONS, EASTERN LONG ISLAND, NEW YORK, AND SURROUNDING COUNTIES (U.S. CLS. 2, 5, 22, 23, 29, 37, 38 AND 50).
FIRST USE 10-12-2001; IN COMMERCE 10-12-2001.

CLASS 16—(Continued).

2,627,003. FRONTIERS UNLIMITED, INC., DBA MILLER PUBLISHING GROUP, SOUTHAMPTON, NY. SN 76-366,848. FILED P.R. 2-5-2002; AM. S.R. 6-26-2002.

HOMES THE MAGAZINE
OF SEASIDE
AND COUNTRY
LIVING
OF EASTERN LONG ISLAND

FOR MAGAZINES CONTAINING EDITORIAL CONTENT, PHOTOGRAPHS, AND RELATED ADVERTISING REGARDING RESIDENTIAL HOMES LOCATED AND SITUATED IN THE HAMPTONS, EASTERN LONG ISLAND, NEW YORK, AND SURROUNDING COUNTIES (U.S. CLS. 2, 5, 22, 23, 29, 37, 38 AND 50).
FIRST USE 10-12-2001; IN COMMERCE 10-12-2001.

2,627,010. ROMBOM, STEVEN P., BROOKLYN, NY. SN 78-016,871. FILED P.R. 7-15-2000; AM. S.R. 1-14-2002.

VANDAM PRESS

NO CLAIM IS MADE TO THE EXCLUSIVE RIGHT TO USE "PRESS", APART FROM THE MARK AS SHOWN.
FOR SERIES OF FICTION AND NON-FICTION BOOKS ON A VARIETY OF TOPICS (U.S. CLS. 2, 5, 22, 23, 29, 37, 38 AND 50).
FIRST USE 1-1-2000; IN COMMERCE 7-1-2000.

2,627,025. IMPRESIONES AEREAS, S.A. DE C.V., COLONIA LOMAS ALTAS, MEXICO. SN 78-074,271. FILED P.R. 7-17-2001; AM. S.R. 3-11-2002.

ESPOSA JOVEN

THE ENGLISH TRANSLATION OF THE WORD "ESPOSA JOVEN" IN THE MARK IS "YOUNG WIFE".
FOR MAGAZINES FEATURING ARTICLES OF INTEREST TO YOUNG WOMEN AND WIVES (U.S. CLS. 2, 5, 22, 23, 29, 37, 38 AND 50).
FIRST USE 3-0-2001; IN COMMERCE 11-0-2001.

2,627,027. INTERNATIONAL MASTERS PUBLISHERS AB, MALMO, SWEDEN. SN 78-077,858. FILED P.R. 8-7-2001; AM. S.R. 5-23-2002.

**GREAT GARDEN PROJECTS
IN UNDER 30 MINUTES**

FOR PRINTED MATERIAL, NAMELY, A SERIES OF CONTINUITY CARDS ON THE SUBJECT OF GARDENING, FOR INSERTION INTO A BINDER, AND A BINDER FOR USE IN CONNECTION THEREWITH (U.S. CLS. 2, 5, 22, 23, 29, 37, 38 AND 50).
FIRST USE 1-16-2002; IN COMMERCE 1-16-2002.

CLASS 19—NON-METALLIC BUILDING MATERIALS

2,626,776. INTERNATIONAL EROSION CONTROL SYSTEMS, WEST LORNE, ONTARIO, CANADA. SN 75-689,225. FILED P.R. 4-23-1999; AM. S.R. 6-11-2001.

Cable Concrete

FOR EROSION CONTROL PRODUCTS, NAMELY FLEXIBLE REVENTMENT SYSTEMS AND CHANNEL LININGS COMPRISED OF CONCRETE BLOCKS CONNECTED BY STEEL CABLE (U.S. CLS. 1, 12, 33 AND 50).
FIRST USE 4-0-1994; IN COMMERCE 4-0-1994.

2,626,949. AMORIM REVESTIMENTOS, S.A., 4536 - SAO PAIO DE OLEIROS, PORTUGAL. SN 76-292,693. FILED P.R. 7-30-2001; AM. S.R. 4-1-2002.

CORKLOC

FOR CORK PARQUET FLOORINGS; PARQUET FLOORINGS OF CORK-BASED AGGLOMERATES, CORK TILE AND TILES OF CORK-BASED AGGLOMERATES FOR COVERING OF WALLS, FLOORS AND CEILINGS; CORK FLOORINGS, FLOORINGS OF CORK-BASED AGGLOMERATES OR HAVING CORK IN ITS COMPOSITION (U.S. CLS. 1, 12, 33 AND 50).
FIRST USE 1-13-2001; IN COMMERCE 3-26-2001.

2,627,032. GREYSTONE QUARRIES, INC., BOYERTOWN, PA. SN 78-098,611. FILED P.R. 12-17-2001; AM. S.R. 6-4-2002.

ALVERSON LIMESTONE

NO CLAIM IS MADE TO THE EXCLUSIVE RIGHT TO USE "LIMESTONE", APART FROM THE MARK AS SHOWN.
FOR NATURAL STONE PRODUCTS FOR USE IN CONSTRUCTION OF BOTH NEW BUILDINGS AND ADDITIONS TO EXISTING BUILDINGS, AND ANY RELATED SITE WORK (U.S. CLS. 1, 12, 33 AND 50).
FIRST USE 8-1-2001; IN COMMERCE 8-1-2001.

CLASS 20—FURNITURE AND ARTICLES NOT OTHERWISE CLASSIFIED

CLASS 20—(Continued).

2,626,906. EUSTIS ENTERPRISES, INC., ASHBURNHAM, MA. SN 76-245,276. FILED P.R. 4-23-2001; AM. S.R. 5-9-2002.

EUSTIS JOINT

NO CLAIM IS MADE TO THE EXCLUSIVE RIGHT TO USE "JOINT", APART FROM THE MARK AS SHOWN, FOR FURNITURE PARTS, NAMELY, FURNITURE JOINT WHICH IS A COMPONENT OF A CHAIR (U.S. CLS. 2, 13, 22, 25, 32 AND 50).
FIRST USE 12-22-2001; IN COMMERCE 12-22-2001.

2,626,939. FENG, HAN, NEW YORK, NY. SN 76-283,632. FILED P.R. 7-11-2001; AM. S.R. 4-30-2002.

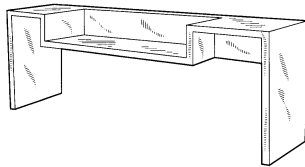

THE MARK CONSISTS OF A THREE DIMENSIONAL CONFIGURATION OF A BENCH DESIGN WITH TWO PARALLEL LEG PORTIONS. THE FIRST LEG PORTION EXTENDS VERTICALLY DOWNWARD FROM A FIRST HORIZONTAL PORTION THAT RUNS PERPENDICULAR TO THE FIRST AND SECOND LEG PORTIONS. THE SECOND LEG PORTION EXTENDS VERTICALLY DOWNWARD FROM A SECOND HORIZONTAL PORTION THAT RUNS PERPENDICULAR TO THE FIRST AND SECOND LEG PORTIONS. THE SECOND HORIZONTAL PORTION EXTENDS HORIZONTALLY FROM THE SECOND LEG PORTION TOWARD THE FIRST LEG PORTION TO A SECOND EDGE POSITION. AT THIS SECOND EDGE POSITION, THERE IS A SECOND SIDE SECTION WHICH EXTENDS VERTICALLY DOWNWARD, PERPENDICULAR TO THE SECOND EDGE PORTION AND PARALLEL TO TWO LEG PORTIONS. THIS FIRST AND SECOND SIDE SECTIONS ARE CONNECTED BY A FLAT, HORIZONTAL BENCH PORTION THAT RUNS PARALLEL TO THE FIRST AND SECOND EDGE POSITIONS. THERE IS ALSO A VERTICAL SEAT BACK PORTION THAT IS CONNECTED TO THE BACK OF THE BENCH PORTION AND SIDE SECTIONS.

FOR FURNITURE (U.S. CLS. 2, 13, 22, 25, 32 AND 50).
FIRST USE 6-19-2001; IN COMMERCE 6-19-2001.

CLASS 20—(Continued).

2,626,940. FENG, HAN, NEW YORK, NY. SN 76-283,634. FILED P.R. 7-11-2001; AM. S.R. 4-30-2002.

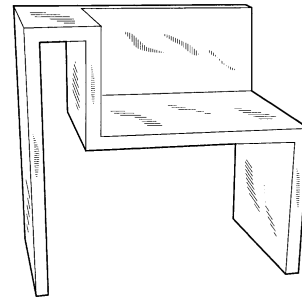

THE MARK CONSISTS OF A THREE DIMENSIONAL CONFIGURATION OF A CHAIR DESIGN WITH TWO PARALLEL LEG PORTIONS. THE FIRST LEG PORTION EXTENDS VERTICALLY DOWNWARD FROM A FIRST SIDE EDGE OF A HORIZONTAL SEAT PORTION IN A PERPENDICULAR CONFIGURATION. THE SEAT PORTION EXTENDS HORIZONTALLY FROM THE FIRST LEG PORTION TO A SECOND SIDE EDGE PORTION AT A POSITION JUST SHORT OF THE SECOND LEG. A SIDE SECTION EXTENDS UPWARDS FROM THE SECOND SIDE EDGE PORTION OF THE SEAT PORTION, PERPENDICULAR TO THE SEAT PORTION AND PARALLEL TO THE TWO LEG PORTIONS UP TO A HEIGHT EQUAL TO THE HEIGHT OF THE SECOND LEG PORTION. THE SIDE SECTION IS CONNECTED TO THE SECOND LEG PORTION BY A FLAT, HORIZONTAL PORTION THAT RUNS PARALLEL TO THE SEAT PORTION. THERE IS ALSO A VERTICAL SEAT BACK PORTION THAT IS CONNECTED TO A BACK EDGE OF THE SEAT PORTION AND A BACK EDGE OF THE SIDE SECTION. THE CONFIGURATION OF THE CHAIR DESIGN PROVIDES FOR AN OPEN SPACE BETWEEN THE SECOND LEG AND THE SIDE SECTION OF THE CHAIR DESIGN.

FOR FURNITURE (U.S. CLS. 2, 13, 22, 25, 32 AND 50).
FIRST USE 6-19-2001; IN COMMERCE 6-19-2001.

2,626,986. APPLE ANNIE'S, INC., LOUISVILLE, KY. SN 76-327,679. FILED P.R. 10-22-2001; AM. S.R. 4-22-2002.

THE BIG APPLE

FOR FIGURINES MADE OF WOOD IN THE FORM OF AN APPLE FEATURING A VIEW OF THE NEW YORK SKYLINE ALONG WITH THE DATE 9-11-01 (U.S. CLS. 2, 13, 22, 25, 32 AND 50).

FIRST USE 10-8-2001; IN COMMERCE 10-8-2001.

CLASS 21—HOUSEWARES AND GLASS

CLASS 21—(Continued).

2,626,768. GODINGER SILVER ART CO., LTD., NEW YORK, NY. SN 75-629,263. FILED P.R. 1-28-1999; AM. S.R. 3-9-2002.

STUDIO SILVERSMITHS

NO CLAIM IS MADE TO THE EXCLUSIVE RIGHT TO USE "SILVERSMITHS", APART FROM THE MARK AS SHOWN.

FOR SILVER PLATED AND/OR STAINLESS STEEL HOLLOWWARE, NAMELY, PITCHERS, BOWLS, DRINKING VESSELS, CHARGER PLATES, VASES AND SERVING TRAYS (U.S. CLS. 2, 13, 23, 29, 30, 33, 40 AND 50). FIRST USE 2-1-1999; IN COMMERCE 2-1-1999.

CLASS 22—CORDAGE AND FIBERS

2,626,944. KIS INDUSTRIES, LTD., MEDINA, OH. SN 76-290,571. FILED P.R. 7-27-2001; AM. S.R. 3-13-2002.

DISHNET

FOR NET FOR RETAINING DISHWARE IN A DISHWASHER (U.S. CLS. 1, 2, 7, 19, 22, 42 AND 50). FIRST USE 2-6-2002; IN COMMERCE 2-6-2002.

CLASS 25—CLOTHING

2,626,772. SPIRITE INDUSTRIES, INC., ENGLEWOOD, NJ. SN 75-665,532. FILED P.R. 3-22-1999; AM. S.R. 4-19-2002.

TROUSSEAU

FOR BRAS AND PANTIES (U.S. CLS. 22 AND 39). FIRST USE 7-16-1992; IN COMMERCE 7-16-1992.

2,626,880. TJX COMPANIES, INC., THE, FRAMINGHAM, MA. SN 76-173,799. FILED P.R. 11-30-2000; AM. S.R. 2-7-2002.

MARCONI

OWNER OF U.S. REG. NO. 1,992,205.
FOR WOMEN'S SWEATERS AND KNIT TOPS (U.S. CLS. 22 AND 39).
FIRST USE 3-1-2001; IN COMMERCE 3-1-2001.

CLASS 25—(Continued).

2,626,898. BABY TOGS, INC., NEW YORK, NY. SN 76-226,425. FILED P.R. 3-16-2001; AM. S.R. 4-25-2002.

CLASSIC CHILDREN'S CLOTHING SINCE 1946

FOR INFANTS' AND CHILDREN'S WEARING APPAREL, NAMELY, DRESSES, SHIRTS, PANTS, JACKETS, SUITS, PINAFORES, SHORTS, COVERALLS, CREEPERS AND SWEATERS (U.S. CLS. 22 AND 39). FIRST USE 4-0-2001; IN COMMERCE 4-0-2001.

2,626,917. A & F TRADEMARK, INC., WILMINGTON, DE. SN 76-258,313. FILED P.R. 5-17-2001; AM. S.R. 5-23-2002.

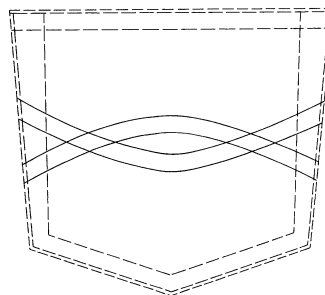

THE MARK CONSISTS OF A PAIR OF DOUBLE-LINED STITCHES, EXTENDING CONTINUOUSLY ACROSS THE REAR POCKET OF THE GOODS. THE STITCHES ARE CURVED, INTERSECTING TWICE, FORMING AN OVAL SHAPE IN THE CENTER OF THE POCKET. THE DOTTED LINES ARE USED TO INDICATE THE POSITIONING OF THE MARK ON THE GOODS AND ARE NOT A FEATURE OF THE MARK.

FOR CLOTHING, NAMELY, DENIM JEANS SOLD IN SPECIALTY RETAIL CLOTHING STORES, SPECIALTY MAIL ORDER CATALOG AND INTERNET WEBSITE (U.S. CLS. 22 AND 39).
FIRST USE 6-0-2001; IN COMMERCE 6-0-2001.

CLASS 25—(Continued).

2,626,918. FOOTSTAR CORPORATION, MAHWAH, NJ. SN 76-258,315. FILED P.R. 5-17-2001; AM. S.R. 3-7-2002.

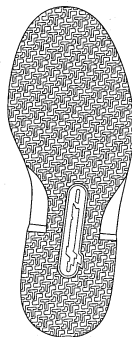

OWNER OF U.S. REG. NO. 2,007,108.
THE MARK CONSISTS OF A REPETITIVE FANCIFUL DESIGN WHICH MAY BE READ AS AN ARRAY OF PATTERNS CONSISTING PRIMARILY OF THE LETTERS "S" AND "T" COVERING SOME OR ALL OF THE SHOE SOLE. SUCH PATTERN IS NOT CONFINED TO A PARTICULAR PORTION OF THE SHOE SOLE AND NEITHER THE BROKEN LINES NOR THE BORDERS OF THE PATTERN OF THE MARK AS SHOWN ARE INTENDED TO LIMIT THE MARK.

FOR FOOTWEAR AND PARTS AND COMPONENTS THEREOF (U.S. CLS. 22 AND 39).
FIRST USE 7-1-2001; IN COMMERCE 7-1-2001.

2,626,924. UNIVERSITY OF NORTH CAROLINA AT CHARLOTTE, THE, CHARLOTTE, NC. SN 76-262,938. FILED P.R. 5-25-2001; AM. S.R. 2-6-2002.



FOR LONG SLEEVE T-SHIRTS; SHORT SLEEVE T-SHIRTS; SWEATSHIRTS; SHORTS (U.S. CLS. 22 AND 39).
FIRST USE 1-0-2001; IN COMMERCE 1-0-2001.

CLASS 28—TOYS AND SPORTING GOODS**CLASS 28—(Continued).**

2,626,909. DUNLOP SLAZENGER GROUP AMERICAS INC., GREENVILLE, SC. SN 76-248,041. FILED P.R. 4-30-2001; AM. S.R. 2-11-2002.

WORLD'S #1 BALL

NO CLAIM IS MADE TO THE EXCLUSIVE RIGHT TO USE "BALL", APART FROM THE MARK AS SHOWN.
FOR TENNIS EQUIPMENT, NAMELY, TENNIS BALLS (U.S. CLS. 22, 23, 38 AND 50).
FIRST USE 1-21-2001; IN COMMERCE 1-21-2001.

2,626,933. W.C. BRADLEY/ZEBCO HOLDINGS, INC., DBA ZEBCO, COLUMBUS, GA, BY ASSIGNMENT BRUNSWICK CORPORATION, LAKE FOREST, IL. SN 76-276,364. FILED P.R. 6-25-2001; AM. S.R. 11-2-2001.

PERFORMANCE TUNED

FOR FISHING REELS (U.S. CLS. 22, 23, 38 AND 50).
FIRST USE 7-8-2001; IN COMMERCE 9-1-2001.

2,626,945. PLACO CORPORATION LIMITED, KOWLOON, HONG KONG. SN 76-290,759. FILED P.R. 7-27-2001; AM. S.R. 5-20-2002.

BUBBLES INSIDE BUBBLES

OWNER OF U.S. REG. NOS. 2,211,837, 2,264,806, AND 2,428,297.

FOR BATTERY OPERATED, HAND-HELD BUBBLE TOYS, NAMELY BUBBLE GUNS, BUBBLE MACHINES, BUBBLE WANDS, AND BUBBLE SOLUTION CONTAINERS (U.S. CLS. 22, 23, 38 AND 50).
FIRST USE 10-18-2001; IN COMMERCE 10-18-2001.

2,626,946. PANLINE USA, NORTHVALE, NJ. SN 76-291,074. FILED P.R. 7-27-2001; AM. S.R. 2-27-2002.

FRIENDSHIP ZIPPERS

NO CLAIM IS MADE TO THE EXCLUSIVE RIGHT TO USE "FRIENDSHIP", APART FROM THE MARK AS SHOWN.

FOR HOBBY CRAFT KIT FOR MAKING BRACELETS, COMPRISING ZIPPER BRACELETS, APPLIQUES, EMBROIDERED MIRRORS, RICK RACK, AND GLUE (U.S. CLS. 22, 23, 38 AND 50).
FIRST USE 2-13-2000; IN COMMERCE 2-13-2000.

CLASS 28—(Continued).

2,626,963. GAIAM INTERNATIONAL, INC., VENICE, CA. SN 76-304,250. FILED P.R. 8-23-2001; AM. S.R. 5-31-2002.

CHI ESSENTIALS

FOR EXERCISE EQUIPMENT FOR USE IN CONNECTION WITH THE PRACTICE OF CHI, NAMELY, BALLS AND RINGS (U.S. CLS. 22, 23, 38 AND 50).

FIRST USE 6-1-2000; IN COMMERCE 6-1-2000.

2,626,973. VAN HERWYNEN, DIANNE, HEWITT, NJ. SN 76-312,068. FILED P.R. 9-17-2001; AM. S.R. 5-16-2002.

RED HAT

FOR BEAN BAG DOLLS; COSTUME MASKS, DOLL ACCESSORIES, DOLL CASES, DOLL CLOTHING, DOLL COSTUMES, KITS FOR MAKING DOLLS, DOLLS, DOLLS AND PLAYSETS THEREFOR, PUPPETS, RAG DOLLS, SOFT SCULPTURE DOLLS, SOFT SCULPTURE PLUSH TOYS, STUFFED TOY ANIMALS, STUFFED TOYS (U.S. CLS. 22, 23, 38 AND 50).

FIRST USE 8-22-2001; IN COMMERCE 8-22-2001.

CLASS 29—MEATS AND PROCESSED FOODS

2,626,798. GAXIOLA, ERNESTO FEDERICO PRIETO, MEXICALI, B.C.C.P. 021100, MEXICO. SN 75-879,671. FILED P.R. 12-21-1999; AM. S.R. 3-16-2001.

SALADITOS

THE MEANING OF "SALADITOS" IN ENGLISH IS, LOOSELY, "SALTY".

FOR CANDIED FRUIT BASED SNACK FOODS, DRIED FRUIT CANDIES, DRIED FRUIT PULP CANDIES, CHILI CANDY, CHILI PULP CANDY (U.S. CL. 46).

FIRST USE 6-18-1999; IN COMMERCE 6-18-1999.

2,626,877. LIDL STIFTUNG & CO. KG, FED REP GERMANY. SN 76-163,658. FILED P.R. 11-13-2000; AM. S.R. 5-21-2002.

CHACON

OWNER OF FED REP GERMANY REG. NO. 397045433, DATED 2-24-1997, EXPIRES 2-28-2007.

FOR FRUIT AND VEGETABLE PRESERVES; PRESERVED, DRIED AND COOKED FRUITS AND VEGETABLES AND MUSHROOMS; ALL GOODS ALSO DEEP FROZEN AND/OR FREEZE-DRIED (U.S. CL. 46).

CLASS 30—STAPLE FOODS**CLASS 30—(Continued).**

2,626,936. KANGAROO BRANDS, INC., MILWAUKEE, WI. SN 76-280,097. FILED P.R. 6-29-2001; AM. S.R. 3-27-2002.

SALAD POCKETS

FOR PITA POCKET BREAD (U.S. CL. 46).
FIRST USE 10-0-2001; IN COMMERCE 10-0-2001.

2,626,941. POPCORN DEPOT, INC., DBA POPCORN AMERICA, BETHPAGE, NY. SN 76-285,661. FILED P.R. 7-16-2001; AM. S.R. 3-7-2002.

POPCORN AMERICA

OWNER OF U.S. REG. NO. 2,567,374.
NO CLAIM IS MADE TO THE EXCLUSIVE RIGHT TO USE "POPCORN", APART FROM THE MARK AS SHOWN.

FOR PROCESSED POPCORN, POPPED POPCORN, GLAZED POPCORN, CANDY COATED POPCORN, CHOCOLATE DRIZZLED POPCORN, CARAMEL POPCORN, BUTTERED POPCORN, MICROWAVE POPCORN, OILED POPCORN, SALTED POPCORN, PROCESSED UNPOPPED POPCORN, OILED AND SALTED POPCORN KERNELS (U.S. CL. 46).

FIRST USE 3-1-2001; IN COMMERCE 3-1-2001.

CLASS 31—NATURAL AGRICULTURAL PRODUCTS

2,626,845. ADVANTA USA, INC., SLATER, IA. SN 76-114,087. FILED P.R. 8-22-2000; AM. S.R. 3-18-2002.

**SUPERIOR
GENETICS...LOCALLY
GROWN**

FOR SEEDS FOR AGRICULTURAL PURPOSES (U.S. CLS. 1 AND 46).

FIRST USE 7-1-2001; IN COMMERCE 7-1-2001.

CLASS 32—LIGHT BEVERAGES

2,626,784. BOULDER BEVERAGE COMPANY, DENVER, CO. SN 75-768,318. FILED P.R. 8-5-1999; AM. S.R. 2-28-2002.

COLORADO COLADA

FOR NON-ALCOHOLIC PINA COLADA FLAVORED TROPICAL DRINK MIX (U.S. CLS. 45, 46 AND 48).
FIRST USE 9-2-1999; IN COMMERCE 9-2-1999.

CLASS 32—(Continued).

2,626,885. YELLOWSTONE VALLEY BREWING, LLC, BILLINGS, MT. SN 76-186,223. FILED P.R. 12-26-2000; AM. S.R. 11-5-2001.

YELLOWSTONE VALLEY BREWING

NO CLAIM IS MADE TO THE EXCLUSIVE RIGHT TO USE "BREWING", APART FROM THE MARK AS SHOWN. FOR BEER, ALE, STOUT, MALT BEER, LAGER, WORT BEER, AND PORTER (U.S. CLS. 45, 46 AND 48). FIRST USE 1-21-1997; IN COMMERCE 6-24-1997.

2,626,976. SPOETZL BREWERY, INC., SAN ANTONIO, TX. SN 76-316,236. FILED P.R. 9-24-2001; AM. S.R. 6-6-2002.

HEFEWEIZEN

NO CLAIM IS MADE TO THE EXCLUSIVE RIGHT TO USE "HEFEWEIZEN", APART FROM THE MARK AS SHOWN.

THE ENGLISH TRANSLATION OF HEFEWEIZEN IS "YEAST AND WHEAT".

FOR BEER (U.S. CLS. 45, 46 AND 48). FIRST USE 9-4-2001; IN COMMERCE 9-4-2001.

SERVICE MARKS

CLASS 35—ADVERTISING AND BUSINESS

2,626,755. NORTH AMERICAN STEEL ALLIANCE, INC., ROCKFORD, IL. SN 75-344,760. FILED P.R. 8-21-1997; AM. S.R. 8-22-2001.

NORTH AMERICAN STEEL ALLIANCE

NO CLAIM IS MADE TO THE EXCLUSIVE RIGHT TO USE "ALLIANCE", APART FROM THE MARK AS SHOWN.

FOR PROCUREMENT SERVICES, NAMELY, PURCHASING A WIDE VARIETY OF GOODS AND SERVICES; COOPERATIVE ADVERTISING AND MARKETING; AND BUSINESS CONSULTATION SERVICES, ALL FOR MEMBERS OF A COOPERATIVE OF STEEL DISTRIBUTORS (U.S. CLS. 100, 101 AND 102). FIRST USE 10-22-1996; IN COMMERCE 10-22-1996.

CLASS 35—(Continued).

2,626,761. KRAUSE, EDWARD J., III, POTOMAC, MD. SN 75-537,404. FILED P.R. 8-14-1998; AM. S.R. 3-19-2001.

EXPO MANUFACTURA

NO CLAIM IS MADE TO THE EXCLUSIVE RIGHT TO USE "EXPO", APART FROM THE MARK AS SHOWN.

THE WORD "MANUFACTURA" IN THE MARK MEANS "MANUFACTURING" IN SPANISH.

FOR ORGANIZING AND CONDUCTING INTERNATIONAL BUSINESS AND TRADE EXHIBITIONS AND CONFERENCES FEATURING MANUFACTURING EQUIPMENT (U.S. CLS. 100, 101 AND 102).

FIRST USE 3-0-1999; IN COMMERCE 3-0-1999.

2,626,782. CYGNUS BUSINESS MEDIA, INC., MELVILLE, NY, BY MERGER; BY MERGER; BY ASSIGNMENT CHAMPION PRODUCTIONS, INC., BURNSVILLE, MN. SN 75-748,963. FILED P.R. 6-28-1999; AM. S.R. 1-4-2001.

DigitalMedia-Expo

FOR TRADE SHOW AND EXHIBITION SERVICES FOR THE HIGH-TECH INDUSTRY (U.S. CLS. 100, 101 AND 102).

FIRST USE 10-0-1995; IN COMMERCE 5-0-1996.

2,626,788. SWITZER, PHILIP, ESTES PARK, CO. SN 75-826,227. FILED P.R. 10-19-1999; AM. S.R. 9-5-2000.

THE VICUNA REGISTRY

NO CLAIM IS MADE TO THE EXCLUSIVE RIGHT TO USE "REGISTRY", APART FROM THE MARK AS SHOWN.

FOR MAINTAINING A REGISTRY OF BREEDS IN THE FIELD OF VICUNAS AND ITS CROSSES WITH OTHER CAMELIDS (U.S. CLS. 100, 101 AND 102).

FIRST USE 7-14-2000; IN COMMERCE 7-14-2000.

2,626,800. IDEA CONNECTION SYSTEMS INC., ROCHESTER, NY. SN 75-889,232. FILED P.R. 1-6-2000; AM. S.R. 10-29-2001.

PROMO CD

FOR BUSINESS MARKETING CONSULTING SERVICES (U.S. CLS. 100, 101 AND 102).

FIRST USE 11-30-2000; IN COMMERCE 11-30-2000.

CLASS 35—(Continued).

2,626,802. AMERICAN CRAFTS ONLINE, INC., GAITHERSBURG, MD. SN 75-897,091. FILED P.R. 1-14-2000; AM. S.R. 12-21-2000.

AMERICANCRAFTSONLINE

OWNER OF U.S. REG. NO. 2,472,542.
FOR COMPUTERIZED ON-LINE RETAIL SERVICES FOR ARTS AND CRAFTS GOODS (U.S. CLS. 100, 101 AND 102).
FIRST USE 2-0-1999; IN COMMERCE 2-0-1999.

CLASS 35—(Continued).

2,626,828. APPLIED TECHNOLOGIES GROUP, INC., NANTUCKET, MA. SN 76-054,989. FILED P.R. 5-23-2000; AM. S.R. 3-12-2002.

ITPAPERS.COM

FOR PROVIDING AN ON-LINE DIRECTORY OF INFORMATION TECHNOLOGY WHITE PAPERS (U.S. CLS. 100, 101 AND 102).
FIRST USE 12-28-2000; IN COMMERCE 3-1-2001.

2,626,805. BENSON, JERRY S., JR., AUSTIN, TX. SN 75-904,209. FILED P.R. 1-27-2000; AM. S.R. 10-31-2001.

ART-EXCHANGE.COM

FOR COMPUTERIZED ONLINE TRADING SERVICES, NAMELY, PROVIDING AN ELECTRONIC MARKETPLACE FOR MATCHING BUYERS AND SELLERS OF WORKS OF ART; MAINTAINING AN ELECTRONIC MARKETPLACE EXCHANGE AND LISTING SERVICES FOR OTHERS, NAMELY, MATCHING BUYERS AND SELLERS OF WORKS OF ART; AND ONLINE RETAIL STORE SERVICES FEATURING WORKS OF ART (U.S. CLS. 100, 101 AND 102).
FIRST USE 9-0-1999; IN COMMERCE 9-0-1999.

2,626,829. AFFORDABLE CASKETS, INC., OCEANSIDE, CA. SN 76-056,556. FILED P.R. 5-25-2000; AM. S.R. 1-29-2001.

AFFORDABLE CASKETS

NO CLAIM IS MADE TO THE EXCLUSIVE RIGHT TO USE "CASKETS", APART FROM THE MARK AS SHOWN.
FOR RETAIL AND WHOLESALE STORE AND ON-LINE RETAIL AND WHOLESALE SERVICES FEATURING FUNERAL SUPPLIES, NAMELY, CASKETS (U.S. CLS. 100, 101 AND 102).
FIRST USE 7-24-1998; IN COMMERCE 7-24-1998.

2,626,819. MEDSTAT GROUP, INC., THE, ANN ARBOR, MI. SN 76-025,381. FILED P.R. 4-13-2000; AM. S.R. 3-28-2002.

MARKET EXPERT

FOR BUSINESS SERVICES, NAMELY, PROVIDING STRATEGIC HEALTHCARE PLANNING AND MARKETING INFORMATION TO BE USED IN MANAGING THE COST, QUALITY AND STRATEGIC POSITIONING OF HEALTH SERVICES AND BENEFITS IN THE FORM OF REPORTS, CHARTS AND MAPS; PROVIDING COMPREHENSIVE ANALYSIS OF CUSTOMER-SPECIFIC REPORTING PACKAGES VIA A GLOBAL COMPUTER NETWORK (U.S. CLS. 100, 101 AND 102).
FIRST USE 7-10-2000; IN COMMERCE 7-10-2000.

2,626,837. MILESPREE, INC., HOUSTON, TX, BY CHANGE OF NAME; BY ASSIGNMENT WANTADS.COM, INC., HOUSTON, TX. SN 76-082,557. FILED P.R. 7-3-2000; AM. S.R. 7-27-2001.

THE FASTEST FREE TRAVEL ON THE NET

FOR PROMOTING THE GOODS AND SERVICES OF OTHERS THROUGH THE ADMINISTRATION OF A LOYALTY AWARD PROGRAM, NAMELY A PROGRAM THAT ADMINISTERS INCENTIVE AWARDS TO PARTICIPANTS FOR VISITING, REGISTERING AND SHOPPING AT RETAIL STORES AND ON INTRANETS AND INTERNET WEBSITES (U.S. CLS. 100, 101 AND 102).
FIRST USE 8-21-2000; IN COMMERCE 8-21-2000.

2,626,824. EEPARTS.COM, INC., DALLAS, TX. SN 76-048,136. FILED P.R. 5-12-2000; AM. S.R. 4-22-2002.

YOUR COMPONENT MARKETPLACE

FOR PROVIDING A WEBSITE FOR DISTRIBUTORS, ASSEMBLERS AND MANUFACTURERS TO BUY AND SELL ELECTRONIC PARTS AND COMPONENTS (U.S. CLS. 100, 101 AND 102).
FIRST USE 10-0-2001; IN COMMERCE 10-0-2001.

2,626,848. BIRNBAUM INTERNATIONAL LTD., DBA DAVID BIRNBAUM/ROCKEFELLER PLAZA, NEW YORK, NY. SN 76-116,651. FILED P.R. 8-28-2000; AM. S.R. 5-9-2002.

THE RARE AND THE EXTRAORDINARY

FOR RETAIL JEWELRY STORE SERVICES (U.S. CLS. 100, 101 AND 102).
FIRST USE 0-0-1990; IN COMMERCE 0-0-1990.

CLASS 35—(Continued).

2,626,854. TESORO PETROLEUM CORPORATION, SAN ANTONIO, TX. SN 76-129,521. FILED P.R. 9-15-2000; AM. S.R. 4-30-2002.



THE DRAWING IS LINED FOR THE COLORS GREEN (TEAL), BLUE, AND GOLD. THE DESIGNATED COLORS ARE A FEATURE OF THE MARK.

THE MARK CONSISTS OF THE COLORS TEAL, BLUE, AND GOLD USED ON THE CANOPY OF GASOLINE STATIONS AND CONVENIENCE STORES.

FOR RETAIL STORE SERVICES FEATURING CONVENIENCE ITEMS AND GASOLINE (U.S. CLS. 100, 101 AND 102).

FIRST USE 4-1-1998; IN COMMERCE 4-1-1998.

2,626,855. TESORO PETROLEUM CORPORATION, SAN ANTONIO, TX. SN 76-129,882. FILED P.R. 9-15-2000; AM. S.R. 5-13-2002.

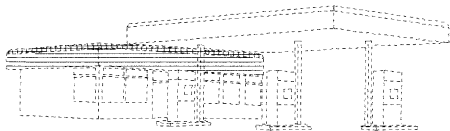

THE DRAWING IS LINED FOR THE COLORS BLUE AND GOLD.

THE MARK CONSISTS OF THE COLORS BLUE AND GOLD USED ON BUILDINGS AT GASOLINE STATIONS AND CONVENIENCE STORES. THE DESIGNATED COLORS ARE A FEATURE OF THE MARK.

FOR RETAIL STORE SERVICES FEATURING CONVENIENCE ITEMS AND GASOLINE (U.S. CLS. 100, 101 AND 102).

FIRST USE 4-1-1998; IN COMMERCE 4-1-1998.

2,626,857. TIBURON STRATEGIC ADVISORS, LLC, TIBURON, CA. SN 76-132,676. FILED P.R. 9-21-2000; AM. S.R. 8-13-2001.

TIBURON STRATEGIC ADVISORS

NO CLAIM IS MADE TO THE EXCLUSIVE RIGHT TO USE "STRATEGIC ADVISORS", APART FROM THE MARK AS SHOWN.

FOR BUSINESS CONSULTATION SERVICES, NAMELY BUSINESS PLANNING ADVICE AND ASSISTANCE, MARKET RESEARCH, BUSINESS PLAN DEVELOPMENT, BUSINESS PLAN IMPLEMENTATION, MARKET ANALYSIS, AND PROJECT MANAGEMENT FOR OTHERS (U.S. CLS. 100, 101 AND 102).

FIRST USE 6-9-1999; IN COMMERCE 6-9-1999.

CLASS 35—(Continued).

2,626,871. BILL GOOD MARKETING, SOUTH JORDAN, UT. SN 76-146,918. FILED P.R. 10-13-2000; AM. S.R. 10-10-2001.

THE LETTERS LIBRARY

FOR PROVIDING ACCESS TO AN ON-LINE DATABASE FEATURING INFORMATION IN THE NATURE OF DOCUMENTS USED IN CONNECTION WITH A COMPUTER-BASED CLIENT MARKETING, PROSPECTING AND OFFICE MANAGEMENT SYSTEM (U.S. CLS. 100, 101 AND 102).

FIRST USE 6-0-1998; IN COMMERCE 10-1-2000.

2,626,887. DIAMOND STAR INTERNATIONAL, CHICAGO, IL. SN 76-191,082. FILED P.R. 1-9-2001; AM. S.R. 5-2-2002.

GIFTSTEAKS.COM

FOR ELECTRONIC AND MAIL ORDER SERVICES FEATURING GOURMET MEATS AND OTHER FOODS (U.S. CLS. 100, 101 AND 102).

FIRST USE 10-1-1998; IN COMMERCE 10-1-1998.

2,626,893. CENTENNIAL FOODS, CALGARY, ALBERTA T2G 4B7, CANADA. SN 76-210,580. FILED P.R. 2-15-2001; AM. S.R. 12-5-2001.

THE GREAT FOOD PARTNERS

PRIORITY CLAIMED UNDER SEC. 44(D) ON CANADA APPLICATION NO. 1,071,115. FILED 8-15-2000.

FOR DISTRIBUTORSHIP SERVICES FEATURING MEAT PACKING AND MEAT BUTCHERY (U.S. CLS. 100, 101 AND 102).

FIRST USE 2-0-1999; IN COMMERCE 2-0-1999.

2,626,897. FLOORSHOP.COM, INC., VENTURA, CA. SN 76-222,730. FILED P.R. 3-9-2001; AM. S.R. 5-8-2002.

FLOORSHOP.COM

FOR ONLINE RETAIL SERVICES FEATURING FLOOR COVERINGS (U.S. CLS. 100, 101 AND 102).

FIRST USE 8-0-1999; IN COMMERCE 8-0-1999.

CLASS 35—(Continued).

2,626,903. AUTOMOTIVE RENTALS, INC., MT. LAUREL, NJ. SN 76-241,494. FILED P.R. 4-16-2001; AM. S.R. 12-27-2001.

FLEETSTATS

FOR COMPUTERIZED VEHICLE FLEET MANAGEMENT SERVICES, NAMELY, PROVIDING AN ELECTRONIC DATABASE IN THE FIELD OF VEHICLE FLEET MANAGEMENT, COMPUTERIZED DATABASE MANAGEMENT AND DATA PROCESSING AND MAINTAINING FLEET VEHICLE RECORDS AND FILES FOR OTHERS (U.S. CLS. 100, 101 AND 102).

FIRST USE 9-0-2001; IN COMMERCE 9-0-2001.

2,626,904. REED ELSEVIER PROPERTIES INC., WILMINGTON, DE. SN 76-241,628. FILED P.R. 4-17-2001; AM. S.R. 6-5-2002.

**CHARLOTTE FISHING
HUNTING & OUTDOORS
SHOW**

NO CLAIM IS MADE TO THE EXCLUSIVE RIGHT TO USE "FISHING HUNTING & OUTDOORS SHOW", APART FROM THE MARK AS SHOWN.

FOR ARRANGING AND CONDUCTING EXHIBITIONS, EXPOSITIONS AND TRADE SHOWS IN THE FIELD OF FISHING AND HUNTING (U.S. CLS. 100, 101 AND 102).

FIRST USE 4-0-2001; IN COMMERCE 4-0-2001.

2,626,905. REED ELSEVIER PROPERTIES INC., WILMINGTON, DE. SN 76-241,629. FILED P.R. 4-17-2001; AM. S.R. 6-5-2002.

**CHARLOTTE OUTDOORS
SHOW**

NO CLAIM IS MADE TO THE EXCLUSIVE RIGHT TO USE "OUTDOORS SHOW", APART FROM THE MARK AS SHOWN.

FOR ARRANGING AND CONDUCTING EXHIBITIONS, EXPOSITIONS AND TRADE SHOWS IN THE FIELD OF FISHING AND HUNTING (U.S. CLS. 100, 101 AND 102).

FIRST USE 4-0-2001; IN COMMERCE 4-0-2001.

CLASS 35—(Continued).

2,626,910. SPRY, JEFFREY D., DULUTH, MN. SN 76-248,069. FILED P.R. 4-30-2001; AM. S.R. 4-8-2002.

**BIRTHDAY FREEBIES
NETWORK**

FOR COLLECTING AND DISTRIBUTING INFORMATION TO THE PUBLIC OVER THE INTERNET IDENTIFYING MERCHANTS IN SPECIFIED GEOGRAPHICAL AREAS THAT PROVIDE PROMOTIONS TO CUSTOMERS ON THEIR BIRTHDAYS (U.S. CLS. 100, 101 AND 102).

FIRST USE 1-15-2001; IN COMMERCE 10-4-2001.

2,626,931. IGNIS OPTICS, INC., SAN JOSE, CA. SN 76-273,701. FILED P.R. 6-19-2001; AM. S.R. 3-4-2002.

**SINGLE MODE MODULES @
MULTIMODE PRICES**

FOR RETAIL AND WHOLESALE SERVICES FEATURING INPUT/OUTPUT FIBER OPTIC COMMUNICATION MODULES (U.S. CLS. 100, 101 AND 102).

FIRST USE 1-7-2001; IN COMMERCE 2-15-2001.

2,626,950. ASCENDES CORPORATION, ALPHARETTA, GA. SN 76-293,320. FILED P.R. 8-1-2001; AM. S.R. 4-15-2002.

**REMOTE PROSPECT
MARKETING**

NO CLAIM IS MADE TO THE EXCLUSIVE RIGHT TO USE "MARKETING", APART FROM THE MARK AS SHOWN.

FOR MAILING LIST PREPARATION AND DATA BASE MANAGEMENT, MAINTAINING DIRECT MARKETING LIST DATABASES FOR OTHERS, AND PROMOTING THE SALE OF GOODS AND SERVICES OF OTHERS, NAMELY, CUSTOMIZED DATABASES CONTAINING CONSUMER AND BUSINESS MARKETING DATA THROUGH A GLOBAL COMPUTER NETWORK (U.S. CLS. 100, 101 AND 102).

FIRST USE 1-11-2002; IN COMMERCE 1-11-2002.

2,626,952. AIR-TRAK.COM, SAN DIEGO, CA. SN 76-293,641. FILED P.R. 8-1-2001; AM. S.R. 4-1-2002.

EXECUTIVE WEB SERVICE

NO CLAIM IS MADE TO THE EXCLUSIVE RIGHT TO USE "WEB SERVICE", APART FROM THE MARK AS SHOWN.

FOR BUSINESS ASSET LOCATION AND MANAGEMENT SERVICES VIA AN ON-LINE GLOBAL COMMUNICATIONS NETWORK (U.S. CLS. 100, 101 AND 102).

FIRST USE 8-22-2001; IN COMMERCE 8-22-2001.

CLASS 35—(Continued).

2,626,960. REED ELSEVIER INC., NEWTON, MA. SN 76-300,356. FILED P.R. 8-17-2001; AM. S.R. 2-14-2002.

WORLD HEALTHCARE INFORMATION & TECHNOLOGY CONGRESS

FOR ARRANGING AND CONDUCTING TRADE SHOWS AND CONFERENCES IN THE FIELD OF CLINICAL MEDICINE, HEALTHCARE DELIVERY MANAGEMENT AND FINANCING (U.S. CLS. 100, 101 AND 102).
FIRST USE 12-7-2001; IN COMMERCE 12-7-2001.

2,626,970. DEVELOPMENT II, INC., WOODBURY, CT. SN 76-310,429. FILED P.R. 9-10-2001; AM. S.R. 5-30-2002.

REVENUE INDEX

FOR MARKET RESEARCH SERVICES (U.S. CLS. 100, 101 AND 102).
FIRST USE 5-1-1999; IN COMMERCE 5-1-1999.

2,626,971. J.P. NOLAN & CO., MAYWOOD, CA. SN 76-310,617. FILED P.R. 9-10-2001; AM. S.R. 1-14-2002.



NO CLAIM IS MADE TO THE EXCLUSIVE RIGHT TO USE "OUTSOURCES", APART FROM THE MARK AS SHOWN.

FOR PROVIDING OUTSOURCING SERVICES WITH OFFSHORE FACILITIES IN THE METAL FORGING AND PLASTIC TOOLING MARKETS FOR THE MANUFACTURE AND FABRICATION OF METAL CASTINGS AND DIE-CASTINGS, AND PLASTIC PARTS AND TOOLING FOR PLASTIC PARTS (U.S. CLS. 100, 101 AND 102).

FIRST USE 6-1-2001; IN COMMERCE 6-1-2001.

2,626,979. INCA SPIRITS, INC., CRAWFORDVILLE, GA. SN 76-318,622. FILED P.R. 10-1-2001; AM. S.R. 6-3-2002.

THE BREW FROM PERU

FOR IMPORT AGENCY AND WHOLESALE DISTRIBUTORSHIP FEATURING BEER FROM PERU (U.S. CLS. 100, 101 AND 102).
FIRST USE 2-0-2001; IN COMMERCE 2-0-2001.

CLASS 35—(Continued).

2,626,980. RUGS BY ROBINSON LTD, ATLANTA, GA. SN 76-318,624. FILED P.R. 10-1-2001; AM. S.R. 6-3-2002.

RUGS BY ROBINSON

NO CLAIM IS MADE TO THE EXCLUSIVE RIGHT TO USE "RUGS", APART FROM THE MARK AS SHOWN.

FOR RETAIL STORE SERVICES AND WHOLESALE DISTRIBUTORSHIP FEATURING RUGS AND CARPETS (U.S. CLS. 100, 101 AND 102).

FIRST USE 11-0-1985; IN COMMERCE 11-0-1985.

2,626,984. ADD2NET.COM, LLC, HUNTSVILLE, AL. SN 76-323,114. FILED P.R. 10-10-2001; AM. S.R. 5-24-2002.

ALLFREEBIES.COM

FOR PROVIDING A WEB SITE THAT EXPLAINS HOW TO OBTAIN GOODS AND SERVICES FOR FREE AND PROVIDES A CATALOG OF GOODS AND SERVICES AVAILABLE FOR FREE (U.S. CLS. 100, 101 AND 102).

FIRST USE 4-10-1998; IN COMMERCE 4-10-1998.

2,626,991. RMC OF ILLINOIS, INC., CHICAGO, IL. SN 76-344,893. FILED P.R. 12-5-2001; AM. S.R. 4-1-2002.

ECUSTOM 360

FOR BUSINESS CONSULTATION SERVICES, CAREER MANAGEMENT SERVICES, CAREER PLACEMENT SERVICES, CAREER RECRUITING SERVICES, EMPLOYMENT COUNSELING SERVICES, EMPLOYMENT OUTPLACEMENT SERVICES, HUMAN RESOURCE CONSULTATION SERVICES, PERSONNEL MANAGEMENT CONSULTATION SERVICES, AND PERSONNEL RETENTION CONSULTATION SERVICES; DEVELOPING, CONDUCTING, ADMINISTERING AND ANALYZING THE RESULTS OF SURVEYS IN THE HUMAN RESOURCES AND CAREER MANAGEMENT FIELDS (U.S. CLS. 100, 101 AND 102).

FIRST USE 10-1-2001; IN COMMERCE 10-1-2001.

2,626,994. TOPBULB.COM, LLC, EAST CHICAGO, IN. SN 76-353,523. FILED P.R. 12-31-2001; AM. S.R. 5-30-2002.

FIND ANY LIGHT BULB

FOR RETAIL CATALOGUE SERVICES AND ON-LINE RETAIL SERVICES PROVIDED OVER A GLOBAL COMPUTER NETWORK, FEATURING LIGHT BULBS, PROJECTION BULBS, AUTOMOTIVE BULBS, HIGH INTENSITY BULBS, MEDICAL/DENTAL/SURGICAL BULBS, MICROSCOPE ILLUMINATION BULBS, FIBER OPTIC ILLUMINATOR BULBS, INCANDESCENT AND FLUORESCENT BULBS, FLASHLIGHTS, BATTERIES AND ACCESSORIES THEREFOR (U.S. CLS. 100, 101 AND 102).

FIRST USE 12-3-2001; IN COMMERCE 12-3-2001.

CLASS 35—(Continued).

2,626,995. SCHNEIDER, DAVID L., SAN DIEGO, CA. SN 76-353,910. FILED P.R. 12-26-2001; AM. S.R. 6-7-2002.

TEMPFINDER

FOR ONLINE REFERRAL SERVICES TO EMPLOYMENT AGENCIES AND TEMPORARY STAFFING AGENCIES; ONLINE DIRECTORY OF EMPLOYMENT AGENCIES AND TEMPORARY STAFFING AGENCIES; ADVERTISING SERVICES, NAMELY, PROVIDING ONLINE MARKETING SERVICES FOR EMPLOYMENT AGENCIES AND TEMPORARY STAFFING AGENCIES IN THE NATURE OF BANNER ADVERTISING, DISPLAY ADVERTISING, LINK EXCHANGES AND SEARCH ENGINE PLACEMENT SERVICES (U.S. CLS. 100, 101 AND 102).

FIRST USE 12-11-2001; IN COMMERCE 12-11-2001.

2,626,996. SCHNEIDER, DAVID L., SAN DIEGO, CA. SN 76-353,911. FILED P.R. 12-26-2001; AM. S.R. 5-2-2002.

AMERICANJOBSEARCH

FOR ONLINE REFERRAL SERVICES TO EMPLOYMENT AGENCIES AND TEMPORARY STAFFING AGENCIES; ONLINE DIRECTORY OF EMPLOYMENT AGENCIES AND TEMPORARY STAFFING AGENCIES; ADVERTISING SERVICES, NAMELY, PROVIDING ONLINE MARKETING SERVICES FOR EMPLOYMENT AGENCIES AND TEMPORARY STAFFING AGENCIES IN THE NATURE OF BANNER ADVERTISING, DISPLAY ADVERTISING, LINK EXCHANGES AND SEARCH ENGINE PLACEMENT SERVICES (U.S. CLS. 100, 101 AND 102).

FIRST USE 12-11-2001; IN COMMERCE 12-11-2001.

2,626,997. SCHNEIDER, DAVID L., SAN DIEGO, CA. SN 76-353,931. FILED P.R. 12-26-2001; AM. S.R. 6-7-2002.

DENTISTLOCATOR

FOR ONLINE REFERRAL SERVICES TO PHYSICIANS AND DENTISTS; ONLINE DIRECTORY OF PHYSICIANS AND DENTISTS; ADVERTISING SERVICES, NAMELY, PROVIDING ONLINE MARKETING SERVICES IN THE NATURE OF BANNER ADVERTISING, DISPLAY ADVERTISING, LINK EXCHANGES AND SEARCH ENGINE PLACEMENT SERVICES FOR PHYSICIANS AND DENTISTS (U.S. CLS. 100, 101 AND 102).

FIRST USE 12-11-2001; IN COMMERCE 12-11-2001.

CLASS 35—(Continued).

2,626,998. SCHNEIDER, DAVID L., SAN DIEGO, CA. SN 76-353,932. FILED P.R. 12-26-2001; AM. S.R. 6-7-2002.

DENTISTSEARCHENGINE

FOR ONLINE REFERRAL SERVICES TO PHYSICIANS AND DENTISTS; ONLINE DIRECTORY OF PHYSICIANS AND DENTISTS; ADVERTISING SERVICES, NAMELY, PROVIDING ONLINE MARKETING SERVICES IN THE NATURE OF BANNER ADVERTISING, DISPLAY ADVERTISING, LINK EXCHANGES AND SEARCH ENGINE PLACEMENT SERVICES FOR PHYSICIANS AND DENTISTS (U.S. CLS. 100, 101 AND 102).

FIRST USE 12-11-2001; IN COMMERCE 12-11-2001.

2,627,009. LOUISIANA ONLINE, INC., BATON ROUGE, LA. SN 78-014,026. FILED P.R. 6-22-2000; AM. S.R. 3-18-2002.

SHREVEPORT ONLINE

OWNER OF U.S. REG. NO. 2,458,838.
NO CLAIM IS MADE TO THE EXCLUSIVE RIGHT TO USE "ONLINE", APART FROM THE MARK AS SHOWN.
FOR ONLINE ADVERTISING AND MARKETING OF RETAIL PRODUCTS AND SERVICES FOR OTHERS AT A GLOBAL COMPUTER INFORMATION NETWORK (U.S. CLS. 100, 101 AND 102).

FIRST USE 3-15-2002; IN COMMERCE 3-15-2002.

2,627,011. PRESS SOLUTIONS, LLC, NEW BERLIN, WI. SN 78-025,864. FILED P.R. 9-14-2000; AM. S.R. 3-15-2002.

PRESS SOLUTIONS

FOR MANUFACTURER REPRESENTATIVES IN THE FIELD OF PRINTING PRESSES, PRINTING ACCESSORIES AND PRINTING SUPPLIES (U.S. CLS. 100, 101 AND 102).

FIRST USE 10-0-1988; IN COMMERCE 10-0-1988.

CLASS 35—(Continued).

2,627,012. STAMATS COMMUNICATIONS, INC., CEDAR RAPIDS, IA. SN 78-026,047. FILED P.R. 9-15-2000; AM. S.R. 5-10-2002.

MEETINGS MEDIA

OWNER OF U.S. REG. NOS. 1,808,657, 2,170,515, AND 2,244,025.

FOR PROMOTING THE SERVICES OF OTHERS BY PREPARING AND PLACING ADVERTISEMENTS IN AN ELECTRONIC MAGAZINE ACCESSED THROUGH A GLOBAL COMPUTER NETWORK IN THE BUSINESS MEETING PLANNING INDUSTRY; PROMOTING THE SALE OF SERVICES OF OTHERS THROUGH THE DISTRIBUTION OF PRINTED MATERIAL; ARRANGING AND CONDUCTING TRADE SHOW EXHIBITIONS OR CONVENTIONS IN THE FIELD OF BUSINESS MEETING PLANNING USING PERIODICAL PRINT PUBLICATIONS AND THE GLOBAL COMPUTER NETWORK; PROVIDING AN ON-LINE COMPUTER DATABASE IN THE FIELD OF BUSINESS MEETING PLANNING; PROVIDING FACILITIES FOR BUSINESS MEETINGS (U.S. CLS. 100, 101 AND 102).
FIRST USE 8-8-2000; IN COMMERCE 8-8-2000.

2,627,022. NATIONAL HEALTH ADMINISTRATORS, INC., PEEKSKILL, NY. SN 78-072,623. FILED P.R. 7-6-2001; AM. S.R. 3-13-2002.

NATIONAL HEALTH ADMINISTRATORS, INC.

FOR ORGANIZING AND MANAGING PREFERRED PROVIDER HEALTH CARE ORGANIZATIONS AND HEALTH MAINTENANCE ORGANIZATIONS AND OTHER ALTERNATIVE HEALTH CARE DELIVERY SYSTEMS FOR INSURERS AND PROVIDERS OF MEDICAL SERVICES (U.S. CLS. 100, 101 AND 102).
FIRST USE 1-1-2001; IN COMMERCE 1-1-2001.

2,627,034. WISNESKI, SHEILA M., DBA MISSION STUDIO, JAMUL, CA. SN 78-101,050. FILED P.R. 1-4-2002; AM. S.R. 6-28-2002.

MISSION STUDIO

FOR RETAIL STORES FEATURING HAND-CRAFTED FURNITURE, HAND-CRAFTED LIGHT FIXTURES AND LAMPS, AND HAND-CRAFTED WALL MURALS (U.S. CLS. 100, 101 AND 102).
FIRST USE 7-1-1998; IN COMMERCE 7-1-1998.

2,627,036. KRUSE, GARY, L, GLENWOOD, IA. SN 78-102,023. FILED P.R. 1-10-2002; AM. S.R. 5-28-2002.

ONLINEQUITY

FOR ONLINE FINANCIAL STATEMENT PREPARATION AND ANALYSIS FOR BUSINESSES (U.S. CLS. 100, 101 AND 102).
FIRST USE 10-1-1999; IN COMMERCE 10-1-2000.

CLASS 36—INSURANCE AND FINANCIAL

2,626,764. SMARTVISION LLC, CAMERON PARK, CA. SN 75-572,191. FILED P.R. 10-16-1998; AM. S.R. 11-12-1999.

STADIUMTICKETS.COM

FOR TICKET BROKER SERVICES, NAMELY THE SERVICE OF LOCATING, OBTAINING AND RESELLING TICKETS TO CONCERTS, SHOWS AND EVENTS (U.S. CLS. 100, 101 AND 102).

FIRST USE 9-15-1998; IN COMMERCE 9-19-1998.

2,626,827. USSERY, TROY A., PLANO, TX. SN 76-050,555. FILED P.R. 5-16-2000; AM. S.R. 4-2-2002.

BUSINESS-TO-INVESTOR

FOR FINANCIAL SERVICES, NAMELY, PROVIDING INTERACTIVE FINANCIAL AND BUSINESS ANALYSIS AND FORECASTS BETWEEN INVESTORS AND PUBLICLY TRADED COMPANIES VIA THE INTERNET (U.S. CLS. 100, 101 AND 102).

FIRST USE 7-0-2000; IN COMMERCE 10-0-2000.

2,626,849. THE TRUSTEES OF FIDELITY INVESTMENTS CHARITABLE GIFT FUND, A MASSACHUSETTS TRUST, THE TRUSTEES COMPRISING RUDMAN J. HAM, ANNE-MARIE SOULLIERE, ROGER H. SALQUIST, DAVID L. YUNICH AND THOMAS J. POWERS, ALL CITIZENS OF THE UNITED STATES, BOSTON, MA. SN 76-118,662. FILED P.R. 8-29-2000; AM. S.R. 7-23-2001.

GIVING ACCOUNT

FOR DONOR-ADVISED INVESTMENT OF FUNDS FOR CHARITABLE PURPOSES; CHARITABLE FUND RAISING SERVICES; FINANCIAL MANAGEMENT SERVICES; PROVIDING FINANCIAL INFORMATION BY ELECTRONIC MEANS (U.S. CLS. 100, 101 AND 102).

FIRST USE 7-28-2000; IN COMMERCE 7-28-2000.

2,626,873. J.P. MORGAN & CO. INCORPORATED, NEW YORK, NY. SN 76-150,850. FILED P.R. 10-20-2000; AM. S.R. 10-26-2001.

CONSUMER PRICE INDEXED SECURITIES

FOR FINANCIAL SERVICES IN THE NATURE OF INVESTMENT SECURITIES (U.S. CLS. 100, 101 AND 102).

FIRST USE 2-1-2000; IN COMMERCE 2-11-2000.

CLASS 36—(Continued).

2,626,876. HOLLARD HOLDINGS (PTY) LIMITED, JOHANNESBURG, GAUTENG, SOUTH AFRICA. SN 76-163,213. FILED P.R. 11-10-2000; AM. S.R. 5-28-2002.

HOLLARD

OWNER OF SOUTH AFRICA REG. NO. 07942, DATED 9-9-1998, EXPIRES 9-9-2008.

THE NAME "HOLLARD" DOES NOT IDENTIFY A LIVING INDIVIDUAL.

FOR ACCIDENT INSURANCE UNDERWRITING; HEALTH INSURANCE UNDERWRITING; LIFE INSURANCE UNDERWRITING; MARINE INSURANCE UNDERWRITING; INSURANCE BROKERAGE; NUMISMATIC APPRAISALS FOR INSURANCE PURPOSES; ACTUARIAL SERVICES FOR INSURANCE PURPOSES (U.S. CLS. 100, 101 AND 102).

2,626,886. 1ST NATIONAL BANK OF SOUTH FLORIDA, HOMESTEAD, FL, BY CHANGE OF NAME FIRST NATIONAL BANK OF HOMESTEAD, THE, HOMESTEAD, FL. SN 76-189,281. FILED P.R. 1-3-2001; AM. S.R. 11-8-2001.

1ST NATIONAL BANK OF SOUTH FLORIDA

NO CLAIM IS MADE TO THE EXCLUSIVE RIGHT TO USE "1ST NATIONAL BANK", APART FROM THE MARK AS SHOWN.

FOR BANKING SERVICES (U.S. CLS. 100, 101 AND 102).

FIRST USE 6-19-2001; IN COMMERCE 6-19-2001.

2,626,895. AFFINITY MORTGAGE, LLC, ROWLETT, TX. SN 76-220,724. FILED P.R. 2-28-2001; AM. S.R. 4-30-2002.

CATHOLIC HOME LOAN

NO CLAIM IS MADE TO THE EXCLUSIVE RIGHT TO USE "HOME LOAN", APART FROM THE MARK AS SHOWN.

FOR FINANCIAL SERVICES, NAMELY MORTGAGE BANKING AND BROKERAGE SERVICES (U.S. CLS. 100, 101 AND 102).

FIRST USE 8-0-2000; IN COMMERCE 8-0-2000.

2,626,896. MIDFIRST BANK, OKLAHOMA CITY, OK. SN 76-220,812. FILED P.R. 3-6-2001; AM. S.R. 5-21-2002.

HOMELINE CARD

NO CLAIM IS MADE TO THE EXCLUSIVE RIGHT TO USE "CARD", APART FROM THE MARK AS SHOWN.

FOR BANKING SERVICES; NAMELY, HOME EQUITY CREDIT LINE SERVICES (U.S. CLS. 100, 101 AND 102).

FIRST USE 4-1-2001; IN COMMERCE 4-1-2001.

CLASS 36—(Continued).

2,626,908. BLUM CAPITAL PARTNERS, L.P., SAN FRANCISCO, CA. SN 76-246,161. FILED P.R. 4-25-2001; AM. S.R. 1-8-2002.

PRIVATE EQUITY IN THE PUBLIC MARKET

FOR INVESTMENT MANAGEMENT, INVESTMENT CONSULTATION AND BANKING SERVICES (U.S. CLS. 100, 101 AND 102).

FIRST USE 1-7-2002; IN COMMERCE 1-7-2002.

2,626,911. SLK ENTERPRISES, INC., NAPERVILLE, IL. SN 76-248,421. FILED P.R. 5-1-2001; AM. S.R. 1-24-2002.

SALON GALLERIA

FOR LEASING OF SHOPPING MALL SPACE TO INDEPENDENT HAIR, NAIL, AND SKIN CARE PROFESSIONALS (U.S. CLS. 100, 101 AND 102).

FIRST USE 11-1-2000; IN COMMERCE 11-1-2000.

2,626,919. CIGNA INTELLECTUAL PROPERTY, INC., WILMINGTON, DE. SN 76-258,494. FILED P.R. 5-18-2001; AM. S.R. 2-20-2002.

CASE MANAGER TOOLBOX

NO CLAIM IS MADE TO THE EXCLUSIVE RIGHT TO USE "CASE MANAGER", APART FROM THE MARK AS SHOWN.

FOR INSURANCE SERVICES, NAMELY, PROVIDING DISABILITY INSURANCE CLAIMS, AND MEDICAL CASE MANAGEMENT SERVICES, NAMELY, ACCESS TO CASE MANAGER PROFILES, PROPRIETARY CLINICAL GUIDELINES AND INDUSTRY RESOURCES VIA A GLOBAL COMPUTER NETWORK (U.S. CLS. 100, 101 AND 102).

FIRST USE 2-1-2001; IN COMMERCE 2-1-2001.

2,626,920. CORPREX, LLC, ORLANDO, FL. SN 76-258,764. FILED P.R. 5-17-2001; AM. S.R. 2-19-2002.

CORPORATE REAL ESTATE eXchange

NO CLAIM IS MADE TO THE EXCLUSIVE RIGHT TO USE "CORPORATE REAL ESTATE", APART FROM THE MARK AS SHOWN.

FOR REAL ESTATE ACQUISITION SERVICES, NAMELY ACQUIRING, DISPOSITION, AND TAX DEFERRED EXCHANGE OF REAL ESTATE (U.S. CLS. 100, 101 AND 102).

FIRST USE 7-7-2000; IN COMMERCE 7-7-2000.

CLASS 36—(Continued).

2,626,923. NATIONAL GUARDIAN LIFE INSURANCE COMPANY, MADISON, WI. SN 76-262,078. FILED P.R. 5-24-2001; AM. S.R. 5-28-2002.

PRENEED REINSURANCE COMPANY OF AMERICA

NO CLAIM IS MADE TO THE EXCLUSIVE RIGHT TO USE "PRENEED REINSURANCE COMPANY", APART FROM THE MARK AS SHOWN.

FOR REINSURANCE UNDERWRITING AND INSURANCE UNDERWRITING IN THE FIELD OF PRE-NEED INSURANCE AND ANNUITIES AND FINAL EXPENSE INSURANCE FOR FUNERAL PLANNING AND FOR FUNERAL, CREMATION AND BURIAL EXPENSES (U.S. CLS. 100, 101 AND 102).

FIRST USE 6-4-2001; IN COMMERCE 6-4-2001.

2,626,932. ERP OPERATING LIMITED PARTNERSHIP, CHICAGO, IL. SN 76-276,104. FILED P.R. 6-25-2001; AM. S.R. 4-17-2002.

AMERICA'S #1 APARTMENT COMPANY

FOR LEASING AND MANAGEMENT OF MULTI-FAMILY AND COMMERCIAL REAL ESTATE PROPERTIES (U.S. CLS. 100, 101 AND 102).

FIRST USE 3-0-1997; IN COMMERCE 3-0-1997.

2,626,951. CONFERENCES OF THE UNITED CHURCH OF CHRIST INSURANCE ADVISORY BOARD, GAITHERSBURG, MD. SN 76-293,387. FILED P.R. 8-1-2001; AM. S.R. 3-25-2002.

UNITED CHURCH INSURANCE COMPANY

NO CLAIM IS MADE TO THE EXCLUSIVE RIGHT TO USE "INSURANCE COMPANY", APART FROM THE MARK AS SHOWN.

FOR INTEGRATED RISK MANAGEMENT AND INSURANCE UNDERWRITING SERVICES FOR ALL TYPES OF INSURANCE FOR THE BENEFIT OF LOCAL CHURCHES, CONFERENCES AND ORGANIZATIONS RELATED TO THE UNITED CHURCH OF CHRIST AND THE CHRISTIAN CHURCH (U.S. CLS. 100, 101 AND 102).

FIRST USE 1-0-2002; IN COMMERCE 1-0-2002.

CLASS 36—(Continued).

2,626,953. PREMIER FINANCIAL PARTNERS, L.L.C., ST. LOUIS, MO. SN 76-294,281. FILED P.R. 8-6-2001; AM. S.R. 4-15-2002.

PREMIER FINANCIAL PARTNERS

FOR SECURITY BROKERAGE SERVICES AND FINANCIAL SERVICES, NAMELY FINANCIAL PLANNING AND RESEARCH (U.S. CLS. 100, 101 AND 102).

FIRST USE 5-13-1997; IN COMMERCE 5-13-1997.

2,626,985. MORTGAGES LTD., PHOENIX, AZ. SN 76-326,029. FILED P.R. 10-9-2001; AM. S.R. 2-15-2002.

CAPITAL OPPORTUNITY

NO CLAIM IS MADE TO THE EXCLUSIVE RIGHT TO USE "CAPITAL", APART FROM THE MARK AS SHOWN.

FOR MORTGAGE BANKING, MORTGAGE LENDING AND MORTGAGE BROKERAGE SERVICES (U.S. CLS. 100, 101 AND 102).

FIRST USE 3-1-2001; IN COMMERCE 3-1-2001.

2,626,989. SCHNEIDER, DAVID L., SAN DIEGO, CA. SN 76-334,610. FILED P.R. 11-6-2001; AM. S.R. 2-1-2002.

INSURANCEMATCH.COM

FOR ON-LINE INSURANCE AGENT REFERRAL SERVICES, NAMELY, MATCHING INSURANCE AGENTS WITH PROSPECTIVE INSUREDS IN THE FIELDS OF PROPERTY, CASUALTY, AND LIFE (U.S. CLS. 100, 101 AND 102).

FIRST USE 10-31-2001; IN COMMERCE 10-31-2001.

2,627,007. LAKE MICHIGAN CREDIT UNION, GRAND RAPIDS, MI. SN 76-382,677. FILED 3-18-2002.

LAKE MICHIGAN

FOR CREDIT UNION SERVICES (U.S. CLS. 100, 101 AND 102).

FIRST USE 3-1-2002; IN COMMERCE 3-1-2002.

CLASS 36—(Continued).

2,627,013. DIMEO SCHNEIDER & ASSOCIATES, L.L.C., CHICAGO, IL. SN 78-027,502. FILED P.R. 9-25-2000; AM. S.R. 3-27-2002.

TAX ELIMINATOR

FOR FINANCIAL SERVICE, NAMELY, FINANCIAL ANALYSIS AND CONSULTATION TO LOWER TAX LIABILITY OF AN INDIVIDUAL'S INVESTMENT ACTIVITY (U.S. CLS. 100, 101 AND 102).

FIRST USE 12-0-2000; IN COMMERCE 12-0-2000.

2,627,017. URBAN RESIDENTIAL PARTNERS, LLC, MINDEN, NV. SN 78-045,013. FILED P.R. 1-25-2001; AM. S.R. 5-7-2002.

URBAN RESIDENTIAL PARTNERS

NO CLAIM IS MADE TO THE EXCLUSIVE RIGHT TO USE "PARTNERS", APART FROM THE MARK AS SHOWN. FOR REAL ESTATE MANAGEMENT AND FINANCIAL INVESTMENT IN THE FIELD OF REAL ESTATE (U.S. CLS. 100, 101 AND 102).

FIRST USE 6-26-2001; IN COMMERCE 6-26-2001.

2,627,020. FIRST ARKANSAS MORTGAGE COMPANY, INC., JACKSONVILLE, AR. SN 78-064,416. FILED P.R. 5-18-2001; AM. S.R. 9-18-2001.

FIRST ARKANSAS MORTGAGE COMPANY

NO CLAIM IS MADE TO THE EXCLUSIVE RIGHT TO USE "FIRST" AND "MORTGAGE COMPANY", APART FROM THE MARK AS SHOWN.

FOR MORTGAGE FINANCING SERVICES (U.S. CLS. 100, 101 AND 102).

FIRST USE 1-1-1998; IN COMMERCE 1-1-1998.

CLASS 37—CONSTRUCTION AND REPAIR

2,626,852. NORTHEAST SYSTEMS, INC., SCARBOROUGH, ME. SN 76-121,192. FILED P.R. 8-28-2000; AM. S.R. 8-14-2001.

NATIONAL TELEPHONE & TECHNOLOGY

NO CLAIM IS MADE TO THE EXCLUSIVE RIGHT TO USE "TELEPHONE & TECHNOLOGY", APART FROM THE MARK AS SHOWN.

FOR INSTALLATION AND MAINTENANCE OF TELEPHONE SYSTEMS, CABLING SYSTEMS AND RELATED COMMUNICATIONS SYSTEMS (U.S. CLS. 100, 103 AND 106).

FIRST USE 1-3-2000; IN COMMERCE 4-7-2000.

CLASS 38—COMMUNICATION

2,626,808. AIRNEX COMMUNICATIONS, INC., SAN RAMON, CA. SN 75-907,973. FILED P.R. 2-1-2000; AM. S.R. 10-16-2000.

TEL.POLONIA

THE ENGLISH TRANSLATION OF "POLONIA" IS "PEOPLE OF POLISH DESCENT LIVING OUTSIDE OF POLAND".

FOR TELECOMMUNICATION SERVICES, NAMELY PROVISION OF LONG-DISTANCE TELEPHONE SERVICES, TELECOMMUNICATION TO A GLOBAL COMPUTER NETWORK, IP TELEPHONY SERVICES, PAGING SERVICES, CELLULAR TELEPHONE SERVICES, WIRELESS TELEPHONE SERVICES, SATELLITE TELEPHONE SERVICES (U.S. CLS. 100, 101 AND 104).

FIRST USE 12-0-1999; IN COMMERCE 12-0-1999.

2,626,913. CYBER MARKETING SERVICES, LLC, TEANECK, NJ. SN 76-252,297. FILED P.R. 5-4-2001; AM. S.R. 2-6-2002.

CRMXCHANGE

FOR PROVIDING AN ON-LINE FORUM FOR THE EXCHANGE OF INFORMATION ON CUSTOMER RELATIONSHIP MANAGEMENT, SALES, CONTACT CENTERS, TELEMARKETING AND BUSINESS INFORMATION ISSUES (U.S. CLS. 100, 101 AND 104).

FIRST USE 2-16-2000; IN COMMERCE 2-16-2000.

2,626,947. QWEST COMMUNICATIONS INTERNATIONAL INC., DENVER, CO. SN 76-292,638. FILED P.R. 7-30-2001; AM. S.R. 3-18-2002.

10 10 056

FOR TELECOMMUNICATIONS SERVICES, NAMELY, LONG DISTANCE TELEPHONE SERVICES (U.S. CLS. 100, 101 AND 104).

FIRST USE 12-31-1997; IN COMMERCE 12-31-1997.

CLASS 39—TRANSPORTATION AND STORAGE

2,626,907. DOOR TO DOOR MEDICAL SUPPLY, INC., TROY, MI. SN 76-245,718. FILED P.R. 4-24-2001; AM. S.R. 2-11-2002.

DOOR TO DOOR

FOR HOME DELIVERY OF MEDICAL, SURGICAL, DIABETES AND PHARMACEUTICAL SUPPLIES (U.S. CLS. 100 AND 105).

FIRST USE 6-30-2001; IN COMMERCE 6-30-2001.

CLASS 39—(Continued).

2,626,914. PERFORMANCE IMPROVEMENTS SPEED SHOPS LIMITED, ETOBICOKE, ONTARIO, CANADA. SN 76-254,048. FILED P.R. 5-7-2001; AM. S.R. 3-6-2000.

PERFORMANCE IMPROVEMENTS

FOR WHOLESALE DISTRIBUTORSHIP AND INTERNET, CATALOGUE AND MAIL ORDER RETAIL SERVICES IN THE AUTOMOTIVE PARTS AND ACCESSORIES FIELD (U.S. CLS. 100 AND 105).
FIRST USE 9-0-2000; IN COMMERCE 9-0-2000.

2,626,993. SIERRA NEVADA HELICOPTERS, INC., RENO, NV. SN 76-351,274. FILED P.R. 12-21-2001; AM. S.R. 5-10-2002.

AIRBORNE EXPEDITIONS

FOR HELICOPTER CHARTER SERVICES; HELICOPTER TOUR SERVICES (U.S. CLS. 100 AND 105).
FIRST USE 12-12-2001; IN COMMERCE 12-12-2001.

CLASS 41—EDUCATION AND ENTERTAINMENT

2,626,758. INTERNATIONAL SURFING ASSOCIATION, LA JOLLA, CA. SN 75-470,862. FILED P.R. 4-20-1998; AM. S.R. 10-29-1999.

BIG WAVE WORLD CHAMPIONSHIP

NO CLAIM IS MADE TO THE EXCLUSIVE RIGHT TO USE "CHAMPIONSHIP", APART FROM THE MARK AS SHOWN.

FOR ORGANIZING AND CONDUCTING SURFING CONTESTS (U.S. CLS. 100, 101 AND 107).
FIRST USE 2-0-1998; IN COMMERCE 2-0-1998.

2,626,778. WEST, SCOTT, ELK GROVE, CA. SN 75-706,013. FILED P.R. 5-12-1999; AM. S.R. 10-18-2000.

ROCK&ROLL.COM

OWNER OF U.S. REG. NOS. 2,308,607 AND 2,428,248.
FOR ENTERTAINMENT SERVICES, NAMELY, A CONTINUING NEWS SHOW ON THE SUBJECTS OF THE MUSIC INDUSTRY, RECORDING ARTISTS, AND OTHER MUSICAL EVENTS (U.S. CLS. 100, 101 AND 107).
FIRST USE 3-24-1994; IN COMMERCE 3-24-1994.

CLASS 41—(Continued).

2,626,785. NATIONAL ACADEMY OF RECORDING ARTS & SCIENCES, SANTA MONICA, CA. SN 75-781,136. FILED P.R. 8-20-1999; AM. S.R. 8-23-2001.

TENNESSEE MUSIC AWARDS

NO CLAIM IS MADE TO THE EXCLUSIVE RIGHT TO USE "MUSIC AWARDS", APART FROM THE MARK AS SHOWN.

FOR ENTERTAINMENT SERVICES IN THE NATURE OF LIVE AND TELEVISED SHOWS FEATURING MUSIC AWARD PROGRAMS; PROVIDING EDUCATIONAL PROGRAMS, NAMELY SCHOOL PROGRAMS AND SEMINARS IN THE FIELD OF MUSIC (U.S. CLS. 100, 101 AND 107).
FIRST USE 4-3-2001; IN COMMERCE 4-3-2001.

2,626,786. DUMMY CORPORATION, LOS ANGELES, CA. SN 75-789,284. FILED P.R. 9-1-1999; AM. S.R. 9-17-2001.

IMPROV HALL OF FAME

NO CLAIM IS MADE TO THE EXCLUSIVE RIGHT TO USE "HALL OF FAME", APART FROM THE MARK AS SHOWN.

FOR EDUCATIONAL AND ENTERTAINMENT SERVICES IN THE NATURE OF A MUSEUM (U.S. CLS. 100, 101 AND 107).
FIRST USE 4-26-2000; IN COMMERCE 4-26-2000.

2,626,792. CYBERU, INC., SANTA MONICA, CA. SN 75-853,199. FILED P.R. 11-18-1999; AM. S.R. 4-15-2002.

CYBERU

FOR EDUCATIONAL SERVICES, NAMELY, CONDUCTING ONLINE CLASSES, SEMINARS, CONFERENCES, AND WORKSHOPS IN THE FIELDS OF SECONDARY, COLLEGE, GRADUATE, POST-GRADUATE, AND ADULT EDUCATION, AND DISTRIBUTING COURSE MATERIALS IN CONNECTION THEREWITH (U.S. CLS. 100, 101 AND 107).
FIRST USE 2-1-2000; IN COMMERCE 2-1-2000.

2,626,796. DISCOVERY COMMUNICATIONS, INC., BETHESDA, MD. SN 75-872,544. FILED P.R. 12-14-1999; AM. S.R. 5-30-2002.

PET STORY

FOR ENTERTAINMENT, NAMELY, AN ONGOING TELEVISION SERIES, EACH EPISODE OF WHICH FEATURES AN ACCOUNT OF HOW AN ANIMAL KEPT FOR AMUSEMENT OR COMPANIONSHIP TOUCHED ITS OWNER'S LIFE (U.S. CLS. 100, 101 AND 107).
FIRST USE 6-26-2000; IN COMMERCE 6-26-2000.

CLASS 41—(Continued).

2,626,797. BOGARTGOLF, INC., BELLEVUE, WA. SN 75-873,806. FILED P.R. 12-16-1999; AM. S.R. 3-25-2002.

BOGARTGOLF

FOR EDUCATIONAL SERVICES, NAMELY PROVIDING INDIVIDUALIZED TRAINING AND INSTRUCTION IN THE GAME OF GOLF THROUGH PERSONAL INSTRUCTION AND THROUGH INTERACTIVE AUDIO AND VIDEO INSTRUCTION PROVIDED VIA A GLOBAL COMPUTER NETWORK (U.S. CLS. 100, 101 AND 107).
FIRST USE 10-1-1999; IN COMMERCE 11-1-1999.

2,626,821. PHOTOFLEX, INC., SANTA CRUZ, CA. SN 76-039,314. FILED P.R. 5-2-2000; AM. S.R. 5-17-2002.

WEB PHOTO SCHOOL

NO CLAIM IS MADE TO THE EXCLUSIVE RIGHT TO USE "PHOTO SCHOOL", APART FROM THE MARK AS SHOWN.

FOR EDUCATIONAL SERVICES, NAMELY ON-LINE EDUCATIONAL INFORMATION CLEARINGHOUSE AND INTERACTIVE AND DOWNLOADABLE LESSON REPOSITORY ON PROFESSIONAL PHOTOGRAPHIC TOPICS (U.S. CLS. 100, 101 AND 107).
FIRST USE 12-31-1997; IN COMMERCE 12-31-1997.

2,626,851. THOMSON LEARNING LICENSING CORPORATION, CLAYMONT, DE. SN 76-120,780. FILED P.R. 8-31-2000; AM. S.R. 5-22-2002.

BEST COLLEGE PICKS

FOR PROVIDING INFORMATION PERTAINING TO EDUCATIONAL INSTITUTIONS, NAMELY, COLLEGES AND UNIVERSITIES, AND ADMISSION THERETO, VIA A GLOBAL COMPUTER NETWORK (U.S. CLS. 100, 101 AND 107).

FIRST USE 10-31-2000; IN COMMERCE 10-31-2000.

2,626,869. SCRIPPS NETWORKS, INC., KNOXVILLE, TN, BY ASSIGNMENT SCRIPPS HOWARD BROADCASTING COMPANY, DBA DIY DO-IT-YOURSELF NETWORK, KNOXVILLE, TN. SN 76-144,010. FILED P.R. 10-10-2000; AM. S.R. 2-1-2002.

FAMILY OUTDOORS

FOR ENTERTAINMENT SERVICES, NAMELY AN ONGOING AUDIO-VISUAL PROGRAM DISTRIBUTED OVER AUDIO AND VIDEO MEDIA IN THE FIELDS OF CRAFTS AND HOBBIES, RECREATION AND ACTIVITIES (U.S. CLS. 100, 101 AND 107).

FIRST USE 9-10-2001; IN COMMERCE 9-10-2001.

CLASS 41—(Continued).

2,626,879. TWI INTERACTIVE, INC., NEWTON, CENTRE, MA. SN 76-169,405. FILED P.R. 11-21-2000; AM. S.R. 8-10-2001.

RACE TRACKER

FOR ON LINE ENTERTAINMENT SERVICES, NAMELY, THE PROVISION OF INFORMATION SERVICES IN THE NATURE OF REAL TIME REPORTING OF SPORTING EVENTS (U.S. CLS. 100, 101 AND 107).

FIRST USE 10-18-1999; IN COMMERCE 10-18-1999.

2,626,890. SCHINKER ENTERTAINMENT GROUP, INC., LIVONIA, MI. SN 76-197,826. FILED P.R. 1-22-2001; AM. S.R. 12-20-2001.

MUSIC VIDEO BINGO

FOR ENTERTAINMENT SERVICES, NAMELY, ORGANIZING AND CONDUCTING A MUSIC VIDEO GAME (U.S. CLS. 100, 101 AND 107).

FIRST USE 3-1-1997; IN COMMERCE 3-1-1997.

2,626,922. CENTER FOR ETHICAL BUSINESS CULTURES, THE, MINNEAPOLIS, MN. SN 76-261,942. FILED P.R. 5-23-2001; AM. S.R. 1-18-2002.

THE CENTER FOR ETHICAL BUSINESS CULTURES

FOR EDUCATIONAL SERVICES, NAMELY, CONDUCTING AND PROVIDING CLASSES, SEMINARS, CONFERENCES AND WORKSHOPS IN THE FIELDS OF ETHICAL LEADERSHIP, MANAGEMENT AND CULTURE, CORPORATE CITIZENSHIP AND EMPLOYER/EMPLOYEE RELATIONSHIPS, AND DISTRIBUTING COURSE MATERIALS IN CONNECTION THEREWITH (U.S. CLS. 100, 101 AND 107).

FIRST USE 9-2-2000; IN COMMERCE 9-27-2000.

2,626,955. KOTLER MARKETING GROUP, WASHINGTON, DC. SN 76-296,115. FILED P.R. 8-8-2001; AM. S.R. 4-23-2002.

KOTLER INSTITUTE

NO CLAIM IS MADE TO THE EXCLUSIVE RIGHT TO USE "INSTITUTE", APART FROM THE MARK AS SHOWN.

FOR EDUCATIONAL AND TRAINING SERVICES, NAMELY, CONDUCTING SEMINARS AND CLASSES IN THE FIELDS OF MARKETING (U.S. CLS. 100, 101 AND 107).

FIRST USE 2-5-2001; IN COMMERCE 2-5-2001.

CLASS 41—(Continued).

2,626,956. SIRACO PRODUCTIONS LTD, HENDERSON, NV. SN 76-296,406. FILED P.R. 8-9-2001; AM. S.R. 3-27-2002.

THE NATIONAL HANDICAPPING CHALLENGE

NO CLAIM IS MADE TO THE EXCLUSIVE RIGHT TO USE "HANDICAPPING CHALLENGE", APART FROM THE MARK AS SHOWN.

FOR ENTERTAINMENT SERVICES, NAMELY, HORSE RACE HANDICAPPING TOURNAMENTS (U.S. CLS. 100, 101 AND 107).

FIRST USE 10-0-1998; IN COMMERCE 10-0-1998.

2,626,961. LARRY H. MILLER THEATERS, INC., MURRAY, UT. SN 76-302,511. FILED P.R. 8-21-2001; AM. S.R. 4-8-2002.

SUPER SCREEN

FOR LARGE FORMAT MOVIE THEATERS (U.S. CLS. 100, 101 AND 107).

FIRST USE 12-1-1999; IN COMMERCE 12-1-1999.

2,626,964. POWERHOUSE PROMOTIONS, LLC, HOT SPRINGS, AR. SN 76-304,446. FILED P.R. 8-27-2001; AM. S.R. 5-20-2002.

THE HUNTER'S JOURNAL

FOR ENTERTAINMENT IN THE NATURE OF ONGOING TELEVISION PROGRAMS CONCERNING OUTDOOR ACTIVITIES (U.S. CLS. 100, 101 AND 107).

FIRST USE 8-21-2001; IN COMMERCE 8-21-2001.

2,626,965. ROUGH, JIM, PORT TOWNSEND, WA. SN 76-308,324. FILED P.R. 9-4-2001; AM. S.R. 4-29-2002.

DYNAMIC FACILITATION

FOR CONDUCTING WORKSHOPS AND SEMINARS IN VERBAL COMMUNICATION SKILLS (U.S. CLS. 100, 101 AND 107).

FIRST USE 9-0-1993; IN COMMERCE 9-0-1993.

CLASS 41—(Continued).

2,626,967. AUTOMOTIVE AFTERMARKET INDUSTRY ASSOCIATION, BETHESDA, MD. SN 76-309,139. FILED P.R. 9-5-2001; AM. S.R. 5-6-2002.

AFTERMARKET EFORUM

OWNER OF U.S. REG. NO. 1,842,483.

FOR EDUCATIONAL SERVICES IN THE FORM OF ORGANIZING AND CONDUCTING AN ANNUAL SEMINAR ON THE SUBJECT OF ELECTRONIC COMMERCE IN THE AUTOMOBILE AFTERMARKET FIELD (U.S. CLS. 100, 101 AND 107).

FIRST USE 8-13-2001; IN COMMERCE 8-13-2001.

2,626,969. AMERICA'S CLEAN WATER FOUNDATION, WASHINGTON, DC. SN 76-309,371. FILED P.R. 8-21-2001; AM. S.R. 5-8-2002.

ON-FARM ASSESSMENT AND ENVIRONMENTAL REVIEW

FOR PROVIDING EDUCATIONAL TRAINING FOR THE AGRICULTURAL AND ANIMAL PRODUCER INDUSTRIES ON ISSUES OF WATER RESOURCE PROTECTION; EDUCATING FARMERS AND LIVESTOCK PRODUCERS ON OVERALL SITE MANAGEMENT, NAMELY THE MANAGEMENT OF WATER RESOURCES AND THE PRODUCTS OF FARM OPERATIONS SO AS TO EFFECT WATER QUALITY AND SANITATION; EDUCATING THE GENERAL PUBLIC ON ISSUES OF WATER QUALITY AND SANITATION (U.S. CLS. 100, 101 AND 107).

FIRST USE 5-0-1999; IN COMMERCE 5-0-1999.

2,626,975. BARTON CREEK RESORT & CLUB, INC., AUSTIN, TX. SN 76-315,263. FILED P.R. 9-21-2001; AM. S.R. 5-22-2002.

THE GOLF CAPITAL OF TEXAS

NO CLAIM IS MADE TO THE EXCLUSIVE RIGHT TO USE "GOLF", APART FROM THE MARK AS SHOWN.

FOR PROVIDING GOLF COURSE AND GOLF CLUB FACILITIES, TENNIS COURT FACILITIES, AND SWIMMING POOL FACILITIES; COUNTRY CLUB SERVICES; HEALTH CLUB SERVICES; INSTRUCTIONS IN GOLF, TENNIS, SWIMMING, AND PHYSICAL FITNESS; ORGANIZING, CONDUCTING AND SPONSORING GOLF AND TENNIS TOURNAMENTS; PROVIDING FACILITIES FOR RECREATION ACTIVITIES, NAMELY SAILING, JOGGING, FISHING, WATER SKIING, SKEET SHOOTING, GOLF DRIVING RANGE, HORSEBACK RIDING, A NATURE TRAIL, AND HORSEBACK RIDING INSTRUCTIONS (U.S. CLS. 100, 101 AND 107).

FIRST USE 1-1-2001; IN COMMERCE 1-1-2001.

CLASS 41—(Continued).

2,626,982. BLINK MUSIC, INC., CAMBRIDGE, MA. SN 76-320,356. FILED P.R. 10-3-2001; AM. S.R. 4-15-2002.

SONIC EXCELLENCE

NO CLAIM IS MADE TO THE EXCLUSIVE RIGHT TO USE "SONIC", APART FROM THE MARK AS SHOWN.
FOR AUDIO RECORDING AND PRODUCTION SERVICES (U.S. CLS. 100, 101 AND 107).
FIRST USE 1-1-2000; IN COMMERCE 1-1-2000.

2,626,988. TICKETS.COM, INC., COSTA MESA, CA. SN 76-332,383. FILED 10-31-2001.

1-800-TICKETS

FOR ONLINE TICKETING AND INFORMATION SERVICES, NAMELY, ARRANGING FOR TICKETS FOR SHOWS AND OTHER ENTERTAINMENT EVENTS AND THE PROVISION OF INFORMATION RELATING TO SHOWS AND OTHER ENTERTAINMENT EVENTS, ALL VIA GLOBAL COMPUTER NETWORK (U.S. CLS. 100, 101 AND 107).
FIRST USE 8-1-1997; IN COMMERCE 8-1-1997.

2,627,000. MULLINS, MICHAEL, GERMANTOWN, TN. SN 76-365,037. FILED P.R. 1-31-2002; AM. S.R. 6-21-2002.

**ARIZONA SKYDIVING
COOLIDGE**

NO CLAIM IS MADE TO THE EXCLUSIVE RIGHT TO USE "SKYDIVING", APART FROM THE MARK AS SHOWN.
FOR TRAINING OF NOVICE AND EXPERIENCED SKYDIVERS IN THE SPORT OF SKYDIVING (U.S. CLS. 100, 101 AND 107).
FIRST USE 11-15-1998; IN COMMERCE 12-1-1998.

2,627,015. SCOTTISH HARP SOCIETY OF AMERICA, THE, CUYAHOGA FALLS, OH. SN 78-034,965. FILED P.R. 11-13-2000; AM. S.R. 6-20-2002.

**THE NATIONAL SCOTTISH
HARP CHAMPIONSHIP OF
AMERICA**

NO CLAIM IS MADE TO THE EXCLUSIVE RIGHT TO USE "HARP CHAMPIONSHIP", APART FROM THE MARK AS SHOWN.
FOR ENTERTAINMENT IN THE NATURE OF A MAJOR COMPETITION WITH AWARDS IN THE FIELD OF LIVE PERFORMANCES ON THE HARP (U.S. CLS. 100, 101 AND 107).
FIRST USE 6-1-1999; IN COMMERCE 4-1-2001.

CLASS 41—(Continued).

2,627,024. AMERICAN BUSINESS ENGLISH SERVICES, LLC, DBA AMERICAN BUSINESS ENGLISH INTERNET SCHOOL, BOULDER, CO. SN 78-073,657. FILED P.R. 7-12-2001; AM. S.R. 2-22-2002.

BIZENGLISH

FOR ONLINE LANGUAGE INSTRUCTION IN BUSINESS ENGLISH FOR INTERNATIONAL BUSINESS PEOPLE (U.S. CLS. 100, 101 AND 107).
FIRST USE 12-15-1997; IN COMMERCE 12-15-1997.

2,627,033. PUBLICATIONS & COMMUNICATIONS, INC., CEDAR PARK, TX. SN 78-099,140. FILED P.R. 12-19-2001; AM. S.R. 6-4-2002.

CONCRETEHOMES

FOR PUBLICATION OF MAGAZINES (U.S. CLS. 100, 101 AND 107).
FIRST USE 10-1-1998; IN COMMERCE 10-1-1998.

**CLASS 42—SCIENTIFIC, COMPUTER AND
LEGAL SERVICES**

2,626,770. RSPNET.COM, INC., EDEN PRAIRIE, MN. SN 75-639,201. FILED P.R. 2-6-1999; AM. S.R. 5-19-2000.

DIGITAL DIALTONE

FOR COMPUTER CONSULTATION, COMPUTER PROGRAMMING FOR OTHERS, COMPUTER SITE DESIGN, COMPUTER SOFTWARE DESIGN FOR OTHERS, AND OTHER COMPUTER SERVICES, NAMELY DEVELOPING AND IMPLEMENTING WEB SITES FOR OTHERS, AND HOSTING WEBSITES OF OTHERS ON A COMPUTER SERVER (U.S. CLS. 100 AND 101).
FIRST USE 2-4-1999; IN COMMERCE 2-4-1999.

2,626,803. MICROMEDEX, INC., ENGLEWOOD, CO. SN 75-898,029. FILED P.R. 1-18-2000; AM. S.R. 9-27-2001.

REGSKNOWLEDGE

FOR COMPUTER SERVICES, NAMELY, PROVIDING REGULATORY INFORMATION DIRECTED TO THE INDUSTRIAL, TOXICOLOGICAL AND ENVIRONMENTAL MARKETS VIA A GLOBAL COMPUTER NETWORK (U.S. CLS. 100 AND 101).
FIRST USE 7-0-2000; IN COMMERCE 7-0-2000.

CLASS 42—(Continued).

2,626,811. LOVELLS, LONDON EC1A 2DY, ENGLAND. SN 75-936,466. FILED P.R. 3-6-2000; AM. S.R. 1-22-2002.

LOVELLS

FOR LEGAL SERVICES (U.S. CLS. 100 AND 101).
FIRST USE 1-1-2000; IN COMMERCE 1-1-2000.

2,626,812. CHINESEIMMIGRANT.COM CORP, MARKHAM ONTARIO, CANADA. SN 75-942,527. FILED P.R. 3-13-2000; AM. S.R. 11-13-2000.

中国移民网
Chineseimmigrant.com

THE NON-LATIN CHARACTERS IN THE MARK TRANSLITERATE TO "CHONG QUI CHE MET JONG" AND THIS MEANS "CHINESE IMMIGRATION" IN ENGLISH.

FOR INFORMATION SERVICES, NAMELY, PROVIDING A DIRECTORY OF CHINESE LANGUAGE MATERIAL AVAILABLE ON GLOBAL COMPUTER NETWORKS BY MEANS OF GLOBAL COMPUTER NETWORKS (U.S. CLS. 100 AND 101).

FIRST USE 2-28-2000; IN COMMERCE 2-28-2000.

2,626,813. CONNECT CENTER, INC., CARTERSVILLE, GA. SN 75-942,632. FILED P.R. 3-13-2000; AM. S.R. 1-16-2002.

DIGITAL FLOORING

NO CLAIM IS MADE TO THE EXCLUSIVE RIGHT TO USE "FLOORING", APART FROM THE MARK AS SHOWN. FOR CONSULTATION IN THE FIELD OF RAISED FLOOR SYSTEMS; DESIGN OF RAISED FLOOR SYSTEMS (U.S. CLS. 100 AND 101).

FIRST USE 1-15-2000; IN COMMERCE 2-1-2000.

CLASS 42—(Continued).

2,626,814. POLYMER ALLIANCE ZONE, INC., RIPLEY, WV, BY ASSIGNMENT SCIENCE APPLICATIONS INTERNATIONAL CORPORATION ("SAIC"), SAN DIEGO, CA. SN 75-981,893. FILED P.R. 11-1-1999; AM. S.R. 8-6-2001.

GREENONLINE.COM

FOR COMPUTER SERVICES, NAMELY, PROVIDING ON-LINE SUBSCRIPTION SERVICES FEATURING UPDATES ON THE PURCHASING CONTRACTS AND BIDDING ON ENVIRONMENTALLY-RELATED SERVICES, UPDATES ON THE STATUS OF REGULATORY PERMITS, ALLOWANCES, AND CERTIFICATES, AND OTHER ENVIRONMENTAL INFORMATION PROVIDED VIA ELECTRONIC MAIL ON A PERIODIC BASIS; PROVIDING ON-LINE NEWS AND INFORMATION REGARDING ENVIRONMENTAL ISSUES AND MATTERS; AND HOSTING THE WEBSITES OF OTHERS ON A COMPUTER NETWORK SERVER FOR A GLOBAL COMPUTER NETWORK (U.S. CLS. 100 AND 101).

FIRST USE 10-25-1999; IN COMMERCE 10-25-1999.

2,626,817. INFORMATION RESOURCES, INC., CHICAGO, IL. SN 76-014,294. FILED P.R. 3-31-2000; AM. S.R. 3-22-2002.

CPGNETWORK.COM

FOR BUSINESS MARKETING CONSULTING SERVICES, MARKET RESEARCH SERVICES AND PROVIDING BUSINESS INFORMATION ABOUT RETAIL SALES, MARKETING AND PROMOTION, CONSUMERS BEHAVIOR, AND RELATED BUSINESS DECISION SUPPORT INFORMATION; BUSINESS MARKETING CONSULTING SERVICES, MARKET RESEARCH SERVICES AND PROVIDING BUSINESS INFORMATION ABOUT RETAIL SALES, MARKETING AND PROMOTION, CONSUMER BEHAVIOR, AND RELATED BUSINESS DECISION SUPPORT INFORMATION VIA THE INTERNET AND A WEBSITE (U.S. CLS. 100 AND 101).

FIRST USE 12-14-1999; IN COMMERCE 3-20-2000.

2,626,820. KAHN-GAUTHIER LAW GROUP, L.L.C., METAIRIE, LA, BY ASSIGNMENT KAHN LAW GROUP (A PROFESSIONAL LAW CORPORATION), METAIRIE, LA. SN 76-035,068. FILED P.R. 4-26-2000; AM. S.R. 4-19-2002.

USJURIS

FOR LEGAL SERVICES, NAMELY PROVIDING LEGAL SERVICES WHICH CATER TO MEMBERS, OR POTENTIAL MEMBERS, OF CONSUMER CLASS, OR OTHER MULTI-PLAINTIFF, ACTIONS; INFORMATION SERVICES, NAMELY PROVIDING INFORMATION BY MEANS OF A GLOBAL COMPUTER NETWORK IN THE FIELD OF LEGAL INFORMATION WHICH CATERS TO MEMBERS, OR POTENTIAL MEMBERS, OF CONSUMER CLASS, OR OTHER MULTI-PLAINTIFF, ACTIONS, NAMELY INFORMATION ON ONE OR MORE LEGAL PROCEEDINGS INVOLVING CLASS, OR OTHER MULTI-PLAINTIFF, ACTIONS (U.S. CLS. 100 AND 101).

FIRST USE 12-1-2000; IN COMMERCE 12-1-2000.

CLASS 42—(Continued).

2,626,822. POSH SALONS, LLC, ATLANTA, GA. SN 76-043,876. FILED P.R. 5-8-2000; AM. S.R. 1-31-2002.

DOBÉL

FOR BEAUTY CARE SERVICES, NAMELY, SALON AND SPA SERVICES (U.S. CLS. 100 AND 101).
FIRST USE 11-11-2000; IN COMMERCE 11-11-2000.

2,626,823. VANMOOR, ARTHUR, BOCA RATON, FL. SN 76-045,926. FILED P.R. 5-11-2000; AM. S.R. 4-25-2002.

AFFORDABLE

FOR ESCORT SERVICES PROVIDED FOR SOCIAL, RECREATIONAL, COURTESY, GUIDANCE, AND BUSINESS PURPOSES (U.S. CLS. 100 AND 101).
FIRST USE 7-1-2000; IN COMMERCE 7-1-2000.

2,626,825. LARGE SCALE BIOLOGY CORPORATION, VACAVILLE, CA. SN 76-050,379. FILED P.R. 5-16-2000; AM. S.R. 12-3-2001.

**PHARMACEUTICAL
PROTEOMICS**

NO CLAIM IS MADE TO THE EXCLUSIVE RIGHT TO USE "PROTEOMICS", APART FROM THE MARK AS SHOWN.

FOR BIOLOGICAL AND PROTEIN RESEARCH SERVICES AND PROVIDING ELECTRONIC DATABASE IN THE FIELD OF PROTEIN RESEARCH (U.S. CLS. 100 AND 101).

FIRST USE 11-0-1999; IN COMMERCE 11-0-1999.

CLASS 42—(Continued).

2,626,830. STEAM SAVER SYSTEMS, INC., LARGO, MD. SN 76-056,785. FILED P.R. 5-25-2000; AM. S.R. 7-10-2001.

STEAM SAVER SYSTEMS

FOR CONSULTING SERVICES IN THE FIELD OF STEAM-RELATED ENERGY COST REDUCTION FOR OTHERS VIA ENERGY AUDITING OF STEAM SYSTEMS INCLUDING ASSESSMENTS AND ANALYSES OF STEAM-RELATED EQUIPMENT AND OF THE ENERGY COSTS OF OPERATING STEAM-RELATED EQUIPMENT, STEAM DISTRIBUTION SYSTEMS AND PROVIDING ENERGY COST SAVING MEASURES RELATED TO STEAM SYSTEMS; DESIGN SERVICES, NAMELY, CUSTOM DESIGN OF STEAM SAVING SERVICES FOR OTHERS; ENGINEERING SERVICES, NAMELY, MECHANICAL ENGINEERING; MONITORING AND VERIFICATION SERVICES, NAMELY, MONITORING AND VERIFICATION OF STEAM OPERATIONS (U.S. CLS. 100 AND 101).

FIRST USE 1-0-1997; IN COMMERCE 1-0-1997.

2,626,835. TABLEWINE.COM, RIDGEWOOD, NJ. SN 76-076,845. FILED P.R. 6-23-2000; AM. S.R. 2-13-2002.

TABLEWINE.COM

FOR PROVIDING INFORMATION CONCERNING AFFORDABLE WINES THROUGH THE MEANS OF A GLOBAL COMPUTER NETWORK (U.S. CLS. 100 AND 101).

FIRST USE 9-0-1996; IN COMMERCE 9-0-1996.

2,626,836. OURFREENET.COM, EL MONTE, CA. SN 76-079,496. FILED P.R. 6-27-2000; AM. S.R. 2-28-2002.

**GEOSPATIAL
TECHNOLOGIES**

FOR PROVIDING COMPUTER CONSULTING SERVICES RELATING TO GEOGRAPHICAL INFORMATION SYSTEMS (GIS) (U.S. CLS. 100 AND 101).

FIRST USE 7-0-1994; IN COMMERCE 7-0-1994.

2,626,838. GENOMEWEB LLC, NEW YORK, NY. SN 76-084,052. FILED P.R. 7-6-2000; AM. S.R. 4-24-2002.

GENOMEWEB

FOR PROVIDING INFORMATION IN THE FIELD OF MANAGEMENT AND ANALYSIS OF BIOLOGICAL DATA; PROVIDING INFORMATION IN THE FIELD OF BIOLOGICAL RESEARCH CONDUCTED USING ADVANCED COMPUTING TECHNIQUES (U.S. CLS. 100 AND 101).

FIRST USE 9-0-2000; IN COMMERCE 9-0-2000.

CLASS 42—(Continued).

2,626,850. MANGOSOFT, INC., WESTBOROUGH, MA. SN 76-120,380. FILED P.R. 8-30-2000; AM. S.R. 8-22-2001.

THE BUSINESS INTERNET FILE SERVICE

NO CLAIM IS MADE TO THE EXCLUSIVE RIGHT TO USE "INTERNET FILE SERVICE", APART FROM THE MARK AS SHOWN.

FOR APPLICATION SERVICE PROVIDER FEATURING BUSINESS SOFTWARE DESIGNED TO ENABLE MULTIPLE USERS TO ACCESS, SHARE AND STORE ON-LINE SOFTWARE FILES; APPLICATION SERVICES PROVIDER FEATURING BUSINESS SOFTWARE DESIGNED TO SECURE ON-LINE BUSINESS-TO-BUSINESS APPLICATIONS AND PROCESSES (U.S. CLS. 100 AND 101).

FIRST USE 10-0-2000; IN COMMERCE 10-0-2000.

2,626,874. LIVINGSTON, BRUCE, SKOKIE, IL. SN 76-154,722. FILED P.R. 10-25-2000; AM. S.R. 5-7-2002.

MEDICAL MALPRACTICE RESOURCE

NO CLAIM IS MADE TO THE EXCLUSIVE RIGHT TO USE "MEDICAL MALPRACTICE", APART FROM THE MARK AS SHOWN.

FOR LEGAL SERVICES, NAMELY PROVIDING MEDICAL CASE PREPARATION GUIDANCE VIA THE GLOBAL COMPUTER NETWORK (U.S. CLS. 100 AND 101).

FIRST USE 0-0-2000; IN COMMERCE 0-0-2000.

2,626,882. STINSON, JOHN, BATON ROUGE, LA. SN 76-179,806. FILED P.R. 12-11-2000; AM. S.R. 3-11-2002.

TECHNOLOGY ENGINEERS

FOR COMPUTER SOFTWARE SERVICES, NAMELY SOFTWARE AND APPLICATION DEVELOPMENT, AND INTEGRATION OF DIFFERENT COMPUTER SYSTEMS AND NETWORKS (U.S. CLS. 100 AND 101).

FIRST USE 12-11-2000; IN COMMERCE 12-11-2000.

2,626,888. RUTGERS, THE STATE UNIVERSITY, NEW BRUNSWICK, NJ. SN 76-193,530. FILED P.R. 1-13-2001; AM. S.R. 8-17-2001.

NATIONAL MARRIAGE PROJECT

FOR PROVIDING INFORMATION ABOUT THE INSTITUTION OF MARRIAGE IN CONTEMPORARY AMERICAN SOCIETY FOR USE IN SHAPING PUBLIC POLICY AND PROMOTING CONSTRUCTIVE PUBLIC DEBATE (U.S. CLS. 100 AND 101).

FIRST USE 2-17-1998; IN COMMERCE 9-30-1998.

CLASS 42—(Continued).

2,626,912. ADVANCED RESEARCH AND TECHNOLOGY INSTITUTE, INC., BLOOMINGTON, IN. SN 76-250,948. FILED P.R. 5-3-2001; AM. S.R. 4-24-2002.

GLOBAL RESEARCH NETWORK OPERATIONS CENTER

NO CLAIM IS MADE TO THE EXCLUSIVE RIGHT TO USE "NETWORK OPERATIONS CENTER", APART FROM THE MARK AS SHOWN.

FOR ONLINE SERVICES, NAMELY PROVIDING NETWORK OPERATIONS SERVICES TO MANAGE THE INTERNATIONAL NETWORK CONNECTIONS OF ADVANCED RESEARCH AND EDUCATION NETWORKS IN ORDER TO FACILITATE INTERNATIONAL COLLABORATION IN RESEARCH AND EDUCATION (U.S. CLS. 100 AND 101).

FIRST USE 10-4-2000; IN COMMERCE 10-4-2000.

2,626,925. AMERICAN PHYSICAL SOCIETY, THE, COLLEGE PARK, MD. SN 76-266,573. FILED P.R. 6-4-2001; AM. S.R. 2-6-2002.

PHYSICAL REVIEW ONLINE ARCHIVE

NO CLAIM IS MADE TO THE EXCLUSIVE RIGHT TO USE "REVIEW ONLINE ARCHIVE", APART FROM THE MARK AS SHOWN.

FOR COMPUTER SERVICES, NAMELY PROVIDING ON-LINE JOURNALS IN THE FIELD OF PHYSICS AND PROVIDING A SEARCHABLE DATABASE IN CONNECTION THEREWITH (U.S. CLS. 100 AND 101).

FIRST USE 0-0-1998; IN COMMERCE 0-0-1998.

2,626,926. AMERICAN PHYSICAL SOCIETY, THE, COLLEGE PARK, MD. SN 76-266,585. FILED P.R. 6-4-2001; AM. S.R. 2-6-2002.

PHYSICAL REVIEW SPECIAL TOPICS

NO CLAIM IS MADE TO THE EXCLUSIVE RIGHT TO USE "REVIEW SPECIAL TOPICS", APART FROM THE MARK AS SHOWN.

FOR COMPUTER SERVICES, NAMELY PROVIDING AN ON-LINE SCIENTIFIC JOURNAL FEATURING TOPICS AND DEVELOPMENTS IN THE FIELD OF PHYSICS (U.S. CLS. 100 AND 101).

FIRST USE 5-0-1998; IN COMMERCE 5-0-1998.

CLASS 42—(Continued).

2,626,927. DETECTIVEHELP.COM, INC., WOODSIDE, CA. SN 76-268,521. FILED P.R. 6-7-2001; AM. S.R. 3-11-2002.

DETECTIVEHELP.COM

FOR COMPUTER SERVICES, NAMELY A SEARCH ENGINE FOR OBTAINING DATA ON THE INTERNET AND USED BY PRIVATE INVESTIGATORS WORLD-WIDE TO OBTAIN A VARIETY OF INFORMATION FOR USE IN CONNECTION WITH THEIR SERVICES AND ALSO FOR THE PURPOSE OF FINDING OTHER PRIVATE INVESTIGATORS (U.S. CLS. 100 AND 101).
FIRST USE 7-17-1999; IN COMMERCE 7-17-1999.

2,626,957. MIDWEST SUSTAINABLE COLLABORATIVE, LLC, MILWAUKEE, WI. SN 76-296,638. FILED P.R. 8-8-2001; AM. S.R. 3-18-2002.

MIDWEST SUSTAINABLE COLLABORATIVE

FOR ARCHITECTURAL DESIGN; ENGINEERING (U.S. CLS. 100 AND 101).
FIRST USE 1-15-2001; IN COMMERCE 1-15-2001.

2,626,959. METAVERSE CORPORATION, WASHINGTON TOWNSHIP, NJ. SN 76-298,455. FILED P.R. 8-13-2001; AM. S.R. 5-6-2002.

DATABASE SCATTERING

FOR PROVIDING TEMPORARY USE OF ON-LINE NON-DOWNLOADABLE COMPUTER SOFTWARE, NAMELY SOFTWARE FOR ENABLING LARGE SCALE DATABASE IMPLEMENTATIONS TO SCALE OUT AND DISTRIBUTE THE WORKLOAD AND REDUNDANCY REQUIREMENTS TO SUPPORT A HUGE AMOUNT OF VOLUME IT IS ACCOMPLISHED BY A LAYER OF SOFTWARE APPLICATIONS MIDDLEWARE THAT ENABLES MULTIPLE DATABASE SERVERS JOIN TO FORM A SCATTER SET THAT ACTS AS ONE DATABASE TO DIVIDE LOAD, ENTIRELY TRANSPARENT TO THE CLIENT (U.S. CLS. 100 AND 101).
FIRST USE 9-1-2001; IN COMMERCE 9-1-2001.

CLASS 42—(Continued).

2,626,974. BARTON CREEK RESORT & CLUB, INC., AUSTIN, TX. SN 76-315,262. FILED P.R. 9-21-2001; AM. S.R. 5-22-2002.

THE GOLF CAPITAL OF TEXAS

FOR PROVIDING FACILITIES FOR CONFERENCES, MEETINGS, EXHIBITIONS AND CONVENTIONS, HEALTH SPAS, RESTAURANT SERVICES, CATERING SERVICES AND BAR SERVICES; RENTAL OF COMPUTERS; BEAUTY SALON SERVICES; MASSAGE SERVICES; AND RESORT HOTEL SERVICES (U.S. CLS. 100 AND 101).
FIRST USE 1-1-2001; IN COMMERCE 1-1-2001.

2,627,019. MAIL ABUSE PREVENTION SYSTEM, LLC, REDWOOD CITY, CA. SN 78-053,098. FILED P.R. 3-14-2001; AM. S.R. 5-16-2002.

MAPS DUL

FOR PROVIDING ONLINE COMPUTER DATABASE IN THE FIELD OF E-MAIL ABUSE PREVENTION, NAMELY, DATABASES THAT CONTAIN INTERNET PROTOCOL ADDRESSES OF VERIFIED DIAL-UP INTERNET ACCESS POINTS, SUCH INFORMATION TO BE USED BY SUBSCRIBERS TO DECIDE WHETHER OR NOT TO ACCEPT E-MAIL OR OTHER INTERNET TRAFFIC ORIGINATING FROM THESE INTERNET PROTOCOL ADDRESSES, THEREBY GREATLY REDUCING THE AMOUNT OF UNWANTED E-MAIL TRAFFIC (U.S. CLS. 100 AND 101).
FIRST USE 11-1-1998; IN COMMERCE 2-1-1999.

2,627,021. FAMIGLIETTA, STEVEN R., BROOKLYN, NY. SN 78-068,514. FILED P.R. 6-11-2001; AM. S.R. 10-18-2001.

RIGATONI RESTAURANT

NO CLAIM IS MADE TO THE EXCLUSIVE RIGHT TO USE "RESTAURANT", APART FROM THE MARK AS SHOWN.
FOR RESTAURANT SERVICES, NAMELY, PROVIDING OF FOOD AND DRINK (U.S. CLS. 100 AND 101).
FIRST USE 9-11-1990; IN COMMERCE 9-11-1990.

2,627,023. GOLDBERG, CAROL, SYOSSET, NY. SN 78-072,904. FILED P.R. 7-9-2001; AM. S.R. 3-8-2002.

WEB SITES AND SOUND BITES

FOR COMPUTER WEB SITE DESIGN FOR PROFESSIONALS AND BUSINESSES (U.S. CLS. 100 AND 101).
FIRST USE 5-5-2001; IN COMMERCE 5-5-2001.

TRADEMARK REGISTRATIONS RENEWED

The designation "U.S. Cl." appearing in this section refers to the U.S. class in effect prior to Sep. 1, 1973 rather than the international class which applies to applications filed on or after that date. For adoption of international classification see notice in the OFFICIAL GAZETTE of Jun. 26, 1973 (911 O.G. TM 210).

87,306.	LINDT. U.S. CL. 46. (INT. CL. 30). REG. 7-9-1912.	732,953.	M AND DESIGN. U.S. CL. 14. (INT. CL. 6). REG. 6-19-1962.
162,309.	WEBSTER'S NEW INTERNATIONAL MW AND DESIGN. U.S. CL. 38. (INT. CL. 16). REG. 12-12-1922.	733,395.	COAXICON. U.S. CL. 23. (INT. CL. 8). REG. 6-26-1962.
278,789.	SEASIDE (STYLIZED). U.S. CL. 46. (INT. CL. 29). REG. 12-30-1930.	733,648.	BLACK MAGIC. U.S. CL. 12. (INT. CL. 19). REG. 7-3-1962.
284,377.	ELECTROLUX. U.S. CL. 21. (INT. CL. 9). REG. 6-23-1931.	734,381.	LAPIS LUSTRE. INT. CL. 1. (U.S. CL. 1). REG. 7-17-1962.
290,424.	HARRIS AND DESIGN. U.S. CL. 12. (INT. CL. 19). REG. 1-5-1932.	734,486.	TERMASPLICE. U.S. CL. 21. (INT. CL. 9). REG. 7-17-1962.
298,293.	SNO SHEEN (STYLIZED). U.S. CL. 46. (INT. CL. 30). REG. 10-18-1932.	734,758.	CHEM-AQUA. U.S. CL. 6. (INT. CL. 1). REG. 7-24-1962.
393,279.	BALCO. U.S. CL. 21. (INT. CL. 9). REG. 2-3-1942.	734,852.	HELICON. U.S. CL. 21. (INT. CL. 9). REG. 7-24-1962.
393,280.	BALLAST (STYLIZED). U.S. CL. 21. (INT. CL. 9). REG. 2-3-1942.	735,074.	SWING BLADE. U.S. CL. 23. (INT. CL. 7). REG. 7-24-1962.
393,283.	CUPRON. U.S. CL. 21. (INT. CL. 9). REG. 2-3-1942.	737,762.	MONTCLAIR. U.S. CL. 17. (INT. CL. 34). REG. 9-18-1962.
395,907.	MISCELLANEOUS DESIGN. U.S. CL. 47. (INT. CL. 33). REG. 6-16-1942.	738,590.	CONSTELLATION. U.S. CL. 26. (INT. CL. 9). REG. 10-2-1962.
396,034.	BANJO. U.S. CL. 46. (INT. CL. 30). REG. 6-23-1942.	739,815.	POLYFIBRON. U.S. CL. 50. (INT. CL. 17). REG. 10-23-1962.
526,056.	SILVER CHIMES (STYLIZED). U.S. CL. 46. (INT. CL. 31). REG. 6-6-1950.	742,180.	FASTBOND. U.S. CL. 5. (INT. CL. 1). REG. 12-18-1962.
545,899.	STA-LUBE. U.S. CL. 52. (INT. CL. 3). REG. 7-31-1951.	749,487.	TATER BOY. U.S. CL. 46. (INT. CL. 29). REG. 5-14-1963.
547,908.	UNIVIT. U.S. CL. 14. (INT. CL. 6). REG. 9-11-1951.	924,279.	TRANS UNION. U.S. CL. 38. (INT. CL. 16). REG. 11-23-1971.
551,533.	KIRSCH (STYLIZED). U.S. CL. 13. (INT. CL. 20). REG. 12-4-1951.	927,498.	THE GROUND ROUND AND DESIGN. U.S. CL. 100. (INT. CL. 42). REG. 1-18-1972.
555,270.	SYNTERGENT. U.S. CL. 52. (INT. CL. 3). REG. 2-26-1952.	929,056.	GE AND DESIGN. U.S. CL. 21. (INT. CLS. 7, 9, 11 AND 17). REG. 2-15-1972.
558,770.	RANDO-WEBBER. U.S. CL. 23. (INT. CL. 7). REG. 5-13-1952.	931,975.	BACCHANAL. U.S. CL. 100. (INT. CL. 42). REG. 4-4-1972.
559,051.	PETRONAUBA (STYLIZED). U.S. CL. 6. (INT. CL. 4). REG. 5-20-1952.	933,860.	JAM PAC. U.S. CL. 22. (INT. CL. 28). REG. 5-16-1972.
559,698.	CARPENTER HYMU "80" (STYLIZED). U.S. CL. 14. (INT. CL. 6). REG. 6-3-1952.	934,651.	MORVEN PARK. U.S. CL. 107. (INT. CL. 41). REG. 5-23-1972.
559,844.	BLIZZARD AND DESIGN. U.S. CL. 46. (INT. CL. 30). REG. 6-10-1952.	934,700.	MISCELLANEOUS DESIGN. U.S. CL. 107. (INT. CL. 41). REG. 5-23-1972.
560,140.	NAPANEE. U.S. CL. 32. (INT. CL. 20). REG. 6-17-1952.	934,915.	SWAROVSKI. U.S. CLS. 28 AND 33 ONLY. (INT. CLS. 14 AND 21). REG. 5-30-1972.
560,929.	FIORINAL. U.S. CL. 18. (INT. CL. 5). REG. 7-1-1952.	935,125.	EDUCARE. U.S. CL. 102. (INT. CL. 36). REG. 5-30-1972.
560,976.	ELECTRICAL WORLD (STYLIZED). U.S. CL. 38. (INT. CL. 16). REG. 7-1-1952.	935,311.	ONION KING. U.S. CL. 23. (INT. CL. 7). REG. 6-6-1972.
563,370.	SUPER MK'T. U.S. CL. 46. (INT. CL. 29). REG. 8-26-1952.	935,663.	COBALT-PLUS. U.S. CL. 23. (INT. CL. 7). REG. 6-13-1972.
564,170.	COVERMARK (STYLIZED). U.S. CL. 51. (INT. CL. 3). REG. 9-16-1952.	936,790.	MISCELLANEOUS DESIGN. U.S. CL. 52. (INT. CL. 3). REG. 6-27-1972.
566,271.	MUSTARGEN (STYLIZED). U.S. CL. 18. (INT. CL. 5). REG. 11-4-1952.	936,944.	TRISLOT. U.S. CL. 14. (INT. CL. 6). REG. 7-4-1972.
568,452.	SCOTCH (STYLIZED). U.S. CL. 37. (INT. CL. 16). REG. 12-30-1952.	937,009.	TAMIYA AND DESIGN. U.S. CL. 22. (INT. CL. 28). REG. 7-4-1972.
573,560.	SCOTCHCAST (STYLIZED). U.S. CL. 6. (INT. CL. 1). REG. 4-21-1953.	938,823.	KELON. U.S. CL. 36. (INT. CL. 15). REG. 7-25-1972.
712,998.	CHESHIRE AND DESIGN. U.S. CL. 5. (INT. CL. 1). REG. 3-28-1961.	939,105.	KK AND DESIGN. U.S. CL. 100. (INT. CL. 42). REG. 7-25-1972.
723,765.	PERMACLAD. U.S. CL. 16. (INT. CL. 2). REG. 11-14-1961.	939,220.	ACCREDITED RURAL APPRAISER. U.S. CL. 200. REG. 7-25-1972.
727,033.	CLEAR SPRING. U.S. CL. 37. (INT. CL. 16). REG. 1-30-1962.	939,566.	BOMBARDIER. U.S. CL. 19. (INT. CL. 12). REG. 8-1-1972.
731,236.	SPANGLER'S AND DESIGN. U.S. CL. 46. (INT. CL. 30). REG. 5-8-1962.	940,216.	ACCREDITED FARM MANAGER. U.S. CL. 200. REG. 8-1-1972.
731,729.	CAMLOC AND DESIGN. U.S. CL. 13. (INT. CL. 6). REG. 5-22-1962.	941,094.	MISCELLANEOUS DESIGN. U.S. CL. 101. (INT. CL. 42). REG. 8-15-1972.
732,024.	ANSAR. U.S. CL. 6. (INT. CLS. 1 AND 5). REG. 5-29-1962.	941,210.	FOUNTAIN BLEU. U.S. CL. 6. (INT. CL. 2). REG. 8-22-1972.
732,612.	TUFECOTE-FOAM. U.S. CL. 1. (INT. CL. 17). REG. 6-12-1962.	942,071.	POPPIN WHEAT. U.S. CL. 46. (INT. CL. 30). REG. 8-29-1972.
732,906.	CRICKET. U.S. CL. 8. (INT. CL. 34). REG. 6-19-1962.		

- 942,743. MONTE CARLO. U.S. CL. 26. (INT. CL. 9). REG. 9-12-1972.
- 942,808. SURFA. U.S. CL. 37. (INT. CL. 16). REG. 9-12-1972.
- 943,571. LYNX. U.S. CL. 22. (INT. CL. 28). REG. 9-26-1972.
- 946,043. MISCELLANEOUS DESIGN. U.S. CL. 103. (INT. CL. 37). REG. 10-24-1972.
- 948,574. PATRIOTS. U.S. CL. 38. (INT. CL. 16). REG. 12-12-1972.
- 952,348. ATWOOD & MORRILL. U.S. CL. 100. (INT. CL. 42). REG. 1-30-1973.
- 953,037. ASF. U.S. CL. 19. (INT. CL. 12). REG. 2-13-1973.
- 954,494. KITCHEN DESIGNERS. U.S. CL. 42. (INT. CLS. 21 AND 24). REG. 3-6-1973.
- 955,917. AQUA CARE. U.S. CL. 51. (INT. CL. 3). REG. 3-20-1973.
- 957,403. NEWLY WEDS. U.S. CL. 46. (INT. CL. 30). REG. 4-17-1973.
- 1,129,747. RHODIASTAB. INT. CL. 1. (U.S. CL. 6). REG. 1-29-1980.
- 1,133,661. HOME PLANNERS AND DESIGN. INT. CL. 16. (U.S. CL. 38). REG. 4-22-1980.
- 1,135,477. LAXATONE. INT. CL. 5. (U.S. CL. 18). REG. 5-20-1980.
- 1,137,537. BREAK-UP. INT. CL. 3. (U.S. CL. 52). REG. 7-8-1980.
- 1,156,168. MICROCAP. INT. CL. 9. (U.S. CL. 21). REG. 6-2-1981.
- 1,157,856. CAVINS. INT. CL. 7. (U.S. CL. 23). REG. 6-23-1981.
- 1,159,059. RIKEN AND DESIGN. INT. CL. 12. (U.S. CLS. 23 AND 35). REG. 6-30-1981.
- 1,163,298. GIORGIO. INT. CL. 3. (U.S. CL. 51). REG. 8-4-1981.
- 1,164,008. BACKWOODS. INT. CL. 34. (U.S. CL. 17). REG. 8-4-1981.
- 1,167,530. CHOC-ETTES. INT. CL. 30. (U.S. CL. 46). REG. 9-1-1981.
- 1,169,284. SIGLA. INT. CL. 21 ONLY. (U.S. CL. 33). REG. 9-15-1981.
- 1,169,499. DAWN AND DESIGN. INT. CL. 30. (U.S. CL. 46). REG. 9-15-1981.
- 1,172,179. EMERICH MEERSON (STYLIZED). INT. CL. 14. (U.S. CL. 28). REG. 10-6-1981.
- 1,173,069. QUADRA-THERM. INT. CL. 11. (U.S. CL. 34). REG. 10-13-1981.
- 1,174,089. TIGAR. INT. CL. 12. (U.S. CL. 35). REG. 10-20-1981.
- 1,174,523. MISCELLANEOUS DESIGN. INT. CL. 36. (U.S. CL. 102). REG. 10-20-1981.
- 1,174,680. MEL-1. INT. CL. 1. (U.S. CL. 6). REG. 10-27-1981.
- 1,175,871. KLIPETTE. INT. CL. 8. (U.S. CL. 44). REG. 11-3-1981.
- 1,175,887. AST. INT. CL. 9. (U.S. CL. 26). REG. 11-3-1981.
- 1,179,846. CARAVELLE (STYLIZED). INT. CL. 7. (U.S. CL. 23). REG. 12-1-1981.
- 1,180,198. SERTA. INT. CL. 20. (U.S. CL. 32). REG. 12-1-1981.
- 1,181,304. KINETIC. INT. CL. 28. (U.S. CL. 22). REG. 12-8-1981.
- 1,181,432. REMY (STYLIZED). INT. CL. 33. (U.S. CL. 49). REG. 12-8-1981.
- 1,182,018. INTERCRAFT. INT. CL. 16 ONLY. (U.S. CL. 37). REG. 12-15-1981.
- 1,182,494. AN EVENING WITH CHAMPIONS. INT. CL. 41. (U.S. CL. 107). REG. 12-15-1981.
- 1,183,696. PIERRE CARDIN. INT. CL. 14. (U.S. CLS. 2, 27, 28 AND 50). REG. 12-29-1981.
- 1,187,361. WOODS. INT. CL. 7. (U.S. CL. 23). REG. 1-26-1982.
- 1,189,106. QUIKTREE (STYLIZED). INT. CL. 6. (U.S. CL. 32). REG. 2-9-1982.
- 1,190,319. FRASER VALLEY. INT. CL. 29. (U.S. CL. 46). REG. 2-16-1982.
- 1,190,541. FOUNDATION. INT. CL. 9. (U.S. CLS. 26 AND 38). REG. 2-23-1982.
- 1,190,544. DATAWEIGH. INT. CL. 9. (U.S. CL. 26). REG. 2-23-1982.
- 1,194,671. TRANQUILLITY. INT. CL. 11. (U.S. CL. 13). REG. 5-4-1982.
- 1,194,890. IVAR'S. INT. CL. 42. (U.S. CL. 100). REG. 5-4-1982.
- 1,195,639. SNORKLER AND DESIGN. INT. CL. 11. (U.S. CL. 34). REG. 5-18-1982.
- 1,195,768. WAYN-TEX INC.. INT. CLS. 23 AND 24. (U.S. CLS. 42 AND 43). REG. 5-18-1982.
- 1,195,879. AS AND DESIGN. INT. CLS. 37 AND 42. (U.S. CLS. 100 AND 103). REG. 5-18-1982.
- 1,195,997. TILT-TOP. INT. CL. 20. (U.S. CL. 50). REG. 5-18-1982.
- 1,196,289. PENSATO (STYLIZED). INT. CL. 25. (U.S. CL. 39). REG. 5-25-1982.
- 1,196,596. SEPISOL. INT. CL. 2. (U.S. CL. 11). REG. 6-1-1982.
- 1,196,667. HYDROSIZER. INT. CL. 7. (U.S. CL. 23). REG. 6-1-1982.
- 1,196,750. MANGIAMELI. INT. CLS. 14, 18 AND 25. (U.S. CLS. 3, 28, 39 AND 41). REG. 6-1-1982.
- 1,196,848. SHIRTAILOR (STYLIZED). INT. CL. 24. (U.S. CL. 42). REG. 6-1-1982.
- 1,196,977. OAKFIELD V&N AND DESIGN. INT. CL. 33. (U.S. CL. 49). REG. 6-1-1982.
- 1,197,024. WHERE FOOD IS ALWAYS GOOD. INT. CL. 42. (U.S. CL. 100). REG. 6-1-1982.
- 1,197,058. PALUMBO BRACE. INT. CL. 10. (U.S. CL. 44). REG. 6-1-1982.
- 1,197,161. SENTINEL. INT. CL. 9. (U.S. CL. 23). REG. 6-8-1982.
- 1,197,189. FACET-AIRE. INT. CL. 11. (U.S. CLS. 31 AND 34). REG. 6-8-1982.
- 1,197,292. B KLIBAN (STYLIZED). INT. CL. 21. (U.S. CLS. 2, 30, 33 AND 50). REG. 6-8-1982.
- 1,197,499. KEEP CLAM. INT. CL. 42. (U.S. CL. 100). REG. 6-8-1982.
- 1,197,699. THREAD-SERT AND DESIGN. INT. CL. 6. (U.S. CL. 13). REG. 6-15-1982.
- 1,197,729. HP-2. INT. CL. 8. (U.S. CL. 23). REG. 6-15-1982.
- 1,198,235. SAN DIEGO (STYLIZED). INT. CLS. 35 AND 39. (U.S. CLS. 101 AND 105). REG. 6-15-1982.
- 1,198,261. HALTER MARINE INC. AND DESIGN. INT. CLS. 37 AND 42. (U.S. CLS. 100 AND 103). REG. 6-15-1982.
- 1,198,342. GIAPPO'S. INT. CL. 42. (U.S. CL. 100). REG. 6-15-1982.
- 1,198,454. VI AND DESIGN. INT. CLS. 6 AND 37. (U.S. CLS. 12 AND 103). REG. 6-22-1982.
- 1,198,514. EC2 (STYLIZED). INT. CL. 9. (U.S. CLS. 21 AND 26). REG. 6-22-1982.
- 1,199,735. ROBINSON AND DESIGN. INT. CLS. 29, 30 AND 32. (U.S. CLS. 45 AND 46). REG. 6-29-1982.
- 1,200,801. MOLD-A-WAX. INT. CL. 4. (U.S. CL. 15). REG. 7-13-1982.
- 1,201,049. LITTLE SIMON. INT. CL. 16. (U.S. CL. 38). REG. 7-13-1982.
- 1,201,555. CAESARS TAHOE (STYLIZED). INT. CL. 42. (U.S. CL. 100). REG. 7-13-1982.
- 1,201,736. ULTRA-TWO. INT. CL. 5. (U.S. CL. 18). REG. 7-20-1982.
- 1,202,021. EWF. INT. CL. 17. (U.S. CL. 1). REG. 7-20-1982.
- 1,204,705. REAL WEST. INT. CL. 29. (U.S. CL. 46). REG. 8-10-1982.
- 1,205,405. ESP (STYLIZED). INT. CL. 15. (U.S. CL. 36). REG. 8-17-1982.
- 1,206,701. MQ AND DESIGN. INT. CL. 7. (U.S. CL. 23). REG. 8-31-1982.
- 1,207,374. TINK'S (STYLIZED). INT. CL. 28. (U.S. CL. 22). REG. 9-7-1982.
- 1,207,444. KYOLIC (STYLIZED). INT. CL. 30. (U.S. CL. 46). REG. 9-7-1982.
- 1,208,821. UNIFLORA. INT. CL. 31. (U.S. CL. 1). REG. 9-14-1982.
- 1,210,894. ISRS AND DESIGN. INT. CL. 36. (U.S. CL. 102). REG. 9-28-1982.
- 1,211,586. KOOL-KAN. INT. CL. 21. (U.S. CL. 2). REG. 10-5-1982.
- 1,211,982. THE GRISWOLD INN SINCE 1776 AND DESIGN. INT. CL. 42. (U.S. CL. 100). REG. 10-5-1982.
- 1,212,045. SEENOX. INT. CL. 1. (U.S. CL. 6). REG. 10-12-1982.
- 1,213,164. SURGIDEV AND DESIGN. INT. CL. 10. (U.S. CLS. 26 AND 44). REG. 10-19-1982.
- 1,213,704. ESPERAL. INT. CL. 1. (U.S. CL. 6). REG. 10-26-1982.
- 1,213,715. VESTENAMER. INT. CLS. 1 AND 17. (U.S. CLS. 1 AND 6). REG. 10-26-1982.
- 1,217,128. BAKE 'R BROIL. INT. CL. 29. (U.S. CL. 46). REG. 11-16-1982.
- 1,218,005. OMEGA CHEMICALS, INC. AND DESIGN. INT. CL. 1. (U.S. CLS. 6 AND 52). REG. 11-30-1982.
- 1,218,601. WILDWOOD. INT. CL. 36. (U.S. CL. 102). REG. 11-30-1982.
- 1,220,196. MEMMI. INT. CL. 29. (U.S. CL. 46). REG. 12-14-1982.
- 1,220,817. PENSATO. INT. CLS. 16 AND 18. (U.S. CLS. 3 AND 37). REG. 12-21-1982.

- 1,224,273. BAKER (STYLIZED). INT. CL. 20. (U.S. CL. 32). REG. 1-18-1983.
- 1,226,851. MISCELLANEOUS DESIGN. INT. CL. 35. (U.S. CL. 101). REG. 2-8-1983.
- 1,228,007. POLYBUFFER. INT. CL. 1. (U.S. CL. 6). REG. 2-22-1983.
- 1,230,390. SEAFARER. INT. CL. 39. (U.S. CL. 105). REG. 3-8-1983.
- 1,231,105. POLYFLEX. INT. CL. 17. (U.S. CL. 35). REG. 3-15-1983.
- 1,231,131. DRIFTWOOD. INT. CL. 19. (U.S. CL. 12). REG. 3-15-1983.
- 1,233,611. ANTIGUA. INT. CL. 21. (U.S. CLS. 2, 13 AND 50). REG. 4-5-1983.
- 1,235,132. ULTRA CONTROL. INT. CL. 3. (U.S. CL. 51). REG. 4-19-1983.
- 1,617,851. TOWERS PERRIN (STYLIZED). INT. CLS. 35 AND 36. (U.S. CLS. 100, 101 AND 102). REG. 10-16-1990.
- 1,618,754. PIX (STYLIZED). INT. CL. 16. (U.S. CL. 38). REG. 10-23-1990.
- 1,628,027. EASE (STYLIZED). INT. CL. 9. (U.S. CL. 38). REG. 12-18-1990.
- 1,633,675. SOUTHEASTERN SEC CONFERENCE AND DESIGN. INT. CLS. 6, 20, 25 AND 42. (U.S. CLS. 14, 32, 39 AND 100). REG. 2-5-1991.
- 1,636,387. MECHTECH. INT. CL. 41. (U.S. CL. 107). REG. 2-26-1991.
- 1,644,174. OMNIColor. INT. CL. 2. (U.S. CL. 6). REG. 5-14-1991.
- 1,645,757. WELLA BALSAM. INT. CL. 3. (U.S. CL. 51). REG. 5-28-1991.
- 1,646,326. TOP ELIMINATOR CLUB AND DESIGN. INT. CL. 41. (U.S. CL. 107). REG. 5-28-1991.
- 1,647,233. SOLUTION SELLING. INT. CLS. 16 AND 41 ONLY. (U.S. CLS. 2, 5, 22, 23, 29, 37, 38, 50, 100, 101 AND 107). REG. 6-11-1991.
- 1,652,227. WDB. INT. CL. 9. (U.S. CLS. 21, 23, 26, 36 AND 38). REG. 7-30-1991.
- 1,652,323. RICOR AND DESIGN. INT. CL. 12. (U.S. CL. 19). REG. 7-30-1991.
- 1,653,670. JAMO. INT. CL. 19. (U.S. CL. 12). REG. 8-13-1991.
- 1,653,934. PARK PAL. INT. CL. 41. (U.S. CL. 107). REG. 8-13-1991.
- 1,658,808. NORELEM (STYLIZED). INT. CL. 8 ONLY. (U.S. CLS. 13 AND 23). REG. 10-1-1991.
- 1,659,435. ZYKON AND DESIGN. INT. CLS. 7 AND 8. (U.S. CL. 23). REG. 10-8-1991.
- 1,660,741. G AND DESIGN. INT. CL. 12. (U.S. CL. 19). REG. 10-15-1991.
- 1,661,204. MISCELLANEOUS DESIGN. INT. CL. 42. (U.S. CL. 100). REG. 10-15-1991.
- 1,663,400. THE SCIENCE OF GATORADE. INT. CLS. 16 AND 41. (U.S. CLS. 38 AND 107). REG. 11-5-1991.
- 1,663,739. PINEHURST RESORT & COUNTRY CLUB. INT. CLS. 35 AND 42. (U.S. CLS. 100, 101 AND 107). REG. 11-5-1991.
- 1,664,428. PREFERRED STATUS. INT. CL. 39. (U.S. CL. 105). REG. 11-12-1991.
- 1,666,183. LRC. INT. CL. 42. (U.S. CLS. 100 AND 101). REG. 11-26-1991.
- 1,666,349. BIMELYZE. INT. CL. 1. (U.S. CL. 6). REG. 12-3-1991.
- 1,666,982. GRAPHICSBANK. INT. CL. 38. (U.S. CL. 104). REG. 12-3-1991.
- 1,667,172. TRIGUIDE. INT. CL. 10. (U.S. CLS. 26, 39 AND 44). REG. 12-3-1991.
- 1,667,417. TEW (STYLIZED). INT. CL. 9. (U.S. CLS. 21 AND 26). REG. 12-10-1991.
- 1,669,133. HYPERCHROME. INT. CL. 6. (U.S. CLS. 13 AND 14). REG. 12-24-1991.
- 1,669,375. LAS AND DESIGN. INT. CL. 14. (U.S. CL. 28). REG. 12-24-1991.
- 1,672,353. DECONGEST HERBAL. INT. CL. 5. (U.S. CL. 18). REG. 1-21-1992.
- 1,673,293. DACEASY. INT. CL. 9. (U.S. CLS. 21, 23, 26, 36 AND 38). REG. 1-28-1992.
- 1,674,099. SONIA RYKIEL. INT. CL. 9. (U.S. CL. 26). REG. 2-4-1992.
- 1,675,239. SKIM PLUS. INT. CL. 29. (U.S. CL. 46). REG. 2-11-1992.
- 1,677,088. MISCELLANEOUS DESIGN. INT. CL. 41. (U.S. CL. 107). REG. 2-25-1992.
- 1,677,329. MULTILINK. INT. CL. 5. (U.S. CL. 18). REG. 3-3-1992.
- 1,677,835. BUDGETEL. INT. CL. 42 ONLY. (U.S. CL. 100). REG. 3-3-1992.
- 1,678,369. SAMMI. INT. CL. 9. (U.S. CL. 38). REG. 3-10-1992.
- 1,680,573. HARTFORD SPECIALTY. INT. CL. 36. (U.S. CL. 102). REG. 3-24-1992.
- 1,680,593. HITACHI DATA SYSTEMS. INT. CL. 37. (U.S. CL. 103). REG. 3-24-1992.
- 1,681,076. STERI-CUFF. INT. CL. 10. (U.S. CL. 44). REG. 3-31-1992.
- 1,681,142. SAFETY-SURE KIDS. INT. CL. 16. (U.S. CL. 38). REG. 3-31-1992.
- 1,681,951. PROFILES (STYLIZED). INT. CL. 14. (U.S. CL. 28). REG. 4-7-1992.
- 1,682,647. SPIRADRIVE. INT. CL. 7. (U.S. CL. 23). REG. 4-14-1992.
- 1,683,637. E FILTER (STYLIZED). INT. CL. 9. (U.S. CL. 26). REG. 4-21-1992.
- 1,684,286. DEERWOOD. INT. CL. 6. (U.S. CLS. 2, 12, 13, 14, 23, 25 AND 50). REG. 4-28-1992.
- 1,684,312. TIME POWER. INT. CL. 16 ONLY. (U.S. CL. 38). REG. 4-28-1992.
- 1,686,133. ENI (STYLIZED). INT. CL. 9. (U.S. CL. 21). REG. 5-12-1992.
- 1,686,134. ENI. INT. CL. 9. (U.S. CL. 21). REG. 5-12-1992.
- 1,686,525. KNIGHTSBRIDGE. INT. CL. 25. (U.S. CL. 39). REG. 5-12-1992.
- 1,686,619. WILD BIRD MARKETPLACE. INT. CLS. 31 AND 42. (U.S. CLS. 46 AND 101). REG. 5-12-1992.
- 1,687,641. NICKELODEON. INT. CL. 9. (U.S. CLS. 21 AND 36). REG. 5-19-1992.
- 1,687,726. SUPRASSON. INT. CL. 10. (U.S. CL. 44). REG. 5-19-1992.
- 1,687,792. JMJ (STYLIZED). INT. CL. 14. (U.S. CL. 28). REG. 5-19-1992.
- 1,687,840. CAT FANCY. INT. CL. 16. (U.S. CL. 38). REG. 5-19-1992.
- 1,688,189. MISCELLANEOUS DESIGN. INT. CL. 42. (U.S. CLS. 100 AND 107). REG. 5-19-1992.
- 1,688,469. CFG (STYLIZED). INT. CL. 36. (U.S. CL. 102). REG. 5-19-1992.
- 1,688,584. PRO DESIGN. INT. CL. 42. (U.S. CL. 100). REG. 5-19-1992.
- 1,688,903. RES-CUE KEY AND DESIGN. INT. CL. 10. (U.S. CL. 44). REG. 5-26-1992.
- 1,688,933. THERMIX. INT. CL. 11. (U.S. CLS. 31 AND 34). REG. 5-26-1992.
- 1,689,096. SAATI. INT. CL. 24. (U.S. CL. 42). REG. 5-26-1992.
- 1,689,099. CLOTHING THAT WORKS!. INT. CL. 25. (U.S. CL. 39). REG. 5-26-1992.
- 1,689,396. NATIONAL FEDERATION OF RETIRED PERSONS. INT. CL. 42. (U.S. CL. 100). REG. 5-26-1992.
- 1,689,565. EXCELLENCE BY DESIGN. INT. CL. 18. (U.S. CL. 3). REG. 5-26-1992.
- 1,689,725. BORIDE AND DESIGN. INT. CL. 1. (U.S. CL. 12). REG. 6-2-1992.
- 1,689,808. STAPLE. INT. CL. 5. (U.S. CL. 6). REG. 6-2-1992.
- 1,689,848. A AND DESIGN. INT. CL. 7. (U.S. CL. 23). REG. 6-2-1992.
- 1,689,905. ISA-PLAN. INT. CL. 9. (U.S. CLS. 21 AND 26). REG. 6-2-1992.
- 1,689,940. AUDIX. INT. CL. 9. (U.S. CLS. 26 AND 38). REG. 6-2-1992.
- 1,689,967. INTER-TEL. INT. CL. 9. (U.S. CL. 38). REG. 6-2-1992.
- 1,690,001. NISCAN. INT. CL. 9. (U.S. CL. 21). REG. 6-2-1992.
- 1,690,055. MONSANTO ENVIRO-CHEM SYSTEMS INC. AND DESIGN. INT. CL. 11. (U.S. CLS. 21 AND 23). REG. 6-2-1992.
- 1,690,207. DREXEL HERITAGE AND DESIGN. INT. CL. 20. (U.S. CL. 32). REG. 6-2-1992.
- 1,690,208. HERITAGE AND DESIGN. INT. CL. 20. (U.S. CL. 32). REG. 6-2-1992.
- 1,690,296. QUICK STRIKE. INT. CL. 28. (U.S. CL. 22). REG. 6-2-1992.
- 1,690,307. CLASSIC CHILDREN. INT. CL. 28. (U.S. CL. 22). REG. 6-2-1992.
- 1,690,323. DATA EAST. INT. CL. 28. (U.S. CLS. 22, 23, 38 AND 50). REG. 6-2-1992.
- 1,690,329. GENESIS. INT. CL. 28. (U.S. CLS. 3, 22, 23 AND 38). REG. 6-2-1992.
- 1,690,342. PACIFIC FITNESS. INT. CL. 28. (U.S. CL. 22). REG. 6-2-1992.

- 1,690,361. CRISPY PLUS. INT. CL. 29. (U.S. CL. 46). REG. 6-2-1992.
- 1,690,372. WORLD CLASSICS. INT. CL. 30. (U.S. CL. 46). REG. 6-2-1992.
- 1,690,387. PREGO. INT. CL. 30. (U.S. CL. 46). REG. 6-2-1992.
- 1,690,412. BURPEE AND DESIGN. INT. CLS. 31 AND 42. (U.S. CLS. 1 AND 101). REG. 6-2-1992.
- 1,690,442. IVY ASSOCIATES. INT. CL. 35. (U.S. CLS. 100 AND 101). REG. 6-2-1992.
- 1,690,544. L LAMINALL AND DESIGN. INT. CL. 40. (U.S. CL. 106). REG. 6-2-1992.
- 1,690,554. KASET. INT. CLS. 41 AND 42. (U.S. CLS. 100 AND 107). REG. 6-2-1992.
- 1,690,556. WHERE HISTORY COMES ALIVE. INT. CL. 41. (U.S. CL. 107). REG. 6-2-1992.
- 1,690,689. NATIONAL LUBRICATING GREASE INSTITUTE NLGI AND DESIGN. U.S. CL. A. REG. 6-2-1992.
- 1,690,759. POWERVATOR. INT. CL. 9. (U.S. CL. 21). REG. 6-2-1992.
- 1,690,806. RICHARD BERNARDI. INT. CL. 18. (U.S. CLS. 1, 2, 3, 22 AND 41). REG. 6-2-1992.
- 1,690,906. SPICE. INT. CL. 41. (U.S. CL. 107). REG. 6-2-1992.
- 1,690,931. GARDEN BOTANIKA. INT. CL. 42. (U.S. CLS. 100 AND 101). REG. 6-2-1992.
- 1,690,990. FEMME INTERNATIONAL ACCESSORIES (STYLIZED). INT. CL. 26. (U.S. CL. 40). REG. 6-2-1992.
- 1,691,313. MATLAB. INT. CL. 9. (U.S. CL. 38). REG. 6-9-1992.
- 1,691,432. POLO. INT. CL. 16. (U.S. CL. 30). REG. 6-9-1992.
- 1,691,433. K.L.U.B. INT. CL. 16. (U.S. CL. 38). REG. 6-9-1992.
- 1,691,502. FORT LEAVENWORTH LAMP. INT. CL. 16. (U.S. CL. 38). REG. 6-9-1992.
- 1,691,551. CANTECH. INT. CL. 17. (U.S. CL. 5). REG. 6-9-1992.
- 1,691,591. BREEZY SINGERS. INT. CL. 20. (U.S. CL. 50). REG. 6-9-1992.
- 1,691,606. GROWER-TO-GROCER. INT. CL. 21. (U.S. CL. 2). REG. 6-9-1992.
- 1,691,638. PRINCE COURSE PRINCEVILLE AND DESIGN. INT. CLS. 25 AND 41. (U.S. CLS. 39 AND 107). REG. 6-9-1992.
- 1,692,085. SEI (STYLIZED). INT. CL. 42. (U.S. CL. 100). REG. 6-9-1992.
- 1,692,390. O-TEN. INT. CL. 6. (U.S. CL. 14). REG. 6-9-1992.
- 1,692,870. SILVA'S. INT. CL. 14. (U.S. CLS. 27 AND 28). REG. 6-9-1992.
- 1,693,094. STOR-MORE. INT. CL. 22. (U.S. CL. 2). REG. 6-9-1992.
- 1,693,095. MICRELL. INT. CL. 23. (U.S. CL. 43). REG. 6-9-1992.
- 1,693,111. GREEN COTTON AND DESIGN. INT. CL. 25. (U.S. CL. 39). REG. 6-9-1992.
- 1,693,512. COLLECTCORP. INT. CL. 36. (U.S. CLS. 101 AND 102). REG. 6-9-1992.
- 1,693,647. SALADWORKS. INT. CL. 42. (U.S. CL. 100). REG. 6-9-1992.
- 1,694,133. GRAND OPTICAL (STYLIZED). INT. CL. 9. (U.S. CL. 26). REG. 6-16-1992.
- 1,694,303. CQ. INT. CL. 16. (U.S. CL. 38). REG. 6-16-1992.
- 1,694,513. YOGAWARE. INT. CLS. 25 AND 28. (U.S. CLS. 22 AND 39). REG. 6-16-1992.
- 1,694,837. CUBS CARE. INT. CL. 36. (U.S. CL. 102). REG. 6-16-1992.
- 1,694,863. MISCELLANEOUS DESIGN. INT. CL. 37. (U.S. CL. 103). REG. 6-16-1992.
- 1,695,145. C COMPEX AND DESIGN. INT. CLS. 18 AND 20. (U.S. CLS. 32 AND 41). REG. 6-16-1992.
- 1,695,441. MISCELLANEOUS DESIGN. INT. CL. 28. (U.S. CLS. 22, 23, 38 AND 50). REG. 6-16-1992.
- 1,695,945. BOHEMIA CRYSTAL AND DESIGN. INT. CLS. 11 AND 21. (U.S. CLS. 2, 13, 21, 30 AND 33). REG. 6-23-1992.
- 1,696,119. RAPIDCLIP AND DESIGN. INT. CL. 20. (U.S. CL. 32). REG. 6-23-1992.
- 1,696,177. NEW YORK TRANSIT. INT. CL. 25. (U.S. CL. 39). REG. 6-23-1992.
- 1,696,364. CINDERELLA. INT. CL. 31. (U.S. CL. 1). REG. 6-23-1992.
- 1,696,371. BLACK SATIN. INT. CL. 31. (U.S. CL. 1). REG. 6-23-1992.
- 1,696,530. ALT AND DESIGN. INT. CL. 40. (U.S. CL. 106). REG. 6-23-1992.
- 1,696,687. RSA ROLLER SKATING ASSOCIATIONS AND DESIGN. INT. CL. 42. (U.S. CL. 107). REG. 6-23-1992.
- 1,696,821. POLARIS. INT. CL. 9. (U.S. CLS. 21 AND 23). REG. 6-23-1992.
- 1,696,860. SLIPGUARD. INT. CL. 9. (U.S. CLS. 26 AND 39). REG. 6-23-1992.
- 1,696,911. DIVERSION. INT. CL. 12. (U.S. CL. 19). REG. 6-23-1992.
- 1,697,120. WINNER'S CIRCLE. INT. CL. 42. (U.S. CL. 100). REG. 6-23-1992.
- 1,697,340. SPEED ERECT AND DESIGN. INT. CL. 6. (U.S. CL. 12). REG. 6-30-1992.
- 1,697,470. GREATEST SPORTS LEGENDS. INT. CLS. 9 AND 41. (U.S. CLS. 21, 101 AND 107). REG. 6-30-1992.
- 1,697,558. KAPPA ALPHA THETA. INT. CL. 16. (U.S. CLS. 37 AND 38). REG. 6-30-1992.
- 1,697,674. KAPPA ALPHA THETA. INT. CL. 21. (U.S. CLS. 2, 13 AND 33). REG. 6-30-1992.
- 1,697,678. SEALFRESH. INT. CL. 21. (U.S. CL. 50). REG. 6-30-1992.
- 1,697,679. PRESENTATIONS. INT. CL. 21. (U.S. CLS. 2, 13, 23, 29, 30, 33, 40 AND 50). REG. 6-30-1992.
- 1,697,702. KAPPA ALPHA THETA. INT. CL. 25. (U.S. CL. 39). REG. 6-30-1992.
- 1,698,024. MISCELLANEOUS DESIGN. INT. CL. 37. (U.S. CL. 103). REG. 6-30-1992.
- 1,698,267. COSART. INT. CL. 3. (U.S. CL. 51). REG. 6-30-1992.
- 1,698,287. GENTLE-FLO. INT. CL. 7. (U.S. CLS. 13, 19, 21, 23, 31, 34 AND 35). REG. 6-30-1992.
- 1,698,348. KLEENHEAT. INT. CL. 11. (U.S. CL. 34). REG. 6-30-1992.
- 1,698,456. ROYALTY. INT. CL. 29. (U.S. CL. 46). REG. 6-30-1992.
- 1,698,473. DEL COMAL (STYLIZED). INT. CL. 30. (U.S. CL. 46). REG. 6-30-1992.
- 1,698,495. RIBS. INT. CL. 36. (U.S. CL. 102). REG. 6-30-1992.
- 1,698,570. FASHION NEWS. INT. CL. 16. (U.S. CL. 38). REG. 6-30-1992.
- 1,698,639. GC GAYLORD CHEMICAL CORPORATION (STYLIZED). INT. CL. 1. (U.S. CLS. 1, 5, 6, 10, 26 AND 46). REG. 7-7-1992.
- 1,698,793. TABLEBASE AND DESIGN. INT. CL. 9. (U.S. CL. 38). REG. 7-7-1992.
- 1,698,890. GROUNDTRAC. INT. CL. 9. (U.S. CL. 26). REG. 7-7-1992.
- 1,699,378. LIFESTYLE GUARANTEE. INT. CL. 36. (U.S. CL. 102). REG. 7-7-1992.
- 1,699,840. ONECUP. INT. CL. 21. (U.S. CLS. 2 AND 30). REG. 7-7-1992.
- 1,699,919. NEO-DIET. INT. CL. 31. (U.S. CL. 46). REG. 7-7-1992.
- 1,699,920. ENO-DIET. INT. CL. 31. (U.S. CL. 46). REG. 7-7-1992.
- 1,699,970. DOUBLETREE CLUB HOTEL. INT. CL. 42. (U.S. CL. 100). REG. 7-7-1992.
- 1,700,171. SUPERVAULT. INT. CL. 6. (U.S. CLS. 2 AND 13). REG. 7-14-1992.
- 1,700,706. PIEMASTER (STYLIZED). INT. CL. 30. (U.S. CL. 46). REG. 7-14-1992.
- 1,700,915. KINDERSAFARI. INT. CL. 41. (U.S. CL. 107). REG. 7-14-1992.
- 1,701,089. IA AND DESIGN. INT. CL. 11. (U.S. CLS. 23, 31 AND 34). REG. 7-14-1992.
- 1,701,205. MISCELLANEOUS DESIGN. INT. CL. 6. (U.S. CLS. 13 AND 25). REG. 7-14-1992.
- 1,701,427. GEARENCH. INT. CLS. 7 AND 8. (U.S. CLS. 13 AND 23). REG. 7-21-1992.
- 1,701,686. RIGOBERTO AND DESIGN. INT. CL. 14. (U.S. CL. 28). REG. 7-21-1992.
- 1,702,194. MAXIMUS (STYLIZED). INT. CL. 41. (U.S. CL. 107). REG. 7-21-1992.
- 1,702,453. DEFENDER. INT. CL. 9. (U.S. CL. 26). REG. 7-21-1992.
- 1,702,643. INSTITUTE OF FUTURE TECHNOLOGY AND DESIGN. INT. CL. 41. (U.S. CL. 107). REG. 7-21-1992.
- 1,702,719. DERMA SHIELD. INT. CL. 3. (U.S. CL. 51). REG. 7-28-1992.
- 1,703,062. HEARING AIDS TODAY AND DESIGN. INT. CLS. 10, 35, 37 AND 42. (U.S. CLS. 44, 101 AND 103). REG. 7-28-1992.
- 1,703,312. HEAVENLY SLEEP. INT. CL. 20. (U.S. CL. 32). REG. 7-28-1992.

- 1,703,618. STONETRADE. INT. CL. 35. (U.S. CL. 101). REG. 7-28-1992.
- 1,703,656. NBA AND DESIGN. INT. CL. 35. (U.S. CL. 101). REG. 7-28-1992.
- 1,703,680. LAWYERS HAVE HEART AND DESIGN. INT. CL. 36. (U.S. CL. 102). REG. 7-28-1992.
- 1,703,882. WEATHERVISION. INT. CL. 42. (U.S. CL. 100). REG. 7-28-1992.
- 1,704,297. GOLFING GREATS. INT. CL. 28. (U.S. CLS. 22, 23 AND 38). REG. 7-28-1992.
- 1,704,347. BASO-DIET. INT. CL. 31. (U.S. CL. 46). REG. 7-28-1992.
- 1,704,494. EXECUTIVE IMPERIALS AND DESIGN. INT. CLS. 3 AND 21. (U.S. CLS. 4, 29, 50 AND 52). REG. 8-4-1992.
- 1,704,816. GUNRUNNER. INT. CL. 13. (U.S. CL. 9). REG. 8-4-1992.
- 1,704,899. COMPOSAC. INT. CL. 16. (U.S. CL. 2). REG. 8-4-1992.
- 1,704,914. MAGIC CASTLE READERS. INT. CL. 16. (U.S. CL. 38). REG. 8-4-1992.
- 1,705,045. PACE. INT. CLS. 20 AND 21. (U.S. CLS. 2 AND 32). REG. 8-4-1992.
- 1,705,086. CASADEI. INT. CL. 25. (U.S. CL. 39). REG. 8-4-1992.
- 1,705,210. R & R'S BEST BY FAR SINCE 1934 AND DESIGN. INT. CLS. 29 AND 42. (U.S. CLS. 46 AND 101). REG. 8-4-1992.
- 1,705,268. PONY EXPRESS. INT. CL. 30. (U.S. CL. 46). REG. 8-4-1992.
- 1,705,579. MISCELLANEOUS DESIGN. INT. CL. 42. (U.S. CLS. 100, 101 AND 106). REG. 8-4-1992.
- 1,705,856. SOUND OUT (STYLIZED). INT. CL. 19. (U.S. CL. 12). REG. 8-4-1992.
- 1,706,191. AIM HERBAL FIBERBLEND (STYLIZED). INT. CL. 5. (U.S. CL. 46). REG. 8-11-1992.
- 1,706,358. GRATEFUL DEAD RECORDS. INT. CL. 9. (U.S. CLS. 21 AND 36). REG. 8-11-1992.
- 1,706,643. YOUR HEALTHY PRACTICE AND DESIGN. INT. CL. 16. (U.S. CL. 38). REG. 8-11-1992.
- 1,707,584. OVERKILL. INT. CL. 28. (U.S. CLS. 22, 23, 38 AND 50). REG. 8-11-1992.
- 1,708,035. RAVELLO BEVERLY HILLS. INT. CL. 14. (U.S. CL. 28). REG. 8-18-1992.
- 1,708,362. HARLEY. INT. CL. 26. (U.S. CL. 40). REG. 8-18-1992.
- 1,708,695. MISCELLANEOUS DESIGN. INT. CL. 37. (U.S. CL. 103). REG. 8-18-1992.
- 1,708,701. VCA AND DESIGN. INT. CLS. 37, 40, 41 AND 42. (U.S. CLS. 100, 103, 106 AND 107). REG. 8-18-1992.
- 1,708,758. PROJECT TERRA AND DESIGN. INT. CL. 41. (U.S. CL. 107). REG. 8-18-1992.
- 1,709,162. RELY-O-DINE (STYLIZED). INT. CL. 5. (U.S. CL. 18). REG. 8-18-1992.
- 1,709,246. SPECTRALITE. INT. CL. 9. (U.S. CL. 26). REG. 8-18-1992.
- 1,710,777. FINN KARELIA AND DESIGN. INT. CL. 25. (U.S. CL. 39). REG. 8-25-1992.
- 1,710,855. CHALLENGER. INT. CL. 39. (U.S. CL. 105). REG. 8-25-1992.
- 1,710,894. POLO LIFE. INT. CL. 16. (U.S. CL. 38). REG. 8-25-1992.
- 1,710,944. STRANG CANCER PREVENTION CENTER. INT. CL. 42. (U.S. CL. 100). REG. 8-25-1992.
- 1,710,955. LA GLORIA. INT. CLS. 1, 4, 39 AND 40. (U.S. CLS. 6, 15, 105 AND 106). REG. 9-1-1992.
- 1,711,016. NORLINE. INT. CL. 2. (U.S. CL. 16). REG. 9-1-1992.
- 1,711,125. HYGINET. INT. CL. 5. (U.S. CL. 44). REG. 9-1-1992.
- 1,711,613. MISCELLANEOUS DESIGN. INT. CL. 16. (U.S. CL. 38). REG. 9-1-1992.
- 1,711,973. TASTEFULLY YOURS. INT. CL. 29. (U.S. CL. 46). REG. 9-1-1992.
- 1,712,424. TOUR STOP. INT. CL. 42. (U.S. CLS. 100 AND 101). REG. 9-1-1992.
- 1,712,697. ELASTISET (STYLIZED). INT. CL. 19. (U.S. CL. 12). REG. 9-1-1992.
- 1,713,292. SILOR (STYLIZED). INT. CL. 9. (U.S. CL. 26). REG. 9-8-1992.
- 1,713,341. PM ELITE. INT. CL. 9. (U.S. CL. 26). REG. 9-8-1992.
- 1,713,536. MISCELLANEOUS DESIGN. INT. CL. 16. (U.S. CLS. 37 AND 38). REG. 9-8-1992.
- 1,713,692. ULTRACURE. INT. CL. 19. (U.S. CL. 12). REG. 9-8-1992.
- 1,713,828. AQUALOCK. INT. CL. 25. (U.S. CL. 39). REG. 9-8-1992.
- 1,713,990. GAO THOM LANG HUONG. INT. CL. 30. (U.S. CL. 46). REG. 9-8-1992.
- 1,714,345. ADDED DIMENSIONS. INT. CL. 42. (U.S. CL. 101). REG. 9-8-1992.
- 1,714,415. HEALTHCARE INFORMATION AND MANAGEMENT SYSTEMS SOCIETY. INT. CL. 42. (U.S. CL. 100). REG. 9-8-1992.
- 1,714,531. SLEEP TRAIN. INT. CL. 42. (U.S. CL. 101). REG. 9-8-1992.
- 1,714,532. YOUR TICKET TO A BETTER NIGHTS SLEEP. INT. CL. 42. (U.S. CL. 100). REG. 9-8-1992.
- 1,714,844. PRECISION BLUE. INT. CL. 1. (U.S. CL. 6). REG. 9-15-1992.
- 1,714,845. PRECISION RED. INT. CL. 1. (U.S. CL. 6). REG. 9-15-1992.
- 1,715,175. VELUX. INT. CL. 9. (U.S. CLS. 21, 23, 26, 36 AND 38). REG. 9-15-1992.
- 1,715,583. MISCELLANEOUS DESIGN. INT. CL. 16. (U.S. CL. 38). REG. 9-15-1992.
- 1,716,221. FAT WITCH AND DESIGN. INT. CL. 30. (U.S. CL. 46). REG. 9-15-1992.
- 1,716,225. BLOSSOM HILL. INT. CL. 30. (U.S. CL. 46). REG. 9-15-1992.
- 1,716,401. THE QUALITY LIFE COMPANY. INT. CL. 36. (U.S. CL. 102). REG. 9-15-1992.
- 1,716,453. FINANCIAL ARCHITECTS AND DESIGN. INT. CL. 36. (U.S. CLS. 101 AND 102). REG. 9-15-1992.
- 1,716,471. GAB. INT. CL. 36. (U.S. CL. 102). REG. 9-15-1992.
- 1,717,285. RED BAND. INT. CL. 1. (U.S. CLS. 1, 5, 6, 10, 26 AND 46). REG. 9-22-1992.
- 1,717,286. VANZOL. INT. CL. 1. (U.S. CL. 6). REG. 9-22-1992.
- 1,717,532. DRAC. INT. CL. 7. (U.S. CL. 23). REG. 9-22-1992.
- 1,717,870. WATERX AND DESIGN. INT. CL. 11. (U.S. CL. 31). REG. 9-22-1992.
- 1,718,161. TAM-CAP (STYLIZED). INT. CL. 19. (U.S. CL. 12). REG. 9-22-1992.
- 1,718,272. MISCELLANEOUS DESIGN. INT. CL. 25. (U.S. CL. 39). REG. 9-22-1992.
- 1,718,325. HAT ATTACK. INT. CL. 25. (U.S. CL. 39). REG. 9-22-1992.
- 1,718,399. HARPER'S AND DESIGN. INT. CL. 29. (U.S. CL. 46). REG. 9-22-1992.
- 1,720,070. MISCELLANEOUS DESIGN. INT. CL. 10. (U.S. CL. 44). REG. 9-29-1992.
- 1,720,271. WINDOW-A-PEEL. INT. CL. 16. (U.S. CL. 37). REG. 9-29-1992.
- 1,720,504. MRS. DI FILLIPPO'S. INT. CL. 29. (U.S. CL. 46). REG. 9-29-1992.
- 1,720,867. PROJECT NORTHSTAR AND DESIGN. INT. CL. 41. (U.S. CL. 107). REG. 9-29-1992.
- 1,720,868. PROJECT NORTHSTAR. INT. CL. 41. (U.S. CL. 107). REG. 9-29-1992.
- 1,720,947. DRS (STYLIZED). INT. CL. 42. (U.S. CL. 100). REG. 9-29-1992.
- 1,720,975. MINUTE MEN OF SAINT GERMAIN. INT. CL. 42. (U.S. CL. 100). REG. 9-29-1992.
- 1,721,154. TASTEFULLY YOURS. INT. CL. 30. (U.S. CL. 46). REG. 9-29-1992.
- 1,722,154. MISCELLANEOUS DESIGN. INT. CL. 28. (U.S. CL. 22). REG. 10-6-1992.
- 1,722,649. JAZZERKAMP FOR KIDS ONLY! AND DESIGN. INT. CL. 41. (U.S. CL. 107). REG. 10-6-1992.
- 1,722,784. Z TEJAS GRILL (STYLIZED). INT. CL. 42. (U.S. CL. 100). REG. 10-6-1992.
- 1,722,970. SUMIGLASS. INT. CL. 19. (U.S. CLS. 12 AND 33). REG. 10-6-1992.
- 1,723,030. TIPS. INT. CL. 36. (U.S. CL. 102). REG. 10-6-1992.
- 1,723,279. KURABO (STYLIZED). INT. CLS. 7 AND 9. (U.S. CLS. 23 AND 26). REG. 10-13-1992.
- 1,723,573. B AND DESIGN. INT. CLS. 11, 21, 29, 30, 32 AND 39. (U.S. CLS. 2, 30, 34, 46 AND 105). REG. 10-13-1992.
- 1,723,720. LOFT AND DESIGN. INT. CL. 16. (U.S. CL. 38). REG. 10-13-1992.
- 1,723,842. PLANTERS' PRIDE. INT. CL. 21. (U.S. CLS. 2 AND 50). REG. 10-13-1992.
- 1,723,906. ATLANTA MOTOR SPEEDWAY AND DESIGN. INT. CLS. 25 AND 41. (U.S. CLS. 39 AND 107). REG. 10-13-1992.
- 1,725,656. CREWMASER (STYLIZED). INT. CL. 16. (U.S. CL. 29). REG. 10-20-1992.

- 1,726,233. PMSLIC. INT. CL. 36. (U.S. CL. 102). REG. 10-20-1992.
- 1,727,145. RAILTRAC. INT. CL. 9. (U.S. CLS. 26 AND 38). REG. 10-27-1992.
- 1,727,732. WATER DOGS. INT. CL. 25. (U.S. CL. 39). REG. 10-27-1992.
- 1,727,914. COOKIE WREATHS. INT. CL. 30. (U.S. CL. 46). REG. 10-27-1992.
- 1,728,442. "RICK CASE BIKES FOR KIDS". INT. CL. 42. (U.S. CL. 100). REG. 10-27-1992.
- 1,728,456. ME AND DESIGN. INT. CL. 42. (U.S. CL. 101). REG. 10-27-1992.
- 1,728,529. POLYSHOT. INT. CL. 7. (U.S. CL. 23). REG. 10-27-1992.
- 1,728,562. DURAGUARD. INT. CL. 11. (U.S. CL. 13). REG. 10-27-1992.
- 1,728,918. HARMONIC DRIVE TECHNOLOGIES. INT. CLS. 7 AND 9. (U.S. CLS. 21 AND 23). REG. 11-3-1992.
- 1,728,958. AMREL AND DESIGN. INT. CL. 9. (U.S. CLS. 21 AND 26). REG. 11-3-1992.
- 1,729,220. ASI QUARTERLY REGISTER. INT. CL. 16. (U.S. CL. 38). REG. 11-3-1992.
- 1,729,721. JOHNSON'S. INT. CL. 33. (U.S. CL. 49). REG. 11-3-1992.
- 1,730,075. OXMOOR HOUSE. INT. CL. 42. (U.S. CL. 101). REG. 11-3-1992.
- 1,732,008. HYDRO-SHIELD. INT. CL. 7. (U.S. CLS. 19 AND 23). REG. 11-10-1992.
- 1,732,190. AGLOG. INT. CL. 40. (U.S. CL. 106). REG. 11-10-1992.
- 1,732,245. WORKTALK. INT. CL. 41. (U.S. CL. 107). REG. 11-10-1992.
- 1,732,360. WOOLITE (STYLIZED). INT. CL. 3. (U.S. CLS. 1, 4, 6, 50, 51 AND 52). REG. 11-17-1992.
- 1,732,411. SUSTAIN III. INT. CL. 5. (U.S. CL. 18). REG. 11-17-1992.
- 1,732,999. AL FRESCO. INT. CL. 16. (U.S. CLS. 37 AND 38). REG. 11-17-1992.
- 1,733,809. SERVICE EXPRESS. INT. CL. 42. (U.S. CLS. 100 AND 101). REG. 11-17-1992.
- 1,733,925. E-COLICIN-S. INT. CL. 5. (U.S. CL. 18). REG. 11-17-1992.
- 1,734,024. ROOKIE READ-ABOUT. INT. CL. 16. (U.S. CL. 38). REG. 11-17-1992.
- 1,734,156. SPECTRUM AND DESIGN. INT. CL. 41. (U.S. CL. 107). REG. 11-17-1992.
- 1,734,257. MISCELLANEOUS DESIGN. INT. CL. 3. (U.S. CL. 52). REG. 11-24-1992.
- 1,734,316. POLYOX. INT. CL. 5. (U.S. CL. 18). REG. 11-24-1992.
- 1,734,635. POP-TOP. INT. CL. 11. (U.S. CL. 31). REG. 11-24-1992.
- 1,734,648. J-MARK AND DESIGN. INT. CL. 12. (U.S. CLS. 19 AND 50). REG. 11-24-1992.
- 1,736,207. AMERICAN VETERINARY MEDICAL ASSOCIATION. INT. CL. 9. (U.S. CLS. 21 AND 36). REG. 12-1-1992.
- 1,736,590. PABCO PREMIER. INT. CL. 19. (U.S. CL. 12). REG. 12-1-1992.
- 1,736,667. SMALL STAR. INT. CL. 25. (U.S. CL. 39). REG. 12-1-1992.
- 1,736,754. DE (STYLIZED). INT. CL. 28. (U.S. CLS. 22, 23, 38 AND 50). REG. 12-1-1992.
- 1,737,250. AMERICAN HORSE PUBLICATIONS AND DESIGN. INT. CL. 42. (U.S. CL. 100). REG. 12-1-1992.
- 1,738,621. AMERICAN CHECK CASHERS AND DESIGN. INT. CL. 36. (U.S. CL. 102). REG. 12-8-1992.
- 1,738,640. CREDITEK (STYLIZED). INT. CL. 36. (U.S. CLS. 101 AND 102). REG. 12-8-1992.
- 1,740,093. ANTIGUA. INT. CL. 33. (U.S. CL. 47). REG. 12-15-1992.
- 1,741,345. SHAPES-N-MATES. INT. CL. 20. (U.S. CLS. 32 AND 50). REG. 12-22-1992.
- 1,742,073. START TO FINISH. INT. CL. 3. (U.S. CL. 51). REG. 12-22-1992.
- 1,742,587. ENVIRO-S. INT. CL. 1. (U.S. CL. 6). REG. 12-29-1992.
- 1,744,531. ULTRA FEND. INT. CL. 17. (U.S. CL. 50). REG. 1-5-1993.
- 1,746,646. EARTH JUICE (STYLIZED). INT. CL. 1. (U.S. CL. 10). REG. 1-19-1993.
- 1,751,210. NEIGHBORS WHO CARE. INT. CL. 16. (U.S. CL. 38). REG. 2-9-1993.
- 1,753,117. INTERVAL. INT. CL. 5. (U.S. CLS. 18 AND 44). REG. 2-16-1993.
- 1,753,800. RINGLE (STYLIZED). INT. CL. 12. (U.S. CL. 19). REG. 2-23-1993.
- 1,754,842. SCB AND DESIGN. INT. CL. 6. (U.S. CL. 13). REG. 3-2-1993.
- 1,756,239. ROOMS TO GO. INT. CL. 42. (U.S. CL. 100). REG. 3-2-1993.
- 1,756,919. THREE DOG DOWN AND DESIGN. INT. CLS. 24 AND 25. (U.S. CLS. 39 AND 42). REG. 3-9-1993.
- 1,758,260. CSA AND DESIGN. INT. CL. 16. (U.S. CL. 38). REG. 3-16-1993.
- 1,760,647. CADENCE. INT. CL. 12. (U.S. CL. 19). REG. 3-23-1993.
- 1,761,523. PRO-WICK. INT. CL. 28. (U.S. CL. 22). REG. 3-30-1993.
- 1,763,255. WORDSHARING PARTNERS. INT. CL. 36. (U.S. CL. 102). REG. 4-6-1993.
- 1,763,257. WORDSHARING PARTNERS AND DESIGN. INT. CL. 36. (U.S. CL. 102). REG. 4-6-1993.
- 1,765,348. MISCELLANEOUS DESIGN. INT. CL. 30. (U.S. CL. 46). REG. 4-13-1993.
- 1,766,545. HORNET. INT. CL. 7. (U.S. CL. 23). REG. 4-20-1993.
- 1,769,366. NAPA VALLEY. INT. CL. 25. (U.S. CL. 39). REG. 5-4-1993.
- 1,771,381. LEONARDO DA DOODLE. INT. CL. 16. (U.S. CL. 37). REG. 5-18-1993.
- 1,772,448. SILVER RIDER. INT. CL. 25. (U.S. CL. 39). REG. 5-18-1993.
- 1,772,664. FACT AND COMMENT. INT. CL. 16. (U.S. CL. 38). REG. 5-18-1993.

* * * * *

TRADEMARK REGISTRATIONS CANCELED

The designation "U.S. Cl." appearing in this section refers to the U.S. class in effect prior to Sep. 1, 1973 rather than the international class which applies to applications filed on or after that date. For adoption of international classification see notice in the OFFICIAL GAZETTE of Jun. 26, 1973 (911 O.G. TM 210).

SECTION 7(D)

817,155.	F FIDELITY NATIONAL BANK OF BATON ROUGE AND DESIGN. U.S. CL. 102. REG. 10-18-1966.	723,498.	HYPERTENSIN-CIBA. U.S. CL. 18. REG. 11-7-1961.
		723,503.	FORT DODGE SULFASOL AND DESIGN. U.S. CL. 18. REG. 11-7-1961.
		723,506.	SULFABID. U.S. CL. 18. REG. 11-7-1961.
		723,509.	AZLYTAL. U.S. CL. 18. REG. 11-7-1961.
		723,510.	AZLIMED. U.S. CL. 18. REG. 11-7-1961.
		723,514.	NEO-CAFERGOT (STYLIZED). U.S. CL. 18. REG. 11-7-1961.

SECTION 8

147,893.	BUTYN AND DESIGN. U.S. CL. 6. REG. 11-8-1921.	723,518.	BELMONT. U.S. CL. 19. REG. 11-7-1961.
148,010.	ENO. U.S. CL. 6. REG. 11-8-1921.	723,526.	GERFLEX. U.S. CL. 20. REG. 11-7-1961.
148,032.	INDIAN AND DESIGN. U.S. CL. 6. REG. 11-8-1921.	723,541.	EQUI-POISED. U.S. CL. 23. REG. 11-7-1961.
148,097.	CEJ. U.S. CL. 26. REG. 11-8-1921.	723,544.	U-BAND. U.S. CL. 23. REG. 11-7-1961.
148,150.	LOXON. U.S. CL. 21. REG. 11-8-1921.	723,545.	MOBILIFT. U.S. CL. 23. REG. 11-7-1961.
148,166.	SOCIETY (STYLIZED). U.S. CL. 39. REG. 11-8-1921.	723,546.	PERMA-FLEX AND DESIGN. U.S. CL. 23. REG. 11-7-1961.
148,185.	NEW JERSEY ZINC AND DESIGN. U.S. CL. 14. REG. 11-8-1921.	723,559.	IRTRAN. U.S. CL. 26. REG. 11-7-1961.
148,245.	ANGELUS. U.S. CL. 46. REG. 11-8-1921.	723,561.	M/D MARTIN DECKER AND DESIGN. U.S. CL. 26. REG. 11-7-1961.
148,277.	ICE-MINT (STYLIZED). U.S. CL. 6. REG. 11-8-1921.	723,562.	CONBEL (STYLIZED). U.S. CL. 26. REG. 11-7-1961.
148,303.	ALADDIN THE WONDER W. R. & CO. AND DESIGN. U.S. CL. 39. REG. 11-8-1921.	723,574.	TORBAL. U.S. CL. 26. REG. 11-7-1961.
284,271.	CRESTOLOY. U.S. CL. 14. REG. 6-23-1931.	723,594.	ECA AND DESIGN. U.S. CL. 26. REG. 11-7-1961.
391,374.	AGI-FLO (STYLIZED). U.S. CL. 23. REG. 11-4-1941.	723,598.	ANGELITE. U.S. CL. 28. REG. 11-7-1961.
391,378.	CORNELI'S GOLD RUSH HYBRID. U.S. CL. 1. REG. 11-4-1941.	723,600.	PRIDE (STYLIZED). U.S. CL. 28. REG. 11-7-1961.
391,384.	SYNFLEUR (STYLIZED). U.S. CL. 46. REG. 11-4-1941.	723,603.	BALLERINA (STYLIZED). U.S. CL. 29. REG. 11-7-1961.
391,386.	TELENEWS AND DESIGN. U.S. CL. 26. REG. 11-4-1941.	723,614.	Q-JET. U.S. CL. 34. REG. 11-7-1961.
391,398.	QUAKER. U.S. CL. 46. REG. 11-4-1941.	723,615.	REVERE. U.S. CL. 35. REG. 11-7-1961.
391,407.	SERENACEL (STYLIZED). U.S. CL. 42. REG. 11-4-1941.	723,622.	LYRIC. U.S. CL. 37. REG. 11-7-1961.
716,684.	BANVEL. U.S. CL. 6. REG. 6-13-1961.	723,642.	MERSHEEN. U.S. CL. 39. REG. 11-7-1961.
722,659.	RED CHEEK (STYLIZED). U.S. CL. 46. REG. 10-10-1961.	723,644.	MILEAGE MAKER. U.S. CL. 39. REG. 11-7-1961.
723,431.	STYRAFIL. INT. CL. 1. REG. 11-7-1961.	723,645.	FRAPPE (STYLIZED). U.S. CL. 39. REG. 11-7-1961.
723,441.	MARCAL. U.S. CL. 2. REG. 11-7-1961.	723,655.	VELTEENA. U.S. CL. 42. REG. 11-7-1961.
723,451.	GOTAPE. U.S. CL. 11. REG. 11-7-1961.	723,660.	SCANDIA. U.S. CL. 43. REG. 11-7-1961.
723,453.	CORKTURF (STYLIZED). U.S. CL. 12. REG. 11-7-1961.	723,663.	NATURELLES. U.S. CL. 44. REG. 11-7-1961.
723,459.	PRIMO-SEAL. U.S. CL. 12. REG. 11-7-1961.	723,666.	PEDI-SPRED AND DESIGN. U.S. CL. 44. REG. 11-7-1961.
723,470.	PERMARK AND DESIGN. U.S. CL. 12. REG. 11-7-1961.	723,676.	VARI-HUE. U.S. CL. 51. REG. 11-7-1961.
723,473.	CLOPAY AND DESIGN. U.S. CL. 12. REG. 11-7-1961.	723,683.	SILVER CHECK AND DESIGN. U.S. CL. 51. REG. 11-7-1961.
723,477.	FIL-A-BLOC. U.S. CL. 12. REG. 11-7-1961.	723,686.	DYNE AND DESIGN. U.S. CL. 52. REG. 11-7-1961.
723,481.	MINI-KING. U.S. CL. 13. REG. 11-7-1961.	723,687.	LA MARICK AND DESIGN. U.S. CL. 100. REG. 11-7-1961.
723,486.	BEMCALLOY AND DESIGN. U.S. CL. 14. REG. 11-7-1961.	723,689.	THE CHARLESTON GARDEN. U.S. CL. 100. REG. 11-7-1961.
723,490.	VITA-HUE (STYLIZED). U.S. CL. 16. REG. 11-7-1961.	723,706.	NARRO-SIDE. U.S. CL. 12. REG. 11-7-1961.
723,491.	POLY-PLUS. U.S. CL. 16. REG. 11-7-1961.	723,710.	STRUCK EYE. U.S. CL. 23. REG. 11-7-1961.
723,493.	F H AND DESIGN. U.S. CL. 16. REG. 11-7-1961.	723,713.	SHANTUNG. U.S. CL. 32. REG. 11-7-1961.
		723,716.	KENT. U.S. CL. 36. REG. 11-7-1961.
		902,731.	LEANIES. U.S. CL. 46. REG. 11-17-1970.
		906,581.	FUNNEL BALL AND DESIGN. U.S. CL. 22. REG. 1-26-1971.
		911,737.	CRISSY. U.S. CL. 22. REG. 5-25-1971.
		913,390.	FLEXI-FOAM (STYLIZED). U.S. CL. 32. REG. 6-8-1971.
		915,196.	ESTODERME. U.S. CL. 51. REG. 6-15-1971.
		1,144,008.	ZENITH (STYLIZED). INT. CL. 9. REG. 12-23-1980.
		1,155,556.	CURITY. INT. CL. 16. REG. 5-26-1981.
		1,159,270.	BASIC. INT. CL. 26. REG. 6-30-1981.
		1,159,790.	M AND DESIGN. INT. CL. 9. REG. 7-7-1981.
		1,167,992.	BODY BUILDER'S PROTEIN (STYLIZED). INT. CL. 5. REG. 9-8-1981.

- 1,169,284. SIGLA. INT. CL. 19 ONLY. REG. 9-15-1981.
1,171,357. LA PERLA AND DESIGN. INT. CL. 25. REG. 9-29-1981.
1,171,854. LETRASET. INT. CL. 2. REG. 10-6-1981.
1,175,644. CO-STAR. INT. CL. 1. REG. 11-3-1981.
1,175,645. AVIEX AND DESIGN. INT. CLS. 1, 3 AND 4. REG. 11-3-1981.
1,175,652. STICKY STUFF AND DESIGN. INT. CL. 1. REG. 11-3-1981.
1,175,653. DIESEL HEET. INT. CL. 1. REG. 11-3-1981.
1,175,654. IDFLO. INT. CL. 1. REG. 11-3-1981.
1,175,657. BARABUF. INT. CL. 1. REG. 11-3-1981.
1,175,661. WONDER BOND. INT. CL. 1. REG. 11-3-1981.
1,175,666. SENSI-TEX. INT. CL. 1. REG. 11-3-1981.
1,175,667. PERFECT-A-BOND. INT. CL. 1. REG. 11-3-1981.
1,175,670. SULFODOX. INT. CL. 1. REG. 11-3-1981.
1,175,673. URESIN. INT. CL. 1. REG. 11-3-1981.
1,175,675. ILFOBROM GALERIE. INT. CL. 1. REG. 11-3-1981.
1,175,676. GALERIE. INT. CL. 1. REG. 11-3-1981.
1,175,682. MCKAY AND DESIGN. INT. CLS. 1, 2, 3, 4 AND 5. REG. 11-3-1981.
1,175,684. PINE-LIFE. INT. CL. 1. REG. 11-3-1981.
1,175,686. SHERBURN. INT. CL. 2. REG. 11-3-1981.
1,175,689. BAFIXAN. INT. CL. 2. REG. 11-3-1981.
1,175,694. VICTORY (STYLIZED). INT. CL. 2. REG. 11-3-1981.
1,175,697. LIP LICKERS AND DESIGN. INT. CL. 3. REG. 11-3-1981.
1,175,701. LIVIA AND DESIGN. INT. CL. 3. REG. 11-3-1981.
1,175,708. HI MS AND DESIGN. INT. CL. 3. REG. 11-3-1981.
1,175,711. JAY-KAY JK AND DESIGN. INT. CL. 3. REG. 11-3-1981.
1,175,714. RADOX SHOWERFRESH. INT. CL. 3. REG. 11-3-1981.
1,175,719. BARRY EVAN. INT. CL. 3. REG. 11-3-1981.
1,175,729. PERM-A-MATIC. INT. CL. 3. REG. 11-3-1981.
1,175,734. KLARDUROL (STYLIZED). INT. CL. 3. REG. 11-3-1981.
1,175,737. RHAPSODIE. INT. CL. 3. REG. 11-3-1981.
1,175,741. VISCOGEN. INT. CL. 4. REG. 11-3-1981.
1,175,752. ARC-COAL. INT. CL. 4. REG. 11-3-1981.
1,175,760. VIOZYMIC (STYLIZED). INT. CL. 5. REG. 11-3-1981.
1,175,762. DITHROCREAM. INT. CL. 5. REG. 11-3-1981.
1,175,763. HEALTHCO H (STYLIZED). INT. CL. 5. REG. 11-3-1981.
1,175,765. DIETIC (STYLIZED). INT. CL. 5. REG. 11-3-1981.
1,175,772. ULTRACEF. INT. CL. 5. REG. 11-3-1981.
1,175,774. NA AND DESIGN. INT. CLS. 6, 7, 9 AND 11. REG. 11-3-1981.
1,175,787. TI, THOMAS INDUSTRIES INC. AND DESIGN. INT. CLS. 6, 8 AND 20. REG. 11-3-1981.
1,175,790. FEDERAL NAILS. INT. CL. 6. REG. 11-3-1981.
1,175,791. MODULE 4. INT. CLS. 6, 11 AND 12. REG. 11-3-1981.
1,175,795. P PYRAMID AND DESIGN. INT. CL. 6. REG. 11-3-1981.
1,175,800. 626. INT. CL. 6. REG. 11-3-1981.
1,175,802. CSC AND DESIGN. INT. CL. 6. REG. 11-3-1981.
1,175,811. AS (STYLIZED). INT. CLS. 7 AND 9. REG. 11-3-1981.
1,175,812. C.M.C.-LEVELFEED. INT. CL. 7. REG. 11-3-1981.
1,175,815. UNITROL. INT. CL. 7. REG. 11-3-1981.
1,175,816. L LIPPMANN MILWAUKEE, INC. AND DESIGN. INT. CL. 7. REG. 11-3-1981.
1,175,818. HASE-GEAR AND DESIGN. INT. CL. 7. REG. 11-3-1981.
1,175,819. RUST BUSTER AND DESIGN. INT. CL. 7. REG. 11-3-1981.
1,175,825. MINI-MASTER. INT. CL. 7. REG. 11-3-1981.
1,175,826. NPD AND DESIGN. INT. CLS. 7, 9 AND 12. REG. 11-3-1981.
1,175,827. ADCO AND DESIGN. INT. CL. 7. REG. 11-3-1981.
1,175,829. MISCELLANEOUS DESIGN. INT. CL. 7. REG. 11-3-1981.
1,175,842. DOWDCO DIAMOND OIL WELL DRILLING COMPANY AND DESIGN. INT. CL. 7. REG. 11-3-1981.
1,175,849. RIBBON-RITE (STYLIZED). INT. CL. 7. REG. 11-3-1981.
1,175,859. THE PROFESSIONAL P B PORT-O-BENDER AND DESIGN. INT. CL. 7. REG. 11-3-1981.
1,175,861. EPOFLEX. INT. CL. 7. REG. 11-3-1981.
1,175,882. AVCO. INT. CL. 9. REG. 11-3-1981.
1,175,885. LITEPAK. INT. CL. 9. REG. 11-3-1981.
1,175,891. MINPAC. INT. CL. 9. REG. 11-3-1981.
1,175,901. UNIMOUNT. INT. CL. 9. REG. 11-3-1981.
1,175,906. S AND DESIGN. INT. CL. 9. REG. 11-3-1981.
1,175,909. SAN FERNANDO (STYLIZED). INT. CL. 9. REG. 11-3-1981.
1,175,913. DIRECT LINE. INT. CL. 9. REG. 11-3-1981.
1,175,915. MARKLINK. INT. CL. 9. REG. 11-3-1981.
1,175,924. ELECTRO-FIX. INT. CL. 9. REG. 11-3-1981.
1,175,925. INDUSTRIAL SMOK SPEC AND DESIGN. INT. CL. 9. REG. 11-3-1981.
1,175,927. T-M-K. INT. CL. 9. REG. 11-3-1981.
1,175,931. ONE-BY-ONE (STYLIZED). INT. CL. 9. REG. 11-3-1981.
1,175,933. SELECTAVISION (STYLIZED). INT. CL. 9. REG. 11-3-1981.
1,175,935. VELANDER. INT. CL. 9. REG. 11-3-1981.
1,175,945. QUANTAMATIC. INT. CL. 9. REG. 11-3-1981.
1,175,947. GARCAN. INT. CL. 9. REG. 11-3-1981.
1,175,949. MISCELLANEOUS DESIGN. INT. CL. 9. REG. 11-3-1981.
1,175,954. COBRA CLAMP. INT. CL. 9. REG. 11-3-1981.
1,175,955. EXPRESS CURL. INT. CL. 9. REG. 11-3-1981.
1,175,967. KV JACKETS (STYLIZED). INT. CL. 9. REG. 11-3-1981.
1,175,968. NEW WINE. INT. CLS. 9 AND 16. REG. 11-3-1981.
1,175,969. TATTLE TAPE. INT. CL. 9. REG. 11-3-1981.
1,175,970. THERMO MIZER. INT. CL. 9. REG. 11-3-1981.
1,175,973. EPICS. INT. CL. 9. REG. 11-3-1981.
1,175,977. MOTECTOR. INT. CL. 9. REG. 11-3-1981.
1,175,980. RAIL. INT. CL. 9. REG. 11-3-1981.
1,175,981. SPORTSMAN. INT. CL. 9. REG. 11-3-1981.
1,175,984. SUPER CHICKEN. INT. CLS. 9 AND 25. REG. 11-3-1981.
1,175,986. STOPMASTER. INT. CL. 9. REG. 11-3-1981.
1,175,990. ASCO AND DESIGN. INT. CL. 10. REG. 11-3-1981.
1,175,993. IMUGARD. INT. CL. 10. REG. 11-3-1981.
1,176,000. REST BREAST. INT. CL. 10. REG. 11-3-1981.
1,176,001. SEQUICOR. INT. CL. 10. REG. 11-3-1981.
1,176,004. MPL. INT. CL. 10. REG. 11-3-1981.
1,176,011. CENTRIFLEX. INT. CL. 11. REG. 11-3-1981.
1,176,017. SUPER SPORT. INT. CL. 11. REG. 11-3-1981.
1,176,020. PENPURE. INT. CL. 11. REG. 11-3-1981.
1,176,021. THE MILK BOX. INT. CL. 11. REG. 11-3-1981.
1,176,022. UNICON. INT. CL. 11. REG. 11-3-1981.
1,176,026. KOFFEE KING WALL HUGGER. INT. CL. 11. REG. 11-3-1981.
1,176,028. DIXIE BELLE. INT. CL. 11. REG. 11-3-1981.
1,176,031. MULTI-PORT. INT. CL. 11. REG. 11-3-1981.
1,176,035. MISCELLANEOUS DESIGN. INT. CL. 12. REG. 11-3-1981.
1,176,036. LECARRA. INT. CL. 12. REG. 11-3-1981.
1,176,037. BY OMAR (STYLIZED). INT. CL. 12. REG. 11-3-1981.
1,176,038. MISCELLANEOUS DESIGN. INT. CL. 12. REG. 11-3-1981.
1,176,046. BIG TRAIL. INT. CL. 12. REG. 11-3-1981.
1,176,048. CABO RICO 38. INT. CL. 12. REG. 11-3-1981.
1,176,049. STADIUM. INT. CL. 12. REG. 11-3-1981.
1,176,050. CORNELIUS AND DESIGN. INT. CL. 12. REG. 11-3-1981.
1,176,053. GAZELLE AND DESIGN. INT. CL. 12. REG. 11-3-1981.
1,176,057. SIMP-LOK. INT. CL. 12. REG. 11-3-1981.
1,176,059. SSS SURF HUNTER AND DESIGN. INT. CL. 12. REG. 11-3-1981.
1,176,064. CUDDY NAUTIQUE. INT. CL. 12. REG. 11-3-1981.
1,176,070. THE FORCE 1 (STYLIZED). INT. CL. 12. REG. 11-3-1981.

- 1,176,078. FRISBEE. INT. CL. 14. REG. 11-3-1981.
 1,176,085. EDWARD HARVEY (STYLIZED). INT. CLS. 16, 18, 28 AND 34. REG. 11-3-1981.
 1,176,089. ANAMOD. INT. CL. 16. REG. 11-3-1981.
 1,176,090. SUPERBOY (STYLIZED). INT. CL. 16. REG. 11-3-1981.
 1,176,091. SILVER & GOLD REPORT. INT. CL. 16. REG. 11-3-1981.
 1,176,103. BUILDING BLOCKS. INT. CL. 16. REG. 11-3-1981.
 1,176,105. ACADEMIC TRACK. INT. CL. 16. REG. 11-3-1981.
 1,176,114. PRO-BUILDING. INT. CL. 16. REG. 11-3-1981.
 1,176,115. JOLLY PUP. INT. CL. 16. REG. 11-3-1981.
 1,176,120. A A C E (STYLIZED). INT. CL. 16. REG. 11-3-1981.
 1,176,122. DYOGAPHY. INT. CL. 16. REG. 11-3-1981.
 1,176,123. DYOLITH. INT. CL. 16. REG. 11-3-1981.
 1,176,124. DYOTONE. INT. CL. 16. REG. 11-3-1981.
 1,176,125. DYOCOLOR. INT. CL. 16. REG. 11-3-1981.
 1,176,132. SIMSNIPS. INT. CL. 16. REG. 11-3-1981.
 1,176,140. TAKING CARE AND DESIGN. INT. CL. 16. REG. 11-3-1981.
 1,176,146. PLANTRONICS KENTROX. INT. CL. 16. REG. 11-3-1981.
 1,176,149. LEWIS MARINE SUPPLY, INC. AND DESIGN. INT. CL. 16. REG. 11-3-1981.
 1,176,155. TRUE VALUE AND DESIGN. INT. CL. 16. REG. 11-3-1981.
 1,176,159. CAR-FREE (STYLIZED). INT. CL. 16. REG. 11-3-1981.
 1,176,160. MAGI-PAK (STYLIZED). INT. CL. 16. REG. 11-3-1981.
 1,176,161. AID (STYLIZED). INT. CL. 16. REG. 11-3-1981.
 1,176,162. CHAPEL ART. INT. CL. 16. REG. 11-3-1981.
 1,176,164. RIBBON-RITE. INT. CL. 16. REG. 11-3-1981.
 1,176,168. POLY-WHITE. INT. CL. 16. REG. 11-3-1981.
 1,176,169. TW 400. INT. CL. 16. REG. 11-3-1981.
 1,176,170. CHAMPION HANDLER. INT. CL. 16. REG. 11-3-1981.
 1,176,175. COPY-SAVER SYSTEM. INT. CL. 16. REG. 11-3-1981.
 1,176,177. THE BENEFACITOR. INT. CL. 16. REG. 11-3-1981.
 1,176,179. ECOPAC. INT. CL. 16. REG. 11-3-1981.
 1,176,180. WALTON PRINTING. INT. CL. 16. REG. 11-3-1981.
 1,176,181. ORIGINAL DESIGNER LETTERS. INT. CL. 16. REG. 11-3-1981.
 1,176,182. PACE WIPES. INT. CL. 16. REG. 11-3-1981.
 1,176,190. KEDDCO. INT. CL. 17. REG. 11-3-1981.
 1,176,204. TWT (STYLIZED). INT. CL. 18. REG. 11-3-1981.
 1,176,207. SDX. INT. CL. 19. REG. 11-3-1981.
 1,176,212. PANELOG. INT. CL. 19. REG. 11-3-1981.
 1,176,219. FW FASHONWALL (STYLIZED). INT. CL. 19. REG. 11-3-1981.
 1,176,220. FASHONWALL. INT. CL. 19. REG. 11-3-1981.
 1,176,222. J-DECK. INT. CL. 19. REG. 11-3-1981.
 1,176,227. MOBILEEZ. INT. CL. 20. REG. 11-3-1981.
 1,176,233. JOB BOX ORGANIZER. INT. CL. 20. REG. 11-3-1981.
 1,176,235. LIGHT SCENE. INT. CL. 20. REG. 11-3-1981.
 1,176,236. MULTISTAND (STYLIZED). INT. CL. 20. REG. 11-3-1981.
 1,176,238. SL AND DESIGN. INT. CL. 20. REG. 11-3-1981.
 1,176,241. S SIMMONS FLOTATION SYSTEMS AND DESIGN. INT. CL. 20. REG. 11-3-1981.
 1,176,260. PARODONTAX. INT. CL. 21. REG. 11-3-1981.
 1,176,266. QUICKSACK. INT. CL. 22. REG. 11-3-1981.
 1,176,267. I'M TOUGH AND DESIGN. INT. CL. 22. REG. 11-3-1981.
 1,176,269. FLASHER. INT. CL. 22. REG. 11-3-1981.
 1,176,271. UNITEAR. INT. CL. 22. REG. 11-3-1981.
 1,176,275. KOLOR MATCH (STYLIZED). INT. CL. 23. REG. 11-3-1981.
 1,176,276. CELIOX. INT. CL. 23. REG. 11-3-1981.
 1,176,282. DUNCAN OF PERTH. INT. CL. 24. REG. 11-3-1981.
 1,176,287. SOFT-O-CLAVE. INT. CL. 24. REG. 11-3-1981.
 1,176,292. PRETTY FEET. INT. CL. 25. REG. 11-3-1981.
 1,176,298. FIORIO (STYLIZED). INT. CL. 25. REG. 11-3-1981.
 1,176,303. LEO CHEVALIER MONTREAL-CANADA (STYLIZED). INT. CL. 25. REG. 11-3-1981.
 1,176,310. MACHO MOC. INT. CL. 25. REG. 11-3-1981.
 1,176,311. BAILA. INT. CL. 25. REG. 11-3-1981.
 1,176,314. TRAKKER. INT. CL. 25. REG. 11-3-1981.
 1,176,319. SHINE-ON-SHINE. INT. CL. 25. REG. 11-3-1981.
 1,176,325. L. SIMSBURY LTD. INT. CL. 25. REG. 11-3-1981.
 1,176,326. MAGIC KNIT. INT. CL. 25. REG. 11-3-1981.
 1,176,328. IVY CLASSICS. INT. CL. 25. REG. 11-3-1981.
 1,176,336. PATTERN PRETTY. INT. CL. 25. REG. 11-3-1981.
 1,176,337. PUMPER NICKEL (STYLIZED). INT. CL. 25. REG. 11-3-1981.
 1,176,338. SOFTWAY. INT. CL. 25. REG. 11-3-1981.
 1,176,340. PRETTY POSY. INT. CL. 26. REG. 11-3-1981.
 1,176,341. SLIMLINE. INT. CL. 26. REG. 11-3-1981.
 1,176,343. LASETTA. INT. CL. 26. REG. 11-3-1981.
 1,176,346. HITCH-HYKER. INT. CL. 26. REG. 11-3-1981.
 1,176,347. TUFBUILT. INT. CL. 26. REG. 11-3-1981.
 1,176,351. CHROMATOUCH. INT. CL. 27. REG. 11-3-1981.
 1,176,352. AAPCO. INT. CL. 27. REG. 11-3-1981.
 1,176,354. DURAFLEX. INT. CL. 27. REG. 11-3-1981.
 1,176,357. DESSO SIGNATURE (STYLIZED). INT. CL. 27. REG. 11-3-1981.
 1,176,359. MUSICAL ENCOUNTERS. INT. CL. 28. REG. 11-3-1981.
 1,176,360. THE UNBALL (STYLIZED). INT. CL. 28. REG. 11-3-1981.
 1,176,362. CARRERA SERVO. INT. CL. 28. REG. 11-3-1981.
 1,176,363. AIR-DYNE (STYLIZED). INT. CL. 28. REG. 11-3-1981.
 1,176,364. MISCELLANEOUS DESIGN. INT. CL. 28. REG. 11-3-1981.
 1,176,366. TAKE ME HOME WE'LL HAVE FUN! AND DESIGN. INT. CL. 28. REG. 11-3-1981.
 1,176,367. ACHIEVER. INT. CL. 28. REG. 11-3-1981.
 1,176,369. BECOME A SUCCESS. INT. CL. 28. REG. 11-3-1981.
 1,176,373. MISCELLANEOUS DESIGN. INT. CL. 28. REG. 11-3-1981.
 1,176,377. SHIP SHAPES. INT. CL. 28. REG. 11-3-1981.
 1,176,378. S.S. HAPPINESS CREW. INT. CL. 28. REG. 11-3-1981.
 1,176,379. GLADIATOR. INT. CL. 28. REG. 11-3-1981.
 1,176,383. TIC TAC TOAD. INT. CL. 28. REG. 11-3-1981.
 1,176,390. LA CURIEUSE. INT. CL. 29. REG. 11-3-1981.
 1,176,398. A AND DESIGN. INT. CLS. 29 AND 30. REG. 11-3-1981.
 1,176,399. GIANT LEAN AND DESIGN. INT. CL. 29. REG. 11-3-1981.
 1,176,401. NEVER A DULL MEAL. INT. CL. 29. REG. 11-3-1981.
 1,176,410. EARLYBIRD. INT. CL. 30. REG. 11-3-1981.
 1,176,411. YOO.HOO (STYLIZED). INT. CL. 30. REG. 11-3-1981.
 1,176,413. DREAMSICLE BRAND AND DESIGN. INT. CL. 30. REG. 11-3-1981.
 1,176,414. ALL NATURAL FUDGSICLE AND DESIGN. INT. CL. 30. REG. 11-3-1981.
 1,176,415. JELLI DELITE. INT. CL. 30. REG. 11-3-1981.
 1,176,416. BUBBLE GUM BOMB. INT. CL. 30. REG. 11-3-1981.
 1,176,417. ICED DELIGHT. INT. CL. 30. REG. 11-3-1981.
 1,176,421. PICKSEED. INT. CL. 31. REG. 11-3-1981.
 1,176,422. VB PRE-MIX. INT. CL. 31. REG. 11-3-1981.
 1,176,424. BUNNY BITE CAR-ETTES AND DESIGN. INT. CL. 31. REG. 11-3-1981.
 1,176,427. FIBAR AND DESIGN. INT. CL. 31. REG. 11-3-1981.
 1,176,430. TCCA. INT. CL. 31. REG. 11-3-1981.
 1,176,433. JENELLE. INT. CL. 31. REG. 11-3-1981.
 1,176,435. TREET ADE. INT. CL. 32. REG. 11-3-1981.
 1,176,441. A STELLA ARTOIS AND DESIGN. INT. CL. 32. REG. 11-3-1981.
 1,176,443. A AND DESIGN. INT. CL. 32. REG. 11-3-1981.
 1,176,447. BANDA AZUL. INT. CL. 33. REG. 11-3-1981.
 1,176,454. MISCELLANEOUS DESIGN. INT. CL. 34. REG. 11-3-1981.

- 1,176,457. ACTIONPLAN AND DESIGN. INT. CL. 35. REG. 11-3-1981.
- 1,176,458. INTERCON RESEARCH. INT. CL. 35. REG. 11-3-1981.
- 1,176,460. INTERCON. INT. CL. 35. REG. 11-3-1981.
- 1,176,462. HERBERT HAWKINS. INT. CLS. 35 AND 36. REG. 11-3-1981.
- 1,176,463. CPC (STYLIZED). INT. CL. 35. REG. 11-3-1981.
- 1,176,466. ARTHUR YOUNG EXECUTIVE RESOURCE CONSULTANTS. INT. CL. 35. REG. 11-3-1981.
- 1,176,471. SCANTEST. INT. CL. 35. REG. 11-3-1981.
- 1,176,472. "A TOUCH OF CLASS" (STYLIZED). INT. CL. 35. REG. 11-3-1981.
- 1,176,479. MISCELLANEOUS DESIGN. INT. CLS. 35 AND 42. REG. 11-3-1981.
- 1,176,481. MIDLAND EXPRESS. INT. CL. 36. REG. 11-3-1981.
- 1,176,482. PRIORITY AND DESIGN. INT. CL. 36. REG. 11-3-1981.
- 1,176,488. AMERICAN LAND SERVICE ALS AND DESIGN. INT. CL. 36. REG. 11-3-1981.
- 1,176,493. MISCELLANEOUS DESIGN. INT. CL. 36. REG. 11-3-1981.
- 1,176,494. VANTAGE AUTO INSURANCE (STYLIZED). INT. CL. 36. REG. 11-3-1981.
- 1,176,498. SSS (STYLIZED). INT. CL. 36. REG. 11-3-1981.
- 1,176,511. OIL X-CHANGE. INT. CL. 37. REG. 11-3-1981.
- 1,176,517. WM AND DESIGN. INT. CL. 37. REG. 11-3-1981.
- 1,176,520. BODY SHOP ON WHEELS. INT. CL. 37. REG. 11-3-1981.
- 1,176,521. B AND DESIGN. INT. CLS. 37 AND 42. REG. 11-3-1981.
- 1,176,522. JF (STYLIZED). INT. CLS. 37, 39 AND 41. REG. 11-3-1981.
- 1,176,530. W AND DESIGN. INT. CL. 37. REG. 11-3-1981.
- 1,176,531. WELLTECH, INC. W AND DESIGN. INT. CL. 37. REG. 11-3-1981.
- 1,176,532. WELLTECH. INT. CL. 37. REG. 11-3-1981.
- 1,176,533. MCDEVITT & STREET COMPANY. INT. CL. 37. REG. 11-3-1981.
- 1,176,537. LIVE EYE. INT. CL. 38. REG. 11-3-1981.
- 1,176,538. INTELPOST. INT. CLS. 38 AND 39. REG. 11-3-1981.
- 1,176,550. FOTO POST. INT. CL. 40. REG. 11-3-1981.
- 1,176,554. COMMODITIES EDUCATIONAL INSTITUTE. INT. CL. 41. REG. 11-3-1981.
- 1,176,555. PETRIE METHOD. INT. CL. 41. REG. 11-3-1981.
- 1,176,570. NETVN. INT. CL. 41. REG. 11-3-1981.
- 1,176,573. WHITE LIGHTNING. INT. CL. 41. REG. 11-3-1981.
- 1,176,579. JAY'S AND DESIGN. INT. CL. 42. REG. 11-3-1981.
- 1,176,581. TRUFFLES & FLOURISHES. INT. CL. 42. REG. 11-3-1981.
- 1,176,583. NATIONAL ASSOCIATION OF SCUBA DIVING SCHOOLS. INT. CL. 42. REG. 11-3-1981.
- 1,176,585. DINNER BELL AND DESIGN. INT. CL. 42. REG. 11-3-1981.
- 1,176,587. LAWN BUILDERS (STYLIZED). INT. CL. 42. REG. 11-3-1981.
- 1,176,588. MORSE AND DESIGN. INT. CL. 42. REG. 11-3-1981.
- 1,176,595. F (STYLIZED). INT. CL. 42. REG. 11-3-1981.
- 1,176,603. BOARDMAN RESORT AND DESIGN. INT. CL. 42. REG. 11-3-1981.
- 1,176,608. MISCELLANEOUS DESIGN. INT. CL. 42. REG. 11-3-1981.
- 1,176,615. CONNECTICUT COUNTRY. INT. CL. 42. REG. 11-3-1981.
- 1,176,617. BIRRA PORETTI'S AND DESIGN. INT. CL. 42. REG. 11-3-1981.
- 1,176,622. NATIONAL ASSOCIATION TRUCK STOP OPERATORS: NATSO AND DESIGN. INT. CL. 42. REG. 11-3-1981.
- 1,176,625. PATRICK'S PUB. INT. CL. 42. REG. 11-3-1981.
- 1,176,628. A DIFFERENT KIND OF SHOE STORE. INT. CL. 42. REG. 11-3-1981.
- 1,176,629. MISCELLANEOUS DESIGN. INT. CL. 42. REG. 11-3-1981.
- 1,176,630. JAFCO. INT. CL. 42. REG. 11-3-1981.
- 1,176,635. HELP. INT. CL. 42. REG. 11-3-1981.
- 1,176,638. HEXTRAN. INT. CL. 42. REG. 11-3-1981.
- 1,176,644. INTERNATIONAL HANDGUN METALLIC SILHOUETTE ASSOCIATION AND DESIGN. U.S. CL. 200. REG. 11-3-1981.
- 1,176,645. RIVERSIDE AQUETTES AND DESIGN. U.S. CL. 200. REG. 11-3-1981.
- 1,176,649. MISCELLANEOUS DESIGN. INT. CLS. 29, 30 AND 32. REG. 11-3-1981.
- 1,176,660. FOG-OFF. INT. CL. 3. REG. 11-3-1981.
- 1,176,661. BLU LUBE. INT. CL. 4. REG. 11-3-1981.
- 1,176,667. WEBER WEEDER. INT. CL. 12. REG. 11-3-1981.
- 1,176,674. BRIEF LIVES. INT. CL. 16. REG. 11-3-1981.
- 1,176,679. BIBLICAL ILLUSTRATOR. INT. CL. 16. REG. 11-3-1981.
- 1,176,685. TRI-WALL (STYLIZED). INT. CL. 17. REG. 11-3-1981.
- 1,176,689. VENINI AND DESIGN. INT. CL. 21. REG. 11-3-1981.
- 1,176,691. SQUAW PEAK AND DESIGN. INT. CL. 25. REG. 11-3-1981.
- 1,176,692. WINTER PARK AND DESIGN. INT. CL. 25. REG. 11-3-1981.
- 1,176,695. SLICE PAC. INT. CL. 29. REG. 11-3-1981.
- 1,176,696. CHICKEN TO GO. INT. CL. 29. REG. 11-3-1981.
- 1,176,702. COUNTRY OF SWEDEN. INT. CL. 33. REG. 11-3-1981.
- 1,176,703. THE WORLD'S BEST WAY TO OWN GOLD. INT. CL. 35. REG. 11-3-1981.
- 1,176,704. DOCUMENT SHUTTLE. INT. CL. 39. REG. 11-3-1981.
- 1,180,134. SCOTTEX. INT. CL. 16. REG. 12-1-1981.
- 1,182,018. INTERCRAFT. INT. CLS. 14 AND 20 ONLY. REG. 12-15-1981.
- 1,188,271. SANI-TEST. INT. CL. 1. REG. 2-2-1982.
- 1,621,412. HEALTH CUISINE (STYLIZED). INT. CL. 29. REG. 11-6-1990.
- 1,624,307. PUGETSOL. INT. CL. 1. REG. 11-27-1990.
- 1,630,890. PYRO SIL. INT. CL. 21. REG. 1-8-1991.
- 1,635,894. T2. INT. CL. 1. REG. 2-26-1991.
- 1,643,510. VC2. INT. CL. 10. REG. 5-7-1991.
- 1,646,399. HEALTH CARE BASICS. INT. CL. 42. REG. 5-28-1991.
- 1,646,773. SELBO. INT. CL. 12. REG. 6-4-1991.
- 1,647,667. BRUTE RACK AND DESIGN. INT. CLS. 37 AND 42. REG. 6-11-1991.
- 1,648,895. ANGELS FLIGHT. INT. CL. 25. REG. 6-25-1991.
- 1,658,808. NORELEM (STYLIZED). INT. CL. 7 ONLY. REG. 10-1-1991.
- 1,663,106. NTTC. INT. CL. 2. REG. 11-5-1991.
- 1,663,110. SPATTER-IT. INT. CL. 2. REG. 11-5-1991.
- 1,663,129. FEMININE BODY BAR AND DESIGN. INT. CL. 3. REG. 11-5-1991.
- 1,663,136. SKINCEPT. INT. CL. 3. REG. 11-5-1991.
- 1,663,137. CHAMBERS. INT. CL. 3. REG. 11-5-1991.
- 1,663,151. PEPPONEN. INT. CL. 5. REG. 11-5-1991.
- 1,663,159. COURIER. INT. CL. 5. REG. 11-5-1991.
- 1,663,171. MISCELLANEOUS DESIGN. INT. CL. 7. REG. 11-5-1991.
- 1,663,186. ESCO (STYLIZED). INT. CL. 7. REG. 11-5-1991.
- 1,663,188. CAMCONTROL. INT. CL. 7. REG. 11-5-1991.
- 1,663,196. SLICKPLANE. INT. CL. 8. REG. 11-5-1991.
- 1,663,211. TOTAL TRAK. INT. CL. 9. REG. 11-5-1991.
- 1,663,222. SACONS FEDERAL AND DESIGN. INT. CL. 9. REG. 11-5-1991.
- 1,663,225. EXPONENT GRAPHICS (STYLIZED). INT. CLS. 9 AND 16. REG. 11-5-1991.
- 1,663,233. CORE FOUNDATION SOFTWARE. INT. CL. 9. REG. 11-5-1991.
- 1,663,236. THE PLAYROOM. INT. CL. 9. REG. 11-5-1991.
- 1,663,239. VIEWPOINT. INT. CL. 9. REG. 11-5-1991.
- 1,663,272. READY PLAY. INT. CL. 9. REG. 11-5-1991.
- 1,663,273. THE SOURCE CREATIVES AND DESIGN. INT. CL. 9. REG. 11-5-1991.
- 1,663,286. BLEND 2000. INT. CL. 9. REG. 11-5-1991.
- 1,663,287. APPLY 2000. INT. CL. 9. REG. 11-5-1991.
- 1,663,289. STATELINE AND DESIGN. INT. CL. 9. REG. 11-5-1991.

- 1,663,290. ACCUFIRE AND DESIGN. INT. CL. 9. REG. 11-5-1991.
- 1,663,294. VCLINK. INT. CL. 9. REG. 11-5-1991.
- 1,663,295. SNAP-LOCK. INT. CL. 9. REG. 11-5-1991.
- 1,663,296. ERGO-GRIP. INT. CL. 9. REG. 11-5-1991.
- 1,663,307. ALSTRUT. INT. CL. 9. REG. 11-5-1991.
- 1,663,323. LINEUPS. INT. CL. 9. REG. 11-5-1991.
- 1,663,325. LINAUM. INT. CL. 9. REG. 11-5-1991.
- 1,663,335. KOOL-GARD. INT. CL. 10. REG. 11-5-1991.
- 1,663,352. MENSOR MAGNA SKIRT (STYLIZED). INT. CL. 10. REG. 11-5-1991.
- 1,663,359. MICROLAMP. INT. CL. 11. REG. 11-5-1991.
- 1,663,363. PROTECH. INT. CL. 11. REG. 11-5-1991.
- 1,663,367. SUPER HICAS. INT. CL. 12. REG. 11-5-1991.
- 1,663,374. SKI RAY. INT. CL. 12. REG. 11-5-1991.
- 1,663,376. BLUE NOTE AND DESIGN. INT. CL. 14. REG. 11-5-1991.
- 1,663,382. 1671 VI (STYLIZED). INT. CL. 14. REG. 11-5-1991.
- 1,663,409. 4" DESIGNERPLUS. INT. CL. 16. REG. 11-5-1991.
- 1,663,428. DANDY PANTS. INT. CL. 18. REG. 11-5-1991.
- 1,663,431. ROOF-BOND. INT. CLS. 19 AND 37. REG. 11-5-1991.
- 1,663,433. MISCELLANEOUS DESIGN. INT. CL. 19. REG. 11-5-1991.
- 1,663,435. IQS INNOVATION QUALITY SERVICE AND DESIGN. INT. CL. 19. REG. 11-5-1991.
- 1,663,438. PEACH BUFF BLEND. INT. CL. 19. REG. 11-5-1991.
- 1,663,439. ADOBE BLEND. INT. CL. 19. REG. 11-5-1991.
- 1,663,442. POLY-STOP. INT. CL. 19. REG. 11-5-1991.
- 1,663,453. CHEF INOX AND DESIGN. INT. CL. 21. REG. 11-5-1991.
- 1,663,457. BOUNCER. INT. CL. 21. REG. 11-5-1991.
- 1,663,463. MAXALON. INT. CL. 21. REG. 11-5-1991.
- 1,663,469. POLY-PURE. INT. CL. 22. REG. 11-5-1991.
- 1,663,470. BLENTEX. INT. CLS. 22 AND 25. REG. 11-5-1991.
- 1,663,480. PARTS DEPT.. INT. CL. 25. REG. 11-5-1991.
- 1,663,486. AD-HOC. INT. CL. 25. REG. 11-5-1991.
- 1,663,494. CUSHION GRIP SYSTEM. INT. CL. 28. REG. 11-5-1991.
- 1,663,497. MEGAGAMES. INT. CL. 28. REG. 11-5-1991.
- 1,663,504. GEMINI GYRO. INT. CL. 28. REG. 11-5-1991.
- 1,663,516. PRINCESS HOUSE. INT. CL. 28. REG. 11-5-1991.
- 1,663,522. "THE FRESH SOUP COMPANY". INT. CL. 29. REG. 11-5-1991.
- 1,663,525. ALASKAN GOURMET. INT. CL. 29. REG. 11-5-1991.
- 1,663,528. TASTE TESTED FOR QUALITY. INT. CLS. 29 AND 30. REG. 11-5-1991.
- 1,663,534. STAR'S PRIDE AND DESIGN. INT. CL. 29. REG. 11-5-1991.
- 1,663,539. RYKOFF SEXTON AND DESIGN. INT. CL. 29. REG. 11-5-1991.
- 1,663,540. CHIMICHURRI ARGENTINA'S FINEST BARBECUE SAUCE AND DESIGN. INT. CL. 30. REG. 11-5-1991.
- 1,663,542. PERSONAL CUISINE. INT. CL. 30. REG. 11-5-1991.
- 1,663,543. THE SAVANNAH COOKIE COMPANY AND DESIGN. INT. CL. 30. REG. 11-5-1991.
- 1,663,555. ALFIE'S POPCORN AND DESIGN. INT. CL. 30. REG. 11-5-1991.
- 1,663,570. DAKOTA. INT. CL. 31. REG. 11-5-1991.
- 1,663,573. BEST HEALTH'S AND DESIGN. INT. CL. 32. REG. 11-5-1991.
- 1,663,574. MISCELLANEOUS DESIGN. INT. CL. 32. REG. 11-5-1991.
- 1,663,586. JACK LONDON VINEYARD (STYLIZED). INT. CL. 33. REG. 11-5-1991.
- 1,663,601. MISCELLANEOUS DESIGN. INT. CLS. 35 AND 42. REG. 11-5-1991.
- 1,663,602. WE DON'T JUST WORK TO GET YOUR BUSINESS...WE WORK TO KEEP IT. INT. CL. 35. REG. 11-5-1991.
- 1,663,613. WE'RE OUT TO PROVE SOMETHING. INT. CL. 35. REG. 11-5-1991.
- 1,663,614. OUT SMART MARKETING AND DESIGN. INT. CL. 35. REG. 11-5-1991.
- 1,663,625. PURCH/ASSURE AND DESIGN. INT. CL. 36. REG. 11-5-1991.
- 1,663,635. BUYERS VOICE AND DESIGN. INT. CL. 36. REG. 11-5-1991.
- 1,663,636. BUYERS VOICE. INT. CL. 36. REG. 11-5-1991.
- 1,663,640. SURE-THING CD. INT. CL. 36. REG. 11-5-1991.
- 1,663,645. USONIAN AUTOMATIC. INT. CL. 37. REG. 11-5-1991.
- 1,663,662. EASTERN COMMUNICATIONS FORUM. INT. CL. 41. REG. 11-5-1991.
- 1,663,673. USONIAN AUTOMATIC. INT. CL. 41. REG. 11-5-1991.
- 1,663,675. DIVERSITY 2000. INT. CL. 41. REG. 11-5-1991.
- 1,663,684. INSIDE GOSPEL. INT. CL. 41. REG. 11-5-1991.
- 1,663,695. OPERATIONAL SYSTEM DESIGNS. INT. CL. 42. REG. 11-5-1991.
- 1,663,708. MISCELLANEOUS DESIGN. INT. CL. 42. REG. 11-5-1991.
- 1,663,717. SWIM MART. INT. CL. 42. REG. 11-5-1991.
- 1,663,721. FAXWICH. INT. CL. 42. REG. 11-5-1991.
- 1,663,727. HAYXPERT. INT. CL. 42. REG. 11-5-1991.
- 1,663,733. MARKET STREET. INT. CL. 42. REG. 11-5-1991.
- 1,663,746. THE DRY AFTER SHAVE BY MEM. INT. CL. 3. REG. 11-5-1991.
- 1,663,772. VISION. INT. CL. 10. REG. 11-5-1991.
- 1,663,781. THOUGHTS TO KEEP. INT. CL. 16. REG. 11-5-1991.
- 1,663,782. BABES IN CHRIST. INT. CL. 16. REG. 11-5-1991.
- 1,663,783. ANTHRACITE. INT. CL. 18. REG. 11-5-1991.
- 1,663,784. HOWDIE ROWDIE. INT. CL. 18. REG. 11-5-1991.
- 1,663,789. RELAY. INT. CL. 20. REG. 11-5-1991.
- 1,663,799. HOUR AFTER HOUR COMFORT BRA. INT. CL. 25. REG. 11-5-1991.
- 1,663,805. NECK TRAINER. INT. CL. 28. REG. 11-5-1991.
- 1,663,807. LAPCASE. INT. CL. 28. REG. 11-5-1991.
- 1,663,813. DON DAVID. INT. CL. 31. REG. 11-5-1991.
- 1,663,820. PERSONAL SPENDING POWER. INT. CL. 35. REG. 11-5-1991.
- 1,663,824. CC HOME LENDERS. INT. CL. 36. REG. 11-5-1991.
- 1,663,836. LAWN-A-LIVE. INT. CL. 42. REG. 11-5-1991.
- 1,663,840. ULTA3 THE ULTIMATE BEAUTY STORE AND DESIGN. INT. CL. 42. REG. 11-5-1991.
- 1,663,842. ULTA 3 THE ULTIMATE BEAUTY STORE. INT. CL. 42. REG. 11-5-1991.
- 1,663,844. JUST FOR PETS SUPERSTORE. INT. CL. 42. REG. 11-5-1991.
- 1,663,862. COFFEE TASTE SAVER. INT. CL. 21. REG. 11-5-1991.
- 1,671,358. HAL NET. INT. CL. 38. REG. 1-7-1992.
- 1,798,555. VIDEO COMMANDER. INT. CL. 9. REG. 10-12-1993.
- 1,823,331. MOTORWEEK AND DESIGN. INT. CL. 41. REG. 2-22-1994.
- 1,859,291. GREAT (STYLIZED). INT. CLS. 21, 24 AND 25. REG. 10-18-1994.
- 1,872,003. MISCELLANEOUS DESIGN. INT. CL. 28. REG. 1-3-1995.
- 1,883,865. HIP HOP. INT. CL. 33. REG. 3-14-1995.
- 1,886,257. MISCELLANEOUS DESIGN. INT. CL. 33. REG. 3-28-1995.
- 1,893,043. INNOVATIVE MEDICAL SYSTEMS INC.. INT. CL. 10. REG. 5-9-1995.
- 1,898,007. TLC. INT. CL. 9. REG. 6-6-1995.
- 1,898,109. SWIGGLE. INT. CL. 17. REG. 6-6-1995.
- 1,898,573. MIXER ON A STICK. INT. CL. 7. REG. 6-13-1995.
- 1,899,472. BORDER BUDDY. INT. CLS. 1 AND 8. REG. 6-13-1995.
- 1,899,566. ALPHA GLOW. INT. CL. 5. REG. 6-13-1995.
- 1,900,349. DYNA-STAT. INT. CLS. 7 AND 8. REG. 6-20-1995.
- 1,900,955. BUY RECYCLED BUSINESS ALLIANCE AND DESIGN. INT. CLS. 41 AND 42. REG. 6-20-1995.
- 1,901,441. GINZA-PLUS. INT. CL. 5. REG. 6-27-1995.
- 1,907,667. B THE BASEBALL SCHOOL AND DESIGN. INT. CL. 41. REG. 7-25-1995.
- 1,916,794. THE SHEPHERD. INT. CL. 36. REG. 9-5-1995.
- 1,918,631. AYURVEDA SCIENCE OF LIFE. INT. CLS. 3 AND 5. REG. 9-12-1995.

- 1,923,306. MISCELLANEOUS DESIGN. INT. CL. 7 ONLY. REG. 10-3-1995.
- 1,932,404. GARNIER AQUAVITAL (STYLIZED). INT. CL. 3. REG. 11-7-1995.
- 1,932,405. THE TRUTH SEEKER. INT. CL. 16. REG. 11-7-1995.
- 1,932,408. THUNDERON. INT. CL. 27. REG. 11-7-1995.
- 1,932,409. FIDELITY ASSET ALLOCATOR. INT. CL. 36. REG. 11-7-1995.
- 1,932,413. SPEED COOKING. INT. CL. 16. REG. 11-7-1995.
- 1,932,416. T TORTUGA AND DESIGN. INT. CLS. 6, 11 AND 12. REG. 11-7-1995.
- 1,932,418. INTEX. INT. CL. 25. REG. 11-7-1995.
- 1,932,419. BAUMA. INT. CL. 9. REG. 11-7-1995.
- 1,932,422. TRAVEL SHAVE AND DESIGN. INT. CL. 8. REG. 11-7-1995.
- 1,932,424. ACCUSYSTEMS AND DESIGN. INT. CL. 10. REG. 11-7-1995.
- 1,932,426. SPECIAL HEALTH (STYLIZED). INT. CL. 42. REG. 11-7-1995.
- 1,932,427. TWINLAB MAXIMUM NUTRITION CAPS. INT. CL. 5. REG. 11-7-1995.
- 1,932,429. SOFTBANK. INT. CLS. 9, 11 AND 42. REG. 11-7-1995.
- 1,932,430. THE ADVANTAGE (STYLIZED). INT. CL. 18. REG. 11-7-1995.
- 1,932,431. T AND DESIGN. INT. CL. 20. REG. 11-7-1995.
- 1,932,432. SUPPORTER; THE STRUGGLE FOR LIFE AND DESIGN. INT. CLS. 14, 18 AND 25. REG. 11-7-1995.
- 1,932,433. ALMEM. INT. CL. 5. REG. 11-7-1995.
- 1,932,435. SURVEYOR PLUS. INT. CL. 9. REG. 11-7-1995.
- 1,932,438. CVS (STYLIZED). INT. CL. 41. REG. 11-7-1995.
- 1,932,441. MAD GIZMO. INT. CLS. 9 AND 28. REG. 11-7-1995.
- 1,932,443. BLUE OPERA. INT. CL. 25. REG. 11-7-1995.
- 1,932,447. NIAX. INT. CLS. 35 AND 42. REG. 11-7-1995.
- 1,932,448. FLEXCHOICE. INT. CL. 42. REG. 11-7-1995.
- 1,932,450. Z-TEX. INT. CLS. 5 AND 10. REG. 11-7-1995.
- 1,932,452. INCOM. INT. CL. 36. REG. 11-7-1995.
- 1,932,453. SOUTHWIND. INT. CLS. 31, 39 AND 42. REG. 11-7-1995.
- 1,932,457. COPYPILOT. INT. CLS. 7 AND 9. REG. 11-7-1995.
- 1,932,458. SEC*CEL. INT. CL. 9. REG. 11-7-1995.
- 1,932,461. MC PANTHON SPORTSWEAR (STYLIZED). INT. CL. 25. REG. 11-7-1995.
- 1,932,463. ZIP GRIP (STYLIZED). INT. CL. 27. REG. 11-7-1995.
- 1,932,464. AUDIOTRIX. INT. CL. 9. REG. 11-7-1995.
- 1,932,466. EVANSGROUP. INT. CL. 35. REG. 11-7-1995.
- 1,932,467. ECORIT. INT. CL. 19. REG. 11-7-1995.
- 1,932,468. PHYSICIANS' QUALITY INITIATIVE. INT. CL. 42. REG. 11-7-1995.
- 1,932,469. GLUE-FOLD (STYLIZED). INT. CL. 40. REG. 11-7-1995.
- 1,932,470. MNN MEDICAL NEWS NETWORK AND DESIGN. INT. CL. 41. REG. 11-7-1995.
- 1,932,471. MNN MEDICAL NEWS NETWORK AND DESIGN. INT. CL. 38. REG. 11-7-1995.
- 1,932,472. CRICKET SHOP. INT. CLS. 25 AND 42. REG. 11-7-1995.
- 1,932,475. JOE LEISURE. INT. CL. 25. REG. 11-7-1995.
- 1,932,478. BFA. INT. CL. 36. REG. 11-7-1995.
- 1,932,480. AVISTA. INT. CLS. 6, 9, 10, 11, 17, 20 AND 21. REG. 11-7-1995.
- 1,932,481. MIDSUMMER FOODS. AND DESIGN. INT. CL. 29. REG. 11-7-1995.
- 1,932,482. SKI THE SUMMIT. INT. CL. 35. REG. 11-7-1995.
- 1,932,483. FIRST IN QVS QUALITY-VALUE-SERVICE AND DESIGN. INT. CL. 37. REG. 11-7-1995.
- 1,932,484. THALONIL. INT. CL. 5. REG. 11-7-1995.
- 1,932,485. ACCORD GROUP. INT. CL. 35. REG. 11-7-1995.
- 1,932,487. BENEFIT AND DESIGN. INT. CL. 5. REG. 11-7-1995.
- 1,932,488. LORENZ MONTECARLO (STYLIZED). INT. CL. 14. REG. 11-7-1995.
- 1,932,489. AVIATION MARINE INSURANCE GROUP, INC. AND DESIGN. INT. CL. 36. REG. 11-7-1995.
- 1,932,491. NEW YORK VUE. INT. CL. 16. REG. 11-7-1995.
- 1,932,492. KNOT US. INT. CL. 42. REG. 11-7-1995.
- 1,932,493. OLYMPUS RALLY. INT. CL. 41. REG. 11-7-1995.
- 1,932,494. WATTWILLER AND DESIGN. INT. CL. 32. REG. 11-7-1995.
- 1,932,495. B AFTER DINNER BRUHL & SOHNE AND DESIGN. INT. CL. 33. REG. 11-7-1995.
- 1,932,497. TELEMEX-U UNIVERSAL TELCO OSS AND DESIGN. INT. CL. 9. REG. 11-7-1995.
- 1,932,499. GLAMOUR SHOTS FOR KIDS. INT. CLS. 16 AND 42. REG. 11-7-1995.
- 1,932,505. COAST TELECOURSES. INT. CLS. 9 AND 16. REG. 11-7-1995.
- 1,932,506. BUSY BELT. INT. CL. 8. REG. 11-7-1995.
- 1,932,507. THE HARTFORD COURANT'S GOOD LIFE. INT. CL. 16. REG. 11-7-1995.
- 1,932,509. THE WHIZ. INT. CL. 11. REG. 11-7-1995.
- 1,932,511. CHAIRWORLD. INT. CL. 20. REG. 11-7-1995.
- 1,932,514. LIGHT. INT. CL. 9. REG. 11-7-1995.
- 1,932,515. CONSOLIDATED ELECTRIC. INT. CL. 9. REG. 11-7-1995.
- 1,932,517. COMMERCIAL UNIFICATION EXPOSURE SOLUTIONS FOR THE 21ST CENTURY. INT. CL. 36. REG. 11-7-1995.
- 1,932,518. PERFDESK. INT. CL. 9. REG. 11-7-1995.
- 1,932,520. LUMEN. INT. CLS. 9 AND 12. REG. 11-7-1995.
- 1,932,521. MICROTOTES. INT. CL. 9. REG. 11-7-1995.
- 1,932,523. CHILDREN SHOULD BE SEEN AND NOT HURT. INT. CL. 20. REG. 11-7-1995.
- 1,932,527. WORKING WITH NATURE TO RECYCLE THE WATER AND DESIGN. INT. CLS. 37, 40 AND 42. REG. 11-7-1995.
- 1,932,528. STARK WOOD'S OWN FIRE STARTER. INT. CL. 4. REG. 11-7-1995.
- 1,932,529. THE GREAT SMOKY MOUNTAIN SPRING WATER COMPANY (STYLIZED). INT. CL. 35. REG. 11-7-1995.
- 1,932,534. OCEAN KAYAK INC. AND DESIGN. INT. CL. 12. REG. 11-7-1995.
- 1,932,535. TIMBER LODGE. INT. CLS. 16 AND 27. REG. 11-7-1995.
- 1,932,537. TEMATIC. INT. CL. 7. REG. 11-7-1995.
- 1,932,540. "THE WORLD SWINGS ON OUR HINGES." (STYLIZED). INT. CL. 6. REG. 11-7-1995.
- 1,932,543. THE WESTERN ORIGINAL. INT. CL. 25. REG. 11-7-1995.
- 1,932,544. CRISTINA CASTANER (STYLIZED). INT. CL. 25. REG. 11-7-1995.
- 1,932,545. WORLD-CLASS SOFTWARE SERVICES AND DESIGN. INT. CLS. 37 AND 42. REG. 11-7-1995.
- 1,932,546. METAL HEAT TREATING. INT. CL. 16. REG. 11-7-1995.
- 1,932,549. CENTRAL DUPAGE HOSPITAL MEDICAL OFFICES AT STRATFORD NORTH. INT. CLS. 16 AND 42. REG. 11-7-1995.
- 1,932,551. MISCELLANEOUS DESIGN. INT. CL. 9. REG. 11-7-1995.
- 1,932,552. MISCELLANEOUS DESIGN. INT. CL. 25. REG. 11-7-1995.
- 1,932,554. TEXAS RICH ICE CREAM. INT. CL. 30. REG. 11-7-1995.
- 1,932,555. PITON AND DESIGN. INT. CL. 32. REG. 11-7-1995.
- 1,932,557. SINFUL. INT. CL. 42. REG. 11-7-1995.
- 1,932,559. ISRS INTERNATIONAL SAFETY RATING SYSTEM AND DESIGN. INT. CLS. 35 AND 42. REG. 11-7-1995.
- 1,932,560. EFALIN. INT. CLS. 5 AND 29. REG. 11-7-1995.
- 1,932,562. ENTREMED. INT. CL. 35. REG. 11-7-1995.
- 1,932,563. KEA AND DESIGN. INT. CL. 9. REG. 11-7-1995.
- 1,932,564. MAKE A WORLD OF DIFFERENCE. INT. CLS. 35, 37, 38 AND 42. REG. 11-7-1995.
- 1,932,565. PROOF & BAKE AND DESIGN. INT. CL. 30. REG. 11-7-1995.
- 1,932,566. DIA-FIBRE. INT. CL. 9. REG. 11-7-1995.
- 1,932,567. MARTINER KONBIER AND DESIGN. INT. CL. 32. REG. 11-7-1995.

- 1,932,569. MISCELLANEOUS DESIGN. INT. CL. 42. REG. 11-7-1995.
- 1,932,571. MALCOLM AND DESIGN. INT. CL. 25. REG. 11-7-1995.
- 1,932,572. ALFRED SUNG. INT. CL. 14. REG. 11-7-1995.
- 1,932,573. ACME PLASTICS. INT. CLS. 1, 17 AND 42. REG. 11-7-1995.
- 1,932,574. NATURALS. INT. CL. 32. REG. 11-7-1995.
- 1,932,575. GLAMOUR SHOTS FOR KIDS AND DESIGN. INT. CL. 42. REG. 11-7-1995.
- 1,932,578. WEBER PROTECTION AND DESIGN. INT. CL. 9. REG. 11-7-1995.
- 1,932,579. DIVE CAT. INT. CL. 9. REG. 11-7-1995.
- 1,932,583. INFORMATION SERVICES FOR THE BORDERLESS WORLD. INT. CL. 38. REG. 11-7-1995.
- 1,932,584. QUESADILLAS INTERNACIONALES. INT. CL. 42. REG. 11-7-1995.
- 1,932,585. RHEOFLOW. INT. CL. 1. REG. 11-7-1995.
- 1,932,587. TORQUE. INT. CL. 28. REG. 11-7-1995.
- 1,932,588. FRIEDMAN/FAIRFAX. INT. CLS. 16 AND 42. REG. 11-7-1995.
- 1,932,589. ANGEL TIME. INT. CL. 14. REG. 11-7-1995.
- 1,932,590. OPENING NIGHT 1993 INAUGURAL GAME AND DESIGN. INT. CL. 21. REG. 11-7-1995.
- 1,932,591. OTTAWA LYNX AND DESIGN. INT. CLS. 16 AND 25. REG. 11-7-1995.
- 1,932,594. TELE-TARGETING. INT. CL. 35. REG. 11-7-1995.
- 1,932,596. POPTERM. INT. CL. 9. REG. 11-7-1995.
- 1,932,597. WILD CHILES AND DESIGN. INT. CL. 29. REG. 11-7-1995.
- 1,932,598. ULTRAGLASS. INT. CL. 11. REG. 11-7-1995.
- 1,932,599. BALDY GOODHAIR. INT. CL. 30. REG. 11-7-1995.
- 1,932,600. DIRECT DISPENSING, INC. (STYLIZED). INT. CL. 42. REG. 11-7-1995.
- 1,932,603. MISCELLANEOUS DESIGN. INT. CL. 9. REG. 11-7-1995.
- 1,932,604. AAPI AMERICAN ASSOCIATION OF PHYSICIANS FROM INDIA AND DESIGN. INT. CLS. 41 AND 42. REG. 11-7-1995.
- 1,932,605. RANGE ROVER CLASSIC. INT. CL. 12. REG. 11-7-1995.
- 1,932,608. TRAVELVIEW. INT. CLS. 35 AND 39. REG. 11-7-1995.
- 1,932,610. GO HARD OR GO HOME.. INT. CLS. 25, 37 AND 42. REG. 11-7-1995.
- 1,932,611. WIROLL. INT. CL. 7. REG. 11-7-1995.
- 1,932,612. ORDER BY 4 AND OUT THE DOOR. INT. CLS. 37 AND 42. REG. 11-7-1995.
- 1,932,614. CASHLIN. INT. CL. 25. REG. 11-7-1995.
- 1,932,616. TEQUILA JR AND DESIGN. INT. CL. 33. REG. 11-7-1995.
- 1,932,618. M-TRACK (STYLIZED). INT. CLS. 9 AND 35. REG. 11-7-1995.
- 1,932,619. C-POST (STYLIZED). INT. CLS. 9 AND 35. REG. 11-7-1995.
- 1,932,620. OUT OF THE BLUE. INT. CLS. 41 AND 42. REG. 11-7-1995.
- 1,932,622. RINBROS VIVE CON ESTILO. INT. CL. 25. REG. 11-7-1995.
- 1,932,623. EDI AND DESIGN. INT. CL. 9. REG. 11-7-1995.
- 1,932,627. SILVER TIDE. INT. CL. 29. REG. 11-7-1995.
- 1,932,628. RADIANCE & POWER ACTION CARDS. INT. CL. 16. REG. 11-7-1995.
- 1,932,629. GAIO. INT. CL. 29. REG. 11-7-1995.
- 1,932,630. PERK POINTS. INT. CL. 42. REG. 11-7-1995.
- 1,932,633. BRANSON SHOWTIME TOURS AND DESIGN. INT. CLS. 39 AND 42. REG. 11-7-1995.
- 1,932,634. SEARS DENTAL ACCESS PROGRAM. INT. CL. 42. REG. 11-7-1995.
- 1,932,636. MOUNTAIN BAGGING INC. AND DESIGN. INT. CL. 4. REG. 11-7-1995.
- 1,932,641. MEAT PROCESSING (STYLIZED). INT. CL. 16. REG. 11-7-1995.
- 1,932,642. GLOBAL MARKETACTICS. INT. CL. 35. REG. 11-7-1995.
- 1,932,643. BAYROPOL. INT. CL. 1. REG. 11-7-1995.
- 1,932,644. CELESTIAL SEASONINGS DIRECT AND DESIGN. INT. CL. 42. REG. 11-7-1995.
- 1,932,647. 123 456 789 0 AND DESIGN. INT. CLS. 37, 38 AND 42. REG. 11-7-1995.
- 1,932,648. THE FIRST, THE BEST, THE ONLY.. INT. CL. 42. REG. 11-7-1995.
- 1,932,649. AMERICAN HOMESTAY AND DESIGN. INT. CL. 35. REG. 11-7-1995.
- 1,932,654. SKANDIC. INT. CL. 12. REG. 11-7-1995.
- 1,932,655. MISCELLANEOUS DESIGN. INT. CL. 4. REG. 11-7-1995.
- 1,932,657. SNO PAK. INT. CL. 10. REG. 11-7-1995.
- 1,932,658. CMR. INT. CL. 1. REG. 11-7-1995.
- 1,932,659. SIGMA STAR. INT. CLS. 29, 30 AND 32. REG. 11-7-1995.
- 1,932,661. RUSSET RIDGE AND DESIGN. INT. CL. 33. REG. 11-7-1995.
- 1,932,668. DEL WEBB'S SUN CITY ROSEVILLE. INT. CL. 37. REG. 11-7-1995.
- 1,932,670. NETWORK GOLF AND DESIGN. INT. CL. 35. REG. 11-7-1995.
- 1,932,678. LEAN LEGS THE AMINOPHYLLINE CELLULITE GEL PIERNAS DELGADAS GELATINA CELLULITE CON AMINOFILINA AND DESIGN. INT. CL. 3. REG. 11-7-1995.
- 1,932,681. DUCK BALL. INT. CL. 28. REG. 11-7-1995.
- 1,932,683. MEZZA LUNA. INT. CL. 25. REG. 11-7-1995.
- 1,932,686. LOGICASE. INT. CL. 9. REG. 11-7-1995.
- 1,932,687. EMPLOYEE PRICE SALE. INT. CL. 42. REG. 11-7-1995.
- 1,932,689. CORRADO'S. INT. CL. 42. REG. 11-7-1995.
- 1,932,690. CHOICE EQUITY LINE. INT. CL. 36. REG. 11-7-1995.
- 1,932,694. WHISKER'S COMPUTER KIDS AND DESIGN. INT. CL. 41. REG. 11-7-1995.
- 1,932,695. UNIVERSAL LANGUAGE. INT. CL. 41. REG. 11-7-1995.
- 1,932,697. DISTINCTION. INT. CLS. 24 AND 25. REG. 11-7-1995.
- 1,932,698. WONDER-MINTS. INT. CL. 30. REG. 11-7-1995.
- 1,932,701. SIMPLY SOFT. INT. CL. 16. REG. 11-7-1995.
- 1,932,704. ON TIME AND DESIGN. INT. CL. 39. REG. 11-7-1995.
- 1,932,707. PRIMARYCARE (STYLIZED). INT. CL. 16. REG. 11-7-1995.
- 1,932,708. SSPM. INT. CLS. 9 AND 42. REG. 11-7-1995.
- 1,932,709. TURKEY & SPICE (STYLIZED). INT. CL. 42. REG. 11-7-1995.
- 1,932,715. SOBRANIE. INT. CL. 34. REG. 11-7-1995.
- 1,932,719. SHORE. INT. CLS. 1 AND 5. REG. 11-7-1995.
- 1,932,721. DATAVISOR (STYLIZED). INT. CL. 9. REG. 11-7-1995.
- 1,932,722. THE SECRET'S IN THE BAG. INT. CL. 16. REG. 11-7-1995.
- 1,932,729. JAMAICAN ME CRAZY AND DESIGN. INT. CL. 25. REG. 11-7-1995.
- 1,932,732. CHISHOLM TRAIL OSTRICH FARM. INT. CL. 42. REG. 11-7-1995.
- 1,932,733. A-1 ALL SUBJECTS AT-HOME TUTORING SERVICE. INT. CL. 41. REG. 11-7-1995.
- 1,932,734. CENTRIC AND DESIGN. INT. CL. 35. REG. 11-7-1995.
- 1,932,735. MISCELLANEOUS DESIGN. INT. CL. 35. REG. 11-7-1995.
- 1,932,738. MURDER MAGIC AND DESIGN. INT. CL. 25. REG. 11-7-1995.
- 1,932,740. CROSSTRAINERS. INT. CLS. 25 AND 41. REG. 11-7-1995.
- 1,932,741. E PLUS AND DESIGN. INT. CL. 42. REG. 11-7-1995.
- 1,932,742. MEMBRAN. INT. CL. 9. REG. 11-7-1995.
- 1,932,744. PREMIER RENT-TO-OWN. INT. CLS. 41 AND 42. REG. 11-7-1995.
- 1,932,746. KNAPP ANGUS PERFORMANCE ANGUS BREEDERS AND DESIGN. INT. CL. 31. REG. 11-7-1995.
- 1,932,747. HELLACIOUS HASH. INT. CL. 30. REG. 11-7-1995.
- 1,932,751. MAPLE BOOTS. INT. CL. 42. REG. 11-7-1995.
- 1,932,753. FICUS FINANCIAL SERVICES AND DESIGN. INT. CL. 36. REG. 11-7-1995.

- 1,932,754. ROUND 1 BAGELS. INT. CL. 42. REG. 11-7-1995.
 1,932,755. TIANNI'S. INT. CL. 30. REG. 11-7-1995.
 1,932,757. ENERGY NOW. INT. CL. 5. REG. 11-7-1995.
 1,932,759. SOLDERMATE. INT. CL. 7. REG. 11-7-1995.
 1,932,760. OMNIGRAM. INT. CL. 36. REG. 11-7-1995.
 1,932,762. CRN COLLEGE RECRUITNET AND DESIGN. INT. CL. 35. REG. 11-7-1995.
 1,932,765. ESPIAL. INT. CL. 3. REG. 11-7-1995.
 1,932,766. GALERIES LAFAYETTE. INT. CL. 42. REG. 11-7-1995.
 1,932,768. SPECIAL-T GRAPHICS AND DESIGN. INT. CL. 25. REG. 11-7-1995.
 1,932,772. MARINA VILLAS AND DESIGN. INT. CL. 12. REG. 11-7-1995.
 1,932,774. CAPELLA. INT. CLS. 16, 18 AND 25. REG. 11-7-1995.
 1,932,776. CORSTATE. INT. CL. 35. REG. 11-7-1995.
 1,932,777. MIGOSCHA. INT. CL. 25. REG. 11-7-1995.
 1,932,778. ROLLTOP LO KICK (STYLIZED). INT. CL. 7. REG. 11-7-1995.
 1,932,780. SMALL FRY AND DESIGN. INT. CL. 20. REG. 11-7-1995.
 1,932,781. UMBRELLA. INT. CL. 2. REG. 11-7-1995.
 1,932,782. THE SCORPION. INT. CL. 28. REG. 11-7-1995.
 1,932,783. TOGA! TOTALLY NATURAL AND DESIGN. INT. CLS. 30 AND 32. REG. 11-7-1995.
 1,932,785. SHIPS CHANDLER. INT. CL. 11. REG. 11-7-1995.
 1,932,786. CHEF KITTY AND DESIGN. INT. CL. 16. REG. 11-7-1995.
 1,932,787. B (STYLIZED). INT. CL. 42. REG. 11-7-1995.
 1,932,788. NCN MOVIE DOLLARS. INT. CL. 35. REG. 11-7-1995.
 1,932,789. ALLERGY ALERT AND DESIGN. INT. CL. 16. REG. 11-7-1995.
 1,932,790. ACCUSIZE. INT. CL. 7. REG. 11-7-1995.
 1,932,791. SMOOTH SAILING AND DESIGN. INT. CL. 32. REG. 11-7-1995.
 1,932,793. TASTE EMERGENCY AND DESIGN. INT. CL. 32. REG. 11-7-1995.
 1,932,794. BIG HURT AND DESIGN. INT. CLS. 16, 21 AND 25. REG. 11-7-1995.
 1,932,796. MOTHER SUPERIOR (STYLIZED). INT. CL. 41. REG. 11-7-1995.
 1,932,797. CHANCELLOR AND DESIGN. INT. CL. 37. REG. 11-7-1995.
 1,932,801. SPORTSTREK. INT. CL. 28. REG. 11-7-1995.
 1,932,804. SYLVIE RIMBAULT. INT. CL. 25. REG. 11-7-1995.
 1,932,806. ATTACK SUPER STRONG SHOCK. INT. CL. 1. REG. 11-7-1995.
 1,932,807. HAIR FLEX. INT. CL. 21. REG. 11-7-1995.
 1,932,809. PEP PLANNER AND DESIGN. INT. CL. 9. REG. 11-7-1995.
 1,932,810. THERMO-TUFF. INT. CL. 24. REG. 11-7-1995.
 1,932,812. EZ RUNNER (STYLIZED). INT. CL. 9. REG. 11-7-1995.
 1,932,814. THE SAFE ROADS TOUR CYCLE FOR SAFE ROADS AND DESIGN. INT. CL. 36. REG. 11-7-1995.
 1,932,815. C-CORE AND DESIGN. INT. CL. 28. REG. 11-7-1995.
 1,932,816. THE VAN NOSTRAND COLLECTION. INT. CL. 25. REG. 11-7-1995.
 1,932,817. CATCH THE ADVANTAGE. INT. CL. 42. REG. 11-7-1995.
 1,932,818. TRIM REDUCED CALORIES & LESS FAT AND DESIGN. INT. CL. 30. REG. 11-7-1995.
 1,932,820. DEPOSA. INT. CL. 24. REG. 11-7-1995.
 1,932,821. THE BALTIMORE CHAMPIONS OF LOYAL TEAM SPIRIT. INT. CL. 25. REG. 11-7-1995.
 1,932,822. PACIFIC PRINT MEDIA AND DESIGN. INT. CL. 42. REG. 11-7-1995.
 1,932,824. R RILLION AND DESIGN. INT. CL. 15. REG. 11-7-1995.
 1,932,826. PURE SWEAT. INT. CL. 25. REG. 11-7-1995.
 1,932,832. ACCU/CUT (STYLIZED). INT. CL. 8. REG. 11-7-1995.
 1,932,833. TRIVIA COUNTRY STYLE. INT. CL. 28. REG. 11-7-1995.
 1,932,834. PARTNERPLUS. INT. CL. 35. REG. 11-7-1995.
 1,932,840. COCOA CASCADE. INT. CL. 30. REG. 11-7-1995.
 1,932,842. HERMES-PARIS AND DESIGN. INT. CL. 9. REG. 11-7-1995.
 1,932,844. FC AND DESIGN. INT. CL. 6. REG. 11-7-1995.
 1,932,845. INFOLANE. INT. CL. 35. REG. 11-7-1995.
 1,932,846. STL INFOKARE. INT. CL. 42. REG. 11-7-1995.
 1,932,849. MISCELLANEOUS DESIGN. INT. CL. 6. REG. 11-7-1995.
 1,932,850. COSMOS. INT. CL. 1. REG. 11-7-1995.
 1,932,853. SIMON MOBILE COMMUNICATIONS MADE SIMPLE AND DESIGN. INT. CL. 9. REG. 11-7-1995.
 1,932,854. HA-LO MARKETING & PROMOTIONS. INT. CL. 35. REG. 11-7-1995.
 1,932,855. OCEANS CUISINE. INT. CL. 29. REG. 11-7-1995.
 1,932,856. 1-800/4-SURPRISE AND DESIGN. INT. CL. 41. REG. 11-7-1995.
 1,932,857. THE AMAZING INCREDIBLES. INT. CL. 41. REG. 11-7-1995.
 1,932,858. MAXX INSIDER (STYLIZED). INT. CL. 16. REG. 11-7-1995.
 1,932,860. LEGAL HORIZONS. INT. CL. 35. REG. 11-7-1995.
 1,932,861. GETTING THE WASTE OUT OF HEALTH CARE. INT. CLS. 37, 40 AND 42. REG. 11-7-1995.
 1,932,863. CARING GRANDPARENTS OF AMERICA. INT. CL. 35. REG. 11-7-1995.
 1,932,864. PREFERRED TRADE. INT. CL. 42. REG. 11-7-1995.
 1,932,865. BOXALL AND DESIGN. INT. CL. 16. REG. 11-7-1995.
 1,932,866. DIET COKE AND DESIGN. INT. CL. 32. REG. 11-7-1995.
 1,932,867. FRENCH SUEDE LUXE SHEER. INT. CL. 25. REG. 11-7-1995.
 1,932,869. SOUTHWEST THE LOW FARE AIRLINE AND DESIGN. INT. CL. 39. REG. 11-7-1995.
 1,932,870. THE BIG SPLASH BAIT. INT. CL. 28. REG. 11-7-1995.
 1,932,871. A GIFT FOR YOU AND DESIGN. INT. CL. 31. REG. 11-7-1995.
 1,932,872. NATUS BORN OF NATURE PURE INDULGENCE AND DESIGN. INT. CLS. 3 AND 4. REG. 11-7-1995.
 1,932,873. THE GOLF SHOP AND DESIGN. INT. CL. 42. REG. 11-7-1995.
 1,932,878. FMP. INT. CL. 41. REG. 11-7-1995.
 1,932,879. EPSILON (STYLIZED). INT. CL. 3. REG. 11-7-1995.
 1,932,880. CLINICAL RESEARCH ALLIANCE A CONTRACT RESEARCH ORGANIZATION AND DESIGN. INT. CL. 42. REG. 11-7-1995.
 1,932,882. MISCELLANEOUS DESIGN. INT. CL. 30. REG. 11-7-1995.
 1,932,883. MISCELLANEOUS DESIGN. INT. CL. 30. REG. 11-7-1995.
 1,932,884. SONGWORKS. INT. CL. 16. REG. 11-7-1995.
 1,932,885. BANNER - S. INT. CL. 10. REG. 11-7-1995.
 1,932,887. THE FOUNTAINHEAD TITLE GROUP. INT. CL. 36. REG. 11-7-1995.
 1,932,889. AEROPLUS ACCESS AND DESIGN. INT. CL. 42. REG. 11-7-1995.
 1,932,890. GOLD TOUCH. INT. CLS. 1 AND 9. REG. 11-7-1995.
 1,932,891. ZODIAC ACTION. INT. CL. 16. REG. 11-7-1995.
 1,932,892. SOUND WIRE. INT. CL. 42. REG. 11-7-1995.
 1,932,893. CLUBLOUNGE. INT. CL. 42. REG. 11-7-1995.
 1,932,897. ULTRA-LITE SHELL. INT. CL. 9. REG. 11-7-1995.
 1,932,899. DRAWMEE. INT. CL. 28. REG. 11-7-1995.
 1,932,901. AFELTRA AND DESIGN. INT. CL. 30. REG. 11-7-1995.
 1,932,902. HYDRO SORB. INT. CL. 1. REG. 11-7-1995.
 1,932,904. VALUEFIRST. INT. CL. 36. REG. 11-7-1995.
 1,932,907. BANG CHANG AND DESIGN. INT. CL. 32. REG. 11-7-1995.
 1,932,913. CBL TRUCKING. INT. CL. 39. REG. 11-7-1995.
 1,932,915. ANADRILL. INT. CLS. 37 AND 42. REG. 11-7-1995.

- 1,932,917. PARKWAY LAUNDROMAT. INT. CL. 37. REG. 11-7-1995.
- 1,932,919. FLIGHT PATTERNS. INT. CL. 6. REG. 11-7-1995.
- 1,932,920. ASPECT AND DESIGN. INT. CL. 42. REG. 11-7-1995.
- 1,932,921. EXOUSIA MINISTRIES FELLOWSHIP AND DESIGN. INT. CL. 41. REG. 11-7-1995.
- 1,932,922. PUT A HALT TO RUST. INT. CL. 3. REG. 11-7-1995.
- 1,932,923. GLADE KENTUCKY BLUEGRASS (STYLIZED). INT. CL. 31. REG. 11-7-1995.
- 1,932,927. VISIONARIES. INT. CLS. 9 AND 41. REG. 11-7-1995.
- 1,932,936. MISCELLANEOUS DESIGN. INT. CL. 36. REG. 11-7-1995.
- 1,932,938. THER AEROBICS AND DESIGN. INT. CL. 42. REG. 11-7-1995.
- 1,932,939. THE PEOPLE PUZZLE. INT. CL. 41. REG. 11-7-1995.
- 1,932,940. WEBB'S MILL. INT. CL. 30. REG. 11-7-1995.
- 1,932,945. ESPRESSO EXPRESS AND DESIGN. INT. CL. 30. REG. 11-7-1995.
- 1,932,946. POLYBIND (STYLIZED). INT. CL. 1. REG. 11-7-1995.
- 1,932,948. THE ORIGINAL CRESTED BUTTE, COLORADO POWERHOUSE SALSA AND DESIGN. INT. CL. 30. REG. 11-7-1995.
- 1,932,952. MUSSO'S ...MADE TODAY IN AN OLD-FASHIONED ITALIAN WAY AND DESIGN. INT. CL. 30. REG. 11-7-1995.
- 1,932,954. PIEROGI PRIEST. INT. CL. 30. REG. 11-7-1995.
- 1,932,956. SYSTEM 2000. INT. CL. 16. REG. 11-7-1995.
- 1,932,957. HAWAIIAN BISCOTTI BY KELI MIA. INT. CL. 30. REG. 11-7-1995.
- 1,932,958. BEAVER. INT. CL. 4. REG. 11-7-1995.
- 1,932,961. MPI MULTIMEDIA. INT. CL. 9. REG. 11-7-1995.
- 1,932,964. OFFICERS' CLUB. INT. CL. 36. REG. 11-7-1995.
- 1,932,967. SYNC SOUND. INT. CL. 41. REG. 11-7-1995.
- 1,932,969. MUSCLEFLEX. INT. CL. 28. REG. 11-7-1995.
- 1,932,971. TASTES LIKE REAL FOOD...BECAUSE IT IS! INT. CL. 30. REG. 11-7-1995.
- 1,932,974. LIVING FREESIA. INT. CLS. 1 AND 3. REG. 11-7-1995.
- 1,932,977. MISCELLANEOUS DESIGN. INT. CLS. 9, 35 AND 41. REG. 11-7-1995.
- 1,932,978. LAWN PATROL GARDENING & LANDSCAPING AND DESIGN. INT. CL. 42. REG. 11-7-1995.
- 1,932,979. SUPERSTAK. INT. CL. 7. REG. 11-7-1995.
- 1,932,980. EMUVERA. INT. CL. 3. REG. 11-7-1995.
- 1,932,983. GLOBE AND DESIGN. INT. CL. 30. REG. 11-7-1995.
- 1,932,985. TIMEBANK. INT. CL. 38. REG. 11-7-1995.
- 1,932,990. SUNPOWER. INT. CLS. 8 AND 21. REG. 11-7-1995.
- 1,932,994. AURA WAX. INT. CL. 4. REG. 11-7-1995.
- 1,932,995. GUERNSEY DELL. INT. CL. 30. REG. 11-7-1995.
- 1,932,996. MANGO MAGIC. INT. CL. 32. REG. 11-7-1995.
- 1,932,997. RYKOFF SEXTON PREMIUM PAK AND DESIGN. INT. CL. 32. REG. 11-7-1995.
- 1,932,999. SUN KING. INT. CL. 1. REG. 11-7-1995.
- 1,933,001. DIAGNOSTIC FOCUS GROUPS AND DESIGN. INT. CL. 35. REG. 11-7-1995.
- 1,933,002. PERSONALITY SCOPE. INT. CL. 35. REG. 11-7-1995.
- 1,933,005. FOOFU. INT. CL. 41. REG. 11-7-1995.
- 1,933,014. MY POCKET DIARY. INT. CL. 9. REG. 11-7-1995.
- 1,933,016. RV WHOLESALE OUTFITTERS FLEETWOOD AND DESIGN. INT. CL. 42. REG. 11-7-1995.
- 1,933,017. MISCELLANEOUS DESIGN. INT. CL. 41. REG. 11-7-1995.
- 1,933,018. T F M. INT. CL. 41. REG. 11-7-1995.
- 1,933,021. SQUAW KNIFE. INT. CL. 41. REG. 11-7-1995.
- 1,933,023. SHOW PLACE AND DESIGN. INT. CL. 42. REG. 11-7-1995.
- 1,933,025. AG (STYLIZED). INT. CLS. 7 AND 8. REG. 11-7-1995.
- 1,933,026. EQUALITY NOW IGUALDAD YA AND DESIGN. INT. CL. 42. REG. 11-7-1995.
- 1,933,027. BUICK CLASSIC AND DESIGN. INT. CL. 41. REG. 11-7-1995.
- 1,933,028. BUICK SOUTHERN OPEN AND DESIGN. INT. CL. 41. REG. 11-7-1995.
- 1,933,029. BUICK OPEN AND DESIGN. INT. CL. 41. REG. 11-7-1995.
- 1,933,030. MISCELLANEOUS DESIGN. INT. CL. 42. REG. 11-7-1995.
- 1,933,031. SHOW PLACE AND DESIGN. INT. CL. 42. REG. 11-7-1995.
- 1,933,035. ERGOWARE AND DESIGN. INT. CL. 9. REG. 11-7-1995.
- 1,933,036. CONDITION A REFRESHING DRINK, CONDITION AND DESIGN. INT. CL. 32. REG. 11-7-1995.
- 1,933,039. THE UNCOMMON BUFFALO PRESS. INT. CL. 37. REG. 11-7-1995.
- 1,933,040. GIFT AND DESIGN. INT. CL. 16. REG. 11-7-1995.
- 1,933,041. GROUPSOFT AND DESIGN. INT. CLS. 9 AND 42. REG. 11-7-1995.
- 1,933,045. E-FARM. INT. CL. 40. REG. 11-7-1995.
- 1,933,047. AT&T TRUE REWARDS. INT. CL. 35. REG. 11-7-1995.
- 1,933,048. TRUE REWARDS. INT. CL. 35. REG. 11-7-1995.
- 1,933,050. LAKELAND NEURO CARE CENTER. INT. CL. 42. REG. 11-7-1995.
- 1,933,052. GINGER CLUB AND DESIGN. INT. CL. 42. REG. 11-7-1995.
- 1,933,054. ARLINGTON HEIGHTS OAKS. INT. CL. 41. REG. 11-7-1995.
- 1,933,056. ZOLITA KO. INT. CL. 25. REG. 11-7-1995.
- 1,933,057. ECOGAS (STYLIZED). INT. CL. 6. REG. 11-7-1995.
- 1,933,059. RAILS TO RICHES. INT. CL. 41. REG. 11-7-1995.
- 1,933,060. THE LEANEST NAME IN DELI MEATS. INT. CL. 29. REG. 11-7-1995.
- 1,933,068. ORGANO. INT. CL. 31. REG. 11-7-1995.
- 1,933,069. ORGANO RECYCLE. INT. CL. 31. REG. 11-7-1995.
- 1,933,072. SPORT MATE! AND DESIGN. INT. CL. 14. REG. 11-7-1995.
- 1,933,074. H AND DESIGN. INT. CL. 32. REG. 11-7-1995.
- 1,933,075. PEELED DELITES AND DESIGN. INT. CL. 29. REG. 11-7-1995.
- 1,933,076. VISUAL IMPACT PLANNING VIP AND DESIGN. INT. CL. 41. REG. 11-7-1995.
- 1,933,078. GOLD BLEND COAST STARBUCKS COFFEE AND DESIGN. INT. CL. 30. REG. 11-7-1995.
- 1,933,079. INTENSIVE CARE CONTINUUM AND DESIGN. INT. CL. 42. REG. 11-7-1995.
- 1,933,080. AUTOPILOT. INT. CL. 7. REG. 11-7-1995.
- 1,933,081. MUSICSTAR (STYLIZED). INT. CL. 15. REG. 11-7-1995.
- 1,933,082. DEAL. INT. CL. 38. REG. 11-7-1995.
- 1,933,084. MASLAND CONTRACT AND DESIGN. INT. CL. 27. REG. 11-7-1995.
- 1,933,085. INFINITY HEART INSTITUTE CHARTERED. INT. CL. 42. REG. 11-7-1995.
- 1,933,087. CENCELL. INT. CL. 19. REG. 11-7-1995.
- 1,933,089. TROPICAL CARNIVAL. INT. CL. 31. REG. 11-7-1995.
- 1,933,090. MISCELLANEOUS DESIGN. INT. CL. 38. REG. 11-7-1995.
- 1,933,091. PIOKAL AND DESIGN. INT. CL. 25. REG. 11-7-1995.
- 1,933,093. YOUR LINK TO BETTER COMMUNICATION. INT. CL. 38. REG. 11-7-1995.
- 1,933,094. PIER SIXTY SIX FORT LAUDERDALE AND DESIGN. INT. CL. 42. REG. 11-7-1995.
- 1,933,095. MISCELLANEOUS DESIGN. INT. CL. 42. REG. 11-7-1995.
- 1,933,096. TRICONI TRICOLOY TRICOCARB AND DESIGN. INT. CL. 6. REG. 11-7-1995.
- 1,933,097. TAM COLOY AND DESIGN. INT. CL. 6. REG. 11-7-1995.
- 1,933,100. POWERSUITE. INT. CL. 9. REG. 11-7-1995.
- 1,933,101. TOWN & COUNTRY. INT. CL. 29. REG. 11-7-1995.
- 1,933,106. AUTOSCORE (STYLIZED). INT. CL. 9. REG. 11-7-1995.

- 1,933,107. CINCINNATI BUSINESS COURIER. INT. CL. 16. REG. 11-7-1995.
- 1,933,108. THE BEST CONNECTED E-MAIL IN THE WORLD. INT. CL. 21. REG. 11-7-1995.
- 1,933,114. KE NUI. INT. CL. 25. REG. 11-7-1995.
- 1,933,115. WNAP. INT. CL. 38. REG. 11-7-1995.
- 1,933,118. BROADMOOR BAKER. INT. CL. 30. REG. 11-7-1995.
- 1,933,121. LOVE POTION NO. 69. INT. CL. 32. REG. 11-7-1995.
- 1,933,122. REGAL BANNER. INT. CL. 20. REG. 11-7-1995.
- 1,933,125. GLAMOUR TEEN. INT. CL. 28. REG. 11-7-1995.
- 1,933,126. POWER SLAMS. INT. CL. 15. REG. 11-7-1995.
- 1,933,133. BEE LINE RECORDS. INT. CL. 9. REG. 11-7-1995.
- 1,933,136. 21ST CENTURY GENETICS AND DESIGN. INT. CL. 42. REG. 11-7-1995.
- 1,933,140. MINOR SCALES. INT. CL. 28. REG. 11-7-1995.
- 1,933,141. MAKING IT BIG AND DESIGN. INT. CLS. 16 AND 25. REG. 11-7-1995.
- 1,933,143. STRATIGRAPHICS. INT. CL. 42. REG. 11-7-1995.
- 1,933,144. PACK-FRAC. INT. CL. 9. REG. 11-7-1995.
- 1,933,145. SPUD-TO-PLUG. INT. CL. 9. REG. 11-7-1995.
- 1,933,146. LYTENING. INT. CL. 9. REG. 11-7-1995.
- 1,933,147. EMERGENCY 911 FEELERS. INT. CL. 9. REG. 11-7-1995.
- 1,933,148. MODULON. INT. CL. 9. REG. 11-7-1995.
- 1,933,151. ACTION AND DESIGN. INT. CL. 25. REG. 11-7-1995.
- 1,933,152. GET SERIOUS. INT. CL. 42. REG. 11-7-1995.
- 1,933,153. FUSION AND DESIGN. INT. CL. 12. REG. 11-7-1995.
- 1,933,154. NATIONAL FAST 500 TECHNOLOGY AND DESIGN. INT. CL. 35. REG. 11-7-1995.
- 1,933,155. STICK WITH IT. INT. CL. 25. REG. 11-7-1995.
- 1,933,157. KA AND DESIGN. INT. CL. 41. REG. 11-7-1995.
- 1,933,158. RSVP. INT. CL. 42. REG. 11-7-1995.
- 1,933,162. CEDARMONT KIDS AND DESIGN. INT. CL. 9. REG. 11-7-1995.
- 1,933,163. CEDARMONT KIDS. INT. CL. 9. REG. 11-7-1995.
- 1,933,165. QUESTECH (STYLIZED). INT. CL. 42. REG. 11-7-1995.
- 1,933,169. FORD MUSTANG AND DESIGN. INT. CL. 8. REG. 11-7-1995.
- 1,933,170. BUBBER'S. INT. CL. 42. REG. 11-7-1995.
- 1,933,172. MISCELLANEOUS DESIGN. INT. CL. 33. REG. 11-7-1995.
- 1,933,173. THE REST OF THE SOLUTION. INT. CL. 36. REG. 11-7-1995.
- 1,933,174. HILLBILLY NATION CELEBRATION. INT. CL. 41. REG. 11-7-1995.
- 1,933,176. NOBLER. INT. CL. 7. REG. 11-7-1995.
- 1,933,177. BOX INNS. INT. CL. 6. REG. 11-7-1995.
- 1,933,178. POT LIPPER. INT. CL. 6. REG. 11-7-1995.
- 1,933,179. EVERFLEX HIVIZ. INT. CL. 9. REG. 11-7-1995.
- 1,933,182. DMS DESIGNS. INT. CL. 16. REG. 11-7-1995.
- 1,933,184. STS 2000 SELF-TRAINING SYSTEM. INT. CLS. 9, 16 AND 41. REG. 11-7-1995.
- 1,933,185. CRATE O'RECIPES. INT. CL. 21. REG. 11-7-1995.
- 1,933,186. COVENANT-OF-CARE. INT. CL. 42. REG. 11-7-1995.
- 1,933,187. SEEREY-LESTER (STYLIZED). INT. CL. 16. REG. 11-7-1995.
- 1,933,192. EXOTEC AND DESIGN. INT. CL. 10. REG. 11-7-1995.
- 1,933,193. GOODNET. INT. CL. 42. REG. 11-7-1995.
- 1,933,196. POINTS OF PEACE. INT. CL. 16. REG. 11-7-1995.
- 1,933,197. PRESTON'S SUPER REGION IT'S AN UNFAIR ADVANTAGE. (STYLIZED). INT. CL. 39. REG. 11-7-1995.
- 1,933,199. KORAL. INT. CL. 14. REG. 11-7-1995.
- 1,933,201. RES ELUT. INT. CL. 9. REG. 11-7-1995.
- 1,933,202. TECH MARK. INT. CL. 16. REG. 11-7-1995.
- 1,933,203. MINIMOVES. INT. CL. 39. REG. 11-7-1995.
- 1,933,205. TRIMMINGS. INT. CL. 18. REG. 11-7-1995.
- 1,933,206. TALL TEE'S BY KNITWAVES INC.. INT. CL. 25. REG. 11-7-1995.
- 1,933,209. AIRLAN CAN. INT. CL. 9. REG. 11-7-1995.
- 1,933,210. SHAKY PALS. INT. CL. 28. REG. 11-7-1995.
- 1,933,211. S2H2 AND DESIGN. INT. CL. 28. REG. 11-7-1995.
- 1,933,212. BIO-BIRDHOUSE. INT. CL. 21. REG. 11-7-1995.
- 1,933,216. QUE PASA. INT. CL. 16. REG. 11-7-1995.
- 1,933,218. MILK HOUSE BRAND AND DESIGN. INT. CL. 42. REG. 11-7-1995.
- 1,933,220. JEAN COUNTRY. INT. CLS. 25 AND 42. REG. 11-7-1995.
- 1,933,221. ZEST. INT. CL. 32. REG. 11-7-1995.
- 1,933,222. MAKE-A-MOBILE AND DESIGN. INT. CL. 20. REG. 11-7-1995.
- 1,933,223. FREE WILLY. INT. CL. 28. REG. 11-7-1995.
- 1,933,225. RUBICON. INT. CL. 12. REG. 11-7-1995.
- 1,933,226. PIPE DREAM. INT. CL. 8. REG. 11-7-1995.
- 1,933,228. TALES TO ASTONISH. INT. CL. 16. REG. 11-7-1995.
- 1,933,229. DR. G'S CLEAR NAIL. INT. CL. 5. REG. 11-7-1995.
- 1,933,230. ALUMARAIL. INT. CL. 6. REG. 11-7-1995.
- 1,933,231. THE ALL-NIGHTER. INT. CL. 4. REG. 11-7-1995.
- 1,933,232. MAXFIRE. INT. CL. 11. REG. 11-7-1995.
- 1,933,233. BOOSTER BYTES. INT. CL. 9. REG. 11-7-1995.
- 1,933,234. HOMETRENDS. INT. CL. 41. REG. 11-7-1995.
- 1,933,237. CSL 1500. INT. CL. 7. REG. 11-7-1995.
- 1,933,242. THE JOX. INT. CL. 41. REG. 11-7-1995.
- 1,933,243. MIRS. INT. CL. 35. REG. 11-7-1995.
- 1,933,246. JENIFER & HAIDEE. INT. CL. 3. REG. 11-7-1995.
- 1,933,247. PANDAS. INT. CL. 9. REG. 11-7-1995.
- 1,933,250. MY THREE SONS. INT. CL. 25. REG. 11-7-1995.
- 1,933,251. FAJITA-EAZY AND DESIGN. INT. CL. 29. REG. 11-7-1995.
- 1,933,252. B.O.G. INT. CL. 25. REG. 11-7-1995.
- 1,933,253. DELSAN. INT. CL. 19. REG. 11-7-1995.
- 1,933,257. NATURES BLESSING. INT. CL. 3. REG. 11-7-1995.
- 1,933,258. MYSTIC ESSENCE. INT. CL. 42. REG. 11-7-1995.
- 1,933,259. FOREVERLAND. INT. CL. 14. REG. 11-7-1995.
- 1,933,262. ANIMAL BALL PARK. INT. CL. 28. REG. 11-7-1995.
- 1,933,264. VESSELS OF HONOR HOLINESS HEROISM VISION RESTRAINT AND DESIGN. INT. CL. 16. REG. 11-7-1995.
- 1,933,268. GTS. INT. CL. 36. REG. 11-7-1995.
- 1,933,269. DRYWEAR. INT. CL. 18. REG. 11-7-1995.
- 1,933,270. IT'S STRIPED TO FIGHT. INT. CL. 3. REG. 11-7-1995.
- 1,933,271. MISCELLANEOUS DESIGN. INT. CL. 25. REG. 11-7-1995.
- 1,933,272. NATURAL ELEGANCE. INT. CL. 26. REG. 11-7-1995.
- 1,933,273. A CELEBRATION OF THE SOUTH. INT. CL. 42. REG. 11-7-1995.
- 1,933,274. BOARD CERTIFIED. INT. CL. 25. REG. 11-7-1995.
- 1,933,275. NEW AGE. INT. CL. 25. REG. 11-7-1995.
- 1,933,276. I GOT A BOOBOO AND DESIGN. INT. CL. 25. REG. 11-7-1995.
- 1,933,277. SOLO. INT. CL. 26. REG. 11-7-1995.
- 1,933,283. KILLJOYS. INT. CL. 41. REG. 11-7-1995.
- 1,933,286. KAUAI GARDEN. INT. CL. 3. REG. 11-7-1995.
- 1,933,287. COUNTRY LEGEND. INT. CL. 3. REG. 11-7-1995.
- 1,933,289. DRIZZLE ETC.. INT. CL. 25. REG. 11-7-1995.
- 1,933,291. IMAGE WORKS. INT. CL. 25. REG. 11-7-1995.
- 1,933,293. STANCE A WHOLE NEW WAY TO LOOK. INT. CL. 42. REG. 11-7-1995.
- 1,933,294. MMIC INSURANCE & FINANCIAL SERVICES AND DESIGN. INT. CL. 36. REG. 11-7-1995.
- 1,933,297. FREEZE FRAME. INT. CL. 25. REG. 11-7-1995.
- 1,933,298. UNBOUND. INT. CL. 25. REG. 11-7-1995.
- 1,933,299. MAGNA CARTA. INT. CL. 16. REG. 11-7-1995.
- 1,933,303. HILTON RESORTS AT THE BEACH AND DESIGN. INT. CL. 42. REG. 11-7-1995.
- 1,933,304. HILTON GAMING RESORTS AND CASINOS AND DESIGN. INT. CL. 42. REG. 11-7-1995.
- 1,933,305. HILTON GAMING RESORTS AND CASINOS AND DESIGN. INT. CL. 41. REG. 11-7-1995.
- 1,933,306. HILTON RESORTS AND CASINOS AND DESIGN. INT. CL. 42. REG. 11-7-1995.
- 1,933,307. HILTON RESORTS AND CASINOS AND DESIGN. INT. CL. 41. REG. 11-7-1995.
- 1,933,308. MAP-GOVERNMENT FUND. INT. CL. 36. REG. 11-7-1995.

- 1,933,309. MUSEUM OF FEAR. INT. CL. 41. REG. 11-7-1995.
 1,933,310. A GUY WHO'S SERIOUS ABOUT SAVINGS. INT. CL. 42. REG. 11-7-1995.
 1,933,311. QUICKLINE. INT. CL. 25. REG. 11-7-1995.
 1,933,312. DARE TO DREAM (STYLIZED). INT. CL. 25. REG. 11-7-1995.
 1,933,314. SALUS. INT. CLS. 22 AND 23. REG. 11-7-1995.
 1,933,316. FOXWOODS AND DESIGN. INT. CL. 41. REG. 11-7-1995.
 1,933,321. JEFFREY BANKS. INT. CL. 25. REG. 11-7-1995.
 1,933,322. EASY LIFE. INT. CL. 25. REG. 11-7-1995.
 1,933,323. MCI ONETEST. INT. CL. 38. REG. 11-7-1995.
 1,933,324. 'TIL DAWN AND DESIGN. INT. CL. 25. REG. 11-7-1995.
 1,933,328. SPECTRIS. INT. CL. 9. REG. 11-7-1995.
 1,933,331. TO THE HOOP. INT. CL. 25. REG. 11-7-1995.
 1,933,332. FINANCIAL TIMES TELEVISION. INT. CL. 41. REG. 11-7-1995.
 1,933,334. GREENWATCH. INT. CL. 1. REG. 11-7-1995.
 1,933,335. DERMA RX. INT. CL. 5. REG. 11-7-1995.
 1,933,339. VISION O-N-E. INT. CL. 9. REG. 11-7-1995.
 1,933,341. CHILI MAC'S 5-WAY CHILI. INT. CL. 42. REG. 11-7-1995.
 1,933,342. PROFLAG. INT. CL. 9. REG. 11-7-1995.
 1,933,346. MARANTZ (STYLIZED). INT. CL. 9. REG. 11-7-1995.
 1,933,347. BUSINESS-TO-BUSINESS. INT. CL. 36. REG. 11-7-1995.
 1,933,351. NEW MEDIA SCHOOLHOUSE. INT. CL. 9. REG. 11-7-1995.
 1,933,352. LAS MONTANAS AND DESIGN. INT. CLS. 25 AND 37. REG. 11-7-1995.
 1,933,353. DAIRY FINEST. U.S. CL. A. REG. 11-7-1995.
 1,933,354. THE ORIGINAL INFLATABLE BOLSTER AND DESIGN. INT. CL. 10. REG. 11-7-1995.
 1,933,355. FINO (STYLIZED). INT. CL. 20. REG. 11-7-1995.
 1,933,356. US STITCH-LINE (STYLIZED). INT. CL. 7. REG. 11-7-1995.
 1,933,363. LICENCED TO JAM. INT. CL. 16. REG. 11-7-1995.
 1,933,364. I.D. LITE. INT. CL. 9. REG. 11-7-1995.
 1,933,366. NET-GARD. INT. CL. 9. REG. 11-7-1995.
 1,933,367. SOFTWAVE. INT. CL. 6. REG. 11-7-1995.
 1,933,368. COMMUNICATIONS MADE EASY. INT. CL. 9. REG. 11-7-1995.
 1,933,369. ALS. INT. CL. 9. REG. 11-7-1995.
 1,933,371. QWICK WRAPS. INT. CL. 25. REG. 11-7-1995.
 1,933,372. SUN SHELTER. INT. CL. 18. REG. 11-7-1995.
 1,933,376. VACUSANDER. INT. CL. 8. REG. 11-7-1995.
 1,933,381. SALAD BAR SERVICES T.J. PUPILLO, INC. AND DESIGN. INT. CLS. 35 AND 37. REG. 11-7-1995.
 1,933,382. ROTATOR. INT. CL. 5. REG. 11-7-1995.
 1,933,385. COLT (STYLIZED). INT. CL. 9. REG. 11-7-1995.
 1,933,386. EBERSPLICE. INT. CL. 7. REG. 11-7-1995.
 1,933,387. AQUAMAT. INT. CL. 19. REG. 11-7-1995.
 1,933,391. LIVE THE DREAM. INT. CL. 16. REG. 11-7-1995.
 1,933,392. REVEX. INT. CL. 5. REG. 11-7-1995.
 1,933,393. ROOM-SERVICE TV. INT. CL. 35. REG. 11-7-1995.
 1,933,397. CHP (STYLIZED). INT. CLS. 25 AND 28. REG. 11-7-1995.
 1,933,398. AMERICAN PREMIER. INT. CL. 30. REG. 11-7-1995.
 1,933,400. PARDEX. INT. CL. 12. REG. 11-7-1995.
 1,933,403. MAESTRO. INT. CL. 9. REG. 11-7-1995.
 1,933,405. MARIDIA. INT. CL. 20. REG. 11-7-1995.
 1,933,406. AIR MAX. INT. CL. 25. REG. 11-7-1995.
 1,933,408. SPORT ARMOR. INT. CL. 28. REG. 11-7-1995.
 1,933,409. I'M 2 GOOD 4 DRUGS. INT. CL. 42. REG. 11-7-1995.
 1,933,411. BRIDGESYS. INT. CL. 37. REG. 11-7-1995.
 1,933,413. INTELIQUEST (STYLIZED). INT. CL. 9. REG. 11-7-1995.
 1,933,415. BIOLOGICAL WEARFARE. INT. CL. 25. REG. 11-7-1995.
 1,933,416. RED-E-HEAT AND DESIGN. INT. CL. 21. REG. 11-7-1995.
 1,933,417. PACALOK. INT. CL. 7. REG. 11-7-1995.
 1,933,418. PASTEVI AND DESIGN. INT. CL. 30. REG. 11-7-1995.
 1,933,420. SHAFT. INT. CL. 16. REG. 11-7-1995.
 1,933,421. MICROLEVEL (STYLIZED). INT. CL. 9. REG. 11-7-1995.
 1,933,422. STEPTRAINER PLUS. INT. CL. 28. REG. 11-7-1995.
 1,933,424. PRO-FORM. INT. CL. 31. REG. 11-7-1995.
 1,933,429. ARABQUEST FARMS. INT. CLS. 31, 41 AND 42. REG. 11-7-1995.
 1,933,430. PLANET SAFE. INT. CL. 1. REG. 11-7-1995.
 1,933,431. LITTLE PAL (STYLIZED). INT. CL. 31. REG. 11-7-1995.
 1,933,432. RICHARD CARUSO. INT. CLS. 3 AND 11. REG. 11-7-1995.
 1,933,433. VALU AND DESIGN. INT. CL. 35. REG. 11-7-1995.
 1,933,437. PIZZAS OF EIGHT. INT. CLS. 11, 30 AND 42. REG. 11-7-1995.
 1,933,438. ADVANTIS AND DESIGN. INT. CLS. 9, 16 AND 38. REG. 11-7-1995.
 1,933,439. OTOKI. INT. CL. 25. REG. 11-7-1995.
 1,933,444. LOCALVIEW. INT. CL. 9. REG. 11-7-1995.
 1,933,445. NACH-R-L KRISPY CHIPS (STYLIZED). INT. CL. 29. REG. 11-7-1995.
 1,933,446. TOPICIDIN. INT. CL. 5. REG. 11-7-1995.
 1,933,447. MISCELLANEOUS DESIGN. INT. CL. 3. REG. 11-7-1995.
 1,933,448. SKOOTERS. INT. CL. 42. REG. 11-7-1995.
 1,933,449. GOOD FORTUNE (STYLIZED). INT. CL. 31. REG. 11-7-1995.
 1,933,450. TAX-POINT. INT. CL. 35. REG. 11-7-1995.
 1,933,456. SURE GRIP. INT. CL. 8. REG. 11-7-1995.
 1,933,458. BIEMCA. INT. CL. 9. REG. 11-7-1995.
 1,933,459. L.A. CONCEPTS. INT. CL. 11. REG. 11-7-1995.
 1,933,462. MADE WITH CARE AND DESIGN. INT. CL. 27. REG. 11-7-1995.
 1,933,463. VIDEO GALAXY. INT. CL. 9. REG. 11-7-1995.
 1,933,466. VEND-IT. INT. CL. 9. REG. 11-7-1995.
 1,933,467. J. AND DESIGN. INT. CL. 41. REG. 11-7-1995.
 1,933,468. SPORTS REFRESHER. INT. CL. 32. REG. 11-7-1995.
 1,933,469. SAFEGARD AND DESIGN. INT. CL. 21. REG. 11-7-1995.
 1,933,470. EVERGREEN. INT. CL. 16. REG. 11-7-1995.
 1,933,473. AT&T PARTNERS IN BUSINESS. INT. CLS. 38, 41 AND 42. REG. 11-7-1995.
 1,933,474. MULTISOURCE 360. INT. CL. 41. REG. 11-7-1995.
 1,933,475. ORANGE MIST MIMOSA. INT. CL. 33. REG. 11-7-1995.
 1,933,477. ARCHIVES EXPRESS. INT. CLS. 39 AND 42. REG. 11-7-1995.
 1,933,479. AZISTIN. INT. CLS. 3 AND 5. REG. 11-7-1995.
 1,933,480. UNOX. INT. CLS. 3 AND 5. REG. 11-7-1995.
 1,933,481. DISCOVERY BAY ADVENTURE WEAR AND DESIGN. INT. CLS. 18, 22, 25 AND 28. REG. 11-7-1995.
 1,933,483. HOSTAPET. INT. CL. 16. REG. 11-7-1995.
 1,933,485. SKIN DREAM AND DESIGN. INT. CL. 3. REG. 11-7-1995.
 1,933,488. PONY EXPRESS. INT. CL. 25. REG. 11-7-1995.
 1,933,494. VIRTUAL GEOGRAPHIC LEAGUE. INT. CL. 41. REG. 11-7-1995.
 1,933,497. B. ROBERT'S COUNTRY OVEN RECIPES AND DESIGN. INT. CLS. 29 AND 30. REG. 11-7-1995.
 1,933,500. URIMATE. INT. CL. 5. REG. 11-7-1995.
 1,933,501. HRI WORLD RESERVE AND DESIGN. INT. CL. 42. REG. 11-7-1995.
 1,933,504. DANCIN' AT THE HOT SPOTS AND DESIGN. INT. CL. 41. REG. 11-7-1995.
 1,933,505. CROWN POINTE. INT. CL. 30. REG. 11-7-1995.
 1,933,508. LIFT "N" GO. INT. CL. 7. REG. 11-7-1995.
 1,933,510. POISONFAX. INT. CL. 38. REG. 11-7-1995.
 1,933,512. GIS MAGIC. INT. CLS. 9 AND 16. REG. 11-7-1995.
 1,933,513. DQE. INT. CL. 9. REG. 11-7-1995.
 1,933,514. VOICE BOT. INT. CL. 28. REG. 11-7-1995.
 1,933,515. INKPROCESSOR. INT. CL. 9. REG. 11-7-1995.
 1,933,517. SMARTRAK. INT. CL. 10. REG. 11-7-1995.
 1,933,518. SPRINT INSTANT FONCARD (STYLIZED). INT. CL. 38. REG. 11-7-1995.

- 1,933,520. FIRST COLONY COFFEE HOUSE AND DESIGN. INT. CL. 30. REG. 11-7-1995.
- 1,933,521. THE GOLF CLUB BY ISACCO BARDA AND DESIGN. INT. CL. 25. REG. 11-7-1995.
- 1,933,523. EXPRESSVECTOR. INT. CLS. 1 AND 5. REG. 11-7-1995.
- 1,933,526. SG-SMART. INT. CL. 9. REG. 11-7-1995.
- 1,933,527. CHROMICA. INT. CL. 12. REG. 11-7-1995.
- 1,933,529. BYE-BYE BUGS. INT. CL. 5. REG. 11-7-1995.
- 1,933,530. PIN-SITE. INT. CL. 5. REG. 11-7-1995.
- 1,933,532. BROTHERS AND SISTERS SPORTSWEAR AND DESIGN. INT. CL. 25. REG. 11-7-1995.
- 1,933,533. DISKBROCHURE. INT. CL. 42. REG. 11-7-1995.
- 1,933,536. GENERRA. INT. CL. 25. REG. 11-7-1995.
- 1,933,538. WINDSP. INT. CL. 9. REG. 11-7-1995.
- 1,933,540. REGAL FOREST. INT. CL. 28. REG. 11-7-1995.
- 1,933,543. GAUGE GARB. INT. CL. 25. REG. 11-7-1995.
- 1,933,545. POWER PLUG. INT. CL. 28. REG. 11-7-1995.
- 1,933,550. THIRST POCKETS. INT. CL. 16. REG. 11-7-1995.
- 1,933,552. UNIDOT. INT. CL. 9. REG. 11-7-1995.
- 1,933,553. NEXT GENERATION. INT. CLS. 29 AND 30. REG. 11-7-1995.
- 1,933,555. MISCELLANEOUS DESIGN. INT. CL. 32. REG. 11-7-1995.
- 1,933,556. LIL'THINGS. INT. CL. 42. REG. 11-7-1995.
- 1,933,557. LIL'THINGS. INT. CL. 25. REG. 11-7-1995.
- 1,933,558. IMPOSTERS. INT. CL. 9. REG. 11-7-1995.
- 1,933,559. AMERICAN RESERVE. INT. CL. 25. REG. 11-7-1995.
- 1,933,560. MAGNA-TUBE. INT. CL. 11. REG. 11-7-1995.
- 1,933,563. POCKETS. INT. CL. 42. REG. 11-7-1995.
- 1,933,564. BABY POCKETS. INT. CL. 42. REG. 11-7-1995.
- 1,933,565. CURADERM. INT. CL. 5. REG. 11-7-1995.
- 1,933,566. COHESIVE TECHNOLOGIES. INT. CL. 9. REG. 11-7-1995.
- 1,933,567. SMART ZIPS. INT. CL. 16. REG. 11-7-1995.
- 1,933,569. GPS TRAILBLAZER. INT. CL. 9. REG. 11-7-1995.
- 1,933,570. GUISSYS/3270. INT. CL. 9. REG. 11-7-1995.
- 1,933,574. MARFORD. INT. CL. 29. REG. 11-7-1995.
- 1,933,577. SOCIETY FOR THE PRESERVATION OF EQUAL RIGHTS FOR MEN. INT. CL. 25. REG. 11-7-1995.
- 1,933,578. NASATUSS. INT. CL. 5. REG. 11-7-1995.
- 1,933,579. BUTLER VIDEO PRODUCTIONS. INT. CL. 25. REG. 11-7-1995.
- 1,933,582. KEY WEST ALOE GENETIC SOLUTION. INT. CL. 3. REG. 11-7-1995.
- 1,933,585. BIOTECH +. INT. CL. 42. REG. 11-7-1995.
- 1,933,586. KAPER RECORDS. INT. CL. 9. REG. 11-7-1995.
- 1,933,587. GTM AND DESIGN. INT. CLS. 20 AND 25. REG. 11-7-1995.
- 1,933,589. GICCOR. INT. CL. 9. REG. 11-7-1995.
- 1,933,591. CUSTOM CONNECTION 800. INT. CL. 38. REG. 11-7-1995.
- 1,933,595. VERSO USA. INT. CL. 25. REG. 11-7-1995.
- 1,933,598. CAPTURED MEMORIES. INT. CL. 40. REG. 11-7-1995.
- 1,933,599. THE KIDS' CANDY COMPANY. INT. CL. 30. REG. 11-7-1995.
- 1,933,602. ADMIT ONE FESTIVALS & SPECIAL EVENTS AND DESIGN. INT. CL. 42. REG. 11-7-1995.
- 1,933,603. MONSTERS OF THE GRIDIRON. INT. CL. 32. REG. 11-7-1995.
- 1,933,604. J.O.B.B.. INT. CL. 25. REG. 11-7-1995.
- 1,933,605. BODYGUARD. INT. CL. 20. REG. 11-7-1995.
- 1,933,606. FOR THE BROTHERS WHO PLAYED AND NEVER GOT PAID!. INT. CL. 25. REG. 11-7-1995.
- 1,933,607. DTR. INT. CL. 40. REG. 11-7-1995.
- 1,933,608. SUPER SKETCH. INT. CL. 9. REG. 11-7-1995.
- 1,933,609. WHITE BOX (STYLIZED). INT. CL. 1. REG. 11-7-1995.
- 1,933,610. G2 CONSULTING. INT. CL. 42. REG. 11-7-1995.
- 1,933,611. KRYO-KOMP AND DESIGN. INT. CL. 10. REG. 11-7-1995.
- 1,933,612. SIX. INT. CL. 28. REG. 11-7-1995.
- 1,933,613. SHOC PAD AND DESIGN. INT. CL. 25. REG. 11-7-1995.
- 1,933,614. LA VILLA VENETA. INT. CL. 33. REG. 11-7-1995.
- 1,933,617. WIN AT PLAY. INT. CL. 9. REG. 11-7-1995.
- 1,933,619. WIN AGAIN. INT. CL. 9. REG. 11-7-1995.
- 1,933,620. WIN AT HOME. INT. CL. 9. REG. 11-7-1995.
- 1,933,621. SPACENOW! (STYLIZED). INT. CL. 20. REG. 11-7-1995.
- 1,933,622. MESSENGER. INT. CL. 9. REG. 11-7-1995.
- 1,933,623. CASTAWAY SOFTWARE. INT. CLS. 9 AND 28. REG. 11-7-1995.
- 1,933,627. MOE'S MO' ROC' N. INT. CLS. 25 AND 42. REG. 11-7-1995.
- 1,933,628. FITNEST. INT. CL. 31. REG. 11-7-1995.
- 1,933,629. JUNGLE SALAD BAR. INT. CL. 31. REG. 11-7-1995.
- 1,933,630. ADORABLE. INT. CL. 16. REG. 11-7-1995.
- 1,933,632. MOE MO'ROC' CA N CAFE AND DESIGN. INT. CLS. 25 AND 42. REG. 11-7-1995.
- 1,933,633. PROTOPTeam (STYLIZED). INT. CL. 36. REG. 11-7-1995.
- 1,933,635. LIVE THE LIFE RESPECT THE MUSIC. INT. CL. 38. REG. 11-7-1995.
- 1,933,641. MONSTERS OF THE GRIDIRON. INT. CL. 21. REG. 11-7-1995.
- 1,933,644. AHF PROVEN PERFORMERS. INT. CLS. 35, 39, 40 AND 42. REG. 11-7-1995.
- 1,933,645. ALTARIS. INT. CL. 9. REG. 11-7-1995.
- 1,933,646. P.V."SEE!". INT. CL. 17. REG. 11-7-1995.
- 1,933,647. RENAISSANCE. INT. CLS. 6, 16 AND 21. REG. 11-7-1995.
- 1,933,649. AT&T 800 SELECT AGAIN. INT. CL. 38. REG. 11-7-1995.
- 1,933,652. TRUCKER'S SHOWER ORGANIZER AND DESIGN. INT. CL. 18. REG. 11-7-1995.
- 1,933,653. TABWORKS. INT. CL. 9. REG. 11-7-1995.
- 1,933,654. RIP SAW. INT. CL. 28. REG. 11-7-1995.
- 1,933,655. TWILIGHT DRESS BY R.J. STEVENS. INT. CL. 25. REG. 11-7-1995.
- 1,933,656. FUNDWORX. INT. CLS. 9 AND 35. REG. 11-7-1995.
- 1,933,658. EGS. INT. CL. 12. REG. 11-7-1995.
- 1,933,659. CHICKEN IN A POCKET. INT. CL. 30. REG. 11-7-1995.
- 1,933,661. SCINTILLA. INT. CL. 33. REG. 11-7-1995.
- 1,933,662. KINETIC. INT. CL. 9. REG. 11-7-1995.
- 1,933,663. PD AND DESIGN. INT. CLS. 5 AND 16. REG. 11-7-1995.
- 1,933,664. MASTERMIND. INT. CL. 9. REG. 11-7-1995.
- 1,933,665. DUCKLING. INT. CL. 10. REG. 11-7-1995.
- 1,933,666. EP BUDDY. INT. CL. 10. REG. 11-7-1995.
- 1,933,667. ENVIROFLEX. INT. CL. 6. REG. 11-7-1995.
- 1,933,668. VECTOR:ENCODE. INT. CL. 9. REG. 11-7-1995.
- 1,933,671. VM:SECURE. INT. CL. 9. REG. 11-7-1995.
- 1,933,672. VM:NOTEKEEPER. INT. CL. 9. REG. 11-7-1995.
- 1,933,673. VM:CENTER. INT. CL. 9. REG. 11-7-1995.
- 1,933,675. GLOBAL PARTNER HOTELS & RESORTS. INT. CLS. 39 AND 42. REG. 11-7-1995.
- 1,933,682. SOLVE:STAT. INT. CL. 9. REG. 11-7-1995.
- 1,933,684. ANSWER:ARCHITECT. INT. CL. 9. REG. 11-7-1995.
- 1,933,685. NOXCAT. INT. CL. 1. REG. 11-7-1995.
- 1,933,687. WORLDS. INT. CL. 9. REG. 11-7-1995.
- 1,933,688. RAPID PREP. INT. CL. 1. REG. 11-7-1995.
- 1,933,690. NEUROATTENDANTS (STYLIZED). INT. CL. 42. REG. 11-7-1995.
- 1,933,693. VECTOR:AVAILABILITY. INT. CL. 9. REG. 11-7-1995.
- 1,933,695. FEEL HEALTHY, FEEL GREAT, OR YOUR MONEY BACK!. INT. CL. 5. REG. 11-7-1995.
- 1,933,696. DELTAPREFERRED OPTION. INT. CL. 36. REG. 11-7-1995.
- 1,933,697. CALL MOVER PLUS. INT. CL. 38. REG. 11-7-1995.
- 1,933,698. CALL MOVER. INT. CL. 38. REG. 11-7-1995.
- 1,933,700. VECTOR:REQUESTS. INT. CL. 9. REG. 11-7-1995.
- 1,933,703. MEMBERLINK. INT. CL. 38. REG. 11-7-1995.
- 1,933,704. TEDDY BUNDLE. INT. CL. 24. REG. 11-7-1995.
- 1,933,706. BUBBLE FLYER. INT. CL. 25. REG. 11-7-1995.
- 1,933,709. LIN PAC. INT. CL. 17. REG. 11-7-1995.

- 1,933,710. THE ONLY THING MORE COMFORTABLE IS THE PRICE. INT. CL. 42. REG. 11-7-1995.
- 1,933,711. TERRAVITA THE HARMONY OF LAND AND LIFE. INT. CL. 36. REG. 11-7-1995.
- 1,933,712. SILENTWRITER SUPERSCRIPIT. INT. CL. 9. REG. 11-7-1995.
- 1,933,715. DOGGY VIBE AND DESIGN. INT. CL. 10. REG. 11-7-1995.
- 1,933,716. COOL DOG. INT. CL. 31. REG. 11-7-1995.
- 1,933,718. GUARDSMAN WOODPRO. INT. CL. 2. REG. 11-7-1995.
- 1,933,719. PRACTICEMASTER. INT. CL. 9. REG. 11-7-1995.
- 1,933,722. SELF-JACKET TICKET JACKET AND DESIGN. INT. CL. 16. REG. 11-7-1995.
- 1,933,723. T.Q. HOT. INT. CL. 33. REG. 11-7-1995.
- 1,933,727. THE MYSTERY AND POWER OF TAI CHI. INT. CL. 9. REG. 11-7-1995.
- 1,933,728. DE BRAYE. INT. CL. 25. REG. 11-7-1995.
- 1,933,731. SWINGTIME. INT. CL. 28. REG. 11-7-1995.
- 1,933,733. EASY UP. INT. CL. 21. REG. 11-7-1995.
- 1,933,735. MISCELLANEOUS DESIGN. INT. CL. 9. REG. 11-7-1995.
- 1,933,737. BLACK OPAL. INT. CL. 25. REG. 11-7-1995.
- 1,933,739. SIGNAL COMPUTING AND DESIGN. INT. CL. 9. REG. 11-7-1995.
- 1,933,740. BRIDGE BUILDER. INT. CL. 9. REG. 11-7-1995.
- 1,933,741. EXTENSIONS IN CARE. INT. CL. 9. REG. 11-7-1995.
- 1,933,742. MANIFEST. INT. CL. 5. REG. 11-7-1995.
- 1,933,743. BINY-BINY (STYLIZED). INT. CL. 3. REG. 11-7-1995.
- 1,933,745. WEST MANITOWOC, INC. AND DESIGN. INT. CL. 7. REG. 11-7-1995.
- 1,933,749. RED ROOST. INT. CL. 32. REG. 11-7-1995.
- 1,933,751. VERTIGO. INT. CL. 9. REG. 11-7-1995.
- 1,933,752. GRANDSTAND. INT. CL. 25. REG. 11-7-1995.
- 1,933,753. ARCO EMISSION CONTROL GASOLINES. INT. CL. 37. REG. 11-7-1995.
- 1,933,754. JWV 1896-1996 WE SERVED 100 YEARS THE JEWISH WAR VETERANS OF THE USA AND DESIGN. INT. CL. 42. REG. 11-7-1995.
- 1,933,756. USCIB AND DESIGN. INT. CLS. 41 AND 42. REG. 11-7-1995.
- 1,933,758. LOOK & LEARN. INT. CLS. 10 AND 21. REG. 11-7-1995.
- 1,933,760. COMMERCIAL BRAKE. INT. CL. 9. REG. 11-7-1995.
- 1,933,761. MOMUS. INT. CL. 20. REG. 11-7-1995.
- 1,933,762. BEAUTYMAX. INT. CL. 42. REG. 11-7-1995.
- 1,933,763. RELIANCE. INT. CL. 10. REG. 11-7-1995.
- 1,933,768. MISCELLANEOUS DESIGN. INT. CL. 1. REG. 11-7-1995.
- 1,933,769. CARB-BOOM. INT. CL. 5. REG. 11-7-1995.
- 1,933,771. MISCELLANEOUS DESIGN. INT. CL. 42. REG. 11-7-1995.
- 1,933,772. DIVE AND DESIGN. INT. CL. 42. REG. 11-7-1995.
- 1,933,773. MISCELLANEOUS DESIGN. INT. CLS. 16 AND 42. REG. 11-7-1995.
- 1,933,774. WIRED FOR SUPERIOR SERVICE. INT. CL. 42. REG. 11-7-1995.
- 1,933,776. FULL CYCLE SERVICE SINCE 1928 MACKIE LIBERTY 1928 AND DESIGN. INT. CL. 37. REG. 11-7-1995.
- 1,933,778. ABCTI SYSTEM AND DESIGN. INT. CL. 42. REG. 11-7-1995.
- 1,933,779. SELECT BALANCE. INT. CL. 31. REG. 11-7-1995.
- 1,933,780. HYPERDAT. INT. CL. 9. REG. 11-7-1995.
- 1,933,783. TOON PLANET AND DESIGN. INT. CL. 42. REG. 11-7-1995.
- 1,933,784. LOUISA BROOKS. INT. CL. 25. REG. 11-7-1995.
- 1,933,786. SATURN AND DESIGN. INT. CL. 28. REG. 11-7-1995.
- 1,933,788. INFO POINT. INT. CL. 35. REG. 11-7-1995.
- 1,933,793. LIQUI-STRAINER. INT. CL. 11. REG. 11-7-1995.
- 1,933,795. MISCELLANEOUS DESIGN. INT. CL. 25. REG. 11-7-1995.
- 1,933,796. ENDLOSS FORMULA. INT. CL. 3. REG. 11-7-1995.
- 1,933,797. WORK GUARDIAN. INT. CL. 25. REG. 11-7-1995.
- 1,933,798. MELTING POT AND DESIGN. INT. CL. 16. REG. 11-7-1995.
- 1,933,799. BELLES & WHISTLES. INT. CL. 25. REG. 11-7-1995.
- 1,933,800. OSCBASE. INT. CL. 9. REG. 11-7-1995.
- 1,933,801. OSCVPF. INT. CL. 9. REG. 11-7-1995.
- 1,933,802. SUPER RED NATURAL. INT. CL. 4. REG. 11-7-1995.
- 1,933,804. OPASCAL. INT. CL. 9. REG. 11-7-1995.
- 1,933,807. AAPEXX. INT. CL. 35. REG. 11-7-1995.
- 1,933,808. ROBERTO RB BARONI AND DESIGN. INT. CL. 9. REG. 11-7-1995.
- 1,933,810. ACCUTINT. INT. CL. 9. REG. 11-7-1995.
- 1,933,811. MATINESSE. INT. CL. 23. REG. 11-7-1995.
- 1,933,812. HEADLINE. INT. CL. 5. REG. 11-7-1995.
- 1,933,813. CABLEPERKS. INT. CL. 35. REG. 11-7-1995.
- 1,933,814. HEALTH2O (STYLIZED). INT. CL. 11. REG. 11-7-1995.
- 1,933,816. PROTECTED BY INFOSAFE. INT. CL. 9. REG. 11-7-1995.
- 1,933,817. THOMPSON'S PASTA TREATS. INT. CL. 31. REG. 11-7-1995.
- 1,933,818. Z STENT AND DESIGN. INT. CL. 10. REG. 11-7-1995.
- 1,933,820. TRUNK GUARD. INT. CL. 12. REG. 11-7-1995.
- 1,933,821. ENCORE AND DESIGN. INT. CLS. 38 AND 41. REG. 11-7-1995.
- 1,933,822. WE PUT THE FUN IN FLYING. INT. CLS. 41 AND 42. REG. 11-7-1995.
- 1,933,823. SURGE AND DESIGN. INT. CL. 9. REG. 11-7-1995.
- 1,933,825. MAXX-MOUNT. INT. CL. 9. REG. 11-7-1995.
- 1,933,827. AGRA LINK. INT. CL. 42. REG. 11-7-1995.
- 1,933,828. PRESUME (STYLIZED). INT. CL. 42. REG. 11-7-1995.
- 1,933,829. COOL CREATIONS. INT. CL. 30. REG. 11-7-1995.
- 1,933,834. ANSWERS. INT. CL. 42. REG. 11-7-1995.
- 1,933,835. NITRO SYSTEM. INT. CL. 1. REG. 11-7-1995.
- 1,933,838. WATERMARK. INT. CL. 3. REG. 11-7-1995.
- 1,933,839. CHROMAX. INT. CL. 9. REG. 11-7-1995.
- 1,933,844. SCSI2GO. INT. CL. 9. REG. 11-7-1995.
- 1,933,846. INSIGNIA RESORTS. INT. CLS. 35, 39 AND 42. REG. 11-7-1995.
- 1,933,847. JOG A NOTE AND DESIGN. INT. CL. 16. REG. 11-7-1995.
- 1,933,848. ACCU-WRAP. INT. CL. 16. REG. 11-7-1995.
- 1,933,849. ENTERPRISE COMPUTING SOLUTIONS. INT. CL. 35. REG. 11-7-1995.
- 1,933,852. SLIDE-A-FILE. INT. CL. 20. REG. 11-7-1995.
- 1,933,853. FOOT TRAIL AND DESIGN. INT. CLS. 20 AND 25. REG. 11-7-1995.
- 1,933,855. GARDENING ANGEL. INT. CL. 31. REG. 11-7-1995.
- 1,933,856. INSULOADER. INT. CL. 20. REG. 11-7-1995.
- 1,933,857. INSULOADER (STYLIZED). INT. CL. 20. REG. 11-7-1995.
- 1,933,859. JESELLE. INT. CL. 25. REG. 11-7-1995.
- 1,933,860. SECURE CLEAR. INT. CL. 9. REG. 11-7-1995.
- 1,933,862. BELLA NONNA. INT. CL. 30. REG. 11-7-1995.
- 1,933,863. MISCELLANEOUS DESIGN. INT. CL. 42. REG. 11-7-1995.
- 1,933,864. KEY WEST SODA LIFE PRESERVER AND DESIGN. INT. CL. 21. REG. 11-7-1995.
- 1,933,865. GALASUPREME. INT. CL. 31. REG. 11-7-1995.
- 1,933,866. IPRAX. INT. CL. 9. REG. 11-7-1995.
- 1,933,867. SERAFINO. INT. CLS. 3 AND 21. REG. 11-7-1995.
- 1,933,872. THE DELTA'S MOST EXCITING CASINO. INT. CL. 41. REG. 11-7-1995.
- 1,933,873. PROMETA. INT. CL. 35. REG. 11-7-1995.
- 1,933,874. EASY NOTEBOOK OFFICE. INT. CL. 9. REG. 11-7-1995.
- 1,933,875. AUTONEB. INT. CL. 10. REG. 11-7-1995.
- 1,933,877. POWER PROBE. INT. CL. 9. REG. 11-7-1995.
- 1,933,879. MARYLAND HEALTH INFORMATION NETWORK MHIN AND DESIGN. INT. CL. 42. REG. 11-7-1995.
- 1,933,881. ABSTRACT CONCEPTS. INT. CL. 42. REG. 11-7-1995.

- 1,933,883. MAR-RAY. INT. CL. 5. REG. 11-7-1995.
 1,933,886. THXTRA-P. INT. CL. 5. REG. 11-7-1995.
 1,933,887. NPR (STYLIZED). INT. CLS. 38 AND 41. REG. 11-7-1995.
 1,933,888. MISCELLANEOUS DESIGN. INT. CL. 14. REG. 11-7-1995.
 1,933,889. JOG A NOTE AND DESIGN. INT. CL. 16. REG. 11-7-1995.
 1,933,891. SPALLETTI. INT. CL. 33. REG. 11-7-1995.
 1,933,896. GIZMO. INT. CL. 8. REG. 11-7-1995.
 1,933,897. BREAKFAST TIME. INT. CL. 41. REG. 11-7-1995.
 1,933,898. SNET PERSONALVISION. INT. CL. 38. REG. 11-7-1995.
 1,933,901. GOSSARD SUPER-UPLIFT. INT. CL. 25. REG. 11-7-1995.
 1,933,902. STACKVIEW. INT. CL. 9. REG. 11-7-1995.
 1,933,905. GET REAL SUMMER FUN. INT. CLS. 41 AND 42. REG. 11-7-1995.
 1,933,906. ZAPMAP. INT. CL. 40. REG. 11-7-1995.
 1,933,908. BESTEAM. INT. CLS. 41 AND 42. REG. 11-7-1995.
 1,933,912. NEAT. INT. CL. 9. REG. 11-7-1995.
 1,933,913. PREP-SAFE. INT. CL. 10. REG. 11-7-1995.
 1,933,914. GOLD TIDE. INT. CL. 31. REG. 11-7-1995.
 1,933,917. KRAFT SIMPLE ANSWERS. INT. CL. 16. REG. 11-7-1995.
 1,933,919. FLEXCON. INT. CL. 9. REG. 11-7-1995.
 1,933,921. AFFOLDABLE. INT. CL. 20. REG. 11-7-1995.
 1,933,922. ORGANIZER III. INT. CL. 18. REG. 11-7-1995.
 1,933,925. SILLY SOUNDSTAGE. INT. CL. 28. REG. 11-7-1995.
 1,933,926. WORDY WAGON. INT. CL. 28. REG. 11-7-1995.
 1,933,927. CRAZY CLUBHOUSE. INT. CL. 28. REG. 11-7-1995.
 1,933,928. BUTCHER BILL'S. INT. CL. 30. REG. 11-7-1995.
 1,933,930. MESA A TASTE OF SANTA FE. INT. CL. 42. REG. 11-7-1995.
 1,933,932. M (STYLIZED). INT. CL. 9. REG. 11-7-1995.
 1,933,933. WINX (STYLIZED). INT. CL. 16. REG. 11-7-1995.
 1,933,934. WINX (STYLIZED). INT. CL. 9. REG. 11-7-1995.
 1,933,935. AL-TAYEB AND DESIGN. INT. CL. 29. REG. 11-7-1995.
 1,933,937. SPORTEL. INT. CL. 9. REG. 11-7-1995.
 1,933,941. MATHQUEST. INT. CL. 9. REG. 11-7-1995.
 1,933,942. LA PIZZERIA. INT. CL. 30. REG. 11-7-1995.
 1,933,943. GARDENDOG. INT. CL. 29. REG. 11-7-1995.
 1,933,944. DECORATIVE TOUCHES. INT. CL. 2. REG. 11-7-1995.
 1,933,945. OMELET MASTER. INT. CL. 29. REG. 11-7-1995.
 1,933,946. HYDRA. INT. CL. 9. REG. 11-7-1995.
 1,933,947. UNITY WAVE. INT. CL. 9. REG. 11-7-1995.
 1,933,950. MISCELLANEOUS DESIGN. INT. CL. 21. REG. 11-7-1995.
 1,933,951. AGORA. INT. CL. 9. REG. 11-7-1995.
 1,933,953. TRAX. INT. CL. 9. REG. 11-7-1995.
 1,933,955. STURDY PLUS. INT. CL. 21. REG. 11-7-1995.
 1,933,956. PRESS PLUS. INT. CL. 21. REG. 11-7-1995.
 1,933,957. WESTERNS ENCORE-3. INT. CLS. 38 AND 41. REG. 11-7-1995.
 1,933,958. CATCH AND HOLD. INT. CL. 10. REG. 11-7-1995.
 1,933,959. LOVE STORIES ENCORE-2. INT. CLS. 38 AND 41. REG. 11-7-1995.
 1,933,964. NUTRA ALOE. INT. CLS. 5 AND 32. REG. 11-7-1995.
 1,933,965. SMART TEA. INT. CLS. 5 AND 30. REG. 11-7-1995.
 1,933,966. ELECTRO CARB. INT. CLS. 5 AND 32. REG. 11-7-1995.
 1,933,967. BRIGHT IDEA. INT. CLS. 5 AND 32. REG. 11-7-1995.
 1,933,968. NUTRA IV. INT. CL. 5. REG. 11-7-1995.
 1,933,971. GUISYS/400. INT. CL. 9. REG. 11-7-1995.
 1,933,972. HERBOTE. INT. CL. 30. REG. 11-7-1995.
 1,933,975. WET TECH. INT. CL. 25. REG. 11-7-1995.
 1,933,976. RAD CADDY. INT. CL. 16. REG. 11-7-1995.
 1,933,978. THE ROCK STATION FOR A NEW GENERATION. INT. CL. 38. REG. 11-7-1995.
 1,933,979. LONG DISTANCE. INT. CL. 10. REG. 11-7-1995.
 1,933,981. VINYLUXE. INT. CL. 24. REG. 11-7-1995.
 1,933,982. CHINOOK. INT. CL. 9. REG. 11-7-1995.
 1,933,983. RED RHINOCEROS. INT. CL. 25. REG. 11-7-1995.
 1,933,984. DETROIT NEON. INT. CL. 41. REG. 11-7-1995.
 1,933,985. BEST OF THE MOUNTAINS. INT. CL. 30. REG. 11-7-1995.
 1,933,986. POP 'N HEAR AND DESIGN. INT. CL. 16. REG. 11-7-1995.
 1,933,987. SPORTS AFIELD. INT. CL. 36. REG. 11-7-1995.
 1,933,988. SPECIFIC SWINE FEEDS. INT. CL. 31. REG. 11-7-1995.
 1,933,989. NO BRAINER. INT. CL. 16. REG. 11-7-1995.
 1,933,990. DETROIT NEON. INT. CL. 28. REG. 11-7-1995.
 1,933,991. COOKWARE FOR THE WAY YOU COOK EVERYDAY COLLECTION. INT. CL. 21. REG. 11-7-1995.
 1,933,992. GRATIS FAT FREE CUISINE AND DESIGN. INT. CL. 42. REG. 11-7-1995.
 1,933,994. CHATELAINE. INT. CL. 16. REG. 11-7-1995.
 1,933,996. APTOS SEMICONDUCTOR. INT. CL. 9. REG. 11-7-1995.
 1,933,999. THE COMMUNITY CARD. INT. CL. 36. REG. 11-7-1995.
 1,934,003. AEO. INT. CL. 14. REG. 11-7-1995.
 1,934,007. FOREST BREEZE. INT. CL. 3. REG. 11-7-1995.
 1,934,009. PULSAR. INT. CL. 20. REG. 11-7-1995.
 1,934,012. THESAURUS. INT. CL. 42. REG. 11-7-1995.
 1,934,014. MORE OF WHAT YOU WANT. LESS OF WHAT YOU DON'T. INT. CL. 32. REG. 11-7-1995.
 1,934,018. THE ULTRA SYSTEM AND DESIGN. INT. CL. 10. REG. 11-7-1995.
 1,934,019. TRI-WEST LOTTO IT'S A KICK IN THE CASH AND DESIGN. INT. CL. 36. REG. 11-7-1995.
 1,934,020. FINSWEEP. INT. CL. 21. REG. 11-7-1995.
 1,934,022. CABLE CAPTIONS CABLE CARES. INT. CL. 41. REG. 11-7-1995.
 1,934,024. INTERNATIONAL GEM GALLERY. INT. CL. 42. REG. 11-7-1995.
 1,934,025. TAP DANCE. INT. CL. 11. REG. 11-7-1995.
 1,934,026. TYCHO. INT. CL. 9. REG. 11-7-1995.
 1,934,027. WORLDWORX. INT. CL. 38. REG. 11-7-1995.
 1,934,028. TOMORROW'S DREAMS. INT. CL. 25. REG. 11-7-1995.
 1,934,029. MONTELL. INT. CL. 32. REG. 11-7-1995.
 1,934,031. SPORTFLICS 2000. INT. CL. 16. REG. 11-7-1995.
 1,934,033. MISCELLANEOUS DESIGN. INT. CL. 25. REG. 11-7-1995.
 1,934,034. LAWGIC. INT. CL. 9. REG. 11-7-1995.
 1,934,042. SOUL EXPLOSION AND DESIGN. INT. CL. 41. REG. 11-7-1995.
 1,934,046. HERBE ROYALE. INT. CL. 30. REG. 11-7-1995.
 1,934,048. QTEX. INT. CL. 26. REG. 11-7-1995.
 1,934,049. POTPOURRI DESIGNS. INT. CLS. 6, 8, 9, 14, 16, 20, 21, 26 AND 28. REG. 11-7-1995.
 1,934,050. SIMON'S FILET. INT. CL. 29. REG. 11-7-1995.
 1,934,051. LO. CAL ZONE HEALTHY FOODS YOU'LL LOVE AND DESIGN. INT. CL. 42. REG. 11-7-1995.
 1,934,053. SWAMP STUFF (STYLIZED). INT. CL. 30. REG. 11-7-1995.
 1,934,056. MISCELLANEOUS DESIGN. INT. CL. 3. REG. 11-7-1995.
 1,934,058. TRAVEL STRATEGIES. INT. CL. 39. REG. 11-7-1995.
 1,934,060. H C (STYLIZED). INT. CL. 42. REG. 11-7-1995.
 1,934,061. OPTIMOIST. INT. CL. 5. REG. 11-7-1995.
 1,934,062. CINNAMON BABIES. INT. CL. 28. REG. 11-7-1995.
 1,934,063. MISCELLANEOUS DESIGN. INT. CL. 28. REG. 11-7-1995.
 1,934,064. BRING A FRIEND BONUS. INT. CLS. 41 AND 42. REG. 11-7-1995.
 1,934,065. DISTINQT LEMONY. INT. CL. 33. REG. 11-7-1995.
 1,934,068. MY FANTASTIC FRAGRANCES. INT. CL. 28. REG. 11-7-1995.
 1,934,071. ID+PLUS. INT. CL. 9. REG. 11-7-1995.
 1,934,072. BEASY II EASY TRANSFER SYSTEM AND DESIGN. INT. CL. 10. REG. 11-7-1995.
 1,934,073. EXPERIENCE THE CHANGING OF THE GUARD. INT. CL. 28. REG. 11-7-1995.

- 1,934,074. MISCELLANEOUS DESIGN. INT. CL. 16. REG. 11-7-1995.
- 1,934,075. KIDSTOR. INT. CL. 20. REG. 11-7-1995.
- 1,934,076. USEXPRESS ADVANTAGE. INT. CL. 38. REG. 11-7-1995.
- 1,934,078. SPA SPECTACULAR. INT. CL. 35. REG. 11-7-1995.
- 1,934,079. THE MOTHER OF ALL JEWELRY. INT. CL. 14. REG. 11-7-1995.
- 1,934,080. KOOKS SURF GEAR AND DESIGN. INT. CL. 25. REG. 11-7-1995.
- 1,934,081. OMNISTAR, THE NATIONAL DGPS SYSTEM. INT. CL. 38. REG. 11-7-1995.
- 1,934,082. SOLFIB. INT. CL. 5. REG. 11-7-1995.
- 1,934,083. MOUSE MASTER. INT. CL. 9. REG. 11-7-1995.
- 1,934,084. FLEXCEL. INT. CL. 7. REG. 11-7-1995.
- 1,934,086. SYSTEM S. INT. CL. 10. REG. 11-7-1995.
- 1,934,088. PRODIGIOUS PESTS. INT. CL. 28. REG. 11-7-1995.
- 1,934,089. TELEMATE. INT. CL. 16. REG. 11-7-1995.
- 1,934,094. LIGHT CHARM. INT. CL. 11. REG. 11-7-1995.
- 1,934,095. COM&DIA. INT. CLS. 9 AND 42. REG. 11-7-1995.
- 1,934,096. DIALOCK BOOT. INT. CL. 9. REG. 11-7-1995.
- 1,934,097. ACROSOUND. INT. CL. 9. REG. 11-7-1995.
- 1,934,098. DENIM TREE. INT. CL. 16. REG. 11-7-1995.
- 1,934,099. DENIM PENCILS. INT. CL. 16. REG. 11-7-1995.
- 1,934,100. OUR PENCILS DON'T GROW ON TREES. INT. CL. 16. REG. 11-7-1995.
- 1,934,102. SOMETHING EXTRA AND DESIGN. INT. CL. 36. REG. 11-7-1995.
- 1,934,103. INFOTRAVEL. INT. CL. 9. REG. 11-7-1995.
- 1,934,104. INDIGLO AND DESIGN. INT. CL. 14. REG. 11-7-1995.
- 1,934,106. GCD. INT. CL. 28. REG. 11-7-1995.
- 1,934,108. IRON BULL. INT. CL. 28. REG. 11-7-1995.
- 1,934,109. ACCOMPRA 120. INT. CL. 10. REG. 11-7-1995.
- 1,934,110. B.E.D. BIG EASY DREAMS. INT. CL. 25. REG. 11-7-1995.
- 1,934,111. AMTEX. INT. CL. 9. REG. 11-7-1995.
- 1,934,113. F/64. INT. CL. 9. REG. 11-7-1995.
- 1,934,116. CRYPTA PLUS. INT. CL. 9. REG. 11-7-1995.
- 1,934,117. MAX 357 AND DESIGN. INT. CL. 28. REG. 11-7-1995.
- 1,934,118. CLAIMIX. INT. CL. 9. REG. 11-7-1995.
- 1,934,120. THE ONE. INT. CL. 17. REG. 11-7-1995.
- 1,934,122. WORRY-FREE. INT. CL. 38. REG. 11-7-1995.
- 1,934,124. HAVE A GOOD MEAL. INT. CL. 42. REG. 11-7-1995.
- 1,934,125. MOORE'S COATING COUNSELOR. INT. CL. 42. REG. 11-7-1995.
- 1,934,126. POWERPRACTICE. INT. CL. 9. REG. 11-7-1995.
- 1,934,128. PRECISECARE. INT. CL. 9. REG. 11-7-1995.
- 1,934,131. IN BOUNDS. INT. CL. 25. REG. 11-7-1995.
- 1,934,135. JAMMIT. INT. CL. 28. REG. 11-7-1995.
- 1,934,138. DIXIE KIDS. INT. CL. 21. REG. 11-7-1995.
- 1,934,139. BEAUTIFUL IMAGES. INT. CL. 25. REG. 11-7-1995.
- 1,934,140. MELTARELLA. INT. CL. 29. REG. 11-7-1995.
- 1,934,145. YESTERDAYS (STYLIZED). INT. CL. 42. REG. 11-7-1995.
- 1,934,146. DISCOVERY GARDEN. INT. CL. 31. REG. 11-7-1995.
- 1,934,147. NFM MEGA MART ELECTRONICS - COMPUTERS - APPLIANCES AND DESIGN. INT. CL. 42. REG. 11-7-1995.
- 1,934,148. EZ-HUB. INT. CL. 9. REG. 11-7-1995.
- 1,934,153. BABY BACKUPS AND DESIGN. INT. CL. 16. REG. 11-7-1995.
- 1,934,159. HELMET HEAD AND DESIGN. INT. CL. 9. REG. 11-7-1995.
- 1,934,161. GOALMASTER. INT. CL. 9. REG. 11-7-1995.
- 1,934,162. STRONG-ARM PRODUCTIONS AND DESIGN. INT. CL. 25. REG. 11-7-1995.
- 1,934,163. MICROCROWNS. INT. CL. 10. REG. 11-7-1995.
- 1,934,164. THE NEW AMERICAN REVOLUTION. INT. CL. 42. REG. 11-7-1995.
- 1,934,166. HALF-BACK. INT. CL. 35. REG. 11-7-1995.
- 1,934,168. DOLLY II. INT. CL. 30. REG. 11-7-1995.
- 1,934,170. INCREDI-MIX. INT. CL. 28. REG. 11-7-1995.
- 1,934,171. 1-800-850-TIES. INT. CL. 38. REG. 11-7-1995.
- 1,934,172. TOTALCONNECT. INT. CL. 9. REG. 11-7-1995.
- 1,934,175. MAKE 'N STRETCH. INT. CL. 28. REG. 11-7-1995.
- 1,934,176. BENDEROIDS. INT. CL. 28. REG. 11-7-1995.
- 1,934,177. PROSCREEN. INT. CL. 3. REG. 11-7-1995.
- 1,934,178. JUST EAT IT.. INT. CL. 29. REG. 11-7-1995.
- 1,934,179. ULTRA-WEB. INT. CL. 12. REG. 11-7-1995.
- 1,934,182. TELEDESIC. INT. CL. 38. REG. 11-7-1995.
- 1,934,185. PACK MASTER. INT. CL. 21. REG. 11-7-1995.
- 1,934,187. FREEMEE. INT. CL. 18. REG. 11-7-1995.
- 1,934,190. SALSAS, ETC! AND DESIGN. INT. CL. 42. REG. 11-7-1995.
- 1,934,193. MICHAELANGELO. INT. CL. 25. REG. 11-7-1995.
- 1,934,195. TYRANNO-MILL. INT. CL. 7. REG. 11-7-1995.
- 1,934,196. LO-PRO. INT. CL. 9. REG. 11-7-1995.
- 1,934,199. DESERT RAIN. INT. CL. 4. REG. 11-7-1995.
- 1,934,200. MYSTERY DATE. INT. CL. 16. REG. 11-7-1995.
- 1,934,201. GEOMESH. INT. CL. 9. REG. 11-7-1995.
- 1,934,202. MCCRACKEN & TUTTLE. INT. CL. 42. REG. 11-7-1995.
- 1,934,205. THE AVEMCO ADVANTAGE. INT. CL. 36. REG. 11-7-1995.
- 1,934,206. LORUS LITE. INT. CL. 14. REG. 11-7-1995.
- 1,934,208. SLEEP'N'SWING. INT. CL. 28. REG. 11-7-1995.
- 1,934,209. CS CARLO SIMONE AND DESIGN. INT. CL. 25. REG. 11-7-1995.
- 1,934,214. SWAMP THING. INT. CL. 11. REG. 11-7-1995.
- 1,934,215. HOT PAGES. INT. CL. 9. REG. 11-7-1995.
- 1,934,216. ROCK-A-BYE BABY. INT. CL. 9. REG. 11-7-1995.
- 1,934,218. PARTY GIRL. INT. CL. 5. REG. 11-7-1995.
- 1,934,222. VINTEA. INT. CL. 30. REG. 11-7-1995.
- 1,934,223. ANNEX. INT. CL. 16. REG. 11-7-1995.
- 1,934,224. WINGS ON THINGS. INT. CL. 21. REG. 11-7-1995.
- 1,934,226. LASERPREMIUMS. INT. CL. 16. REG. 11-7-1995.
- 1,934,231. IDWARE (STYLIZED). INT. CL. 9. REG. 11-7-1995.
- 1,934,232. ROAD RUNNER. INT. CL. 9. REG. 11-7-1995.
- 1,934,233. UNLOCK THE POWER OF YOUR PROMOTION. INT. CL. 35. REG. 11-7-1995.
- 1,934,234. CYTOMED. INT. CL. 5. REG. 11-7-1995.
- 1,934,237. CYTOMED AND DESIGN. INT. CL. 5. REG. 11-7-1995.
- 1,934,238. MISCELLANEOUS DESIGN. INT. CL. 5. REG. 11-7-1995.
- 1,934,239. DRIVELINE EXPRESS. INT. CLS. 12 AND 40. REG. 11-7-1995.
- 1,934,243. IMMORTAL. INT. CLS. 16 AND 28. REG. 11-7-1995.
- 1,934,251. FALCON. INT. CL. 10. REG. 11-7-1995.
- 1,934,254. VERSI-TEMP. INT. CL. 4. REG. 11-7-1995.
- 1,934,255. TIMEMASTER AND DESIGN. INT. CL. 9. REG. 11-7-1995.
- 1,934,257. COMPOST CORRAL. INT. CL. 20. REG. 11-7-1995.
- 1,934,261. TOUCHTACH. INT. CL. 9. REG. 11-7-1995.
- 1,934,262. MAGIC KLENZ. INT. CL. 3. REG. 11-7-1995.
- 1,934,264. SARGE-GUARD. INT. CL. 2. REG. 11-7-1995.
- 1,934,267. GREAT 28. INT. CL. 30. REG. 11-7-1995.
- 1,934,270. TIMBERWOLF. INT. CL. 41. REG. 11-7-1995.
- 1,934,271. PIDAZZLE DESIGNS BY RUSTY AND DESIGN. INT. CL. 42. REG. 11-7-1995.
- 1,934,276. AMERICAN TERMINAL EXCHANGE. INT. CL. 9. REG. 11-7-1995.
- 1,934,277. TRUMPCARD. INT. CL. 9. REG. 11-7-1995.
- 1,934,278. RADICAL GOLF. INT. CL. 41. REG. 11-7-1995.
- 1,934,279. EMBLEM. INT. CL. 5. REG. 11-7-1995.
- 1,934,280. ENSIGN. INT. CL. 5. REG. 11-7-1995.
- 1,934,282. CAPSICRUMB. INT. CL. 30. REG. 11-7-1995.
- 1,934,285. VALVOLUBE. INT. CL. 1. REG. 11-7-1995.
- 1,934,286. AQUARIUS. INT. CL. 9. REG. 11-7-1995.
- 1,934,287. WASH 'N MOIST. INT. CL. 3. REG. 11-7-1995.
- 1,934,288. RIVERHILL USA. INT. CL. 28. REG. 11-7-1995.
- 1,934,291. MOUNTAIN AIR. INT. CL. 11. REG. 11-7-1995.
- 1,934,292. DESIGN RESOURCES & SOLUTIONS GROUP AND DESIGN. INT. CL. 42. REG. 11-7-1995.
- 1,934,293. LAREDO GRILL. INT. CL. 42. REG. 11-7-1995.
- 1,934,294. ASTRO CONFETTI POP. INT. CL. 30. REG. 11-7-1995.
- 1,934,295. ROASTERY. INT. CL. 29. REG. 11-7-1995.
- 1,934,297. PASSION FOR COFFEE. INT. CL. 16. REG. 11-7-1995.

- 1,934,300. DOLLY. INT. CL. 26. REG. 11-7-1995.
 1,934,301. DOLLY PARTON. INT. CL. 26. REG. 11-7-1995.
 1,934,302. EQUUS IV MAN AND DESIGN. INT. CL. 25. REG. 11-7-1995.
 1,934,308. DIGISCAN. INT. CL. 9. REG. 11-7-1995.
 1,934,309. HERITAGE. INT. CL. 20. REG. 11-7-1995.
 1,934,310. DC (STYLIZED). INT. CL. 3. REG. 11-7-1995.
 1,934,311. TRACER-PLUS. INT. CL. 9. REG. 11-7-1995.
 1,934,312. OATMEAL CRUNCH. INT. CL. 30. REG. 11-7-1995.
 1,934,315. POWER PISTON. INT. CL. 28. REG. 11-7-1995.
 1,934,316. NUWAVE. INT. CL. 32. REG. 11-7-1995.
 1,934,317. GARDEN CRITTERS. INT. CL. 25. REG. 11-7-1995.
 1,934,318. TENDER TOTS. INT. CL. 28. REG. 11-7-1995.
 1,934,319. Z-M. INT. CL. 4. REG. 11-7-1995.
 1,934,320. DOLL DEPOT. INT. CL. 28. REG. 11-7-1995.
 1,934,321. THE CHALLENGE OF CHANGE. INT. CL. 41. REG. 11-7-1995.
 1,934,322. SPACE AGE CRYSTAL CAVES. INT. CL. 16. REG. 11-7-1995.
 1,934,323. BEE EXCELLENT. INT. CL. 4. REG. 11-7-1995.
 1,934,324. PARAMETERS, GUIDELINES & PROTOCOLS. INT. CL. 16. REG. 11-7-1995.
 1,934,326. LANDMARK. INT. CL. 11. REG. 11-7-1995.
 1,934,327. GLIS N AND DESIGN. INT. CL. 3. REG. 11-7-1995.
 1,934,328. STARBURST. INT. CL. 16. REG. 11-7-1995.
 1,934,332. HARBOR LIGHT. INT. CL. 14. REG. 11-7-1995.
 1,934,333. MAKE-UP PRETTY. INT. CL. 28. REG. 11-7-1995.
 1,934,334. SLASHCAT. INT. CL. 28. REG. 11-7-1995.
 1,934,337. GRAND RAPIDS MACKERS. INT. CL. 41. REG. 11-7-1995.
 1,934,338. CAMEO. INT. CL. 10. REG. 11-7-1995.
 1,934,339. PEDIAPAP. INT. CL. 5. REG. 11-7-1995.
 1,934,340. A GOLDEN TAKE-A-LOOK BOOK. INT. CL. 16. REG. 11-7-1995.
 1,934,342. SLIDER CLOSES TIGHT FIRST TIME, EVERY TIME. INT. CL. 16. REG. 11-7-1995.
 1,934,343. CHILD OF GOD. INT. CL. 28. REG. 11-7-1995.
 1,934,345. EXCESS. INT. CL. 28. REG. 11-7-1995.
 1,934,346. G E-GARD (STYLIZED). INT. CL. 6. REG. 11-7-1995.
 1,934,348. DOUBLE PLAY. INT. CL. 36. REG. 11-7-1995.
 1,934,351. WHERE THE ORDINARY BECOMES THE EXTRAORDINARY. INT. CL. 29. REG. 11-7-1995.
 1,934,352. GET OFF ME AND DESIGN. INT. CL. 25. REG. 11-7-1995.
 1,934,353. DOS CABALLOS AND DESIGN. INT. CL. 29. REG. 11-7-1995.
 1,934,359. P P.U.R.E .5 AND DESIGN. INT. CL. 25. REG. 11-7-1995.
 1,934,361. BADROCK. INT. CL. 28. REG. 11-7-1995.
 1,934,363. POPULAR MECHANICS. INT. CLS. 6, 8, 9, 11, 17, 20 AND 21. REG. 11-7-1995.
 1,934,364. COLOR CODE, THE SKIN CARE SECRET FOR THE WOMAN OF COLOR. INT. CL. 3. REG. 11-7-1995.
 1,934,365. EARTHSHELL AND DESIGN. INT. CL. 21. REG. 11-7-1995.
 1,934,366. EUREXPAN. INT. CL. 9. REG. 11-7-1995.
 1,934,371. ROOT CAUSES. INT. CL. 16. REG. 11-7-1995.
 1,934,375. QUICKRING. INT. CL. 9. REG. 11-7-1995.
 1,934,377. AMERICAN VINTAGE CYCLES. INT. CL. 16. REG. 11-7-1995.
 1,934,379. THE RESIDENTIAL APPRAISER. INT. CL. 9. REG. 11-7-1995.
 1,934,380. INTERACTIVE MULTIPLAYER. INT. CL. 9. REG. 11-7-1995.
 1,934,381. KITTY. INT. CL. 21. REG. 11-7-1995.
 1,934,383. ZERMATT. INT. CL. 25. REG. 11-7-1995.
 1,934,384. MACADAMIA NUTS SAMPLER AND DESIGN. INT. CL. 29. REG. 11-7-1995.
 1,934,387. BUTTER FLAKES. INT. CL. 29. REG. 11-7-1995.
 1,934,388. MISCELLANEOUS DESIGN. INT. CL. 25. REG. 11-7-1995.
 1,934,389. RICH & CHUNKY. INT. CL. 30. REG. 11-7-1995.
 1,934,391. THE ITINERATE FRAMER. INT. CL. 40. REG. 11-7-1995.
 1,934,394. LAN AND DESIGN. INT. CL. 9. REG. 11-7-1995.
 1,934,395. TEACHER'S PUBLISHING GROUP. INT. CL. 41. REG. 11-7-1995.
 1,934,397. WATERVAC. INT. CL. 9. REG. 11-7-1995.
 1,934,398. THE DO WHAT'S RIGHT CLUB SKIPPY DRUG-PHREY AND DESIGN. INT. CL. 25. REG. 11-7-1995.
 1,934,399. KITCHENETTE. INT. CLS. 20, 21, 22 AND 26. REG. 11-7-1995.
 1,934,402. CD WATCHDOG. INT. CL. 16. REG. 11-7-1995.
 1,934,403. THE OVER THE SHOULDER LAUNDRY HOLDER. INT. CL. 18. REG. 11-7-1995.
 1,934,406. MUSSO. INT. CL. 12. REG. 11-7-1995.
 1,934,409. VIRTUAL DISTRIBUTION SYSTEM. INT. CL. 9. REG. 11-7-1995.
 1,934,410. VIRTUAL INFORMATION SYSTEM. INT. CL. 9. REG. 11-7-1995.
 1,934,412. SNAPPABLE. INT. CL. 9. REG. 11-7-1995.
 1,934,415. SHOE COIL. INT. CL. 6. REG. 11-7-1995.
 1,934,417. INDOOR TRY-ATHLON. INT. CL. 41. REG. 11-7-1995.
 1,934,418. PRESCRIBED. INT. CL. 36. REG. 11-7-1995.
 1,934,419. THE TRENDS RESEARCH INSTITUTE. INT. CL. 35. REG. 11-7-1995.
 1,934,421. BEFORE YOU BUY GUIDE TO MULTIMEDIA. INT. CL. 16. REG. 11-7-1995.
 1,934,422. HEALTH NETWORK FOR CHILDREN. INT. CL. 42. REG. 11-7-1995.
 1,934,425. IV ID AND DESIGN. INT. CL. 10. REG. 11-7-1995.
 1,934,428. SMITHWICK'S. INT. CL. 32. REG. 11-7-1995.
 1,934,432. AMERICA'S BRIDAL STORE. INT. CL. 42. REG. 11-7-1995.
 1,934,433. NICK SANDER. INT. CL. 8. REG. 11-7-1995.
 1,934,435. WORKFLOW DESIGNS, INC. (STYLIZED). INT. CL. 41. REG. 11-7-1995.
 1,934,440. REGULATE. INT. CL. 7. REG. 11-7-1995.
 1,934,441. ULTIMATE GUARANTEE. INT. CL. 42. REG. 11-7-1995.
 1,934,442. MULTIPLE OBLIQUE. INT. CL. 9. REG. 11-7-1995.
 1,934,444. THIS PRODUCT MEETS THE SAFETY AND EFFICACY REQUIREMENTS OF A CLASS II MEDICAL DEVICE AND DESIGN. INT. CL. 11. REG. 11-7-1995.
 1,934,446. SIMPLY THE BEST! (STYLIZED). INT. CL. 41. REG. 11-7-1995.
 1,934,449. FLAGYL MR AND DESIGN. INT. CL. 5. REG. 11-7-1995.
 1,934,450. NEVER RE-ROOF AGAIN. INT. CLS. 6 AND 35. REG. 11-7-1995.
 1,934,455. MOTOR BOATING & SAILING. INT. CL. 35. REG. 11-7-1995.
 1,934,458. TOWN PREVIEW. INT. CL. 42. REG. 11-7-1995.
 1,934,463. M. K CHAM. INT. CL. 25. REG. 11-7-1995.
 1,934,464. SIVIK. INT. CL. 25. REG. 11-7-1995.
 1,934,466. SPECIALISTS IN HEALTHCARE DEVELOPMENT. INT. CL. 42. REG. 11-7-1995.
 1,934,467. SPECIALISTS IN HEALTHCARE DEVELOPMENT. INT. CL. 37. REG. 11-7-1995.
 1,934,468. PHONEKITS. INT. CL. 9. REG. 11-7-1995.
 1,934,469. KITCHENWARE NEWS. INT. CL. 16. REG. 11-7-1995.
 1,934,471. BEYOND THE MIX. INT. CL. 16. REG. 11-7-1995.
 1,934,472. BEACH WAGON (STYLIZED). INT. CL. 28. REG. 11-7-1995.
 1,934,474. OUTDOOR GEAR. INT. CL. 16. REG. 11-7-1995.
 1,934,475. DENSITY PATCH. INT. CL. 9. REG. 11-7-1995.
 1,934,477. AMERICA'S FAVORITE HOBBY HEADQUARTERS. INT. CL. 42. REG. 11-7-1995.
 1,934,479. THE LAWYER STRESS CENTER AND DESIGN. INT. CL. 42. REG. 11-7-1995.
 1,934,483. U.S. COMEDY ARTS FESTIVAL. INT. CL. 41. REG. 11-7-1995.
 1,934,484. SCUM STOP R AND DESIGN. INT. CL. 20. REG. 11-7-1995.
 1,934,485. WELL PERFORMANCE ANALYSIS (STYLIZED). INT. CL. 9. REG. 11-7-1995.
 1,934,487. WEEKLY MORTGAGE UPDATE. INT. CL. 36. REG. 11-7-1995.

- 1,934,489. THE BRIDESMAID. INT. CL. 14. REG. 11-7-1995.
- 1,934,490. INTIMATE PORTRAIT. INT. CL. 41. REG. 11-7-1995.
- 1,934,492. MISCELLANEOUS DESIGN. INT. CL. 22. REG. 11-7-1995.
- 1,934,494. ACTIVE AREA CARPETS. INT. CL. 27. REG. 11-7-1995.
- 1,934,496. PC UPGRADES, USA (STYLIZED). INT. CL. 42. REG. 11-7-1995.
- 1,934,497. SPACE RISKS INTERNATIONAL. INT. CL. 36. REG. 11-7-1995.
- 1,934,498. GOLDPOINT. INT. CL. 28. REG. 11-7-1995.
- 1,934,501. THE DOCTOR'S PRESCRIPTION FOR ENHANCED SPINE REHABILITATION. INT. CL. 10. REG. 11-7-1995.
- 1,934,502. AMERICAN OPHTHALMIC INCORPORATED. INT. CLS. 35 AND 42. REG. 11-7-1995.
- 1,934,503. FED DEP INS CALC (STYLIZED). INT. CL. 9. REG. 11-7-1995.
- 1,934,505. STAY & SKI FREE. INT. CL. 41. REG. 11-7-1995.
- 1,934,506. WASHINGTON'S RV EXPO. INT. CL. 35. REG. 11-7-1995.
- 1,934,507. ARROWSMITH. INT. CL. 18. REG. 11-7-1995.
- 1,934,509. VIRTUAL INTERVIEWING. INT. CL. 35. REG. 11-7-1995.
- 1,934,510. GRIDIRON GREATS. INT. CL. 35. REG. 11-7-1995.
- 1,934,512. WHEY BETTER PROTEIN. INT. CL. 5. REG. 11-7-1995.
- 1,934,513. GOLDEN STATE DERBY. INT. CL. 41. REG. 11-7-1995.
- 1,934,514. DESIGNS FOR WORLD-CLASS QUALITY. INT. CLS. 9 AND 16. REG. 11-7-1995.
- 1,934,515. ROSSER. INT. CL. 20. REG. 11-7-1995.
- 1,934,519. BRAIDS LOCKS AND SKIN. INT. CL. 3. REG. 11-7-1995.
- 1,937,697. NEW TATTOO. INT. CL. 41. REG. 11-28-1995.
- 1,940,042. DURABUILT. INT. CL. 7. REG. 12-5-1995.
- 1,940,997. OPENING NIGHT BARBIE. INT. CL. 28. REG. 12-12-1995.
- 1,942,026. DIAMOND BRITE AND DESIGN. INT. CL. 9. REG. 12-19-1995.
- 1,942,519. WHEEL MIST. INT. CL. 3. REG. 12-19-1995.
- 1,942,938. DULUTH NEWS-TRIBUNE AND DESIGN. INT. CL. 16. REG. 12-19-1995.
- 1,945,131. MONTEREY PASTA COMPANY AND DESIGN. INT. CL. 42. REG. 1-2-1996.
- 1,963,196. LUMINARE. INT. CLS. 9 AND 16 ONLY. REG. 3-19-1996.
- 1,964,692. BUTLER AND DESIGN. INT. CL. 3 ONLY. REG. 3-26-1996.
- 1,983,445. NUTONE. INT. CLS. 7 AND 21 ONLY. REG. 7-2-1996.
- 1,984,156. COMPAGNIE INTERNATIONALE EXPRESS. INT. CLS. 25 AND 36 ONLY. REG. 7-2-1996.
- 1,989,416. SENSaura. INT. CL. 41 ONLY. REG. 7-30-1996.
- 1,996,259. CONTRACTOR QUALITY. INT. CL. 7 ONLY. REG. 8-20-1996.
- 1,999,116. HOLLYWOOD WAX MUSEUM. INT. CLS. 6 AND 25 ONLY. REG. 9-10-1996.
- 2,039,194. PORTAL AND DESIGN. INT. CL. 25 ONLY. REG. 2-18-1997.
- 2,045,970. AUX DELICES DES BOIS. INT. CLS. 30 AND 31 ONLY. REG. 3-18-1997.

SECTION 18

- 362,575. KITTY CLOVER AND DESIGN. U.S. CL. 46. REG. 11-22-1938.

- 1,042,960. COLIN. INT. CL. 25. REG. 7-6-1976.
- 1,252,546. LIFESCANNING AND DESIGN. INT. CL. 42. REG. 9-27-1983.
- 1,315,637. MIGHTY BRITE. INT. CL. 11. REG. 1-22-1985.
- 1,340,959. M MOUNTEX (STYLIZED). INT. CL. 25. REG. 6-11-1985.
- 1,424,462. SYNERGETICS. INT. CL. 42. REG. 1-6-1987.
- 1,466,581. DESTINY. INT. CL. 36. REG. 11-24-1987.
- 1,545,771. HORIZON DENTAL GROUP INTERNATIONAL. INT. CL. 42. REG. 6-27-1989.
- 1,714,776. SHAW'S (STYLIZED). INT. CL. 21. REG. 9-8-1992.
- 1,937,637. COBRA. INT. CL. 12 ONLY. REG. 11-28-1995.
- 1,937,674. INGENUE. INT. CL. 16. REG. 11-28-1995.
- 1,959,384. ELAN. INT. CL. 10. REG. 2-27-1996.
- 1,965,948. CORINTHIAN. INT. CL. 14. REG. 4-2-1996.
- 1,967,238. CLEARLY REMARKABLE. INT. CL. 32. REG. 4-9-1996.
- 1,994,851. "MAP" ANALYSIS. INT. CL. 35. REG. 8-20-1996.
- 2,019,050. MAKING LIFE EASIER AND DESIGN. INT. CL. 42. REG. 11-26-1996.
- 2,035,064. 1-888 MY LAWYER. INT. CL. 35. REG. 2-4-1997.
- 2,116,946. BODITONICS (STYLIZED). INT. CL. 42. REG. 11-25-1997.
- 2,122,597. GOLDEN. INT. CL. 29 ONLY. REG. 12-23-1997.
- 2,157,531. CONNECTEDHEALTH.NET. INT. CL. 42. REG. 5-12-1998.
- 2,202,550. EFUSION AND DESIGN. INT. CLS. 9 AND 42. REG. 11-10-1998.
- 2,208,042. EFUSION. INT. CLS. 9 AND 42. REG. 12-8-1998.
- 2,227,259. LIGHTSPEED. INT. CL. 11. REG. 3-2-1999.
- 2,229,744. PRENEED. INT. CL. 9. REG. 3-2-1999.
- 2,381,167. SANTA RITA. INT. CL. 29. REG. 8-29-2000.
- 2,394,524. TREK BARR AND DESIGN. INT. CL. 30. REG. 10-17-2000.

INADVERTENTLY ISSUED REGISTRATION NUMBERS

- 2,447,281. ATHLETICS. INT. CL. 3. REG. 5-1-2001. RESTORED TO SN 75-349,064.
- 2,497,843. STRIPES. INT. CLS. 6 AND 20. REG. 10-16-2001. RESTORED TO SN 75-926,513.
- 2,521,854. BULTACO. INT. CLS. 3, 9, 14 AND 16. REG. 12-25-2001. RESTORED TO SN 76-010,478.
- 2,531,102. MICROSAFE. INT. CL. 9. REG. 1-22-2002. RESTORED TO SN 75-564,063.
- 2,535,340. BINGO MAGIC. INT. CL. 41. REG. 2-5-2002. RESTORED TO SN 75-759,010.
- 2,535,363. CHEOP. INT. CLS. 35, 36, 38 AND 39. REG. 2-5-2002. RESTORED TO SN 75-782,011.
- 2,545,589. ESPOR. INT. CLS. 1 AND 7. REG. 3-12-2002. RESTORED TO SN 75-573,125.
- 2,569,739. VIRGIN SLUT. INT. CL. 24. REG. 5-14-2002. RESTORED TO SN 76-197,810.
- 2,584,582. SPA SISTER. INT. CL. 21. REG. 6-25-2002. RESTORED TO SN 76-102,984.

TRADEMARK REGISTRATIONS AMENDED, CORRECTED, ETC.

The designation "U.S. Cl." appearing in this section refers to the U.S. class in effect prior to Sep. 1, 1973 rather than the international class which applies to applications filed on or after that date. For adoption of international classification see notice in the OFFICIAL GAZETTE of Jun. 26, 1973 (911 O.G. TM 210).

Any change to the registration will be indicated at the bottom of each entry under ELEMENTS AMENDED, CORRECTED OR RESTRICTED. With the exception of changes to the goods and services, additions to the registration will appear in asterisks and deletions of the registration will appear in brackets. Elements which are only changed will be listed with no punctuation. As to the goods/services statement, amendments to the goods/services will appear in asterisks and deletions will appear in brackets. In addition if any change to the goods/services occurs, the element "Goods/Services" will be listed under ELEMENTS AMENDED, CORRECTED OR RESTRICTED.

518,087. REG. 11-29-1949. MAGLINE, INC. (MICHIGAN CORPORATION) 503 SOURT MERCER STREET, PINCONNING, MI., SN 71-538,425. FILED 10-20-1947. PRINCIPAL REGISTER.

1,198,008. REG. 6-15-1982. BAKERS FOOTWEAR GROUP INC. (MISSOURI CORPORATION) 2815 SCOTT AVENUE, ST. LOUIS, MO. 63103, BY ASSIGNMENT, BY CHANGE OF NAME EDISON BROTHERS STORES, INC. CORPORATION) ST. LOUIS, DE, SN 73-304,622. FILED 4-3-1981. PRINCIPAL REGISTER.

The logo for MAGLINER features a stylized, dark, triangular shape on the left, followed by the word "MAGLINER" in a bold, italicized, sans-serif font.

INT. CL. 12/U.S. CL. 19
FOR HAND OPERATED TWO-WHEELED TRUCKS,
AND HAND-OPERATED FOUR-WHEELED INDUSTRIAL TRUCKS.
FIRST USE 6-15-1947; IN COMMERCE 6-15-1947.

ELEMENTS AMENDED
MARK

WILD PAIR

OWNER OF U.S. REG. NOS. 955,819 AND 977,532.
INT. CL. 25/U.S. CL. 39
FOR SHOES.
FIRST USE 2-22-1980; IN COMMERCE 2-22-1980.

ELEMENTS AMENDED
MARK

627,236. REG. 5-22-1956. PENNZOIL-QUAKER STATE COMPANY (DELAWARE CORPORATION) 700 MILAM, HOUSTON, TX, 77002, BY CHANGE OF NAME FROM; BY CHANGE OF NAME, BY MERGER QUAKER STATE OIL REFINING CORPORATION CORPORATION) OIL CITY, PA. SN 71-688,666. FILED 6-1-1955. PRINCIPAL REGISTER.

1,211,844. REG. 10-5-1982. RALPH MALTBY ENTERPRISES, INC. (OHIO CORPORATION) P.O. BOX 976, NEWARK, OH, 43055. SN 73-187,247. FILED 9-27-1978. PRINCIPAL REGISTER.

Q

THE GOLFWORKS

INT. CL. 4/U.S. CL. 15
FOR MOTOR OIL.
FIRST USE 9-16-1954; IN COMMERCE 9-16-1954.

ELEMENTS AMENDED
OWNER NAME
OWNER ADDRESS
CITIZENSHIP
ENTITY
ASSIGNMENT/NAME CHANGE

INT. CL. 37/U.S. CL. 103
FOR CUSTOM MANUFACTURE AND REPAIR OF GOLF CLUBS.
FIRST USE 9-15-1976; IN COMMERCE 9-15-1976.
INT. CL. 42/U.S. CL. 103
FOR CUSTOM DESIGN OF GOLF CLUBS.
FIRST USE 9-15-1976; IN COMMERCE 9-15-1976.

ELEMENTS AMENDED
MARK

1,405,249. REG. 8-12-1986. LIBERTY MUTUAL INSURANCE COMPANY (MASSACHUSETTS CORPORATION), DBA LIBERTY MUTUAL INSURANCE GROUP, 175 BERKELEY STREET, BOSTON, MA, 02117, SN 73-564,102. FILED 10-21-1985. PRINCIPAL REGISTER.



OWNER OF U.S. REG. NOS. 518,838 AND 642,145.
NO CLAIM IS MADE TO THE EXCLUSIVE RIGHT TO USE "MUTUAL", APART FROM THE MARK AS SHOWN.
THE LINING IS A FEATURE OF THE MARK AND DOES NOT INDICATE COLOR.
INT. CL. 36/U.S. CL. 102

FOR UNDERWRITING AND ADMINISTRATION OF INSURANCE DEALING WITH ACCIDENT, LIABILITY AND PROPERTY INSURANCE AND REINSURANCE, INCLUDING THE FOLLOWING KINDS OF INSURANCE; FIRE AND OTHER PROPERTY, GENERAL LIABILITY, WORKERS COMPENSATION, AUTOMOBILE AND AIRCRAFT DAMAGE AND LIABILITY, DISABILITY FIDELITY, SURETY, BURGLARY, FORTGARY AND WATER DAMAGE.
FIRST USE 8-26-1985; IN COMMERCE 8-26-1985.

ELEMENTS AMENDED
MARK

1,651,752. REG. 7-23-1991. DELPHI CONSULTING GROUP, INC. (MASSACHUSETTS CORPORATION) 100 CITY HALL PLAZA, BOSTON, MA, 02108, SN 74-016,016. FILED 1-3-1990. PRINCIPAL REGISTER.

DELPHI

INT. CL. 41/U.S. CLS. 100, 101 AND 107
FOR EDUCATIONAL SERVICES; NAMELY, CONDUCTING CLASSES AND SEMINARS IN THE *UNIFIED* FIELD OF COMPUTER HARDWARE AND *COMPUTER * SOFTWARE *AS USED IN CONJUNCTION WITH EACH OTHER OR SEPARATELY FROM EACH OTHER IN THE AREA OF INFORMATION TECHNOLOGY*.
FIRST USE 2-13-1989; IN COMMERCE 2-13-1989.

ELEMENTS AMENDED
GOODS/SERVICES

1,709,729. REG. 8-25-1992. CTA MANUFACTURING CORP. (NEW JERSEY CORPORATION) 263 VETERANS BOULEVARD, CARLSTADT, NJ, 07072, SN 74-157,038. FILED 4-15-1991. PRINCIPAL REGISTER.

RITEFIT

INT. CL. 8/U.S. CL. 23

FOR OIL FILTER REMOVING HANDTOOLS, INCLUDING OIL FILTER WRENCHES, USED IN THE AUTOMOTIVE INDUSTRY TO REMOVE OIL FILTERS FROM MOTOR VEHICLES.
FIRST USE 7-0-1991; IN COMMERCE 7-0-1991.

ELEMENTS AMENDED
MARK

1,936,529. REG. 11-21-1995. INTERNATIONAL INSTITUTE FOR SUSTAINABLE DEVELOPMENT (CANADA COMPANY) 161 PORTAGE AVENUE EAST, 6TH FLOOR, WINNIPEG, MANITOBA, CANADA, R3B 0Y4, SN 74-513,833. FILED 4-18-1994. PRINCIPAL REGISTER.

EARTH NEGOTIATIONS BULLETIN

NO CLAIM IS MADE TO THE EXCLUSIVE RIGHT TO USE "BULLETIN", APART FROM THE MARK AS SHOWN.
INT. CL. 9/U.S. CLS. 21, 23, 26, 36 AND 38
FOR ELECTRONIC PUBLICATIONS STORED ON COMPUTER DISCS * AND DISTRIBUTED ELECTRONICALLY THROUGH A COMPUTER NETWORK * FEATURING INFORMATION ON ENVIRONMENTAL ISSUES.
FIRST USE 8-0-1993; IN COMMERCE 8-0-1993.
INT. CL. 16/U.S. CLS. 2, 5, 22, 23, 29, 37, 38 AND 50
FOR PRINTED PUBLICATIONS, NAMELY BOOKS AND NEWSLETTERS FEATURING ENVIRONMENTAL ISSUES.
FIRST USE 8-0-1993; IN COMMERCE 8-0-1993.

ELEMENTS AMENDED
GOODS/SERVICES

1,956,888. REG. 2-13-1996. BAINBRIDGE INTERNATIONAL INC. (CONNECTICUT CORPORATION) 255 REVERE STREET, CANTON, MA, 02021, BY CHANGE OF NAME BAINBRIDGE/AQUABATTEN, INC. CORPORATION) CANTON, MA, SN 74-570,807. FILED 9-7-1994. PRINCIPAL REGISTER.

COVER GUARD

INT. CL. 17/U.S. CLS. 1, 5, 12, 13, 35 AND 50
FOR FIRE RETARDANT POLYETHYLENE FILM USED AS A PROTECTOR ON FLOOR AND WALL SURFACES DURING CONSTRUCTION AND REFURBISHMENT.
FIRST USE 1-18-1995; IN COMMERCE 1-18-1995.

ELEMENTS CORRECTED
OWNER NAME
OWNER ADDRESS
ENTITY
ASSIGNMENT/NAME CHANGE
CITIZENSHIP

1,962,802. REG. 3-19-1996. TOTAL INFORMATION, INC. (NEW YORK CORPORATION) 844 DEWEY AVENUE, ROCHESTER, NY, 14613, SN 74-564,260. FILED 8-22-1994. PRINCIPAL REGISTER.

TOTAL INFORMATION

INT. CL. 35/U.S. CLS. 100, 101 AND 102
 FOR LIBRARY BOOK JOBBER SERVICES, NAMELY PURCHASING PUBLICATIONS IN ALL MEDIA FOR CLIENTS.
 FIRST USE 6-0-1975; IN COMMERCE 1-0-1978.
 INT. CL. 42/U.S. CLS. 100 AND 101
 FOR WHOLESALE AND RETAIL BOOKSTORE SERVICES.
 FIRST USE 1-0-1978; IN COMMERCE 1-0-1978.

ELEMENTS AMENDED
 MARK
 [DISCLAIMER]

FOR KEYS, KEY CYLINDERS, AND LOCKS FOR LAND VEHICLES; CLOSING MECHANISMS AND LATCHES FOR LAND VEHICLES; AND OPERATING MECHANISMS FOR LAND VEHICLE WINDOWS, NAMELY WINDOW CRANKS.
 FIRST USE 11-2-1995; IN COMMERCE 11-2-1995.

INT. CL. 9/U.S. CLS. 21, 23, 26, 36 AND 38
 FOR ELECTRIC OR ELECTRONIC LOCKS AND LATCHES FOR LAND VEHICLES, CONSISTING OF LOCKS, LATCHES, KEYLESS ENTRY PADS, AND MECHANICALLY OPERATED PADS, AND PARTS THEREFOR.
 FIRST USE 11-2-1995; IN COMMERCE 11-2-1995.
 INT. CL. 12/U.S. CLS. 19, 21, 23, 31, 35 AND 44
 FOR ANTI-THEFT ALARMS FOR LAND VEHICLES.
 FIRST USE 11-2-1995; IN COMMERCE 11-2-1995.

ELEMENTS AMENDED
 OWNER NAME
 OWNER ADDRESS
 CITIZENSHIP
 ENTITY
 ASSIGNMENT/NAME CHANGE

1,979,298. REG. 6-11-1996. COLOP STEMPERLERZEUGUNG SKOPEK GESELLSCHAFT M.B.H. & CO. KG (AUSTRIA CORPORATION) DR.-F.-ARMING-STRASSE 5, A-4600 WELS, AUSTRIA., SN 74-601,521. FILED 11-21-1994. PRINCIPAL REGISTER.

COLOP

INT. CL. 16/U.S. CLS. 2, 5, 22, 23, 29, 37, 38 AND 50
 FOR DATE STAMPS, RUBBER STAMPS, AND SELF INKING STAMPS.
 FIRST USE 0-0-1982; IN COMMERCE 8-0-1984.

ELEMENTS CORRECTED
 OWNER ADDRESS
 CITIZENSHIP

1,998,734. REG. 9-3-1996. SCANSOFT, INC. (DELAWARE CORPORATION) 9 CENTENNIAL DRIVE, PEABODY, MA, 01960, BY MERGER, BY CHANGE OF NAME VISIONEER COMMUNICATIONS, INC. CORPORATION) PALO ALTO, CA, SN 74-589,230. FILED 10-21-1994. PRINCIPAL REGISTER.

PAPERPORT

INT. CL. 9/U.S. CLS. 21, 23, 26, 36 AND 38
 FOR COMPUTER HARDWARE AND SOFTWARE FOR SCANNING AND OPTICAL CHARACTER RECOGNITION.
 FIRST USE 11-0-1994; IN COMMERCE 11-0-1994.

ELEMENTS AMENDED
 OWNER NAME
 OWNER ADDRESS
 CITIZENSHIP
 ENTITY
 ASSIGNMENT/NAME CHANGE

1,983,039. REG. 6-25-1996. HUF HULSBECK & FURST GMBH & CO. KG (FED REP GERMANY COMPANY) STEEGER STR. 17, D-042551 VELBERT, FED REP GERMANY., BY CHANGE OF NAME HULSBECK & FURST GMBH & CO. KG. COMPANY) D-042551 VELBERT, FED REP GERMANY, SN 74-572,793. FILED 9-13-1994. PRINCIPAL REGISTER.



2,047,418. REG. 3-25-1997. FUTURE FARMERS OF AMERICA (UNITED STATES CORPORATION) 5632 MT. VERNON MEMORIAL HIGHWAY, ALEXANDRIA, VA, 223090160, SN 75-054,066. FILED 2-6-1996. PRINCIPAL REGISTER.



FOR PROMOTING SAFETY IN THE AGRICULTURAL COMMUNITY BY COMPILING AND DISTRIBUTING YOUTH SAFETY AND HEALTH EDUCATION INFORMATION RESOURCES TO TEACHERS AND COMMUNITY LEADERS.
FIRST USE 10-18-1995; IN COMMERCE 10-23-1995.

ELEMENTS CORRECTED
OWNER NAME

2,129,694. REG. 1-20-1998. RENTOKIL INITIAL PLC (UNITED KINGDOM CORPORATION) FELCOURT, EAST GRINSTEAD, WEST SUSSEX RH19 2JY, ENGLAND, BY CHANGE OF NAME, BY ASSIGNMENT RENTOKIL LIMITED CORPORATION) WEST SUSSEX RH19 2JY, ENGLAND, SN 74-658,760. FILED 4-10-1995. PRINCIPAL REGISTER.

RENTOKIL

OWNER OF UNITED KINGDOM REG. NO. 2003308, DATED 11-25-1994.
OWNER OF UNITED KINGDOM REG. NO. 1277384, DATED 10-1-1986.
OWNER OF UNITED KINGDOM REG. NO. 1521857, DATED 12-21-1992.
OWNER OF UNITED KINGDOM REG. NO. 1543878, DATED 8-4-1993.
OWNER OF UNITED KINGDOM REG. NO. 1277382, DATED 10-1-1986.
OWNER OF UNITED KINGDOM REG. NO. 682546, DATED 9-19-1949.
OWNER OF U.S. REG. NOS. 1,424,146 AND 1,480,003.
INT. CL. 5/U.S. CLS. 6, 18, 44, 46, 51 AND 52
FOR PESTICIDES, INSECTICIDES, PARASITICIDES, FUNGICIDES, PREPARATIONS FOR DESTROYING VERMIN, BACTERICIDES AND DISINFECTANTS, ALL FOR SANITARY AND/OR HYGIENIC DOMESTIC, COMMERCIAL AND INSTITUTIONAL USES; ALL-PURPOSE DISINFECTANTS AND DEODORANTS FOR SANITARY AND/OR HYGIENIC PURPOSES AND DOMESTIC, COMMERCIAL AND INSTITUTIONAL USE; AIR FRESHENERS, AND FEMININE HYGIENE PREPARATIONS, NAMELY, SANITARY DRESSINGS, SANITARY TOWELS AND SANITARY TAMPONS.
INT. CL. 10/U.S. CLS. 26, 39 AND 44
FOR MEDICAL WASTE RECEPTACLES FOR DISPOSAL OF NEEDLES, SYRINGES, SHARPS, MEDICAL DRESSINGS, AND MEDICAL WASTE.
INT. CL. 11/U.S. CLS. 13, 21, 23, 31 AND 34
FOR DISPENSING UNITS FOR DISPENSING DETERGENT, DISINFECTANT AND/OR DEODORIZER INTO TOILET OR URINAL FLUSHING WATER; AIR FILTERS FOR DOMESTIC AND INDUSTRIAL USE; AIR PURIFYING AND CLEANING UNITS FOR HOUSEHOLD, COMMERCIAL AND INDUSTRIAL USE AND PARTS AND FITTINGS FOR THE AFOREMENTIONED.
INT. CL. 21/U.S. CLS. 2, 13, 23, 29, 30, 33, 40 AND 50
FOR DISPENSERS FOR SOAP, SANITARY DRESSINGS, SANITARY TOWELS AND SANITARY TAMPONS; TOILET PAPER HOLDERS; PEST TRAPS; AND RECEPTACLES FOR THE DISPOSAL OF WASTE MATERIALS AND ARTICLES.
INT. CL. 31/U.S. CLS. 1 AND 46
FOR LIVE PLANTS, TREES, FLOWERS, AND FLORAL DISPLAYS.
INT. CL. 37/U.S. CLS. 100, 103 AND 106

FOR DETECTION, CONTROL AND EXTERMINATION OF PESTS, VERMIN, INSECTS, PARASITES AND BIRDS (NOT FOR AGRICULTURAL PURPOSES); FUMIGATING SERVICES (NOT FOR AGRICULTURAL PURPOSES); REPAIR, INSULATING AND WATERPROOFING OF BUILDINGS; INSTALLATION OF DAMP PROOF COURSES; REPAIR, MAINTENANCE, PRESERVATION AND REPLACEMENT OF WINDOWS; REPLACEMENT OF WALL TIES; MAINTENANCE, CLEANING AND DISINFECTING OF BUILDINGS, ROOMS, WASHROOMS, REFUSE APPARATUS, SANITARY APPARATUS, KITCHEN EQUIPMENT, AIR CONDITIONING APPARATUS, VENTILATING APPARATUS, HUMIDIFIERS, WATER STORAGE APPARATUS AND WATER SUPPLY APPARATUS; INSTALLATION AND REPLACEMENT OF RECEPTACLES FOR WASTE MATERIALS AND ARTICLES; INSTALLATION, REPLACEMENT, REPLENISHING, CLEANING, MAINTENANCE AND REPAIR OF VENDING MACHINES, INSECTICIDAL APPARATUS, DRYING APPARATUS, AIR FILTERING APPARATUS, AIR FRESHENING APPARATUS, AIR TREATING APPARATUS AND OF APPARATUS AND MATERIALS FOR OFFICE, TOILET, WASHROOM, CLEANING, SANITARY AND HYGIENIC PURPOSES; PLUMBING; CLEARING OF BLOCKAGE IN PIPES, DRAINS, AND SEWERS; RENTAL AND LEASING OF INSECT KILLING APPARATUS, PEST CONTROL APPARATUS, AND APPARATUS AND MATERIALS FOR CLEANING PURPOSES; INSTALLATION, MAINTENANCE, REPAIR AND RENTAL OF SANITARY APPARATUS, SANITIZING APPARATUS, WATER FLUSHING APPARATUS, SANITIZERS, AND OF APPARATUS FOR DISPENSING DETERGENT, DISINFECTANT AND/OR DEODORIZER INTO TOILET OR URINAL FLUSHING WATER; CLEANING, REPAIRING AND RESTORING OF CARPETS, CURTAINS, UPHOLSTERY AND FABRICS; ADVISORY AND CONSULTANCY SERVICES RELATING TO PEST CONTROL AND TO THE CLEANING AND MAINTENANCE OF WASHROOMS.
INT. CL. 39/U.S. CLS. 100 AND 105

FOR GARBAGE AND WASTE COLLECTION AND REMOVAL; AND DELIVERY, COLLECTION AND REMOVAL OF CONTAINERS FOR WASTE MATERIALS AND ARTICLES.
INT. CL. 42/U.S. CLS. 100 AND 101

FOR RENTAL, LEASING, FILLING AND REFILLING OF VENDING MACHINES, APPARATUS AND MATERIALS FOR TOILET, WASHROOM, SANITARY AND HYGIENIC PURPOSES, TOWEL DISPENSERS, SOAP DISPENSERS, AND APPARATUS FOR DISPENSING DETERGENT, DISINFECTANT AND/OR DEODORIZER INTO TOILET OR URINAL FLUSHING WATER; RENTAL AND LEASING OF CONTAINERS FOR WASTE MATERIALS AND ARTICLES; VEGETATION CARE SERVICES, NAMELY, PLANTING, REPLACING, AND ROUTINE CARE OF PLANTS, TREES, FLOWERS, AND FLORAL DISPLAYS.

ELEMENTS AMENDED
OWNER NAME
OWNER ADDRESS
CITIZENSHIP
ENTITY
ASSIGNMENT/NAME CHANGE

2,185,063. REG. 8-25-1998. W.C. SPORTS, LLC (CONNECTICUT CORPORATION) 326 WEST MAIN STREET, MILFORD, CT, 06460, SN 75-256,829. FILED 3-13-1997. PRINCIPAL REGISTER.

WATERBURY SPIRIT

NO CLAIM IS MADE TO THE EXCLUSIVE RIGHT TO USE "WATERBURY", APART FROM THE MARK AS SHOWN.
INT. CL. 41/U.S. CLS. 100, 101 AND 107

FOR ENTERTAINMENT SERVICES, NAMELY, ORGANIZING AND CONDUCTING PROFESSIONAL BASEBALL COMPETITIONS, MATCHES AND EXHIBITIONS OF A PROFESSIONAL BASEBALL TEAM.
FIRST USE 6-6-1997; IN COMMERCE 6-6-1997.

2,244,117. REG. 5-11-1999. FF ACQUISITION, L.L.C. (VIRGINIA LTD LIAB CO) 4860 COX ROAD, GLEN ALLEN, VA, 23060, BY ASSIGNMENT FARM FRESH, INC. CORPORATION) NORFOLK, VA, SN 75-115,530. FILED 6-7-1996. PRINCIPAL REGISTER.

ELEMENTS CORRECTED
OWNER NAME

FARM FRESH GOLD

OWNER OF U.S. REG. NOS. 1,544,928 AND 2,023,674.
NO CLAIM IS MADE TO THE EXCLUSIVE RIGHT TO USE "FRESH", APART FROM THE MARK AS SHOWN.
INT. CL. 30/U.S. CL. 46
FOR PIZZA.
FIRST USE 12-1-1995; IN COMMERCE 12-1-1995.

2,190,609. REG. 9-22-1998. FUTURE FARMERS OF AMERICA (UNITED STATES CORPORATION) 6060 FFA DRIVE, PO BOX 68960, INDIANAPOLIS, IN, 46268, SN 75-292,332. FILED 5-15-1997. PRINCIPAL REGISTER.

ELEMENTS CORRECTED
ASSIGNMENT/NAME CHANGE
OWNER NAME
OWNER ADDRESS
ENTITY



NO CLAIM IS MADE TO THE EXCLUSIVE RIGHT TO USE "AGRICULTURAL EDUCATION", APART FROM THE MARK AS SHOWN.
INT. CL. 16/U.S. CLS. 2, 5, 22, 23, 29, 37, 38 AND 50

2,341,633. REG. 4-11-2000. ALEX NOEL, INC. (NEW YORK CORPORATION) 48 WEST 25TH STREET, 4TH FLOOR, NEW YORK, NY, 10001, SN 75-220,511. FILED 1-2-1997. PRINCIPAL REGISTER.

FOR PRINTED INSTRUCTIONAL, EDUCATIONAL AND TEACHING MATERIALS FOR TEACHERS AND EDUCATIONAL PROFESSIONALS IN THE FIELD OF AGRICULTURE.
FIRST USE 10-0-1996; IN COMMERCE 11-0-1996.

JACK SPADE

THE MARK DOES NOT IDENTIFY A PARTICULAR LIVING INDIVIDUAL.
INT. CL. 18/U.S. CLS. 1, 2, 3, 22 AND 41
FOR * COIN PURSES * HANDBAGS, ALL-PURPOSE CARRYING BAGS, TOTE BAGS, TRAVELING BAGS, SHOULDER BAGS, ALL-PURPOSE ATHLETIC BAGS, BACKPACKS, AND WALLETS.
FIRST USE 11-1-1998; IN COMMERCE 11-1-1998.

ELEMENTS CORRECTED
OWNER NAME
OWNER ADDRESS

ELEMENTS CORRECTED
GOODS/SERVICES

2,238,320. REG. 4-13-1999. SEVEN CIRCLE RESORTS, INC. (DELAWARE CORPORATION) 1512 LARIMER STREET, DENVER, CO, 80202, SN 75-359,538. FILED 9-19-1997. PRINCIPAL REGISTER.

BREAK THE BANK

2,345,085. REG. 4-25-2000. SECURETEC CONTRABAND DETECTION & IDENTIFICATION, INC. (DELAWARE CORPORATION) 21 ROUND HILL ROAD, WILLIAMSPORT, PA, 17701, SN 75-644,525. FILED 2-17-1999. PRINCIPAL REGISTER.

OWNER OF U.S. REG. NO. 1,885,265.
INT. CL. 36/U.S. CLS. 100, 101 AND 102
FOR [LOTTERY SERVICES, NAMELY, LOTTERY GAMES INCLUDING BUT NOT LIMITED TO SCRATCH-OFF TICKET GAMES] *PROVIDING PROGRESSIVE SLOT MACHINE JACKPOT, I.E., A JACKPOT OR PRIZE WITH A FIXED MINIMUM VALUE THAT GROWS UNTIL WON, IN PROPORTION TO PLAY UPON DESIGNATED SLOT MACHINES LINKED TO THE PRIZE*.
FIRST USE 10-1-1992; IN COMMERCE 10-1-1992.

DRUGWIPE

INT. CL. 5/U.S. CLS. 6, 18, 44, 46, 51 AND 52
FOR DRUG SCREENING KIT CONSISTING PRIMARILY OF IMMUNOASSAY TEST STRIP AND ANALYTE TRANSFER SURFACE FOR THE DETECTION OF AMPHETAMINES, OPIATES, CANNABIS, AND COCAINE.
FIRST USE 2-13-1995; IN COMMERCE 2-13-1995.

ELEMENTS AMENDED
GOODS/SERVICES

ELEMENTS CORRECTED
OWNER NAME

2,362,572. REG. 6-27-2000. W.C. SPORTS, LLC (CONNECTICUT CORPORATION) 100 BANK STREET, SEYMOUR, CT, 06483, SN 75-256,830. FILED S.R. 3-13-1997; AM. P.R. 3-23-1998. PRINCIPAL REGISTER.

WATERBURY SPIRIT

NO CLAIM IS MADE TO THE EXCLUSIVE RIGHT TO USE "WATERBURY", APART FROM THE MARK AS SHOWN.

INT. CL. 16/U.S. CLS. 2, 5, 22, 23, 29, 37, 38 AND 50

FOR *PAPER GOODS AND PRINTED MATTER; NAMELY,* BUMPER STICKERS, POSTERS, TRADING CARDS, SCOREBOOKS, STATIONERY FOLDERS AND POSTCARDS, PENCILS.

FIRST USE 5-0-1997; IN COMMERCE 5-0-1997.

INT. CL. 25/U.S. CLS. 22 AND 39

FOR CLOTHING, NAMELY, SHIRTS, SHORTS, WARM-UPS, SOCKS, JACKETS, SWEATERS, HATS, CAPS, WRISTBANDS.

FIRST USE 4-0-1997; IN COMMERCE 4-0-1997.

ELEMENTS CORRECTED
OWNER NAME

2,435,553. REG. 3-13-2001. A.G. FERRARI FOODS (CALIFORNIA CORPORATION) 14310 CATALINA STREET, SAN LEANDRO, CA, 94577, BY CHANGE OF NAME ULTRA LUCCA, INC. CORPORATION) SAN LEANDRO, CA, SN 75-426,698. FILED 1-30-1998. PRINCIPAL REGISTER.



NO CLAIM IS MADE TO THE EXCLUSIVE RIGHT TO USE "FOODS", "ESTD. 1919" AND "BORGO TARO, "ITALIA", APART FROM THE MARK AS SHOWN.

THE LINING ON THE DRAWING IS A DESIGN FEATURE OF THE MARK AND DOES NOT INDICATE COLOR. THE NAME "A. G. FERRARI" DOES NOT IDENTIFY A LIVING INDIVIDUAL.

THE ENGLISH TRANSLATION OF "LA QUALITA NON HA TEMPO" IS "QUALITY IS TIMELESS".

INT. CL. 42/U.S. CLS. 100 AND 101

FOR DELICATESSEN SERVICES.

FIRST USE 3-0-1998; IN COMMERCE 4-0-1998.

ELEMENTS CORRECTED
ASSIGNMENT/NAME CHANGE

2,442,255. REG. 4-10-2001. AVIAREPS AIRLINE MANAGEMENT GROUP AG (FED REP GERMANY CORPORATION) LANDSBERGER STR. 155, 80687 MUNCHEN, FED REP GERMANY., SN 75-842,189. FILED 11-6-1999. PRINCIPAL REGISTER.

AVIAREPS

OWNER OF FED REP GERMANY REG. NO. 39817456, DATED 6-26-1998, EXPIRES 3-31-2008.

INT. CL. 35/U.S. CLS. 100, 101 AND 102

FOR BUSINESS MANAGEMENT; ARRANGING OF BUSINESS FOR OTHERS NAMELY, ARRANGING CONTRACTS FOR AIRLINE SERVICES, SALES AND NEGOTIATION REPRESENTATION FOR OTHERS AND ON BEHALF OF AIRLINES AND HOTELS; ARRANGING CONTRACTS FOR THE PURCHASE AND DISPOSAL OF GOODS, NAMELY, THE PURCHASE OF AIRPLANES AND AIRPLANE FITTINGS.

FIRST USE ; IN COMMERCE .

INT. CL. 39/U.S. CLS. 100 AND 105

FOR AIRLINE SERVICES, NAMELY, PASSENGER TRANSPORT AND FREIGHT FORWARDING BY AIR.

FIRST USE ; IN COMMERCE .

ELEMENTS CORRECTED
FILING DATE

2,458,695. REG. 6-5-2001. J.D. POWER CLUBS, INC. (CALIFORNIA CORPORATION) 221 MAIN STREET, SUITE 250, SAN FRANCISCO, CA, 94105, BY CHANGE OF NAME, BY CHANGE OF NAME AMERICAN INFORMATION COMPANY, INC. CORPORATION) SAN FRANCISCO, CA, SN 75-220,737. FILED P.R. 1-2-1997; AM. S.R. 7-13-2000. SUPPLEMENTAL REGISTER.

CARCLUB.COM

OWNER OF U.S. REG. NOS. 2,148,474, 2,188,852 AND OTHERS.

INT. CL. 35/U.S. CLS. 100, 101 AND 102

FOR STATISTICAL, MARKET RESEARCH, AND TRADE INFORMATION SERVICES; BUYING AND REFERRAL SERVICES FOR NEW AND USED AUTOMOBILES.

FIRST USE 7-28-1999; IN COMMERCE 7-28-1999.

INT. CL. 36/U.S. CLS. 100, 101 AND 102

FOR PROVIDING TELEPHONE SHOPPERS WITH AUTOMOBILE PRICE QUOTATIONS, ASSISTING CUSTOMERS IN SECURING AUTOMOBILE FINANCING BY LOCATING LENDERS, PUTTING LENDERS IN CONTACT WITH CUSTOMERS AND PROCESSING PAPERWORK IN CONNECTION WITH LOANS.

FIRST USE 7-28-1999; IN COMMERCE 7-28-1999.

INT. CL. 39/U.S. CLS. 100 AND 105

FOR ASSISTING CUSTOMERS IN SECURING AUTOMOBILE LEASES BY LOCATING LESSORS, PUTTING LESSORS IN CONTACT WITH CUSTOMERS AND PROCESSING PAPERWORK IN CONNECTION WITH LEASES.

FIRST USE 7-28-1999; IN COMMERCE 7-28-1999.

ELEMENTS CORRECTED
ASSIGNMENT/NAME CHANGE
OWNER NAME

2,465,992. REG. 7-3-2001. INTERMUNE, INC. (DELAWARE CORPORATION) 3280 BAYSHORE BOULEVARD, BRISBANE, CA, 94005, BY ASSIGNMENT; BY CHANGE OF NAME HARKONEN, SCOTT (INDIVIDUAL) SAN FRANCISCO, CA. SN 75-439,455. FILED 2-24-1998. PRINCIPAL REGISTER.

FOR PROTECTIVE GLOVES FOR INDUSTRIAL USE. FIRST USE 11-0-1996; IN COMMERCE 11-0-1998.

ELEMENTS CORRECTED
OWNER ADDRESS

INTERMUNE

INT. CL. 5/U.S. CLS. 6, 18, 44, 46, 51 AND 52
FOR PHARMACEUTICAL PREPARATIONS FOR THE TREATMENT OF A VARIETY OF HUMAN MEDICAL CONDITIONS, NAMELY, INFECTIOUS DISEASES, CANCER, CONGENITAL DISEASES, PULMONARY CONDITIONS AND IMMUNOLOGICAL DISORDERS.
FIRST USE 5-3-1999; IN COMMERCE 5-3-1999.

2,472,816. REG. 7-31-2001. 8440 LLC (CALIFORNIA CORPORATION) 8440 SUNSET BOULEVARD, WEST HOLLYWOOD, CA, 90069, SN 75-750,929. FILED 6-30-1999. PRINCIPAL REGISTER.

ELEMENTS CORRECTED
OWNER NAME
OWNER ADDRESS
ASSIGNMENT/NAME CHANGE

2,466,184. REG. 7-3-2001. PIERANGELO FENZI S.R.L. (ITALY LIMITED LIABILITY COMPANY) VIA CARLO PORTA, 34, LONIGO (VICENZA), ITALY., SN 75-595,340. FILED 11-24-1998. PRINCIPAL REGISTER.



falconeri

PRIORITY CLAIMED UNDER SEC. 44(D) ON ITALY APPLICATION NO. MI98C 008198, FILED 8-13-1998, REG. NO. 761546, DATED 12-11-1998, EXPIRES 8-13-2008.

THE MARK CONSISTS OF THE WORDING "FALCONERI" IN STYLIZED FORM.
INT. CL. 25/U.S. CLS. 22 AND 39

FOR SINGLET, PETTICOATS, NIGHTGOWNS, PAJAMAS, DRESSING GOWNS, PULLOVERS, BATH ROBES, GLOVES, CARDIGANS, JERSEYS, NECKTIES, NECKERCHIEFS, SCARVES, SWEATERS, SOCKS, STOCKINGS, TIGHTS, TROUSERS, LEGGINGS, SKIRTS, JACKETS, JERKINS, SHIRTS, VESTS, WAISTCOATS, JUMPERS, TRACK SUITS, BLOUSES, PANTIES, PANTS, BERMUDA SHORTS, T-SHIRTS, SWEAT-SHIRTS, SUITS AND DRESSES, OVERCOATS, ANORAKS, COATS, BELTS, SUSPENDERS, HATS, CAPS.

FIRST USE 12-16-1998; IN COMMERCE 8-9-2000.

ELEMENTS CORRECTED
PRIORITY CLAIMED STATEMENT
FOREIGN APPLICATION NO.
FOREIGN REG. NO.
FOREIGN REG. DATE
PRIORITY CLAIMED STATEMENT

OWNER OF U.S. REG. NO. 2,222,666.
INT. CL. 42/U.S. CLS. 100 AND 101
FOR BAR AND RESTAURANT SERVICES.
FIRST USE 12-0-1996; IN COMMERCE 12-0-1996.

ELEMENTS CORRECTED
OWNER NAME

2,476,083. REG. 8-7-2001. ARCH CHEMICALS, INC. (VIRGINIA CORPORATION) 501 MERRITT 7, NORWALK, CT, 06851, BY ASSIGNMENT; BY ASSIGNMENT OLIN CORPORATION (CORPORATION) NORWALK, CT, SN 75-426,732. FILED 1-30-1998. PRINCIPAL REGISTER.

DURIMIDE

2,471,943. REG. 7-24-2001. LRC PRODUCTS LIMITED (UNITED KINGDOM CORPORATION) LONDON INTERNATIONAL HOUSE, TURNFORD PLACE BROXBORNE, HERTFORDSHIRE EN10 6LN, UNITED KINGDOM., SN 75-523,642. FILED 7-22-1998. PRINCIPAL REGISTER.

INT. CL. 1/U.S. CLS. 1
FOR POLYIMIDE RESINS FOR USE IN THE MANUFACTURE OF SEMICONDUCTORS AND ELECTRONIC EQUIPMENT.
FIRST USE 1-1-2000; IN COMMERCE 1-1-2000.

FIREBLADE

INT. CL. 9/U.S. CLS. 21, 23, 26, 36 AND 38

ELEMENTS CORRECTED
ASSIGNMENT/NAME CHANGE
OWNER NAME
OWNER ADDRESS

2,478,452. REG. 8-14-2001. AGETEC, INC. (CALIFORNIA CORPORATION) 1070 STEWART DRIVE, SUITE 4, SUNNYVALE, CA, 94086, SN 75-699,345. FILED 5-7-1999. PRINCIPAL REGISTER.



INT. CL. 9/U.S. CLS. 21, 23, 26, 36 AND 38
FOR INTERACTIVE VIDEO GAMES OF VIRTUAL [REALITY] *REALITY * COMPRISED OF COMPUTER HARDWARE AND SOFTWARE.
FIRST USE 6-16-1999; IN COMMERCE 6-16-1999.

ELEMENTS CORRECTED
GOODS/SERVICES
OWNER ADDRESS

2,481,080. REG. 8-28-2001. CDME WORLD TRADE (FRANCE FRANCE PARTNERSHIP) 15 RUE D'ATHENES, 75009 PARIS, FRANCE., SN 75-129,741. FILED 7-3-1996. PRINCIPAL REGISTER.

WEBCO

PRIORITY CLAIMED UNDER SEC. 44(D) ON FRANCE APPLICATION NO. 96604699, FILED 1-5-1996, REG. NO. 96604699, DATED 1-5-1996, EXPIRES 1-5-2006.

INT. CL. 1/U.S. CLS. 1

FOR CHEMICAL PRODUCTS FOR INDUSTRY, NAMELY, PREPARATIONS FOR QUENCHING AND WELDING METAL; SOLDERING FLUXES; CHEMICAL PREPARATIONS TO FACILITATE THE ALLOYING OF METALS; SOLDERING FLUX, IN PARTICULAR SOLDERING LIQUID; PROTECTIVE GASES FOR WELDING; UNTREATED PLASTICS AND SYNTHETIC RESINS IN THE FORM OF POWDERS, LIQUIDS OR PASTES FOR USE IN THE MANUFACTURE OF PLASTIC MOLDING COMPOUNDS AND PLASTIC SHEETS AND FILMS; FIRE EXTINGUISHING COMPOSITIONS; GLUES AND OTHER ADHESIVE SUBSTANCES FOR USE ON ELECTRICAL APPARATUS AND HOUSINGS THEREFOR, TELEPHONE COMMUNICATIONS EQUIPMENTS, ELECTRICAL AND ELECTRONIC COMPONENTS AND PRINTED CIRCUIT BOARDS; PHOTO-SENSITIVE RESINS FOR PRINTED CIRCUITS; FERRIC CHLORIDE FOR USE IN THE MANUFACTURE OF PRINTED CIRCUITRY.

INT. CL. 3/U.S. CLS. 1, 4, 6, 50, 51 AND 52

FOR ALL PURPOSE CLEANING PREPARATIONS FOR CLEANING, POLISHING, DEGREASING, DETACHING, ABRADING, DESICCATING, RUST REMOVAL FOR USE ON MOTORS, MACHINES, MACHINE PARTS, MACHINE TOOLS, TOOLS, FINISHED AND SEMI-FINISHED METAL CASTINGS AND SHAPES; ALL PURPOSE CLEANING AND MAINTENANCE PREPARATIONS FOR INDUSTRIAL USE, IN PARTICULAR FOR MECHANICAL PARTS, FOR METALS, FOR MOTORS, FOR TOOLS, FOR MACHINES; ALL PURPOSE CLEANING AND MAINTENANCE PREPARATIONS FOR THE OFFICE, OFFICE AUTOMATION AND ELECTRONIC DATA PROCESSING APPARATUS.

INT. CL. 4/U.S. CLS. 1, 6 AND 15

FOR INDUSTRIAL LUBRICANTS; INDUSTRIAL OILS AND GREASES.

INT. CL. 6/U.S. CLS. 2, 12, 13, 14, 23, 25 AND 50

FOR METAL CABLE CLIPS AND MOUNTING BASES THEREFOR; METAL CLIPS, EXPANDING SLEEVES AND COLLARS FOR AFFIXING SCREWS; METAL CABLE CLAMPS; METAL MACHINE BELT CLIPS; METAL ROPE THIMBLES; METAL CASES, LOCKS, HANDLES AND KEYS; DOOR HARDWARE, NAMELY, KEYS AND CYLINDERS; NON-ELECTRIC METAL LOCKS; METAL SCREW FASTENERS; METAL NUT AND BOLT FASTENERS; NON-MECHANICAL METAL REELS AND DRUMS FOR METAL WIRES AND CABLES; NON-LUMINOUS AND NON-MECHANICAL METAL PLATES AND PANELS, NAMELY, SIGNALING, WARNING, SAFETY AND INFORMATION, ORDER AND INSTRUCTION PLATES AND PANELS; NON-ELECTRIC METAL DOOR CLOSURES; METAL CABINETS, BAYS, MODULES, ENCLOSURES, BINS AND CASHBOXES; METAL STRUCTURAL, ENCLOSURE, APPARATUS, SUPPORT, FIXING, LOCKING, MOUNTING AND WIRING ELEMENTS FOR CABINETS, BAYS, MODULES, ENCLOSURES, BINS AND CASHBOXES, NAMELY, CHASSIS, ARMATURES, FRAMES, SUPPORT FRAMES, PANELS, PLATES, UPRIGHTS, DOORS, ROOFS, TOPS, PLINTHS, BASES, HEIGHT ADAPTERS, EMBELLISHES, TRAYS, SUPPORTS, BRACKETS, RACKS, RAILS, SLIDES, COVERS, BOARDS, CABLE SUPPORTS, CONNECTOR SUPPORTS; METAL FIXING CLIPS AND CASTERS FOR FURNITURE; ALL OF THE AFORESAID GOODS BEING ENTIRELY OR PRINCIPALLY OF METAL; METALS, ALLOYS OF METALS AND METALLIC COMPOSITIONS FOR WELDING AND BRAZING, NAMELY, FILLER METALS, SOLDERS FOR SOLDERING AND SOLDERS FOR BRAZING; METAL STUDS, METAL FOIL.

INT. CL. 7/U.S. CLS. 13, 19, 21, 23, 31, 34 AND 35

FOR MACHINES FOR CONSTRUCTION AND PUBLIC WORKS, NAMELY, EARTHMOVERS AND STEAMROLLERS; MACHINES FOR WORKING METAL, WOOD OR PLASTICS MATERIALS, NAMELY, LATHES, DEBRANDERS AND GRINDERS; MACHINE TOOLS, NAMELY, LATHES, DRILLS AND METAL PUNCHERS; PORTABLE POWER TOOLS, NAMELY, DRILLS, SCREWDRIVERS AND SAWS; ENGINES (OTHER THAN FOR LAND VEHICLES) MOTORS FOR MACHINES AND MACHINES TOOLS, INCLUDING MINIATURIZED MOTORS AND MICROMOTORS; MOTOR STARTERS; COUPLINGS (NON-ELECTRIC) AND TRANSMISSION UNITS (OTHER THAN FOR LAND VEHICLES); ELECTRIC POWER GENERATOR SETS COMPRISED OF ELECTRICAL TRANSFORMERS, FIELD MAGNETS AND ARMATURES, SLIP RINGS, ROTORS AND STATORS SOLD AS A UNIT; SHARPENING AND GRINDING MACHINES AND GRINDING WHEELS THEREFOR; STIRRERS, AIR CONDENSERS; COMPRESSED AIR MACHINES, COMPRESSOR PUMPS AND MOTORS; SIZING MACHINES; WOODWORKING MACHINES; SUCTION MACHINES FOR INDUSTRIAL USE; SUCTION BLOWERS; BLOWER MACHINES; SPARKING PLUGS AND IGNITION DEVICES FOR INTERNAL COMBUSTION ENGINES; ADHESIVE TAPE DISPENSING MACHINES; LATHES; PUMPS, NAMELY, WATER OIL AND OIL PUMPS FOR MOTORS AND ENGINES; VACUUM PUMPS; CENTRIFUGAL PUMPS; ROBOTS; SAWING MACHINES AND POWER SAWS; CROPPERS; PLANERS; RIVETERS; ELECTRIC SOLDERING AND DESOLDERING MACHINES; PUNCHES; CUTTERS; ELECTRIC CABLE CUTTERS; MACHINES FOR THE TEXTILE INDUSTRY, NAMELY, CLOTH CUTTING MACHINES, SEWING MACHINES AND KNITTING MACHINES; AUTOMATIC CONTROLLERS; SERVO-CONTROLLERS; POLISHING MACHINES; ELECTRIC KNIVES; ELECTRIC SCISSORS; ELECTRIC SHEARS; ELECTRIC GLUE GUNS; PAINT SPRAYER GUNS; COMPRESSED AIR GUNS FOR EXTRUDING MASTIC; SOLDERLESS WIRE-WRAP CONNECTION GUNS; HOT AIR GUNS; STRAPPING GUNS; ELECTRIC HAND DRILLS-SCREWDRIVERS; ELECTRIC SCREWDRIVERS-UNSCREWERS; STAPLING MACHINES; POLISHERS; GRINDERS; ROUTES; ELECTRO-PNEUMATIC HAMMERS; CONTROL DEVICES FOR MACHINES OR MOTORS; MECHANICALLY OR ELECTRICALLY POWERED HAND-HELD TOOLS, NAMELY, DRILLS, SCREWDRIVERS AND SAWS; MECHANICALLY OR ELECTRICALLY POWERED TOOLS FOR PRINTED CIRCUITS, NAMELY, BRAZERS AND CRIMPERS; MECHANICALLY POWERED TOOLS FOR PRINTED CIRCUITS, NAMELY, SOLDERERS; PRINTED CIRCUIT ETCHING MACHINES; PRINTED CIRCUIT DRILLING MACHINES; MECHANICALLY OR ELECTRICALLY POWERED TOOLS USED IN THE ELECTRIC AND

ELECTRONIC INDUSTRY, NAMELY, BRAZERS, CRIMPERS, BASE LAYER APPLICATORS AND CONDUCTIVE LAYER APPLICATORS; MECHANICALLY POWERED TOOLS USED IN THE ELECTRIC AND ELECTRONIC INDUSTRY, NAMELY, SOLDERERS; ERASABLE PROGRAMMABLE READ-ONLY MEMORY ERASERS; ELECTRONIC COMPONENT ASSEMBLY MACHINES; COMPONENT LEAD CUTTING MACHINES; COMPONENT PRE-FORMING MACHINES; SOLDERLESS WIRE-WRAP CONNECTION MACHINES; PRINTING MACHINES; MECHANICAL REELS, NAMELY, HOSE REELS; OVERHEAD, UNDERGROUND ELECTRIC LINE AND CABLE PULLING MACHINES; BITS; CHUCKS; PARTS AND FITTINGS FOR ALL THE AFORESAID GOODS.

INT. CL. 8/U.S. CLS. 23, 28 AND 44

FOR MANUALLY POWERED HAND-HELD TOOLS AND INSTRUMENTS, IN PARTICULAR FOR ELECTRICIANS, NAMELY, SHEARS, KNIVES, PLIERS, CABLE TIE APPLICATORS, WIRING TOOLS, SIDE CUTTERS, CABLE CUTTERS, WIRE STRIPPERS, STRIPPERS, CRIMPERS, NIBBLERS, SCREWDRIVERS, DRILL BITS, MANUAL GLUE GUNS, GUNS FOR EXTRUDING MASTIC, TWEEZERS, TOOLS FOR PRINTED CIRCUITS, NAMELY, DRILL BITS FOR PRINTED CIRCUITS, MILLING CUTTERS FOR PRINTED CIRCUITS, SAWS AND SAW BLADES FOR PRINTED CIRCUITS; HAND TOOLS, NAMELY, SCREWDRIVERS, PLIERS, CRIMPERS AND CUTTERS USED IN THE ELECTRICAL AND ELECTRONIC INDUSTRY; VISES, IN PARTICULAR FOR ELECTRONICS; TOOLS AND INSTRUMENTS, NAMELY, DISPENSERS AND APPLICATORS FOR DISPENSING AND APPLYING ELECTRIC CONDUCTOR MARKERS; TOOLS, NAMELY, APPLICATORS FOR APPLYING MARKERS TO MARKER-HOLDERS, EXTRACTORS FOR REMOVING MARKERS FROM MARKER-HOLDERS, TOOLS, NAMELY, DISPENSERS AND CRIMPERS FOR DISPENSING STRIPS OF WIRING FERRULES AND CRIMPING THE FERRULES NEEDLES AND WIRE PULLERS FOR PULLING ELECTRIC CABLES, PUNCHES, STRAPPING GUNS, CABLE CLAMP APPLICATORS, NON-ELECTRIC SOLDERING IRONS; TOOLS, NAMELY, CRIMPERS AND CUTTERS FOR OPTICAL FIBERS; BITS (PARTS OF TOOLS) PARTS AND FITTINGS FOR ALL THE AFORESAID GOODS; CASES FOR ALL OF THE AFORESAID GOODS.

INT. CL. 9/U.S. CLS. 21, 23, 26, 36 AND 38

FOR ELECTRONIC REMOTE CONTROL, SIGNALING, SURVEILLANCE, REMOTE SURVEILLANCE, INSPECTION, ACCESS CONTROL, DETECTION AND ALARM EQUIPMENT AND INSTRUMENTS, NAMELY, ELECTRICAL REMOTE CONTROLLERS, VIDEO CAMERAS, VIDEO MONITORS, ELECTRONIC IDENTIFICATION CARD READERS; BLANK COMPUTER DISKETTES, FLEXIBLE DISKETTES, MINIDISKS, AUDIO TAPES, VIDEOTAPES, CASSETTES, CARTRIDGES, MAGNETIC CARTRIDGES, MAGNETIC CARTRIDGES, BACKUP CARTRIDGES, FILM WIRES, MEMORY CARDS, GRAPHICS CARDS, SOUND CARDS, ACCELERATOR CARDS, COMMUNICATION CONTROLLER CARDS, DISK CONTROLLER CARDS, MEMORY EXPANSION TERMINAL STRIPS; BLANK VIDEODISKS, VIDEOCASSETTES, COMPACT DISCS, AUDIO AND VIDEO OPTICAL DISKS, OPTICAL COMPACT DISCS, INTERACTIVE OPTICAL COMPACT DISCS PHONOGRAMS, IDEOGRAMS; FILMS FOR RECORDING SOUND; COMPUTER SOFTWARE AND COMPUTER PROGRAMS FOR USE IN DESIGNING ELECTRONIC CIRCUITRY; COMPUTER SOFTWARE AND COMPUTER PROGRAMS FOR USE IN THE DESIGN OF PRINTED CIRCUIT BOARDS; PRINTED CIRCUITS; PRINTED CIRCUIT BOARDS AND MICROBOARDS, SEMICONDUCTORS, NAMELY, INTEGRATED CIRCUITS, ANALOG INTEGRATED CIRCUITS, DIGITAL INTEGRATED CIRCUITS, INTERFACE AND PERIPHERAL DEVICE INTEGRATED CIRCUITS, DIODES, MOLDERED BRIDGES AND MODULES, MEMORIES, MICROPROCESSORS, MICROCONTROLLERS, PROGRAMMABLE CIRCUITS, TRANSISTORS, DISCS, MODULES, THYRISTORS AND TRACES; OPTO-ELECTRONIC SEMICONDUCTORS; ELECTRONIC CHIPS; ELECTRONIC TUBES; MAGNETIC ENCODERS; DATA ENCODERS; DATA DECODERS; AUTOMATIC DISPENSERS AND MECHANISMS FOR PRE-PAYMENT APPARATUS; CASH REGISTERS; CALCULATING MACHINES; CALCULATORS, IN PARTICULAR POCKET CALCULATORS; ELECTRONIC DATA PROCESSORS; COMPUTERS, MINICOMPUTERS; MICROCOMPUTERS; PORTABLE COMPUTERS; COMPUTER AND MICRO-

COMPUTER CENTRAL PROCESSOR UNITS; COMPUTER PERIPHERAL DEVICES, INCLUDING [;] * - * DISPLAY CONSOLES, MONITORS, SCREENS, GRAPHICS SCREENS, TACTILE SCREENS, READERS, KEYBOARDS, PRINTERS, DIGITIZER PADS, REMOVABLE OR NON-REMOVABLE DISK DRIVES, INTERFACES, MODEMS; ELECTRONIC DATA PROCESSING TERMINALS; MAGNETIC STRIPE CARD READERS AND ENCODERS; CD-ROM DRIVES; OPTICAL DISK DRIVES; DISKETTE DRIVES; BAR CODE READERS; INTERFACE APPARATUS FOR ELECTRONIC DATA PROCESSORS, NAMELY, COMMUNICATION ADAPTERS FOR ASYNCHRONOUS CONVERSION, NETWORK ADAPTERS, DATA COMMUNICATION TEST APPARATUS, ELECTRONIC DATA PROCESSING CABLES, NETWORK SWITCHES, NETWORK CONCENTRATORS, ELECTRONIC DATA PROCESSING APPARATUS UNINTERRUPTIBLE POWER SUPPLIES, LOCAL AREA NETWORK INTERFACES, LOCAL AREA NETWORK GATEWAYS; ANALOG-DIGITAL CONVERTERS; OPTICAL READERS; DATA CAPTURE APPARATUS; COMPUTER MEMORIES; RANDOM ACCESS MEMORIES; READ ONLY MEMORIES; PROGRAMMABLE READ ONLY MEMORIES; ERASABLE PROGRAMMABLE READ ONLY MEMORIES; ERASABLE PROGRAMMABLE READ ONLY MEMORY PROGRAMMERS; MICE (COMPUTER) AND MOUSE MATS; IMAGE AND TEXT SCANNERS FOR COMPUTERS; DIGITAL PLOTTERS AND PLOTTING TABLES; TEXT PROCESSING APPARATUS; TELEPRINTERS; DATA TRANSMITTERS; MULTIPLEXERS; CARRYING CASES SPECIALLY ADAPTED FOR COMPUTERS; TELEPHONE SETS; TELEPHONES; CAR TELEPHONES; TELEPHONE ANSWERING MACHINES AND DEVICES FOR REMOTELY INTERROGATING THE LATTER; TELEPHONE JACKS; TELEPHONE SWITCHBOARDS; RADIOTELEPHONE SETS; VOICE MAIL APPARATUS; PAGING TERMINALS; TRANSMITTERS AND RECEIVERS (TELECOMMUNICATION); TELEPHONE TRANSMITTERS; DISTRIBUTION FRAMES (TELECOMMUNICATIONS); CABLE TERMINATION'S (TELECOMMUNICATION); HF RADIO COMMUNICATION TRANSMITTERS; AUDIO AND/OR VIDEO RECEIVERS; VIDEOPHONES; VIDEO CONFERENCE APPARATUS; AUDIO AND/OR VIDEO APPARATUS FOR LANGUAGE LABORATORIES, NAMELY, AUDIO CASSETTE RECORDERS AND PLAYERS, VIDEO CASSETTE RECORDERS AND PLAYERS AND VIDEO MONITORS; TELEPHONE EAR PIECES; TELEPHONE HEADSETS; HEADPHONES; EAR PIECES; AUDIO AND/OR VIDEO ENTRY PHONE APPARATUS FOR HOUSES AND BUILDINGS; TELEPHONE AND KEYPHONE HANDSETS; VIDEO AND KEYPHONE EXCHANGES; VIDEO DISTRIBUTION AMPLIFIERS; ELECTRIC DEVICES FOR SUPPRESSING NOISE AND INTERFERENCE; KEYPHONES; MICROPHONES; WALKIE-TALKIES, AMPLIFIERS AND PRE-AMPLIFIERS; LOUDSPEAKERS; LOUDSPEAKER ENCLOSURES; HIGH FIDELITY STEREO PLAYERS AND COMPONENTS THEREOF; AUDIO CASSETTE DECKS; AUDIO/VIDEO COMPACT DISC PLAYERS; AUDIO/VIDEO TAPE RECORDERS; DICTATING MACHINES; PUBLIC ADDRESS APPARATUS; SOUND PROJECTORS; MIXING DESKS; RADIO AND TELEVISION SETS; ANTENNAS; PHOTOCOPIER APPARATUS AND MACHINES; PROJECTION APPARATUS, SCREENS AND LAMPS; SLIDES; SCREENS, FILTERS, MASKS AND FLASHES FOR PHOTOGRAPHY; FACSIMILE MACHINES; DATA TRANSMISSION CONSOLES; VIDEO SURVEILLANCE APPARATUS, NAMELY, VIDEO CAMERAS AND VIDEO MONITORS; VIDEO CAMERAS AND CASES AND OBJECTIVES THEREFOR; VIDEO SCREENS AND MONITORS; VIDEO TAPE RECORDERS; VIDEO SELECTORS; CAMERA CASE AND MONITOR SUPPORTS REVOLVING OBJECTIVE CHANGERS FOR CAMERAS; ELECTRICAL FITTINGS AND WIRING ACCESSORIES, NAMELY, PLUGS, SOCKETS AND ELECTRICAL CORDS; CABINETS; BAYS; CASES; BOXES; DESKS; CONSOLES; PANELS AND BOARDS FOR ELECTRICAL APPARATUS AND CIRCUITS, IN PARTICULAR FOR SUPPLYING INSTALLATION WITH ELECTRIC CURRENT DISTRIBUTION, BRANCHING TRANSFORMATION OF ELECTRIC CURRENT, CONTROL OF ELECTRIC CURRENT AND OF APPARATUS SUPPLIED WITH ELECTRIC CURRENT; CONTROL AND DISTRIBUTION PANEL (ELECTRICITY); CONTROL OHMMETER PANELS (ELECTRICITY) ELECTRIC CONTROL AND REMOTE CONTROL APPARATUS AND INSTALLATIONS, IN PARTICULAR FOR LIGHTING,

HEATING, AIR CONDITIONING, SHUTTERS, AWNINGS, PROJECTION SCREENS, DOORS, GATES, LOCKS AND, IN GENERAL, FOR ANY ELECTRICALLY POWERED APPARATUS; LIGHTING CONTROL, REMOTE CONTROL AND MONITORING APPARATUS; REMOTE CONTROLLERS; WIRELESS REMOTE CONTROLLERS; REMOTE TRANSMITTERS; CROSS-CONNECT PANELS; ELECTRIC DISTRIBUTION PANELS ELECTRONIC DATA PROCESSORS; MODULAR PANELS (ELECTRICITY); OPTICAL MODULES; OUTDOOR METER BOXES (ELECTRICITY); ELECTRIC ACCUMULATORS; ELECTRIC CELLS AND BATTERIES; ACCUMULATOR BATTERY CHARGERS; CURRENT RECTIFIERS; ELECTRIC BALLASTS AND MONITORS THEREFOR; MAGNETS; POWER SUPPLIES (ELECTRICITY); LOAD DISPATCHERS (ELECTRICITY); CONVERTERS; SURGE ARRESTERS; TRANSFORMERS; AUTO-TRANSFORMERS; MODULAR CONNECTOR; FILTERS (ELECTRICITY); CAPACITORS; INDUCTOR WINDINGS; MAGNETIC CORES; CHOKES; DIODES; MODULAR UNITS (ELECTRICITY); INVERTERS (ELECTRICITY) CONCENTRATORS; BUSBARS AND TERMINAL STRIPS, JUNCTION STRIPS; ELECTRIC DISTRIBUTION STRIPS; TERMINALS AND CABINETS FOR ELECTRICAL CONNECTIONS; TRACK CONNECTORS (ELECTRICITY); QUARTER-TURN CONNECTORS, SCREW CONNECTORS, INSULATION DISPLACEMENT CONNECTORS, COAXIAL CONNECTORS AND ADAPTERS, POWER CONNECTORS, SEALED CONNECTORS, HIGH AND VERY HIGH VOLTAGE CONNECTORS, MICROMINUTORIZED CONNECTORS, MINIATURE TERMINAL STRIPS AND CONNECTORS FOR PRINTED CIRCUITS, MULTIPIN CONNECTORS, SPECIAL-PURPOSE MODULAR ELECTRONIC DATA PROCESSING AND TELEPHONE CONNECTORS, OPTICAL CONNECTORS, OPTICAL FIBER CONNECTORS; CONNECTOR PROTECTION SLEEVES; TERMINAL BLOCKS; CONTROL AND DISTRIBUTION BOXES (ELECTRICITY); ELECTRONIC CONDUCTOR BOXES; JUNCTION BOXES; JUNCTION BLOCKS; FLUSH BOXES TERMINAL AND TERMINAL BOARDS (ELECTRICITY); ELECTRIC PROTECTION APPARATUS, NAMELY, CIRCUIT BREAKERS AND BREAKER BOXES; CUTOUPS FOR POWER AND DISTRIBUTION CIRCUITS; ISOLATORS; CUTOUT BARS IN THE NATURE OF IN THE NATURE OF ON/OFF SWITCHING DEVICES; SWITCHES; KEYSWITCHES; INTERMEDIATE SWITCHES; CHANGEOVER SWITCHES; EXCHANGES; PUSHES AND PUSH-BUTTONS, LUMINOUS AND NON-LUMINOUS; PUSH-BUTTON BOXES; CONTROL KEYPADS (ELECTRICITY); TWO-WAY SWITCHES; PENDANT SWITCHES; CONTROL FINGERS AND EMBELLISHERS FOR ELECTRICAL FITTINGS AND WIRING ACCESSORIES; ELECTRIC CORDS FOR PULL-CORD SWITCHES; PULSE OPERATED LATCHING RELAYS; MINIATURE CIRCUIT-BREAKERS; CIRCUIT-BREAKERS; DIFFERENTIAL CIRCUIT-BREAKERS; LIGHTNING ARRESTERS; FUSES; CARTRIDGE FUSES; SUBSCRIBER PANELS (ELECTRICITY); JUNCTION PANELS; ELECTRIC RESISTORS; CABLE OUTLETS; TIME-LEG SWITCHES FOR LIGHTING AND/OR ELECTRIC INSTALLATIONS; INDICATORS AND SIGNAL LAMPS (ELECTRICITY); CONTRACTORS; RELAYS; PROGRAMMERS; ELECTRIC HEATING AND DOMESTIC APPLIANCE PROGRAMMERS; TIME SWITCHES; LIGHT-SENSITIVE SWITCHES AND RELAYS; LOAD SHEDDERS; VOLTAGE REGULATORS; VOLTAGE CONTROLLERS; LIGHT DIMMERS AND REMOTE CONTROL DIMMERS SPEED CONTROLLERS (ELECTRICITY); PLUGS AND SOCKETS; BLANKING PLATES (ELECTRICITY); SOCKET OUTLET/BLANKING PLATES; SOCKET OUTLET PROTECTION UNITS; LOUDSPEAKER PLUGS AND SOCKETS; TELEVISION PLUGS AND SOCKETS; VIDEO PLUGS AND SOCKETS; HIGH FIDELITY PLUGS AND SOCKETS; TELEPHONE PLUGS AND SOCKETS; ELECTRONIC DATA PROCESSING APPARATUS PLUGS AND SOCKETS; OPTICAL PLUGS AND SOCKETS; MULTI-OUTLET SOCKET BLOCKS; DOUBLE AND TRIPLE SOCKET OUTLETS; CABLE-MOUNTING SOCKET OUTLETS; SOCKET OUTLET WALL BOXES; ADAPTERS; PLUGS; ELECTRIC EXTENSION LEADS; TELEPHONE EXTENSION LEADS; ELECTRONIC DATA PROCESSING APPARATUS CABLES AND ADAPTERS; ELECTRONIC DATA PROCESSING LINE PROTECTION APPARATUS; PARALLEL LINE AMPLIFIERS; ELECTRONIC DATA PROCESSING AND OPTICAL FIBER REPEATERS; REELS AND DRUMS FOR ELECTRIC CONDUCTORS; GROMMETS FOR ELECTRIC CONDUCTORS; JUNCTION SLEEVES FOR ELECTRIC

CABLES; ELECTRIC LINE CONNECTORS; ELECTRIC CABLE AND TERMINAL BLOCK MARKER APPARATUS (ELECTRICITY), NAMELY, MARKERS, MARKER-HOLDERS AND MARKER APPLICATORS; SPECIAL-PURPOSE BOXES, CASES, CONTAINERS AND CHESTS FOR STORING APPARATUS FOR MARKING ELECTRIC CONDUCTORS AND FOR MAKING UP MARKERS PRIOR TO FITTING; GROUNDING DEVICES; GROUND SPIKES; MAINS ELECTRIC POWER SUPPLY PROTECTION APPARATUS, NAMELY, ELECTRONIC AND ELECTRICAL PROTECTION CIRCUITRY (ELECTRICITY); ELECTRIC CONDUCTOR CLIPS; ELECTRIC CONDUCTOR INSTALLATION EQUIPMENT, NAMELY, STRAPPING, WIRING, ATTACHMENT AND CLAMPING COLLARS; ELECTRIC CONDUCTORS, IN PARTICULAR CABLES, WIRES, CORDS, TRACKS AND BUSBARS; ELECTRONIC DATA PROCESSING APPARATUS CABLES; SPECIAL CABLES FORM ELECTRONIC DATA PROCESSING LOCAL AREA NETWORKS; ETHERNET CABLES; TWINAX CABLES; COAXIAL CABLES; ETHERNET CARDS; OPTICAL FIBERS; INSTALLATION AND/OR DISTRIBUTION STRUCTURAL SECTIONS FOR ELECTRIC CONDUCTORS AND/OR APPARATUS, NAMELY, DUCTING, SHEATHING, CONDUCT, PIPES, COLUMNS, TUBES, MOLDINGS, BASEBOARDS, RAILS, WIRING ENCLOSURE STRIPS, FLOOR BOXES, CABLE GUIDES, WIRE COVERS; PREFABRICATED ELECTRIC DUCTS AND SUPPORTS THEREFOR; EQUIPMENT, STRAPPING, JOINTING, JUNCTION, SUPPORT, ASSEMBLY, CONNECTION AND FINISHING PARTS FOR ELECTRIC CONDUCTORS AND/OR APPARATUS, NAMELY, ELECTRIC CABLE SUPPORTS, JUNCTION BOXES AND TEES, CONNECTOR OUTLETS, JUNCTION BOXES CONNECTION ELBOWS, END PIECES, COVER SEALS, ADAPTERS, INTERNAL PARTITIONS, EXPANSION SLEEVES; LUMINOUS OR MECHANICAL SIGN; SIGNAL LAMPS; LIGHTED SIGNS, BEACONS, STUDS, BULKHEAD LIGHTS, BLOCKS, PLATES, BOXES AND BOX-SECTIONS, ALL LUMINOUS, EQUIPPED WITH SOCKET OUTLETS OR NOT, AND ALL FOR BEACHING SIGNALING; DISPLAYING INFORMATION AND/OR ADVERTISING; LUMINOUS BLOCKS AND PLATES, CARRYING TEXT OR PICTOGRAMS OR NOT, FOR INFORMATION AND SAFETY SIGNALING; BEACON LAMPS; (SIGNALING); LUMINOUS OR MECHANICAL SIGNS; LUMINOUS OR MECHANICAL SIGNALLY PANELS; NEON SIGNS; ELECTRIC LIGHT BULB OR TUBE HOLDERS AND MOUNTINGS; BELL PUSHES; BELTS AND CHIMES (WARNING DEVICES), IN PARTICULAR FOR DOORS; ELECTRIC DOORBELLS; ELECTRIC NETWORK ALARM DEVICES; LUMINOUS ALARMS; FLASHLAMPS (SIGNALING AND ALARM; AUDIO ALARM; ACOUSTIC ALARMS; THEFT ALARMS (OTHER THAN FOR VEHICLES); FIRE ALARMS; ELECTRIC ALARM GONGS; BUZZERS; SIRENS; RADIO TRANSMITTERS AND RECEIVERS; ALARM SYSTEM CENTRAL CONTROL UNITS; FIRE ALARM SYSTEM CENTRAL CONTROL UNITS; DOMESTIC ALARM SYSTEM CENTRAL CONTROL UNITS; DETECTORS; INFRARED DETECTORS; MOVEMENT DETECTORS BEAM INTERRUPTION DETECTORS; INTRUDER DETECTORS; PROXIMITY DETECTORS; RADIO FREQUENCY DETECTORS; SMOKE AND FIRE DETECTORS; GAS DETECTORS; METAL DETECTORS; LEVEL DETECTORS; PHOTO-ELECTRIC CELLS; ELECTRIC CONTACTS, IN PARTICULAR FOR DOORS AND GATES; ELECTRIC AND ELECTRONIC BOLTS, ELECTRIC LOCKS AND CLOSURES AND CONTROL AND REMOTE CONTROL DEVICES THEREFOR, IN PARTICULAR KEYPAD TYPE; ELECTRIC DOOR CLOSURES; ACCESS CONTROL APPARATUS, NAMELY, KEYPADS, ACCESS CONTROL APPARATUS CASINGS AND READERS; BUILDING ENTRY DOOR CODE KEYPADS; MAGNETIC AND/OR ELECTRONIC AND/OR OPTICAL AND/OR DIGITAL CARDS AND BADGES FOR ACCESS CONTROL; SMART CARDS; OPTICAL READERS; BAR CODE READERS; SMART CARD READERS; OPTICAL LAMPS; METERING APPARATUS, NAMELY, VOLTMETERS, AMMETERS AND FLUID FLOW METERS; ELECTRIC POWER METERS; MEASURING APPARATUS FOR ELECTRIC CIRCUITS; MEASURING APPARATUS, IN PARTICULAR FOR MEASURING CHARACTERISTICS OF ELECTRIC CURRENT AND VOLTAGE; GROUND MEASURING, CHECKING AND MONITORING APPARATUS; VOLTAGE, GROUNDING AND SHORT-CIRCUIT MONITORS, DETECTORS AND INDICATORS; TEST APPARATUS FOR TESTING ELECTRIC CURRENT AND ITS CHARACTERISTICS;

APPARATUS FOR TESTING THE CONFORMITY OF ELECTRIC INSTALLATIONS; FAULT DETECTORS; SHORT-CIRCUITING DEVICES; ELECTRIC SOLDERING IRONS; ELECTRIC SOLDERING AND DESOLDERING APPARATUS; WELDING ELECTRODES ELECTRIC AND ELECTRONIC APPARATUS FOR SOLDERING ELECTRONIC COMPONENTS TO CIRCUIT BOARDS AND CIRCUITS; ELECTRIC WELDING APPARATUS AND STATIONS; INDUSTRIAL ELECTRONIC APPARATUS, NAMELY, PHOTO-ELECTRIC SAFETY BARRIERS, ELECTRONIC SENSORS, ROTARY POSITION SENSORS, COLOR RECOGNITION CELLS, ELECTROMAGNETIC ENCODERS, INCREMENTAL OPTICAL ENCODERS, PHOTO-ELECTRIC DEVICES, ELECTROMECHANICAL COUNTERS, ELECTRONIC COUNTERS, ELECTRONIC LIGHT DETECTORS, ELECTRONIC TORQUE LIMITERS, DATA ACQUISITION DEVICES FOR INDUSTRIAL USE, NAMELY, DATA ENCODERS AND DATA TRANSMITTERS; COMPUTER-AIDED DRAFTING DEVICES, NAMELY, SOFTWARE FOR USE IN COMPUTER AIDED DESIGN AND ELECTROMECHANICAL PLOTTERS; MONITORING AND ANALYSIS APPARATUS AND INSTRUMENTS FOR CIRCUITS AND NETWORKS, NAMELY, HARMONIC ANALYZERS, ELECTRIC NETWORK ANALYZERS, ELECTRONIC DATA PROCESSING NETWORK ANALYZERS, INSULATION TESTERS, DIFFERENTIAL CIRCUIT-BREAKER TESTERS, DIELECTRIC STRENGTH METERS, INTERFERENCE RECORDING APPARATUS, CABLE LOCATORS, OHMMETERS, LEAKAGE CURRENT CLAMPS, FAULT LOCATING BRIDGES, TIMING LIGHTS, TELLUROMETERS, ELECTRIC WIRING TESTS, MULTIFUNCTIONAL ELECTRIC TESTING APPARATUS; RECORDERS AND PLOTTERS; CURRENT, VOLTAGE, POWER, FREQUENCY, PHASE AND ENERGY INDICATORS, NAMELY, AMMETER, ELECTRIC METERS, ELAPSED TIME COUNTERS, MEASUREMENT CONVERTERS, FREQUENCY METERS, PHASE METERS, CURRENT MEASURING CLAMPS, SHUNTS, MEASUREMENT TRANSFORMERS, VOLTAGE CHECKERS AND DETECTORS, VOLTMETERS, WATTMETERS; MAGNETIC MEASURING INSTRUMENTS, INCLUDING FIELD METERS, FLUX METERS, GAUSS METERS, MAGNETOMETERS; ELECTRONIC MEASURING APPARATUS AND INSTRUMENTS, NAMELY, LOGIC ANALYZERS, INTEGRATED CIRCUIT TESTERS, ELECTRONIC COMPONENT TESTERS, LOW FREQUENCY SIGNAL GENERATORS, PLUS GENERATORS, FUNCTION GENERATORS, MEASURING SOFTWARE, MULTIMETERS AND PROBES THEREFOR, OSCILLOSCOPES AND PROBES THEREFOR, MULTIMETER CLAMPS, SOUND PRESSURE LEVEL METERS; PHYSICAL-CHEMICAL MEASURING APPARATUS AND INSTRUMENTS, INCLUDING - DATA ACQUISITION CENTERS, VIBRATION AESTERS, HARMONIC GENERATORS, BINARY WORD GENERATORS, ELECTRONIC LEVEL GENERATORS, LIGHT METERS, STROBOSCOPES, TACHOMETERS AND TACHOMETERS SENSORS; ELECTRIC MEASURING APPARATUS AND INSTRUMENTS, NAMELY, MEASUREMENT BRIDGES, METERS; RADIO FREQUENCY MEASUREMENT APPARATUS AND INSTRUMENTS, INCLUDING VERY HIGH FREQUENCY MEASURING SETS, RADIO FELED METERS, FREQUENCY METERS, PERIOD METERS, MEDIUM FREQUENCY, HIGH FREQUENCY AND VERY HIGH FREQUENCY SIGNAL GENERATORS, ELECTRONIC TEST PATTERN GENERATORS, WAVE METERS, LOSS ANGLE MEASURING BRIDGES, Q-METERS, TIMING LIGHTS, TRANSISTOR TESTERS, WOBBLATORS HIGH-FREQUENCY VOLTMETERS; INDUCTANCE, RESISTANCE AND CAPACITANCE MEASURING APPARATUS AND INSTRUMENTS, NAMELY, STANDARD CAPACITOR BOXES, STANDARD RESISTOR BOXES, STANDARD INDUCTOR BOXES, VOLTAGE DIVIDERS, VOLTAGE DIVIDER BOXES, CAPACITANCE METERS, CONDUCTANCE METERS, OHMMETERS, MEGOHMMETERS, MEASURING APPARATUS AND INSTRUMENTS FOR TEMPERATURE REGULATION, NAMELY, THERMOCOUPLE COMPENSATORY CABLES, PYROMETER RODS, TEMPERATURE SENSORS, THERMOCOUPLE COLD WELD COMPENSATORS, THERMOCOUPLE PLUG-IN CONNECTORS, HIGHTEMPERATURE THERMOCOUPLES, TEMPERATURE RECORDERS, TEMPERATURE INDICATORS, PYROMETERS, PROSTATES TEMPERATURE REGULATORS, SENSORS, THERMOMETERS, ELECTRONIC THERMOMETERS; INFRARED THERMOMETERS, THERMOSTATS; MEASURING LEADS; CASES, JACK-

ETS AND COVERS FOR MEASURING INSTRUMENTS; SPECIAL CASES FOR MEASURING INSTRUMENTS; MEASURING SETS; DENSITY MEASURING APPARATUS; CASES, CABINETS, RACKS, MODULES, SUBRACKS, CASSETTES AND PLUG-IN MODULES, ALL SPECIFICALLY ADAPTED TO HOUSE ELECTRIC, ELECTRONIC AND/OR ELECTRONIC DATA PROCESSING APPARATUS, INCLUDING ELECTRONIC CARDS AND PRINTED CIRCUITS; EXTENDERS, GUIDES, SUPPORTS AND EXTRACTORS, ALL FOR ELECTRONIC CARDS AND PRINTER CIRCUITS; ELECTRIC WIRING FOR THE AFORESAID GOODS; ELECTRIC CABLE DUCTING FOR THE AFORESAID GOODS; ELECTRIC APPARATUS FOR THE AFORESAID GOODS, NAMELY, DISTRIBUTION BOXES, DISTRIBUTION RAILS, ELECTRIC CONTACTS, CONNECTORS; FRAME GROUNDS AND PARTS THEREOF FOR THE AFORESAID GOODS, NAMELY, GROUND CLAMPS AND GROUNDING TERMINALS; ELECTRIC OR ELECTRONIC LOCKS FOR THE AFORESAID GOODS; APPARATUS, HARDWARE AND PARTS FOR THE ELECTRONIC INDUSTRY, NAMELY, POWER SUPPLY BUSBARS, KNOBS AND DIALS, PIECE-ELECTRIC BUZZER AND RINGERS, TEST LEADS AND ADAPTERS, BANANA SOCKETS, BANANA PLUGS, CROCODILE CLIPS, TEST PROBES, SEMICONDUCTOR, INTEGRATED CIRCUIT AND ELECTRONIC COMPONENT SOCKETS, SUPPORTS DESIGNED FOR CELLS AND BATTERIES, MINIATURE SWITCHES FOR PRINTED CIRCUITS, FERRITE COMPONENTS AND MAGNETIC CORES, ATTENUATES, INTERFERENCE SUPPRESSERS, FILTERS AND DELAY LINES, POTENTIOMETERS AND RESISTORS, QUARTZ CRYSTALS, RELAYS, RELAY SOCKETS; SAFETY NETS; SAFETY CLOTHING AND FOOTWEAR, NAMELY, RADIATION AND FIRE RESISTANT CLOTHING AND FOOTWEAR, INSULATING CLOTHING AND FOOTWEAR, SAFETY AND FIREPROOF GLOVES; SAFETY HELMETS; SAFETY MASKS, VISORS AND GOGGLES FOR WORKERS AND WELDERS; ANTI-GLARE GOGGLES AND VISION; SAFETY HARNESSSES AND BELTS FOR ELECTRIC POWER LINeworkERS; ELECTRIC COUPLINGS (OTHER THAN FOR LAND VEHICLES); PRINTED CIRCUIT CARD SUBRACKS; PRINTED CIRCUIT CARD EXTENDERS; PRINTED CIRCUIT CARD GUIDES; PRINTED CIRCUIT CARD SUPPORTS; PRINTED CIRCUIT CARD EXTRACTORS; PRINTED CIRCUIT CARD HANDLES; BALLASTS FOR LIGHTING TUBES; LUMINOUS SIGNS; BULKHEAD LIGHTS AND BOX UNITS, EQUIPPED WITH ELECTRIC SOCKET OUTLETS; ELECTRICALLY POWERED TOOLS FOR PRINTED CIRCUITS, NAMELY, ELECTRIC SOLDERERS; ELECTRICALLY POWERED TOOLS USED IN THE ELECTRIC AND ELECTRONIC INDUSTRY, NAMELY, ELECTRIC SOLDERERS; AND PARTS FOR ALL THE AFORESAID GOODS.

FIRST USE ; IN COMMERCE .

INT. CL. 11/U.S. CLS. 13, 21, 23, 31 AND 34

FOR ELECTRIC LAMPS; LAMPS; TUBULAR ELECTRIC LAMPS; DIACHRONIC LAMPS; ELECTRIC BULB; LIGHT BULBS; LIGHT TUBES; ELECTRIC DISCHARGE LIGHT TUBES; FLUORESCENT LIGHT TUBES; INFRARED LAMPS; ULTRAVIOLET LAMPS FOR NON-MEDICAL [USEL] * USE * * ; * GERMICIDAL LAMPS; LAMP BRACKETS; AUTONOMOUS LIGHTING UNITS, INCLUDING EMERGENCY LIGHTING; MODULAR EMERGENCY LIGHTING UNITS; EMERGENCY LIGHTING UNITS AND PLATES WITH OR WITHOUT TEXT OR PICTOGRAMS; SPOTLIGHTS; FLOODLIGHTS; LIGHTING TRACKS; READING LAMPS; LANTERNS; CEILING LIGHTS; LUMINARIES; LAMP AND FIRE GLOBES; PORTABLE LAMPS; INSPECTION LAMPS; FLASHLIGHTS; POCKET FLASHLIGHTS; LAMP REFLECTORS; DIFFUSERS; BAYONET AND SCREW LAMP HOLDERS, BULB HOLDERS AND TUBE SOCKETS; LIGHTING UNITS FOR CASES, CABINETS, RACKS AND MODULES ACCOMMODATING ELECTRIC, ELECTRONIC AND/OR [ELECTRIC] *ELECTRONIC * DATA PROCESSING APPARATUS; PARTS AND FITTINGS FOR ALL THE AFORESAID GOODS.

FIRST USE ; IN COMMERCE .

INT. CL. 16/U.S. CLS. 2, 5, 22, 23, 29, 37, 38 AND 50

FOR PRINTED PRODUCTS, NAMELY, PRINTED FORMS, PROSPECTUSES, FLYERS, BROCHURES, CATALOGUES, NEWSPAPERS, MAGAZINES, JOURNALS, BOOKS, GUIDES, MANUALS, TECHNICAL MANUALS, TECHNICAL CODES, DICTIONARIES, BULLETINS, INDEXES BOOKLETS ALL IN THE FIELDS OF ELECTRICAL AND ELECTRONIC APPARATUS AND THE OPERATION, REPAIR AND MAINTENANCE THEREOF; PRINTED PRODUCTS, NAMELY, FILE FOLDERS, COMPOSITION BOOKS, DRAWING BOOKS AND NOTEBOOKS; MOUNTED ARCHITECTURAL DRAWINGS OR ART PICTURES; PHOTOGRAPHS; UNMOUNTED ARCHITECTURAL DRAWINGS OR ART PICTURES; PHOTOGRAPHS; STATIONERY; GLUES AND ADHESIVES FOR STATIONERY, OFFICE AND/OR HOUSEHOLD USE; OFFICE SUPPLIES, NAMELY, ELECTRIC TYPEWRITERS AND THEIR PARTS AND COMPONENT PARTS; PRINTED INSTRUCTION, TRAINING AND TEACHING MATERIALS IN THE FIELDS OF ELECTRICAL AND ELECTRONIC APPARATUS AND THE OPERATION, REPAIR AND MAINTENANCE THEREOF; PAPER OR CARDBOARD PACKAGING, NAMELY, SHEETS, BAGS, ENVELOPES, SLEEVES AND FOLDERS; PAPER AND/OR CARDBOARD PLACARDS, ESCUTCHEONS AND SIGNS; DRAWING INSTRUMENTS; DRAWING SUPPLIES, NAMELY, PENS, PENCILS, ERASERS, CHALKS AND CHARCOALS; WRITING INSTRUMENTS; CASES AND CONTAINERS FOR WRITING OR DRAWING INSTRUMENTS AND SUPPLIES; PAPER TRANSFERS FOR PRINTED CIRCUITS; SELF ADHESIVE PAPER LABELS; OFFICE SUPPLIES, NAMELY, STAPLERS AND STAPLES; MARKER PENS FOR PRINTED CIRCUITS; PUNCHED CARD OFFICE MACHINES; DIAGRAMS FOR BUILDING COMPUTER CIRCUITS.

INT. CL. 17/U.S. CLS. 1, 5, 12, 13, 35 AND 50

FOR INSULATORS FOR ELECTRICAL CABLES; INSULATING MATERIALS, NAMELY, GLASS FIBERS FOR USE IN THE MANUFACTURE OF BUILDING INSULATION; INSULATION, NAMELY, GLASS FIBER INSULATION FOR USE IN BUILDING AND CONSTRUCTION; INSULATING TAPES; INSULATING FABRICS, NAMELY, ASBESTOS FABRICS FOR USE AS CABLE INSULATION; INSULATING PAPERS FOR USE IN THE MANUFACTURE OF ELECTRONIC COMPONENTS; THERMAL INSULATION, NAMELY, FLAME RETARDANT MATERIALS AND FABRICS FOR USE IN ELECTRICAL AND ELECTRONIC APPARATUS AND HOUSINGS THEREFOR; INSULATION FOR ELECTRICAL CONNECTIONS; ADHESIVE SEALANT FOR USE AS AN ELECTRICAL INSULATOR; INSULATING RESINS FOR ELECTRIC USE; INSULATING VARNISHES FOR ELECTRIC USE; INSULATING SLEEVES AND INSULATING CASING AND CONTAINERS FOR CABLES; ELECTRICAL INSULATING FLOOR MATS OF RUBBER FOR USE BY ELECTRICIANS; ELECTRICAL CABLE INSULATOR; SEMI-FINISHED PLASTICS MATERIAL STRUCTURAL SECTIONS AND COMPONENTS FOR USE AS BUILDING INSULATION; PLASTIC LAMINATE USED IN THE MANUFACTURE OF PRINTED CIRCUIT BOARDS FOR USE AS CIRCUIT BOARD INSULATION; PLASTIC FILMS FOR USE IN GLASS AND/OR PLASTIC LAMINATIONS; METAL FOIL FOR BUILDING INSULATION.

INT. CL. 20/U.S. CLS. 2, 13, 22, 25, 32 AND 50

FOR CLIPS; EXPANDING SLEEVES; SCREW AND BOLT FASTENERS; NON-ELECTRIC LOCKS; CABLE CLIPS AND BASES THEREFOR; INSTALLATION EQUIPMENT, STRAPPING WIRING, ATTACHMENT AND CLAMPING COLLARS; CABLE CLAMPS; INDICATOR PLATES; MARKERS; SHEETS OF PRE-CUT MARKERS; MARKER-HOLDERS AND MARKER SUPPORT STRIPS; BOXES, CASES, CONTAINERS AND CHESTS FOR MARKER APPARATUS; LOCKS; ALL THE AFORESAID GOODS BEING ENTIRELY OR PRINCIPALLY MADE OF SYNTHETIC MATERIALS; FURNITURE, NAMELY, CABINETS; BAYS, DESKS, ENCLOSURES, SHELVING UNITS, STORAGE SHELVES, FURNITURE SHELVES, DRAWERS, OFFICE FURNITURE CASTERS FOR FURNITURE; PLASTIC MATERIAL SOLDERING AND BRAZING WIRE AND RODS.

ELEMENTS CORRECTED
GOODS/SERVICES

2,482,597. REG. 8-28-2001. MERCIS B.V. (NETHERLANDS CORPORATION) JOHANNES VERMEERPLEIN 3, 1071 DV AMSTERDAM, NETHERLANDS., SN 75-150,486. FILED 8-15-1996. PRINCIPAL REGISTER.

MIFFY

INT. CL. 9/U.S. CLS. 21, 23, 26, 36 AND 38

FOR APPARATUS FOR RECORDING, TRANSMISSION OR REPRODUCTION OF SOUND OR IMAGES, NAMELY, STEREO RECEIVERS AND AUDIO CASSETTE PLAYERS; MAGNETIC DATA CARRIERS, NAMELY, COMPUTER DISCS, RECORDING DISCS, AUDIO AND VIDEO CASSETTES, VIDEO TAPES, COMPACT DISCS, LASER DISCS, MINI DISCS, ALL FEATURING CHILDREN'S FILMS, MUSIC AND/OR CHILDREN'S STORIES.

FIRST USE 4-0-2000; IN COMMERCE 4-0-2000.

INT. CL. 16/U.S. CLS. 2, 5, 22, 23, 29, 37, 38 AND 50

FOR PRINTED MATTER, NAMELY CHILDREN'S ACTIVITY BOOKS, CHILDREN'S BOOKS, COLORING BOOKS, BABY BOOKS, GENERAL FEATURE MAGAZINES, CHILDREN'S MAGAZINES, ALL FEATURING, OR SOLD IN CONNECTION WITH, THE LIKENESS OF A BUNNY CHARACTER BY THE SAME NAME, FEATURED IN CHILDREN'S BOOKS.

FIRST USE 10-0-1998; IN COMMERCE 10-0-1998.

INT. CL. 18/U.S. CLS. 1, 2, 3, 22 AND 41

FOR LEATHER AND IMITATIONS OF LEATHER, AND GOODS MADE OF THESE MATERIALS AND NOT INCLUDED IN OTHER CLASSES, NAMELY, TRUNKS AND TRAVELLING BAGS; BAGS, NAMELY, TRAVEL BAGS, CARRY-ON BAGS, OVERNIGHT BAGS, DUFFEL BAGS, BACKPACKS, ALL PURPOSE SPORT BAGS, GYM BAGS, BEACH BAGS, BOOK BAGS, SCHOOL BOOK BAGS, LEATHER SHOPPING BAGS, TEXTILE SHOPPING BAGS, TOTE BAGS, SHOULDER BAGS, LEATHER MERCHANDISE BAGS; UMBRELLAS, PARASOLS; WALLETS, PURSES.

FIRST USE 3-0-2000; IN COMMERCE 3-0-2000.

INT. CL. 25/U.S. CLS. 22 AND 39

FOR CLOTHING, NAMELY BATHING SUITS, BEACHWEAR, BLOUSES, COATS, COVERALLS, CRAVATS, DRESSES, GLOVES, JACKETS, JEANS, JOGGING SUITS, JUMPERS, NECKWEAR, NIGHT GOWNS, NIGHT SHIRTS, PAJAMAS, PANTS, PULLOVERS, RAINWEAR, SHIRTS, SHORTS, SKIRTS, SLEEPWEAR, SOCKS, SPORT SHIRTS, SUITS, SWEATERS, T-SHIRTS, BOW TIES, TROUSERS, UNDERCLOTHES, UNDERWEAR, WARMUP SUITS; FOOTWEAR AND HEADWEAR.

FIRST USE 3-0-2000; IN COMMERCE 3-0-2000.

INT. CL. 28/U.S. CLS. 22, 23, 38 AND 50

FOR HAND BALLS; BABY RATTLES; JIGSAW PUZZLES.

FIRST USE 10-0-1998; IN COMMERCE 10-0-1998.

ELEMENTS CORRECTED
OWNER NAME

2,483,787. REG. 8-28-2001. GRECO, ALAN (UNITED STATES INDIVIDUAL) 300 OCEAN AVENUE, APT. 6C, LONG BRANCH, NJ, 07740, SN 75-980,707. FILED 10-1-1998. PRINCIPAL REGISTER.

ENRICO SEBASTIANO

"ENRICO SEBASTIANO" DOES NOT IDENTIFY A PARTICULAR LIVING INDIVIDUAL.

INT. CL. 3/U.S. CLS. 1, 4, 6, 50, 51 AND 52

FOR FRAGRANCES, NAMELY, COLOGNE, AFTERSHAVE [LOTION,] SKIN MOISTURIZER [AND] PERSONAL DEODORANT.

FIRST USE 5-10-2000; IN COMMERCE 5-10-2000.

ELEMENTS CORRECTED
GOODS/SERVICES

2,486,499. REG. 9-11-2001. DANIELI CORUS EUROPE BV (NETHERLANDS CORPORATION) WENCKEBACH-
STRAAT 1, POOSTBUS 10.000, CA IMULIDEN, NETHER-
LANDS., BY MERGER, BY CHANGE OF NAME; BY
MERGER, BY MERGER, BY CHANGE OF NAME HOO-
GOVENS TECHNICAL SERVICES ENERGY & ENVIRON-
MENT BV COMPANY) 1970 CA IMULIDEN,
NETHERLANDS, SN 75-513,487. FILED 7-6-1998. PRINCI-
PAL REGISTER.

CARBOLITE

OWNER OF BENELUX REG. NO. 598268, DATED 10-4-
1996, EXPIRES 10-4-2006.
INT. CL. 42/U.S. CLS. 100 AND 101

FOR MATERIAL TESTING SERVICES, ENGINEER-
ING SERVICES, CHEMIST AND PHYSICIST SERVICES,
CHEMICAL LABORATORY SERVICES, COMPUTER
PROGRAMMING FOR OTHERS; TECHNICAL CONSUL-
TATION AND RESEARCH IN THE FIELD OF ENGI-
NEERING AND CHEMISTRY; AND LEGAL RESEARCH.
FIRST USE ; IN COMMERCE .

ELEMENTS CORRECTED
ASSIGNMENT/NAME CHANGE

2,503,981. REG. 11-6-2001. CAPITAL CROSSING BANK
(MASSACHUSETTS CHARTERED BANK) 101 SUMMER
STREET, BOSTON, MA, 02110, SN 76-151,164. FILED 10-20-
2000. PRINCIPAL REGISTER.



NO CLAIM IS MADE TO THE EXCLUSIVE RIGHT TO
USE "CAPITAL" AND "BANK", APART FROM THE MARK
AS SHOWN.

THE LINING SHOWN ON THE DRAWING IS A FEAT-
URE OF THE MARK AND IS NOT INTENDED TO
INDICATE COLOR. COLOR IS NOT CLAIMED AS A
FEATURE OF THE MARK.

THE MARK CONSISTS OF THE WORDS "CAPITAL
CROSSING BANK" BENEATH A STYLIZED REPRESENTA-
TION OF A CABLE-STAY BRIDGE.

INT. CL. 36/U.S. CLS. 100, 101 AND 102

FOR COMMERCIAL AND RETAIL BANKING SER-
VICES.

FIRST USE 10-1-2000; IN COMMERCE 10-1-2000.

ELEMENTS CORRECTED
MARK

2,498,931. REG. 10-16-2001. MORNINGSTAR SERVICES INC.
(DELAWARE CORPORATION) 300 DELAWARE AVE-
NUE, SUITE 546, WILMINGTON, DE, 19801, SN 75-
809,185. FILED 9-24-1999. PRINCIPAL REGISTER.



NO CLAIM IS MADE TO THE EXCLUSIVE RIGHT TO
USE "SOY", APART FROM THE MARK AS SHOWN.
INT. CL. 29/U.S. CL. 46

FOR SOY-BASED FOOD BEVERAGE USED AS A
MILK SUBSTITUTE.
FIRST USE 1-0-2000; IN COMMERCE 1-0-2000.

ELEMENTS CORRECTED
OWNER NAME
OWNER ADDRESS

2,511,613. REG. 11-27-2001. ARTISTDIRECT, INC. (DELA-
WARE CORPORATION) 5670 WILSHIRE BOULEVARD,
SUITE 200, LOS ANGELES, CA, 90036, SN 75-826,546.
FILED 10-19-1999. PRINCIPAL REGISTER.

IMUSIC

OWNER OF U.S. REG. NO. 2,124,712.
SEC. 2(F).
INT. CL. 42/U.S. CLS. 100 AND 101

FOR COMPUTER SERVICES, NAMELY, PROVIDING
ON-LINE MAGAZINES AND NEWSLETTERS FEATUR-
ING ARTICLES, INTERVIEWS AND REVIEWS IN THE
FIELD OF MUSIC AND ENTERTAINMENT.

FIRST USE 8-0-1995; IN COMMERCE 8-0-1995.

ELEMENTS AMENDED
OWNER ADDRESS

2,511,614. REG. 11-27-2001. ARTISTDIRECT, INC. (DELA-
WARE CORPORATION) 5670 WILSHIRE BOULEVARD,
SUITE 200, LOS ANGELES, CA, 90036, SN 75-826,806.
FILED 10-19-1999. PRINCIPAL REGISTER.

IMUSIC

OWNER OF U.S. REG. NO. 2,124,712.
SEC. 2(F).
INT. CL. 38/U.S. CLS. 100, 101 AND 104

FOR PROVIDING ON-LINE CHAT ROOMS FOR TRANSMISSION OF MESSAGES AMONG COMPUTER USERS CONCERNING ENTERTAINMENT, MUSIC AND TOPICS OF GENERAL INTEREST; PROVIDING ON-LINE ELECTRONIC BULLETIN BOARDS FOR THE TRANSMISSION OF MESSAGES AMONG COMPUTER USERS CONCERNING EMPLOYMENT OPPORTUNITIES, USED GOODS, TICKETS, ENTERTAINMENT, MUSIC AND TOPICS OF GENERAL INTEREST; BROADCASTING PRE-RECORDED AND LIVE AUDIO AND AUDIO-VISUAL MATERIAL IN THE FIELDS OF ENTERTAINMENT AND MUSIC VIA A VARIETY OF MEDIA, NAMELY, THE INTERNET, CABLE TELEVISION, TELEVISION, RADIO, ONLINE INFORMATION SERVICES, NARROWBAND, AND BROADBAND MEDIA.

FIRST USE 8-0-1995; IN COMMERCE 8-0-1995.

ELEMENTS AMENDED
OWNER ADDRESS

2,511,615. REG. 11-27-2001. ARTISTDIRECT, INC. (DELAWARE CORPORATION) 5670 WILSHIRE BOULEVARD, SUITE 200, LOS ANGELES, CA, 90036, SN 75-826,941. FILED 10-19-1999. PRINCIPAL REGISTER.

IMUSIC

OWNER OF U.S. REG. NO. 2,124,712.
SEC. 2(F).

INT. CL. 41/U.S. CLS. 100, 101 AND 107

FOR PROVIDING ENTERTAINMENT AND EDUCATIONAL SERVICES, NAMELY, DEVELOPING AND DISSEMINATING IN AUDIO, AUDIO-VISUAL AND PRINT FORMATS DELIVERED BY AN ON-LINE GLOBAL COMPUTER NETWORK ONLINE VISUAL ARTS, MUSIC, AND ENTERTAINMENT AND EDUCATIONAL INFORMATION IN THE FIELDS OF VISUAL ARTS AND MUSIC; PROVIDING AN ON-LINE COMPUTER DATABASE TO ACCESS, TRANSMIT AND RECEIVE INFORMATION IN THE FIELD ENTERTAINMENT, AND LINKS TO RELATED WEBSITES; AND PROVIDING DATABASES FEATURING GENERAL AND LOCAL NEWS AND OTHER INFORMATION OF INTEREST IN THE FIELDS OF ENTERTAINMENT AND MUSIC AND LINKS TO RELATED WEBSITES.

FIRST USE 8-0-1995; IN COMMERCE 8-0-1995.

ELEMENTS AMENDED
OWNER ADDRESS

2,513,715. REG. 12-4-2001. ECSOFT GROUP PLC (UNITED KINGDOM LIMITED COMPANY) 101 WIGMORE STREET, LONDON W1H 9AB, ENGLAND., SN 75-584,724. FILED 11-9-1998. PRINCIPAL REGISTER.

ENTERPRISM

PRIORITY CLAIMED UNDER SEC. 44(D) ON ERPN CMNTY TM OFC APPLICATION NO. 853937, FILED 6-17-1998, REG. NO. 853937, DATED 10-25-1999, EXPIRES 10-25-2009.

INT. CL. 9/U.S. CLS. 21, 23, 26, 36 AND 38

FOR COMPUTERS; COMPUTER PROGRAMS AND SOFTWARE FOR MANAGING COMPUTER AND INFORMATION SYSTEMS, NAMELY, SOFTWARE USED TO MANIPULATE, TRANSLATE, CONVERT AND MANAGE DATA BETWEEN DIFFERENT COMPUTER SYSTEMS; PUBLICATIONS IN ELECTRONIC FORM SUPPLIED ON DISC, DISKETTE, CD ROM AND ON-LINE FROM DATABASES OR FROM FACILITIES PROVIDED ON A GLOBAL COMPUTER NETWORK ALL RELATING TO COMPUTERS AND INFORMATION MANAGEMENT SYSTEMS; TELECOMMUNICATIONS APPARATUS, NAMELY, MOBILE PHONES AND MODEMS FOR INTERCONNECTING NETWORKS OF COMPUTERS, DATABASES AND TELEPHONY DEVICES; ELECTRONIC MOBILE COMPUTING APPARATUS, NAMELY, PORTABLE COMPUTERS, HANDHELD COMPUTERS, PERSONAL DIGITAL ASSISTANTS, PAGERS AND ELECTRONIC ORGANIZERS; BLANK DISCS FOR COMPUTERS; BLANK MAGNETIC COMPUTER TAPES; BLANK ELECTRONIC CHIP CARDS; BLANK INTEGRATED CIRCUIT CARDS; MICROCHIPS IN THE FORM OF CENTRAL PROCESSING UNITS AND ELECTRONIC CIRCUITS FOR CONNECTING CENTRAL PROCESSING UNITS TO PERIPHERAL DEVICES.

FIRST USE ; IN COMMERCE .

INT. CL. 16/U.S. CLS. 2, 5, 22, 23, 29, 37, 38 AND 50

FOR PRINTED MATTER, NAMELY, NEWSLETTERS, MAGAZINES AND JOURNALS, MANUALS AND BOOKS, ALL RELATING TO INFORMATION TECHNOLOGY, COMPUTER HARDWARE, COMPUTER SOFTWARE OR COMPUTER CONSULTANCY SERVICES.

FIRST USE ; IN COMMERCE .

INT. CL. 35/U.S. CLS. 100, 101 AND 102

FOR JOB PLACEMENT SERVICES, NAMELY, PLACEMENT OF SPECIALISTS PERSONNEL IN THE AREA OF COMPUTING AND INFORMATION SYSTEMS; BUSINESS MANAGEMENT AND CONSULTATION SERVICES IN THE AREA OF COMPUTING AND INFORMATION SYSTEMS.

FIRST USE ; IN COMMERCE .

INT. CL. 41/U.S. CLS. 100, 101 AND 107

FOR EDUCATION, TRAINING AND INSTRUCTIONAL SERVICES RELATING TO THE MANAGEMENT OF COMPUTING AND INFORMATION SYSTEMS.

FIRST USE ; IN COMMERCE .

INT. CL. 42/U.S. CLS. 100 AND 101

FOR COMPUTER PROGRAMMING SERVICES FOR OTHERS; COMPUTER SYSTEMS ANALYSIS; COMPUTER AIDED DESIGN SERVICES; CONSULTANCY SERVICES FOR THE SELECTION OF COMPUTER HARDWARE AND SOFTWARE; COMPUTER SOFTWARE DESIGN AND DEVELOPMENT SERVICES FOR OTHERS; COMPUTER SOFTWARE DEVELOPMENT SERVICES IN THE NATURE OF THE PERFORMANCE OF CONSULTANCY STUDIES AND PRODUCTION OF REPORTS RELATING THERETO ACCORDING TO PRE-DETERMINED METHODOLOGIES; COMPUTER SERVICES, NAMELY, DESIGNING AND IMPLEMENTING NETWORK WEB PAGES FOR OTHERS; PROVIDING INFORMATION REGARDING COMPUTING AND INFORMATION TECHNOLOGY VIA ON-LINE COMPUTER DATABASES AND GLOBAL COMPUTER NETWORKS; PROVIDING ADVICE AND INFORMATION RELATING TO THE PROVISION OF ACCESS TO A GLOBAL COMPUTER INFORMATION NETWORK.

FIRST USE ; IN COMMERCE .

ELEMENTS CORRECTED
PRIORITY CLAIMED STATEMENT

2,513,978. REG. 12-4-2001. ARTISTDIRECT, INC. (DELAWARE CORPORATION) 5670 WILSHIRE BOULEVARD, SUITE 200, LOS ANGELES, CA, 90036, SN 75-826,807. FILED 10-19-1999. PRINCIPAL REGISTER.

IMUSIC

OWNER OF U.S. REG. NO. 2,124,712.
SEC. 2(F).

INT. CL. 35/U.S. CLS. 100, 101 AND 102

FOR PROMOTING THE GOODS AND SERVICES OF OTHERS BY PREPARING AND PLACING ADVERTISEMENTS AND PROMOTIONS ON A WEBSITE ACCESSED THROUGH A GLOBAL COMPUTER INFORMATION NETWORK AND OTHER MEDIA, NAMELY, CABLE TELEVISION, TELEVISION, GLOBAL COMPUTER NETWORKS, COMMERCIAL ON-LINE NETWORKS, NARROWBAND AND BROADBAND MEDIA; PROMOTING THE SALE OF GOODS AND SERVICES OF OTHERS THROUGH PROMOTIONAL CONTESTS; AND ON-LINE RETAIL STORE SERVICES FEATURING MUSICAL SOUND AND VIDEO RECORDINGS AND RELATED MERCHANDISE IN THE FIELDS OF ENTERTAINMENT AND MUSIC.

FIRST USE 8-0-1995; IN COMMERCE 8-0-1995.

ELEMENTS AMENDED
OWNER ADDRESS

2,515,940. REG. 12-4-2001. MANITOWOC FOODSERVICE COMPANIES, INC. (NEVADA CORPORATION) 905 SOUTHERN WAY, SPARKS, NV, 89431, BY CHANGE OF NAME MANITOWOC FOODSERVICE GROUP, INC. CORPORATION) SPARKS, NV, SN 76-135,430. FILED P.R. 9-25-2000; AM. S.R. 5-3-2001. SUPPLEMENTAL REGISTER.

KOOLAIRE

INT. CL. 11/U.S. CLS. 13, 21, 23, 31 AND 34

FOR REACH-IN REFRIGERATION EQUIPMENT, NAMELY, UPRIGHT REACH-IN REFRIGERATORS AND FREEZERS AND UNDER-THE-COUNTER REACH-IN REFRIGERATORS AND FREEZERS.

FIRST USE 1-1-2000; IN COMMERCE 2-18-2000.

ELEMENTS CORRECTED
ASSIGNMENT/NAME CHANGE

2,516,267. REG. 12-11-2001. ATLAS PLUMBING & MECHANICAL, INC. (DELAWARE LIMITED LIABILITY CORPORATION) 9095 OWENS COURT, MANASSAS PARK, VA, 20111, SN 75-768,727. FILED 8-5-1999. PRINCIPAL REGISTER.

ATLAS PLUMBING & MECHANICAL

NO CLAIM IS MADE TO THE EXCLUSIVE RIGHT TO USE "PLUMBING & MECHANICAL", APART FROM THE MARK AS SHOWN.

INT. CL. 37/U.S. CLS. 100, 103 AND 106

FOR PLUMBING AND MECHANICAL SERVICES NAMELY, INSTALLATION OF WASTE AND WATER PIPING SYSTEMS AND WATER PIPING SYSTEMS FOR FIRE SUPPRESSION.

FIRST USE 1-0-1982; IN COMMERCE 1-0-1982.

ELEMENTS CORRECTED
MARK

2,518,194. REG. 12-11-2001. OIKOCREDIT, ECUMENICAL DEVELOPMENT (NETHERLANDS CORPORATION) PC. HOOFTLAAN 3, 3818 HG AMERSFOORT, NETHERLANDS, BY CHANGE OF NAME ECUMENICAL DEVELOPMENT COOPERATIVE SOCIETY U.A. CORPORATION) 3818 HG AMERSFOORT, NETHERLANDS, SN 75-754,958. FILED 7-16-1999. PRINCIPAL REGISTER.

OIKOCREDIT

PRIORITY CLAIMED UNDER SEC. 44(D) ON BENELUX APPLICATION NO. 641417, FILED 7-16-1999, REG. NO. 0930788, DATED 1-20-1999, EXPIRES 1-20-2009.

INT. CL. 35/U.S. CLS. 100, 101 AND 102

FOR EVALUATING THE SOCIAL AND ECONOMIC EFFECTS OF DEVELOPMENT PROJECTS AND DEVELOPMENT-AID PROGRAMS IN ORDER TO FACILITATE RELIEF AND DEVELOPMENT INVESTMENT DECISIONS AND TO ENCOURAGE THE FINANCING OF RELIEF ACTIONS, ECONOMIC DEVELOPMENT, AND STIMULATION OF ECONOMIC SELF SUFFICIENCY IN THIRD WORLD COUNTRIES.

FIRST USE 7-29-1999; IN COMMERCE 1-6-2000.

INT. CL. 36/U.S. CLS. 100, 101 AND 102

FOR FINANCIAL SERVICES, NAMELY, RAISING CAPITAL FOR INVESTMENT IN DEVELOPMENT PROJECTS, ISSUING AND INVESTING IN BONDS AND SECURITIES, MAKING AND ADMINISTERING LOANS; ACQUISITION AND ADMINISTRATION OF INVESTMENTS, NAMELY, REAL PROPERTY, SECURITIES, MUTUAL FUNDS, AND PARTICIPATION IN COMMERCIAL ENTERPRISES THAT ARE INVOLVED WITH DEVELOPMENT PROJECTS, FOR THE BENEFIT OF THE FINANCING OF RELIEF ACTIONS, ECONOMIC DEVELOPMENT, AND STIMULATING ECONOMIC SELF SUFFICIENCY IN THIRD WORLD COUNTRIES; FISCAL ASSESSMENT AND EVALUATION OF SOCIAL-ECONOMIC ASPECTS OF DEVELOPMENT PROJECTS AND DEVELOPMENT AID PROGRAMS; FUNDRAISING FOR RELIEF ACTIONS AND DEVELOPMENT PROJECTS IN THIRD WORLD COUNTRIES.

FIRST USE 7-29-1999; IN COMMERCE 1-6-2000.

INT. CL. 41/U.S. CLS. 100, 101 AND 107

FOR EDUCATIONAL SERVICES, NAMELY, CONDUCTING SEMINARS AND WORKSHOPS IN THE FIELD OF THIRD WORLD ECONOMIC DEVELOPMENT, DEVELOPMENT FINANCING, DEVELOPMENT FUNDRAISING, RAISING AWARENESS OF THE PLIGHT OF THIRD WORLD POOR, AND THE ASSESSMENT OF SOCIAL-CULTURAL ASPECTS OF DEVELOPMENT PROJECTS AND DEVELOPMENT-AID PROGRAMS.

FIRST USE 7-29-1999; IN COMMERCE 1-6-2000.

ELEMENTS CORRECTED
ASSIGNMENT/NAME CHANGE
OWNER NAME
OWNER ADDRESS

2,519,143. REG. 12-18-2001. VERIS NAHRUNGSMITTEL GMBH (FED REP GERMANY LIMITED LIABILITY COMPANY) RINGSTRASSE 1, D-55425 WALDALGESHEIM, FED REP GERMANY., SN 75-762,203. FILED 7-28-1999. PRINCIPAL REGISTER.

2,525,343. REG. 1-1-2002. NPULSE SOFTWARE, INC. (DELAWARE CORPORATION) 100 SUPERIOR PLAZA WAY, SUITE 200, SUPERIOR, CO. 80027, BY ASSIGNMENT GOMBAS, GEORGE (INDIVIDUAL) BOULDER, CO. SN 75-246,628. FILED 2-24-1997. PRINCIPAL REGISTER.

VISION

OWNER OF FED REP GERMANY REG. NO. 2,099,987, DATED 4-19-1996, EXPIRES 4-19-2006.

INT. CL. 1/U.S. CLS. 1

FOR YEAST POWDER, YEAST FLAKES AND YEAST TABLETS FOR USE IN THE MANUFACTURE OF COSMETICS.

FIRST USE ; IN COMMERCE .

INT. CL. 29/U.S. CL. 46

FOR SOUPS; SOUPS, NAMELY CONSOMMES, FRUIT SOUPS, COLD FRUIT SOUPS, AND COLD SOUPS IN DRY OR PASTE FORM; FRUIT SAUCES; FRUIT JELLIES; MEAT JELLIES; FISH JELLIES; JELLIED FRUIT; PROCESSED VEGETABLES, NAMELY JELLIED VEGETABLES; COOKING OILS; EDIBLE FATS; MEAT EXTRACTS; DAIRY PRODUCTS, NAMELY BUTTER, CHEESE, AND WHIPPING CREAM IN DRY FORM; MILK POWDER FOR NOURISHMENT PURPOSES; CANNED MEATS; CANNED FISH; CANNED FRUIT; CANNED CUT VEGETABLES; LUNCHEON MEAT.

FIRST USE ; IN COMMERCE .

INT. CL. 30/U.S. CL. 46

FOR SAUCES; GRAVIES; SALAD DRESSINGS; SPICES; SEASONINGS; AROMATIC FOOD ADDITIVES FOR NON-NUTRITIONAL PURPOSES; DESSERTS, NAMELY PUDDINGS AND FLAVORED, SWEETENED FRUIT GELATIN DESSERTS; BREAD CRUMBS; PASTA; EXTRACTS USED AS FLAVORINGS, NAMELY FRUIT EXTRACTS; YEAST EXTRACTS FOR USE AS FOOD FLAVORINGS AND SEASONINGS; YEAST; YEAST FOR THE PURPOSE OF NOURISHMENT, NAMELY YEAST POWDER, LACTIC YEAST FLAKES FOR HUMAN CONSUMPTION, YEAST GRANULES; YEAST AUTOLYSATE FOR FLAVORING SOUPS AND GRAVIES .

FIRST USE ; IN COMMERCE .

ELEMENTS CORRECTED
OWNER ADDRESS

2,524,543. REG. 1-1-2002. HILL, THOMAS A. (UNITED STATES INDIVIDUAL) RURAL ROUTE 2, BOX 276A, SOUTH ROYALTON, VT. 05068, SN 76-079,125. FILED 6-15-2000. PRINCIPAL REGISTER.

HALF A BUBBLE OFF PLUMB

INT. CL. 16/U.S. CLS. 2, 5, 22, 23, 29, 37, 38 AND 50

FOR SYNDICATED NEWSPAPER COLUMNS DEALING WITH OPINION, CURRENT EVENTS AND HUMOR.

FIRST USE 12-3-1980; IN COMMERCE 12-3-1980.

ELEMENTS CORRECTED
CITIZENSHIP

NPULSE

INT. CL. 42/U.S. CLS. 100 AND 101
FOR COMPUTER CONSULTATION.
FIRST USE 6-21-2000; IN COMMERCE 6-21-2000.

ELEMENTS CORRECTED
MARK TYPE
DATE OF FIRST USE
DATE OF FIRST USE IN COMMERCE
[GOODS/SERVICES]
[INTERNATIONAL CLASS(ES)]

2,530,163. REG. 1-15-2002. LARUS & BROTHER COMPANY (VIRGINIA CORPORATION) 5016 BYRD INDUSTRIAL DRIVE, RICHMOND, VA, 23231, SN 75-504,986. FILED 6-18-1998. PRINCIPAL REGISTER.



NO CLAIM IS MADE TO THE EXCLUSIVE RIGHT TO USE "BRAND", APART FROM THE MARK AS SHOWN.

THE STIPPLING IN THE MARK IS FOR SHADING PURPOSES ONLY AND IS NOT INTENDED TO INDICATE COLOR. THE BROKEN LINES IN THE MARK ARE USED TO SHOW THE POSITION OF THE MARK ON THE PACKAGING FOR THE GOODS AND ARE NOT A FEATURE OF THE MARK.

THE NAME IN THE MARK IDENTIFIES A LIVING INDIVIDUAL WHOSE CONSENT IS OF RECORD.

INT. CL. 34/U.S. CLS. 2, 8, 9 AND 17

FOR CIGARETTES [AND SMOKING TOBACCO].
FIRST USE 6-1-1998; IN COMMERCE 7-31-1998.

ELEMENTS CORRECTED
GOODS/SERVICES

2,532,643. REG. 1-22-2002. MEDIFACE CO., LTD. (REPUBLIC OF KOREA CORPORATION) #134, SHINCHON-DONG, SEODAEMUN-KU, SEOUL, REPUBLIC OF KOREA., SN 75-742,859. FILED 6-25-1999. PRINCIPAL REGISTER.

MEDIFACE

INT. CL. 9/U.S. CLS. 21, 23, 26, 36 AND 38
FOR COMPUTER SOFTWARE FOR USE IN MANIPULATION AND MANAGEMENT OF IMAGES FOR MEDICAL PURPOSE.
FIRST USE 1-1-1998; IN COMMERCE 5-15-1998.

ELEMENTS CORRECTED
MARK

2,532,650. REG. 1-22-2002. NEOSTRATA COMPANY, INC. (DELAWARE CORPORATION) FOUR RESEARCH WAY, PRINCETON FORRESTAL CENTER, PRINCETON, NJ, 08540, SN 75-746,880. FILED 7-9-1999. PRINCIPAL REGISTER.

VESPERA

INT. CL. 3/U.S. CLS. 1, 4, 6, 50, 51 AND 52
FOR COSMETIC AND PERSONAL CARE TOPICAL FORMULATIONS FOR THE INTEGUMENTARY SYSTEM NAMELY TINTED FOUNDATIONS, SUNSCREENS, CREAMS, LOTIONS, GELS, SOLUTIONS, SPRAYS, OINTMENTS, POWDERS, LACQUERS, FOAMS, BODY AND FACE OILS AND BARS FOR THE SKIN, HAIR AND NAILS.
FIRST USE 1-10-2001; IN COMMERCE 1-10-2001.

ELEMENTS CORRECTED
DATE OF FIRST USE
DATE OF FIRST USE IN COMMERCE
[GOODS/SERVICES]
[INTERNATIONAL CLASS(ES)]

2,533,833. REG. 1-29-2002. RUDOLPH/LIBBE INC. (OHIO CORPORATION) 6494 LATCHA ROAD, WALBRIDGE, OH, 434659738, SN 76-109,054. FILED 8-14-2000. PRINCIPAL REGISTER.

FSM²

INT. CL. 37/U.S. CLS. 100, 103 AND 106
FOR CONSTRUCTION SITE SERVICES, NAMELY, FACILITY AND SITE MAINTENANCE CONTRACTOR SERVICES.
FIRST USE 7-1-2000; IN COMMERCE 7-1-2000.

ELEMENTS CORRECTED
MARK

2,540,720. REG. 2-19-2002. TV SHOPPING SOURCE, INC., THE (CONNECTICUT CORPORATION) 92 LOST DISTRICT DRIVE, NEW CANAAN, CT, 06840, SN 75-333,305. FILED 7-30-1997. PRINCIPAL REGISTER.

SCENT OF A WOMAN

NO CLAIM IS MADE TO THE EXCLUSIVE RIGHT TO USE "SCENT", APART FROM THE MARK AS SHOWN.
INT. CL. 3/U.S. CLS. 1, 4, 6, 50, 51 AND 52
FOR COLOGNE, PERFUME*, EAU DE COLOGNE, EAU DE PARFUM, EAU DE TOILETTE, TOILET WATER, BATH AND SHOWER GEL, BODY LOTION, BODY SOUFFLE CREME, AROMATHERAPY CREAMS, LOTIONS AND OILS AND NON-MEDICATED SKIN CARE PREPARATIONS*.
FIRST USE 9-26-2001; IN COMMERCE 9-26-2001.

ELEMENTS CORRECTED
GOODS/SERVICES

2,540,747. REG. 2-19-2002. CONNECT 24 INC. (CANADA CORPORATION) 1645 FLINT ROAD, DOWNSVIEW, ONTARIO, CANADA, M3J 2J6, SN 75-393,206. FILED 11-20-1997. PRINCIPAL REGISTER.

CONNECT 24

PRIORITY CLAIMED UNDER SEC. 44(D) ON CANADA APPLICATION NO. 861700, FILED 11-17-1997.
NO CLAIM IS MADE TO THE EXCLUSIVE RIGHT TO USE "24" AND "TWENTY FOUR", APART FROM THE MARK AS SHOWN.
INT. CL. 38/U.S. CLS. 100, 101 AND 104
FOR TELECOMMUNICATIONS, NAMELY, ELECTRONIC TRANSMISSION OF DATA .
FIRST USE 9-21-1997; IN COMMERCE 8-17-1999.
INT. CL. 42/U.S. CLS. 100 AND 101
FOR REMOTE MONITORING OF MACHINES AND SECURITY SYSTEMS.
FIRST USE 9-21-1997; IN COMMERCE 8-17-1999.

ELEMENTS CORRECTED
MARK TYPE
DATE OF FIRST USE
DATE OF FIRST USE IN COMMERCE
[GOODS/SERVICES]
[INTERNATIONAL CLASS(ES)]

2,543,794. REG. 3-5-2002. AISLO OY (FINLAND CORPORATION) MAHLATIE 1, FIN-94200 KEMI, FINLAND., SN 75-746,784. FILED 7-8-1999. PRINCIPAL REGISTER.



PRIORITY CLAIMED UNDER SEC. 44(D) ON FINLAND APPLICATION NO. T-199900091, FILED 1-12-1999, REG. NO. 217647, DATED 5-31-2000, EXPIRES 5-31-2010.
INT. CL. 1/U.S. CLS. 1

FOR WATERPROOFING CHEMICAL COMPOSITIONS FOR PRESERVING AGAINST CONDENSATION FOR WOOD AND MASONRY.

FIRST USE ; IN COMMERCE .
INT. CL. 17/U.S. CLS. 1, 5, 12, 13, 35 AND 50

FOR BUILDING INSULATION; FOAM INSULATION FOR USE IN BUILDING AND CONSTRUCTION; ACOUSTICAL INSULATION FOR BUILDINGS; ACOUSTICAL INSULATION BARRIER PANELS; WOOD PULP-BASED FIBERS FOR USE IN THE MANUFACTURE OF BUILDING INSULATION; SEALANTS FOR BUILDINGS.

FIRST USE ; IN COMMERCE .
INT. CL. 19/U.S. CLS. 1, 12, 33 AND 50

FOR WOOD PULP FIBER-BASED BOARD MATERIAL USED AS A WOOD SUBSTITUTE IN BUILDING CONSTRUCTION.

FIRST USE ; IN COMMERCE .
INT. CL. 37/U.S. CLS. 100, 103 AND 106

FOR INSTALLATION OF BUILDING INSULATION.
FIRST USE ; IN COMMERCE .

ELEMENTS CORRECTED
FOREIGN APPLICATION NO.
FOREIGN APPLICATION FILING DATE
PRIORITY CLAIMED STATEMENT

2,544,282. REG. 3-5-2002. NEWMINDSETS, INC. (CANADA CORPORATION) 4800 DUNDAS STREET WEST, SUITE 105, TORONTO, ONTARIO, CANADA, M9A 1B1, BY CHANGE OF NAME NEW MINDSETS.COM INC. CORPORATION) TORONTO, ONTARIO, CANADA, SN 76-076,781. FILED 6-23-2000. PRINCIPAL REGISTER.

NEWMINDSETS.COM

PRIORITY CLAIMED UNDER SEC. 44(D) ON CANADA APPLICATION NO. 1040806, FILED 12-24-1999.
INT. CL. 41/U.S. CLS. 100, 101 AND 107

FOR EDUCATIONAL SERVICES, NAMELY COURSES IN THE FIELDS OF MANAGEMENT AND OTHER SKILL SETS REQUIRED IN BUSINESS, GOVERNMENT OR ACADEMIA OFFERED IN MODULAR ELEMENTS ALLOWING LEARNERS TO TAILOR THEIR COURSES AND EDUCATIONAL PROGRAMS.

FIRST USE 9-0-1999; IN COMMERCE 9-0-1999.

ELEMENTS CORRECTED
ASSIGNMENT/NAME CHANGE
OWNER NAME
OWNER ADDRESS

2,547,968. REG. 3-12-2002. NIPPON PAINT (USA) INC. (DELAWARE CORPORATION) GLENPOINTE CENTRE WEST, 500 FRANK W. BURR BLVD., TEANECK, NJ, 07666895, BY MERGER NIPPON PAINT (AMERICA) CORP. CORPORATION) TEANECK, NJ, SN 75-783,294, FILED 8-24-1999. PRINCIPAL REGISTER.

LINKING YOUR VISION TO THE MARKET

INT. CL. 35/U.S. CLS. 100, 101 AND 102

FOR IMPORT AND EXPORT SERVICES, AND DISTRIBUTORSHIP SERVICES, ALL IN THE FIELDS OF PAINTS, COATINGS, SURFACE TREATMENT SYSTEMS, AND RAW MATERIALS USED IN THE AUTOMOTIVE, PRINTING, ELECTRICAL, AND ELECTRONIC INDUSTRIES AND IN THE PRODUCTION OF MEDICAL DEVICES, VINYL, FABRICS, COSMETICS, CANS, AND ROADWAY MARKERS.

FIRST USE 7-1-1999; IN COMMERCE 7-1-1999.

ELEMENTS CORRECTED
ASSIGNMENT/NAME CHANGE
OWNER NAME
CITIZENSHIP

2,550,916. REG. 3-19-2002. CHUCKWALLA, INC. (CALIFORNIA CORPORATION) 2005 HAMILTON AVENUE, SUITE 220, SAN JOSE, CA, 95125, BY CHANGE OF NAME MEDIAWAY, INC. CORPORATION) MILPITAS, CA, SN 75-942,154. FILED 3-13-2000. PRINCIPAL REGISTER.

CHUCKWALLA

INT. CL. 9/U.S. CLS. 21, 23, 26, 36 AND 38

FOR COMPUTER SOFTWARE FOR USE IN MULTIMEDIA DATABASE MANAGEMENT, IN CATALOGING MULTIMEDIA PROPERTIES, AND FOR TRANSMITTING INFORMATION OVER GLOBAL AND LOCAL NETWORKS.

FIRST USE 7-0-2000; IN COMMERCE 7-0-2000.

ELEMENTS CORRECTED
ASSIGNMENT/NAME CHANGE

2,553,534. REG. 3-26-2002. DOMANIA.COM, INC. (MASSACHUSETTS CORPORATION) 1360 SOLDIERS FIELD ROAD, BOSTON, MA, 02135, BY CHANGE OF NAME INPHO, INC. CORPORATION) CAMBRIDGE, MA, SN 75-856,101, FILED 11-22-1999. PRINCIPAL REGISTER.

DOMANIA.COM

INT. CL. 35/U.S. CLS. 100, 101 AND 102

FOR PROMOTING THE GOODS AND SERVICES OF OTHERS BY PLACING ADVERTISEMENTS AND PROMOTIONAL DISPLAYS IN AN ELECTRONIC SITE ACCESSED VIA GLOBAL COMPUTER NETWORKS.

FIRST USE 4-0-2000; IN COMMERCE 4-0-2000.

INT. CL. 36/U.S. CLS. 100, 101 AND 102

FOR ONLINE REAL ESTATE SERVICES, NAMELY, PROVIDING A WEBSITE FEATURING INFORMATION TO CONSUMERS IN THE FIELD OF REAL ESTATE REGARDING THE SALE, PURCHASE, AND OWNERSHIP OF HOMES, INCLUDING SALE PRICE, DEEDS, TAXES, SCHOOLS, NEIGHBORHOODS, MAPPING, NEWS, EDITORIALS, VALUATIONS, LOANS, AND MORTGAGES.

FIRST USE 4-0-2000; IN COMMERCE 4-0-2000.

ELEMENTS CORRECTED
CITIZENSHIP
ASSIGNMENT/NAME CHANGE

2,553,535. REG. 3-26-2002. DOMANIA.COM, INC. (MASSACHUSETTS CORPORATION) 1360 SOLDIERS FIELD ROAD, BOSTON, MA, 02135, BY CHANGE OF NAME INPHO, INC. CORPORATION) CAMBRIDGE, MA, SN 75-856,104. FILED 11-22-1999. PRINCIPAL REGISTER.

DOMANIA

INT. CL. 35/U.S. CLS. 100, 101 AND 102

FOR PROMOTING THE GOODS AND SERVICES OF OTHERS BY PLACING ADVERTISEMENTS AND PROMOTIONAL DISPLAYS IN AN ELECTRONIC SITE ACCESSED VIA GLOBAL COMPUTER NETWORKS.

FIRST USE 4-0-2000; IN COMMERCE 4-0-2000.

INT. CL. 36/U.S. CLS. 100, 101 AND 102

FOR ONLINE REAL ESTATE SERVICES, NAMELY, PROVIDING A WEBSITE FEATURING INFORMATION TO CONSUMERS IN THE FIELD OF REAL ESTATE REGARDING THE SALE, PURCHASE, AND OWNERSHIP OF HOMES, INCLUDING SALE PRICE, DEEDS, TAXES, SCHOOLS, NEIGHBORHOODS, MAPPING, NEWS, EDITORIALS, VALUATIONS, LOANS, AND MORTGAGES.

FIRST USE 4-0-2000; IN COMMERCE 4-0-2000.

ELEMENTS CORRECTED

CITIZENSHIP

ASSIGNMENT/NAME CHANGE

2,556,628. REG. 4-2-2002. SHURE INCORPORATED (ILLINOIS CORPORATION) 222 HARTREY AVENUE, EVANSTON, IL, 602023696, BY CHANGE OF NAME SHURE BROTHERS INCORPORATED CORPORATION) EVANSTON, IL, SN 75-728,446. FILED 6-14-1999. PRINCIPAL REGISTER.

AUXPANDER

INT. CL. 9/U.S. CLS. 21, 23, 26, 36 AND 38

FOR AUDIO MIXERS.

FIRST USE 8-16-2001; IN COMMERCE 8-16-2001.

ELEMENTS CORRECTED

ASSIGNMENT/NAME CHANGE

2,557,967. REG. 4-9-2002. UNIGLOBE TRAVEL (INTERNATIONAL) INC. (CANADA CORPORATION) 1199 WEST PENDER STREET, SUITE 900, VANCOUVER, BRITISH COLUMBIA, V6E 2R1, SN 76-037,851. FILED 5-1-2000. PRINCIPAL REGISTER.

UNIGLOBE.COM

OWNER OF U.S. REG. NOS. 1,183,195, 1,241,491 AND OTHERS.

INT. CL. 39/U.S. CLS. 100 AND 105

FOR TRAVEL AGENCY SERVICES, NAMELY, ARRANGING * TRAVEL * TOURS, MAKING RESERVATIONS AND BOOKINGS FOR AIR, CAR, HOTEL AND CRUISE, TRAVEL GUIDE SERVICES, ARRANGING TRAVEL VISAS, PASSPORTS AND TRAVEL DOCUMENTS FOR PERSONS TRAVELLING ABROAD VIA THE INTERNET.

FIRST USE 6-0-1994; IN COMMERCE 6-0-1994.

INT. CL. 42/U.S. CLS. 100 AND 101

FOR TRAVEL AGENCY SERVICES, NAMELY, MAKING RESERVATIONS AND BOOKINGS FOR AIR, CAR, HOTEL AND CRUISE VIA THE INTERNET.

FIRST USE 6-0-1994; IN COMMERCE 6-0-1994.

ELEMENTS CORRECTED

GOODS/SERVICES

OWNER NAME

2,559,101. REG. 4-9-2002. J.P. MORGAN CHASE & CO. (DELAWARE CORPORATION) 270 PARK AVENUE, NEW YORK, NY, 10017, SN 75-376,852. FILED 10-21-1997. PRINCIPAL REGISTER.

SmartIndex

INT. CL. 36/U.S. CLS. 100, 101 AND 102

FOR FINANCIAL AND ASSET MANAGEMENT, FINANCIAL PLANNING AND FINANCIAL PORTFOLIO MANAGEMENT AND [IVNVESTMENT] * INVESTMENT * ADVICE, INVESTMENT BROKERAGE, CAPITAL INVESTMENT CONSULTATION AND INVESTMENT CONSULTATION.

FIRST USE 12-1-1998; IN COMMERCE 12-31-1998.

ELEMENTS CORRECTED

GOODS/SERVICES

2,559,219. REG. 4-9-2002. YAHOO! INC. (DELAWARE CORPORATION) 701 FIRST AVENUE, SUNNYVALE, CA, 94089, BY MERGER YAHOO! INC. CORPORATION) SANTA CLARA, CA, SN 75-536,235. FILED 8-13-1998. PRINCIPAL REGISTER.

YAHOO!

OWNER OF U.S. REG. NOS. 2,040,222, 2,243,823 AND OTHERS.

INT. CL. 9/U.S. CLS. 21, 23, 26, 36 AND 38

FOR PRE-RECORDED SOUND RECORDINGS FEATURING EDUCATIONAL MATERIALS.

FIRST USE 8-3-2001; IN COMMERCE 8-3-2001.

ELEMENTS CORRECTED

ASSIGNMENT/NAME CHANGE

OWNER ADDRESS

2,559,252. REG. 4-9-2002. INTERACTIVE TRANSACTION SERVICES CORP. (CALIFORNIA CORPORATION) 19 DAVIS DRIVE, BELMONT, CA, 94002, SN 75-571,168. FILED 10-15-1998. PRINCIPAL REGISTER.

IPIN

INT. CL. 9/U.S. CLS. 21, 23, 26, 36 AND 38

FOR COMPUTER HARDWARE; COMPUTER SOFTWARE FOR POINT OF SALE TRANSACTION MANAGEMENT, NAMELY, MANAGING PURCHASES AND SALES OVER COMPUTER NETWORKS; COMPUTER SOFTWARE FOR ACCOUNT MANAGEMENT OF ELECTRONIC PURCHASES BY CONSUMERS; COMPUTER SOFTWARE FOR AUTHENTICATION AND PURCHASE APPROVAL FOR MERCHANTS AND CONSUMERS; COMPUTER SOFTWARE FOR AUTHENTICATION AND APPROVAL OF PURCHASES BY BILLING SERVICE PROVIDERS; COMPUTER SOFTWARE FOR DIRECTING BILLING FOR PURCHASES FROM MERCHANT TO THIRD PARTY BILLING SERVICE PROVIDER; COMPUTER SOFTWARE FOR BILLING SERVICE PROVIDERS WHICH MANAGES PURCHASES FOR CONSUMERS AND MERCHANTS.

FIRST USE 10-0-2000; IN COMMERCE 10-0-2000.
INT. CL. 36/U.S. CLS. 100, 101 AND 102

FOR TRANSACTION PROCESSING SERVICES, NAMELY, ELECTRONIC CREDIT CARD TRANSACTIONS, ELECTRONIC DEBIT TRANSACTIONS, AND TRANSACTION AGGREGATION AND PROCESSING OF CREDIT CARD, BANK CARD, DEBIT CARD, AND ELECTRONIC PAYMENT TRANSACTIONS; PAYMENT SERVICES, NAMELY, ELECTRONIC PROCESSING AND TRANSMISSION OF BILL PAYMENT DATA; FINANCIAL SERVICES, NAMELY, SUPPORTING AND MANAGING REVOLVING CREDIT ACCOUNTS.

FIRST USE 1-8-1998; IN COMMERCE 1-8-1998.

ELEMENTS CORRECTED
OWNER ADDRESS

2,559,704. REG. 4-9-2002. FOUNDATION FOR A BETTER LIFE, THE (COLORADO CORPORATION) 1727 TREMONT PLACE, DENVER, CO. 80202, SN 75-863,294. FILED 12-1-1999. PRINCIPAL REGISTER.

THE FOUNDATION FOR A BETTER LIFE

NO CLAIM IS MADE TO THE EXCLUSIVE RIGHT TO USE "FOUNDATION", APART FROM THE MARK AS SHOWN.

INT. CL. 42/U.S. CLS. 100 AND 101

FOR PROMOTING PUBLIC AWARENESS OF THE NEED TO DO GOOD, TO PROMOTE VALUES, TO BE A GOOD CITIZEN, AND TO PERFORM COMMUNITY SERVICE AND CHARITABLE ACTIVITIES.

FIRST USE 12-0-1999; IN COMMERCE 12-0-1999.

ELEMENTS CORRECTED
MARK

2,559,948. REG. 4-9-2002. GRT PRODUCTIONS, INC. (ILLINOIS CORPORATION) 303 W. MADISON STREET, SUITE 650, CHICAGO, IL. 60606, SN 76-003,137. FILED 3-17-2000. PRINCIPAL REGISTER.

TACTIX

INT. CL. 16/U.S. CLS. 2, 5, 22, 23, 29, 37, 38 AND 50

FOR PRINTED EDUCATIONAL AND INSTRUCTIONAL MATERIALS USED IN DEVELOPING STRATEGIES FOR INTERPERSONAL RELATIONSHIPS.

FIRST USE 4-0-2000; IN COMMERCE 8-0-2000.

ELEMENTS CORRECTED
MARK

2,560,342. REG. 4-9-2002. FLORISTS' TRANSWORLD DELIVERY, INC. (MICHIGAN CORPORATION) 3113 WOOD-CREEK DRIVE, DOWNERS GROVE, IL. 605155420, SN 76-151,041. FILED 10-20-2000. PRINCIPAL REGISTER.

AUTUMN SPLENDOR

INT. CL. 31/U.S. CLS. 1 AND 46

FOR LIVE CUT FLORAL ARRANGEMENTS.
FIRST USE 0-0-2000; IN COMMERCE 0-0-2000.

ELEMENTS CORRECTED
MARK TYPE

2,560,693. REG. 4-9-2002. PUREOLOGY RESEARCH, LLC (CALIFORNIA LIMITED LIABILITY COMPANY) 1920 MAIN STREET, SUITE 1090, IRVINE, CA. 92614, SN 76-217,279. FILED P.R. 2-28-2001; AM. S.R. 12-14-2001. SUPPLEMENTAL REGISTER.

ZEROSULPHATE

INT. CL. 3/U.S. CLS. 1, 4, 6, 50, 51 AND 52

FOR HAIR CARE PRODUCTS, NAMELY NON-MEDICATED HAIR SHAMPOOS AND CONDITIONERS.
FIRST USE 6-0-2001; IN COMMERCE 7-26-2001.

ELEMENTS CORRECTED
MARK

2,560,710. REG. 4-9-2002. J&L INK INC. (UNITED STATES CORPORATION) 935 8TH AVENUE, APT. 1, LAGRANGE, IL. 60525, SN 76-255,751. FILED P.R. 5-10-2001; AM. S.R. 9-4-2001. SUPPLEMENTAL REGISTER.

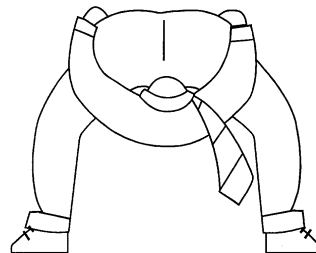

INT. CL. 25/U.S. CLS. 22 AND 39

FOR CLOTHING, NAMELY T-SHIRTS, HATS, JACKETS AND SWEATCLOTHES, NAMELY SWEAT BANDS, SWEAT PANTS, SWEAT SHIRTS, SWEAT SHORTS, SWEAT SUITS AND SWEAT SOCKS.

FIRST USE 2-0-2001; IN COMMERCE 2-0-2001.

ELEMENTS CORRECTED
OWNER ADDRESS

2,560,786. REG. 4-16-2002. M. H. WILKENS & SOHNE GMBH (FED REP GERMANY LIMITED LIABILITY COMPANY) AN DER SILBERPRAGE, 28309 BREMEN, FED REP GERMANY., SN 75-412,602. FILED 12-30-1997. PRINCIPAL REGISTER.

PRIORITY CLAIMED UNDER SEC. 44(D) ON FED REP GERMANY APPLICATION NO. 39734471, FILED 7-22-1997, REG. NO. 39734471, DATED 9-4-1997, EXPIRES 7-31-2007.

INT. CL. 8/U.S. CLS. 23, 28 AND 44

FOR TABLEWARE, NAMELY, KNIVES, FORKS AND SPOONS MADE OF PRECIOUS METAL; KNIVES, FORKS AND SPOONS NOT MADE OF PRECIOUS METAL.

FIRST USE : IN COMMERCE .

INT. CL. 14/U.S. CLS. 2, 27, 28 AND 50

FOR JEWELS AND ART OBJECTS MADE OF PRECIOUS METALS, NAMELY, BRACELETS, ARMBANDS, NECKLACES, MONEY CLIPS, HAIR BUCKLES, NECKTIE CLASPS, CUFFLINKS, EAR JEWELRY AND RINGS; SMALL HOUSEHOLD UTENSILS MADE OF PRECIOUS METAL, NAMELY, NON-ELECTRIC CANDELABRAS, ASHTRAYS, CUPS, PICTURE FRAMES, BREAD BOXES, CANS WITH AND WITHOUT A LID, NAMELY COFFEE POTS, TEA POTS, CREAM PITCHERS, WINE JUGS, MOCHA POTS; EGG CUPS, BOTTLE HOLDERS, BOTTLE CORKS, BOTTLE OPENERS, BOTTLE TRAYS, TONGS FOR BAKED GOODS/SALADS, TRAYS FOR GLASSES, CHILDREN'S CUPS, BOOKMARKS, CANDLESTICKS; FOOD CARRIERS, NAMELY TRAYS, BOWLS, DISHES, SERVING CUPS, CHAMPAGNE PAILS, NAPKIN RINGS, NAPKIN HOLDERS, MONEY BOXES, TEA GLASSES WITH HOLDER; TEA HEATER, NAMELY, CANDLE HOLDERS OF PRECIOUS METAL USED FOR KEEPING TEAPOTS WARM; TEA LIGHT CANDLE HOLDERS OF PRECIOUS METAL; VASES, ICE PAILS FOR WINE; HURRICANE LAMP CANDLE HOLDERS OF PRECIOUS METAL; TINS FOR CIGARS AND CIGARETTES.

FIRST USE : IN COMMERCE .

INT. CL. 21/U.S. CLS. 2, 13, 23, 29, 30, 33, 40 AND 50

FOR SMALL HOUSEHOLD AND KITCHEN UTENSILS NOT OF PRECIOUS METAL AND NOT PLATED THEREWITH, NAMELY, NON-ELECTRIC CANDELABRAS, CUPS, BREAD BOXES, CANS WITH AND WITHOUT A LID, NAMELY, NON-ELECTRIC COFFEE POTS, TEA POTS, CREAM PITCHERS, WINE JUGS, MOCHA POTS, MILK CANS, OIL CANS, WATERING CANS, DECORATIVE CANS SOLD EMPTY; EGG CUPS, BOTTLE HOLDERS, BOTTLE CORKS, BOTTLE OPENERS, BOTTLE TRAYS, TONGS FOR BAKED GOODS/SALADS, TRAYS FOR GLASSES, CHILDREN'S CUPS, CANDLESTICKS, FOOD CARRIERS NAMELY BOWLS, SERVING TRAYS, PLATES, CONTAINERS, DISHES, SERVING PLATTERS; KNIFE RESTS, TABLE PLATES, CREAM SETS, * TEA HEATERS * SALT AND PEPPER SHAKERS, SAUCE BOATS, SERVING CUPS, BOWLS, CHAMPAGNE PAILS, NAPKIN RINGS, NAPKIN HOLDERS, TEA GLASSES WITH HOLDER; TEA HEATERS, NAMELY, CANDLE HOLDERS NOT OF PRECIOUS METAL USED FOR KEEPING TEAPOTS WARM; TEA LIGHT CANDLE HOLDERS NOT OF PRECIOUS METAL; VASES, ICE PAILS FOR WINE; HURRICANE LAMP CANDLE HOLDERS NOT OF PRECIOUS METAL; CONTAINERS FOR KITCHEN AND HOUSEHOLD USE NOT OF PRECIOUS METAL AND NOT PLATED THEREWITH; BEVERAGE GLASSWARE; CHINA AND EARTHENWARE, NAMELY CHINA AND EARTHENWARE BUSTS, FIGURINES, STATUES, STATUETTES, SCULPTURES, ORNAMENTS, DINNERWARE.

FIRST USE : IN COMMERCE .

ELEMENTS CORRECTED
GOODS/SERVICES

2,561,998. REG. 4-16-2002. TOPDOG SOFTWARE, INC. (TEXAS CORPORATION) 875 LAWRENCEVILLE SUWANEE RD., SUITE 310-295, LAWRENCEVILLE, GA, 30043, SN 78-059,199. FILED 4-19-2001. PRINCIPAL REGISTER.

NO CLAIM IS MADE TO THE EXCLUSIVE RIGHT TO USE "SOFTWARE", APART FROM THE MARK AS SHOWN.

INT. CL. 9/U.S. CLS. 21, 23, 26, 36 AND 38

FOR COMPUTER SOFTWARE FOR AUTOMATICALLY SUBMITTING INTERNET WEB SITES TO SEARCH ENGINES, MONITORING THEIR POSITION WITHIN THOSE SEARCH ENGINES, AND OPTIMIZING THEIR CONTENT FOR IMPROVING THEIR POSITION IN SEARCH ENGINES.

FIRST USE 4-20-1995; IN COMMERCE 4-20-1995.

ELEMENTS CORRECTED
CITIZENSHIP

2,562,067. REG. 4-16-2002. STORM SHELTER CORPORATION (GEORGIA CORPORATION) P.O. BOX 481, RINCON, GA, 31326, SN 75-181,270. FILED 10-14-1996. PRINCIPAL REGISTER.

STORM SHELTER

INT. CL. 9/U.S. CLS. 21, 23, 26, 36 AND 38

FOR LIGHTNING PROTECTION EQUIPMENT, NAMELY, SURGE PROTECTORS.

FIRST USE 11-29-2001; IN COMMERCE 11-29-2001.

ELEMENTS CORRECTED
OWNER ADDRESS

2,562,585. REG. 4-16-2002. NORCROSS MARINE PRODUCTS, INC. (FLORIDA CORPORATION) 1629 PRIME COURT, SUITE 800, ORLANDO, FL, 328593812, SN 78-026,989. FILED 9-21-2000. PRINCIPAL REGISTER.

MARINELINK

INT. CL. 9/U.S. CLS. 21, 23, 26, 36 AND 38

FOR MARINE SENSING INSTRUMENTATION FOR VESSELS, NAMELY, DATA REPEATERS, FISH FINDERS, DEPTH FINDERS, KNOT METERS, WIND INDICATORS AND GLOBAL POSITIONING SYSTEMS COMPRISING RECEIVERS, TRANSMITTERS AND MONITORS .

FIRST USE 9-25-2000; IN COMMERCE 1-15-2001.

ELEMENTS CORRECTED
MARK
[DISCLAIMER]

2,562,764. REG. 4-23-2002. CITIZENS FINANCIAL GROUP, INC. (DELAWARE CORPORATION) ONE CITIZENS PLAZA, PROVIDENCE, RI, 02903, BY ASSIGNMENT MELLON BANK, N.A. (UNITED STATES), PITTSBURGH, PA, SN 75-660,996. FILED 3-15-1999. PRINCIPAL REGISTER.

BUSINESS BUILDER

NO CLAIM IS MADE TO THE EXCLUSIVE RIGHT TO USE "BUSINESS", APART FROM THE MARK AS SHOWN. INT. CL. 36/U.S. CLS. 100, 101 AND 102 FOR BANKING SERVICES.
FIRST USE 9-1-1994; IN COMMERCE 9-1-1994.

ELEMENTS CORRECTED
ASSIGNMENT/NAME CHANGE
OWNER NAME
OWNER ADDRESS
CITIZENSHIP
ENTITY

2,564,504. REG. 4-23-2002. BANFI PRODUCTS CORPORATION (NEW YORK CORPORATION) 1111 CEDAR SWAMP ROAD, OLD BROOKVILLE, NY, 11545, SN 76-083,849. FILED 7-6-2000. PRINCIPAL REGISTER.

ROSA REGALE

NO CLAIM IS MADE TO THE EXCLUSIVE RIGHT TO USE "ROSA", APART FROM THE MARK AS SHOWN. THE ENGLISH TRANSLATION OF "ROSA REGALE" IS "ROYAL ROSE".
INT. CL. 33/U.S. CLS. 47 AND 49 FOR WINES.
FIRST USE 11-24-2000; IN COMMERCE 6-15-2001.

ELEMENTS CORRECTED
DISCLAIMER
TRANSLATION OF MARK

2,564,809. REG. 4-23-2002. ROXIO, INC. (DELAWARE CORPORATION) 455 EL CAMINO REAL, SANTA CLARA, CA, 95050, SN 76-262,295. FILED 5-17-2001. SUPPLEMENTAL REGISTER.

THE DIGITAL MEDIA COMPANY

NO CLAIM IS MADE TO THE EXCLUSIVE RIGHT TO USE "DIGITAL MEDIA", APART FROM THE MARK AS SHOWN.
INT. CL. 9/U.S. CLS. 21, 23, 26, 36 AND 38

FOR COMPUTER SOFTWARE, NAMELY, SOFTWARE FOR AUTHORIZING, CREATING, MANAGING, SHARING, CONVERTING [THE] * AND * RECORDING DIGITAL MEDIA FOR USE IN THE FIELD OF DIGITAL MEDIA RECORDING AND MANAGEMENT, COMPUTER SOFTWARE FOR MANAGING THE USE AND COPYING OF MUSIC, VIDEOS, DATA, PICTURES AND SOUND, MANAGING LICENSING ARRANGEMENTS INVOLVING MUSIC, VIDEOS, DATA, PICTURES AND SOUND, AND FOR TRACKING THE USE AND COPYING OF MUSIC, VIDEOS, DATA, PICTURES AND SOUND FOR USE IN THE FIELD OF DIGITAL RIGHTS MANAGEMENT, AND COMPUTER SOFTWARE FOR COMPUTER NETWORK SYSTEM RECOVERY, AND USER MANUALS PROVIDED TOGETHER THEREWITH AS A UNIT.

FIRST USE 2-28-2001; IN COMMERCE 2-28-2001.

ELEMENTS CORRECTED
GOODS/SERVICES
OWNER ADDRESS

2,565,447. REG. 4-30-2002. POLY HI SOLIDUR, INC. (DELAWARE CORPORATION) 1645 BERGSTROM ROAD, NEENAH, WI, 54956, ASSIGNEE OF; ASSIGNEE OF; MENASHA CORPORATION (CORPORATION) NEENAH, WI, SN 75-039,658. FILED 1-3-1996. PRINCIPAL REGISTER.

LTD LINER

NO CLAIM IS MADE TO THE EXCLUSIVE RIGHT TO USE "LINER", APART FROM THE MARK AS SHOWN. INT. CL. 12/U.S. CLS. 19, 21, 23, 31, 35 AND 44 FOR FITTED LINERS FOR THE CARGO AREAS OF DUMP TRUCKS .
FIRST USE 3-31-1997; IN COMMERCE 3-31-1997.

ELEMENTS CORRECTED
FILING DATE

2,568,031. REG. 5-7-2002. SORRENTO LACTALIS, INC. (IOWA CORPORATION) 2375 SOUTH PARK AVENUE, BUFFALO, NY, 14230, BY MERGER SORRENTO CHEESE COMPANY, INC. (CORPORATION) BUFFALO, NY, SN 75-839,381. FILED 11-4-1999. PRINCIPAL REGISTER.

STUFFSTERS

INT. CL. 29/U.S. CL. 46
FOR CHEESE FILLED WITH PIZZA SAUCE.
FIRST USE 2-0-2000; IN COMMERCE 7-0-2000.

ELEMENTS CORRECTED
ASSIGNMENT/NAME CHANGE
OWNER NAME
CITIZENSHIP

2,568,219. REG. 5-7-2002. WASHINGTON POST COMPANY, THE (DELAWARE CORPORATION) 1150 15TH STREET, N.W., WASHINGTON, DC, 20071, SN 76-014,173. FILED 3-31-2000. PRINCIPAL REGISTER.

RED AND ROVER

INT. CL. 16/U.S. CLS. 2, 5, 22, 23, 29, 37, 38 AND 50

FOR PRINTED MATTER; PRINTED MATTER, NAMELY, A NEWSPAPER COMIC STRIP; CARTOON. FIRST USE 9-8-2000; IN COMMERCE 9-8-2000. INT. CL. 42/U.S. CLS. 100 AND 101 FOR COMPUTER SERVICES, NAMELY, PROVIDING A CARTOON AND COMIC STRIP VIA A GLOBAL COMPUTER NETWORK. FIRST USE 9-12-2000; IN COMMERCE 9-12-2000.

2,568,747. REG. 5-14-2002. HERBON NATURALS, INC. (CANADA CORPORATION) 6691 ELMBRIDGE WAY, SUITE 160, BRIGHOUSE WEST INDUSTRIAL PARK, RICHMOND, BC V7C 4N1, CANADA., SN 75-272,722. FILED 4-10-1997. PRINCIPAL REGISTER.

ELEMENTS CORRECTED
MARK



2,568,434. REG. 5-7-2002. BEL-ORO INTERNATIONAL, INC (NEW YORK CORPORATION) 516 FIFTH AVENUE, NEW YORK, NY, 10036, SN 76-188,982. FILED 1-3-2001. PRINCIPAL REGISTER.

PRIORITY CLAIMED UNDER SEC. 44(D) ON CANADA APPLICATION NO. 829717, FILED 11-22-1996, REG. NO. TMA519416, DATED 11-16-1999, EXPIRES 11-16-2014. THE LINING SHOWN ON THE MARK IN THE DRAWING IS A FEATURE OF THE MARK, AND IS NOT INTENDED TO INDICATE COLOR.



INT. CL. 5/U.S. CLS. 6, 18, 44, 46, 51 AND 52 FOR HERBAL, NATURAL AND HEALTH PREPARATIONS, NAMELY, COUGH DROPS, THROAT LOZENGES, COUGH LOZENGES, MEDICATED CANDIES FOR THE TREATMENT OF COUGHS AND SORE THROAT, NUTRACEUTICAL CANDIES, COUGH SYRUP, VITAMINS, MINERALS, FOOD SUPPLEMENTS, HERBAL EXTRACTS FOR THERAPEUTIC AND PREVENTATIVE USE AND TINCTURES.

ELEMENTS CORRECTED
OWNER ADDRESS

INT. CL. 14/U.S. CLS. 2, 27, 28 AND 50 FOR JEWELRY. FIRST USE 6-0-2001; IN COMMERCE 6-0-2001.

ELEMENTS CORRECTED
MARK

2,568,748. REG. 5-14-2002. ROLLS-ROYCE OY AB (FINLAND LIMITED LIABILITY COMPANY) SUOJANTIE 5, 26100 RAUMA, FINLAND., BY CHANGE OF NAME, BY CHANGE OF NAME AQUAMASTER-RAUMA LTD. CORPORATION) FIN-26100 RAUMA, FINLAND, SN 75-280,316. FILED 4-24-1997. PRINCIPAL REGISTER.

2,568,538. REG. 5-7-2002. ORATEC INTERVENTIONS, INC. (CALIFORNIA CORPORATION) 3700 HAVEN COURT, MENLO PARK, CA, 94025, SN 75-714,237. FILED P.R. 5-24-1999; AM. S.R. 6-30-2000. SUPPLEMENTAL REGISTER.

CONTAZ

AUTOTEMP

PRIORITY CLAIMED UNDER SEC. 44(D) ON FINLAND APPLICATION NO. T199700481, FILED 2-5-1997, REG. NO. 208613, DATED 12-15-1997, EXPIRES 12-15-2007. INT. CL. 7/U.S. CLS. 13, 19, 21, 23, 31, 34 AND 35 FOR PROPULSION UNITS FOR SHIPS, NAMELY, PROPELLER MEANS, TRANSMISSION AND DRIVE MECHANISMS, ENGINES, CLUTCHES, GEARS, PUMPS, AND CURRENT GENERATORS. INT. CL. 12/U.S. CLS. 19, 21, 23, 31, 35 AND 44 FOR PROPELLERS AND AXLES FOR SHIPS.

INT. CL. 9/U.S. CLS. 21, 23, 26, 36 AND 38 FOR COMPUTER SOFTWARE USED TO CONTROL THE POWER AND TEMPERATURE OF MEDICAL DEVICES SOLD AS A COMPONENT OF AN ELECTRO THERMAL GENERATOR. FIRST USE 6-0-1999; IN COMMERCE 6-0-1999.

ELEMENTS CORRECTED
OWNER ADDRESS

ELEMENTS CORRECTED
OWNER NAME
OWNER ADDRESS
ENTITY
ASSIGNMENT/NAME CHANGE

2,568,768. REG. 5-14-2002. IWATANI INTERNATIONAL CORPORATION (JAPAN CORPORATION) 4-8, HOMMACHI 3-CHOME, CHOU-KU, OSAKA 541, JAPAN., SN 75-421,697. FILED 1-22-1998. PRINCIPAL REGISTER.



PRIORITY CLAIMED UNDER SEC. 44(D) ON JAPAN APPLICATION NO. 9-182315, FILED 12-4-1997, REG. NO. 4274068, DATED 5-21-1999, EXPIRES 5-21-2009.

OWNER OF U.S. REG. NO. 1,489,222.

INT. CL. 1/U.S. CLS. 1

FOR CHEMICAL GASES, NAMELY, OXYGEN, HYDROGEN, NITROGEN, HELIUM, CARBON ACID GAS, CARBIDES, NAMELY, HYDROGEN CARBIDES FOR INDUSTRIAL USE; LIQUID AIR, COMPRESSED AIR FOR INDUSTRIAL USE; FERTILIZERS FOR HORTICULTURAL AND AGRICULTURAL USE; ARTIFICIAL SOIL SUBSTITUTES FOR GROWING PLANTS AND VEGETABLES; ARTIFICIAL PROCESSED POLYETHYLENE RESINS, POLYVINYLIDENE CHLORIDE RESINS, UNPROCESSED ACRYLIC RESINS, AND POLYVINYL CHLORIDE RESINS FOR AGRICULTURAL AND INDUSTRIAL USE.

FIRST USE ; IN COMMERCE .

INT. CL. 4/U.S. CLS. 1, 6 AND 15

FOR ALL PURPOSE LUBRICATING OIL; GASOLINE; RAW OR REFINED PETROLEUM; KEROSENE; LIQUIFIED PETROLEUM GAS; NATURAL GAS.

FIRST USE ; IN COMMERCE .

INT. CL. 6/U.S. CLS. 2, 12, 13, 14, 23, 25 AND 50

FOR STAINLESS STEEL; STEEL SHEETS; PIPES, RAILS AND BARS; GALVANIZED STEEL SHEETS; CLAD STEEL PLATES; [TINE] * TIN * PLATES; COPPER ALLOY; ALUMINUM ALLOY; NICKEL ALLOY; TITANIUM ALLOY; METAL GAS STORAGE TANKS; METAL PIPE FITTINGS; METAL FLANGES AND WIRE NETS.

FIRST USE ; IN COMMERCE .

INT. CL. 7/U.S. CLS. 13, 19, 21, 23, 31, 34 AND 35

FOR LATHES; BROACHING MACHINES; MECHANICAL PRESSES FOR INDUSTRIAL USE; GAS-OPERATED WELDING MACHINES; OXYACETYLENE WELDING AND CUTTING MACHINES; MOTOR OTHER THAN FOR LAND VEHICLES, NAMELY COMPRESSED AIR ENGINES; DISH WASHERS; ELECTRIC KITCHEN MIXERS; PRESSURE AUTOMATIC CONTROL MACHINES AND INSTRUMENTS FOR INDUSTRIAL AND DOMESTIC USE; AUTOMATIC COMBUSTION CONTROL MACHINES AND INSTRUMENTS FOR INDUSTRIAL AND DOMESTIC USE; FLUID FLOW AUTOMATIC CONTROL MACHINES AND INSTRUMENTS * FOR * INDUSTRIAL AND DOMESTIC USE.

FIRST USE ; IN COMMERCE .

INT. CL. 9/U.S. CLS. 21, 23, 26, 36 AND 38

FOR GAS METERS; PRESSURE METERS; OPTICAL FIBER CABLES; FACSIMILE MACHINES; TELEPHONES; WORD PROCESSORS; GAS LEAK ALARMS; [OZONIZES] * OZONIZERS * , ARC-WELDING MACHINES.

FIRST USE ; IN COMMERCE .

INT. CL. 11/U.S. CLS. 13, 21, 23, 31 AND 34

FOR HEATING FURNACES; GAS STOVES; FURNACE BOILERS; GAS HEATERS FOR WATER; ELECTRIC WARMERS FOR WATER FOR DOMESTIC USE; GAS RANGES; SINKS; GAS DRYERS FOR INDUSTRIAL USE AND ELECTRIC DRYERS FOR INDUSTRIAL USE; GAS DRYERS FOR CLOTHES; GAS-OPERATED ROOM AIR CONDITIONERS, CALCINERS; GAS FIRED SPACE HEATERS FOR COMMERCIAL AND DOMESTIC USE; HOUSEHOLD AIR CLEANERS; ICE-MAKING MACHINE AND APPARATUS, NAMELY, ICE MACHINES; REFRIGERATORS; GAS-OPERATED RICE COOKERS AND ELECTRIC RICE COOKERS; BATH TUBS; SHOWERS; WATER PURIFIERS; SEWAGE DISPOSAL TANKS; GARBAGE INCINERATORS.

FIRST USE ; IN COMMERCE .

INT. CL. 17/U.S. CLS. 1, 5, 12, 13, 35 AND 50

FOR CHEMICAL FIBERS FOR INDUSTRIAL AND DOMESTIC USE AND NOT FOR USE IN TEXTILES; FILM BASES IN THE NATURE OF PLASTIC FOR INDUSTRIAL AND AGRICULTURAL USE; FORMED PLASTIC SPONGE FOR INDUSTRIAL USE; PLASTIC SHEETS FOR COMMERCIAL AND INDUSTRIAL USE; PLASTIC FILMS FOR AGRICULTURAL USE.

FIRST USE ; IN COMMERCE .

INT. CL. 20/U.S. CLS. 2, 13, 22, 25, 32 AND 50

FOR KITCHEN TABLES.

FIRST USE ; IN COMMERCE .

INT. CL. 21/U.S. CLS. 2, 13, 23, 29, 30, 33, 40 AND 50

FOR BOXES OF GLASS, BOXES OF PORCELAIN, TABLEWARE NOT OF PRECIOUS METAL, NAMELY, KNIVES, FORKS, SPOONS, CUPS, DISHES, SALAD BOWLS, PAN CASES, BUTTER CASES, BUTTER KNIVES, CAKE CASES, POTS, PITCHERS, MUDDLERS, CHOPSTICKS, WINE COOLER, TONGS; NON-ELECTRIC PRESSURE COOKERS.

FIRST USE ; IN COMMERCE .

INT. CL. 39/U.S. CLS. 100 AND 105

FOR PUBLIC UTILITY SERVICE IN THE NATURE OF GAS DISTRIBUTION AND ELECTRICITY DISTRIBUTION; BOAT TRANSPORT; BOAT RENTAL; SHIP BROKERAGES; INTERMEDIATION FOR COMMISSION OF FREIGHT TRAFFIC .

FIRST USE ; IN COMMERCE .

ELEMENTS CORRECTED
GOODS/SERVICES

2,570,483. REG. 5-21-2002. CUIRICO DIFFUSION (FRANCE CORPORATION) 8, RUE DUPUIS, 75003 PARIS, FRANCE., SN 74-707,993. FILED 7-31-1995. PRINCIPAL REGISTER.

LES FERRAILLEURS

PRIORITY CLAIMED UNDER SEC. 44(D) ON FRANCE APPLICATION NO. 95/555927, FILED 1-31-1995, REG. NO. 95/555927, DATED 1-31-1995, EXPIRES 1-31-2005.

THE FRENCH WORDS IN THE MARK ARE TRANSLATABLE AS "SCRAP MERCHANTS".

INT. CL. 18/U.S. CLS. 1, 2, 3, 22 AND 41

FOR LEATHER AND IMITATIONS OF LEATHER AND ARTICLES MADE FROM THESE MATERIALS AND NOT INCLUDED IN OTHER CLASSES, NAMELY, SKINS AND HIDES SOLD IN BULK, TRUNKS FOR TRAVEL AND TRAVELLING BAGS, SUITCASES, HANDBAGS, SHOULDER BAGS, LUGGAGE, SPORT BAGS, ATTACHE CASES, CASES FOR BEAUTY PRODUCTS, POUCHES, VANITY CASES AND MAKE-UP KITS, BILLFOLDS, WALLETS, PURSES, CARD CASES, BRIEF CASES, TOTE BAGS, DRAWSTRING POUCHES, HAT BOXES FOR TRAVEL, KNAPSACKS, BACKPACKS, PASSPORT CASES, UMBRELLAS, PARASOLS, WALKING STICKS AND CANES, WHIPS, HARNESSES AND SADDLERY, AND PET ACCESSORIES, NAMELY, COLLARS, LEADS, HARNESS, CARRIERS AND CUSHIONS.

FIRST USE ; IN COMMERCE .

INT. CL. 25/U.S. CLS. 22 AND 39

FOR CLOTHING, NAMELY, SPORTSWEAR AND CLOTHING FOR CASUAL WEAR FOR MEN, WOMEN AND CHILDREN, NAMELY, COATS, PARKAS, RAINCOATS, RAINWEAR, WINDCHEATERS, WIND-RESISTANT JACKETS, CAPES, DUST-COATS, WAISTCOATS, SPORT JACKETS, OVER-COATS, SUITS, TUXEDOS, UNIFORMS, CHASUBLES, VESTS, JACKETS, OVERALLS, BLAZERS, CARDIGANS, MINI-VESTS, PANTS, JEANS, TROUSERS, ONE PIECE SUITS, TAILORED SUITS, DRESSES, SKIRTS, KILTS, PULLOVERS, TWIN SETS, BOLERO JACKETS, TOPS, BLOUSES, SHIRTS, SWEAT SHIRTS, T-SHIRTS, SWEATERS, SHORTS, BERMUDA SHORTS, CYCLIST PANTS, ANORAKS, JOGGING OUTFITS, NAMELY, TOPS AND BOTTOMS; ATHLETIC PULLOVERS; SLEEPWEAR, BATH ROBES, DRESSING GOWNS; BEACHWEAR, SWIMWEAR, BATH WRAPS; UNDERWEAR; GLOVES, MUFFLES, MITTENS; SCARVES, PONCHOS, STOLE, SHAWLS; TIES, NECKTIES, FOULARDS, POCKET SQUARES, BELTS, WRISTBANDS, SUSPENDERS; HOUSECOATS, BED JACKETS, NEGLIGEEES, BLOUSES, APRONS; HOSIERY AND SOCKS, PANTY HOSE, STOCKINGS, TIGHTS, LEGWARMERS, GAITERS; FOOTWEAR FOR MEN, WOMEN AND CHILDREN; HEADWEAR, MUFFS, AND EARMUFFS.
FIRST USE ; IN COMMERCE .

ELEMENTS CORRECTED
 FOREIGN APPLICATION NO.
 FOREIGN APPLICATION FILING DATE
 PRIORITY CLAIMED STATEMENT

2,571,738, REG. 5-21-2002, PROCYTE CORPORATION (WASHINGTON CORPORATION) 8511 - 154TH AVENUE NORTHEAST, REDMOND, WA, 980523557, BY ASSIGNMENT HUMATECH CORP. CORPORATION) BOCA RATON, FL, SN 75-449,180. FILED 3-12-1998. PRINCIPAL REGISTER.

HUMACEUTICALS

INT. CL. 35/U.S. CLS. 100, 101 AND 102

FOR PACKAGING AND PRIVATE LABELING OF SKIN CARE AND SKIN PROTECTION PRODUCTS, PHARMACEUTICALS, AND WOUND CARE PRODUCTS.
 FIRST USE 7-27-2001; IN COMMERCE 7-27-2001.
 INT. CL. 40/U.S. CLS. 100, 103 AND 106
 FOR CUSTOM MANUFACTURE OF SKIN CARE AND SKIN PROTECTION PRODUCTS, PHARMACEUTICALS, AND WOUND CARE PRODUCTS.
 FIRST USE 7-27-2001; IN COMMERCE 7-27-2001.

ELEMENTS CORRECTED
 OWNER ADDRESS

2,575,454, REG. 6-4-2002, OTSUKA PHARMACEUTICAL CO., LTD. (JAPAN CORPORATION) NO.9, KANDA TSUKASACHO 2-CHOME, CHIYODA-KU, TOKYO, JAPAN., SN 76-111,784. FILED 8-17-2000. PRINCIPAL REGISTER.



OWNER OF JAPAN REG. NO. 2444968, DATED 8-31-1992, EXPIRES 8-31-2002.
 INT. CL. 32/U.S. CLS. 45, 46 AND 48
 FOR SOFT DRINKS AND PREPARATIONS FOR MAKING SOFT DRINKS.

ELEMENTS CORRECTED
 MARK

* * * * *

TRADEMARK REGISTRATIONS—NEW CERTIFICATES

New Certificates issued under section 7(e) of the Trademark Act of 1946 for the unexpired term of the original registrations.

2,078,155. BIG DOG. INT. CL. 12. BIG DOG MOTORCYCLES, INC., WICHITA, KS. REG. 7-8-1997. NEW CERT. SEC. 7(C) TO BIG DOG HOLDINGS, INC., SANTA BARBARA, CA.

2,251,003. JIGGY UNLIMITED. INT. CL. 25. SAULTERS, DAVID, NEW YORK, NY. REG. 6-8-1999. NEW CERT. SEC. 7(C) TO BLUE MOON INTERNET SERVICES, INC., STUARTS DRAFT, VA.

2,109,020. BIGDOG MOTORCYCLES AND DESIGN. INT. CL. 12. BIG DOG MOTORCYCLES, L.L.C., WICHITA, KS. REG. 10-28-1997. NEW CERT. SEC. 7(C) TO BIG DOG HOLDINGS, INC., SANTA BARBARA, CA.

2,373,632. REBAR. INT. CL. 5. WEIDER NUTRITION INTERNATIONAL, INC., SALT LAKE CITY, UT. REG. 8-1-2000. NEW CERT. SEC. 7(C) TO HEALTHCO CANADA ENTERPRISES, KELOWNA, BRITISH COLUMBIA.

* * * * *

INDEX OF REGISTRANTS

SEPT. 24, 2002

(Registered; Renewed; Canceled; Amended, Corrected, etc.; New Certificates; 12c Publications.)

The designation "U.S. Cl." appearing in this section refers to the U.S. class in effect prior to Sep. 1, 1973 rather than the international class which applies to applications filed on or after that date. For adoption of international classification see notice in the OFFICIAL GAZETTE of Jun. 26, 1973 (911 O.G. TM 210).

- (OHIO CORP.), NEW YORK N.Y.:
391,374, CANC. U.S. CL. 23.
- (OHIO CORP.), LAKEWOOD OHIO:
723,676, CANC. U.S. CL. 51.
- (PA. CORP.), ARDMORE PA.:
723,493, CANC. U.S. CL. 16.
- "BROUWERIJEN ARTOIS", IN HET FRANS: "BRASSERIES ARTOIS", LEUVEN, BELGIUM:
1,176,441, CANC. INT. CL. 32.
1,176,443, CANC. INT. CL. 32.
- A & A GLOBAL INDUSTRIES, INC., TIMONIUM, MD:
1,713,341, REN. 8-14-02. INT. CL. 9.
- A & B PROCESS SYSTEMS CORPORATION, STRATFORD, WI:
2,626,546, MULTIPLE CLASS, INT. CLS. 40 AND 42.
- A & F TRADEMARK, INC., WILMINGTON, DE:
2,626,917, INT. CL. 25.
- A & K INC., BURBANK, CA:
1,933,275, CANC. INT. CL. 25.
- A AAABAM CO., HOUSTON, TX, DBA DRAIN-IT:
2,624,369, PUB. 7-2-2002. INT. CL. 3.
2,624,370, PUB. 6-25-2002. INT. CL. 37.
- A BLESSED COOKIE COMPANY, INC., COLUMBUS, OH:
2,625,018, PUB. 7-2-2002. INT. CL. 35.
- A BROWN SOUN, INC., SAN RAFAEL, CA:
2,627,030, INT. CL. 9.
- A. L. LEE CORPORATION, BECKLEY (LESTER), WV:
1,175,825, CANC. INT. CL. 7.
- A.E.B. S.R.L., 42025 CAVRIAGO (RE), ITALY:
2,622,586, PUB. 7-2-2002. INT. CL. 9.
- A.J.E. LLC, STERLING HEIGHTS, MI:
2,625,271, PUB. 7-2-2002. INT. CL. 41.
- A.K.A. SAUNDERS, INC., BERKELEY, CA, DBA TERRA NOVA:
1,934,199, CANC. INT. CL. 4.
- A.L.S. INDUSTRIES, INC., TORRANCE, CA:
2,625,644, INT. CL. 9.
- A.S GIBBS & ASSOCIATES, INC., REDONDO BEACH, CA:
2,625,039, PUB. 7-2-2002. INT. CL. 35.
- A/S NIRO ATOMIZER, SOBORG, DENMARK:
1,175,774, CANC. MULTIPLE CLASS, INT. CLS. 6, 7, 9 AND 11.
- AAA AUTO CLUB SOUTH, INC., TAMPA, FL:
2,623,009, PUB. 7-2-2002. INT. CL. 39.
- AARDVARK TACTICAL, INC., ARCADIA, CA:
2,625,295, PUB. 7-2-2002. INT. CL. 35.
- AARON PROCESS EQUIPMENT COMPANY, BENSONVILLE, IL:
2,623,289, PUB. 1-8-2002. INT. CL. 7.
2,623,367, PUB. 7-2-2002. INT. CL. 7.
- AARON-STONE, INC., YUCCA VALLEY, CA, DBA LOGIC TECHNOLOGIES:
1,932,686, CANC. INT. CL. 9.
- AARP, WASHINGTON, DC:
2,623,034, PUB. 7-2-2002. MULTIPLE CLASS, INT. CLS. 16, 35 AND 42.
- AB VIN- & SPRITCENTRALEN (SWEDISH LIQUORMONO-POLY), STOCKHOLM, SWEDEN:
1,176,702, CANC. INT. CL. 33.
- ABACUS 2000 S.R.L., VICENZA, ITALY FROM ALTA VISTA SRL, 36100 VICENZA, ITALY:
2,622,681, PUB. 10-31-2000. INT. CL. 25.
- ABACUS 2000 SRL, 36100 VICENZA, ITALY:
2,624,192, PUB. 7-2-2002. INT. CL. 25.
- ABANA PHARMACEUTICALS, INC., BIRMINGHAM, AL:
1,933,578, CANC. INT. CL. 5.
- ABB BODY IN WHITE, 95250 BEAUCHAMP, FRANCE:
2,623,717, PUB. 7-2-2002. MULTIPLE CLASS, INT. CLS. 7 AND 9.
- ABBOTSBURY SOFTWARE LIMITED, ABBOTSBURY, DORSET DT3 4JP, ENGLAND:
1,932,579, CANC. INT. CL. 9.
- ABBOTT LABORATORIES, NORTH CHICAGO, IL:
147,893, CANC. U.S. CL. 6.
- ABBOTT LABORATORIES, ABBOTT PARK, IL:
1,933,863, CANC. INT. CL. 42.
- ABC ADVISORS, INC.:
See—E-LYNXX CORPORATION.
- ABC APPLIANCE, INC., PONTIAC, MI:
2,624,410, PUB. 7-2-2002. INT. CL. 35.
- ABC BUS COMPANIES, INC., FARIBAULT, MN:
2,626,520, INT. CL. 12.
- ABE MAGAZINE, INC., PHOENIX, AZ:
2,624,350, PUB. 7-2-2002. INT. CL. 16.
- ABEL INDUSTRIES, INC., NEWTON HIGHLANDS, MA:
1,176,691, CANC. INT. CL. 25.
1,176,692, CANC. INT. CL. 25.
- ABERDEEN ROAD COMPANY, EMIGSVILLE, PA:
2,626,715, INT. CL. 17.
- ABRAHAM, JOSEPH D., TULSA, OK:
2,625,070, PUB. 7-2-2002. INT. CL. 35.
- ABSORB-PLUS TEXTILES INC., VILLE MONT-ROYAL, QUEBEC, CANADA:
1,932,450, CANC. MULTIPLE CLASS, INT. CLS. 5 AND 10.
- ABSTRACT CONCEPTS, INC., GOLDEN VALLEY, MN:
1,933,881, CANC. INT. CL. 42.
- ACADEMY FOR JEWISH RELIGION, THE, RIVERDALE, NY:
2,624,701, PUB. 7-2-2002. INT. CL. 41.
- ACADEMY OF COMMUNITY MUSIC, FORT WASHINGTON, PA:
2,623,344, PUB. 7-2-2002. INT. CL. 41.
- ACCELERATED MOVING AND STORAGE, INC., GROVEPORT, OH:
2,625,100, PUB. 7-2-2002. INT. CL. 39.
- ACCENTURE GLOBAL SERVICES GMBH, 8212 NEUHAUSEN AM RHEINFALL, SWITZERLAND, APPLIED DATA RESEARCH, INC., PRINCETON, NJ:
1,190,541, REN. 8-15-02. INT. CL. 9.
- ACCESS VG, L.L.C., SALT LAKE CITY, UT:
2,624,224, PUB. 7-2-2002. INT. CL. 35.
- ACCO WORLD CORPORATION, DEERFIELD, IL:
1,934,083, CANC. INT. CL. 9.
- ACCO-AIR CONDITIONING COMPANY, INC., GLENDALE, CA:
2,625,260, PUB. 7-2-2002. MULTIPLE CLASS, INT. CLS. 36, 37, 40 AND 42.
- ACCOLADE, INC., SAN JOSE, CA:
1,872,003, CANC. INT. CL. 28.
- ACCORD GROUP LIMITED, NEW YORK, NY:
1,932,485, CANC. INT. CL. 35.
- ACCUBUILT, INC., LIMA, OH:
2,624,704, PUB. 7-2-2002. INT. CL. 12.

- ACCUDYNE CORPORATION, PALM BAY, FL:
1,933,148, CANC. INT. CL. 9.
- ACCURATE DATA SYSTEMS, INC., HOLLISTON, MA:
2,623,767, PUB. 7-2-2002. INT. CL. 9.
- ACCUSIGHT, INC., CORAL GABLES, FL:
2,624,138, PUB. 7-2-2002. INT. CL. 42.
- ACCUSPRAY, INC., CLEVELAND, OH:
2,626,420, INT. CL. 7.
- ACCUSYSTEMS, INC., KIRKLAND, WA:
1,932,424, CANC. INT. CL. 10.
- ACENTO ADVERTISING, INC., LOS ANGELES, CA:
2,624,205, PUB. 7-2-2002. INT. CL. 35.
- ACHIEVEGLOBAL, INC., TAMPA, FL, KASET, INC., TAMPA, FL:
1,690,554. REN. 8-15-02. MULTIPLE CLASS, INT. CLS. 41 AND 42.
- ACME LAUNDRY AND CLEANERS, INC., ORLANDO, FL:
2,625,265, PUB. 7-2-2002. INT. CL. 37.
- ACME PLASTICS, INC., WEST PATERSON, NJ:
1,932,573, CANC. MULTIPLE CLASS, INT. CLS. 1, 17 AND 42.
- ACORN CONSULTING INC., CARY, NC:
2,623,227, PUB. 7-2-2002. MULTIPLE CLASS, INT. CLS. 35 AND 41.
- ACORN PARTNERS, SAN LORENZO, PUERTO RICO:
1,933,439, CANC. INT. CL. 25.
- ACQUA DI PARMA S.R.L., 40125 TORINO, ITALY:
2,623,101, PUB. 7-2-2002. INT. CL. 4.
- ACROPRINT, INC., RALEIGH, NC:
2,622,854, PUB. 7-2-2002. INT. CL. 9.
- ACRY-TECH COATINGS, INC., FT. LAUDERDALE, FL:
2,624,823, PUB. 7-2-2002. INT. CL. 3.
- ACTIVATE.NET CORP., SEATTLE, WA:
2,623,938, PUB. 7-2-2002. INT. CL. 38.
2,623,939, PUB. 7-2-2002. INT. CL. 38.
- ACTIVE IMAGINATIONS, INC., HOUSTON, TX:
1,933,274, CANC. INT. CL. 25.
- ACTIVE RESEARCH INC., LOS ANGELES, CA, DBA MSR VIDEOS:
2,622,963, PUB. 7-2-2002. INT. CL. 9.
- ACTIVE TEMPORARY SERVICES, INC., CHICAGO, IL:
1,663,602, CANC. INT. CL. 35.
- ACTIVESTATE CORPORATION, VANCOUVER BBC-BRITISH COLUMBIA, CANADA FROM ACTIVESTATE TOOL CORP., VANCOUVER BRITISH COLUMBIA, CANADA:
2,626,756, INT. CL. 9.
- ACTIVESTATE TOOL CORP.:
See— ACTIVESTATE CORPORATION.
- ACTORS' EQUITY ASSOCIATION, NEW YORK, NY:
2,624,178, PUB. 7-2-2002. INT. CL. 42.
- ACUFEX MICROSURGICAL, INC., MANSFIELD, MA:
1,933,665, CANC. INT. CL. 10.
- ACUSHNET COMPANY, FAIRHAVEN, MA:
2,624,539, PUB. 7-2-2002. INT. CL. 25.
- AD-TECH MEDICAL INSTRUMENT CORPORATION, RACINE, WI:
2,626,464, INT. CL. 10.
2,626,465, INT. CL. 10.
- ADAC LABORATORIES, MILPITAS, CA:
2,626,458, INT. CL. 10.
- ADAMS/HUNTER PUBLISHING, INC., CATHEDRAL CITY, CA:
2,624,190, PUB. 7-2-2002. INT. CL. 16.
- ADAMS, BRIAN, EAST ORANGE, NJ AND DESIRE, WOODLORD, EAST ORANGE, NJ:
2,624,934, PUB. 7-2-2002. INT. CL. 25.
- ADAPTEC, INC., MILPITAS, CA:
1,934,172, CANC. INT. CL. 9.
- ADCHEM CORPORATION, RIVERHEAD, NY:
2,626,992, MULTIPLE CLASS, INT. CLS. 40 AND 42.
- ADDAZI, INC., LOS ANGELES, CA:
2,625,250, PUB. 7-2-2002. INT. CL. 5.
- ADDITION TECHNOLOGY, INC., FREMONT, CA FROM KERAVISION, INC, FREMONT, CA:
2,625,446, INT. CL. 10.
- ADD2NET.COM, LLC, HUNTSVILLE, AL:
2,626,984, INT. CL. 35.
- ADED WEAR, INC., CHICAGO, IL:
2,625,685, INT. CL. 25.
- ADEPT TECHNOLOGY, INC., SAN JOSE, CA:
2,623,647, PUB. 7-2-2002. INT. CL. 9.
- ADES & GISH NURSERIES, INC., ENCINITAS, CA:
2,624,440, PUB. 7-2-2002. INT. CL. 31.
- ADF VENTURES, LTD., NEW YORK, NY:
2,622,576, PUB. 11-27-2001. INT. CL. 35.
- ADIVAN HIGH TECH AG, CH-8855 WANGEN, SWITZERLAND:
2,623,964, PUB. 7-2-2002. INT. CL. 9.
- ADMIT ONE FESTIVALS & SPECIAL EVENTS, INC., EMPORIA, VA:
1,933,602, CANC. INT. CL. 42.
- ADOLF RIEDL GMBH & CO., D-95448 BAYREUTH, FED REP GERMANY:
2,623,459, PUB. 7-2-2002. INT. CL. 25.
- ADOLPH GOTTSCHO, INC., UNION, NJ:
723,451, CANC. U.S. CL. 11.
- ADPLEX, INC., HOUSTON, TX:
2,623,744, PUB. 7-2-2002. INT. CL. 35.
- ADS LOGISTICS, LLC, HOMEWOOD, IL FROM ALTERNATIVE DISTRIBUTION SYSTEMS, INC., HOMEWOOD, IL:
2,623,248, PUB. 7-2-2002. INT. CL. 42.
- ADVANCE MAGAZINE PUBLISHERS INC., NEW YORK, NY:
2,624,443, PUB. 7-2-2002. INT. CL. 41.
- ADVANCE NEWS SERVICE, INC., WASHINGTON, DC:
2,626,381, INT. CL. 42.
- ADVANCE SEED COMPANY, FULTON, KY:
1,934,146, CANC. INT. CL. 31.
- ADVANCED DEPOSITION TECHNOLOGIES, INC., TAUNTON, MA:
1,932,722, CANC. INT. CL. 16.
- ADVANCED DIGITAL, INC., CAMARILLO, CA:
2,623,812, PUB. 7-2-2002. MULTIPLE CLASS, INT. CLS. 7 AND 9.
- ADVANCED NAVIGATION AND POSITIONING CORP., HOOD RIVER, OR:
1,933,369, CANC. INT. CL. 9.
- ADVANCED NMR SYSTEMS, INC., WILMINGTON, MA:
1,933,958, CANC. INT. CL. 10.
- ADVANCED RESEARCH AND TECHNOLOGY INSTITUTE, INC., BLOOMINGTON, IN:
2,625,379, INT. CL. 42.
2,626,912, INT. CL. 42.
- ADVANCED TECHNOLOGY MATERIALS, INC., DANBURY, CT:
2,625,475, MULTIPLE CLASS, INT. CLS. 1 AND 9.
- ADVANCED TECHNOLOGY SYSTEMS, INC., MCLEAN, VA:
1,932,721, CANC. INT. CL. 9.
- ADVANTA USA, INC., SLATER, IA:
2,626,845, INT. CL. 31.
- ADVANTAGE COMMUNICATIONS GROUP, INC., OAKLAND, CA:
1,932,817, CANC. INT. CL. 42.
- ADVANTAGE GEOCHEMICAL SOLUTIONS PTY LTD, MELBOURNE, AUSTRALIA:
2,624,241, PUB. 7-2-2002. INT. CL. 42.
- ADVANTAGE NUTRACEUTICALS, INC., DESTIN, FL:
2,622,781, PUB. 7-2-2002. INT. CL. 5.
- ADVANTIS, SCHAUMBURG, IL:
1,933,438, CANC. MULTIPLE CLASS, INT. CLS. 9, 16 AND 38.
- ADVERTISING SPECIALTY INSTITUTE INC., TREVOSE, PA, NATIONAL BUSINESS SERVICES, INC., LANGHORNE, PA:
1,729,220. REN. 8-10-02. INT. CL. 16.
- AEGON USA, INC., LOS ANGELES, CA:
2,624,216, PUB. 7-2-2002. INT. CL. 36.
2,624,236, PUB. 7-2-2002. INT. CL. 36.
2,624,238, PUB. 7-2-2002. INT. CL. 36.
2,624,239, PUB. 7-2-2002. INT. CL. 36.
2,624,240, PUB. 7-2-2002. INT. CL. 36.
2,624,249, PUB. 7-2-2002. INT. CL. 36.
2,624,329, PUB. 7-2-2002. INT. CL. 36.

AEROSPACE EDUCATION FOUNDATION, ARLINGTON, VA:
2,624,101, PUB. 7-2-2002. INT. CL. 36.

AEROVIAS NACIONALES DE COLOMBIA S.A. AVIANCA, BARRANQUILLA, COLOMBIA:
2,625,413, INT. CL. 39.

AETNA INC., BLUE BELL, CT:
2,625,284, PUB. 7-2-2002. INT. CL. 36.

AFCO, INC., MEMPHIS, TN:
2,626,789, INT. CL. 9.

AFFINITY GROUP, INC., VENTURA, CA:
2,624,334, PUB. 7-2-2002. INT. CL. 16.

AFFINITY MORTGAGE, LLC, ROWLETT, TX:
2,626,895, INT. CL. 36.

AFFORDABLE CASKETS, INC., OCEANSIDE, CA:
2,626,829, INT. CL. 35.

AFL-CIO HOUSING INVESTMENT TRUST, WASHINGTON, DC:
2,626,170, MULTIPLE CLASS, INT. CLS. 36 AND 42.

AF2 ENTERPRISES LLC, CHICAGO, IL:
2,626,207, MULTIPLE CLASS, INT. CLS. 16, 25 AND 41.

AG-BAG CORPORATION, WARRENTON, OR:
1,933,778, CANC. INT. CL. 42.

AGAVE TEQUILANA PRODUCTORES Y COMERCIALIZADORES SA DE CV, ZAPOPAN JALISCO, MEXICO:
2,626,590, INT. CL. 33.

AGC, INC., CLEVELAND, OH:
1,933,277, CANC. INT. CL. 26.

AGER MEDICAL ASSOCIATES, P.C., CHERRY HILL, NJ, DBA THE LAWYER STRESS CENTER:
1,934,479, CANC. INT. CL. 42.

AGERE SYSTEMS INC., ALLENTOWN, PA FROM LUCENT TECHNOLOGIES INC., MURRAY HILL, NJ:
2,625,324, INT. CL. 9.

AGETEC, INC., REDWOOD CITY, CA:
2,478,452, COR. INT. CL. 9.

AGF MANUFACTURING INC., MALVERN, PA:
2,623,810, PUB. 7-2-2002. INT. CL. 11.

AGFA CORPORATION, WILMINGTON, MA FROM BAYER CORPORATION, PITTSBURGH, PA:
2,625,453, INT. CL. 9.

AGGADHAMVONG, MANODHAM, BANGKOK, THAILAND:
2,625,207, PUB. 7-2-2002. INT. CL. 11.

AGILE SOFTWARE CORPORATION, SAN JOSE, CA:
2,625,541, INT. CL. 9.

AGILENT TECHNOLOGIES, INC., PALO ALTO, CA FROM HP MEASUREMENT, INC., PALO ALTO, CA:
2,625,554, MULTIPLE CLASS, INT. CLS. 1, 9, 10, 14, 16, 35, 36, 37, 41 AND 42.

AGRI LABORATORIES, LTD., ST. JOSEPH, MO:
1,733,925, REN. 8-15-02. INT. CL. 5.

AGRIC BEEF CO., BOISE, ID:
1,934,440, CANC. INT. CL. 7.

AGRIMOND, L.L.C., CAPE CANAVERAL, FL:
2,626,078, INT. CL. 9.

AGROMAR CORPORATION, BAKERSFIELD, CA:
2,626,476, INT. CL. 1.

AGUILAR, NOEL, CAMARILLO, CA:
2,623,594, PUB. 7-2-2002. INT. CL. 3.

AHA! SOFTWARE CORPORATION, MOUNTAIN VIEW, CA:
1,933,515, CANC. INT. CL. 9.

AIM INTERNATIONAL, INC., NAMPA, ID:
1,706,191, REN. 8-14-02. INT. CL. 5.
2,625,522, INT. CL. 5.

AINS, INC., ROCKVILLE, MD:
2,625,168, PUB. 7-2-2002. INT. CL. 9.

AIR MOVEMENT GROUP, LIMITED, LONDON, ENGLAND:
2,626,005, INT. CL. 11.

AIR PRODUCTS AND CHEMICALS, INC., ALLENTOWN, PA:
2,625,963, MULTIPLE CLASS, INT. CLS. 1 AND 7.

AIR SPONGE FILTER COMPANY, INC., CORAL SPRINGS, FL:
2,626,742, INT. CL. 11.

AIR-TRAK.COM, SAN DIEGO, CA:
2,626,342, INT. CL. 9.
2,626,952, INT. CL. 35.

AIRNEX COMMUNICATIONS, INC., SAN RAMON, CA:
2,626,808, INT. CL. 38.

AIRPRINT SYSTEMS, INC., ITASCA, IL:
1,175,811, CANC. MULTIPLE CLASS, INT. CLS. 7 AND 9.

AIRWAY INDUSTRIES, INC., ELLWOOD CITY, PA:
2,626,733, INT. CL. 18.

AIR2WEB, INC., ATLANTA, GA:
2,624,225, PUB. 7-2-2002. INT. CL. 9.

AISE STEEL FOUNDATION, THE, PITTSBURGH, PA:
2,623,057, PUB. 7-2-2002. INT. CL. 16.

AISLO OY, FINLAND:
2,543,794, COR. MULTIPLE CLASS, INT. CLS. 1, 17, 19 AND 37.

AJR PRODUCTIONS LTD., AVENTURA, FL:
2,626,218, INT. CL. 3.

AK STEEL CORPORATION, MIDDLETOWN, OH, ARMCO STEEL CORPORATION, MIDDLETOWN, OH:
547,908, REN. 8-11-02. U.S. CL. 14 (INT. CL. 6).

AKEYER TEC. CORP., MONTEREY PARK, CA:
2,626,270, INT. CL. 28.

AKKERMAN, JOAN, WEST HILLS, CA:
1,932,786, CANC. INT. CL. 16.

AKSHUN & AKSHUN, INC., NORWALK, CA:
2,625,342, MULTIPLE CLASS, INT. CLS. 25 AND 42.

AKTIEBOLAGET C. E. JOHANSSON, ESKILSTUNA, SWEDEN:
148,097, CANC. U.S. CL. 26.

AKTIEBOLAGET ELECTROLUX, 45 STOCKHOLM, SWEDEN, ELECTROLUX, INC., NEW YORK, NY:
284,377, REN. 8-15-02. U.S. CL. 21 (INT. CL. 9).

AKZO NOBEL CHEMICALS B.V., AMERSFOORT, 3818 LE, NETHERLANDS:
2,624,408, PUB. 7-2-2002. INT. CL. 1.

AKZO NOBEL CHEMICALS INC., CHICAGO, IL:
2,625,866, INT. CL. 6.

AL-MAWARED NATURAL BEAUTY PRODUCTS CORP., AMMAN 11192, JORDAN:
2,624,446, PUB. 7-2-2002. INT. CL. 3.

ALABAMA A&M UNIVERSITY RESEARCH INSTITUTE, NORMAL, AL:
2,625,535, INT. CL. 42.

ALAN DICK & COMPANY LIMITED, GLOUCESTERSHIRE GL52 6UT, UNITED KINGDOM:
2,623,548, PUB. 4-16-2002. MULTIPLE CLASS, INT. CLS. 6, 9 AND 20.

ALAN HAJJAR, CHRIS BREED AND GEORGE NAHAS JOINT VENTURE, THE, RESEDA, CA:
2,622,749, PUB. 7-2-2002. INT. CL. 42.

ALAN YAU LIMITED, LONDON, UNITED KINGDOM:
2,622,850, PUB. 7-2-2002. MULTIPLE CLASS, INT. CLS. 9, 16, 25, 29, 30, 31, 32, 33 AND 42.

ALASKAN GOURMENT, INC., ANCHORAGE, AK:
1,663,525, CANC. INT. CL. 29.

ALBERDINGK BOLEY GMBH, KREFELD, FED REP GERMANY:
2,625,806, INT. CL. 1.

ALBERTO ASPESI & C.S.P.A., LEGANO (MILANO), ITALY:
2,623,916, PUB. 7-2-2002. INT. CL. 18.

ALBERTSON'S, INC., BOISE, ID:
2,624,570, PUB. 7-2-2002. INT. CL. 3.

ALCAN ALUMINIUM UK LIMITED, BUCKINGHAMSHIRE, SL9 0QB, UNITED KINGDOM:
2,622,566, PUB. 7-2-2002. INT. CL. 1.

ALCOA INC., PITTSBURGH, PA:
2,623,952, PUB. 7-2-2002. INT. CL. 12.
2,626,666, INT. CL. 19.

ALEX NOEL, INC., NEW YORK, NY:
2,341,633, COR. INT. CL. 18.

ALEXANDER, STEPHEN J., SANIBEL ISLAND, FL:
2,626,556, INT. CL. 35.

ALFA BIOTECH S.P.A.:
See—ALFA WASSERMAN S.P.A..

- ALFA WASSERMAN S.P.A., 65020 ALANNO SCALO (PESCARA), BOLOGNA, ITALY FROM ALFA BIOTECH S.P.A., 0040 POMEZIA (ROMA), ITALY:
2,622,677, PUB. 11-13-2001. MULTIPLE CLASS, INT. CLS. 9 AND 16.
- ALFRED P. SLOAN FOUNDATION, NEW YORK, NY:
2,624,227, PUB. 7-2-2002. MULTIPLE CLASS, INT. CLS. 16, 35 AND 41.
- ALG INC., BOZEMAN, MT:
2,624,098, PUB. 7-2-2002. INT. CL. 42.
- ALGORHYTHMS, INC., DALLAS, TX:
1,934,468, CANC. INT. CL. 9.
- ALIGN360, INC.:
See—ALIGN360, LLC.
- ALIGN360, LLC, RICHMOND, VA FROM ALIGN360, INC., WALTHAM, MA:
2,623,516, PUB. 7-2-2002. MULTIPLE CLASS, INT. CLS. 35 AND 42.
- ALISTAIR SOMERSET PTY. LTD., NUNAWADING, VICTORIA, AUSTRALIA:
2,626,673, INT. CL. 24.
- ALKANATER S.A.L., MKALLES, BEIRUT, LEBANON:
2,624,298, PUB. 7-2-2002. MULTIPLE CLASS, INT. CLS. 29, 30 AND 32.
- ALL CHILDREN'S HOSPITAL FOUNDATION, INC., ST. PETERSBURG, FL:
2,626,362, INT. CL. 41.
- ALL-CONTROL SYSTEMS, INC., WEST CHESTER, PA:
1,933,873, CANC. INT. CL. 35.
- ALLAFRICA, INC., WASHINGTON, DC FROM ALLAFRICA.COM, INC., WILMINGTON, DE:
2,625,893, INT. CL. 42.
- ALLBALL ATHLETICS, INC., BELLE MEADE, NJ:
2,625,720, INT. CL. 25.
- ALLCONNECT.COM, INC., ATLANTA, GA FROM ALLCONNECT.COM, INC., ATLANTA, GA:
2,626,064, MULTIPLE CLASS, INT. CLS. 35 AND 42.
- ALLEGHANY PHARMACAL CORPORATION, GREAT NECK, NY:
2,624,573, PUB. 7-2-2002. INT. CL. 3.
- ALLEN AND ASSOCIATES, INC., BAINBRIDGE ISLAND, WA:
2,623,074, PUB. 7-2-2002. INT. CL. 25.
- ALLEN CAMPBELL, GOLETA, CA:
2,622,600, PUB. 7-2-2002. INT. CL. 41.
- ALLEN RESOURCES, INC., N. KINGSTOWN, RI:
2,623,503, PUB. 7-2-2002. MULTIPLE CLASS, INT. CLS. 9 AND 16.
- ALLEN, CLINTON A. SANTA MONICA, CA:
2,627,008, MULTIPLE CLASS, INT. CLS. 38 AND 41.
- ALLIANCE FOODS, INC., COLDWATER, MI:
1,933,424, CANC. INT. CL. 31.
- ALLIANCE PERIPHERAL SYSTEMS, INC., KANSAS CITY, MO:
1,933,780, CANC. INT. CL. 9.
- ALLIDEX, INC., BOCA RATON, FL:
2,626,165, INT. CL. 42.
- ALLIED FASHION INC., SAVANNAH, GA:
2,625,829, INT. CL. 35.
- ALLIED PAPER INCORPORATED, MIAMISBURG, OH:
1,176,180, CANC. INT. CL. 16.
- ALLIED TELESYN INTERNATIONAL CORP., BOTHELL, WA:
2,626,164, INT. CL. 35.
- ALLOY VENTURES, INC., PALO ALTO, CA:
2,625,466, INT. CL. 36.
- ALLPRO CORPORATION, BRANDON, FL:
2,624,830, PUB. 7-2-2002. INT. CL. 2.
- ALLTECH ASSOCIATES, INC., DEERFIELD, IL:
2,626,236, INT. CL. 9.
- ALLTRADE INC., LONG BEACH, CA:
1,940,042, CANC. INT. CL. 7.
- ALLURE, INC., NEW YORK, NY:
2,624,940, PUB. 7-2-2002. INT. CL. 25.
- ALMA INC.:
See—ILLINOIS TOOL WORKS, INC..
- ALMOND BROTHERS, LLC, PHOENIX, AZ:
2,624,073, PUB. 7-2-2002. MULTIPLE CLASS, INT. CLS. 29 AND 30.
- ALOIS POSCHL GMBH & CO. KG, D-84144 GEISENHAUSEN BEI LANDSHUT, FED REP GERMANY:
2,625,546, INT. CL. 34.
- ALPHA & OMEGA FINANCIAL MANAGEMENT CONSULTANTS, INC., LA MESA, CA:
1,176,177, CANC. INT. CL. 16.
- ALPHA RESOURCES, INC., STEVENSVILLE, MI:
2,623,386, PUB. 7-2-2002. INT. CL. 1.
- ALPHA-M, INC., MINNEAPOLIS, MN:
2,624,637, PUB. 7-2-2002. INT. CL. 16.
- ALPHAMICRON, INC., KENT, OH:
2,624,596, PUB. 7-2-2002. INT. CL. 9.
- ALSTOM, 75116 PARIS, FRANCE:
2,623,514, PUB. 7-2-2002. INT. CL. 9.
- ALTA VISTA SRL:
See—ABACUS 2000 S.R.L..
- ALTAMA DELTA CORPORATION, ROSWELL, GA:
2,626,182, INT. CL. 25.
- ALTERNATIVE DISTRIBUTION SYSTEMS, INC.:
See—ADS LOGISTICS, LLC.
- ALTIVIA, HOUSTON, TX:
2,624,333, PUB. 7-2-2002. INT. CL. 40.
- ALTO INTERNATIONAL A/S, DK-1050 COPENHAGEN K, DENMARK FROM INTERNATIONAL CLEANING EQUIPMENT A/S, 1050 KOBENHAVN K, DENMARK:
2,625,370, MULTIPLE CLASS, INT. CLS. 7, 11 AND 21.
- ALUMINUM PRECISION PRODUCTS, INC., SANTA ANA, CA:
2,623,937, PUB. 7-2-2002. INT. CL. 12.
- ALVIN E. COX, SANTA ANA, CA:
2,625,582, INT. CL. 7.
- ALVITI TOOL & DIE, INC., JOHNSTON, RI:
1,681,951, REN. 8-16-02. INT. CL. 14.
- ALWAYS POSITIVE, INC., ESCONDIDO, CA:
2,624,707, PUB. 7-2-2002. INT. CL. 25.
- AMALIA MORETTI, INC., ATLANTA, GA, DBA LA GIOIOSA U.S.A.:
1,933,614, CANC. INT. CL. 33.
- AMALIE AOC, LTD., TAMPA, FL:
2,623,383, PUB. 7-2-2002. INT. CL. 4.
- AMANO CORPORATION, YOKOHAMA-SHI, KANAGAWA-KEN, JAPAN:
2,622,538, PUB. 3-7-2000. INT. CL. 9.
- AMBAC INTERNATIONAL CORPORATION, COLUMBIA, SC:
1,689,848, REN. 8-14-02. INT. CL. 7.
- AMBER HOLDINGS INC., CALGARY, ALBERTA, CANADA:
2,625,678, MULTIPLE CLASS, INT. CLS. 16 AND 28.
- AMBERLEY ESTATE PTY LTD, WESTERN AUSTRALIA, AUSTRALIA:
2,623,327, PUB. 8-21-2001. INT. CL. 33.
- AMBITECH, INC., CANOGA PARK, CA:
2,625,377, INT. CL. 9.
- AMBITECH, INC., CHATSWORTH, CA:
2,625,391, INT. CL. 9.
- AMBU INTERNATIONAL A/S, DK-2600 GLOSTRUP, DENMARK:
1,688,903, REN. 8-15-02. INT. CL. 10.
- AMBULATORY MONITORING, INC., ARDSLEY, NY:
2,626,124, INT. CL. 10.
- AMCOL INTERNATIONAL CORPORATION, ARLINGTON, HEIGHTS, IL FROM EASTMAN CHEMICAL COMPANY, KINGSPORT, TN:
2,625,776, INT. CL. 1.
- AMEDS, LLC, DUXBURY, MA:
2,625,974, INT. CL. 10.
- AMERICA WEST AIRLINES, INC., PHOENIX, AZ:
2,622,992, PUB. 7-2-2002. INT. CL. 39.
- AMERICA'S CLEAN WATER FOUNDATION, WASHINGTON, DC:
2,626,969, INT. CL. 41.
- AMERICA'S CUTTING EDGE HOLDINGS INC., HAUPAUGE, NY:
2,624,286, PUB. 7-2-2002. INT. CL. 36.
- AMERICA'S HOBBY CENTER, INC., NEW YORK, NY:
1,934,477, CANC. INT. CL. 42.

- AMERICAN ACADEMY OF PROFESSIONAL CODERS, INC., SALT LAKE CITY, UT:
2,623,769, PUB. 7-2-2002. INT. CL. 41.
- AMERICAN ANTENNA CORPORATION, ELGIN, IL:
1,175,901, CANC. INT. CL. 9.
- AMERICAN ASSOCIATION OF COST ENGINEERS (AAACE, INC.), MORGANTOWN, WV:
1,176,120, CANC. INT. CL. 16.
- AMERICAN ASSOCIATION OF PHYSICIANS FROM INDIA, BURTON, MI:
1,932,604, CANC. MULTIPLE CLASS, INT. CLS. 41 AND 42.
- AMERICAN AUTOMOBILE ASSOCIATION, INC., HEATHROW, FL:
2,626,663, INT. CL. 41.
- AMERICAN B.D. COMPANY, HAWTHORNE, NJ, DBA OPICI WINE CO.:
1,933,661, CANC. INT. CL. 33.
- AMERICAN BIOGENETIC SCIENCES, INC., COPIAGUE, NY:
1,934,082, CANC. INT. CL. 5.
- AMERICAN BUSINESS ENGLISH SERVICES, LLC, BOULDER, CO, DBA AMERICAN BUSINESS ENGLISH INTERNET SCHOOL:
2,627,024, INT. CL. 41.
- AMERICAN CHECK CASHERS, INC., LAFAYETTE, LA:
1,738,621, REN. 8-14-02. INT. CL. 36.
- AMERICAN CITY BUSINESS JOURNALS, INC., CHARLOTTE, NC:
1,933,107, CANC. INT. CL. 16.
- AMERICAN COLLEGE OF VETERINARY ANESTHESIOLOGISTS, BOISE, ID:
2,624,099, PUB. 7-2-2002. INT. CL. 16.
- AMERICAN COLLEGE, THE, BRYN MAWR, PA FROM AMERICAN COLLEGE, THE, BRYN MAWR, PA AND LIMRA INTERNATIONAL, INC., WINDSOR, CT:
2,625,352, INT. CL. 41.
2,625,353, INT. CL. 41.
- AMERICAN COLLOID COMPANY, ARLINGTON HEIGHTS, IL:
1,933,387, CANC. INT. CL. 19.
- AMERICAN CONEY ISLAND, INC., DETROIT, MI:
2,625,238, PUB. 7-2-2002. INT. CL. 42.
- AMERICAN CONTACT LENS, INC., SAN DIEGO, CA:
2,626,154, INT. CL. 9.
- AMERICAN CRAFTS ONLINE, INC., GAITHERSBURG, MD:
2,626,802, INT. CL. 35.
- AMERICAN DAIRY QUEEN CORPORATION, MINNEAPOLIS, MN, DAIRY QUEEN OF FLORIDA, PALM BEACH, FL:
559,844, REN. 8-12-02. U.S. CL. 46 (INT. CL. 30).
- AMERICAN DIRECT CARE, INC., BOSTON, MA:
2,622,958, PUB. 7-2-2002. INT. CL. 42.
- AMERICAN EAGLE OUTFITTERS, INC., WARRENDALE, PA:
1,934,003, CANC. INT. CL. 14.
- AMERICAN ELECTRONIC SIGN COMPANY, SPOKANE, WA:
1,942,026, CANC. INT. CL. 9.
- AMERICAN EXPRESS COMPANY, NEW YORK, NY:
2,623,485, PUB. 7-2-2002. INT. CL. 36.
- AMERICAN GOLF CORPORATION, SANTA MONICA, CA:
2,622,647, PUB. 7-2-2002. INT. CL. 41.
- AMERICAN HEART ASSOCIATION/NATION'S CAPITAL AFFILIATE, ANNANDALE, VA AND RAUL, ALAN C., WASHINGTON, DC AND FRANK, RICHARD L., WASHINGTON, DC:
1,703,680, REN. 8-16-02. INT. CL. 36.
- AMERICAN HEART ASSOCIATION, INC., DALLAS, TX:
2,625,662, MULTIPLE CLASS, INT. CLS. 16 AND 42.
- AMERICAN HOME FOOD PRODUCTS, INC., MADISON, NJ:
1,933,644, CANC. MULTIPLE CLASS, INT. CLS. 35, 39, 40 AND 42.
- AMERICAN HOME PRODUCTS CORPORATION, NEW YORK, NY:
723,503, CANC. U.S. CL. 18.
- AMERICAN HOME PRODUCTS CORPORATION, MADISON, NJ:
2,625,202, PUB. 7-2-2002. INT. CL. 5.
- AMERICAN HORSE PUBLICATIONS, INC., SOUTH DAYTONA, FL:
1,737,250, REN. 8-15-02. INT. CL. 42.
- AMERICAN HOSPITAL ASSOCIATION, CHICAGO, IL:
2,625,474, MULTIPLE CLASS, INT. CLS. 9, 16, 35 AND 41.
- AMERICAN INFORMATION COMPANY, INC., SAN FRANCISCO, CA TO AMERICAN INFORMATION COMPANY, INC., SAN FRANCISCO, CA:
2,458,695, COR. MULTIPLE CLASS, INT. CLS. 35, 36 AND 39.
- AMERICAN INNOVATIONS, LTD., AUSTIN, TX:
2,623,655, PUB. 7-2-2002. INT. CL. 42.
- AMERICAN INSTITUTE FOR FOREIGN STUDY, INC., STAMFORD, CT:
2,626,197, INT. CL. 42.
- AMERICAN INSTITUTE OF AERONAUTICS AND ASTRONAUTICS (AIAA), WASHINGTON, DC:
1,932,889, CANC. INT. CL. 42.
- AMERICAN INSTITUTE OF PHYSICS INCORPORATED, COLLEGE PARK, MD, AKA AIP:
2,624,658, PUB. 7-2-2002. INT. CL. 16.
- AMERICAN INTERNATIONAL GROUP, INC., NEW YORK, NY:
2,622,944, PUB. 7-2-2002. INT. CL. 36.
- AMERICAN LAND SERVICE, INC., FLORENCE, SC:
1,176,488, CANC. INT. CL. 36.
- AMERICAN LEBANESE SYRIAN ASSOCIATED CHARITIES, INC., MEMPHIS, TN:
2,626,353, INT. CL. 36.
- AMERICAN MANAGEMENT SYSTEMS, INC., ARLINGTON, VA:
1,663,233, CANC. INT. CL. 9.
1,934,026, CANC. INT. CL. 9.
- AMERICAN MEDIA OPERATIONS, INC., BOCA RATON, FL:
2,625,275, PUB. 7-2-2002. INT. CL. 16.
- AMERICAN MEDICAL AND LIFE INSURANCE COMPANY, HICKSVILLE, NY:
2,626,081, INT. CL. 36.
- AMERICAN MEDICAL DESIGN CORPORATION, CHICAGO, IL:
1,934,466, CANC. INT. CL. 42.
1,934,467, CANC. INT. CL. 37.
- AMERICAN MEDICAL SECURITY GROUP, INC., GREEN BAY, WI:
2,622,843, PUB. 7-2-2002. INT. CL. 36.
- AMERICAN MOVING AND STORAGE ASSOCIATION, ALEXANDRIA, VA:
2,625,506, U.S. CL. B.
- AMERICAN MULTI-CINEMA, INC., KANSAS CITY, MO:
1,932,788, CANC. INT. CL. 35.
- AMERICAN NATIONAL RED CROSS, WASHINGTON, DC:
2,623,788, PUB. 7-2-2002. INT. CL. 16.
- AMERICAN OPHTHALMIC, INC., WINTER PARK, FL:
1,934,502, CANC. MULTIPLE CLASS, INT. CLS. 35 AND 42.
- AMERICAN ORTHOPEDIC SUPPORTS, INC., HALLANDALE, FL:
2,626,518, INT. CL. 35.
- AMERICAN OUTBACK, INCORPORATED, MAYSVILLE, OK:
1,932,980, CANC. INT. CL. 3.
- AMERICAN PHYSICAL SOCIETY, THE, COLLEGE PARK, MD:
2,626,925, INT. CL. 42.
2,626,926, INT. CL. 42.
- AMERICAN PLASTICS INC., LITTLE ROCK, AR:
2,624,181, PUB. 7-2-2002. INT. CL. 28.
- AMERICAN POWER CONVERSION CORPORATION, W. KINGSTON, RI:
2,626,391, INT. CL. 42.

- AMERICAN PSYCHOLOGICAL ASSOCIATION, WASHINGTON, DC:
2,624,488, PUB. 7-2-2002. INT. CL. 16.
2,626,934, INT. CL. 9.
2,626,938, INT. CL. 16.
- AMERICAN RELIANCE INC., ARCADIA, CA:
1,728,958. REN. 8-13-02. INT. CL. 9.
- AMERICAN SEATING COMPANY, GRAND RAPIDS, MI:
2,622,598, PUB. 7-2-2002. INT. CL. 12.
- AMERICAN SOCIETY FOR INDUSTRIAL SECURITY, ALEXANDRIA, VA:
2,624,248, PUB. 7-2-2002. INT. CL. 41.
- AMERICAN SOCIETY OF FARM MANAGERS AND RURAL APPRAISERS, INC., THE, DENVER, CO, AMERICAN SOCIETY OF FARM MANAGERS AND RURAL APPRAISERS, INC., THE, DENVER, CO:
939,220. REN. 8-12-02. U.S. CL. 200.
940,216. REN. 8-12-02. U.S. CL. 200.
- AMERICAN SPORTING GOODS CORPORATION, IRVINE, CA FROM KPR SPORTS INTERNATIONAL, INC., KING OF PRUSSIA, PA:
2,625,319, MULTIPLE CLASS, INT. CLS. 18 AND 25.
- AMERICAN SPORTS DESIGN COMPANY, SPRINGBORO, OH:
2,626,316, INT. CL. 12.
- AMERICAN STANDARD INC., PISCATAWAY, NJ:
2,625,298, PUB. 7-2-2002. INT. CL. 11.
- AMERICAN STRENGTH & FITNESS SUPPLY, LIMITED, TOLEDO, OH:
1,932,610, CANC. MULTIPLE CLASS, INT. CLS. 25, 37 AND 42.
- AMERICAN TECHNICAL CERAMICS CORP., HUNTING STATION, NY, PHASE INDUSTRIES, INC., HUNTINGTON STATION, NY:
1,156,168. REN. 8-12-02. INT. CL. 9.
- AMERICAN TELEPHONE AND TELEGRAPH COMPANY, NEW YORK, NY:
1,934,171, CANC. INT. CL. 38.
- AMERICAN TERMINAL EXCHANGE, INC., DANBURY, CT:
1,934,111, CANC. INT. CL. 9.
1,934,276, CANC. INT. CL. 9.
- AMERICAN THRESHOLD INDUSTRIES, INC., ENKA, NC:
1,663,335, CANC. INT. CL. 10.
- AMERICAN TISSUE CORPORATION, HAUPPAUGE, NY:
1,934,328, CANC. INT. CL. 16.
- AMERICAN TOOL COMPANIES, INC., HOFFMAN ESTATES, IL:
2,627,026, INT. CL. 8.
- AMERICAN TOURISTER, INC., WARREN, RI:
1,933,922, CANC. INT. CL. 18.
- AMERICAN VETERINARY MEDICAL ASSOCIATION, SCHAUMBURG, IL:
1,736,207. REN. 8-16-02. INT. CL. 9.
- AMERICORP FINANCIAL SERVICES, INC., NEW YORK, NY:
1,932,936, CANC. INT. CL. 36.
- AMERIFIT, INC., BLOOMFIELD, CT:
2,625,765, INT. CL. 5.
- AMERITECH CORPORATION, CHICAGO, IL:
1,933,093, CANC. INT. CL. 38.
- AMERSHAM BIOSCIENCES AB, SE-751 84 UPPSALA, SWEDEN, PHARMACIA FINE CHEMICALS AB, UPPSALA, SWEDEN:
1,228,007. REN. 8-10-02. INT. CL. 1.
- AMETEK, INC., PAOLI, PA:
2,623,835, PUB. 7-2-2002. INT. CL. 9.
- AMFM OHIO, INC., BURBANK, CA:
2,625,304, PUB. 7-2-2002. INT. CL. 41.
- AMHERST MEDIA, INC., BUFFALO, NY:
2,623,685, PUB. 7-2-2002. INT. CL. 16.
- AMORIM REVESTIMENTOS, S.A., 4536 - SAO PAIO DE OLEIROS, PORTUGAL:
2,626,949, INT. CL. 19.
- AMPAM CORPORATE SERVICES, L.P., ROUND ROCK, TX:
2,624,547, PUB. 7-2-2002. INT. CL. 37.
- AMSCO WINDOWS, INC., SALT LAKE CITY, UT:
2,626,618, MULTIPLE CLASS, INT. CLS. 6 AND 19.
- AMSTED INDUSTRIES INCORPORATED, CHICAGO, IL:
953,037. REN. 8-10-02. U.S. CL. 19 (INT. CL. 12).
- AMTECH U S A, INC., ALPHARETTA, GA:
1,933,768, CANC. INT. CL. 1.
- AMTROL, INC., WEST WARWICK, RI:
2,623,669, PUB. 7-2-2002. INT. CL. 7.
2,623,674, PUB. 7-2-2002. INT. CL. 11.
- AMYLIN PHARMACEUTICALS, INC, SAN DIEGO, CA FROM LIFESCAN, INC., MILPITAS, CA AND AMYLIN PHARMACEUTICALS, INC., SAN DIEGO, CA:
2,625,333, INT. CL. 5.
- AMYLIN PHARMACEUTICALS, INC., SAN DIEGO, CA FROM LIFESCAN, INC., MILPITAS, CA AND AMYLIN PHARMACEUTICALS, INC., SAN DIEGO, CA:
2,625,334, INT. CL. 5.
- ANACOMP, INC., POWAY, CA:
2,625,767, MULTIPLE CLASS, INT. CLS. 38, 39, 40 AND 42.
- ANALOG DEVICES, INCORPORATED, NORWOOD, MA:
1,933,735, CANC. INT. CL. 9.
1,933,739, CANC. INT. CL. 9.
- ANAREN MICROWAVE, INC., EAST SYRACUSE, NY:
2,624,585, PUB. 7-2-2002. INT. CL. 9.
2,624,586, PUB. 7-2-2002. INT. CL. 9.
- ANAYA, MICHELLE, MANHATTAN BEACH, CA:
2,626,211, INT. CL. 28.
- ANCHOR FOOD PRODUCTS, INC., APPLETON, WI:
1,932,597, CANC. INT. CL. 29.
- ANCHOR HOCKING CORPORATION, FREEPORT, IL:
1,663,463, CANC. INT. CL. 21.
- ANCILLARY SERVICES PARTNERSHIP, CIRCLEVILLE, OH:
1,933,951, CANC. INT. CL. 9.
- ANCORA S.A.:
See— SYSTEM GESELLSCHAFT AG.
- AND ARTIFICIAL NEURAL DEVICES, CORPORATION, TORONTO, ONTARIO, CANADA:
2,623,338, PUB. 7-2-2002. INT. CL. 9.
- AND ARTIFICIAL NEURAL DEVICES, CORPORATION, TORONTO ONTARIO, CANADA:
2,623,339, PUB. 7-2-2002. INT. CL. 9.
- ANDERSEN CORPORATION, BAYPORT, MN:
2,625,301, PUB. 7-2-2002. INT. CL. 19.
- ANDERSON GREENWOOD LP, WRENTHAM, MA:
2,623,818, PUB. 7-2-2002. INT. CL. 9.
- ANDERSON-TULLY VENEERS, L.P., VICKSBURG, MS:
2,626,377, INT. CL. 19.
2,626,378, INT. CL. 19.
- ANDERSON, DAVID, HOY, NORTHFIELD, MN:
2,625,133, PUB. 7-2-2002. INT. CL. 9.
- ANDIS COMPANY, RACINE, WI:
2,623,462, PUB. 7-2-2002. INT. CL. 8.
- ANDREWS SALES CO., INC., VANCOUVER, WA:
1,933,226, CANC. INT. CL. 8.
- ANESTA CORPORATION, SALT LAKE CITY, UT:
2,622,734, PUB. 7-2-2002. INT. CL. 5.
- ANESTHESIA RECORDING, INC., PITTSBURGH, PA:
2,623,411, PUB. 7-2-2002. INT. CL. 9.
- ANGEL SPIRIT, INC., CREEDMOOR, NC:
1,934,343, CANC. INT. CL. 28.
- ANGLIA OILS LIMITED, HUMBERSIDE, HU9 5PX, ENGLAND:
1,932,481, CANC. INT. CL. 29.
- ANHEUSER-BUSCH, INCORPORATED, ST. LOUIS, MO:
1,176,398, CANC. MULTIPLE CLASS, INT. CLS. 29 AND 30.
2,626,241, INT. CL. 32.
- ANHING CORPORATION, LOS ANGELES, CA:
1,713,990. REN. 8-10-02. INT. CL. 30.
1,765,348. REN. 8-16-02. INT. CL. 30.
- ANNA GROUP, INC., THE, SPRING LAKE, NJ:
2,622,805, PUB. 7-2-2002. INT. CL. 25.
- ANNIE CHUN'S GOURMET FOODS, INC.:
See— ANNIE CHUN'S INC.
- ANNIE CHUN'S INC., SAN RAFAEL, CA FROM ANNIE CHUN'S GOURMET FOODS, INC., SAN RAFAEL, CA:
2,623,868, PUB. 7-2-2002. INT. CL. 30.

ANN TAYLOR, INC., NEW YORK, NY:
1,933,151, CANC. INT. CL. 25.

ANNUAL REVIEWS, INC., PALO ALTO, CA:
2,624,758, PUB. 7-2-2002. INT. CL. 16.

ANNUITY BOARD OF THE SOUTHERN BAPTIST CONVENTION, DALLAS, TX:
2,626,087, INT. CL. 36.

ANNUITYNET, INC., LEESBURG, VA:
2,623,977, PUB. 7-2-2002. MULTIPLE CLASS, INT. CLS. 35 AND 36.

ANODIZING, INC., PORTLAND, OR:
1,933,230, CANC. INT. CL. 6.

ANRA PROPERTY MANAGEMENT, INC., MIRAMAR, FL:
2,625,278, PUB. 7-2-2002. INT. CL. 9.

ANSELL EDMONT INDUSTRIAL INC., COSHOCTON, OH:
1,663,296, CANC. INT. CL. 9.

ANSELL EDMONT INDUSTRIAL INC., COSHOCTON, OH:
1,933,179, CANC. INT. CL. 9.

ANSELL HEALTHCARE PRODUCTS INC., RED BANK, NJ:
2,624,174, PUB. 7-2-2002. INT. CL. 10.

ANSELL PROTECTIVE PRODUCTS INC., COSHOCTON, OH:
2,625,999, INT. CL. 9.

ANSUL COMPANY, THE, MARINETTE, WI TO SPECIALTYCHEM PRODUCTS CORPORATION, MARINETTE, WI:
1,175,670, CANC. INT. CL. 1.

ANSUL, INCORPORATED, MARINETTE, WI:
2,626,692, INT. CL. 17.

ANT FARM INTERACTIVE, LLC, ATLANTA, GA:
2,626,534, INT. CL. 35.

ANTHOLOGY, INC., TRAVERSE CITY, MI:
2,623,091, PUB. 7-2-2002. INT. CL. 35.

ANTHONY FOREST PRODUCTS COMPANY, EL DORADO, AR:
2,622,951, PUB. 7-2-2002. INT. CL. 19.

ANTHONY TESSELAAR INTERNATIONAL PTY LTD, SILVAN, VICTORIA, AUSTRALIA:
2,623,463, PUB. 7-2-2002. INT. CL. 31.

ANTHONY TESSELAAR INTERNATIONAL PTY LTD, SILVAN, VICTORIA 3795, AUSTRALIA:
2,623,464, PUB. 7-2-2002. INT. CL. 31.

ANTHONY WILLIAMS, INC., MINNEAPOLIS, MN:
1,663,807, CANC. INT. CL. 28.

ANTICANCER, INC., SAN DIEGO, CA:
2,624,611, PUB. 7-2-2002. INT. CL. 42.

ANTIOCH COMPANY, THE, YELLOW SPRINGS, OH:
2,624,162, PUB. 7-2-2002. INT. CL. 16.

ANTRIM CORPORATION, PLANO, TX:
1,933,834, CANC. INT. CL. 42.

AOC, LLC, COLLIERVILLE, TN:
2,625,477, INT. CL. 1.

AON RISK SERVICES COMPANIES, INC., CHICAGO, IL:
2,624,739, PUB. 7-2-2002. INT. CL. 36.

APEX THERAPEUTIC CARE, INC., WESTLAKE VILLAGE, CA:
2,624,532, PUB. 7-2-2002. INT. CL. 16.

APOLLO ENVIRONMENTAL CORPORATION, BOZEMAN, MT:
1,934,262, CANC. INT. CL. 3.

APOSTOLIC TEAM MINISTRIES, INTERNATIONAL, TOLEDO, OH:
2,623,523, PUB. 7-2-2002. INT. CL. 42.

APOTECH S.A., 1211 GENEVA, SWITZERLAND:
2,622,660, PUB. 10-10-2000. MULTIPLE CLASS, INT. CLS. 1, 5 AND 42.

APPALACHIAN TECHNICAL SERVICES, INC., WISE, VA:
2,624,669, PUB. 7-2-2002. INT. CL. 42.

APPALSHOP, INC., WHITESBURG, KY:
1,933,174, CANC. INT. CL. 41.

APPAREL AMERICA, INC., NEW HAVEN, CT:
1,933,784, CANC. INT. CL. 25.

APPETITO PROVISIONS CO., INC., UNION CITY, NJ:
2,622,751, PUB. 7-2-2002. MULTIPLE CLASS, INT. CLS. 29 AND 30.

APPLE ANNIE'S, INC., LOUISVILLE, KY:
2,626,986, INT. CL. 20.

APPLE COMPUTER, INC., CUPERTINO, CA:
1,934,375, CANC. INT. CL. 9.
2,623,641, PUB. 7-2-2002. INT. CL. 9.

APPLETON COATED LLC, KIMBERLY, WI:
2,624,674, PUB. 7-2-2002. INT. CL. 16.

APPLIED INFORMATION TECHNOLOGY, LLC, HOPEWELL, NJ:
2,623,760, PUB. 7-2-2002. INT. CL. 35.

APPLIED LASER TECHNOLOGY, INC., BEAVERTON, OR:
1,696,530, REN. 8-10-02. INT. CL. 40.

APPLIED MATERIAL TECHNOLOGIES, INC., SANTA ANA, CA:
2,624,726, PUB. 7-2-2002. INT. CL. 42.

APPLIED MEDICAL RESOURCES CORPORATION, LAGUNA HILLS, CA:
2,626,787, INT. CL. 10.

APPLIED PHOTONICS, INC., ORLANDO, FL:
2,625,696, INT. CL. 9.

APPLIED TECHNOLOGIES GROUP, INC., NATICK, MA:
2,626,828, INT. CL. 35.

APRISA, INC., WESTLAKE VILLAGE, CA:
2,625,095, PUB. 7-2-2002. INT. CL. 42.

APSLEY-BOLTON COMPUTERS, INC., BOLTON, MA:
1,933,874, CANC. INT. CL. 9.

APTOS SEMICONDUCTOR CORPORATION, MOUNTAIN VIEW, CA:
1,933,996, CANC. INT. CL. 9.

AQUA TECHNOLOGIES INC., DURHAM, NC:
2,624,516, PUB. 7-2-2002. INT. CL. 1.

AQUARIA, INC., MOORPARK, CA:
2,626,844, INT. CL. 11.

AQUATROLS CORPORATION OF AMERICA, INC., CHERRY HILL, NJ:
2,626,524, INT. CL. 1.

AQUOR, INC., BOULDER, CO:
2,625,810, INT. CL. 9.

ARABICA FUNDING, INC., BABYLON, NY:
2,624,819, PUB. 7-2-2002. INT. CL. 30.

ARACHNE INC., LOS ANGELES, CA:
2,622,788, PUB. 7-2-2002. INT. CL. 25.

ARAMARK UNIFORM SERVICES, INC., BURBANK, CA, WEARGUARD CORPORATION, NORWELL, MA:
1,689,099, REN. 8-14-02. INT. CL. 25.

ARAMIS INC., NEW YORK, NY:
2,447,281, CANC. IIRN. RESTORED TO S.N. 75-349,064.

ARCAM AB, S-411 39 GOTEBORG, SWEDEN FROM LARSON, RALF, LONDON SE5, ENGLAND:
2,622,520, PUB. 8-29-2000. MULTIPLE CLASS, INT. CLS. 7 AND 9.

ARCH OHIO, INC., TAMARAC, FL, SUMITEC, INC., BENTON HARBOR, MI:
1,722,970, REN. 8-13-02. INT. CL. 19.

ARCHIVES EXPRESS, INC., VISTA, CA:
1,933,477, CANC. MULTIPLE CLASS, INT. CLS. 39 AND 42.

ARCHWING INNOVATIONS LLC, MINNEAPOLIS, MN:
2,625,056, PUB. 7-2-2002. INT. CL. 42.

ARDENT, INC., LENEXA, KS:
2,626,051, INT. CL. 28.

AREA 51, INC., NEW YORK, NY:
2,622,954, PUB. 7-2-2002. INT. CL. 35.

AREA, INC., NEW YORK, NY:
2,622,618, PUB. 7-2-2002. INT. CL. 24.

AREM, DEBORAH R., LAYTONSVILLE, MD:
1,933,202, CANC. INT. CL. 16.

ARENA ASSOCIATES, INC., AUBURN HILLS, MI:
1,933,984, CANC. INT. CL. 41.
1,933,990, CANC. INT. CL. 28.

ARGENTA TRADING & CONSULTING CORP., PEMBROKE PINES, FL:
2,626,670, INT. CL. 11.

ARGOSY ELECTRONICS, INC., MINNEAPOLIS, MN:
1,934,338, CANC. INT. CL. 10.

ARI-ARMATUREN ALBERT RICHTER GMBH & CO. KG, SCHLOB HOLTE-STUKENBROCK, FED REP GERMANY:
2,626,656, INT. CL. 6.

ARIES ENGINEERING COMPANY, INC., DUNDEE, MI:
2,626,608, INT. CL. 7.

- ARISE & SHINE HERBAL PRODUCTS, INC., MT. SHASTA, CA:
2,623,209, PUB. 7-2-2002. INT. CL. 5.
- ARISTA TECHNOLOGIES, INC., HAUPPAUGE, NY:
1,933,760, CANC. INT. CL. 9.
- ARISTOCRAT LEISURE INDUSTRIES PTY LTD:
See— ARISTOCRAT TECHNOLOGIES AUSTRALIA PTY. LIMITED.
- ARISTOCRAT TECHNOLOGIES AUSTRALIA PTY LTD, LANE COVE, NEW SOUTH WALES, 2066, AUSTRALIA:
2,623,702, PUB. 7-2-2002. INT. CL. 9.
- ARISTOCRAT TECHNOLOGIES AUSTRALIA PTY LTD, AUSTRALIA:
2,623,703, PUB. 7-2-2002. INT. CL. 9.
- ARISTOCRAT TECHNOLOGIES AUSTRALIA PTY LTD, LANE COVE, NEW SOUTH WALES, AUSTRALIA:
2,624,479, PUB. 7-2-2002. INT. CL. 9.
- ARISTOCRAT TECHNOLOGIES AUSTRALIA PTY. LIMITED, NEW SOUTH WALES, AUSTRALIA FROM ARISTOCRAT LEISURE INDUSTRIES PTY LTD, LANE COVE, NEW SOUTH WALES 2066, AUSTRALIA:
2,622,808, PUB. 10-23-2001. INT. CL. 9.
- ARIZONA CHEMICAL COMPANY, JACKSONVILLE, FL:
2,623,918, PUB. 7-2-2002. INT. CL. 1.
2,623,919, PUB. 7-2-2002. MULTIPLE CLASS, INT. CLS. 1 AND 2.
- ARIZONA FEDERAL CREDIT UNION, PHOENIX, AZ:
2,624,785, PUB. 7-2-2002. INT. CL. 36.
- ARJO WIGGINS FINE PAPERS LIMITED, CHINEHAM BASINGSTOKE RG24 8AB, ENGLAND:
2,623,713, PUB. 7-2-2002. INT. CL. 16.
- ARKAOS S.A., 6120 HAM-SUR-HEURE, BELGIUM:
2,622,955, PUB. 7-2-2002. MULTIPLE CLASS, INT. CLS. 9, 41 AND 42.
- ARKOPHARMA S.A., CARROS, FRANCE:
2,626,641, INT. CL. 5.
- ARLINGTON INTERNATIONAL RACECOURSE, INC., ARLINGTON HEIGHTS, IL:
1,933,054, CANC. INT. CL. 41.
- ARMANI SHOES CORPORATION, THE, MIAMI, FL:
2,623,890, PUB. 7-2-2002. INT. CL. 25.
- ARMOR INOX SA, 56430 MAURON, FRANCE:
1,688,933, REN. 8-10-02. INT. CL. 11.
- ARNOLD COMMUNICATIONS, INC., BOSTON, MA:
2,623,378, PUB. 7-2-2002. INT. CL. 42.
- AROUND THE SHOP, INC., BUFORD, GA:
2,626,258, INT. CL. 3.
- ARROW INTERNATIONAL, INC., CLEVELAND, OH:
2,624,341, PUB. 7-2-2002. INT. CL. 28.
- ARROWSMITH LEATHER GOODS INC., NEW YORK, NY:
1,934,507, CANC. INT. CL. 18.
- ART AEROSPATIAL RECHERCHES ET TECHNOLOGIES INC./ART AEROSPACE RESEARCH TECHNOLOGIES INC., VILLA SAINT-LAURENT,(QUEBEC), CANADA:
2,622,551, PUB. 11-6-2001. INT. CL. 10.
- ART OF CONTROL, INC., THE, MOUNT KISCO, NY:
2,626,459, INT. CL. 41.
- ARTEFATOS DE BORRACHA RECORD S/A, CURITIBA, PR, BRAZIL:
1,932,416, CANC. MULTIPLE CLASS, INT. CLS. 6, 11 AND 12.
- ARTESIA COMPANIES, INC., THE, TULARE, CA:
2,623,799, PUB. 7-2-2002. MULTIPLE CLASS, INT. CLS. 19, 35, 37 AND 39.
2,623,800, PUB. 7-2-2002. MULTIPLE CLASS, INT. CLS. 19, 35, 37 AND 39.
- ARTESIA COMPANIES, INC., THE, TULARE, CA:
2,623,798, PUB. 7-2-2002. MULTIPLE CLASS, INT. CLS. 19, 35, 37 AND 39.
- ARTHUR G. DIETRICH CO., INC., CUDAHY, WI:
1,175,827, CANC. INT. CL. 7.
- ARTHUR P. STEELE, L.L.C., PLYMOUTH, MN:
2,625,487, INT. CL. 6.
- ARTHUR YOUNG & COMPANY, NEW YORK, NY:
1,176,466, CANC. INT. CL. 35.
- ARTHUS- BERTRAND, PARIS 75006, FRANCE, MEERSON; EMERICH, PARIS 7EME, FRANCE:
1,172,179, REN. 8-15-02. INT. CL. 14.
- ARTIN INDUSTRIAL CO.LTD., SAN POKONG, KOWLOON, HONG KONG:
2,625,285, PUB. 7-2-2002. INT. CL. 28.
- ARTISTDIRECT, INC., LOS ANGELES, CA:
2,511,613, AM. INT. CL. 42.
2,511,614, AM. INT. CL. 38.
2,511,615, AM. INT. CL. 41.
2,513,978, AM. INT. CL. 35.
- ARTMARK FABRICS CO., INC., FRAZER, PA:
1,176,595, CANC. INT. CL. 42.
- ASBURY PARK PRESS, INC., NEPTUNE, NJ:
1,934,458, CANC. INT. CL. 42.
- ASCENDES CORPORATION, ALPHARETTA, GA:
2,626,950, INT. CL. 35.
- ASD SYSTEMS, INC., GARLAND, TX, DBA ASCENDANT SOLUTIONS:
2,623,278, PUB. 7-2-2002. INT. CL. 35.
- ASEA BROWN BOVERI JUMET S.A., B-6040, CHARLEROI (JUMET), BELGIUM:
1,932,429, CANC. MULTIPLE CLASS, INT. CLS. 9, 11 AND 42.
- ASHBY-CROSS COMPANY, TOPSFIELD, MA:
1,900,349, CANC. MULTIPLE CLASS, INT. CLS. 7 AND 8.
- ASHBY, RODNEY, PINE, CO:
2,623,000, PUB. 7-2-2002. INT. CL. 42.
- ASHLAND INC., COVINGTON, KY, ASHLAND OIL, INC., ASHLAND, KY:
1,708,758, REN. 8-13-02. INT. CL. 41.
- ASHLAND OIL, INC., RUSSELL, KY:
1,934,285, CANC. INT. CL. 1.
- ASHTON & PRICE, APC, CITRUS HEIGHTS, CA:
2,624,633, PUB. 7-2-2002. INT. CL. 42.
- ASIADEMAND, INC., DIAMOND BAR, CA:
2,623,372, PUB. 7-2-2002. MULTIPLE CLASS, INT. CLS. 35 AND 36.
- ASIC ADVANTAGE, INC., SUNNYVALE, CA:
2,625,710, INT. CL. 9.
- ASPEN PET PRODUCTS, INC, DENVER, CO:
2,624,050, PUB. 7-2-2002. MULTIPLE CLASS, INT. CLS. 6, 18 AND 28.
- ASPEN PET PRODUCTS, INC., DENVER, CO:
2,624,847, PUB. 7-2-2002. INT. CL. 18.
- ASPEN PUBLISHERS, INC., GAITHERSBURG, MD FROM CUTTER INFORMATION CORP., ARLINGTON, MA:
2,624,521, PUB. 2-19-2002. INT. CL. 16.
- ASSOCIATED CHRISTIAN TELEVISION SYSTEM, INC., ORLANDO, FL:
2,623,263, PUB. 7-2-2002. INT. CL. 38.
- ASSOCIATED PRESS, THE, NEW YORK, NY:
1,666,982, REN. 8-16-02. INT. CL. 38.
- ASSOCIATION FOR PUBLIC TRANSPORTATION, INC., CAMBRIDGE, MA:
1,176,159, CANC. INT. CL. 16.
- ASSOCIATION FOR THE ACCREDITATION OF HUMAN RESEARCH PROTECTION PROGRAMS, INC. (AAHRPP), ROCKVILLE, MD:
2,624,632, PUB. 7-2-2002. INT. CL. 42.
2,624,709, PUB. 7-2-2002. INT. CL. 42.
- ASTRA AKTIEBOLAG:
See— ASTRAZENECA AB.
- ASTRAZENECA AB, 151 85 SODERTALJE, SWEDEN FROM ASTRA AKTIEBOLAG, S-151 85 SODERTALJE, SWEDEN:
2,622,542, PUB. 7-2-2002. INT. CL. 5.
- ASTRAZENECA AB, 151 85 SODERTALJE, SWEDEN FROM ASTRA AKTIEBOLAG, S- 151 85 SODERTALJE, SWEDEN:
2,625,430, INT. CL. 5.
- ASTRO-MED, INC., WEST WARWICK, RI:
2,624,040, PUB. 7-2-2002. INT. CL. 9.
- AT&T CORP., NEW YORK, NY:
1,933,047, CANC. INT. CL. 35.
1,933,048, CANC. INT. CL. 35.
1,933,473, CANC. MULTIPLE CLASS, INT. CLS. 38, 41 AND 42.
1,933,649, CANC. INT. CL. 38.
1,934,027, CANC. INT. CL. 38.
2,624,800, PUB. 7-2-2002. INT. CL. 38.
2,626,645, INT. CL. 38.

- AT&T UNIVERSAL CARD SERVICES CORPORATION, JACKSONVILLE, FL:
1,934,102, CANC. INT. CL. 36.
- ATICO INTERNATIONAL USA INC., FORT LAUDERDALE, FL:
2,625,898, INT. CL. 4.
2,626,398, INT. CL. 3.
- ATLANTA MOTOR SPEEDWAY, INC., HAMPTON, GA:
1,723,906, REN. 8-12-02. MULTIPLE CLASS, INT. CLS. 25 AND 41.
- ATLANTIC FOUNDATION, THE, HAMILTON HM EX, BERMUDA:
2,624,141, PUB. 7-2-2002. INT. CL. 36.
- ATLANTIC RESEARCH CORPORATION, ALEXANDRIA, VA:
1,175,752, CANC. INT. CL. 4.
- ATLANTIC RICHFIELD COMPANY, LOS ANGELES, CA:
1,933,753, CANC. INT. CL. 37.
- ATLAS COPCO AIRPOWER, NAAMLOZE VEN-
NOOTSCHAP, WILRIJK, BELGIUM:
2,624,295, PUB. 7-2-2002. INT. CL. 7.
- ATLAS PLUMBING & MECHANICAL, INC., MANASSAS
PARK, VA:
2,516,267, COR. INT. CL. 37.
- ATLAS SUPPLY COMPANY, SPRINGFIELD, NJ:
1,176,046, CANC. INT. CL. 12.
- ATMEL CORPORATION, SAN JOSE, CA FROM ATMEL
CORPORATION, SAN JOSE, CA:
2,625,572, INT. CL. 9.
- ATOFINA CHEMICALS, INC., PHILADELPHIA, PA:
2,626,261, INT. CL. 1.
- ATTACHMATE CORPORATION, BELLEVUE, WA:
1,932,563, CANC. INT. CL. 9.
- ATTACHMENT TECHNOLOGIES, INC., DELHI, IA:
2,625,123, PUB. 7-2-2002. INT. CL. 7.
- ATTEXOR TOOLS S.A., CH-1024 ECUBLENS, SWITZER-
LAND:
2,623,967, PUB. 7-2-2002. MULTIPLE CLASS, INT. CLS. 7
AND 8.
- AUCTION MANAGEMENT SOLUTIONS, INC., TAMPA, FL:
2,622,726, PUB. 7-2-2002. INT. CL. 35.
- AUDIO INFORMATION NETWORK, INC., EAST HAMP-
TON, NY, DBA ARTIST HELP NETWORK:
2,624,343, PUB. 7-2-2002. INT. CL. 35.
- AUDIOAUDIT, INC., WHITE PLAINS, NY:
2,626,382, INT. CL. 42.
- AURA SYSTEMS, INC., EL SEGUNDO, CA:
1,663,325, CANC. INT. CL. 9.
- AURAN HOLDINGS PTY LTD, TENERIFFE, AUSTRALIA:
2,625,087, PUB. 7-2-2002. MULTIPLE CLASS, INT. CLS. 9
AND 41.
- AURORA BIOSCIENCES CORPORATION, SAN DIEGO, CA:
2,625,495, INT. CL. 42.
- AUTHENTEC, INCORPORATED, PALM BAY, FL:
2,625,654, INT. CL. 9.
- AUTO-LINE MANUFACTURING CORP., WESTBURY, NY:
1,175,954, CANC. INT. CL. 9.
- AUTOBELL CAR WASH, INC., CHARLOTTE, NC:
946,043, REN. 8-13-02. U.S. CL. 103 (INT. CL. 37).
- AUTOMATED SYSTEMS COMPANY, INC., SILVER
SPRING, MD:
1,175,990, CANC. INT. CL. 10.
- AUTOMATIC PRODUCTS INTERNATIONAL, LTD., ST.
PAUL, MN:
2,623,822, PUB. 7-2-2002. INT. CL. 35.
- AUTOMATIC SYSTEMS, INC., KANSAS CITY, MO:
1,195,879, REN. 8-10-02. MULTIPLE CLASS, INT. CLS. 37
AND 42.
- AUTOMATIX INC., BURLINGTON, MA:
1,175,980, CANC. INT. CL. 9.
- AUTOMOTIVE AFTERMARKET INDUSTRY ASSOCIA-
TION, BETHESDA, MD:
2,626,967, INT. CL. 41.
- AUTOMOTIVE RENTALS, INC., MT. LAUREL, NJ:
2,626,903, INT. CL. 35.
- AUTOSOUND 2000, INC., BURLINGTON, NC:
1,932,742, CANC. INT. CL. 9.
- AVADO BRANDS INC., MADISON, GA:
2,624,939, PUB. 7-2-2002. INT. CL. 25.
- AVALON PUBLISHING GROUP, INC., BERKELEY, CA:
2,624,460, PUB. 7-2-2002. INT. CL. 16.
- AVAYA INC., BASKING RIDGE, NJ, AMERICAN TELE-
PHONE AND TELEGRAPH COMPANY, NEW YORK, NY:
1,689,940, REN. 8-16-02. INT. CL. 9.
- AVCO CORPORATION, PROVIDENCE, RI:
1,175,882, CANC. INT. CL. 9.
- AVECIA LIMITED, MANCHESTER, UNITED KINGDOM
FROM ZENECA LIMITED, ENGLAND:
2,622,721, PUB. 7-2-2002. INT. CL. 5.
- AVECIA LIMITED, BLACKLEY, MANCHESTER M9 8ZS,
UNITED KINGDOM:
2,626,252, INT. CL. 11.
- AVEDIS ZILDJIAN CO., NORWELL, MA:
2,625,791, INT. CL. 15.
- AVEMCO CORPORATION, FREDERICK, MD:
1,934,205, CANC. INT. CL. 36.
- AVERY DENNISON CORPORATION, PASADENA, CA:
2,624,983, PUB. 7-2-2002. INT. CL. 35.
- AVIAREPS AIRLINE MANAGEMENT GROUP AG, 80687
MUNCHEN, FED REP GERMANY:
2,442,255, COR. MULTIPLE CLASS, INT. CLS. 35 AND
39.
- AVIATION & MARINE INSURANCE GROUP, INC., DAL-
LAS, TX:
1,932,489, CANC. INT. CL. 36.
- AVIKO USA L.L.C., JAMESTOWN, ND:
2,623,249, PUB. 7-2-2002. INT. CL. 29.
- AVIMO PRECISION INSTRUMENTS, INC., FAIRPORT, NY:
2,623,658, PUB. 7-2-2002. INT. CL. 9.
- AVN, PENFIELD, NY:
2,622,515, PUB. 7-2-2002. INT. CL. 42.
- AVON PRODUCTS, INC., NEW YORK, NY:
2,623,893, PUB. 7-2-2002. INT. CL. 3.
2,625,444, INT. CL. 35.
2,626,637, INT. CL. 3.
2,626,667, INT. CL. 3.
2,626,668, INT. CL. 3.
2,626,669, INT. CL. 3.
2,626,677, INT. CL. 3.
2,626,678, INT. CL. 3.
2,626,691, INT. CL. 3.
2,626,722, INT. CL. 3.
- AVP ASSOCIATES, CLARKSVILLE, TN:
2,623,606, PUB. 7-2-2002. INT. CL. 16.
- AVTURF L.L.C., CHICAGO, IL:
2,623,819, PUB. 7-2-2002. MULTIPLE CLASS, INT. CLS. 37
AND 42.
- AXIS BIOCHEMICALS ASA, N-0510 OSLO, NORWAY:
2,622,545, PUB. 10-5-1999. INT. CL. 9.
- AXISOFT TECHNOLOGIES, INC., TAIPEI, TAIWAN:
2,625,601, INT. CL. 9.
- AXON DEVELOPMENT CORPORATION, SASKATOON,
CANADA:
2,625,055, PUB. 7-2-2002. INT. CL. 9.
- AZTECH SYSTEMS PTE LTD, SINGAPORE:
1,933,463, CANC. INT. CL. 9.
- B & G FOODS, INC., HIBBING, MN:
1,932,755, CANC. INT. CL. 30.
- B & M MANUFACTURING, INC., JAMESTOWN, NY:
2,625,956, INT. CL. 12.
- B. ALTMAN & CO., NEW YORK, NY:
723,689, CANC. U.S. CL. 100.
- B. BLUMENTHAL & COMPANY, INC., CARLSTADT, NJ:
1,159,270, CANC. INT. CL. 26.
- B.D. OF NEVADA, LIMITED PARTNERSHIP, RENO, NV
FROM B.D. OF NEVADA, LIMITED PARTNERSHIP,
RENO, NV:
2,625,722, INT. CL. 36.
2,625,729, INT. CL. 36.
- BABCOCK, JOHN A, HOUSTON, TX:
2,624,646, PUB. 7-2-2002. INT. CL. 42.
- BABY EINSTEIN COMPANY, LLC, THE, LONE TREE, CO:
2,626,361, INT. CL. 9.

- BABY GATE POOL FENCE MANUFACTURING, INC., INDIAN HARBOUR BEACH, FL:
2,626,759, MULTIPLE CLASS, INT. CLS. 6 AND 37.
- BABY TOGS, INC., NEW YORK, NY:
2,626,898, INT. CL. 25.
- BABY'S BIRTH BENEFITS, LLC, NEW BERLIN, WI:
2,622,970, PUB. 7-2-2002. INT. CL. 28.
- BACARDI & COMPANY LIMITED, NEW PROVIDENCE, BAHAMAS:
2,623,199, PUB. 7-2-2002. INT. CL. 33.
- BADALL COMPANY, INC., THE, HAMMOND, IN:
723,486, CANC. U.S. CL. 14.
- BAE SYSTEMS PLC, FARNBOROUGH, HAMPSHIRE GU14 6YU, GREAT BRITAIN:
2,623,791, PUB. 7-2-2002. INT. CL. 36.
- BAEKWAH CO., LTD., CHOLLABUK-DO, REPUBLIC OF KOREA:
1,932,569, CANC. INT. CL. 42.
- BAFIN S.P.A.:
See— ROAL ELECTORNICS S.P.A.
- BAILEY, HARVEY, LOS ANGELES, CA:
1,663,684, CANC. INT. CL. 41.
- BAINBRIDGE/AQUABATTEN, INC., CANTON, MA TO BAINBRIDGE/AQUABATTEN, INC., CANTON, MA:
1,956,888, COR. INT. CL. 17.
- BAINBRIDGE, INC., SAN DIEGO, CA:
2,624,153, PUB. 7-2-2002. INT. CL. 35.
2,624,155, PUB. 7-2-2002. INT. CL. 35.
- BAITER-UP, INC., LA CRESCENTA, CA:
2,623,490, PUB. 7-2-2002. INT. CL. 28.
- BAIXAULI Y LAFUENTE CORPORATION, S.L., E-46910 SEDAVI, SPAIN:
2,623,043, PUB. 7-2-2002. MULTIPLE CLASS, INT. CLS. 39 AND 42.
- BAJA TRADING CO., INC., CHICAGO, IL:
2,622,959, PUB. 7-2-2002. INT. CL. 30.
- BAKER HUGHES INCORPORATED, HOUSTON, TX, BARECO OIL COMPANY, TULSA, OK:
559,051. REN. 8-15-02. U.S. CL. 6 (INT. CL. 4).
- BAKER, DONALD A., HUNTINGTON BEACH, CA:
2,625,292, PUB. 7-2-2002. INT. CL. 28.
- BAKER, KNAPP & TUBBS, INC., CHICAGO, IL:
1,224,273. REN. 8-10-02. INT. CL. 20.
- BALBOA MANUFACTURING CO. LLC, SAN DIEGO, CA:
2,623,394, PUB. 7-2-2002. INT. CL. 25.
- BALCOM CHEMICALS, INC., GREELEY, CO:
1,933,827, CANC. INT. CL. 42.
- BALDWIN PIANO & ORGAN COMPANY, LOVELAND, OH:
1,933,719, CANC. INT. CL. 9.
- BALLIN, SHARON ROSE, STAMFORD, CT:
2,626,642, INT. CL. 36.
- BALTIMORE ORIOLES LIMITED PARTNERSHIP, BALTIMORE, MD:
2,623,330, PUB. 7-2-2002. INT. CL. 41.
- BAMMEL BAPTIST CHURCH, INC., HOUSTON, TX:
2,624,984, PUB. 7-2-2002. INT. CL. 16.
- BANCHIK, ROBIN F., WEST HOLLYWOOD, CA, DBA CRYSTALARIIUM:
2,623,437, PUB. 7-2-2002. MULTIPLE CLASS, INT. CLS. 14, 35 AND 40.
- BANCASTAR, INC., LOUIS, MO:
2,623,022, PUB. 7-2-2002. INT. CL. 36.
- BANFI PRODUCTS CORPORATION, OLD BROOKVILLE, NY:
2,564,504, COR. INT. CL. 33.
- BANK OF MONTREAL, TORONTO, ONTARIO, CANADA:
2,623,335, PUB. 7-2-2002. MULTIPLE CLASS, INT. CLS. 35, 36 AND 42.
- BANKA, PAUL E., ST. CHARLES, IL:
2,624,964, PUB. 1-30-2001. MULTIPLE CLASS, INT. CLS. 39 AND 42.
- BANKERS TRUST COMPANY, LOS ANGELES, CA FROM HINES HORTICULTURE, INC., IRVINE, CA:
2,622,986, PUB. 7-2-2002. INT. CL. 31.
- BANNER DIAMONDS, INC., NEW YORK, NY:
2,624,536, PUB. 7-2-2002. INT. CL. 14.
- BANYAN LICENSING, L.C., FORT LAUDERDALE, FL:
2,626,092, INT. CL. 20.
- BAPTIST GENERAL CONVENTION OF TEXAS, DALLAS, TX:
2,624,592, PUB. 7-2-2002. INT. CL. 41.
- BARANZYK, GERALD L., HAYWARD, WI:
1,701,205. REN. 8-15-02. INT. CL. 6.
- BARBERA, RAYMOND LA, BROOKLYN, NY:
1,932,733, CANC. INT. CL. 41.
- BARBILL, INC., THE, TUCSON, AZ:
2,626,810, MULTIPLE CLASS, INT. CLS. 16 AND 35.
- BARCO OF CALIFORNIA, GARDENA, CA:
1,933,271, CANC. INT. CL. 25.
- BARDA, ISACCO, 00162 ROME, ITALY:
1,933,521, CANC. INT. CL. 25.
- BARELA, THEODORE, ENGLEWOOD, CO:
2,624,005, PUB. 7-2-2002. INT. CL. 25.
- BARKER & MEOWSKY, INC., CHICAGO, IL:
2,624,430, PUB. 7-2-2002. INT. CL. 35.
- BARNESANDNOBLE.COM LLC, NEW YORK, NY:
2,622,636, PUB. 7-2-2002. INT. CL. 35.
- BARON SERVICES, INC., HUNTSVILLE, AL:
2,625,692, INT. CL. 9.
- BARRY EVAN LTD., BAYSIDE, NY:
1,175,719, CANC. INT. CL. 3.
- BARRY GRANT, INC., DAHLONEGA, GA FROM GPT 300, INC., DAHLONEGA, GA:
2,626,661, INT. CL. 7.
- BARRY, WILLIAM, ST. JOHN'S, NEWFOUNDLAND A1C5J9, CANADA, DBA THE REAL GAME, INC.:
2,624,779, PUB. 7-2-2002. MULTIPLE CLASS, INT. CLS. 16 AND 41.
- BARRY, WILLIAM, ST. JOHN'S, NEWFOUNDLAND, A1C 5J9, CANADA, DBA THE REAL GAME, INC.:
2,624,780, PUB. 7-2-2002. MULTIPLE CLASS, INT. CLS. 16 AND 41.
- BARRY'S JEWELERS INCORPORATED, MONROVIA, CA:
1,934,432, CANC. INT. CL. 42.
- BARTON CREEK RESORT & CLUB, INC., AUSTIN, TX:
2,626,974, INT. CL. 42.
2,626,975, INT. CL. 41.
- BARTON INSTRUMENT SYSTEMS, LLC, CITY OF INDUSTRY, CA:
2,623,090, PUB. 7-2-2002. INT. CL. 9.
- BASEBALL SCHOOL, INC., THE, BURTONSVILLE, MD TO BABBITT BASEBALL, INC., BURTONSVILLE, MD:
1,907,667, CANC. INT. CL. 41.
- BASF AKTIENGESELLSCHAFT, LUDWIGSHAFEN, FED REP GERMANY:
1,175,689, CANC. INT. CL. 2.
- BASF AKTIENGESELLSCHAFT, LUDWIGSHAFEN AM RHEIN, FED REP GERMANY:
2,623,650, PUB. 7-2-2002. INT. CL. 2.
- BASF CORPORATION, PARSIPPANY, NJ:
1,933,742, CANC. INT. CL. 5.
1,933,811, CANC. INT. CL. 23.
1,933,812, CANC. INT. CL. 5.
- BASF CORPORATION, MOUNT OLIVE, NJ:
2,626,552, INT. CL. 5.
- BASIC SOLUTIONS, LLC, SAN FERNANDO, CA:
2,625,885, MULTIPLE CLASS, INT. CLS. 3 AND 5.
- BASS BARBARIANS, INC., HAYWARD, CA:
2,625,675, MULTIPLE CLASS, INT. CLS. 35 AND 41.
- BATH & BODY WORKS, INC., REYNOLDSBURG, OH:
2,626,711, MULTIPLE CLASS, INT. CLS. 3 AND 4.
- BATH ACCESSORIES CO., SOUTH SAN FRANCISCO, CA:
2,584,582, CANC. IIRN. RESTORED TO S.N. 76-102,984.
- BATH UNLIMITED, INC., RACHO DOMINQUEZ, CA, FRANKLIN BRASS MANUFACTURING CO., LOS ANGELES, CA:
1,233,611. REN. 8-14-02. INT. CL. 21.
- BATTER UP, INC., CHICAGO, IL:
1,933,341, CANC. INT. CL. 42.
- BATTLEPLAY INC., CORAL SPRINGS, FL:
2,626,562, INT. CL. 40.
- BATTS, INC.:
1,176,346, CANC. INT. CL. 26.
1,176,347, CANC. INT. CL. 26.

- BAUMGARTEL, JOHANN-GEORG, LEIPZIG, FED REP GERMANY:
2,625,119, PUB. 7-2-2002. INT. CL. 3.
- BAUSCH & LOMB INCORPORATED, ROCHESTER, NY:
1,933,839, CANC. INT. CL. 9.
- BAXTER DIAGNOSTICS INC., DEERFIELD, IL:
1,933,146, CANC. INT. CL. 9.
- BAXTER INTERNATIONAL INC., DEERFIELD, IL:
1,933,979, CANC. INT. CL. 10.
- BAXTER TRAVENOL LABORATORIES, INC., MUNDELEIN, IL:
1,176,271, CANC. INT. CL. 22.
- BAY MEADOWS OPERATING COMPANY, SAN MATEO, CA:
1,934,513, CANC. INT. CL. 41.
- BAY MILLS INDIAN COMMUNITY, BRIMLEY, MI:
2,624,157, PUB. 7-2-2002. MULTIPLE CLASS, INT. CLS. 25 AND 41.
- BAYER AKTIENGESELLSCHAFT, FED REP GERMANY:
1,932,643, CANC. INT. CL. 1.
- BAYER AKTIENGESELLSCHAFT, D-51368 LEVERKUSEN-BAYERWERK, FED REP GERMANY:
2,622,539, PUB. 7-2-2002. INT. CL. 5.
- BAYER AKTIENGESELLSCHAFT, LEVERKUSEN-BAYERWERK, FED REP GERMANY:
2,622,847, PUB. 7-2-2002. INT. CL. 5.
2,623,948, PUB. 7-2-2002. INT. CL. 1.
- BAYER AKTIENGESELLSCHAFT, D-51368, LEVERKUSEN-BAYERWERK, FED REP GERMANY:
2,625,782, INT. CL. 1.
- BAYOU FITNESS PRODUCTS, L.L.C., SHREVEPORT, LA:
2,626,460, INT. CL. 28.
2,626,461, INT. CL. 28.
- BB&T CORPORATION, WINSTON-SALEM, NC:
2,624,104, PUB. 7-2-2002. INT. CL. 36.
2,624,579, PUB. 7-2-2002. INT. CL. 36.
- BC-USA, INC., NEW HOLLAND, PA:
2,626,034, INT. CL. 29.
- BCATCO ARL, ST. HELLIER, JERSEY JE2 3JW, CHANNEL ISLANDS:
2,623,192, PUB. 7-2-2002. INT. CL. 12.
2,623,193, PUB. 7-2-2002. INT. CL. 12.
2,623,194, PUB. 7-2-2002. INT. CL. 12.
2,623,195, PUB. 7-2-2002. INT. CL. 12.
2,626,858, INT. CL. 12.
- BCB USA CORP., COLUMBUS, GA:
1,967,238, CANC. INT. CL. 32.
- BCD ELECTRONICS LTD., BURNABY, BC, CANADA:
2,623,864, PUB. 7-2-2002. INT. CL. 9.
- BCI BURKE COMPANY, INC., FOND DU LAC, WI:
906,581, CANC. U.S. CL. 22.
- BEACON FOOD SERVICES, INC., SPARTANBURG, SC, WHITE; JOHN B., SPARTANBURG, SC, DBA BEACON DRIVE-IN:
1,197,024, REN. 8-16-02. INT. CL. 42.
- BEADLE, JOSHUA, SAN DIEGO, CA AND BEADLE, ELEANOR, SAN DIEGO, CA:
2,626,791, INT. CL. 11.
- BEAR U.S.A., INC., SECAUCUS, NJ:
2,623,471, PUB. 7-2-2002. MULTIPLE CLASS, INT. CLS. 18 AND 25.
- BEARD ENGINEERING, INC., BATON ROUGE, LA:
1,176,521, CANC. MULTIPLE CLASS, INT. CLS. 37 AND 42.
- BEARDEN, DENNIS, HOUSTON, TX:
1,932,999, CANC. INT. CL. 1.
- BEAU TOWNSEND FORD, INC., VANDALIA, OH:
1,932,864, CANC. INT. CL. 42.
- BEAUTE CREATEURS (SOCIETE ANONYME), 75002 PARIS, FRANCE FROM BEAUTE CREATEURS (SOCIETE ANONYME), 75002 PARIS, FRANCE:
2,625,048, PUB. 7-2-2002. INT. CL. 3.
- BEAUTE CREATEURS (SOCIETE ANONYME):
See— BEAUTE CREATEURS (SOCIETE ANONYME).
- BEAUTIFUL IMAGE COSMETICS, LLC, COSTA MESA, CA:
2,626,736, INT. CL. 3.
- BEAUTIFUL IMAGES, INC., TUCSON, AZ:
1,934,139, CANC. INT. CL. 25.
- BEAUTY PLUS TRADING CO., INC., CLIFTON, NJ:
2,624,793, PUB. 7-2-2002. INT. CL. 26.
- BEAUTYMAX INTERNATIONAL, INC., PLANO, TX:
1,933,762, CANC. INT. CL. 42.
- BECTION DICKINSON AND COMPANY, FRANKLIN LAKES, NJ:
2,623,582, PUB. 7-2-2002. INT. CL. 35.
- BEDESSEE IMPORTS LTD., SCARBOROUGH, ONTARIO, CANADA, DBA BROWN BETTY FOODS:
2,622,512, PUB. 7-2-2002. MULTIPLE CLASS, INT. CLS. 29 AND 30.
- BEECHOM INC., CLIFTON, NJ:
148,010, CANC. U.S. CL. 6.
- BEELINE LABORATORIES, INC., MILL VALLEY, CA:
723,683, CANC. U.S. CL. 51.
- BEETS N° SNIPS, L.L.C., SALT LAKE CITY, UT:
2,625,649, MULTIPLE CLASS, INT. CLS. 25 AND 28.
- BEIERSDORF AKTIENGESELLSCHAFT:
See— TESA AG.
- BEIERSDORF AKTIENGESELLSCHAFT, 20245 HAMBURG, FED REP GERMANY:
2,623,138, PUB. 7-2-2002. MULTIPLE CLASS, INT. CLS. 5 AND 10.
2,626,059, INT. CL. 5.
- BEISEKER AGRI SERVICES LTD., BEISEKER, ALBERTA T0J 0V0, CANADA FROM SHERRITT INC., FORT SAKATCHEWAN, ALBERTA, CANADA:
2,622,509, PUB. 4-17-2001. MULTIPLE CLASS, INT. CLS. 1, 5 AND 7.
- BEL-ORO INTERNATIONAL, INC, NEW YORK, NY:
2,568,434, COR. INT. CL. 14.
- BELARUS MACHINERY OF U.S.A., INC., MILWAUKEE, WI:
1,923,306, CANC. INT. CL. 7.
- BELBIN ASSOCIATES, CAMBRIDGESHIRE, UNITED KINGDOM:
2,622,595, PUB. 7-2-2002. MULTIPLE CLASS, INT. CLS. 9, 16 AND 41.
- BELGARD GROUP, INC., THE, HILLSBORO, OR:
2,625,800, INT. CL. 9.
- BELGIOIOSO CHEESE, INC., DENMARK, WI:
2,623,976, PUB. 7-2-2002. INT. CL. 29.
- BELL ATLANTIC CORPORATION, PHILADELPHIA, PA:
1,934,103, CANC. INT. CL. 9.
- BELL MOBILITY CELLULAR, INC., MISSISSAUGA (ONTARIO) L4W 5J4, CANADA:
2,622,830, PUB. 7-2-2002. INT. CL. 38.
- BELLANGER, PIERRE, PARIS, FRANCE:
2,625,189, PUB. 7-2-2002. INT. CL. 41.
- BELLE TIRE DISTRIBUTORS, INC., ALLEN PARK, MI:
2,622,806, PUB. 7-2-2002. INT. CL. 35.
- BELLSOUTH CORPORATION, ATLANTA, GA:
1,932,853, CANC. INT. CL. 9.
- BELLY, S.R.O., PSC 11000, CZECH REPUBLIC:
2,625,883, INT. CL. 25.
- BELMARK, INC., DE PERE, WI:
1,720,271, REN. 8-10-02. INT. CL. 16.
- BELTONE ELECTRONICS CORPORATION LLC, CHICAGO, IL, BELTONE ELECTRONICS CORPORATION, CHICAGO, IL:
1,720,070, REN. 8-12-02. INT. CL. 10.
- BELVEDERE, 21200 BEAUNE, FRANCE:
2,622,552, PUB. 4-10-2001. MULTIPLE CLASS, INT. CLS. 21 AND 33.
- BEMIS MANUFACTURING COMPANY, SHEBOYGAN FALLS, WI:
1,728,562, REN. 8-14-02. INT. CL. 11.
- BEN HOGAN CO., RICHMOND, VA:
1,934,106, CANC. INT. CL. 28.
- BENCHMARK COMMERCIAL, INC., SALT LAKE CITY, UT, EMPEY, HAL, SANDY, UT:
1,702,719, REN. 8-16-02. INT. CL. 3.
- BENCHMARK INDUSTRIES, INC., RIVERSIDE, CA:
1,932,787, CANC. INT. CL. 42.
- BENCKISER N.V.:
See— RECKITT BENCKISER N.V..

- BENEFICIO CUSTEPEC, S.A. DE C.V., 30360 CONCORDIA, CHIAPAS, MEXICO:
2,623,016, PUB. 1-22-2002. INT. CL. 30.
- BENJAMIN MOORE & CO., MONTVALE, NJ:
1,934,125, CANC. INT. CL. 42.
- BENNETT PRODUCTIONS, INC., LOS ANGELES, CA:
2,625,840, INT. CL. 16.
- BENNETT, TREVOR STEARN, NORTH VANCOUVER, BRITISH COLUMBIA, CANADA:
1,933,354, CANC. INT. CL. 10.
- BENSON, JERRY S., JR., AUSTIN, TX:
2,626,805, INT. CL. 35.
- BENSUSAN RESTAURANT CORPORATION, NEW YORK, NY:
1,663,376, CANC. INT. CL. 14.
- BENTLEY LINGERIE, INC., JERSEY CITY, NJ:
1,934,110, CANC. INT. CL. 25.
- BENTLEY SOFTWARE, INC., EXTON, PA:
2,623,891, PUB. 7-2-2002. MULTIPLE CLASS, INT. CLS. 9 AND 42.
2,624,221, PUB. 7-2-2002. INT. CL. 9.
- BERG, LYNNE, MARBLEHEAD, MA:
2,624,268, PUB. 7-2-2002. INT. CL. 16.
- BERGEN BRUNSWIG CORPORATION, ORANGE, CA:
2,624,231, PUB. 7-2-2002. INT. CL. 42.
- BERGMAN, DAVID, NEW YORK, NY:
2,624,316, PUB. 7-2-2002. INT. CL. 11.
- BERKLEY INC., SPIRIT LAKE, IA:
1,934,498, CANC. INT. CL. 28.
- BERMUDA DEPARTMENT OF TOURISM, HAMILTON, HM12, BERMUDA:
2,622,796, PUB. 7-2-2002. INT. CL. 35.
- BERMUDEZ INDUSTRIA ELECTRO-METALURGICA C.A., CARACAS, VENEZUELA:
1,933,458, CANC. INT. CL. 9.
- BERNAT YARN & CRAFT CORPORATION, UXBRIDGE, MA:
723,660, CANC. U.S. CL. 43.
- BEROL CORPORATION, BRENTWOOD, TN:
1,933,989, CANC. INT. CL. 16.
1,934,074, CANC. INT. CL. 16.
- BERRY, CHUCK, INDIANAPOLIS, IN:
2,624,331, PUB. 7-2-2002. INT. CL. 41.
- BERTHOLD TYPES LIMITED, CHICAGO, IL:
2,624,424, PUB. 7-2-2002. INT. CL. 9.
- BEST DRESSED HOMES, SHELBY, NC:
1,934,291, CANC. INT. CL. 11.
- BEST OF THE MOUNTAINS, INC., LAKE PLACID, NY:
1,933,985, CANC. INT. CL. 30.
- BEST SHOT, INC., TAMPA, FL:
2,623,478, PUB. 7-2-2002. MULTIPLE CLASS, INT. CLS. 9, 35 AND 42.
2,623,479, PUB. 7-2-2002. MULTIPLE CLASS, INT. CLS. 9, 35 AND 42.
- BEST VALUE TEXTILES, INC., DENVER, CO:
2,625,305, PUB. 7-2-2002. INT. CL. 24.
- BET DIRECT, INC., WASHINGTON, DC:
1,934,364, CANC. INT. CL. 3.
- BETTER BAKED FOODS, INC., NORTH EAST, PA:
2,625,439, INT. CL. 30.
- BETTER ON YOUR BODY, INC., HOUSTON, TX:
2,626,600, INT. CL. 3.
- BEVERAGE MARKETING USA, INC., LARCHMONT, NY:
2,625,638, INT. CL. 30.
- BHC, INC., BIRMINGHAM, AL:
1,934,388, CANC. INT. CL. 25.
- BIBLE LEAGUE, THE, CRETE, IL:
1,763,255, REN. 8-14-02. INT. CL. 36.
1,763,257, REN. 8-16-02. INT. CL. 36.
- BIG BOB GIBSON BAR-B-Q, INC., DECATUR, AL:
2,624,092, PUB. 7-2-2002. MULTIPLE CLASS, INT. CLS. 25, 30 AND 42.
- BIG CHICAGO CORP., CHICAGO, IL:
2,622,528, CON. USE, PUB. 4-13-1999. INT. CL. 42.
- BIG COMFY CORP., TORONTO, ONTARIO M6P 3M9, CANADA:
2,625,315, MULTIPLE CLASS, INT. CLS. 9 AND 28.
2,625,316, MULTIPLE CLASS, INT. CLS. 9, 16, 28 AND 41.
- BIG DOG MOTORCYCLES, INC., WICHITA, KS TO BIG DOG HOLDINGS, INC., SANTA BARBARA, CA:
2,078,155 NEW CERT. 9-24-2002. INT. CL. 12.
- BIG DOG MOTORCYCLES, L.L.C., WICHITA, KS TO BIG DOG HOLDINGS, INC., SANTA BARBARA, CA:
2,109,020 NEW CERT. 9-24-2002. INT. CL. 12.
- BIG EAST CONFERENCE, THE, PROVIDENCE, RI:
2,623,728, PUB. 7-2-2002. MULTIPLE CLASS, INT. CLS. 16, 18, 21, 25, 28, 41 AND 42.
- BIG M, INC., TOTOWA, NJ:
2,624,089, PUB. 7-2-2002. MULTIPLE CLASS, INT. CLS. 3, 16 AND 20.
- BIG WAVE NET VENTURES, LLC, DALLAS, TX:
2,626,409, INT. CL. 35.
- BILL GOOD MARKETING, SOUTH JORDAN, UT:
2,626,246, INT. CL. 9.
2,626,871, INT. CL. 35.
- BILL R. STEPHENS ASSOCIATES, INC., SAN ANTONIO, TX:
2,626,076, INT. CL. 41.
- BILL'S FOREST CITY SUPERMARKET, INC., FOREST CITY, IA:
2,622,593, PUB. 12-7-1999. MULTIPLE CLASS, INT. CLS. 35 AND 42.
- BILLBOARD VIDEO, INC., FRISCO, TX:
2,623,179, PUB. 7-2-2002. INT. CL. 35.
- BILLY-BOB TEETH, INC., MICHAEL, IL:
2,626,111, INT. CL. 10.
- BIMA 83, CLICKY, FRANCE, SOCIETE D'EXPLOITATION DE PRODUITS POUR LES INDUSTRIES CHIMIQUES - S.E.P.P.I.C., PARIS, FRANCE:
1,196,596, REN. 8-13-02. INT. CL. 2.
- BIMEDA INC., TALLAGHT, DUBLIN 24, IRELAND, SANOFI ANIMAL HEALTH, INC., OVERLAND PARK, KS:
1,732,411, REN. 8-13-02. INT. CL. 5.
1,734,316, REN. 8-13-02. INT. CL. 5.
- BIO ESSENZA S.R.L., 20124 MILANO, ITALY:
2,623,721, PUB. 7-2-2002. INT. CL. 3.
- BIO NEBRASKA, INC., LINCOLN, NE:
1,666,349, REN. 8-10-02. INT. CL. 1.
- BIO SYNTECH CANADA INC., LAVAL, QUEBEC, CANADA:
2,622,619, PUB. 7-2-2002. INT. CL. 5.
- BIO-BOTANICA, INC., HAUPPAUGE, NY:
2,625,613, INT. CL. 5.
- BIO-DEX LABORATORIES, SCOTTSDALE, AZ:
1,932,806, CANC. INT. CL. 1.
- BIO-MEDICAL & PHARMACEUTICAL MANUFACTURING CORPORATION, HOUSTON, TX:
2,625,600, MULTIPLE CLASS, INT. CLS. 3 AND 40.
- BIOFARMA, 92200 NEUILLY-SUR-SEINE, FRANCE:
2,624,555, PUB. 7-2-2002. INT. CL. 5.
- BIOGAL GYOGYSZERGYAR RT, PALLAGI UT 13, HUNGARY:
1,663,151, CANC. INT. CL. 5.
- BIOGENEX LABORATORIES, SAN RAMON, CA:
1,677,329, REN. 8-15-02. INT. CL. 5.
- BIONUTRATECH, INC., HOUSTON, TX:
2,625,823, INT. CL. 1.
- BIOPATTERNS CENTER FOR HEALTH LLC, THE, LAGRANGE, IL FROM RUSH, PATRICIA, LAGRANGE, IL:
2,626,075, INT. CL. 42.
- BIOSOURCE TECHNOLOGIES, INC., VACAVILLE, CA:
1,933,523, CANC. MULTIPLE CLASS, INT. CLS. 1 AND 5.
- BIOSPHERE MEDICAL, INC., ROCKLAND, MA:
2,626,321, INT. CL. 10.
- BIOWEAR, INC., RUTLAND, MA:
1,933,415, CANC. INT. CL. 25.
- BIRNBAUM INTERNATIONAL LTD., NEW YORK, NY, DBA DAVID BIRNBAUM/ROCKEFELLER PLAZA:
2,626,848, INT. CL. 35.
- BIRRAPORETTI'S RESTAURANTS, INC., HOUSTON, TX:
1,176,617, CANC. INT. CL. 42.
- BISHOP, JEFFREY, EASTON, CT:
2,625,431, INT. CL. 7.
- BISHOP, MICHAEL, RIVIERA BEACH, FL:
2,624,115, PUB. 9-25-2001. INT. CL. 12.
- BITTERS CO., SEATTLE, WA:
2,622,927, PUB. 7-2-2002. INT. CL. 20.

- BIWATER PLC, DORKING, SURREY RH4 1TZ, UNITED KINGDOM:
2,623,480, PUB. 7-2-2002. INT. CL. 42.
- BK ENTERPRISES, A DIVISION OF TOMORROW, INC., MANDEVILLE, LA:
2,624,444, PUB. 7-2-2002. INT. CL. 5.
- BLACHFORD, STEPHEN R., FARMINGTON, MI:
2,624,542, PUB. 7-2-2002. INT. CL. 3.
- BLACHMAN, LINDA, BERKELEY, CA:
2,624,023, PUB. 7-2-2002. MULTIPLE CLASS, INT. CLS. 16, 41 AND 42.
- BLACK & DECKER CORPORATION, THE, TOWSON, MD:
1,933,823, CANC. INT. CL. 9.
2,622,774, PUB. 7-2-2002. INT. CL. 7.
2,625,066, PUB. 12-25-2001. INT. CL. 9.
- BLACK BELT CHAMPIONSHIPS, LLC, PACIFIC PALISADES, CA:
2,623,349, PUB. 7-2-2002. INT. CL. 41.
- BLACK CINEMA CAFE, NEW YORK, NY:
2,625,141, PUB. 7-2-2002. INT. CL. 41.
- BLACK DRAGON, INC., SANTA MONICA, CA:
2,624,960, PUB. 7-2-2002. INT. CL. 42.
- BLACK HOLE INDUSTRIES, SANTA CRUZ, CA:
2,625,094, PUB. 7-2-2002. INT. CL. 25.
- BLACKWOOD INDUSTRIES, INC., BENTONVILLE, AR:
2,626,511, INT. CL. 29.
- BLAIR CORPORATION, WARREN, PA:
1,933,447, CANC. INT. CL. 3.
- BLANCHARD, MARC, SAN DIEGO, CA:
2,626,278, INT. CL. 14.
- BLAZER GOLD S.R.L., VICENZA, ITALY:
1,663,382, CANC. INT. CL. 14.
- BLINK MUSIC, INC., CAMBRIDGE, MA:
2,626,982, INT. CL. 41.
- BLISS WORLD LLC, BROOKLYN, NY FROM KILGORE, MARCIA, NEW YORK, NY:
2,625,451, INT. CL. 35.
- BLOCK SPORTSWEAR, INC., WILMINGTON, NC:
2,625,545, INT. CL. 25.
- BLOOMFIELD INDUSTRIES, INC., CHICAGO, IL:
1,175,791, CANC. MULTIPLE CLASS, INT. CLS. 6, 11 AND 12.
1,176,026, CANC. INT. CL. 11.
- BLT PRODUCTIONS, BILLINGS, MT FROM BLOCKIT & LOCKIT SYSTEMS, BILLINGS, MT:
2,626,654, INT. CL. 35.
- BLUE CANARY, INC., WHITE PLAINS, NY FROM ABEL ENTERPRISES, INC., NEW YORK, NY:
2,625,350, INT. CL. 42.
- BLUE CIRCLE CANADA, INC., TORONTO, ONTARIO M4G 3W9, CANADA:
2,622,743, PUB. 7-2-2002. INT. CL. 19.
- BLUE COLLAR COMMERCE, LTD., SNYDER, NY:
2,622,756, PUB. 7-2-2002. INT. CL. 9.
- BLUE Q, PITTSFIELD, MA:
2,569,739, CANC. IIRN. RESTORED TO S.N. 76-197,810.
- BLUE RIDGE PHARMACEUTICALS, INC., GREENSBORO, NC:
2,625,931, INT. CL. 5.
- BLUEBERRY HILL DESSERTERY, INC., WILMINGTON, NC:
2,625,122, PUB. 7-2-2002. MULTIPLE CLASS, INT. CLS. 30 AND 35.
- BLUM CAPITAL PARTNERS, L.P., SAN FRANCISCO, CA:
2,626,908, INT. CL. 36.
- BLUNT, DAVID, HARBOR CITY, CA:
2,623,612, PUB. 7-2-2002. INT. CL. 36.
- BMC PLAYERS INC., WILMINGTON, DE:
2,623,391, PUB. 7-2-2002. INT. CL. 25.
- BMCW SOUTHCENTRAL, L.P., CAPEL, TEXAS, TX:
2,624,689, PUB. 7-2-2002. INT. CL. 37.
- BMP MEDICAL PRODUCTS, INC., LARGO, FL:
2,624,077, PUB. 7-2-2002. INT. CL. 10.
- BMR BATH MASTER REGLAZING LTD., PEACHLAND, BRITISH COLUMBIA:
2,624,495, PUB. 1-15-2002. INT. CL. 37.
- BMS PAPIER CONCEPT GMBH, 65191 WEISBADEN, FED REP GERMANY FROM MOLLER, KARL-HEINZ, 65191 WIESBADEN, FED REP GERMANY:
2,625,434, INT. CL. 16.
- BND MESSENGER SERVICE, INC., NEW YORK, NY:
1,176,704, CANC. INT. CL. 39.
- BOARD OF DIRECTORS OF WITTENBERG COLLEGE, THE, SPRINGFIELD, OH, DBA WITTENBERG UNIVERSITY:
2,623,960, PUB. 7-2-2002. MULTIPLE CLASS, INT. CLS. 14, 16, 20, 21, 25 AND 41.
- BOARD OF EDUCATION OF THE TOLEDO CITY SCHOOL DISTRICT, TOLEDO, OH:
2,626,462, INT. CL. 41.
- BOARD OF REGENTS FOR OKLAHOMA STATE UNIVERSITY, STILLWATER, OK:
2,623,574, PUB. 7-2-2002. INT. CL. 25.
- BOARD OF REGENTS OF THE UNIVERSITY OF WISCONSIN SYSTEM, THE, MADISON, WI, DBA WHA RADIO/UNIVERSITY OF WISCONSIN-EXTENSION:
2,623,292, PUB. 7-2-2002. INT. CL. 41.
- BOARD OF REGENTS, THE UNIVERSITY OF TEXAS SYSTEM, AUSTIN, TX:
2,624,212, PUB. 7-2-2002. MULTIPLE CLASS, INT. CLS. 35, 41 AND 42.
- BOARDROOM, INC., GREENWICH, CT:
1,934,371, CANC. INT. CL. 16.
- BOAT OWNERS ASSOCIATION OF THE UNITED STATES, ALEXANDRIA, VA:
2,623,990, PUB. 7-2-2002. MULTIPLE CLASS, INT. CLS. 16, 35, 36 AND 42.
2,623,991, PUB. 7-2-2002. MULTIPLE CLASS, INT. CLS. 37 AND 39.
2,624,164, PUB. 7-2-2002. MULTIPLE CLASS, INT. CLS. 37 AND 39.
- BOATENG, JOSEPH O., CAMBRIDGE, MA:
2,624,645, PUB. 7-2-2002. INT. CL. 28.
- BOB ADAMS HOMES, INC., TYRONE, GA:
2,624,575, PUB. 7-2-2002. INT. CL. 37.
- BOB EVANS RESTAURANTS OF MICHIGAN, INC., ANN ARBOR, MI:
2,624,372, PUB. 7-2-2002. INT. CL. 42.
- BOB HARPER'S COMPANY, SAN DIEGO, CA:
1,994,851, CANC. INT. CL. 35.
- BOBO, LINDA:
See—KINDERLANGUAGE LLC.
- BOC GROUP PLC, THE, LONDON, ENGLAND:
1,176,035, CANC. INT. CL. 12.
- BOCHASANWASI SHREE AKSHAR PURUSHOTTAM SWAMINARAYAN SANSTHA INC., FLUSHING, NY:
2,623,396, PUB. 7-2-2002. INT. CL. 42.
- BOCK, ELIZABETH, ENCINITAS, CA:
2,623,081, PUB. 7-2-2002. MULTIPLE CLASS, INT. CLS. 35 AND 36.
2,623,180, PUB. 7-2-2002. MULTIPLE CLASS, INT. CLS. 35 AND 36.
- BOCKOW, BARRY I., SEATTLE, WA:
1,933,335, CANC. INT. CL. 5.
- BODEGAS Y BEBIDAS, S.A., GUIPUZCOA, SPAIN:
2,625,786, INT. CL. 33.
- BODEGAS Y VINEDOS NICOLAS CATENA S.A., (5579) RIVADAVIA MENDOZA, ARGENTINA:
2,626,174, INT. CL. 33.
- BODY PROS PHYSICAL THERAPY, LLC, ALPHARETTA, GA:
2,624,382, PUB. 7-2-2002. INT. CL. 42.
- BODYWEAR BY BOSOM BUDDIES, INC., DALLAS, TX:
2,622,762, PUB. 7-2-2002. INT. CL. 25.
- BOEHRINGER INGELHEIM PHARMA KG, 55216 INGELHEIM AM RHEIN, FED REP GERMANY:
2,624,294, PUB. 3-12-2002. INT. CL. 5.
- BOEHRINGER INGELHEIM VETMEDICA GMBH, 55216 INGELHEIM AM RHEIN, FED REP GERMANY:
2,624,078, PUB. 9-25-2001. INT. CL. 5.
- BOGAR AG, 8002 ZURICH, SWITZERLAND:
2,624,060, PUB. 7-2-2002. MULTIPLE CLASS, INT. CLS. 5 AND 31.

- BOGARTGOLF, INC., BELLEVUE, WA:
2,626,797, INT. CL. 41.
- BOHAN GROUP, LLC, THE, SAN FRANCISCO, CA:
2,622,732, PUB. 6-19-2001. INT. CL. 36.
- BOLLINGER INDUSTRIES, INC., IRVING, TX:
1,933,786, CANC. INT. CL. 28.
- BOLNER'S FIESTA PRODUCTS, INC., SAN ANTONIO, TX:
2,626,125, INT. CL. 30.
- BOMBARDIER, INC., MONTREAL, QUEBEC H3B 1Y8,
CANADA, BOMBARDIER LIMITED, VALCOURT, QUE-
BEC, CANADA:
939,566, REN. 8-10-02. U.S. CL. 19 (INT. CL. 12).
- BONAR INC., BURLINGTON, ONTARIO, L7R 4A1, CANA-
DA:
1,933,856, CANC. INT. CL. 20.
1,933,857, CANC. INT. CL. 20.
- BONDO CORPORATION, ATLANTA, GA, SWISS LABORA-
TORY INC., CLEVELAND, OH:
733,648, REN. 8-10-02. U.S. CL. 12 (INT. CL. 19).
- BONJOUR, INC., PACHECO, CA:
2,622,938, PUB. 7-2-2002. INT. CL. 7.
- BONNE BELL, INC., LAKEWOOD, OH:
2,624,230, PUB. 7-2-2002. INT. CL. 3.
- BONNER & MOORE ASSOCIATES, INC., HOUSTON, TX,
DBA BONNER & MOORE MANAGEMENT SCIENCE:
1,663,286, CANC. INT. CL. 9.
1,663,287, CANC. INT. CL. 9.
- BONNER, KATHLEEN L., SCOTTSDALE, AZ:
2,623,144, PUB. 7-2-2002. INT. CL. 42.
- BONTAZ CENTRE, 74460 MARNAZ, FRANCE:
2,622,846, PUB. 7-2-2002. MULTIPLE CLASS, INT. CLS. 7
AND 12.
- BORDEN, INC., COLUMBUS, OH:
148,245, CANC. U.S. CL. 46.
1,175,661, CANC. INT. CL. 1.
- BORER, JEFFERY, NEW YORK, NY:
2,625,293, PUB. 7-2-2002. MULTIPLE CLASS, INT. CLS. 41
AND 42.
- BORTHWICKS FLAVORS USA, INC., HAUPPAUGE, NY:
1,932,983, CANC. INT. CL. 30.
- BOSCORALE OPERATING, LLC, NEW YORK, NY:
2,624,863, PUB. 7-2-2002. INT. CL. 25.
- BOSTON ANCHOR, INC., QUINCY, MA:
2,626,977, INT. CL. 9.
- BOSTON METAL PRODUCTS CORPORATION, MEDFORD,
MA:
1,934,120, CANC. INT. CL. 17.
- BOSTON MILLENNIA PARTNERS LIMITED PARTNER-
SHIP, BOSTON, MA FROM CALLOW, A. DANA, JR.,
WESTON, MA:
2,625,343, INT. CL. 36.
- BOTANICAL LABORATORIES, INC., FERNDALE, WA,
MCZAND HERBAL, INC., SANTA MONICA, CA:
1,672,353, REN. 8-16-02. INT. CL. 5.
- BOUCHER GROUP, INC., THE, GREENFIELD, WI:
2,623,508, PUB. 7-2-2002. INT. CL. 35.
- BOULDER BEVERAGE COMPANY, DENVER, CO:
2,626,784, INT. CL. 32.
- BOUNTIFUL MATTRESS COMPANY, INCORPORATED,
SALT LAKE CITY, UT:
1,703,312, REN. 8-10-02. INT. CL. 20.
- BOURNS, INC., RIVERSIDE, CA:
2,626,372, INT. CL. 9.
- BOURQUE DATA SYSTEMS, INC., DALLAS, TX:
1,727,145, REN. 8-13-02. INT. CL. 9.
- BOV AKTIENGESELLSCHAFT, D-45133, ESSEN, FED REP
GERMANY:
2,623,460, PUB. 7-2-2002. MULTIPLE CLASS, INT. CLS. 9
AND 42.
- BOWIE-SIMS-PRANGE, INC., CARROLLTON, TX:
1,176,608, CANC. INT. CL. 42.
- BOWLING, MICHAEL A., TUCSON, AZ:
2,624,133, PUB. 7-2-2002. INT. CL. 28.
- BOXER HOLDINGS, INC., SAN FRANCISCO, CA:
2,625,508, INT. CL. 25.
- BOXLIGHT CORPORATION, POULSBO, WA:
2,624,594, PUB. 7-2-2002. INT. CL. 9.
- BOYD COFFEE COMPANY, PORTLAND, OR:
1,723,573, REN. 8-12-02. MULTIPLE CLASS, INT. CLS. 11,
21, 29, 30, 32 AND 39.
- BOYDS COLLECTION, LTD, THE, MCSHERRYSTOWN, PA:
2,625,834, INT. CL. 28.
- BOYLES, RUSSELL A, LAKE OSWEGO, OR:
2,625,194, PUB. 7-2-2002. INT. CL. 41.
- BP AMOCO P.L.C.:
See—BP P.L.C.
- BP P.L.C., LONDON, ENGLAND FROM BP AMOCO P.L.C.,
LONDON EC2M 7BA, UNITED KINGDOM:
2,623,737, PUB. 7-2-2002. INT. CL. 16.
- BP P.L.C., LONDON, ENGLAND FROM BP AMOCO P.L.C.,
LONDON EC2M 7BA, ENGLAND:
2,625,595, INT. CL. 1.
- BRADLEES STORES, INC., BRAINTREE, MA:
1,933,252, CANC. INT. CL. 25.
- BRADLEY PRODUCTS INC., BLOOMINGTON, MN:
941,210, REN. 8-10-02. U.S. CL. 6 (INT. CL. 2).
- BRADLEY PRODUCTS, INC., BLOOMINGTON, MN:
2,623,926, PUB. 7-2-2002. MULTIPLE CLASS, INT. CLS. 5
AND 9.
- BRADY, LEON, LLL, SAN DIEGO, CA:
2,623,509, PUB. 7-2-2002. INT. CL. 42.
- BRAINTREE LABORATORIES, INC., BRAINTREE, MA:
2,625,832, INT. CL. 5.
- BRAKEWORKS, INC., HAWTHORNE, CA:
2,622,642, PUB. 7-2-2002. INT. CL. 12.
- BRANCH OFFICE, INC., THE, ALEXANDRIA, IN:
2,622,772, PUB. 7-2-2002. INT. CL. 41.
- BRANDON FEMME, INC., CHATSWORTH, CA, ATLANTIC
INDUSTRIES, INC., VAN NUYS, CA:
1,690,990, REN. 8-16-02. INT. CL. 26.
- BRANDT'S FRUIT TREES, INC., WAPATO, WA:
2,625,463, INT. CL. 31.
- BRAUCKMANN & PROBSTING GMBH & CO. KG, 58509
LUDENSCHIED, FED REP GERMANY:
1,932,849, CANC. INT. CL. 6.
- BRAVEMAN, GYDA, NEW YORK, NY:
1,932,796, CANC. INT. CL. 41.
- BRAVO DEVELOPMENT, INC., COLUMBUS, OH:
2,622,985, PUB. 7-2-2002. INT. CL. 43.
2,622,987, PUB. 7-2-2002. INT. CL. 43.
- BRAY, MICHAEL R., PORTVILLE, NY, DBA MICHELLE DE
BRAYE CLOTHING COMPANY:
1,933,728, CANC. INT. CL. 25.
- BREAK IT, FIX IT, RIDE IT, INC., HONEOYE FALLS, NY:
2,625,082, PUB. 7-2-2002. INT. CL. 9.
- BREEDING ENTERPRISES, INC., BREA, CA:
1,932,873, CANC. INT. CL. 42.
- BRENEMAN OF WISCONSIN, INC., CINCINNATI, OH:
723,713, CANC. U.S. CL. 32.
- BRENT ALLEN, INC., CHARLOTTE, NC:
2,622,755, PUB. 8-28-2001. MULTIPLE CLASS, INT. CLS.
25, 35 AND 41.
- BRENTANO, MIAMI, FL:
2,626,635, INT. CL. 18.
- BRENTWOOD BAPTIST CHURCH, HOUSTON, TX:
2,623,718, PUB. 7-2-2002. INT. CL. 42.
- BRENTWOOD MUSIC, INC., BRENTWOOD, TN:
1,933,133, CANC. INT. CL. 9.
- BREZINSKI, JESSICA MARIE, PONTIAC, MI, DBA WIG-
GLES, WAGS, & WHISKERS:
2,624,546, PUB. 7-2-2002. INT. CL. 18.
- BRIAN L. GOLDBERG, PLANTATION, FL:
2,622,594, PUB. 7-2-2002. MULTIPLE CLASS, INT. CLS. 35
AND 37.
- BRICO INDUSTRIES, INC.:
See—VICTAULIC DEPEND-O-LOK, INC.
- BRIDGE BUILDER TECHNOLOGIES, INC., WELLESLEY
HILLS, MA:
1,933,740, CANC. INT. CL. 9.
- BRIDGE, DONALD RAY, BEREAS, OH:
2,623,162, PUB. 7-2-2002. INT. CL. 30.
- BRIDGESTONE SPORTS CO., LTD., TOKYO, JAPAN:
2,625,565, INT. CL. 18.

- BRILLIANT TRADING INC., VANCOUVER, BRITISH COLUMBIA V6A 1R5, CANADA:
2,227,259, CANC. INT. CL. 11.
- BRINKMANN CORPORATION, THE, DALLAS, TX:
1,933,232, CANC. INT. CL. 11.
- BRIO CORPORATION, GERMANTOWN, WI:
2,626,090, INT. CL. 28.
- BRISTOL-MYERS COMPANY, NEW YORK, NY:
1,175,772, CANC. INT. CL. 5.
- BRITISH TELECOMMUNICATIONS PUBLIC LIMITED COMPANY, LONDON, ENGLAND:
2,623,526, PUB. 7-2-2002. MULTIPLE CLASS, INT. CLS. 38, 39 AND 42.
- BROADCOM CORPORATION, IRVINE, CA:
2,625,799, INT. CL. 42.
- BROADLAWNS MEDICAL CENTER, DES MOINES, IA:
2,624,001, PUB. 5-28-2002. MULTIPLE CLASS, INT. CLS. 35 AND 42.
- BROADMOOR BAKER, INC., SEATTLE, WA:
1,933,118, CANC. INT. CL. 30.
- BROADNAX, JOHN, ZEPHYR COVE, NV:
2,623,618, PUB. 7-2-2002. INT. CL. 28.
- BRODA, DOMINIQUE, 75001 PARIS, FRANCE:
2,623,346, PUB. 7-2-2002. INT. CL. 25.
- BRODERBUND SOFTWARE, INC., NOVATO, CA:
1,663,236, CANC. INT. CL. 9.
- BRODERBUND SOFTWARE, INC.:
See— TLC PRODUCTIVITY PROPERTIES, LLC.
- BRODERBUND SOFTWARE, INC.:
See— GENEALOGY.COM, LLC.
- BRODY COMMUNICATIONS LTD., JENKINTOWN, PA:
2,626,686, INT. CL. 41.
- BROOK MAYS MUSIC COMPANY, DALLAS, TX:
2,626,212, INT. CL. 15.
- BROOKLYN BOTTLING CORP., BROOKLYN, NY:
1,663,573, CANC. INT. CL. 32.
1,663,574, CANC. INT. CL. 32.
- BROOKLYN BOTTLING CORPORATION, BROOKLYN, NY:
2,624,026, PUB. 7-2-2002. INT. CL. 32.
- BROOKS BROTHERS, INC., NEW YORK, NY:
2,625,045, PUB. 7-2-2002. INT. CL. 35.
- BROOKS III, LONNIE W., ADDISON, TX:
2,625,214, PUB. 7-2-2002. INT. CL. 36.
- BROOKS SPORTS, INC., BOTHELL, WA:
2,625,911, INT. CL. 25.
- BROOKS, MALCOLM, NANTUCKET, MA:
1,932,571, CANC. INT. CL. 25.
- BROOKSIDE FOODS LTD., V2T 6G2, CANADA:
2,624,090, PUB. 7-2-2002. INT. CL. 29.
- BROOKVILLE WOOD PRODUCTS, INC., BROOKVILLE, PA:
2,624,727, PUB. 7-2-2002. INT. CL. 28.
- BROUWERIJ DE KONINCK, N.V., 2018 ANTWERP, BELGIUM:
2,622,638, PUB. 7-11-2000. INT. CL. 32.
- BROWN BROTHERS HARRIMAN & CO, NEW YORK, NY:
2,623,764, PUB. 7-2-2002. INT. CL. 36.
- BROWN BROTHERS HARRIMAN & CO., NEW YORK, NY:
2,623,763, PUB. 7-2-2002. INT. CL. 36.
- BROWN, GEOFFREY P., VANCOUVER, BRITISH COLUMBIA, CANADA:
1,933,376, CANC. INT. CL. 8.
- BROWNE, H. LEE, GREENWICH, CT:
2,625,478, INT. CL. 9.
- BROWNING-FERRIS INDUSTRIES, INC., HOUSTON, TX:
1,932,861, CANC. MULTIPLE CLASS, INT. CLS. 37, 40 AND 42.
1,933,068, CANC. INT. CL. 31.
1,933,069, CANC. INT. CL. 31.
- BRUDER HEALTHCARE COMPANY, MARIETTA, GA:
1,933,886, CANC. INT. CL. 5.
- BRUNEL CARRIAGE PLC, LONDON E1 1LX, ENGLAND:
2,623,497, PUB. 7-2-2002. INT. CL. 39.
- BRUNEL S.R.L. PREZIOSI D'AUTORE, 62018 P. PICENO (MC), ITALY:
2,622,517, PUB. 7-2-2002. INT. CL. 14.
- BRUNN, RONI, LOS ANGELES, CA:
2,622,841, PUB. 7-2-2002. INT. CL. 18.
- BRUNO MARKETING UND VERTRIEB GMBH, 63322 RODERMARK, FED REP GERMANY:
2,623,605, PUB. 7-2-2002. MULTIPLE CLASS, INT. CLS. 18 AND 25.
- BRUNSWICK CORPORATION:
See— W.C. BRADLEY/ZEBCO HOLDINGS, INC..
- BRUSH, EDWARD JOHN, COLUMBIA, MD:
1,932,887, CANC. INT. CL. 36.
- BRUTE FABRICATORS, INC., SAN ANTONIO, TX:
1,647,667, CANC. MULTIPLE CLASS, INT. CLS. 37 AND 42.
- BRYAN EDWARDS, A PUBLISHING COMPANY, INC., ANAHEIM, CA:
2,624,699, PUB. 7-2-2002. INT. CL. 16.
- BRYDELS, JOHN JR., BATON ROUGE, LA:
2,626,626, INT. CL. 35.
- BUCHANAN INGERSOLL PROFESSIONAL CORPORATION, PITTSBURGH, PA:
2,623,208, PUB. 7-2-2002. INT. CL. 42.
2,624,702, PUB. 7-2-2002. INT. CL. 35.
- BUCKEYE STEEL CASTINGS CO., COLUMBUS, OH:
1,660,741, REN. 8-15-02. INT. CL. 12.
- BUDDY L INC., NEW YORK, NY:
1,933,422, CANC. INT. CL. 28.
- BUILD-A-BEAR WORKSHOP, INC., ST. LOUIS, MS:
2,625,899, INT. CL. 36.
- BUILDING CHAMPIONS, INC., LAKE OSWEGO, OR:
2,622,915, PUB. 7-2-2002. INT. CL. 41.
- BUNGE FOODS CORPORATION, BRADLEY, IL, LEO, LOUIS E., SEATTLE, WA, DBA LEO'S BAKERY SERVICE:
942,071, REN. 8-15-02. U.S. CL. 46 (INT. CL. 30).
- BUNN, LOUIS J., VIRGINIA BEACH, VA:
2,624,826, PUB. 7-2-2002. INT. CL. 29.
- BURBERRY LIMITED, LONDON SW1Y 4DO, UNITED KINGDOM:
2,624,684, PUB. 7-2-2002. INT. CL. 35.
- BUREAU OF NATIONAL AFFAIRS, INC., THE, WASHINGTON, D.C., DC:
2,626,841, MULTIPLE CLASS, INT. CLS. 16 AND 42.
- BURGER, ALVIN, MIAMI, FL:
1,932,557, CANC. INT. CL. 42.
- BURGESS & BURGESS INC., GURNEE, IL:
2,626,243, INT. CL. 31.
- BURKMANN INDUSTRIES, INC., DANVILLE, KY, DBA BURKMANN FEEDS:
2,623,308, PUB. 7-2-2002. INT. CL. 5.
- BURKS, RUFUS W., HYATTSVILLE, MD:
1,933,847, CANC. INT. CL. 16.
1,933,889, CANC. INT. CL. 16.
- BURLINGTON INDUSTRIES, INC., GREENSBORO, NC:
148,303, CANC. U.S. CL. 39.
- BURLINGTON INDUSTRIES, INC., NEW YORK, NY:
1,176,351, CANC. INT. CL. 27.
- BURLINGTON NORTHERN AND SANTA FE RAILWAY COMPANY, THE, FORT WORTH, TX:
2,624,402, PUB. 7-2-2002. INT. CL. 39.
- BURNETT, ALFRED COLEMAN II, CHARLOTTE, NC:
1,934,359, CANC. INT. CL. 25.
- BURSON, WILLIAM C., MANCOS, CO:
2,623,351, PUB. 7-2-2002. INT. CL. 20.
- BURTON CORPORATION, THE, BURLINGTON, VT:
2,623,908, PUB. 7-2-2002. INT. CL. 25.
- BUSCH AGRICULTURAL RESOURCES, INC., ST. LOUIS, MO:
2,623,082, PUB. 7-2-2002. INT. CL. 30.
- BUSH, DANNY, HUNTINGTON STATION, NY:
2,625,610, INT. CL. 9.
- BUSINESS EQUIPMENT RESEARCH AND TEST LABORATORIES LTD, PANGBOURNE BERKSHIRE, UNITED KINGDOM:
2,625,139, PUB. 7-2-2002. INT. CL. 42.
- BUSINESS INTEGRATION SERVICES, INC., BLOOMINGTON, MN:
1,933,617, CANC. INT. CL. 9.
1,933,619, CANC. INT. CL. 9.
1,933,620, CANC. INT. CL. 9.

- BUTLER VIDEO PRODUCTIONS, BELLEVUE, WA:
1,933,579, CANC. INT. CL. 25.
- BUY-RITE COSTUME JEWELRY, INC., FREEHOLD, NJ:
2,626,113, INT. CL. 14.
- BUYANDHOLD.COM, INC.:
See—BUYANDHOLD, INC..
- BUYANDHOLD, INC., EDISON, NJ FROM BUYANDHOLD.COM, INC., NEW YORK, NY:
2,626,780, MULTIPLE CLASS, INT. CLS. 35 AND 36.
- BUYERS VOICE REAL ESTATE, INC., DALLAS, TX:
1,663,635, CANC. INT. CL. 36.
1,663,636, CANC. INT. CL. 36.
- BVS ENTERTAINMENT, INC., LOS ANGELES, CA FROM SABAN ENTERTAINMENT, INC., LOS ANGELES, CA:
2,624,629, PUB. 7-2-2002. INT. CL. 28.
2,624,647, PUB. 7-2-2002. INT. CL. 28.
- BYTEAUDIO.COM, INC., PALM BEACH GARDENS, FL:
2,625,081, PUB. 7-2-2002. INT. CL. 42.
- C. & J. CLARK AMERICA, INC., KENNETT SQUARE, PA:
2,625,338, INT. CL. 25.
- C. BARRETT MARKETING AND DESIGN CONSULTANTS, INC., MATTHEWS, NC:
1,934,145, CANC. INT. CL. 42.
- C. J. FOODS, INC., PAWNEE CITY, NE:
2,625,909, INT. CL. 40.
- C. R. BARD, INC., MURRAY HILL, NJ:
2,626,456, INT. CL. 10.
- C.B. FLEET INVESTMENT CORPORATION, WILMINGTON, DE:
1,663,129, CANC. INT. CL. 3.
- C.D.C. APPLIANCES, INC., CINCINNATI, OH, DBA OHIO VALLEY FLOORING:
2,626,082, INT. CL. 35.
- C.K.F. FOODS, INC., MT. PROSPECT, IL:
2,626,024, INT. CL. 29.
- C.R. BARD, INC., MURRAY HILL, NJ:
1,933,517, CANC. INT. CL. 10.
- C.U. PROCESSING, INC., SOUTHFIELD, MI:
2,622,778, PUB. 7-2-2002. INT. CL. 9.
- C/BASE, INC., CONSHOHOCKEN, PA:
2,625,689, INT. CL. 36.
- CA' D'ZAN INTERNATIONAL, INC., SARASOTA, FL:
1,932,729, CANC. INT. CL. 25.
- CABLE ONE, INC., PHOENIX, AZ:
2,625,854, INT. CL. 38.
- CABLE SERVICES GROUP, INC., OMAHA, NE:
1,933,813, CANC. INT. CL. 35.
- CABO RICO YACHTS, INC., FORT LAUDERDALE, FL:
1,176,048, CANC. INT. CL. 12.
- CABOT SAFETY INTERMEDIATE CORPORATION, NEWARK, DE, SPECIALTY CONVERTERS, INC., EAST BRAINTREE, MA:
732,612. REN. 8-15-02. U.S. CL. 1 (INT. CL. 17).
- CABOT SAFETY INTERMEDIATE CORPORATION, NEWARK, DE:
2,625,514, INT. CL. 9.
- CABOT TECHNOLOGY CORPORATION, WILMINGTON, DE:
1,934,515, CANC. INT. CL. 20.
- CACI, INC. - FEDERAL, ARLINGTON, VA:
1,176,132, CANC. INT. CL. 16.
- CACI, INC. - FEDERAL, FAIRFAX, VA:
1,663,222, CANC. INT. CL. 9.
- CADEC CORPORATION, LONDONDERRY, NH:
2,626,432, INT. CL. 35.
- CADENCE DESIGN SYSTEMS, INC., SAN JOSE, CA:
2,625,774, INT. CL. 42.
- CAESARS WORLD, INC., LOS ANGELES, CA, LUM'S INC., MIAMI, FL:
931,975. REN. 8-10-02. U.S. CL. 100 (INT. CL. 42).
- CAESARS WORLD, INC., LOS ANGELES, CA:
1,201,555. REN. 8-16-02. INT. CL. 42.
- CAICE SOFTWARE CORPORATION, TAMPA, FL:
2,623,601, PUB. 7-2-2002. INT. CL. 9.
- CAJUN SEAFOOD KITCHEN LLC, SAN ANTONIO, TX:
2,623,659, PUB. 7-2-2002. INT. CL. 42.
- CAL FARLEY'S BOYS RANCH AND AFFILIATES, AMARILLO, TX:
2,624,506, PUB. 7-2-2002. MULTIPLE CLASS, INT. CLS. 41 AND 42.
2,624,507, PUB. 7-2-2002. INT. CL. 35.
- CALABRESE, LINDA, HINSDALE, IL:
2,624,458, PUB. 7-2-2002. INT. CL. 21.
- CALEDONIAN PACIFIC LTD., HOUSTON, TX FROM HILLOCK SERVICES LIMITED, TORTOLA, BR. VIRGIN ISLANDS:
2,625,310, INT. CL. 42.
- CALICO BRANDS, INC., ONTARIO, CA:
2,626,202, INT. CL. 34.
- CALIDAD HOLDINGS PTY LTD., NEW SOUTH WALES, 2011, AUSTRALIA:
2,626,771, INT. CL. 2.
- CALIENT NETWORKS, INC., SAN JOSE, CA:
2,625,844, INT. CL. 9.
- CALIFORNIA ACRYLIC INDUSTRIES, INC., POMONA, CA:
1,934,078, CANC. INT. CL. 35.
- CALIFORNIA DESSERTS, INC., BEVERLY HILLS, CA:
1,933,992, CANC. INT. CL. 42.
- CALIFORNIA HAWAII PROMOTIONS CO., LTD., CHOSEIGUN, CHIBA-KEN, JAPAN:
1,933,397, CANC. MULTIPLE CLASS, INT. CLS. 25 AND 28.
- CALIFORNIA TOMATO MACHINERY, LLC, CROWS LANDING, CA:
2,624,752, PUB. 7-2-2002. INT. CL. 7.
- CALIFORNIA TRUSS COMPANY, INC., PERRIS, CA:
2,624,917, PUB. 7-2-2002. INT. CL. 19.
- CALLAWAY GOLF COMPANY, CARLSBAD, CA:
1,933,211, CANC. INT. CL. 28.
2,626,615, INT. CL. 28.
2,626,672, INT. CL. 28.
- CALLAWAY, RICHARD E., ST. LOUIS, MO:
2,622,731, PUB. 1-23-2001. MULTIPLE CLASS, INT. CLS. 1 AND 19.
- CALLISMA, INC., SAN JOSE, CA:
2,624,412, PUB. 7-2-2002. MULTIPLE CLASS, INT. CLS. 35, 37 AND 42.
- CALNETIX, INNOVATIVE MAGNETIC TECHNOLOGIES INC., TORRANCE, CA:
2,623,705, PUB. 7-2-2002. INT. CL. 7.
- CALUORI, MARCO, CH-7000 CHUR, SWITZERLAND:
1,932,467, CANC. INT. CL. 19.
- CALYPSO ICE, LLC, DENVER, CO:
2,625,259, PUB. 7-2-2002. INT. CL. 32.
- CALZATURIFICIO CASADEI S.P.A., 47030 SAN MAURO PASCOLI - FORLI, ITALY:
1,705,086. REN. 8-12-02. INT. CL. 25.
- CAMBATA AVIATION S.A., NASSAU, BAHAMAS:
2,623,322, PUB. 7-2-2002. MULTIPLE CLASS, INT. CLS. 37 AND 39.
- CAMERICAN INTERNATIONAL, INC., PARAMUS, NJ, CONAGRA, INC., OMAHA, NE:
1,698,456. REN. 8-15-02. INT. CL. 29.
- CAMERON ASHLEY BUILDING PRODUCTS, INC., GREENVILLE, SC:
2,624,215, PUB. 7-2-2002. INT. CL. 6.
- CAMPAGNOLO SRL, 36100 VICENZA, ITALY:
2,622,768, PUB. 7-2-2002. MULTIPLE CLASS, INT. CLS. 8, 9 AND 25.
- CAMPBELL OIL COMPANY, MASSILLON, OH:
2,625,639, INT. CL. 35.
- CAMPBELL, RICHARD WAYNE:
See—RICHARD WAYNE CAMPBELL, INC..
- CAMPBELLSVILLE APPAREL COMPANY, LLC, CAMPBELLSVILLE, KY:
2,622,670, PUB. 7-2-2002. INT. CL. 25.
- CAMPER, S.L., INCA 7300 BALEARES, SPAIN:
2,622,708, PUB. 12-4-2001. INT. CL. 25.
- CAMY DEVELOPMENT CORP., PANAMA:
2,625,361, MULTIPLE CLASS, INT. CLS. 18 AND 25.
- CAN-D ELECTRIFICATION SYSTEMS LTD., BURLINGTON, ONTARIO:
2,623,505, PUB. 7-2-2002. INT. CL. 9.

- CANADIAN ATLAS FURNITURE CORPORATION, MISSISSAUGA, ONTARIO, CANADA:
2,623,780, PUB. 7-2-2002. INT. CL. 20.
- CANADIAN BUSINESS MACHINES LIMITED, MISSISSAUGA, ONTARIO, L5T 1C4, CANADA:
2,626,806, MULTIPLE CLASS, INT. CLS. 6, 20 AND 40.
- CANADIAN CANOPY CO. LTD., BARRIE, ONTARIO, CANADA:
1,176,037, CANC. INT. CL. 12.
1,176,038, CANC. INT. CL. 12.
- CANADIAN STANDARDS ASSOCIATION, TORONTO, ONTARIO, CANADA:
1,758,260. REN. 8-16-02. INT. CL. 16.
- CANADIAN TECHNICAL TAPE LTD., MONTREAL 9, QUEBEC, CANADA:
1,691,551. REN. 8-12-02. INT. CL. 17.
- CANALE, WILLIAM P., QUEENSBURY, NY:
1,933,529, CANC. INT. CL. 5.
- CANDESIGN, INC., OKLAHOMA CITY, OK:
2,622,785, PUB. 7-2-2002. INT. CL. 9.
- CANDLE DISTRICT INC., THE, DALLAS, TX:
2,625,131, PUB. 7-2-2002. INT. CL. 4.
- CANFIBRE GROUP INC., THE, TORONTO, ONTARIO, CANADA:
2,625,421, INT. CL. 19.
- CANNON STRUCTURES, INC., BLACKFOOT, ID:
2,623,808, PUB. 7-2-2002. INT. CL. 35.
- CANNONBALL MUSICAL INSTRUMENTS, LLC, SANDY, UT:
2,623,947, PUB. 7-2-2002. INT. CL. 15.
- CANTINA COLLI DEL SOLIGO - SOC. FRA PRODUTTORI DI UVE PREGIATE - COOP. A RESP. LIMITATA, 31050 PIEVE DI SOLIGO (TV), ITALY:
2,624,226, PUB. 7-2-2002. INT. CL. 33.
- CAPELLA AMERICA, INC., LIVINGSTON, NJ:
1,932,774, CANC. MULTIPLE CLASS, INT. CLS. 16, 18 AND 25.
- CAPITAL CROSSING BANK, BOSTON, MA:
2,503,981, COR. INT. CL. 36.
- CAPITOL RECORDS, INC., NEW YORK, NY:
2,622,534, PUB. 7-2-2002. INT. CL. 36.
- CAPITOL SYSTEMS CORPORATION, PHOENIX, AZ:
2,625,666, INT. CL. 9.
- CAPITOL TOOL AND DIE CO., WILLIAMSTON, MI:
1,933,508, CANC. INT. CL. 7.
- CAPLAN INDUSTRIES INC., RICHMOND, BRITISH COLUMBIA, CANADA:
2,623,840, PUB. 7-2-2002. INT. CL. 9.
- CAPRA SRL, ITALIA, ITALY:
2,623,887, PUB. 7-2-2002. INT. CL. 14.
- CAPT. HARRY'S FISHING SUPPLY, MIAMI, FL:
2,623,839, PUB. 7-2-2002. MULTIPLE CLASS, INT. CLS. 28 AND 35.
- CAPTUS NETWORKS CORP., WOODLAND, CA:
2,626,163, INT. CL. 9.
- CARBOLINE COMPANY, ST. LOUIS, MO:
2,625,723, INT. CL. 2.
- CARBON NANOTECHNOLOGIES INCORPORATED, HOUSTON, TX:
2,626,326, INT. CL. 1.
- CARBONTEC ENERGY CORPORATION, BISMARCK, ND:
2,626,485, INT. CL. 7.
- CARDCLUES.COM, LLC, LAS VEGAS, NV:
2,625,608, INT. CL. 36.
- CAREER PATHWAYS, CLEVELAND, OH:
1,932,977, CANC. MULTIPLE CLASS, INT. CLS. 9, 35 AND 41.
- CAREFIRST OF MARYLAND, INC., OWINGS MILL, MD, DBA CAREFIRST BLUE CROSS BLUE SHIELD:
2,625,659, MULTIPLE CLASS, INT. CLS. 35, 36 AND 42.
- CAREY COMPANY, THE, DAYTON, OH:
2,624,340, PUB. 7-2-2002. INT. CL. 42.
- CARGO CHEMICAL CORPORATION, CONROE, TX:
2,623,816, PUB. 7-2-2002. INT. CL. 1.
- CARL FREUDENBERG, D-69469 WEINHEIM, FED REP GERMANY:
2,624,321, PUB. 7-2-2002. MULTIPLE CLASS, INT. CLS. 39, 41 AND 42.
- CARL KARCHER ENTERPRISES, INC., ANAHEIM, CA:
2,625,830, INT. CL. 42.
- CARL-ZEISS-STIFTUNG, OBERKOCHEN, WUERTTEMBERG, FED REP GERMANY, AKA CARL ZEISS:
1,175,981, CANC. INT. CL. 9.
- CARL, CHARLENE, DEFIANCE, IA:
2,624,194, PUB. 7-2-2002. INT. CL. 3.
- CARLISLE CORPORATION, SYRACUSE, NY:
1,663,431, CANC. MULTIPLE CLASS, INT. CLS. 19 AND 37.
- CARLOS A. CASTANEDA Y COMPANIA, S.C., PALMIRA VALLE, COLOMBIA:
2,623,681, PUB. 7-2-2002. INT. CL. 30.
- CARNIVAL CORPORATION, MIAMI, FL:
2,625,322, INT. CL. 25.
- CAROLINA BEVERAGE CORPORATION, SALISBURY, NC:
1,932,793, CANC. INT. CL. 32.
- CARPE DIEM DESIGN PTY. LIMITED, BALMAIN, NEW SOUTH WALES, AUSTRALIA:
2,622,994, PUB. 7-2-2002. MULTIPLE CLASS, INT. CLS. 35 AND 42.
- CARPENTER MANUFACTURING CO., INC., MANLIUS, NY:
735,074. REN. 8-10-02. U.S. CL. 23 (INT. CL. 7).
- CARRERA CENTURY TOYS GMBH, FURTH, FED REP GERMANY:
1,176,362, CANC. INT. CL. 28.
- CARRIAGE REALTY, INC., LIBERTYVILLE, IL:
2,624,431, PUB. 7-2-2002. INT. CL. 36.
- CARRIER ACCESS CORPORATION, BOULDER, CO:
2,625,939, INT. CL. 9.
- CARROLL, THOMAS M., ST. LOUIS, MO, DBA POWER-SOLUTIONS FOR BUSINESS:
2,229,744, CANC. INT. CL. 9.
- CARTER-WALLACE, INC., NEW YORK, NY:
1,934,007, CANC. INT. CL. 3.
- CARTER, WALLACE T., WILMINGTON, NC:
2,623,376, PUB. 7-2-2002. INT. CL. 18.
- CARTIER INTERNATIONAL B.V., 3980 AMSTERDAM, NETHERLANDS:
2,624,232, PUB. 7-2-2002. INT. CL. 14.
- CARTOON NETWORK LP, LLLP, ATLANTA, GA:
2,625,473, INT. CL. 38.
- CARTOON NETWORK LP, LLLP, THE, ATLANTA, GA:
2,623,966, PUB. 7-2-2002. INT. CL. 41.
2,625,483, INT. CL. 41.
2,625,979, INT. CL. 41.
- CARTY, DAVID, JR., LOS ANGELES, CA:
2,626,453, INT. CL. 9.
- CARUSO INTERNATIONAL, INC., WARMINSTER, PA:
1,933,432, CANC. MULTIPLE CLASS, INT. CLS. 3 AND 11.
- CARUSO, JEFFREY V., CROFTON, MD:
2,624,503, PUB. 7-2-2002. INT. CL. 37.
- CARVALHO, VANIO BORGES, BURBANK, CA:
2,626,248, INT. CL. 41.
- CARVELLE INDUSTRIES, INC., VIENNA, VA, SOFT BRUSH CAR WASH SYSTEMS, INC., VIENNA, VA:
1,179,846. REN. 8-16-02. INT. CL. 7.
- CASCADE FRESH, INC., SEATTLE, WA:
2,622,793, PUB. 7-2-2002. INT. CL. 29.
- CASCO BAY GARDENS, LLC., SOUTH PORTLAND, ME:
2,626,699, INT. CL. 3.
- CASE MANAGEMENT SYSTEMS, LLC, BOISE, ID:
2,623,224, PUB. 7-2-2002. MULTIPLE CLASS, INT. CLS. 9 AND 42.
- CASHDISC.COM INC., EVERETT, WA:
2,623,513, PUB. 7-2-2002. MULTIPLE CLASS, INT. CLS. 9 AND 35.
- CASHFLOW TECHNOLOGIES, INC., SCOTTSDALE, AZ:
2,623,352, PUB. 7-2-2002. INT. CL. 16.
- CASHFLOW TECHNOLOGIES, INC., PARADISE VALLEY, AZ:
2,625,704, INT. CL. 28.
- CASIO KEISANKI KABUSHIKI KAISHA, TOKYO, JAPAN, DBA CASIO COMPUTER CO., LTD.:
1,933,014, CANC. INT. CL. 9.

- CASSENTI, LAWRENCE W., ROWLEY, MA AND CASSENTI, CHRISTINE M., ROWLEY, MA:
2,624,222, PUB. 7-2-2002. INT. CL. 41.
- CASTANER SAURAS, CRISTINA, BARCELONA, SPAIN:
1,932,544, CANC. INT. CL. 25.
- CASTEK SOFTWARE FACTORY INC., TORONTO, ONTARIO, CANADA:
2,622,669, PUB. 7-2-2002. MULTIPLE CLASS, INT. CLS. 9, 41 AND 42.
- CASTELINHO (VINHOS) S.A., 5130 SAO JOAO DA PESQUEIRA, PORTUGAL:
2,624,136, PUB. 7-2-2002. INT. CL. 33.
- CASTELLO DI BORGHESE, LLC, CUTCHOGUE, NY:
2,626,147, MULTIPLE CLASS, INT. CLS. 29 AND 33.
- CATALINA MARKETING INTERNATIONAL, INC., ST. PETERSBURG, FL:
2,624,986, PUB. 7-2-2002. INT. CL. 35.
- CATALINA PERFORMANCE ACCESSORIES, INC., MOUNTAINBURG, AR:
2,626,306, INT. CL. 9.
- CATALYST APPLIED TECHNOLOGIES, INC., SYOSSET, NY:
2,625,410, INT. CL. 18.
- CATAPULT SYSTEMS CORP., AUSTIN, TX:
2,624,213, PUB. 7-2-2002. INT. CL. 42.
- CATCO INC., NEW YORK, NY:
1,933,599, CANC. INT. CL. 30.
- CATERPILLAR INC., PEORIA, IL:
2,626,708, INT. CL. 41.
- CATEYE CO., LTD., OSAKA-SHI, OSAKA, JAPAN:
2,622,679, PUB. 12-4-2001. INT. CL. 9.
- CATHAY PIGMENTS (INTERNATIONAL) LIMITED, SURREY KT17 1RW, ENGLAND:
2,625,482, MULTIPLE CLASS, INT. CLS. 1 AND 2.
- CATHERINES OF CALIFORNIA, INC., ROWLAND HEIGHTS, CA, VIRGINIA SPECIALTY STORES, INC., NEWPORT NEWS, VA:
1,714,345, REN. 8-12-02. INT. CL. 42.
- CATTLEMEN'S BEEF PROMOTION AND RESEARCH BOARD, THE, ENGLEWOOD, CO. AKA CATTLEMEN'S BEEF BOARD, AKA BEEF BOARD AND NATIONAL CATTLEMEN'S BEEF ASSOCIATION, ENGLEWOOD, CO:
2,623,855, PUB. 7-2-2002. INT. CL. 16.
- CAUDALIES, 75017 PARIS, FRANCE:
2,625,456, INT. CL. 3.
- CAVU, INC., ORLANDO, FL FROM CAVU, INC., ORLANDO, FL:
2,623,077, PUB. 7-2-2002. INT. CL. 38.
- CAVU, INC.:
See—CAVU, INC.
- CBL TRUCKING, INC., DELANCO, NJ:
1,932,913, CANC. INT. CL. 39.
- CBS INC., NEW YORK, NY:
1,933,250, CANC. INT. CL. 25.
- CCA INDUSTRIES, INC., RUTHERFORD, NJ:
1,934,287, CANC. INT. CL. 3.
- CCH INCORPORATED, RIVERWOODS, IL:
2,624,736, PUB. 7-2-2002. INT. CL. 36.
- CCL LABEL, INC., ONTARIO, CA:
2,625,821, INT. CL. 28.
- CDC, INC., REDMOND, WA:
1,663,555, CANC. INT. CL. 30.
- CDDB, INC., INDIANAPOLIS, IN:
2,624,841, PUB. 7-2-2002. INT. CL. 41.
- CDM TECHNOLOGIES, INCORPORATED, SAN LUIS OBISPO, CA:
2,625,778, INT. CL. 9.
- CDME WORLD TRADE, 75009 PARIS, FRANCE:
2,481,080, COR. MULTIPLE CLASS, INT. CLS. 1, 3, 4, 6, 7, 8, 9, 11, 16, 17 AND 20.
- CECIAS, OSCAR MARTINEZ, C.P. 76120, QUERETARO, QRO, MEXICO:
2,625,479, INT. CL. 1.
- CEDAR RIVER PAPER COMPANY, CEDAR RAPIDS, IA:
2,624,541, PUB. 7-2-2002. INT. CL. 16.
- CELAIN ENTERPRISE CO., LTD., SAN-SHIA CHEN, TAIPEI HSIEN, TAIWAN:
2,623,648, PUB. 7-2-2002. INT. CL. 17.
- CELANESE CORPORATION, NEW YORK, NY:
391,407, CANC. U.S. CL. 42.
1,176,276, CANC. INT. CL. 23.
- CELEBRATE FAIRFAX, INC., FAIRFAX, VA:
2,623,995, PUB. 7-2-2002. INT. CL. 41.
- CELESTIAL SEASONINGS, INC., BOULDER, CO:
1,932,644, CANC. INT. CL. 42.
2,624,713, PUB. 7-2-2002. INT. CL. 30.
- CELLCO PARTNERSHIP, BEDMINSTER, NJ, DBA VERIZON WIRELESS:
2,624,121, PUB. 7-2-2002. INT. CL. 38.
2,624,122, PUB. 7-2-2002. INT. CL. 38.
- CELLCO PARTNERSHIP, BEDMINSTER, NJ, DBA VERIZON WIRELESS:
2,626,314, INT. CL. 9.
- CELLTECH R & D LIMITED, SLOUGH, BERKSHIRE, ENGLAND FROM CELLTECH THERAPEUTICS LIMITED, SLOUGH, BERKSHIRE, UNITED KINGDOM:
2,622,758, PUB. 6-6-2000. INT. CL. 5.
- CELLTECH THERAPEUTICS LIMITED:
See—CELLTECH R & D LIMITED.
- CELON AG MEDICAL INSTRUMENTS, 14513 TELTOW, FED REP GERMANY:
2,623,968, PUB. 7-2-2002. INT. CL. 10.
- CELTIC PLC, GLASGOW G40 3RE, UNITED KINGDOM:
2,622,857, PUB. 10-9-2001. MULTIPLE CLASS, INT. CLS. 16, 25, 26 AND 28.
- CENTENNIAL FOODS, CALGARY, ALBERTA T2G 4B7, CANADA:
2,626,893, INT. CL. 35.
- CENTER FOR CORPORATE HEALTH PROMOTION, INC., RESTON, VA:
1,176,140, CANC. INT. CL. 16.
- CENTER FOR ETHICAL BUSINESS CULTURES, THE, MINNEAPOLIS, MN:
2,626,922, INT. CL. 41.
- CENTRAL DUPAGE HEALTH SYSTEM, INC., WINFIELD, IL:
1,932,549, CANC. MULTIPLE CLASS, INT. CLS. 16 AND 42.
- CENTRAL FIBER CORPORATION, WELLSVILLE, KS:
1,933,087, CANC. INT. CL. 19.
- CENTRAL FLORIDA INVESTMENTS, INC, ORLANDO, FL:
2,622,930, PUB. 7-2-2002. INT. CL. 39.
- CENTRAL INSTITUTE FOR THE DEAF, ST. LOUIS, MO:
2,623,413, PUB. 7-2-2002. INT. CL. 42.
- CENTRAL PHARMACEUTICALS, INC., SEYMOUR, IN:
1,934,339, CANC. INT. CL. 5.
- CENTRAL RESEARCH LABORATORIES LIMITED, MIDDLESEX, ENGLAND:
1,989,416, CANC. INT. CL. 41.
- CENTRAL STEEL AND WIRE COMPANY, CHICAGO, IL:
2,626,392, INT. CL. 6.
- CENTRAL VIRGINIA EDUCATIONAL TELECOMMUNICATIONS CORPORATION, FALLS CHURCH, VA:
2,626,183, MULTIPLE CLASS, INT. CLS. 38 AND 41.
- CENTRE ANALYTICAL LABORATORIES, INC., STATE COLLEGE, PA:
2,624,204, PUB. 7-2-2002. INT. CL. 42.
- CENTRIC CORPORATION, PORTLAND, OR:
1,932,734, CANC. INT. CL. 35.
1,932,735, CANC. INT. CL. 35.
- CENTRIC GROUP, L.L.C., ST. LOUIS, MO:
2,626,027, MULTIPLE CLASS, INT. CLS. 29 AND 30.
- CENTRIC SOFTWARE, INC., SAN JOSE, CA:
2,625,426, INT. CL. 9.
- CENTRICUT, LLC, WEST LEBANON, NH:
2,622,754, PUB. 7-2-2002. INT. CL. 9.
- CENTURION TECHNOLOGIES, INC., FENTON, MO:
2,626,507, INT. CL. 9.
- CENTURY DISTRIBUTION SYSTEMS, INC., ISELIN, NJ:
2,624,620, PUB. 7-2-2002. INT. CL. 35.
- CENTURY SERVICES, L.P., STAFFORD, TX:
2,622,943, PUB. 7-2-2002. INT. CL. 35.
- CENTURY SPRING CORPORATION, LOS ANGELES, CA:
1,175,802, CANC. INT. CL. 6.
- CENTURY STAFFING SERVICES, INC., BEL AIR, MD:
2,622,981, PUB. 3-27-2001. INT. CL. 35.

- CEPHALON, INC., WEST CHESTER, PA:
2,624,880, PUB. 7-2-2002. INT. CL. 5.
- CERAGON NETWORKS LTD., TEL AVIV, ISRAEL:
2,626,470, INT. CL. 9.
- CERAMICA URUSSANGA S/A. CEUSA, 88.840 ESTACAO -
URUSSANGA, BRAZIL:
1,663,433, CANC. INT. CL. 19.
- CERAMICHE GARDENIA ORCHIDEA S.P.A., 41040 SPEZ-
ZANO DI FIORANO (MODENA), ITALY:
2,622,941, PUB. 7-2-2002. INT. CL. 19.
- CEREVA NETWORKS INC., MARLBOROUGH, MA:
2,626,257, INT. CL. 9.
- CERO-CERO, INC., BEVERLY HILLS, CA:
2,625,273, PUB. 7-2-2002. INT. CL. 3.
- CESKE SKLO A.S., HAVLICKOVA 15/1682, CZECH REPUB-
LIC, SKLOEXPORT, AKCIOVA SPOLECNOST, 561 74
LIBEREC, CZECHOSLOVAKIA, AKA GLASSEXPORT
COMPANY LIMITED:
1,695,945. REN. 8-10-02. MULTIPLE CLASS, INT. CLS. 11
AND 21.
- CFD RESEARCH CORPORATION, HUNTSVILLE, AL:
2,623,680, PUB. 10-30-2001. INT. CL. 9.
- CFR CORPORATION, NEW BRIGHTON, MN:
1,932,812, CANC. INT. CL. 9.
- CHAIKEN AND CAPONE, SAN FRANCISCO, CA:
2,625,902, INT. CL. 25.
- CHALLENGE PRODUCTS, INC., OSAGE BEACH, MO:
1,137,537. REN. 8-14-02. INT. CL. 3.
- CHALLENGER MOTOR FREIGHT INC., CAMBRIDGE,
ONTARIO, CANADA:
1,710,855. REN. 8-16-02. INT. CL. 39.
- CHAMBER OF COMMERCE OF THE UNITED STATES,
THE, WASHINGTON, DC:
2,625,485, MULTIPLE CLASS, INT. CLS. 35, 41 AND 42.
- CHAMP CELLARS, INC., CROZET, VA:
2,623,676, PUB. 7-2-2002. INT. CL. 33.
- CHAMPION INTERNATIONAL CORPORATION, STAM-
FORD, CT:
723,459, CANC. U.S. CL. 12.
723,622, CANC. U.S. CL. 37.
1,176,170, CANC. INT. CL. 16.
- CHAMPION MICROELECTRONIC CORP., HSINCHU 300,
TAIWAN:
2,626,054, INT. CL. 9.
- CHAMPION PRODUCTIONS, INC.:
See— CYGNUS BUSINESS MEDIA, INC..
- CHAMPIONSHIP COMMITTEE MERCHANDISING LIM-
ITED, THE, LONDON, UNITED KINGDOM:
2,625,220, PUB. 7-2-2002. INT. CL. 18.
- CHANCELLOR CORPORATION, BOSTON, MA:
1,932,797, CANC. INT. CL. 37.
- CHANCERY SOFTWARE LTD., BURNABY, B.C. V5G 4W1,
CANADA:
2,625,738, MULTIPLE CLASS, INT. CLS. 38 AND 42.
- CHANDLER, VINAL, DURHAM, NH:
1,932,785, CANC. INT. CL. 11.
- CHANG INTERNATIONAL, INC., SEATTLE, WA:
2,626,609, INT. CL. 29.
- CHANGEPLANET, INC., WALNUT CREEK, CA:
2,625,872, INT. CL. 41.
- CHANNEL ONE, INC., MILWAUKEE, WI:
2,625,795, INT. CL. 35.
- CHAPIN WATERMATICS, INC., WATERTOWN, NY:
1,176,685, CANC. INT. CL. 17.
- CHAPMAN/LEONARD STUDIO EQUIPMENT, NORTH
HOLLYWOOD, CA:
2,625,564, MULTIPLE CLASS, INT. CLS. 37 AND 42.
- CHARLES BUCKLES CONSULTING, INC., LAKE MARY,
FL:
2,626,141, INT. CL. 42.
- CHARLES E. SMITH MANAGEMENT, INC., ARLINGTON,
VA FROM CHARLES E. SMITH RESIDENTIAL REALTY,
L.P., ARLINGTON, VA:
2,622,789, PUB. 7-2-2002. INT. CL. 36.
- CHARLES E. SMITH RESIDENTIAL REALTY, L.P.:
See— CHARLES E. SMITH MANAGEMENT, INC..
- CHARLES SCHWAB & CO., INC., SAN FRANCISCO, CA:
2,625,452, INT. CL. 36.
- CHARLES SIMPSON MINISTRIES, MOBILE, AL:
1,175,968, CANC. MULTIPLE CLASS, INT. CLS. 9 AND
16.
- CHARLES ULMER, INCORPORATED, BRONX, NY:
1,176,269, CANC. INT. CL. 22.
- CHARTER FUNERALS OF MISSOURI, L.L.C., GRAND-
VIEW, MO:
2,624,574, PUB. 7-2-2002. INT. CL. 42.
- CHARTER OAK GROUP, LTD., VIENNA, VA:
2,624,946, PUB. 7-2-2002. INT. CL. 36.
- CHASE, TRINETTE, GERMANTOWN, MD:
1,934,062, CANC. INT. CL. 28.
1,934,063, CANC. INT. CL. 28.
- CHASTITY, INC., LOS ANGELES, CA:
1,934,033, CANC. INT. CL. 25.
- CHATHAM HOLDINGS CORPORATION, ROSWELL, GA:
2,622,765, PUB. 7-2-2002. INT. CL. 36.
- CHECK SIX PRODUCTIONS, INC., SHERMAN OAKS, CA:
2,624,938, PUB. 7-2-2002. INT. CL. 41.
- CHEESE MERCHANTS OF AMERICA, LLC, CAROL
STREAM, IL:
2,623,992, PUB. 7-2-2002. MULTIPLE CLASS, INT. CLS. 29
AND 30.
- CHEIL FOODS & CHEMICALS, INC., CHUNG-KU, SEOUL,
REPUBLIC OF KOREA:
1,933,036, CANC. INT. CL. 32.
- CHEM-AQUA, INC., IRVING, TX, NATIONAL CHEM-
SEARCH CORPORATION OF TEXAS, DALLAS, TX:
734,758. REN. 8-10-02. U.S. CL. 6 (INT. CL. 1).
- CHEMBRIDGE CORPORATION, SAN DIEGO, CA:
2,623,510, PUB. 7-2-2002. INT. CL. 42.
- CHEMINEER, INC., DAYTON, OH:
2,624,811, PUB. 7-2-2002. INT. CL. 7.
- CHEN, ZHI, OVERLAND PARK, KS:
2,627,016, INT. CL. 11.
- CHERRY HILL, L.L.C., FOREST GROVE, OR:
2,625,518, INT. CL. 33.
- CHESAPEAKE CONSULTING, INC., SEVERNA PARK, MD:
2,626,567, INT. CL. 35.
- CHESNUT, WILLIAM RICHARD, FAIRFIELD, NJ:
2,626,620, INT. CL. 7.
- CHEVALIER ORIGINALS, INC., MINNEAPOLIS, MN:
2,624,691, PUB. 7-2-2002. INT. CL. 28.
- CHEVRE DIFFUSION, INC., ROLLING HILLS ESTATES,
CA:
2,623,657, PUB. 7-2-2002. INT. CL. 29.
- CHEVRON CORPORATION, SAN FRANCISCO, CA:
2,623,698, PUB. 7-2-2002. INT. CL. 4.
- CHI HONG TOY FACTORY LTD., 11 ANDAR D/B, D/C,
MACAU:
2,622,641, PUB. 7-2-2002. INT. CL. 28.
- CHI TEMPORARY SERVICES, INC., WOODBURY, NY:
1,932,860, CANC. INT. CL. 35.
- CHICAGO JUNIOR HOCKEY LLC, BENSENVILLE, IL:
2,623,358, PUB. 7-2-2002. INT. CL. 41.
- CHICAGO NATIONAL LEAGUE BALL CLUB, INC., CHI-
CAGO, IL:
1,694,837. REN. 8-14-02. INT. CL. 36.
- CHIEF SUPPLY CORPORATION, EUGENE, OR:
2,626,048, INT. CL. 25.
- CHILAY FOODS, INC., CITY OF INDUSTRY, CA:
2,627,005, MULTIPLE CLASS, INT. CLS. 29 AND 30.
- CHILD STUDY CENTER, FORT WORTH, TX:
2,623,216, PUB. 7-2-2002. MULTIPLE CLASS, INT. CLS. 41
AND 42.
- CHILD'S WORLD INC., THE, EDEN PRAIRIE, MN:
1,704,914. REN. 8-16-02. INT. CL. 16.
- CHILDREN'S HOSPITAL OF PHILADELPHIA, THE, PHI-
LADELPHIA, PA:
2,622,858, PUB. 7-2-2002. INT. CL. 42.
- CHILDREN'S COMPREHENSIVE SERVICES, INC., NASH-
VILLE, TN:
2,624,029, PUB. 7-2-2002. MULTIPLE CLASS, INT. CLS. 35
AND 42.
- 2,624,030, PUB. 7-2-2002. MULTIPLE CLASS, INT. CLS. 35
AND 42.
- CHILDREN'S HEALTH CARE, INC., MINNEAPOLIS, MN:
2,625,380, INT. CL. 42.

- CHILDREN'S HOME, INC., THE, TAMPA, FL:
2,624,425, PUB. 7-2-2002. INT. CL. 42.
- CHILDREN'S MUSEUM OF INDIANAPOLIS, INC., THE,
INDIANAPOLIS, IN:
2,626,435, INT. CL. 41.
- CHILDREN'S SAFETY CARE, GAITHERSBURG, MD:
2,625,970, INT. CL. 35.
- CHILDREN'S WORLD LEARNING CENTERS, INC., GOLD-
EN, CO:
1,933,905, CANC. MULTIPLE CLASS, INT. CLS. 41 AND
42.
- CHILDU, INC., WESTON, FL:
2,624,853, PUB. 7-2-2002. INT. CL. 41.
2,624,854, PUB. 7-2-2002. INT. CL. 35.
- CHINA BEAR INC., STAFFORD, TX:
2,624,729, PUB. 7-2-2002. INT. CL. 42.
- CHINESE HERBAL USA, INC., CAMPBELL, CA:
2,624,455, PUB. 7-2-2002. INT. CL. 5.
- CHINESEIMMIGRANT.COM CORP, MARKHAM ONTAR-
IO, CANADA:
2,626,812, INT. CL. 42.
- CHININ U.S.A., INC., OAK BROOK, IL:
2,625,641, INT. CL. 25.
- CHIPWICH, INC., RIDGEWOOD, NJ:
2,625,390, INT. CL. 30.
- CHIRON BEHRING GMBH & CO., D-35006 MARBURG, FED
REP GERMANY:
2,626,071, INT. CL. 5.
- CHISHOLM TRAIL OSTRICH FARM, INC., BELTON, TX:
1,932,732, CANC. INT. CL. 42.
- CHLOROPHYLLA PHITOCOSMETICA LTDA., CURITIBA,
PARANA, BRAZIL:
2,623,247, PUB. 7-2-2002. INT. CL. 3.
- CHOCK FULL O' NUTS CORP., NEW YORK, NY, DBA LA
TOURAIN COFFEE COMPANY:
1,663,528, CANC. MULTIPLE CLASS, INT. CLS. 29 AND
30.
- CHOCOLADEFABRIKEN LINDT & SPRUNGLI AG, KILCH-
BERG, SWITZERLAND, AKTIEN-GESELLSCHAFT VER-
E I N I G T E B E R N E R & Z U R C H E R
CHOCOLADEFABRIKEN LINDT & SPRUNGLI, KILCH-
BERG, SWITZERLAND:
87,306, REN. 8-14-02. U.S. CL. 46 (INT. CL. 30).
- CHOCOLADEFABRIKEN LINDT & SPRUNGLI AG, CH-
8802 KILCHBERG, SWITZERLAND:
2,622,683, PUB. 11-13-2001. INT. CL. 30.
- CHOCOLATE CHIX, INC., DALLAS, TX:
2,624,626, PUB. 7-2-2002. INT. CL. 30.
- CHOCOVISION CORPORATION, POUGHKEEPSIE, NY:
2,624,187, PUB. 7-2-2002. INT. CL. 35.
- CHOUCAIR, NIZAR AHMAD, BEIRUT, LEBANON:
2,623,989, PUB. 7-2-2002. INT. CL. 30.
- CHRISTY, JOSEPH, TEMPE, AZ AND CHRISTY, MARTHA,
TEMPE, AZ:
2,622,883, PUB. 7-2-2002. INT. CL. 5.
- CHUBB CORPORATION, THE, WARREN, NJ:
2,626,380, INT. CL. 36.
2,626,427, INT. CL. 36.
- CHURCH & DWIGHT COMPANY, GREEN RIVER, WY,
CHURCH & DWIGHT CO., INC., PRINCETON, NJ:
936,790, REN. 8-10-02. U.S. CL. 52 (INT. CL. 3).
- CHURCH OF GOD, CLEVELAND, TN:
2,624,379, PUB. 7-2-2002. INT. CL. 42.
- CHURCH PUBLISHING INCORPORATED, NEW YORK,
NY:
2,623,625, PUB. 7-2-2002. INT. CL. 9.
- CIBA-GEIGY CORPORATION, ARDSLEY, NY:
723,498, CANC. U.S. CL. 18.
- CIGNA INTELLECTUAL PROPERTY, INC., WILMINGTON,
DE:
2,626,919, INT. CL. 36.
- CIMENTS CALCIA, 78930 GUERVILLE, FRANCE:
2,624,330, PUB. 7-2-2002. MULTIPLE CLASS, INT. CLS. 19
AND 37.
- CIMETRICS, INC., BOSTON, MA, DBA CIMETRICS TECH-
NOLOGY:
1,934,394, CANC. INT. CL. 9.
- CINCINNATI BELL LONG DISTANCE INC., CINCINNATI,
OH:
1,933,591, CANC. INT. CL. 38.
- CINCINNATI BELL TELEPHONE COMPANY, CINCINNA-
TI, OH:
2,622,571, CON. USE, PUB. 1-4-2000. MULTIPLE CLASS,
INT. CLS. 35, 37 AND 42.
2,625,442, INT. CL. 35.
- CINCOM SYSTEMS, INC., CINCINNATI, OH:
2,622,585, PUB. 7-2-2002. INT. CL. 9.
- CINTI S.P.A., I - 40050 FUNO DI ARGELATO, ITALY:
2,623,740, PUB. 7-2-2002. INT. CL. 25.
- CIRCUIT CITY STORES WEST COAST, INC., WALNUT, CA:
2,626,492, INT. CL. 35.
2,626,493, INT. CL. 35.
- CIRCUIT RESEARCH LABS, INC., TEMPE, AZ:
2,625,574, INT. CL. 9.
- CIRCUIT SEMANTICS, INC., SAN JOSE, CA:
2,624,735, PUB. 7-2-2002. INT. CL. 9.
- CIRCUL-AIR CORPORATION, THE, NORTHBROOK, IL:
1,195,997, REN. 8-14-02. INT. CL. 20.
- CIS SERVICE BUREAU, LLC, BRIDGEPORT, CT:
2,622,740, PUB. 7-2-2002. INT. CL. 42.
- CITADEL GROUP, INC., DAYTONA BEACH, FL:
2,622,880, PUB. 10-30-2001. INT. CL. 36.
- CITATION CAROLINA CORP., BIRMINGHAM, AL:
1,175,800, CANC. INT. CL. 6.
- CITICRAZE CASUALWEAR INC, NORTH BERGEN, NJ:
2,624,096, PUB. 7-2-2002. INT. CL. 25.
- CITIGROUP INC., NEW YORK, NY:
2,625,648, INT. CL. 36.
- CITIZENS GAS & COKE UTILITY, INDIANAPOLIS, IN:
2,625,693, INT. CL. 42.
- CITY ELECTRIC COMPANY OF BOULDER, INC.,
BOULDER, CO:
2,623,771, PUB. 7-2-2002. INT. CL. 37.
- CITY OF PHOENIX, PHOENIX, AZ:
1,859,291, CANC. MULTIPLE CLASS, INT. CLS. 21, 24
AND 25.
- CITYMEALS-ON-WHEELS, NEW YORK, NY:
2,624,422, PUB. 7-2-2002. MULTIPLE CLASS, INT. CLS. 36
AND 42.
- CIVITALI RESTAURANT CORPORATION, ST. PAUL, MN:
2,623,475, PUB. 7-2-2002. INT. CL. 42.
- CLADDAGH COMPANY, THE, HAMMOND, IN:
2,626,351, INT. CL. 9.
- CLAIRE'S BOUTIQUES, INC., HOFFMAN ESTATES, IL:
2,623,039, PUB. 7-2-2002. INT. CL. 35.
- CLARCO COMMUNICATIONS LTD., OAKVILLE, ONTAR-
IO L6J 6K8, CANADA:
1,937,674, CANC. INT. CL. 16.
- CLARIANT AG, MUTTENZ, SWEDEN, SANDOZ AG (SAN-
DOZ LTD., SANDOZ S.A.), BASLE, SWITZERLAND:
1,644,174, REN. 8-15-02. INT. CL. 2.
- CLARIANT AG, MUTTENZ, SWITZERLAND:
2,625,170, PUB. 7-2-2002. INT. CL. 1.
- CLARK-RELIANCE CORPORATION, STRONGSVILLE, OH:
1,933,421, CANC. INT. CL. 9.
- CLARKSTON-POTOMAC GROUP, INC., DURHAM, NC:
2,623,336, PUB. 7-2-2002. MULTIPLE CLASS, INT. CLS. 35
AND 42.
- CLASSBRAIN.COM, SANTA ANA, CA:
2,625,096, PUB. 7-2-2002. INT. CL. 35.
2,625,097, PUB. 7-2-2002. INT. CL. 35.
- CLASSIC FOODS INC., ANAHEIM, CA:
2,623,979, PUB. 7-2-2002. INT. CL. 30.
- CLASSIC MOTOR CARRIAGES, INC., MIAMI, FL:
1,176,053, CANC. INT. CL. 12.
- CLASSIC SPORTING ENTERPRISES, INC., BARTON, VT:
2,623,663, PUB. 7-2-2002. INT. CL. 28.
2,623,664, PUB. 7-2-2002. INT. CL. 28.
- CLASSICS CHICAGO, INC., THE, CHICAGO, IL:
2,624,384, PUB. 7-2-2002. MULTIPLE CLASS, INT. CLS. 3
AND 4.
2,624,385, PUB. 7-2-2002. INT. CL. 3.
2,624,386, PUB. 7-2-2002. MULTIPLE CLASS, INT. CLS. 3
AND 4.

- CLASSNOTES INC., SACRAMENTO, CA:
2,625,945, INT. CL. 36.
- CLAYTON D. RILEY AND DARRELL J. HICKEY PARTNERSHIP, THE, BAKERSFIELD, CA:
2,623,186, PUB. 7-2-2002. INT. CL. 25.
- CLEAR STEEL AUSTRALIA PTY, LTD., WANGARA, AUSTRALIA FROM JESTELLE PTY LTD, WANGARA, WESTERN AUSTRALIA, AUSTRALIA:
2,622,761, PUB. 7-2-2002. INT. CL. 19.
- CLEARCROSS INC., NEW YORK, NY FROM SYNTRA LIMITED, NEW YORK, NY:
2,626,004, MULTIPLE CLASS, INT. CLS. 9, 35, 36 AND 42.
- CLEARNET COMMUNICATIONS INC., SCARBOROUGH, ONTARIO, CANADA:
2,622,547, PUB. 7-2-2002. MULTIPLE CLASS, INT. CLS. 9 AND 38.
- CLEARWATER, INC., PITTSBURGH, PA:
2,624,929, PUB. 7-2-2002. INT. CL. 1.
2,624,935, PUB. 7-2-2002. INT. CL. 1.
2,624,936, PUB. 7-2-2002. INT. CL. 1.
2,624,937, PUB. 7-2-2002. INT. CL. 1.
- CLEMINSON, LAURA S., SOMERSWORTH, NH:
1,933,276, CANC. INT. CL. 25.
- CLEVELAND CHILDREN'S MUSEUM, CLEVELAND, OH:
1,932,939, CANC. INT. CL. 41.
- CLEVELAND HOME PRODUCTS, INC., EUCLID, OH:
1,176,233, CANC. INT. CL. 20.
- CLEVER FELLOWS INNOVATION CONSORTIUM, INC., TROY, NY:
2,624,186, PUB. 7-2-2002. INT. CL. 9.
- CLIENT/SERVER TECHNOLOGY, LTD., TEL AVIV 61580, ISRAEL:
1,933,570, CANC. INT. CL. 9.
1,933,971, CANC. INT. CL. 9.
- CLIGNOSIS, INC., BOSTON, MA:
2,625,461, MULTIPLE CLASS, INT. CLS. 35 AND 42.
- CLINICAL RESEARCH ALLIANCE, BELMONT, CA:
1,932,880, CANC. INT. CL. 42.
- CLOPAY CORPORATION, CINCINNATI, OH:
723,473, CANC. U.S. CL. 12.
- CLOROX COMPANY, THE, OAKLAND, CA:
1,734,257. REN. 8-16-02. INT. CL. 3.
- CLOROX PET PRODUCTS COMPANY, THE, OAKLAND, CA FROM A&M PRODUCTS, INC., OAKLAND, CA:
2,625,519, INT. CL. 31.
- CLOSETTEC FRANCHISE CORPORATION, NORWOOD, MA:
2,625,804, MULTIPLE CLASS, INT. CLS. 37 AND 42.
- CLUBFONE, INC., NEW YORK, NY:
2,625,067, PUB. 7-2-2002. INT. CL. 41.
- CLUBHOUSE INNS OF AMERICA, INC., OVERLAND PARK, KS:
1,932,893, CANC. INT. CL. 42.
- CMA CGM, SOCIETE ANONYME, 13002 MARSEILLE, FRANCE:
2,623,206, PUB. 7-2-2002. INT. CL. 39.
- CMF OMAT S.R.L., PIACENZA (PC), ITALY:
2,622,801, PUB. 1-29-2002. INT. CL. 7.
- CMP MEDIA INC.:
See—CMP MEDIA LLC.
- CMP MEDIA LLC, MANHASSET, NY FROM CMP MEDIA INC., MANHASSET, NY:
2,623,696, PUB. 7-2-2002. INT. CL. 41.
- CMP MEDIA LLC, MANHASSET, NY:
2,624,649, PUB. 7-2-2002. MULTIPLE CLASS, INT. CLS. 16 AND 41.
- CNA FINANCIAL CORPORATION, TORONTO, ONTARIO, M5C 2V9, CANADA:
2,625,420, INT. CL. 36.
- COACH, INC., NEW YORK, NY FROM SARA LEE CORPORATION, WINSTON-SALEM, NC:
2,626,565, INT. CL. 18.
- COACHPATEMO.COM, INC., STATE COLLEGE, PA:
2,623,704, PUB. 7-2-2002. MULTIPLE CLASS, INT. CLS. 35, 38 AND 42.
- COALITION FOR AUTOMOTIVE REPAIR EQUALITY, INC., ALEXANDRIA, VA:
2,622,812, PUB. 7-2-2002. INT. CL. 42.
- COAST COMMUNITY COLLEGE DISTRICT, COSTA MESA, CA:
1,932,505, CANC. MULTIPLE CLASS, INT. CLS. 9 AND 16.
- COBRA ELECTRONICS CORPORATION, CHICAGO, IL:
1,937,637, CANC. INT. CL. 12.
- COCA-COLA COMPANY, THE, ATLANTA, GA:
1,932,574, CANC. INT. CL. 32.
1,932,866, CANC. INT. CL. 32.
1,933,603, CANC. INT. CL. 32.
1,933,641, CANC. INT. CL. 21.
2,624,837, PUB. 7-2-2002. INT. CL. 32.
- COCHRAN T.A.P., INC., EAST SETAUKET, NY:
1,663,272, CANC. INT. CL. 9.
- COCKEYES COMPANY, PERRIS, CA:
2,626,198, INT. CL. 9.
- COCOON (NORTH AMERICA) INC., WILMINGTON, DE:
2,623,975, PUB. 7-2-2002. INT. CL. 24.
- CODE REFINERY, LLC, APEX, NC:
2,624,905, PUB. 7-2-2002. INT. CL. 42.
- COFFEE BEANERY, LTD., THE, FLUSHING, MI:
1,932,840, CANC. INT. CL. 30.
1,933,505, CANC. INT. CL. 30.
- COFFEE, SUGAR & COCOA EXCHANGE, INC., NEW YORK, NY:
1,723,030. REN. 8-14-02. INT. CL. 36.
- COFFEY, CHRISTOPHER, GARDENA, CA:
2,623,772, PUB. 7-2-2002. INT. CL. 42.
- COGITO LEARNING MEDIA, INC., NEW YORK, NY FROM INTERACTIVE SCIENCES, INC., NEW YORK, NY:
2,625,314, INT. CL. 42.
- COGNIS CORPORATION, GULPH MILLS, PA, NOPCO CHEMICAL COMPANY, HARRISON, NJ:
555,270. REN. 8-15-02. U.S. CL. 52 (INT. CL. 3).
- COGNIS DEUTSCHLAND GMBH, DUESSELDORF, FED REP GERMANY:
2,622,990, PUB. 7-2-2002. INT. CL. 1.
- COHESIA CORPORATION, DAYTON, OH FROM RENAISSANCE ENGINEERING, INC., DAYTON, OH:
2,625,715, INT. CL. 9.
- COHESIVE TECHNOLOGIES INC., ACTON, MA:
1,933,566, CANC. INT. CL. 9.
- COI CONSULTING FUR OFFICE UND INFORMATION MANAGEMENT GMBH, 91074 HERZOGENAURACH, FED REP GERMANY:
2,622,649, PUB. 7-2-2002. MULTIPLE CLASS, INT. CLS. 9 AND 42.
- COIDWATER CREEK, INC., SANDPOINT, ID:
2,625,622, INT. CL. 35.
- COLEMAN POWERMATE, INC., KEARNEY, NE:
2,625,797, INT. CL. 7.
- COLEMAN, KELLY R., CLEARWATER, FL, DBA TEAM MONEY TREES:
2,625,687, U.S. CL. 200.
- COLGATE-PALMOLIVE COMPANY, NEW YORK, NY:
1,934,061, CANC. INT. CL. 5.
2,622,575, PUB. 7-2-2002. INT. CL. 3.
2,625,148, PUB. 7-2-2002. INT. CL. 3.
2,625,274, PUB. 7-2-2002. INT. CL. 3.
- COLINS INC., MONTREAL, QUEBEC H4S 1V9, CANADA:
1,042,960, CANC. INT. CL. 25.
- COLLABORATIVE GROUP, LTD., THE, STONY BROOK, NY:
2,623,083, PUB. 7-2-2002. INT. CL. 1.
- COLLAGENEX PHARMACEUTICALS, INC., NEWTOWN, PA:
2,625,597, INT. CL. 5.
- COLLECTCORP INC., TORONTO, ONTARIO, CANADA, COLLECTCORP GROUP INC., CAMBRIDGE, ONTARIO, CANADA:
1,693,512. REN. 8-15-02. INT. CL. 36.
- COLLEGE RECRUITING NETWORK, INC., PHOENIX, AZ:
1,932,762, CANC. INT. CL. 35.
- COLLEGE-MATCH, INC., SHERBORN, MA:
2,623,387, PUB. 7-2-2002. INT. CL. 42.
- COLLEGIATE WATER COMPANY, OLATHE, KS:
1,934,316, CANC. INT. CL. 32.

- COLLETTE TRAVEL SERVICE, INC., PAWTUCKET, RI:
2,622,738, PUB. 7-2-2002. MULTIPLE CLASS, INT. CLS. 39
AND 42.
- COLLINS & AIKMAN FLOORCOVERINGS, INC., DALTON,
GA:
2,624,721, PUB. 7-2-2002. INT. CL. 22.
- COLMAN GROUP, INC., THE, ELKHORN, WI:
2,625,484, INT. CL. 21.
- COLONIAL CIRCUITS, INC., FREDERICKSBURG, VA:
2,622,658, PUB. 7-2-2002. MULTIPLE CLASS, INT. CLS. 40
AND 42.
- COLONIAL WILLIAMSBURG FOUNDATION, THE, WIL-
LIAMSBURG, VA:
2,622,692, PUB. 7-2-2002. INT. CL. 42.
2,625,351, MULTIPLE CLASS, INT. CLS. 26 AND 31.
- COLOP STEPELERZEUGUNG SKOPEK GESELLSCHAFT
M.B.H. & CO. KG, A-4600 WELS, AUSTRIA:
1,979,298, COR. INT. CL. 16.
- COLOPLAST A/S, DK-3050 HUMLEBAEK, DENMARK
FROM COLOPLAST A/S, DK-3050 HUMLEBAEK, DEN-
MARK:
2,625,658, INT. CL. 10.
- COLOR ART OFFICE INTERIORS, INC., ST. LOUIS, MO:
2,622,558, PUB. 7-2-2002. INT. CL. 35.
- COLOR TILE, INC., FORT WORTH, TX:
1,934,441, CANC. INT. CL. 42.
- COLORCRAFT CORPORATION, DURHAM, NC:
1,176,550, CANC. INT. CL. 40.
- COLTEC INDUSTRIES INC., CHARLOTTE, NC:
2,626,208, INT. CL. 9.
- COLUMBIA BEAUTY SUPPLY, INC., CHARLOTTE, NC:
2,624,376, PUB. 7-2-2002. INT. CL. 3.
- COLUMBIA INSURANCE COMPANY, OMAHA, NE:
2,626,426, INT. CL. 25.
- COLUMBIA LIGHTING, INC., SPOKANE, WA:
2,626,506, INT. CL. 11.
- COLUMBIA MARKING TOOLS, INC., HARRISON TWP.,
MI:
2,626,688, INT. CL. 7.
- COLUMBIAN MUTUAL LIFE INSURANCE COMPANY,
BINGHAMTON, NY:
1,688,469, REN. 8-15-02. INT. CL. 36.
- COM&DIA, L.L.C., RALEIGH, NC:
1,934,095, CANC. MULTIPLE CLASS, INT. CLS. 9 AND
42.
1,934,096, CANC. INT. CL. 9.
- COMBE INCORPORATED, WHITE PLAINS, NY:
2,624,763, PUB. 7-2-2002. INT. CL. 25.
- COMBEX, INC., LAKE GENEVA, WI:
2,626,479, INT. CL. 14.
- COMEBACK BREWING, INC., SAN ANTONIO, TX:
2,625,950, MULTIPLE CLASS, INT. CLS. 25 AND 32.
- COMING ATTRACTIONS PARTIES, INC., BRISBANE, CA:
2,624,482, PUB. 7-2-2002. MULTIPLE CLASS, INT. CLS. 3,
5, 16, 25 AND 35.
- COMMERCIAL CREDIT COMPANY, BALTIMORE, MD:
1,663,824, CANC. INT. CL. 36.
- COMMONWEALTH BRANDS, INC., BOWLING GREEN,
KY, AMERICAN TOBACCO COMPANY, THE, NEW
YORK, NY:
737,762, REN. 8-12-02. U.S. CL. 17 (INT. CL. 34).
- COMMONWEALTH CLINICAL SYSTEMS, INC., CHAR-
LOTTESVILLE, VA:
1,932,468, CANC. INT. CL. 42.
- COMMONWEALTH EDISON COMPANY, CHICAGO, IL:
2,624,018, PUB. 7-2-2002. INT. CL. 39.
- COMMONWEALTH GENERAL CORPORATION, LOUIS-
VILLE, KY:
2,625,401, INT. CL. 36.
- COMMONWEALTH OF PENNSYLVANIA, DEPARTMENT
OF CONSERVATION & NATURAL RESOURCES, HAR-
RISBURG, PA:
2,624,753, PUB. 7-2-2002. INT. CL. 28.
- COMMORATO, JOHN, INDIANAPOLIS, IN AND COM-
MORATO, NORMA, INDIANAPOLIS, IN:
2,626,526, INT. CL. 9.
- COMMSCOPE PROPERTIES, LLC, SPARKS, NV FROM
COMMSCOPE, INC., HICKORY, NC:
2,625,326, INT. CL. 9.
- COMMUNICATION DEVELOPMENT COMPANY, INC.,
WEST DES MOINES, IA:
2,626,532, INT. CL. 9.
- COMMUNICATION RESEARCH ASSOCIATES, INC., VAL-
LEY FORGE, PA:
2,623,452, PUB. 7-2-2002. INT. CL. 41.
2,623,453, PUB. 7-2-2002. INT. CL. 41.
- COMMUNITY CONNECT INC., NEW YORK, NY:
2,622,803, PUB. 7-2-2002. MULTIPLE CLASS, INT. CLS. 38
AND 42.
- COMMUNITY CRUSADE FOR CHILDREN, INC., NEW
HAVEN, CT:
2,623,678, PUB. 7-2-2002. INT. CL. 36.
- COMPADRES (HAWAII), THE, HONOLULU, HI:
1,932,584, CANC. INT. CL. 42.
- COMPAGNIE GENERALE DES ETABLISSEMENTS MICHE-
LIN MICHELIN & CIE, FERRAND CEDEX 09, FRANCE:
2,623,135, PUB. 7-31-2001. INT. CL. 12.
- COMPAGNIE NATIONALE AIR FRANCE:
See— SOCIETE AIR FRANCE.
- COMPEX INTERNATIONAL CO., LTD, CHIA YI HSIAN,
TAIWAN:
1,695,145, REN. 8-16-02. MULTIPLE CLASS, INT. CLS. 18
AND 20.
- COMPLEX SALE, INC., THE, ALPHARETTA, GA:
2,622,579, PUB. 7-2-2002. INT. CL. 41.
- COMPENDIUM PROFESSIONAL DEVELOPMENT SER-
VICES, LLC, MINNEAPOLIS, MN:
2,623,412, PUB. 7-2-2002. INT. CL. 41.
- COMPUCREDIT CORPORATION, ATLANTA, GA:
2,626,181, INT. CL. 9.
- COMPUSA MANAGEMENT COMPANY, A DELAWARE
BUSINESS TRUST, THE TRUSTEES COMPRISING
JAMES F. HALPIN, JAMES E. SKINNER AND MARK R.
WALKER, ALL U.S. CITIZENS AND THE COMMON-
WEALTH TRUST CO., A DELAWARE CORPORATION,
DALLAS, TX:
2,625,337, INT. CL. 16.
- COMPUTACENTER (UK) LIMITED, LONDON, UNITED
KINGDOM:
2,622,865, PUB. 11-20-2001. INT. CL. 35.
- COMPUTER BOARDS, INC., MIDDLEBORO, MA FROM
COMPUTER BOARDS, INC., MIDDLEBORO, MA:
2,625,695, INT. CL. 9.
- COMPUTER PETROLEUM CORPORATION, STILLWATER,
MN:
1,176,463, CANC. INT. CL. 35.
- COMPUTER SYSTEMS PRODUCTS, INC., MINNEAPOLIS,
MN:
1,933,902, CANC. INT. CL. 9.
- COMPUTER WIZ KIDS, INC., MIAMI, FL:
1,932,694, CANC. INT. CL. 41.
- COMSCORE, INC., RESTON, VA:
2,626,109, INT. CL. 35.
2,626,210, INT. CL. 35.
- CONAGRA GROCERY PRODUCTS LIMITED, MARKHAM,
ONTARIO L3R 0G4, CANADA, THOMAS J. LIPTON,
LIMITED, TORONTO, CANADA:
1,190,319, REN. 8-15-02. INT. CL. 29.
- CONAIR CORPORATION, EDISON, NJ:
1,175,955, CANC. INT. CL. 9.
- CONAIR CORPORATION, STAMFORD, CT:
2,626,639, INT. CL. 9.
- CONCORD FOODS, INC., BROCKTON, MA:
1,700,706, REN. 8-16-02. INT. CL. 30.
2,624,405, PUB. 7-2-2002. INT. CL. 30.
- CONCOURSE C, INC.:
See— EDUCATION WORLD, INC..
- CONCURRENT TECHNOLOGIES CORPORATION, JOHNS-
TOWN, PA:
2,622,975, PUB. 7-2-2002. INT. CL. 42.
2,622,976, PUB. 7-2-2002. INT. CL. 42.

- CONFERENCES OF THE UNITED CHURCH OF CHRIST INSURANCE ADVISORY BOARD, GAITHERSBURG, MD:
2,626,951, INT. CL. 36.
- CONFLUENCE GROUP, INC., THE, HARTFORD, CT:
2,623,041, PUB. 11-13-2001. MULTIPLE CLASS, INT. CLS. 35, 36 AND 42.
- CONNAUGHT TECHNOLOGY CORPORATION, GREENVILLE, DE:
2,626,373, INT. CL. 42.
- CONNECT CENTER, INC., CARTERSVILLE, GA:
2,626,813, INT. CL. 42.
- CONNECT 24 INC., DOWNSVIEW, ONTARIO, CANADA:
2,540,747, COR. MULTIPLE CLASS, INT. CLS. 38 AND 42.
- CONNEXIM, MONTREAL, QUEBEC, CANADA:
2,625,114, PUB. 7-2-2002. MULTIPLE CLASS, INT. CLS. 35 AND 37.
- CONOCO INC., PONCA CITY, OK:
2,626,633, INT. CL. 36.
- CONOPCO, INC., GREENWICH, CT, DBA CHESEBROUGH-POND'S USA CO.:
1,933,950, CANC. INT. CL. 21.
- CONOPCO, INC., NEW YORK, NY:
2,625,906, INT. CL. 29.
- CONOPCO, INC., GREEN BAY, WI, DBA GOOD HUMOR-BREYERS ICE CREAM:
2,626,096, INT. CL. 30.
- CONSERVERA PENTZKE S.A., SAN FELIPE, CHILE:
1,934,353, CANC. INT. CL. 29.
- CONSOLIDATED CHEMICAL COMPANY, WARREN, MI:
2,624,391, PUB. 7-2-2002. INT. CL. 3.
- CONSOLIDATED ELECTRIC COMPANY, ST. PAUL, MN:
1,932,515, CANC. INT. CL. 9.
- CONSOLIDATED MEDIA SYSTEMS, NASHVILLE, TN:
2,622,620, PUB. 7-2-2002. MULTIPLE CLASS, INT. CLS. 35, 37 AND 41.
2,622,621, PUB. 7-2-2002. MULTIPLE CLASS, INT. CLS. 35, 37 AND 41.
- CONSOLIDATED NUTRITION, L.C., OMAHA, NE:
1,933,988, CANC. INT. CL. 31.
- CONSTRUCTION MARKET DATA GROUP, INC., NORCROSS, GA:
2,625,981, MULTIPLE CLASS, INT. CLS. 9 AND 37.
- CONSULTORES TECNOLOGICOS ALLOY 2107, C.A., LA FLORESTA, CARACAS, VENEZUELA:
2,625,971, INT. CL. 9.
- CONSUMER BROADCAST GROUP, LOS ANGELES, CA:
2,623,400, PUB. 7-2-2002. INT. CL. 35.
- CONTENT TECHNOLOGIES LIMITED, THEALE, BERKSHIRE, UNITED KINGDOM:
2,623,306, PUB. 7-2-2002. MULTIPLE CLASS, INT. CLS. 9, 41 AND 42.
- CONTINENTAL DISC CORPORATION, LIBERTY, MO:
2,624,920, PUB. 7-2-2002. INT. CL. 6.
- CONTRACTORS REGISTER, INC., JEFFERSON VALLEY, NY:
2,623,107, PUB. 7-2-2002. INT. CL. 35.
2,623,108, PUB. 7-2-2002. INT. CL. 35.
- CONTROL MICROSYSTEMS INC./MICROSYSTEMES DE CONTROLE INC., KANATA, ONTARIO, CANADA:
2,531,102, CANC. IIRN. RESTORED TO S.N. 75-564,063.
- CONTROL.COM INC., HOPKINTON, MA:
2,625,831, INT. CL. 9.
- CONVENIENCE FOOD SYSTEMS B.V., NL-5760 AA BAKE1, NETHERLANDS:
2,622,685, PUB. 1-23-2001. MULTIPLE CLASS, INT. CLS. 16, 20 AND 39.
- CONVERSATIONAL VOICE TECHNOLOGIES CORPORATION, GURNEE, IL:
1,663,601, CANC. MULTIPLE CLASS, INT. CLS. 35 AND 42.
- CONVERSE INC., NORTH ANDOVER, MA:
1,736,667. REN. 8-12-02. INT. CL. 25.
- CONVEYOR INDUSTRIES CORPORATION, ST. PETERSBURG, FL, DBA CHRIS INDUSTRIES CORPORATION:
2,624,927, PUB. 7-2-2002. INT. CL. 7.
- COOK COMMUNICATION MINISTRIES, COLORADO SPRINGS, CO, DAVID C. COOK PUBLISHING CO., COLORADO SPRINGS, CO:
1,618,754. REN. 8-14-02. INT. CL. 16.
- COOK PACEMAKER CORPORATION, LEECHBURG, PA:
1,933,666, CANC. INT. CL. 10.
- COOLESTATE.COM, TORONTO, ONTARIO, CANADA:
2,624,928, PUB. 7-2-2002. INT. CL. 35.
- COOLNOTCRUEL, INC., BROOKLYN, NY:
2,624,924, PUB. 7-2-2002. INT. CL. 25.
- COONEY, JOHN MICHAEL, SEVERNA PARK, MD:
1,933,769, CANC. INT. CL. 5.
- COOPER INDUSTRIES, INC., HOUSTON, TX:
284,271, CANC. U.S. CL. 14.
723,561, CANC. U.S. CL. 26.
1,176,457, CANC. INT. CL. 35.
1,933,025, CANC. MULTIPLE CLASS, INT. CLS. 7 AND 8.
- COOPER, WHITE AND COOPER LLP, SAN FRANCISCO, CA:
2,624,364, PUB. 7-2-2002. INT. CL. 42.
- COOPER, WILLIAM E., FT. LAUDERDALE, FL:
2,623,163, PUB. 7-2-2002. INT. CL. 42.
- COOPERATIVE FOR AMERICAN RELIEF EVERYWHERE, INC., NEW YORK, NY, DBA CARE:
1,933,462, CANC. INT. CL. 27.
- COOPERS & LYBRAND L.L.P., NEW YORK, NY:
1,932,448, CANC. INT. CL. 42.
- COPERNIC TECHNOLOGIES INC., SAINTE-FOY (QUEBEC), GIN 4N6, CANADA:
2,623,067, PUB. 7-2-2002. INT. CL. 9.
- COPPER MOUNTAIN, INC., COPPER MOUNTAIN, CO:
2,626,230, INT. CL. 41.
- COPPER RIDGE INSTITUTE, INC., THE, SYKESVILLE, MD:
2,625,598, INT. CL. 41.
- COPPE NAPANEE CO., INC., NAPPANEE, IN, COPPE, INC., NAPPANEE, IN:
560,140. REN. 8-16-02. U.S. CL. 32 (INT. CL. 20).
- COPROHNIJAR S. COOP. AND., SAN ISIDRO-NIJAR (ALMERIA), SPAIN:
2,623,125, PUB. 7-2-2002. INT. CL. 31.
- COPYRIGHT OFFICE, LIBRARY OF CONGRESS, WASHINGTON, DC:
2,625,041, PUB. 7-2-2002. INT. CL. 16.
- CORDIS CORPORATION, MIAMI, FL TO TPL-CORDIS, INC., MIAMI LAKES, FL:
1,176,001, CANC. INT. CL. 10.
- CORDIS CORPORATION, MIAMI LAKES, FL:
2,625,991, INT. CL. 10.
- CORECO INC., ST. LAURENT, QUEBEC, CANADA:
1,934,113, CANC. INT. CL. 9.
- CORGI CLASSICS LIMITED., MERIDIAN BUSINESS PARK LEICESTER LE3 2RL, ENGLAND:
2,626,388, INT. CL. 28.
- CORINTHIAN GROUP, INC., THE, SAN CLEMENTE, CA:
2,624,219, PUB. 7-2-2002. MULTIPLE CLASS, INT. CLS. 9, 16 AND 41.
- CORNELIUS COMPANY, THE, ANOKA, MN:
1,176,050, CANC. INT. CL. 12.
- CORNERBARPR, KANSAS CITY, MO:
2,626,335, INT. CL. 35.
- CORO (CANADA) INC., TORONTO, ONTARIO, M4A 1E4, CANADA:
1,965,948, CANC. INT. CL. 14.
- CORPORATE EXPRESS, INC., BROOMFIELD, CO FROM CORPORATE EXPRESS PROMOTIONAL MARKETING, INC., ST. LOUIS, MO:
2,625,900, INT. CL. 25.
- CORPORATE NETWORK ECOM, LLC, OVERLAND PARK, KS:
2,623,753, PUB. 7-2-2002. INT. CL. 36.
- CORPORATE TECHNOLOGY VENTURES, INC., PHILADELPHIA, PA:
1,933,533, CANC. INT. CL. 42.
- CORPREX, LLC, ORLANDO, FL:
2,626,920, INT. CL. 36.
- CORRADO'S SPECIALTY GOODS, INC., CLIFTON, NJ:
1,932,689, CANC. INT. CL. 42.

- CORRECT CRAFT, INC., ORLANDO, FL:
1,176,064, CANC. INT. CL. 12.
- CORSEARCH, INC., NEW YORK, NY:
1,932,776, CANC. INT. CL. 35.
- CORSINI, FRANK A., TIBURON, CA:
1,933,221, CANC. INT. CL. 32.
- CORSTONE, INC., NORTH ATTLEBORO, MA:
2,625,429, INT. CL. 11.
- COSCO, INC.:
See—DOREL JUVENILE GROUP, INC..
- COSMEDENT, INC., CHICAGO, IL:
2,626,201, INT. CL. 5.
- COSMETIC CENTER, INC., THE, SAVAGE, MD:
1,933,743, CANC. INT. CL. 3.
- COSMOFORM B.V., 2611 XT DELFT, NETHERLANDS:
2,622,537, PUB. 7-2-2002. INT. CL. 21.
- COSTCO WHOLESALE CORPORATION, ISSAQUAH, WA:
2,626,491, INT. CL. 40.
- COTTEN, STEPHEN S., KEAUHOU, HI:
2,624,498, PUB. 7-2-2002. INT. CL. 3.
- COTTER & COMPANY, CHICAGO, IL:
1,176,155, CANC. INT. CL. 16.
- COULTER CORPORATION, HIALEAH, FL:
1,175,973, CANC. INT. CL. 9.
- COUNCIL FOR AFFORDABLE AND RURAL HOUSING,
ALEXANDRIA, VA:
2,623,683, PUB. 7-2-2002. MULTIPLE CLASS, INT. CLS.
16, 35 AND 41.
- COUNCILOR, BUCHANAN & MITCHELL, P.C., BETHES-
DA, MD:
2,624,930, PUB. 7-2-2002. MULTIPLE CLASS, INT. CLS. 35
AND 36.
2,624,931, PUB. 7-2-2002. MULTIPLE CLASS, INT. CLS. 35
AND 36.
- COUNTERCLAIM.COM INC., EUGENE, OR:
2,626,110, INT. CL. 42.
- COUNTRY INNS & SUITES BY CARLSON, INC., MINNEA-
POLIS, MN, COUNTRY LODGING BY CARLSON, INC.,
MINNEAPOLIS, MN:
1,712,424, REN. 8-14-02. INT. CL. 42.
- COUNTY SEAT STORES, INC., DALLAS, TX:
1,933,322, CANC. INT. CL. 25.
- COUPONS, INC., ATLANTA, GA:
2,625,258, PUB. 7-2-2002. INT. CL. 35.
- COURTAULDS TEXTILES (HOLDINGS) LIMITED, WALK-
DEN, WORSLEY MANCHESTER M28 5WR, ENGLAND:
1,933,901, CANC. INT. CL. 25.
- COURTAULDS TEXTILES (HOLDINGS) LIMITED, LON-
DON, W1A 3DA, UNITED KINGDOM:
2,622,628, PUB. 7-2-2002. INT. CL. 25.
- COURTNESS LLC, NEW YORK, NY, DBA SIREN RESTAU-
RANT AND BAR:
2,623,187, PUB. 7-31-2001. INT. CL. 42.
- COUSINE, HENRY J., DANA POINT, CA:
2,625,679, INT. CL. 25.
- COVE BIKE SHOP LTD., NORTH VANCOUVER, B.C.,
CANADA:
2,625,511, INT. CL. 12.
- COX TARGET MEDIA, INC., LARGO, FL:
2,624,948, PUB. 7-2-2002. INT. CL. 35.
- CPAMERICA INTERNATIONAL INC., ALACHU, FL, AC-
COUNTING FIRMS ASSOCIATED, INC., GAINESVILLE,
FL:
1,706,643, REN. 8-14-02. INT. CL. 16.
- CQ COMMUNICATIONS, INC., HICKSVILLE, NY:
1,694,303, REN. 8-12-02. INT. CL. 16.
- CQS MANAGEMENT LIMITED, LONDON E14 4DA, ENG-
LAND:
2,622,694, PUB. 11-27-2001. INT. CL. 36.
- CRAFT HOUSE CORPORATION, TOLEDO, OH:
2,626,665, INT. CL. 28.
- CRAFTY'S FEATHERWORKS, INC., OVERTON, NV:
2,624,447, PUB. 7-2-2002. INT. CL. 28.
- CRAIG MURRAY PRODUCTIONS, LLC, BURBANK, CA:
2,625,862, INT. CL. 42.
- CRAIG, MELVIN:
See—WYOMING WEST DESIGNS, LLC.
- CRANIUM INC., SEATTLE, WA:
2,626,727, INT. CL. 28.
- CRAVE ENTERTAINMENT, INC., RANCHO DOMINGUEZ,
CA:
2,622,862, PUB. 7-2-2002. INT. CL. 9.
- CRAWFORD & CRAWFORD, BEVERLY HILLS, CA:
2,624,959, PUB. 7-2-2002. INT. CL. 42.
- CRAWFORD, THOMAS, RAPID CITY, SD:
1,932,917, CANC. INT. CL. 37.
- CRC INDUSTRIES HOLDINGS, INC., WILMINGTON, DE,
LAIRD, INC., RANCHO DOMINGUEZ, CA:
545,899, REN. 8-12-02. U.S. CL. 52 (INT. CL. 3).
- CREATIVE COMPUTER APPLICATIONS, INC., CALABA-
SAS, CA:
2,625,559, INT. CL. 42.
- CREATIVE IMPRESSIONS, INC., BUENA PARK, CA:
2,626,972, INT. CL. 16.
- CREATIVE MINDS, INC., WASHINGTON, DC:
1,934,042, CANC. INT. CL. 41.
- CREATIVE NAIL DESIGN, INC., VISTA, CA:
2,624,508, PUB. 7-2-2002. INT. CL. 3.
2,624,601, PUB. 7-2-2002. INT. CL. 3.
- CREDIT SUISSE FIRST BOSTON CORPORATION, NEW
YORK, NY:
2,624,086, PUB. 7-2-2002. INT. CL. 42.
- CREDIT UNION EXECUTIVES SOCIETY, INC., MADISON,
WI:
2,625,655, INT. CL. 35.
2,625,656, INT. CL. 41.
2,625,657, INT. CL. 42.
- CREDITEK CORPORATION, PARSIPPANY, NJ:
1,738,640, REN. 8-14-02. INT. CL. 36.
- CRELCO INC., SOLANA BEACH, CA:
1,176,204, CANC. INT. CL. 18.
- CRESCENT NETWORKS, INC., LOWELL, MA:
2,626,134, INT. CL. 9.
- CRESTED BUTTE POWER CO., CRESTED BUTTE, CO:
1,932,948, CANC. INT. CL. 30.
- CRICKET, RILLIEUX LA PAPE, FRANCE:
732,906, REN. 8-16-02. U.S. CL. 8 (INT. CL. 34).
- CRICKET SHOP CORPORATION, INCORPORATED, BONI-
TA SPRINGS, FL:
1,932,472, CANC. MULTIPLE CLASS, INT. CLS. 25 AND
42.
- CRISTALL U.S.A., INC., BOCA RATON, FL:
2,624,636, PUB. 7-2-2002. INT. CL. 33.
- CROMPTON COMPANY, INC., NEW YORK, NY:
723,655, CANC. U.S. CL. 42.
- CROMPTON CORPORATION, GREENWICH, CT, ARGUS
CHEMICAL CORPORATION, BROOKLYN, NY:
1,212,045, REN. 8-15-02. INT. CL. 1.
- CROMPTON CORPORATION, GREENWICH, CT, U.S. PER-
OXYGEN COMPANY, RICHMOND, CA:
1,213,704, REN. 8-15-02. INT. CL. 1.
- CROMPTON CORPORATION, GREENWICH, CT:
2,623,972, PUB. 7-2-2002. INT. CL. 1.
- CROSS COUNTRY AUTOMOTIVE SERVICES, INC., TUC-
SON, AZ:
2,623,732, PUB. 7-2-2002. MULTIPLE CLASS, INT. CLS.
35, 36, 37 AND 42.
- CROSS, SARA, ALIZE, DENVER, CO:
2,625,870, MULTIPLE CLASS, INT. CLS. 25 AND 35.
- CROSSROADS DISTRIBUTION, LTD., TEMPLE, TX:
2,625,021, PUB. 7-2-2002. INT. CL. 39.
- CROSSTRAINER MINISTRIES, INC., DES MOINES, IA:
1,932,740, CANC. MULTIPLE CLASS, INT. CLS. 25 AND
41.
- CRS HOLDINGS, INC., WILMINGTON, DE, WILBUR B.
DRIVER COMPANY, NEWARK, NJ:
393,279, REN. 8-16-02. U.S. CL. 21 (INT. CL. 9).
393,280, REN. 8-16-02. U.S. CL. 21 (INT. CL. 9).
393,283, REN. 8-16-02. U.S. CL. 21 (INT. CL. 9).
- CRS HOLDINGS, INC., WILMINGTON, DE, CARPENTER
STEEL COMPANY, THE, READING, PA:
559,698, REN. 8-14-02. U.S. CL. 14 (INT. CL. 6).
- CRUISE LADY, INC., THE, BALTIMORE, MD:
2,622,933, PUB. 7-2-2002. INT. CL. 39.

- CRUISES INTERNATIONAL, INC., SCHAUMBURG, IL:
2,623,350, PUB. 7-2-2002. INT. CL. 39.
- CRUISESHIPCENTERS WESTERN CANADA LTD., VAN-
COUVER, BRITISH COLUMBIA:
2,626,883, INT. CL. 16.
- CSC BRANDS, INC., CAMDEN, NJ:
1,690,387, REN. 8-12-02. INT. CL. 30.
- CTA MANUFACTURING CORP., CARLSTADT, NJ:
1,709,729, AM. INT. CL. 8.
- CTN MEDIA GROUP, INC., ATLANTA, GA:
2,622,906, PUB. 7-2-2002. INT. CL. 41.
- CUBAN CIGAR BRANDS, N.V., FORT LAUDERDALE, FL:
2,623,858, PUB. 7-2-2002. INT. CL. 42.
- CUIRCO DIFFUSION, 75003 PARIS, FRANCE:
2,570,483, COR. MULTIPLE CLASS, INT. CLS. 18 AND
25.
- CUISINARTS CORP., STAMFORD, CT:
1,933,991, CANC. INT. CL. 21.
- CUNARD LINE LIMITED, MIAMI, FL:
2,622,550, PUB. 7-2-2002. INT. CL. 16.
- CURECRETE CHEMICAL CO., INC., SPRINGVILLE, UT:
2,624,113, PUB. 7-2-2002. INT. CL. 1.
- CURIOUS NETWORKS, INC., CHICAGO, IL:
2,623,345, PUB. 7-2-2002. INT. CL. 42.
- CUSTOM BUILDING PRODUCTS, SEAL BEACH, CA,
MONTGOMERY, JAMES D., JR., FORT LAUDERDALE,
FL:
1,705,856, REN. 8-16-02. INT. CL. 19.
1,712,697, REN. 8-16-02. INT. CL. 19.
- CUSTOM BUILDING PRODUCTS, SEAL BEACH, CA, C-
CURE CHEMICAL COMPANY, INC., HOUSTON, TX:
1,713,692, REN. 8-16-02. INT. CL. 19.
- CUSTOM BUILDING PRODUCTS, SEAL BEACH, CA:
1,899,472, CANC. MULTIPLE CLASS, INT. CLS. 1 AND 8.
- CUSTOM BUILDING PRODUCTS, INC., SEAL BEACH, CA,
MONTGOMERY, JR., JAMES D., FT. LAUDERDALE, FL:
1,653,670, REN. 8-10-02. INT. CL. 19.
- CUSTOM ENTERPRISES, INC., IRVINE, CA:
2,624,537, PUB. 7-2-2002. INT. CL. 35.
- CUSTOM GRAPHICS, INC., SOLON, OH:
1,934,377, CANC. INT. CL. 16.
- CUSTOM LEATHER CANADA LIMITED, WATERLOO,
ONTARIO, N2L 3X2, CANADA:
2,626,098, INT. CL. 25.
- CUTTER INFORMATION CORP.:
See— ASPEN PUBLISHERS, INC.
- CUTTERS EXCHANGE, INC., NASHVILLE, TN:
723,710, CANC. U.S. CL. 23.
- CYBER MARKETING SERVICES, LLC, TEANECK, NJ:
2,626,913, INT. CL. 38.
- CYBERBOND, L.L.C., BATAVIA, IL:
2,625,355, INT. CL. 1.
- CYBERDEL TECHNOLOGY, INC., WHIPPANY, NJ:
2,626,138, INT. CL. 42.
- CYBERIAN OUTPOST, INC., KENT, CT:
2,622,613, PUB. 7-2-2002. INT. CL. 35.
- CYBERSPACE TO PARADISE, INC., DELAND, FL:
2,624,791, PUB. 7-2-2002. INT. CL. 9.
- CYBERU, INC., SANTA MONICA, CA:
2,626,792, INT. CL. 41.
- CYCLICS CORPORATION, RENNSSELEAR, NY:
2,626,143, INT. CL. 1.
- CYGNAL INTEGRATED PRODUCTS, INC., AUSTIN, TX:
2,625,607, INT. CL. 9.
- CYGNUS BUSINESS MEDIA, INC., MELVILLE, NY FROM
CHAMPION PRODUCTIONS, INC., BURNSVILLE, MN:
2,626,782, INT. CL. 35.
- CYGRON PTE LTD., #03-04 CREATIVE RESOURCE, SIN-
GAPORE:
2,623,364, PUB. 7-2-2002. INT. CL. 9.
- CYI, INC., CHATSWORTH, CA:
2,623,129, PUB. 7-2-2002. INT. CL. 28.
- CYNOCOM CORPORATION, BOCA RATON, FL:
2,623,185, PUB. 7-2-2002. INT. CL. 42.
- CYTEC TECHNOLOGY CORP., WILMINGTON, DE:
2,626,547, INT. CL. 1.
- CYTOMED, INC., CAMBRIDGE, MA:
1,934,234, CANC. INT. CL. 5.
1,934,237, CANC. INT. CL. 5.
1,934,238, CANC. INT. CL. 5.
- C2 DESIGN AUTOMATION, SAN JOSE, CA:
2,623,672, PUB. 7-2-2002. INT. CL. 9.
- D. T. CONSULTING, INC., FREMONT, CA, DBA DTI:
2,623,132, PUB. 7-2-2002. INT. CL. 42.
- D.E.J. PRODUCTIONS INC., DALLAS, TX:
2,626,050, MULTIPLE CLASS, INT. CLS. 9 AND 41.
- D.F. STAUFFER BISCUIT CO., INC., YORK, PA:
1,932,882, CANC. INT. CL. 30.
1,932,883, CANC. INT. CL. 30.
- D.I. SYSTEMS, INC., ST. PETERSBURG, FL:
1,932,564, CANC. MULTIPLE CLASS, INT. CLS. 35, 37, 38
AND 42.
- D.L.N. PTY LTD, KOGARAH NSW 2217, AUSTRALIA:
2,624,515, PUB. 7-2-2002. INT. CL. 30.
- D&B AUDIOTECHNIK AG., 71522 BACKNANG, FED REP
GERMANY:
2,622,650, PUB. 8-28-2001. INT. CL. 9.
- D&K INTERNATIONAL, INC., ELK GROVE VILLAGE, IL:
2,622,978, PUB. 7-2-2002. INT. CL. 17.
- D&R ASSOCIATES, INC., MALDEN, MA:
2,622,524, PUB. 7-2-2002. INT. CL. 30.
- D-GENERATION, INC., ORMOND BEACH, FL:
2,623,997, PUB. 7-2-2002. MULTIPLE CLASS, INT. CLS.
16, 25 AND 28.
- DABBIERO, FRANK A., BERTHOUD, CO:
2,626,621, INT. CL. 25.
- DADA CORPORATION, SEOUL, REPUBLIC OF KOREA:
2,626,719, INT. CL. 25.
- DAH CONSULTING, INC., NEW YORK, NY:
2,626,570, INT. CL. 35.
- DAIICHI PHARMACEUTICAL CO., LTD., CHUO-KU, TO-
KYO, JAPAN:
2,622,706, PUB. 12-5-2000. INT. CL. 5.
- DAILY NEWS, L.P., NEW YORK, NY:
1,932,491, CANC. INT. CL. 16.
- DAIMLERCHRYSLER AG, 70567 STUTTGART, FED REP
GERMANY:
2,622,715, PUB. 4-16-2002. INT. CL. 12.
- DAINICHISEIKA COLOR & CHEMICALS MFG. CO., LTD.,
CHUO-KU, TOKYO 103-8383, JAPAN:
2,623,547, PUB. 7-2-2002. INT. CL. 2.
- DAIRY INNOVATIONS, LLC, ATTICA, NY FROM SKID-
MORE, ANDREW L., ATTICA, NY:
2,626,074, INT. CL. 9.
- DAIRY, LLC, DALLAS, TX:
2,626,833, MULTIPLE CLASS, INT. CLS. 35 AND 36.
- DAKOTA SYSTEMS, INC., METHUEN, MA:
2,623,903, PUB. 7-2-2002. INT. CL. 39.
- DALER-ROWNEY USA LIMITED, CRANBURY, NJ:
2,625,918, INT. CL. 2.
- DALLAS JAZZ ORCHESTRA OF DALLAS TEXAS, DALLAS,
TX:
2,623,432, PUB. 7-2-2002. INT. CL. 41.
- DALMAS S.P.A., BOLOGNA, ITALY:
1,171,357, CANC. INT. CL. 25.
- DAMON CORPORATION, NEEDHAM HEIGHTS, MA:
1,176,089, CANC. INT. CL. 16.
- DAMSE ENGINEERING, INC., NORTH HOLLYWOOD, CA:
1,176,031, CANC. INT. CL. 11.
- DAN'S FAN CITY INC., NORTH SAFETY HARBOR, FL:
1,176,028, CANC. INT. CL. 11.
- DAN'S PUB, INC., MOLINE, IL:
2,624,176, PUB. 7-2-2002. INT. CL. 42.
- DANBURY HEALTH SYSTEMS, INC., DANBURY, CT:
2,624,006, PUB. 7-2-2002. MULTIPLE CLASS, INT. CLS. 35
AND 42.
- DANIELI CORUS EUROPE B.V., CA IJMUIDEN, NETHER-
LANDS TO HOOGOVENS TECHNICAL SERVICES EN-
ERGY & ENVIRONMENT BV, 1970 CA IMULIDEN,
NETHERLANDS:
2,486,499, COR. INT. CL. 42.
- DANIELS & ASSOCIATES, ELKINS PARK, PA:
2,625,908, INT. CL. 16.

- DANIELS, DONALD R., BOSSIER CITY, LA:
2,626,011, MULTIPLE CLASS, INT. CLS. 24 AND 25.
- DANNON COMPANY, INC., THE, WHITE PLAINS, NY:
1,934,351, CANC. INT. CL. 29.
- DANSKIN, INC., NEW YORK, NY:
1,932,867, CANC. INT. CL. 25.
- DANTEC DYNAMICS, INC., MAHWAY, NJ FROM DAN-
TEC MEASUREMENT TECHNOLOGY INC., MAHWAH,
NJ:
2,626,446, INT. CL. 42.
- DARE TO DREAM, LAS VEGAS, NV:
1,933,312, CANC. INT. CL. 25.
- DAROS INTERNATIONAL, INC., CHERRY HILL, NJ:
2,623,965, PUB. 7-2-2002. INT. CL. 19.
- DARREN FORBES, INC., SPARTANBURG, SC:
2,624,922, PUB. 7-2-2002. INT. CL. 24.
- DARST, DIANE W, GREENWICH, CT AND MASSEY, SUE J,
GREENWICH, CT:
2,623,946, PUB. 7-2-2002. INT. CL. 41.
- DART INDUSTRIES INC., LOS ANGELES, CA:
723,431, CANC. U.S. CL. 1.
- DATA BECKER CORPORATION, NEEDHAM, MA:
2,625,761, INT. CL. 9.
- DATA CONNECT, INC., WEST CHESTER, PA:
2,624,052, PUB. 7-2-2002. INT. CL. 35.
- DATA EAST USA, INC., MENLO PARK, CA:
1,690,323, REN. 8-16-02. INT. CL. 28.
1,736,754, REN. 8-16-02. INT. CL. 28.
- DATA KINETICS LTD., OTTAWA, ONTARIO, CANADA:
1,698,793, REN. 8-10-02. INT. CL. 9.
- DATABASE CONSULTING ASSOCIATES, INC.:
See— DYNAMIC COMMERCE APPLICATIONS, INC..
- DATACORE SOFTWARE CORPORATION, FORT LAUDER-
DALE, FL:
2,625,960, INT. CL. 35.
- DATAQUE INTERNATIONAL, INC., CHICAGO, IL:
1,176,629, CANC. INT. CL. 42.
- DATARADIO, INC., QUEBEC, CANADA:
2,623,894, PUB. 7-2-2002. INT. CL. 9.
- DATATRAK INTERNATIONAL, INC. CLEVELAND, OH:
2,623,546, PUB. 7-2-2002. MULTIPLE CLASS, INT. CLS. 9
AND 35.
- DATATREASURY CORPORATION, NEW YORK, NY
FROM CSP HOLDINGS, LLC, LLOYD HARBOR, NY:
2,625,881, INT. CL. 35.
- DATAVOX BUSINESS COMMUNICATIONS, HOUSTON,
TX:
2,624,336, PUB. 7-2-2002. INT. CL. 42.
- DATREK PROFESSIONAL BAGS, INC., SPRINGFIELD, TN:
1,932,801, CANC. INT. CL. 28.
- DAUGHERTY SYSTEMS, INC., ST. LOUIS, MO:
2,623,487, PUB. 7-2-2002. INT. CL. 9.
- DAVALL GEAR COMPANY LIMITED, THE, HATFIELD,
HERTS AL9 7JB, ENGLAND:
1,682,647, REN. 8-14-02. INT. CL. 7.
- DAVID A. TENNANT, HOUSTON, TX, DBA BESTON DE-
SIGN GROUP:
1,932,443, CANC. INT. CL. 25.
- DAVID RIGBY ASSOCIATES LIMITED, MANCHESTER M1
5AQ, UNITED KINGDOM:
2,626,055, INT. CL. 35.
- DAVID S. PIERPONT AND SHANE L. YATES PARTNER-
SHIP, THE, LEHI, UT:
2,625,643, INT. CL. 25.
- DAVIS, NICK L., WENATCHEE, WA:
1,933,865, CANC. INT. CL. 31.
- DAVITT & HANSER MUSIC CO., INC., CINCINNATI, OH:
2,622,544, PUB. 7-2-2002. INT. CL. 15.
- DAWKAR, ABSECON, NJ:
2,626,077, INT. CL. 24.
- DAWN FOODS, INC., JACKSON, MI, DAWN FOOD PRO-
DUCTS, INCORPORATED, JACKSON, MI:
1,169,499, REN. 8-14-02. INT. CL. 30.
- DAWSON ENTERPRISES, LONG BEACH, CA, DAWSON
ENTERPRISES, LONG BEACH, CA:
1,157,856, REN. 8-16-02. INT. CL. 7.
- DAY-TIMERS, INC., EAST TEXAS, PA:
1,684,312, REN. 8-15-02. INT. CL. 16.
- DAY, DAVID, PEBBLE BEACH, CA:
2,624,497, PUB. 7-2-2002. INT. CL. 35.
- DAYAN, DANIEL, DEAL, NJ:
2,626,559, INT. CL. 25.
- DAYDREAMERS INC., IRVINE, CA:
2,623,008, PUB. 7-2-2002. INT. CL. 24.
- DAYSRING CARDS, INC., SILOAM SPRINGS, AR:
2,623,821, PUB. 7-2-2002. INT. CL. 16.
- DBA DIRECT, INC., FLORENCE, KY:
2,623,684, PUB. 7-2-2002. INT. CL. 42.
- DBC INTERNATIONAL LTD., 01510 VANTAA, FINLAND:
2,625,887, INT. CL. 42.
- DC COMICS, NEW YORK, NY:
2,626,700, INT. CL. 41.
- DC COMICS INC., NEW YORK, NY:
1,175,906, CANC. INT. CL. 9.
1,176,090, CANC. INT. CL. 16.
- DCN INDUSTRIES INC., BOYNTON BEACH, FL:
1,934,288, CANC. INT. CL. 28.
- DE GOEIJ, MARC ALEXANDER, 1019 AX AMSTERDAM,
NETHERLANDS, TA EFFECTIVE MANAGEMENT CON-
SULTANCY:
2,623,724, PUB. 7-2-2002. MULTIPLE CLASS, INT. CLS. 9,
35 AND 42.
- DE NADA RESTAURANTS, INC., DALLAS, TX:
1,933,930, CANC. INT. CL. 42.
- DE SMET, FRANCIS, ASSEBROEK, BELGIUM:
2,623,189, PUB. 7-2-2002. INT. CL. 9.
- DEAKINS, JONI, LOS ANGELES, CA:
2,625,827, INT. CL. 35.
- DEAN & DELUCA BRANDS, INC., NEW YORK, NY:
2,625,530, INT. CL. 35.
- DEC-KOR, INC., WHITEHALL, MI:
1,933,177, CANC. INT. CL. 6.
1,933,178, CANC. INT. CL. 6.
- DECISION MANAGEMENT COMPANY, INC., MISSION
VIEJO, CA:
2,624,464, PUB. 7-2-2002. INT. CL. 9.
- DECK HOUSE, INC., ACTON, MA:
2,625,845, MULTIPLE CLASS, INT. CLS. 6, 19 AND 41.
- DECKERS OUTDOOR CORPORATION, CARPINTERIA,
CA:
1,933,613, CANC. INT. CL. 25.
- DECO PATENTS, INC., EDISON, NJ FROM REVLON
CONSUMER PRODUCTS CORPORATION, NEW YORK,
NY:
2,625,576, MULTIPLE CLASS, INT. CLS. 2 AND 42.
- DECORATING DETAILS, LLC, PITTSBURGH, PA:
2,625,073, PUB. 7-2-2002. INT. CL. 42.
- DEDICATED NET ACCESS, BEVERLY HILLS, CA:
2,626,287, INT. CL. 42.
- DEEP FOODS, INC., UNION, NJ:
2,625,816, INT. CL. 35.
- DEERE & COMPANY, MOLINE, IL:
2,626,085, INT. CL. 14.
- DEERWOOD FASTENERS INTERNATIONAL, INC., HUN-
TERSVILLE, NC, THREE D CORPORATION, HUNTERS-
VILLE, NC:
1,684,286, REN. 8-15-02. INT. CL. 6.
- DEFENDERS OF WILDLIFE, WASHINGTON, DC:
2,625,488, INT. CL. 42.
- DEGUSSA AG, D-40474 DUSSELDORF, FED REP GER-
MANY, CHEMISCHE WERKE HUELS AKTIENGE-
SELLSCHAFT, MARL 1, FED REP GERMANY:
1,213,715, REN. 8-13-02. MULTIPLE CLASS, INT. CLS. 1
AND 17.
- DEGUSSA AG, D-45772 MARL, FED REP GERMANY FROM
HULS AKTIENGESELLSCHAFT, D-45772 MARL, FED
REP GERMANY:
2,625,385, MULTIPLE CLASS, INT. CLS. 35, 36 AND 42.
- DEGUSSA-HUELS AG, FRANKFURT A.M., FED REP
GERMANY, KOLENE CORPORATION, DETROIT, MI:
1,174,680, REN. 8-10-02. INT. CL. 1.
- DEGUSSA-HULS AG, D-60287 FRANKFURT, FED REP
GERMANY:
2,623,483, PUB. 7-2-2002. INT. CL. 1.
- DEI MATTIOLI S.P.A., BOLOGNA, ITALY:
1,176,311, CANC. INT. CL. 25.

DEL MAR RACE MANAGEMENT, INC., LONG BEACH, CA:
1,933,311, CANC. INT. CL. 25.

DEL MONTE FRESH PRODUCE INTERNATIONAL, INC., MONTE CARLO 98000, MONACO:
2,625,603, INT. CL. 29.

DEL WEBB CORPORATION, PHOENIX, AZ:
1,932,668, CANC. INT. CL. 37.
1,933,711, CANC. INT. CL. 36.

DELANO COMPANY, INC, GROVER BEACH, CA:
2,626,687, INT. CL. 5.

DELAVAL INC., KANSAS CITY, MO, UNIVERSAL DAIRY EQUIPMENT, INC., KANSAS CITY, MO:
1,709,162, REN. 8-16-02. INT. CL. 5.

DELAWARE CAPITAL FORMATION, INC., WILMINGTON, DE:
2,623,318, PUB. 7-2-2002. INT. CL. 22.

DELPHI CONSULTING GROUP, INC., BOSTON, MA:
1,651,752, AM. INT. CL. 41.

DELSAN INDUSTRIES, INC., ST. LOUIS, MO:
1,933,253, CANC. INT. CL. 19.

DELTA DENTAL PLANS ASSOCIATION, CHICAGO, IL:
1,933,696, CANC. INT. CL. 36.

DEMARCO MAXVAC CORPORATION, MCHENRY, IL:
2,622,587, PUB. 7-2-2002. INT. CL. 7.

DEMARTINI, JOHN F., HOUSTON, TX:
2,623,856, PUB. 7-2-2002. INT. CL. 41.

DEMERT & DOUGHERTY, INC., CHICAGO, IL:
1,175,653, CANC. INT. CL. 1.

DEMINICO, JOHN, STOCKTON, NJ:
2,624,790, PUB. 7-2-2002. INT. CL. 41.

DENCOMPANY LLC, MANLIUS, NY, DBA BUS PARTS WAREHOUSE:
2,625,146, PUB. 7-2-2002. MULTIPLE CLASS, INT. CLS. 12 AND 40.

DENNY'S, INC., SPARTANBURG, SC:
1,933,324, CANC. INT. CL. 25.

DENTIFAX INTERNATIONAL, INC., WAPPINGERS FALLS, NY:
1,932,994, CANC. INT. CL. 4.

DENVER MATTRESS CO., LLC, LAKEWOOD, CO:
2,624,838, PUB. 7-2-2002. INT. CL. 20.

DEPARTMENT OF THE ARMY, THE, ARLINGTON, VA:
1,691,502, REN. 8-15-02. INT. CL. 16.

DEPOT DIRECT, INC., PERRYSBURG, OH:
2,626,206, INT. CL. 35.

DEPUY ORTHOPAEDICS, INC., WARSAW, IN, BOEHRINGER MANNHEIM CORPORATION, INDIANAPOLIS, IN:
1,681,076, REN. 8-14-02. INT. CL. 10.

DEPUY, INC., WARSAW, IN:
2,623,530, PUB. 7-2-2002. INT. CL. 10.

DERMAL LABORATORIES LIMITED, HERTS., ENGLAND:
1,175,762, CANC. INT. CL. 5.

DERMAL RESEARCH LABORATORIES, INC., KANSAS CITY, MO:
2,626,582, INT. CL. 5.
2,626,583, INT. CL. 5.

DERMATOLOGIC COSMETIC LABORATORIES, LTD., EAST HAVEN, CT:
2,623,515, PUB. 7-2-2002. INT. CL. 3.

DERWENT INFORMATION LTD., LONDON, ENGLAND:
2,625,440, INT. CL. 42.

DES-L INDUSTRIES, INC., IRVINGTON, NJ:
2,624,662, PUB. 7-2-2002. INT. CL. 20.

DESCO VON SCHULTHESS AG, ZURICH, SWITZERLAND:
2,623,174, PUB. 7-2-2002. INT. CL. 14.

DESERT COOL FOODS, INC., PHOENIX, AZ:
2,624,591, PUB. 7-2-2002. INT. CL. 30.

DESIGN ENTERPRISES LIMITED, TORTOLA, BR. VIRGIN ISLANDS:
2,625,503, MULTIPLE CLASS, INT. CLS. 9, 38, 41 AND 42.

DESIGN RESOURCES & SOLUTIONS GROUP, INC., NEWTON CENTRE, MA:
1,934,292, CANC. INT. CL. 42.

DESIGN TREND, INC., ST. LOUIS, MO:
1,933,955, CANC. INT. CL. 21.
1,933,956, CANC. INT. CL. 21.

DESIGNER BRAIDS AND TRADE INC., BROOKLYN, NY:
2,623,741, PUB. 10-30-2001. INT. CL. 42.

DESIGNS BY SKAFFLES, INC., NEW YORK, NY:
2,626,114, INT. CL. 26.

DESLER, MORDEHAI, LYNBROOK, NY, DBA KORAL INTERNATIONAL:
1,933,199, CANC. INT. CL. 14.

DESTINATION IMAGINATION, INC., GLASSBORO, NJ:
2,623,431, PUB. 7-2-2002. INT. CL. 16.

DESTINATION PRODUCTS INTERNATIONAL, LTD., MISSISSAUGA, ONTARIO L5B 2V2, CANADA:
2,625,697, MULTIPLE CLASS, INT. CLS. 29 AND 30.

DET NORSKE VERITAS INDUSTRY AS, N-1322, HOVIK, NORWAY:
1,932,559, CANC. MULTIPLE CLASS, INT. CLS. 35 AND 42.

DETECTIVEHELP.COM, INC., WOODSIDE, CA:
2,626,927, INT. CL. 42.

DETERMINED PRODUCTIONS INC., SAN FRANCISCO, CA:
1,176,377, CANC. INT. CL. 28.
1,176,378, CANC. INT. CL. 28.

DETROIT NEWSPAPER AGENCY, DETROIT, MI:
2,623,929, PUB. 7-2-2002. INT. CL. 16.

DEUTREL INDUSTRIES, LANCASTER, CA:
2,625,226, PUB. 7-2-2002. INT. CL. 1.

DEUTSCHE GRAMMOPHON GESELLSCHAFT MBH, D-20148 HAMBURG, FED REP GERMANY:
2,626,292, INT. CL. 9.

DEUTSCHE LUFTHANSA AG, 50679 KOLN, FED REP GERMANY:
2,623,342, PUB. 7-2-2002. MULTIPLE CLASS, INT. CLS. 9, 38, 39 AND 42.

DEUTSCHE TELEKOM AG, D-53175 BONN, FED REP GERMANY:
2,622,507, PUB. 11-11-1997. MULTIPLE CLASS, INT. CLS. 9, 14, 16, 18, 25, 28, 36, 37, 38, 41 AND 42.

DEUTSCHE TELEKOM AG, 53113 BONN, FED REP GERMANY:
2,622,632, PUB. 11-13-2001. MULTIPLE CLASS, INT. CLS. 9, 16, 38 AND 42.

DEVAULT PACKING CO., DEVAULT, PA:
1,720,504, REN. 8-16-02. INT. CL. 29.

DEVELOPERS DIVERSIFIED REALTY CORPORATION, BEACHWOOD, OH:
2,624,643, PUB. 7-2-2002. INT. CL. 37.
2,624,644, PUB. 7-2-2002. INT. CL. 37.

DEVELOPERS@WORK, INC., MAPLEWOOD, NJ:
2,625,763, INT. CL. 42.

DEVELOPMENT DIMENSIONS INTERNATIONAL, INC., BRIDGEVILLE, PA:
2,623,710, PUB. 7-2-2002. INT. CL. 9.

DEVELOPMENT II, INC., WOODBURY, CT:
2,626,970, INT. CL. 35.

DEVELOPMENTAL THERAPY INSTITUTE, INC., ATHENS, GA:
2,623,879, PUB. 7-2-2002. INT. CL. 41.

DEVORE, STEVEN A., DANVILLE, CA:
1,933,413, CANC. INT. CL. 9.

DEVRIES COMMUNICATIONS, INC., DES MOINES, IA, DBA COLORFX:
2,622,622, PUB. 7-2-2002. INT. CL. 42.

DEWEY'S FOODS, INC., HARLINGEN, TX:
1,933,251, CANC. INT. CL. 29.

DEY LP, NAPA, CA:
2,625,464, INT. CL. 5.

DG PRODUCTIONS, INC., LONGWOOD, FL:
2,625,739, INT. CL. 28.

DI GIULIO CHIROPRACTIC, INC., BURBANK, CA:
2,626,195, INT. CL. 3.

DIABETES JUNCTION.COM, INC., PHILADELPHIA, PA:
2,625,770, MULTIPLE CLASS, INT. CLS. 35 AND 42.

DIABETIC YOUTH FOUNDATION, WALNUT CREEK, CA:
2,623,643, PUB. 7-2-2002. INT. CL. 35.

DIAL, KELLI K, TOWSON, MD AND RASKIN, LEONARD, TOWSON, MD:
2,623,410, PUB. 7-2-2002. INT. CL. 36.

- DIAMOND & ESTATE JEWELRY, INC., LOS ANGELES, CA:
1,701,686, REN. 8-15-02. INT. CL. 14.
- DIAMOND COSMETICS, INC., SUNRISE, FL:
2,623,957, PUB. 7-2-2002. INT. CL. 3.
- DIAMOND OIL WELL DRILLING COMPANY, MIDLAND, TX:
1,175,842, CANC. INT. CL. 7.
- DIAMOND STAR INTERNATIONAL, CHICAGO, IL:
2,626,887, INT. CL. 35.
- DIAMOND V MILLS, INC., CEDAR RAPIDS, IA:
2,624,036, PUB. 7-2-2002. INT. CL. 5.
- DIAMONDWARE, LTD., MESA, AZ:
2,625,228, PUB. 7-2-2002. INT. CL. 9.
- DIBA IMPORTS L.P., ST. LOUIS, MO:
2,624,043, PUB. 7-2-2002. MULTIPLE CLASS, INT. CLS. 18, 25 AND 35.
- DIBLE, DONALD M., SUNNYVALE, CA:
2,625,347, INT. CL. 16.
- DICHTOMATIK VERTRIEBSGESELLSCHAFT FUR TECHNISCHE DICHTUNGEN MBH, D-22045 HAMBURG, FED REP GERMANY:
2,623,007, PUB. 7-2-2002. INT. CL. 17.
- DICK CLARK PRODUCTIONS, INC., BURBANK, CA:
1,934,310, CANC. INT. CL. 3.
- DICTATIONS & TRANSCRIPTIONS LTD., LONDON, ENGLAND:
2,623,035, PUB. 4-16-2002. INT. CL. 35.
- DIEBOLD, INCORPORATED, NORTH CANTON, OH:
2,625,760, INT. CL. 9.
- DIEBOLT INTERNATIONAL, INC, PLYMOUTH, MI:
2,625,501, INT. CL. 7.
- DIET FITNESS CORPORATION, GILBERT, AZ:
2,626,774, INT. CL. 16.
- DIETARY MANAGERS ASSOCIATION, ITASCA, IL:
2,623,049, PUB. 7-2-2002. MULTIPLE CLASS, INT. CLS. 16, 35, 41 AND 42.
- DIGI INTERNATIONAL INC., MINNETONKA, MN:
2,624,198, PUB. 7-2-2002. MULTIPLE CLASS, INT. CLS. 9 AND 42.
- DIGINEER, INC., MASON, OH:
2,624,801, PUB. 7-2-2002. INT. CL. 9.
- DIGIREPROGRAPHICS USA, INC., ST. LOUIS, MI:
2,623,940, PUB. 7-2-2002. INT. CL. 42.
- DIGITAL CONTROLS CORPORATION, SPRINGBORO, OH:
2,626,080, MULTIPLE CLASS, INT. CLS. 9 AND 42.
- DIGITAL LIGHTWAVE, INC., CLEARWATER, FL:
2,623,154, PUB. 7-2-2002. INT. CL. 9.
- DIGITAS, LLC, BOSTON, MA FROM BRONNERCOM, LLC, BOSTON, MA:
2,625,719, MULTIPLE CLASS, INT. CLS. 35 AND 42.
- DIGITEK TECHNOLOGY CO., LTD, SHIJR CITY, TAIPEI HSIEN, TAIWAN:
2,624,778, PUB. 7-2-2002. INT. CL. 9.
- DILOR INDUSTRIES LTD., NORTH VANCOUVER, BRITISH COLUMBIA, CANADA:
1,175,885, CANC. INT. CL. 9.
- DIMARZIO, INC., STATEN ISLAND, NY:
2,626,474, INT. CL. 9.
- DIMC, INC., WILMINGTON, DE:
1,663,106, CANC. INT. CL. 2.
- DIMENT, ELMAR, SHERMAN OAKS, CA:
2,623,755, PUB. 7-2-2002. INT. CL. 35.
- DIMEO SCHNEIDER & ASSOCIATES, L.L.C., CHICAGO, IL:
2,627,013, INT. CL. 36.
- DINIS, ANTONIO, SAN DIEGO, CA:
1,933,411, CANC. INT. CL. 37.
- DINNER BELL FOODS, INC., DEFIANCE, OH:
1,176,585, CANC. INT. CL. 42.
- DINNERGUEST, INC., RIDGELAND, MS:
2,624,839, PUB. 7-2-2002. INT. CL. 9.
- DION ENTERTAINMENT CORP., SURREY, BRITISH COLUMBIA, CANADA:
2,535,340, CANC. IIRN. RESTORED TO S.N. 75-759,010.
- DIRAD TELECOM, INC., TORRANCE, CA:
2,626,168, INT. CL. 9.
- DIRECT DISPENSING, INCORPORATED, MIAMI, FL:
1,932,600, CANC. INT. CL. 42.
- DIRECTORIESAMERICA, INC., OVERLAND PARK, KS:
2,622,499, PUB. 1-31-1989. INT. CL. 35.
2,622,500, PUB. 7-25-1989. INT. CL. 35.
- DISABILITY CONSULTING GROUP, PORTLAND, ME AND REED GROUP, LTD, BOULDER, CO:
2,624,774, PUB. 7-2-2002. MULTIPLE CLASS, INT. CLS. 35 AND 36.
- DISCOUNT SPORT NUTRITION, L.L.C., DENTON, TX:
2,622,644, PUB. 7-2-2002. INT. CL. 35.
- DISCOURSE SKILLS PRODUCTIONS, INC., EASTHAMPTON, MA:
2,622,527, PUB. 7-2-2002. INT. CL. 16.
- DISCOVERTHEOUTDOORS.COM, INC, OVERLAND PARK, KS:
2,626,155, INT. CL. 9.
- DISCOVERY COMMUNICATIONS, INC., BETHESDA, MD:
2,622,893, PUB. 7-2-2002. INT. CL. 41.
2,624,024, PUB. 7-2-2002. INT. CL. 41.
2,626,001, INT. CL. 38.
2,626,463, INT. CL. 41.
2,626,796, INT. CL. 41.
- DISCOVERY TECHNOLOGIES, INC., MILWAUKEE, WI:
2,622,782, PUB. 7-2-2002. INT. CL. 42.
- DISCTRONICS LIMITED, MELBOURNE, VICTORIA 3000, AUSTRALIA:
2,622,709, PUB. 7-2-2002. MULTIPLE CLASS, INT. CLS. 9, 16, 39, 40, 41 AND 42.
- DISNEY ENTERPRISES, INC., BURBANK, CA:
2,623,099, PUB. 7-2-2002. INT. CL. 24.
2,625,419, INT. CL. 41.
2,625,447, INT. CL. 41.
- DISS, JUDITH, SEDRO-WOOLLEY, WA AND HOWARD, TIM, SEDRO-WOOLLEY, WA:
2,625,252, PUB. 7-2-2002. INT. CL. 5.
- DISTRI-GROS, 72000 LE MANS, FRANCE:
2,623,118, PUB. 7-2-2002. INT. CL. 25.
- DISTRIBUTION CONTROL SYSTEMS CARIBE, INC., CAGUAS, PUERTO RICO:
2,625,411, INT. CL. 9.
- DISTRIBUTOR INFORMATION SYSTEMS CORPORATION, FARMINGTON, CT:
2,623,013, PUB. 7-2-2002. INT. CL. 9.
- DIVERSIFIED RESTAURANT VENTURES LLC, SPRINGFIELD, OR:
2,623,088, PUB. 7-2-2002. MULTIPLE CLASS, INT. CLS. 30 AND 35.
- DIVI INTERNATIONAL CO., MIAMI, FL:
2,625,889, INT. CL. 3.
- DIVISION SALES, INC., ITASCA, IL, DBA JUSTEN PRODUCTS:
1,934,399, CANC. MULTIPLE CLASS, INT. CLS. 20, 21, 22 AND 26.
- DIXIE YARNS, INC., CHATTANOOGA, TN:
723,642, CANC. U.S. CL. 39.
- DLM, INC., MALVERN, AR:
1,663,188, CANC. INT. CL. 7.
- DML MARKETING GROUP, LTD., SYLMAR, CA:
2,625,699, INT. CL. 25.
- DOCCO MANUFACTURING LTD., RICHMOND HILL, ONTARIO, CANADA:
2,625,781, INT. CL. 8.
- DOCK-PRO, LTD., VENETIA, PA:
2,623,357, PUB. 7-2-2002. INT. CL. 12.
- DODAH, INC., LARGO, FL:
2,624,509, PUB. 7-2-2002. INT. CL. 42.
- DODSON, DAVID A., HAMILTON HM 11, BERMUDA:
1,932,517, CANC. INT. CL. 36.
- DOG GENERATION, PARIS, FRANCE:
2,625,047, PUB. 7-2-2002. INT. CL. 3.
- DOHRING, RAHN, ORION, MI:
2,622,728, PUB. 7-2-2002. INT. CL. 38.
- DOLLFUS ET MULLER, FRANCE, FRANCE:
2,623,040, PUB. 5-21-2002. MULTIPLE CLASS, INT. CLS. 7, 17 AND 24.
- DOMAINE LTD., PROVIDENCE, RI:
2,624,833, PUB. 7-2-2002. INT. CL. 14.

- DOMANIA.COM, INC., BOSTON, MA TO INPHO, INC., CAMBRIDGE, MA:
2,553,534, COR. MULTIPLE CLASS, INT. CLS. 35 AND 36.
2,553,535, COR. MULTIPLE CLASS, INT. CLS. 35 AND 36.
- DOMINI SOCIAL INVESTMENTS LLC, NEW YORK, NY:
2,624,842, PUB. 7-2-2002. INT. CL. 36.
- DOMINO'S PIZZA PMC, INC., ANN ARBOR, MI:
2,626,581, INT. CL. 42.
- DONALD R. KONOLD AND ANNEMARIE H. KONOLD PARTNERSHIP, THE, MALIBU, CA:
2,624,992, PUB. 7-2-2002. INT. CL. 11.
- DONALD, THOMAS C., BIRMINGHAM, AL:
2,624,985, PUB. 7-2-2002. INT. CL. 9.
- DONALDSON COMPANY, INC., MINNEAPOLIS, MN:
1,934,179, CANC. INT. CL. 12.
- DONG-A PHARMACEUTICAL CO., LTD., DONGDAEMUN-KU, REPUBLIC OF KOREA:
2,625,108, PUB. 7-2-2002. INT. CL. 5.
- DONPRINT, INC., MUNDELEN, IL:
2,623,875, PUB. 7-2-2002. MULTIPLE CLASS, INT. CLS. 6 AND 20.
- DOODLELAB, INC., HEALDSBURG, CA:
2,623,362, PUB. 7-2-2002. INT. CL. 40.
- DOOR TO DOOR MEDICAL SUPPLY, INC., TROY, MI:
2,626,907, INT. CL. 39.
- DOREL JUVENILE GROUP, INC., CANTON, MA FROM COSCO, INC., COLUMBUS, IN:
2,622,872, PUB. 7-2-2002. INT. CL. 20.
- DORFCO, INC., DAVIE, FL:
2,626,300, INT. CL. 42.
- DOROTHY LANE MARKET, INC., DAYTON, OH:
2,622,602, PUB. 7-2-2002. INT. CL. 29.
- DOWN ISLAND, INC., WILMINGTON, NC:
1,933,222, CANC. INT. CL. 20.
- DOWTY, MILTON E., WICHITA, KS:
2,624,392, PUB. 7-2-2002. INT. CL. 41.
2,624,393, PUB. 7-2-2002. INT. CL. 42.
2,624,548, PUB. 7-2-2002. INT. CL. 41.
- DR. CHEF, INC., PHOENIX, AZ:
2,623,219, PUB. 7-2-2002. INT. CL. 30.
2,623,285, PUB. 7-2-2002. INT. CL. 30.
- DR. SEUSS ENTERPRISES L.P., LA JOLLA, CA:
2,626,097, INT. CL. 41.
- DR.MADAUS GMBH & CO.:
1,176,260, CANC. INT. CL. 21.
- DRAFTCO, INC., GARLAND, TX:
2,624,259, PUB. 7-2-2002. INT. CL. 16.
- DRAYTON, SHAWN, NEW YORK, NY AND VASQUEZ, ARGEE, GLENDALE, NY:
2,625,300, PUB. 7-2-2002. INT. CL. 25.
- DREAMERS CANDLES, LTD., STRAWN, TX:
2,624,686, PUB. 7-2-2002. INT. CL. 4.
- DREIFUS ASSOCIATES LIMITED, INC., LAKE MARY, FL:
2,626,558, MULTIPLE CLASS, INT. CLS. 35, 36 AND 42.
- DRESSER EQUIPMENT GROUP, INC.:
See— DRESSER, INC..
- DRESSER INDUSTRIES, INC., DALLAS, TX:
1,934,254, CANC. INT. CL. 4.
- DRESSER, INC., ADDISON, TX FROM DRESSER EQUIPMENT GROUP, INC., CARROLLTON, TX:
2,623,904, PUB. 7-2-2002. MULTIPLE CLASS, INT. CLS. 7 AND 9.
2,625,802, INT. CL. 9.
- DREW SHOE CORPORATION, LANCASTER, OH:
2,624,734, PUB. 7-2-2002. MULTIPLE CLASS, INT. CLS. 10 AND 25.
- DREWS, THOMAS JON, BELMONT, CA, DBA ACTIVE STICK WEAR:
1,933,155, CANC. INT. CL. 25.
- DREXEL HERITAGE FURNISHINGS INC., DREXEL, NC:
2,623,250, PUB. 7-2-2002. INT. CL. 20.
- DREXEL HERITAGE FURNITURE INDUSTRIES, INC., DREXEL, NC, DREXEL HERITAGE FURNISHINGS INC., DREXEL, NC:
1,690,207, REN. 8-16-02. INT. CL. 20.
1,690,208, REN. 8-16-02. INT. CL. 20.
- DRIZZLE, INC., NEW YORK, NY:
1,933,289, CANC. INT. CL. 25.
- DRUM INDUSTRIES, INC., LOUISVILLE, KY:
1,933,080, CANC. INT. CL. 7.
- DRY CREEK NUTRITION, INC., MODESTO, CA:
2,624,748, PUB. 7-2-2002. MULTIPLE CLASS, INT. CLS. 1, 5, 29, 30 AND 32.
- DRYER; DALE R., OAKLAND, CA, DBA HANK & FRANK BICYCLES:
1,176,070, CANC. INT. CL. 12.
- DSI, LIMITED, NASSAU, BAHAMAS:
2,622,714, PUB. 7-2-2002. INT. CL. 34.
2,622,827, PUB. 8-28-2001. INT. CL. 34.
- DTN FINANCIAL SERVICES, LLC, OMAHA, NE:
2,624,416, PUB. 7-2-2002. INT. CL. 36.
- DU VOITEL, ROLAND DUMONT, 69126 HEIDELBERG, FED REP GERMANY:
2,623,917, PUB. 7-2-2002. MULTIPLE CLASS, INT. CLS. 35, 41 AND 42.
- DUCTBUSTERS, INC., CLEARWATER, FL:
1,698,024, REN. 8-15-02. INT. CL. 37.
- DUFF, WILLIAM B., JR., ODESSA, TX:
2,623,820, PUB. 7-2-2002. INT. CL. 9.
- DUMEX MEDICAL SURGICAL PRODUCTS, LTD., SCARBOROUGH, ONTARIO M1S3S4, CANADA:
2,622,583, PUB. 9-21-1999. MULTIPLE CLASS, INT. CLS. 5, 10 AND 35.
- DUMMEN GMBH & CO. KG, D-47495 RHEINBERG FVERSAEL, FED REP GERMANY:
2,624,767, PUB. 7-2-2002. INT. CL. 31.
- DUMMY CORPORATION, LOS ANGELES, CA:
2,626,786, INT. CL. 41.
- DUNBAR, AMANDA, ALLEN, TX:
2,624,561, PUB. 7-2-2002. INT. CL. 36.
- DUNK'S HOT SAUCE, LLC., FOSTERS, AL:
2,624,389, PUB. 1-29-2002. INT. CL. 30.
- DUNKIN' DONUTS USA, INC., PLYMOUTH, MI:
2,626,238, INT. CL. 35.
- DUNLOP SLAZENGER CORPORATION, GREENVILLE, SC:
1,934,117, CANC. INT. CL. 28.
- DUNLOP SLAZENGER GROUP AMERICAS, GREENVILLE, SC:
2,624,027, PUB. 7-2-2002. INT. CL. 28.
- DUNLOP SLAZENGER GROUP AMERICAS INC., GREENVILLE, SC:
2,626,909, INT. CL. 28.
- DUNN-EDWARDS CORPORATION, LOS ANGELES, CA:
2,626,219, INT. CL. 2.
- DUNRITE PRODUCTIONS, INC., WESTLAKE VILLAGE, CA:
2,622,570, PUB. 7-2-2002. INT. CL. 9.
- DUOTONE AUDIO GROUP LTD., NEW YORK, NY:
2,626,508, MULTIPLE CLASS, INT. CLS. 9 AND 41.
- DUPONT, ANDRE, BOUCHERVILLE, QUEBEC, CANADA:
2,622,506, PUB. 7-2-2002. INT. CL. 11.
- DURAFLAME, INC., STOCKTON, CA:
2,626,394, INT. CL. 4.
- DURATION SOFTWARE, INC., HOUSTON, TX:
2,622,923, PUB. 7-2-2002. MULTIPLE CLASS, INT. CLS. 9 AND 42.
- DURAWELD LIMITED, SCARBOROUGH, NORTH YORKSHIRE, ENGLAND:
2,622,825, PUB. 7-2-2002. INT. CL. 20.
- DUROL GMBH & CO. KG CHEMISCHE FABRIK LINDAU-BODENSEE, LINDAU, BODENSEE, FED REP GERMANY:
1,175,734, CANC. INT. CL. 3.
- DUTCH BROTHERS FLOWER MARKET, LLC, DENVER, CO:
2,624,007, PUB. 7-2-2002. INT. CL. 35.
- DUTCH GOLD HONEY, INC., LANCASTER, PA:
1,716,225, REN. 8-15-02. INT. CL. 30.
- DUTSON, DALLAS, SONOMA, CA:
2,623,392, PUB. 7-2-2002. INT. CL. 35.
- DWIGHT'S ENERGYDATA, INC., RICHARDSON, TX:
1,934,485, CANC. INT. CL. 9.
- DWYER, ARTHUR, ST LOUIS, MO:
2,623,561, PUB. 7-2-2002. MULTIPLE CLASS, INT. CLS. 9 AND 41.

- DYNACRAFT INDUSTRIES INC., ENGLISHTOWN, NJ, TA
BACK TO NATURE PRODUCTS CO.:
2,626,345, INT. CL. 3.
- DYNACRAFT INDUSTRIES, INC., SAN RAFAEL, CA:
2,624,500, PUB. 7-2-2002. INT. CL. 12.
- DYNAGEN, INC., CAMBRIDGE, MA:
1,933,500, CANC. INT. CL. 5.
- DYNAMIC COMMERCE APPLICATIONS, INC., SPRING-
FIELD, PA FROM DATABASE CONSULTING ASSOCI-
ATES, INC, SPRINGFIELD, PA:
2,625,001, PUB. 7-2-2002. INT. CL. 9.
- DYNAMICS OF GROWTH, INC., MAPLEWOOD, MN:
2,623,847, PUB. 7-2-2002. INT. CL. 16.
- DYNASTY CONSOLIDATED INDUSTRIES, INC., DALLAS,
TX:
2,623,949, PUB. 7-2-2002. INT. CL. 20.
- DYNORTHOTICS, INC., VIENNA, TYSONS CORNER, VA:
1,197,058, REN. 8-10-02. INT. CL. 10.
- E. I. DU PONT DE NEMOURS AND COMPANY, WILMING-
TON, DE:
1,689,808, REN. 8-16-02. INT. CL. 5.
2,625,349, INT. CL. 7.
- E. REMY MARTIN & CO., SOCIETE ANONYME, COGNAC,
FRANCE:
1,181,432, REN. 8-10-02. INT. CL. 33.
- E.B.T., INC., BROOKLINE, MA:
1,760,647, REN. 8-10-02. INT. CL. 12.
- E.K. SUCCESS, LTD., CLIFTON, NJ:
2,626,395, INT. CL. 16.
- E-LYNXX CORPORATION, CHAMBERSBURG, PA, DBA E-
LYNXX FROM ABC ADVISORS, INC., CHAMBERS-
BURG, PA:
2,622,659, PUB. 7-2-2002. INT. CL. 35.
- E-LYNXX CORPORATION, CHAMBERSBURG, PA:
2,622,995, PUB. 7-2-2002. INT. CL. 35.
- E/M CORPORATION, WEST LAFAYETTE, IN:
1,934,264, CANC. INT. CL. 2.
- EAGLE AFFILIATES, INC., HARRISON, NJ:
1,934,075, CANC. INT. CL. 20.
- EAGLE AUTO BODY, INC., ORLANDO, FL:
1,176,520, CANC. INT. CL. 37.
- EAGLE ENGINEERING AEROSPACE CO., LTD., TOKYO,
JAPAN:
2,625,942, MULTIPLE CLASS, INT. CLS. 37 AND 42.
- EAGLE ENGINEERING AEROSPACE CO., LTD., MINATO-
KU, TOKYO, JAPAN:
2,625,943, MULTIPLE CLASS, INT. CLS. 7 AND 12.
- EAGLE PHYSICAL THERAPY, CRANBERRY TOWNSHIP,
PA:
1,932,938, CANC. INT. CL. 42.
- EAGLE RESEARCH GROUP, INC., THE, DENVER, CO:
1,933,001, CANC. INT. CL. 35.
1,933,002, CANC. INT. CL. 35.
- EAGLEDIRECT.COM, INC.:
See—PREMIER GRAPHICS, INC..
- EARLHAM COLLEGE, RICHMOND, IN, DBA CONNER
PRAIRIE:
1,690,556, REN. 8-15-02. INT. CL. 41.
- EARTH PRESERV, LTD., IRVING, TX, DBA MAKING
SCENTS:
1,934,056, CANC. INT. CL. 3.
- EARTHEN INC., TARRYTOWN, NY:
2,624,635, PUB. 7-2-2002. INT. CL. 3.
- EARTHSHELL CONTAINER CORPORATION, SANTA BAR-
BARA, CA:
1,934,365, CANC. INT. CL. 21.
- EARTHWATCH INCORPORATED, LONGMONT, CO:
2,626,153, INT. CL. 42.
- EAST SIDE PIZZA, INC., CHICAGO, IL:
1,198,342, REN. 8-16-02. INT. CL. 42.
- EASTERN FINANCIAL FEDERAL CREDIT UNION, MIR-
AMAR, FL:
2,625,270, PUB. 7-2-2002. INT. CL. 36.
- EASTERN MERCHANDISE CORP., LOS ANGELES, CA,
DBA SUPERIOR INDUSTRIES COMPANY:
1,932,990, CANC. MULTIPLE CLASS, INT. CLS. 8 AND
21.
- EASTERN SLEEP PRODUCTS CO., INC., RICHMOND, VA,
DBA SYMBOL MATTRESS COMPANY:
2,626,026, INT. CL. 20.
- EASTLAND FOOD CORPORATION, COLUMBIA, MD:
1,932,907, CANC. INT. CL. 32.
- EASTMAN CHEMICAL COMPANY, KINGSPORT, TN:
2,626,660, INT. CL. 1.
- EASTMAN KODAK COMPANY, ROCHESTER, NY:
723,559, CANC. U.S. CL. 26.
1,932,850, CANC. INT. CL. 1.
- EASTMAN STRINGS, INC., GAITHERSBURG, MD:
2,625,216, PUB. 7-2-2002. INT. CL. 15.
2,625,217, PUB. 7-2-2002. INT. CL. 15.
- EASTMAN, KEVIN B., NORTHAMPTON, MA:
1,933,798, CANC. INT. CL. 16.
- EASYDOING OY (LTD.), FIN-77700 RAUTALAMPI, FIN-
LAND:
2,623,801, PUB. 7-2-2002. INT. CL. 20.
- EASYTEL, WOODLAND HILLS, CA:
2,623,368, PUB. 7-2-2002. INT. CL. 39.
- EAU DE COLOGNE- & PARFUMERIE-FABRIK GLOCK-
ENGASSE NO. 4711 GEGENUBER DER PFERDEPOST
VON FERD. MULHENS, COLOGNE ON RHINE, FED REP
GERMANY:
1,175,737, CANC. INT. CL. 3.
- EBERSPACHER, WOLFGANG, 7312 KIRCHHEIM-TECK.,
FED REP GERMANY:
1,933,386, CANC. INT. CL. 7.
- EBIZ SOFTWARE, INC., TOPEKA, KS:
2,625,925, INT. CL. 42.
- EBUSINESSWARE, INC., NEW YORK, NY:
2,623,563, PUB. 7-2-2002. MULTIPLE CLASS, INT. CLS. 35
AND 42.
- EBY HOLDINGS, INC., OLATHE, KS:
2,625,516, INT. CL. 35.
- ECG2, L.L.C, ST. LOUIS, MO, DBA RIDDELL FOOTWEAR:
2,626,390, INT. CL. 25.
- ECHOLAB, INC.:
See—ESTUDIOLIVE, INC..
- ECHOLS, CATHI, D., ODESSA, TX:
2,626,718, INT. CL. 14.
- ELECTIC CONTRACT FURNITURE INDUSTRIES, INC.,
NEW YORK, NY:
2,622,799, PUB. 7-2-2002. INT. CL. 40.
- ELECTIC INTERNATIONAL B.V., 4838 GM BREDA,
NETHERLANDS:
2,622,913, PUB. 7-2-2002. INT. CL. 35.
- ECOGAS CORPORATION, AUSTIN, TX:
1,933,057, CANC. INT. CL. 6.
- ECOLAB INC., ST. PAUL, MN:
2,624,206, PUB. 7-2-2002. MULTIPLE CLASS, INT. CLS. 3
AND 5.
- ECOLE INTERNATIONALE DE THEATRE JACQUES LE-
COQ, 75010 PARIS, FRANCE:
2,624,770, PUB. 7-2-2002. INT. CL. 41.
- ECSOFT GROUP PLC, LONDON W1H 9AB, ENGLAND:
2,513,715, COR. MULTIPLE CLASS, INT. CLS. 9, 16, 35, 41
AND 42.
- ECT INC., KING OF PRUSSIA, PA:
2,624,067, PUB. 7-2-2002. INT. CL. 3.
- ECUMENICAL DEVELOPMENT COOPERATIVE SOCIETY
U.A., 3818 HG AMERSFOORT, NETHERLANDS TO
ECUMENICAL DEVELOPMENT COOPERATIVE SO-
CIETY U.A., 3818 HG AMERSFOORT, NETHERLANDS:
2,518,194, COR. MULTIPLE CLASS, INT. CLS. 35, 36
AND 41.
- EDDIE BAUER, INC., REDMOND, WA:
2,626,680, MULTIPLE CLASS, INT. CLS. 16 AND 35.
- EDFUND, RANCHO CORDOVA, CA:
2,623,337, PUB. 7-2-2002. INT. CL. 35.
2,623,942, PUB. 7-2-2002. INT. CL. 35.
- EDG, INC., METAIRIE, LA:
2,623,234, PUB. 7-2-2002. INT. CL. 6.
- EDGE SCIENTIFIC INSTRUMENT CORPORATION, LOS
ANGELES, CA:
1,934,442, CANC. INT. CL. 9.
- EDGE SYSTEMS CORPORATION, SIGNAL HILL, CA:
2,626,121, INT. CL. 10.

- EDGECRAFT CORPORATION, AVONDALE, PA:
2,623,785, PUB. 7-2-2002. INT. CL. 11.
2,623,786, PUB. 7-2-2002. INT. CL. 11.
2,625,105, PUB. 7-2-2002. INT. CL. 11.
2,625,106, PUB. 7-2-2002. INT. CL. 7.
2,625,107, PUB. 7-2-2002. INT. CL. 11.
- EDISON BROTHERS STORES, INC., ST. LOUIS, DE TO
BAKERS FOOTWEAR GROUP INC., ST. LOUIS, MO:
1,198,008, AM. INT. CL. 25.
- EDISON PRICE LIGHTING, INC., NEW YORK, NY:
1,934,094, CANC. INT. CL. 11.
- EDLONG CORPORATION, THE, ELK GROVE VILLAGE, IL:
2,623,691, PUB. 7-2-2002. MULTIPLE CLASS, INT. CLS. 1,
29 AND 30.
- EDMONDS, MARY J., ZIONSVILLE, IN:
2,625,159, PUB. 7-2-2002. INT. CL. 36.
- EDUCATION WORLD, INC., OKLAHOMA CITY, OK FROM
CONCOURSE C, INC., OKLAHOMA CITY, OK:
2,622,736, PUB. 7-2-2002. MULTIPLE CLASS, INT. CLS. 35
AND 41.
- EDWARD HARVEY LEATHER ACCESSORIES, INC., EXE-
TER, NH:
1,176,085, CANC. MULTIPLE CLASS, INT. CLS. 16, 18, 28
AND 34.
- EDWARDS, RAYMOND A., TUXEDO PARK, NY:
2,624,197, PUB. 7-2-2002. INT. CL. 10.
- EEPARTS.COM, INC., DALLAS, TX:
2,626,824, INT. CL. 35.
- EFFECTIVE PRODUCTS, INC., DEER PARK, NY FROM
CENTURY 21 PRODUCTS, INC., GREAT NECK, NY:
2,625,869, INT. CL. 7.
- EFUSION, INC., BEAVERTON, OR:
2,202,550, CANC. MULTIPLE CLASS, INT. CLS. 9 AND
42.
2,208,042, CANC. MULTIPLE CLASS, INT. CLS. 9 AND
42.
- EGERT, MARTIN, KEWANEE, IL AND EGERT, MI-
CHELLE, KEWANEE, IL:
2,626,274, INT. CL. 5.
- EGG INNOVATIONS, LLC, PORT WASHINGTON, WI:
2,623,628, PUB. 7-2-2002. INT. CL. 29.
- EGGLAND'S BEST, INC., KING OF PRUSSIA, PA AND
HERBRUCK'S POULTRY RANCH, SARANAC, MI:
2,622,824, PUB. 7-2-2002. MULTIPLE CLASS, INT. CLS. 29
AND 30.
- EHP INFORMATIK GMBH, D-53604 BAD HONNEF, DE,
FED REP GERMANY:
2,622,791, PUB. 7-2-2002. INT. CL. 9.
- EIBL, PETER, RHEINE, FED REP GERMANY:
2,625,932, INT. CL. 18.
- EIDOS INTERACTIVE LIMITED, WIMBLEDON, LONDON,
ENGLAND:
2,625,402, INT. CL. 9.
- EILEEN FISHER, INC., IRVINGTON, NY:
2,624,540, PUB. 7-2-2002. INT. CL. 25.
- EISNER, SUSAN, LOS ANGELES, CA:
2,624,281, PUB. 7-2-2002. INT. CL. 14.
- EJEWELRY, LLC, FAIRFIELD, OH:
2,625,856, INT. CL. 35.
- EL DORADO SALES, INC., PHOENIX, AZ:
2,622,573, PUB. 7-2-2002. INT. CL. 42.
- ELAH DUFOUR SOCIETA' ALIMENTARI RIUNITE S.R.L.,
7-16155 GENOVA, ITALY:
2,622,773, PUB. 7-2-2002. INT. CL. 30.
- ELASTIC CORPORATION OF AMERICA, INC., NEW
YORK, NY:
2,622,898, PUB. 7-2-2002. MULTIPLE CLASS, INT. CLS. 5
AND 10.
- ELAXY AG, BAN NEUHEIM, FED REP GERMANY FROM
HEYDE AKTIENGESELLSCHAFT, BAD NAUHEIM, FED
REP GERMANY:
2,623,859, PUB. 7-2-2002. MULTIPLE CLASS, INT. CLS. 9,
41 AND 42.
- ELDER-BEERMAN STORES CORPORATION, THE, DAY-
TON, OH:
2,625,820, INT. CL. 25.
- ELECTRICAL SOUTH LIMITED PARTNERSHIP, GREEN-
SBORO, NC:
2,626,856, MULTIPLE CLASS, INT. CLS. 9 AND 35.
- ELECTRO CHECK, INC., HERNDON, VA:
2,625,969, INT. CL. 42.
- ELECTRO-FIX, INC., NORTH ATTLEBORO, MA:
1,175,924, CANC. INT. CL. 9.
- ELECTROLUX HOME PRODUCTS, INC., CLEVELAND, OH
FROM WHITE CONSOLIDATED INDUSTRIES, INC.,
CLEVELAND, OH:
2,626,256, INT. CL. 11.
- ELECTRONIC DATA SYSTEMS CORPORATION, PLANO,
TX:
1,933,879, CANC. INT. CL. 42.
- ELECTRONIC INDUSTRIES CORP., PLEASANTVILLE, NJ:
2,626,948, INT. CL. 9.
- ELECTRONIC LABEL TECHNOLOGY, INC., BROKEN AR-
ROW, OK:
2,626,320, INT. CL. 2.
- ELECTRONIC TRANSACTIONS ASSOCIATION, KANSAS
CITY, MO:
2,624,468, PUB. 7-2-2002. INT. CL. 16.
- ELECTRONICS CORPORATION OF AMERICA, CAM-
BRIDGE, MA:
723,594, CANC. U.S. CL. 26.
- ELF LUBRICANTS NORTH AMERICA INC., LINDEN, NJ:
1,933,469, CANC. INT. CL. 21.
- ELGAR ELECTRONICS CORPORATION, SAN DIEGO, CA:
2,624,856, PUB. 7-2-2002. INT. CL. 9.
2,624,857, PUB. 7-2-2002. INT. CL. 9.
- ELIO CAVAGNA S.R.L., 20077 MELEGNANO, ITALY:
1,663,171, CANC. INT. CL. 7.
- ELITE INFORMATION SYSTEMS, INC., LOS ANGELES,
CA:
2,625,433, INT. CL. 9.
- ELLEX MEDICAL PTY. LTD., ADELAIDE, SOUTH, AUS-
TRALIA FROM TARACAN PTY. LTD, ADELAIDE,
SOUTH AUSTRALIA 5000, AUSTRALIA:
2,626,303, INT. CL. 10.
- ELLIS, JOHN, LOS ANGELES, CA:
2,623,060, PUB. 7-2-2002. INT. CL. 42.
- ELLIS, LYNDA, SANTA BARBARA, CA:
2,624,771, PUB. 7-2-2002. INT. CL. 36.
- ELLMAN INTERNATIONAL, INC., HEWLETT, NY:
2,626,112, INT. CL. 10.
- ELSCO, INC., SAN DIEGO, CA:
1,932,922, CANC. INT. CL. 3.
- EMC CORPORATION, HOPKINTON, MA:
2,623,553, PUB. 7-2-2002. INT. CL. 41.
2,623,554, PUB. 7-2-2002. INT. CL. 35.
2,623,555, PUB. 7-2-2002. INT. CL. 42.
2,623,556, PUB. 7-2-2002. INT. CL. 42.
2,623,557, PUB. 7-2-2002. INT. CL. 35.
- EMC DOCUMENT SYSTEMS, INC., BATAVIA, IL:
2,623,033, PUB. 7-2-2002. INT. CL. 7.
- EMCO LIMITED, LASALLE, QUEBEC, CANADA:
2,622,909, PUB. 7-2-2002. INT. CL. 19.
- EMERSON ELECTRIC CO., ST LOUIS, MO:
2,622,875, PUB. 7-2-2002. MULTIPLE CLASS, INT. CLS. 7,
9 AND 11.
- EMERSON ELECTRIC CO., ST. LOUIS, MO:
2,625,384, INT. CL. 7.
- EMHART INC., NEWARK, DE:
2,625,910, INT. CL. 11.
- EMILIO MAURI S.P.A., 23818 PASTURO (LECCO), ITALY:
2,623,255, PUB. 7-2-2002. INT. CL. 29.
- EMISSARY, LLC, AUSTIN, TX:
2,623,046, PUB. 7-2-2002. MULTIPLE CLASS, INT. CLS. 35
AND 42.
- EMITEC GESELLSCHAFT FUR EMISSIONSTECHOLOGIE
MBH, LOHMAR, FED REP GERMANY:
2,625,381, MULTIPLE CLASS, INT. CLS. 7 AND 11.
- EMMA L. BIXBY MEDICAL CENTER, ADRIAN, MI:
2,623,923, PUB. 7-2-2002. INT. CL. 42.
- EMMIS FM RADIO CORPORATION OF INDIANAPOLIS,
INDIANAPOLIS, IN:
1,933,090, CANC. INT. CL. 38.
1,933,115, CANC. INT. CL. 38.

- EMPIRE ENTERPRISES, INC., SHELBYVILLE, TN:
1,176,160, CANC. INT. CL. 16.
- EMPRESA PESQUERA ROBINSON CRUSOE, S.A., SANTIAGO, CHILE:
2,623,985, PUB. 7-2-2002. INT. CL. 42.
- ENATEC SOFTWARE SYSTEMS, INC., CUPERTINO, CA:
1,933,982, CANC. INT. CL. 9.
- ENCORE MEDIA CORPORATION, DENVER, CO:
1,933,821, CANC. MULTIPLE CLASS, INT. CLS. 38 AND 41.
1,933,957, CANC. MULTIPLE CLASS, INT. CLS. 38 AND 41.
1,933,959, CANC. MULTIPLE CLASS, INT. CLS. 38 AND 41.
- ENDOART SA, SWITZERLAND:
2,623,468, PUB. 7-2-2002. INT. CL. 10.
- ENDOCARE, INC., IRVINE, CA:
2,626,598, INT. CL. 10.
- ENDRESS + HAUSER CONDUCTA MESS- UND REGEL-TECHNIK GMBH & CO., D-70839 GERLINGEN, FED REP GERMANY:
2,623,275, PUB. 7-2-2002. INT. CL. 9.
- ENERNET, INC., REDLANDS, CA, DBA ENERPATH:
2,624,061, PUB. 7-2-2002. INT. CL. 9.
- ENGELHARD CORPORATION, ISELIN, NJ:
1,933,685, CANC. INT. CL. 1.
- ENGINEERING ANALYSIS ASSOCIATES INC., BINGHAM FARMS, MI:
2,626,140, INT. CL. 42.
- ENGLEWOOD PARTNERS LLC, ENGLEWOOD, NJ:
2,623,714, PUB. 7-2-2002. INT. CL. 37.
- ENGLISH TEA HOUSE, LTD., WASHINGTON, DC:
2,625,864, INT. CL. 30.
- ENI TECHNOLOGY, INC., ROCHESTER, NY, ASTEC AMERICA, INC., OCEANSIDE, CA:
1,686,133, REN. 8-10-02. INT. CL. 9.
1,686,134, REN. 8-10-02. INT. CL. 9.
- ENRECO, INC., MANITOWOC, WI:
2,624,269, PUB. 7-2-2002. INT. CL. 31.
- ENSKILDA SECURITIES HOLDING AB, STOCKHOLM, SWEDEN:
2,624,999, PUB. 7-2-2002. INT. CL. 36.
- ENTEK IRD INTERNATIONAL CORPORATION, MILFORD, OH:
2,625,538, INT. CL. 9.
- ENTERPRISE MESSAGING SERVICES, INC., WEST CHESTER, PA:
2,622,674, PUB. 7-2-2002. MULTIPLE CLASS, INT. CLS. 9 AND 38.
2,622,675, PUB. 7-2-2002. MULTIPLE CLASS, INT. CLS. 9 AND 38.
- ENTERTAINMENT SYSTEMS TECHNOLOGY, INC., HUNTINGTON BEACH, CA:
2,626,765, INT. CL. 9.
- ENTHERMICS MEDICAL SYSTEMS INC., MEMONONEE FALLS, WI:
2,626,086, INT. CL. 10.
- ENTREMED, OAKLAND, CA:
1,932,562, CANC. INT. CL. 35.
- ENTRUST AGENCIES, INC., HOUSTON, TX:
2,622,717, PUB. 7-2-2002. INT. CL. 36.
- ENVIRO-DYNAMICS, INC., DALLAS, TX:
2,626,262, INT. CL. 21.
- ENVIRONMANAGEMENT, ST. LOUIS, MO:
1,933,045, CANC. INT. CL. 40.
- ENVIRONMENTAL SITE ASSESSMENTS, LLC, LOUISVILLE, KY:
2,623,196, PUB. 7-2-2002. INT. CL. 36.
- ENZYMATIC THERAPY, INC., GREEN BAY, WI:
1,933,695, CANC. INT. CL. 5.
- EON TECHNOLOGIES, LTD., DUBLIN 2, IRELAND:
2,622,834, PUB. 7-2-2002. INT. CL. 9.
- EORIGINAL, INC., BALTIMORE, MD:
2,622,983, PUB. 7-2-2002. MULTIPLE CLASS, INT. CLS. 9, 38 AND 39.
- EPIK COMMUNICATION INCORPORATED, ORLANDO, FL FROM FEC TELECOM, INC., ORLANDO, FL:
2,625,745, INT. CL. 38.
2,625,865, INT. CL. 38.
- EPIUM PLC, BERKSHIRE RG40 3SS, ENGLAND:
2,623,832, PUB. 7-2-2002. MULTIPLE CLASS, INT. CLS. 9, 36, 41 AND 42.
- EPOCA, INC., EAST BRUNSWICK, NJ:
2,626,120, INT. CL. 21.
- EPSILON ELECTRONICS, INC., COMMERCE, CA:
2,623,662, PUB. 12-18-2001. INT. CL. 9.
- EPSTEIN, DARREN L., FT. LAUDERDALE, FL:
2,626,069, INT. CL. 42.
- EQUALITY NOW, INC., NEW YORK, NY:
1,933,026, CANC. INT. CL. 42.
- EQUINIX USA, INC., ARLINGTON, MA:
2,623,762, PUB. 7-2-2002. MULTIPLE CLASS, INT. CLS. 9 AND 42.
- EQUUS GROUP, INC., TULSA, OK:
1,934,302, CANC. INT. CL. 25.
- ERB INDUSTRIES, INC., WOODSTOCK, GA:
2,626,066, INT. CL. 9.
- ERCO LEUCHTEN GMBH, 58507 LUDENSCHIED, FED REP GERMANY:
2,626,135, INT. CL. 11.
- ERCOLE BELTRAMINI, INC., MAPLEWOOD, NJ:
1,932,865, CANC. INT. CL. 16.
- ERGO PARTNERS, L.C., LAKE QUIVIRA, KS:
2,626,739, INT. CL. 9.
- ERGOFLEX, INC., CARPENTERSVILLE, IL:
2,624,576, PUB. 7-2-2002. INT. CL. 35.
- ERGONOMIC WORLD, INC., TARPON SPRINGS, FL:
2,626,188, INT. CL. 42.
- ERI ECONOMIC RESEARCH INSTITUTE, INC., REDMOND, WA:
2,622,695, PUB. 7-2-2002. INT. CL. 9.
2,625,034, PUB. 7-2-2002. INT. CL. 9.
- ERIE MUNICIPAL AIRPORT AUTHORITY, ERIE, PA:
2,626,128, INT. CL. 39.
- ERLANGER GROUP, LTD., THE, BRAINTREE, MA FROM BALSAN-HERCULES GROUP LTD., THE, NEW YORK, NY:
2,625,843, INT. CL. 24.
- ERNST & YOUNG U.S. LLP, NEW YORK, NY:
2,157,531, CANC. INT. CL. 42.
- ERNST BENZ LIMITED, WILMINGTON, NC:
2,626,516, INT. CL. 14.
2,626,517, INT. CL. 14.
- ERNST MUHLBAUER GMBH & CO. KG, 25870 NORDER-FRIEDRICHSKOOG, FED REP GERMANY FROM ERNST MUHLBAUER KG, D-22547 HAMBURG, FED REP GERMANY:
2,622,815, PUB. 10-30-2001. INT. CL. 5.
- ERNST MUHLBAUER KG:
See—ERNST MUHLBAUER GMBH & CO. KG.
- ERP OPERATING LIMITED PARTNERSHIP, CHICAGO, IL:
2,626,932, INT. CL. 36.
- ERRANDS N MORE LLC, MUNCIE, IN:
2,625,847, MULTIPLE CLASS, INT. CLS. 39 AND 42.
- ERWIN-KEITH, INC., WYNNE, AR:
2,625,670, INT. CL. 31.
- ESCO CORPORATION, PORTLAND, OR:
1,663,186, CANC. INT. CL. 7.
- ESI INTERNATIONAL, ARLINGTON, VA:
2,626,892, INT. CL. 16.
- ESIRG'S MANUFACTURING CO., INC., SACRAMENTO, CA, AKA ESIRG MFG. CO., INC.:
1,663,136, CANC. INT. CL. 3.
- ESJ DESIGN, LLC, GRAND RAPIDS, MI:
2,626,178, INT. CL. 42.
- ESMOD, 75009 PARIS, FRANCE:
2,623,956, PUB. 7-2-2002. MULTIPLE CLASS, INT. CLS. 16, 35, 40, 41 AND 42.
- ESOLO.COM, INC., SAN FRANCISCO, CA:
2,623,595, PUB. 7-2-2002. INT. CL. 38.
- ESP CO., LTD., CHIYODA-KU, TOKYO, JAPAN:
1,205,405, REN. 8-10-02. INT. CL. 15.

- ESPIAL, INC., ENGLEWOOD, CO:
1,932,765, CANC. INT. CL. 3.
- ESPN, INC., BRISTOL, CT:
2,623,987, PUB. 7-2-2002. INT. CL. 41.
- ESQUIVEL APPAREL, ANAHEIM, CA:
2,623,045, PUB. 7-2-2002. INT. CL. 25.
- ESSELTE PENDAFLEX CORPORATION, PARAMUS, NJ:
1,171,854, CANC. INT. CL. 2.
- ESSILOR OF AMERICA, INC., ST. PETERSBURG, FL:
1,713,292, REN. 8-16-02. INT. CL. 9.
- ESTEE LAUDER INC., NEW YORK, NY TO ESTEE LAUDER INC., NEW YORK, NY:
915,196, CANC. U.S. CL. 51.
- ESTEE LAUDER INC., NEW YORK, NY:
2,624,844, PUB. 7-2-2002. INT. CL. 3.
- ESTUDIOLIVE, INC., CHELMSFORD, MA FROM ECHOLAB, INC., CHELMSFORD, MA:
2,626,790, INT. CL. 9.
- ETF GROUP, 6928 MANNO, SWITZERLAND:
2,622,871, PUB. 7-2-2002. INT. CL. 35.
- ETHICAL INTERNET RETAILERS ASSOCIATION, LLC, BEACHWOOD, OH:
2,626,254, U.S. CL. 200.
- ETHNIC GOURMET FOODS, INC., FRAMINGHAM, MA:
2,624,280, PUB. 7-2-2002. INT. CL. 29.
- ETIENNE AIGNER, INC., NEW YORK, NY:
2,625,625, INT. CL. 25.
- EUGENE STEPTOE, SAN FRANCISCO, CA FROM BOSSALINI, SAN FRANCISCO, CA:
2,625,599, INT. CL. 25.
- EUPEC EUROPAISCHE GESELLSCHAFT FUR LEISTUNGSHALBLEITER MBH & CO. KG, WARSTEIN-BELECKE, FED REP GERMANY:
2,624,079, PUB. 7-2-2002. INT. CL. 9.
- EUREXPAN-LABO S.A., 41120 CELLETES, FRANCE:
1,934,366, CANC. INT. CL. 9.
- EUROPEAN PATENT ORGANIZATION, THE, D-80331 MURNICH, FED REP GERMANY:
2,622,639, PUB. 1-9-2001. INT. CL. 42.
- EUROSTAR, INC., LOS ANGELES, CA:
2,625,705, INT. CL. 25.
- EUSTIS ENTERPRISES, INC., ASHBURNHAM, MA:
2,626,906, INT. CL. 20.
- EVANSGROUP, INC., SALT LAKE CITY, UT:
1,932,466, CANC. INT. CL. 35.
- EVEREADY BATTERY COMPANY, INC., ST. LOUIS, MO:
2,626,522, INT. CL. 9.
- EVEREST DOMAIN SERVICES, LLC, CHICAGO, IL:
2,624,041, PUB. 7-2-2002. MULTIPLE CLASS, INT. CLS. 9 AND 42.
- EVERLITE, INC., LONGVIEW, TX:
2,624,588, PUB. 7-2-2002. INT. CL. 12.
- EVERYTHING PREPAID, INC., DALLAS, TX:
2,624,831, PUB. 7-2-2002. INT. CL. 36.
- EXACTO INC., RICHMOND, IL:
2,623,328, PUB. 7-2-2002. INT. CL. 35.
- EXACTTARGET, LLC, GREENFIELD, IN:
2,624,201, PUB. 7-2-2002. INT. CL. 35.
- EXCEL NETWORKS, INCORPORATED, SWARTHMORE, PA:
2,626,538, INT. CL. 42.
- EXCELSIOR FITNESS EQUIPMENT CO., NORTHBROOK, IL:
1,176,363, CANC. INT. CL. 28.
- EXECUTIVE DIMENSIONS, LTD, OXFORD, NC, DBA SOFTWARE DIMENSIONS:
2,623,102, PUB. 7-2-2002. INT. CL. 9.
- EXELUS, LLC, MINNEAPOLIS, MN:
2,623,692, PUB. 7-2-2002. INT. CL. 37.
- EXIDE CORPORATION, READING, PA:
1,933,877, CANC. INT. CL. 9.
- EXONHIT THERAPEUTICS SA, PARIS, FRANCE:
2,625,901, INT. CL. 42.
- EXOUSIA MINISTRIES, INC., BROOKLYN, NY:
1,932,921, CANC. INT. CL. 41.
- EXPANDACARD LTD., RUISLIP, MIDDLESEX, UNITED KINGDOM FROM PRINT LAMINATION PLASTICS LIMITED, UXBRIDGE, MIDDLESEX UB9 4BJ, UNITED KINGDOM:
2,625,348, MULTIPLE CLASS, INT. CLS. 16 AND 35.
- EXPERIMENTAL AIRCRAFT ASSOCIATION, INC., OSHKOSH, WI:
1,933,822, CANC. MULTIPLE CLASS, INT. CLS. 41 AND 42.
- EXPERT SYSTEMS PUBLISHING COMPANY, LAKE OSWEGO, OR:
1,934,034, CANC. INT. CL. 9.
- EXPRESSCO, INC., WILMINGTON, DE:
1,984,156, CANC. MULTIPLE CLASS, INT. CLS. 25 AND 36.
- EXPRESSIONTOOLS, INC., FUKUOKA-SHI FUKUOKA-KEN, JAPAN:
2,626,171, INT. CL. 9.
- EXQUISITE ACQUISITION INC., LONG ISLAND CITY, NY:
1,663,799, CANC. INT. CL. 25.
- EXTECH INSTRUMENTS CORP., WALTHAM, MA:
2,626,441, INT. CL. 9.
- EXTENSIONS IN CARE, INC., STREETSBORO, OH:
1,933,741, CANC. INT. CL. 9.
- EXTERIOR SYSTEMS, INC., MACEDONIA, OH:
2,626,527, INT. CL. 19.
- EXTREME ATHLETIC CORP, SUGAR LAND, TX:
2,625,524, INT. CL. 5.
- EYE CARE CENTERS OF AMERICA, INC., SAN ANTONIO, TX:
2,623,042, PUB. 7-2-2002. INT. CL. 9.
- EYVIND EARLE PUBLISHING LLC, MONTEREY, CA:
2,623,898, PUB. 7-2-2002. INT. CL. 16.
- E2GROW, INC., CHESTERLAND, OH:
2,626,555, MULTIPLE CLASS, INT. CLS. 35, 38 AND 42.
- F & P INC., PASADENA, CA:
1,934,166, CANC. INT. CL. 35.
- F. C. FEISE COMPANY, NARBERTH, PA:
723,453, CANC. U.S. CL. 12.
- F. M. BROWN'S SONS, INC., SINKING SPRING, PA:
1,933,089, CANC. INT. CL. 31.
- FABBRICA D'ARMI P. BERETTA, S.P.A., PROVINCE OF BRESCIA, ITALY:
2,625,997, INT. CL. 14.
- FABRICA MOLINERA SALVADORENA S.A., ANTIGUO CUSCATLAN, EL SALVADOR:
1,698,473, REN. 8-15-02. INT. CL. 30.
- FACE & BODY PROFESSIONALS, INC., NOVATO, CA:
2,624,673, PUB. 7-2-2002. INT. CL. 5.
- FACTOR 5, LLC, SAN RAFAEL, CA:
2,625,533, INT. CL. 9.
2,625,562, INT. CL. 9.
- FADA ITALIA S.P.A., 00196 ROME, ITALY:
2,624,003, PUB. 7-2-2002. MULTIPLE CLASS, INT. CLS. 1, 5 AND 10.
- FAI GROUP, INC., NEW YORK, NY:
1,933,467, CANC. INT. CL. 41.
- FAIR MARKET, INC., WENTZVILLE, MO:
2,623,794, PUB. 7-2-2002. INT. CL. 29.
- FAIRCHILD HOLDING CORP., DULLES, VA, CAMLOC FASTENER CORPORATION, PARAMUS, NJ:
731,729, REN. 8-14-02. U.S. CL. 13 (INT. CL. 6).
- FAIRCHILD PUBLICATIONS, INC., NEW YORK, NY:
2,624,545, PUB. 7-2-2002. MULTIPLE CLASS, INT. CLS. 35 AND 42.
- FAIRWAY UNDERWRITERS INC, LOWELL, ME:
2,626,301, INT. CL. 36.
- FALK CORPORATION, THE, MILWAUKEE, WI:
723,541, CANC. U.S. CL. 23.
- FAME INTERNATIONAL LIMITED, PORT LOUIS, MAURITIUS:
2,624,981, PUB. 7-2-2002. MULTIPLE CLASS, INT. CLS. 9, 35, 38, 41 AND 42.
- FAMIGLIETTA, STEVEN R., BROOKLYN, NY:
2,627,021, INT. CL. 42.
- FAMILY QUALITY PORK PROCESSORS COOPERATIVE, CRESTON, NE:
2,624,134, PUB. 7-2-2002. INT. CL. 29.

- FAMILY SAFETY PRODUCTS, INC., GRANDVILLE, MI:
2,624,167, PUB. 7-2-2002. INT. CL. 9.
- FAMILY SNACKS INCORPORATED, LIBERTY, MO:
362,575, CANC. U.S. CL. 46.
- FANCY PUBLICATIONS, INC., LOS ANGELES, CA:
1,687,840. REN. 8-10-02. INT. CL. 16.
- FAPS, INC., PORT NEWARK, NJ:
2,622,786, PUB. 7-2-2002. INT. CL. 37.
- FAR STAR PRODUCTIONS, INC., MARINA DEL REY, CA:
2,625,237, PUB. 7-2-2002. INT. CL. 41.
- FARGES, THIERRY, NEW YORK, NY AND FARGES, AMY,
NEW YORK, NY:
2,045,970, CANC. MULTIPLE CLASS, INT. CLS. 30 AND
31.
- FARHAT, ERNIE, MARINA DEL REY, CA, DBA ZEN GOLF:
2,623,134, PUB. 7-2-2002. INT. CL. 9.
- FARIBAULT FOODS, INC., MINNEAPOLIS, MN, CALIFOR-
NIA LIMA BEAN GROWERS ASSOCIATION, OXNARD,
CA:
278,789. REN. 8-15-02. U.S. CL. 46 (INT. CL. 29).
- FARM & HOME FOODS, INC., ENGLEWOOD, CO:
2,624,962, PUB. 9-18-2001. INT. CL. 29.
- FARM FRESH, INC., NORFOLK, VA TO FARM FRESH,
INC., NORFOLK, VA:
2,244,117, COR. INT. CL. 30.
- FARMER, PETER P., RANCHO SANTA FE, CA:
2,625,077, PUB. 7-2-2002. MULTIPLE CLASS, INT. CLS. 35
AND 41.
- FARMLAND DAIRIES, WALLINGTON, NJ:
1,675,239. REN. 8-16-02. INT. CL. 29.
- FAREL CORPORATION, ANSONIA, CT:
2,625,938, INT. CL. 7.
- FASHION CLICK, INC., LOS ANGELES, CA:
2,622,998, PUB. 7-2-2002. INT. CL. 25.
- FASHION TECH, INC., PORTLAND, OR:
2,625,172, PUB. 7-2-2002. INT. CL. 20.
- FASHIONWALL PRODUCTS COMPANY, INC., FARMING-
TON HILLS, MI:
1,176,219, CANC. INT. CL. 19.
1,176,220, CANC. INT. CL. 19.
- FAT WITCH BAKERY, INC., NEW YORK, NY:
1,716,221. REN. 8-15-02. INT. CL. 30.
- FATHER EDMUND NADOLNY GOOD NEWS FUND, INC.,
NEW BRITAIN, CT:
1,932,954, CANC. INT. CL. 30.
- FBCIP, INC., KATY, TX:
2,625,857, INT. CL. 37.
2,625,859, INT. CL. 35.
- FDMC HOLDINGS, INC., BENSALEM, PA:
2,623,416, PUB. 7-2-2002. INT. CL. 35.
- FEA SOFT CO., LTD., TAEJON, REPUBLIC OF KOREA:
2,625,009, PUB. 7-2-2002. INT. CL. 9.
- FEDERAL HOME LOAN MORTGAGE CORPORATION,
MCLEAN, VA:
2,626,434, INT. CL. 36.
- FEDERAL NAIL MANUFACTURING COMPANY, WIN-
STON-SALEM, NC:
1,175,790, CANC. INT. CL. 6.
- FEDERATED DEPARTMENT STORES, INC., CINCINNATI,
OH:
2,624,143, PUB. 7-2-2002. INT. CL. 35.
- FEDERATED INVESTORS, INC., PITTSBURGH, PA:
1,934,161, CANC. INT. CL. 9.
- FEDERATED WESTERN PROPERTIES, INC., LAS VEGAS,
NV:
2,624,139, PUB. 7-2-2002. INT. CL. 35.
2,626,450, INT. CL. 35.
2,626,451, INT. CL. 35.
- FEDERATION OF DINING ROOM PROFESSIONALS, LLC,
MAHWAH, NJ FROM NUANCE CORPORATION, MAH-
WAH, NJ:
2,625,438, MULTIPLE CLASS, INT. CLS. 9 AND 42.
- FEDERICO PATERNINA, S.A., HARO (LOGRONO), SPAIN:
1,176,447, CANC. INT. CL. 33.
- FEEDBACK SYSTEMS, INC., LONG BEACH, CA:
2,623,032, PUB. 7-2-2002. INT. CL. 35.
- FEEDING FRENZY, INC., SUMMERVILLE, SC:
2,626,929, INT. CL. 16.
2,626,930, INT. CL. 16.
- FEHLBAUM & CO., CH-4132 MUTTENZ, SWITZERLAND:
2,497,843, CANC. IIRN. RESTORED TO S.N. 75-926,513.
- FELIX; LUISA, HOBOKEN, NJ:
1,176,115, CANC. INT. CL. 16.
- FELLER, BRIAN D., RICHBORO, PA:
2,624,717, PUB. 7-2-2002. INT. CL. 30.
- FENDER MUSEUM OF THE ARTS FOUNDATION, COR-
ONA, CA:
2,622,896, PUB. 7-3-2001. MULTIPLE CLASS, INT. CLS.
16, 21, 25 AND 28.
- FENG, HAN, NEW YORK, NY:
2,626,939, INT. CL. 20.
2,626,940, INT. CL. 20.
- FENNEMORE CRAIG A PROFESSIONAL, PHOENIX, AZ:
2,623,639, PUB. 6-4-2002. INT. CL. 42.
- FERNANDEZ, RAMON M., LOS ANGELES, CA:
2,625,619, INT. CL. 41.
- FERRARI S.P.A., 41100 MODENA, ITALY:
2,623,076, PUB. 7-2-2002. INT. CL. 36.
- FERRO CORPORATION (OHIO CORP.):
723,470, CANC. U.S. CL. 12.
- FESTIVAL SHIPPING & TOURIST ENTERPRISES LTD.,
LIMASSOL, CYPRUS:
2,624,245, PUB. 7-2-2002. MULTIPLE CLASS, INT. CLS. 39
AND 42.
- FETZER INSTITUTE, THE, KALAMAZOO, MI:
2,625,631, INT. CL. 41.
- FIBAR, INC., HARRISON, NY:
1,176,427, CANC. INT. CL. 31.
- FIBERWEB SODOCA S.A.R.L., 68600 BIESHEIM, FRANCE:
1,932,820, CANC. INT. CL. 24.
- FIBRES OPTIQUES RECHERCHES ET TECHNOLOGIE,
91410 DOURDAN, FRANCE:
2,625,684, MULTIPLE CLASS, INT. CLS. 9 AND 10.
- FICUS FINANCIAL SERVICES, INC., CHICAGO, IL:
1,932,753, CANC. INT. CL. 36.
- FIDELITY NATIONAL BANK OF BATON ROUGE, BATON
ROUGE, LA:
817,155, CANC. U.S. CL. 102.
- FIDIA S.P.A., 1-35031 ABANO TERME, ITALY:
2,622,626, PUB. 2-26-2002. MULTIPLE CLASS, INT. CLS. 3
AND 5.
- FIEDLER, L.P., ALPHARETTA, GA:
2,624,728, PUB. 7-2-2002. MULTIPLE CLASS, INT. CLS. 37
AND 40.
- FIELD CONTROLS, L.L.C., KINSTON, NC:
2,626,363, INT. CL. 11.
- FIELDCREST CANNON LICENSING, INC., KANNAPOLIS,
NC:
2,625,436, INT. CL. 24.
- FIESTA, S.A., MADRID, SPAIN:
1,934,053, CANC. INT. CL. 30.
- FILAMENT FIBER TECHNOLOGY, INC., BAY HEAD, NJ:
1,933,314, CANC. MULTIPLE CLASS, INT. CLS. 22 AND
23.
- FIN AP S.P.A., COMO, ITALY, SAATI SPA, 22070 APPIANO
GENTILE (COMO), ITALY:
1,689,096. REN. 8-15-02. INT. CL. 24.
- FINAL ANALYSIS, INC., CLEARWATER, FL:
2,625,251, PUB. 7-2-2002. INT. CL. 16.
- FINANCIAL EDUCATION, INC., ST. PAUL, MN:
2,624,845, PUB. 7-2-2002. MULTIPLE CLASS, INT. CLS. 36
AND 41.
- FINANCIAL TIMES LIMITED, THE, LONDON SE1, ENG-
LAND:
1,933,332, CANC. INT. CL. 41.
- FINCASTLE COUNTY CHAIRWORKS, LLC, LOUISVILLE,
KY:
2,625,871, INT. CL. 17.
- FINCK CIGAR COMPANY, SAN ANTONIO, TX:
2,622,569, PUB. 7-2-2002. INT. CL. 34.
- FINDERS INTERNATIONAL LIMITED, GOUDHURST,
UNITED KINGDOM:
2,622,903, PUB. 4-23-2002. INT. CL. 3.

- FINDLAY INDUSTRIES, INC., FINDLAY, OH:
2,622,952, PUB. 7-2-2002. INT. CL. 12.
- FINGERETT, SALLY, COLUMBUS, OH:
2,625,104, PUB. 7-2-2002. INT. CL. 41.
- FINKSTROM PRODUCTIONS LLC, EDEN PRAIRIE, MN:
2,625,513, INT. CL. 16.
- FINO, INC., CHICAGO, IL:
1,933,355, CANC. INT. CL. 20.
- FIORIO S.R.L., 20154 MILAN, ITALY:
1,176,298, CANC. INT. CL. 25.
- FIRE PROGRAM SOLUTIONS, LLC, ESTACADA, OR AND
CALVIN, MICHAEL, HOUT BAY, SOUTH AFRICA, DBA
ACACIA SERVICES:
2,624,358, PUB. 7-2-2002. INT. CL. 9.
- FIREMAN'S FUND INSURANCE COMPANY, SAN FRAN-
CISCO, CA:
1,176,494, CANC. INT. CL. 36.
- FIRESTEED CORPORATION, SEATTLE, WA:
1,886,257, CANC. INT. CL. 33.
- FIRMA DILO ARMATUREN UND ANLAGEN GMBH, D-
87727 BABENHAUSEN, FED REP GERMANY:
2,622,590, PUB. 10-30-2001. MULTIPLE CLASS, INT. CLS.
6, 7, 9, 11 AND 17.
- FIRST AMERICAN BANK, SSB, BRYAN, TX:
2,623,253, PUB. 7-2-2002. INT. CL. 36.
- FIRST AMERICAN NATIONAL BANK, NASHVILLE, TN:
1,932,904, CANC. INT. CL. 36.
- FIRST ARKANSAS MORTGAGE COMPANY, INC., JACK-
SONVILLE, AR:
2,627,020, INT. CL. 36.
- FIRST COLONY COFFEE & TEA COMPANY, INC., NOR-
FOLK, VA:
1,933,520, CANC. INT. CL. 30.
- FIRST DELAWARE LIFE INSURANCE COMPANY, BEV-
ERLY HILLS, CA:
1,466,581, CANC. INT. CL. 36.
- FIRST MANHATTAN CONSULTING GROUP, NEW YORK,
NY:
2,626,413, INT. CL. 35.
- FIRST MEDICA, GREENSBORO, NC:
2,622,884, PUB. 7-2-2002. INT. CL. 10.
- FIRST MICHIGAN BANK CORPORATION, HOLLAND, MI:
1,934,487, CANC. INT. CL. 36.
- FIRST MOVER, INC., BOSTON, MA:
2,625,577, INT. CL. 42.
- FIRST NATIONAL BANK, RONCEVERTE, WV:
2,626,220, INT. CL. 36.
- FIRST NATIONAL BANK OF HOMESTEAD, THE:
See— 1ST NATIONAL BANK OF SOUTH FLORIDA.
- FIRST NATIONAL BANK OF OMAHA, OMAHA, NE:
2,623,476, PUB. 7-2-2002. INT. CL. 36.
2,623,477, PUB. 7-2-2002. INT. CL. 36.
2,626,323, INT. CL. 36.
- FIRST ORGANIC GARDEN COMPANY LIMITED, OTTA-
WA, ONTARIO, CANADA:
1,933,430, CANC. INT. CL. 1.
- FIRST STEPS IN MUSIC LLC, SIMSBURY, CT:
2,624,193, PUB. 7-2-2002. MULTIPLE CLASS, INT. CLS. 16
AND 41.
- FIRST TENNESSEE NATIONAL CORPORATION, MEM-
PHIS, TN:
2,623,458, PUB. 7-2-2002. INT. CL. 36.
- FIRST TEXAS PRODUCTS, L.P., EL PASO, TX, FIRST
TEXAS MANUFACTURING CO., EL PASO, TX:
1,698,890, REN. 8-15-02. INT. CL. 9.
- FIRSTDOOR.COM, INC., KENNESAW, GA:
2,625,593, MULTIPLE CLASS, INT. CLS. 35 AND 36.
- FISCHER PHARMACEUTICALS LTD., BNEI BRAK, IS-
RAEL:
1,899,566, CANC. INT. CL. 5.
- FISCHER, JEFFREY, BOCA RATON, FL:
2,626,139, MULTIPLE CLASS, INT. CLS. 14 AND 25.
- FISCHERWERKE ARTUR FISCHER GMBH & CO. KG., D-
7244 TUMLINGEN/WALDACHTAL, FED REP GER-
MANY:
1,659,435, REN. 8-16-02. MULTIPLE CLASS, INT. CLS. 7
AND 8.
- FISHERY PRODUCTS INTERNATIONAL LIMITED, ST.
JOHN'S, NEWFOUNDLAND, CANADA, CARIBOU FISH-
ERIES, INC., BOSTON, MA:
1,217,128, REN. 8-10-02. INT. CL. 29.
- FITNESS LABS NUTRITION CORPORATION, TORRANCE,
CA:
2,626,477, INT. CL. 5.
- FLAMINGO SURPRISE, INC., MIDDLEBURG HEIGHTS,
OH:
1,932,856, CANC. INT. CL. 41.
- FLANDERS DIAMOND USA, NEW YORK, NY:
2,626,457, INT. CL. 14.
- FLC INSTRUMENTS, INC., SUGAR GROVE, IL:
1,932,527, CANC. MULTIPLE CLASS, INT. CLS. 37, 40
AND 42.
- FLEER/SKYBOX INTERNATIONAL LP, MT. LAUREL, NJ:
2,625,746, INT. CL. 16.
- FLEET BOSTON CORPORATION:
See— FLEETBOSTON FINANCIAL CORPORATION.
- FLEET CREDIT CARD SERVICES, L.P., HORSHAM, PA:
2,626,535, MULTIPLE CLASS, INT. CLS. 35 AND 36.
- FLEET STREET PUBLISHING CORPORATION, GAITHERS-
BURG, MD:
1,691,432, REN. 8-10-02. INT. CL. 16.
- FLEETBOSTON FINANCIAL CORPORATION, BOSTON,
MA FROM FLEET BOSTON CORPORATION, BOSTON,
MA:
2,622,829, PUB. 7-2-2002. INT. CL. 36.
- FLEETWOOD ENTERPRISES, INC., RIVERSIDE, CA:
1,933,016, CANC. INT. CL. 42.
- FLEETWOOD ENTERPRISES, INC., RIVERSIDE, CA FROM
FLEETWOOD ENTERPRISES, INC., RIVERSIDE, CA:
2,625,680, INT. CL. 19.
- FLEETWOOD MANAGEMENT, LLC, WARWICK, RI:
2,624,145, PUB. 7-2-2002. INT. CL. 36.
- FLEMING COMPANIES, INC., OKLAHOMA CITY, OK:
2,624,185, PUB. 7-2-2002. INT. CL. 35.
2,625,726, INT. CL. 30.
- FLENTS PRODUCTS CO., INC., ST. CHARLES, MI:
2,624,587, PUB. 3-5-2002. INT. CL. 3.
- FLEX-FOOT, INC., ALISO VIEJO, CA:
2,625,450, INT. CL. 10.
- FLEXCON COMPANY, INC., SPENCER, MA:
2,625,153, PUB. 7-2-2002. INT. CL. 1.
- FLEXI-MAT CORPORATION, CHICAGO, IL:
913,390, CANC. U.S. CL. 32.
- FLOAT SRL, LIVORNO, ITALY:
2,622,557, PUB. 3-28-2000. INT. CL. 25.
- FLOORSHOP.COM, INC., VENTURA, CA:
2,626,897, INT. CL. 35.
- FLORIDA BOARD OF REGENTS, FOR AND ON BEHALF
OF FLORIDA STATE UNIVERSITY:
See— FLORIDA STATE UNIVERSITY, THE.
- FLORIDA GRAINS, INC., MIAMI, FL:
2,623,630, PUB. 7-2-2002. INT. CL. 35.
- FLORIDA PANTHERS HOCKEY CLUB, LTD., FORT LAU-
DERDALE, FL:
1,932,590, CANC. INT. CL. 21.
- FLORIDA POWER AND LIGHT COMPANY, JUNO BEACH,
FL:
2,625,156, PUB. 7-2-2002. INT. CL. 35.
- FLORIDA ROLLER & BRUSH, INC., MELBOURNE, FL:
1,725,656, REN. 8-15-02. INT. CL. 16.
- FLORIDA SHERIFFS' COUNCIL OF ADVISORY DEPU-
TIES, INC., THE, FT. LAUDERDALE, FL:
1,933,409, CANC. INT. CL. 42.
- FLORIDA STATE UNIVERSITY, THE, TALLAHASSEE, FL
FROM FLORIDA BOARD OF REGENTS, FOR AND ON
BEHALF OF FLORIDA STATE UNIVERSITY, TALLA-
HASSEE, FL:
2,623,851, PUB. 7-2-2002. MULTIPLE CLASS, INT. CLS. 25
AND 41.
- FLORISTS' TRANSWORLD DELIVERY, INC., DOWNERS
GROVE, IL:
2,560,342, COR. INT. CL. 31.
- FLOSCAN INSTRUMENT COMPANY, INC., SEATTLE, WA:
2,626,053, INT. CL. 9.

- FLOW AUTOMATION INC., HOUSTON, TX:
2,623,603, PUB. 7-2-2002. INT. CL. 9.
- FLOWERS, JUDITH T., NOVATO, CA:
2,625,198, PUB. 7-2-2002. INT. CL. 25.
- FLOWTITE TECHNOLOGY A/S, SANDEFJORD, NORWAY
FROM FLUID CONTAINMENT, INC., CONROE, TX:
2,622,564, PUB. 7-2-2002. MULTIPLE CLASS, INT. CLS. 11
AND 19.
- FLUENCE TECHNOLOGY, INC., BEAVERTON, OR:
1,652,227. REN. 8-12-02. INT. CL. 9.
- FLUENT BABY, INC., PALO ALTO, CA:
2,625,879, MULTIPLE CLASS, INT. CLS. 18 AND 25.
2,625,880, MULTIPLE CLASS, INT. CLS. 18 AND 25.
2,626,859, MULTIPLE CLASS, INT. CLS. 9, 16, 28 AND 41.
2,626,860, MULTIPLE CLASS, INT. CLS. 9, 16, 28 AND 41.
2,626,861, MULTIPLE CLASS, INT. CLS. 9, 16, 28 AND 41.
2,626,862, MULTIPLE CLASS, INT. CLS. 9, 16, 28 AND 41.
2,626,863, MULTIPLE CLASS, INT. CLS. 9, 16, 28 AND 41.
2,626,864, MULTIPLE CLASS, INT. CLS. 9, 16, 28 AND 41.
2,626,865, MULTIPLE CLASS, INT. CLS. 9, 16, 28 AND 41.
- FLUENT INC., LEBANON, NH:
1,934,201, CANC. INT. CL. 9.
- FLUID CONTAINMENT, INC.:
See— FLOWTITE TECHNOLOGY A/S.
- FLUOROWARE, INC., CHASKA, MN:
2,626,296, INT. CL. 9.
- FLY IN MY SOUP ENTERTAINMENT, INC., ST. LOUIS
PARK, MN:
2,625,984, INT. CL. 41.
- FMC TECHNOLOGIES, INC., CHICAGO, IL FROM FMC
CORPORATION, PHILADELPHIA, PA:
2,625,346, INT. CL. 42.
- FMR CORP., BOSTON, MA:
1,932,409, CANC. INT. CL. 36.
2,626,682, INT. CL. 36.
- FOAMEX L.P., LINWOOD, PA:
2,626,728, INT. CL. 17.
- FOGCO SYSTEMS, INC., GILBERT, AZ:
2,624,918, PUB. 7-2-2002. INT. CL. 11.
- FOLEY & LARDNER, MILWAUKEE, WI:
2,624,567, PUB. 7-2-2002. MULTIPLE CLASS, INT. CLS. 35
AND 42.
- FOLLETT COLLEGE STORES CORPORATION, ELM-
HURST, IL:
2,625,467, INT. CL. 35.
- FONDA GROUP, INC., THE, OSHKOSH, WI:
2,623,757, PUB. 7-2-2002. INT. CL. 16.
- FOOD ADDICTS ANONYMOUS, INC., WEST PALM
BEACH, FL:
2,622,936, PUB. 7-2-2002. INT. CL. 16.
- FOOD DISTRIBUTORS INTERNATIONAL - - NAWGA/
IFDA, INC., FALLS CHURCH, VA:
2,623,395, PUB. 7-2-2002. INT. CL. 35.
- FOOD FOR HEALTH CO., INC., PHOENIX, AZ:
2,622,763, PUB. 11-27-2001. INT. CL. 5.
- FOODHANDLER INC., WESTBURY, NY FROM ISLAND
POLYETHYLENE BAG & SUPPLY CORP., WESTBURY,
NY:
2,625,922, INT. CL. 21.
- FOOFU INC., WILMINGTON, DE:
1,933,005, CANC. INT. CL. 41.
- FOOTFALL LIMITED, SOLIHULL B90 4LE, UNITED KING-
DOM:
2,623,461, PUB. 7-2-2002. MULTIPLE CLASS, INT. CLS. 9,
16, 35 AND 42.
- FOOTSTAR CORPORATION, MAHWAH, NJ:
2,626,083, INT. CL. 25.
2,626,918, INT. CL. 25.
- FORBES MANAGEMENT CO., INC., NEW YORK, NY,
FORBES INC., NEW YORK, NY:
1,772,664. REN. 8-12-02. INT. CL. 16.
- FORD LISA BETH, RESTON, VA:
2,625,033, PUB. 7-2-2002. INT. CL. 36.
- FORD MOTOR COMPANY, DEARBORN, MI:
1,933,169, CANC. INT. CL. 8.
2,623,439, PUB. 7-2-2002. INT. CL. 28.
- FORREST FINANCIAL, INC., OAKBROOK TERRACE, IL:
1,933,173, CANC. INT. CL. 36.
- FORSYTHE RACING, INC., WHEELING, IL:
2,622,519, PUB. 1-8-2002. INT. CL. 25.
- FORT WAYNE POOLS, INC., FORT WAYNE, IN:
2,623,428, PUB. 7-2-2002. MULTIPLE CLASS, INT. CLS. 6
AND 19.
- FORTIFIBER CORPORATION, INCLINE VILLAGE, NV,
DBA FORTIFIBER BUILDING PRODUCTS SYSTEMS:
2,622,665, PUB. 7-2-2002. INT. CL. 19.
- FORTOP INDUSTRIAL CO., LTD., TAINAN, TAIWAN,
CHINA:
2,625,388, MULTIPLE CLASS, INT. CLS. 11 AND 12.
- FORTRESS MEDICAL SYSTEMS, INC., HOPKINS, MN:
2,625,457, MULTIPLE CLASS, INT. CLS. 9 AND 16.
- FORTUN FOODS, INC., REDMOND, WA:
1,663,522, CANC. INT. CL. 29.
- FORTUNA PUBLISHING, INC., CALABASAS, CA:
1,176,161, CANC. INT. CL. 16.
- FORTUNE PLASTICS, INC., OLD SAYBROOK, CT:
2,624,000, PUB. 7-2-2002. INT. CL. 16.
- FOSTER ASSETS CORPORATION, KWUN TONG, KOW-
LOON, HONG KONG:
2,625,793, MULTIPLE CLASS, INT. CLS. 1 AND 9.
- FOSTER, TOM, PALM DESERT, CA:
2,624,277, PUB. 7-2-2002. INT. CL. 36.
- FOUNDATION FOR A BETTER LIFE, THE, DENVER, CO:
2,559,704, COR. INT. CL. 42.
- FOUNDATION SURGERY AFFILIATES, INC., OKLAHO-
MA CITY, OK:
2,624,483, PUB. 7-2-2002. INT. CL. 35.
2,624,484, PUB. 7-2-2002. INT. CL. 35.
- FOUR D RUBBER CO. LIMITED, HEANOR, DERBYSHIRE,
UNITED KINGDOM:
2,623,686, PUB. 7-2-2002. INT. CL. 10.
- FOURTEENTH CENTURY ZINC CORPORATION, BETH-
LEHEM, PA:
148,185, CANC. U.S. CL. 14.
- FOX DESIGN INTERNATIONAL LIMITED, CHELMS-
FORD, ESSEX CM3 8HQ, UNITED KINGDOM:
2,622,588, PUB. 12-14-1999. INT. CL. 28.
- FOX ELECTRONICS & TECHNOLOGY, INC., LOMBARD,
IL:
1,934,308, CANC. INT. CL. 9.
- FOX, STEPHEN C., CHERRY HILL, NJ:
1,933,429, CANC. MULTIPLE CLASS, INT. CLS. 31, 41
AND 42.
- FOXCRAFT INDUSTRIES, INC., NEW YORK, NY:
1,663,486, CANC. INT. CL. 25.
- FPBA GROUP, LLC, SHERMAN OAKS, CA:
2,624,466, PUB. 7-2-2002. INT. CL. 35.
- FRA FRAGRANCE RESOURCES AGENCY, S.A., CH-1814
LA TOUR-DE-PEILZ, SWITZERLAND:
2,622,574, PUB. 11-30-1999. INT. CL. 1.
- FRAME SPECIALTIES INC., ELKART, IN:
2,624,650, PUB. 7-2-2002. INT. CL. 3.
- FRAN WILSON CREATIVE COSMETICS, INC., NEW YORK,
NY:
2,626,225, INT. CL. 3.
- FRANCE TELECOM, 75015 PARIS, FRANCE:
2,622,572, PUB. 10-17-2000. MULTIPLE CLASS, INT. CLS.
9, 35, 38 AND 42.
- FRANCO MANUFACTURING CO., INC., METUCHEN, NJ:
954,494. REN. 8-13-02. U.S. CL. 42 (INT. CLS. 21 AND 24).
- FRANK LLOYD WRIGHT FOUNDATION, THE, SCOTTS-
DALE, AZ:
1,663,645, CANC. INT. CL. 37.
1,663,673, CANC. INT. CL. 41.
- FRANK W. CAWOOD & ASSOCIATES, PEACHTREE CITY,
GA:
2,622,648, PUB. 7-2-2002. INT. CL. 16.
- FRANKLIN QUEST CO., SALT LAKE CITY, UT:
1,934,321, CANC. INT. CL. 41.
- FREDDIE FRESH'S, INC., SHARON, PA:
2,625,930, INT. CL. 42.
- FREDDIE'S DAISY, INC., CANOGA PARK, CA:
2,623,567, PUB. 7-2-2002. MULTIPLE CLASS, INT. CLS.
24, 25 AND 42.
- FREDERICK GOLDMAN, INC., NEW YORK, NY:
2,626,057, INT. CL. 14.

- FREE, RON, THURMONT, MD:
1,932,821, CANC. INT. CL. 25.
- FREEDMAN, MICHAEL A., OWINGS MILLS, MD:
2,623,716, PUB. 7-2-2002. INT. CL. 25.
- FREELANCERS B.V.B.A., 2630 AARTSELAAR, BELGIUM:
2,623,262, PUB. 7-2-2002. INT. CL. 35.
- FREELIFE INTERNATIONAL LLC, MILFORD, CT:
2,623,143, PUB. 11-6-2001. INT. CL. 5.
- FREEMAN HEALTH SYSTEM, JOPLIN, MO:
2,624,631, PUB. 7-2-2002. INT. CL. 41.
2,626,983, INT. CL. 5.
- FRESENIUS AG, D-61352 BAD HOMBURG, FED REP GERMANY:
2,622,657, PUB. 8-8-2000. INT. CL. 5.
- FRESHLABS, INC., WARREN, MI:
1,175,765, CANC. INT. CL. 5.
- FREUDENBERG NONWOVENS LIMITED PARTNERSHIP, DURHAM, NC, PELLON CORPORATION, NEW YORK, NY:
1,196,848, REN. 8-16-02. INT. CL. 24.
- FRIENDLY ICE CREAM CORPORATION, WILBRAHAM, MA:
2,623,028, PUB. 7-2-2002. INT. CL. 30.
- FRITZ EGGER GESELLSCHAFT M.B.H. & CO., A-6380 ST. JOHANN IN TIROL, AUSTRIA:
2,625,936, MULTIPLE CLASS, INT. CLS. 17, 19, 20 AND 27.
- FROMAGERIES PERREAULT, CHATEAU-GONTIER, FRANCE:
1,176,390, CANC. INT. CL. 29.
- FRONT PORCH CLASSICS, INC., SEATTLE, WA FROM FRONT PORCH CLASSICS, LLC, SEATTLE, WA:
2,624,135, PUB. 7-2-2002. INT. CL. 28.
- FRONT PORCH CLASSICS, LLC:
See— FRONT PORCH CLASSICS, INC..
- FRONTIERS UNLIMITED, INC., SOUTHAMPTON, NY, DBA MILLER PUBLISHING GROUP:
2,627,001, INT. CL. 16.
2,627,002, INT. CL. 16.
2,627,003, INT. CL. 16.
- FRUIT OF THE LOOM, INC., BOWLING GREEN, KY:
2,624,360, PUB. 7-2-2002. INT. CL. 25.
- FSI INTERNATIONAL, INC., CHASKA, MN:
1,696,821, REN. 8-16-02. INT. CL. 9.
- FSJ SERVICES, INC.:
See— HRSERV, INCORPORATED.
- FTL SYSTEMS, INC., ROCHESTER, MN:
2,625,537, INT. CL. 9.
- FUCHS SCHRAUBENWERK GMBH, D-57076 SIEGEN, FED REP GERMANY:
1,932,844, CANC. INT. CL. 6.
- FUEL ADVANTAGE MARKETING, INC., DERRY, NH:
2,626,006, INT. CL. 1.
- FUEL AND MARINE MARKETING LLC, WHITE PLAINS, NY:
2,625,171, PUB. 7-2-2002. INT. CL. 4.
- FUEL LINKS, INC., IRVING, TX:
2,626,229, INT. CL. 35.
- FULFILLMENT PLUS, INC., WALTHAM, MA:
2,625,579, INT. CL. 39.
- FULL SAIL, INC., ORLANDO, FL:
2,624,080, PUB. 7-2-2002. INT. CL. 9.
- FULLER'S CAR WASH, INC., COUNTRYSIDE, IL:
2,624,244, PUB. 6-4-2002. INT. CL. 37.
- FULTON; VERONICA B., DBA J & V FULTON COMPANY:
1,176,369, CANC. INT. CL. 28.
- FUN EXPRESS, INC.:
See— ORIENTAL TRADING COMPANY, INC..
- FUNG SENG INDUSTRIAL CO., LTD., TSUEN WAN N.T., KOWLOON, HONG KONG:
1,934,318, CANC. INT. CL. 28.
1,934,320, CANC. INT. CL. 28.
- FUNNY GARBAGE INC., NEW YORK, NY:
2,624,183, PUB. 7-2-2002. INT. CL. 41.
2,624,184, PUB. 7-2-2002. INT. CL. 41.
- FURNITURE CONCEPTS, INC., PEPPER PIKE, OH:
2,625,239, PUB. 7-2-2002. INT. CL. 35.
- FUSION 360, TURLOCK, CA:
2,623,114, PUB. 7-2-2002. INT. CL. 1.
2,623,115, PUB. 7-2-2002. INT. CL. 1.
- FUTURE DOMAIN CORPORATION, IRVINE, CA:
1,933,844, CANC. INT. CL. 9.
- FUTURE FARMERS OF AMERICA, ALEXANDRIA, VA:
2,047,418, COR. INT. CL. 42.
2,190,609, COR. INT. CL. 16.
- G. D. SEARLE & CO., SKOKIE, IL:
1,934,449, CANC. INT. CL. 5.
- G.F.I. PUBLISHING, INC., TEMPE, AZ:
2,624,805, PUB. 7-2-2002. INT. CL. 16.
- G.H. MUMM & CIE, SOCIETE VINICOLE DE CHAMPAGNE SUCCESSEUR S.A., 51053 REIMS, FRANCE, G. H. MUMM CHAMPAGNE AND ASSOCIATES INCORPORATED (SOCIETE VINICOLE DE CHAMPAGNE, SUCCESSEUR), NEW YORK, NY:
395,907, REN. 8-14-02. U.S. CL. 47 (INT. CL. 33).
- GAB ROBINS NOTH AMERICA, INC., PARSIPPANY, NJ, GAB BUSINESS SERVICES, INC., PARSIPPANY, NJ:
1,716,471, REN. 8-16-02. INT. CL. 36.
- GAB, GAB, GAB, GLEN ELLYN, IL:
2,626,179, INT. CL. 16.
- GAC INTERNATIONAL, INC., CENTRAL ISLIP, NY:
1,959,384, CANC. INT. CL. 10.
- GAFFIN, SAMUEL R., WINTER PARK, FL, DBA ABNORMAL FUN COMICS:
2,626,584, INT. CL. 16.
- GAGE MARKETING GROUP, LLC, PLYMOUTH, MN:
2,624,126, PUB. 7-2-2002. INT. CL. 35.
- GAHLER ENTERPRISES LTD.:
See— NATURAL FACTORS NUTRITIONAL PRODUCTS LTD..
- GAIAM INTERNATIONAL, INC., VENICE, CA:
2,626,963, INT. CL. 28.
- GALAN LAULAND DESIGNS, INC., NEW YORK, NY:
1,933,543, CANC. INT. CL. 25.
- GALAXY FIREWORKS, INC., TAMPA, FL:
2,625,907, INT. CL. 13.
- GALAXY INTERNATIONAL INC., SALT LAKE CITY, UT:
2,626,636, INT. CL. 9.
- GALBRAITH ENTERPRISES, INC., DALLAS, TX:
1,663,784, CANC. INT. CL. 18.
- GALLAHER LIMITED, WEYBRIDGE SURREY KT13 OQU, GREAT BRITAIN:
1,932,715, CANC. INT. CL. 34.
- GALLERY M, DENVER, CO:
2,625,174, PUB. 7-2-2002. INT. CL. 35.
- GALLO CATTLE COMPANY, ATWATER, CA, DBA JOSEPH GALLO FARMS:
2,381,167, CANC. INT. CL. 29.
- GAMEDAY, INC., OMAHA, NE:
2,624,803, PUB. 7-2-2002. INT. CL. 35.
- GAMESVILLE.COM, INC., WATERTOWN, MA:
2,623,147, PUB. 9-18-2001. INT. CL. 41.
- GAMMA FREIGHT FORWARDERS, INC., MIAMI, FL:
2,624,777, PUB. 7-2-2002. INT. CL. 39.
- GANDY, SUSAN, BENICIA, CA AND GANDY, ALLAN, BENICIA, CA:
2,625,191, PUB. 7-2-2002. INT. CL. 27.
- GANT AB, SE-114 32 STOCKHOLM, SWEDEN:
2,626,023, INT. CL. 14.
- GANZ, WOODBRIDGE, ONTARIO L4L 3T2, CANADA:
1,934,224, CANC. INT. CL. 21.
- GARDNER, JOHN F., BRISTOL, BLOOMFIELD, NY, A F & G SUPPLY INC., NEW HOLLAND, PA, DBA THE WILD BIRD MARKETPLACE:
1,686,619, REN. 8-15-02. MULTIPLE CLASS, INT. CLS. 31 AND 42.
- GASLAMP POPCORN CO., SAN DIEGO, CA:
2,626,116, INT. CL. 30.
- GAST MANUFACTURING, INC., BENTON HARBOR, MI:
2,624,093, PUB. 7-2-2002. INT. CL. 36.
- GATES CORPORATION, THE, DENVER, CO:
2,624,912, PUB. 7-2-2002. INT. CL. 7.
- GATES; ELGIN T., IDAHO FALLS, ID:
1,176,644, CANC. U.S. CL. 200.

- GATEWAY, INC., SAN DIEGO, CA:
2,623,568, PUB. 7-2-2002. INT. CL. 28.
2,623,572, PUB. 7-2-2002. INT. CL. 9.
2,623,834, PUB. 7-2-2002. INT. CL. 9.
- GAVIN, PETER, MANCHESTER, MA, DBA MINOR SCALES:
1,933,140, CANC. INT. CL. 28.
- GAXIOLA, ERNESTO FEDERICO PRIETO, MEXICALI, B.C.C.P. 021100, MEXICO:
2,626,798, INT. CL. 29.
- GAYHEALTHINSURANCE SERVICES, INC., SAN DIEGO, CA:
2,624,979, PUB. 10-9-2001. INT. CL. 36.
- GAYLORD CHEMICAL CORPORATION, SLIDELL, LA:
1,698,639. REN. 8-12-02. INT. CL. 1.
1,742,587. REN. 8-12-02. INT. CL. 1.
- GAYLORD CONTAINER CORPORATION, DEERFIELD, IL:
1,688,584. REN. 8-13-02. INT. CL. 42.
- GCP, INC., SANTA MONICA, CA:
1,932,807, CANC. INT. CL. 21.
- GE FINANCIAL ASSURANCE HOLDINGS, INC., LYNCHBURG, VA:
2,622,601, PUB. 7-2-2002. INT. CL. 36.
- GEAR UP TECHNOLOGIES CORPORATION, PERRYSBURG, OH:
1,934,257, CANC. INT. CL. 20.
- GEBO CONVOYEURS CONSULTANTS AND SYSTEMES INC., LAVAL, QUEBEC, CANADA:
2,623,103, PUB. 7-2-2002. MULTIPLE CLASS, INT. CLS. 7, 41 AND 42.
- GEBRUDER SCHUMACHER GERATEBAUGESELLSCHAFT M.B.H., D-5231 EICHELHARDT I WSTERWALD, FED REP GERMANY:
1,932,457, CANC. MULTIPLE CLASS, INT. CLS. 7 AND 9.
- GEL, INC., GREENWOOD, IN:
2,625,640, INT. CL. 41.
- GEISINGER HEALTH SYSTEM FOUNDATION, DANVILLE, PA:
2,624,158, PUB. 7-2-2002. MULTIPLE CLASS, INT. CLS. 41 AND 42.
- GELCO CORPORATION DBA GE CAPITAL FLEET SERVICES:
See— GENERAL ELECTRIC COMPANY.
- GEMS OF THE PAST, INC., EAST HAMPTON, NY:
2,624,252, PUB. 7-2-2002. INT. CL. 35.
- GENEALOGY.COM, LLC, FREMONT, CA FROM BRODERBUND SOFTWARE, INC., NOVATO, CA:
2,626,762, INT. CL. 9.
- GENERAL CABLE TECHNOLOGIES CORPORATION, HIGHLAND HEIGHTS, KY:
2,623,172, PUB. 7-2-2002. INT. CL. 9.
- GENERAL CIGAR CO., INC., BLOOMFIELD, CT:
2,622,503, PUB. 7-2-2002. INT. CL. 34.
2,622,567, PUB. 7-2-2002. INT. CL. 34.
- GENERAL ELECTRIC COMPANY, SCHENECTADY, NY:
929,056. REN. 8-10-02. U.S. CL. 21 (INT. CLS. 7, 9, 11 AND 17).
1,175,945, CANC. INT. CL. 9.
- GENERAL ELECTRIC COMPANY, SCHENECTADY, NY FROM GELCO CORPORATION, EDEN PRAIRIE, MN, DBA GE CAPITAL FLEET SERVICES:
2,623,254, PUB. 7-2-2002. INT. CL. 35.
- GENERAL ELECTRIC COMPANY, WAUKESHA, WI:
2,625,801, INT. CL. 10.
- GENERAL ELECTRIC COMPANY, SCHENECTADY, NY:
2,626,343, INT. CL. 14.
- GENERAL ELECTRIC INFORMATION SERVICES COMPANY, ROCKVILLE, MD:
1,175,915, CANC. INT. CL. 9.
- GENERAL ENGINES CO., INC., LAKE WALES, FL:
2,624,076, PUB. 7-2-2002. INT. CL. 12.
- GENERAL INDUSTRIAL CORPORATION, FT. WORTH, TX:
1,176,493, CANC. INT. CL. 36.
- GENERAL INSTRUMENT CORPORATION, NEW YORK, NY TO GI CORPORATION, CHICAGO, IL:
1,663,294, CANC. INT. CL. 9.
- GENERAL INSTRUMENT CORPORATION, HORSHAM, PA:
2,625,707, INT. CL. 9.
- GENERAL MACHINE PRODUCTS CO., INC., TREVOSE, PA:
2,624,815, PUB. 7-2-2002. MULTIPLE CLASS, INT. CLS. 7 AND 8.
- GENERAL MILLS, INC., MINNEAPOLIS, MN:
1,176,401, CANC. INT. CL. 29.
1,934,267, CANC. INT. CL. 30.
1,934,389, CANC. INT. CL. 30.
2,625,229, PUB. 7-2-2002. INT. CL. 30.
- GENERAL MOTORS ACCEPTANCE CORPORATION, DETROIT, MI:
2,626,734, INT. CL. 36.
- GENERAL MOTORS CORPORATION, DETROIT, MI:
1,933,027, CANC. INT. CL. 41.
1,933,028, CANC. INT. CL. 41.
1,933,029, CANC. INT. CL. 41.
2,625,008, PUB. 7-2-2002. INT. CL. 9.
2,625,050, PUB. 7-2-2002. INT. CL. 26.
2,625,051, PUB. 7-2-2002. INT. CL. 6.
2,625,101, PUB. 7-2-2002. INT. CL. 6.
2,625,102, PUB. 7-2-2002. INT. CL. 6.
2,625,151, PUB. 7-2-2002. INT. CL. 18.
2,625,152, PUB. 7-2-2002. INT. CL. 18.
- GENERAL NUTRITION, INCORPORATED, PITTSBURGH, PA, AKA NATURAL SALES COMPANY:
1,167,992, CANC. INT. CL. 5.
- GENERAL SCIENTIFIC CORPORATION, ANN ARBOR, MI:
1,933,937, CANC. INT. CL. 9.
- GENERAL TECHNOLOGIES, INC., STAFFORD, TX:
2,626,757, INT. CL. 6.
- GENERAL VITAMIN OF NORTH CAROLINA, INC., CARRBORO, NC:
2,624,237, PUB. 7-2-2002. MULTIPLE CLASS, INT. CLS. 5 AND 35.
- GENERAL WIG MANUFACTURERS, INC., MIAMI LAKES, FL:
2,626,271, MULTIPLE CLASS, INT. CLS. 3, 18, 20, 21, 25 AND 26.
- GENERRA COMPANY, THE, SEATTLE, WA:
1,933,536, CANC. INT. CL. 25.
- GENESIS HEALTH SYSTEMS, LLC, LOUISVILLE, KY:
2,624,703, PUB. 7-2-2002. INT. CL. 42.
- GENESIS MICROCHIP INC., THORNHILL, ONTARIO, CANADA:
2,626,866, INT. CL. 9.
- GENETIC SERVICES MANAGEMENT, INC., OMAHA, NE:
2,626,611, INT. CL. 5.
- GENETIC SOLUTIONS PTY LTD, FAIRFIELD GARDENS QLD 4103, AUSTRALIA:
2,623,900, PUB. 7-2-2002. MULTIPLE CLASS, INT. CLS. 16, 35 AND 42.
- GENETICA DNA LABORATORIES, INC., CINCINNATI, OH:
2,624,695, PUB. 7-2-2002. INT. CL. 16.
- GENMECH AEROSPACE CORPORATION, FARMINGDALE, NY:
2,624,908, PUB. 7-2-2002. INT. CL. 40.
- GENNUM CORPORATION, BURLINGTON, ONTARIO, CANADA:
1,933,403, CANC. INT. CL. 9.
- GENOMEWEB LLC, NEW YORK, NY:
2,626,838, INT. CL. 42.
- GENTEK BUILDING PRODUCTS, INC., CLEVELAND, OH, ALCAN ALUMINUM CORPORATION, CLEVELAND, OH:
1,231,131. REN. 8-15-02. INT. CL. 19.
- GENTRA SYSTEMS, INC., MINNEAPOLIS, MN:
2,624,976, PUB. 7-2-2002. INT. CL. 9.
- GENUITY INC., BURLINGTON, MA:
2,623,270, PUB. 7-2-2002. MULTIPLE CLASS, INT. CLS. 38 AND 42.
- GENX INTERNATIONAL, INCORPORATED, GUILFORD, CT:
2,627,004, INT. CL. 10.
- GENZYME CORPORATION, CAMBRIDGE, MA:
2,625,855, INT. CL. 10.

- GEOPHYSICAL SERVICE INCORPORATED, CALGARY, ALBERTA T2P 0L6, CANADA:
2,626,875, MULTIPLE CLASS, INT. CLS. 35, 39 AND 42.
- GEORGE, IRENE, OXFORDSHIRE OX7 6SJ, ENGLAND AND TYACK, VINCE, OXFORDSHIRE OX7 6SJ, ENGLAND:
2,624,117, PUB. 7-2-2002. MULTIPLE CLASS, INT. CLS. 9, 16 AND 25.
- GEORGIA TECH ALUMNI ASSOCIATION, ATLANTA, GA:
2,624,065, PUB. 7-2-2002. INT. CL. 42.
- GEORGIA-PACIFIC CORPORATION, PORTLAND, OR:
1,176,182, CANC. INT. CL. 16.
- GEORGIA-PACIFIC CORPORATION, ATLANTA, GA:
2,626,374, INT. CL. 19.
- GEORGIA-PACIFIC WEST, INC., PORTLAND, OR:
1,624,307, CANC. INT. CL. 1.
- GERBER GROUP, INC., THE, SKOKIE, IL:
2,626,606, INT. CL. 37.
- GET FINANCIAL ADVICE, INC., CHARLOTTE, NC:
2,624,363, PUB. 7-2-2002. INT. CL. 35.
- GET OFF ME WEAR, INC., GARDEN GROVE, CA:
1,934,352, CANC. INT. CL. 25.
- GETRONICS NEDERLAND B.V., 1043 AJ AMSTERDAM, NETHERLANDS:
2,622,700, PUB. 7-2-2002. INT. CL. 38.
2,622,701, PUB. 7-2-2002. INT. CL. 35.
- GETTY, PAUL M., BOCA RATON, FL:
2,623,527, PUB. 7-2-2002. INT. CL. 42.
- GI-GO TOYS FACTORY LTD., YAU TONG KOWLOON, HONG KONG:
2,622,746, PUB. 7-2-2002. INT. CL. 28.
- GIANT BICYCLE, INC., NEWBURY PARK, CA:
1,696,911, REN. 8-16-02. INT. CL. 12.
- GIANT BICYCLE, INC., RANCHO DOMINGUEZ, CA:
1,933,658, CANC. INT. CL. 12.
- GIANT ELECTRIC TRANSFORMER CO., LTD., SI HU TOWN, CHANG HUA HSIEN 514, TAIWAN:
2,623,793, PUB. 7-2-2002. INT. CL. 9.
- GIANT FOOD INC., LANDOVER, MD:
1,176,399, CANC. INT. CL. 29.
- GIAT INDUSTRIES, 78034 VERSAILLES, FRANCE:
2,622,617, PUB. 7-2-2002. MULTIPLE CLASS, INT. CLS. 12 AND 13.
- GIBBENS GROUP INSURANCE AGENCY LTD., GUELPH, ONTARIO N1G 4T3, CANADA:
1,932,452, CANC. INT. CL. 36.
- GIBBONS, THERESA, MINNEAPOLIS, MN:
2,626,564, INT. CL. 5.
- GIBSON GUITAR CORP., NASHVILLE, TN:
2,624,523, PUB. 7-2-2002. INT. CL. 15.
2,624,578, PUB. 7-2-2002. MULTIPLE CLASS, INT. CLS. 9 AND 15.
- GIBSON WINE COMPANY, SANGER, CA, DBA GIBSON VINEYARDS:
1,933,172, CANC. INT. CL. 33.
- GIE MEDIA, INC., CLEVELAND, OH:
2,624,609, PUB. 7-2-2002. INT. CL. 9.
- GILBERT/ROBINSON, INC., KANSAS CITY, MO:
1,933,273, CANC. INT. CL. 42.
- GILLESPIE ORGANIZATION, INC., THE, LAWRENCEVILLE, NJ:
2,626,643, INT. CL. 35.
- GILLETTE COMPANY, THE, BOSTON, MA:
1,176,169, CANC. INT. CL. 16.
- GILMAN COMPANY, INC., THE, CHATTANOOGA, TN:
723,477, CANC. U.S. CL. 12.
- GINGER CLUB, INC., SAN FRANCISCO, CA:
1,933,052, CANC. INT. CL. 42.
- GIOLFO & CALCAGNO S.P.A., GENOA, ITALY:
2,623,730, PUB. 7-2-2002. INT. CL. 29.
- GIORGIO, INC., CINCINNATI, OH, GIORGIO, INC., BEVERLY HILLS, CA:
1,163,298, REN. 8-12-02. INT. CL. 3.
- GIOVINA INTERNATIONAL NUTRITION, INC., WESTON, ONTARIO M9P 1L3, CANADA:
2,624,140, PUB. 7-2-2002. INT. CL. 42.
- GITS FOOD PRODUCTS PVT. LTD., BANDRA (E), MUMBAI - 400 051, INDIA:
2,623,969, PUB. 7-2-2002. INT. CL. 30.
- GIVAUDAN SA, 1214 VERNIER, SWITZERLAND:
2,624,947, PUB. 7-2-2002. MULTIPLE CLASS, INT. CLS. 1, 4 AND 42.
- GLACIER INDUSTRIES LTD., MISSION, BRITISH COLUMBIA, CANADA:
2,625,015, PUB. 7-2-2002. INT. CL. 11.
- GLADCO ENTERPRISES, INC., CORAOPOLIS, PA:
1,933,448, CANC. INT. CL. 42.
- GLAMOUR SHOTS LICENSING, INC., OKLAHOMA CITY, OK, DBA GLAMOUR SHOTS:
1,932,499, CANC. MULTIPLE CLASS, INT. CLS. 16 AND 42.
1,932,575, CANC. INT. CL. 42.
- GLASS, PHYLLIS, ALLSTON, MA:
2,623,141, PUB. 7-2-2002. MULTIPLE CLASS, INT. CLS. 41 AND 42.
- GLASSER, ALAN, SANTA CLARITA, CA:
2,626,842, INT. CL. 9.
- GLAXO GROUP LIMITED, MIDDLESEX UB6 0NN, ENGLAND:
1,932,433, CANC. INT. CL. 5.
- GLAXO GROUP LIMITED, GREENFORD, MIDDLESEX UB6 0NN, UNITED KINGDOM:
2,625,335, MULTIPLE CLASS, INT. CLS. 5 AND 10.
- GLAZOV, SHEILA N., BARRINGTON, IL, DBA VISUAL IMPACT PLANNING:
1,933,076, CANC. INT. CL. 41.
- GLEESON, KERRY JOHN, BOCA RATON, FL:
1,932,809, CANC. INT. CL. 9.
- GLICK, ELIZABETH D. VICK, BIG SKY, MT:
2,624,021, PUB. 7-2-2002. MULTIPLE CLASS, INT. CLS. 18, 24 AND 25.
- GLICKSTEIN NEUSTADT INC., PITTSBURGH, PA:
1,932,878, CANC. INT. CL. 41.
- GLOBAL CHANNEL SOLUTIONS, INC., DULUTH, GA:
2,625,163, PUB. 7-2-2002. INT. CL. 9.
- GLOBAL CONCEPTS, INC., LITTLE ROCK, AR:
2,624,195, PUB. 7-2-2002. INT. CL. 42.
- GLOBAL MARKETACTICS, L.L.C., CHICAGO, IL:
1,932,642, CANC. INT. CL. 35.
- GLOBAL RESOURCE NETWORK, LLC, SOUTHFIELD, MI FROM MICHAEL A. SCHULTZ & ASSOCIATES, INC., SOUTHFIELD, MI:
2,625,676, MULTIPLE CLASS, INT. CLS. 35 AND 36.
- GLOBAL SAFETY SURVEILLANCE, INC., LITTLE FALLS, NJ:
2,626,407, INT. CL. 42.
- GLOBALQUEST, LLC, PRINCETON, NJ:
2,624,059, PUB. 7-2-2002. INT. CL. 42.
- GLOBE BUSINESS FURNITURE, INC., HENDERSONVILLE, TN:
1,932,511, CANC. INT. CL. 20.
- GLOBEXPLORER, INC., WALNUT CREEK, CA:
2,622,870, PUB. 7-2-2002. INT. CL. 35.
- GLUE-FOLD, INC., SIGNAL HILL, CA:
1,932,469, CANC. INT. CL. 40.
- GMP CO., LTD., CHUNG-GU, REPUBLIC OF KOREA:
2,622,919, PUB. 7-2-2002. INT. CL. 7.
- GNP - CRESCENDO RECORD CO., INC., LOS ANGELES, CA:
2,622,713, PUB. 7-2-2002. MULTIPLE CLASS, INT. CLS. 35 AND 41.
- GNS DEVELOPMENT CORPORATION, NORWALK, CA:
1,176,573, CANC. INT. CL. 41.
- GO LENDER DIRECT, INC., MISSION VIEJO, CA:
2,622,836, PUB. 7-2-2002. INT. CL. 35.
2,622,837, PUB. 7-2-2002. INT. CL. 35.
- GOAR BIESENKAMP, 81825 MUNCHEN, FED REP GERMANY:
2,625,940, MULTIPLE CLASS, INT. CLS. 25 AND 28.
- GOCARD LLC, NEW YORK, NY:
2,626,675, INT. CL. 35.
- GODFREY, D. KENT, IDAHO FALLS, ID:
2,626,750, INT. CL. 10.

- GODINGER SILVER ART CO., LTD., NEW YORK, NY:
2,626,768, INT. CL. 21.
- GOGGIN, RICHARD J., JR., BROOMALL, PA:
1,933,635, CANC. INT. CL. 38.
- GOLD TOUCH, INC., CLEVELAND, OH:
1,932,890, CANC. MULTIPLE CLASS, INT. CLS. 1 AND 9.
- GOLD, MICHAEL H., NASHVILLE, TN:
2,624,105, PUB. 7-2-2002. INT. CL. 3.
- GOLDBERG, CAROL, SYOSSET, NY:
2,627,023, INT. CL. 42.
- GOLDEN BEAR INTERNATIONAL, INC., NORTH PALM BEACH, FL:
2,626,498, INT. CL. 3.
- GOLDEN CARDS, L.P., MOUNT LAUREL, NJ FROM FLEER CORP., MT. LAUREL, NJ:
2,625,311, INT. CL. 16.
- GOLDEN CROSS TRADING, INC., PHILADELPHIA, PA:
2,623,177, PUB. 7-2-2002. INT. CL. 25.
- GOLDEN PRIDE, INC., WEST PALM BEACH, FL:
2,626,176, INT. CL. 5.
- GOLDSMITHS KAUAI, INC., KAPAA, HI:
2,623,500, PUB. 7-2-2002. INT. CL. 14.
- GOLF AND HOME, INC., NEW CANAAN, CT:
2,625,002, PUB. 7-2-2002. MULTIPLE CLASS, INT. CLS. 36 AND 42.
- GOLFCOACH, INC., THE, TUCKER, GA:
2,624,297, PUB. 7-2-2002. INT. CL. 28.
- GOLFERS 911, INC., GAINESVILLE, GA:
1,934,177, CANC. INT. CL. 3.
- GOLFSMITH INTERNATIONAL, INC., AUSTIN, TX, GOLF LYNX, PARAMOUNT, CA:
943,571, REN. 8-15-02. U.S. CL. 22 (INT. CL. 28).
- GOMBAS, GEORGE, BOULDER, CO TO GOMBAS, GEORGE, BOULDER, CO:
2,525,343, COR. INT. CL. 42.
- GOODNET, INC., MESA, AZ:
1,933,193, CANC. INT. CL. 42.
- GOODWILL COMMUNITY FOUNDATION, INC., DURHAM, NC:
2,624,347, PUB. 7-2-2002. MULTIPLE CLASS, INT. CLS. 35, 36 AND 41.
- GOPETS, INC., WESTON, CT:
2,625,399, MULTIPLE CLASS, INT. CLS. 9 AND 41.
- GORDON, DANA J., PACIFIC GROVE, CA:
2,625,225, PUB. 7-2-2002. INT. CL. 35.
- GOSPEL LIGHT, VENTURA, CA:
2,624,706, PUB. 7-2-2002. INT. CL. 16.
- GOTTA HAVE IT! COLLECTIBLES, INC., NEW YORK, NY:
2,625,249, PUB. 7-2-2002. INT. CL. 35.
- GOURMET A GO GO L.L.C., SOUTHERN PINES, NC:
2,624,722, PUB. 7-2-2002. MULTIPLE CLASS, INT. CLS. 35 AND 42.
- GOURMET BAKERY, INC., UNION CITY, CA:
1,932,952, CANC. INT. CL. 30.
- GRACE, MARK T., BRIDGEWATER, NJ:
2,625,874, INT. CL. 42.
- GRAFF PAY-PER-VIEW, INC., NEW YORK, NY:
1,932,438, CANC. INT. CL. 41.
- GRAHAM CORPORATION, BATAVIA, NY:
2,626,331, MULTIPLE CLASS, INT. CLS. 16 AND 41.
- GRAHAM FORD, INC., COLUMBUS, OH:
2,623,897, PUB. 7-2-2002. INT. CL. 35.
- GRAHL; PAUL F., EDEN, WI:
1,176,661, CANC. INT. CL. 4.
- GRAND BOULE OF THE SIGMA PI PHI FRATERNITY, NEW YORK, NY:
2,622,800, PUB. 3-12-2002. U.S. CL. 200.
- GRAND CASINOS, INC., PLYMOUTH, MN:
1,934,446, CANC. INT. CL. 41.
- GRAND CYPRESS DEVELOPMENT COMPANY, L.L.C., ATLANTA, GA:
2,625,891, MULTIPLE CLASS, INT. CLS. 41 AND 42.
- GRAND HALL ENTERPRISE CO., LTD., NEIHU, TAIPEI, TAIWAN:
2,624,870, PUB. 7-2-2002. INT. CL. 11.
- GRAND SUMMIT RESORT PROPERTIES, INC., BETHEL, ME:
2,622,720, PUB. 7-2-2002. MULTIPLE CLASS, INT. CLS. 35 AND 42.
- GRANDE CHEESE COMPANY, BROWNSVILLE, WI:
2,625,289, PUB. 7-2-2002. INT. CL. 30.
2,625,290, PUB. 7-2-2002. INT. CL. 30.
2,625,291, PUB. 7-2-2002. INT. CL. 30.
- GRANDPARTNERS, INC., WASHINGTON, DC, DBA CARING GRANDPARENTS OF AMERICA:
1,932,863, CANC. INT. CL. 35.
- GRANDVISION, PARIS, FRANCE, BOBROFF, JACQUES, 92400 COURBEVOIE, FRANCE:
1,694,133, REN. 8-16-02. INT. CL. 9.
- GRANDWAY USA CORP., SALT LAKE CITY, UT:
2,625,690, MULTIPLE CLASS, INT. CLS. 1 AND 9.
- GRANDWAY USA CORPORATION, SALT LAKE CITY, UT:
2,625,764, INT. CL. 11.
- GRANGE INSURANCE ASSOCIATION, SEATTLE, WA:
2,624,258, PUB. 7-2-2002. INT. CL. 36.
- GRANT, BRIAN TANO, LOS ANGELES, CA:
2,625,946, INT. CL. 38.
- GRAPHIC ARTS TECHNICAL FOUNDATION, SEWICKLEY, PA:
2,623,688, PUB. 7-2-2002. MULTIPLE CLASS, INT. CLS. 14, 16, 20 AND 25.
- GRASSROOTS SERVICES CORP., BROKEN ARROW, OK:
2,625,186, PUB. 7-2-2002. MULTIPLE CLASS, INT. CLS. 37 AND 42.
- GRATEFUL DEAD PRODUCTIONS, NOVATO, CA:
1,706,358, REN. 8-15-02. INT. CL. 9.
- GRATEFUL DEAD PRODUCTIONS, NOVATO, CA, GRATEFUL DEAD MERCHANDISING, SAN RAFAEL, CA:
1,711,613, REN. 8-15-02. INT. CL. 16.
1,713,536, REN. 8-15-02. INT. CL. 16.
1,715,583, REN. 8-15-02. INT. CL. 16.
- GRATEFUL DEAR PRODUCTIONS, NOVATO, CA, GRATEFUL DEAD MERCHANDISING, SAN RAFAEL, CA:
1,718,272, REN. 8-15-02. INT. CL. 25.
- GRAY, REBECCA, SHERMAN OAKS, CA:
2,625,020, PUB. 7-2-2002. INT. CL. 41.
- GREAT AMERICAN AUDIO CORP., NEW ROCHELLE, NY:
1,934,216, CANC. INT. CL. 9.
- GREAT AMERICAN CATTLE DRIVE, LTD., FORT WORTH, TX:
1,933,021, CANC. INT. CL. 41.
- GREAT AMERICAN FUN CORP., COLUMBUS, OH:
1,933,210, CANC. INT. CL. 28.
- GREAT AMERICAN PRODUCTS, INC., DESTIN, FL:
2,626,167, INT. CL. 5.
- GREAT COMPUTER CORP., TAIPEI HSIEN, TAIWAN:
2,624,109, PUB. 7-2-2002. MULTIPLE CLASS, INT. CLS. 7 AND 9.
- GREAT MEADOW MUSIC, WESTMORELAND, NH:
2,625,563, INT. CL. 9.
- GREAT PLAINS SOFTWARE, INC., FARGO, ND:
2,623,072, PUB. 7-2-2002. INT. CL. 35.
- GREAT POND TECHNOLOGIES, INC., BELGRADE LAKES, ME:
1,934,503, CANC. INT. CL. 9.
- GREAT SMOKY MOUNTAIN SPRING WATER COMPANY, INC., THE, CHIEFLAND, FL:
1,932,529, CANC. INT. CL. 35.
- GREATER KNOXVILLE SPORTS CORPORATION, KNOXVILLE, TN:
2,624,020, PUB. 7-2-2002. INT. CL. 25.
- GREATER PITTSBURGH CONVENTION & VISITORS BUREAU, INC., PITTSBURGH, PA:
2,622,907, PUB. 7-2-2002. INT. CL. 35.
- GRECIAN DELIGHT FOODS, INC., ROSEMONT, IL:
1,933,659, CANC. INT. CL. 30.
- GRECO MANUFACTURING, INC., BUCHANAN, MI:
2,625,721, INT. CL. 7.
- GRECO, ALAN, LONG BRANCH, NJ:
2,483,787, COR. INT. CL. 3.
- GREEN LEAF, INC., FONTANET, IN:
2,624,106, PUB. 7-2-2002. INT. CL. 17.
- GREEN OPTIONS, INC., SAN FRANCISCO, CA:
2,625,913, INT. CL. 29.
- GREEN SNEAKERS, INC., FLEMINGTON, NJ:
2,625,089, PUB. 7-2-2002. INT. CL. 16.

- GREEN, WENDY, LOS ANGELES, CA:
1,933,595, CANC. INT. CL. 25.
- GREENBRANCH PUBLISHING, L.L.C., PHOENIX, MD:
2,624,324, PUB. 7-2-2002. INT. CL. 16.
- GREENHAWK INC., ONTARIO L4W 2V1, CANADA:
2,623,113, PUB. 3-27-2001. MULTIPLE CLASS, INT. CLS. 18 AND 25.
- GREENHORNE & O'MARA, INC., GREENBELT, MD:
2,625,218, PUB. 7-2-2002. INT. CL. 42.
- GREENLITE LIGHTING CORPORATION / LA CORPORATION D'ECLAIRAGE GREENLITE, POINTE-CLAIRE, QUEBEC, CANADA:
2,622,911, PUB. 7-2-2002. MULTIPLE CLASS, INT. CLS. 11 AND 35.
- GREENPOINT FINANCIAL CORP., NEW YORK, NY:
2,622,882, PUB. 7-2-2002. INT. CL. 36.
- GREENWATCH LIMITED, LONDON W11 4EY, UNITED KINGDOM:
1,933,334, CANC. INT. CL. 1.
- GREGORY RANDOLPH FOR MEN, INC., MT. KISCO, NY:
2,622,855, PUB. 7-2-2002. INT. CL. 3.
- GREGORY, JAMES, WOODSTOCK, GA:
2,624,044, PUB. 7-2-2002. MULTIPLE CLASS, INT. CLS. 9, 25 AND 41.
- GREYSTONE QUARRIES, INC., BOYERTOWN, PA:
2,627,032, INT. CL. 19.
- GRIFFIN, HELEN, MANHATTAN BEACH, CA:
2,625,499, INT. CL. 25.
- GRIMM & PAUL NEUWERK GMBH, D-98711 SCHMIEDE-FELD, FED REP GERMANY:
2,625,609, MULTIPLE CLASS, INT. CLS. 6 AND 20.
- GRISWOLD INN LLC, THE, ESSEX, CT, GRISWOLD INN, INC., THE, ESSEX, CT:
1,211,982. REN. 8-10-02. INT. CL. 42.
- GROLIER PUBLISHING CO., INC., DANBURY, CT, CHIL-DRENS PRESS, INC., CHICAGO, IL:
1,734,024. REN. 8-16-02. INT. CL. 16.
- GROUND DESIGNS 2000, ALHAMBRA, CA:
2,623,296, PUB. 7-2-2002. INT. CL. 12.
- GROUND ROUND, INC., THE, BRAINTREE, MA:
927,498. REN. 8-16-02. U.S. CL. 100 (INT. CL. 42).
- GROUND SPECIALTIES, INC., MILACA, MN:
2,627,029, INT. CL. 11.
- GROUP III INTERNATIONAL LTD., FORT LAUDERDALE, FL:
1,663,783, CANC. INT. CL. 18.
- GROUP MONEY MAKERS OF JACKSONVILLE, INC., JACKSONVILLE, FL, LUCK; EUGENE F., JACKSONVILLE, FL, DBA GROUP MONEY MAKERS:
1,167,530. REN. 8-15-02. INT. CL. 30.
- GROUPE PROCYCLE INC./PROCYCLE GROUP INC., BEAUCE, QUEBEC, CANADA:
2,622,863, PUB. 3-12-2002. INT. CL. 12.
- GROUPSOFT, INC., PALMYRA, NY:
1,933,041, CANC. MULTIPLE CLASS, INT. CLS. 9 AND 42.
- GROWMARK, INC., BLOOMINGTON, IL:
1,176,422, CANC. INT. CL. 31.
- GROZ-BECKERT KG, D-72458 ALBSTADT, FED REP GERMANY:
2,622,920, PUB. 6-19-2001. INT. CL. 7.
- GRT PRODUCTIONS, INC., CHICAGO, IL:
2,559,948, COR. INT. CL. 16.
- GRUEBER; ROY G., SAGINAW, MI, DBA ACADEMIC TRACK SERVICES, D.B.A. GRUEBER'S ACADEMIC TRACK TEST CO.:
1,176,105, CANC. INT. CL. 16.
- GRUMA CORPORATION, IRVING, TX:
2,624,448, PUB. 7-2-2002. INT. CL. 30.
2,624,789, PUB. 7-2-2002. INT. CL. 30.
- GRUPO DRAGADOS, S.A., (MADRID), SPAIN:
2,623,907, PUB. 7-2-2002. MULTIPLE CLASS, INT. CLS. 1, 6, 11, 16, 19, 20, 35, 36, 37, 38, 39, 40 AND 42.
- GRUPP LINTERNACIONAL, SA, 03 320 TORRELLANO ALICANTE, SPAIN:
2,622,868, PUB. 7-2-2002. MULTIPLE CLASS, INT. CLS. 18 AND 25.
- GTE VANTAGE INCORPORATED, CARLSBAD, CA:
1,934,135, CANC. INT. CL. 28.
- GUARANTEE KOREA CO., LTD., GANGSEO-GU, SEOUL 157-031, REPUBLIC OF KOREA:
2,624,427, PUB. 7-2-2002. INT. CL. 28.
- GUARDSMAN PRODUCTS, INC., GRAND RAPIDS, MI:
1,933,718, CANC. INT. CL. 2.
- GUASCOR, S.A., 20750 ZUMAIA (GUIPUZCOA), SPAIN:
2,625,674, MULTIPLE CLASS, INT. CLS. 7, 9, 11 AND 37.
- GUERDON INDUSTRIES, INC., LOUISVILLE, KY:
723,518, CANC. U.S. CL. 19.
- GUERLAIN S.A., 75008 PARIS, FRANCE:
2,624,417, PUB. 7-2-2002. INT. CL. 3.
- GUERNSEY DELL, INC., CHICAGO, IL:
1,932,995, CANC. INT. CL. 30.
- GUINNESS UDV NORTH AMERICA, INC., STAMFORD, CT FROM UDV NORTH AMERICA, INC., STAMFORD, CT:
2,623,056, PUB. 7-2-2002. INT. CL. 33.
- GUKURAKUCHO KABUSHIKI KAISHA, SHIBUYA-KU, TOKYO, JAPAN FROM KABUSHIKI KAISHA KUR-ATCHI, SHIBUYA-KU, TOKYO 150-0013, JAPAN:
2,622,663, PUB. 8-15-2000. INT. CL. 25.
- GULCK, TONY VAN, 9170 SINT-PAUWELS, BELGIUM:
2,623,295, PUB. 7-2-2002. INT. CL. 18.
- GULF COAST JEWISH FAMILY SERVICES, INC., CLEAR-WATER, FL, DBA GULF COAST COMMUNITY CARE:
2,623,921, PUB. 7-2-2002. INT. CL. 42.
- GULF OPTICS CORPORATION, NICEVILLE, FL, DBA A2Z OPTICS CORPORATION:
2,626,809, MULTIPLE CLASS, INT. CLS. 9 AND 10.
- GULF TRADING (ALABAMA) INC., CARNEGIE, PA:
2,626,597, INT. CL. 19.
- GUSTAV WOLF SEIL-UND DRAHTWERKE GMBH & CO., D-33332 GUTERSLOH, FED REP GERMANY:
2,625,587, MULTIPLE CLASS, INT. CLS. 6 AND 22.
- GUTNISKY, DENISE A., COVINGTON, LA:
2,624,744, PUB. 7-2-2002. INT. CL. 41.
- GUTZEES, LLC, ENGLEWOOD, NJ:
2,626,101, INT. CL. 21.
- H & S DISTRIBUTING, INC., BARBERTON, OH, DBA THE COBRA PRODUCTS OF AMERICA:
1,932,782, CANC. INT. CL. 28.
- H. APPELBOOM B.V., 1435 EX RIJSENHOUT, NETHERLANDS:
2,622,823, PUB. 7-2-2002. INT. CL. 31.
- H. BUTTING GMBH & CO. KG, D-29379 WITTINGEN-KNESEBECK, FED REP GERMANY:
2,624,017, PUB. 7-2-2002. MULTIPLE CLASS, INT. CLS. 6, 7 AND 11.
- H. E. BUTT GROCERY COMPANY, CORPUS CHRISTI, TX, AKA PARKS PRODUCT COMPANY AND H.E.B. FOOD STORES:
1,176,649, CANC. MULTIPLE CLASS, INT. CLS. 29, 30 AND 32.
- H. E. BUTT GROCERY COMPANY:
See—HEB GROCERY COMPANY, LP.
- H. H. ROBERTSON COMPANY, PITTSBURGH, PA:
723,614, CANC. U.S. CL. 34.
- H. SCHMITT SOEHNE, INC., ATLANTA, GA:
1,933,475, CANC. INT. CL. 33.
- H.B PAULK GROCERY CO., OPP, AL:
2,626,540, INT. CL. 16.
- H.H.H., INC., ORLANDO, FL:
2,623,304, PUB. 7-2-2002. INT. CL. 9.
- H-D MICHIGAN, INC., ANN ARBOR, MI:
1,708,362. REN. 8-16-02. INT. CL. 26.
- H-P PRODUCTS, INC., LOUISVILLE, OH:
2,623,011, PUB. 7-2-2002. INT. CL. 7.
- HA-LO INDUSTRIES, INC., NILES, IL:
1,932,854, CANC. INT. CL. 35.
- HABAND COMPANY, INC., OAKLAND, NJ:
2,622,820, PUB. 7-2-2002. INT. CL. 25.
- HACHETTE FILIPACCHI MAGAZINES, INC.:
See—HACHETTE FILIPACCHI MEDIA U.S., INC..
- HACHETTE FILIPACCHI MEDIA U.S., INC., NEW YORK, NY FROM HACHETTE FILIPACCHI MAGAZINES, INC., NEW YORK, NY:
2,626,016, INT. CL. 16.

- HACHETTE FILIPACCHI MEDIA U.S., INC., NEW YORK, NY FROM HACHETTE FILIPACCHI MAGAZINES, INC., NEW YORK, NY:
2,623,784, PUB. 7-2-2002. INT. CL. 42.
- HACIENDA RECORDS, L. P., CORPUS CHRISTI, TX:
2,623,204, PUB. 7-2-2002. INT. CL. 9.
- HACKNEY'S ON LAKE, INC., GLENVIEW, IL:
2,626,393, INT. CL. 29.
- HADASH, KIMBERLY A., NEWPORT BEACH, CA:
2,623,533, PUB. 7-2-2002. INT. CL. 12.
2,623,534, PUB. 7-2-2002. INT. CL. 12.
- HALL, EVERETT T., SILVER SPRING, MD:
2,623,239, PUB. 7-2-2002. INT. CL. 25.
- HALLIBURTON COMPANY, DALLAS, TX:
1,175,815, CANC. INT. CL. 7.
- HALLIBURTON ENERGY SERVICES, INC., DALLAS, TX:
1,671,358, CANC. INT. CL. 38.
- HALLIBURTON ENERGY SERVICES, INC., CARROLLTON, TX:
2,626,467, INT. CL. 1.
- HALLMARK CARDS, INCORPORATED, KANSAS CITY, MO:
1,663,781, CANC. INT. CL. 16.
- HALLOWELL, ROBERT LEROY II, LOS ANGELES, CA:
2,623,191, PUB. 7-2-2002. INT. CL. 42.
- HALOGEN SOFTWARE, INC., ONTARIO K1J 9B8, CANADA FROM MANTA CORPORATION, ONTARIO K1J 9B8, CANADA:
2,623,836, PUB. 7-2-2002. MULTIPLE CLASS, INT. CLS. 9 AND 35.
- HALTER MARINE, INC., GULFPORT, MS, HALTER MARINE, INC., NEW ORLEANS, LA:
1,198,261, REN. 8-16-02. MULTIPLE CLASS, INT. CLS. 37 AND 42.
- HALVORSON IT CONSULTING, SAN JOSE, CA:
2,626,713, INT. CL. 42.
- HAMIGAMI/CARROLL & ASSOCIATES, SANTA MONICA, CA:
2,623,404, PUB. 7-2-2002. MULTIPLE CLASS, INT. CLS. 40 AND 42.
- HAMILTON BEACH/PROCTOR-SILEX, INC., GLEN ALLEN, VA:
2,626,065, INT. CL. 11.
- HAMMACHER-SCHLEMMER & CO., INC., CHICAGO, IL:
1,932,648, CANC. INT. CL. 42.
- HAMPTON INDUSTRIES, INC., KINSTON, NC:
1,176,328, CANC. INT. CL. 25.
- HAMPTON INDUSTRIES, INC., KINSTON, NC TO HAMPTON INDUSTRIES, INC., KINSTON, NC:
1,648,895, CANC. INT. CL. 25.
- HAMWORTHY KSE AB, S-411 04 GOTEBOG, SWEDEN:
2,623,023, PUB. 7-2-2002. INT. CL. 12.
- HANCO SYSTEMS, INC., PEACHTREE CITY, GA:
2,624,407, PUB. 7-2-2002. MULTIPLE CLASS, INT. CLS. 9 AND 36.
- HANCOCK INTERNATIONAL CORPORATION, WINFIELD, IL:
2,624,361, PUB. 7-2-2002. INT. CL. 9.
- HANDSOME, L.P., HOUSTON, TX:
2,626,280, INT. CL. 36.
- HANG TAT FOODS USA INC., ALHAMBRA, CA:
1,933,574, CANC. INT. CL. 29.
- HANKINS, R. JOHN, GOSHEN, KY, DBA J & J FAMILY FUN:
2,624,069, PUB. 7-2-2002. INT. CL. 28.
- HANKOOK TIRE CO., LTD., SEOUL, 135-723, REPUBLIC OF KOREA:
2,626,454, INT. CL. 12.
- HANOVER BRANDS, INC., WEEHAWKEN, NJ:
2,626,383, INT. CL. 24.
- HANOVER DIRECT, INC., WEEHAWKEN, NJ:
1,933,293, CANC. INT. CL. 42.
- HANS GROHE GMBH & CO. KG, 7622 SOHILTACH, FED REP GERMANY:
1,932,480, CANC. MULTIPLE CLASS, INT. CLS. 6, 9, 10, 11, 17, 20 AND 21.
- HANSEN BEVERAGE COMPANY, ANAHEIM, CA:
1,932,996, CANC. INT. CL. 32.
- HANSEN, INC., CANONSBURG, PA:
1,176,011, CANC. INT. CL. 11.
- HANSON, PETRA, NEW YORK, NY:
1,933,056, CANC. INT. CL. 25.
- HANSON'S WINDOWS & CONSTRUCTION, INC., FRASER, MI:
2,624,700, PUB. 7-2-2002. INT. CL. 19.
- HAPPY GUESTS INTERNATIONAL, INC., SEATTLE, WA:
2,625,773, INT. CL. 42.
- HARBOR FOOTWEAR GROUP, LTD., PORT WASHINGTON, NY:
2,625,824, INT. CL. 25.
- HARDCAP LLC, NEW YORK, NY:
2,626,525, INT. CL. 3.
- HARDEE'S FOOD SYSTEMS, INC., ROCKY MOUNT, NC:
1,934,124, CANC. INT. CL. 42.
- HARDEN, DAVID, CHILLICOTHE, OH:
2,624,982, PUB. 7-2-2002. INT. CL. 16.
- HARGRAY INFORMATION SYSTEMS INTERNATIONAL, INC., HILTON HEAD ISLAND, SC:
1,932,497, CANC. INT. CL. 9.
- HARIBO OF AMERICA, INC., BALTIMORE, MD:
2,625,794, INT. CL. 30.
- HARMAN INTERNATIONAL INDUSTRIES, INCORPORATED, NORTHRIDGE, CA:
2,623,517, PUB. 7-2-2002. INT. CL. 9.
- HARMONIA MUNDI USA INC., LOS ANGELES, CA:
2,626,103, INT. CL. 9.
- HARPER ENGRAVING & PRINTING COMPANY, COLUMBUS, OH:
2,624,291, PUB. 7-2-2002. MULTIPLE CLASS, INT. CLS. 35 AND 42.
- HARPER'S COUNTRY HAMS, CLINTON, KY:
1,718,399, REN. 8-16-02. INT. CL. 29.
- HARRAH'S CLUB, RENO, NV:
1,933,872, CANC. INT. CL. 41.
- HARRIS AND ROSE, LITHONIA, GA, DBA DEME TOTS:
2,625,743, INT. CL. 25.
- HARRIS PUBLICATIONS, INC., NEW YORK, NY:
1,934,474, CANC. INT. CL. 16.
- HARRIS-TARKETT, INC., JOHNSON CITY, TN:
290,424, REN. 8-15-02. U.S. CL. 12 (INT. CL. 19).
- HARRIS, DAVID BARLOW, NORTH ADAMS, MA:
2,626,710, INT. CL. 42.
- HARRIS, VINNIE G., AUSTIN, TX:
2,626,617, INT. CL. 35.
- HARRISON & STAR, INC., NEW YORK, NY:
2,626,288, INT. CL. 35.
- HARRISON SPORTS, INC., PACOIMA, CA:
2,624,380, PUB. 7-2-2002. INT. CL. 28.
- HARRY AND DAVID, MEDFORD, OR:
2,624,862, PUB. 7-2-2002. INT. CL. 31.
- HARTFORD COURANT COMPANY, THE, HARTFORD, CT:
1,932,507, CANC. INT. CL. 16.
- HARTFORD SPECIALTY COMPANY, HARTFORD, CT:
1,680,573, REN. 8-16-02. INT. CL. 36.
- HARTMAN PRODUCTS, LOS ANGELES, CA:
1,663,363, CANC. INT. CL. 11.
- HARVANEK, DANIEL, LITTLETON, CO:
2,624,614, PUB. 7-2-2002. INT. CL. 28.
- HARVEST CHAIN COMPANY, HONG KONG:
2,626,429, INT. CL. 14.
- HARVEST CHRISTIAN FELLOWSHIP, SPOKANE, WA:
1,933,264, CANC. INT. CL. 16.
- HARVEST INDUSTRIES, INC., LINCOLNSHIRE, IL:
1,933,431, CANC. INT. CL. 31.
- HARVICK, MARIE G., HOUSTON, TX:
1,175,708, CANC. INT. CL. 3.
- HASBRO, INC., PAWTUCKET, RI:
2,626,444, INT. CL. 28.
- HASCO INTERNATIONAL, INC., ST. CHARLES, MO:
1,932,945, CANC. INT. CL. 30.
- HASEGAWA MACHINE CO., LTD., KAWAGUSHI, SAITAMA-KEN, JAPAN:
1,175,818, CANC. INT. CL. 7.
- HASTINGS COLLEGE, HASTINGS, NE:
2,624,732, PUB. 7-2-2002. INT. CL. 41.

- HAT ATTACK, INC., BRONX, NY:
1,718,325, REN. 8-10-02. INT. CL. 25.
- HATCH, BRENT, S. PASADENA, CA:
2,625,019, PUB. 7-2-2002. INT. CL. 20.
- HAUSER TECHNOLOGY INTEGRATION, INC., RICHARDSON, TX:
2,622,678, PUB. 7-2-2002. MULTIPLE CLASS, INT. CLS. 9 AND 42.
- HAWAII VISITORS & CONVENTION BUREAU, HONOLULU, HI:
2,622,892, PUB. 7-2-2002. INT. CL. 35.
- HAY ACQUISITION COMPANY I, INC., WASHINGTON, DC:
1,663,727, CANC. INT. CL. 42.
- HAYES, JAMES B., SCARBOROUGH, NY:
1,934,164, CANC. INT. CL. 42.
- HAYNE, WILLIAM ALSTON, ST. HELENA, CA:
1,934,222, CANC. INT. CL. 30.
- HAYWIN TEXTILE PRODUCTS, INC., BROOKLYN, NY:
2,625,972, INT. CL. 24.
- HAZARD CONTROL TECHNOLOGIES, INC., FAYETTEVILLE, GA:
2,623,607, PUB. 7-2-2002. INT. CL. 1.
- HBO & COMPANY, ALPHARETTA, GA, EXPERT SYSTEMS, INC., ATLANTA, GA:
1,628,027, REN. 8-14-02. INT. CL. 9.
- HBR COMPUTER STORES, INC., CARROLLTON, TX, DBA HBR TECHNOLOGIES:
2,623,860, PUB. 7-2-2002. INT. CL. 35.
- HCC INVESTORS, LLC, CARLSBAD, CA:
2,622,697, PUB. 7-2-2002. INT. CL. 37.
- HDN DEVELOPMENT CORPORATION, FLORENCE, KY, KRISPY KREME DOUGHNUT CORPORATION, WINSTON-SALEM, NC:
939,105, REN. 8-10-02. U.S. CL. 100 (INT. CL. 42).
- HEAD INJURY REHABILITATION SERVICES, INC., SANTA MONICA, CA:
1,933,690, CANC. INT. CL. 42.
- HEAGY, RONALD C., ALBANY, OR:
2,624,816, PUB. 7-2-2002. INT. CL. 41.
- HEALTH AND NUTRITIONAL SYSTEMS INTERNATIONAL, INC., WEST PALM BEACH, FL:
2,622,877, PUB. 7-2-2002. INT. CL. 5.
- HEALTH NETWORK FOR CHILDREN, OMAHA, NE:
1,934,422, CANC. INT. CL. 42.
- HEALTH ON HAND, CLEARWATER, FL:
2,624,977, PUB. 4-16-2002. INT. CL. 16.
- HEALTH PROMOTING PRODUCTS AND SERVICES, INC., ROHNERT PARK, CA:
2,626,022, INT. CL. 42.
- HEALTH TECH, INTERNATIONAL, ST. GEORGE, UT:
2,626,545, INT. CL. 5.
- HEALTHCARE INFORMATION AND MANAGEMENT SYSTEMS SOCIETY, CHICAGO, IL, AMERICAN HOSPITAL ASSOCIATION, CHICAGO, IL:
1,714,415, REN. 8-14-02. INT. CL. 42.
- HEALTHCARE MANAGEMENT ADVISORS, INC., ALPHARETTA, GA:
2,622,502, PUB. 7-2-2002. INT. CL. 36.
- HEALTHCO, INC., BOSTON, MA:
1,175,763, CANC. INT. CL. 5.
- HEALTHCOMMUNITIES.COM, INC., NORTHAMPTON, MA:
2,626,180, INT. CL. 42.
- HEALTHLINK, JACKSONVILLE, FL:
2,623,161, PUB. 7-2-2002. MULTIPLE CLASS, INT. CLS. 1 AND 5.
- HEALTHNET MANAGEMENT SERVICES, LLC, MARIETTA, GA FROM FREEDMAN, HARRY, MARIETTA, GA:
2,626,172, INT. CL. 9.
- HEALTHTRAC, INC., MENLO PARK, CA:
2,625,371, INT. CL. 16.
- HEALTHY HABIT INC., PROVO, UT:
1,932,971, CANC. INT. CL. 30.
- HEARST CORPORATION, THE, NEW YORK, NY:
391,386, CANC. U.S. CL. 26.
1,933,987, CANC. INT. CL. 36.
1,934,363, CANC. MULTIPLE CLASS, INT. CLS. 6, 8, 9, 11, 17, 20 AND 21.
1,934,455, CANC. INT. CL. 35.
- HEARST HOLDINGS, INC., NEW YORK, NY:
2,624,668, PUB. 7-2-2002. MULTIPLE CLASS, INT. CLS. 16 AND 24.
- HEAT AND CONTROL, INC., SOUTH SAN FRANCISCO, CA:
1,698,287, REN. 8-10-02. INT. CL. 7.
- HEAT AND CONTROL, INC., HAYWARD, CA:
1,698,348, REN. 8-10-02. INT. CL. 11.
- HEAT AND ENERGY LOSS PREVENTION CO., STATEN ISLAND, NY:
1,176,635, CANC. INT. CL. 42.
- HEB GROCERY COMPANY, LP, SAN ANTONIO, TX FROM H. E. BUTT GROCERY COMPANY, SAN ANTONIO, TX:
2,623,441, PUB. 7-2-2002. INT. CL. 30.
2,625,614, INT. CL. 29.
2,625,615, INT. CL. 35.
2,625,846, INT. CL. 29.
- HEDSON TECHNOLOGIES AB, S-232 37 ARLOV, SWEDEN:
2,624,485, PUB. 7-2-2002. MULTIPLE CLASS, INT. CLS. 9 AND 11.
- HEIDELBERGER DRUCKMASCHINEN AKTIENGESELLSCHAFT, D-69115 HEIDELBERG, FED REP GERMANY:
2,622,553, PUB. 7-2-2002. MULTIPLE CLASS, INT. CLS. 7, 9 AND 20.
- HEIDELBERGER DRUCKMASCHINEN AKTIENGESELLSCHAFT, 69115 HEIDELBERG, FED REP GERMANY:
2,623,287, PUB. 7-2-2002. INT. CL. 7.
- HEINZ SCHWARZ GMBH, D-75177 PFORZHEIM, FED REP GERMANY:
2,623,221, PUB. 7-2-2002. INT. CL. 14.
- HEITZ, JAMES M., ST. JOSEPH, MO:
2,624,025, PUB. 7-2-2002. INT. CL. 28.
- HELEN, DUCLOS LAURENE, ROCHESTER, NY, DBA PRETTY GOOD POPCORN:
2,626,573, INT. CL. 30.
- HELENA RUBINSTEIN, 75008 PARIS, FRANCE:
2,623,440, PUB. 7-2-2002. INT. CL. 3.
- HELENE CURTIS, INC., CHICAGO, IL:
1,175,729, CANC. INT. CL. 3.
- HELLFIRE SYSTEMS, L.L.C., ORLANDO, FL:
2,624,655, PUB. 7-2-2002. INT. CL. 13.
- HELLMAN, PAUL, FRAMINGHAM, MA:
2,626,158, INT. CL. 41.
- HEMAMETRICS, KAYSVILLE, UT, FORMERLY IN-LINE DIAGNOSTICS CORPORATION:
2,624,755, PUB. 7-2-2002. INT. CL. 10.
- HENBURY LIMITED, BRISTOL, UNITED KINGDOM:
2,622,688, PUB. 11-7-2000. MULTIPLE CLASS, INT. CLS. 18 AND 25.
- HENDERSON AQUATICS, INC., MILLVILLE, NJ, NEO SPORT, INC., MILLVILLE, NJ:
1,713,828, REN. 8-12-02. INT. CL. 25.
- HENDERSON, MICHAEL D., MEMPHIS, TN:
1,933,186, CANC. INT. CL. 42.
- HENDRON, DEBRA A, WINFIELD, MO:
2,625,263, PUB. 7-2-2002. INT. CL. 3.
- HENDRON, DEBRA, A, WINFIELD, MO:
2,625,264, PUB. 7-2-2002. INT. CL. 3.
- HENKEL CORPORATION, AMBLER, PA:
2,625,339, INT. CL. 1.
- HENKEL KGAA, D-40191 DUSSELDORF, FED REP GERMANY:
2,625,592, INT. CL. 1.
- HENRY RAK CONSULTING PARTNERS, INC., LIBERTYVILLE, IL:
2,626,681, INT. CL. 35.
- HERAEUS ELEKTROCHEMIE BITTERFELD GMBH, 06749 BITTERFELD, FED REP GERMANY:
1,932,566, CANC. INT. CL. 9.
- HERAEUS KULZER GMBH & CO. KG, D-63450 HANAU, FED REP GERMANY:
2,623,218, PUB. 10-9-2001. INT. CL. 5.
- HERBERT HAWKINS COMPANY, INC., TEMPLE CITY, CA:
1,176,462, CANC. MULTIPLE CLASS, INT. CLS. 35 AND

36.
 HERBON NATURALS, INC., RICHMOND, BRITISH COLUMBIA, CANADA:
 2,568,747, COR. INT. CL. 5.
 HERBSMART INC., SOUTH SAN FRANCISCO, CA:
 2,626,020, INT. CL. 1.
 HERCULES INCORPORATED, WILMINGTON, DE:
 2,626,255, INT. CL. 7.
 HERITAGE GOLF GROUP, LLC, SAN DIEGO, CA:
 2,626,325, INT. CL. 35.
 HERITAGE PRESERVATION CORPORATION, SPARTANBURG, SC:
 2,624,418, PUB. 7-2-2002. INT. CL. 42.
 HERMAN MILLER, INC., ZEELAND, MI:
 2,626,315, INT. CL. 36.
 HERMAN MILLER, INCORPORATED, ZEELAND, MI:
 1,663,789, CANC. INT. CL. 20.
 HERMANNNS, REGINA, ONTARIO, CANADA:
 2,623,803, PUB. 7-2-2002. MULTIPLE CLASS, INT. CLS. 3, 5 AND 31.
 HERMES INTERNATIONAL, PARIS 75008, FRANCE:
 1,932,842, CANC. INT. CL. 9.
 HERMES INTERNATIONAL, PARIS, FRANCE:
 2,623,070, PUB. 7-2-2002. MULTIPLE CLASS, INT. CLS. 35, 37, 39, 40 AND 41.
 HERMES SWEETENERS LTD., 8004 ZURICH, SWITZERLAND:
 2,623,585, PUB. 7-2-2002. INT. CL. 1.
 HERNANDEZ, REYNALDO, PARAMOUNT, CA:
 1,932,751, CANC. INT. CL. 42.
 HERRENKOHL, ERIC, ST. LOUIS, MO:
 2,626,488, INT. CL. 35.
 HERRING, CONRAD, SAN DIEGO, CA:
 2,625,867, INT. CL. 25.
 HERSHEY CHOCOLATE & CONFECTIONERY CORPORATION, WHEAT RIDGE, CO:
 2,626,634, INT. CL. 30.
 HERSHEY CREAMERY COMPANY, HARRISBURG, PA:
 396,034, REN. 8-13-02. U.S. CL. 46 (INT. CL. 30).
 HESKA CORPORATION, FORT COLLINS, CO:
 2,623,862, PUB. 7-2-2002. INT. CL. 10.
 HESS, CAROL, FREEHOLD, NJ:
 1,690,307, REN. 8-16-02. INT. CL. 28.
 HESS, LARRY, PHOENIX, AZ:
 2,626,701, INT. CL. 16.
 HESTER INDUSTRIES, INC., MOOREFIELD, WV:
 1,934,295, CANC. INT. CL. 29.
 HEUCHERT, JOHANN K., GREEN BAY, WI:
 1,933,807, CANC. INT. CL. 35.
 HEXAGON INDUSTRIES, INC., CLEVELAND, OH:
 2,625,839, INT. CL. 6.
 HEYDE AKTIENGESELLSCHAFT:
See—ELAXY AG.
 HI COUNTRY BEEF JERKY, LINCOLN, MT:
 2,394,524, CANC. INT. CL. 30.
 HI MOUNTAIN JERKY, INC, RIVERTON, WY:
 2,626,539, INT. CL. 21.
 HI TIDE SALES, INC., FORT PIERCE, FL:
 2,626,891, INT. CL. 7.
 HI-LINE ELECTRIC INC., DALLAS, TX:
 2,624,217, PUB. 7-2-2002. MULTIPLE CLASS, INT. CLS. 6 AND 9.
 HIATT AND COMPANY LIMITED, BIRMINGHAM B42 1DN, UNITED KINGDOM:
 2,623,359, PUB. 7-2-2002. INT. CL. 6.
 HICKORY TRAVEL SYSTEMS, INC., SADDLE BROOK, NJ:
 2,624,678, PUB. 7-2-2002. INT. CL. 39.
 HIGGINS, TERRENCE M., RIDGEWOOD, NJ:
 1,663,836, CANC. INT. CL. 42.
 HIGH COUNTRY FOODS, INC., WHEAT RIDGE, CO:
 1,176,410, CANC. INT. CL. 30.
 HIGH SPEED METAL & PLASTIC PRODUCTS MFG. CO., LTD., TUEN MUN, N.T., HONG KONG:
 2,626,289, INT. CL. 28.
 HIGHER DIMENSION MEDICAL, INC., SAINT PAUL, MN:
 2,623,912, PUB. 7-2-2002. INT. CL. 40.
 HIGHLAND SUPPLY CORPORATION, HIGHLAND, IL:
 1,933,647, CANC. MULTIPLE CLASS, INT. CLS. 6, 16 AND 21.
 HIGHLIGHTS FOR CHILDREN, INC., COLUMBUS, OH:
 1,934,395, CANC. INT. CL. 41.
 HIGHMARK CORPORATION, SARASOTA, FL:
 2,626,033, INT. CL. 42.
 HIGHWEB & PAGE GROUP, INC., MISSISSAUGA, ONTARIO, CANADA:
 2,626,037, INT. CL. 9.
 HIJET, INC., HOUSTON, TX:
 2,625,053, PUB. 7-2-2002. INT. CL. 7.
 HILL, MEREDITH L., LA MESA, CA:
 2,624,817, PUB. 7-2-2002. INT. CL. 41.
 HILL, RICHARD B., TUCSON, AZ:
 1,932,698, CANC. INT. CL. 30.
 HILL, THOMAS A., SOUTH ROYALTON, VT:
 2,524,543, COR. INT. CL. 16.
 HILLSDALE COLLEGE, HILLSDALE, MI:
 2,623,616, PUB. 7-2-2002. INT. CL. 41.
 HILLYARD ENTERPRISES, INC., ST. JOSEPH, MO:
 2,626,512, INT. CL. 3.
 HILTON HOSPITALITY, INC., BEVERLY HILLS, CA, DOUBLETREE HOTELS CORPORATION, MEMPHIS, TN:
 1,699,970, REN. 8-12-02. INT. CL. 42.
 HILTON HOTELS CORPORATION, BEVERLY HILLS, CA:
 1,933,303, CANC. INT. CL. 42.
 1,933,304, CANC. INT. CL. 42.
 1,933,305, CANC. INT. CL. 41.
 1,933,306, CANC. INT. CL. 42.
 1,933,307, CANC. INT. CL. 41.
 HINES HORTICULTURE, INC.:
See—BANKERS TRUST COMPANY.
 HINGES, INC., ENTERPRISE, AL:
 1,932,540, CANC. INT. CL. 6.
 HINTERSEHR, JOSEF, D-64347 GRIESHEIM, FED REP GERMANY:
 2,622,684, PUB. 11-20-2001. MULTIPLE CLASS, INT. CLS. 5, 9, 10 AND 16.
 HIPPO DYNAMIX PFERDEPRODUKTE GESELLSCHAFT M.B.H:
See—PELLEGRINUS HOLDING AG.
 HIRAM WALKER & SONS, INC., DETROIT, MI:
 1,933,723, CANC. INT. CL. 33.
 HIRANANDANI, DEEPAK J., ANAHEIM, CA:
 2,623,575, PUB. 7-2-2002. INT. CL. 16.
 HIRESHARP PARTNERS, LLC, PHILADELPHIA, PA:
 2,624,813, PUB. 7-2-2002. INT. CL. 35.
 HIWARE.COM LLC, POTSDAM, NY:
 2,625,628, INT. CL. 9.
 HIRSH INDUSTRIES, INC., DES MOINES, IA FROM STEELWORKS, INC., DES MOINES, IA:
 2,625,521, INT. CL. 20.
 HIT SHOW CLUB, INC., NEW YORK, NY:
 2,624,381, PUB. 7-2-2002. INT. CL. 35.
 HM ENTERPRISES, INC., GULFPORT, FL:
 2,626,679, INT. CL. 36.
 HNC, INC., SAN DIEGO, CA:
 1,934,286, CANC. INT. CL. 9.
 HNT HOLDINGS ACQUISITION, LLC, PLYMOUTH, MN:
 2,624,942, PUB. 7-2-2002. INT. CL. 10.
 HOBART CORPORATION, TROY, OH, VULCAN-HART CORPORATION, LOUISVILLE, KY:
 1,195,639, REN. 8-12-02. INT. CL. 11.
 HOCKEY MINISTRIES INTERNATIONAL, QUEBEC, CANADA:
 2,624,697, PUB. 7-2-2002. INT. CL. 41.
 2,624,698, PUB. 7-2-2002. INT. CL. 45.
 HOD, AYAL, GREAT NECK, NY:
 2,624,961, PUB. 7-2-2002. INT. CL. 35.
 HOECHST AKTIENGESELLSCHAFT, FRANKFURT AM MAIN-80, FED REP GERMANY:
 1,175,673, CANC. INT. CL. 1.
 HOECHST AKTIENGESELLSCHAFT, W-6230 FRANKFURT AM MAIN 80, FED REP GERMANY:
 1,933,483, CANC. INT. CL. 16.
 HOECHST SCHERING AGREVO S.A., 91190 GIF SUR YVETTE, FRANCE FROM HOECHST SCHERING AGREVO S.A., 75020 PARIS, FRANCE:
 2,625,378, MULTIPLE CLASS, INT. CLS. 1 AND 5.

- HOFFMANN-LA ROCHE INC., NUTLEY, NJ:
1,175,666, CANC. INT. CL. 1.
- HOLDEN, RANDY, DANA POINT, CA:
2,625,222, PUB. 7-2-2002. MULTIPLE CLASS, INT. CLS. 9 AND 41.
- HOLIDAY, STEVEN GEFFEN, MILWAUKEE, WI:
2,624,751, PUB. 7-2-2002. INT. CL. 16.
- HOLLAND AMERICA LINE - USA INC., SEATTLE, WA,
HOLLAND AMERICA CRUISES, INC., NEW YORK, NY:
1,230,390, REN. 8-10-02. INT. CL. 39.
- HOLLARD HOLDINGS (PTY) LIMITED, JOHANNESBURG,
GAUTENG, SOUTH AFRICA:
2,626,876, INT. CL. 36.
- HOLLYWOOD SOUND INTERNATIONAL CORP., TEMPLE
CITY, CA, DBA HOLLYWOOD SOUND LABS:
2,625,480, INT. CL. 9.
- HOLLYWOOD WAX MUSEUM, INC., HOLLYWOOD, CA:
1,999,116, CANC. MULTIPLE CLASS, INT. CLS. 6 AND
25.
- HOLMES PLACE PLC, KENSINGTON, ENGLAND:
2,623,884, PUB. 7-2-2002. MULTIPLE CLASS, INT. CLS. 18
AND 25.
- HOLMES PRODUCTS CORP., MILFORD, MA:
1,934,444, CANC. INT. CL. 11.
- HOLSTEN-BRAUEREI AG, 22765 HAMBURG, FED REP
GERMANY:
1,933,074, CANC. INT. CL. 32.
- HOLT, ANNETTE, HORNBEAK, TN:
1,176,603, CANC. INT. CL. 42.
- HOLT, PAULA, WESTMINSTER, CO, DBA HIGH MOUN-
TAIN HERBALS:
2,624,125, PUB. 7-2-2002. INT. CL. 3.
- HOLUB, HOWARD J., EMPIRE, CA:
2,626,576, INT. CL. 42.
- HOME DIAGNOSTICS, INC., FT. LAUDERDALE, FL:
2,626,223, INT. CL. 10.
- HOME HEALTH CARE MANAGEMENT, INC., WYOMISS-
ING, PA:
2,624,287, PUB. 7-2-2002. INT. CL. 16.
- HOME HEALTH CARE OF NEW JERSEY, GLEN ROCK, NJ:
1,646,399, CANC. INT. CL. 42.
- HOME PLANNERS, LLC, TUCSON, AZ, HOME PLANNERS,
INC., DETROIT, MI:
1,133,661, REN. 8-14-02. INT. CL. 16.
- HOME-LINK SERVICES, INC., SHELTON, CT:
2,623,759, PUB. 7-2-2002. INT. CL. 36.
- HOMEBUSINESS.TO, INC., AIKEN, SC:
2,623,238, PUB. 7-2-2002. INT. CL. 42.
- HOMEDICS, INC., COMMERCE TOWNSHIP, MI:
2,626,089, INT. CL. 10.
- HOMELESS CHILDREN'S TUTORIAL PROJECT, INC., THE,
WASHINGTON, DC:
1,720,867, REN. 8-10-02. INT. CL. 41.
1,720,868, REN. 8-10-02. INT. CL. 41.
- HOMELINE CORPORATION, MIAMI, FL:
1,176,267, CANC. INT. CL. 22.
- HOMESTAR FINANCIAL GROUP, INC., MANTENO, IL
FROM MANTENO BANCSHARES, INC., MANTENO, IL:
2,625,808, INT. CL. 36.
- HONADELS, INC., SOUTH MILWAUKEE, WI:
2,624,255, PUB. 7-2-2002. INT. CL. 21.
- HONEY HOUND, LLC, WEST LAFAYETTE, IN FROM
ROMJUE, COLLEEN M., WEST LAFAYETTE, IN AND
ROMJUE, JERRY A., WEST LAFAYETTE, IN:
2,625,575, INT. CL. 31.
- HOOD PACKAGING CORPORATION/EMBALLAGE HOOD
CORPORATION, BURLINGTON, ONTARIO, CANADA,
BONAR INC., BURLINGTON, ONTARIO, L7R 4A1, CA-
NADA:
1,704,899, REN. 8-15-02. INT. CL. 16.
- HOOVER MATERIALS HANDLING GROUP, INC., AL-
PHARETTA, GA:
2,626,200, INT. CL. 37.
- HOPHOLD A&M, INC., SALEM, MA, ATWOOD & MOR-
RILL CO., INC., SALEM, MA:
952,348, REN. 8-14-02. U.S. CL. 100 (INT. CL. 42).
- HORACE MANN LIFE INSURANCE COMPANY, SPRING-
FIELD, IL:
935,125, REN. 8-13-02. U.S. CL. 102 (INT. CL. 36).
- HORIZON GROUP INTERNATIONAL, INC., LORAIN, OH:
1,545,771, CANC. INT. CL. 42.
- HORMEL FOODS CORPORATION, AUSTIN, MN:
1,933,945, CANC. INT. CL. 29.
- HORN, BRADLEY, CINCINNATI, OH:
1,933,716, CANC. INT. CL. 31.
- HORNBECK, TODD M., MANDEVILLE, LA AND HORN-
BECK, TROY A., MANDEVILLE, LA, DBA HORNBECK-
LEEVEAC MARINE SERVICES, INC.:
2,622,908, PUB. 7-2-2002. INT. CL. 39.
2,622,910, PUB. 7-2-2002. INT. CL. 39.
- HORSE FENCE DIRECT, LLC, FRIDLEY, MN:
2,626,962, INT. CL. 9.
- HORWEEN LEATHER COMPANY, CHICAGO, IL:
1,933,269, CANC. INT. CL. 18.
- HOSPITALAR FEIRAS, CONGRESSOS E EMPREENDIMEN-
TOS LTDA., EM SAO PAULO (SP), BRAZIL:
2,623,324, PUB. 12-11-2001. INT. CL. 35.
- HOSUK CO., LTD., UMSUNG-GUN, CHOONGBUK 369-830,
REPUBLIC OF KOREA:
2,625,748, INT. CL. 10.
- HOT STAMP SUPPLY COMPANY, WINCHESTER, VA:
2,623,173, PUB. 7-2-2002. MULTIPLE CLASS, INT. CLS. 7
AND 37.
- HOTEL REPRESENTATIVE, INC., NEW YORK, NY:
1,933,501, CANC. INT. CL. 42.
- HOUSE OF PRINCE A/S, SOBORG, DENMARK:
2,624,634, PUB. 7-2-2002. INT. CL. 34.
- HOUSE-AUTRY MILLS, INC., NEWTON GROVE, NC:
1,932,940, CANC. INT. CL. 30.
- HOUSEWARES INTERNATIONAL, INC., VERNON, CA:
2,623,715, PUB. 7-2-2002. INT. CL. 21.
- HOWARD BERGER CO., INC., BROOKLYN, NY:
2,625,507, INT. CL. 12.
- HOWARD, PETER J., SANTA MONICA, CA:
1,934,402, CANC. INT. CL. 16.
- HP INTELLECTUAL CORP., WILMINGTON, DE:
2,625,848, MULTIPLE CLASS, INT. CLS. 7, 9 AND 11.
2,626,594, INT. CL. 9.
- HR FIRST CONTACT, LLC, DALLAS, TX FROM BTI,
EMPLOYEE SCREENING SERVICES, INC., DALLAS, TX:
2,625,496, INT. CL. 42.
- HRSERV, INCORPORATED, ATLANTA, GA FROM FSJ
SERVICES, INC., ATLANTA, GA:
2,623,348, PUB. 6-4-2002. INT. CL. 35.
- HSIN LIEN PANG ENTERPRISE CO., LTD., NAN DIST.,
TAINAN CITY, TAIWAN:
1,933,040, CANC. INT. CL. 16.
- HTS HONGTA SUISSE SA, VEVEY, SWITZERLAND:
2,624,228, PUB. 7-2-2002. INT. CL. 34.
- HTZ INVESTMENT CORP., WILMINGTON, DE:
2,625,362, INT. CL. 28.
2,626,481, MULTIPLE CLASS, INT. CLS. 10 AND 31.
- HUA XIN INTERNATIONAL, INC., NEW YORK, NY:
2,623,880, PUB. 7-2-2002. INT. CL. 25.
- HUBMAR INC., QUE, CANADA:
2,626,921, INT. CL. 12.
- HUDSON PRODUCTS CORPORATION, HOUSTON, TX:
2,626,603, INT. CL. 42.
- HUGHES ELECTRONICS CORPORATION, EL SEGUNDO,
CA:
2,625,957, MULTIPLE CLASS, INT. CLS. 9 AND 38.
- HUGHES, MARK ELVIN, BATON ROUGE, LA:
2,625,126, PUB. 7-2-2002. INT. CL. 5.
- HUHHOT SIGMA REED-INSTRUMENT CO., HUHHOT,
INNER MONGOLIA, CA:
1,932,824, CANC. INT. CL. 15.
- HULSBECK & FURST GMBH & CO. KG., D-042551 VEL-
BERT, FED REP GERMANY TO HUF HULSBECK &
FURST GMBH & CO. KG, D-042551 VELBERT, FED REP
GERMANY:
1,983,039, AM. MULTIPLE CLASS, INT. CLS. 6, 9 AND
12.
- HUMONGOUS ENTERTAINMENT, INC.:
See—INFOGRAMES, INC..

- HUNKERS FOOTWEAR USA INC., ONTARIO, CA:
2,626,610, INT. CL. 25.
- HUNT HOLDINGS, INC., WILMINGTON, DE:
2,626,484, INT. CL. 16.
- HUNT, MARY M., PARAMOUNT, CA:
2,623,150, PUB. 7-2-2002. INT. CL. 16.
- HUNTER DOUGLAS INDUSTRIES B.V., 3071 EL ROTTERDAM, NETHERLANDS:
1,933,367, CANC. INT. CL. 6.
- HUNTER DOUGLAS, INC., UPPER SADDLE RIVER, NJ:
2,626,008, INT. CL. 20.
- HUNTER FAN COMPANY, MEMPHIS, TN:
2,624,901, PUB. 7-2-2002. INT. CL. 11.
- HUNTING WORLD, INCORPORATED, NEW YORK, NY:
1,933,488, CANC. INT. CL. 25.
- HUNTS, RICK, SAN DIEGO, CA:
2,623,998, PUB. 7-2-2002. INT. CL. 28.
- HUNTSINC.COM CORPORATION, MEAD, WA:
2,623,983, PUB. 7-2-2002. INT. CL. 9.
- HUTCHINS, KENNETH M., ALTAMONTE SPRINGS, FL:
2,626,068, INT. CL. 41.
- HUTHWAITE RESEARCH GROUP LIMITED, SOUTH YORKSHIRE S62 7SA, UNITED KINGDOM:
2,622,671, PUB. 3-12-2002. MULTIPLE CLASS, INT. CLS. 9, 16, 35, 38 AND 41.
- HVL COS., LLC, SEATTLE, WA:
2,625,441, INT. CL. 1.
2,625,443, INT. CL. 4.
- HWE, INC., NORTH HOLLYWOOD, CA:
1,933,715, CANC. INT. CL. 10.
- HYDRAULIC INVESTMENTS, LLC., HOUSTON, TX:
2,625,682, INT. CL. 35.
- HYDROTEX, INC., DALLAS, TX:
1,932,902, CANC. INT. CL. 1.
- HYGIENIC SOLUTIONS, L.L.C., MUNDELEIN, IL:
2,623,124, PUB. 7-2-2002. INT. CL. 21.
- HYPERCEL CORPORATION, SAN FERNANDO, CA:
2,626,290, INT. CL. 9.
- H2 FUELS, LLC, SPOKANE, WA:
2,626,881, INT. CL. 7.
- I. W. INDUSTRIES, INC., HOUSTON, TX:
723,491, CANC. U.S. CL. 16.
- I.D. LITE, INC., W. PALM BEACH, FL:
1,933,364, CANC. INT. CL. 9.
- I-CRUISE.COM CORP., NEW YORK, NY:
2,622,744, PUB. 7-2-2002. INT. CL. 39.
- I/OMAGIC CORPORATION, IRVINE, CA:
2,623,403, PUB. 7-2-2002. INT. CL. 9.
- IACCESS, INC., BLUFFDALE, UT:
2,626,942, INT. CL. 9.
- IAMS COMPANY, THE, DAYTON, OH:
2,626,709, INT. CL. 31.
- IAN S. BENISON, D.C., P.A., BOYNTON BEACH, FL:
2,624,353, PUB. 7-2-2002. INT. CL. 42.
- IASD HEALTH SERVICES CORP., DES MOINES, IA, DBA BLUE CROSS AND BLUE SHIELD OF IOWA AND DBA BLUE CROSS OF SOUTH DAKOTA:
1,934,418, CANC. INT. CL. 36.
- IBERIA, LINEAS AEREAS DE ESPANA S.A., 130-28006 MADRID, SPAIN:
2,623,454, PUB. 7-2-2002. INT. CL. 39.
- IBEROSTAR S.A., 07012 PALMA DE MALLORCA, SPAIN:
2,625,330, INT. CL. 35.
- ICAM S.P.A., 22053 LECCO, ITALY:
2,622,759, PUB. 11-7-2000. INT. CL. 30.
- ICARIAN, INC., SUNNYVALE, CA:
2,623,590, PUB. 7-2-2002. INT. CL. 9.
- ICARZ, INC., NEWTON, NJ:
2,623,226, PUB. 7-2-2002. MULTIPLE CLASS, INT. CLS. 9 AND 35.
- ICB MANUFACTURING CORP., SOUTH PASADENA, CA, DBA TIME LABORATORIES, INC.:
2,622,925, PUB. 12-11-2001. MULTIPLE CLASS, INT. CLS. 3 AND 5.
- ICE MILLER, INDIANAPOLIS, IN:
2,623,467, PUB. 7-2-2002. MULTIPLE CLASS, INT. CLS. 35 AND 42.
- ICON CORPORATION, WOBURN, MA:
1,932,759, CANC. INT. CL. 7.
- ICOR INTERNATIONAL, INC., INDIANAPOLIS, IN:
2,626,291, INT. CL. 1.
- ICP GLOBAL TECHNOLOGIES, MONTREAL, QUEBEC, CANADA:
2,626,915, INT. CL. 9.
- IDEA CONNECTION SYSTEMS INC., ROCHESTER, NY:
2,626,800, INT. CL. 35.
- IDEAL PARTNERS, LLC, ARLINGTON, VA:
2,623,197, PUB. 7-2-2002. INT. CL. 36.
- IDEAL TOY CORPORATION, HOLLIS, NY TO MATTEL, INC., EL SEGUNDO, CA:
911,737, CANC. U.S. CL. 22.
- IDEAL, INCORPORATED, MAPLE GROVE, MN:
2,625,735, INT. CL. 9.
- IDEAMAX CORP., ALHAMBRA, CA:
2,623,302, PUB. 7-2-2002. MULTIPLE CLASS, INT. CLS. 9, 35 AND 41.
2,624,010, PUB. 7-2-2002. MULTIPLE CLASS, INT. CLS. 9 AND 41.
2,624,657, PUB. 7-2-2002. INT. CL. 9.
- IDG BOOKS WORLDWIDE, INC., FOSTER CITY, CA:
2,622,783, PUB. 7-2-2002. INT. CL. 16.
2,623,329, PUB. 7-2-2002. INT. CL. 42.
2,626,234, INT. CL. 16.
- IDG BOOKS WORLDWIDE, INC., FOSTER CITY, CA FROM INTERNATIONAL DATA GROUP, INC., FRAMINGHAM, MA:
2,626,754, INT. CL. 16.
- IES UTILITIES INC., CEDAR RAPIDS, IA:
1,932,741, CANC. INT. CL. 42.
- IGA, INC., CHICAGO, IL:
2,623,419, PUB. 7-2-2002. INT. CL. 35.
- IGLOO PRODUCTS CORP., HOUSTON, TX:
1,934,185, CANC. INT. CL. 21.
- IGNIS OPTICS, INC., SAN JOSE, CA:
2,626,931, INT. CL. 35.
- IGT, RENO, NV:
2,625,590, INT. CL. 9.
2,626,052, INT. CL. 9.
- IGUANA PRODUCTIONS LTD. (BVI), BAL HARBOUR, FL:
2,624,602, PUB. 7-2-2002. INT. CL. 41.
- IKON OFFICE SOLUTIONS WEST, INC., PORTLAND, OR:
2,624,766, PUB. 7-2-2002. INT. CL. 16.
2,626,794, MULTIPLE CLASS, INT. CLS. 9, 35, 39 AND 42.
- ILFORD LIMITED, CHESHIRE, WA16 7HA, ENGLAND:
1,175,675, CANC. INT. CL. 1.
- ILFORD LIMITED, WA16 7HA, ENGLAND:
1,175,676, CANC. INT. CL. 1.
- ILIFE.COM, INC., NORTH PALM BEACH, FL FROM INTELLIGENT LIFE CORPORATION, NORTH PALM BEACH, FL:
2,622,645, PUB. 11-14-2000. INT. CL. 42.
- ILIOS PARTNERS LLC, NEW YORK, NY:
2,626,355, INT. CL. 36.
- ILLINI CORPORATION, SPRINGFIELD, IL:
2,624,146, PUB. 7-2-2002. INT. CL. 36.
- ILLINOIS HIGH SCHOOL ASSOCIATION, BLOOMINGTON, IL:
2,623,881, PUB. 7-2-2002. INT. CL. 28.
- ILLINOIS SECRETARY OF STATE, SPRINGFIELD, IL:
2,623,299, PUB. 7-2-2002. INT. CL. 42.
- ILLINOIS TOOL WORKS INC., GLENVIEW, IL:
2,624,665, PUB. 7-2-2002. INT. CL. 9.
2,625,281, PUB. 7-2-2002. INT. CL. 1.
- ILLINOIS TOOL WORKS, INC., GLENVIEW, IL FROM ALMA INC., PALM SPRINGS, CA:
2,624,047, PUB. 7-2-2002. INT. CL. 27.
- ILORI, STEPHEN, TEMPE, AZ:
2,624,621, PUB. 7-2-2002. INT. CL. 35.
- IMA-SAF S.P.A., 35013 CITTADELLA, PADOVA, ITALY:
2,624,681, PUB. 7-2-2002. INT. CL. 7.
- IMAGE COSMETICS, LTD., OAK LAWN, IL:
1,932,678, CANC. INT. CL. 3.
- IMAGE WORKS, INC., ATLANTA, GA:
1,933,291, CANC. INT. CL. 25.

- IMAGEWORKS, LAWDALE, CA:
2,623,237, PUB. 3-26-2002. MULTIPLE CLASS, INT. CLS. 35 AND 42.
- IMAGING CONSORTIUM, INC.:
See—PRINTCO, INC.
- IMAVEX, LLC, CARMEL, IN:
2,624,737, PUB. 7-2-2002. INT. CL. 42.
- IMC CONFERENCES, INC., MINNEAPOLIS, MN:
2,626,831, MULTIPLE CLASS, INT. CLS. 41 AND 42.
- IMMUNOCORP, IRVINE, CA:
2,623,634, PUB. 7-2-2002. INT. CL. 3.
- IMPACT INSTRUMENTATION, INC., WEST CALDWELL, NJ:
2,625,000, PUB. 7-2-2002. INT. CL. 10.
- IMPERIAL PANTS CO. LTD./LA COMPAGNIE DES PANTALONS IMPERIAL LTEE., QUEBEC, CANADA:
2,625,809, MULTIPLE CLASS, INT. CLS. 25 AND 26.
- IMPERIAL POOLS, INC., LATHAM, NY:
2,623,320, PUB. 7-2-2002. INT. CL. 35.
- IMPERIAL SCHRADER CORP., ELLENVILLE, NY:
2,626,232, INT. CL. 8.
- IMPEX, INC., CITY OF INDUSTRY, CA:
2,624,107, PUB. 7-2-2002. INT. CL. 28.
- IMPORT PRODUCTS CO., INC., W. BRIDGEWATER, MA:
1,934,239, CANC. MULTIPLE CLASS, INT. CLS. 12 AND 40.
- IMPOSTER MARK, SANTA MONICA, CA:
1,933,558, CANC. INT. CL. 9.
- IMPRESIONES AEREAS, S.A. DE C.V., COLONIA LOMAS ALTAS, MEXICO:
2,627,025, INT. CL. 16.
- IMS MESSSYSTEME GMBH, D-42579 HEILIGENHAUS, FED REP GERMANY:
2,622,832, PUB. 7-2-2002. MULTIPLE CLASS, INT. CLS. 9 AND 42.
- INAMCO INTERNATIONAL CORP., S. PLAINFIELD, NJ:
2,623,562, PUB. 7-2-2002. INT. CL. 5.
- INCA SPIRITS, INC., CRAWFORDVILLE, GA:
2,626,979, INT. CL. 35.
- INCENTIVE GROUP, INC.:
1,176,379, CANC. INT. CL. 28.
- INDEPENDENCE COMMUNITY BANK, BROOKLYN, NY:
2,623,943, PUB. 7-2-2002. INT. CL. 36.
- INDEPENDENT MEDICAL CO-OP, INC., DAYTONA BEACH, FL:
2,624,906, PUB. 7-2-2002. INT. CL. 36.
- INDIAN VALLEY INDUSTRIES, INC., JOHNSON CITY, NY:
2,624,423, PUB. 7-2-2002. INT. CL. 19.
- INDIANA BUILDING SYSTEMS, LLC, MIDDLEBURY, IN:
2,623,914, PUB. 7-2-2002. INT. CL. 19.
- INDIANA GLASS COMPANY, CINCINNATI, OH:
1,697,679, REN. 8-12-02. INT. CL. 21.
- INDIANAPOLIS COLTS, INC., INDIANAPOLIS, IN, BALTIMORE FOOTBALL, INC., BALTIMORE, MD:
934,700, REN. 8-11-02. U.S. CL. 107 (INT. CL. 41).
- INDIGLO CORPORATION, MIDDLEBURY, CT:
1,934,104, CANC. INT. CL. 14.
- INDIGOVISION LIMITED, EDINBURGH, UNITED KINGDOM FROM INDIGOVISION LIMITED, EDINBURGH, GREAT BRITAIN:
2,623,246, PUB. 7-2-2002. INT. CL. 40.
- INDIGOVISION LIMITED:
See—INDIGOVISION LIMITED.
- INDIVIDUAL NETWORK, INC., PLANO, TX:
2,625,796, INT. CL. 9.
- INDOPCO, INC., BRIDGEWATER, NJ, DBA NATIONAL STARCH & CHEMICAL COMPANY:
2,624,740, PUB. 7-2-2002. INT. CL. 1.
- INDOPCO, INC., BRIDGEWATER, NJ, DBA NATIONAL STARCH AND CHEMICAL COMPANY:
2,626,047, INT. CL. 1.
- INDUSTRI AB THULE, HILLERSTORP, SWEDEN:
2,625,028, PUB. 7-2-2002. INT. CL. 12.
- INDUSTRIA DE CALCADOS NELSON PALERMO S.A., SAO PAULO, BRAZIL:
1,176,310, CANC. INT. CL. 25.
- INDUSTRIA DE DISEÑO TEXTIL, S.A., ARTEIXO, LA CORUNA, SPAIN, AKA INDITEX, S.A.:
2,622,530, PUB. 7-2-2002. INT. CL. 18.
- INDUSTRIA TECNICA VALENCIANA, S. A., VALENCIA, SPAIN:
2,623,031, PUB. 7-2-2002. MULTIPLE CLASS, INT. CLS. 11, 35 AND 37.
- INDUSTRIA TEXTIL, S.A., SAN JOSE, COSTA RICA:
1,932,418, CANC. INT. CL. 25.
- INDUSTRIAL AIR, INC., GREENSBORO, NC:
1,701,089, REN. 8-10-02. INT. CL. 11.
- INDUSTRIAL AUTOMATION INTEGRATORS (IAI) B.V., 5504 DR VELDHOVEN, NETHERLANDS:
2,622,940, PUB. 4-9-2002. INT. CL. 7.
- INFINITY BROADCASTING CORPORATION OF PENNSYLVANIA, NEW YORK, NY:
2,623,848, PUB. 7-2-2002. INT. CL. 41.
- INFINITY BROADCASTING CORPORATION OF SAN FRANCISCO, NEW YORK, NY:
2,624,921, PUB. 7-2-2002. INT. CL. 38.
- INFINITY HEART INSTITUTE CHARTERED, MILWAUKEE, WI:
1,933,085, CANC. INT. CL. 42.
- INFOGRAMS, INC., NEW YORK, NY FROM HUMONGOUS ENTERTAINMENT, INC., BOTHELL, WA:
2,623,869, PUB. 8-28-2001. INT. CL. 9.
- INFOLANE CORPORATION, FREMONT, CA:
1,932,845, CANC. INT. CL. 35.
- INFORMATION RESOURCES, INC., CHICAGO, IL:
2,626,817, INT. CL. 42.
- INFOSAFE SYSTEMS, INC., NEW YORK, NY:
1,933,816, CANC. INT. CL. 9.
- INFOSAGE, INC., PITTSBURGH, PA:
2,623,423, PUB. 3-12-2002. INT. CL. 42.
- INFOSERVE TELECOM CORPORATION, HAUPPAUGE, NY:
2,623,167, PUB. 7-2-2002. MULTIPLE CLASS, INT. CLS. 38 AND 42.
- INFOSOURCE, INC., FALLS CHURCH, VA:
2,625,276, PUB. 7-2-2002. INT. CL. 42.
- INFOSPHERES CORPORATION:
See—ISPHERES CORPORATION.
- INFOSTRENGTH BUSINESS SOLUTIONS INC., CARY, NC:
2,623,623, PUB. 7-2-2002. MULTIPLE CLASS, INT. CLS. 35 AND 42.
- 2,623,624, PUB. 7-2-2002. MULTIPLE CLASS, INT. CLS. 35 AND 42.
- INGENIA POLYMERS, INC., HOUSTON, TX:
2,626,352, INT. CL. 40.
- INGERMANN GOLF, INC, ARVADA, CO:
2,625,416, INT. CL. 28.
- INGERSOLL-RAND COMPANY, WOODCLIFF LAKE, NJ:
2,625,154, PUB. 7-2-2002. INT. CL. 42.
- INLET MEDICAL, INC., EDEN PRAIRIE, MN:
2,625,424, INT. CL. 10.
- INN DIAGNOSTICS LTD., NESS ZIONA 70400, ISRAEL:
2,625,637, INT. CL. 10.
- INNER OCEAN PUBLISHING, INC., TRAVERSE CITY, MI:
2,624,170, PUB. 7-2-2002. INT. CL. 41.
- INNERACTIVE NUTRITION NETWORK, INC., LOS ANGELES, CA:
2,624,251, PUB. 7-2-2002. INT. CL. 42.
- INNOFEED LIMITED, TORONTO, ONTARIO, CANADA:
2,626,411, INT. CL. 5.
- INNOGEAR, INC., MORGAN HILL, CA:
2,624,742, PUB. 7-2-2002. INT. CL. 9.
- INNOVATIVE CONCEPT DEVELOPMENT, INC., HIGHLANDS RANCH, CO:
1,934,425, CANC. INT. CL. 10.
- INNOVATIVE MEDICAL SYSTEMS, INC., HAMPTON, NH:
1,893,043, CANC. INT. CL. 10.
- INNOVATIVE RECYCLED PRODUCTS, INC., CHESTERFIELD, MO:
1,933,212, CANC. INT. CL. 21.
- INNOVATIVE SPORTS VISION PRODUCTS, INC., LOUISVILLE, MS:
1,663,323, CANC. INT. CL. 9.

- INO VX SOLUTIONS, IRVINE, CA:
2,625,965, INT. CL. 9.
- INPHI CORPORATION, WESTLAKE VILLAGE, CA:
2,626,442, INT. CL. 9.
- INPUT/OUTPUT, INC., STAFFORD, TX:
2,626,346, INT. CL. 9.
- INSTA-FOAM PRODUCTS, INC., JOLIET, IL:
1,175,652, CANC. INT. CL. 1.
- INSTITUT FRANCAIS DU PETROLE, RUEIL MALMAISON, FRANCE:
2,623,719, PUB. 7-2-2002. MULTIPLE CLASS, INT. CLS. 9, 35 AND 42.
- INSTITUTE FOR INFORMATION INDUSTRY, TAIPEI, TAIWAN:
1,933,933, CANC. INT. CL. 16.
1,933,934, CANC. INT. CL. 9.
- INSTITUTE FOR INNOVATION, INTEGRATION & IMPACT, INC., THE, REDWOOD CITY, CA:
2,623,414, PUB. 7-2-2002. INT. CL. 35.
- INSTRUMENTARIUM CORPORATION, 00510 HELSINKI, FINLAND:
2,625,888, MULTIPLE CLASS, INT. CLS. 9 AND 10.
- INSURANCE AUTO AUCTIONS, INC., NORTH HOLLYWOOD, CA:
1,932,834, CANC. INT. CL. 35.
- INSURANCE CENTRAL CORPORATION, CARPINTERIA, CA:
2,626,724, INT. CL. 36.
- INSUREZONE, INC., FORT WORTH, TX:
2,624,855, PUB. 7-2-2002. MULTIPLE CLASS, INT. CLS. 35, 36 AND 42.
- INTEGRASOLV CORP., MIDDLETOWN, NJ:
2,622,776, PUB. 7-2-2002. INT. CL. 42.
- INTEGRATED TECHNOLOGY CORPORATION, TEMPE, AZ:
2,623,524, PUB. 7-2-2002. INT. CL. 20.
- INTEGRATION DIAGNOSTICS LTD, SAVEDALEN, SWEDEN:
2,626,599, MULTIPLE CLASS, INT. CLS. 9 AND 10.
- INTEGRIMED, INC., ROSWELL, GA:
2,624,481, PUB. 7-2-2002. INT. CL. 9.
- INTEGRITY SPORTSWEAR, INC., NEW YORK, NY:
1,933,604, CANC. INT. CL. 25.
- INTEHEALTH INCORPORATED, MALVERN, PA:
2,624,189, PUB. 7-2-2002. MULTIPLE CLASS, INT. CLS. 9 AND 42.
- INTELLEGO, INC., MIDDLETOWN, OH:
2,624,273, PUB. 7-2-2002. INT. CL. 9.
- INTELLIGENT LIFE CORPORATION:
See— ILIFE.COM, INC..
- INTELLIGROUP, INC., EDISON, NJ:
2,625,634, MULTIPLE CLASS, INT. CLS. 35 AND 42.
- INTELLISHARE, LLC, CHICAGO, IL:
2,624,489, PUB. 7-2-2002. INT. CL. 42.
- INTELLISPACE, INC., NEW YORK, NY:
2,625,841, MULTIPLE CLASS, INT. CLS. 38 AND 42.
- INTELLISPHERE, LLC, PLAINSBORO, NJ:
2,626,990, INT. CL. 16.
- INTELLISYS CORPORATION, CHATTANOOGA, TN:
2,625,282, PUB. 7-2-2002. INT. CL. 9.
- INTER-CONTINENTAL HOTELS CORPORATION, NEW YORK, NY:
1,933,675, CANC. MULTIPLE CLASS, INT. CLS. 39 AND 42.
- INTER-TEL, INC., PHOENIX, AZ:
1,689,967, REN. 8-10-02. INT. CL. 9.
- INTER/MEDIA TIME BUYING CORPORATION, ENCINO, CA:
2,623,690, PUB. 7-2-2002. INT. CL. 35.
- INTERACT COMMUNICATIONS, INC., BOCA RATON, FL:
2,623,930, PUB. 7-2-2002. INT. CL. 9.
- INTERACTIVE MARKETING CORP., SAN JUAN, PUERTO RICO:
2,625,115, PUB. 7-2-2002. INT. CL. 42.
- INTERACTIVE MULTIMEDIA NETWORK, INC., JERSEY CITY, NJ:
2,625,944, MULTIPLE CLASS, INT. CLS. 5, 29 AND 32.
- INTERACTIVE TRANSACTION SERVICES CORP., SAN FRANCISCO, CA:
2,559,252, COR. MULTIPLE CLASS, INT. CLS. 9 AND 36.
- INTERACTIVE VOICE, DATA & FAX, INC., CLINTON TOWNSHIP, MI:
2,623,407, PUB. 7-2-2002. INT. CL. 35.
- INTERALIGN, LLC, RICHMOND, VA:
2,626,705, INT. CL. 16.
- INTERCON RESEARCH ASSOCIATES LTD., EVANSTON, IL:
1,176,458, CANC. INT. CL. 35.
1,176,460, CANC. INT. CL. 35.
- INTERCRAFT COMPANY, TAYLOR, TX, INTERCRAFT INDUSTRIES CORPORATION, CHICAGO, IL:
1,182,018, REN. 8-13-02. INT. CL. 16.
- INTERCRAFT INDUSTRIES CORPORATION, CHICAGO, IL TO INTERCRAFT COMPANY, TAYLOR, TX:
1,182,018, CANC. MULTIPLE CLASS, INT. CLS. 14 AND 20.
- INTERELATE, INC., EDEN PRAIRIE, MN:
2,626,127, INT. CL. 35.
- INTERIM FUNDING L.L.C., PALOS HEIGHTS, IL:
2,622,945, PUB. 7-2-2002. INT. CL. 36.
- INTERMUNE PHARMACEUTICALS, INC., BURLINGAME, CA TO HARKONEN, SCOTT, SAN FRANCISCO, CA:
2,465,992, COR. INT. CL. 5.
- INTERNATIONAL ASSOCIATION OF FOOD PROTECTION, DES MOINES, IA, FORMERLY THE INTERNATIONAL ASSOCIATION OF MILK, FOOD AND ENVIRONMENT:
2,623,723, PUB. 7-2-2002. INT. CL. 41.
- INTERNATIONAL BROADCASTING CORPORATION, SACRAMENTO, CA AND ROYCE INTERNATIONAL BROADCASTING CORPORATION, SACRAMENTO, CA:
2,623,615, PUB. 7-2-2002. INT. CL. 41.
- INTERNATIONAL BUSINESS MACHINES CORPORATION, ARMONK, NY:
1,932,518, CANC. INT. CL. 9.
1,933,908, CANC. MULTIPLE CLASS, INT. CLS. 41 AND 42.
2,625,884, MULTIPLE CLASS, INT. CLS. 16 AND 42.
2,626,783, INT. CL. 9.
2,626,795, MULTIPLE CLASS, INT. CLS. 9, 16, 37 AND 42.
- INTERNATIONAL CHINA COMPANY, INC., SECAUCUS, NJ:
2,623,425, PUB. 7-2-2002. INT. CL. 21.
- INTERNATIONAL COMFORT PRODUCTS CORPORATION (USA), LEWISBURG, TN:
2,625,359, INT. CL. 11.
- INTERNATIONAL CRYSTAL LABORATORIES, GARFIELD, NJ:
2,623,962, PUB. 7-2-2002. INT. CL. 16.
- INTERNATIONAL DATA GROUP, INC., FRAMINGHAM, MA:
1,934,421, CANC. INT. CL. 16.
- INTERNATIONAL DATA GROUP, INC.:
See— IDG BOOKS WORLDWIDE, INC..
2,626,760, MULTIPLE CLASS, INT. CLS. 16 AND 42.
- INTERNATIONAL DRILLING FLUIDS LIMITED, LONDON, E.C.4, ENGLAND:
1,175,654, CANC. INT. CL. 1.
- INTERNATIONAL DRIVE TRANSIT & IMPROVEMENT DISTRICT, ORLANDO, FL:
2,623,853, PUB. 7-2-2002. INT. CL. 35.
- INTERNATIONAL ENZYMES, INC., FALLBROOK, CA:
1,932,946, CANC. INT. CL. 1.
- INTERNATIONAL EQUIPMENT CO., NEEDHAM HEIGHTS, MA FROM INTERNATIONAL EQUIPMENT CO., NEEDHAM HEIGHTS, MA:
2,626,194, INT. CL. 9.
- INTERNATIONAL EROSION CONTROL SYSTEMS, WEST LORNE, ONTARIO, CANADA:
2,626,776, INT. CL. 19.
- INTERNATIONAL FAMILY ENTERTAINMENT, INC., LOS ANGELES, CA:
2,625,221, PUB. 7-2-2002. INT. CL. 41.
- INTERNATIONAL FLAVORS & FRAGRANCES INC., NEW YORK, NY:
1,932,974, CANC. MULTIPLE CLASS, INT. CLS. 1 AND 3.

- INTERNATIONAL GOLD CORPORATION LIMITED, NEW YORK, NY:
1,176,703, CANC. INT. CL. 35.
- INTERNATIONAL GOLDEN FOODS, INC., NILES, IL:
2,122,597, CANC. INT. CL. 29.
- INTERNATIONAL INSTITUTE FOR SUSTAINABLE DEVELOPMENT, WINNIPEG, MANITOBA, CANADA:
1,936,529, AM. MULTIPLE CLASS, INT. CLS. 9 AND 16.
- INTERNATIONAL INSTITUTE OF REFLEXOLOGY, INC., ST. PETERSBURG, FL:
2,623,053, PUB. 7-2-2002. INT. CL. 41.
- INTERNATIONAL MARKETING CONSORTIUM, INC., BALTIMORE, MD:
1,932,567, CANC. INT. CL. 32.
- INTERNATIONAL MARKETING SERVICES, INC., NORTH ANDOVER, MA:
2,625,127, PUB. 7-2-2002. MULTIPLE CLASS, INT. CLS. 9 AND 42.
- INTERNATIONAL MASTERS PUBLISHERS AB, MALMO, SWEDEN:
2,627,027, INT. CL. 16.
- INTERNATIONAL MEDICAL GROUP, INC., INDIANAPOLIS, IN:
2,623,591, PUB. 7-2-2002. INT. CL. 36.
2,626,419, INT. CL. 36.
- INTERNATIONAL MISSIONS, INC., READING, PA:
2,625,620, INT. CL. 42.
- INTERNATIONAL PAPER COMPANY, PURCHASE, NY:
1,933,470, CANC. INT. CL. 16.
- INTERNATIONAL SCIENTIFIC COMMUNICATIONS, INC., SHELTON, CT:
2,626,999, INT. CL. 16.
- INTERNATIONAL SPORTS SPECIALISTS, INC., NORTH LOGAN, UT:
2,623,865, PUB. 7-2-2002. INT. CL. 41.
2,623,866, PUB. 7-2-2002. INT. CL. 41.
- INTERNATIONAL SUPREME PRODUCTS, LLC, COPPELL, TX:
2,626,566, INT. CL. 30.
- INTERNATIONAL SURFING ASSOCIATION, LA JOLLA, CA:
2,626,758, INT. CL. 41.
- INTERNATIONAL TOP VALUE AUTOMOTIVE, L.L.C., LIVONIA, MI:
2,623,269, PUB. 7-2-2002. INT. CL. 37.
- INTERNATIONAL UNION, SECURITY, POLICE AND FIRE PROFESSIONALS OF AMERICA (SPFPA), ROSEVILLE, MI:
2,624,279, PUB. 7-2-2002. INT. CL. 35.
- INTERNET VENTURE COMPANY LTD., THE, LONDON, UNITED KINGDOM:
2,624,971, PUB. 8-21-2001. INT. CL. 36.
- INTERNETINNS.COM CORPORATION, OKLAHOMA, OK:
2,625,037, PUB. 7-2-2002. INT. CL. 35.
- INTERNETIX, INC., WILMINGTON, DE:
2,623,700, PUB. 7-2-2002. MULTIPLE CLASS, INT. CLS. 35 AND 42.
- INTEROPS:
See—INTEROPS MANAGEMENT SOLUTIONS, INC..
- INTEROPS MANAGEMENT SOLUTIONS, INC., MEDFORD, MA FROM INTEROPS, BOSTON, MA:
2,623,711, PUB. 7-2-2002. MULTIPLE CLASS, INT. CLS. 35 AND 42.
- INTERSPORT, INC, FREDERICK, MD:
2,623,535, PUB. 7-2-2002. INT. CL. 25.
- INTERSTATE BRANDS COMPANY - LICENSING CO., KANSAS CITY, MO:
1,934,168, CANC. INT. CL. 30.
- INTERVIDEO, INC., FREMONT, CA:
2,625,835, INT. CL. 9.
2,625,836, INT. CL. 9.
2,625,837, INT. CL. 9.
2,625,838, INT. CL. 9.
- INTOWN SUITES MANAGEMENT, INC., ATLANTA, GA:
2,624,085, PUB. 7-2-2002. INT. CL. 42.
- INTRABIOTICS PHARMACEUTICALS, INC., MOUNTAIN VIEW, CA:
2,626,012, INT. CL. 5.
- INVENTIO AG, CH-6052 HERGISWIL, SWITZERLAND:
2,623,507, PUB. 4-30-2002. MULTIPLE CLASS, INT. CLS. 7, 9 AND 37.
- INVERGRAM, C.A., CARACAS, VENEZUELA:
1,933,418, CANC. INT. CL. 30.
- INVERSIONES Y SERVICIOS CRESSIDA, S.A. DE C.V., TEGUCIGALPA, D.C., HONDURAS:
1,933,479, CANC. MULTIPLE CLASS, INT. CLS. 3 AND 5.
1,933,480, CANC. MULTIPLE CLASS, INT. CLS. 3 AND 5.
- INVESTFORCLOSURES.COM, ELGIN, IL:
2,624,997, PUB. 7-2-2002. INT. CL. 36.
- INVICTA NETWORKS, INC., LAUREL, MD:
2,626,019, INT. CL. 9.
- IN2M.COM LLC, HOLLADAY, UT:
2,623,152, PUB. 7-2-2002. MULTIPLE CLASS, INT. CLS. 35 AND 36.
- ION STORM, L.P., DALLAS, TX:
2,625,712, MULTIPLE CLASS, INT. CLS. 9 AND 16.
- IPCAPITAL GROUP, INC., WILLISTON, VT:
2,625,061, PUB. 7-2-2002. MULTIPLE CLASS, INT. CLS. 16 AND 42.
- IPG PHOTONICS CORPORATION, STURBRIDGE, MA:
2,623,529, PUB. 7-2-2002. MULTIPLE CLASS, INT. CLS. 9, 40 AND 42.
2,623,531, PUB. 7-2-2002. MULTIPLE CLASS, INT. CLS. 9, 40 AND 42.
- IPL INC., PROVINCE OF QUEBEC, CANADA:
2,622,631, PUB. 7-2-2002. INT. CL. 21.
- IPRAX CORPORATION, LEXINGTON, MA:
1,933,866, CANC. INT. CL. 9.
- IPT WEINFELDEN AG, 8570 WEINFELDEN, SWITZERLAND:
2,622,689, PUB. 7-2-2002. MULTIPLE CLASS, INT. CLS. 7, 9 AND 40.
- IRIDES, LLC, WASHINGTON, DC:
2,625,611, MULTIPLE CLASS, INT. CLS. 38 AND 42.
- IRISH ALE BREWERIES LIMITED, DUBLIN 2, IRELAND:
1,934,428, CANC. INT. CL. 32.
- IRON CROSS LTD., CENTERPORT, NY:
2,624,467, PUB. 7-2-2002. INT. CL. 16.
- IRRISOFT, LLC, TAYLORSVILLE, UT:
2,622,741, PUB. 7-2-2002. INT. CL. 9.
- IRWIN, KLEE, CULVER CITY, CA, DBA IRWIN NATURALS:
1,901,441, CANC. INT. CL. 5.
- ISABELLENHUTTE HEUSLER GMBH KG, 35664 DILLENBURG, FED REP GERMANY:
1,689,905, REN. 8-15-02. INT. CL. 9.
- ISCHOOLFUND.COM, SAN DIEGO, CA, DBA KIDS FLOWERS:
2,623,935, PUB. 7-2-2002. INT. CL. 36.
- ISCREEN, LLC, MEMPHIS, TN FROM VISION PARTNERS, L.P., MEMPHIS, TN:
2,622,651, PUB. 7-2-2002. MULTIPLE CLASS, INT. CLS. 10 AND 42.
- ISK BIOSCIENCES CORPORATION, MENTOR, OH:
1,934,279, CANC. INT. CL. 5.
1,934,280, CANC. INT. CL. 5.
- ISLANDQUEST VACATIONS LLC, RIDGEFIELD, CT:
2,625,167, PUB. 7-2-2002. INT. CL. 39.
- ISLE OF CAPRI CASINOS, INC., BILOXI, MS:
2,626,265, INT. CL. 42.
- ISOPRINT, INC., TUALATIN, OR:
2,624,264, PUB. 7-2-2002. INT. CL. 42.
- ISPHERES CORPORATION, OAKLAND, CA FROM INFO-SPHERES CORPORATION, SAN FRANCISCO, CA:
2,622,826, PUB. 7-2-2002. INT. CL. 35.
- ISUZU JIDOSHA KABUSHIKI, TOKYO, JAPAN:
1,175,829, CANC. INT. CL. 7.
- IT NETWORK, INC., IRVING, TX:
2,624,519, PUB. 7-2-2002. INT. CL. 38.
- IT'S ACADEMIC OF ILLINOIS, INC., NORTHBROOK, IL:
2,623,941, PUB. 7-2-2002. MULTIPLE CLASS, INT. CLS. 9 AND 16.
- IT'S SO EASY, LTD., MORGANVILLE, NJ:
2,624,603, PUB. 7-2-2002. INT. CL. 26.
- ITEC ENTERTAINMENT CORPORATION, ORLANDO, FL:
2,622,682, PUB. 7-2-2002. MULTIPLE CLASS, INT. CLS. 35

- AND 41.
 ITOCHU TECHNOLOGY, INC., SANTA CLARA, CA:
 2,625,570, INT. CL. 42.
 ITP LICENSING CORPORATION, WILMINGTON, DE:
 1,933,941, CANC. INT. CL. 9.
 ITP OF USA, INC., ELIZABETHTOWN, PA:
 2,626,359, INT. CL. 42.
 ITT FLYGT CORPORATION, TRUMBULL, CT:
 1,898,573, CANC. INT. CL. 7.
 ITT INDUSTRIES, INC., WHITE PLAINS, NY:
 2,623,381, PUB. 7-2-2002. INT. CL. 9.
 2,623,707, PUB. 7-2-2002. INT. CL. 42.
 ITX INTERNATIONAL HOLDINGS, INC., MOUNTAIN
 VIEW, CA:
 2,624,300, PUB. 7-2-2002. MULTIPLE CLASS, INT. CLS.
 35, 36, 41 AND 42.
 IU, STEPHEN C., DALLAS, TX:
 2,623,743, PUB. 7-2-2002. INT. CL. 40.
 IUCN, INTERNATIONAL UNION FOR THE CONSERVA-
 TION OF NATURE AND NATURAL RESOURCES,
 GLAND, SWITZERLAND:
 2,622,703, PUB. 7-2-2002. MULTIPLE CLASS, INT. CLS. 41
 AND 42.
 IVAR'S INC., SEATTLE, WA, IVAR'S, INC., SEATTLE, WA:
 1,194,890, REN. 8-15-02. INT. CL. 42.
 1,197,499, REN. 8-15-02. INT. CL. 42.
 IVAX DIAGNOSTICS, INC., MIAMI, FL:
 2,623,725, PUB. 7-2-2002. MULTIPLE CLASS, INT. CLS. 1
 AND 5.
 IVY ASSOCIATES, MENLO PARK, CA:
 1,690,442, REN. 8-15-02. INT. CL. 35.
 IWATANI INTERNATIONAL CORPORATION, CHOU-KU,
 OSAKA 541, JAPAN:
 2,568,768, COR. MULTIPLE CLASS, INT. CLS. 1, 4, 6, 7, 9,
 11, 17, 20, 21 AND 39.
 J & B WHOLESALE DISTRIBUTING, INC., ST. MICHAEL,
 MN:
 2,625,868, INT. CL. 29.
 J & H FOOD AND BEVERAGE, INC., CITY OF COMMERCE,
 CA:
 1,933,121, CANC. INT. CL. 32.
 J & S MANUFACTURERS, PINEHURST, NC:
 2,624,705, PUB. 7-2-2002. INT. CL. 3.
 J. F. JELENKO & CO., ARMONK, NY:
 2,622,611, PUB. 4-10-2001. INT. CL. 10.
 J. M. SMUCKER COMPANY, THE, ORRVILLE, OH:
 2,623,577, PUB. 7-2-2002. INT. CL. 30.
 J. R. MAXX, INC., CHARLOTTE, NC:
 1,932,858, CANC. INT. CL. 16.
 J. WEBER ENGINEERING COMPANY, INC., ANCHOR, IL:
 1,176,667, CANC. INT. CL. 12.
 J.P. MORGAN CHASE & CO., NEW YORK, NY:
 2,559,101, COR. INT. CL. 36.
 J.P. MORGAN & CO. INCORPORATED, NEW YORK, NY:
 2,626,873, INT. CL. 36.
 J.P. NOLAN & CO., MAYWOOD, CA:
 2,626,971, INT. CL. 35.
 J.R., INC., UNIVERSAL CITY, TX:
 2,626,123, INT. CL. 35.
 J.T. CUSTOM WORKS, INC., ELKHART, IN:
 2,625,850, INT. CL. 40.
 J.T.M. CHARITABLE FOUNDATION, INC., HARRISON,
 OH, DBA THE ZONE BOOK:
 2,624,513, PUB. 7-2-2002. INT. CL. 35.
 J&J INDUSTRIES, INC., DALTON, GA:
 2,623,170, PUB. 7-2-2002. MULTIPLE CLASS, INT. CLS. 1
 AND 2.
 J&L INK INC., LAGRANGE, IL:
 2,560,710, COR. INT. CL. 25.
 JABBER.COM, INC., DENVER, CO:
 2,623,241, PUB. 7-2-2002. MULTIPLE CLASS, INT. CLS. 9
 AND 42.
 JACADI, 92000 NANTERRE, FRANCE:
 2,623,442, PUB. 7-2-2002. INT. CL. 25.
 JACK DANIEL'S PROPERTIES, INC., SAN RAFAEL, CA:
 2,624,566, PUB. 7-2-2002. INT. CL. 33.
 2,625,959, INT. CL. 34.
 2,626,122, INT. CL. 30.
 JACK-POST CORPORATION, BUCHANAN, MI:
 1,934,309, CANC. INT. CL. 20.
 JACK'S FAMILY RESTAURANTS, INC., HOMEWOOD, AL:
 2,624,814, PUB. 7-2-2002. INT. CL. 43.
 JACKCO TRANSNATIONAL INC., SOUTH EL MONTE, CA:
 2,625,180, PUB. 7-2-2002. INT. CL. 7.
 JACKLIN SEED COMPANY, POST FALLS, ID:
 1,932,923, CANC. INT. CL. 31.
 JACKSON INTERNATIONAL TRADING COMPANY KURT
 D. BRUHL GESELLSCHAFT M.B.H. & CO. KG, 8041
 GRAZ, AUSTRIA:
 1,932,495, CANC. INT. CL. 33.
 JACKSON; JAMES A., COLUMBUS, OH:
 1,176,222, CANC. INT. CL. 19.
 JACKSON, BRUCE E., NOVELTY, OH:
 2,625,642, INT. CL. 28.
 JACOVINI, STACEY, NEW YORK, NY:
 2,626,364, INT. CL. 42.
 JACQUES CARTIER CLOTHIERS, BANFF INC., BANFF,
 ALBERTA, CANADA:
 2,622,750, PUB. 7-2-2002. MULTIPLE CLASS, INT. CLS. 23
 AND 25.
 JAMATEX, INC., OXFORD, PA:
 2,623,176, PUB. 7-2-2002. INT. CL. 25.
 JAMES HENRY COUNSELING ASSOCIATES, MIDLAND,
 NJ:
 2,623,768, PUB. 7-2-2002. INT. CL. 42.
 JAMES KNOSKA INDUSTRIES, LTD., JENSEN BEACH, FL:
 2,624,296, PUB. 7-2-2002. INT. CL. 42.
 JAMES RIVER PAPER COMPANY, INC., NORWALK, CT:
 1,933,550, CANC. INT. CL. 16.
 1,934,138, CANC. INT. CL. 21.
 JAMESON HOME PRODUCTS, DOWNERS GROVE, IL:
 1,315,637, CANC. INT. CL. 11.
 JAMIESON, JAMES, TOWN & COUNTRY, MO AND JAMIE-
 SON, JENNIFER, ST. LOUIS, MO, DBA NUTRACEUTICS
 CORPORATION:
 2,624,781, PUB. 7-2-2002. INT. CL. 3.
 JANUS INTERNATIONAL HOLDING COMPANY, DEN-
 VER, CO:
 2,623,734, PUB. 7-2-2002. INT. CL. 36.
 JAQUA GIRLS, INC., SANTA BARBARA, CA:
 2,624,615, PUB. 7-2-2002. INT. CL. 3.
 JARL INVESTMENTS, L.P., CARNEGIE, PA:
 2,622,881, PUB. 7-2-2002. INT. CL. 29.
 JARROW FORMULAS, INC., LOS ANGELES, CA:
 2,625,306, PUB. 7-2-2002. INT. CL. 5.
 JAS. D. EASTON, INC., VAN NUYS, CA, DBA EASTON:
 1,932,815, CANC. INT. CL. 28.
 JAVA CITY, SACRAMENTO, CA:
 2,623,576, PUB. 7-2-2002. INT. CL. 30.
 JAW JOINTS & ALLIED MUSCULO-SKELETAL DISOR-
 DERS FOUNDATION, INC., BOSTON, MA:
 2,626,779, MULTIPLE CLASS, INT. CLS. 41 AND 42.
 JAX CAFE, INC., MINNEAPOLIS, MN:
 2,625,231, PUB. 7-2-2002. INT. CL. 43.
 JAY-KAY DISTRIBUTORS, INC., STATE COLLEGE, PA:
 1,175,711, CANC. INT. CL. 3.
 JAY'S MARKETS, INC., YORK, PA:
 1,176,579, CANC. INT. CL. 42.
 JAZZERCISE, INC., CARLSBAD, CA:
 1,722,649, REN. 8-14-02. INT. CL. 41.
 JBI, INC., CANTON, MA:
 1,932,826, CANC. INT. CL. 25.
 JEANNE D'ARC CREDIT UNION, LOWELL, MA:
 2,623,371, PUB. 7-2-2002. MULTIPLE CLASS, INT. CLS. 16
 AND 36.
 JEFF'S BASEMENT, INC., ST. LOUIS, MO:
 2,626,028, INT. CL. 41.
 JEFFREY BANKS, LTD., NEW YORK, NY:
 1,933,321, CANC. INT. CL. 25.
 JEFFREY JOSEPH CARSWELL, BOONE, IA, DBA CAR-
 SWELL PRODUCT DESIGNS:
 2,624,718, PUB. 7-2-2002. INT. CL. 28.
 JEFFS, MICHAEL, HAVERHILL, SUFFOLK CB9 7YF, UNI-
 TED KINGDOM:
 2,622,597, PUB. 12-14-1999. INT. CL. 6.

- JEKIELEK, ELIZABETH ANN, VALENCIA, CA:
2,625,988, INT. CL. 42.
- JENERIC/PENTRON, INCORPORATED, WALLINGFORD, CT:
2,626,737, INT. CL. 5.
- JENKS, KEN, SAN JOSE, CA:
1,933,853, CANC. MULTIPLE CLASS, INT. CLS. 20 AND 25.
- JENNIE-O FOODS, INC.:
See— JENNIE-O TURKEY STORE, INC..
- JENNIE-O TURKEY STORE, INC., WILLMAR, MN FROM JENNIE-O FOODS, INC., WILLMAR, MN:
2,623,473, PUB. 7-2-2002. INT. CL. 29.
- JENRIK MARKETING GROUP INC., SCANDIA, MN:
1,934,071, CANC. INT. CL. 9.
- JERUSALEM TEMPLE FUND, INC., THE, SUGAR LAND, TX:
2,625,573, INT. CL. 36.
- JESS HALL'S SEASONED SALT COMPANY, WEATHERFORD, TX:
2,624,563, PUB. 5-28-2002. INT. CL. 30.
- JESTELLE PTY LTD:
See— CLEAR STEEL AUSTRALIA PTY, LTD..
- JESTERTEK, INC., WOODBURY, NY:
2,623,501, PUB. 7-2-2002. INT. CL. 9.
- JET FLEET CORPORATION, DALLAS, TX:
1,176,522, CANC. MULTIPLE CLASS, INT. CLS. 37, 39 AND 41.
- JETER REAL ESTATE:
See— JETER, RODERICK.
- JETER, RODERICK, LEMON GROVE, CA FROM JETER REAL ESTATE, LEMON GROVE, CA:
2,622,581, PUB. 7-2-2002. INT. CL. 25.
- JETNET CORPORATION, CARNEGIE, PA:
1,711,125, REN. 8-16-02. INT. CL. 5.
- JEUP, CHRISTY L., BRANDON, FL:
2,624,987, PUB. 7-2-2002. INT. CL. 16.
- JEWISH WAR VETERANS OF THE UNITED STATES OF AMERICA, INC., WASHINGTON, DC:
1,933,754, CANC. INT. CL. 42.
- JFA LIMITED, MAIDENHEAD SL6 OAA, UNITED KINGDOM:
2,623,961, PUB. 7-2-2002. INT. CL. 4.
- JHRG, LLC, SPRING HOPE, NC:
2,623,409, PUB. 7-2-2002. INT. CL. 12.
- JIM MUDD ADVERTISING, INC., CEDAR FALLS, IA, DBA THE MUDD GROUP:
2,625,088, PUB. 7-2-2002. INT. CL. 35.
- JIN BEN SUN CO., LTD., TAOYUAN HSIEN, TAIWAN, TAIWAN:
2,623,765, PUB. 7-2-2002. INT. CL. 9.
- JINTOWN ENTERPRISE LTD., CONNAUGHT WEST, HONG KONG:
2,624,865, PUB. 7-2-2002. INT. CL. 29.
- JIVAN, LTD., MIAMI, FL:
2,623,986, PUB. 7-2-2002. INT. CL. 14.
- JKA, INC., WOONSOCKET, RI, DBA DIVERSIFIED DISTRIBUTION:
2,625,526, INT. CL. 3.
- JLW & COMPANY, TULSA, OK:
1,932,899, CANC. INT. CL. 28.
- JMK INTERNTIONAL, INC., FORT WORTH, TX:
1,933,416, CANC. INT. CL. 21.
- JMP INDUSTRIES, INC., CLEVELAND, OH:
2,623,883, PUB. 7-2-2002. INT. CL. 17.
- JMP-NEWCOR INTERNATIONAL, INC., SKOKIE, IL:
1,933,456, CANC. INT. CL. 8.
- JMX, INC., MINNEAPOLIS, MN:
1,734,648, REN. 8-16-02. INT. CL. 12.
- JO MALONE LIMITED, LONDON SW11 4XW, ENGLAND:
2,626,339, INT. CL. 3.
- JOCKEY INTERNATIONAL, INC., KENOSHA, WI:
1,934,131, CANC. INT. CL. 25.
- JOEAUTO.COM, INC.:
See— JOEAUTO, INC..
- JOEAUTO, INC., THE WOODLANDS, TX FROM JOEAUTO.COM, INC., THE WOODLANDS, TX:
2,623,781, PUB. 7-2-2002. MULTIPLE CLASS, INT. CLS. 37 AND 42.
- JOHN E. CHANCE & ASSOCIATES, LAFAYETTE, LA:
1,934,081, CANC. INT. CL. 38.
- JOHN JACOBS GOLF SCHOOLS, INC., SCOTTSDALE, AZ:
2,626,242, INT. CL. 41.
- JOHN O. BUTLER COMPANY, CHICAGO, IL:
1,964,692, CANC. INT. CL. 3.
- JOHN RICH & SONS INVESTMENT HOLDING COMPANY, WILMINGTON, PA:
2,625,078, PUB. 7-2-2002. MULTIPLE CLASS, INT. CLS. 20, 24, 25 AND 27.
- JOHN RICH AND SONS INVESTMENT HOLDING COMPANY, WILMINGTON, DE:
2,624,998, PUB. 7-2-2002. MULTIPLE CLASS, INT. CLS. 24 AND 25.
- JOHNNY APPLESEED'S, INC., BEVERLY, MA, DBA JOHNNY APPLESEED'S:
941,094, REN. 8-14-02. U.S. CL. 101 (INT. CL. 42).
- JOHNSEN, MARK L., SAN ANTONIO, TX:
1,702,194, REN. 8-16-02. INT. CL. 41.
- JOHNSON & JOHNSON, NEW BRUNSWICK, NJ:
2,622,556, PUB. 7-2-2002. INT. CL. 10.
2,623,738, PUB. 7-2-2002. INT. CL. 3.
2,625,042, PUB. 7-2-2002. INT. CL. 3.
2,625,043, PUB. 7-2-2002. INT. CL. 3.
2,626,693, INT. CL. 3.
- JOHNSON CONTROLS, INC., MILWAUKEE, WI FROM HOOVER UNIVERSAL, INC., PLYMOUTH, MI:
2,625,372, MULTIPLE CLASS, INT. CLS. 9 AND 12.
- JOHNSON GROSSFIELD, MINNEAPOLIS, MN:
1,934,233, CANC. INT. CL. 35.
- JOHNSON, MICHAEL GREGG, WASHINGTON, DC:
2,625,536, MULTIPLE CLASS, INT. CLS. 18 AND 25.
- JOHNSON, PETER, HALEIWA, HI:
1,933,114, CANC. INT. CL. 25.
- JOINER, MARGIE, MERIDIAN, MS:
1,933,883, CANC. INT. CL. 5.
- JOINT ACTIVE SYSTEMS INC., EFFINAHAM, IL:
2,622,968, PUB. 7-2-2002. INT. CL. 10.
- JOINT JUICE, INC., SAN FRANCISCO, CA FROM STONE, KEVIN R., SAN FRANCISCO, CA:
2,625,534, INT. CL. 5.
- JONES INTERNATIONAL, LTD., ENGLEWOOD, CO:
2,625,302, PUB. 7-2-2002. INT. CL. 41.
- JONES STAR SPORTS LTD., IRVING, TX:
2,626,402, INT. CL. 41.
2,626,403, INT. CL. 41.
- JONES, DAY, REAVIS & POGUE, CLEVELAND, OH:
2,626,209, INT. CL. 42.
- JONES, RICHARD, H, WASHINGTON, DC:
2,626,625, INT. CL. 42.
- JOSEPH, LINDA, POWELL, OH:
2,623,402, PUB. 7-2-2002. MULTIPLE CLASS, INT. CLS. 9 AND 16.
- JOSHUA CREEK SHOOTING RESORT, INC., BOEME, TX, DBA JOSHUA CREEK RANCH:
2,623,465, PUB. 7-2-2002. MULTIPLE CLASS, INT. CLS. 35, 41 AND 42.
- JOSLYN, GLENN X., CHICOPEE, MA:
2,625,142, PUB. 7-2-2002. INT. CL. 39.
- JOSUMA CORPORATION, MENLO PARK, CA:
2,623,910, PUB. 7-2-2002. INT. CL. 30.
- JOY ATHLETIC, INC., HIALEAH, FL:
2,624,821, PUB. 7-2-2002. INT. CL. 25.
- JPD MANUFACTURING LIMITED, LAKE ZURICH, IL:
1,175,819, CANC. INT. CL. 7.
- JUDEE K. CREATIONS, INC., NORTH HOLLYWOOD, CA:
1,933,628, CANC. INT. CL. 31.
1,933,629, CANC. INT. CL. 31.
- JULIE ANN TURNER & COMPANY, PLANO, TX:
2,625,725, INT. CL. 41.
- JULIE ANN TURNER COMPANY, PLANO, TX:
2,625,724, INT. CL. 41.
- JUNG SUWON MARTIAL ART ACADEMY, MILPITAS, CA:
2,623,867, PUB. 7-2-2002. INT. CL. 41.
- JUNGLE JACK'S, INC., CARLSBAD, CA:
2,624,051, PUB. 7-2-2002. INT. CL. 31.
2,624,118, PUB. 7-2-2002. INT. CL. 31.

- JUPITER COMMUNICATIONS, INC., NEW YORK, NY:
2,622,742, PUB. 7-2-2002. INT. CL. 42.
- JURAK HOLDINGS LIMITED, LAS VEGAS, NV:
2,625,515, MULTIPLE CLASS, INT. CLS. 5 AND 32.
- JURAN INSTITUTE, INC., WILTON, CT:
1,934,514, CANC. MULTIPLE CLASS, INT. CLS. 9 AND 16.
- JUST LIKE ME 3D STORES, INC., WINDERMERE, FL:
2,625,427, MULTIPLE CLASS, INT. CLS. 20, 28 AND 40.
- JUST TIES, INC., DEERFIELD BEACH, FL:
1,932,492, CANC. INT. CL. 42.
- K MART CORPORATION, TROY, MI:
1,176,275, CANC. INT. CL. 23.
- K MART PROPERTIES, INC., TROY, MI:
1,663,469, CANC. INT. CL. 22.
- K. HOVNANIAN COMPANIES OF METRO WASHINGTON, INC., FAIRFAX, VA:
1,932,483, CANC. INT. CL. 37.
- K.G.M. CONSUMER GROUP, INC., CINCINNATI, OH:
2,624,318, PUB. 7-2-2002. INT. CL. 3.
- K.V. DREAMS, INC., MORRISTOWN, NJ:
2,624,095, PUB. 7-2-2002. INT. CL. 28.
- K-JACK ENGINEERING COMPANY, INC., GARDENA, CA:
1,175,931, CANC. INT. CL. 9.
- K-MONT INDUSTRIES, INC., BROUSSARD, LA:
2,623,052, PUB. 12-18-2001. INT. CL. 37.
- K-SUN CORPORATION, SOMERSET, WI:
2,625,365, INT. CL. 9.
- K-2 CORPORATION, VASHON, WA:
2,626,543, INT. CL. 28.
- KABUSHIKI KAISHA BANDAI, TAITO-KU, TOKYO, JAPAN:
2,622,529, PUB. 3-21-2000. INT. CL. 25.
2,622,616, PUB. 4-18-2000. INT. CL. 28.
2,622,931, PUB. 10-2-2001. INT. CL. 9.
2,623,735, PUB. 7-2-2002. INT. CL. 28.
- KABUSHIKI KAISHA HATTORI SEIKO, TOKYO, JAPAN, TA SEIKO CORPORATION:
1,934,206, CANC. INT. CL. 14.
- KABUSHIKI KAISHA HITACHI SEISAKUSHO, CHIYODAKU, TOKYO, JAPAN, DBA HITACHI, LTD.:
1,680,593, REN. 8-12-02. INT. CL. 37.
1,933,800, CANC. INT. CL. 9.
1,933,801, CANC. INT. CL. 9.
1,933,804, CANC. INT. CL. 9.
- KABUSHIKI KAISHA INFAS, MINATO-KU, TOKYO, JAPAN:
1,698,570, REN. 8-12-02. INT. CL. 16.
- KABUSHIKI KAISHA KURATCHI:
See— GUKURAKUCHO KABUSHIKI KAISHA.
- KABUSHIKI KAISHA PILOT, CHUO-KU, TOKYO, JAPAN:
2,626,486, INT. CL. 16.
- KABUSHIKI KAISHA RIKEN, CHIYODA-KU, TOKYO, JAPAN:
1,159,059, REN. 8-15-02. INT. CL. 12.
- KABUSHIKI KAISHA TOSHIBA, KAWASAKI-SHI, KANAGAWA-KEN, JAPAN, TA TOSHIBA CORPORATION:
2,624,290, PUB. 7-2-2002. INT. CL. 9.
- KABUSHIKI KAISHA YAKULT HONSHA, MINATO-KU, TOKYO, JAPAN:
2,622,612, PUB. 6-27-2000. MULTIPLE CLASS, INT. CLS. 29, 30 AND 32.
- KADER INDUSTRIAL COMPANY LIMITED, KOWLOON BAY, HONG KONG:
2,625,750, INT. CL. 28.
- KAHN LAW GROUP (A PROFESSIONAL LAW CORPORATION):
See— KAHN-GAUTHIER LAW GROUP, L.L.C.
- KAHN-GAUTHIER LAW GROUP, L.L.C., METAIRIE, LA FROM KAHN LAW GROUP (A PROFESSIONAL LAW CORPORATION), METAIRIE, LA:
2,626,820, INT. CL. 42.
- KAIM & ASSOCIATES INTERNATIONAL MARKETING, INC., LODI, WI:
2,624,502, PUB. 7-2-2002. INT. CL. 7.
- KAISER, ROLF DIETER, 17012 ALBISSOLA MARINA (SAVONA), ITALY:
2,626,275, INT. CL. 42.
- KAL KAN FOODS, INC., VERNON, CA:
2,623,266, PUB. 7-2-2002. INT. CL. 42.
2,623,267, PUB. 7-2-2002. INT. CL. 42.
2,623,268, PUB. 7-2-2002. INT. CL. 42.
2,623,290, PUB. 7-2-2002. INT. CL. 42.
2,623,291, PUB. 7-2-2002. INT. CL. 42.
2,623,298, PUB. 7-2-2002. INT. CL. 42.
- KALUDIS CONSULTING GROUP, INC., WASHINGTON, DC, DBA KALUDIS CONSULTING:
2,624,383, PUB. 7-2-2002. INT. CL. 35.
- KAMEWA FINLAND LTD, FIN-26100 RAUMA, FINLAND TO AQUAMASTER-RAUMA LTD., FIN-26100 RAUMA, FINLAND:
2,568,748, COR. MULTIPLE CLASS, INT. CLS. 7 AND 12.
- KANEGAFUCHI KAGAKU KOGYO KABUSHIKI KAISHA, KITAKU, OSAKA, JAPAN, DBA KANEGAFUCHI CHEMICAL INDUSTRY COMPANY, LTD.:
1,663,470, CANC. MULTIPLE CLASS, INT. CLS. 22 AND 25.
- KANG, DAE SUM, YONGDUNGPO-GU, SEOUL, REPUBLIC OF KOREA:
2,622,864, PUB. 7-2-2002. INT. CL. 39.
- KANG, JOHN, MANHASSET, NY:
2,625,113, PUB. 7-2-2002. INT. CL. 3.
- KANGAROO BRANDS, INC., MILWAUKEE, WI:
2,626,936, INT. CL. 30.
- KANSAS CITY ROYALS BASEBALL CORPORATION, KANSAS CITY, MO:
2,623,374, PUB. 7-2-2002. INT. CL. 41.
- KANSAS INT'L LIMITED, HONG KONG, HONG KONG:
2,624,996, PUB. 7-2-2002. INT. CL. 15.
- KANTEK INC., EAST ROCKAWAY, NY:
2,626,285, INT. CL. 16.
- KAO KABUSHIKI KAISHA, TOKYO 103-8210, JAPAN, TA KAO CORPORATION:
2,623,106, PUB. 7-2-2002. INT. CL. 1.
- KAO KABUSHIKI KAISHA, TOKYO 103-8210, JAPAN, TA KAO CORPORATION:
2,623,608, PUB. 7-2-2002. INT. CL. 3.
- KAPPA ALPHA THETA FRATERNITY, INC., INDIANAPOLIS, IN:
1,697,558, REN. 8-14-02. INT. CL. 16.
1,697,674, REN. 8-14-02. INT. CL. 21.
1,697,702, REN. 8-14-02. INT. CL. 25.
- KARI, SHAWN DVM, VICTORVILLE, CA:
2,623,142, PUB. 7-2-2002. INT. CL. 42.
- KARIDI, INC., BURLINGAME, CA FROM DECISIS CORPORATION, SAN MATEO, CA:
2,625,863, INT. CL. 9.
- KARL KANI INTERNATIONAL, INC., CITY OF INDUSTRY, CA:
2,624,177, PUB. 7-2-2002. INT. CL. 25.
- KARL STORZ GMBH & CO. KG, TUTTLINGEN, FED REP GERMANY:
2,624,292, PUB. 7-2-2002. INT. CL. 10.
- KAROL-WARNER, INC., HIGHLAND PARK, NJ:
723,562, CANC. U.S. CL. 26.
- KARPEN, MARIAN J., NEW YORK, NY:
1,732,245, REN. 8-10-02. INT. CL. 41.
- KASZANICS, ARTHUR J., GILROY, CA:
1,934,261, CANC. INT. CL. 9.
- KATE SPADE, LLC, NEW YORK, NY:
2,626,385, INT. CL. 9.
- KATICA, LC, DERBY, KS:
2,624,595, PUB. 7-2-2002. INT. CL. 11.
- KATSURANIS, RONALD M., BELMONT, CA:
2,627,031, INT. CL. 9.
- KAUFMANN, JEAN-CLAUDE, NEW YORK, NY:
2,626,415, INT. CL. 42.
- KAYDON ACQUISITION XI, INC., ANN ARBOR, MI:
2,624,142, PUB. 7-2-2002. INT. CL. 6.
2,624,144, PUB. 7-2-2002. INT. CL. 6.
2,624,911, PUB. 7-2-2002. INT. CL. 6.
- KAYE, JONATHAN, ENCINO, CA:
2,626,322, INT. CL. 25.
- KAYSER-ROTH CORPORATION, GREENSBORO, NC:
2,626,231, INT. CL. 25.

KAZAH FASHION INC., LOS ANGELES, CA:
1,934,463, CANC. INT. CL. 25.
1,934,464, CANC. INT. CL. 25.

KBE, LONG BRANCH, NJ:
2,626,695, INT. CL. 42.

KEDDCO MFG. LTD., SARNIA, ONTARIO, CANADA:
1,176,190, CANC. INT. CL. 17.

KEENER MARKETING, INC., DAYTON, TN:
2,625,138, PUB. 7-2-2002. INT. CL. 35.

KEIMFARBEN GMBH & CO. KG, D-86420 DIEDORF, FED
REP GERMANY:
2,622,752, PUB. 1-30-2001. INT. CL. 2.

KELLER, ANDREW A., LOGAN, UT:
2,626,560, INT. CL. 42.

KELLY, LARRY A., GRAFTON, OH:
2,626,357, INT. CL. 39.

KENDALL COMPANY, THE, WALPOLE, MA TO TYCO
HEALTHCARE GROUP LP, MANSFIELD, MA:
1,155,556, CANC. INT. CL. 16.

KENDALL COMPANY, THE, MANSFIELD, MA:
1,933,565, CANC. INT. CL. 5.

KENOSHA BEEF INTERNATIONAL LTD., KENOSHA, WI:
2,623,777, PUB. 7-2-2002. INT. CL. 29.

KENSINGTON PUBLISHING CORP., NEW YORK, NY:
1,934,200, CANC. INT. CL. 16.

KENT ELECTRONICS CORPORATION, HOUSTON, TX:
2,623,212, PUB. 7-2-2002. MULTIPLE CLASS, INT. CLS. 35
AND 42.

KENT SPORTS INC., CHATSWORTH, CA:
2,624,275, PUB. 7-2-2002. INT. CL. 28.

KENWOOD VINEYARDS, KENWOOD, CA:
1,663,586, CANC. INT. CL. 33.

KERN RIDGE GROWERS, INC., ARVIN, CA:
1,933,075, CANC. INT. CL. 29.

KERRIGAN, PATRICIA J., WOODLAND HILLS, CA:
2,623,260, PUB. 7-2-2002. INT. CL. 35.

KESSLER REHABILITATION CORPORATION, WEST OR-
ANGE, NJ:
2,624,512, PUB. 7-2-2002. INT. CL. 42.

KESSLER/LAKE BUENA VISTA I, LTD., ORLANDO, FL:
2,625,617, INT. CL. 42.

KESSLER, BARRY J., NEW YORK, NY:
1,933,450, CANC. INT. CL. 35.

KEY WEST FRAGRANCE & COSMETIC FACTORY, INC.,
KEY WEST, FL:
1,933,582, CANC. INT. CL. 3.

KEYBOARD CONCEPTS, INC., VAN NUYS, CA:
2,623,443, PUB. 7-2-2002. INT. CL. 35.

KEYENCE CORPORATION, OSAKA, JAPAN:
2,623,682, PUB. 7-2-2002. MULTIPLE CLASS, INT. CLS. 7
AND 9.

KEYES COMPANY, THE, MIAMI, FL:
2,624,487, PUB. 7-2-2002. INT. CL. 36.

KEYSTONE DRILL SERVICES, INC., SOMERSET, PA:
2,624,582, PUB. 7-2-2002. MULTIPLE CLASS, INT. CLS. 7
AND 37.

KEYSTONE SEED COMPANY, INC., SANTA FE, NM:
391,378, CANC. U.S. CL. 1.

KFORCE INC., TAMPA, FL FROM ROMAC INTERNA-
TIONAL, INC., TAMPA, FL:
2,625,418, INT. CL. 35.

KHANLIAN, HRATCH, PANORAMA CITY, CA AND
KHANLIAN, SILVA, PANORAMA CITY, CA:
1,692,870, REN. 8-15-02. INT. CL. 14.

KHJ INTEGRATED MARKETING INC., BOSTON, MA:
2,623,981, PUB. 7-2-2002. INT. CL. 35.

KIDDIE KORRAL COMPANY, DALLAS, TX:
2,625,512, INT. CL. 25.

KIDS AGAIN, INC., DUBLIN, CA:
1,933,563, CANC. INT. CL. 42.
1,933,564, CANC. INT. CL. 42.

KIDS INCORPORATED, WALTHAM, MA, DBA THE CHIL-
DREN'S WORKSHOP:
2,625,588, INT. CL. 42.

KIDS@HOME, INC., BOCA RATON, FL:
2,626,036, INT. CL. 42.

KIDSPACE, INC., BETHLEHEM, PA:
1,933,196, CANC. INT. CL. 16.

KIDVID, INC., ALPHARETTA, GA, DBA SMALL FRY
PRODUCTIONS:
2,625,706, INT. CL. 9.

KIKKOMAN CORPORATION, NODA CITY, CHIBA, JA-
PAN:
1,220,196, REN. 8-10-02. INT. CL. 29.

KIM SENG COMPANY, LOS ANGELES, CA:
2,622,984, PUB. 5-21-2002. MULTIPLE CLASS, INT. CLS.
29 AND 30.

KIM, SANG S., NEW YORK, NY:
2,624,019, PUB. 7-2-2002. INT. CL. 14.

KIM, YOUNG TAE, HACKENSACK, NJ, AKA: SEAN KIM:
2,626,405, INT. CL. 25.

KIMBERLY-CLARK CORPORATION, NEENAH, WI:
2,623,954, PUB. 7-2-2002. INT. CL. 16.

KINDERLANGUAGE LLC, MOUNT LAUREL, NM FROM
BOBO, LINDA, NEW JERSEY, NJ:
2,624,055, PUB. 7-2-2002. MULTIPLE CLASS, INT. CLS. 35
AND 41.

KINDERSTART, LLC, NORWALK, CA:
2,623,552, PUB. 7-2-2002. INT. CL. 42.

KINDERSTREET CORPORATION, ANN ARBOR, MI:
2,626,595, INT. CL. 9.

KINDT COLLINS COMPANY, THE, CLEVELAND, OH,
KINDT-COLLINS CO., DIVISION OF HINES INVEST-
MENT CORPORATION, THE, CLEVELAND, OH:
1,200,801, REN. 8-14-02. INT. CL. 4.

KINESIX CORPORATION, HOUSTON, TX, SCIENTIFIC
SOFTWARE-INTERCOMP, INC., DENVER, CO:
1,678,369, REN. 8-16-02. INT. CL. 9.

KINETIC MARKETING INC., NEW YORK, NY:
1,933,662, CANC. INT. CL. 9.

KING COLE DUCKS LIMITED, RR #3, NEW MARKET
ONTARIO, CANADA:
2,623,726, PUB. 7-2-2002. INT. CL. 29.

KINKO'S VENTURES, INC., VENTURA, CA:
2,625,645, INT. CL. 9.

KIRK'S FOLLY, INC., PROVIDENCE, RI:
1,932,589, CANC. INT. CL. 14.
1,933,259, CANC. INT. CL. 14.

KIRKLE; KAL E., MODESTO, CA, DBA KIRKLE BEAUTY
AND BARBER SUPPLY:
148,032, CANC. U.S. CL. 6.

KIRSCH, STEVEN PHILIP, NEWPORT BEACH, CA:
1,934,187, CANC. INT. CL. 18.

KIS INDUSTRIES, LTD., MEDINA, OH:
2,626,944, INT. CL. 22.

KISS MY FACE, GARDINER, NY:
2,626,664, INT. CL. 3.

KIWI BRANDS INC., DOUGLASSVILLE, PA:
1,175,714, CANC. INT. CL. 3.

KLEER-VU PLASTICS CORPORATION, BROWNVILLE, TN:
1,175,967, CANC. INT. CL. 9.

KLIBAN, JUDITH K., CORTE MADERA, CA, KLIBAN; B.,
SAN ANSELMO, CA:
1,197,292, REN. 8-13-02. INT. CL. 21.

KLOPCIC, KIM, ANNAPOLIS, MD:
2,622,874, PUB. 12-5-2000. INT. CL. 42.

KLUTZNICK, JOHN F., SAUSALITO, CA:
1,933,953, CANC. INT. CL. 9.

KLX, LLC, WESTLAKE VILLAGE, CA:
2,625,744, MULTIPLE CLASS, INT. CLS. 25 AND 28.

KMART OF MICHIGAN, INC., TROY, MI, KMART PROP-
ERTIES, INC., TROY, MI:
1,686,525, REN. 8-10-02. INT. CL. 25.

KMART PROPERTIES, INC., TROY, MI:
2,623,010, PUB. 7-2-2002. INT. CL. 3.

KMG-BERNUTH, INC., HOUSTON, TX, ANSUL CHEMICAL
COMPANY, MARINETTE, WI:
732,024, REN. 8-14-02. U.S. CL. 6 (INT. CLS. 1 AND 5).

KMT ENTERPRISES, LLC, NEW YORK, NY:
2,623,537, PUB. 7-2-2002. INT. CL. 25.

- KNAPP, FRIEDRICH, 38112 BRAUNSCHWEIG, FED REP GERMANY AND CZECH, ANDREAS, 38102 BRAUNSCHWEIG, FED REP GERMANY AND SCHMITT, FRANZ, 38106 BRAUNSCHWEIG, FED REP GERMANY AND AHRENS, HANS-JOACHIM, 38855, WERNIGERODE, FED REP GERMANY:
2,623,203, PUB. 7-2-2002. MULTIPLE CLASS, INT. CLS. 3, 9, 14, 18, 25 AND 28.
- KNAPP, JOHN, SANDY, OR AND KNAPP, REGENA, SANDY, OR:
1,932,746, CANC. INT. CL. 31.
- KNESSE MFG. CO., INC., ALBIA, IA:
2,622,924, PUB. 7-2-2002. INT. CL. 5.
2,623,251, PUB. 7-2-2002. INT. CL. 21.
- KNF NEUBERGER GMBH, 79112 FREIBURG, FED REP GERMANY:
2,622,711, PUB. 7-2-2002. MULTIPLE CLASS, INT. CLS. 6, 7, 11 AND 17.
- KNIGHT CORPORATION, TORONTO, ONTARIO, CANADA:
2,626,259, INT. CL. 22.
- KNITWAVES INC., NEW YORK, NY:
1,933,206, CANC. INT. CL. 25.
- KNOWASTE, L.L.C., MISSISSAUGA, ONTARIO, CANADA:
2,626,018, INT. CL. 40.
- KNOWCONFLICT, LLC, PHOENIX, AZ:
2,626,079, INT. CL. 41.
- KNOWLEDGE ADVENTURE WORLDS, FAIRFAX STAT., VA:
1,933,687, CANC. INT. CL. 9.
- KNOWLEDGE ANYWHERE, INC., BELLEVUE, WA:
2,624,211, PUB. 7-2-2002. INT. CL. 42.
- KNOWLEDGE PARK AG, D-80336 MUNCHEN, FED REP GERMANY:
2,623,469, PUB. 7-2-2002. MULTIPLE CLASS, INT. CLS. 9 AND 42.
- KNOX OIL OF TEXAS, INC., DALLAS, TX:
1,933,802, CANC. INT. CL. 4.
- KOA SPEER ELECTRONICS, INC., BRADFORD, PA:
2,624,220, PUB. 7-2-2002. INT. CL. 9.
- KOBELCO CONSTRUCTION MACHINERY AMERICA LLC, WILMINGTON, DE FROM KOBELCO AMERICA INC., STAFFORD, TX:
2,626,247, INT. CL. 7.
- KOEBERLE, BRIAN E., PITTSBURGH, PA:
1,934,510, CANC. INT. CL. 35.
- KOEFF, MARK JORDAN, RANCHO SANTA MARGARITA, CA:
2,625,340, INT. CL. 16.
- KOHLER CO., KOHLER, WI, OWENS-CORNING FIBERGLAS CORPORATION, TOLEDO, OH:
1,194,671, REN. 8-13-02. INT. CL. 11.
- KOHLER CO., KOHLER, WI:
2,626,430, INT. CL. 11.
- KOLADIS, RANDALL S., HARTFORD, CT:
2,624,776, PUB. 7-2-2002. INT. CL. 16.
- KOLCRAFT ENTERPRISES, INC., CHICAGO, IL:
1,933,731, CANC. INT. CL. 28.
- KONAMI CO., LTD., MINATO-KU, TOKYO 105-6021, JAPAN:
2,625,664, INT. CL. 28.
- KONAMI OF AMERICA, INC., BUFFALO GROVE, IL, KONAMI INC., BUFFALO GROVE, IL:
1,704,297, REN. 8-16-02. INT. CL. 28.
- KONE MATERIALS HANDLING, INC., SPRINGFIELD, OH:
1,175,986, CANC. INT. CL. 9.
- KONICA CORPORATION, SHINJUKU-KU, TOKYO, JAPAN:
2,623,384, PUB. 7-2-2002. INT. CL. 9.
- KONICA QUALITY PHOTO (EAST), INC., SCARBOROUGH, ME:
1,663,409, CANC. INT. CL. 16.
- KONINKLIJKE PHILIPS ELECTRONICS N.V., EINDHOVEN, NETHERLANDS:
2,622,629, PUB. 1-9-2001. INT. CL. 9.
2,622,947, PUB. 7-2-2002. INT. CL. 9.
2,622,964, PUB. 7-2-2002. INT. CL. 9.
2,623,924, PUB. 7-2-2002. INT. CL. 9.
2,624,577, PUB. 7-2-2002. INT. CL. 42.
- KOOL STOP INTERNATIONAL, INC., LAKE OSWEGO, OR:
2,626,177, INT. CL. 12.
- KOPLOW GAMES, INC., BOSTON, MA:
1,722,154, REN. 8-10-02. INT. CL. 28.
- KORD PRODUCTS INC., BRANTFORD, ONTARIO, CANADA, KORD PRODUCTS LIMITED, BRAMPTON, ONTARIO, CANADA:
1,723,842, REN. 8-15-02. INT. CL. 21.
- KORET OF CALIFORNIA, INC., OAKLAND, CA:
1,769,366, REN. 8-10-02. INT. CL. 25.
- KOSE CORPORATION, TOKYO, JAPAN:
2,625,652, INT. CL. 3.
- KOSTUR, KRISTAN JANE, CHARLOTTE, NC AND LURZ, SUSAN L., CHARLOTTE, NC:
1,933,497, CANC. MULTIPLE CLASS, INT. CLS. 29 AND 30.
- KOTLER MARKETING GROUP, WASHINGTON, DC:
2,626,955, INT. CL. 41.
- KOTLER, BEN, FOUNTAIN VALLEY, CA:
2,625,627, INT. CL. 25.
- KRAFT FOODS HOLDINGS, INC, NORTHFIELD, IL FROM NABISCO BRANDS COMPANY, WILMINGTON, DE:
2,626,607, INT. CL. 29.
2,626,655, INT. CL. 29.
- KRAFT FOODS HOLDINGS, INC., NORTHFIELD, IL:
2,625,935, INT. CL. 35.
- KRAFT FOODS, INC., NORTHFIELD, IL:
1,932,630, CANC. INT. CL. 42.
1,933,917, CANC. INT. CL. 16.
- KRAFT, INC.:
1,176,417, CANC. INT. CL. 30.
- KRAMER TRENTON COMPANY, TRENTON, NJ:
1,176,022, CANC. INT. CL. 11.
- KRANSCO MANUFACTURING, INC., SAN FRANCISCO, CA:
1,176,078, CANC. INT. CL. 14.
- KRAUS-ANDERSON, INCORPORATED, MINNEAPOLIS, MN:
1,933,157, CANC. INT. CL. 41.
- KRAUSE PUBLICATIONS, INC., LOLA, WI:
2,624,028, PUB. 7-2-2002. INT. CL. 16.
- KRAUSE, EDWARD J., III, POTOMAC, MD:
2,626,761, INT. CL. 35.
- KRAUT, BILLEE, MINNETONKA, MN AND JOHNSON, HOWARD R., MINNETONKA, MN:
2,623,697, PUB. 7-2-2002. INT. CL. 35.
- KRENT, EDWARD D., BOSTON, MA AND PAFFETT, NICHOLAS B., BOSTON, MA:
1,933,408, CANC. INT. CL. 28.
- KREUTER MANUFACTURING CO., INC., NEW PARIS, IN:
2,626,867, INT. CL. 9.
- KRISTAL CORPORATION, SPARKS, NV:
1,934,322, CANC. INT. CL. 16.
- KROEBER, KENNETH, EDGEWATER, FL:
1,732,008, REN. 8-16-02. INT. CL. 7.
- KROEHLER CORPORATION, COLUMBUS, OH:
2,625,895, INT. CL. 35.
- KROGER CO. OF MICHIGAN, THE, LIVONIA, MI, KROGER CO., THE, CINCINNATI, OH:
1,204,705, REN. 8-16-02. INT. CL. 29.
- KROGER CO. OF MICHIGAN, THE, LIVONIA, MI:
2,623,620, PUB. 7-2-2002. MULTIPLE CLASS, INT. CLS. 3, 4, 5, 6, 8, 16, 20 AND 21.
- KRONE AG, 14167 BERLIN, FED REP GERMANY:
1,933,919, CANC. INT. CL. 9.
- KRONE DIGITAL COMMUNICATIONS INC., SIDNEY, NE FROM PRESTOLITE WIRE CORPORATION, SOUTHFIELD, MI:
2,625,629, MULTIPLE CLASS, INT. CLS. 41 AND 42.

- KRONE GMBH, D-14167 BERLIN ZEHELENDORF, FED REP GERMANY FROM KRONE AKTIENGESELLSCHAFT, W-1000 BERLIN 37, FED REP GERMANY:
2,625,397, INT. CL. 9.
- KRONOS INCORPORATED, WALTHAM, MA:
2,625,552, INT. CL. 9.
- KROY INTERNATIONAL INC., TORONTO, ONTARIO, CANADA:
2,623,733, PUB. 7-2-2002. INT. CL. 1.
- KRUEGER INTERNATIONAL, INC., GREEN BAY, WI:
2,626,401, INT. CL. 20.
- KRUISPUNT B.V., 3437 KV NIEUWEGEIN, NETHERLANDS:
2,623,055, PUB. 10-16-2001. MULTIPLE CLASS, INT. CLS. 14, 20 AND 25.
- KRUSE, GARY, L., GLENWOOD, IA:
2,627,035, INT. CL. 9.
2,627,036, INT. CL. 35.
- KUBINDKI, JAMES, WARE, MA, MECHTECH, INC., GREENVILLE, RI:
1,636,387. REN. 8-13-02. INT. CL. 41.
- KUHN & KUHN PRODUCTS, INC., ST. LOUIS, MO:
1,663,428, CANC. INT. CL. 18.
- KUHN, DANIEL, NEW YORK, NY:
2,625,386, INT. CL. 42.
- KURARAY CO., LTD., OKAYAMA, JAPAN:
2,623,325, PUB. 7-2-2002. MULTIPLE CLASS, INT. CLS. 22 AND 23.
- KURASHIKI BOSEKI KABUSHIKI KAISHA, OKAYAMA-KEN, JAPAN, TA KURABO INDUSTRIES LTD.:
1,723,279. REN. 8-10-02. MULTIPLE CLASS, INT. CLS. 7 AND 9.
- KURGAN, JOHN, RINGWOOD, NJ:
1,932,857, CANC. INT. CL. 41.
- KUSEK, MARION, LUDLOW, MA, DBA KUSEK PUBLICATIONS & DISTRIBUTION:
1,932,413, CANC. INT. CL. 16.
- KVH INDUSTRIES, INC., MIDDLETOWN, RI:
2,623,778, PUB. 7-2-2002. INT. CL. 9.
- KWC AG, 5726 UNTERKULM, SWITZERLAND:
2,624,165, PUB. 7-2-2002. INT. CL. 11.
2,624,253, PUB. 7-2-2002. INT. CL. 11.
- KWIK TEK INC., DENVER, CO:
2,625,288, PUB. 7-2-2002. INT. CL. 28.
- KYSOR INDUSTRIAL CORPORATION, CONYERS, GA:
2,626,438, INT. CL. 11.
- L & F PRODUCTS INC., MONTVALE, NJ:
1,933,944, CANC. INT. CL. 2.
- L & P PROPERTY MANAGEMENT COMPANY, SOUTH GATE, CA:
2,623,994, PUB. 7-2-2002. INT. CL. 21.
2,626,237, INT. CL. 20.
- L.A.C. CONCEPTS, INC., TORRANCE, CA:
1,933,459, CANC. INT. CL. 11.
- L.F.P., INC., BEVERLY HILLS, CA:
2,624,783, PUB. 7-2-2002. INT. CL. 9.
- L&P PROPERTY MANAGEMENT COMPANY, SOUTH GATE, CA, JARKE CORPORATION, NILES, IL:
1,189,106. REN. 8-14-02. INT. CL. 6.
- L-3 COMMUNICATIONS CORPORATION, NEW YORK, NY, SINGER COMPANY, THE, STAMFORD, CT:
1,175,887. REN. 8-13-02. INT. CL. 9.
- L'IMPERIALE, COMPAGNIE D'ASSURANCE- VIE/THE IMPERIAL LIFE ASSURANCE COMPANY OF CANADA, TORONTO, ONTARIO, CANADA:
2,622,859, PUB. 7-2-2002. INT. CL. 36.
- L'OREAL USA CREATIVE, INC., NEW YORK, NY:
2,624,798, PUB. 7-2-2002. INT. CL. 3.
- L'OREAL USA CREATIVE, INC., NEW YORK, NY FROM COSMAIR CREATIVE, INC., NEW YORK, NY:
2,626,049, INT. CL. 3.
- LA CUMBRE, INC., PONTE VEDRA, FL:
2,622,770, PUB. 7-2-2002. INT. CL. 35.
- LA GLORIA OIL AND GAS COMPANY, BELLAIRE, TX:
1,710,955. REN. 8-10-02. MULTIPLE CLASS, INT. CLS. 1, 4, 39 AND 40.
- LA JOLLA BREWING COMPANY, LA JOLLA, CA:
1,933,749, CANC. INT. CL. 32.
- LA MARICK BEAUTY SYSTEM, INC., CHARLOTTE, NC:
723,687, CANC. U.S. CL. 100.
- LA SOUND USA, INC., ONTARIO, CA:
2,622,710, PUB. 7-2-2002. INT. CL. 9.
- LAB SAFETY CORPORATION, DES PLAINES, IL:
2,624,969, PUB. 7-2-2002. INT. CL. 9.
- LABATOS, DIMITRIS, MIAMI, FL:
2,624,175, PUB. 7-2-2002. INT. CL. 42.
- LABORATOIRE GARNIER & CIE, 75008 PARIS, FRANCE:
1,932,404, CANC. INT. CL. 3.
- LABORATOIRE NUXE, 75010 PARIS, FRANCE:
2,622,988, PUB. 7-2-2002. INT. CL. 3.
- LABORATOIRES BESINS INTERNATIONAL, 75003 PARIS, FRANCE:
2,623,398, PUB. 7-2-2002. INT. CL. 5.
- LABORATORIOS JALOMA S.A DE C.V., JALISCO, MEXICO:
2,625,605, INT. CL. 10.
- LACONTE, MICHAEL, CHICAGO, IL:
1,934,403, CANC. INT. CL. 18.
- LAKE MICHIGAN CREDIT UNION, GRAND RAPIDS, MI:
2,627,007, INT. CL. 36.
- LAKELAND NEURO CARE CENTER LIMITED PARTNERSHIP, TROY, MI:
1,933,050, CANC. INT. CL. 42.
- LAKESIDE BANK, CHICAGO, IL:
2,623,882, PUB. 7-2-2002. INT. CL. 36.
- LAKESIDE SOFTWARE, INC., KEEGO HARBOR, MI:
2,624,039, PUB. 7-2-2002. MULTIPLE CLASS, INT. CLS. 9 AND 42.
- LAMB CORPORATION, THE, LEWISVILLE, TX:
2,624,765, PUB. 7-2-2002. INT. CL. 7.
- LAMB-WESTON, INC., KENNEWICK, WA, BETTERS FOOD SALES, INC., OAKFIELD, NY:
749,487. REN. 8-16-02. U.S. CL. 46 (INT. CL. 29).
- LAMBDA PHYSIK AG, GOTTINGEN, FED REP GERMANY FROM LAMBDA PHYSIK GMBH, 37079 GOTTINGEN, FED REP GERMANY:
2,625,663, INT. CL. 9.
- LAMINALL, INC., LONG ISLAND CITY, NY:
1,690,544. REN. 8-15-02. INT. CL. 40.
- LAMONS METAL GASKET CO., HOUSTON, TX:
2,624,773, PUB. 7-2-2002. MULTIPLE CLASS, INT. CLS. 6 AND 17.
- LAMONT PARTNERSHIP, THE, BRIGHTON, MA:
2,624,756, PUB. 7-2-2002. INT. CL. 41.
- LAMY, BRUNO, 93360 - NEUILLY - PLAISANCE, FRANCE:
2,622,957, PUB. 7-2-2002. INT. CL. 24.
- LANCE ENTERPRISES, INC., MAUMEE, OH:
2,624,714, PUB. 7-2-2002. INT. CL. 3.
- LANCE MFG. LLC, CHARLOTTE, NC:
2,625,244, PUB. 7-2-2002. INT. CL. 30.
2,625,247, PUB. 7-2-2002. INT. CL. 30.
2,625,256, PUB. 7-2-2002. INT. CL. 29.
2,625,257, PUB. 7-2-2002. INT. CL. 29.
2,625,661, INT. CL. 30.
- LANCER ENTERPRISES, INC., DALTON, GA:
1,176,354, CANC. INT. CL. 27.
- LANCIAUX, FRANCIS E., JR., GRAND RAPIDS, OH:
2,623,838, PUB. 7-2-2002. INT. CL. 37.
- LANCOME PARFUMS ET BEAUTE & CIE, 75008 PARIS, FRANCE:
2,624,559, PUB. 3-26-2002. INT. CL. 3.
- LANDATA SYSTEMS, INC., HOUSTON, TX:
2,624,505, PUB. 7-2-2002. MULTIPLE CLASS, INT. CLS. 35, 36 AND 39.
- LANDEC AG, INC., MONTICELLO, IN FROM INTELLICOAT CORPORATION, MONTICELLO, IN, DBA FIELDER'S CHOICE DIRECT:
2,626,228, INT. CL. 31.
- LANDMAR GROUP, LLC, JACKSONVILLE, FL:
2,623,811, PUB. 7-2-2002. INT. CL. 35.
- LANDMARK PANTS CORPORATION, LYNBROOK, NY:
1,933,220, CANC. MULTIPLE CLASS, INT. CLS. 25 AND 42.
- LANDRY, JEAN, VILLE VANIER, QUEBEC G1M 2E7, CANADA:
2,622,724, PUB. 10-16-2001. INT. CL. 35.

- LANE BRYANT, INC., REYNOLDSBURG, OH:
2,625,568, INT. CL. 25.
- LANGE, MERVYN DOUGLAS, FRANKLAND WA 6396,
AUSTRALIA AND LANGE, JUDITH ANN, FRANKLAND
WA 6396, AUSTRALIA:
2,623,584, PUB. 7-2-2002. INT. CL. 33.
- LANTIS PRODUCTIONS, INC., DRAPER, UT:
2,623,123, PUB. 7-2-2002. MULTIPLE CLASS, INT. CLS. 13
AND 41.
- LAPORTE, ALBERT, 32100 BERAUT, FRANCE:
2,623,661, PUB. 7-2-2002. INT. CL. 3.
- LARGE SCALE BIOLOGY CORPORATION, VACAVILLE,
CA:
2,626,825, INT. CL. 42.
- LARRY H. MILLER THEATERS, INC., MURRAY, UT:
2,626,961, INT. CL. 41.
- LARSON, RALF:
See— ARCAM AB.
- LARUS & BROTHER COMPANY, RICHMOND, VA:
2,530,163, COR. INT. CL. 34.
- LAS VEGAS HELICOPTERS, INC., LAS VEGAS, NV:
2,623,274, PUB. 7-2-2002. INT. CL. 39.
- LAUTER & LAUTER, INC., CHICAGO, IL:
1,934,051, CANC. INT. CL. 42.
- LAVALLEE & IDE, INC., CHICOPEE, MA:
935,663, REN. 8-15-02. U.S. CL. 23 (INT. CL. 7).
- LAVENIR, LLC, FAIRFIELD, NJ:
2,624,641, PUB. 7-2-2002. INT. CL. 3.
- LAWMAN ARMOR CORP., BERWYN, PA:
2,625,892, INT. CL. 12.
- LAWN DOCTOR, INC., HOLMDEL, NJ:
2,624,915, PUB. 7-2-2002. MULTIPLE CLASS, INT. CLS. 37
AND 44.
- LAWN PATROL INC., BROOKLYN, NY:
1,932,978, CANC. INT. CL. 42.
- LAWRENCE, MARTIN, BEVERLY HILLS, CA:
2,624,872, PUB. 7-2-2002. INT. CL. 41.
2,624,873, PUB. 7-2-2002. INT. CL. 25.
- LB INNOVATORS, INC., CHULA VISTA, CA:
1,933,035, CANC. INT. CL. 9.
- LC TECHNOLOGY INTERNATIONAL, INC., CLEAR-
WATER, FL:
2,627,006, INT. CL. 9.
- LEA ROME PARIS, PARIS, FRANCE:
2,622,878, PUB. 7-2-2002. INT. CL. 25.
- LEADER CAPITAL CORP, PORTLAND, OR:
2,624,949, PUB. 7-2-2002. INT. CL. 36.
- LEADERS-TRUST, MANAGEMENT CONSULTANTS S.A.,
GENEVA 6 GENEVA, SWITZERLAND:
2,625,079, PUB. 7-2-2002. MULTIPLE CLASS, INT. CLS. 35
AND 42.
- LEAGUE FOR EDUCATIONAL AWARENESS OF THE
HOLOCAUST INC, BOCA RATON, FL:
2,622,725, PUB. 7-2-2002. INT. CL. 41.
- LEARNING IS FUN, LAS VEGAS, NV:
2,624,910, PUB. 7-2-2002. INT. CL. 35.
- LEARNING KEY, INC., THE, ALBUQUERQUE, NM:
2,623,307, PUB. 7-2-2002. INT. CL. 28.
- LEARNING TOOLS INTERNATIONAL, INC., SANTA
ROSA, CA:
2,624,257, PUB. 7-2-2002. INT. CL. 42.
- LEARNING TREE INTERNATIONAL, INC., LOS ANGELES,
CA:
2,625,328, INT. CL. 41.
- LEATH MCCARTHY & MAYNARD, INC., BURLINGTON,
NC:
1,176,338, CANC. INT. CL. 25.
- LEAVITT, DON, BELMONT, MA, DBA CEDAR RESEARCH:
1,176,122, CANC. INT. CL. 16.
1,176,123, CANC. INT. CL. 16.
1,176,124, CANC. INT. CL. 16.
1,176,125, CANC. INT. CL. 16.
- LEBA, CHRIS DUNG, BROOKLYN, NY:
2,624,907, PUB. 7-2-2002. INT. CL. 25.
- LECTEC CORPORATION, MINNETONKA, MN FROM
COSMO INTERNATIONAL GROUP, INC., GARDEN
GROVE, CA:
2,625,686, INT. CL. 3.
- LEDERWERKE SCHMIDT FELDBACH GMBH & CO. KG,
A-8330 FELDBACH, AUSTRALIA:
2,622,966, PUB. 7-2-2002. INT. CL. 1.
- LEE ENTERPRISES, INCORPORATED, DAVENPORT, IA:
1,933,788, CANC. INT. CL. 35.
- LEE HECHT HARRISON, LLC, WOODCLIFF LAKE, NJ:
2,625,103, PUB. 7-2-2002. INT. CL. 42.
- LEE PHARMACEUTICALS, INC., SOUTH EL MONTE, CA:
2,626,104, INT. CL. 3.
- LEE, SANG-JIN, ARLINGTON, TX:
1,934,163, CANC. INT. CL. 10.
- LEE, SUN-JA, ALPINE, NJ:
2,625,031, PUB. 7-2-2002. INT. CL. 29.
- LEECO INDUSTRIES, INC., OLIVE BRANCH, MI:
1,933,976, CANC. INT. CL. 16.
- LEGACY SPECIALISTS, LLC, THE, ST. LOUIS, MO:
2,624,168, PUB. 7-2-2002. INT. CL. 36.
- LEGAL RESEARCH CENTER, INC., MINNEAPOLIS, MN:
1,666,183, REN. 8-14-02. INT. CL. 42.
- LEGALKEY TECHNOLOGIES, INC., NEW YORK, NY:
2,623,982, PUB. 7-2-2002. INT. CL. 42.
- LEGAN, INC., DENVER, CO:
1,699,378, REN. 8-16-02. INT. CL. 36.
- LEGENT INTERNATIONAL, LTD., NEW YORK, NY:
2,624,359, PUB. 7-2-2002. INT. CL. 18.
2,626,319, INT. CL. 18.
2,626,431, INT. CL. 18.
- LEHIGH VALLEY HEALTH NETWORK, INC., ALLEN-
TOWN, PA:
2,624,456, PUB. 7-2-2002. INT. CL. 42.
- LEHMAN BROS. CORP., JERSEY CITY, NJ:
723,490, CANC. U.S. CL. 16.
- LEHMAN BROTHERS INC., NEW YORK, NY, SHEARSON
LEHMAN BROTHERS INC., NEW YORK, NY:
1,698,495, REN. 8-14-02. INT. CL. 36.
- LEISURE LINK GROUP LIMITED, STAFFORDSHIRE DE14
1SE, UNITED KINGDOM:
2,623,564, PUB. 7-2-2002. MULTIPLE CLASS, INT. CLS. 9
AND 41.
- LEMICA CORPORATION, DETROIT, MI:
2,624,524, PUB. 7-2-2002. INT. CL. 20.
- LEMONAKIS, MIKE, CAPE CORAL, FL:
1,934,079, CANC. INT. CL. 14.
- LEMOND, GREG, BLOOMINGTON, MN:
2,626,035, INT. CL. 28.
- LENNOX INDUSTRIES INC., RICHARDSON, TX:
2,625,677, INT. CL. 11.
- LENZ ELEKTRONIK, GMBH, ALLENDORF, FED REP
GERMANY:
2,625,130, PUB. 7-2-2002. INT. CL. 9.
- LENZ, CAROL A., PALOS HEIGHTS, IL:
1,933,125, CANC. INT. CL. 28.
- LEO BURNETT WORLDWIDE, INC., CHICAGO, IL:
2,625,491, INT. CL. 35.
- LEO CHEVALIER INTERNATIONAL, LTD., MONTREAL,
QUEBEC, CANADA:
1,176,303, CANC. INT. CL. 25.
- LEO SCHACHTER DIAMONDS, L.L.C., NEW YORK, NY:
2,626,447, INT. CL. 14.
- LEONICS CO., LTD., CHACHOENSAO 24180, THAILAND:
2,625,417, INT. CL. 9.
- LEROUX, ROBERT J., ATLANTA, GA:
2,624,957, PUB. 7-2-2002. INT. CL. 35.
- LES PRODUITS ADDICO, INC., DOLLAD-DES-ORMEAUX,
QC., CANADA:
2,624,966, PUB. 7-2-2002. INT. CL. 11.
- LET'S CLEAR THE AIR, INC., SHELTON, CT:
1,934,020, CANC. INT. CL. 21.
- LEUCADIA NATIONAL CORPORATION, SALT LAKE
CITY, UT:
2,624,103, PUB. 4-9-2002. MULTIPLE CLASS, INT. CLS. 35
AND 42.
- LEVERING, ROBERT, GRAND RAPIDS, MI:
2,626,684, INT. CL. 25.
- LEVI TOOL & MOLD CORPORATION, FLETCHER, NC:
2,626,333, INT. CL. 22.

- LEVITAN YEGIDIS & GOLDSTEIN LLP, MIDDLETOWN, NY:
2,624,554, PUB. 7-2-2002. INT. CL. 35.
- LEWIS MARINE SUPPLY INC., FT. LAUDERDALE, FL:
1,176,149, CANC. INT. CL. 16.
- LEWIS, JOHN, LAS VEGAS, NV:
2,625,254, PUB. 7-2-2002. INT. CL. 41.
- LEXINGTON PROFESSIONAL BASEBALL COMPANY, LLC, LEXINGTON, KY:
2,626,489, INT. CL. 28.
2,626,490, INT. CL. 16.
- LIBBY, PERSZYK, KATHMAN, INC., CINCINNATI, OH:
2,625,586, MULTIPLE CLASS, INT. CLS. 35 AND 42.
- LIBERTY FINANCIAL COMPANIES, INC., BOSTON, MA:
2,625,964, INT. CL. 36.
- LIBERTY HARDWARE MFG. CORP., WINSTON-SALEM, NC:
2,626,341, INT. CL. 21.
- LIBERTY MARKETING GROUP, INC., ST. PETERSBURG, FL:
2,624,754, PUB. 7-2-2002. INT. CL. 36.
- LIBERTY MUTUAL INSURANCE COMPANY, BOSTON, MA, DBA LIBERTY MUTUAL INSURANCE GROUP:
1,405,249, AM. INT. CL. 36.
- LIBERTYVILLE SADDLE SHOP, INC., LIBERTYVILLE, IL:
2,624,529, PUB. 6-18-2002. INT. CL. 18.
- LIDCO LTD, LONDON, N1 5QL, UNITED KINGDOM:
2,625,589, MULTIPLE CLASS, INT. CLS. 10 AND 42.
- LIDL STIFTUNG & CO. KG, 74172 NECKARSULM, FED REP GERMANY:
2,623,444, PUB. 7-2-2002. INT. CL. 33.
2,623,583, PUB. 7-2-2002. INT. CL. 30.
2,623,596, PUB. 7-2-2002. MULTIPLE CLASS, INT. CLS. 29, 31 AND 32.
2,623,597, PUB. 7-2-2002. MULTIPLE CLASS, INT. CLS. 29 AND 30.
2,623,598, PUB. 7-2-2002. MULTIPLE CLASS, INT. CLS. 29 AND 30.
2,623,749, PUB. 7-2-2002. INT. CL. 3.
2,623,750, PUB. 7-2-2002. INT. CL. 29.
2,623,815, PUB. 7-2-2002. MULTIPLE CLASS, INT. CLS. 3 AND 5.
2,623,817, PUB. 7-2-2002. MULTIPLE CLASS, INT. CLS. 29 AND 31.
- LIDL STIFTUNG & CO. KG, FED REP GERMANY:
2,626,877, INT. CL. 29.
- LIFE'S A CHARM, INC., CLEVELAND HEIGHTS, OH:
2,624,088, PUB. 7-2-2002. INT. CL. 6.
- LIFECORE BIOMEDICAL, INC., MINNEAPOLIS, MN:
1,663,159, CANC. INT. CL. 5.
- LIFEPOINT, INC., ONTARIO, CA:
2,626,593, INT. CL. 10.
- LIFESTREAM TECHNOLOGIES, INC., FORT COLLINS, CO:
2,622,623, PUB. 7-2-2002. INT. CL. 9.
- LIFETIME ENTERTAINMENT SERVICES, NEW YORK, NY:
1,934,490, CANC. INT. CL. 41.
- LIFETOUCH INC., EDEN PRAIRIE, MN:
2,626,187, INT. CL. 42.
- LIFUNG.COM, INC., NEW YORK, NY:
2,626,726, INT. CL. 25.
- LIGGENS, PATRICIA, COPLEY, OH:
1,932,891, CANC. INT. CL. 16.
- LIGHT RECORDS, INC., DOWNERS GROVE, IL:
1,932,514, CANC. INT. CL. 9.
- LIL' THINGS, INC., ARLINGTON, TX:
1,933,556, CANC. INT. CL. 42.
1,933,557, CANC. INT. CL. 25.
- LILAJON ASSOCIATES, NEW YORK, NY:
2,626,102, INT. CL. 14.
- LILY POND CAPITAL MANAGEMENT LLC, NEW YORK, NY:
2,626,674, INT. CL. 36.
- LIN, DANIEL F., MIAMI, FL:
1,932,623, CANC. INT. CL. 9.
- LIN, GERARD, LOS GATOS, CA:
2,625,004, PUB. 7-2-2002. INT. CL. 42.
- LINCOLN FOODSERVICE PRODUCTS HOLDING COMPANY, NEW PORT RICHEY, FL, REDCO, INC., WILMINGTON, DE:
935,311, REN. 8-12-02. U.S. CL. 23 (INT. CL. 7).
- LINCOLN FOODSERVICE PRODUCTS, LTD., FORT WAYNE, IN:
2,626,015, INT. CL. 21.
- LINCOLN GLOBAL, INC., MONTEREY PARK, CA:
2,626,424, INT. CL. 40.
- LINPAC PLASTICS INTERNATIONAL LTD, LINCOLNSHIRE, LN11 ONA, ENGLAND:
1,933,709, CANC. INT. CL. 17.
- LION BREWERY INC., THE, WILKES-BARRE, PA:
2,622,526, PUB. 7-2-2002. INT. CL. 32.
- LION ROCK HOLDINGS L.L.C., GRAND RAPIDS, MI:
2,624,867, PUB. 7-2-2002. INT. CL. 29.
- LIPPINCOTT WILLIAMS & WILKINS, INC., BALTIMORE, MD:
2,622,979, PUB. 7-2-2002. INT. CL. 16.
- LIPPMANN-MILWAUKEE, INC., MILWAUKEE, WI:
1,175,816, CANC. INT. CL. 7.
- LIPSON ASSOCIATES, INC., NORTHBROOK, IL, DBA LIPSON ALPORT GLASS & ASSOCIATES:
2,624,683, PUB. 7-2-2002. INT. CL. 35.
- LIQUID LIVING LLC, SOLON, OH:
2,624,110, PUB. 7-2-2002. INT. CL. 42.
- LISA FRANK, INC., TUCSON, AZ:
1,933,567, CANC. INT. CL. 16.
- LISCO, INC., TAMPA, FL:
1,933,468, CANC. INT. CL. 32.
- LISIUS, MARTIN, ARLINGTON, TX:
2,625,978, MULTIPLE CLASS, INT. CLS. 9 AND 16.
- LITERATE WORLD INC., FREMONT, CA:
2,624,898, PUB. 7-2-2002. INT. CL. 41.
- LITTLE COMPANY OF MARY HOSPITAL AND HEALTH CARE CENTERS, INC., EVERGREEN PARK, IL:
2,624,820, PUB. 7-2-2002. INT. CL. 42.
- LITTLE MOON INC., POUGHKEEPSIE, NY:
2,623,813, PUB. 11-6-2001. INT. CL. 30.
- LITTLE SIX, INC., PRIOR LAKE, MN:
2,624,454, PUB. 7-2-2002. INT. CL. 25.
- LITTLE TREE INDUSTRIES, NEW YORK, NY, AKA HOLLIS COMPANY:
1,175,871, REN. 8-15-02. INT. CL. 8.
- LIU, KUI FANG, ARCADIA, CA:
2,624,517, PUB. 7-2-2002. INT. CL. 11.
- LIV IN THE GAME, INC., AUSTIN, TX:
2,626,529, INT. CL. 41.
- LIVEONTHENET.COM, INC., HUNTSVILLE, AL:
2,622,873, PUB. 7-2-2002. INT. CL. 9.
- LIVIA SYLVA, INC., NEW YORK, NY:
1,175,701, CANC. INT. CL. 3.
- LIVINGSTON, BRUCE, SKOKIE, IL:
2,626,874, INT. CL. 42.
- LL INTERNATIONAL SHOE COMPANY, INC., LOS ANGELES, CA:
2,626,348, INT. CL. 25.
- LLUMAR STAR KITES INC., YUMA, AZ, DBA SPECTRA STAR:
1,932,681, CANC. INT. CL. 28.
- LME INVESTORS, LA MESA, CA:
1,933,352, CANC. MULTIPLE CLASS, INT. CLS. 25 AND 37.
- LOCARTA TECHNOLOGIES, INC., OKLAHOMA CITY, OK:
2,624,368, PUB. 7-2-2002. INT. CL. 9.
- LOCKETT, RICKY P., BROOKLYN, NY:
1,663,805, CANC. INT. CL. 28.
- LOCKHEED MARTIN CORPORATION, BETHESDA, MD:
2,622,885, PUB. 7-2-2002. INT. CL. 28.
- LOCKMAN FOUNDATION, THE, LA HABRA, CA:
2,626,384, INT. CL. 9.
- LOCKTON COMPANIES, INC., KANSAS CITY, MO:
2,624,149, PUB. 7-2-2002. INT. CL. 36.
- LOEW'S HOTELS, INC., NEW YORK, NY:
2,625,398, MULTIPLE CLASS, INT. CLS. 3, 16 AND 42.

- LOFLIN, RICHARD, CINCINNATI, OH AND LOFLIN, DEBORAH, CINCINNATI, OH, PERFORMANCE FILTERS OF N.A., INC., CINCINNATI, OH: 1,717,870. REN. 8-15-02. INT. CL. 11.
- LOFT PRESS, FORT VALLEY, VA: 1,723,720. REN. 8-14-02. INT. CL. 16.
- LOGISTICK, INC., SOUTH BEND, IN: 2,624,308, PUB. 7-2-2002. INT. CL. 20.
- LOGIX COMPANIES, LLC, THE, LONGMONT, CO: 2,624,518, PUB. 7-2-2002. INT. CL. 35.
- LOLLILOCKS KIDS SALON, LLC, LITTLETON, CO: 2,626,039, MULTIPLE CLASS, INT. CLS. 35 AND 42.
- LONA, ANDREW W., MOUNT VERNON, NY AND FREY, BRENTLY L., MOUNT VERNON, NY: 2,626,622, INT. CL. 36.
2,626,644, INT. CL. 36.
- LONG & FOSTER COMPANIES, INC., FAIRFAX, VA: 2,624,233, PUB. 7-2-2002. MULTIPLE CLASS, INT. CLS. 36 AND 42.
- LONG BEACH SEAFOOD COMPANY, INC., LONG BEACH, CA, DBA LONG BEACH SEAFOODS CO.: 1,663,534, CANC. INT. CL. 29.
- LONGVIE S.A., ARGENTINA: 2,624,293, PUB. 7-2-2002. MULTIPLE CLASS, INT. CLS. 7 AND 11.
- LORDMOND CORP., NEW YORK, NY: 2,623,565, PUB. 8-14-2001. INT. CL. 25.
- LORENZ S.P.A., 20121 MILAN, ITALY: 1,932,488, CANC. INT. CL. 14.
- LORILLARD LICENSING COMPANY, LLC, GREENSBORO, NC: 2,624,399, PUB. 7-2-2002. INT. CL. 34.
- LOS ANGELES COUNTY DEPARTMENT OF PUBLIC WORKS, ALHAMBRA, CA: 2,624,560, PUB. 7-2-2002. INT. CL. 42.
- LOS ANGELES MISSION, SANTA ANA, CA: 2,624,528, PUB. 7-2-2002. INT. CL. 42.
- LOTTOTRON, INC., HACKENSACK, NJ: 2,624,166, PUB. 7-2-2002. INT. CL. 42.
- LOUIS FERRE, INC., NEW YORK, NY: 1,934,048, CANC. INT. CL. 26.
- LOUIS WIDMER AG, 8952 SCHLIEREN, SWITZERLAND: 2,623,315, PUB. 7-2-2002. MULTIPLE CLASS, INT. CLS. 3 AND 5.
- LOUISIANA ONLINE, INC., BATON ROUGE, LA: 2,626,579, INT. CL. 35.
2,626,580, INT. CL. 38.
2,627,009, INT. CL. 35.
- LOUISVILLE BEDDING COMPANY, LOUISVILLE, KY: 2,626,735, INT. CL. 24.
- LOVABLE COMPANY, THE, BUFORD, GA: 1,176,319, CANC. INT. CL. 25.
1,176,336, CANC. INT. CL. 25.
- LOVELLS, LONDON EC1A 2DY, ENGLAND: 2,626,811, INT. CL. 42.
- LOWENTHAL, JANET B., PENSACOLA, FL, DBA MAKING LIFE EASIER: 2,019,050, CANC. INT. CL. 42.
- LPT GROUP INC., GALLATIN, TN, LINATEX CORPORATION OF AMERICA, STAFFORD SPRINGS, CT: 1,196,667. REN. 8-16-02. INT. CL. 7.
- LRC PRODUCTS LIMITED, HERTFORDSHIRE EN10 6LN, UNITED KINGDOM: 2,471,943, COR. INT. CL. 9.
- LSI LOGIC CORPORATION, MILPITAS, CA: 1,933,946, CANC. INT. CL. 9.
- LUC, HARDY, R, COS COB, CT: 2,625,165, PUB. 7-2-2002. MULTIPLE CLASS, INT. CLS. 35 AND 36.
- LUCAS LICENSING LTD., NICASIO, CA FROM LUCAS-FILM LTD., NICASIO, CA: 2,625,341, INT. CL. 28.
- LUCENT TECHNOLOGIES INC., MURRAY HILL, NJ: 2,625,111, PUB. 7-2-2002. INT. CL. 9.
2,626,630, INT. CL. 9.
- LUCK, JOHN, S, PASADENA, CA: 2,625,233, PUB. 7-2-2002. INT. CL. 41.
- LUCKY STORES, INC., DUBLIN, CA: 1,932,701, CANC. INT. CL. 16.
1,933,398, CANC. INT. CL. 30.
- LUDLOW BUILDING PRODUCTS, INC., ADRIAN, MI: 2,626,657, INT. CL. 19.
- LUG-STUFF INC., MARIETTA, GA, DBA RJ JR. CREATIONS: 2,625,529, INT. CL. 28.
- LUGER QUALITY MEATS, INC., HATFIELD, PA: 1,933,060, CANC. INT. CL. 29.
- LUIGINO'S, INC., DULUTH, MN: 2,625,428, INT. CL. 30.
- LUMATECH, EMERYVILLE, CA: 1,663,359, CANC. INT. CL. 11.
- LUMBER FINISHERS INCORPORATED, GRAFTON, MA: 2,624,878, PUB. 7-2-2002. INT. CL. 19.
- LUMEN ELECTRONICS CORPORATION, YUNG HANG HSIANG, TAINAN HSIEN 710, TAIWAN: 1,932,520, CANC. MULTIPLE CLASS, INT. CLS. 9 AND 12.
- LUMENOS, INC., ALEXANDRIA, VA: 2,626,269, INT. CL. 42.
- LUMINARE MULTIMEDIA, INC., SAN FRANCISCO, CA: 1,963,196, CANC. MULTIPLE CLASS, INT. CLS. 9 AND 16.
- LUNAR VISIONS CUISINE, INC., SILVER SPRING, MD: 1,933,862, CANC. INT. CL. 30.
- LUOYANG NORTHERN EK CHOR MOTORCYCLE CO., LTD., CHINA: 2,624,367, PUB. 7-2-2002. INT. CL. 12.
- LUVJAM INDUSTRIES, L.L.C., ATLANTIC HIGHLANDS, NJ: 2,624,348, PUB. 7-2-2002. MULTIPLE CLASS, INT. CLS. 4 AND 5.
- LUZENAC AMERICA, INC., ENGLEWOOD, CO: 2,623,519, PUB. 7-2-2002. INT. CL. 42.
- LYON, DOUGLAS, MILFORD, CT: 2,625,085, PUB. 7-2-2002. INT. CL. 30.
- LZB PROPERTIES, INC., MONROE, MI: 2,624,129, PUB. 7-2-2002. INT. CL. 20.
- M. E. TAYLOR ENGINEERING, INC., BROOKEVILLE, MD: 2,623,773, PUB. 7-2-2002. INT. CL. 17.
- M. H. WILKENS & SOHNE GMBH, 28309 BREMEN, FED REP GERMANY: 2,560,786, COR. MULTIPLE CLASS, INT. CLS. 8, 14 AND 21.
- M. SCHACHTER & CO. INC., SHORT HILLS, NJ: 2,626,422, INT. CL. 14.
- M. SPIEGEL & SONS OIL CORP., TUXEDO PARK, NY: 1,932,958, CANC. INT. CL. 4.
- M.D. INTERNATIONAL MARKETING, INC., ORMOND BEACH, FL: 2,623,578, PUB. 8-28-2001. INT. CL. 3.
- M.H.J. MEELIS, 2261 CN LEIDSCHENDAM, NETHERLANDS, DBA MEELIX INFORMATION TECHNOLOGY: 2,622,989, PUB. 7-2-2002. INT. CL. 35.
- M.O.M. TEAM INC., THE, WATERLOO, ONTARIO, CANADA: 2,624,696, PUB. 7-2-2002. INT. CL. 41.
- M-I DRILLING FLUIDS L.L.C., HOUSTON, TX: 1,933,526, CANC. INT. CL. 9.
- M-SYSTEMS FLASH DISK PIONEERS, LTD., KFAR SABA 44425, ISRAEL: 2,624,284, PUB. 7-2-2002. INT. CL. 9.
- M/T OWNER AB, SE-436 83 ASKIM, SWEDEN: 2,624,191, PUB. 7-2-2002. INT. CL. 25.
- MA SYSTEM AB, SE-224 78 LUND, SWEDEN: 2,622,891, PUB. 12-4-2001. INT. CL. 9.
- MACDERMID GRAPHIC ARTS, INC., ATLANTA, GA, W. R. GRACE & CO., CAMBRIDGE, MA: 739,815. REN. 8-13-02. U.S. CL. 50 (INT. CL. 17).
- MACDONALD LUMBER COMPANY, DENVER, CO: 2,624,832, PUB. 7-2-2002. INT. CL. 21.
- MACDONALD, MURRAY G., VANCOUVER, B.C. V6B 4Y4, CANADA: 2,623,252, PUB. 7-2-2002. INT. CL. 9.

- MACDOUGALL, TIMOTHY F., WILMINGTON, MA, DBA KELLIE'S CANDIES NUT-FREE CONFECTIONS AND MACDOUGALL, MARTHA A., WILMINGTON, MA, DBA KELLIE'S CANDIES NUT-FREE CONFECTIONS: 2,625,164, PUB. 7-2-2002. INT. CL. 30.
- MACGREGOR GROUP, INC., THE, BOSTON, MA: 2,626,499, MULTIPLE CLASS, INT. CLS. 9, 36 AND 42.
- MACKE LAUNDRY SERVICE, LTD, WHEELING, IL: 1,933,776, CANC. INT. CL. 37.
- MACKER HOLDING CORPORATION, BELDING, MI: 1,934,337, CANC. INT. CL. 41.
- MACKLE COMPANY, INC., THE, MIAMI, FL: 2,625,903, MULTIPLE CLASS, INT. CLS. 7 AND 11.
- MACNEIL LEHRER PRODUCTIONS, NEW YORK, NY: 2,625,366, INT. CL. 41.
- MACOLA, INC., MARION, OH: 2,623,729, PUB. 7-2-2002. INT. CL. 9.
- MACRO MARKETING CORPORATION, BEAVERTON, OR: 1,176,660, CANC. INT. CL. 3.
- MACROMEDIA INC., SAN FRANCISCO, CA: 2,625,325, MULTIPLE CLASS, INT. CLS. 38 AND 42.
- MADISON CUTTING TOOLS, INC., LINCOLN, RI: 1,932,790, CANC. INT. CL. 7.
- MADTHEEZ, INC., CALUMET CITY, IL: 2,626,084, INT. CL. 25.
- MAGELLAN SYSTEMS CORPORATION, SAN DIMAS, CA: 1,933,569, CANC. INT. CL. 9.
- MAGLA WORLD WIDE, LTD, VILLA REAL DEV, VEGA BAJA, PUERTO RICO: 2,622,821, PUB. 7-2-2002. MULTIPLE CLASS, INT. CLS. 9 AND 21.
2,622,822, PUB. 7-2-2002. MULTIPLE CLASS, INT. CLS. 9 AND 21.
- MAGLINE, INC., PINCONNING, MI: 518,087, AM. U.S. CL. 19.
- MAGUIRE, PENELOPE H., MIDDLETOWN, RI, DBA PARADISE PRODUCTIONS: 1,934,159, CANC. INT. CL. 9.
- MAHAR MANUFACTURING, VAN BUREN, AR: 2,626,235, INT. CL. 20.
- MAIDENFORM, INC., NEW YORK, NY: 723,645, CANC. U.S. CL. 39.
- MAIL ABUSE PREVENTION SYSTEM, LLC, REDWOOD CITY, CA: 2,627,019, INT. CL. 42.
- MAILBANK.COM INC., RENO, NV: 2,626,338, MULTIPLE CLASS, INT. CLS. 38 AND 42.
- MAJOR MEDICAL MANUFACTURING, INC., CLEVELAND, TN: 1,932,657, CANC. INT. CL. 10.
- MAKE QUICK MONEY, INC., STUART, FL: 2,623,931, PUB. 7-2-2002. INT. CL. 35.
2,623,932, PUB. 7-2-2002. INT. CL. 35.
- MAKE-UP ART COSMETICS INC., NEW YORK, NY: 2,624,824, PUB. 7-2-2002. INT. CL. 3.
- MAKING WAVES HAIR SALON, INC., DARIEN, CT: 2,623,430, PUB. 7-2-2002. INT. CL. 42.
- MALINCHAK, WILLIAM J., BOCA RATON, FL: 2,625,566, INT. CL. 42.
- MALJACK PRODUCTIONS, INC., ORLAND PARK, IL: 1,932,961, CANC. INT. CL. 9.
- MALLINCKRODT INC., ST. LOUIS, MO: 2,625,520, INT. CL. 10.
- MALLINCKRODT VETERINARY, INC., MUNDELEIN, IL: 1,933,382, CANC. INT. CL. 5.
- MANA PRODUCTS, INC., LONG ISLAND CITY, NY: 1,933,737, CANC. INT. CL. 25.
2,623,988, PUB. 7-2-2002. MULTIPLE CLASS, INT. CLS. 40 AND 41.
- MANAGEMENT SCIENCE ASSOCIATES, INC., PITTSBURGH, PA: 1,932,594, CANC. INT. CL. 35.
1,932,618, CANC. MULTIPLE CLASS, INT. CLS. 9 AND 35.
1,932,619, CANC. MULTIPLE CLASS, INT. CLS. 9 AND 35.
- MANALASTAS, RALPH, HAUPPAUGE, NY: 2,624,731, PUB. 7-2-2002. INT. CL. 39.
- MANCHESTER CRAFTSMEN'S GUILD, PITTSBURGH, PA: 2,623,317, PUB. 7-2-2002. INT. CL. 41.
- MANCO, INC., AVON, OH: 2,625,673, INT. CL. 1.
- MANGIAMELI S.P.A., MILANO, ITALY: 1,196,750, REN. 8-10-02. MULTIPLE CLASS, INT. CLS. 14, 18 AND 25.
- MANGOSOFT, INC., WESTBOROUGH, MA: 2,626,850, INT. CL. 42.
- MANHEIM AUCTIONS, INC., ATLANTA, GA: 2,626,505, INT. CL. 35.
- MANILA S.R.L., CALDOGNO (VICENZA), ITALY: 2,624,504, PUB. 7-2-2002. INT. CL. 25.
- MANITOWOC COMPANY, INC., THE, MANITOWOC, WI: 1,933,745, CANC. INT. CL. 7.
- MANITOWOC FOODSERVICE GROUP, INC., SPARKS, NV TO MANITOWOC FOODSERVICE GROUP, INC., SPARKS, NV: 2,515,940, COR. INT. CL. 11.
- MANNINGTON MILLS, INC., SALEM, NJ: 2,622,977, PUB. 7-2-2002. MULTIPLE CLASS, INT. CLS. 19 AND 27.
- MANTA CORPORATION:
See— HALOGEN SOFTWARE, INC..
- MANYWORLDS, INC., HOUSTON, TX: 2,626,358, INT. CL. 9.
- MAR-KEY FOODS, INC., VIDALIA, GA: 1,176,435, CANC. INT. CL. 32.
- MAR-MAC WIRE, INC., MCBEE, SC: 2,623,100, PUB. 7-2-2002. INT. CL. 6.
- MARCAL PAPER MILLS, INC., EAST PATERSON, NJ: 723,441, CANC. U.S. CL. 2.
- MARCAL PAPER MILLS, INC., ELMWOOD PARK, NJ: 1,176,179, CANC. INT. CL. 16.
- MARCHIO, ALBERTO D'ATTIMIS-MANIAGO, 33085 MANIAGO (PN), ITALY: 2,623,978, PUB. 7-2-2002. INT. CL. 33.
- MARCONI DATA SYSTEMS INC., WOOD DALE, IL, CHESHIRE, INCORPORATED, CHICAGO, IL: 712,998, REN. 8-15-02. U.S. CL. 5 (INT. CL. 1).
- MARCOTTE, ROBERT, SAINT-AUGUSTIN, QUEBEC, CANADA: 1,932,422, CANC. INT. CL. 8.
- MARCUS CORPORATION, THE, MILWAUKEE, WI: 1,677,835, REN. 8-10-02. INT. CL. 42.
2,624,879, PUB. 7-2-2002. INT. CL. 43.
- MARENZANA GROUP, INC., WOODBURY, CT: 2,626,099, INT. CL. 41.
2,626,100, INT. CL. 41.
- MAREX.COM, INC.:
See— MAREX, INC..
- MAREX, INC., COCONUT GROVE, FL FROM MAREX-COM, INC., MIAMI, FL: 2,623,109, PUB. 7-2-2002. INT. CL. 35.
- MARGOLIS, RONALD J., MANHATTAN BEACH, CA: 1,933,532, CANC. INT. CL. 25.
- MARIA'S BOUTIQUE, FORT WORTH, TX: 2,625,280, PUB. 7-2-2002. INT. CL. 25.
- MARIMON BUSINESS MACHINES, INC., HOUSTON, TX: 1,933,152, CANC. INT. CL. 42.
- MARINA VILLAS INC., LOS ANGELES, CA: 1,932,772, CANC. INT. CL. 12.
- MARINE BIOLOGICAL LABORATORY, WOODS HOLE, MA: 2,622,531, PUB. 7-2-2002. INT. CL. 25.
- MARINE BIOPRODUCTS INC., DELTA, BRITISH COLUMBIA, CANADA: 2,626,901, INT. CL. 1.
- MARINE ENTERPRISE PROJECTS - SOCIETA' UNIPERSONALE DI ALBERTO FIORENZI - S.R.L., VIA TONNINI, 54, ITALY: 2,622,591, PUB. 11-7-2000. INT. CL. 25.
- MARINE EXHAUST SYSTEMS, INC., RIVIERA BEACH, FL: 2,626,804, INT. CL. 7.
- MARINSA MIAMI CORPORATION, MIAMI, FL: 1,932,627, CANC. INT. CL. 29.

- MARISOL S.A., CEP: 89256-901, JARAGUA DO SUL, S.C., BRAZIL:
2,623,422, PUB. 7-2-2002. INT. CL. 25.
- MARISOL S/A., JARAGUA DO SUL, S.C., BRAZIL:
2,624,210, PUB. 7-2-2002. INT. CL. 25.
- MARK/TRECE, INC., BALTIMORE, MD:
1,933,848, CANC. INT. CL. 16.
- MARKEE INTERNATIONAL CORPORATION, COLUMBUS, OH:
2,623,841, PUB. 7-2-2002. MULTIPLE CLASS, INT. CLS. 1, 3 AND 4.
- MARKETING DISPLAYS, INC., FARMINGTON HILLS, MI:
2,623,166, PUB. 7-2-2002. INT. CL. 6.
- MARKETING ONE INCORPORATED, PORTLAND, OR:
1,933,268, CANC. INT. CL. 36.
- MARKETING RESOURCES & SOLUTIONS, SECAUCUS, NJ:
2,625,234, PUB. 7-2-2002. INT. CL. 16.
- MARLEY COMPANY, THE, CHARLOTTE, NC:
2,623,622, PUB. 7-2-2002. INT. CL. 11.
- MARQUARDT S.A., LA MONNERIE LE MONTEL, FRANCE:
2,624,346, PUB. 7-2-2002. INT. CL. 16.
- MARRIOTT EMPLOYEES FEDERAL CREDIT UNION, BETHESDA, MD:
2,626,624, INT. CL. 41.
- MARS, INCORPORATED, MCLEAN, VA:
2,623,824, PUB. 7-2-2002. INT. CL. 30.
2,624,889, PUB. 7-2-2002. INT. CL. 16.
2,624,890, PUB. 7-2-2002. INT. CL. 16.
2,624,891, PUB. 7-2-2002. INT. CL. 16.
2,624,892, PUB. 7-2-2002. INT. CL. 16.
2,624,893, PUB. 7-2-2002. INT. CL. 16.
2,626,365, INT. CL. 30.
- MARSHALL SOLUTIONS, INC., OAK PARK, IL:
2,624,056, PUB. 7-2-2002. INT. CL. 41.
2,624,057, PUB. 7-2-2002. INT. CL. 35.
- MARSHALL, BRIAN, ST. PETERSBURG, FL:
1,937,697, CANC. INT. CL. 41.
- MARSHALL, RUTH, LA MESA, CA:
2,623,236, PUB. 7-2-2002. INT. CL. 25.
- MARSON CREATIVE FASTENER, INC., STOUGHTON, MA, CREATIVE ENGINEERING, INC., STOUGHTON, MA:
1,197,699, REN. 8-14-02. INT. CL. 6.
- MARSON CREATIVE FASTENER, INC., STOUGHTON, MA, DBA MARSON CORPORATION:
2,626,717, INT. CL. 6.
- MARTECH MARKETING LIMITED, EDMONTON, ALBERTA, CANADA:
2,626,870, INT. CL. 11.
- MARTEK (S.A.), 92800 PUTEAUX, FRANCE:
2,625,471, INT. CL. 9.
- MARTIN COLOR-FI INCORPORATED, EDGEFIELD, SC:
2,623,370, PUB. 7-2-2002. MULTIPLE CLASS, INT. CLS. 22 AND 23.
- MARTIN INDUSTRIES, INC., FLORENCE, AL:
1,173,069, REN. 8-14-02. INT. CL. 11.
- MARTIN, BRUCE W., COS COB, CT:
1,933,610, CANC. INT. CL. 42.
- MARTIN, DIANE W., NORTHVILLE, MI, DBA THE ITINERATE FRAMER:
1,934,391, CANC. INT. CL. 40.
- MARTIN, EDWARD A., WESTBOROUGH, MA:
1,934,029, CANC. INT. CL. 32.
- MARTIN, JOHN R., NAPLES, FL:
2,625,219, PUB. 7-2-2002. INT. CL. 9.
- MARTIN, ROSS DANIEL, STAMPFORD, CT:
2,625,780, INT. CL. 16.
- MARTIN, TROY A., NEW BRIGHTON, PA:
2,622,719, PUB. 3-14-2000. INT. CL. 41.
- MARTINEZ, DANIEL, AMHERST, MA:
1,933,182, CANC. INT. CL. 16.
- MARUHACHI CERAMICS OF AMERICA, INC., CORONA, CA:
1,663,438, CANC. INT. CL. 19.
1,663,439, CANC. INT. CL. 19.
- MARUI LTD., KOBE PORT, KOBE, JAPAN:
1,176,049, CANC. INT. CL. 12.
- MARVEL ENTERTAINMENT GROUP, INC., NEW YORK, NY:
1,933,228, CANC. INT. CL. 16.
1,934,223, CANC. INT. CL. 16.
- MARY ENGELBREIT ENTERPRISES, ST. LOUIS, MO, DBA ME INK, ENGELBREIT, MARY, ST. LOUIS, MO:
1,728,456, REN. 8-10-02. INT. CL. 42.
- MARYLAND PUBLIC BROADCASTING COMMISSION, OWINGS MILLS, MD:
1,823,331, CANC. INT. CL. 41.
- MASHANTUCKET PEQUOT TRIBE, THE, LEDYARD, CT:
1,933,316, CANC. INT. CL. 41.
- MASLAND CARPETS, INC., MOBILE, AZ:
1,933,084, CANC. INT. CL. 27.
- MASON CREATIVE FASTENER, INC., STOUGHTON, MA, MARSON CORPORATION, CHELSEA, MA:
1,197,729, REN. 8-14-02. INT. CL. 8.
- MASON SHOE MANUFACTURING CO., CHIPPEWA FALLS, WI:
1,704,494, REN. 8-16-02. MULTIPLE CLASS, INT. CLS. 3 AND 21.
2,625,448, MULTIPLE CLASS, INT. CLS. 18 AND 25.
- MASSACHUSETTS MUTUAL LIFE INSURANCE COMPANY, SPRINGFIELD, MA:
2,625,783, INT. CL. 36.
2,625,784, INT. CL. 36.
2,626,468, INT. CL. 36.
- MASSENGILL, R. KEMP, LEUCADIA, CA:
2,625,313, INT. CL. 10.
- MASTECH SYSTEMS CORPORATION, OAKDALE, PA, DBA MASTECH CORPORATION:
1,932,545, CANC. MULTIPLE CLASS, INT. CLS. 37 AND 42.
- MASTER DESIGN FURNITURE, ONTARIO, CA:
2,624,305, PUB. 7-2-2002. INT. CL. 20.
- MASTERMINDS OF FUN, INC., UNION, NJ:
2,625,751, MULTIPLE CLASS, INT. CLS. 25 AND 41.
2,625,752, MULTIPLE CLASS, INT. CLS. 25 AND 41.
- MASTRAPASQUA & ASSOCIATES, NASHVILLE, TN:
2,623,111, PUB. 7-2-2002. INT. CL. 36.
- MATERIAL HANDLING INDUSTRY, CHARLOTTE, NC:
2,625,948, INT. CL. 9.
- MATERIALS AND SYSTEMS RESEARCH, INC., SALT LAKE CITY, UT:
2,626,587, INT. CL. 42.
- MATERFER & CIE S.A., 93260 LES LILAS, FRANCE:
1,663,453, CANC. INT. CL. 21.
- MATHERS, MARSHALL B. III, NEW YORK, NY:
2,626,305, INT. CL. 25.
- MATRIX GROUP LIMITED, INC., SAFETY HARBOR, FL:
2,626,264, MULTIPLE CLASS, INT. CLS. 25 AND 35.
- MATRIX REAL ESTATE ADVISORS, INC., DUBLIN, OH:
1,933,912, CANC. INT. CL. 9.
- MATRIX TECHNOLOGIES CORP., HUDSON, NH:
2,626,017, INT. CL. 9.
- MATRIX TECHNOLOGIES CORPORATION, HUDSON, NH:
2,626,544, INT. CL. 9.
- MATSUSHITA ELECTRIC CORPORATION OF AMERICA, SECAUCUS, NJ:
2,624,011, PUB. 7-2-2002. INT. CL. 9.
- MATTEL, INC., EL SEGUNDO, CA:
1,934,333, CANC. INT. CL. 28.
1,934,334, CANC. INT. CL. 28.
1,940,997, CANC. INT. CL. 28.
2,625,470, INT. CL. 28.
2,625,547, INT. CL. 28.
2,626,574, INT. CL. 28.
2,626,575, INT. CL. 28.
2,626,591, INT. CL. 28.
2,626,646, INT. CL. 28.
2,626,647, INT. CL. 28.
2,626,648, INT. CL. 28.
2,626,649, INT. CL. 28.
2,626,650, INT. CL. 28.
2,626,651, INT. CL. 28.
2,626,652, INT. CL. 28.

- MATTIOLI, DOMENIC, QUEENS, NY, DBA LA MELA RISTORANTE:
2,624,463, PUB. 7-2-2002. INT. CL. 42.
- MATZDORFF, JAMES A., LAGUNA BEACH, CA, DBA JAMES A. MATZDORFF & CO.:
2,624,404, PUB. 7-2-2002. INT. CL. 35.
- MAUI JIM, INC., PEORIA, IL:
2,624,152, PUB. 7-2-2002. MULTIPLE CLASS, INT. CLS. 9 AND 35.
- MAUNA LOA MACADAMIA NUT CORPORATION, HONOLULU, HI:
1,934,384, CANC. INT. CL. 29.
- MAURICE CORPORATION, WORCESTER, MA:
1,933,310, CANC. INT. CL. 42.
- MAVERICK TECHNOLOGIES HOLDINGS, LLC, FAIRVIEW HEIGHTS, IL:
2,623,277, PUB. 7-2-2002. INT. CL. 42.
- MAX ROHR, INC., WILMINGTON, DE, GULF & WESTERN CORPORATION, NEW YORK, NY, AKA CONSOLIDATED CIGAR COMPANY:
1,164,008. REN. 8-16-02. INT. CL. 34.
- MAX, PETER, NEW YORK, NY:
2,625,317, INT. CL. 42.
- MAXIM GROUP, INC., COLUMBIA, MD:
2,624,597, PUB. 7-2-2002. INT. CL. 35.
- MAY LONG TECHNOLOGY GROUP, INC, CITY OF INDUSTRY, CA:
2,625,286, PUB. 7-2-2002. INT. CL. 35.
- MAYER FINANCIAL SERVICES, INC., NAPLES, FL:
1,932,478, CANC. INT. CL. 36.
- MAZZETTI, SYLVIE RIMBAULT, PALM BEACH, FL:
1,932,804, CANC. INT. CL. 25.
- MAZZOTTA, LOUIS, MIDDLETOWN, CT:
1,933,722, CANC. INT. CL. 16.
- MBI, INC., NORWALK, CT:
1,934,315, CANC. INT. CL. 28.
- MBL FINANCIAL SERVICES, INC., MARIETTA, GA:
2,623,709, PUB. 7-2-2002. INT. CL. 36.
- MBL LIFE ASSURANCE CORPORATION, NEWARK, NJ:
1,933,308, CANC. INT. CL. 36.
- MCCALL, GEOFF E., LITITZ, PA:
2,622,852, PUB. 7-2-2002. INT. CL. 9.
- MCCLELLAN, JAYME, LYN, CANTON, MA:
2,625,149, PUB. 7-2-2002. INT. CL. 42.
- MCCLLOUD, CLAIRE, LAVERNE, CA AND MCCLLOUD, KIMBALL P., LAVERNE, CA:
1,663,540, CANC. INT. CL. 30.
- MCCONNELL, DAVID W., LEHIGH ACRES, FL:
1,933,752, CANC. INT. CL. 25.
- MCCORMICK DELAWARE, INC., WILMINGTON, DE:
2,625,203, PUB. 7-2-2002. MULTIPLE CLASS, INT. CLS. 29 AND 30.
- MCCRACKEN & TUTTLE, INC., MIDVALE, UT:
1,934,202, CANC. INT. CL. 42.
- MCCREA MARKETING, INC., CORNELIUS, NC:
2,625,708, INT. CL. 35.
- MCCULLOCH, SAUNDRA, DIANE, RIVERBANK, CA:
2,625,036, PUB. 3-5-2002. INT. CL. 18.
- MCDERMOTT, SHIRLEY F., FAIRFAX, VA:
1,933,039, CANC. INT. CL. 37.
- MCDEVITT & STREET COMPANY, CHARLOTTE, NC:
1,176,533, CANC. INT. CL. 37.
- MCDONALD, CEOLA, GARDENA, CA:
2,624,058, PUB. 7-2-2002. INT. CL. 16.
- MCDOWELL, THOMAS JOHN, CARMEL, CA:
2,623,708, PUB. 7-2-2002. MULTIPLE CLASS, INT. CLS. 3 AND 21.
- MCFALL, A. SNOWDEN, NASHUA, NH:
1,932,628, CANC. INT. CL. 16.
- MCGILL MANUFACTURING COMPANY, INC., VALPARAISO, IN:
148,150, CANC. U.S. CL. 21.
- MCGRAW-HILL COMPANIES, INC., THE, NEW YORK, NY, MCGRAW-HILL PUBLISHING COMPANY, INC., NEW YORK, NY:
560,976. REN. 8-10-02. U.S. CL. 38 (INT. CL. 16).
- MCGREGOR-DONIGER, INC., NEW YORK, NY:
723,644, CANC. U.S. CL. 39.
- MCI COMMUNICATIONS CORPORATION, WASHINGTON, DC:
1,933,082, CANC. INT. CL. 38.
1,933,323, CANC. INT. CL. 38.
- MCINNIS, TIMOTHY, J., NEW YORK, NY:
2,625,024, PUB. 7-2-2002. INT. CL. 42.
- MCKAY CHEMICAL COMPANY, CLEVELAND, OH:
1,175,682, CANC. MULTIPLE CLASS, INT. CLS. 1, 2, 3, 4 AND 5.
- MCKAY, BRYON L., NEW YORK, NY:
2,625,223, PUB. 7-2-2002. INT. CL. 42.
- MCKEE FOODS CORPORATION, COLLEGEDALE, TN, MCKEE FOODS CORPORATION, COLLEGEDALE, TN:
1,727,914. REN. 8-15-02. INT. CL. 30.
- MCKENNEY, MARK G., MIAMI BEACH, FL AND KATARIYA, KUSHAGRA, MIAMI BEACH, FL:
2,625,924, INT. CL. 35.
- MCLEAN, ADAM JOFI, SAN DIEGO, CA:
1,932,969, CANC. INT. CL. 28.
- MCLEOD TELEMANAGEMENT, INC., CEDAR RAPIDS, IA:
1,933,703, CANC. INT. CL. 38.
- MCNEIL, MELVIN, MEMPHIS, TN:
2,623,424, PUB. 7-2-2002. INT. CL. 35.
- MCSTAIN ENTERPRISES, INC., BOULDER, CO:
2,624,605, PUB. 7-2-2002. INT. CL. 37.
- MCSUN INC., SEOUL, REPUBLIC OF KOREA:
2,622,921, PUB. 7-2-2002. INT. CL. 7.
- MD CHEDDAR FARMS CORPORATION, GEORGETOWN, ONTARIO L7G 4S1, CANADA:
1,934,387, CANC. INT. CL. 29.
- MD FOODS AMBA, 8260 VIBY J, DENMARK:
1,932,629, CANC. INT. CL. 29.
- MEASURE THIS, L.L.C., RICHARDSON, TX:
2,623,886, PUB. 7-2-2002. INT. CL. 35.
- MECOS TRAXLER AG, CH-8404 WINTERTHUR, SWITZERLAND:
2,624,327, PUB. 7-2-2002. MULTIPLE CLASS, INT. CLS. 7, 9 AND 42.
2,624,328, PUB. 7-2-2002. MULTIPLE CLASS, INT. CLS. 7, 9 AND 42.
- MEDAC GESELLSCHAFT FOR KLINISCHE SPEZIALPREPARATE MBH, D-22880 WEDEL, FED REP GERMANY:
2,622,991, PUB. 7-2-2002. INT. CL. 5.
- MEDALLION BRANDS INTERNATIONAL COMPANY, CHICAGO, IL:
2,625,647, INT. CL. 34.
- MEDAREX, INC., PRINCETON, NJ:
2,623,104, PUB. 7-2-2002. INT. CL. 42.
- MEDATZ, INC., DOVER, NH:
1,135,477. REN. 8-14-02. INT. CL. 5.
- MEDIABAY.COM, INC.:
See—MEDIABAY, INC..
- MEDIABAY, INC., BOCA RATON, FL FROM MEDIABAY.COM, INC., MORRISTOWN, NJ:
2,622,900, PUB. 7-2-2002. INT. CL. 35.
- MEDIASONIC, INC., FREMONT, CA:
1,798,555, CANC. INT. CL. 9.
- MEDIATRIX PERIPHERALS INC., SHERBROOKE PROVINCE OF QUEBEC, CANADA:
1,932,464, CANC. INT. CL. 9.
- MEDIATRONIC SA, GENEVA, SWITZERLAND:
2,622,577, PUB. 8-15-2000. MULTIPLE CLASS, INT. CLS. 3, 5, 8 AND 10.
- MEDIAWAY, INC., MILPITAS, CA TO MEDIAWAY, INC., MILPITAS, CA:
2,550,916, COR. INT. CL. 9.
- MEDICAL DEVICE SYSTEMS, INC., AUBURNDALE, FL:
1,934,018, CANC. INT. CL. 10.
- MEDICAL INTELLIGENCE REVIEW SERVICE, INC., BROOKLINE, MA:
1,933,243, CANC. INT. CL. 35.
- MEDICAL MANAGEMENT INNOVATORS, LTD., BLUE BELL, PA:
1,933,079, CANC. INT. CL. 42.
- MEDICAL MUTUAL INSURANCE COMPANY OF NORTH CAROLINA, RALEIGH, NC:
1,933,294, CANC. INT. CL. 36.

- MEDICAL RESEARCH LABORATORIES, INC., BUFFALO GROVE, IL:
2,626,793, INT. CL. 10.
- MEDICS FOR CHRIST INT'L., ALLENDALE, MI:
2,623,636, PUB. 7-2-2002. INT. CL. 42.
- MEDIFACE CO., LTD., SEODAEMUN-KU, SEOUL, REPUBLIC OF KOREA:
2,532,643, COR. INT. CL. 9.
- MEDIMPACT HEALTHCARE SYSTEMS, INC., SAN DIEGO, CA:
2,626,175, INT. CL. 9.
- MEDINTELL SYSTEMS CORPORATION, MINNEAPOLIS, MN:
1,934,128, CANC. INT. CL. 9.
- MEDIVISION, INC., ANAHEIM, CA:
2,625,297, PUB. 7-2-2002. MULTIPLE CLASS, INT. CLS. 9 AND 10.
- MEDNICK, KELIMIA, HONOLULU, HI:
1,932,957, CANC. INT. CL. 30.
- MEDONE SURGICAL, INC., TALLEVAST, FL:
2,624,063, PUB. 7-2-2002. INT. CL. 10.
- MEDSTAT GROUP, INC., THE, ANN ARBOR, MI:
2,623,828, PUB. 7-2-2002. INT. CL. 9.
2,626,819, INT. CL. 35.
- MEDTOX DIAGNOSTICS, INC., BURLINGTON, NC:
2,626,058, INT. CL. 5.
- MEDTRONIC, INC., MINNEAPOLIS, MN:
1,643,510, CANC. INT. CL. 10.
1,934,251, CANC. INT. CL. 10.
2,625,591, INT. CL. 10.
- MEDUSA GROUP INC., FORT LAUDERDALE, FL:
2,626,340, INT. CL. 5.
- MEEKS FIREWOOD COMPANY, LIMITED PARTNERSHIP, BARNESVILLE, GA:
1,933,231, CANC. INT. CL. 4.
- MEGA ENTERTAINMENT INTERNATIONAL, INC., NEW YORK, NY:
2,625,435, INT. CL. 41.
- MEGA GAMES, INC., HOUSTON, TX:
1,663,497, CANC. INT. CL. 28.
- MELALEUCA, INC., IDAHO FALLS, ID:
2,626,549, INT. CL. 3.
- MELITTA HAUSHALTSPRODUKTE GMBH & CO. KG, D-32427 MINDEN, FED REP GERMANY:
2,626,978, INT. CL. 11.
- MELLON BANK, N.A., PITTSBURGH, PA TO MELLON BANK, N.A., PITTSBURGH, PA:
2,562,764, COR. INT. CL. 36.
- MEM COMPANY, INC., NORTHVALE, NJ:
1,663,746, CANC. INT. CL. 3.
- MENARDI MIKROPUL LLC, CHARLOTTE, NC, HOSOKAWA MICRON INTERNATIONAL INC., NEW YORK, NY:
1,734,635, REN. 8-12-02. INT. CL. 11.
- MENG, HORIZON PETER, SAN FRANCISCO, CA:
2,625,140, PUB. 7-2-2002. INT. CL. 12.
- MENSOR, MERRILL C., RENO, NV:
1,663,352, CANC. INT. CL. 10.
- MENTOR ARC INC., FREMONT, CA:
2,625,492, INT. CL. 9.
- MENTOR 4, INC., COLUMBIA, MD:
2,626,537, INT. CL. 35.
- MERCADIEN GROUP, L.L.C., THE, MERCERVILLE, NJ:
2,626,131, MULTIPLE CLASS, INT. CLS. 35, 36 AND 42.
- MERCANTILE-SAFE DEPOSIT AND TRUST COMPANY, BALTIMORE, MD:
2,626,144, INT. CL. 36.
- MERCEDES TEXTILES LIMITED, KIRKLAND, QUEBEC, CANADA:
1,231,105, REN. 8-13-02. INT. CL. 17.
- MERCIS B.V., 1071 DV AMSTERDAM, NETHERLANDS:
2,482,597, COR. MULTIPLE CLASS, INT. CLS. 9, 16, 18, 25 AND 28.
- MERCK & CO., INC., WHITEHOUSE, NJ:
566,271, REN. 8-16-02. U.S. CL. 18 (INT. CL. 5).
- MERCK-MEDCO MANAGED CARE, LLC, FRANKLIN LAKES, NJ:
2,624,827, PUB. 7-2-2002. INT. CL. 35.
- MERCURY COMPUTER SYSTEMS, INC., CHELMSFORD, MA:
2,625,279, PUB. 7-2-2002. INT. CL. 9.
- MEREDITH CORPORATION, DES MOINES, IA:
2,623,640, PUB. 7-2-2002. INT. CL. 16.
2,626,966, INT. CL. 16.
2,626,968, INT. CL. 16.
- MERELINDA FARM L.L.C., WHITMORE LAKE, MI, DBA ALPACA.COM L.L.C.:
2,624,711, PUB. 7-2-2002. MULTIPLE CLASS, INT. CLS. 25 AND 35.
- MERIAL LIMITED, LONDON SW1X 7QT, ENGLAND:
2,623,712, PUB. 7-2-2002. INT. CL. 5.
2,624,373, PUB. 7-2-2002. INT. CL. 10.
- MERICON CORPORATION, REDFORD, MI:
1,932,523, CANC. INT. CL. 20.
- MERISTEM THERAPEUTICS, CLERMONT-FERRAND, FRANCE:
2,623,068, PUB. 7-2-2002. MULTIPLE CLASS, INT. CLS. 1, 3, 5 AND 42.
- MERRIAM-WEBSTER, INCORPORATED, SPRINGFIELD, MA:
162,309, REN. 8-10-02. U.S. CL. 38 (INT. CL. 16).
- MERRILL LYNCH & CO., INC., NEW YORK, NY:
2,623,491, PUB. 7-2-2002. INT. CL. 36.
2,625,771, INT. CL. 36.
2,626,203, INT. CL. 36.
- METACRITIC.COM, INC., INCLINE VILLAGE, NV:
2,625,905, INT. CL. 41.
- METAGENICS, INC., SAN CLEMENTE, CA:
2,626,510, INT. CL. 16.
- METAVERSE CORPORATION, WASHINGTON TOWNSHIP, NJ:
2,626,959, INT. CL. 42.
- METCALF, PATTY, FULLERTON, CA, DBA PATTY METCALF DESIGN:
1,932,789, CANC. INT. CL. 16.
- METRO ONE TELECOMMUNICATIONS, INC., BEAVERTON, OR:
2,625,986, INT. CL. 35.
- METRO SB-HANDELS AG, 6340 BAAR, SWITZERLAND:
2,622,890, PUB. 7-2-2002. MULTIPLE CLASS, INT. CLS. 8, 9, 12, 18, 25, 27 AND 28.
- METRO-GOLDWYN-MAYER STUDIOS INC., SANTA MONICA, CA:
2,625,509, INT. CL. 20.
- METRO/THEBE, INC., GARDENA, CA:
1,934,381, CANC. INT. CL. 21.
- METROHM LTD., 9100 HERISAU, SWITZERLAND:
2,622,999, PUB. 7-2-2002. INT. CL. 9.
- METROHM LTD., HERISAU, SWITZERLAND:
2,623,003, PUB. 7-2-2002. INT. CL. 9.
- METROHM LTD., 9100 HERISAU, SWITZERLAND:
2,623,004, PUB. 7-2-2002. INT. CL. 9.
2,623,005, PUB. 7-2-2002. INT. CL. 9.
- METRON TECHNOLOGY, INC., BOULDER, CO:
2,622,845, PUB. 7-2-2002. MULTIPLE CLASS, INT. CLS. 9 AND 35.
- METRON, INC., RESTON, VA:
2,624,693, PUB. 7-2-2002. MULTIPLE CLASS, INT. CLS. 9 AND 35.
- METROPOLITAN TRANSPORTATION AUTHORITY, NEW YORK, NY:
2,624,499, PUB. 7-2-2002. MULTIPLE CLASS, INT. CLS. 35 AND 37.
- METROTILE (N.Z.) LIMITED, TAKANINI, AUCKLAND, NEW ZEALAND:
2,623,220, PUB. 7-2-2002. INT. CL. 6.
- MEYER DISTRIBUTING LLC, TEMPE, AZ:
2,625,027, PUB. 7-2-2002. INT. CL. 12.
- MEZRA FINANCE LTD, BROMLEY, KENT, UNITED KINGDOM:
2,625,187, PUB. 7-2-2002. INT. CL. 36.
- MEZURE, INC., BEND, OR:
2,626,281, INT. CL. 42.
- MFI HOLDINGS, INC.:
See— VNU BUSINESS MEDIA, INC. A DELAWARE CORPORATION.

- MG ELECTRONIC COMMERCE SERVICES GMBH, 60322 FRANKFURT AM MAIN, FED REP GERMANY:
2,535,363, CANC. IIRN. RESTORED TO S.N. 75-782,011.
- MGH ADVERTISING INC., OWINGS MILLS, MD:
2,624,970, PUB. 7-2-2002. INT. CL. 35.
- MHE CORP., ROGERSVILLE, MO:
2,626,107, INT. CL. 11.
- MIAVANA WHOLESALE CO., INC., MIAMI, FL:
2,625,032, PUB. 7-2-2002. MULTIPLE CLASS, INT. CLS. 29, 30 AND 32.
- MICHAEL BEST & FRIEDRICH LLP, MILWAUKEE, WI:
2,622,867, PUB. 7-2-2002. INT. CL. 42.
- MICHAEL FRIEDMAN PUBLISHING GROUP, INC., NEW YORK, NY:
1,932,588, CANC. MULTIPLE CLASS, INT. CLS. 16 AND 42.
- MICHAEL NICKOLAS AND RAY GREENE, SWAMPSCOTT, MA:
1,932,695, CANC. INT. CL. 41.
- MICHAEL WARD STOUT, NEW YORK, NY, DBA EXECUTRIX OF ROBERT MAPPLETHORPE ESTATE, AN ESTATE OF NEW YORK:
2,624,476, PUB. 7-2-2002. MULTIPLE CLASS, INT. CLS. 16 AND 35.
- MICHAELS OF OREGON CO., OREGON CITY, OR:
1,704,816, REN. 8-12-02. INT. CL. 13.
2,626,046, INT. CL. 13.
- MICHIGAN SPORTING GOODS DISTRIBUTORS, INC., GRAND RAPIDS, MI:
2,625,989, MULTIPLE CLASS, INT. CLS. 25 AND 28.
- MICRO ACCESSORIES TAIWAN LTD., TAIPEI HSIEN, TAIWAN:
2,623,933, PUB. 7-2-2002. INT. CL. 9.
- MICRO E.D.S., INC., NARBERTH, PA:
2,622,766, PUB. 6-5-2001. INT. CL. 35.
- MICROBAR, INC., SUNNYVALE, CA:
2,624,002, PUB. 7-2-2002. INT. CL. 9.
- MICROCAL SOFTWARE, INC.:
See—ORIGINLAB CORPORATION.
- MICROMEDEX, INC., ENGLEWOOD, CO:
2,626,803, INT. CL. 42.
- MICROPLAS, INC., CLINTON, MA:
1,932,521, CANC. INT. CL. 9.
- MICROSOFT CORPORATION, REDMOND, WA:
2,625,296, PUB. 7-2-2002. INT. CL. 36.
2,625,732, INT. CL. 36.
2,625,733, INT. CL. 38.
2,625,734, INT. CL. 39.
2,625,740, INT. CL. 39.
2,625,741, INT. CL. 38.
2,625,742, INT. CL. 36.
- MID ISLAND THERAPY ASSOCIATES, L.L.C., PLAINVIEW, NY:
2,624,094, PUB. 7-2-2002. MULTIPLE CLASS, INT. CLS. 41 AND 42.
- MID-AMERICA GRAPHICS INCORPORATED, HARRISONVILLE, MO:
2,624,874, PUB. 7-2-2002. INT. CL. 7.
- MID-ATLANTIC FOODS, INC., POCOMOKE CITY, MD:
2,622,948, PUB. 5-28-2002. INT. CL. 29.
- MID-ATLANTIC REALTY TRUST, LUTHERVILLE, MD:
2,624,173, PUB. 7-2-2002. INT. CL. 36.
- MID-WEST METAL PRODUCTS COMPANY, INC., MUNCIE, IN:
2,625,585, INT. CL. 2.
- MIDFIRST BANK, OKLAHOMA CITY, OK:
2,624,473, PUB. 7-2-2002. INT. CL. 36.
2,626,896, INT. CL. 36.
- MIDLAND FUNDS, LTD., DENHAM SPRINGS, LA:
1,932,757, CANC. INT. CL. 5.
- MIDLAND NATIONAL BANK, NEWTON, KS:
1,176,481, CANC. INT. CL. 36.
- MIDLANTIC CORPORATION, EDISON, NJ:
1,932,690, CANC. INT. CL. 36.
- MIDNIGHT OIL COMPANY, LLC, NEW YORK, NY:
2,472,816, COR. INT. CL. 42.
- MIDTECH R&D, INC., FAIRMONT, MN:
2,624,349, PUB. 7-2-2002. INT. CL. 9.
- MIDWAY SPRING TRAILS, INC., HOUSTON, TX:
2,626,327, INT. CL. 37.
- MIDWEST DENTAL PRODUCTS CORPORATION, DES PLAINES, IL:
2,625,376, INT. CL. 10.
- MIDWEST FOUNDATION INDEPENDENT PHYSICIANS ASSOCIATION, CINCINNATI, OH:
1,932,426, CANC. INT. CL. 42.
- MIDWEST OF CANNON FALLS, INC., CANNON FALLS, MN:
2,624,182, PUB. 7-2-2002. INT. CL. 28.
- MIDWEST PAYMENT SYSTEMS, CINCINNATI, OH:
2,626,436, INT. CL. 36.
- MIDWEST SUSTAINABLE COLLABORATIVE, LLC, MILWAUKEE, WI:
2,626,957, INT. CL. 42.
- MIGOSCHA S.A., BRUSSELS, BELGIUM:
1,932,777, CANC. INT. CL. 25.
- MIKE AND SUE GAY, FRANKLIN, TN, DBA CEDARMONT MUSIC:
1,933,163, CANC. INT. CL. 9.
- MIKE GAY AND SUE GAY, PARTNERSHIP, THE, FRANKLIN, TN, DBA CEDARMONT MUSIC:
1,933,162, CANC. INT. CL. 9.
- MIKISSIMES, S.A., 1700 FRIBOURG, SWITZERLAND:
2,622,508, PUB. 12-2-1997. MULTIPLE CLASS, INT. CLS. 9, 14 AND 42.
- MIKROS SYSTEMS CORP., MERCERVILLE, DE:
1,159,790, CANC. INT. CL. 9.
- MIKULAS, ROBERT, FRANK, MONUMENT, CO:
2,625,243, PUB. 7-2-2002. INT. CL. 35.
- MILCA BOTTLING CO., KEY BISCAYNE, FL:
2,624,514, PUB. 7-2-2002. INT. CL. 32.
- MILES HANDELSGESELLSCHAFT INTERNATIONAL MBH & CO., D-2000 HAMBURG 36, FED REP GERMANY:
1,932,461, CANC. INT. CL. 25.
- MILES LABORATORIES, INC., ELKHART, IN:
1,175,644, CANC. INT. CL. 1.
- MILESPREE, INC., HOUSTON, TX FROM WANTADS.COM, INC., HOUSTON, TX:
2,626,837, INT. CL. 35.
- MILKHOUSE BRAND MUSIC INC., GRAND RAPIDS, MI:
1,933,218, CANC. INT. CL. 42.
- MILLENNET, SARATOGA, CA:
1,934,148, CANC. INT. CL. 9.
- MILLER BREWING COMPANY, MILWAUKEE, WI:
1,934,014, CANC. INT. CL. 32.
2,626,293, INT. CL. 41.
- MILLER, ANNE MCINTOSH, SAN FRANCISCO, CA:
2,626,561, INT. CL. 42.
- MILLER, DANIEL, BALTIMORE, MD:
1,933,309, CANC. INT. CL. 41.
- MILLER, GAY J., BEAVERTON, OR:
2,624,583, PUB. 7-2-2002. INT. CL. 35.
- MILLIKEN & COMPANY, NEW YORK, NY:
1,176,282, CANC. INT. CL. 24.
- MILLIPORE CORPORATION:
See—MYKROLIS CORPORATION.
- MILWAUKEE BREWERS BASEBALL CLUB, MILWAUKEE, WI:
2,623,286, PUB. 7-2-2002. INT. CL. 41.
- MILWAUKEE ELECTRIC TOOL CORPORATION, BROOKFIELD, WI:
2,624,843, PUB. 7-2-2002. INT. CL. 7.
- MIMRAN GROUP INC., TORONTO, ONTARIO, CANADA:
1,932,572, CANC. INT. CL. 14.
- MINDER RESEARCH CORPORATION, BRAMPTON, ONTARIO, CANADA:
2,625,412, INT. CL. 9.
- MINIMOVES, INC., WESTMONT, IL:
1,933,203, CANC. INT. CL. 39.
- MINITAB, INC., STATE COLLEGE, PA:
2,624,053, PUB. 7-2-2002. INT. CL. 41.
- MINNESOTA MINING AND MANUFACTURING COMPANY, SAINT PAUL, MN, AKA 3M:
1,175,969, CANC. INT. CL. 9.
- MINNETONKA, INC., CHASKA, MN:
1,175,697, CANC. INT. CL. 3.

- MINTER-WEISMAN COMPANY, MINNEAPOLIS, MN:
1,711,973. REN. 8-10-02. INT. CL. 29.
1,721,154. REN. 8-10-02. INT. CL. 30.
- MIRACLE HILL MINISTRIES, INC., GREENVILLE, SC:
2,625,941. INT. CL. 42.
- MIRAGE FINE FOODS, INC., TORRANCE, CA:
2,625,777. INT. CL. 29.
- MIRALINK CORPORATION, PORTLAND, OR:
2,625,968. INT. CL. 9.
- MIRANT CORPORATION, ATLANTA, GA FROM SOUTHERN ENERGY, INC., ATLANTA, GA:
2,626,299. INT. CL. 37.
2,626,337. INT. CL. 37.
- MISS ELAINE, INC., ST. LOUIS, MO:
2,623,984. PUB. 7-2-2002. INT. CL. 25.
- MISSION CONTROL, CHICAGO, IL:
1,933,771. CANC. INT. CL. 42.
1,933,772. CANC. INT. CL. 42.
- MISSISSIPPI BAND OF CHOCTAW INDIANS, PHILADELPHIA, MS:
2,626,853. MULTIPLE CLASS, INT. CLS. 35, 41 AND 42.
- MISSOURI BASIN MUNICIPAL POWER AGENCY, SIOUX FALLS, SD:
2,625,392. INT. CL. 38.
- MITCHELL, RICCO A. MEMPHIS, TN:
2,626,118. INT. CL. 25.
- MITEQ, INC., HAUPPAUGE, NY:
2,622,929. PUB. 7-2-2002. MULTIPLE CLASS, INT. CLS. 9 AND 42.
2,622,953. PUB. 7-2-2002. MULTIPLE CLASS, INT. CLS. 9 AND 42.
- MITSUI CHEMICALS, INC., CHIYODA-KU, TOKYO, JAPAN, AKA MITSUI KAGAKU:
2,623,518. PUB. 7-2-2002. INT. CL. 1.
- MITSUI O.S.K. LINES, LTD., TOKYO 105-91, JAPAN:
2,623,360. PUB. 7-2-2002. INT. CL. 39.
2,623,361. PUB. 7-2-2002. INT. CL. 39.
- MJ RESEARCH, INCORPORATED, WALTHAM, MA:
2,624,207. PUB. 7-2-2002. INT. CL. 9.
2,624,208. PUB. 7-2-2002. INT. CL. 9.
- MOAM, INC., CHICAGO, IL:
2,624,419. PUB. 10-23-2001. INT. CL. 9.
- MOBELLA, AB, ESKILSTUNA, SWEDEN:
2,624,663. PUB. 7-2-2002. MULTIPLE CLASS, INT. CLS. 6 AND 20.
- MOBIL OIL CORPORATION, FAIRFAX, VA:
1,934,342. CANC. INT. CL. 16.
- MOBILE BAY AREA PARTNERSHIP FOR YOUTH, MOBILE, AL:
1,934,398. CANC. INT. CL. 25.
- MOBILITY TECHNOLOGIES, INC., WAYNE, PA FROM TRAFFIC.COM, INC., WAYNE, PA:
2,626,421. INT. CL. 39.
- MOCKLER'S BAR INC., LITTLE NECK, NY:
1,176,625. CANC. INT. CL. 42.
- MODERN ICE EQUIPMENT AND SUPPLY COMPANY, HARRISON, OH:
1,932,612. CANC. MULTIPLE CLASS, INT. CLS. 37 AND 42.
- MODERN MERCHANDISING, INC., RICHMOND, VA:
1,176,630. CANC. INT. CL. 42.
- MODERN WAY IMMOBILIZERS, INC., CLIFTON, TN:
2,624,761. PUB. 7-2-2002. INT. CL. 10.
- MODI RUBBER LTD., NEW YORK, NY:
1,932,683. CANC. INT. CL. 25.
- MODISCH SPORTSWEAR, INC., LOS ANGELES, CA:
2,623,486. PUB. 7-2-2002. INT. CL. 25.
- MOH'D ABU TAHA & RIZEQ BANI HANI CO, AMMAN, JORDAN:
2,623,538. PUB. 7-2-2002. INT. CL. 25.
- MOHAWK BRANDS, INC., WILMINGTON, DE FROM MOHAWK CARPET CORPORATION, CALHOUN, GA:
2,626,062. INT. CL. 19.
- MOHAWK BRANDS, INC., WILMINGTON, DE:
2,626,744. INT. CL. 27.
- MOHENIS SERVICES, INC., PETERSBURG, VA:
1,694,863. REN. 8-16-02. INT. CL. 37.
1,705,579. REN. 8-16-02. INT. CL. 42.
- MOJO'S FAMOUS BARBECUE, L.L.C., CATOOSA, OK:
2,625,633. INT. CL. 30.
- MOMENTUM, REDONDO BCH., CA:
1,933,704. CANC. INT. CL. 24.
- MOMUS INCORPORATED, ANN ARBOR, MI:
1,933,761. CANC. INT. CL. 20.
- MONKS OF THE BROTHERHOOD OF ST. FRANCIS, INC., THE, CAMBRIDGE, NY:
2,624,202. PUB. 7-2-2002. MULTIPLE CLASS, INT. CLS. 16 AND 29.
- MONOTUB INDUSTRIES, PLC, ESHER, SURREY, ENGLAND:
2,622,733. PUB. 1-9-2001. MULTIPLE CLASS, INT. CLS. 7 AND 11.
- MONROE COUNTY, ROCHESTER, NY:
2,623,748. PUB. 5-28-2002. INT. CL. 42.
- MONROE, WILLIAM F., CINCINNATI, OH:
1,932,919. CANC. INT. CL. 6.
- MONSANTO TECHNOLOGY LLC, ST. LOUIS, MO, MONSANTO COMPANY, ST. LOUIS, MO:
1,690,055. REN. 8-15-02. INT. CL. 11.
- MONSTER CABLE PRODUCTS, INC., BRISBANE, CA FROM MONSTERBOOK.COM, LLC, SAN FRANCISCO, CA:
2,622,686. PUB. 11-14-2000. MULTIPLE CLASS, INT. CLS. 16 AND 35.
- MONSTER CABLE PRODUCTS, INC., BRISBANE, CA:
2,623,566. PUB. 7-2-2002. INT. CL. 35.
- MONSTERBOOK.COM, LLC:
See—MONSTER CABLE PRODUCTS, INC..
- MONTANARI, INC., KANSAS CITY, MO:
1,687,792. REN. 8-10-02. INT. CL. 14.
- MONTAPLAST GMBH, D-51597 MORSBACH/SIEG, FED REP GERMANY:
2,623,054. PUB. 7-2-2002. MULTIPLE CLASS, INT. CLS. 7, 9 AND 12.
- MONTEREY PASTA COMPANY, DANVILLE, CA:
1,945,131. CANC. INT. CL. 42.
- MONTGOMERY HOME TITLE, INC., SILVER SPRING, MD:
2,625,580. INT. CL. 42.
- MONTRES UNIVERSAL S.A., 1227 LES ACACIAS - GENEVE, SWITZERLAND:
2,623,188. PUB. 7-2-2002. INT. CL. 14.
- MONUMENTAL LIFE INSURANCE COMPANY, BALTIMORE, MD:
1,716,401. REN. 8-15-02. INT. CL. 36.
- MOONDOGGIES, INC., SAN DIEGO, CA:
2,623,084. PUB. 7-2-2002. MULTIPLE CLASS, INT. CLS. 25 AND 42.
- MOONSHADOW, S.P.A., 20122 MILAN, ITALY:
2,622,886. PUB. 7-2-2002. MULTIPLE CLASS, INT. CLS. 18 AND 25.
- MOORE, BRANDON C., QUEENS VILLAGE, NY:
2,625,636. INT. CL. 25.
- MOORE, KENNETH J., PEORIA, AZ, DBA KEN MOORE:
1,714,776. CANC. INT. CL. 21.
- MOORE, LAWRENCE WILLIAM, MIAMI, FL:
2,625,192. PUB. 7-2-2002. INT. CL. 41.
- MORCHELES, BERNARD, SHORT HILLS, NJ:
1,933,621. CANC. INT. CL. 20.
- MOREL, JULIO, MIRAMAR, FL:
2,622,673. PUB. 7-2-2002. MULTIPLE CLASS, INT. CLS. 16 AND 35.
- MORESTEAM.COM LLC, POWELL, OH:
2,626,282. INT. CL. 41.
2,626,283. INT. CL. 41.
2,626,284. INT. CL. 41.
- MORINAGA & CO., LTD., TOKYO, JAPAN:
2,626,396. INT. CL. 30.
- MORITZ, ROB, MISSION, KS:
2,622,917. PUB. 7-2-2002. INT. CL. 35.
- MORLAN & ASSOCIATES, INC., COLUMBUS, OH:
2,624,299. PUB. 7-2-2002. INT. CL. 9.
- MORLEY CANDY MAKERS, INC., CLINTON TOWNSHIP, MI:
2,624,510. PUB. 7-2-2002. INT. CL. 30.
2,624,511. PUB. 7-2-2002. INT. CL. 30.

- MORNING STUDIOS, INC., LOS ANGELES, CA:
1,933,897, CANC. INT. CL. 41.
- MORNINGSTAR FOODS INC., DALLAS, TX:
2,498,931, COR. INT. CL. 29.
- MORRIS, MANNING & MARTIN, LLP, ATLANTA, GA:
2,624,491, PUB. 7-2-2002. INT. CL. 42.
- MORSE SHOE, INC., CANTON, MA:
1,176,628, CANC. INT. CL. 42.
- MORSE SIGNAL DEVICES OF CALIFORNIA, LOS ANGELES, CA, AKA MORSE SIGNAL DEVICES AND A.K.A. MORSE ALARM SYSTEMS:
1,176,588, CANC. INT. CL. 42.
- MORSE, WADE O., PLEASANTON, CA:
1,934,080, CANC. INT. CL. 25.
- MORTGAGES LTD., PHOENIX, AZ:
2,626,985, INT. CL. 36.
- MORTON INTERNATIONAL, INC., CHICAGO, IL:
1,933,237, CANC. INT. CL. 7.
- MOSAIC COMMUNICATIONS GROUP LLC, LEXINGTON, MA:
2,623,837, PUB. 7-2-2002. INT. CL. 16.
- MOSBY-YEAR BOOK, INC., ST. LOUIS, MO:
1,932,470, CANC. INT. CL. 41.
1,932,471, CANC. INT. CL. 38.
- MOSELLE, MICHAEL D., LAKELAND, FL, DBA KING SHIELD PRODUCTIONS:
2,625,711, INT. CL. 9.
- MOSHIER, KEVIN, WEST HOLLYWOOD, CA:
2,625,975, INT. CL. 42.
- MOTECTOR SYSTEMS, INC., MCLEAN, VA:
1,175,977, CANC. INT. CL. 9.
- MOTHER'S KEEPER, INC., COLLEGE PARK, GA:
2,623,638, PUB. 7-2-2002. INT. CL. 42.
- MOTHERS AGAINST DRUNK DRIVING, IRVING, TX:
1,932,814, CANC. INT. CL. 36.
- MOTHERS IN MOTION, INC., ROUND ROCK, TX:
2,625,861, MULTIPLE CLASS, INT. CLS. 25, 35 AND 42.
- MOTHERS POLISHES WAXES CLEANERS, HUNTINGTON BEACH, CA:
1,942,519, CANC. INT. CL. 3.
- MOTOROLA, INC., SCHAUMBURG, IL:
1,933,444, CANC. INT. CL. 9.
1,933,860, CANC. INT. CL. 9.
- MOTORVAC TECHNOLOGIES, INC., SANTA ANA, CA:
2,622,842, PUB. 7-2-2002. INT. CL. 9.
- MOULINEX S.A., F-93171 BAGNOLET, FRANCE:
1,932,509, CANC. INT. CL. 11.
- MOUNTAIN BAGGING, INC., ELKHORN CITY, KY:
1,932,636, CANC. INT. CL. 4.
- MOUNTAIN PLEASURE HORSE ASSOCIATION, INC., WELLINGTON, KY:
2,625,098, PUB. 3-12-2002. INT. CL. 42.
- MOUNTEX KNITTING CORP., TAIPEI, TAIWAN:
1,340,959, CANC. INT. CL. 25.
- MOVADO CORPORATION:
See—MOVADO LLC.
- MOVADO LLC, WILMINGTON, DE FROM MOVADO CORPORATION, WILMINGTON, DE:
2,623,626, PUB. 2-19-2002. INT. CL. 14.
- MOYNIHAN, MICHAEL, WASHINGTON, DC:
2,625,961, INT. CL. 41.
- MPL, INC., CHICAGO, IL:
1,176,004, CANC. INT. CL. 10.
- MR. GREEK RESTAURANTS INC., TORONTO, ONTARIO M3C 3S2, CANADA FROM MR. GREEK SHISH-KEBOB RESTAURANTS INC., SCARBOROUGH, ONTARIO, CANADA:
2,622,554, PUB. 7-11-2000. INT. CL. 42.
- MR. GREEK SHISH-KEBOB RESTAURANTS INC.:
See—MR. GREEK RESTAURANTS INC..
- MR. TINT, COLUMBIA, SC:
2,623,261, PUB. 7-2-2002. INT. CL. 35.
- MS. FOUNDATION FOR WOMEN, NEW YORK, NY:
2,624,571, PUB. 7-2-2002. INT. CL. 26.
- MSC.SOFTWARE CORPORATION, LOS ANGELES, CA, FORMERLY THE MACNEAL-SCHWENDLER CORPORATION:
2,626,818, INT. CL. 9.
- MTI CORPORATION, AURORA, IL:
1,663,295, CANC. INT. CL. 9.
- MTM LABORATORIES AG, HEIDELBERG, FED REP GERMANY:
2,623,148, PUB. 7-2-2002. MULTIPLE CLASS, INT. CLS. 1, 5 AND 42.
- MTS SYSTEMS CORPORATION, EDEN PRAIRIE, MN:
2,626,868, INT. CL. 9.
- MTS, INCORPORATED, WEST SACRAMENTO, CA:
2,625,996, INT. CL. 35.
- MU NET, INC., LEXINGTON, MA:
2,623,901, PUB. 7-2-2002. INT. CL. 9.
- MUASHER, GHADA, HOUSTON, TX:
2,624,525, PUB. 7-2-2002. INT. CL. 9.
- MUDHOUSE, LLC, CHARLOTTESVILLE, VA:
2,623,198, PUB. 7-2-2002. INT. CL. 35.
- MUELLER INDUSTRIES, INC., MEMPHIS, TN, MUELLER BRASS CO., PORT HURON, MI:
732,953. REN. 8-16-02. U.S. CL. 14 (INT. CL. 6).
- MULLINAX FORD OF CENTRAL FLORIDA, INC., APOPKA, FL:
2,624,151, PUB. 7-2-2002. INT. CL. 35.
- MULLINS, MICHAEL, GERMANTOWN, TN:
2,627,000, INT. CL. 41.
- MULTI-MEDIA COMMUNICATIONS MELBOURNE PTY LTD, BRUNSWICK, VICTORIA, AUSTRALIA:
2,626,578, INT. CL. 41.
- MULTI-PLASTICS, INC., LEWIS CENTER, OH:
1,202,021. REN. 8-10-02. INT. CL. 17.
- MULTI-STATE LOTTERY ASSOCIATION, WEST DES MOINES, IA, DBA TRI-WEST LOTTERY:
1,934,019, CANC. INT. CL. 36.
- MULTI-TECH SYSTEMS, INC., MOUNDS VIEW, MN:
2,623,155, PUB. 7-2-2002. INT. CL. 9.
- MULTIQUIP, INC., CARSON, CA:
1,206,701. REN. 8-16-02. INT. CL. 7.
- MULTISORB TECHNOLOGIES, INC., BUFFALO, NY:
2,626,250, INT. CL. 12.
- MUNDUS-VERLAGSGESELLSCHAFT M.B.H, D-45219 ESSEN, FED REP GERMANY:
2,623,341, PUB. 7-2-2002. MULTIPLE CLASS, INT. CLS. 9 AND 16.
- MUNICO INTERNATIONAL CORPORATION, HOUSTON, TX:
1,934,065, CANC. INT. CL. 33.
- MURDOCK, ROSEMARY ANN, WATERFORD, MI:
2,625,035, PUB. 7-2-2002. MULTIPLE CLASS, INT. CLS. 16 AND 42.
- MURPHY, EDWARD L., JR., DUXBURY, MA:
2,625,815, INT. CL. 11.
- MURTECH'S CONSULTING, LLC, SEVEN HILLS, OH:
2,623,885, PUB. 7-2-2002. INT. CL. 35.
- MUSTO LIMITED, ESSEX, ENGLAND:
2,626,040, INT. CL. 12.
- MWW GROUP, THE, EAST RUTHERFORD, NJ:
2,625,076, PUB. 7-2-2002. MULTIPLE CLASS, INT. CLS. 35 AND 42.
- MYER BALD INC., TORONTO, ONTARIO, M6M 4Y3, CANADA:
1,933,481, CANC. MULTIPLE CLASS, INT. CLS. 18, 22, 25 AND 28.
- MYERS INTERNATIONAL, LTD., ALLEN, TX:
2,623,498, PUB. 7-2-2002. INT. CL. 35.
- MYKROLIS CORPORATION, BEDFORD, MA FROM MILLIPORE CORPORATION, BEDFORD, MA:
2,624,994, PUB. 7-2-2002. INT. CL. 11.
- MYOCOR, INC., MAPLE GROVE, MN:
2,623,797, PUB. 7-2-2002. INT. CL. 10.
- MYRICOM, INC., ARCADIA, CA:
2,624,902, PUB. 7-2-2002. INT. CL. 42.
- MYSTIC ESSENCE, BROOKLYN, NY:
1,933,257, CANC. INT. CL. 3.
1,933,258, CANC. INT. CL. 42.
- MYTEAM. COM, INC, WOBURN, MA FROM KATZMAN, ELLIOT, NORTH ANDOVER, MA:
2,625,468, INT. CL. 35.
- MYTRLE KNOLL GAME CO., INC., BROADBENT, OR:
2,625,454, INT. CL. 28.

- MYWEBCAST.NET, INC., OKLAHOMA CITY, OK:
2,623,857, PUB. 7-2-2002. INT. CL. 38.
- M2 POLYMER TECHNOLOGIES, INC., WEST DUNDEE, IL:
2,624,990, PUB. 7-2-2002. INT. CL. 1.
- N L INDUSTRIES, INC., HOUSTON, TX:
1,175,657, CANC. INT. CL. 1.
- N. WASSERSTROM & SONS, INC., COLUMBUS, OH:
1,176,227, CANC. INT. CL. 20.
- N.A.C.O.L.A.H., CHICAGO, IL:
2,623,149, PUB. 7-2-2002. INT. CL. 36.
- N.V. ORGANON, 5349 AB OSS, NETHERLANDS:
2,625,698, INT. CL. 9.
- N.V. TRISLOT, WAREGEM, BELGIUM, N. V. BEKAERT S. A., ZWEVEGEM, BELGIUM:
936,944, REN. 8-15-02. U.S. CL. 14 (INT. CL. 6).
- N.Z., INC., NEWTON, NJ, TA DAVEY ENTERPRISES:
1,933,122, CANC. INT. CL. 20.
- NABISCO, INC., PARSIPPANY, NJ:
1,934,312, CANC. INT. CL. 30.
- NACH, INC., LA VERNE, CA:
1,933,445, CANC. INT. CL. 29.
- NALU KAI INCORPORATED, KAILUA, HI:
2,625,063, PUB. 7-2-2002. INT. CL. 28.
- NAM LIONG ENTERPRISE CO., LTD., TAINAN, TAIWAN:
2,626,221, INT. CL. 24.
- NANCY KAHN DESIGNS, INC., FRANKLIN LAKE, NJ:
1,933,331, CANC. INT. CL. 25.
- NAP, INC., NEW YORK, NY:
1,934,028, CANC. INT. CL. 25.
1,934,317, CANC. INT. CL. 25.
- NAPP SYSTEMS, INC., SAN MARCOS, CA:
1,934,084, CANC. INT. CL. 7.
- NASDAQ STOCK MARKET, INC., THE, WASHINGTON, DC:
2,624,169, PUB. 7-2-2002. INT. CL. 36.
- NASH, ALBERT J., MERRICK, NY:
2,626,013, INT. CL. 3.
- NASTA FAR EAST LIMITED, HONG KONG, HONG KONG:
1,176,366, CANC. INT. CL. 28.
- NATHAN, TINK, MCLEAN, VA, AKA AUBREY P. NATHAN, JR:
1,207,374, REN. 8-15-02. INT. CL. 28.
- NATIONAL ACADEMY OF RECORDING ARTS & SCIENCES, SANTA MONICA, CA:
2,626,785, INT. CL. 41.
- NATIONAL ASSOCIATION FOR STOCK CAR AUTO RACING, INC., DAYTONA BEACH, FL:
2,622,745, PUB. 7-2-2002. INT. CL. 16.
- NATIONAL ASSOCIATION OF BANKRUPTCY TRUSTEES, COLUMBIA, SC:
2,624,828, PUB. 7-2-2002. INT. CL. 16.
- NATIONAL ASSOCIATION OF CONVENIENCE STORES, ALEXANDRIA, VA:
2,623,588, PUB. 7-2-2002. INT. CL. 35.
- NATIONAL ASSOCIATION OF DEALERS OF HEARING AIDS TODAY, NASHVILLE, TN, DBA HEARING AIDS TODAY, HEARING AIDS TODAY OF AMERICA, INC., MARIETTA, GA:
1,703,062, REN. 8-16-02. MULTIPLE CLASS, INT. CLS. 10, 35, 37 AND 42.
- NATIONAL ASSOCIATION OF INSURANCE WOMEN (INTERNATIONAL), TULSA, OK:
2,625,199, PUB. 7-2-2002. INT. CL. 16.
2,625,266, PUB. 7-2-2002. INT. CL. 41.
- NATIONAL ASSOCIATION OF SCUBA DIVING SCHOOLS, INC., LONG BEACH, CA:
1,176,583, CANC. INT. CL. 42.
- NATIONAL ASSOCIATION OF TRUCK STOP OPERATORS, INC., ALEXANDRIA, VA:
1,176,622, CANC. INT. CL. 42.
- NATIONAL AUTOMOBILE DEALERS ASSOCIATION, MCLEAN, VA:
2,624,474, PUB. 7-2-2002. INT. CL. 41.
- NATIONAL AUTOMOTIVE MANUFACTURING, INC., MCPHERSON, KS:
2,626,916, INT. CL. 11.
- NATIONAL BOARD OF YOUNG WOMEN'S CHRISTIAN ASSOCIATION OF THE UNITED STATES OF AMERICA, NEW YORK, NY, TA YWCA OF THE USA:
2,626,439, INT. CL. 41.
- NATIONAL BULK FOOD DISTRIBUTORS, INC., TAYLOR, MI:
2,624,439, PUB. 7-2-2002. INT. CL. 30.
2,624,441, PUB. 7-2-2002. INT. CL. 30.
- NATIONAL CAPTIONING INSTITUTE, INC., FALLS CHURCH, VA:
1,934,022, CANC. INT. CL. 41.
- NATIONAL CHILD SAFETY COUNCIL, JACKSON, MI:
1,681,142, REN. 8-10-02. INT. CL. 16.
1,691,433, REN. 8-10-02. INT. CL. 16.
- NATIONAL FAMILY CAREGIVERS ASSOCIATION, KENSINGTON, MD:
2,623,599, PUB. 7-2-2002. MULTIPLE CLASS, INT. CLS. 41 AND 42.
- NATIONAL FEDERATION OF RETIRED PERSONS, SAN ANTONIO, TX:
1,689,396, REN. 8-16-02. INT. CL. 42.
- NATIONAL GUARDIAN LIFE INSURANCE COMPANY, MADISON, WI:
2,626,923, INT. CL. 36.
- NATIONAL HEAD START ASSOCIATION, ALEXANDRIA, VA:
2,626,021, MULTIPLE CLASS, INT. CLS. 6 AND 14.
- NATIONAL HEALTH ADMINISTRATORS, INC., PEEKSKILL, NY:
2,627,022, INT. CL. 35.
- NATIONAL HOT ROD ASSOCIATION (NHRA), GLEN DORA, CA:
1,646,326, REN. 8-12-02. INT. CL. 41.
- NATIONAL INFORMATION CORPORATION, SPRING HILL, FL:
2,625,145, PUB. 7-2-2002. INT. CL. 41.
- NATIONAL LEISURE GROUP, INC., BOSTON, MA:
2,623,736, PUB. 7-2-2002. MULTIPLE CLASS, INT. CLS. 39 AND 42.
- NATIONAL LUBRICATING GREASE INSTITUTE, THE, KANSAS CITY, MO:
1,690,689, REN. 8-15-02. U.S. CL. A.
- NATIONAL NARCOTIC DETECTOR DOG ASSOCIATION, INC., THE, CARTHAGE, TX:
2,624,132, PUB. 7-2-2002. INT. CL. 42.
- NATIONAL NEUROFIBROMATOSIS FOUNDATION, INC., NEW YORK, NY:
2,623,637, PUB. 7-2-2002. MULTIPLE CLASS, INT. CLS. 36 AND 42.
- NATIONAL OCEANIC AND ATMOSPHERIC ADMINISTRATION U.S. DEPARTMENT OF COMMERCE, WASHINGTON, DC:
2,625,407, INT. CL. 21.
- NATIONAL PACKAGING SOLUTIONS GROUP, INC., MOUNT PLEASANT, SC:
2,623,589, PUB. 7-2-2002. INT. CL. 40.
- NATIONAL PARTS DISTRIBUTORS, INC., MIAMI, FL:
1,175,826, CANC. MULTIPLE CLASS, INT. CLS. 7, 9 AND 12.
- NATIONAL PUBLIC RADIO, WASHINGTON, DC:
1,933,887, CANC. MULTIPLE CLASS, INT. CLS. 38 AND 41.
- NATIONAL RAILROAD PASSENGER CORPORATION, WASHINGTON, DC:
2,623,854, PUB. 7-2-2002. MULTIPLE CLASS, INT. CLS. 39 AND 43.
- NATIONAL RECYCLING COALITION, INC., THE, WASHINGTON, DC:
1,900,955, CANC. MULTIPLE CLASS, INT. CLS. 41 AND 42.
- NATIONAL RIFLE ASSOCIATION OF AMERICA, FAIRFAX, VA:
2,623,276, PUB. 7-2-2002. MULTIPLE CLASS, INT. CLS. 36 AND 42.
- NATIONAL SECURITY AGENCY AS EXECUTIVE AGENT FOR THE INFORMATION OPERATIONS TECHNOLOGY CENTER, FORT MEADE, MD:
2,625,083, PUB. 7-2-2002. INT. CL. 9.

- NATIONAL SPINNING CO., INC., NEW YORK, NY:
1,176,343, CANC. INT. CL. 26.
- NATIONAL SYNDICATIONS, INC., NEW YORK, NY FROM
NATIONAL SYNDICATIONS, INC., NEW YORK, NY:
2,625,987, INT. CL. 18.
- NATIONAL TOBACCO CO., L.P., NEW YORK, NY:
2,624,913, PUB. 7-2-2002. INT. CL. 34.
- NATIONAL TOBACCO COMPANY, L.P., NEW YORK, NY:
2,626,653, INT. CL. 20.
- NATIONAL WILD TURKEY FEDERATION, INC., THE,
EDGEFIELD, SC:
2,626,480, INT. CL. 41.
- NATIONALPAK LIMITED, TUEN MUN, N.T., HONG
KONG:
2,622,811, PUB. 7-2-2002. INT. CL. 14.
- NATIONSBANK CORPORATION, CHARLOTTE, NC:
1,663,640, CANC. INT. CL. 36.
- NATIONWIDE LIFE INSURANCE COMPANY, COLUM-
BUS, OH:
2,624,692, PUB. 7-2-2002. INT. CL. 36.
- NATROL, INC., CHATSWORTH, CA:
2,625,812, INT. CL. 5.
2,626,157, INT. CL. 5.
- NATURAL BEAUTY PRODUCTS LIMITED, MID GLA-
MORGAN CF31 3RT, WALES:
1,933,485, CANC. INT. CL. 3.
- NATURAL FACTORS NUTRITIONAL PRODUCTS LTD.,
BURNABY, BRITISH COLUMBIA, CANADA FROM GAH-
LER ENTERPRISES LTD., BURNABY, BRITISH COLUM-
BIA, CANADA:
2,626,753, INT. CL. 5.
- NATURAL IMPLANT, BREST, FRANCE:
2,623,282, PUB. 7-2-2002. INT. CL. 5.
- NATURAL LIVING, ALTAMONTE SPRINGS, FL:
2,625,309, PUB. 7-2-2002. INT. CL. 5.
- NATURAL NECTAR CORPORATION, CITY OF INDUS-
TRY, CA:
1,934,417, CANC. INT. CL. 41.
- NATURAL ORGANICS INCORPORATED, MELVILLE, NY:
1,201,736, REN. 8-15-02. INT. CL. 5.
- NATURAL WELLNESS CENTERS OF AMERICA, ANA-
HEIM, CA:
2,624,530, PUB. 7-2-2002. INT. CL. 5.
- NATURE'S HEALTH CONNECTION, INC., CAMPTON, KY:
2,626,482, INT. CL. 5.
- NATUS CORPORATION, EDINA, MN:
1,932,872, CANC. MULTIPLE CLASS, INT. CLS. 3 AND 4.
- NAUTICRAFT CORPORATION, MUSKEGON, MI:
2,625,716, INT. CL. 12.
- NAVIGATOR SYSTEMS, INC., ADDISON, TX:
2,625,993, MULTIPLE CLASS, INT. CLS. 35 AND 42.
- NBA PROPERTIES INC., NEW YORK, NY:
1,703,656, REN. 8-12-02. INT. CL. 35.
- NBA PROPERTIES, INC., NEW YORK, NY:
2,622,637, PUB. 7-2-2002. INT. CL. 41.
2,626,569, INT. CL. 25.
- NBG RADIO NETWORK, INC., PORTLAND, OR:
2,625,011, PUB. 7-2-2002. INT. CL. 9.
- NCAST CORPORATION, SUNNYVALE, CA:
2,626,428, INT. CL. 9.
- NCP MARKETING GROUP, INC., CANTON, OH:
2,623,944, PUB. 7-2-2002. INT. CL. 9.
- NEARLY ME, LOS ANGELES, CA:
1,176,000, CANC. INT. CL. 10.
- NEARTEK INC., WILMINGTON, DE:
2,627,014, INT. CL. 9.
- NEBRASKA FURNITURE MART, INC., OMAHA, NE:
1,934,147, CANC. INT. CL. 42.
- NEGRO LEAGUES BASEBALL MUSEUM, INC., KANSAS
CITY, MO:
2,623,183, PUB. 7-2-2002. INT. CL. 25.
- NELSON, IRIS, WASHINGTON, DC:
2,622,584, PUB. 9-5-2000. INT. CL. 25.
- NEOSE TECHNOLOGIES, INC., HORSHAM, PA:
2,625,449, INT. CL. 5.
- NEOSTRATA COMPANY, INC., PRINCETON, NJ:
2,532,650, COR. INT. CL. 3.
- NEOVACS, 75116 PARIS, FRANCE:
2,622,580, PUB. 5-23-2000. INT. CL. 5.
- NESTLE COMPANY, INC., THE, WHITE PLAINS, NY:
391,384, CANC. U.S. CL. 46.
- NETAMIN COMMUNICATIONS CORP., DIAMOND BAR,
CA:
2,623,673, PUB. 7-2-2002. MULTIPLE CLASS, INT. CLS. 38
AND 41.
- NETEXS, LTD., OCONOMOWOC, WI FROM NETEXS, LTD.,
OCONOMOWOC, WI:
2,625,713, INT. CL. 9.
- NETILLA NETWORKS INCORPORATED, SOMERSET, NJ
FROM INET CORPORATION, SOMERSET, NJ:
2,625,755, MULTIPLE CLASS, INT. CLS. 9, 35, 37, 38 AND
42.
- NETIQ CORPORATION, SANTA CLARA, CA:
2,626,840, INT. CL. 9.
- NETTASKING TECHNOLOGY (BVI) LTD, ROAD TOWN,
TORTOLA, BR. VIRGIN ISLANDS:
2,626,536, INT. CL. 42.
- NETWORK EQUIPMENT TECHNOLOGIES, INC., FRE-
MONT, CA:
2,626,571, INT. CL. 9.
- NETWORK GOLF LIMITED PARTNERSHIP, MIDDLETON,
OH:
1,932,670, CANC. INT. CL. 35.
- NETWORKTOLOGY, INC., SUNNYVALE, CA:
2,624,374, PUB. 7-2-2002. INT. CL. 42.
- NETWORTH, INC., IRVING, TX:
1,934,412, CANC. INT. CL. 9.
- NET2S (S.A.), 92 800 PUTEAUX, FRANCE:
2,623,036, PUB. 7-2-2002. MULTIPLE CLASS, INT. CLS.
37, 38, 41 AND 42.
- NEUROCOM INTERNATIONAL, INC., CLACKAMAS, OR:
2,624,712, PUB. 7-2-2002. MULTIPLE CLASS, INT. CLS. 16
AND 42.
- NEURON THERAPEUTICS, INC., MALVERN, PA:
2,626,773, MULTIPLE CLASS, INT. CLS. 5 AND 10.
- NEW COLT HOLDING CORP., NEW YORK, NY:
1,933,385, CANC. INT. CL. 9.
- NEW CREATIVE ENTERPRISES, INC., MILFORD, OH:
2,625,976, MULTIPLE CLASS, INT. CLS. 6, 11, 15, 18, 20
AND 21.
- NEW DIMENSIONS IN MEDICINE, INC., DAYTON, OH:
1,933,530, CANC. INT. CL. 5.
- NEW ENGLAND LIFE INSURANCE COMPANY, BOSTON,
MA:
2,625,389, INT. CL. 36.
- NEW ENGLAND LOG HOMES, INC., HAMDEN, CT:
1,176,212, CANC. INT. CL. 19.
- NEW ENGLAND PATRIOTS L.P., FOXBORO, MA, NEW
ENGLAND PATRIOTS FOOTBALL CLUB, INC., BOSTON,
MA:
948,574, REN. 8-10-02. U.S. CL. 38 (INT. CL. 16).
- NEW ENGLAND SCIENCE FICTION ASSOCIATION, INC.,
FRAMINGHAM, MA:
2,624,345, PUB. 7-2-2002. INT. CL. 42.
- NEW IDEAS INTERNATIONAL, INC., THOMASVILLE, GA:
1,934,218, CANC. INT. CL. 5.
- NEW MEDIA SCHOOLHOUSE, INC., POUND RIDGE, NY:
1,933,351, CANC. INT. CL. 9.
- NEW MINDSETS.COM INC., TORONTO, ONTARIO, CANA-
DA TO NEW MINDSETS.COM INC., TORONTO, ONTAR-
IO, CANADA:
2,544,282, COR. INT. CL. 41.
- NEW OPTION INTL., INC., THE, CHULA VISTA, CA:
2,624,390, PUB. 7-2-2002. INT. CL. 5.
- NEW SKIN RESEARCH, INC., NEW YORK, NY:
1,933,246, CANC. INT. CL. 3.
- NEW SOUND RECORDS, INC., ATLANTA, GA:
1,933,586, CANC. INT. CL. 9.
- NEW VISION ATHLETICS, INC., LAKE BLUFF, IL:
2,625,003, PUB. 7-2-2002. INT. CL. 28.
- NEW WORLD COMMUNICATIONS OF TAMPA, INC.,
TAMPA, FL, WTVT HOLDINGS, INC., TAMPA, FL:
1,703,882, REN. 8-12-02. INT. CL. 42.

- NEW YORK CHIROPRACTIC COLLEGE, SENECA FALLS, NY:
2,625,210, PUB. 7-2-2002. INT. CL. 41.
- NEW YORK TRANSIT, INC., HAYWARD, CA:
1,696,177. REN. 8-10-02. INT. CL. 25.
- NEW YORK UNIVERSITY, NEW YORK, NY AND LONDON SCHOOL OF ECONOMICS AND POLITICAL SCIENCE, LONDON WC2A 2AE, UNITED KINGDOM AND HEC PARIS GRADUATE BUSINESS SCHOOL, 78351 JOUY-EN-JOSAS CEDEX, FRANCE:
2,626,367, INT. CL. 41.
- NEWCO PRODUCTIONS, FREMONT, CA:
2,625,052, PUB. 7-2-2002. INT. CL. 35.
- NEWDEAL, VIENNE, FRANCE:
2,625,505, INT. CL. 10.
2,626,746, INT. CL. 10.
2,626,747, INT. CL. 10.
- NEWELL WINDOW FURNISHINGS, INC., FREEPORT, IL:
551,533. REN. 8-12-02. U.S. CL. 13 (INT. CL. 20).
- NEWLY WEDS FOODS, INC., CHICAGO, IL, NEWLY WEDS FOODS, INC., CHICAGO, IL:
957,403. REN. 8-10-02. U.S. CL. 46 (INT. CL. 30).
- NEWLY WEDS FOODS, INC., CHICAGO, IL:
1,934,282, CANC. INT. CL. 30.
- NEWPORT CORPORATION, IRVINE, CA:
2,624,282, PUB. 7-2-2002. INT. CL. 9.
- NEWPORT ELECTRONICS, INC., SANTA ANA, CA:
2,625,395, INT. CL. 42.
- NEWPORT INTERNATIONAL OF TIERRA VERDE, FLORIDA, INC., TIERRA VERDE, FL:
2,622,897, PUB. 7-2-2002. INT. CL. 29.
- NEWS AMERICA PUBLISHING INCORPORATED, NEW YORK, NY:
1,176,674, CANC. INT. CL. 16.
- NEWTON-WELLESLEY HOSPITAL, NEWTON, MA:
2,625,161, PUB. 7-2-2002. INT. CL. 42.
2,625,162, PUB. 7-2-2002. INT. CL. 42.
- NEX NUTRITION, INC., CARLSBAD, CA:
1,934,512, CANC. INT. CL. 5.
- NEXT GENERATION, INC., GOLDEN, CO:
1,933,553, CANC. MULTIPLE CLASS, INT. CLS. 29 AND 30.
- NEXT LEVEL FITNESS, INC., NORTHFIELD, MN:
2,624,235, PUB. 7-2-2002. INT. CL. 41.
- NEXTCOM, LLC, NORWALK, CT:
2,625,788, INT. CL. 9.
- NEXTECH, INC., DAYTON, OH:
2,623,852, PUB. 7-2-2002. INT. CL. 9.
- NEXTED LIMITED, CENTRAL, HONG KONG:
2,622,912, PUB. 7-2-2002. INT. CL. 41.
- NEXUS WORLD SERVICES, DENVER, CO:
2,624,465, PUB. 7-2-2002. MULTIPLE CLASS, INT. CLS. 9 AND 42.
- NGATARAWA WINES LIMITED, HASTINGS, NEW ZEALAND:
2,622,767, PUB. 7-2-2002. INT. CL. 33.
- NGUYEN, THINH V., LOS GATOS, CA:
2,625,612, INT. CL. 38.
- NHB INDUSTRIES LIMITED, PETERBOROUGH, ONTARIO K9J 3X2, CANADA:
2,622,653, PUB. 7-2-2002. INT. CL. 20.
- NICE BLENDS CORP., WEST HEMPSTEAD, NY:
2,624,881, PUB. 7-2-2002. INT. CL. 30.
- NICHINO AMERICA, INC., WILMINGTON, DE FROM NIHON NOHYAKU AMERICA, INC., WILMINGTON, DE:
2,626,347, INT. CL. 5.
- NICHOLSON, CHRISTINE, ALBUQUERQUE, NM:
2,626,043, MULTIPLE CLASS, INT. CLS. 41 AND 42.
- NICKEL SA, 92600 ASNIERES, FRANCE:
2,625,150, PUB. 7-2-2002. INT. CL. 3.
- NICSAND, INC., CLEVELAND, OH:
1,934,433, CANC. INT. CL. 8.
- NIELSEN MEDIA RESEARCH, INC., NEW YORK, NY:
2,625,858, MULTIPLE CLASS, INT. CLS. 9 AND 35.
- NIFTY NIBLICKS, THE, ADDISON, IL:
2,623,627, PUB. 7-2-2002. U.S. CL. 200.
- NIGHTINGALE-CONANT CORPORATION, CHICAGO, IL:
1,933,184, CANC. MULTIPLE CLASS, INT. CLS. 9, 16 AND 41.
- NIHON COMPUTER KOGYO KABUSHIKI KAISHA, HIGASHI OSAKA-SHI, OSAKA, JAPAN:
2,625,818, INT. CL. 9.
- NIHON SANMO SENSHOKU KABUSHIKI KAISHA, KYOTO-SHI, KYOTO-FU, JAPAN, TA NIHON SANMO DYEING CO., LTD.:
1,932,408, CANC. INT. CL. 27.
- NIIT (USA), INC., ATLANTA, GA:
2,625,540, INT. CL. 42.
- NIKE, INC., BEAVERTON, OR:
1,933,406, CANC. INT. CL. 25.
- NILES AUDIO CORPORATION, MIAMI, FL:
2,625,790, INT. CL. 9.
- NILS EKJORD A/S, LILLEAKER, 0216 OSLO, NORWAY:
1,196,977. REN. 8-14-02. INT. CL. 33.
- NILSEN CORP., AMHERST JUNCTION, WI:
2,623,895, PUB. 7-2-2002. INT. CL. 41.
2,623,896, PUB. 7-2-2002. INT. CL. 41.
- NINE WEST DEVELOPMENT CORP, WILMINGTON, DE:
2,626,723, INT. CL. 14.
- NIOXIN RESEARCH LABORATORIES, INC., LITHIA SPRINGS, GA:
2,626,551, INT. CL. 16.
- NIPPON DENKI KABUSHIKI KAISHA, MINATO-KU, TOKYO 108-01, JAPAN, DBA NEC CORPORATION:
1,933,712, CANC. INT. CL. 9.
- NIPPON PAINT (AMERICA) CORP., TEANECK, NJ TO NIPPON PAINT (AMERICA) CORP., TEANECK, NJ:
2,547,968, COR. INT. CL. 35.
- NISCA KABUSHIKI KAISHA, MINAMIKOMA-GUN, YAMANASHI-KEN, JAPAN:
1,690,001. REN. 8-12-02. INT. CL. 9.
- NISSAN CHEMICAL INDUSTRIES, LTD., CHIYODA-KU TOKYO, JAPAN:
2,625,766, INT. CL. 1.
- NISSAN JIDOSHA KABUSHIKI KAISHA, YOKOHAMA-SHI, KANAGAWA-KEN, JAPAN, TA NISSAN MOTOR CO., LTD.:
1,663,367, CANC. INT. CL. 12.
2,622,792, PUB. 5-15-2001. INT. CL. 12.
- NISSHO IWAI TEXTILES (U.S.A.), INC., NEW YORK, NY:
1,932,447, CANC. MULTIPLE CLASS, INT. CLS. 35 AND 42.
- NLP IP COMPANY, WILMINGTON, DE:
2,624,223, PUB. 7-2-2002. INT. CL. 35.
- NO-MUV CORPORATION, INC., JACKSONVILLE, FL:
1,932,463, CANC. INT. CL. 27.
- NOBEL BIOCARE USA, INC., YORBA LINDA, CA:
2,626,397, INT. CL. 10.
- NOBLE & CO., INC., PHILADELPHIA, PA:
2,624,690, PUB. 7-2-2002. INT. CL. 25.
- NOBLER TECHNOLOGIES, INC., STOUGHTON, MA:
1,933,176, CANC. INT. CL. 7.
- NOCTON LIMITED, DUBLIN, ISLE OF MAN:
723,663, CANC. U.S. CL. 44.
- NODINE, RICHARD, SAN FRANCISCO, CA:
1,932,822, CANC. INT. CL. 42.
- NOF CORPORATION, SHIBUYA-KU, TOKYO 150, JAPAN:
1,663,110, CANC. INT. CL. 2.
- NOKIA CORPORATION, FIN-00130 HELSINKI, FINLAND:
2,622,514, PUB. 10-31-2000. MULTIPLE CLASS, INT. CLS. 9 AND 38.
- NOKIA CORPORATION, 02150 ESPOO, FINLAND:
2,623,913, PUB. 7-2-2002. MULTIPLE CLASS, INT. CLS. 9 AND 38.
- NOMURA TRADING CO., LTD., CHUO-KU, OSAKA, JAPAN:
2,624,396, PUB. 7-2-2002. INT. CL. 1.
- NORCO MANUFACTURING CORPORATION, FRANKSVILLE, WI:
2,622,905, PUB. 10-30-2001. MULTIPLE CLASS, INT. CLS. 6, 9 AND 42.
- NORCROSS MARINE PRODUCTS, INC., ORLANDO, FL:
2,562,585, COR. INT. CL. 9.
2,624,989, PUB. 7-2-2002. INT. CL. 9.

- NORDENIA U.S.A., INC., JACKSON, MO:
2,625,912, INT. CL. 40.
2,625,915, INT. CL. 40.
- NORDSTROM OIL COMPANY, CEDAR RAPIDS, IA, DBA
HANDIMART FOOD STORES:
2,625,230, PUB. 7-2-2002. INT. CL. 35.
- NORELEM FRANCE S.A.S., 91300 MASSAY, FRANCE,
NORELEM S.A., 91380 CHILLY-MAZARIN, FRANCE:
1,658,808, REN. 8-12-02. INT. CL. 8.
- NORELEM S.A., 91380 CHILLY-MAZARIN, FRANCE TO
NORELEM FRANCE S.A.S., 91300 MASSAY, FRANCE:
1,658,808, CANC. INT. CL. 7.
- NORFOLK SOUTHERN CORPORATION, NORFOLK, VA:
2,626,350, INT. CL. 39.
- NORMAN ROCKWELL ESTATE LICENSING COMPANY,
THE, NILES, IL:
2,623,927, PUB. 7-2-2002. INT. CL. 35.
- NORPAC FOODS, INC., LAKE OSWEGO, OR, NORTH
PACIFIC CANNERS & PACKERS, INC., PORTLAND 4,
OR:
563,370, REN. 8-15-02. U.S. CL. 46 (INT. CL. 29).
- NORSK KOSMETIKK AS, N-0284 OSLO, NORWAY:
1,932,879, CANC. INT. CL. 3.
- NORTH AMERICAN MEMBERSHIP GROUP INC., MINNE-
TONKA, MN:
2,626,884, INT. CL. 9.
- NORTH AMERICAN MISSION BOARD OF THE SOUTH-
ERN BAPTIST CONVENTION, INC., THE, ALPHARETTA,
GA:
2,624,397, PUB. 7-2-2002. INT. CL. 41.
- NORTH AMERICAN STEEL ALLIANCE, INC., ROCK-
FORD, IL:
2,626,755, INT. CL. 35.
- NORTH CAROLINA ANIMAL RELIEF FUND, RALEIGH,
NC:
2,625,144, PUB. 7-2-2002. INT. CL. 42.
- NORTH COAST SEA-FOODS, INC., BOSTON, MA:
2,625,548, INT. CL. 29.
- NORTHEAST SYSTEMS, INC., SCARBOROUGH, ME:
2,626,852, INT. CL. 37.
- NORTHEAST TELECOM, INC., COLLINSTON, LA:
2,622,722, PUB. 7-2-2002. INT. CL. 38.
- NORTHERN TRUST CORPORATION, CHICAGO, IL:
2,626,406, INT. CL. 36.
- NORTHERN VIRGINIA COMMUNITY COLLEGE, ANNAN-
DALE, VA:
2,625,245, PUB. 7-2-2002. INT. CL. 41.
- NORTHSTAR PRINT GROUP, WATERTOWN, WI:
2,626,541, INT. CL. 16.
- NORTHWEST AGRICULTURAL PRODUCTS, INC., PASCO,
WA:
2,626,400, INT. CL. 1.
- NORTHWEST PUBLICATIONS, INC., DULUTH, MN:
1,942,938, CANC. INT. CL. 16.
- NORTHWEST SOFTWARE, INC., BEAVERTON, OR:
2,624,084, PUB. 7-2-2002. INT. CL. 42.
- NORWICH EATON PHARMACEUTICALS, INC., NOR-
WICH, NY:
1,176,570, CANC. INT. CL. 41.
- NOTRA TRADING, INC., WOODBRIDGE, NJ:
1,933,981, CANC. INT. CL. 24.
- NOTSOLDSEPARATELY.COM, LLC, MAPLE SHADE, NJ:
2,625,038, PUB. 7-2-2002. INT. CL. 9.
- NOVA SCOTIA BUSINESS DEVELOPMENT CORPORA-
TION, HALIFAX, NOVA SCOTIA, CANADA:
1,933,820, CANC. INT. CL. 12.
- NOVAMETRIX MEDICAL SYSTEMS INC., WALLING-
FORD, CT:
2,624,608, PUB. 7-2-2002. INT. CL. 10.
- NOVAR CONTROLS CORPORATION, COPLEY, OH:
2,626,509, INT. CL. 9.
- NOVARE SURGICAL SYSTEMS, INC., CUPERTINO, CA
FROM MINUMYS SURGICAL, INC., CUPERTINO, CA:
2,625,606, INT. CL. 10.
- NOVARTIS AG, BASEL, SWITZERLAND:
2,625,069, PUB. 7-2-2002. MULTIPLE CLASS, INT. CLS. 5
AND 10.
- NOVARTIS PHARMACEUTICALS CORPORATION, EAST
HANOVER, NJ, SANDOZ CHEMICAL WORKS, INC.,
NEW YORK 14, NY:
560,929, REN. 8-10-02. U.S. CL. 18 (INT. CL. 5).
- NOVATECH GLASS INC./ LES PRODUITS VERRIERS
NOVATECH INC., ST. JULIE, QUEBEC J3E 1Y2, CANA-
DA:
2,624,366, PUB. 7-2-2002. INT. CL. 19.
- NOVOTEX A/S, DK-7430 IKAST, DENMARK:
1,693,111, REN. 8-10-02. INT. CL. 25.
- NOXELL CORPORATION, HUNT VALLEY, MD:
2,626,725, INT. CL. 3.
- NTH GENERATION COMPUTING, INC., SAN DIEGO, CA:
2,623,747, PUB. 7-2-2002. MULTIPLE CLASS, INT. CLS. 37
AND 42.
- NU-GRO AMERICA CORP., BRANTFORD, ONTARIO, CA-
NADA:
2,624,724, PUB. 7-2-2002. INT. CL. 1.
- NUMARK LABORATORIES, INC., EDISON, NJ:
955,917, REN. 8-10-02. U.S. CL. 51 (INT. CL. 3).
- NUTONE INC., CINCINNATI, OH:
1,983,445, CANC. MULTIPLE CLASS, INT. CLS. 7 AND
21.
- NUTRA-SOURCE CORPORATION, NEPTUNE, NJ, TA LIFE
SERVICES NETWORK:
1,933,964, CANC. MULTIPLE CLASS, INT. CLS. 5 AND
32.
1,933,965, CANC. MULTIPLE CLASS, INT. CLS. 5 AND
30.
1,933,966, CANC. MULTIPLE CLASS, INT. CLS. 5 AND
32.
1,933,967, CANC. MULTIPLE CLASS, INT. CLS. 5 AND
32.
1,933,968, CANC. INT. CL. 5.
- NUTRITION NOW, INC., VANCOUVER, WA:
2,626,399, INT. CL. 5.
- NUTRITION 21, PURCHASE, NY:
2,626,190, INT. CL. 5.
- NYNEX CORPORATION, NEW YORK, NY:
1,933,697, CANC. INT. CL. 38.
1,933,698, CANC. INT. CL. 38.
- NYP HOLDINGS, INC., NEW YORK, NY:
2,624,102, PUB. 7-2-2002. INT. CL. 42.
- O.O.B. INC., TERREBONNE (QUEBEC), CANADA:
2,622,582, PUB. 10-24-2000. INT. CL. 4.
- O-LINE LLC, GEORGETOWN, DE:
2,626,244, INT. CL. 25.
- O'LOUGHLIN, KATHERINE MARIE, CULBURRA BEACH
NSW 2540, AUSTRALIA AND O'LOUGHLIN, WILLIAM
ROBIN, CULBURRA BEACH NSW 2540, AUSTRALIA:
2,625,396, INT. CL. 14.
- OAKES, JEFF, CARROLLTON, TX:
2,625,253, PUB. 7-2-2002. INT. CL. 9.
- OAKLEY, INC., FOOTHILL RANCH, CA:
2,624,923, PUB. 7-2-2002. INT. CL. 25.
- OBERBILLIG, KAREN L., MILTON, WA:
2,625,224, PUB. 7-2-2002. INT. CL. 28.
- OBREGON, TEODORO, CARACAS, VENEZUELA:
2,623,511, PUB. 7-2-2002. INT. CL. 25.
- OC SYSTEMS, INCORPORATED, FAIRFAX, VA:
2,624,534, PUB. 7-2-2002. MULTIPLE CLASS, INT. CLS. 9
AND 42.
- OCEAN BLUE COMMUNICATIONS, INC., SAMMAMISH,
WA:
2,624,848, PUB. 7-2-2002. INT. CL. 35.
- OCEAN KAYAK, INC., FERNDALE, WA:
1,932,534, CANC. INT. CL. 12.
- OCEAN ORGANICS, INC., ANN ARBOR, MI:
2,623,609, PUB. 7-2-2002. INT. CL. 1.
- OCEAN RIDER, INC., KAILUA-KONA, HI:
2,625,155, PUB. 7-2-2002. INT. CL. 31.
- OCEANA SENSOR TECHNOLOGIES, INC., VIRGINIA
BEACH, VA:
2,625,437, INT. CL. 9.
- OCEANS CUISINE, LTD., PORT JEFFERSON, NY:
1,932,855, CANC. INT. CL. 29.
- OCULEX PHARMACEUTICALS, INC., SUNNYVALE, CA:
2,623,871, PUB. 7-2-2002. INT. CL. 5.

- ODL, INCORPORATED, ZEELAND, MI:
2,626,318, INT. CL. 6.
- ODYSSEY COMMUNICATIONS INC., HAWTHORNE, NY:
1,933,978, CANC. INT. CL. 38.
- ODYSSEY SHOES, INC., CITY OF COMMERCE, CA:
2,625,904, INT. CL. 25.
- OEC MEDICAL SYSTEMS, INC., SALT LAKE CITY, UT:
2,626,279, INT. CL. 10.
- OERDING, JAMES B., GREENCASTLE, PA AND PELLE-
TIER, SANDRA L., GREENCASTLE, PA, DBA ESCAPES
UNLIMITED:
2,623,613, PUB. 7-2-2002. INT. CL. 39.
- OFFICEPLUS CORPORATION, ST. LOUIS, MO:
1,176,479, CANC. MULTIPLE CLASS, INT. CLS. 35 AND
42.
- OGER, PATRICK LOUIS MICHEL, LONDON SW3, 1DE,
ENGLAND:
2,622,889, PUB. 7-2-2002. INT. CL. 9.
- OHIO MATTRESS COMPANY LICENSING AND COMPO-
NENTS GROUP, THE, CLEVELAND, OH:
1,934,009, CANC. INT. CL. 20.
- OHMEDA PHARMACEUTICAL PRODUCTS DIVISION
INC., LIBERTY CORNER, NJ:
1,933,392, CANC. INT. CL. 5.
- OHMICRON TECHNOLOGY, INC., WILMINGTON, DE:
1,933,688, CANC. INT. CL. 1.
- OHTSU TIRE & RUBBER CO., LTD., THE, IZUMI-OHTSU,
OSAKA, JAPAN:
2,624,932, PUB. 7-2-2002. INT. CL. 12.
- OIL X-CHANGE, INC., THE, HANOVER PARK, IL:
1,176,511, CANC. INT. CL. 37.
- OILSPOT.COM, INC., CHICAGO, IL:
2,623,140, PUB. 7-2-2002. INT. CL. 35.
- OKI AMERICA, INC.:
1,175,913, CANC. INT. CL. 9.
- OKLAHOMA ENERGY RESOURCES BOARD, OKLAHOMA
CITY, OK:
2,625,272, PUB. 7-2-2002. INT. CL. 41.
- OKLAHOMA TOURISM AND RECREATION DEPART-
MENT, OKLAHOMA CITY, OK:
1,653,934, REN. 8-15-02. INT. CL. 41.
- OLAY COMPANY, INC., CINCINNATI, OH:
2,626,730, INT. CL. 3.
- OLD EUROPEAN BREWERY COMPANY, SAN DIEGO, CA:
2,622,949, PUB. 7-2-2002. INT. CL. 32.
- OLDHAM ASSOCIATES, LLC, SPRINGVILLE, UT:
2,623,679, PUB. 7-2-2002. INT. CL. 9.
- OLEDA AND COMPANY, INC., FORT WORTH, TX:
2,623,131, PUB. 7-2-2002. INT. CL. 5.
- OLIN CORPORATION, NORWALK, CT TO OLIN COR-
PORATION, NORWALK, CT:
2,476,083, COR. INT. CL. 1.
- OLIVER WOLFENSBERGER, 8706 FELDMEILEN, SWIT-
ZERLAND:
2,622,607, PUB. 9-25-2001. MULTIPLE CLASS, INT. CLS.
33, 35, 41 AND 42.
- OLYMPUS AMERICA INC., MELVILLE, NY:
2,624,119, PUB. 7-2-2002. MULTIPLE CLASS, INT. CLS. 36
AND 42.
- OLYMPUS GYM, INC., FALLS CHURCH, VA:
2,622,501, PUB. 9-28-1993. INT. CL. 25.
- OM AKTIEBOLAG, STOCKHOLM, SWEDEN FROM OM
GRUPPEN AB, STOCKHOLM, SWEDEN:
2,622,705, PUB. 7-2-2002. INT. CL. 42.
- OM GRUPPEN AB:
See— OM AKTIEBOLAG.
- OMEGA CHEMICALS, INC., SPARTANBURG, SC:
1,218,005, REN. 8-10-02. INT. CL. 1.
- OMNICLUSTER TECHNOLOGIES, INC., BOCA RATON, FL:
2,623,877, PUB. 7-2-2002. INT. CL. 42.
- OMNIPURE FILTER COMPANY, CALDWELL, ID:
2,623,846, PUB. 7-2-2002. INT. CL. 11.
- OMNIVIZ, INC., MAYNARD, MA:
2,624,654, PUB. 7-2-2002. INT. CL. 9.
- OMS INVESTMENTS, INC., WILMINGTON, DE:
2,623,455, PUB. 7-2-2002. INT. CL. 1.
- OMS INVESTMENTS, INC., WILMINGTON, DE:
2,623,456, PUB. 7-2-2002. INT. CL. 1.
2,624,834, PUB. 7-2-2002. INT. CL. 42.
- ON TIME DELIVERY SERVICE, INC., BLOOMINGTON,
MN:
1,932,704, CANC. INT. CL. 39.
- ON YOUR MARK, LTD., NORTH CANTON, OH:
2,624,371, PUB. 7-2-2002. MULTIPLE CLASS, INT. CLS. 3,
5 AND 21.
- ONE WORLD NETWORKS INTEGRATED TECHNOLO-
GIES, INC., LOS ANGELES, CA:
2,626,328, INT. CL. 3.
2,626,354, INT. CL. 5.
- ONEMONDAY GROUP PLC, LONDON, UNITED KING-
DOM FROM TEXT 100 GROUP PLC, LONDON W12 7SL,
ENGLAND:
2,622,962, PUB. 12-11-2001. INT. CL. 35.
- ONEPUB.COM, ORANGE, CA:
2,623,356, PUB. 7-2-2002. INT. CL. 42.
- ONLINE HIGHWAYS, FLORENCE, OR:
2,625,215, PUB. 7-2-2002. INT. CL. 39.
- ONSHARE, LLC, ITHACA, NY:
2,622,775, PUB. 7-2-2002. INT. CL. 38.
- OPENCONNECT SYSTEMS INCORPORATED, DALLAS,
TX:
2,626,801, INT. CL. 9.
- OPENFIRST, INC., MILWAUKEE, WI:
2,624,882, PUB. 7-2-2002. INT. CL. 35.
2,624,885, PUB. 7-2-2002. MULTIPLE CLASS, INT. CLS. 35
AND 40.
2,624,886, PUB. 7-2-2002. INT. CL. 35.
2,624,887, PUB. 7-2-2002. INT. CL. 35.
- OPERA SYSTEMS, INC., MCALLEN, TX:
2,623,151, PUB. 7-2-2002. MULTIPLE CLASS, INT. CLS. 9
AND 42.
- OPERATIONAL SYSTEM DESIGNS, INC., DALLAS, TX:
1,663,695, CANC. INT. CL. 42.
- OPI PRODUCTS, INC., NORTH HOLLYWOOD, CA:
1,742,073, REN. 8-16-02. INT. CL. 3.
- OPRY MILLS LIMITED PARTNERSHIP, ARLINGTON, VA:
2,624,283, PUB. 7-2-2002. INT. CL. 25.
- OPTICAL DYNAMICS CORPORATION, LOUISVILLE, KY:
2,623,950, PUB. 7-2-2002. MULTIPLE CLASS, INT. CLS. 1,
7 AND 9.
2,623,951, PUB. 7-2-2002. MULTIPLE CLASS, INT. CLS. 1,
7 AND 9.
- OPTICARE EYE HEALTH CENTER, P.C. - WATERBURY,
WATERBURY, CT TO OPTICARE EYE HEALTH Cen-
TERS, INC., WATERBURY, CT:
1,898,007, CANC. INT. CL. 9.
- OPTICONX, INC., OXFORD, MA:
2,624,452, PUB. 7-2-2002. INT. CL. 9.
- OPTICUS, INC., MONTREAL, QUEBEC H2Y 1X2, CANADA:
1,933,808, CANC. INT. CL. 9.
- OPTIEM LLC, CLEVELAND, OH:
2,623,474, PUB. 7-2-2002. MULTIPLE CLASS, INT. CLS. 35
AND 42.
- OPTIMO, INC., ATLANTA, GA:
2,625,283, PUB. 7-2-2002. INT. CL. 35.
- OPTIMUM PERFORMANCE GOLF, INC., CLARKSTON,
MI:
2,626,379, INT. CL. 28.
- OPTISTREAMS, INC., FRESNO, CA:
2,623,389, PUB. 11-13-2001. INT. CL. 9.
- OPTITEC AMERICA CORPORATION, SANFORD, NC:
1,175,741, CANC. INT. CL. 4.
- OPTREX LIMITED, NOTTINGHAM, NG2 3AA, ENGLAND:
2,622,614, PUB. 4-24-2001. INT. CL. 5.
- ORATEC INTERVENTIONS, INC., MENLO PARK, CA:
2,568,538, COR. INT. CL. 9.
- ORBIX CORPORATION, CLIFTON, TX:
1,701,427, REN. 8-15-02. MULTIPLE CLASS, INT. CLS. 7
AND 8.
- ORE-IDA FOODS, INC., BOISE, ID:
1,933,942, CANC. INT. CL. 30.
- ORGANIZED LIVING, INC., LENEXA, KS:
2,625,775, MULTIPLE CLASS, INT. CLS. 6, 16, 20 AND 21.

- ORICA EXPLOSIVES TECHNOLOGY PTY. LTD., MELBOURNE, VICTORIA, 3000, AUSTRALIA:
2,626,846, INT. CL. 13.
- ORIEL CORPORATION, STRATFORD, CT:
2,622,866, PUB. 7-2-2002. MULTIPLE CLASS, INT. CLS. 9 AND 11.
- ORIENTAL TRADING COMPANY, INC., OMAHA, NE FROM FUN EXPRESS, INC., OMAHA, NE:
2,623,826, PUB. 7-2-2002. INT. CL. 35.
- ORIGINLAB CORPORATION, NORTHAMPTON, MA FROM MICROCAL SOFTWARE, INC., NORTHAMPTON, MA:
2,623,064, PUB. 7-2-2002. INT. CL. 9.
- ORION INTERNATIONAL CONSULTING GROUP, INC., FRANKLIN, TN:
2,626,577, INT. CL. 35.
- ORION RESEARCH, INC., BEVERLY, MA:
2,626,273, INT. CL. 9.
- ORION TIRE CORPORATION, SAN CLEMENTE, CA:
1,932,654, CANC. INT. CL. 12.
- ORLANDO FOOD SALES INC., MAYWOOD, NJ:
2,625,626, INT. CL. 29.
- ORLANDO WYNDHAM GROUP PTY LTD, AUSTRALIA, AUSTRALIA:
1,932,661, CANC. INT. CL. 33.
- ORLY INTERNATIONAL, INC., CHATSWORTH, CA:
2,624,810, PUB. 7-2-2002. INT. CL. 3.
2,625,822, INT. CL. 3.
2,626,169, INT. CL. 3.
- ORNAMOTOR, INC., SUWANEE, GA:
2,623,229, PUB. 7-2-2002. INT. CL. 7.
- OROZ, LLC, RICHMOND HILL, NY:
2,624,797, PUB. 7-2-2002. INT. CL. 3.
- ORR, JOHN LINDSAY, LINCOLN, NE:
2,622,848, PUB. 7-2-2002. INT. CL. 9.
- ORTA, RODNEY L., AUSTIN, TX:
2,624,884, PUB. 7-2-2002. INT. CL. 41.
- ORTHOPEDIC HOSPITAL OF OKLAHOMA, L.L.C., TULSA, OK:
2,626,473, MULTIPLE CLASS, INT. CLS. 35 AND 42.
- ORTHOPEDIC SYSTEMS, INC., UNION CITY, CA:
2,626,843, INT. CL. 9.
- OSBORN MEDICAL CORP., UTICA, MN:
2,624,738, PUB. 7-2-2002. INT. CL. 10.
- OSITECH COMMUNICATIONS INC., GUELPH, ONTARIO, CANADA:
1,934,277, CANC. INT. CL. 9.
- OSMONICS, INC., MINNETONKA, MN:
2,623,789, PUB. 7-2-2002. INT. CL. 11.
- OSTEEN, ROY E., CHULA VISTA, CA:
1,176,036, CANC. INT. CL. 12.
- OSTER COMMUNICATIONS, INC., CEDAR FALLS, IA:
1,176,554, CANC. INT. CL. 41.
- OSTERHOLT, GERALD, LAS VEGAS, NV AND OSTERHOLT, LANA, LAS VEGAS, NV:
2,623,521, PUB. 6-4-2002. INT. CL. 20.
- OTAY PROJECT L.P., SAN DIEGO, CA:
2,622,838, PUB. 11-27-2001. INT. CL. 37.
- OTKRVTOE AKTSIONERNOE OBSHESTVO "SOLIKAMSKBUMPROM", PERMSKAYA OBLAST, RU-618500, RUSSIAN FEDERATIO:
2,623,314, PUB. 7-2-2002. INT. CL. 16.
- OTSUKA PHARMACEUTICAL CO., LTD., TOKYO, JAPAN:
2,575,454, COR. INT. CL. 32.
- OTSUKA PHARMACEUTICAL CO., LTD., CHIYODA-KU, TOKYO, JAPAN:
2,623,699, PUB. 7-2-2002. INT. CL. 5.
- OTSUKA PHARMACEUTICAL CO., LTD., TOKYO, JAPAN:
2,624,522, PUB. 7-2-2002. INT. CL. 5.
- OTSUKA PHARMACEUTICAL CO, LTD., TOKYO, JAPAN:
2,624,659, PUB. 7-2-2002. INT. CL. 5.
- OTTAWA TRIPLE A BASEBALL, INC., OTTAWA, ONTARIO K1K 4P5, CANADA:
1,932,591, CANC. MULTIPLE CLASS, INT. CLS. 16 AND 25.
- OTTER TAIL CORPORATION, FERGUS FALLS, MN:
2,624,849, PUB. 7-2-2002. INT. CL. 40.
2,624,866, PUB. 7-2-2002. INT. CL. 39.
- OTTINGER, MAUREEN, NAUGATUCK, CT:
2,624,470, PUB. 7-2-2002. INT. CL. 16.
- OTTO PICK & SONS SEEDS LTD., RICHMOND HILL, ONTARIO, CANADA:
1,176,421, CANC. INT. CL. 31.
- OUIDAD, INC., BETHEL, CT:
2,622,565, PUB. 7-2-2002. INT. CL. 41.
- OURFREENET.COM, EL MONTE, CA:
2,626,836, INT. CL. 42.
- OUTDOOR OPTICS, INC., MEMPHIS, TN, DBA OLYMPIC OPTICAL CO.:
2,626,740, INT. CL. 9.
- OUTSPOKIN' BICYCLE AND SPORT, LLC, NEWBURY, NH:
2,623,211, PUB. 7-2-2002. INT. CL. 35.
- OVERKILL RESEARCH & DEVELOPMENT LABORATORIES, INC., JACKSON, MI, OVERKILL RESEARCH & DEVELOPMENT LABORATORIES, INC., JACKSON, MI:
1,707,584, REN. 8-12-02. INT. CL. 28.
- OVERSEAS MONEY NETWORK, INC., GREENWICH, CT:
1,932,760, CANC. INT. CL. 36.
- OVERTURE LIMITED LIABILITY COMPANY, WILMINGTON, DE:
2,622,505, PUB. 7-2-2002. INT. CL. 35.
- OWENS-CORNING FIBERGLAS TECHNOLOGY INC., SUMMIT, IL:
2,622,655, PUB. 7-2-2002. MULTIPLE CLASS, INT. CLS. 9 AND 17.
2,625,246, PUB. 7-2-2002. INT. CL. 19.
2,626,616, INT. CL. 19.
- OXFORD BIOMEDICA PLC, OXFORD, UNITED KINGDOM:
2,622,533, PUB. 7-2-2002. MULTIPLE CLASS, INT. CLS. 1, 5 AND 10.
- OXMOOR HOUSE, INC., BIRMINGHAM, AL:
1,730,075, REN. 8-16-02. INT. CL. 42.
- OY JUVANTIA PHARMA LTD., FIN 20520 TURKU, FINLAND:
2,622,680, PUB. 7-2-2002. MULTIPLE CLASS, INT. CLS. 1, 5 AND 42.
- P.C. INTERNATIONAL MARKETING LIMITED, TORTOLA, BR. VIRGIN ISLANDS, CARDIN; PIERRE, 75008 PARIS, FRANCE:
1,183,696, REN. 8-14-02. INT. CL. 14.
- P.G. PRODUCTIONS, MYRTLE BEACH, SC:
2,622,787, PUB. 7-2-2002. INT. CL. 41.
- P.M. WRIGHT LTEE, ST-LAURENT, QUEBEC, CANADA:
1,932,435, CANC. INT. CL. 9.
- P.W.H. ORIGINALS AVV, 1507 CB ZAANDAM, NETHERLANDS:
2,623,536, PUB. 7-2-2002. INT. CL. 25.
- PABLOSKY, S.L., TOLEDO, SPAIN:
2,625,916, MULTIPLE CLASS, INT. CLS. 25 AND 35.
- PACE INDUSTRIES, INC., CHICAGO, IL:
1,705,045, REN. 8-14-02. MULTIPLE CLASS, INT. CLS. 20 AND 21.
- PACIFIC BAY INTERNATIONAL, INC., SEQUIM, WA:
2,623,408, PUB. 12-11-2001. INT. CL. 28.
- PACIFIC COAST BUILDING PRODUCTS, INC., SACRAMENTO, CA, DBA PACIFIC COAST BUILDING PRODUCTS:
1,736,590, REN. 8-10-02. INT. CL. 19.
- PACIFIC DIGITAL CORPORATION, IRVINE, CA:
2,624,285, PUB. 7-2-2002. MULTIPLE CLASS, INT. CLS. 9, 35 AND 42.
- PACIFIC PEBBLES CORPORATION, SAN DIEGO, CA, DBA LIFE DECK:
2,624,311, PUB. 7-2-2002. INT. CL. 37.
- PACIFIC RIM INTERNATIONAL BROKERAGE INC., VANCOUVER, BRITISH COLUMBIA, CANADA:
2,624,680, PUB. 7-2-2002. INT. CL. 31.
- PACIFIC TRADING CARDS, INC., LYNNWOOD, WA:
2,622,654, PUB. 7-2-2002. INT. CL. 16.
- PACIFICARE HEALTH SYSTEMS, INC., SANTA ANA, CA:
2,623,787, PUB. 7-2-2002. INT. CL. 36.
- PACKAGING CONCEPTS ASSOC. INC., BOYNTON BEACH, FL:
2,626,440, INT. CL. 3.

- PACTIV CORPORATION, LAKE FOREST, IL, AMOCO FOAM PRODUCTS COMPANY, ATLANTA, GA: 1,697,678, REN. 8-14-02. INT. CL. 21.
- PACTIV CORPORATION, LAKE FOREST, IL, AMOCO FOAM PRODUCTS COMPANY, EVANSTON, IL: 1,699,840, REN. 8-14-02. INT. CL. 21.
- PAGE, SUSAN, L. LOS GATOS, CA: 2,626,671, INT. CL. 42.
- PAGO HOLDING AG, POSTFACH CH-9472, SWITZERLAND: 2,625,458, MULTIPLE CLASS, INT. CLS. 7, 16 AND 20.
- PAINWEBBER INCORPORATED, WEEHAWKEN, NJ: 2,623,272, PUB. 7-2-2002. INT. CL. 36.
- PAISANO PUBLICATIONS, INC., AGOURA HILLS, CA: 2,622,904, PUB. 7-2-2002. INT. CL. 35.
- PALLOTTA TEAMWORKS, LOS ANGELES, CA: 2,624,137, PUB. 7-2-2002. INT. CL. 36.
- PALM BAY IMPORTS, INC., BOCA RATON, FL: 2,624,664, PUB. 7-2-2002. INT. CL. 33.
- PALMAVIVA, INC., NEW YORK, NY: 2,623,586, PUB. 7-2-2002. INT. CL. 21.
- PALOMAR MEDICAL TECHNOLOGIES, INC., BURLINGTON, MA: 2,624,624, PUB. 7-2-2002. INT. CL. 10.
- PAMP S.A., 6874 CASTEL SAN PIETRO, SWITZERLAND: 2,623,159, PUB. 7-2-2002. INT. CL. 14.
- PAN AMERICAN NURSERY PRODUCTS INC., SURREY, BRITISH COLUMBIA V4P 4J9, CANADA: 2,622,939, PUB. 7-2-2002. INT. CL. 31.
- PANGEO COLLECTIONS LTD., CHICAGO, IL: 2,624,320, PUB. 7-2-2002. INT. CL. 35.
- PANLINE USA, NORTHVALE, NJ: 2,624,433, PUB. 7-2-2002. INT. CL. 16.
2,624,434, PUB. 7-2-2002. INT. CL. 28.
2,624,449, PUB. 7-2-2002. INT. CL. 28.
2,626,946, INT. CL. 28.
- PANLINE USA, INC., NORTHVALE, NJ: 2,626,752, INT. CL. 28.
- PANOR CORP., HAUPPAGE, NY: 1,933,825, CANC. INT. CL. 9.
- PANSING, JEFFREY M., WEST ALEXANDRIA, OH: 2,625,772, INT. CL. 31.
- PANTRESSE, INC., CANTON, MA, HOFFMANN-LA ROCHE INC., NUTLEY, NJ: 1,235,132, REN. 8-16-02. INT. CL. 3.
- PAPER, CALMENSEN & CO., ST. PAUL, MN: 1,933,417, CANC. INT. CL. 7.
- PAPERDIRECT, INC., LYNDHURST, NJ: 1,934,226, CANC. INT. CL. 16.
- PAPPALARDO, MARILYN, MARTINEZ, CA, DBA AMERICAN HOMESTAY: 1,932,649, CANC. INT. CL. 35.
- PARADIGM GEOPHYSICAL LTD., HERZLIYA, ISRAEL: 2,625,099, PUB. 7-2-2002. INT. CL. 9.
- PARADIGM INTERNATIONAL, INC., SANTA ANA, CA: 2,625,054, PUB. 7-2-2002. INT. CL. 3.
- PARAGON TRADE BRANDS, INC., FEDERAL WAY, WA: 1,933,630, CANC. INT. CL. 16.
- PARAISO LOS CABOS S.A. DE CV, BAJA CALIFORNIA SUR 23400, MEXICO: 2,623,795, PUB. 7-2-2002. INT. CL. 42.
- PARAMOUNT PICTURES CORPORATION, LOS ANGELES, CA: 2,626,425, INT. CL. 9.
- PARD'S WESTERN SHOP, INC., URBANA, IL: 1,932,430, CANC. INT. CL. 18.
- PARDNERS UNLIMITED, INC., TULSA, OK: 1,933,400, CANC. INT. CL. 12.
- PARISH PUBLICATIONS, L.L.C., MADISON HEIGHTS, MI: 2,626,240, MULTIPLE CLASS, INT. CLS. 16 AND 35.
- PARK B. SMITH, INC., NEW YORK, NY: 2,626,928, MULTIPLE CLASS, INT. CLS. 19, 20 AND 24.
- PARK HOSPITALITY LLC, PLYMOUTH, MN: 2,623,457, PUB. 7-2-2002. INT. CL. 42.
- PARK NICOLLET HEALTH SERVICES, ST. LOUIS PARK, MN: 2,626,437, INT. CL. 16.
- PARKER HANNIFIN SA, ANNEMASSE, FRANCE: 2,623,779, PUB. 7-2-2002. INT. CL. 7.
- PARKS, STEVEN JAMES, VA BEACH, VA: 2,626,443, INT. CL. 41.
- PARLANT TECHNOLOGY, INC., PROVO, UT: 2,622,661, PUB. 7-2-2002. INT. CL. 9.
- PARMALAT DAIRY & BAKERY INC., ETOBICOKE, ONTARIO M9C 5J1, CANADA: 2,622,666, PUB. 7-4-2000. INT. CL. 29.
- PARMALAT S.P.A., 43044 COLLECCHIO, ITALY: 2,625,785, MULTIPLE CLASS, INT. CLS. 5 AND 29.
- PARSONS TECHNOLOGY, INC., HIAWATHA, IA: 1,933,608, CANC. INT. CL. 9.
- PARTNER PLUS, LLC, MINNEAPOLIS, MN: 2,625,571, INT. CL. 35.
- PARTON, DOLLY, LOS ANGELES, CA: 1,934,300, CANC. INT. CL. 26.
1,934,301, CANC. INT. CL. 26.
- PASCAL COMPANY, INC., BELLEVUE, WA: 2,626,298, INT. CL. 5.
- PASCOE PHARMAZEUTISCHE PRAPARATE GMBH, 35394 GIEBEN, FED REP GERMANY: 2,622,604, PUB. 8-22-2000. INT. CL. 5.
- PASPALLEY PEARL SALES PTY LIMITED, NORTHERN TERRITORY 0800, AUSTRALIA: 2,623,092, PUB. 7-2-2002. MULTIPLE CLASS, INT. CLS. 14, 20, 29 AND 35.
- PASSLOGIX, INC., NEW YORK, NY: 2,625,394, INT. CL. 42.
- PATANE, VICTOR, PEMBROKE PINES, FL: 1,933,633, CANC. INT. CL. 36.
- PATCH INDUSTRIES, INC., BOONTON TOWNSHIP, NJ: 2,626,751, INT. CL. 42.
- PATINA GROUP, LLC, THE, LOS ANGELES, CA: 2,624,750, PUB. 7-2-2002. INT. CL. 43.
- PATRIOT INDUSTRIES, INC., MONTICELLO, KY: 2,625,181, PUB. 7-2-2002. INT. CL. 25.
- PAUL HARTMANN AG, HEIDENHEIM, FED REP GERMANY: 2,624,428, PUB. 7-2-2002. INT. CL. 5.
2,624,429, PUB. 7-2-2002. INT. CL. 5.
2,624,435, PUB. 7-2-2002. MULTIPLE CLASS, INT. CLS. 3, 5 AND 10.
- PAUL HEMMER CONSTRUCTION COMPANY, FT. MITCHELL, KY: 2,622,902, PUB. 7-2-2002. INT. CL. 37.
- PAUL, HASTINGS, JANOFSKY & WALKER LLP, LOS ANGELES, CA: 2,626,356, INT. CL. 42.
- PAULA DORF COSMETICS, INC., NEW YORK, NY: 2,625,983, INT. CL. 3.
- PAVE TECH, INC., PRIOR LAKE, MN: 2,626,304, INT. CL. 1.
- PAWLAK, LAURA, HERMOSA BEACH, CA: 2,623,399, PUB. 7-2-2002. INT. CL. 42.
- PAX, INC., NEW YORK, NY: 2,625,813, INT. CL. 42.
2,625,814, INT. CL. 42.
- PAYGRO COMPANY, INC., SOUTH CHARLESTON, OH: 1,696,371, REN. 8-10-02. INT. CL. 31.
- PAYLESS CAR RENTAL SYSTEM, INC., ST. PETERSBURG, FL: 2,623,098, PUB. 7-2-2002. INT. CL. 39.
- PAYLESS SHOESOURCE WORLDWIDE, INC., TOPEKA, KS: 2,625,065, PUB. 7-2-2002. INT. CL. 25.
2,626,596, INT. CL. 35.
- PB MANAGEMENT CO., INC., LEBANON TOWNSHIP, NJ: 1,934,270, CANC. INT. CL. 41.
- PC UPGRADES, USA, CARROLLTON, TX: 1,934,496, CANC. INT. CL. 42.
- PCH VENTURES LLC, MALIBU, CA: 2,626,239, INT. CL. 42.
- PCI-SIG, INC., PORTLAND, OR: 2,623,790, PUB. 7-2-2002. INT. CL. 35.
- PDF SOLUTIONS, INC., SAN JOSE, CA: 2,624,315, PUB. 7-2-2002. MULTIPLE CLASS, INT. CLS. 9 AND 42.

- PE CORPORATION, FOSTER CITY, CA FROM PE CORPORATION, FOSTER CITY, CA:
2,626,044, INT. CL. 1.
- PEABODY MANAGEMENT, INC., MEMPHIS, TN:
2,623,024, PUB. 7-2-2002. INT. CL. 20.
- PEACHTREE SOFTWARE, INC., NORCROSS, GA, DA-CEASY, INC., DALLAS, TX:
1,673,293. REN. 8-15-02. INT. CL. 9.
- PEAKS LODGE DEVELOPMENT, LLC, BRECKENRIDGE, CO:
2,623,928, PUB. 7-2-2002. INT. CL. 36.
- PEARLE VISION, INC., TWINSBURG, OH:
2,624,581, PUB. 7-2-2002. MULTIPLE CLASS, INT. CLS. 35 AND 42.
- PEARSON PROFESSIONAL INC, BOCA RATON, FL:
1,663,273, CANC. INT. CL. 9.
- PEDIATRIC FEDERATION, LLC, SAN RAFAEL, CA:
2,624,260, PUB. 7-2-2002. INT. CL. 35.
- PEDIFIX, INC., MOUNT KISCO, NY:
2,622,797, PUB. 7-2-2002. MULTIPLE CLASS, INT. CLS. 5 AND 10.
- PEDRO DOMEQ MEXICO, S.A. DE C.V., 04100, D.F., MEXICO:
2,622,608, PUB. 7-2-2002. INT. CL. 33.
- PEEKAY, INC., AUBURN, WA:
2,623,551, PUB. 7-2-2002. INT. CL. 35.
- PEERLESS CLOTHING INC., MONTREAL, PROVINCE OF QUEBEC, CANADA:
1,934,209, CANC. INT. CL. 25.
- PEERLESS LEVEL AND TOOL COMPANY, THE, WALNUT, IL:
1,175,935, CANC. INT. CL. 9.
- PEGASUS COMMUNICATIONS, BALA CYNWYD, PA:
2,625,990, INT. CL. 38.
- PEGASUS INTERNATIONAL INC., FORT WASHINGTON, PA:
2,625,995, INT. CL. 3.
- PELLECHIA, JAMES, MELVILLE, NY:
1,934,108, CANC. INT. CL. 28.
- PELLEGRINUS HOLDING AG, 8002 ZURICH, SWITZERLAND FROM HIPPO DYNAMIX PFERDEPRODUKTE GESELLSCHAFT M.B.H, 8121 DEUTSCHFEISTRITZ, AUSTRIA:
2,622,605, PUB. 9-5-2000. MULTIPLE CLASS, INT. CLS. 5, 6, 8, 16, 20, 35, 41 AND 42.
- PELTOR AB, VARNAMO S-331 02, SWEDEN:
2,626,872, INT. CL. 9.
- PENFIELD, INC., CRANSTON, RI:
1,176,020, CANC. INT. CL. 11.
- PENN TREATY AMERICAN CORPORATION, ALLENTOWN, PA:
2,623,805, PUB. 7-2-2002. INT. CL. 9.
- PENN-TEX AEROSPACE, INC., AUSTIN, TX:
2,626,159, INT. CL. 42.
- PENNROSE SERVICE COMPANY, PHILADELPHIA, PA:
2,625,092, PUB. 7-2-2002. MULTIPLE CLASS, INT. CLS. 35, 37 AND 42.
- PENNSYLVANIA INTERNATIONAL RACEWAY, INC., NAZARETH, PA:
2,626,466, INT. CL. 25.
- PENNSYLVANIA MEDICAL SOCIETY LIABILITY INSURANCE COMPANY, HARRISBURG, PA:
1,726,233. REN. 8-14-02. INT. CL. 36.
- PENNSYLVANIA-AMERICAN WATER COMPANY, HERSHEY, PA:
2,624,747, PUB. 7-2-2002. INT. CL. 39.
- PENNWALT CORPORATION, PHILADELPHIA, PA:
1,176,207, CANC. INT. CL. 19.
- PENNWELL CORPORATION, TULSA, OK:
2,623,354, PUB. 7-2-2002. INT. CL. 35.
- PENNY-FARTHING PRESS, INC., HOUSTON, TX:
2,626,009, INT. CL. 16.
- PENNZOIL PRODUCTS COMPANY, HOUSTON, TX:
1,934,319, CANC. INT. CL. 4.
- PENSATO, BRUNO, MUNICH 90, FED REP GERMANY, DBA FA. BRUNO PENSATO:
1,220,817. REN. 8-14-02. MULTIPLE CLASS, INT. CLS. 16 AND 18.
- PENSATO, BRUNO, 8000 MUNICH 90, FED REP GERMANY, DBA FA. BRUNO PENSATO:
1,196,289. REN. 8-14-02. INT. CL. 25.
- PENTA, NICHOLAS, MOORPARK, CA:
2,626,741, INT. CL. 4.
- PENTON PUBLISHING, INC., CLEVELAND, OH:
1,932,546, CANC. INT. CL. 16.
- PENULTIMATE, INC., IRVINE, CA:
1,932,708, CANC. MULTIPLE CLASS, INT. CLS. 9 AND 42.
- PEOPLECAPITAL, INC., DUBLIN, CA:
2,623,830, PUB. 7-2-2002. INT. CL. 42.
- PEOPLES SAVINGS BANK, INC., THE, HOLYOKE, MA, DBA PEOPLES BANK:
2,626,521, INT. CL. 36.
- PEPIN HEIGHTS ORCHARD, INC., LAKE CITY, MN:
2,625,404, MULTIPLE CLASS, INT. CLS. 31 AND 32.
- PEPPER TREE WINES PTY LIMITED, NEW SOUTH WALES, 2320, AUSTRALIA:
2,625,694, INT. CL. 33.
- PERFECT PRODUCTS COMPANY, MALVERN, OH:
1,695,441. REN. 8-14-02. INT. CL. 28.
- PERFECTION-SCHWANK, INC., WAYNESBORO, GA:
2,624,013, PUB. 7-2-2002. INT. CL. 11.
- PERFORMANCE ADMINISTRATION CORP., CANTON, OH:
2,623,326, PUB. 7-2-2002. INT. CL. 36.
- PERFORMANCE FOOD GROUP COMPANY, RICHMOND, VA:
2,623,506, PUB. 7-2-2002. INT. CL. 30.
2,623,727, PUB. 7-2-2002. MULTIPLE CLASS, INT. CLS. 35 AND 42.
- PERFORMANCE HOSPITALITY MANAGEMENT CORPORATION, DALLAS, TX:
2,622,814, PUB. 11-6-2001. MULTIPLE CLASS, INT. CLS. 35 AND 36.
- PERFORMANCE IMPROVEMENTS SPEED SHOPS LIMITED, ETOBICOKE, ONTARIO, CANADA:
2,626,914, INT. CL. 39.
- PERFORMANCE SYSTEMS CORPORATION, DALLAS, TX:
1,933,474, CANC. INT. CL. 41.
- PERFORMINGPEOPLE CONSULTING, INC., WILLOWICK, OH:
2,624,214, PUB. 7-2-2002. INT. CL. 35.
- PERKINS & WILL, S.E, ATLANTA, GA:
2,623,558, PUB. 7-2-2002. INT. CL. 6.
- PERKINS & WILL, S.E., ATLANTA, GA:
2,623,560, PUB. 7-2-2002. INT. CL. 6.
- PERKY'S FOODSERVICE CONCEPTS, INC., TAMPA, FL:
1,933,170, CANC. INT. CL. 42.
- PERMA-FLEX INC., ONTARIO, CANADA:
723,546, CANC. U.S. CL. 23.
- PERSONA CONSULTING AB, 111 57 STOCKHOLM, SWEDEN:
1,932,920, CANC. INT. CL. 42.
- PET SITTERS INTERNATIONAL, INC., KING, NC:
2,623,434, PUB. 7-2-2002. INT. CL. 42.
- PETCO ANIMAL SUPPLIES, INC., SAN DIEGO, CA:
1,663,844, CANC. INT. CL. 42.
- PETER KWASNY GMBH, D-74831 GUNDELSHEIM, FED REP GERMANY:
2,623,592, PUB. 7-2-2002. MULTIPLE CLASS, INT. CLS. 2 AND 7.
- PETERSEN + VOCKE WEB-UND STRICKWARENFABRIK GMBH & CO. KG, 2160 STADE, FED REP GERMANY:
1,932,614, CANC. INT. CL. 25.
- PETERSON, DAVID, HOUSTON, TX, DBA AGLOG SYSTEMS:
1,732,190. REN. 8-10-02. INT. CL. 40.
- PETERSON, MICHAEL CRAIG, LAKEWOOD, CO AND PETERSON, MARTHA MARIE, LAKEWOOD, CO:
1,933,828, CANC. INT. CL. 42.
- PETRICH-LAFEVRE, KATHRYN, PHILADELPHIA, PA:
1,934,097, CANC. INT. CL. 9.
- PETRIE; SIDNEY, JERICHO, NY:
1,176,555, CANC. INT. CL. 41.

- PETSMART STORE SUPPORT GROUP, INC., PHOENIX, AZ
FROM PETSMART, INC., PHOENIX, AZ:
2,625,472, INT. CL. 7.
- PETSUITES OF AMERICA, LLC, CINCINNATI, OH:
2,622,895, PUB. 7-2-2002. INT. CL. 44.
- PEYTON STREET INDEPENDENT FINANCIAL SERVICES
CORPORATION, FARMINGTON, CT:
2,626,245, INT. CL. 36.
- PG RESEARCH FOUNDATION, INC., DARIEN, IL:
2,624,638, PUB. 7-2-2002. MULTIPLE CLASS, INT. CLS. 36
AND 42.
- PHARMWEST, INC., MARINA DEL REY, CA:
2,627,018, INT. CL. 3.
- PHAROS SYSTEMS USA, INC., HOUSTON, TX:
2,624,154, PUB. 7-2-2002. INT. CL. 9.
- PHARSIGHT CORPORATION, MOUNTAIN VIEW, CA:
2,624,925, PUB. 7-2-2002. INT. CL. 35.
- PHATNOISE, INC., LOS ANGELES, CA:
2,625,630, INT. CL. 9.
- PHENOMEDIA AG, 44866 BOCHUM, FED REP GERMANY:
2,622,901, PUB. 7-2-2002. MULTIPLE CLASS, INT. CLS. 9, 14, 16, 18, 25, 28, 30, 34, 35, 38, 41 AND 42.
- PHH VEHICLE MANAGEMENT SERVICES, LLC, HUNT
VALLEY, MD:
2,623,892, PUB. 7-2-2002. INT. CL. 35.
- PHILIPP BROTHERS CHEMICALS, INC., FORT LEE, NJ:
2,623,044, PUB. 7-2-2002. INT. CL. 1.
- PHILIPS ELECTRONICS N.V., EINDHOVEN, NETHER-
LANDS:
1,933,346, CANC. INT. CL. 9.
- PHILLIE BRIDALS, INC., ARDMORE, PA:
1,934,193, CANC. INT. CL. 25.
- PHILLIPS PETROLEUM COMPANY, BARTLESVILLE, OK:
1,933,094, CANC. INT. CL. 42.
1,933,095, CANC. INT. CL. 42.
- PHILLIPS-VAN HEUSEN CORPORATION, NEW YORK, NY:
2,624,289, PUB. 7-2-2002. INT. CL. 25.
- PHILLIPS, FAY, HIXSON, TN:
2,623,999, PUB. 7-2-2002. INT. CL. 20.
- PHILLIPS, LINDANNE, HAYDEN, AL:
2,624,775, PUB. 7-2-2002. INT. CL. 20.
- PHILPOT, IRA J., GAINESVILLE, FL:
2,625,062, PUB. 7-2-2002. INT. CL. 41.
- PHOENIX ENVIRONMENTAL LTD., PALM DESERT, CA:
2,625,375, INT. CL. 6.
- PHOENIX TECHNOLOGIES LTD., SAN JOSE, CA:
2,625,542, INT. CL. 9.
- PHOTO COMMUNICATIONS CORPORATION, JENKIN-
TOWN, PA:
1,933,158, CANC. INT. CL. 42.
- PHOTO FILE, INC., YONKERS, NY:
2,622,667, PUB. 7-2-2002. INT. CL. 35.
- PHOTOFLEX, INC., SANTA CRUZ, CA:
2,626,821, INT. CL. 41.
- PHYSICIAN WEBLINK, INC., WHITE PLAINS, NY:
2,623,380, PUB. 7-2-2002. MULTIPLE CLASS, INT. CLS. 35
AND 36.
- PHYSICIANS CONSULTING, INC., AUSTIN, TX:
1,934,501, CANC. INT. CL. 10.
- PHYSICIANS FORMULA COSMETICS, INC., AZUSA, CA:
2,626,623, INT. CL. 3.
- PHYSICIANS WEIGHT LOSS CENTERS OF AMERICA,
INC., AKRON, OH:
1,697,120, REN. 8-14-02. INT. CL. 42.
- PIAZZA OPTICAL CORP., NORTH MIAMI, FL:
2,625,190, PUB. 7-2-2002. INT. CL. 9.
- PIEDMONT LC, VIENNA, VA:
2,625,064, PUB. 7-2-2002. INT. CL. 37.
- PIERANGELO FENZI S.R.L., LONIGO (VICENZA), ITALY:
2,466,184, COR. INT. CL. 25.
- PIERCE ARROW SOCIETY, THE, ROCHESTER, NY:
2,625,651, INT. CL. 41.
- PIERRE ALLIO, 75020 PARIS, FRANCE:
2,623,829, PUB. 7-2-2002. INT. CL. 9.
- PIERRE FABRE DERMO-COSMETIQUE, 92100 BOU-
LOGNE, FRANCE:
2,624,276, PUB. 7-2-2002. MULTIPLE CLASS, INT. CLS. 3
AND 5.
2,624,394, PUB. 7-2-2002. INT. CL. 5.
- PIJNENBURG CUSTOM CHIPS B.V., 5261 NE VUGHT,
NETHERLANDS:
2,625,826, INT. CL. 9.
- PILKINGTON DEUTSCHLAND AG, 45884 GELSENKIRCH-
EN, FED REP GERMANY:
1,169,284, REN. 8-14-02. INT. CL. 21.
1,169,284, CANC. INT. CL. 19.
- PILLOW TECH INTERNATIONAL, LTD., STOUGHTON,
MA:
2,625,373, INT. CL. 25.
- PILLSBURY COMPANY, THE, MINNEAPOLIS, MN, PILLS-
BURY FLOUR MILLS COMPANY, MINNEAPOLIS, MN:
298,293, REN. 8-10-02. U.S. CL. 46 (INT. CL. 30).
- PILOT AIR FREIGHT CORP, LIMA, PA:
2,623,542, PUB. 7-2-2002. INT. CL. 39.
- PINEHURST, INC., VILLAGE OF PINEHURST, NC, RE-
SORTS OF PINEHURST, INC., DALLAS, TX:
1,663,739, REN. 8-14-02. MULTIPLE CLASS, INT. CLS. 35
AND 42.
- PINNACLE BRANDS, INC., GRAND PRAIRIE, TX:
1,934,031, CANC. INT. CL. 16.
- PION, LESLIE, NEWPORT BEACH, CA FROM PION,
LESLIE, NEWPORT BEACH, CA AND ETHELL, CAMIL-
LA, NEWPORT BEACH, CA:
2,625,876, INT. CL. 25.
- PIONEER-STANDARD ELECTRONICS, INC., CLEVELAND,
OH:
2,623,579, PUB. 7-2-2002. INT. CL. 16.
- PIPER-HEIDSIECK - ANCIENNE MAISON HEIDSIECK
FONDEE EN 1785 - COMPAGNIE CHAMPENOISE S.A.,
51100 REIMS, FRANCE:
2,623,906, PUB. 7-2-2002. INT. CL. 42.
- PISCATORY, INC., FULLERTON, CA, DBA BOB MAR-
RIOTT'S FLYFISHING STORE:
2,623,861, PUB. 7-2-2002. INT. CL. 35.
- PISCINES DESJOYAUX S.A, F-42480 LA FOUILLOUSE,
FRANCE:
2,623,504, PUB. 7-2-2002. MULTIPLE CLASS, INT. CLS. 11
AND 19.
- PIVOTAL PROMONTORY DEVELOPMENT, L.L.C, PHOE-
NIX, AZ:
2,624,859, PUB. 7-2-2002. INT. CL. 42.
- PIVOTAL PROMONTORY DEVELOPMENT, L.L.C., PHOE-
NIX, AZ:
2,624,858, PUB. 7-2-2002. INT. CL. 37.
- PIXEL LIGHT DIGITAL MEDIA, INC., RUTHERFORD, NJ:
2,624,218, PUB. 7-2-2002. INT. CL. 42.
- PIZZAS OF EIGHT, INC., ST. LOUIS, MO:
1,933,437, CANC. MULTIPLE CLASS, INT. CLS. 11, 30
AND 42.
- PLACO CORPORATION LIMITED, KOWLOON, HONG
KONG:
2,626,945, INT. CL. 28.
- PLAIA, GERALDINE O'KEEFE, SPRING LAKE HEIGHTS,
NJ:
2,625,336, INT. CL. 30.
- PLANET EARTH FOUNDATION, SEATTLE, WA:
2,625,953, INT. CL. 42.
2,625,954, INT. CL. 42.
2,625,955, INT. CL. 42.
2,625,982, INT. CL. 42.
- PLANET WIRELESS INC., MESA, AZ:
2,625,423, MULTIPLE CLASS, INT. CLS. 9 AND 38.
- PLANT PRODUCTS CO. LTD., BRAMPTON, ONTARIO L6T
1G1, CANADA:
2,623,086, PUB. 4-10-2001. INT. CL. 5.
- PLANT PROMOTIONS, INC., SOUTHFIELD, MI:
1,932,871, CANC. INT. CL. 31.
- PLANTRONICS, INC., SANTA CRUZ, CA:
1,176,146, CANC. INT. CL. 16.
- PLANTS FOR THE WESTERN GARDEN, INC., SANTA FE,
NM:
2,622,816, PUB. 7-2-2002. INT. CL. 31.
- PLASMA-THERM, INC.:
See—UNAXIS USA, INC.

- PLASTON AG KUNSTSTOFFWERK, CH-9443 WIDNAU, SWITZERLAND:
2,624,272, PUB. 7-2-2002. INT. CL. 11.
- PLATO BEHEER B.V., 6704 AT WAGENINGEN, NETHERLANDS:
2,623,245, PUB. 7-2-2002. MULTIPLE CLASS, INT. CLS. 19 AND 40.
- PLAY BY THE RULES ATHLETIC CONSULTING, LLC, LANHAM, MD:
2,622,723, PUB. 7-2-2002. MULTIPLE CLASS, INT. CLS. 41 AND 42.
- PLAY LIKE THE PROS, LLC, EDGEWOOD, KY:
2,624,398, PUB. 7-2-2002. INT. CL. 35.
- PLAYBOY ENTERPRISES INTERNATIONAL, INC., CHICAGO, IL:
2,626,072, INT. CL. 28.
2,626,133, INT. CL. 28.
- PLAYOFF CORPORATION, GRAND PRAIRIE, TX:
2,626,276, INT. CL. 16.
2,626,937, INT. CL. 16.
- PLAYSMART, INC., BOSTON, MA:
2,625,578, MULTIPLE CLASS, INT. CLS. 36 AND 42.
- PLAYTEX APPAREL, INC., STAMFORD, CT:
2,625,010, PUB. 7-2-2002. INT. CL. 25.
2,626,640, INT. CL. 25.
- PLAYTEX PRODUCTS, INC., STAMFORD, CT:
1,933,758, CANC. MULTIPLE CLASS, INT. CLS. 10 AND 21.
- PLAYTEX PRODUCTS, INC., WESTPORT, CT:
2,625,632, INT. CL. 10.
- PLAZA MEXICO, INC., NEW YORK, NY:
2,623,980, PUB. 7-2-2002. INT. CL. 42.
- PLUS GROUP, INC. THE, MEMPHIS, TN:
2,623,936, PUB. 7-2-2002. INT. CL. 35.
- PLUS ZUCCA CO., LTD., TAICHUNG HSIEN, TAIWAN:
2,626,554, MULTIPLE CLASS, INT. CLS. 18 AND 25.
- PMG HEALTHCOM, INC., ASHEVILLE, NC:
2,623,581, PUB. 7-2-2002. INT. CL. 42.
- PNC BANK CORP., PITTSBURGH, PA:
1,932,964, CANC. INT. CL. 36.
2,625,504, INT. CL. 42.
- PNC MORTGAGE CORP. OF AMERICA, VERNON HILLS, IL:
1,934,348, CANC. INT. CL. 36.
- POETIC DIGITAL GROUP, INC., SAN FRANCISCO, CA:
2,626,349, INT. CL. 41.
- POINT GREY RESEARCH INC., VANCOUVER, BRITISH COLUMBIA:
2,625,616, INT. CL. 9.
- POLAR GEMSTONES LTD., BRITISH COLUMBIA V4P 1M7, CANADA:
2,623,365, PUB. 7-2-2002. INT. CL. 14.
- POLARIS MANAGEMENT PARTNERS, L.L.C., UNION, NJ:
2,624,795, PUB. 7-2-2002. INT. CL. 35.
- POLAROID CORPORATION, CAMBRIDGE, MA:
1,934,231, CANC. INT. CL. 9.
2,625,358, INT. CL. 9.
- POLIFACE NORTH AMERICA, INC, BALTIMORE, MD:
2,626,448, INT. CL. 1.
- POLO RALPH LAUREN, L.P., NEW YORK, NY:
1,933,888, CANC. INT. CL. 14.
- POLY HI SOLIDUR, INC., NEENAH, WI TO MENASHA CORPORATION, NEENAH, WI:
2,565,447, COR. INT. CL. 12.
- POLYMER ALLIANCE ZONE, INC., RIPLEY, WV FROM SCIENCE APPLICATIONS INTERNATIONAL CORPORATION, SAN DIEGO, CA:
2,626,777, MULTIPLE CLASS, INT. CLS. 35, 38 AND 42.
- POLYMER ALLIANCE ZONE, INC., RIPLEY, WV FROM SCIENCE APPLICATIONS INTERNATIONAL CORPORATION ("SAIC"), SAN DIEGO, CA:
2,626,814, INT. CL. 42.
- POLYPHALT LLC, EAST HOLLADAY, UT FROM POLYPHALT INC., TORONTO, ONTARIO, CANADA:
2,625,318, MULTIPLE CLASS, INT. CLS. 1 AND 40.
- POLYSHOT CORPORATION, INC., WEST HENRIETTA, NY:
1,728,529, REN. 8-16-02. INT. CL. 7.
- POMAIR TRADING INC., ROAD TOWN, TORTOLA, BR.VIRGIN ISLANDS:
2,624,234, PUB. 7-2-2002. INT. CL. 14.
- POMEGRANATE COMMUNICATIONS, INC., ROHNERT PARK, CA:
2,624,442, PUB. 7-2-2002. INT. CL. 16.
- POPCORN DEPOT, INC., BETHPAGE, NY, DBA POPCORN AMERICA:
2,626,941, INT. CL. 30.
- POPKAPSULE, INC., STURBRIDGE, MA:
2,625,208, PUB. 7-2-2002. INT. CL. 25.
- POPPE, INC., PARAGOULD, AR:
2,622,546, PUB. 7-2-2002. INT. CL. 32.
- POPSICLE INDUSTRIES, INC., ENGLEWOOD, NJ:
1,176,413, CANC. INT. CL. 30.
1,176,414, CANC. INT. CL. 30.
- POPULAR, INC., SAN JUAN, PUERTO RICO:
2,625,665, INT. CL. 36.
- POPULATION SERVICES INTERNATIONAL, WASHINGTON, DC:
2,624,723, PUB. 7-2-2002. INT. CL. 42.
- PORCH SWING PUBLISHING, INC., OREM, UT:
2,626,145, INT. CL. 9.
- PORKY PIES LLC, SOUTH PASADENA, CA:
2,625,819, INT. CL. 25.
- PORT AUTHORITY, INC., LOS ANGELES, CA, DBA JOCKO:
2,625,500, INT. CL. 35.
- PORTABLE PRODUCTS, INC., SAINT PAUL, MN:
1,932,506, CANC. INT. CL. 8.
- PORTAL CONNECT, INC., HERNDON, VA:
2,623,522, PUB. 7-2-2002. INT. CL. 9.
- PORTAL PUBLICATIONS, LTD., NOVATO, CA:
2,039,194, CANC. INT. CL. 25.
- PORTEC AG, 8404 WINTERTHUR, SWITZERLAND:
2,545,589, CANC. IIRN. RESTORED TO S.N. 75-573,125.
- PORTER MATTHEWS PLACEMENT SERVICES, INC., WINDSOR, ONTARIO:
2,623,377, PUB. 7-2-2002. INT. CL. 35.
- PORTER'S CAMERA STORE, INC., CEDAR FALLS, IA:
1,933,609, CANC. INT. CL. 1.
- PORTIVA CORPORATION, AMARILLO, TX:
2,623,761, PUB. 7-2-2002. INT. CL. 9.
- PORTLAND BASEBALL, INC., PORTLAND, OR:
2,626,445, INT. CL. 41.
- PORTOFINO GRILLE, INC., NEW YORK, NY:
2,623,689, PUB. 7-2-2002. INT. CL. 42.
- POSH SALONS, LLC, ATLANTA, GA:
2,626,822, INT. CL. 42.
- POSITIVE RESPONSE TELEVISION, INC., SHERMAN OAKS, CA:
1,933,727, CANC. INT. CL. 9.
- POST APARTMENT HOMES, L.P., ATLANTA, GA:
2,625,321, MULTIPLE CLASS, INT. CLS. 36 AND 37.
- POST WALLCOVERING DISTRIBUTORS, INC., BLOOMFIELD, MI:
1,176,352, CANC. INT. CL. 27.
- POSTAJIAN, MADLEN, LA CRESCENTA, CA:
2,624,733, PUB. 7-2-2002. INT. CL. 3.
- POSTCRAFT COMPANY, TUCSON, AZ:
1,176,287, CANC. INT. CL. 24.
- POTBELLY SANDWICH WORKS, LLC, CHICAGO, IL FROM POTBELLY SANDWICH WORKS, LLC, CHICAGO, IL:
2,623,614, PUB. 7-2-2002. INT. CL. 25.
- POTBELLY SANDWICH WORKS, LLC:
See— POTBELLY SANDWICH WORKS, LLC.
- POTOMAC ELECTRIC POWER COMPANY, WASHINGTON, DC:
2,622,835, PUB. 7-2-2002. MULTIPLE CLASS, INT. CLS. 35, 36 AND 42.
- POTPOURRI PRESS, INC., GREENSBORO, NC:
1,934,049, CANC. MULTIPLE CLASS, INT. CLS. 6, 8, 9, 14, 16, 20, 21, 26 AND 28.
- POULSEN ROSER APS, FREDENSBORG, DENMARK:
2,623,244, PUB. 7-2-2002. INT. CL. 31.
- POWELL-ESCO COMPANY, GREENVILLE, TX:
1,933,366, CANC. INT. CL. 9.

- POWER COMM 2000, INC., OVERLAND PARK, KS:
2,624,944, PUB. 7-2-2002. INT. CL. 41.
- POWER GUARD, INC., OPELIKA, AL:
1,933,947, CANC. INT. CL. 9.
- POWER POLES, INC., RIO GRANDE, PUERTO RICO:
2,625,013, PUB. 7-2-2002. INT. CL. 19.
- POWERHOUSE PROMOTIONS, LLC, HOT SPRINGS, AR:
2,626,964, INT. CL. 41.
- POWERHOUSE TECHNOLOGIES, INC., BOZEMAN, MT
FROM VIDEO LOTTERY TECHNOLOGIES, INC., BOZE-
MAN, MT:
2,622,513, PUB. 7-2-2002. INT. CL. 9.
- POWERIT-UP, INCORPORATED, HOUSTON, TX:
2,624,963, PUB. 7-2-2002. MULTIPLE CLASS, INT. CLS. 38
AND 42.
- POWERPLAY RINKS, INC., CHESTER SPRINGS, PA:
2,626,332, INT. CL. 42.
- POWERWAY, INC., INDIANAPOLIS, IN:
2,623,742, PUB. 7-2-2002. INT. CL. 42.
- POZZUOLI, ENRICO DAVID, TUSTIN, CA:
2,622,541, PUB. 7-2-2002. INT. CL. 42.
- PQ CORPORATION, VALLEY FORGE, PA:
2,626,501, INT. CL. 1.
- PRACTICEMATCH, INC., ST. LOUIS, MO:
2,625,025, PUB. 7-2-2002. INT. CL. 35.
2,625,026, PUB. 7-2-2002. INT. CL. 35.
- PRADA S.A., LUXEMBOURG FROM PREFEL S.A., LE
FORUM ROYAL L-2449, LUXEMBOURG:
2,622,757, PUB. 7-2-2002. MULTIPLE CLASS, INT. CLS. 6,
8, 11, 22, 23, 24, 26, 27, 28, 32, 33, 35, 36, 39 AND 41.
- PRAGMATICS, INC., MCLEAN, VA:
2,624,387, PUB. 7-2-2002. INT. CL. 42.
- PRAIRIE SYSTEMS, INC., OMAHA, NE:
1,932,583, CANC. INT. CL. 38.
- PRANDIUM, INC, IRVINE, CA:
2,623,334, PUB. 7-2-2002. INT. CL. 41.
- PRC INC., MCLEAN, VA:
1,933,513, CANC. INT. CL. 9.
1,933,645, CANC. INT. CL. 9.
- PRECEDENCE PUBLISHING, INC., TEMPE, AZ:
1,934,243, CANC. MULTIPLE CLASS, INT. CLS. 16 AND
28.
- PRECIOUS METALS REPORT, INC., NEWTON, CT:
1,176,091, CANC. INT. CL. 16.
- PRECISION ENGINE CONTROLS CORPORATION, SAN
DIEGO, CA:
1,663,290, CANC. INT. CL. 9.
- PRECISION FRANCHISING LLC, LEESBURG, VA FROM
PRECISION TUNE AUTO CARE, INC., LEESBURG, VA:
2,624,568, PUB. 7-2-2002. INT. CL. 37.
- PRECISION STEEL WAREHOUSE, INC., FRANKLIN PARK,
IL:
1,714,844, REN. 8-10-02. INT. CL. 1.
1,714,845, REN. 8-10-02. INT. CL. 1.
- PRECISION TUNE AUTO CARE, INC.:
See—PRECISION FRANCHISING LLC.
- PRECISION TWIST DRILL CO., CRYSTAL LAKE, IL:
2,623,905, PUB. 7-2-2002. INT. CL. 8.
- PRECOR INCORPORATED, WOODINVILLE, WA, PACIFIC
FITNESS CORPORATION, SANTA FE SPRINGS, CA:
1,690,342, REN. 8-15-02. INT. CL. 28.
- PREDATOR RIDGE GOLF CLUB LTD., VERNON, BRITISH
COLUMBIA, CANADA:
2,623,029, PUB. 7-2-2002. MULTIPLE CLASS, INT. CLS.
35, 37, 41 AND 42.
- PREFEL S.A.:
See—PRADA S.A.
- PREFERRED ALLIANCE, INC., LAWRENCEVILLE, GA:
2,624,804, PUB. 7-2-2002. INT. CL. 35.
- PRELUDE SYSTEMS, INC., CARROLLTON, TX:
1,934,409, CANC. INT. CL. 9.
1,934,410, CANC. INT. CL. 9.
- PREMIER FINANCIAL PARTNERS, L.L.C., ST. LOUIS, MO:
2,626,953, INT. CL. 36.
- PREMIER GRAPHICS, INC., CORDOVA, TN FROM EA-
GLEDIRECT.COM, INC., DENVER, CO:
2,622,887, PUB. 6-19-2001. MULTIPLE CLASS, INT. CLS.
35 AND 42.
- PRENTICE-HALL, INC., ENGLEWOOD CLIFFS, NJ:
1,934,215, CANC. INT. CL. 9.
- PRESIDENT AND FELLOWS OF HARVARD COLLEGE,
CAMBRIDGE, MA:
1,182,494, REN. 8-15-02. INT. CL. 41.
2,624,199, PUB. 7-2-2002. INT. CL. 41.
2,624,200, PUB. 7-2-2002. INT. CL. 16.
- PRESIDENT RIVERBOAT CASINOS, INC., DAVENPORT,
IA:
1,933,059, CANC. INT. CL. 41.
- PRESS SOLUTIONS, LLC, NEW BERLIN, WI:
2,627,011, INT. CL. 35.
- PRESTIGE ENTERPRISE INTERNATIONAL INC., CINCIN-
NATI, OH:
2,624,759, PUB. 7-2-2002. INT. CL. 40.
- PRESTON INDUSTRIES, INC., NILES, IL:
2,624,409, PUB. 7-2-2002. INT. CL. 16.
- PRESTONE PRODUCTS CORPORATION, DANBURY, CT:
2,626,334, INT. CL. 1.
- PRETTY FEET, INC., NEW YORK, NY:
1,176,292, CANC. INT. CL. 25.
- PREVENT CHILD ABUSE ROANOKE VALLEY, INC., ROA-
NOKE, VA:
2,624,553, PUB. 7-2-2002. INT. CL. 41.
- PREVENTIVE MEDICINE INSTITUTE, NEW YORK, NY:
1,710,944, REN. 8-10-02. INT. CL. 42.
- PREVOST CAR INC., STE-CLAIRE, QUEBEC:
2,625,758, INT. CL. 36.
- PRICEWATERHOUSECOOPERS LLP, NEW YORK, NY:
2,626,987, MULTIPLE CLASS, INT. CLS. 35 AND 41.
- PRIMEDIA MAGAZINE FINANCE, INC., NEW YORK, NY:
2,624,243, PUB. 7-2-2002. INT. CL. 16.
- PRIMESTAR PARTNERS L.P., BALA CYNWYD, PA:
1,934,122, CANC. INT. CL. 38.
- PRIMEWARE CERAMICS LIMITED, CHISWICK, LONDON
W4 3TW, UNITED KINGDOM:
2,622,646, PUB. 7-2-2002. INT. CL. 21.
- PRINCE SPORTS GROUP, INC., BORDENTOWN, NJ:
1,663,494, CANC. INT. CL. 28.
- PRINCESS HOUSE, INC., NORTH DIGHTON, MA:
1,663,516, CANC. INT. CL. 28.
- PRINCESS PRIDE CREATIONS, INC., CHICAGO, IL:
723,598, CANC. U.S. CL. 28.
- PRINCETON CO-GENERATION CORPORATION, PRINCE-
TON, BC, CANADA:
2,624,256, PUB. 7-2-2002. INT. CL. 31.
- PRINCEVILLE CORPORATION, PRINCEVILLE, KAUAI,
HI:
1,691,638, REN. 8-10-02. MULTIPLE CLASS, INT. CLS. 25
AND 41.
- PRINTCO., INC., GREENVILLE, MI FROM TREASURE
CHEST ADVERTISING COMPANY, INC., BALTIMORE,
MD:
2,622,888, PUB. 7-2-2002. INT. CL. 35.
- PRINTCO., INC., GREENVILLE, MI FROM IMAGING
CONSORTIUM, INC., NEW YORK, NY:
2,623,127, PUB. 7-2-2002. MULTIPLE CLASS, INT. CLS.
35, 41 AND 42.
- PRISON FELLOWSHIP MINISTRIES, WASHINGTON, DC:
1,751,210, REN. 8-10-02. INT. CL. 16.
- PRIVATE EYE SCAPE, LLC, NEW YORK, NY:
2,626,839, INT. CL. 1.
- PRIVATE LABEL INTERNATIONAL LTD., NEW YORK,
NY:
1,933,655, CANC. INT. CL. 25.
- PRIZM MEDICAL, INC., DULUTH, GA:
2,626,553, INT. CL. 10.
- PRIZMALITE INDUSTRIES, INC., NEW YORK, NY FROM
INNOVATIVE CONCEPTS UNLIMITED, LLC, COVEN-
TRY, CT:
2,625,400, INT. CL. 24.
- PRO-TEAM, INC., BOISE, ID:
2,623,814, PUB. 7-2-2002. MULTIPLE CLASS, INT. CLS. 16
AND 41.
- PROCESS SIMULATION INTERNATIONAL, FULLERTON,
CA:
1,176,638, CANC. INT. CL. 42.

- PROCESSED PLASTIC CORPORATION, MONTGOMERY, IL:
1,934,472, CANC. INT. CL. 28.
- PROCTER & GAMBLE COMPANY, THE, CINCINNATI, OH:
2,625,805, INT. CL. 16.
2,625,873, MULTIPLE CLASS, INT. CLS. 35, 36 AND 41.
2,626,563, MULTIPLE CLASS, INT. CLS. 3, 21 AND 28.
2,626,568, INT. CL. 5.
2,626,604, INT. CL. 16.
- PROCTOR STRAYFIELD, LTD., READING, ENGLAND:
1,933,560, CANC. INT. CL. 11.
- PROCYTE CORPORATION, KIRKLAND, WA TO HUMATECH CORP., BOCA RATON, FL:
2,571,738, COR. MULTIPLE CLASS, INT. CLS. 35 AND 40.
- PRODUCTIVE RESOURCES, INC., COLUMBUS, IN:
2,626,586, INT. CL. 42.
- PROFESSIONAL EDUCATION INTERNATIONAL, INC., CHICAGO, IL:
1,663,662, CANC. INT. CL. 41.
2,623,532, PUB. 7-2-2002. INT. CL. 41.
- PROFESSIONAL FINANCIAL SERVICES L.P., BEDFORD HILLS, NY:
2,624,437, PUB. 7-2-2002. INT. CL. 36.
- PROFESSIONAL MFG. CORP., DEER PARK, NY:
1,932,885, CANC. INT. CL. 10.
- PROFESSIONAL PRODUCTS, INC., DEFUNIACK SPRINGS, FL:
1,933,192, CANC. INT. CL. 10.
- PROFESSIONALS NETWORK GROUP, INC., SHERMAN OAKS, CA:
2,623,340, PUB. 7-2-2002. INT. CL. 35.
- PROFILE NETWORK, INC., SKOKIE, IL:
2,625,558, INT. CL. 35.
- PROFIRST MORTGAGE CORPORATION, LUTHERVILLE, MD:
2,626,042, INT. CL. 36.
- PROFIT CENTER SYSTEMS, INC., MEMPHIS, TN:
2,626,136, INT. CL. 40.
- PROJECT SAMARITAN AIDS SERVICES, INC., BRONX, NY:
2,624,616, PUB. 7-2-2002. INT. CL. 42.
- PROJECT SOLVERS, INC., NEW YORK, NY:
2,625,049, PUB. 7-2-2002. INT. CL. 35.
2,625,132, PUB. 7-2-2002. INT. CL. 35.
- PROJEKTGRUPPEN A/S, KOBENHAVN K, DENMARK:
2,622,937, PUB. 7-2-2002. MULTIPLE CLASS, INT. CLS. 9, 35 AND 42.
- PROLAB NUTRITION, INC., BLOOMFIELD, CT:
2,626,067, INT. CL. 5.
- PROLINX, INC., BOTHELL, WA:
2,625,364, INT. CL. 1.
- PROMARK INTERNATIONAL, INC., BOISE, ID:
2,624,741, PUB. 7-2-2002. INT. CL. 31.
- PROMISTAR FINANCIAL CORPORATION, JOHNSTOWN, PA:
2,623,770, PUB. 7-2-2002. INT. CL. 6.
- PROS REVENUE MANAGEMENT, INC., HOUSTON, TX:
2,625,753, MULTIPLE CLASS, INT. CLS. 9 AND 35.
- PROSISE, MICHAEL A, BRISTOW, VA:
2,625,561, INT. CL. 42.
- PROSPECT PETE ENTERPRISES, INC., WESTPORT, KY:
2,624,988, PUB. 7-2-2002. INT. CL. 30.
- PROTEL RECORDS, INC., MIAMI, FL:
2,626,528, INT. CL. 15.
- PROTHERA, INC., PLEASANTON, CA:
2,626,749, INT. CL. 5.
- PROTOTYPE EQUIPMENT CORP., WAUKEGAN, IL, DBA GOODMAN PACKAGING EQUIPMENT:
2,625,176, PUB. 7-2-2002. INT. CL. 7.
- PRUDENTIAL INSURANCE COMPANY OF AMERICA, THE, NEWARK, NJ:
2,623,205, PUB. 7-2-2002. INT. CL. 36.
2,625,204, PUB. 7-2-2002. INT. CL. 36.
- PSC INC., WEBSTER, NY:
2,625,415, INT. CL. 9.
- PSI INTEGRATION, INC., CAMPBELL, CA:
1,933,368, CANC. INT. CL. 9.
- PSMJ RESOURCES, INC., NEWTON, MA:
2,623,633, PUB. 7-2-2002. INT. CL. 16.
- PT. BAUMA PRATAMA INDONESIA, JAKARTA, INDONESIA:
1,932,419, CANC. INT. CL. 9.
- PTI TECHNOLOGIES, INC., NEWBURY PARK, CA:
1,932,598, CANC. INT. CL. 11.
- PTW-NEW YORK CORPORATION, HICKSVILLE, NY:
2,625,080, PUB. 7-2-2002. INT. CL. 9.
- PUBLIC BROADCASTING SERVICE, ALEXANDRIA, VA:
2,626,226, INT. CL. 41.
- PUBLICATIONS & COMMUNICATIONS, INC., CEDAR PARK, TX:
2,627,033, INT. CL. 41.
- PUCHNIAK, STEPHEN C, BOSTON, MA:
2,625,493, INT. CL. 42.
- PUFFIN INDUSTRIES, L.L.C., BORDENTOWN, NJ:
2,624,549, PUB. 7-2-2002. INT. CL. 12.
- PUMPERNICKEL, INC., LOS ANGELES, CA:
1,176,337, CANC. INT. CL. 25.
- PUMPHREY MARKETING, INC., CLEVELAND, OH:
2,625,240, PUB. 7-2-2002. INT. CL. 35.
- PUNCH STUDIO, LLC, CULVER CITY, CA FROM WEE GOOD, INC., CULVER CITY, CA, DBA MICHEL & CO.:
2,625,747, INT. CL. 20.
- PURCHASINGNET, INC., LINCROFT, NJ:
2,623,288, PUB. 7-2-2002. INT. CL. 9.
- PURDUE FREDRICK COMPANY, THE, NORWALK, CT:
723,506, CANC. U.S. CL. 18.
- PUREOLOGY RESEARCH, LLC, IRVINE, CA:
2,560,693, COR. INT. CL. 3.
- PURI-CLEAN ENTERPRISES, INC., TEMPE, AZ:
2,625,248, PUB. 7-2-2002. INT. CL. 5.
- PURULATOR PRODUCTS AIR FILTRATION COMPANY, HENDERSON, NC, FACET ENTERPRISES, INC., TULSA, OK:
1,197,189, REN. 8-16-02. INT. CL. 11.
- PUUOA SOFTWARE DEVELOPMENT OF HAWAII, INC., HONOLULU, HI:
1,933,622, CANC. INT. CL. 9.
1,933,623, CANC. MULTIPLE CLASS, INT. CLS. 9 AND 28.
- PYRAMID DIGITAL SOLUTIONS, LLC, BIRMINGHAM, AL:
2,624,124, PUB. 7-2-2002. INT. CL. 9.
- PYRAMID SCREW PRODUCTS INC., ARLINGTON HEIGHTS, IL:
1,175,795, CANC. INT. CL. 6.
- PYROMATICS, INC., WILLOUGHBY, OH:
1,630,890, CANC. INT. CL. 21.
- Q MED, INC., LAURENCE HARBOR, NJ:
1,663,772, CANC. INT. CL. 10.
- Q.DATA INC., MARKHAM, ONTARIO, L3R 4S1, CANADA:
2,624,091, PUB. 7-2-2002. INT. CL. 9.
- Q.P.I. CONSUMER PRODUCTS CORPORATION, TAMPA, FL:
1,934,484, CANC. INT. CL. 20.
- QFLOW SYSTEMS, LLC, ST. LOUIS, MO:
2,623,231, PUB. 7-2-2002. INT. CL. 42.
- QOL RESTAURANT GROUP, INC., SPOKANE, WA:
2,625,929, MULTIPLE CLASS, INT. CLS. 21 AND 42.
- QSOUND LABS, INC., CALGARY, ALBERTA T2E 7J2, CANADA:
2,625,618, INT. CL. 9.
- QSR CONCEPTS, INC., TARZANA, CA:
2,626,417, INT. CL. 42.
- QTC MANAGEMENT, INC., DIAMOND BAR, CA:
2,623,489, PUB. 7-2-2002. MULTIPLE CLASS, INT. CLS. 35 AND 36.
- QTL BIOSYSTEMS, LLC, SANTA FE, NM:
2,624,415, PUB. 7-2-2002. INT. CL. 42.
- QUAKER OATS COMPANY (N.J. CORP.), THE, CHICAGO ILL.:
391,398, CANC. U.S. CL. 46.
- QUAKER OATS COMPANY, THE, CHICAGO, IL:
1,932,565, CANC. INT. CL. 30.

- QUAKER STATE OIL REFINING CORPORATION, OIL CITY, PA TO PENNZOIL-QUAKER STATE COMPANY, HOUSTON, TX:
627,236, AM. U.S. CL. 15.
- QUALCOMM INCORPORATED, SAN DIEGO, CA:
1,933,108, CANC. INT. CL. 21.
- QUALITY BICYCLE PRODUCTS, INC., BLOOMINGTON, MN:
2,624,072, PUB. 7-2-2002. INT. CL. 12.
- QUALITY STORES SERVICES, INC., MUSKEGON, MI FROM QUALITY STORES, INC., MUSKEGON, MI:
2,625,875, INT. CL. 35.
- QUALITY STORES, INC., MUSKEGON, MI:
1,933,797, CANC. INT. CL. 25.
- QUASAR KNOWLEDGE SYSTEMS, INC., HALF MOON BAY, CA:
2,623,156, PUB. 7-2-2002. INT. CL. 9.
- QUE PASA, INC., NEEDHAM, MA:
1,933,216, CANC. INT. CL. 16.
- QUEEN CARPET CORPORATION, DALTON, GA:
1,934,494, CANC. INT. CL. 27.
- QUEST-ENERGY, LLC, ANN ARBOR, MI:
2,623,014, PUB. 7-2-2002. INT. CL. 39.
- QUESTCOR PHARMACEUTICALS, INC., HAYWARD, CA:
2,623,137, PUB. 7-2-2002. INT. CL. 5.
- QUESTECH, INC., FALLS CHURCH, VA:
1,933,165, CANC. INT. CL. 42.
- QUIMBY, WILLIAM S., RAMSEY, NJ:
2,035,064, CANC. INT. CL. 35.
- QUINN, OLIVER H., PALM BEACH, FL, DBA CITRUS-NOW.COM:
2,625,539, INT. CL. 35.
- QUINN, WILLIAM J., WEBSTER, NY:
1,690,296, REN. 8-15-02. INT. CL. 28.
- QUINTA GESELLSCHAFT FUR PRODUKT-MARKETING MBH, W-7800 FREIBURG, FED REP GERMANY:
1,933,611, CANC. INT. CL. 10.
- QUINTANA, DANIEL T., GLENDALE, AZ:
2,622,777, PUB. 7-2-2002. INT. CL. 24.
- QUINTESSENT COMMUNICATIONS, INC., REDMOND, WA:
2,623,970, PUB. 7-2-2002. INT. CL. 9.
- QUTAB, ABBAS SYED, AUBURN, NY:
1,918,631, CANC. MULTIPLE CLASS, INT. CLS. 3 AND 5.
- QVC, INC., WEST CHESTER, PA:
1,934,024, CANC. INT. CL. 42.
1,934,332, CANC. INT. CL. 14.
2,625,653, MULTIPLE CLASS, INT. CLS. 35 AND 42.
2,626,475, INT. CL. 14.
- QWEST COMMUNICATIONS INTERNATIONAL INC., DENVER, CO:
2,626,947, INT. CL. 38.
- R & G MEDICAL AND DEVELOPMENT CORPORATION, BOCA RATON, FL:
2,626,889, INT. CL. 10.
- R & J FARMS, INC., MADERA, CA:
1,176,433, CANC. INT. CL. 31.
- R & R PROVISION COMPANY, EASTON, PA:
1,705,210, REN. 8-15-02. MULTIPLE CLASS, INT. CLS. 29 AND 42.
- R & T LANDSCAPING, INC., NEW BALTIMORE, OH:
1,176,587, CANC. INT. CL. 42.
- R. HIRT JR. CO., DETROIT, MI:
1,663,733, CANC. INT. CL. 42.
- R. J. REYNOLDS TOBACCO COMPANY, WINSTON-SALEM, NC:
1,176,454, CANC. INT. CL. 34.
- R. L. POLK & CO., SOUTHFIELD, MI:
2,624,719, PUB. 7-2-2002. INT. CL. 35.
- R.R. DONNELLEY & SONS COMPANY, CHICAGO, IL:
1,933,656, CANC. MULTIPLE CLASS, INT. CLS. 9 AND 35.
- R.R. MORRISON & SON, INC., VICKSBURG, MS FROM R.R. MORRISON & SON, INC., VICKSBURG, MS:
2,626,294, INT. CL. 35.
- R.T. VANDERBILT COMPANY, INC., NORWALK, CT:
2,626,712, INT. CL. 1.
- R&R POOL & PATIO, INC., STAMFORD, CT:
2,623,321, PUB. 7-2-2002. INT. CL. 35.
- RACING CHAMPIONS ERTL, INC., DYERSVILLE, IA:
2,626,589, INT. CL. 28.
- RACK MANUFACTURERS INSTITUTE, CHARLOTTE, NC:
2,625,489, U.S. CL. A.
- RADDON, STANLEY JAMES, ARCADIA, CA:
2,623,766, PUB. 7-2-2002. INT. CL. 4.
- RADIATORS, INC., SALT LAKE CITY, UT:
2,624,250, PUB. 7-2-2002. INT. CL. 35.
- RADICA CHINA LTD., TORTOLA, BRITISH VIRGIN ISLANDS, HONG KONG:
2,625,604, INT. CL. 28.
- RADIO CITY TRADEMARKS LLC, NEW YORK, NY:
2,623,240, PUB. 7-2-2002. INT. CL. 41.
- RADIO CITY TRADEMARKS, LLC, NEW YORK, NY:
2,623,470, PUB. 7-2-2002. INT. CL. 39.
- RADIO FLYER INC., CHICAGO, IL:
2,623,202, PUB. 7-2-2002. INT. CL. 12.
- RADIO LAZLOW, INC., LONG BEACH, NY:
2,624,042, PUB. 7-2-2002. INT. CL. 41.
- RADIOFRAME NETWORKS, INC., REDMOND, WA:
2,623,061, PUB. 7-2-2002. MULTIPLE CLASS, INT. CLS. 9 AND 38.
- RADTECH INTERNATIONAL NORTH AMERICA, BETHESDA, MD:
2,624,083, PUB. 7-2-2002. U.S. CL. 200.
- RAE, KIT, KODAK, TN:
2,623,843, PUB. 7-2-2002. INT. CL. 8.
2,623,844, PUB. 7-2-2002. INT. CL. 8.
2,623,845, PUB. 7-2-2002. INT. CL. 8.
- RAFFELOCK, STEPHANIE, BOULDER, CO:
2,626,173, INT. CL. 5.
- RAIL SETTLEMENT PLAN LIMITED, LONDON, UNITED KINGDOM:
2,622,869, PUB. 7-2-2002. MULTIPLE CLASS, INT. CLS. 39 AND 42.
- RAINBOW FOODS LLC, ACWORTH, GA:
2,624,459, PUB. 7-2-2002. INT. CL. 5.
- RAJU, SESHADRI, JACKSON, MS:
2,625,531, INT. CL. 42.
- RALEY'S, WEST SACRAMENTO, CA:
2,622,662, PUB. 7-2-2002. INT. CL. 35.
2,625,332, INT. CL. 29.
- RALPH MALTBY ENTERPRISES, INC., NEWARK, OH:
1,211,844, AM. MULTIPLE CLASS, INT. CLS. 37 AND 42.
- RAMSEY HEALTHCARE, INC., ST. PAUL, MN:
1,933,510, CANC. INT. CL. 38.
- RANDALL'S FOOD & DRUGS, INC., HOUSTON, TX:
2,622,624, PUB. 7-2-2002. INT. CL. 40.
- RANDO MACHINE CORPORATION, MACEDON, NY, CURLATOR CORPORATION, ROCHESTER, NY:
558,770, REN. 8-14-02. U.S. CL. 23 (INT. CL. 7).
- RANDO MACHINE CORPORATION, MACEDON, NY:
1,175,812, CANC. INT. CL. 7.
- RANKA ENTERPRISES INC., MARKHAM, ONTARIO, CANADA:
1,932,475, CANC. INT. CL. 25.
- RATBAG PTY LTD, ADELAIDE 5000, SOUTH AUSTRALIA, AUSTRALIA:
2,622,627, PUB. 9-4-2001. INT. CL. 9.
- RATIONAL DATA SYSTEMS, SAN RAFAEL, CA:
1,932,596, CANC. INT. CL. 9.
- RAVIZE, JOHN THOMAS, STATELINE, NV AND RAVIZE, LINDE CHRISTIANA, STATELINE, NV:
2,625,650, MULTIPLE CLASS, INT. CLS. 16, 25 AND 35.
- RAY INDUSTRIES, INC., KNOXVILLE, TN:
1,663,374, CANC. INT. CL. 12.
- RAYMENT, ROBERT, SAN JOSE, CA, DBA SAL SAS, INC!:
1,934,190, CANC. INT. CL. 42.
- RCA CORPORATION, NEW YORK, NY:
1,175,933, CANC. INT. CL. 9.
- REACH FOR TOMORROW, CHANTILLY, VA:
2,623,806, PUB. 7-2-2002. INT. CL. 36.
- REACTIVE SYSTEMS, INCORPORATED, PORT JEFFERSON, NY:
2,626,588, INT. CL. 9.

- READING IS FUNDAMENTAL, INC., WASHINGTON, DC:
2,623,466, PUB. 7-2-2002. INT. CL. 41.
- REAL ESTATE SUPPORT SYSTEMS, INC., LONGWOOD, FL:
2,625,356, INT. CL. 36.
- REAL-TIME INNOVATIONS, INC., SUNNYVALE, CA:
2,624,749, PUB. 7-2-2002. INT. CL. 9.
- REALNETWORKS, INC., SEATTLE, WA:
2,626,592, INT. CL. 9.
- REBMAN; JOSEPH GERARD, HOUSTON, TX, DBA JERRY REBMAN ELECTRONICS, D.B.A. REB'S:
1,175,947, CANC. INT. CL. 9.
- REBUILDING TOGETHER, INC., WASHINGTON, DC FROM CHRISTMAS IN APRIL * USA, WASHINGTON, DC:
2,626,108, INT. CL. 37.
- RECKITT & COLMAN (OVERSEAS) LIMITED, HULL, UNITED KINGDOM:
2,626,317, INT. CL. 3.
- RECKITT BENCKISER INC., WAYNE, NJ, RECKITT & COLMAN SUBSIDIARY CORPORATION, WILMINGTON, DE:
1,732,360. REN. 8-15-02. INT. CL. 3.
- RECKITT BENCKISER N.V., SCHIPHOL AIRPORT 118 BH, NETHERLANDS FROM BENCKISER N.V., 1118 BH SCHIPHOL AIRPORT, NETHERLANDS:
2,622,560, PUB. 4-2-2002. MULTIPLE CLASS, INT. CLS. 1, 3 AND 5.
- RECKITT BENCKISER NV, SCHIPOL AIRPORT, NETHERLANDS:
2,625,206, PUB. 7-2-2002. INT. CL. 3.
- RECREATIONAL EQUIPMENT, INC., SUMNER, WA:
2,623,233, PUB. 9-18-2001. INT. CL. 38.
- RECRUITUSA INC., MINNEAPOLIS, MN:
2,622,899, PUB. 7-2-2002. INT. CL. 35.
- RED CASTLE FRANCE, 13100 AIX EN PROVENCE, FRANCE:
2,623,776, PUB. 7-2-2002. INT. CL. 12.
- RED CHEEK, INC., FLEETWOOD, PA:
722,659, CANC. U.S. CL. 46.
- RED DELICIOUS, BEVERLY HILLS, CA:
2,625,933, INT. CL. 41.
- RED FOX EXECUTIVE SEARCH, INC., BOTHELL, WA:
2,622,856, PUB. 7-2-2002. INT. CL. 35.
- REDCATS SOCIETE ANONYME, 59100 ROUBAIX NORD, FRANCE:
2,623,110, PUB. 7-2-2002. INT. CL. 25.
- REDI-REFRIGERATION, INC., TOPEKA, KS:
2,623,915, PUB. 7-2-2002. INT. CL. 37.
- REED ELSEVIER INC., NEWTON, MA:
2,626,960, INT. CL. 35.
- REED ELSEVIER PROPERTIES INC., WILMINGTON, DE:
2,626,904, INT. CL. 35.
2,626,905, INT. CL. 35.
- REED TELEPUBLISHING LIMITED, DUNSTABLE, BEDFORDSHIRE LU5 4HB, UNITED KINGDOM:
1,933,846, CANC. MULTIPLE CLASS, INT. CLS. 35, 39 AND 42.
- REED, STANLEY FOSTER, CHARLESTON, SC, DBA REED ASSOCIATES FROM STANLEY FOSTER REED & ASSOCIATES, INC., CHARLESTON, SC:
2,623,870, PUB. 7-2-2002. INT. CL. 42.
- REEDERS MEMORIAL HOME, BOONSBORO, MD:
2,623,139, PUB. 7-2-2002. INT. CL. 42.
- REESE PRODUCTS, INC., ELKHART, IN:
2,623,214, PUB. 7-2-2002. MULTIPLE CLASS, INT. CLS. 11 AND 12.
- REGAL BAG CORPORATION, NEWBURGH, NY:
1,690,806. REN. 8-10-02. INT. CL. 18.
- REGAL WARE, INC., KEWASKUM, WI:
2,624,265, PUB. 7-2-2002. INT. CL. 21.
2,624,266, PUB. 7-2-2002. INT. CL. 21.
2,624,270, PUB. 7-2-2002. INT. CL. 21.
2,624,271, PUB. 7-2-2002. INT. CL. 21.
- REGENTS OF THE UNIVERSITY OF MICHIGAN, THE, ANN ARBOR, MI:
2,624,916, PUB. 7-2-2002. INT. CL. 38.
- REGENTS OF THE UNIVERSITY OF MINNESOTA, MINNEAPOLIS, MN:
2,623,746, PUB. 7-2-2002. INT. CL. 41.
- REGISTER.COM, INC., NEW YORK, NY:
2,626,038, INT. CL. 42.
- REH, GEORGE P., CARLSBAD, CA:
2,626,329, INT. CL. 37.
- REICHHOLD, INC., DURHAM, NC:
2,625,481, INT. CL. 1.
- REILY, JOHN BOATNER, IV, EL PASO, TX:
1,932,956, CANC. INT. CL. 16.
- REIMAN PUBLICATIONS, L.P., GREENDALE, WI:
1,933,185, CANC. INT. CL. 21.
- RELATIONSHIP MARKETING, INC., DES MOINES, IA:
2,625,169, PUB. 7-2-2002. INT. CL. 35.
- RELEVANT PRODUCTS, LLC, OKLAHOMA CITY, OK:
2,624,876, PUB. 7-2-2002. INT. CL. 18.
2,624,877, PUB. 7-2-2002. INT. CL. 25.
- RELIABLE CONTROLS CORPORATION, VICTORIA, BRITISH COLUMBIA:
2,625,143, PUB. 7-2-2002. INT. CL. 9.
- RELOCATION EXCHANGE CORP., THE, SPRINGFIELD, NJ:
2,624,160, PUB. 7-2-2002. INT. CL. 36.
- RELOCATION RESOURCES INTERNATIONAL, INC., NORWELL, MA:
2,623,756, PUB. 7-2-2002. MULTIPLE CLASS, INT. CLS. 35 AND 36.
- RELY SOFTWARE, INC., NEW YORK, NY:
2,626,497, INT. CL. 9.
- REMITDATA, INC., MEMPHIS, TN:
2,625,046, PUB. 7-2-2002. INT. CL. 36.
- RENAISSANCE POWER, INC., BATON ROUGE, LA:
2,625,583, INT. CL. 39.
- RENOIR VISIONS LLC, CELINA, OH:
2,623,823, PUB. 7-2-2002. INT. CL. 20.
- RENOVIS, INC., BERKELEY, CA:
2,625,886, INT. CL. 42.
- RENTOKIL LIMITED, WEST SUSSEX RH19 2JY, ENGLAND TO RENTOKIL INITIAL PLC, WEST SUSSEX RH19 2JY, ENGLAND:
2,129,694, AM. MULTIPLE CLASS, INT. CLS. 5, 10, 11, 21, 31, 37, 39 AND 42.
- REPLACEMENT CONCEPTS, INC., PALM BEACH GARDENS, FL:
1,916,794, CANC. INT. CL. 36.
- RESEARCH ENGINEERING AND MANUFACTURING, INC., MIDDLETOWN, RI:
2,623,001, PUB. 7-2-2002. INT. CL. 6.
- RESEARCH TRIANGLE INSTITUTE, RESEARCH TRIANGLE PARK, NC:
2,626,184, INT. CL. 42.
- RESEARCH TRIANGLE REGIONAL PARTNERSHIP, RDU AIRPORT, NC:
2,624,377, PUB. 7-2-2002. INT. CL. 35.
2,624,378, PUB. 7-2-2002. INT. CL. 35.
- RESIDENSEA LIMITED, MIAMI, FL:
2,626,386, MULTIPLE CLASS, INT. CLS. 39 AND 42.
2,626,387, MULTIPLE CLASS, INT. CLS. 39 AND 42.
- RESORT PARKS INTERNATIONAL, INC., LONG BEACH, CA:
2,622,727, PUB. 7-2-2002. INT. CL. 35.
- RESOURCES ENGINEERING SYSTEMS, INC., CAMBRIDGE, CA:
1,933,144, CANC. INT. CL. 9.
- RESOURCES ENGINEERING SYSTEMS, INC., CAMBRIDGE, MA:
1,933,145, CANC. INT. CL. 9.
- RESTAURANT DEVELOPMENT INCORPORATED, SEATTLE, WA:
1,933,627, CANC. MULTIPLE CLASS, INT. CLS. 25 AND 42.
1,933,632, CANC. MULTIPLE CLASS, INT. CLS. 25 AND 42.
- RESTAURANT ENTERPRISES, INC., MUSKOGEE, OK:
2,626,662, INT. CL. 42.
- RETAIL ROYALTY COMPANY, LAS VEGAS, NV:
2,625,393, INT. CL. 25.

- REVCARE, INC, CYPRESS, CA:
2,623,512, PUB. 7-2-2002. MULTIPLE CLASS, INT. CLS. 35 AND 36.
- REVEAL COMPUTER PRODUCTS COMPANY, WESTLAKE VILLAGE, CA:
1,933,081, CANC. INT. CL. 15.
- REVLON CONSUMER PRODUCTS CORPORATION, NEW YORK, NY:
2,623,058, PUB. 7-2-2002. INT. CL. 3.
2,624,461, PUB. 7-2-2002. INT. CL. 3.
- REYNOLDS & REYNOLDS ELECTRONICS, INC., BETHLEHEM, PA:
1,690,759. REN. 8-10-02. INT. CL. 9.
- REYNOLDS CONSUMER PRODUCTS, INC., RICHMOND, VA, DBA PRESTO PRODUCTS COMPANY:
1,663,442, CANC. INT. CL. 19.
- REYNOLDS METALS COMPANY, RICHMOND, VA:
2,626,698, INT. CL. 16.
- REYTER S.R.L., PROVINCE DE MENDOZA, ARGENTINA:
2,626,060, INT. CL. 33.
- RHEIN MEDICAL, INC., TAMPA, FL:
2,625,196, PUB. 7-2-2002. INT. CL. 10.
2,625,197, PUB. 7-2-2002. INT. CL. 10.
- RHG AND COMPANY INC., MIDDLETOWN, CT:
2,626,775, INT. CL. 5.
- RHM HOLDINGS LIMITED, MISSISSAUGA, ONTARIO, CANADA, AKA COPE MARKETING CONCEPTS:
1,176,340, CANC. INT. CL. 26.
- RHINOCEROS SPORTSWEAR INC., NEW YORK, NY:
1,933,983, CANC. INT. CL. 25.
- RHODIA CHIMIE, 92400 COURBEVOIE, FRANCE, RHONE-POULENE INDUSTRIES, PARIS, FRANCE:
1,129,747. REN. 8-14-02. INT. CL. 1.
- RHONE-POULENC AGRO (SOCIETE ANONYME), 69009 LYON, FRANCE:
2,622,771, PUB. 7-2-2002. INT. CL. 31.
- RHONE-POULENC CHIMIE, 92400 COURBEVOIE, FRANCE:
1,932,585, CANC. INT. CL. 1.
- RICH MAY, A PROFESSIONAL CORPORATION, BOSTON, MA:
2,624,326, PUB. 7-2-2002. INT. CL. 42.
- RICHARD ROBERTS LTD., INC., MORRISTOWN, NJ:
2,625,112, PUB. 7-2-2002. INT. CL. 4.
- RICHARD S. CARSON & ASSOCIATES, INC., BETHESDA, MD:
2,626,267, MULTIPLE CLASS, INT. CLS. 9 AND 42.
- RICHARD WAGNER, INC., CORNWELLS HEIGHTS, PA, AKA BARLOW CORP.:
1,175,927, CANC. INT. CL. 9.
- RICHARD WAYNE CAMPBELL, INC., MISSION HILLS, CA FROM CAMPBELL, RICHARD WAYNE, GARDEN GROVE, CA:
2,622,702, PUB. 7-2-2002. INT. CL. 25.
- RICHARDSON, TYRONE, CINCINNATI, OH:
2,625,973, INT. CL. 25.
- RICHERSON, THOMAS A., JACKSON, TN:
2,625,200, PUB. 7-2-2002. INT. CL. 41.
- RICK CASE ENTERPRISES, INC., FT. LAUDERDALE, FL:
1,728,442. REN. 8-15-02. INT. CL. 42.
- RICK FRIEDMAN ENTERPRISES, LTD, NEW YORK, NY:
2,624,617, PUB. 7-2-2002. INT. CL. 25.
- RICKETTS, ROBERT A., POLSON, MT, DBA THREE DOG DOWN:
1,756,919. REN. 8-16-02. MULTIPLE CLASS, INT. CLS. 24 AND 25.
- RICOR RACING & DEVELOPMENT, L.P., SUTTER CREEK, CA, RICHARDSON TECHNOLOGY LTD., VALENCIA, CA:
1,652,323. REN. 8-14-02. INT. CL. 12.
- RIDGE VINEYARDS, INC., CUPERTINO, CA:
2,625,227, PUB. 7-2-2002. INT. CL. 33.
- RIGGS, CYNTHIA, COLATI, CA:
1,933,141, CANC. MULTIPLE CLASS, INT. CLS. 16 AND 25.
- RIHA DESIGN GROUP, INC., CHICAGO, IL:
2,624,261, PUB. 7-2-2002. MULTIPLE CLASS, INT. CLS. 37 AND 42.
- RINBROS S.A. DE C.V., MEXICO:
1,932,622, CANC. INT. CL. 25.
- RINGCRAFTERS, INC., FRUIT HEIGHTS, UT:
2,626,685, INT. CL. 14.
- RIRI SA, 6850 MENDRISIO, SWITZERLAND:
2,623,668, PUB. 7-2-2002. INT. CL. 26.
- RISK PLACEMENT SERVICES, INC., ITASCA, IL, APPLICATION OF INTERNATIONAL SPECIAL RISK SERVICES, INC., ROLLING MEADOWS, IL:
1,210,894. REN. 8-13-02. INT. CL. 36.
- RISNER, CLARENCE, SPRING VALLEY, OH:
2,624,471, PUB. 7-2-2002. INT. CL. 8.
- RIVERS WEST APPAREL, INC., SEATTLE, WA:
2,623,230, PUB. 7-2-2002. INT. CL. 35.
- RIVERSIDE AQUETTE SWIM CLUB, INC., RIVERSIDE, CA:
1,176,645, CANC. U.S. CL. 200.
- RIVERSIDE PAPER CORPORATION, APPLETON, WI:
1,732,999, REN. 8-16-02. INT. CL. 16.
1,771,381, REN. 8-16-02. INT. CL. 16.
- RIVIERA TRADING INC., NEW YORK, NY, RIVIERA TRADING CORP., NEW YORK, NY:
942,743. REN. 8-10-02. U.S. CL. 26 (INT. CL. 9).
- RMC OF ILLINOIS, INC., CHICAGO, IL:
2,626,991, INT. CL. 35.
- RMC PACIFIC MATERIALS, INC., PLEASANTON, CA, PACIFIC CEMENT & AGGREGATES, INC., SAN FRANCISCO, CA:
734,381. REN. 8-14-02. U.S. CL. 1 (INT. CL. 1).
- RMJ ENTERPRISES, INC., CLEVELAND, OH:
2,116,946, CANC. INT. CL. 42.
- ROAD RUNNER MEDICAL, INC., WINCHESTER, MA:
1,934,232, CANC. INT. CL. 9.
- ROAL ELECTORNICS S.P.A., CASTELFIDARDO (AN), ITALY FROM BAFIN S.P.A., CASTELFIDARDO (AN), ITALY:
2,622,980, PUB. 7-2-2002. INT. CL. 9.
- ROB LIEFELD, INC., ANAHEIM, CA:
1,933,420, CANC. INT. CL. 16.
1,934,361, CANC. INT. CL. 28.
- ROBBINS, JONATHAN L., SALT LAKE CITY, UT:
1,934,025, CANC. INT. CL. 11.
- ROBCO, INC., MONTREAL, CANADA:
1,933,667, CANC. INT. CL. 6.
- ROBECO, INC., NEW YORK, NY:
1,933,646, CANC. INT. CL. 17.
- ROBERDS, INC., WEST CARROLLTON, OH:
1,932,687, CANC. INT. CL. 42.
- ROBERN SKIWEAR, INC., NEW YORK, NY:
1,934,383, CANC. INT. CL. 25.
- ROBERT BOSCH CORPORATION, BROADVIEW, IL:
2,625,147, PUB. 7-2-2002. INT. CL. 12.
- ROBERT CEFAIL & ASSOCIATES, INC., CLEARWATER, FL:
1,932,647, CANC. MULTIPLE CLASS, INT. CLS. 37, 38 AND 42.
- ROBERT F. BRANTMAN, INC., LAKE FOREST, IL:
1,934,072, CANC. INT. CL. 10.
- ROBERT WOOD JOHNSON FOUNDATION, THE, PRINCETON, NJ:
2,623,095, PUB. 7-2-2002. INT. CL. 42.
- ROBERTS PROPRIETARIES, INC., NEW YORK, NY, LYDIA O'LEARY, INC., NEW YORK CITY, NY:
564,170. REN. 8-10-02. U.S. CL. 51 (INT. CL. 3).
- ROBERTS, JOHN T, CLOVER, SC:
2,623,494, PUB. 7-2-2002. INT. CL. 41.
- ROBERTS, LAURA T., ANN ARBOR, MI:
1,694,513. REN. 8-10-02. MULTIPLE CLASS, INT. CLS. 25 AND 28.
- ROBIN BLACKBURNE, LTD., SMITHS FL07, BERMUDA, DBA BLACKBURNE ADVANCED RACQUET SYSTEMS:
2,624,097, PUB. 7-2-2002. INT. CL. 28.
- ROBINSON DAIRY, INC., DENVER, CO:
1,199,735. REN. 8-16-02. MULTIPLE CLASS, INT. CLS. 29, 30 AND 32.
- ROBISON ELECTRONICS, INC., SAN LUIS OBISPO, CA, AKA ENGINEERED COMPONENTS COMPANY:
1,198,514. REN. 8-12-02. INT. CL. 9.

- ROCHE, WILLIAM J., WESTBORO, MA:
1,933,928, CANC. INT. CL. 30.
- ROCHESTER MIDLAND CORPORATION, ROCHESTER, NY:
2,625,789, MULTIPLE CLASS, INT. CLS. 3 AND 5.
- ROCHESTER PORTABLE, HONEOYE FALLS, NY:
2,624,179, PUB. 7-2-2002. INT. CL. 11.
2,624,180, PUB. 7-2-2002. INT. CL. 11.
- ROCK WOOL MANUFACTURING COMPANY, LEEDS, AL:
2,622,817, PUB. 7-2-2002. INT. CL. 17.
- ROCKBRIDGE CAPITAL, INC., COLUMBUS, OH:
2,623,934, PUB. 7-2-2002. INT. CL. 36.
- ROCKET CITY TELEVISION, HUNTSVILLE, AL:
1,176,537, CANC. INT. CL. 38.
- ROCKSHOX, INC., SAN JOSE, CA:
2,622,562, PUB. 7-2-2002. INT. CL. 12.
- ROCKY MOUNTAIN PORTABLE COOLING, INC., DENVER, CO:
2,624,757, PUB. 7-2-2002. INT. CL. 37.
- ROD-N-BOBB'S INC., EAU CLAIRE, WI:
2,623,955, PUB. 7-2-2002. INT. CL. 11.
- RODALE INC., EMMAUS, PA:
2,624,401, PUB. 7-2-2002. MULTIPLE CLASS, INT. CLS. 16 AND 42.
- ROGAN, PETER K., OVERLAND PARK, KS AND KNOLL, JOAN H., OVERLAND PARK, KS:
2,625,917, MULTIPLE CLASS, INT. CLS. 1 AND 5.
- ROGER MONDELIN S.A., 42820 AMBIERLE, FRANCE:
2,622,942, PUB. 7-2-2002. MULTIPLE CLASS, INT. CLS. 6, 7, 8, 12, 19 AND 20.
- ROGERS PUBLISHING LIMITED, TORONTO, ONTARIO, CANADA FROM MACLEAN HUNTER PUBLISHING LIMITED, TORONTO, ONTARIO M5W 1A7, CANADA:
2,625,344, INT. CL. 16.
- ROGERS TOOL WORKS, INC., ROGERS, AR, BORIDE PRODUCTS, INC., TRAVERSE CITY, MI:
1,689,725. REN. 8-10-02. INT. CL. 1.
- ROGERS, DAVID, NORWOOD, MA:
2,625,543, MULTIPLE CLASS, INT. CLS. 37, 40 AND 42.
- ROGERS, FAWN, SANTA MONICA, CA:
2,623,675, PUB. 7-2-2002. INT. CL. 25.
- ROHDE & SCHWARZ GMBH & CO. KG, MUNICH 81671, FED REP GERMANY:
2,623,025, PUB. 7-2-2002. INT. CL. 9.
- ROHTO PHARMACEUTICAL CO., LTD., OSAKA, JAPAN:
2,626,455, INT. CL. 5.
- ROICK, REINHARD M., BURK FALLS, ONTARIO, CANADA:
1,696,119. REN. 8-15-02. INT. CL. 20.
- ROJAS, MIGUEL, SAN DIEGO, CA:
2,623,427, PUB. 5-28-2002. INT. CL. 42.
- ROLLER BEARING COMPANY OF AMERICA, INC., FAIRFIELD, CT:
2,624,337, PUB. 7-2-2002. INT. CL. 7.
- ROLLER SKATING RINK OPERATORS ASSOCIATION, INDIANAPOLIS, IN, ROLLER SKATING RINK OPERATORS ASSOCIATION OF AMERICA, LINCOLN, NE:
1,696,687. REN. 8-16-02. INT. CL. 42.
- ROLLIN B. CHILD, INC., MINNEAPOLIS, MN:
2,625,923, INT. CL. 35.
- ROLLINS HUDIG HALL CO., CHICAGO, IL:
1,934,497, CANC. INT. CL. 36.
- ROMANCING YOUR HOME, INC., FLOWER MOUND, TX:
2,626,126, INT. CL. 42.
- ROMBOM, STEVEN P., BROOKLYN, NY:
2,627,010, INT. CL. 16.
- RONALD N. BAKER AND DONNA L. BAKER PARTNERSHIP, THE, TOPTON, NC:
2,625,074, PUB. 7-2-2002. INT. CL. 36.
- ROOM-SERVICE TV, INC., POINT PLEASANT BEACH, NJ:
1,933,393, CANC. INT. CL. 35.
- ROOMS TO GO INC., SEFFNER, FL, ROOMS TO GO INC., SEFFNER, FL:
1,756,239. REN. 8-12-02. INT. CL. 42.
- ROSBORO LUMBER COMPANY, SPRINGFIELD, OR:
2,624,888, PUB. 7-2-2002. INT. CL. 19.
- ROSE CAGE INK, INC., SAN FRANCISCO, CA:
1,933,799, CANC. INT. CL. 25.
- ROSE GROUP, LTD., THE, MAINEVILLE, OH:
2,625,759, MULTIPLE CLASS, INT. CLS. 35 AND 42.
- ROSE HILL ENTERPRISES LLC, CORNELIUS, OR:
2,624,301, PUB. 7-2-2002. INT. CL. 6.
2,624,302, PUB. 7-2-2002. INT. CL. 30.
- ROSE SPICE, INC., WILMINGTON, NC:
1,934,046, CANC. INT. CL. 30.
- ROSE, FORREST E., COLUMBIA, MO:
2,624,087, PUB. 5-21-2002. INT. CL. 41.
- ROSEBUD INCORPORATED, PRAY, MT:
2,623,363, PUB. 7-2-2002. INT. CL. 31.
- ROSEDALE WALLCOVERINGS INC., CONCORD, ONTARIO L4K 1Z5, CANADA:
1,932,535, CANC. MULTIPLE CLASS, INT. CLS. 16 AND 27.
- ROSEMONT HOCKEY PARTNERS, L.P., GLENVIEW, IL:
2,626,186, INT. CL. 38.
- ROSENBLUM, CARMEN E., SCOTTSDALE, AZ AND ROSENBLUM, ALLAN S., SCOTTSDALE, AZ:
2,622,861, PUB. 7-2-2002. INT. CL. 35.
- ROSIE'S VERMONT BEEF JERKY, SWANTON, VT:
2,624,544, PUB. 7-2-2002. INT. CL. 29.
- ROSILE, SHERI DAWN, WICHITA, KS:
1,934,153, CANC. INT. CL. 16.
- ROSO HONEY, INC., CLEARBROOK, MN:
1,934,323, CANC. INT. CL. 4.
- ROSS-SMITH, PHILIP MICHAEL, LONDON EC4 1DW, ENGLAND:
2,622,967, PUB. 7-2-2002. INT. CL. 35.
- ROSS, CHARLES H., JR., UNION CITY, NJ:
2,625,849, INT. CL. 25.
- ROSSIGNOL SKI COMPANY, INC., WILLISTON, VT:
1,934,345, CANC. INT. CL. 28.
- ROSSINI, 75009 PARIS, FRANCE:
2,626,894, MULTIPLE CLASS, INT. CLS. 35, 36 AND 42.
- ROSKOWSKI, JEFFREY JOSEPH, DAVIE, FL, DBA ISLAND FLOWERS, INC.:
2,624,772, PUB. 7-2-2002. INT. CL. 1.
- ROTARY INTERNATIONAL, EVANSTON, IL:
2,625,058, PUB. 7-2-2002. INT. CL. 24.
- ROTH KASE U.S.A. LTD., MONROE, WI:
2,624,899, PUB. 7-2-2002. INT. CL. 29.
- ROTHBERG, SARANNE, ALPINE, NJ:
2,625,949, INT. CL. 36.
- ROTTAPHARM LTD., MULHUDDART, DUBLIN, IRELAND:
2,623,833, PUB. 7-2-2002. INT. CL. 5.
- ROUGH, JIM, PORT TOWNSEND, WA:
2,626,965, INT. CL. 41.
- ROUND 1 BAGELS, INC., SALISBURY, MD:
1,932,754, CANC. INT. CL. 42.
- ROUTEMATCH SOFTWARE, INC., ATLANTA, GA FROM ROUTEMATCH.COM, INC., ATLANTA, GA:
2,624,066, PUB. 7-2-2002. INT. CL. 42.
- ROUTEMATCH.COM, INC.:
See—ROUTEMATCH SOFTWARE, INC.
- ROUX LABORATORIES, INC., JACKSONVILLE, FL:
1,934,327, CANC. INT. CL. 3.
2,623,020, PUB. 7-2-2002. INT. CL. 3.
2,626,389, INT. CL. 3.
- ROVER GROUP LIMITED, BICKENHILL, BIRMINGHAM B37 7HQ, ENGLAND:
1,932,605, CANC. INT. CL. 12.
- ROVOS RAIL TOURS (PROPRIETARY) LIMITED, PRETORIA, SOUTH AFRICA:
2,623,550, PUB. 7-2-2002. INT. CL. 39.
- ROWE DIVERSIFIED, INC., WILMINGTON, DE:
2,626,091, INT. CL. 35.
- ROWENTA-WERKE GMBH, OFFENBACH A.M., FED REP GERMANY:
2,623,048, PUB. 3-19-2002. INT. CL. 9.
- ROXIO, INC., MILPITAS, CA:
2,564,809, COR. INT. CL. 9.
- ROYAL ADVENTURE TRAVEL, INC., HONOLULU, HI:
2,623,644, PUB. 7-2-2002. INT. CL. 39.
- ROYAL BANK OF CANADA, MONTREAL, QUEBEC, CANADA:
1,933,347, CANC. INT. CL. 36.

- ROYAL CARIBBEAN CRUISES LTD., MIAMI, FL:
2,626,070, INT. CL. 39.
- ROYAL INTERCONTINENTAL INC., NEW YORK, NY:
2,626,375, INT. CL. 25.
- ROYAL LIMITED PARTNERSHIP, EUGENE, OR:
2,624,784, PUB. 7-2-2002. MULTIPLE CLASS, INT. CLS. 9
AND 16.
- ROYAL PACKAGING CORP., WEST SALEM, OH:
1,175,684, CANC. INT. CL. 1.
- ROYAL STONE INDUSTRIES, INC., PHOENIX, AZ:
2,624,926, PUB. 7-2-2002. INT. CL. 17.
- ROYCE HOSIERY MILLS, INCORPORATED, THE, NEW
YORK, NY:
1,176,326, CANC. INT. CL. 25.
- ROYSTON LLC, JASPER, GA:
2,625,462, INT. CL. 20.
- RSA BIOMEDICAL INNOVATIONS AB, 907 19 UMEA,
SWEDEN:
2,623,063, PUB. 7-2-2002. MULTIPLE CLASS, INT. CLS. 9
AND 10.
- RSA LIGHTING, LLC, CHATSWORTH, CA:
2,624,688, PUB. 7-2-2002. INT. CL. 11.
- RSPNET.COM, INC., EDEN PRAIRIE, MN:
2,626,770, INT. CL. 42.
- RUBBERMAID INCORPORATED, WOOSTER, OH TO RUB-
BERMAID SPECIALTY PRODUCTS INC., WOOSTER, OH:
1,663,457, CANC. INT. CL. 21.
- RUBY TECHNOLOGIES, INC., LANCASTER, PA:
2,624,550, PUB. 7-2-2002. INT. CL. 35.
- RUDNICK, GARY P., PALM DESERT, CA:
1,663,480, CANC. INT. CL. 25.
- RUDOLPH/LIBBE INC., WALBRIDGE, OH:
2,533,833, COR. INT. CL. 37.
- RUG DOCTOR, L.P., PLANO, TX:
2,624,580, PUB. 7-2-2002. INT. CL. 37.
- RUGBY WORLD CUP LIMITED, DUBLIN 2, IRELAND:
2,622,563, PUB. 4-10-2001. MULTIPLE CLASS, INT. CLS.
16 AND 41.
- RUGS BY ROBINSON LTD, ATLANTA, GA:
2,626,980, INT. CL. 35.
- RULE INDUSTRIES, INC., GLOUCESTER, MA, WILFRID O.
WHITE & SONS, INC., BOSTON, MA:
738,590. REN. 8-15-02. U.S. CL. 26 (INT. CL. 9).
- RULNICK, MARY JO, PITTSBURGH, PA AND SCHNEI-
DER, JUDITH BURNETT, PITTSBURGH, PA:
2,624,526, PUB. 7-2-2002. INT. CL. 41.
- RUSSELL, JANIE, DALLAS, TX:
2,625,029, PUB. 7-2-2002. INT. CL. 16.
- RUSSO, MICHAEL DAVID, SKOKIE, IL:
1,932,768, CANC. INT. CL. 25.
- RUSSO, VINCENT, STATEN ISLAND, NY:
1,932,901, CANC. INT. CL. 30.
- RUTGERS, THE STATE UNIVERSITY, NEW BRUNSWICK,
NJ:
2,626,888, INT. CL. 42.
- RUTLAND FIRE CLAY COMPANY, RUTLAND, VT, DBA
RUTLAND PRODUCTS:
2,624,945, PUB. 7-2-2002. INT. CL. 3.
- RYAN'S PROPERTIES, INC., GREER, SC:
1,934,293, CANC. INT. CL. 42.
- RYKOFF-SEXTON, INC., LOS ANGELES, CA:
1,663,539, CANC. INT. CL. 29.
1,932,997, CANC. INT. CL. 32.
- S & H CITADEL INC, METUCHEN, NJ:
1,663,820, CANC. INT. CL. 35.
- S & S MEDICAL SUPPLY CO., BERKLEY, MA:
1,932,832, CANC. INT. CL. 8.
- S. MARTINELLI & COMPANY, WATSONVILLE, CA:
2,623,122, PUB. 7-2-2002. INT. CL. 30.
- S. PARKER HARDWARE MANUFACTURING CORP., ENG-
LEWOOD, NJ:
1,996,259, CANC. INT. CL. 7.
- S.A.J. JEWELRY, INC., NORTH HOLLYWOOD, CA:
2,625,528, INT. CL. 4.
- S.C.A.C.D., INC., CITY OF INDUSTRY, CA:
2,624,520, PUB. 7-2-2002. INT. CL. 35.
- S.N.C. MOREL & CIE, FREJUS 83600, FRANCE FROM
MOREL DIFFUSION SARL, 83600 FREJUS, FRANCE:
2,625,425, INT. CL. 31.
- S.N.F., 42000 SAINT-ETIENNE, FRANCE:
2,623,827, PUB. 7-2-2002. INT. CL. 1.
- SA-BON ENTERPRISES INC., FT. LAUDERDALE, FL:
1,934,450, CANC. MULTIPLE CLASS, INT. CLS. 6 AND
35.
- SABA SOFTWARE, INC., REDWOOD SHORES, CA:
2,622,625, PUB. 7-2-2002. MULTIPLE CLASS, INT. CLS. 41
AND 42.
- SABAN ENTERTAINMENT, INC.:
See— BVS ENTERTAINMENT, INC..
- SABAN ENTERTAINMENT, INC.:
See— BVS ENTERTAINMENT, INC..
- SABATINO, DOMINICK R., GARFIELD, NJ AND NOCITO,
MATTHEW M., GARFIELD, NJ AND ESPOSITO, FRANK,
BERGENFIELD, NJ AND RAINEY, KENNETH J., LODI,
NJ:
2,624,064, PUB. 7-2-2002. MULTIPLE CLASS, INT. CLS. 9
AND 41.
- SACO FOODS, INC., MIDDLETON, WI:
2,624,600, PUB. 7-2-2002. INT. CL. 43.
- SACRAMENTO RIVER CATS BASEBALL CLUB, LLC, OLD
SACRAMENTO, CA:
2,625,059, PUB. 7-2-2002. MULTIPLE CLASS, INT. CLS.
14, 16, 25 AND 28.
2,625,060, PUB. 11-6-2001. MULTIPLE CLASS, INT. CLS.
14 AND 25.
- SAFCO PRODUCTS COMPANY, MINNEAPOLIS, MN:
2,625,212, PUB. 7-2-2002. MULTIPLE CLASS, INT. CLS. 9,
12, 16, 20 AND 21.
- SAFE CHOICE FOOD INC, OMAHA, NE:
2,623,405, PUB. 7-2-2002. INT. CL. 39.
- SAFERTEK INTERNATIONAL, INC., IRVING, TX:
2,623,667, PUB. 6-11-2002. INT. CL. 42.
- SAFETY SYRINGES, INC., CARLSBAD, CA:
2,624,070, PUB. 7-2-2002. MULTIPLE CLASS, INT. CLS. 10
AND 40.
- SAFETY VISION, HOUSTON, TX:
2,623,849, PUB. 7-2-2002. INT. CL. 40.
2,623,850, PUB. 7-2-2002. INT. CL. 35.
- SAINT GERMAIN FOUNDATION, SCHAUMBURG, IL:
1,720,975. REN. 8-13-02. INT. CL. 42.
- SAL HOLLAND, INC., EL PASO, TX:
1,772,448. REN. 8-16-02. INT. CL. 25.
- SALAAM, BLOOMINGTON, IN:
2,624,453, PUB. 7-2-2002. INT. CL. 41.
- SALADWORKD, INC., PHILADELPHIA, PA, SCARDAPANE
CORPORATION, PHILADELPHIA, PA:
1,693,647. REN. 8-14-02. INT. CL. 42.
- SALESFORCE.COM, INC., SAN FRANCISCO, CA:
2,624,014, PUB. 7-2-2002. MULTIPLE CLASS, INT. CLS. 35
AND 42.
- SALESMOUNTAIN.COM, INC., LOS ANGELES, CA:
2,623,210, PUB. 7-2-2002. INT. CL. 42.
- SALIENCE ASSOCIATES, INC., ANDOVER, MA:
2,623,120, PUB. 7-2-2002. INT. CL. 41.
- SALIENT SYSTEMS, INC., DUBLIN, OH:
2,625,811, INT. CL. 9.
- SALMO S.C., POLAND:
2,622,914, PUB. 7-2-2002. INT. CL. 28.
- SALUS HAUS DR. MED. OTTO GREITHER NACHF, GMBH
& CO. KG, BAVARIA, FED REP GERMANY:
2,623,382, PUB. 1-15-2002. MULTIPLE CLASS, INT. CLS. 5
AND 30.
- SALVATION ARMY, THE, DALLAS, TX:
2,623,281, PUB. 7-2-2002. INT. CL. 42.
- SALZ, JENNIFER B., DEL MAR, CA AND BENDER,
JEANNE, DEL MAR, CA:
2,625,703, INT. CL. 9.
- SAMBRAILO PACKAGING, WATSONVILLE, CA, CHAS.
SAMBRAILO PAPER CO., WATSONVILLE, CA:
1,691,606. REN. 8-12-02. INT. CL. 21.
- SAME DEUTZ-FAHR S.P.A., BERGAMO, ITALY:
2,625,523, INT. CL. 12.

- SAMSONITE CORPORATION, DENVER, CO:
2,626,612, INT. CL. 9.
2,626,703, INT. CL. 18.
2,626,721, INT. CL. 18.
- SAMSUNG ELECTRONICS CO., LTD., SUWON-CITY, KYUNGKI-DO, REPUBLIC OF KOREA:
2,623,888, PUB. 7-2-2002. INT. CL. 9.
- SAN ANTONIO CONVENTION & VISITORS BUREAU, SAN ANTONIO, TX:
2,623,264, PUB. 7-2-2002. INT. CL. 35.
- SAN CRISTOBAL MANAGEMENT, LTD.:
See— SAN CRISTOBAL, LTD..
- SAN CRISTOBAL, LTD., DALLAS, TX FROM SAN CRISTOBAL MANAGEMENT, LTD., DALLAS, TX:
2,623,963, PUB. 7-2-2002. INT. CL. 39.
- SAN DIEGO CONVENTION & TOURIST BUREAU, SAN DIEGO, CA, AKA SAN DIEGO CONVENTION AND VISITORS BUREAU:
1,198,235. REN. 8-12-02. MULTIPLE CLASS, INT. CLS. 35 AND 39.
- SAN DIEGO COUNTY TAXPAYERS ASSOCIATION, SAN DIEGO, CA:
2,622,798, PUB. 7-2-2002. INT. CL. 42.
- SAN DIEGO EYE BANK, SAN DIEGO, CA:
2,623,333, PUB. 7-2-2002. INT. CL. 42.
- SAN FRANCISCO CONVENTION & VISITORS BUREAU, SAN FRANCISCO, CA:
2,626,000, INT. CL. 25.
- SAN JOAQUIN COUNTY OFFICE OF EDUCATION, ALTERNATIVE PROGRAMS, STOCKTON, CA:
2,625,369, INT. CL. 41.
- SANDERS, ANDREW I., PRATTVILLE, AL:
2,626,514, INT. CL. 16.
- SANDHILLS PUBLISHING COMPANY, LINCOLN, NE:
2,623,136, PUB. 7-2-2002. MULTIPLE CLASS, INT. CLS. 16 AND 42.
- SANDMAR MARKETING, NEW CASTLE, PA:
2,624,851, PUB. 7-2-2002. INT. CL. 21.
2,624,852, PUB. 7-2-2002. INT. CL. 21.
- SANDOZ, INC., EAST HANOVER, NJ:
723,514, CANC. U.S. CL. 18.
- SANDPOINT DESIGN, INC., WATSONVILLE, CA:
1,933,225, CANC. INT. CL. 12.
- SANDSTORM ENTERPRISES, INC., CAMBRIDGE, MA:
2,625,517, INT. CL. 9.
- SANDVIK AB, S-811 81 SANDVIKEN, SWEDEN:
1,932,778, CANC. INT. CL. 7.
- SANTA & COLE EDICIONES DE DISEÑO S.A., 08017-BARCELONA, SPAIN:
2,622,894, PUB. 7-2-2002. INT. CL. 21.
- SANTA CRUZ SPORTS AND NUTRITION, LLC, SANTA CRUZ, CA:
2,626,847, INT. CL. 5.
- SANTEN PHARMACEUTICAL CO. LTD., OSAKA, JAPAN:
2,626,935, INT. CL. 5.
- SANTINI, ANNA LUISA, 20136 MILANO, ITALY:
2,623,722, PUB. 7-2-2002. MULTIPLE CLASS, INT. CLS. 24 AND 25.
- SARA LEE CORPORATION, WINSTON-SALEM, NC:
2,625,012, PUB. 7-2-2002. INT. CL. 25.
- SARACENI, DEANNA, GREENLAWN, NY:
2,624,438, PUB. 7-2-2002. INT. CL. 41.
- SARAMAR L.L.C., CHICAGO, IL:
2,626,619, INT. CL. 25.
- SARAMAR, L.L.C., CHICAGO, IL:
2,623,922, PUB. 7-2-2002. INT. CL. 29.
2,625,116, PUB. 7-2-2002. INT. CL. 29.
2,626,716, INT. CL. 3.
- SARATOGA SPRING WATER COMPANY, SARATOGA SPRINGS, NY:
1,932,783, CANC. MULTIPLE CLASS, INT. CLS. 30 AND 32.
- SARDINIA, CARLOS A., BOCA RATON, FL:
1,932,744, CANC. MULTIPLE CLASS, INT. CLS. 41 AND 42.
- SAREEN, IVA, LOS ANGELES, CA:
2,624,123, PUB. 7-2-2002. MULTIPLE CLASS, INT. CLS. 41 AND 42.
- SARGENTO FOODS INC., PLYMOUTH, WI:
2,624,475, PUB. 7-2-2002. INT. CL. 29.
2,624,557, PUB. 7-2-2002. INT. CL. 30.
- SAROYAN LUMBER COMPANY, HUNTINGTON PARK, CA:
2,624,457, PUB. 7-2-2002. INT. CL. 19.
- SASIB S.P.A., 43040 PARMA, ITALY:
2,623,631, PUB. 7-2-2002. MULTIPLE CLASS, INT. CLS. 29, 30 AND 32.
- SATAMA INTERACTIVE OYJ, 00150 HELSINKI, FINLAND:
2,623,758, PUB. 7-2-2002. INT. CL. 42.
- SAUCONY, INC., PEABODY, MA:
2,625,502, MULTIPLE CLASS, INT. CLS. 24 AND 25.
- SAULTERS, DAVID, NEW YORK, NY TO BLUE MOON INTERNET SERVICES, INC., STUARTS DRAFT, VA:
2,251,003 NEW CERT. 9-24-2002. INT. CL. 25.
- SAUR INTERNATIONAL, 78280 GUYANCOURT, FRANCE:
2,623,695, PUB. 7-2-2002. MULTIPLE CLASS, INT. CLS. 4, 37 AND 40.
- SAVAJE TECHNOLOGIES, INC., N. CHELMSFORD, MA:
2,626,495, INT. CL. 9.
2,626,496, INT. CL. 9.
- SAVANT, INC., MIDLAND, MI:
2,623,706, PUB. 7-2-2002. INT. CL. 42.
- SAVANTAGE, INC., AUSTIN, TX:
2,622,511, PUB. 12-3-1996. INT. CL. 9.
- SAVE4YOU, REDMOND, WA:
2,622,643, PUB. 7-2-2002. INT. CL. 35.
- SAVKA, AARON C., MURPHYSBORO, IL:
2,625,268, PUB. 7-2-2002. INT. CL. 35.
- SAVOLA COMPANY, THE, JEDDAH 21424, SAUDI ARABIA:
1,933,935, CANC. INT. CL. 29.
- SAVVIDES, SAVVAS, NICOSIA 2412, CYPRUS:
2,626,336, INT. CL. 9.
- SAX, AMY, STAMFORD, CA:
2,623,062, PUB. 7-2-2002. INT. CL. 14.
- SAZERAC CO., INC., NEW ORLEANS, LA:
2,622,735, PUB. 6-19-2001. MULTIPLE CLASS, INT. CLS. 16, 21, 25 AND 33.
- SBC COMMUNICATIONS INC., SAN ANTONIO, TX:
2,625,128, PUB. 7-2-2002. INT. CL. 38.
2,625,129, PUB. 7-2-2002. INT. CL. 38.
2,625,178, PUB. 7-2-2002. INT. CL. 41.
- SBZ PRODUCTIONS LTD., NEW YORK, NY:
2,623,190, PUB. 7-2-2002. INT. CL. 41.
- SCANA CORPORATION, COLUMBIA, SC:
2,624,527, PUB. 7-2-2002. MULTIPLE CLASS, INT. CLS. 39 AND 40.
- SCANNING CONCEPTS, INC., DULUTH, MN:
1,933,247, CANC. INT. CL. 9.
- SCANTEST LIMITED, MANCHESTER, ENGLAND:
1,176,471, CANC. INT. CL. 35.
- SCHACH, BERNADINE, BEDFORD, TX:
2,624,648, PUB. 7-2-2002. INT. CL. 26.
- SCHACHTER, LAUREN, RIVERDALE, NY:
1,663,708, CANC. INT. CL. 42.
- SCHAFFER MICOMED GMBH:
See— SCHAFFER, BERND.
- SCHAFFER, BERND, CH-6315 OBERAGERI, SWITZERLAND FROM SCHAFFER MICOMED GMBH, D-73035 GOPPINGEN, FED REP GERMANY:
2,622,555, PUB. 3-20-2001. MULTIPLE CLASS, INT. CLS. 10, 40 AND 42.
- SCHANZ, STEPHEN J., CARY, NC:
1,934,324, CANC. INT. CL. 16.
- SCHAWBEL CORPORATION, THE, BOSTON, MA:
2,622,561, PUB. 7-2-2002. INT. CL. 11.
- SCHERER, ANTHONY, TAZEWEILL, TN:
2,622,603, PUB. 7-2-2002. INT. CL. 13.
- SCHERING CORPORATION, KENILWORTH, NJ:
2,625,928, INT. CL. 5.
- SCHERING-PLOUGH HEALTHCARE PRODUCTS, INC., MEMPHIS, TN:
2,625,882, INT. CL. 10.
- SCHINDLER, A. RUSSELL, TRAVERSE CITY, MI:
2,624,247, PUB. 7-2-2002. INT. CL. 40.

- SCHINKER ENTERTAINMENT GROUP, INC., LIVONIA, MI:
2,626,890, INT. CL. 41.
- SCHLUMBERGER TECHNOLOGY CORPORATION, SUGAR LAND, TX:
1,932,915, CANC. MULTIPLE CLASS, INT. CLS. 37 AND 42.
- SCHLUMBERGER TECHNOLOGY CORPORATION, HOUSTON, TX:
2,626,160, MULTIPLE CLASS, INT. CLS. 37 AND 42.
- SCHMERER, JACK R., BUFFALO GROVE, IL, DBA RMS PRODUCTIONS:
2,626,628, INT. CL. 41.
- SCHMIDT, GUNTER F., D-79312 EMMENDINGEN, FED REP GERMANY:
2,622,932, PUB. 7-2-2002. MULTIPLE CLASS, INT. CLS. 24 AND 25.
- SCHNADER HARRISON SEGAL & LEWIS LLP, PHILADELPHIA, PA:
2,624,667, PUB. 7-2-2002. INT. CL. 42.
- SCHNEEHAGEN, EDWARD L., NORTH LAUDERDALE, FL, DBA TROPICAL WEB CREATIONS:
2,624,496, PUB. 7-2-2002. INT. CL. 9.
- SCHNEIDER COMMUNICATIONS, INC., GREEN BAY, WI:
1,934,076, CANC. INT. CL. 38.
- SCHNEIDER, DAVID L, SAN DIEGO, CA:
2,626,997, INT. CL. 35.
- SCHNEIDER, DAVID L., SAN DIEGO, CA:
2,624,869, PUB. 7-2-2002. INT. CL. 35.
2,624,950, PUB. 7-2-2002. INT. CL. 35.
2,624,951, PUB. 7-2-2002. INT. CL. 35.
2,624,952, PUB. 7-2-2002. INT. CL. 35.
2,624,953, PUB. 7-2-2002. INT. CL. 35.
2,624,954, PUB. 7-2-2002. INT. CL. 35.
2,624,955, PUB. 7-2-2002. INT. CL. 35.
2,624,956, PUB. 7-2-2002. INT. CL. 35.
2,626,989, INT. CL. 36.
2,626,995, INT. CL. 35.
2,626,996, INT. CL. 35.
2,626,998, INT. CL. 35.
- SCHOLASTIC INC., NEW YORK, NY:
2,624,613, PUB. 7-2-2002. INT. CL. 16.
2,626,523, INT. CL. 35.
- SCHOLL, INC., MEMPHIS, TN:
723,666, CANC. U.S. CL. 44.
- SCHOLTEN ROOFING INC., LYNDEN, WA:
2,623,232, PUB. 7-2-2002. INT. CL. 37.
- SCHREIBER CORPORATION, INC., TRUSSVILLE, AL:
2,624,262, PUB. 7-2-2002. INT. CL. 11.
- SCHREINER, GARY B., GLEN HEAD, NY:
2,625,173, PUB. 7-2-2002. INT. CL. 42.
- SCHROEDER & TREMAYNE, INC., ST. LOUIS, MO, GARDEN BOTANIKA, INC., REDMOND, WA:
1,690,931, REN. 8-16-02. INT. CL. 42.
- SCHUBERTH HELME GMBH, D - 38106 BRAUNSCHWEIG, FED REP GERMANY:
2,623,225, PUB. 7-2-2002. INT. CL. 9.
- SCHUMACHER GROUP OF DELAWARE, INC., THE, LAFAYETTE, LA:
2,625,232, PUB. 7-2-2002. MULTIPLE CLASS, INT. CLS. 35, 36 AND 41.
- SCHUTZ GMBH & CO. KGAA, D-56242 SELTERS, FED REP GERMANY:
2,624,147, PUB. 7-2-2002. MULTIPLE CLASS, INT. CLS. 6 AND 20.
- SCHWARZWAELDER, DOUGLAS C., CHERRY HILL, NJ:
1,933,299, CANC. INT. CL. 16.
- SCHWEISS DISTRIBUTING, INC., FAIRFAX, MN:
2,626,900, INT. CL. 6.
- SCHWINN BICYCLE COMPANY, CHICAGO, IL:
1,176,017, CANC. INT. CL. 11.
- SCIENCE APPLICATION INTERNATIONAL CORPORATION, SAN DIEGO, CA:
1,933,512, CANC. MULTIPLE CLASS, INT. CLS. 9 AND 16.
- SCIENCE APPLICATIONS INTERNATIONAL CORPORATION:
See— POLYMER ALLIANCE ZONE, INC..
- SCIENCE APPLICATIONS INTERNATIONAL CORPORATION ("SAIC"):
See— POLYMER ALLIANCE ZONE, INC..
- SCIENTIFIC-ATLANTA, INC., LAWRENCEVILLE, GA:
2,626,738, INT. CL. 42.
- SCIMED LIFE SYSTEMS, INC., MAPLE GROVE, MN:
1,667,172, REN. 8-16-02. INT. CL. 10.
2,622,729, PUB. 7-2-2002. INT. CL. 10.
2,626,324, INT. CL. 10.
- SCLINDLER AUFZUGE AG, EBikon, SWITZERLAND:
2,623,393, PUB. 7-2-2002. MULTIPLE CLASS, INT. CLS. 7, 22 AND 37.
- SCOBRA SOFTWARE SOLUTIONS, LTD, TAMPA, FL:
1,933,106, CANC. INT. CL. 9.
- SCOOTER STORE, INC., THE, NEW BRAUNFELS, TX:
2,623,482, PUB. 7-2-2002. MULTIPLE CLASS, INT. CLS. 35, 36, 37 AND 39.
2,623,496, PUB. 7-2-2002. MULTIPLE CLASS, INT. CLS. 35, 36, 37 AND 39.
- SCOOTERBUG, INC., WOBURN, MA:
2,624,627, PUB. 7-2-2002. MULTIPLE CLASS, INT. CLS. 12 AND 39.
2,624,628, PUB. 7-2-2002. MULTIPLE CLASS, INT. CLS. 12 AND 39.
- SCOREBOARD WIRELESS CORPORATION:
See— SCOREBOARD, INC..
- SCOREBOARD, INC., HERNDON, VA FROM SCOREBOARD WIRELESS CORPORATION, HERNDON, VA:
2,622,704, PUB. 7-2-2002. MULTIPLE CLASS, INT. CLS. 38, 39 AND 42.
- SCOTIA PHARMACEUTICALS LTD., GUILDFORD, SURREY, GUI IBA, ENGLAND:
1,932,560, CANC. MULTIPLE CLASS, INT. CLS. 5 AND 29.
- SCOTT CAMERON GOLF DESIGN INC., CARLSBAD, CA:
2,623,971, PUB. 7-2-2002. INT. CL. 42.
- SCOTT PAPER COMPANY, DELAWARE COUNTY, PA:
1,180,134, CANC. INT. CL. 16.
- SCOTT PLASTICS CO., SARASOTA, FL:
1,176,181, CANC. INT. CL. 16.
- SCOTT-LEVIN ASSOCIATES, INC., NEWTOWN, PA:
1,663,289, CANC. INT. CL. 9.
- SCOTT, MILDRED E., LAKEVIEW TERRACE, CA:
1,933,587, CANC. MULTIPLE CLASS, INT. CLS. 20 AND 25.
- SCOTTISH HARP SOCIETY OF AMERICA, THE, CUYAHOGA FALLS, OH:
2,627,015, INT. CL. 41.
- SCOTTS-SIERRA CROP PROTECTION COMPANY, MARYSVILLE, OH:
1,932,487, CANC. INT. CL. 5.
- SCOUT SOLUTIONS, INC., MT. GRETN, PA:
2,626,601, INT. CL. 9.
2,626,602, INT. CL. 9.
- SCOVILL INC., WATERBURY, CT:
723,481, CANC. U.S. CL. 13.
- SCRANTON GILLETTE COMMUNICATIONS, INC., DES PLAINES, IL:
2,626,981, INT. CL. 16.
- SCREAM GRAPHIX, INC., PHILADELPHIA, PA:
2,625,754, MULTIPLE CLASS, INT. CLS. 25 AND 42.
- SCREEN DOOR GRAPHICS, INC., MINNEAPOLIS, MN:
2,622,656, PUB. 7-2-2002. INT. CL. 9.
- SCRIPPS HOWARD BROADCASTING COMPANY, CINCINNATI, OH:
1,933,504, CANC. INT. CL. 41.
- SCRIPPS HOWARD BROADCASTING COMPANY DBA DIY DO-IT-YOURSELF NETWORK:
See— SCRIPPS NETWORKS, INC..
- SCRIPPS NETWORKS, INC., KNOXVILLE, TN FROM SCRIPPS HOWARD BROADCASTING COMPANY, KNOXVILLE, TN, DBA DIY DO-IT-YOURSELF NETWORK:
2,626,869, INT. CL. 41.
- SCRIPT TO SCREEN PRODUCTIONS, SANTA ANA, CA:
2,624,420, PUB. 7-2-2002. INT. CL. 35.
- SCUBA SPEC, INC., SAVANNAH, GA:
1,175,925, CANC. INT. CL. 9.

- SCUBAFARES, L.L.C., LAS VEGAS, NV:
2,626,205, INT. CL. 42.
- SEA PORT PRODUCTS CORPORATION, SAN MATEO, CA:
2,623,207, PUB. 7-2-2002. INT. CL. 29.
- SEABROOK WALLCOVERINGS, INC., MEMPHIS, TN:
1,933,994, CANC. INT. CL. 16.
- SEACOAST UNDERWRITERS, INC., CORAL GABLES, FL:
2,624,310, PUB. 7-2-2002. INT. CL. 36.
- SEAL-A-FRIDGE, INC., ORLANDO, FL:
2,623,153, PUB. 7-2-2002. INT. CL. 37.
- SEAL, SUSAN T., ANDERSON, IN, DBA BEAD RELISH
AND PETIT, REBECCA L., LOUISVILLE, KY, DBA BEAD
RELISH AND CARTER, JAMA R., ZIONSVILLE, IN, DBA
BEAD RELISH:
2,625,731, INT. CL. 35.
- SEALY TECHNOLOGY, LLC, TRINITY, NC FROM OHIO
MATTRESS COMPANY LICENSING AND COMPONENTS
GROUP, THE, CLEVELAND, OH:
2,625,354, MULTIPLE CLASS, INT. CLS. 20 AND 24.
- SEAN A. LEDEIT, SAN FRANCISCO, CA:
2,623,018, PUB. 7-2-2002. INT. CL. 18.
- SEARS, MIKE, PARKSTONE, POOLE, DORSET, ENGLAND:
2,622,543, PUB. 7-2-2002. MULTIPLE CLASS, INT. CLS. 32
AND 33.
- SEARS, ROEBUCK AND CO., HOFFMAN ESTATES, IL:
1,932,634, CANC. INT. CL. 42.
1,933,297, CANC. INT. CL. 25.
2,624,156, PUB. 7-2-2002. INT. CL. 21.
- SEASONAL CONCEPTS, INC., PLYMOUTH, MN:
2,622,664, PUB. 7-2-2002. INT. CL. 35.
- SEATTLE BIKE SUPPLY, INC., KENT, WA:
2,624,492, PUB. 7-2-2002. INT. CL. 41.
- SEBA, TONY, SAN FRANCISCO, CA:
2,626,714, INT. CL. 35.
- SEBACH S.R.L., CERTALDO (FLORENCE), ITALY:
2,622,860, PUB. 7-2-2002. INT. CL. 11.
- SECRET LEVEL, INC., SAN FRANCISCO, CA:
2,624,710, PUB. 7-2-2002. MULTIPLE CLASS, INT. CLS. 9
AND 42.
- SECTOR 42 TECHNOLOGY INC., HULL, QUEBEC, CANA-
DA:
2,622,833, PUB. 7-2-2002. INT. CL. 9.
- SECULUS DA AMZAONIA S/A JOIAS E RELOGIOS, 69030-
520 - MANAUS - AM, BRAZIL:
2,622,523, PUB. 5-9-2000. INT. CL. 14.
- SECURETEC CONTRABAND DETECTION & IDENTIFICA-
TION, INC., WILLIAMSPORT, PA:
2,345,085, COR. INT. CL. 5.
- SECURITY LOGISTICS, INC., NORCO, CA:
2,622,809, PUB. 7-2-2002. INT. CL. 42.
- SECURITY VOICE, INC., DUBLIN, OH:
2,622,691, PUB. 7-2-2002. INT. CL. 38.
- SEEC, INC., PITTSBURGH, PA:
2,626,002, INT. CL. 42.
- SEED HAWK INC., SASKATCHEWAN, CANADA:
2,624,809, PUB. 7-2-2002. INT. CL. 7.
- SEEDS FOR THE WORLD, INC., GRANITEVILLE, SC:
2,622,802, PUB. 7-2-2002. INT. CL. 31.
- SEEKERS COFFEE HOUSE, MIDDLEBURG HEIGHTS, OH:
2,624,501, PUB. 7-2-2002. INT. CL. 42.
- SEEREY-LESTER, JOHN, NOKOMAS, FL:
1,933,187, CANC. INT. CL. 16.
- SEFAS TECHNOLOGIES, S.A., 94110 ARCUEIL CEDEX,
FRANCE:
2,623,012, PUB. 3-19-2002. MULTIPLE CLASS, INT. CLS. 9
AND 42.
2,623,078, PUB. 7-2-2002. INT. CL. 42.
- SEGA ENTERPRISES LTD., OHTA-KU, TOKYO, JAPAN:
1,690,329, REN. 8-10-02. INT. CL. 28.
- SEISINT, INC., BOCA RATON, FL:
2,624,082, PUB. 7-2-2002. MULTIPLE CLASS, INT. CLS. 35
AND 42.
2,624,319, PUB. 7-2-2002. INT. CL. 42.
- SEISMIC MICRO-TECHNOLOGY, INC., HOUSTON, TX:
2,624,812, PUB. 7-2-2002. INT. CL. 9.
- SELECT DISTRIBUTORS, INC., MIRAMAR, FL, DBA SE-
LECT PRODUCTS:
2,624,074, PUB. 7-2-2002. INT. CL. 35.
- SELECTION NEW PLANT SARL, 06603 ANTIBES CEDEX,
FRANCE:
1,933,914, CANC. INT. CL. 31.
- SELMER COMPANY, INC., THE, ELKHART, IN, LUDWIG
INDUSTRIES, CHICAGO, IL:
938,823, REN. 8-14-02. U.S. CL. 36 (INT. CL. 15).
- SEMBLEX CORPORATION, ELMHURST, IL:
2,624,720, PUB. 7-2-2002. INT. CL. 6.
- SEMICONDUCTOR RESEARCH CORPORATION, DUR-
HAM, NC:
2,623,447, PUB. 7-2-2002. INT. CL. 42.
- SENARIO LLC, CRYSTAL LAKE, IL:
2,624,322, PUB. 7-2-2002. INT. CL. 28.
- SENEY, JOHN, SUGARLOAF SHORES, FL, DBA JOHN
SENEY, INC.:
1,933,864, CANC. INT. CL. 21.
- SENIOR GOLFERS ASSOCIATION OF AMERICA INC.,
MYRTLE BEACH, SC:
2,623,256, PUB. 7-2-2002. INT. CL. 16.
2,623,257, PUB. 7-2-2002. MULTIPLE CLASS, INT. CLS. 41
AND 42.
- SENSCOM, INC., SAN DIEGO, CA:
2,625,952, MULTIPLE CLASS, INT. CLS. 9 AND 38.
- SENSE OF SMELL INSTITUTE, LTD., NEW YORK, NY
FROM OLFACTORY RESEARCH FUND, LTD., THE,
NEW YORK, NY:
2,626,249, INT. CL. 35.
- SENTIL 2000, S.L., 31350 PERALTA (NAVARRA) / SPAIN,
SPAIN:
2,623,418, PUB. 7-2-2002. INT. CL. 39.
- SENTINEL PRODUCTS CORP, HYANNIS, MA:
1,932,658, CANC. INT. CL. 1.
- SEOUL AUTO BODY IND. CO., LTD., YOUNGDEUNGPO-
GU, SEOUL, REPUBLIC OF KOREA:
1,646,773, CANC. INT. CL. 12.
- SERAFINO, INC., SOLANA BEACH, CA:
1,933,867, CANC. MULTIPLE CLASS, INT. CLS. 3 AND
21.
- SERFLING, LINDA, BECKER, MN AND SERFLING, DALE,
BECKER, MN:
2,624,421, PUB. 7-2-2002. INT. CL. 30.
- SERRAO, MAUREEN ANNE, AUSTIN, TX:
2,625,213, PUB. 7-2-2002. INT. CL. 16.
- SERTA, INC., ITASCA, IL:
1,180,198, REN. 8-10-02. INT. CL. 20.
2,626,376, INT. CL. 20.
- SERVE-EM.COM, INC., WEST PALM BEACH, FL:
2,623,259, PUB. 7-2-2002. INT. CL. 42.
- SERVICE AMERICA CORPORATION, STAMFORD, CT:
1,932,818, CANC. INT. CL. 30.
- SERVICE CONTRACT SYSTEMS CORPORATION, INDIA-
NAPOLIS, IN:
2,622,716, PUB. 7-2-2002. INT. CL. 36.
- SERVICIOS CORPORATIVOS DE ADMINISTRACION GMZ,
S.A. DE C.V., 03100, MEXICO, D. F., MEXICO:
2,625,717, INT. CL. 16.
2,625,718, INT. CL. 1.
- SEVEN CIRCLE RESORTS, INC., DENVER, CO:
2,238,320, AM. INT. CL. 36.
- SEVIN ROSEN BAYLESS MANAGEMENT COMPANY,
DALLAS, TX:
2,624,584, PUB. 7-2-2002. INT. CL. 36.
- SEXTON, TOM, SANTA MONICA, CA:
1,933,975, CANC. INT. CL. 25.
- SF INVESTMENTS, INC., WILMINGTON, DE:
2,624,764, PUB. 7-2-2002. INT. CL. 29.
- SFE TECHNOLOGIES:
1,175,909, CANC. INT. CL. 9.
- SFK CO., INC., ENGLEWOOD, NJ:
2,625,669, INT. CL. 28.
- SFS 39 INC., SAN FRANCISCO, CA:
2,624,796, PUB. 7-2-2002. INT. CL. 42.
- SG HOLDINGS, INC., NEW YORK, NY:
2,624,639, PUB. 7-2-2002. INT. CL. 36.
- SGE ENTERTAINMENT CORPORATION, STUDIO CITY,
CA:
1,934,255, CANC. INT. CL. 9.

- SHAH, KIRAN M., NASHUA, NH:
2,624,993, PUB. 7-2-2002. INT. CL. 42.
- SHAKESPEARE COMPANY, COLUMBIA, SC:
1,176,373, CANC. INT. CL. 28.
- SHALEM CENTER, THE, WASHINGTON, DC:
2,623,909, PUB. 7-2-2002. MULTIPLE CLASS, INT. CLS.
16, 36, 41 AND 42.
- SHALLBETTER, INC., OSHKOSH, WI:
2,624,309, PUB. 7-2-2002. INT. CL. 9.
- SHAMIR INSIGHT, INC., SAN DIEGO, CA:
2,624,604, PUB. 7-2-2002. INT. CL. 9.
- SHAPE, INC., BIDDEFORD, ME:
1,176,236, CANC. INT. CL. 20.
- SHAPIRO, JEFFREY A., MANALAPAN, NJ:
1,933,072, CANC. INT. CL. 14.
- SHARED GLOBAL SYSTEMS, INC, HOUSTON, TX:
2,623,228, PUB. 7-2-2002. INT. CL. 36.
- SHARKCOLLECTOR, SCOTTSDALE, AZ:
2,624,120, PUB. 7-2-2002. INT. CL. 36.
- SHARP MICROELECTRONICS TECHNOLOGY, INC., CAMAS, WA:
1,933,538, CANC. INT. CL. 9.
- SHAW MILLWORK, INC., RIDGEFIELD, CT:
2,625,360, INT. CL. 7.
- SHECUT ENTERPRISES, INC., SELDON, NY, DBA WHIRLWIND GREETING CARDS:
2,623,223, PUB. 7-2-2002. INT. CL. 16.
- SHEDD AQUARIUM SOCIETY, CHICAGO, IL:
2,622,961, PUB. 7-2-2002. INT. CL. 41.
- SHELBY ONE, LLC, CHEVY CHASE, MD:
2,624,653, PUB. 7-2-2002. INT. CL. 35.
- SHELD AHL, INC., NORTHFIELD, MN:
1,934,475, CANC. INT. CL. 9.
- SHELL OIL COMPANY, HOUSTON, TX:
2,625,736, MULTIPLE CLASS, INT. CLS. 9, 16 AND 37.
- SHELL TRADEMARK MANAGEMENT B.V., HOUSTON, TX:
2,625,307, PUB. 7-2-2002. INT. CL. 1.
2,625,308, PUB. 7-2-2002. INT. CL. 4.
- SHEL SKY, THOMAS M., CHICO, CA, DBA O.G.M.:
1,746,646, REN. 8-15-02. INT. CL. 1.
- SHENANDOAH ELECTRONIC INTELLIGENCE, INC., HARRISONBURG, VA:
1,692,085, REN. 8-13-02. INT. CL. 42.
- SHERATON CORPORATION, THE, BOSTON, MA:
2,624,344, PUB. 7-2-2002. INT. CL. 42.
- SHERBURN PAINT CORP., SHERBURN, MN:
1,175,686, CANC. INT. CL. 2.
- SHERRITT INC.:
See— BEISEKER AGRI SERVICES LTD.
- SHERWIN-WILLIAMS AUTOMOTIVE FINISHES CORP., CLEVELAND, OH:
2,626,585, INT. CL. 3.
- SHERWIN-WILLIAMS COMPANY, THE:
See— SWIMC, INC.
- SHERWOOD BRANDS, LLC, ROCKVILLE, MD:
2,626,542, INT. CL. 30.
- SHERWOOD SERVICES AG, SCH-8200 SCHAFFHAUSEN, SWITZERLAND:
2,623,996, PUB. 7-2-2002. INT. CL. 9.
- SHIFFLETT, CAROL, STANARDSVILLE, VA:
1,663,782, CANC. INT. CL. 16.
- SHIMADZU CORPORATION, NAKAGYO-KU, KYOTO 604, JAPAN:
1,708,695, REN. 8-12-02. INT. CL. 37.
- SHIMANO AMERICAN CORPORATION, IRVINE, CA:
2,625,926, INT. CL. 35.
- SHIMANO, INC., SAKAI, OSAKA 590, JAPAN:
1,933,527, CANC. INT. CL. 12.
- SHIN JONG FOODS CO., LTD., CHUNG PU HSIANG, CHIA YI HSIEN, TAIWAN:
1,933,555, CANC. INT. CL. 32.
- SHIN-DER ENTERPRISE CO., LTD., SHIN CHU HSIEN, TAIWAN:
2,624,612, PUB. 5-28-2002. INT. CL. 29.
- SHIPLEY, CALVERT J., BEAVERTON, OR, DBA TRIAL IMAGE:
2,625,195, PUB. 7-2-2002. INT. CL. 41.
- SHISEIDO CO., LTD., CHUO-KU, TOKYO 104-10, JAPAN:
2,622,839, PUB. 7-2-2002. INT. CL. 3.
- SHOETRAIDING.COM INCORPORATED, BUSAN, REPUBLIC OF KOREA:
2,623,297, PUB. 7-2-2002. INT. CL. 25.
- SHOP FOOD, L.P., STOCKTON, CA:
2,623,038, PUB. 7-2-2002. INT. CL. 35.
- SHOP'N CHEK, INC., NORCROSS, GA:
2,626,030, INT. CL. 35.
2,626,031, INT. CL. 35.
- SHOPKO STORES, INC., GREEN BAY, WI:
2,625,405, INT. CL. 30.
- SHORE HEALTH SERVICES, INC., NASSAWADOX, VA:
2,622,521, PUB. 7-2-2002. MULTIPLE CLASS, INT. CLS.
35, 41 AND 42.
- SHORE HEALTH SYSTEM, INC., EASTON, MD:
2,625,403, INT. CL. 42.
- SHOW PLACE, INC., BEACH HAVEN, NJ:
1,933,023, CANC. INT. CL. 42.
1,933,030, CANC. INT. CL. 42.
1,933,031, CANC. INT. CL. 42.
- SHOWA HIGHPOLYMER CO., LTD., TOKYO, JAPAN:
2,624,033, PUB. 7-2-2002. INT. CL. 1.
- SHOWALL, INC., CHILHOWIE, VA, DISPLAY SYSTEMS, INC., CHILHOWIE, VA:
1,741,345, REN. 8-10-02. INT. CL. 20.
- SHOWERS, DAVID C., ETTERS, PA AND SHOWERS, KIM M., ETTERS, PA, DBA D & K BAR-B-QUE:
2,624,836, PUB. 7-2-2002. INT. CL. 30.
- SHOWTIME NETWORKS INC., NEW YORK, NY:
2,623,280, PUB. 7-2-2002. INT. CL. 38.
2,623,310, PUB. 7-2-2002. INT. CL. 41.
2,625,086, PUB. 7-2-2002. INT. CL. 38.
2,626,676, INT. CL. 41.
- SHURE BROTHERS INCORPORATED, EVANSTON, IL TO SHURE BROTHERS INCORPORATED, EVANSTON, IL:
2,556,628, COR. INT. CL. 9.
- SIBIU PTY LTD, NEW SOUTH WALES, AUSTRALIA:
2,622,780, PUB. 7-2-2002. INT. CL. 24.
- SIC MARKING, 69380 LISSIEU, FRANCE:
2,623,301, PUB. 3-26-2002. MULTIPLE CLASS, INT. CLS. 7 AND 37.
- SICO INCORPORATED, MINNEAPOLIS, MN:
2,624,100, PUB. 7-2-2002. MULTIPLE CLASS, INT. CLS. 20 AND 40.
- SIEMENS AKTIENGESELLSCHAFT, MUNCHEN, FED REP GERMANY:
2,623,451, PUB. 7-2-2002. MULTIPLE CLASS, INT. CLS. 9, 41 AND 42.
2,624,395, PUB. 7-2-2002. INT. CL. 9.
- SIEMENS STROMBERG-CARLSON, LAKE MARY, FL:
1,933,339, CANC. INT. CL. 9.
- SIEMON COMPANY, THE, WATERTOWN, CT:
2,626,769, INT. CL. 9.
- SIERRA NEVADA HELICOPTERS, INC., RENO, NV:
2,626,993, INT. CL. 39.
- SIERRA PEARL ENTERTAINMENT, LLC, JONESBORO, GA:
2,624,196, PUB. 7-2-2002. INT. CL. 41.
- SIGMA STAR FOOD CORP., NEW YORK, NY:
1,932,659, CANC. MULTIPLE CLASS, INT. CLS. 29, 30 AND 32.
- SIGNAL LAKE MANAGEMENT, LLC, BOSTON, MA:
2,624,037, PUB. 7-2-2002. INT. CL. 36.
2,624,038, PUB. 7-2-2002. INT. CL. 35.
- SIGNAL ONE, L.L.C., CHATTANOOGA, TN:
2,623,158, PUB. 7-2-2002. INT. CL. 38.
- SIGNALTREE SOLUTIONS, INC., IRVINE, CA:
2,624,411, PUB. 7-2-2002. INT. CL. 42.
- SIGNATURE CONTROL SYSTEMS, INC., CHINO, CA:
2,623,481, PUB. 7-2-2002. MULTIPLE CLASS, INT. CLS. 9 AND 11.
- SIGNET SYSTEMS, LLC, MILWAUKEE, WI:
2,623,401, PUB. 7-2-2002. INT. CL. 42.
- SILICORE CORPORATION, CORCORAN, MN:
2,624,967, PUB. 7-2-2002. INT. CL. 9.

- SILVER HARVEST FOODS INC., ROYSTON, BRITISH COLUMBIA, CANADA:
2,622,549, PUB. 3-27-2001. INT. CL. 31.
- SILVERCLICKS.COM, INC., NORTH LITTLE ROCK, AR:
2,623,213, PUB. 7-2-2002. INT. CL. 35.
- SILVIA'S LANGUAGE SERVICES, INC., HENDERSON, NV:
2,624,675, PUB. 7-2-2002. INT. CL. 41.
- SIMILOR S.A., 1227 CAROUGE GE, SWITZERLAND:
2,624,130, PUB. 7-2-2002. INT. CL. 11.
- SIMMONS COMPANY, ATLANTA, GA:
2,622,831, PUB. 7-2-2002. INT. CL. 17.
- SIMMONS U.S.A. CORPORATION, ATLANTA, GA:
1,176,241, CANC. INT. CL. 20.
- SIMMONS, TERENCE R., NEW HOPE, PA, DBA SIMMONS ASSOCIATES:
1,663,675, CANC. INT. CL. 41.
- SIMMONS, THOMAS E II, PINSON, AL:
2,623,420, PUB. 7-2-2002. INT. CL. 28.
- SIMON & SCHUSTER, INC., NEW YORK, NY, GULF & WESTERN CORPORATION, NEW YORK, NY, AKA SIMON & SCHUSTER:
1,201,049, REN. 8-15-02. INT. CL. 16.
- SIMON PROPERTY GROUP, L.P., INDIANAPOLIS, IN:
2,623,973, PUB. 7-2-2002. INT. CL. 36.
2,624,618, PUB. 7-2-2002. INT. CL. 36.
- SIMPLE ABUNDANCE, INC., BETHESDA, MD:
2,625,757, INT. CL. 42.
- SIMULATION SYSTEMS AND APPLICATIONS, INC., PINELLAS PARK, FL:
2,625,700, INT. CL. 9.
- SINCLAIR EQUIPMENT COMPANY, DIAMOND SPRINGS, CA:
2,623,449, PUB. 10-30-2001. INT. CL. 7.
- SINGH, HARI P., DALLAS, TX:
2,625,185, PUB. 7-2-2002. INT. CL. 30.
- SIoux VALLEY HOSPITAL & HEALTH SYSTEM, SIOUX FALLS, SD:
2,623,309, PUB. 7-2-2002. MULTIPLE CLASS, INT. CLS. 35 AND 44.
- SIRACO PRODUCTIONS LTD, HENDERSON, NV:
2,626,956, INT. CL. 41.
- SIRSI CORPORATION, HUNTSVILLE, AL:
2,623,181, PUB. 7-2-2002. MULTIPLE CLASS, INT. CLS. 35 AND 41.
- SISTERS OF MERCY HEALTH CORPORATION, PONTIAC, MI, DBA ST. JOSEPH MERCY HOSPITAL OF PONTIAC:
1,252,546, CANC. INT. CL. 42.
- SITE CONFIDENCE LTD., DORKING, SURREY RH4 1QT, ENGLAND:
2,624,538, PUB. 7-2-2002. INT. CL. 42.
- SITESOURCE TECHNOLOGIES, LLC, NEW ORLEANS, LA:
2,624,973, PUB. 7-2-2002. INT. CL. 42.
- SIVAD BIORESEARCH CO., INC., MADISON HEIGHTS, MI:
1,175,760, CANC. INT. CL. 5.
- SIX COUNTINENTS HOTELS, INC., ATLANTA, GA FROM BASS HOTELS & RESORTS, INC., ATLANTA, GA:
2,626,014, INT. CL. 42.
- SIX FLAGS THEME PARKS, INC., OKLAHOMA CITY, OK:
2,626,295, INT. CL. 41.
- SKI LAKE CORPORATION, HUNTSVILLE, UT:
2,624,188, PUB. 7-2-2002. INT. CL. 37.
- SKI MARKETING CORPORATION, HOUSTON, TX:
2,623,629, PUB. 7-2-2002. INT. CL. 39.
- SKI THE SUMMIT, DILLON, CO:
1,932,482, CANC. INT. CL. 35.
- SKINMEDICA, INC., CARLSBAD, CA:
2,626,494, INT. CL. 3.
- SKIS DYNASTAR, INC., COLCHESTER, VT:
2,626,308, INT. CL. 28.
- SKYSCAPE, INC., HUDSON, MA:
2,624,400, PUB. 7-2-2002. INT. CL. 9.
- SKYTHEATER, INC., MIAMI BEACH, FL:
2,623,332, PUB. 7-2-2002. MULTIPLE CLASS, INT. CLS. 37 AND 42.
- SKYWAY LUGGAGE COMPANY, SEATTLE, WA:
2,625,269, PUB. 7-2-2002. INT. CL. 18.
- SLE SALES & SERVICE ELECTRONIC GMBH, 94481 GRAFENAU, FED REP GERMANY:
2,622,971, PUB. 7-2-2002. MULTIPLE CLASS, INT. CLS. 7, 9 AND 37.
- SLEEP TRAIN, INC., THE, NORTH HIGHLANDS, CA:
1,714,531, REN. 8-14-02. INT. CL. 42.
1,714,532, REN. 8-14-02. INT. CL. 42.
1,733,809, REN. 8-14-02. INT. CL. 42.
- SLK ENTERPRISES, INC., NAPERVILLE, IL:
2,626,911, INT. CL. 36.
- SLONG & MIDAS PROPERTIES, INC., MINEOLA, NY:
1,934,060, CANC. INT. CL. 42.
- SM SWISS AMMUNITION ENTERPRISE CORP., SWITZERLAND:
2,622,849, PUB. 7-2-2002. INT. CL. 13.
- SMART CARD ALLIANCE, NEW YORK, NY:
2,624,835, PUB. 7-2-2002. INT. CL. 42.
- SMART STARTERS INC., KIRKLAND, WA FROM SMART STARTERS LLC, WOODINVILLE, WA:
2,622,950, PUB. 7-2-2002. MULTIPLE CLASS, INT. CLS. 35 AND 36.
- SMART STARTERS LLC:
See— SMART STARTERS INC..
- SMARTSCAN, INC., BOULDER, CO:
1,933,906, CANC. INT. CL. 40.
- SMARTVISION LLC, CAMERON PARK, CA:
2,626,764, INT. CL. 36.
- SMASHING TIMES, INC., DALLAS, TX:
2,624,357, PUB. 7-2-2002. MULTIPLE CLASS, INT. CLS. 20, 35 AND 41.
- SMILEY GROUP, INC., THE, LOS ANGELES, CA:
2,623,484, PUB. 7-2-2002. INT. CL. 41.
- SMITH & NEPHEW RICHARDS, INC., MEMPHIS, TN:
1,934,109, CANC. INT. CL. 10.
- SMITH, MIKE, LAS VEGAS, NV:
2,623,889, PUB. 7-2-2002. INT. CL. 16.
- SMITH, SHAWNEE, LOS ANGELES, CA:
2,623,525, PUB. 7-2-2002. INT. CL. 41.
2,623,528, PUB. 7-2-2002. INT. CL. 9.
- SMITHKLINE BEECHAM BIOLOGICALS S.A., B-1330 RIXENSART, BELGIUM:
2,622,596, PUB. 7-2-2002. INT. CL. 5.
- SMITHKLINE BEECHAM CORPORATION, PHILADELPHIA, PA:
1,933,270, CANC. INT. CL. 3.
- SMITHKLINE BEECHAM P.L.C., BRENTFORD, MIDDLESEX TW8 9EP, ENGLAND:
1,933,773, CANC. MULTIPLE CLASS, INT. CLS. 16 AND 42.
1,933,774, CANC. INT. CL. 42.
- SMITHKLINE BEECHAM P.L.C., BRENTFORD, UNITED KINGDOM:
2,625,188, PUB. 7-2-2002. INT. CL. 3.
- SMOOTH SAILING BEVERAGE COMPANY, BELLINGHAM, WA:
1,932,791, CANC. INT. CL. 32.
- SNAP TRACK, INC., SAN JOSE, CA FROM PRECISION TRACKING, INC., SAN JOSE, CA:
2,625,320, INT. CL. 38.
- SNAP-ON DEUTSCHLAND HOLDING GMBH, 40822 METTMANN, FED REP GERMANY:
2,623,573, PUB. 7-2-2002. MULTIPLE CLASS, INT. CLS. 7, 8 AND 37.
- SNAPNAMES.COM, INC., PORTLAND, OR:
2,624,671, PUB. 7-2-2002. INT. CL. 42.
- SNAPPIT TOY, INC., NEW YORK, NY:
2,622,918, PUB. 7-2-2002. MULTIPLE CLASS, INT. CLS. 28 AND 35.
- SNAPWARE CORPORATION, FULLERTON, CA:
2,623,543, PUB. 7-2-2002. INT. CL. 21.
- SNELL & WILCOX LIMITED, HAMPSHIRE GU31 5AZ, ENGLAND:
2,622,518, PUB. 7-2-2002. INT. CL. 9.
- SNYDER, LAVINIA BRANCA, NEW YORK, NY:
2,626,311, INT. CL. 25.
2,626,312, INT. CL. 25.
2,626,449, INT. CL. 25.

- SOCCER INTERNATIONAL J.S. INC., ETOBICOKE, ONTARIO, CANADA, DBA SPORTSPHERE:
2,622,753, PUB. 7-2-2002. INT. CL. 25.
- SOCIAL & SCIENTIFIC SYSTEMS, INC., BETHESDA, MD:
2,625,109, PUB. 7-2-2002. MULTIPLE CLASS, INT. CLS. 35, 41 AND 42.
- SOCIEDAD AGRICOLA BEN DAVID LIMITADA, BUIN, CHILE:
1,663,813, CANC. INT. CL. 31.
- SOCIETA' PER AZIONI CHIANTI RUFFINO ESPORTAZIONE VINICOLA TOSCANA, 25125 BRESCIA, ITALY:
1,933,891, CANC. INT. CL. 33.
- SOCIETE AIR FRANCE, 95747 ROISSY-CHARLES-DE GAULLE, FRANCE FROM COMPAGNIE NATIONALE AIR FRANCE, 95747 ROISSY-CHARLES-DE-GAULLE, FRANCE:
2,622,578, PUB. 7-2-2002. MULTIPLE CLASS, INT. CLS. 16, 18, 25, 28, 39, 41 AND 42.
- SOCIETE ANONYME DES GALERIES LAFAYETTE, PARIS, FRANCE:
1,932,766, CANC. INT. CL. 42.
- SOCIETE CHIMIQUE DE GERLAND (SOCIETE ANONYME), LYON, FRANCE:
723,526, CANC. U.S. CL. 20.
- SOCIETE DES GRANDES SOURCES DE WATTWILLER, 68700 WATTWILLER, FRANCE:
1,932,494, CANC. INT. CL. 32.
- SOCIETE DES PRODUITS NESTLE S.A., 1800 VEVEY, SWITZERLAND:
1,933,829, CANC. INT. CL. 30.
2,626,142, INT. CL. 29.
2,626,227, MULTIPLE CLASS, INT. CLS. 29 AND 30.
- SOCIETE POUR LA CONCEPTION DES APPLICATIONS DES TECHNIQUES, 33708 MERIGNAC, FRANCE, SANOFFI, 75008 PARIS, FRANCE:
1,687,726, REN. 8-16-02. INT. CL. 10.
- SOCIETY BRAND HAT COMPANY, ST. LOUIS, MO:
148,166, CANC. U.S. CL. 39.
- SOCIETY FOR THE PRESERVATION OF EQUAL RIGHTS FOR MEN, INC., MISSION, KS:
1,933,577, CANC. INT. CL. 25.
- SOCIETY OF MANUFACTURING ENGINEERS, DEARBORN, MI:
2,624,009, PUB. 7-2-2002. INT. CL. 35.
- SOCIO-ECONOMIC RESEARCH INSTITUTE OF AMERICA, INC., THE, RHINEBECK, NY:
1,934,419, CANC. INT. CL. 35.
- SOCRATICLAW.COM, INC., WILMINGTON, DE:
2,626,330, INT. CL. 42.
- SODETANI, WENDY NAOMI, HONOLULU, HI:
1,932,620, CANC. MULTIPLE CLASS, INT. CLS. 41 AND 42.
- SODEXHO OPERATIONS, LLC, GAITHERSBURG, MD:
2,626,627, INT. CL. 35.
- SOFT SHEEN/CARSON, INC., CHICAGO, IL FROM DERMA BLEND, INC., RICHFIELD, NJ:
2,625,727, INT. CL. 3.
- SOFTBANK COMDEX INC., NEEDHAM, MA:
1,933,849, CANC. INT. CL. 35.
- SOFTDEV, INC., BOCA RATON, FL:
2,624,131, PUB. 7-2-2002. INT. CL. 42.
- SOFTEASY SOFTWARE, INC., CONSHOHOCKEN, PA:
1,934,126, CANC. INT. CL. 9.
- SOFTPLC CORPORATION, HUMBLE, TX:
1,663,239, CANC. INT. CL. 9.
- SOFTSOAP ENTERPRISES, INC., CHASKA, MN:
1,933,286, CANC. INT. CL. 3.
- SOFTWARE FOR REAL ESTATE PROFESSIONALS, INC., BATON ROUGE, LA:
1,934,379, CANC. INT. CL. 9.
- SOFTWARE SETT CORPORATION, LOS GATOS, CA:
2,626,029, INT. CL. 42.
- SOGRAPE-VINHOS DE PORTUGAL, S.A., 4400 VILA NOVA DE GAIA, PORTUGAL:
2,623,355, PUB. 7-2-2002. INT. CL. 33.
- SOHO CORPORATION, GLENVIEW, IL:
2,622,535, PUB. 7-2-2002. INT. CL. 16.
- SOLA INTERNATIONAL INC., SAN DIEGO, CA, SOLA OPTICAL USA, INC., PETALUMA, CA:
1,709,246, REN. 8-14-02. INT. CL. 9.
- SOLECTEK CORPORATION, SAN DIEGO, CA:
1,933,209, CANC. INT. CL. 9.
- SOLMETEX, INCORPORATED, NORTHBOROUGH, MA:
2,623,925, PUB. 7-2-2002. INT. CL. 11.
- SOLUTIONS SELLING, INC., CHARLOTTE, NC, BOSWORTH, MICHAEL T., RANCHO SANTA FE, CA:
1,647,233, REN. 8-15-02. MULTIPLE CLASS, INT. CLS. 16 AND 41.
- SOLVAY (SOCIETE ANONYME), B-1050 BRUSSELS, BELGIUM:
2,622,804, PUB. 7-2-2002. MULTIPLE CLASS, INT. CLS. 1 AND 5.
- SOLVAY PHARMA PROPERTIES, INC., BAUDETTE, MN:
2,624,762, PUB. 7-2-2002. INT. CL. 5.
- SOMC GROUP, INC., CARLSBAD, CA:
2,623,201, PUB. 7-2-2002. INT. CL. 35.
- SOMETHING OLD, SOMETHING NEW, INC., EDGEWATER, NJ, DBA CYBUL DESIGNS:
1,934,489, CANC. INT. CL. 14.
- SONAFI, 78220 VIROFLAY, FRANCE:
2,626,105, INT. CL. 30.
- SONGWORKS, BOZEMAN, MT:
1,932,884, CANC. INT. CL. 16.
- SONIA RYKIEL CREATION ET DIFFUSION DE MODELES, 75006 PARIS, FRANCE, RYKIEL, SONIA ANNETTE, 75007 PARIS, FRANCE:
1,674,099, REN. 8-13-02. INT. CL. 9.
- SONIC RANCH VOYAGER 51, INC., TORNILLO, TX:
2,623,646, PUB. 7-2-2002. INT. CL. 41.
2,623,649, PUB. 7-2-2002. INT. CL. 41.
- SONIC SOLUTIONS, NOVATO, CA:
2,623,300, PUB. 7-2-2002. INT. CL. 9.
- SONITROL CORPORATION, ALEXANDRIA, VA:
2,623,863, PUB. 7-2-2002. MULTIPLE CLASS, INT. CLS. 37 AND 42.
- SONOMA EYEWORKS INC., SANTA ROSA, CA:
2,623,369, PUB. 7-2-2002. MULTIPLE CLASS, INT. CLS. 35 AND 42.
- SONOMA SPA RESORTS, L.P., FORT WORTH, TX:
2,623,015, PUB. 7-2-2002. INT. CL. 36.
2,623,017, PUB. 7-2-2002. INT. CL. 37.
2,623,019, PUB. 7-2-2002. INT. CL. 41.
2,623,093, PUB. 7-2-2002. INT. CL. 36.
- SONY CORPORATION, TOKYO, JAPAN:
1,933,932, CANC. INT. CL. 9.
- SONY KABUSHIKI KAISHA, TOKYO, JAPAN, TA SONY CORPORATION:
2,625,383, MULTIPLE CLASS, INT. CLS. 35, 36, 37, 38, 39, 41 AND 42.
- SOPHEON N.V., 1082 LD AMSTERDAM, NETHERLANDS:
2,623,089, PUB. 7-2-2002. INT. CL. 9.
- SORRENTO CHEESE COMPANY, INC., BUFFALO, NY TO SORRENTO CHEESE COMPANY, INC., BUFFALO, NY:
2,568,031, COR. INT. CL. 29.
- SOULUTION ENTERPRISES, INC., NEW YORK, NY:
2,624,743, PUB. 7-2-2002. INT. CL. 41.
- SOUND WIRE, INC., BROOKLYN, NY:
1,932,892, CANC. INT. CL. 42.
- SOUNDAIR, INC., WOODINVILLE, WA:
2,624,589, PUB. 7-2-2002. INT. CL. 35.
2,624,590, PUB. 7-2-2002. MULTIPLE CLASS, INT. CLS. 37 AND 39.
- SOUNDATION, INC., NEW YORK, NY, DBA SONOMIC:
2,625,022, PUB. 7-2-2002. INT. CL. 41.
- SOUNDSTORM, INC., BURBANK, CA:
2,624,263, PUB. 7-2-2002. INT. CL. 42.
- SOUTH AFRICAN RUGBY FOOTBALL UNION, BOUNDARY ROAD, NEWLANDS 7700, SOUTH AFRICA:
2,625,683, INT. CL. 25.
- SOUTH TEXAS PET PRODUCTS, INC., SAN ANTONIO, TX:
1,933,287, CANC. INT. CL. 3.
- SOUTHEASTERN CONFERENCE, BIRMINGHAM, AL:
1,633,675, REN. 8-14-02. MULTIPLE CLASS, INT. CLS. 6, 20, 25 AND 42.

- SOUTHERN COMFORT PROPERTIES, INC., SAN RAFAEL, CA:
2,625,958, INT. CL. 26.
- SOUTHERN NEW ENGLAND TELECOMMUNICATIONS CORPORATION, NEW HAVEN, CT:
1,933,898, CANC. INT. CL. 38.
- SOUTHERN SAW SERVICE, INCORPORATED, ATLANTA, GA:
723,544, CANC. U.S. CL. 23.
- SOUTHERN SMOKE LLC, ATLANTA, GA:
2,624,974, PUB. 7-2-2002. INT. CL. 34.
2,624,975, PUB. 7-2-2002. INT. CL. 34.
- SOUTHERN SUN, WILLIAMSBURG, KY:
2,624,045, PUB. 7-2-2002. INT. CL. 25.
- SOUTHERN TERRY, INC., GRIFFIN, GA:
1,932,697, CANC. MULTIPLE CLASS, INT. CLS. 24 AND 25.
- SOUTHERN TOBACCO, INC., TAMPA, FL:
2,625,817, INT. CL. 34.
- SOUTHLAND CORPORATION, THE, DALLAS, TX:
1,176,416, CANC. INT. CL. 30.
- SOUTHLAND MUSICAL MERCANDISE CORP., GREENSBORO, NC:
723,716, CANC. U.S. CL. 36.
- SOUTHTRUST MORTGAGE CORPORATION, BIRMINGHAM, AL:
2,624,150, PUB. 7-2-2002. INT. CL. 36.
- SOUTHWEST AIRLINES CO., DALLAS, TX:
1,932,869, CANC. INT. CL. 39.
2,623,807, PUB. 7-2-2002. INT. CL. 39.
- SOUTHWEST ART, INC., HOUSTON, TX:
2,626,504, INT. CL. 16.
- SOUTHWEST RECREATIONAL INDUSTRIES, INC., LEANDER, TX:
2,624,630, PUB. 7-2-2002. INT. CL. 27.
- SOUTHWEST RESEARCH INSTITUTE, SAN ANTONIO, TX:
2,626,309, INT. CL. 9.
- SOUTHWIND OSTRICH RANCH, INC., MT. VERNON, IN:
1,932,453, CANC. MULTIPLE CLASS, INT. CLS. 31, 39 AND 42.
- SP NEWSPRINT COMPANY, ATLANTA, GA, DBA SP NEWSPRINT SALES CO.:
2,622,969, PUB. 7-2-2002. INT. CL. 16.
- SPACE CONTROL INDUSTRIES, D-82284 GRAFRATH, FED REP GERMANY:
2,625,422, INT. CL. 9.
- SPACE4RENT.COM, LLC, CARLSBAD, CA:
2,623,050, PUB. 7-2-2002. INT. CL. 39.
2,623,051, PUB. 7-2-2002. INT. CL. 39.
- SPANG & COMPANY, BUTLER, PA:
2,626,766, MULTIPLE CLASS, INT. CLS. 20 AND 28.
2,626,781, MULTIPLE CLASS, INT. CLS. 20 AND 21.
- SPANGLER CANDY COMPANY, BRYAN, OH:
731,236, REN. 8-10-02. U.S. CL. 46 (INT. CL. 30).
1,934,294, CANC. INT. CL. 30.
- SPARE PARTS PUBLISHING, LLC, WESTWOOD, NJ:
2,626,954, INT. CL. 16.
- SPARKNOTES LLC, NEW YORK, NY:
2,624,068, PUB. 7-2-2002. INT. CL. 41.
- SPARKS BELTING COMPANY, A DIVISION OF JSJ CORPORATION, GRAND RAPIDS, MI:
2,624,552, PUB. 7-2-2002. INT. CL. 7.
- SPARTACOM TECHNOLOGIES, INC., TUCSON, AZ:
2,624,462, PUB. 7-2-2002. INT. CL. 38.
- SPECIALIZED PACKAGING GROUP, INC., HAMDEN, CT:
2,622,760, PUB. 7-2-2002. INT. CL. 42.
- SPECIALIZED PRODUCTS, CO., IRVING, TX:
1,933,328, CANC. INT. CL. 9.
- SPECIALMADE GOODS AND SERVICES, INC., WINCHESTER, VA:
2,623,388, PUB. 7-2-2002. INT. CL. 42.
- SPECIALTY FOODS INVESTMENT COMPANY, WILMINGTON, DE:
902,731, CANC. U.S. CL. 46.
- SPECTRA-PHYSICS LASERPLANE, INC., DAYTON, OH:
1,934,311, CANC. INT. CL. 9.
- SPECTRUM FILMS, INCORPORATED, CARLSBAD, CA:
1,175,949, CANC. INT. CL. 9.
- SPECTRUM GOLF, INC., SCOTTSDALE, AZ:
2,623,539, PUB. 7-2-2002. INT. CL. 41.
- SPECTRUM HEALTHCARE RESOURCES, INC., ST. LOUIS, MO:
2,624,323, PUB. 7-2-2002. INT. CL. 35.
- SPECTRUM UNDERWRITING MANAGERS, INC., INDIANAPOLIS, IN:
2,624,388, PUB. 7-2-2002. INT. CL. 36.
- SPEED-COMM.COM, L.L.C., TULSA, OK:
2,626,199, INT. CL. 38.
- SPEEDDIVA LLC, MALIBU, CA:
2,623,945, PUB. 2-19-2002. INT. CL. 25.
- SPEEDFREAKS, LTD., LOS ANGELES, CA:
2,625,118, PUB. 7-2-2002. INT. CL. 41.
- SPEEDWAY MOTORS, INC., LINCOLN, NE:
2,622,946, PUB. 7-2-2002. INT. CL. 12.
- SPELLBOUND DEVELOPMENT GROUP, INC., NEWPORT BEACH, CA:
2,622,960, PUB. 7-2-2002. MULTIPLE CLASS, INT. CLS. 16 AND 20.
- SPERO FORGE CORPORATION, TAICHUNG, TAIWAN:
2,626,313, INT. CL. 8.
- SPICE ENTERTAINMENT, INC., CHICAGO, IL, GRAFF PAY-PER-VIEW, INC., NEW YORK, NY:
1,690,906, REN. 8-12-02. INT. CL. 41.
- SPINNAKER MEDICAL CONSULTANTS INTERNATIONAL, LLC, ATLANTA, GA:
2,623,265, PUB. 7-2-2002. MULTIPLE CLASS, INT. CLS. 41 AND 42.
- SPINSIT.COM, INC., MIAMI, FL, DBA SEGUROSMARKET.COM:
2,623,694, PUB. 7-2-2002. MULTIPLE CLASS, INT. CLS. 35, 36 AND 38.
- SPINX OIL COMPANY, INC., GREENVILLE, SC:
2,626,266, INT. CL. 35.
- SPIRIT IMPORTS, INC., BOCA RATON, FL:
1,883,865, CANC. INT. CL. 33.
- SPIRITE INDUSTRIES, INC., ENGLEWOOD, NJ:
2,626,772, INT. CL. 25.
- SPITZNAGEL, INC., SIOUX FALLS, SD:
2,624,565, PUB. 7-2-2002. INT. CL. 42.
- SPOETZL BREWERY, INC., SAN ANTONIO, TX:
2,626,976, INT. CL. 32.
- SPORTMART INC., NILES, IL:
1,934,415, CANC. INT. CL. 6.
- SPORTS AUTHORITY MICHIGAN, INC., THE, FORT LAUDERDALE, FL:
2,626,263, MULTIPLE CLASS, INT. CLS. 9 AND 28.
- SPORTS CAR CLUB OF AMERICA, INC., ENGLEWOOD, CO, AKA SCCA:
1,932,493, CANC. INT. CL. 41.
- SPORTS DESIGN AND DEVELOPMENT, INC., ALEXANDRIA, LA:
1,932,870, CANC. INT. CL. 28.
- SPORTS LEGENDS, INC., NARBERTH, PA:
1,697,470, REN. 8-14-02. MULTIPLE CLASS, INT. CLS. 9 AND 41.
- SPORTS SOURCE, INC., TORRANCE, CA:
2,626,550, INT. CL. 28.
- SPORTS TACTICS L.C., WINDERMERE, FL:
2,626,763, INT. CL. 9.
- SPORTSMAN'S GUIDE, INC., THE, SOUTH ST. PAUL, MN:
2,624,677, PUB. 7-2-2002. INT. CL. 35.
- SPORTSSOUTH NETWORK, LTD., ATLANTA, GA AND SOUTHEASTERN CONFERENCE, BIRMINGHAM, AL:
2,625,623, INT. CL. 41.
- SPORTSSOUTH NETWORK, LTD., ATLANTA, AL AND SOUTHEASTERN CONFERENCE, BIRMINGHAM, AL:
2,625,624, INT. CL. 38.
- SPORTVISION, INC., NEW YORK, NY:
2,622,916, PUB. 7-2-2002. INT. CL. 40.
- SPOTLIGHT ENTERPRISES, INC., WOODLAND HILLS, CA:
2,626,767, MULTIPLE CLASS, INT. CLS. 28 AND 41.
- SPRENGELMEYER, JOHN, LAWRENCE, KS AND DAVIS, II, RICH, LAWRENCE, KS:
2,624,242, PUB. 7-2-2002. MULTIPLE CLASS, INT. CLS. 16 AND 41.

- SPRING AIR COMPANY, THE, DES PLAINES, IL:
2,624,171, PUB. 7-2-2002. INT. CL. 20.
- SPRING COMMUNICATIONS II, LLC, ENCINO, CA:
2,624,172, PUB. 7-2-2002. INT. CL. 9.
2,624,306, PUB. 7-2-2002. INT. CL. 9.
- SPRINGBOARD ANGELS, PALO ALTO, CA:
2,625,030, PUB. 7-2-2002. INT. CL. 36.
- SPRINGFIELD PRECISION INSTRUMENTS, INC., WOOD-
RIDGE, NJ:
2,624,022, PUB. 7-2-2002. MULTIPLE CLASS, INT. CLS. 9
AND 14.
- SPRINGS LICENSING GROUP, INC., FORT MILL, SC:
2,626,478, INT. CL. 24.
- SPRINT COMMUNICATIONS COMPANY L.P., KANSAS
CITY, MO:
1,932,985, CANC. INT. CL. 38.
1,933,518, CANC. INT. CL. 38.
- SPRINT COMMUNICATIONS COMPANY L.P., WEST-
WOOD, KS:
2,623,660, PUB. 7-2-2002. INT. CL. 38.
2,624,016, PUB. 7-2-2002. INT. CL. 42.
- SPRY, JEFFREY D., DULUTH, MN:
2,626,910, INT. CL. 35.
- SPX CORPORATION, MUSKEGON, MI:
2,623,665, PUB. 7-2-2002. MULTIPLE CLASS, INT. CLS.
35, 41 AND 42.
2,625,560, INT. CL. 9.
- SPYDERNET, WAYZATA, MN:
2,624,365, PUB. 7-2-2002. INT. CL. 36.
- SQUID INK MANUFACTURING, INC., SPRING LAKE
PARK, MN:
2,623,745, PUB. 7-2-2002. MULTIPLE CLASS, INT. CLS. 2
AND 9.
- SQUIRE-COGSWELL COMPANY, NORTHBROOK, IL:
1,933,814, CANC. INT. CL. 11.
- SRI ENTERPRISES INCORPORATED, NASHVILLE, TN:
1,934,397, CANC. INT. CL. 9.
- SRJ INCORPORATED, SCHAUMBURG, IL:
2,625,179, PUB. 7-2-2002. INT. CL. 7.
- SSAC INC., BALDWINVILLE, NY:
2,624,694, PUB. 7-2-2002. INT. CL. 9.
- SSANGYONG MOTOR COMPANY, CHUNG-KU, SEOUL,
REPUBLIC OF KOREA:
1,934,406, CANC. INT. CL. 12.
- SSCO OF AMERICA, INC., GREAT NECK, NY:
1,933,540, CANC. INT. CL. 28.
- SSI GROUP, INC., THE, MOBILE, AL:
2,625,730, INT. CL. 9.
- ST. FRANCIS MEDICAL TECHNOLOGIES, INC., CON-
CORD, CA FROM ST. FRANCIS MEDICAL TECHNOLO-
GIES, INC., CONCORD, CA:
2,625,825, INT. CL. 10.
- ST. JOE COMPANY, THE, JACKSONVILLE, FL:
2,626,297, INT. CL. 42.
- ST. JOHN KNITS, INC., IRVINE, CA:
2,623,493, PUB. 7-2-2002. INT. CL. 25.
- ST. LOUIS PAINT MANUFACTURING COMPANY, ST.
LOUIS, MO:
1,175,694, CANC. INT. CL. 2.
- ST. PAUL COMPANIES, INC., THE, ST. PAUL, MN:
2,625,267, PUB. 7-2-2002. INT. CL. 36.
- STACS CORPORATION, WEST PALM BEACH, FL:
2,623,782, PUB. 7-2-2002. INT. CL. 30.
- STAEDTLER, INC, CHATSWORTH, CA:
2,626,189, INT. CL. 16.
- STAFF ONE INTERNATIONAL INC., MINNEAPOLIS, MN:
1,176,472, CANC. INT. CL. 35.
- STAGECOACH VINEYARDS LIMITED PARTNERSHIP,
NAPA, CA:
2,623,312, PUB. 7-2-2002. INT. CL. 31.
2,626,196, INT. CL. 31.
- STAHELI, LYNN T., SEATTLE, WA:
2,625,235, PUB. 7-2-2002. INT. CL. 41.
- STAMATS COMMUNICATIONS, INC., CEDAR RAPIDS, IA:
2,627,012, INT. CL. 35.
- STAMPIN' UP! INC., SANDY, UT:
2,624,715, PUB. 7-2-2002. INT. CL. 16.
2,624,716, PUB. 7-2-2002. INT. CL. 16.
- STAND-BY SYSTEMS, INC., DALLAS, TX:
2,624,229, PUB. 7-2-2002. INT. CL. 9.
- STANDARD STEEL COMPANIES, THE, PORTLAND, OR:
1,176,057, CANC. INT. CL. 12.
- STANDRIS MEDICAL SUPPLY, INC., COATESVILLE, PA:
2,624,660, PUB. 7-2-2002. INT. CL. 35.
- STANLEY FOSTER REED & ASSOCIATES, INC.:
See— REED, STANLEY FOSTER.
- STANLEY HOME PRODUCTS, INC., WESTFIELD, MA:
723,603, CANC. U.S. CL. 29.
- STANLEY LOGISTICS, INC., NEW BRITAIN, CT:
2,623,085, PUB. 7-2-2002. INT. CL. 7.
2,623,959, PUB. 7-2-2002. INT. CL. 35.
- STAPLETON TECHNOLOGIES INC., LONG BEACH, CA:
2,622,699, PUB. 11-27-2001. MULTIPLE CLASS, INT. CLS.
1 AND 40.
- STAR BLUE STUDIO, INC., NEW YORK, NY:
2,626,277, INT. CL. 28.
- STAR KAY WHITE, INC., CONGERS, NY:
1,932,747, CANC. INT. CL. 30.
- STAR REFINING PLC, STANMORE, HA73YQ, UNITED
KINGDOM:
2,624,562, PUB. 7-2-2002. INT. CL. 42.
- STAR SALES & DISTRIBUTING CORP., WOBURN, MA:
2,625,937, INT. CL. 6.
- STAR-KIST FOODS, INC., NEWPORT, KY:
1,933,779, CANC. INT. CL. 31.
- STARBUCKS CORPORATION, SEATTLE, WA:
1,933,078, CANC. INT. CL. 30.
- STARCITE, INC., PHILADELPHIA, PA:
2,625,769, INT. CL. 35.
- STARDATE COMPUTER SYSTEMS, INC., BROOKLYN, NY:
2,626,697, INT. CL. 9.
- STARK TRUSS COMPANY, INC., CANTON, OH:
1,932,528, CANC. INT. CL. 4.
- STARLIGHT INTERNATIONAL, LTD. LP, MONTEREY, CA:
2,625,962, INT. CL. 35.
- STARWOOD HOTELS & RESORTS WORLDWIDE, INC.,
WHITE PLAINS, NY, CAESARS WORLD, INC., LOS
ANGELES, CA:
1,688,189, REN. 8-16-02. INT. CL. 42.
- STARWOOD HOTELS & RESORTS WORLDWIDE, INC.,
WHITE PLAINS, NY:
2,624,406, PUB. 7-2-2002. INT. CL. 42.
- STARZ ENCORE GROUP LLC, ENGLEWOOD, CO:
2,623,610, PUB. 7-2-2002. MULTIPLE CLASS, INT. CLS. 38
AND 41.
- STATE FAIR FOODS, INC., HALTOM CITY, TX:
2,625,006, PUB. 7-2-2002. INT. CL. 30.
- STATE FAIR OF TEXAS, INC., DALLAS, TX:
2,624,868, PUB. 7-2-2002. INT. CL. 21.
- STATE INDUSTRIAL PRODUCTS CORPORATION, CLEVE-
LAND, OH:
2,623,128, PUB. 7-2-2002. INT. CL. 41.
- STATE OF CALIFORNIA, DEPARTMENT OF FOOD AND
AGRICULTURE, THE, SACRAMENTO, CA:
2,623,073, PUB. 7-2-2002. MULTIPLE CLASS, INT. CLS. 29
AND 35.
- STATION CASINOS, INC., LAS VEGAS, NV:
2,622,668, PUB. 7-2-2002. INT. CL. 42.
- STATPOWER TECHNOLOGIES PARTNERSHIP:
See— XANTREX INTERNATIONAL.
- STATPOWER TECHNOLOGIES PARTNERSHIP:
See— XANTREX INTERNATIONAL.
- STATPROBE, INC., ANN ARBOR, MI:
2,624,640, PUB. 7-2-2002. MULTIPLE CLASS, INT. CLS. 35
AND 42.
- STEAM BY JACQUI, HOLLYWOOD, CA:
2,624,352, PUB. 7-2-2002. INT. CL. 25.
2,624,356, PUB. 7-2-2002. INT. CL. 25.
- STEAM SAVER SYSTEMS, INC., LARGO, MD:
2,626,830, INT. CL. 42.
- STEEL CITY BOLT & SCREW, LLC, BIRMINGHAM, AL:
1,754,842, REN. 8-14-02. INT. CL. 6.
- STEEVES, HARRISON, BLACKSBURG, VA AND CHOCK-
LETT, BLANE, ROANOKE, VA AND CHOCKLETT, JEN-
NIFER S., ROANOKE, VA:
2,624,128, PUB. 7-2-2002. INT. CL. 17.

- STEIN, ELIZABETH, NEW YORK, NY:
2,625,787, INT. CL. 42.
- STEIN, HOWARD, NEW YORK, NY:
2,624,071, PUB. 7-2-2002. INT. CL. 41.
- STEIN, STEVEN, MARK, LOUISVILLE, KY:
2,625,209, PUB. 7-2-2002. INT. CL. 42.
- STEINWAY, INC., LONG ISLAND CITY, NY:
2,624,786, PUB. 7-2-2002. INT. CL. 16.
- STELLAR GROUP, INC., JACKSONVILLE, FL:
2,623,323, PUB. 7-2-2002. MULTIPLE CLASS, INT. CLS.
37, 40 AND 42.
- STELLAR HOLDINGS, INC., TAMPA, FL:
1,933,921, CANC. INT. CL. 20.
- STELLCOM, INC., SAN DIEGO, CA:
2,623,126, PUB. 7-2-2002. MULTIPLE CLASS, INT. CLS. 35
AND 42.
- STEPHENS, BARBARA, NORRISTOWN, PA:
2,626,472, INT. CL. 25.
- STEPTOE, ROBBY LYNN, BEAUMONT, TX:
2,624,625, PUB. 7-2-2002. INT. CL. 41.
- STERLING SOFTWARE, INC., DALLAS, TX:
1,933,668, CANC. INT. CL. 9.
1,933,671, CANC. INT. CL. 9.
1,933,672, CANC. INT. CL. 9.
1,933,673, CANC. INT. CL. 9.
1,933,682, CANC. INT. CL. 9.
1,933,684, CANC. INT. CL. 9.
1,933,693, CANC. INT. CL. 9.
1,933,700, CANC. INT. CL. 9.
- STERN/LEACH COMPANY, ATTLEBORO, MA:
2,626,129, INT. CL. 14.
- STEVEN E. GROSS, INCORPORATED, CHICAGO, IL:
2,624,670, PUB. 7-2-2002. INT. CL. 41.
- STEVEN M. COTTON SERVICES, INCORPORATED, EL
TORO, CA:
2,624,968, PUB. 7-2-2002. INT. CL. 35.
- STEVENS-LEE COMPANY, INDUSTRIAL PARK, MN:
1,176,021, CANC. INT. CL. 11.
- STEVENS, DAVIS, MILLER & MOSHER, WASHINGTON,
DC:
2,624,325, PUB. 7-2-2002. INT. CL. 42.
- STEWART, DUANE, ARLINGTON, MA:
2,625,646, INT. CL. 42.
- STEWART TITLE COMPANY, HOUSTON, TX:
2,623,621, PUB. 7-2-2002. INT. CL. 36.
- STEWART, STEPHEN E., SAN MATEO, CA:
1,933,598, CANC. INT. CL. 40.
- STG MEDIA, LLC, HUNTSVILLE, AL:
2,623,168, PUB. 7-2-2002. INT. CL. 41.
- STICHTING LODESTAR, 1077 WV AMSTERDAM, NETHER-
LANDS:
2,623,065, PUB. 7-2-2002. INT. CL. 42.
2,623,066, PUB. 7-2-2002. INT. CL. 34.
- STINSON, JOHN, BATON ROUGE, LA:
2,626,882, INT. CL. 42.
- STINSON, LAURIE, BEAUFORT, NC, DBA JEWELERS
WORKBENCH:
1,669,375, REN. 8-16-02. INT. CL. 14.
- STIRLING ENTERPRISES, LLC., LAGUNA HILLS, CA:
2,623,569, PUB. 7-2-2002. INT. CL. 35.
2,623,570, PUB. 7-2-2002. INT. CL. 35.
- STL INFOKARE, INC., TOMS RIVER, NJ:
1,932,846, CANC. INT. CL. 42.
- STOCK YARDS BANK & TRUST COMPANY, LOUISVILLE,
KY:
2,623,258, PUB. 7-2-2002. INT. CL. 36.
- STOILOV, VALENTIN, SANTA MONICA, CA:
2,625,602, INT. CL. 41.
- STOKELY-VAN CAMP, INC., CHICAGO, IL:
1,663,400, REN. 8-15-02. MULTIPLE CLASS, INT. CLS. 16
AND 41.
- STONE CONTAINER CORPORATION, CHICAGO, IL:
1,663,435, CANC. INT. CL. 19.
- STONE INTERNATIONAL, INC., EAST GREENWICH, RI:
1,703,618, REN. 8-15-02. INT. CL. 35.
- STORAGE ACCESS, INC., TORONTO, CANADA:
2,623,652, PUB. 7-2-2002. MULTIPLE CLASS, INT. CLS. 39
AND 42.
- STORM PRODUCTS, INC., BRIGHAM CITY, UT:
2,622,973, PUB. 7-2-2002. INT. CL. 1.
2,622,974, PUB. 7-2-2002. INT. CL. 1.
- STORM SHELTER CORPORATION, RINCON, GA:
2,562,067, COR. INT. CL. 9.
- STOSICH, MICHAEL N., DOWNERS GROVE, IL:
2,624,972, PUB. 7-2-2002. INT. CL. 9.
- STOUFFER CORPORATION, THE, SOLON, OH:
1,621,412, CANC. INT. CL. 29.
- STRATAGENE, LA JOLLA, CA:
2,626,222, INT. CL. 1.
- STRATCOM, LLC, WHITE PLAINS, NY:
2,623,775, PUB. 7-2-2002. INT. CL. 35.
- STRATEGIC MANAGEMENT GROUP, INC., PHILADEL-
PHIA, PA:
2,623,651, PUB. 7-2-2002. INT. CL. 41.
- STRATEGIC TECHNOLOGIES, INC., ISELIN, NJ:
1,933,100, CANC. INT. CL. 9.
- STRATEGIC WORLD IMPACT, BARTLESVILLE, OK:
2,625,255, PUB. 7-2-2002. INT. CL. 16.
- STRATICON CONSTRUCTION SERVICES, LLC, RICH-
LAND, MI:
2,624,864, PUB. 7-2-2002. INT. CL. 37.
- STRATIGRAPHICS, THE GEOTECHNICAL DATA ACQUI-
SITION CORP., GLEN ELLYN, IL:
1,933,143, CANC. INT. CL. 42.
- STRATOSPHERE SKATEBOARDS, INC., ATLANTA, GA:
1,932,587, CANC. INT. CL. 28.
- STRAUSS, CAROLYN SUE, NEW YORK, NY:
2,625,312, INT. CL. 25.
- STREAMLINE INDUSTRIES, INC., NEW YORK, NY:
1,176,341, CANC. INT. CL. 26.
- STREETSPACE, INC., SAN FRANCISCO, CA:
2,625,557, MULTIPLE CLASS, INT. CLS. 9, 35, 38 AND 42.
- STRIVE ENTERPRISES, INC., CANONSBURG, PA:
2,623,604, PUB. 7-2-2002. INT. CL. 28.
- STROEHMANN BAKERIES, INC., WILLIAMSPORT, PA:
1,176,415, CANC. INT. CL. 30.
- STROMBECKER CORPORATION, CHICAGO, IL:
933,860, REN. 8-14-02. U.S. CL. 22 (INT. CL. 28).
1,933,706, CANC. INT. CL. 25.
- STRUCTRON CORPORATION, SAN MARCOS, CA:
2,624,572, PUB. 7-2-2002. INT. CL. 8.
- STRUWE, MARK B., CARL JUNCTION, MO, DBA NA-
TIONAL INTEGRATED PEST MANAGEMENT:
2,623,666, PUB. 7-2-2002. INT. CL. 37.
- STRUYF, JOHAN, 3050 OUD-HEVERLEE, BELGIUM:
2,622,690, PUB. 7-11-2000. INT. CL. 10.
- STRYKER CORPORATION, KALAMAZOO, MI:
2,623,739, PUB. 7-2-2002. INT. CL. 10.
- STUBBINS ASSOCIATES, INC., THE, CAMBRIDGE, MA:
1,933,585, CANC. INT. CL. 42.
- STUDI, PHILIPPE, 4532 FELDBRUNNEN, SWITZERLAND:
2,622,790, PUB. 7-2-2002. MULTIPLE CLASS, INT. CLS.
35, 36, 41 AND 42.
- STUHLMACHER, LORRIE ANN, CROWN POINT, IN:
2,623,872, PUB. 7-2-2002. INT. CL. 42.
- STULLER, INC., LAFAYETTE, LA FROM STULLER SET-
TINGS, INC., LAFAYETTE, LA:
2,625,998, INT. CL. 14.
- STUPPY, INCORPORATED, NORTH KANSAS CITY, MO:
1,934,214, CANC. INT. CL. 11.
- STYLE-LINE MANUFACTURING CO., INC., MILWAUKEE,
WI:
1,176,238, CANC. INT. CL. 20.
- SUCCESS MOTIVATION, INC., WACO, TX:
2,624,161, PUB. 7-2-2002. INT. CL. 9.
- SUCESORES DE ALFREDO WILLINER S.A., RAFAELA,
ARGENTINA:
2,625,184, PUB. 7-2-2002. MULTIPLE CLASS, INT. CLS. 29
AND 30.
- SUELTHAUS & WALSH, P.C., ST. LOUIS, MO:
2,625,303, PUB. 7-2-2002. INT. CL. 42.
- SUGAR FOODS CORPORATION, NEW YORK, NY:
2,625,183, PUB. 7-2-2002. INT. CL. 29.
- SUGGS, YOLANDA GAIL, CLARKSVILLE, FL:
2,624,472, PUB. 7-2-2002. INT. CL. 3.

- SUH, MYUNG IN, RANCHO PALOS VERDES, CA:
2,624,794, PUB. 7-2-2002. INT. CL. 25.
- SULZER CARBOMEDICS INC., AUSTIN, TX:
2,624,919, PUB. 7-2-2002. INT. CL. 10.
- SUMMER PRODUCTIONS, INC., ALEXANDRIA, VA:
2,625,007, PUB. 7-2-2002. MULTIPLE CLASS, INT. CLS. 9,
41 AND 42.
- SUMMERS LABORATORIES, INC., COLLEGEVILLE, PA:
2,623,450, PUB. 7-2-2002. INT. CL. 3.
- SUMMIT INDUSTRIES, INC., CORONA, CA:
2,622,696, PUB. 7-2-2002. INT. CL. 7.
- SUMMIT VIEWS, LLC, LOS GATOS, CA:
2,626,743, INT. CL. 4.
- SUN CHEMICAL CORP., FORT LEE, NJ:
2,624,478, PUB. 7-2-2002. INT. CL. 35.
- SUN CHEMICAL CORPORATION, FORT LEE, NJ:
2,624,403, PUB. 7-2-2002. INT. CL. 42.
- SUN METAL PRODUCTS, INC., WARSAW, IN, RINGLE',
GEOFFREY F., TRENTON, NJ, DBA RINGLE' COMPO-
NENTS:
1,753,800. REN. 8-12-02. INT. CL. 12.
- SUN SAME ENTERPRISES CO., LTD., YUAN KANG CITY,
TAINAN HSIEN 711, TAIWAN:
2,625,737, INT. CL. 16.
- SUN SMART, INC., WAINSCOTT, NY:
1,933,372, CANC. INT. CL. 18.
- SUN STATE SAVINGS AND LOAN ASSOCIATION, PHOE-
NIX, AZ:
1,176,498, CANC. INT. CL. 36.
- SUN-MAR CORPORATION, BURLINGTON, ONTARIO, L7L
5V2, CANADA:
2,622,640, PUB. 7-2-2002. INT. CL. 7.
- SUNDANCE ENTERPRISES, INC., SUNDANCE, UT:
2,622,606, PUB. 7-2-2002. MULTIPLE CLASS, INT. CLS. 3
AND 21.
- SUNDAY SCHOOL BOARD OF THE SOUTHERN BAPTIST
CONVENTION, THE, NASHVILLE, TN:
1,176,679, CANC. INT. CL. 16.
- SUNDQUIST HOMES, INC., LYNNWOOD, WA:
2,624,312, PUB. 7-2-2002. INT. CL. 37.
- SUNDRIES PLUS, INC., TROY, MI:
1,663,721, CANC. INT. CL. 42.
- SUNDS DEFIBRATOR INDUSTRIES AB, S-851 94 SUNDS-
VALL, SWEDEN:
1,932,611, CANC. INT. CL. 7.
- SUNG HYUK CHOI AND JUNG WON KIM PARTNERSHIP,
THE, ENGLEWOOD CLIFFS, NJ:
2,625,567, INT. CL. 40.
- SUNNY BATES ASSOCIATES, INC., NEW YORK, NY:
2,623,283, PUB. 7-2-2002. INT. CL. 35.
- SUNRIDER CORPORATION, THE, TORRANCE, CA, DBA
SUNRIDER:
2,622,615, PUB. 12-28-1999. INT. CL. 5.
- SUNRISE MACHINE & TOOL, INC., DETROIT LAKES, MN:
2,624,015, PUB. 7-2-2002. INT. CL. 10.
- SUNSET PUBLISHING CORPORATION, MENLO PARK,
CA:
1,934,297, CANC. INT. CL. 16.
- SUNTERRA FOOD CORPORATION, CALGARY, AB, CA-
NADA:
2,625,158, PUB. 7-2-2002. MULTIPLE CLASS, INT. CLS. 29
AND 31.
- SUNTREAT GROWERS & SHIPPERS, INC., LINDSAY, CA,
LINDSAY CO-OPERATIVE CITRUS ASSOCIATION,
LINDSAY, CA:
526,056. REN. 8-16-02. U.S. CL. 46 (INT. CL. 31).
- SUPER BAKERY, INCORPORATED, PITTSBURGH, PA:
2,624,008, PUB. 7-2-2002. INT. CL. 30.
- SUPER CHICKEN ADVENTURES, INC., SCOTTSDALE, AZ:
1,175,984, CANC. MULTIPLE CLASS, INT. CLS. 9 AND
25.
- SUPER DUPER INC., GREENVILLE, SC, DBA SUPER
DUPER PULICATIONS:
2,624,339, PUB. 7-2-2002. INT. CL. 28.
- SUPER DUPER INC., GREENVILLE, SC, DBA SUPER
DUPER PULICATIONS:
2,625,134, PUB. 7-2-2002. INT. CL. 28.
- SUPER GLUE CORPORATION, HOLLIS, NY:
1,175,667, CANC. INT. CL. 1.
- SUPERFLY PRODUCTION LLC, NEW ORLEANS, LA:
2,623,899, PUB. 7-2-2002. INT. CL. 41.
- SUPERIOR QUALITY FOODS, INC., ONTARIO, CA:
2,624,619, PUB. 7-2-2002. INT. CL. 30.
- SUPERKARTS! U.S.A., INC., COLUMBUS, IN:
2,623,544, PUB. 7-2-2002. MULTIPLE CLASS, U.S. CL. 200
INT. CL. 41.
- SUPRADUR COMPANIES, INC., RYE, NY:
723,706, CANC. U.S. CL. 12.
- SUPREME SMOOTHIE, INC., MIAMI LAKES, FL:
2,626,191, INT. CL. 42.
- SURF HUNTER CORPORATION, FAIRHAVEN, MA:
1,176,059, CANC. INT. CL. 12.
- SURGIDEV CORPORATION, GOLETA, CA:
1,213,164. REN. 8-10-02. INT. CL. 10.
- SURVIVAIR INC., SANTA ANA, CA:
1,934,196, CANC. INT. CL. 9.
- SURVIVAL INSTINCT ENTERTAINMENT, LLC, DULUTH,
GA:
2,623,433, PUB. 7-2-2002. INT. CL. 41.
- SURYA ROSHNI LIMITED, NEW DELHI, INDIA:
2,626,572, MULTIPLE CLASS, INT. CLS. 9 AND 11.
- SUSAN ANTHONY INC., IRVINGTON, NY:
2,626,251, INT. CL. 42.
- SUSAN B. ANTHONY HOUSE, INC., THE, ROCHESTER,
NY:
2,624,569, PUB. 7-2-2002. INT. CL. 41.
- SUSQUEHANNA INTERNATIONAL GROUP, LLP, PHILA-
DELPHIA, PA FROM SUSQUEHANNA PARTNERS, GP,
BALA CYNWYD, PA:
2,624,035, PUB. 7-2-2002. INT. CL. 36.
- SUSQUEHANNA PARTNERS, GP:
See—SUSQUEHANNA INTERNATIONAL GROUP, LLP.
- SUTTER CORPORATION, SAN DIEGO, CA:
1,934,086, CANC. INT. CL. 10.
- SUZUKI MOTOR CORPORATION, SHIZUOKA-PREF. 432-
8611, JAPAN:
2,626,902, INT. CL. 12.
- SVANTE BJORK AB, S-434 46 KUNGSBACKA, SWEDEN:
1,933,552, CANC. INT. CL. 9.
- SWAFFORD, WILLIAM J., COLORADO SPRINGS, CO:
2,625,985, INT. CL. 16.
- SWALLET, INC., ATWATER, CA:
2,622,599, PUB. 7-2-2002. INT. CL. 25.
- SWAROVSKI AKTIENGESELLSCHAFT, FL-9495 TRIESEN,
LIECHTENSTEIN, D. SWAROVSKI & CO., GLASSCHLEI-
FEREI, WATTENS (TYROL), AUSTRIA:
934,915. REN. 8-13-02. MULTIPLE CLASS, U.S. CLS. 28
(INT. CL. 14) AND 33 (INT. CL. 21).
- SWEEBE, LAWRENCE EDWARD, LAKELAND, FL:
2,624,163, PUB. 7-2-2002. INT. CL. 42.
- SWEENEY, JOHN M., CHAPEL HILL, NC:
1,934,278, CANC. INT. CL. 41.
- SWEET BLESSINGS LLC, SANTA MONICA, CA:
2,623,435, PUB. 7-2-2002. INT. CL. 30.
- SWEET ENTERTAINMENT GROUP, CARSON CITY, NV:
2,623,602, PUB. 7-2-2002. INT. CL. 41.
- SWEET GRASS COMPANY, THE, ATLANTA, MI:
2,623,146, PUB. 7-2-2002. INT. CL. 3.
- SWEET POTATO PIE, INC., PATERSON, NJ:
2,622,819, PUB. 7-2-2002. INT. CL. 30.
- SWEETRIVER FRANCHISE, L.L.C., MERCED, CA:
2,624,551, PUB. 7-2-2002. INT. CL. 42.
- SWENCO PRODUCTS, INC., POPLAR BLUFF, MO:
2,624,792, PUB. 7-2-2002. INT. CL. 9.
- SWIFT NEWSPAPERS, INC., RENO, NV:
2,625,135, PUB. 7-2-2002. INT. CL. 41.
- SWIFT-ECKRICH, INC., FORT WAYNE, IN:
1,176,695, CANC. INT. CL. 29.
- SWIM MART, SARASOTA, FL:
1,663,717, CANC. INT. CL. 42.
- SWIMC, INC., WILMINGTON, DE, SHERWIN-WILLIAMS
COMPANY, THE, CLEVELAND, OH:
723,765. REN. 8-16-02. U.S. CL. 16 (INT. CL. 2).

- SWIMC, INC., WILMINGTON, DE FROM SHERWIN-WIL-
LIAMS COMPANY, THE, CLEVELAND, OH:
2,625,040, PUB. 7-2-2002. INT. CL. 16.
- SWITLIK PARACHUTE COMPANY, INC., TRENTON, NJ:
2,623,920, PUB. 7-2-2002. INT. CL. 9.
- SWITZER, PHILIP, ESTES PARK, CO:
2,626,788, INT. CL. 35.
- SWMG PRODUCTIONS, INC., PHOENIX, AZ, DBA NFO-
CUS.COM:
2,622,707, PUB. 7-2-2002. INT. CL. 9.
- SWOP, INC., CHICAGO, IL:
2,622,810, PUB. 7-2-2002. MULTIPLE CLASS, INT. CLS. 2,
9 AND 16.
- SYLVAN APPAREL GROUP, INC., ENGLEWOOD CLIFFS,
NJ:
1,932,816, CANC. INT. CL. 25.
- SYMMETRICS MARKETING CORPORATION, TEMPE, AZ:
2,626,115, INT. CL. 35.
- SYMYX TECHNOLOGIES, SANTA CLARA, CA:
2,625,459, MULTIPLE CLASS, INT. CLS. 1 AND 9.
2,625,878, MULTIPLE CLASS, INT. CLS. 9 AND 42.
- SYNC SOUND INC., NEW YORK, NY:
1,932,967, CANC. INT. CL. 41.
- SYNCHRONOSS TECHNOLOGIES, INC., BETHLEHEM, PA:
2,623,426, PUB. 7-2-2002. INT. CL. 42.
- SYNCRONIS, INC., LONG BEACH, CA, DBA DECISION
TOOLBOX:
1,934,509, CANC. INT. CL. 35.
- SYNERGETIC DATA SYSTEMS, INC., LATROBE, CA:
2,623,809, PUB. 7-2-2002. INT. CL. 9.
- SYNERGISTICS RESEARCH CORPORATION, NEW YORK,
NY:
1,176,383, CANC. INT. CL. 28.
- SYNET, INC., WARWICK, RI:
2,622,718, PUB. 7-2-2002. INT. CL. 37.
- SYNOPTICS LIMITED, CAMBRIDGE, UNITED KINGDOM:
2,623,693, PUB. 7-2-2002. INT. CL. 9.
- SYNPPLICITY, INC., SUNNYVALE, CA:
2,624,642, PUB. 7-2-2002. INT. CL. 9.
- SYNTHESES (U.S.A.), PAOLI, PA:
2,626,156, INT. CL. 10.
- SYRACUSE UNIVERSITY, SYRACUSE, NY:
2,623,379, PUB. 7-2-2002. INT. CL. 41.
- SYSFORMANCE AG, ZURICH, SWITZERLAND:
2,623,687, PUB. 7-2-2002. MULTIPLE CLASS, INT. CLS.
16, 38 AND 42.
- SYSTEM GESELLSCHAFT AG, SWITZERLAND FROM
ANCORA S.A., L-1882 LUXEMBOURG, LUXEMBOURG:
2,622,536, PUB. 10-12-1999. MULTIPLE CLASS, INT. CLS.
9, 35 AND 42.
- SYSTEM SAFETY SOCIETY, INC., UNIONVILLE, VA:
2,623,446, PUB. 7-2-2002. INT. CL. 42.
- SYSTEM THREE RESINS, INC., AUBURN, WA:
2,625,160, PUB. 7-2-2002. INT. CL. 1.
- SYSTEMS ENGINEERING SERVICE, INC., EHIME, JAPAN:
2,624,414, PUB. 7-2-2002. INT. CL. 9.
- T & C IMPORTS, ESST DENNIS, MA:
2,626,557, INT. CL. 24.
- T SECTOR, INC., THE, SAN DIEGO, CA:
2,623,319, PUB. 7-2-2002. MULTIPLE CLASS, INT. CLS. 9,
16, 35, 36, 41 AND 42.
- T. STUDIOS INC., SILVER SPRING, MD:
1,933,017, CANC. INT. CL. 41.
1,933,018, CANC. INT. CL. 41.
- T.C. MANUFACTURING CO., INC., EVANSTON, IL:
1,176,266, CANC. INT. CL. 22.
- T.I.M.M.-E. COMPANY, INC., THE, NEW YORK, NY:
2,626,025, INT. CL. 16.
- T.J. PUPILLO, INC., CONSHOHOCKEN, PA:
1,933,381, CANC. MULTIPLE CLASS, INT. CLS. 35 AND
37.
- T-TOCS FARMS, LLC, HENDERSONVILLE, TN FROM
AMERICAN AUSSIE FOODS, LLC, TOWSON, MD:
2,625,387, MULTIPLE CLASS, INT. CLS. 25 AND 29.
- T'LATTE COMPANY, L.L.C., THE, BELLEVUE, WA:
2,624,900, PUB. 7-2-2002. INT. CL. 35.
- TABLEWINE.COM, RIDGEWOOD, NJ:
2,626,835, INT. CL. 42.
- TACK CHEUNG CORPORATION, VERNON, CA:
2,622,982, PUB. 1-30-2001. INT. CL. 28.
- TAGMAR, INC., FRESNO, CA:
2,626,272, INT. CL. 16.
- TAI CHEER INDUSTRIAL CO., LTD., YUN LIN HSIEN,
TAIWAN:
2,626,412, INT. CL. 6.
- TAKARA U.S.A. CORPORATION, NEW YORK, NY:
1,691,591, REN. 8-12-02. INT. CL. 20.
- TAKE CHARGE CONSULTANTS, INC., DOWNINGTOWN,
PA:
2,622,635, PUB. 7-2-2002. INT. CL. 35.
- TALENT PLUS, INC., LINCOLN, NE, DBA TALENT +:
2,624,108, PUB. 7-2-2002. INT. CL. 35.
- TALENTBANK, LLC, IRVING, TX:
2,625,980, INT. CL. 35.
- TALK AMERICA HOLDINGS, INC., NEW HOPE, PA FROM
TALK.COM, INC., NEW HOPE, PA:
2,625,798, INT. CL. 38.
- TAMER INDUSTRIES, INC., SOMERSET, MA:
1,697,340, REN. 8-15-02. INT. CL. 6.
- TAMIYA PLASTIC MODEL CO., SHIZUOKA-CITY, SHI-
ZUOKA-PREFECTURE, JAPAN, TAMIYA, SHUNSAKU,
SHIZUOKA, JAPAN:
937,009, REN. 8-10-02. U.S. CL. 22 (INT. CL. 28).
- TAMKO ROOFING PRODUCTS, INC., JOPLIN, MO, TAM-
KO ASPHALT PRODUCTS, INC., JOPLIN, MO:
1,718,161, REN. 8-12-02. INT. CL. 19.
- TAMKO ROOFING PRODUCTS, INC., JOPLIN, MO:
2,625,709, INT. CL. 1.
- TAMP COMPUTER SYSTEMS INC., MERRICK, NY:
1,720,947, REN. 8-15-02. INT. CL. 42.
- TAPCO PRODUCTS COMPANY, INC., DETROIT, MI:
1,175,859, CANC. INT. CL. 7.
- TAPIJTFABRIEK H. DESSEAUX N.V., OSS, NETHER-
LANDS:
1,176,357, CANC. INT. CL. 27.
- TARGET BRANDS, INC., MINNEAPOLIS, MN:
2,624,666, PUB. 7-2-2002. MULTIPLE CLASS, INT. CLS. 35
AND 36.
2,626,007, INT. CL. 24.
- TARGET VISION, INC., PITTSFORD, NY:
2,626,689, INT. CL. 9.
- TARGETED ADVERTISING GROUP INC, WOODCLIFF
LAKE, NJ:
2,625,117, PUB. 7-2-2002. INT. CL. 35.
- TARK INC., NEWTON, NJ, TA S.T.A.R.S.:
1,933,242, CANC. INT. CL. 41.
- TASK FORCE TIPS, INC., VALPARAISO, IN:
2,624,342, PUB. 7-2-2002. INT. CL. 9.
- TASMANIA RESOURCE, INC., NEWARK, DE:
2,625,833, INT. CL. 9.
- TAUBMAN COMPANY, LLC, THE, BLOOMFIELD HILLS,
MI, TAUBMAN COMPANY, INC., THE, TROY, MI:
1,226,851, REN. 8-15-02. INT. CL. 35.
- TAULELL, S.A., CASTELLON, SPAIN:
2,625,014, PUB. 7-2-2002. INT. CL. 35.
- TAYANG SPORTING GOODS CO., LTD., KAOHSIUNG,
TAIWAN:
2,623,804, PUB. 7-2-2002. INT. CL. 18.
- TAYLOR & FRANCIS BOOKS, INC., PHILADELPHIA, PA:
2,623,169, PUB. 7-2-2002. MULTIPLE CLASS, INT. CLS. 16
AND 42.
- TAYLOR COMPANIES, INC., SCOTTSDALE, AZ:
1,934,089, CANC. INT. CL. 16.
- TAYLOR CORPORATION, NORTH MANKATO, MN:
2,626,418, INT. CL. 35.
- TAYLOR, BIANCA, PASADENA, CA:
1,934,519, CANC. INT. CL. 3.
- TAYLOR, ROBERT L., NORTH EASTON, MA, DBA TAY-
LOR ENTERTAINMENT:
2,625,842, INT. CL. 41.
- TAYLOR, SUSAN, BOULDER, CO:
2,625,068, PUB. 7-2-2002. INT. CL. 41.
- TECH-MED SERVICES, INC., HAUPPAUGE, NY:
2,624,903, PUB. 7-2-2002. INT. CL. 39.
- TECHNEWS, INC., VIENNA, VA:
1,933,154, CANC. INT. CL. 35.

- TECHNISOFT OF LOUISIANA, INC., BATON ROUGE, LA:
2,625,277, PUB. 7-2-2002. INT. CL. 9.
- TECHNOLOGY SERVICE CORPORATION, SILVER SPRING, MD:
2,623,792, PUB. 7-2-2002. INT. CL. 42.
- TECSEC INCORPORATED, VIENNA, VA:
1,932,458, CANC. INT. CL. 9.
- TECUMSEH POULTRY LLC, OMAHA, NE:
2,626,513, INT. CL. 29.
- TED LAPIDUS, 75008 PARIS, FRANCE:
2,623,178, PUB. 7-2-2002. MULTIPLE CLASS, INT. CLS. 9, 14, 18 AND 25.
- TEIJIN SEIKI BOSTON, INC., PEABODY, MA:
1,728,918. REN. 8-10-02. MULTIPLE CLASS, INT. CLS. 7 AND 9.
- TEISSIER, MARK, 30900 NIMES, FRANCE:
2,521,854, CANC. IIRN. RESTORED TO S.N. 76-010,478.
- TEKTRONIX, INC., BEAVERTON, OR:
2,625,581, INT. CL. 9.
- TEL.N.FORM INTERACTIVE COMMUNICATION CORPORATION, SAN DIEGO, CA:
2,622,532, PUB. 7-2-2002. INT. CL. 35.
- TELAUTOGRAPH CORPORATION, LOS ANGELES, CA TO HASA, INC., SAUGUS, CAMBODIA:
1,188,271, CANC. INT. CL. 1.
- TELCO CREATIONS, INC., HICKSVILLE, NY:
1,932,780, CANC. INT. CL. 20.
- TELEDESIC CORPORATION, KIRKLAND, WA:
1,934,182, CANC. INT. CL. 38.
- TELEDIFFUSION DE FRANCE, 75015 PARIS, FRANCE:
2,623,559, PUB. 7-2-2002. MULTIPLE CLASS, INT. CLS. 9, 16, 28, 35, 38, 41 AND 42.
- TELEDYNE INDUSTRIES, INC., LOS ANGELES, CA:
1,934,195, CANC. INT. CL. 7.
- TELEMUNDO NETWORK GROUP LLC, HIALEAH, FL:
2,624,904, PUB. 7-2-2002. INT. CL. 41.
- TELEQUIP CORPORATION, HOLLIS, NH:
1,934,116, CANC. INT. CL. 9.
- TELESIS TECHNOLOGIES, INC., CIRCLEVILLE, OH:
2,626,483, INT. CL. 7.
- TELETEC DE MEXICO, S.A. DE C.V., 53500 NAUCALPAN, ESTADO DE MEXICO, MEXICO:
2,622,784, PUB. 7-2-2002. INT. CL. 11.
- TELETECH CUSTOMER CARE MANAGEMENT (CALIFORNIA), INC., DENVER, CO FROM TELETECH TELECOMMUNICATIONS, INCORPORATED, DENVER, CO:
2,625,327, MULTIPLE CLASS, INT. CLS. 35, 38, 41 AND 42.
- TELETRON, L.P., BLOOMINGTON, IN:
2,624,494, PUB. 7-2-2002. MULTIPLE CLASS, INT. CLS. 35, 36 AND 42.
- TELLSOFT TECHNOLOGIES, INC., COLORADO SPRINGS, CO FROM TELLSOFT TECHNOLOGIES, INC., COLORADO SPRINGS, CO:
2,622,630, PUB. 7-2-2002. INT. CL. 9.
- TELLSOFT TECHNOLOGIES, INC.:
See— TELLSOFT TECHNOLOGIES, INC..
- TELUS CORPORATION, EDMONTON, ALBERTA:
2,622,589, PUB. 11-6-2001. MULTIPLE CLASS, INT. CLS. 38 AND 42.
- TEMBEC USA LLC, ST. FRANCIS-VILLE, LA, CROWN ZELLERBACH CORPORATION, SAN FRANCISCO, CA:
942,808. REN. 8-10-02. U.S. CL. 37 (INT. CL. 16).
- TEMET INSTRUMENTS OY, HELSINKI, FINLAND:
1,933,589, CANC. INT. CL. 9.
- TEMPLE-INLAND FOREST PRODUCTS CORPORATION, DIBOLL, TX:
2,623,366, PUB. 7-2-2002. INT. CL. 19.
- TEMREX CORPORATION, FREEPORT, NY:
1,753,117. REN. 8-15-02. INT. CL. 5.
- TENDURA, L.L.C., TROY, AL:
2,626,731, INT. CL. 19.
- TENENBAUM'S TRAVEL SERVICES, INC., KINGSTON, PA, DBA LAURALEE FOX TRAVEL:
1,932,633, CANC. MULTIPLE CLASS, INT. CLS. 39 AND 42.
- TENNESSEE ONCOLOGY, PLLC, NASHVILLE, TN:
2,623,273, PUB. 7-2-2002. INT. CL. 42.
- TEODORO GROUP INC, THE, MENLO PARK, CA:
2,626,729, MULTIPLE CLASS, INT. CLS. 25 AND 28.
- TEQUILAS Y MEZCALES, S.A. DE C.V., C.P. 44050 - ZAPOPAN, JALISCO, MEXICO:
1,932,616, CANC. INT. CL. 33.
- TERABEAN CORPORATION, SEATTLE, WA FROM TERABEAM CORPORATION, SEATTLE, WA:
2,625,635, MULTIPLE CLASS, INT. CLS. 9 AND 38.
- TERABURST NETWORKS, INC., SUNNYVALE, CA:
2,626,137, INT. CL. 9.
- TERABYTE COMPUTERS, INC., BOONE, NC:
2,624,958, PUB. 7-2-2002. INT. CL. 42.
- TERAX ITALIA S.N.C. DI CANE' FRANCA & C., 40138 BOLOGNA, ITALY:
2,623,293, PUB. 7-2-2002. MULTIPLE CLASS, INT. CLS. 3 AND 5.
- TERME DI MONTECATINI S.P.A., MONTECATINI TERME(PT), ITALY:
2,625,044, PUB. 7-2-2002. INT. CL. 3.
- TERRA INTERNATIONAL, INC., SIOUX CITY, IA:
1,932,484, CANC. INT. CL. 5.
- TERRA NOVA NURSERIES, INC., TIGARD, OR:
2,622,795, PUB. 7-2-2002. MULTIPLE CLASS, INT. CLS. 31 AND 42.
- TERRAL, MIKE D., CLAREMORE, OK AND MCCAW, JOHN D., CLAREMORE, OK:
2,625,853, INT. CL. 25.
- TERRCO, INC., WATERTOWN, SD:
2,624,114, PUB. 12-4-2001. INT. CL. 7.
- TERRYBERRY COMPANY LIMITED PARTNERSHIP, GRAND RAPIDS, MI:
2,624,426, PUB. 7-2-2002. INT. CL. 14.
- TERUMO KABUSHIKI KAISHA, SHIBUYA-KU, TOKYO, JAPAN, AKA TERUMO CORPORATION:
1,175,993, CANC. INT. CL. 10.
- TESA AG, HAMBURG, FED REP GERMANY FROM BEIERSDORF AKTIENGESELLSCHAFT, 20245 HAMBURG, FED REP GERMANY:
2,623,021, PUB. 7-2-2002. MULTIPLE CLASS, INT. CLS. 9, 16 AND 17.
- TESORO PETROLEUM CORPORATION, SAN ANTONIO, TX:
2,626,854, INT. CL. 35.
2,626,855, INT. CL. 35.
- TEX TECH INDUSTRIES, NORTH MONMOUTH, ME:
1,932,810, CANC. INT. CL. 24.
- TEXACO INC., WHITE PLAINS, NY:
2,626,253, INT. CL. 41.
- TEXAS ALLIED CHEMICALS, INC., SAN ANTONIO, TX:
2,625,409, INT. CL. 4.
- TEXAS INSTRUMENTS INCORPORATED, DALLAS, TX:
2,623,796, PUB. 7-2-2002. INT. CL. 35.
- TEXAS RECREATION CORPORATION, WICHITA FALLS, TX:
1,211,586. REN. 8-12-02. INT. CL. 21.
- TEXT 100 GROUP PLC:
See— ONEMONDAY GROUP PLC.
- TEXTRON FINANCIAL CORPORATION, PROVIDENCE, RI:
2,624,679, PUB. 7-2-2002. INT. CL. 36.
- THAI ORIGINAL BBQ FRANCHISE, INC., LOS ANGELES, CA:
2,623,774, PUB. 7-2-2002. INT. CL. 30.
- THAMES WATER PRODUCTS LIMITED, LONDON W1M 0NU, ENGLAND:
2,622,794, PUB. 7-2-2002. MULTIPLE CLASS, INT. CLS. 11, 32 AND 40.
- THANK GOD FOR FRIENDS, TGFF, LLC, SNELLVILLE, GA:
2,625,294, PUB. 7-2-2002. MULTIPLE CLASS, INT. CLS. 16, 21 AND 30.
- THANKSGIVING COFFEE COMPANY, FORT BRAGG, CA:
1,705,268. REN. 8-10-02. INT. CL. 30.
2,624,875, PUB. 7-2-2002. INT. CL. 30.
- THE MATHWORKS INC., NATICK, MA, MATHWORKS, INC., THE, NATICK, MA:
1,691,313. REN. 8-15-02. INT. CL. 9.

- THE MCNAUGHTON GROUP, INC., ESCONDIDO, CA:
2,625,236, PUB. 7-2-2002. INT. CL. 35.
- THE RITZ-CARLTON HOTEL COMPANY, L.L.C., BETHESDA, MD:
2,625,242, PUB. 7-2-2002. INT. CL. 42.
- THE TRUSTEES OF CORNERSTONE FINANCIAL MANAGEMENT, AN ARKANSAS TRUST, THE TRUSTEE COMPRISING VERN M. ROW, A U.S. CITIZEN, LITTLE ROCK, AR:
2,623,305, PUB. 7-2-2002. INT. CL. 21.
- THE TRUSTEES OF FIDELITY INVESTMENTS CHARITABLE GIFT FUND, A MASSACHUSETTS TRUST, THE TRUSTEES COMPRISING RUDMAN J. HAM, ANNE-MARIE SOULLIERE, ROGER H. SALQUIST, DAVID L. YUNICH AND THOMAS J. POWERS, ALL CITIZENS OF THE UNITED STATES, BOSTON, MA:
2,626,849, INT. CL. 36.
- THERMO ELECTRON WEB SYSTEMS, INC., AUBURN, MA:
1,175,861, CANC. INT. CL. 7.
- THERMO ENGINEERING, INC., RIDGEFIELD, NJ:
1,175,970, CANC. INT. CL. 9.
- THERMOGUARD EQUIPMENT INC., SPOKANE, WA:
1,932,979, CANC. INT. CL. 7.
- THERMOPATCH CORPORATION, SYRACUSE, NY:
1,175,849, CANC. INT. CL. 7.
1,176,164, CANC. INT. CL. 16.
- THERMOQUEST CORPORATION, AUSTIN, TX:
2,625,681, INT. CL. 9.
- THERMOSTATIC INDUSTRIES, INC., LOS ANGELES, CA:
1,663,862, CANC. INT. CL. 21.
- THERMOTEKNIK SYSTEMS LTD, CAMBRIDGE, CAMBRIDGESHIRE, UNITED KINGDOM:
2,625,205, PUB. 7-2-2002. INT. CL. 9.
- THESAURUS GROUP LIMITED, NEWPORT, ISLE OF WIGHT, PO 30 2AA, UNITED KINGDOM:
1,934,012, CANC. INT. CL. 42.
- THESPORTSCOACH.COM, INC., MOORPARK, CA:
2,622,922, PUB. 7-2-2002. INT. CL. 41.
- THINAIRAPPS, INC., NEW YORK, NY:
2,623,079, PUB. 7-2-2002. MULTIPLE CLASS, INT. CLS. 9, 38 AND 42.
2,623,373, PUB. 7-2-2002. MULTIPLE CLASS, INT. CLS. 9, 38 AND 42.
- THINK GOD, INC., FT. WORTH, TX:
2,626,094, INT. CL. 21.
- THINK OF ENGLAND, LLC, LOS ANGELES, CA:
2,624,730, PUB. 7-2-2002. INT. CL. 41.
- THINKING TECHNOLOGY INC., NASSAU, BAHAMAS:
2,626,152, INT. CL. 28.
- THOMAS F. WHITE & CO., INC., SAN FRANCISCO, CA:
2,626,487, INT. CL. 36.
- THOMAS INDUSTRIES INC., LOUISVILLE, KY:
1,175,787, CANC. MULTIPLE CLASS, INT. CLS. 6, 8 AND 20.
- THOMAS PUBLISHING COMPANY, NEW YORK, NY:
2,624,825, PUB. 7-2-2002. MULTIPLE CLASS, INT. CLS. 9 AND 35.
- THOMAS SWAN & COMPANY, CONSETT, UNITED KINGDOM:
2,625,193, PUB. 7-2-2002. INT. CL. 1.
- THOMAS, FRANK, BURR RIDGE, IL:
1,932,794, CANC. MULTIPLE CLASS, INT. CLS. 16, 21 AND 25.
- THOMPSON & CO. OF TAMPA, INC., TAMPA, FL:
2,626,151, INT. CL. 34.
- THOMPSON, CHERIE R., NEWTON CENTRE, MA:
1,934,271, CANC. INT. CL. 42.
- THOMPSON'S PET PASTA PRODUCTS, INC., FT. LAUDERDALE, FL:
1,933,817, CANC. INT. CL. 31.
- THOMSON LEARNING LICENSING CORPORATION, CLAYMONT, DE:
2,626,851, INT. CL. 41.
- THOR TECH, INC., LAS VEGAS, NV:
2,623,243, PUB. 7-2-2002. INT. CL. 12.
- THORNE RESEARCH, INC., DOVER, ID:
2,624,943, PUB. 7-2-2002. INT. CL. 5.
- THORSMAN & CO. AB, 611 29 NYKOPPLNG, SWEDEN:
2,625,851, MULTIPLE CLASS, INT. CLS. 6, 9, 17 AND 20.
- THOSE CHARACTERS FROM CLEVELAND, INC., CLEVELAND, OH:
2,626,368, INT. CL. 28.
2,626,369, INT. CL. 28.
2,626,370, INT. CL. 28.
2,626,371, INT. CL. 28.
- THUNDERBIRD, THE AMERICAN GRADUATE SCHOOL OF INTERNATIONAL MANAGEMENT, GLENDALE, AZ:
2,625,860, INT. CL. 41.
- THUNDERWEAR, INC., SAN CLEMENTE, CA:
1,727,732, REN. 8-12-02. INT. CL. 25.
- THYMES LIMITED, THE, MINNEAPOLIS, MN:
1,933,838, CANC. INT. CL. 3.
- TIBURON STRATEGIC ADVISORS, LLC, TIBURON, CA:
2,626,857, INT. CL. 35.
- TICKETS.COM, INC., COSTA MESA, CA:
2,626,988, INT. CL. 41.
- TIER TECHNOLOGIES, INC., WALNUT CREEK, CA:
2,626,215, INT. CL. 35.
- TIGAR AMERICAS CORPORATION, JACKSONVILLE, FL:
1,174,089, REN. 8-15-02. INT. CL. 12.
- TIGER ELECTRONICS, INC., VERNON HILLS, IL:
1,933,925, CANC. INT. CL. 28.
1,933,926, CANC. INT. CL. 28.
1,933,927, CANC. INT. CL. 28.
- TIKKURILA OY, 01300 VANTAA, FINLAND:
1,932,537, CANC. INT. CL. 7.
- TILIA INTERNATIONAL, INC., TAI KOK TSUI, KOWLOON, HONG KONG:
2,623,116, PUB. 5-21-2002. MULTIPLE CLASS, INT. CLS. 16, 20 AND 21.
- TIM GIRVIN DESIGN, INC., SEATTLE, WA:
2,622,676, PUB. 7-2-2002. MULTIPLE CLASS, INT. CLS. 35 AND 42.
- TIME DOMAIN CORPORATION, HUNTSVILLE, AL:
2,624,054, PUB. 7-2-2002. INT. CL. 9.
- TIME FOR TWO, SAN FRANCISCO, CA FROM GAMES PARTNERSHIP, LTD., INC., SAN FRANCISCO, CA:
2,625,368, INT. CL. 35.
- TIME WARNER ENTERTAINMENT COMPANY, L. P., NEW YORK, NY:
1,933,223, CANC. INT. CL. 28.
- TIME WARNER ENTERTAINMENT COMPANY, L.P., NEW YORK, NY:
2,626,658, INT. CL. 41.
- TIME/DESIGN, INC., AGAWAM, MA:
2,623,587, PUB. 7-2-2002. INT. CL. 18.
- TIMEX CORPORATION, MIDDLEBURY, CT:
2,626,416, INT. CL. 14.
- TIMEX GROUP B.V., 1075 AD AMSTERDAM, NETHERLANDS:
2,626,503, INT. CL. 14.
- TIME4 MEDIA, INC., NEW YORK, NY FROM TIMES MIRROR MAGAZINES, INC., NEW YORK, NY:
2,626,414, INT. CL. 16.
- TIMPSON TAMCO INC., TIMPSON, TX:
1,933,096, CANC. INT. CL. 6.
1,933,097, CANC. INT. CL. 6.
- TINKER'S DEN, TORRANCE, CA:
2,624,432, PUB. 7-2-2002. INT. CL. 35.
- TIS SOFTWARE, INC., TAMPA, FL:
1,934,118, CANC. INT. CL. 9.
- TISHERMAN, WILLIAM R., KATONAH, NY:
2,624,818, PUB. 7-2-2002. INT. CL. 16.
- TITAN INTERNATIONAL, INC., QUINCY, IL:
2,622,934, PUB. 7-2-2002. INT. CL. 12.
2,622,935, PUB. 7-2-2002. INT. CL. 12.
2,622,956, PUB. 7-2-2002. INT. CL. 12.
2,624,606, PUB. 7-2-2002. INT. CL. 12.
- TJX COMPANIES, INC., THE, FRAMINGHAM, MA:
2,626,880, INT. CL. 25.
- TLC PRODUCTIVITY PROPERTIES, LLC, NOVATO, CA FROM BRODERBUND SOFTWARE, INC., NOVATO, CA:
2,622,525, PUB. 7-2-2002. INT. CL. 9.

- TM AQUISITION CORP., PHOENIX, AZ, GLEN IVY FINANCIAL GROUP, INC., CORONA, CA:
1,664,428. REN. 8-15-02. INT. CL. 39.
- TMC BACK TO BUSINESS, INC., ALBANY, NY:
2,625,966, MULTIPLE CLASS, INT. CLS. 14, 16, 41 AND 42.
2,625,967, MULTIPLE CLASS, INT. CLS. 16, 41 AND 42.
- TMT-PATHWAY, L.L.C., CHESTERFIELD, MO, MORTON COATINGS, INC., CHICAGO, IL:
1,711,016. REN. 8-10-02. INT. CL. 2.
- TNEMEC COMPANY, INC., KANSAS CITY, MO:
2,625,807, INT. CL. 2.
2,626,807, INT. CL. 2.
- TO-RO ENTERPRISES, INC., PORTLAND, OR, DBA O'LOUGHLIN TRADE SHOWS:
1,934,506, CANC. INT. CL. 35.
- TOBISH, JOHN, ST. PAUL, MN:
1,933,147, CANC. INT. CL. 9.
- TOBY-O INCORPORATED, TUCSON, AZ:
2,625,093, PUB. 7-2-2002. MULTIPLE CLASS, INT. CLS. 5, 31 AND 41.
- TOFTEJORG TECHNOLOGY A/S, DK-2635 ISHOJ, DENMARK:
2,622,876, PUB. 7-2-2002. MULTIPLE CLASS, INT. CLS. 7 AND 37.
- TOHKUTSU AMERICA CORP., ENGLEWOOD CLIFFS, NJ:
1,933,710, CANC. INT. CL. 42.
- TOKUYAMA CORPORATION, TOKUYAMA, YAMAGUCHI, JAPAN:
2,622,548, PUB. 4-11-2000. INT. CL. 10.
- TOKYO DENPA COMPANY, LTD., OHTA-KU, TOKYO (143), JAPAN:
1,667,417. REN. 8-14-02. INT. CL. 9.
- TOKYO RIKI CO., LTD., TOKYO, JAPAN:
2,624,914, PUB. 7-2-2002. INT. CL. 8.
- TOM THUMB FOOD & DRUGS, INC., HOUSTON, TX:
1,932,554, CANC. INT. CL. 30.
- TOMATO, INC., VERNON, CA:
1,933,606, CANC. INT. CL. 25.
- TOMORROW, L.L.C., DAPHNE, AL:
2,623,097, PUB. 7-2-2002. INT. CL. 3.
- TOMWAY LLC, ATLANTA, GA:
2,624,413, PUB. 7-2-2002. INT. CL. 20.
- TOMY AMERICA, INC., BREA, CA:
1,933,262, CANC. INT. CL. 28.
- TONKA CORPORATION, PAWTUCKET, RI:
1,933,654, CANC. INT. CL. 28.
- TONY MARGERIE & ASSOCIATES, SAUSALITO, CA:
2,625,594, INT. CL. 25.
- TOO, INC., COLUMBUS, OH:
2,623,653, PUB. 7-2-2002. INT. CL. 3.
- TOON PLANET, INC., CARROLLTON, TX:
1,933,783, CANC. INT. CL. 42.
- TOORALLIE PTY. LIMITED, SYDNEY, NEW SOUTH WALES, AUSTRALIA:
1,932,552, CANC. INT. CL. 25.
- TOP TURF, LAWRENCEVILLE, GA:
2,626,605, INT. CL. 42.
- TOPBULB.COM, LLC, EAST CHICAGO, IN:
2,626,994, INT. CL. 35.
- TOPCO ASSOCIATES, INC., SKOKIE, IL:
1,690,372. REN. 8-15-02. INT. CL. 30.
- TOPDOG SOFTWARE, INC., LAWRENCEVILLE, GA:
2,561,998, COR. INT. CL. 9.
- TOPEAK, INC., TAICHUNG, TAIWAN:
2,625,241, PUB. 7-2-2002. INT. CL. 11.
- TOPETE D., FERNANDO, 45230 ZAPOPAN, JALISCO, MEXICO:
1,932,599, CANC. INT. CL. 30.
- TOPMOST DESIGNS, INC., CITY OF INDUSTRY, CA:
2,625,702, INT. CL. 35.
- TOPPS COMPANY, INC., THE, NEW YORK, NY:
2,623,642, PUB. 7-2-2002. INT. CL. 16.
- TOPPY COMPANY (HONG KONG) LIMITED, KWAI CHUNG, NEW TERRITORIES, HONG KONG:
1,933,859, CANC. INT. CL. 25.
- TORAY KABUSHIKI KAISHA (TORAY INDUSTRIES, INC.), CHUO-KU, TOKYO, JAPAN:
1,683,637. REN. 8-16-02. INT. CL. 9.
- TORBRECK VINEYARDS PTY LTD, MARANANGA 5355, SOUTH AUSTRALIA, AUSTRALIA:
2,623,421, PUB. 5-28-2002. INT. CL. 33.
- TORFINO ENTERPRISES, INC., WEST PALM BEACH, FL:
2,624,012, PUB. 7-2-2002. INT. CL. 9.
- TORSION BALANCE CO., THE, CLIFTON, NJ:
723,574, CANC. U.S. CL. 26.
- TOTAL, 92800 PUTEAUX, FRANCE:
1,932,655, CANC. INT. CL. 4.
- TOTAL INFORMATION, INC., ROCHESTER, NY:
1,962,802, AM. MULTIPLE CLASS, INT. CLS. 35 AND 42.
- TOTAL WAREHOUSING, INC., PHOENIX, AZ:
2,624,314, PUB. 7-2-2002. INT. CL. 39.
- TOUCAN, INC., ARCATA, CA:
2,624,745, PUB. 7-2-2002. INT. CL. 14.
- TOWER SOLUTIONS, INC., PINE CITY, MN:
2,626,095, INT. CL. 42.
- TOWER SOLUTIONS, LLC, PINE CITY, MN FROM TOWER SOLUTIONS, INC., PINE CITY, MN:
2,626,093, INT. CL. 40.
- TOWERS PERRIN CAPITAL CORP., WILMINGTON, DE, TOWERS, PERRIN, FORSTER & CROSBY, INC., PHILADELPHIA, PA:
1,617,851. REN. 8-15-02. MULTIPLE CLASS, INT. CLS. 35 AND 36.
- TOWERS, PERRIN, FORSTER & CROSBY, INC., PHILADELPHIA, PA:
2,623,438, PUB. 7-2-2002. INT. CL. 36.
- TOY BIZ ACQUISITION, INC., NEW YORK, NY:
1,933,514, CANC. INT. CL. 28.
- TOYMAX INC., WESTBURY, NY:
1,934,068, CANC. INT. CL. 28.
1,934,088, CANC. INT. CL. 28.
1,934,170, CANC. INT. CL. 28.
1,934,175, CANC. INT. CL. 28.
1,934,176, CANC. INT. CL. 28.
- TP COMPOSITES, INC., ASTON, PA:
2,623,080, PUB. 11-13-2001. INT. CL. 17.
- TRACE BIOTECH AG, 38124 BRAUNSCHWEIG, FED REP GERMANY:
2,625,803, MULTIPLE CLASS, INT. CLS. 1 AND 9.
- TRACK III INC., CYPRESS, CA:
1,933,835, CANC. INT. CL. 1.
- TRACY FOODS, INC., BELMONT, MA:
2,623,436, PUB. 11-13-2001. INT. CL. 29.
- TRADE ONE, INC., MINNEAPOLIS, MN:
1,663,570, CANC. INT. CL. 31.
- TRADEATTACHE.COM, INC., BEVERLY HILLS, CA:
2,623,184, PUB. 7-2-2002. INT. CL. 35.
- TRADENETONE.COM AG, FRANKFURT, FED REP GERMANY FROM TRADENETONE.COM OHG, D-61462 KONIGSTEIN, FED REP GERMANY:
2,622,828, PUB. 7-2-2002. MULTIPLE CLASS, INT. CLS. 9, 16, 35, 36, 38, 41 AND 42.
- TRADENETONE.COM OHG:
See— TRADENETONE.COM AG.
- TRADEPOWER, INC., LINTHICUM HEIGHTS, MD:
2,624,978, PUB. 7-2-2002. MULTIPLE CLASS, INT. CLS. 9 AND 35.
- TRAMPLANCOMPANY MUSIKPRODUKTION UND WERBEGES. M.B.H., 6290 MAYRHOFEN, AUSTRIA:
2,625,357, INT. CL. 24.
- TRANS UNION L.L.C., CHICAGO, IL:
2,625,919, INT. CL. 36.
- TRANSCENTRIC LLC, ST. LOUIS, MO FROM UNION PACIFIC CORPORATION, OMAHA, NE:
2,626,149, INT. CL. 9.
- TRANSCENTRIC LLLC, ST. LOUIS, MO FROM UNION PACIFIC CORPORATION, OMAHA, NE:
2,626,148, INT. CL. 9.
- TRANSGO, EL MONTE, CA:
1,176,114, CANC. INT. CL. 16.
- TRANSMATION, INC., ROCHESTER, NY:
2,626,816, MULTIPLE CLASS, INT. CLS. 9 AND 35.

- TRANSUNION L.L.C., CHICAGO, IL, TRANS UNION CORPORATION, CHICAGO, IL:
924,279, REN. 8-14-02. U.S. CL. 38 (INT. CL. 16).
- TRAVEL GOODS ASSOCIATION, NEW YORK, NY:
2,623,448, PUB. 7-2-2002. INT. CL. 16.
- TRAVEL STRATEGIES, INC., STAMFORD, CT:
1,934,058, CANC. INT. CL. 39.
- TRAVEL TRADE PRODUCTIONS, NEW YORK, NY:
2,624,895, PUB. 7-2-2002. INT. CL. 41.
- TRAVELERS EXPRESS COMPANY, INC., ST. LOUIS PARK, MN:
2,624,661, PUB. 7-2-2002. INT. CL. 38.
- TRAVELONG, INC., FLORHAM PARK, NJ:
1,932,608, CANC. MULTIPLE CLASS, INT. CLS. 35 AND 39.
- TRAVELPRO INTERNATIONAL, INC., BOCA RATON, FL:
2,626,063, INT. CL. 18.
- TREASURE CHEST ADVERTISING COMPANY, INC.:
See— PRINTCO., INC.
- TREASURES AND TRINKETS INC., MANCHESTER, CT:
1,933,855, CANC. INT. CL. 31.
- TREAT ENTERTAINMENT, INC., FLORENCE, AL:
1,933,363, CANC. INT. CL. 16.
1,933,391, CANC. INT. CL. 16.
- TREAT VENTURE LLC, WILMINGTON, DE FROM JOSEPH E. SEAGRAM & SONS, INC., NEW YORK, NY:
2,625,779, INT. CL. 32.
- TREBILCOCK, MIKE, TORONTO, ONTARIO M5T 1X8, CANADA:
1,933,283, CANC. INT. CL. 41.
- TREK BICYCLE CORPORATION, WATERLOO, WI:
2,624,558, PUB. 7-2-2002. INT. CL. 12.
2,624,593, PUB. 7-2-2002. INT. CL. 12.
- TREMCO INCORPORATED, BEACHWOOD, OH:
1,898,109, CANC. INT. CL. 17.
- TRENDMASTERS, INC., ST. LOUIS, MO:
1,934,208, CANC. INT. CL. 28.
2,622,972, PUB. 7-2-2002. INT. CL. 9.
- TRESTLETREE, INC., FAYETTEVILLE, AR:
2,624,533, PUB. 7-2-2002. MULTIPLE CLASS, INT. CLS. 35 AND 42.
- TREVANNA, LLC, NEW YORK, NY:
2,625,927, INT. CL. 35.
- TRG ACCESSORIES, L.L.C., ST. LOUIS, MO:
2,624,896, PUB. 7-2-2002. INT. CL. 18.
- TRI SPAN, L.L.C., BILOXI, MO:
2,625,768, INT. CL. 12.
- TRI VALLEY GROWERS, SAN FRANCISCO, CA:
1,933,101, CANC. INT. CL. 29.
- TRIATHLON GROUP NORTH AMERICA LLC, CARDIFF, CA:
2,623,222, PUB. 7-2-2002. INT. CL. 41.
- TRIFLES, LLC, WHITE LAKE TWP., MI:
2,625,090, PUB. 7-2-2002. INT. CL. 30.
2,625,091, PUB. 7-2-2002. INT. CL. 30.
- TRIGON ELECTRONICS, INC., ORANGE, CA:
2,625,110, PUB. 7-2-2002. INT. CL. 9.
- TRILIMAR LLC, MINNEAPOLIS, MN:
2,624,846, PUB. 7-2-2002. INT. CL. 30.
- TRIMEDIC, INC., PITTSBURGH, PA:
1,933,913, CANC. INT. CL. 10.
- TRIMONT LAND COMPANY, TRUCKEE, CA:
1,934,505, CANC. INT. CL. 41.
- TRINITY CORPORATION, READING, PA:
2,624,148, PUB. 7-2-2002. MULTIPLE CLASS, INT. CLS. 9, 35 AND 42.
- TRIPLE-S MANAGEMENT CORPORATION, SAN JUAN, PUERTO RICO:
2,623,502, PUB. 7-2-2002. INT. CL. 36.
- TRISTAR ONLINE SALES CORPORATION, LAS VEGAS, NV:
2,626,707, INT. CL. 5.
- TRISTAR SPORTS INC., WARD HILL, MA:
1,176,314, CANC. INT. CL. 25.
- TRITON INDUSTRIES LLC, LOTTIE, LA:
2,623,720, PUB. 7-2-2002. MULTIPLE CLASS, INT. CLS. 37 AND 40.
- TRIUMPH BRANDS, INC., WAYNE, PA:
2,623,911, PUB. 7-2-2002. MULTIPLE CLASS, INT. CLS. 37, 40 AND 42.
- TRIUMPH PET INDUSTRIES, INC., WARWICK, NY:
1,699,919, REN. 8-15-02. INT. CL. 31.
1,699,920, REN. 8-15-02. INT. CL. 31.
1,704,347, REN. 8-15-02. INT. CL. 31.
- TROIANO-SCERBO PRODUCTIONS, INC., BALDWINVILLE, NY:
1,932,833, CANC. INT. CL. 28.
- TROIS AMIS LLC, ISELIN, NJ:
2,624,599, PUB. 7-2-2002. INT. CL. 29.
- TROPICAL TOURISM AND MARKETING INC., MONCTON (NEW-BRUNSWICK), CANADA:
2,626,423, MULTIPLE CLASS, INT. CLS. 39 AND 42.
- TROPUS, INC., LOUISVILLE, KY:
1,932,603, CANC. INT. CL. 9.
- TROUVERE, INC., CAMBRIDGE, MA:
2,624,965, PUB. 7-2-2002. INT. CL. 9.
- TROWER ENTERPRISES, INC., FORT WORTH, TX, DBA MONSTRO GRAPHICS:
2,626,217, MULTIPLE CLASS, INT. CLS. 18 AND 28.
- TRU-FIT MARKETING CORPORATION, LYNN, MA:
1,934,073, CANC. INT. CL. 28.
- TRUMP'S CASTLE ASSOCIATES, ATLANTIC CITY, NJ:
1,934,064, CANC. MULTIPLE CLASS, INT. CLS. 41 AND 42.
- TRUSCO TANK INC., SAN LUIS OBISPO, CA:
1,700,171, REN. 8-16-02. INT. CL. 6.
- TRUSECURE CORPORATION, RESTON, VA:
2,625,136, PUB. 7-2-2002. INT. CL. 16.
2,625,137, PUB. 7-2-2002. INT. CL. 42.
- TRUSERV CORPORATION, CHICAGO, IL:
2,625,177, PUB. 7-2-2002. INT. CL. 35.
2,626,745, INT. CL. 35.
- TRUSSARDI S.P.A., MILANO, ITALY:
2,623,047, PUB. 7-2-2002. MULTIPLE CLASS, INT. CLS. 3, 18 AND 25.
- TRUSTEES OF DARTMOUTH COLLEGE, HANOVER, NH, DBA DARTMOUTH COLLEGE:
2,624,303, PUB. 7-2-2002. INT. CL. 25.
2,624,304, PUB. 7-2-2002. INT. CL. 21.
- TRUSTEES OF THE VARTEC BUSINESS TRUST, THE, DALLAS, TX FROM VARTEC TELECOM, INC., DALLAS, TX:
2,624,332, PUB. 7-2-2002. INT. CL. 38.
- TRUSTMARK NATIONAL BANK, JACKSON, MS:
2,624,307, PUB. 7-2-2002. INT. CL. 36.
- TRUTH HARDWARE CORPORATION, OWATONNA, MN:
1,934,346, CANC. INT. CL. 6.
- TRUTH SEEKER COMPANY, INC., THE, SAN DIEGO, CA:
1,932,405, CANC. INT. CL. 16.
- TSANG, SHIRLEY M, HAYWARD, CA:
2,624,672, PUB. 7-2-2002. INT. CL. 25.
- TTOOLS, LLC, PROVIDENCE, RI:
2,626,452, INT. CL. 16.
- TUBE ICE, LLC, LOUISVILLE, KY FROM ICE ONE, INC., LOUISVILLE, KS:
2,625,367, INT. CL. 11.
- TUBOPLAST HISPANIA, S.A., 01013-VITORIAL-GASTEIZ, SPAIN:
1,932,431, CANC. INT. CL. 20.
- TUCHMAN, PAUL B., MINNEAPOLIS, MN, DBA OUT-SMART MARKETING:
1,663,613, CANC. INT. CL. 35.
1,663,614, CANC. INT. CL. 35.
- TULA'S TUTUS, LLC, HINSDALE, IL:
2,622,739, PUB. 7-2-2002. INT. CL. 25.
- TUMI, INC., SOUTH PLAINFIELD, NJ, TUMI LUGGAGE, INC., MIDDLESEX, NJ:
1,689,565, REN. 8-10-02. INT. CL. 18.
- TURF MANAGEMENT SYSTEMS INC., MISSISSAUGA, ONTARIO, CANADA:
1,176,517, CANC. INT. CL. 37.
- TURKEY & SPICE SYSTEMS, INC., NORTH PALM BEACH, FL:
1,932,709, CANC. INT. CL. 42.

- TURNER LEARNING, INC., ATLANTA, GA:
2,623,075, PUB. 7-2-2002. INT. CL. 41.
- TURNER, LAN H., PROVIDENCE, UT:
2,625,005, PUB. 7-2-2002. INT. CL. 9.
- TURNER, NOEL A., NEWPORT BEACH, CA:
1,934,178, CANC. INT. CL. 29.
- TURRISI, THOMAS JAMES, FAIRFAX, VA:
1,933,126, CANC. INT. CL. 15.
- TUTHILL CORPORATION, HINSDALE, IL:
1,766,545, REN. 8-16-02. INT. CL. 7.
- TUV AMERICA, INC., DANVERS, MA FROM TUV PRO-
DUCT SERVICE, INC., DANVERS, MA:
2,625,469, U.S. CL. A.
- TV SHOPPING SOURCE, INC., THE, NEW CANAAN, CT:
2,540,720, COR. INT. CL. 3.
- TWENTIETH CENTURY FOX FILM CORPORATION, LOS
ANGELES, CA:
2,623,492, PUB. 7-24-2001. INT. CL. 41.
2,624,493, PUB. 7-2-2002. INT. CL. 38.
2,625,182, PUB. 7-2-2002. INT. CL. 9.
2,625,497, INT. CL. 28.
- TWI INTERACTIVE, INC., NEWTON, CENTRE, MA:
2,626,879, INT. CL. 41.
- TWIN LABORATORIES, INC., RONKONKOMA, NY:
1,932,427, CANC. INT. CL. 5.
- TWINSIES INC., LOS ANGELES, CA:
2,623,645, PUB. 7-2-2002. MULTIPLE CLASS, INT. CLS. 14
AND 26.
- TWO LITTLE FISHIES INC., COCONUT GROVE, FL:
2,625,120, PUB. 7-2-2002. INT. CL. 1.
- TWO QUEENS, INC., NEW YORK, NY:
2,622,840, PUB. 7-2-2002. INT. CL. 16.
- TWO TSUNAMI PRODUCTIONS, INC., BROOKLYN, NY:
2,622,634, PUB. 5-21-2002. INT. CL. 25.
- TXI OPERATIONS, LP, DALLAS, TX:
2,625,688, INT. CL. 37.
- TYCO ELECTRONICS CORPORATION, MIDDLETOWN,
PA:
2,624,480, PUB. 7-2-2002. INT. CL. 9.
- TYCO INDUSTRIES, INC., MT. LAUREL, NJ:
1,933,545, CANC. INT. CL. 28.
- TYCO PLASTICS LP, MINNEAPOLIS, MN, CARLISLE
PLASTICS, INC., MINNEAPOLIS, MN:
1,693,094, REN. 8-14-02. INT. CL. 22.
- TZUNG WEI CO., LTD., FENG YUAN CITY, TAICHUNG
HSIEN, TAIWAN:
2,626,192, INT. CL. 17.
- U SCRIPT CORP., FLEMINGTON, NJ:
2,625,408, INT. CL. 36.
- U.B. TUFF LLC, PERTH AMBOY, NJ:
2,625,994, INT. CL. 25.
- U.S. CONCEPTS, INC., NEW YORK, NY:
1,934,483, CANC. INT. CL. 41.
- U.S. COUNCIL ON INTERNATIONAL BANKING, INC.,
NEW YORK, NY:
1,933,756, CANC. MULTIPLE CLASS, INT. CLS. 41 AND
42.
- U.S. DEPARTMENT OF THE TREASURY, FINANCIAL
MANAGEMENT SERVICE, WASHINGTON, DC:
2,625,792, INT. CL. 36.
- U.S. ETHICALS, INC., LONG ISLAND CITY, NY:
723,509, CANC. U.S. CL. 18.
723,510, CANC. U.S. CL. 18.
- U.S. HOME MORTGAGE, LLC, KIRKLAND, WA:
2,624,822, PUB. 7-2-2002. INT. CL. 36.
- U.S. MAGNETICS CORP., EDISON, NJ:
1,932,897, CANC. INT. CL. 9.
- U.S.E. HICKSON PRODUCTS LTD., SCARBOROUGH, ON-
TARIO, CANADA:
2,625,749, MULTIPLE CLASS, INT. CLS. 17 AND 19.
- UARCO INCORPORATED, BARRINGTON, IL:
1,176,175, CANC. INT. CL. 16.
- UCB, SOCIETE ANONYME, 60, BRUXELLES, BELGIUM:
2,624,111, PUB. 7-2-2002. INT. CL. 1.
2,624,112, PUB. 7-2-2002. INT. CL. 1.
- UCSF STANFORD HEALTH CARE, SAN FRANCISCO, CA
FROM UCSF STANFORD HEALTH CARE, SAN FRAN-
CISCO, CA:
2,625,555, INT. CL. 41.
2,625,556, INT. CL. 42.
- UDV NORTH AMERICA, INC.:
See—GUINNESS UDV NORTH AMERICA, INC..
- UGG HOLDINGS, INC., GOLETA, CA:
2,624,802, PUB. 7-2-2002. INT. CL. 25.
- UGI PRODUCTIONS, INC., READING, PA:
1,933,234, CANC. INT. CL. 41.
- ULTA3 COSMETICS & SALON, INC., ROMEVILLE, IL:
1,663,840, CANC. INT. CL. 42.
1,663,842, CANC. INT. CL. 42.
- ULTRA LUCCA, INC., SAN LEANDRO, CA TO ULTRA
LUCCA, INC., SAN LEANDRO, CA:
2,435,553, COR. INT. CL. 42.
- ULTRA POLY, INC., TACOMA, WA:
1,744,531, REN. 8-14-02. INT. CL. 17.
- ULTRADENT PRODUCTS, INC., SOUTH JORDAN, UT:
2,626,056, INT. CL. 10.
- UMAX DATA SYSTEMS INC., SCIENCE-BASED INDUS-
TRIAL PARK HSINCHU, TAIWAN:
2,623,105, PUB. 7-2-2002. INT. CL. 9.
- UMBANET, INC., NEW YORK, NY:
2,626,010, INT. CL. 9.
- UNAXIS USA, INC., ST. PETERSBURG, FL FROM PLASMA-
THERM, INC., ST. PETERSBURG, FL:
2,622,559, PUB. 7-2-2002. INT. CL. 7.
- UNCLE MILTON INDUSTRIES, INC., WESTLAKE VIL-
LAGE, CA:
2,626,799, INT. CL. 9.
- UND AEROSPACE FOUNDATION, THE, GRAND FORKS,
ND:
1,734,156, REN. 8-15-02. INT. CL. 41.
- UNI-SELECT INC., PROVINCE OF QUEBEC, CANADA:
2,622,807, PUB. 7-2-2002. INT. CL. 35.
- UNIBALL, INC., DANVILLE, CA:
1,176,360, CANC. INT. CL. 28.
- UNIFLORA OVERSEAS FLORIDA, INC., OKAHUMPKA,
FL:
1,208,821, REN. 8-14-02. INT. CL. 31.
- UNIFORM CODE COUNCIL, INC., LAWRENCEVILLE, NJ:
2,622,879, PUB. 7-2-2002. INT. CL. 16.
- UNIGLOBE TRAVEL (INTERNATIONAL) INC., VANCOU-
VER, BRITISH COLUMBIA:
2,557,967, COR. MULTIPLE CLASS, INT. CLS. 39 AND
42.
- UNILENS CORP., U.S.A., LARGO, FL:
2,622,712, PUB. 3-28-2000. INT. CL. 9.
- UNILOCK, LTD., GEORGETOWN, ONTARIO:
2,623,026, PUB. 7-2-2002. MULTIPLE CLASS, INT. CLS. 19
AND 42.
- UNILOCK, LTD., GEORGETOWN, ONTARIO, CANADA:
2,623,027, PUB. 7-2-2002. MULTIPLE CLASS, INT. CLS. 19
AND 42.
- UNILOY MILACRON INC., MANCHESTER, MI:
2,626,003, INT. CL. 7.
- UNIMAX TOYS LIMITED, KOWLOON, HONG KONG:
2,626,302, INT. CL. 28.
- UNIMAX TOYS LIMITED, TSIM SHA TSUI, KOWLOON,
HONG KONG:
2,626,548, INT. CL. 28.
- UNIMIN CORPORATION, NEW CANAAN, CT:
2,625,691, INT. CL. 1.
- UNION BANK, LOS ANGELES, CA:
1,176,482, CANC. INT. CL. 36.
- UNION BANKERS INSURANCE COMPANY, DALLAS, TX:
1,174,523, REN. 8-15-02. INT. CL. 36.
- UNION CAMP CORPORATION, WAYNE, NJ:
1,176,168, CANC. INT. CL. 16.
- UNION MEMORIAL HOSPITAL, INC., BALTIMORE, MD:
2,624,351, PUB. 7-2-2002. INT. CL. 42.
- UNION SCIENTIFIC CORPORATION, RANDALLSTOWN,
MD:
2,626,166, INT. CL. 9.
- UNION SPECIAL CORPORATION, CHICAGO, IL:
1,933,356, CANC. INT. CL. 7.

- UNIONTOOLS, INC., COLUMBUS, OH:
2,624,897, PUB. 7-2-2002. INT. CL. 8.
- UNIQUE FILING & STORAGE, LTD., ROCKVILLE CENTRE, NY:
1,933,852, CANC. INT. CL. 20.
- UNIQUEFOCUS, INC., MONTEREY, CA:
2,623,331, PUB. 7-2-2002. MULTIPLE CLASS, INT. CLS. 41 AND 42.
- UNIRADIO CORP., SAN DIEGO, CA:
2,625,084, PUB. 7-2-2002. MULTIPLE CLASS, INT. CLS. 38 AND 41.
- UNIROYAL CHEMICAL COMPANY, INC., MIDDLEBURY, CT FROM UNIROYAL CHEMICAL COMPANY, INC., MIDDLEBURY, CT:
2,626,193, INT. CL. 1.
- UNIROYAL, INC., NEW YORK, NY:
723,615, CANC. U.S. CL. 35.
- UNISTRUT INTERNATIONAL CORP., ANN ARBOR, MI:
1,663,307, CANC. INT. CL. 9.
- UNITED AIR LINES, INC., CHICAGO, IL:
2,623,171, PUB. 7-2-2002. INT. CL. 39.
- UNITED AIRLINES EMPLOYEES' CREDIT UNION, CHICAGO, IL:
2,623,520, PUB. 7-2-2002. INT. CL. 36.
- UNITED BANK CLUB ASSOCIATION, INC., NORMAN, OK, DBA UNITED BANK SERVICES:
1,663,625, CANC. INT. CL. 36.
- UNITED DOMINION INDUSTRIES, INC., CHARLOTTE, NC, UNITED DOMINION INDUSTRIES, INC., CHARLOTTE, NC:
1,197,161, REN. 8-15-02. INT. CL. 9.
- UNITED DOMINION INDUSTRIES, INC., MUSKEGON, MI:
2,624,708, PUB. 7-2-2002. INT. CL. 35.
- UNITED ELECTRONIC INDUSTRIES, INC., WATERTOWN, MA:
2,625,525, INT. CL. 9.
- UNITED GUARANTY CORPORATION, GREENSBORO, NC:
2,623,632, PUB. 7-2-2002. INT. CL. 36.
- UNITED PUBLICATIONS, INC., YARMOUTH, ME:
1,934,469, CANC. INT. CL. 16.
- UNITED SLEEP PRODUCTS, INC., DENVER, PA:
2,626,146, INT. CL. 20.
- UNITED SPIRITS COMPANY, SAN JUAN CAPISTRANO, CA:
2,622,516, PUB. 7-2-2002. INT. CL. 33.
- UNITED STATES AVIEX COMPANY, NILES, MI:
1,175,645, CANC. MULTIPLE CLASS, INT. CLS. 1, 3 AND 4.
- UNITED STATES DISTILLED PRODUCTS COMPANY, PRINCETON, MN:
1,729,721, REN. 8-15-02. INT. CL. 33.
- UNITED STATES FILTER CORPORATION, PALM DESERT, CA:
2,626,519, INT. CL. 1.
- UNITED STATES HISPANIC CHAMBER OF COMMERCE, WASHINGTON, DC:
2,625,211, PUB. 7-2-2002. INT. CL. 35.
- UNITED STATES PLAYING CARD COMPANY, THE, CINCINNATI, OH:
2,623,030, PUB. 7-2-2002. INT. CL. 16.
- UNITED STATES POSTAL SERVICE, WASHINGTON, DC:
1,176,538, CANC. MULTIPLE CLASS, INT. CLS. 38 AND 39.
- UNITED STATES SHOE CORPORATION, THE, CINCINNATI, OH:
1,176,325, CANC. INT. CL. 25.
- UNITED STATES STEEL CORPORATION, PITTSBURGH, PA, USX CORPORATION, PITTSBURGH, PA:
1,692,390, REN. 8-13-02. INT. CL. 6.
- UNITED STEEL ENTERPRISES, INC., EAST STROUDSBURG, PA, DBA UNITED STEEL PRODUCTS COMPANY:
2,626,410, INT. CL. 6.
- UNITED SUCCESS INTERNATIONAL INCORPORATED, DALY CITY, CA:
2,625,921, MULTIPLE CLASS, INT. CLS. 18 AND 25.
- UNITED VAN LINES, LLC, FENTON, MO:
2,624,746, PUB. 7-2-2002. INT. CL. 39.
- UNITERS S.P.A., MONTECCHIO MAGGIORE, ITALY:
2,623,873, PUB. 7-2-2002. INT. CL. 3.
2,623,874, PUB. 7-2-2002. INT. CL. 3.
- UNIVERSAL CITY STUDIOS, INC., UNIVERSAL CITY, CA:
1,702,643, REN. 8-14-02. INT. CL. 41.
2,626,307, INT. CL. 25.
2,626,310, INT. CL. 41.
- UNIVERSAL COOPERATIVES, INC., EAGAN, MN:
2,624,354, PUB. 7-2-2002. INT. CL. 22.
- UNIVERSAL TRACKING SERVICES, INC., CORVALLIS, OR:
2,622,851, PUB. 7-2-2002. MULTIPLE CLASS, INT. CLS. 16, 41 AND 42.
- UNIVERSEOFFUN.COM, INC., BUFFALO GROVE, IL:
2,623,593, PUB. 7-2-2002. INT. CL. 42.
- UNIVERSITY OF IOWA, THE, IOWA CITY, IA:
2,623,316, PUB. 7-2-2002. MULTIPLE CLASS, INT. CLS. 41 AND 42.
- UNIVERSITY OF NORTH CAROLINA AT CHARLOTTE, THE, CHARLOTTE, NC:
2,626,924, INT. CL. 25.
- UNIVERSITY OF SOUTHERN MISSISSIPPI, THE, HATTIESBURG, MS:
2,623,654, PUB. 7-2-2002. MULTIPLE CLASS, INT. CLS. 16, 20, 21 AND 25.
- UPPER DECK COMPANY, LLC, THE, CARLSBAD, CA:
2,623,842, PUB. 7-2-2002. MULTIPLE CLASS, INT. CLS. 16, 25 AND 28.
- UPTILT, INC., REDWOOD CITY, CA:
2,623,037, PUB. 7-2-2002. INT. CL. 42.
- URBAN RESIDENTIAL PARTNERS, LLC, MINDEN, NV:
2,627,017, INT. CL. 36.
- URBAN WAFER COMPANY INC., CALGARY, AB T2E 7A4, CANADA:
2,626,366, INT. CL. 30.
- URBAN WIRELESS, INC., NEW YORK, NY:
2,622,609, PUB. 7-2-2002. INT. CL. 38.
- UROMED CORPORATION, WATERTOWN, MA:
1,933,763, CANC. INT. CL. 10.
- US AIRWAYS FEDERAL CREDIT UNION, MOON TOWNSHIP, PA:
2,624,531, PUB. 7-2-2002. INT. CL. 36.
- US WEEKLY LLC, NEW YORK, NY:
2,626,958, INT. CL. 16.
- USA WOODS INTERNATIONAL, INC., MEMPHIS, TN:
2,623,087, PUB. 7-2-2002. INT. CL. 35.
- USADVANTAGE HEALTH PRODUCTS, LLC, GREEN BAY, WI FROM ICP, INC., GREEN BAY, WI:
2,625,762, INT. CL. 35.
- USI GROUP, INC., UPPER DARBY, PA:
2,622,965, PUB. 7-2-2002. INT. CL. 35.
- USSERY, TROY A., PLANO, TX:
2,626,826, INT. CL. 9.
2,626,827, INT. CL. 36.
- UTXL ENTERPRISES, INC., KANSAS CITY, MO FROM UTS, INC., KANSAS CITY, MO:
2,626,032, INT. CL. 39.
- UVA SUN SYSTEMS, INC., GREENSBORO, NC:
2,623,417, PUB. 7-2-2002. INT. CL. 11.
- UVEX SAFETY, INC., SMITHFIELD, RI:
1,933,896, CANC. INT. CL. 8.
- UVIEW ULTRAVIOLET SYSTEMS INC., MISSISSAUGA, ONTARIO, CANADA:
2,622,818, PUB. 7-2-2002. INT. CL. 11.
- V.T.S.S., INC., NEW YORK, NY:
2,622,997, PUB. 11-6-2001. INT. CL. 35.
- VAC-ALERT IP HOLDINGS, L.L.C., FT. PIERCE, FL:
2,624,127, PUB. 7-2-2002. INT. CL. 11.
- VAL LESINA SPA, 23014 ANDALO VALTELLINO (SO), ITALY:
1,693,095, REN. 8-13-02. INT. CL. 23.
- VALHALLA VINEYARDS, LLC, ROANOKE, VA:
2,626,268, INT. CL. 33.
- VALLEY MANUFACTURING, INCORPORATED, TROY, NY:
2,625,977, INT. CL. 16.
- VALLEY MEAT COMPANY, MODESTO, CA:
2,625,075, PUB. 7-2-2002. INT. CL. 29.

- VALU TRAVEL MARKETING, INC., BOWIE, MD:
1,933,433, CANC. INT. CL. 35.
- VAN HERWYNEN, DIANNE, HEWITT, NJ:
2,626,973, INT. CL. 28.
- VAN MELLE NEDERLAND B.V., 4815 HK BREDA, NETHERLANDS:
2,625,490, INT. CL. 30.
- VAN ROOY ENTERPRISES, LLC, E. GRAND RAPIDS, MI:
2,624,725, PUB. 7-2-2002. INT. CL. 12.
- VANDERBILT UNIVERSITY, THE, NASHVILLE, TN:
2,624,338, PUB. 7-2-2002. MULTIPLE CLASS, INT. CLS. 41 AND 42.
2,624,445, PUB. 7-2-2002. MULTIPLE CLASS, INT. CLS. 41 AND 42.
- VANDOR CORPORATION, RICHMOND, IN:
1,933,605, CANC. INT. CL. 20.
- VANGUARD GROUP, INC., THE, MALVERN, PA:
2,625,299, PUB. 7-2-2002. INT. CL. 36.
- VANMOOR, ARTHUR, BOCA RATON, FL:
2,626,815, INT. CL. 5.
2,626,823, INT. CL. 42.
- VANS, INC., SANTA FE SPRINGS, CA:
2,623,752, PUB. 7-2-2002. INT. CL. 25.
- VANSOLKEMA FARMS, INC., BYRON CENTER, MI:
1,176,424, CANC. INT. CL. 31.
- VARCON SYSTEMS, INC., SAN DIEGO, CA:
2,626,702, INT. CL. 9.
- VARIAN ASSOCIATES, INC., PALO ALTO, CA:
1,933,201, CANC. INT. CL. 9.
- VARTEC TELECOM, INC.:
See— TRUSTEES OF THE VARTEC BUSINESS TRUST, THE.
- VAST SYSTEMS TECHNOLOGY CORPORATION, SUNNYVALE, CA:
2,623,119, PUB. 7-2-2002. INT. CL. 9.
- VAUGHAN, SARABETH, LAFAYETTE, IN FROM RISK, MELINDA B., WEST LAFAYETTE, IN AND VAUGHAN, SARABETH, WEST LAFAYETTE, IN:
2,626,073, INT. CL. 14.
- VAUGHAN, SARABETH, LAFAYETTE, IN:
2,626,213, INT. CL. 14.
- VCE, INC, SYLMAR, CA:
2,624,598, PUB. 7-2-2002. INT. CL. 40.
- VDSL SYSTEMS OY, 02150 ESPOO, FINLAND:
2,626,832, MULTIPLE CLASS, INT. CLS. 9 AND 37.
- VEAL CONNECTION CORP., THE, SANTA ROSA, CA:
1,934,050, CANC. INT. CL. 29.
- VECTOR STRATEGIC RESOURCES, INC., NEW YORK, NY:
2,623,549, PUB. 7-2-2002. MULTIPLE CLASS, INT. CLS. 35 AND 41.
- VECTORNET INTEGRATED SOLUTIONS, CARLSBAD, CA:
2,624,991, PUB. 7-2-2002. INT. CL. 42.
- VECTREN COMMUNICATIONS SERVICES, INC., EVANSVILLE, IN:
2,623,160, PUB. 7-2-2002. MULTIPLE CLASS, INT. CLS. 35, 37 AND 42.
- VEE-JAY LIMITED PARTNERSHIP, REDDING, CT:
2,626,233, INT. CL. 9.
- VELARDI, PAUL J., BREWSTER, NY:
2,626,119, INT. CL. 42.
- VELIQUETTE, CYNTHIA CHERYL, SOLANA BEACH, CA:
2,625,828, INT. CL. 9.
- VELSICOL CHEMICAL CORPORATION, CHICAGO, IL:
716,684, CANC. U.S. CL. 6.
- VEND-IT CORP., PERRYSBURG, OH:
1,933,466, CANC. INT. CL. 9.
- VENGRA DESIGN GROUP, INC., CHANHASSEN, MN:
2,625,672, INT. CL. 20.
- VENINI S.P.A., 50 MURANO-VENEZIA, ITALY:
1,176,689, CANC. INT. CL. 21.
- VENTANA MEDICAL SYSTEMS, INC., TUCSON, AZ:
2,624,313, PUB. 7-2-2002. INT. CL. 1.
- VENTRY, LTD., LOCUST, NJ:
2,624,081, PUB. 7-2-2002. INT. CL. 20.
- VENVEST, INC., ST. LOUIS, MO:
2,625,175, PUB. 7-2-2002. INT. CL. 37.
- VERANT INTERACTIVE, INC., SAN DIEGO, CA:
2,625,072, PUB. 7-2-2002. MULTIPLE CLASS, INT. CLS. 35, 38, 41 AND 42.
- VERBATIM CORPORATION, CHARLOTTE, NC:
2,624,980, PUB. 1-22-2002. INT. CL. 9.
- VERESTAR, INC., FAIRFAX, VA FROM ATC TELEPORTS, INC., FAIRFAX, VA:
2,626,061, INT. CL. 38.
- VERIMETRA, INC., PITTSBURGH, PA:
2,624,004, PUB. 7-2-2002. MULTIPLE CLASS, INT. CLS. 40 AND 42.
- VERIS NAHRUNGSMITTEL GMBH, D-55425 WALDALGESHEIM, FED REP GERMANY:
2,519,143, COR. MULTIPLE CLASS, INT. CLS. 1, 29 AND 30.
- VERMONT TEDDY BEAR COMPANY, INC., THE, SHELBURNE, VT:
2,625,569, INT. CL. 39.
- VERMONT WARE, INC., ST. GEORGE, VT:
2,626,834, MULTIPLE CLASS, INT. CLS. 12 AND 40.
- VERTIGO DEVELOPMENT GROUP, INC., CAMBRIDGE, MA:
1,933,751, CANC. INT. CL. 9.
- VESTEL ELEKTRONIK SANAYI VE TICARET AS, 45030 MANISA, TURKEY:
2,625,584, MULTIPLE CLASS, INT. CLS. 9 AND 11.
- VESTIDITOS S.A., BUENOS AIRES, ARGENTINA:
2,625,374, INT. CL. 25.
- VETBLE U.S.A. COMPANY, SAN JOSE, CA:
2,626,704, INT. CL. 12.
- VI-JON LABORATORIES, INC., ST. LOUIS, MO, DBA VI-JON, INC.:
2,626,533, INT. CL. 3.
- VIACOM INTERNATIONAL INC., NEW YORK, NY:
1,687,641, REN. 8-16-02. INT. CL. 9.
2,623,429, PUB. 7-2-2002. INT. CL. 41.
2,624,048, PUB. 7-2-2002. INT. CL. 38.
2,624,049, PUB. 7-2-2002. INT. CL. 41.
2,624,278, PUB. 7-2-2002. INT. CL. 25.
- VIAQUEST, INC., ENCINO, CA:
2,626,720, MULTIPLE CLASS, INT. CLS. 20 AND 24.
- VICERE ASSOCIATES, INC., STATE COLLEGE, PA:
2,624,787, PUB. 7-2-2002. INT. CL. 35.
2,624,788, PUB. 7-2-2002. INT. CL. 35.
- VICK COMPANIES, INC., WILLIAMSBURG, VA:
2,625,852, INT. CL. 42.
- VICTAULIC DEPEND-O-LOK, INC., DORAVILLE, GA FROM BRICO INDUSTRIES, INC., ATLANTA, GA:
2,623,294, PUB. 7-2-2002. INT. CL. 17.
- VICTOR F. WEAVER, INC., NEW HOLLAND, PA:
1,176,696, CANC. INT. CL. 29.
- VICTORIA EYE CENTER, P.A., VICTORIA, TX:
2,623,953, PUB. 7-2-2002. INT. CL. 42.
- VICTORY ENERGY OPERATIONS, L.L.C., OWASSO, OK:
2,624,656, PUB. 7-2-2002. INT. CL. 11.
- VIDEO CORPORATION OF AMERICA, SOMERSET, NJ:
1,708,701, REN. 8-14-02. MULTIPLE CLASS, INT. CLS. 37, 40, 41 AND 42.
- VIDEO LOTTERY TECHNOLOGIES, INC.:
See— POWERHOUSE TECHNOLOGIES, INC..
- VIDERE GROUP LLP, THE, PARSIPPANY, NJ:
2,624,883, PUB. 7-2-2002. INT. CL. 35.
- VIDERE, LLC, LAKE OSWEGO, OR:
2,622,928, PUB. 7-2-2002. MULTIPLE CLASS, INT. CLS. 38 AND 42.
- VIENNA SAUSAGE MANUFACTURING COMPANY, CHICAGO, IL:
2,624,116, PUB. 7-2-2002. INT. CL. 29.
- VIGORO INDUSTRIES, INC., FAIRVIEW HEIGHTS, IL:
1,932,719, CANC. MULTIPLE CLASS, INT. CLS. 1 AND 5.
- VIGORTONE AG PRODUCTS, INC., CEDAR RAPIDS, IA:
2,625,016, PUB. 2-12-2002. INT. CL. 31.
- VIKING INDUSTRIES, INC., PORTLAND, OR:
1,198,454, REN. 8-16-02. MULTIPLE CLASS, INT. CLS. 6 AND 37.
- VILLAGE VOICE MEDIA, INC., NEW YORK, NY:
2,623,303, PUB. 7-2-2002. INT. CL. 16.
- VILLANI S.P.A., 45051 CASTELNUOVO RANGONE (MO), ITALY:
2,623,164, PUB. 3-5-2002. INT. CL. 29.

- VINCENT, JEAN, 01250 JOURNANS, FRANCE:
2,624,159, PUB. 7-2-2002. MULTIPLE CLASS, INT. CLS. 9 AND 28.
- VINCI ENVIRONNEMENT, 92500 RUEIL-MALMAISON, FRANCE:
2,623,902, PUB. 7-2-2002. MULTIPLE CLASS, INT. CLS. 7, 11 AND 40.
- VINEYARDS LLC, ST. HELENA, CA, MERRYVALE VENTURE, ST. HELENA, CA, DBA MERRYVALE VINEYARDS:
1,740,093. REN. 8-15-02. INT. CL. 33.
- VINTNERS EDGE, INC., EAST AMHERST, NY:
2,625,756, INT. CL. 33.
- VIR-AMERICA, INC, LAS VEGAS, NV:
2,623,347, PUB. 7-2-2002. INT. CL. 41.
- VIRGIN ENTERPRISES LIMITED, LONDON W8 7AR, GB2, ENGLAND:
2,622,510, PUB. 7-2-2002. INT. CL. 36.
- VIRGIN ENTERPRISES LIMITED, LONDON W8 7AR, ENGLAND:
2,625,455, MULTIPLE CLASS, INT. CLS. 35 AND 38.
- VIRGIN RENTALS OF AMERICA, INC., NORWALK, CT:
2,625,329, MULTIPLE CLASS, INT. CLS. 41 AND 42.
- VIRKE OY, 16301 ORIMATTILA, FINLAND:
1,710,777. REN. 8-12-02. INT. CL. 25.
- VIRTUAL EQUESTRIAN, LLC, STAMFORD, CT:
2,623,617, PUB. 7-2-2002. INT. CL. 38.
- VIRTUAL WORLD ENTERTAINMENT, INC., LOS ANGELES, CA:
1,933,494, CANC. INT. CL. 41.
- VIRTUAL, INC., SAN JUAN, PUERTO RICO:
2,625,667, MULTIPLE CLASS, INT. CLS. 35 AND 36.
2,625,668, MULTIPLE CLASS, INT. CLS. 38 AND 42.
- VISA INTERNATIONAL SERVICE ASSOCIATION, FOSTER CITY, CA:
2,623,006, PUB. 7-2-2002. INT. CL. 36.
- VISALIA CITRUS PACKERS, VISALIA, CA:
1,176,430, CANC. INT. CL. 31.
- VISION INTERNATIONAL, INC., SALT LAKE CITY, UT:
2,623,059, PUB. 7-2-2002. INT. CL. 42.
- VISION PARTNERS, L.P.:
See—ISCREEN, LLC.
- VISION SOLUTIONS, INC., IRVINE, CA:
2,624,687, PUB. 7-2-2002. INT. CL. 9.
- VISIONARY SOLUTIONS, INC., LANSDALE, PA:
2,625,261, PUB. 7-2-2002. INT. CL. 9.
- VISIONEER COMMUNICATIONS, INC., PALO ALTO, CA TO SCANSOFT, INC., PEABODY, MA:
1,998,734, AM. INT. CL. 9.
- VISIWORLD AS, 4068 STAVANGER, NORWAY:
2,624,450, PUB. 7-2-2002. MULTIPLE CLASS, INT. CLS. 9, 35 AND 42.
2,624,451, PUB. 7-2-2002. MULTIPLE CLASS, INT. CLS. 9, 35 AND 42.
- VISTA INFORMATION TECHNOLOGIES, INC., HERNDON, VA:
2,623,415, PUB. 7-2-2002. INT. CL. 42.
- VISTEON CORPORATION, DEARBORN, MI FROM FORD MOTOR COMPANY, DEARBORN, MI:
2,625,549, INT. CL. 11.
2,625,550, INT. CL. 11.
2,625,551, INT. CL. 11.
2,625,553, INT. CL. 11.
- VISUAL GRAPHIC SYSTEMS INC., NEW YORK, NY:
2,624,317, PUB. 7-2-2002. INT. CL. 20.
2,624,610, PUB. 7-2-2002. INT. CL. 20.
- VISUAL NUMERICS, INC., HOUSTON, TX:
1,663,225, CANC. MULTIPLE CLASS, INT. CLS. 9 AND 16.
- VITAL DYNAMICS, INC., CANOGA PARK, CA:
2,624,564, PUB. 7-2-2002. INT. CL. 3.
- VITAWELL S.P. A., ITALY:
2,623,670, PUB. 7-2-2002. INT. CL. 28.
- VITECH AMERICA CORPORATION, KENT, WA:
2,623,878, PUB. 7-2-2002. INT. CL. 30.
- VKR HOLDING A/S, DK-2860, SOBORG, DENMARK, V. KANN RASMUSSEN INDUSTRI A/S, DK-2860 SOBORG, DENMARK:
1,715,175. REN. 8-13-02. INT. CL. 9.
- VMG TECHNOLOGIES, ST. PETERSBURG, FL:
2,625,714, MULTIPLE CLASS, INT. CLS. 37 AND 42.
- VMS-KEYTRADE S.A., 1170 BRUXELLES, BELGIUM:
2,623,071, PUB. 7-2-2002. MULTIPLE CLASS, INT. CLS. 36, 38 AND 42.
- VNA-COMMUNITY SERVICES, INC., ABINGTON, PA:
2,625,331, INT. CL. 42.
- VNU BUSINESS MEDIA, INC. A DELAWARE CORPORATION, NEW YORK, NY FROM MFI HOLDINGS, INC., SAN FRANCISCO, CA:
2,623,117, PUB. 7-2-2002. INT. CL. 16.
- VNU BUSINESS PRESS SYNDICATION INTERNATIONAL B V, 2003 EA HAARLEM, NETHERLANDS:
1,934,471, CANC. INT. CL. 16.
- VOELTZ, LELAND, RANCHO PALOS VERDES, CA:
1,933,449, CANC. INT. CL. 31.
- VOGEL PETERSON FURNITURE COMPANY, ELMHURST, IL:
1,933,405, CANC. INT. CL. 20.
- VOICEDATA WARE INC., IRVING, TX:
2,623,200, PUB. 7-2-2002. MULTIPLE CLASS, INT. CLS. 9 AND 38.
- VOLKSWAGEN AKTIENGESELLSCHAFT, D-38436 WOLFSBURG, FED REP GERMANY:
2,622,996, PUB. 7-2-2002. MULTIPLE CLASS, INT. CLS. 12, 28 AND 37.
- VON STAFF REITZENSTEIN, HANS, D-95176, KONRADREUTH, FED REP GERMANY:
2,625,920, INT. CL. 41.
- VOPAK USA INC., KIRKLAND, WA, VAN WATERS & ROGERS INC., KIRKLAND, WA:
1,717,285. REN. 8-14-02. INT. CL. 1.
- VOPAK USA INC., KIRKLAND, WA, VAN WATERS & ROGERS INC., SEATTLE, WA:
1,717,286. REN. 8-10-02. INT. CL. 1.
- VORTRAN MEDICAL TECHNOLOGY, INC., SACRAMENTO, CA:
1,933,875, CANC. INT. CL. 10.
- VOYAGER EXPANDED LEARNING, INC., DALLAS, TX FROM VOYAGER EXPANDED LEARNING SYSTEMS, INC., DALLAS, TX:
2,626,404, MULTIPLE CLASS, INT. CLS. 16 AND 41.
- VTRANSCRIBE, INC., BELLEVUE, WA:
2,623,751, PUB. 7-2-2002. INT. CL. 35.
- VULCAN INDUSTRIES, INC., MISSOURI VALLEY, IA:
1,933,793, CANC. INT. CL. 11.
- W. ATLEE BURPEE COMPANY, WARMINSTER, PA:
1,690,412. REN. 8-14-02. MULTIPLE CLASS, INT. CLS. 31 AND 42.
- W. L. GORE & ASSOCIATES, INC., NEWARK, DE:
2,625,728, INT. CL. 15.
- W.C. BRADLEY/ZEBCO HOLDINGS, INC., COLUMBUS, GA, DBA ZEBCO FROM BRUNSWICK CORPORATION, LAKE FOREST, IL:
2,626,933, INT. CL. 28.
- W.C. SPORTS, LLC, MILFORD, CT:
2,185,063, COR. INT. CL. 41.
- W.C. SPORTS, LLC, SEYMOUR, CT:
2,362,572, COR. MULTIPLE CLASS, INT. CLS. 16 AND 25.
- W.D. HILTON, JR., JAMES CLAYBURN LAFORCE, GERALD S. LEVEY, M.D., THOMAS V. MCKERNAN, JR., CHRISTOPHER N. ORNDORFF, JOAN A. PAYDEN, DENNIS C. POULSEN, STENDER E. SWEENEY AND MARY BETH SYAL, ALL UNITED STATES CITIZENS, AS TRUSTEES OF THE THE PAYDEN & RYDEL INVESTMENT GROUP, LOS ANGELES, CA:
2,623,876, PUB. 7-2-2002. INT. CL. 36.
- W.M. BARR & CO., INC., MEMPHIS, TN:
1,932,781, CANC. INT. CL. 2.
- W.R. MOSHER PRODUCTIONS, INC., POCASSET, MA:
1,932,927, CANC. MULTIPLE CLASS, INT. CLS. 9 AND 41.

- W.T. LEY, P. C., AUSTIN, TX:
2,624,267, PUB. 7-2-2002. INT. CL. 42.
- WABASH NATIONAL, L.P., LAFAYETTE, IN:
2,624,209, PUB. 7-2-2002. INT. CL. 12.
- WAHLCOR, INC., KANSAS CITY, MO:
1,933,342, CANC. INT. CL. 9.
- WAINWRIGHT BANK & TRUST COMPANY, BOSTON, MA:
1,933,999, CANC. INT. CL. 36.
- WAITT FAMILY FOUNDATION, LA JOLLA, CA, DBA TED W. WAITT FAMILY FOUNDATION:
2,624,254, PUB. 7-2-2002. MULTIPLE CLASS, INT. CLS. 36 AND 42.
- WAKUNAGA OF AMERICA CO., LTD., MISSION VIEGO, CA:
1,207,444, REN. 8-16-02. INT. CL. 30.
- WAL-MART STORES, INC., BENTONVILLE, AR:
1,933,205, CANC. INT. CL. 18.
- WALCHEM CORPORATION, HOLLISTON, MA:
2,625,671, INT. CL. 38.
- WALDENBOOKS PROPERTIES, INC., ANN ARBOR, MI:
2,624,652, PUB. 7-2-2002. INT. CL. 42.
2,624,682, PUB. 7-2-2002. INT. CL. 35.
- WALGREEN CO., DEERFIELD, IL:
2,626,502, INT. CL. 9.
2,626,899, INT. CL. 10.
- WALKER; GRAHAM GEORGE, TORRANCE, CA, DBA GRAHAM WALKER GOLF COMPANY:
1,176,367, CANC. INT. CL. 28.
- WALKER, JAMES P., TUCSON, AZ:
1,716,453, REN. 8-10-02. INT. CL. 36.
- WALKER, SANDRA S., SHELTON, NE AND WALKER, DON D., SHELTON, NE:
2,624,469, PUB. 7-2-2002. INT. CL. 25.
- WALLACE BARNES COMPANY, THE, BRISTOL, CT, TELEDYNE INDUSTRIES, INC., LOS ANGELES, CA, DBA TELEDYNE HYSON:
1,717,532, REN. 8-13-02. INT. CL. 7.
- WALLACE INTERNATIONAL SILVERSMITHS, INC., EAST BOSTON, MA:
2,626,530, INT. CL. 8.
2,626,531, INT. CL. 8.
- WALSH DISTRIBUTION, INC.:
See— WALSH HEALTHCARE SOLUTIONS, INC.
- WALSH HEALTHCARE SOLUTIONS, INC., TEXARKANA, TX FROM WALSH DISTRIBUTION, INC., TEXARKANA, TX:
2,622,926, PUB. 7-2-2002. MULTIPLE CLASS, INT. CLS. 35 AND 42.
- WALT DISNEY COMPANY, THE, BURBANK, CA:
1,933,612, CANC. INT. CL. 28.
- WALTER, DEBRA A., LINCOLN, NE:
2,626,629, INT. CL. 42.
- WALTER, TIM, CARPENTER, SD:
2,623,133, PUB. 8-7-2001. MULTIPLE CLASS, INT. CLS. 29 AND 31.
- WAMWARE, LTD, INCLINE VILLAGE, NV:
2,623,313, PUB. 7-2-2002. INT. CL. 42.
- WANDRES GMBH MICRO-CLEANING, 79256 BUCHENBACH-WAGENSTEIG, FED REP GERMANY:
2,623,279, PUB. 7-2-2002. INT. CL. 7.
- WANG, CHING-YUNG, TAICHUNG HSIEN, TAIWAN:
2,626,433, INT. CL. 11.
- WANG, CHUNG HAO, E. ELMHURST, NY:
2,624,933, PUB. 7-2-2002. INT. CL. 35.
- WANG, PHILLIP H., ALPHARETTA, GA:
2,625,532, INT. CL. 9.
- WANOBA GROUP, INC., TORRANCE, CA:
2,625,460, INT. CL. 35.
- WANTADS.COM, INC.:
See— MILESPREE, INC.
- WARMAN INTERNATIONAL LTD., ARTARMON, NSW 2064, AUSTRALIA:
1,669,133, REN. 8-14-02. INT. CL. 6.
- WARNACO U.S., INC., BRIDGEPORT, CT FROM WARNACO INC., NEW YORK, NY:
2,625,345, INT. CL. 25.
- WARNACO U.S., INC., MILFORD, CT:
2,626,088, INT. CL. 25.
- WARNER-LAMBERT COMPANY, MORRIS PLAINS, NJ:
1,933,663, CANC. MULTIPLE CLASS, INT. CLS. 5 AND 16.
2,624,486, PUB. 7-2-2002. MULTIPLE CLASS, INT. CLS. 3 AND 5.
- WARRINGTON; PAUL, PRAIRIE VILLAGE, KS:
1,176,359, CANC. INT. CL. 28.
- WARRIOR LACROSSE, INC., WARREN, MI:
2,624,477, PUB. 11-27-2001. INT. CL. 28.
- WASHINGTON POST COMPANY, THE, WASHINGTON, DC:
2,568,219, COR. MULTIPLE CLASS, INT. CLS. 16 AND 42.
- WASHINGTONPOST.NEWSWEEK INTERACTIVE COMPANY, LLC, ARLINGTON, VA:
2,623,635, PUB. 7-2-2002. INT. CL. 42.
- WATCH HILL CONSERVANCY, THE, WESTERLY, RI:
2,624,556, PUB. 7-2-2002. INT. CL. 42.
- WATER PIK, INC., NEWPORT BEACH, CA:
2,624,850, PUB. 7-2-2002. INT. CL. 11.
- WATERBABIES LLC, EUGENE, OR:
2,623,175, PUB. 7-2-2002. INT. CL. 18.
- WATERMAN S.A., 92693 LEVALLOIS-PERRET CEDEX, FRANCE:
2,625,992, INT. CL. 16.
- WATERMARK COMMUNITIES, INC., BONITA SPRINGS, FL:
2,623,002, PUB. 7-2-2002. INT. CL. 37.
- WATERS INDUSTRIES, INC., WEST DUNDEE, IL:
2,624,782, PUB. 7-2-2002. INT. CL. 9.
2,626,878, INT. CL. 9.
- WATKINS MANUFACTURING CORPORATION, VISTA, CA:
2,626,500, INT. CL. 11.
- WATKINS-JOHNSON COMPANY, PALO ALTO, CA:
1,175,891, CANC. INT. CL. 9.
- WATSON PAPER COMPANY, ALBUQUERQUE, NM:
1,934,098, CANC. INT. CL. 16.
1,934,099, CANC. INT. CL. 16.
1,934,100, CANC. INT. CL. 16.
- WATT PUBLISHING COMPANY, MOUNT MORRIS, IL:
1,932,641, CANC. INT. CL. 16.
- WAVE SPORTS, INC., STEAMBOAT SPRINGS, CO:
1,933,153, CANC. INT. CL. 12.
- WAVERLY, INC., BALTIMORE, MD:
1,932,707, CANC. INT. CL. 16.
- WAYNE FARMS LLC., GAINESVILLE, GA:
2,624,288, PUB. 3-12-2002. INT. CL. 29.
- WAYNE TEX INC., WAYNESBORO, VA, WAYN-TEX INC., WAYNESBORO, VA:
1,195,768, REN. 8-15-02. MULTIPLE CLASS, INT. CLS. 23 AND 24.
- WAYNESBOROUGH COUNTRY CLUB, PAOLI, PA:
2,622,844, PUB. 7-2-2002. MULTIPLE CLASS, INT. CLS. 25, 28, 41 AND 42.
- WAYSIDE FURNITURE SHOPS, INC., MILFORD, CT:
1,176,615, CANC. INT. CL. 42.
- WCW, INC., STAMFORD, CT FROM WORLD CHAMPIONSHIP WRESTLING, INC., ATLANTA, GA:
2,622,813, PUB. 7-2-2002. INT. CL. 41.
- WE CARE AMERICA, INC., LAWRENCEVILLE, GA FROM CHURCHCARE AMERICA, SPRINGFIELD, MO:
2,625,382, MULTIPLE CLASS, INT. CLS. 36, 41 AND 42.
- WEALTHARBOR CAPITAL GROUP, L.L.C., NEW ORLEANS, LA:
2,625,498, INT. CL. 36.
- WEATHER CENTRAL, INC., MADISON, WI:
2,624,760, PUB. 7-2-2002. MULTIPLE CLASS, INT. CLS. 9 AND 42.
- WEAVER LEATHER, INC., MT. HOPE, OH:
2,626,515, INT. CL. 18.
- WEBB COUNTY HERITAGE FOUNDATION, LAREDO, TX:
2,623,731, PUB. 7-2-2002. INT. CL. 41.
- WEBB, JAMES W., TORRANCE, CA, DBA WEBB ENTERPRISES:
2,626,613, INT. CL. 9.
2,626,614, INT. CL. 9.

- WEBED, INC., HAMPTON, NH:
2,623,217, PUB. 7-2-2002. INT. CL. 41.
- WEBER PROTECTION AG, 6020 EMMENBRUCKE, SWITZERLAND:
1,932,578, CANC. INT. CL. 9.
- WEBLOPE, INC., OLD GREENWICH, CT:
2,623,406, PUB. 7-2-2002. INT. CL. 39.
2,623,783, PUB. 7-2-2002. INT. CL. 39.
- WEC COMPANY, ROCKFORD, IL, DBA WOODS EQUIPMENT COMPANY, HESSTON CORPORATION, HESSTON, KS:
1,187,361. REN. 8-10-02. INT. CL. 7.
- WECKERLE SALES CORPORATION, TORRANCE, CA:
1,698,267. REN. 8-14-02. INT. CL. 3.
- WEGMANS FOOD MARKETS, INC., ROCHESTER, NY:
2,623,993, PUB. 7-2-2002. INT. CL. 31.
- WEIDER NUTRITION INTERNATIONAL, INC., SALT LAKE CITY, UT TO HEALTHCO CANADA ENTERPRISES, KELOWNA, BRITISH COLUMBIA:
2,373,632 NEW CERT. 9-24-2002. INT. CL. 5.
- WEIGHT WATCHERS INTERNATIONAL, INC., JERICHO, NY:
1,663,542, CANC. INT. CL. 30.
- WEIL PUBLISHING CO., INC., AUGUSTA, ME:
2,623,656, PUB. 7-2-2002. MULTIPLE CLASS, INT. CLS. 16 AND 41.
- WEILER ENGINEERING, INC., ELGIN, IL:
2,623,385, PUB. 12-25-2001. INT. CL. 7.
- WEINBRENNER SHOE COMPANY, INC, MERRILL, WI:
2,622,672, PUB. 7-2-2002. INT. CL. 9.
- WEINSTEIN, TED, SAN FRANCISCO, CA:
1,932,551, CANC. INT. CL. 9.
- WEISER LOCK CORPORATION, TUCSON, AZ:
2,624,046, PUB. 7-2-2002. INT. CL. 6.
- WEITZMAN, KAREN, NEW YORK, NY:
2,623,540, PUB. 7-2-2002. INT. CL. 9.
2,623,541, PUB. 7-2-2002. INT. CL. 9.
2,623,545, PUB. 7-2-2002. INT. CL. 41.
- WELBILT CORPORATION, STAMFORD, CT FROM WELBILT CORPORATION, STAMFORD, CT:
2,625,510, INT. CL. 6.
- WELKER BEARING COMPANY, TROY, MI:
2,625,476, INT. CL. 7.
- WELLA CORPOATION, THE, WOODLAND HILLS, CA, WELLA CORPORATION, THE, ENGLEWOOD, NJ:
1,645,757. REN. 8-12-02. INT. CL. 3.
- WELLCOME FOUNDATION LIMITED, THE, MIDDLESEX UB6 ONN, UNITED KINGDOM:
2,622,687, PUB. 7-2-2002. INT. CL. 5.
- WELLPOINT HEALTH NETWORKS INC., THOUSAND OAKS, DE:
2,623,235, PUB. 7-2-2002. INT. CL. 36.
- WELLS FARGO & COMPANY, MINNEAPOLIS, MN:
2,622,693, PUB. 11-27-2001. INT. CL. 36.
- WELLS FARGO HOME MORTGAGE, INC, DES MOINES, IA:
2,623,701, PUB. 7-2-2002. INT. CL. 36.
- WELLS LAMONT INDUSTRY GROUP, INC., CHICAGO, IL, BETTCHER INDUSTRIES, INC., BIRMINGHAM, OH:
1,696,860. REN. 8-15-02. INT. CL. 9.
1,702,453. REN. 8-14-02. INT. CL. 9.
- WELLSTREAM, INC., PANAMA CITY, FL:
2,623,271, PUB. 10-23-2001. MULTIPLE CLASS, INT. CLS. 6 AND 17.
- WELLTECH, INC., HOUSTON, TX:
1,176,530, CANC. INT. CL. 37.
1,176,531, CANC. INT. CL. 37.
1,176,532, CANC. INT. CL. 37.
- WENTWORTH TECHNOLOGIES, INC., MISSISSAUGA, ONTARIO L4Z 1W7, CANADA:
2,623,242, PUB. 7-2-2002. INT. CL. 42.
- WEST CHEMICAL PRODUCTS, INC., LONG ISLAND CITY, NY:
723,686, CANC. U.S. CL. 52.
- WEST MARINE IHC I, INC., WATSONVILLE, CA FROM WEST MARINE IHC II, INC., WATSONVILLE, CA:
2,622,993, PUB. 1-29-2002. INT. CL. 35.
- WEST MARINE IHC II, INC.:
See— WEST MARINE IHC I, INC..
- WEST POINT-PEPPERELL ENTERPRISES, INC., WILMINGTON, DE FROM WEST POINT-PEPPERELL ENTERPRISES, INC., WILMINGTON, DE:
2,625,660, MULTIPLE CLASS, INT. CLS. 24 AND 27.
- WEST, SCOTT, ELK GROVE, CA:
2,626,778, INT. CL. 41.
- WESTCHESTER MEDIA COMPANY, L.P., HOUSTON, TX, FLEET STREET PUBLISHING CORPORATION, GAITHERSBURG, MD:
1,677,088. REN. 8-10-02. INT. CL. 41.
1,710,894. REN. 8-10-02. INT. CL. 16.
- WESTERN FAMILY FOODS, INC., TIGARD, OR:
2,626,045, INT. CL. 30.
- WESTERN MANUFACTURING COMPANY, INC., NEW YORK, NY:
723,600, CANC. U.S. CL. 28.
- WESTERN PUBLISHING COMPANY, INC., RACINE, WI:
1,934,340, CANC. INT. CL. 16.
- WESTERN RESEARCH COMPANY, INCORPORATED, TUCSON, AZ:
2,623,671, PUB. 7-2-2002. INT. CL. 9.
- WESTERN, OWEN, C., SAN DIEGO, CA:
2,625,071, PUB. 7-2-2002. INT. CL. 42.
- WESTEX DESIGN CONCEPTS, LLC, CLEARWATER, FL:
2,626,204, INT. CL. 2.
- WESTINGHOUSE ELECTRIC CORPORATION, PITTSBURGH, PA:
1,933,607, CANC. INT. CL. 40.
- WESTMORELAND DAVIS MEMORIAL FOUNDATION, INCORPORATED, THE, LEESBURG, VA:
934,651. REN. 8-10-02. U.S. CL. 107 (INT. CL. 41).
- WESTRA CONSTRUCTION, INC., WAUPUN, WI:
2,623,825, PUB. 7-2-2002. INT. CL. 37.
- WESTVACO CORPORATION, STAMFORD, CT:
727,033. REN. 8-14-02. U.S. CL. 37 (INT. CL. 16).
- WESTWOOD PHARMACEUTICALS, INC., BUFFALO, NY:
148,277, CANC. U.S. CL. 6.
- WESTWOOD-SQUIBB PHARMACEUTICALS, INC., BUFFALO, NY:
1,933,446, CANC. INT. CL. 5.
- WEYERHAEUSER COMPANY, FEDERAL WAY, WA:
2,624,909, PUB. 7-2-2002. INT. CL. 19.
- WHAM-O, INC., SAN FRANCISCO, CA:
2,625,057, PUB. 7-2-2002. INT. CL. 28.
- WHIRLPOOL PROPERTIES, INC., ST. JOSEPH, MI:
2,626,659, INT. CL. 24.
- WHITAKER CORPORATION, THE, WILMINGTON, DE, AMP INCORPORATED, HARRISBURG, PA:
733,395. REN. 8-10-02. U.S. CL. 23 (INT. CL. 8).
734,486. REN. 8-10-02. U.S. CL. 21 (INT. CL. 9).
734,852. REN. 8-10-02. U.S. CL. 21 (INT. CL. 9).
- WHITE FARM EQUIPMENT COMPANY, THE, OAK BROOK, IL:
723,545, CANC. U.S. CL. 23.
- WHITE MOUNTAIN IMAGING, INC., WEBSTER, NH:
1,635,894, CANC. INT. CL. 1.
- WHITE, STEPHON, LAS VEGAS, NV:
2,625,934, INT. CL. 25.
- WHITEHALL SPECIALTIES, INC., WHITEHALL, WI:
1,934,140, CANC. INT. CL. 29.
- WHOLE SOME & HEARTY FOODS, INC., PORTLAND, OR:
1,933,943, CANC. INT. CL. 29.
- WHOLLEY, VIRGINIA, WORCESTER, MA:
2,622,652, PUB. 7-2-2002. INT. CL. 3.
- WIDOPENWEST NETWORKS, LLC, CASTLE ROCK, CO:
2,623,311, PUB. 7-2-2002. INT. CL. 38.
- WIDMAIER, JAMES T., ROCHESTER, NY:
2,623,571, PUB. 7-2-2002. INT. CL. 9.
- WIECK FAMILY LTD. PARTNERSHIP, THE, SHERMAN OAKS, CA, AMKOR PACIFIC, ENCINO, CA:
1,708,035. REN. 8-10-02. INT. CL. 14.
- WIELAND ELECTRIC GMBH, D-96052 BAMBERG, FED REP GERMANY:
2,623,397, PUB. 7-2-2002. INT. CL. 9.
- WILD BRAIN, INC., SAN FRANCISCO, CA:
2,625,527, INT. CL. 41.

- WILD PLANET TOYS, INC., SAN FRANCISCO, CA:
2,626,150, INT. CL. 28.
- WILD ROSE VINEYARDS, LLC, PASO ROBLES, CA:
2,626,694, INT. CL. 42.
- WILDLIFE RESEARCH CENTER, INC., ANOKA, MN:
1,761,523, REN. 8-10-02. INT. CL. 28.
- WILDMAN, CHRIS T., ORANGE PARK, FL:
2,626,286, INT. CL. 35.
- WILDTANGENT, INC., REDMOND, WA:
2,626,260, INT. CL. 41.
2,626,360, INT. CL. 41.
- WILDWOOD OFFICE PARK, INC., ATLANTA, GA:
1,218,601, REN. 8-16-02. INT. CL. 36.
- WILEN MEDIA CORPORATION, DEERFIELD BEACH, FL:
2,624,274, PUB. 7-2-2002. INT. CL. 16.
- WILLIAM M. MERCER, INCORPORATED, NEW YORK, NY:
2,624,861, PUB. 7-2-2002. INT. CL. 35.
- WILLIAM MARSH RICE UNIVERSITY, HOUSTON, TX:
2,623,754, PUB. 7-2-2002. INT. CL. 25.
- WILLIAMHOUSE-REGENCY OF DELAWARE, INC., NEW YORK, NY:
1,176,162, CANC. INT. CL. 16.
- WILLIAMS III, ROBERT K., LAS VEGAS, NV:
2,625,287, PUB. 7-2-2002. INT. CL. 32.
- WILLIAMS-SONOMA, INC., SAN FRANCISCO, CA:
1,663,137, CANC. INT. CL. 3.
- WILLIAMS, DEMETRIUS A., MAPLE HTS, OH:
2,622,698, PUB. 7-2-2002. INT. CL. 9.
- WILLIAMS, MORDECAI P. JR., ALEXANDRIA, VA AND JUE, MICHAEL, ALEXANDRIA, VA:
1,934,162, CANC. INT. CL. 25.
- WILLIAMS, WINDELL, NEW YORK, NY:
1,932,738, CANC. INT. CL. 25.
- WILLIAMSON-DICKIE MANUFACTURING COMPANY, FORT WORTH, TX:
1,933,795, CANC. INT. CL. 25.
- WILLOUGHBY INDUSTRIES, INC., INDIANAPOLIS, IN:
2,626,471, INT. CL. 11.
- WILMES; RICHARD, DUNDEE, IL, DBA BUILDING BLOCKS NEWSPAPER:
1,176,103, CANC. INT. CL. 16.
- WILSHIRE PARTNERS, CLEVELAND, OH:
1,934,326, CANC. INT. CL. 11.
- WILSON DOORS INC., ELKHORN, WI:
2,624,894, PUB. 7-2-2002. INT. CL. 6.
- WILSON-COOK MEDICAL INC., WINSTON-SALEM, NC:
1,933,818, CANC. INT. CL. 10.
2,624,062, PUB. 7-2-2002. INT. CL. 10.
- WILSON, LARRY S., DUNWOODY, GA:
2,626,638, INT. CL. 12.
- WILSON, RAY, NEW YORK, NY:
2,624,335, PUB. 7-2-2002. INT. CL. 9.
- WINCHELL'S DONUT HOUSES OPERATING COMPANY, L.P., SANTA ANA, CA:
2,623,831, PUB. 7-2-2002. MULTIPLE CLASS, INT. CLS. 30 AND 42.
- WINCHESTER AUBURN MILLS, INC., WOBURN, MA:
1,934,492, CANC. INT. CL. 22.
- WIND-2 SOFTWARE, INC., FORT COLLINS, CO:
1,663,211, CANC. INT. CL. 9.
- WINDMERE CORPORATION, HIALEAH, FL:
1,176,235, CANC. INT. CL. 20.
- WINDWARD & LEEWARD BREWERY LIMITED, VIEUX-FORT, ST.LUCIA:
1,932,555, CANC. INT. CL. 32.
- WINEBOW, INC., HO-HO-KUS, NJ:
2,624,860, PUB. 7-2-2002. INT. CL. 33.
- WINESERVE LIMITED, GATLEY, CHESHIRE, UNITED KINGDOM:
2,626,130, INT. CL. 33.
- WINIKOFF, NEIL, BELLEVUE, WA:
2,622,540, PUB. 7-2-2002. INT. CL. 40.
- WINK PUBLISHING VENTURES, INC., NEW YORK, NY:
2,622,853, PUB. 7-2-2002. INT. CL. 16.
- WINKLER, DANA, GRAND VIEW, NY:
1,424,462, CANC. INT. CL. 42.
- WINN, CHRISTOPHER HARDING, DRAYTON, NORWICH, NR8 6RY, UNITED KINGDOM:
1,932,441, CANC. MULTIPLE CLASS, INT. CLS. 9 AND 28.
- WINNEBAGO INDUSTRIES, INC., FOREST CITY, IA:
2,624,807, PUB. 7-2-2002. INT. CL. 39.
- WINNER INTERNATIONAL ROYALTY LLC, SHARON, PA:
2,626,162, INT. CL. 12.
- WINNER'S INTERNATIONAL RESTAURANTS, INC., ATLANTA, GA. SHONEY'S, INC., NASHVILLE, TN:
1,690,361, REN. 8-15-02. INT. CL. 29.
- WINNERS' CIRCLE RANCH, PETALUMA, CA:
1,661,204, REN. 8-10-02. INT. CL. 42.
- WINNING MOVES, INC., DANVERS, MA:
2,623,130, PUB. 7-2-2002. INT. CL. 16.
- WINSTON GROUP, INC., THE, CHILLUM, MD, AKA BRAUN'S FINE CATERERS:
1,176,581, CANC. INT. CL. 42.
- WINTERFEST GROUP, INC., EDMOND, OK:
2,623,096, PUB. 7-2-2002. INT. CL. 41.
- WINTERS, KRIS, F, BRIDGEWATER, NJ:
2,624,995, PUB. 7-2-2002. INT. CL. 37.
- WINWARD INTERNATIONAL, UNION CITY, CA:
1,933,272, CANC. INT. CL. 26.
- WIRES, GREG, HUGO, MN, DBA GOLF MINNESOTA:
2,623,157, PUB. 7-2-2002. MULTIPLE CLASS, INT. CLS. 16 AND 42.
- WISCONSIN MILK MARKETING BOARD, INC., MADISON, WI:
1,933,353, CANC. U.S. CL. A.
- WISNESKI, SHEILA M., JAMUL, CA, DBA MISSION STUDIO:
2,627,034, INT. CL. 35.
- WISNIEWSKI, DAVID ALAN, FAIR OAKS, CA:
2,626,706, INT. CL. 38.
- WITEX AG, AUGUSTDORF, FED REP GERMANY:
2,623,343, PUB. 4-23-2002. MULTIPLE CLASS, INT. CLS. 19 AND 27.
- WITTENBERG, GEORGE J., RANCHO PALOS VERDES, CA:
2,626,943, INT. CL. 9.
- WITTSCHKE, GARY L., CORPUS CHRISTI, TX:
2,623,112, PUB. 7-2-2002. INT. CL. 36.
- WMK HOLDINGS, INC., WILMINGTON, DE:
2,624,808, PUB. 7-2-2002. INT. CL. 29.
- WMS GAMING INC., WAUKEGAN, IL:
2,626,696, INT. CL. 9.
2,626,732, INT. CL. 9.
2,626,748, INT. CL. 9.
- WNBA ENTERPRISES, LLC, SECAUCUS, NJ:
2,623,958, PUB. 7-2-2002. INT. CL. 42.
- WOJECK, JULIE A., MONROE, CT:
2,625,323, INT. CL. 41.
- WOLNEY, BLAKE ANTHONY, WASHINGTON, DC:
2,624,355, PUB. 7-2-2002. INT. CL. 41.
- WOLPER WOOTTEN & COMPANY, INC., BURBANK, CA:
2,623,580, PUB. 7-2-2002. INT. CL. 3.
- WOMEN'S PROFESSIONAL SOCCER, L.L.C., NEW YORK, NY:
2,626,216, INT. CL. 41.
- WOODS COMMUNICATIONS LTD., NEW YORK, NY:
2,623,677, PUB. 7-2-2002. MULTIPLE CLASS, INT. CLS. 25 AND 41.
- WOODSTOCK INTERNATIONAL, INC., BELLINGHAM, WA:
1,663,196, CANC. INT. CL. 8.
- WOODWARD LABORATORIES, INC., LOS ALAMITOS, CA:
1,933,229, CANC. INT. CL. 5.
- WOOSHCORP CORPORATION, MORRISON, CO FROM POLYCOM DEVELOPMENT CORPORATION, MORRISON, CO:
2,625,877, INT. CL. 9.
- WORCESTER CONTROLS LICENSCO INC., WILMINGTON, DE:
1,933,664, CANC. INT. CL. 9.
- WORD OF LIFE CHURCH, INC., SAND SPRINGS, OK:
2,623,619, PUB. 7-2-2002. MULTIPLE CLASS, INT. CLS. 9 AND 42.

- WORD OF LIFE FELLOWSHIP, INC., SCHROON LAKE, NY:
2,624,622, PUB. 7-2-2002. INT. CL. 16.
- WORDEN BROTHERS, INC., DURHAM, NC:
2,623,495, PUB. 7-2-2002. INT. CL. 9.
- WORKFLOW DESIGNS, INC., DALLAS, TX:
1,934,435, CANC. INT. CL. 41.
- WORKFLOW DYNAMICS, INC., CINCINNATI, OH:
2,622,779, PUB. 7-2-2002. INT. CL. 35.
- WORKGROUP TECHNOLOGY CORPORATION, LEXINGTON, MA:
2,623,802, PUB. 7-2-2002. MULTIPLE CLASS, INT. CLS. 41 AND 42.
- WORKSMART SYSTEMS, INC., INDIANAPOLIS, IN:
2,625,414, INT. CL. 35.
- WORLD CHAMPIONSHIP WRESTLING, INC.:
See— WCW, INC..
- WORLD E-TRADERS, L.L.C., BEVERLY HILLS, CA:
2,622,730, PUB. 7-2-2002. INT. CL. 35.
- WORLD PRO KENNEX, INC., CARLSBAD, CA, TRUE TEMPER CORPORATION, CLEVELAND, OH:
1,181,304. REN. 8-12-02. INT. CL. 28.
- WORLD STATISTICS LTD., NEW YORK, NY:
2,624,375, PUB. 7-2-2002. MULTIPLE CLASS, INT. CLS. 35 AND 42.
- WORLD WIDE IMPORTS ENTERPRISES, INC., FORT LAUDERDALE, FL:
2,626,408, INT. CL. 35.
- WORLD WIDE PET SUPPLY ASSOCIATION, INC., ARCADIA, CA:
2,623,488, PUB. 7-2-2002. MULTIPLE CLASS, INT. CLS. 35 AND 41.
- WORLD WRESTLING FEDERATION ENTERTAINMENT, INC., STAMFORD, CT:
2,625,121, PUB. 7-2-2002. INT. CL. 16.
2,625,125, PUB. 7-2-2002. INT. CL. 9.
2,625,262, PUB. 7-2-2002. INT. CL. 42.
- WORLDS APART LIMITED, LONDON SW4 6JP, UNITED KINGDOM:
2,623,611, PUB. 7-2-2002. INT. CL. 28.
- WORLDS.COM, INC., BOSTON, MA:
2,623,121, PUB. 7-2-2002. INT. CL. 41.
- WORLDWIDE DRUG FREE YOUTH, INC., NASHVILLE, TN:
2,626,214, INT. CL. 42.
- WORTHINGTON INDUSTRIES, INC., COLUMBUS, OH:
2,623,182, PUB. 7-2-2002. INT. CL. 6.
- WPC BRANDS, INC., JACKSON, WI:
2,624,941, PUB. 7-2-2002. INT. CL. 5.
- WRANGLER CLOTHING CORP., WILMINGTON, DE:
1,932,543, CANC. INT. CL. 25.
1,933,559, CANC. INT. CL. 25.
- WRIGHT, ANN, GARRISON, NY:
2,625,896, INT. CL. 21.
2,625,897, INT. CL. 21.
- WWAV RAPP COLLINS GROUP LTD., LONDON W6 9WA, ENGLAND:
2,622,737, PUB. 7-2-2002. MULTIPLE CLASS, INT. CLS. 9 AND 35.
- WYETH, LEONARD, IVORYTON, CT:
2,625,596, INT. CL. 35.
- WYLSON, S.A., 75018 PARIS, FRANCE:
2,623,284, PUB. 7-2-2002. INT. CL. 18.
- WYMAN COMPANY, INC., SAN FRANCISCO, CA, DBA SRO & CLIENTS:
1,933,233, CANC. INT. CL. 9.
- WYNDSTONE SPECIALTY PRODUCTS, L.L.C., WHEELING, IL:
2,624,535, PUB. 7-2-2002. INT. CL. 16.
- WYNMAR, INC., SAVANNAH, GA, DBA SAVANNAH COOKIE CO.:
1,663,543, CANC. INT. CL. 30.
- WYOMING WEST DESIGNS, LLC, JACKSON, WY FROM CRAIG, MELVIN, VALLEY CENTER, CA:
2,622,504, PUB. 7-2-2002. INT. CL. 25.
- WYPER, BONNIE, NEW YORK, NY:
2,623,472, PUB. 7-2-2002. INT. CL. 16.
- XACTWARE, INC., OREM, UT:
2,624,871, PUB. 7-2-2002. INT. CL. 9.
- XAMAX INDUSTRIES, INC., SEYMOUR, CT:
2,624,543, PUB. 7-2-2002. INT. CL. 24.
- XANTREX INTERNATIONAL, ST. MICHAEL, BARBADOS FROM STATPOWER TECHNOLOGIES PARTNERSHIP, BURNABY, BRITISH COLUMBIA, CANADA:
2,622,764, PUB. 7-2-2002. INT. CL. 9.
- XANTREX INTERNATIONAL, ST. MICHAEL, BARBADOS FROM STATPOWER TECHNOLOGIES PARTNERSHIP, ST. MICHAEL, BARBADOS:
2,623,069, PUB. 7-2-2002. INT. CL. 9.
- XCEL INDUSTRIAL GROUP, INC., ELKO, NV:
1,933,733, CANC. INT. CL. 21.
- XEROX CORPORATION, STAMFORD, CT:
1,933,653, CANC. INT. CL. 9.
2,624,769, PUB. 7-2-2002. INT. CL. 39.
2,625,465, INT. CL. 9.
- XEVEX INTERNATIONAL CORPORATION, SARASOTA, FL:
2,625,494, INT. CL. 36.
- XINET, INC., BERKELEY, CA:
2,624,768, PUB. 7-2-2002. INT. CL. 42.
- XL CAPITAL LTD, HAMILTON, BERMUDA:
2,623,390, PUB. 7-2-2002. INT. CL. 36.
- XM SATELLITE RADIO INC., WASHINGTON, DC:
2,624,362, PUB. 7-2-2002. INT. CL. 41.
2,624,806, PUB. 7-2-2002. INT. CL. 41.
- XPOINT TECHNOLOGIES, INC., BOCA RATON, FL:
2,627,028, INT. CL. 9.
- XRADICAL, INC., BOSTON, MA:
2,625,157, PUB. 7-2-2002. INT. CL. 35.
- XSILOGY, INC., SAN DIEGO, CA:
2,623,499, PUB. 7-2-2002. INT. CL. 9.
- XTREME PERFORMANCE, LLC, LITTLETON, CO:
2,625,947, INT. CL. 5.
- XYBERNAUT CORPORATION, FAIRFAX, VA:
2,624,651, PUB. 7-2-2002. MULTIPLE CLASS, INT. CLS. 9, 41 AND 42.
- XYTEK, INC., AKRON, OH:
2,622,769, PUB. 7-2-2002. INT. CL. 35.
- YAHOO! INC., SUNNYVALE, CA TO YAHOO! INC., SANTA CLARA, CA:
2,559,219, COR. INT. CL. 9.
- YALEET INC., FARMINGDALE, NY:
2,626,469, INT. CL. 25.
- YAMATO SCALE COMPANY, LIMITED, HYOGO-KEN, JAPAN:
1,190,544. REN. 8-13-02. INT. CL. 9.
- YAN'S NATURAL HEALTH CARE, ACUPUNCTURIST, P.C., KEW GARDENS, NY:
2,626,117, INT. CL. 42.
- YANKEE CANDLE COMPANY, INC., THE, SOUTH DEERFIELD, MA:
2,622,568, PUB. 7-2-2002. INT. CL. 4.
- YARRA VALLEY WATER LIMITED, MITCHAM, VICTORIA 3132, AUSTRALIA:
2,622,610, PUB. 12-18-2001. INT. CL. 11.
- YELLOW CORPORATION, OVERLAND PARK, KS:
1,933,197, CANC. INT. CL. 39.
- YELLOWSTONE VALLEY BREWING, LLC, BILLINGS, MT:
2,626,885, INT. CL. 32.
- YES! ENTERTAINMENT CORPORATION, PLEASANTON, CA:
1,933,986, CANC. INT. CL. 16.
- YESSAYAN, ERNEST, CHARLOTTE, NC:
2,626,631, INT. CL. 42.
2,626,632, INT. CL. 42.
- YIP*EEE, INC., NEW YORK, NY:
2,624,685, PUB. 7-2-2002. INT. CL. 42.
- YOMEGA CORP., FALL RIVER, MA:
1,663,504, CANC. INT. CL. 28.
- YONEX KABUSHIKI KAISHA, KOSHIIJI-MACHI, SANTOGUN, NIIGATA-KEN, JAPAN:
1,176,364, CANC. INT. CL. 28.
- YOO-HOO CHOCOLATE BEVERAGE CORP., CARLSTADT, NJ:
1,176,411, CANC. INT. CL. 30.
- YOUNG LIFE, COLORADO SPRINGS, CO:
2,626,041, INT. CL. 25.

- YOUNG LIFE, A TEXAS NONPROFIT CORPORATION, COLORADO SPRINGS, CO:
2,626,161, MULTIPLE CLASS, INT. CLS. 25, 41 AND 42.
- YOUNG, DAVID, WALNUT, CA:
2,625,017, PUB. 7-2-2002. INT. CL. 9.
- YTC CORPORATION LIMITED, SINGAPORE 179098, SINGAPORE:
2,622,522, PUB. 10-9-2001. INT. CL. 42.
- YVES E. PRIVAS AND TANGUY M. PRIVAS PARTNERSHIP, THE SEA RANCH LAKES, FL:
2,626,106, INT. CL. 11.
- Z TEJAS, INC., DALLAS, TX, Z TEJAS GRILL ARIZONA, INC., SCOTTSDALE, AZ:
1,722,784. REN. 8-12-02. INT. CL. 42.
- Z-TEL TECHNOLOGIES, INC., TAMPA, FL:
2,625,406, INT. CL. 38.
- ZACHYS WINE AND LIQUOR STORE, INC., SCARSDALE, NY:
2,624,203, PUB. 7-2-2002. INT. CL. 35.
- ZACK'Z PRODUCTS, INC., HAZELCREST, IL:
1,933,371, CANC. INT. CL. 25.
- ZADI FOODS LIMITED, BRAMPTON, ONTARIO, CANADA:
2,625,701, INT. CL. 29.
- ZADIAN - S.R.L., ZONA INDUSTRIALE C.DA VIBRATA, ITALY:
1,932,432, CANC. MULTIPLE CLASS, INT. CLS. 14, 18 AND 25.
- ZAGORA, BOZENA, CHICAGO, IL AND ZAGORA, DANUTA, CHICAGO, IL:
1,933,652, CANC. INT. CL. 18.
- ZAKLAD PRODUKCYJNO-HANDLOWY PIOKAL - ENG. ALICJA PIOTROWICZ, 32-500 CHRZANOW, POLAND:
1,933,091, CANC. INT. CL. 25.
- ZALESKI, INESSA, FREEHOLD, NJ:
2,625,124, PUB. 7-2-2002. INT. CL. 41.
- ZAMPINI, JAMES W., PERRY, OH, DBA NEW PLANTS:
1,696,364. REN. 8-10-02. INT. CL. 31.
- ZAPATURE.COM, LLC, CAMAS, WA:
2,624,607, PUB. 7-2-2002. INT. CL. 42.
- ZAVAR INC., MESA, AZ:
2,625,201, PUB. 7-2-2002. INT. CL. 37.
- ZEBRA IMAGING, INC., PFLUGERVILLE, TX:
2,623,445, PUB. 7-2-2002. INT. CL. 9.
- ZEBRA KNITWEAR CORP., BROOKLYN, NY:
1,933,298, CANC. INT. CL. 25.
- ZELMAN, STEPHANIE, W. NEWTON, MA, DBA UTURN DESIGN:
2,623,165, PUB. 7-2-2002. MULTIPLE CLASS, INT. CLS. 35 AND 42.
- ZENECA LIMITED:
See— AVECIA LIMITED.
- ZENITH ELECTRONICS CORPORATION, GLENVIEW, IL:
1,144,008, CANC. INT. CL. 9.
1,933,810, CANC. INT. CL. 9.
- ZETA-TECH ASSOCIATES, INC., CHERRY HILL, NJ:
2,624,075, PUB. 7-2-2002. INT. CL. 42.
- ZIEGLER COMPANIES, INC., THE, WEST BEND, WI:
2,626,344, INT. CL. 36.
- ZIFF DAVIS PUBLISHING HOLDINGS INC., NEW YORK, NY:
2,623,145, PUB. 7-2-2002. INT. CL. 16.
2,623,215, PUB. 7-2-2002. MULTIPLE CLASS, INT. CLS. 16 AND 42.
- ZILA, INC., PHOENIX, AZ:
2,625,621, INT. CL. 5.
- ZIMMER, KARL R. III, PLAINFIELD, IN:
2,625,363, INT. CL. 41.
- ZINELOGIC, INC., ARLINGTON, VA:
2,624,829, PUB. 7-2-2002. INT. CL. 9.
- ZOHAIFI, ABDUL RAHMAN AL, CULVER CITY, CA AND ZOHAIFI, YAHYA AL, CULVER CITY, CA AND IRWIN, KLEE M., CULVER CITY, CA, DBA DE VIRO, BEVERLY HILLS:
1,933,796, CANC. INT. CL. 3.
- ZONDERVAN CORPORATION, THE, GRAND RAPIDS, MI:
2,625,445, MULTIPLE CLASS, INT. CLS. 9 AND 16.
- ZONE SKIN CARE, INC., MARBLEHEAD, MA:
2,623,974, PUB. 7-2-2002. INT. CL. 3.
- ZOOLOGICAL SOCIETY OF SAN DIEGO, INC., SAN DIEGO, CA:
2,624,034, PUB. 7-2-2002. MULTIPLE CLASS, INT. CLS. 25, 28 AND 41.
- ZOOLOGICAL SOCIETY OF SAN DIEGO, INC., THE, SAN DIEGO, CA:
1,700,915. REN. 8-13-02. INT. CL. 41.
- ZOTOS INTERNATIONAL, INC., DARIEN, CT:
2,626,690, INT. CL. 3.
- ZPROMPT INC., IRVINE, CA:
2,626,132, INT. CL. 42.
- ZR ASSOCIATES LLC, NEW BERLIN, WI:
2,625,023, PUB. 7-2-2002. MULTIPLE CLASS, INT. CLS. 35 AND 37.
- ZUBRAS, VINCENT G. JR., DALLAS, TX:
2,623,600, PUB. 7-2-2002. U.S. CL. 200.
- ZULA, LTD., COLUMBUS, OH:
2,625,914, INT. CL. 28.
- ZULAUF, INC., LUBBOCK, TX:
2,623,353, PUB. 7-2-2002. INT. CL. 16.
- ZURICH AMERICAN INSURANCE COMPANY, SCHAUMBURG, IL:
2,623,094, PUB. 7-2-2002. INT. CL. 21.
- ZYCOS INC., CAMBRIDGE, MA:
2,625,894, INT. CL. 5.
- ZYFERS, GERALD, REDMOND, WA:
2,626,683, INT. CL. 41.
- ZYGOX, INC., SANTA CLARA, CA:
2,624,246, PUB. 7-2-2002. INT. CL. 42.
- ZYMAN MARKETING GROUP, INC., ATLANTA, GA:
2,624,799, PUB. 7-2-2002. INT. CL. 35.
- ZYVAX, INC., E. ELLIJAY, GA:
2,624,031, PUB. 7-2-2002. INT. CL. 1.
2,624,032, PUB. 7-2-2002. INT. CL. 1.
- ZZYZX MARKETING INCORPORATED, TUSTIN, CA:
2,626,224, INT. CL. 36.
- 02 HOLDINGS, LLC, NEW YORK, NY:
2,623,375, PUB. 7-2-2002. INT. CL. 35.
- 1E LIMITED, LONDON W5 5LB, UNITED KINGDOM:
2,624,840, PUB. 7-2-2002. INT. CL. 9.
- 1ST NATIONAL BANK OF SOUTH FLORIDA, HOMESTEAD, FL FROM FIRST NATIONAL BANK OF HOMESTEAD, THE, HOMESTEAD, FL:
2,626,886, INT. CL. 36.
- 1164256 ONTARIO LIMITED, THUNDER BAY, ONTARIO:
2,625,486, MULTIPLE CLASS, INT. CLS. 4 AND 37.
- 12TH MAN PRODUCTIONS, INC., HANOVER, PA:
2,624,623, PUB. 7-2-2002. INT. CL. 28.
- 1318120 ONTARIO INC., TORONTO, ONTARIO, M6H 2B2, CANADA:
2,622,633, PUB. 11-6-2001. MULTIPLE CLASS, INT. CLS. 40 AND 42.
- 139001 CANADA, INC., DORVAL, QUEBEC H9P 2N4, CANADA, DBA VINO THEQUE:
2,622,592, PUB. 7-2-2002. INT. CL. 5.
- 2001 STEREO SYSTEMS, INC., HOUSTON, TX:
2,625,166, PUB. 7-2-2002. INT. CL. 35.
- 21ST CENTURY GENETICS, SHAWANO, WI:
1,933,136, CANC. INT. CL. 42.
- 21ST CENTURY TOYS, INC., ALAMEDA, CA:
2,625,951, INT. CL. 28.
- 2734338 CANADA INC., MONTREAL, QUEBEC, H2Y 1M1, CANADA:
1,933,972, CANC. INT. CL. 30.
- 3DO COMPANY, THE, REDWOOD CITY, CA:
1,934,380, CANC. INT. CL. 9.
- 3M COMPANY, ST. PAUL, MN, MINNESOTA MINING & MANUFACTURING COMPANY, SAINT PAUL, MN:
568,452. REN. 8-14-02. U.S. CL. 37 (INT. CL. 16).
- 3M COMPANY, ST. PAUL, MN, MINNESOTA MINING AND MANUFACTURING COMPANY, SAINT PAUL, MN:
573,560. REN. 8-14-02. U.S. CL. 6 (INT. CL. 1).
- 3M COMPANY, ST. PAUL, MN, MINNEOSTA MINING AND MANUFACTURING COMPANY, ST. PAUL, MN:
742,180. REN. 8-14-02. U.S. CL. 5 (INT. CL. 1).

4THPASS INC., SEATTLE, WA:

2,624,436, PUB. 7-2-2002. INT. CL. 9.

401(K) PRO, INC., SHERMAN OAKS, CA:

2,624,676, PUB. 7-2-2002. INT. CL. 9.

7-DIPPITY, INC., CORAL GABLES, FL:

2,624,490, PUB. 7-2-2002. MULTIPLE CLASS, INT. CLS.
16, 25, 28 AND 42.

7-ELEVEN, INC., DALLAS, TX FROM SOUTHLAND COR-
PORATION, THE, DALLAS, TX:

2,625,890, INT. CL. 16.

800.COM, INC., PORTLAND, OR:

2,626,185, INT. CL. 35.

9069-0470 QUEBEC INC., ST-PRIME, CANADA FROM GES-
TION GHISLAIN LAMONTAGNE INC., ST-PRIME, PRO-
VINCE OF QUEBEC, CANADA:

2,625,432, INT. CL. 19.

9080-3628 QUEBEC INC., MONTREAL, QUEBEC, CANADA:
2,622,747, PUB. 7-2-2002. MULTIPLE CLASS, INT. CLS. 9
AND 42.

2,622,748, PUB. 7-2-2002. MULTIPLE CLASS, INT. CLS. 9
AND 42.

* * * * *